

Delphi
Technologies

Steering & Suspension

Track Control Arms, Link Stabilisers, Inner & Outer Tie Rods, Ball Joints, Rubber-to-Metal Bushes, Rod Assemblies, Steering Rack Gaiters, Engine Mounts.

DTCZ100A



Steering & Suspension portfolio



1 Aluminium wishbone

2 Pressed steel wishbone

3 Steering rack gaiter

4 Rod assembly

5 Link stabiliser

6 Ball joints

7 Inner tie rod

8 Engine mount

9 Control arm bush

10 Anti-roll bar bushes

11 Bush with metal sleeve

i	Assistance	2	New to Range.....	3	Translations.....	16	General Information.....	35		2-40

41-1088

1089-1182

1183-1209

1211-1217









APPLICATIONS

BUYERS GUIDE









APPLICATIONS

BUYERS GUIDE









543 New to Range

D   				D   				D   					
TA2934	CITROËN	C4 GRAND PICASSO	287	TA3173	MINI	COOPER S COUNTRYMAN	625	TA3202	BMW	X3 (F25 SERIES)	249		
		C4 PICASSO	289			COOPER SX COUNTRYMAN	625			X4 (F26 SERIES)	251		
	PEUGEOT	308	716			COOPER D COUNTRYMAN	625			X4M (F26 SERIES)	251		
		3008	736			COOPER DX COUNTRYMAN	625			TA3204	HYUNDAI	ACCENT BLUE	429
5008	738	COOPER SD COUNTRYMAN	625	KIA	RIO III	478							
TA2935	CITROËN	C4 GRAND PICASSO	287	TA3174	MINI	COOPER SDX COUNTRYMAN	625	TA3205	DAIHATSU	MATERIA	328		
		C4 PICASSO	289			ONE COUNTRYMAN	625			SIRION	328		
	PEUGEOT	308	716			ONE D COUNTRYMAN	625			TA3206	DAIHATSU	MATERIA	328
		3008	736			TA3175	BMW			525xi (E60, E61 SERIES)	222	SIRION	328
5008	738	525xd (E60, E61 SERIES)	222	TA3207	SUZUKI	ALTO	892						
TA2936	PEUGEOT	308	716	530xi (E60, E61 SERIES)	222	TA3208	LEXUS	GS300	510				
TA2937	RENAULT	CLIO II	758	530xd (E60, E61 SERIES)	222			GS430	510				
TA3088		TOYOTA	KANGOO	772	TA3176			AUDI	A8 (4H SERIES)	130	GS450H	510	
			KANGOO EXPRESS	776	S8 (4H SERIES)			167	GS460	510			
TA3162	CHEVROLET	TRAX	271	TA3177	AUDI			A8 (4H SERIES)	130	IS200d	511		
		OPTEL	689	S8 (4H SERIES)	167			IS250	511				
		VAUXHALL	MOKKA	937	TA3178			MINI	COOPER COUNTRYMAN	625	IS250 Cabrio	511	
TA3163	HYUNDAI	IX20	441	COOPER S COUNTRYMAN	625			IS-F	511				
		KIA	SOUK I	482	COOPER SX COUNTRYMAN			625	IS200t	512			
TA3164	CITROËN	C4 AIRCROSS	285	COOPER D COUNTRYMAN	625			IS300h	512				
		MITSUBISHI	ASX	632	COOPER DX COUNTRYMAN			625	TA3209	LEXUS	GS300	510	
		LANCER	639	COOPER SD COUNTRYMAN	625	GS430	510						
		LANCER SPORTBACK	640	COOPER SDX COUNTRYMAN	625	GS450H	510						
	OUTLANDER III	644	ONE COUNTRYMAN	625	GS460	510							
PEUGEOT	4008	737	ONE D COUNTRYMAN	625	IS200d	511							
TA3165	SUBARU	IMPREZA	889	PACEMAN COOPER	630	IS220d	511						
TA3167	SEAT	INCA (6K SERIES)	836	PACEMAN COOPER S	630	IS250	511						
		VOLKSWAGEN CADDY II	961	PACEMAN COOPER S JCW	630	IS250 Cabrio	511						
TA3168	AUDI	TT (8N SERIES)	168	PACEMAN COOPER SX	630	IS-F	511						
		SEAT	LEON I (1M SERIES)	838	PACEMAN COOPER D	630	IS200t	512					
		VOLKSWAGEN GOLF IV	985	PACEMAN COOPER DX	630	IS300h	512						
TA3169	TOYOTA	AVENSIS	901	TA3179	MINI	COOPER COUNTRYMAN	625	TA3210	SSANGYONG	ACTYON	886		
		114i (F20, F21 SERIES)	178	COOPER S COUNTRYMAN	625	ACTYON SPORTS	886						
		114d (F20, F21 SERIES)	178	COOPER SX COUNTRYMAN	625	KYRON	886						
		116i (F20, F21 SERIES)	178	COOPER D COUNTRYMAN	625	REXTON	886						
		116d (F20, F21 SERIES)	178	COOPER DX COUNTRYMAN	625	TA3211	SSANGYONG			ACTYON	886		
		118i (F20, F21 SERIES)	178	COOPER SD COUNTRYMAN	625			ACTYON SPORTS	886				
		118d (F20, F21 SERIES)	178	ONE COUNTRYMAN	625			KYRON	886				
		120i (F20, F21 SERIES)	178	ONE D COUNTRYMAN	625			REXTON	886				
		120d (F20, F21 SERIES)	178	PACEMAN COOPER	630			TA3212	KIA	CARNIVAL	464		
		125i (F20, F21 SERIES)	178	PACEMAN COOPER S	630					SEDONA	479		
		125d (F20, F21 SERIES)	178	PACEMAN COOPER S JCW	630					TA3213	KIA	CARNIVAL	464
		135i (F20, F21 SERIES)	179	PACEMAN COOPER SX	630							SEDONA	479
		140i (F20, F21 SERIES)	179	PACEMAN COOPER D	630							TA3214	MERCEDES
		218i (F22, F23 SERIES)	181	PACEMAN COOPER DX	630			E250 (212 SERIES)	565				
		218d (F22, F23 SERIES)	181	PACEMAN COOPER SD	630			E300 (212 SERIES)	565				
		220i (F22, F23 SERIES)	181	PACEMAN COOPER SDX	630	E350 (212 SERIES)	565						
		220d (F22, F23 SERIES)	181	TA3180	SMART	CITY-CABRIO	882	E500 (212 SERIES)	565				
		225d (F22, F23 SERIES)	181	CITY- COUPE	882	CROSSBLADE	883	E63 (212 SERIES)	564				
		228i (F22, F23 SERIES)	181	ROADSTER	883	FORTWO (450 SERIES)	884	E400 (212 SERIES)	565				
		230i (F22, F23 SERIES)	181	TA3182	HYUNDAI	GRAND SANTA FE	433	GLK200 (X204 SERIES)	570				
		235i (F22, F23 SERIES)	182	SANTA FE	445	SANTA FE	445	GLK220 (X204 SERIES)	570				
		240i (F22, F23 SERIES)	182	TA3183	HYUNDAI	GRAND SANTA FE	433	GLK250 (X204 SERIES)	570				
		316i (F30, F31 SERIES)	199	SANTA FE	445	TA3184	VOLVO	XC60	1082				
		316d (F30, F31 SERIES)	199	TA3185	HONDA	CR-V III	424	TA3186	FORD	TOURNEO CUSTOM	403		
		318d (F30, F31 SERIES)	199	TA3186	FORD	TRANSIT	407	TRANSIT CUSTOM	409				
		320i (F30, F31 SERIES)	199	TA3187	PEUGEOT	508	726	TA3188	PEUGEOT	508	726		
		320d (F30, F31 SERIES)	199	TA3188	PEUGEOT	508	726	TA3189	LEXUS	CT 200h	509		
		325d (F30, F31 SERIES)	199	TA3189	LEXUS	CT 200h	509	TOYOTA	PRIUS	916			
		328i (F30, F31 SERIES)	199	TA3190	LEXUS	CT 200h	509	TOYOTA	PRIUS	916			
		330i (F30, F31 SERIES)	199	TA3191	TOYOTA	LANDCRUISER	914	TA3192	TOYOTA	LANDCRUISER	914		
		330d (F30, F31 SERIES)	199	TA3192	TOYOTA	LANDCRUISER	914	TA3193	DAIHATSU	TERIOS II	329		
		335i (F30, F31 SERIES)	199	TA3193	DAIHATSU	TERIOS II	329	TA3194	DAIHATSU	TERIOS II	329		
		340i (F30, F31 SERIES)	199	TA3194	DAIHATSU	TERIOS II	329	TA3195	HYUNDAI	i40	440		
		318d (F34 SERIES)	202	TA3195	HYUNDAI	i40	440	TA3197	HYUNDAI	iX55	442		
		320i (F34 SERIES)	202	TA3197	HYUNDAI	iX55	442	TA3198	HYUNDAI	GRAND SANTA FE	433		
		320d (F34 SERIES)	202	TA3198	HYUNDAI	SANTA FE	445			SANTA FE	445		
		325d (F34 SERIES)	202			KIA	OPTIMA			472			
		328i (F34 SERIES)	202			SORENTO	482						
		330i (F34 SERIES)	202			TA3201	BMW			X3 (F25 SERIES)	249		
		330d (F34 SERIES)	202			X4 (F26 SERIES)	251						
		335i (F34 SERIES)	202			X4M (F26 SERIES)	251						
		340i (F34 SERIES)	202			TA3202	BMW			X3 (F25 SERIES)	249		
		420i (F32, F33 SERIES)	204			X4 (F26 SERIES)	251						
		420d (F32, F33 SERIES)	204			TA3203	BMW			X3 (F25 SERIES)	249		
		425d (F32, F33 SERIES)	204			X4 (F26 SERIES)	251						
		428i (F32, F33 SERIES)	204			TA3204	HYUNDAI	ACCENT BLUE	429				
		430i (F32, F33 SERIES)	204	KIA	RIO III	478							
		430d (F32, F33 SERIES)	204	TA3205	DAIHATSU	MATERIA	328						
		435i (F32, F33 SERIES)	204	SIRION	328								
		435d (F32, F33 SERIES)	204	TA3206	DAIHATSU	MATERIA	328						
		440i (F32, F33 SERIES)	204	SIRION	328								
		418d (F36 SERIES)	206	TA3207	SUZUKI	ALTO	892						
		420i (F36 SERIES)	206	TA3208	LEXUS	GS300	510						
		420d (F36 SERIES)	206	GS430	510								
		428i (F36 SERIES)	206	GS450H	510								
430i (F36 SERIES)	206	GS460	510										
430d (F36 SERIES)	206	IS200d	511										
435i (F36 SERIES)	206	IS250	511										
440i (F36 SERIES)	206	IS250 Cabrio	511										
TA3172	VOLVO	XC60	1082	IS-F	511								
TA3173	MINI	COOPER COUNTRYMAN	625	IS200t	512								
				IS300h	512								

543 New to Range

D				D				D					
TA3217	AUDI	A1 (8X SERIES)	63	TA3221	BMW	240i (F22, F23 SERIES)	182	TA3232	SKODA	CITIGO	849		
		SEAT	IBIZA (6J SERIES)			834	SEAT				IBIZA (6J SERIES)	834	
		TOLEDO IV (NH SERIES)	848				TOLEDO IV (NH SERIES)	848		VOLKSWAGEN	e-up!	972	
	SKODA	FABIA (NJ SERIES)	854				SKODA	FABIA (NJ SERIES)	854		VOLKSWAGEN	e-up!	1054
	RAPID	868			316d (F30, F31 SERIES)	199		TA3233	SUZUKI	SWIFT	897		
	VOLKSWAGEN	POLO (6C SERIES)	1031		318d (F30, F31 SERIES)	199		TA3234	SUZUKI	SWIFT	897		
TA3218	SEAT	IBIZA (6J SERIES)	834	TA3219	SEAT	IBIZA (6J SERIES)	834	TA3235	TOYOTA	AURIS	899		
		SEAT	TOLEDO IV (NH SERIES)			848					COROLLA	908	
		TOLEDO IV (NH SERIES)	848				SEAT	AROSA (6H SERIES)	823	TA3236	VOLKSWAGEN	LUPO	1009
	SKODA	FABIA (NJ SERIES)	854				SKODA	FABIA (NJ SERIES)	854				TA3237
	RAPID	868		SKODA	RAPID	868			6	521			
	VOLKSWAGEN	POLO (6C SERIES)	1031		TOLEDO IV (NH SERIES)	848		TA3238	MAZDA	3	517		
TA3219	SEAT	IBIZA (6J SERIES)	834		TOLEDO IV (NH SERIES)	848			6	521			
		SEAT	TOLEDO IV (NH SERIES)	848		SKODA	FABIA (NJ SERIES)	854	TA3239	NISSAN	OASHOAI	669	
		TOLEDO IV (NH SERIES)	848		SKODA	RAPID	868					RENAULT	KADJAR
	SKODA	FABIA (NJ SERIES)	854		VOLKSWAGEN	POLO (6C SERIES)	1031				NISSAN	OASHOAI	669
	VOLKSWAGEN	POLO (6C SERIES)	1031	TA3220	BMW	114i (F20, F21 SERIES)	178				RENAULT	KADJAR	769
TA3220	BMW	114d (F20, F21 SERIES)	178				114d (F20, F21 SERIES)	178		TA3240	NISSAN	OASHOAI	669
		116i (F20, F21 SERIES)	178				116i (F20, F21 SERIES)	178			RENAULT	KADJAR	769
		116d (F20, F21 SERIES)	178				116d (F20, F21 SERIES)	178		TA3241	CITROËN	C3	280
		118i (F20, F21 SERIES)	178		118i (F20, F21 SERIES)	178			PEUGEOT	1007			732
118d (F20, F21 SERIES)	178		118d (F20, F21 SERIES)	178		120i (F20, F21 SERIES)	178		CITROËN	C3	280		
120i (F20, F21 SERIES)	178		120i (F20, F21 SERIES)	178		120d (F20, F21 SERIES)	178			PEUGEOT	1007	732	
120d (F20, F21 SERIES)	178		120d (F20, F21 SERIES)	178		125i (F20, F21 SERIES)	178		TA3242	RENAULT	MEGANE IV	792	
125i (F20, F21 SERIES)	178		125i (F20, F21 SERIES)	178		125d (F20, F21 SERIES)	178			TALISMAN	TALISMAN	797	
125d (F20, F21 SERIES)	178		125d (F20, F21 SERIES)	178		135i (F20, F21 SERIES)	179			TALISMAN	TALISMAN GRANDTOUR	797	
135i (F20, F21 SERIES)	179		135i (F20, F21 SERIES)	179		140i (F20, F21 SERIES)	179		TA3243	RENAULT	MEGANE IV	792	
140i (F20, F21 SERIES)	179		140i (F20, F21 SERIES)	179		218i (F22, F23 SERIES)	181				TALISMAN	TALISMAN GRANDTOUR	797
218i (F22, F23 SERIES)	181		218i (F22, F23 SERIES)	181		218d (F22, F23 SERIES)	181		TA3244	RENAULT	MEGANE IV	792	
218d (F22, F23 SERIES)	181		218d (F22, F23 SERIES)	181		220i (F22, F23 SERIES)	181				TALISMAN	TALISMAN GRANDTOUR	797
220i (F22, F23 SERIES)	181		220i (F22, F23 SERIES)	181		220d (F22, F23 SERIES)	181		TA3245	RENAULT	TALISMAN	TALISMAN GRANDTOUR	797
220d (F22, F23 SERIES)	181		220d (F22, F23 SERIES)	181		225d (F22, F23 SERIES)	181				TALISMAN	TALISMAN GRANDTOUR	797
225d (F22, F23 SERIES)	181		225d (F22, F23 SERIES)	181		228i (F22, F23 SERIES)	181		TA3246	CITROËN	C4 GRAND PICASSO	287	
228i (F22, F23 SERIES)	181		228i (F22, F23 SERIES)	181		230i (F22, F23 SERIES)	181				C4 PICASSO	289	
230i (F22, F23 SERIES)	181		230i (F22, F23 SERIES)	181		235i (F22, F23 SERIES)	182				PEUGEOT	5008	738
235i (F22, F23 SERIES)	182		235i (F22, F23 SERIES)	182		240i (F22, F23 SERIES)	182		TA3247	RENAULT	KOLEOS	777	
240i (F22, F23 SERIES)	182		240i (F22, F23 SERIES)	182		316i (F30, F31 SERIES)	199		TA3248	MERCEDES	C63 (204 SERIES)	534	
316i (F30, F31 SERIES)	199		316i (F30, F31 SERIES)	199		316d (F30, F31 SERIES)	199				SLC180 (172 SERIES)	586	
316d (F30, F31 SERIES)	199		316d (F30, F31 SERIES)	199		318d (F30, F31 SERIES)	199				SLC200 (172 SERIES)	586	
318d (F30, F31 SERIES)	199		318d (F30, F31 SERIES)	199		320i (F30, F31 SERIES)	199				SLC250 (172 SERIES)	586	
320i (F30, F31 SERIES)	199		320i (F30, F31 SERIES)	199		320d (F30, F31 SERIES)	199		TA3249	OPEL	ASTRA K	678	
320d (F30, F31 SERIES)	199		320d (F30, F31 SERIES)	199		325d (F30, F31 SERIES)	199				VAUXHALL	ASTRA K (MK VII)	928
325d (F30, F31 SERIES)	199		325d (F30, F31 SERIES)	199		328i (F30, F31 SERIES)	199		TA3250	OPEL	ASTRA K	678	
328i (F30, F31 SERIES)	199		328i (F30, F31 SERIES)	199		330i (F30, F31 SERIES)	199				VAUXHALL	ASTRA K (MK VII)	928
330i (F30, F31 SERIES)	199		330i (F30, F31 SERIES)	199		330d (F30, F31 SERIES)	199		TA3254	FORD	C-MAX II	365	
330d (F30, F31 SERIES)	199		330d (F30, F31 SERIES)	199		335i (F30, F31 SERIES)	199					FOCUS III	377
335i (F30, F31 SERIES)	199		335i (F30, F31 SERIES)	199		340i (F30, F31 SERIES)	199					GRAND C-MAX	386
340i (F30, F31 SERIES)	199		340i (F30, F31 SERIES)	199		318d (F34 SERIES)	202					KUGA II	390
318d (F34 SERIES)	202		318d (F34 SERIES)	202		320i (F34 SERIES)	202					TOURNEO CONNECT	403
320i (F34 SERIES)	202		320i (F34 SERIES)	202		320d (F34 SERIES)	202				TRANSIT CONNECT	409	
320d (F34 SERIES)	202		320d (F34 SERIES)	202		325d (F34 SERIES)	202		TA3255	HYUNDAI	i30	439	
325d (F34 SERIES)	202		325d (F34 SERIES)	202		328i (F34 SERIES)	202				KIA	CEE'D	467
328i (F34 SERIES)	202		328i (F34 SERIES)	202		330i (F34 SERIES)	202		TA3256	JAGUAR	S TYPE	456	
330i (F34 SERIES)	202		330i (F34 SERIES)	202		330d (F34 SERIES)	202				XJ	458	
330d (F34 SERIES)	202		330d (F34 SERIES)	202		335i (F34 SERIES)	202		TA3257	MERCEDES	SPRINTER (901, 902, 903 SERIES)	593	
335i (F34 SERIES)	202		335i (F34 SERIES)	202		340i (F34 SERIES)	202				SPRINTER (904 SERIES)	594	
340i (F34 SERIES)	202		340i (F34 SERIES)	202		420i (F32, F33 SERIES)	204		TA3258	MAZDA	3	517	
420i (F32, F33 SERIES)	204		420i (F32, F33 SERIES)	204		420d (F32, F33 SERIES)	204				6	521	
420d (F32, F33 SERIES)	204		420d (F32, F33 SERIES)	204		425d (F32, F33 SERIES)	204		TA3259	OPEL	KARL	686	
425d (F32, F33 SERIES)	204		425d (F32, F33 SERIES)	204		428i (F32, F33 SERIES)	204					KARL ROCKS	686
428i (F32, F33 SERIES)	204		428i (F32, F33 SERIES)	204		430i (F32, F33 SERIES)	204					VIVA	944
430i (F32, F33 SERIES)	204		430i (F32, F33 SERIES)	204		430d (F32, F33 SERIES)	204				VIVA ROCKS	944	
430d (F32, F33 SERIES)	204		430d (F32, F33 SERIES)	204		435i (F32, F33 SERIES)	204		TA3260	OPEL	KARL	686	
435i (F32, F33 SERIES)	204		435i (F32, F33 SERIES)	204		435d (F32, F33 SERIES)	204					KARL ROCKS	686
435d (F32, F33 SERIES)	204		435d (F32, F33 SERIES)	204		440i (F32, F33 SERIES)	204					VIVA	944
440i (F32, F33 SERIES)	204		440i (F32, F33 SERIES)	204		418d (F36 SERIES)	206				VIVA ROCKS	944	
418d (F36 SERIES)	206		418d (F36 SERIES)	206		420i (F36 SERIES)	206		TA3261	OPEL	KARL	686	
420i (F36 SERIES)	206		420i (F36 SERIES)	206		420d (F36 SERIES)	206					KARL ROCKS	686
420d (F36 SERIES)	206		420d (F36 SERIES)	206		428i (F36 SERIES)	206					VIVA	944
428i (F36 SERIES)	206		428i (F36 SERIES)	206		430i (F36 SERIES)	206				VIVA ROCKS	944	
430i (F36 SERIES)	206		430i (F36 SERIES)	206		430d (F36 SERIES)	206		TA3262	OPEL	ASTRA J	677	
430d (F36 SERIES)	206		430d (F36 SERIES)	206		435i (F36 SERIES)	206					CASCADA	681
435i (F36 SERIES)	206		435i (F36 SERIES)	206		440i (F36 SERIES)	206				VAUXHALL	ASTRA J (MK VI)	927
440i (F36 SERIES)	206		440i (F36 SERIES)	206		M2 (F87 SERIES)	237				CASCADA	930	
M2 (F87 SERIES)	237		M2 (F87 SERIES)	237		M3 (F80 SERIES)	239		TA3263	OPEL	ASTRA K	678	
M3 (F80 SERIES)	239		M3 (F80 SERIES)	239		M4 (F82, F83 SERIES)	239				VAUXHALL	ASTRA K (MK VII)	928
M4 (F82, F83 SERIES)	239		M4 (F82, F83 SERIES)	239					TA3264	VOLKSWAGEN	POLO (6R SERIES)	1029	
									TA3265	FIAT	TIPO	362	
									TA3266	JAGUAR	F TYPE	455	
											S TYPE	456	
											XJ	458	
											XK	460	
									TC2644	NISSAN	PATROL	663	
									TC2816	AUDI	A6 (4F SERIES)	123	

543 New to Range









D				D				D			
TC2816	AUDI	S6 (4F SERIES)	165	TC3215	SEAT	IBIZA (6J SERIES) TOLEDO IV (NH SERIES)	832 848	TC3267	SAAB	9-5	813
TC2920	HONDA	CR-V I	420		SKODA	FABIA (NJ SERIES) RAPID	854 868	TC3268	MERCEDES	GL320 (164 SERIES) GL350 (164 SERIES) GL420 (164 SERIES) GL450 (164 SERIES) GL500 (164 SERIES) ML280 (164 SERIES) ML300 (164 SERIES) ML320 (164 SERIES) ML350 (164 SERIES) ML420 (164 SERIES) ML450 (164 SERIES) ML500 (164 SERIES) ML63 (164 SERIES) R280 (251 SERIES) R300 (251 SERIES) R320 (251 SERIES) R350 (251 SERIES) R500 (251 SERIES) R63 (251 SERIES)	566 566 566 566 566 573 573 573 573 573 573 573 573 573 573 575 575 575 575 575 575
TC2921	HONDA	CR-V I	420		VOLKSWAGEN	POLO (6R SERIES) POLO (6C SERIES)	1029 1031				
TC2932	LEXUS	GS300 GS400 GS430 SC430	510 510 510 514	TC3216	AUDI	A1 (8X SERIES)	63				
TC2933	LEXUS	GS300 GS400 GS430 SC430	510 510 510 514		SEAT	IBIZA (6J SERIES) TOLEDO IV (NH SERIES)	832 848				
TC2938	NISSAN	350 Z	649		SKODA	FABIA (NJ SERIES) RAPID	854 868				
TC2939	NISSAN	350 Z	649		VOLKSWAGEN	POLO (6R SERIES) POLO (6C SERIES)	1029 1031				
TC2944	AUDI	A1 (8X SERIES) A3 (8P SERIES) A3 CABRIO (8P SERIES) Q3 (8U SERIES) S3 (8P SERIES) TT (8J SERIES)	69 76 83 135 150 171	TC3218	HYUNDAI	MATRIX	443				
	SEAT	ALTEA (5P SERIES) LEON II (1P SERIES) TOLEDO III (5P SERIES)	816 840 846	TC3219	HYUNDAI	MATRIX	443				
	SKODA	OCTAVIA (1Z SERIES) OCTAVIATOUR (1Z SERIES) SUPERB (3T SERIES) YETI	858 864 873 878	TC3220	MAZDA	6	519				
	VOLKSWAGEN	CC EOS GOLF V GOLF VI GOLF VI CABRIO GOLF PLUS JETTA III (1K SERIES) PASSAT V PASSAT VI PASSAT CC PASSAT ALLTRACK TIGUAN TOURAN	970 973 986 990 995 998 1002 1019 1020 1023 1024 1038 1046	TC3237	MINIBUSHI	MONTERO PAJERO SHOGUN	642 645 647	TC3269	MERCEDES	GL320 (164 SERIES) GL350 (164 SERIES) GL420 (164 SERIES) GL450 (164 SERIES) GL500 (164 SERIES) ML280 (164 SERIES) ML300 (164 SERIES) ML320 (164 SERIES) ML350 (164 SERIES) ML420 (164 SERIES) ML450 (164 SERIES) ML500 (164 SERIES) ML63 (164 SERIES) R280 (251 SERIES) R300 (251 SERIES) R320 (251 SERIES) R350 (251 SERIES) R500 (251 SERIES) R63 (251 SERIES)	566 566 566 566 566 573 573 573 573 573 573 573 573 575 575 575 575 575 575 575
TC2981	CITROEN	C4 GRAND PICASSO C4 PICASSO	287 289	TC3238	MINIBUSHI	MONTERO PAJERO SHOGUN	642 645 647				
	PEUGEOT	308 3008 5008	716 736 738	TC3239	VOLVO	XC60	1082				
TC2982	PEUGEOT	308	716	TC3240	VOLVO	XC60	1082				
TC2985	CITROEN	C4 GRAND PICASSO C4 PICASSO	287 289	TC3241	HYUNDAI	i40	440				
	PEUGEOT	308	716	TC3242	HYUNDAI	i40	440				
TC2986	CITROEN	C4 GRAND PICASSO C4 PICASSO	287 289	TC3243	MERCEDES	R280 (251 SERIES) R300 (251 SERIES) R320 (251 SERIES) R350 (251 SERIES) R500 (251 SERIES) R63 (251 SERIES)	575 575 575 575 575 575				
	PEUGEOT	308	716	TC3244	MERCEDES	R280 (251 SERIES) R300 (251 SERIES) R320 (251 SERIES) R350 (251 SERIES) R500 (251 SERIES) R63 (251 SERIES)	575 575 575 575 575 575				
TC3004	LAND ROVER	DISCOVERY 3	492	TC3245	KIA	CERATO I	468	TC3270	RENAULT	TWINGO II	803
TC3005	LAND ROVER	DISCOVERY 3	492	TC3246	KIA	CERATO I	468	TC3271	RENAULT	TWINGO II	803
TC3030	LAND ROVER	DISCOVERY 4	495	TC3247	HYUNDAI	MATRIX	443	TC3272	MINIBUSHI	LANCER LANCER SPORTBACK OUTLANDER II	632 639 641 644
TC3031	LAND ROVER	DISCOVERY 4	495	TC3248	CHEVROLET	TRAX	271				
TC3062	LEXUS	GS300 GS430 GS450H GS460 IS200d IS220d IS250 IS250 Cabrio IS-F IS200t IS300h	510 510 510 510 511 511 511 511 511 512 512	TC3249	CHEVROLET	TRAX OPEL MOKKA VAUXHALL MOKKA	271 689 937	TC3275	FORD	MONDEO III	390
TC3063	LEXUS	GS300 GS430 GS450H GS460 IS200d IS220d IS250 IS250 Cabrio IS-F IS200t IS300h	510 510 510 510 511 511 511 511 511 512 512	TC3250	OPEL	MOKKA VAUXHALL MOKKA	689 937	TC3276	SMART	CITY-CABRIO CITY- COUPE CROSSBLADE ROADSTER FORTWO (450 SERIES)	882 882 883 883 884
TC3149	LAND ROVER	RANGE ROVER IV RANGE ROVER SPORT	502 508	TC3251	RENAULT	ESPACE IV VEL SATIS	766 804	TC3277	SMART	CITY-CABRIO CITY- COUPE CROSSBLADE ROADSTER FORTWO (450 SERIES)	882 882 883 883 884
TC3150	LAND ROVER	RANGE ROVER IV RANGE ROVER SPORT	502 508	TC3252	RENAULT	ESPACE IV VEL SATIS	766 804	TC3278	SMART	CITY-CABRIO CITY- COUPE CROSSBLADE ROADSTER FORTWO (450 SERIES)	882 882 883 883 884
TC3208	RENAULT	LATITUDE	779	TC3253	RENAULT	CLIO IV CLIO GRANDTOUR IV ZOE	760 762 804	TC3279	TOYOTA	RAV4 III	918
TC3209	TOYOTA	HI-LUX	912	TC3254	RENAULT	CLIO IV CLIO GRANDTOUR IV ZOE	760 762 804	TC3280	TOYOTA	RAV4 III	918
TC3210	TOYOTA	HI-LUX	912	TC3255	FIAT	PANDA (312)	353	TC3281	MERCEDES	GL320 (164 SERIES) GL350 (164 SERIES) GL420 (164 SERIES) GL450 (164 SERIES) GL500 (164 SERIES) ML280 (164 SERIES) ML300 (164 SERIES) ML320 (164 SERIES) ML350 (164 SERIES) ML420 (164 SERIES) ML450 (164 SERIES) ML500 (164 SERIES) ML63 (164 SERIES) R280 (251 SERIES) R300 (251 SERIES) R320 (251 SERIES) R350 (251 SERIES) R500 (251 SERIES) R63 (251 SERIES)	566 566 566 566 566 573 573 573 573 573 573 573 573 575 575 575 575 575
TC3211	AUDI	A1 (8X SERIES)	64	TC3256	FIAT	PANDA (312)	353				
	SEAT	IBIZA (6J SERIES)	832	TC3257	FORD	GALAXY MONDEO IV S-MAX	385 395 399	TC3282	AUDI	A1 (8X SERIES) A3 (8P SERIES) A3 CABRIO (8P SERIES) S3 (8P SERIES) TT (8J SERIES)	69 76 83 150 171
TC3212	AUDI	A1 (8X SERIES)	64	TC3258	BMW	X3 (F25 SERIES) X4 (F26 SERIES) X4M (F26 SERIES)	249 251 251				
	SEAT	IBIZA (6J SERIES)	832	TC3259	BMW	X3 (F25 SERIES) X4 (F26 SERIES) X4M (F26 SERIES)	249 251 251				
TC3213	MINIBUSHI	L200	637	TC3260	BMW	X3 (F25 SERIES) X4 (F26 SERIES) X4M (F26 SERIES)	249 251 251				
TC3214	MINIBUSHI	L200	637	TC3261	TOYOTA	iQ	913				
TC3215	AUDI	A1 (8X SERIES)	63	TC3262	TOYOTA	iQ	913				
				TC3263	NISSAN	NAVARA PATHFINDER	660 663				
				TC3264	NISSAN	NAVARA PATHFINDER	660 663				
				TC3265	AUDI	A3 (8L SERIES) S3 (8L SERIES) TT (8N SERIES)	74 148 169				
					SEAT	LEON I (1M SERIES)	838				
					SKODA	OCTAVIA (1U SERIES)	856				
					VOLKSWAGEN	BEEETLE BORA GOLF IV	951 956 981				
				TC3266	SAAB	9-5	813				

TC3282 ...









543 New to Range

D				D				D						
... TC3282	VOLKSWAGEN	BEE TLE (5C SERIES)	952	TC3314	MINI	COOPER	613	TC3341	BMW	518d (F10, F11 SERIES)	225			
		BEE TLE CABRIO	954			ONE	613			520i (F10, F11 SERIES)	225			
		EOS	973			COOPER S	616			520d (F10, F11 SERIES)	225			
		GOLF V	986			ONE D	614			523i (F10, F11 SERIES)	225			
		GOLF VI	990			COOPER D	616			525d (F10, F11 SERIES)	225			
		GOLF VI CABRIO	995			COOPER SD	616			528i (F10, F11 SERIES)	225			
		GOLF PLUS	998			JOHN COOPER WORKS	616			530i (F10, F11 SERIES)	225			
		JETTA III (1K SERIES)	1002			COOPER CLUBMAN	619			530d (F10, F11 SERIES)	225			
		JETTA IV (16 SERIES)	1006			ONE CLUBMAN	619			535i (F10, F11 SERIES)	225			
		SCIROCCO	1032			COOPER D CLUBMAN	620			535d (F10, F11 SERIES)	225			
TC3283	AUDI	A1 (8X SERIES)	69			COOPER S CLUBMAN	622			550i (F10, F11 SERIES)	225			
		A3 (8P SERIES)	76			COOPER SD CLUBMAN	622			Active Hybrid 5 (F10, F11 SERIES)	225			
		A3 CABRIO (8P SERIES)	83			JOHN COOPER WORKS CLUBMAN	622			520dX (F10, F11 SERIES)	227			
		S3 (8P SERIES)	150			ONE D CLUBMAN	622			525dX (F10, F11 SERIES)	227			
		TT (8J SERIES)	171			COOPER CLUBVAN	624			528iX (F10, F11 SERIES)	227			
	SEAT	ALTEA (5P SERIES)	816			COOPER D CLUBVAN	624			530dX (F10, F11 SERIES)	227			
		LEON II (1P SERIES)	840			ONE CLUBVAN	624			535iX (F10, F11 SERIES)	227			
		TOLEDO III (5P SERIES)	846			COUPE COOPER	626			535dX (F10, F11 SERIES)	227			
	SKODA	OCTAVIA (1Z SERIES)	858			COUPE COOPER S	628			550iX (F10, F11 SERIES)	227			
		OCTAVIATOUR (1Z SERIES)	864			COUPE COOPER SD	628			M550dX (F10, F11 SERIES)	227			
		SUPERB (3T SERIES)	873			COUPE JOHN COOPER WORKS	628			640i (F06, F12, F13 SERIES)	229			
		YETI	878			ROADSTER COOPER	631			640d (F06, F12, F13 SERIES)	229			
	VOLKSWAGEN	BEE TLE (5C SERIES)	952			ROADSTER COOPER S	631			650i (F06, F12, F13 SERIES)	229			
		BEE TLE CABRIO	954			ROADSTER COOPER SD	631			640iX (F06, F12, F13 SERIES)	231			
		EOS	973			ROADSTER COOPER S JCW	631			640dX (F06, F12, F13 SERIES)	231			
		GOLF V	986							650iX (F06, F12, F13 SERIES)	231			
		GOLF VI	990		TC3315	AUDI	A3 (8P SERIES)	78			730i (F01, F02 SERIES)	233		
		GOLF VI CABRIO	995			A3 CABRIO (8P SERIES)	83			730d (F01, F02 SERIES)	233			
		GOLF PLUS	998			SEAT	ALTEA (5P SERIES)	818			740i (F01, F02 SERIES)	233		
		JETTA III (1K SERIES)	1002			SKODA	OCTAVIA (1Z SERIES)	860			740d (F01, F02 SERIES)	233		
		JETTA IV (16 SERIES)	1006				OCTAVIATOUR (1Z SERIES)	866			750i (F01, F02 SERIES)	233		
		SCIROCCO	1032				SUPERB (3T SERIES)	875			760i (F01, F02 SERIES)	233		
							YETI	878			730dX (F01, F02 SERIES)	234		
TC3286	MAZDA	DEMIO	524			VOLKSWAGEN	CADDY III	964			740iX (F01, F02 SERIES)	234		
TC3287	MAZDA	DEMIO	524				EOS	976			740dX (F01, F02 SERIES)	234		
TC3288	MITSUBISHI	COLT	633				GOLF VI	990			750iX (F01, F02 SERIES)	234		
TC3289	MITSUBISHI	COLT	633				GOLF VI CABRIO	995			750dX (F01, F02 SERIES)	234		
TC3290	HONDA	CIVIC	418				GOLF PLUS	1000			Active Hybrid 7 (F04 SERIES)	236		
TC3291	HONDA	CIVIC	418				JETTA III (1K SERIES)	1004			Active Hybrid 7L (F04 SERIES)	236		
TC3292	HYUNDAI	SANTA FE	445				SCIROCCO	1033		TC3344	NISSAN	PIXO	664	
TC3293	HYUNDAI	SANTA FE	445				TOURAN	1048			SUZUKI	ALTO	893	
TC3297	TOYOTA	LANDCRUISER PRADO	914		TC3316	AUDI	A3 (8P SERIES)	78						
TC3298	TOYOTA	LANDCRUISER PRADO	914			A3 CABRIO (8P SERIES)	83			TC3345	NISSAN	PIXO	664	
TC3299	MERCEDES	SPRINTER (904 SERIES)	594			SEAT	ALTEA (5P SERIES)	818			SUZUKI	ALTO	893	
TC3301	MITSUBISHI	L200	637			SKODA	OCTAVIA (1Z SERIES)	860		TC3346	ALFA ROMEO	GIULIETTA	54	
TC3302	MITSUBISHI	L200	637				OCTAVIATOUR (1Z SERIES)	866		TC3347	ALFA ROMEO	GIULIETTA	54	
TC3303	MITSUBISHI	MONTERO	642				SUPERB (3T SERIES)	875		TC3348	MERCEDES	S350 (220 SERIES)	578	
		PAJERO	645				YETI	878				S430 (220 SERIES)	578	
		SHOGUN	647				VOLKSWAGEN	CADDY III	964				S500 (220 SERIES)	578
TC3304	MITSUBISHI	MONTERO	642				EOS	976		TC3349	MERCEDES	S350 (220 SERIES)	578	
		PAJERO	645				GOLF VI	990				S430 (220 SERIES)	578	
		SHOGUN	647				GOLF VI CABRIO	995				S500 (220 SERIES)	578	
TC3307	CHRYSLER	SEBRING	273				GOLF PLUS	1000		TC3350	MAZDA	6	520	
	DODGE	AVENGER	330				JETTA III (1K SERIES)	1004		TC3351	MAZDA	6	520	
		CALIBER	330				SCIROCCO	1033		TC3352	HYUNDAI	i40	440	
	JEEP	COMPASS	460				TOURAN	1048		TC3353	KIA	SOUL I	482	
		PATRIOT	461		TC3330	JAGUAR	S TYPE	456		TC3354	KIA	SOUL I	482	
							XF	458		TC3355	CHRYSLER	VOYAGER III	274	
TC3310	IVECO	DAILY IV	455				XF	458		TC3356	HYUNDAI	GRAND SANTA FE	433	
TC3311	VOLKSWAGEN	CC	970								SANTA FE	445		
		PASSAT VI	1020			TC3337	AUDI	A4 (8K SERIES)	93		TC3357	TOYOTA	AVENSIS	903
		PASSAT CC	1023				A4 ALLROAD (8K SERIES)	100				COROLLA VERSO	909	
		PASSAT ALLTRACK	1024				A5 CABRIO (8F SERIES)	105		TC3358	DAIHATSU	TERIOS II	329	
		TIGUAN	1042				A5 COUPE (8T SERIES)	110		TC3359	SUZUKI	ALTO	892	
							A5 COUPE, SPORTBACK (8T SERIES)	112		TC3360	TOYOTA	PRIUS	916	
TC3312	VOLKSWAGEN	CC	970				A6 (4G SERIES)	124		TC3361	MAZDA	6	520	
		PASSAT VI	1020				A7 (4G SERIES)	126		TC3362	IVECO	DAILY IV	455	
		PASSAT CC	1023				A8 (4H SERIES)	130		TC3363	IVECO	DAILY IV	455	
		PASSAT ALLTRACK	1024				Q5 (8R SERIES)	136		TC3364	RENAULT	CLIO III	760	
		TIGUAN	1042				RS6 (4G SERIES)	148			MEGANE II	791		
							S4 (8K SERIES)	153		TC3365	MAZDA	E2000	524	
TC3313	MINI	COOPER	613				S6 (4G SERIES)	166			E2200	524		
		ONE	613			TC3338	AUDI	A4 (8K SERIES)	93		TC3366	HYUNDAI	i800	440
		COOPER S	616				A4 ALLROAD (8K SERIES)	100			iLOAD	440		
		ONE D	614				A5 CABRIO (8F SERIES)	105			IX55	442		
		COOPER D	616				A5 COUPE (8T SERIES)	110						
		COOPER SD	616				A5 COUPE, SPORTBACK (8T SERIES)	112			KIA	CARNIVAL	464	
		JOHN COOPER WORKS	616				A6 (4G SERIES)	124			SEDONA	479		
		COOPER CLUBMAN	619				A7 (4G SERIES)	126		TC3367	NISSAN	CABSTAR	650	
		ONE CLUBMAN	619				A8 (4H SERIES)	130		TC3368	TOYOTA	LANDCRUISER	914	
		COOPER D CLUBMAN	620				Q5 (8R SERIES)	136		TC3369	MERCEDES	SLK200 (171 SERIES)	590	
		COOPER S CLUBMAN	622				RS6 (4G SERIES)	148				SLK280 (171 SERIES)	590	
		COOPER SD CLUBMAN	622				S4 (8K SERIES)	153				SLK300 (171 SERIES)	590	
		JOHN COOPER WORKS CLUBMAN	622				S6 (4G SERIES)	166				SLK350 (171 SERIES)	590	
		ONE D CLUBMAN	622			TC3341	BMW	520d (F07 SERIES)	223			SLK55 (171 SERIES)	590	
		COOPER CLUBVAN	624					528i (F07 SERIES)	223		TC3370	LEXUS	GS300	510
		COOPER D CLUBVAN	624					530d (F07 SERIES)	223			GS430	510	
		ONE CLUBVAN	624					530dX (F07 SERIES)	223			GS450H	510	
		COUPE COOPER	626					535i (F07 SERIES)	223			GS460	510	
		COUPE COOPER S	628					535d (F07 SERIES)	223			IS200d	511	
		COUPE COOPER SD	628					550i (F07 SERIES)	223			IS220d	511	
		COUPE JOHN COOPER WORKS	628					530dX (F07 SERIES)	224			IS250	511	
		ROADSTER COOPER	631					535iX (F07 SERIES)	224					
		ROADSTER COOPER S	631					535dX (F07 SERIES)	224					
		ROADSTER COOPER SD	631					550iX (F07 SERIES)	224					
		ROADSTER COOPER S JCW	631											













543 New to Range

D   				D   				D   			
TC3370	LEXUS	IS250 Cabrio	511	TC3389	SSANGYONG	ACTYON SPORTS KYRON REXTON	886 886 886	TC3408	MERCEDES	GL350 (166 SERIES) GL400 (166 SERIES) GL450 (166 SERIES) GL500 (166 SERIES) GL63 (166 SERIES) GLE250 (166 SERIES) GLE350 (166 SERIES) GLE400 (166 SERIES) GLE450 (166 SERIES) GLE500 (166 SERIES) GLE63 (166 SERIES) GLE350 COUPE (292 SERIES) GLE400 COUPE (292 SERIES) GLE450 COUPE (292 SERIES) GLE500 COUPE (292 SERIES) GLE63 COUPE (292 SERIES) GLS350 (166 SERIES) GLS400 (166 SERIES) GLS400 (166 SERIES) GLS500 (166 SERIES) GLS63 (166 SERIES) ML250 (166 SERIES) ML350 (166 SERIES) ML400 (166 SERIES) ML500 (166 SERIES) ML63 (166 SERIES)	567 567 567 567 567 568 568 568 568 568 568 569 569 569 569 569 571 571 571 571 571 574 574 574 574 574
TC3371	LEXUS	GS300 GS430 GS450H GS460 IS200d IS220d IS250 IS250 Cabrio	510 510 510 511 511 511 511	TC3392	MAZDA	6	520	TC3409	MERCEDES	GL350 (166 SERIES) GL400 (166 SERIES) GL450 (166 SERIES) GL500 (166 SERIES) GL63 (166 SERIES) GLE250 (166 SERIES) GLE350 (166 SERIES) GLE400 (166 SERIES) GLE450 (166 SERIES) GLE500 (166 SERIES) GLE63 (166 SERIES) GLE350 COUPE (292 SERIES) GLE400 COUPE (292 SERIES) GLE450 COUPE (292 SERIES) GLE500 COUPE (292 SERIES) GLE63 COUPE (292 SERIES) GLS350 (166 SERIES) GLS400 (166 SERIES) GLS400 (166 SERIES) GLS500 (166 SERIES) GLS63 (166 SERIES) ML250 (166 SERIES) ML350 (166 SERIES) ML400 (166 SERIES) ML500 (166 SERIES) ML63 (166 SERIES)	567 567 567 567 567 568 568 568 568 568 568 569 569 569 569 569 571 571 571 571 571 574 574 574 574 574
TC3372	MAZDA	6	520	TC3393	MAZDA	6	520	TC3410	MERCEDES	GL350 (166 SERIES) GL400 (166 SERIES) GL450 (166 SERIES) GL500 (166 SERIES) GL63 (166 SERIES) GLE250 (166 SERIES) GLE350 (166 SERIES) GLE400 (166 SERIES) GLE450 (166 SERIES) GLE500 (166 SERIES) GLE63 (166 SERIES) GLE350 COUPE (292 SERIES) GLE400 COUPE (292 SERIES) GLE450 COUPE (292 SERIES) GLE500 COUPE (292 SERIES) GLE63 COUPE (292 SERIES) GLS350 (166 SERIES) GLS400 (166 SERIES) GLS400 (166 SERIES) GLS500 (166 SERIES) GLS63 (166 SERIES) ML250 (166 SERIES) ML350 (166 SERIES) ML400 (166 SERIES) ML500 (166 SERIES) ML63 (166 SERIES)	567 567 567 567 567 568 568 568 568 568 568 569 569 569 569 569 571 571 571 571 571 574 574 574 574 574
TC3373	MITSUBISHI	L200 MONTERO SPORT PAJERO SPORT SHOGUN SPORT	636 643 646 648	TC3394	MERCEDES	C220 (204 SERIES) C230 (204 SERIES) C250 (204 SERIES) C280 (204 SERIES) C300 (204 SERIES) C320 (204 SERIES) C350 (204 SERIES)	534 534 534 534 534 534 534	TC3411	MAZDA	3 6 CX-5	517 521 523
TC3374	MITSUBISHI	L200 MONTERO SPORT PAJERO SPORT SHOGUN SPORT	636 643 646 648	TC3395	MERCEDES	C220 (204 SERIES) C230 (204 SERIES) C250 (204 SERIES) C280 (204 SERIES) C300 (204 SERIES) C320 (204 SERIES) C350 (204 SERIES)	534 534 534 534 534 534 534	TC3412	MAZDA	3 6 CX-5	517 521 523
TC3375	BMW	X3 (F25 SERIES) X4 (F26 SERIES) X4M (F26 SERIES)	249 251 251	TC3396	MERCEDES	CLS250 (218 SERIES) CLS350 (218 SERIES) CLS500 (218 SERIES) E200 (212 SERIES) E220 (212 SERIES) E250 (212 SERIES) E300 Hybrid (212 SERIES) E300 (212 SERIES) E350 BlueTec (212 SERIES) E350 (212 SERIES) E500 (212 SERIES) E63 (212 SERIES)	547 547 547 563 563 563 563 563 563 563 564	TC3413	MAZDA	ASTRA K VAUXHALL ASTRA K (MK VII)	678 928
TC3376	BMW	730i (F01, F02 SERIES) 730d (F01, F02 SERIES) 740i (F01, F02 SERIES) 740d (F01, F02 SERIES) 750i (F01, F02 SERIES) 760i (F01, F02 SERIES) 730dX (F01, F02 SERIES) 740iX (F01, F02 SERIES) 740dX (F01, F02 SERIES) 750iX (F01, F02 SERIES) 750dX (F01, F02 SERIES)	233 233 233 233 233 233 234 234 234 234 234	TC3397	MERCEDES	VIANO (639 SERIES) VITO (639 SERIES)	601 604	TC3414	MAZDA	ASTRA K VAUXHALL ASTRA K (MK VII)	678 928
TC3377	BMW	730i (F01, F02 SERIES) 730d (F01, F02 SERIES) 740i (F01, F02 SERIES) 740d (F01, F02 SERIES) 750i (F01, F02 SERIES) 760i (F01, F02 SERIES) 730dX (F01, F02 SERIES) 740iX (F01, F02 SERIES) 740dX (F01, F02 SERIES) 750iX (F01, F02 SERIES) 750dX (F01, F02 SERIES)	233 233 233 233 233 233 234 234 234 234 234	TC3398	AUDI	A1 (8X SERIES)	63	TC3415	MAZDA	CARNIVAL SEDONA	464 479
TC3380	AUDI	A3 (8L SERIES) S3 (8L SERIES) TT (8N SERIES) SKODA OCTAVIA (1U SERIES) VOLKSWAGEN BORA GOLF IV	74 148 169 856 956 981	TC3399	AUDI	A1 (8X SERIES) SEAT IBIZA (6J SERIES) TOLEDO IV (NH SERIES) SKODA FABIA (NJ SERIES) RAPID VOLKSWAGEN POLO (6R SERIES) POLO (6C SERIES)	63 832 848 854 868 1029 1031	TC3416	MAZDA	PICANTO	473
TC3381	BMW	X3 (F25 SERIES) X4 (F26 SERIES) X4M (F26 SERIES)	249 251 251	TC3400	BMW	X5 (F15 SERIES) X5M (F85 SERIES) X6 (F16 SERIES) X6M (F86 SERIES)	254 255 257 258	TC3417	MAZDA	PICANTO	473
TC3382	FORD	C-MAX C-MAX II FOCUS II FOCUS III FOCUS C-MAX	364 365 373 377 381	TC3401	BMW	X5 (F15 SERIES) X5M (F85 SERIES) X6 (F16 SERIES) X6M (F86 SERIES)	254 255 257 258	TC3418	MAZDA	PICANTO	473
TC3383	FORD	C-MAX C-MAX II FOCUS II FOCUS III FOCUS C-MAX	364 365 373 377 381	TC3402	HONDA	CIVIC	419	TC3419	MAZDA	PICANTO	473
TC3384	MERCEDES	C220 (204 SERIES) C230 (204 SERIES) C250 (204 SERIES) C250 (204 SERIES) C280 (204 SERIES) C300 (204 SERIES) C320 (204 SERIES) C350 (204 SERIES) GLK200 (X204 SERIES) GLK220 (X204 SERIES) GLK250 (X204 SERIES) GLK280 (X204 SERIES) GLK300 (X204 SERIES) GLK320 (X204 SERIES) GLK350 (X204 SERIES)	534 534 534 534 534 534 534 534 570 570 570 570 570 570 570	TC3403	HONDA	CIVIC	419	TC3420	MAZDA	PICANTO	473
TC3385	MERCEDES	C220 (204 SERIES) C230 (204 SERIES) C250 (204 SERIES) C250 (204 SERIES) C280 (204 SERIES) C300 (204 SERIES) C320 (204 SERIES) C350 (204 SERIES) GLK200 (X204 SERIES) GLK220 (X204 SERIES) GLK250 (X204 SERIES) GLK280 (X204 SERIES) GLK300 (X204 SERIES) GLK320 (X204 SERIES) GLK350 (X204 SERIES)	534 534 534 534 534 534 534 534 570 570 570 570 570 570 570	TC3404	HYUNDAI	i10	436	TC3421	MAZDA	PICANTO	473
TC3386	IVECO	DAILY III DAILY IV	454 455	TC3405	KIA	PICANTO RIO III SOUL I	473 478 482	TC3422	MAZDA	PICANTO	473
TC3387	SSANGYONG	KYRON REXTON	886 886	TC3406	AUDI	A1 (8X SERIES) A3 (8P SERIES) A3 CABRIO (8P SERIES) Q3 (8U SERIES) S3 (8P SERIES) TT (8J SERIES) SEAT ALTEA (5P SERIES) LEON II (1P SERIES) TOLEDO III (5P SERIES) SKODA OCTAVIA (1Z SERIES) OCTAVIATOUR (1Z SERIES) SUPERB (3T SERIES) YETI VOLKSWAGEN BEETLE (5C SERIES) BEETLE CABRIO CC EOS GOLF V GOLF VI GOLF VI CABRIO GOLF PLUS JETTA III (1K SERIES) JETTA IV (16 SERIES) PASSAT V PASSAT VI PASSAT CC PASSAT ALLTRACK SCIROCCO TIGUAN TOURAN	69 76 83 135 150 171 816 840 846 858 864 873 878 952 954 970 973 986 990 995 998 1002 1006 1019 1020 1023 1024 1032 1038 1046	TC3423	MAZDA	PICANTO A160 (176 SERIES) A180 (176 SERIES)	473 473 528 528
TC3388	SSANGYONG	KYRON REXTON	886 886	TC3407	VOLVO	V40 V40	1074 1074	TC3423	MAZDA	PICANTO A160 (176 SERIES) A180 (176 SERIES)	473 528 528
TC3389	SSANGYONG	ACTYON	886								









543 New to Range

D				D				D																																																																																																																																																																																																																																																																																														
TC3423	MERCEDES	A200 (176 SERIES) A220 (176 SERIES) A250 (176 SERIES) B160 (246 SERIES) B180 (246 SERIES) B200 (246 SERIES) B220 (246 SERIES) B250 (246 SERIES) CLA180 (117 SERIES) CLA200 (117 SERIES) CLA220 (117 SERIES) CLA250 (117 SERIES) CLA45 (117 SERIES) GLA180 (156 SERIES) GLA200 (156 SERIES) GLA220 (156 SERIES) GLA250 (156 SERIES) GLA45 (156 SERIES)	528 528 528 530 530 530 530 530 540 540 540 540 540 568 568 568 568 568	TC3437	BMW	320d (F30, F31 SERIES) 328i (F30, F31 SERIES) 330i (F30, F31 SERIES) 330d (F30, F31 SERIES) 335i (F30, F31 SERIES) 340i (F30, F31 SERIES) 335d (F30, F31 SERIES) 420i (F32, F33 SERIES) 420d (F32, F33 SERIES) 428i (F32, F33 SERIES) 430i (F32, F33 SERIES) 430d (F32, F33 SERIES) 435i (F32, F33 SERIES) 435d (F32, F33 SERIES) 440i (F32, F33 SERIES) 420i (F36 SERIES) 420d (F36 SERIES) 428i (F36 SERIES) 430i (F36 SERIES) 430d (F36 SERIES) 435i (F36 SERIES) 435d (F36 SERIES)	201 201 201 201 201 201 201 205 205 205 205 205 205 205 208 208 208 208 208 208 208	TC3448	MERCEDES	GLS63 (166 SERIES) ML250 (166 SERIES) ML350 (166 SERIES) ML400 (166 SERIES) ML500 (166 SERIES) ML63 (166 SERIES)	571 574 574 574 574 574	TC3424	FORD	MONDEO V	398	TC3438	BMW	118d (F20, F21 SERIES) 120d (F20, F21 SERIES) 135i (F20, F21 SERIES) 140i (F20, F21 SERIES) 220d (F22, F23 SERIES) 235i (F22, F23 SERIES) 240i (F22, F23 SERIES) 318d (F30, F31 SERIES) 320i (F30, F31 SERIES) 320d (F30, F31 SERIES) 328i (F30, F31 SERIES) 330i (F30, F31 SERIES) 330d (F30, F31 SERIES) 335i (F30, F31 SERIES) 340i (F30, F31 SERIES) 335d (F30, F31 SERIES) 420i (F32, F33 SERIES) 420d (F32, F33 SERIES) 428i (F32, F33 SERIES) 430i (F32, F33 SERIES) 430d (F32, F33 SERIES) 435i (F32, F33 SERIES) 435d (F32, F33 SERIES) 440i (F36 SERIES) 420i (F36 SERIES) 420d (F36 SERIES) 428i (F36 SERIES) 430i (F36 SERIES) 430d (F36 SERIES) 435i (F36 SERIES) 435d (F36 SERIES)	180 180 180 180 183 183 183 201 201 201 201 201 201 201 205 205 205 205 208 208 208 208 208 208 208 208 208 208 208 208	TC3449	MERCEDES	GL350 (166 SERIES) GL400 (166 SERIES) GL450 (166 SERIES) GL500 (166 SERIES) GL63 (166 SERIES) GLE250 (166 SERIES) GLE350 (166 SERIES) GLE400 (166 SERIES) GLE450 (166 SERIES) GLE500 (166 SERIES) GLE63 (166 SERIES) GLE350 COUPE (292 SERIES) GLE400 COUPE (292 SERIES) GLE450 COUPE (292 SERIES) GLE500 COUPE (292 SERIES) GLE63 COUPE (292 SERIES) GLS350 (166 SERIES) GLS400 (166 SERIES) GLS500 (166 SERIES) GLS63 (166 SERIES) ML250 (166 SERIES) ML350 (166 SERIES) ML400 (166 SERIES) ML500 (166 SERIES) ML63 (166 SERIES)	567 567 567 567 567 568 568 568 568 568 568 569 569 569 569 569 571 571 571 571 574 574 574 574 574	TC3425	AUDI	A1 (8X SERIES) A3 (8P SERIES) A3 (8V SERIES) A3 CABRIO (8P SERIES) A3 CABRIO (8V SERIES) Q3 (8U SERIES) RS3 (8V SERIES) S3 (8V SERIES) TT (8J SERIES)	69 80 82 85 87 135 141 151 172	TC3439	FORD	GRAND C-MAX	386	TC3450	CITROEN	C4 GRAND PICASSO C4 PICASSO	287 289	TC3426	CITROEN	C5 C6	290 292	TC3440	SEAT	ATECA (KH7 SERIES)	825	TC3451	CITROEN	C4 GRAND PICASSO C4 PICASSO	287 289	TC3427	HYUNDAI	i20	437	TC3441	SEAT	ATECA (KH7 SERIES)	825	TC3454	FIAT	500X	334	TC3428	LEXUS	NX200t NX300H	512 512	SKODA	KODIAQ KAROQ	855 855	TC3455	FIAT	500X	334	TC3429	TOYOTA	RAV4 IV	918	VOLKSWAGEN	ARTEON PASSAT VII PASSAT ALLTRACK TIGUAN TOURAN	949 1022 1026 1043 1051	JEOP	RENEGADE	462	TC3430	CITROEN	C4 GRAND PICASSO C4 PICASSO	287 289	TC3442	PORSCHE	911 (997 SERIES)	750	TC3456	LAND ROVER	RANGE ROVER IV	502	TC3431	MAZDA	3	517	TC3443	PORSCHE	911 (997 SERIES)	750	TC3457	LAND ROVER	RANGE ROVER IV	502	TC3432	MAZDA	3	517	TC3444	RENAULT	MEGANE IV TALISMAN TALISMAN GRANDTOUR	792 797 797	TC3460	MERCEDES	SLC180 (172 SERIES) SLC200 (172 SERIES) SLC250 (172 SERIES) SLC300 (172 SERIES) SLC43 (172 SERIES) SLK200 (172 SERIES) SLK250 (172 SERIES) SLK350 (172 SERIES) SLK55 (172 SERIES)	586 586 586 586 587 591 591 591 592	TC3433	FORD	KA	388	TC3445	RENAULT	MEGANE IV TALISMAN TALISMAN GRANDTOUR	792 797 797	TC3461	MERCEDES	SLC180 (172 SERIES) SLC200 (172 SERIES) SLC250 (172 SERIES) SLC300 (172 SERIES) SLC43 (172 SERIES) SLK200 (172 SERIES) SLK250 (172 SERIES) SLK350 (172 SERIES) SLK55 (172 SERIES)	586 586 586 586 587 591 591 591 592	TC3434	FORD	KA	388	TC3446	MERCEDES	GL350 (166 SERIES) GL400 (166 SERIES) GL450 (166 SERIES) GL500 (166 SERIES) GL63 (166 SERIES) GLE250 (166 SERIES) GLE350 (166 SERIES) GLE400 (166 SERIES) GLE450 (166 SERIES) GLE500 (166 SERIES) GLE63 (166 SERIES) GLE350 COUPE (292 SERIES) GLE400 COUPE (292 SERIES) GLE450 COUPE (292 SERIES) GLE500 COUPE (292 SERIES) GLE63 COUPE (292 SERIES) GLS350 (166 SERIES) GLS400 (166 SERIES) GLS500 (166 SERIES)	567 567 567 567 567 568 568 568 568 568 568 569 569 569 569 569 571 571 571	TC3462	NISSAN	OASHQAI OASHQAI + 2 X-TRAIL	668 668 672	TC3435	BMW	320i (F34 SERIES) 320d (F34 SERIES) 328i (F34 SERIES) 330d (F34 SERIES) 335i (F34 SERIES) 340i (F34 SERIES) 335d (F34 SERIES)	203 203 203 203 203 203 203	TC3447	MERCEDES	GL350 (166 SERIES) GL400 (166 SERIES) GL450 (166 SERIES) GL500 (166 SERIES) GL63 (166 SERIES) GLE250 (166 SERIES) GLE350 (166 SERIES) GLE400 (166 SERIES) GLE450 (166 SERIES) GLE500 (166 SERIES) GLE63 (166 SERIES) GLE350 COUPE (292 SERIES) GLE400 COUPE (292 SERIES) GLE450 COUPE (292 SERIES) GLE500 COUPE (292 SERIES) GLE63 COUPE (292 SERIES) GLS350 (166 SERIES) GLS400 (166 SERIES) GLS500 (166 SERIES)	567 567 567 567 567 568 568 568 568 568 568 569 569 569 569 569 571 571 571	RENAULT	KADJAR KOLEOS	769 777	TC3436	BMW	320i (F34 SERIES) 320d (F34 SERIES) 328i (F34 SERIES) 330d (F34 SERIES) 335i (F34 SERIES) 340i (F34 SERIES) 335d (F34 SERIES)	203 203 203 203 203 203 203	TC3448	MERCEDES	GL350 (166 SERIES) GL400 (166 SERIES) GL450 (166 SERIES) GL500 (166 SERIES) GL63 (166 SERIES) GLE250 (166 SERIES) GLE350 (166 SERIES) GLE400 (166 SERIES) GLE450 (166 SERIES) GLE500 (166 SERIES) GLE63 (166 SERIES) GLE350 COUPE (292 SERIES) GLE400 COUPE (292 SERIES) GLE450 COUPE (292 SERIES) GLE500 COUPE (292 SERIES) GLE63 COUPE (292 SERIES) GLS350 (166 SERIES) GLS400 (166 SERIES) GLS500 (166 SERIES)	567 567 567 567 567 568 568 568 568 568 568 569 569 569 569 569 571 571 571	TC3463	NISSAN	OASHQAI OASHQAI + 2 X-TRAIL	668 668 672	TC3437	BMW	118d (F20, F21 SERIES) 120d (F20, F21 SERIES) 135i (F20, F21 SERIES) 140i (F20, F21 SERIES) 220d (F22, F23 SERIES) 235i (F22, F23 SERIES) 240i (F22, F23 SERIES) 318d (F30, F31 SERIES) 320i (F30, F31 SERIES)	180 180 180 180 183 183 183 201 201	TC3449	MERCEDES	GL350 (166 SERIES) GL400 (166 SERIES) GL450 (166 SERIES) GL500 (166 SERIES) GL63 (166 SERIES) GLE250 (166 SERIES) GLE350 (166 SERIES) GLE400 (166 SERIES) GLE450 (166 SERIES) GLE500 (166 SERIES) GLE63 (166 SERIES) GLE350 COUPE (292 SERIES) GLE400 COUPE (292 SERIES) GLE450 COUPE (292 SERIES) GLE500 COUPE (292 SERIES) GLE63 COUPE (292 SERIES) GLS350 (166 SERIES) GLS400 (166 SERIES) GLS500 (166 SERIES)	567 567 567 567 567 568 568 568 568 568 568 569 569 569 569 569 571 571 571	RENAULT	KADJAR KOLEOS	769 777					TC3450	CITROEN	C4 GRAND PICASSO C4 PICASSO	287 289	TC3464	LAND ROVER	FREELANDER 2	499					TC3451	CITROEN	C4 GRAND PICASSO C4 PICASSO	287 289	TC3468	HONDA	CIVIC	419					TC3454	FIAT	500X	334	TC3469	HONDA	CIVIC	419					TC3455	FIAT	500X	334	TC3472	MERCEDES	C220 (204 SERIES) C230 (204 SERIES) C250 (204 SERIES) C280 (204 SERIES) C300 (204 SERIES) C320 (204 SERIES) C350 (204 SERIES)	534 534 534 534 534 534 534					TC3456	LAND ROVER	RANGE ROVER IV	502	TC3473	MERCEDES	C220 (204 SERIES) C230 (204 SERIES) C250 (204 SERIES) C280 (204 SERIES) C300 (204 SERIES) C320 (204 SERIES) C350 (204 SERIES)	534 534 534 534 534 534 534					TC3457	LAND ROVER	RANGE ROVER IV	502	TC3475	KIA	SPORTAGE	483					TC3460	MERCEDES	SLC180 (172 SERIES) SLC200 (172 SERIES) SLC250 (172 SERIES) SLC300 (172 SERIES) SLC43 (172 SERIES) SLK200 (172 SERIES) SLK250 (172 SERIES) SLK350 (172 SERIES) SLK55 (172 SERIES)	586 586 586 586 587 591 591 591 592	TC3476	NISSAN	X-TRAIL	670					TC3461	MERCEDES	SLC180 (172 SERIES) SLC200 (172 SERIES) SLC250 (172 SERIES) SLC300 (172 SERIES) SLC43 (172 SERIES) SLK200 (172 SERIES) SLK250 (172 SERIES) SLK350 (172 SERIES) SLK55 (172 SERIES)	586 586 586 586 587 591 591 591 592	TC3477	NISSAN	X-TRAIL	670					TC3462	NISSAN	OASHQAI OASHQAI + 2 X-TRAIL	668 668 672	TC3478	MERCEDES	SLC180 (172 SERIES) SLC200 (172 SERIES) SLC250 (172 SERIES) SLC300 (172 SERIES)	586 586 586 586					TC3463	NISSAN	OASHQAI OASHQAI + 2 X-TRAIL	668 668 672				
TC3424	FORD	MONDEO V	398	TC3438	BMW	118d (F20, F21 SERIES) 120d (F20, F21 SERIES) 135i (F20, F21 SERIES) 140i (F20, F21 SERIES) 220d (F22, F23 SERIES) 235i (F22, F23 SERIES) 240i (F22, F23 SERIES) 318d (F30, F31 SERIES) 320i (F30, F31 SERIES) 320d (F30, F31 SERIES) 328i (F30, F31 SERIES) 330i (F30, F31 SERIES) 330d (F30, F31 SERIES) 335i (F30, F31 SERIES) 340i (F30, F31 SERIES) 335d (F30, F31 SERIES) 420i (F32, F33 SERIES) 420d (F32, F33 SERIES) 428i (F32, F33 SERIES) 430i (F32, F33 SERIES) 430d (F32, F33 SERIES) 435i (F32, F33 SERIES) 435d (F32, F33 SERIES) 440i (F36 SERIES) 420i (F36 SERIES) 420d (F36 SERIES) 428i (F36 SERIES) 430i (F36 SERIES) 430d (F36 SERIES) 435i (F36 SERIES) 435d (F36 SERIES)	180 180 180 180 183 183 183 201 201 201 201 201 201 201 205 205 205 205 208 208 208 208 208 208 208 208 208 208 208 208	TC3449	MERCEDES	GL350 (166 SERIES) GL400 (166 SERIES) GL450 (166 SERIES) GL500 (166 SERIES) GL63 (166 SERIES) GLE250 (166 SERIES) GLE350 (166 SERIES) GLE400 (166 SERIES) GLE450 (166 SERIES) GLE500 (166 SERIES) GLE63 (166 SERIES) GLE350 COUPE (292 SERIES) GLE400 COUPE (292 SERIES) GLE450 COUPE (292 SERIES) GLE500 COUPE (292 SERIES) GLE63 COUPE (292 SERIES) GLS350 (166 SERIES) GLS400 (166 SERIES) GLS500 (166 SERIES) GLS63 (166 SERIES) ML250 (166 SERIES) ML350 (166 SERIES) ML400 (166 SERIES) ML500 (166 SERIES) ML63 (166 SERIES)	567 567 567 567 567 568 568 568 568 568 568 569 569 569 569 569 571 571 571 571 574 574 574 574 574	TC3425	AUDI	A1 (8X SERIES) A3 (8P SERIES) A3 (8V SERIES) A3 CABRIO (8P SERIES) A3 CABRIO (8V SERIES) Q3 (8U SERIES) RS3 (8V SERIES) S3 (8V SERIES) TT (8J SERIES)	69 80 82 85 87 135 141 151 172	TC3439	FORD	GRAND C-MAX	386	TC3450	CITROEN	C4 GRAND PICASSO C4 PICASSO	287 289	TC3426	CITROEN	C5 C6	290 292	TC3440	SEAT	ATECA (KH7 SERIES)	825	TC3451	CITROEN	C4 GRAND PICASSO C4 PICASSO	287 289	TC3427	HYUNDAI	i20	437	TC3441	SEAT	ATECA (KH7 SERIES)	825	TC3454	FIAT	500X	334	TC3428	LEXUS	NX200t NX300H	512 512	SKODA	KODIAQ KAROQ	855 855	TC3455	FIAT	500X	334	TC3429	TOYOTA	RAV4 IV	918	VOLKSWAGEN	ARTEON PASSAT VII PASSAT ALLTRACK TIGUAN TOURAN	949 1022 1026 1043 1051	JEOP	RENEGADE	462	TC3430	CITROEN	C4 GRAND PICASSO C4 PICASSO	287 289	TC3442	PORSCHE	911 (997 SERIES)	750	TC3456	LAND ROVER	RANGE ROVER IV	502	TC3431	MAZDA	3	517	TC3443	PORSCHE	911 (997 SERIES)	750	TC3457	LAND ROVER	RANGE ROVER IV	502	TC3432	MAZDA	3	517	TC3444	RENAULT	MEGANE IV TALISMAN TALISMAN GRANDTOUR	792 797 797	TC3460	MERCEDES	SLC180 (172 SERIES) SLC200 (172 SERIES) SLC250 (172 SERIES) SLC300 (172 SERIES) SLC43 (172 SERIES) SLK200 (172 SERIES) SLK250 (172 SERIES) SLK350 (172 SERIES) SLK55 (172 SERIES)	586 586 586 586 587 591 591 591 592	TC3433	FORD	KA	388	TC3445	RENAULT	MEGANE IV TALISMAN TALISMAN GRANDTOUR	792 797 797	TC3461	MERCEDES	SLC180 (172 SERIES) SLC200 (172 SERIES) SLC250 (172 SERIES) SLC300 (172 SERIES) SLC43 (172 SERIES) SLK200 (172 SERIES) SLK250 (172 SERIES) SLK350 (172 SERIES) SLK55 (172 SERIES)	586 586 586 586 587 591 591 591 592	TC3434	FORD	KA	388	TC3446	MERCEDES	GL350 (166 SERIES) GL400 (166 SERIES) GL450 (166 SERIES) GL500 (166 SERIES) GL63 (166 SERIES) GLE250 (166 SERIES) GLE350 (166 SERIES) GLE400 (166 SERIES) GLE450 (166 SERIES) GLE500 (166 SERIES) GLE63 (166 SERIES) GLE350 COUPE (292 SERIES) GLE400 COUPE (292 SERIES) GLE450 COUPE (292 SERIES) GLE500 COUPE (292 SERIES) GLE63 COUPE (292 SERIES) GLS350 (166 SERIES) GLS400 (166 SERIES) GLS500 (166 SERIES)	567 567 567 567 567 568 568 568 568 568 568 569 569 569 569 569 571 571 571	TC3462	NISSAN	OASHQAI OASHQAI + 2 X-TRAIL	668 668 672	TC3435	BMW	320i (F34 SERIES) 320d (F34 SERIES) 328i (F34 SERIES) 330d (F34 SERIES) 335i (F34 SERIES) 340i (F34 SERIES) 335d (F34 SERIES)	203 203 203 203 203 203 203	TC3447	MERCEDES	GL350 (166 SERIES) GL400 (166 SERIES) GL450 (166 SERIES) GL500 (166 SERIES) GL63 (166 SERIES) GLE250 (166 SERIES) GLE350 (166 SERIES) GLE400 (166 SERIES) GLE450 (166 SERIES) GLE500 (166 SERIES) GLE63 (166 SERIES) GLE350 COUPE (292 SERIES) GLE400 COUPE (292 SERIES) GLE450 COUPE (292 SERIES) GLE500 COUPE (292 SERIES) GLE63 COUPE (292 SERIES) GLS350 (166 SERIES) GLS400 (166 SERIES) GLS500 (166 SERIES)	567 567 567 567 567 568 568 568 568 568 568 569 569 569 569 569 571 571 571	RENAULT	KADJAR KOLEOS	769 777	TC3436	BMW	320i (F34 SERIES) 320d (F34 SERIES) 328i (F34 SERIES) 330d (F34 SERIES) 335i (F34 SERIES) 340i (F34 SERIES) 335d (F34 SERIES)	203 203 203 203 203 203 203	TC3448	MERCEDES	GL350 (166 SERIES) GL400 (166 SERIES) GL450 (166 SERIES) GL500 (166 SERIES) GL63 (166 SERIES) GLE250 (166 SERIES) GLE350 (166 SERIES) GLE400 (166 SERIES) GLE450 (166 SERIES) GLE500 (166 SERIES) GLE63 (166 SERIES) GLE350 COUPE (292 SERIES) GLE400 COUPE (292 SERIES) GLE450 COUPE (292 SERIES) GLE500 COUPE (292 SERIES) GLE63 COUPE (292 SERIES) GLS350 (166 SERIES) GLS400 (166 SERIES) GLS500 (166 SERIES)	567 567 567 567 567 568 568 568 568 568 568 569 569 569 569 569 571 571 571	TC3463	NISSAN	OASHQAI OASHQAI + 2 X-TRAIL	668 668 672	TC3437	BMW	118d (F20, F21 SERIES) 120d (F20, F21 SERIES) 135i (F20, F21 SERIES) 140i (F20, F21 SERIES) 220d (F22, F23 SERIES) 235i (F22, F23 SERIES) 240i (F22, F23 SERIES) 318d (F30, F31 SERIES) 320i (F30, F31 SERIES)	180 180 180 180 183 183 183 201 201	TC3449	MERCEDES	GL350 (166 SERIES) GL400 (166 SERIES) GL450 (166 SERIES) GL500 (166 SERIES) GL63 (166 SERIES) GLE250 (166 SERIES) GLE350 (166 SERIES) GLE400 (166 SERIES) GLE450 (166 SERIES) GLE500 (166 SERIES) GLE63 (166 SERIES) GLE350 COUPE (292 SERIES) GLE400 COUPE (292 SERIES) GLE450 COUPE (292 SERIES) GLE500 COUPE (292 SERIES) GLE63 COUPE (292 SERIES) GLS350 (166 SERIES) GLS400 (166 SERIES) GLS500 (166 SERIES)	567 567 567 567 567 568 568 568 568 568 568 569 569 569 569 569 571 571 571	RENAULT	KADJAR KOLEOS	769 777					TC3450	CITROEN	C4 GRAND PICASSO C4 PICASSO	287 289	TC3464	LAND ROVER	FREELANDER 2	499					TC3451	CITROEN	C4 GRAND PICASSO C4 PICASSO	287 289	TC3468	HONDA	CIVIC	419					TC3454	FIAT	500X	334	TC3469	HONDA	CIVIC	419					TC3455	FIAT	500X	334	TC3472	MERCEDES	C220 (204 SERIES) C230 (204 SERIES) C250 (204 SERIES) C280 (204 SERIES) C300 (204 SERIES) C320 (204 SERIES) C350 (204 SERIES)	534 534 534 534 534 534 534					TC3456	LAND ROVER	RANGE ROVER IV	502	TC3473	MERCEDES	C220 (204 SERIES) C230 (204 SERIES) C250 (204 SERIES) C280 (204 SERIES) C300 (204 SERIES) C320 (204 SERIES) C350 (204 SERIES)	534 534 534 534 534 534 534					TC3457	LAND ROVER	RANGE ROVER IV	502	TC3475	KIA	SPORTAGE	483					TC3460	MERCEDES	SLC180 (172 SERIES) SLC200 (172 SERIES) SLC250 (172 SERIES) SLC300 (172 SERIES) SLC43 (172 SERIES) SLK200 (172 SERIES) SLK250 (172 SERIES) SLK350 (172 SERIES) SLK55 (172 SERIES)	586 586 586 586 587 591 591 591 592	TC3476	NISSAN	X-TRAIL	670					TC3461	MERCEDES	SLC180 (172 SERIES) SLC200 (172 SERIES) SLC250 (172 SERIES) SLC300 (172 SERIES) SLC43 (172 SERIES) SLK200 (172 SERIES) SLK250 (172 SERIES) SLK350 (172 SERIES) SLK55 (172 SERIES)	586 586 586 586 587 591 591 591 592	TC3477	NISSAN	X-TRAIL	670					TC3462	NISSAN	OASHQAI OASHQAI + 2 X-TRAIL	668 668 672	TC3478	MERCEDES	SLC180 (172 SERIES) SLC200 (172 SERIES) SLC250 (172 SERIES) SLC300 (172 SERIES)	586 586 586 586					TC3463	NISSAN	OASHQAI OASHQAI + 2 X-TRAIL	668 668 672																
TC3425	AUDI	A1 (8X SERIES) A3 (8P SERIES) A3 (8V SERIES) A3 CABRIO (8P SERIES) A3 CABRIO (8V SERIES) Q3 (8U SERIES) RS3 (8V SERIES) S3 (8V SERIES) TT (8J SERIES)	69 80 82 85 87 135 141 151 172	TC3439	FORD	GRAND C-MAX	386	TC3450	CITROEN	C4 GRAND PICASSO C4 PICASSO	287 289	TC3426	CITROEN	C5 C6	290 292	TC3440	SEAT	ATECA (KH7 SERIES)	825	TC3451	CITROEN	C4 GRAND PICASSO C4 PICASSO	287 289	TC3427	HYUNDAI	i20	437	TC3441	SEAT	ATECA (KH7 SERIES)	825	TC3454	FIAT	500X	334	TC3428	LEXUS	NX200t NX300H	512 512	SKODA	KODIAQ KAROQ	855 855	TC3455	FIAT	500X	334	TC3429	TOYOTA	RAV4 IV	918	VOLKSWAGEN	ARTEON PASSAT VII PASSAT ALLTRACK TIGUAN TOURAN	949 1022 1026 1043 1051	JEOP	RENEGADE	462	TC3430	CITROEN	C4 GRAND PICASSO C4 PICASSO	287 289	TC3442	PORSCHE	911 (997 SERIES)	750	TC3456	LAND ROVER	RANGE ROVER IV	502	TC3431	MAZDA	3	517	TC3443	PORSCHE	911 (997 SERIES)	750	TC3457	LAND ROVER	RANGE ROVER IV	502	TC3432	MAZDA	3	517	TC3444	RENAULT	MEGANE IV TALISMAN TALISMAN GRANDTOUR	792 797 797	TC3460	MERCEDES	SLC180 (172 SERIES) SLC200 (172 SERIES) SLC250 (172 SERIES) SLC300 (172 SERIES) SLC43 (172 SERIES) SLK200 (172 SERIES) SLK250 (172 SERIES) SLK350 (172 SERIES) SLK55 (172 SERIES)	586 586 586 586 587 591 591 591 592	TC3433	FORD	KA	388	TC3445	RENAULT	MEGANE IV TALISMAN TALISMAN GRANDTOUR	792 797 797	TC3461	MERCEDES	SLC180 (172 SERIES) SLC200 (172 SERIES) SLC250 (172 SERIES) SLC300 (172 SERIES) SLC43 (172 SERIES) SLK200 (172 SERIES) SLK250 (172 SERIES) SLK350 (172 SERIES) SLK55 (172 SERIES)	586 586 586 586 587 591 591 591 592	TC3434	FORD	KA	388	TC3446	MERCEDES	GL350 (166 SERIES) GL400 (166 SERIES) GL450 (166 SERIES) GL500 (166 SERIES) GL63 (166 SERIES) GLE250 (166 SERIES) GLE350 (166 SERIES) GLE400 (166 SERIES) GLE450 (166 SERIES) GLE500 (166 SERIES) GLE63 (166 SERIES) GLE350 COUPE (292 SERIES) GLE400 COUPE (292 SERIES) GLE450 COUPE (292 SERIES) GLE500 COUPE (292 SERIES) GLE63 COUPE (292 SERIES) GLS350 (166 SERIES) GLS400 (166 SERIES) GLS500 (166 SERIES)	567 567 567 567 567 568 568 568 568 568 568 569 569 569 569 569 571 571 571	TC3462	NISSAN	OASHQAI OASHQAI + 2 X-TRAIL	668 668 672	TC3435	BMW	320i (F34 SERIES) 320d (F34 SERIES) 328i (F34 SERIES) 330d (F34 SERIES) 335i (F34 SERIES) 340i (F34 SERIES) 335d (F34 SERIES)	203 203 203 203 203 203 203	TC3447	MERCEDES	GL350 (166 SERIES) GL400 (166 SERIES) GL450 (166 SERIES) GL500 (166 SERIES) GL63 (166 SERIES) GLE250 (166 SERIES) GLE350 (166 SERIES) GLE400 (166 SERIES) GLE450 (166 SERIES) GLE500 (166 SERIES) GLE63 (166 SERIES) GLE350 COUPE (292 SERIES) GLE400 COUPE (292 SERIES) GLE450 COUPE (292 SERIES) GLE500 COUPE (292 SERIES) GLE63 COUPE (292 SERIES) GLS350 (166 SERIES) GLS400 (166 SERIES) GLS500 (166 SERIES)	567 567 567 567 567 568 568 568 568 568 568 569 569 569 569 569 571 571 571	RENAULT	KADJAR KOLEOS	769 777	TC3436	BMW	320i (F34 SERIES) 320d (F34 SERIES) 328i (F34 SERIES) 330d (F34 SERIES) 335i (F34 SERIES) 340i (F34 SERIES) 335d (F34 SERIES)	203 203 203 203 203 203 203	TC3448	MERCEDES	GL350 (166 SERIES) GL400 (166 SERIES) GL450 (166 SERIES) GL500 (166 SERIES) GL63 (166 SERIES) GLE250 (166 SERIES) GLE350 (166 SERIES) GLE400 (166 SERIES) GLE450 (166 SERIES) GLE500 (166 SERIES) GLE63 (166 SERIES) GLE350 COUPE (292 SERIES) GLE400 COUPE (292 SERIES) GLE450 COUPE (292 SERIES) GLE500 COUPE (292 SERIES) GLE63 COUPE (292 SERIES) GLS350 (166 SERIES) GLS400 (166 SERIES) GLS500 (166 SERIES)	567 567 567 567 567 568 568 568 568 568 568 569 569 569 569 569 571 571 571	TC3463	NISSAN	OASHQAI OASHQAI + 2 X-TRAIL	668 668 672	TC3437	BMW	118d (F20, F21 SERIES) 120d (F20, F21 SERIES) 135i (F20, F21 SERIES) 140i (F20, F21 SERIES) 220d (F22, F23 SERIES) 235i (F22, F23 SERIES) 240i (F22, F23 SERIES) 318d (F30, F31 SERIES) 320i (F30, F31 SERIES)	180 180 180 180 183 183 183 201 201	TC3449	MERCEDES	GL350 (166 SERIES) GL400 (166 SERIES) GL450 (166 SERIES) GL500 (166 SERIES) GL63 (166 SERIES) GLE250 (166 SERIES) GLE350 (166 SERIES) GLE400 (166 SERIES) GLE450 (166 SERIES) GLE500 (166 SERIES) GLE63 (166 SERIES) GLE350 COUPE (292 SERIES) GLE400 COUPE (292 SERIES) GLE450 COUPE (292 SERIES) GLE500 COUPE (292 SERIES) GLE63 COUPE (292 SERIES) GLS350 (166 SERIES) GLS400 (166 SERIES) GLS500 (166 SERIES)	567 567 567 567 567 568 568 568 568 568 568 569 569 569 569 569 571 571 571	RENAULT	KADJAR KOLEOS	769 777					TC3450	CITROEN	C4 GRAND PICASSO C4 PICASSO	287 289	TC3464	LAND ROVER	FREELANDER 2	499					TC3451	CITROEN	C4 GRAND PICASSO C4 PICASSO	287 289	TC3468	HONDA	CIVIC	419					TC3454	FIAT	500X	334	TC3469	HONDA	CIVIC	419					TC3455	FIAT	500X	334	TC3472	MERCEDES	C220 (204 SERIES) C230 (204 SERIES) C250 (204 SERIES) C280 (204 SERIES) C300 (204 SERIES) C320 (204 SERIES) C350 (204 SERIES)	534 534 534 534 534 534 534					TC3456	LAND ROVER	RANGE ROVER IV	502	TC3473	MERCEDES	C220 (204 SERIES) C230 (204 SERIES) C250 (204 SERIES) C280 (204 SERIES) C300 (204 SERIES) C320 (204 SERIES) C350 (204 SERIES)	534 534 534 534 534 534 534					TC3457	LAND ROVER	RANGE ROVER IV	502	TC3475	KIA	SPORTAGE	483					TC3460	MERCEDES	SLC180 (172 SERIES) SLC200 (172 SERIES) SLC250 (172 SERIES) SLC300 (172 SERIES) SLC43 (172 SERIES) SLK200 (172 SERIES) SLK250 (172 SERIES) SLK350 (172 SERIES) SLK55 (172 SERIES)	586 586 586 586 587 591 591 591 592	TC3476	NISSAN	X-TRAIL	670					TC3461	MERCEDES	SLC180 (172 SERIES) SLC200 (172 SERIES) SLC250 (172 SERIES) SLC300 (172 SERIES) SLC43 (172 SERIES) SLK200 (172 SERIES) SLK250 (172 SERIES) SLK350 (172 SERIES) SLK55 (172 SERIES)	586 586 586 586 587 591 591 591 592	TC3477	NISSAN	X-TRAIL	670					TC3462	NISSAN	OASHQAI OASHQAI + 2 X-TRAIL	668 668 672	TC3478	MERCEDES	SLC180 (172 SERIES) SLC200 (172 SERIES) SLC250 (172 SERIES) SLC300 (172 SERIES)	586 586 586 586					TC3463	NISSAN	OASHQAI OASHQAI + 2 X-TRAIL	668 668 672																												
TC3426	CITROEN	C5 C6	290 292	TC3440	SEAT	ATECA (KH7 SERIES)	825	TC3451	CITROEN	C4 GRAND PICASSO C4 PICASSO	287 289	TC3427	HYUNDAI	i20	437	TC3441	SEAT	ATECA (KH7 SERIES)	825	TC3454	FIAT	500X	334	TC3428	LEXUS	NX200t NX300H	512 512	SKODA	KODIAQ KAROQ	855 855	TC3455	FIAT	500X	334	TC3429	TOYOTA	RAV4 IV	918	VOLKSWAGEN	ARTEON PASSAT VII PASSAT ALLTRACK TIGUAN TOURAN	949 1022 1026 1043 1051	JEOP	RENEGADE	462	TC3430	CITROEN	C4 GRAND PICASSO C4 PICASSO	287 289	TC3442	PORSCHE	911 (997 SERIES)	750	TC3456	LAND ROVER	RANGE ROVER IV	502	TC3431	MAZDA	3	517	TC3443	PORSCHE	911 (997 SERIES)	750	TC3457	LAND ROVER	RANGE ROVER IV	502	TC3432	MAZDA	3	517	TC3444	RENAULT	MEGANE IV TALISMAN TALISMAN GRANDTOUR	792 797 797	TC3460	MERCEDES	SLC180 (172 SERIES) SLC200 (172 SERIES) SLC250 (172 SERIES) SLC300 (172 SERIES) SLC43 (172 SERIES) SLK200 (172 SERIES) SLK250 (172 SERIES) SLK350 (172 SERIES) SLK55 (172 SERIES)	586 586 586 586 587 591 591 591 592	TC3433	FORD	KA	388	TC3445	RENAULT	MEGANE IV TALISMAN TALISMAN GRANDTOUR	792 797 797	TC3461	MERCEDES	SLC180 (172 SERIES) SLC200 (172 SERIES) SLC250 (172 SERIES) SLC300 (172 SERIES) SLC43 (172 SERIES) SLK200 (172 SERIES) SLK250 (172 SERIES) SLK350 (172 SERIES) SLK55 (172 SERIES)	586 586 586 586 587 591 591 591 592	TC3434	FORD	KA	388	TC3446	MERCEDES	GL350 (166 SERIES) GL400 (166 SERIES) GL450 (166 SERIES) GL500 (166 SERIES) GL63 (166 SERIES) GLE250 (166 SERIES) GLE350 (166 SERIES) GLE400 (166 SERIES) GLE450 (166 SERIES) GLE500 (166 SERIES) GLE63 (166 SERIES) GLE350 COUPE (292 SERIES) GLE400 COUPE (292 SERIES) GLE450 COUPE (292 SERIES) GLE500 COUPE (292 SERIES) GLE63 COUPE (292 SERIES) GLS350 (166 SERIES) GLS400 (166 SERIES) GLS500 (166 SERIES)	567 567 567 567 567 568 568 568 568 568 568 569 569 569 569 569 571 571 571	TC3462	NISSAN	OASHQAI OASHQAI + 2 X-TRAIL	668 668 672	TC3435	BMW	320i (F34 SERIES) 320d (F34 SERIES) 328i (F34 SERIES) 330d (F34 SERIES) 335i (F34 SERIES) 340i (F34 SERIES) 335d (F34 SERIES)	203 203 203 203 203 203 203	TC3447	MERCEDES	GL350 (166 SERIES) GL400 (166 SERIES) GL450 (166 SERIES) GL500 (166 SERIES) GL63 (166 SERIES) GLE250 (166 SERIES) GLE350 (166 SERIES) GLE400 (166 SERIES) GLE450 (166 SERIES) GLE500 (166 SERIES) GLE63 (166 SERIES) GLE350 COUPE (292 SERIES) GLE400 COUPE (292 SERIES) GLE450 COUPE (292 SERIES) GLE500 COUPE (292 SERIES) GLE63 COUPE (292 SERIES) GLS350 (166 SERIES) GLS400 (166 SERIES) GLS500 (166 SERIES)	567 567 567 567 567 568 568 568 568 568 568 569 569 569 569 569 571 571 571	RENAULT	KADJAR KOLEOS	769 777	TC3436	BMW	320i (F34 SERIES) 320d (F34 SERIES) 328i (F34 SERIES) 330d (F34 SERIES) 335i (F34 SERIES) 340i (F34 SERIES) 335d (F34 SERIES)	203 203 203 203 203 203 203	TC3448	MERCEDES	GL350 (166 SERIES) GL400 (166 SERIES) GL450 (166 SERIES) GL500 (166 SERIES) GL63 (166 SERIES) GLE250 (166 SERIES) GLE350 (166 SERIES) GLE400 (166 SERIES) GLE450 (166 SERIES) GLE500 (166 SERIES) GLE63 (166 SERIES) GLE350 COUPE (292 SERIES) GLE400 COUPE (292 SERIES) GLE450 COUPE (292 SERIES) GLE500 COUPE (292 SERIES) GLE63 COUPE (292 SERIES) GLS350 (166 SERIES) GLS400 (166 SERIES) GLS500 (166 SERIES)	567 567 567 567 567 568 568 568 568 568 568 569 569 569 569 569 571 571 571	TC3463	NISSAN	OASHQAI OASHQAI + 2 X-TRAIL	668 668 672	TC3437	BMW	118d (F20, F21 SERIES) 120d (F20, F21 SERIES) 135i (F20, F21 SERIES) 140i (F20, F21 SERIES) 220d (F22, F23 SERIES) 235i (F22, F23 SERIES) 240i (F22, F23 SERIES) 318d (F30, F31 SERIES) 320i (F30, F31 SERIES)	180 180 180 180 183 183 183 201 201	TC3449	MERCEDES	GL350 (166 SERIES) GL400 (166 SERIES) GL450 (166 SERIES) GL500 (166 SERIES) GL63 (166 SERIES) GLE250 (166 SERIES) GLE350 (166 SERIES) GLE400 (166 SERIES) GLE450 (166 SERIES) GLE500 (166 SERIES) GLE63 (166 SERIES) GLE350 COUPE (292 SERIES) GLE400 COUPE (292 SERIES) GLE450 COUPE (292 SERIES) GLE500 COUPE (292 SERIES) GLE63 COUPE (292 SERIES) GLS350 (166 SERIES) GLS400 (166 SERIES) GLS500 (166 SERIES)	567 567 567 567 567 568 568 568 568 568 568 569 569 569 569 569 571 571 571	RENAULT	KADJAR KOLEOS	769 777					TC3450	CITROEN	C4 GRAND PICASSO C4 PICASSO	287 289	TC3464	LAND ROVER	FREELANDER 2	499					TC3451	CITROEN	C4 GRAND PICASSO C4 PICASSO	287 289	TC3468	HONDA	CIVIC	419					TC3454	FIAT	500X	334	TC3469	HONDA	CIVIC	419					TC3455	FIAT	500X	334	TC3472	MERCEDES	C220 (204 SERIES) C230 (204 SERIES) C250 (204 SERIES) C280 (204 SERIES) C300 (204 SERIES) C320 (204 SERIES) C350 (204 SERIES)	534 534 534 534 534 534 534					TC3456	LAND ROVER	RANGE ROVER IV	502	TC3473	MERCEDES	C220 (204 SERIES) C230 (204 SERIES) C250 (204 SERIES) C280 (204 SERIES) C300 (204 SERIES) C320 (204 SERIES) C350 (204 SERIES)	534 534 534 534 534 534 534					TC3457	LAND ROVER	RANGE ROVER IV	502	TC3475	KIA	SPORTAGE	483					TC3460	MERCEDES	SLC180 (172 SERIES) SLC200 (172 SERIES) SLC250 (172 SERIES) SLC300 (172 SERIES) SLC43 (172 SERIES) SLK200 (172 SERIES) SLK250 (172 SERIES) SLK350 (172 SERIES) SLK55 (172 SERIES)	586 586 586 586 587 591 591 591 592	TC3476	NISSAN	X-TRAIL	670					TC3461	MERCEDES	SLC180 (172 SERIES) SLC200 (172 SERIES) SLC250 (172 SERIES) SLC300 (172 SERIES) SLC43 (172 SERIES) SLK200 (172 SERIES) SLK250 (172 SERIES) SLK350 (172 SERIES) SLK55 (172 SERIES)	586 586 586 586 587 591 591 591 592	TC3477	NISSAN	X-TRAIL	670					TC3462	NISSAN	OASHQAI OASHQAI + 2 X-TRAIL	668 668 672	TC3478	MERCEDES	SLC180 (172 SERIES) SLC200 (172 SERIES) SLC250 (172 SERIES) SLC300 (172 SERIES)	586 586 586 586					TC3463	NISSAN	OASHQAI OASHQAI + 2 X-TRAIL	668 668 672																																								
TC3427	HYUNDAI	i20	437	TC3441	SEAT	ATECA (KH7 SERIES)	825	TC3454	FIAT	500X	334	TC3428	LEXUS	NX200t NX300H	512 512	SKODA	KODIAQ KAROQ	855 855	TC3455	FIAT	500X	334	TC3429	TOYOTA	RAV4 IV	918	VOLKSWAGEN	ARTEON PASSAT VII PASSAT ALLTRACK TIGUAN TOURAN	949 1022 1026 1043 1051	JEOP	RENEGADE	462	TC3430	CITROEN	C4 GRAND PICASSO C4 PICASSO	287 289	TC3442	PORSCHE	911 (997 SERIES)	750	TC3456	LAND ROVER	RANGE ROVER IV	502	TC3431	MAZDA	3	517	TC3443	PORSCHE	911 (997 SERIES)	750	TC3457	LAND ROVER	RANGE ROVER IV	502	TC3432	MAZDA	3	517	TC3444	RENAULT	MEGANE IV TALISMAN TALISMAN GRANDTOUR	792 797 797	TC3460	MERCEDES	SLC180 (172 SERIES) SLC200 (172 SERIES) SLC250 (172 SERIES) SLC300 (172 SERIES) SLC43 (172 SERIES) SLK200 (172 SERIES) SLK250 (172 SERIES) SLK350 (172 SERIES) SLK55 (172 SERIES)	586 586 586 586 587 591 591 591 592	TC3433	FORD	KA	388	TC3445	RENAULT	MEGANE IV TALISMAN TALISMAN GRANDTOUR	792 797 797	TC3461	MERCEDES	SLC180 (172 SERIES) SLC200 (172 SERIES) SLC250 (172 SERIES) SLC300 (172 SERIES) SLC43 (172 SERIES) SLK200 (172 SERIES) SLK250 (172 SERIES) SLK350 (172 SERIES) SLK55 (172 SERIES)	586 586 586 586 587 591 591 591 592	TC3434	FORD	KA	388	TC3446	MERCEDES	GL350 (166 SERIES) GL400 (166 SERIES) GL450 (166 SERIES) GL500 (166 SERIES) GL63 (166 SERIES) GLE250 (166 SERIES) GLE350 (166 SERIES) GLE400 (166 SERIES) GLE450 (166 SERIES) GLE500 (166 SERIES) GLE63 (166 SERIES) GLE350 COUPE (292 SERIES) GLE400 COUPE (292 SERIES) GLE450 COUPE (292 SERIES) GLE500 COUPE (292 SERIES) GLE63 COUPE (292 SERIES) GLS350 (166 SERIES) GLS400 (166 SERIES) GLS500 (166 SERIES)	567 567 567 567 567 568 568 568 568 568 568 569 569 569 569 569 571 571 571	TC3462	NISSAN	OASHQAI OASHQAI + 2 X-TRAIL	668 668 672	TC3435	BMW	320i (F34 SERIES) 320d (F34 SERIES) 328i (F34 SERIES) 330d (F34 SERIES) 335i (F34 SERIES) 340i (F34 SERIES) 335d (F34 SERIES)	203 203 203 203 203 203 203	TC3447	MERCEDES	GL350 (166 SERIES) GL400 (166 SERIES) GL450 (166 SERIES) GL500 (166 SERIES) GL63 (166 SERIES) GLE250 (166 SERIES) GLE350 (166 SERIES) GLE400 (166 SERIES) GLE450 (166 SERIES) GLE500 (166 SERIES) GLE63 (166 SERIES) GLE350 COUPE (292 SERIES) GLE400 COUPE (292 SERIES) GLE450 COUPE (292 SERIES) GLE500 COUPE (292 SERIES) GLE63 COUPE (292 SERIES) GLS350 (166 SERIES) GLS400 (166 SERIES) GLS500 (166 SERIES)	567 567 567 567 567 568 568 568 568 568 568 569 569 569 569 569 571 571 571	RENAULT	KADJAR KOLEOS	769 777	TC3436	BMW	320i (F34 SERIES) 320d (F34 SERIES) 328i (F34 SERIES) 330d (F34 SERIES) 335i (F34 SERIES) 340i (F34 SERIES) 335d (F34 SERIES)	203 203 203 203 203 203 203	TC3448	MERCEDES	GL350 (166 SERIES) GL400 (166 SERIES) GL450 (166 SERIES) GL500 (166 SERIES) GL63 (166 SERIES) GLE250 (166 SERIES) GLE350 (166 SERIES) GLE400 (166 SERIES) GLE450 (166 SERIES) GLE500 (166 SERIES) GLE63 (166 SERIES) GLE350 COUPE (292 SERIES) GLE400 COUPE (292 SERIES) GLE450 COUPE (292 SERIES) GLE500 COUPE (292 SERIES) GLE63 COUPE (292 SERIES) GLS350 (166 SERIES) GLS400 (166 SERIES) GLS500 (166 SERIES)	567 567 567 567 567 568 568 568 568 568 568 569 569 569 569 569 571 571 571	TC3463	NISSAN	OASHQAI OASHQAI + 2 X-TRAIL	668 668 672	TC3437	BMW	118d (F20, F21 SERIES) 120d (F20, F21 SERIES) 135i (F20, F21 SERIES) 140i (F20, F21 SERIES) 220d (F22, F23 SERIES) 235i (F22, F23 SERIES) 240i (F22, F23 SERIES) 318d (F30, F31 SERIES) 320i (F30, F31 SERIES)	180 180 180 180 183 183 183 201 201	TC3449	MERCEDES	GL350 (166 SERIES) GL400 (166 SERIES) GL450 (166 SERIES) GL500 (166 SERIES) GL63 (166 SERIES) GLE250 (166 SERIES) GLE350 (166 SERIES) GLE400 (166 SERIES) GLE450 (166 SERIES) GLE500 (166 SERIES) GLE63 (166 SERIES) GLE350 COUPE (292 SERIES) GLE400 COUPE (292 SERIES) GLE450 COUPE (292 SERIES) GLE500 COUPE (292 SERIES) GLE63 COUPE (292 SERIES) GLS350 (166 SERIES) GLS400 (166 SERIES) GLS500 (166 SERIES)	567 567 567 567 567 568 568 568 568 568 568 569 569 569 569 569 571 571 571	RENAULT	KADJAR KOLEOS	769 777					TC3450	CITROEN	C4 GRAND PICASSO C4 PICASSO	287 289	TC3464	LAND ROVER	FREELANDER 2	499					TC3451	CITROEN	C4 GRAND PICASSO C4 PICASSO	287 289	TC3468	HONDA	CIVIC	419					TC3454	FIAT	500X	334	TC3469	HONDA	CIVIC	419					TC3455	FIAT	500X	334	TC3472	MERCEDES	C220 (204 SERIES) C230 (204 SERIES) C250 (204 SERIES) C280 (204 SERIES) C300 (204 SERIES) C320 (204 SERIES) C350 (204 SERIES)	534 534 534 534 534 534 534					TC3456	LAND ROVER	RANGE ROVER IV	502	TC3473	MERCEDES	C220 (204 SERIES) C230 (204 SERIES) C250 (204 SERIES) C280 (204 SERIES) C300 (204 SERIES) C320 (204 SERIES) C350 (204 SERIES)	534 534 534 534 534 534 534					TC3457	LAND ROVER	RANGE ROVER IV	502	TC3475	KIA	SPORTAGE	483					TC3460	MERCEDES	SLC180 (172 SERIES) SLC200 (172 SERIES) SLC250 (172 SERIES) SLC300 (172 SERIES) SLC43 (172 SERIES) SLK200 (172 SERIES) SLK250 (172 SERIES) SLK350 (172 SERIES) SLK55 (172 SERIES)	586 586 586 586 587 591 591 591 592	TC3476	NISSAN	X-TRAIL	670					TC3461	MERCEDES	SLC180 (172 SERIES) SLC200 (172 SERIES) SLC250 (172 SERIES) SLC300 (172 SERIES) SLC43 (172 SERIES) SLK200 (172 SERIES) SLK250 (172 SERIES) SLK350 (172 SERIES) SLK55 (172 SERIES)	586 586 586 586 587 591 591 591 592	TC3477	NISSAN	X-TRAIL	670					TC3462	NISSAN	OASHQAI OASHQAI + 2 X-TRAIL	668 668 672	TC3478	MERCEDES	SLC180 (172 SERIES) SLC200 (172 SERIES) SLC250 (172 SERIES) SLC300 (172 SERIES)	586 586 586 586					TC3463	NISSAN	OASHQAI OASHQAI + 2 X-TRAIL	668 668 672																																																				
TC3428	LEXUS	NX200t NX300H	512 512	SKODA	KODIAQ KAROQ	855 855	TC3455	FIAT	500X	334	TC3429	TOYOTA	RAV4 IV	918	VOLKSWAGEN	ARTEON PASSAT VII PASSAT ALLTRACK TIGUAN TOURAN	949 1022 1026 1043 1051	JEOP	RENEGADE	462	TC3430	CITROEN	C4 GRAND PICASSO C4 PICASSO	287 289	TC3442	PORSCHE	911 (997 SERIES)	750	TC3456	LAND ROVER	RANGE ROVER IV	502	TC3431	MAZDA	3	517	TC3443	PORSCHE	911 (997 SERIES)	750	TC3457	LAND ROVER	RANGE ROVER IV	502	TC3432	MAZDA	3	517	TC3444	RENAULT	MEGANE IV TALISMAN TALISMAN GRANDTOUR	792 797 797	TC3460	MERCEDES	SLC180 (172 SERIES) SLC200 (172 SERIES) SLC250 (172 SERIES) SLC300 (172 SERIES) SLC43 (172 SERIES) SLK200 (172 SERIES) SLK250 (172 SERIES) SLK350 (172 SERIES) SLK55 (172 SERIES)	586 586 586 586 587 591 591 591 592	TC3433	FORD	KA	388	TC3445	RENAULT	MEGANE IV TALISMAN TALISMAN GRANDTOUR	792 797 797	TC3461	MERCEDES	SLC180 (172 SERIES) SLC200 (172 SERIES) SLC250 (172 SERIES) SLC300 (172 SERIES) SLC43 (172 SERIES) SLK200 (172 SERIES) SLK250 (172 SERIES) SLK350 (172 SERIES) SLK55 (172 SERIES)	586 586 586 586 587 591 591 591 592	TC3434	FORD	KA	388	TC3446	MERCEDES	GL350 (166 SERIES) GL400 (166 SERIES) GL450 (166 SERIES) GL500 (166 SERIES) GL63 (166 SERIES) GLE250 (166 SERIES) GLE350 (166 SERIES) GLE400 (166 SERIES) GLE450 (166 SERIES) GLE500 (166 SERIES) GLE63 (166 SERIES) GLE350 COUPE (292 SERIES) GLE400 COUPE (292 SERIES) GLE450 COUPE (292 SERIES) GLE500 COUPE (292 SERIES) GLE63 COUPE (292 SERIES) GLS350 (166 SERIES) GLS400 (166 SERIES) GLS500 (166 SERIES)	567 567 567 567 567 568 568 568 568 568 568 569 569 569 569 569 571 571 571	TC3462	NISSAN	OASHQAI OASHQAI + 2 X-TRAIL	668 668 672	TC3435	BMW	320i (F34 SERIES) 320d (F34 SERIES) 328i (F34 SERIES) 330d (F34 SERIES) 335i (F34 SERIES) 340i (F34 SERIES) 335d (F34 SERIES)	203 203 203 203 203 203 203	TC3447	MERCEDES	GL350 (166 SERIES) GL400 (166 SERIES) GL450 (166 SERIES) GL500 (166 SERIES) GL63 (166 SERIES) GLE250 (166 SERIES) GLE350 (166 SERIES) GLE400 (166 SERIES) GLE450 (166 SERIES) GLE500 (166 SERIES) GLE63 (166 SERIES) GLE350 COUPE (292 SERIES) GLE400 COUPE (292 SERIES) GLE450 COUPE (292 SERIES) GLE500 COUPE (292 SERIES) GLE63 COUPE (292 SERIES) GLS350 (166 SERIES) GLS400 (166 SERIES) GLS500 (166 SERIES)	567 567 567 567 567 568 568 568 568 568 568 569 569 569 569 569 571 571 571	RENAULT	KADJAR KOLEOS	769 777	TC3436	BMW	320i (F34 SERIES) 320d (F34 SERIES) 328i (F34 SERIES) 330d (F34 SERIES) 335i (F34 SERIES) 340i (F34 SERIES) 335d (F34 SERIES)	203 203 203 203 203 203 203	TC3448	MERCEDES	GL350 (166 SERIES) GL400 (166 SERIES) GL450 (166 SERIES) GL500 (166 SERIES) GL63 (166 SERIES) GLE250 (166 SERIES) GLE350 (166 SERIES) GLE400 (166 SERIES) GLE450 (166 SERIES) GLE500 (166 SERIES) GLE63 (166 SERIES) GLE350 COUPE (292 SERIES) GLE400 COUPE (292 SERIES) GLE450 COUPE (292 SERIES) GLE500 COUPE (292 SERIES) GLE63 COUPE (292 SERIES) GLS350 (166 SERIES) GLS400 (166 SERIES) GLS500 (166 SERIES)	567 567 567 567 567 568 568 568 568 568 568 569 569 569 569 569 571 571 571	TC3463	NISSAN	OASHQAI OASHQAI + 2 X-TRAIL	668 668 672	TC3437	BMW	118d (F20, F21 SERIES) 120d (F20, F21 SERIES) 135i (F20, F21 SERIES) 140i (F20, F21 SERIES) 220d (F22, F23 SERIES) 235i (F22, F23 SERIES) 240i (F22, F23 SERIES) 318d (F30, F31 SERIES) 320i (F30, F31 SERIES)	180 180 180 180 183 183 183 201 201	TC3449	MERCEDES	GL350 (166 SERIES) GL400 (166 SERIES) GL450 (166 SERIES) GL500 (166 SERIES) GL63 (166 SERIES) GLE250 (166 SERIES) GLE350 (166 SERIES) GLE400 (166 SERIES) GLE450 (166 SERIES) GLE500 (166 SERIES) GLE63 (166 SERIES) GLE350 COUPE (292 SERIES) GLE400 COUPE (292 SERIES) GLE450 COUPE (292 SERIES) GLE500 COUPE (292 SERIES) GLE63 COUPE (292 SERIES) GLS350 (166 SERIES) GLS400 (166 SERIES) GLS500 (166 SERIES)	567 567 567 567 567 568 568 568 568 568 568 569 569 569 569 569 571 571 571	RENAULT	KADJAR KOLEOS	769 777					TC3450	CITROEN	C4 GRAND PICASSO C4 PICASSO	287 289	TC3464	LAND ROVER	FREELANDER 2	499					TC3451	CITROEN	C4 GRAND PICASSO C4 PICASSO	287 289	TC3468	HONDA	CIVIC	419					TC3454	FIAT	500X	334	TC3469	HONDA	CIVIC	419					TC3455	FIAT	500X	334	TC3472	MERCEDES	C220 (204 SERIES) C230 (204 SERIES) C250 (204 SERIES) C280 (204 SERIES) C300 (204 SERIES) C320 (204 SERIES) C350 (204 SERIES)	534 534 534 534 534 534 534					TC3456	LAND ROVER	RANGE ROVER IV	502	TC3473	MERCEDES	C220 (204 SERIES) C230 (204 SERIES) C250 (204 SERIES) C280 (204 SERIES) C300 (204 SERIES) C320 (204 SERIES) C350 (204 SERIES)	534 534 534 534 534 534 534					TC3457	LAND ROVER	RANGE ROVER IV	502	TC3475	KIA	SPORTAGE	483					TC3460	MERCEDES	SLC180 (172 SERIES) SLC200 (172 SERIES) SLC250 (172 SERIES) SLC300 (172 SERIES) SLC43 (172 SERIES) SLK200 (172 SERIES) SLK250 (172 SERIES) SLK350 (172 SERIES) SLK55 (172 SERIES)	586 586 586 586 587 591 591 591 592	TC3476	NISSAN	X-TRAIL	670					TC3461	MERCEDES	SLC180 (172 SERIES) SLC200 (172 SERIES) SLC250 (172 SERIES) SLC300 (172 SERIES) SLC43 (172 SERIES) SLK200 (172 SERIES) SLK250 (172 SERIES) SLK350 (172 SERIES) SLK55 (172 SERIES)	586 586 586 586 587 591 591 591 592	TC3477	NISSAN	X-TRAIL	670					TC3462	NISSAN	OASHQAI OASHQAI + 2 X-TRAIL	668 668 672	TC3478	MERCEDES	SLC180 (172 SERIES) SLC200 (172 SERIES) SLC250 (172 SERIES) SLC300 (172 SERIES)	586 586 586 586					TC3463	NISSAN	OASHQAI OASHQAI + 2 X-TRAIL	668 668 672																																																																
TC3429	TOYOTA	RAV4 IV	918	VOLKSWAGEN	ARTEON PASSAT VII PASSAT ALLTRACK TIGUAN TOURAN	949 1022 1026 1043 1051	JEOP	RENEGADE	462	TC3430	CITROEN	C4 GRAND PICASSO C4 PICASSO	287 289	TC3442	PORSCHE	911 (997 SERIES)	750	TC3456	LAND ROVER	RANGE ROVER IV	502	TC3431	MAZDA	3	517	TC3443	PORSCHE	911 (997 SERIES)	750	TC3457	LAND ROVER	RANGE ROVER IV	502	TC3432	MAZDA	3	517	TC3444	RENAULT	MEGANE IV TALISMAN TALISMAN GRANDTOUR	792 797 797	TC3460	MERCEDES	SLC180 (172 SERIES) SLC200 (172 SERIES) SLC250 (172 SERIES) SLC300 (172 SERIES) SLC43 (172 SERIES) SLK200 (172 SERIES) SLK250 (172 SERIES) SLK350 (172 SERIES) SLK55 (172 SERIES)	586 586 586 586 587 591 591 591 592	TC3433	FORD	KA	388	TC3445	RENAULT	MEGANE IV TALISMAN TALISMAN GRANDTOUR	792 797 797	TC3461	MERCEDES	SLC180 (172 SERIES) SLC200 (172 SERIES) SLC250 (172 SERIES) SLC300 (172 SERIES) SLC43 (172 SERIES) SLK200 (172 SERIES) SLK250 (172 SERIES) SLK350 (172 SERIES) SLK55 (172 SERIES)	586 586 586 586 587 591 591 591 592	TC3434	FORD	KA	388	TC3446	MERCEDES	GL350 (166 SERIES) GL400 (166 SERIES) GL450 (166 SERIES) GL500 (166 SERIES) GL63 (166 SERIES) GLE250 (166 SERIES) GLE350 (166 SERIES) GLE400 (166 SERIES) GLE450 (166 SERIES) GLE500 (166 SERIES) GLE63 (166 SERIES) GLE350 COUPE (292 SERIES) GLE400 COUPE (292 SERIES) GLE450 COUPE (292 SERIES) GLE500 COUPE (292 SERIES) GLE63 COUPE (292 SERIES) GLS350 (166 SERIES) GLS400 (166 SERIES) GLS500 (166 SERIES)	567 567 567 567 567 568 568 568 568 568 568 569 569 569 569 569 571 571 571	TC3462	NISSAN	OASHQAI OASHQAI + 2 X-TRAIL	668 668 672	TC3435	BMW	320i (F34 SERIES) 320d (F34 SERIES) 328i (F34 SERIES) 330d (F34 SERIES) 335i (F34 SERIES) 340i (F34 SERIES) 335d (F34 SERIES)	203 203 203 203 203 203 203	TC3447	MERCEDES	GL350 (166 SERIES) GL400 (166 SERIES) GL450 (166 SERIES) GL500 (166 SERIES) GL63 (166 SERIES) GLE250 (166 SERIES) GLE350 (166 SERIES) GLE400 (166 SERIES) GLE450 (166 SERIES) GLE500 (166 SERIES) GLE63 (166 SERIES) GLE350 COUPE (292 SERIES) GLE400 COUPE (292 SERIES) GLE450 COUPE (292 SERIES) GLE500 COUPE (292 SERIES) GLE63 COUPE (292 SERIES) GLS350 (166 SERIES) GLS400 (166 SERIES) GLS500 (166 SERIES)	567 567 567 567 567 568 568 568 568 568 568 569 569 569 569 569 571 571 571	RENAULT	KADJAR KOLEOS	769 777	TC3436	BMW	320i (F34 SERIES) 320d (F34 SERIES) 328i (F34 SERIES) 330d (F34 SERIES) 335i (F34 SERIES) 340i (F34 SERIES) 335d (F34 SERIES)	203 203 203 203 203 203 203	TC3448	MERCEDES	GL350 (166 SERIES) GL400 (166 SERIES) GL450 (166 SERIES) GL500 (166 SERIES) GL63 (166 SERIES) GLE250 (166 SERIES) GLE350 (166 SERIES) GLE400 (166 SERIES) GLE450 (166 SERIES) GLE500 (166 SERIES) GLE63 (166 SERIES) GLE350 COUPE (292 SERIES) GLE400 COUPE (292 SERIES) GLE450 COUPE (292 SERIES) GLE500 COUPE (292 SERIES) GLE63 COUPE (292 SERIES) GLS350 (166 SERIES) GLS400 (166 SERIES) GLS500 (166 SERIES)	567 567 567 567 567 568 568 568 568 568 568 569 569 569 569 569 571 571 571	TC3463	NISSAN	OASHQAI OASHQAI + 2 X-TRAIL	668 668 672	TC3437	BMW	118d (F20, F21 SERIES) 120d (F20, F21 SERIES) 135i (F20, F21 SERIES) 140i (F20, F21 SERIES) 220d (F22, F23 SERIES) 235i (F22, F23 SERIES) 240i (F22, F23 SERIES) 318d (F30, F31 SERIES) 320i (F30, F31 SERIES)	180 180 180 180 183 183 183 201 201	TC3449	MERCEDES	GL350 (166 SERIES) GL400 (166 SERIES) GL450 (166 SERIES) GL500 (166 SERIES) GL63 (166 SERIES) GLE250 (166 SERIES) GLE350 (166 SERIES) GLE400 (166 SERIES) GLE450 (166 SERIES) GLE500 (166 SERIES) GLE63 (166 SERIES) GLE350 COUPE (292 SERIES) GLE400 COUPE (292 SERIES) GLE450 COUPE (292 SERIES) GLE500 COUPE (292 SERIES) GLE63 COUPE (292 SERIES) GLS350 (166 SERIES) GLS400 (166 SERIES) GLS500 (166 SERIES)	567 567 567 567 567 568 568 568 568 568 568 569 569 569 569 569 571 571 571	RENAULT	KADJAR KOLEOS	769 777					TC3450	CITROEN	C4 GRAND PICASSO C4 PICASSO	287 289	TC3464	LAND ROVER	FREELANDER 2	499					TC3451	CITROEN	C4 GRAND PICASSO C4 PICASSO	287 289	TC3468	HONDA	CIVIC	419					TC3454	FIAT	500X	334	TC3469	HONDA	CIVIC	419					TC3455	FIAT	500X	334	TC3472	MERCEDES	C220 (204 SERIES) C230 (204 SERIES) C250 (204 SERIES) C280 (204 SERIES) C300 (204 SERIES) C320 (204 SERIES) C350 (204 SERIES)	534 534 534 534 534 534 534					TC3456	LAND ROVER	RANGE ROVER IV	502	TC3473	MERCEDES	C220 (204 SERIES) C230 (204 SERIES) C250 (204 SERIES) C280 (204 SERIES) C300 (204 SERIES) C320 (204 SERIES) C350 (204 SERIES)	534 534 534 534 534 534 534					TC3457	LAND ROVER	RANGE ROVER IV	502	TC3475	KIA	SPORTAGE	483					TC3460	MERCEDES	SLC180 (172 SERIES) SLC200 (172 SERIES) SLC250 (172 SERIES) SLC300 (172 SERIES) SLC43 (172 SERIES) SLK200 (172 SERIES) SLK250 (172 SERIES) SLK350 (172 SERIES) SLK55 (172 SERIES)	586 586 586 586 587 591 591 591 592	TC3476	NISSAN	X-TRAIL	670					TC3461	MERCEDES	SLC180 (172 SERIES) SLC200 (172 SERIES) SLC250 (172 SERIES) SLC300 (172 SERIES) SLC43 (172 SERIES) SLK200 (172 SERIES) SLK250 (172 SERIES) SLK350 (172 SERIES) SLK55 (172 SERIES)	586 586 586 586 587 591 591 591 592	TC3477	NISSAN	X-TRAIL	670					TC3462	NISSAN	OASHQAI OASHQAI + 2 X-TRAIL	668 668 672	TC3478	MERCEDES	SLC180 (172 SERIES) SLC200 (172 SERIES) SLC250 (172 SERIES) SLC300 (172 SERIES)	586 586 586 586					TC3463	NISSAN	OASHQAI OASHQAI + 2 X-TRAIL	668 668 672																																																																											
TC3430	CITROEN	C4 GRAND PICASSO C4 PICASSO	287 289	TC3442	PORSCHE	911 (997 SERIES)	750	TC3456	LAND ROVER	RANGE ROVER IV	502	TC3431	MAZDA	3	517	TC3443	PORSCHE	911 (997 SERIES)	750	TC3457	LAND ROVER	RANGE ROVER IV	502	TC3432	MAZDA	3	517	TC3444	RENAULT	MEGANE IV TALISMAN TALISMAN GRANDTOUR	792 797 797	TC3460	MERCEDES	SLC180 (172 SERIES) SLC200 (172 SERIES) SLC250 (172 SERIES) SLC300 (172 SERIES) SLC43 (172 SERIES) SLK200 (172 SERIES) SLK250 (172 SERIES) SLK350 (172 SERIES) SLK55 (172 SERIES)	586 586 586 586 587 591 591 591 592	TC3433	FORD	KA	388	TC3445	RENAULT	MEGANE IV TALISMAN TALISMAN GRANDTOUR	792 797 797	TC3461	MERCEDES	SLC180 (172 SERIES) SLC200 (172 SERIES) SLC250 (172 SERIES) SLC300 (172 SERIES) SLC43 (172 SERIES) SLK200 (172 SERIES) SLK250 (172 SERIES) SLK350 (172 SERIES) SLK55 (172 SERIES)	586 586 586 586 587 591 591 591 592	TC3434	FORD	KA	388	TC3446	MERCEDES	GL350 (166 SERIES) GL400 (166 SERIES) GL450 (166 SERIES) GL500 (166 SERIES) GL63 (166 SERIES) GLE250 (166 SERIES) GLE350 (166 SERIES) GLE400 (166 SERIES) GLE450 (166 SERIES) GLE500 (166 SERIES) GLE63 (166 SERIES) GLE350 COUPE (292 SERIES) GLE400 COUPE (292 SERIES) GLE450 COUPE (292 SERIES) GLE500 COUPE (292 SERIES) GLE63 COUPE (292 SERIES) GLS350 (166 SERIES) GLS400 (166 SERIES) GLS500 (166 SERIES)	567 567 567 567 567 568 568 568 568 568 568 569 569 569 569 569 571 571 571	TC3462	NISSAN	OASHQAI OASHQAI + 2 X-TRAIL	668 668 672	TC3435	BMW	320i (F34 SERIES) 320d (F34 SERIES) 328i (F34 SERIES) 330d (F34 SERIES) 335i (F34 SERIES) 340i (F34 SERIES) 335d (F34 SERIES)	203 203 203 203 203 203 203	TC3447	MERCEDES	GL350 (166 SERIES) GL400 (166 SERIES) GL450 (166 SERIES) GL500 (166 SERIES) GL63 (166 SERIES) GLE250 (166 SERIES) GLE350 (166 SERIES) GLE400 (166 SERIES) GLE450 (166 SERIES) GLE500 (166 SERIES) GLE63 (166 SERIES) GLE350 COUPE (292 SERIES) GLE400 COUPE (292 SERIES) GLE450 COUPE (292 SERIES) GLE500 COUPE (292 SERIES) GLE63 COUPE (292 SERIES) GLS350 (166 SERIES) GLS400 (166 SERIES) GLS500 (166 SERIES)	567 567 567 567 567 568 568 568 568 568 568 569 569 569 569 569 571 571 571	RENAULT	KADJAR KOLEOS	769 777	TC3436	BMW	320i (F34 SERIES) 320d (F34 SERIES) 328i (F34 SERIES) 330d (F34 SERIES) 335i (F34 SERIES) 340i (F34 SERIES) 335d (F34 SERIES)	203 203 203 203 203 203 203	TC3448	MERCEDES	GL350 (166 SERIES) GL400 (166 SERIES) GL450 (166 SERIES) GL500 (166 SERIES) GL63 (166 SERIES) GLE250 (166 SERIES) GLE350 (166 SERIES) GLE400 (166 SERIES) GLE450 (166 SERIES) GLE500 (166 SERIES) GLE63 (166 SERIES) GLE350 COUPE (292 SERIES) GLE400 COUPE (292 SERIES) GLE450 COUPE (292 SERIES) GLE500 COUPE (292 SERIES) GLE63 COUPE (292 SERIES) GLS350 (166 SERIES) GLS400 (166 SERIES) GLS500 (166 SERIES)	567 567 567 567 567 568 568 568 568 568 568 569 569 569 569 569 571 571 571	TC3463	NISSAN	OASHQAI OASHQAI + 2 X-TRAIL	668 668 672	TC3437	BMW	118d (F20, F21 SERIES) 120d (F20, F21 SERIES) 135i (F20, F21 SERIES) 140i (F20, F21 SERIES) 220d (F22, F23 SERIES) 235i (F22, F23 SERIES) 240i (F22, F23 SERIES) 318d (F30, F31 SERIES) 320i (F30, F31 SERIES)	180 180 180 180 183 183 183 201 201	TC3449	MERCEDES	GL350 (166 SERIES) GL400 (166 SERIES) GL450 (166 SERIES) GL500 (166 SERIES) GL63 (166 SERIES) GLE250 (166 SERIES) GLE350 (166 SERIES) GLE400 (166 SERIES) GLE450 (166 SERIES) GLE500 (166 SERIES) GLE63 (166 SERIES) GLE350 COUPE (292 SERIES) GLE400 COUPE (292 SERIES) GLE450 COUPE (292 SERIES) GLE500 COUPE (292 SERIES) GLE63 COUPE (292 SERIES) GLS350 (166 SERIES) GLS400 (166 SERIES) GLS500 (166 SERIES)	567 567 567 567 567 568 568 568 568 568 568 569 569 569 569 569 571 571 571	RENAULT	KADJAR KOLEOS	769 777					TC3450	CITROEN	C4 GRAND PICASSO C4 PICASSO	287 289	TC3464	LAND ROVER	FREELANDER 2	499					TC3451	CITROEN	C4 GRAND PICASSO C4 PICASSO	287 289	TC3468	HONDA	CIVIC	419					TC3454	FIAT	500X	334	TC3469	HONDA	CIVIC	419					TC3455	FIAT	500X	334	TC3472	MERCEDES	C220 (204 SERIES) C230 (204 SERIES) C250 (204 SERIES) C280 (204 SERIES) C300 (204 SERIES) C320 (204 SERIES) C350 (204 SERIES)	534 534 534 534 534 534 534					TC3456	LAND ROVER	RANGE ROVER IV	502	TC3473	MERCEDES	C220 (204 SERIES) C230 (204 SERIES) C250 (204 SERIES) C280 (204 SERIES) C300 (204 SERIES) C320 (204 SERIES) C350 (204 SERIES)	534 534 534 534 534 534 534					TC3457	LAND ROVER	RANGE ROVER IV	502	TC3475	KIA	SPORTAGE	483					TC3460	MERCEDES	SLC180 (172 SERIES) SLC200 (172 SERIES) SLC250 (172 SERIES) SLC300 (172 SERIES) SLC43 (172 SERIES) SLK200 (172 SERIES) SLK250 (172 SERIES) SLK350 (172 SERIES) SLK55 (172 SERIES)	586 586 586 586 587 591 591 591 592	TC3476	NISSAN	X-TRAIL	670					TC3461	MERCEDES	SLC180 (172 SERIES) SLC200 (172 SERIES) SLC250 (172 SERIES) SLC300 (172 SERIES) SLC43 (172 SERIES) SLK200 (172 SERIES) SLK250 (172 SERIES) SLK350 (172 SERIES) SLK55 (172 SERIES)	586 586 586 586 587 591 591 591 592	TC3477	NISSAN	X-TRAIL	670					TC3462	NISSAN	OASHQAI OASHQAI + 2 X-TRAIL	668 668 672	TC3478	MERCEDES	SLC180 (172 SERIES) SLC200 (172 SERIES) SLC250 (172 SERIES) SLC300 (172 SERIES)	586 586 586 586					TC3463	NISSAN	OASHQAI OASHQAI + 2 X-TRAIL	668 668 672																																																																																					
TC3431	MAZDA	3	517	TC3443	PORSCHE	911 (997 SERIES)	750	TC3457	LAND ROVER	RANGE ROVER IV	502	TC3432	MAZDA	3	517	TC3444	RENAULT	MEGANE IV TALISMAN TALISMAN GRANDTOUR	792 797 797	TC3460	MERCEDES	SLC180 (172 SERIES) SLC200 (172 SERIES) SLC250 (172 SERIES) SLC300 (172 SERIES) SLC43 (172 SERIES) SLK200 (172 SERIES) SLK250 (172 SERIES) SLK350 (172 SERIES) SLK55 (172 SERIES)	586 586 586 586 587 591 591 591 592	TC3433	FORD	KA	388	TC3445	RENAULT	MEGANE IV TALISMAN TALISMAN GRANDTOUR	792 797 797	TC3461	MERCEDES	SLC180 (172 SERIES) SLC200 (172 SERIES) SLC250 (172 SERIES) SLC300 (172 SERIES) SLC43 (172 SERIES) SLK200 (172 SERIES) SLK250 (172 SERIES) SLK350 (172 SERIES) SLK55 (172 SERIES)	586 586 586 586 587 591 591 591 592	TC3434	FORD	KA	388	TC3446	MERCEDES	GL350 (166 SERIES) GL400 (166 SERIES) GL450 (166 SERIES) GL500 (166 SERIES) GL63 (166 SERIES) GLE250 (166 SERIES) GLE350 (166 SERIES) GLE400 (166 SERIES) GLE450 (166 SERIES) GLE500 (166 SERIES) GLE63 (166 SERIES) GLE350 COUPE (292 SERIES) GLE400 COUPE (292 SERIES) GLE450 COUPE (292 SERIES) GLE500 COUPE (292 SERIES) GLE63 COUPE (292 SERIES) GLS350 (166 SERIES) GLS400 (166 SERIES) GLS500 (166 SERIES)	567 567 567 567 567 568 568 568 568 568 568 569 569 569 569 569 571 571 571	TC3462	NISSAN	OASHQAI OASHQAI + 2 X-TRAIL	668 668 672	TC3435	BMW	320i (F34 SERIES) 320d (F34 SERIES) 328i (F34 SERIES) 330d (F34 SERIES) 335i (F34 SERIES) 340i (F34 SERIES) 335d (F34 SERIES)	203 203 203 203 203 203 203	TC3447	MERCEDES	GL350 (166 SERIES) GL400 (166 SERIES) GL450 (166 SERIES) GL500 (166 SERIES) GL63 (166 SERIES) GLE250 (166 SERIES) GLE350 (166 SERIES) GLE400 (166 SERIES) GLE450 (166 SERIES) GLE500 (166 SERIES) GLE63 (166 SERIES) GLE350 COUPE (292 SERIES) GLE400 COUPE (292 SERIES) GLE450 COUPE (292 SERIES) GLE500 COUPE (292 SERIES) GLE63 COUPE (292 SERIES) GLS350 (166 SERIES) GLS400 (166 SERIES) GLS500 (166 SERIES)	567 567 567 567 567 568 568 568 568 568 568 569 569 569 569 569 571 571 571	RENAULT	KADJAR KOLEOS	769 777	TC3436	BMW	320i (F34 SERIES) 320d (F34 SERIES) 328i (F34 SERIES) 330d (F34 SERIES) 335i (F34 SERIES) 340i (F34 SERIES) 335d (F34 SERIES)	203 203 203 203 203 203 203	TC3448	MERCEDES	GL350 (166 SERIES) GL400 (166 SERIES) GL450 (166 SERIES) GL500 (166 SERIES) GL63 (166 SERIES) GLE250 (166 SERIES) GLE350 (166 SERIES) GLE400 (166 SERIES) GLE450 (166 SERIES) GLE500 (166 SERIES) GLE63 (166 SERIES) GLE350 COUPE (292 SERIES) GLE400 COUPE (292 SERIES) GLE450 COUPE (292 SERIES) GLE500 COUPE (292 SERIES) GLE63 COUPE (292 SERIES) GLS350 (166 SERIES) GLS400 (166 SERIES) GLS500 (166 SERIES)	567 567 567 567 567 568 568 568 568 568 568 569 569 569 569 569 571 571 571	TC3463	NISSAN	OASHQAI OASHQAI + 2 X-TRAIL	668 668 672	TC3437	BMW	118d (F20, F21 SERIES) 120d (F20, F21 SERIES) 135i (F20, F21 SERIES) 140i (F20, F21 SERIES) 220d (F22, F23 SERIES) 235i (F22, F23 SERIES) 240i (F22, F23 SERIES) 318d (F30, F31 SERIES) 320i (F30, F31 SERIES)	180 180 180 180 183 183 183 201 201	TC3449	MERCEDES	GL350 (166 SERIES) GL400 (166 SERIES) GL450 (166 SERIES) GL500 (166 SERIES) GL63 (166 SERIES) GLE250 (166 SERIES) GLE350 (166 SERIES) GLE400 (166 SERIES) GLE450 (166 SERIES) GLE500 (166 SERIES) GLE63 (166 SERIES) GLE350 COUPE (292 SERIES) GLE400 COUPE (292 SERIES) GLE450 COUPE (292 SERIES) GLE500 COUPE (292 SERIES) GLE63 COUPE (292 SERIES) GLS350 (166 SERIES) GLS400 (166 SERIES) GLS500 (166 SERIES)	567 567 567 567 567 568 568 568 568 568 568 569 569 569 569 569 571 571 571	RENAULT	KADJAR KOLEOS	769 777					TC3450	CITROEN	C4 GRAND PICASSO C4 PICASSO	287 289	TC3464	LAND ROVER	FREELANDER 2	499					TC3451	CITROEN	C4 GRAND PICASSO C4 PICASSO	287 289	TC3468	HONDA	CIVIC	419					TC3454	FIAT	500X	334	TC3469	HONDA	CIVIC	419					TC3455	FIAT	500X	334	TC3472	MERCEDES	C220 (204 SERIES) C230 (204 SERIES) C250 (204 SERIES) C280 (204 SERIES) C300 (204 SERIES) C320 (204 SERIES) C350 (204 SERIES)	534 534 534 534 534 534 534					TC3456	LAND ROVER	RANGE ROVER IV	502	TC3473	MERCEDES	C220 (204 SERIES) C230 (204 SERIES) C250 (204 SERIES) C280 (204 SERIES) C300 (204 SERIES) C320 (204 SERIES) C350 (204 SERIES)	534 534 534 534 534 534 534					TC3457	LAND ROVER	RANGE ROVER IV	502	TC3475	KIA	SPORTAGE	483					TC3460	MERCEDES	SLC180 (172 SERIES) SLC200 (172 SERIES) SLC250 (172 SERIES) SLC300 (172 SERIES) SLC43 (172 SERIES) SLK200 (172 SERIES) SLK250 (172 SERIES) SLK350 (172 SERIES) SLK55 (172 SERIES)	586 586 586 586 587 591 591 591 592	TC3476	NISSAN	X-TRAIL	670					TC3461	MERCEDES	SLC180 (172 SERIES) SLC200 (172 SERIES) SLC250 (172 SERIES) SLC300 (172 SERIES) SLC43 (172 SERIES) SLK200 (172 SERIES) SLK250 (172 SERIES) SLK350 (172 SERIES) SLK55 (172 SERIES)	586 586 586 586 587 591 591 591 592	TC3477	NISSAN	X-TRAIL	670					TC3462	NISSAN	OASHQAI OASHQAI + 2 X-TRAIL	668 668 672	TC3478	MERCEDES	SLC180 (172 SERIES) SLC200 (172 SERIES) SLC250 (172 SERIES) SLC300 (172 SERIES)	586 586 586 586					TC3463	NISSAN	OASHQAI OASHQAI + 2 X-TRAIL	668 668 672																																																																																																	
TC3432	MAZDA	3	517	TC3444	RENAULT	MEGANE IV TALISMAN TALISMAN GRANDTOUR	792 797 797	TC3460	MERCEDES	SLC180 (172 SERIES) SLC200 (172 SERIES) SLC250 (172 SERIES) SLC300 (172 SERIES) SLC43 (172 SERIES) SLK200 (172 SERIES) SLK250 (172 SERIES) SLK350 (172 SERIES) SLK55 (172 SERIES)	586 586 586 586 587 591 591 591 592	TC3433	FORD	KA	388	TC3445	RENAULT	MEGANE IV TALISMAN TALISMAN GRANDTOUR	792 797 797	TC3461	MERCEDES	SLC180 (172 SERIES) SLC200 (172 SERIES) SLC250 (172 SERIES) SLC300 (172 SERIES) SLC43 (172 SERIES) SLK200 (172 SERIES) SLK250 (172 SERIES) SLK350 (172 SERIES) SLK55 (172 SERIES)	586 586 586 586 587 591 591 591 592	TC3434	FORD	KA	388	TC3446	MERCEDES	GL350 (166 SERIES) GL400 (166 SERIES) GL450 (166 SERIES) GL500 (166 SERIES) GL63 (166 SERIES) GLE250 (166 SERIES) GLE350 (166 SERIES) GLE400 (166 SERIES) GLE450 (166 SERIES) GLE500 (166 SERIES) GLE63 (166 SERIES) GLE350 COUPE (292 SERIES) GLE400 COUPE (292 SERIES) GLE450 COUPE (292 SERIES) GLE500 COUPE (292 SERIES) GLE63 COUPE (292 SERIES) GLS350 (166 SERIES) GLS400 (166 SERIES) GLS500 (166 SERIES)	567 567 567 567 567 568 568 568 568 568 568 569 569 569 569 569 571 571 571	TC3462	NISSAN	OASHQAI OASHQAI + 2 X-TRAIL	668 668 672	TC3435	BMW	320i (F34 SERIES) 320d (F34 SERIES) 328i (F34 SERIES) 330d (F34 SERIES) 335i (F34 SERIES) 340i (F34 SERIES) 335d (F34 SERIES)	203 203 203 203 203 203 203	TC3447	MERCEDES	GL350 (166 SERIES) GL400 (166 SERIES) GL450 (166 SERIES) GL500 (166 SERIES) GL63 (166 SERIES) GLE250 (166 SERIES) GLE350 (166 SERIES) GLE400 (166 SERIES) GLE450 (166 SERIES) GLE500 (166 SERIES) GLE63 (166 SERIES) GLE350 COUPE (292 SERIES) GLE400 COUPE (292 SERIES) GLE450 COUPE (292 SERIES) GLE500 COUPE (292 SERIES) GLE63 COUPE (292 SERIES) GLS350 (166 SERIES) GLS400 (166 SERIES) GLS500 (166 SERIES)	567 567 567 567 567 568 568 568 568 568 568 569 569 569 569 569 571 571 571	RENAULT	KADJAR KOLEOS	769 777	TC3436	BMW	320i (F34 SERIES) 320d (F34 SERIES) 328i (F34 SERIES) 330d (F34 SERIES) 335i (F34 SERIES) 340i (F34 SERIES) 335d (F34 SERIES)	203 203 203 203 203 203 203	TC3448	MERCEDES	GL350 (166 SERIES) GL400 (166 SERIES) GL450 (166 SERIES) GL500 (166 SERIES) GL63 (166 SERIES) GLE250 (166 SERIES) GLE350 (166 SERIES) GLE400 (166 SERIES) GLE450 (166 SERIES) GLE500 (166 SERIES) GLE63 (166 SERIES) GLE350 COUPE (292 SERIES) GLE400 COUPE (292 SERIES) GLE450 COUPE (292 SERIES) GLE500 COUPE (292 SERIES) GLE63 COUPE (292 SERIES) GLS350 (166 SERIES) GLS400 (166 SERIES) GLS500 (166 SERIES)	567 567 567 567 567 568 568 568 568 568 568 569 569 569 569 569 571 571 571	TC3463	NISSAN	OASHQAI OASHQAI + 2 X-TRAIL	668 668 672	TC3437	BMW	118d (F20, F21 SERIES) 120d (F20, F21 SERIES) 135i (F20, F21 SERIES) 140i (F20, F21 SERIES) 220d (F22, F23 SERIES) 235i (F22, F23 SERIES) 240i (F22, F23 SERIES) 318d (F30, F31 SERIES) 320i (F30, F31 SERIES)	180 180 180 180 183 183 183 201 201	TC3449	MERCEDES	GL350 (166 SERIES) GL400 (166 SERIES) GL450 (166 SERIES) GL500 (166 SERIES) GL63 (166 SERIES) GLE250 (166 SERIES) GLE350 (166 SERIES) GLE400 (166 SERIES) GLE450 (166 SERIES) GLE500 (166 SERIES) GLE63 (166 SERIES) GLE350 COUPE (292 SERIES) GLE400 COUPE (292 SERIES) GLE450 COUPE (292 SERIES) GLE500 COUPE (292 SERIES) GLE63 COUPE (292 SERIES) GLS350 (166 SERIES) GLS400 (166 SERIES) GLS500 (166 SERIES)	567 567 567 567 567 568 568 568 568 568 568 569 569 569 569 569 571 571 571	RENAULT	KADJAR KOLEOS	769 777					TC3450	CITROEN	C4 GRAND PICASSO C4 PICASSO	287 289	TC3464	LAND ROVER	FREELANDER 2	499					TC3451	CITROEN	C4 GRAND PICASSO C4 PICASSO	287 289	TC3468	HONDA	CIVIC	419					TC3454	FIAT	500X	334	TC3469	HONDA	CIVIC	419					TC3455	FIAT	500X	334	TC3472	MERCEDES	C220 (204 SERIES) C230 (204 SERIES) C250 (204 SERIES) C280 (204 SERIES) C300 (204 SERIES) C320 (204 SERIES) C350 (204 SERIES)	534 534 534 534 534 534 534					TC3456	LAND ROVER	RANGE ROVER IV	502	TC3473	MERCEDES	C220 (204 SERIES) C230 (204 SERIES) C250 (204 SERIES) C280 (204 SERIES) C300 (204 SERIES) C320 (204 SERIES) C350 (204 SERIES)	534 534 534 534 534 534 534					TC3457	LAND ROVER	RANGE ROVER IV	502	TC3475	KIA	SPORTAGE	483					TC3460	MERCEDES	SLC180 (172 SERIES) SLC200 (172 SERIES) SLC250 (172 SERIES) SLC300 (172 SERIES) SLC43 (172 SERIES) SLK200 (172 SERIES) SLK250 (172 SERIES) SLK350 (172 SERIES) SLK55 (172 SERIES)	586 586 586 586 587 591 591 591 592	TC3476	NISSAN	X-TRAIL	670					TC3461	MERCEDES	SLC180 (172 SERIES) SLC200 (172 SERIES) SLC250 (172 SERIES) SLC300 (172 SERIES) SLC43 (172 SERIES) SLK200 (172 SERIES) SLK250 (172 SERIES) SLK350 (172 SERIES) SLK55 (172 SERIES)	586 586 586 586 587 591 591 591 592	TC3477	NISSAN	X-TRAIL	670					TC3462	NISSAN	OASHQAI OASHQAI + 2 X-TRAIL	668 668 672	TC3478	MERCEDES	SLC180 (172 SERIES) SLC200 (172 SERIES) SLC250 (172 SERIES) SLC300 (172 SERIES)	586 586 586 586					TC3463	NISSAN	OASHQAI OASHQAI + 2 X-TRAIL	668 668 672																																																																																																													
TC3433	FORD	KA	388	TC3445	RENAULT	MEGANE IV TALISMAN TALISMAN GRANDTOUR	792 797 797	TC3461	MERCEDES	SLC180 (172 SERIES) SLC200 (172 SERIES) SLC250 (172 SERIES) SLC300 (172 SERIES) SLC43 (172 SERIES) SLK200 (172 SERIES) SLK250 (172 SERIES) SLK350 (172 SERIES) SLK55 (172 SERIES)	586 586 586 586 587 591 591 591 592	TC3434	FORD	KA	388	TC3446	MERCEDES	GL350 (166 SERIES) GL400 (166 SERIES) GL450 (166 SERIES) GL500 (166 SERIES) GL63 (166 SERIES) GLE250 (166 SERIES) GLE350 (166 SERIES) GLE400 (166 SERIES) GLE450 (166 SERIES) GLE500 (166 SERIES) GLE63 (166 SERIES) GLE350 COUPE (292 SERIES) GLE400 COUPE (292 SERIES) GLE450 COUPE (292 SERIES) GLE500 COUPE (292 SERIES) GLE63 COUPE (292 SERIES) GLS350 (166 SERIES) GLS400 (166 SERIES) GLS500 (166 SERIES)	567 567 567 567 567 568 568 568 568 568 568 569 569 569 569 569 571 571 571	TC3462	NISSAN	OASHQAI OASHQAI + 2 X-TRAIL	668 668 672	TC3435	BMW	320i (F34 SERIES) 320d (F34 SERIES) 328i (F34 SERIES) 330d (F34 SERIES) 335i (F34 SERIES) 340i (F34 SERIES) 335d (F34 SERIES)	203 203 203 203 203 203 203	TC3447	MERCEDES	GL350 (166 SERIES) GL400 (166 SERIES) GL450 (166 SERIES) GL500 (166 SERIES) GL63 (166 SERIES) GLE250 (166 SERIES) GLE350 (166 SERIES) GLE400 (166 SERIES) GLE450 (166 SERIES) GLE500 (166 SERIES) GLE63 (166 SERIES) GLE350 COUPE (292 SERIES) GLE400 COUPE (292 SERIES) GLE450 COUPE (292 SERIES) GLE500 COUPE (292 SERIES) GLE63 COUPE (292 SERIES) GLS350 (166 SERIES) GLS400 (166 SERIES) GLS500 (166 SERIES)	567 567 567 567 567 568 568 568 568 568 568 569 569 569 569 569 571 571 571	RENAULT	KADJAR KOLEOS	769 777	TC3436	BMW	320i (F34 SERIES) 320d (F34 SERIES) 328i (F34 SERIES) 330d (F34 SERIES) 335i (F34 SERIES) 340i (F34 SERIES) 335d (F34 SERIES)	203 203 203 203 203 203 203	TC3448	MERCEDES	GL350 (166 SERIES) GL400 (166 SERIES) GL450 (166 SERIES) GL500 (166 SERIES) GL63 (166 SERIES) GLE250 (166 SERIES) GLE350 (166 SERIES) GLE400 (166 SERIES) GLE450 (166 SERIES) GLE500 (166 SERIES) GLE63 (166 SERIES) GLE350 COUPE (292 SERIES) GLE400 COUPE (292 SERIES) GLE450 COUPE (292 SERIES) GLE500 COUPE (292 SERIES) GLE63 COUPE (292 SERIES) GLS350 (166 SERIES) GLS400 (166 SERIES) GLS500 (166 SERIES)	567 567 567 567 567 568 568 568 568 568 568 569 569 569 569 569 571 571 571	TC3463	NISSAN	OASHQAI OASHQAI + 2 X-TRAIL	668 668 672	TC3437	BMW	118d (F20, F21 SERIES) 120d (F20, F21 SERIES) 135i (F20, F21 SERIES) 140i (F20, F21 SERIES) 220d (F22, F23 SERIES) 235i (F22, F23 SERIES) 240i (F22, F23 SERIES) 318d (F30, F31 SERIES) 320i (F30, F31 SERIES)	180 180 180 180 183 183 183 201 201	TC3449	MERCEDES	GL350 (166 SERIES) GL400 (166 SERIES) GL450 (166 SERIES) GL500 (166 SERIES) GL63 (166 SERIES) GLE250 (166 SERIES) GLE350 (166 SERIES) GLE400 (166 SERIES) GLE450 (166 SERIES) GLE500 (166 SERIES) GLE63 (166 SERIES) GLE350 COUPE (292 SERIES) GLE400 COUPE (292 SERIES) GLE450 COUPE (292 SERIES) GLE500 COUPE (292 SERIES) GLE63 COUPE (292 SERIES) GLS350 (166 SERIES) GLS400 (166 SERIES) GLS500 (166 SERIES)	567 567 567 567 567 568 568 568 568 568 568 569 569 569 569 569 571 571 571	RENAULT	KADJAR KOLEOS	769 777					TC3450	CITROEN	C4 GRAND PICASSO C4 PICASSO	287 289	TC3464	LAND ROVER	FREELANDER 2	499					TC3451	CITROEN	C4 GRAND PICASSO C4 PICASSO	287 289	TC3468	HONDA	CIVIC	419					TC3454	FIAT	500X	334	TC3469	HONDA	CIVIC	419					TC3455	FIAT	500X	334	TC3472	MERCEDES	C220 (204 SERIES) C230 (204 SERIES) C250 (204 SERIES) C280 (204 SERIES) C300 (204 SERIES) C320 (204 SERIES) C350 (204 SERIES)	534 534 534 534 534 534 534					TC3456	LAND ROVER	RANGE ROVER IV	502	TC3473	MERCEDES	C220 (204 SERIES) C230 (204 SERIES) C250 (204 SERIES) C280 (204 SERIES) C300 (204 SERIES) C320 (204 SERIES) C350 (204 SERIES)	534 534 534 534 534 534 534					TC3457	LAND ROVER	RANGE ROVER IV	502	TC3475	KIA	SPORTAGE	483					TC3460	MERCEDES	SLC180 (172 SERIES) SLC200 (172 SERIES) SLC250 (172 SERIES) SLC300 (172 SERIES) SLC43 (172 SERIES) SLK200 (172 SERIES) SLK250 (172 SERIES) SLK350 (172 SERIES) SLK55 (172 SERIES)	586 586 586 586 587 591 591 591 592	TC3476	NISSAN	X-TRAIL	670					TC3461	MERCEDES	SLC180 (172 SERIES) SLC200 (172 SERIES) SLC250 (172 SERIES) SLC300 (172 SERIES) SLC43 (172 SERIES) SLK200 (172 SERIES) SLK250 (172 SERIES) SLK350 (172 SERIES) SLK55 (172 SERIES)	586 586 586 586 587 591 591 591 592	TC3477	NISSAN	X-TRAIL	670					TC3462	NISSAN	OASHQAI OASHQAI + 2 X-TRAIL	668 668 672	TC3478	MERCEDES	SLC180 (172 SERIES) SLC200 (172 SERIES) SLC250 (172 SERIES) SLC300 (172 SERIES)	586 586 586 586					TC3463	NISSAN	OASHQAI OASHQAI + 2 X-TRAIL	668 668 672																																																																																																																									
TC3434	FORD	KA	388	TC3446	MERCEDES	GL350 (166 SERIES) GL400 (166 SERIES) GL450 (166 SERIES) GL500 (166 SERIES) GL63 (166 SERIES) GLE250 (166 SERIES) GLE350 (166 SERIES) GLE400 (166 SERIES) GLE450 (166 SERIES) GLE500 (166 SERIES) GLE63 (166 SERIES) GLE350 COUPE (292 SERIES) GLE400 COUPE (292 SERIES) GLE450 COUPE (292 SERIES) GLE500 COUPE (292 SERIES) GLE63 COUPE (292 SERIES) GLS350 (166 SERIES) GLS400 (166 SERIES) GLS500 (166 SERIES)	567 567 567 567 567 568 568 568 568 568 568 569 569 569 569 569 571 571 571	TC3462	NISSAN	OASHQAI OASHQAI + 2 X-TRAIL	668 668 672	TC3435	BMW	320i (F34 SERIES) 320d (F34 SERIES) 328i (F34 SERIES) 330d (F34 SERIES) 335i (F34 SERIES) 340i (F34 SERIES) 335d (F34 SERIES)	203 203 203 203 203 203 203	TC3447	MERCEDES	GL350 (166 SERIES) GL400 (166 SERIES) GL450 (166 SERIES) GL500 (166 SERIES) GL63 (166 SERIES) GLE250 (166 SERIES) GLE350 (166 SERIES) GLE400 (166 SERIES) GLE450 (166 SERIES) GLE500 (166 SERIES) GLE63 (166 SERIES) GLE350 COUPE (292 SERIES) GLE400 COUPE (292 SERIES) GLE450 COUPE (292 SERIES) GLE500 COUPE (292 SERIES) GLE63 COUPE (292 SERIES) GLS350 (166 SERIES) GLS400 (166 SERIES) GLS500 (166 SERIES)	567 567 567 567 567 568 568 568 568 568 568 569 569 569 569 569 571 571 571	RENAULT	KADJAR KOLEOS	769 777	TC3436	BMW	320i (F34 SERIES) 320d (F34 SERIES) 328i (F34 SERIES) 330d (F34 SERIES) 335i (F34 SERIES) 340i (F34 SERIES) 335d (F34 SERIES)	203 203 203 203 203 203 203	TC3448	MERCEDES	GL350 (166 SERIES) GL400 (166 SERIES) GL450 (166 SERIES) GL500 (166 SERIES) GL63 (166 SERIES) GLE250 (166 SERIES) GLE350 (166 SERIES) GLE400 (166 SERIES) GLE450 (166 SERIES) GLE500 (166 SERIES) GLE63 (166 SERIES) GLE350 COUPE (292 SERIES) GLE400 COUPE (292 SERIES) GLE450 COUPE (292 SERIES) GLE500 COUPE (292 SERIES) GLE63 COUPE (292 SERIES) GLS350 (166 SERIES) GLS400 (166 SERIES) GLS500 (166 SERIES)	567 567 567 567 567 568 568 568 568 568 568 569 569 569 569 569 571 571 571	TC3463	NISSAN	OASHQAI OASHQAI + 2 X-TRAIL	668 668 672	TC3437	BMW	118d (F20, F21 SERIES) 120d (F20, F21 SERIES) 135i (F20, F21 SERIES) 140i (F20, F21 SERIES) 220d (F22, F23 SERIES) 235i (F22, F23 SERIES) 240i (F22, F23 SERIES) 318d (F30, F31 SERIES) 320i (F30, F31 SERIES)	180 180 180 180 183 183 183 201 201	TC3449	MERCEDES	GL350 (166 SERIES) GL400 (166 SERIES) GL450 (166 SERIES) GL500 (166 SERIES) GL63 (166 SERIES) GLE250 (166 SERIES) GLE350 (166 SERIES) GLE400 (166 SERIES) GLE450 (166 SERIES) GLE500 (166 SERIES) GLE63 (166 SERIES) GLE350 COUPE (292 SERIES) GLE400 COUPE (292 SERIES) GLE450 COUPE (292 SERIES) GLE500 COUPE (292 SERIES) GLE63 COUPE (292 SERIES) GLS350 (166 SERIES) GLS400 (166 SERIES) GLS500 (166 SERIES)	567 567 567 567 567 568 568 568 568 568 568 569 569 569 569 569 571 571 571	RENAULT	KADJAR KOLEOS	769 777					TC3450	CITROEN	C4 GRAND PICASSO C4 PICASSO	287 289	TC3464	LAND ROVER	FREELANDER 2	499					TC3451	CITROEN	C4 GRAND PICASSO C4 PICASSO	287 289	TC3468	HONDA	CIVIC	419					TC3454	FIAT	500X	334	TC3469	HONDA	CIVIC	419					TC3455	FIAT	500X	334	TC3472	MERCEDES	C220 (204 SERIES) C230 (204 SERIES) C250 (204 SERIES) C280 (204 SERIES) C300 (204 SERIES) C320 (204 SERIES) C350 (204 SERIES)	534 534 534 534 534 534 534					TC3456	LAND ROVER	RANGE ROVER IV	502	TC3473	MERCEDES	C220 (204 SERIES) C230 (204 SERIES) C250 (204 SERIES) C280 (204 SERIES) C300 (204 SERIES) C320 (204 SERIES) C350 (204 SERIES)	534 534 534 534 534 534 534					TC3457	LAND ROVER	RANGE ROVER IV	502	TC3475	KIA	SPORTAGE	483					TC3460	MERCEDES	SLC180 (172 SERIES) SLC200 (172 SERIES) SLC250 (172 SERIES) SLC300 (172 SERIES) SLC43 (172 SERIES) SLK200 (172 SERIES) SLK250 (172 SERIES) SLK350 (172 SERIES) SLK55 (172 SERIES)	586 586 586 586 587 591 591 591 592	TC3476	NISSAN	X-TRAIL	670					TC3461	MERCEDES	SLC180 (172 SERIES) SLC200 (172 SERIES) SLC250 (172 SERIES) SLC300 (172 SERIES) SLC43 (172 SERIES) SLK200 (172 SERIES) SLK250 (172 SERIES) SLK350 (172 SERIES) SLK55 (172 SERIES)	586 586 586 586 587 591 591 591 592	TC3477	NISSAN	X-TRAIL	670					TC3462	NISSAN	OASHQAI OASHQAI + 2 X-TRAIL	668 668 672	TC3478	MERCEDES	SLC180 (172 SERIES) SLC200 (172 SERIES) SLC250 (172 SERIES) SLC300 (172 SERIES)	586 586 586 586					TC3463	NISSAN	OASHQAI OASHQAI + 2 X-TRAIL	668 668 672																																																																																																																																					
TC3435	BMW	320i (F34 SERIES) 320d (F34 SERIES) 328i (F34 SERIES) 330d (F34 SERIES) 335i (F34 SERIES) 340i (F34 SERIES) 335d (F34 SERIES)	203 203 203 203 203 203 203	TC3447	MERCEDES	GL350 (166 SERIES) GL400 (166 SERIES) GL450 (166 SERIES) GL500 (166 SERIES) GL63 (166 SERIES) GLE250 (166 SERIES) GLE350 (166 SERIES) GLE400 (166 SERIES) GLE450 (166 SERIES) GLE500 (166 SERIES) GLE63 (166 SERIES) GLE350 COUPE (292 SERIES) GLE400 COUPE (292 SERIES) GLE450 COUPE (292 SERIES) GLE500 COUPE (292 SERIES) GLE63 COUPE (292 SERIES) GLS350 (166 SERIES) GLS400 (166 SERIES) GLS500 (166 SERIES)	567 567 567 567 567 568 568 568 568 568 568 569 569 569 569 569 571 571 571	RENAULT	KADJAR KOLEOS	769 777	TC3436	BMW	320i (F34 SERIES) 320d (F34 SERIES) 328i (F34 SERIES) 330d (F34 SERIES) 335i (F34 SERIES) 340i (F34 SERIES) 335d (F34 SERIES)	203 203 203 203 203 203 203	TC3448	MERCEDES	GL350 (166 SERIES) GL400 (166 SERIES) GL450 (166 SERIES) GL500 (166 SERIES) GL63 (166 SERIES) GLE250 (166 SERIES) GLE350 (166 SERIES) GLE400 (166 SERIES) GLE450 (166 SERIES) GLE500 (166 SERIES) GLE63 (166 SERIES) GLE350 COUPE (292 SERIES) GLE400 COUPE (292 SERIES) GLE450 COUPE (292 SERIES) GLE500 COUPE (292 SERIES) GLE63 COUPE (292 SERIES) GLS350 (166 SERIES) GLS400 (166 SERIES) GLS500 (166 SERIES)	567 567 567 567 567 568 568 568 568 568 568 569 569 569 569 569 571 571 571	TC3463	NISSAN	OASHQAI OASHQAI + 2 X-TRAIL	668 668 672	TC3437	BMW	118d (F20, F21 SERIES) 120d (F20, F21 SERIES) 135i (F20, F21 SERIES) 140i (F20, F21 SERIES) 220d (F22, F23 SERIES) 235i (F22, F23 SERIES) 240i (F22, F23 SERIES) 318d (F30, F31 SERIES) 320i (F30, F31 SERIES)	180 180 180 180 183 183 183 201 201	TC3449	MERCEDES	GL350 (166 SERIES) GL400 (166 SERIES) GL450 (166 SERIES) GL500 (166 SERIES) GL63 (166 SERIES) GLE250 (166 SERIES) GLE350 (166 SERIES) GLE400 (166 SERIES) GLE450 (166 SERIES) GLE500 (166 SERIES) GLE63 (166 SERIES) GLE350 COUPE (292 SERIES) GLE400 COUPE (292 SERIES) GLE450 COUPE (292 SERIES) GLE500 COUPE (292 SERIES) GLE63 COUPE (292 SERIES) GLS350 (166 SERIES) GLS400 (166 SERIES) GLS500 (166 SERIES)	567 567 567 567 567 568 568 568 568 568 568 569 569 569 569 569 571 571 571	RENAULT	KADJAR KOLEOS	769 777					TC3450	CITROEN	C4 GRAND PICASSO C4 PICASSO	287 289	TC3464	LAND ROVER	FREELANDER 2	499					TC3451	CITROEN	C4 GRAND PICASSO C4 PICASSO	287 289	TC3468	HONDA	CIVIC	419					TC3454	FIAT	500X	334	TC3469	HONDA	CIVIC	419					TC3455	FIAT	500X	334	TC3472	MERCEDES	C220 (204 SERIES) C230 (204 SERIES) C250 (204 SERIES) C280 (204 SERIES) C300 (204 SERIES) C320 (204 SERIES) C350 (204 SERIES)	534 534 534 534 534 534 534					TC3456	LAND ROVER	RANGE ROVER IV	502	TC3473	MERCEDES	C220 (204 SERIES) C230 (204 SERIES) C250 (204 SERIES) C280 (204 SERIES) C300 (204 SERIES) C320 (204 SERIES) C350 (204 SERIES)	534 534 534 534 534 534 534					TC3457	LAND ROVER	RANGE ROVER IV	502	TC3475	KIA	SPORTAGE	483					TC3460	MERCEDES	SLC180 (172 SERIES) SLC200 (172 SERIES) SLC250 (172 SERIES) SLC300 (172 SERIES) SLC43 (172 SERIES) SLK200 (172 SERIES) SLK250 (172 SERIES) SLK350 (172 SERIES) SLK55 (172 SERIES)	586 586 586 586 587 591 591 591 592	TC3476	NISSAN	X-TRAIL	670					TC3461	MERCEDES	SLC180 (172 SERIES) SLC200 (172 SERIES) SLC250 (172 SERIES) SLC300 (172 SERIES) SLC43 (172 SERIES) SLK200 (172 SERIES) SLK250 (172 SERIES) SLK350 (172 SERIES) SLK55 (172 SERIES)	586 586 586 586 587 591 591 591 592	TC3477	NISSAN	X-TRAIL	670					TC3462	NISSAN	OASHQAI OASHQAI + 2 X-TRAIL	668 668 672	TC3478	MERCEDES	SLC180 (172 SERIES) SLC200 (172 SERIES) SLC250 (172 SERIES) SLC300 (172 SERIES)	586 586 586 586					TC3463	NISSAN	OASHQAI OASHQAI + 2 X-TRAIL	668 668 672																																																																																																																																																	
TC3436	BMW	320i (F34 SERIES) 320d (F34 SERIES) 328i (F34 SERIES) 330d (F34 SERIES) 335i (F34 SERIES) 340i (F34 SERIES) 335d (F34 SERIES)	203 203 203 203 203 203 203	TC3448	MERCEDES	GL350 (166 SERIES) GL400 (166 SERIES) GL450 (166 SERIES) GL500 (166 SERIES) GL63 (166 SERIES) GLE250 (166 SERIES) GLE350 (166 SERIES) GLE400 (166 SERIES) GLE450 (166 SERIES) GLE500 (166 SERIES) GLE63 (166 SERIES) GLE350 COUPE (292 SERIES) GLE400 COUPE (292 SERIES) GLE450 COUPE (292 SERIES) GLE500 COUPE (292 SERIES) GLE63 COUPE (292 SERIES) GLS350 (166 SERIES) GLS400 (166 SERIES) GLS500 (166 SERIES)	567 567 567 567 567 568 568 568 568 568 568 569 569 569 569 569 571 571 571	TC3463	NISSAN	OASHQAI OASHQAI + 2 X-TRAIL	668 668 672	TC3437	BMW	118d (F20, F21 SERIES) 120d (F20, F21 SERIES) 135i (F20, F21 SERIES) 140i (F20, F21 SERIES) 220d (F22, F23 SERIES) 235i (F22, F23 SERIES) 240i (F22, F23 SERIES) 318d (F30, F31 SERIES) 320i (F30, F31 SERIES)	180 180 180 180 183 183 183 201 201	TC3449	MERCEDES	GL350 (166 SERIES) GL400 (166 SERIES) GL450 (166 SERIES) GL500 (166 SERIES) GL63 (166 SERIES) GLE250 (166 SERIES) GLE350 (166 SERIES) GLE400 (166 SERIES) GLE450 (166 SERIES) GLE500 (166 SERIES) GLE63 (166 SERIES) GLE350 COUPE (292 SERIES) GLE400 COUPE (292 SERIES) GLE450 COUPE (292 SERIES) GLE500 COUPE (292 SERIES) GLE63 COUPE (292 SERIES) GLS350 (166 SERIES) GLS400 (166 SERIES) GLS500 (166 SERIES)	567 567 567 567 567 568 568 568 568 568 568 569 569 569 569 569 571 571 571	RENAULT	KADJAR KOLEOS	769 777					TC3450	CITROEN	C4 GRAND PICASSO C4 PICASSO	287 289	TC3464	LAND ROVER	FREELANDER 2	499					TC3451	CITROEN	C4 GRAND PICASSO C4 PICASSO	287 289	TC3468	HONDA	CIVIC	419					TC3454	FIAT	500X	334	TC3469	HONDA	CIVIC	419					TC3455	FIAT	500X	334	TC3472	MERCEDES	C220 (204 SERIES) C230 (204 SERIES) C250 (204 SERIES) C280 (204 SERIES) C300 (204 SERIES) C320 (204 SERIES) C350 (204 SERIES)	534 534 534 534 534 534 534					TC3456	LAND ROVER	RANGE ROVER IV	502	TC3473	MERCEDES	C220 (204 SERIES) C230 (204 SERIES) C250 (204 SERIES) C280 (204 SERIES) C300 (204 SERIES) C320 (204 SERIES) C350 (204 SERIES)	534 534 534 534 534 534 534					TC3457	LAND ROVER	RANGE ROVER IV	502	TC3475	KIA	SPORTAGE	483					TC3460	MERCEDES	SLC180 (172 SERIES) SLC200 (172 SERIES) SLC250 (172 SERIES) SLC300 (172 SERIES) SLC43 (172 SERIES) SLK200 (172 SERIES) SLK250 (172 SERIES) SLK350 (172 SERIES) SLK55 (172 SERIES)	586 586 586 586 587 591 591 591 592	TC3476	NISSAN	X-TRAIL	670					TC3461	MERCEDES	SLC180 (172 SERIES) SLC200 (172 SERIES) SLC250 (172 SERIES) SLC300 (172 SERIES) SLC43 (172 SERIES) SLK200 (172 SERIES) SLK250 (172 SERIES) SLK350 (172 SERIES) SLK55 (172 SERIES)	586 586 586 586 587 591 591 591 592	TC3477	NISSAN	X-TRAIL	670					TC3462	NISSAN	OASHQAI OASHQAI + 2 X-TRAIL	668 668 672	TC3478	MERCEDES	SLC180 (172 SERIES) SLC200 (172 SERIES) SLC250 (172 SERIES) SLC300 (172 SERIES)	586 586 586 586					TC3463	NISSAN	OASHQAI OASHQAI + 2 X-TRAIL	668 668 672																																																																																																																																																												
TC3437	BMW	118d (F20, F21 SERIES) 120d (F20, F21 SERIES) 135i (F20, F21 SERIES) 140i (F20, F21 SERIES) 220d (F22, F23 SERIES) 235i (F22, F23 SERIES) 240i (F22, F23 SERIES) 318d (F30, F31 SERIES) 320i (F30, F31 SERIES)	180 180 180 180 183 183 183 201 201	TC3449	MERCEDES	GL350 (166 SERIES) GL400 (166 SERIES) GL450 (166 SERIES) GL500 (166 SERIES) GL63 (166 SERIES) GLE250 (166 SERIES) GLE350 (166 SERIES) GLE400 (166 SERIES) GLE450 (166 SERIES) GLE500 (166 SERIES) GLE63 (166 SERIES) GLE350 COUPE (292 SERIES) GLE400 COUPE (292 SERIES) GLE450 COUPE (292 SERIES) GLE500 COUPE (292 SERIES) GLE63 COUPE (292 SERIES) GLS350 (166 SERIES) GLS400 (166 SERIES) GLS500 (166 SERIES)	567 567 567 567 567 568 568 568 568 568 568 569 569 569 569 569 571 571 571	RENAULT	KADJAR KOLEOS	769 777					TC3450	CITROEN	C4 GRAND PICASSO C4 PICASSO	287 289	TC3464	LAND ROVER	FREELANDER 2	499					TC3451	CITROEN	C4 GRAND PICASSO C4 PICASSO	287 289	TC3468	HONDA	CIVIC	419					TC3454	FIAT	500X	334	TC3469	HONDA	CIVIC	419					TC3455	FIAT	500X	334	TC3472	MERCEDES	C220 (204 SERIES) C230 (204 SERIES) C250 (204 SERIES) C280 (204 SERIES) C300 (204 SERIES) C320 (204 SERIES) C350 (204 SERIES)	534 534 534 534 534 534 534					TC3456	LAND ROVER	RANGE ROVER IV	502	TC3473	MERCEDES	C220 (204 SERIES) C230 (204 SERIES) C250 (204 SERIES) C280 (204 SERIES) C300 (204 SERIES) C320 (204 SERIES) C350 (204 SERIES)	534 534 534 534 534 534 534					TC3457	LAND ROVER	RANGE ROVER IV	502	TC3475	KIA	SPORTAGE	483					TC3460	MERCEDES	SLC180 (172 SERIES) SLC200 (172 SERIES) SLC250 (172 SERIES) SLC300 (172 SERIES) SLC43 (172 SERIES) SLK200 (172 SERIES) SLK250 (172 SERIES) SLK350 (172 SERIES) SLK55 (172 SERIES)	586 586 586 586 587 591 591 591 592	TC3476	NISSAN	X-TRAIL	670					TC3461	MERCEDES	SLC180 (172 SERIES) SLC200 (172 SERIES) SLC250 (172 SERIES) SLC300 (172 SERIES) SLC43 (172 SERIES) SLK200 (172 SERIES) SLK250 (172 SERIES) SLK350 (172 SERIES) SLK55 (172 SERIES)	586 586 586 586 587 591 591 591 592	TC3477	NISSAN	X-TRAIL	670					TC3462	NISSAN	OASHQAI OASHQAI + 2 X-TRAIL	668 668 672	TC3478	MERCEDES	SLC180 (172 SERIES) SLC200 (172 SERIES) SLC250 (172 SERIES) SLC300 (172 SERIES)	586 586 586 586					TC3463	NISSAN	OASHQAI OASHQAI + 2 X-TRAIL	668 668 672																																																																																																																																																																								
				TC3450	CITROEN	C4 GRAND PICASSO C4 PICASSO	287 289	TC3464	LAND ROVER	FREELANDER 2	499					TC3451	CITROEN	C4 GRAND PICASSO C4 PICASSO	287 289	TC3468	HONDA	CIVIC	419					TC3454	FIAT	500X	334	TC3469	HONDA	CIVIC	419					TC3455	FIAT	500X	334	TC3472	MERCEDES	C220 (204 SERIES) C230 (204 SERIES) C250 (204 SERIES) C280 (204 SERIES) C300 (204 SERIES) C320 (204 SERIES) C350 (204 SERIES)	534 534 534 534 534 534 534					TC3456	LAND ROVER	RANGE ROVER IV	502	TC3473	MERCEDES	C220 (204 SERIES) C230 (204 SERIES) C250 (204 SERIES) C280 (204 SERIES) C300 (204 SERIES) C320 (204 SERIES) C350 (204 SERIES)	534 534 534 534 534 534 534					TC3457	LAND ROVER	RANGE ROVER IV	502	TC3475	KIA	SPORTAGE	483					TC3460	MERCEDES	SLC180 (172 SERIES) SLC200 (172 SERIES) SLC250 (172 SERIES) SLC300 (172 SERIES) SLC43 (172 SERIES) SLK200 (172 SERIES) SLK250 (172 SERIES) SLK350 (172 SERIES) SLK55 (172 SERIES)	586 586 586 586 587 591 591 591 592	TC3476	NISSAN	X-TRAIL	670					TC3461	MERCEDES	SLC180 (172 SERIES) SLC200 (172 SERIES) SLC250 (172 SERIES) SLC300 (172 SERIES) SLC43 (172 SERIES) SLK200 (172 SERIES) SLK250 (172 SERIES) SLK350 (172 SERIES) SLK55 (172 SERIES)	586 586 586 586 587 591 591 591 592	TC3477	NISSAN	X-TRAIL	670					TC3462	NISSAN	OASHQAI OASHQAI + 2 X-TRAIL	668 668 672	TC3478	MERCEDES	SLC180 (172 SERIES) SLC200 (172 SERIES) SLC250 (172 SERIES) SLC300 (172 SERIES)	586 586 586 586					TC3463	NISSAN	OASHQAI OASHQAI + 2 X-TRAIL	668 668 672																																																																																																																																																																																			
				TC3451	CITROEN	C4 GRAND PICASSO C4 PICASSO	287 289	TC3468	HONDA	CIVIC	419					TC3454	FIAT	500X	334	TC3469	HONDA	CIVIC	419					TC3455	FIAT	500X	334	TC3472	MERCEDES	C220 (204 SERIES) C230 (204 SERIES) C250 (204 SERIES) C280 (204 SERIES) C300 (204 SERIES) C320 (204 SERIES) C350 (204 SERIES)	534 534 534 534 534 534 534					TC3456	LAND ROVER	RANGE ROVER IV	502	TC3473	MERCEDES	C220 (204 SERIES) C230 (204 SERIES) C250 (204 SERIES) C280 (204 SERIES) C300 (204 SERIES) C320 (204 SERIES) C350 (204 SERIES)	534 534 534 534 534 534 534					TC3457	LAND ROVER	RANGE ROVER IV	502	TC3475	KIA	SPORTAGE	483					TC3460	MERCEDES	SLC180 (172 SERIES) SLC200 (172 SERIES) SLC250 (172 SERIES) SLC300 (172 SERIES) SLC43 (172 SERIES) SLK200 (172 SERIES) SLK250 (172 SERIES) SLK350 (172 SERIES) SLK55 (172 SERIES)	586 586 586 586 587 591 591 591 592	TC3476	NISSAN	X-TRAIL	670					TC3461	MERCEDES	SLC180 (172 SERIES) SLC200 (172 SERIES) SLC250 (172 SERIES) SLC300 (172 SERIES) SLC43 (172 SERIES) SLK200 (172 SERIES) SLK250 (172 SERIES) SLK350 (172 SERIES) SLK55 (172 SERIES)	586 586 586 586 587 591 591 591 592	TC3477	NISSAN	X-TRAIL	670					TC3462	NISSAN	OASHQAI OASHQAI + 2 X-TRAIL	668 668 672	TC3478	MERCEDES	SLC180 (172 SERIES) SLC200 (172 SERIES) SLC250 (172 SERIES) SLC300 (172 SERIES)	586 586 586 586					TC3463	NISSAN	OASHQAI OASHQAI + 2 X-TRAIL	668 668 672																																																																																																																																																																																															
				TC3454	FIAT	500X	334	TC3469	HONDA	CIVIC	419					TC3455	FIAT	500X	334	TC3472	MERCEDES	C220 (204 SERIES) C230 (204 SERIES) C250 (204 SERIES) C280 (204 SERIES) C300 (204 SERIES) C320 (204 SERIES) C350 (204 SERIES)	534 534 534 534 534 534 534					TC3456	LAND ROVER	RANGE ROVER IV	502	TC3473	MERCEDES	C220 (204 SERIES) C230 (204 SERIES) C250 (204 SERIES) C280 (204 SERIES) C300 (204 SERIES) C320 (204 SERIES) C350 (204 SERIES)	534 534 534 534 534 534 534					TC3457	LAND ROVER	RANGE ROVER IV	502	TC3475	KIA	SPORTAGE	483					TC3460	MERCEDES	SLC180 (172 SERIES) SLC200 (172 SERIES) SLC250 (172 SERIES) SLC300 (172 SERIES) SLC43 (172 SERIES) SLK200 (172 SERIES) SLK250 (172 SERIES) SLK350 (172 SERIES) SLK55 (172 SERIES)	586 586 586 586 587 591 591 591 592	TC3476	NISSAN	X-TRAIL	670					TC3461	MERCEDES	SLC180 (172 SERIES) SLC200 (172 SERIES) SLC250 (172 SERIES) SLC300 (172 SERIES) SLC43 (172 SERIES) SLK200 (172 SERIES) SLK250 (172 SERIES) SLK350 (172 SERIES) SLK55 (172 SERIES)	586 586 586 586 587 591 591 591 592	TC3477	NISSAN	X-TRAIL	670					TC3462	NISSAN	OASHQAI OASHQAI + 2 X-TRAIL	668 668 672	TC3478	MERCEDES	SLC180 (172 SERIES) SLC200 (172 SERIES) SLC250 (172 SERIES) SLC300 (172 SERIES)	586 586 586 586					TC3463	NISSAN	OASHQAI OASHQAI + 2 X-TRAIL	668 668 672																																																																																																																																																																																																											
				TC3455	FIAT	500X	334	TC3472	MERCEDES	C220 (204 SERIES) C230 (204 SERIES) C250 (204 SERIES) C280 (204 SERIES) C300 (204 SERIES) C320 (204 SERIES) C350 (204 SERIES)	534 534 534 534 534 534 534					TC3456	LAND ROVER	RANGE ROVER IV	502	TC3473	MERCEDES	C220 (204 SERIES) C230 (204 SERIES) C250 (204 SERIES) C280 (204 SERIES) C300 (204 SERIES) C320 (204 SERIES) C350 (204 SERIES)	534 534 534 534 534 534 534					TC3457	LAND ROVER	RANGE ROVER IV	502	TC3475	KIA	SPORTAGE	483					TC3460	MERCEDES	SLC180 (172 SERIES) SLC200 (172 SERIES) SLC250 (172 SERIES) SLC300 (172 SERIES) SLC43 (172 SERIES) SLK200 (172 SERIES) SLK250 (172 SERIES) SLK350 (172 SERIES) SLK55 (172 SERIES)	586 586 586 586 587 591 591 591 592	TC3476	NISSAN	X-TRAIL	670					TC3461	MERCEDES	SLC180 (172 SERIES) SLC200 (172 SERIES) SLC250 (172 SERIES) SLC300 (172 SERIES) SLC43 (172 SERIES) SLK200 (172 SERIES) SLK250 (172 SERIES) SLK350 (172 SERIES) SLK55 (172 SERIES)	586 586 586 586 587 591 591 591 592	TC3477	NISSAN	X-TRAIL	670					TC3462	NISSAN	OASHQAI OASHQAI + 2 X-TRAIL	668 668 672	TC3478	MERCEDES	SLC180 (172 SERIES) SLC200 (172 SERIES) SLC250 (172 SERIES) SLC300 (172 SERIES)	586 586 586 586					TC3463	NISSAN	OASHQAI OASHQAI + 2 X-TRAIL	668 668 672																																																																																																																																																																																																																							
				TC3456	LAND ROVER	RANGE ROVER IV	502	TC3473	MERCEDES	C220 (204 SERIES) C230 (204 SERIES) C250 (204 SERIES) C280 (204 SERIES) C300 (204 SERIES) C320 (204 SERIES) C350 (204 SERIES)	534 534 534 534 534 534 534					TC3457	LAND ROVER	RANGE ROVER IV	502	TC3475	KIA	SPORTAGE	483					TC3460	MERCEDES	SLC180 (172 SERIES) SLC200 (172 SERIES) SLC250 (172 SERIES) SLC300 (172 SERIES) SLC43 (172 SERIES) SLK200 (172 SERIES) SLK250 (172 SERIES) SLK350 (172 SERIES) SLK55 (172 SERIES)	586 586 586 586 587 591 591 591 592	TC3476	NISSAN	X-TRAIL	670					TC3461	MERCEDES	SLC180 (172 SERIES) SLC200 (172 SERIES) SLC250 (172 SERIES) SLC300 (172 SERIES) SLC43 (172 SERIES) SLK200 (172 SERIES) SLK250 (172 SERIES) SLK350 (172 SERIES) SLK55 (172 SERIES)	586 586 586 586 587 591 591 591 592	TC3477	NISSAN	X-TRAIL	670					TC3462	NISSAN	OASHQAI OASHQAI + 2 X-TRAIL	668 668 672	TC3478	MERCEDES	SLC180 (172 SERIES) SLC200 (172 SERIES) SLC250 (172 SERIES) SLC300 (172 SERIES)	586 586 586 586					TC3463	NISSAN	OASHQAI OASHQAI + 2 X-TRAIL	668 668 672																																																																																																																																																																																																																																			
				TC3457	LAND ROVER	RANGE ROVER IV	502	TC3475	KIA	SPORTAGE	483					TC3460	MERCEDES	SLC180 (172 SERIES) SLC200 (172 SERIES) SLC250 (172 SERIES) SLC300 (172 SERIES) SLC43 (172 SERIES) SLK200 (172 SERIES) SLK250 (172 SERIES) SLK350 (172 SERIES) SLK55 (172 SERIES)	586 586 586 586 587 591 591 591 592	TC3476	NISSAN	X-TRAIL	670					TC3461	MERCEDES	SLC180 (172 SERIES) SLC200 (172 SERIES) SLC250 (172 SERIES) SLC300 (172 SERIES) SLC43 (172 SERIES) SLK200 (172 SERIES) SLK250 (172 SERIES) SLK350 (172 SERIES) SLK55 (172 SERIES)	586 586 586 586 587 591 591 591 592	TC3477	NISSAN	X-TRAIL	670					TC3462	NISSAN	OASHQAI OASHQAI + 2 X-TRAIL	668 668 672	TC3478	MERCEDES	SLC180 (172 SERIES) SLC200 (172 SERIES) SLC250 (172 SERIES) SLC300 (172 SERIES)	586 586 586 586					TC3463	NISSAN	OASHQAI OASHQAI + 2 X-TRAIL	668 668 672																																																																																																																																																																																																																																															
				TC3460	MERCEDES	SLC180 (172 SERIES) SLC200 (172 SERIES) SLC250 (172 SERIES) SLC300 (172 SERIES) SLC43 (172 SERIES) SLK200 (172 SERIES) SLK250 (172 SERIES) SLK350 (172 SERIES) SLK55 (172 SERIES)	586 586 586 586 587 591 591 591 592	TC3476	NISSAN	X-TRAIL	670					TC3461	MERCEDES	SLC180 (172 SERIES) SLC200 (172 SERIES) SLC250 (172 SERIES) SLC300 (172 SERIES) SLC43 (172 SERIES) SLK200 (172 SERIES) SLK250 (172 SERIES) SLK350 (172 SERIES) SLK55 (172 SERIES)	586 586 586 586 587 591 591 591 592	TC3477	NISSAN	X-TRAIL	670					TC3462	NISSAN	OASHQAI OASHQAI + 2 X-TRAIL	668 668 672	TC3478	MERCEDES	SLC180 (172 SERIES) SLC200 (172 SERIES) SLC250 (172 SERIES) SLC300 (172 SERIES)	586 586 586 586					TC3463	NISSAN	OASHQAI OASHQAI + 2 X-TRAIL	668 668 672																																																																																																																																																																																																																																																											
				TC3461	MERCEDES	SLC180 (172 SERIES) SLC200 (172 SERIES) SLC250 (172 SERIES) SLC300 (172 SERIES) SLC43 (172 SERIES) SLK200 (172 SERIES) SLK250 (172 SERIES) SLK350 (172 SERIES) SLK55 (172 SERIES)	586 586 586 586 587 591 591 591 592	TC3477	NISSAN	X-TRAIL	670					TC3462	NISSAN	OASHQAI OASHQAI + 2 X-TRAIL	668 668 672	TC3478	MERCEDES	SLC180 (172 SERIES) SLC200 (172 SERIES) SLC250 (172 SERIES) SLC300 (172 SERIES)	586 586 586 586					TC3463	NISSAN	OASHQAI OASHQAI + 2 X-TRAIL	668 668 672																																																																																																																																																																																																																																																																							
				TC3462	NISSAN	OASHQAI OASHQAI + 2 X-TRAIL	668 668 672	TC3478	MERCEDES	SLC180 (172 SERIES) SLC200 (172 SERIES) SLC250 (172 SERIES) SLC300 (172 SERIES)	586 586 586 586					TC3463	NISSAN	OASHQAI OASHQAI + 2 X-TRAIL	668 668 672																																																																																																																																																																																																																																																																																			
				TC3463	NISSAN	OASHQAI OASHQAI + 2 X-TRAIL	668 668 672																																																																																																																																																																																																																																																																																															













543 New to Range

   				   				   			
... TC3597	AUDI	S6 (4G SERIES)	166	TC3609	BMW	228i (F22, F23 SERIES)	181	TC3611	BMW	118d (F20, F21 SERIES)	178
	PORSCHE	MACAN	753			230i (F22, F23 SERIES)	181			120i (F20, F21 SERIES)	178
TC3598	AUDI	A4 (8W SERIES)	98	TC3610	BMW	316i (F30, F31 SERIES)	199	TC3612	BMW	114i (F20, F21 SERIES)	178
		A8 (4H SERIES)	130			116d (F20, F21 SERIES)	178				
		ALLROAD (4G SERIES)	133			118i (F20, F21 SERIES)	178				
		Q7	141			118d (F20, F21 SERIES)	178				
TC3599	AUDI	A8 (4H SERIES)	130	TC3611	BMW	120i (F20, F21 SERIES)	178	TC3612	BMW	114d (F20, F21 SERIES)	178
		S8 (4H SERIES)	167			120d (F20, F21 SERIES)	178				
TC3600	AUDI	A8 (4H SERIES)	130	TC3610	BMW	125i (F20, F21 SERIES)	178	TC3612	BMW	116i (F20, F21 SERIES)	178
		S8 (4H SERIES)	167			125d (F20, F21 SERIES)	178				
TC3601	AUDI	A8 (4H SERIES)	130	TC3610	BMW	128i (F30, F31 SERIES)	199	TC3612	BMW	116d (F20, F21 SERIES)	178
		S8 (4H SERIES)	167			128i (F20, F21 SERIES)	178				
TC3602	AUDI	A8 (4H SERIES)	130	TC3610	BMW	128i (F30, F31 SERIES)	199	TC3612	BMW	118i (F20, F21 SERIES)	178
		S8 (4H SERIES)	167			128i (F20, F21 SERIES)	178				
TC3603	AUDI	Q3 (8U SERIES)	135	TC3610	BMW	128i (F30, F31 SERIES)	199	TC3612	BMW	118d (F20, F21 SERIES)	178
		VOLKSWAGEN PASSAT V	1019			128i (F20, F21 SERIES)	178				
TC3604	AUDI	Q3 (8U SERIES)	135	TC3610	BMW	128i (F20, F21 SERIES)	178	TC3612	BMW	120i (F20, F21 SERIES)	178
		VOLKSWAGEN PASSAT V	1019			128i (F20, F21 SERIES)	178				
TC3605	BMW	114i (F20, F21 SERIES)	178	TC3610	BMW	128i (F20, F21 SERIES)	178	TC3612	BMW	120d (F20, F21 SERIES)	178
		114d (F20, F21 SERIES)	178			128i (F20, F21 SERIES)	178				
TC3609	BMW	116i (F20, F21 SERIES)	178	TC3610	BMW	128i (F20, F21 SERIES)	178	TC3612	BMW	125i (F20, F21 SERIES)	178
		116d (F20, F21 SERIES)	178			128i (F20, F21 SERIES)	178				
TC3609	BMW	118i (F20, F21 SERIES)	178	TC3610	BMW	128i (F20, F21 SERIES)	178	TC3612	BMW	125d (F20, F21 SERIES)	178
		118d (F20, F21 SERIES)	178			128i (F20, F21 SERIES)	178				
TC3609	BMW	120i (F20, F21 SERIES)	178	TC3610	BMW	128i (F20, F21 SERIES)	178	TC3612	BMW	128i (F20, F21 SERIES)	178
		120d (F20, F21 SERIES)	178			128i (F20, F21 SERIES)	178				
TC3609	BMW	125i (F20, F21 SERIES)	178	TC3610	BMW	128i (F20, F21 SERIES)	178	TC3612	BMW	128i (F20, F21 SERIES)	178
		125d (F20, F21 SERIES)	178			128i (F20, F21 SERIES)	178				
TC3609	BMW	218i (F22, F23 SERIES)	181	TC3610	BMW	128i (F20, F21 SERIES)	178	TC3612	BMW	128i (F20, F21 SERIES)	178
		218d (F22, F23 SERIES)	181			128i (F20, F21 SERIES)	178				
TC3609	BMW	220i (F22, F23 SERIES)	181	TC3610	BMW	128i (F20, F21 SERIES)	178	TC3612	BMW	128i (F20, F21 SERIES)	178
		220d (F22, F23 SERIES)	181			128i (F20, F21 SERIES)	178				
TC3609	BMW	225d (F22, F23 SERIES)	181	TC3610	BMW	128i (F20, F21 SERIES)	178	TC3612	BMW	128i (F20, F21 SERIES)	178
						128i (F20, F21 SERIES)	178				









543 New to Range

D   				D   				D   											
TD1463W	MINI	COOPER CLUBMAN	619	TD1620W	AUDI	A6 (4F SERIES)	123	TD1633W	AUDI	Q5 (8R SERIES)	136								
		ONE CLUBMAN	619			ALLROAD (4F SERIES)	132			RS4 (8K SERIES)	144								
		COOPER D CLUBMAN	620			S6 (4F SERIES)	165			RS5 (8T SERIES)	144								
		COOPER S CLUBMAN	622		TD1621W	MITSUBISHI	LANCER			638	S4 (8K SERIES)	153							
		COOPER SD CLUBMAN	622				OUTLANDER I			643	S5 CABRIO (8F SERIES)	156							
		JOHN COOPER WORKS CLUBMAN	622		TD1622W	MERCEDES	SPRINTER (901, 902, 903 SERIES)		593	S5 COUPÉ (8T SERIES)	160								
		ONE D CLUBMAN	622				SPRINTER CLASSIC (909 SERIES) RUSSIAN BUILD		598	S5 COUPÉ, SPORTBACK (8T SERIES)	162								
		COOPER CLUBVAN	624				TD1623W		OPEL	ASTRA J	677	TD1634W	BMW	116i (E81, E87 SERIES)	174				
		COOPER D CLUBVAN	624		CASCADA	681				116d (E81, E87 SERIES)	174								
		ONE CLUBVAN	624		ZAFIRA TOURER	700			118i (E81, E87 SERIES)	174									
		COUPÉ COOPER	626		VAUXHALL	ASTRA J (MK VI)			927	118d (E81, E87 SERIES)	174								
		COUPÉ COOPER S	628			CASCADA			930	120i (E81, E87 SERIES)	174								
		COUPÉ COOPER SD	628			ZAFIRA TOURER	948		120d (E81, E87 SERIES)	174									
		COUPÉ JOHN COOPER WORKS	628		TD1624W	MERCEDES	SPRINTER (901, 902, 903 SERIES)		593	123d (E81, E87 SERIES)	174								
		TD1464W	MINI				COOPER		613	TD1625W	PEUGEOT			407	724	125i (E81, E87 SERIES)	174		
ONE	613			TD1626W			AUDI	A8 (4H SERIES)	130					125i (E81, E87 SERIES)	174				
COOPER S	616				S8 (4H SERIES)	167		130i (E81, E87 SERIES)	174										
ONE D	614				TD1627W	HYUNDAI	iX20	441	130i (E81, E87 SERIES)					174					
COOPER D	616						KIA	VENGA	485					130i (E81, E87 SERIES)	174				
COOPER SD	616				TD1628W	LAND ROVER	FREELANDER 2	499	118i (E82, E88 SERIES)					176					
JOHN COOPER WORKS	616						TD1629W	FORD	FIESTA VII					370	118d (E82, E88 SERIES)	176			
COUPÉ COOPER	626				FIESTA VAN VII	370			120d (E82, E88 SERIES)					176					
COUPÉ COOPER S	628				TD1630W	BMW	114i (F20, F21 SERIES)	178	123d (E82, E88 SERIES)			176							
COUPÉ COOPER SD	628						114d (F20, F21 SERIES)	178	125i (E82, E88 SERIES)			176							
COUPÉ JOHN COOPER WORKS	628						116i (F20, F21 SERIES)	178	125i (E82, E88 SERIES)			176							
TD1465W	BMW						520i (E39 SERIES)	209	116d (F20, F21 SERIES)			178	125i (E82, E88 SERIES)	176					
							520d (E39 SERIES)	209	118i (F20, F21 SERIES)			178	135i (E82, E88 SERIES)	176					
							523i (E39 SERIES)	209	118d (F20, F21 SERIES)			178	135i (E82, E88 SERIES)	176					
							525i (E39 SERIES)	209	120i (F20, F21 SERIES)			178	316i (E90, E92, E93 SERIES)	195					
		525d (E39 SERIES)	209				118d (F20, F21 SERIES)	178	316d (E90, E92, E93 SERIES)	195									
		525td (E39 SERIES)	209	120i (F20, F21 SERIES)			178	318i (E90, E92, E93 SERIES)	195										
		525tds (E39 SERIES)	209	120d (F20, F21 SERIES)			178	318d (E90, E92, E93 SERIES)	195										
		528i (E39 SERIES)	209	125i (F20, F21 SERIES)			178	320i (E90, E92, E93 SERIES)	195										
		530d (E39 SERIES)	209	125d (F20, F21 SERIES)			178	320d (E90, E92, E93 SERIES)	195										
		530i (E39 SERIES)	209	135i (F20, F21 SERIES)			179	323i (E90, E92, E93 SERIES)	195										
		535i (E39 SERIES)	213	140i (F20, F21 SERIES)			179	325i (E90, E92, E93 SERIES)	195										
		540i (E39 SERIES)	213	218i (F22, F23 SERIES)			181	325d (E90, E92, E93 SERIES)	195										
		M5 (E39 SERIES)	239	218d (F22, F23 SERIES)	181	328i (E90, E92, E93 SERIES)	195												
		TD1466W	DACIA	DOKKER	320	220i (F22, F23 SERIES)	181	330i (E90, E92, E93 SERIES)	195										
				LOGGY	322	225d (F22, F23 SERIES)	181	330d (E90, E92, E93 SERIES)	195										
MERCEDES	CITAN (415 SERIES)			536	228i (F22, F23 SERIES)	181	335i (E90, E92, E93 SERIES)	195											
	RENAULT		KANGOO	772	230i (F22, F23 SERIES)	181	335d (E90, E92, E93 SERIES)	195											
			KANGOO BE BOP	773	235i (F22, F23 SERIES)	182	316i (E91 SERIES)	196											
KANGOO EXPRESS			776	240i (F22, F23 SERIES)	182	316d (E91 SERIES)	196												
TD1467W	RENAULT		CLIO II	758	316i (F30, F31 SERIES)	199	318i (E91 SERIES)	196											
			MEGANE I	785	318d (F30, F31 SERIES)	199	318d (E91 SERIES)	196											
TD1469W	RENAULT		MEGANE III	792	320i (F30, F31 SERIES)	199	320i (E91 SERIES)	196											
TD1470W	CITROEN		C1	278	320d (F30, F31 SERIES)	199	320d (E91 SERIES)	196											
			PEUGEOT	107	325d (F30, F31 SERIES)	199	323i (E91 SERIES)	196											
			TOYOTA	AYGO	905	328i (F30, F31 SERIES)	199	325i (E91 SERIES)	196										
TD1475W	HYUNDAI		SONATA	446	330i (F30, F31 SERIES)	199	325d (E91 SERIES)	196											
			XG	451	330d (F30, F31 SERIES)	199	328i (E91 SERIES)	196											
			KIA	MAGENTIS	469	335i (F30, F31 SERIES)	199	330i (E91 SERIES)	196										
TD1477W	HYUNDAI	SONATA	446	340i (F30, F31 SERIES)	199	330d (E91 SERIES)	196												
		XG	451	335d (F30, F31 SERIES)	201	335i (E91 SERIES)	196												
		KIA	MAGENTIS	469	318d (F34 SERIES)	202	335d (E91 SERIES)	196											
TD1478W	HYUNDAI	SONATA	446	320i (F34 SERIES)	202	320xd (E90, E91, E92 SERIES)	198												
		XG	451	325d (F34 SERIES)	202	325xi (E90, E91, E92 SERIES)	198												
		KIA	MAGENTIS	469	328i (F34 SERIES)	202	330xi (E90, E91, E92 SERIES)	198											
TD1479W	KIA	CARENS II	462	325d (F34 SERIES)	202	330xd (E90, E91, E92 SERIES)	198												
		MENTOR II	470	328i (F34 SERIES)	202	335xi (E90, E91, E92 SERIES)	198												
		SHUMA II	480	330i (F34 SERIES)	202	335xd (E90, E91, E92 SERIES)	198												
TD1480W	KIA	SPECTRA II	483	330d (F34 SERIES)	202	525xi (E60, E61 SERIES)	222												
		CARENS II	462	335i (F34 SERIES)	202	530xi (E60, E61 SERIES)	222												
		MENTOR II	470	340i (F34 SERIES)	202	530xd (E60, E61 SERIES)	222												
		SHUMA II	480	420i (F32, F33 SERIES)	204	X1 (E84 SERIES)	243												
		SPECTRA II	483	420d (F32, F33 SERIES)	204	TD1635W	NISSAN	QASHQAI	668										
TD1482W	HONDA	CR-V I	420	425d (F32, F33 SERIES)	204			QASHQAI + 2	668										
		TD1483W	HONDA	ACCORD	411		428i (F32, F33 SERIES)	204	RENAULT	KADJAR	769								
				TD1485W	HYUNDAI		SONATA	446		430i (F32, F33 SERIES)	204	TD1636W	AUDI	A6 (4G SERIES)	124				
							XG	451	430d (F32, F33 SERIES)	204	A7 (4G SERIES)			126					
		TD1487W	KIA				CARENS II	462	435i (F32, F33 SERIES)	204	A8 (4H SERIES)			130					
				MENTOR II	470		435d (F32, F33 SERIES)	204	ALLROAD (4G SERIES)	133									
				SHUMA II	480		440i (F32, F33 SERIES)	204	RS6 (4G SERIES)	148									
		TD1489W	TOYOTA	CAMRY	906		418d (F36 SERIES)	206	TD1637W	MERCEDES	VANEO (414 SERIES)		601						
				TD1503W	LAND ROVER		FREELANDER 1	498			420i (F36 SERIES)		206	TD1638W	BMW	118d (F20, F21 SERIES)	180		
							TD1504W	LAND ROVER			FREELANDER 1		498			425d (F36 SERIES)	206	120d (F20, F21 SERIES)	180
		TD1618W	MERCEDES								CL500 (215 SERIES)		536			428i (F32, F33 SERIES)	204	135i (F20, F21 SERIES)	180
											CL600 (215 SERIES)		536			430i (F32, F33 SERIES)	204	140i (F20, F21 SERIES)	180
							CL63 (215 SERIES)	536			430d (F32, F33 SERIES)		204			220d (F22, F23 SERIES)	183		
							CL65 (215 SERIES)	536			435i (F32, F33 SERIES)		204			235i (F22, F23 SERIES)	183		
						CL63 (215 SERIES)	536	435d (F32, F33 SERIES)			204		240i (F22, F23 SERIES)			183			
CL65 (215 SERIES)	536					440i (F32, F33 SERIES)	204	318d (F30, F31 SERIES)			201								
S280 (220 SERIES)	576					418d (F36 SERIES)	206	320i (F30, F31 SERIES)			201								
S320 (220 SERIES)	576					420i (F36 SERIES)	206	320d (F30, F31 SERIES)			201								
S350 (220 SERIES)	576					428i (F36 SERIES)	206	328i (F30, F31 SERIES)			201								
S400 (220 SERIES)	576					430i (F36 SERIES)	206	330i (F30, F31 SERIES)			201								
S430 (220 SERIES)	576					430d (F36 SERIES)	206	330d (F30, F31 SERIES)			201								
S500 (220 SERIES)	576					435i (F36 SERIES)	206	335i (F30, F31 SERIES)			201								
S600 (220 SERIES)	576					440i (F36 SERIES)	206	340i (F30, F31 SERIES)	201										
TD1619W	SUBARU			IMPREZA	888	435d (F36 SERIES)	208	335d (F30, F31 SERIES)	201										
				TD1631W	FORD	GRAND C-MAX	386	TD1632W	JEEP	GRAND CHEROKEE	461								
		TD1632W	JEEP			COMMANDER	461			TD1633W	AUDI	A4 (8K SERIES)	95						
						TD1633W	AUDI					A4 ALLROAD (8K SERIES)	100	A5 CABRIO (8F SERIES)	108				
												A5 CABRIO (8T SERIES)	110	A5 COUPÉ (8T SERIES)	110				
												A5 COUPÉ, SPORTBACK (8T SERIES)	112	A5 COUPÉ, SPORTBACK (8T SERIES)	112				







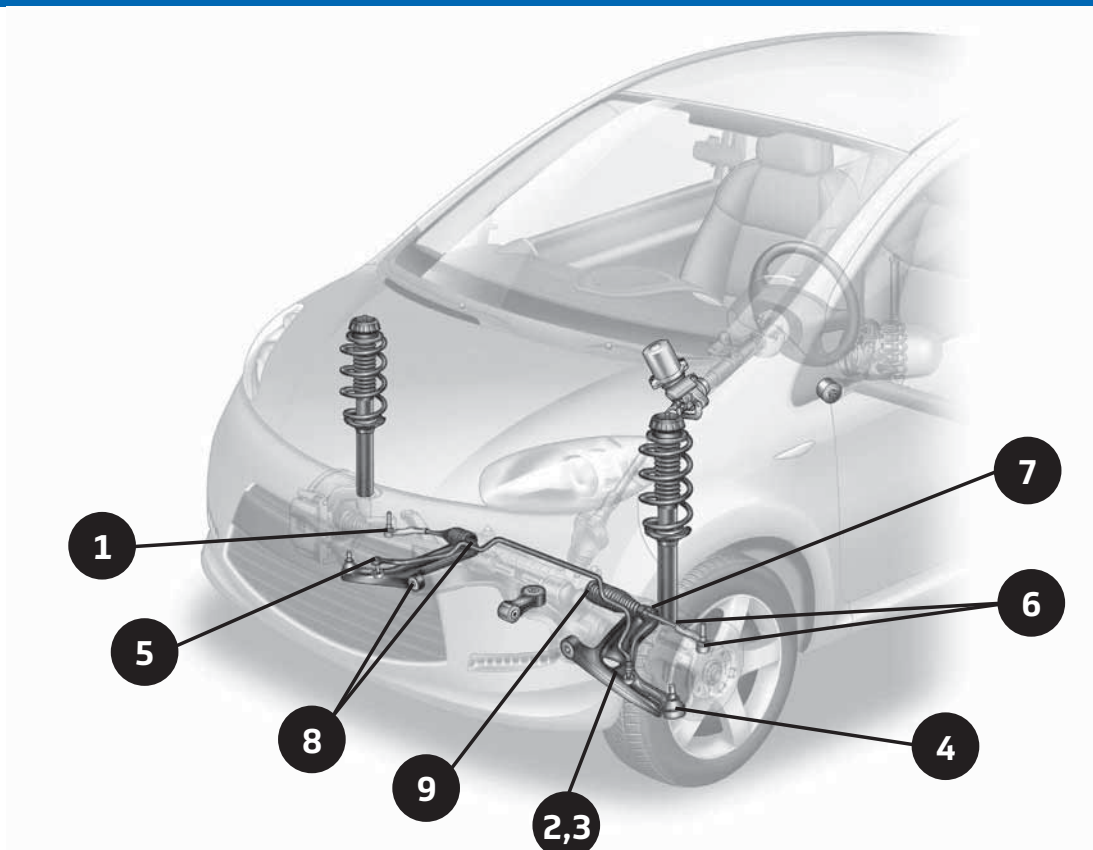

543 New to Range

   	   	   
TD1638W BMW 420d (F32, F33 SERIES) 205 VOLKSWAGEN 428i (F32, F33 SERIES) 205 430i (F32, F33 SERIES) 205 430d (F32, F33 SERIES) 205 435i (F32, F33 SERIES) 205 435d (F32, F33 SERIES) 205 440i (F32, F33 SERIES) 205 420i (F36 SERIES) 208 420d (F36 SERIES) 208 428i (F36 SERIES) 208 430i (F36 SERIES) 208 430d (F36 SERIES) 208 435i (F36 SERIES) 208 440i (F36 SERIES) 208 435d (F36 SERIES) 208	TD1652W VOLKSWAGEN EOS 973 GOLF V 986 GOLF VI 990 GOLF VI CABRIO 995 GOLF PLUS 998 JETTA III (1K SERIES) 1002 JETTA IV (16 SERIES) 1006 PASSAT V 1019 PASSAT VI 1020 PASSAT CC 1023 SCIROCCO 1032 SHARAN (7N SERIES) 1036 TIGUAN 1038 TOURAN 1046	TD1658W MERCEDES E400 (212 SERIES) 565 GLA180 (156 SERIES) 568 GLA200 (156 SERIES) 568 GLA220 (156 SERIES) 568 GLA250 (156 SERIES) 568 GLA45 (156 SERIES) 568 GLK200 (X204 SERIES) 570 GLK220 (X204 SERIES) 570 GLK250 (X204 SERIES) 570 GLK280 (X204 SERIES) 570 GLK300 (X204 SERIES) 570 GLK320 (X204 SERIES) 570 GLK350 (X204 SERIES) 570 SL350 (231 SERIES) 586 SL400 (231 SERIES) 586 SL500 (231 SERIES) 586
TD1639W DACIA DUSTER 321	TD1653W AUDI A1 (8X SERIES) 69 A3 (8P SERIES) 76 A3 CABRIO (8P SERIES) 83 Q3 (8U SERIES) 135 S3 (8P SERIES) 150 TT (8J SERIES) 171	TD1663W KIA CARNIVAL 464 SEDONA 479
TD1640W FORD C-MAX II 365 FOCUS III 377 GRAND C-MAX 386	SEAT ALHAMBRA (710 SERIES) 815 ALTEA (5P SERIES) 816 LEON II (1P SERIES) 840 TOLEDO III (5P SERIES) 846	TD1664W HONDA CR-V II 422
TD1641W FORD C-MAX II 365 FOCUS III 377 GRAND C-MAX 386	SKODA OCTAVIA (1Z SERIES) 858 OCTAVIATOUR (1Z SERIES) 864 SUPERB (3T SERIES) 873 YETI 878	TD1666W HONDA CR-V III 423 CR-V IV 424
TD1642W HYUNDAI i20 437	VOLKSWAGEN BEETLE (5C SERIES) 952 BEETLE CABRIO 954 CC 970 EOS 973 GOLF V 986 GOLF VI 990 GOLF VI CABRIO 995 GOLF PLUS 998 JETTA III (1K SERIES) 1002 JETTA IV (16 SERIES) 1006 PASSAT V 1019 PASSAT VI 1020 PASSAT CC 1023 SCIROCCO 1032 SHARAN (7N SERIES) 1036 TIGUAN 1038 TOURAN 1046	TD1667W HONDA ACCORD 411
TD1643W HYUNDAI i10 436	TD1654W BMW X3 (F25 SERIES) 249 X4 (F26 SERIES) 251 X4M (F26 SERIES) 251	TD1668W HONDA ACCORD 412
TD1644W FORD MONDEO V 398	TD1655W LAND ROVER RANGE ROVER IV 502	TD1669W MAZDA 2 515
TD1645W HYUNDAI ELANTRA 432 i30 438	TD1656W HYUNDAI ELANTRA 432 GRAND SANTA FE 433 i30 438 i40 440 IX55 442 SANTA FE 445	TD1670W OPEL ASTRA K 678 VAUXHALL ASTRA K (MK VII) 928
KIA CEE'D 465 CERATO II 468 PRO CEE'D 474	KIA CARENS III 463 CARNIVAL 464 CEE'D 465 PRO CEE'D 474 SEDONA 479 SPORTAGE 484	TD1672W FORD TOURNEO CUSTOM 403 TRANSIT 407 TRANSIT CUSTOM 409
TD1647W BMW 316i (E46 SERIES) 187 318i (E46 SERIES) 187 320i (E46 SERIES) 187 318d (E46 SERIES) 187 320d (E46 SERIES) 187 323i (E46 SERIES) 187 328i (E46 SERIES) 187	TD1657W DACIA DUSTER 321	TD1675W KIA CARNIVAL 464 SEDONA 479
TD1648W AUDI A1 (8X SERIES) 69 A3 (8P SERIES) 76 A3 CABRIO (8P SERIES) 83 Q3 (8U SERIES) 135 S3 (8P SERIES) 150 TT (8J SERIES) 171	TD1658W MERCEDES A45 (176 SERIES) 529 C180 (204 SERIES) 533 C200 (204 SERIES) 533 C220 (204 SERIES) 533 C230 (204 SERIES) 533 C250CGI (204 SERIES) 533 C250 (204 SERIES) 533 C280 (204 SERIES) 533 C300 (204 SERIES) 533 C320 (204 SERIES) 533 C350 (204 SERIES) 533 C350CGI (204 SERIES) 533 C63 (204 SERIES) 534 CLA45 (117 SERIES) 540 CLS250 (218 SERIES) 547 CLS350 (218 SERIES) 547 CLS500 (218 SERIES) 547 CLS63 (218 SERIES) 547 E200 (207 SERIES) 552 E220 (207 SERIES) 552 E250 (207 SERIES) 552 E300 (207 SERIES) 552 E350 (207 SERIES) 552 E400 (207 SERIES) 552 E500 (207 SERIES) 552 E550 (207 SERIES) 552 E200 (212 SERIES) 563 E220 (212 SERIES) 563 E250 (212 SERIES) 563 E300 Hybrid (212 SERIES) 563 E300 (212 SERIES) 563 E350 BlueTec (212 SERIES) 563 E350 (212 SERIES) 563 E500 (212 SERIES) 563 E63 (212 SERIES) 564	TD1676W KIA CARNIVAL 464 SEDONA 479
SEAT ALTEA (5P SERIES) 816 LEON II (1P SERIES) 840 TOLEDO III (5P SERIES) 846	TD1659W AUDI A1 (8X SERIES) 63 A3 (8P SERIES) 76 A3 CABRIO (8P SERIES) 83 Q3 (8U SERIES) 135 S3 (8P SERIES) 150 TT (8J SERIES) 171	TD1686W FORD MONDEO V 398
SKODA OCTAVIA (1Z SERIES) 858 OCTAVIATOUR (1Z SERIES) 864 SUPERB (3T SERIES) 873 YETI 878	TD1660W MERCEDES GLA180 (156 SERIES) 568 GLA200 (156 SERIES) 568 GLA220 (156 SERIES) 568 GLA250 (156 SERIES) 568 GLA45 (156 SERIES) 568 GLK200 (X204 SERIES) 570 GLK220 (X204 SERIES) 570 GLK250 (X204 SERIES) 570 GLK280 (X204 SERIES) 570 GLK300 (X204 SERIES) 570 GLK320 (X204 SERIES) 570 GLK350 (X204 SERIES) 570 SL350 (231 SERIES) 586 SL400 (231 SERIES) 586 SL500 (231 SERIES) 586	TD1687W FORD MONDEO V 398
VOLKSWAGEN BEETLE (5C SERIES) 952 BEETLE CABRIO 954 CC 970 EOS 973 GOLF V 986 GOLF VI 990 GOLF VI CABRIO 995 GOLF PLUS 998 JETTA III (1K SERIES) 1002 JETTA IV (16 SERIES) 1006 PASSAT V 1019 PASSAT VI 1020 PASSAT CC 1023 PASSAT ALLTRACK 1024 SCIROCCO 1032 TIGUAN 1038 TOURAN 1046	TD1661W AUDI A1 (8X SERIES) 63 A3 (8P SERIES) 76 A3 CABRIO (8P SERIES) 83 Q3 (8U SERIES) 135 S3 (8P SERIES) 150 TT (8J SERIES) 171	TD1688W FORD MONDEO V 398
TD1649W MERCEDES SLC180 (172 SERIES) 586 SLC200 (172 SERIES) 586 SLC250 (172 SERIES) 586 SLC300 (172 SERIES) 586 SLK200 (172 SERIES) 591 SLK250 (172 SERIES) 591 SLK350 (172 SERIES) 591 SLK55 (172 SERIES) 592	TD1662W KIA CARNIVAL 464 SEDONA 479	TD1690W FORD GALAXY 385 MONDEO IV 395 S-MAX 399 VOLVO S60 II 1064
TD1650W NISSAN QASHQAI 669	TD1663W KIA CARNIVAL 464 SEDONA 479	TL553 LAND ROVER DEFENDER 90 491 DEFENDER 110 491 DEFENDER 130 491
TD1651W FIAT PANDA (312) 353	TD1664W HONDA CR-V II 422	TL554 CHRYSLER CROSSFIRE 273 MERCEDES SLK200 (170 SERIES) 588 SLK230 (170 SERIES) 588 SLK320 (170 SERIES) 588
TD1652W AUDI A1 (8X SERIES) 69 A3 (8P SERIES) 76 A3 CABRIO (8P SERIES) 83 Q3 (8U SERIES) 135 S3 (8P SERIES) 150 TT (8J SERIES) 171	SEAT ALHAMBRA (710 SERIES) 815 ALTEA (5P SERIES) 816 LEON II (1P SERIES) 840 TOLEDO III (5P SERIES) 846	TL555 AUDI A1 (8X SERIES) 63 SEAT IBIZA (6J SERIES) 832 TOLEDO IV (NH SERIES) 848 SKODA RAPID 868 VOLKSWAGEN POLO (6R SERIES) 1029
SKODA OCTAVIA (1Z SERIES) 858 OCTAVIATOUR (1Z SERIES) 864 SUPERB (3T SERIES) 873 YETI 878	VOLKSWAGEN BEETLE (5C SERIES) 952 BEETLE CABRIO 954 CC 970	TL556 AUDI A1 (8X SERIES) 63 SEAT IBIZA (6J SERIES) 832 TOLEDO IV (NH SERIES) 848 SKODA RAPID 868 VOLKSWAGEN POLO (6R SERIES) 1029
		TL557 AUDI A8 (4E SERIES) 128 VOLKSWAGEN PHAETON 1027
		TL611 BMW 114i (F20, F21 SERIES) 178 114d (F20, F21 SERIES) 178 116i (F20, F21 SERIES) 178 116d (F20, F21 SERIES) 178 118i (F20, F21 SERIES) 178 118d (F20, F21 SERIES) 178 120i (F20, F21 SERIES) 178 120d (F20, F21 SERIES) 178 125i (F20, F21 SERIES) 178 125d (F20, F21 SERIES) 178 135i (F20, F21 SERIES) 179 140i (F20, F21 SERIES) 179 218i (F22, F23 SERIES) 181 218d (F22, F23 SERIES) 181 220i (F22, F23 SERIES) 181 220d (F22, F23 SERIES) 181 225d (F22, F23 SERIES) 181 228i (F22, F23 SERIES) 181 230i (F22, F23 SERIES) 181 235i (F22, F23 SERIES) 182 240i (F22, F23 SERIES) 182 316i (F30, F31 SERIES) 199 316d (F30, F31 SERIES) 199 318d (F30, F31 SERIES) 199 320i (F30, F31 SERIES) 199 320d (F30, F31 SERIES) 199 325d (F30, F31 SERIES) 199 328i (F30, F31 SERIES) 199 330i (F30, F31 SERIES) 199 330d (F30, F31 SERIES) 199 335i (F30, F31 SERIES) 199 340i (F30, F31 SERIES) 199 318d (F34 SERIES) 202

543 New to Range

D				D				D			
TL611	BMW	320i (F34 SERIES)	202	TL614	AUDI	A5 CABRIO (8F SERIES)	105				
		320d (F34 SERIES)	202			A5 COUPÉ (8T SERIES)	110				
		325d (F34 SERIES)	202			A5 COUPÉ, SPORTBACK (8T SERIES)	112				
		328i (F34 SERIES)	202			Q5 (8R SERIES)	136				
		330i (F34 SERIES)	202			RS5 (8T SERIES)	144				
		330d (F34 SERIES)	202			S4 (8K SERIES)	153				
		335i (F34 SERIES)	202			S5 CABRIO (8F SERIES)	156				
		340i (F34 SERIES)	202			S5 COUPÉ (8T SERIES)	160				
		420i (F32, F33 SERIES)	204			S5 COUPÉ, SPORTBACK (8T SERIES)	162				
		420d (F32, F33 SERIES)	204								
		425d (F32, F33 SERIES)	204								
		428i (F32, F33 SERIES)	204								
		430i (F32, F33 SERIES)	204								
		430d (F32, F33 SERIES)	204								
		435i (F32, F33 SERIES)	204								
		435d (F32, F33 SERIES)	204								
		440i (F32, F33 SERIES)	204								
		418d (F36 SERIES)	206								
		420i (F36 SERIES)	206								
		420d (F36 SERIES)	206								
		428i (F36 SERIES)	206								
		430i (F36 SERIES)	206								
		430d (F36 SERIES)	206								
		435i (F36 SERIES)	206								
		440i (F36 SERIES)	206								
		TL612	BMW			114i (F20, F21 SERIES)	178				
114d (F20, F21 SERIES)	178										
116i (F20, F21 SERIES)	178										
116d (F20, F21 SERIES)	178										
118i (F20, F21 SERIES)	178										
118d (F20, F21 SERIES)	178										
120i (F20, F21 SERIES)	178										
120d (F20, F21 SERIES)	178										
125i (F20, F21 SERIES)	178										
125d (F20, F21 SERIES)	178										
135i (F20, F21 SERIES)	179										
140i (F20, F21 SERIES)	179										
218i (F22, F23 SERIES)	181										
218d (F22, F23 SERIES)	181										
220i (F22, F23 SERIES)	181										
220d (F22, F23 SERIES)	181										
225d (F22, F23 SERIES)	181										
228i (F22, F23 SERIES)	181										
230i (F22, F23 SERIES)	181										
235i (F22, F23 SERIES)	182										
240i (F22, F23 SERIES)	182										
316i (F30, F31 SERIES)	199										
316d (F30, F31 SERIES)	199										
318d (F30, F31 SERIES)	199										
320i (F30, F31 SERIES)	199										
320d (F30, F31 SERIES)	199										
325d (F30, F31 SERIES)	199										
328i (F30, F31 SERIES)	199										
330i (F30, F31 SERIES)	199										
330d (F30, F31 SERIES)	199										
335i (F30, F31 SERIES)	199										
340i (F30, F31 SERIES)	199										
318d (F34 SERIES)	202										
320i (F34 SERIES)	202										
320d (F34 SERIES)	202										
325d (F34 SERIES)	202										
328i (F34 SERIES)	202										
330i (F34 SERIES)	202										
330d (F34 SERIES)	202										
335i (F34 SERIES)	202										
340i (F34 SERIES)	202										
420i (F32, F33 SERIES)	204										
420d (F32, F33 SERIES)	204										
425d (F32, F33 SERIES)	204										
428i (F32, F33 SERIES)	204										
430i (F32, F33 SERIES)	204										
430d (F32, F33 SERIES)	204										
435i (F32, F33 SERIES)	204										
435d (F32, F33 SERIES)	204										
440i (F32, F33 SERIES)	204										
418d (F36 SERIES)	206										
420i (F36 SERIES)	206										
420d (F36 SERIES)	206										
428i (F36 SERIES)	206										
430i (F36 SERIES)	206										
430d (F36 SERIES)	206										
435i (F36 SERIES)	206										
440i (F36 SERIES)	206										
TL613	AUDI	A4 (8K SERIES)	93								
		A4 ALLROAD (8K SERIES)	100								
		A5 CABRIO (8F SERIES)	105								
		A5 COUPÉ (8T SERIES)	110								
		A5 COUPÉ, SPORTBACK (8T SERIES)	112								
		Q5 (8R SERIES)	136								
		RS5 (8T SERIES)	144								
		S4 (8K SERIES)	153								
		S5 CABRIO (8F SERIES)	156								
		S5 COUPÉ (8T SERIES)	160								
TL614	AUDI	A4 (8K SERIES)	93								
		A4 ALLROAD (8K SERIES)	100								



	1	2	3	4	5	6	7	8	9
									
GB	Tie Rod End	Track Control Arm	Wishbone	Ball Joint	Link Stabiliser	Tie Rod Assembly	Tie Rod Inner	Bush Kit	Steering Rack Gaiters

(-1)	(-) 17" Wheels	(105)	For brake disc diameter	(209)	Standard travel pack
(-2)	(-) 18" wheels	(106)	for halogen headlamp	(210)	Steel
(-3)	(-) 19" Wheels	(107)	For OE wishbone	(211)	Steering and suspension kit
(-4)	(-) 3 door	(108)	Front	(212)	Steering kit
(-5)	(-) 6 speed gearbox	(109)	front axle	(213)	Steering rack gaiter kit
(-6)	(-) Active Anti-Roll	(110)	Front/ Rear axle	(214)	Straight head
(-7)	(-) Active stabiliser	(111)	Heavy Duty	(215)	Sub-frame bush
(-8)	(-) Adaptive M chassis	(112)	Hub	(216)	Sub-frame mounting
(-9)	(-) Air suspension	(113)	Hub carrier bush	(217)	Support arm bush
(-10)	(-) Armoured	(114)	Hybrid	(218)	Suspension arm repair kit
(-11)	(-) Ball Joint	(115)	Hydraulic	(219)	Suspension bolt kit
(-12)	(-) Bracket	(116)	Hydraulic Steering	(220)	Suspension kit
(-13)	(-) Bush	(117)	Increased ground clearance	(221)	SWB
(-14)	(-) Dynamic drive	(118)	In-line	(222)	Swivel pin bush
(-15)	(-) Electric	(119)	Inner	(223)	Thermoplastic
(-16)	(-) Electronic suspension	(120)	Inner Diameter 1	(224)	Tie Rod End
(-17)	(-) Heavy duty	(121)	Inner Diameter 2	(225)	Track Control Arm
(-18)	(-) Heavy duty suspension	(122)	Inner part of wishbone	(226)	Trailing arm
(-19)	(-) Housing	(123)	Inner tie rod	(227)	Trailing arm bush
(-20)	(-) Hybrid	(124)	into steering rack	(228)	Transverse
(-21)	(-) Hydro-Pneumatic suspension	(125)	Japan Build	(229)	Twin Rear Wheels
(-22)	(-) Multifunction roof	(126)	Knuckle bush	(230)	UK build
(-23)	(-) Painted	(127)	Leading arm bush	(231)	upper
(-24)	(-) Police	(128)	Leaf spring bush	(232)	Upper ball joint
(-25)	(-) Ride height	(129)	Length	(233)	Upper camber arm
(-26)	(-) sport	(130)	LH	(234)	Upper camber arm bush
(-27)	(-) sport suspension	(131)	LH & RH	(235)	Upper control arm
(-28)	(-) Steel sub-frame	(132)	Link	(236)	Upper guide rod
(-29)	(-) Variable suspension	(133)	Link arm	(237)	Upper guide rod bush
(-30)	(-) very cold climate	(134)	link bush	(238)	Upper hub carrier bush
(-31)	(-) Xenon light	(135)	Link Stabiliser	(239)	Upper link arm
(-32)	(+) 3 door	(136)	Link stabiliser bush	(240)	Upper link arm bush
(-33)	(+) Active stabiliser	(137)	Link stabiliser kit	(241)	Upper torque rod
(-34)	(+) Adaptive M chassis	(138)	Location bolt kit	(242)	Upper track control arm
(-35)	(+) Air suspension	(139)	lower	(243)	Upper track control arm bush
(-36)	(+) Airmatic dual control	(140)	Lower ball joint	(244)	Upper track rod
(-37)	(+) Aluminium sub-frame	(141)	Lower control arm	(245)	Upper trailing arm
(-38)	(+) Armoured	(142)	Lower control arm bush	(246)	Upper trailing arm bush
(-39)	(+) Ball Joint	(143)	Lower hub carrier bush	(247)	Upper wishbone
(-40)	(+) Black	(144)	Lower link arm	(248)	Upper wishbone bush
(-41)	(+) Bracket	(145)	Lower link arm bush	(249)	V shaped head
(-42)	(+) Bush	(146)	Lower rod assembly	(250)	Variable power steering
(-43)	(+) Dynamic drive	(147)	Lower rod assembly bolt	(251)	Wishbone accessory kit
(-44)	(+) Electric	(148)	Lower suspension arm bush	(252)	Male
(-45)	(+) Electronic suspension	(149)	Lower torque rod	(253)	Female
(-46)	(+) heavy duty	(150)	Lower track control arm	(254)	Bulk Pack
(-47)	(+) Heavy duty suspension	(151)	Lower track control arm	(255)	Pinch Bolt
(-48)	(+) Housing	(152)	Lower track control arm bolt	(256)	Metal
(-49)	(+) Hybrid	(153)	Lower track control arm bush	(257)	(-) A/C
(-50)	(+) Multifunction roof	(154)	Lower track control arm bush kit	(258)	(+) A/C
(-51)	(+) Panoramic roof	(155)	Lower track rod	(259)	(-) Anti squeal assembly
(-52)	(+) Ride height	(156)	Lower trailing arm	(260)	(+) off-road suspension
(-53)	(+) Sport suspension	(157)	Lower trailing arm bush	(261)	Raised suspension
(-54)	(+) Steel sub-frame	(158)	Lower wishbone	(262)	5 speed
(-55)	(+) Variable power steering	(159)	Lower wishbone bush	(263)	6 Speed
(-56)	(+) very cold climate	(160)	Lower wishbone bush bracket	a	Ambulance
(-57)	(+) Xenon light	(161)	Lower wishbone bush kit	m	Cabriolet / Cabrio
(-58)	10mm mounting holes	(162)	Lower wishbone bush sleeve	c	Coupe
(-59)	12mm mounting holes	(163)	Lower wishbone repair kit	e	Estate
(-60)	13" wheels	(164)	LWB	n	Hatchback
(-61)	155 Tyres	(165)	MacPherson suspension	g	Minibus / Mini Bus
(-62)	16" wheels	(166)	Made in Czech Republic	p	Pick-Up / Pickup / Pickup
(-63)	17" wheels	(167)	Made in France	j	Saloon
(-64)	175 tyres	(168)	Made in South Korea	v	Van
(-65)	18" wheels	(169)	Manual gearbox	L	LHD
(-66)	19" Wheels	(170)	Manual steering	-	LHT
(-67)	2 bolt fitting	(171)	Multi-link Axle	L	RHD
(-68)	3 door	(172)	Non-variable power steering	£	RHT
(-69)	4 bolt fitting	(173)	Normal suspension		
(-70)	4 Door	(174)	Not adjustable		
(-71)	5 Door	(175)	Not for OE wishbone		
(-72)	Adjustable	(176)	Outer		
(-73)	Aluminium	(177)	Outer part of wishbone		
(-74)	Anti-roll bar	(178)	Oval bore (-) slot		
(-75)	automatic gearbox	(179)	Pack of		
(-76)	Axle bush	(180)	Panhard rod		
(-77)	axle kit	(181)	Panhard rod bush		
(-78)	Ball Joint	(182)	Pinch bolt kit		
(-79)	Ball joint kit	(183)	Pitman arm bush		
(-80)	Ball joint seat	(184)	Plastic		
(-81)	ball pin	(185)	Power steering		
(-82)	Bolt fitting	(186)	Radius arm bush		
(-83)	BRAKE CALIPER	(187)	Rear		
(-84)	Brake system	(188)	Rear Axle		
(-85)	Bush	(189)	Reduced travel pack		
(-86)	Bush Kit	(190)	Reinforced version		
(-87)	Camber Adjustment	(191)	Reinforcement arm		
(-88)	Cast iron	(192)	Replace in pairs		
(-89)	Centre	(193)	RH		
(-90)	Centre rod assembly	(194)	Rod assembly		
(-91)	Centre top link	(195)	Round bore (+) slot		
(-92)	Complete Axle Kit	(196)	round mounting		
(-93)	Cone size	(197)	Rubber		
(-94)	Conical Seat	(198)	Rwd		
(-95)	Connecting link	(199)	Screw fit		
(-96)	Connecting rod	(200)	Self levelling unit		
(-97)	Control arm bush	(201)	Sheet steel		
(-98)	Cross member	(202)	Single Cab		
(-99)	Cross member bush	(203)	Single Rear Wheels		
(100)	Disc	(204)	Sport suspension		
(101)	Drag link assembly	(205)	Spring eye bush		
(102)	Drag link end	(206)	Spring shackle bush		
(103)	Electric	(207)	Standard		
(104)	Fit in pairs when replacing hydraulic type	(208)	Standard suspension		

TBR1000

Multi-size car & small van gaiter

A pair of gaiters suitable for cars and car derived vans, supplied with 4 nylon ties and full fitting instructions

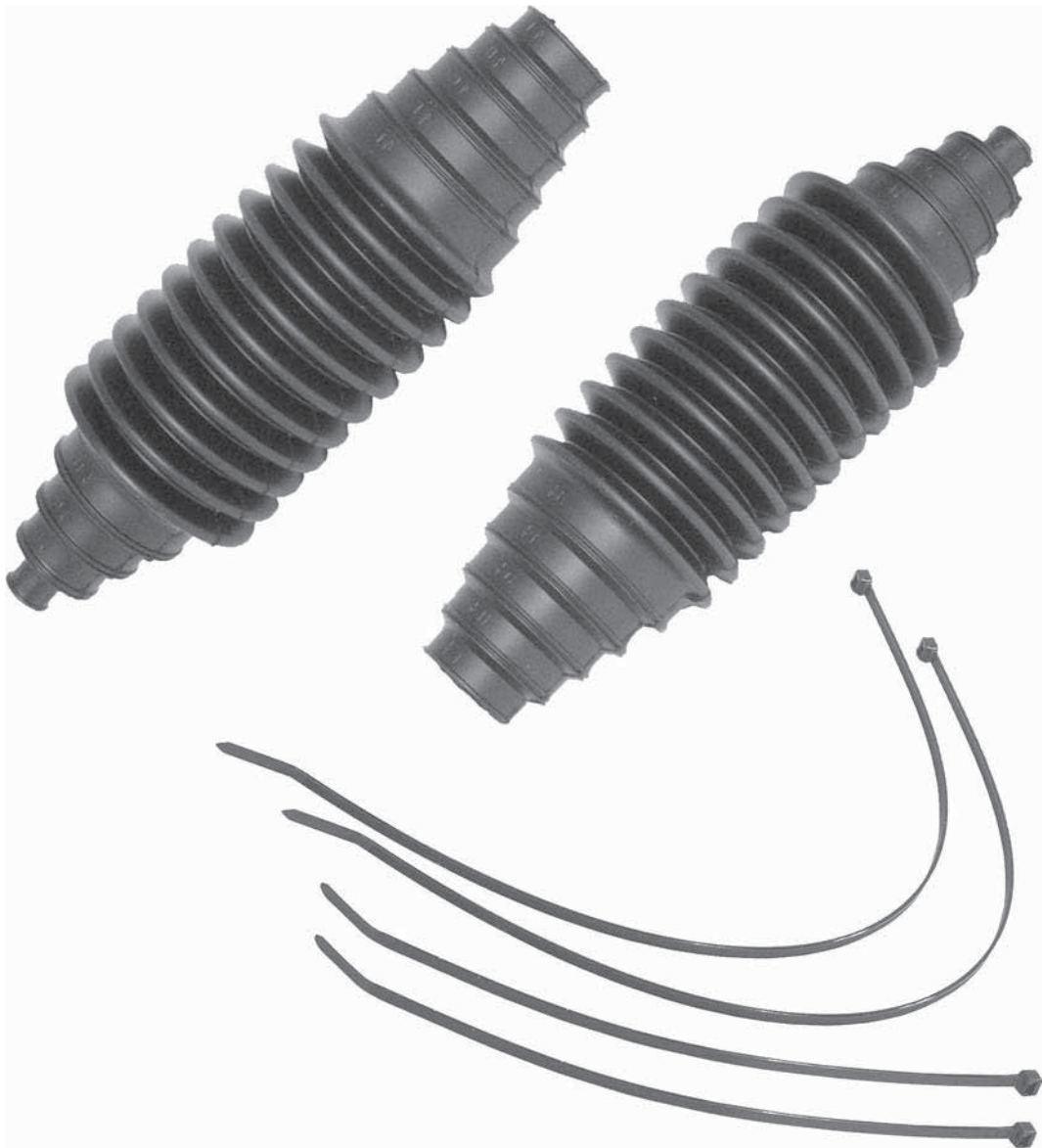

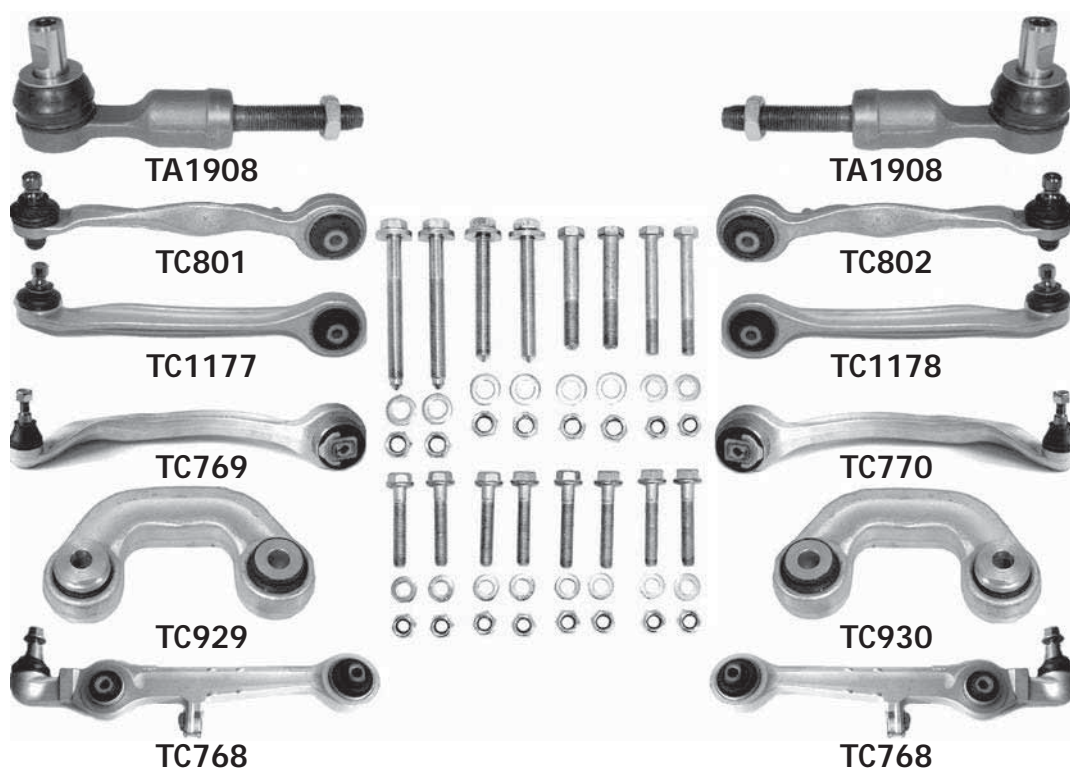
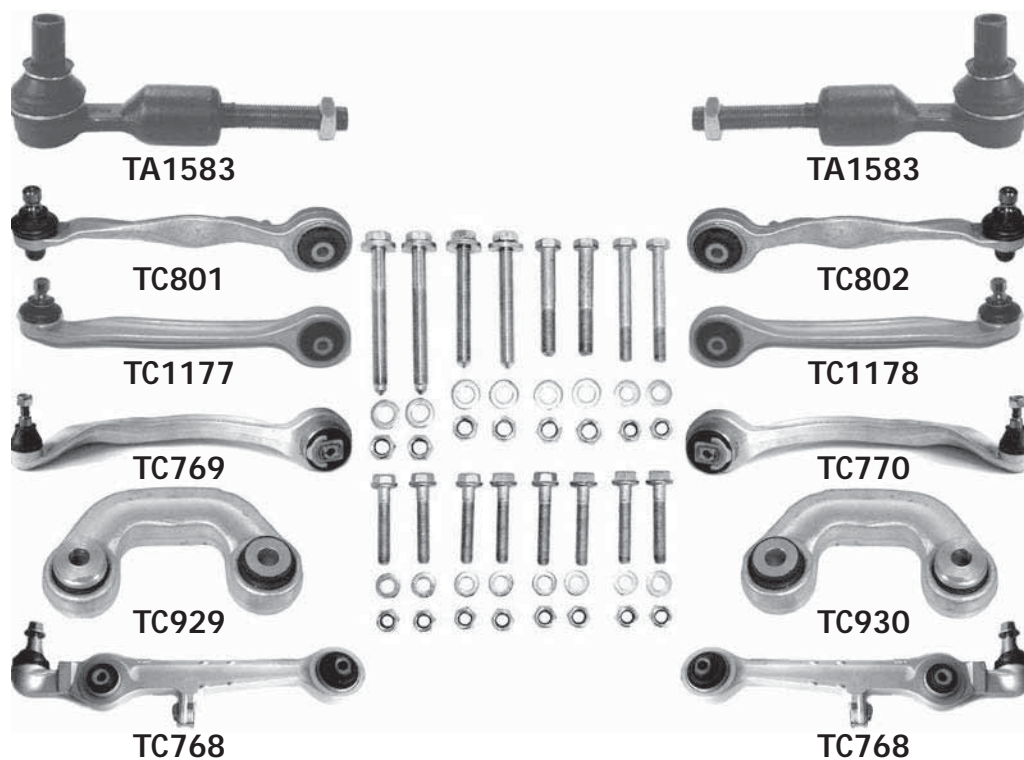

TC1500KIT

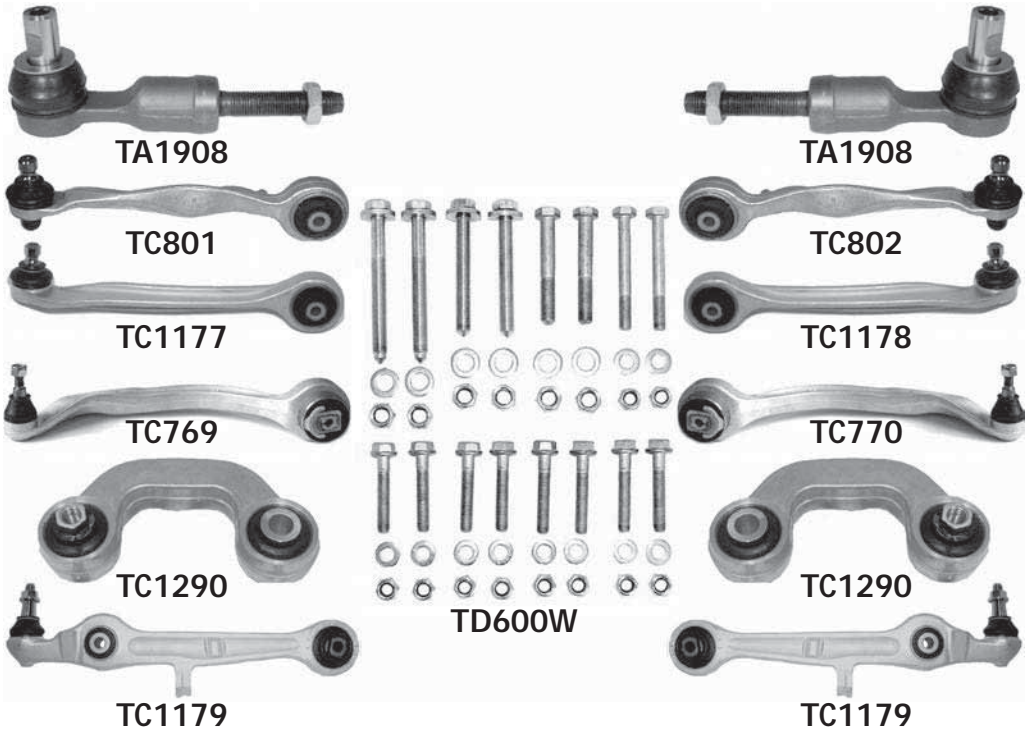

TC1600KIT

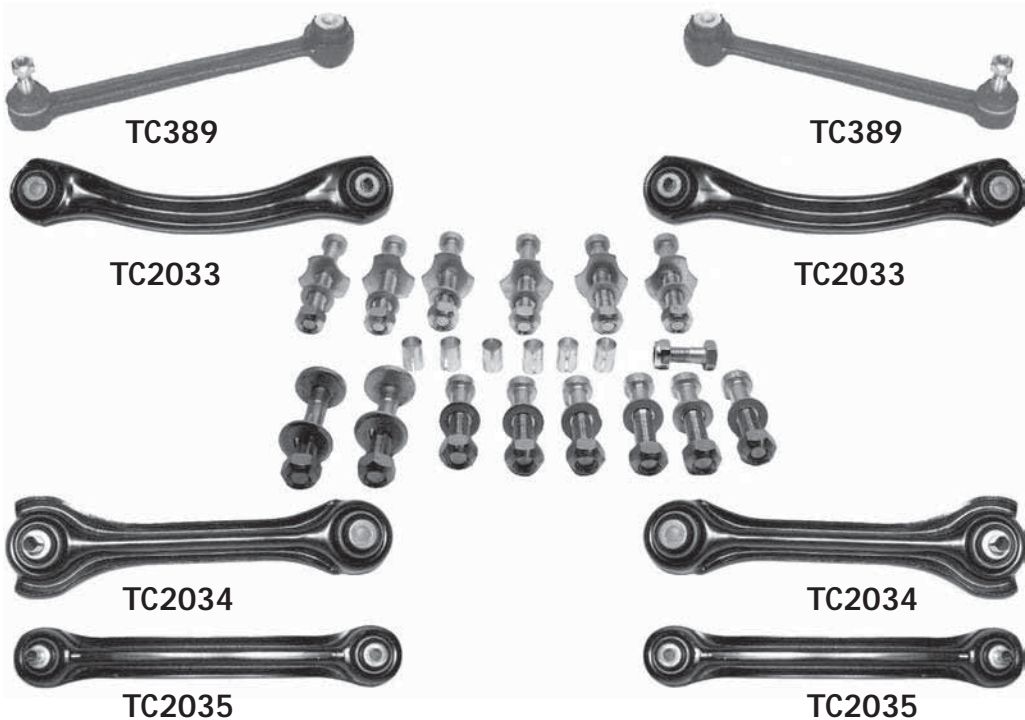

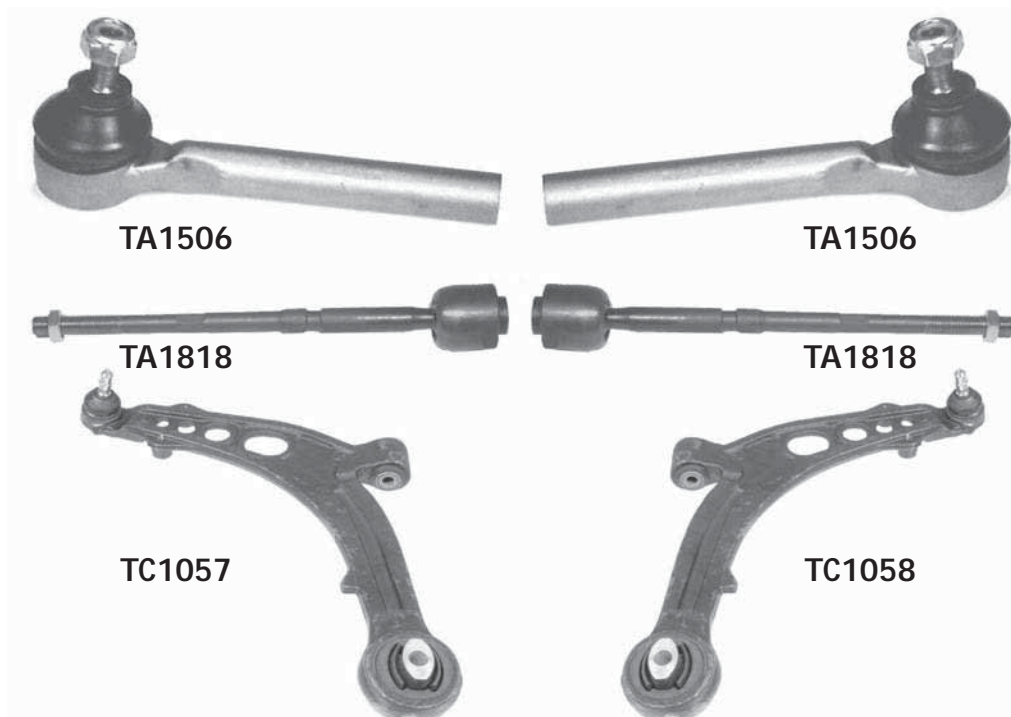
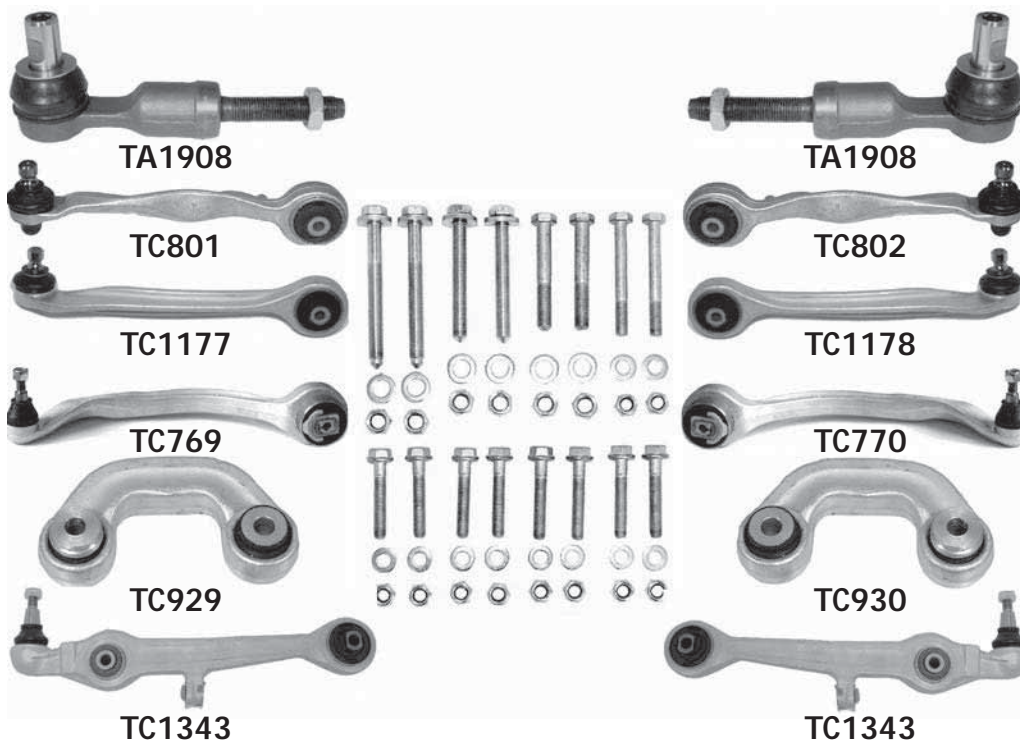

TC1970KIT

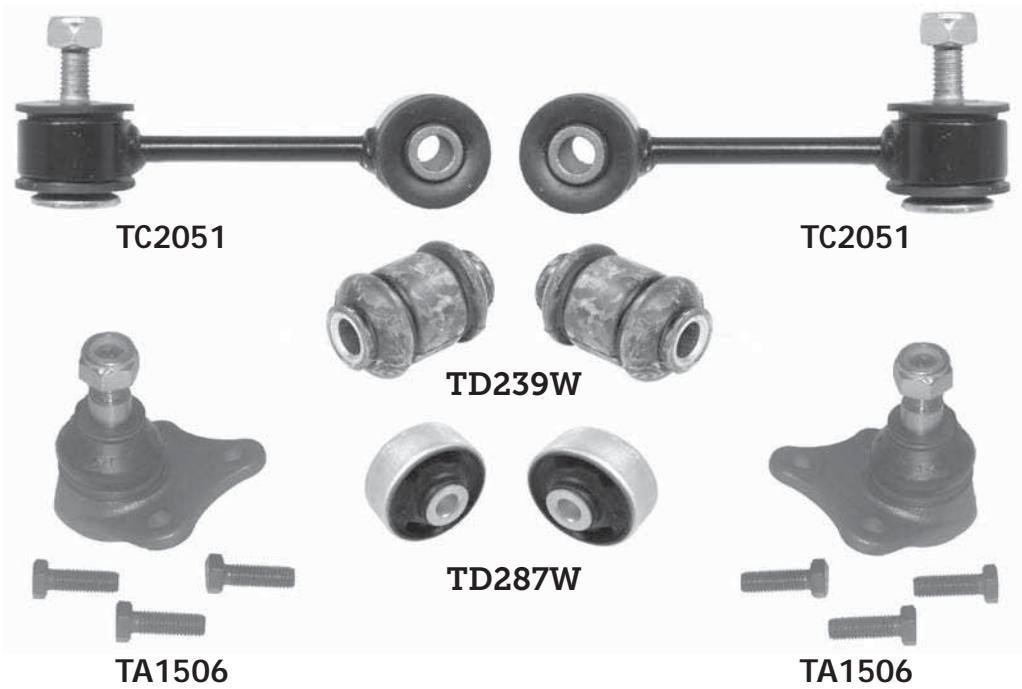

TC1980KIT

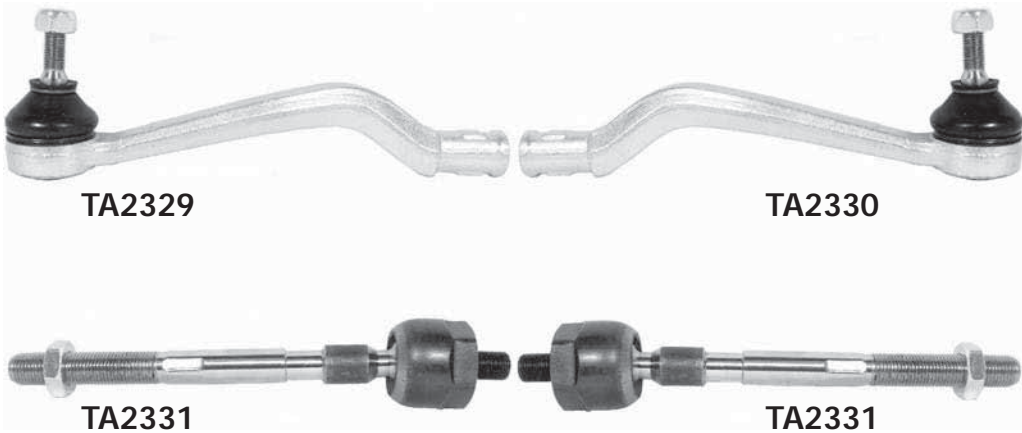



TD601W

6 x Pinch Bolts
 6 x Nuts

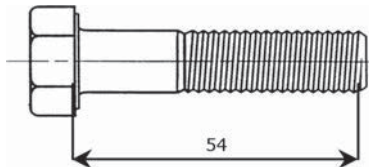

Mondeo I

02/93 - 10/00

TD602W

8 x Pinch Bolts
 8 x Nuts

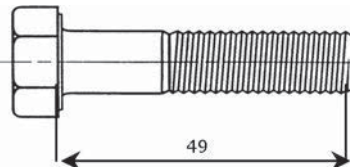

Courier I, II

10/91 →

Escort V, VI

07/90 - 07/00

Fiesta III, IV

04/89 - 04/02

Ka

09/96 →

Orion III

08/90 - 12/93

Puma

03/97 →

TD603W

4 x Location Bolts
 4 x Nuts

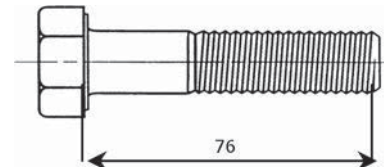

Courier I

10/91 - 10/95

Escort V, VI

07/90 - 07/00

Fiesta III

04/89 - 08/96

Ka

09/96 →

Mondeo I

02/93 - 10/00

Orion III

08/90 - 12/93



ALFA ROMEO	43	MAZDA	514
AUDI	63	MERCEDES	527
BMW	174	MINI	605
CHEVROLET	264	MITSUBISHI	632
CHRYSLER	272	NISSAN	649
CITROËN	275	OPEL	673
DACIA	320	PEUGEOT	700
DAEWOO	324	PORSCHE	749
DAIHATSU	328	PROTON	754
DODGE	330	RENAULT	755
DS	330	ROVER GROUP	805
FIAT	333	ROVER GROUP MG	807
FORD	364	SAAB	809
HONDA	411	SEAT	814
HYUNDAI	428	SKODA	849
ISUZU	453	SMART	882
IVECO	454	SSANGYONG	886
JAGUAR	455	SUBARU	887
JEEP	460	SUZUKI	892
KIA	462	TAXI	898
LADA	486	TOYOTA	899
LANCIA	486	VAUXHALL	922
LAND ROVER	491	VOLKSWAGEN	948
LDV	509	VOLVO	1055
LEXUS	509		

Applications

147 1.6i, 1.9JTD, 2.0JTS (01/01→)

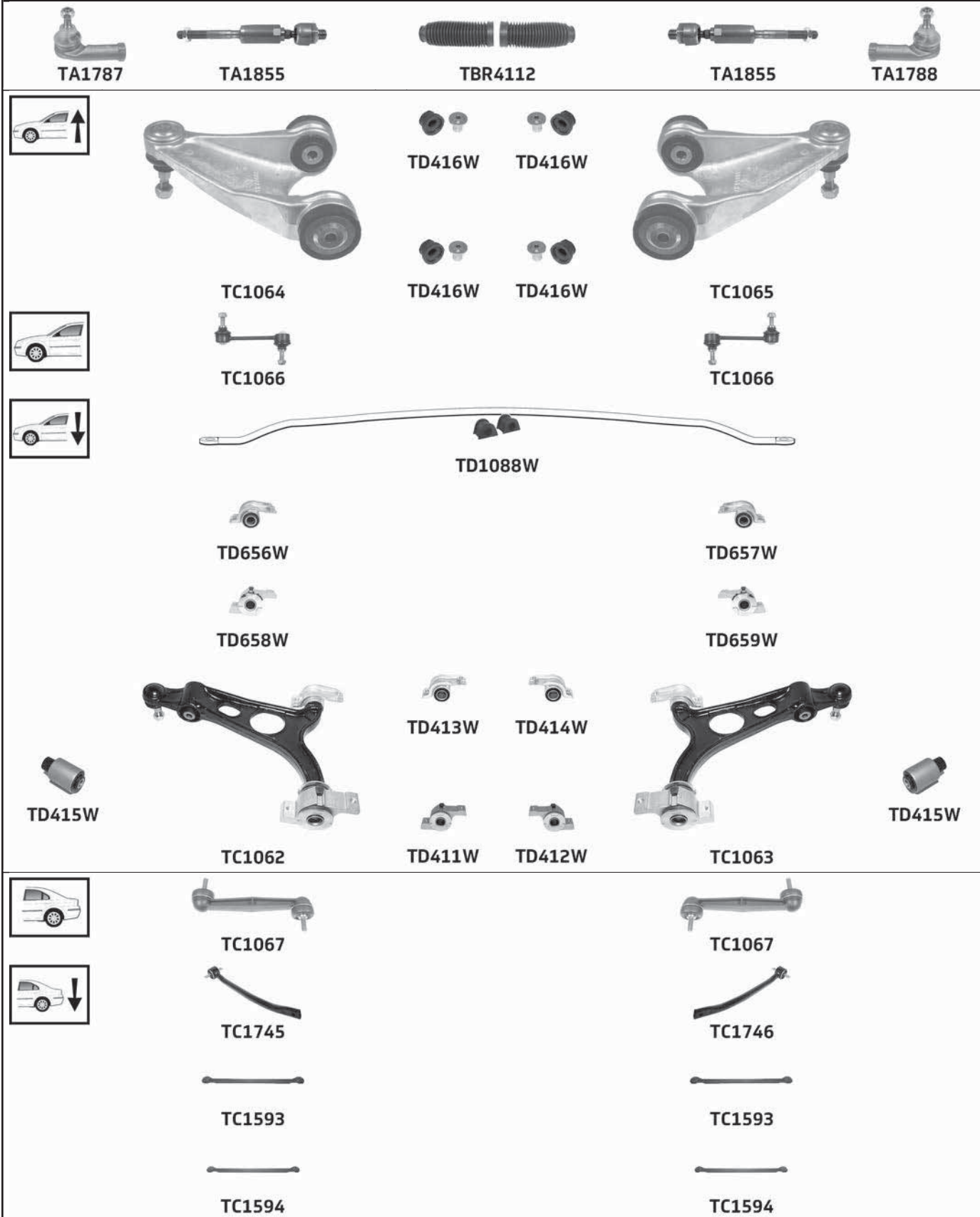

Part No	Description	Pos	Info	Technical
TA1787	Tie rod end(224)	A		M14x1.5 Female(253) £
TA1788	Tie rod end(224)	B		M14x1.5 Female(253) £
TA1855	Inner tie rod(123)	A B		M14x1.5 Male(252) £
TBR4112	Steering rack gaiter kit(213)	K	Thermoplastic(223)	1 :12x61x61 2 :12x61x61
TC1062	Lower wishbone(158)	A		M14x1.5
TC1063	Lower wishbone(158)	B		M14x1.5

ALFA ROMEO

... ALFA ROMEO

... 147 1.6i, 1.9JTD, 2.0JTS (01/01→)

Part No	Description	Pos	Info	Technical
TC1064	Upper wishbone(247)	A		M10x1.5
TC1065	Upper wishbone(247)	B		M10x1.5
TC1066	Link stabiliser(135)	A B		M10x1.25
TC1067	Link stabiliser(135)	A B		M10x1.25
TC1593	Lower track control arm(151)	A B	Front(108)	
TC1594	Lower track control arm(151)	A B	Rear(187)	
TC1745	Lower link arm(144)	A		
TC1746	Lower link arm(144)	B		
TD411W	Lower wishbone bush(159)	A	Rear(187) Ø20.9mm Not for OE wishbone(175)	Inner(119) Ø20.9mm
TD412W	Lower wishbone bush(159)	B	Rear(187) Ø20.9mm Not for OE wishbone(175)	Inner(119) Ø20.9mm
TD413W	Lower wishbone bush(159)	A	Front(108) Ø20.9mm Not for OE wishbone(175)	Inner(119) Ø20.9mm
TD414W	Lower wishbone bush(159)	B	Front(108) Ø20.9mm Not for OE wishbone(175)	Inner(119) Ø20.9mm
TD415W	Lower wishbone bush(159)	A B	Outer(176)	
TD416W	Upper wishbone bush(248)	A B	Front(108) Rear(187)	
TD656W	Lower wishbone bush(159)	A	Front(108) Ø18.9mm For OE wishbone(107)	Inner(119) Ø18.9mm
TD657W	Lower wishbone bush(159)	B	Front(108) Ø18.9mm For OE wishbone(107)	Inner(119) Ø18.9mm
TD658W	Lower wishbone bush(159)	A	Rear(187) Ø19.9mm For OE wishbone(107)	Inner(119) Ø19.9mm
TD659W	Lower wishbone bush(159)	B	Rear(187) Ø19.9mm For OE wishbone(107)	Inner(119) Ø19.9mm
TD1088W	Anti-roll bar(-74-) bush kit(-86-)	K	Ø20 Complete axle kit(-92-)	

147 3.2i (02/03-05/03)

TA1787 TA1855 TBR4112 TA1855 TA1788

TD416W TD416W

TC1064 TD416W TD416W TC1065

TC1066 TC1066

TD656W TD657W

TD658W TD659W

TD415W TD413W TD414W TD415W

TC1062 TD411W TD412W TC1063

... 147 3.2i (02/03-05/03)



TC1067



TC1067



TC1745



TC1746



TC1594



TC1594

Part No	Description	Pos	Info	Technical
TA1787	Tie rod end(224)	A		M14x1.5 Female(253) £
TA1788	Tie rod end(224)	B		M14x1.5 Female(253) £
TA1855	Inner tie rod(123)	A B		M14x1.5 Male(252) £
TBR4112	Steering rack gaiter kit(213)	K	Thermoplastic(223)	1 :12x61x61 2 :12x61x61
TC1062	Lower wishbone(158)	A		M14x1.5
TC1063	Lower wishbone(158)	B		M14x1.5
TC1064	Upper wishbone(247)	A		M10x1.5
TC1065	Upper wishbone(247)	B		M10x1.5
TC1066	Link stabiliser(135)	A B		M10x1.25
TC1067	Link stabiliser(135)	A B		M10x1.25
TC1594	Lower track control arm(151)	A B	Rear(187)	
TC1745	Lower link arm(144)	A		
TC1746	Lower link arm(144)	B		
TD411W	Lower wishbone bush(159)	A	Rear(187) Ø20.9mm Not for OE wishbone(175)	Inner(119) Ø20.9mm
TD412W	Lower wishbone bush(159)	B	Rear(187) Ø20.9mm Not for OE wishbone(175)	Inner(119) Ø20.9mm
TD413W	Lower wishbone bush(159)	A	Front(108) Ø20.9mm Not for OE wishbone(175)	Inner(119) Ø20.9mm
TD414W	Lower wishbone bush(159)	B	Front(108) Ø20.9mm Not for OE wishbone(175)	Inner(119) Ø20.9mm
TD415W	Lower wishbone bush(159)	A B	Outer(176)	
TD416W	Upper wishbone bush(248)	A B	Front(108) Rear(187)	
TD656W	Lower wishbone bush(159)	A	Front(108) Ø18.9mm For OE wishbone(107)	Inner(119) Ø18.9mm
TD657W	Lower wishbone bush(159)	B	Front(108) Ø18.9mm For OE wishbone(107)	Inner(119) Ø18.9mm
TD658W	Lower wishbone bush(159)	A	Rear(187) Ø19.9mm For OE wishbone(107)	Inner(119) Ø19.9mm
TD659W	Lower wishbone bush(159)	B	Rear(187) Ø19.9mm For OE wishbone(107)	Inner(119) Ø19.9mm

... ALFA ROMEO

147 3.2i (06/03→)

ALFA ROMEO

TA1787	TA1855	TBR4112	TA1855	TA1788
	TC1064	TD416W	TD416W	TC1065
	TC1066	TD416W	TD416W	TC1066
	TD656W	TD657W	TD659W	
	TD658W	TD413W	TD414W	
TD415W	TC1062	TD411W	TD412W	TC1063
	TC1067	TC1067		
	TC1745	TC1746		
	TC1593	TC1593		
	TC1594	TC1594		
Part No	Description	Pos	Info	Technical
TA1787	Tie rod end(224)	A		M14x1.5 Female(253) £
TA1788	Tie rod end(224)	B		M14x1.5 Female(253) £
TA1855	Inner tie rod(123)	A B		M14x1.5 Male(252) £
TBR4112	Steering rack gaiter kit(213)	K	Thermoplastic(223)	1 :12x61x61 2 :12x61x61
TC1062	Lower wishbone(158)	A		M14x1.5
TC1063	Lower wishbone(158)	B		M14x1.5
TC1064	Upper wishbone(247)	A		M10x1.5
TC1065	Upper wishbone(247)	B		M10x1.5
TC1066	Link stabiliser(135)	A B		M10x1.25
TC1067	Link stabiliser(135)	A B		M10x1.25
TC1593	Lower track control arm(151)	A B	Front(108)	

... 147 3.2i (06/03→)

Part No	Description	Pos	Info	Technical
TC1594	Lower track control arm(151)	A B	Rear(187)	
TC1745	Lower link arm(144)	A		
TC1746	Lower link arm(144)	B		
TD411W	Lower wishbone bush(159)	A	Rear(187) Ø20.9mm Not for OE wishbone(175)	Inner(119) Ø20.9mm
TD412W	Lower wishbone bush(159)	B	Rear(187) Ø20.9mm Not for OE wishbone(175)	Inner(119) Ø20.9mm
TD413W	Lower wishbone bush(159)	A	Front(108) Ø20.9mm Not for OE wishbone(175)	Inner(119) Ø20.9mm
TD414W	Lower wishbone bush(159)	B	Front(108) Ø20.9mm Not for OE wishbone(175)	Inner(119) Ø20.9mm
TD415W	Lower wishbone bush(159)	A B	Outer(176)	
TD416W	Upper wishbone bush(248)	A B	Front(108) Rear(187)	
TD656W	Lower wishbone bush(159)	A	Front(108) Ø18.9mm For OE wishbone(107)	Inner(119) Ø18.9mm
TD657W	Lower wishbone bush(159)	B	Front(108) Ø18.9mm For OE wishbone(107)	Inner(119) Ø18.9mm
TD658W	Lower wishbone bush(159)	A	Rear(187) Ø19.9mm For OE wishbone(107)	Inner(119) Ø19.9mm
TD659W	Lower wishbone bush(159)	B	Rear(187) Ø19.9mm For OE wishbone(107)	Inner(119) Ø19.9mm

156 1.6i, 1.8i, 1.9JTD, 2.0i, 2.0JTS, 2.4JTD, 2.5i (09/97-05/06)

TA1787 TA1892 TBR4112 TA1892 TA1788

↑

TC1064 TD416W TD416W TC1065

TD416W TD416W

↔

TC1066 TC1066

↓

TD1088W

TD656W TD657W

TD658W TD659W

TD413W TD414W

TD415W TC1062 TD411W TD412W TC1063 TD415W

ALFA ROMEO

... ALFA ROMEO

... 156 1.6i, 1.8i, 1.9JTD, 2.0i, 2.0JTS, 2.4JTD, 2.5i (09/97-05/06)



TC1067



TC1067



TC1745



TC1746



TC1593



TC1593



TC1594



TC1594

Part No	Description	Pos	Info	Technical
TA1787	Tie rod end(224)	A		M14x1.5 Female(253) £
TA1788	Tie rod end(224)	B		M14x1.5 Female(253) £
TA1892	Inner tie rod(123)	A B		M14x1.5 Male(252) £
TBR4112	Steering rack gaiter kit(213)	K	Thermoplastic(223)	1 :12x61x61 2 :12x61x61
TC1062	Lower wishbone(158)	A		M14x1.5
TC1063	Lower wishbone(158)	B		M14x1.5
TC1064	Upper wishbone(247)	A		M10x1.5
TC1065	Upper wishbone(247)	B		M10x1.5
TC1066	Link stabiliser(135)	A B		M10x1.25
TC1067	Link stabiliser(135)	A B		M10x1.25
TC1593	Lower track control arm(151)	A B	Front(108)	
TC1594	Lower track control arm(151)	A B	Rear(187)	
TC1745	Lower link arm(144)	A		
TC1746	Lower link arm(144)	B		
TD411W	Lower wishbone bush(159)	A	Rear(187) Ø20.9mm Not for OE wishbone(175)	Inner(119) Ø20.9mm
TD412W	Lower wishbone bush(159)	B	Rear(187) Ø20.9mm Not for OE wishbone(175)	Inner(119) Ø20.9mm
TD413W	Lower wishbone bush(159)	A	Front(108) Ø20.9mm Not for OE wishbone(175)	Inner(119) Ø20.9mm
TD414W	Lower wishbone bush(159)	B	Front(108) Ø20.9mm Not for OE wishbone(175)	Inner(119) Ø20.9mm
TD415W	Lower wishbone bush(159)	A B	Outer(176)	
TD416W	Upper wishbone bush(248)	A B	Front(108) Rear(187)	
TD656W	Lower wishbone bush(159)	A	Front(108) Ø18.9mm For OE wishbone(107)	Inner(119) Ø18.9mm
TD657W	Lower wishbone bush(159)	B	Front(108) Ø18.9mm For OE wishbone(107)	Inner(119) Ø18.9mm
TD658W	Lower wishbone bush(159)	A	Rear(187) Ø19.9mm For OE wishbone(107)	Inner(119) Ø19.9mm
TD659W	Lower wishbone bush(159)	B	Rear(187) Ø19.9mm For OE wishbone(107)	Inner(119) Ø19.9mm
TD1088W	Anti-roll bar(-74) bush kit(-86-)	K	Ø20 Complete axle kit(-92-) 11/00 →	

159 1.8i, 1.9JTD, 1.9JTS, 2.2JTS, 2.4JTD, 3.2JTS (09/05-02/09)

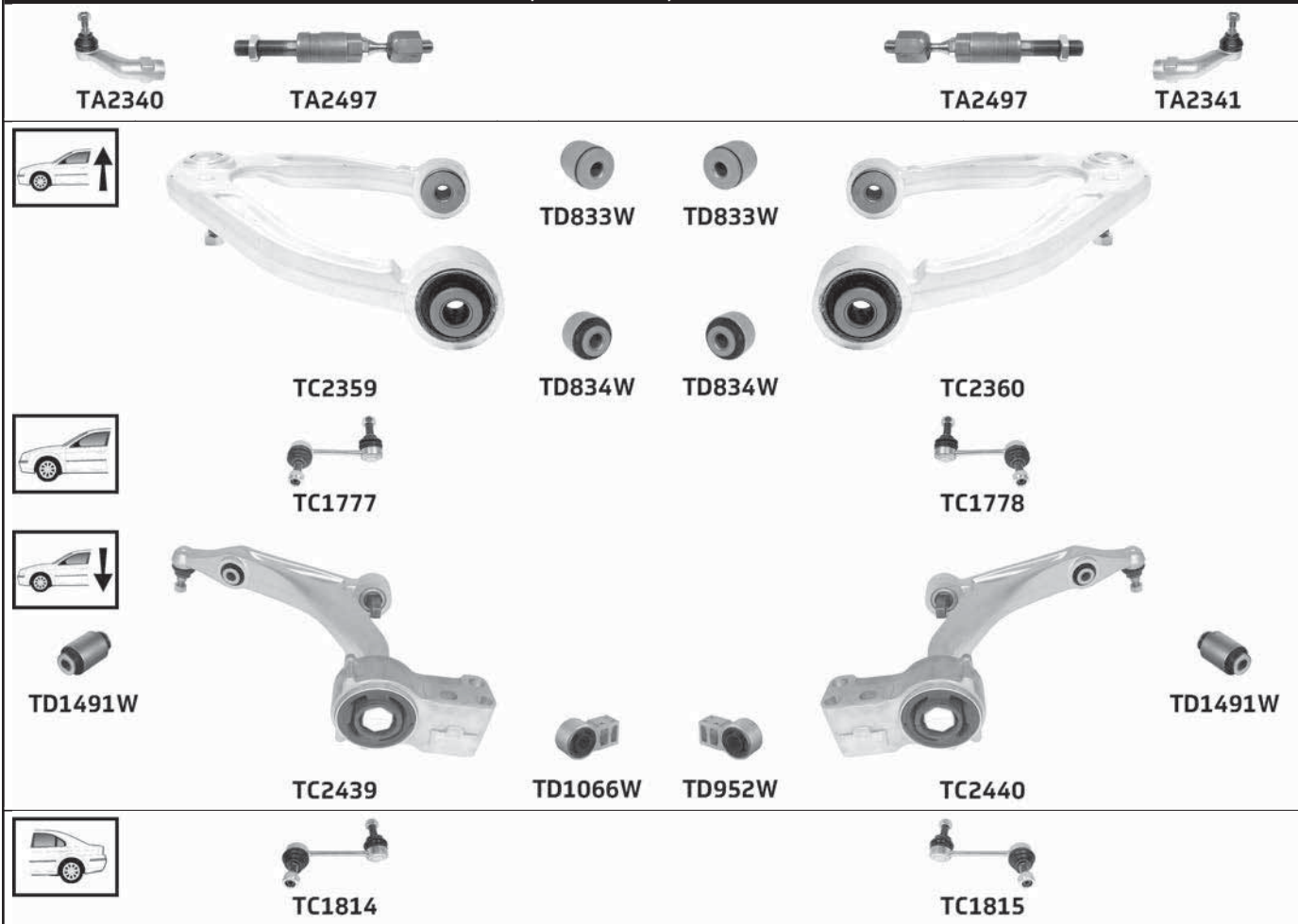

Part No	Description	Pos	Info	Technical
TA2340	Tie rod end (224)	A		M20x1.5 Female (253) £
TA2341	Tie rod end (224)	B		M20x1.5 Female (253) £
TA2497	Inner tie rod (123)	A B	Replace in pairs (192)	M20x1.5 Male (252) £
TC1777	Link stabiliser (135)	A		M12x1.75
TC1778	Link stabiliser (135)	B		M12x1.75
TC1814	Link stabiliser (135)	A		M12x1.75
TC1815	Link stabiliser (135)	B		M12x1.75
TC2359	Upper wishbone (247)	A		M10x1.25
TC2360	Upper wishbone (247)	B		M10x1.25
TC2439	Lower wishbone (158)	A		M14x1.5
TC2440	Lower wishbone (158)	B		M14x1.5
TD833W	Upper wishbone bush (248)	A B	Front (108)	
TD834W	Upper wishbone bush (248)	A B	Rear (187)	
TD952W	Lower wishbone bush (159)	B	Rear (187) (+) Housing (-48)	
TD1066W	Lower wishbone bush (159)	A	Rear (187) (+) Housing (-48)	
TD1491W	Lower wishbone bush (159)	A B	Outer (176)	

ALFA ROMEO

... ALFA ROMEO

159 1.8i, 1.9JTD, 1.9JTS, 2.0JTD, 2.2JTS, 2.4JTD, 3.2JTS (02/09-11/11)



Part No	Description	Pos	Info	Technical
TA2340	Tie rod end(224)	A		M20x1.5 Female(253) £
TA2341	Tie rod end(224)	B		M20x1.5 Female(253) £
TA2497	Inner tie rod(123)	A B	Replace in pairs(192)	M20x1.5 Male(252) £
TC1777	Link stabiliser(135)	A		M12x1.75
TC1778	Link stabiliser(135)	B		M12x1.75
TC1814	Link stabiliser(135)	A		M12x1.75
TC1815	Link stabiliser(135)	B		M12x1.75
TC2439	Lower wishbone(158)	A		M14x1.5
TC2440	Lower wishbone(158)	B		M14x1.5
TC3491	Upper wishbone(247)	A		M10 x 1.25
TC3492	Upper wishbone(247)	B		M10 x 1.25
TD952W	Lower wishbone bush(159)	B	Rear(187) (+) Housing(-48)	
TD1066W	Lower wishbone bush(159)	A	Rear(187) (+) Housing(-48)	
TD1491W	Lower wishbone bush(159)	A B	Outer(176)	

166 2.0i, 2.4JTD, 2.5i, 3.0i (09/98-06/07)

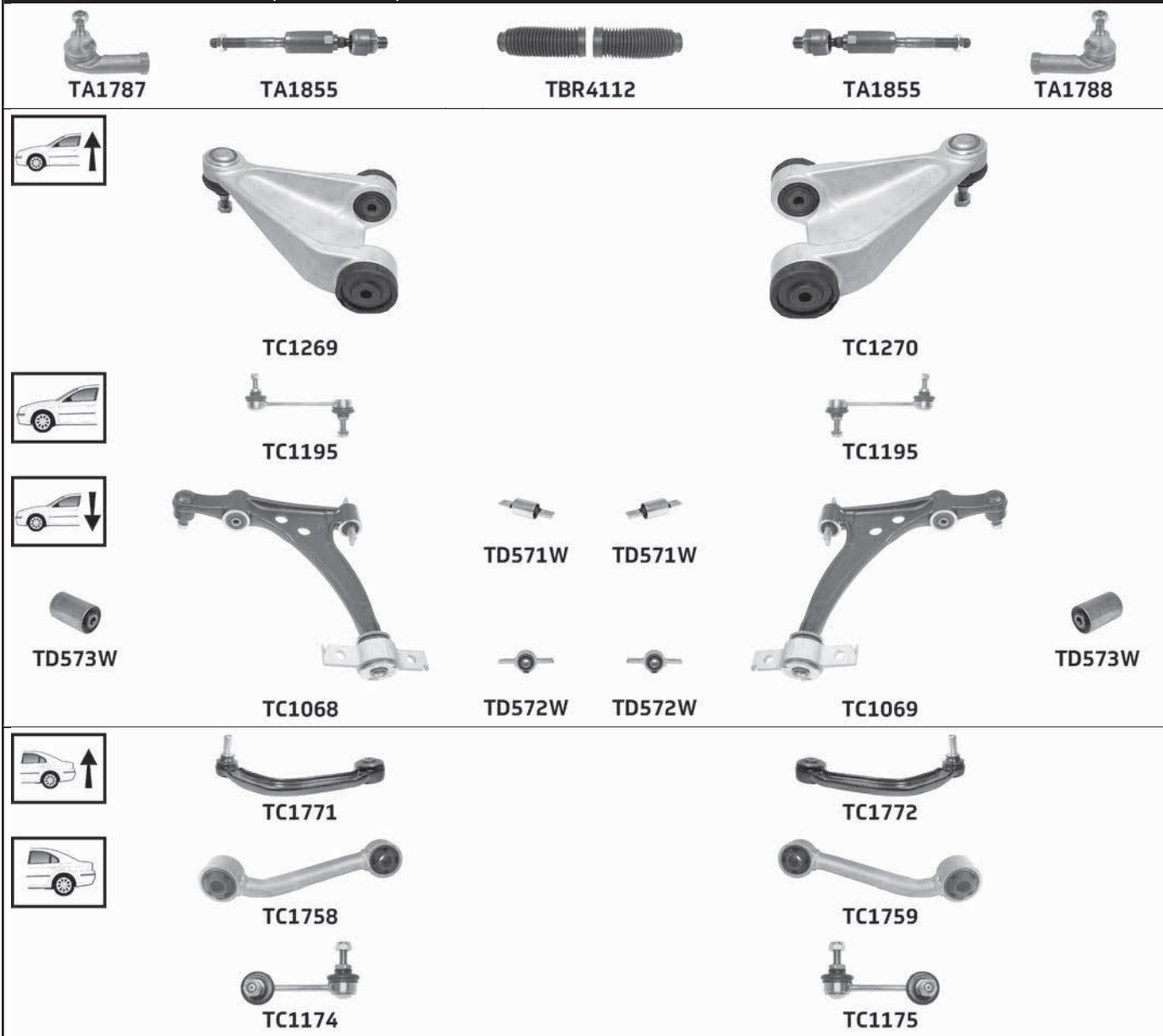

Part No	Description	Pos	Info	Technical
TA1787	Tie rod end(224)	A		M14x1.5 Female(253) £
TA1788	Tie rod end(224)	B		M14x1.5 Female(253) £
TA1855	Inner tie rod(123)	A B		M14x1.5 Male(252) £
TBR4112	Steering rack gaiter kit(213)	K	Thermoplastic(223)	1 :12x61x61 2 :12x61x61
TC1068	Lower wishbone(158)	A		M14x1.5
TC1069	Lower wishbone(158)	B		M14x1.5
TC1174	Link stabiliser(135)	A		M10x1.25
TC1175	Link stabiliser(135)	B		M10x1.25
TC1195	Link stabiliser(135)	A B		M10x1.25
TC1269	Upper wishbone(247)	A		M10x1.25
TC1270	Upper wishbone(247)	B		M10x1.25
TC1758	Link arm(133)	A		
TC1759	Link arm(133)	B		
TC1771	Upper track control arm(242)	A		M12x1.25
TC1772	Upper track control arm(242)	B		M12x1.25
TD571W	Lower wishbone bush(159)	A B	Front(108)	
TD572W	Lower wishbone bush(159)	A B	Rear(187)	
TD573W	Lower wishbone bush(159)	A B	Outer(176)	

ALFA ROMEO

... ALFA ROMEO

BRERA 2.0JTD, 2.2JTS, 2.4JTD, 3.2JTS (01/06-02/09)



Part No	Description	Pos	Info	Technical
TA2340	Tie rod end(224)	A		M20x1.5 Female(253) £
TA2341	Tie rod end(224)	B		M20x1.5 Female(253) £
TA2497	Inner tie rod(123)	A B	Replace in pairs(192)	M20x1.5 Male(252) £
TC1777	Link stabiliser(135)	A		M12x1.75
TC1778	Link stabiliser(135)	B		M12x1.75
TC1814	Link stabiliser(135)	A		M12x1.75
TC1815	Link stabiliser(135)	B		M12x1.75
TC2359	Upper wishbone(247)	A		M10x1.25
TC2360	Upper wishbone(247)	B		M10x1.25
TC2439	Lower wishbone(158)	A		M14x1.5
TC2440	Lower wishbone(158)	B		M14x1.5
TD833W	Upper wishbone bush(248)	A B	Front(108)	
TD834W	Upper wishbone bush(248)	A B	Rear(187)	
TD952W	Lower wishbone bush(159)	B	Rear(187) (+) Housing(-48-)	
TD1066W	Lower wishbone bush(159)	A	Rear(187) (+) Housing(-48-)	
TD1491W	Lower wishbone bush(159)	A B	Outer(176)	

BRERA 1.8Tbi, 2.0JTD, 2.2JTS, 2.4JTD, 3.2JTS (02/09→)

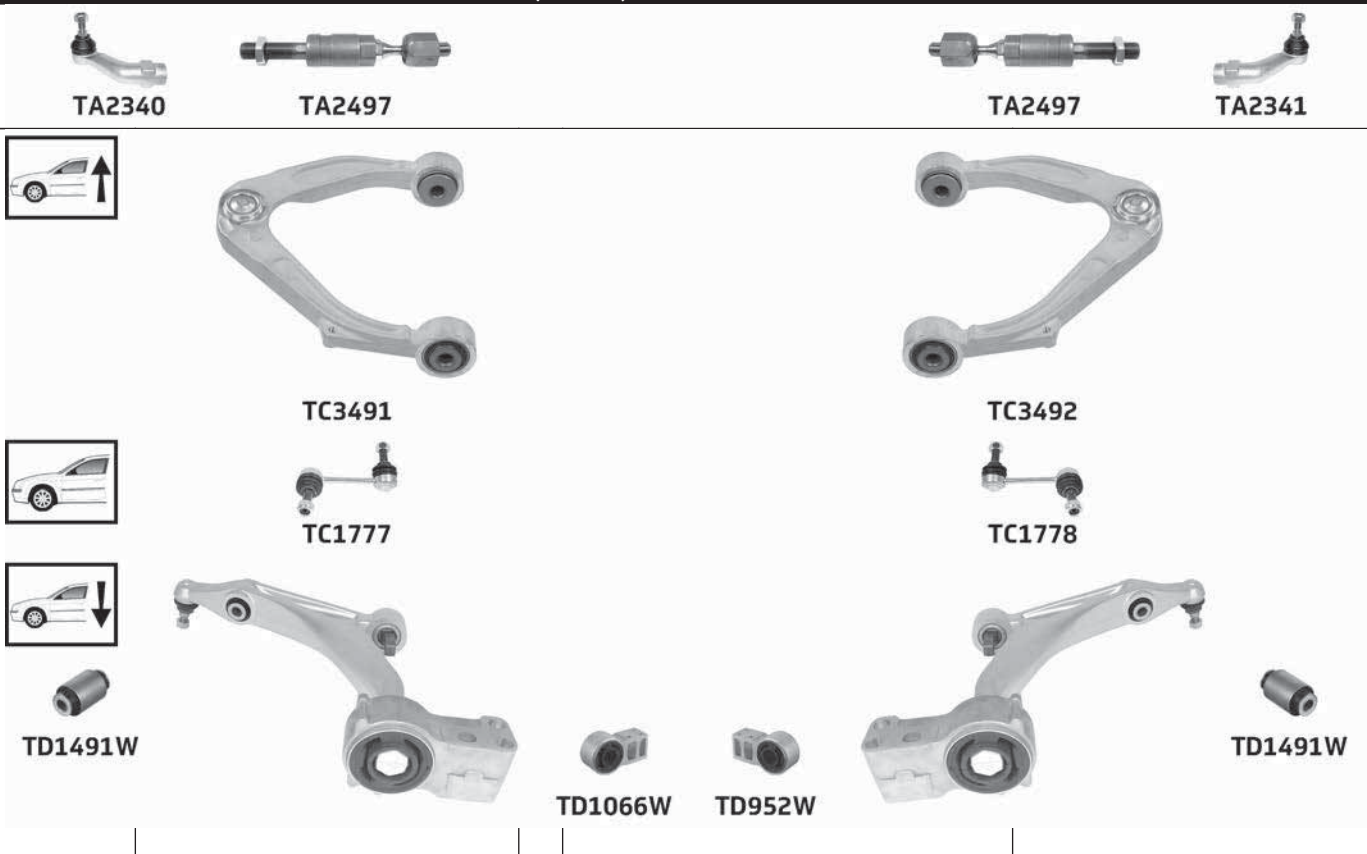

Part No	Description	Pos	Info	Technical
TA2340	Tie rod end(224)	A		M20x1.5 Female(253) £
TA2341	Tie rod end(224)	B		M20x1.5 Female(253) £
TA2497	Inner tie rod(123)	A B	Replace in pairs(192)	M20x1.5 Male(252) £
TC1777	Link stabiliser(135)	A		M12x1.75
TC1778	Link stabiliser(135)	B		M12x1.75
TC1814	Link stabiliser(135)	A		M12x1.75
TC1815	Link stabiliser(135)	B		M12x1.75
TC2439	Lower wishbone(158)	A		M14x1.5
TC2440	Lower wishbone(158)	B		M14x1.5
TC3491	Upper wishbone(247)	A		M10 x 1.25
TC3492	Upper wishbone(247)	B		M10 x 1.25
TD952W	Lower wishbone bush(159)	B	Rear(187) (+) Housing(-48-)	
TD1066W	Lower wishbone bush(159)	A	Rear(187) (+) Housing(-48-)	
TD1491W	Lower wishbone bush(159)	A B	Outer(176)	

ALFA ROMEO

... ALFA ROMEO

GIULIETTA 1.4i, 1.6JTD, 1.8i, 2.0JTD (04/10→)



Part No	Description	Pos	Info	Technical
TA3027	Tie rod end(224)	B		M16x1.5 Female(253) £
TA3028	Tie rod end(224)	A		M16x1.5 Female(253) £
TC1806	Link stabiliser(135)	A B		M10x1.5
TC2678	Lower ball joint(140)	A B		Pinch Bolt(255) 19mm
TC2861	Lower wishbone(158)	A	→Vet 7034861	Pinch Bolt(255) 19mm
TC2862	Lower wishbone(158)	B	→Vet 7034861	Pinch Bolt(255) 19mm
TC3346	Link stabiliser(135)	A		M10x1.25
TC3347	Link stabiliser(135)	B		M10x1.25

GT 1.8i, 1.9JTD, 2.0JTS (11/03-09/10)



... GT 1.8i, 1.9JTD, 2.0JTS (11/03-09/10)

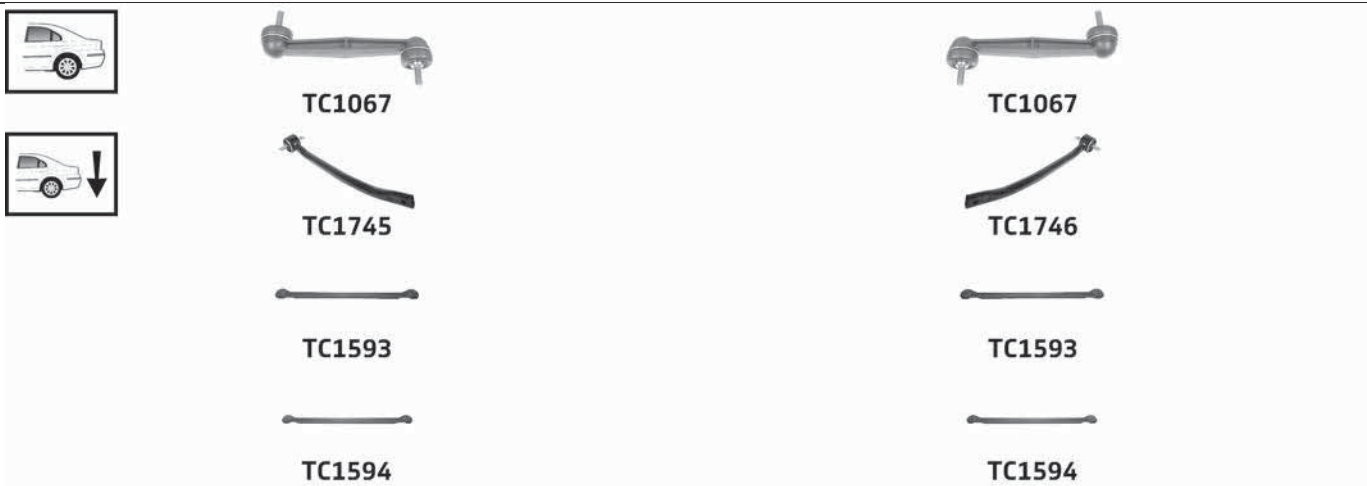
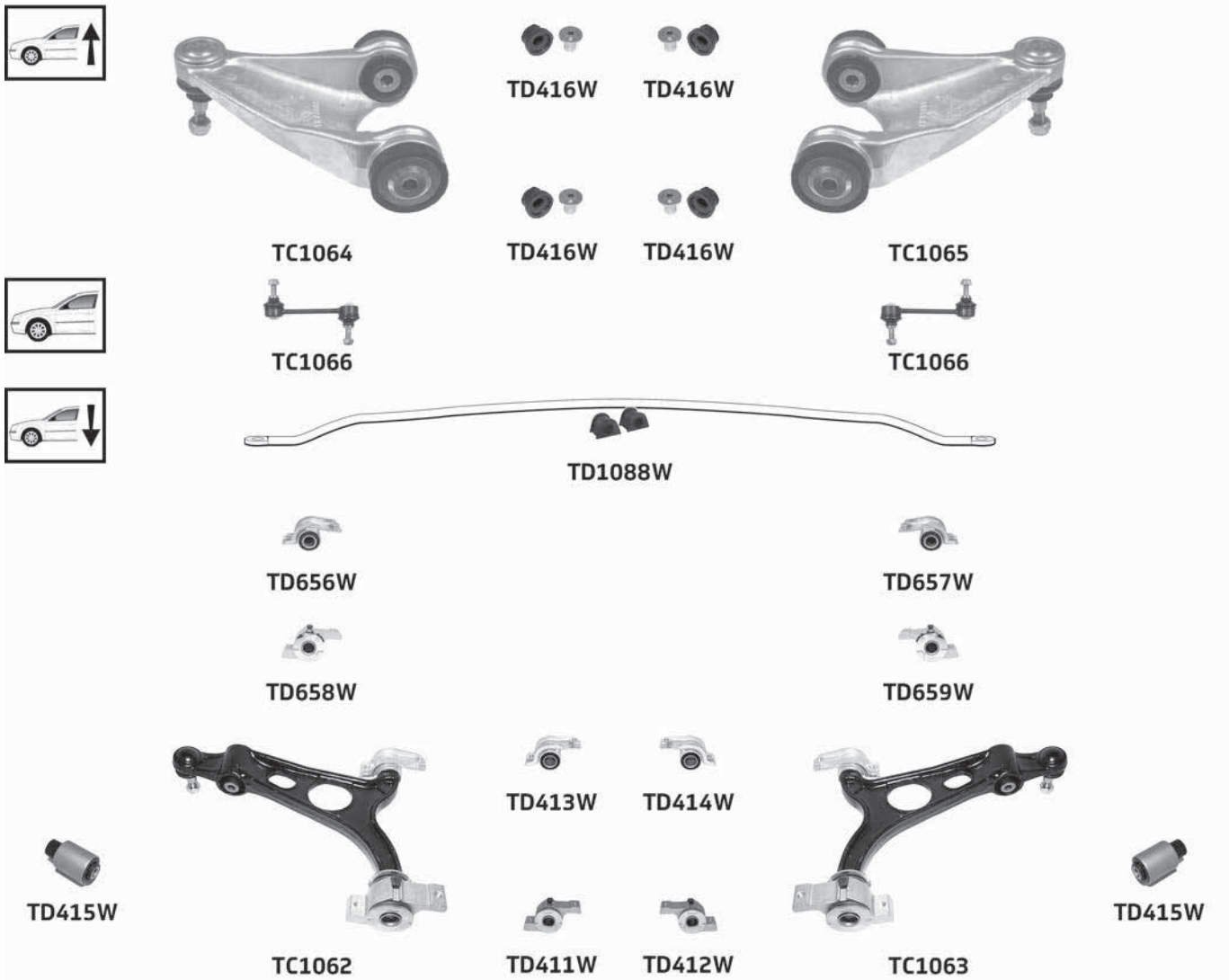

Part No	Description	Pos	Info	Technical
TA1787	Tie rod end(224)	A		M14x1.5 Female(253) £
TA1788	Tie rod end(224)	B		M14x1.5 Female(253) £
TA1855	Inner tie rod(123)	A B		M14x1.5 Male(252) £
TBR4112	Steering rack gaiter kit(213)	K	Thermoplastic(223)	1 :12x61x61 2 :12x61x61
TC1062	Lower wishbone(158)	A		M14x1.5
TC1063	Lower wishbone(158)	B		M14x1.5
TC1064	Upper wishbone(247)	A		M10x1.5
TC1065	Upper wishbone(247)	B		M10x1.5
TC1066	Link stabiliser(135)	A B		M10x1.25
TC1067	Link stabiliser(135)	A B		M10x1.25
TC1593	Lower track control arm(151)	A B	Front(108)	

(...)

... ALFA ROMEO

... GT 1.8i, 1.9JTD, 2.0JTS (11/03-09/10)

Part No	Description	Pos	Info	Technical
TC1594	Lower track control arm(151)	A B	Rear(187)	
TC1745	Lower link arm(144)	A		
TC1746	Lower link arm(144)	B		
TD411W	Lower wishbone bush(159)	A	Rear(187) Ø20.9mm Not for OE wishbone(175)	Inner(119) Ø20.9mm
TD412W	Lower wishbone bush(159)	B	Rear(187) Ø20.9mm Not for OE wishbone(175)	Inner(119) Ø20.9mm
TD413W	Lower wishbone bush(159)	A	Front(108) Ø20.9mm Not for OE wishbone(175)	Inner(119) Ø20.9mm
TD414W	Lower wishbone bush(159)	B	Front(108) Ø20.9mm Not for OE wishbone(175)	Inner(119) Ø20.9mm
TD415W	Lower wishbone bush(159)	A B	Outer(176)	
TD416W	Upper wishbone bush(248)	A B	Front(108) Rear(187)	
TD656W	Lower wishbone bush(159)	A	Front(108) Ø18.9mm For OE wishbone(107)	Inner(119) Ø18.9mm
TD657W	Lower wishbone bush(159)	B	Front(108) Ø18.9mm For OE wishbone(107)	Inner(119) Ø18.9mm
TD658W	Lower wishbone bush(159)	A	Rear(187) Ø19.9mm For OE wishbone(107)	Inner(119) Ø19.9mm
TD659W	Lower wishbone bush(159)	B	Rear(187) Ø19.9mm For OE wishbone(107)	Inner(119) Ø19.9mm
TD1088W	Anti-roll bar(-74-) bush kit(-86-)	K	Ø20 Complete axle kit(-92-) (-) Q2	

GT 3.2i (11/03-09/10)

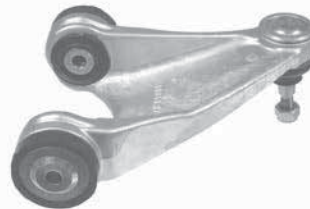
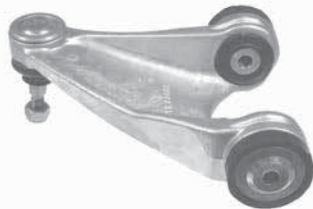

TC1062



TC1063



... GT 3.2i (11/03-09/10)

Part No	Description	Pos	Info	Technical
TA1787	Tie rod end(224)	A		M14x1.5 Female(253) £
TA1788	Tie rod end(224)	B		M14x1.5 Female(253) £
TA1855	Inner tie rod(123)	A B		M14x1.5 Male(252) £
TBR4112	Steering rack gaiter kit(213)	K	Thermoplastic(223)	1 :12x61x61 2 :12x61x61
TC1062	Lower wishbone(158)	A		M14x1.5
TC1063	Lower wishbone(158)	B		M14x1.5
TC1064	Upper wishbone(247)	A		M10x1.5
TC1065	Upper wishbone(247)	B		M10x1.5
TC1066	Link stabiliser(135)	A B		M10x1.25
TC1067	Link stabiliser(135)	A B		M10x1.25
TC1594	Lower track control arm(151)	A B	Rear(187)	
TC1745	Lower link arm(144)	A		
TC1746	Lower link arm(144)	B		
TD411W	Lower wishbone bush(159)	A	Rear(187) Ø20.9mm Not for OE wishbone(175)	Inner(119) Ø20.9mm
TD412W	Lower wishbone bush(159)	B	Rear(187) Ø20.9mm Not for OE wishbone(175)	Inner(119) Ø20.9mm
TD413W	Lower wishbone bush(159)	A	Front(108) Ø20.9mm Not for OE wishbone(175)	Inner(119) Ø20.9mm
TD414W	Lower wishbone bush(159)	B	Front(108) Ø20.9mm Not for OE wishbone(175)	Inner(119) Ø20.9mm
TD415W	Lower wishbone bush(159)	A B	Outer(176)	
TD416W	Upper wishbone bush(248)	A B	Front(108) Rear(187)	
TD656W	Lower wishbone bush(159)	A	Front(108) Ø18.9mm For OE wishbone(107)	Inner(119) Ø18.9mm
TD657W	Lower wishbone bush(159)	B	Front(108) Ø18.9mm For OE wishbone(107)	Inner(119) Ø18.9mm
TD658W	Lower wishbone bush(159)	A	Rear(187) Ø19.9mm For OE wishbone(107)	Inner(119) Ø19.9mm
TD659W	Lower wishbone bush(159)	B	Rear(187) Ø19.9mm For OE wishbone(107)	Inner(119) Ø19.9mm

GTV 1.8i, 2.0i (-) V6 Turbo (06/95-10/05)



Part No	Description	Pos	Info	Technical
TA1692	Tie rod end(224)	A B		M14x1.5 Female(253) £
TA1887	Inner tie rod(123)	A B		M14x1.5 Male(252) £
TC894	Lower wishbone(158)	A		Pinch Bolt(255) 17mm
TC895	Lower wishbone(158)	B		Pinch Bolt(255) 17mm
TC2102	Link stabiliser(135)	A B		
TD378W	Lower wishbone bush(159)	A B	Front(108)	
TD381W	Lower wishbone bush(159)	A	Rear(187)	
TD382W	Lower wishbone bush(159)	B	Rear(187)	

... ALFA ROMEO

GTV 2.0i V6 Turbo (06/95-10/05)

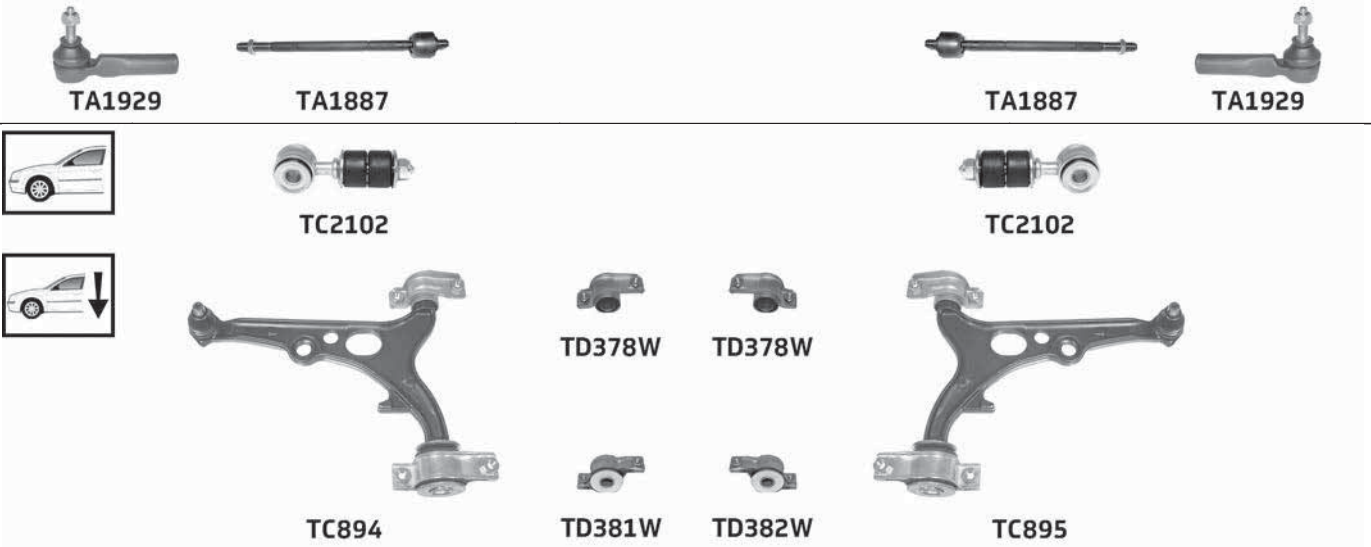

Part No	Description	Pos	Info	Technical
TA1887	Inner tie rod(123)	A B		M14x1.5 Male(252) £
TA1929	Tie rod end(224)	A B		M14x1.5 Female(253) £
TC894	Lower wishbone(158)	A		Pinch Bolt(255) 17mm
TC895	Lower wishbone(158)	B		Pinch Bolt(255) 17mm
TC2102	Link stabiliser(135)	A B		
TD378W	Lower wishbone bush(159)	A B	Front(108)	
TD381W	Lower wishbone bush(159)	A	Rear(187)	
TD382W	Lower wishbone bush(159)	B	Rear(187)	

GTV 2.0JTS (04/03-10/05)



Part No	Description	Pos	Info	Technical
TA1692	Tie rod end(224)	A B		M14x1.5 Female(253) £
TA1887	Inner tie rod(123)	A B		M14x1.5 Male(252) £
TC894	Lower wishbone(158)	A		Pinch Bolt(255) 17mm
TC895	Lower wishbone(158)	B		Pinch Bolt(255) 17mm
TC2195	Link stabiliser(135)	A B		M10x1.5
TD378W	Lower wishbone bush(159)	A B	Front(108)	
TD381W	Lower wishbone bush(159)	A	Rear(187)	
TD382W	Lower wishbone bush(159)	B	Rear(187)	

GTV 3.0i V6 24v, 3.2i V6 24v (10/96-10/05)



Part No	Description	Pos	Info	Technical
TA1887	Inner tie rod(123)	A B		M14x1.5 Male(252) £
TA1929	Tie rod end(224)	A B		M14x1.5 Female(253) £
TC894	Lower wishbone(158)	A		Pinch Bolt(255) 17mm
TC895	Lower wishbone(158)	B		Pinch Bolt(255) 17mm
TC2195	Link stabiliser(135)	A B		M10x1.5
TD378W	Lower wishbone bush(159)	A B	Front(108)	
TD381W	Lower wishbone bush(159)	A	Rear(187)	
TD382W	Lower wishbone bush(159)	B	Rear(187)	

MiTo 900cc, 1.3JTD, 1.4, 1.4i 16v Turbo, 1.6JTD (06/08→)

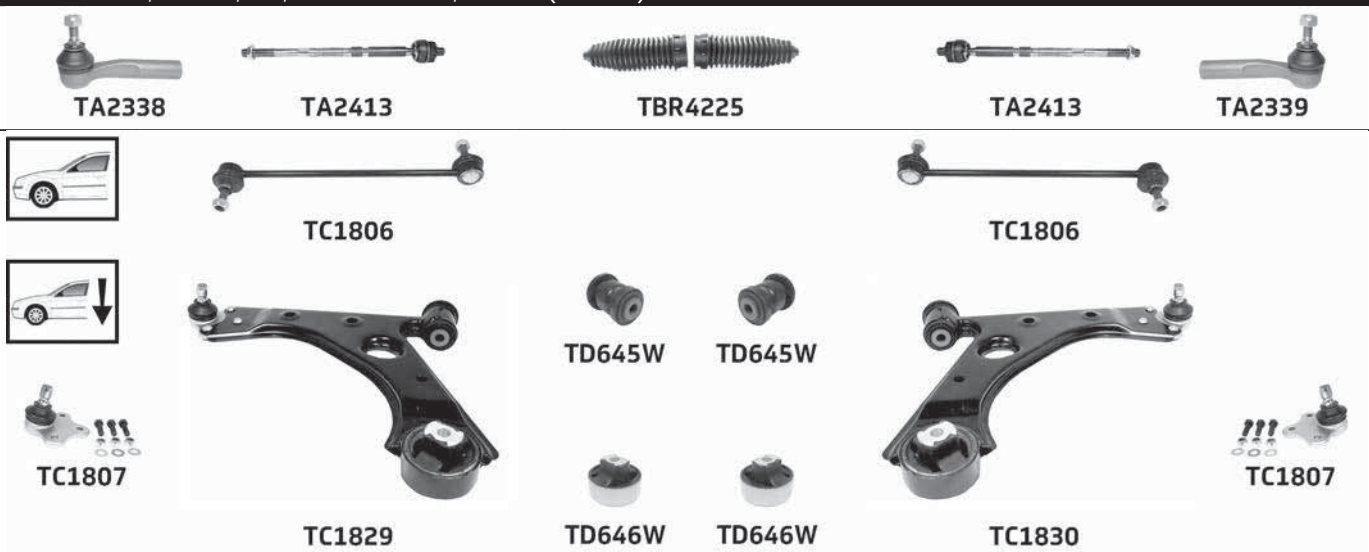

Part No	Description	Pos	Info	Technical
TA2338	Tie rod end(224)	A		M14x1.5 Female(253) £
TA2339	Tie rod end(224)	B		M14x1.5 Female(253) £
TA2413	Inner tie rod(123)	A B		M14x1.5 Male(252) £
TBR4225	Steering rack gaiter kit(213)	K	Thermoplastic(223)	1 :12x55x55 2 :12x55x55
TC1806	Link stabiliser(135)	A B		M10x1.5
TC1807	Lower ball joint(140)	A B		Pinch Bolt(255) 16mm
TC1829	Lower wishbone(158)	A		Pinch Bolt(255) 16mm
TC1830	Lower wishbone(158)	B		Pinch Bolt(255) 16mm
TD645W	Lower wishbone bush(159)	A B	Front(108)	
TD646W	Lower wishbone bush(159)	A B	Rear(187)	

ALFA ROMEO

... ALFA ROMEO

SPIDER 1.8i, 2.0i (-) V6 Turbo (06/95-04/05)

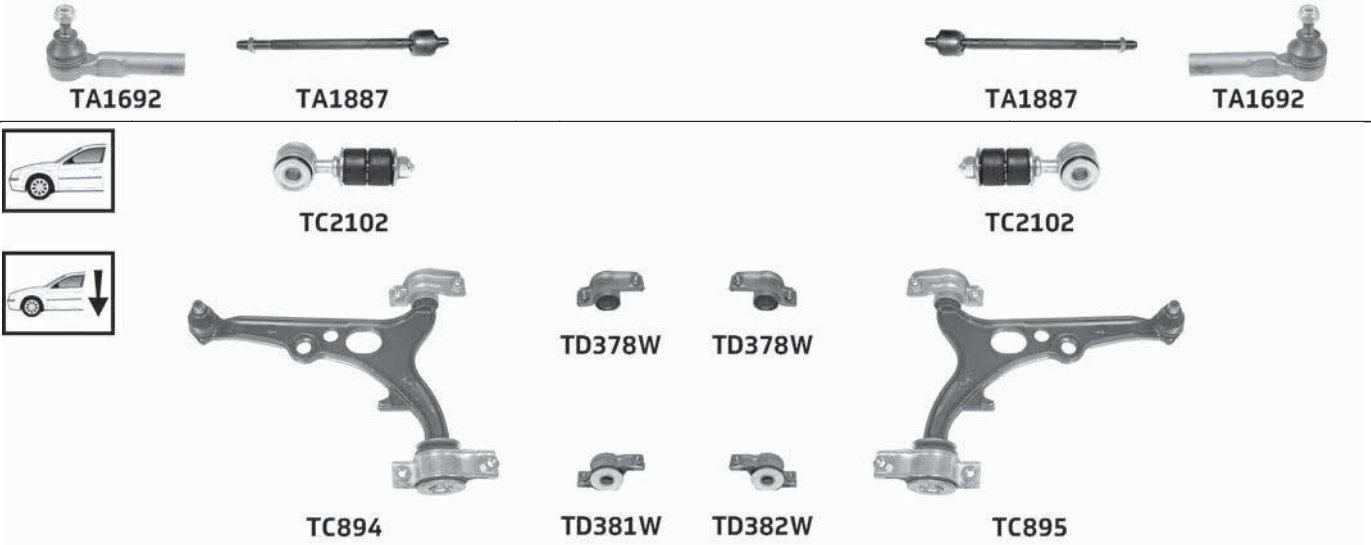

Part No	Description	Pos	Info	Technical
TA1692	Tie rod end(224)	A B		M14x1.5 Female(253) £
TA1887	Inner tie rod(123)	A B		M14x1.5 Male(252) £
TC894	Lower wishbone(158)	A		Pinch Bolt(255) 17mm
TC895	Lower wishbone(158)	B		Pinch Bolt(255) 17mm
TC2102	Link stabiliser(135)	A B		
TD378W	Lower wishbone bush(159)	A B	Front(108)	
TD381W	Lower wishbone bush(159)	A	Rear(187)	
TD382W	Lower wishbone bush(159)	B	Rear(187)	

SPIDER 2.0i V6 Turbo, 3.0i V6 12v (06/95-04/05)

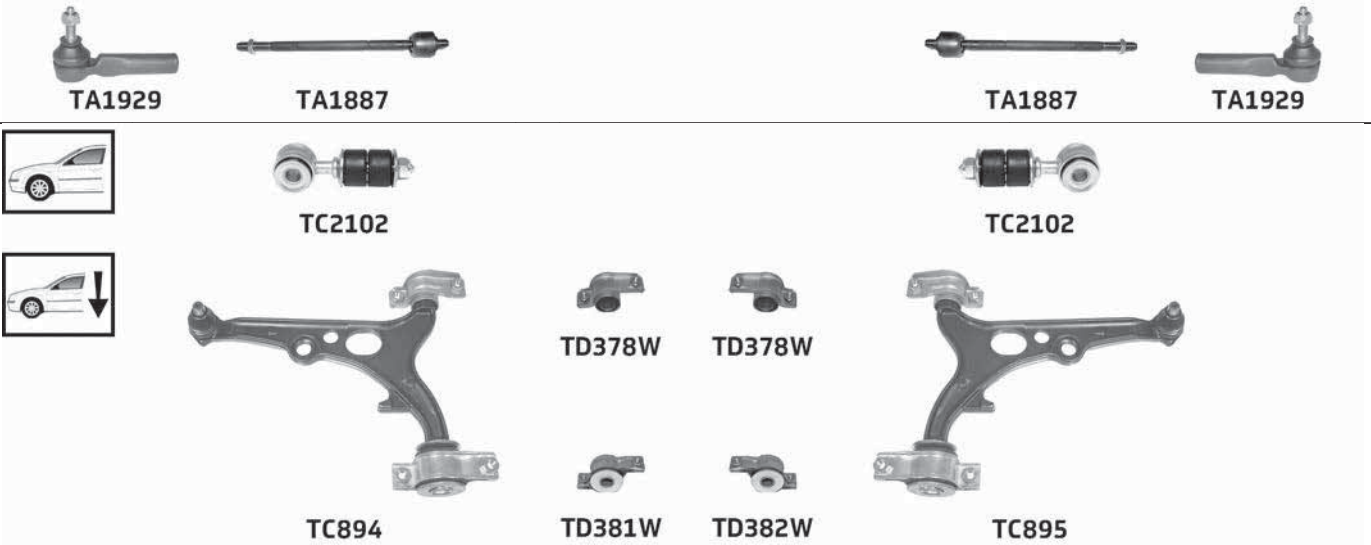

Part No	Description	Pos	Info	Technical
TA1887	Inner tie rod(123)	A B		M14x1.5 Male(252) £
TA1929	Tie rod end(224)	A B		M14x1.5 Female(253) £
TC894	Lower wishbone(158)	A		Pinch Bolt(255) 17mm
TC895	Lower wishbone(158)	B		Pinch Bolt(255) 17mm
TC2102	Link stabiliser(135)	A B		
TD378W	Lower wishbone bush(159)	A B	Front(108)	
TD381W	Lower wishbone bush(159)	A	Rear(187)	
TD382W	Lower wishbone bush(159)	B	Rear(187)	

SPIDER 2.0JTS (04/03-04/05)



TC2195



TC2195



TC894



TD378W



TD378W



TC895



TD381W



TD382W

Part No	Description	Pos	Info	Technical
TA1692	Tie rod end(224)	A B		M14x1.5 Female(253) £
TA1887	Inner tie rod(123)	A B		M14x1.5 Male(252) £
TC894	Lower wishbone(158)	A		Pinch Bolt(255) 17mm
TC895	Lower wishbone(158)	B		Pinch Bolt(255) 17mm
TC2195	Link stabiliser(135)	A B		M10x1.5
TD378W	Lower wishbone bush(159)	A B	Front(108)	
TD381W	Lower wishbone bush(159)	A	Rear(187)	
TD382W	Lower wishbone bush(159)	B	Rear(187)	

SPIDER 3.0i V6 24v, 3.2i V6 24v (01/99-04/05)



TC2195



TC2195



TC894



TD378W



TD378W



TC895



TD381W



TD382W

Part No	Description	Pos	Info	Technical
TA1887	Inner tie rod(123)	A B		M14x1.5 Male(252) £
TA1929	Tie rod end(224)	A B		M14x1.5 Female(253) £
TC894	Lower wishbone(158)	A		Pinch Bolt(255) 17mm
TC895	Lower wishbone(158)	B		Pinch Bolt(255) 17mm
TC2195	Link stabiliser(135)	A B		M10x1.5
TD378W	Lower wishbone bush(159)	A B	Front(108)	
TD381W	Lower wishbone bush(159)	A	Rear(187)	
TD382W	Lower wishbone bush(159)	B	Rear(187)	

... ALFA ROMEO

SPIDER 2.2JTS, 2.4JTD, 3.2JTS (09/06-02/09)

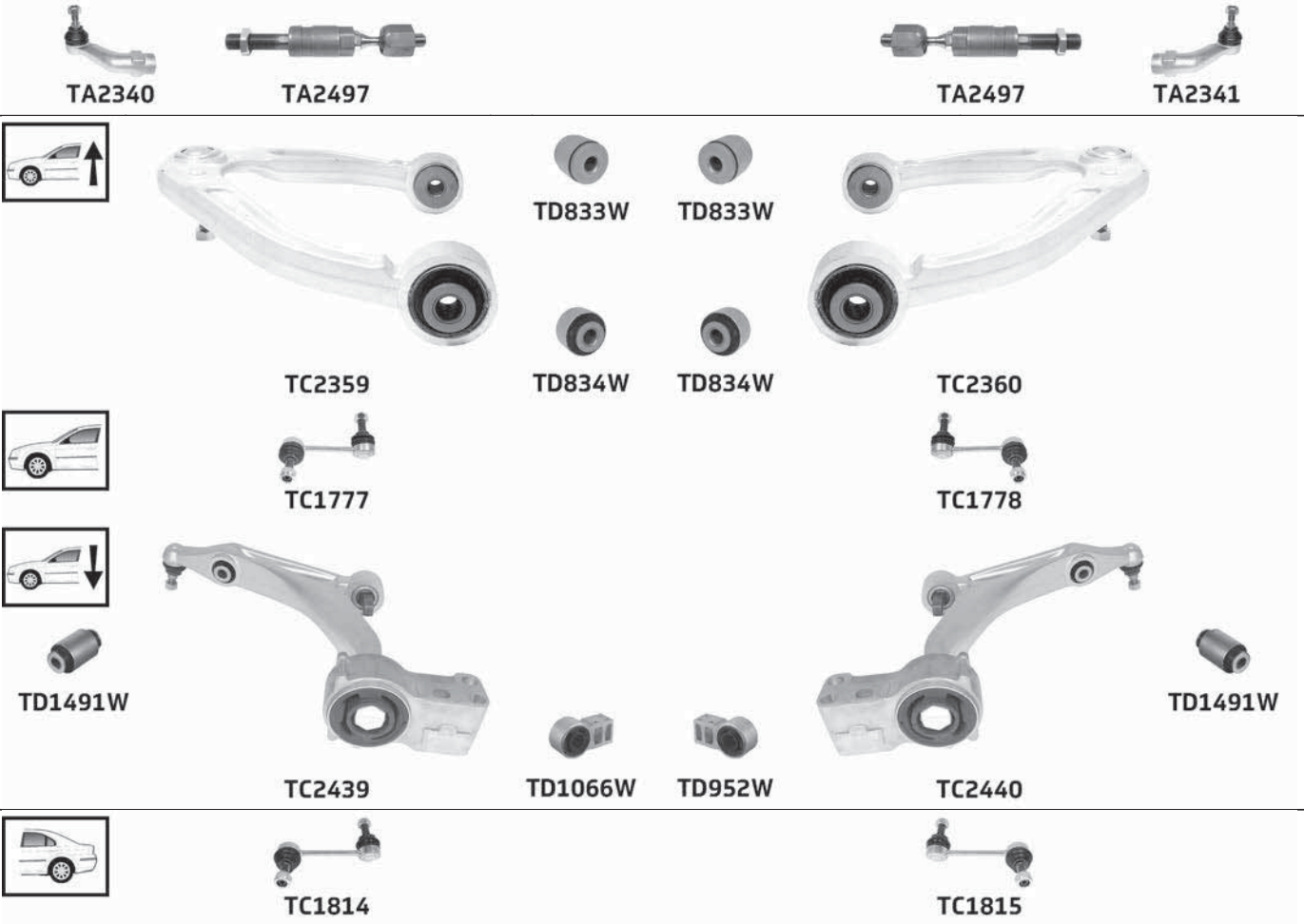

Part No	Description	Pos	Info	Technical
TA2340	Tie rod end(224)	A		M20x1.5 Female(253) £
TA2341	Tie rod end(224)	B		M20x1.5 Female(253) £
TA2497	Inner tie rod(123)	A B	Replace in pairs(192)	M20x1.5 Male(252) £
TC1777	Link stabiliser(135)	A		M12x1.75
TC1778	Link stabiliser(135)	B		M12x1.75
TC1814	Link stabiliser(135)	A		M12x1.75
TC1815	Link stabiliser(135)	B		M12x1.75
TC2359	Upper wishbone(247)	A		M10x1.25
TC2360	Upper wishbone(247)	B		M10x1.25
TC2439	Lower wishbone(158)	A		M14x1.5
TC2440	Lower wishbone(158)	B		M14x1.5
TD833W	Upper wishbone bush(248)	A B	Front(108)	
TD834W	Upper wishbone bush(248)	A B	Rear(187)	
TD952W	Lower wishbone bush(159)	B	Rear(187) (+) Housing(-48-)	
TD1066W	Lower wishbone bush(159)	A	Rear(187) (+) Housing(-48-)	
TD1491W	Lower wishbone bush(159)	A B	Outer(176)	

SPIDER 1.8TBi, 2.0JTD, 2.2JTS, 2.4JTD, 3.2JTS (02/09→)



... SPIDER 1.8Tbi, 2.0JTD, 2.2JTS, 2.4JTD, 3.2JTS (02/09→)

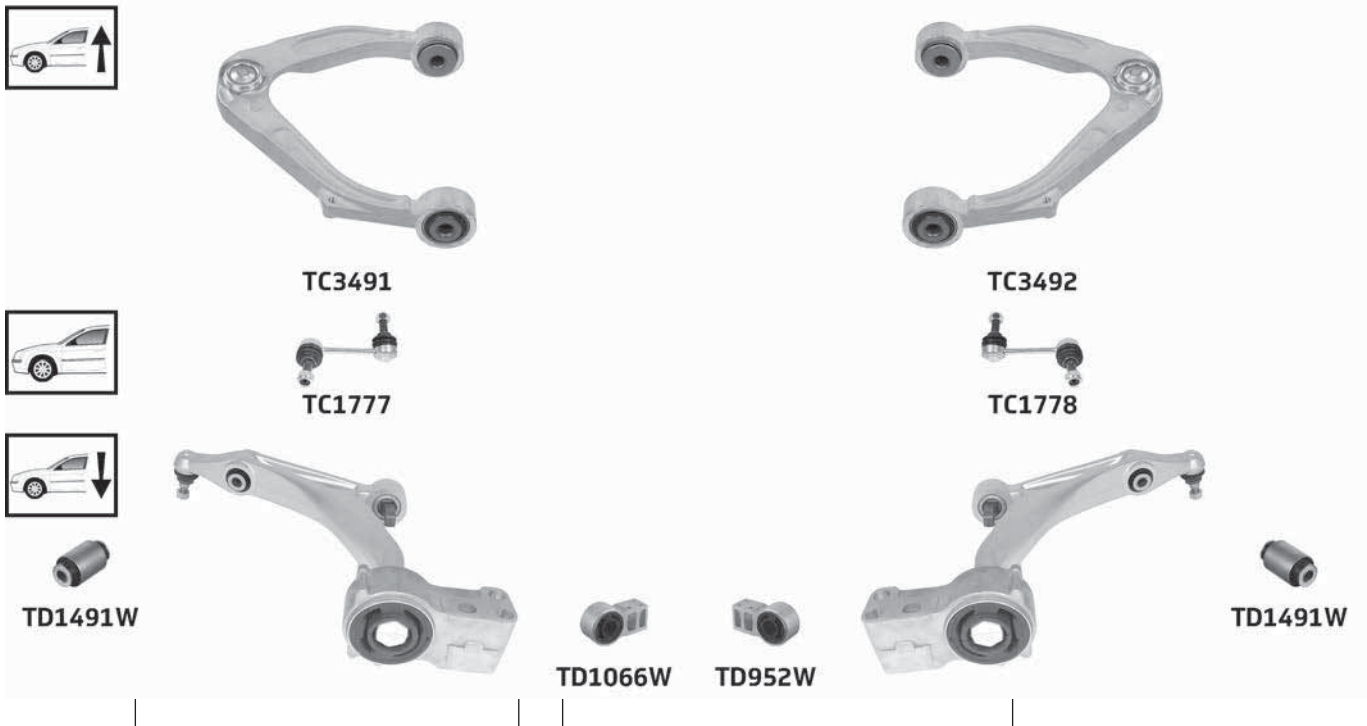

Part No	Description	Pos	Info	Technical
TA2340	Tie rod end (224)	A		M20x1.5 Female (253) £
TA2341	Tie rod end (224)	B		M20x1.5 Female (253) £
TA2497	Inner tie rod (123)	A B	Replace in pairs (192)	M20x1.5 Male (252) £
TC1777	Link stabiliser (135)	A		M12x1.75
TC1778	Link stabiliser (135)	B		M12x1.75
TC1814	Link stabiliser (135)	A		M12x1.75
TC1815	Link stabiliser (135)	B		M12x1.75
TC2439	Lower wishbone (158)	A		M14x1.5
TC2440	Lower wishbone (158)	B		M14x1.5
TC3491	Upper wishbone (247)	A		M10 x 1.25
TC3492	Upper wishbone (247)	B		M10 x 1.25
TD952W	Lower wishbone bush (159)	B	Rear (187) (+) Housing (-48-)	
TD1066W	Lower wishbone bush (159)	A	Rear (187) (+) Housing (-48-)	
TD1491W	Lower wishbone bush (159)	A B	Outer (176)	

AUDI

A1 (8X SERIES) 1.2TFSI, 1.4TFSI, 1.6TDI, 2.0TDI Standard suspension (208) (05/10→)



... AUDI

... A1 (8X SERIES) 1.2TFSI, 1.4TFSI, 1.6TDI, 2.0TDi Standard suspension (208) (05/10→)

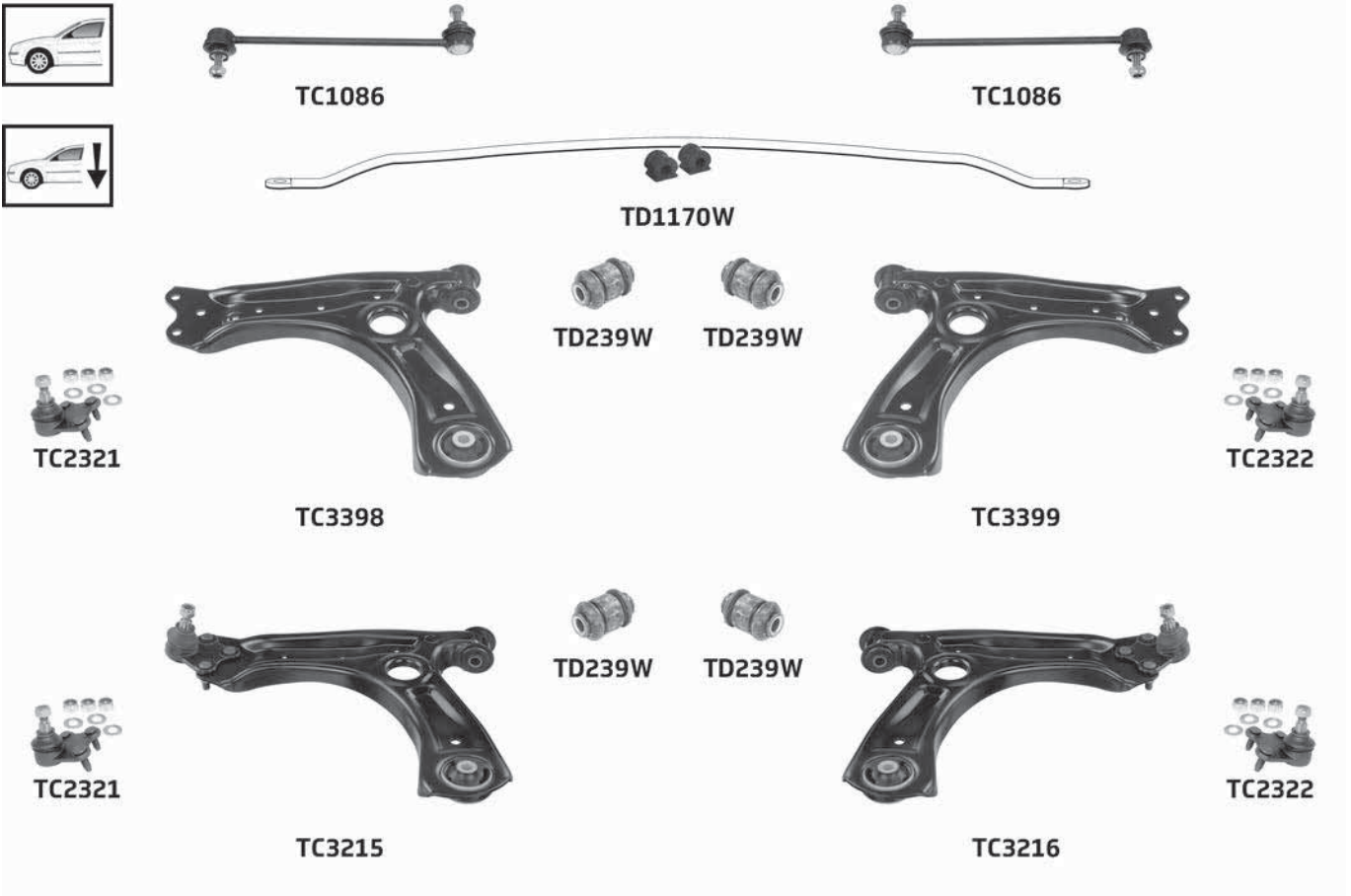

Part No	Description	Pos	Info	Technical
TA1667	Tie rod end(224)	A	→Ch. 8X EB200000	M14x1.5 Female(253) £
TA1668	Tie rod end(224)	B	→Ch. 8X EB200000	M14x1.5 Female(253) £
TA2587	Inner tie rod(123)	A B	→Ch. 8X EB200000	M14x1.5 Male(252) £
TA3217	Inner tie rod(123)	A B	Ch. 8X FB000001→	M14x1.5 Male(252) £
TA3231	Tie rod end(224)	A	Ch. 8X FB000001→	M14x1.5 Female(253) £
TA3232	Tie rod end(224)	B	Ch. 8X FB000001→	M14x1.5 Female(253) £
TBR4241	Steering rack gaiter kit(213)	K	→Ch. 8X-EB200000 Thermoplastic(223)	1 :14.5x48x48 2 :14.5x48x48
TC1086	Link stabiliser(135)	A B		M10x1.5
TC2321	Lower ball joint(140)	A		M12x1.5
TC2322	Lower ball joint(140)	B		M12x1.5
TC3215	Lower wishbone(158)	A	(+) Ball joint(-39)	M12x1.5
TC3216	Lower wishbone(158)	B	(+) Ball joint(-39)	M12x1.5
TC3398	Lower wishbone(158)	A	(-) Ball joint(-11)	
TC3399	Lower wishbone(158)	B	(-) Ball joint(-11)	
TD239W	Lower wishbone bush(159)	A B	Front(108)	
TD1170W	Anti-roll bar(-74) bush kit(-86)	K	Ø17 Complete axle kit(-92)	
TL555	Rod assembly(194)	A	→Ch. 8X EB200000	M12x1.5
TL556	Rod assembly(194)	B	→Ch. 8X EB200000	M12x1.5

A1 (8X SERIES) 1.2TFSI, 2.0TDi Sport suspension (204) (05/10→)



... A1 (8X SERIES) 1.2TFSI, 2.0TDi, 1.6TDI Sport suspension (204) (05/10→)

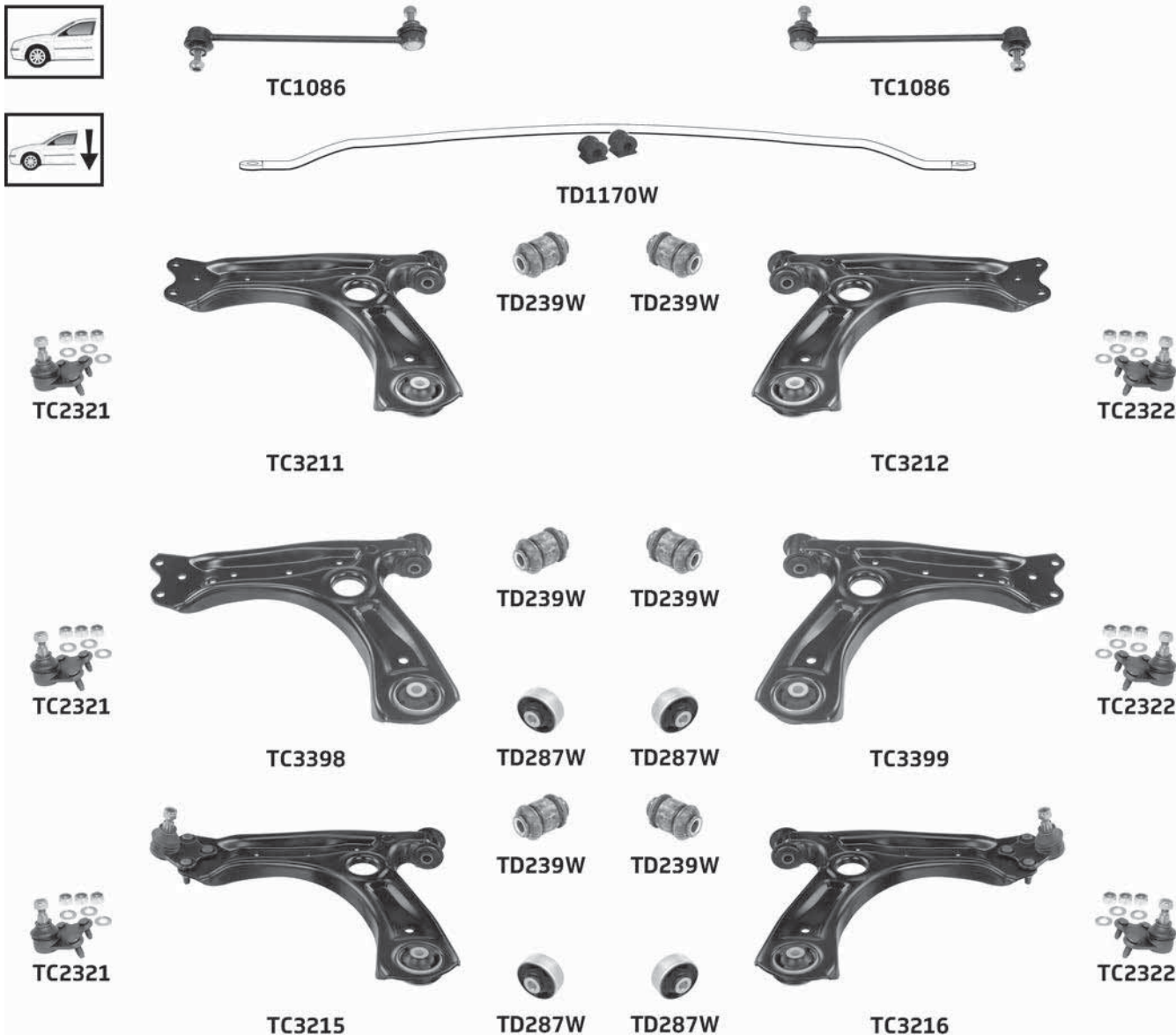

Part No	Description	Pos	Info	Technical
TA1667	Tie rod end (224)	A	→Ch. 8X EB200000	M14x1.5 Female (253) £
TA1668	Tie rod end (224)	B	→Ch. 8X EB200000	M14x1.5 Female (253) £
TA2587	Inner tie rod (123)	A B	→Ch. 8X EB200000	M14x1.5 Male (252) £
TA3217	Inner tie rod (123)	A B	Ch. 8X FB000001→	M14x1.5 Male (252) £
TA3231	Tie rod end (224)	A	Ch. 8X FB000001→	M14x1.5 Female (253) £
TA3232	Tie rod end (224)	B	Ch. 8X FB000001→	M14x1.5 Female (253) £
TBR4241	Steering rack gaiter kit (213)	K	→Ch. 8X-EB200000 Thermoplastic (223)	1 :14.5x48x48 2 :14.5x48x48
TC1086	Link stabiliser (135)	A B		M10x1.5
TC2321	Lower ball joint (140)	A		M12x1.5
TC2322	Lower ball joint (140)	B		M12x1.5
TC3211	Lower wishbone (158)	A	(-) Bush (-13) →20/12/2010	
TC3212	Lower wishbone (158)	B	(-) Bush (-13) →20/12/2010	
TC3215	Lower wishbone (158)	A	(+) Ball joint (-39) 20/12/2010→	M12x1.5
TC3216	Lower wishbone (158)	B	(+) Ball joint (-39) 20/12/2010→	M12x1.5
TC3398	Lower wishbone (158)	A	(-) Bush (-13) 20/12/2010→	
TC3399	Lower wishbone (158)	B	(-) Bush (-13) 20/12/2010→	
TD239W	Lower wishbone bush (159)	A B	Front (108)	
TD287W	Lower wishbone bush (159)	A B	Rear (187)	
TD1170W	Anti-roll bar (-74) bush kit (-86)	K	Ø17 Complete axle kit (-92)	
TL555	Rod assembly (194)	A	→Ch. 8X EB200000	M12x1.5
TL556	Rod assembly (194)	B	→Ch. 8X EB200000	M12x1.5

... AUDI

A1 (8X SERIES) 1.4TFSI Sport suspension (204) | CAVG, CTHG, CTJA (05/10→)

A1 (8X SERIES) 1.4TFSI Sport suspension (204) | CAXA, CNVA (05/10→)



Part No	Description	Pos	Info	Technical
TA1667	Tie rod end(224)	A	→Ch. 8X EB200000	M14x1.5 Female(253) £
TA1668	Tie rod end(224)	B	→Ch. 8X EB200000	M14x1.5 Female(253) £
TA2587	Inner tie rod(123)	A B	→Ch. 8X EB200000	M14x1.5 Male(252) £
TA3217	Inner tie rod(123)	A B	Ch. 8X FB000001→	M14x1.5 Male(252) £
TA3231	Tie rod end(224)	A	Ch. 8X FB000001→	M14x1.5 Female(253) £
TA3232	Tie rod end(224)	B	Ch. 8X FB000001→	M14x1.5 Female(253) £
TBR4241	Steering rack gaiter kit(213)	K	→Ch. 8X-EB200000 Thermoplastic(223)	1 :14.5x48x48 2 :14.5x48x48
TC1086	Link stabiliser(135)	A B		M10x1.5
TC2321	Lower ball joint(140)	A		M12x1.5
TC2322	Lower ball joint(140)	B		M12x1.5
TC3211	Lower wishbone(158)	A	(-) Bush(-13) →3/10/2011	
TC3212	Lower wishbone(158)	B	(-) Bush(-13) →3/10/2011	

... **A1 (8X SERIES) 1.4TFSI Sport suspension(204) | CAVG, CTHG, CTJA (05/10→)**

... **A1 (8X SERIES) 1.4TFSI Sport suspension(204) | CAXA, CNVA (05/10→)**

Part No	Description	Pos	Info	Technical
TC3215	Lower wishbone(158)	A	(+) Ball joint(-39) 03/10/2011 →	M12x1.5
TC3216	Lower wishbone(158)	B	(+) Ball joint(-39) 03/10/2011 →	M12x1.5
TC3398	Lower wishbone(158)	A	(-) Bush(-13) 03/10/2011 →	
TC3399	Lower wishbone(158)	B	(-) Bush(-13) 03/10/2011 →	
TD239W	Lower wishbone bush(159)	A B	Front(108)	
TD287W	Lower wishbone bush(159)	A B	Rear(187)	
TD1170W	Anti-roll bar(-74) bush kit(-86)	K	Ø17 Complete axle kit(-92)	
TL555	Rod assembly(194)	A	→Ch. 8X EB200000	M12x1.5
TL556	Rod assembly(194)	B	→Ch. 8X EB200000	M12x1.5

A1 (8X SERIES) 1.4TFSI Sport suspension(204) | CPTA (05/10→)

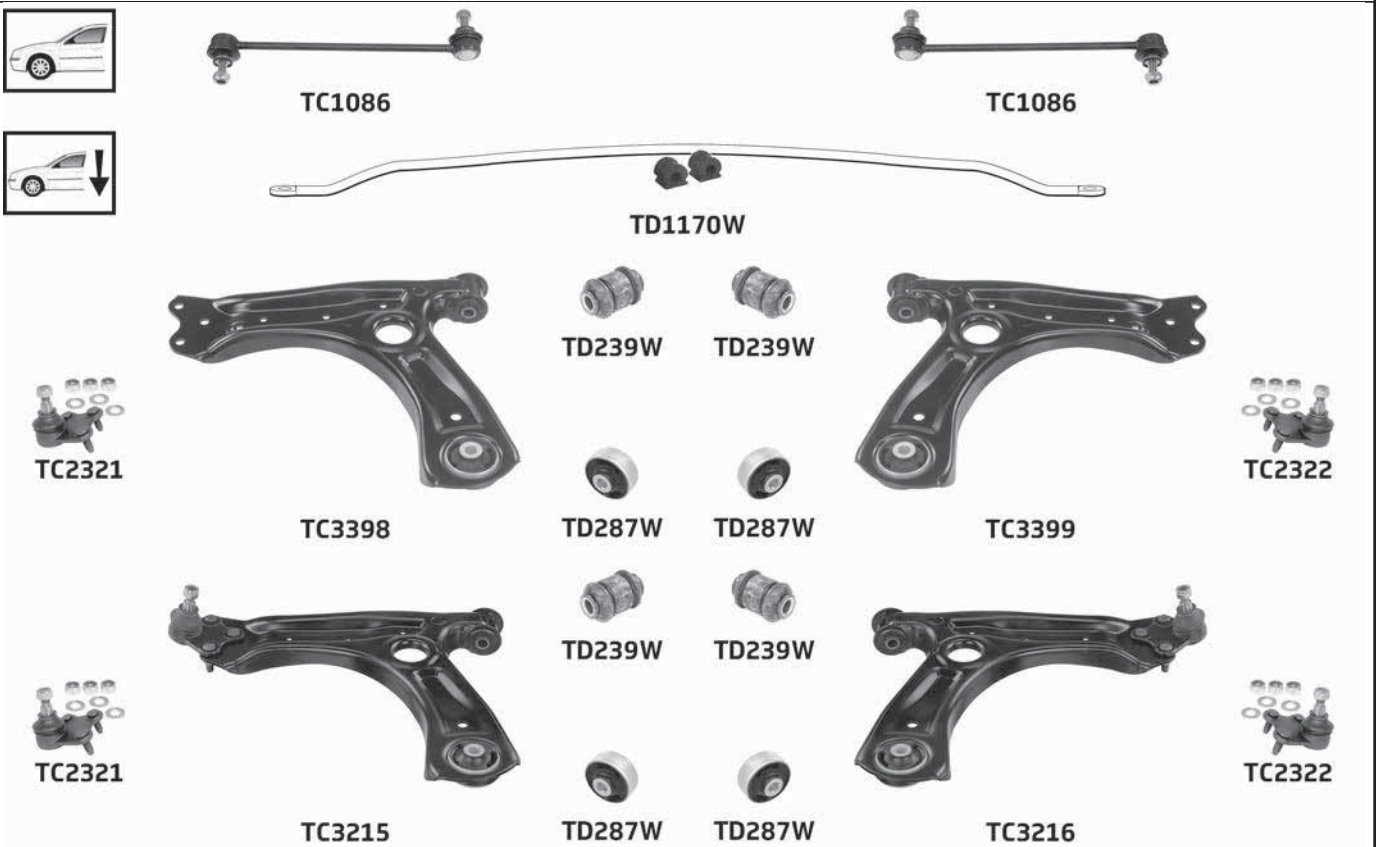

Part No	Description	Pos	Info	Technical
TA1667	Tie rod end(224)	A	→Ch. 8X EB200000	M14x1.5 Female(253) £
TA1668	Tie rod end(224)	B	→Ch. 8X EB200000	M14x1.5 Female(253) £
TA2587	Inner tie rod(123)	A B	→Ch. 8X EB200000	M14x1.5 Male(252) £
TA3217	Inner tie rod(123)	A B	Ch. 8X FB000001→	M14x1.5 Male(252) £
TA3231	Tie rod end(224)	A	Ch. 8X FB000001→	M14x1.5 Female(253) £
TA3232	Tie rod end(224)	B	Ch. 8X FB000001→	M14x1.5 Female(253) £
TBR4241	Steering rack gaiter kit(213)	K	→Ch. 8X-EB200000 Thermoplastic(223)	1 :14.5x48x48 2 :14.5x48x48
TC1086	Link stabiliser(135)	A B		M10x1.5
TC2321	Lower ball joint(140)	A		M12x1.5
TC2322	Lower ball joint(140)	B		M12x1.5
TC3215	Lower wishbone(158)	A	(+) Ball joint(-39)	M12x1.5

(...)

... AUDI

... A1 (8X SERIES) 1.4TFSI Sport suspension (204) | CPTA (05/10→)

Part No	Description	Pos	Info	Technical
TC3216	Lower wishbone(158)	B	(+) Ball joint(-39)	M12x1.5
TC3398	Lower wishbone(158)	A	(-) Ball joint(-11)	
TC3399	Lower wishbone(158)	B	(-) Ball joint(-11)	
TD239W	Lower wishbone bush(159)	A B	Front(108)	
TD287W	Lower wishbone bush(159)	A B	Rear(187)	
TD1170W	Anti-roll bar(-74) bush kit(-86)	K	Ø17 Complete axle kit(-92)	
TL555	Rod assembly(194)	A	→Ch. 8X EB200000	M12x1.5
TL556	Rod assembly(194)	B	→Ch. 8X EB200000	M12x1.5

A1 (8X SERIES) 1.6TDI Sport suspension (204) (05/10→)

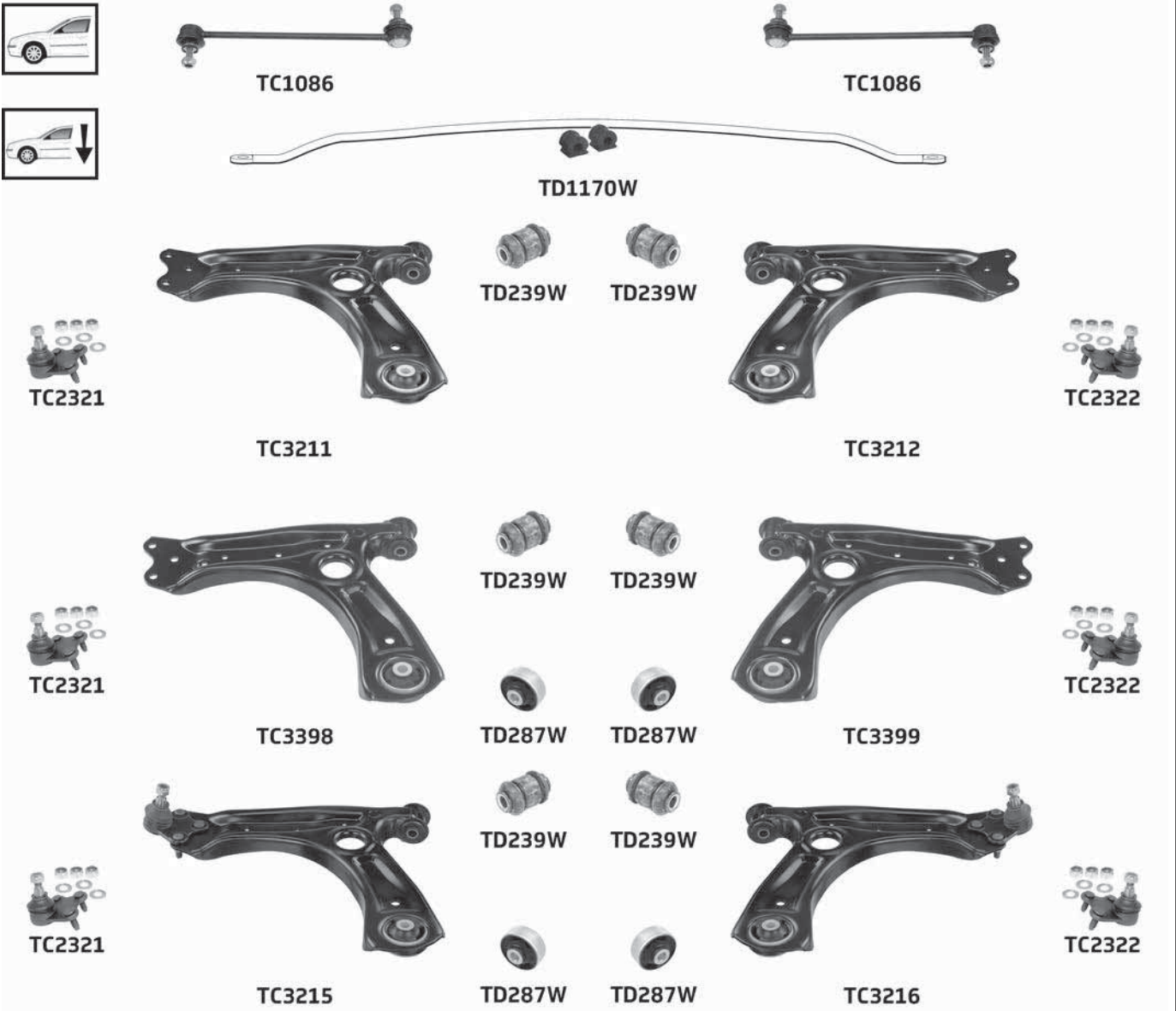

Part No	Description	Pos	Info	Technical
TA1667	Tie rod end(224)	A	→Ch. 8X EB200000	M14x1.5 Female(253) £
TA1668	Tie rod end(224)	B	→Ch. 8X EB200000	M14x1.5 Female(253) £
TA2587	Inner tie rod(123)	A B	→Ch. 8X EB200000	M14x1.5 Male(252) £

... A1 (8X SERIES) 1.2TFSI, 2.0TDi, 1.6TDI Sport suspension (204) (05/10→)

Part No	Description	Pos	Info	Technical
TA3217	Inner tie rod(123)	A B	Ch. 8X FB000001→	M14x1.5 Male(252) £
TA3231	Tie rod end(224)	A	Ch. 8X FB000001→	M14x1.5 Female(253) £
TA3232	Tie rod end(224)	B	Ch. 8X FB000001→	M14x1.5 Female(253) £
TBR4241	Steering rack gaiter kit(213)	K	→Ch. 8X-EB200000 Thermoplastic(223)	1 :14.5x48x48 2 :14.5x48x48
TC1086	Link stabiliser(135)	A B		M10x1.5
TC2321	Lower ball joint(140)	A		M12x1.5
TC2322	Lower ball joint(140)	B		M12x1.5
TC3211	Lower wishbone(158)	A	(-) Bush(-13) →20/12/2010	
TC3212	Lower wishbone(158)	B	(-) Bush(-13) →20/12/2010	
TC3215	Lower wishbone(158)	A	(+) Ball joint(-39) 20/12/2010→	M12x1.5
TC3216	Lower wishbone(158)	B	(+) Ball joint(-39) 20/12/2010→	M12x1.5
TC3398	Lower wishbone(158)	A	(-) Bush(-13) 20/12/2010→	
TC3399	Lower wishbone(158)	B	(-) Bush(-13) 20/12/2010→	
TD239W	Lower wishbone bush(159)	A B	Front(108)	
TD287W	Lower wishbone bush(159)	A B	Rear(187)	
TD1170W	Anti-roll bar(-74) bush kit(-86)	K	Ø17 Complete axle kit(-92)	
TL555	Rod assembly(194)	A	→Ch. 8X EB200000	M12x1.5
TL556	Rod assembly(194)	B	→Ch. 8X EB200000	M12x1.5

A1 (8X SERIES) 2.0TFSI Quattro (03/12→)

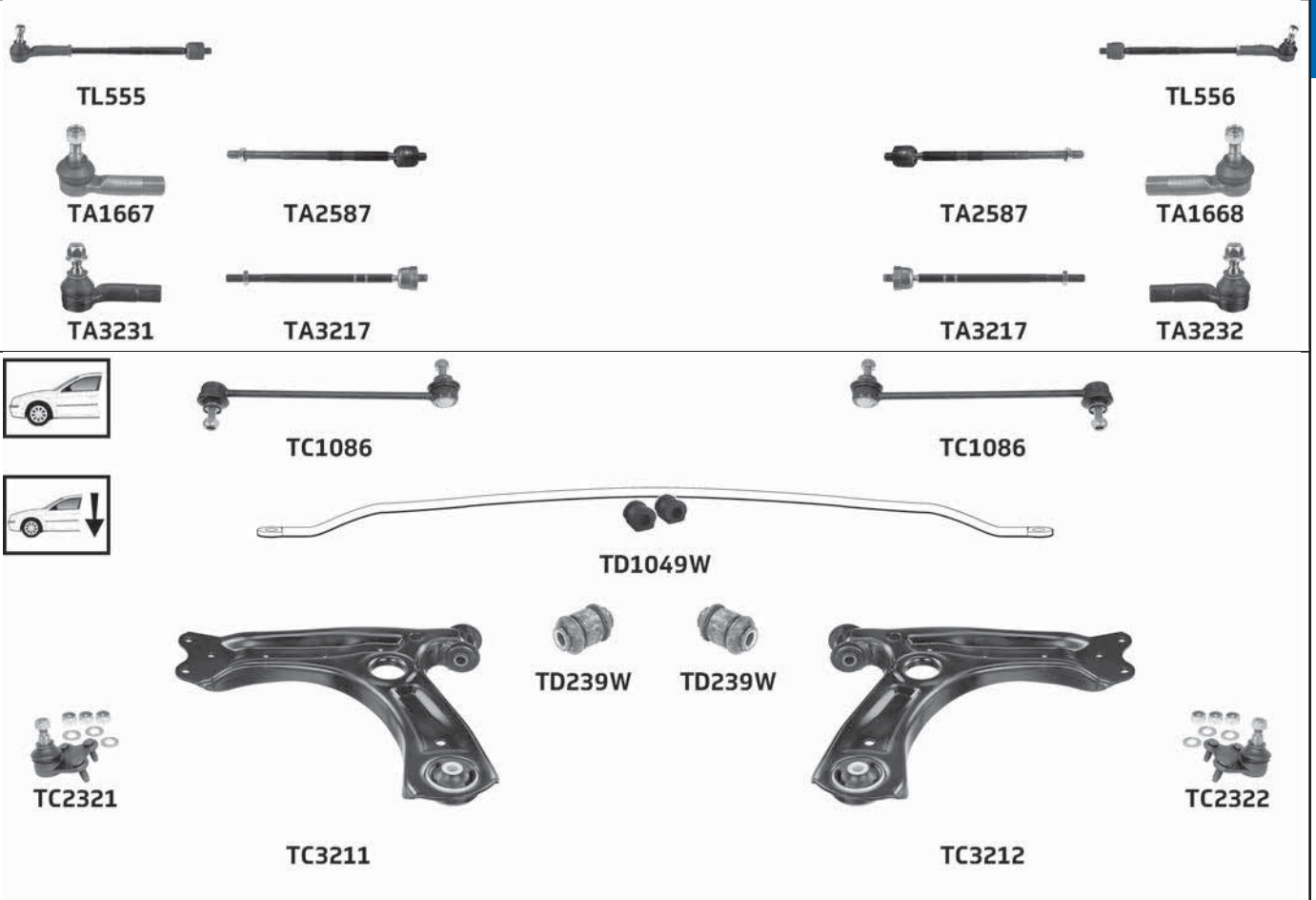

... AUDI

... A1 (8X SERIES) 2.0TFSI Quattro (03/12→)



TC3425



TC3425



TD1653W



TC2256



TD1652W



TD1652W



TC2256



TD1653W



TC3410



TC3410



TC2944



TC2944



TC3282



TC3283



TD1058W



TD1058W



TC3405



TD1648W



TD1648W



TC3405

Part No	Description	Pos	Info	Technical
TA1667	Tie rod end(224)	A	→Ch. 8X EB200000	M14x1.5 Female(253) £
TA1668	Tie rod end(224)	B	→Ch. 8X EB200000	M14x1.5 Female(253) £
TA2587	Inner tie rod(123)	A B	→Ch. 8X EB200000	M14x1.5 Male(252) £
TA3217	Inner tie rod(123)	A B	Ch. 8X FB000001→	M14x1.5 Male(252) £
TA3231	Tie rod end(224)	A	Ch. 8X FB000001→	M14x1.5 Female(253) £
TA3232	Tie rod end(224)	B	Ch. 8X FB000001→	M14x1.5 Female(253) £
TC1086	Link stabiliser(135)	A B		M10x1.5
TC2256	Upper track control arm(242)	A B	→Ch. 8X EB200000	
TC2321	Lower ball joint(140)	A		M12x1.5
TC2322	Lower ball joint(140)	B		M12x1.5
TC2944	Trailing arm(226)	A B		
TC3211	Lower wishbone(158)	A	(-) Ball Joint(-11)	
TC3212	Lower wishbone(158)	B	(-) Ball Joint(-11)	
TC3282	Lower link arm(144)	A	Front(108)	
TC3283	Lower link arm(144)	B	Front(108)	
TC3405	Lower track control arm(151)	A B	Rear(187)	
TC3410	Link stabiliser(135)	A B		M10x1.5
TC3425	Upper track control arm(242)	A B	Ch. 8X FB000001→	
TD239W	Lower wishbone bush(159)	A B	Front(108)	
TD1049W	Anti-roll bar(-74) bush kit(-86)	K	Ø18 Complete axle kit(-92)	
TD1058W	Lower hub carrier bush(143)	A B		
TD1648W	Lower track control arm bush(153)	A B	Inner(119)	
TD1652W	Upper track control arm bush(243)	A B		
TD1653W	Upper track control arm bush(243)	A B		
TL555	Rod assembly(194)	A	→Ch. 8X EB200000	M12x1.5
TL556	Rod assembly(194)	B	→Ch. 8X EB200000	M12x1.5

A2 (8Z SERIES) 1.2TDi (02/00-08/05)



TC1341

TC1341

Part No	Description	Pos	Info	Technical
TA1778	Tie rod end (224)	A	Power steering (185)	M14x1.5 Female (253) £
TA1779	Tie rod end (224)	B	Power steering (185)	M14x1.5 Female (253) £
TA2587	Inner tie rod (123)	A B	Power steering (185)	M14x1.5 Male (252) £
TBR4184	Steering rack gaiter kit (213)	K		1 :11x42x42 2 :11x42x42
TBR4241	Steering rack gaiter kit (213)	K	Ch. 8Z-3-027001 → EHPS Thermoplastic (223)	1 :14.5x48x48 2 :14.5x48x48
TC1341	Link stabiliser (135)	A B		M10x1.5

A2 (8Z SERIES) 1.4i (02/00-08/05)



TC1086

TC1086



TD1171W



TC1439

TC1440

Part No	Description	Pos	Info	Technical
TA1778	Tie rod end (224)	A		M14x1.5 Female (253) £
TA1779	Tie rod end (224)	B		M14x1.5 Female (253) £
TA2587	Inner tie rod (123)	A B		M14x1.5 Male (252) £
TBR4183	Steering rack gaiter kit (213)	K		1 :25x40x40 2 :25x40x40
TBR4241	Steering rack gaiter kit (213)	K	Ch. 8Z-3-027001 → EHPS Thermoplastic (223)	1 :14.5x48x48 2 :14.5x48x48
TC1086	Link stabiliser (135)	A B		M10x1.5
TC1439	Lower wishbone (158)	A	→Ch. 8Z3 019682	M12x1.5
TC1440	Lower wishbone (158)	B	→Ch. 8Z3 019682	M12x1.5
TD842W	Lower wishbone bush (159)	A B	Front (108) →Ch. 8Z3 019682	
TD1171W	Anti-roll bar (-74) bush kit (-86)	K	Ø16 Complete axle kit (-92)	

... AUDI

A2 (8Z SERIES) 1.4TDi (02/00-08/05)



Part No	Description	Pos	Info	Technical
TA1778	Tie rod end(224)	A		M14x1.5 Female(253) £
TA1779	Tie rod end(224)	B		M14x1.5 Female(253) £
TA2587	Inner tie rod(123)	A B		M14x1.5 Male(252) £
TBR4184	Steering rack gaiter kit(213)	K		1 :11x42x42 2 :11x42x42
TBR4241	Steering rack gaiter kit(213)	K	Ch. 8Z-3-027001→ EHPS Thermoplastic(223)	1 :14.5x48x48 2 :14.5x48x48
TC1086	Link stabiliser(135)	A B		M10x1.5
TD1171W	Anti-roll bar(-74) bush kit(-86-)	K	Ø16 Complete axle kit(-92)	

A2 (8Z SERIES) 1.6FSi (02/00-08/05)



Part No	Description	Pos	Info	Technical
TA1778	Tie rod end(224)	A		M14x1.5 Female(253) £
TA1779	Tie rod end(224)	B		M14x1.5 Female(253) £
TA2587	Inner tie rod(123)	A B		M14x1.5 Male(252) £
TBR4241	Steering rack gaiter kit(213)	K	Ch. 8Z-3-027001→ EHPS Thermoplastic(223)	1 :14.5x48x48 2 :14.5x48x48
TC1086	Link stabiliser(135)	A B		M10x1.5
TC1439	Lower wishbone(158)	A	→Ch. 8Z3 019682	M12x1.5
TC1440	Lower wishbone(158)	B	→Ch. 8Z3 019682	M12x1.5
TD842W	Lower wishbone bush(159)	A B	Front(108) →Ch. 8Z3 019682	
TD1171W	Anti-roll bar(-74) bush kit(-86-)	K	Ø16 Complete axle kit(-92)	

A3 (8L SERIES) 1.6i, 1.8i (-) Quattro, 1.9TDi (-) Quattro (09/96-05/03)



TA1665



TA2000



TBR4113



TA2000



TA1666



TA1667



TA2001



TA2001



TA1668



TC2026



TC2026



TD790W



TD560W



TD823W



TD823W



TC2010



TD239W



TD239W



TC2010



TC824



TC825



TD287W



TD287W



TC786



TD239W



TD239W



TC787



TD287W



TD287W



TC825



TD655W



TD655W

Part No	Description	Pos	Info	Technical
TA1665	Tie rod end(224)	A	→Ch. 8LW 050421	M14x1.5 Female(253) £
TA1666	Tie rod end(224)	B	→Ch. 8LW 050421	M14x1.5 Female(253) £
TA1667	Tie rod end(224)	A	Ch. 8LW 050422→	M14x1.5 Female(253) £
TA1668	Tie rod end(224)	B	Ch. 8LW 050422→	M14x1.5 Female(253) £
TA2000	Inner tie rod(123)	A B	→Ch. 8LW 050421	M14x1.5 Male(252) £
TA2001	Inner tie rod(123)	A B	Ch. 8LW 050422→	M14x1.5 Male(252) £
TBR4113	Steering rack gaiter kit(213)	K	Thermoplastic(223)	1 :16x48x48 2 :16x48x48
TC786	Lower wishbone(158)	A	(+) Ball joint(-39)	M12x1.25
TC787	Lower wishbone(158)	B	(+) Ball joint(-39)	M12x1.25
TC824	Lower ball joint(140)	A		M12x1.25
TC825	Lower ball joint(140)	B		M12x1.25
TC2010	Lower wishbone(158)	A B	(-) Ball joint(-11)	
TC2026	Link stabiliser(135)	A B		M10x1.5
TD239W	Lower wishbone bush(159)	A B	Front(108)	
TD287W	Lower wishbone bush(159)	A B	Rear(187)	

(...)

... AUDI

... A3 (8L SERIES) 1.6i, 1.8i (-) Quattro, 1.9TDi (-) Quattro (09/96-05/03)

Part No	Description	Pos	Info	Technical
TD560W	Anti-roll bar (-74) bush kit (-86)	K	Ø21 Complete axle kit (-92)	
TD655W	Sub-frame bush (215)	A B	Fit in pairs when replacing hydraulic type (104)	
TD790W	Anti-roll bar (-74) bush kit (-86)	K	Ø19 Complete axle kit (-92)	
TD823W	Cross member bush (-99)	A B		

A3 (8L SERIES) 1.8i, 1.9TDi Quattro (09/96-05/03)



... A3 (8L SERIES) 1.8i, 1.9TDi Quattro (09/96-05/03)



Part No	Description	Pos	Info	Technical
TA1665	Tie rod end(224)	A	→Ch. 8LW 050421	M14x1.5 Female(253) £
TA1666	Tie rod end(224)	B	→Ch. 8LW 050421	M14x1.5 Female(253) £
TA1667	Tie rod end(224)	A	Ch. 8LW 050422→	M14x1.5 Female(253) £
TA1668	Tie rod end(224)	B	Ch. 8LW 050422→	M14x1.5 Female(253) £
TA2000	Inner tie rod(123)	A B	→Ch. 8LW 050421	M14x1.5 Male(252) £
TA2001	Inner tie rod(123)	A B	Ch. 8LW 050422→	M14x1.5 Male(252) £
TBR4113	Steering rack gaiter kit(213)	K	Thermoplastic(223)	1 :16x48x48 2 :16x48x48
TC786	Lower wishbone(158)	A	(+) Ball joint(-39)	M12x1.25
TC787	Lower wishbone(158)	B	(+) Ball joint(-39)	M12x1.25
TC824	Lower ball joint(140)	A		M12x1.25
TC825	Lower ball joint(140)	B		M12x1.25
TC1040	Link stabiliser(135)	A	Ch. 8LX 140001→	M12x1.5
TC1041	Link stabiliser(135)	B	Ch. 8LX 140001→	M12x1.5
TC1790	Link stabiliser(135)	A B		M10x1.5
TC2010	Lower wishbone(158)	A B	(-) Ball joint(-11)	
TC2026	Link stabiliser(135)	A B	→Ch. 8LX 140000	M10x1.5
TC3265	Lower track control arm(151)	A B		
TC3380	Link stabiliser(135)	A B	(+) Heavy duty suspension(-47)	M10x1.5
TD239W	Lower wishbone bush(159)	A B	Front(108)	
TD287W	Lower wishbone bush(159)	A B	Rear(187)	
TD560W	Anti-roll bar(-74) bush kit(-86)	K	Ø21 Complete axle kit(-92) →Ch. 8LX 140000	
TD790W	Anti-roll bar(-74) bush kit(-86)	K	Ø19 Complete axle kit(-92)	
TD823W	Cross member bush(-99)	A B		
TD1153W	Trailing arm bush(227)	A B	Front(108)	

... AUDI

A3 (8P SERIES) 1.4TFSi, 1.6i, 1.6FSi, 1.8TFSi, 1.9TDi, 2.0FSi, 2.0FSi Quattro, 2.0TFSi, 2.0TFSi Quattro, 2.0TDi, 2.0TDi Quattro, 3.2i Quattro →Ch. 8P-8A250000, 8P-8B050000 (05/03-06/08)



TA1914



TA1905



TBR4218



TA1905



TA1915



TC1315



TC1315



TC1334



TD521W



TD521W



TC1335



TD522W



TD523W



TC1317



TC1316



TD410W



TD410W



TC2141



TD521W



TD521W



TC2142



TD522W



TD523W



TC1317



TC1316



TD410W



TD410W

... A3 (8P SERIES) 1.4TFSi, 1.6i, 1.6FSi, 1.8TFSi, 1.9TDi, 2.0FSi, 2.0FSi Quattro, 2.0TFSi, 2.0TFSi Quattro, 2.0TDi, 2.0TDi Quattro, 3.2i Quattro → Ch. 8P-8A250000, 8P-8B050000 (05/03-06/08)



TD1653W



TC2256



TD1652W



TD1652W



TC2256



TD1653W



TC1325



TC1325



TD1043W



TC2944



TC2944



TC3282



TC3283



TD1058W



TD1058W



TC3405



TD1648W



TD1648W



TC3405

Part No	Description	Pos	Info	Technical
TA1905	Inner tie rod(123)	A B		M16x1.5 Male(252) £
TA1914	Tie rod end(224)	A		M16x1.5 Female(253) £
TA1915	Tie rod end(224)	B		M16x1.5 Female(253) £
TBR4218	Steering rack gaiter kit(213)	K	Thermoplastic(223)	1 :15.5x49.5x49.5 2 :15.5x49.5x49.5
TC1315	Link stabiliser(135)	A B		M12x1.5
TC1316	Lower ball joint(140)	A		M12x1.5
TC1317	Lower ball joint(140)	B		M12x1.5
TC1325	Link stabiliser(135)	A B		M10x1.5
TC1334	Lower wishbone(158)	A	(-) Bush(-13) Sheet steel(201)	
TC1335	Lower wishbone(158)	B	(-) Bush(-13) Sheet steel(201)	
TC2141	Lower wishbone(158)	A	(-) Bush(-13) Cast iron(-88)	
TC2142	Lower wishbone(158)	B	(-) Bush(-13) Cast iron(-88)	
TC2256	Upper track control arm(242)	A B		
TC2944	Trailing arm(226)	A B		
TC3282	Lower link arm(144)	A	Front(108)	
TC3283	Lower link arm(144)	B	Front(108)	
TC3405	Lower track control arm(151)	A B	Rear(187)	
TD410W	Lower wishbone bush(159)	A B	Rear(187) (-) Housing(-19)	
TD521W	Lower wishbone bush(159)	A B	Front(108)	
TD522W	Lower wishbone bush(159)	A	Rear(187) (+) Housing(-48)	
TD523W	Lower wishbone bush(159)	B	Rear(187) (+) Housing(-48)	
TD1043W	Anti-roll bar(-74) bush kit(-86)	K	Ø18.5 Complete axle kit(-92)	
TD1058W	Lower hub carrier bush(143)	A B		
TD1648W	Lower track control arm bush(153)	A B	Inner(119)	
TD1652W	Upper track control arm bush(243)	A B		
TD1653W	Upper track control arm bush(243)	A B		

... AUDI

A3 (8P SERIES) 1.4TFSi, 1.6i, 1.6FSi, 1.8TFSi, 1.8TFSi Quattro, 1.9TDi, 2.0FSi, 2.0FSi Quattro, 2.0TFSi, 2.0TFSi Quattro, 2.0TDi, 2.0TDi Quattro, 3.2i Quattro Ch. 8P-9A000001, 8P-9B000001 → (07/08-05/09)



TA1914



TA1905



TBR4218



TA1905



TA1915



TC1315



TC1315



TC2482



TD521W



TD521W



TC2483



TC1317



TC1316



TD522W



TD523W



TD410W



TD410W



TC3315



TD521W



TD521W



TC3316



TC1317



TC1316



TD522W



TD523W



TD410W



TD410W



TC2141



TD521W



TD521W



TC2142



TC1317



TC1316



TD522W



TD523W



TD410W



TD410W

... A3 (8P SERIES) 1.4TFSi, 1.6i, 1.6FSi, 1.8TFSi, 1.8TFSi Quattro, 1.9TDi, 2.0FSi, 2.0FSi Quattro, 2.0TFSi, 2.0TFSi Quattro, 2.0TDi, 2.0TDi Quattro, 3.2i Quattro Ch. 8P-9A000001, 8P-9B000001 → (07/08-05/09)



TD1653W



TC2256



TD1652W



TD1652W



TC2256



TD1653W



TC1325



TC1325



TD1043W



TC2944



TC2944



TC3282



TC3283



TD1058W



TD1058W



TC3405



TD1648W



TD1648W



TC3405

Part No	Description	Pos	Info	Technical
TA1905	Inner tie rod(123)	A B		M16x1.5 Male(252) £
TA1914	Tie rod end(224)	A		M16x1.5 Female(253) £
TA1915	Tie rod end(224)	B		M16x1.5 Female(253) £
TBR4218	Steering rack gaiter kit(213)	K	Thermoplastic(223)	1 :15.5x49.5x49.5 2 :15.5x49.5x49.5
TC1315	Link stabiliser(135)	A B		M12x1.5
TC1316	Lower ball joint(140)	A		M12x1.5
TC1317	Lower ball joint(140)	B		M12x1.5
TC1325	Link stabiliser(135)	A B		M10x1.5
TC2141	Lower wishbone(158)	A	(-) Bush(-13) Cast iron(-88)	
TC2142	Lower wishbone(158)	B	(-) Bush(-13) Cast iron(-88)	
TC2256	Upper track control arm(242)	A B		
TC2482	Lower wishbone(158)	A	(-) Bush(-13) (-) Sport suspension(-27) Sheet steel(201)	
TC2483	Lower wishbone(158)	B	(-) Bush(-13) (-) Sport suspension(-27) Sheet steel(201)	
TC2944	Trailing arm(226)	A B		
TC3282	Lower link arm(144)	A	Front(108)	
TC3283	Lower link arm(144)	B	Front(108)	
TC3315	Lower wishbone(158)	A	(+) Ball joint(-39) (-) Sport suspension(-27) Sheet steel(201)	M12x1.5
TC3316	Lower wishbone(158)	B	(+) Ball joint(-39) (-) Sport suspension(-27) Sheet steel(201)	M12x1.5
TC3405	Lower track control arm(151)	A B	Rear(187)	
TD410W	Lower wishbone bush(159)	A B	Rear(187) (-) Housing(-19)	
TD521W	Lower wishbone bush(159)	A B	Front(108)	
TD522W	Lower wishbone bush(159)	A	Rear(187) (+) Housing(-48)	
TD523W	Lower wishbone bush(159)	B	Rear(187) (+) Housing(-48)	
TD1043W	Anti-roll bar(-74) bush kit(-86)	K	Ø18.5 Complete axle kit(-92)	
TD1058W	Lower hub carrier bush(143)	A B		
TD1648W	Lower track control arm bush(153)	A B	Inner(119)	
TD1652W	Upper track control arm bush(243)	A B		
TD1653W	Upper track control arm bush(243)	A B		

... AUDI

A3 (8P SERIES) 1.2TFSi, 1.4TFSi, 1.6i, 1.6FSi, 1.6TDi, 1.8TFSi, 1.8TFSi Quattro, 1.9TDi, 2.0FSi, 2.0FSi Quattro, 2.0TFSi, 2.0TFSi Quattro, 2.0TDi, 2.0TDi Quattro, 3.2i Quattro (05/09→)



TA1914



TA1905



TBR4218



TA1905



TA1915



TC1315



TC1315



TC2690



TC2690



TC2482



TD521W



TD521W



TC2483



TC1317



TC1316



TD522W



TD523W



TD410W



TD410W



TC3315



TD521W



TD521W



TC3316



TC1317



TC1316



TD522W



TD523W



TD410W



TD410W



TC2141



TD521W



TD521W



TC2142



TC1317



TC1316



TD522W



TD523W



TD410W



TD410W

... A3 (8P SERIES) 1.2TFSi, 1.4TFSi, 1.6i, 1.6FSi, 1.6TDi, 1.8TFSi, 1.8TFSi Quattro, 1.9TDi, 2.0FSi, 2.0FSi Quattro, 2.0TFSi, 2.0TFSi Quattro, 2.0TDi, 2.0TDi Quattro, 3.2i Quattro (05/09→)

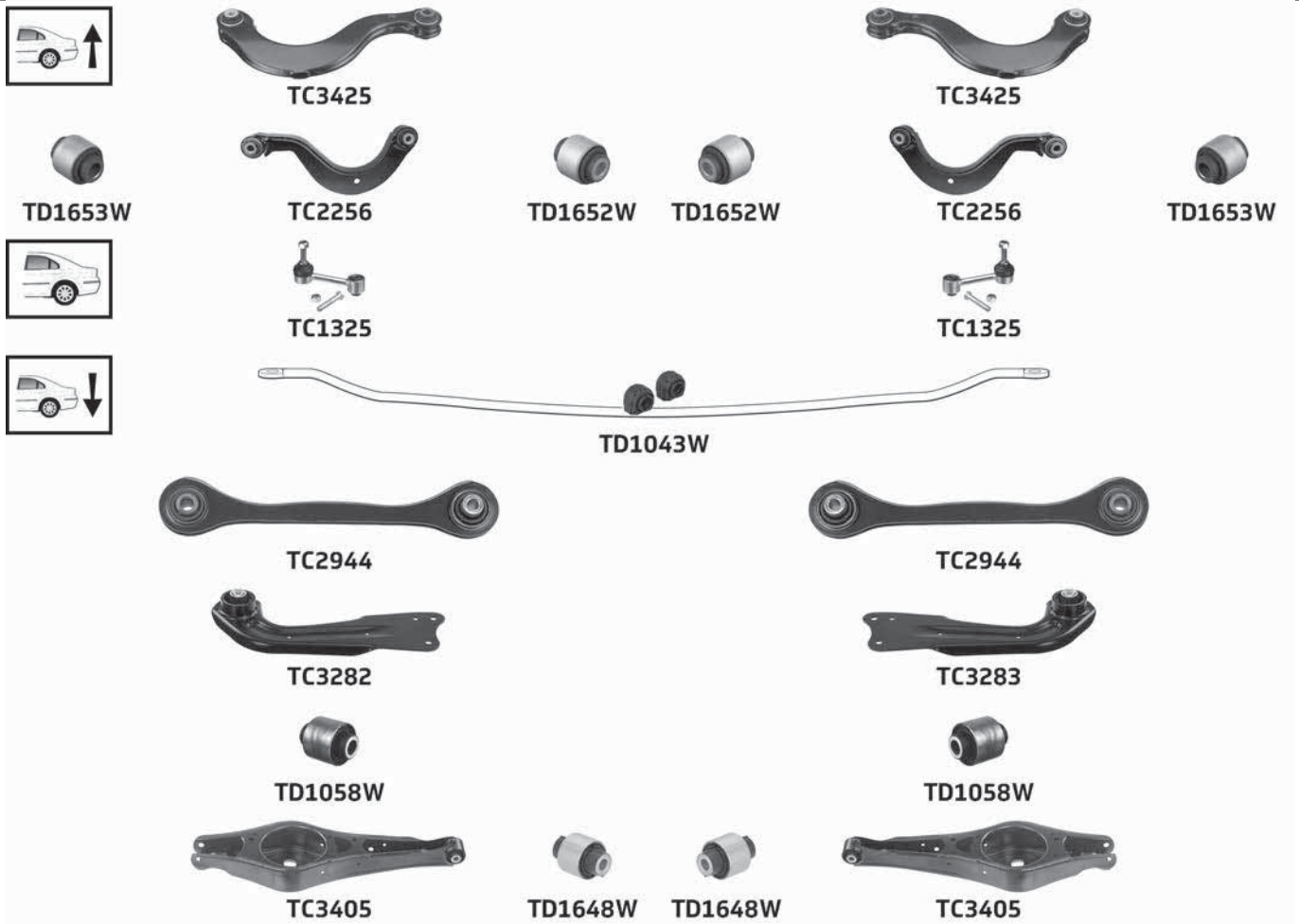

Part No	Description	Pos	Info	Technical
TA1905	Inner tie rod(123)	A B		M16x1.5 Male(252) £
TA1914	Tie rod end(224)	A		M16x1.5 Female(253) £
TA1915	Tie rod end(224)	B		M16x1.5 Female(253) £
TBR4218	Steering rack gaiter kit(213)	K	Thermoplastic(223)	1 :15.5x49.5x49.5 2 :15.5x49.5x49.5
TC1315	Link stabiliser(135)	A B	(-) 3.2 Quattro	M12x1.5
TC1316	Lower ball joint(140)	A		M12x1.5
TC1317	Lower ball joint(140)	B		M12x1.5
TC1325	Link stabiliser(135)	A B		M10x1.5
TC2141	Lower wishbone(158)	A	(-) Bush(-13) Cast iron(-88)	
TC2142	Lower wishbone(158)	B	(-) Bush(-13) Cast iron(-88)	
TC2256	Upper track control arm(242)	A B	→28/05/2012	
TC2482	Lower wishbone(158)	A	(-) Bush(-13) (-) Sport suspension(-27) Sheet steel(201)	
TC2483	Lower wishbone(158)	B	(-) Bush(-13) (-) Sport suspension(-27) Sheet steel(201)	
TC2690	Link stabiliser(135)	A B	(+) 3.2 Quattro	M12x1.5
TC2944	Trailing arm(226)	A B		
TC3282	Lower link arm(144)	A	Front(108)	
TC3283	Lower link arm(144)	B	Front(108)	
TC3315	Lower wishbone(158)	A	(+) Ball joint(-39) (-) Sport suspension(-27) Sheet steel(201)	M12x1.5
TC3316	Lower wishbone(158)	B	(+) Ball joint(-39) (-) Sport suspension(-27) Sheet steel(201)	M12x1.5
TC3405	Lower track control arm(151)	A B	Rear(187)	
TC3425	Upper track control arm(242)	A B	28/05/2012→	
TD410W	Lower wishbone bush(159)	A B	Rear(187) (-) Housing(-19)	
TD521W	Lower wishbone bush(159)	A B	Front(108)	
TD522W	Lower wishbone bush(159)	A	Rear(187) (+) Housing(-48)	
TD523W	Lower wishbone bush(159)	B	Rear(187) (+) Housing(-48)	
TD1043W	Anti-roll bar(-74) bush kit(-86)	K	Ø18.5 Complete axle kit(-92)	
TD1058W	Lower hub carrier bush(143)	A B		

(...)

... AUDI

... A3 (8P SERIES) 1.2TFSi, 1.4TFSi, 1.6i, 1.6FSi, 1.6TDi, 1.8TFSi, 1.8TFSi Quattro, 1.9TDi, 2.0FSi, 2.0FSi Quattro, 2.0TFSi, 2.0TFSi Quattro, 2.0TDi, 2.0TDi Quattro, 3.2i Quattro (05/09→)

Part No	Description	Pos	Info	Technical
TD1648W	Lower track control arm bush(153)	A B	Inner(119)	
TD1652W	Upper track control arm bush(243)	A B		
TD1653W	Upper track control arm bush(243)	A B		

A3 (8V SERIES) 1.4TFSi, 1.6TDi, 1.8TFSi, 1.8TFSi Quattro, 2.0TDi, 2.0TDi Quattro (08/12→)

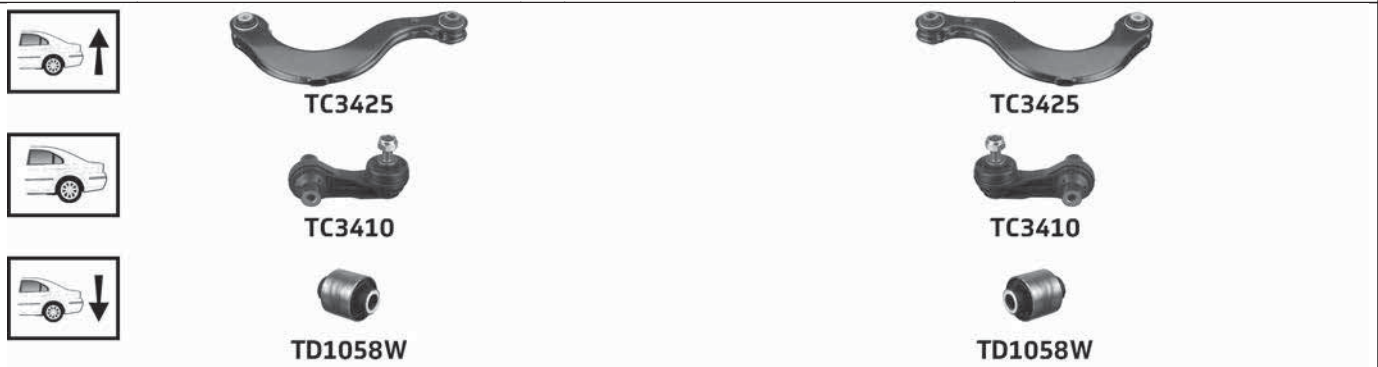
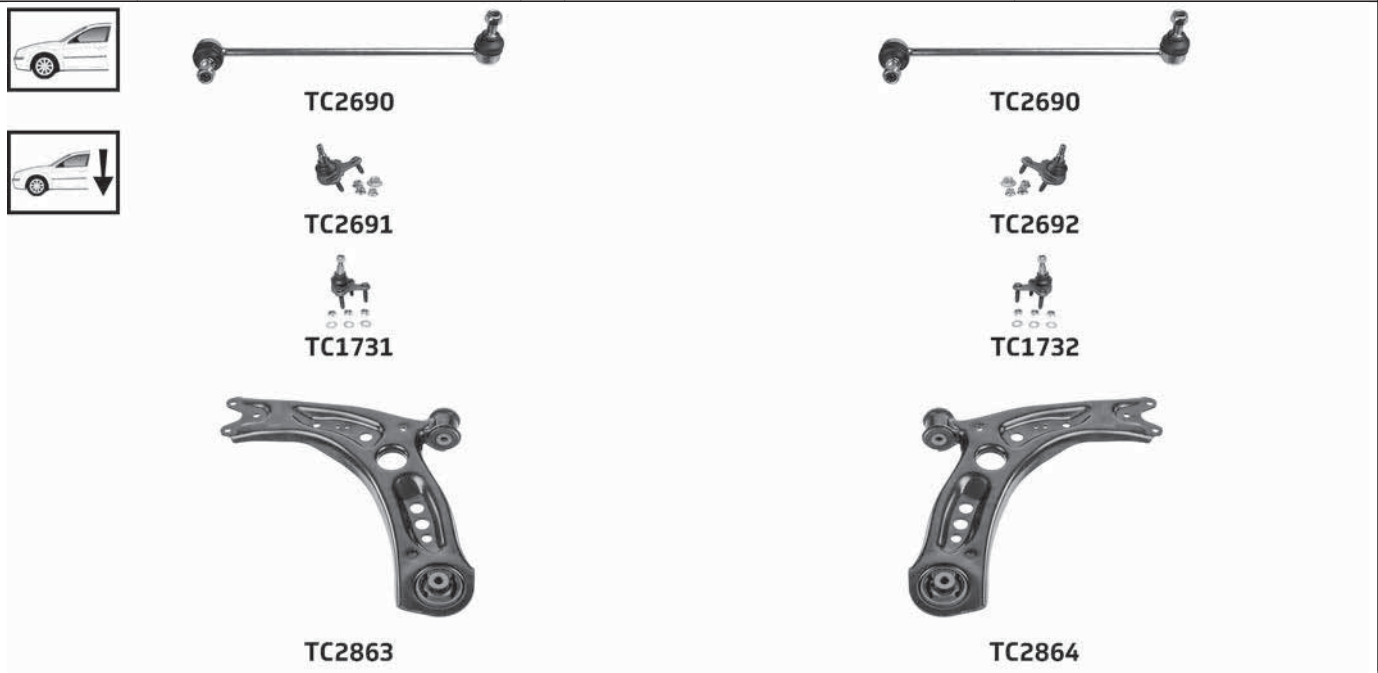

Part No	Description	Pos	Info	Technical
TA1905	Inner tie rod(123)	A B		M16x1.5 Male(252) £
TA1914	Tie rod end(224)	A		M16x1.5 Female(253) £
TA1915	Tie rod end(224)	B		M16x1.5 Female(253) £
TBR4218	Steering rack gaiter kit(213)	K	Thermoplastic(223)	1 :15.5x49.5x49.5 2 :15.5x49.5x49.5
TC1731	Lower ball joint(140)	A	PR-1ZA, 1ZD, 1LC, 1LJ For brake disc diameter(105) 312mm & 340mm	M12x1.5
TC1732	Lower ball joint(140)	B	PR-1ZA, 1ZD, 1LC, 1LJ For brake disc diameter(105) 312mm & 340mm	M12x1.5
TC2690	Link stabiliser(135)	A B		M12x1.5
TC2691	Lower ball joint(140)	A	PR-1ZE, 1ZF, 1ZP For brake disc diameter(105) 288mm	M12x1.5
TC2692	Lower ball joint(140)	B	PR-1ZE, 1ZF, 1ZP For brake disc diameter(105) 288mm	M12x1.5
TC2863	Lower wishbone(158)	A	(-) Ball joint(-11-)	
TC2864	Lower wishbone(158)	B	(-) Ball joint(-11-)	
TC3410	Link stabiliser(135)	A B		M10x1.5
TC3425	Upper track control arm(242)	A B		
TD1058W	Lower hub carrier bush(143)	A B		

A3 CABRIO (8P SERIES) 1.6i, 1.8TFSi, 1.9TDi, 2.0TFSi, 2.0TDi (04/08-05/09)



... AUDI

... A3 CABRIO (8P SERIES) 1.6i, 1.8TFSi, 1.9TDi, 2.0TFSi, 2.0TDi (04/08-05/09)



TD1653W



TC2256



TD1652W



TD1652W



TC2256



TD1653W



TC1325



TC1325



TC2944



TC2944



TC3282



TC3283



TD1058W



TD1058W



TC3405



TD1648W



TD1648W



TC3405

Part No	Description	Pos	Info	Technical
TA1905	Inner tie rod(123)	A B		M16x1.5 Male(252) E
TA1914	Tie rod end(224)	A		M16x1.5 Female(253) E
TA1915	Tie rod end(224)	B		M16x1.5 Female(253) E
TBR4218	Steering rack gaiter kit(213)	K	Thermoplastic(223)	1 :15.5x49.5x49.5 2 :15.5x49.5x49.5
TC1315	Link stabiliser(135)	A B		M12x1.5
TC1316	Lower ball joint(140)	A		M12x1.5
TC1317	Lower ball joint(140)	B		M12x1.5
TC1325	Link stabiliser(135)	A B		M10x1.5
TC2141	Lower wishbone(158)	A	(-) Bush(-13) Cast iron(-88)	
TC2142	Lower wishbone(158)	B	(-) Bush(-13) Cast iron(-88)	
TC2256	Upper track control arm(242)	A B		
TC2482	Lower wishbone(158)	A	(-) Bush(-13) Sheet steel(201)	
TC2483	Lower wishbone(158)	B	(-) Bush(-13) Sheet steel(201)	
TC2944	Trailing arm(226)	A B		
TC3282	Lower link arm(144)	A	Front(108)	
TC3283	Lower link arm(144)	B	Front(108)	
TC3315	Lower wishbone(158)	A	(+) Ball joint(-39) Sheet steel(201)	M12x1.5
TC3316	Lower wishbone(158)	B	(+) Ball joint(-39) Sheet steel(201)	M12x1.5
TC3405	Lower track control arm(151)	A B	Rear(187)	
TD410W	Lower wishbone bush(159)	A B	Rear(187) (-) Housing(-19)	
TD521W	Lower wishbone bush(159)	A B	Front(108)	
TD522W	Lower wishbone bush(159)	A	Rear(187) (+) Housing(-48)	
TD523W	Lower wishbone bush(159)	B	Rear(187) (+) Housing(-48)	
TD1058W	Lower hub carrier bush(143)	A B		
TD1648W	Lower track control arm bush(153)	A B	Inner(119)	
TD1652W	Upper track control arm bush(243)	A B		
TD1653W	Upper track control arm bush(243)	A B		

A3 CABRIO (8P SERIES) 1.2TFSi, 1.6i, 1.6TDi, 1.8TFSi, 1.9TDi, 2.0TFSi, 2.0TDi →Ch. 8P-D1050000 (05/09-06/13)



... AUDI

... A3 CABRIO (8P SERIES) 1.2TFSi, 1.6i, 1.6TDi, 1.8TFSi, 1.9TDi, 2.0TFSi, 2.0TDi →Ch. 8P-D1050000 (05/09-06/13)



TC3425



TC3425



TD1653W



TC2256



TD1652W



TD1652W



TC2256



TD1653W



TC1325



TC1325



TC2944



TC2944



TC3282



TC3283



TD1058W



TD1058W



TC3405



TD1648W



TD1648W



TC3405

Part No	Description	Pos	Info	Technical
TA1905	Inner tie rod(123)	A B		M16x1.5 Male(252) £
TA1914	Tie rod end(224)	A		M16x1.5 Female(253) £
TA1915	Tie rod end(224)	B		M16x1.5 Female(253) £
TBR4218	Steering rack gaiter kit(213)	K	Thermoplastic(223)	1 :15.5x49.5x49.5 2 :15.5x49.5x49.5
TC1315	Link stabiliser(135)	A B		M12x1.5
TC1316	Lower ball joint(140)	A		M12x1.5
TC1317	Lower ball joint(140)	B		M12x1.5
TC1325	Link stabiliser(135)	A B		M10x1.5
TC2141	Lower wishbone(158)	A	(-) Bush(-13) Cast iron(-88-)	
TC2142	Lower wishbone(158)	B	(-) Bush(-13) Cast iron(-88-)	
TC2256	Upper track control arm(242)	A B	→28/05/2012	
TC2482	Lower wishbone(158)	A	(-) Bush(-13) Sheet steel(201)	
TC2483	Lower wishbone(158)	B	(-) Bush(-13) Sheet steel(201)	
TC2944	Trailing arm(226)	A B		
TC3282	Lower link arm(144)	A	Front(108)	
TC3283	Lower link arm(144)	B	Front(108)	
TC3315	Lower wishbone(158)	A	(+) Ball joint(-39) Sheet steel(201)	M12x1.5
TC3316	Lower wishbone(158)	B	(+) Ball joint(-39) Sheet steel(201)	M12x1.5
TC3405	Lower track control arm(151)	A B	Rear(187)	
TC3425	Upper track control arm(242)	A B	28/05/2012→	
TD410W	Lower wishbone bush(159)	A B	Rear(187) (-) Housing(-19)	
TD521W	Lower wishbone bush(159)	A B	Front(108)	
TD522W	Lower wishbone bush(159)	A	Rear(187) (+) Housing(-48-)	
TD523W	Lower wishbone bush(159)	B	Rear(187) (+) Housing(-48-)	
TD1058W	Lower hub carrier bush(143)	A B		
TD1648W	Lower track control arm bush(153)	A B	Inner(119)	
TD1652W	Upper track control arm bush(243)	A B		
TD1653W	Upper track control arm bush(243)	A B		

A3 CABRIO (8V SERIES) 1.4TFSi, 1.8TFSi, 2.0TDi (10/13→)

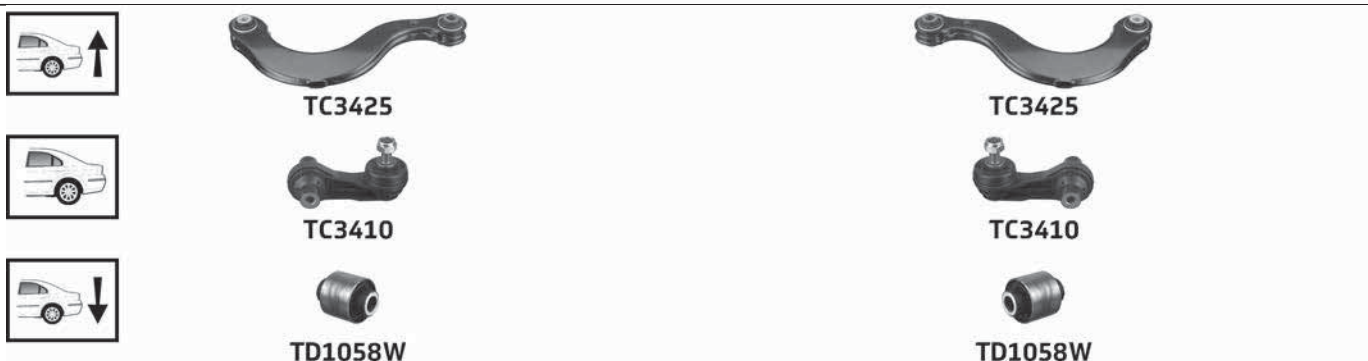
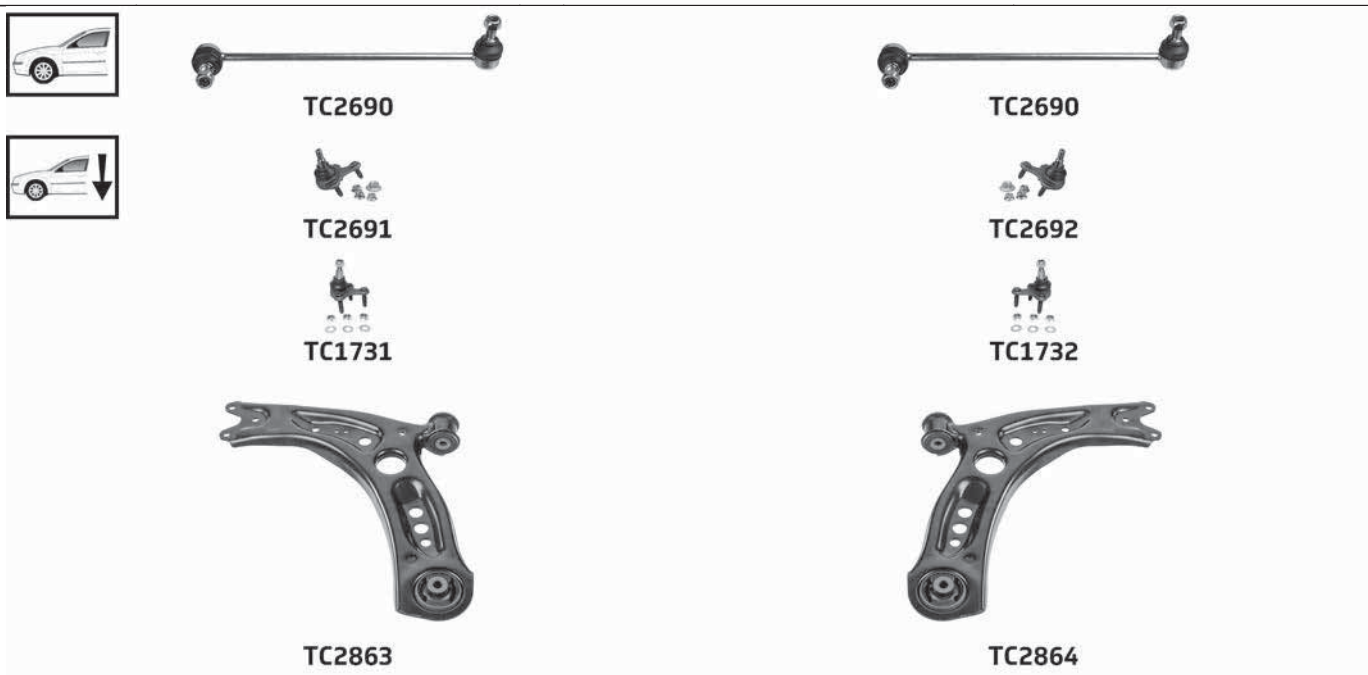

Part No	Description	Pos	Info	Technical
TA1905	Inner tie rod(123)	A B		M16x1.5 Male(252) £
TA1914	Tie rod end(224)	A		M16x1.5 Female(253) £
TA1915	Tie rod end(224)	B		M16x1.5 Female(253) £
TBR4218	Steering rack gaiter kit(213)	K	Thermoplastic(223)	1 :15.5x49.5x49.5 2 :15.5x49.5x49.5
TC1731	Lower ball joint(140)	A	PR-1ZA, 1ZD, 1LC, 1LJ For brake disc diameter(105) 312mm & 340mm	M12x1.5
TC1732	Lower ball joint(140)	B	PR-1ZA, 1ZD, 1LC, 1LJ For brake disc diameter(105) 312mm & 340mm	M12x1.5
TC2690	Link stabiliser(135)	A B		M12x1.5
TC2691	Lower ball joint(140)	A	PR-1ZE, 1ZP For brake disc diameter(105) 288mm	M12x1.5
TC2692	Lower ball joint(140)	B	PR-1ZE, 1ZP For brake disc diameter(105) 288mm	M12x1.5
TC2863	Lower wishbone(158)	A	(-) Ball joint(-11-)	
TC2864	Lower wishbone(158)	B	(-) Ball joint(-11-)	
TC3410	Link stabiliser(135)	A B		M10x1.5
TC3425	Upper track control arm(242)	A B		
TD1058W	Lower hub carrier bush(143)	A B		

AUDI

... AUDI

A4 (8D SERIES) 1.6i, 1.8i, 1.9TDi, 2.4i, 2.5TDi, 2.6i, 2.8i Standard suspension⁽²⁰⁸⁾ (01/95-09/01)



TL501



TL501



TA1583



TA1644



TA1644



TA1583



TC1177



TD437W



TD437W



TC1178



TC801



TD437W



TD437W



TC802



TC1300KIT



TD600W



TC929



TC930



TD826W



TD810W



TD441W



TC768



TD440W



TD440W



TC768



TD441W



TC769



TD439W



TD439W



TC770



TD983W



TD983W

Part No	Description	Pos	Info	Technical
TA1583	Tie rod end(224)	A B		M14x1.5 Male(252) £
TA1644	Inner tie rod(123)	A B		M14x1.5 Female(253) £
TC768	Lower track control arm(151)	A B	Front(108)	M12x1.25
TC769	Lower link arm(144)	A	Rear(187)	M12x1.5
TC770	Lower link arm(144)	B	Rear(187)	M12x1.5
TC801	Upper link arm(239)	A	Rear(187)	Pinch Bolt(255) 16mm
TC802	Upper link arm(239)	B	Rear(187)	Pinch Bolt(255) 16mm
TC929	Link stabiliser(135)	A		
TC930	Link stabiliser(135)	B		
TC1177	Upper link arm(239)	A	Front(108)	Pinch Bolt(255) 16mm
TC1178	Upper link arm(239)	B	Front(108)	Pinch Bolt(255) 16mm
TC1300KIT	Suspension kit(220)	K		
TD437W	Upper link arm bush(240)	A B		
TD439W	Lower link arm bush(145)	A B		
TD440W	Lower track control arm bush(153)	A B	Inner(119)	
TD441W	Lower track control arm bush(153)	A B	Outer(176)	

... A4 (8D SERIES) 1.6i, 1.8i, 1.9TDi, 2.4i, 2.5TDi, 2.6i, 2.8i Standard suspension⁽²⁰⁸⁾ (01/95-09/01)

Part No	Description	Pos	Info	Technical
TD600W	Suspension bolt kit(219)	K		
TD810W	Anti-roll bar(-74) bush kit(-86)	K	Ø27 Complete axle kit(-92)	
TD826W	Anti-roll bar(-74) bush kit(-86)	K	Ø25 Complete axle kit(-92)	
TD983W	Axle bush(-76)	A B		
TL501	Rod assembly(194)	A B		M16x1.5

A4 (8D SERIES) 1.8i, 1.9TDi, 2.4i, 2.5TDi, 2.6i, 2.8i Quattro | Standard suspension⁽²⁰⁸⁾ (01/95-09/01)

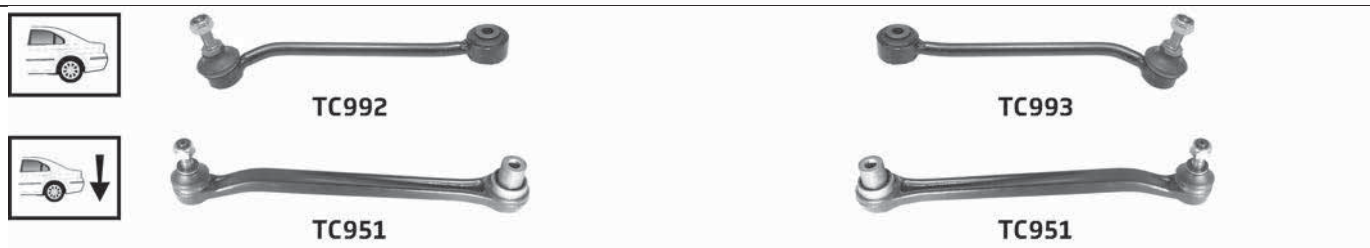
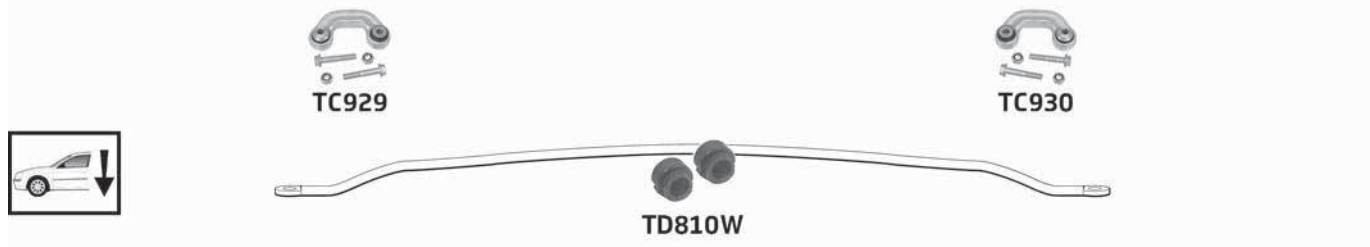
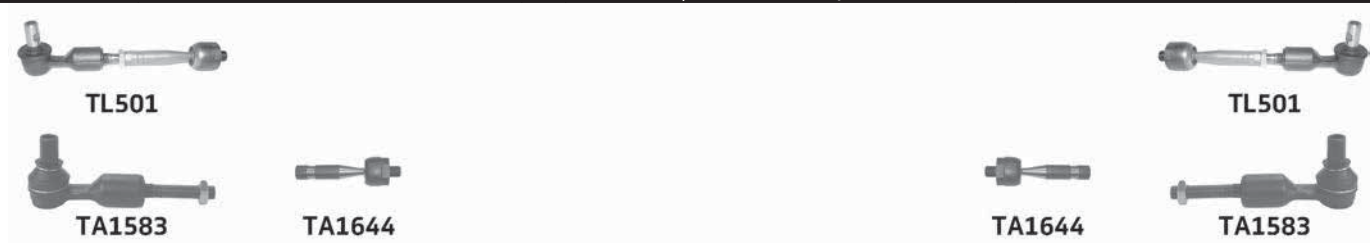

Part No	Description	Pos	Info	Technical
TA1583	Tie rod end(224)	A B		M14x1.5 Male(252) £
TA1644	Inner tie rod(123)	A B		M14x1.5 Female(253) £
TC768	Lower track control arm(151)	A B	Front(108)	M12x1.25
TC769	Lower link arm(144)	A	Rear(187)	M12x1.5
TC770	Lower link arm(144)	B	Rear(187)	M12x1.5
TC801	Upper link arm(239)	A	Rear(187)	Pinch Bolt(255) 16mm
TC802	Upper link arm(239)	B	Rear(187)	Pinch Bolt(255) 16mm
TC929	Link stabiliser(135)	A		

(...)

... AUDI

... A4 (8D SERIES) 1.8i, 1.9TDi, 2.4i, 2.5TDi, 2.6i, 2.8i Quattro | Standard suspension⁽²⁰⁸⁾ (01/95-09/01)

Part No	Description	Pos	Info	Technical
TC930	Link stabiliser (135)	B		
TC951	Lower rod assembly (146)	A B		M12x1.5
TC992	Link stabiliser (135)	A		M10x1.5
TC993	Link stabiliser (135)	B		M10x1.5
TC1177	Upper link arm (239)	A	Front (108)	Pinch Bolt (255) 16mm
TC1178	Upper link arm (239)	B	Front (108)	Pinch Bolt (255) 16mm
TC1300KIT	Suspension kit (220)	K		
TD437W	Upper link arm bush (240)	A B		
TD439W	Lower link arm bush (145)	A B		
TD440W	Lower track control arm bush (153)	A B	Inner (119)	
TD441W	Lower track control arm bush (153)	A B	Outer (176)	
TD600W	Suspension bolt kit (219)	K		
TD810W	Anti-roll bar (-74-) bush kit (-86-)	K	Ø27 Complete axle kit (-92-)	
TL501	Rod assembly (194)	A B		M16x1.5

A4 (8E SERIES) 1.6i, 1.8i, 1.8i Quattro, 1.9TDi, 1.9TDi Quattro, 2.0i, 2.0FSi, 2.4i, 2.4i Quattro, 2.5TDi, 2.5TDi Quattro, 2.6i, 2.6i Quattro, 2.8i, 2.8i Quattro, 3.0i, 3.0i Quattro → Ch. 8E5 400000 | Standard suspension⁽²⁰⁸⁾ (12/00-12/04)



TC1177



TD437W TD437W



TC1178



TC801



TD437W TD437W



TC802



TC1500KIT



TD600W



TC1290



TC1291



TD475W



TC1179



TD440W TD440W



TC1179



TD475W



TC769



TD439W TD439W



TC770

... A4 (8E SERIES) 1.6i, 1.8i, 1.8i Quattro, 1.9TDi, 1.9TDi Quattro, 2.0i, 2.0FSi, 2.4i, 2.4i Quattro, 2.5TDi, 2.5TDi Quattro, 2.6i, 2.6i Quattro, 2.8i, 2.8i Quattro, 3.0i, 3.0i Quattro →Ch. 8E5 400000 | Standard suspension⁽²⁰⁸⁾ (12/00-12/04)



TC3088



TC3087



TC2100



TC2100



TC3195



TC3195



TD1095W



TD1095W



TD1378W



TD1378W



TD1378W



TD1378W



TD1246W



TD1246W

Part No	Description	Pos	Info	Technical
TA1644	Inner tie rod(123)	A B		M14x1.5 Female(253) £
TA1908	Tie rod end(224)	A B		M14x1.5 Male(252) £
TC769	Lower link arm(144)	A	Rear(187)	M12x1.5
TC770	Lower link arm(144)	B	Rear(187)	M12x1.5
TC801	Upper link arm(239)	A	Rear(187)	Pinch Bolt(255) 16mm
TC802	Upper link arm(239)	B	Rear(187)	Pinch Bolt(255) 16mm
TC1177	Upper link arm(239)	A	Front(108)	Pinch Bolt(255) 16mm
TC1178	Upper link arm(239)	B	Front(108)	Pinch Bolt(255) 16mm
TC1179	Lower track control arm(151)	A B	Front(108)	M12x1.5
TC1290	Link stabiliser(135)	A		
TC1291	Link stabiliser(135)	B		
TC1500KIT	Suspension kit(220)	K		
TC2100	Link stabiliser(135)	A B		M10x1.5
TC3087	Upper track control arm(242)	B		
TC3088	Upper track control arm(242)	A		
TC3195	Lower track rod(155)	A B		
TD437W	Upper link arm bush(240)	A B		
TD439W	Lower link arm bush(145)	A B		
TD440W	Lower track control arm bush(153)	A B	Inner(119)	
TD475W	Lower track control arm bush(153)	A B	Outer(176)	
TD600W	Suspension bolt kit(219)	K		
TD1095W	Sub-frame bush(215)	A B	Front(108) Fit in pairs when replacing hydraulic type(104)	
TD1246W	Lower hub carrier bush(143)	A B		
TD1378W	Sub-frame bush(215)	A B	Rear(187) Ch.No. 8E-2-120 001→ (-) Eng AVF Quattro Fit in pairs when replacing hydraulic type(104)	

... AUDI

A4 (8E SERIES) 1.6i, 1.8i, 1.8i Quattro, 1.9TDi, 2.0i, 2.0FSi, 2.0TFSi, 2.0TFSi Quattro, 2.0TDi, 2.0TDi Quattro, 2.5TDi, 2.7TDi, 3.0i, 3.0i Quattro, 3.0TDi Quattro, 3.2FSi, 3.2FSi Quattro Ch. 8E5 400001-8E8 250000 (11/04-06/08)

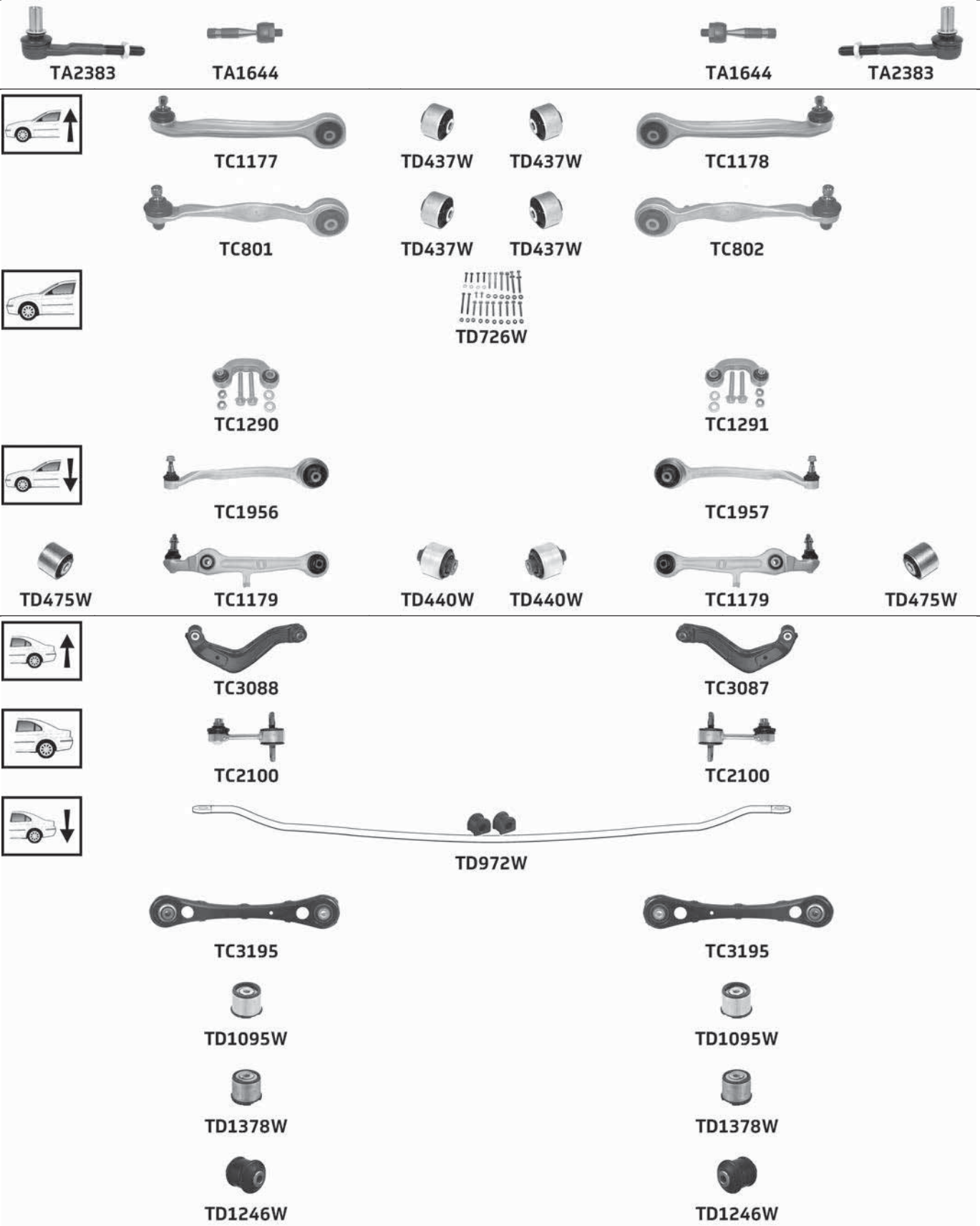

Part No	Description	Pos	Info	Technical
TA1644	Inner tie rod(123)	A B		M14x1.5 Female(253) E
TA2383	Tie rod end(224)	A B		M14x1.5 Male(252) E
TC801	Upper link arm(239)	A	Rear(187)	Pinch Bolt(255) 16mm
TC802	Upper link arm(239)	B	Rear(187)	Pinch Bolt(255) 16mm
TC1177	Upper link arm(239)	A	Front(108)	Pinch Bolt(255) 16mm
TC1178	Upper link arm(239)	B	Front(108)	Pinch Bolt(255) 16mm

... **A4 (8E SERIES)** 1.6i, 1.8i, 1.8i Quattro, 1.9TDi, 2.0i, 2.0FSi, 2.0TFSi, 2.0TFSi Quattro, 2.0TDi, 2.0TDi Quattro, 2.5TDi, 2.7TDi, 3.0i, 3.0i Quattro, 3.0TDi Quattro, 3.2FSi, 3.2FSi Quattro Ch. 8E5 400001-8E8 250000 (11/04-06/08)

Part No	Description	Pos	Info	Technical
TC1179	Lower track control arm(151)	A B	Front(108)	M12x1.5
TC1290	Link stabiliser(135)	A		
TC1291	Link stabiliser(135)	B		
TC1956	Lower link arm(144)	A	Rear(187)	M12x1.5
TC1957	Lower link arm(144)	B	Rear(187)	M12x1.5
TC2100	Link stabiliser(135)	A B		M10x1.5
TC3087	Upper track control arm(242)	B		
TC3088	Upper track control arm(242)	A		
TC3195	Lower track rod(155)	A B		
TD437W	Upper link arm bush(240)	A B		
TD440W	Lower track control arm bush(153)	A B	Inner(119)	
TD475W	Lower track control arm bush(153)	A B	Outer(176)	
TD726W	Suspension bolt kit(219)	K		
TD972W	Anti-roll bar(-74) bush kit(-86)	K	Ø16 Complete axle kit(-92) →Ch. 8E-6-200000	
TD1095W	Sub-frame bush(215)	A B	Front(108) Fit in pairs when replacing hydraulic type(104)	
TD1246W	Lower hub carrier bush(143)	A B		
TD1378W	Sub-frame bush(215)	A B	Rear(187) (-) Eng BPW, BRD, BVA Quattro Fit in pairs when replacing hydraulic type(104)	

A4 (8K SERIES) 1.8TFSi, 1.8TFSi Quattro, 2.0TFSi, 2.0TFSi Quattro, 2.0TDi, 2.0TDi Quattro, 2.7TDi, 3.0TDi Quattro, 3.2FSi, 3.2FSi Quattro Ch. 8K8 000001→ (11/07-11/09)

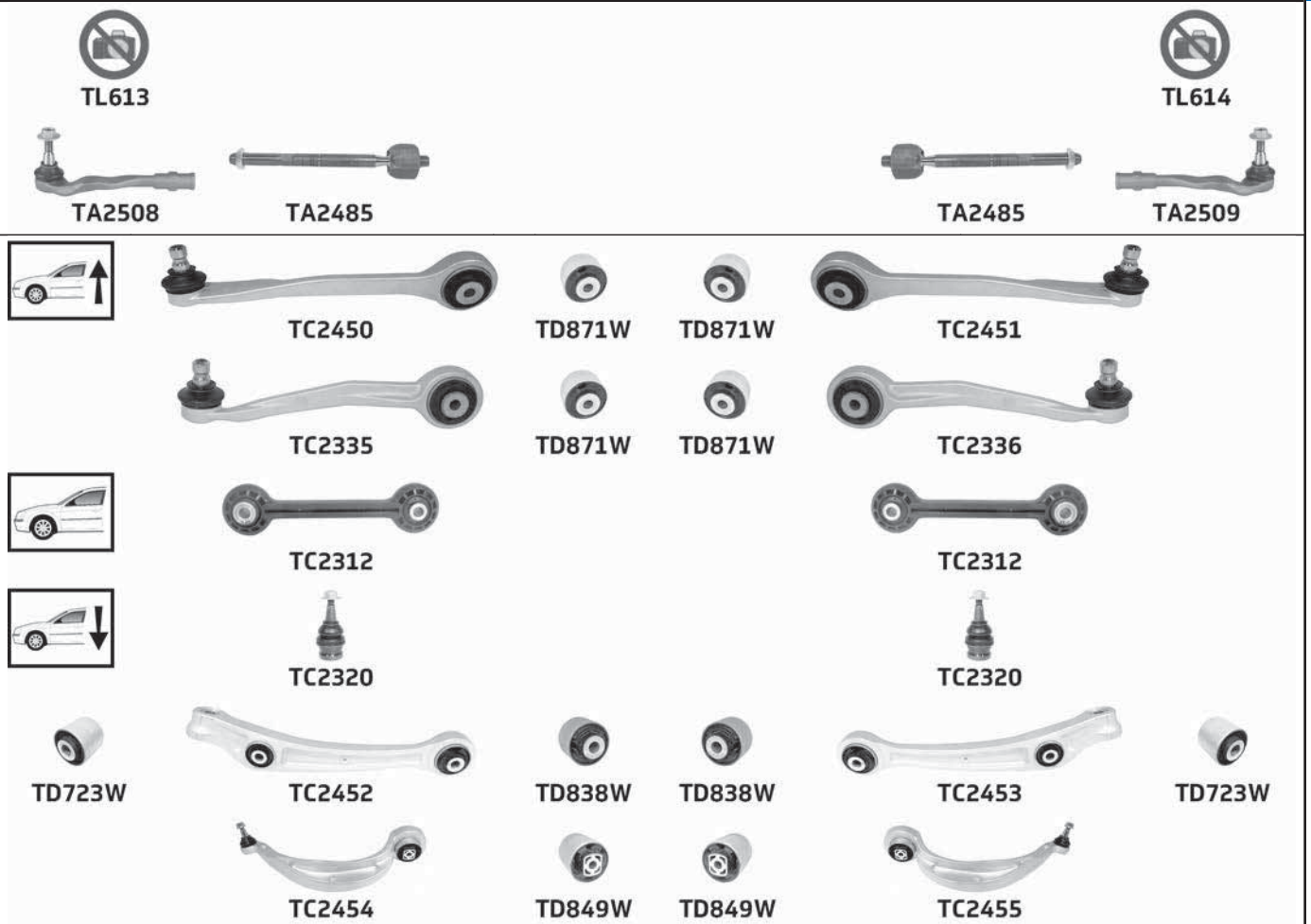

... AUDI

... A4 (8K SERIES) 1.8TFSI, 1.8TFSI Quattro, 2.0TFSI, 2.0TFSI Quattro, 2.0TDI, 2.0TDI Quattro, 2.7TDI, 3.0TDI Quattro, 3.2FSI, 3.2FSI Quattro Ch. 8K8 000001→ (11/07-11/09)



TC3089



TC3090



TC2275



TC2275



TC3597



TC3597



TD1493W



TC3337



TD1493W



TD1493W



TC3338



TD1493W

Part No	Description	Pos	Info	Technical
TA2485	Inner tie rod(123)	A B		M16x1.5 Male(252) £
TA2508	Tie rod end(224)	A		M16x1.5 Female(253) £
TA2509	Tie rod end(224)	B		M16x1.5 Female(253) £
TC2275	Link stabiliser(135)	A B		
TC2312	Link stabiliser(135)	A B		
TC2320	Lower ball joint(140)	A B		M12x1.5
TC2335	Upper link arm(239)	A	Rear(187)	Pinch Bolt(255) 16mm
TC2336	Upper link arm(239)	B	Rear(187)	Pinch Bolt(255) 16mm
TC2450	Upper link arm(239)	A	Front(108)	Pinch Bolt(255) 16mm
TC2451	Upper link arm(239)	B	Front(108)	Pinch Bolt(255) 16mm
TC2452	Lower track control arm(151)	A	Front(108)	
TC2453	Lower track control arm(151)	B	Front(108)	
TC2454	Lower link arm(144)	A	Rear(187)	M12x1.5
TC2455	Lower link arm(144)	B	Rear(187)	M12x1.5
TC3089	Upper track control arm(242)	A		
TC3090	Upper track control arm(242)	B		
TC3337	Lower track control arm(150)	A	Aluminium(-73) → 20/07/2009	
TC3338	Lower track control arm(150)	B	Aluminium(-73) → 20/07/2009	
TC3597	Lower track control arm(150)	A B	Steel(210) 20/07/2009→	
TD723W	Lower track control arm bush(153)	A B	Outer(176)	
TD838W	Lower track control arm bush(153)	A B	Inner(119)	
TD849W	Lower link arm bush(145)	A B	Ø65	
TD871W	Upper link arm bush(240)	A B		
TD1493W	Lower track control arm bush(153)	A B	Outer(176) Inner(119) → 20/07/2009	
TL613	Rod assembly(194)	A		M12x1.5
TL614	Rod assembly(194)	B		M12x1.5

A4 (8K SERIES) 1.8TFSI, 1.8TFSI Quattro, 2.0TFSI, 2.0TFSI Quattro, 2.0TDI, 2.0TDI Quattro, 2.7TDI, 3.0TDI Quattro, 3.2FSI, 3.2FSI Quattro (11/09-05/10)

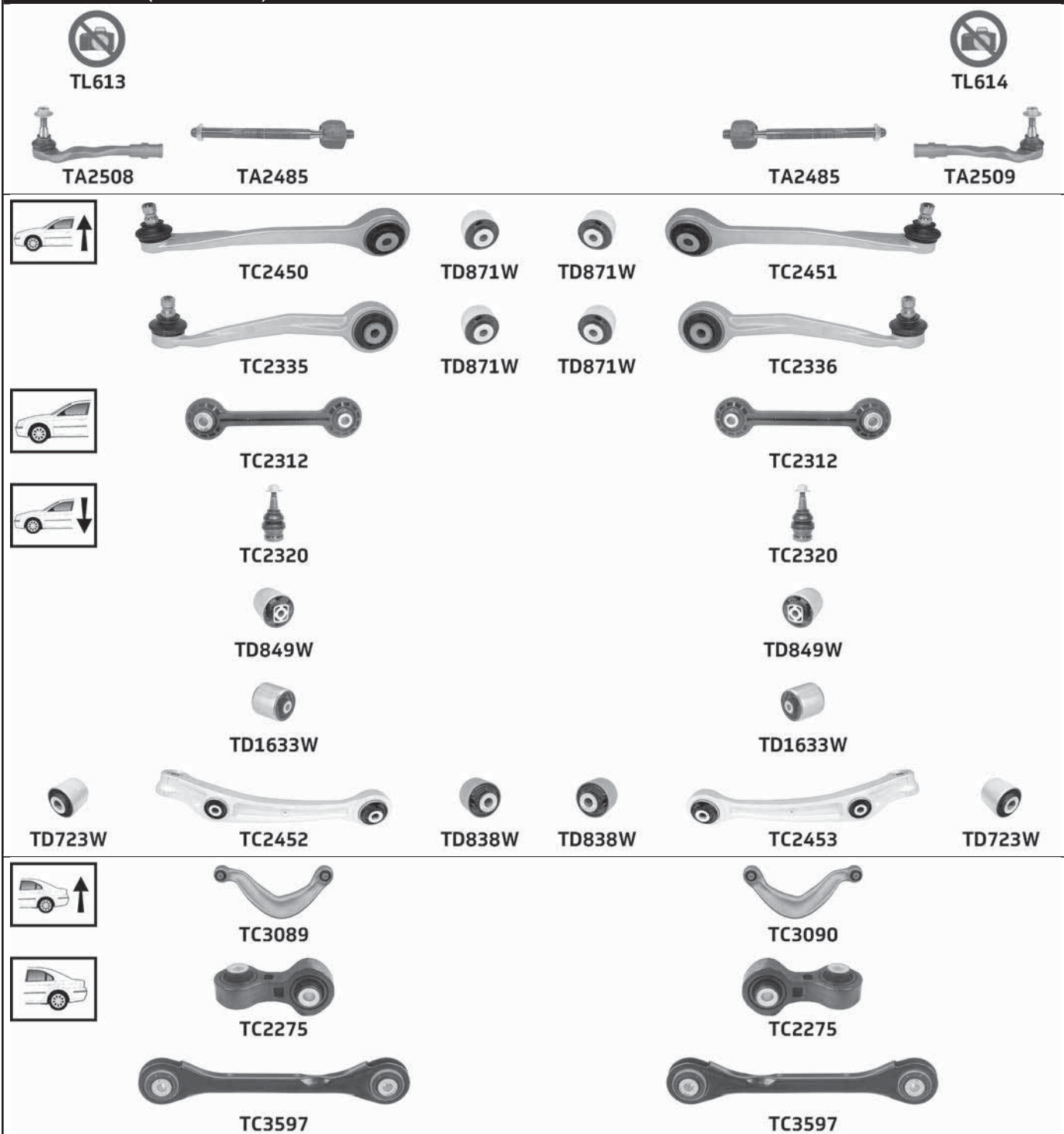

Part No	Description	Pos	Info	Technical
TA2485	Inner tie rod(123)	A B		M16x1.5 Male(252) £
TA2508	Tie rod end(224)	A		M16x1.5 Female(253) £
TA2509	Tie rod end(224)	B		M16x1.5 Female(253) £
TC2275	Link stabiliser(135)	A B		
TC2312	Link stabiliser(135)	A B		
TC2320	Lower ball joint(140)	A B		M12x1.5
TC2335	Upper link arm(239)	A	Rear(187)	Pinch Bolt(255) 16mm
TC2336	Upper link arm(239)	B	Rear(187)	Pinch Bolt(255) 16mm
TC2450	Upper link arm(239)	A	Front(108)	Pinch Bolt(255) 16mm
TC2451	Upper link arm(239)	B	Front(108)	Pinch Bolt(255) 16mm
TC2452	Lower track control arm(151)	A	Front(108)	
TC2453	Lower track control arm(151)	B	Front(108)	
TC3089	Upper track control arm(242)	A		

(...)

... AUDI

... A4 (8K SERIES) 1.8TFSI, 1.8TFSI Quattro, 2.0TFSI, 2.0TFSI Quattro, 2.0TDI, 2.0TDI Quattro, 2.7TDI, 3.0TDI Quattro, 3.2FSI, 3.2FSI Quattro (11/09-05/10)

Part No	Description	Pos	Info	Technical
TC3090	Upper track control arm(242)	B		
TC3597	Lower track control arm(150)	A B		
TD723W	Lower track control arm bush(153)	A B	Outer(176)	
TD838W	Lower track control arm bush(153)	A B	Inner(119)	
TD849W	Lower link arm bush(145)	A B	Rear(187) Ø65	
TD871W	Upper link arm bush(240)	A B		
TD1633W	Lower link arm bush(145)	A B	Rear(187) Ø75	
TL613	Rod assembly(194)	A		M12x1.5
TL614	Rod assembly(194)	B		M12x1.5

A4 (8K SERIES) 1.8TFSI, 1.8TFSI Quattro, 2.0TFSI, 2.0TFSI Quattro, 2.0TDI, 2.0TDI Quattro, 2.7TDI, 3.0TDI Quattro, 3.2FSI, 3.2FSI Quattro (05/10-08/11)



TL613



TL614



TA2508



TA2485



TA2485



TA2509





TC2450



TD871W



TD871W



TC2451





TC2335



TD871W



TD871W



TC2336





TC2312



TC2312





TC2320



TC2320



TD1633W



TD1633W



TD723W



TC2452



TD838W



TD838W



TC2453



TD723W





TC3089



TC3090



TC2275

TC2275

TC3597



TC3597

Part No	Description	Pos	Info	Technical
TA2485	Inner tie rod(123)	A B		M16x1.5 Male(252) £
TA2508	Tie rod end(224)	A		M16x1.5 Female(253) £
TA2509	Tie rod end(224)	B		M16x1.5 Female(253) £
TC2275	Link stabiliser(135)	A B		
TC2312	Link stabiliser(135)	A B		
TC2320	Lower ball joint(140)	A B		M12x1.5

... **A4 (8K SERIES)** 1.8TFSI, 1.8TFSI Quattro, 2.0TFSI, 2.0TFSI Quattro, 2.0TDI, 2.0TDI Quattro, 2.7TDI, 3.0TDI Quattro, 3.2FSI, 3.2FSI Quattro (05/10-08/11)

Part No	Description	Pos	Info	Technical
TC2335	Upper link arm(239)	A	Rear(187)	Pinch Bolt(255) 16mm
TC2336	Upper link arm(239)	B	Rear(187)	Pinch Bolt(255) 16mm
TC2450	Upper link arm(239)	A	Front(108)	Pinch Bolt(255) 16mm
TC2451	Upper link arm(239)	B	Front(108)	Pinch Bolt(255) 16mm
TC2452	Lower track control arm(151)	A	Front(108)	
TC2453	Lower track control arm(151)	B	Front(108)	
TC3089	Upper track control arm(242)	A		
TC3090	Upper track control arm(242)	B		
TC3597	Lower track control arm(150)	A B		
TD723W	Lower track control arm bush(153)	A B	Outer(176)	
TD838W	Lower track control arm bush(153)	A B	Inner(119)	
TD871W	Upper link arm bush(240)	A B		
TD1633W	Lower link arm bush(145)	A B	Rear(187) Ø75	
TL613	Rod assembly(194)	A		M12x1.5
TL614	Rod assembly(194)	B		M12x1.5

A4 (8K SERIES) 1.8TFSI, 1.8TFSI Quattro, 2.0TFSI, 2.0TFSI Quattro, 2.0TDI, 2.0TDI Quattro, 2.7TDI, 3.0TDI, 3.0TDI Quattro, 3.2FSI, 3.2FSI Quattro (08/11-12/15)



TL613



TA2508



TA2915



TA2485



TA2485



TA2485



TA2485



TL614



TA2509



TA2916







TC2450



TC2335



TC2312



TC2684



TD1633W



TC2708



TD871W



TD871W



TD871W



TD871W



TD871W



TD838W



TD838W



TC2451



TC2336



TC2312



TC2684



TD1633W



TC2709



TD723W

... AUDI

... A4 (8K SERIES) 1.8TFSI, 1.8TFSI Quattro, 2.0TFSI, 2.0TFSI Quattro, 2.0TDI, 2.0TDI Quattro, 2.7TDI, 3.0TDI, 3.0TDI Quattro, 3.2FSI, 3.2FSI Quattro (08/11-12/15)



TC3089



TC3090



TC2275



TC2275



TC3597



TC3597

Part No	Description	Pos	Info	Technical
TA2485	Inner tie rod(123)	A B		M16x1.5 Male(252) £
TA2508	Tie rod end(224)	A	Hydraulic(115) Power steering(185) →Ch. 8K CA200000, 8K CN075000, 8K CY715000	M16x1.5 Female(253) £
TA2509	Tie rod end(224)	B	Hydraulic(115) Power steering(185) →Ch. 8K CA200000, 8K CN075000, 8K CY715000	M16x1.5 Female(253) £
TA2915	Tie rod end(224)	A	Electric(103) Power steering(185)	M16x1.5 Female(253) £
TA2916	Tie rod end(224)	B	Electric(103) Power steering(185)	M16x1.5 Female(253) £
TC2275	Link stabiliser(135)	A B		
TC2312	Link stabiliser(135)	A B		
TC2335	Upper link arm(239)	A	Rear(187)	Pinch Bolt(255) 16mm
TC2336	Upper link arm(239)	B	Rear(187)	Pinch Bolt(255) 16mm
TC2450	Upper link arm(239)	A	Front(108)	Pinch Bolt(255) 16mm
TC2451	Upper link arm(239)	B	Front(108)	Pinch Bolt(255) 16mm
TC2684	Lower ball joint(140)	A B		M14x1.5
TC2708	Lower track control arm(151)	A	Front(108)	
TC2709	Lower track control arm(151)	B	Front(108)	
TC3089	Upper track control arm(242)	A		
TC3090	Upper track control arm(242)	B		
TC3597	Lower track control arm(150)	A B		
TD723W	Lower track control arm bush(153)	A B	Outer(176)	
TD838W	Lower track control arm bush(153)	A B	Inner(119)	
TD871W	Upper link arm bush(240)	A B		
TD1633W	Lower link arm bush(145)	A B	Rear(187) Ø75	
TL613	Rod assembly(194)	A	Hydraulic(115) Power steering(185) →Ch. 8K CA200000, 8K CN075000, 8K CY715000	M12x1.5
TL614	Rod assembly(194)	B	Hydraulic(115) Power steering(185) →Ch. 8K CA200000, 8K CN075000, 8K CY715000	M12x1.5

A4 (8W SERIES) 1.4TFSI, 2.0TFSI, 2.0TFSI Quattro, 2.0TDI, 2.0TDI Quattro, 3.0TDI, 3.0TDI Quattro (08/15→)



TC2312



TC2312



TC3598



TC3598

Part No	Description	Pos	Info	Technical
TC2312	Link stabiliser(135)	A B	(-) Heavy duty suspension(-18-) Plastic(184)	
TC3598	Link stabiliser(135)	A B	(+) Heavy duty suspension(-47-) Aluminium(-73-)	

A4 CABRIO (8H SERIES) 1.8i, 1.8i Quattro, 2.0i, 2.0TFSi, 2.0TDi, 2.4i, 2.5TDi, 2.7TDi, 3.0i, 3.0i Quattro, 3.0TDi Quattro, 3.2FSi, 3.2FSi Quattro (04/02-03/09)

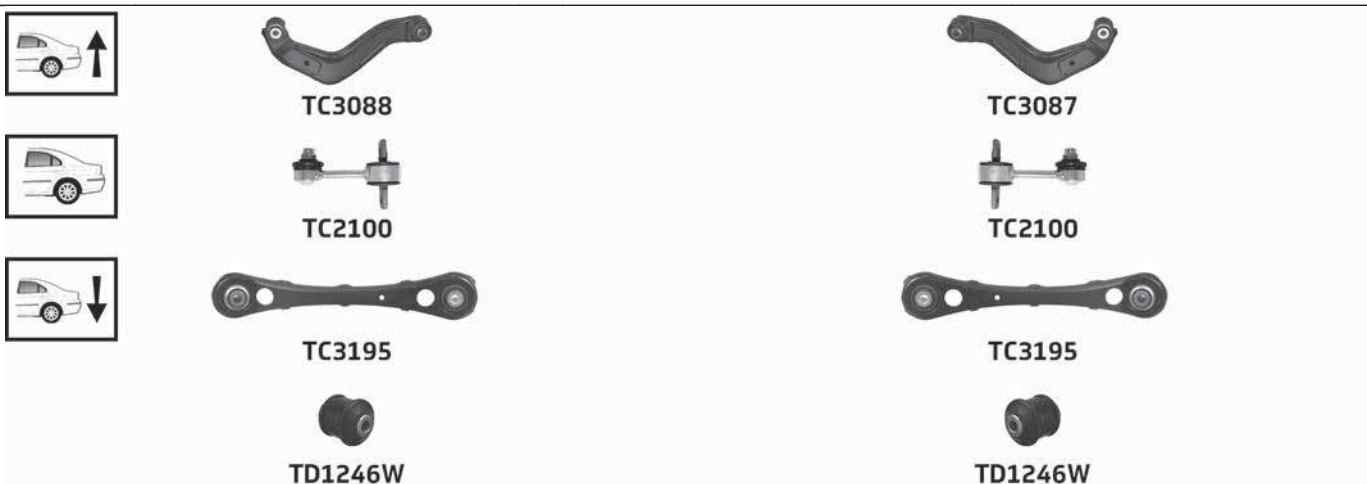
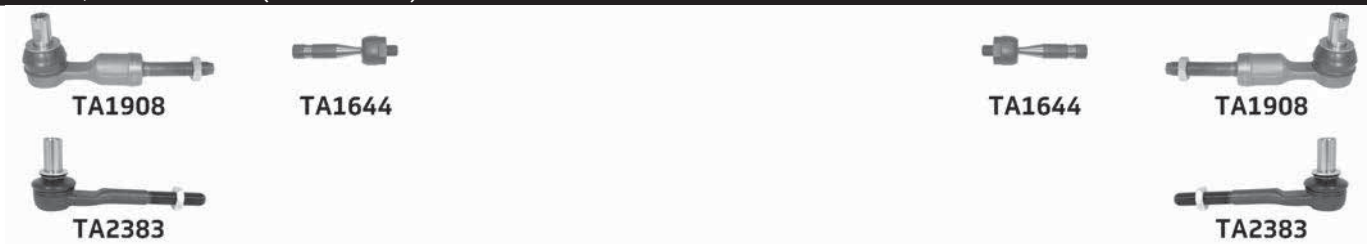

Part No	Description	Pos	Info	Technical
TA1644	Inner tie rod(123)	A B		M14x1.5 Female(253) £
TA1908	Tie rod end(224)	A B	→Ch. 8H5 014475	M14x1.5 Male(252) £
TA2383	Tie rod end(224)	A B	Ch. 8H5 014476→	M14x1.5 Male(252) £
TC769	Lower link arm(144)	A	Rear(187) →Ch. 8H6 025000	M12x1.5
TC770	Lower link arm(144)	B	Rear(187) →Ch. 8H6 025000	M12x1.5

AUDI

(...)

... AUDI

... A4 CABRIO (8H SERIES) 1.8i, 1.8i Quattro, 2.0i, 2.0TFSi, 2.0TDi, 2.4i, 2.5TDi, 2.7TDi, 3.0i, 3.0i Quattro, 3.0TDi Quattro, 3.2FSi, 3.2FSi Quattro (04/02-03/09)

Part No	Description	Pos	Info	Technical
TC801	Upper link arm(239)	A	Rear(187)	Pinch Bolt(255) 16mm
TC802	Upper link arm(239)	B	Rear(187)	Pinch Bolt(255) 16mm
TC1177	Upper link arm(239)	A	Front(108)	Pinch Bolt(255) 16mm
TC1178	Upper link arm(239)	B	Front(108)	Pinch Bolt(255) 16mm
TC1179	Lower track control arm(151)	A B	Front(108)	M12x1.5
TC1290	Link stabiliser(135)	A		
TC1291	Link stabiliser(135)	B		
TC1500KIT	Suspension kit(220)	K	→Ch. 8H5 014475	
TC1956	Lower link arm(144)	A	Rear(187) Ch. 8H7 000001→	M12x1.5
TC1957	Lower link arm(144)	B	Rear(187) Ch. 8H7 000001→	M12x1.5
TC2100	Link stabiliser(135)	A B		M10x1.5
TC3087	Upper track control arm(242)	B		
TC3088	Upper track control arm(242)	A		
TC3195	Lower track rod(155)	A B		
TD437W	Upper link arm bush(240)	A B		
TD439W	Lower link arm bush(145)	A B	→Ch. 8H6 025000	
TD440W	Lower track control arm bush(153)	A B	Inner(119)	
TD475W	Lower track control arm bush(153)	A B	Outer(176)	
TD600W	Suspension bolt kit(219)	K		
TD1246W	Lower hub carrier bush(143)	A B		

A4 ALLROAD (8K SERIES) 2.0TFSi, 2.0TDI, 3.0TDI Quattro (04/09-11/09)



TL613



TL614



TA2508



TA2485



TA2485



TA2509





TC2972



TC2973





TC2974



TC2975





TC2312



TC2312



TC2320



TD1633W



TC2320



TD1633W



TD723W



TC2452



TD838W



TD838W



TC2453

TD723W

TC2454

TD849W

TD849W

TC2455

... A4 ALLROAD (8K SERIES) 2.0TFSI, 2.0TDI, 3.0TDI Quattro (04/09-11/09)



TC3089



TC3090



TC2275



TC2275



TC3597



TC3597



TD1493W



TC3337



TD1493W



TD1493W



TC3338



TD1493W

Part No	Description	Pos	Info	Technical
TA2485	Inner tie rod(123)	A B		M16x1.5 Male(252) £
TA2508	Tie rod end(224)	A	Hydraulic(115) Power steering(185)	M16x1.5 Female(253) £
TA2509	Tie rod end(224)	B	Hydraulic(115) Power steering(185)	M16x1.5 Female(253) £
TC2275	Link stabiliser(135)	A B		
TC2312	Link stabiliser(135)	A B		
TC2320	Lower ball joint(140)	A B		M12x1.5
TC2452	Lower track control arm(151)	A	Front(108)	
TC2453	Lower track control arm(151)	B	Front(108)	
TC2454	Lower link arm(144)	A	Rear(187)	M12x1.5
TC2455	Lower link arm(144)	B	Rear(187)	M12x1.5
TC2972	Upper link arm(239)	A	Front(108)	Pinch Bolt(255) 16mm
TC2973	Upper link arm(239)	B	Front(108)	Pinch Bolt(255) 16mm
TC2974	Upper link arm(239)	A	Rear(187)	Pinch Bolt(255) 16mm
TC2975	Upper link arm(239)	B	Rear(187)	Pinch Bolt(255) 16mm
TC3089	Upper track control arm(242)	A		
TC3090	Upper track control arm(242)	B		
TC3337	Lower track control arm(150)	A	Aluminium(-73-) → 20/07/2009	
TC3338	Lower track control arm(150)	B	Aluminium(-73-) → 20/07/2009	
TC3597	Lower track control arm(150)	A B	Steel(210) 20/07/2009→	
TD723W	Lower track control arm bush(153)	A B	Outer(176)	
TD838W	Lower track control arm bush(153)	A B	Inner(119)	
TD849W	Lower link arm bush(145)	A B	Rear(187) Ø65	
TD1493W	Lower track control arm bush(153)	A B	Outer(176) Inner(119) → 20/07/2009	
TD1633W	Lower link arm bush(145)	A B	Rear(187) Ø75	
TL613	Rod assembly(194)	A	Hydraulic(115) Power steering(185)	M12x1.5
TL614	Rod assembly(194)	B	Hydraulic(115) Power steering(185)	M12x1.5

A4 ALLROAD (8K SERIES) 2.0TFSI, 2.0TDI, 3.0TDI Quattro (11/09-05/10)



TL613



TA2508



TA2485



TL614



TA2485



TA2509

... AUDI

... A4 ALLROAD (8K SERIES) 2.0TFSI, 2.0TDI, 3.0TDI Quattro (11/09-05/10)



TC2972



TC2973



TC2974



TC2975



TC2312



TC2312



TC2320



TC2320



TD849W



TD849W



TD1633W



TD1633W



TD723W



TC2452



TD838W



TD838W



TC2453



TD723W



TC3089



TC3090



TC2275



TC2275



TC3597



TC3597

Part No	Description	Pos	Info	Technical
TA2485	Inner tie rod(123)	A B		M16x1.5 Male(252) £
TA2508	Tie rod end(224)	A	Hydraulic(115) Power steering(185)	M16x1.5 Female(253) £
TA2509	Tie rod end(224)	B	Hydraulic(115) Power steering(185)	M16x1.5 Female(253) £
TC2275	Link stabiliser(135)	A B		
TC2312	Link stabiliser(135)	A B		
TC2320	Lower ball joint(140)	A B		M12x1.5
TC2452	Lower track control arm(151)	A	Front(108)	
TC2453	Lower track control arm(151)	B	Front(108)	
TC2972	Upper link arm(239)	A	Front(108)	Pinch Bolt(255) 16mm
TC2973	Upper link arm(239)	B	Front(108)	Pinch Bolt(255) 16mm
TC2974	Upper link arm(239)	A	Rear(187)	Pinch Bolt(255) 16mm
TC2975	Upper link arm(239)	B	Rear(187)	Pinch Bolt(255) 16mm
TC3089	Upper track control arm(242)	A		
TC3090	Upper track control arm(242)	B		
TC3597	Lower track control arm(150)	A B		
TD723W	Lower track control arm bush(153)	A B	Outer(176)	
TD838W	Lower track control arm bush(153)	A B	Inner(119)	
TD849W	Lower link arm bush(145)	A B	Rear(187) Ø65	
TD1633W	Lower link arm bush(145)	A B	Rear(187) Ø75	
TL613	Rod assembly(194)	A	Hydraulic(115) Power steering(185)	M12x1.5
TL614	Rod assembly(194)	B	Hydraulic(115) Power steering(185)	M12x1.5

A4 ALLROAD (8K SERIES) 2.0TFSI, 2.0TDI, 3.0TDI Quattro (05/10-08/11)

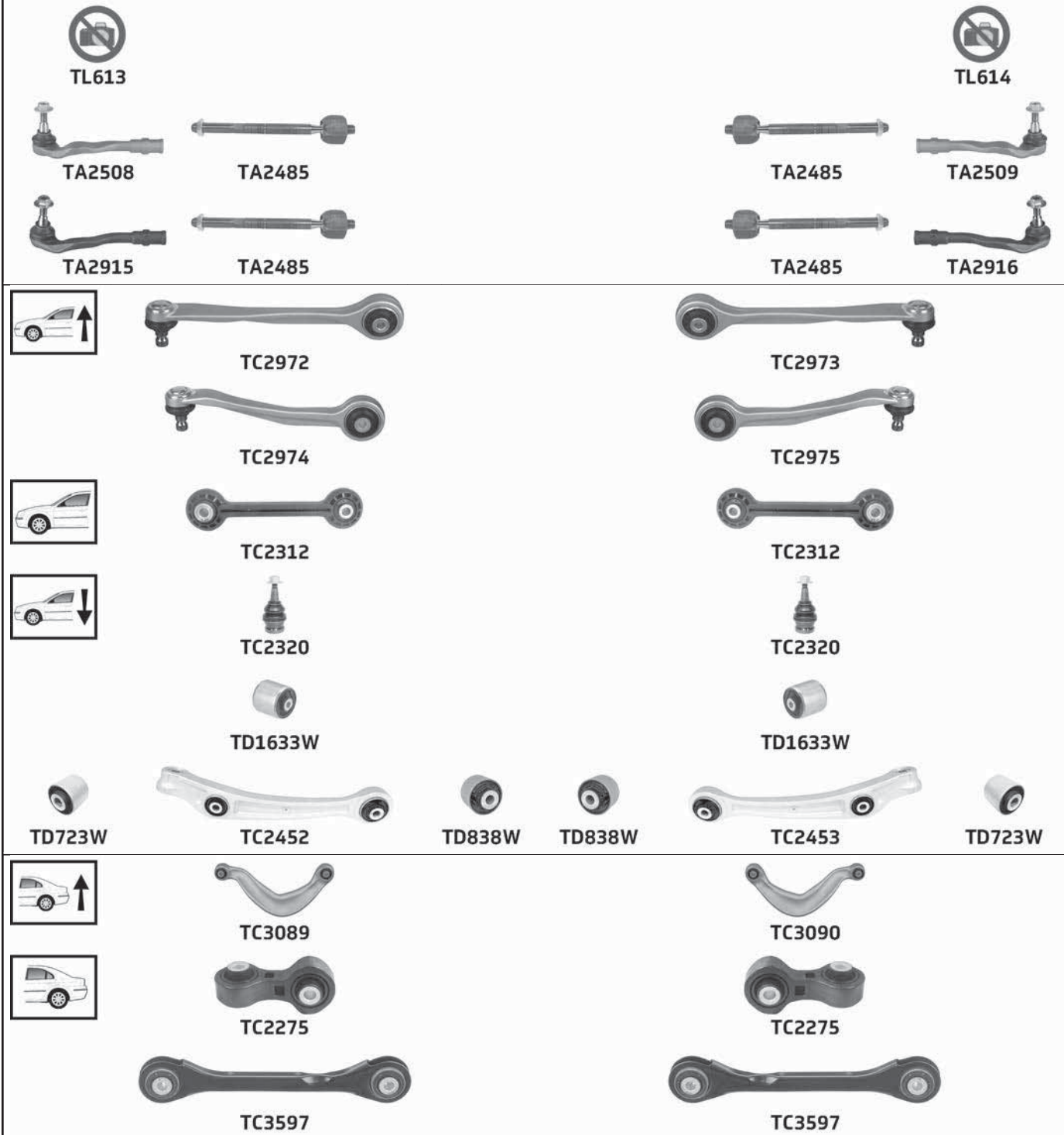

Part No	Description	Pos	Info	Technical
TA2485	Inner tie rod(123)	A B		M16x1.5 Male(252) £
TA2508	Tie rod end(224)	A	Hydraulic(115) Power steering(185)	M16x1.5 Female(253) £
TA2509	Tie rod end(224)	B	Hydraulic(115) Power steering(185)	M16x1.5 Female(253) £
TA2915	Tie rod end(224)	A	Electric(103) Power steering(185)	M16x1.5 Female(253) £
TA2916	Tie rod end(224)	B	Electric(103) Power steering(185)	M16x1.5 Female(253) £
TC2275	Link stabiliser(135)	A B		
TC2312	Link stabiliser(135)	A B		
TC2320	Lower ball joint(140)	A B		M12x1.5
TC2452	Lower track control arm(151)	A	Front(108)	
TC2453	Lower track control arm(151)	B	Front(108)	
TC2972	Upper link arm(239)	A	Front(108)	Pinch Bolt(255) 16mm
TC2973	Upper link arm(239)	B	Front(108)	Pinch Bolt(255) 16mm
TC2974	Upper link arm(239)	A	Rear(187)	Pinch Bolt(255) 16mm
TC2975	Upper link arm(239)	B	Rear(187)	Pinch Bolt(255) 16mm
				(...)

... AUDI

... A4 ALLROAD (8K SERIES) 2.0TFSI, 2.0TDI, 3.0TDI Quattro (05/10-08/11)

Part No	Description	Pos	Info	Technical
TC3089	Upper track control arm(242)	A		
TC3090	Upper track control arm(242)	B		
TC3597	Lower track control arm(150)	A B		
TD723W	Lower track control arm bush(153)	A B	Outer(176)	
TD838W	Lower track control arm bush(153)	A B	Inner(119)	
TD1633W	Lower link arm bush(145)	A B	Rear(187) Ø75	
TL613	Rod assembly(194)	A	Hydraulic(115) Power steering(185)	M12x1.5
TL614	Rod assembly(194)	B	Hydraulic(115) Power steering(185)	M12x1.5

A4 ALLROAD (8K SERIES) 2.0TFSI, 2.0TDI, 3.0TDI Quattro (08/11→)

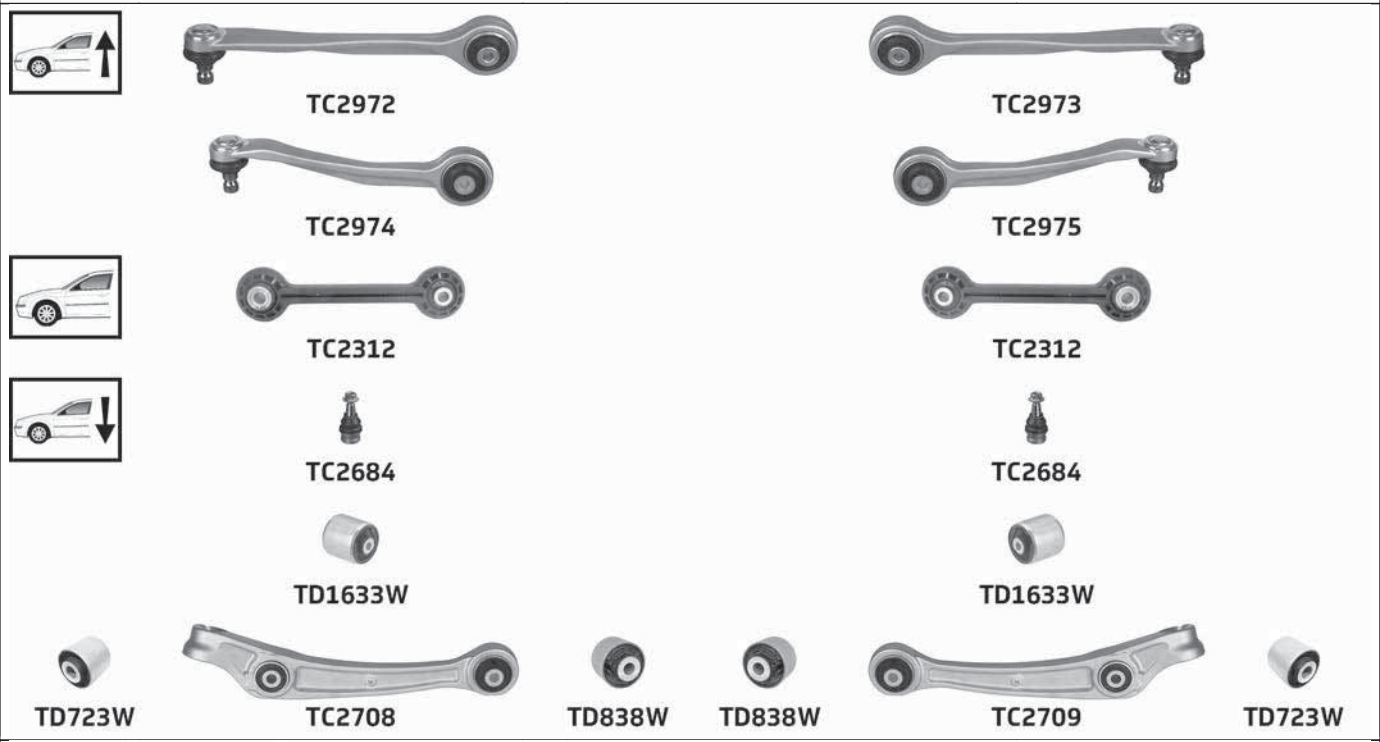

Part No	Description	Pos	Info	Technical
TA2485	Inner tie rod(123)	A B		M16x1.5 Male(252) £
TA2508	Tie rod end(224)	A	Hydraulic(115) Power steering(185)	M16x1.5 Female(253) £
TA2509	Tie rod end(224)	B	Hydraulic(115) Power steering(185)	M16x1.5 Female(253) £
TA2915	Tie rod end(224)	A	Electric(103) Power steering(185)	M16x1.5 Female(253) £
TA2916	Tie rod end(224)	B	Electric(103) Power steering(185)	M16x1.5 Female(253) £

AUDI

... A4 ALLROAD (8K SERIES) 2.0TFSI, 2.0TDI, 3.0TDI Quattro (08/11→)

Part No	Description	Pos	Info	Technical
TC2275	Link stabiliser(135)	A B		
TC2312	Link stabiliser(135)	A B		
TC2684	Lower ball joint(140)	A B		M14x1.5
TC2708	Lower track control arm(151)	A	Front(108)	
TC2709	Lower track control arm(151)	B	Front(108)	
TC2972	Upper link arm(239)	A	Front(108)	Pinch Bolt(255) 16mm
TC2973	Upper link arm(239)	B	Front(108)	Pinch Bolt(255) 16mm
TC2974	Upper link arm(239)	A	Rear(187)	Pinch Bolt(255) 16mm
TC2975	Upper link arm(239)	B	Rear(187)	Pinch Bolt(255) 16mm
TC3089	Upper track control arm(242)	A		
TC3090	Upper track control arm(242)	B		
TC3597	Lower track control arm(150)	A B		
TD723W	Lower track control arm bush(153)	A B	Outer(176)	
TD838W	Lower track control arm bush(153)	A B	Inner(119)	
TD1633W	Lower link arm bush(145)	A B	Rear(187) Ø75	
TL613	Rod assembly(194)	A	Hydraulic(115) Power steering(185)	M12x1.5
TL614	Rod assembly(194)	B	Hydraulic(115) Power steering(185)	M12x1.5

A5 CABRIO (8F SERIES) 1.8TFSI, 2.0TFSI, 2.0TFSI Quattro, 2.0TDI, 2.7TDI, 3.0TDI Quattro, 3.2FSI, 3.2FSI Quattro (03/09-11/09)



TL613



TA2508



TA2485





TL614



TA2485





TA2509



TC2972



TC2974

TC2312

TC2320



TD723W



TC2452



TD838W



TD838W



TC2453



TD723W



TC2454



TD849W



TD849W



TC2455



TC2973



TC2975



TC2312



TC2320



TC2452



TD838W



TD838W



TC2453



TD723W



TC2454



TD849W



TD849W



TC2455

... AUDI

... A5 CABRIO (8F SERIES) 1.8TFSI, 2.0TFSI, 2.0TFSI Quattro, 2.0TDI, 2.7TDI, 3.0TDI Quattro, 3.2FSI, 3.2FSI Quattro (03/09-11/09)



TC3089



TC3090



TC2275



TC2275



TC3597



TC3597



TD1493W



TC3337



TD1493W



TD1493W



TC3338



TD1493W

Part No	Description	Pos	Info	Technical
TA2485	Inner tie rod(123)	A B		M16x1.5 Male(252) £
TA2508	Tie rod end(224)	A		M16x1.5 Female(253) £
TA2509	Tie rod end(224)	B		M16x1.5 Female(253) £
TC2275	Link stabiliser(135)	A B		
TC2312	Link stabiliser(135)	A B		
TC2320	Lower ball joint(140)	A B		M12x1.5
TC2452	Lower track control arm(151)	A	Front(108)	
TC2453	Lower track control arm(151)	B	Front(108)	
TC2454	Lower link arm(144)	A	Rear(187)	M12x1.5
TC2455	Lower link arm(144)	B	Rear(187)	M12x1.5
TC2972	Upper link arm(239)	A	Front(108)	Pinch Bolt(255) 16mm
TC2973	Upper link arm(239)	B	Front(108)	Pinch Bolt(255) 16mm
TC2974	Upper link arm(239)	A	Rear(187)	Pinch Bolt(255) 16mm
TC2975	Upper link arm(239)	B	Rear(187)	Pinch Bolt(255) 16mm
TC3089	Upper track control arm(242)	A		
TC3090	Upper track control arm(242)	B		
TC3337	Lower track control arm(150)	A	Aluminium(-73) → 20/07/2009	
TC3338	Lower track control arm(150)	B	Aluminium(-73) → 20/07/2009	
TC3597	Lower track control arm(150)	A B	Steel(210) 20/07/2009→	
TD723W	Lower track control arm bush(153)	A B	Outer(176)	
TD838W	Lower track control arm bush(153)	A B	Inner(119)	
TD849W	Lower link arm bush(145)	A B	Rear(187) Ø65	
TD1493W	Lower track control arm bush(153)	A B	Outer(176) Inner(119) → 20/07/2009	
TL613	Rod assembly(194)	A		M12x1.5
TL614	Rod assembly(194)	B		M12x1.5

AUDI

A5 CABRIO (8F SERIES) 1.8TFSI, 2.0TFSI, 2.0TFSI Quattro, 2.0TDI, 2.7TDI, 3.0TDI Quattro, 3.2FSI, 3.2FSI Quattro (11/09-05/10)

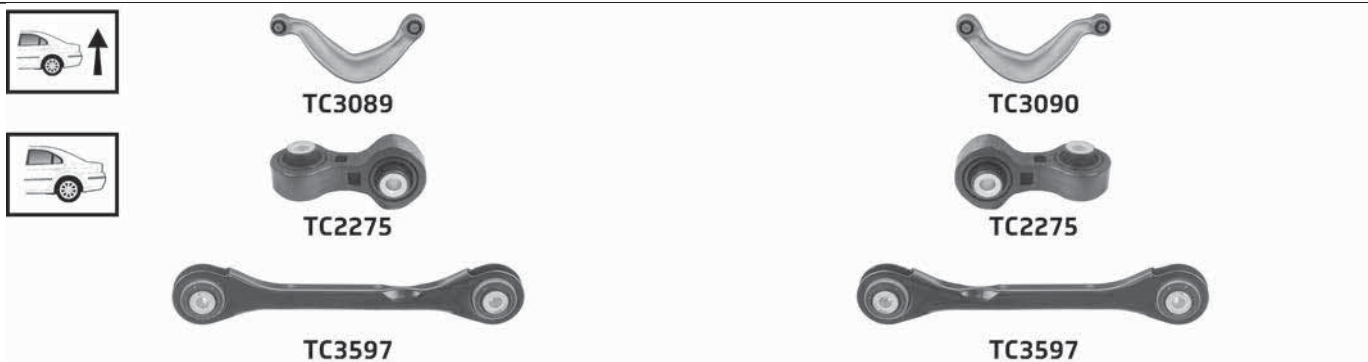
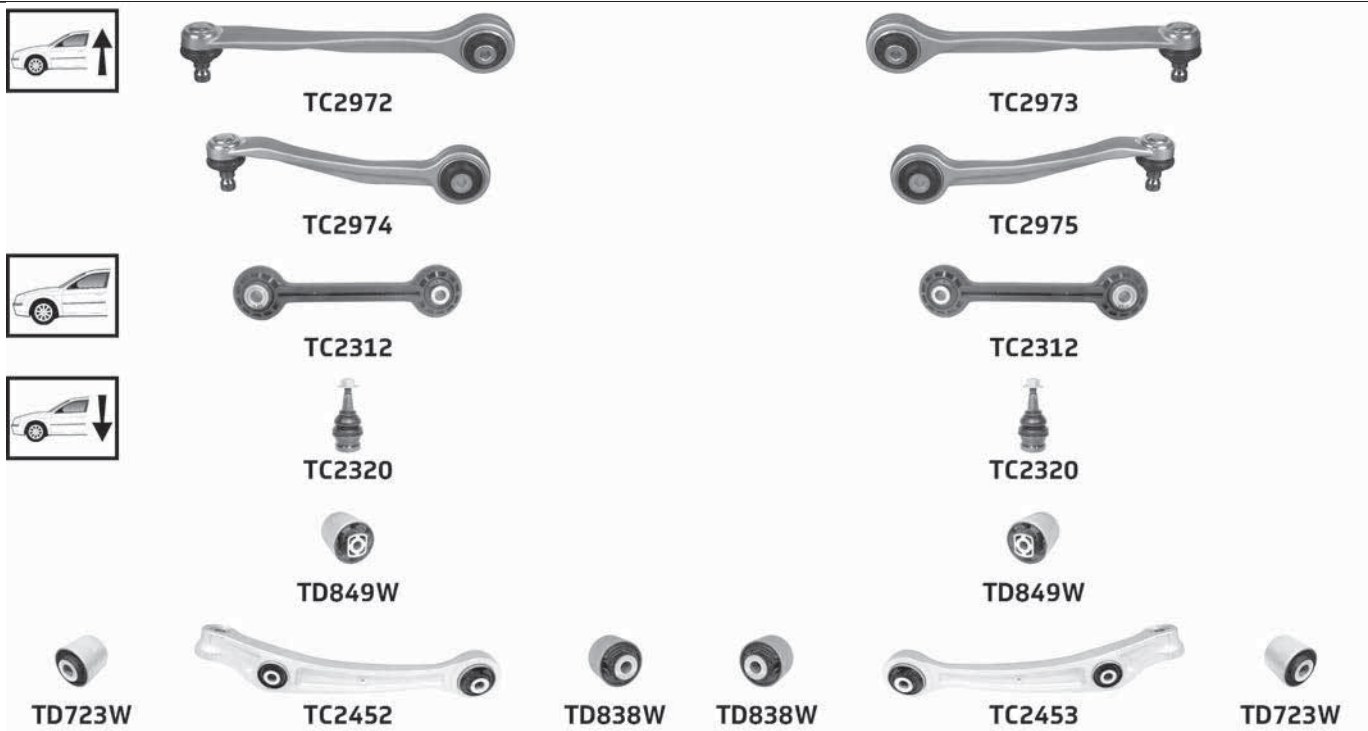
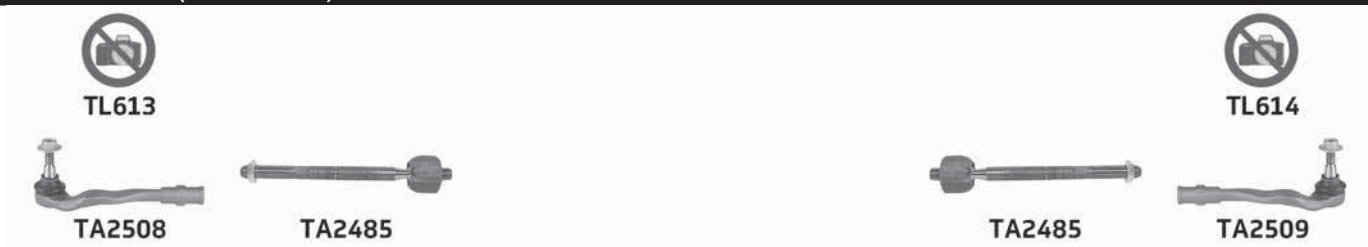

Part No	Description	Pos	Info	Technical
TA2485	Inner tie rod(123)	A B		M16x1.5 Male(252) £
TA2508	Tie rod end(224)	A		M16x1.5 Female(253) £
TA2509	Tie rod end(224)	B		M16x1.5 Female(253) £
TC2275	Link stabiliser(135)	A B		
TC2312	Link stabiliser(135)	A B		
TC2320	Lower ball joint(140)	A B		M12x1.5
TC2452	Lower track control arm(151)	A	Front(108)	
TC2453	Lower track control arm(151)	B	Front(108)	
TC2972	Upper link arm(239)	A	Front(108)	Pinch Bolt(255) 16mm
TC2973	Upper link arm(239)	B	Front(108)	Pinch Bolt(255) 16mm
TC2974	Upper link arm(239)	A	Rear(187)	Pinch Bolt(255) 16mm
TC2975	Upper link arm(239)	B	Rear(187)	Pinch Bolt(255) 16mm
TC3089	Upper track control arm(242)	A		
TC3090	Upper track control arm(242)	B		
TC3597	Lower track control arm(150)	A B		
TD723W	Lower track control arm bush(153)	A B	Outer(176)	
TD838W	Lower track control arm bush(153)	A B	Inner(119)	
TD849W	Lower link arm bush(145)	A B	Rear(187) Ø65	

(...)

AUDI

... AUDI

... A5 CABRIO (8F SERIES) 1.8TFSI, 2.0TFSI, 2.0TFSI Quattro, 2.0TDI, 2.7TDI, 3.0TDI Quattro, 3.2FSI, 3.2FSI Quattro (11/09-05/10)

Part No	Description	Pos	Info	Technical
TL613	Rod assembly(194)	A		M12x1.5
TL614	Rod assembly(194)	B		M12x1.5

A5 CABRIO (8F SERIES) 1.8TFSI, 2.0TFSI, 2.0TFSI Quattro, 2.0TDI, 2.7TDI, 3.0TDI Quattro, 3.2FSI, 3.2FSI Quattro (05/10-08/11)

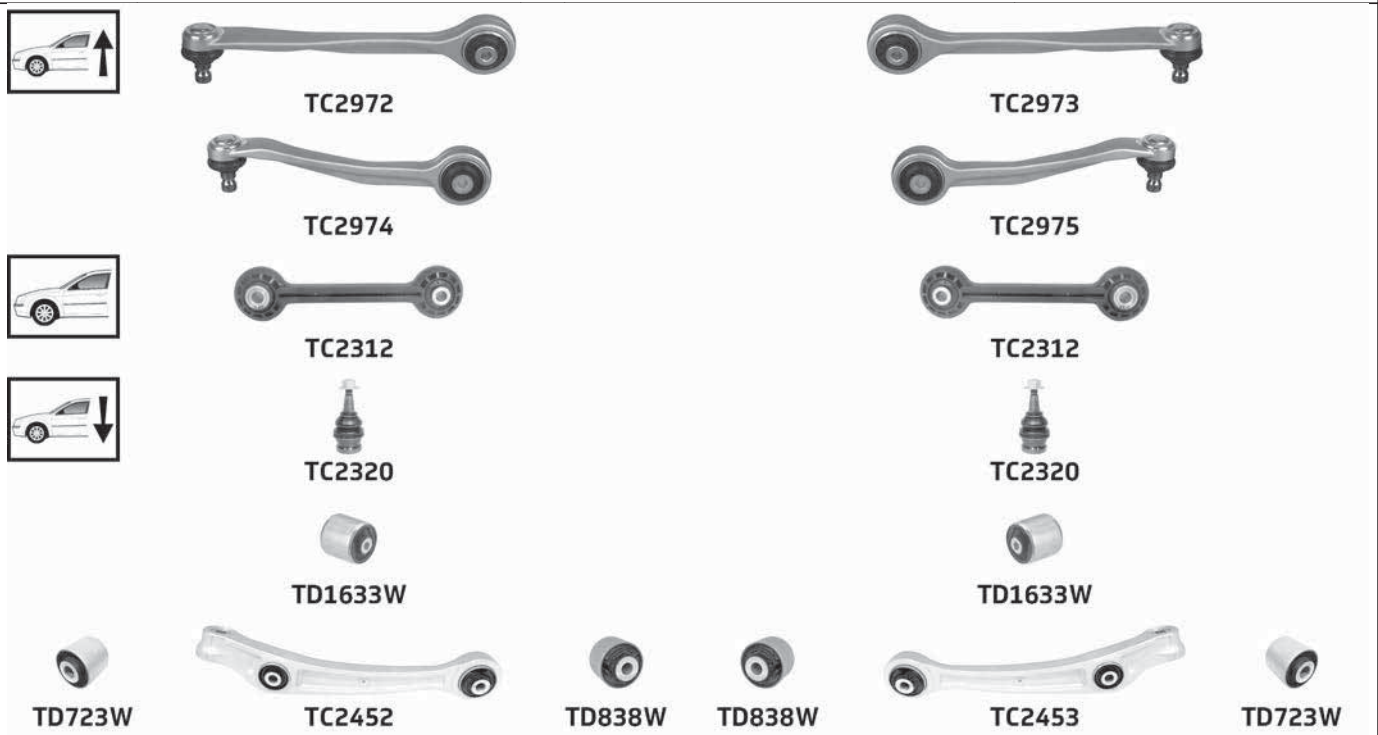











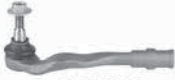























Part No	Description	Pos	Info	Technical
TA2485	Inner tie rod(123)	A B		M16x1.5 Male(252) £
TA2508	Tie rod end(224)	A		M16x1.5 Female(253) £
TA2509	Tie rod end(224)	B		M16x1.5 Female(253) £
TC2275	Link stabiliser(135)	A B		
TC2312	Link stabiliser(135)	A B		
TC2320	Lower ball joint(140)	A B		M12x1.5
TC2452	Lower track control arm(151)	A	Front(108)	
TC2453	Lower track control arm(151)	B	Front(108)	
TC2972	Upper link arm(239)	A	Front(108)	Pinch Bolt(255) 16mm
TC2973	Upper link arm(239)	B	Front(108)	Pinch Bolt(255) 16mm
TC2974	Upper link arm(239)	A	Rear(187)	Pinch Bolt(255) 16mm
TC2975	Upper link arm(239)	B	Rear(187)	Pinch Bolt(255) 16mm
TC3089	Upper track control arm(242)	A		

... A5 CABRIO (8F SERIES) 1.8TFSI, 2.0TFSI, 2.0TFSI Quattro, 2.0TDI, 2.7TDI, 3.0TDI Quattro, 3.2FSI, 3.2FSI Quattro (05/10-08/11)

Part No	Description	Pos	Info	Technical
TC3090	Upper track control arm(242)	B		
TC3597	Lower track control arm(150)	A B		
TD723W	Lower track control arm bush(153)	A B	Outer(176)	
TD838W	Lower track control arm bush(153)	A B	Inner(119)	
TD1633W	Lower link arm bush(145)	A B	Rear(187) Ø75	
TL613	Rod assembly(194)	A		M12x1.5
TL614	Rod assembly(194)	B		M12x1.5

A5 CABRIO (8F SERIES) 1.8TFSI, 2.0TFSI, 2.0TFSI Quattro, 2.0TDI, 2.0TDI Quattro, 2.7TDI, 3.0TFSI Quattro, 3.0TDI, 3.0TDI Quattro, 3.2FSI, 3.2FSI Quattro (08/11→)

 TL613				 TL614
 TA2508	 TA2485			 TA2485
 TA2915	 TA2485			 TA2916
	 TC2972	 TD871W	 TD871W	 TC2973
	 TC2450			 TC2451
	 TC2335	 TD871W	 TD871W	 TC2336
	 TC2974			 TC2975
	 TC2312			 TC2312
	 TC2684			 TC2684
	 TD1633W			 TD1633W
 TD723W	 TC2708	 TD838W	 TD838W	 TC2709
				 TD723W

... AUDI

... A5 CABRIO (8F SERIES) 1.8TFSI, 2.0TFSI, 2.0TFSI Quattro, 2.0TDI, 2.0TDI Quattro, 2.7TDI, 3.0TFSI Quattro, 3.0TDI, 3.0TDI Quattro, 3.2FSI, 3.2FSI Quattro (08/11→)



TC3089



TC3090



TC2275



TC2275



TC3597



TC3597

Part No	Description	Pos	Info	Technical
TA2485	Inner tie rod(123)	A B		M16x1.5 Male(252) £
TA2508	Tie rod end(224)	A	Hydraulic(115) Power steering(185) →Ch. 8F BN050000	M16x1.5 Female(253) £
TA2509	Tie rod end(224)	B	Hydraulic(115) Power steering(185) →Ch. 8F BN050000	M16x1.5 Female(253) £
TA2915	Tie rod end(224)	A	Electric(103) Power steering(185)	M16x1.5 Female(253) £
TA2916	Tie rod end(224)	B	Electric(103) Power steering(185)	M16x1.5 Female(253) £
TC2275	Link stabiliser(135)	A B		
TC2312	Link stabiliser(135)	A B		
TC2335	Upper link arm(239)	A	Rear(187) Ch. 8F C000001→	Pinch Bolt(255) 16mm
TC2336	Upper link arm(239)	B	Rear(187) Ch. 8F C000001→	Pinch Bolt(255) 16mm
TC2450	Upper link arm(239)	A	Front(108) Ch. 8F C000001→	Pinch Bolt(255) 16mm
TC2451	Upper link arm(239)	B	Front(108) Ch. 8F C000001→	Pinch Bolt(255) 16mm
TC2684	Lower ball joint(140)	A B		M14x1.5
TC2708	Lower track control arm(151)	A	Front(108)	
TC2709	Lower track control arm(151)	B	Front(108)	
TC2972	Upper link arm(239)	A	Front(108) →Ch. 8F BN050000 / FH BN050000	Pinch Bolt(255) 16mm
TC2973	Upper link arm(239)	B	Front(108) →Ch. 8F BN050000 / FH BN050000	Pinch Bolt(255) 16mm
TC2974	Upper link arm(239)	A	Rear(187) →Ch. 8F BN050000 / FH BN050000	Pinch Bolt(255) 16mm
TC2975	Upper link arm(239)	B	Rear(187) →Ch. 8F BN050000 / FH BN050000	Pinch Bolt(255) 16mm
TC3089	Upper track control arm(242)	A		
TC3090	Upper track control arm(242)	B		
TC3597	Lower track control arm(150)	A B		
TD723W	Lower track control arm bush(153)	A B	Outer(176)	
TD838W	Lower track control arm bush(153)	A B	Inner(119)	
TD871W	Upper link arm bush(240)	A B	Ch. 8F C000001→	
TD1633W	Lower link arm bush(145)	A B	Rear(187) Ø75	
TL613	Rod assembly(194)	A	Hydraulic(115) Power steering(185) →Ch. 8F BN050000	M12x1.5
TL614	Rod assembly(194)	B	Hydraulic(115) Power steering(185) →Ch. 8F BN050000	M12x1.5

A5 COUPÉ (8T SERIES) 2.7TDI, 3.0TDI Quattro, 3.2FSI, 3.2FSI Quattro (06/07-09/07)



TL613



TL614



TA2508



TA2485



TA2485



TA2509

... A5 COUPÉ (8T SERIES) 2.7TDI, 3.0TDI Quattro, 3.2FSI, 3.2FSI Quattro (06/07-09/07)

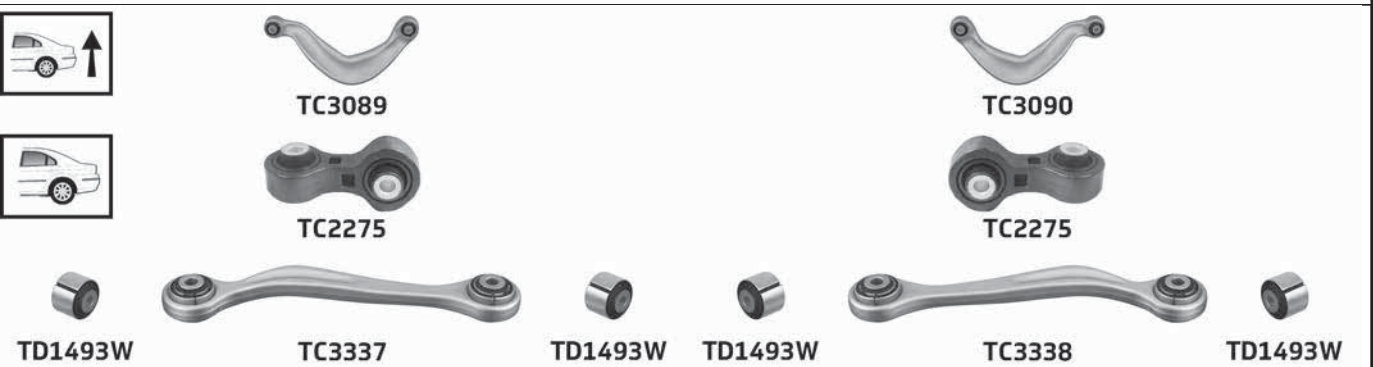
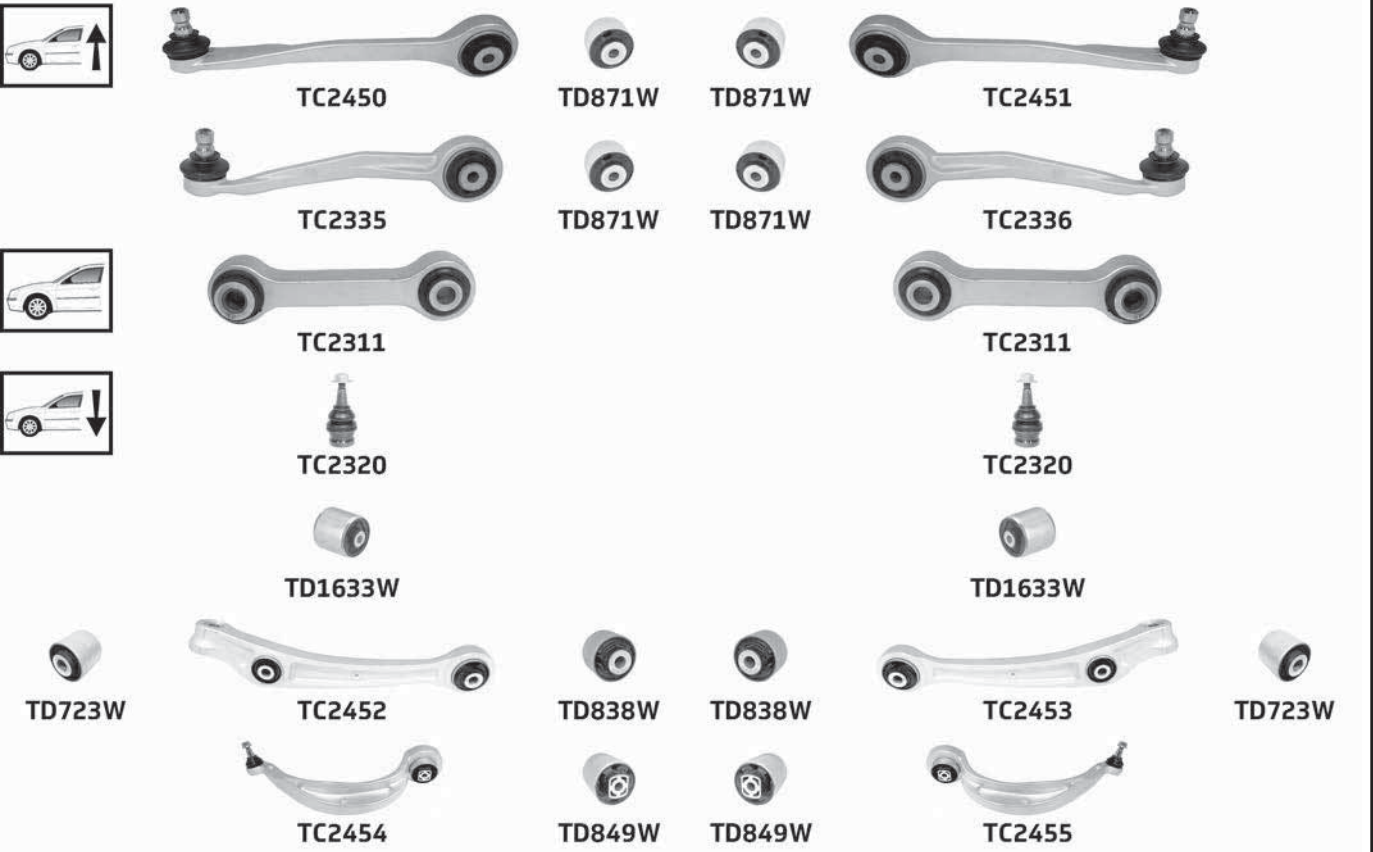

Part No	Description	Pos	Info	Technical
TA2485	Inner tie rod(123)	A B		M16x1.5 Male(252) £
TA2508	Tie rod end(224)	A		M16x1.5 Female(253) £
TA2509	Tie rod end(224)	B		M16x1.5 Female(253) £
TC2275	Link stabiliser(135)	A B		
TC2311	Link stabiliser(135)	A B	Length(129) 110mm	
TC2320	Lower ball joint(140)	A B		M12x1.5
TC2335	Upper link arm(239)	A	Rear(187)	Pinch Bolt(255) 16mm
TC2336	Upper link arm(239)	B	Rear(187)	Pinch Bolt(255) 16mm
TC2450	Upper link arm(239)	A	Front(108)	Pinch Bolt(255) 16mm
TC2451	Upper link arm(239)	B	Front(108)	Pinch Bolt(255) 16mm
TC2452	Lower track control arm(151)	A	Front(108)	
TC2453	Lower track control arm(151)	B	Front(108)	
TC2454	Lower link arm(144)	A	Rear(187)	M12x1.5
TC2455	Lower link arm(144)	B	Rear(187)	M12x1.5
TC3089	Upper track control arm(242)	A		
TC3090	Upper track control arm(242)	B		
TC3337	Lower track control arm(150)	A		
TC3338	Lower track control arm(150)	B		
TD723W	Lower track control arm bush(153)	A B	Outer(176)	
TD838W	Lower track control arm bush(153)	A B	Inner(119)	
TD849W	Lower link arm bush(145)	A B	Ø65	
TD871W	Upper link arm bush(240)	A B		
TD1493W	Lower track control arm bush(153)	A B	Outer(176) Inner(119)	

(..)

... AUDI

... A5 COUPÉ (8T SERIES) 2.7TDI, 3.0TDI Quattro, 3.2FSI, 3.2FSI Quattro (06/07-09/07)

Part No	Description	Pos	Info	Technical
TD1633W	Lower link arm bush(145)	A B	Rear(187) Ø75	
TL613	Rod assembly(194)	A		M12x1.5
TL614	Rod assembly(194)	B		M12x1.5

A5 COUPÉ, SPORTBACK (8T SERIES) 1.8TFSI, 2.0TFSI, 2.0TFSI Quattro, 2.0TDI, 2.0TDI Quattro, 2.7TDI, 3.0TDI Quattro, 3.2FSI, 3.2FSI Quattro (09/07-11/09)

TL613

TA2508

TA2485

TA2485

TL614

TA2509



TC2450

TD871W

TD871W

TC2451

TC2335

TD871W

TD871W

TC2336



TC2312

TC2312



TC2320

TC2320

TD1633W

TD1633W

TD723W

TC2452

TD838W

TD838W

TC2453

TD723W

TC2454

TD849W

TD849W

TC2455



TC3089

TC3090



TC2275

TC2275

TC3597

TC3597

TD1493W

TC3337

TD1493W

TD1493W

TC3338

TD1493W

Part No	Description	Pos	Info	Technical
TA2485	Inner tie rod(123)	A B		M16x1.5 Male(252) £
TA2508	Tie rod end(224)	A		M16x1.5 Female(253) £
TA2509	Tie rod end(224)	B		M16x1.5 Female(253) £
TC2275	Link stabiliser(135)	A B		
TC2312	Link stabiliser(135)	A B	Length(129) 170mm	

AUDI

... A5 COUPÉ, SPORTBACK (8T SERIES) 1.8TFSI, 2.0TFSI, 2.0TFSI Quattro, 2.0TDI, 2.0TDI Quattro, 2.7TDI, 3.0TDI Quattro, 3.2FSI, 3.2FSI Quattro (09/07-11/09)

Part No	Description	Pos	Info	Technical
TC2320	Lower ball joint(140)	A B		M12x1.5
TC2335	Upper link arm(239)	A	Rear(187)	Pinch Bolt(255) 16mm
TC2336	Upper link arm(239)	B	Rear(187)	Pinch Bolt(255) 16mm
TC2450	Upper link arm(239)	A	Front(108)	Pinch Bolt(255) 16mm
TC2451	Upper link arm(239)	B	Front(108)	Pinch Bolt(255) 16mm
TC2452	Lower track control arm(151)	A	Front(108)	
TC2453	Lower track control arm(151)	B	Front(108)	
TC2454	Lower link arm(144)	A	Rear(187)	M12x1.5
TC2455	Lower link arm(144)	B	Rear(187)	M12x1.5
TC3089	Upper track control arm(242)	A		
TC3090	Upper track control arm(242)	B		
TC3337	Lower track control arm(150)	A	Aluminium(-73) → 20/07/2009	
TC3338	Lower track control arm(150)	B	Aluminium(-73) → 20/07/2009	
TC3597	Lower track control arm(150)	A B	Steel(210) 20/07/2009→	
TD723W	Lower track control arm bush(153)	A B	Outer(176)	
TD838W	Lower track control arm bush(153)	A B	Inner(119)	
TD849W	Lower link arm bush(145)	A B	Ø65	
TD871W	Upper link arm bush(240)	A B		
TD1493W	Lower track control arm bush(153)	A B	Outer(176) Inner(119) → 20/07/2009	
TD1633W	Lower link arm bush(145)	A B	Rear(187) Ø75	
TL613	Rod assembly(194)	A		M12x1.5
TL614	Rod assembly(194)	B		M12x1.5

A5 COUPÉ, SPORTBACK (8T SERIES) 1.8TFSI, 2.0TFSI, 2.0TFSI Quattro, 2.0TDI, 2.0TDI Quattro, 2.7TDI, 3.0TDI Quattro, 3.2FSI, 3.2FSI Quattro (11/09-08/11)



... AUDI

... A5 COUPÉ, SPORTBACK (8T SERIES) 1.8TFSI, 2.0TFSI, 2.0TFSI Quattro, 2.0TDI, 2.0TDI Quattro, 2.7TDI, 3.0TDI Quattro, 3.2FSI, 3.2FSI Quattro (11/09-08/11)



TC2450



TD871W



TD871W



TC2451



TC2335



TD871W



TD871W



TC2336



TC2312



TC2312



TC2320



TC2320



TD849W



TD849W



TD1633W



TD1633W



TD723W



TC2452



TD838W



TD838W



TC2453



TD723W



TC3089



TC3090



TC2275



TC2275



TC3597



TC3597

Part No	Description	Pos	Info	Technical
TA2485	Inner tie rod(123)	A B		M16x1.5 Male(252) £
TA2508	Tie rod end(224)	A	Hydraulic(115) Power steering(185)	M16x1.5 Female(253) £
TA2509	Tie rod end(224)	B	Hydraulic(115) Power steering(185)	M16x1.5 Female(253) £
TA2915	Tie rod end(224)	A	Electric(103) Power steering(185)	M16x1.5 Female(253) £
TA2916	Tie rod end(224)	B	Electric(103) Power steering(185)	M16x1.5 Female(253) £
TC2275	Link stabiliser(135)	A B		
TC2312	Link stabiliser(135)	A B		
TC2320	Lower ball joint(140)	A B		M12x1.5
TC2335	Upper link arm(239)	A	Rear(187)	Pinch Bolt(255) 16mm
TC2336	Upper link arm(239)	B	Rear(187)	Pinch Bolt(255) 16mm
TC2450	Upper link arm(239)	A	Front(108)	Pinch Bolt(255) 16mm
TC2451	Upper link arm(239)	B	Front(108)	Pinch Bolt(255) 16mm
TC2452	Lower track control arm(151)	A	Front(108)	
TC2453	Lower track control arm(151)	B	Front(108)	
TC3089	Upper track control arm(242)	A		
TC3090	Upper track control arm(242)	B		
TC3597	Lower track control arm(150)	A B		
TD723W	Lower track control arm bush(153)	A B	Outer(176)	
TD838W	Lower track control arm bush(153)	A B	Inner(119)	
TD849W	Lower link arm bush(145)	A B	Ø65	
TD871W	Upper link arm bush(240)	A B		
TD1633W	Lower link arm bush(145)	A B	Rear(187) Ø75	
TL613	Rod assembly(194)	A	Hydraulic(115) Power steering(185)	M12x1.5

... A5 COUPÉ, SPORTBACK (8T SERIES) 1.8TFSI, 2.0TFSI, 2.0TFSI Quattro, 2.0TDI, 2.0TDI Quattro, 2.7TDI, 3.0TDI Quattro, 3.2FSI, 3.2FSI Quattro (11/09-08/11)

Part No	Description	Pos	Info	Technical
TL614	Rod assembly(194)	B	Hydraulic(115) Power steering(185)	M12x1.5

A5 COUPÉ, SPORTBACK (8T SERIES) 1.8TFSI, 2.0TFSI, 2.0TFSI Quattro, 2.0TDI, 2.0TDI Quattro, 2.7TDI, 3.0TFSI Quattro, 3.0TDI, 3.0TDI Quattro, 3.2FSI, 3.2FSI Quattro (08/11→)

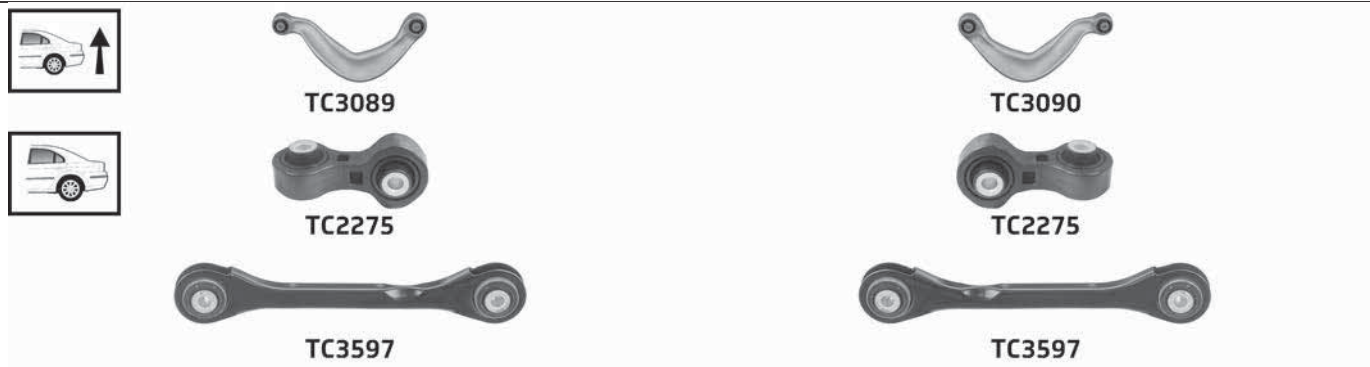
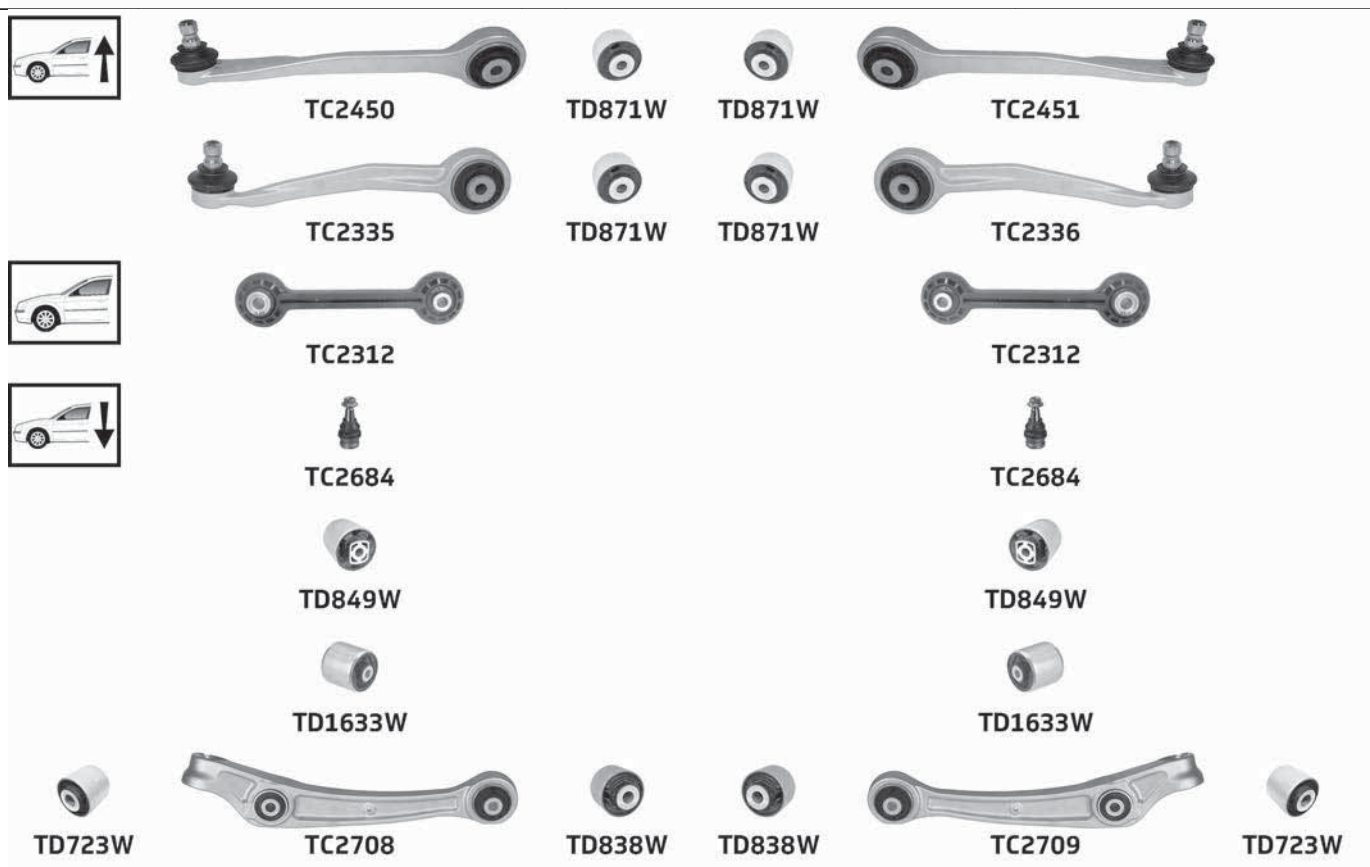

Part No	Description	Pos	Info	Technical
TA2485	Inner tie rod(123)	A B		M16x1.5 Male(252) £
TA2508	Tie rod end(224)	A	Hydraulic(115) Power steering(185) →Ch. 8T BA150000	M16x1.5 Female(253) £
TA2509	Tie rod end(224)	B	Hydraulic(115) Power steering(185) →Ch. 8T BA150000	M16x1.5 Female(253) £
TA2915	Tie rod end(224)	A	Electric(103) Power steering(185)	M16x1.5 Female(253) £

(...)

... AUDI

A5 COUPÉ, SPORTBACK (8T SERIES) 1.8TFSI, 2.0TFSI, 2.0TFSI Quattro, 2.0TDI, 2.0TDI Quattro, 2.7TDI, 3.0TFSI Quattro, 3.0TDI, 3.0TDI Quattro, 3.2FSI, 3.2FSI Quattro (08/11→)

Part No	Description	Pos	Info	Technical
TA2916	Tie rod end(224)	B	Electric(103) Power steering(185)	M16x1.5 Female(253) £
TC2275	Link stabiliser(135)	A B		
TC2312	Link stabiliser(135)	A B		
TC2335	Upper link arm(239)	A	Rear(187)	Pinch Bolt(255) 16mm
TC2336	Upper link arm(239)	B	Rear(187)	Pinch Bolt(255) 16mm
TC2450	Upper link arm(239)	A	Front(108)	Pinch Bolt(255) 16mm
TC2451	Upper link arm(239)	B	Front(108)	Pinch Bolt(255) 16mm
TC2684	Lower ball joint(140)	A B		M14x1.5
TC2708	Lower track control arm(151)	A	Front(108)	
TC2709	Lower track control arm(151)	B	Front(108)	
TC3089	Upper track control arm(242)	A		
TC3090	Upper track control arm(242)	B		
TC3597	Lower track control arm(150)	A B		
TD723W	Lower track control arm bush(153)	A B	Outer(176)	
TD838W	Lower track control arm bush(153)	A B	Inner(119)	
TD849W	Lower link arm bush(145)	A B	Ø65	
TD871W	Upper link arm bush(240)	A B		
TD1633W	Lower link arm bush(145)	A B	Rear(187) Ø75	
TL613	Rod assembly(194)	A	Hydraulic(115) Power steering(185) →Ch. 8T BA150000	M12x1.5
TL614	Rod assembly(194)	B	Hydraulic(115) Power steering(185) →Ch. 8T BA150000	M12x1.5

A6 (4B SERIES) 1.8i, 1.9TDi, 2.4i, 2.5TDi, 2.7i, 2.8i →Ch. 4B1 200000 (02/97-05/01)

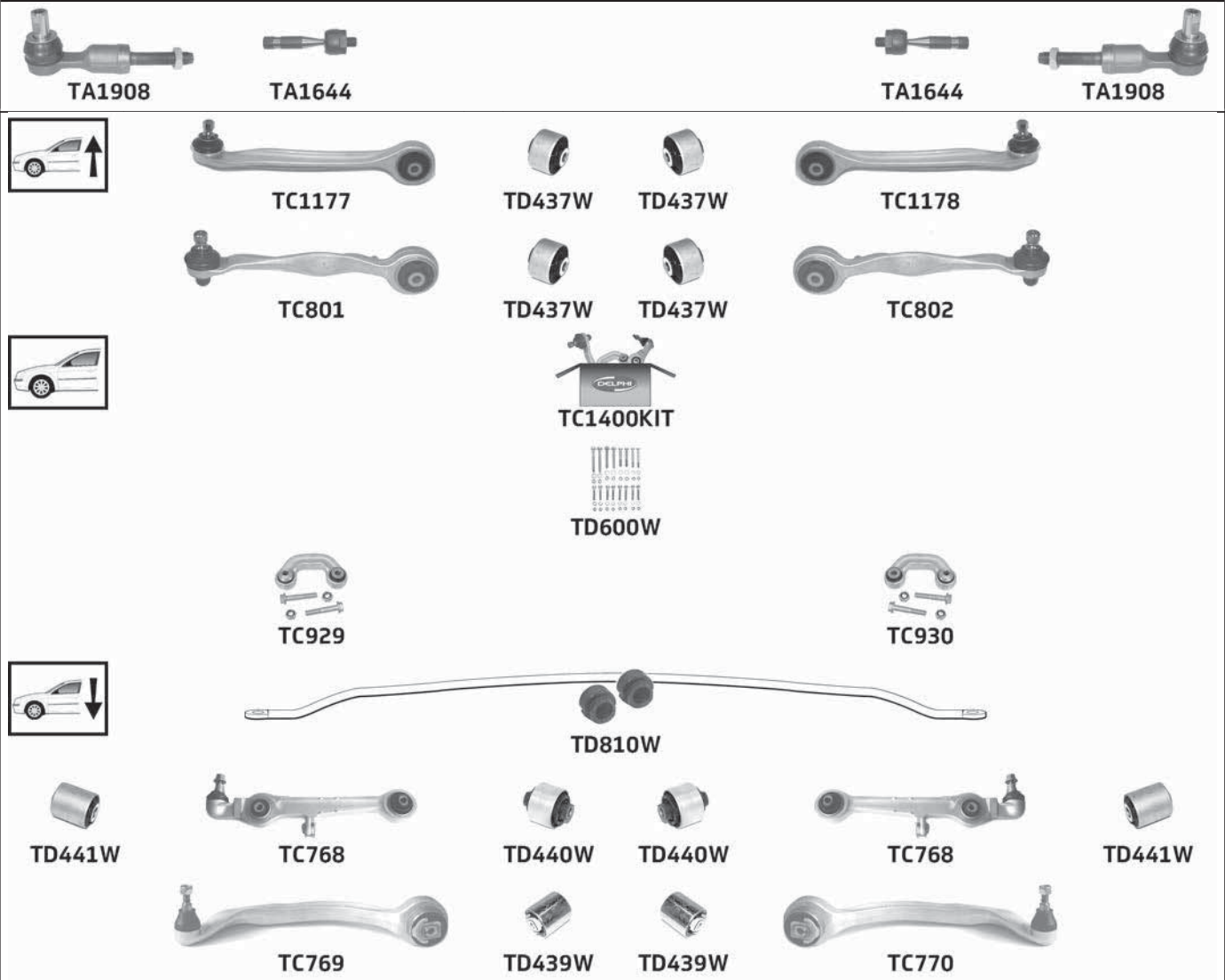

Part No	Description	Pos	Info	Technical
TA1644	Inner tie rod(123)	A B		M14x1.5 Female(253) £
TA1908	Tie rod end(224)	A B		M14x1.5 Male(252) £
TC768	Lower track control arm(151)	A B	Front(108)	M12x1.25

... A6 (4B SERIES) 1.8i, 1.9TDi, 2.4i, 2.5TDi, 2.7i, 2.8i →Ch. 4B1 200000 (02/97-05/01)

Part No	Description	Pos	Info	Technical
TC769	Lower link arm(144)	A	Rear(187)	M12x1.5
TC770	Lower link arm(144)	B	Rear(187)	M12x1.5
TC801	Upper link arm(239)	A	Rear(187)	Pinch Bolt(255) 16mm
TC802	Upper link arm(239)	B	Rear(187)	Pinch Bolt(255) 16mm
TC929	Link stabiliser(135)	A		
TC930	Link stabiliser(135)	B		
TC1177	Upper link arm(239)	A	Front(108)	Pinch Bolt(255) 16mm
TC1178	Upper link arm(239)	B	Front(108)	Pinch Bolt(255) 16mm
TC1400KIT	Suspension kit(220)	K		
TD437W	Upper link arm bush(240)	A B		
TD439W	Lower link arm bush(145)	A B		
TD440W	Lower track control arm bush(153)	A B	Inner(119)	
TD441W	Lower track control arm bush(153)	A B	Outer(176)	
TD600W	Suspension bolt kit(219)	K		
TD810W	Anti-roll bar(-74) bush kit(-86-)	K	Ø27 Complete axle kit(-92)	

A6 (4B SERIES) 1.8i, 2.4i, 2.5TDi, 2.7i, 2.8i Quattro | →Ch. 4B1 200000 (02/97-05/01)

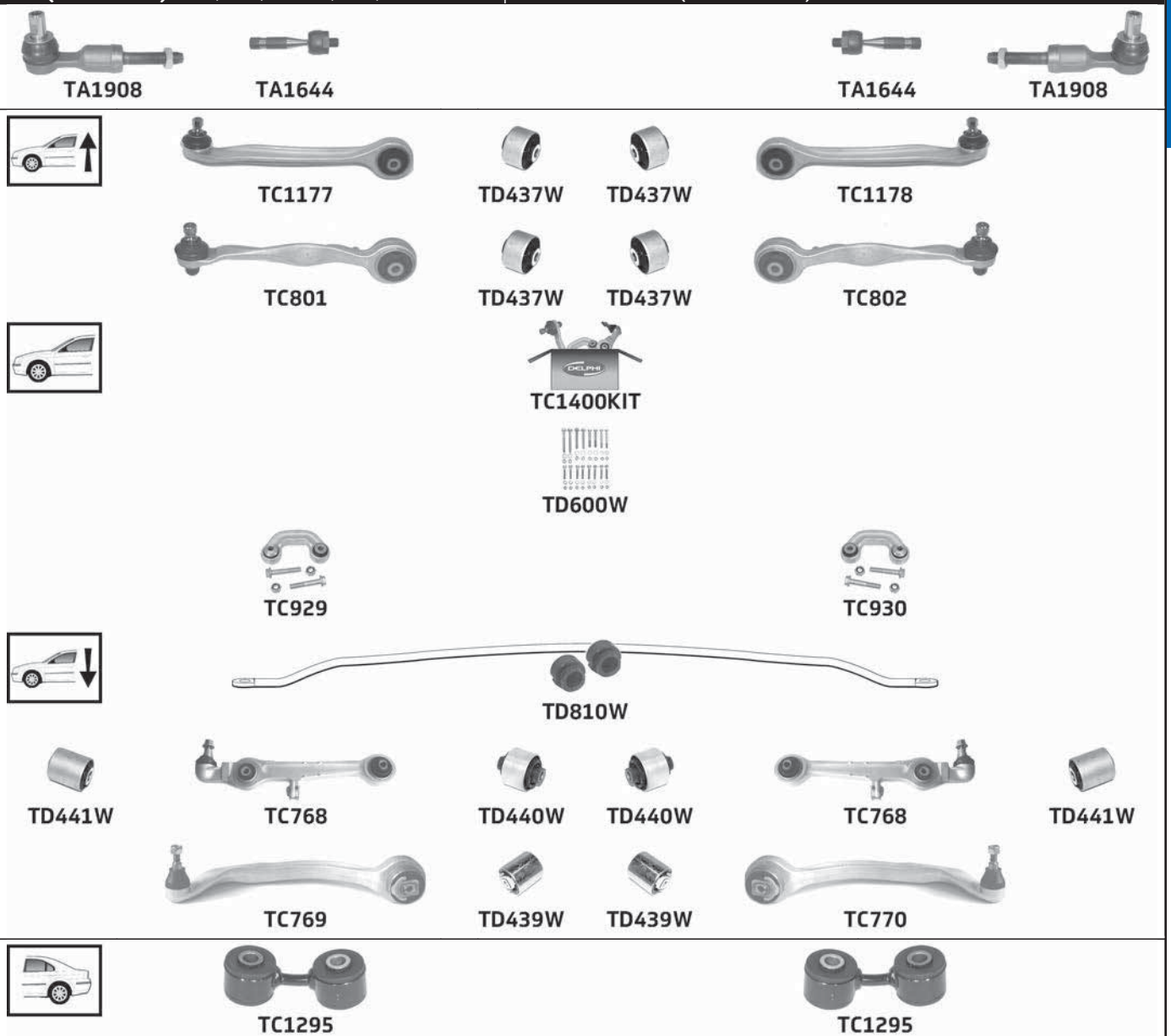

Part No	Description	Pos	Info	Technical
TA1644	Inner tie rod(123)	A B		M14x1.5 Female(253) E
TA1908	Tie rod end(224)	A B		M14x1.5 Male(252) E
TC768	Lower track control arm(151)	A B	Front(108)	M12x1.25
TC769	Lower link arm(144)	A	Rear(187)	M12x1.5
TC770	Lower link arm(144)	B	Rear(187)	M12x1.5
TC801	Upper link arm(239)	A	Rear(187)	Pinch Bolt(255) 16mm

... AUDI

... A6 (4B SERIES) 1.8i, 2.4i, 2.5TDi, 2.7i, 2.8i Quattro | →Ch. 4B1 200000 (02/97-05/01)

Part No	Description	Pos	Info	Technical
TC802	Upper link arm(239)	B	Rear(187)	Pinch Bolt(255) 16mm
TC929	Link stabiliser(135)	A		
TC930	Link stabiliser(135)	B		
TC1177	Upper link arm(239)	A	Front(108)	Pinch Bolt(255) 16mm
TC1178	Upper link arm(239)	B	Front(108)	Pinch Bolt(255) 16mm
TC1295	Link stabiliser(135)	A B		
TC1400KIT	Suspension kit(220)	K		
TD437W	Upper link arm bush(240)	A B		
TD439W	Lower link arm bush(145)	A B		
TD440W	Lower track control arm bush(153)	A B	Inner(119)	
TD441W	Lower track control arm bush(153)	A B	Outer(176)	
TD600W	Suspension bolt kit(219)	K		
TD810W	Anti-roll bar(-74-) bush kit(-86-)	K	Ø27 Complete axle kit(-92-)	

A6 (4B SERIES) 1.8i, 1.9TDi, 2.0i, 2.4i, 2.5TDi, 2.7i, 2.8i, 3.0i Ch. 4B2 000001-4B2 031500 (06/01-09/01)

Part No	Description	Pos	Info	Technical
TA1644	Inner tie rod(123)	A B		M14x1.5 Female(253) £
TA1908	Tie rod end(224)	A B		M14x1.5 Male(252) £
TC768	Lower track control arm(151)	A B	Front(108) 16" Wheels(-62-)	M12x1.25
TC769	Lower link arm(144)	A	Rear(187)	M12x1.5
TC770	Lower link arm(144)	B	Rear(187)	M12x1.5

AUDI

... A6 (4B SERIES) 1.8i, 1.9TDi, 2.0i, 2.4i, 2.5TDi, 2.7i, 2.8i, 3.0i Ch. 4B2 00001-4B2 031500 (06/01-09/01)

Part No	Description	Pos	Info	Technical
TC801	Upper link arm(239)	A	Rear(187)	Pinch Bolt(255) 16mm
TC802	Upper link arm(239)	B	Rear(187)	Pinch Bolt(255) 16mm
TC929	Link stabiliser(135)	A		
TC930	Link stabiliser(135)	B		
TC1177	Upper link arm(239)	A	Front(108)	Pinch Bolt(255) 16mm
TC1178	Upper link arm(239)	B	Front(108)	Pinch Bolt(255) 16mm
TC1343	Lower track control arm(151)	A B	Front(108) 17" Wheels(-63-) 18" Wheels(-65-)	M12x1.5
TC1400KIT	Suspension kit(220)	K	16" Wheels(-62-)	
TC1900KIT	Suspension kit(220)	K	17" Wheels(-63-) 18" Wheels(-65-)	
TD437W	Upper link arm bush(240)	A B		
TD439W	Lower link arm bush(145)	A B		
TD440W	Lower track control arm bush(153)	A B	Inner(119)	
TD441W	Lower track control arm bush(153)	A B	Outer(176)	
TD600W	Suspension bolt kit(219)	K		
TD810W	Anti-roll bar(-74-) bush kit(-86-)	K	Ø27 Complete axle kit(-92-)	

A6 (4B SERIES) 1.8i, 2.4i, 2.5TDi, 2.7i, 2.8i, 3.0i Quattro | Ch. 4B2 00001-4B2 031500 (06/01-09/01)

TA1908 TA1644 TA1644 TA1908

TC1177 TD437W TD437W TC1178

TC801 TD437W TD437W TC802

TC1400KIT

TC1900KIT

TD600W

TC929 TC930

TD810W

TD441W TC768 TD440W TD440W TC768 TD441W

TD441W TC1343 TD440W TD440W TC1343 TD441W

TC769 TD439W TD439W TC770

AUDI

... AUDI

... A6 (4B SERIES) 1.8i, 2.4i, 2.5TDi, 2.7i, 2.8i, 3.0i Quattro | Ch. 4B2 000001-4B2 031500 (06/01-09/01)



TC1295



TC1295

Part No	Description	Pos	Info	Technical
TA1644	Inner tie rod(123)	A B		M14x1.5 Female(253) £
TA1908	Tie rod end(224)	A B		M14x1.5 Male(252) £
TC768	Lower track control arm(151)	A B	Front(108) 16" Wheels(-62-)	M12x1.25
TC769	Lower link arm(144)	A	Rear(187)	M12x1.5
TC770	Lower link arm(144)	B	Rear(187)	M12x1.5
TC801	Upper link arm(239)	A	Rear(187)	Pinch Bolt(255) 16mm
TC802	Upper link arm(239)	B	Rear(187)	Pinch Bolt(255) 16mm
TC929	Link stabiliser(135)	A		
TC930	Link stabiliser(135)	B		
TC1177	Upper link arm(239)	A	Front(108)	Pinch Bolt(255) 16mm
TC1178	Upper link arm(239)	B	Front(108)	Pinch Bolt(255) 16mm
TC1295	Link stabiliser(135)	A B		
TC1343	Lower track control arm(151)	A B	Front(108) 17" Wheels(-63-) 18" Wheels(-65-)	M12x1.5
TC1400KIT	Suspension kit(220)	K	16" Wheels(-62-)	
TC1900KIT	Suspension kit(220)	K	17" Wheels(-63-) 18" Wheels(-65-)	
TD437W	Upper link arm bush(240)	A B		
TD439W	Lower link arm bush(145)	A B		
TD440W	Lower track control arm bush(153)	A B	Inner(119)	
TD441W	Lower track control arm bush(153)	A B	Outer(176)	
TD600W	Suspension bolt kit(219)	K		
TD810W	Anti-roll bar(-74-) bush kit(-86-)	K	Ø27 Complete axle kit(-92-)	

A6 (4B SERIES) 1.8i, 1.9TDi, 2.0i, 2.4i, 2.5TDi, 2.7i, 2.8i, 3.0i Ch. 4B2 031501→ (09/01-01/05)



TA1908



TA1644



TA1644



TA1908



TA2383



TA2383

... A6 (4B SERIES) 1.8i, 1.9TDi, 2.0i, 2.4i, 2.5TDi, 2.7i, 2.8i, 3.0i Ch. 4B2 031501→ (09/01-01/05)

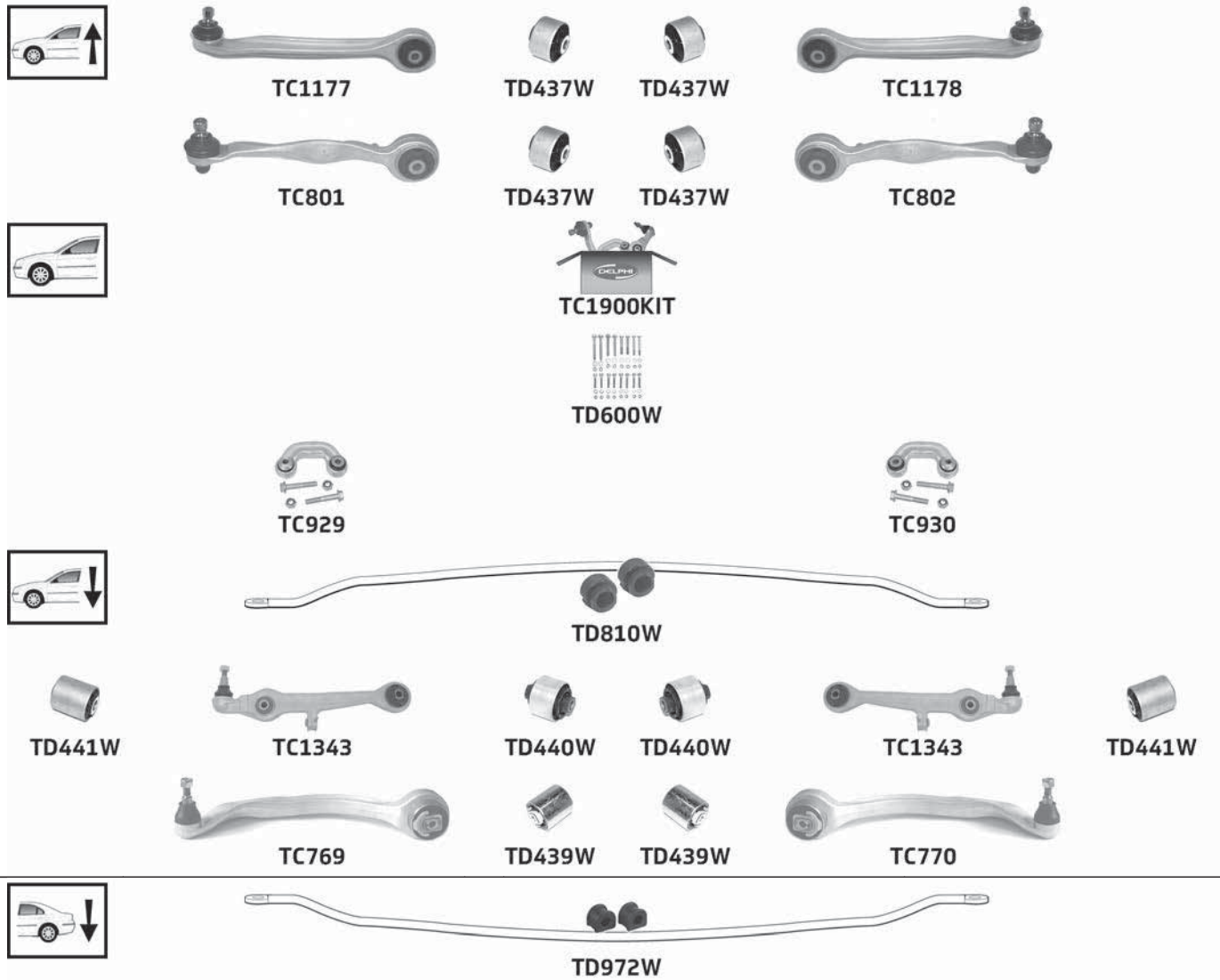

Part No	Description	Pos	Info	Technical
TA1644	Inner tie rod(123)	A B		M14x1.5 Female(253) £
TA1908	Tie rod end(224)	A B	→Ch. 4B3 011544	M14x1.5 Male(252) £
TA2383	Tie rod end(224)	A B	Ch. 4B3 011545→	M14x1.5 Male(252) £
TC769	Lower link arm(144)	A	Rear(187)	M12x1.5
TC770	Lower link arm(144)	B	Rear(187)	M12x1.5
TC801	Upper link arm(239)	A	Rear(187)	Pinch Bolt(255) 16mm
TC802	Upper link arm(239)	B	Rear(187)	Pinch Bolt(255) 16mm
TC929	Link stabiliser(135)	A		
TC930	Link stabiliser(135)	B		
TC1177	Upper link arm(239)	A	Front(108)	Pinch Bolt(255) 16mm
TC1178	Upper link arm(239)	B	Front(108)	Pinch Bolt(255) 16mm
TC1343	Lower track control arm(151)	A B	Front(108)	M12x1.5
TC1900KIT	Suspension kit(220)	K	→Ch. 4B3 011544	
TD437W	Upper link arm bush(240)	A B		
TD439W	Lower link arm bush(145)	A B		
TD440W	Lower track control arm bush(153)	A B	Inner(119)	
TD441W	Lower track control arm bush(153)	A B	Outer(176)	
TD600W	Suspension bolt kit(219)	K		
TD810W	Anti-roll bar(-74) bush kit(-86)	K	Ø27 Complete axle kit(-92)	
TD972W	Anti-roll bar(-74) bush kit(-86)	K	Ø16 Complete axle kit(-92) →Ch. 4B-5-050000 (+) Sport suspension(-53)	

... AUDI

A6 (4B SERIES) 1.8i, 2.4i, 2.5TDi, 2.7i, 2.8i, 3.0i Quattro | Ch. 4B2 031501→ (09/01-01/05)



Part No	Description	Pos	Info	Technical
TA1644	Inner tie rod(123)	A B		M14x1.5 Female(253) £
TA1908	Tie rod end(224)	A B	→Ch. 4B3 011544	M14x1.5 Male(252) £
TA2383	Tie rod end(224)	A B	Ch. 4B3 011545→	M14x1.5 Male(252) £
TC769	Lower link arm(144)	A	Rear(187)	M12x1.5
TC770	Lower link arm(144)	B	Rear(187)	M12x1.5
TC801	Upper link arm(239)	A	Rear(187)	Pinch Bolt(255) 16mm
TC802	Upper link arm(239)	B	Rear(187)	Pinch Bolt(255) 16mm
TC929	Link stabiliser(135)	A		
TC930	Link stabiliser(135)	B		
TC1177	Upper link arm(239)	A	Front(108)	Pinch Bolt(255) 16mm
TC1178	Upper link arm(239)	B	Front(108)	Pinch Bolt(255) 16mm
TC1295	Link stabiliser(135)	A B		
TC1343	Lower track control arm(151)	A B	Front(108)	M12x1.5
TC1900KIT	Suspension kit(220)	K	→Ch. 4B3 011544	
TD437W	Upper link arm bush(240)	A B		

... A6 (4B SERIES) 1.8i, 2.4i, 2.5TDi, 2.7i, 2.8i, 3.0i Quattro | Ch. 4B2 031501→ (09/01-01/05)

Part No	Description	Pos	Info	Technical
TD439W	Lower link arm bush(145)	A B		
TD440W	Lower track control arm bush(153)	A B	Inner(119)	
TD441W	Lower track control arm bush(153)	A B	Outer(176)	
TD600W	Suspension bolt kit(219)	K		
TD810W	Anti-roll bar(-74) bush kit(-86-)	K	Ø27 Complete axle kit(-92)	
TD972W	Anti-roll bar(-74) bush kit(-86-)	K	Ø16 Complete axle kit(-92) →Ch. 4B-5-050000 (+) Sport suspension(-53)	

A6 (4F SERIES) 2.0TFSi, 2.0TDi, 2.4i, 2.4i Quattro, 2.7TDi, 2.7TDi Quattro, 2.8FSi, 2.8FSi Quattro, 3.0i, 3.0i Quattro, 3.0TFSi Quattro, 3.0TDi, 3.0TDi Quattro, 3.2FSi, 3.2FSi Quattro, 4.2i Quattro, 4.2FSi Quattro Ch. 4F5 000001→ (04/04-03/11)

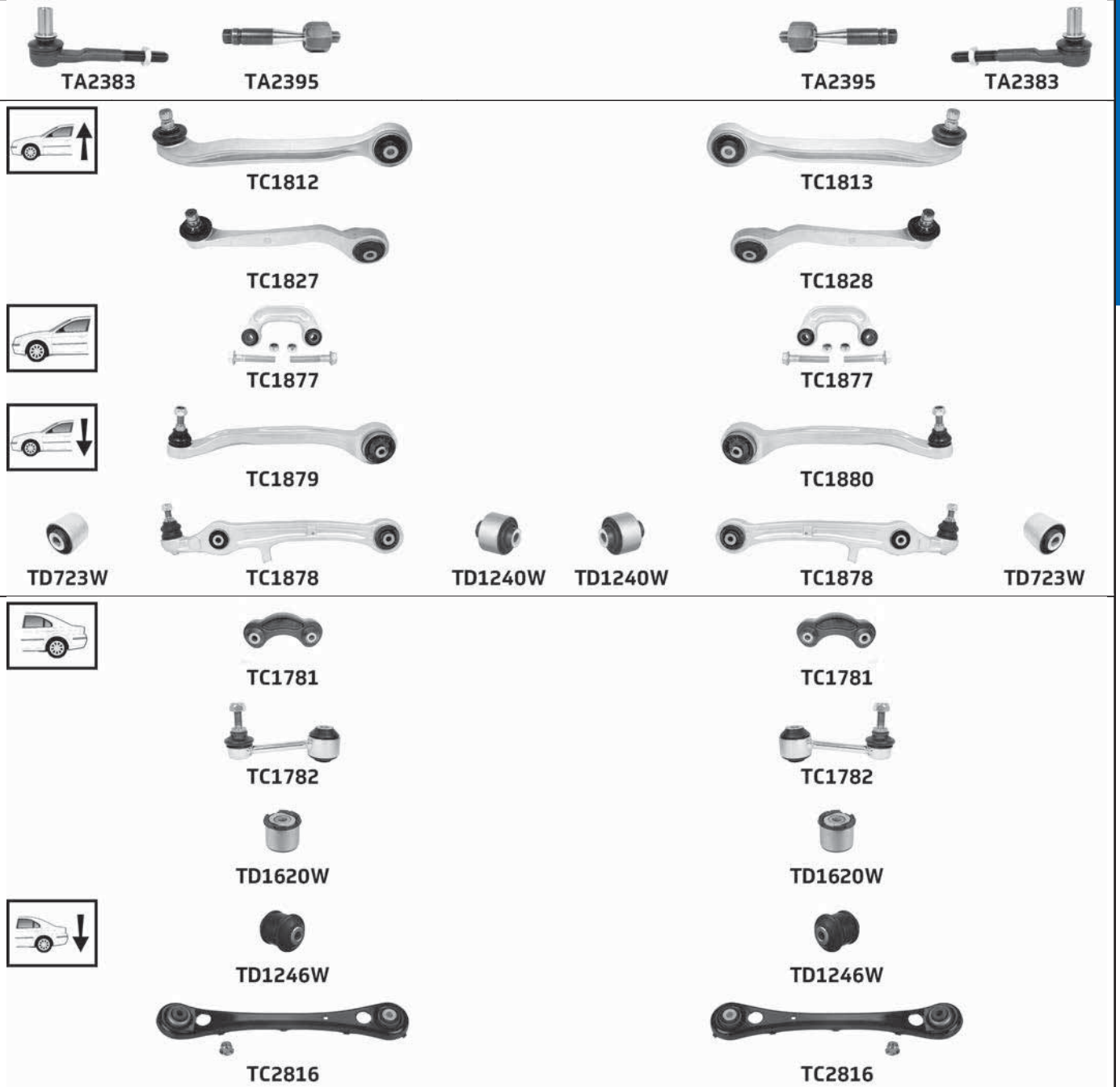

Part No	Description	Pos	Info	Technical
TA2383	Tie rod end(224)	A B		M14x1.5 Male(252) £
TA2395	Inner tie rod(123)	A B		M14x1.5 Female(253) £
TC1781	Link stabiliser(135)	A B	Plastic(184) (-) Air suspension(-9_)	
TC1782	Link stabiliser(135)	A B	Metal(256) (+) Air suspension(-35-)	M10x1.5
TC1812	Upper link arm(239)	A	Front(108)	Pinch Bolt(255) 18mm
TC1813	Upper link arm(239)	B	Front(108)	Pinch Bolt(255) 18mm
TC1827	Upper link arm(239)	A	Rear(187)	Pinch Bolt(255) 18mm
TC1828	Upper link arm(239)	B	Rear(187)	Pinch Bolt(255) 18mm
TC1877	Link stabiliser(135)	A B		

... AUDI

... A6 (4F SERIES) 2.0TFSi, 2.0TDi, 2.4i, 2.4i Quattro, 2.7TDi, 2.7TDi Quattro, 2.8FSi, 2.8FSi Quattro, 3.0i, 3.0i Quattro, 3.0TFSi Quattro, 3.0TDi, 3.0TDi Quattro, 3.2FSi, 3.2FSi Quattro, 4.2i Quattro, 4.2FSi Quattro Ch. 4F5 000001→ (04/04-03/11)

Part No	Description	Pos	Info	Technical
TC1878	Lower track control arm(151)	A B	Front(108)	M14x1.5
TC1879	Lower link arm(144)	A	Rear(187)	M14x1.5
TC1880	Lower link arm(144)	B	Rear(187)	M14x1.5
TC2816	Lower track control arm(151)	A B		
TD723W	Lower track control arm bush(153)	A B	Outer(176)	
TD1240W	Lower track control arm bush(153)	A B	Inner(119)	
TD1246W	Lower hub carrier bush(143)	A B		
TD1620W	Sub-frame bush(215)	A B	Rear(187)	

A6 (4G SERIES) 2.0TFSi, 2.0TDi, 2.8FSi, 2.8FSi Quattro, 3.0TFSi Quattro, 3.0TDi, 3.0TDi Quattro Ch. 4GB 000001→ (11/10-08/11)

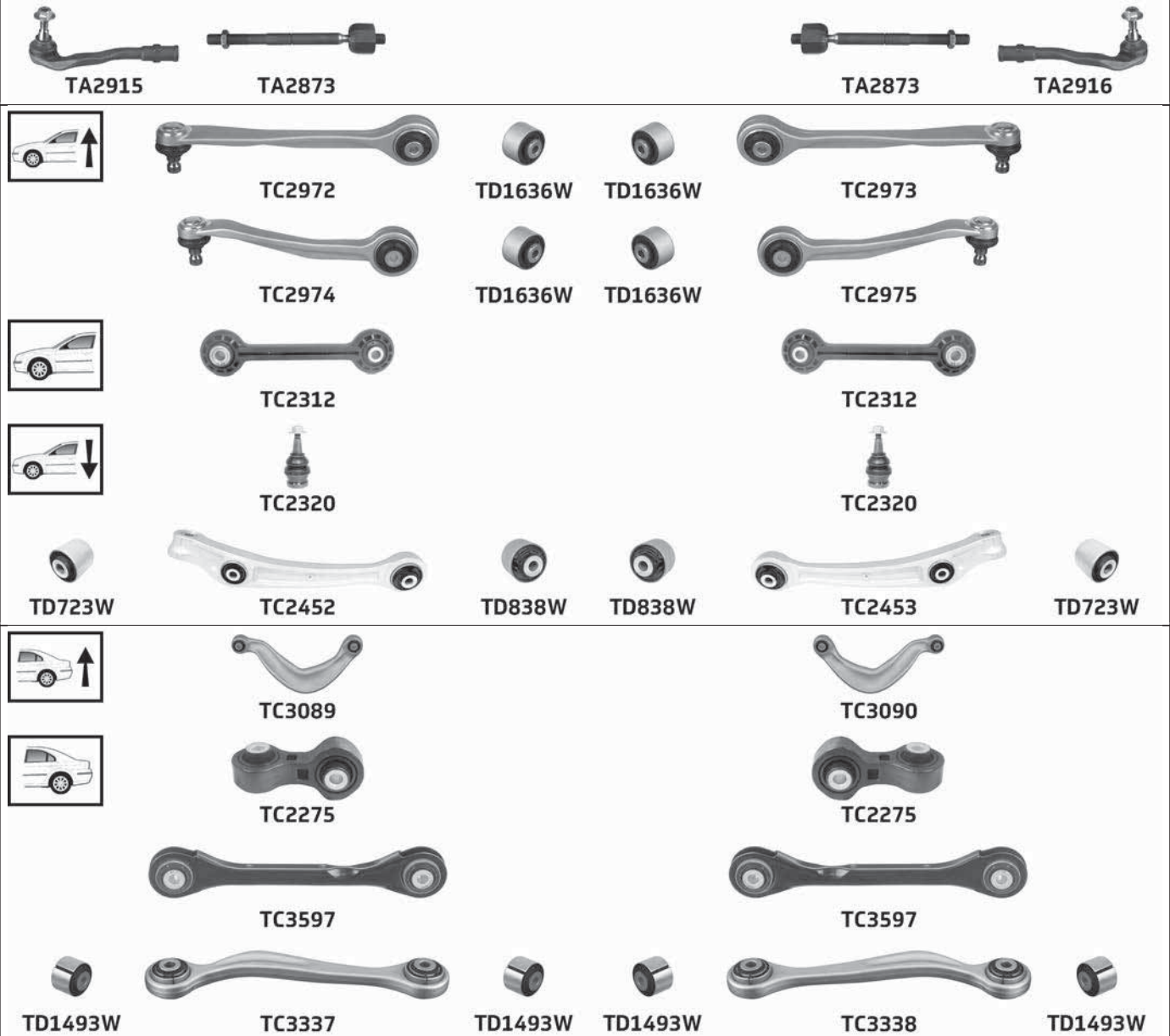

Part No	Description	Pos	Info	Technical
TA2873	Inner tie rod(123)	A B		M16x1.5 Male(252) £
TA2915	Tie rod end(224)	A		M16x1.5 Female(253) £
TA2916	Tie rod end(224)	B		M16x1.5 Female(253) £
TC2275	Link stabiliser(135)	A B		
TC2312	Link stabiliser(135)	A B		
TC2320	Lower ball joint(140)	A B		M12x1.5
TC2452	Lower track control arm(151)	A	Front(108)	
TC2453	Lower track control arm(151)	B	Front(108)	
TC2972	Upper link arm(239)	A	Front(108)	Pinch Bolt(255) 16mm
TC2973	Upper link arm(239)	B	Front(108)	Pinch Bolt(255) 16mm
TC2974	Upper link arm(239)	A	Rear(187)	Pinch Bolt(255) 16mm
TC2975	Upper link arm(239)	B	Rear(187)	Pinch Bolt(255) 16mm

... A6 (4G SERIES) 2.0TFSi, 2.0TDi, 2.8FSi, 2.8FSi Quattro, 3.0TFSi Quattro, 3.0TDi, 3.0TDi Quattro Ch. 4GB 000001→ (11/10-08/11)

Part No	Description	Pos	Info	Technical
TC3089	Upper track control arm(242)	A		
TC3090	Upper track control arm(242)	B		
TC3337	Lower track control arm(151)	A	Aluminium(-73) (+) Air suspension(-35)	
TC3338	Lower track control arm(151)	B	Aluminium(-73) (+) Air suspension(-35)	
TC3597	Lower track control arm(150)	A B	Steel(210) (-) Air suspension(_9_)	
TD723W	Lower track control arm bush(153)	A B	Outer(176)	
TD838W	Lower track control arm bush(153)	A B	Inner(119)	
TD1493W	Lower track control arm bush(153)	A B	(+) Air suspension(-35) Outer(176) Inner(119)	
TD1636W	Upper link arm bush(240)	A B		

A6 (4G SERIES) 2.0TFSi, 2.0TFSi Quattro, 2.0TDi, 2.8FSi, 2.8FSi Quattro, 3.0TFSi Quattro, 3.0TDi, 3.0TDi Quattro (08/11→)

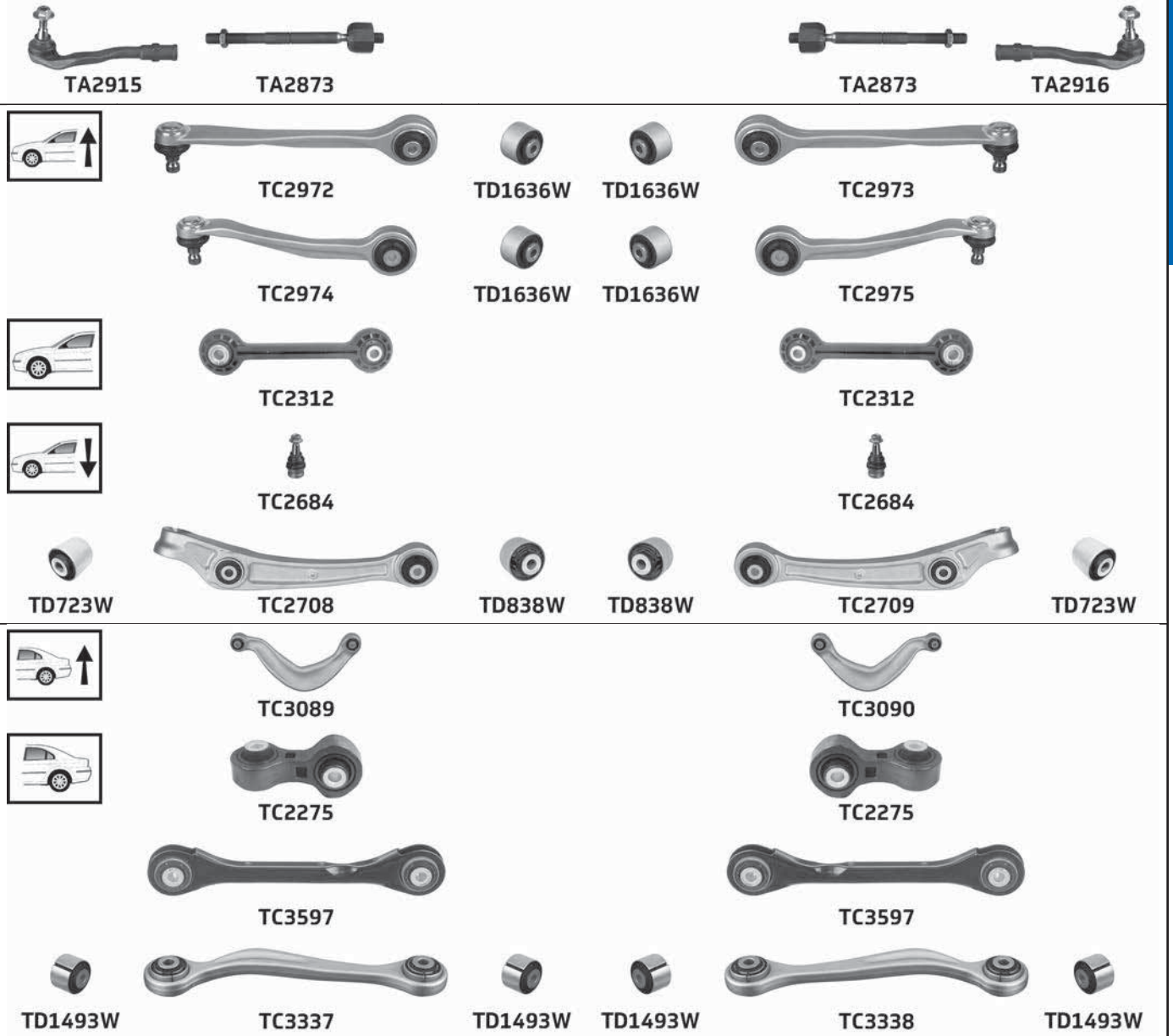

Part No	Description	Pos	Info	Technical
TA2873	Inner tie rod(123)	A B		M16x1.5 Male(252) £
TA2915	Tie rod end(224)	A		M16x1.5 Female(253) £
TA2916	Tie rod end(224)	B		M16x1.5 Female(253) £
TC2275	Link stabiliser(135)	A B		
TC2312	Link stabiliser(135)	A B		
TC2684	Lower ball joint(140)	A B		M14x1.5
TC2708	Lower track control arm(151)	A	Front(108)	
TC2709	Lower track control arm(151)	B	Front(108)	
TC2972	Upper link arm(239)	A	Front(108)	Pinch Bolt(255) 16mm
TC2973	Upper link arm(239)	B	Front(108)	Pinch Bolt(255) 16mm
TC2974	Upper link arm(239)	A	Rear(187)	Pinch Bolt(255) 16mm

... AUDI

... A6 (4G SERIES) 2.0TFSi, 2.0TFSi Quattro, 2.0TDi, 2.8FSi, 2.8FSi Quattro, 3.0TFSi Quattro, 3.0TDi, 3.0TDi Quattro (08/11→)

Part No	Description	Pos	Info	Technical
TC2975	Upper link arm(239)	B	Rear(187)	Pinch Bolt(255) 16mm
TC3089	Upper track control arm(242)	A		
TC3090	Upper track control arm(242)	B		
TC3337	Lower track control arm(151)	A	Aluminium(-73) (+) Air suspension(-35) →16/02/2015	
TC3338	Lower track control arm(151)	B	Aluminium(-73) (+) Air suspension(-35) →16/02/2015	
TC3597	Lower track control arm(150)	A B	Steel(210) (+) Air suspension(-35) 16/02/2015→	
TC3597	Lower track control arm(150)	A B	Steel(210) (-) Air suspension(-9)	
TD723W	Lower track control arm bush(153)	A B	Outer(176)	
TD838W	Lower track control arm bush(153)	A B	Inner(119)	
TD1493W	Lower track control arm bush(153)	A B	(+) Air suspension(-35) Outer(176) Inner(119) →16/02/2015	
TD1636W	Upper link arm bush(240)	A B		

A7 (4G SERIES) 2.8FSi, 2.8FSi Quattro, 3.0TFSi Quattro, 3.0TDi, 3.0TDi Quattro (10/10-08/11)

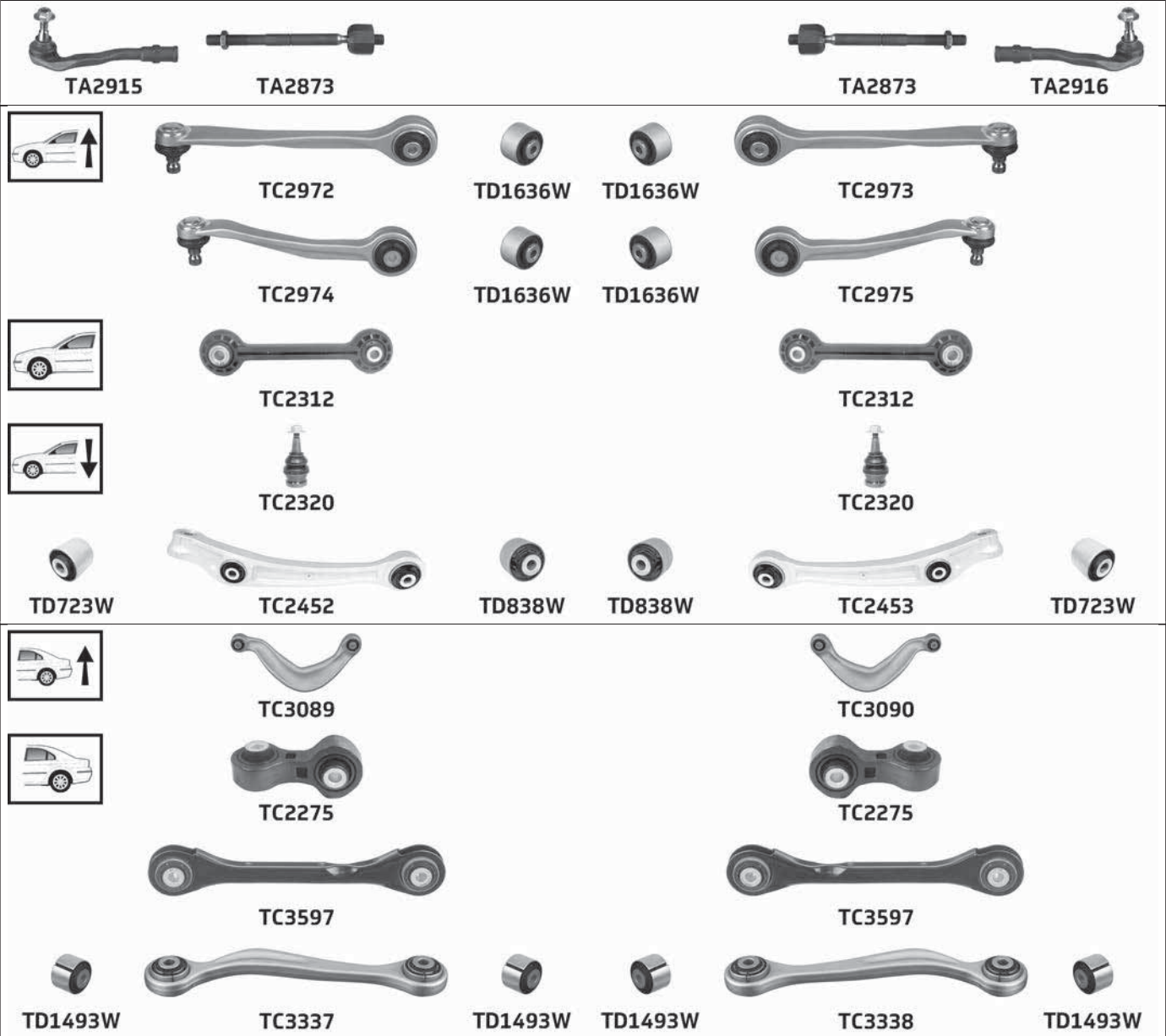

Part No	Description	Pos	Info	Technical
TA2873	Inner tie rod(123)	A B		M16x1.5 Male(252) £
TA2915	Tie rod end(224)	A		M16x1.5 Female(253) £
TA2916	Tie rod end(224)	B		M16x1.5 Female(253) £
TC2275	Link stabiliser(135)	A B		
TC2312	Link stabiliser(135)	A B		
TC2320	Lower ball joint(140)	A B		M12x1.5
TC2452	Lower track control arm(151)	A	Front(108)	

... A7 (4G SERIES) 2.8FSi, 2.8FSi Quattro, 3.0TFSi Quattro, 3.0TDi, 3.0TDi Quattro (10/10-08/11)

Part No	Description	Pos	Info	Technical
TC2453	Lower track control arm(151)	B	Front(108)	
TC2972	Upper link arm(239)	A	Front(108)	Pinch Bolt(255) 16mm
TC2973	Upper link arm(239)	B	Front(108)	Pinch Bolt(255) 16mm
TC2974	Upper link arm(239)	A	Rear(187)	Pinch Bolt(255) 16mm
TC2975	Upper link arm(239)	B	Rear(187)	Pinch Bolt(255) 16mm
TC3089	Upper track control arm(242)	A		
TC3090	Upper track control arm(242)	B		
TC3337	Lower track control arm(151)	A	Aluminium(-73) (+) Air suspension(-35)	
TC3338	Lower track control arm(151)	B	Aluminium(-73) (+) Air suspension(-35)	
TC3597	Lower track control arm(150)	A B	Steel(210) (-) Air suspension(_9_)	
TD723W	Lower track control arm bush(153)	A B	Outer(176)	
TD838W	Lower track control arm bush(153)	A B	Inner(119)	
TD1493W	Lower track control arm bush(153)	A B	(+) Air suspension(-35) Outer(176) Inner(119)	
TD1636W	Upper link arm bush(240)	A B		

A7 (4G SERIES) 2.8FSi, 2.8FSi Quattro, 3.0TFSi Quattro, 3.0TDi, 3.0TDi Quattro (08/11-)

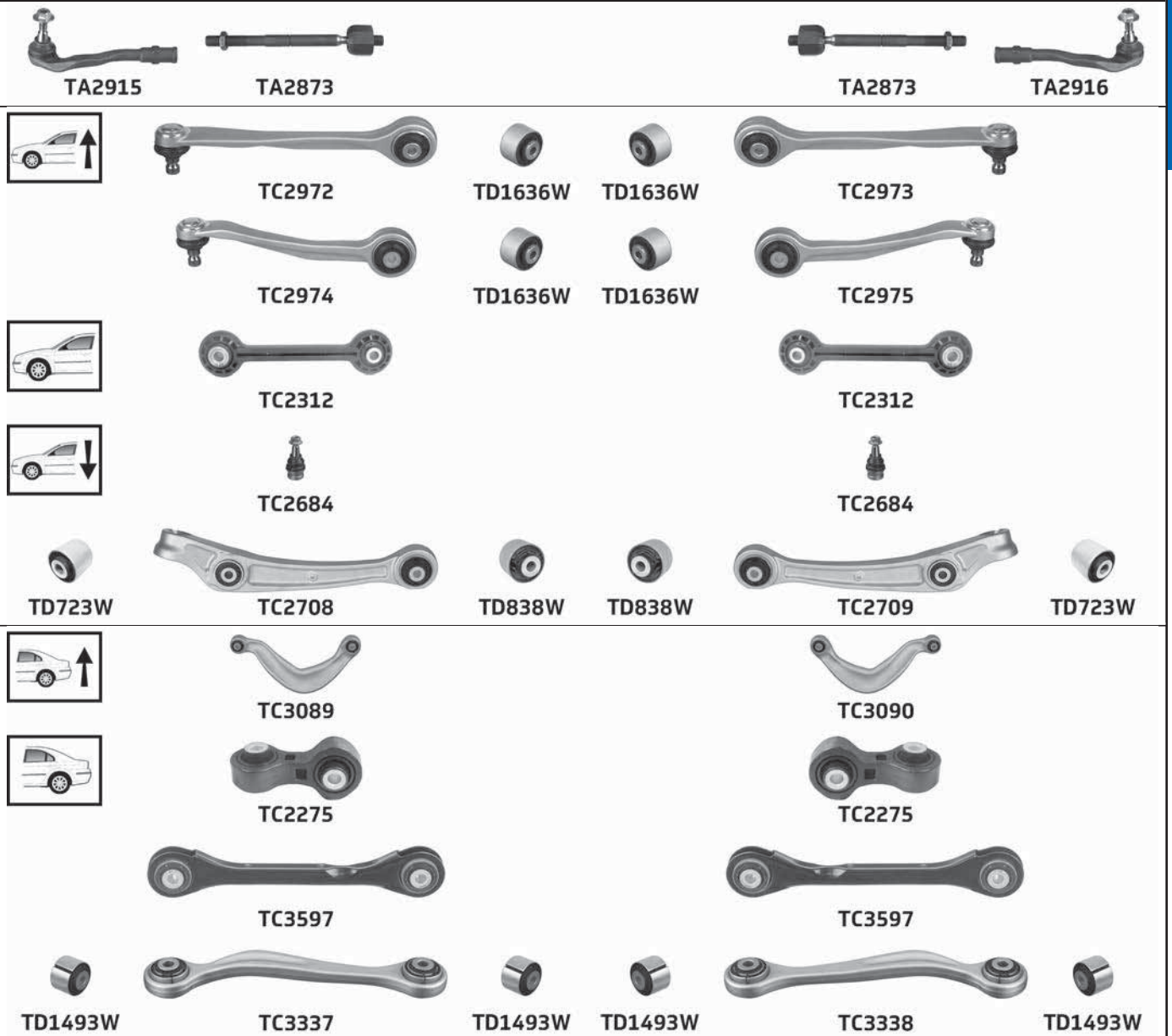

Part No	Description	Pos	Info	Technical
TA2873	Inner tie rod(123)	A B		M16x1.5 Male(252) £
TA2915	Tie rod end(224)	A		M16x1.5 Female(253) £
TA2916	Tie rod end(224)	B		M16x1.5 Female(253) £
TC2275	Link stabiliser(135)	A B		
TC2312	Link stabiliser(135)	A B		
TC2684	Lower ball joint(140)	A B		M14x1.5
TC2708	Lower track control arm(151)	A	Front(108)	

... AUDI

A7 (4G SERIES) 2.8FSi, 2.8FSi Quattro, 3.0TFSi Quattro, 3.0TDi, 3.0TDi Quattro (08/11→)

Part No	Description	Pos	Info	Technical
TC2709	Lower track control arm(151)	B	Front(108)	
TC2972	Upper link arm(239)	A	Front(108)	Pinch Bolt(255) 16mm
TC2973	Upper link arm(239)	B	Front(108)	Pinch Bolt(255) 16mm
TC2974	Upper link arm(239)	A	Rear(187)	Pinch Bolt(255) 16mm
TC2975	Upper link arm(239)	B	Rear(187)	Pinch Bolt(255) 16mm
TC3089	Upper track control arm(242)	A		
TC3090	Upper track control arm(242)	B		
TC3337	Lower track control arm(151)	A	Aluminium(-73) (+) Air suspension(-35) →16/02/2015	
TC3338	Lower track control arm(151)	B	Aluminium(-73) (+) Air suspension(-35) →16/02/2015	
TC3597	Lower track control arm(150)	A B	Steel(210) (+) Air suspension(-35) 16/02/2015→	
TC3597	Lower track control arm(150)	A B	Steel(210) (-) Air suspension(-9_)	
TD723W	Lower track control arm bush(153)	A B	Outer(176)	
TD838W	Lower track control arm bush(153)	A B	Inner(119)	
TD1493W	Lower track control arm bush(153)	A B	(+) Air suspension(-35) Outer(176) Inner(119) →16/02/2015	
TD1636W	Upper link arm bush(240)	A B		

A8 (4E SERIES) 3.0i, 3.0TDi Quattro, 3.2FSi, 3.2FSi Quattro, 3.7i Quattro, 4.0TDi Quattro, 4.2i Quattro, 4.2FSi Quattro, 4.2TDi Quattro, 6.0i Quattro (10/02-07/10)



... A8 (4E SERIES) 3.0i, 3.0TDi Quattro, 3.2FSI, 3.2FSI Quattro, 3.7i Quattro, 4.0TDi Quattro, 4.2i Quattro, 4.2FSI Quattro, 4.2TDi Quattro, 6.0i Quattro (10/02-07/10)



TC1757



TC1757



TC3086



TC3086



TC1207



TC1206

Part No	Description	Pos	Info	Technical
TA2376	Tie rod end (224)	A B		M16x1.5 Male (252) £
TA2377	Inner tie rod (123)	A B		M16x1.5 Female (253) £
TC1206	Connecting link (-95)	B		
TC1207	Connecting link (-95)	A		
TC1757	Link stabiliser (135)	A B		M10x1.5
TC1812	Upper link arm (239)	A	Front (108)	Pinch Bolt (255) 18mm
TC1813	Upper link arm (239)	B	Front (108)	Pinch Bolt (255) 18mm
TC1827	Upper link arm (239)	A	Rear (187)	Pinch Bolt (255) 18mm
TC1828	Upper link arm (239)	B	Rear (187)	Pinch Bolt (255) 18mm
TC1877	Link stabiliser (135)	A B		
TC1946	Lower track control arm (151)	A B	Front (108)	M14x1.5
TC1968	Lower link arm (144)	A	Rear (187)	M14x1.5
TC1969	Lower link arm (144)	B	Rear (187)	M14x1.5
TC3086	Lower track control arm (151)	A B	Rear (187)	M12x1.5
TD723W	Lower track control arm bush (153)	A B	Outer (176)	
TD1240W	Lower track control arm bush (153)	A B	Inner (119)	
TD1247W	Lower link arm bush (145)	A B		
TL557	Rod assembly (194)	A B		Ø23mm, M8x1.25 Female (253)

... AUDI

A8 (4H SERIES) 2.0TFSI, 2.5TFSI, 3.0TFSI Quattro, 3.0TDi, 3.0TDi Quattro, 4.0TFSI Quattro, 4.2FSI Quattro, 4.2TDi Quattro, 6.3FSI Quattro (11/09→)

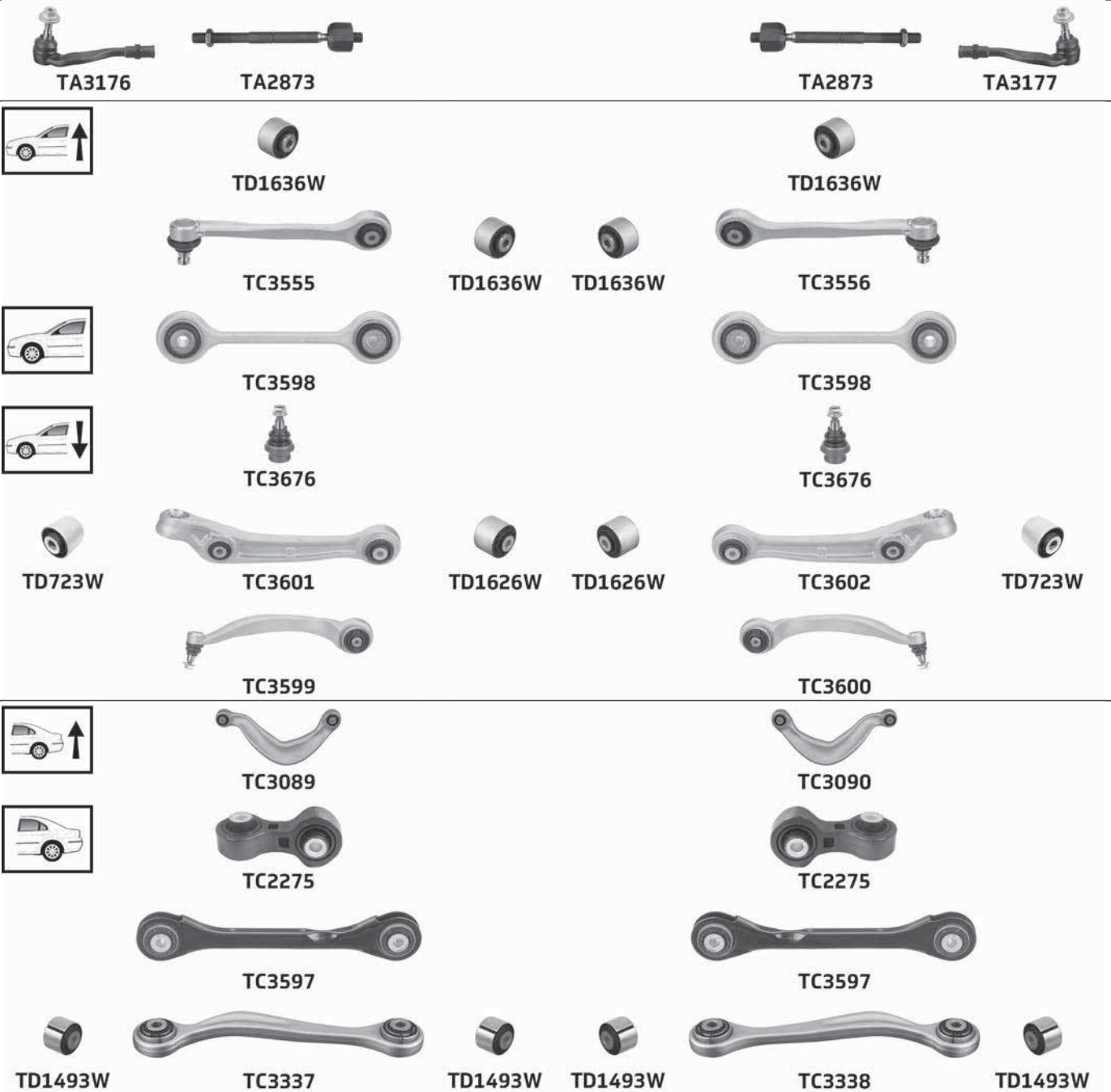

Part No	Description	Pos	Info	Technical
TA2873	Inner tie rod(123)	A B		M16x1.5 Male(252) £
TA3176	Tie rod end(224)	A		M16x1.5 Female(252) £
TA3177	Tie rod end(224)	B		M16x1.5 Female(253) £
TC2275	Link stabiliser(135)	A B		
TC3089	Upper track control arm(242)	A	(-) Armoured(-10)	
TC3090	Upper track control arm(242)	B	(-) Armoured(-10)	
TC3337	Lower track control arm(151)	A	Aluminium(-73) → 06/10/2010	
TC3338	Lower track control arm(151)	B	Aluminium(-73) → 06/10/2010	
TC3555	Upper link arm(239)	A	Front(108)	ø18
TC3556	Upper link arm(239)	B	Front(108)	ø18
TC3597	Lower track control arm(151)	A B	Steel(210) 06/10/2010→	
TC3598	Link stabiliser(135)	A B		
TC3599	Lower track control arm(151)	A	Rear(187)	M14x1.5
TC3600	Lower track control arm(151)	B	Rear(187)	M14x1.5
TC3601	Lower track control arm(151)	A	Front(108)	
TC3602	Lower track control arm(151)	B	Front(108)	
TC3676	Lower ball joint(140)	A B	Front(108)	M14 x 1.5 x 26.5
TD723W	Lower track control arm bush(153)	A B	Front(108) Outer(176)	

... A8 (4H SERIES) 2.0TFSI, 2.5TFSI, 3.0TFSI Quattro, 3.0TDi, 3.0TDi Quattro, 4.0TFSI Quattro, 4.2FSI Quattro, 4.2TDi Quattro, 6.3FSI Quattro (11/09→)

Part No	Description	Pos	Info	Technical
TD1493W	Lower track control arm bush(153)	A B	Outer(176) Inner(119) → 06/10/2010	
TD1626W	Lower track control arm bush(153)	A B	Front(108) Inner(119)	
TD1636W	Upper link arm bush(240)	A B	Rear(187)	

ALLROAD (4B SERIES) 2.5TDi, 2.7i, 4.2i V8 Quattro (05/00-08/05)



Part No	Description	Pos	Info	Technical
TA1644	Inner tie rod(123)	A B		M14x1.5 Female(253) E
TA1908	Tie rod end(224)	A B	→Ch. 4B2 150000	M14x1.5 Male(252) E
TC771	Link stabiliser(135)	A B		M10x1.5
TC801	Upper link arm(239)	A	Rear(187)	Pinch Bolt(255) 16mm
TC802	Upper link arm(239)	B	Rear(187)	Pinch Bolt(255) 16mm
TC1177	Upper link arm(239)	A	Front(108)	Pinch Bolt(255) 16mm
TC1178	Upper link arm(239)	B	Front(108)	Pinch Bolt(255) 16mm
TC1295	Link stabiliser(135)	A B		
TD437W	Upper link arm bush(240)	A B		
TD441W	Lower track control arm bush(153)	A B	Outer(176)	
TD810W	Anti-roll bar(-74) bush kit(-86-)	K	Ø27 Complete axle kit(-92)	

... AUDI

ALLROAD (4F SERIES) 2.7TDi, 3.0TDi, 3.0TFSI, 3.2FSI, 4.2FSI Quattro (05/06→)

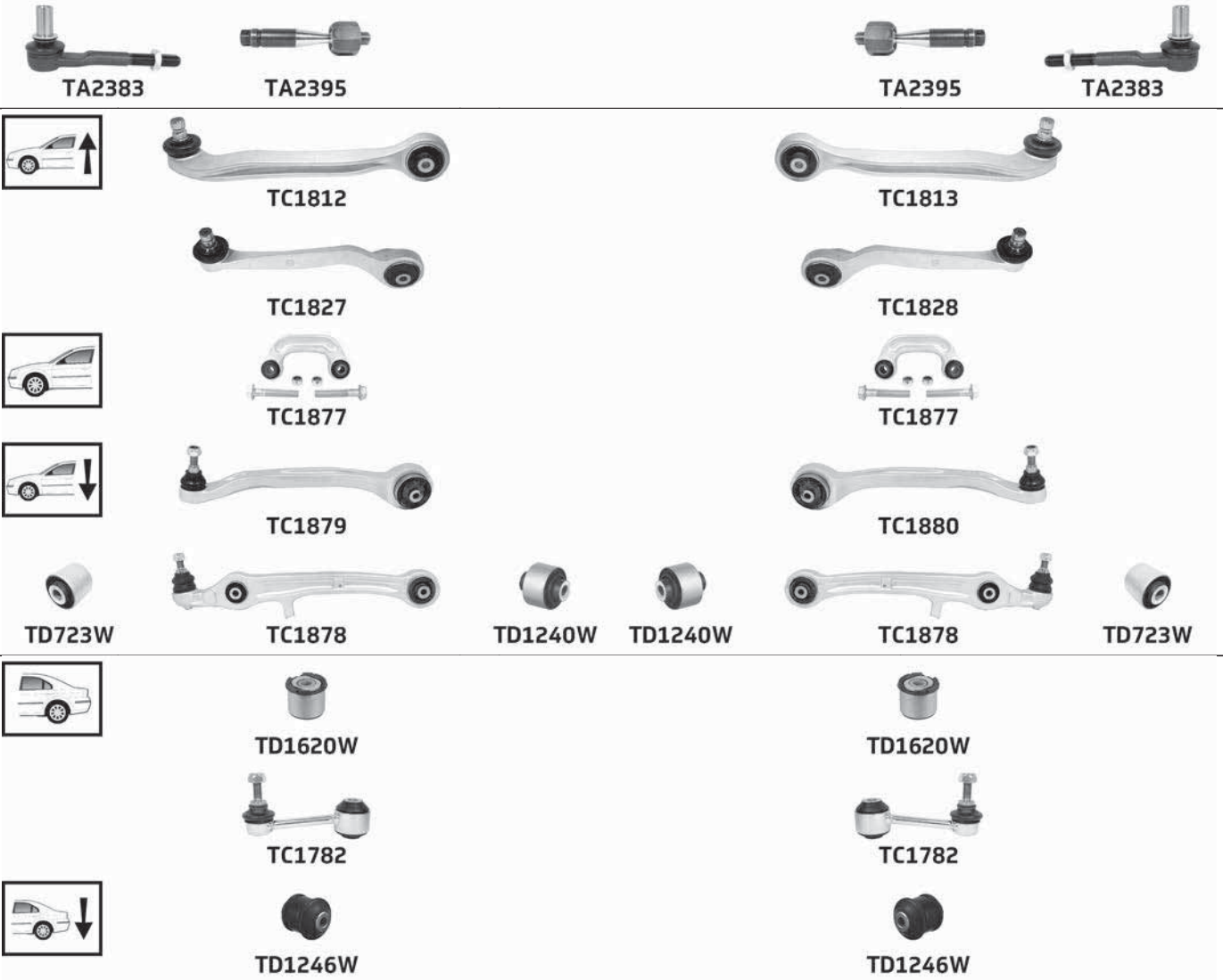

Part No	Description	Pos	Info	Technical
TA2383	Tie rod end(224)	A B		M14x1.5 Male(252) £
TA2395	Inner tie rod(123)	A B		M14x1.5 Female(253) £
TC1782	Link stabiliser(135)	A B		M10x1.5
TC1812	Upper link arm(239)	A	Front(108)	Pinch Bolt(255) 18mm
TC1813	Upper link arm(239)	B	Front(108)	Pinch Bolt(255) 18mm
TC1827	Upper link arm(239)	A	Rear(187)	Pinch Bolt(255) 18mm
TC1828	Upper link arm(239)	B	Rear(187)	Pinch Bolt(255) 18mm
TC1877	Link stabiliser(135)	A B		
TC1878	Lower track control arm(151)	A B	Front(108)	M14x1.5
TC1879	Lower link arm(144)	A	Rear(187)	M14x1.5
TC1880	Lower link arm(144)	B	Rear(187)	M14x1.5
TD723W	Lower track control arm bush(153)	A B	Outer(176)	
TD1240W	Lower track control arm bush(153)	A B	Inner(119)	
TD1246W	Lower hub carrier bush(143)	A B		
TD1620W	Sub-frame bush(215)	A B	Rear(187)	

ALLROAD (4G SERIES) 3.0TDi, 3.0TFSI Quattro (01/12→)

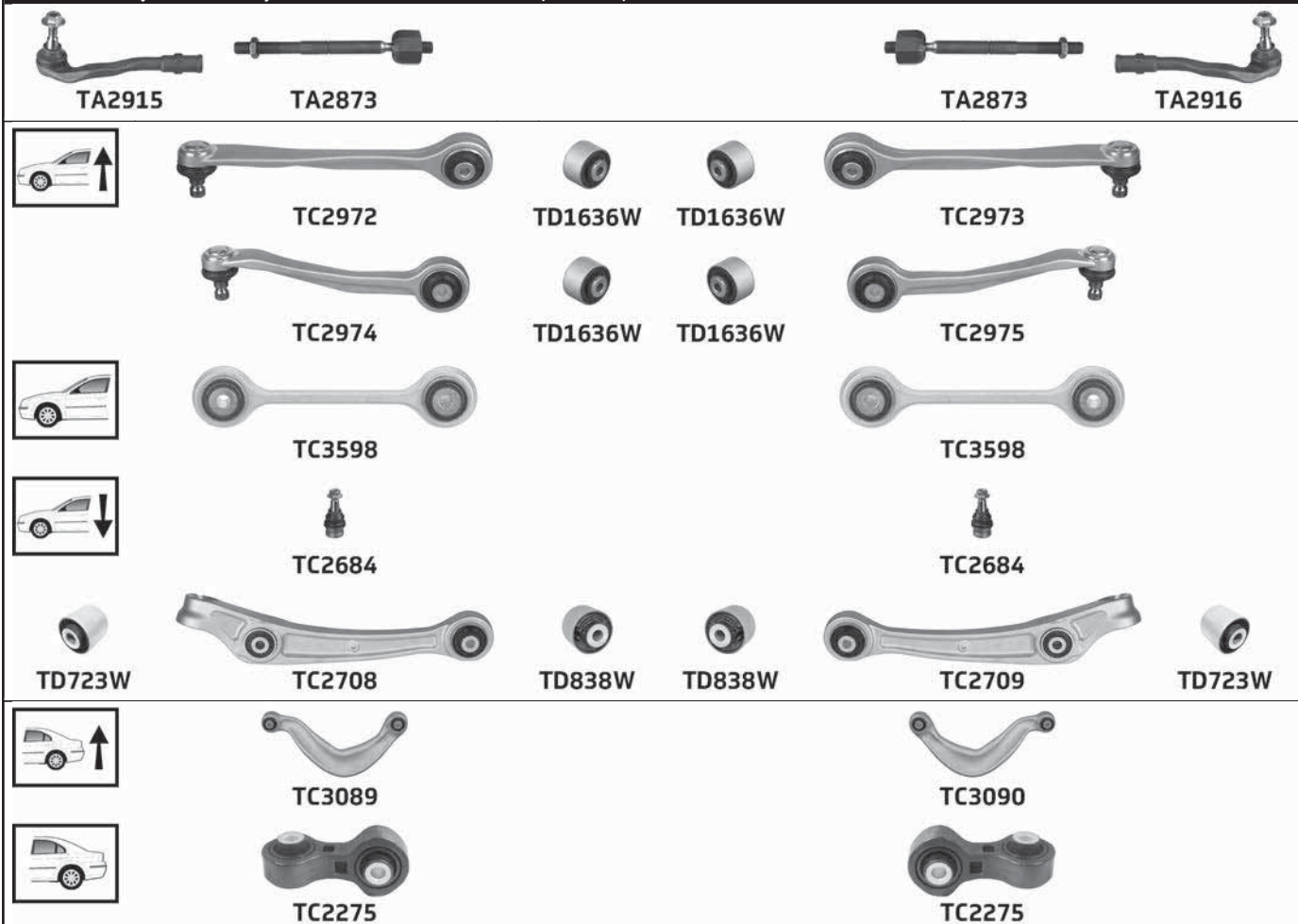

Part No	Description	Pos	Info	Technical
TA2873	Inner tie rod(123)	A B		M16x1.5 Male(252) £
TA2915	Tie rod end(224)	A		M16x1.5 Female(253) £
TA2916	Tie rod end(224)	B		M16x1.5 Female(253) £
TC2275	Link stabiliser(135)	A B		
TC2684	Lower ball joint(140)	A B		M14x1.5
TC2708	Lower track control arm(151)	A	Front(108)	
TC2709	Lower track control arm(151)	B	Front(108)	
TC2972	Upper link arm(239)	A	Front(108)	Pinch Bolt(255) 16mm
TC2973	Upper link arm(239)	B	Front(108)	Pinch Bolt(255) 16mm
TC2974	Upper link arm(239)	A	Rear(187)	Pinch Bolt(255) 16mm
TC2975	Upper link arm(239)	B	Rear(187)	Pinch Bolt(255) 16mm
TC3089	Upper track control arm(242)	A	(-) Armoured(-10-)	
TC3090	Upper track control arm(242)	B	(-) Armoured(-10-)	
TC3598	Link stabiliser(135)	A B		
TD723W	Lower track control arm bush(153)	A B	Outer(176)	
TD838W	Lower track control arm bush(153)	A B	Inner(119)	
TD1636W	Upper link arm bush(240)	A B		

AUDI

... AUDI

Q2 1.0TFSI, 1.4TFSI, 1.6TDI, 2.0TDI, 2.0TDI Quattro (06/16→)

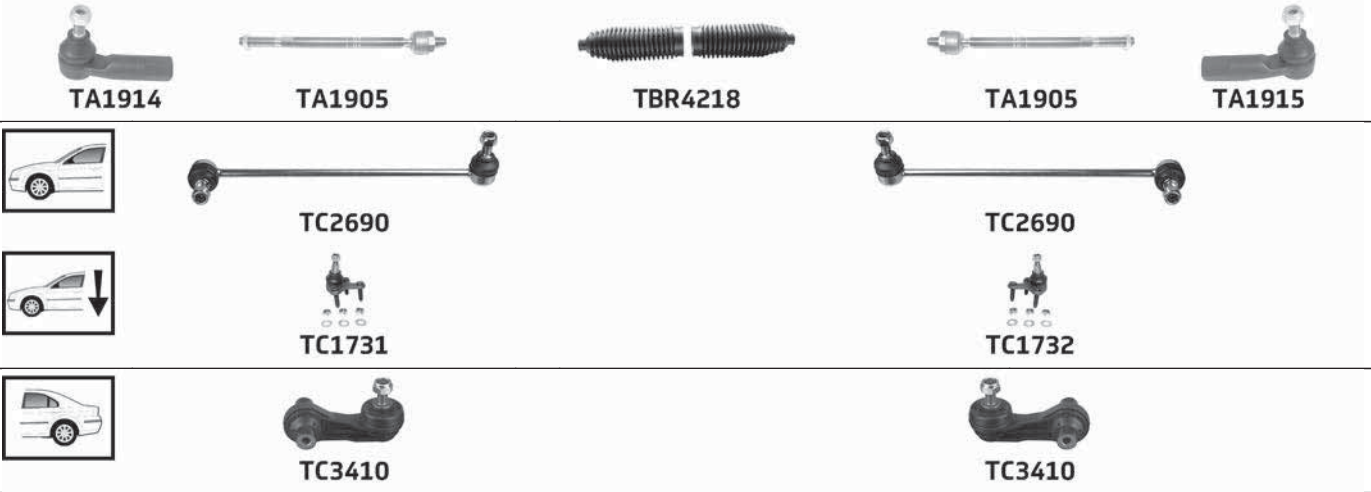

Part No	Description	Pos	Info	Technical
TA1905	Inner tie rod(123)	A B		M16x1.5 Male(252) £
TA1914	Tie rod end(224)	A		M16x1.5 Female(253) £
TA1915	Tie rod end(224)	B		M16x1.5 Female(253) £
TBR4218	Steering rack gaiter kit (213)	K	Thermoplastic(223)	1 :15.5x49.5x49.5 2 :15.5x49.5x49.5
TC1731	Lower ball joint (140)	A		M12x1.5
TC1732	Lower ball joint (140)	B		M12x1.5
TC2690	Link stabiliser (135)	A B		M12x1.5
TC3410	Link stabiliser (135)	A B	(+) Quattro	M10x1.5

AUDI

Q3 (8U SERIES) 2.0TFSI Quattro, 2.0TDI, 2.0TDI Quattro (06/11→)

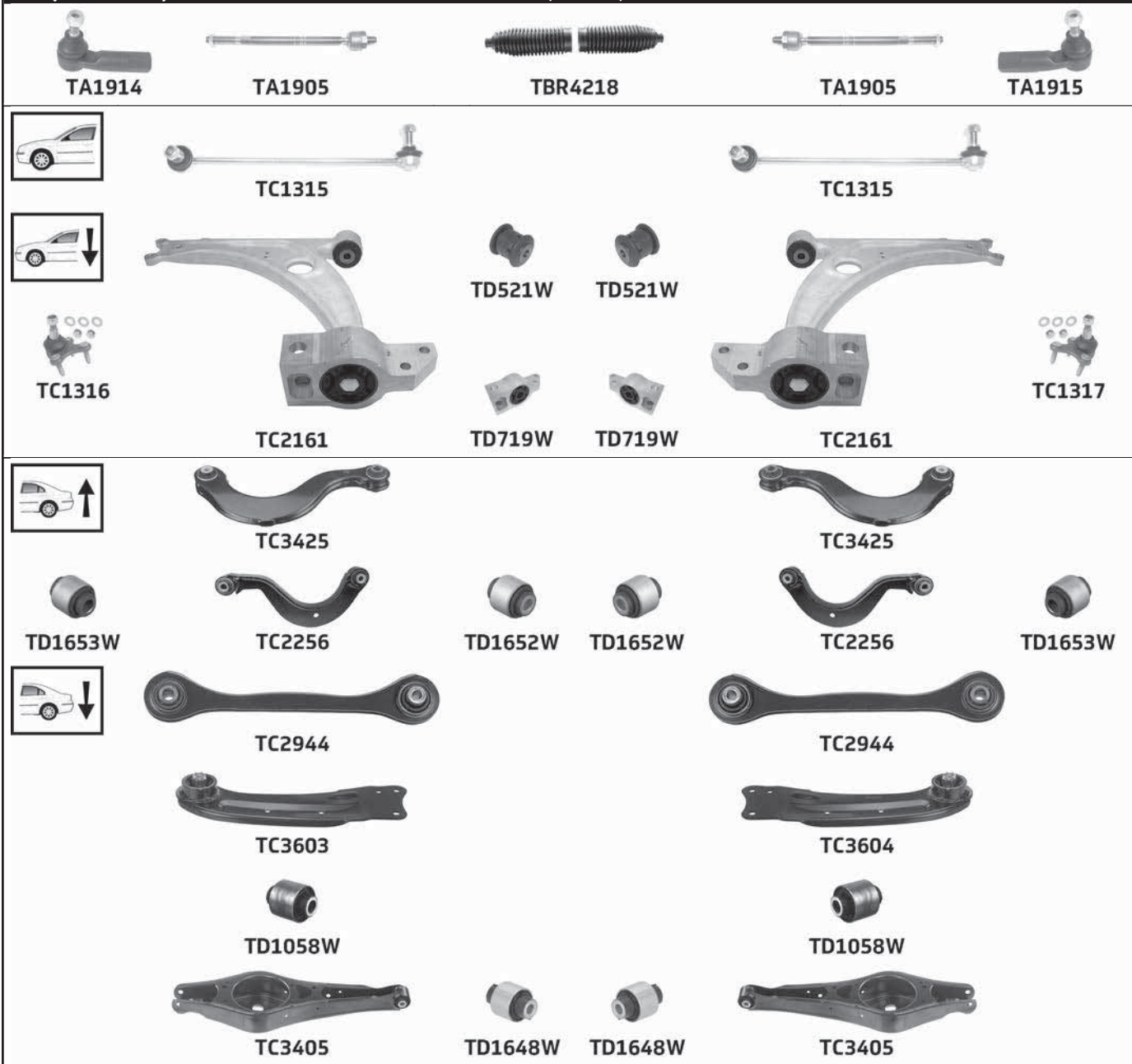

Part No	Description	Pos	Info	Technical
TA1905	Inner tie rod(123)	A B		M16x1.5 Male(252) £
TA1914	Tie rod end(224)	A		M16x1.5 Female(253) £
TA1915	Tie rod end(224)	B		M16x1.5 Female(253) £
TBR4218	Steering rack gaiter kit(213)	K	Thermoplastic(223)	1 :15.5x49.5x49.5 2 :15.5x49.5x49.5
TC1315	Link stabiliser(135)	A B		M12x1.5
TC1316	Lower ball joint(140)	A		M12x1.5
TC1317	Lower ball joint(140)	B		M12x1.5
TC2161	Lower wishbone(158)	A B	(-) Ball joint(-11)	
TC2256	Upper track control arm(242)	A B	→28/05/2012	
TC2944	Trailing arm(226)	A B		
TC3405	Lower track control arm(151)	A B	Rear(187)	
TC3425	Upper track control arm(242)	A B	28/05/2012→	
TC3603	Track control arm(225)	A	Front(108)	
TC3604	Track control arm(225)	B	Front(108)	
TD521W	Lower wishbone bush(159)	A B	Front(108)	
TD719W	Lower wishbone bush(159)	A B	Rear(187)	
TD1058W	Lower hub carrier bush(143)	A B		
TD1648W	Lower track control arm bush(153)	A B	Inner(119)	
TD1652W	Upper track control arm bush(243)	A B		
TD1653W	Upper track control arm bush(243)	A B		

... AUDI

O5 (8R SERIES) 2.0TFSI, 2.0TDI, 3.0TDI, 3.2FSI Quattro (11/08-07/09)



TL613



TA2508



TA2485



TA2915



TA2873



TL614



TA2485



TA2509



TA2873



TA2916



TC2972



TC2973



TC2974



TC2975



TC2312



TC2312



TC2320



TC2320



TD1633W



TD1633W



TD723W



TC2452



TD838W



TD838W



TC2453



TD723W



TC2454



TD849W



TD849W



TC2455



TC3089



TC3090



TC2275



TC2275



TD1493W



TC3337



TD1493W



TD1493W



TC3338



TD1493W

Part No	Description	Pos	Info	Technical
TA2485	Inner tie rod(123)	A B	Hydraulic(115) Power steering(185)	M16x1.5 Male(252) £
TA2508	Tie rod end(224)	A	Hydraulic(115) Power steering(185)	M16x1.5 Female(253) £
TA2509	Tie rod end(224)	B	Hydraulic(115) Power steering(185)	M16x1.5 Female(253) £
TA2873	Inner tie rod(123)	A B	Electric(103) Power steering(185)	M16x1.5 Male(252) £
TA2915	Tie rod end(224)	A	Electric(103) Power steering(185)	M16x1.5 Female(253) £
TA2916	Tie rod end(224)	B	Electric(103) Power steering(185)	M16x1.5 Female(253) £
TC2275	Link stabiliser(135)	A B		
TC2312	Link stabiliser(135)	A B		
TC2320	Lower ball joint(140)	A B		M12x1.5
TC2452	Lower track control arm(151)	A	Front(108)	
TC2453	Lower track control arm(151)	B	Front(108)	

... Q5 (8R SERIES) 2.0TFSI, 2.0TDI, 3.0TDI, 3.2FSI Quattro (11/08-07/09)

Part No	Description	Pos	Info	Technical
TC2454	Lower link arm(144)	A	Rear(187)	M12x1.5
TC2455	Lower link arm(144)	B	Rear(187)	M12x1.5
TC2972	Upper link arm(239)	A	Front(108)	Pinch Bolt(255) 16mm
TC2973	Upper link arm(239)	B	Front(108)	Pinch Bolt(255) 16mm
TC2974	Upper link arm(239)	A	Rear(187)	Pinch Bolt(255) 16mm
TC2975	Upper link arm(239)	B	Rear(187)	Pinch Bolt(255) 16mm
TC3089	Upper track control arm(242)	A		
TC3090	Upper track control arm(242)	B		
TC3337	Lower track control arm(151)	A		
TC3338	Lower track control arm(151)	B		
TD723W	Lower track control arm bush(153)	A B	Outer(176)	
TD838W	Lower track control arm bush(153)	A B	Inner(119)	
TD849W	Lower link arm bush(145)	A B	Ø65	
TD1493W	Lower track control arm bush(153)	A B	Outer(176) Inner(119)	
TD1633W	Lower link arm bush(145)	A B	Rear(187) Ø75	
TL613	Rod assembly(194)	A	Hydraulic(115) Power steering(185)	M12x1.5
TL614	Rod assembly(194)	B	Hydraulic(115) Power steering(185)	M12x1.5

Q5 (8R SERIES) 2.0TFSI Quattro, 2.0TDI, 2.0TDI Quattro, 3.0TDI Quattro, 3.2FSI Quattro (07/09-08/11)



TL613



TA2508



TA2485



TA2915



TA2873



TL614



TA2485



TA2509



TA2873



TA2916



TC2972



TC2974



TC2312



TC2320



TD1633W



TD723W



TC2452



TD838W



TD838W



TC2973



TC2975



TC2312



TC2320



TD1633W



TC2453



TD723W



... AUDI

... Q5 (8R SERIES) 2.0TFSI Quattro, 2.0TDI, 2.0TDI Quattro, 3.0TDI Quattro, 3.2FSI Quattro (07/09-08/11)



TC3089



TC3090



TC2275



TC2275



TC3597



TC3597



TD1493W



TC3337



TD1493W



TD1493W



TC3338



TD1493W

Part No	Description	Pos	Info	Technical
TA2485	Inner tie rod(123)	A B	Hydraulic(115) Power steering(185)	M16x1.5 Male(252) £
TA2508	Tie rod end(224)	A	Hydraulic(115) Power steering(185)	M16x1.5 Female(253) £
TA2509	Tie rod end(224)	B	Hydraulic(115) Power steering(185)	M16x1.5 Female(253) £
TA2873	Inner tie rod(123)	A B	Electric(103) Power steering(185)	M16x1.5 Male(252) £
TA2915	Tie rod end(224)	A	Electric(103) Power steering(185)	M16x1.5 Female(253) £
TA2916	Tie rod end(224)	B	Electric(103) Power steering(185)	M16x1.5 Female(253) £
TC2275	Link stabiliser(135)	A B		
TC2312	Link stabiliser(135)	A B		
TC2320	Lower ball joint(140)	A B		M12x1.5
TC2452	Lower track control arm(151)	A	Front(108)	
TC2453	Lower track control arm(151)	B	Front(108)	
TC2972	Upper link arm(239)	A	Front(108)	Pinch Bolt(255) 16mm
TC2973	Upper link arm(239)	B	Front(108)	Pinch Bolt(255) 16mm
TC2974	Upper link arm(239)	A	Rear(187)	Pinch Bolt(255) 16mm
TC2975	Upper link arm(239)	B	Rear(187)	Pinch Bolt(255) 16mm
TC3089	Upper track control arm(242)	A		
TC3090	Upper track control arm(242)	B		
TC3337	Lower track control arm(151)	A	Aluminium(-73) → 08/11/2010	
TC3338	Lower track control arm(151)	B	Aluminium(-73) → 08/11/2010	
TC3597	Lower track control arm(151)	A B	Steel(210) 08/11/2010→	
TD723W	Lower track control arm bush(153)	A B	Outer(176)	
TD838W	Lower track control arm bush(153)	A B	Inner(119)	
TD1493W	Lower track control arm bush(153)	A B	Outer(176) Inner(119) → 08/11/2010	
TD1633W	Lower link arm bush(145)	A B	Rear(187) Ø75	
TL613	Rod assembly(194)	A	Hydraulic(115) Power steering(185)	M12x1.5
TL614	Rod assembly(194)	B	Hydraulic(115) Power steering(185)	M12x1.5

Q5 (8R SERIES) 2.0TFSI Quattro, 2.0TDI, 2.0TDI Quattro, 3.0TFSI Quattro, 3.0TDI Quattro, 3.2FSI Quattro (08/11→)



TL613



TA2508



TA2485



TL614



TA2485



TA2509



TA2915



TA2873



TA2873



TA2916

... Q5 (8R SERIES) 2.0TFSI Quattro, 2.0TDI, 2.0TDI Quattro, 3.0TFSI Quattro, 3.0TDI Quattro, 3.2FSI Quattro (08/11→)

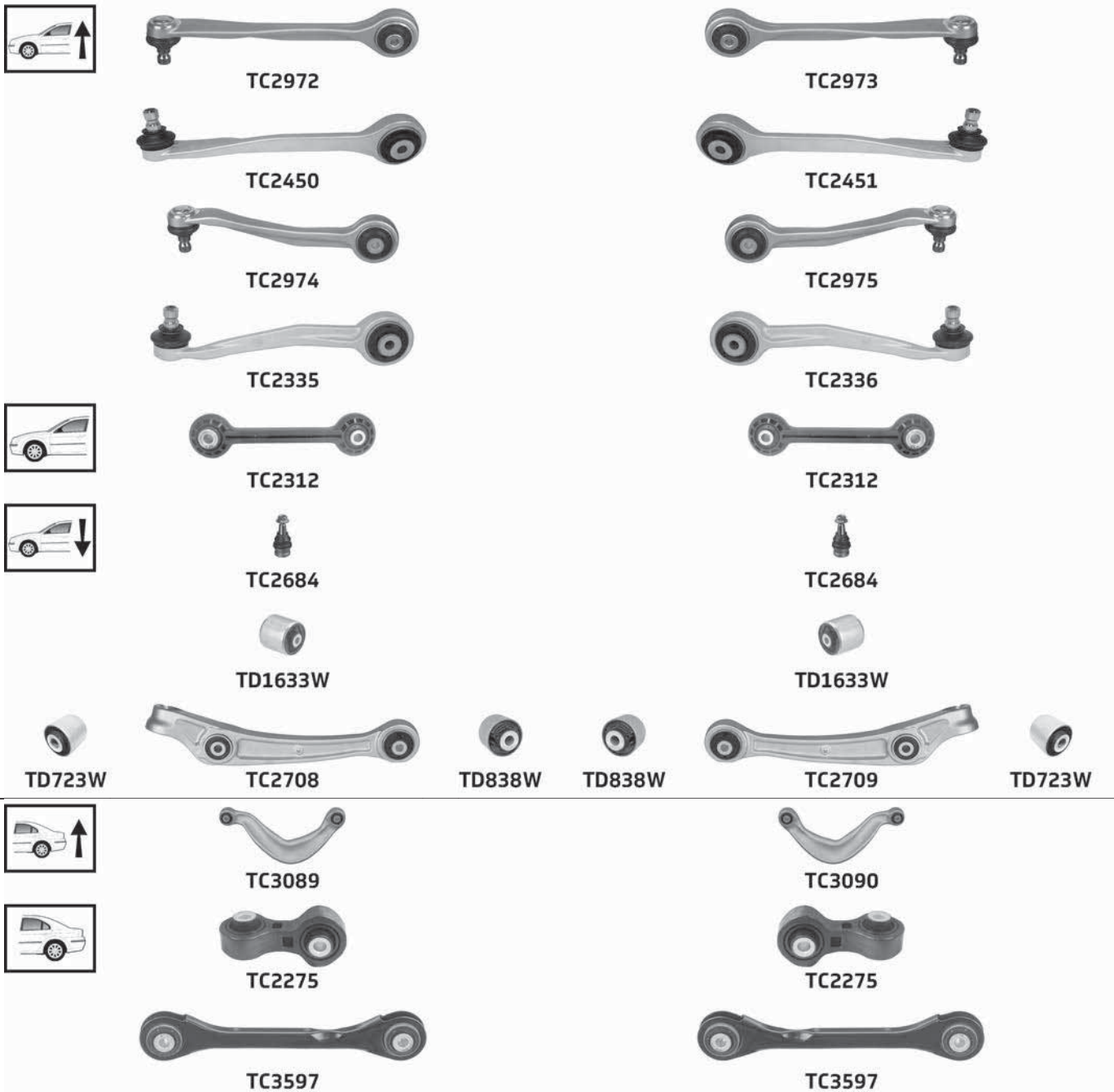

Part No	Description	Pos	Info	Technical
TA2485	Inner tie rod(123)	A B	Hydraulic(115) Power steering(185)	M16x1.5 Male(252) £
TA2508	Tie rod end(224)	A	Hydraulic(115) Power steering(185)	M16x1.5 Female(253) £
TA2509	Tie rod end(224)	B	Hydraulic(115) Power steering(185)	M16x1.5 Female(253) £
TA2873	Inner tie rod(123)	A B	Electric(103) Power steering(185)	M16x1.5 Male(252) £
TA2915	Tie rod end(224)	A	Electric(103) Power steering(185)	M16x1.5 Female(253) £
TA2916	Tie rod end(224)	B	Electric(103) Power steering(185)	M16x1.5 Female(253) £
TC2275	Link stabiliser(135)	A B		
TC2312	Link stabiliser(135)	A B		
TC2335	Upper link arm(239)	A	Rear(187) 08/12 →	Pinch Bolt(255) 16mm
TC2336	Upper link arm(239)	B	Rear(187) 08/12 →	Pinch Bolt(255) 16mm
TC2450	Upper link arm(239)	A	Front(108) 08/12 →	Pinch Bolt(255) 16mm
TC2451	Upper link arm(239)	B	Front(108) 08/12 →	Pinch Bolt(255) 16mm
TC2684	Lower ball joint(140)	A B		M14x1.5
TC2708	Lower track control arm(151)	A	Front(108)	
TC2709	Lower track control arm(151)	B	Front(108)	
TC2972	Upper link arm(239)	A	Front(108) →08/12	Pinch Bolt(255) 16mm
TC2973	Upper link arm(239)	B	Front(108) →08/12	Pinch Bolt(255) 16mm
TC2974	Upper link arm(239)	A	Rear(187) →08/12	Pinch Bolt(255) 16mm
TC2975	Upper link arm(239)	B	Rear(187) →08/12	Pinch Bolt(255) 16mm

(...)

AUDI

... AUDI

... Q5 (8R SERIES) 2.0TFSI Quattro, 2.0TDI, 2.0TDI Quattro, 3.0TFSI Quattro, 3.0TDI Quattro, 3.2FSI Quattro (08/11→)

Part No	Description	Pos	Info	Technical
TC3089	Upper track control arm(242)	A		
TC3090	Upper track control arm(242)	B		
TC3597	Lower track control arm(151)	A B		
TD723W	Lower track control arm bush(153)	A B	Outer(176)	
TD838W	Lower track control arm bush(153)	A B	Inner(119)	
TD1633W	Lower link arm bush(145)	A B	Rear(187) Ø75	
TL613	Rod assembly(194)	A	Hydraulic(115) Power steering(185)	M12x1.5
TL614	Rod assembly(194)	B	Hydraulic(115) Power steering(185)	M12x1.5

Q7 (4L SERIES) 3.0TDi, 3.6FSI, 4.2FSI, 4.2TDi, 6.0TDI (03/06→)

TA2154	TA2391	TBR4250	TA2391	TA2155
	TC2529	TD977W	TD977W	TC2529
	TC1783	TD977W	TD977W	TC1783
	TC2589	TD843W	TD843W	TC2590
	TC2589	TD844W	TD844W	TC2590
	TC3009			TC3010
	TC1798			TC1799
	TC3221			TC3221
	TD843W			TD843W

Part No	Description	Pos	Info	Technical
TA2154	Tie rod end(224)	A		M16x1.5 Female(253) £
TA2155	Tie rod end(224)	B		M16x1.5 Female(253) £
TA2391	Inner tie rod(123)	A B		M16x1.5 Male(252) £
TBR4250	Steering rack gaiter kit(213)	K	Thermoplastic(223)	1 :16x66x66 2 :16x66x66
TC1783	Link stabiliser(135)	A B		
TC1798	Link stabiliser(135)	A	Ch. 4L8 030301→	M12x1.5
TC1799	Link stabiliser(135)	B	Ch. 4L8 030301→	M12x1.5
TC2529	Upper wishbone(247)	A B		M12x1.5
TC2589	Lower wishbone(158)	A		M14x1.5
TC2590	Lower wishbone(158)	B		M14x1.5

... Q7 (4L SERIES) 3.0TDi, 3.6FSI, 4.2FSI, 4.2TDi, 6.0TDI (03/06→)

Part No	Description	Pos	Info	Technical
TC3009	Upper link arm(239)	A	Rear(187)	
TC3010	Upper link arm(239)	B	Rear(187)	
TC3221	Lower track control arm(151)	A B		
TD843W	Lower wishbone bush(159)	A B	Front axle(109) Front/ Rear axle(110) Outer(176)	
TD844W	Lower wishbone bush(159)	A B	Rear(187)	
TD845W	Lower wishbone bush(159)	A B	Outer(176)	
TD977W	Upper wishbone bush(248)	A B	Front(108) Rear(187)	

Q7 2.0TFSI, 3.0TFSI, 3.0TDI (01/15→)



Part No	Description	Pos	Info	Technical
TC3598	Link stabiliser(135)	A B		

RS3 (8V SERIES) 2.5i Quattro (03/15→)

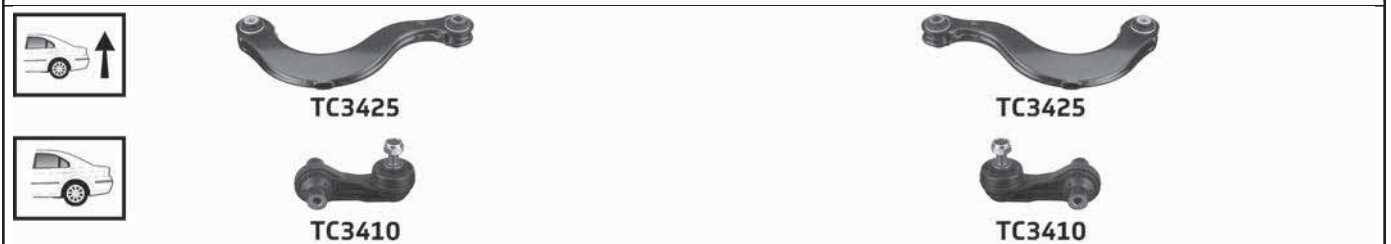

Part No	Description	Pos	Info	Technical
TA1905	Inner tie rod(123)	A B		M16x1.5 Male(252) £
TBR4218	Steering rack gaiter kit(213)	K	Thermoplastic(223)	1 :15.5x49.5x49.5 2 :15.5x49.5x49.5
TC1731	Lower ball joint(140)	A		M12x1.5
TC1732	Lower ball joint(140)	B		M12x1.5
TC2690	Link stabiliser(135)	A B		M12x1.5
TC3410	Link stabiliser(135)	A B		M10x1.5
TC3425	Upper track control arm(242)	A B		

... AUDI

RS4 (8D SERIES) 2.7i Quattro (09/01-12/02)

AUDI

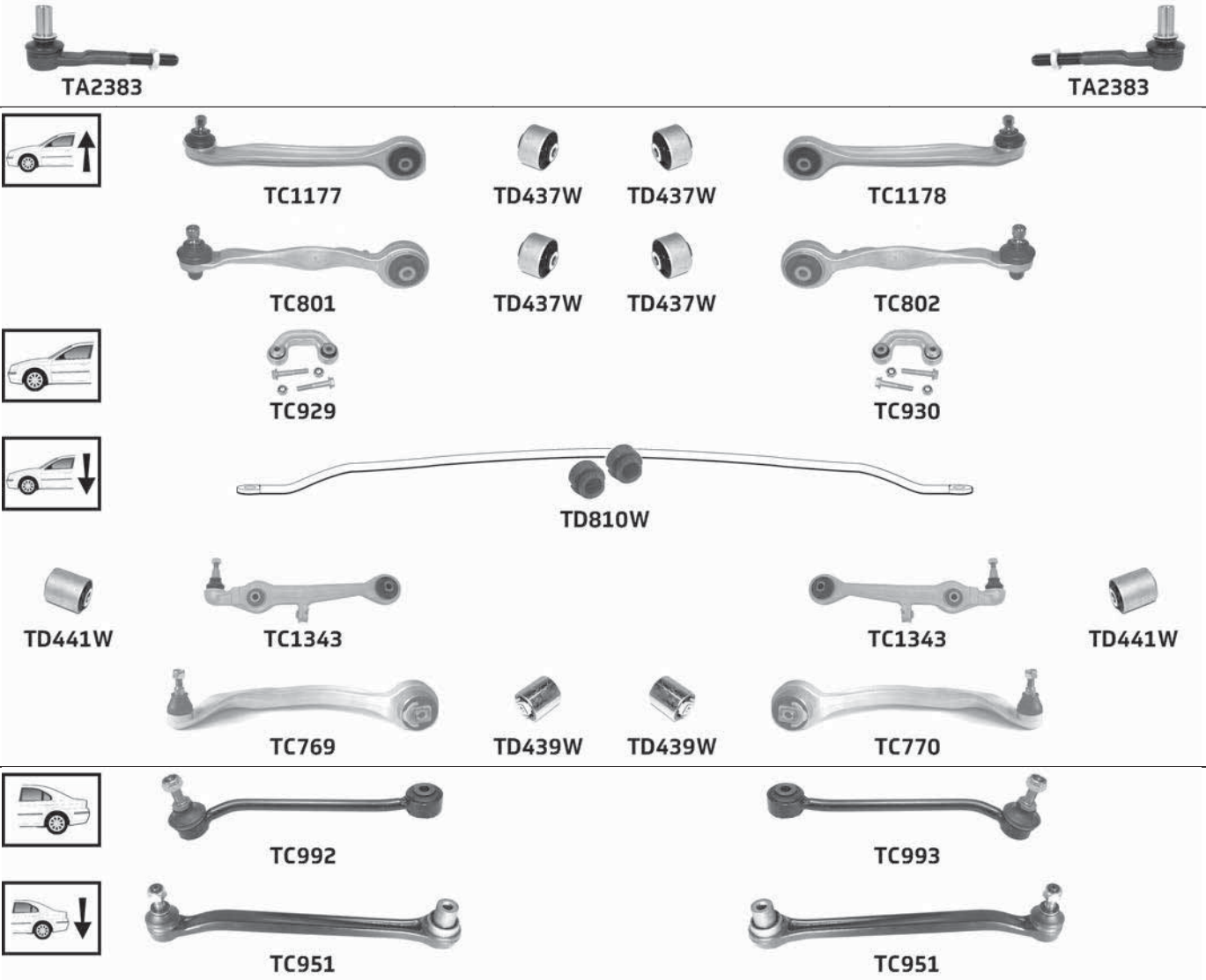

Part No	Description	Pos	Info	Technical
TA2383	Tie rod end(224)	A B		M14x1.5 Male(252) E
TC769	Lower link arm(144)	A	Rear(187)	M12x1.5
TC770	Lower link arm(144)	B	Rear(187)	M12x1.5
TC801	Upper link arm(239)	A	Rear(187)	Pinch Bolt(255) 16mm
TC802	Upper link arm(239)	B	Rear(187)	Pinch Bolt(255) 16mm
TC929	Link stabiliser(135)	A		
TC930	Link stabiliser(135)	B		
TC951	Lower rod assembly(146)	A B		M12x1.5
TC992	Link stabiliser(135)	A		M10x1.5
TC993	Link stabiliser(135)	B		M10x1.5
TC1177	Upper link arm(239)	A	Front(108)	Pinch Bolt(255) 16mm
TC1178	Upper link arm(239)	B	Front(108)	Pinch Bolt(255) 16mm
TC1343	Lower track control arm(151)	A B	Front(108)	M12x1.5
TD437W	Upper link arm bush(240)	A B		
TD439W	Lower link arm bush(145)	A B		
TD441W	Lower track control arm bush(153)	A B	Outer(176)	
TD810W	Anti-roll bar(-74) bush kit(-86)	K	Ø27 Complete axle kit(-92)	

RS4 (8E SERIES) 4.2i Quattro (09/05-06/08)

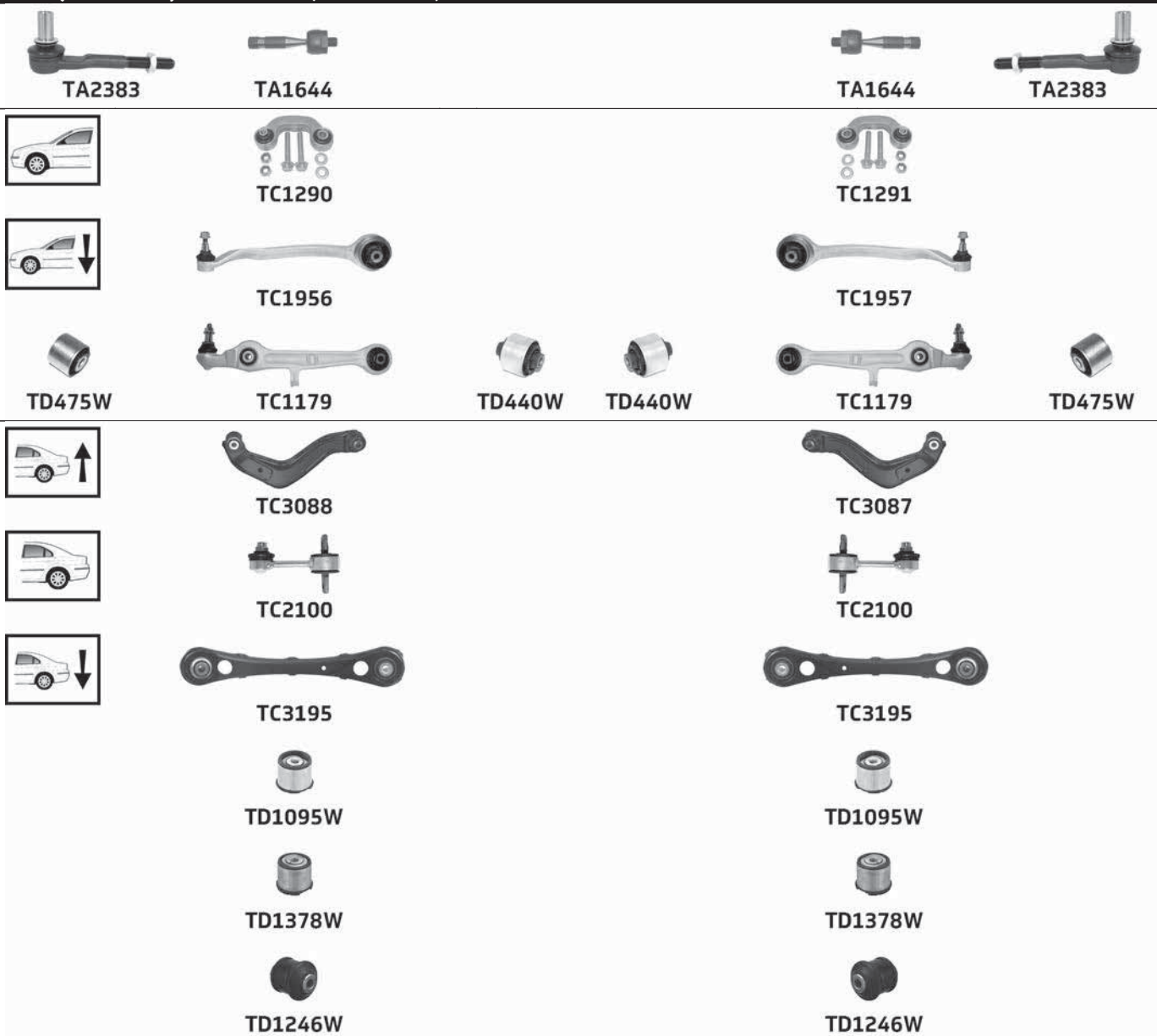

Part No	Description	Pos	Info	Technical
TA1644	Inner tie rod(123)	A B		M14x1.5 Female(253) £
TA2383	Tie rod end(224)	A B		M14x1.5 Male(252) £
TC1179	Lower track control arm(151)	A B	Front(108)	M12x1.5
TC1290	Link stabiliser(135)	A		
TC1291	Link stabiliser(135)	B		
TC1956	Lower link arm(144)	A	Rear(187)	M12x1.5
TC1957	Lower link arm(144)	B	Rear(187)	M12x1.5
TC2100	Link stabiliser(135)	A B		M10x1.5
TC3087	Upper track control arm(242)	B		
TC3088	Upper track control arm(242)	A		
TC3195	Lower track rod(155)	A B		
TD440W	Lower track control arm bush(153)	A B	Inner(119)	
TD475W	Lower track control arm bush(153)	A B	Outer(176)	
TD1095W	Sub-frame bush(215)	A B	Front(108) Fit in pairs when replacing hydraulic type(104)	
TD1246W	Lower hub carrier bush(143)	A B		
TD1378W	Sub-frame bush(215)	A B	Rear(187) Fit in pairs when replacing hydraulic type(104)	

AUDI

... AUDI

RS4 (8K SERIES) 4.2i Quattro (05/12-)



Part No	Description	Pos	Info	Technical
TC3089	Upper track control arm(242)	A		
TC3090	Upper track control arm(242)	B		
TC3597	Lower track control arm(150)	A B		
TD1633W	Lower link arm bush(145)	A B	Rear(187) Ø75	

RS5 (8T SERIES) 4.2i Quattro (03/10-08/11)

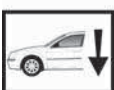

... RS5 (8T SERIES) 4.2i Quattro (03/10-08/11)



TC3089



TC2275



TC3597



TC3090



TC2275



TC3597

Part No	Description	Pos	Info	Technical
TA2485	Inner tie rod(123)	A B	Hydraulic(115) Power steering(185)	M16x1.5 Male(252) £
TA2508	Tie rod end(224)	A	Hydraulic(115) Power steering(185)	M16x1.5 Female(253) £
TA2509	Tie rod end(224)	B	Hydraulic(115) Power steering(185)	M16x1.5 Female(253) £
TA2915	Tie rod end(224)	A	Electric(103) Power steering(185)	M16x1.5 Female(253) £
TA2916	Tie rod end(224)	B	Electric(103) Power steering(185)	M16x1.5 Female(253) £
TC2275	Link stabiliser(135)	A B		
TC2312	Link stabiliser(135)	A B		
TC2320	Lower ball joint(140)	A B		M12x1.5
TC2335	Upper link arm(239)	A	Rear(187)	Pinch Bolt(255) 16mm
TC2336	Upper link arm(239)	B	Rear(187)	Pinch Bolt(255) 16mm
TC2450	Upper link arm(239)	A	Front(108)	Pinch Bolt(255) 16mm
TC2451	Upper link arm(239)	B	Front(108)	Pinch Bolt(255) 16mm
TC2452	Lower track control arm(151)	A	Front(108)	
TC2453	Lower track control arm(151)	B	Front(108)	
TC3089	Upper track control arm(242)	A		
TC3090	Upper track control arm(242)	B		
TC3597	Lower track control arm(150)	A B		
TD723W	Lower track control arm bush(153)	A B	Outer(176)	
TD838W	Lower track control arm bush(153)	A B	Inner(119)	
TD871W	Upper link arm bush(240)	A B		
TD1633W	Lower link arm bush(145)	A B	Rear(187) Ø75	
TL613	Rod assembly(194)	A	Hydraulic(115) Power steering(185)	M12x1.5
TL614	Rod assembly(194)	B	Hydraulic(115) Power steering(185)	M12x1.5

... AUDI

RS5 (8T SERIES) 4.2i Quattro (08/11→)

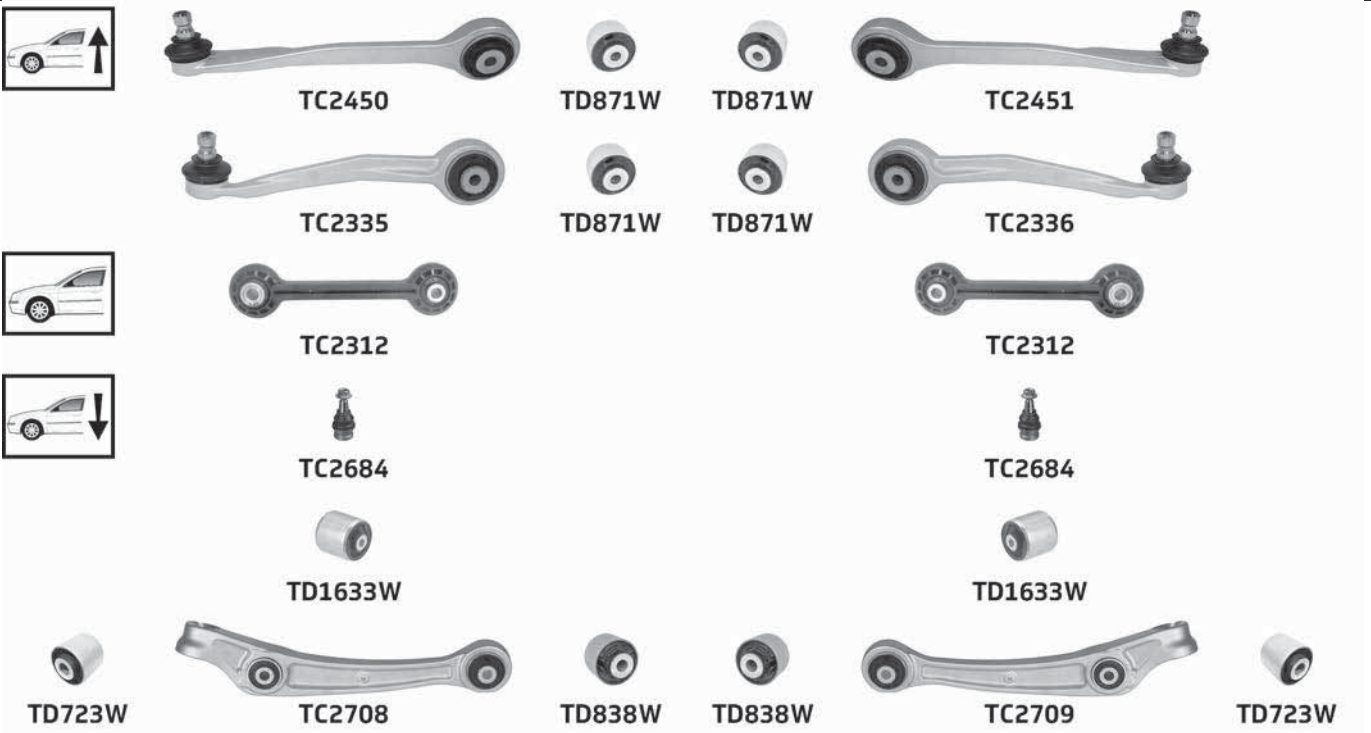

Part No	Description	Pos	Info	Technical
TA2485	Inner tie rod(123)	A B	Hydraulic(115) Power steering(185)	M16x1.5 Male(252) E
TA2508	Tie rod end(224)	A	Hydraulic(115) Power steering(185)	M16x1.5 Female(253) E
TA2509	Tie rod end(224)	B	Hydraulic(115) Power steering(185)	M16x1.5 Female(253) E
TA2915	Tie rod end(224)	A	Electric(103) Power steering(185)	M16x1.5 Female(253) E
TA2916	Tie rod end(224)	B	Electric(103) Power steering(185)	M16x1.5 Female(253) E
TC2275	Link stabiliser(135)	A B		
TC2312	Link stabiliser(135)	A B		
TC2335	Upper link arm(239)	A	Rear(187)	Pinch Bolt(255) 16mm
TC2336	Upper link arm(239)	B	Rear(187)	Pinch Bolt(255) 16mm
TC2450	Upper link arm(239)	A	Front(108)	Pinch Bolt(255) 16mm
TC2451	Upper link arm(239)	B	Front(108)	Pinch Bolt(255) 16mm
TC2684	Lower ball joint(140)	A B		M14x1.5
TC2708	Lower track control arm(151)	A	Front(108)	
TC2709	Lower track control arm(151)	B	Front(108)	
TC3089	Upper track control arm(242)	A		

... RS5 (8T SERIES) 4.2i Quattro (08/11→)

Part No	Description	Pos	Info	Technical
TC3090	Upper track control arm(242)	B		
TC3597	Lower track control arm(150)	A B		
TD723W	Lower track control arm bush(153)	A B	Outer(176)	
TD838W	Lower track control arm bush(153)	A B	Inner(119)	
TD871W	Upper link arm bush(240)	A B		
TD1633W	Lower link arm bush(145)	A B	Rear(187) Ø75	
TL613	Rod assembly(194)	A	Hydraulic(115) Power steering(185)	M12x1.5
TL614	Rod assembly(194)	B	Hydraulic(115) Power steering(185)	M12x1.5

RS6 (4B SERIES) 4.2i Quattro (07/02-01/05)

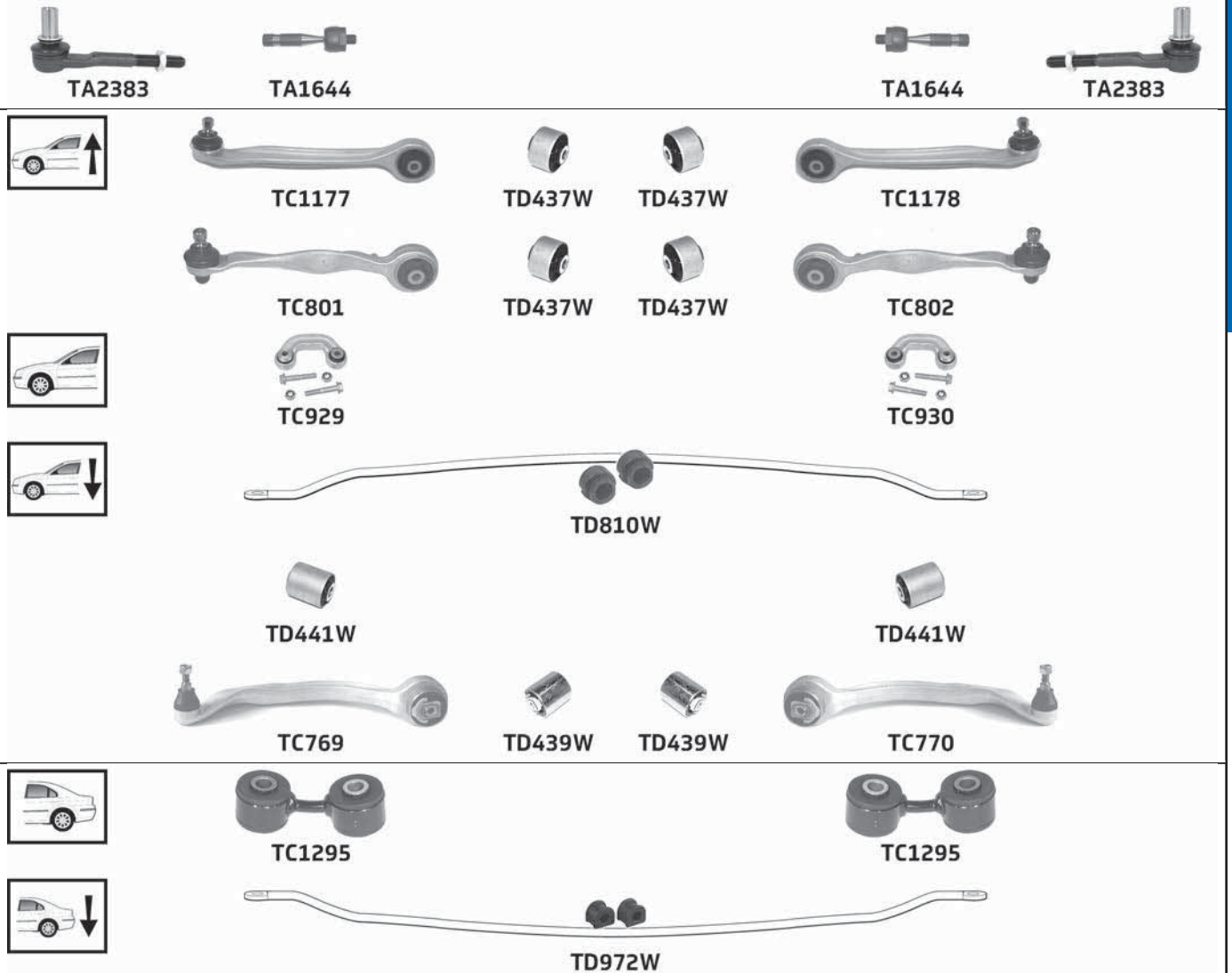

Part No	Description	Pos	Info	Technical
TA1644	Inner tie rod(123)	A B		M14x1.5 Female(253) £
TA2383	Tie rod end(224)	A B		M14x1.5 Male(252) £
TC769	Lower link arm(144)	A	Rear(187)	M12x1.5
TC770	Lower link arm(144)	B	Rear(187)	M12x1.5
TC801	Upper link arm(239)	A	Rear(187)	Pinch Bolt(255) 16mm
TC802	Upper link arm(239)	B	Rear(187)	Pinch Bolt(255) 16mm
TC929	Link stabiliser(135)	A		
TC930	Link stabiliser(135)	B		
TC1177	Upper link arm(239)	A	Front(108)	Pinch Bolt(255) 16mm
TC1178	Upper link arm(239)	B	Front(108)	Pinch Bolt(255) 16mm
TC1295	Link stabiliser(135)	A B		
TD437W	Upper link arm bush(240)	A B		
TD439W	Lower link arm bush(145)	A B		
TD441W	Lower track control arm bush(153)	A B	Outer(176)	
TD810W	Anti-roll bar(-74) bush kit(-86)	K	Ø27 Complete axle kit(-92)	
TD972W	Anti-roll bar(-74) bush kit(-86)	K	Ø16 Complete axle kit(-92)	

... AUDI

RS6 (4G SERIES) 4.0i Quattro (01/13-)



Part No	Description	Pos	Info	Technical
TC3089	Upper track control arm(242)	A		
TC3090	Upper track control arm(242)	B		
TC3337	Lower track control arm(151)	A	Aluminium(-73) (+) Air suspension(-35-)	
TC3338	Lower track control arm(151)	B	Aluminium(-73) (+) Air suspension(-35-)	
TC3597	Lower track control arm(150)	A B	Steel(210) (-) Air suspension(_9_)	
TD1493W	Lower track control arm bush(153)	A B	(+) Air suspension (-35-)	
TD1636W	Upper link arm bush(240)	A B	Front (108) Rear(187)	

S3 (8L SERIES) 1.8i Quattro (03/99-06/03)

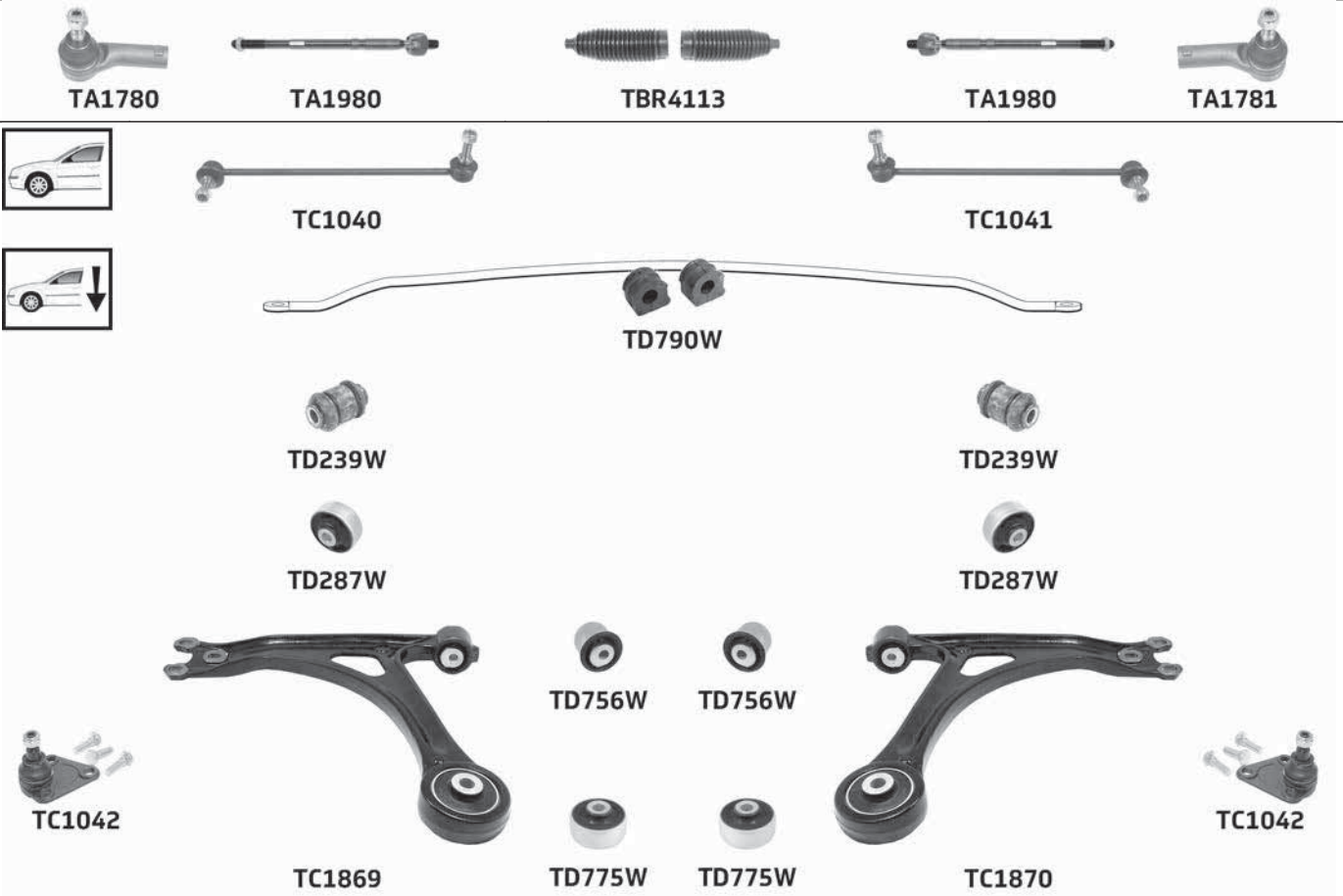

... S3 (8L SERIES) 1.8i Quattro (03/99-06/03)



TC1790



TC1790



TC3380



TC3380

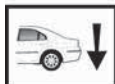

TC3265



TC3265



TD1153W



TD1153W

Part No	Description	Pos	Info	Technical
TA1780	Tie rod end(224)	A		M16x1.5 Female(253) £
TA1781	Tie rod end(224)	B		M16x1.5 Female(253) £
TA1980	Inner tie rod(123)	A B		M16x1.5 Male(252) £
TBR4113	Steering rack gaiter kit(213)	K	Thermoplastic(223)	1 :16x48x48 2 :16x48x48
TC1040	Link stabiliser(135)	A		M12x1.5
TC1041	Link stabiliser(135)	B		M12x1.5
TC1042	Lower ball joint(140)	A B		M12x1.5
TC1790	Link stabiliser(135)	A B		M10x1.5
TC1869	Lower wishbone(158)	A	(-) Ball joint(-11)	
TC1870	Lower wishbone(158)	B	(-) Ball joint(-11)	
TC3265	Lower track control arm(151)	A B		
TC3380	Link stabiliser(135)	A B	(+) Heavy duty suspension(-47)	M10x1.5
TD239W	Lower wishbone bush(159)	A B	Front(108) →Ch. 8LY 117500	
TD287W	Lower wishbone bush(159)	A B	Rear(187) →Ch. 8LY 117500	
TD756W	Lower wishbone bush(159)	A B	Front(108) Ch. 8LY 117501→	
TD775W	Lower wishbone bush(159)	A B	Rear(187) Ch. 8LY 117501→	
TD790W	Anti-roll bar(-74) bush kit(-86)	K	Ø19 Complete axle kit(-92)	
TD1153W	Trailing arm bush(227)	A B	Front(108)	

... AUDI

S3 (8P SERIES) 2.0i Quattro (11/06→)

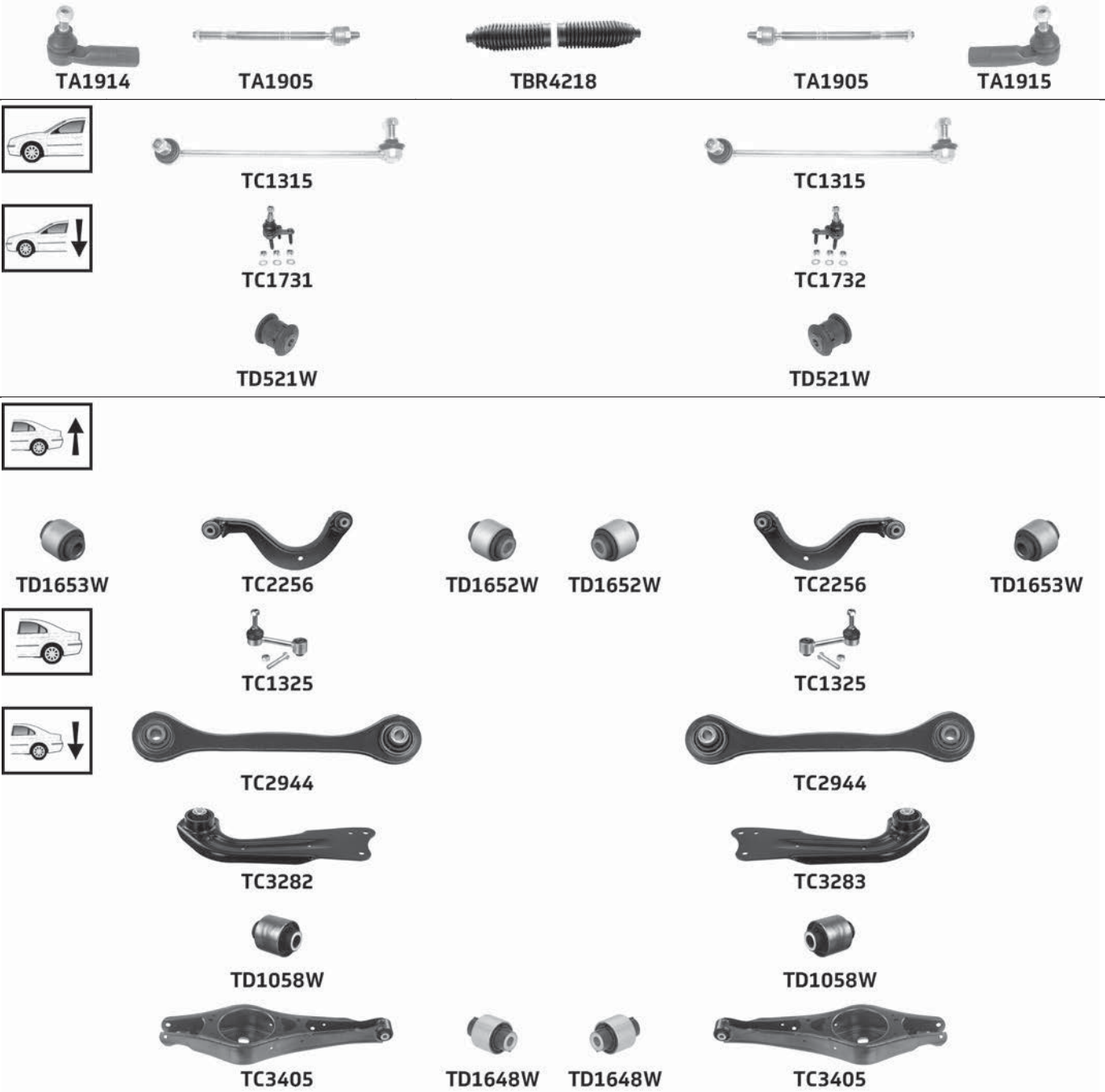

Part No	Description	Pos	Info	Technical
TA1905	Inner tie rod(123)	A B		M16x1.5 Male(252) £
TA1914	Tie rod end(224)	A		M16x1.5 Female(253) £
TA1915	Tie rod end(224)	B		M16x1.5 Female(253) £
TBR4218	Steering rack gaiter kit(213)	K	Thermoplastic(223)	1 :15.5x49.5x49.5 2 :15.5x49.5x49.5
TC1315	Link stabiliser(135)	A B		M12x1.5
TC1325	Link stabiliser(135)	A B		M10x1.5
TC1731	Lower ball joint(140)	A		M12x1.5
TC1732	Lower ball joint(140)	B		M12x1.5
TC2256	Upper track control arm(242)	A B		
TC2944	Trailing arm(226)	A B		
TC3282	Lower link arm(144)	A	Front(108)	
TC3283	Lower link arm(144)	B	Front(108)	
TC3405	Lower track control arm(151)	A B	Rear(187)	
TD521W	Lower wishbone bush(159)	A B	Front(108)	
TD1058W	Lower hub carrier bush(143)	A B		
TD1648W	Lower track control arm bush(153)	A B	Inner(119)	
TD1652W	Upper track control arm bush(243)	A B		
TD1653W	Upper track control arm bush(243)	A B		

S3 (8V SERIES) 2.0i Quattro (11/12→)

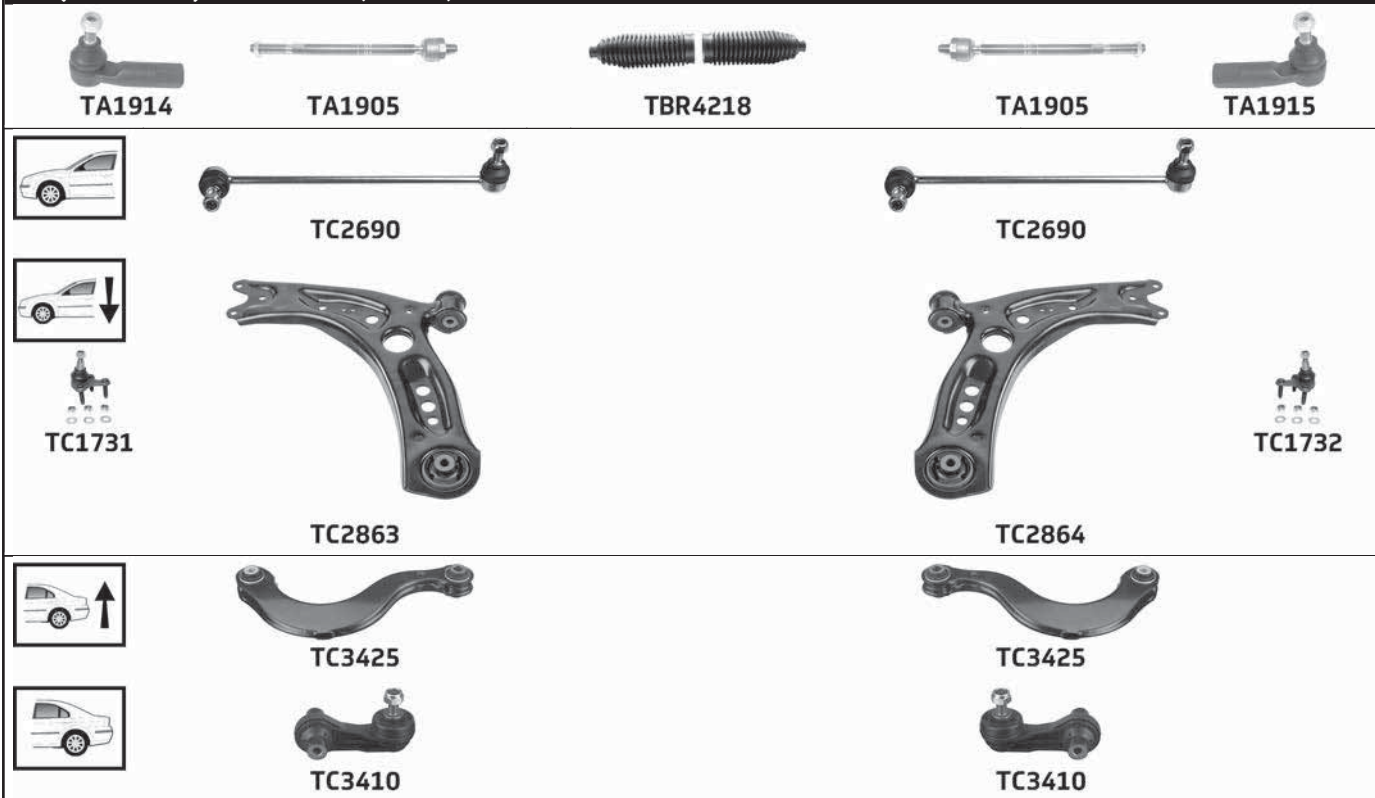

Part No	Description	Pos	Info	Technical
TA1905	Inner tie rod(123)	A B		M16x1.5 Male(252) £
TA1914	Tie rod end(224)	A		M16x1.5 Female(253) £
TA1915	Tie rod end(224)	B		M16x1.5 Female(253) £
TBR4218	Steering rack gaiter kit(213)	K	Thermoplastic(223)	1 :15.5x49.5x49.5 2 :15.5x49.5x49.5
TC1731	Lower ball joint(140)	A		M12x1.5
TC1732	Lower ball joint(140)	B		M12x1.5
TC2690	Link stabiliser(135)	A B		M12x1.5
TC2863	Lower wishbone(158)	A	(-) Ball Joint(-11) →22/06/2015	
TC2864	Lower wishbone(158)	B	(-) Ball Joint(-11) →22/06/2015	
TC3410	Link stabiliser(135)	A B		M10x1.5
TC3425	Upper track control arm(242)	A B		

AUDI

... AUDI

S4 (8E SERIES) 4.2i Quattro (03/03-06/08)

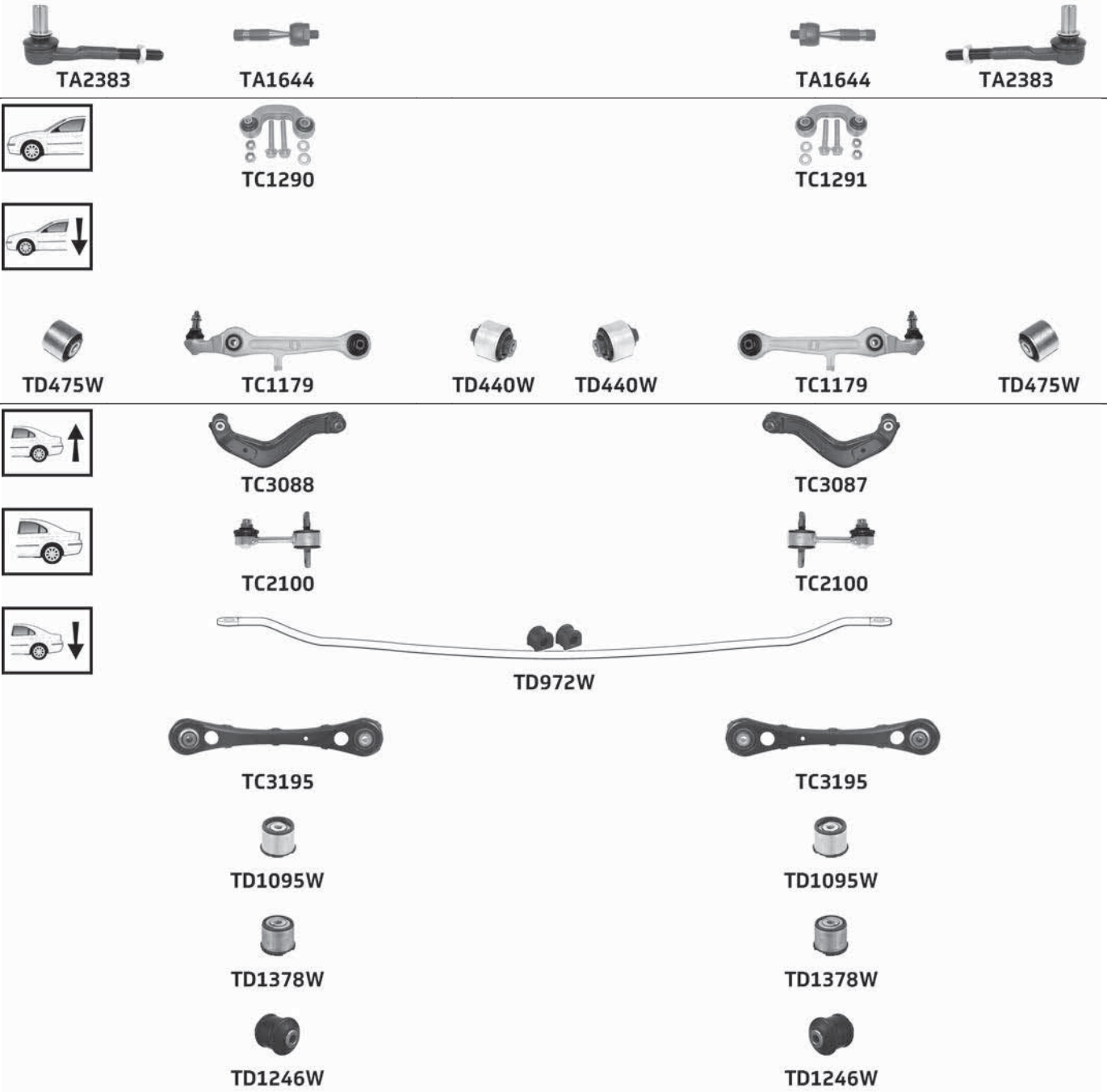

Part No	Description	Pos	Info	Technical
TA1644	Inner tie rod(123)	A B		M14x1.5 Female(253) £
TA2383	Tie rod end(224)	A B		M14x1.5 Male(252) £
TC1179	Lower track control arm(151)	A B	Front(108)	M12x1.5
TC1290	Link stabiliser(135)	A		
TC1291	Link stabiliser(135)	B		
TC2100	Link stabiliser(135)	A B		M10x1.5
TC3087	Upper track control arm(242)	B		
TC3088	Upper track control arm(242)	A		
TC3195	Lower track rod(155)	A B		
TD440W	Lower track control arm bush(153)	A B	Inner(119)	
TD475W	Lower track control arm bush(153)	A B	Outer(176)	
TD972W	Anti-roll bar(-74-) bush kit(-86-)	K	Ø16 Complete axle kit(-92-) Ch. 8E-5-400001→	
TD1095W	Sub-frame bush(215)	A B	Front(108) Fit in pairs when replacing hydraulic type(104)	
TD1246W	Lower hub carrier bush(143)	A B		
TD1378W	Sub-frame bush(215)	A B	Rear(187) Fit in pairs when replacing hydraulic type(104)	

S4 (8K SERIES) 3.0i Quattro (11/08-08/11)

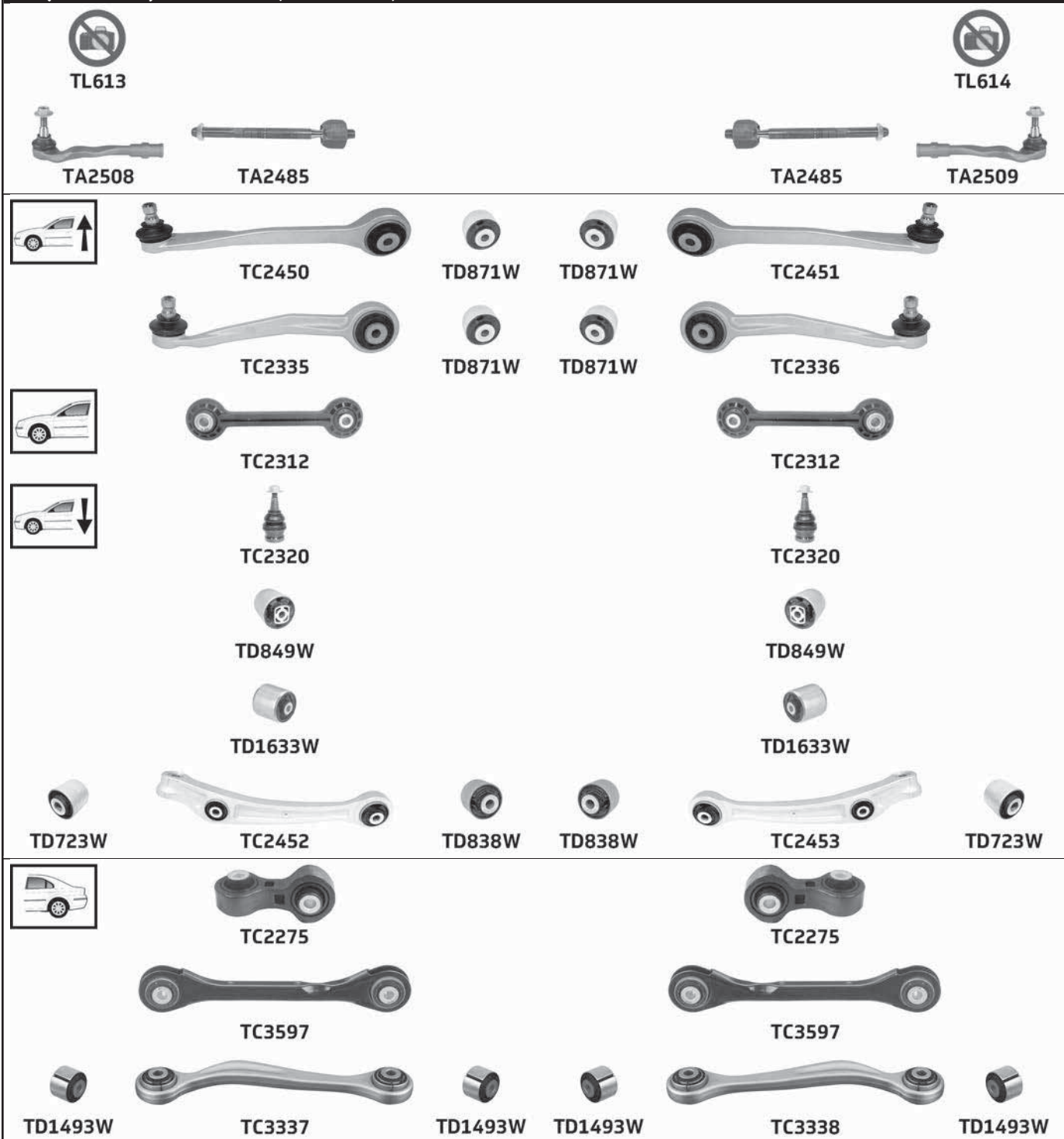

Part No	Description	Pos	Info	Technical
TA2485	Inner tie rod(123)	A B		M16x1.5 Male(252) E
TA2508	Tie rod end(224)	A		M16x1.5 Female(253) E
TA2509	Tie rod end(224)	B		M16x1.5 Female(253) E
TC2275	Link stabiliser(135)	A B		
TC2312	Link stabiliser(135)	A B		
TC2320	Lower ball joint(140)	A B		M12x1.5
TC2335	Upper link arm(239)	A	Rear(187)	Pinch Bolt(255) 16mm
TC2336	Upper link arm(239)	B	Rear(187)	Pinch Bolt(255) 16mm
TC2450	Upper link arm(239)	A	Front(108)	Pinch Bolt(255) 16mm
TC2451	Upper link arm(239)	B	Front(108)	Pinch Bolt(255) 16mm
TC2452	Lower track control arm(151)	A	Front(108)	
TC2453	Lower track control arm(151)	B	Front(108)	
TC3337	Lower track control arm(150)	A	Aluminium(-73) → 20/07/2009	
TC3338	Lower track control arm(150)	B	Aluminium(-73) → 20/07/2009	

(...)

... AUDI

... S4 (8K SERIES) 3.0i Quattro (11/08-08/11)

Part No	Description	Pos	Info	Technical
TC3597	Lower track control arm(150)	A B	Steel(210) 20/07/2009→	
TD723W	Lower track control arm bush(153)	A B	Outer(176)	
TD838W	Lower track control arm bush(153)	A B	Inner(119)	
TD849W	Lower link arm bush(145)	A B	Rear(187) Ø65	
TD871W	Upper link arm bush(240)	A B		
TD1493W	Lower track control arm bush(153)	A B	Outer(176) Inner(119) → 20/07/2009	
TD1633W	Lower link arm bush(145)	A B	Rear(187) Ø75	
TL613	Rod assembly(194)	A		M12x1.5
TL614	Rod assembly(194)	B		M12x1.5

S4 (8K SERIES) 3.0i Quattro (08/11→)

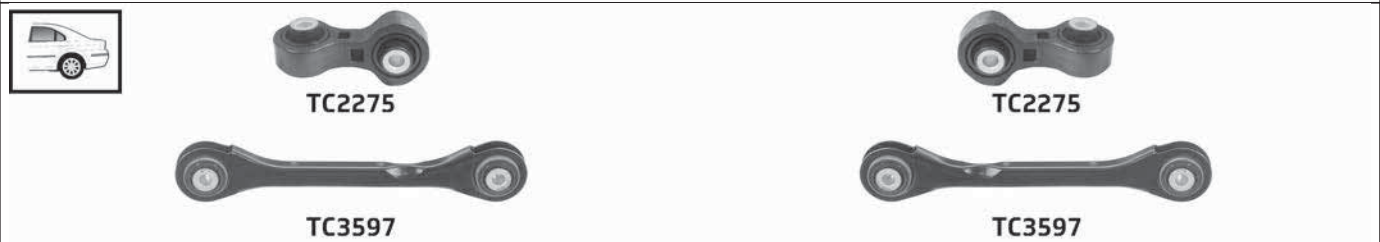
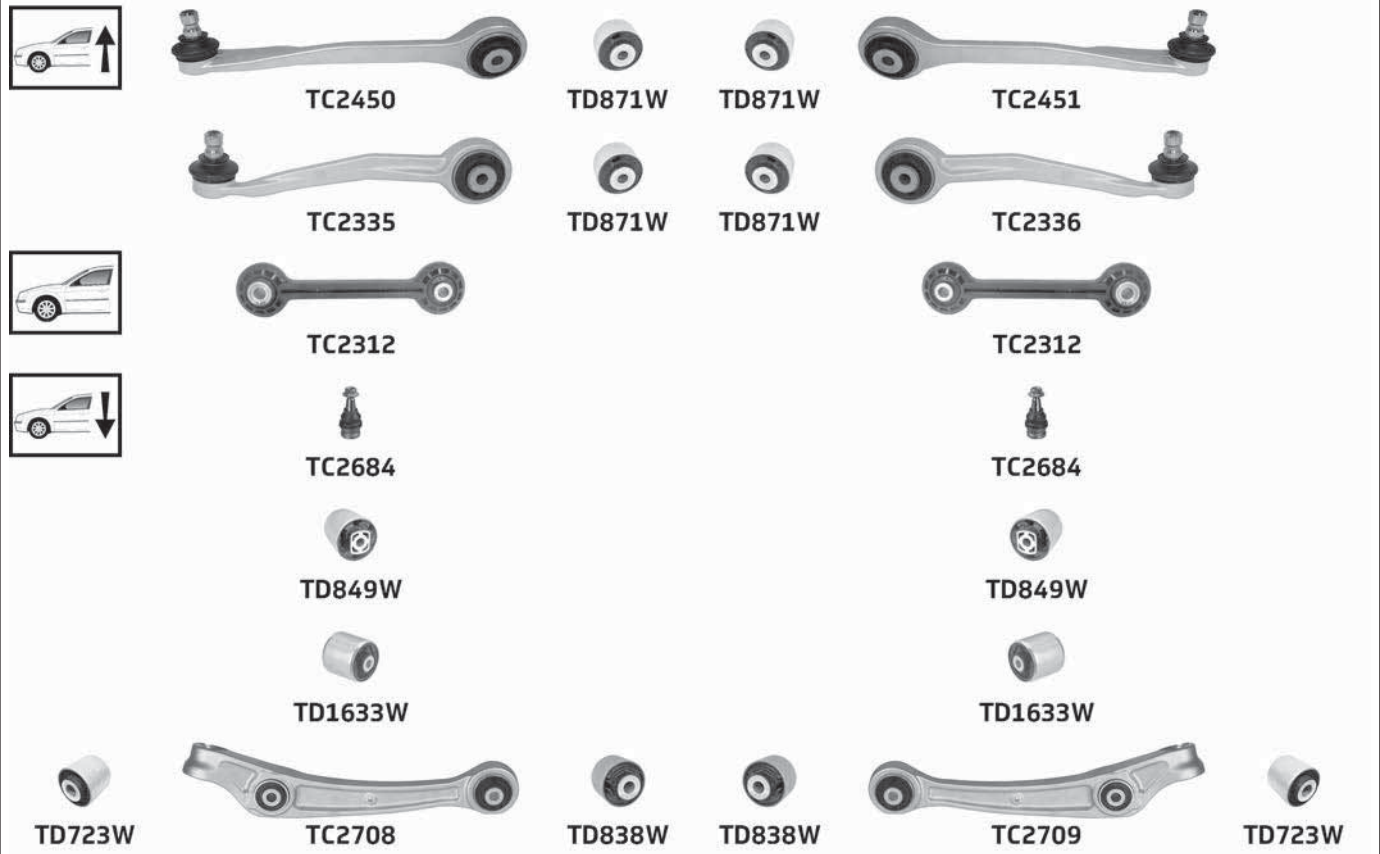

Part No	Description	Pos	Info	Technical
TA2485	Inner tie rod(123)	A B		M16x1.5 Male(252) £
TA2508	Tie rod end(224)	A	Hydraulic(115) Power steering(185) →Ch. 8K CA200000, 8K CN075000, 8K CY715000	M16x1.5 Female(253) £
TA2509	Tie rod end(224)	B	Hydraulic(115) Power steering(185) →Ch. 8K CA200000, 8K CN075000, 8K CY715000	M16x1.5 Female(253) £

AUDI

... S4 (8K SERIES) 3.0i Quattro (08/11→)

Part No	Description	Pos	Info	Technical
TA2915	Tie rod end(224)	A	Electric(103) Power steering(185)	M16x1.5 Female(253) £
TA2916	Tie rod end(224)	B	Electric(103) Power steering(185)	M16x1.5 Female(253) £
TC2275	Link stabiliser(135)	A B		
TC2312	Link stabiliser(135)	A B		
TC2335	Upper link arm(239)	A	Rear(187)	Pinch Bolt(255) 16mm
TC2336	Upper link arm(239)	B	Rear(187)	Pinch Bolt(255) 16mm
TC2450	Upper link arm(239)	A	Front(108)	Pinch Bolt(255) 16mm
TC2451	Upper link arm(239)	B	Front(108)	Pinch Bolt(255) 16mm
TC2684	Lower ball joint(140)	A B		M14x1.5
TC2708	Lower track control arm(151)	A	Front(108)	
TC2709	Lower track control arm(151)	B	Front(108)	
TC3597	Lower track control arm(150)	A B		
TD723W	Lower track control arm bush(153)	A B	Outer(176)	
TD838W	Lower track control arm bush(153)	A B	Inner(119)	
TD849W	Lower link arm bush(145)	A B	Rear(187) Ø65	
TD871W	Upper link arm bush(240)	A B		
TD1633W	Lower link arm bush(145)	A B	Rear(187) Ø75	
TL613	Rod assembly(194)	A	Hydraulic(115) Power steering(185) →Ch. 8K CA200000, 8K CN075000, 8K CY715000	M12x1.5
TL614	Rod assembly(194)	B	Hydraulic(115) Power steering(185) →Ch. 8K CA200000, 8K CN075000, 8K CY715000	M12x1.5

S4 CABRIO (8H SERIES) 4.2i Quattro (03/04-03/09)



TA2383



TA1644



TA1644



TA2383







TD600W



TC1290



TC1291







TC1956



TC1957



TD475W



TC1179



TD440W



TD440W



TC1179



TD475W



TC769



TD439W



TD439W



TC770







TC3088



TC3087





TC2100



TC2100

Part No	Description	Pos	Info	Technical
TA1644	Inner tie rod(123)	A B		M14x1.5 Female(253) £
TA2383	Tie rod end(224)	A B		M14x1.5 Male(252) £
TC769	Lower link arm(144)	A	Rear(187) →Ch. 8H6 905000	M12x1.5
TC770	Lower link arm(144)	B	Rear(187) →Ch. 8H6 905000	M12x1.5
TC1179	Lower track control arm(151)	A B	Front(108)	M12x1.5
TC1290	Link stabiliser(135)	A		
TC1291	Link stabiliser(135)	B		
TC1956	Lower link arm(144)	A	Rear(187) Ch. 8H7 000001→	M12x1.5
TC1957	Lower link arm(144)	B	Rear(187) Ch. 8H7 000001→	M12x1.5

(...)

... AUDI

... S4 CABRIO (8H SERIES) 4.2i Quattro (03/04-03/09)

Part No	Description	Pos	Info	Technical
TC2100	Link stabiliser(135)	A B		M10x1.5
TC3087	Upper track control arm(242)	B		
TC3088	Upper track control arm(242)	A		
TD439W	Lower link arm bush(145)	A B	→Ch. 8H6 905000	
TD440W	Lower track control arm bush(153)	A B	Inner(119)	
TD475W	Lower track control arm bush(153)	A B	Outer(176)	
TD600W	Suspension bolt kit(219)	K		

S5 CABRIO (8F SERIES) 3.0TFSI Quattro (06/09-11/09)

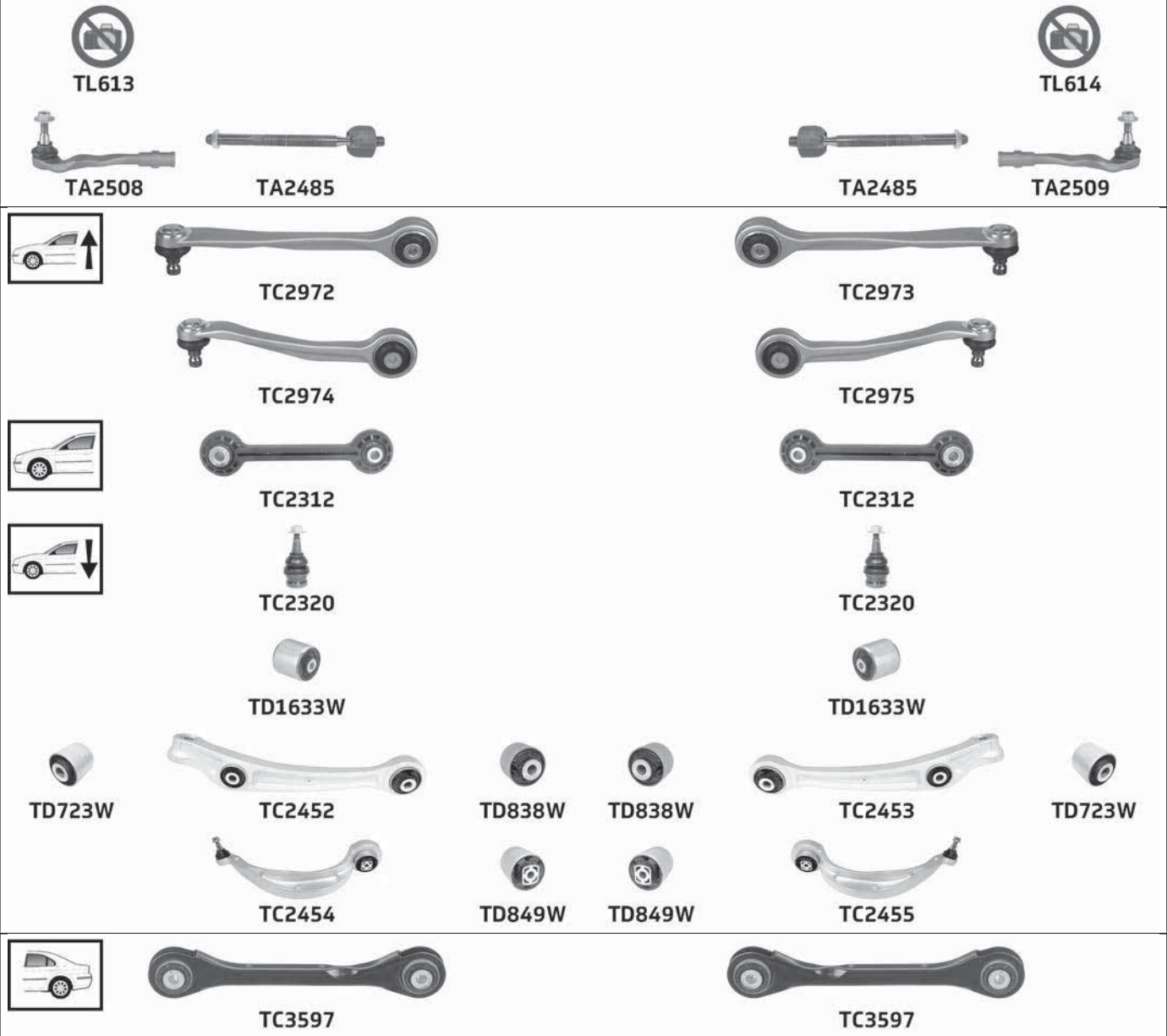

Part No	Description	Pos	Info	Technical
TA2485	Inner tie rod(123)	A B		M16x1.5 Male(252) E
TA2508	Tie rod end(224)	A		M16x1.5 Female(253) E
TA2509	Tie rod end(224)	B		M16x1.5 Female(253) E
TC2312	Link stabiliser(135)	A B		
TC2320	Lower ball joint(140)	A B		M12x1.5
TC2452	Lower track control arm(151)	A	Front(108)	
TC2453	Lower track control arm(151)	B	Front(108)	
TC2454	Lower link arm(144)	A	Rear(187)	M12x1.5
TC2455	Lower link arm(144)	B	Rear(187)	M12x1.5
TC2972	Upper link arm(239)	A	Front(108)	Pinch Bolt(255) 16mm
TC2973	Upper link arm(239)	B	Front(108)	Pinch Bolt(255) 16mm
TC2974	Upper link arm(239)	A	Rear(187)	Pinch Bolt(255) 16mm
TC2975	Upper link arm(239)	B	Rear(187)	Pinch Bolt(255) 16mm
TC3597	Lower track control arm(150)	A B	21/07/2009→	
TD723W	Lower track control arm bush(153)	A B	Outer(176)	

... S5 CABRIO (8F SERIES) 3.0TFSI Quattro (06/09-11/09)

Part No	Description	Pos	Info	Technical
TD838W	Lower track control arm bush(153)	A B	Inner(119)	
TD849W	Lower link arm bush(145)	A B	Ø65	
TD1633W	Lower link arm bush(145)	A B	Rear(187) Ø75	
TL613	Rod assembly(194)	A		M12x1.5
TL614	Rod assembly(194)	B		M12x1.5

S5 CABRIO (8F SERIES) 3.0TFSI Quattro (11/09-05/10)

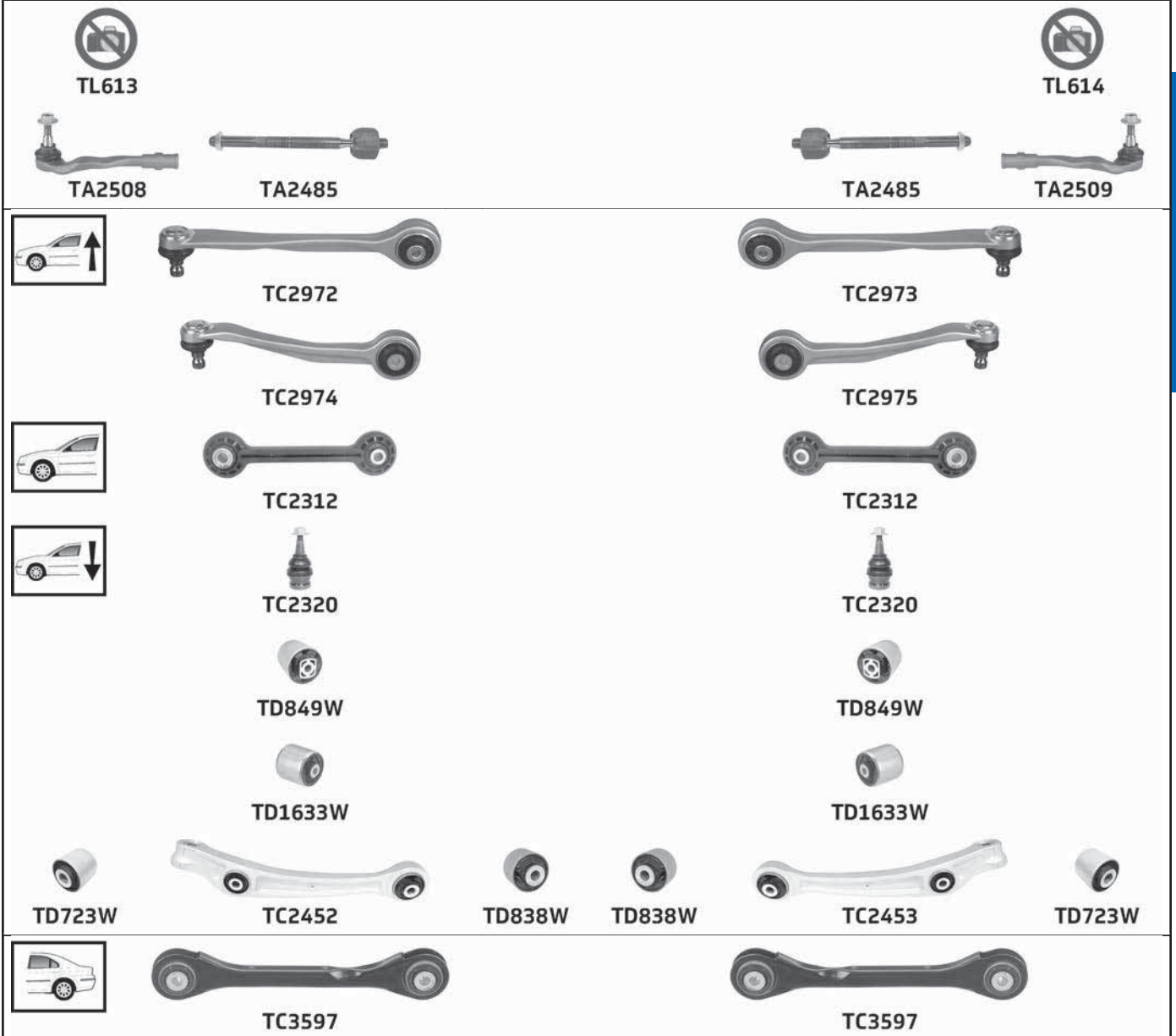

Part No	Description	Pos	Info	Technical
TA2485	Inner tie rod(123)	A B		M16x1.5 Male(252) £
TA2508	Tie rod end(224)	A		M16x1.5 Female(253) £
TA2509	Tie rod end(224)	B		M16x1.5 Female(253) £
TC2312	Link stabiliser(135)	A B		
TC2320	Lower ball joint(140)	A B		M12x1.5
TC2452	Lower track control arm(151)	A	Front(108)	
TC2453	Lower track control arm(151)	B	Front(108)	
TC2972	Upper link arm(239)	A	Front(108)	Pinch Bolt(255) 16mm
TC2973	Upper link arm(239)	B	Front(108)	Pinch Bolt(255) 16mm
TC2974	Upper link arm(239)	A	Rear(187)	Pinch Bolt(255) 16mm
TC2975	Upper link arm(239)	B	Rear(187)	Pinch Bolt(255) 16mm
TC3597	Lower track control arm(150)	A B		
TD723W	Lower track control arm bush(153)	A B	Outer(176)	
TD838W	Lower track control arm bush(153)	A B	Inner(119)	
TD849W	Lower link arm bush(145)	A B	Ø65	
TD1633W	Lower link arm bush(145)	A B	Rear(187) Ø75	

(...)

... AUDI

... S5 CABRIO (8F SERIES) 3.0TFSI Quattro (11/09-05/10)

Part No	Description	Pos	Info	Technical
TL613	Rod assembly(194)	A		M12x1.5
TL614	Rod assembly(194)	B		M12x1.5

S5 CABRIO (8F SERIES) 3.0TFSI Quattro (05/10-08/11)

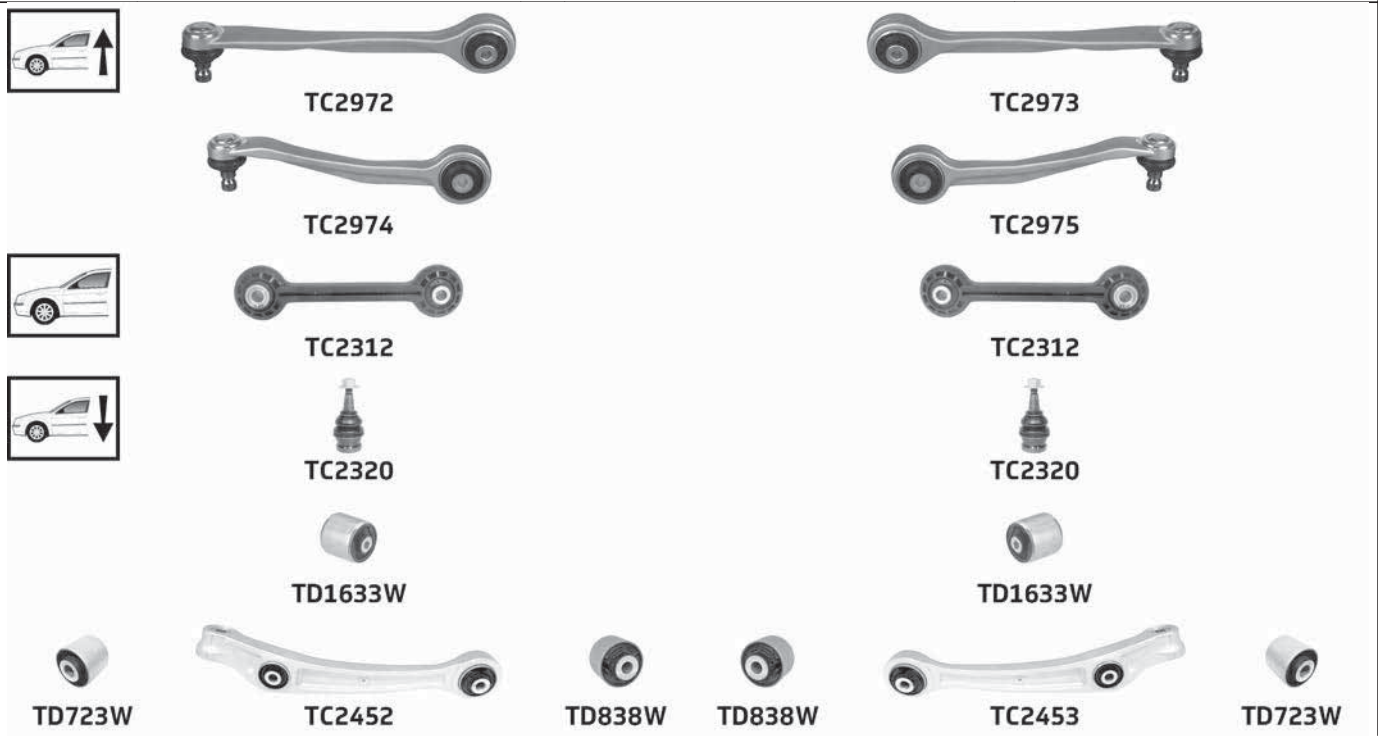
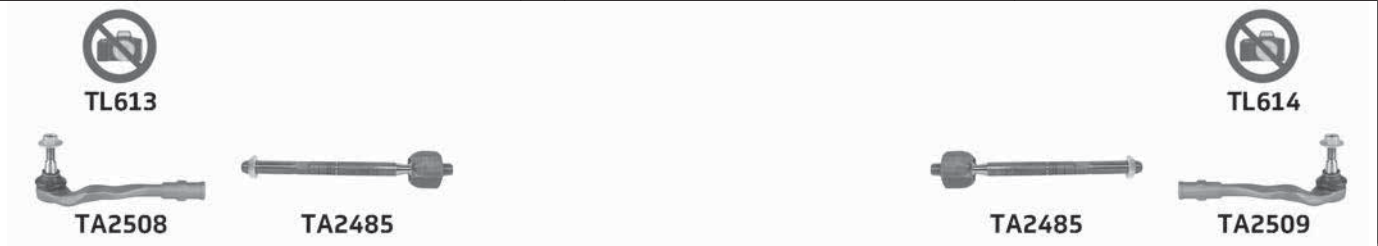

Part No	Description	Pos	Info	Technical
TA2485	Inner tie rod(123)	A B		M16x1.5 Male(252) £
TA2508	Tie rod end(224)	A		M16x1.5 Female(253) £
TA2509	Tie rod end(224)	B		M16x1.5 Female(253) £
TC2312	Link stabiliser(135)	A B		
TC2320	Lower ball joint(140)	A B		M12x1.5
TC2452	Lower track control arm(151)	A	Front(108)	
TC2453	Lower track control arm(151)	B	Front(108)	
TC2972	Upper link arm(239)	A	Front(108)	Pinch Bolt(255) 16mm
TC2973	Upper link arm(239)	B	Front(108)	Pinch Bolt(255) 16mm
TC2974	Upper link arm(239)	A	Rear(187)	Pinch Bolt(255) 16mm
TC2975	Upper link arm(239)	B	Rear(187)	Pinch Bolt(255) 16mm
TC3597	Lower track control arm(150)	A B		
TD723W	Lower track control arm bush(153)	A B	Outer(176)	
TD838W	Lower track control arm bush(153)	A B	Inner(119)	
TD1633W	Lower link arm bush(145)	A B	Rear(187) Ø75	
TL613	Rod assembly(194)	A		M12x1.5
TL614	Rod assembly(194)	B		M12x1.5

S5 CABRIO (8F SERIES) 3.0TFSI Quattro (08/11→)

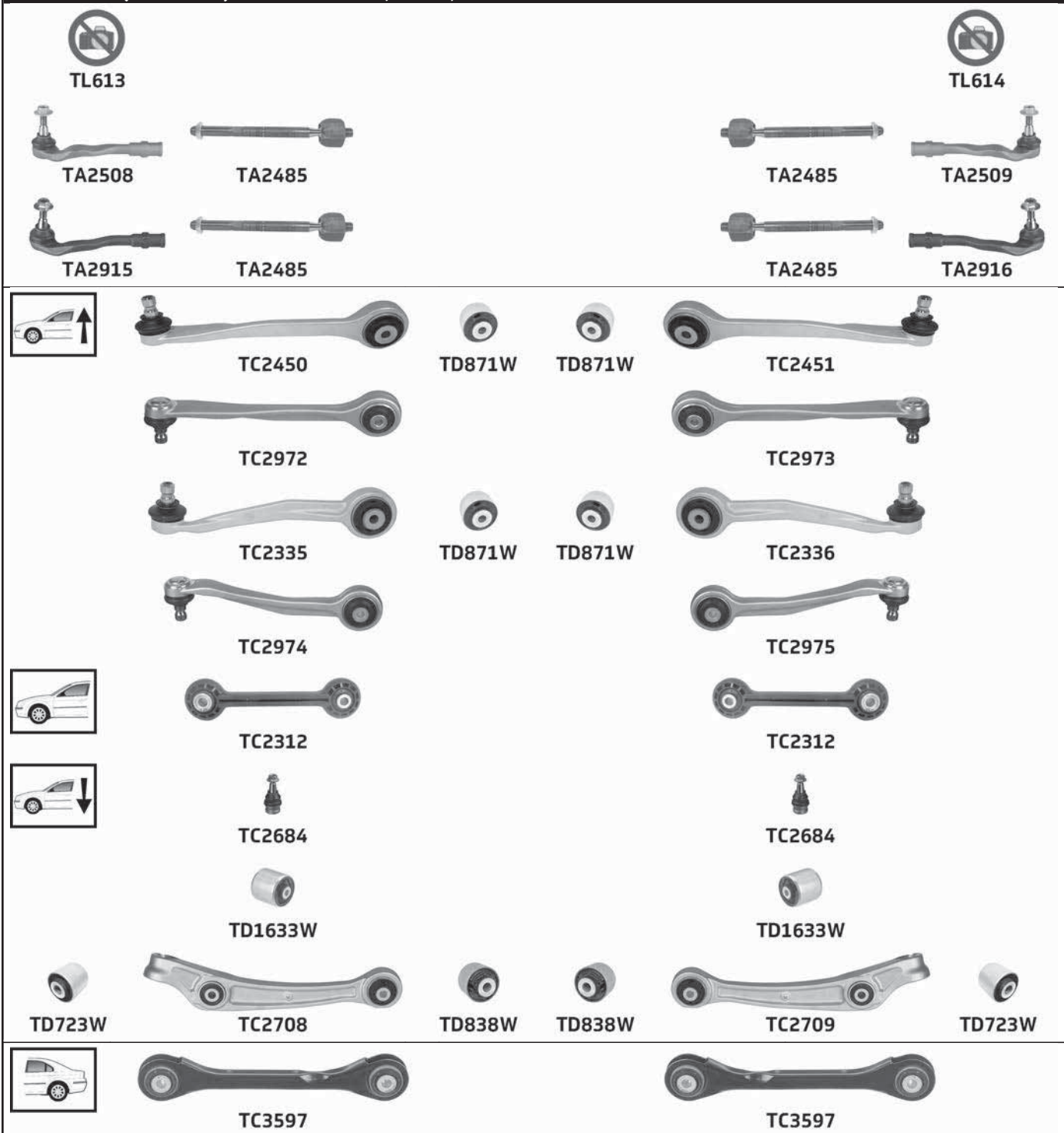

Part No	Description	Pos	Info	Technical
TA2485	Inner tie rod(123)	A B		M16x1.5 Male(252) £
TA2508	Tie rod end(224)	A	Hydraulic(115) Power steering(185) →Ch. 8F BN050000	M16x1.5 Female(253) £
TA2509	Tie rod end(224)	B	Hydraulic(115) Power steering(185) →Ch. 8F BN050000	M16x1.5 Female(253) £
TA2915	Tie rod end(224)	A	Electric(103) Power steering(185)	M16x1.5 Female(253) £
TA2916	Tie rod end(224)	B	Electric(103) Power steering(185)	M16x1.5 Female(253) £
TC2312	Link stabiliser(135)	A B		
TC2335	Upper link arm(239)	A	Rear(187) Ch. 8F C000001→	Pinch Bolt(255) 16mm
TC2336	Upper link arm(239)	B	Rear(187) Ch. 8F C000001→	Pinch Bolt(255) 16mm
TC2450	Upper link arm(239)	A	Front(108) Ch. 8F C000001→	Pinch Bolt(255) 16mm
TC2451	Upper link arm(239)	B	Front(108) Ch. 8F C000001→	Pinch Bolt(255) 16mm
TC2684	Lower ball joint(140)	A B		M14x1.5
TC2708	Lower track control arm(151)	A	Front(108)	
TC2709	Lower track control arm(151)	B	Front(108)	

(...)

... AUDI

... S5 CABRIO (8F SERIES) 3.0TFSI Quattro (08/11→)

Part No	Description	Pos	Info	Technical
TC2972	Upper link arm(239)	A	Front(108) →Ch. 8F BN050000 / FH BN050000	Pinch Bolt(255) 16mm
TC2973	Upper link arm(239)	B	Front(108) →Ch. 8F BN050000 / FH BN050000	Pinch Bolt(255) 16mm
TC2974	Upper link arm(239)	A	Rear(187) →Ch. 8F BN050000 / FH BN050000	Pinch Bolt(255) 16mm
TC2975	Upper link arm(239)	B	Rear(187) →Ch. 8F BN050000 / FH BN050000	Pinch Bolt(255) 16mm
TC3597	Lower track control arm(150)	A B		
TD723W	Lower track control arm bush(153)	A B	Outer(176)	
TD838W	Lower track control arm bush(153)	A B	Inner(119)	
TD871W	Upper link arm bush(240)	A B	Ch. 8F C000001→	
TD1633W	Lower link arm bush(145)	A B	Rear(187) Ø75	
TL613	Rod assembly(194)	A	Hydraulic(115) Power steering(185) →Ch. 8F BN050000	M12x1.5
TL614	Rod assembly(194)	B	Hydraulic(115) Power steering(185) →Ch. 8F BN050000	M12x1.5

S5 COUPÉ (8T SERIES) 4.2i Quattro (06/07-09/07)

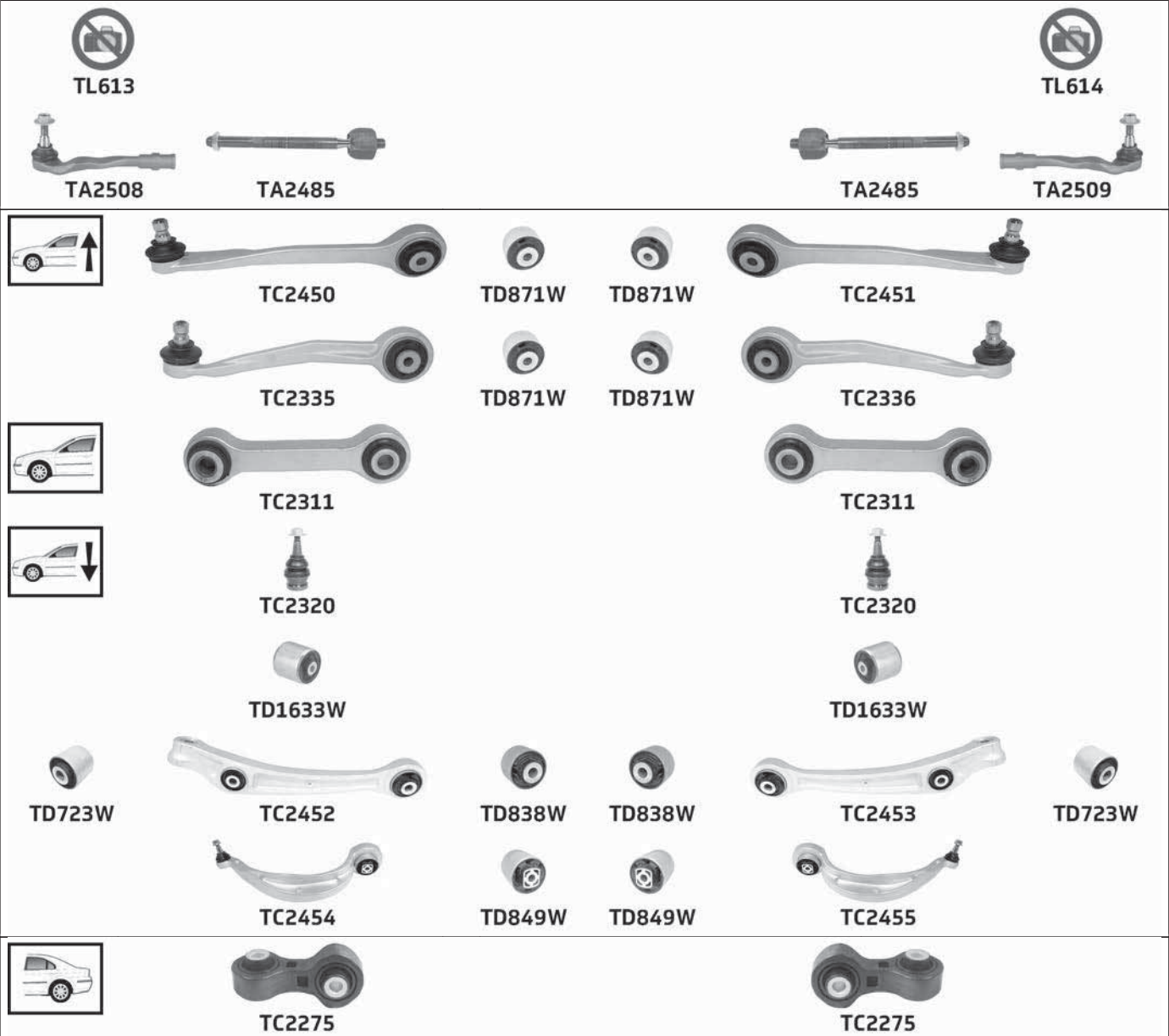

Part No	Description	Pos	Info	Technical
TA2485	Inner tie rod(123)	A B		M16x1.5 Male(252) £
TA2508	Tie rod end(224)	A		M16x1.5 Female(253) £
TA2509	Tie rod end(224)	B		M16x1.5 Female(253) £
TC2275	Link stabiliser(135)	A B		
TC2311	Link stabiliser(135)	A B	Length(129) 110mm	
TC2320	Lower ball joint(140)	A B		M12x1.5
TC2335	Upper link arm(239)	A	Rear(187)	Pinch Bolt(255) 16mm
TC2336	Upper link arm(239)	B	Rear(187)	Pinch Bolt(255) 16mm
TC2450	Upper link arm(239)	A	Front(108)	Pinch Bolt(255) 16mm

... S5 COUPÉ (8T SERIES) 4.2i Quattro (06/07-09/07)				
Part No	Description	Pos	Info	Technical
TC2451	Upper link arm(239)	B	Front(108)	Pinch Bolt(255) 16mm
TC2452	Lower track control arm(151)	A	Front(108)	
TC2453	Lower track control arm(151)	B	Front(108)	
TC2454	Lower link arm(144)	A	Rear(187)	M12x1.5
TC2455	Lower link arm(144)	B	Rear(187)	M12x1.5
TD723W	Lower track control arm bush(153)	A B	Outer(176)	
TD838W	Lower track control arm bush(153)	A B	Inner(119)	
TD849W	Lower link arm bush(145)	A B	Ø65	
TD871W	Upper link arm bush(240)	A B		
TD1633W	Lower link arm bush(145)	A B	Rear(187) Ø75	
TL613	Rod assembly(194)	A		M12x1.5
TL614	Rod assembly(194)	B		M12x1.5

S5 COUPÉ (8T SERIES) 4.2i Quattro (09/07-11/09)

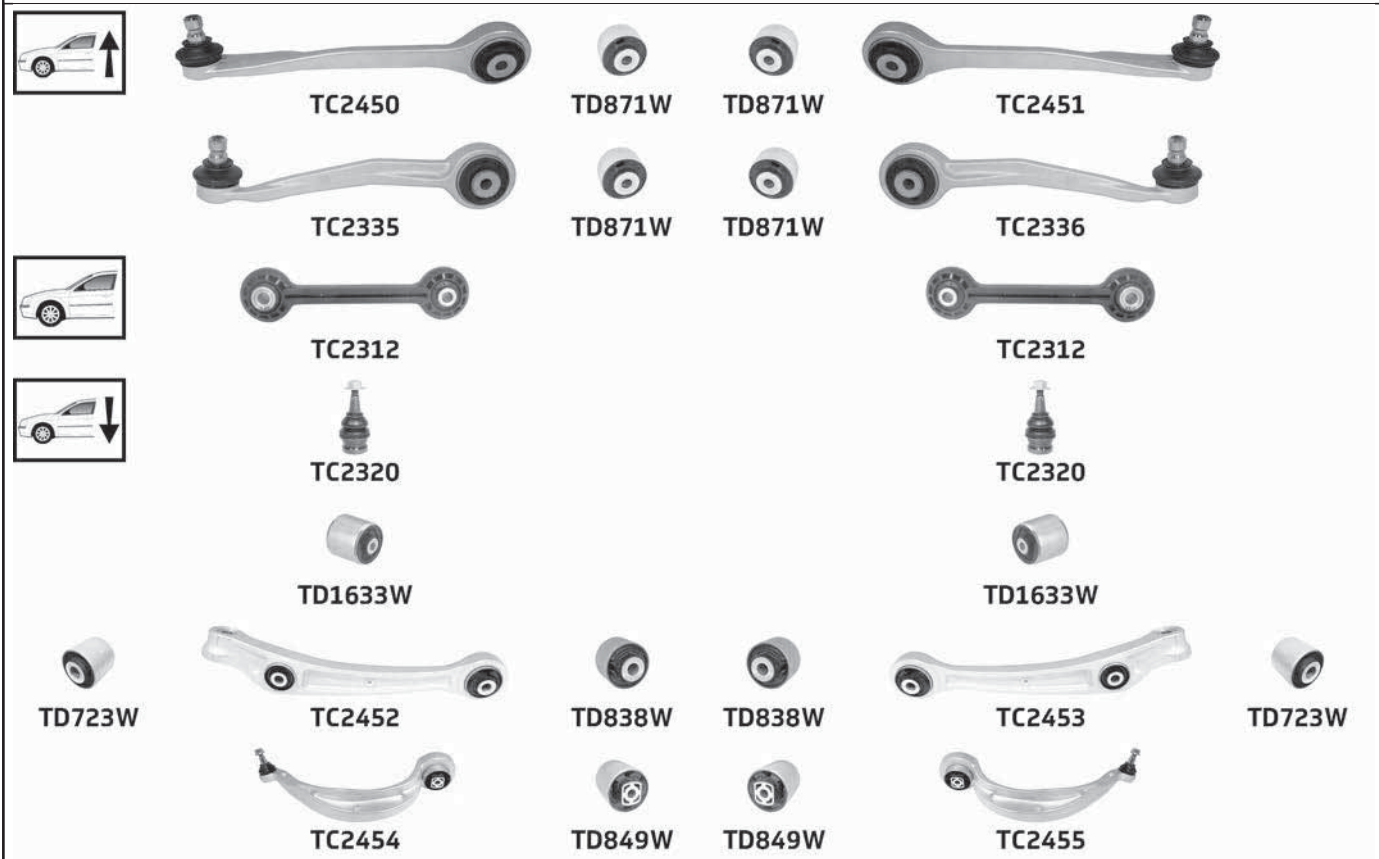



Part No	Description	Pos	Info	Technical
TA2485	Inner tie rod(123)	A B		M16x1.5 Male(252) £
TA2508	Tie rod end(224)	A		M16x1.5 Female(253) £
TA2509	Tie rod end(224)	B		M16x1.5 Female(253) £
TC2275	Link stabiliser(135)	A B		
TC2312	Link stabiliser(135)	A B	Length(129) 170mm	



... AUDI



... S5 COUPÉ (8T SERIES) 4.2i Quattro (09/07-11/09)



Part No	Description	Pos	Info	Technical
TC2320	Lower ball joint(140)	A B		M12x1.5
TC2335	Upper link arm(239)	A	Rear(187)	Pinch Bolt(255) 16mm
TC2336	Upper link arm(239)	B	Rear(187)	Pinch Bolt(255) 16mm
TC2450	Upper link arm(239)	A	Front(108)	Pinch Bolt(255) 16mm
TC2451	Upper link arm(239)	B	Front(108)	Pinch Bolt(255) 16mm
TC2452	Lower track control arm(151)	A	Front(108)	
TC2453	Lower track control arm(151)	B	Front(108)	
TC2454	Lower link arm(144)	A	Rear(187)	M12x1.5
TC2455	Lower link arm(144)	B	Rear(187)	M12x1.5
TC3597	Lower track control arm(150)	A B	21/07/2009→	
TD723W	Lower track control arm bush(153)	A B	Outer(176)	
TD838W	Lower track control arm bush(153)	A B	Inner(119)	
TD849W	Lower link arm bush(145)	A B	Ø65	
TD871W	Upper link arm bush(240)	A B		
TD1633W	Lower link arm bush(145)	A B	Rear(187) Ø75	
TL613	Rod assembly(194)	A		M12x1.5
TL614	Rod assembly(194)	B		M12x1.5





S5 COUPÉ, SPORTBACK (8T SERIES) 3.0TFSI, 4.2i Quattro (11/09-08/11)







TL613

TA2508

TA2915





TA2485

TA2485





TA2485

TA2485



TL614

TA2509

TA2916





TC2450

TD871W

TD871W

TC2451









TC2335

TD871W

TD871W

TC2336



TC2312

TC2312



TC2320

TC2320

TD849W

TD849W

TD1633W

TD1633W

TD723W

TC2452

TD838W

TD838W

TC2453

TD723W

... S5 COUPÉ, SPORTBACK (8T SERIES) 3.0TFSI, 4.2i Quattro (11/09-08/11)



TC2275

TC3597



TC2275

TC3597

Part No	Description	Pos	Info	Technical
TA2485	Inner tie rod(123)	A B		M16x1.5 Male(252) £
TA2508	Tie rod end(224)	A	Hydraulic(115) Power steering(185)	M16x1.5 Female(253) £
TA2509	Tie rod end(224)	B	Hydraulic(115) Power steering(185)	M16x1.5 Female(253) £
TA2915	Tie rod end(224)	A	Electric(103) Power steering(185)	M16x1.5 Female(253) £
TA2916	Tie rod end(224)	B	Electric(103) Power steering(185)	M16x1.5 Female(253) £
TC2275	Link stabiliser(135)	A B		
TC2312	Link stabiliser(135)	A B		
TC2320	Lower ball joint(140)	A B		M12x1.5
TC2335	Upper link arm(239)	A	Rear(187)	Pinch Bolt(255) 16mm
TC2336	Upper link arm(239)	B	Rear(187)	Pinch Bolt(255) 16mm
TC2450	Upper link arm(239)	A	Front(108)	Pinch Bolt(255) 16mm
TC2451	Upper link arm(239)	B	Front(108)	Pinch Bolt(255) 16mm
TC2452	Lower track control arm(151)	A	Front(108)	
TC2453	Lower track control arm(151)	B	Front(108)	
TC3597	Lower track control arm(150)	A B	21/07/2009→	
TD723W	Lower track control arm bush(153)	A B	Outer(176)	
TD838W	Lower track control arm bush(153)	A B	Inner(119)	
TD849W	Lower link arm bush(145)	A B	Ø65	
TD871W	Upper link arm bush(240)	A B		
TD1633W	Lower link arm bush(145)	A B	Rear(187) Ø75	
TL613	Rod assembly(194)	A	Hydraulic(115) Power steering(185)	M12x1.5
TL614	Rod assembly(194)	B	Hydraulic(115) Power steering(185)	M12x1.5

S5 COUPÉ, SPORTBACK (8T SERIES) 3.0TFSI, 4.2i Quattro (08/11→)



TL613

TA2508

TA2915



TA2485

TA2485



TL614

TA2485

TA2485

TA2509

TA2916

... AUDI

... S5 COUPÉ, SPORTBACK (8T SERIES) 3.0TFSI, 4.2i Quattro (08/11→)



Part No	Description	Pos	Info	Technical
TA2485	Inner tie rod(123)	A B		M16x1.5 Male(252) £
TA2508	Tie rod end(224)	A	Hydraulic(115) Power steering(185) →Ch. 8T BA150000	M16x1.5 Female(253) £
TA2509	Tie rod end(224)	B	Hydraulic(115) Power steering(185) →Ch. 8T BA150000	M16x1.5 Female(253) £
TA2915	Tie rod end(224)	A	Electric(103) Power steering(185)	M16x1.5 Female(253) £
TA2916	Tie rod end(224)	B	Electric(103) Power steering(185)	M16x1.5 Female(253) £
TC2275	Link stabiliser(135)	A B		
TC2312	Link stabiliser(135)	A B		
TC2335	Upper link arm(239)	A	Rear(187)	Pinch Bolt(255) 16mm
TC2336	Upper link arm(239)	B	Rear(187)	Pinch Bolt(255) 16mm
TC2450	Upper link arm(239)	A	Front(108)	Pinch Bolt(255) 16mm
TC2451	Upper link arm(239)	B	Front(108)	Pinch Bolt(255) 16mm
TC2684	Lower ball joint(140)	A B		M14x1.5
TC2708	Lower track control arm(151)	A	Front(108)	
TC2709	Lower track control arm(151)	B	Front(108)	
TC3597	Lower track control arm(150)	A B	21/07/2009→	
TD723W	Lower track control arm bush(153)	A B	Outer(176)	
TD838W	Lower track control arm bush(153)	A B	Inner(119)	
TD849W	Lower link arm bush(145)	A B	∅65	
TD871W	Upper link arm bush(240)	A B		
TD1633W	Lower link arm bush(145)	A B	Rear(187) ∅75	
TL613	Rod assembly(194)	A	Hydraulic(115) Power steering(185) →Ch. 8T BA150000	M12x1.5
TL614	Rod assembly(194)	B	Hydraulic(115) Power steering(185) →Ch. 8T BA150000	M12x1.5

S6 (4F SERIES) 5.2FSi Quattro (03/06-03/11)

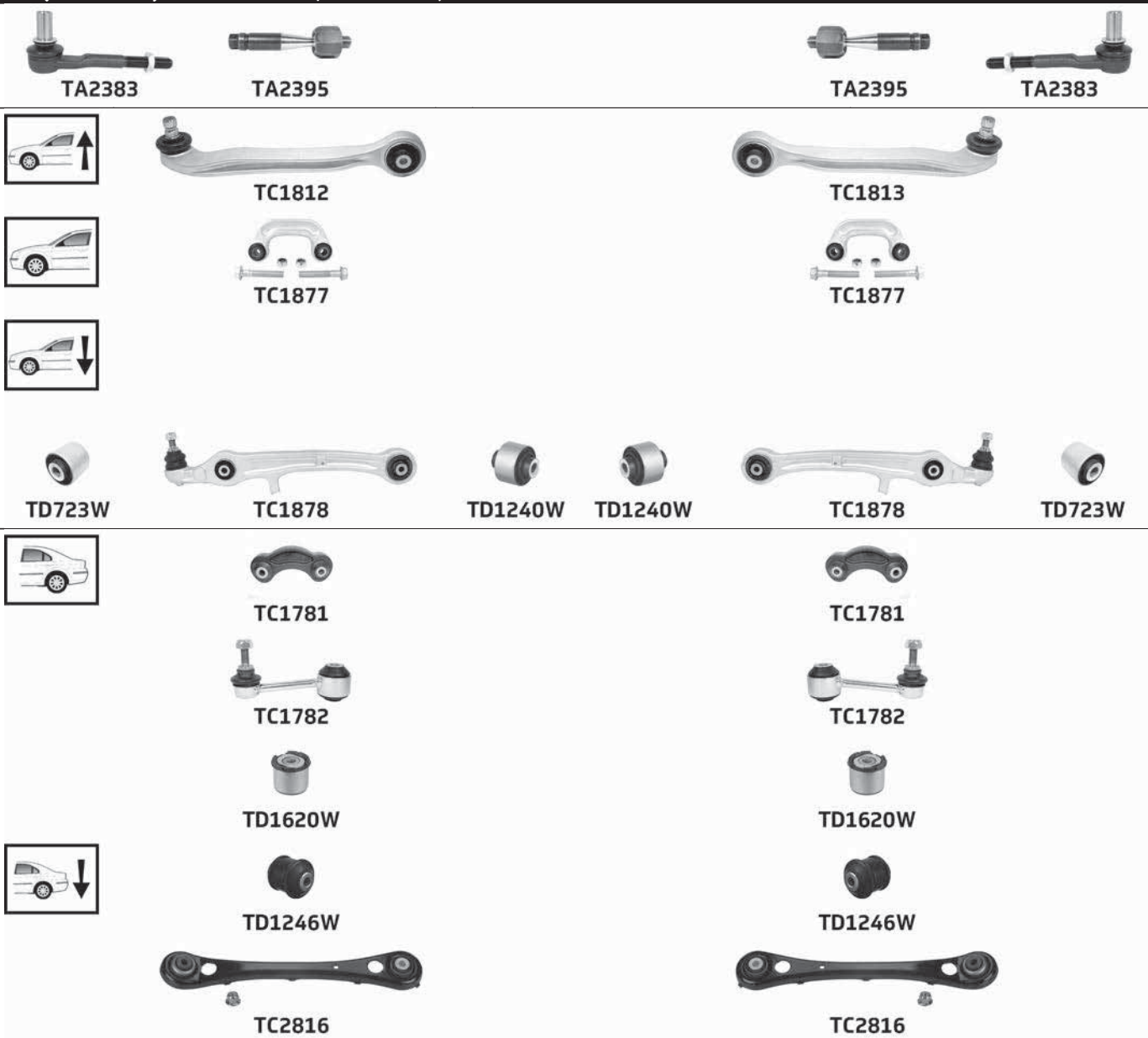

Part No	Description	Pos	Info	Technical
TA2383	Tie rod end(224)	A B		M14x1.5 Male(252) £
TA2395	Inner tie rod(123)	A B		M14x1.5 Female(253) £
TC1781	Link stabiliser(135)	A B	Plastic(184) (-) Air suspension(_9_)	
TC1782	Link stabiliser(135)	A B	Metal(256) (+) Air suspension(-35-)	M10x1.5
TC1812	Upper link arm(239)	A	Front(108)	Pinch Bolt(255) 18mm
TC1813	Upper link arm(239)	B	Front(108)	Pinch Bolt(255) 18mm
TC1877	Link stabiliser(135)	A B		
TC1878	Lower track control arm(151)	A B	Front(108)	M14x1.5
TC2816	Lower track control arm(151)	A B		
TD723W	Lower track control arm bush(153)	A B	Outer(176)	
TD1240W	Lower track control arm bush(153)	A B	Inner(119)	
TD1246W	Lower hub carrier bush(143)	A B		
TD1620W	Sub-frame bush(215)	A B	Rear(187)	

AUDI

... AUDI

S6 (4G SERIES) 4.0TFSi Quattro (02/12→)

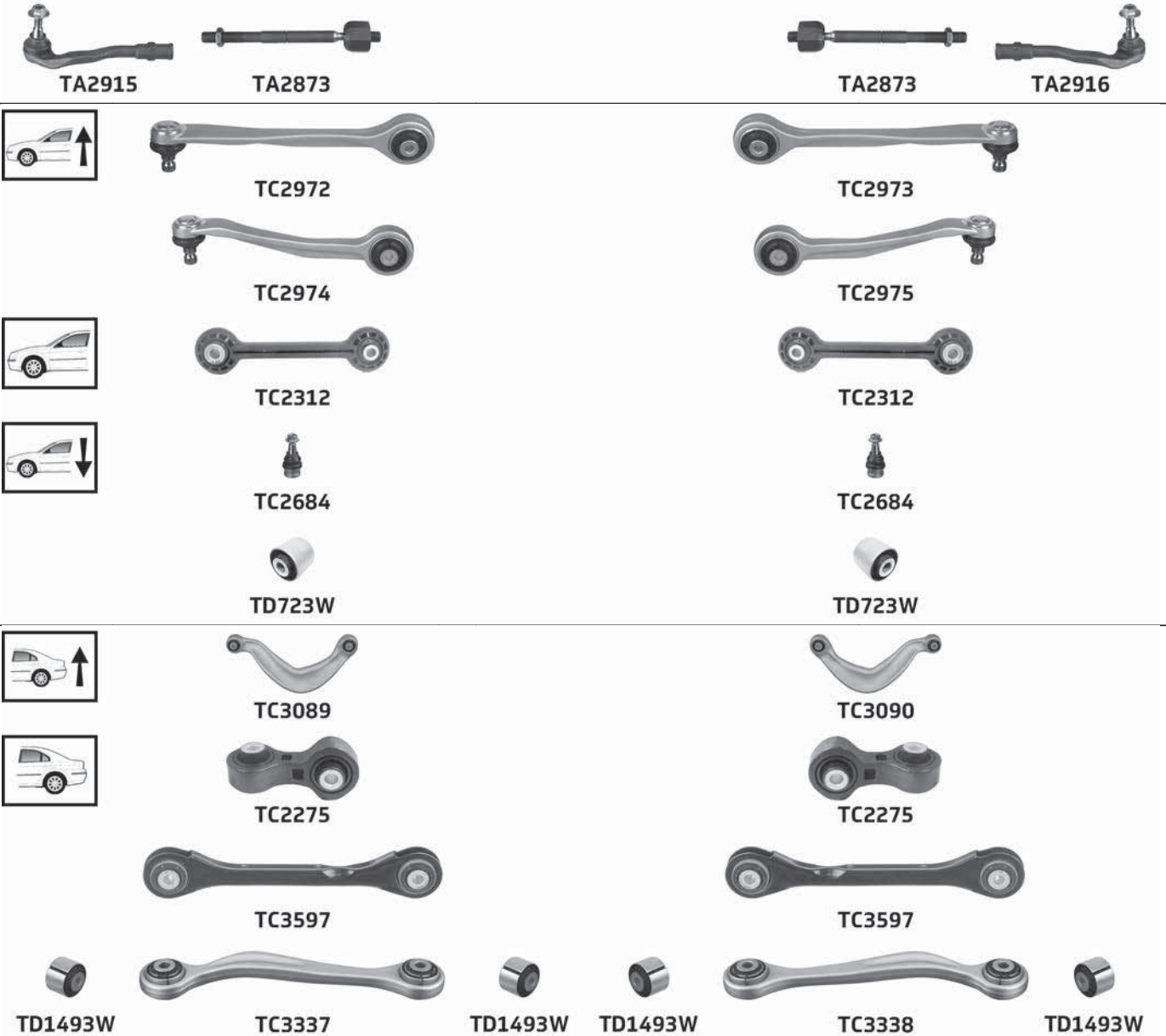

Part No	Description	Pos	Info	Technical
TA2873	Inner tie rod(123)	A B		M16x1.5 Male(252) £
TA2915	Tie rod end(224)	A		M16x1.5 Female(253) £
TA2916	Tie rod end(224)	B		M16x1.5 Female(253) £
TC2275	Link stabiliser(135)	A B		
TC2312	Link stabiliser(135)	A B		
TC2684	Lower ball joint(140)	A B		M14x1.5
TC2972	Upper link arm(239)	A	Front(108)	Pinch Bolt(255) 16mm
TC2973	Upper link arm(239)	B	Front(108)	Pinch Bolt(255) 16mm
TC2974	Upper link arm(239)	A	Rear(187)	Pinch Bolt(255) 16mm
TC2975	Upper link arm(239)	B	Rear(187)	Pinch Bolt(255) 16mm
TC3089	Upper track control arm(242)	A		
TC3090	Upper track control arm(242)	B		
TC3337	Lower track control arm(151)	A	Aluminium(-73) (+) Air suspension(-35) →16/02/2015	
TC3338	Lower track control arm(151)	B	Aluminium(-73) (+) Air suspension(-35) →16/02/2015	
TC3597	Lower track control arm(150)	A B	Steel(210) (+) Air suspension(-35) 16/02/2015→	
TC3597	Lower track control arm(150)	A B	Steel(210) (-) Air suspension(-9_)	
TD723W	Lower track control arm bush(153)	A B	Outer(176)	
TD1493W	Lower track control arm bush(153)	A B	(+) Air suspension(-35) Outer(176) Inner(119) →16/02/2015	

S8 (4E SERIES) 5.2FSi Quattro (06/06-07/10)



TC1757



TC1757



TC1207



TC1206

Part No	Description	Pos	Info	Technical
TC1206	Connecting link(-95)	B		
TC1207	Connecting link(-95)	A		
TC1757	Link stabiliser(135)	A B		M10x1.5

S8 (4H SERIES) 4.0i Quattro (04/12→)



TA3176



TA2873



TA2873



TA3177



TC3676



TC3676



TD723W



TC3601



TD1626W



TD1626W



TC3602



TD723W



TC3599



TC3600



TC2275



TC2275

Part No	Description	Pos	Info	Technical
TA2873	Inner tie rod(123)	A B		M16x1.5 Male(252) £
TA3176	Tie rod end(224)	A		M16x1.5 Female(253) £
TA3177	Tie rod end(224)	B		M16x1.5 Female(253) £
TC2275	Link stabiliser(135)	A B		
TC3599	Lower track control arm(151)	A	Rear(187)	M14x1.5
TC3600	Lower track control arm(151)	B	Rear(187)	M14x1.5
TC3601	Lower track control arm(151)	A	Front(108)	
TC3602	Lower track control arm(151)	B	Front(108)	
TC3676	Lower ball joint(140)	A B	Front(108)	M14 x 1.5 x 26.5
TD723W	Lower track control arm bush(153)	A B	Front(108) Outer(176)	
TD1626W	Lower track control arm bush(153)	A B	Front(108) Inner(119)	

... AUDI

TT (8N SERIES) 1.8i (10/98-07/06)

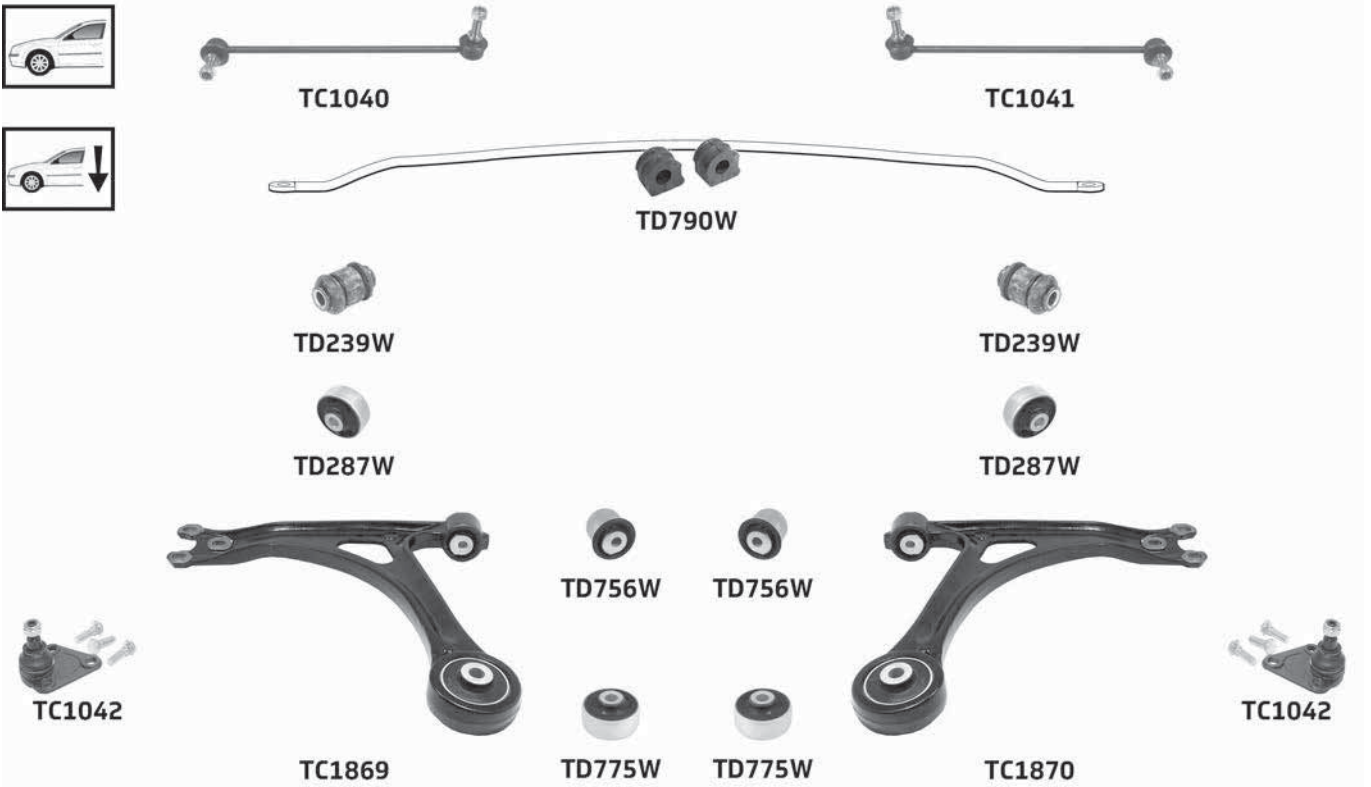

Part No	Description	Pos	Info	Technical
TA1780	Tie rod end(224)	A		M16x1.5 Female(253) £
TA1781	Tie rod end(224)	B		M16x1.5 Female(253) £
TA1980	Inner tie rod(123)	A B	(-) Sport suspension(-27-)	M16x1.5 Male(252) £
TA3168	Inner tie rod(123)	A B	(+) Sport suspension(-53-)	M16x1.5 Male(252) £
TBR4113	Steering rack gaiter kit(213)	K	Thermoplastic(223)	1 :16x48x48 2 :16x48x48
TC1040	Link stabiliser(135)	A		M12x1.5
TC1041	Link stabiliser(135)	B		M12x1.5
TC1042	Lower ball joint(140)	A B		M12x1.5
TC1869	Lower wishbone(158)	A	(-) Ball joint(-11-)	
TC1870	Lower wishbone(158)	B	(-) Ball joint(-11-)	
TD239W	Lower wishbone bush(159)	A B	Front(108) →Ch. 8NY 060000	
TD287W	Lower wishbone bush(159)	A B	Rear(187) →Ch. 8NY 060000	
TD655W	Sub-frame bush(215)	A B	Fit in pairs when replacing hydraulic type(104)	
TD756W	Lower wishbone bush(159)	A B	Front(108) Ch. 8NY 060001→	
TD775W	Lower wishbone bush(159)	A B	Rear(187) Ch. 8NY 060001→	
TD790W	Anti-roll bar(-74-) bush kit(-86-)	K	Ø19 →Ch. 8NY 060000 Complete axle kit(-92-)	

TT (8N SERIES) 1.8i Quattro (10/98-07/06)

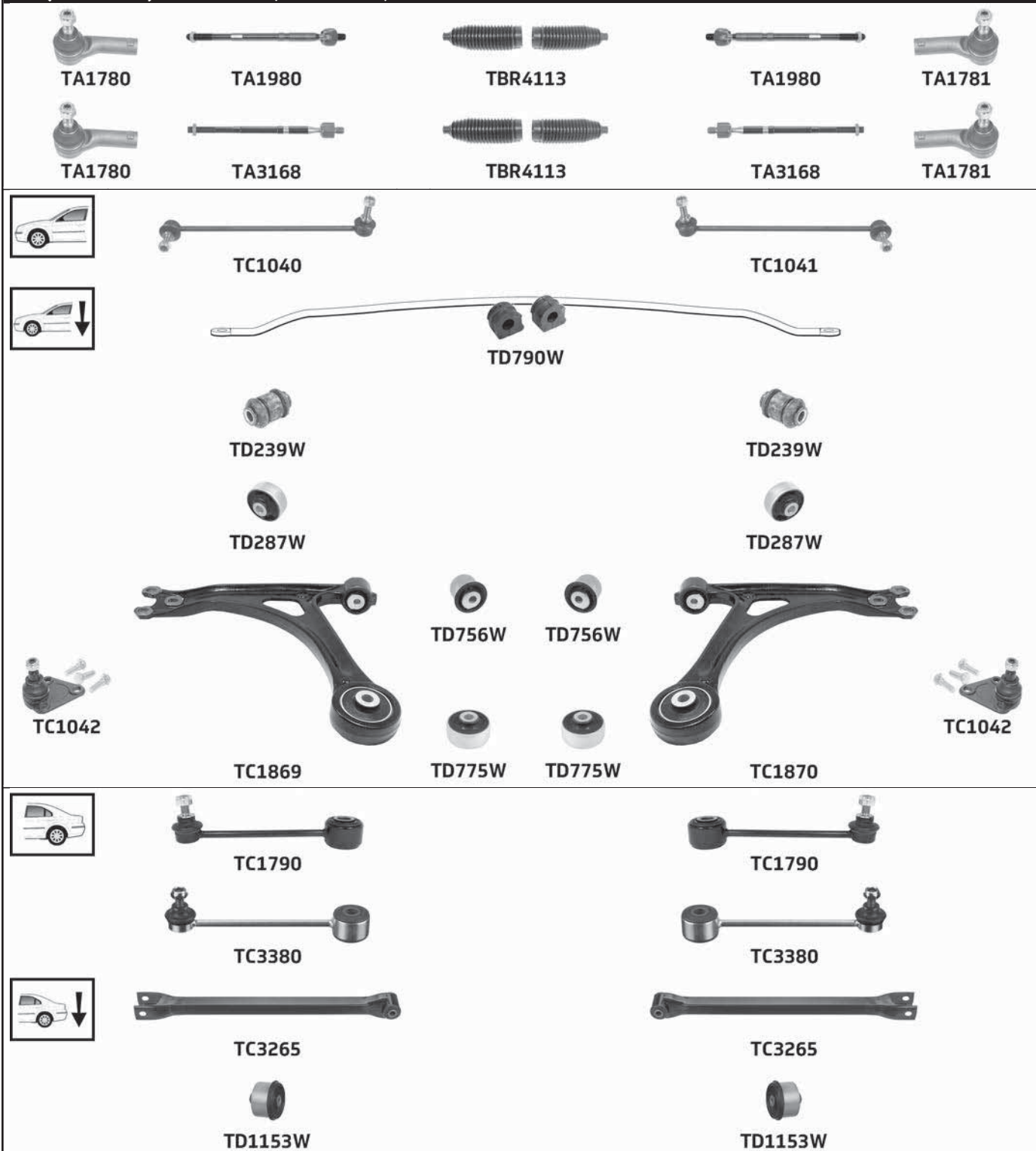

Part No	Description	Pos	Info	Technical
TA1780	Tie rod end(224)	A		M16x1.5 Female(253) £
TA1781	Tie rod end(224)	B		M16x1.5 Female(253) £
TA1980	Inner tie rod(123)	A B	(-) Sport suspension(-27-)	M16x1.5 Male(252) £
TA3168	Inner tie rod(123)	A B	(+) Sport suspension(-53-)	M16x1.5 Male(252) £
TBR4113	Steering rack gaiter kit(213)	K	Thermoplastic(223)	1 :16x48x48 2 :16x48x48
TC1040	Link stabiliser(135)	A		M12x1.5
TC1041	Link stabiliser(135)	B		M12x1.5
TC1042	Lower ball joint(140)	A B		M12x1.5
TC1790	Link stabiliser(135)	A B		M10x1.5
TC1869	Lower wishbone(158)	A	(-) Ball joint(-11-)	
TC1870	Lower wishbone(158)	B	(-) Ball joint(-11-)	
TC3265	Lower track control arm(151)	A B		
TC3380	Link stabiliser(135)	A B	(+) Heavy duty suspension(-47-)	M10x1.5

AUDI

... AUDI

... TT (8N SERIES) 1.8i Quattro (10/98-07/06)

Part No	Description	Pos	Info	Technical
TD239W	Lower wishbone bush(159)	A B	Front(108) →Ch. 8NY 060000	
TD287W	Lower wishbone bush(159)	A B	Rear(187) →Ch. 8NY 060000	
TD756W	Lower wishbone bush(159)	A B	Front(108) Ch. 8NY 060001→	
TD775W	Lower wishbone bush(159)	A B	Rear(187) Ch. 8NY 060001→	
TD790W	Anti-roll bar (-74) bush kit(-86-)	K	Ø19 →Ch. 8NY 060000 Complete axle kit(-92)	
TD1153W	Trailing arm bush(227)	A B	Front(108)	

TT (8N SERIES) 3.2i VR6 Quattro (07/03-07/06)

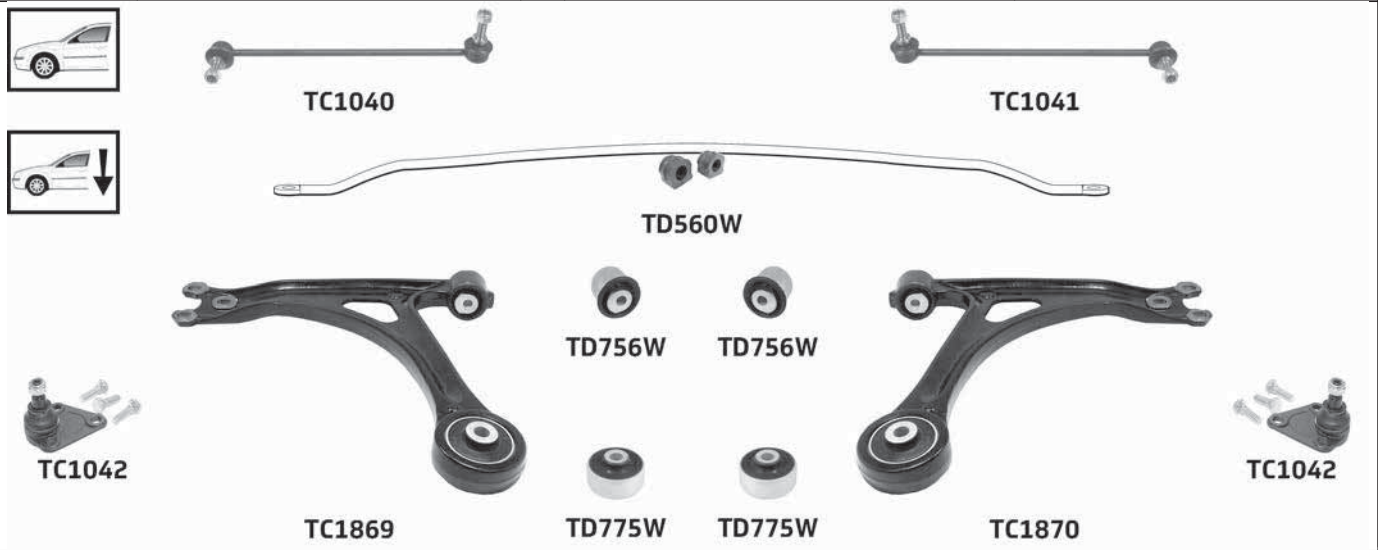

Part No	Description	Pos	Info	Technical
TA1780	Tie rod end(224)	A		M16x1.5 Female(253) E
TA1781	Tie rod end(224)	B		M16x1.5 Female(253) E
TA1980	Inner tie rod(123)	A B	(-) Sport suspension(-27-)	M16x1.5 Male(252) E
TA3168	Inner tie rod(123)	A B	(+) Sport suspension(-53-)	M16x1.5 Male(252) E
TBR4113	Steering rack gaiter kit(213)	K	Thermoplastic(223)	1 :16x48x48 2 :16x48x48
TC1040	Link stabiliser(135)	A		M12x1.5
TC1041	Link stabiliser(135)	B		M12x1.5
TC1042	Lower ball joint(140)	A B		M12x1.5
TC1790	Link stabiliser(135)	A B		M10x1.5
TC1869	Lower wishbone(158)	A	(-) Ball joint(-11-)	
TC1870	Lower wishbone(158)	B	(-) Ball joint(-11-)	
TC3265	Lower track control arm(151)	A B		
TC3380	Link stabiliser(135)	A B	(+) Heavy duty suspension(-47-)	M10x1.5
TD560W	Anti-roll bar (-74) bush kit(-86-)	K	Ø21 Complete axle kit(-92)	

... TT (8N SERIES) 3.2i VR6 Quattro (07/03-07/06)

Part No	Description	Pos	Info	Technical
TD756W	Lower wishbone bush(159)	A B	Front(108)	
TD775W	Lower wishbone bush(159)	A B	Rear(187)	
TD1153W	Trailing arm bush(227)	A B	Front(108)	

TT (8J SERIES) 1.8TFSi, 2.0TDi Quattro, 2.0TFSi, 2.0TFSi Quattro, 3.2i VR6 Quattro (08/06-05/09)

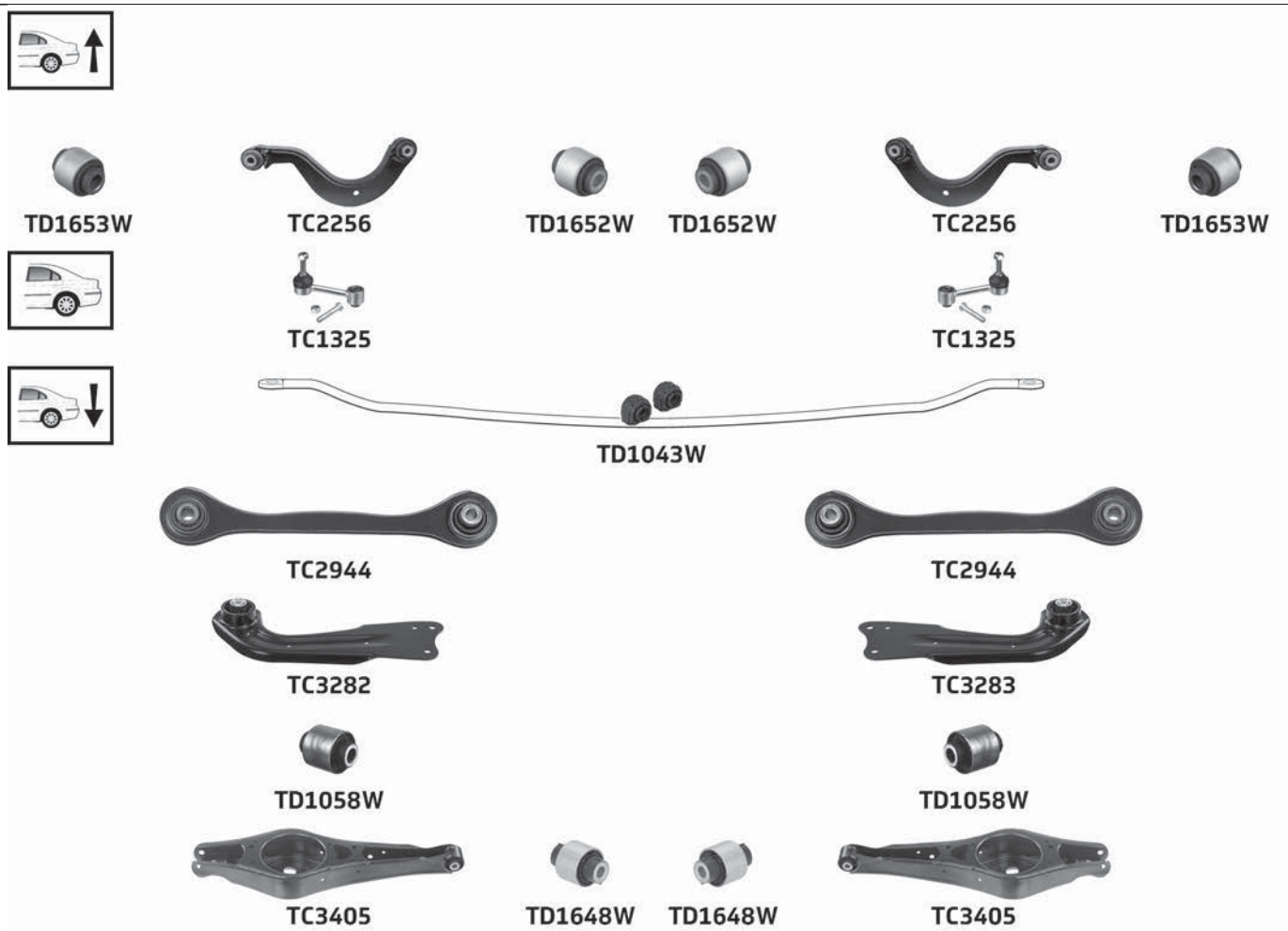
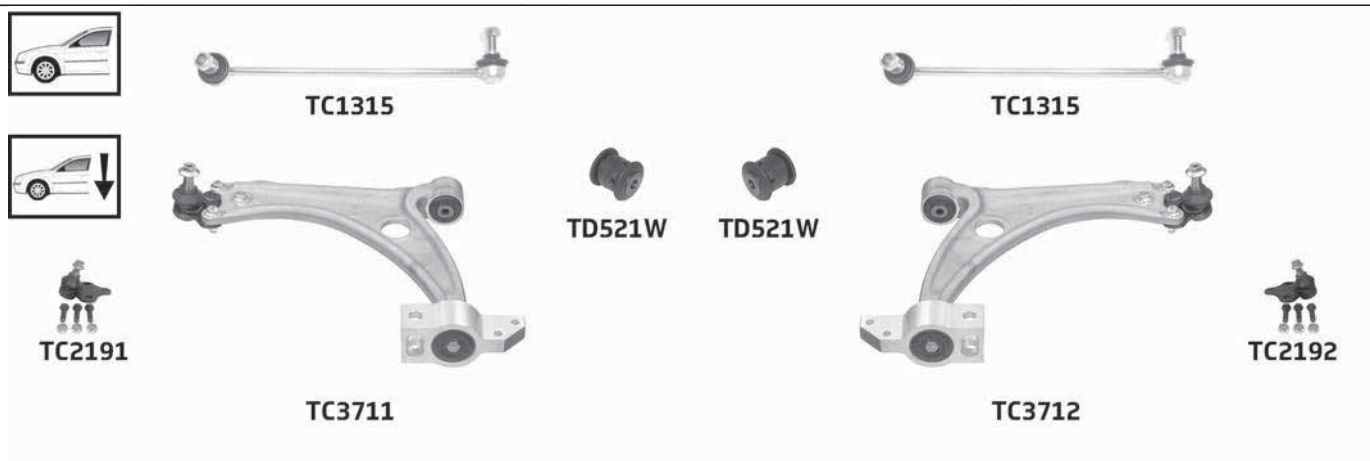

Part No	Description	Pos	Info	Technical
TA2470	Tie rod end(224)	A		M16x1.5 Female(253) £
TA2471	Tie rod end(224)	B		M16x1.5 Female(253) £
TA2485	Inner tie rod(123)	A B		M16x1.5 Male(252) £
TBR4218	Steering rack gaiter kit(213)	K	Thermoplastic(223)	1 :15.5x49.5x49.5 2 :15.5x49.5x49.5
TC1315	Link stabiliser(135)	A B		M12x1.5
TC1325	Link stabiliser(135)	A B		M10x1.5

AUDI

... AUDI

... TT (8J SERIES) 1.8TFSi, 2.0TDi Quattro, 2.0TFSi, 2.0TFSi Quattro, 3.2i VR6 Quattro (08/06-05/09)

Part No	Description	Pos	Info	Technical
TC2191	Lower ball joint(140)	A		M12x1.5
TC2192	Lower ball joint(140)	B		M12x1.5
TC2256	Upper track control arm(242)	A B		
TC2944	Trailing arm(226)	A B		
TC3282	Lower link arm(144)	A	Front(108)	
TC3283	Lower link arm(144)	B	Front(108)	
TC3405	Lower track control arm(151)	A B	Rear(187)	
TC3711	Lower wishbone(158)	A	(+) Ball joint(-39)	
TC3712	Lower wishbone(158)	B	(+) Ball joint(-39)	
TD521W	Lower wishbone bush(159)	A B	Front(108)	
TD1043W	Anti-roll bar(-74) bush kit(-86)	K	Ø18.5 Complete axle kit(-92)	
TD1058W	Lower hub carrier bush(143)	A B		
TD1648W	Lower track control arm bush(153)	A B	Inner(119)	
TD1652W	Upper track control arm bush(243)	A B		
TD1653W	Upper track control arm bush(243)	A B		

TT (8J SERIES) 1.8TFSi, 2.0TDi Quattro, 2.0TFSi, 2.0TFSi Quattro, 2.5TFSi Quattro, 3.2i VR6 Quattro (05/09→)

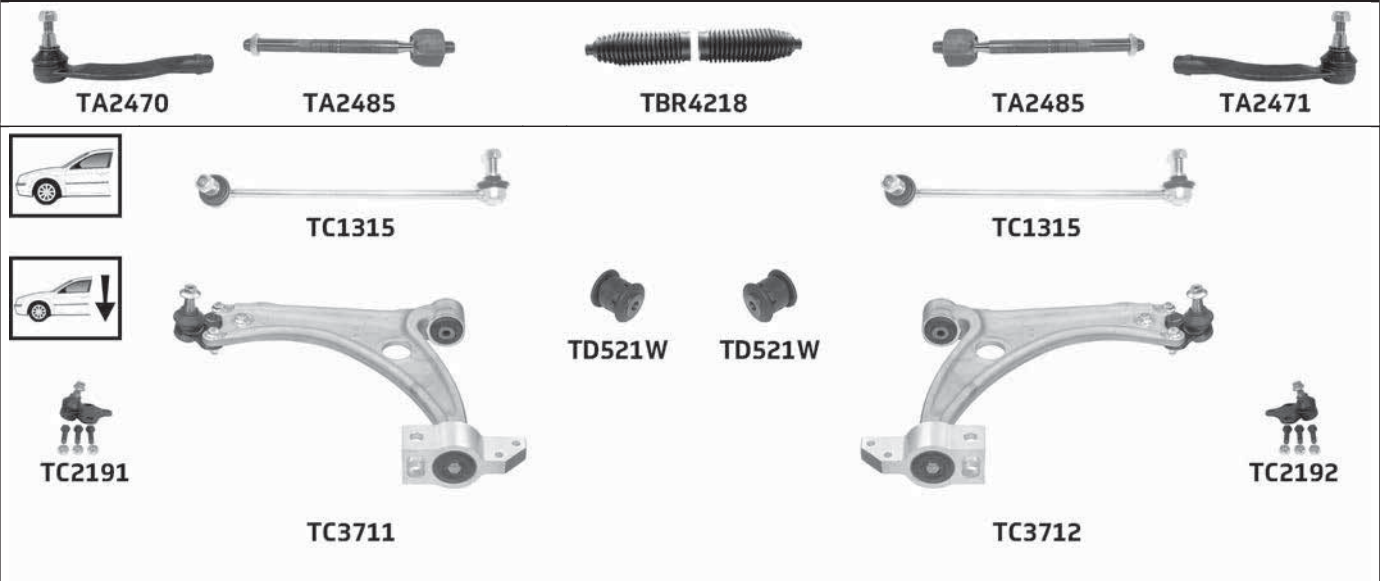

... TT (8J SERIES) 1.8TFSi, 2.0TDi Quattro, 2.0TFSi, 2.0TFSi Quattro, 2.5TFSi Quattro, 3.2i VR6 Quattro (05/09→)

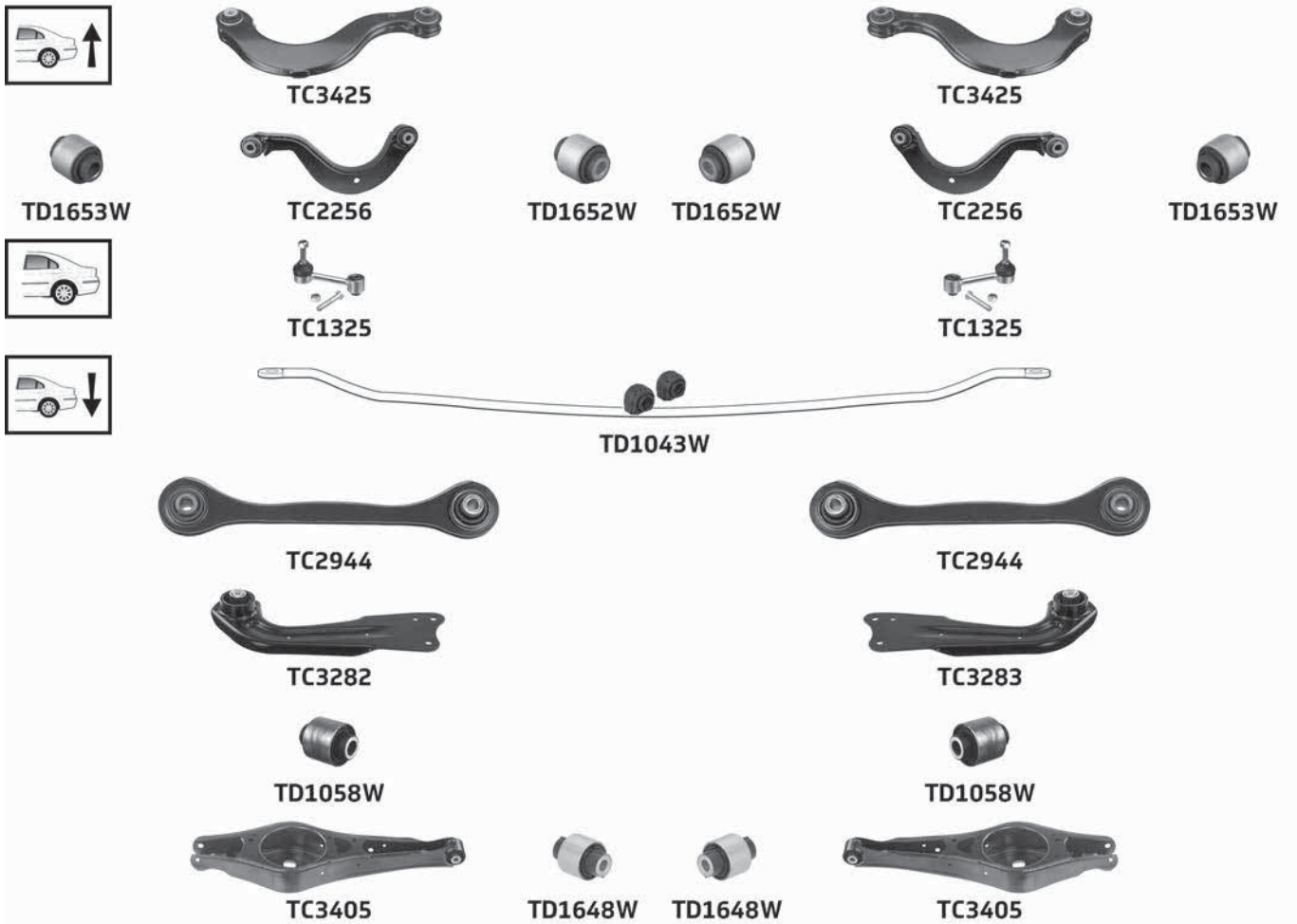

Part No	Description	Pos	Info	Technical
TA2470	Tie rod end (224)	A		M16x1.5 Female (253) £
TA2471	Tie rod end (224)	B		M16x1.5 Female (253) £
TA2485	Inner tie rod (123)	A B		M16x1.5 Male (252) £
TBR4218	Steering rack gaiter kit (213)	K	Thermoplastic (223)	1 :15.5x49.5x49.5 2 :15.5x49.5x49.5
TC1315	Link stabiliser (135)	A B		M12x1.5
TC1325	Link stabiliser (135)	A B		M10x1.5
TC2191	Lower ball joint (140)	A		M12x1.5
TC2192	Lower ball joint (140)	B		M12x1.5
TC2256	Upper track control arm (242)	A B	→28/05/2012	
TC2944	Trailing arm (226)	A B		
TC3282	Lower link arm (144)	A	Front (108)	
TC3283	Lower link arm (144)	B	Front (108)	
TC3405	Lower track control arm (151)	A B	Rear (187)	
TC3425	Upper track control arm (242)	A B	28/05/2012→	
TC3711	Lower wishbone (158)	A	(+) Ball joint (-39)	
TC3712	Lower wishbone (158)	B	(+) Ball joint (-39)	
TD521W	Lower wishbone bush (159)	A B	Front (108)	
TD1043W	Anti-roll bar (-74) bush kit (-86-)	K	Ø18.5 Complete axle kit (-92)	
TD1058W	Lower hub carrier bush (143)	A B		
TD1648W	Lower track control arm bush (153)	A B	Inner (119)	
TD1652W	Upper track control arm bush (243)	A B		
TD1653W	Upper track control arm bush (243)	A B		

AUDI

... AUDI

TT (FV SERIES) 1.8TFSi, 2.0TDi, 2.0TDi Quattro, 2.0TFSi, 2.0TFSi Quattro (07/14→)



TBR4218



TC2690



TC2690



TC2191



TC2192



TC3410



TC3410

Part No	Description	Pos	Info	Technical
TBR4218	Steering rack gaiter kit (213)	K	Thermoplastic (223)	1 :15.5x49.5x49.5 2 :15.5x49.5x49.5
TC2191	Lower ball joint (140)	A		M12x1.5
TC2192	Lower ball joint (140)	B		M12x1.5
TC2690	Link stabiliser (135)	A B		M12x1.5
TC3410	Link stabiliser (135)	A B		M10x1.5

TT (FV SERIES) 2.5TFSi RS (10/16→)



TBR4218



TC2690



TC2690



TC2191



TC2192



TC3410



TC3410

Part No	Description	Pos	Info	Technical
TBR4218	Steering rack gaiter kit (213)	K	Thermoplastic (223)	1 :15.5x49.5x49.5 2 :15.5x49.5x49.5
TC2191	Lower ball joint (140)	A		M12x1.5
TC2192	Lower ball joint (140)	B		M12x1.5
TC2690	Link stabiliser (135)	A B		M12x1.5
TC3410	Link stabiliser (135)	A B		M10x1.5

BMW

1 SERIES (E81, E87 SERIES) 116i 1.6i, 2.0i, 116d 2.0d, 118i 2.0i, 118d 2.0d, 120i 2.0i, 120d 2.0d, 123d 2.0d, 125i 3.0i, 130i 3.0i (11/03-09/12)



TA2060



TA2062



TBR4223



TA2062



TA2061



TA2060



TA2109



TBR4200



TA2109



TA2061

... 1 SERIES (E81, E87 SERIES) 116i 1.6i, 2.0i, 116d 2.0d, 118i 2.0i, 118d 2.0d, 120i 2.0i, 120d 2.0d, 123d 2.0d, 125i 3.0i, 130i 3.0i (11/03-09/12)

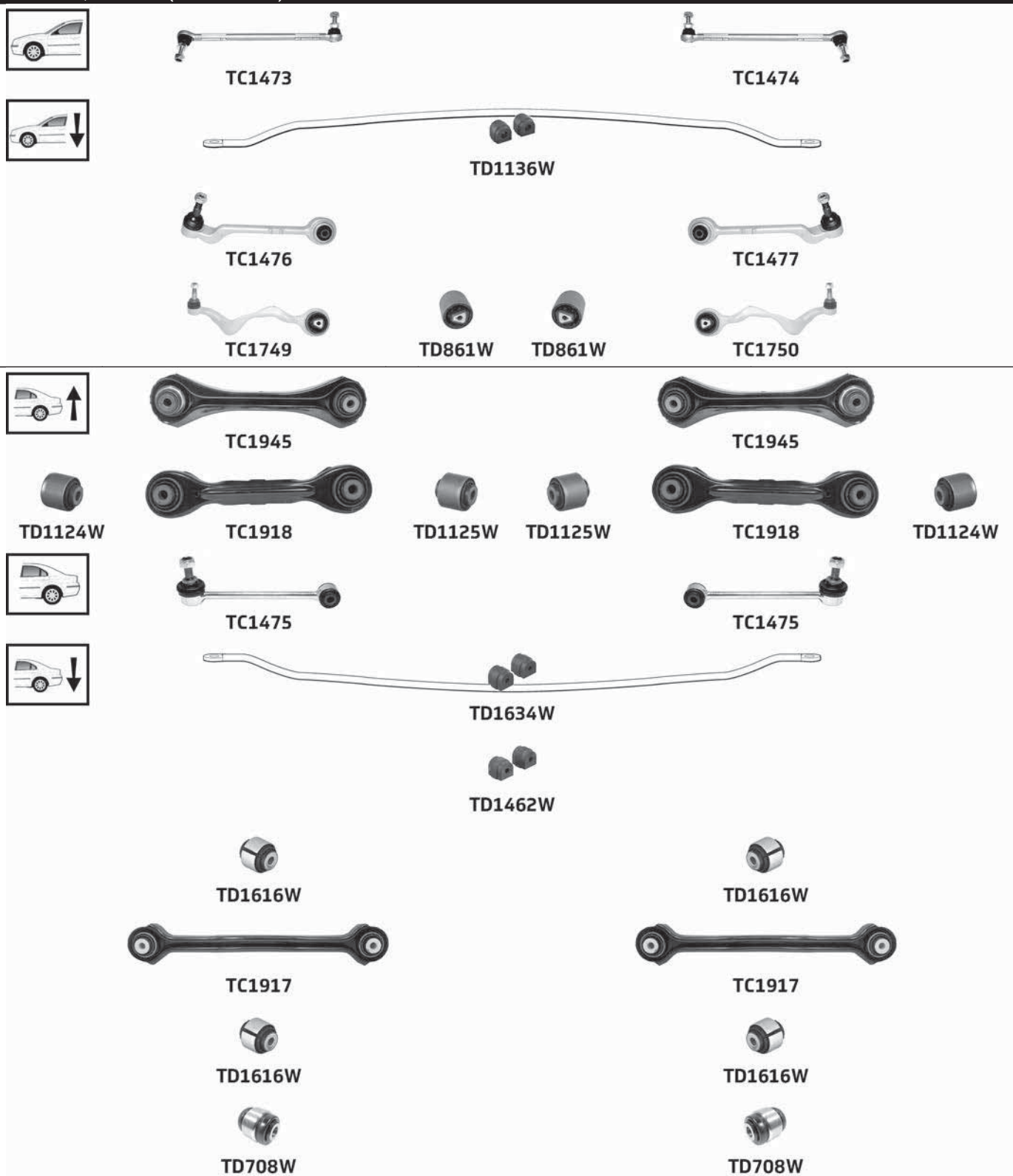

Part No	Description	Pos	Info	Technical
TA2060	Tie rod end (224)	A		M14x1.5 Female (253) £
TA2061	Tie rod end (224)	B		M14x1.5 Female (253) £
TA2062	Inner tie rod (123)	A B	TRW	M14x1.5 Male (252) £
TA2109	Inner tie rod (123)	A B	ZF	M14x1.5 Male (252) £
TBR4200	Steering rack gaiter kit (213)	K	ZF Thermoplastic (223)	1 :15.5x64x64 2 :15.5x64x64
TBR4223	Steering rack gaiter kit (213)	K	TRW Thermoplastic (223)	1 :14x60x60 2 :14x60x60
TC1473	Link stabiliser (135)	A		M10x1.5
TC1474	Link stabiliser (135)	B		M10x1.5
TC1475	Link stabiliser (135)	A B		M10x1.5
				(...)

... BMW

... 1 SERIES (E81, E87 SERIES) 116i 1.6i, 2.0i, 116d 2.0d, 118i 2.0i, 118d 2.0d, 120i 2.0i, 120d 2.0d, 123d 2.0d, 125i 3.0i, 130i 3.0i (11/03-09/12)

Part No	Description	Pos	Info	Technical
TC1476	Lower track control arm(151)	A	Rear(187)	M14x1.5
TC1477	Lower track control arm(151)	B	Rear(187)	M14x1.5
TC1749	Lower track control arm(151)	A	Front(108)	M14x1.5
TC1750	Lower track control arm(151)	B	Front(108)	M14x1.5
TC1917	Lower track control arm(151)	A B	Rear(187)	
TC1918	Upper track control arm(242)	A B	Front(108)	
TC1945	Upper track control arm(242)	A B	Rear(187)	
TD708W	Lower hub carrier bush(143)	A B	Centre(-89-)	
TD861W	Lower track control arm bush(153)	A B	Front(108)	
TD1124W	Upper track control arm bush(243)	A B	Outer(176)	
TD1125W	Upper track control arm bush(243)	A B	Inner(119)	
TD1136W	Anti-roll bar(-74-) bush kit(-86-)	K	Ø26.5 Complete axle kit(-92-) →05/10	
TD1462W	Anti-roll bar(-74-) bush kit(-86-)	K	Ø14 Complete axle kit(-92-) 5 Door(-71-) 118d, 120d, 130i (+) M-Sport Suspension	
TD1616W	Lower hub carrier bush(143)	A B	Front(108)	
TD1616W	Sub-frame mounting(216)	A B	Front(108) Outer(176)	
TD1634W	Anti-roll bar(-74-) bush kit(-86-)	K	Ø13 Complete axle kit (-92-) (+) Sport suspension(-53-)	

1 SERIES (E82, E88 SERIES) 118i 2.0i, 118d 2.0d, 120i 2.0i, 120d 2.0d, 123d 2.0d, 125i 3.0i, 135i 3.0i (11/03-09/12)



... 1 SERIES (E82, E88 SERIES) 118i 2.0i, 118d 2.0d, 120i 2.0i, 120d 2.0d, 123d 2.0d, 125i 3.0i, 135i 3.0i (11/03-09/12)



TC1945



TC1945



TD1124W



TC1918



TD1125W



TD1125W



TC1918



TD1124W



TC1475



TC1475



TD1634W



TD1616W



TD1616W



TC1917



TC1917



TD1616W



TD1616W



TD708W



TD708W

Part No	Description	Pos	Info	Technical
TA2060	Tie rod end(224)	A		M14x1.5 Female(253) £
TA2061	Tie rod end(224)	B		M14x1.5 Female(253) £
TA2062	Inner tie rod(123)	A B	TRW	M14x1.5 Male(252) £
TA2109	Inner tie rod(123)	A B	ZF	M14x1.5 Male(252) £
TBR4200	Steering rack gaiter kit(213)	K	ZF Thermoplastic(223)	1 :15.5x64x64 2 :15.5x64x64
TBR4223	Steering rack gaiter kit(213)	K	TRW Thermoplastic(223)	1 :14x60x60 2 :14x60x60
TC1473	Link stabiliser(135)	A		M10x1.5
TC1474	Link stabiliser(135)	B		M10x1.5
TC1475	Link stabiliser(135)	A B		M10x1.5
TC1476	Lower track control arm(151)	A	Rear(187)	M14x1.5
TC1477	Lower track control arm(151)	B	Rear(187)	M14x1.5
TC1749	Lower track control arm(151)	A	Front(108)	M14x1.5
TC1750	Lower track control arm(151)	B	Front(108)	M14x1.5
TC1917	Lower track control arm(151)	A B	Rear(187)	
TC1918	Upper track control arm(242)	A B	Front(108)	
TC1945	Upper track control arm(242)	A B	Rear(187)	
TD708W	Lower hub carrier bush(143)	A B	Centre(-89-)	
TD861W	Lower track control arm bush(153)	A B	Front(108)	
TD1124W	Upper track control arm bush(243)	A B	Outer(176)	
TD1125W	Upper track control arm bush(243)	A B	Inner(119)	
TD1616W	Lower hub carrier bush(143)	A B	Front(108)	
TD1616W	Sub-frame mounting(216)	A B	Front(108) Outer(176)	
TD1634W	Anti-roll bar(-74) bush kit(-86-)	K	Ø13 Complete axle kit (-92)  (+) M-Sport Suspension	

... BMW

1 SERIES (F20, F21 SERIES) 114i 1.6i, 114d 1.6d, 116i 1.6i, 116d 1.6d, 2.0d, 118i 1.6i, 118d 2.0d, 120i 2.0i, 120d 2.0d, 125i 2.0i, 125d 2.0d (11/10→)

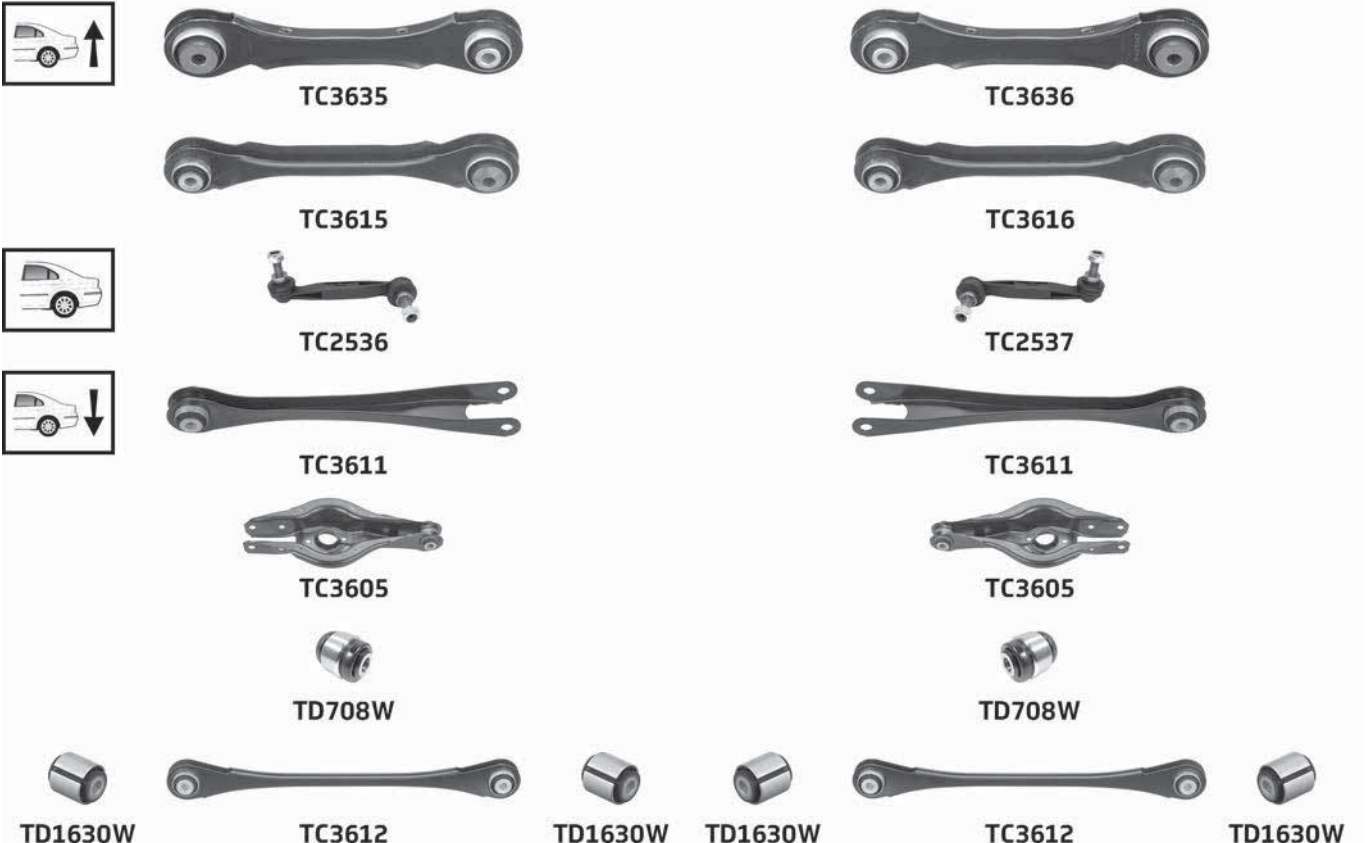

Part No	Description	Pos	Info	Technical
TA3170	Inner tie rod(123)	A B		M14x1.5 Male(252) E
TA3220	Tie rod end(224)	A		M14x1.5 Female(253) E
TA3221	Tie rod end(224)	B		M14x1.5 Female(253) E
TC2536	Link stabiliser(135)	A		M10x1.5
TC2537	Link stabiliser(135)	B		M10x1.5
TC2645	Link stabiliser(135)	A		M10x1.5
TC2645	Link stabiliser(135)	B	(-) Adaptive M chassis	M10x1.5
TC2646	Link stabiliser(135)	B	(+) Adaptive M chassis	M10x1.5
TC3605	Lower track control arm(151)	A B		
TC3609	Lower track control arm(151)	A	Rear(187)	M14x1.5
TC3610	Lower track control arm(151)	B	Rear(187)	M14x1.5
TC3611	Trailing arm(226)	A B	Front(108)	
TC3612	Lower track control arm(151)	A B	Rear(187)	
TC3615	Upper track control arm(242)	A	Rear(187)	

... 1 SERIES (F20, F21 SERIES) 114i 1.6i, 114d 1.6d, 116i 1.6i, 116d 1.6d, 2.0d, 118i 1.6i, 118d 2.0d, 120i 2.0i, 120d 2.0d, 125i 2.0i, 125d 2.0d (11/10→)

Part No	Description	Pos	Info	Technical
TC3616	Upper track control arm(242)	B	Rear(187)	
TC3635	Upper guide rod(236)	A	Front(108)	
TC3636	Upper guide rod(236)	B	Front(108)	
TD708W	Lower hub carrier bush(143)	A B	Centre(-89-)	
TD1630W	Lower track control arm bush(153)	A B	Rear(187) Inner(119) Outer(176)	
TL611	Rod assembly(194)	A		
TL612	Rod assembly(194)	B		

1 SERIES (F20, F21 SERIES) 135i 3.0i M Sport, 140i 3.0i M Sport (11/10→)

TL611, TA3220, TA3170, TA3170, TA3221, TC2645, TC2646, TC3635, TC3615, TC2536, TC2537, TC3611, TC3605, TD708W, TD1630W, TC3612, TD1630W, TD1630W, TC3611, TD1630W

Part No	Description	Pos	Info	Technical
TA3170	Inner tie rod(123)	A B		M14x1.5 Male(252) £
TA3220	Tie rod end(224)	A		M14x1.5 Female(253) £
TA3221	Tie rod end(224)	B		M14x1.5 Female(253) £
TC2536	Link stabiliser(135)	A		M10x1.5
TC2537	Link stabiliser(135)	B		M10x1.5
TC2645	Link stabiliser(135)	A		M10x1.5
TC2645	Link stabiliser(135)	B	(-) Adaptive M chassis	M10x1.5
TC2646	Link stabiliser(135)	B	(+) Adaptive M chassis	M10x1.5
TC3605	Lower track control arm(151)	A B		

(...)

... BMW

... 1 SERIES (F20, F21 SERIES) 135i 3.0i M Sport, 140i 3.0i M Sport (11/10→)

Part No	Description	Pos	Info	Technical
TC3611	Trailing arm(226)	A B	Front(108)	
TC3612	Lower track control arm(151)	A B	Rear(187)	
TC3615	Upper track control arm(242)	A	Rear(187)	
TC3616	Upper track control arm(242)	B	Rear(187)	
TC3635	Upper guide rod(236)	A	Front(108)	
TC3636	Upper guide rod(236)	B	Front(108)	
TD708W	Lower hub carrier bush(143)	A B	Centre(-89-)	
TD1630W	Lower track control arm bush(153)	A B	Rear(187) Inner(119) Outer(176)	
TL611	Rod assembly(194)	A		
TL612	Rod assembly(194)	B		

1 SERIES (F20, F21 SERIES) 118d 2.0d, 120d 2.0d, 135i 3.0i M Sport, 140i 3.0i M Sport xDrive (11/10→)

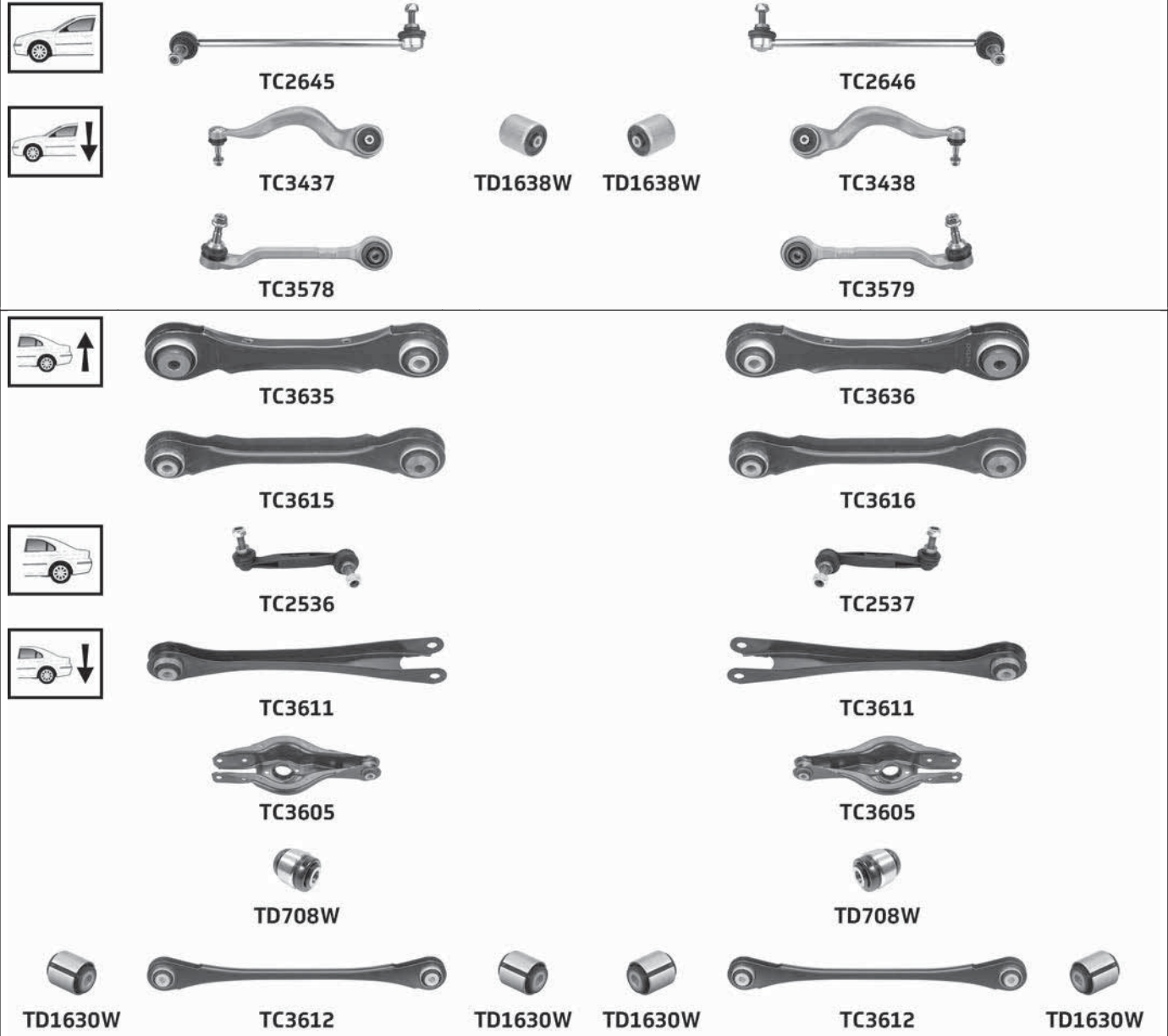

Part No	Description	Pos	Info	Technical
TC2536	Link stabiliser(135)	A		M10x1.5
TC2537	Link stabiliser(135)	B		M10x1.5
TC2645	Link stabiliser(135)	A		M10x1.5
TC2646	Link stabiliser(135)	B		M10x1.5
TC3437	Lower track control arm(151)	A	Front(108)	M14x1.5
TC3438	Lower track control arm(151)	B	Front(108)	M14x1.5
TC3578	Lower track control arm(151)	A	Rear(187)	M14 x 1.5 x 30.5
TC3579	Lower track control arm(151)	B	Rear(187)	M14 x 1.5 x 30.5
TC3605	Lower track control arm(151)	A B		
TC3611	Trailing arm(226)	A B	Front(108)	
TC3612	Lower track control arm(151)	A B	Rear(187)	
TC3615	Upper track control arm(242)	A	Rear(187)	

... 1 SERIES (F20, F21 SERIES) 118d 2.0d, 120d 2.0d, 135i 3.0i M Sport, 140i 3.0i M Sport xDrive (11/10→)

Part No	Description	Pos	Info	Technical
TC3616	Upper track control arm(242)	B	Rear(187)	
TC3635	Upper guide rod(236)	A	Front(108)	
TC3636	Upper guide rod(236)	B	Front(108)	
TD708W	Lower hub carrier bush(143)	A B	Centre(-89-)	
TD1630W	Lower track control arm bush(153)	A B	Rear(187) Inner(119) Outer(176)	
TD1638W	Lower track control arm bush(153)	A B	Inner(119)	

2 SERIES (F22, F23 SERIES) 218i 1.5i, 218d 2.0d, 220i 2.0i, 220d 2.0d, 225d 2.0d, 228i 2.0i, 230i 2.0i (10/13→)

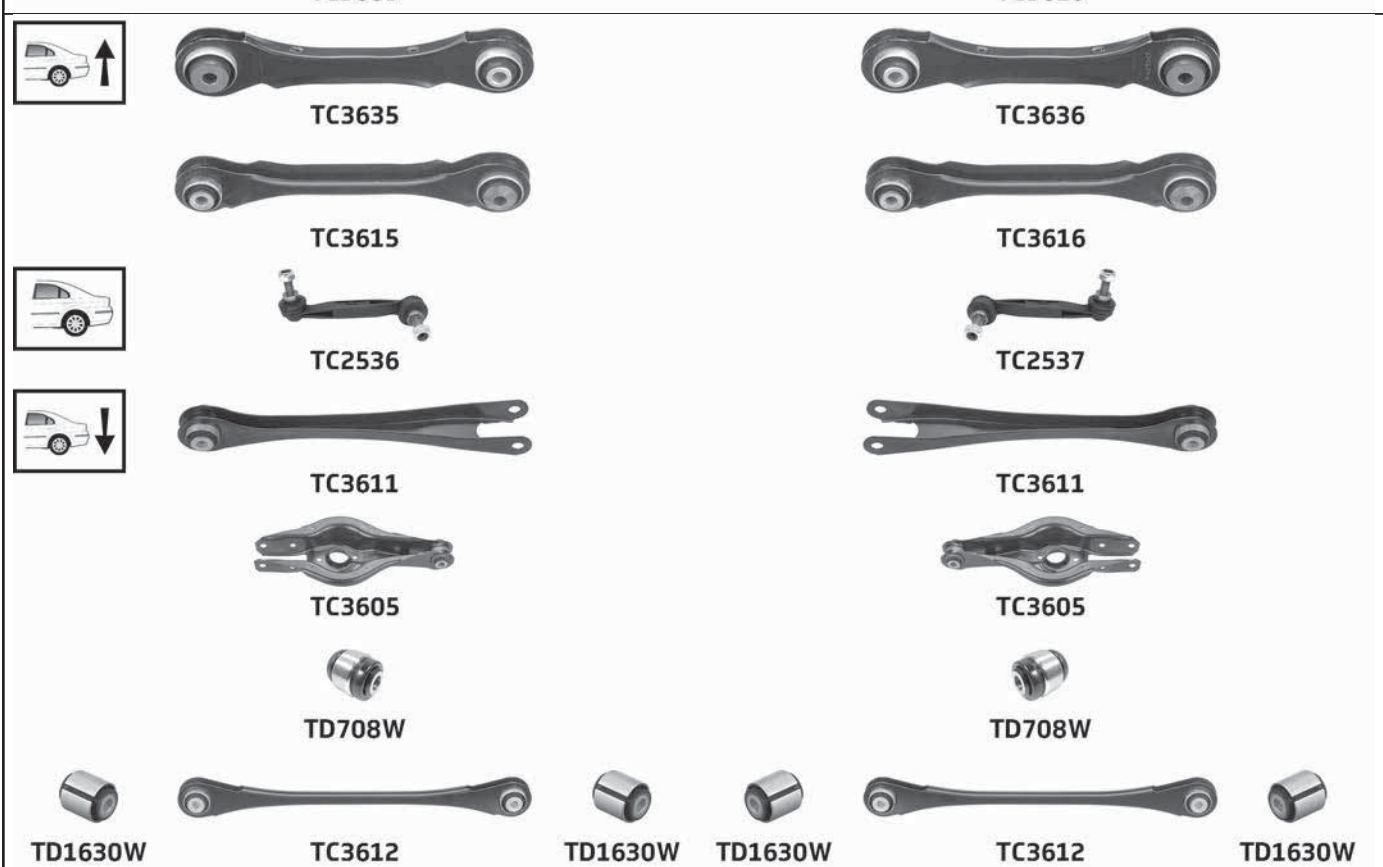
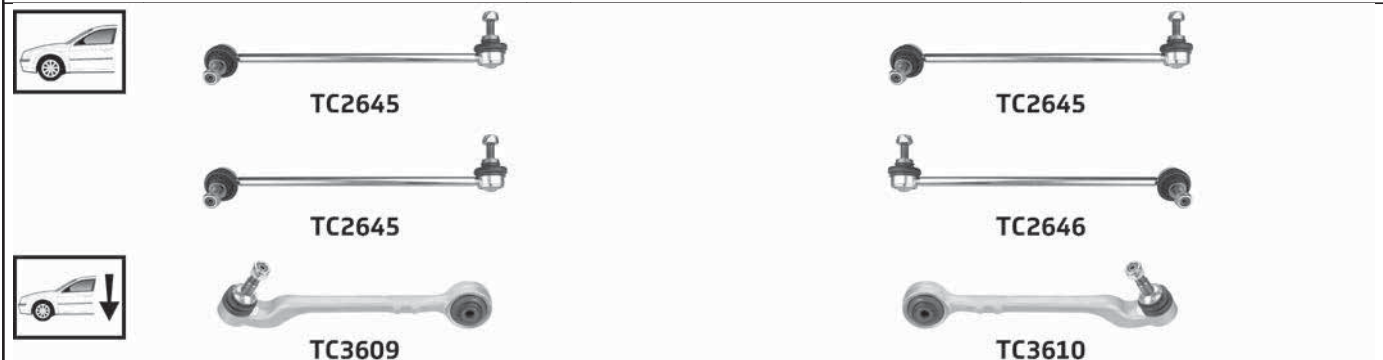
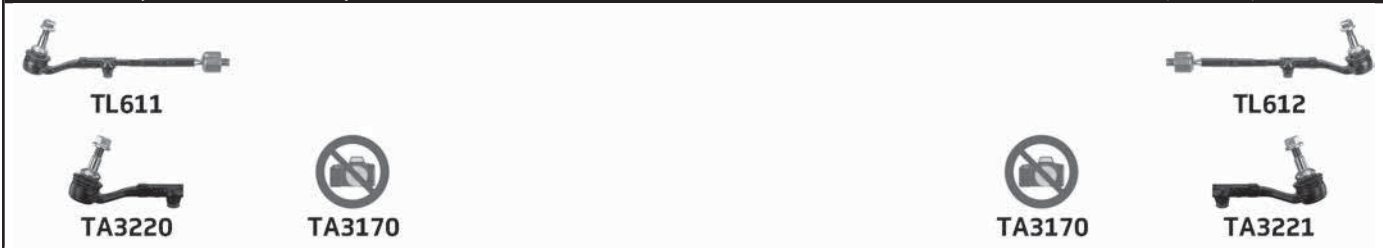

Part No	Description	Pos	Info	Technical
TA3170	Inner tie rod(123)	A B		M14x1.5 Male(252) £
TA3220	Tie rod end(224)	A		M14x1.5 Female(253) £
TA3221	Tie rod end(224)	B		M14x1.5 Female(253) £
TC2536	Link stabiliser(135)	A		M10x1.5
TC2537	Link stabiliser(135)	B		M10x1.5
TC2645	Link stabiliser(135)	A		M10x1.5
TC2645	Link stabiliser(135)	B	(-) Adaptive M chassis	M10x1.5

... BMW

... 2 SERIES (F22, F23 SERIES) 218i 1.5i, 218d 2.0d, 220i 2.0i, 220d 2.0d, 225d 2.0d, 228i 2.0i, 230i 2.0i (10/13→)

Part No	Description	Pos	Info	Technical
TC2646	Link stabiliser (135)	B	(+) Adaptive M chassis	M10x1.5
TC3605	Lower track control arm (151)	A B		
TC3609	Lower track control arm (151)	A	Rear (187)	M14x1.5
TC3610	Lower track control arm (151)	B	Rear (187)	M14x1.5
TC3611	Trailing arm (226)	A B	Front (108)	
TC3612	Lower track control arm (151)	A B	Rear (187)	
TC3615	Upper track control arm (242)	A	Rear (187)	
TC3616	Upper track control arm (242)	B	Rear (187)	
TC3635	Upper guide rod (236)	A	Front (108)	
TC3636	Upper guide rod (236)	B	Front (108)	
TD708W	Lower hub carrier bush (143)	A B	Centre (-89-)	
TD1630W	Lower track control arm bush (153)	A B	Rear (187) Inner (119) Outer (176)	
TL611	Rod assembly (194)	A		
TL612	Rod assembly (194)	B		

2 SERIES (F22, F23 SERIES) 235i 3.0i M Sport, 240i 3.0i M Sport (10/13→)

Visual comparison of suspension parts for BMW 2 Series (F22, F23 Series) models. The image shows various components like tie rods (TA3220, TA3221, TA3170), control arms (TC2645, TC3615, TC3616, TC3611, TC3605), and stabilizers (TC2536, TC2537, TC2646) for different chassis configurations. Icons indicate front/rear view and chassis type (adaptive M chassis).

Part No	Description	Pos	Info	Technical
TA3170	Inner tie rod (123)	A B		M14x1.5 Male (252) £
TA3220	Tie rod end (224)	A		M14x1.5 Female (253) £
TA3221	Tie rod end (224)	B		M14x1.5 Female (253) £
TC2536	Link stabiliser (135)	A		M10x1.5

BMW

... 2 SERIES (F22, F23 SERIES) 235i 3.0i M Sport, 240i 3.0i M Sport (10/13→)

Part No	Description	Pos	Info	Technical
TC2537	Link stabiliser(135)	B		M10x1.5
TC2645	Link stabiliser(135)	A		M10x1.5
TC2645	Link stabiliser(135)	B	(-) Adaptive M chassis	M10x1.5
TC2646	Link stabiliser(135)	B	(+) Adaptive M chassis	M10x1.5
TC3605	Lower track control arm(151)	A B		
TC3611	Trailing arm(226)	A B	Front(108)	
TC3612	Lower track control arm(151)	A B	Rear(187)	
TC3615	Upper track control arm(242)	A	Rear(187)	
TC3616	Upper track control arm(242)	B	Rear(187)	
TC3635	Upper guide rod(236)	A	Front(108)	
TC3636	Upper guide rod(236)	B	Front(108)	
TD708W	Lower hub carrier bush(143)	A B	Centre(-89°)	
TD1630W	Lower track control arm bush(153)	A B	Rear(187) Inner(119) Outer(176)	
TL611	Rod assembly(194)	A		
TL612	Rod assembly(194)	B		

2 SERIES (F22, F23 SERIES) 220d 2.0d, 235i 3.0i M Sport, 240i 3.0i M Sport xDrive (07/14→)

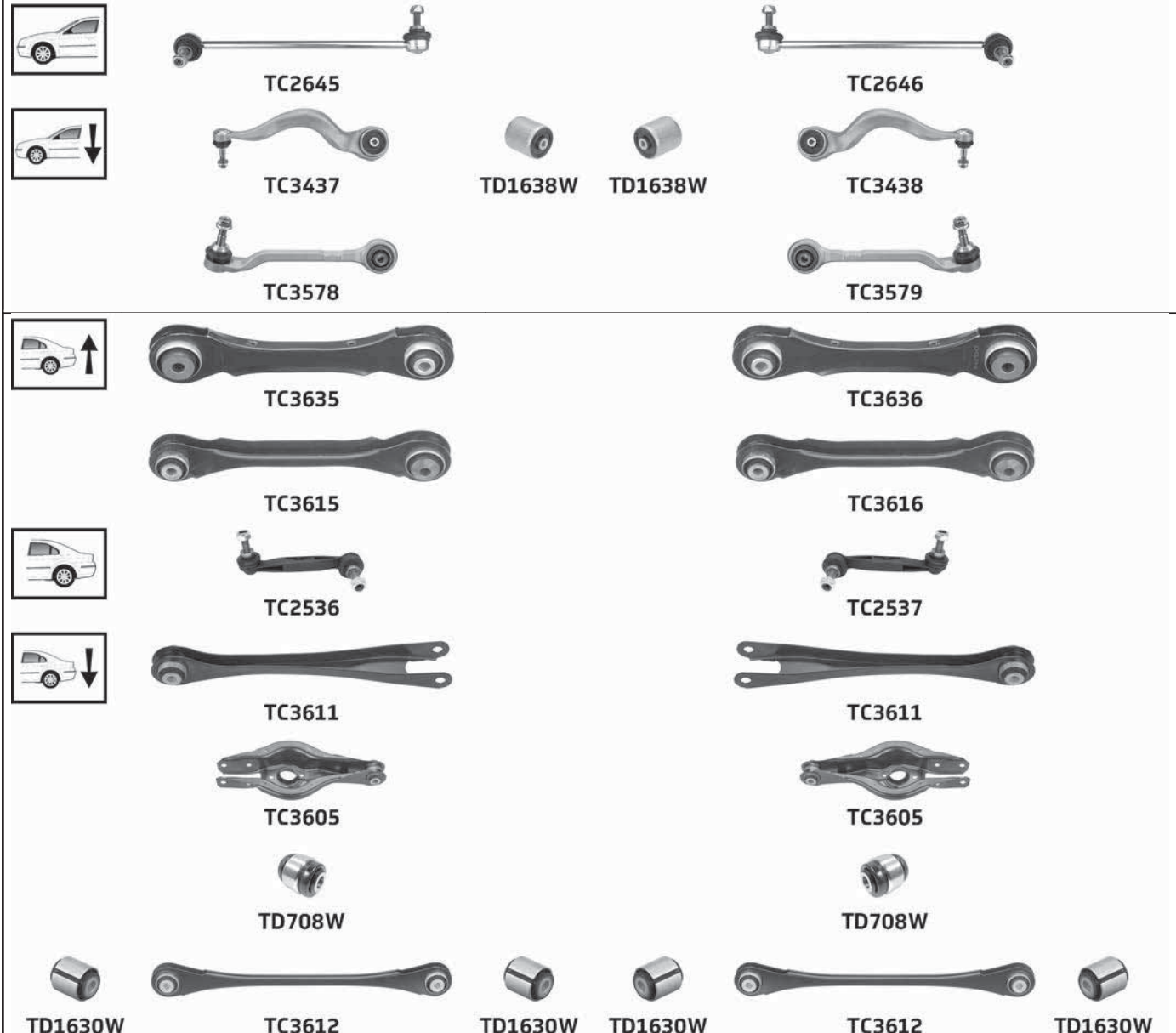

Part No	Description	Pos	Info	Technical
TC2536	Link stabiliser(135)	A		M10x1.5
TC2537	Link stabiliser(135)	B		M10x1.5
TC2645	Link stabiliser(135)	A		M10x1.5
TC2646	Link stabiliser(135)	B		M10x1.5
TC3437	Lower track control arm(151)	A	Front(108)	M14x1.5
TC3438	Lower track control arm(151)	B	Front(108)	M14x1.5

... BMW

... 2 SERIES (F22, F23 SERIES) 220d 2.0d, 235i 3.0i M Sport, 240i 3.0i M Sport xDrive (07/14→)

Part No	Description	Pos	Info	Technical
TC3578	Lower track control arm(151)	A	Rear(187)	M14 x 1.5 x 30.5
TC3579	Lower track control arm(151)	B	Rear(187)	M14 x 1.5 x 30.5
TC3605	Lower track control arm(151)	A B		
TC3611	Trailing arm(226)	A B	Front(108)	
TC3612	Lower track control arm(151)	A B	Rear(187)	
TC3615	Upper track control arm(242)	A	Rear(187)	
TC3616	Upper track control arm(242)	B	Rear(187)	
TC3635	Upper guide rod(236)	A	Front(108)	
TC3636	Upper guide rod(236)	B	Front(108)	
TD708W	Lower hub carrier bush(143)	A B	Centre(-89-)	
TD1630W	Lower track control arm bush(153)	A B	Rear(187) Inner(119) Outer(176)	
TD1638W	Lower track control arm bush(153)	A B	Inner(119)	

2 SERIES (F45, F46 SERIES) 214d 1.5di Active Tourer, Gran Tourer, 216i 1.5 Active Tourer, Gran Tourer, 216d 1.5d Active Tourer, Gran Tourer, 218i 1.5i Active Tourer, Gran Tourer, 218d 2.0d Active Tourer, Gran Tourer, 220i 2.0i Active Tourer, Gran Tourer, 220d 2.0d Active Tourer, Gran Tourer, 225i 2.0i Active Tourer, Gran Tourer (11/13→)



Part No	Description	Pos	Info	Technical
TC3617	Link stabiliser(135)	A B		M10x1.5

2 SERIES (F45, F46 SERIES) 218d 2.0d Active Tourer, Gran Tourer xDrive, 220d 2.0d Active Tourer, Gran Tourer xDrive, 225i 2.0i Active Tourer, Gran Tourer xDrive (11/13→)



Part No	Description	Pos	Info	Technical
TC3617	Link stabiliser(135)	A B		M10x1.5

Part No	Description	Pos	Info	Technical
TC3617	Link stabiliser(135)	A B		M10x1.5

BMW

3 SERIES (E36 SERIES) 316e 1.6i, 316g 1.6i, 316i 1.6i, 318tds 1.7TD, 318i 1.8i, 316i 1.9i, 318i 1.9i, 320i 2.0i, 323i 2.5i, 325i 2.5i, 325td 2.5TD, 325tds 2.5TD, 328i 2.8i (10/91-08/00)

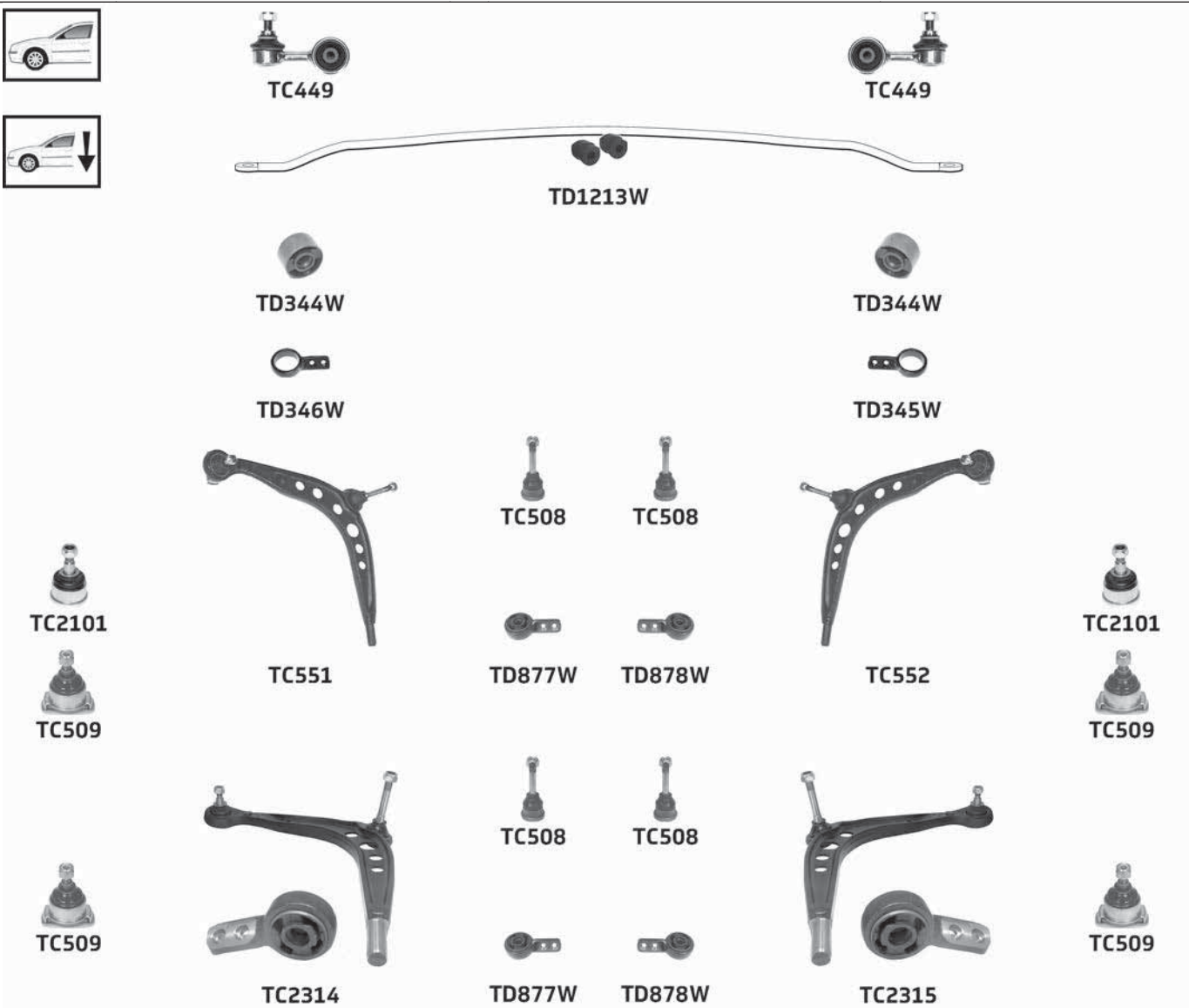
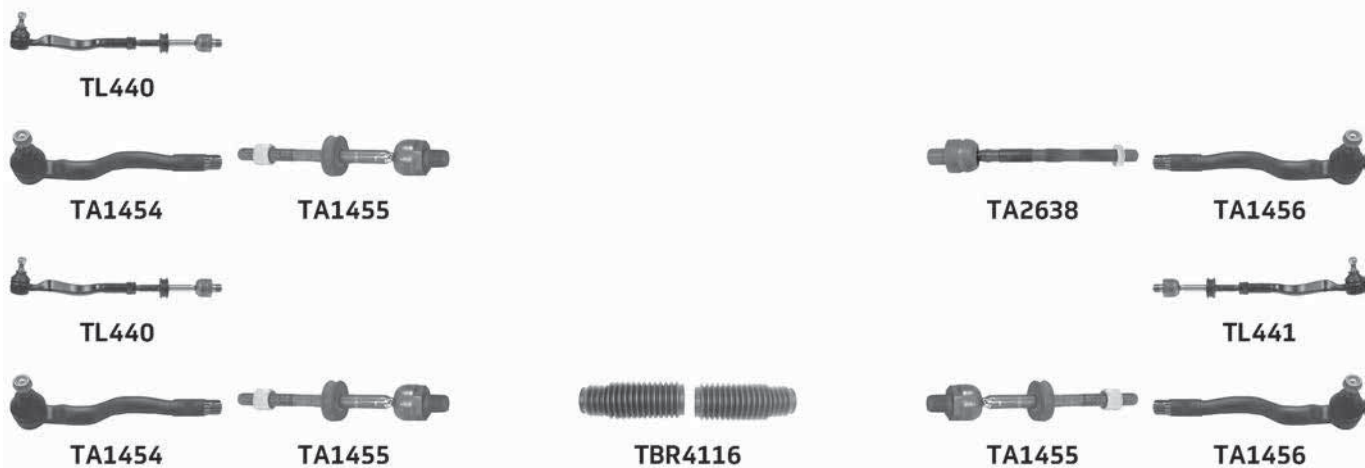

... BMW

... 3 SERIES (E36 SERIES) 316e 1.6i, 316g 1.6i, 316i 1.6i, 318tds 1.7TD, 318i 1.8i, 316i 1.9i, 318i 1.9i, 320i 2.0i, 323i 2.5i, 325i 2.5i, 325td 2.5TD, 325tds 2.5TD, 328i 2.8i (10/91-08/00)



TD549W



TD760W



TC1097



TC1002



TD935W



TD736W



TD872W



TD865W



TD549W



TD760W



TC1097



TC1002



TD667W



TC2232



TD668W



TD668W



TC2232



TD667W

Part No	Description	Pos	Info	Technical
TA1454	Tie rod end(224)	A		M14x1.5 Female(253) £
TA1455	Inner tie rod(123)	A B	Manual steering(170) LH(130) Power steering(185) LH & RH(131)	M14x1.5 Male(252) £
TA1456	Tie rod end(224)	B		M14x1.5 Female(253) £
TA2638	Inner tie rod(123)	B	Manual steering(170)	M14x1.5 Male(252) £
TBR4116	Steering rack gaiter kit(213)	K	Power steering(185)	1 :37x51x51 2 :37x51x51
TC449	Link stabiliser(135)	A B		M10x1.5
TC508	Lower ball joint(140)	A B	Inner part of wishbone(122)	M14x1.5
TC509	Lower ball joint(140)	A B	Outer part of wishbone(177)	M12x1.5
TC551	Lower wishbone(158)	A	(-) Bush(-13) (-) Bracket(-12)	M12x1.5 / M14x1.5
TC552	Lower wishbone(158)	B	(-) Bush(-13) (-) Bracket(-12)	M12x1.5 / M14x1.5
TC1002	Link stabiliser(135)	A B	Compact	
TC1097	Link stabiliser(135)	A B	(-) Compact	
TC2101	Lower ball joint(140)	A B	Outer part of wishbone(177) Heavy duty(111)	M12x1.5
TC2232	Lower track control arm(151)	A B	(-) Compact	
TC2314	Lower wishbone(158)	A	(+) Bush(-42) (+) Bracket(-41)	M12x1.5 / M14x1.5
TC2315	Lower wishbone(158)	B	(+) Bush(-42) (+) Bracket(-41)	M12x1.5 / M14x1.5
TD344W	Lower wishbone bush(159)	A B	Rear(187)	
TD345W	Lower wishbone bush bracket(160)	B		
TD346W	Lower wishbone bush bracket(160)	A		
TD549W	Trailing arm bush(227)	A B	Upper(231) Outer(176) (-) Compact	
TD667W	Lower track control arm bush(153)	A B	Outer(176) (-) Compact	
TD668W	Lower track control arm bush(153)	A B	Inner(119) (-) Compact	
TD736W	Trailing arm bush(227)	A B	Lower(139) Front(108) (-) Compact	
TD760W	Upper track control arm bush(243)	A B	Inner(119) (-) Compact	
TD865W	Axle bush(-76)	A B	Rear(187) (-) Compact	
TD872W	Axle bush(-76)	A B	Front(108) (-) Compact	

... 3 SERIES (E36 SERIES) 316e 1.6i, 316g 1.6i, 316i 1.6i, 318tds 1.7TD, 318i 1.8i, 316i 1.9i, 318i 1.9i, 320i 2.0i, 323i 2.5i, 325i 2.5i, 325td 2.5TD, 325tds 2.5TD, 328i 2.8i (10/91-08/00)

Part No	Description	Pos	Info	Technical
TD877W	Lower wishbone bush(159)	A	Rear(187)	
TD878W	Lower wishbone bush(159)	B	Rear(187)	
TD935W	Anti-roll bar(-74) bush kit(-86)	K	Ø15 Complete axle kit(-92)	
TD1213W	Anti-roll bar(-74) bush kit(-86)	K	Ø24 Complete axle kit(-92) (-) 	
TL440	Rod assembly(194)	A	Manual steering(170) Power steering(185)	M10x1.25
TL441	Rod assembly(194)	B	Power steering(185)	M10x1.25

3 SERIES (E46 SERIES) 316i 1.8i, 1.9i, 318i 1.9i, 2.0i, 320i 2.0i, 318d 2.0TD, 320d 2.0TD, 323i 2.5i, 328i 2.8i (02/98→)



... BMW

... 3 SERIES (E46 SERIES) 316i 1.8i, 1.9i, 318i 1.9i, 2.0i, 320i 2.0i, 318d 2.0TD, 320d 2.0TD, 323i 2.5i, 328i 2.8i (02/98→)



TC932



TC932



TD1165W



TD1647W



TD1204W



TD1169W



TD890W



TC2596



TC2597



TC881



TD407W



TD408W



TC882



TD1047W



TD1047W



TC1727



TD407W



TD408W



TC1728



TD1047W



TD1047W

... 3 SERIES (E46 SERIES) 316i 1.8i, 1.9i, 318i 1.9i, 2.0i, 320i 2.0i, 318d 2.0TD, 320d 2.0TD, 323i 2.5i, 328i 2.8i (02/98→)



TD549W



TD549W



TD760W



TD760W



TC1272



TC1272



TD1212W



TD980W



TD981W



TD730W



TD730W



TD949W



TD949W



TD736W



TD736W



TD667W



TC2232



TD668W



TD668W



TC2232



TD667W

Part No	Description	Pos	Info	Technical
TA1686	Tie rod end(224)	A		M14x1.5 Female(253) £
TA1687	Tie rod end(224)	B		M14x1.5 Female(253) £
TA2037	Inner tie rod(123)	A B		M14x1.5 Male(252) £
TBR4201	Steering rack gaiter kit(213)	K		1 :15x55x55 2 :15x55x55
TC881	Lower wishbone(158)	A	(-) Bush(-13) (-) Sport suspension(-27)	M12x1.5 / M14x1.5
TC882	Lower wishbone(158)	B	(-) Bush(-13) (-) Sport suspension(-27)	M12x1.5 / M14x1.5
TC932	Link stabiliser(135)	A B		M10x1.5
TC1272	Link stabiliser(135)	A B		
TC1727	Lower wishbone(158)	A	(+) Bush(-42) (-) Sport suspension(-27)	M12x1.5 / M14x1.5
TC1728	Lower wishbone(158)	B	(+) Bush(-42) (-) Sport suspension(-27)	M12x1.5 / M14x1.5
TC2232	Lower track control arm(151)	A B		
TC2596	Lower wishbone(158)	A	(-) Bush(-13) Sport suspension(204)	M12x1.5 / M14x1.5
TC2597	Lower wishbone(158)	B	(-) Bush(-13) Sport suspension(204)	M12x1.5 / M14x1.5
TD407W	Lower wishbone bush(159)	A	Rear(187) (+) Housing(-48) (-) Sport suspension(-27)	
TD408W	Lower wishbone bush(159)	B	Rear(187) (+) Housing(-48) (-) Sport suspension(-27)	
TD549W	Trailing arm bush(227)	A B	Upper(231) Outer(176)	
TD667W	Lower track control arm bush(153)	A B	Outer(176)	
TD668W	Lower track control arm bush(153)	A B	Inner(119)	
TD730W	Sub-frame mounting(216)	A B	Front(108) Inner(119)	
TD736W	Trailing arm bush(227)	A B	Lower(139) Front(108)	
TD760W	Upper track control arm bush(243)	A B	Inner(119)	
TD890W	Lower wishbone bush kit(161)	K	Rear(187) (-) Sport suspension(-27)	
TD949W	Sub-frame mounting(216)	A B	Rear(187) Outer(176)	
TD980W	Sub-frame mounting(216)	A	Front(108) Outer(176)	
TD981W	Sub-frame mounting(216)	B	Front(108) Outer(176)	
TD1047W	Lower wishbone bush(159)	A B	Rear(187) (-) Housing(-19)	
TD1165W	Anti-roll bar(-74) bush kit(-86)	K	Ø21.5 Complete axle kit(-92) 320i, 323i, 328i	

(...)

... BMW

... 3 SERIES (E46 SERIES) 316i 1.8i, 1.9i, 318i 1.9i, 2.0i, 320i 2.0i, 318d 2.0TD, 320d 2.0TD, 323i 2.5i, 328i 2.8i (02/98→)

Part No	Description	Pos	Info	Technical
TD1169W	Anti-roll bar (-74) bush kit (-86)	K	Ø24.6 Complete axle kit (-92) 316i, 318i, 318d, 320d	
TD1204W	Anti-roll bar (-74) bush kit (-86)	K	Ø23.0 Complete axle kit (-92) 316i, 318i, 318d, 320i, 320d, 323i, 328i	
TD1212W	Anti-roll bar (-74) bush kit (-86)	K	Ø20 Complete axle kit (-92) (+)  (-) 318Ci	
TD1647W	Anti-roll bar (-74) bush kit (-86)	K	Ø22.5 Complete axle kit (-92) 316i, 318i, 318d, 320d	
TL466	Rod assembly (194)	A		M12x1.5
TL467	Rod assembly (194)	B		M12x1.5

3 SERIES (E46 SERIES) 320i 2.2i, 325i 2.5i, 330i 3.0i (01/00-12/06)



TD1204W



TD890W



TC2596



TC2597



TC881



TD407W

TD408W



TC882



TD1047W

TD1047W



TC1727



TD407W

TD408W



TC1728



TD1047W

TD1047W

... 3 SERIES (E46 SERIES) 320i 2.2i, 325i 2.5i, 330i 3.0i (01/00-12/06)



TD549W



TD760W



TC1272



TD549W



TD760W



TC1272



TD1212W



TD980W



TD730W



TD949W



TD736W



TD981W



TD730W



TD949W



TD736W



TD667W



TC2232



TD668W



TD668W



TC2232



TD667W

Part No	Description	Pos	Info	Technical
TA1686	Tie rod end(224)	A		M14x1.5 Female(253) £
TA1687	Tie rod end(224)	B		M14x1.5 Female(253) £
TA2037	Inner tie rod(123)	A B		M14x1.5 Male(252) £
TBR4201	Steering rack gaiter kit(213)	K		1 :15x55x55 2 :15x55x55
TC881	Lower wishbone(158)	A	(-) Bush(-13) (-) Sport suspension(-27)	M12x1.5 / M14x1.5
TC882	Lower wishbone(158)	B	(-) Bush(-13) (-) Sport suspension(-27)	M12x1.5 / M14x1.5
TC932	Link stabiliser(135)	A B		M10x1.5
TC1272	Link stabiliser(135)	A B		
TC1727	Lower wishbone(158)	A	(+) Bush(-42) (-) Sport suspension(-27)	M12x1.5 / M14x1.5
TC1728	Lower wishbone(158)	B	(+) Bush(-42) (-) Sport suspension(-27)	M12x1.5 / M14x1.5
TC2232	Lower track control arm(151)	A B		
TC2596	Lower wishbone(158)	A	(-) Bush(-13) Sport suspension(204)	M12x1.5 / M14x1.5
TC2597	Lower wishbone(158)	B	(-) Bush(-13) Sport suspension(204)	M12x1.5 / M14x1.5
TD407W	Lower wishbone bush(159)	A	Rear(187) (+) Housing(-48) (-) Sport suspension(-27)	
TD408W	Lower wishbone bush(159)	B	Rear(187) (+) Housing(-48) (-) Sport suspension(-27)	
TD549W	Trailing arm bush(227)	A B	Upper(231) Outer(176)	
TD667W	Lower track control arm bush(153)	A B	Outer(176)	
TD668W	Lower track control arm bush(153)	A B	Inner(119)	
TD730W	Sub-frame mounting(216)	A B	Front(108) Inner(119)	
TD736W	Trailing arm bush(227)	A B	Lower(139) Front(108)	
TD760W	Upper track control arm bush(243)	A B	Inner(119)	
TD890W	Lower wishbone bush kit(161)	K	Rear(187) (-) Sport suspension(-27)	
TD949W	Sub-frame mounting(216)	A B	Rear(187) Outer(176)	
TD980W	Sub-frame mounting(216)	A	Front(108) Outer(176)	
TD981W	Sub-frame mounting(216)	B	Front(108) Outer(176)	
TD1047W	Lower wishbone bush(159)	A B	Rear(187) (-) Housing(-19)	
TD1204W	Anti-roll bar(-74) bush kit(-86)	K	Ø23.0 Complete axle kit(-92)	

(...)

... BMW

... 3 SERIES (E46 SERIES) 320i 2.2i, 325i 2.5i, 330i 3.0i (01/00-12/06)

Part No	Description	Pos	Info	Technical
TD1212W	Anti-roll bar (-74) bush kit (-86)	K	Ø20 Complete axle kit (-92) (+) 	
TL466	Rod assembly(194)	A		M12x1.5
TL467	Rod assembly(194)	B		M12x1.5

3 SERIES (E46 SERIES) 330d 2.9TD, 3.0d (01/99-12/04)

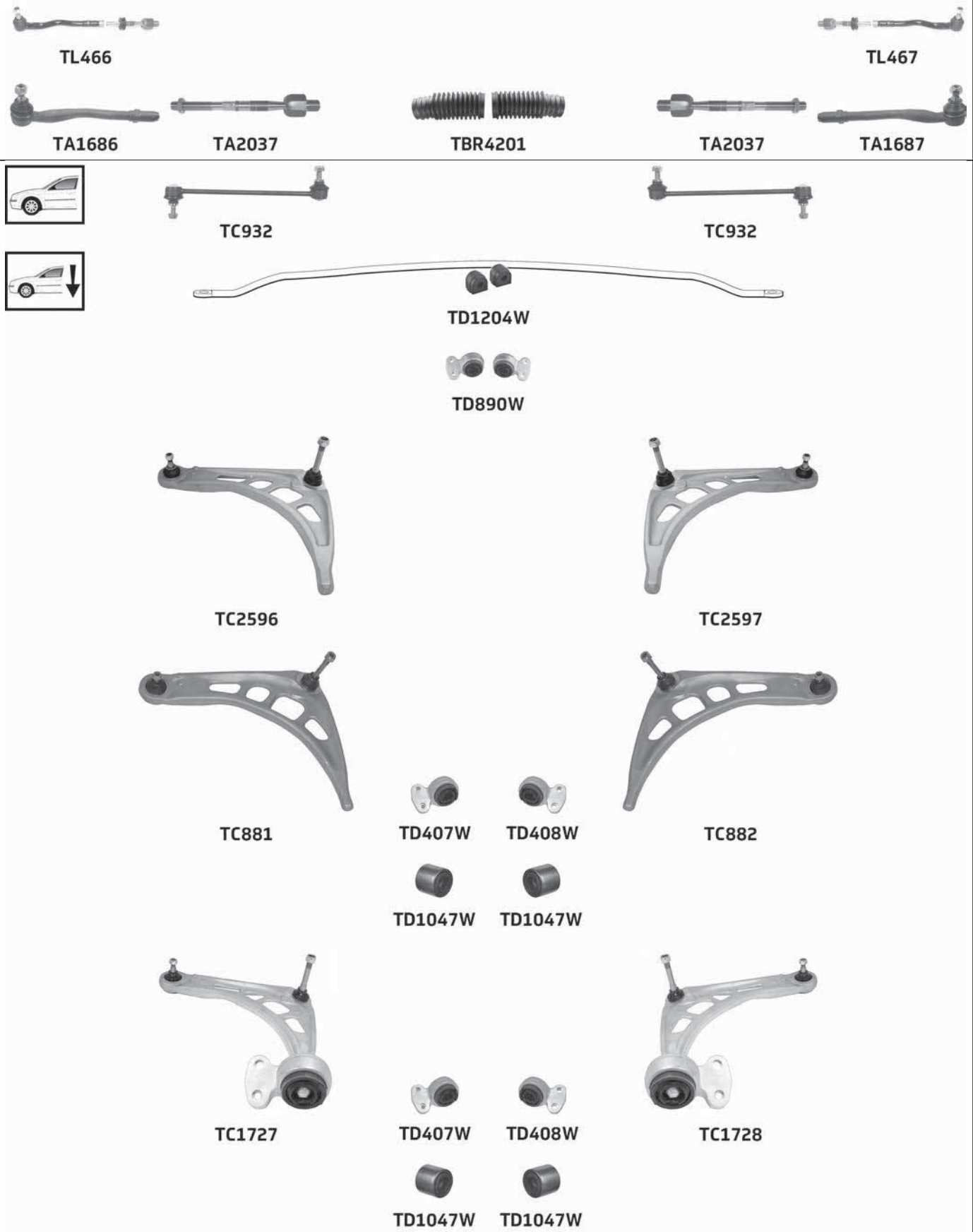

BMW

... 3 SERIES (E46 SERIES) 330d 2.9TD, 3.0d (01/99-12/04)

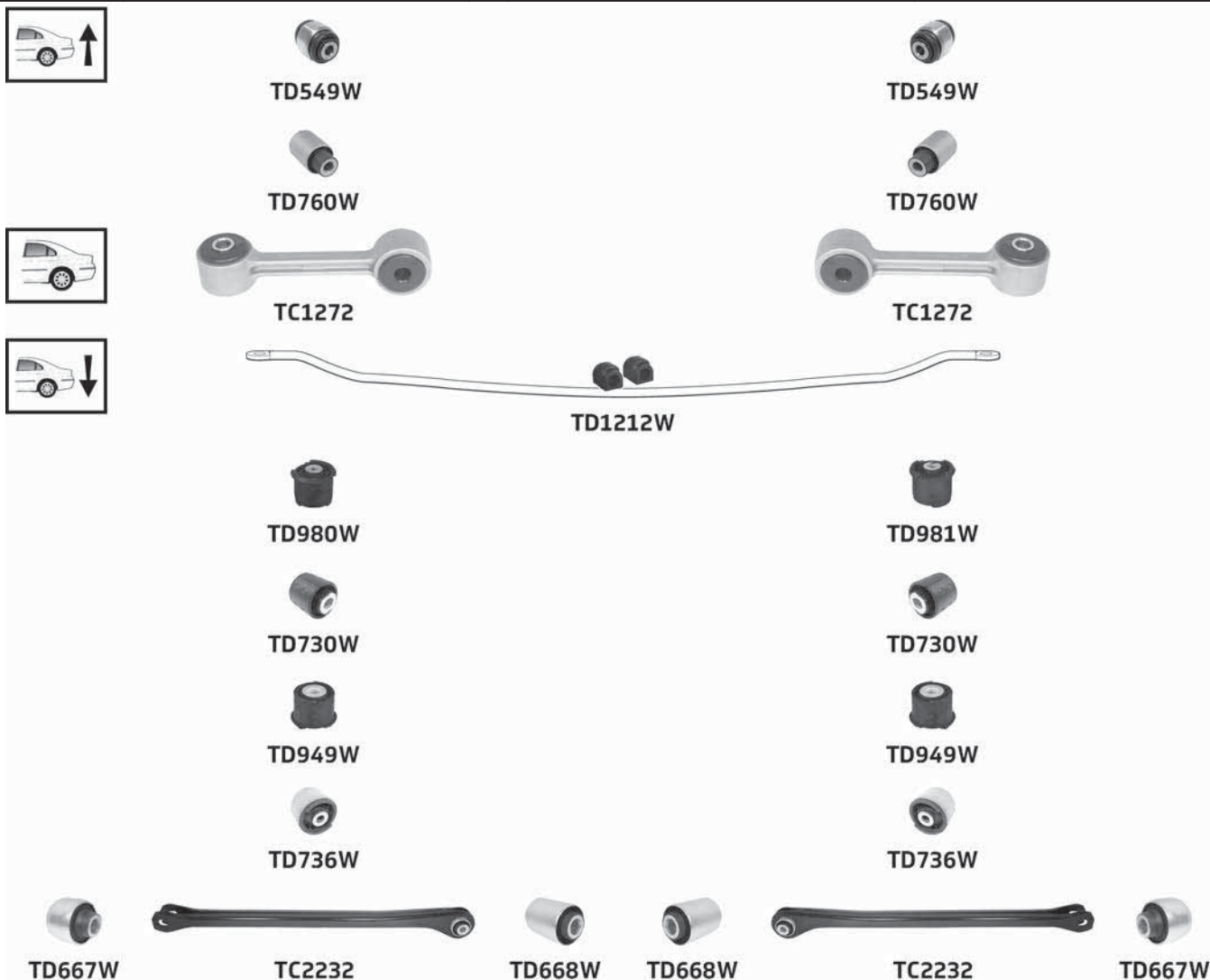

Part No	Description	Pos	Info	Technical
TA1686	Tie rod end(224)	A		M14x1.5 Female(253) £
TA1687	Tie rod end(224)	B		M14x1.5 Female(253) £
TA2037	Inner tie rod(123)	A B		M14x1.5 Male(252) £
TBR4201	Steering rack gaiter kit(213)	K		1 :15x55x55 2 :15x55x55
TC881	Lower wishbone(158)	A	(-) Bush(-13) (-) Sport suspension(-27)	M12x1.5 / M14x1.5
TC882	Lower wishbone(158)	B	(-) Bush(-13) (-) Sport suspension(-27)	M12x1.5 / M14x1.5
TC932	Link stabiliser(135)	A B		M10x1.5
TC1272	Link stabiliser(135)	A B		
TC1727	Lower wishbone(158)	A	(+) Bush(-42) (-) Sport suspension(-27)	M12x1.5 / M14x1.5
TC1728	Lower wishbone(158)	B	(+) Bush(-42) (-) Sport suspension(-27)	M12x1.5 / M14x1.5
TC2232	Lower track control arm(151)	A B		
TC2596	Lower wishbone(158)	A	(-) Bush(-13) Sport suspension(204)	M12x1.5 / M14x1.5
TC2597	Lower wishbone(158)	B	(-) Bush(-13) Sport suspension(204)	M12x1.5 / M14x1.5
TD407W	Lower wishbone bush(159)	A	Rear(187) (+) Housing(-48) (-) Sport suspension(-27)	
TD408W	Lower wishbone bush(159)	B	Rear(187) (+) Housing(-48) (-) Sport suspension(-27)	
TD549W	Trailing arm bush(227)	A B	Upper(231) Outer(176)	
TD667W	Lower track control arm bush(153)	A B	Outer(176)	
TD668W	Lower track control arm bush(153)	A B	Inner(119)	
TD730W	Sub-frame mounting(216)	A B	Front(108) Inner(119)	
TD736W	Trailing arm bush(227)	A B	Lower(139) Front(108)	
TD760W	Upper track control arm bush(243)	A B	Inner(119)	
TD890W	Lower wishbone bush kit(161)	K	Rear(187) (-) Sport suspension(-27)	
TD949W	Sub-frame mounting(216)	A B	Rear(187) Outer(176)	
TD980W	Sub-frame mounting(216)	A	Front(108) Outer(176)	
TD981W	Sub-frame mounting(216)	B	Front(108) Outer(176)	
TD1047W	Lower wishbone bush(159)	A B	Rear(187) (-) Housing(-19)	
TD1204W	Anti-roll bar(-74) bush kit(-86)	K	Ø23.0 Complete axle kit(-92)	
				(...)

... BMW

... 3 SERIES (E46 SERIES) 330d 2.9TD, 3.0d (01/99-12/04)

Part No	Description	Pos	Info	Technical
TD1212W	Anti-roll bar (-74) bush kit (-86)	K	Ø20 Complete axle kit (-92) (+)	
TL466	Rod assembly (194)	A		M12x1.5
TL467	Rod assembly (194)	B		M12x1.5

3 SERIES (E46 SERIES) 325xi 2.5i, 330xi 3.0i, 330xd 3.0TD (06/00→)

TC1800 **TC1801**

TD549W **TD549W**

TD760W **TD760W**

TC1272 **TC1272**

TD1212W

TD980W **TD981W**

TD730W **TD730W**

TD949W **TD949W**

TD736W **TD736W**

TD667W **TC2232** **TD668W** **TD668W** **TC2232** **TD667W**

Part No	Description	Pos	Info	Technical
TC1272	Link stabiliser (135)	A B		
TC1800	Link stabiliser (135)	A		M10x1.5
TC1801	Link stabiliser (135)	B		M10x1.5
TC2232	Lower track control arm (151)	A B		
TD549W	Trailing arm bush (227)	A B	Upper (231) Outer (176)	
TD667W	Lower track control arm bush (153)	A B	Outer (176)	
TD668W	Lower track control arm bush (153)	A B	Inner (119)	
TD730W	Sub-frame mounting (216)	A B	Front (108) Inner (119)	
TD736W	Trailing arm bush (227)	A B	Lower (139) Front (108)	
TD760W	Upper track control arm bush (243)	A B	Inner (119)	
TD949W	Sub-frame mounting (216)	A B	Rear (187) Outer (176)	
TD980W	Sub-frame mounting (216)	A	Front (108) Outer (176)	
TD981W	Sub-frame mounting (216)	B	Front (108) Outer (176)	
TD1212W	Anti-roll bar (-74) bush kit (-86)	K	Ø20 Complete axle kit (-92)	

3 SERIES (E90, E92, E93 SERIES) 316i 1.6i, 316d 2.0d, 318i 2.0i, 318d 2.0d, 320i 2.0i, 320d 2.0d, 323i 2.5i, 325i 2.5i, 3.0i, 325d 3.0d, 328i 3.0i, 330i 3.0i, 330d 3.0d, 335i 3.0i, 335d 3.0d (01/05→)

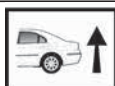

Part No	Description	Pos	Info	Technical
TA2060	Tie rod end (224)	A		M14x1.5 Female (253) E
				(...)

... BMW

... 3 SERIES (E90, E92, E93 SERIES) 316i 1.6i, 316d 2.0d, 318i 2.0i, 318d 2.0d, 320i 2.0i, 320d 2.0d, 323i 2.5i, 325i 2.5i, 3.0i, 325d 3.0d, 328i 3.0i, 330i 3.0i, 330d 3.0d, 335i 3.0i, 335d 3.0d (01/05→)

Part No	Description	Pos	Info	Technical
TA2061	Tie rod end(224)	B		M14x1.5 Female(253) E
TA2062	Inner tie rod(123)	A B	TRW	M14x1.5 Male(252) E
TA2109	Inner tie rod(123)	A B	ZF	M14x1.5 Male(252) E
TBR4200	Steering rack gaiter kit(213)	K	ZF Thermoplastic(223)	1 :15.5x64x64 2 :15.5x64x64
TBR4223	Steering rack gaiter kit(213)	K	TRW Thermoplastic(223)	1 :14x60x60 2 :14x60x60
TC1473	Link stabiliser(135)	A		M10x1.5
TC1474	Link stabiliser(135)	B		M10x1.5
TC1475	Link stabiliser(135)	A B		M10x1.5
TC1476	Lower track control arm(151)	A	Rear(187)	M14x1.5
TC1477	Lower track control arm(151)	B	Rear(187)	M14x1.5
TC1749	Lower track control arm(151)	A	Front(108)	M14x1.5
TC1750	Lower track control arm(151)	B	Front(108)	M14x1.5
TC1917	Lower track control arm(151)	A B	Rear(187)	
TC1918	Upper track control arm(242)	A B	Front(108)	
TC1945	Upper track control arm(242)	A B	Rear(187)	
TD708W	Lower hub carrier bush(143)	A B	Centre(-89-)	
TD861W	Lower track control arm bush(153)	A B	Front(108)	
TD1124W	Upper track control arm bush(243)	A B	Outer(176)	
TD1125W	Upper track control arm bush(243)	A B	Inner(119)	
TD1136W	Anti-roll bar(-74-) bush kit(-86-)	K	Ø26.5 Complete axle kit(-92-) →05/10	
TD1462W	Anti-roll bar(-74-) bush kit(-86-)	K	Ø14 Complete axle kit(-92-) (-) E92 (+) M-Sport Suspension →03/07	
TD1616W	Lower hub carrier bush(143)	A B	Front(108)	
TD1616W	Sub-frame mounting(216)	A B	Front(108) Outer(176)	
TD1634W	Anti-roll bar(-74-) bush kit(-86-)	K	Ø13 Complete axle kit(-92-)	

3 SERIES (E91 SERIES) 316i 1.6i Touring, 316d 2.0d Touring, 318i 2.0i Touring, 318d 2.0d Touring, 320i 2.0i Touring, 320d 2.0d Touring, 323i 2.5i Touring, 325i 2.5i Touring, 3.0i Touring, 325d 3.0d Touring, 328i 3.0i Touring, 330i 3.0i Touring, 330d 3.0d Touring, 335i 3.0i Touring, 335d 3.0d Touring (01/05→)

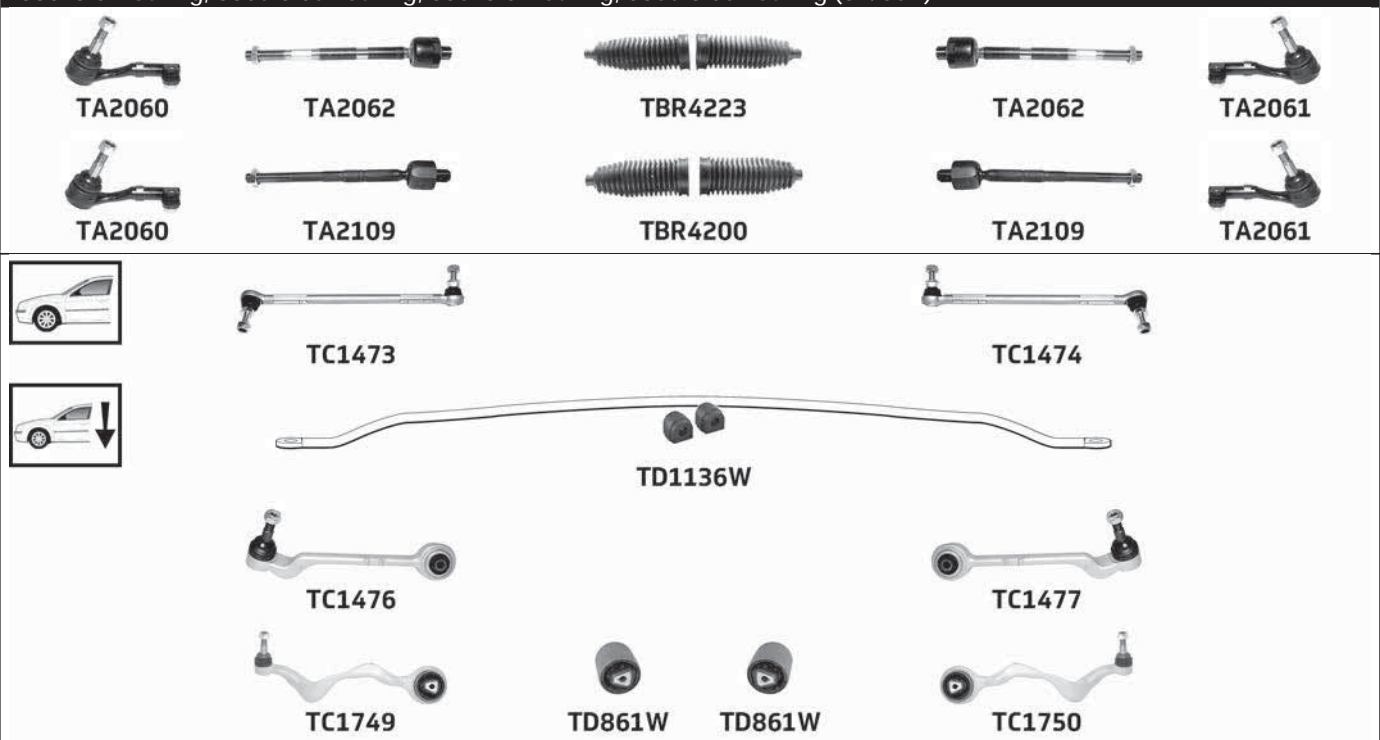

... 3 SERIES (E91 SERIES) 316i 1.6i Touring, 316d 2.0d Touring, 318i 2.0i Touring, 318d 2.0d Touring, 320i 2.0i Touring, 320d 2.0d Touring, 323i 2.5i Touring, 325i 2.5i Touring, 3.0i Touring, 325d 3.0d Touring, 328i 3.0i Touring, 330i 3.0i Touring, 330d 3.0d Touring, 335i 3.0i Touring, 335d 3.0d Touring (01/05→)

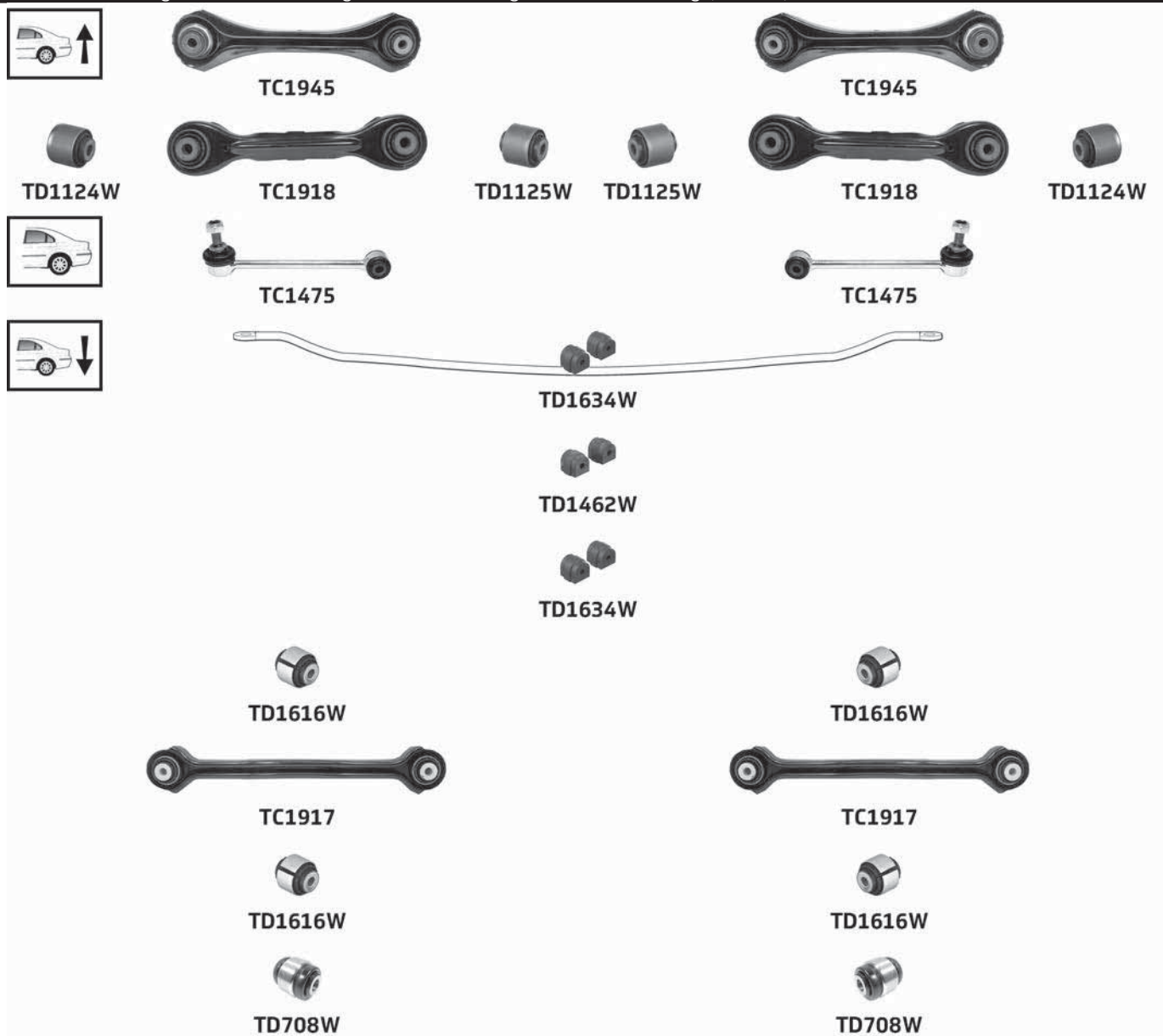

Part No	Description	Pos	Info	Technical
TA2060	Tie rod end (224)	A		M14x1.5 Female (253) £
TA2061	Tie rod end (224)	B		M14x1.5 Female (253) £
TA2062	Inner tie rod (123)	A B	TRW	M14x1.5 Male (252) £
TA2109	Inner tie rod (123)	A B	ZF	M14x1.5 Male (252) £
TBR4200	Steering rack gaiter kit (213)	K	ZF Thermoplastic (223)	1 :15.5x64x64 2 :15.5x64x64
TBR4223	Steering rack gaiter kit (213)	K	TRW Thermoplastic (223)	1 :14x60x60 2 :14x60x60
TC1473	Link stabiliser (135)	A		M10x1.5
TC1474	Link stabiliser (135)	B		M10x1.5
TC1475	Link stabiliser (135)	A B		M10x1.5
TC1476	Lower track control arm (151)	A	Rear (187)	M14x1.5
TC1477	Lower track control arm (151)	B	Rear (187)	M14x1.5
TC1749	Lower track control arm (151)	A	Front (108)	M14x1.5
TC1750	Lower track control arm (151)	B	Front (108)	M14x1.5
TC1917	Lower track control arm (151)	A B	Rear (187)	
TC1918	Upper track control arm (242)	A B	Front (108)	
TC1945	Upper track control arm (242)	A B	Rear (187)	
TD708W	Lower hub carrier bush (143)	A B	Centre (-89-)	
TD861W	Lower track control arm bush (153)	A B	Front (108)	
TD1124W	Upper track control arm bush (243)	A B	Outer (176)	
TD1125W	Upper track control arm bush (243)	A B	Inner (119)	
				(...)

... BMW

... 3 SERIES (E91 SERIES) 316i 1.6i Touring, 316d 2.0d Touring, 318i 2.0i Touring, 318d 2.0d Touring, 320i 2.0i Touring, 320d 2.0d Touring, 323i 2.5i Touring, 325i 2.5i Touring, 3.0i Touring, 325d 3.0d Touring, 328i 3.0i Touring, 330i 3.0i Touring, 330d 3.0d Touring, 335i 3.0i Touring, 335d 3.0d Touring (01/05→)

Part No	Description	Pos	Info	Technical
TD1136W	Anti-roll bar (-74) bush kit (-86)	K	Ø26.5 Complete axle kit (-92) →05/10	
TD1462W	Anti-roll bar (-74) bush kit (-86)	K	Ø14 Complete axle kit (-92) 320d, 323i, 325i, 330d, 330i (+) Panoramic roof →01/06	
TD1616W	Lower hub carrier bush (143)	A B	Front (108)	
TD1616W	Sub-frame mounting (216)	A B	Front (108)	
TD1634W	Anti-roll bar (-74) bush kit (-86)	K	Ø13 Complete axle kit (-92) 320d, 323i, 325i, 330d, 330i (+) Panoramic roof 01/06→	

3 SERIES (E90, E91, E92 SERIES) 320xd 2.0d, 325xi 2.5i, 3.0i, 330xi 3.0i, 330xd 3.0d, 335xi 3.0i, 335xd 3.0d 4x4 (01/05→)

TA2807 TA3230 TBR4200 TA3230 TA2808

TC2515 TC2516

TC2980 TC2980

TC2064 TC3230 TC3231 TC2064

TC1945 TC1945

TD1124W TC1918 TD1125W TD1125W TC1918 TD1124W

TC1475 TC1475

TD1634W

TD1616W TD1616W

TC1917 TC1917

TD1616W TD1616W

TD708W TD708W

Part No	Description	Pos	Info	Technical
TA2807	Tie rod end (224)	A		M14x1.5 Female (253) £
TA2808	Tie rod end (224)	B		M14x1.5 Female (253) £
TA3230	Inner tie rod (123)	A B		M14x1.5 Male (252) £
TBR4200	Steering rack gaiter kit (213)	K	ZF Thermoplastic (223)	1 :15.5x64x64 2 :15.5x64x64

BMW

... 3 SERIES (E90, E91, E92 SERIES) 320xd 2.0d, 325xi 2.5i, 3.0i, 330xi 3.0i, 330xd 3.0d, 335xi 3.0i, 335xd 3.0d 4x4 (01/05→)

Part No	Description	Pos	Info	Technical
TC1475	Link stabiliser(135)	A B		M10x1.5
TC1917	Lower track control arm(151)	A B	Rear(187)	
TC1918	Upper track control arm(242)	A B	Front(108)	
TC1945	Upper track control arm(242)	A B	Rear(187)	
TC2064	Lower ball joint(140)	A B	Rear(187)	M14x1.5
TC2515	Link stabiliser(135)	A		M10x1.5
TC2516	Link stabiliser(135)	B		M10x1.5
TC2980	Lower track control arm(151)	A B	Front(108)	M14x1.5
TC3230	Lower track control arm(151)	A	Rear(187) (-) Ball joint(-11)	
TC3231	Lower track control arm(151)	B	Rear(187) (-) Ball joint(-11)	
TD708W	Lower hub carrier bush(143)	A B	Centre(-89)	
TD1124W	Upper track control arm bush(243)	A B	Outer(176)	
TD1125W	Upper track control arm bush(243)	A B	Inner(119)	
TD1616W	Lower hub carrier bush(143)	A B	Front(108)	
TD1616W	Sub-frame mounting(216)	A B	Front(108)	
TD1634W	Anti-roll bar(-74) bush kit(-86)	K	Ø13 Complete axle kit(-92)	

3 SERIES (F30, F31 SERIES) 316i 1.6i (-) xDrive, 2.0d (-) xDrive, 2.0d (-) xDrive, 2.0i (-) xDrive, 2.0d (-) xDrive, 2.0d (-) xDrive, 2.0i (-) xDrive, 2.0i (-) xDrive, 3.0d (-) xDrive, 3.0i (-) xDrive, 3.0i (-) xDrive (10/11→)



... BMW

... 3 SERIES (F30, F31 SERIES) 316i 1.6i (-) xDrive, 2.0d (-) xDrive, 2.0d (-) xDrive, 2.0i (-) xDrive, 2.0d (-) xDrive, 2.0d (-) xDrive, 2.0i (-) xDrive, 2.0i (-) xDrive, 3.0d (-) xDrive, 3.0i (-) xDrive, 3.0i (-) xDrive (10/11→)



TC3635



TC3636



TC3615



TC3616



TC2536



TC2537



TC3611



TC3611



TC3605



TC3605



TD708W



TD708W



TD1630W



TC3612



TD1630W



TD1630W



TC3612



TD1630W

Part No	Description	Pos	Info	Technical
TA3170	Inner tie rod(123)	A B		M14x1.5 Male(252) £
TA3220	Tie rod end(224)	A		M14x1.5 Female(253) £
TA3221	Tie rod end(224)	B		M14x1.5 Female(253) £
TC2536	Link stabiliser(135)	A		M10x1.5
TC2537	Link stabiliser(135)	B		M10x1.5
TC2645	Link stabiliser(135)	A		M10x1.5
TC2645	Link stabiliser(135)	B	(-) Adaptive M chassis	M10x1.5
TC2646	Link stabiliser(135)	B	(+) Adaptive M chassis	M10x1.5
TC3605	Lower track control arm(151)	A B		
TC3609	Lower track control arm(151)	A	Rear(187)	M14x1.5
TC3610	Lower track control arm(151)	B	Rear(187)	M14x1.5
TC3611	Trailing arm(226)	A B	Front(108)	
TC3612	Lower track control arm(151)	A B	Rear(187)	
TC3615	Upper track control arm(242)	A	Rear(187)	
TC3616	Upper track control arm(242)	B	Rear(187)	
TC3635	Upper guide rod(236)	A	Front(108)	
TC3636	Upper guide rod(236)	B	Front(108)	
TD708W	Lower hub carrier bush(143)	A B	Centre(-89-)	
TD1630W	Lower track control arm bush(153)	A B	Rear(187) Inner(119) Outer(176)	
TL611	Rod assembly(194)	A		
TL612	Rod assembly(194)	B		

3 SERIES (F30, F31 SERIES) 318d 2.0d, 320i 2.0i, 320d 2.0d, 328i 2.0i, 330i 2.0i, 330d 3.0d, 335i 3.0i, 335d 3.0d, 340i 3.0i xDrive (10/11→)

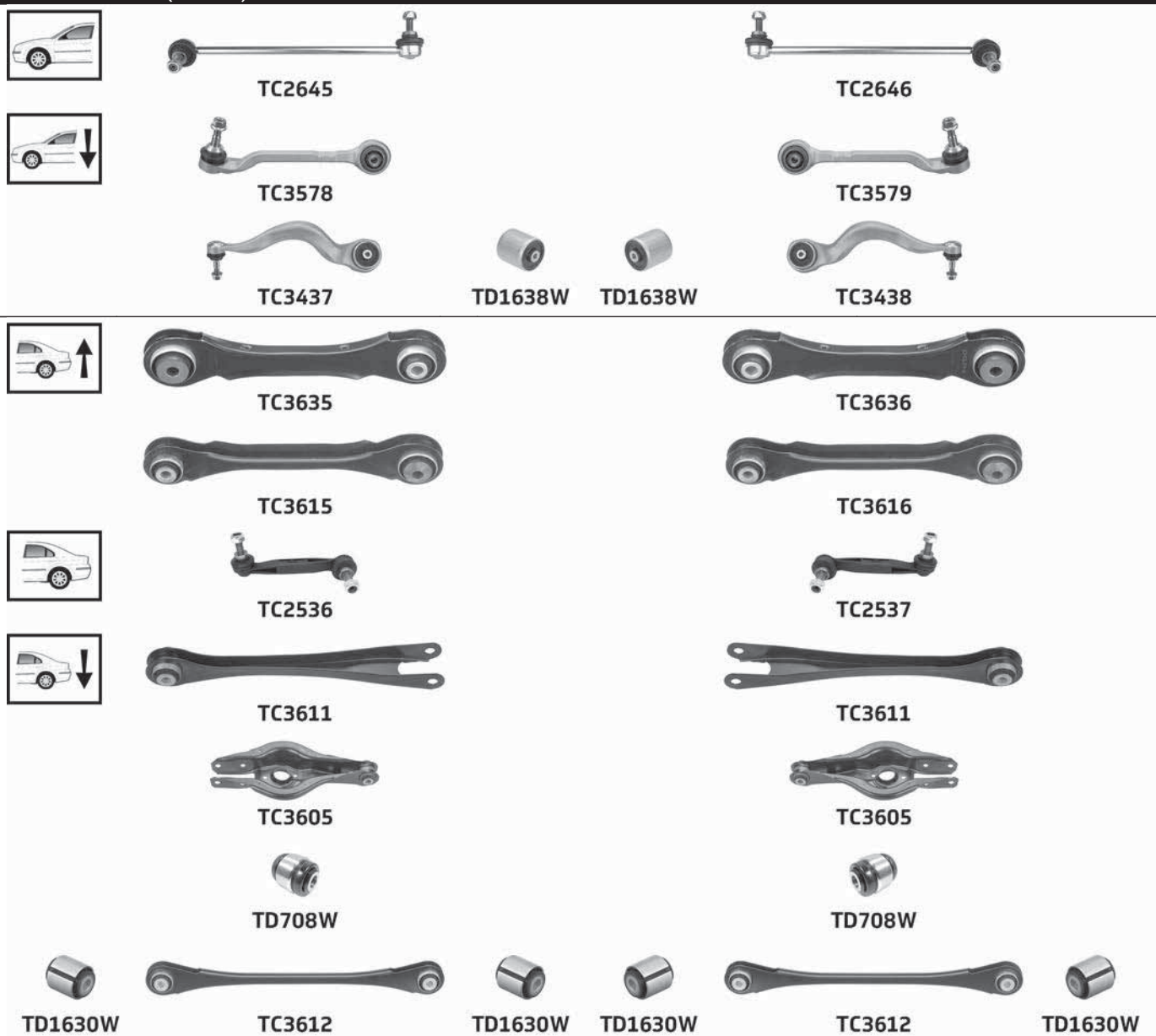

Part No	Description	Pos	Info	Technical
TC2536	Link stabiliser (135)	A		M10x1.5
TC2537	Link stabiliser (135)	B		M10x1.5
TC2645	Link stabiliser (135)	A		M10x1.5
TC2646	Link stabiliser (135)	B		M10x1.5
TC3437	Lower track control arm (151)	A	Front (108)	M14x1.5
TC3438	Lower track control arm (151)	B	Front (108)	M14x1.5
TC3578	Lower track control arm (151)	A	Rear (187)	M14 x 1.5 x 30.5
TC3579	Lower track control arm (151)	B	Rear (187)	M14 x 1.5 x 30.5
TC3605	Lower track control arm (151)	A B		
TC3611	Trailing arm (226)	A B	Front (108)	
TC3612	Lower track control arm (151)	A B	Rear (187)	
TC3615	Upper track control arm (242)	A	Rear (187)	
TC3616	Upper track control arm (242)	B	Rear (187)	
TC3635	Upper guide rod (236)	A	Front (108)	
TC3636	Upper guide rod (236)	B	Front (108)	
TD708W	Lower hub carrier bush (143)	A B	Centre (-89°)	
TD1630W	Lower track control arm bush (153)	A B	Rear (187) Inner (119) Outer (176)	
TD1638W	Lower track control arm bush (153)	A B	Inner (119)	

... BMW

3 SERIES (F34 SERIES) 318d 2.0d (-) xDrive, 2.0i (-) xDrive, 2.0d (-) xDrive, 2.0d (-) xDrive, 2.0i (-) xDrive, 2.0i (-) xDrive, 3.0d (-) xDrive, 3.0i (-) xDrive, 3.0i (-) xDrive (03/13→)

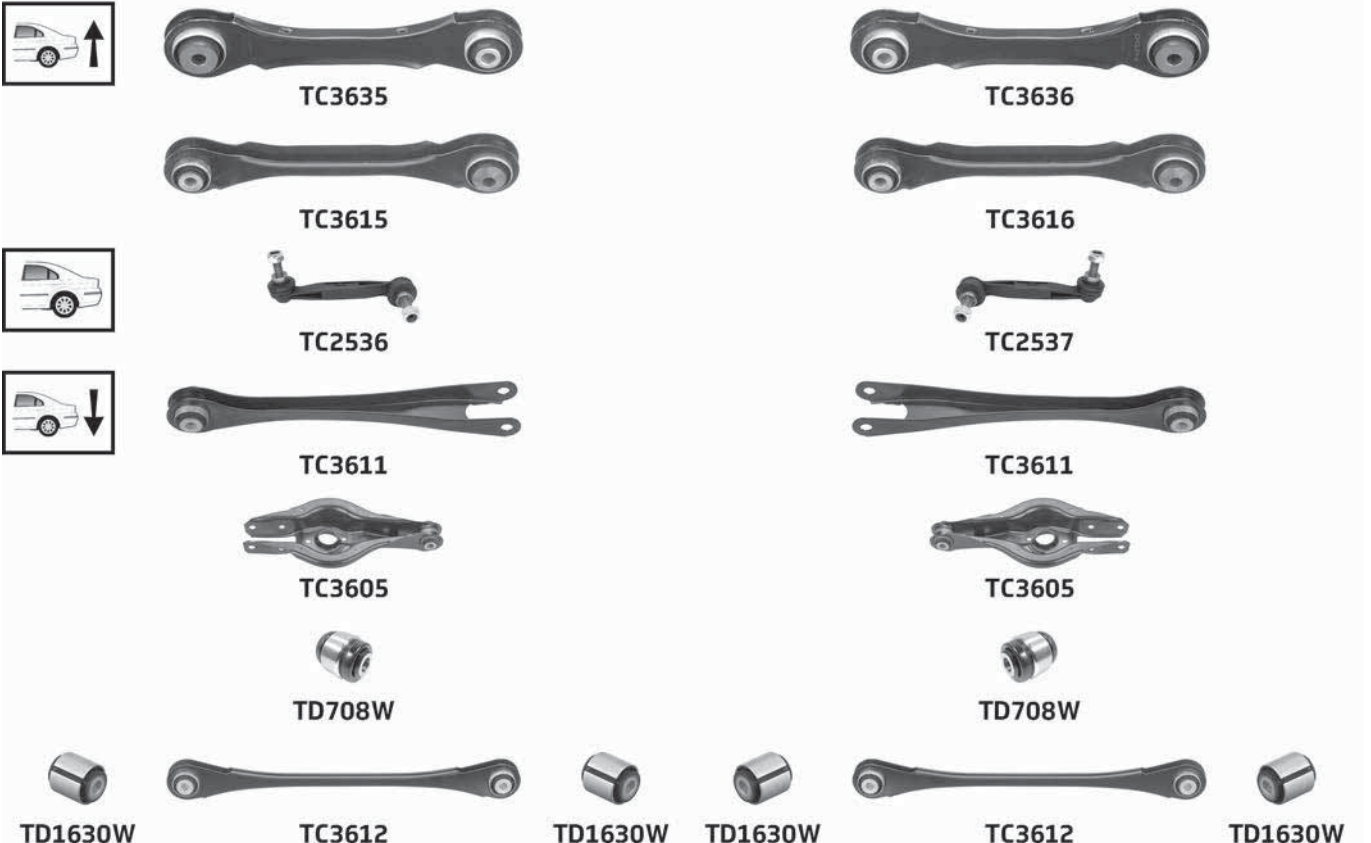

Part No	Description	Pos	Info	Technical
TA3170	Inner tie rod(123)	A B		M14x1.5 Male(252) E
TA3220	Tie rod end(224)	A		M14x1.5 Female(253) E
TA3221	Tie rod end(224)	B		M14x1.5 Female(253) E
TC2536	Link stabiliser(135)	A		M10x1.5
TC2537	Link stabiliser(135)	B		M10x1.5
TC2645	Link stabiliser(135)	A		M10x1.5
TC2645	Link stabiliser(135)	B	(-) Adaptive M chassis	M10x1.5
TC2646	Link stabiliser(135)	B	(+) Adaptive M chassis	M10x1.5
TC3605	Lower track control arm(151)	A B		
TC3609	Lower track control arm(151)	A	Rear(187)	M14x1.5
TC3610	Lower track control arm(151)	B	Rear(187)	M14x1.5
TC3611	Trailing arm(226)	A B	Front(108)	
TC3612	Lower track control arm(151)	A B	Rear(187)	
TC3615	Upper track control arm(242)	A	Rear(187)	

... 3 SERIES (F34 SERIES) 318d 2.0d (-) xDrive, 2.0i (-) xDrive, 2.0d (-) xDrive, 2.0d (-) xDrive, 2.0i (-) xDrive, 2.0i (-) xDrive, 3.0d (-) xDrive, 3.0i (-) xDrive, 3.0i (-) xDrive (03/13→)

Part No	Description	Pos	Info	Technical
TC3616	Upper track control arm(242)	B	Rear(187)	
TC3635	Upper guide rod(236)	A	Front(108)	
TC3636	Upper guide rod(236)	B	Front(108)	
TD708W	Lower hub carrier bush(143)	A B	Centre(-89-)	
TD1630W	Lower track control arm bush(153)	A B	Rear(187) Inner(119) Outer(176)	
TL611	Rod assembly(194)	A		
TL612	Rod assembly(194)	B		

3 SERIES (F34 SERIES) 320i 2.0i, 320d 2.0d, 328i 2.0i, 330d 3.0d, 335i 3.0i, 335d 3.0d, 340i 3.0i xDrive | Gran Turismo (03/13→)

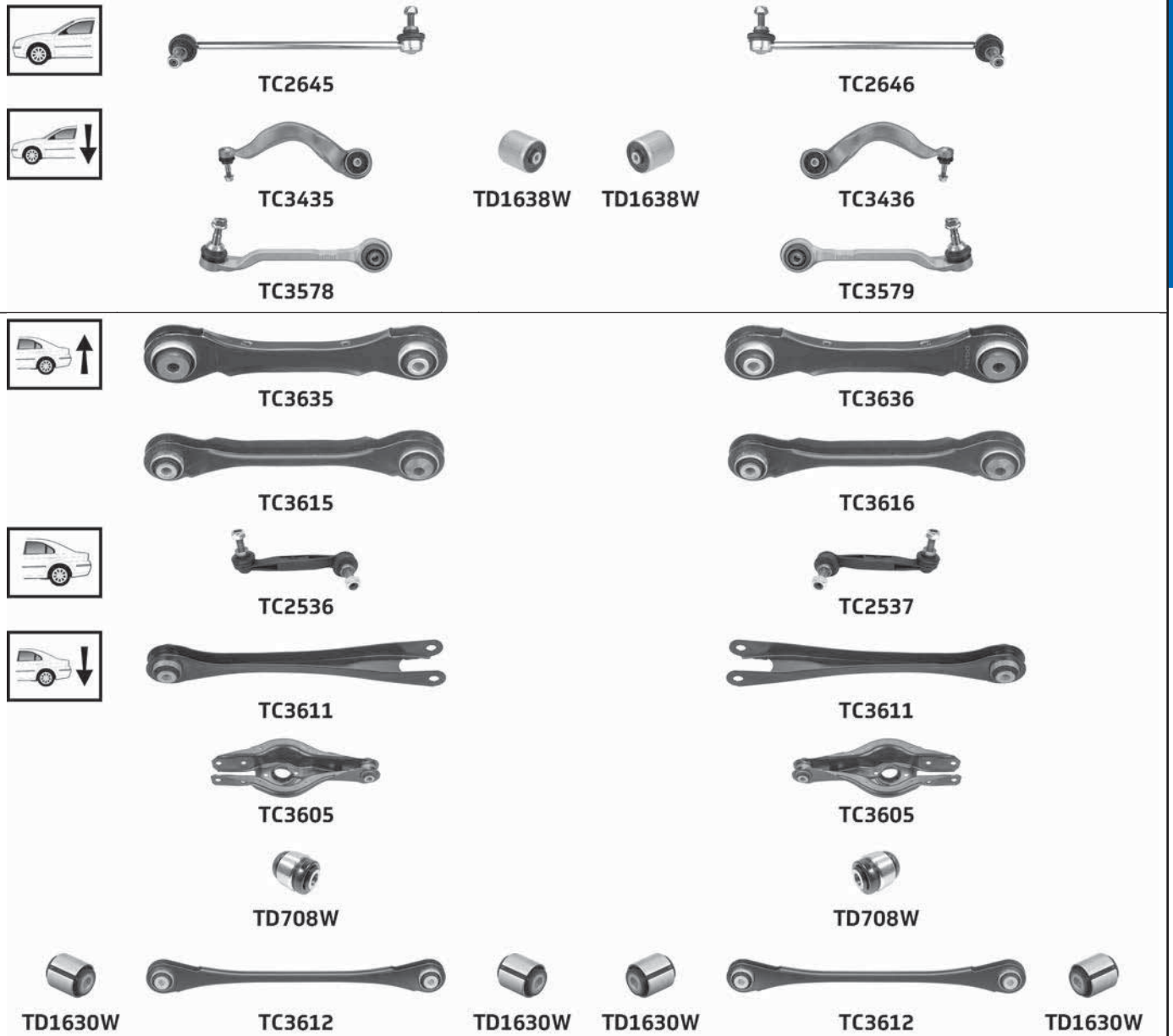

Part No	Description	Pos	Info	Technical
TC2536	Link stabiliser(135)	A		M10x1.5
TC2537	Link stabiliser(135)	B		M10x1.5
TC2645	Link stabiliser(135)	A		M10x1.5
TC2646	Link stabiliser(135)	B		M10x1.5
TC3435	Lower track control arm(151)	A	Front(108)	M14x1.5
TC3436	Lower track control arm(151)	B	Front(108)	M14x1.5
TC3578	Lower track control arm(151)	A	Rear(187)	M14 x 1.5 x 30.5
TC3579	Lower track control arm(151)	B	Rear(187)	M14 x 1.5 x 30.5
TC3605	Lower track control arm(151)	A B		
TC3611	Trailing arm(226)	A B	Front(108)	
TC3612	Lower track control arm(151)	A B	Rear(187)	
TC3615	Upper track control arm(242)	A	Rear(187)	

(...)

... BMW

... 3 SERIES (F34 SERIES) 320i 2.0i, 320d 2.0d, 328i 2.0i, 330d 3.0d, 335i 3.0i, 335d 3.0d,
340i 3.0i xDrive | Gran Turismo (03/13→)

Part No	Description	Pos	Info	Technical
TC3616	Upper track control arm(242)	B	Rear(187)	
TC3635	Upper guide rod(236)	A	Front(108)	
TC3636	Upper guide rod(236)	B	Front(108)	
TD708W	Lower hub carrier bush(143)	A B	Centre(-89→)	
TD1630W	Lower track control arm bush(153)	A B	Rear(187) Inner(119) Outer(176)	
TD1638W	Lower track control arm bush(153)	A B	Inner(119)	

4 SERIES (F32, F33 SERIES) 420i 2.0i (-) xDrive, 420d 2.0d (-) xDrive, 425d 2.0d (-) xDrive, 428i 2.0i (-) xDrive,
430i 2.0i (-) xDrive, 430d 3.0d (-) xDrive, 435i 3.0i (-) xDrive, 435d 3.0d (-) xDrive, 440i 3.0i (-) xDrive (07/13→)

TL611	TL612				
TA3220	TA3170				
TA3170	TA3221				
TC2645	TC2645				
TC2645	TC2646				
TC3609	TC3610				
TC3635	TC3636				
TC3615	TC3616				
TC2536	TC2537				
TC3611	TC3611				
TC3605	TC3605				
TD708W	TD708W				
TD1630W	TC3612	TD1630W	TD1630W	TC3612	TD1630W

Part No	Description	Pos	Info	Technical
TA3170	Inner tie rod(123)	A B		M14x1.5 Male(252) E
TA3220	Tie rod end(224)	A		M14x1.5 Female(253) E
TA3221	Tie rod end(224)	B		M14x1.5 Female(253) E
TC2536	Link stabiliser(135)	A		M10x1.5
TC2537	Link stabiliser(135)	B		M10x1.5

... 4 SERIES (F32, F33 SERIES) 420i 2.0i (-) xDrive, 420d 2.0d (-) xDrive, 425d 2.0d (-) xDrive, 428i 2.0i (-) xDrive, 430i 2.0i (-) xDrive, 430d 3.0d (-) xDrive, 435i 3.0i (-) xDrive, 435d 3.0d (-) xDrive, 440i 3.0i (-) xDrive (07/13→)

TC2645	Link stabiliser (135)	A		M10x1.5
TC2645	Link stabiliser (135)	B	(-) Adaptive M chassis	M10x1.5
TC2646	Link stabiliser (135)	B	(+) Adaptive M chassis	M10x1.5
TC3605	Lower track control arm (151)	A B		
TC3609	Lower track control arm (151)	A	Rear (187)	M14x1.5
TC3610	Lower track control arm (151)	B	Rear (187)	M14x1.5
TC3611	Trailing arm (226)	A B	Front (108)	
TC3612	Lower track control arm (151)	A B	Rear (187)	
TC3615	Upper track control arm (242)	A	Rear (187)	
TC3616	Upper track control arm (242)	B	Rear (187)	
TC3635	Upper guide rod (236)	A	Front (108)	
TC3636	Upper guide rod (236)	B	Front (108)	
TD708W	Lower hub carrier bush (143)	A B	Centre (-89-)	
TD1630W	Lower track control arm bush (153)	A B	Rear (187) Inner (119) Outer (176)	
TL611	Rod assembly (194)	A		
TL612	Rod assembly (194)	B		

4 SERIES (F32, F33 SERIES) 420i 2.0i, 420d 2.0d, 428i 2.0i, 430i 2.0i, 430d 3.0d, 435i 3.0i, 435d 3.0d, 440i 3.0i xDrive (07/13→)

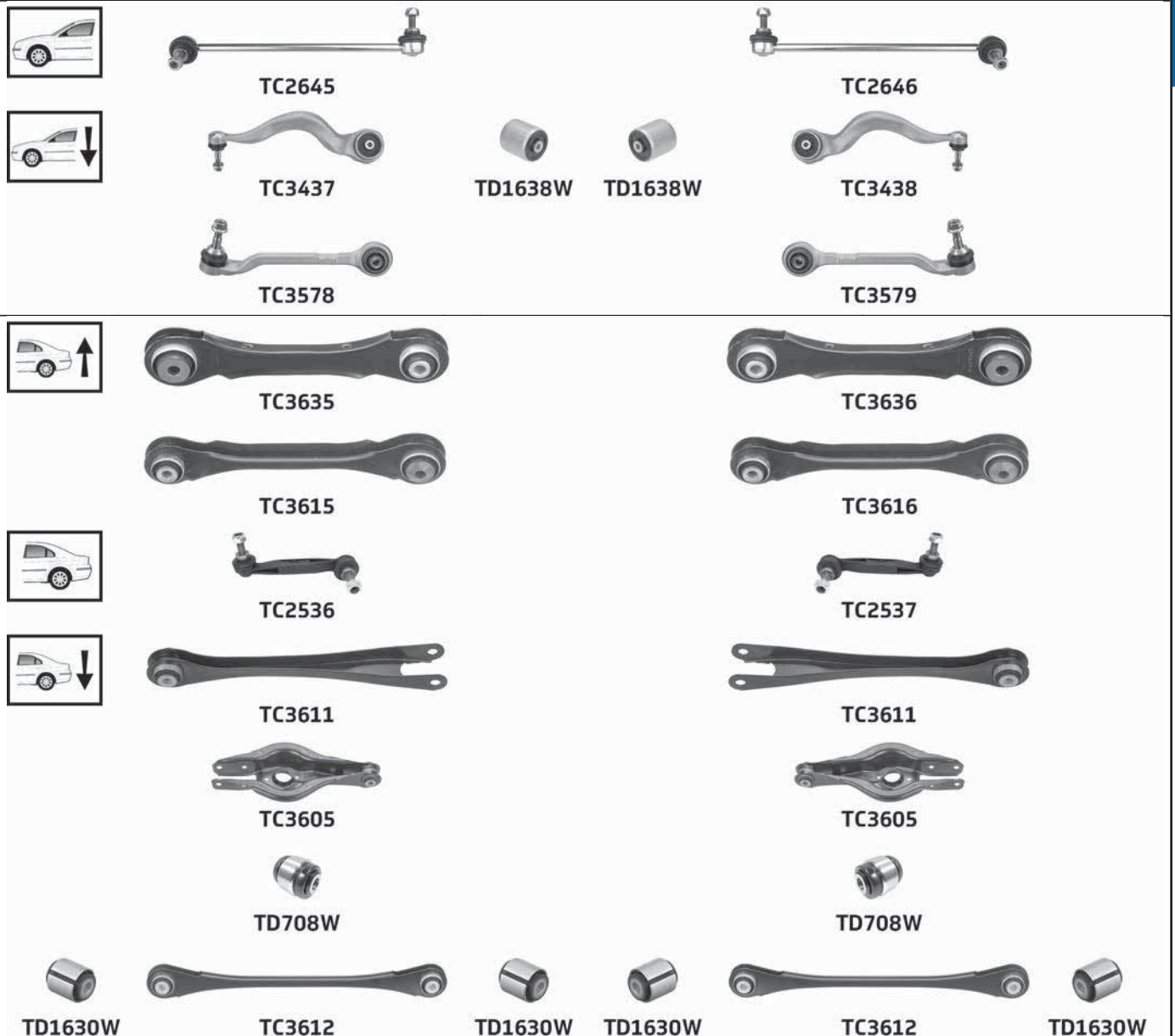

Part No	Description	Pos	Info	Technical
TC2536	Link stabiliser (135)	A		M10x1.5
TC2537	Link stabiliser (135)	B		M10x1.5
TC2645	Link stabiliser (135)	A		M10x1.5
				(...)

... BMW

... 4 SERIES (F32, F33 SERIES) 420i 2.0i, 420d 2.0d, 428i 2.0i, 430i 2.0i, 430d 3.0d, 435i 3.0i, 435d 3.0d, 440i 3.0i xDrive (07/13→)

Part No	Description	Pos	Info	Technical
TC2646	Link stabiliser(135)	B		M10x1.5
TC3437	Lower track control arm(151)	A	Front(108)	M14x1.5
TC3438	Lower track control arm(151)	B	Front(108)	M14x1.5
TC3578	Lower track control arm(151)	A	Rear(187)	M14 x 1.5 x 30.5
TC3579	Lower track control arm(151)	B	Rear(187)	M14 x 1.5 x 30.5
TC3605	Lower track control arm(151)	A B		
TC3611	Trailing arm(226)	A B	Front(108)	
TC3612	Lower track control arm(151)	A B	Rear(187)	
TC3615	Upper track control arm(242)	A	Rear(187)	
TC3616	Upper track control arm(242)	B	Rear(187)	
TC3635	Upper guide rod(236)	A	Front(108)	
TC3636	Upper guide rod(236)	B	Front(108)	
TD708W	Lower hub carrier bush(143)	A B	Centre(-89-)	
TD1630W	Lower track control arm bush(153)	A B	Rear(187) Inner(119) Outer(176)	
TD1638W	Lower track control arm bush(153)	A B	Inner(119)	

4 SERIES (F36 SERIES) 418d 2.0d, 420i 2.0i, 420d 2.0d, 428i 2.0i, 430i 2.0i, 430d 3.0d, 435i 3.0i, 440i 3.0i Gran Coupé (10/13→)



TL611



TL612



TA3220



TA3170



TA3170



TA3221



TC2645



TC2645



TC2645



TC2646



TC3609



TC3610

... 4 SERIES (F36 SERIES) 418d 2.0d, 420i 2.0i, 420d 2.0d, 428i 2.0i, 430i 2.0i, 430d 3.0d, 435i 3.0i, 440i 3.0i Gran Coupé (10/13→)

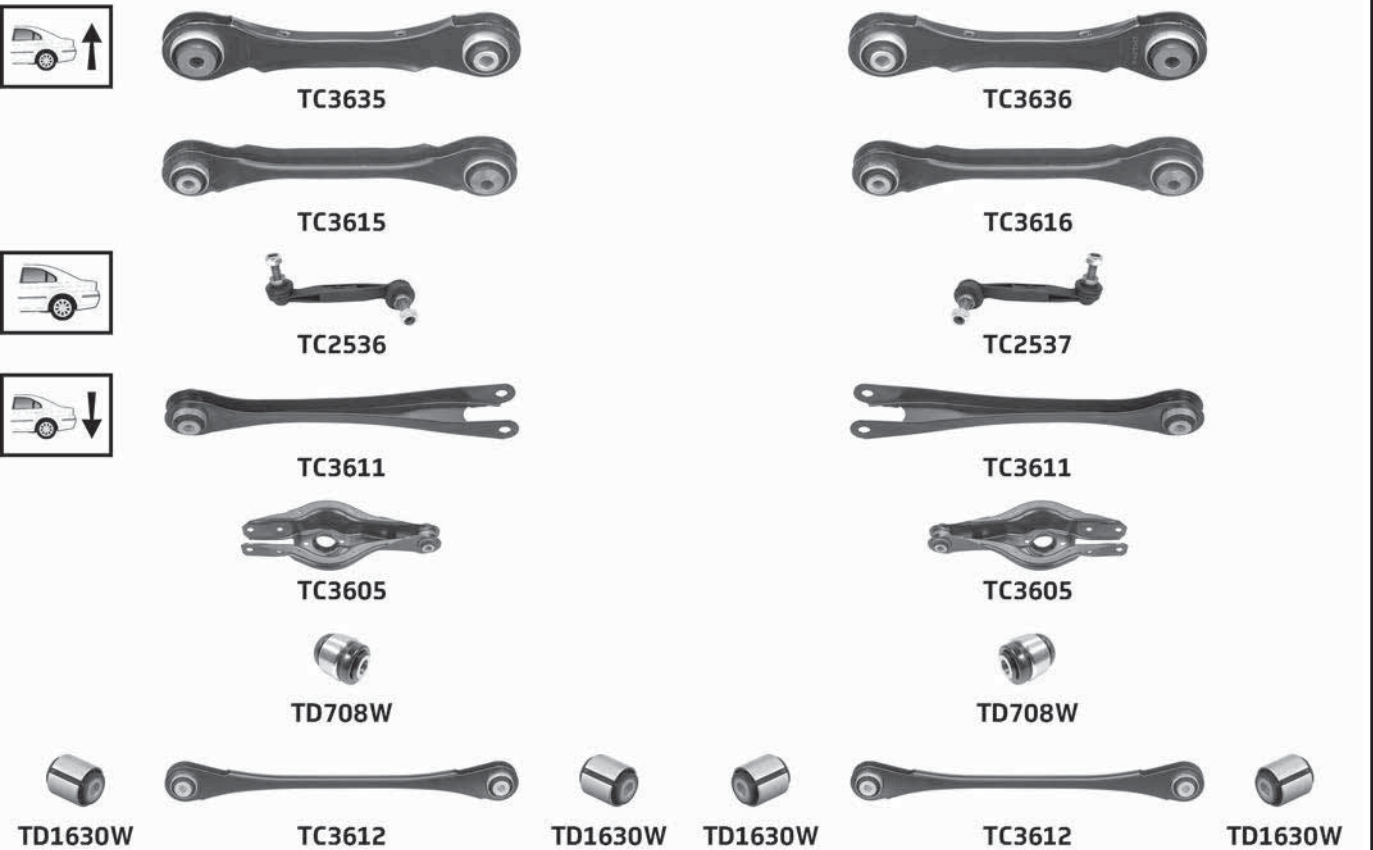

Part No	Description	Pos	Info	Technical
TA3170	Inner tie rod(123)	A B		M14x1.5 Male(252) £
TA3220	Tie rod end(224)	A		M14x1.5 Female(253) £
TA3221	Tie rod end(224)	B		M14x1.5 Female(253) £
TC2536	Link stabiliser(135)	A		M10x1.5
TC2537	Link stabiliser(135)	B		M10x1.5
TC2645	Link stabiliser(135)	A		M10x1.5
TC2645	Link stabiliser(135)	B	(-) Adaptive M chassis	M10x1.5
TC2646	Link stabiliser(135)	B	(+) Adaptive M chassis	M10x1.5
TC3605	Lower track control arm(151)	A B		
TC3609	Lower track control arm(151)	A	Rear(187)	M14x1.5
TC3610	Lower track control arm(151)	B	Rear(187)	M14x1.5
TC3611	Trailing arm(226)	A B	Front(108)	
TC3612	Lower track control arm(151)	A B	Rear(187)	
TC3615	Upper track control arm(242)	A	Rear(187)	
TC3616	Upper track control arm(242)	B	Rear(187)	
TC3635	Upper guide rod(236)	A	Front(108)	
TC3636	Upper guide rod(236)	B	Front(108)	
TD708W	Lower hub carrier bush(143)	A B	Centre(-89-)	
TD1630W	Lower track control arm bush(153)	A B	Rear(187) Inner(119) Outer(176)	
TL611	Rod assembly(194)	A		
TL612	Rod assembly(194)	B		

... BMW

4 SERIES (F36 SERIES) 420i 2.0i, 420d 2.0d, 428i 2.0i, 430i 2.0i, 430d 3.0d, 435d 3.0d, 435i 3.0i, 440i 3.0i xDrive | Gran Coupé (10/13→)

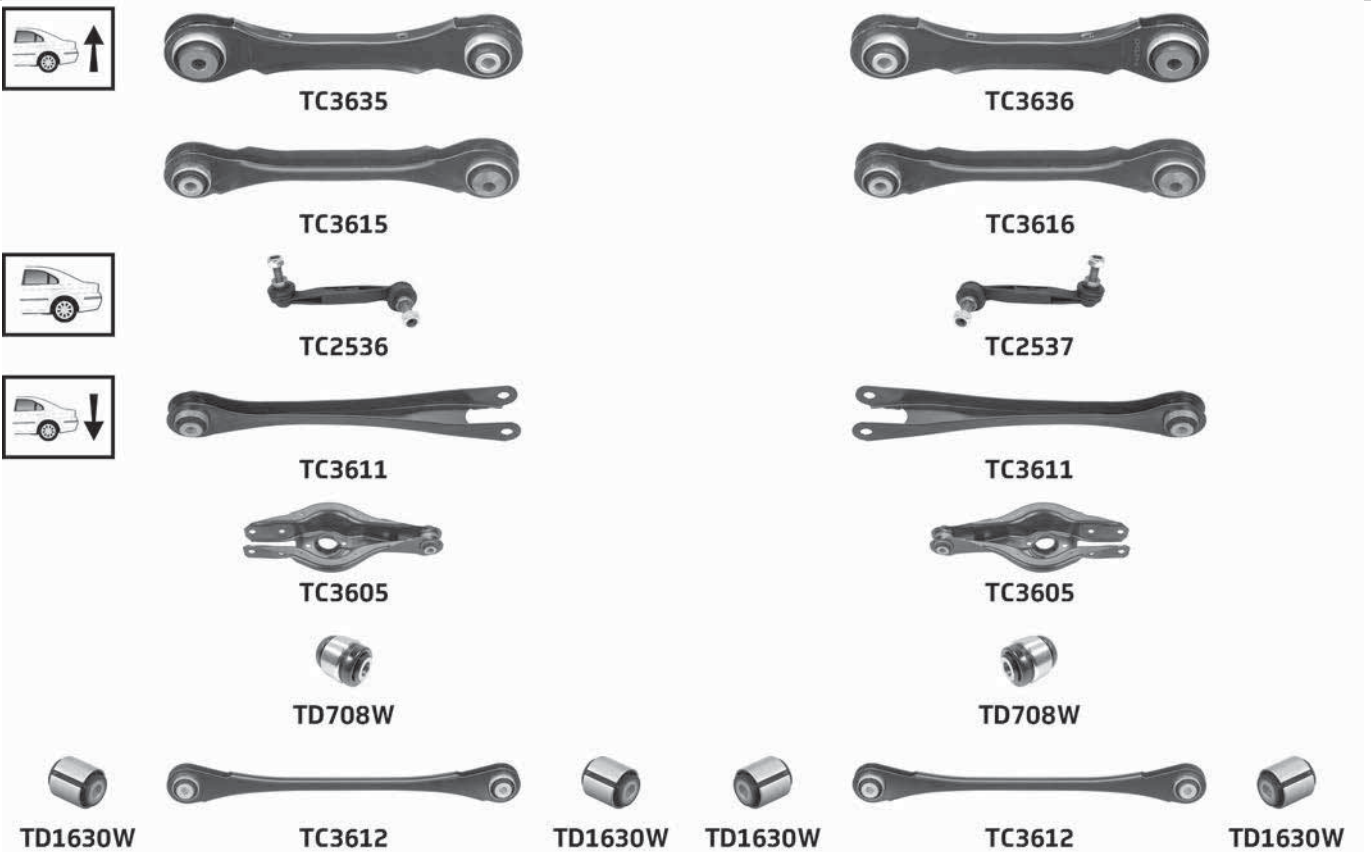

Part No	Description	Pos	Info	Technical
TC2536	Link stabiliser(135)	A		M10x1.5
TC2537	Link stabiliser(135)	B		M10x1.5
TC2645	Link stabiliser(135)	A		M10x1.5
TC2646	Link stabiliser(135)	B		M10x1.5
TC3437	Lower track control arm(151)	A	Front(108)	M14x1.5
TC3438	Lower track control arm(151)	B	Front(108)	M14x1.5
TC3578	Lower track control arm(151)	A	Rear(187)	M14 x 1.5 x 30.5
TC3579	Lower track control arm(151)	B	Rear(187)	M14 x 1.5 x 30.5
TC3605	Lower track control arm(151)	A B		
TC3611	Trailing arm(226)	A B	Front(108)	
TC3612	Lower track control arm(151)	A B	Rear(187)	
TC3615	Upper track control arm(242)	A	Rear(187)	
TC3616	Upper track control arm(242)	B	Rear(187)	
TC3635	Upper guide rod(236)	A	Front(108)	
TC3636	Upper guide rod(236)	B	Front(108)	
TD708W	Lower hub carrier bush(143)	A B	Centre(-89-)	
TD1630W	Lower track control arm bush(153)	A B	Rear(187) Inner(119) Outer(176)	
TD1638W	Lower track control arm bush(153)	A B	Inner(119)	

5 SERIES (E39 SERIES) 520i 2.0i, 520d 2.0TD, 520i 2.2i, 523i 2.5i, 525i 2.5i, 525d 2.5TD, 525td 2.5TD, 525tds 2.5TD, 528i 2.8i, 530d 2.9TD, 530i 3.0i (11/95-12/01)

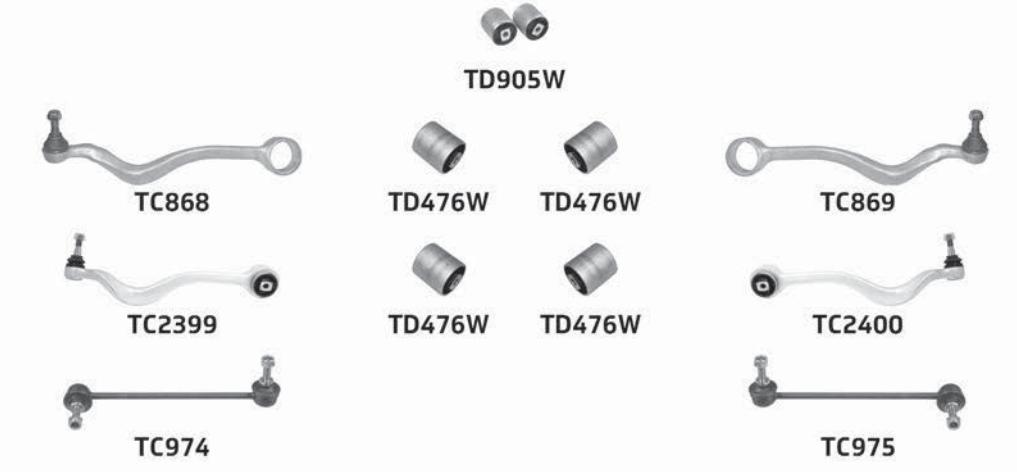

... BMW

... 5 SERIES (E39 SERIES) 520i 2.0i, 520d 2.0TD, 520i 2.2i, 523i 2.5i, 525i 2.5i, 525d 2.5TD, 525td 2.5TD, 525tds 2.5TD, 528i 2.8i, 530d 2.9TD, 530i 3.0i (11/95-12/01)

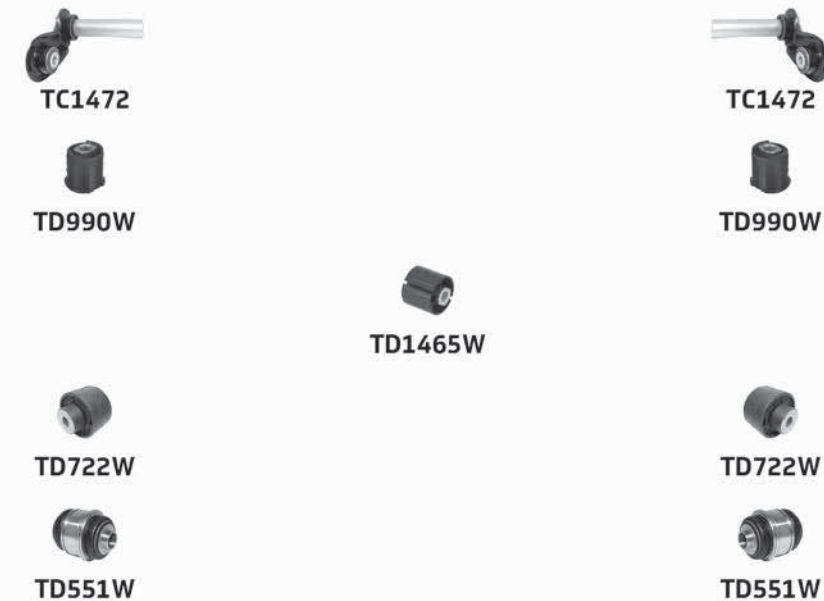
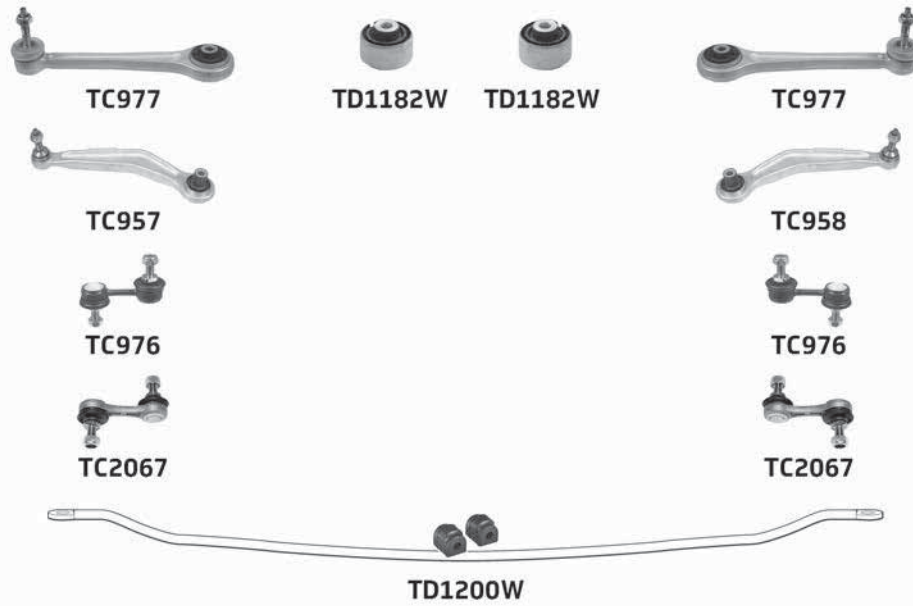

Part No	Description	Pos	Info	Technical
TA1645	Tie rod end(224)	A		M16x1 Female(253) £
TA1646	Tie rod end(224)	B		M16x1 Female(253) £
TA1647	Inner tie rod(123)	A B		M16x1 Male(252) £
TBR4117	Steering rack gaiter kit(213)	K		1 :37x53x53 2 :37x53x53
TC814	Lower track control arm(151)	A		M14x1.5
TC815	Lower track control arm(151)	B		M14x1.5
TC868	Upper track control arm(242)	A	(-) Bush(-13)	M14x1.5
TC869	Upper track control arm(242)	B	(-) Bush(-13)	M14x1.5
TC957	Upper control arm(235)	A	Rear(187)	M14x1.5
TC958	Upper control arm(235)	B	Rear(187)	M14x1.5
TC974	Link stabiliser(135)	A		M10x1.5
TC975	Link stabiliser(135)	B		M10x1.5
TC976	Link stabiliser(135)	A B	Metal	M10x1.25
TC977	Upper guide rod(236)	A B	Front(108)	M10x1.5
TC1472	Lower link arm(144)	A B		
TC2067	Link stabiliser(135)	A B	Aluminium(-73)	M10x1.5
TC2399	Upper track control arm(242)	A	(+) Bush(-42)	M14x1.5
TC2400	Upper track control arm(242)	B	(+) Bush(-42)	M14x1.5
TD476W	Upper track control arm bush(243)	A B		
TD477W	Lower track control arm bush(153)	A B		
TD551W	Lower hub carrier bush(143)	A B		
TD722W	Sub-frame mounting(216)	A B	Rear(187) Inner(119)	
TD905W	Upper track control arm bush(243)	K	Pack of(179) 2	

... 5 SERIES (E39 SERIES) 520i 2.0i, 520d 2.0TD, 520i 2.2i, 523i 2.5i, 525i 2.5i, 525d 2.5TD, 525td 2.5TD, 525tds 2.5TD, 528i 2.8i, 530d 2.9TD, 530i 3.0i (11/95-12/01)

Part No	Description	Pos	Info	Technical
TD990W	Sub-frame bush(215)	A B	Front(108) Rear(187) (-)	
TD1041W	Anti-roll bar(-74) bush kit(-86)	K	Ø22.5 Complete axle kit(-92)	
TD1182W	Upper guide rod bush(237)	A B	Inner(119)	
TD1200W	Anti-roll bar(-74) bush kit(-86)	K	Ø13 Complete axle kit(-92) (-) Sport suspension(-27)	
TD1465W	Sub-frame bush(215)	K	Front(108) Centre(-89)	
TL475	Rod assembly(194)	A		M12x1.5
TL476	Rod assembly(194)	B		M12x1.5

5 SERIES (E39 SERIES) 520i 2.0i, 520d 2.0TD, 520i 2.2i, 525i 2.5i, 525d 2.5TD, 525td 2.5TD, 525tds 2.5TD, 530d 2.9TD, 530i 3.0i (12/01-05/04)

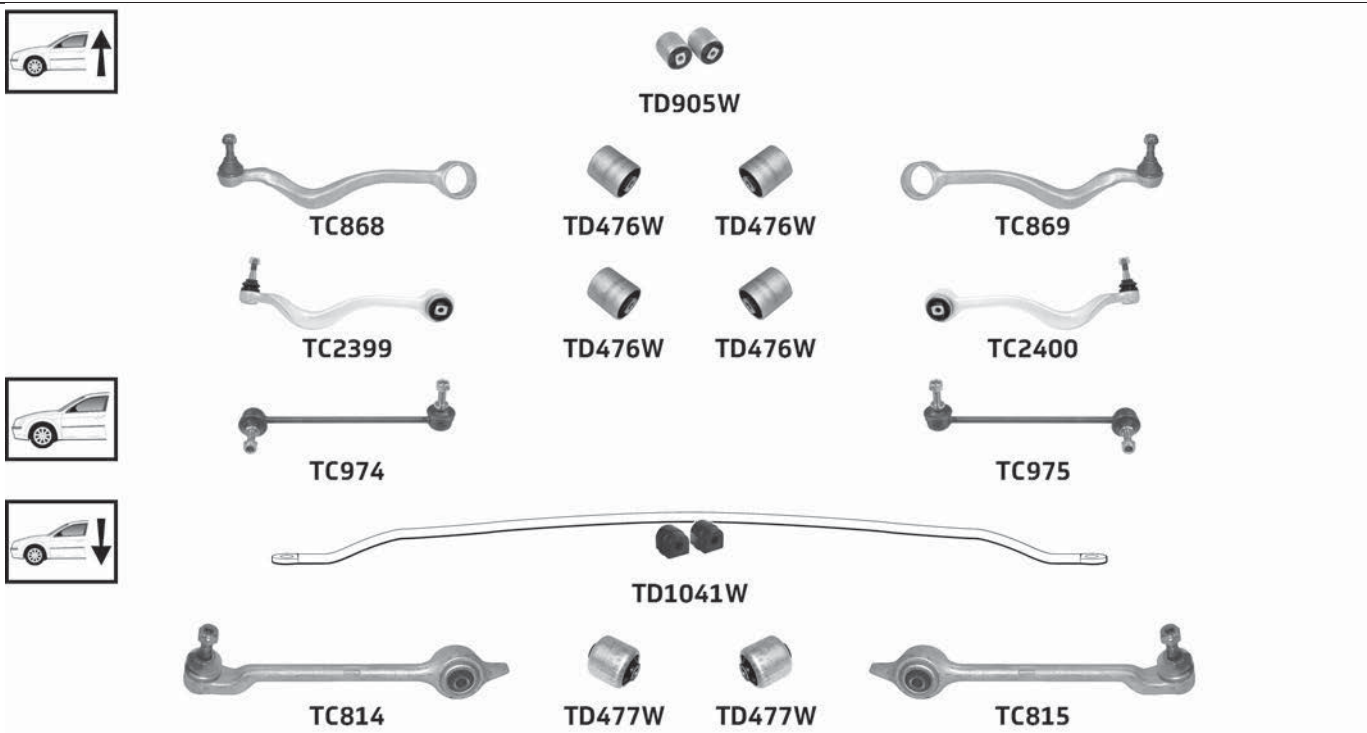

BMW

... BMW

... 5 SERIES (E39 SERIES) 520i 2.0i, 520d 2.0TD, 520i 2.2i, 525i 2.5i, 525d 2.5TD, 525td 2.5TD, 525tds 2.5TD, 530d 2.9TD, 530i 3.0i (12/01-05/04)

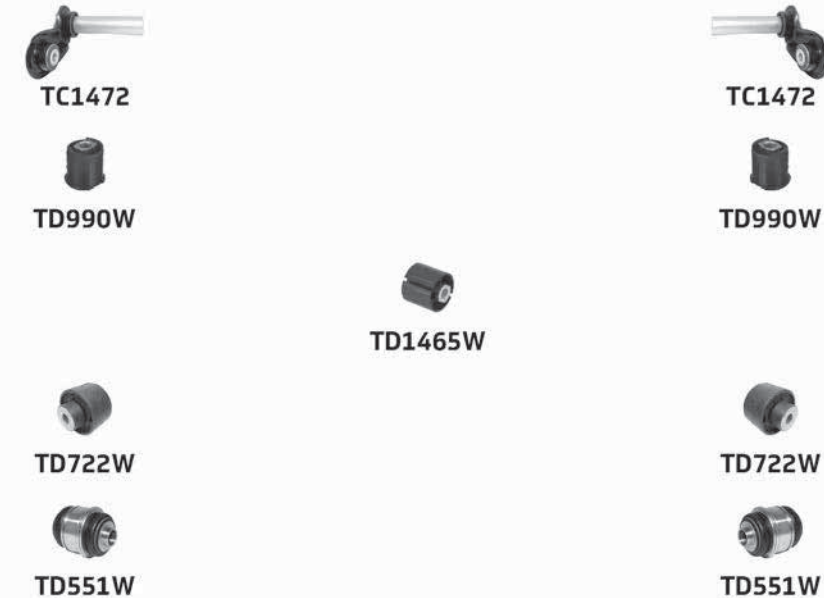
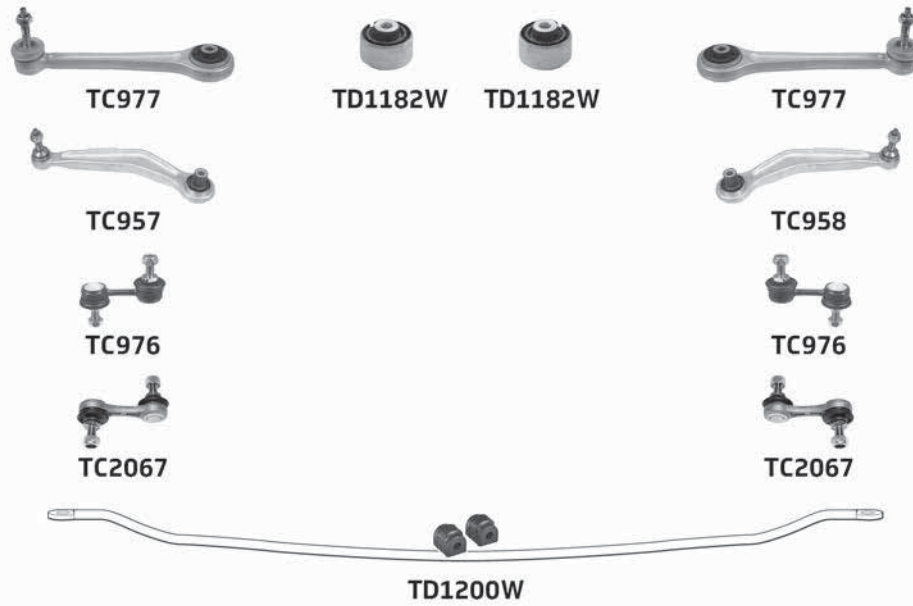

Part No	Description	Pos	Info	Technical
TA1645	Tie rod end(224)	A		M16x1 Female(253) £
TA1646	Tie rod end(224)	B		M16x1 Female(253) £
TA1647	Inner tie rod(123)	A B		M16x1 Male(252) £
TBR4117	Steering rack gaiter kit(213)	K		1 :37x53x53 2 :37x53x53
TC814	Lower track control arm(151)	A		M14x1.5
TC815	Lower track control arm(151)	B		M14x1.5
TC868	Upper track control arm(242)	A	(-) Bush(-13)	M14x1.5
TC869	Upper track control arm(242)	B	(-) Bush(-13)	M14x1.5
TC957	Upper control arm(235)	A	Rear(187)	M14x1.5
TC958	Upper control arm(235)	B	Rear(187)	M14x1.5
TC974	Link stabiliser(135)	A		M10x1.5
TC975	Link stabiliser(135)	B		M10x1.5
TC976	Link stabiliser(135)	A B	Metal	M10x1.25
TC1342	Upper guide rod(236)	A B	Front(108)	M10x1.5
TC1472	Lower link arm(144)	A B		
TC2067	Link stabiliser(135)	A B	Aluminium(-73)	M10x1.5
TC2399	Upper track control arm(242)	A	(+) Bush(-42)	M14x1.5
TC2400	Upper track control arm(242)	B	(+) Bush(-42)	M14x1.5
TD476W	Upper track control arm bush(243)	A B		
TD477W	Lower track control arm bush(153)	A B		
TD551W	Lower hub carrier bush(143)	A B		
TD722W	Sub-frame mounting(216)	A B	Rear(187) Inner(119)	
TD905W	Upper track control arm bush(243)	K	Pack of(179) 2	

... 5 SERIES (E39 SERIES) 520i 2.0i, 520d 2.0TD, 520i 2.2i, 525i 2.5i, 525d 2.5TD, 525td 2.5TD, 525tds 2.5TD, 530d 2.9TD, 530i 3.0i (12/01-05/04)

Part No	Description	Pos	Info	Technical
TD990W	Sub-frame bush(215)	A B	Front(108) Rear(187) (-)	
TD1041W	Anti-roll bar(-74) bush kit(-86)	K	Ø22.5 Complete axle kit(-92)	
TD1182W	Upper guide rod bush(237)	A B	Inner(119)	
TD1200W	Anti-roll bar(-74) bush kit(-86)	K	Ø13 Complete axle kit(-92) (-) Sport suspension(-27)	
TD1465W	Sub-frame bush(215)	K	Front(108) Centre(-89)	
TL475	Rod assembly(194)	A		M12x1.5
TL476	Rod assembly(194)	B		M12x1.5

5 SERIES (E39 SERIES) 535i 3.5i, 540i 4.4i (11/95-12/01)



... BMW

... 5 SERIES (E39 SERIES) 535i 3.5i, 540i 4.4i (11/95-12/01)



Part No	Description	Pos	Info	Technical
TA1875	Tie rod end(224)	A		M16x1.5 Female(253) £
TA1876	Tie rod end(224)	B		M16x1.5 Female(253) £
TC957	Upper control arm(235)	A	Rear(187)	M14x1.5
TC958	Upper control arm(235)	B	Rear(187)	M14x1.5
TC976	Link stabiliser(135)	A B	Metal	M10x1.25
TC977	Upper guide rod(236)	A B	Front(108)	M10x1.5
TC1226	Lower track control arm(151)	A		M14x1.5
TC1227	Lower track control arm(151)	B		M14x1.5
TC1472	Lower link arm(144)	A B		
TC2052	Link stabiliser(135)	A B		M10x1.5
TC2067	Link stabiliser(135)	A B	Aluminium(-73-)	M10x1.5
TC2246	Upper track control arm(242)	A		M14x1.5
TC2247	Upper track control arm(242)	B		M14x1.5
TD477W	Lower track control arm bush(153)	A B		
TD486W	Pitman arm bush(183)	K		
TD551W	Lower hub carrier bush(143)	A B		
TD722W	Sub-frame mounting(216)	A B	Rear(187) Inner(119)	
TD788W	Upper track control arm bush(243)	A B		
TD990W	Sub-frame bush(215)	A B	Front(108) Rear(187) (-)	
TD1182W	Upper guide rod bush(237)	A B	Inner(119)	
TD1200W	Anti-roll bar(-74-) bush kit(-86-)	K	Ø13 Complete axle kit(-92-) (-) (+) EDC	
TD1465W	Sub-frame bush(215)	K	Front(108) Centre(-89-)	
TL458	Centre rod assembly(-90-)	K	L	M12x1.5
TL459	Centre rod assembly(-90-)	K	R	M12x1.5

5 SERIES (E39 SERIES) 535i 3.5i, 540i 4.4i (12/01-06/03)

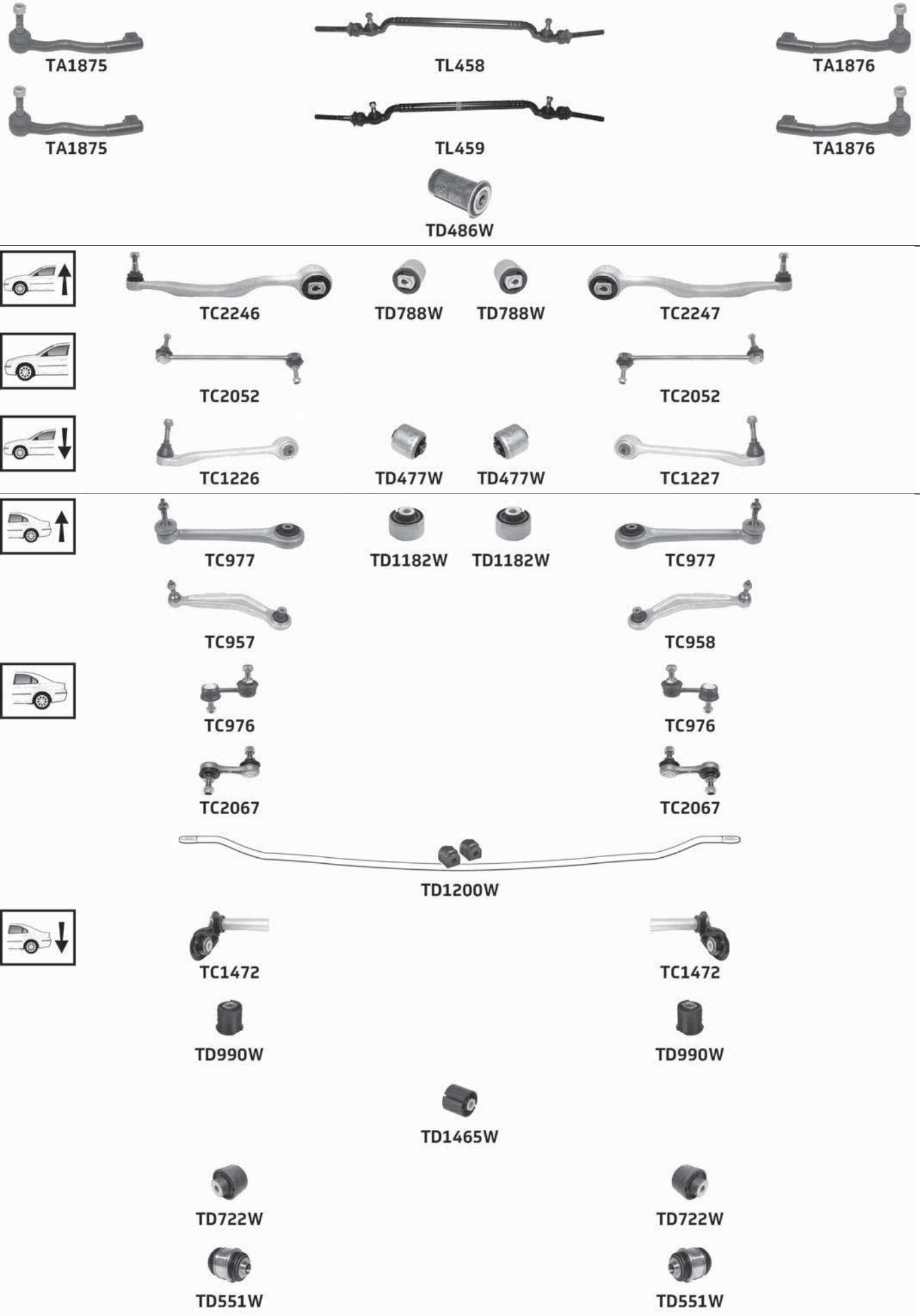

BMW

... BMW

... 5 SERIES (E39 SERIES) 535i 3.5i, 540i 4.4i (12/01-06/03)

Part No	Description	Pos	Info	Technical
TA1875	Tie rod end(224)	A		M16x1.5 Female(253) £
TA1876	Tie rod end(224)	B		M16x1.5 Female(253) £
TC957	Upper control arm(235)	A	Rear(187)	M14x1.5
TC958	Upper control arm(235)	B	Rear(187)	M14x1.5
TC976	Link stabiliser(135)	A B	Metal	M10x1.25
TC1226	Lower track control arm(151)	A		M14x1.5
TC1227	Lower track control arm(151)	B		M14x1.5
TC1342	Upper guide rod(236)	A B	Front(108)	M10x1.5
TC1472	Lower link arm(144)	A B		
TC2052	Link stabiliser(135)	A B		M10x1.5
TC2067	Link stabiliser(135)	A B	Aluminium(-73)	M10x1.5
TC2246	Upper track control arm(242)	A		M14x1.5
TC2247	Upper track control arm(242)	B		M14x1.5
TD477W	Lower track control arm bush(153)	A B		
TD486W	Pitman arm bush(183)	K		
TD551W	Lower hub carrier bush(143)	A B		
TD722W	Sub-frame mounting(216)	A B	Rear(187) Inner(119)	
TD788W	Upper track control arm bush(243)	A B		
TD990W	Sub-frame bush(215)	A B	Front(108) Rear(187) (-)	
TD1182W	Upper guide rod bush(237)	A B	Inner(119)	
TD1200W	Anti-roll bar(-74) bush kit(-86-)	K	Ø13 Complete axle kit(-92) (-) (+) EDC	
TD1465W	Sub-frame bush(215)	K	Front(108) Centre(-89)	
TL458	Centre rod assembly(-90)	K	L	M12x1.5
TL459	Centre rod assembly(-90)	K	R	M12x1.5

5 SERIES (E60 SERIES) 520i 2.2i, 525i 2.5i, 530i 3.0i, 530d 3.0d (07/03-03/05)

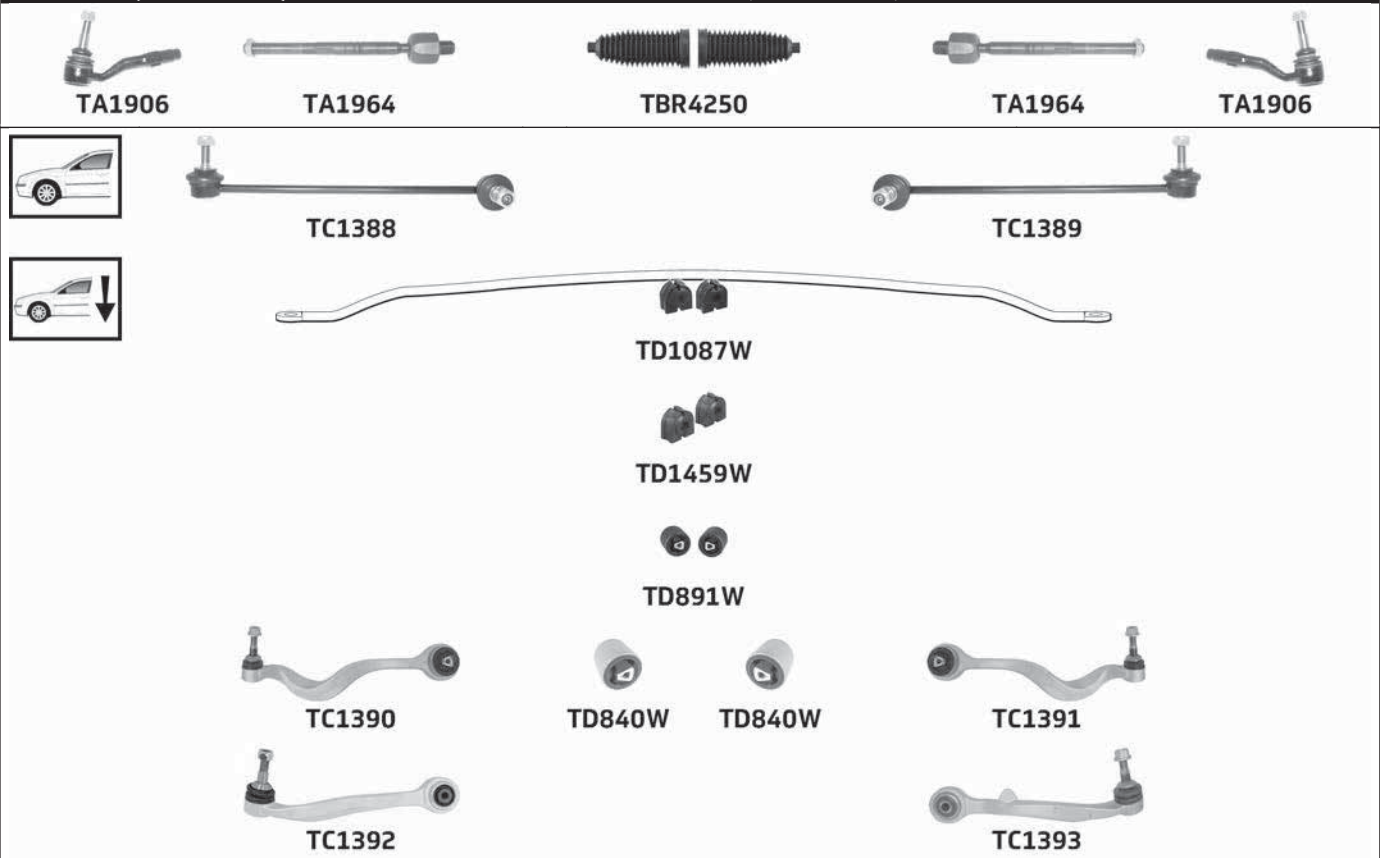

... 5 SERIES (E60 SERIES) 520i 2.2i, 525i 2.5i, 530i 3.0i, 530d 3.0d (07/03-03/05)



TC1342



TD1182W TD1182W



TC1342



TC957



TC958



TC2954



TC2953



TC1394



TC1394



TC2641



TC2641



TD1462W



TC1472



TC1472



TD551W



TD551W

Part No	Description	Pos	Info	Technical
TA1906	Tie rod end(224)	A B		M16x1.5 Female(253) £
TA1964	Inner tie rod(123)	A B		M16x1.5 Male(252) £
TBR4250	Steering rack gaiter kit(213)	K	Thermoplastic(223)	1 :16x66x66 2 :16x66x66
TC957	Upper control arm(235)	A	Rear(187) Conical Seat(-94) 30.5mm	M14x1.5
TC958	Upper control arm(235)	B	Rear(187) Conical Seat(-94) 30.5mm	M14x1.5
TC1342	Upper guide rod(236)	A B	Front(108)	M10x1.5
TC1388	Link stabiliser(135)	A		M10x1.5
TC1389	Link stabiliser(135)	B		M10x1.5
TC1390	Lower track control arm(151)	A	Front(108)	M14x1.5
TC1391	Lower track control arm(151)	B	Front(108)	M14x1.5
TC1392	Lower track control arm(151)	A	Rear(187)	M14x1.5
TC1393	Lower track control arm(151)	B	Rear(187)	M14x1.5
TC1394	Link stabiliser(135)	A B	(-) Dynamic drive(-14)	M10x1.5
TC1472	Lower link arm(144)	A B		
TC2641	Link stabiliser(135)	A B	(+) Dynamic drive(-43)	M12x1.5
TC2953	Upper control arm(235)	B	Rear(187) Ball Joint Seat(-80) 33.5mm	M14x1.5
TC2954	Upper control arm(235)	A	Rear(187) Ball Joint Seat(-80) 33.5mm	M14x1.5
TD551W	Lower hub carrier bush(143)	A B		
TD840W	Lower track control arm bush(153)	A B	Front(108)	
TD891W	Lower track control arm bush kit(154)	K	Front(108)	
TD1087W	Anti-roll bar(-74) bush kit(-86-)	K	Ø24.6 Complete axle kit(-92) (-) Sport suspension(-27-)	
TD1182W	Upper guide rod bush(237)	A B	Inner(119)	
TD1459W	Anti-roll bar(-74) bush kit(-86-)	K	Ø25 Complete axle kit(-92) (+) Sport suspension(-53-)	
TD1462W	Anti-roll bar(-74) bush kit(-86-)	K	Ø14 Complete axle kit(-92) (+) Sport suspension(-53-)	

... BMW

5 SERIES (E60 SERIES) 545i 4.4i (07/03-03/05)

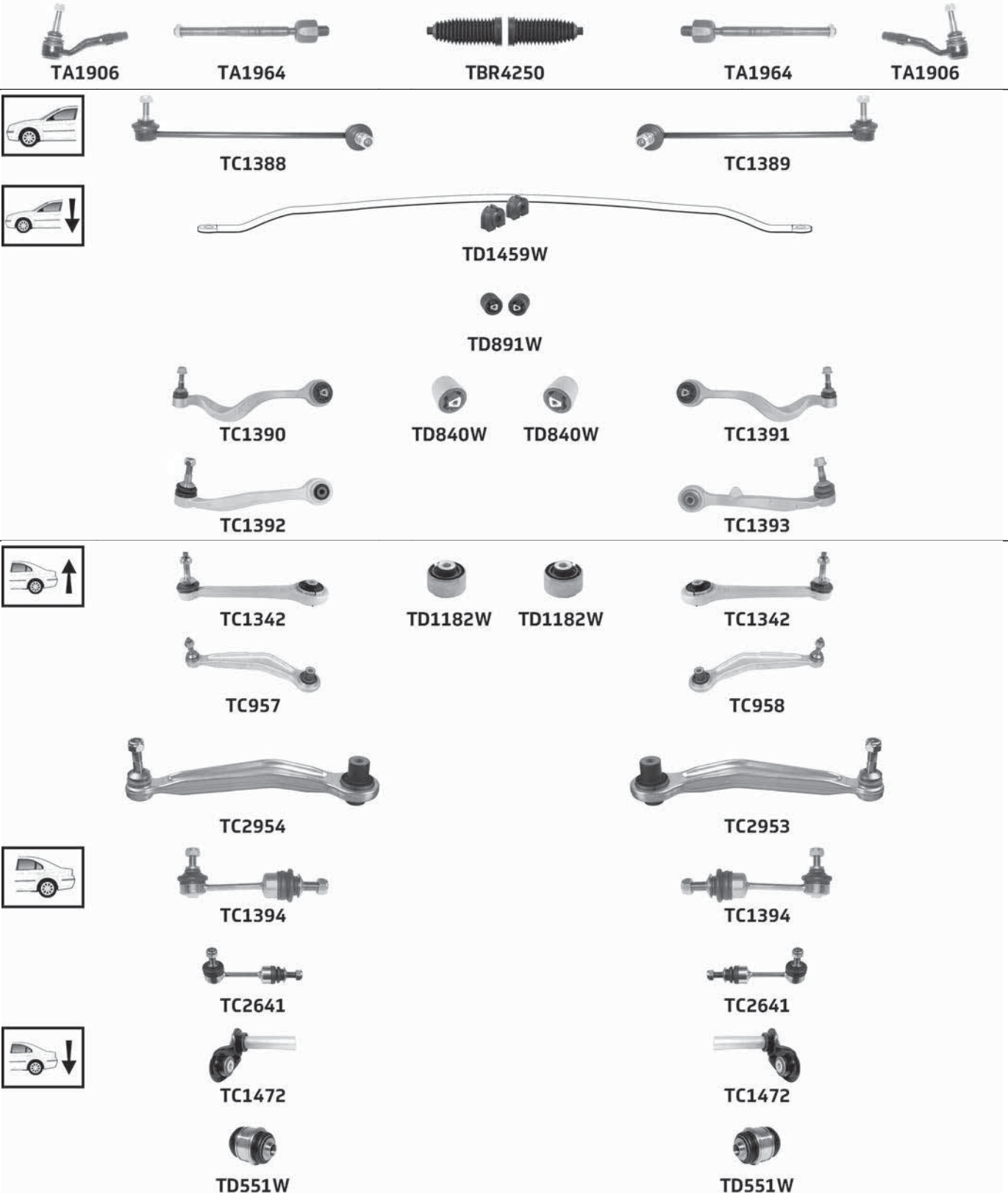

Part No	Description	Pos	Info	Technical
TA1906	Tie rod end(224)	A B		M16x1.5 Female(253) E
TA1964	Inner tie rod(123)	A B		M16x1.5 Male(252) E
TBR4250	Steering rack gaiter kit(213)	K	Thermoplastic(223)	1 :16x66x66 2 :16x66x66
TC957	Upper control arm(235)	A	Rear(187) Conical Seat(-94) 30.5mm	M14x1.5
TC958	Upper control arm(235)	B	Rear(187) Conical Seat(-94) 30.5mm	M14x1.5
TC1342	Upper guide rod(236)	A B	Front(108)	M10x1.5
TC1388	Link stabiliser(135)	A		M10x1.5
TC1389	Link stabiliser(135)	B		M10x1.5
TC1390	Lower track control arm(151)	A	Front(108)	M14x1.5
TC1391	Lower track control arm(151)	B	Front(108)	M14x1.5

... 5 SERIES (E60 SERIES) 545i 4.4i (07/03-03/05)				
Part No	Description	Pos	Info	Technical
TC1392	Lower track control arm(151)	A	Rear(187)	M14x1.5
TC1393	Lower track control arm(151)	B	Rear(187)	M14x1.5
TC1394	Link stabiliser(135)	A B	(-) Dynamic drive(-14)	M10x1.5
TC1472	Lower link arm(144)	A B		
TC2641	Link stabiliser(135)	A B	(+) Dynamic drive(-43)	M12x1.5
TC2953	Upper control arm(235)	B	Rear(187) Ball Joint Seat(-80) 33.5mm	M14x1.5
TC2954	Upper control arm(235)	A	Rear(187) Ball Joint Seat(-80) 33.5mm	M14x1.5
TD551W	Lower hub carrier bush(143)	A B		
TD840W	Lower track control arm bush(153)	A B	Front(108)	
TD891W	Lower track control arm bush kit(154)	K	Front(108)	
TD1182W	Upper guide rod bush(237)	A B	Inner(119)	
TD1459W	Anti-roll bar(-74) bush kit(-86)	K	Ø25 Complete axle kit(-92) (-) Sport suspension(-27)	

5 SERIES (E60, E61 SERIES) 520i 2.2i, 520d 2.0d, 523i 2.5i, 525i 2.5i, 525d 2.5d, 530i 3.0i, 530d 3.0d (03/05-)

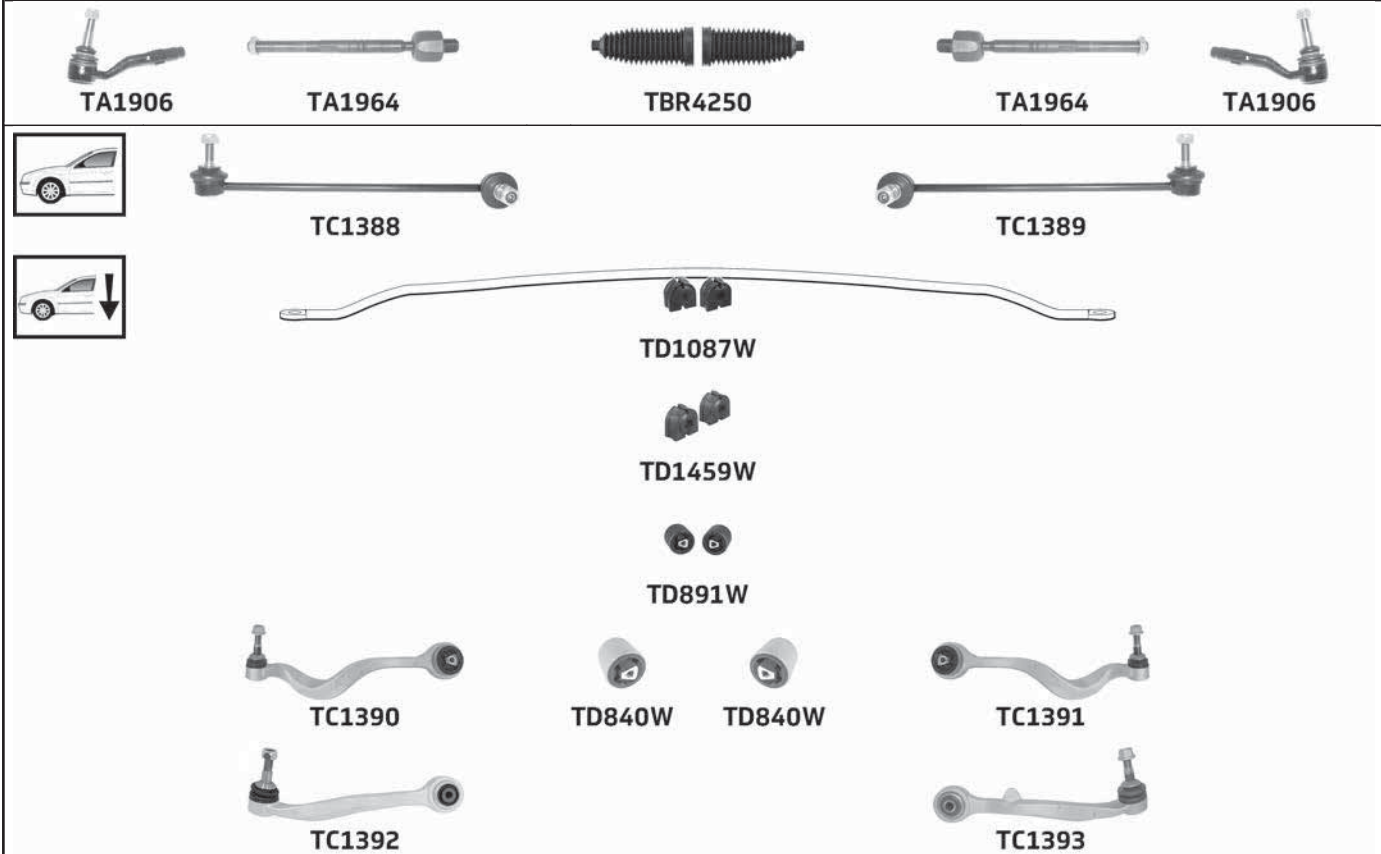

BMW

... BMW

... 5 SERIES (E60, E61 SERIES) 520i 2.2i, 520d 2.0d, 523i 2.5i, 525i 2.5i, 525d 2.5d, 530i 3.0i, 530d 3.0d (03/05→)



Part No	Description	Pos	Info	Technical
TA1906	Tie rod end(224)	A B		M16x1.5 Female(253) £
TA1964	Inner tie rod(123)	A B		M16x1.5 Male(252) £
TBR4250	Steering rack gaiter kit(213)	K	Thermoplastic(223)	1 :16x66x66 2 :16x66x66
TC1342	Upper guide rod(236)	A B	Front(108)	M10x1.5
TC1388	Link stabiliser(135)	A		M10x1.5
TC1389	Link stabiliser(135)	B		M10x1.5
TC1390	Lower track control arm(151)	A	Front(108)	M14x1.5
TC1391	Lower track control arm(151)	B	Front(108)	M14x1.5
TC1392	Lower track control arm(151)	A	Rear(187)	M14x1.5
TC1393	Lower track control arm(151)	B	Rear(187)	M14x1.5
TC1394	Link stabiliser(135)	A B	(-) Dynamic drive(-14-)	M10x1.5
TC1472	Lower link arm(144)	A B		
TC2641	Link stabiliser(135)	A B	(+) Dynamic drive(-43-)	M12x1.5
TC2953	Upper control arm(235)	B	Rear(187)	M14x1.5
TC2954	Upper control arm(235)	A	Rear(187)	M14x1.5
TD551W	Lower hub carrier bush(143)	A B		
TD840W	Lower track control arm bush(153)	A B	Front(108)	
TD891W	Lower track control arm bush kit(154)	K	Front(108)	
TD1087W	Anti-roll bar(-74-) bush kit(-86-)	K	Ø24.6 Complete axle kit(-92-) (-) Sport suspension(-27-)	
TD1182W	Upper guide rod bush(237)	A B	Inner(119)	
TD1459W	Anti-roll bar(-74-) bush kit(-86-)	K	Ø25 Complete axle kit(-92-) (+) Sport suspension(-53-)	
TD1462W	Anti-roll bar(-74-) bush kit(-86-)	K	Ø14 Complete axle kit(-92-) (-)  (+) Sport suspension(-53-)	

5 SERIES (E60, E61 SERIES) 535d 3.0d, 540i 4.0i, 545i 4.4i, 550i 4.8i (03/05→)

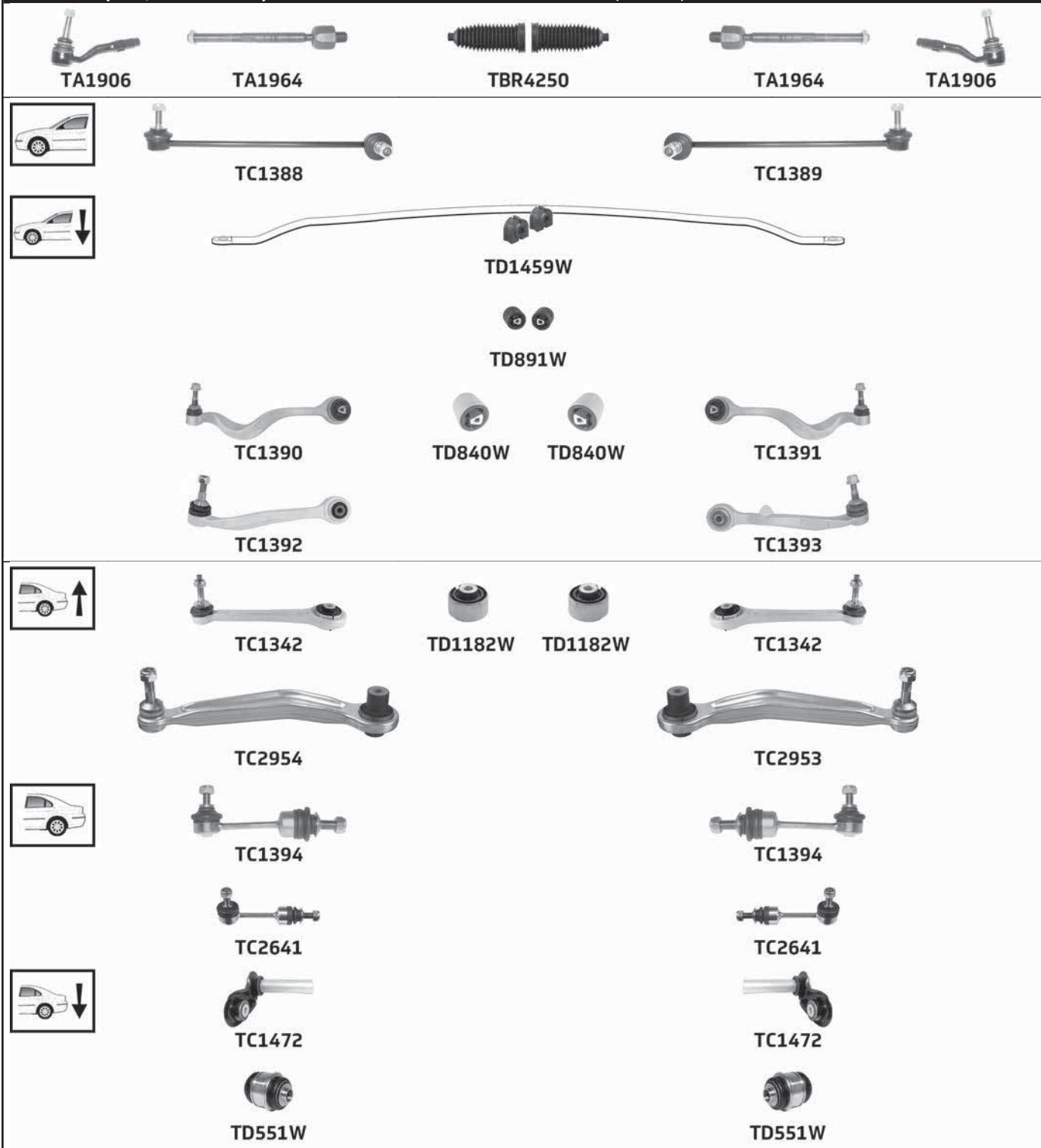

Part No	Description	Pos	Info	Technical
TA1906	Tie rod end(224)	A B		M16x1.5 Female(253) £
TA1964	Inner tie rod(123)	A B		M16x1.5 Male(252) £
TBR4250	Steering rack gaiter kit(213)	K	Thermoplastic(223)	1 :16x66x66 2 :16x66x66
TC1342	Upper guide rod(236)	A B	Front(108)	M10x1.5
TC1388	Link stabiliser(135)	A		M10x1.5
TC1389	Link stabiliser(135)	B		M10x1.5
TC1390	Lower track control arm(151)	A	Front(108)	M14x1.5
TC1391	Lower track control arm(151)	B	Front(108)	M14x1.5
TC1392	Lower track control arm(151)	A	Rear(187)	M14x1.5
TC1393	Lower track control arm(151)	B	Rear(187)	M14x1.5
TC1394	Link stabiliser(135)	A B	(-) Dynamic drive(-14)	M10x1.5
TC1472	Lower link arm(144)	A B		
TC2641	Link stabiliser(135)	A B	(+) Dynamic drive(-43)	M12x1.5
TC2953	Upper control arm(235)	B	Rear(187)	M14x1.5

BMW

... BMW

... 5 SERIES (E60, E61 SERIES) 535d 3.0d, 540i 4.0i, 545i 4.4i, 550i 4.8i (03/05→)

Part No	Description	Pos	Info	Technical
TC2954	Upper control arm (235)	A	Rear(187)	M14x1.5
TD551W	Lower hub carrier bush(143)	A B		
TD840W	Lower track control arm bush(153)	A B	Front(108)	
TD891W	Lower track control arm bush kit(154)	K	Front(108)	
TD1182W	Upper guide rod bush(237)	A B	Inner(119)	
TD1459W	Anti-roll bar(-74) bush kit(-86)	K	Ø25 Complete axle kit(-92) (-) Sport suspension(-27)	

5 SERIES (E60, E61 SERIES) 525xi 2.5i, 525xd 3.0d, 530xi 3.0i, 530xd 3.0d 4x4 (07/05→)



TA3175



TBR4250



TA3175



TC2610



TC2611



TC3222



TC3223



TC3014



TC3015



TC1342



TD1182W



TD1182W



TC1342



TC2954



TC2953



TC1394



TC1394



TD1634W



TC1472



TC1472



TD551W



TD551W

Part No	Description	Pos	Info	Technical
TA3175	Tie rod end(224)	A B		M16x1.5 Female(253) E
TBR4250	Steering rack gaiter kit(213)	K	Thermoplastic(223)	1 :16x66x66 2 :16x66x66
TC1342	Upper guide rod(236)	A B	Front(108)	M10x1.5
TC1394	Link stabiliser(135)	A B		M10x1.5
TC1472	Lower link arm(144)	A B		
TC2610	Link stabiliser(135)	A		M10x1.5
TC2611	Link stabiliser(135)	B		M10x1.5
TC2953	Upper control arm(235)	B	Rear(187)	M14x1.5
TC2954	Upper control arm(235)	A	Rear(187)	M14x1.5
TC3014	Lower track control arm(151)	A	Rear(187)	M14x1.5
TC3015	Lower track control arm(151)	B	Rear(187)	M14x1.5
TC3222	Lower track control arm(151)	A	Front(108)	
TC3223	Lower track control arm(151)	B	Front(108)	

(...)

... 5 SERIES (E60, E61 SERIES) 525xi 2.5i, 525xd 3.0d, 530xi 3.0i, 530xd 3.0d 4x4 (07/05→)

Part No	Description	Pos	Info	Technical
TD551W	Lower hub carrier bush(143)	A B		
TD1182W	Upper guide rod bush(237)	A B	Inner(119)	
TD1634W	Anti-roll bar(-74) bush kit(-86)	K	Ø13 Complete axle kit(-92)	

5 SERIES (F07 SERIES) 520d 2.0d, 528i 2.0i, 530d 3.0d, 535i 3.0i, 535d 3.0d, 550i 4.4i Gran Turismo (10/09→)

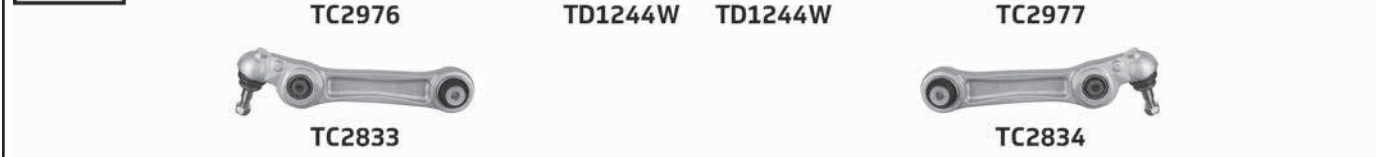
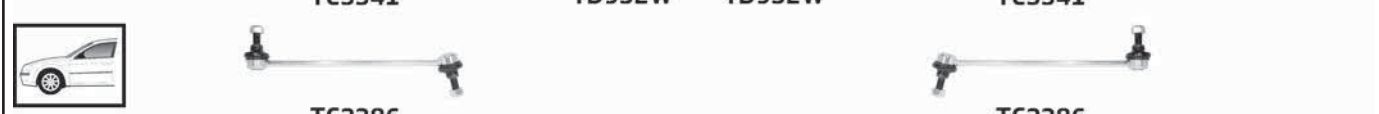
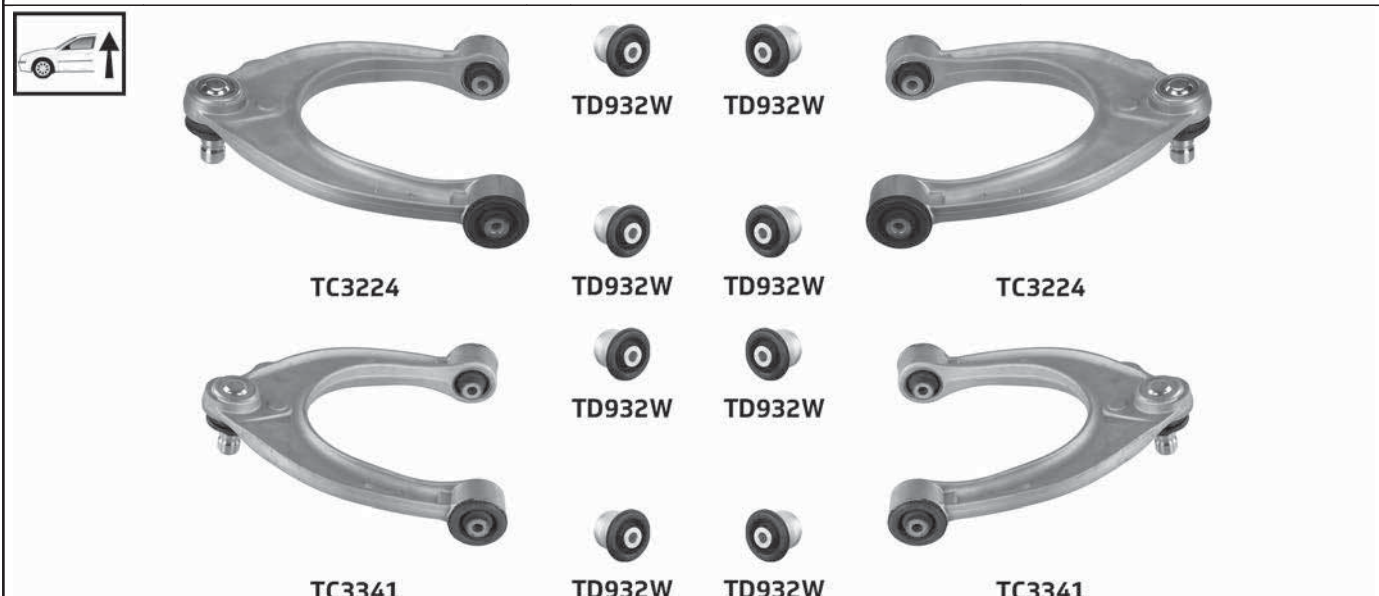

Part No	Description	Pos	Info	Technical
TA2707	Tie rod end(224)	A		M14x1.5 Female(253) £
TA2708	Tie rod end(224)	B		M14x1.5 Female(253) £
TA2780	Inner tie rod(123)	A B		M14x1.5 Male(252) £
TBR4250	Steering rack gaiter kit(213)	K	Hydraulic Steering(116) Thermoplastic(223)	1 :16x66x66 2 :16x66x66
TC2386	Link stabiliser(135)	A B		M12x1.5
TC2410	Link stabiliser(135)	A B		M12x1.5

BMW

... BMW

... 5 SERIES (F07 SERIES) 520d 2.0d, 528i 2.0i, 530d 3.0d, 535i 3.0i, 535d 3.0d, 550i 4.4i Gran Turismo (10/09→)

Part No	Description	Pos	Info	Technical
TC2824	Connecting link (-95-)	A B	Front (108)	
TC2833	Lower track control arm (151)	A	Rear (187)	M16x1.5
TC2834	Lower track control arm (151)	B	Rear (187)	M16x1.5
TC2976	Lower track control arm (151)	A	Front (108)	M16x1.5
TC2977	Lower track control arm (151)	B	Front (108)	M16x1.5
TC3224	Upper wishbone (247)	A B		Pinch Bolt (255) 21mm
TC3235	Upper track control arm (242)	A B	Front (108)	
TC3341	Upper wishbone (247)	A B	-30 MIN Camber Adjustment (-87-)	Pinch Bolt (255) 21mm
TC3563	Upper track control arm (242)	A	Rear (187)	
TC3564	Upper track control arm (242)	B	Rear (187)	
TD932W	Upper wishbone bush (248)	A B	Front (108) Rear (187)	
TD1244W	Lower track control arm bush (153)	A B	Front (108) Fit in pairs when replacing hydraulic type (104)	

5 SERIES (F07 SERIES) 530dX 3.0d, 535iX 3.0i, 535dX 3.0d, 550iX 4.4i Gran Turismo (10/09→)



TA2707





TA2780



TBR4250





TA2780



TA2708







TC3224

TD932W

TD932W

TC3224







TC3341

TD932W

TD932W

TC3341





TC2386

TC2386





TC3226

TC3227



TD1241W



TD1114W



TD1114W



TD1241W





TC3563

TC3564



TC2410

TC2410



TC2824

TC2824

Part No	Description	Pos	Info	Technical
TA2707	Tie rod end (224)	A		M14x1.5 Female (253) £

BMW

... 5 SERIES (F07 SERIES) 530dX 3.0d, 535iX 3.0i, 535dX 3.0d, 550iX 4.4i Gran Turismo (10/09→)

Part No	Description	Pos	Info	Technical
TA2708	Tie rod end(224)	B		M14x1.5 Female(253) E
TA2780	Inner tie rod(123)	A B		M14x1.5 Male(252) E
TBR4250	Steering rack gaiter kit(213)	K	Hydraulic Steering(116) Thermoplastic(223)	1 :16x66x66 2 :16x66x66
TC2386	Link stabiliser (135)	A B		M12x1.5
TC2410	Link stabiliser (135)	A B		M12x1.5
TC2824	Connecting link(-95)	A B	Front(108)	
TC3224	Upper wishbone(247)	A B		Pinch Bolt(255) 21mm
TC3226	Lower track control arm(151)	A	Front(108)	M16x1.5
TC3227	Lower track control arm(151)	B	Front(108)	M16x1.5
TC3341	Upper wishbone(247)	A B	-30 MIN Camber Adjustment (-87)	Pinch Bolt(255) 21mm
TC3563	Upper track control arm(242)	A	Rear(187)	
TC3564	Upper track control arm(242)	B	Rear(187)	
TC3565	Lower track control arm(151)	A	Rear(187)	
TC3566	Lower track control arm(151)	B	Rear(187)	
TD932W	Upper wishbone bush(248)	A B	Front(108) Rear(187)	
TD1114W	Lower control arm bush(142)	A B	Rear(187) Inner(119)	
TD1241W	Lower control arm bush(142)	A B	Rear(187) Outer(176)	

5 SERIES (F10, F11 SERIES) 518d 2.0d, 520i 2.0i, 520d 2.0d, 523i 2.5i, 3.0i, 525d 2.0d, 3.0d, 528i 2.0i, 3.0i, 530i 3.0i, 530d 3.0d, 535i 3.0i, 535d 3.0d, 550i 4.4i, ActiveHybrid 5 3.0i (03/10→)



TA2707



TA2780



TA2780



TA2708



TC3224



TD932W



TD932W



TC3224



TC3341



TD932W



TD932W



TC3341



TC2386



TC2386



TC2821



TD931W



TD931W



TC2822



TC2869



TD962W



TD962W



TC2870

... BMW

... 5 SERIES (F10, F11 SERIES) 518d 2.0d, 520i 2.0i, 520d 2.0d, 523i 2.5i, 3.0i, 525d 2.0d, 3.0d, 528i 2.0i, 3.0i, 530i 3.0i, 530d 3.0d, 535i 3.0i, 535d 3.0d, 550i 4.4i, ActiveHybrid 5 3.0i (03/10→)



TC2838



TC2839



TC3235



TC3235



TC2823



TC2823



TC3563



TC3564



TC2409



TC2409



TC2535



TC2535



TC2410



TC2410



TC2824



TC2824

Part No	Description	Pos	Info	Technical
TA2707	Tie rod end(224)	A		M14x1.5 Female(253) £
TA2708	Tie rod end(224)	B		M14x1.5 Female(253) £
TA2780	Inner tie rod(123)	A B		M14x1.5 Male(252) £
TC2386	Link stabiliser(135)	A B		M12x1.5
TC2409	Link stabiliser(135)	A B	(+) Dynamic drive(-43) (-) ActiveHybrid	M12x1.5
TC2410	Link stabiliser(135)	A B		M12x1.5
TC2535	Link stabiliser(135)	A B	(-) Dynamic drive(-14)	M12x1.5 / M10x1.5
TC2821	Lower track control arm(151)	A	Front(108)	M16x1.5
TC2822	Lower track control arm(151)	B	Front(108)	M16x1.5
TC2823	Upper track control arm(242)	A B	Rear(187)	M14x1.5
TC2824	Connecting link(-95-)	A B	Front(108)	
TC2838	Upper track control arm(242)	A	Front(108)	
TC2839	Upper track control arm(242)	B	Front(108)	
TC2869	Lower track control arm(151)	A	Rear(187)	M16x1.5
TC2870	Lower track control arm(151)	B	Rear(187)	M16x1.5
TC3224	Upper wishbone(247)	A B		Pinch Bolt(255) 21mm
TC3235	Upper track control arm(242)	A B	Front(108)	
TC3341	Upper wishbone(247)	A B	-30 MIN Camber Adjustment(-87-)	Pinch Bolt(255) 21mm
TC3563	Upper track control arm(242)	A	Rear(187)	
TC3564	Upper track control arm(242)	B	Rear(187)	
TD931W	Lower track control arm bush(153)	A B	Front(108)	
TD932W	Upper wishbone bush(248)	A B	Front(108) Rear(187)	
TD962W	Lower track control arm bush(153)	A B	Rear(187) Inner(119)	

5 SERIES (F10, F11 SERIES) 520dX 2.0d, 525dX 2.0d, 528iX 2.0i, 530dX 3.0d, 535iX 3.0i, 535dX 3.0d, 550iX 4.4i, M550dX 3.0d (03/10→)

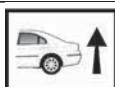

TC3563



TC3564

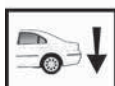

Part No	Description	Pos	Info	Technical
TA2707	Tie rod end(224)	A		M14x1.5 Female(253) £
				(...)

... BMW

... 5 SERIES (F10, F11 SERIES) 520dX 2.0d, 525dX 2.0d, 528iX 2.0i, 530dX 3.0d, 535iX 3.0i, 535dX 3.0d, 550iX 4.4i, M550dX 3.0d (03/10→)

Part No	Description	Pos	Info	Technical
TA2708	Tie rod end(224)	B		M14x1.5 Female(253) E
TA2780	Inner tie rod(123)	A B		M14x1.5 Male(252) E
TBR4250	Steering rack gaiter kit(213)	K	Hydraulic Steering(116) Thermoplastic(223)	1 :16x66x66 2 :16x66x66
TC2386	Link stabiliser(135)	A B		M12x1.5
TC2409	Link stabiliser(135)	A B	Dynamic drive(-43)	M12x1.5
TC2410	Link stabiliser(135)	A B		M12x1.5
TC2535	Link stabiliser(135)	A B	Dynamic drive(-14)	M12x1.5 / M10x1.5
TC2823	Upper track control arm(242)	A B	Rear(187)	M14x1.5
TC2824	Connecting link(-95)	A B	Front(108)	
TC2838	Upper track control arm(242)	A	Front(108)	
TC2839	Upper track control arm(242)	B	Front(108)	
TC3224	Upper wishbone(247)	A B		Pinch Bolt(255) 21mm
TC3235	Upper track control arm(242)	A B	Front(108)	
TC3341	Upper wishbone(247)	A B	-30 MIN Camber Adjustment(-87)	Pinch Bolt(255) 21mm
TC3563	Upper track control arm(242)	A	Rear(187)	
TC3564	Upper track control arm(242)	B	Rear(187)	
TD932W	Upper wishbone bush(248)	A B	Front(108) Rear(187)	

6 SERIES (E63, E64 SERIES) 630i 3.0i, 635d 3.0, 645Ci 4.4i, 650i 4.8i (01/04→)

TA1906	TA1964	TBR4250	TA1964	TA1906
	TC1804		TC1805	
	TD1459W			
	TC1322		TC1323	
	TC2954		TC2953	
	TC1394		TC1394	
	TC2641		TC2641	
	TC1472		TC1472	
	TD551W		TD551W	
Part No	Description	Pos	Info	Technical
TA1906	Tie rod end(224)	A B		M16x1.5 Female(253) E
TA1964	Inner tie rod(123)	A B		M16x1.5 Male(252) E
TBR4250	Steering rack gaiter kit(213)	K	Thermoplastic(223)	1 :16x66x66 2 :16x66x66
TC1322	Lower track control arm(151)	A		M14x1.5
TC1323	Lower track control arm(151)	B		M14x1.5
TC1394	Link stabiliser(135)	A B	(-) Dynamic drive(-14)	M10x1.5
TC1472	Lower link arm(144)	A B		

... 6 SERIES (E63, E64 SERIES) 630i 3.0i, 635d 3.0, 645Ci 4.4i, 650i 4.8i (01/04→)

Part No	Description	Pos	Info	Technical
TC1804	Link stabiliser(135)	A		M10x1.5
TC1805	Link stabiliser(135)	B		M10x1.5
TC2641	Link stabiliser(135)	A B	(+) Dynamic drive(-43)	M12x1.5
TC2953	Upper control arm(235)	B	Rear (187)	M14x1.5
TC2954	Upper control arm(235)	A	Rear (187)	M14x1.5
TD551W	Lower hub carrier bush(143)	A B		
TD1459W	Anti-roll bar(-74) bush kit(-86)	K	Ø25 Complete axle kit(-92) (-)  (-) Sport suspension(-27)	

6 SERIES (F06, F12, F13 SERIES) 640i 3.0i, 640d 3.0d, 650i 4.4i (03/11→)



TA2707



TA2780



TBR4250



TA2780



TA2708



TC3224



TD932W



TD932W



TC3224



TD932W



TD932W



TC3341



TD932W



TD932W



TC3341



TD932W



TD932W



TC2386



TC2386



TC2821



TD931W



TD931W



TC2822



TC2869



TD962W



TD962W



TC2870

... BMW

... 6 SERIES (F06, F12, F13 SERIES) 640i 3.0i, 640d 3.0d, 650i 4.4i (03/11→)



TC2838



TC2839



TC2823



TC2823



TC2409



TC2409



TC2535



TC2535



TC2824



TC2824

Part No	Description	Pos	Info	Technical
TA2707	Tie rod end(224)	A		M14x1.5 Female(253) £
TA2708	Tie rod end(224)	B		M14x1.5 Female(253) £
TA2780	Inner tie rod(123)	A B		M14x1.5 Male(252) £
TBR4250	Steering rack gaiter kit(213)	K	Thermoplastic(223)	1 :16x66x66 2 :16x66x66
TC2386	Link stabiliser(135)	A B		M12x1.5
TC2409	Link stabiliser(135)	A B	(+) Dynamic drive(-43-)	M12x1.5
TC2535	Link stabiliser(135)	A B	(-) Dynamic drive(-14-)	M12x1.5 / M10x1.5
TC2821	Lower track control arm(151)	A	Front(108)	M16x1.5
TC2822	Lower track control arm(151)	B	Front(108)	M16x1.5
TC2823	Upper track control arm(242)	A B	Rear(187)	M14x1.5
TC2824	Connecting link(-95-)	A B	Front(108)	
TC2838	Upper track control arm(242)	A	Front(108)	
TC2839	Upper track control arm(242)	B	Front(108)	
TC2869	Lower track control arm(151)	A	Rear(187)	M16x1.5
TC2870	Lower track control arm(151)	B	Rear(187)	M16x1.5
TC3224	Upper wishbone(247)	A B		Pinch Bolt(255) 21mm
TC3341	Upper wishbone(247)	A B	-30 MIN Camber Adjustment(-87-)	Pinch Bolt(255) 21mm
TD931W	Lower track control arm bush(153)	A B	Front(108)	
TD932W	Upper wishbone bush(248)	A B	Front(108) Rear(187)	
TD962W	Lower track control arm bush(153)	A B	Rear(187) Inner(119)	

6 SERIES (F06, F12, F13 SERIES) 640iX 3.0i, 640dX 3.0d, 650iX 4.4i (03/11→)

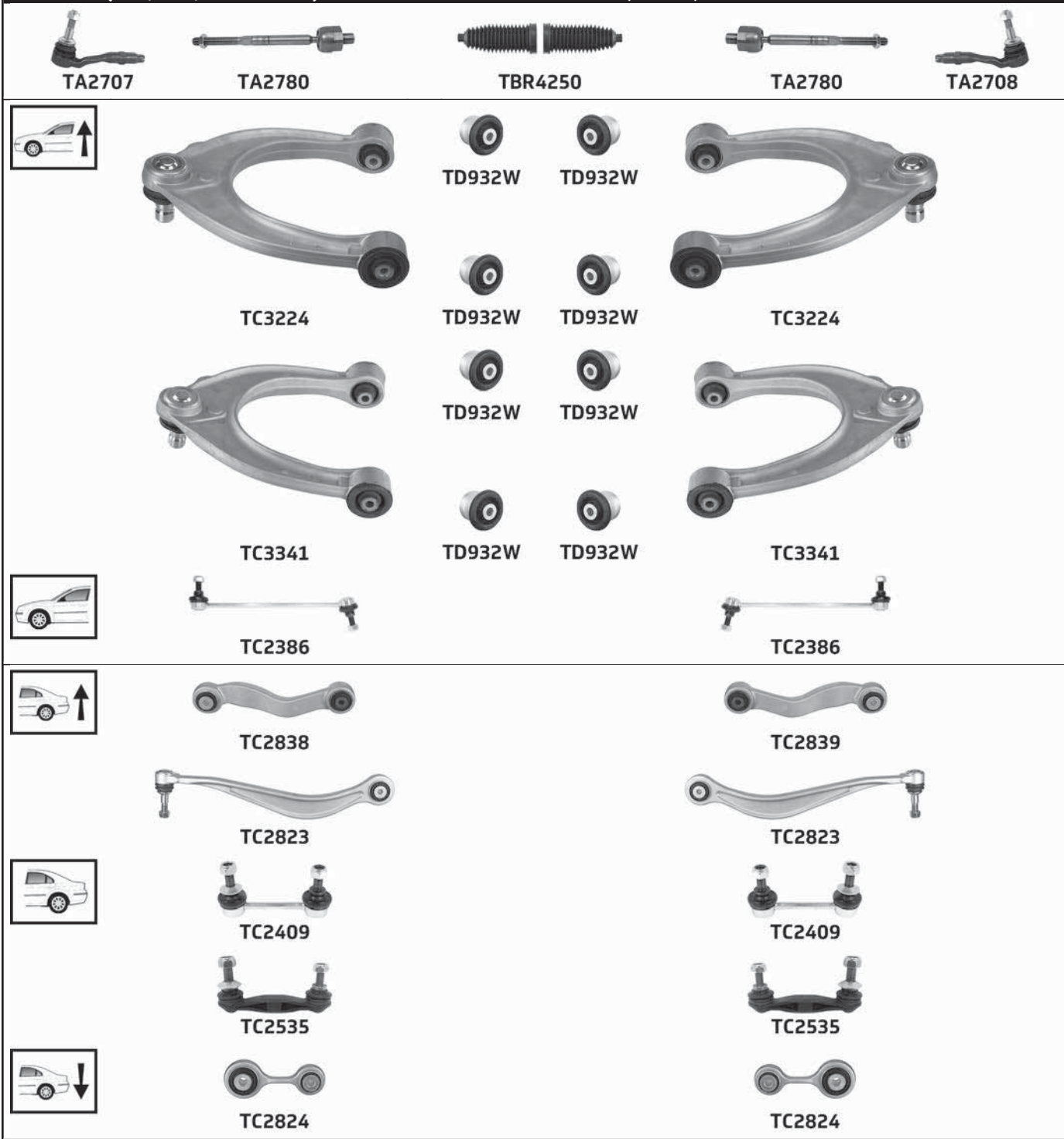

Part No	Description	Pos	Info	Technical
TA2707	Tie rod end(224)	A		M14x1.5 Female(253) £
TA2708	Tie rod end(224)	B		M14x1.5 Female(253) £
TA2780	Inner tie rod(123)	A B		M14x1.5 Male(252) £
TBR4250	Steering rack gaiter kit(213)	K	Thermoplastic(223)	1 :16x66x66 2 :16x66x66
TC2386	Link stabiliser(135)	A B		M12x1.5
TC2409	Link stabiliser(135)	A B	(+) Dynamic drive(-43-)	M12x1.5
TC2535	Link stabiliser(135)	A B	(-) Dynamic drive(-14-)	M12x1.5 / M10x1.5
TC2823	Upper track control arm(242)	A B	Rear(187)	M14x1.5
TC2824	Connecting link(-95-)	A B	Front(108)	
TC2838	Upper track control arm(242)	A	Front(108)	
TC2839	Upper track control arm(242)	B	Front(108)	
TC3224	Upper wishbone(247)	A B		Pinch Bolt(255) 21mm
TC3341	Upper wishbone(247)	A B	-30 MIN Camber Adjustment (-87-)	Pinch Bolt(255) 21mm
TD932W	Upper wishbone bush(248)	A B	Front(108) Rear(187)	

BMW

... BMW

7 SERIES (E65, E66 SERIES) 730i 3.0i, 730Li 3.0i, 730d 3.0TD, 735i 3.6i, 735Li 3.6i, 740d 3.9TD, 745i 4.4i, 745Li 4.4i, 760i 6.0i, 760Li 6.0i (11/01→)

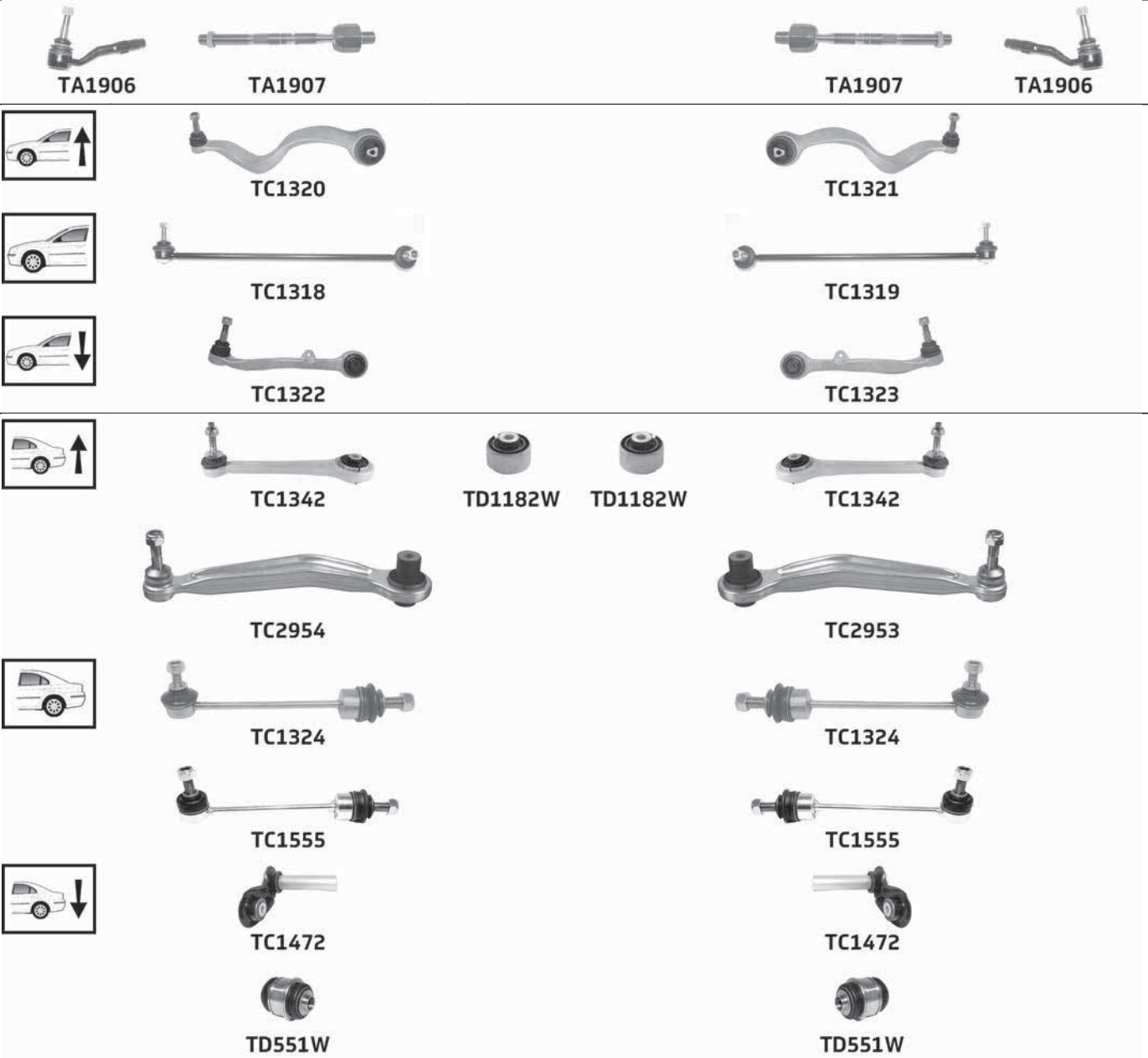

Part No	Description	Pos	Info	Technical
TA1906	Tie rod end(224)	A B		M16x1.5 Female(253) £
TA1907	Inner tie rod(123)	A B		M16x1.5 Male(252) £
TC1318	Link stabiliser(135)	A		M10x1.5
TC1319	Link stabiliser(135)	B		M10x1.5
TC1320	Upper track control arm(242)	A		M14x1.5
TC1321	Upper track control arm(242)	B		M14x1.5
TC1322	Lower track control arm(151)	A		M14x1.5
TC1323	Lower track control arm(151)	B		M14x1.5
TC1324	Link stabiliser(135)	A B	(-) Dynamic drive(-14)	M12x1.5
TC1342	Upper guide rod(236)	A B	Front(108)	M10x1.5
TC1472	Lower link arm(144)	A B		
TC1555	Link stabiliser(135)	A B	(+) Dynamic drive(-43)	M12x1.5
TC2953	Upper control arm(235)	B	Rear(187)	M14x1.5
TC2954	Upper control arm(235)	A	Rear(187)	M14x1.5
TD551W	Lower hub carrier bush(143)	A B		
TD1182W	Upper guide rod bush(237)	A B	Inner(119)	

7 SERIES (F01, F02 SERIES) 730i 3.0i, 730d 3.0d, 740i 3.0i, 740d 3.0d, 750i 4.4i, 760i 6.0i (06/08→)

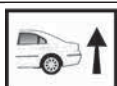

Part No	Description	Pos	Info	Technical
TA2707	Tie rod end (224)	A		M14x1.5 Female(253) £
TA2708	Tie rod end (224)	B		M14x1.5 Female(253) £
				(...)

BMW

... BMW

... 7 SERIES (F01, F02 SERIES) 730i 3.0i, 730d 3.0d, 740i 3.0i, 740d 3.0d, 750i 4.4i, 760i 6.0i (06/08→)

Part No	Description	Pos	Info	Technical
TA2780	Inner tie rod(123)	A B		M14x1.5 Male(252) E
TBR4250	Steering rack gaiter kit(213)	K	Hydraulic Steering(116) Thermoplastic(223)	1 :16x66x66 2 :16x66x66
TC2386	Link stabiliser(135)	A B		M12x1.5
TC2409	Link stabiliser(135)	A B	(+) Dynamic drive(-14) (-) ActiveHybrid	M12x1.5
TC2535	Link stabiliser(135)	A B	(-) Dynamic drive(-14)	M12x1.5 / M10x1.5
TC2823	Upper track control arm(242)	A B	Rear(187)	M14x1.5
TC2824	Connecting link(-95)	A B	Front(108)	
TC2833	Lower track control arm(151)	A	Rear(187)	M16x1.5
TC2834	Lower track control arm(151)	B	Rear(187)	M16x1.5
TC2838	Upper track control arm(242)	A	Front(108) 7/12→	
TC2839	Upper track control arm(242)	B	Front(108) 7/12→	
TC2976	Lower track control arm(151)	A	Front(108)	M16x1.5
TC2977	Lower track control arm(151)	B	Front(108)	M16x1.5
TC3224	Upper wishbone(247)	A B		Pinch Bolt(255) 21mm
TC3341	Upper wishbone(247)	A B	-30 MIN Camber Adjustment(-87)	Pinch Bolt(255) 21mm
TC3376	Upper track control arm(242)	A	Front(108) →06/12	
TC3377	Upper track control arm(242)	B	Front(108) →06/12	
TD932W	Upper wishbone bush(248)	A B	Front(108) Rear(187)	
TD1244W	Lower track control arm bush(153)	A B	Front(108) Fit in pairs when replacing hydraulic type(104)	

7 SERIES (F01, F02 SERIES) 730dX 3.0d, 740iX 3.0i, 740dX 3.0d, 750iX 4.4i, 750dX 3.0d (06/08→)

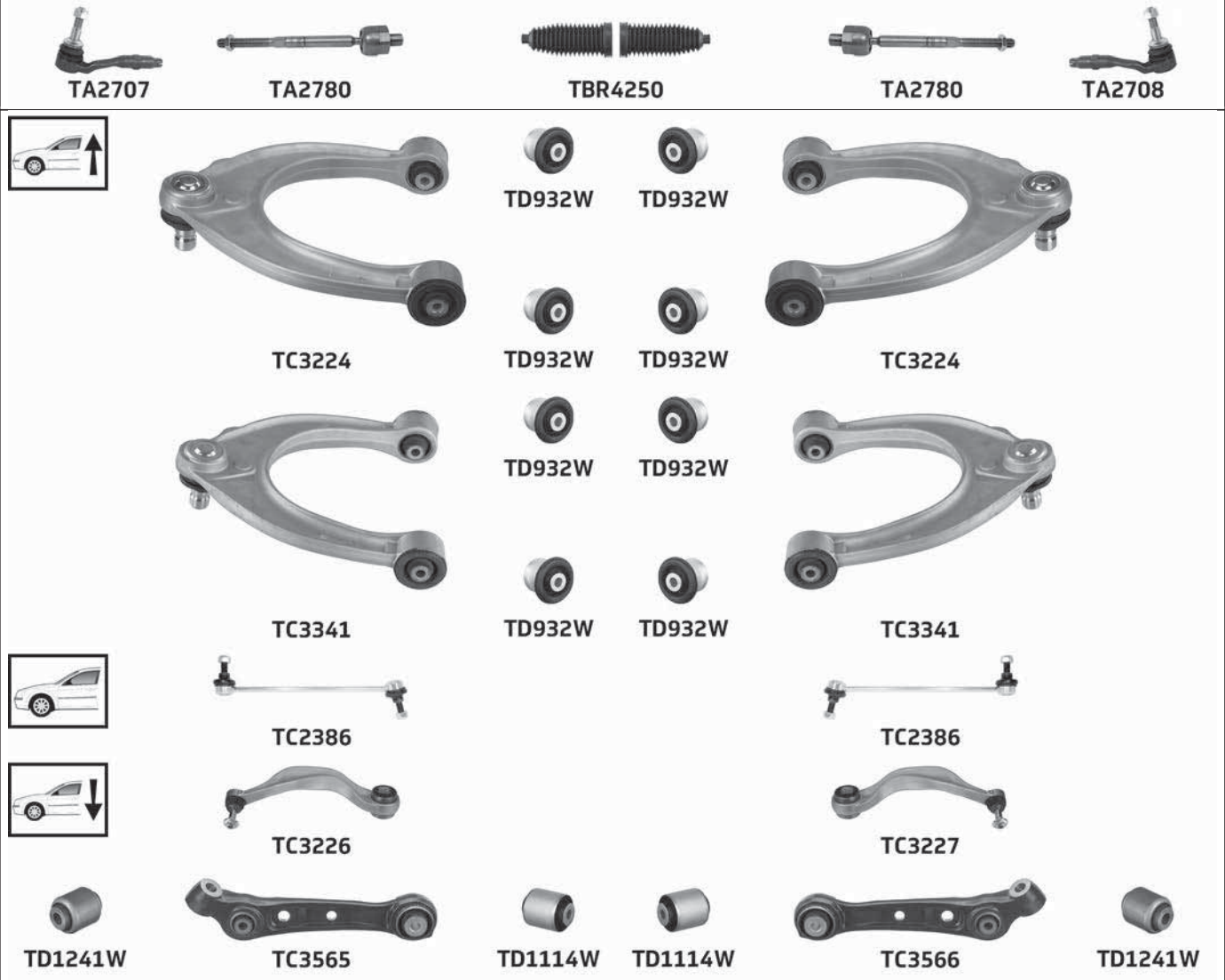

... 7 SERIES (F01, F02 SERIES) 730dX 3.0d, 740iX 3.0i, 740dX 3.0d, 750iX 4.4i, 750dX 3.0d (06/08→)



Part No	Description	Pos	Info	Technical
TA2707	Tie rod end(224)	A		M14x1.5 Female(253) £
TA2708	Tie rod end(224)	B		M14x1.5 Female(253) £
TA2780	Inner tie rod(123)	A B		M14x1.5 Male(252) £
TBR4250	Steering rack gaiter kit(213)	K	Hydraulic Steering(116) Thermoplastic(223)	1 :16x66x66 2 :16x66x66
TC2386	Link stabiliser(135)	A B		M12x1.5
TC2409	Link stabiliser(135)	A B	(+) Dynamic drive(-43-)	M12x1.5
TC2535	Link stabiliser(135)	A B	(-) Dynamic drive(-14-)	M12x1.5 / M10x1.5
TC2823	Upper track control arm(242)	A B	Rear(187)	M14x1.5
TC2824	Connecting link(-95-)	A B	Front(108)	
TC2838	Upper track control arm(242)	A	Front(108) 07/12→	
TC2839	Upper track control arm(242)	B	Front(108) 07/12→	
TC3224	Upper wishbone(247)	A B		Pinch Bolt(255) 21mm
TC3226	Lower track control arm(151)	A	Front(108)	M16x1.5
TC3227	Lower track control arm(151)	B	Front(108)	M16x1.5
TC3341	Upper wishbone(247)	A B	-30 MIN Camber Adjustment(-87-)	Pinch Bolt(255) 21mm
TC3376	Upper track control arm(242)	A	Front(108) →06/12	
TC3377	Upper track control arm(242)	B	Front(108) →06/12	
TC3565	Lower track control arm(151)	A	Rear(187)	
TC3566	Lower track control arm(151)	B	Rear(187)	
TD932W	Upper wishbone bush(248)	A B	Front(108) Rear(187)	
TD1114W	Lower control arm bush(142)	A B	Rear(187) Inner(119)	
TD1241W	Lower control arm bush(142)	A B	Rear(187) Outer(176)	

7 SERIES (F03 SERIES) 750LiS 4.4i, 760LiS 6.0i (06/08→)



Part No	Description	Pos	Info	Technical
TC2386	Link stabiliser(135)	A B		M12x1.5
TC2535	Link stabiliser(135)	A B		M12x1.5 / M10x1.5

... BMW

7 SERIES (F04 SERIES) ActiveHybrid 7 3.0i, 4.4i, ActiveHybrid 7L 4.4i (06/08→)

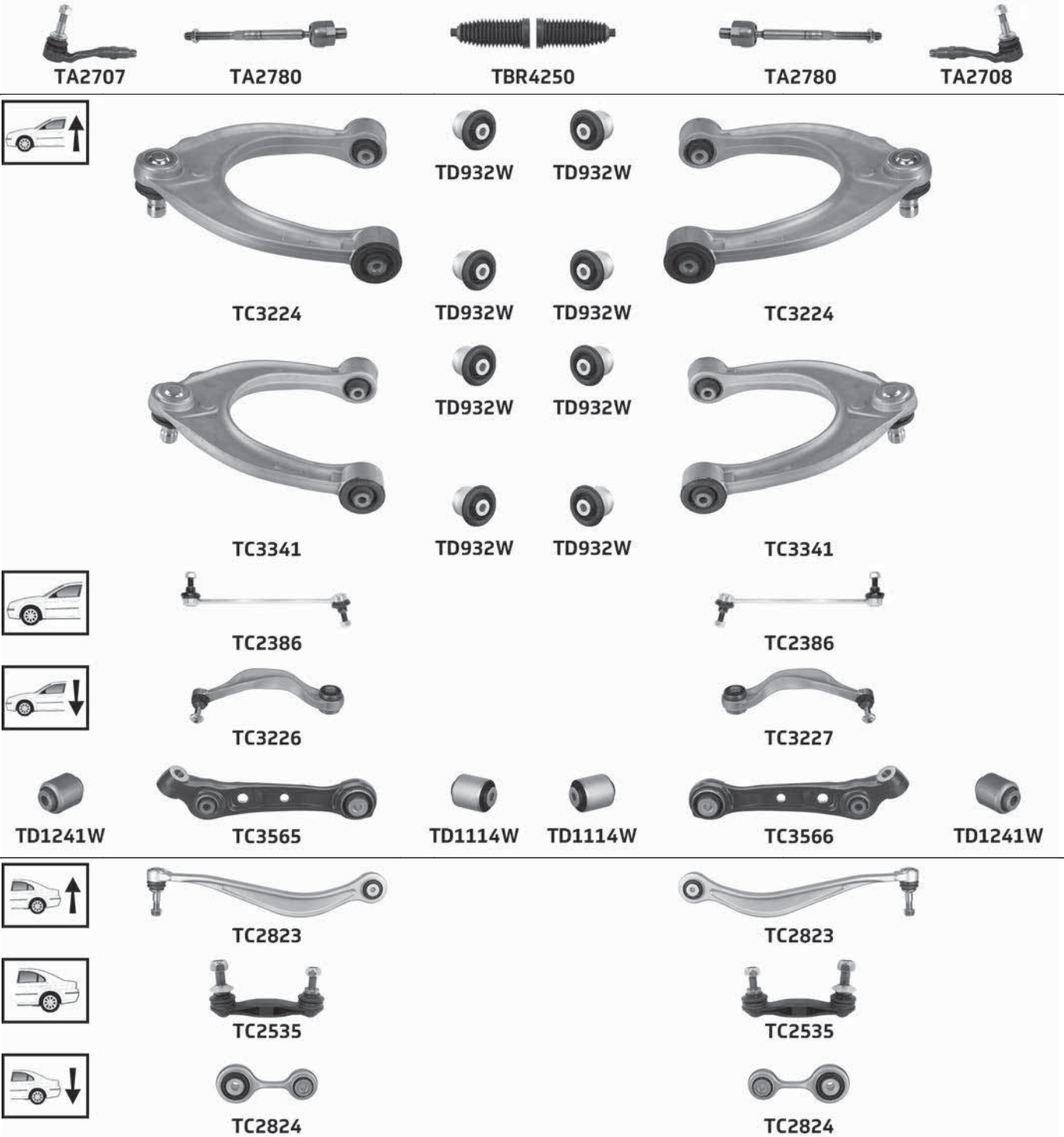

Part No	Description	Pos	Info	Technical
TA2707	Tie rod end(224)	A		M14x1.5 Female(253) £
TA2708	Tie rod end(224)	B		M14x1.5 Female(253) £
TA2780	Inner tie rod(123)	A B		M14x1.5 Male(252) £
TBR4250	Steering rack gaiter kit(213)	K	Hydraulic Steering(116) Thermoplastic(223)	1 :16x66x66 2 :16x66x66
TC2386	Link stabiliser(135)	A B		M12x1.5
TC2535	Link stabiliser(135)	A B		M12x1.5 / M10x1.5
TC2823	Upper track control arm(242)	A B	Rear(187)	M14x1.5
TC2824	Connecting link(-95-)	A B	Front(108)	
TC3224	Upper wishbone(247)	A B		Pinch Bolt(255) 21mm
TC3226	Lower track control arm(151)	A	Front(108)	M16x1.5
TC3227	Lower track control arm(151)	B	Front(108)	M16x1.5
TC3341	Upper wishbone(247)	A B	-30 MIN Camber Adjustment(-87-)	Pinch Bolt(255) 21mm
TC3565	Lower track control arm(151)	A	Rear(187)	
TC3566	Lower track control arm(151)	B	Rear(187)	
TD932W	Upper wishbone bush(248)	A B	Front(108) Rear(187)	

... 7 SERIES (F04 SERIES) ActiveHybrid 7 3.0i, 4.4i, ActiveHybrid 7L 4.4i (06/08→)

Part No	Description	Pos	Info	Technical
TD1114W	Lower control arm bush(142)	A B	Rear(187) Inner(119)	
TD1241W	Lower control arm bush(142)	A B	Rear(187) Outer(176) (+) xDrive	

M SERIES (E82 SERIES) M1 3.0i (04/11-06/12)



		TC1475		TC1475
		TD1616W		TD1616W
		TD1616W		TD1616W
		TD708W		TD708W

Part No	Description	Pos	Info	Technical
TA2060	Tie rod end(224)	A		M14x1.5 Female(253) £
TA2061	Tie rod end(224)	B		M14x1.5 Female(253) £
TBR4200	Steering rack gaiter kit(213)	K	ZF Thermoplastic(223)	1 :15.5x64x64 2 :15.5x64x64
TC1475	Link stabiliser(135)	A B		M10x1.5
TD708W	Lower hub carrier bush(143)	A B	Centre(-89-)	
TD1616W	Lower hub carrier bush(143)	A B	Front(108)	
TD1616W	Sub-frame mounting(216)	A B	Front(108) Outer(176)	

M SERIES (F87 SERIES) M2 3.0i (11/15→)



		TC3586		TC3587
		TD708W		TD708W

Part No	Description	Pos	Info	Technical
TA3220	Tie rod end(224)	A		M14x1.5 Female(253) £
TA3221	Tie rod end(224)	B		M14x1.5 Female(253) £
TC3586	Lower track control arm(151)	A	Rear(187)	
TC3587	Lower track control arm(151)	B	Rear(187)	
TD708W	Lower hub carrier bush(143)	A B	Centre(-89-)	

... BMW

M SERIES (E46 SERIES) M3 3.2i (06/00→)



TBR4201



TC932



TC932



TD549W



TD549W



TC2499



TC2499



TD549W



TD549W



TD668W



TD668W

Part No	Description	Pos	Info	Technical
TBR4201	Steering rack gaiter kit(213)	K		1 :15x55x55 2 :15x55x55
TC932	Link stabiliser(135)	A B		M10x1.5
TC2499	Link stabiliser(135)	A B		
TD549W	Trailing arm bush(227)	A B	Upper(231) Lower(139) Outer(176)	
TD668W	Lower track control arm bush(153)	A B	Inner(119)	

M SERIES (E90, E92, E93 SERIES) M3 4.0i (03/07→)



TA2060



TBR4200



TA2061



TC1475



TC1475



TD1616W



TD1616W



TD1616W



TD1616W



TD708W



TD708W

Part No	Description	Pos	Info	Technical
TA2060	Tie rod end(224)	A		M14x1.5 Female(253) £
TA2061	Tie rod end(224)	B		M14x1.5 Female(253) £
TBR4200	Steering rack gaiter kit(213)	K	ZF Thermoplastic(223)	1 :15.5x64x64 2 :15.5x64x64
TC1475	Link stabiliser(135)	A B		M10x1.5
TD708W	Lower hub carrier bush(143)	A B	Centre(-89-)	
TD1616W	Lower hub carrier bush(143)	A B	Front(108)	
TD1616W	Sub-frame mounting(216)	A B	Front(108) Outer(176)	

M SERIES (F80 SERIES) M3 3.0i (01/14→)



Part No	Description	Pos	Info	Technical
TA3220	Tie rod end(224)	A		M14x1.5 Female(253) £
TA3221	Tie rod end(224)	B		M14x1.5 Female(253) £
TC3586	Lower track control arm(151)	A	Rear(187)	
TC3587	Lower track control arm(151)	B	Rear(187)	
TD708W	Lower hub carrier bush(143)	A B	Centre(-89-)	

M SERIES (F82, F83 SERIES) M4 3.0i (01/14→)



Part No	Description	Pos	Info	Technical
TA3220	Tie rod end(224)	A		M14x1.5 Female(253) £
TA3221	Tie rod end(224)	B		M14x1.5 Female(253) £
TC3586	Lower track control arm(151)	A	Rear(187)	
TC3587	Lower track control arm(151)	B	Rear(187)	
TD708W	Lower hub carrier bush(143)	A B	Centre(-89-)	

M SERIES (E39 SERIES) M5 4.9i (10/98-07/00)



... BMW

... M SERIES (E39 SERIES) M5 4.9i (10/98-07/00)



TC977



TD1182W



TD1182W



TC977



TC957



TC958



TC976



TC976



TC2067



TC2067



TC1472



TC1472



TD990W



TD990W



TD1465W



TD722W



TD722W



TD551W



TD551W

Part No	Description	Pos	Info	Technical
TA1875	Tie rod end(224)	A		M16x1.5 Female(253) £
TA1876	Tie rod end(224)	B		M16x1.5 Female(253) £
TC957	Upper control arm(235)	A	Rear(187)	M14x1.5
TC958	Upper control arm(235)	B	Rear(187)	M14x1.5
TC976	Link stabiliser(135)	A B	Metal	M10x1.25
TC977	Upper guide rod(236)	A B	Front(108)	M10x1.5
TC1226	Lower track control arm(151)	A		M14x1.5
TC1227	Lower track control arm(151)	B		M14x1.5
TC1472	Lower link arm(144)	A B		
TC2052	Link stabiliser(135)	A B		M10x1.5
TC2067	Link stabiliser(135)	A B	Aluminium(-73)	M10x1.5
TC2246	Upper track control arm(242)	A		M14x1.5
TC2247	Upper track control arm(242)	B		M14x1.5
TD477W	Lower track control arm bush(153)	A B		
TD486W	Pitman arm bush(183)	K		
TD551W	Lower hub carrier bush(143)	A B		
TD722W	Sub-frame mounting(216)	A B	Rear(187) Inner(119)	
TD788W	Upper track control arm bush(243)	A B		
TD990W	Sub-frame bush(215)	A B	Front(108) Rear(187)	
TD1182W	Upper guide rod bush(237)	A B	Inner(119)	
TD1465W	Sub-frame bush(215)	K	Front(108) Centre(-89)	
TL458	Centre rod assembly(-90)	K	L	M12x1.5
TL459	Centre rod assembly(-90)	K	R	M12x1.5

M SERIES (E39 SERIES) M5 4.9i (07/00-06/03)

BMW

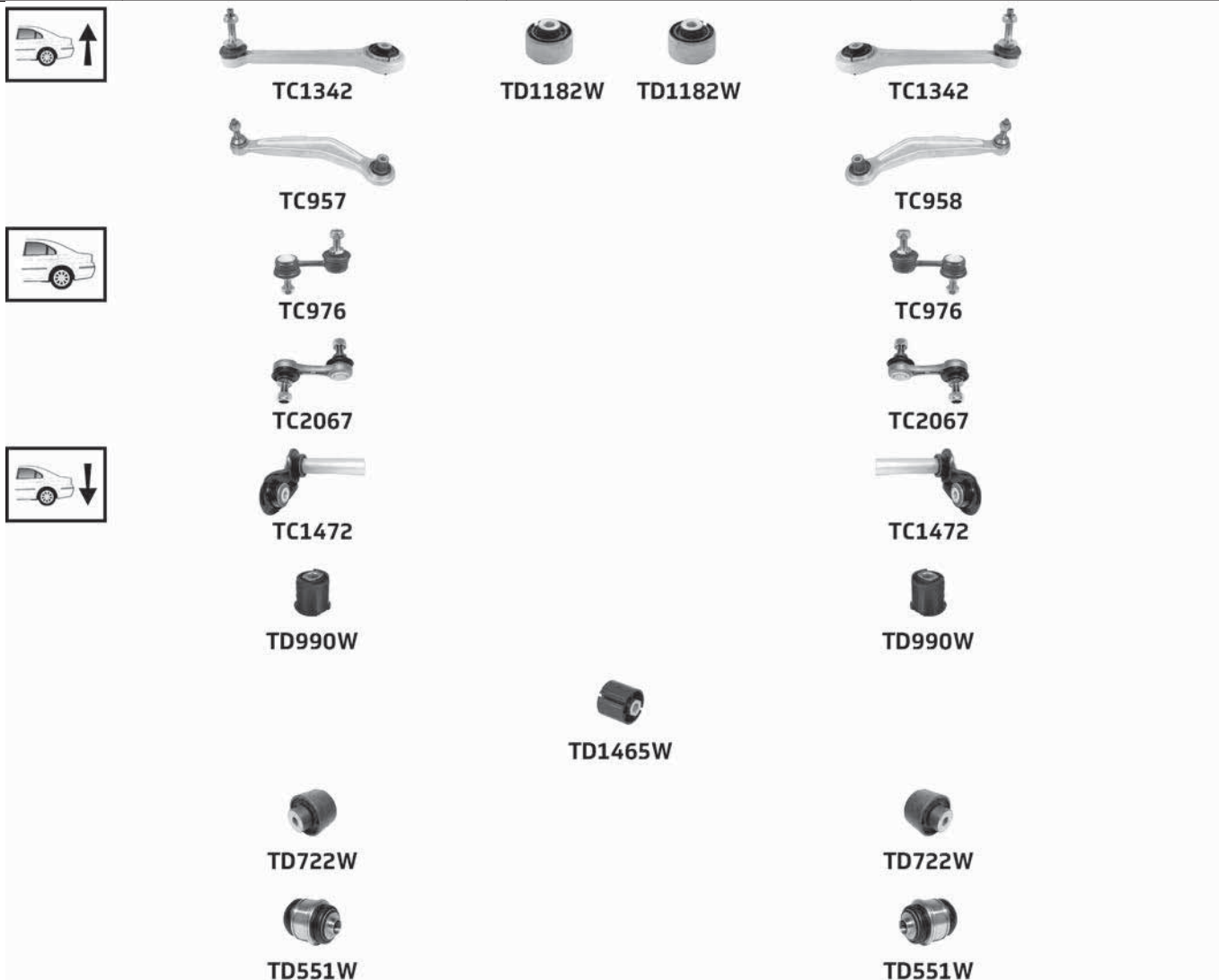

Part No	Description	Pos	Info	Technical
TA1875	Tie rod end (224)	A		M16x1.5 Female (253) £
TA1876	Tie rod end (224)	B		M16x1.5 Female (253) £
				(...)

... BMW

... M SERIES (E39 SERIES) M5 4.9i (07/00-06/03)

TC957	Upper control arm(235)	A	Rear(187)	M14x1.5
TC958	Upper control arm(235)	B	Rear(187)	M14x1.5
TC976	Link stabiliser(135)	A B	Metal	M10x1.25
TC1226	Lower track control arm(151)	A		M14x1.5
TC1227	Lower track control arm(151)	B		M14x1.5
TC1342	Upper guide rod(236)	A B	Front(108)	M10x1.5
TC1472	Lower link arm(144)	A B		
TC2052	Link stabiliser(135)	A B		M10x1.5
TC2067	Link stabiliser(135)	A B	Aluminium(-73)	M10x1.5
TC2246	Upper track control arm(242)	A		M14x1.5
TC2247	Upper track control arm(242)	B		M14x1.5
TD477W	Lower track control arm bush(153)	A B		
TD486W	Pitman arm bush(183)	K		
TD551W	Lower hub carrier bush(143)	A B		
TD722W	Sub-frame mounting(216)	A B	Rear(187) Inner(119)	
TD788W	Upper track control arm bush(243)	A B		
TD990W	Sub-frame bush(215)	A B	Front(108) Rear(187)	
TD1182W	Upper guide rod bush(237)	A B	Inner(119)	
TD1465W	Sub-frame bush(215)	K	Front(108) Centre(-89)	
TL458	Centre rod assembly(-90)	K	L	M12x1.5
TL459	Centre rod assembly(-90)	K	R	M12x1.5

M SERIES (E60, E61 SERIES) M5 5.0i (09/04-04/10)

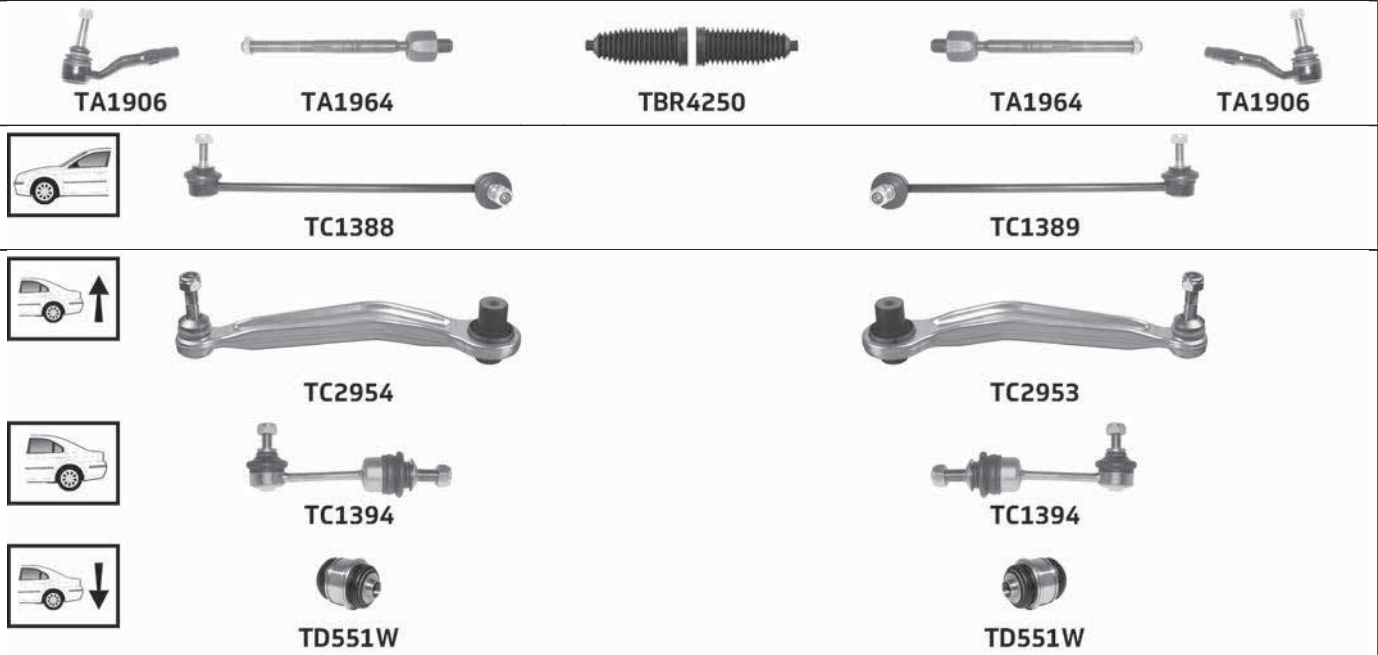

Part No	Description	Pos	Info	Technical
TA1906	Tie rod end(224)	A B		M16x1.5 Female(253) £
TA1964	Inner tie rod(123)	A B		M16x1.5 Male(252) £
TBR4250	Steering rack gaiter kit(213)	K	Thermoplastic(223)	1 :16x66x66 2 :16x66x66
TC1388	Link stabiliser(135)	A		M10x1.5
TC1389	Link stabiliser(135)	B		M10x1.5
TC1394	Link stabiliser(135)	A B		M10x1.5
TC2953	Upper control arm(235)	B	Rear(187)	M14x1.5
TC2954	Upper control arm(235)	A	Rear(187)	M14x1.5
TD551W	Lower hub carrier bush(143)	A B		

X SERIES (E84 SERIES) X1 2.0i S drive 18i, 20i, 2.0d S drive 18d, 20d (10/09→)



TA2060



TA2062



TBR4223



TA2062



TA2061



TA2060



TA2109



TBR4200



TA2109



TA2061



TC1473



TC1474



TC1749



TD861W



TD861W



TC1750



TC1476



TC1477

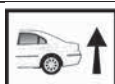

TC3576



TC3577



TC3663



TC3663



TD1125W



TD1125W



TC2536



TC2537



TD1634W



TD1616W



TD1616W



TC1917



TC1917



TD1616W



TD1616W



TD708W



TD708W















Part No	Description	Pos	Info	Technical
TA2060	Tie rod end(224)	A		M14x1.5 Female(253) £
TA2061	Tie rod end(224)	B		M14x1.5 Female(253) £
TA2062	Inner tie rod(123)	A B	TRW	M14x1.5 Male(252) £
TA2109	Inner tie rod(123)	A B	ZF	M14x1.5 Male(252) £
TBR4200	Steering rack gaiter kit(213)	K	ZF Thermoplastic(223)	1 :15.5x64x64 2 :15.5x64x64
TBR4223	Steering rack gaiter kit(213)	K	TRW Thermoplastic(223)	1 :14x60x60 2 :14x60x60
				(...)

... BMW

... X SERIES (E84 SERIES) X1 2.0i S drive 18i, 20i, 2.0d S drive 18d, 20d (10/09→)

Part No	Description	Pos	Info	Technical
TC1473	Link stabiliser(135)	A		M10x1.5
TC1474	Link stabiliser(135)	B		M10x1.5
TC1476	Lower track control arm(151)	A	Rear(187)	M14x1.5
TC1477	Lower track control arm(151)	B	Rear(187)	M14x1.5
TC1749	Lower track control arm(151)	A	Front(108)	M14x1.5
TC1750	Lower track control arm(151)	B	Front(108)	M14x1.5
TC1917	Lower track control arm(151)	A B	Rear(187)	
TC2536	Link stabiliser(135)	A		M10x1.5
TC2537	Link stabiliser(135)	B		M10x1.5
TC3576	Upper track control arm(242)	A	Front(108)	
TC3577	Lower track control arm(151)	B	Front(108)	
TC3663	Upper track control arm(242)	A B	Centre(-89-)	
TD708W	Lower hub carrier bush(143)	A B	Centre(-89-)	
TD861W	Lower track control arm bush(153)	A B	Front(108)	
TD1125W	Upper hub carrier bush(238)	A B		
TD1616W	Lower hub carrier bush(143)	A B	Front(108)	
TD1616W	Sub-frame mounting(216)	A B	Front(108) Outer(176)	
TD1634W	Anti-roll bar(-74-) bush kit(-86-)	K	Ø13 Complete axle kit(-92-) (-) Sport suspension(-27-)	

X SERIES (E84 SERIES) X1 2.0i X drive 20i, 28i, 2.0d X drive 18d, 20d, 23d, 25d, 3.0i X drive 25i, 28i (10/09→)

				
TA2807	TA3230	TBR4200	TA3230	TA2808
				
	TC2515		TC2516	
				
	TC2980		TC2980	
				
TC2064	TC3230		TC3231	TC2064

... X SERIES (E84 SERIES) X1 2.0i X drive 20i, 28i, 2.0d X drive 18d, 20d, 23d, 25d, 3.0i X drive 25i, 28i (10/09→)



TC3576



TC3577



TC3663



TC3663



TD1125W



TD1125W



TC2536



TC2537



TD1634W



TD1616W



TD1616W



TC1917



TC1917



TD1616W



TD1616W



TD708W



TD708W

Part No	Description	Pos	Info	Technical
TA2807	Tie rod end(224)	A		M14x1.5 Female(253) £
TA2808	Tie rod end(224)	B		M14x1.5 Female(253) £
TA3230	Inner tie rod(123)	A B		M14x1.5 Male(252) £
TBR4200	Steering rack gaiter kit(213)	K	ZF Thermoplastic(223)	1 :15.5x64x64 2 :15.5x64x64
TC1917	Lower track control arm(151)	A B	Rear(187)	
TC2064	Lower ball joint(140)	A B	Rear(187)	M14x1.5
TC2515	Link stabiliser(135)	A		M10x1.5
TC2516	Link stabiliser(135)	B		M10x1.5
TC2536	Link stabiliser(135)	A		M10x1.5
TC2537	Link stabiliser(135)	B		M10x1.5
TC2980	Lower track control arm(151)	A B	Front(108)	M14x1.5
TC3230	Lower track control arm(151)	A	Rear(187) (-) Ball joint(-11-)	
TC3231	Lower track control arm(151)	B	Rear(187) (-) Ball joint(-11-)	
TC3576	Upper track control arm(242)	A	Front(108)	
TC3577	Lower track control arm(151)	B	Front(108)	
TC3663	Upper track control arm(242)	A B	Centre(-89-)	
TD708W	Lower hub carrier bush(143)	A B	Centre(-89-)	
TD1125W	Upper hub carrier bush(238)	A B		
TD1616W	Lower hub carrier bush(143)	A B	Front(108)	
TD1616W	Sub-frame mounting(216)	A B	Front(108)	
TD1634W	Anti-roll bar(-74) bush kit(-86-)	K	Ø13 Complete axle kit(-92) (-) Sport suspension(-27-)	

... BMW

X SERIES (F48 SERIES) X1 1.5i S drive 18i, 1.5d S drive 16d, 2.0i S drive 20i, 2.0d S drive 18d, 20d, 2.0d X drive 18d, 20d, 25d, 2.0i X drive 20i, 25i (11/14→)



TC3617



TC3617

Part No	Description	Pos	Info	Technical
TC3617	Link stabiliser (135)	A B		M10x1.5

X SERIES (F39 SERIES) X2 1.5i S drive 18i, 2.0d S drive 18d, 2.0i S drive 20i, 2.0d X drive 18d, 20d, 25d, 2.0i X drive 20i (02/18→)



TC3617



TC3617

Part No	Description	Pos	Info	Technical
TC3617	Link stabiliser (135)	A B		M10x1.5

X SERIES (E83 SERIES) X3 2.0i, 2.0d, 2.5i, 3.0i, 3.0d (01/04-12/06)



TA2063



TA2324

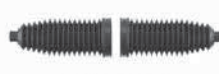

TBR4250



TA2324



TA2063



TC1478



TC1479



TC1480



TC1483



TD508W



TD508W



TC1484



TC1480



TC2623



TC2624



TD508W



TD508W



TC2625



TC2623



TC1481



TD483W



TD483W



TC1482

... X SERIES (E83 SERIES) X3 2.0i, 2.0d, 2.5i, 3.0i, 3.0d (01/04-12/06)



Part No	Description	Pos	Info	Technical
TA2063	Tie rod end(224)	A B		M14x1.5 Female(253) £
TA2324	Inner tie rod(123)	A B		M14x1.5 Male(252) £
TBR4250	Steering rack gaiter kit(213)	K	Thermoplastic(223)	1 :16x66x66 2 :16x66x66
TC1478	Link stabiliser(135)	A		M10x1.5
TC1479	Link stabiliser(135)	B		M10x1.5
TC1480	Lower ball joint(140)	A B		M14x1.5
TC1481	Lower track control arm(151)	A	Rear(187)	M14x1.5
TC1482	Lower track control arm(151)	B	Rear(187)	M14x1.5
TC1483	Lower track control arm(151)	A	Front(108) (-) Ball joint(-11)	
TC1484	Lower track control arm(151)	B	Front(108) (-) Ball joint(-11)	
TC1485	Link stabiliser(135)	A B		M10x1.5
TC2232	Lower track control arm(151)	A B		
TC2623	Lower ball joint(140)	A B	Reinforced version(190)	M14x1.5
TC2624	Lower track control arm(151)	A	Front(108) Reinforced version(190) (-) Ball joint(-11)	
TC2625	Lower track control arm(151)	B	Front(108) Reinforced version(190) (-) Ball joint(-11)	
TD483W	Lower track control arm bush(153)	A B	Rear(187)	
TD508W	Lower track control arm bush(153)	A B	Front(108)	
TD667W	Lower track control arm bush(153)	A B	Outer(176)	
TD668W	Lower track control arm bush(153)	A B	Inner(119)	
TD730W	Sub-frame mounting(216)	A B	Front(108) Inner(119)	
TD736W	Trailing arm bush(227)	A B	Lower(139) Front(108)	
TD760W	Upper track control arm bush(243)	A B	Inner(119)	
TD916W	Upper hub carrier bush(238)	A B		
TD949W	Sub-frame mounting(216)	A B	Rear(187) Outer(176)	
TD980W	Sub-frame mounting(216)	A	Front(108) Outer(176)	
TD981W	Sub-frame mounting(216)	B	Front(108) Outer(176)	

... BMW

X SERIES (E83 SERIES) X3 2.0i, 2.0d, 2.5i, 3.0i, 3.0d (12/06→)



TA2063



TA2324



TBR4250



TA2324



TA2063



TC1478



TC1479



TC2623



TC2624



TD508W



TD508W



TC2625



TC2623



TC1481



TD483W



TD483W



TC1482



TD916W



TD916W



TD760W



TD760W



TC1485



TC1485



TD980W



TD981W



TD730W



TD730W



TD949W



TD949W



TD736W



TD736W



TD667W



TC2232



TD668W



TD668W



TC2232



TD667W

Part No	Description	Pos	Info	Technical
TA2063	Tie rod end(224)	A B		M14x1.5 Female(253) E
TA2324	Inner tie rod(123)	A B		M14x1.5 Male(252) E
TBR4250	Steering rack gaiter kit(213)	K	Thermoplastic(223)	1 :16x66x66 2 :16x66x66
TC1478	Link stabiliser(135)	A		M10x1.5
TC1479	Link stabiliser(135)	B		M10x1.5
TC1481	Lower track control arm(151)	A	Rear(187)	M14x1.5
TC1482	Lower track control arm(151)	B	Rear(187)	M14x1.5
TC1485	Link stabiliser(135)	A B		M10x1.5
TC2232	Lower track control arm(151)	A B		
TC2623	Lower ball joint(140)	A B		M14x1.5
TC2624	Lower track control arm(151)	A	Front(108) (-) Ball joint(-11-)	

... X SERIES (E83 SERIES) X3 2.0i, 2.0d, 2.5i, 3.0i, 3.0d (12/06→)

Part No	Description	Pos	Info	Technical
TC2625	Lower track control arm(151)	B	Front(108) (-) Ball joint(-11-)	
TD483W	Lower track control arm bush(153)	A B	Rear(187)	
TD508W	Lower track control arm bush(153)	A B	Front(108)	
TD667W	Lower track control arm bush(153)	A B	Outer(176)	
TD668W	Lower track control arm bush(153)	A B	Inner(119)	
TD730W	Sub-frame mounting(216)	A B	Front(108) Inner(119)	
TD736W	Trailing arm bush(227)	A B	Lower(139) Front(108)	
TD760W	Upper track control arm bush(243)	A B	Inner(119)	
TD916W	Upper hub carrier bush(238)	A B		
TD949W	Sub-frame mounting(216)	A B	Rear(187) Outer(176)	
TD980W	Sub-frame mounting(216)	A	Front(108) Outer(176)	
TD981W	Sub-frame mounting(216)	B	Front(108) Outer(176)	

X SERIES (F25 SERIES) X3 2.0i S drive 20i, 2.0d S drive 18d (08/11→)

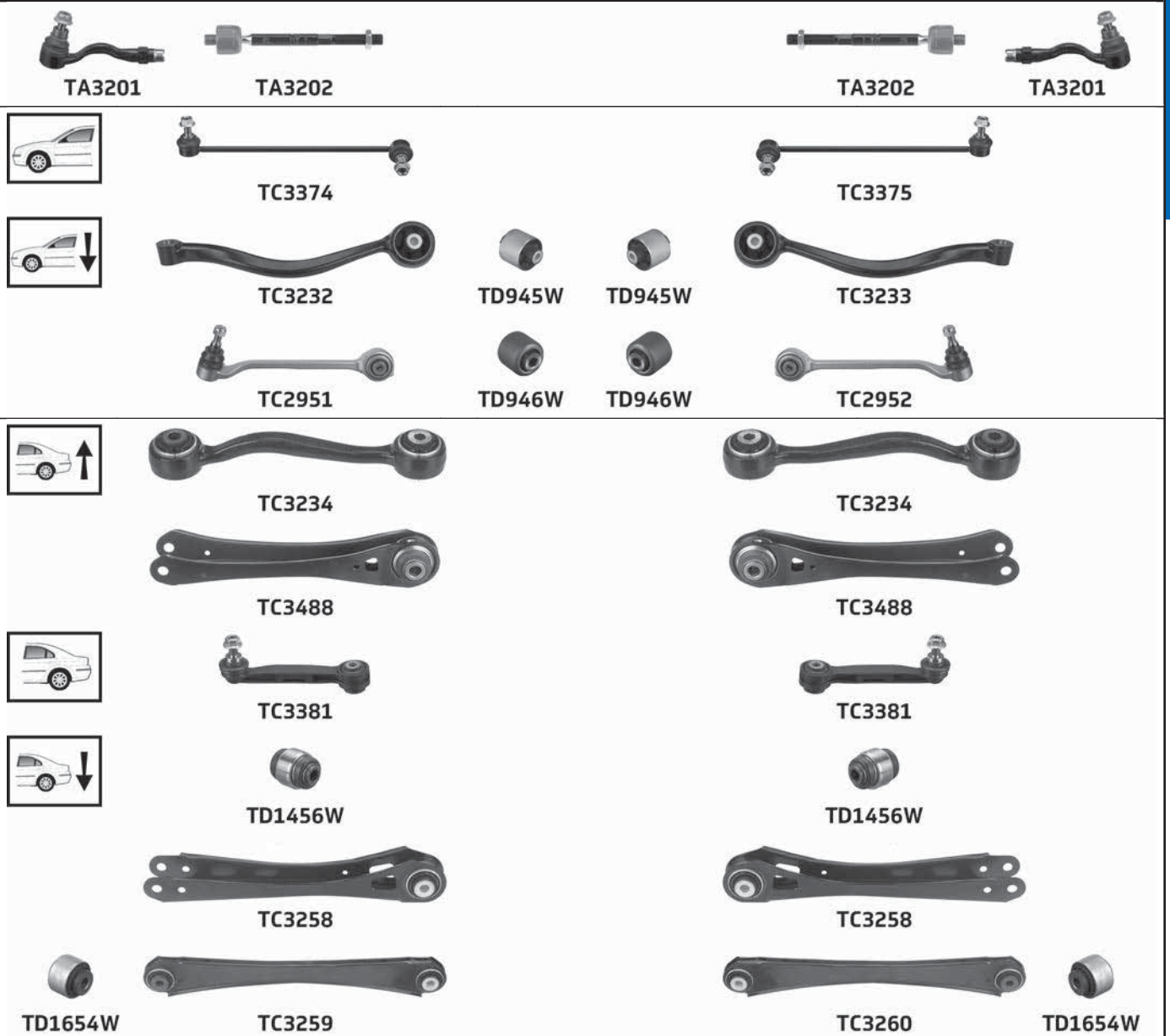

Part No	Description	Pos	Info	Technical
TA3201	Tie rod end(224)	A B		M16x1.5 Female(253) £
TA3202	Inner tie rod(123)	A B		M16x1.5 Male(252) £
TC2951	Lower track control arm(151)	A	Rear(187)	M14x1.5
TC2952	Lower track control arm(151)	B	Rear(187)	M14x1.5
TC3232	Lower track control arm(151)	A	Front(108) (-) Ball joint(-11-)	
TC3233	Lower track control arm(151)	B	Front(108) (-) Ball joint(-11-)	
TC3234	Upper guide rod(236)	A B	Front(108)	
TC3258	Lower trailing arm(156)	A B	Front(108)	
TC3259	Lower track control arm(151)	A	Rear(187)	

... BMW

... X SERIES (F25 SERIES) X3 2.0i S drive 20i, 2.0d S drive 18d (08/11→)

Part No	Description	Pos	Info	Technical
TC3260	Lower track control arm(151)	B	Rear(187)	
TC3374	Link stabiliser(135)	A		M12x1.5
TC3375	Link stabiliser(135)	B		M12x1.5
TC3381	Link stabiliser(135)	A B		M10x1.5
TC3488	Upper track control arm(242)	A B	Centre(-89-)	
TD945W	Lower track control arm bush(153)	A B	Front(108)	
TD946W	Lower track control arm bush(153)	A B	Rear(187)	
TD1456W	Lower hub carrier bush(143)	A B	Rear(187)	
TD1654W	Lower track control arm bush(153)	A B	Outer(176)	

X SERIES (F25 SERIES) X3 2.0i X drive 20i, 28i, 2.0d X drive 20d, 3.0i X drive 28i, 35i, 3.0d X drive 30d, 35d (09/10→)

Part No	Description	Pos	Info	Technical
TA3201	Tie rod end(224)	A B		M16x1.5 Female(253) E
TA3202	Inner tie rod(123)	A B		M16x1.5 Male(252) E
TC2951	Lower track control arm(151)	A B	Rear(187)	M14x1.5
TC2952	Lower track control arm(151)	B	Rear(187)	M14x1.5
TC3232	Lower track control arm(151)	A	Front(108) (-) Ball joint(-11-)	
TC3233	Lower track control arm(151)	B	Front(108) (-) Ball joint(-11-)	
TC3234	Upper guide rod(236)	A B	Front(108)	
TC3258	Lower trailing arm(156)	A B	Front(108)	
TC3259	Lower track control arm(151)	A	Rear(187)	
TC3260	Lower track control arm(151)	B	Rear(187)	
TC3374	Link stabiliser(135)	A		M12x1.5
TC3375	Link stabiliser(135)	B		M12x1.5
TC3381	Link stabiliser(135)	A B		M10x1.5

... X SERIES (F25 SERIES) X3 2.0i X drive 20i, 28i, 2.0d X drive 20d, 3.0i X drive 28i, 35i, 3.0d X drive 30d, 35d (09/10→)

Part No	Description	Pos	Info	Technical
TC3488	Upper track control arm(242)	A B	Centre(-89)	
TD945W	Lower track control arm bush(153)	A B	Front(108)	
TD946W	Lower track control arm bush(153)	A B	Rear(187)	
TD1456W	Lower hub carrier bush(143)	A B	Rear(187)	
TD1654W	Lower track control arm bush(153)	A B	Outer(176)	

X SERIES (F26 SERIES) X4 2.0i X drive 20i, 28i, 2.0d X drive 20d, 3.0i X drive 35i, 3.0d X drive 30d, 35d (04/14→)

X SERIES (F26 SERIES) X4M 3.0i X drive 40i (12/15→)

TA3201 TA3202 TA3202 TA3201

TC3374 TC3375

TC3232 TD945W TD945W TC3233

TC2951 TD946W TD946W TC2952

TC3234 TC3234

TC3488 TC3488

TC3381 TC3381

TD1456W TD1456W

TC3258 TC3258

TD1654W TC3259 TC3260 TD1654W

Part No	Description	Pos	Info	Technical
TA3201	Tie rod end(224)	A B		M16x1.5 Female(253) £
TA3202	Inner tie rod(123)	A B		M16x1.5 Male(252) £
TC2951	Lower track control arm(151)	A	Rear(187)	M14x1.5
TC2952	Lower track control arm(151)	B	Rear(187)	M14x1.5
TC3232	Lower track control arm(151)	A	Front(108) (-) Ball joint(-11)	
TC3233	Lower track control arm(151)	B	Front(108) (-) Ball joint(-11)	
TC3234	Upper guide rod(236)	A B	Front(108)	
TC3258	Lower trailing arm(156)	A B	Front(108)	
TC3259	Lower track control arm(151)	A	Rear(187)	
TC3260	Lower track control arm(151)	B	Rear(187)	
TC3374	Link stabiliser(135)	A	(-) X4M	M12x1.5
TC3375	Link stabiliser(135)	B	(-) X4M	M12x1.5
TC3381	Link stabiliser(135)	A B		M10x1.5
TC3488	Upper track control arm(242)	A B	Centre(-89)	
TD945W	Lower track control arm bush(153)	A B	Front(108)	

... BMW

... X SERIES (F26 SERIES) X4 2.0i X drive 20i, 28i, 2.0d X drive 20d, 3.0i X drive 35i, 3.0d X drive 30d, 35d (04/14→)

... X SERIES (F26 SERIES) X4M 3.0i X drive 40i (12/15→)

Part No	Description	Pos	Info	Technical
TD946W	Lower track control arm bush(153)	A B	Rear(187)	
TD1456W	Lower hub carrier bush(143)	A B	Rear(187)	
TD1654W	Lower track control arm bush(153)	A B	Outer(176)	

X SERIES (E53 SERIES) X5 3.0i, 3.0D, 4.4i, 4.6i, 4.8i (05/00→)

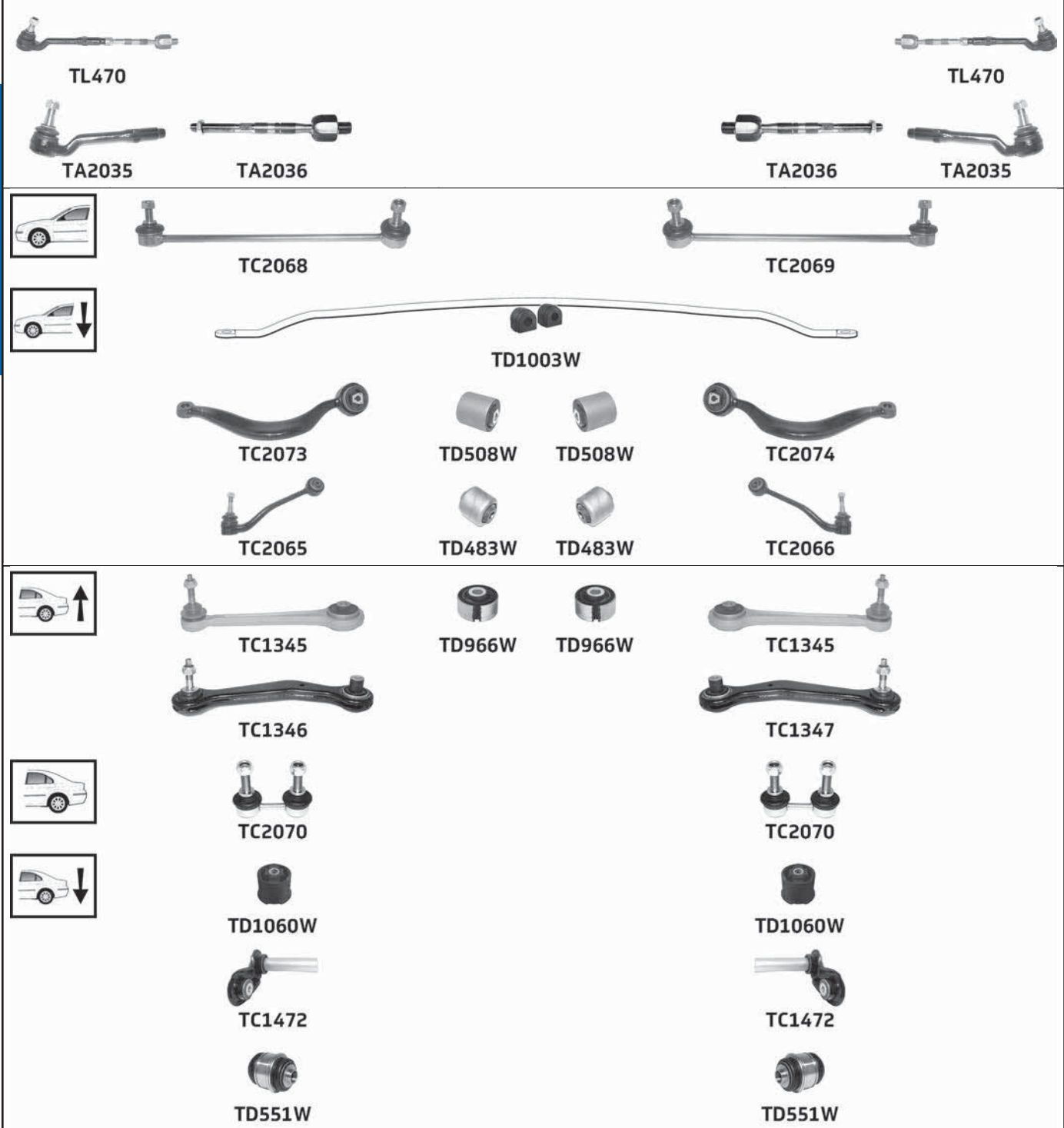

Part No	Description	Pos	Info	Technical
TA2035	Tie rod end(224)	A B		M14x1.5 Female(253) E
TA2036	Inner tie rod(123)	A B		M14x1.5 Male(252) E
TC1345	Upper guide rod(236)	A B	Front(108)	M10x1.5
TC1346	Upper control arm(235)	A	Rear(187)	M14x1.5
TC1347	Upper control arm(235)	B	Rear(187)	M14x1.5
TC1472	Lower link arm(144)	A B		
TC2065	Lower track control arm(151)	A	Rear(187)	M14x1.5
TC2066	Lower track control arm(151)	B	Rear(187)	M14x1.5
TC2068	Link stabiliser(135)	A		M12x1.5
TC2069	Link stabiliser(135)	B		M12x1.5

... X SERIES (E53 SERIES) X5 3.0i, 3.0D, 4.4i, 4.6i, 4.8i (05/00→)

Part No	Description	Pos	Info	Technical
TC2070	Link stabiliser(135)	A B		M12x1.5
TC2073	Lower track control arm(151)	A	Front(108) (-) Ball joint(-11)	
TC2074	Lower track control arm(151)	B	Front(108) (-) Ball joint(-11)	
TD483W	Lower track control arm bush(153)	A B	Rear(187)	
TD508W	Lower track control arm bush(153)	A B	Front(108)	
TD551W	Lower hub carrier bush(143)	A B		
TD966W	Upper guide rod bush(237)	A B	Inner(119)	
TD1003W	Anti-roll bar(-74) bush kit(-86)	K	Ø29 Complete axle kit(-92)	
TD1060W	Sub-frame bush(215)	A B	Front(108) Rear(187)	
TL470	Rod assembly(194)	A B		M14x1.5

X SERIES (E70 SERIES) X5 3.0si, 3.0d, 3.0sd, 4.4i, 4.8i (02/07→)

TA2678 TA2520 TA2520 TA2678

↑

TC2328 TD929W TD929W TC2329

TC2155 TC2156

TC2257 TC2258

↓

TC2227 TD914W TD914W TC2228

TD951W TC2229 TD950W TD950W TC2230 TD951W

↑

TC2867 TC2868

TC3011 TC3012

TC2146 TC2146

↓

TC3013 TC3013

Part No	Description	Pos	Info	Technical
TA2520	Inner tie rod(123)	A B		M14x1.5 Male(252) £
TA2678	Tie rod end(224)	A B		M14x1.5 Female(253) £
				(...)

... BMW

... X SERIES (E70 SERIES) X5 3.0si, 3.0d, 3.0sd, 4.4i, 4.8i (02/07→)

Part No	Description	Pos	Info	Technical
TC2146	Link stabiliser (135)	A B		M12x1.5
TC2155	Link stabiliser (135)	A	(-) Dynamic drive(-14-)	M12x1.5
TC2156	Link stabiliser (135)	B	(-) Dynamic drive(-14-)	M12x1.5
TC2227	Lower track control arm (151)	A	Front (108)	M14x1.5
TC2228	Lower track control arm (151)	B	Front (108)	M14x1.5
TC2229	Lower track control arm (151)	A	Rear (187)	M14x1.5
TC2230	Lower track control arm (151)	B	Rear (187)	M14x1.5
TC2257	Link stabiliser (135)	A	(+) Dynamic drive(-43-)	M12x1.5
TC2258	Link stabiliser (135)	B	(+) Dynamic drive(-43-)	M12x1.5
TC2328	Upper wishbone (247)	A		Pinch Bolt (255) 20mm
TC2329	Upper wishbone (247)	B		Pinch Bolt (255) 20mm
TC2867	Upper guide rod (236)	A	Front (108)	M12x1.5
TC2868	Upper guide rod (236)	B	Front (108)	M12x1.5
TC3011	Upper control arm (235)	A	Rear (187) → 07/13	M14x1.5
TC3012	Upper control arm (235)	B	Rear (187) → 07/13	M14x1.5
TC3013	Lower link arm (144)	A B		
TD914W	Lower track control arm bush (153)	A B		
TD929W	Upper wishbone bush (248)	A B	Front (108) Rear (187)	
TD950W	Lower track control arm bush (153)	A B	Inner (119)	
TD951W	Lower track control arm bush (153)	A B	Outer (176)	

X SERIES (F15 SERIES) X5 2.0d S drive 25d (11/12→)



Part No	Description	Pos	Info	Technical
TC2867	Upper guide rod (236)	A	Front (108)	M12x1.5
TC2868	Upper guide rod (236)	B	Front (108)	M12x1.5
TC3013	Lower link arm (144)	A B		
TC3400	Upper control arm (235)	A	Rear (187)	M14x1.5
TC3401	Upper control arm (235)	B	Rear (187)	M14x1.5
TC3574	Lower track control arm (151)	A	Rear (187)	M14 x 1.5 x 25
TC3575	Lower track control arm (151)	B	Rear (187)	M14 x 1.5 x 25
TD951W	Lower track control arm bush (153)	A B	Rear (187) Outer (176)	

X SERIES (F15 SERIES) X5 2.0d X drive 25d, 3.0d X drive 30d, 40d, M50d, 3.0i X drive 35i, 4.4i X drive 50i (11/12→)

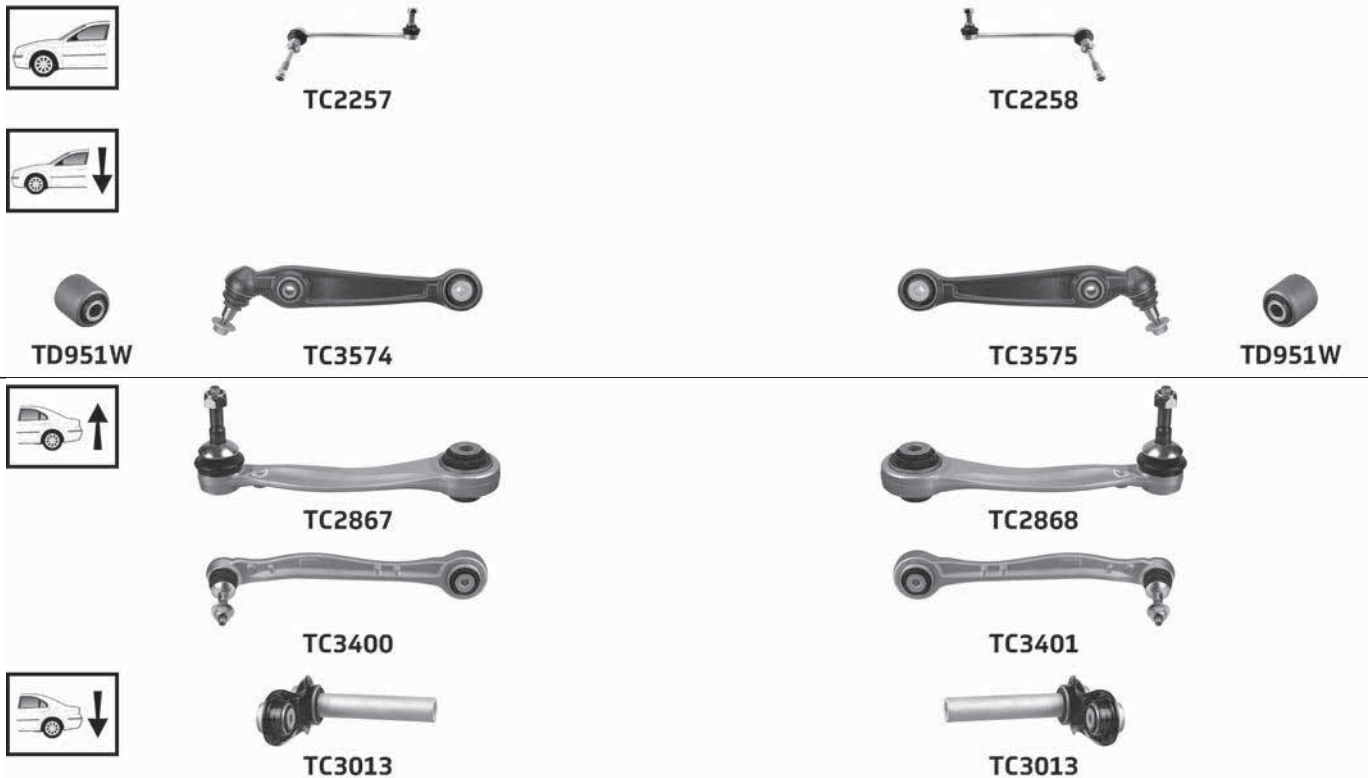

Part No	Description	Pos	Info	Technical
TC2257	Link stabiliser(135)	A	(+) Dynamic drive(-43)	M12x1.5
TC2258	Link stabiliser(135)	B	(+) Dynamic drive(-43)	M12x1.5
TC2867	Upper guide rod(236)	A	Front(108)	M12x1.5
TC2868	Upper guide rod(236)	B	Front(108)	M12x1.5
TC3013	Lower link arm(144)	A B		
TC3400	Upper control arm(235)	A	Rear(187)	M14x1.5
TC3401	Upper control arm(235)	B	Rear(187)	M14x1.5
TC3574	Lower track control arm(151)	A	Rear(187)	M14 x 1.5 x 25
TC3575	Lower track control arm(151)	B	Rear(187)	M14 x 1.5 x 25
TD951W	Lower track control arm bush(153)	A B	Rear(187) Outer(176)	

X SERIES (F85 SERIES) X5M 4.4i (12/14→)

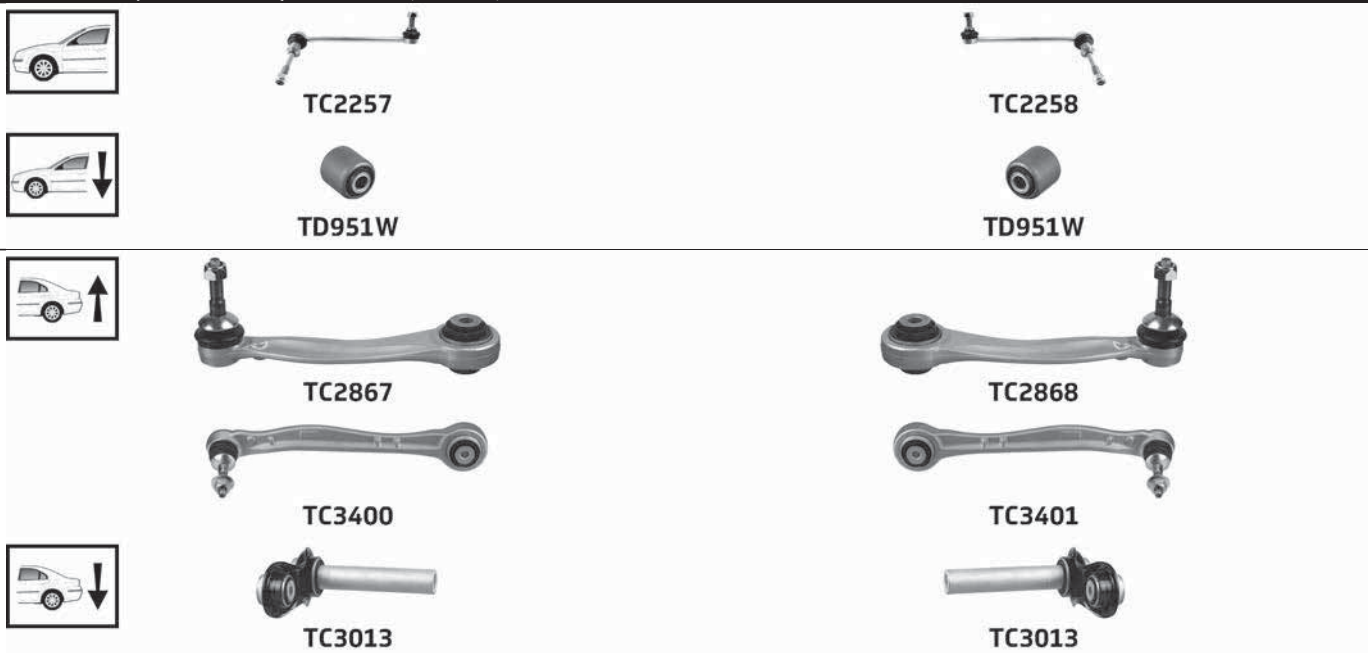

Part No	Description	Pos	Info	Technical
TC2257	Link stabiliser(135)	A		M12x1.5
TC2258	Link stabiliser(135)	B		M12x1.5
TC2867	Upper guide rod(236)	A	Front(108)	M12x1.5
TC2868	Upper guide rod(236)	B	Front(108)	M12x1.5

(...)

... BMW

... X SERIES (F85 SERIES) X5M 4.4i (12/14→)

Part No	Description	Pos	Info	Technical
TC3013	Lower link arm(144)	A B		
TC3400	Upper control arm(235)	A	Rear(187)	M14x1.5
TC3401	Upper control arm(235)	B	Rear(187)	M14x1.5
TD951W	Lower track control arm bush(153)	A B	Rear(187) Outer(176)	

X SERIES (E71, E72 SERIES) X6 3.0i, 3.0d, 4.4i (05/08→)

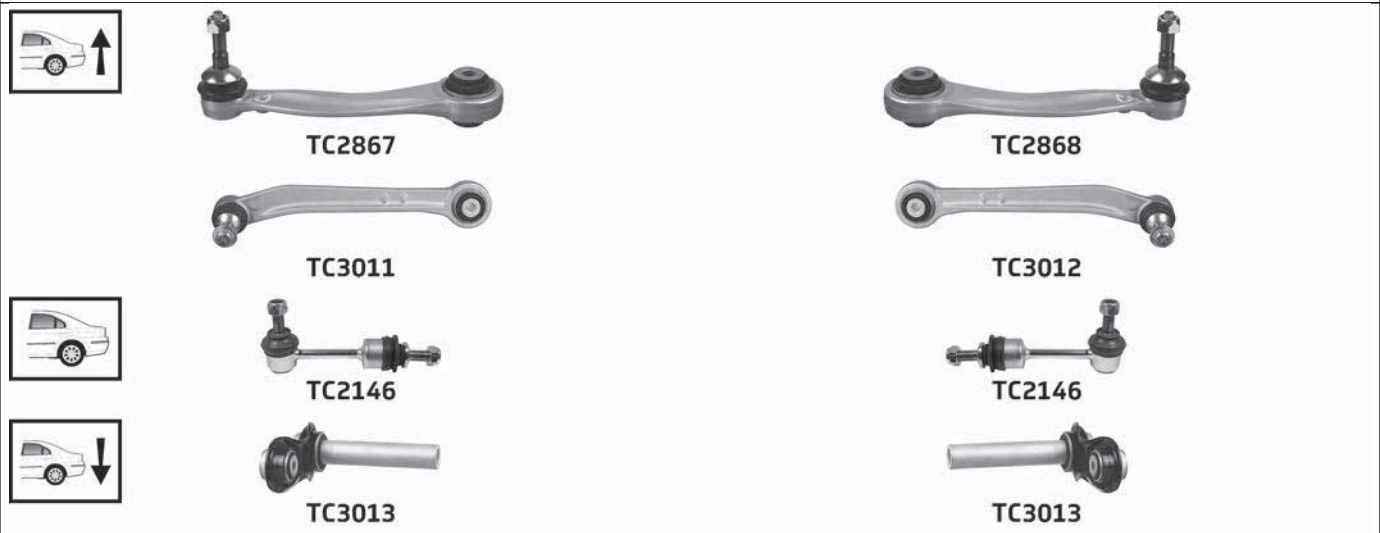
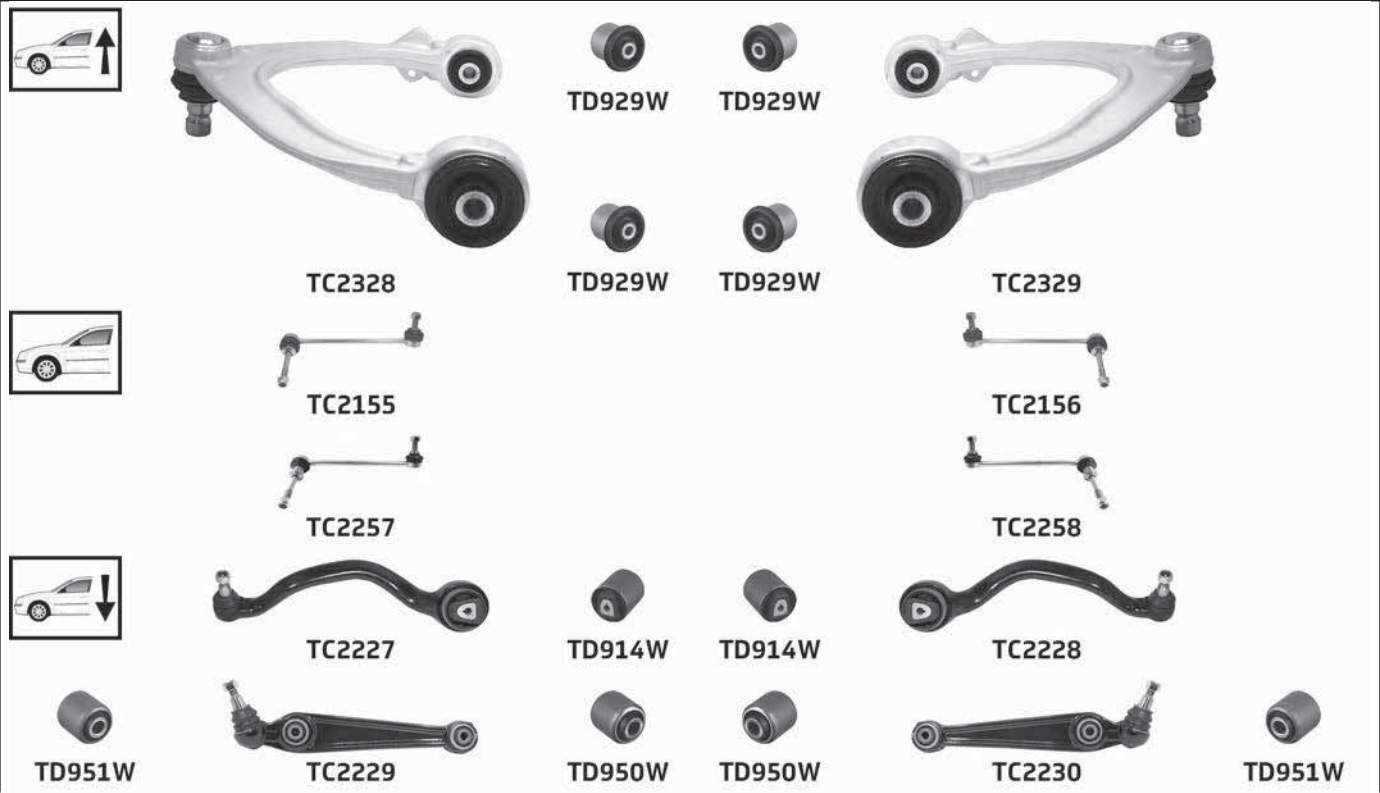

Part No	Description	Pos	Info	Technical
TA2520	Inner tie rod(123)	A B		M14x1.5 Male(252) £
TA2678	Tie rod end(224)	A B		M14x1.5 Female(253) £
TC2146	Link stabiliser(135)	A B		M12x1.5
TC2155	Link stabiliser(135)	A	(-) Dynamic drive(-14-)	M12x1.5
TC2156	Link stabiliser(135)	B	(-) Dynamic drive(-14-)	M12x1.5
TC2227	Lower track control arm(151)	A	Front(108)	M14x1.5
TC2228	Lower track control arm(151)	B	Front(108)	M14x1.5
TC2229	Lower track control arm(151)	A	Rear(187)	M14x1.5
TC2230	Lower track control arm(151)	B	Rear(187)	M14x1.5
TC2257	Link stabiliser(135)	A	(+) Dynamic drive(-43-)	M12x1.5

BMW

... X SERIES (E71, E72 SERIES) X6 3.0i, 3.0d, 4.4i (05/08→)

Part No	Description	Pos	Info	Technical
TC2258	Link stabiliser(135)	B	(+) Dynamic drive(-43)	M12x1.5
TC2328	Upper wishbone(247)	A		Pinch Bolt(255) 20mm
TC2329	Upper wishbone(247)	B		Pinch Bolt(255) 20mm
TC2867	Upper guide rod(236)	A	Front(108)	M12x1.5
TC2868	Upper guide rod(236)	B	Front(108)	M12x1.5
TC3011	Upper control arm(235)	A	Rear(187) → 07/13	M14x1.5
TC3012	Upper control arm(235)	B	Rear(187) → 07/13	M14x1.5
TC3013	Lower link arm(144)	A B		
TD914W	Lower track control arm bush(153)	A B		
TD929W	Upper wishbone bush(248)	A B	Front(108) Rear(187)	
TD950W	Lower track control arm bush(153)	A B	Inner(119)	
TD951W	Lower track control arm bush(153)	A B	Outer(176)	

X SERIES (F16 SERIES) X6 3.0d X drive 30d, 40d, M50d, 3.0i X drive 35i, 4.4i X drive 50i (08/14→)

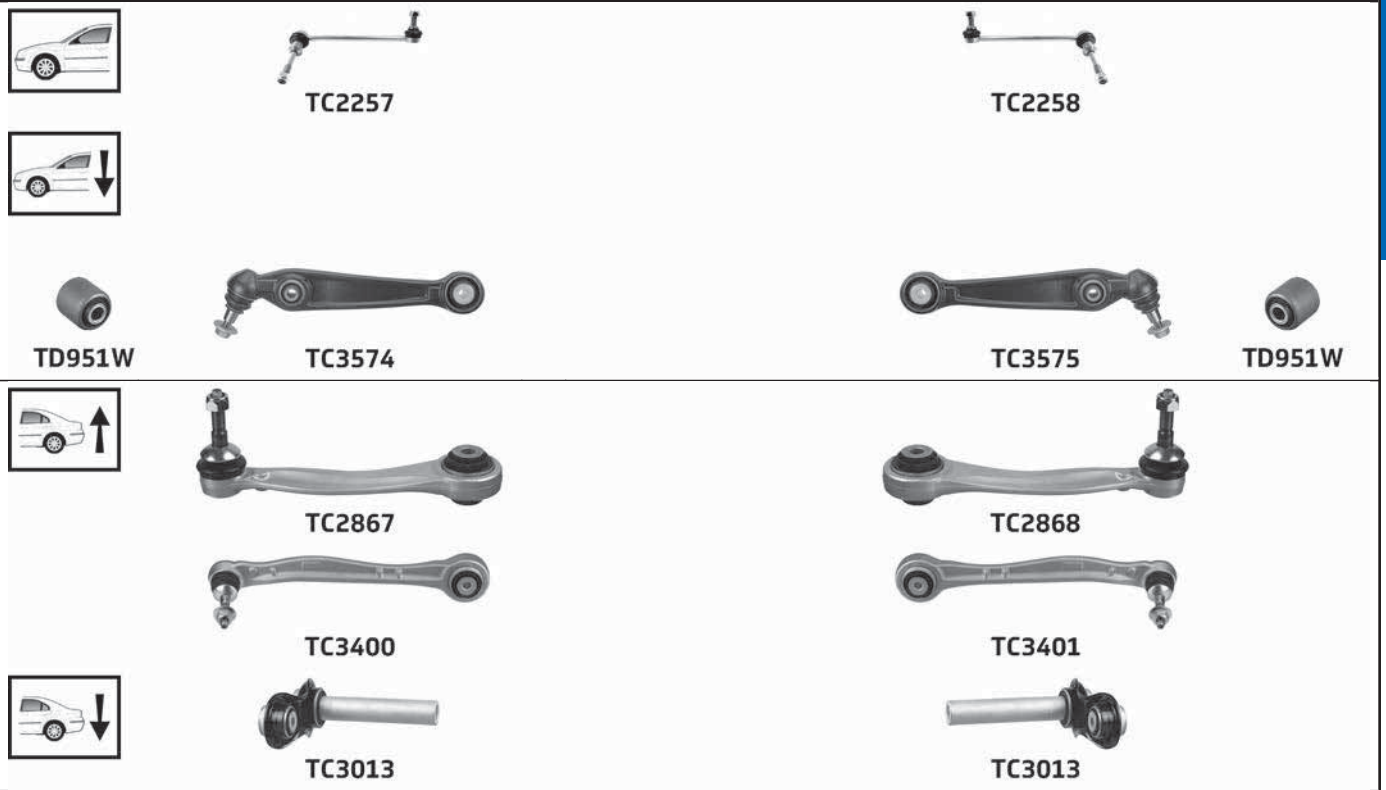

Part No	Description	Pos	Info	Technical
TC2257	Link stabiliser(135)	A	(+) Dynamic drive(-43)	M12x1.5
TC2258	Link stabiliser(135)	B	(+) Dynamic drive(-43)	M12x1.5
TC2867	Upper guide rod(236)	A	Front(108)	M12x1.5
TC2868	Upper guide rod(236)	B	Front(108)	M12x1.5
TC3013	Lower link arm(144)	A B		
TC3400	Upper control arm(235)	A	Rear(187)	M14x1.5
TC3401	Upper control arm(235)	B	Rear(187)	M14x1.5
TC3574	Lower track control arm(151)	A	Rear(187)	M14 x 1.5 x 25
TC3575	Lower track control arm(151)	B	Rear(187)	M14 x 1.5 x 25
TD951W	Lower track control arm bush(153)	A B	Rear(187) Outer(176)	

... BMW

X SERIES (F86 SERIES) X6M 4.4i (12/14→)



TC2257



TC2258



TD951W



TD951W



TC2867



TC2868



TC3400



TC3401



TC3013



TC3013

Part No	Description	Pos	Info	Technical
TC2257	Link stabiliser (135)	A		M12x1.5
TC2258	Link stabiliser (135)	B		M12x1.5
TC2867	Upper guide rod (236)	A	Front (108)	M12x1.5
TC2868	Upper guide rod (236)	B	Front (108)	M12x1.5
TC3013	Lower link arm (144)	A B		
TC3400	Upper control arm (235)	A	Rear (187)	M14x1.5
TC3401	Upper control arm (235)	B	Rear (187)	M14x1.5
TD951W	Lower track control arm bush (153)	A B	Rear (187) Outer (176)	

Z SERIES Z3 1.8i, 1.9i, 2.0i, 2.2i, 2.8i, 3.0i (10/95-06/03)



TL440



TL441



TA1454



TA1455



TBR4116



TA1455



TA1456

... Z SERIES Z3 1.8i, 1.9i, 2.0i, 2.2i, 2.8i, 3.0i (10/95-06/03)

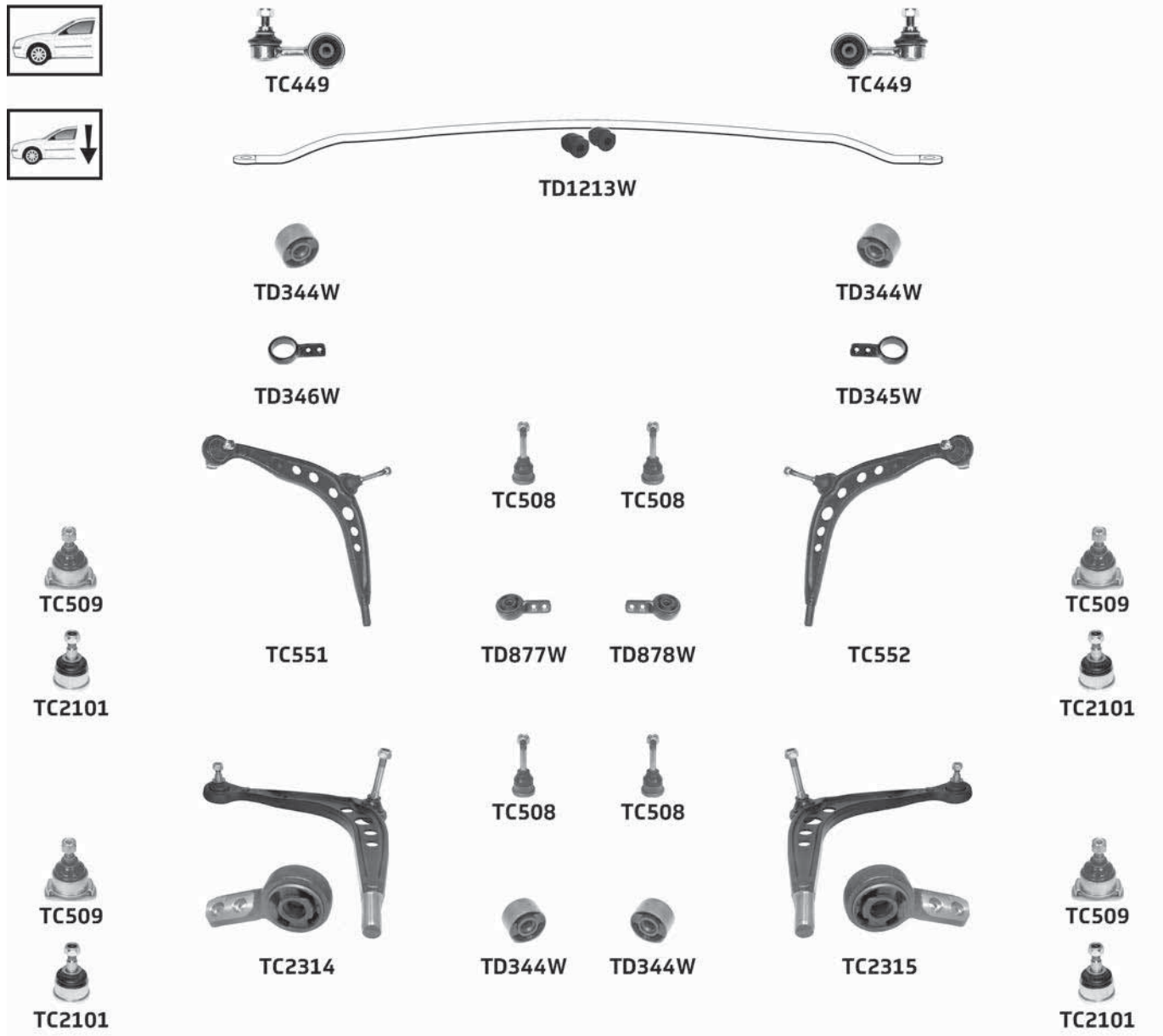

Part No	Description	Pos	Info	Technical
TA1454	Tie rod end(224)	A		M14x1.5 Female(253) £
TA1455	Inner tie rod(123)	A B		M14x1.5 Male(252) £
TA1456	Tie rod end(224)	B		M14x1.5 Female(253) £
TBR4116	Steering rack gaiter kit(213)	K		1 :37x51x51 2 :37x51x51
TC449	Link stabiliser(135)	A B		M10x1.5
TC508	Lower ball joint(140)	A B	Inner part of wishbone(122)	M14x1.5
TC509	Lower ball joint(140)	A B	Outer part of wishbone(177)	M12x1.5
TC551	Lower wishbone(158)	A	(-) Bush(-13) (-) Bracket(-12)	M12x1.5 / M14x1.5
TC552	Lower wishbone(158)	B	(-) Bush(-13) (-) Bracket(-12)	M12x1.5 / M14x1.5
TC1002	Link stabiliser(135)	A B		
TC2101	Lower ball joint(140)	A B	Outer part of wishbone(177) Heavy duty(111)	M12x1.5
TC2314	Lower wishbone(158)	A	(+) Bush(-42) (+) Bracket(-41)	M12x1.5 / M14x1.5
TC2315	Lower wishbone(158)	B	(+) Bush(-42) (+) Bracket(-41)	M12x1.5 / M14x1.5
TD344W	Lower wishbone bush(159)	A B	Rear(187)	
TD345W	Lower wishbone bush bracket(160)	B		
TD346W	Lower wishbone bush bracket(160)	A		
TD877W	Lower wishbone bush(159)	A	Rear(187)	
TD878W	Lower wishbone bush(159)	B	Rear(187)	
TD1213W	Anti-roll bar(-74) bush kit(-86)	K	Ø24 Complete axle kit(-92) (-)	

(...)

... BMW

... Z SERIES Z3 1.8i, 1.9i, 2.0i, 2.2i, 2.8i, 3.0i (10/95-06/03)

TL440	Rod assembly(194)	A		M10x1.25
TL441	Rod assembly(194)	B		M10x1.25

Z SERIES Z3 3.2i (03/97-06/03)

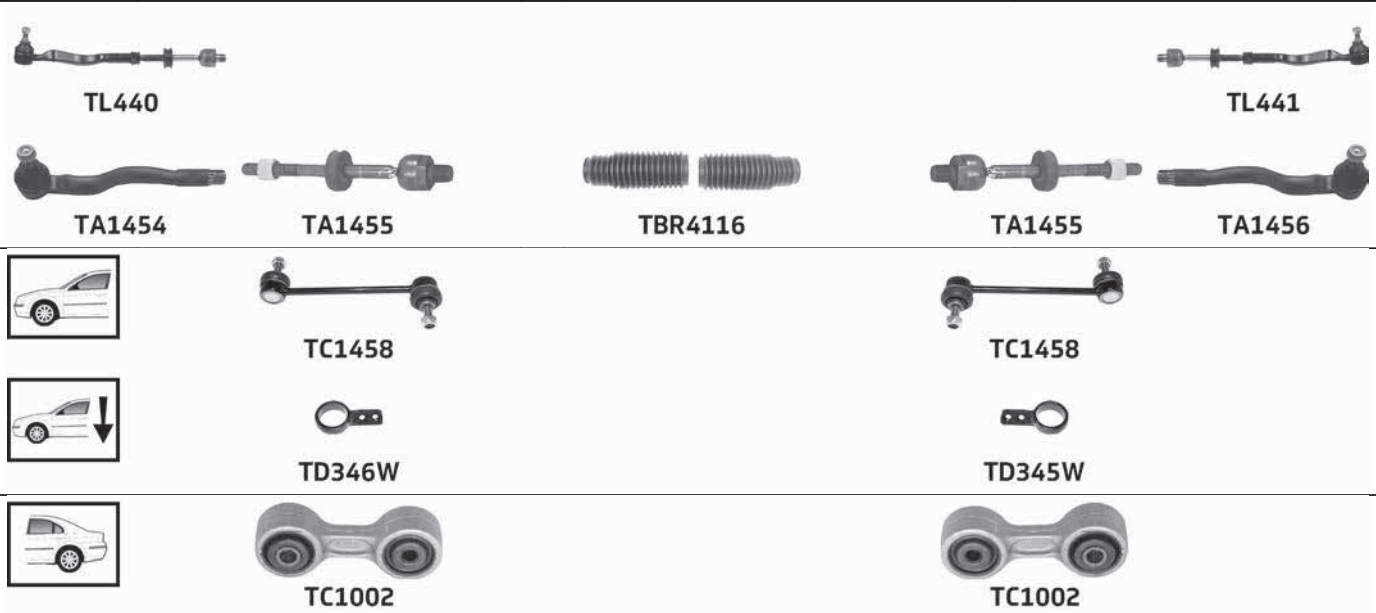

Part No	Description	Pos	Info	Technical
TA1454	Tie rod end(224)	A		M14x1.5 Female(253) £
TA1455	Inner tie rod(123)	A B		M14x1.5 Male(252) £
TA1456	Tie rod end(224)	B		M14x1.5 Female(253) £
TBR4116	Steering rack gaiter kit(213)	K		1 :37x51x51 2 :37x51x51
TC1002	Link stabiliser(135)	A B		
TC1458	Link stabiliser(135)	A B		M10x1.5
TD345W	Lower wishbone bush bracket(160)	B		
TD346W	Lower wishbone bush bracket(160)	A		
TL440	Rod assembly(194)	A		M10x1.25
TL441	Rod assembly(194)	B		M10x1.25

Z SERIES (E85, E86 SERIES) Z4 2.0i, 2.2i, 2.5i, 2.5si, 3.0i, 3.0si (02/03-)



... Z SERIES (E85, E86 SERIES) Z4 2.0i, 2.2i, 2.5i, 2.5si, 3.0i, 3.0si (02/03→)



TC932



TC932



TD890W



TC881



TD407W



TD408W



TC882



TD1047W



TD1047W



TC1727



TD407W



TD408W



TC1728



TD1047W



TD1047W

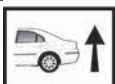

TD549W



TD549W



TD760W



TD760W



TC2499



TC2499



TD730W



TD730W



TD949W



TD949W



TD667W



TC2232



TD668W



TD668W



TC2232



TD667W

Part No	Description	Pos	Info	Technical
TA1686	Tie rod end (224)	A		M14x1.5 Female(253) £
TA1687	Tie rod end (224)	B		M14x1.5 Female(253) £
				(...)

... BMW

... Z SERIES (E85, E86 SERIES) Z4 2.0i, 2.2i, 2.5i, 2.5si, 3.0i, 3.0si (02/03→)

Part No	Description	Pos	Info	Technical
TA2037	Inner tie rod(123)	A B		M14x1.5 Male(252) £
TBR4201	Steering rack gaiter kit(213)	K		1 :15x55x55 2 :15x55x55
TC881	Lower wishbone(158)	A	(-) Bush(-13)	M12x1.5 / M14x1.5
TC882	Lower wishbone(158)	B	(-) Bush(-13)	M12x1.5 / M14x1.5
TC932	Link stabiliser(135)	A B		M10x1.5
TC1727	Lower wishbone(158)	A	(+) Bush(-42)	M12x1.5 / M14x1.5
TC1728	Lower wishbone(158)	B	(+) Bush(-42)	M12x1.5 / M14x1.5
TC2232	Lower track control arm(151)	A B		
TC2499	Link stabiliser(135)	A B		
TD407W	Lower wishbone bush(159)	A	Rear(187) (+) Housing(-48)	
TD408W	Lower wishbone bush(159)	B	Rear(187) (+) Housing(-48)	
TD549W	Trailing arm bush(227)	A B	Upper(231) Outer(176)	
TD667W	Lower track control arm bush(153)	A B	Outer(176)	
TD668W	Lower track control arm bush(153)	A B	Inner(119)	
TD730W	Sub-frame mounting(216)	A B	Front(108) Inner(119)	
TD760W	Upper track control arm bush(243)	A B	Inner(119)	
TD890W	Lower wishbone bush kit(161)	K	Rear(187)	
TD949W	Sub-frame mounting(216)	A B	Rear(187) Outer(176)	
TD1047W	Lower wishbone bush(159)	A B	Rear(187) (-) Housing(-19)	
TL466	Rod assembly(194)	A		M12x1.5
TL467	Rod assembly(194)	B		M12x1.5

Z SERIES (E85, E86 SERIES) Z4 3.2i (03/06→)

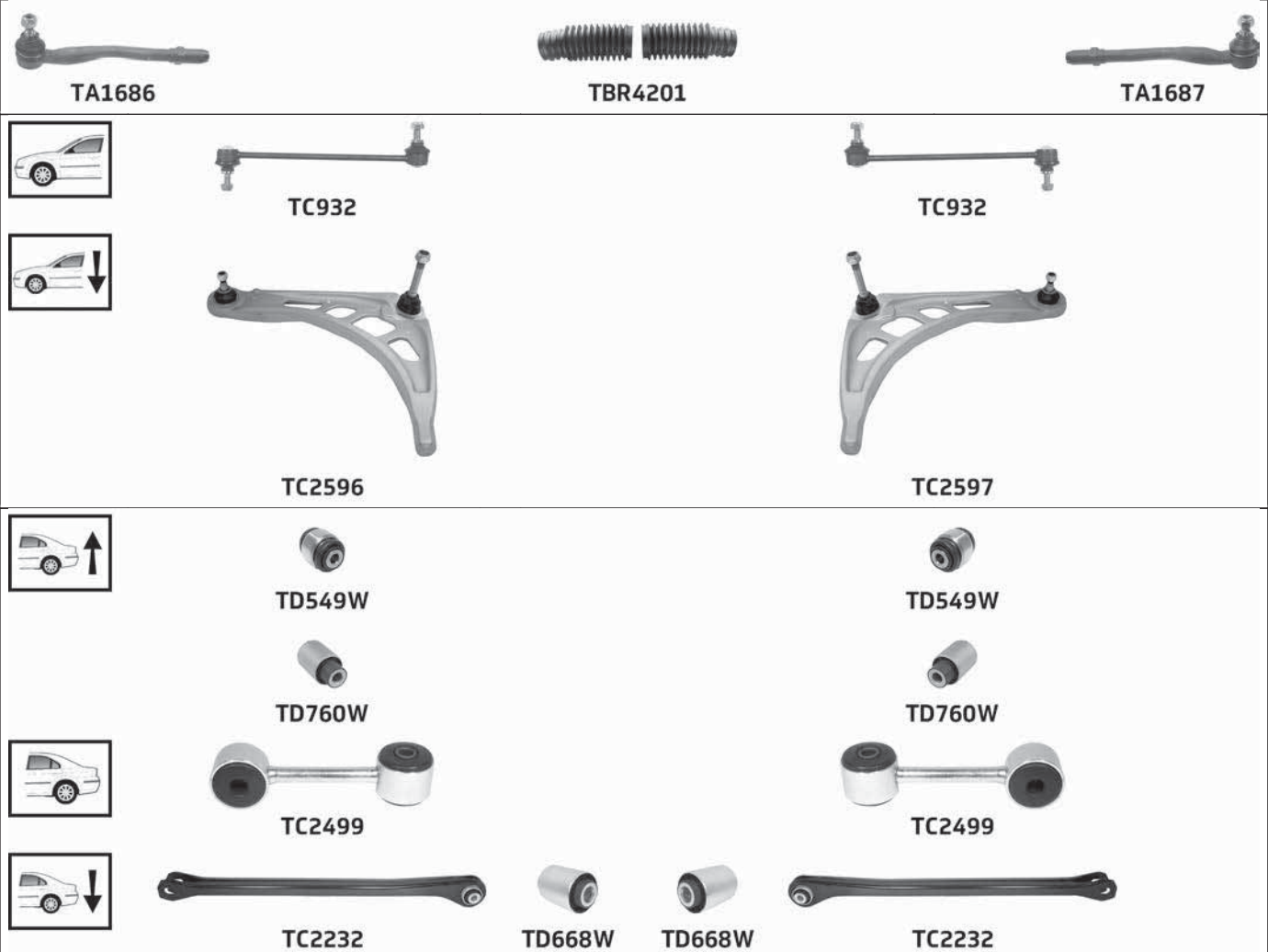

Part No	Description	Pos	Info	Technical
TA1686	Tie rod end(224)	A		M14x1.5 Female(253) £
TA1687	Tie rod end(224)	B		M14x1.5 Female(253) £
TBR4201	Steering rack gaiter kit(213)	K		1 :15x55x55 2 :15x55x55
TC932	Link stabiliser(135)	A B		M10x1.5
TC2232	Lower track control arm(151)	A B		
TC2499	Link stabiliser(135)	A B		
TC2596	Lower wishbone(158)	A	(-) Bush(-13)	M12x1.5 / M14x1.5

... Z SERIES (E85, E86 SERIES) Z4 3.2i (03/06→)

Part No	Description	Pos	Info	Technical
TC2597	Lower wishbone(158)	B	(-) Bush(-13)	M12x1.5 / M14x1.5
TD549W	Trailing arm bush(227)	A B	Upper(231) Outer(176)	
TD668W	Lower track control arm bush(153)	A B	Inner(119)	
TD760W	Upper track control arm bush(243)	A B	Inner(119)	

Z SERIES (E89 SERIES) Z4 2.5i S drive 23i, 3.0i S drive 30i, 3.0i S drive 35i (05/09→)

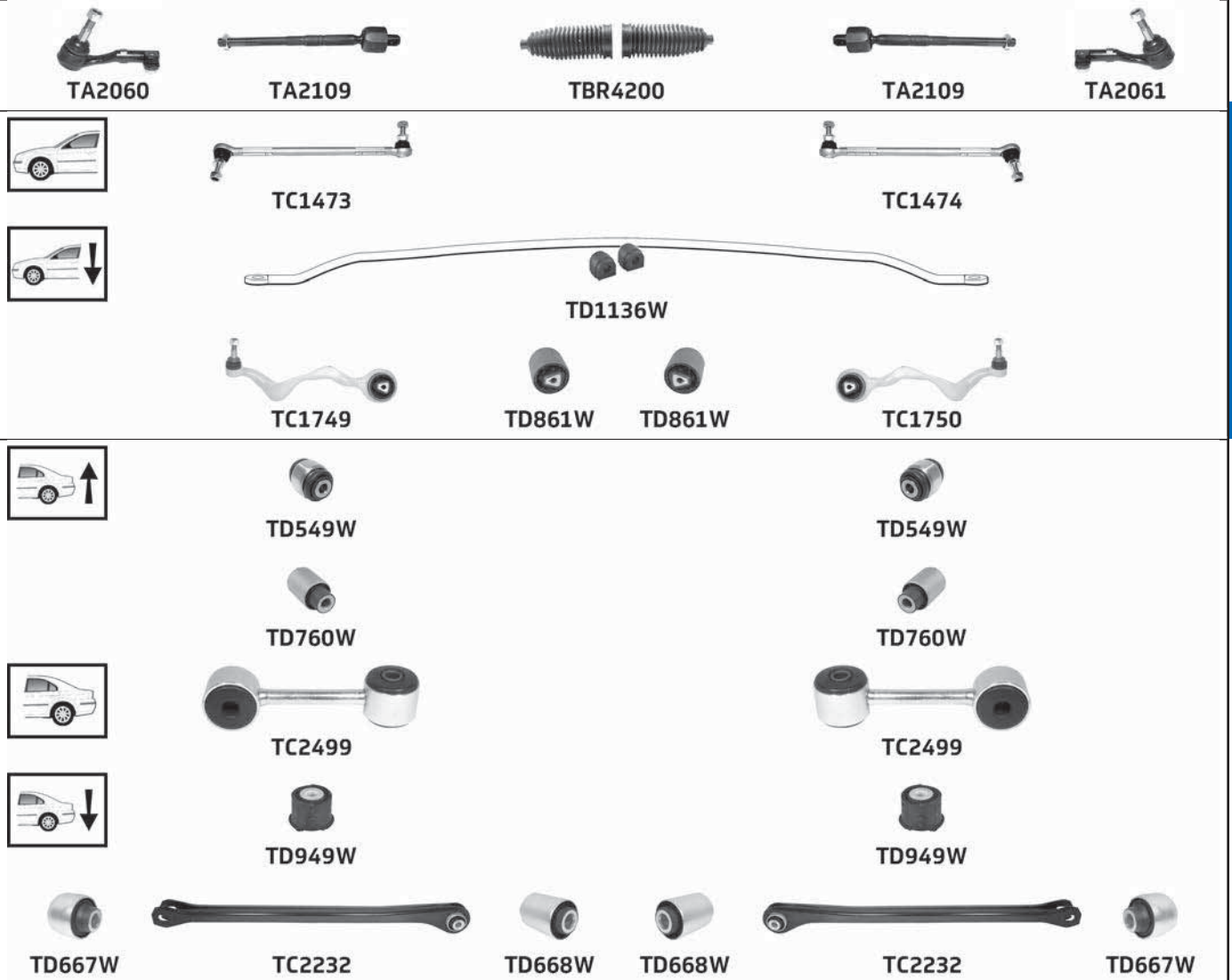

Part No	Description	Pos	Info	Technical
TA2060	Tie rod end(224)	A		M14x1.5 Female(253) £
TA2061	Tie rod end(224)	B		M14x1.5 Female(253) £
TA2109	Inner tie rod(123)	A B	ZF	M14x1.5 Male(252) £
TBR4200	Steering rack gaiter kit(213)	K	ZF Thermoplastic(223)	1 :15.5x64x64 2 :15.5x64x64
TC1473	Link stabiliser(135)	A		M10x1.5
TC1474	Link stabiliser(135)	B		M10x1.5
TC1749	Lower track control arm(151)	A	Front(108)	M14x1.5
TC1750	Lower track control arm(151)	B	Front(108)	M14x1.5
TC2232	Lower track control arm(151)	A B		
TC2499	Link stabiliser(135)	A B		
TD549W	Trailing arm bush(227)	A B	Upper(231) Outer(176)	
TD667W	Lower track control arm bush(153)	A B	Outer(176)	
TD668W	Lower track control arm bush(153)	A B	Inner(119)	
TD760W	Upper track control arm bush(243)	A B	Inner(119)	
TD861W	Lower track control arm bush(153)	A B	Front(108)	
TD949W	Sub-frame mounting(216)	A B	Rear(187) Outer(176)	
TD1136W	Anti-roll bar(-74) bush kit(-86)	K	Ø26.5 Complete axle kit(-92) →05/10	

CHEVROLET

AVEO 1.2i, 1.4i, 1.5i T200, T250 (05/05→)

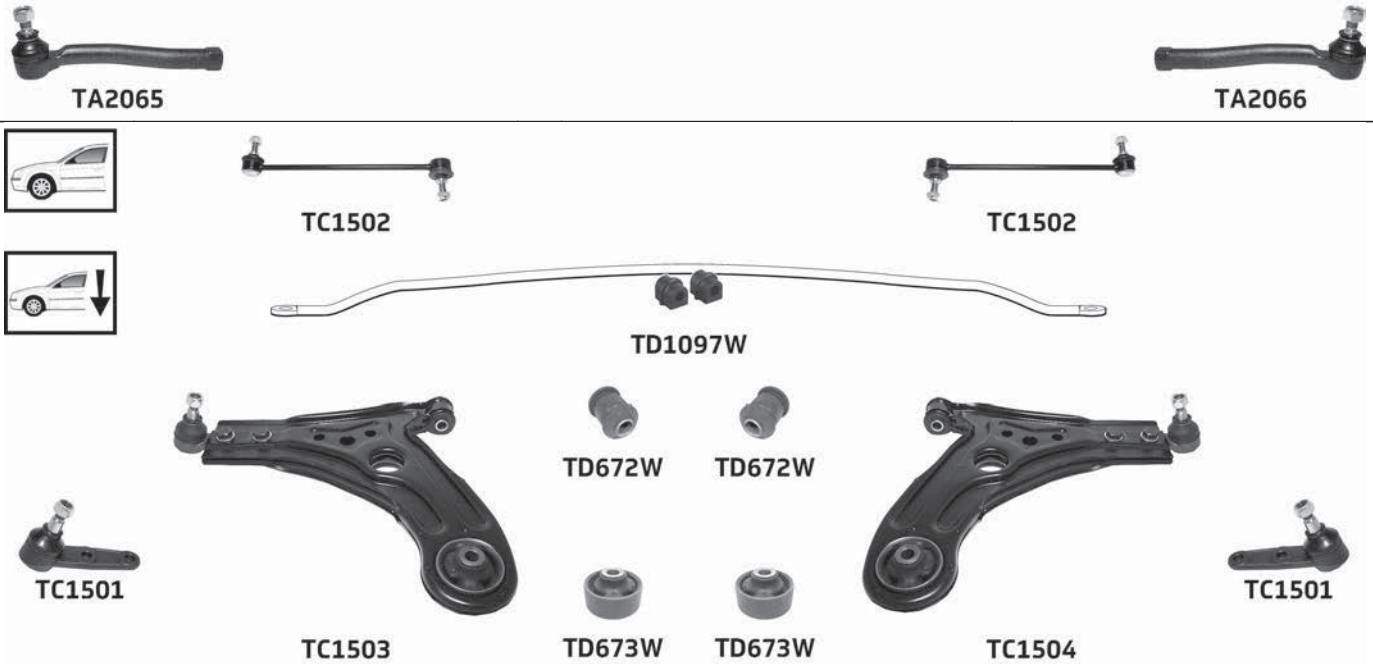

Part No	Description	Pos	Info	Technical
TA2065	Tie rod end(224)	A		M12x1.5 Female(253) £
TA2066	Tie rod end(224)	B		M12x1.5 Female(253) £
TC1501	Lower ball joint(140)	A B		M12x1.25
TC1502	Link stabiliser(135)	A B		M10x1.25
TC1503	Lower wishbone(158)	A		M12x1.25
TC1504	Lower wishbone(158)	B		M12x1.25
TD672W	Lower wishbone bush(159)	A B	Front(108)	
TD673W	Lower wishbone bush(159)	A B	Rear(187)	
TD1097W	Anti-roll bar(-74) bush kit(-86-)	K	Complete axle kit(-92-)	

AVEO 1.2i, 1.3CDTi, 1.4i, 1.6i T300 (03/11→)

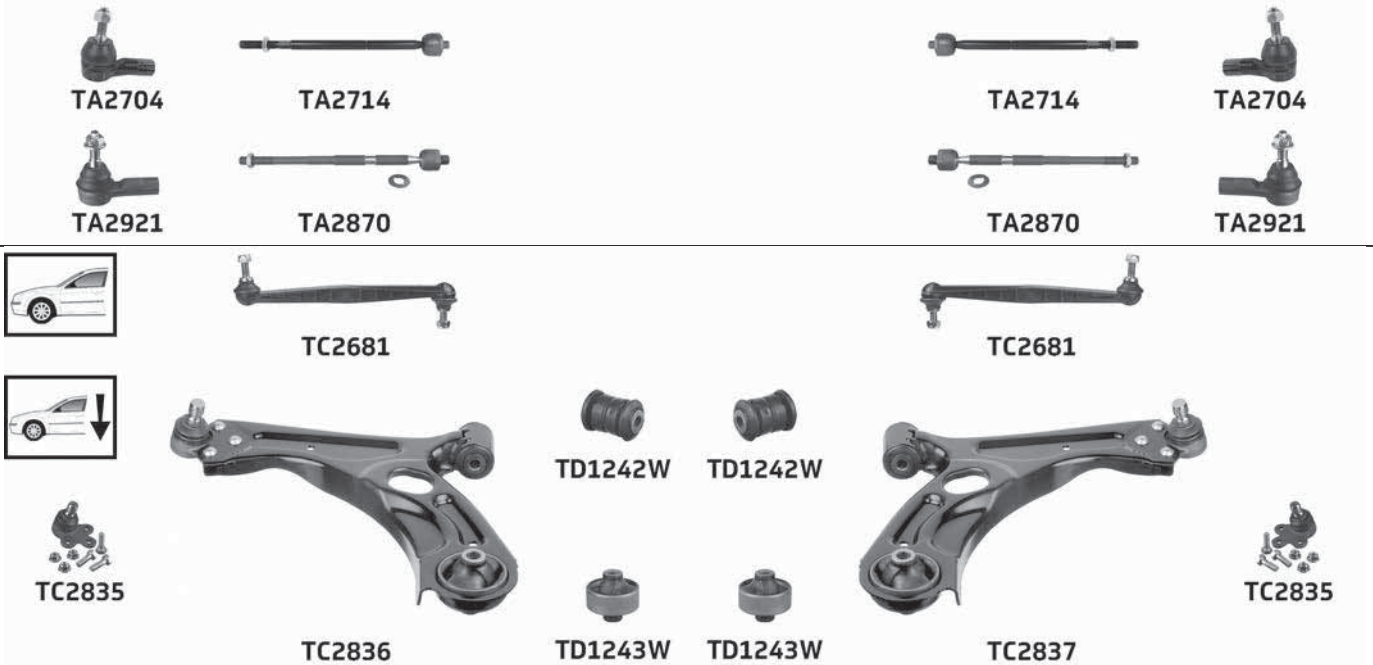

Part No	Description	Pos	Info	Technical
TA2704	Tie rod end(224)	A B	Electric(103) Power steering(185)	M14x1.5 Female(253) £
TA2714	Inner tie rod(123)	A B	Electric(103) Power steering(185)	M14x1.5 Male(252) £
TA2870	Inner tie rod(123)	A B	Hydraulic(115) Power steering(185)	M14x1.5 Male(252) £
TA2921	Tie rod end(224)	A B	Hydraulic(115) Power steering(185)	M14x1.5 Female(253) £
TC2681	Link stabiliser(135)	A B		M12x1.75
TC2835	Lower ball joint(140)	A B		Pinch Bolt(255) 18.2mm
TC2836	Lower wishbone(158)	A		Pinch Bolt(255) 18mm
TC2837	Lower wishbone(158)	B		Pinch Bolt(255) 18mm
TD1242W	Lower wishbone bush(159)	A B	Front(108)	

... AVEO 1.2i, 1.3CDTi, 1.4i, 1.6i T300 (03/11→)

Part No	Description	Pos	Info	Technical
TD1243W	Lower wishbone bush(159)	A B	Rear(187)	

CAPTIVA 2.0CDTi, 2.4i, 3.2i (06/06→)

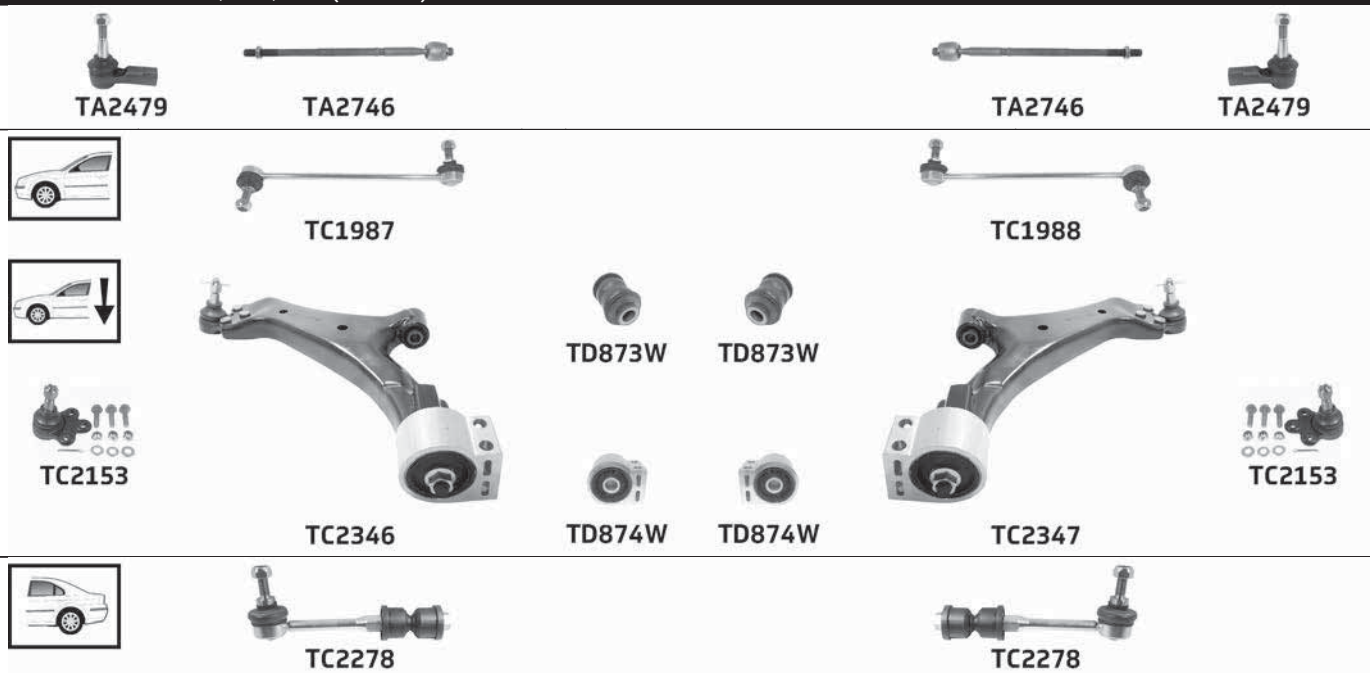

Part No	Description	Pos	Info	Technical
TA2479	Tie rod end(224)	A B		M14x1.5 Female(253) £
TA2746	Inner tie rod(123)	A B		M14x1.5 Male(252) £
TC1987	Link stabiliser(135)	A		M12x1.75
TC1988	Link stabiliser(135)	B		M12x1.75
TC2153	Lower ball joint(140)	A B		M12x1.75
TC2278	Link stabiliser(135)	A B		M10x1.5
TC2346	Lower wishbone(158)	A		M12x1.75
TC2347	Lower wishbone(158)	B		M12x1.75
TD873W	Lower wishbone bush(159)	A B	Front(108)	
TD874W	Lower wishbone bush(159)	A B	Rear(187)	

CRUZE 1.6i, 1.8i, 1.7VCDi, 2.0VCDi (05/09→)



Part No	Description	Pos	Info	Technical
TA2665	Inner tie rod(123)	A B		M16x1.5 Male(252) £
TA2694	Tie rod end(224)	A B		M16x1.5 Female(253) £
TC2279	Link stabiliser(135)	A B	Plastic(184)	M12x1.75
TC2587	Lower wishbone(158)	A		Pinch Bolt(255) 20mm
TC2588	Lower wishbone(158)	B		Pinch Bolt(255) 20mm
TD855W	Lower wishbone bush(159)	A B	Front(108)	

CHEVROLET

... CHEVROLET

EPICA 2.0i, 2.5i (01/05-12/06)



TA2442



TA2442



TC1893



TC1894



TC1895



TC1895



TD674W



TD675W

Part No	Description	Pos	Info	Technical
TA2442	Tie rod end(224)	A B		M14x1.5 Female(253) £
TC1893	Link stabiliser (135)	A		M12x1.25
TC1894	Link stabiliser (135)	B		M12x1.25
TC1895	Lower ball joint (140)	A B		Pinch Bolt (255) 18mm
TD674W	Lower wishbone bush(159)	A	Rear(187)	
TD675W	Lower wishbone bush(159)	B	Rear(187)	

EPICA 2.0i, 2.0TD, 2.5i (01/07→)



TA2442



TA2442



TC1893



TC1894



TC1896



TC1896



TD674W



TD675W

Part No	Description	Pos	Info	Technical
TA2442	Tie rod end(224)	A B		M14x1.5 Female(253) £
TC1893	Link stabiliser (135)	A		M12x1.25
TC1894	Link stabiliser (135)	B		M12x1.25
TC1896	Lower ball joint (140)	A B		Pinch Bolt (255) 18mm
TD674W	Lower wishbone bush(159)	A	Rear(187)	
TD675W	Lower wishbone bush(159)	B	Rear(187)	

KALOS 1.2i, 1.4i (03/05→)

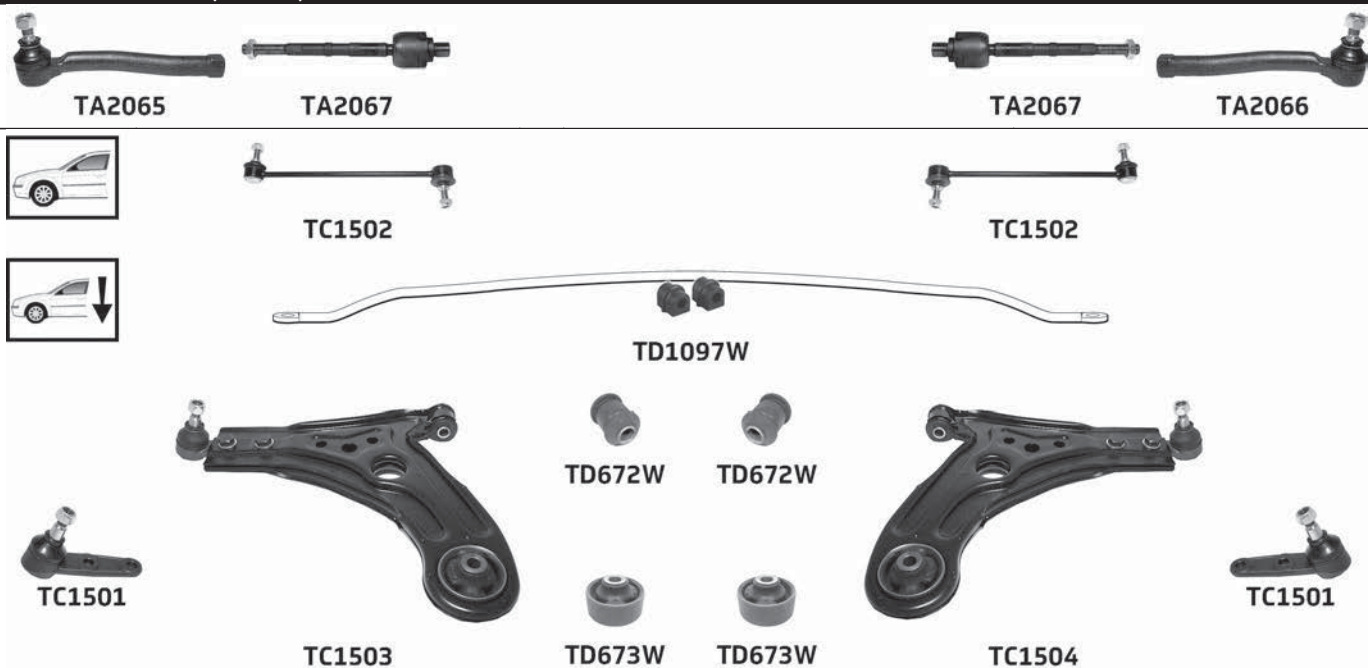

Part No	Description	Pos	Info	Technical
TA2065	Tie rod end(224)	A		M12x1.5 Female(253) £
TA2066	Tie rod end(224)	B		M12x1.5 Female(253) £
TA2067	Inner tie rod(123)	A B		M12x1.5 Male(252) £
TC1501	Lower ball joint(140)	A B		M12x1.25
TC1502	Link stabiliser(135)	A B		M10x1.25
TC1503	Lower wishbone(158)	A		M12x1.25
TC1504	Lower wishbone(158)	B		M12x1.25
TD672W	Lower wishbone bush(159)	A B	Front(108)	
TD673W	Lower wishbone bush(159)	A B	Rear(187)	
TD1097W	Anti-roll bar(-74) bush kit(-86-)	K	Complete axle kit(-92)	

LACETTI 1.4i, 1.6i, 1.8i (03/05→)

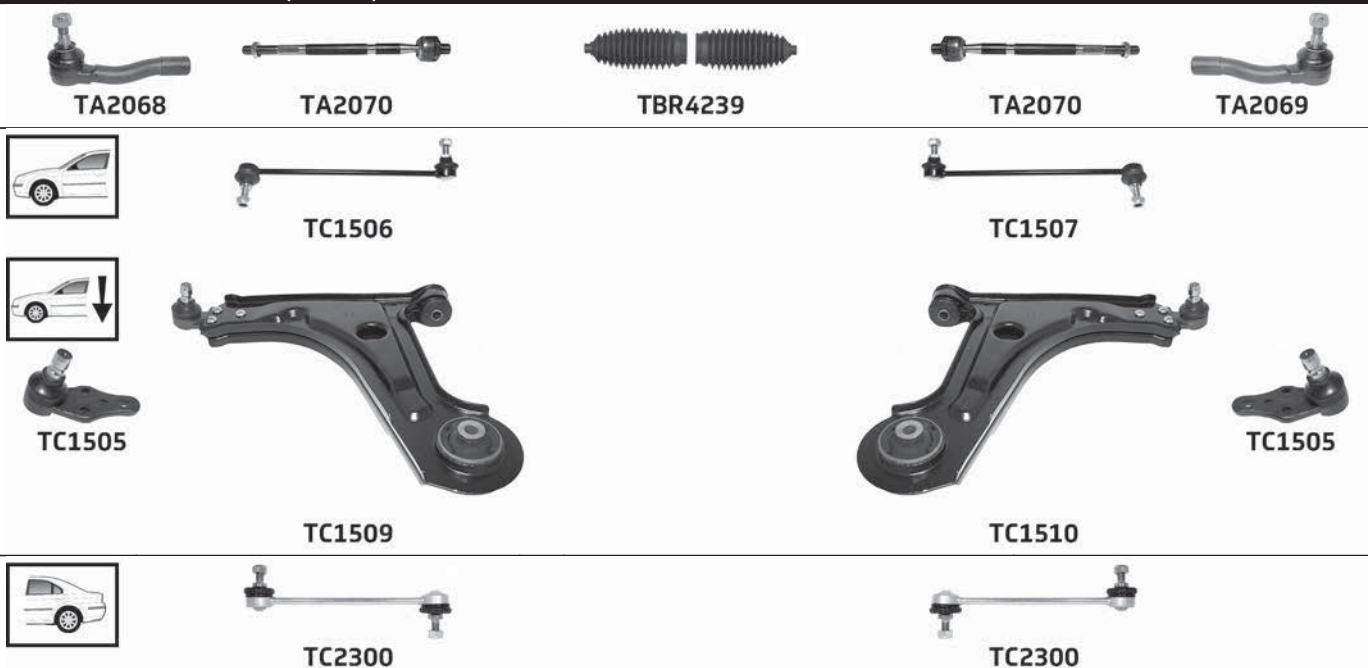

Part No	Description	Pos	Info	Technical
TA2068	Tie rod end(224)	A		M14x1.5 Female(253) £
TA2069	Tie rod end(224)	B		M14x1.5 Female(253) £
TA2070	Inner tie rod(123)	A B		M14x1.5 Male(252) £
TBR4239	Steering rack gaiter kit(213)	K		1 :13x49x49 2 :13x49x49
TC1505	Lower ball joint(140)	A B		Pinch Bolt(255) 18mm
TC1506	Link stabiliser(135)	A		M10x1.25
TC1507	Link stabiliser(135)	B		M10x1.25

... CHEVROLET

... LACETTI 1.4i, 1.6i, 1.8i (03/05→)

Part No	Description	Pos	Info	Technical
TC1509	Lower wishbone(158)	A		Pinch Bolt(255) 18mm
TC1510	Lower wishbone(158)	B		Pinch Bolt(255) 18mm
TC2300	Link stabiliser(135)	A B		M10x1.25

MALIBU 2.0CDTi, 2.4i (01/12→)



Part No	Description	Pos	Info	Technical
TA2496	Inner tie rod(123)	A B		M16x1.5 Male(252) £
TA2592	Tie rod end(224)	A B		M16x1.5 Female(253) £
TC1979	Link stabiliser(135)	A B		
TC2279	Link stabiliser(135)	A B		M12x1.75

MATIZ 800cci, 1.0i (03/05→)



Part No	Description	Pos	Info	Technical
TA1769	Tie rod end(224)	A B		M12x1.5 Female(253) £
TA1858	Inner tie rod(123)	A B	Manual steering(170) 155 tyres(-61-)	M12x1.5 Male(252) £
TA1859	Inner tie rod(123)	A B	Manual steering(170) 175 tyres(-64-)	M12x1.5 Male(252) £
TC631	Lower track control arm(151)	A B		Pinch Bolt(255) 15mm
TD419W	Lower track control arm bush(153)	A B	Inner(119)	
TD1617W	Lower track control arm bush(153)	A B	Outer(176) Pack of(179) 2	

NUBIRA 1.4i, 1.5i, 1.6i, 1.8i, 2.0D (03/05→)



TC1509



TC1510



Part No	Description	Pos	Info	Technical
TA2068	Tie rod end (224)	A		M14x1.5 Female (253) £
TA2069	Tie rod end (224)	B		M14x1.5 Female (253) £
TA2070	Inner tie rod (123)	A B		M14x1.5 Male (252) £
TBR4239	Steering rack gaiter kit (213)	K		1 :13x49x49 2 :13x49x49
TC1505	Lower ball joint (140)	A B		Pinch Bolt (255) 18mm
TC1506	Link stabiliser (135)	A		M10x1.25
TC1507	Link stabiliser (135)	B		M10x1.25
TC1509	Lower wishbone (158)	A		Pinch Bolt (255) 18mm
TC1510	Lower wishbone (158)	B		Pinch Bolt (255) 18mm
TC2300	Link stabiliser (135)	A B		M10x1.25

ORLANDO 1.4i, 1.8i, 2.0VCDi (12/10→)



Part No	Description	Pos	Info	Technical
TA2694	Tie rod end (224)	A B		M16x1.5 Female (253) £
TC2279	Link stabiliser (135)	A B	Plastic (184)	M12x1.75

... CHEVROLET

REZZO 1.6i, 2.0i (03/05→)



Part No	Description	Pos	Info	Technical
TA2071	Tie rod end(224)	A		M14x1.5 Female(253) £
TA2072	Tie rod end(224)	B		M14x1.5 Female(253) £
TA2073	Inner tie rod(123)	A B		M14x1.5 Male(252) £
TC1502	Link stabiliser(135)	A B		M10x1.25
TC1511	Lower ball joint(140)	A B		Pinch Bolt(255) 16mm
TC1913	Lower wishbone(158)	A		Pinch Bolt(255) 16mm
TC1914	Lower wishbone(158)	B		Pinch Bolt(255) 16mm

SPARK 1.0i, 1.2i M300 (03/10→)



Part No	Description	Pos	Info	Technical
TA2854	Inner tie rod(123)	A B		M12x1.25 Male(252) £
TA2876	Tie rod end(224)	A B		M12x1.25 Female(253) £
TC2658	Link stabiliser(135)	A B		M10x1.5
TC2720	Lower wishbone(158)	A		Pinch Bolt(255) 16mm
TC2721	Lower wishbone(158)	B		Pinch Bolt(255) 16mm
TC2860	Lower ball joint(140)	A B		Pinch Bolt(255) 16mm
TD919W	Lower wishbone bush(159)	A B	Front(108)	
TD920W	Lower wishbone bush(159)	A B	Rear(187)	

TACUMA 1.6i, 2.0i (03/05→)

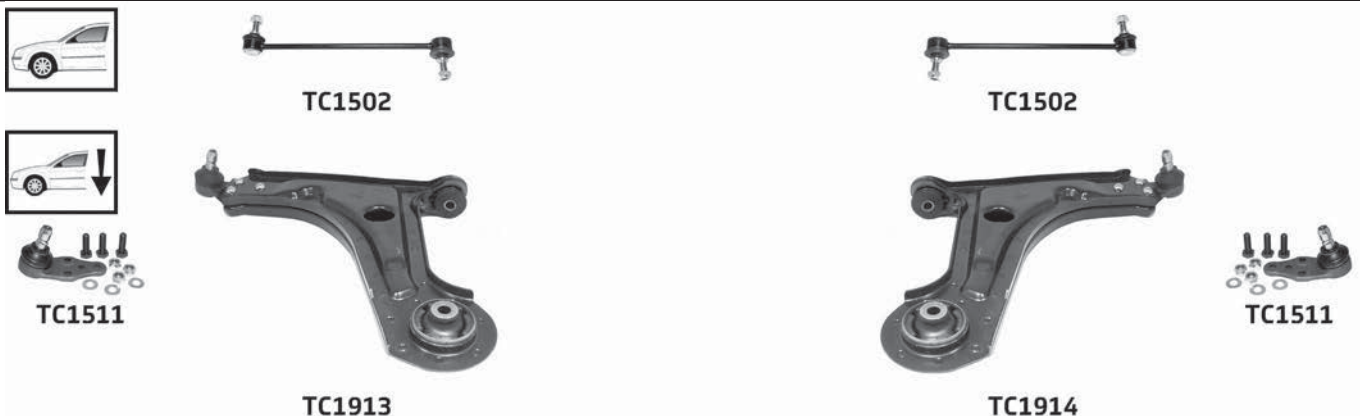

Part No	Description	Pos	Info	Technical
TA2071	Tie rod end(224)	A		M14x1.5 Female(253) £
TA2072	Tie rod end(224)	B		M14x1.5 Female(253) £
TA2073	Inner tie rod(123)	A B		M14x1.5 Male(252) £
TC1502	Link stabiliser(135)	A B		M10x1.25
TC1511	Lower ball joint(140)	A B		Pinch Bolt(255) 16mm
TC1913	Lower wishbone(158)	A		Pinch Bolt(255) 16mm
TC1914	Lower wishbone(158)	B		Pinch Bolt(255) 16mm

TRAX 1.4i, 1.6i, 1.7CDTi, 1.8i (12/12→)

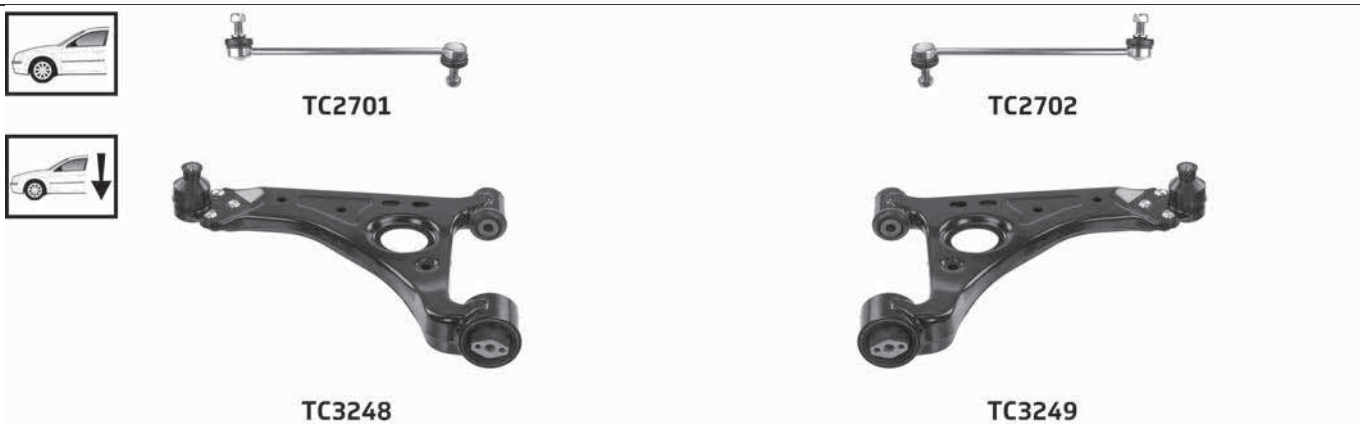
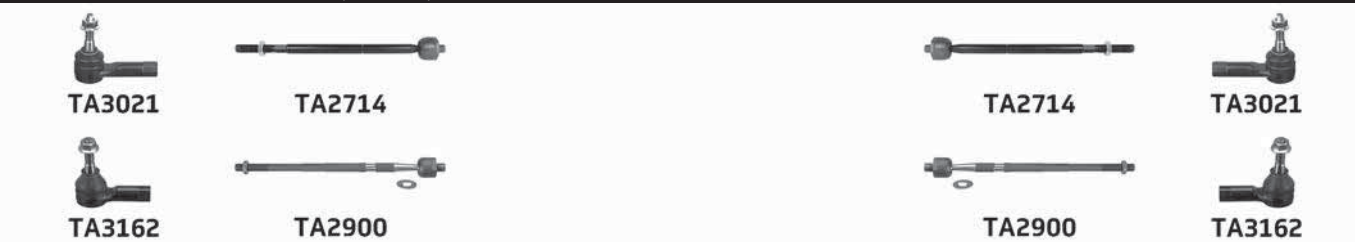

Part No	Description	Pos	Info	Technical
TA2714	Inner tie rod(123)	A B	Electric(103) Power steering(185)	M14x1.5 Male(252) £
TA2900	Inner tie rod(123)	A B	Hydraulic(115) Power steering(185)	M14x1.5 Male(252) £
TA3021	Tie rod end(224)	A B	Electric(103) Power steering(185)	M14x1.5 Female(253) £
TA3162	Tie rod end(224)	A B	Hydraulic(115) Power steering(185)	M14x1.5 Female(253) £
TC2701	Link stabiliser(135)	A		M12x1.75
TC2702	Link stabiliser(135)	B		M12x1.75
TC3248	Lower wishbone(158)	A		Pinch Bolt(255) 18.2mm
TC3249	Lower wishbone(158)	B		Pinch Bolt(255) 18.2mm

... CHEVROLET

VOLT 1.4 (11/11→)



TA2693

TA2693



TC2279



TC2279



TC2587



TD855W



TD855W



TC2588

Part No	Description	Pos	Info	Technical
TA2693	Tie rod end(224)	A B		M16x1.5 Female(253) £
TC2279	Link stabiliser(135)	A B		M12x1.75
TC2587	Lower wishbone(158)	A		Pinch Bolt(255) 20mm
TC2588	Lower wishbone(158)	B		Pinch Bolt(255) 20mm
TD855W	Lower wishbone bush(159)	A B	Front(108)	

CHRYSLER

300 C 2.7i, 3.0CRD, 3.5i, 5.7i, 6.1i RWD⁽¹⁹⁸⁾ (09/04-12/10)



TA2488



TA2488



TA2624



TC3705



TC3706



TC2148



TC2149



TC3646



TC3647

Part No	Description	Pos	Info	Technical
TA2488	Inner tie rod(123)	A B		M15x1.5 Male(252) £
TA2624	Tie rod end(224)	A B		M15x1.5 Female(253) £
TC2148	Link stabiliser(135)	A		M14x2
TC2149	Link stabiliser(135)	B		M14x2
TC3646	Lower track control arm(151)	A	Front(108)	M14x1.5
TC3647	Lower track control arm(151)	B	Front(108)	M14x1.5
TC3705	Upper wishbone(247)	A		
TC3706	Upper wishbone(247)	B		

CHRYSLER

CROSSFIRE 3.2i (09/03→)



TA1643



TL554



TA1643



TC835



TC835

Part No	Description	Pos	Info	Technical
TA1643	Tie rod end (224)	A B		M12x1.5 Male (252) £
TC835	Lower ball joint (140)	A B		M14x1.5
TL554	Centre rod assembly (-90-)	K		M12x1.5

SEBRING 2.0i, 2.0CRD, 2.4i (09/06→)



TA2753



TA2753



TC3675



TC3675



TC3307



TC3307

Part No	Description	Pos	Info	Technical
TA2753	Tie rod end (224)	A B		M14x1.5 Female (253) £
TC3307	Link stabiliser (135)	A B		
TC3675	Lower ball joint (140)	A B		

NEON II 1.8i, 2.0i (08/99-07/01)



TA2289



TA2289

Part No	Description	Pos	Info	Technical
TA2289	Tie rod end (224)	A B		M14x1.5 Female (253) £

NEON II 1.6i, 1.8i, 2.0i (08/01-12/06)



TA2289



TA2289



TC1974



TD1121W

TD1121W



TC1975

Part No	Description	Pos	Info	Technical
TA2289	Tie rod end (224)	A B		M14x1.5 Female (253) £
TC1974	Lower wishbone (158)	A		Pinch Bolt (255) 18mm
TC1975	Lower wishbone (158)	B		Pinch Bolt (255) 18mm
TD1121W	Lower wishbone bush (159)	A B	Front (108)	

PT CRUISER 1.6i, 2.0i, 2.2CRD, 2.4i (06/00-12/10)



TA2289



TA2289

... CHRYSLER

... PT CRUISER 1.6i, 2.0i, 2.2CRD, 2.4i (06/00-12/10)



Part No	Description	Pos	Info	Technical
TA2289	Tie rod end(224)	A B		M14x1.5 Female(253) £
TC1974	Lower wishbone(158)	A		Pinch Bolt(255) 18mm
TC1975	Lower wishbone(158)	B		Pinch Bolt(255) 18mm
TC2593	Link stabiliser(135)	A B		
TD1121W	Lower wishbone bush(159)	A B	Front(108)	

VOYAGER III 2.4i, 2.5CRD, 2.8CRD, 3.3i, 3.8i (02/00-12/08)



Part No	Description	Pos	Info	Technical
TA2753	Tie rod end(224)	A B		M14x1.5 Female(253) £
TC1575	Link stabiliser(135)	A B		M12x1.75
TC2218	Lower wishbone(158)	A		M12x1.25
TC2219	Lower wishbone(158)	B		M12x1.25
TC3355	Link stabiliser(135)	A B		

YPSILON 900cc, 1.2i, 1.3JTD (09/11→)

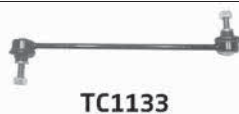
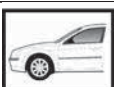

Part No	Description	Pos	Info	Technical
TA2848	Tie rod end(224)	A B		M12x1.5 Female(253) £
TBR4205	Steering rack gaiter kit(213)	K	Thermoplastic(223)	1 :10.5x54.5x54.5 2 :10.5x54.5x54.5
TC1133	Link stabiliser(135)	A B		M10x1.5

BERLINGO 1.1i, 1.4i, 1.6i, 1.8i, 1.8D, 1.9D RPO07973→ (09/98→)

BERLINGO MULTISPACE 1.1i, 1.4i, 1.6i, 1.8i, 1.9D RPO07973→ (09/98→)



Part No	Description	Pos	Info	Technical
TA977	Tie rod end(224)	A B		M14x1.5 Male(252) £
TA1503	Inner tie rod(123)	A B		M14x1.5 Female(253) £
TBR4010	Steering rack gaiter kit(213)	K		1 :40x40x40 ≥ :10x40x40
TC554	Link stabiliser(135)	A B		M10x1.5
TC952	Lower ball joint(140)	A B	(-) Multifunction roof(-22) (-) Heavy duty suspension(-18)	Pinch Bolt(255) 18mm
TC953	Lower wishbone(158)	A	(+) Ball joint(-39) (-) Multifunction roof(-22) (-) Heavy duty suspension(-18)	Pinch Bolt(255) 18mm
				(...)

CITROËN

... CITROËN

... BERLINGO 1.1i, 1.4i, 1.6i, 1.8i, 1.8D, 1.9D RPO07973→ (09/98→)

... BERLINGO MULTISPACE 1.1i, 1.4i, 1.6i, 1.8i, 1.9D RPO07973→ (09/98→)

Part No	Description	Pos	Info	Technical
TC954	Lower wishbone(158)	B	(+) Ball joint(-39) (-) Multifunction roof(-22) (-) Heavy duty suspension(-18)	Pinch Bolt(255) 18mm
TC1251	Lower wishbone(158)	A	(+) Multifunction roof(-50) (+) Heavy duty suspension(-47) RPO08016→	Pinch Bolt(255) 18mm
TC1252	Lower wishbone(158)	B	(+) Multifunction roof(-50) (+) Heavy duty suspension(-47) RPO08016→	Pinch Bolt(255) 18mm
TC2086	Lower wishbone(158)	A	(-) Bush(-13) (-) Multifunction roof(-22) (-) Heavy duty suspension(-18)	
TC2087	Lower wishbone(158)	B	(-) Bush(-13) (-) Multifunction roof(-22) (-) Heavy duty suspension(-18)	
TD300W	Lower wishbone bush(159)	A B	Front(108) Pack of(179) 2	
TD301W	Lower wishbone bush(159)	A B	Rear(187) (-) Multifunction roof(-22) (-) Heavy duty suspension(-18)	
TD574W	Lower wishbone bush(159)	A B	Rear(187) (+) Multifunction roof(-50) (+) Heavy duty suspension(-47) RPO08016→	
TD701W	Anti-roll bar(-74) bush kit(-86)	K	Ø21 Complete axle kit(-92)	
TD703W	Anti-roll bar(-74) bush kit(-86)	K	Ø22 Complete axle kit(-92)	
TD1057W	Cross member bush(-99)	A B	Rear(187)	
TL437	Rod assembly(194)	A B		M10x1.25

BERLINGO 1.6HDi, 2.0HDi (12/99-07/08)

BERLINGO MULTISPACE 1.6HDi, 2.0HDi (12/99-07/08)

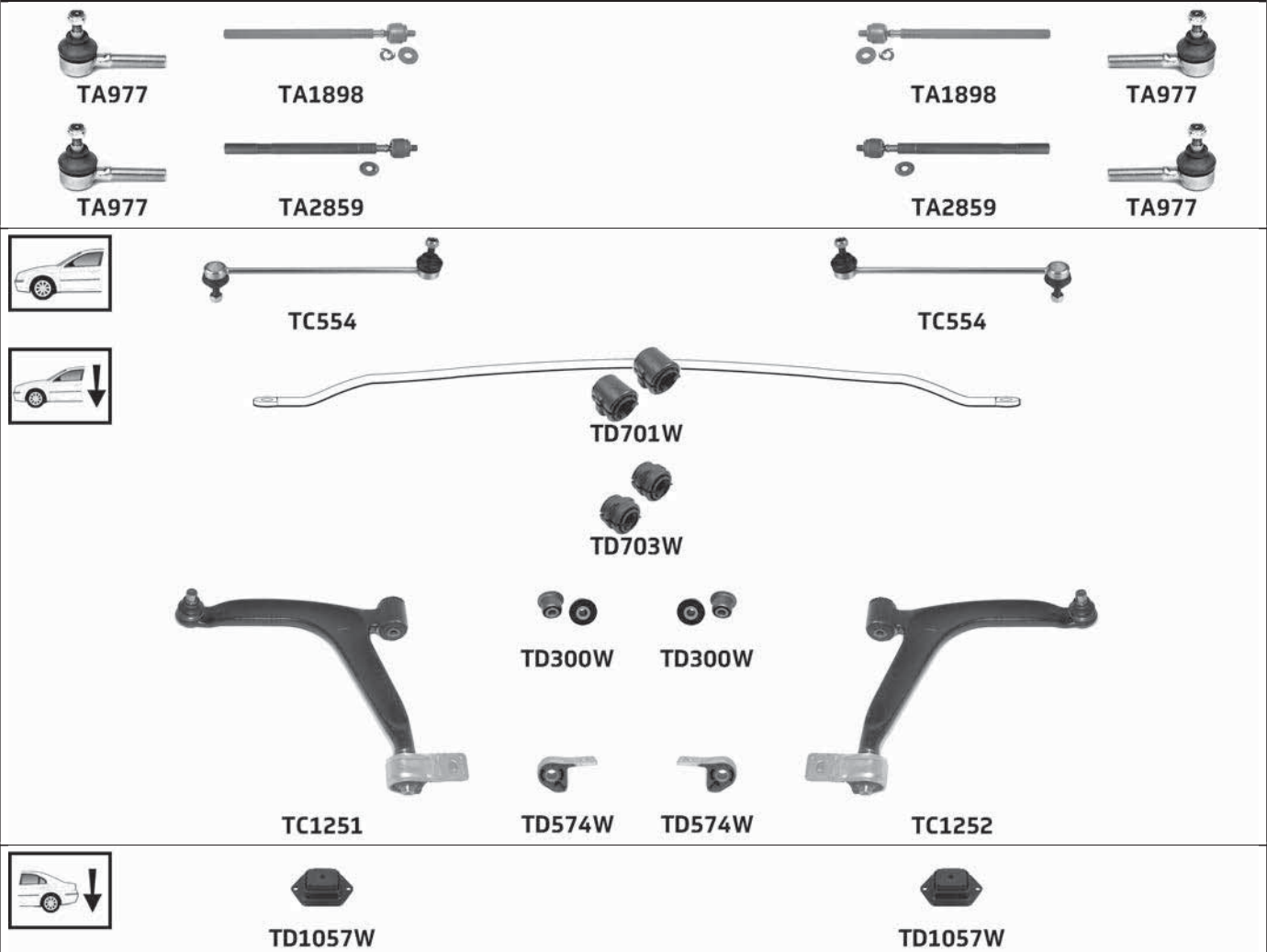

Part No	Description	Pos	Info	Technical
TA977	Tie rod end(224)	A B		M14x1.5 Male(252) £
TA1898	Inner tie rod(123)	A B	→RPO10016	M14x1.5 Female(253) £
TA2859	Inner tie rod(123)	A B	RPO10017→	M14x1.5 Female(253) £
TC554	Link stabiliser(135)	A B		M10x1.5
TC1251	Lower wishbone(158)	A		Pinch Bolt(255) 18mm
TC1252	Lower wishbone(158)	B		Pinch Bolt(255) 18mm
TD300W	Lower wishbone bush(159)	A B	Front(108) Pack of(179) 2	
TD574W	Lower wishbone bush(159)	A B	Rear(187)	

... BERLINGO 1.6Hdi, 2.0Hdi (12/99-07/08)

... BERLINGO MULTISPACE 1.6Hdi, 2.0Hdi (12/99-07/08)

Part No	Description	Pos	Info	Technical
TD701W	Anti-roll bar(-74) bush kit(-86)	K	Ø21 Complete axle kit(-92)	
TD703W	Anti-roll bar(-74) bush kit(-86)	K	Ø22 Complete axle kit(-92)	
TD1057W	Cross member bush(-99)	A B	Rear(187)	

BERLINGO 1.6i, 1.6Hdi (04/08→)

BERLINGO MULTISPACE 1.6i, 1.6Hdi (04/08→)



TD1001W



TD1002W



TD1013W



TD1016W



TD1014W



TD1014W

Part No	Description	Pos	Info	Technical
TA2465	Tie rod end(224)	A		M14x1.5 Female(253) £
TA2466	Tie rod end(224)	B		M14x1.5 Female(253) £
TA2510	Inner tie rod(123)	A B		M14x1.5 Male(252) £
TC1022	Lower ball joint(140)	A B		M14x1.5
TC1023	Link stabiliser(135)	A B		M10x1.5
TC1156	Lower wishbone(158)	A	(-) Ball joint(-11)	
TC1157	Lower wishbone(158)	B	(-) Ball joint(-11)	
TD316W	Lower wishbone bush(159)	A B	Rear(187)	
TD390W	Lower wishbone bush(159)	A B	Front(108)	
TD1001W	Anti-roll bar(-74) bush kit(-86)	K	Ø23 Complete axle kit(-92) (+) Multispace	
TD1002W	Anti-roll bar(-74) bush kit(-86)	K	Ø24 Complete axle kit(-92)	
TD1013W	Anti-roll bar(-74) bush kit(-86)	K	Ø24.5 Complete axle kit(-92) (-) Multispace	
TD1014W	Axle bush(-76)	A B	Round mounting(196)	
TD1016W	Anti-roll bar(-74) bush kit(-86)	K	Ø25 Complete axle kit(-92)	

... CITROËN

C1 1.0i, 1.4Hdi (06/05→)

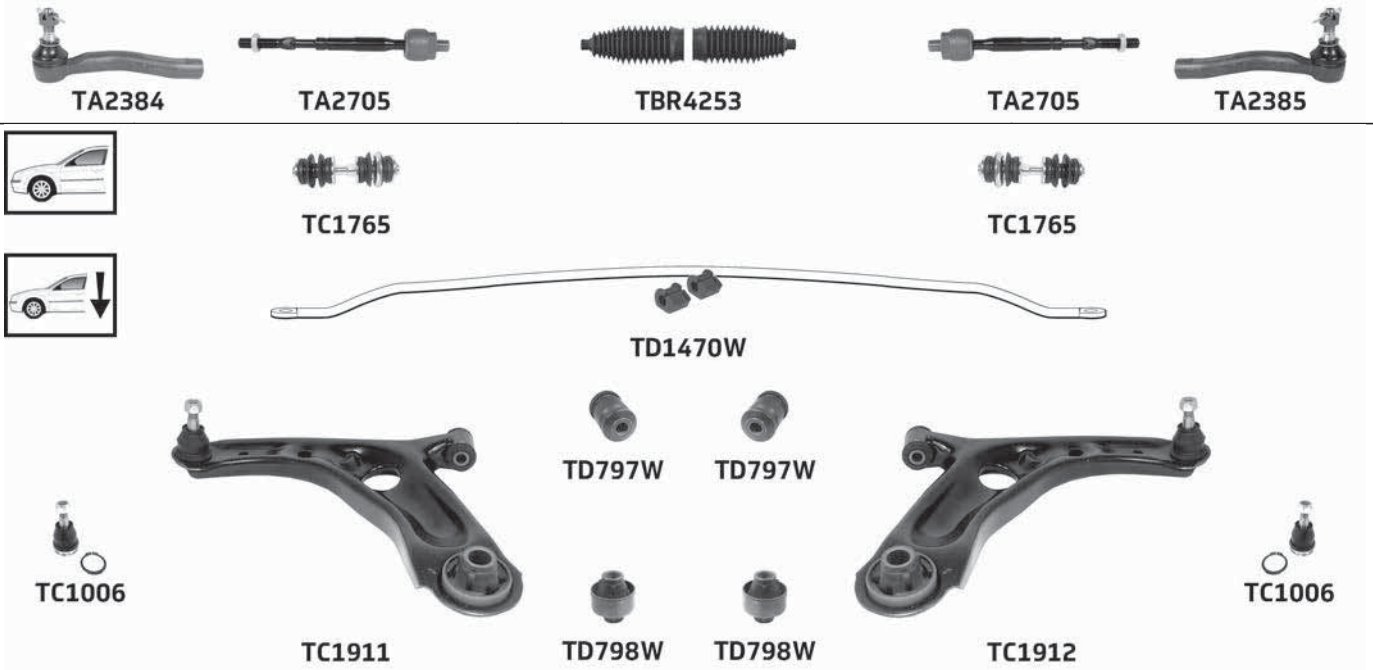

Part No	Description	Pos	Info	Technical
TA2384	Tie rod end(224)	A		M12x1.25 Female(253) £
TA2385	Tie rod end(224)	B		M12x1.25 Female(253) £
TA2705	Inner tie rod(123)	A B		M12x1.25 Male(252) £
TBR4253	Steering rack gaiter kit(213)	K	Thermoplastic(223)	1 :11.5x51x51 2 :11.5x51x51
TC1006	Lower ball joint(140)	A B		M12x1.25
TC1765	Link stabiliser(135)	A B		
TC1911	Lower wishbone(158)	A		M12x1.25
TC1912	Lower wishbone(158)	B		M12x1.25
TD797W	Lower wishbone bush(159)	A B	Front(108)	
TD798W	Lower wishbone bush(159)	A B	Rear(187)	
TD1470W	Anti-roll bar(-74) bush kit(-86)	K	Complete axle kit(-92)	

C1 1.0i, 1.2i (04/14→)



Part No	Description	Pos	Info	Technical
TA2384	Tie rod end(224)	A		M12x1.25 Female(253) £
TA2385	Tie rod end(224)	B		M12x1.25 Female(253) £
TBR4253	Steering rack gaiter kit(213)	K	Thermoplastic(223)	1 :11.5x51x51 2 :11.5x51x51

C2 1.1i, 1.4i, 1.4Hdi, 1.6i, 1.6Hdi (09/03→)



Part No	Description	Pos	Info	Technical
TA1827	Tie rod end(224)	A		M14x1.5 Female(253) £
TA1828	Tie rod end(224)	B		M14x1.5 Female(253) £

... C2 1.1i, 1.4i, 1.4HDi, 1.6i, 1.6HDi (09/03→)

Part No	Description	Pos	Info	Technical
TA1829	Inner tie rod(123)	A B		M14x1.5 Male(252) £
TBR4202	Steering rack gaiter kit(213)	K	Thermoplastic(223)	1 :15x50x50 2 :15x50x50
TC880	Link stabiliser(135)	A B		M10x1.5
TC1176	Lower ball joint(140)	A B		Pinch Bolt(255) 18mm
TC1247	Lower wishbone(158)	A		Pinch Bolt(255) 18mm
TC1248	Lower wishbone(158)	B		Pinch Bolt(255) 18mm
TD503W	Lower wishbone bush(159)	A B	Front(108)	
TD504W	Lower wishbone bush(159)	A B	Rear(187)	

C3 1.1i, 1.4i, 1.4HDi (01/02-12/09)

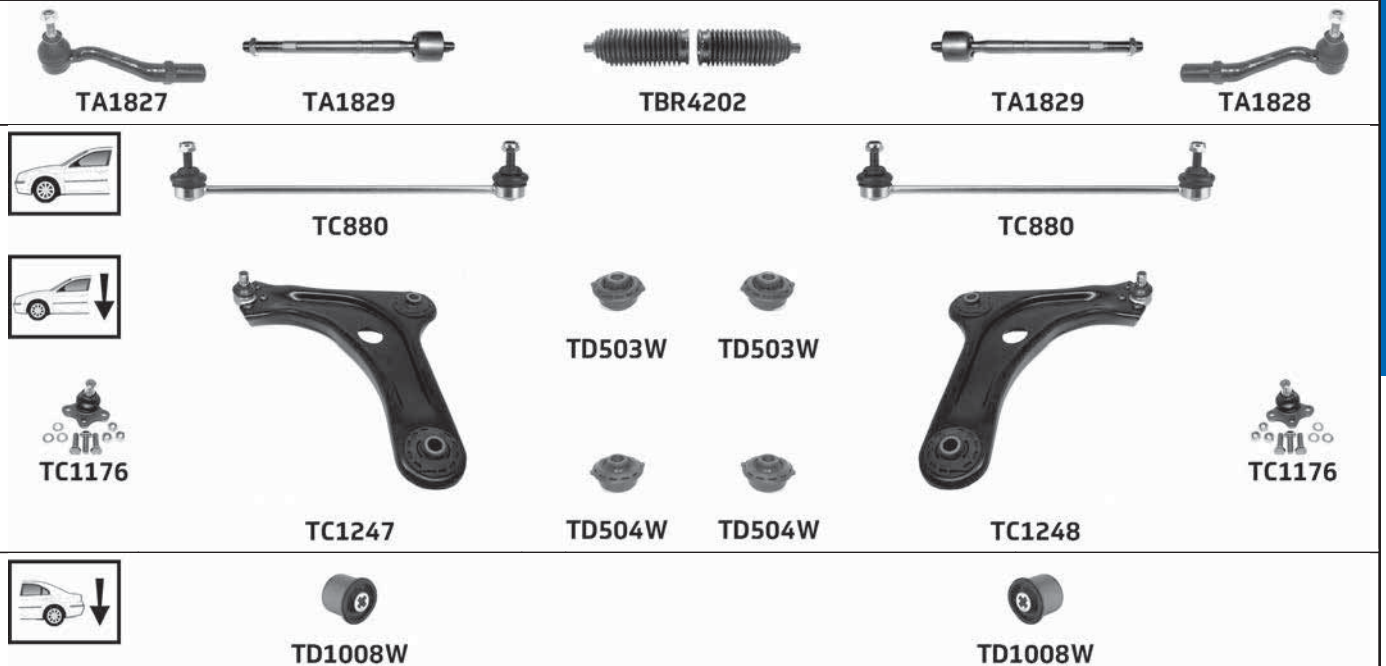

Part No	Description	Pos	Info	Technical
TA1827	Tie rod end(224)	A		M14x1.5 Female(253) £
TA1828	Tie rod end(224)	B		M14x1.5 Female(253) £
TA1829	Inner tie rod(123)	A B		M14x1.5 Male(252) £
TBR4202	Steering rack gaiter kit(213)	K	Thermoplastic(223)	1 :15x50x50 2 :15x50x50
TC880	Link stabiliser(135)	A B		M10x1.5
TC1176	Lower ball joint(140)	A B		Pinch Bolt(255) 18mm
TC1247	Lower wishbone(158)	A		Pinch Bolt(255) 18mm
TC1248	Lower wishbone(158)	B		Pinch Bolt(255) 18mm
TD503W	Lower wishbone bush(159)	A B	Front(108)	
TD504W	Lower wishbone bush(159)	A B	Rear(187)	
TD1008W	Sub-frame bush(215)	A B	RPO10003→	

... CITROËN

C3 1.6i (01/02-12/09)



Part No	Description	Pos	Info	Technical
TA1827	Tie rod end(224)	A	Manual gearbox(169)	M14x1.5 Female(253) £
TA1828	Tie rod end(224)	B	Manual gearbox(169)	M14x1.5 Female(253) £
TA1829	Inner tie rod(123)	A B	Manual gearbox(169)	M14x1.5 Male(252) £
TA3241	Tie rod end(224)	A	Automatic gearbox(-75-)	
TA3242	Tie rod end(224)	B	Automatic gearbox(-75-)	
TBR4202	Steering rack gaiter kit(213)	K	Manual gearbox(169) Thermoplastic(223)	1 :15x50x50 2 :15x50x50
TC880	Link stabiliser(135)	A B		M10x1.5
TC1176	Lower ball joint(140)	A B		Pinch Bolt(255) 18mm
TC1247	Lower wishbone(158)	A		Pinch Bolt(255) 18mm
TC1248	Lower wishbone(158)	B		Pinch Bolt(255) 18mm
TD503W	Lower wishbone bush(159)	A B	Front(108)	
TD504W	Lower wishbone bush(159)	A B	Rear(187)	
TD1008W	Sub-frame bush(215)	A B	RPO10003→	

CITROËN

C3 1.6HDi (09/05-12/09)



Part No	Description	Pos	Info	Technical
TA3241	Tie rod end (224)	A		
TA3242	Tie rod end (224)	B		
TC880	Link stabiliser (135)	A B		M10x1.5
TC1176	Lower ball joint (140)	A B		Pinch Bolt (255) 18mm
TC1247	Lower wishbone (158)	A		Pinch Bolt (255) 18mm
TC1248	Lower wishbone (158)	B		Pinch Bolt (255) 18mm
TD503W	Lower wishbone bush (159)	A B	Front (108)	
TD504W	Lower wishbone bush (159)	A B	Rear (187)	
TD1008W	Sub-frame bush (215)	A B	RPO10003→	

C3 1.1i, 1.4i, 1.4HDi, 1.4VTi, 1.6VTi, 1.6HDi (11/09→)

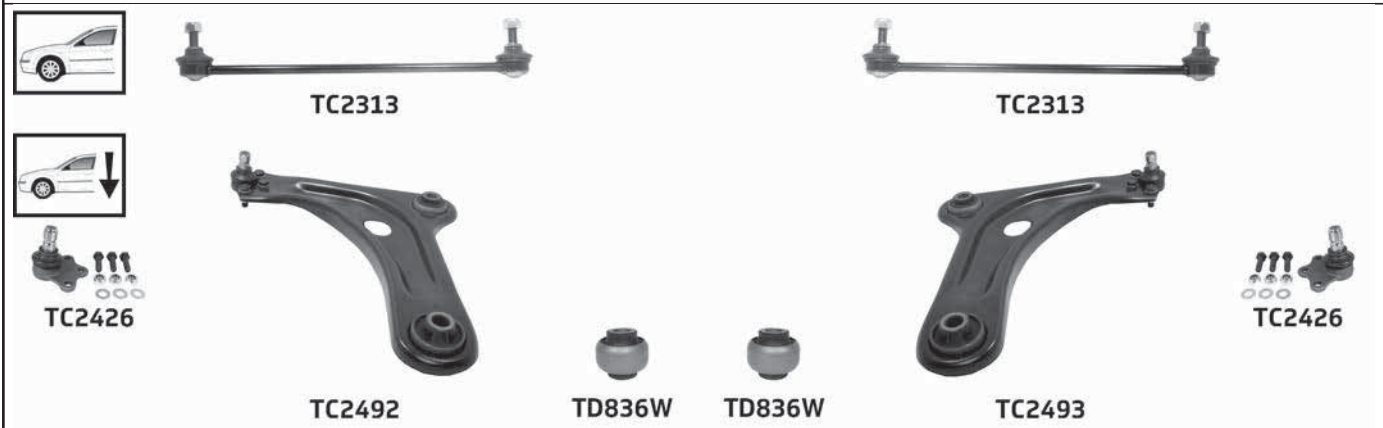

Part No	Description	Pos	Info	Technical
TA2621	Inner tie rod (123)	A B		M14x1.5 Male (252) £
TA2662	Tie rod end (224)	A		M14x1.5 Female (253) £
TA2663	Tie rod end (224)	B		M14x1.5 Female (253) £
TC2313	Link stabiliser (135)	A B		M10x1.25
TC2426	Lower ball joint (140)	A B		Pinch Bolt (255) 18mm
TC2492	Lower wishbone (158)	A	(-) Heavy duty suspension (-18-)	Pinch Bolt (255) 18mm
TC2493	Lower wishbone (158)	B	(-) Heavy duty suspension (-18-)	Pinch Bolt (255) 18mm
TD836W	Lower wishbone bush (159)	A B	Rear (187) (-) Heavy duty suspension (-18-)	
TD1012W	Sub-frame bush (215)	A B		

... CITROËN

C3 PICASSO 1.4VTi, 1.6VTi, 1.6HDi (02/09→)

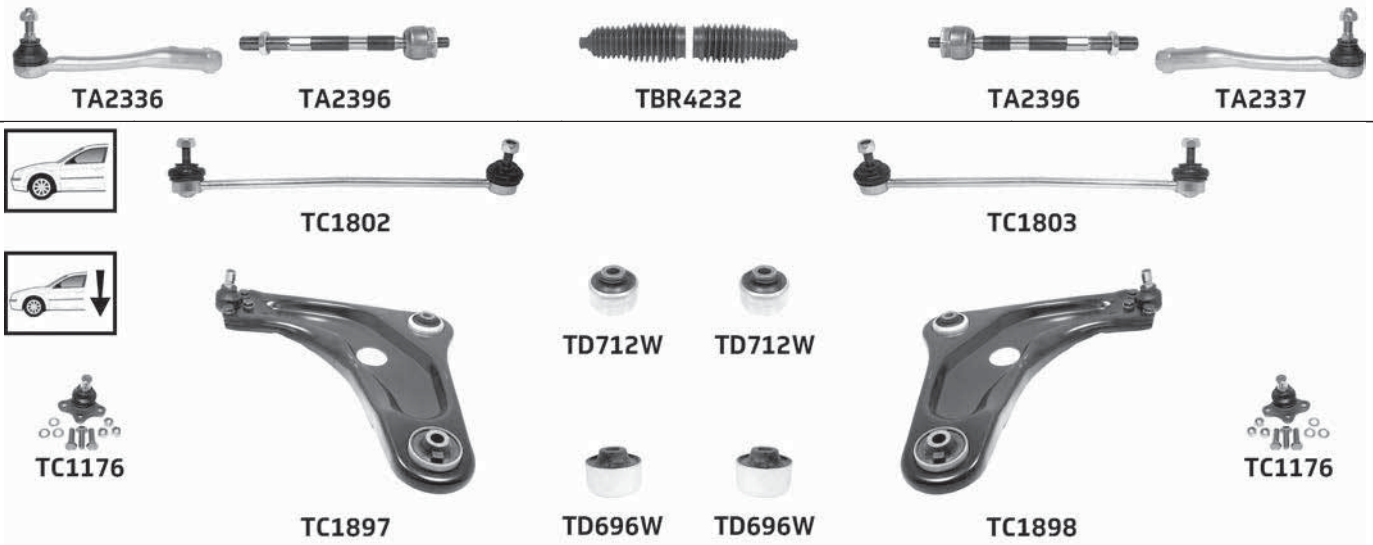

Part No	Description	Pos	Info	Technical
TA2336	Tie rod end(224)	A		M16x1.5 Female(253) £
TA2337	Tie rod end(224)	B		M16x1.5 Female(253) £
TA2396	Inner tie rod(123)	A B		M16x1.5 Male(252) £
TBR4232	Steering rack gaiter kit(213)	K		1 :15.5x51.5x51.5 2 :15.5x51.5x51.5
TC1176	Lower ball joint(140)	A B		Pinch Bolt(255) 18mm
TC1802	Link stabiliser(135)	A		M10x1.5
TC1803	Link stabiliser(135)	B		M10x1.5
TC1897	Lower wishbone(158)	A	(+) Heavy duty suspension(-47-)	Pinch Bolt(255) 18mm
TC1898	Lower wishbone(158)	B	(+) Heavy duty suspension(-47-)	Pinch Bolt(255) 18mm
TD696W	Lower wishbone bush(159)	A B	Rear(187)	
TD712W	Lower wishbone bush(159)	A B	Front(108)	
TD1012W	Sub-frame bush(215)	A B	(-) Heavy duty suspension(-18-)	

C3 PLURIEL 1.4i, 1.4HDi, 1.6i (05/03→)



Part No	Description	Pos	Info	Technical
TA1827	Tie rod end(224)	A		M14x1.5 Female(253) £
TA1828	Tie rod end(224)	B		M14x1.5 Female(253) £
TA1829	Inner tie rod(123)	A B		M14x1.5 Male(252) £
TBR4202	Steering rack gaiter kit(213)	K	Thermoplastic(223)	1 :15x50x50 2 :15x50x50
TC880	Link stabiliser(135)	A B		M10x1.5
TC1176	Lower ball joint(140)	A B		Pinch Bolt(255) 18mm
TC1247	Lower wishbone(158)	A		Pinch Bolt(255) 18mm
TC1248	Lower wishbone(158)	B		Pinch Bolt(255) 18mm
TD503W	Lower wishbone bush(159)	A B	Front(108)	
TD504W	Lower wishbone bush(159)	A B	Rear(187)	

C4 1.4i, 1.6i, 1.6THP, 1.6VTi, 1.6HDi, 2.0i, 2.0HDi (11/04-10/10)



TA1155



TA1776



TBR4139



TA1776



TA1154



TA977



TA2463



TA2463



TA977



TC1023



TC1023



TD984W



TD1007W



TD1001W



TC1156



TD390W



TD390W



TD316W



TD316W



TC1157



TC1022



TC1022



TD1157W



TD1157W

Part No	Description	Pos	Info	Technical
TA977	Tie rod end(224)	A B	RPO10311→	M14x1.5 Male(252) £
TA1154	Tie rod end(224)	B	→RPO10310	M14x1.5 Male(252) £
TA1155	Tie rod end(224)	A	→RPO10310	M14x1.5 Male(252) £
TA1776	Inner tie rod(123)	A B	→RPO10310	M14x1.5 Female(253) £
TA2463	Inner tie rod(123)	A B	RPO10311→	M14x1.5 Female(253) £
TBR4139	Steering rack gaiter kit(213)	K	→RPO10310	1 :17x60x60 2 :17x60x60
TC1022	Lower ball joint(140)	A B		M14x1.5
TC1023	Link stabiliser(135)	A B		M10x1.5
TC1156	Lower wishbone(158)	A	(-) Ball joint(-11)	
TC1157	Lower wishbone(158)	B	(-) Ball joint(-11)	
TD316W	Lower wishbone bush(159)	A B	Rear(187)	
TD390W	Lower wishbone bush(159)	A B	Front(108)	
TD984W	Anti-roll bar(-74) bush kit(-86)	K	Ø22 Complete axle kit(-92)	
TD1001W	Anti-roll bar(-74) bush kit(-86)	K	Ø23 Complete axle kit(-92)	
TD1007W	Anti-roll bar(-74) bush kit(-86)	K	Ø22.5 Complete axle kit(-92)	
TD1157W	Axle bush(-76)	A B		

... CITROËN

C4 1.4VTi, 1.6THP, 1.6VTi, 1.6HDi, 2.0HDi (10/10→)

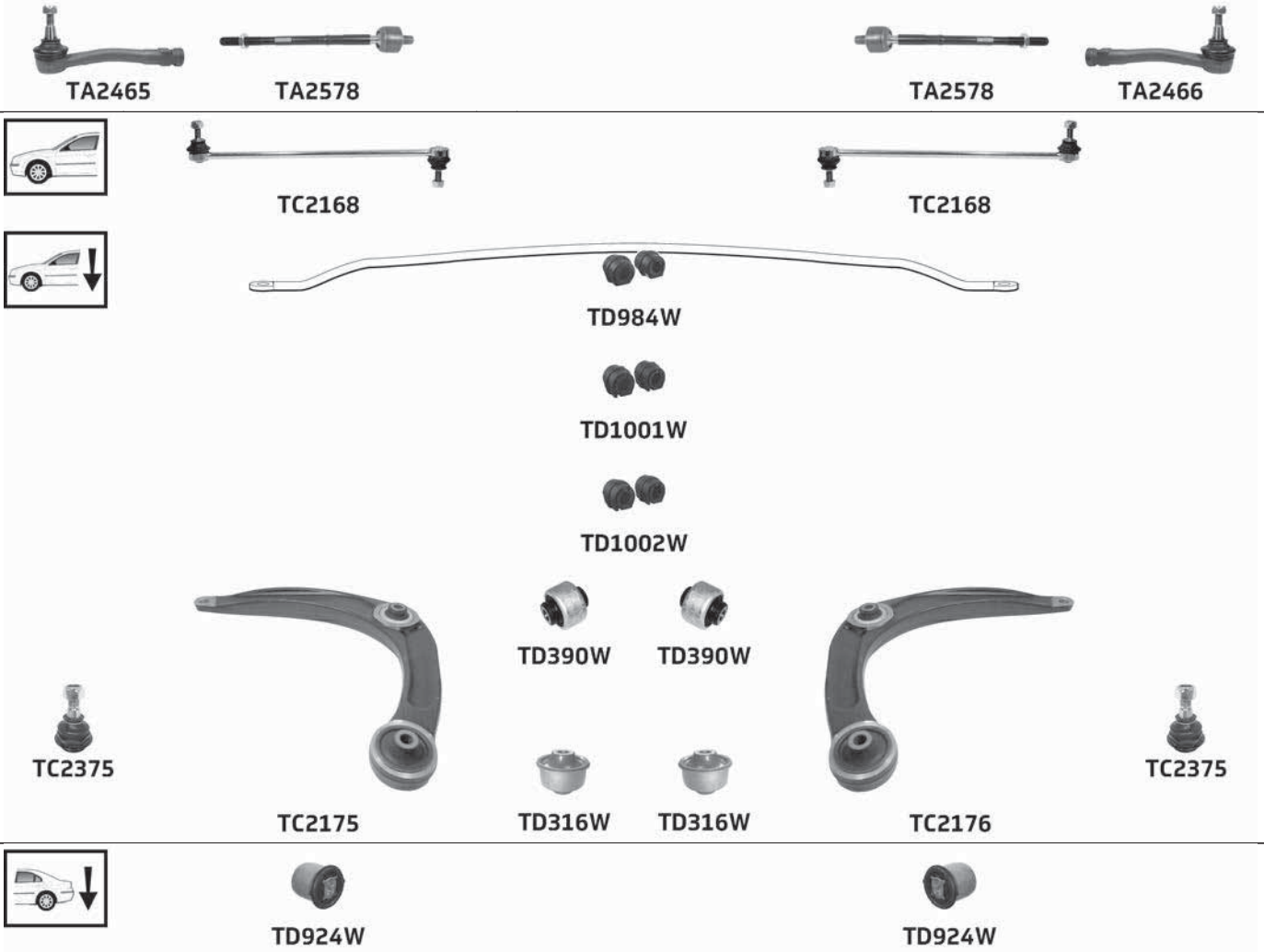

Part No	Description	Pos	Info	Technical
TA2465	Tie rod end(224)	A		M14x1.5 Female(253) £
TA2466	Tie rod end(224)	B		M14x1.5 Female(253) £
TA2578	Inner tie rod(123)	A B		M14x1.5 Male(252) £
TC2168	Link stabiliser(135)	A B		M10x1.5
TC2175	Lower wishbone(158)	A	(-) Ball joint(-11-)	
TC2176	Lower wishbone(158)	B	(-) Ball joint(-11-)	
TC2375	Lower ball joint(140)	A B		M14x1.5
TD316W	Lower wishbone bush(159)	A B	Rear(187)	
TD390W	Lower wishbone bush(159)	A B	Front(108)	
TD924W	Axle bush(-76-)	A B		
TD984W	Anti-roll bar(-74-) bush kit(-86-)	K	Ø22 Complete axle kit(-92-)	
TD1001W	Anti-roll bar(-74-) bush kit(-86-)	K	Ø23 Complete axle kit(-92-)	
TD1002W	Anti-roll bar(-74-) bush kit(-86-)	K	Ø24 Complete axle kit(-92-)	

C4 AIRCROSS 1.6i, 1.6HDi, 1.8HDi, 2.0i (04/12→)

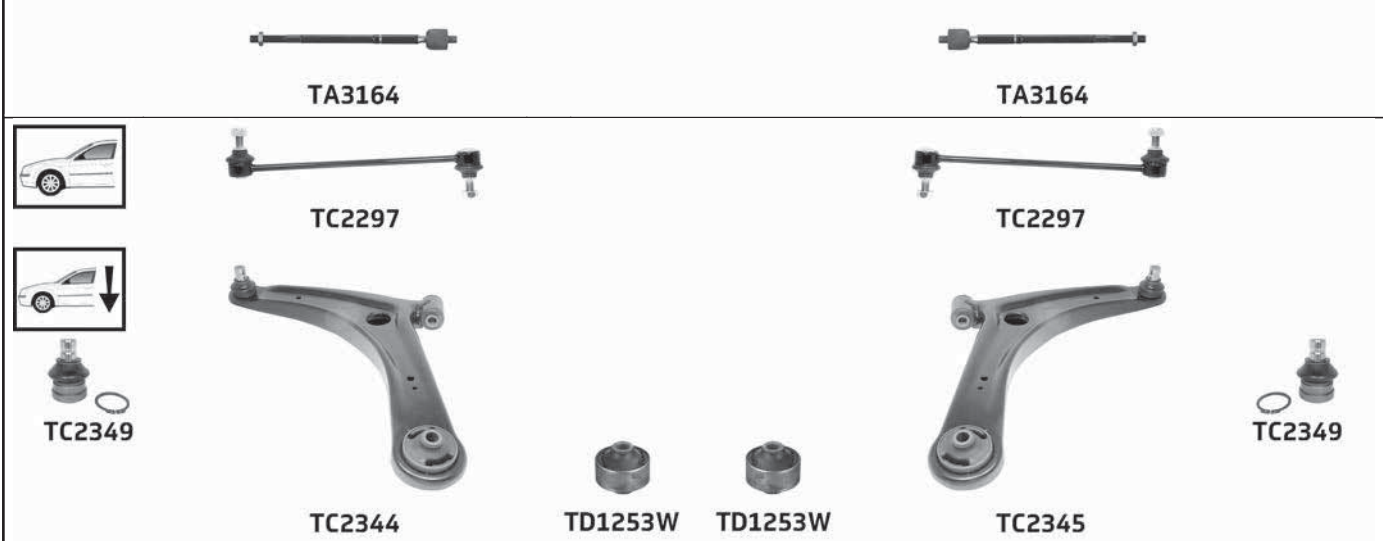

Part No	Description	Pos	Info	Technical
TA3164	Inner tie rod(123)	A B		M14x1.5 Male(252) £
TC2289	Link stabiliser(135)	A B		M10x1.25
TC2297	Link stabiliser(135)	A B		M10x1.25
TC2344	Lower wishbone(158)	A		Pinch Bolt(255) 20mm
TC2345	Lower wishbone(158)	B		Pinch Bolt(255) 20mm
TC2349	Lower ball joint(140)	A B		Pinch Bolt(255) 20mm
TD1253W	Lower wishbone bush(159)	A B	Rear(187)	

C4 CACTUS 1.2VTi, 1.2THP, 1.6HDi (06/14→)

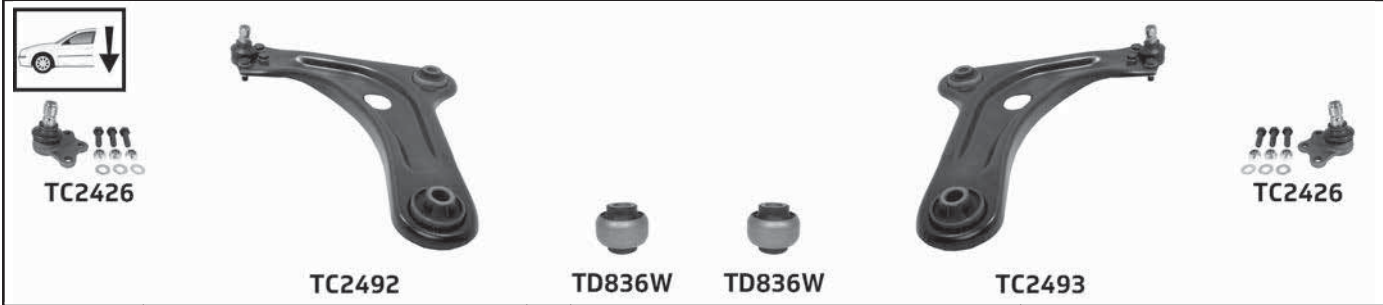

Part No	Description	Pos	Info	Technical
TA2806	Inner tie rod(123)	A B		M14x1.5 Male(252) £
TA2849	Tie rod end(224)	A		M14x1.5 Female(253) £
TA2850	Tie rod end(224)	B		M14x1.5 Female(253) £
TC2426	Lower ball joint(140)	A B		Pinch Bolt(255) 18mm
TC2492	Lower wishbone(158)	A		Pinch Bolt(255) 18mm
TC2493	Lower wishbone(158)	B		Pinch Bolt(255) 18mm
TD836W	Lower wishbone bush(159)	A B	Rear(187)	
TD1012W	Sub-frame bush(215)	A B		

... CITROËN

C4 GRAND PICASSO 1.6i, 1.6HDi, 1.6THP, 1.8i, 2.0i, 2.0HDi (10/06→)

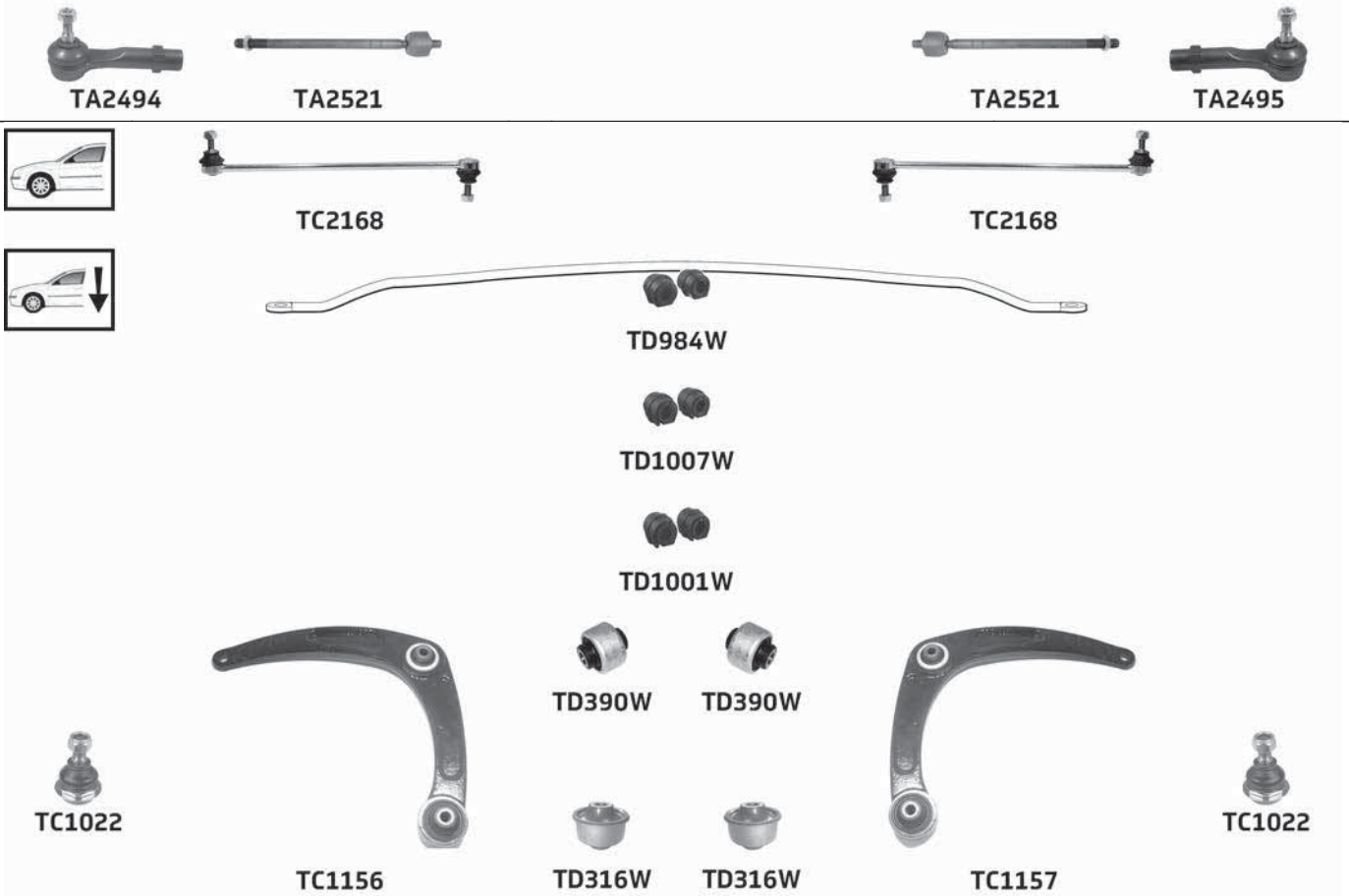

Part No	Description	Pos	Info	Technical
TA2494	Tie rod end(224)	A		M16x1.5 Female(253) £
TA2495	Tie rod end(224)	B		M16x1.5 Female(253) £
TA2521	Inner tie rod(123)	A B		M16x1.5 Male(252) £
TC1022	Lower ball joint(140)	A B		M14x1.5
TC1156	Lower wishbone(158)	A	(-) Ball joint(-11-)	
TC1157	Lower wishbone(158)	B	(-) Ball joint(-11-)	
TC2168	Link stabiliser(135)	A B		M10x1.5
TD316W	Lower wishbone bush(159)	A B	Rear(187)	
TD390W	Lower wishbone bush(159)	A B	Front(108)	
TD984W	Anti-roll bar(-74-) bush kit(-86-)	K	Ø22 Complete axle kit(-92-)	
TD1001W	Anti-roll bar(-74-) bush kit(-86-)	K	Ø23 Complete axle kit(-92-)	
TD1007W	Anti-roll bar(-74-) bush kit(-86-)	K	Ø22.5 Complete axle kit(-92-)	

C4 GRAND PICASSO 1.2VTi, 1.2THP, 1.6VTi, 1.6THP, 1.6HDi, 2.0HDi (02/13→)

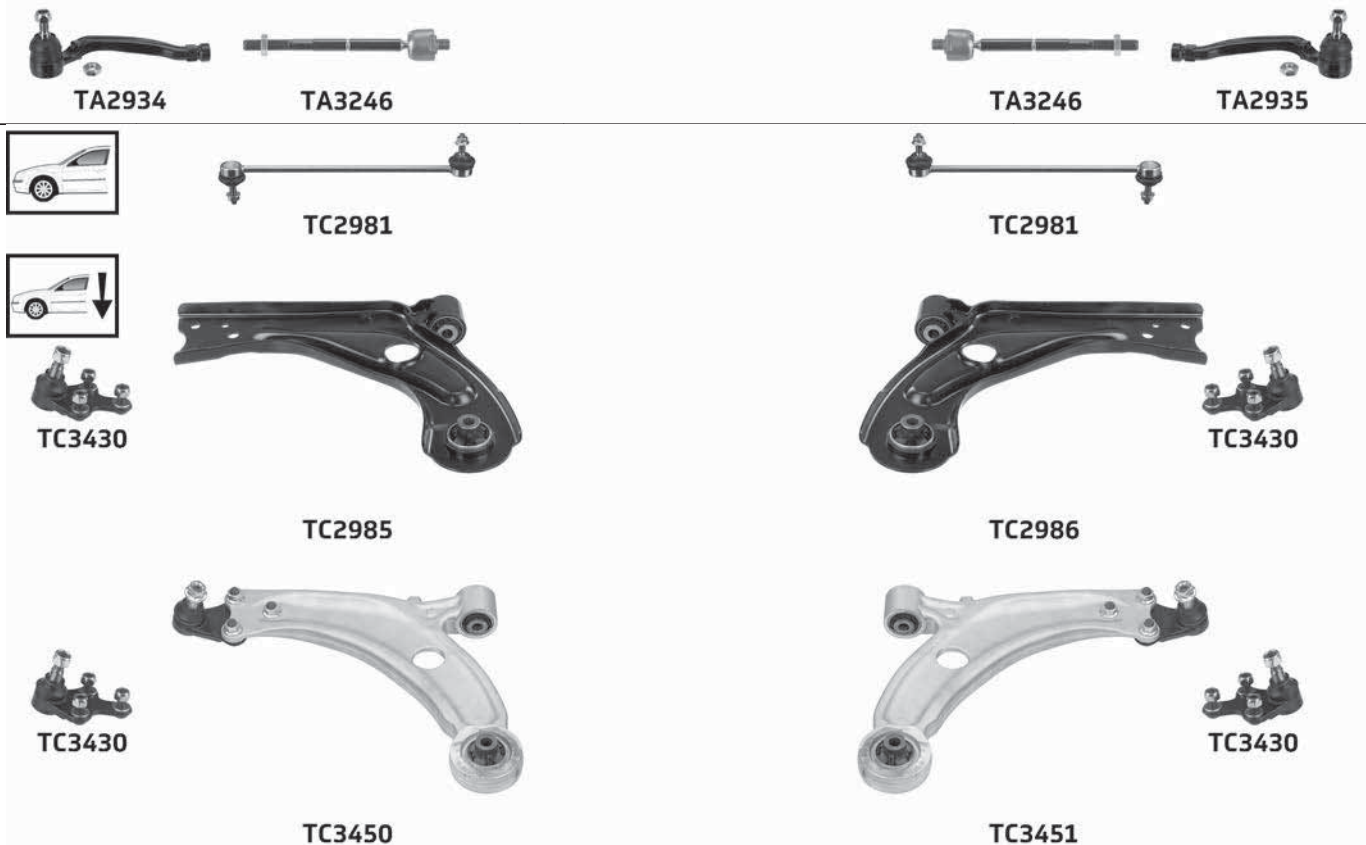

Part No	Description	Pos	Info	Technical
TA2934	Tie rod end(224)	A		M14x1.5 Female(253) £
TA2935	Tie rod end(224)	B		M14x1.5 Female(253) £
TA3246	Inner tie rod(123)	A B		M14x1.5 Male(252) £ / ~
TC2981	Link stabiliser(135)	A B		M10x1.5
TC2985	Lower wishbone(158)	A	(-) Bush(-13) Sheet steel(201)	
TC2986	Lower wishbone(158)	B	(-) Bush(-13) Sheet steel(201)	
TC3430	Lower ball joint(140)	A B		
TC3450	Lower wishbone(158)	A	(+) Ball joint(-39) Aluminium(-73)	M14x1.5
TC3451	Lower wishbone(158)	B	(+) Ball joint(-39) Aluminium(-73)	M14x1.5

... CITROËN

C4 PICASSO 1.6i, 1.6HDi, 1.6THP, 1.8i, 2.0i, 2.0HDi (02/07-08/13)

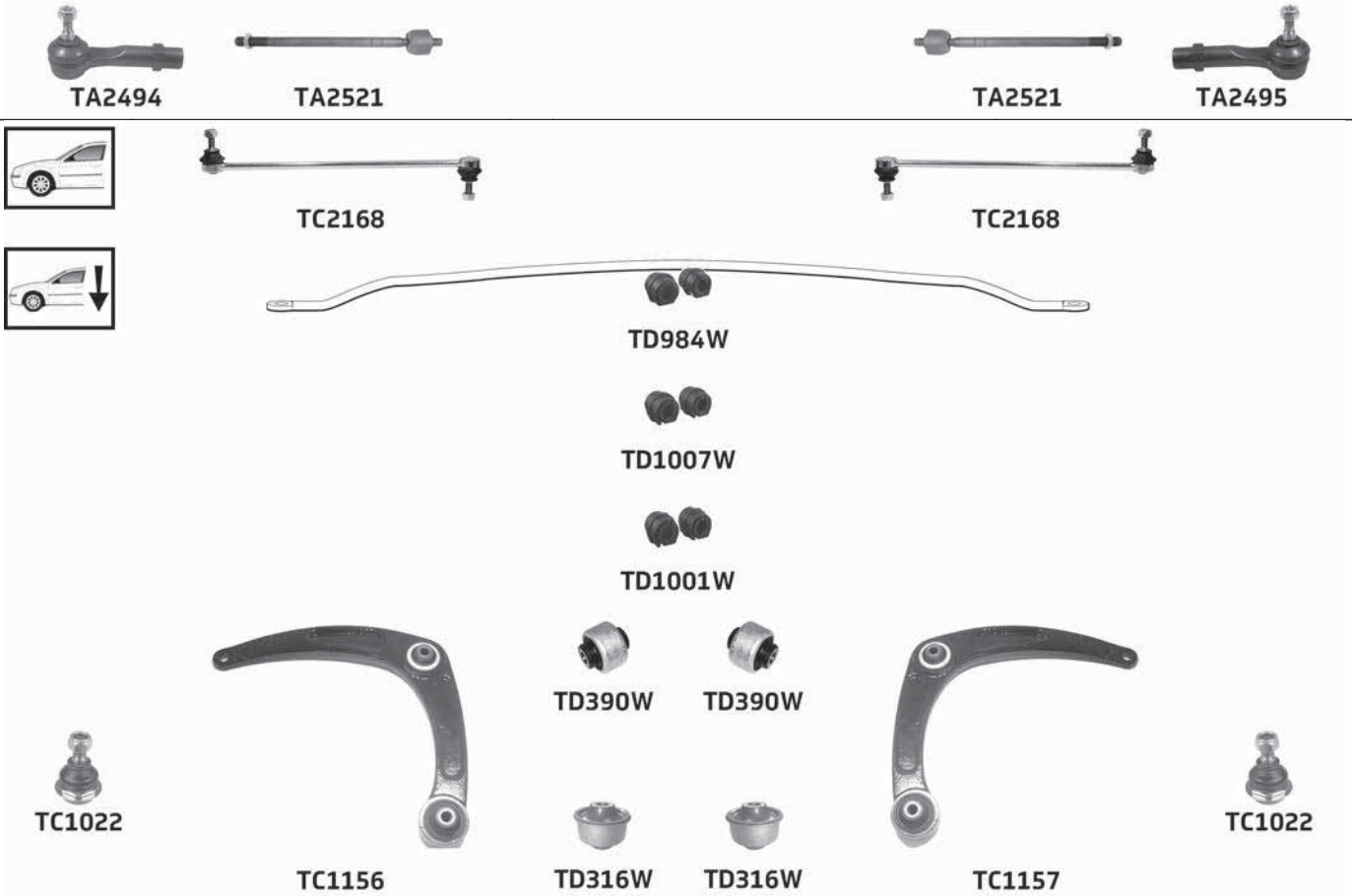

Part No	Description	Pos	Info	Technical
TA2494	Tie rod end(224)	A		M16x1.5 Female(253) £
TA2495	Tie rod end(224)	B		M16x1.5 Female(253) £
TA2521	Inner tie rod(123)	A B		M16x1.5 Male(252) £
TC1022	Lower ball joint(140)	A B		M14x1.5
TC1156	Lower wishbone(158)	A	(-) Ball joint(-11-)	
TC1157	Lower wishbone(158)	B	(-) Ball joint(-11-)	
TC2168	Link stabiliser(135)	A B		M10x1.5
TD316W	Lower wishbone bush(159)	A B	Rear(187)	
TD390W	Lower wishbone bush(159)	A B	Front(108)	
TD984W	Anti-roll bar(-74-) bush kit(-86-)	K	Ø22 Complete axle kit(-92-)	
TD1001W	Anti-roll bar(-74-) bush kit(-86-)	K	Ø23 Complete axle kit(-92-)	
TD1007W	Anti-roll bar(-74-) bush kit(-86-)	K	Ø22.5 Complete axle kit(-92-)	

C4 PICASSO 1.2VTi, 1.2THP, 1.6VTi, 1.6THP, 1.6HDi, 2.0HDi (02/13→)

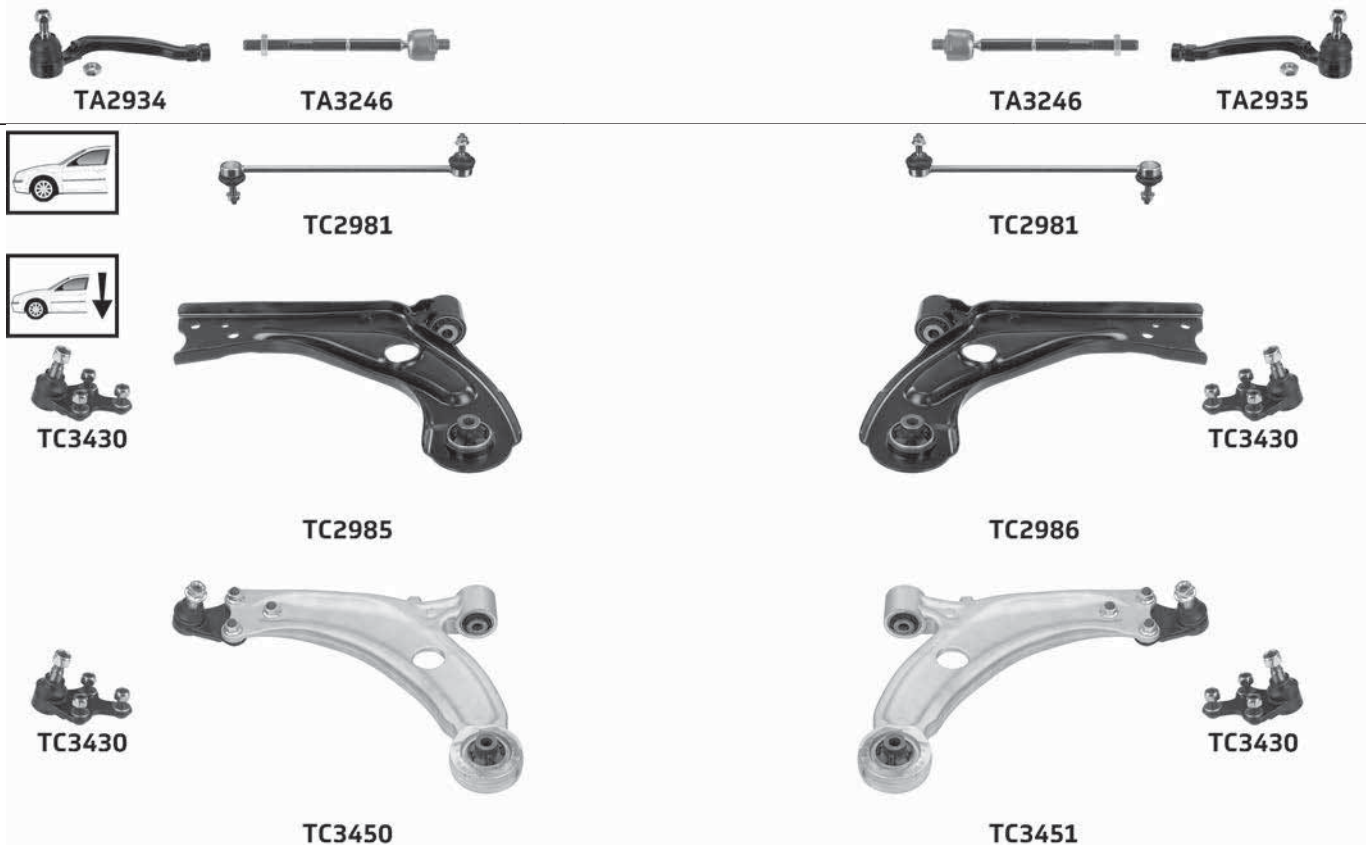

Part No	Description	Pos	Info	Technical
TA2934	Tie rod end(224)	A		M14x1.5 Female(253) £
TA2935	Tie rod end(224)	B		M14x1.5 Female(253) £
TA3246	Inner tie rod(123)	A B		M14x1.5 Male(252) £ / ~
TC2981	Link stabiliser(135)	A B		M10x1.5
TC2985	Lower wishbone(158)	A	(-) Bush(-13) Sheet steel(201)	
TC2986	Lower wishbone(158)	B	(-) Bush(-13) Sheet steel(201)	
TC3430	Lower ball joint(140)	A B		
TC3450	Lower wishbone(158)	A	(+) Ball joint(-39) Aluminium(-73)	M14x1.5
TC3451	Lower wishbone(158)	B	(+) Ball joint(-39) Aluminium(-73)	M14x1.5

... CITROËN

C5 1.6HDI, 1.8i, 2.0i, 2.0HPI, 2.0HDI, 2.2HDI, 3.0i V6 (03/01-02/08)

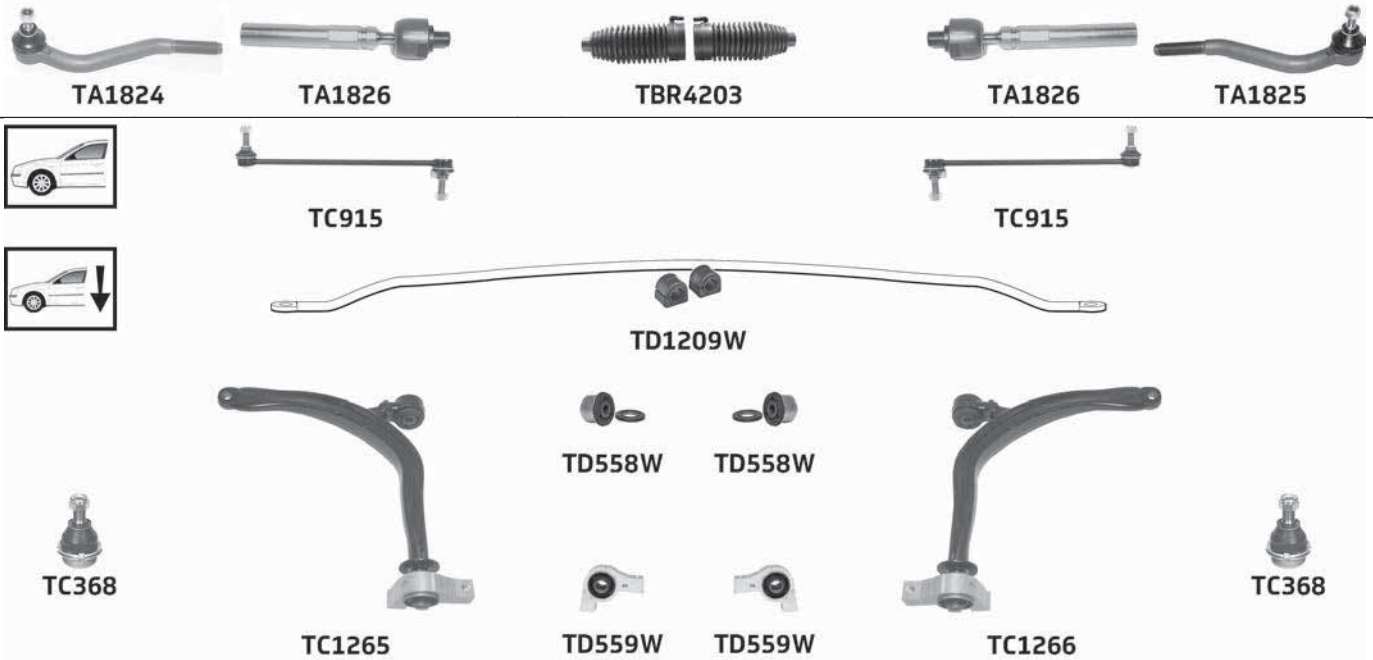

Part No	Description	Pos	Info	Technical
TA1824	Tie rod end(224)	A		M16x1.5 Male(252) £
TA1825	Tie rod end(224)	B		M16x1.5 Male(252) £
TA1826	Inner tie rod(123)	A B		M16x1.5 Female(253) £
TBR4203	Steering rack gaiter kit (213)	K	Thermoplastic(223)	1 :21x58x58 2 :21x58x58
TC368	Lower ball joint (140)	A B		M14x1.5
TC915	Link stabiliser (135)	A B		M12x1.75
TC1265	Lower wishbone(158)	A	(-) Ball joint (-11-)	
TC1266	Lower wishbone(158)	B	(-) Ball joint (-11-)	
TD558W	Lower wishbone bush(159)	A B	Front(108)	
TD559W	Lower wishbone bush(159)	A B	Rear(187)	
TD1209W	Anti-roll bar(-74) bush kit(-86)	K	Ø23.5 Complete axle kit(-92-) (-) 2.2 HDI 130kW Eng DW12BTED4 (-) 2.2 HDI 130kW Eng DW12BTED4 (-) 3.0i Eng ES9J4S, (-) 3.0i Eng ES9A	

C5 1.6THP, 1.6HDI, 1.8i, 2.0i, 2.0HDI, 2.2HDI, 2.7HDI, 3.0i V6, 3.0HDI (02/08→)



CITROËN

... C5 1.6THP, 1.6HDi, 1.8i, 2.0i, 2.0HDi, 2.2HDi, 2.7HDi, 3.0i V6, 3.0HDi (02/08→)



TD997W



TD997W



TD1000W



TD1000W



TC1370



TC1370



TC1372



TC1373



TD1228W



TD1228W



TD1017W



TD999W



TD998W



TC2829



TD535W



TD535W



TC2830



TC3082



TD535W



TD535W



TC3083



TD933W



TD933W



TC1374



TC1374



TC3426



TC3426

Part No	Description	Pos	Info	Technical
TA2683	Tie rod end (224)	A		M14x1.5 Female (253) £
TA2684	Tie rod end (224)	B		M14x1.5 Female (253) £

(...)

... CITROËN

... C5 1.6THP, 1.6HdI, 1.8i, 2.0i, 2.0HdI, 2.2HdI, 2.7HdI, 3.0i V6, 3.0HdI (02/08→)

TA2752	Inner tie rod(123)	A B		M14x1.5 Male(252) E
TC1370	Upper ball joint(232)	A B		M14x1.5
TC1372	Link stabiliser(135)	A		M16x1.5
TC1373	Link stabiliser(135)	B		M16x1.5
TC1374	Link stabiliser(135)	A B		M10x1.5
TC2829	Lower wishbone(158)	A	(-) Ball joint(-11) (-) Hydro-Pneumatic suspension(-21) → RPO11983	
TC2829	Lower wishbone(158)	A	(-) Bush(-13) (-) Hydro-Pneumatic suspension(-21) (-) Steel sub-frame(-28) (+) Aluminium sub-frame(-37) RPO11984 →	
TC2830	Lower wishbone(158)	B	(-) Ball joint(-11) (-) Hydro-Pneumatic suspension(-21) → RPO11983	
TC2830	Lower wishbone(158)	B	(-) Bush(-13) (-) Hydro-Pneumatic suspension(-21) (-) Steel sub-frame(-28) (+) Aluminium sub-frame(-37) RPO11984 →	
TC3082	Lower wishbone(158)	A	(-) Bush(-13) (+) Steel sub-frame(-54) RPO11984→	
TC3083	Lower wishbone(158)	B	(-) Bush(-13) (+) Steel sub-frame(-54) RPO11984→	
TC3426	Track control arm(225)	A B	Rear(187)	
TD535W	Lower wishbone bush(159)	A B	Front(108)	
TD933W	Lower wishbone bush(159)	A B	Rear(187) (+) Steel sub-frame RPO11984→	
TD997W	Upper track control arm bush(243)	A B	Inner(119) Front(108) Rear(187)	
TD998W	Anti-roll bar(-74) bush kit(-86)	K	Ø24.5 Complete axle kit(-92)	
TD999W	Anti-roll bar(-74) bush kit(-86)	K	Ø24 Complete axle kit(-92)	
TD1000W	Upper track control arm bush(243)	A B	Outer(176) Front(108) Rear(187)	
TD1017W	Anti-roll bar(-74) bush kit(-86)	K	Ø23.5 Complete axle kit(-92)	
TD1228W	Upper track control arm bush(243)	A B	Lower(139)	

C6 2.2HdI, 2.7HdI, 3.0i V6 (09/05→)



TA2489



TA1949



TBR4231



TA1949



TA2490

... C6 2.2Hdi, 2.7Hdi, 3.0i V6 (09/05→)



TD997W



TD997W



TD1000W



TD1000W



TC1370



TC1370



TC1700KIT



TC1700KIT



TC1372



TC1373



TD1228W



TD1228W



TD999W



TC2139



TD535W



TD535W



TC2140



TC1371



TC1371



TD536W



TD536W



TC1374



TC1374



TC3426



TC3426

Part No	Description	Pos	Info	Technical
TA1949	Inner tie rod(123)	A B		M14x1.5 Female(253) £
TA2489	Tie rod end(224)	A		M14x1.5 Male(252) £
TA2490	Tie rod end(224)	B		M14x1.5 Male(252) £
TBR4231	Steering rack gaiter kit(213)	K	Thermoplastic(223)	1 :24x48x48 2 :24x53x53
TC1370	Upper ball joint(232)	A B		M14x1.5
TC1371	Lower ball joint(140)	A B		
TC1372	Link stabiliser(135)	A		M16x1.5
TC1373	Link stabiliser(135)	B		M16x1.5
TC1374	Link stabiliser(135)	A B		M10x1.5
TC1700KIT	Ball joint kit(-79)	A B		
TC2139	Lower wishbone(158)	A	(-) Ball joint(-11)	
TC2140	Lower wishbone(158)	B	(-) Ball joint(-11)	
TC3426	Track control arm(225)	A B	Rear(187)	
TD535W	Lower wishbone bush(159)	A B	Front(108)	
TD536W	Lower wishbone bush(159)	A B	Rear(187)	
TD997W	Upper track control arm bush(243)	A B	Inner(119) Front(108) Rear(187)	
TD999W	Anti-roll bar(-74) bush kit(-86)	K	Ø24 Complete axle kit(-92)	

(...)

... CITROËN

... C6 2.2HdI, 2.7HdI, 3.0i V6 (09/05→)

Part No	Description	Pos	Info	Technical
TD1000W	Upper track control arm bush(243)	A B	Outer(176) Front(108) Rear(187)	
TD1228W	Upper track control arm bush(243)	A B	Lower(139)	

C8 2.0i, 2.0HdI, 2.2i, 2.2HdI, 3.0i V6 (07/02→)

Part No	Description	Pos	Info	Technical
TA2058	Tie rod end(224)	A B		M14x1.5 Female(253) £
TA2059	Inner tie rod(123)	A B		M14x1.5 Male(252) £
TBR4224	Steering rack gaiter kit(213)	K	Thermoplastic(223)	1 :14.5x64x64 2 :14.5x64x64
TC1469	Link stabiliser(135)	A B		M10x1.25
TC1470	Lower wishbone(158)	A	→RPO10823	Pinch Bolt(255) 17mm
TC1471	Lower wishbone(158)	B	→RPO10823	Pinch Bolt(255) 17mm
TC3569	Lower wishbone(158)	A	RPO10824→	∅16.4
TC3570	Lower wishbone(158)	B	RPO10824→	∅16.4
TD353W	Lower wishbone bush(159)	A B	Front(108) →RPO10823	
TD643W	Lower wishbone bush(159)	A	Rear(187) →RPO10823	
TD644W	Lower wishbone bush(159)	B	Rear(187) →RPO10823	

C8 2.0HdI 163HP, 2.2HdI 170HP (06/02→)

Part No	Description	Pos	Info	Technical
TA2058	Tie rod end(224)	A B		M14x1.5 Female(253) £
TA2059	Inner tie rod(123)	A B		M14x1.5 Male(252) £
TBR4224	Steering rack gaiter kit(213)	K	Thermoplastic(223)	1 :14.5x64x64 2 :14.5x64x64
TC1469	Link stabiliser(135)	A B		M10x1.25

C-CROSSER 2.2HdI, 2.4i (02/07→)

... C-CROSSER 2.2HDi, 2.4i (02/07→)



Part No	Description	Pos	Info	Technical
TA2620	Inner tie rod (123)	A B		M14x1.5 Male (252) £
TA2639	Tie rod end (224)	A B		M14x1.5 Female (253) £
TC2288	Link stabiliser (135)	A		M10x1.25
TC2289	Link stabiliser (135)	B		M10x1.25
TC2297	Link stabiliser (135)	A B		M10x1.25
TC2344	Lower wishbone (158)	A		Pinch Bolt (255) 20mm
TC2345	Lower wishbone (158)	B		Pinch Bolt (255) 20mm
TC2349	Lower ball joint (140)	A B		Pinch Bolt (255) 20mm
TD1253W	Lower wishbone bush (159)	A B	Rear (187)	

C-ELYSEE 1.2VTi, 1.6VTi, 1.6HDi (11/12→)



Part No	Description	Pos	Info	Technical
TA2889	Inner tie rod (123)	A B		M16x1.5 Male (252) £
TA2911	Tie rod end (224)	A		M16x1.5 Female (253) £
TA2912	Tie rod end (224)	B		M16x1.5 Female (253) £
TBR4232	Steering rack gaiter kit (213)	K		1 :15.5x51.5x51.5 2 :15.5x51.5x51.5
TC1802	Link stabiliser (135)	A		M10x1.5
TC1803	Link stabiliser (135)	B		M10x1.5
TC2426	Lower ball joint (140)	A B		Pinch Bolt (255) 18mm
TC2705	Lower wishbone (158)	A		Pinch Bolt (255) 18mm
TC2706	Lower wishbone (158)	B		Pinch Bolt (255) 18mm
TD1012W	Sub-frame bush (215)	A B		

... CITROËN

DISPATCH 1.6i, 1.9D, 1.9TD, 2.0Hdi (09/96-01/07)

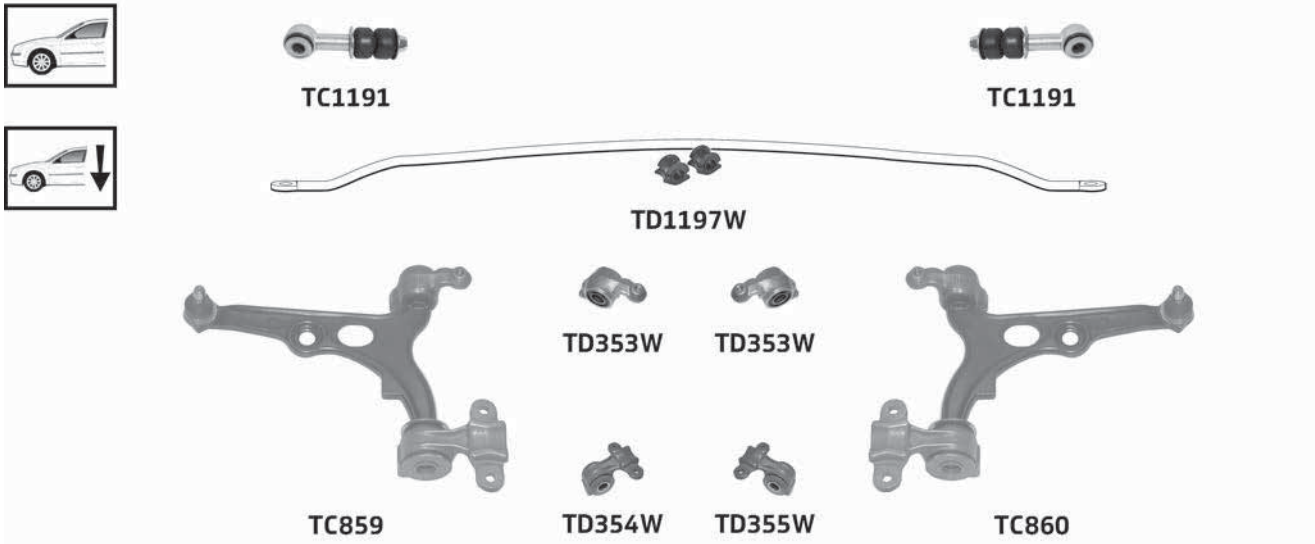

Part No	Description	Pos	Info	Technical
TA1607	Tie rod end(224)	A B	→RPO09792	M14x1.5 Female(253) £
TA1608	Inner tie rod(123)	A B		M14x1.5 Male(252) £
TA2058	Tie rod end(224)	A B	RPO09793→	M14x1.5 Female(253) £
TBR4121	Steering rack gaiter kit(213)	K		1 :13x62x62 2 :13x62x62
TC859	Lower wishbone(158)	A	12mm mounting holes(-59) →RPO10830	Pinch Bolt(255) 17mm
TC860	Lower wishbone(158)	B	12mm mounting holes(-59) →RPO10830	Pinch Bolt(255) 17mm
TC1191	Link stabiliser(135)	A B		
TD353W	Lower wishbone bush(159)	A B	Front(108) 12mm mounting holes(-59) →RPO10830	
TD354W	Lower wishbone bush(159)	A	Rear(187) 12mm mounting holes(-59) →RPO10830	
TD355W	Lower wishbone bush(159)	B	Rear(187) 12mm mounting holes(-59) →RPO10830	
TD1126W	Axle Bush(-76-)	A B		
TD1197W	Anti-roll bar(-74-) bush kit(-86-)	K		

CITROËN

DISPATCH 1.6Hdi, 2.0i, 2.0Hdi (01/07→)



Part No	Description	Pos	Info	Technical
TA2506	Tie rod end (224)	A B		M14x1.5 Female (253) £
TA2507	Inner tie rod (123)	A B		M14x1.5 Male (252) £
TC2167	Link stabiliser (135)	A B		M12x1.75
TC2244	Lower wishbone (158)	A		Pinch Bolt (255) 19mm
TC2245	Lower wishbone (158)	B		Pinch Bolt (255) 19mm
TD643W	Lower wishbone bush (159)	A	Rear (187)	
TD644W	Lower wishbone bush (159)	B	Rear (187)	
TD1103W	Lower wishbone bush (159)	A B	Front (108)	
TD1178W	Anti-roll bar (-74) bush kit (-86)	K	Ø25.5 Complete axle kit (-92)	

DS3 1.4VTi, 1.6THP, 1.6VTi, 1.6Hdi (11/09→)



Part No	Description	Pos	Info	Technical
TA2621	Inner tie rod (123)	A B		M14x1.5 Male (252) £
TA2662	Tie rod end (224)	A		M14x1.5 Female (253) £
TA2663	Tie rod end (224)	B		M14x1.5 Female (253) £
TC880	Link stabiliser (135)	A B	RP012390→ (+) very cold climate (-56)	M10x1.5
TC2313	Link stabiliser (135)	A B	→RP012389 RP012390→ (-) very cold climate (-30)	M10x1.25
TD1012W	Sub-frame bush (215)	A B		

... CITROËN

DS4 1.6THP 155HP, 1.6VTi, 1.6HDi, 2.0HDi (-) 19" Wheels(3) (04/11→)

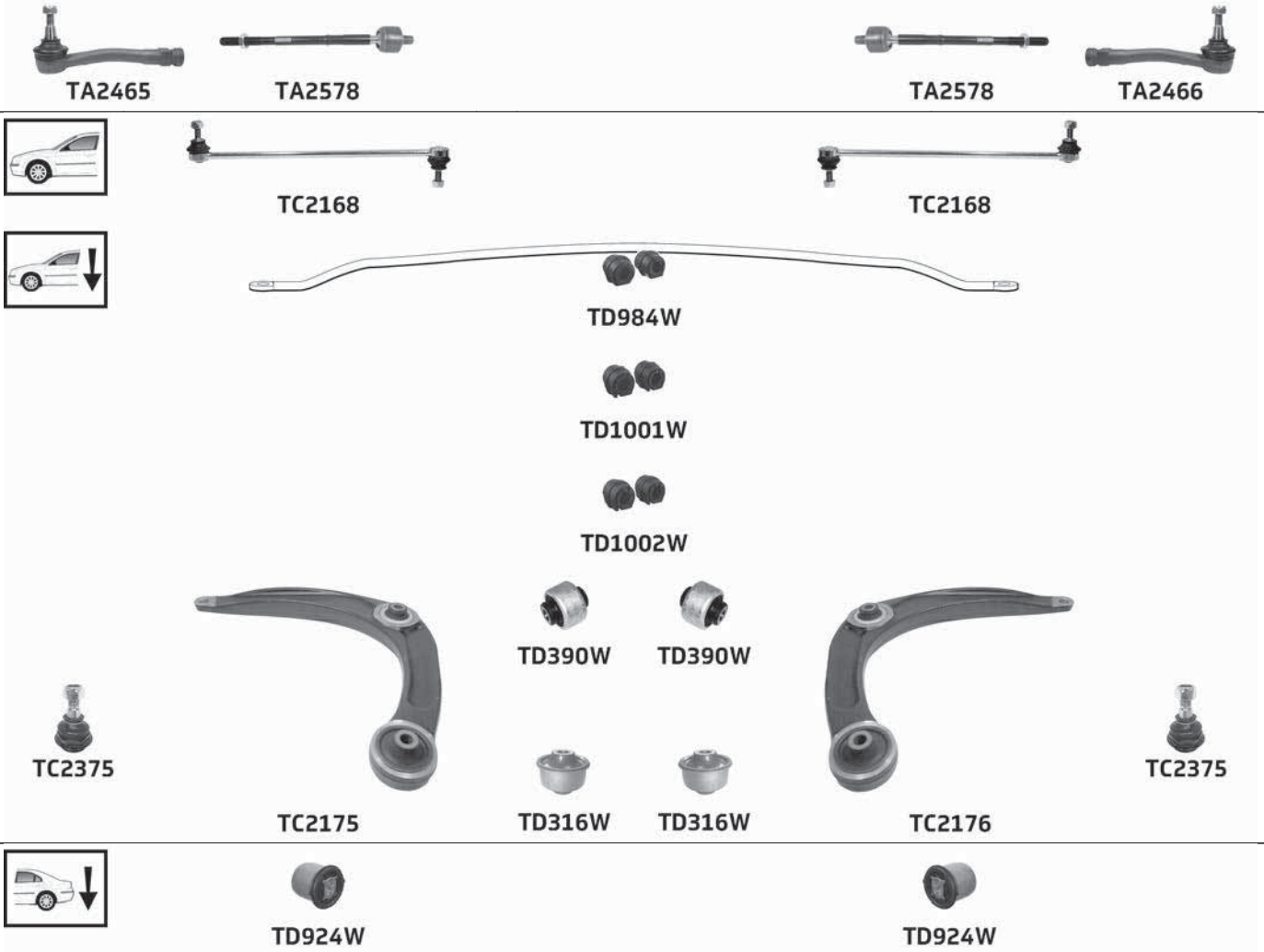

Part No	Description	Pos	Info	Technical
TA2465	Tie rod end(224)	A		M14x1.5 Female(253) £
TA2466	Tie rod end(224)	B		M14x1.5 Female(253) £
TA2578	Inner tie rod(123)	A B		M14x1.5 Male(252) £
TC2168	Link stabiliser(135)	A B		M10x1.5
TC2175	Lower wishbone(158)	A	(-) Ball joint(-11-)	
TC2176	Lower wishbone(158)	B	(-) Ball joint(-11-)	
TC2375	Lower ball joint(140)	A B		M14x1.5
TD316W	Lower wishbone bush(159)	A B	Rear(187)	
TD390W	Lower wishbone bush(159)	A B	Front(108)	
TD924W	Axle bush(-76-)	A B		
TD984W	Anti-roll bar(-74-) bush kit(-86-)	K	Ø22 Complete axle kit(-92-)	
TD1001W	Anti-roll bar(-74-) bush kit(-86-)	K	Ø23 Complete axle kit(-92-)	
TD1002W	Anti-roll bar(-74-) bush kit(-86-)	K	Ø24 Complete axle kit(-92-)	

DS4 1.6THP 200HP, 2.0HdI 19" Wheels(-66-) (04/11→)

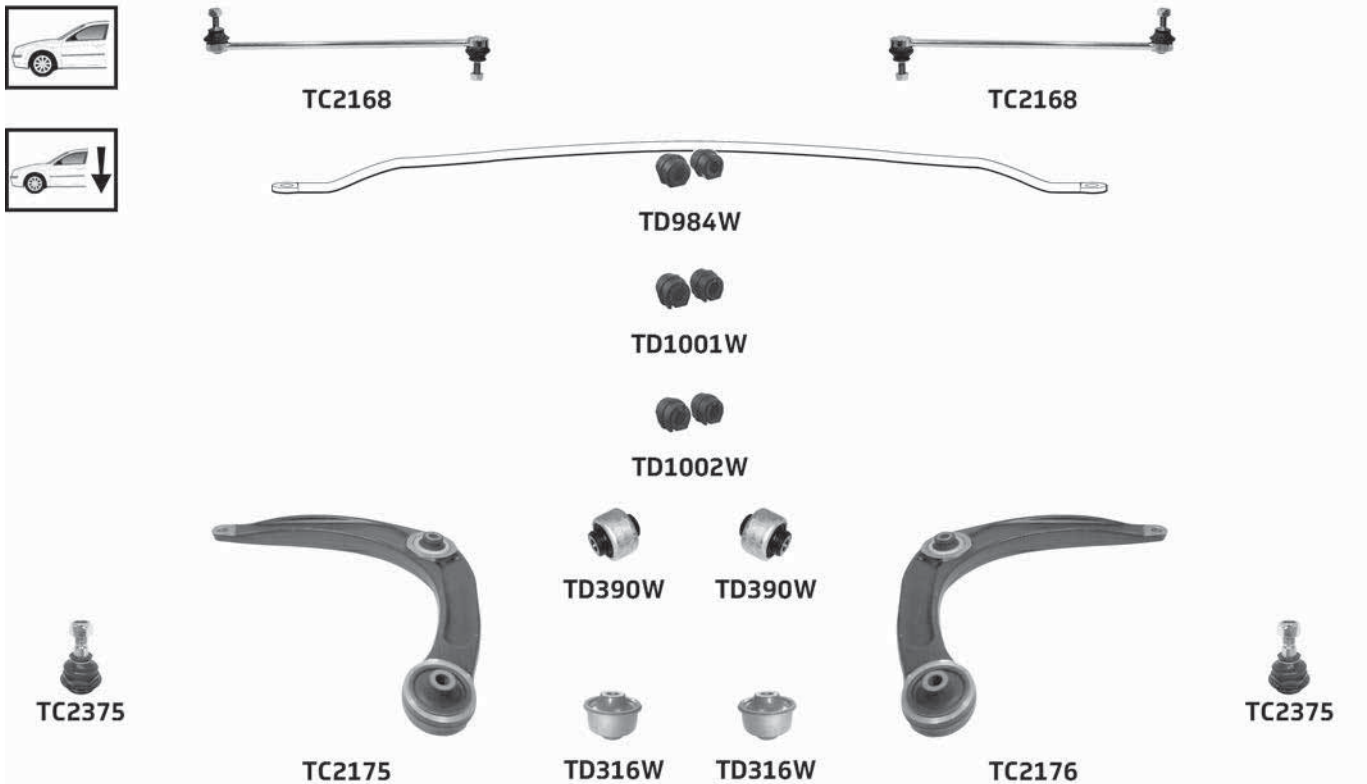

Part No	Description	Pos	Info	Technical
TC2168	Link stabiliser(135)	A B		M10x1.5
TC2175	Lower wishbone(158)	A	(-) Ball joint(-11)	
TC2176	Lower wishbone(158)	B	(-) Ball joint(-11)	
TC2375	Lower ball joint(140)	A B		M14x1.5
TD316W	Lower wishbone bush(159)	A B	Rear(187)	
TD390W	Lower wishbone bush(159)	A B	Front(108)	
TD924W	Axle bush(-76)	A B		
TD984W	Anti-roll bar(-74) bush kit(-86)	K	Ø22 Complete axle kit(-92)	
TD1001W	Anti-roll bar(-74) bush kit(-86)	K	Ø23 Complete axle kit(-92)	
TD1002W	Anti-roll bar(-74) bush kit(-86)	K	Ø24 Complete axle kit(-92)	

DS5 1.6THP, 1.6HdI, 2.0HdI (11/11→)



Part No	Description	Pos	Info	Technical
TC2168	Link stabiliser(135)	A B		M10x1.5
TC2375	Lower ball joint(140)	A B		M14x1.5
TD316W	Lower wishbone bush(159)	A B	Rear(187)	
TD1016W	Anti-roll bar(-74) bush kit(-86)	K	Ø25 Complete axle kit(-92)	

... CITROËN

EVASION 1.8i, 1.9TD, 2.0i, 2.0HDi, 2.1TD (06/94-07/02)



Part No	Description	Pos	Info	Technical
TA1607	Tie rod end(224)	A B		M14x1.5 Female(253) £
TA1608	Inner tie rod(123)	A B		M14x1.5 Male(252) £
TBR4121	Steering rack gaiter kit(213)	K		1 :13x62x62 2 :13x62x62
TC859	Lower wishbone(158)	A		Pinch Bolt(255) 17mm
TC860	Lower wishbone(158)	B		Pinch Bolt(255) 17mm
TC1191	Link stabiliser(135)	A B		
TD353W	Lower wishbone bush(159)	A B	Front(108)	
TD354W	Lower wishbone bush(159)	A	Rear(187)	
TD355W	Lower wishbone bush(159)	B	Rear(187)	
TD1126W	Axle Bush(-76-)	A B		
TD1197W	Anti-roll bar(-74-) bush kit(-86-)	K		

JUMPER 1.9D, 1.9TD, 2.0i, 2.5D, 2.5TD, 2.8HDi (02/94-01/01)

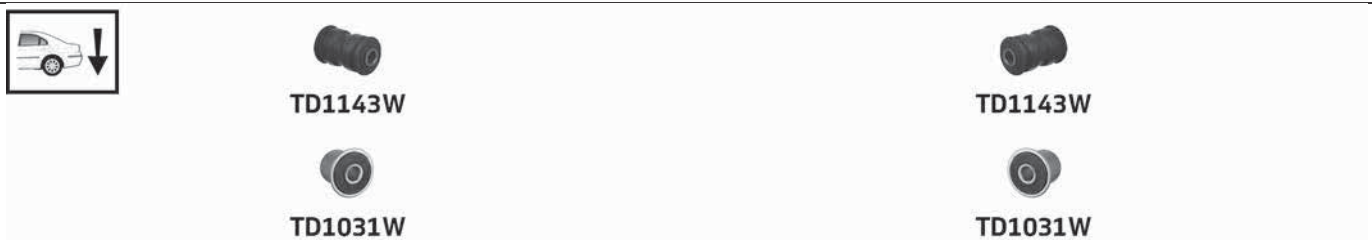
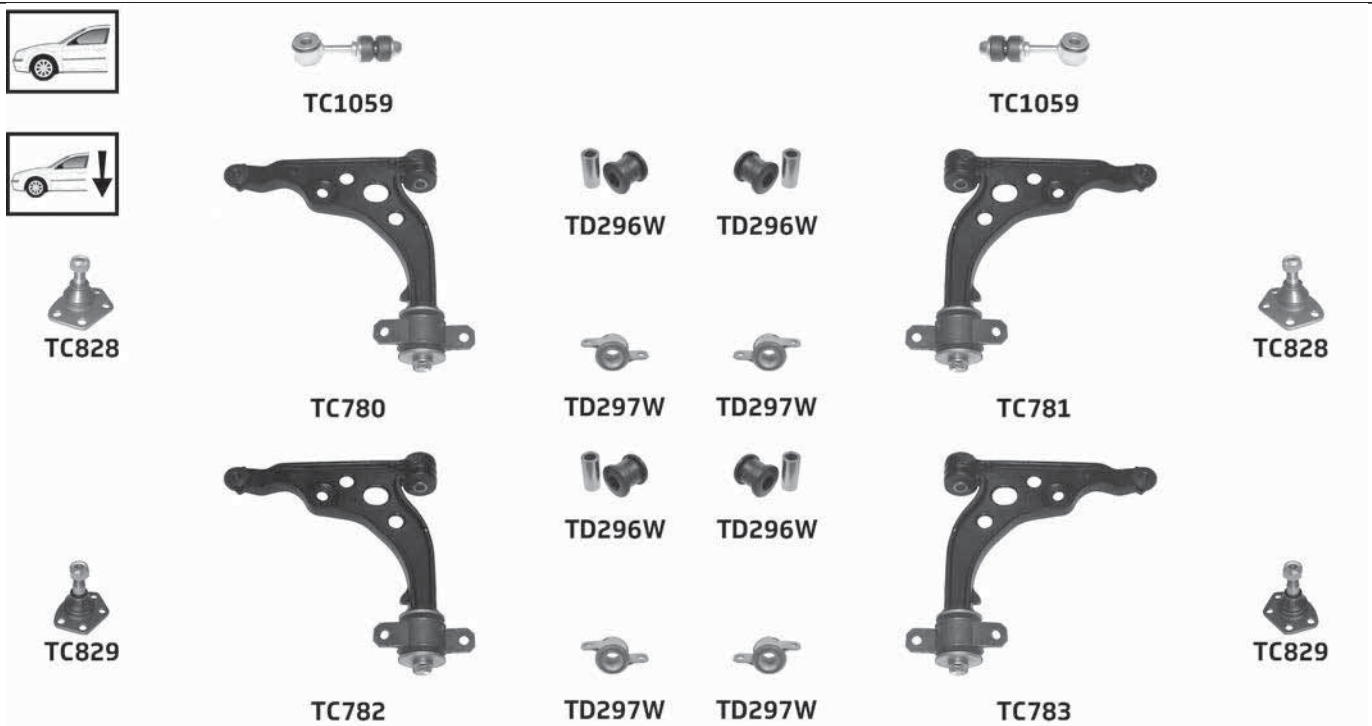

Part No	Description	Pos	Info	Technical
TA1671	Tie rod end(224)	A B		M16x1.5 Female(253) £
TA1785	Inner tie rod(123)	A B		M16x1.5 Male(252) £
TBR4122	Steering rack gaiter kit(213)	K	Power steering(185)	1 :15x53x53 2 :15x62x62
TBR4123	Steering rack gaiter kit(213)	K	Manual steering(170)	1 :15x53x53 2 :15x53x53
TC780	Lower wishbone(158)	A	1000/1400 Kg (-) Ball joint(-11-)	
TC781	Lower wishbone(158)	B	1000/1400 Kg (-) Ball joint(-11-)	
TC782	Lower wishbone(158)	A	1800 Kg (-) Ball joint(-11-)	
TC783	Lower wishbone(158)	B	1800 Kg (-) Ball joint(-11-)	
TC828	Lower ball joint(140)	A B	1000/1400 Kg	M16x1.5
TC829	Lower ball joint(140)	A B	1800 Kg	M18x1.5
TC1059	Link stabiliser(135)	A B		
TD296W	Lower wishbone bush(159)	A B	Front(108)	
TD297W	Lower wishbone bush(159)	A B	Rear(187)	
TD1031W	Leaf spring bush(128)	A B	Rear(187)	
TD1143W	Leaf spring bush(128)	A B	Front(108)	

CITROËN

... CITROËN

JUMPER 1.9D, 1.9TD, 2.0i, 2.0HDi, 2.5D, 2.5TD, 2.8HDi (02/01-04/02)

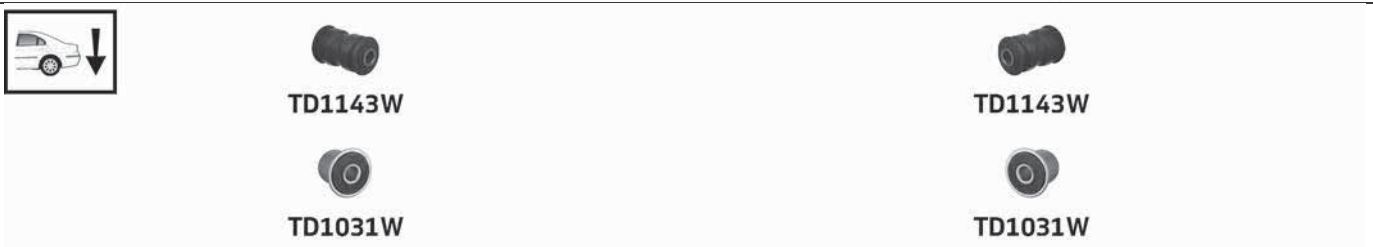
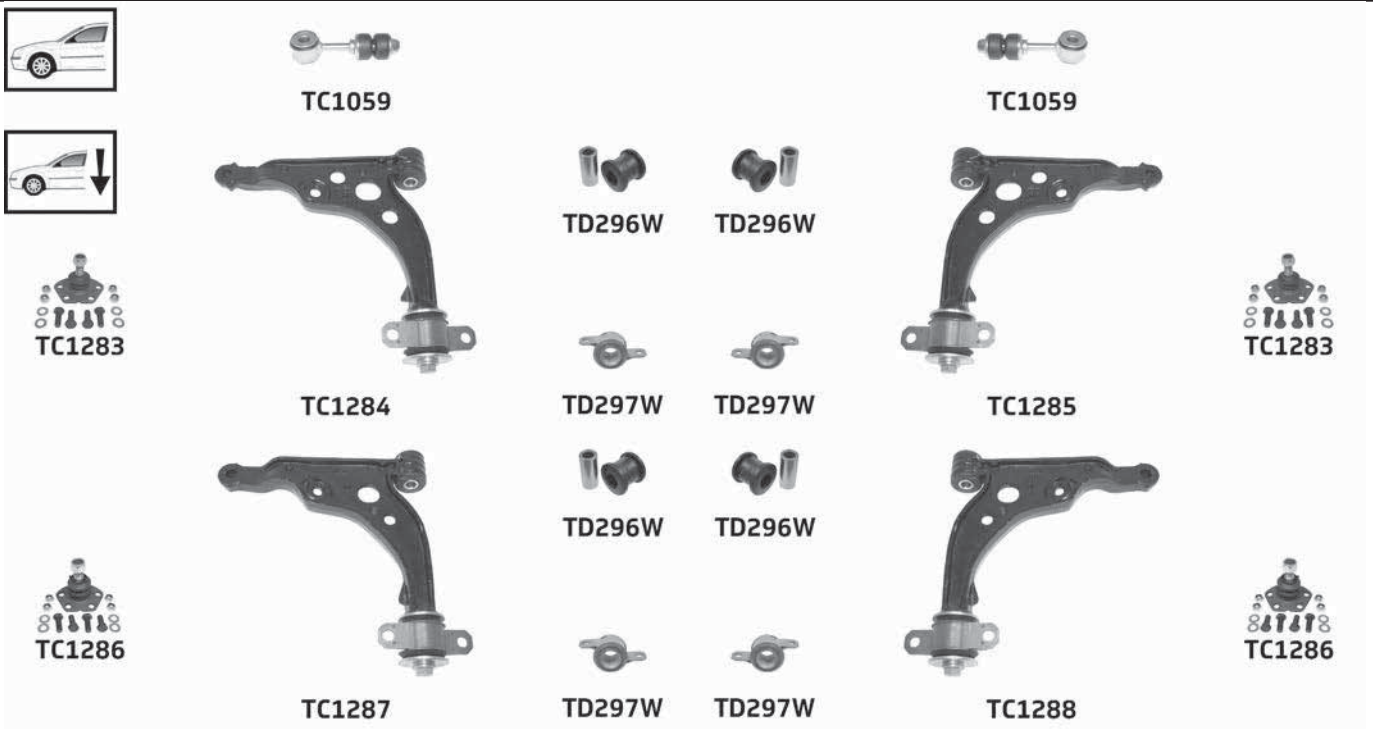

Part No	Description	Pos	Info	Technical
TA1671	Tie rod end(224)	A B		M16x1.5 Female(253) £
TA1785	Inner tie rod(123)	A B		M16x1.5 Male(252) £
TBR4122	Steering rack gaiter kit(213)	K	Power steering(185)	1 :15x53x53 2 :15x62x62
TBR4123	Steering rack gaiter kit(213)	K	Manual steering(170)	1 :15x53x53 2 :15x53x53
TC1059	Link stabiliser(135)	A B		
TC1283	Lower ball joint(140)	A B	1000/1400 Kg	M16x1.5
TC1284	Lower wishbone(158)	A	1000/1400 Kg (-) Ball joint(-11)	
TC1285	Lower wishbone(158)	B	1000/1400 Kg (-) Ball joint(-11)	
TC1286	Lower ball joint(140)	A B	1800 Kg	M18x1.5
TC1287	Lower wishbone(158)	A	1800 Kg (-) Ball joint(-11)	
TC1288	Lower wishbone(158)	B	1800 Kg (-) Ball joint(-11)	
TD296W	Lower wishbone bush(159)	A B	Front(108)	
TD297W	Lower wishbone bush(159)	A B	Rear(187)	
TD1031W	Leaf spring bush(128)	A B	Rear(187)	
TD1143W	Leaf spring bush(128)	A B	Front(108)	

JUMPER 2.0i, 2.0HDi, 2.2HDi, 2.8HDi (04/02-12/02)

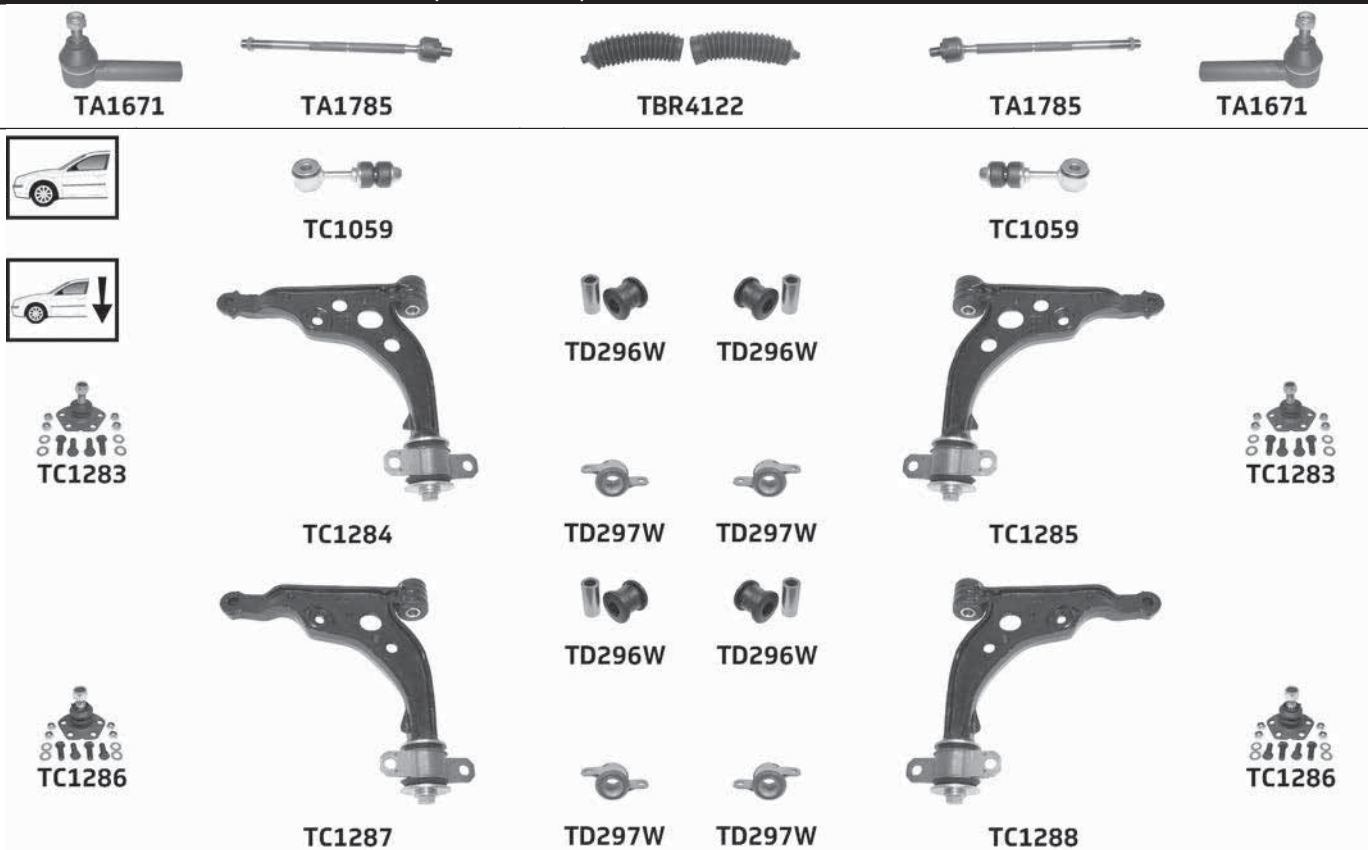

Part No	Description	Pos	Info	Technical
TA1671	Tie rod end(224)	A B		M16x1.5 Female(253) £
TA1785	Inner tie rod(123)	A B		M16x1.5 Male(252) £
TBR4122	Steering rack gaiter kit(213)	K		1 :15x53x53 2 :15x62x62
TC1059	Link stabiliser(135)	A B		
TC1283	Lower ball joint(140)	A B	1100/1500 Kg	M16x1.5
TC1284	Lower wishbone(158)	A	1100/1500 Kg (-) Ball joint(-11)	
TC1285	Lower wishbone(158)	B	1100/1500 Kg (-) Ball joint(-11)	
TC1286	Lower ball joint(140)	A B	1800 Kg	M18x1.5
TC1287	Lower wishbone(158)	A	1800 Kg (-) Ball joint(-11)	
TC1288	Lower wishbone(158)	B	1800 Kg (-) Ball joint(-11)	
TD296W	Lower wishbone bush(159)	A B	Front(108)	
TD297W	Lower wishbone bush(159)	A B	Rear(187)	

CITROËN

... CITROËN

JUMPER 2.0i, 2.0HdI, 2.2HdI, 2.8HdI (12/02-03/06)

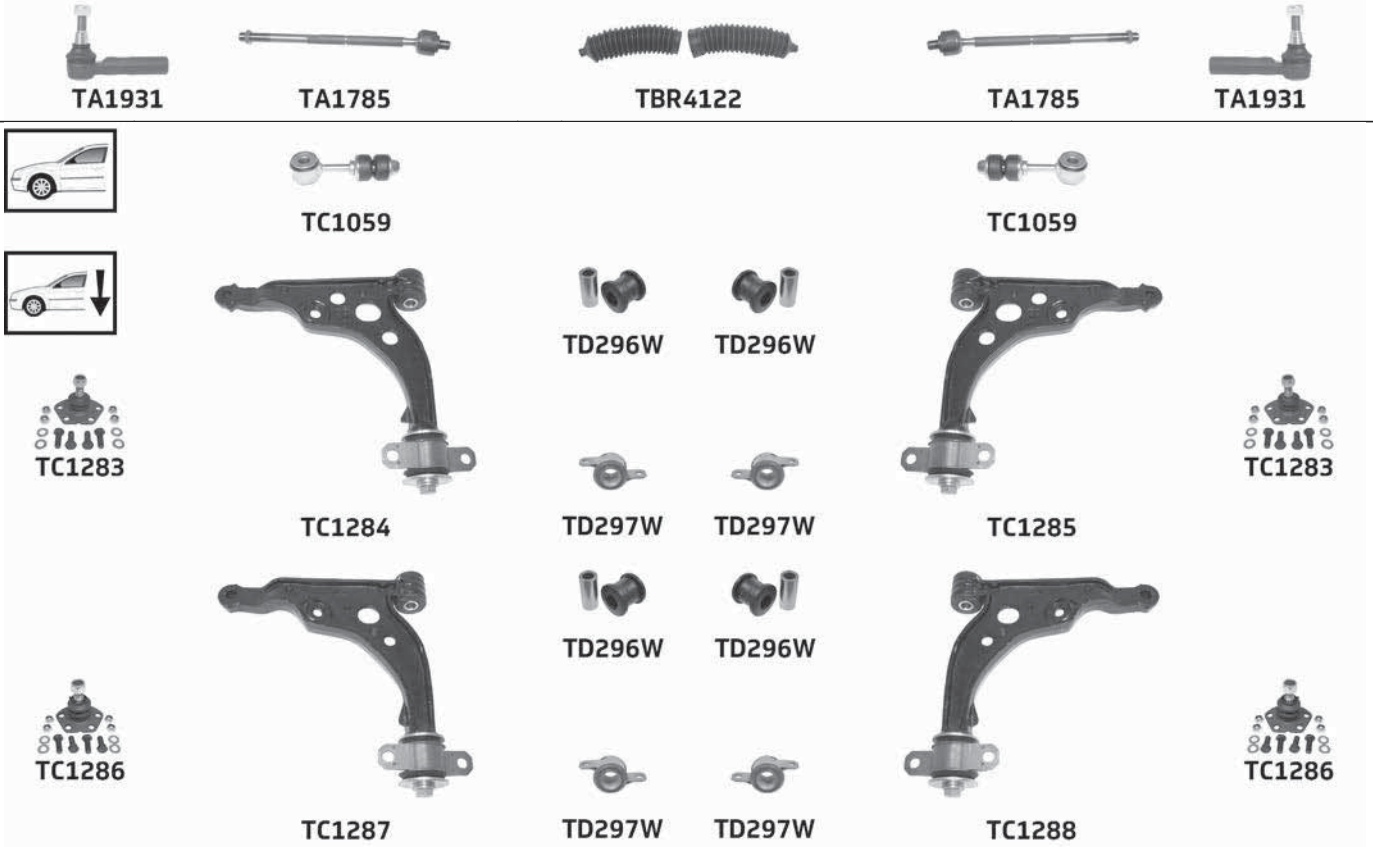

Part No	Description	Pos	Info	Technical
TA1785	Inner tie rod(123)	A B		M16x1.5 Male(252) £
TA1931	Tie rod end(224)	A B		M16x1.5 Female(253) £
TBR4122	Steering rack gaiter kit(213)	K		1 :15x53x53 2 :15x62x62
TC1059	Link stabiliser(135)	A B		
TC1283	Lower ball joint(140)	A B	1100/1500 Kg	M16x1.5
TC1284	Lower wishbone(158)	A	1100/1500 Kg (-) Ball joint(-11)	
TC1285	Lower wishbone(158)	B	1100/1500 Kg (-) Ball joint(-11)	
TC1286	Lower ball joint(140)	A B	1800 Kg	M18x1.5
TC1287	Lower wishbone(158)	A	1800 Kg (-) Ball joint(-11)	
TC1288	Lower wishbone(158)	B	1800 Kg (-) Ball joint(-11)	
TD296W	Lower wishbone bush(159)	A B	Front(108)	
TD297W	Lower wishbone bush(159)	A B	Rear(187)	

CITROËN

JUMPER 2.2Hdi, 3.0Hdi (04/06→)

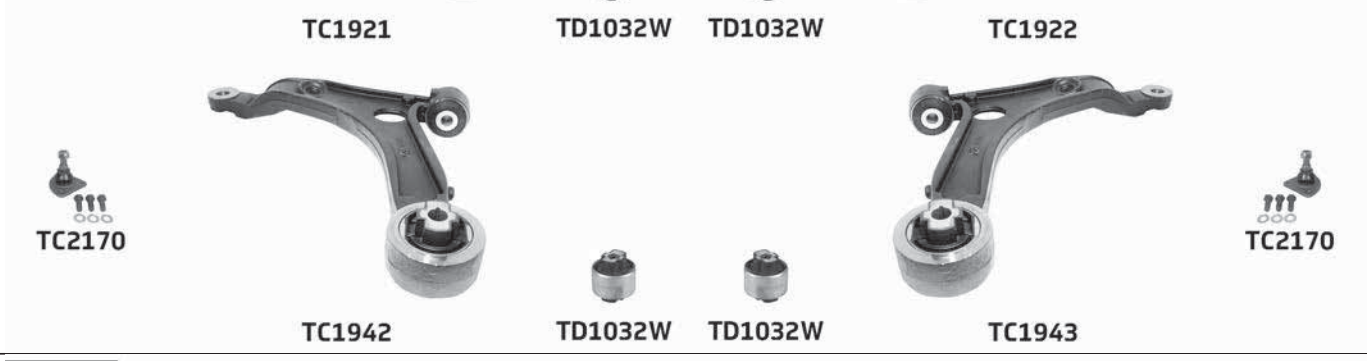
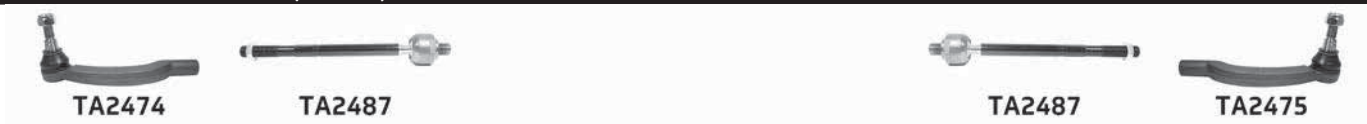

Part No	Description	Pos	Info	Technical
TA2474	Tie rod end(224)	A		M16x1.5 Female(253) £
TA2475	Tie rod end(224)	B		M16x1.5 Female(253) £
TA2487	Inner tie rod(123)	A B		M16x1.5 Male(252) £
TC1921	Lower wishbone(158)	A	1100/1700L Kg (-) Ball joint(-11-)	
TC1922	Lower wishbone(158)	B	1100/1700L Kg (-) Ball joint(-11-)	
TC1942	Lower wishbone(158)	A	1700H/2000 Kg (-) Ball joint(-11-)	
TC1943	Lower wishbone(158)	B	1700H/2000 Kg (-) Ball joint(-11-)	
TC1997	Link stabiliser(135)	A B		
TC2170	Lower ball joint(140)	A B		M16x1.5
TC2570	Link stabiliser(135)	A B		M10x1.25
TD1032W	Lower wishbone bush(159)	A B	Rear(187)	

JUMPY 1.6i, 1.9D, 1.9TD, 2.0i, 2.0Hdi (10/95-01/07)



... CITROËN

... JUMPY 1.6i, 1.9D, 1.9TD, 2.0i, 2.0HDi (10/95-01/07)



TC859

TD354W

TD355W

TC860



Part No	Description	Pos	Info	Technical
TA1607	Tie rod end(224)	A B	→RPO09792	M14x1.5 Female(253) £
TA1608	Inner tie rod(123)	A B		M14x1.5 Male(252) £
TA2058	Tie rod end(224)	A B	RPO09793→	M14x1.5 Female(253) £
TBR4121	Steering rack gaiter kit (213)	K		1 :13x62x62 2 :13x62x62
TC859	Lower wishbone(158)	A	12mm mounting holes(-59) →RPO10830	Pinch Bolt(255) 17mm
TC860	Lower wishbone(158)	B	12mm mounting holes(-59) →RPO10830	Pinch Bolt(255) 17mm
TC1191	Link stabiliser(135)	A B		
TD353W	Lower wishbone bush(159)	A B	Front(108) 12mm mounting holes(-59) →RPO10830	
TD354W	Lower wishbone bush(159)	A	Rear(187) 12mm mounting holes(-59) →RPO10830	
TD355W	Lower wishbone bush(159)	B	Rear(187) 12mm mounting holes(-59) →RPO10830	
TD1126W	Axle Bush(-76-)	A B		
TD1197W	Anti-roll bar(-74-) bush kit(-86-)	K		

JUMPY 1.6HDi, 2.0i, 2.0HDi (01/07→)



TC2244

TD643W

TD644W

TC2245

Part No	Description	Pos	Info	Technical
TA2506	Tie rod end(224)	A B		M14x1.5 Female(253) £
TA2507	Inner tie rod(123)	A B		M14x1.5 Male(252) £
TC2167	Link stabiliser(135)	A B		M12x1.75
TC2244	Lower wishbone(158)	A		Pinch Bolt(255) 19mm
TC2245	Lower wishbone(158)	B		Pinch Bolt(255) 19mm
TD643W	Lower wishbone bush(159)	A	Rear(187)	

... JUMPY 1.6Hdi, 2.0i, 2.0Hdi (01/07→)

Part No	Description	Pos	Info	Technical
TD644W	Lower wishbone bush(159)	B	Rear(187)	
TD1103W	Lower wishbone bush(159)	A B	Front(108)	
TD1178W	Anti-roll bar(-74) bush kit(-86)	K	Ø25 Complete axle kit(-92)	

NEMO 1.3Hdi, 1.4i, 1.4Hdi (02/08→)



Part No	Description	Pos	Info	Technical
TA2338	Tie rod end(224)	A		M14x1.5 Female(253) £
TA2339	Tie rod end(224)	B		M14x1.5 Female(253) £
TA2781	Inner tie rod(123)	A B		M14x1.5 Male(252) £
TBR4225	Steering rack gaiter kit(213)	K	Thermoplastic(223)	1 :12x55x55 2 :12x55x55
TC1807	Lower ball joint(140)	A B		Pinch Bolt(255) 16mm
TC1829	Lower wishbone(158)	A		Pinch Bolt(255) 16mm
TC1830	Lower wishbone(158)	B		Pinch Bolt(255) 16mm
TC2222	Link stabiliser(135)	A B		M10x1.25
TD645W	Lower wishbone bush(159)	A B	Front(108)	
TD646W	Lower wishbone bush(159)	A B	Rear(187)	

... CITROËN

RELAY 1.9D, 2.5D, 2.5TD, 2.8HDi (06/94-01/01)

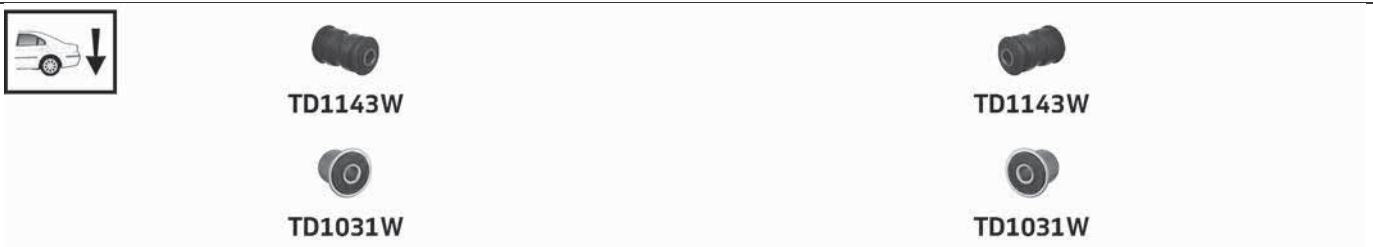
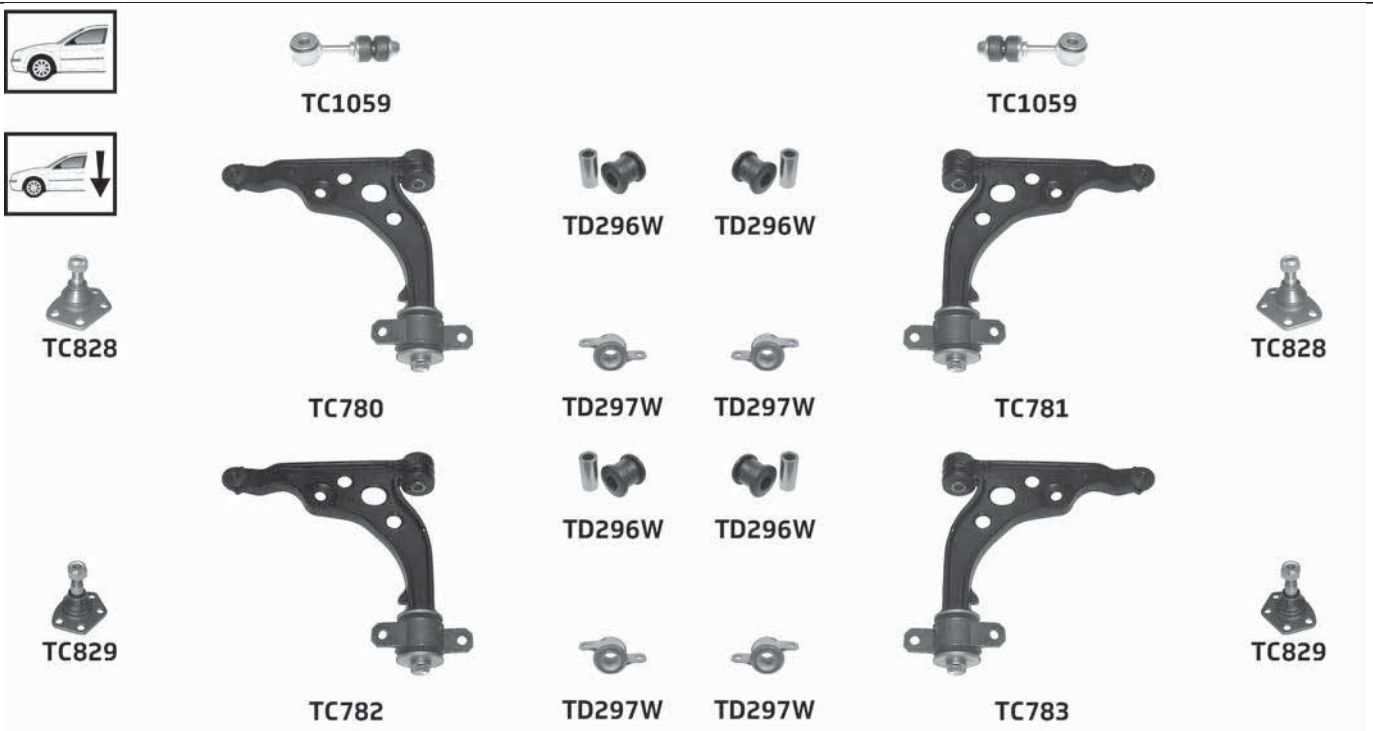

Part No	Description	Pos	Info	Technical
TA1671	Tie rod end(224)	A B		M16x1.5 Female(253) £
TA1785	Inner tie rod(123)	A B		M16x1.5 Male(252) £
TBR4122	Steering rack gaiter kit(213)	K	Power steering(185)	1 :15x53x53 2 :15x62x62
TBR4123	Steering rack gaiter kit(213)	K	Manual steering(170)	1 :15x53x53 2 :15x53x53
TC780	Lower wishbone(158)	A	1000/1400 Kg (-) Ball joint(-11)	
TC781	Lower wishbone(158)	B	1000/1400 Kg (-) Ball joint(-11)	
TC782	Lower wishbone(158)	A	1800 Kg (-) Ball joint(-11)	
TC783	Lower wishbone(158)	B	1800 Kg (-) Ball joint(-11)	
TC828	Lower ball joint(140)	A B	1000/1400 Kg	M16x1.5
TC829	Lower ball joint(140)	A B	1800 Kg	M18x1.5
TC1059	Link stabiliser(135)	A B		
TD296W	Lower wishbone bush(159)	A B	Front(108)	
TD297W	Lower wishbone bush(159)	A B	Rear(187)	
TD1031W	Leaf spring bush(128)	A B	Rear(187)	
TD1143W	Leaf spring bush(128)	A B	Front(108)	

RELAY 1.9D, 1.9TD, 2.0i, 2.0HDi, 2.5D, 2.5TD, 2.8HDi (02/01-04/02)

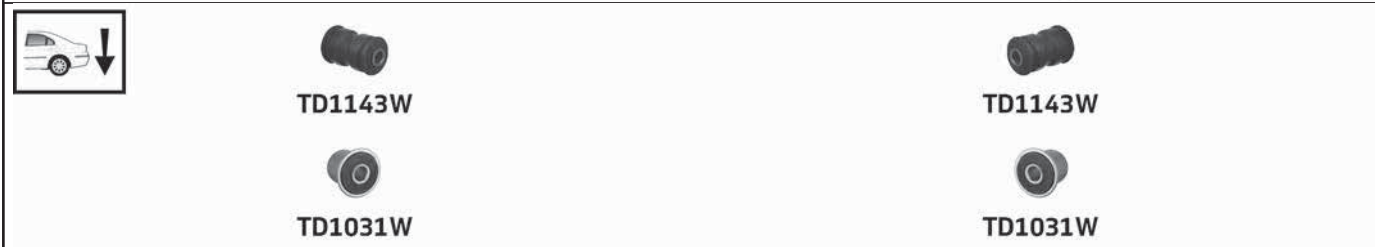
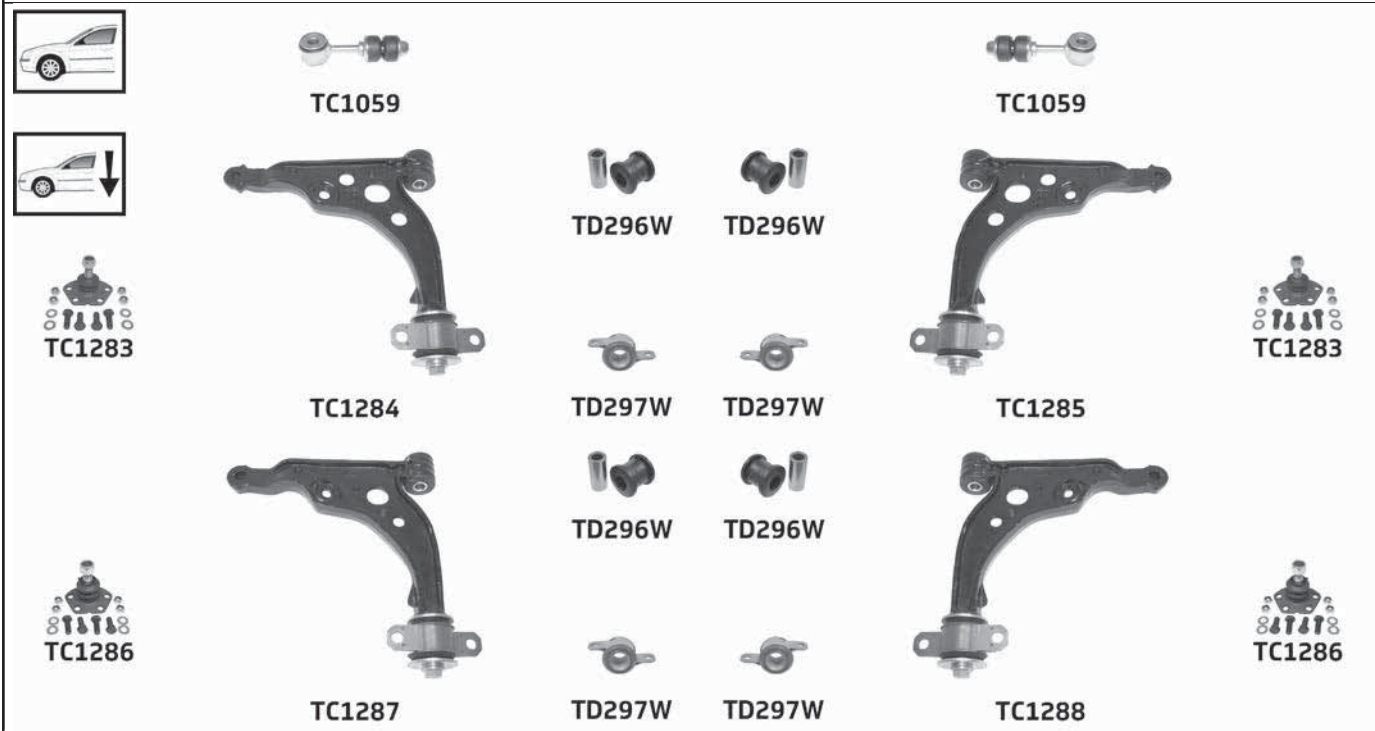

Part No	Description	Pos	Info	Technical
TA1671	Tie rod end(224)	A B		M16x1.5 Female(253) £
TA1785	Inner tie rod(123)	A B		M16x1.5 Male(252) £
TBR4122	Steering rack gaiter kit(213)	K	Power steering(185)	1 :15x53x53 2 :15x62x62
TBR4123	Steering rack gaiter kit(213)	K	Manual steering(170)	1 :15x53x53 2 :15x53x53
TC1059	Link stabiliser(135)	A B		
TC1283	Lower ball joint(140)	A B	1000/1400 Kg	M16x1.5
TC1284	Lower wishbone(158)	A	1000/1400 Kg (-) Ball joint(-11)	
TC1285	Lower wishbone(158)	B	1000/1400 Kg (-) Ball joint(-11)	
TC1286	Lower ball joint(140)	A B	1800 Kg	M18x1.5
TC1287	Lower wishbone(158)	A	1800 Kg (-) Ball joint(-11)	
TC1288	Lower wishbone(158)	B	1800 Kg (-) Ball joint(-11)	
TD296W	Lower wishbone bush(159)	A B	Front(108)	
TD297W	Lower wishbone bush(159)	A B	Rear(187)	
TD1031W	Leaf spring bush(128)	A B	Rear(187)	
TD1143W	Leaf spring bush(128)	A B	Front(108)	

CITROËN

... CITROËN

RELAY 2.0i, 2.0HDI, 2.2HDI, 2.8HDI (04/02-12/02)

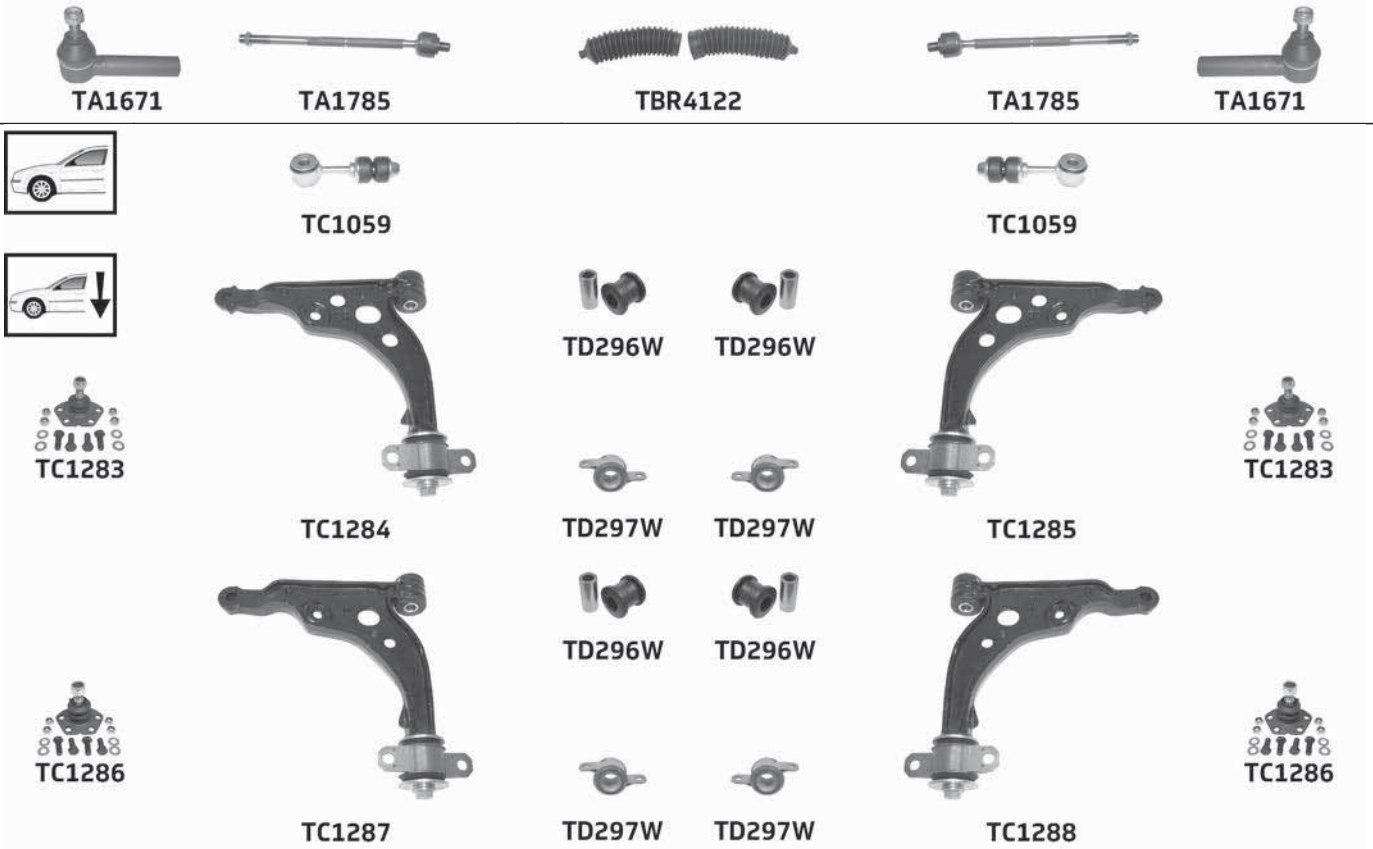

Part No	Description	Pos	Info	Technical
TA1671	Tie rod end(224)	A B		M16x1.5 Female(253) £
TA1785	Inner tie rod(123)	A B		M16x1.5 Male(252) £
TBR4122	Steering rack gaiter kit(213)	K		1 :15x53x53 2 :15x62x62
TC1059	Link stabiliser(135)	A B		
TC1283	Lower ball joint(140)	A B	1100/1500 Kg	M16x1.5
TC1284	Lower wishbone(158)	A	1100/1500 Kg (-) Ball joint(-11)	
TC1285	Lower wishbone(158)	B	1100/1500 Kg (-) Ball joint(-11)	
TC1286	Lower ball joint(140)	A B	1800 Kg	M18x1.5
TC1287	Lower wishbone(158)	A	1800 Kg (-) Ball joint(-11)	
TC1288	Lower wishbone(158)	B	1800 Kg (-) Ball joint(-11)	
TD296W	Lower wishbone bush(159)	A B	Front(108)	
TD297W	Lower wishbone bush(159)	A B	Rear(187)	

RELAY 2.0i, 2.0Hdi, 2.2Hdi, 2.8Hdi (12/02-03/06)

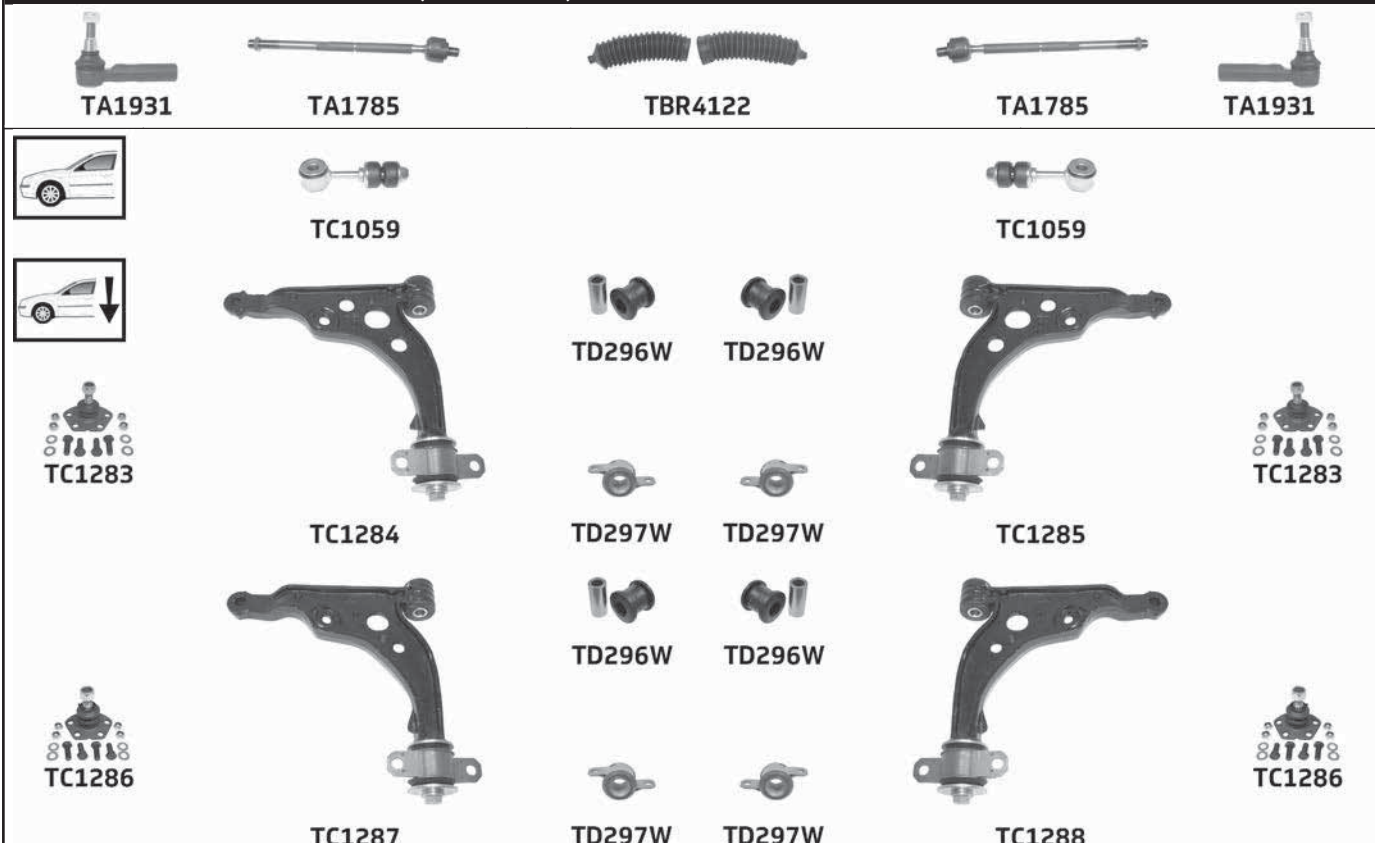

Part No	Description	Pos	Info	Technical
TA1785	Inner tie rod(123)	A B		M16x1.5 Male(252) £
TA1931	Tie rod end(224)	A B		M16x1.5 Female(253) £
TBR4122	Steering rack gaiter kit(213)	K		1 :15x53x53 2 :15x62x62
TC1059	Link stabiliser(135)	A B		
TC1283	Lower ball joint(140)	A B	1100/1500 Kg	M16x1.5
TC1284	Lower wishbone(158)	A	1100/1500 Kg (-) Ball joint(-11)	
TC1285	Lower wishbone(158)	B	1100/1500 Kg (-) Ball joint(-11)	
TC1286	Lower ball joint(140)	A B	1800 Kg	M18x1.5
TC1287	Lower wishbone(158)	A	1800 Kg (-) Ball joint(-11)	
TC1288	Lower wishbone(158)	B	1800 Kg (-) Ball joint(-11)	
TD296W	Lower wishbone bush(159)	A B	Front(108)	
TD297W	Lower wishbone bush(159)	A B	Rear(187)	

CITROËN

... CITROËN

RELAY 2.2Hdi, 3.0Hdi (04/06→)

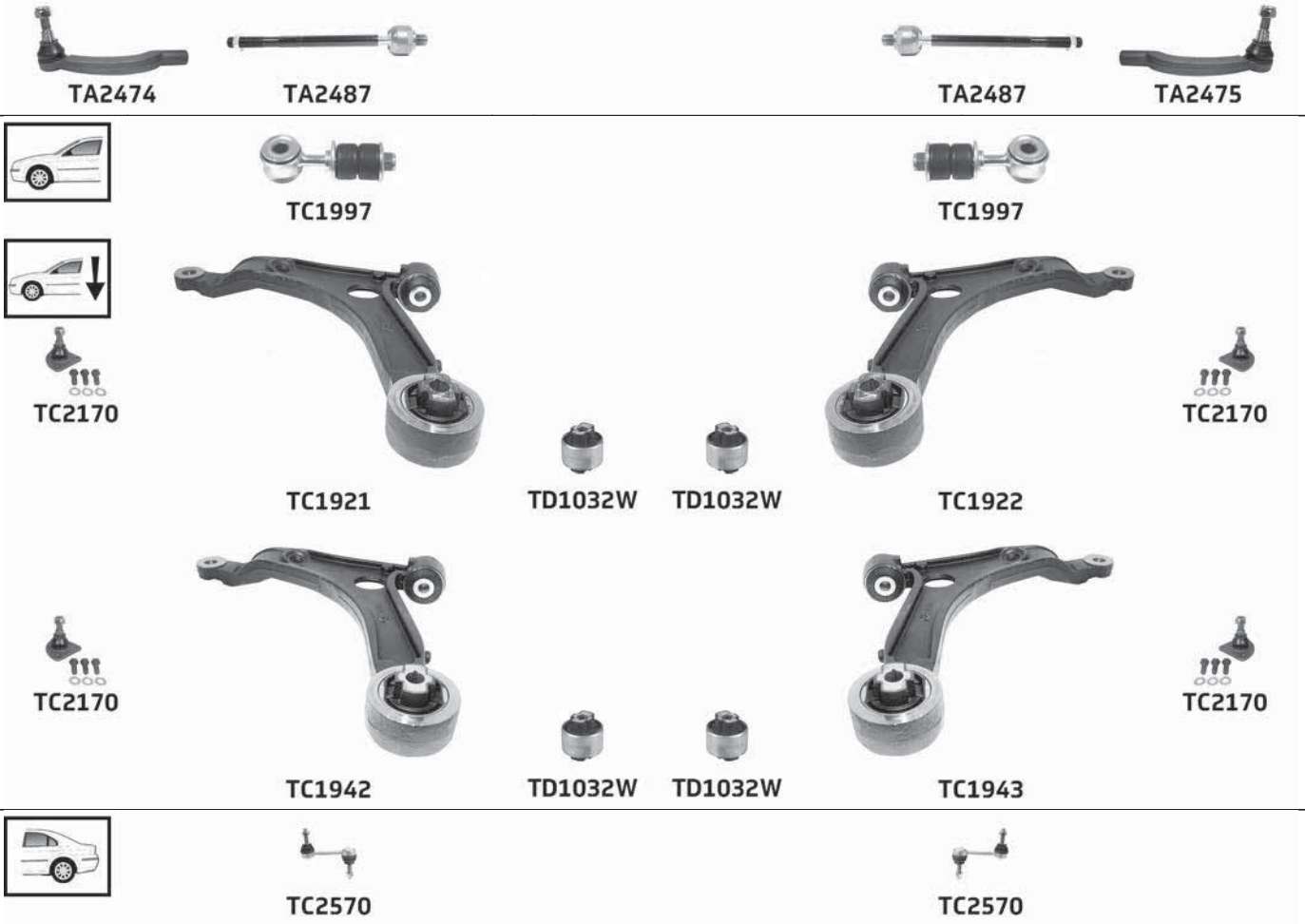

Part No	Description	Pos	Info	Technical
TA2474	Tie rod end(224)	A		M16x1.5 Female(253) £
TA2475	Tie rod end(224)	B		M16x1.5 Female(253) £
TA2487	Inner tie rod(123)	A B		M16x1.5 Male(252) £
TC1921	Lower wishbone(158)	A	1100/1700L Kg (-) Ball joint(-11-)	
TC1922	Lower wishbone(158)	B	1100/1700Lkg (-) Ball joint(-11-)	
TC1942	Lower wishbone(158)	A	1700H/2000 Kg (-) Ball joint(-11-)	
TC1943	Lower wishbone(158)	B	1700H/2000 Kg (-) Ball joint(-11-)	
TC1997	Link stabiliser (135)	A B		
TC2170	Lower ball joint(140)	A B		M16x1.5
TC2570	Link stabiliser (135)	A B		M10x1.25
TD1032W	Lower wishbone bush(159)	A B	Rear(187)	

SYNERGIE 1.8i, 1.9TD, 2.0i, 2.0HDi, 2.1TD (10/95-07/02)

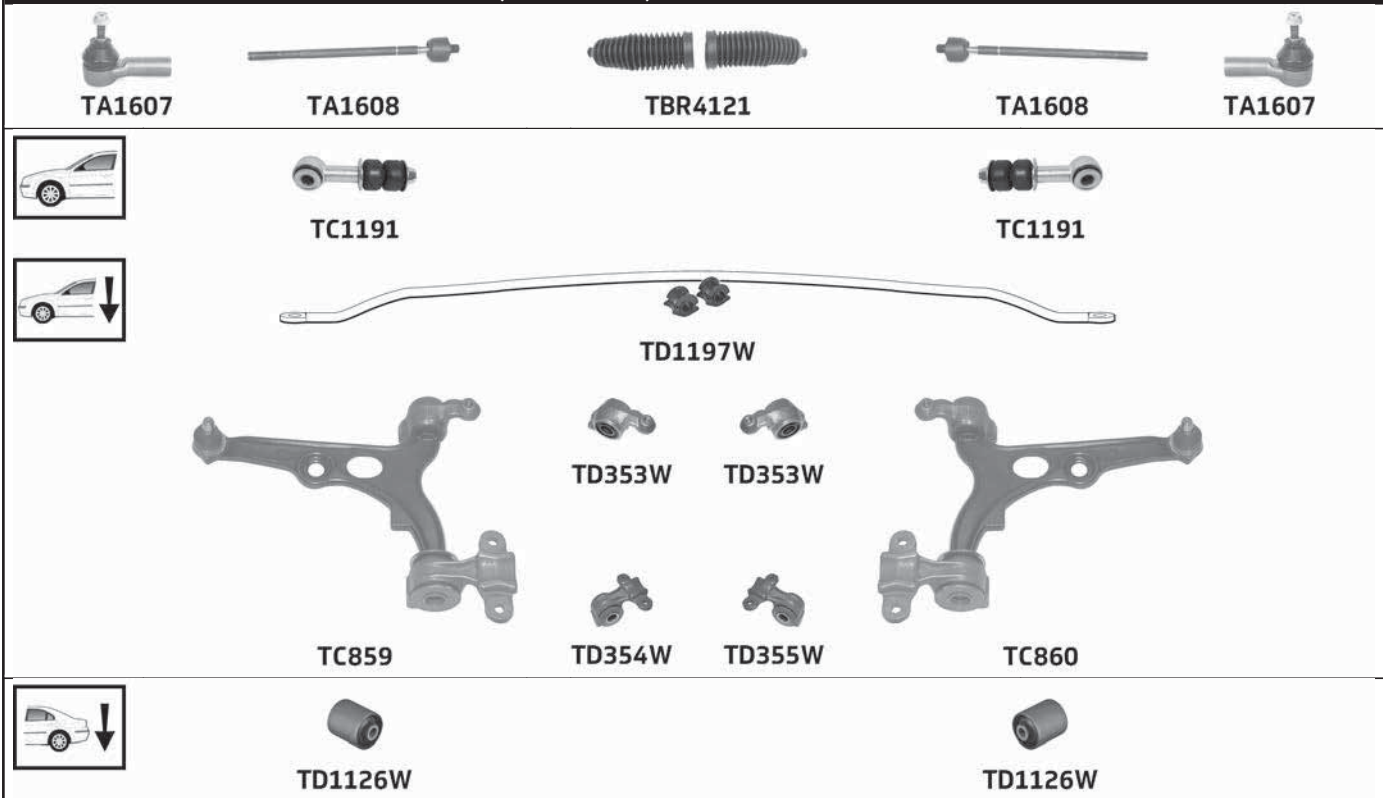

Part No	Description	Pos	Info	Technical
TA1607	Tie rod end(224)	A B		M14x1.5 Female(253) £
TA1608	Inner tie rod(123)	A B		M14x1.5 Male(252) £
TBR4121	Steering rack gaiter kit(213)	K		1 :13x62x62 2 :13x62x62
TC859	Lower wishbone(158)	A		Pinch Bolt(255) 17mm
TC860	Lower wishbone(158)	B		Pinch Bolt(255) 17mm
TC1191	Link stabiliser(135)	A B		
TD353W	Lower wishbone bush(159)	A B	Front(108)	
TD354W	Lower wishbone bush(159)	A	Rear(187)	
TD355W	Lower wishbone bush(159)	B	Rear(187)	
TD1126W	Axle Bush(-76-)	A B		
TD1197W	Anti-roll bar(-74-) bush kit(-86-)	K		

CITROËN

... CITROËN

XANTIA 1.6i, 1.8i, 1.9D, 1.9TD, 2.0HDi 90HP, 2.0i (03/93-04/03)

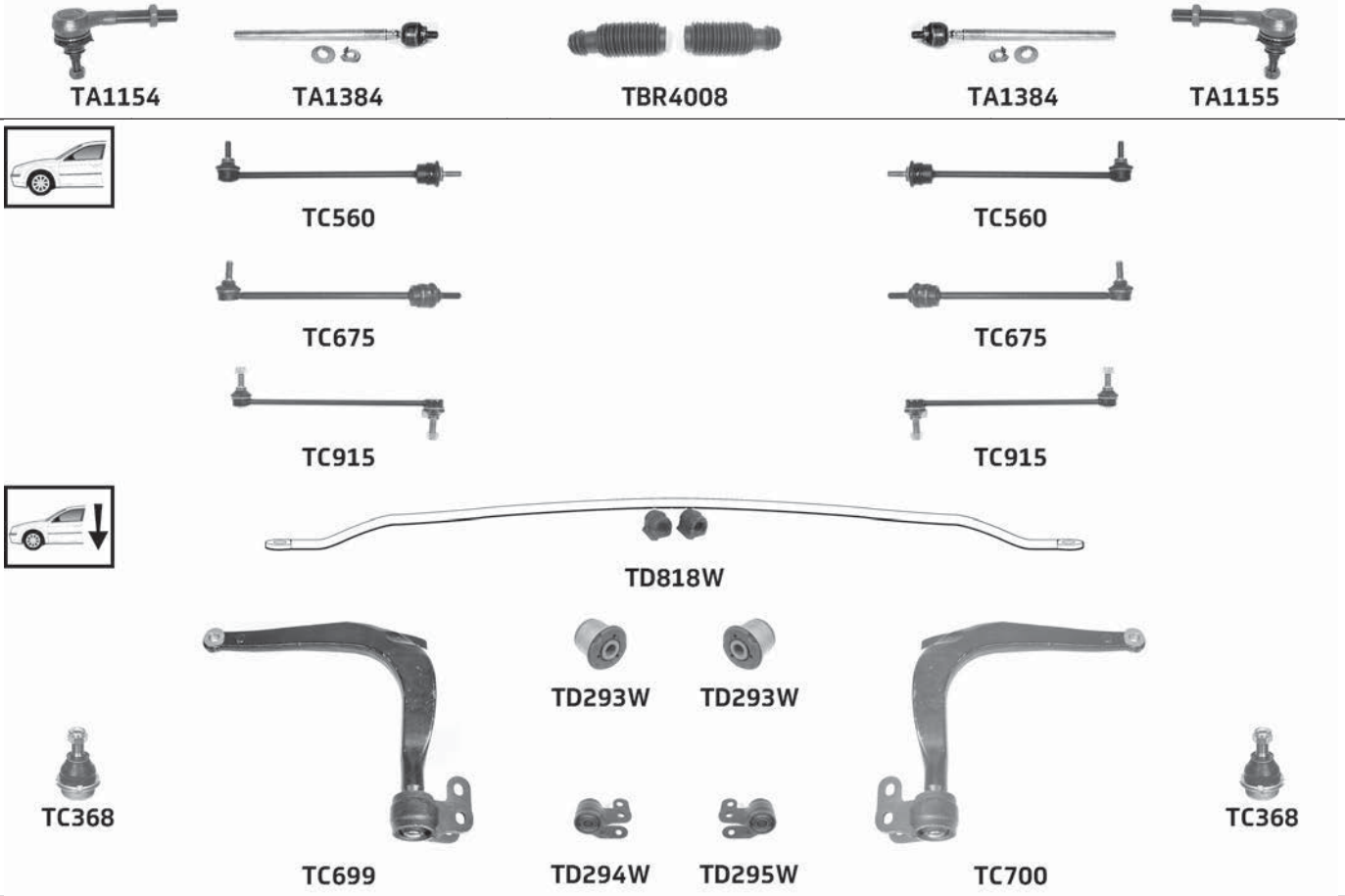

Part No	Description	Pos	Info	Technical
TA1154	Tie rod end(224)	A		
TA1155	Tie rod end(224)	B		
TA1384	Inner tie rod(123)	A B		M14x1.5 Female(253) E
TBR4008	Steering rack gaiter kit(213)	K	Manual steering(170)	1 :11x44x44 2 :11x44x44
TC368	Lower ball joint(140)	A B		M14x1.5
TC560	Link stabiliser(135)	A B	→RPO06614	M10x1.5
TC675	Link stabiliser(135)	A B	RPO06615-RPO08150	M12x1
TC699	Lower wishbone(158)	A	(-) Ball joint(-11-)	
TC700	Lower wishbone(158)	B	(-) Ball joint(-11-)	
TC915	Link stabiliser(135)	A B	RPO08151→	M12x1.75
TD293W	Lower wishbone bush(159)	A B	Front(108)	
TD294W	Lower wishbone bush(159)	A	Rear(187)	
TD295W	Lower wishbone bush(159)	B	Rear(187)	
TD818W	Anti-roll bar(-74-) bush kit(-86-)	K	∅22 (-) Complete axle kit(-92-)	

CITROËN

XANTIA 2.0i Turbo, 2.1TD (06/95-04/03)

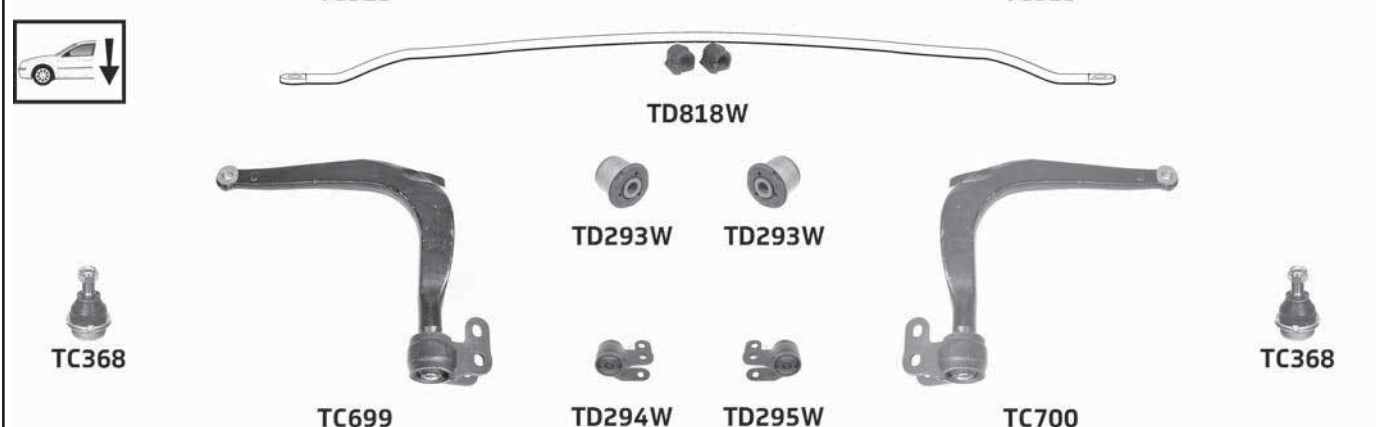
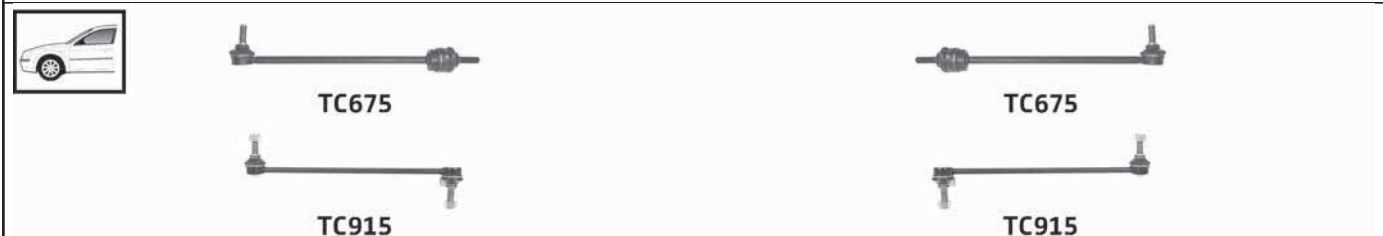

Part No	Description	Pos	Info	Technical
TA1154	Tie rod end(224)	A	→RPO06778	
TA1155	Tie rod end(224)	B	→RPO06778	
TA1384	Inner tie rod(123)	A B	→RPO06778	M14x1.5 Female(253) £
TA1681	Tie rod end(224)	A	RPO06779→	M16x1.5 Male(252) £
TA1682	Tie rod end(224)	B	RPO06779→	M16x1.5 Male(252) £
TA1786	Inner tie rod(123)	A B	RPO06779→	M16x1.5 Female(253) £
TBR4008	Steering rack gaiter kit(213)	K	Manual steering(170)	1 :11x44x44 2 :11x44x44
TC368	Lower ball joint(140)	A B		M14x1.5
TC675	Link stabiliser(135)	A B	→RPO08150	M12x1
TC699	Lower wishbone(158)	A	(-) Bush(-13) (-) Active anti-roll(_6_)	
TC700	Lower wishbone(158)	B	(-) Bush(-13) (-) Active anti-roll(_6_)	
TC915	Link stabiliser(135)	A B	RPO08151→	M12x1.75
TD293W	Lower wishbone bush(159)	A B	Front(108)	
TD294W	Lower wishbone bush(159)	A	Rear(187)	
TD295W	Lower wishbone bush(159)	B	Rear(187)	
TD818W	Anti-roll bar(-74) bush kit(-86)	K	Ø22 (-) Complete axle kit(-92)	

CITROËN

... CITROËN

XANTIA 2.0HDi 109HP (06/95-04/03)

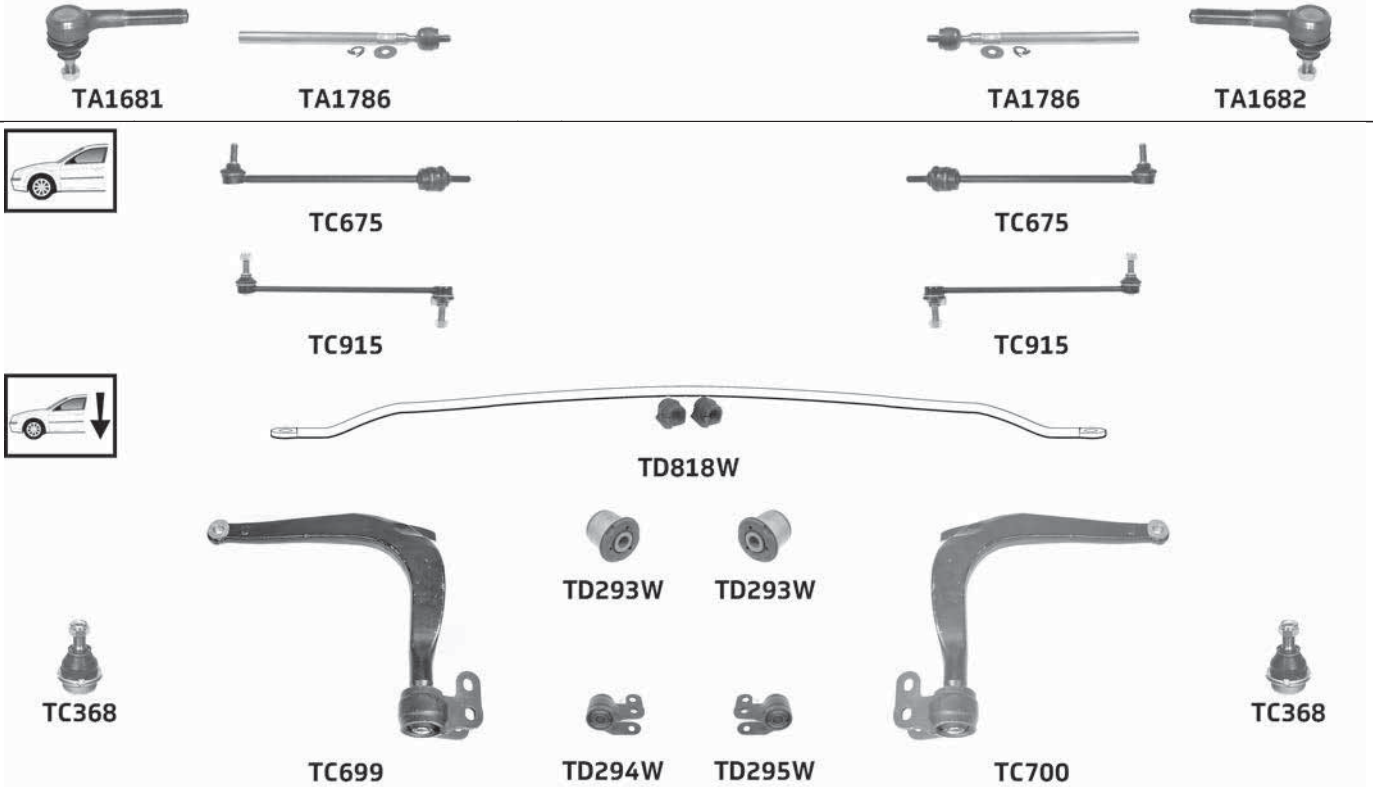

Part No	Description	Pos	Info	Technical
TA1681	Tie rod end(224)	A		M16x1.5 Male(252) £
TA1682	Tie rod end(224)	B		M16x1.5 Male(252) £
TA1786	Inner tie rod(123)	A B		M16x1.5 Female(253) £
TC368	Lower ball joint(140)	A B		M14x1.5
TC675	Link stabiliser(135)	A B	→RPO08150	M12x1
TC699	Lower wishbone(158)	A	(-) Bush(-13) (-) Active anti-roll(_6_)	
TC700	Lower wishbone(158)	B	(-) Bush(-13) (-) Active anti-roll(_6_)	
TC915	Link stabiliser(135)	A B	RPO08151→	M12x1.75
TD293W	Lower wishbone bush(159)	A B	Front(108)	
TD294W	Lower wishbone bush(159)	A	Rear(187)	
TD295W	Lower wishbone bush(159)	B	Rear(187)	
TD818W	Anti-roll bar(-74) bush kit(-86-)	K	Ø22 (-) Complete axle kit(-92-)	

CITROËN

XANTIA 3.0i (06/95-04/03)

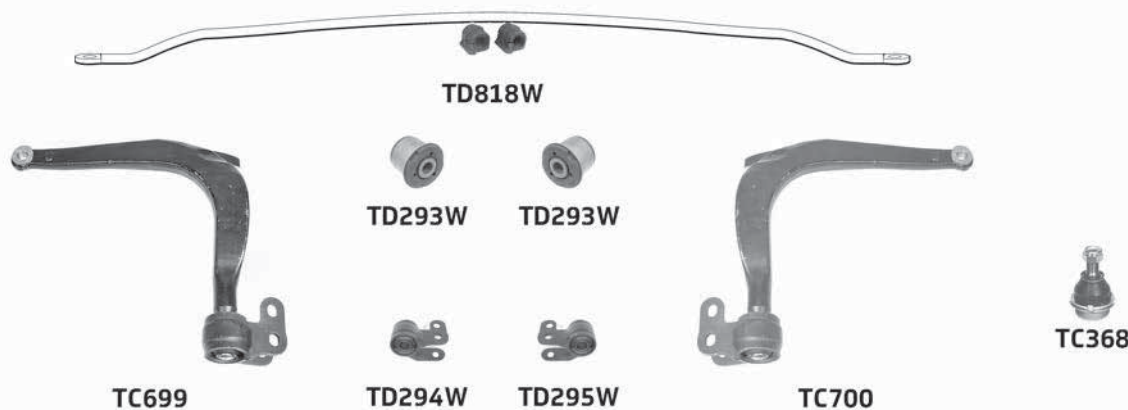

Part No	Description	Pos	Info	Technical
TA1154	Tie rod end(224)	A	→RPO07126	
TA1155	Tie rod end(224)	B	→RPO07126	
TA1384	Inner tie rod(123)	A B	→RPO07126	M14x1.5 Female(253) £
TA1681	Tie rod end(224)	A	RPO07127→	M16x1.5 Male(252) £
TA1682	Tie rod end(224)	B	RPO07127→	M16x1.5 Male(252) £
TA1786	Inner tie rod(123)	A B	RPO07127→	M16x1.5 Female(253) £
TBR4008	Steering rack gaiter kit(213)	K	Manual steering(170)	1 :11x44x44 2 :11x44x44
TC368	Lower ball joint(140)	A B		M14x1.5
TC675	Link stabiliser(135)	A B	→RPO08150	M12x1
TC699	Lower wishbone(158)	A	(-) Bush(-13) (-) Active anti-roll(_6_)	
TC700	Lower wishbone(158)	B	(-) Bush(-13) (-) Active anti-roll(_6_)	
TC915	Link stabiliser(135)	A B	RPO08151→	M12x1.75
TD293W	Lower wishbone bush(159)	A B	Front(108)	
TD294W	Lower wishbone bush(159)	A	Rear(187)	
TD295W	Lower wishbone bush(159)	B	Rear(187)	
TD818W	Anti-roll bar(-74) bush kit(-86)	K	Ø22 (-) Complete axle kit(-92)	

CITROËN

... CITROËN

XSARA 1.4i, 1.4HDi, 1.5D, 1.6i, 1.8i, 1.8D, 1.8TD, 1.9D, 1.9TD, 2.0i, 2.0HDi RPO07970 → (09/98-08/05)

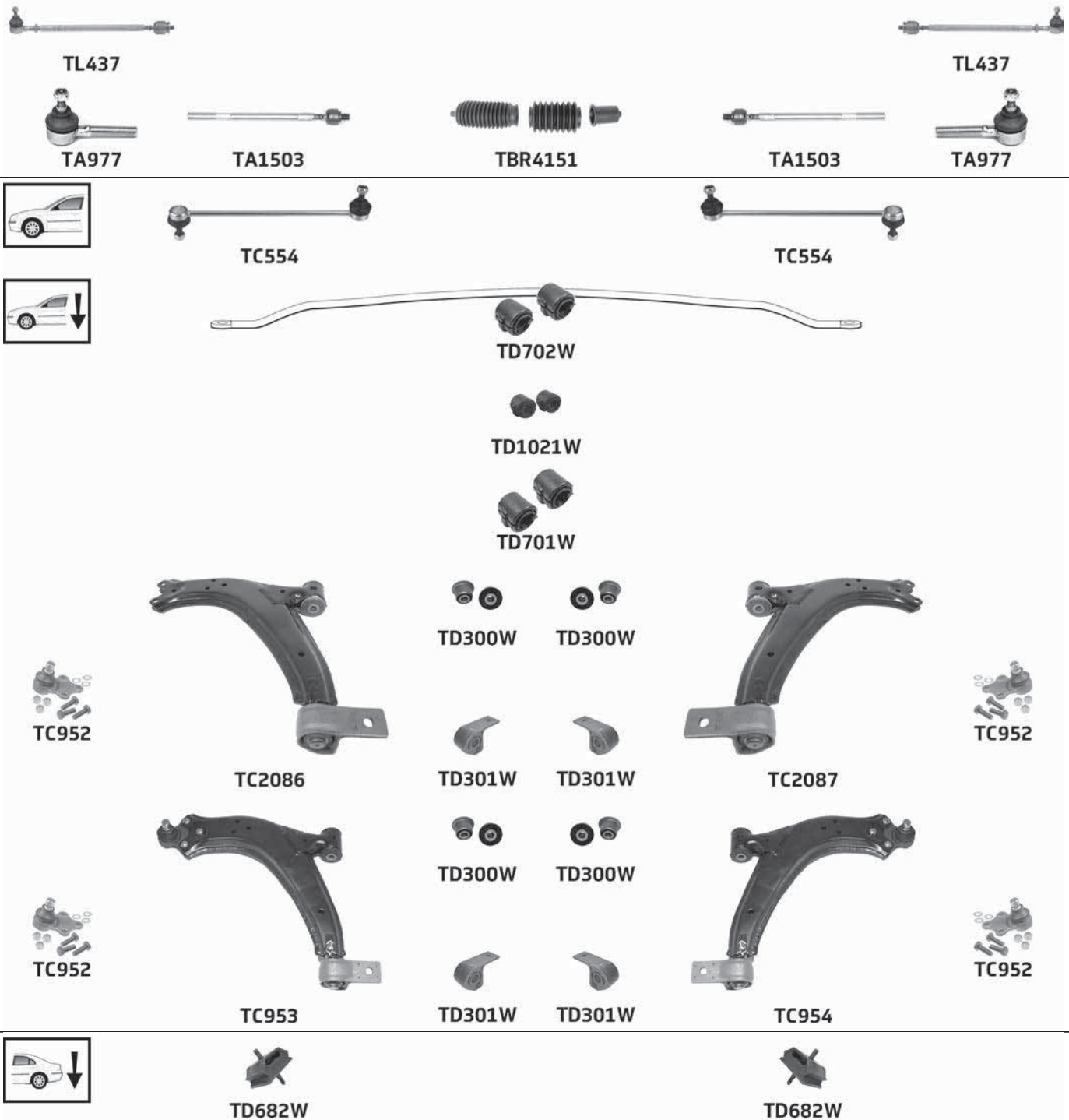

Part No	Description	Pos	Info	Technical
TA977	Tie rod end(224)	A B		M14x1.5 Male(252) £
TA1503	Inner tie rod(123)	A B		M14x1.5 Female(253) £
TBR4151	Steering rack gaiter kit(213)	K		1 :40x40x40 2 :11x42x42 3 :11x39x39
TC554	Link stabiliser(135)	A B		M10x1.5
TC952	Lower ball joint(140)	A B	(-) Heavy duty suspension(-18-)	Pinch Bolt(255) 18mm
TC953	Lower wishbone(158)	A	(+) Ball joint(-39) (-) Heavy duty suspension(-18-)	Pinch Bolt(255) 18mm
TC954	Lower wishbone(158)	B	(+) Ball joint(-39) (-) Heavy duty suspension(-18-)	Pinch Bolt(255) 18mm
TC2086	Lower wishbone(158)	A	(-) Bush(-13) (-) Heavy duty suspension(-18-)	
TC2087	Lower wishbone(158)	B	(-) Bush(-13) (-) Heavy duty suspension(-18-)	
TD300W	Lower wishbone bush(159)	A B	Front(108) Pack of(179) 2	
TD301W	Lower wishbone bush(159)	A B	Rear(187)	
TD682W	Sub-frame mounting(216)	A B	Rear(187)	
TD701W	Anti-roll bar(-74) bush kit(-86-)	K	Ø21 Complete axle kit(-92-)	
TD702W	Anti-roll bar(-74) bush kit(-86-)	K	Ø19 Complete axle kit(-92-)	
TD1021W	Anti-roll bar(-74) bush kit(-86-)	K	Ø20 Complete axle kit(-92-)	
TL437	Rod assembly(194)	A B		M10x1.25

XSARA PICASSO 1.6i, 1.8i (12/99→)

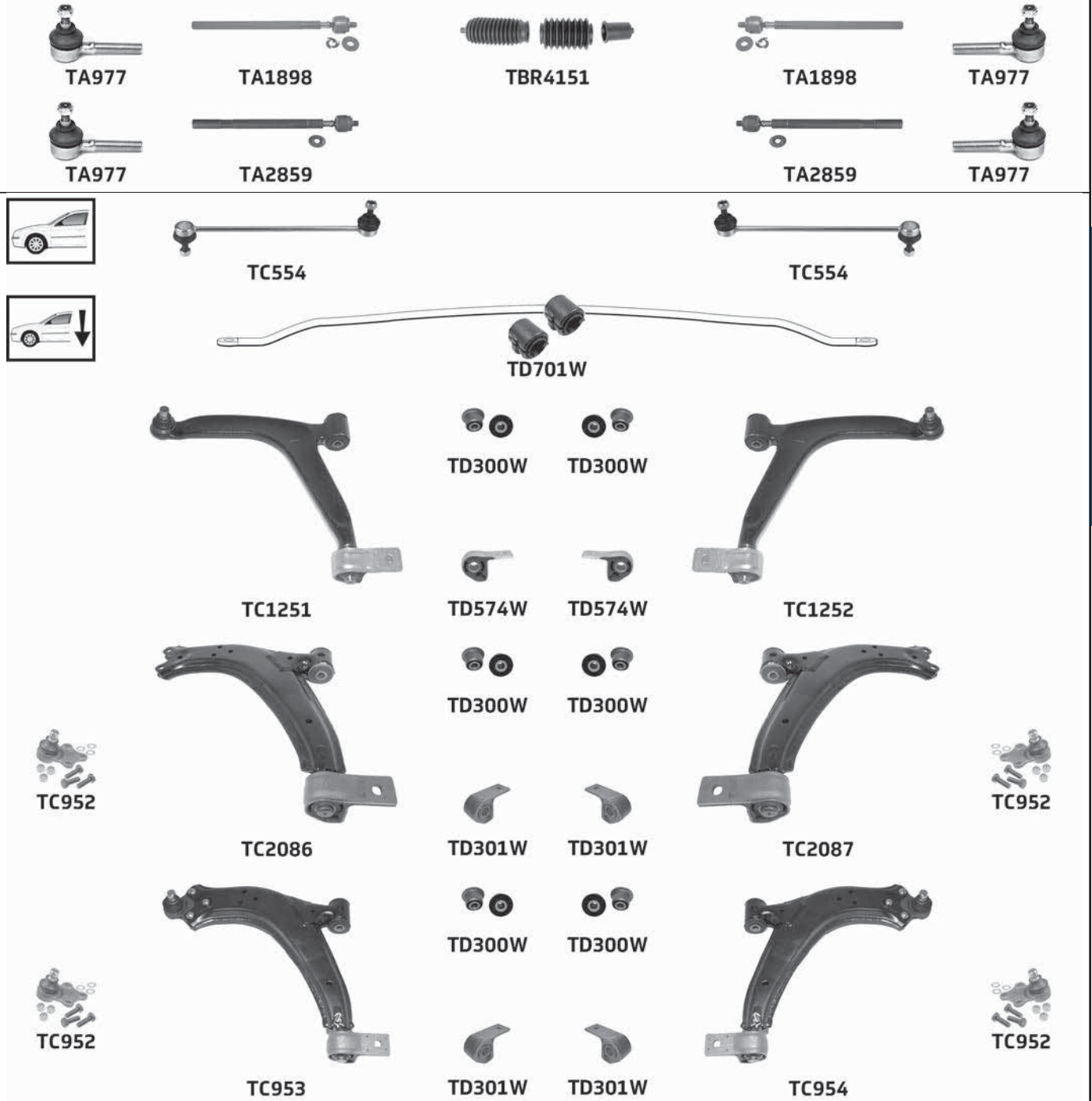

Part No	Description	Pos	Info	Technical
TA977	Tie rod end(224)	A B		M14x1.5 Male(252) £
TA1898	Inner tie rod(123)	A B	→RPO10016	M14x1.5 Female(253) £
TA2859	Inner tie rod(123)	A B	RPO10017→	M14x1.5 Female(253) £
TBR4151	Steering rack gaiter kit(213)	K	Power steering(185)	1 :40x40x40 2 :11x42x42 3 :11x39x39
TC554	Link stabiliser(135)	A B		M10x1.5
TC952	Lower ball joint(140)	A B	(-) Heavy duty suspension(-18) MAD09064FV, MAD11193CJ→	Pinch Bolt(255) 18mm
TC953	Lower wishbone(158)	A	(+) Ball joint(-39) (-) Heavy duty suspension(-18) MAD09064FV, MAD11193CJ→	Pinch Bolt(255) 18mm
TC954	Lower wishbone(158)	B	(+) Ball joint(-39) (-) Heavy duty suspension MAD09064FV, MAD11193CJ→	Pinch Bolt(255) 18mm
TC1251	Lower wishbone(158)	A	(-) Heavy duty suspension(-18) →MAD09063FV	Pinch Bolt(255) 18mm
TC1252	Lower wishbone(158)	B	(-) Heavy duty suspension(-18) →MAD09063FV	Pinch Bolt(255) 18mm
TC2086	Lower wishbone(158)	A	(-) Bush(-13) (-) Heavy duty suspension(-18) MAD09064FV, MAD11193CJ→	
TC2087	Lower wishbone(158)	B	(-) Bush(-13) (-) Heavy duty suspension(-18) MAD09064FV, MAD11193CJ→	
TD300W	Lower wishbone bush(159)	A B	Front(108) Pack of(179) 2	

(...)

... CITROËN

... XSARA PICASSO 1.6i, 1.8i (12/99→)

Part No	Description	Pos	Info	Technical
TD301W	Lower wishbone bush(159)	A B	Rear(187) MAD09064FV, MAD11193CJ→	
TD574W	Lower wishbone bush(159)	A B	Rear(187) →MAD09063FV	
TD701W	Anti-roll bar(-74) bush kit(-86)	K	Complete axle kit(-92)	

XSARA PICASSO 1.6HDi, 2.0i, 2.0HDi (12/99→)

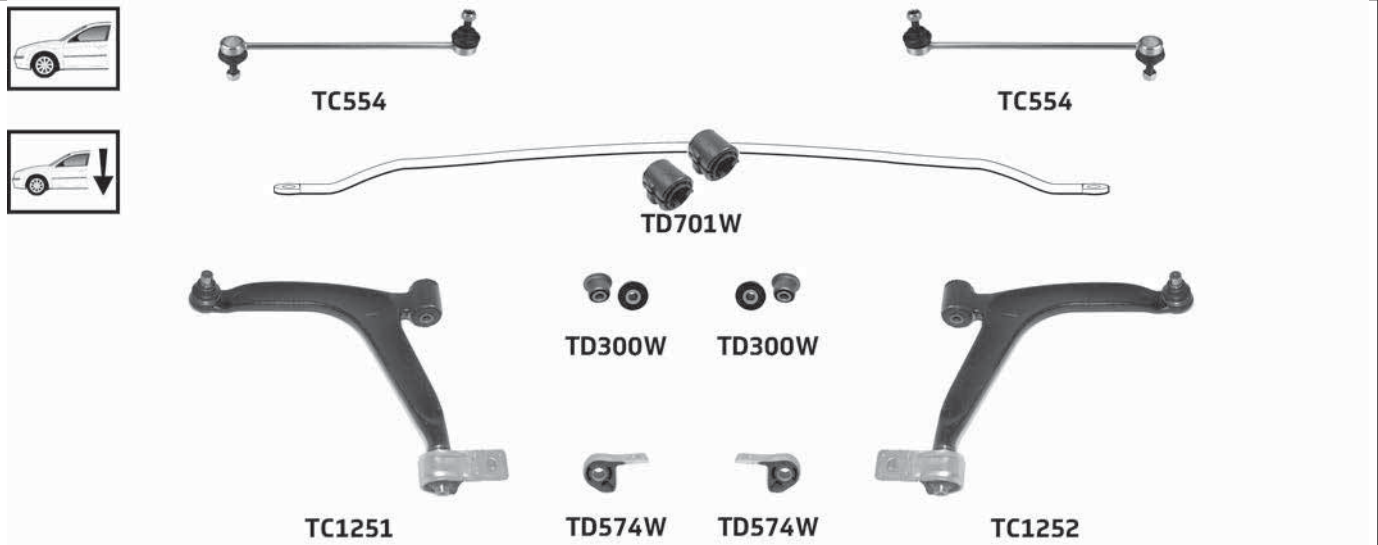

Part No	Description	Pos	Info	Technical
TA977	Tie rod end(224)	A B		M14x1.5 Male(252) £
TA1898	Inner tie rod(123)	A B	→RPO10016	M14x1.5 Female(253) £
TA2859	Inner tie rod(123)	A B	RPO10017→	M14x1.5 Female(253) £
TBR4151	Steering rack gaiter kit(213)	K	Power steering(185)	1 :40x40x40 2 :11x42x42 3 :11x39x39
TC554	Link stabiliser(135)	A B		M10x1.5
TC1251	Lower wishbone(158)	A	(-) Heavy duty suspension(-18-)	Pinch Bolt(255) 18mm
TC1252	Lower wishbone(158)	B	(-) Heavy duty suspension(-18-)	Pinch Bolt(255) 18mm
TD300W	Lower wishbone bush(159)	A B	Front(108) Pack of(179) 2	
TD574W	Lower wishbone bush(159)	A B	Rear(187)	
TD701W	Anti-roll bar(-74) bush kit(-86)	K	Complete axle kit(-92)	

DACIA

DOKKER 1.2i, 1.5dCi, 1.6i (11/12→)

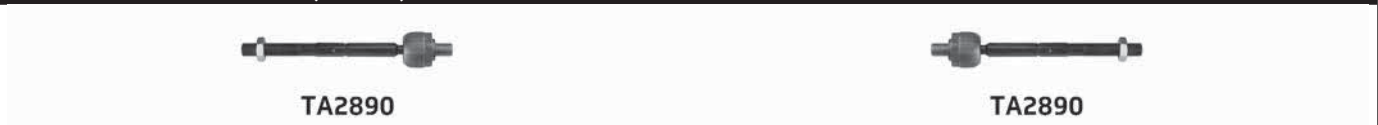

Part No	Description	Pos	Info	Technical
TA2890	Inner tie rod(123)	A B		M14x1.5 Male(252) £
TD1466W	Axle Bush(-76)	A B		

Part No	Description	Pos	Info	Technical

DACIA

DUSTER 1.5dCi, 1.6i (04/10→)



Part No	Description	Pos	Info	Technical
TA2628	Inner tie rod(123)	A B		M14x1.5 Male(252) £
TA2669	Tie rod end(224)	A		M14x1.5 Female(253) £
TA2670	Tie rod end(224)	B		M14x1.5 Female(253) £
TC2373	Link stabiliser(135)	A B		M10x1.5
TC2373	Link stabiliser(135)	A B		M10x1.5
TC2407	Lower ball joint(140)	A B		M12x1.25
TC2444	Lower wishbone(158)	A		M12x1.25
TC2445	Lower wishbone(158)	B		M12x1.25
TD992W	Anti-roll bar(-74) bush kit(-86)	K	Complete axle kit(-92)	
TD1639W	Anti-roll bar(-74) bush kit(-86)	K	Complete axle kit(-92) (+) 4x4	
TD1657W	Control arm bush(-97)	A B	(+) 4X4 Front(108) In-line(118) Rear(187)	
TD1657W	Control arm bush(-97)	A B	(+) 4X4 Front(108) Transverse(228) Outer(176)	
TD1657W	Control arm bush(-97)	A B	(+) 4x4 Rear(187) Transverse(228) Rear(187)	

DACIA

... DACIA

LOGGY 1.2i, 1.5dCi, 1.6i (03/12→)



TA2890



TA2890



TD1466W



TD1466W

Part No	Description	Pos	Info	Technical
TA2890	Inner tie rod(123)	A B		M14x1.5 Male(252) £
TD1466W	Axle Bush(-76-)	A B		

LOGAN 1.4i, 1.5dCi, 1.6i (09/04→)



TA2329



TA2331



TBR4140



TA2331



TA2330



TC1980KIT



TC2237



TC2237



TC1729



TD729W



TD729W



TC1730



TC1366

Part No	Description	Pos	Info	Technical
TA2329	Tie rod end(224)	A		M14x1.5 Female(253) £
TA2330	Tie rod end(224)	B		M14x1.5 Female(253) £
TA2331	Inner tie rod(123)	A B		M14x1.5 Male(252) £
TBR4140	Steering rack gaiter kit(213)	K		1 :9.5x42x42 2 :9.5x42x42
TC1366	Lower ball joint(140)	A B		Pinch Bolt(255) 18mm
TC1729	Lower wishbone(158)	A		Pinch Bolt(255) 18mm
TC1730	Lower wishbone(158)	B		Pinch Bolt(255) 18mm
TC1980KIT	Steering kit(212)	K		
TC2237	Link stabiliser(135)	A B		
TD729W	Lower wishbone bush(159)	A B	Front(108) Rear(187)	

LOGAN II 900cc, 1.2i, 1.5dCi (10/12→)



TA2890



TA2890

Part No	Description	Pos	Info	Technical
TA2890	Inner tie rod(123)	A B		M14x1.5 Male(252) £

DACIA

SANDERO 1.2i, 1.4i, 1.5dCi, 1.6i (06/08→)



Part No	Description	Pos	Info	Technical
TA2329	Tie rod end (224)	A		M14x1.5 Female (253) £
TA2330	Tie rod end (224)	B		M14x1.5 Female (253) £
TA2331	Inner tie rod (123)	A B		M14x1.5 Male (252) £
TBR4140	Steering rack gaiter kit (213)	K		1 :9.5x42x42 2 :9.5x42x42
TC1366	Lower ball joint (140)	A B		Pinch Bolt (255) 18mm
TC1729	Lower wishbone (158)	A		Pinch Bolt (255) 18mm
TC1730	Lower wishbone (158)	B		Pinch Bolt (255) 18mm
TC1980KIT	Steering kit (212)	K		
TC2237	Link stabiliser (135)	A B		
TD729W	Lower wishbone bush (159)	A B	Front (108) Rear (187)	

SANDERO II 900cc, 1.2i, 1.5dCi (01/13→)



Part No	Description	Pos	Info	Technical
TA2329	Tie rod end (224)	A		M14x1.5 Female (253) £
TA2330	Tie rod end (224)	B		M14x1.5 Female (253) £
TA2890	Inner tie rod (123)	A B		M14x1.5 Male (252) £
TC2237	Link stabiliser (135)	A B		

DACIA

DAEWOO

KALOS 1.2i, 1.4i (09/02→)

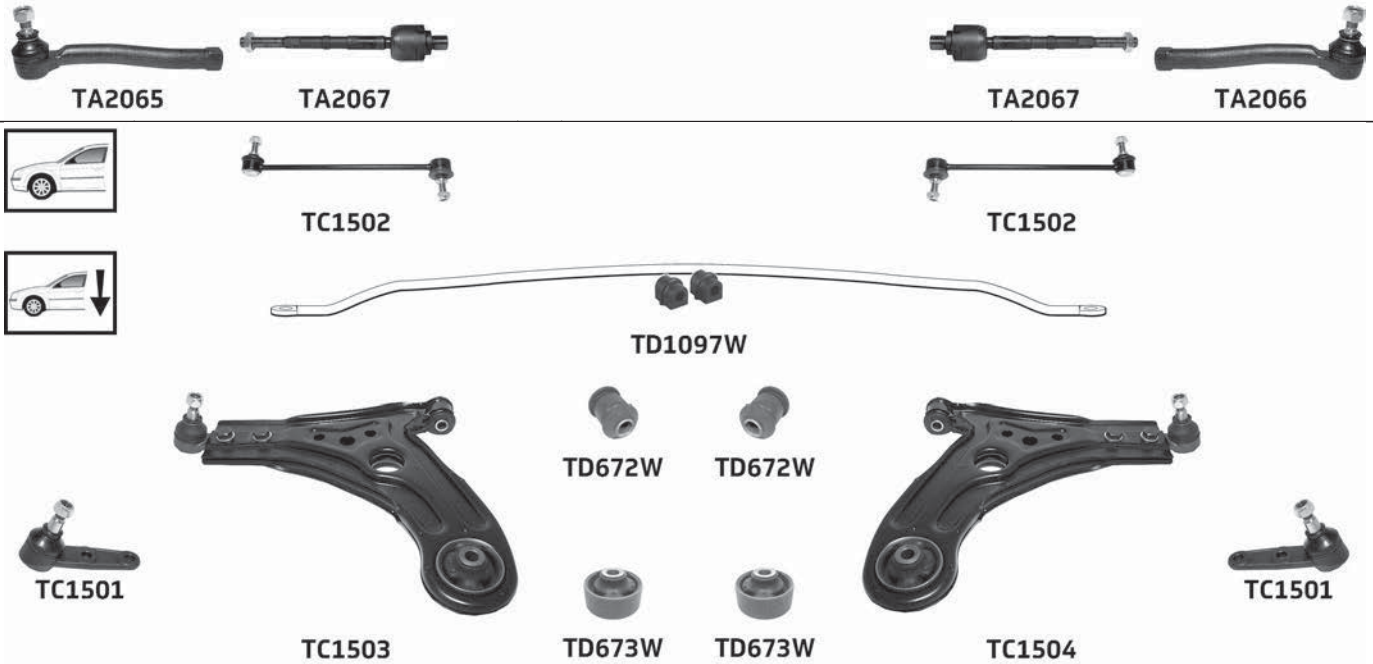

Part No	Description	Pos	Info	Technical
TA2065	Tie rod end(224)	A		M12x1.5 Female(253) £
TA2066	Tie rod end(224)	B		M12x1.5 Female(253) £
TA2067	Inner tie rod(123)	A B		M12x1.5 Male(252) £
TC1501	Lower ball joint(140)	A B		M12x1.25
TC1502	Link stabiliser(135)	A B		M10x1.25
TC1503	Lower wishbone(158)	A		M12x1.25
TC1504	Lower wishbone(158)	B		M12x1.25
TD672W	Lower wishbone bush(159)	A B	Front(108)	
TD673W	Lower wishbone bush(159)	A B	Rear(187)	
TD1097W	Anti-roll bar(-74) bush kit(-86-)	K	Complete axle kit(-92-)	

KORANDO 2.0i, 2.3i, 2.9D, 2.9TD, 3.2i (01/99→)



Part No	Description	Pos	Info	Technical
TA1890	Tie rod end(224)	A B		M14x1.5 Female(253) £
TC1230	Upper ball joint(232)	A B		M16x1.5
TC1231	Lower ball joint(140)	A B		M16x1.5
TC2350	Link stabiliser(135)	A B		M10x1.25
TC2350	Link stabiliser(135)	A B		M10x1.25

LACETTI 1.4i, 1.6i, 1.8i (07/03→)



Part No	Description	Pos	Info	Technical
TA2068	Tie rod end(224)	A		M14x1.5 Female(253) £
TA2069	Tie rod end(224)	B		M14x1.5 Female(253) £
TA2070	Inner tie rod(123)	A B		M14x1.5 Male(252) £
TBR4239	Steering rack gaiter kit(213)	K		1 :13x49x49 2 :13x49x49
TC1505	Lower ball joint(140)	A B		Pinch Bolt(255) 18mm
TC1506	Link stabiliser(135)	A		M10x1.25
TC1507	Link stabiliser(135)	B		M10x1.25
TC1509	Lower wishbone(158)	A		Pinch Bolt(255) 18mm
TC1510	Lower wishbone(158)	B		Pinch Bolt(255) 18mm
TC2300	Link stabiliser(135)	A B		M10x1.25

MATIZ 800cci, 1.0i (09/98-12/04)



Part No	Description	Pos	Info	Technical
TA1769	Tie rod end(224)	A B		M12x1.5 Female(253) £
TA1858	Inner tie rod(123)	A B	Manual steering(170) 155 tyres(-61-)	M12x1.5 Male(252) £
TA1859	Inner tie rod(123)	A B	Manual steering(170) 175 tyres(-64-)	M12x1.5 Male(252) £
TBR4243	Steering rack gaiter kit(213)	K	Power steering(185) Thermoplastic(223)	1 :11x45x45 2 :11x45x45
TC631	Lower track control arm(151)	A B		Pinch Bolt(255) 15mm
TD419W	Lower track control arm bush(153)	A B	Inner(119)	
TD1617W	Lower track control arm bush(153)	A B	Outer(176) Pack of(179) 2	

... DAEWOO

MUSSO 2.3i, 2.3TD, 2.9D, 2.9TD, 3.2i (01/99-)



Part No	Description	Pos	Info	Technical
TA1890	Tie rod end(224)	A B		M14x1.5 Female(253) £
TC1230	Upper ball joint(232)	A B		M16x1.5
TC1231	Lower ball joint(140)	A B		M16x1.5
TC2350	Link stabiliser(135)	A B		M10x1.25
TC2350	Link stabiliser(135)	A B		M10x1.25

NUBIRA I 1.6i, 1.8i, 2.0i (08/99-06/03)



Part No	Description	Pos	Info	Technical
TA1693	Tie rod end(224)	A B		M14x1.5 Female(253) £
TA1694	Inner tie rod(123)	A B		M14x1.5 Male(252) £
TBR4035	Steering rack gaiter kit(213)	K		1 :13x49x49 2 :13x49x49
TC897	Lower ball joint(140)	A B		Pinch Bolt(255) 16mm
TC1096	Link stabiliser(135)	A B		M10x1.25
TC1098	Lower wishbone(158)	A		Pinch Bolt(255) 16mm
TC1099	Lower wishbone(158)	B		Pinch Bolt(255) 16mm
TC1294	Link stabiliser(135)	A B		M10x1.25
TD399W	Lower wishbone bush(159)	A B	Front(108)	
TD400W	Lower wishbone bush(159)	A B	Rear(187)	

NUBIRA II 1.6i, 1.8i (07/03→)



TA2068



TA2070



TBR4239



TA2070



TA2069



TC1506



TC1507



TC1509



TC1510



TC1505



TC1505



TC2300



TC2300

Part No	Description	Pos	Info	Technical
TA2068	Tie rod end (224)	A		M14x1.5 Female (253) £
TA2069	Tie rod end (224)	B		M14x1.5 Female (253) £
TA2070	Inner tie rod (123)	A B		M14x1.5 Male (252) £
TBR4239	Steering rack gaiter kit (213)	K		1 :13x49x49 2 :13x49x49
TC1505	Lower ball joint (140)	A B		Pinch Bolt (255) 18mm
TC1506	Link stabiliser (135)	A		M10x1.25
TC1507	Link stabiliser (135)	B		M10x1.25
TC1509	Lower wishbone (158)	A		Pinch Bolt (255) 18mm
TC1510	Lower wishbone (158)	B		Pinch Bolt (255) 18mm
TC2300	Link stabiliser (135)	A B		M10x1.25

REZZO 1.6i, 1.8i, 2.0i (09/00→)



TA2071



TA2073



TA2073



TA2072



TC1502



TC1502



TC1511



TC1913



TC1914



TC1511

Part No	Description	Pos	Info	Technical
TA2071	Tie rod end (224)	A		M14x1.5 Female (253) £
TA2072	Tie rod end (224)	B		M14x1.5 Female (253) £
TA2073	Inner tie rod (123)	A B		M14x1.5 Male (252) £
TC1502	Link stabiliser (135)	A B		M10x1.25
TC1511	Lower ball joint (140)	A B		Pinch Bolt (255) 16mm
TC1913	Lower wishbone (158)	A		Pinch Bolt (255) 16mm
TC1914	Lower wishbone (158)	B		Pinch Bolt (255) 16mm

... DAEWOO

TACUMA 1.6i, 1.8i, 2.0i (09/00→)



TA2071



TA2073



TA2073



TA2072



TC1502



TC1502



TC1511



TC1913



TC1914



TC1511

Part No	Description	Pos	Info	Technical
TA2071	Tie rod end(224)	A		M14x1.5 Female(253) £
TA2072	Tie rod end(224)	B		M14x1.5 Female(253) £
TA2073	Inner tie rod(123)	A B		M14x1.5 Male(252) £
TC1502	Link stabiliser(135)	A B		M10x1.25
TC1511	Lower ball joint(140)	A B		Pinch Bolt(255) 16mm
TC1913	Lower wishbone(158)	A		Pinch Bolt(255) 16mm
TC1914	Lower wishbone(158)	B		Pinch Bolt(255) 16mm

DAIHATSU

MATERIA 1.3i M401, M411, 1.5i M402 (10/06→)



TA3205



TA3206

Part No	Description	Pos	Info	Technical
TA3205	Tie rod end(224)	A		M14x1.5 Female(253) £
TA3206	Tie rod end(224)	B		M14x1.5 Female(253) £

MOVE 850cci L601 (01/97-10/00)



TA1877



TA1878

Part No	Description	Pos	Info	Technical
TA1877	Tie rod end(224)	A		M12x1.25 Female(253) £
TA1878	Tie rod end(224)	B		M12x1.25 Female(253) £

SIRION 1.0i M100, M110, 1.3i M101, M111 (04/98-02/05)



TA2574



TA2637



TA2637



TA2575

Part No	Description	Pos	Info	Technical
TA2574	Tie rod end(224)	A		M12x1.25 Female(253) £
TA2575	Tie rod end(224)	B		M12x1.25 Female(253) £
TA2637	Inner tie rod(123)	A B		M12x1.25 Male(252) £

SIRION 1.0i M300, 1.3i M301, M311, 1.5i M303 (01/05→)



TA3205



TA2664



TA2664



TA3206

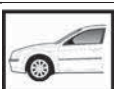

TC2273



TC2274

Part No	Description	Pos	Info	Technical
TA2664	Inner tie rod(123)	A B		M12x1.25 Male(252) £
TA3205	Tie rod end(224)	A	M14 11/05→	M14x1.5 Female(253) £

... SIRION 1.0i M300, 1.3i M301, M311, 1.5i M303 (01/05→)

Part No	Description	Pos	Info	Technical
TA3206	Tie rod end (224)	B	M14 11/05→	M14x1.5 Female(253) £
TC2273	Link stabiliser (135)	A		M10x1.25
TC2274	Link stabiliser (135)	B		M10x1.25

TERIOS I 1.3i, 1.3i 4x4 (10/97-10/05)



Part No	Description	Pos	Info	Technical
TA2467	Tie rod end (224)	A B		M14x1.5 Female(253) £
TA2473	Inner tie rod (123)	A B		M14x1.5 Male(252) £
TC1940	Lower wishbone (158)	A		M12x1.25
TC1941	Lower wishbone (158)	B		M12x1.25

TERIOS II 1.3i 4x4, 1.5i, 1.5i 4x4 (11/05→)

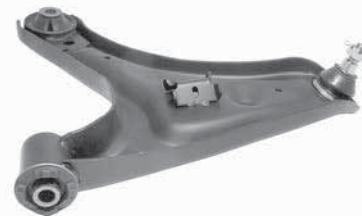

Part No	Description	Pos	Info	Technical
TA2473	Inner tie rod (123)	A B		M14x1.5 Male(252) £
TA3193	Tie rod end (224)	A		M14x1.5 Female(253) £
TA3194	Tie rod end (224)	B		M14x1.5 Female(253) £
TC2179	Link stabiliser (135)	A B		M10x1.25
TC2339	Lower wishbone (158)	A		M14x1.5
TC2340	Lower wishbone (158)	B		M14x1.5
TC3358	Lower ball joint (140)	A B		M14x1.5

YRV 1.0i M200, 1.3i M201, M211, 1.3i Turbo M202 (02/01→)



Part No	Description	Pos	Info	Technical
TA2574	Tie rod end (224)	A		M12x1.25 Female(253) £
TA2575	Tie rod end (224)	B		M12x1.25 Female(253) £
TA2637	Inner tie rod (123)	A B		M12x1.25 Male(252) £

DODGE

AVENGER 2.0i, 2.0CRD, 2.4i (10/06→)



Part No	Description	Pos	Info	Technical
TC3307	Link stabiliser (135)	A B		
TC3675	Lower ball joint (140)	A B		

CALIBER 1.8i, 2.0i, 2.0CRD, 2.4i (01/07→)



Part No	Description	Pos	Info	Technical
TA2753	Tie rod end (224)	A B		M14x1.5 Female (253) £
TC3307	Link stabiliser (135)	A B		

JOURNEY 2.0CRD, 2.4i (06/08→)



Part No	Description	Pos	Info	Technical
TA2753	Tie rod end (224)	A B		M14x1.5 Female (253) £
TC3203	Lower wishbone (158)	A		
TC3204	Lower wishbone (158)	B		
TC3675	Lower ball joint (140)	A B		

DS

DS3 1.4VTi, 1.6THP, 1.6VTi, 1.6HDi (04/15→)



Part No	Description	Pos	Info	Technical
TA2621	Inner tie rod (123)	A B		M14x1.5 Male (252) £
TA2662	Tie rod end (224)	A		M14x1.5 Female (253) £

... DS3 1.4VTi, 1.6THP, 1.6VTi, 1.6HDi (04/15→)

Part No	Description	Pos	Info	Technical
TA2663	Tie rod end(224)	B		M14x1.5 Female(253) £
TC880	Link stabiliser(135)	A B	RPO12390→ (+) very cold climate(-56)	M10x1.5
TC2313	Link stabiliser(135)	A B	→RPO12389 RPO12390→ (-) very cold climate(-30)	M10x1.25
TD1012W	Sub-frame bush(215)	A B		

DS4 1.6THP 155HP, 1.6VTi, 1.6HDi, 2.0HDi (-) 19" Wheels(3) (04/15→)

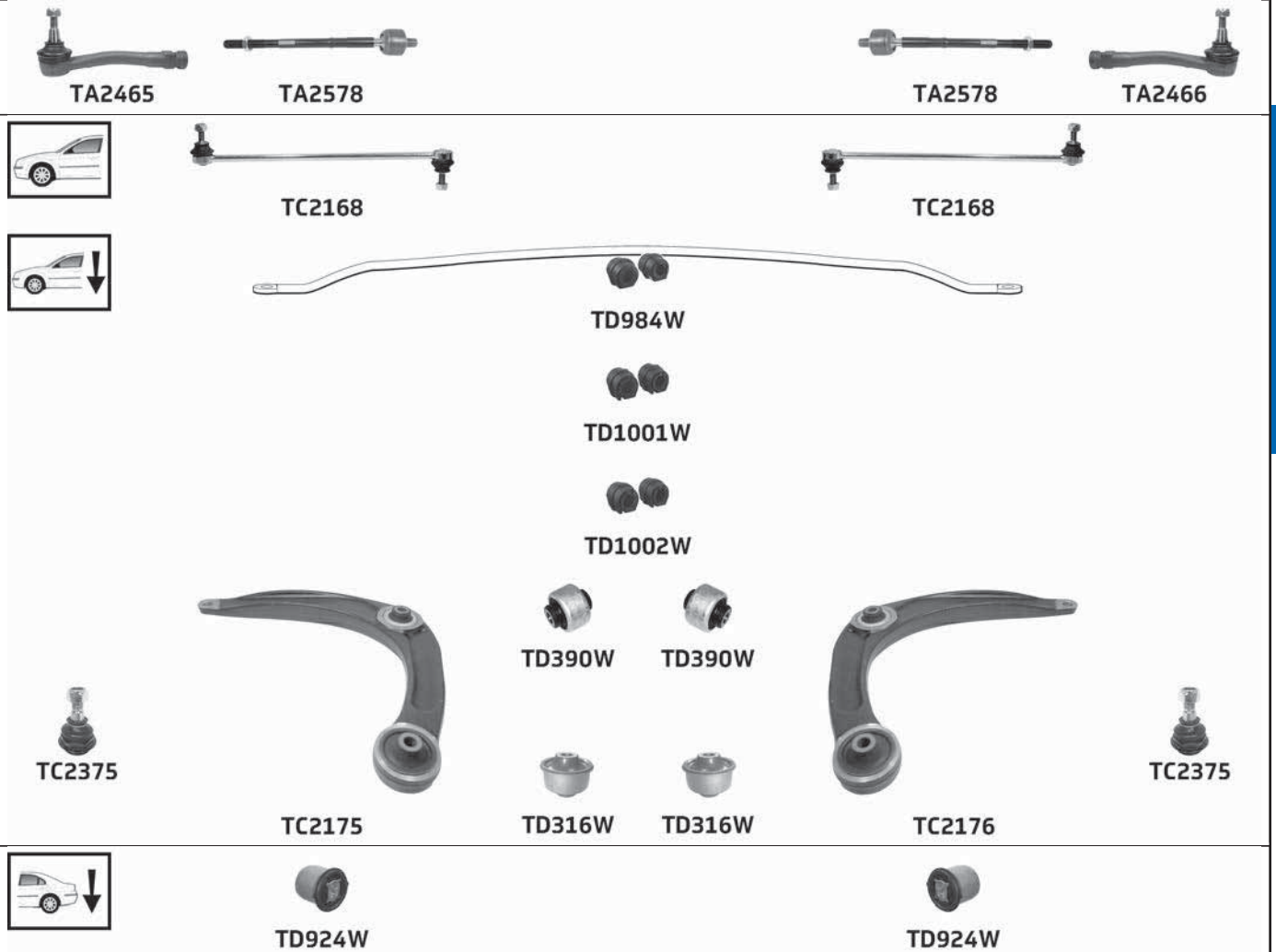

Part No	Description	Pos	Info	Technical
TA2465	Tie rod end(224)	A		M14x1.5 Female(253) £
TA2466	Tie rod end(224)	B		M14x1.5 Female(253) £
TA2578	Inner tie rod(123)	A B		M14x1.5 Male(252) £
TC2168	Link stabiliser(135)	A B		M10x1.5
TC2175	Lower wishbone(158)	A	(-) Ball joint(-11)	
TC2176	Lower wishbone(158)	B	(-) Ball joint(-11)	
TC2375	Lower ball joint(140)	A B		M14x1.5
TD316W	Lower wishbone bush(159)	A B	Rear(187)	
TD390W	Lower wishbone bush(159)	A B	Front(108)	
TD924W	Axle bush(-76)	A B		
TD984W	Anti-roll bar(-74) bush kit(-86)	K	Ø22 Complete axle kit(-92)	
TD1001W	Anti-roll bar(-74) bush kit(-86)	K	Ø23 Complete axle kit(-92)	
TD1002W	Anti-roll bar(-74) bush kit(-86)	K	Ø24 Complete axle kit(-92)	

... DS

DS4 1.6THP 200HP, 2.0HDi 19" Wheels⁽⁻⁶⁶⁻⁾ (04/15→)



TD984W



TD1001W



TD1002W



TC2375



TC2175



TD390W

TD390W



TD316W



TD316W



TC2176



TC2375



TD924W



TD924W

Part No	Description	Pos	Info	Technical
TC2168	Link stabiliser (135)	A B		M10x1.5
TC2175	Lower wishbone (158)	A	(-) Ball joint (-11-)	
TC2176	Lower wishbone (158)	B	(-) Ball joint (-11-)	
TC2375	Lower ball joint (140)	A B		M14x1.5
TD316W	Lower wishbone bush (159)	A B	Rear (187)	
TD390W	Lower wishbone bush (159)	A B	Front (108)	
TD924W	Axle bush (-76)	A B		
TD984W	Anti-roll bar (-74) bush kit (-86)	K	Ø22 Complete axle kit (-92-)	
TD1001W	Anti-roll bar (-74) bush kit (-86)	K	Ø23 Complete axle kit (-92-)	
TD1002W	Anti-roll bar (-74) bush kit (-86)	K	Ø24 Complete axle kit (-92-)	

DS5 1.6THP, 1.6Hdi, 2.0HDi (04/15→)



TD1016W



TC2375



TC2375



TD316W



TD316W

Part No	Description	Pos	Info	Technical
TC2168	Link stabiliser (135)	A B		M10x1.5
TC2375	Lower ball joint (140)	A B		M14x1.5
TD316W	Lower wishbone bush (159)	A B	Rear (187)	
TD1016W	Anti-roll bar (-74) bush kit (-86)	K	Ø25 Complete axle kit (-92-)	

500 900cc, 1.2i, 1.3JTD, 1.4i, 1.4i ABARTH (10/07→)



Part No	Description	Pos	Info	Technical
TA1967	Tie rod end (224)	A		M12x1.5 Female(253) £
TA1968	Tie rod end (224)	B		M12x1.5 Female(253) £
TA2716	Inner tie rod (123)	A B		M12x1.5 Male (252) £
TBR4205	Steering rack gaiter kit (213)	K	Thermoplastic (223)	1 :10.5x54.5x54.5 2 :10.5x54.5x54.5
TC1133	Link stabiliser (135)	A B		M10x1.5
TC2351	Lower wishbone (158)	A	(-) Xenon light (-31-)	Pinch Bolt (255) 17mm
TC2352	Lower wishbone (158)	B		Pinch Bolt (255) 17mm
TD358W	Lower wishbone bush (159)	A B	Front (108)	
TD912W	Axle bush (-76-)	A B	(-) Abarth	
TD1113W	Lower wishbone bush (159)	A B	Rear (187)	

500L 900cc, 1.4i, 1.3JTD, 1.6JTD (09/12-10/15)

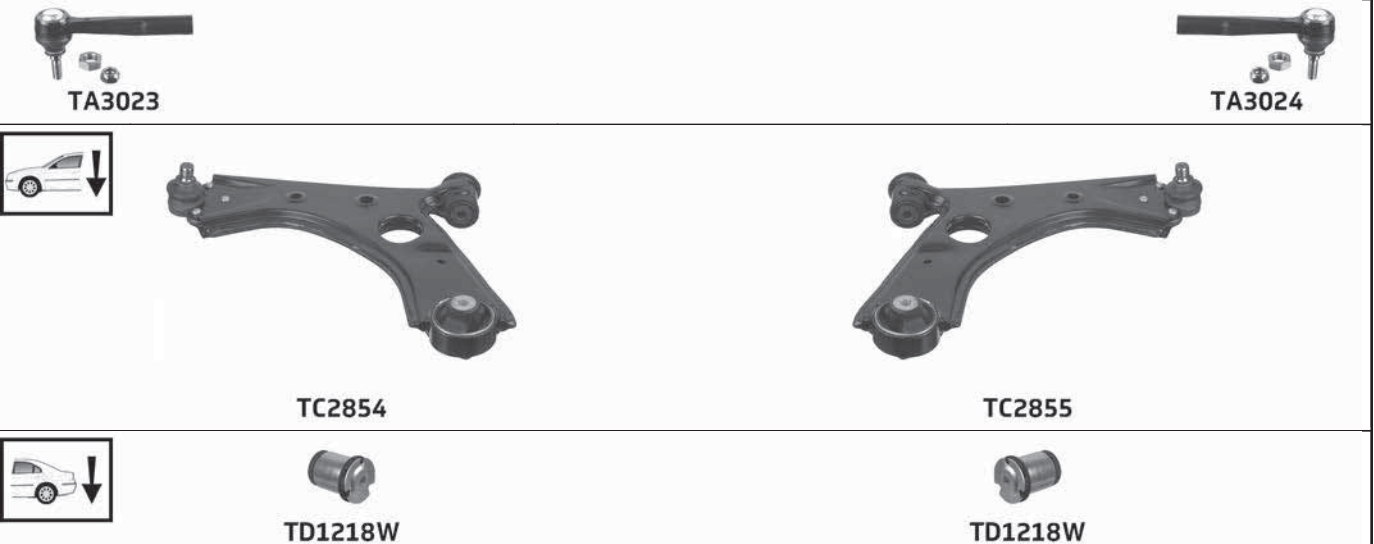

Part No	Description	Pos	Info	Technical
TA3023	Tie rod end (224)	A		M14x1.5 Female(253) £
TA3024	Tie rod end (224)	B		M14x1.5 Female(253) £
TC2854	Lower wishbone (158)	A		Pinch Bolt (255) 18mm
TC2855	Lower wishbone (158)	B		Pinch Bolt (255) 18mm
TD1218W	Axle Bush (-76-)	A B		

...FIAT

500L 900cc, 1.4i, 1.3JTD, 1.6JTD (10/15→)



Part No	Description	Pos	Info	Technical
TA3023	Tie rod end(224)	A		M14x1.5 Female(253) £
TA3024	Tie rod end(224)	B		M14x1.5 Female(253) £
TD1218W	Axle Bush(-76-)	A B		

500X 1.3JTD, 1.4i, 1.4i 4x4, 1.6i, 1.6JTD, 2.0JTD, 2.0JTD 4x4 (09/14→)



Part No	Description	Pos	Info	Technical
TC3454	Lower wishbone(158)	A	(+) 4x4	Pinch Bolt(255) 19mm
TC3455	Lower wishbone(158)	B	(+) 4x4	Pinch Bolt(255) 19mm

BARCETTA 1.8i (04/95-05/05)



Part No	Description	Pos	Info	Technical
TA1506	Tie rod end(224)	A B		M12x1.5 Female(253) £
TA1507	Inner tie rod(123)	A B		M12x1.5 Male(252) £
TBR4040	Steering rack gaiter kit(213)	K		1 :10x53x53 2 :10x53x53
TC562	Lower wishbone(158)	B		Pinch Bolt(255) 15mm
TC563	Lower wishbone(158)	A		Pinch Bolt(255) 15mm
TD237W	Lower wishbone bush(159)	A B	Front(108)	
TD356W	Lower wishbone bush(159)	A	Rear(187)	
TD357W	Lower wishbone bush(159)	B	Rear(187)	
TD685W	Anti-roll bar(-74-) bush(-85-)	A B	Outer(176)	
TD1237W	Anti-roll bar(-74-) bush kit(-86-)	K	Ø17 Complete axle kit(-92-) Inner(119)	

BRAVA 1.2i, 1.4i, 1.6i, 1.8i, 1.9D, 1.9TD, 1.9JTD (01/98-12/02)

BRAVO 1.2i, 1.4i, 1.6i, 1.8i, 1.9D, 1.9TD, 1.9JTD (01/98-10/01)



TA1250



TA1597



TBR3098



TA1597



TA1249



TC2102



TC2102



TD448W



TC428



TD378W



TD378W



TC427



TD381W



TD382W



TD548W



TD548W

Part No	Description	Pos	Info	Technical
TA1249	Tie rod end(224)	B		M12x1.5 Female(253) £
TA1250	Tie rod end(224)	A		M12x1.5 Female(253) £
TA1597	Inner tie rod(123)	A B		M12x1.5 Male(252) £
TBR3098	Steering rack gaiter kit(213)	K		1 :11x55x55 2 :11x55x55
TC427	Lower wishbone(158)	B		Pinch Bolt(255) 17mm
TC428	Lower wishbone(158)	A		Pinch Bolt(255) 17mm
TC2102	Link stabiliser(135)	A B		
TD378W	Lower wishbone bush(159)	A B	Front(108)	
TD381W	Lower wishbone bush(159)	A	Rear(187)	
TD382W	Lower wishbone bush(159)	B	Rear(187)	
TD448W	Anti-roll bar(-74) bush kit(-86)	K	Ø23 Complete axle kit(-92)	
TD548W	Suspension arm repair kit(218)	A B		

BRAVO 2.0i (10/95-10/01)



TA1926



TA1597



TBR3098



TA1597



TA1927



TA1851



TA1852

...FIAT

... BRAVO 2.0i (10/95-10/01)



Part No	Description	Pos	Info	Technical
TA1597	Inner tie rod(123)	A B	(-) Sport	M12x1.5 Male(252) £
TA1851	Tie rod end(224)	A	Sport	M12x1.5 Female(253) £
TA1852	Tie rod end(224)	B	Sport	M12x1.5 Female(253) £
TA1926	Tie rod end(224)	A	(-) Sport	M12x1.5 Female(253) £
TA1927	Tie rod end(224)	B	(-) Sport	M12x1.5 Female(253) £
TBR3098	Steering rack gaiter kit(213)	K		1 :11x55x55 2 :11x55x55
TC894	Lower wishbone(158)	A		Pinch Bolt(255) 17mm
TC895	Lower wishbone(158)	B		Pinch Bolt(255) 17mm
TC2102	Link stabiliser(135)	A B		
TD378W	Lower wishbone bush(159)	A B	Front(108)	
TD381W	Lower wishbone bush(159)	A	Rear(187)	
TD382W	Lower wishbone bush(159)	B	Rear(187)	
TD448W	Anti-roll bar(-74) bush kit(-86)	K	Complete axle kit(-92)	
TD548W	Suspension arm repair kit(218)	A B		

BRAVO 1.4i, 1.6JTD, 1.8i, 1.9JTD, 2.0JTD (11/06→)



Part No	Description	Pos	Info	Technical
TA1806	Tie rod end(224)	A B		M14x1.5 Female(253) £
TA1807	Inner tie rod(123)	A B		M14x1.5 Male(252) £
TC1133	Link stabiliser(135)	A B		M10x1.5
TC2571	Lower wishbone(158)	A		Pinch Bolt(255) 17mm

... BRAVO 1.4i, 1.6JTD, 1.8i, 1.9JTD, 2.0JTD (11/06→)

Part No	Description	Pos	Info	Technical
TC2572	Lower wishbone(158)	B		Pinch Bolt (255) 17mm
TC2946	Lower ball joint(140)	A B		Pinch Bolt (255) 17mm
TD366W	Lower wishbone bush(159)	A B	Rear (187)	
TD1218W	Axle Bush(-76-)	A B		

CROMA 1.9JTD, 2.2i, 2.4JTD (06/05-10/05)



Part No	Description	Pos	Info	Technical
TA2041	Tie rod end(224)	A		M14x1.5 Female(253) £
TA2042	Tie rod end(224)	B		M14x1.5 Female(253) £
TBR4214	Steering rack gaiter kit(213)	K	Thermoplastic(223)	1 :13.5x56x56 2 :13.5x56x56
TC1573	Link stabiliser(135)	A B		
TC2075	Lower wishbone(158)	A		Pinch Bolt (255) 20mm
TC2076	Lower wishbone(158)	B		Pinch Bolt (255) 20mm
TC2085	Link stabiliser(135)	A B		M12x1.5
TC2143	Upper track control arm(242)	A B		
TD332W	Lower wishbone bush(159)	A B	Front (108)	
TD507W	Lower wishbone bush(159)	A B	Rear (187)	
TD554W	Upper track control arm bush(243)	A B	Outer (176)	
TD909W	Anti-roll bar(-74) bush kit(-86-)	K	Complete axle kit(-92)	
TD1024W	Anti-roll bar(-74) bush kit(-86-)	K	Complete axle kit(-92)	

...FIAT

CROMA 1.8i, 1.9JTD, 2.2i, 2.4JTD (10/05→)

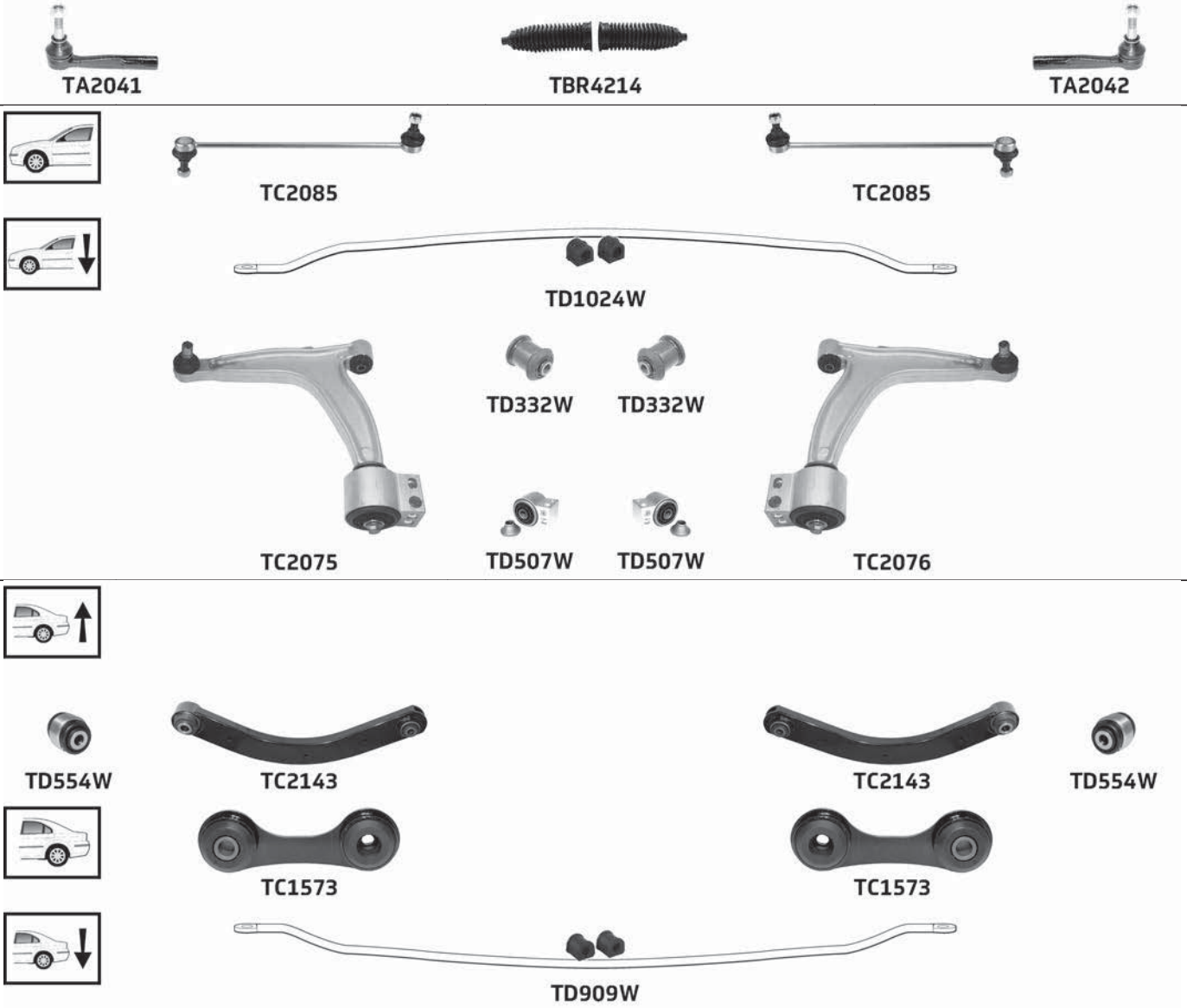

Part No	Description	Pos	Info	Technical
TA2041	Tie rod end(224)	A		M14x1.5 Female(253) £
TA2042	Tie rod end(224)	B		M14x1.5 Female(253) £
TBR4214	Steering rack gaiter kit(213)	K	Thermoplastic(223)	1 :13.5x56x56 2 :13.5x56x56
TC1573	Link stabiliser(135)	A B		
TC2075	Lower wishbone(158)	A		Pinch Bolt(255) 20mm
TC2076	Lower wishbone(158)	B		Pinch Bolt(255) 20mm
TC2085	Link stabiliser(135)	A B		M12x1.5
TC2143	Upper track control arm(242)	A B		
TD332W	Lower wishbone bush(159)	A B	Front(108)	
TD507W	Lower wishbone bush(159)	A B	Rear(187)	
TD554W	Upper track control arm bush(243)	A B	Outer(176)	
TD909W	Anti-roll bar(-74) bush kit(-86-)	K	Complete axle kit(-92-)	
TD1024W	Anti-roll bar(-74) bush kit(-86-)	K	Complete axle kit(-92-)	

DOBLÒ (119) 1.2i, 1.6i (03/01-09/05)
DOBLÒ CARGO (223) 1.2i, 1.6i (03/01-09/05)

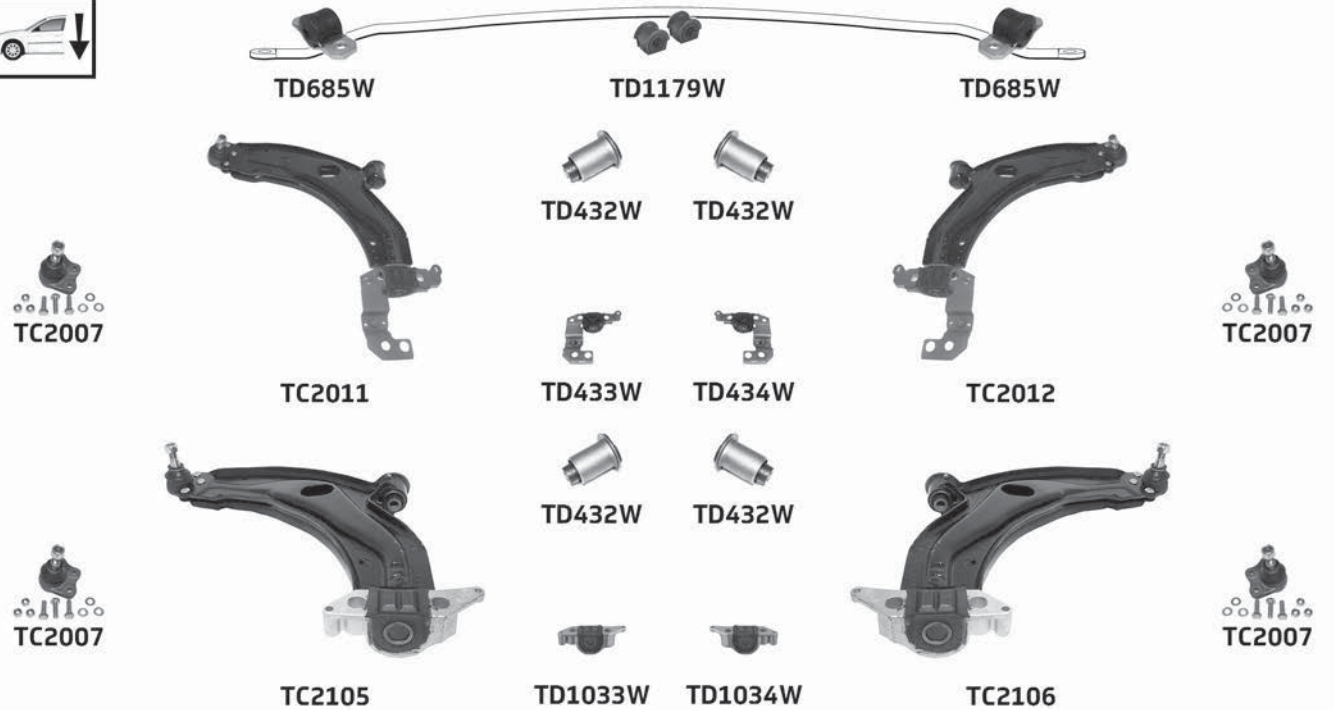

Part No	Description	Pos	Info	Technical
TA1692	Tie rod end(224)	A B	Manual steering(170) Power steering(185) →Ch. 5120134	M14x1.5 Female(253) £
TA1770	Tie rod end(224)	A	Power steering(185) Ch. 5120134→	M14x1.5 Female(253) £
TA1771	Tie rod end(224)	B	Power steering(185) Ch. 5120134→	M14x1.5 Female(253) £
TA1896	Inner tie rod(123)	A B	Power steering(185) Ch. 5120134→	M14x1.5 Male(252) £
TA2004	Inner tie rod(123)	A B	Manual steering(170) Power steering(185) →Ch. 5120134	M14x1.5 Male(252) £
TBR4204	Steering rack gaiter kit(213)	K	Thermoplastic(223)	1 :14x53x53 2 :14x53x53
TC2007	Lower ball joint(140)	A B		M12x1.25
TC2011	Lower wishbone(158)	A	(-) Heavy duty(-17-)	M12x1.25
TC2012	Lower wishbone(158)	B	(-) Heavy duty(-17-)	M12x1.25
TC2021	Link stabiliser(135)	A B		M10x1.25
TC2105	Lower wishbone(158)	A	Heavy duty(111)	M12x1.25
TC2106	Lower wishbone(158)	B	Heavy duty(111)	M12x1.25
TD432W	Lower wishbone bush(159)	A B	Front(108)	
TD433W	Lower wishbone bush(159)	A	Rear(187) (-) Heavy duty(-17-)	
TD434W	Lower wishbone bush(159)	B	Rear(187) (-) Heavy duty(-17-)	
TD685W	Anti-roll bar(-74-) bush(-85-)	A B	Outer(176) →Ch. 5023343	
TD1033W	Lower wishbone bush(159)	A	Rear(187) Heavy duty(111)	
TD1034W	Lower wishbone bush(159)	B	Rear(187) Heavy duty(111)	
TD1179W	Anti-roll bar(-74-) bush kit(-86-)	K	Inner(119) Ø21, Ø22 Anti-roll bar(-74-) Complete axle kit(-92-)	

...FIAT

DOBLÒ (119) 1.3JTD, 1.9D, 1.9JTD (03/01-09/05)

DOBLÒ CARGO (223) 1.3JTD, 1.9D, 1.9JTD (03/01-09/05)

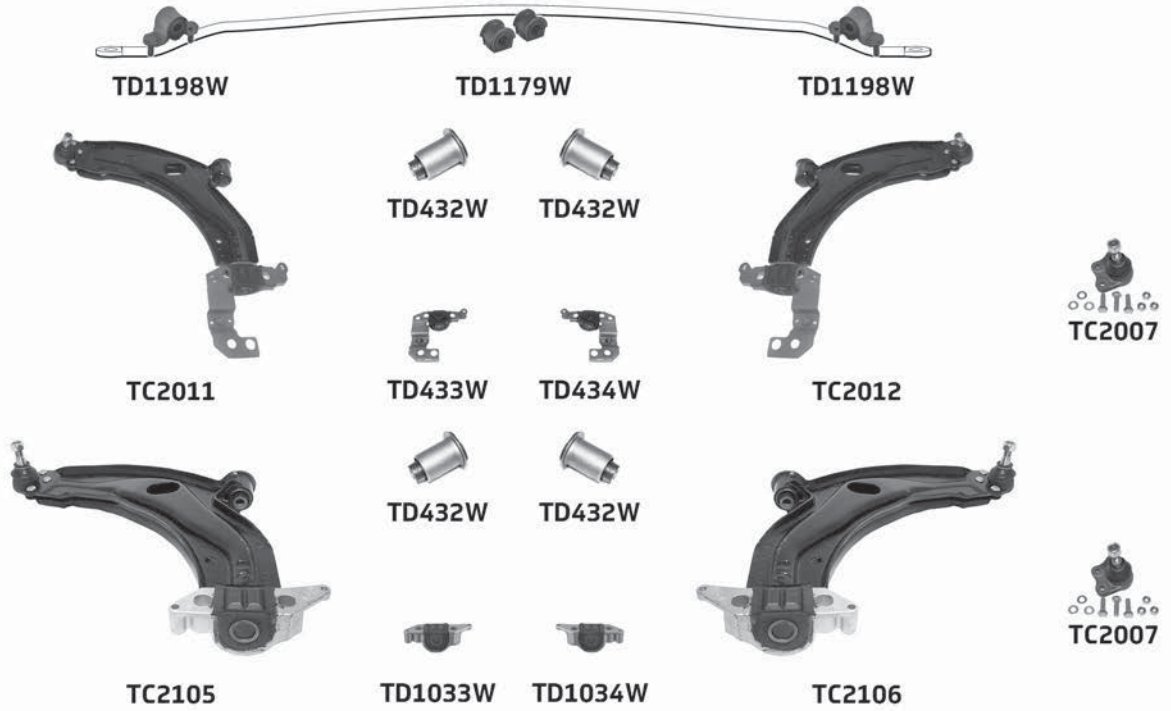

Part No	Description	Pos	Info	Technical
TA1692	Tie rod end(224)	A B	Manual steering(170) Power steering(185) →Ch. 5120134	M14x1.5 Female(253) E
TA1770	Tie rod end(224)	A	Power steering(185) Ch. 5120134→	M14x1.5 Female(253) E
TA1771	Tie rod end(224)	B	Power steering(185) Ch. 5120134→	M14x1.5 Female(253) E
TA1896	Inner tie rod(123)	A B	Power steering(185) Ch. 5120134→	M14x1.5 Male(252) E
TA2004	Inner tie rod(123)	A B	Manual steering(170) Power steering(185) →Ch. 5120134	M14x1.5 Male(252) E
TBR4204	Steering rack gaiter kit(213)	K	Thermoplastic(223)	1 :14x53x53 2 :14x53x53
TC2007	Lower ball joint(140)	A B		M12x1.25
TC2011	Lower wishbone(158)	A	(-) Heavy duty(-17-)	M12x1.25
TC2012	Lower wishbone(158)	B	(-) Heavy duty(-17-)	M12x1.25
TC2021	Link stabiliser(135)	A B		M10x1.25
TC2105	Lower wishbone(158)	A	Heavy duty(111)	M12x1.25
TC2106	Lower wishbone(158)	B	Heavy duty(111)	M12x1.25
TD432W	Lower wishbone bush(159)	A B	Front(108)	
TD433W	Lower wishbone bush(159)	A	Rear(187) (-) Heavy duty(-17-)	
TD434W	Lower wishbone bush(159)	B	Rear(187) (-) Heavy duty(-17-)	
TD1033W	Lower wishbone bush(159)	A	Rear(187) Heavy duty(111)	
TD1034W	Lower wishbone bush(159)	B	Rear(187) Heavy duty(111)	
TD1179W	Anti-roll bar(-74-) bush kit(-86-)	K	Inner(119) Ø21, Ø22 Anti-roll bar(-74-) Complete axle kit(-92-)	
TD1198W	Anti-roll bar(-74-) bush(-85-)	A B	Outer(176)	

DOBLÒ (119) 1.2i, 1.3JTD, 1.4i, 1.6i, 1.9D, 1.9JTD (10/05→)
DOBLÒ CARGO (223) 1.2i, 1.3JTD, 1.4i, 1.6i, 1.9D, 1.9JTD (10/05→)

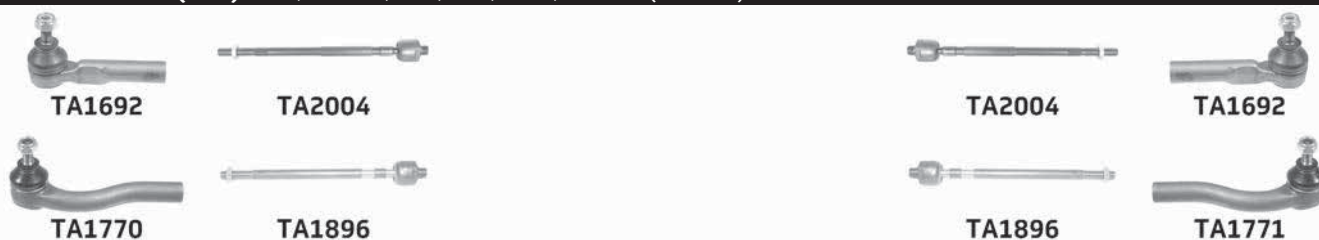

Part No	Description	Pos	Info	Technical
TA1692	Tie rod end(224)	A B	Manual steering(170)	M14x1.5 Female(253) £
TA1770	Tie rod end(224)	A	Power steering(185)	M14x1.5 Female(253) £
TA1771	Tie rod end(224)	B	Power steering(185)	M14x1.5 Female(253) £
TA1896	Inner tie rod(123)	A B	Power steering(185)	M14x1.5 Male(252) £
TA2004	Inner tie rod(123)	A B	Manual steering(170)	M14x1.5 Male(252) £
TC2007	Lower ball joint(140)	A B		M12x1.25
TC2021	Link stabiliser(135)	A B		M10x1.25
TC2635	Lower wishbone(158)	A		M12x1.25
TC2636	Lower wishbone(158)	B		M12x1.25
TD432W	Lower wishbone bush(159)	A B	Front(108)	
TD1198W	Anti-roll bar(-74) bush(-85-)	A B	Outer(176)	

DOBLÒ (152, 263) 1.3JTD, 1.4i, 1.6JTD, 2.0JTD (11/09→)
DOBLÒ CARGO (152, 263) 1.3JTD, 1.4i, 1.6JTD, 2.0JTD (11/09→)

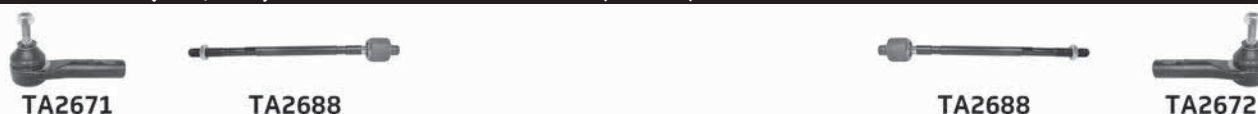

Part No	Description	Pos	Info	Technical
TA2671	Tie rod end(224)	A		M14x1.5 Female(253) £
TA2672	Tie rod end(224)	B		M14x1.5 Female(253) £
				(...)

...FIAT

... DOBLÒ (152, 263) 1.3JTD, 1.4i, 1.6JTD, 2.0JTD (11/09→)

... DOBLÒ CARGO (152, 263) 1.3JTD, 1.4i, 1.6JTD, 2.0JTD (11/09→)

Part No	Description	Pos	Info	Technical
TA2688	Inner tie rod(123)	A B	M16 into steering rack(124)	M14x1.5 Male(252) E
TC2432	Link stabiliser(135)	A B		M10x1.25
TC2484	Lower wishbone(158)	A		Pinch Bolt(255) 18mm
TC2485	Lower wishbone(158)	B		Pinch Bolt(255) 18mm
TD645W	Lower wishbone bush(159)	A B	Front(108)	
TD1109W	Lower wishbone bush(159)	A B	Rear(187)	

DUCATO 1.9D, 1.9TD, 2.0i, 2.0JTD, 2.5D, 2.5TD, 2.8D, 2.8JTD, 2.8TDi (03/94-04/02)



TA1671



TA1785



TBR4123



TA1785



TA1671



TBR4122



TC1059



TC1059



TC780



TD296W



TD296W



TC781



TC828



TC828



TC1284



TD296W



TD296W



TC1285



TC1283



TC1283



TC782



TD296W



TD296W



TC783



TC829



TC829



TC1287



TD296W



TD296W



TC1288



TC1286



TC1286



TD297W



TD297W

DUCATO 1.9D, 1.9TD, 2.0i, 2.0JTD, 2.5D, 2.5TD, 2.8D, 2.8JTD, 2.8TDi (03/94-04/02)



Part No	Description	Pos	Info	Technical
TA1671	Tie rod end(224)	A B		M16x1.5 Female(253) £
TA1785	Inner tie rod(123)	A B		M16x1.5 Male(252) £
TBR4122	Steering rack gaiter kit(213)	K	Power steering(185)	1 :15x53x53 2 :15x62x62
TBR4123	Steering rack gaiter kit(213)	K	Manual steering(170)	1 :15x53x53 2 :15x53x53
TC780	Lower wishbone(158)	A	1000/1400 Kg (-) Ball joint(-11) →Ch. 6086765, 6087205	
TC781	Lower wishbone(158)	B	1000/1400 Kg (-) Ball joint(-11) →Ch. 6086765, 6087205	
TC782	Lower wishbone(158)	A	1800 Kg (-) Ball joint(-11) →Ch. 6086765, 6087205	
TC783	Lower wishbone(158)	B	1800 Kg (-) Ball joint(-11) →Ch. 6086765, 6087205	
TC828	Lower ball joint(140)	A B	1000/1400 Kg →Ch. 6086765, 6087205	M16x1.5
TC829	Lower ball joint(140)	A B	1800 Kg →Ch. 6086765, 6087205	M18x1.5
TC1059	Link stabiliser(135)	A B		
TC1283	Lower ball joint(140)	A B	1000/1400 Kg Ch. 6086766, 6087206→	M16x1.5
TC1284	Lower wishbone(158)	A	1000/1400 Kg (-) Ball joint(-11) Ch. 6086766, 6087206→	
TC1285	Lower wishbone(158)	B	1000/1400 Kg (-) Ball joint(-11) Ch. 6086766, 6087206→	
TC1286	Lower ball joint(140)	A B	1800 Kg Ch. 6086766, 6087206→	M18x1.5
TC1287	Lower wishbone(158)	A	1800 Kg (-) Ball joint(-11) Ch. 6086766, 6087206→	
TC1288	Lower wishbone(158)	B	1800 Kg (-) Ball joint(-11) Ch. 6086766, 6087206→	
TD296W	Lower wishbone bush(159)	A B	Front(108)	
TD297W	Lower wishbone bush(159)	A B	Rear(187)	
TD1031W	Leaf spring bush(128)	A B	Rear(187)	
TD1143W	Leaf spring bush(128)	A B	Front(108)	

FIAT

...FIAT

DUCATO 2.0i, 2.0JTD, 2.3JTD, 2.8JTD (04/02-06/06)

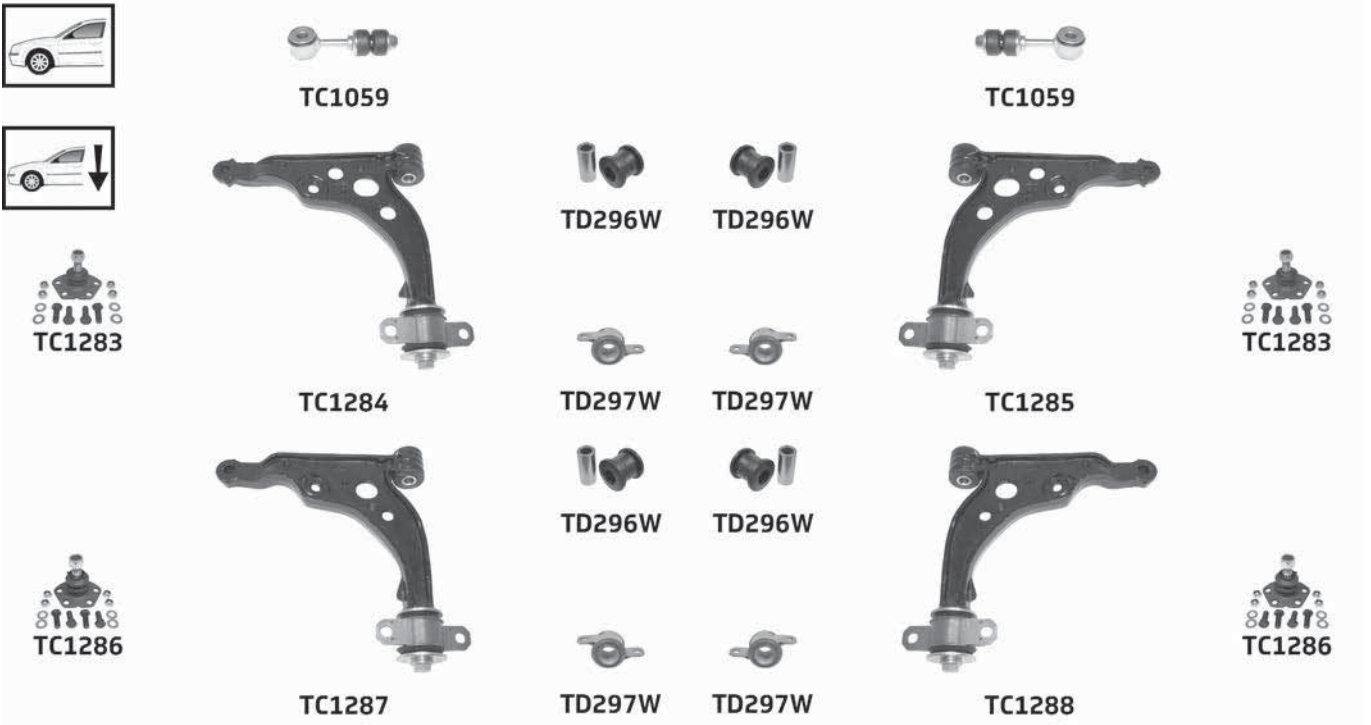

Part No	Description	Pos	Info	Technical
TA1671	Tie rod end(224)	A B	→Ch. 7175290	M16x1.5 Female(253) £
TA1785	Inner tie rod(123)	A B		M16x1.5 Male(252) £
TA1931	Tie rod end(224)	A B	Ch. 7175291→	M16x1.5 Female(253) £
TBR4122	Steering rack gaiter kit(213)	K		1 :15x53x53 2 :15x62x62
TC1059	Link stabiliser(135)	A B		
TC1283	Lower ball joint(140)	A B	1100/1500 Kg	M16x1.5
TC1284	Lower wishbone(158)	A	1100/1500 Kg (-) Ball joint(-11)	
TC1285	Lower wishbone(158)	B	1100/1500 Kg (-) Ball joint(-11)	
TC1286	Lower ball joint(140)	A B	1800 Kg	M18x1.5
TC1287	Lower wishbone(158)	A	1800 Kg (-) Ball joint(-11)	
TC1288	Lower wishbone(158)	B	1800 Kg (-) Ball joint(-11)	
TD296W	Lower wishbone bush(159)	A B	Front(108)	
TD297W	Lower wishbone bush(159)	A B	Rear(187)	

--	--	--	--	--

FIAT

DUCATO 2.2JTD, 2.3JTD, 3.0JTD (07/06→)

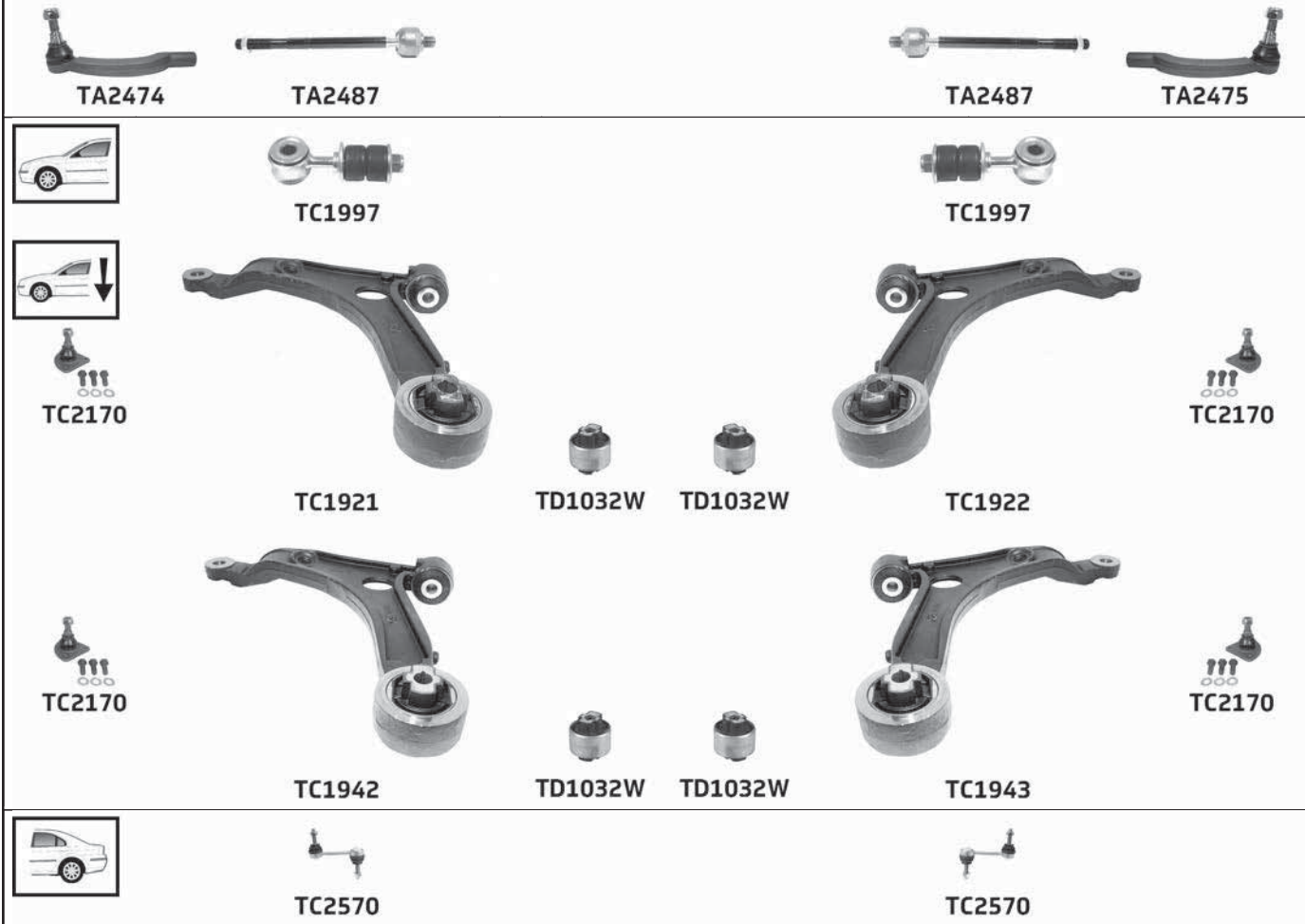

Part No	Description	Pos	Info	Technical
TA2474	Tie rod end (224)	A		M16x1.5 Female(253) £
TA2475	Tie rod end (224)	B		M16x1.5 Female(253) £
TA2487	Inner tie rod (123)	A B		M16x1.5 Male (252) £
TC1921	Lower wishbone (158)	A	1100/1700L Kg (-) Ball joint (-11-)	
TC1922	Lower wishbone (158)	B	1100/1700L Kg (-) Ball joint (-11-)	
TC1942	Lower wishbone (158)	A	1700H/2000 Kg (-) Ball joint (-11-)	
TC1943	Lower wishbone (158)	B	1700H/2000 Kg (-) Ball joint (-11-)	
TC1997	Link stabiliser (135)	A B		
TC2170	Lower ball joint (140)	A B		M16x1.5
TC2570	Link stabiliser (135)	A B		M10x1.25
TD1032W	Lower wishbone bush (159)	A B	Rear (187)	

...FIAT

DUCATO (RUSSIAN BUILD) 2.3JTD (02/08→)

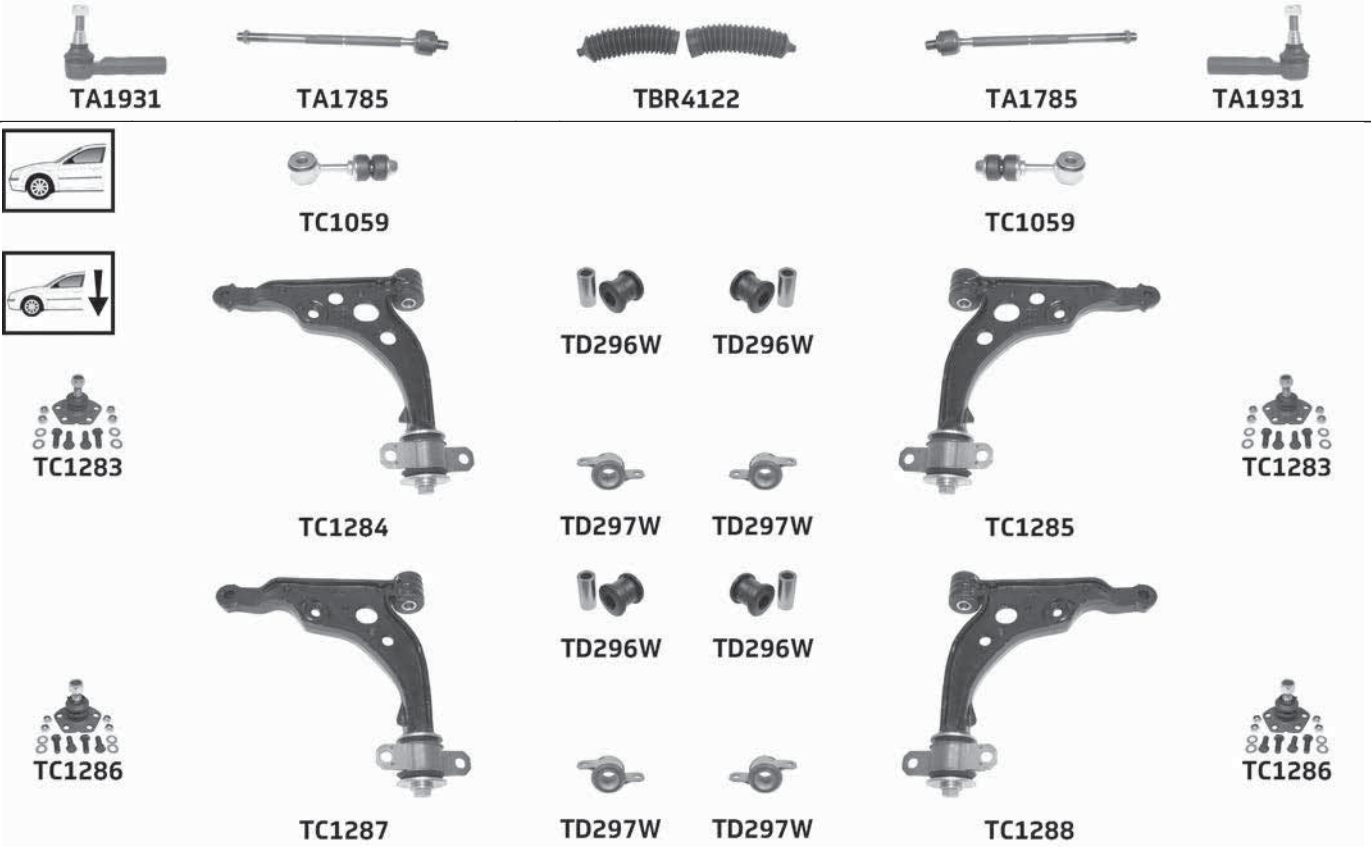

Part No	Description	Pos	Info	Technical
TA1785	Inner tie rod(123)	A B		M16x1.5 Male(252) £
TA1931	Tie rod end(224)	A B		M16x1.5 Female(253) £
TBR4122	Steering rack gaiter kit(213)	K		1 :15x53x53 2 :15x62x62
TC1059	Link stabiliser(135)	A B		
TC1283	Lower ball joint(140)	A B	1100/1500 Kg	M16x1.5
TC1284	Lower wishbone(158)	A	1100/1500 Kg (-) Ball joint(-11)	
TC1285	Lower wishbone(158)	B	1100/1500 Kg (-) Ball joint(-11)	
TC1286	Lower ball joint(140)	A B	1800 Kg	M18x1.5
TC1287	Lower wishbone(158)	A	1800 Kg (-) Ball joint(-11)	
TC1288	Lower wishbone(158)	B	1800 Kg (-) Ball joint(-11)	
TD296W	Lower wishbone bush(159)	A B	Front(108)	
TD297W	Lower wishbone bush(159)	A B	Rear(187)	

FIORINO 1.3JTD, 1.4i (02/08→)

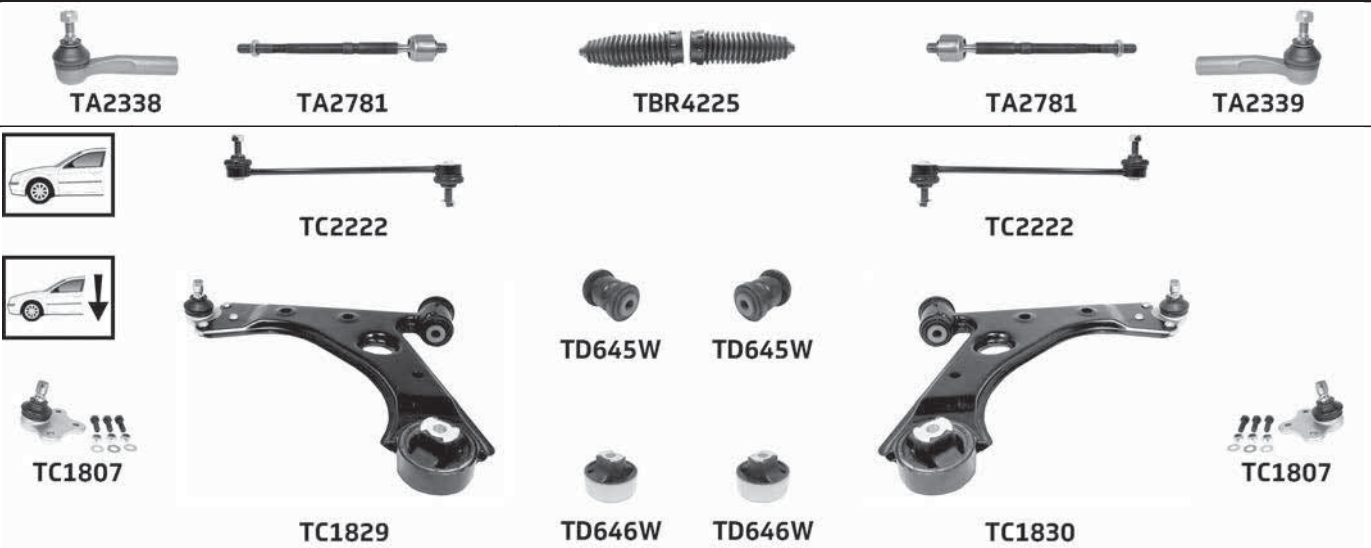

Part No	Description	Pos	Info	Technical
TA2338	Tie rod end(224)	A		M14x1.5 Female(253) £
TA2339	Tie rod end(224)	B		M14x1.5 Female(253) £
TA2781	Inner tie rod(123)	A B		M14x1.5 Male(252) £
TBR4225	Steering rack gaiter kit(213)	K	Thermoplastic(223)	1 :12x55x55 2 :12x55x55

... FIORINO 1.3JTD, 1.4i (02/08→)

Part No	Description	Pos	Info	Technical
TC1807	Lower ball joint(140)	A B		Pinch Bolt(255) 16mm
TC1829	Lower wishbone(158)	A		Pinch Bolt(255) 16mm
TC1830	Lower wishbone(158)	B		Pinch Bolt(255) 16mm
TC2222	Link stabiliser(135)	A B		M10x1.25
TD645W	Lower wishbone bush(159)	A B	Front(108)	
TD646W	Lower wishbone bush(159)	A B	Rear(187)	

FREEMONT 2.0JTD, 3.6i (08/11→)



Part No	Description	Pos	Info	Technical
TC3203	Lower wishbone(158)	A		
TC3204	Lower wishbone(158)	B		
TC3675	Lower ball joint(140)	A B		

GRANDE PUNTO 1.2i, 1.3JTD, 1.4i, 1.4i Abarth, 1.6JTD, 1.9JTD (10/05→)



Part No	Description	Pos	Info	Technical
TA2338	Tie rod end(224)	A		M14x1.5 Female(253) £
TA2339	Tie rod end(224)	B		M14x1.5 Female(253) £
TA2413	Inner tie rod(123)	A B		M14x1.5 Male(252) £
TBR4225	Steering rack gaiter kit(213)	K	Thermoplastic(223)	1 :12x55x55 2 :12x55x55
TC1806	Link stabiliser(135)	A B		M10x1.5
TC1807	Lower ball joint(140)	A B		Pinch Bolt(255) 16mm
TC1829	Lower wishbone(158)	A		Pinch Bolt(255) 16mm
TC1830	Lower wishbone(158)	B		Pinch Bolt(255) 16mm
TD645W	Lower wishbone bush(159)	A B	Front(108)	
TD646W	Lower wishbone bush(159)	A B	Rear(187)	
TD921W	Axle bush(-76)	A B	(-) Abarth	

...FIAT

GRANDE PUNTO ACTUAL 1.2i, 1.3JTD, 1.4i (10/09→)

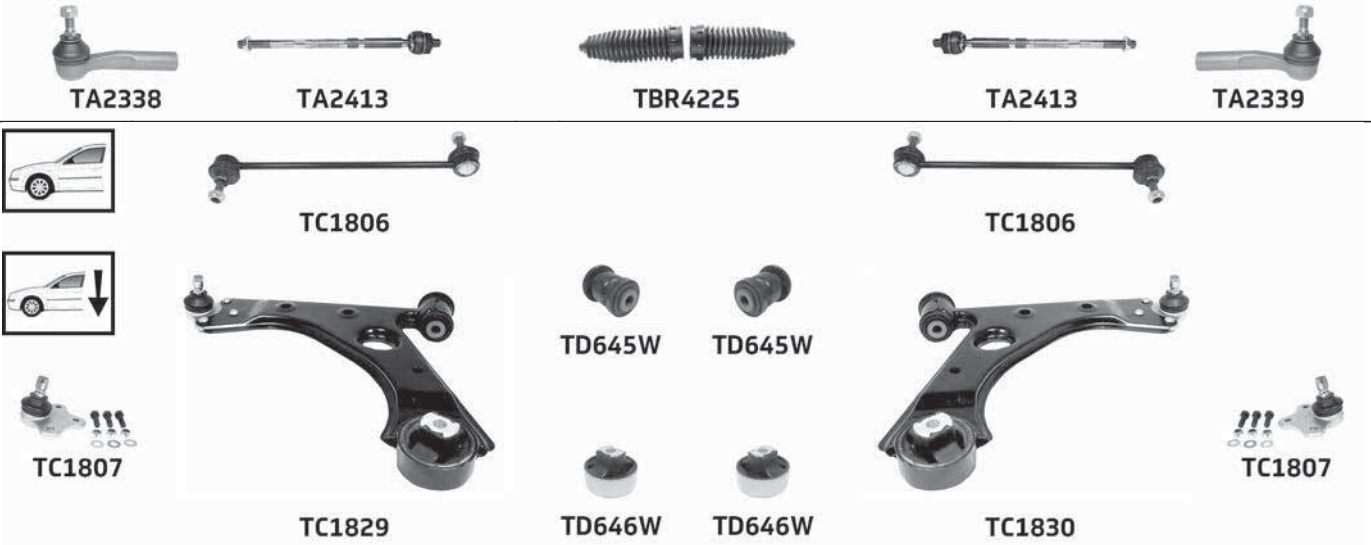

Part No	Description	Pos	Info	Technical
TA2338	Tie rod end(224)	A		M14x1.5 Female(253) £
TA2339	Tie rod end(224)	B		M14x1.5 Female(253) £
TA2413	Inner tie rod(123)	A B		M14x1.5 Male(252) £
TBR4225	Steering rack gaiter kit(213)	K	Thermoplastic(223)	1 :12x55x55 2 :12x55x55
TC1806	Link stabiliser(135)	A B		M10x1.5
TC1807	Lower ball joint(140)	A B		Pinch Bolt(255) 16mm
TC1829	Lower wishbone(158)	A		Pinch Bolt(255) 16mm
TC1830	Lower wishbone(158)	B		Pinch Bolt(255) 16mm
TD645W	Lower wishbone bush(159)	A B	Front(108)	
TD646W	Lower wishbone bush(159)	A B	Rear(187)	
TD921W	Axle bush(-76-)	A B	(-) Abarth	

IDEA 1.2i, 1.3JTD, 1.4i, 1.9JTD (01/04→)



Part No	Description	Pos	Info	Technical
TA1985	Tie rod end(224)	A B		M14x1.5 Female(253) £
TA1986	Inner tie rod(123)	A B		M14x1.5 Male(252) £
TBR4227	Steering rack gaiter kit(213)	K		1 :12.5x54x54 2 :12.5x54x54
TC1431	Lower wishbone(158)	A		Pinch Bolt(255) 17mm
TC1432	Lower wishbone(158)	B		Pinch Bolt(255) 17mm
TD706W	Lower wishbone bush(159)	A B	Front(108)	
TD707W	Lower wishbone bush(159)	A B	Rear(187)	

LINEA 1.3JTD, 1.4i (06/07-)

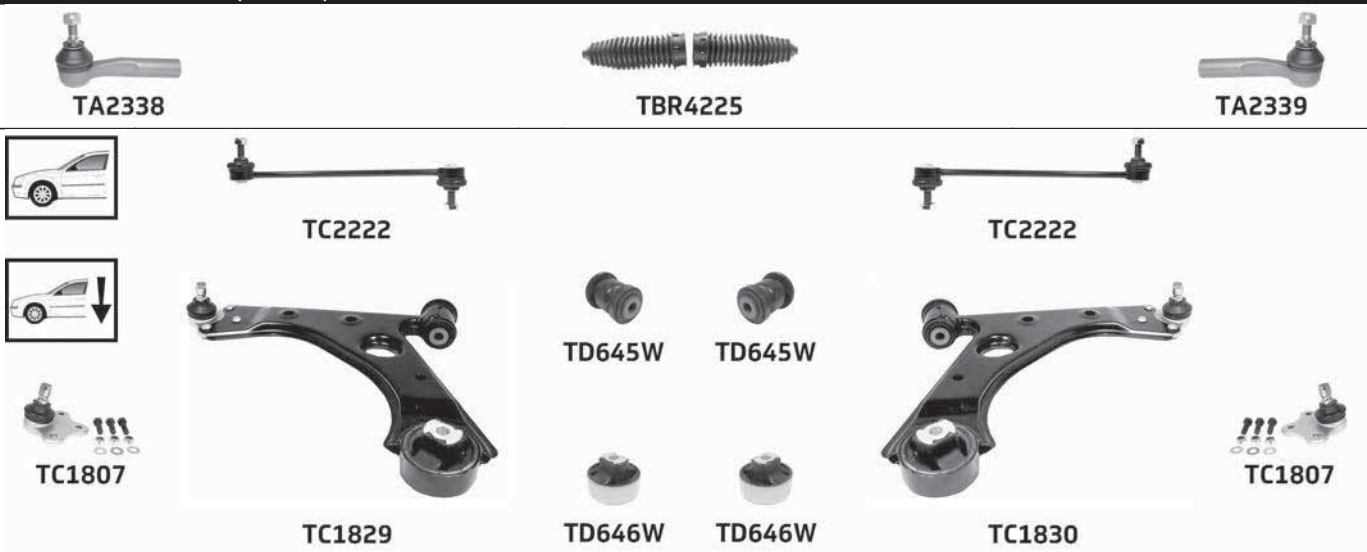

Part No	Description	Pos	Info	Technical
TA2338	Tie rod end(224)	A		M14x1.5 Female(253) £
TA2339	Tie rod end(224)	B		M14x1.5 Female(253) £
TBR4225	Steering rack gaiter kit(213)	K	Thermoplastic(223)	1 :12x55x55 2 :12x55x55
TC1807	Lower ball joint(140)	A B		Pinch Bolt(255) 16mm
TC1829	Lower wishbone(158)	A		Pinch Bolt(255) 16mm
TC1830	Lower wishbone(158)	B		Pinch Bolt(255) 16mm
TC2222	Link stabiliser(135)	A B		M10x1.25
TD645W	Lower wishbone bush(159)	A B	Front(108)	
TD646W	Lower wishbone bush(159)	A B	Rear(187)	

MULTIPLA 1.6i, 1.9JTD (04/99-12/10)

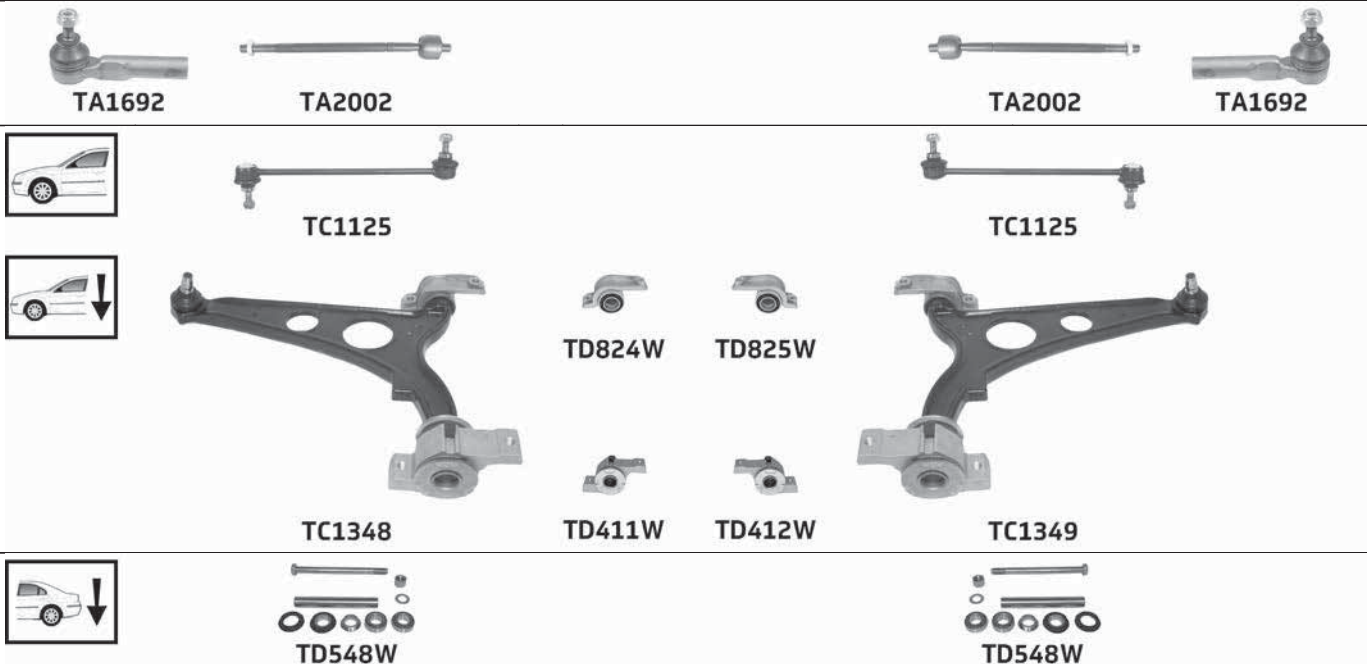

Part No	Description	Pos	Info	Technical
TA1692	Tie rod end(224)	A B		M14x1.5 Female(253) £
TA2002	Inner tie rod(123)	A B		M14x1.5 Male(252) £
TC1125	Link stabiliser(135)	A B		M10x1.25
TC1348	Lower wishbone(158)	A		Pinch Bolt(255) 17mm
TC1349	Lower wishbone(158)	B		Pinch Bolt(255) 17mm
TD411W	Lower wishbone bush(159)	A	Rear(187)	Inner(119) Ø20.9mm
TD412W	Lower wishbone bush(159)	B	Rear(187)	Inner(119) Ø20.9mm
TD548W	Suspension arm repair kit(218)	A B		
TD824W	Lower wishbone bush(159)	A	Front(108)	
TD825W	Lower wishbone bush(159)	B	Front(108)	

...FIAT

PALIO 1.0i, 1.2i, 1.4i, 1.5i, 1.6i, 1.7TD, 1.9D (09/99-12/01)

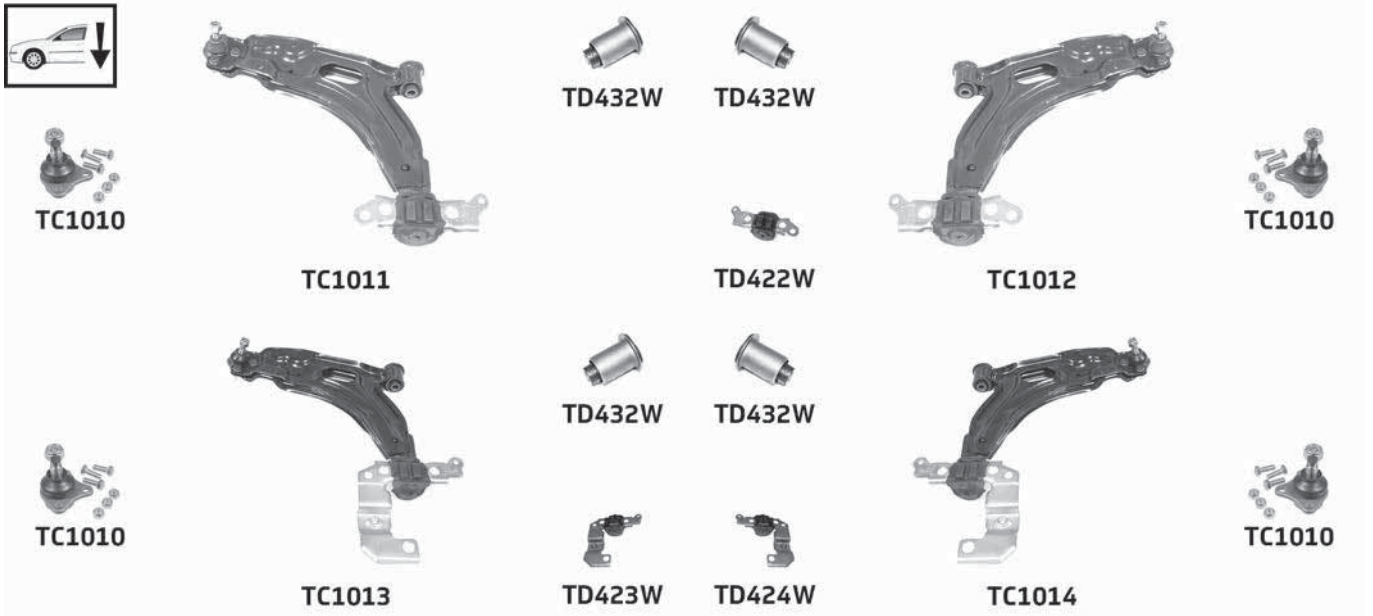

Part No	Description	Pos	Info	Technical
TA1770	Tie rod end(224)	A		M14x1.5 Female(253) £
TA1771	Tie rod end(224)	B		M14x1.5 Female(253) £
TA2615	Inner tie rod(123)	A B	Power steering(185)	M14x1.5 Male(252) £
TA2691	Inner tie rod(123)	A B	Manual steering(170)	M14x1.5 Male(252) £
TC1010	Lower ball joint(140)	A B		M12x1.25
TC1011	Lower wishbone(158)	A	Manual steering(170)	M12x1.25
TC1012	Lower wishbone(158)	B	Manual steering(170)	M12x1.25
TC1013	Lower wishbone(158)	A	Power steering(185)	M12x1.25
TC1014	Lower wishbone(158)	B	Power steering(185)	M12x1.25
TD422W	Lower wishbone bush(159)	B	Rear(187) Manual steering(170)	
TD423W	Lower wishbone bush(159)	A	Rear(187) Power steering(185)	
TD424W	Lower wishbone bush(159)	B	Rear(187) Power steering(185)	
TD432W	Lower wishbone bush(159)	A B	Front(108)	
TD548W	Suspension arm repair kit(218)	A B		

PALIO 1.0i, 1.2i, 1.4i, 1.5i, 1.6i, 1.7TD, 1.9D (01/02→)



Part No	Description	Pos	Info	Technical
TA1770	Tie rod end(224)	A		M14x1.5 Female(253) £
TA1771	Tie rod end(224)	B		M14x1.5 Female(253) £
TA2616	Inner tie rod(123)	A B	Power steering(185)	M14x1.5 Male(252) £
TA2635	Inner tie rod(123)	A B	Manual steering(170)	M14x1.5 Male(252) £
TC2007	Lower ball joint(140)	A B		M12x1.25
TC2011	Lower wishbone(158)	A		M12x1.25
TC2012	Lower wishbone(158)	B		M12x1.25
TD432W	Lower wishbone bush(159)	A B	Front(108)	
TD433W	Lower wishbone bush(159)	A	Rear(187)	
TD434W	Lower wishbone bush(159)	B	Rear(187)	
TD548W	Suspension arm repair kit(218)	A B		
TD1179W	Anti-roll bar(-74) bush kit(-86-)	K	Inner(119) Ø21, Ø22 Anti-roll bar(-74) Complete axle kit(-92-)	
TD1198W	Anti-roll bar(-74) bush(-85-)	A B	Outer(176)	

PANDA (169) 1.1i, 1.2i (-) 4x4, 1.3JTD (-) 4x4 (09/03→)

PANDA VAN (169) 1.1i, 1.2i (-) 4x4, 1.3JTD (-) 4x4 (03/04→)



Part No	Description	Pos	Info	Technical
TA1967	Tie rod end(224)	A		M12x1.5 Female(253) £
TA1968	Tie rod end(224)	B		M12x1.5 Female(253) £

(...)

...FIAT

... PANDA (169) 1.1i, 1.2i (-) 4x4, 1.3JTD (-) 4x4 (09/03→)

... PANDA VAN (169) 1.1i, 1.2i (-) 4x4, 1.3JTD (-) 4x4 (03/04→)

Part No	Description	Pos	Info	Technical
TA1969	Inner tie rod(123)	A B		M12x1.5 Male(252) £
TBR4205	Steering rack gaiter kit(213)	K	Thermoplastic(223)	1 :10.5x54.5x54.5 2 :10.5x54.5x54.5
TC1406	Link stabiliser(135)	A B		M10x1.25
TC1407	Lower wishbone(158)	A		Pinch Bolt(255) 15mm
TC1408	Lower wishbone(158)	B		Pinch Bolt(255) 15mm
TD358W	Lower wishbone bush(159)	A B	Front(108)	
TD1027W	Lower wishbone bush(159)	A B	Rear(187)	

PANDA (169) 1.4i (10/06→)

PANDA VAN (169) 1.4i (10/09→)



Part No	Description	Pos	Info	Technical
TA1967	Tie rod end(224)	A		M12x1.5 Female(253) £
TA1968	Tie rod end(224)	B		M12x1.5 Female(253) £
TA1969	Inner tie rod(123)	A B		M12x1.5 Male(252) £
TBR4205	Steering rack gaiter kit(213)	K	Thermoplastic(223)	1 :10.5x54.5x54.5 2 :10.5x54.5x54.5

PANDA (169) 1.2i 4x4, 1.3JTD 4x4 (09/04→)

PANDA VAN (169) 1.2i 4x4, 1.3JTD 4x4 (09/04→)

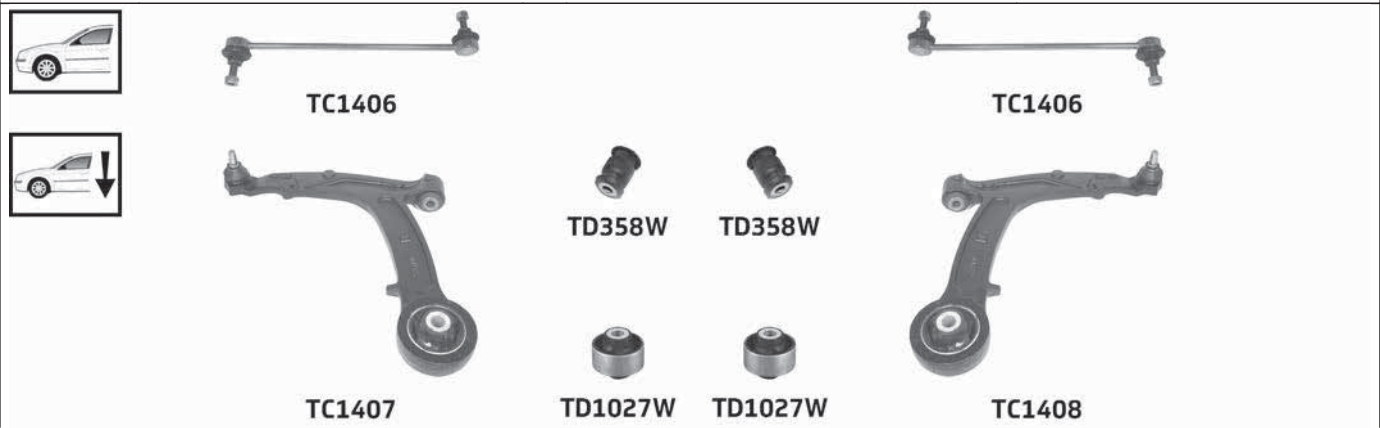

Part No	Description	Pos	Info	Technical
TA1967	Tie rod end(224)	A		M12x1.5 Female(253) £
TA1968	Tie rod end(224)	B		M12x1.5 Female(253) £
TBR4205	Steering rack gaiter kit(213)	K	Thermoplastic(223)	1 :10.5x54.5x54.5 2 :10.5x54.5x54.5
TC1406	Link stabiliser(135)	A B		M10x1.25
TC1407	Lower wishbone(158)	A		Pinch Bolt(255) 15mm
TC1408	Lower wishbone(158)	B		Pinch Bolt(255) 15mm
TC2290	Link stabiliser(135)	A B		M10x1.25
TD358W	Lower wishbone bush(159)	A B	Front(108)	
TD1027W	Lower wishbone bush(159)	A B	Rear(187)	

PANDA (312) 900cc, 900cc 4x4, 1.2i, 1.3JTD, 1.3JTD 4x4 (02/12→)

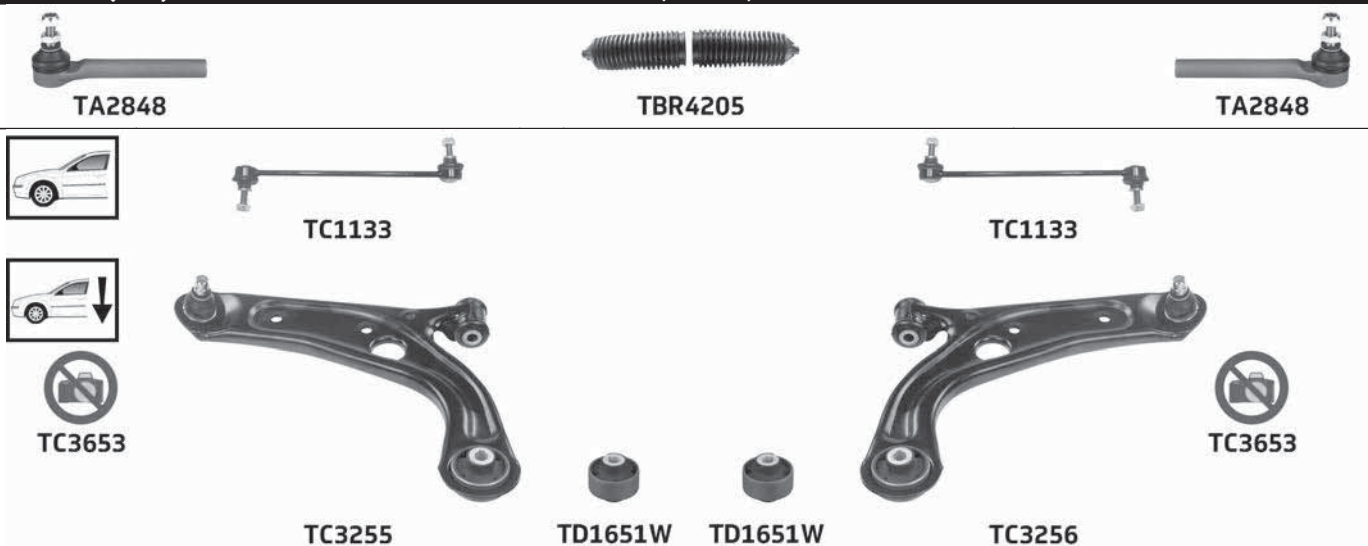

Part No	Description	Pos	Info	Technical
TA2848	Tie rod end (224)	A B		M12x1.5 Female(253) £
TBR4205	Steering rack gaiter kit (213)	K	Thermoplastic(223)	1 :10.5x54.5x54.5 2 :10.5x54.5x54.5
TC1133	Link stabiliser (135)	A B		M10x1.5
TC3255	Lower wishbone (158)	A		Pinch Bolt (255) 17mm
TC3256	Lower wishbone (158)	B		Pinch Bolt (255) 17mm
TC3653	Lower ball joint (140)	A B		
TD1651W	Lower wishbone bush (159)	A B	Rear (187)	

PANDA CLASSIC 1.2i, 1.3JTD, 1.4i (01/12→)

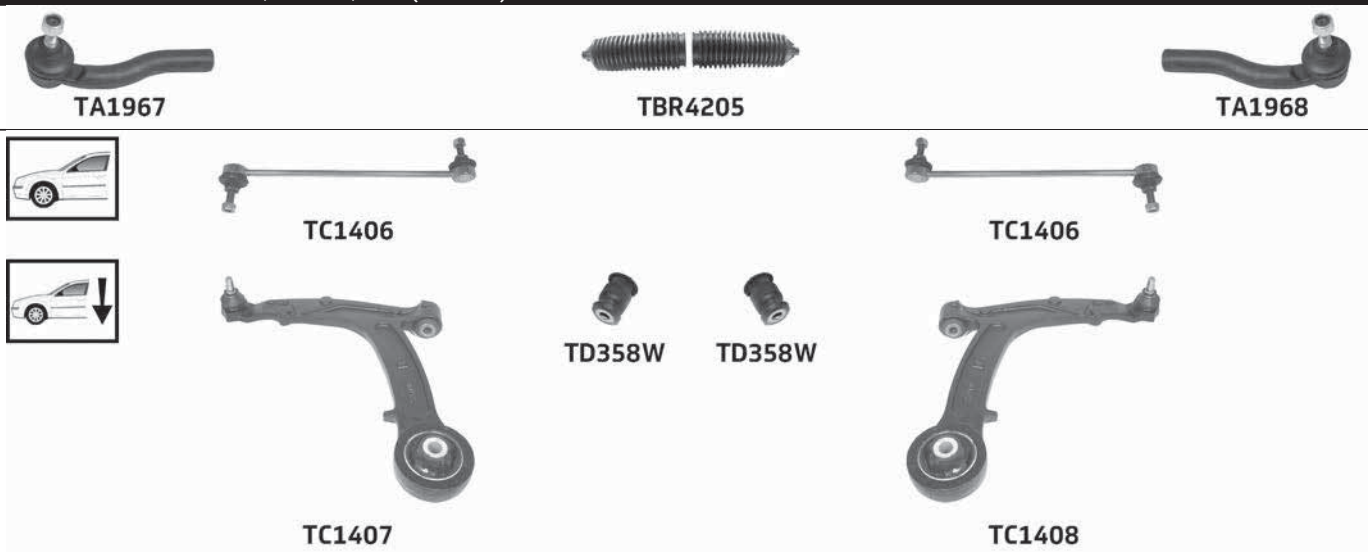

Part No	Description	Pos	Info	Technical
TA1967	Tie rod end (224)	A		M12x1.5 Female(253) £
TA1968	Tie rod end (224)	B		M12x1.5 Female(253) £
TBR4205	Steering rack gaiter kit (213)	K	Thermoplastic(223)	1 :10.5x54.5x54.5 2 :10.5x54.5x54.5
TC1406	Link stabiliser (135)	A B		M10x1.25
TC1407	Lower wishbone (158)	A		Pinch Bolt (255) 15mm
TC1408	Lower wishbone (158)	B		Pinch Bolt (255) 15mm
TD358W	Lower wishbone bush (159)	A B	Front (108)	
TD1027W	Lower wishbone bush (159)	A B	Rear (187)	

...FIAT

PUNTO (188) 1.2i, 1.3JTD, 1.4i, 1.9D, 1.9JTD (08/99→)

PUNTO VAN (188) 1.2i, 1.9D, 1.9JTD (02/00-10/09)



TA1506



TA1818



TBR4040



TA1818



TA1506



TC1960KIT



TD685W



TD685W



TC1057



TD358W



TD358W



TD359W



TD359W



TC1058

Part No	Description	Pos	Info	Technical
TA1506	Tie rod end(224)	A B		M12x1.5 Female(253) £
TA1818	Inner tie rod(123)	A B		M12x1.5 Male(252) £
TBR4040	Steering rack gaiter kit(213)	K		1 :10x53x53 2 :10x53x53
TC1057	Lower wishbone(158)	A		Pinch Bolt(255) 15mm
TC1058	Lower wishbone(158)	B		Pinch Bolt(255) 15mm
TC1960KIT	Steering and suspension kit(211)	K		
TD358W	Lower wishbone bush(159)	A B	Front(108)	
TD359W	Lower wishbone bush(159)	A B	Rear(187)	
TD685W	Anti-roll bar(-74) bush(-85)	A B	Outer(176)	

PUNTO (188) 1.8i HGT (08/99→)



TA1506



TA1818



TBR4040



TA1818



TA1506



TD685W



TD685W

Part No	Description	Pos	Info	Technical
TA1506	Tie rod end(224)	A B		M12x1.5 Female(253) £
TA1818	Inner tie rod(123)	A B		M12x1.5 Male(252) £
TBR4040	Steering rack gaiter kit(213)	K		1 :10x53x53 2 :10x53x53
TD685W	Anti-roll bar(-74) bush(-85)	A B	Outer(176)	

PUNTO (199) 900cc, 1.2i, 1.3JTD, 1.4i, 1.4i Abarth (03/12→)

PUNTO VAN (199) 900cc, 1.3JTD, 1.4i (04/08→)

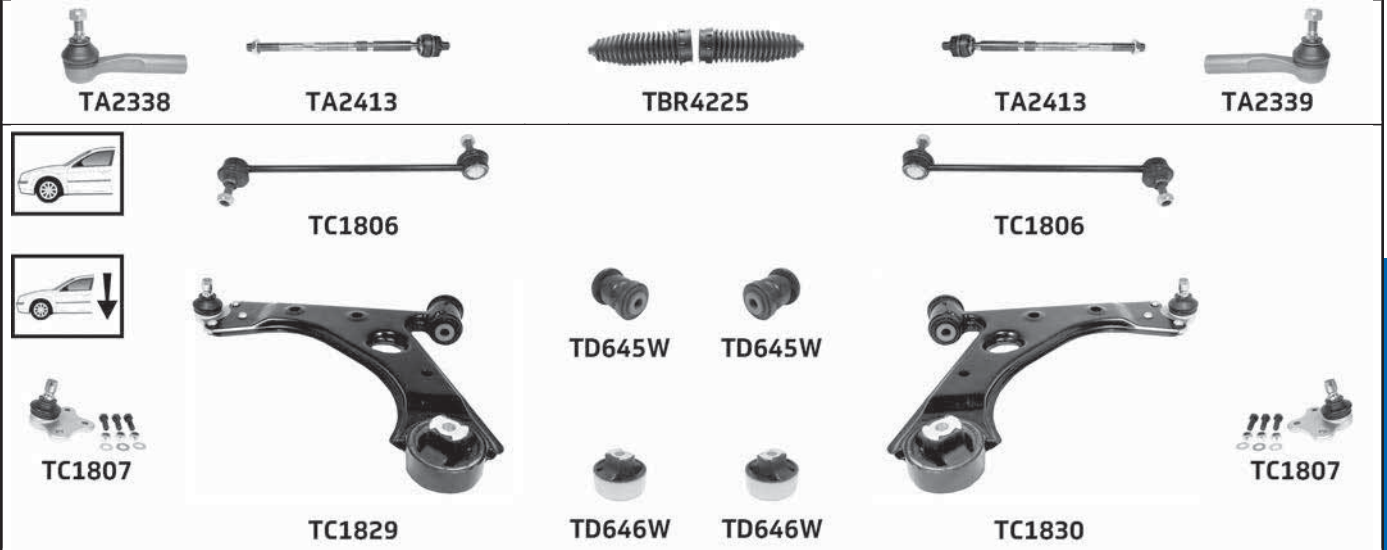

Part No	Description	Pos	Info	Technical
TA2338	Tie rod end(224)	A		M14x1.5 Female(253) £
TA2339	Tie rod end(224)	B		M14x1.5 Female(253) £
TA2413	Inner tie rod(123)	A B		M14x1.5 Male(252) £
TBR4225	Steering rack gaiter kit(213)	K	Thermoplastic(223)	1 :12x55x55 2 :12x55x55
TC1806	Link stabiliser(135)	A B		M10x1.5
TC1807	Lower ball joint(140)	A B		Pinch Bolt(255) 16mm
TC1829	Lower wishbone(158)	A		Pinch Bolt(255) 16mm
TC1830	Lower wishbone(158)	B		Pinch Bolt(255) 16mm
TD645W	Lower wishbone bush(159)	A B	Front(108)	
TD646W	Lower wishbone bush(159)	A B	Rear(187)	
TD921W	Axle bush(-76)	A B	(-) Abarth	

PUNTO EVO (199) 1.2i, 1.3JTD, 1.4i, 1.4i Abarth, 1.6JTD (10/09-02/12)

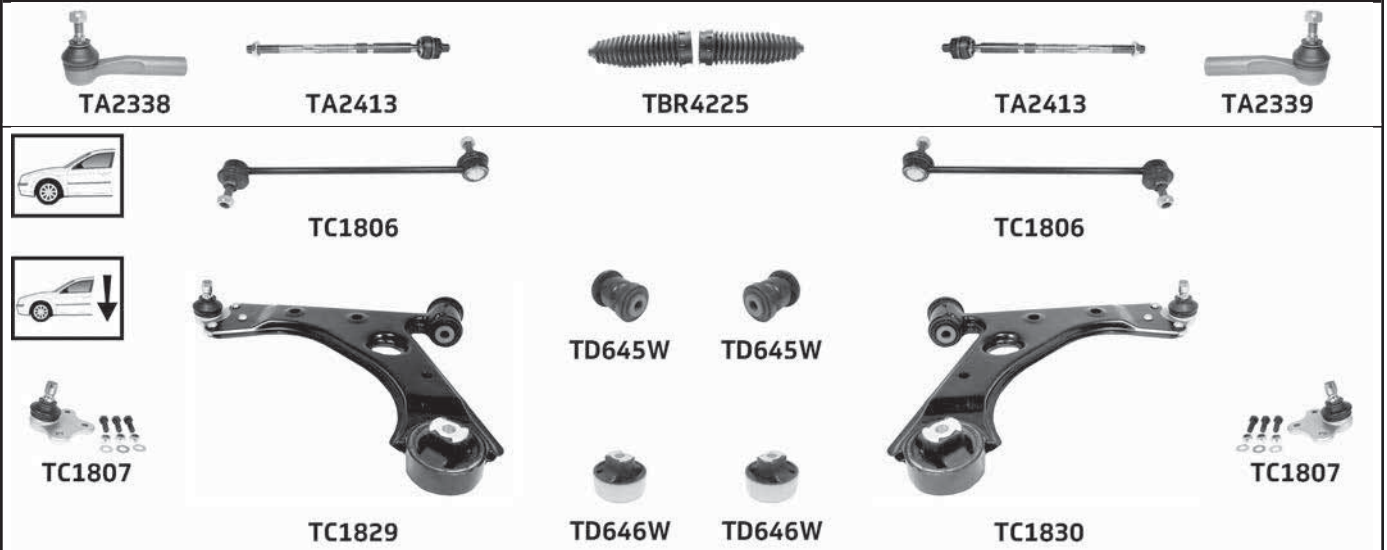

Part No	Description	Pos	Info	Technical
TA2338	Tie rod end(224)	A		M14x1.5 Female(253) £
TA2339	Tie rod end(224)	B		M14x1.5 Female(253) £
TA2413	Inner tie rod(123)	A B		M14x1.5 Male(252) £
TBR4225	Steering rack gaiter kit(213)	K	Thermoplastic(223)	1 :12x55x55 2 :12x55x55
TC1806	Link stabiliser(135)	A B		M10x1.5

(...)

...FIAT

... PUNTO EVO (199) 1.2i, 1.3JTD, 1.4i, 1.4i Abarth, 1.6JTD (10/09-02/12)

Part No	Description	Pos	Info	Technical
TC1807	Lower ball joint(140)	A B		Pinch Bolt(255) 16mm
TC1829	Lower wishbone(158)	A		Pinch Bolt(255) 16mm
TC1830	Lower wishbone(158)	B		Pinch Bolt(255) 16mm
TD645W	Lower wishbone bush(159)	A B	Front(108)	
TD646W	Lower wishbone bush(159)	A B	Rear(187)	
TD921W	Axle bush(-76-)	A B	(-) Abarth	

QUBO 1.3JTD, 1.4i (12/08→)

Part No	Description	Pos	Info	Technical
TA2338	Tie rod end(224)	A		M14x1.5 Female(253) £
TA2339	Tie rod end(224)	B		M14x1.5 Female(253) £
TA2781	Inner tie rod(123)	A B		M14x1.5 Male(252) £
TBR4225	Steering rack gaiter kit(213)	K	Thermoplastic(223)	1 :12x55x55 2 :12x55x55
TC1807	Lower ball joint(140)	A B		Pinch Bolt(255) 16mm
TC1829	Lower wishbone(158)	A		Pinch Bolt(255) 16mm
TC1830	Lower wishbone(158)	B		Pinch Bolt(255) 16mm
TC2222	Link stabiliser(135)	A B		M10x1.25
TD645W	Lower wishbone bush(159)	A B	Front(108)	
TD646W	Lower wishbone bush(159)	A B	Rear(187)	

SCUDO 1.6i, 1.9D, 1.9TD, 2.0i, 2.0JTD (01/96-06/03)

SCUDO 1.6i, 1.9D, 1.9TD, 2.0i, 2.0JTD (01/96-06/03)



Part No	Description	Pos	Info	Technical
TA1607	Tie rod end(224)	A B	→Vet 0009714	M14x1.5 Female(253) £
TA1608	Inner tie rod(123)	A B		M14x1.5 Male(252) £
TBR4121	Steering rack gaiter kit(213)	K		1 :13x62x62 2 :13x62x62
TC859	Lower wishbone(158)	A	12mm mounting holes(-59-)	Pinch Bolt(255) 17mm
TC860	Lower wishbone(158)	B	12mm mounting holes(-59-)	Pinch Bolt(255) 17mm
TC1191	Link stabiliser(135)	A B		
TD353W	Lower wishbone bush(159)	A B	Front(108) 12mm mounting holes(-59-)	
TD354W	Lower wishbone bush(159)	A	Rear(187) 12mm mounting holes(-59-)	
TD355W	Lower wishbone bush(159)	B	Rear(187) 12mm mounting holes(-59-)	
TD1126W	Axle Bush(-76-)	A B		
TD1197W	Anti-roll bar(-74-) bush kit(-86-)	K		

SCUDO 1.6i, 1.9D, 1.9TD, 2.0i, 2.0JTD (06/03-07/06)



TC859

TD354W

TD355W

TC860



Part No	Description	Pos	Info	Technical
TA1608	Inner tie rod(123)	A B		M14x1.5 Male(252) £
TA2058	Tie rod end(224)	A B	Vet 0009715→	M14x1.5 Female(253) £
TBR4121	Steering rack gaiter kit(213)	K		1 :13x62x62 2 :13x62x62
TC859	Lower wishbone(158)	A	12mm mounting holes(-59-)	Pinch Bolt(255) 17mm
TC860	Lower wishbone(158)	B	12mm mounting holes(-59-)	Pinch Bolt(255) 17mm
TC1191	Link stabiliser(135)	A B		
TD353W	Lower wishbone bush(159)	A B	Front(108) 12mm mounting holes(-59-)	
TD354W	Lower wishbone bush(159)	A	Rear(187) 12mm mounting holes(-59-)	
TD355W	Lower wishbone bush(159)	B	Rear(187) 12mm mounting holes(-59-)	
TD1126W	Axle Bush(-76-)	A B		

...FIAT

SCUDO 1.6i, 1.9D, 1.9TD, 2.0i, 2.0JTD (07/06-12/06)

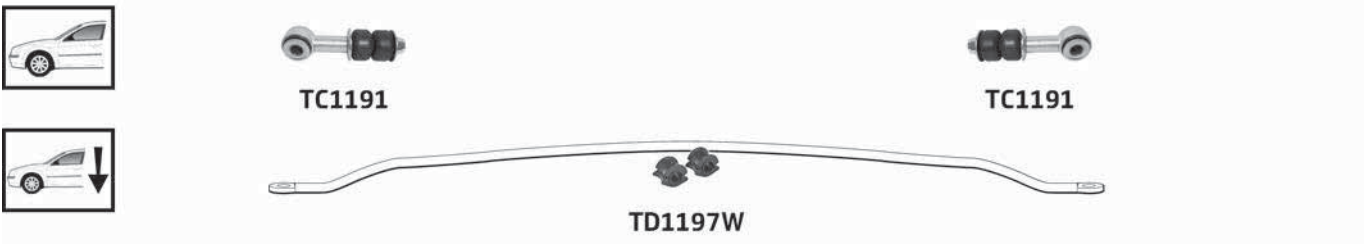

Part No	Description	Pos	Info	Technical
TA1608	Inner tie rod(123)	A B		M14x1.5 Male(252) £
TA2058	Tie rod end(224)	A B		M14x1.5 Female(253) £
TBR4121	Steering rack gaiter kit(213)	K		1 :13x62x62 2 :13x62x62
TC1191	Link stabiliser(135)	A B		
TD1126W	Axle Bush(-76-)	A B		
TD1197W	Anti-roll bar(-74-) bush kit(-86-)	K		

SCUDO 1.6HDi, 2.0HDi (01/07→)



Part No	Description	Pos	Info	Technical
TA2506	Tie rod end(224)	A B		M14x1.5 Female(253) £
TA2507	Inner tie rod(123)	A B		M14x1.5 Male(252) £
TC2167	Link stabiliser(135)	A B		M12x1.75
TC2244	Lower wishbone(158)	A		Pinch Bolt(255) 19mm
TC2245	Lower wishbone(158)	B		Pinch Bolt(255) 19mm
TD643W	Lower wishbone bush(159)	A	Rear(187)	
TD644W	Lower wishbone bush(159)	B	Rear(187)	
TD1103W	Lower wishbone bush(159)	A B	Front(108)	
TD1178W	Anti-roll bar(-74-) bush kit(-86-)	K	Ø25 Complete axle kit(-92-)	

SEDICI 1.6i, 1.9JTD, 2.0JTD (06/06→)

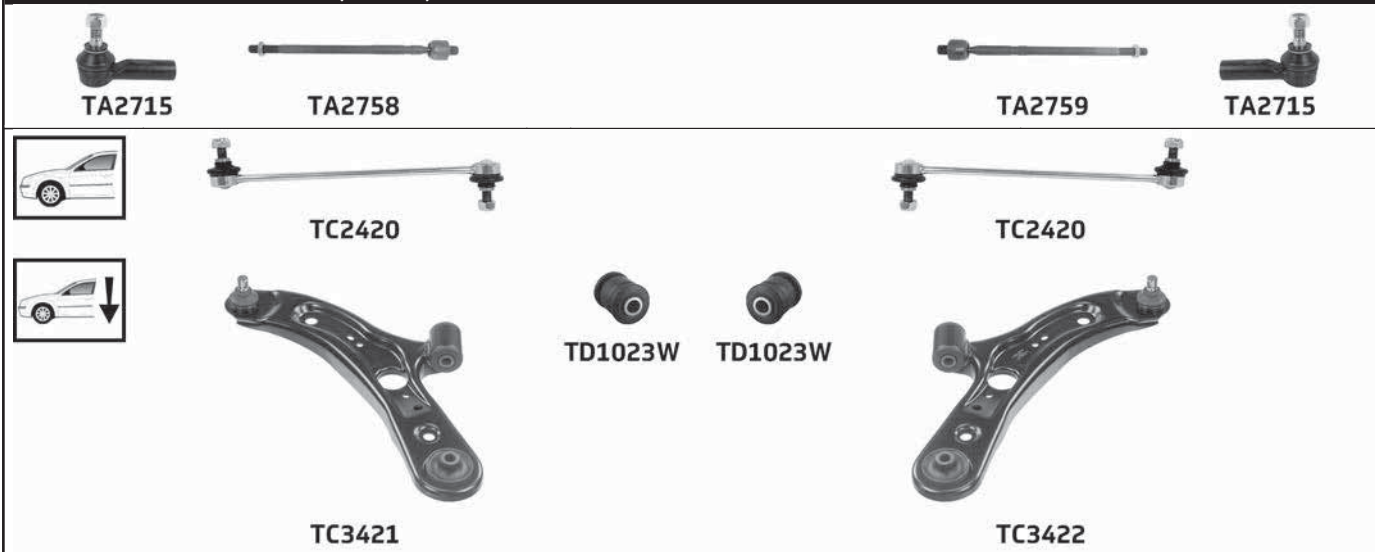

Part No	Description	Pos	Info	Technical
TA2715	Tie rod end(224)	A B		M14x1.5 Female(253) £
TA2758	Inner tie rod(123)	A		M14x1.5 Male(252) £
TA2759	Inner tie rod(123)	B		M14x1.5 Male(252) £
TC2420	Link stabiliser(135)	A B		M10x1.25
TC3421	Lower wishbone(158)	A		Pinch Bolt(255) Ø16.5mm
TC3422	Lower wishbone(158)	B		Pinch Bolt(255) Ø16.5mm
TD1023W	Lower wishbone bush(159)	A B	Front(108)	

SEICENTO 900cci, 1.1i (01/98-01/10)



Part No	Description	Pos	Info	Technical
TA1133	Tie rod end(224)	A B		M12x1.5 Female(253) £
TA1461	Inner tie rod(123)	A B		M12x1.5 Male(252) £
TBR4012	Steering rack gaiter kit(213)	K		1 :9x40x40 2 :9x40x40
TC568	Lower wishbone(158)	B		M10x1.25
TC569	Lower wishbone(158)	A		M10x1.25
TD237W	Lower wishbone bush(159)	A B	Front(108)	
TD238W	Lower wishbone bush(159)	A B	Rear(187)	

FIAT

...FIAT

STILO 1.2i, 1.4i, 1.6i, 1.8i, 1.9JTD, 2.4i (10/01-10/06)

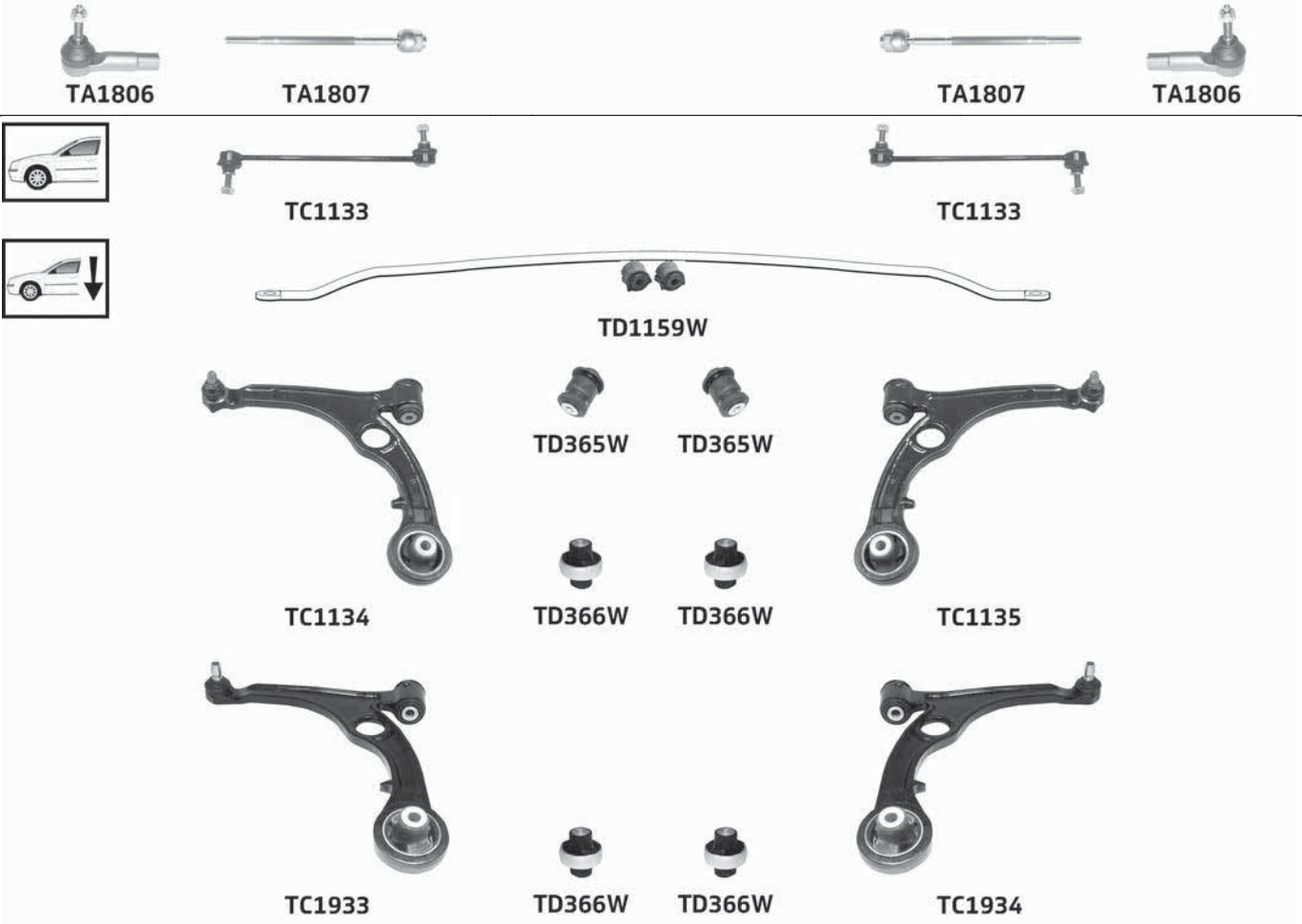

Part No	Description	Pos	Info	Technical
TA1806	Tie rod end(224)	A B		M14x1.5 Female(253) £
TA1807	Inner tie rod(123)	A B		M14x1.5 Male(252) £
TC1133	Link stabiliser(135)	A B		M10x1.5
TC1134	Lower wishbone(158)	A	→Ch. 495306, 495452	Pinch Bolt(255) 17mm
TC1135	Lower wishbone(158)	B	→Ch. 495306, 495452	Pinch Bolt(255) 17mm
TC1933	Lower wishbone(158)	A	Ch. 495307, 495453→	Pinch Bolt(255) 17mm
TC1934	Lower wishbone(158)	B	Ch. 495307, 495453→	Pinch Bolt(255) 17mm
TD365W	Lower wishbone bush(159)	A B	Front(108) →Ch. 495306, 495452	
TD366W	Lower wishbone bush(159)	A B	Rear(187)	
TD1159W	Anti-roll bar(-74) bush kit(-86-)	K	Ø17 Complete axle kit(-92-)	
TD1218W	Axle Bush(-76-)	A B		

FIAT

STILO 1.2i, 1.4i, 1.6i, 1.8i, 1.9JTD, 2.4i (10/06-08/08)

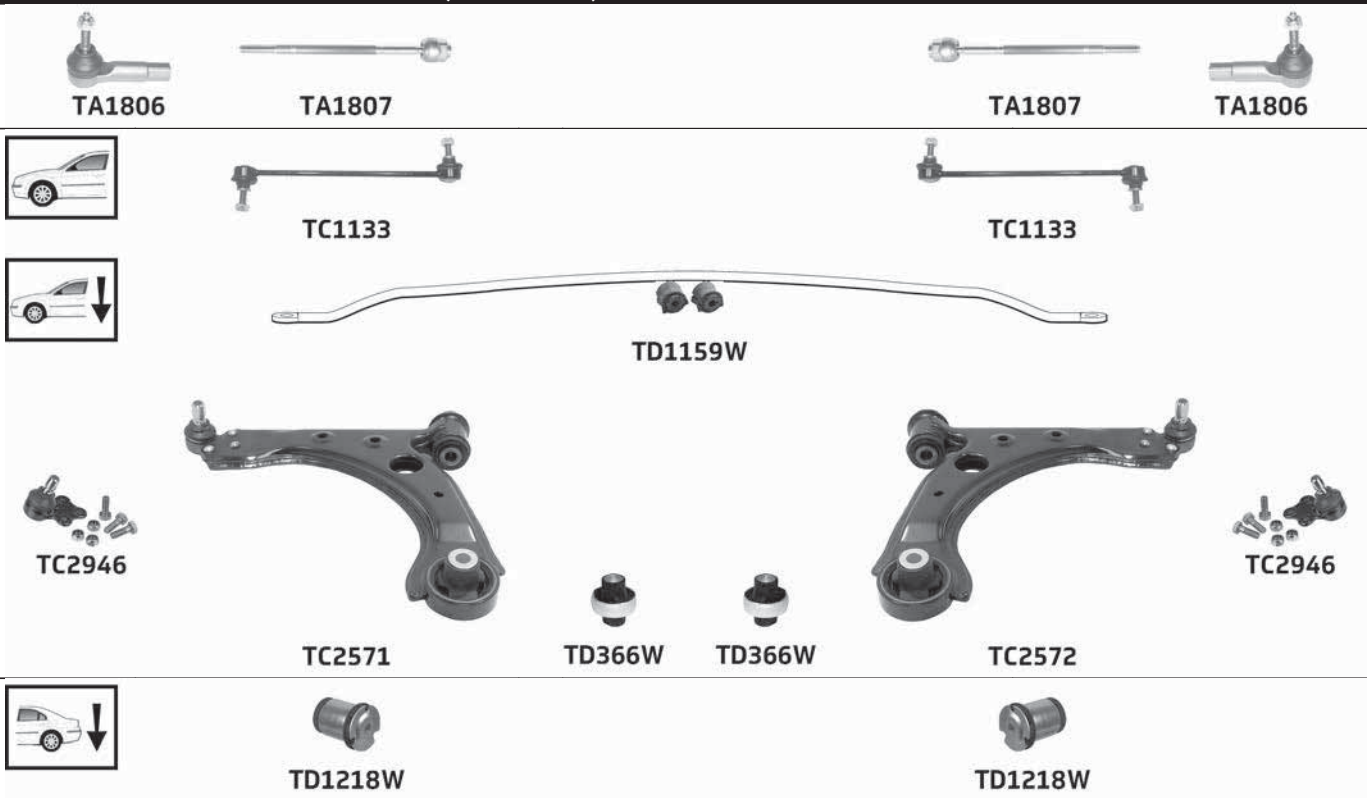

Part No	Description	Pos	Info	Technical
TA1806	Tie rod end(224)	A B		M14x1.5 Female(253) £
TA1807	Inner tie rod(123)	A B		M14x1.5 Male(252) £
TC1133	Link stabiliser(135)	A B		M10x1.5
TC2571	Lower wishbone(158)	A		Pinch Bolt(255) 17mm
TC2572	Lower wishbone(158)	B		Pinch Bolt(255) 17mm
TC2946	Lower ball joint(140)	A B		Pinch Bolt(255) 17mm
TD366W	Lower wishbone bush(159)	A B	Rear(187)	
TD1159W	Anti-roll bar(-74) bush kit(-86)	K	Ø17 Complete axle kit(-92)	
TD1218W	Axle Bush(-76)	A B		

STRADA 1.2i, 1.3D, 1.4i, 1.6i, 1.7TD, 1.8i, 1.9D, 1.9JTD Pick-up (08/01→)

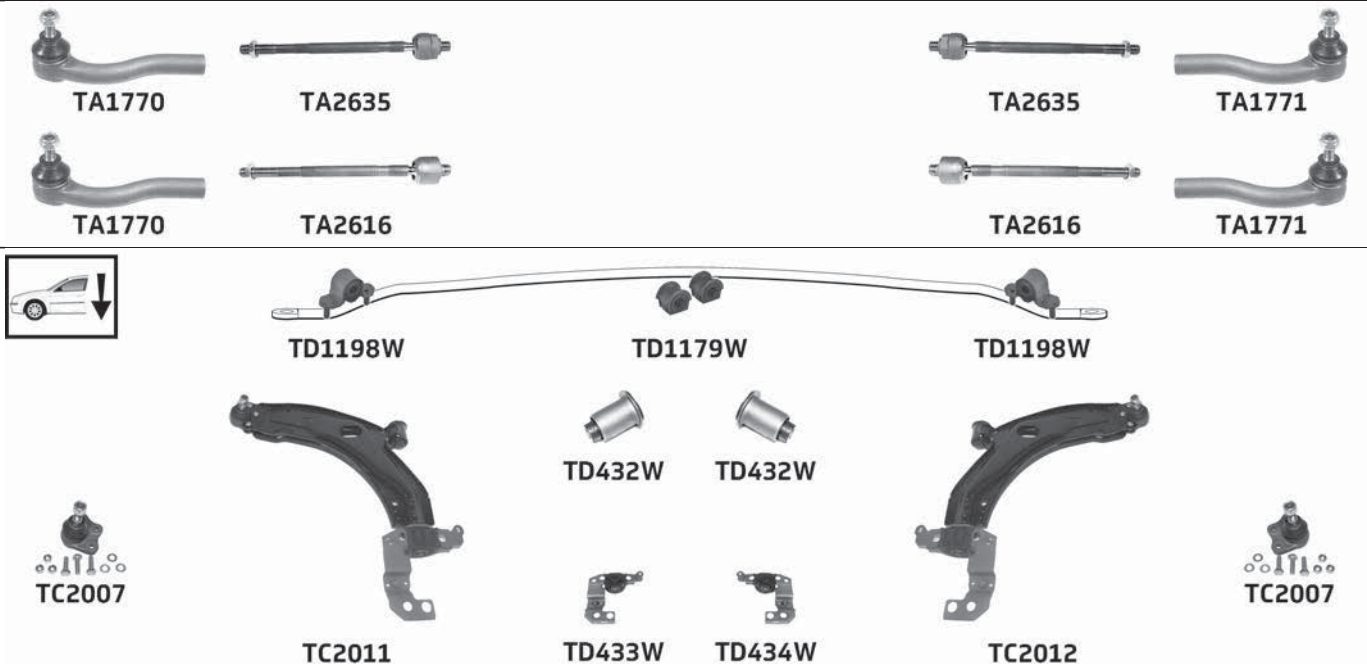

Part No	Description	Pos	Info	Technical
TA1770	Tie rod end(224)	A		M14x1.5 Female(253) £
TA1771	Tie rod end(224)	B		M14x1.5 Female(253) £
TA2616	Inner tie rod(123)	A B	Power steering(185)	M14x1.5 Male(252) £
TA2635	Inner tie rod(123)	A B	Manual steering(170)	M14x1.5 Male(252) £

(...)

...FIAT

... STRADA 1.2i, 1.3D, 1.4i, 1.6i, 1.7TD, 1.8i, 1.9D, 1.9JTD Pick-up (08/01→)

Part No	Description	Pos	Info	Technical
TC2007	Lower ball joint(140)	A B		M12x1.25
TC2011	Lower wishbone(158)	A		M12x1.25
TC2012	Lower wishbone(158)	B		M12x1.25
TD432W	Lower wishbone bush(159)	A B	Front(108)	
TD433W	Lower wishbone bush(159)	A	Rear(187)	
TD434W	Lower wishbone bush(159)	B	Rear(187)	
TD1179W	Anti-roll bar(-74-) bush kit(-86-)	K	Ø21, Ø22 Anti-roll bar(-74-) Complete axle kit(-92-)	
TD1198W	Anti-roll bar(-74-) bush(-85-)	A B	Outer(176)	

TIPO 1.3JTD, 1.4i, 1.6i, 1.6JTD (10/15→)

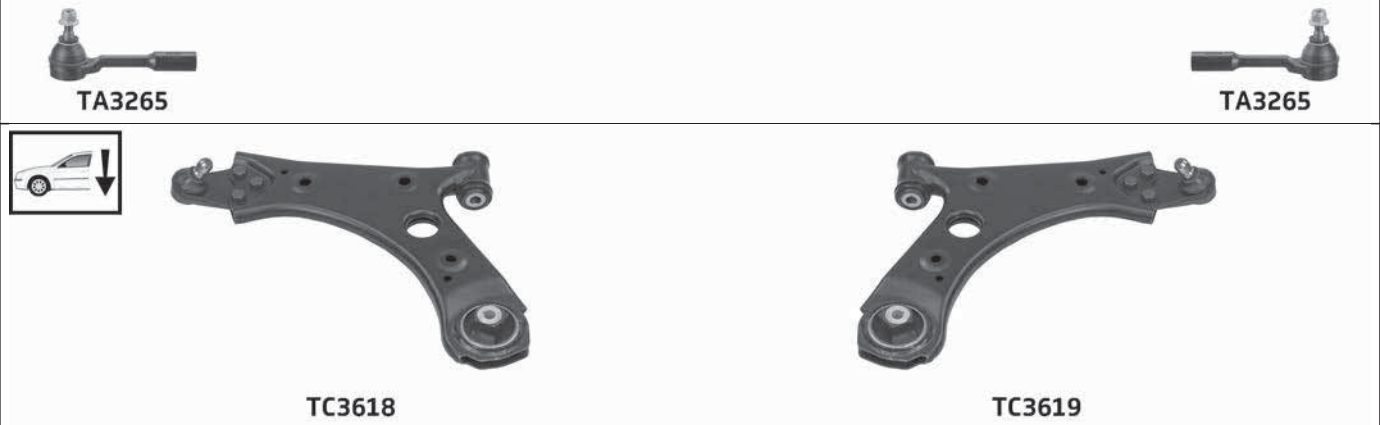

Part No	Description	Pos	Info	Technical
TA3265	Tie rod end(224)	A B		
TC3618	Lower wishbone(158)	A		
TC3619	Lower wishbone(158)	B		

ULYSSE 1.8i, 1.9TD, 2.0i, 2.0JTD, 2.1TD (04/94-08/02)

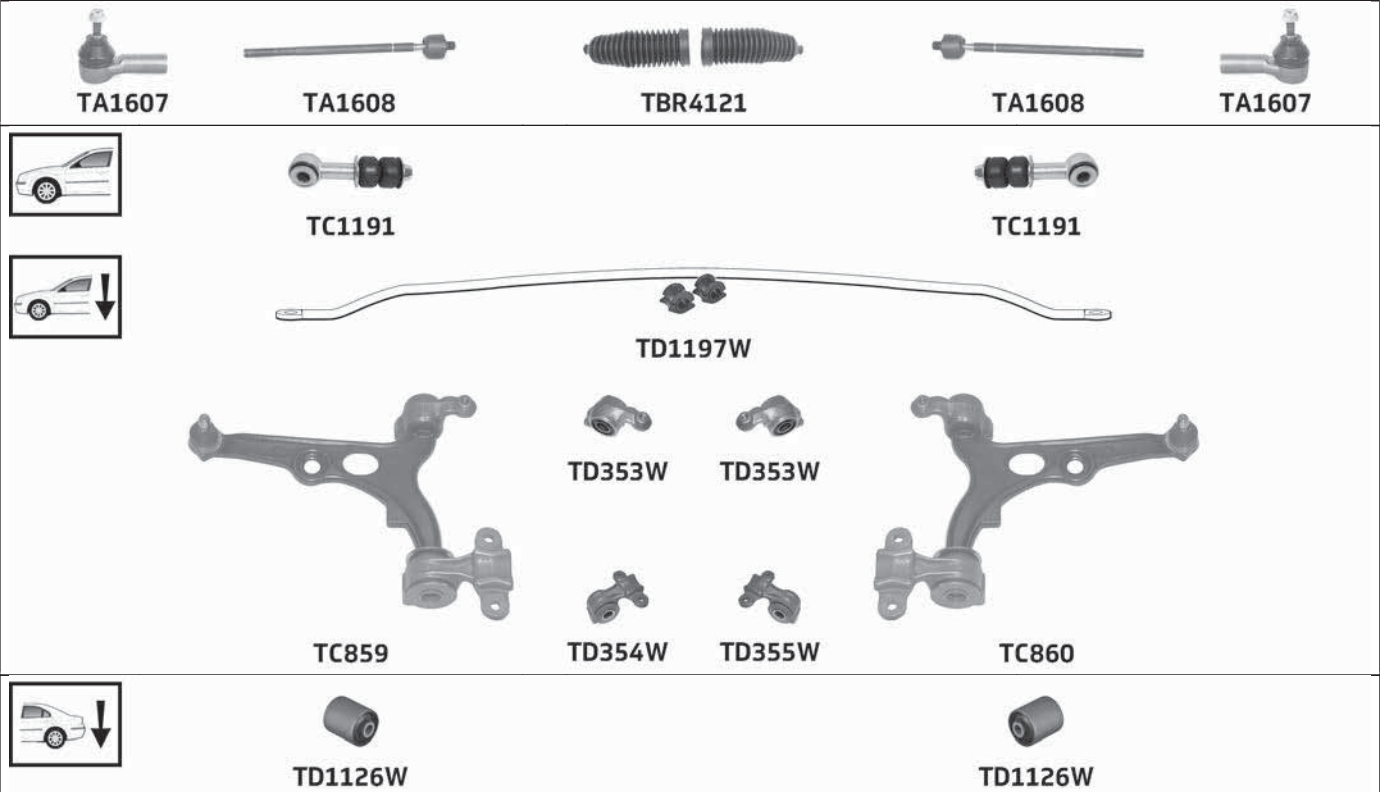

Part No	Description	Pos	Info	Technical
TA1607	Tie rod end(224)	A B		M14x1.5 Female(253) E
TA1608	Inner tie rod(123)	A B		M14x1.5 Male(252) E
TBR4121	Steering rack gaiter kit(213)	K		1 :13x62x62 2 :13x62x62
TC859	Lower wishbone(158)	A		Pinch Bolt(255) 17mm
TC860	Lower wishbone(158)	B		Pinch Bolt(255) 17mm
TC1191	Link stabiliser(135)	A B		
TD353W	Lower wishbone bush(159)	A B	Front(108)	
TD354W	Lower wishbone bush(159)	A	Rear(187)	
TD355W	Lower wishbone bush(159)	B	Rear(187)	

... ULYSSE 1.8i, 1.9TD, 2.0i, 2.0JTD, 2.1TD (04/94-08/02)

Part No	Description	Pos	Info	Technical
TD1126W	Axle Bush(-76-)	A B		
TD1197W	Anti-roll bar(-74- bush kit(-86-)	K		

ULYSSE 2.0i, 2.0JTD, 2.2JTD, 3.0i V6 (08/02-06/06)

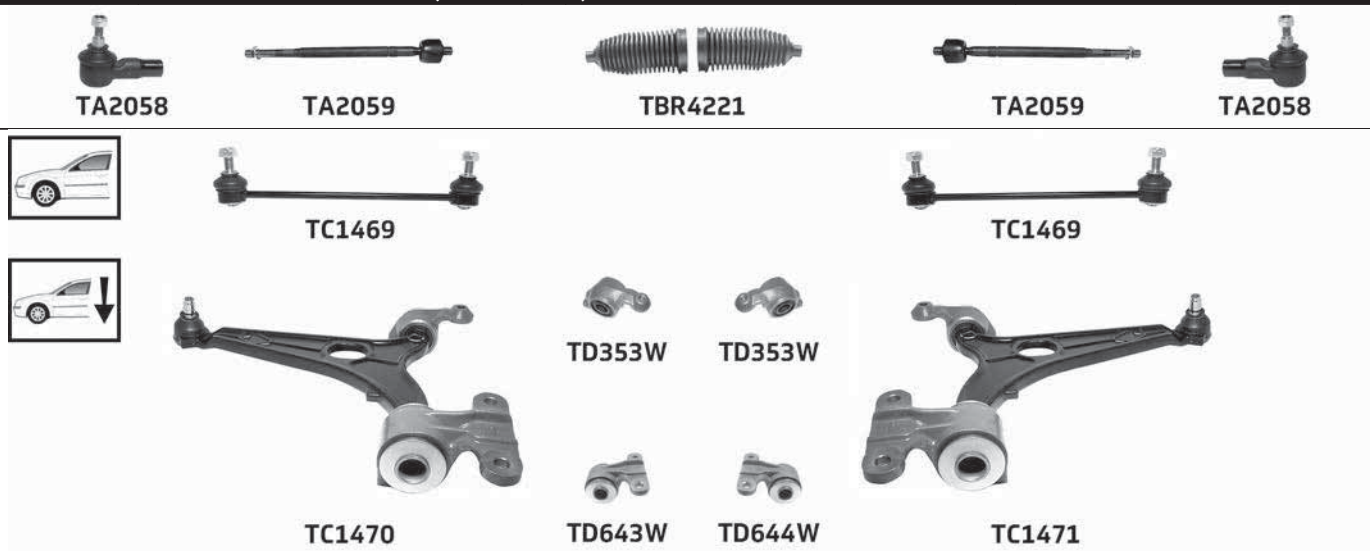

Part No	Description	Pos	Info	Technical
TA2058	Tie rod end(224)	A B		M14x1.5 Female(253) £
TA2059	Inner tie rod(123)	A B		M14x1.5 Male(252) £
TBR4221	Steering rack gaiter kit(213)	K	Thermoplastic(223)	1 :14.5x64x64 2 :14.5x64x64
TC1469	Link stabiliser(135)	A B		M10x1.25
TC1470	Lower wishbone(158)	A		Pinch Bolt(255) 17mm
TC1471	Lower wishbone(158)	B		Pinch Bolt(255) 17mm
TD353W	Lower wishbone bush(159)	A B	Front(108)	
TD643W	Lower wishbone bush(159)	A	Rear(187)	
TD644W	Lower wishbone bush(159)	B	Rear(187)	

ULYSSE 2.0i, 2.0JTD, 2.2JTD, 3.0i V6 (07/06-06/11)

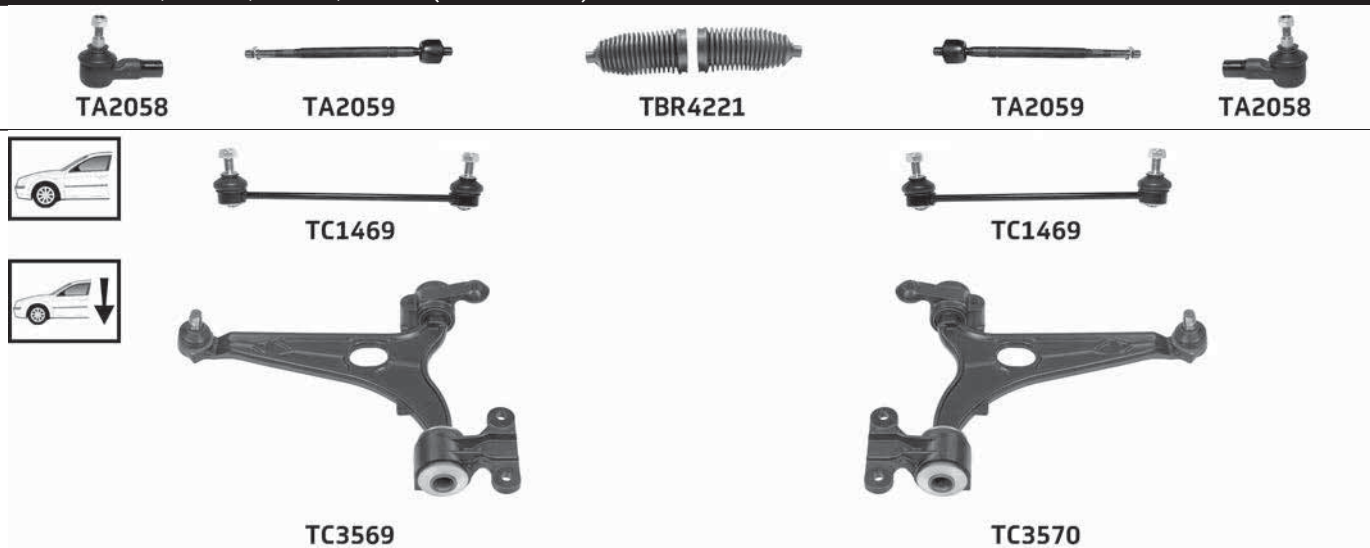

Part No	Description	Pos	Info	Technical
TA2058	Tie rod end(224)	A B		M14x1.5 Female(253) £
TA2059	Inner tie rod(123)	A B		M14x1.5 Male(252) £
TBR4221	Steering rack gaiter kit(213)	K	Thermoplastic(223)	1 :14.5x64x64 2 :14.5x64x64
TC1469	Link stabiliser(135)	A B		M10x1.25
TC3569	Lower wishbone(158)	A		ø16.4
TC3570	Lower wishbone(158)	B		ø16.4

FORD

B-MAX 1.0i, 1.4i, 1.5TDCi, 1.6Ti, 1.6TDCi (10/12→)



Part No	Description	Pos	Info	Technical
TA2498	Tie rod end(224)	A		M14x1.5 Female(253) £
TA2499	Tie rod end(224)	B		M14x1.5 Female(253) £
TA2504	Inner tie rod(123)	A B		M14x1.5 Male(252) £
TBR4225	Steering rack gaiter kit(213)	K	Thermoplastic(223)	1 :12x55x55 2 :12x55x55
TC2562	Link stabiliser(135)	A B		M10x1.5

C-MAX 1.6i, 1.6TDCi, 1.8i, 1.8TDCi, 2.0i, 2.0TDCi (02/07-12/10)

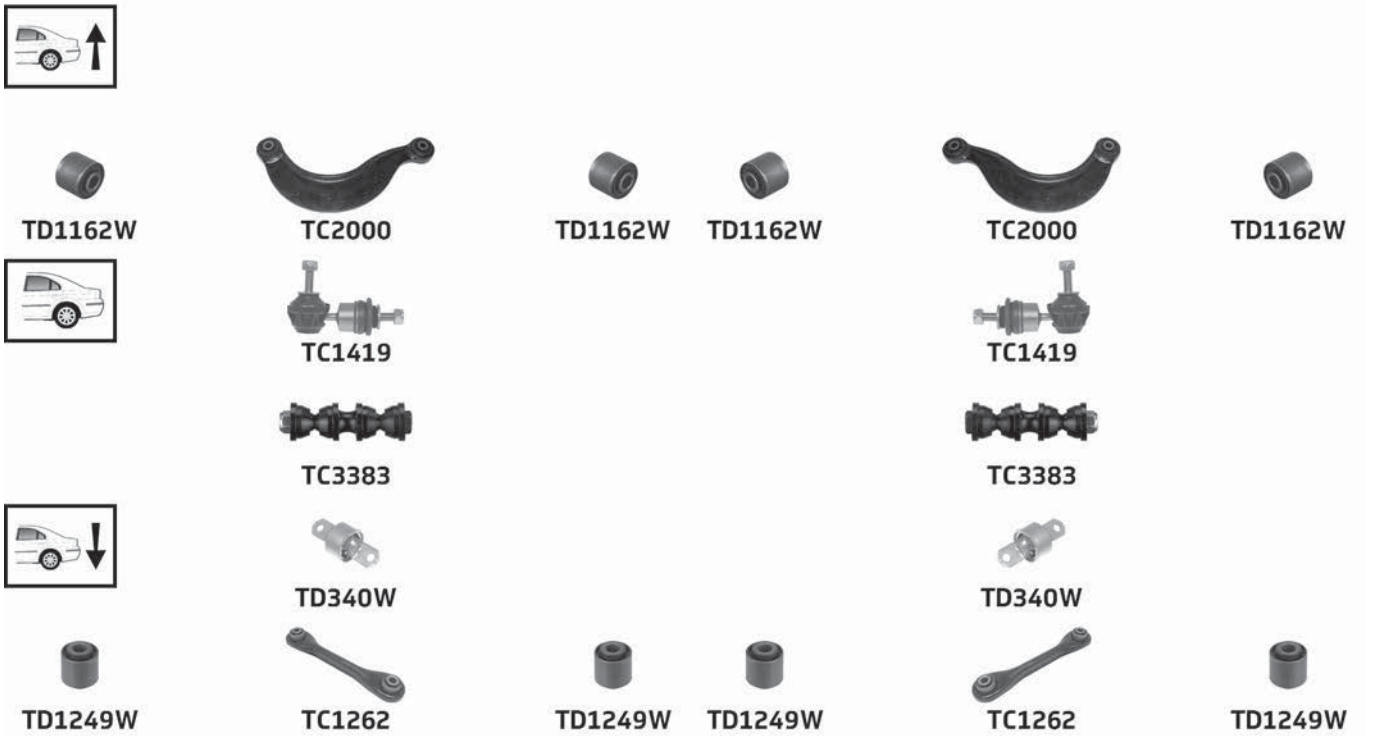

Part No	Description	Pos	Info	Technical
TA1989	Tie rod end(224)	A		M16x1.5 Female(253) £
TA1990	Tie rod end(224)	B		M16x1.5 Female(253) £
TA2049	Inner tie rod(123)	A B		M16x1.5 Male(252) £
TBR4226	Steering rack gaiter kit(213)	K	Thermoplastic(223)	1 :15x54x54 2 :15x54x54
TC1262	Lower trailing arm(156)	A B		
TC1418	Link stabiliser(135)	A B		M10x1.5

FORD

... C-MAX 1.6i, 1.6TDCi, 1.8i, 1.8TDCi, 2.0i, 2.0TDCi (02/07-12/10)

Part No	Description	Pos	Info	Technical
TC1419	Link stabiliser(135)	A B	(+) Sport suspension(-53)	M10x1.5
TC1971	Lower ball joint(140)	A B	Cone size(-93) Ø21mm	M14x1.5
TC2000	Upper trailing arm(245)	A B		
TC2252	Lower wishbone(158)	A	Cone size(-93) Ø21mm	M14x1.5
TC2253	Lower wishbone(158)	B	Cone size(-93) Ø21mm	M14x1.5
TC3383	Link stabiliser(135)	A B	(-) Sport suspension(-27)	
TD340W	Knuckle bush(126)	A B		
TD652W	Lower wishbone bush(159)	A B	Front(108)	
TD795W	Lower wishbone bush(159)	A B	Rear(187)	
TD1162W	Upper trailing arm bush(246)	A B	Outer(176) Inner(119)	
TD1249W	Lower trailing arm bush(157)	A B	Outer(176) Inner(119)	

C-MAX II 1.0i EcoBoost, 1.6Ti (12/10→)

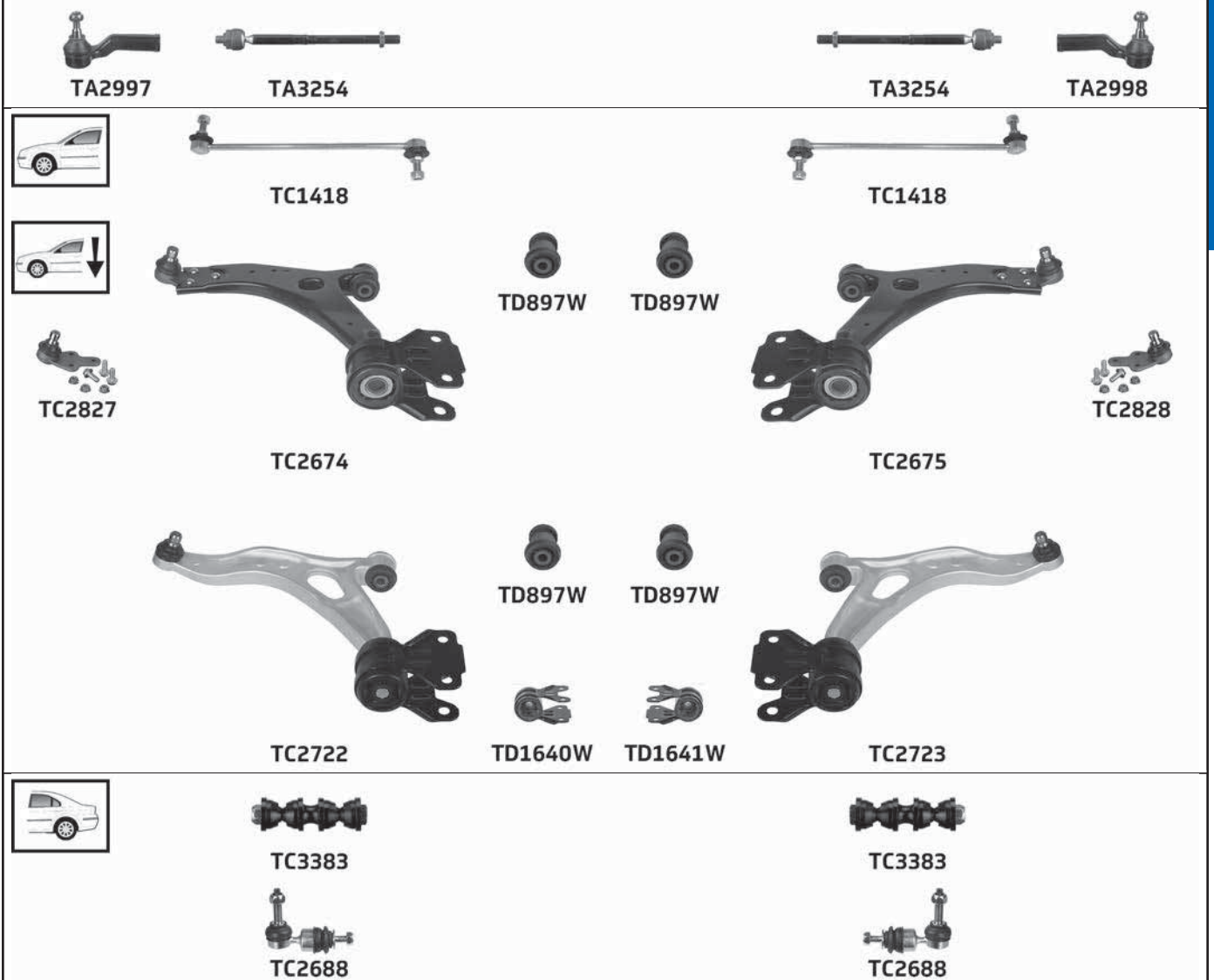

Part No	Description	Pos	Info	Technical
TA2997	Tie rod end(224)	A		M16x1.5 Female(253) £
TA2998	Tie rod end(224)	B		M16x1.5 Female(253) £
TA3254	Inner tie rod(123)	A B		M16x1.5 Male(252) £
TC1418	Link stabiliser(135)	A B		M10x1.5
TC2674	Lower wishbone(158)	A	Sheet steel(201)	Pinch Bolt(255) 21mm
TC2675	Lower wishbone(158)	B	Sheet steel(201)	Pinch Bolt(255) 21mm
TC2688	Link stabiliser(135)	A B	13/04/2015→	M12x1.75 / M10x1.5
TC2722	Lower wishbone(158)	A	Aluminium(-73)	Pinch Bolt(255) 21mm
TC2723	Lower wishbone(158)	B	Aluminium(-73) for halogen headlamp(106)	Pinch Bolt(255) 21mm
TC2827	Lower ball joint(140)	A		Pinch Bolt(255) 21mm
TC2828	Lower ball joint(140)	B		Pinch Bolt(255) 21mm
TC3383	Link stabiliser(135)	A B	Bolt Fitting(-82) →02/06/2015	
TD897W	Lower wishbone bush(159)	A B	Front(108)	

(...)

... FORD

... C-MAX II 1.0i EcoBoost, 1.6Ti (12/10→)

Part No	Description	Pos	Info	Technical
TD1640W	Lower wishbone bush(159)	A	Rear(187)	
TD1641W	Lower wishbone bush(159)	B	Rear(187)	

C-MAX II 1.5i EcoBoost, 1.6i EcoBoost, 1.6TDCi, 2.0TDCi (12/10→)

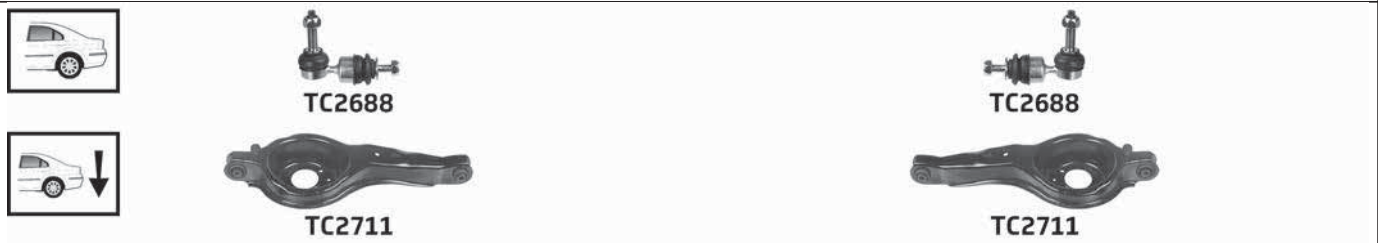

Part No	Description	Pos	Info	Technical
TA2997	Tie rod end(224)	A		M16x1.5 Female(253) E
TA2998	Tie rod end(224)	B		M16x1.5 Female(253) E
TA3254	Inner tie rod(123)	A B		M16x1.5 Male(252) E
TC1418	Link stabiliser(135)	A B		M10x1.5
TC2674	Lower wishbone(158)	A	Sheet steel(201)	Pinch Bolt(255) 21mm
TC2675	Lower wishbone(158)	B	Sheet steel(201)	Pinch Bolt(255) 21mm
TC2688	Link stabiliser(135)	A B		M12x1.75 / M10x1.5
TC2711	Lower track control arm(151)	A B		
TC2722	Lower wishbone(158)	A	Aluminium(-73-)	Pinch Bolt(255) 21mm
TC2723	Lower wishbone(158)	B	Aluminium(-73-) for halogen headlamp(106)	Pinch Bolt(255) 21mm
TC2827	Lower ball joint(140)	A		Pinch Bolt(255) 21mm
TC2828	Lower ball joint(140)	B		Pinch Bolt(255) 21mm
TD897W	Lower wishbone bush(159)	A B	Front(108)	
TD1640W	Lower wishbone bush(159)	A	Rear(187)	
TD1641W	Lower wishbone bush(159)	B	Rear(187)	

FORD

COURIER II 1.3i, 1.8D (05/98-08/03)



Part No	Description	Pos	Info	Technical
TA1584	Tie rod end(224)	A		M14x2 Female(253) £
TA1585	Tie rod end(224)	B		M14x2 Female(253) £
TA1611	Inner tie rod(123)	A B		M14x2 Male(252) £
TC663	Lower ball joint(140)	A B		Pinch Bolt(255) 16.5mm
TC720	Link stabiliser(135)	A B		M10x1.25
TC1033	Lower wishbone(158)	A		Pinch Bolt(255) 16.5mm
TC1034	Lower wishbone(158)	B		Pinch Bolt(255) 16.5mm
TD284W	Lower wishbone bush(159)	A B	Front(108)	
TD285W	Lower wishbone bush(159)	A B	Rear(187)	
TD435W	Anti-roll bar(-74) bush kit(-86)	K	Ø16 Complete axle kit(-92)	
TD444W	Anti-roll bar(-74) bush kit(-86)	K	Ø15 Complete axle kit(-92)	
TD602W	Pinch bolt kit(182)	K		

ECOSPORT 1.0i EcoBoost, 1.5Ti, 1.5TDCi (10/13→)

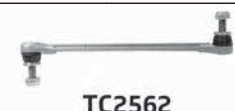

Part No	Description	Pos	Info	Technical
TA2498	Tie rod end(224)	A		M14x1.5 Female(253) £
TA2499	Tie rod end(224)	B		M14x1.5 Female(253) £
TBR4225	Steering rack gaiter kit(213)	K	Thermoplastic(223)	1 :12x55x55 2 :12x55x55
TC2562	Link stabiliser(135)	A B		M10x1.5

... FORD

FIESTA V 1.25i, 1.3i, 1.4i, 1.6i, 1.8D Manual steering⁽¹⁷⁰⁾ (09/99-04/02)

FIESTA VAN V 1.3i, 1.8D Manual steering⁽¹⁷⁰⁾ (09/99-11/02)

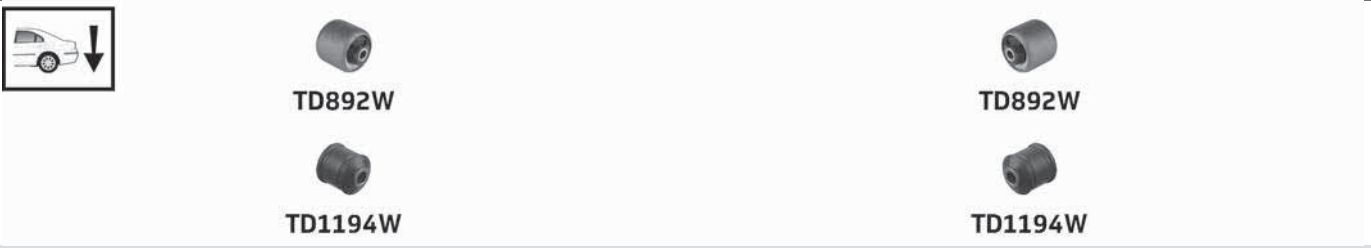
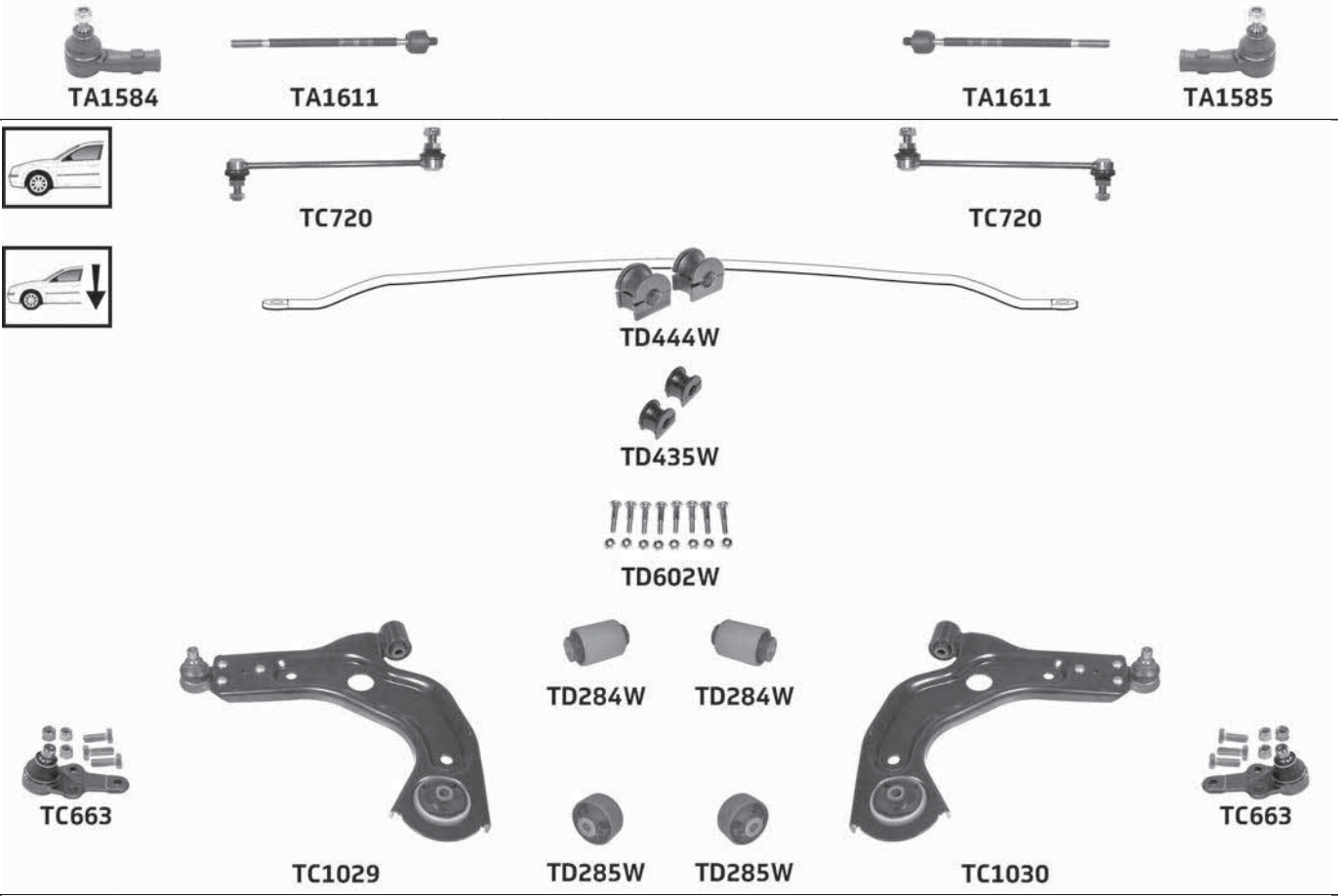

Part No	Description	Pos	Info	Technical
TA1584	Tie rod end(224)	A		M14x2 Female(253) £
TA1585	Tie rod end(224)	B		M14x2 Female(253) £
TA1611	Inner tie rod(123)	A B		M14x2 Male(252) £
TC663	Lower ball joint(140)	A B		Pinch Bolt(255) 16.5mm
TC720	Link stabiliser(135)	A B		M10x1.25
TC1029	Lower wishbone(158)	A		Pinch Bolt(255) 16.5mm
TC1030	Lower wishbone(158)	B		Pinch Bolt(255) 16.5mm
TD284W	Lower wishbone bush(159)	A B	Front(108)	
TD285W	Lower wishbone bush(159)	A B	Rear(187)	
TD435W	Anti-roll bar(-74-) bush kit(-86-)	K	Ø16 Complete axle kit(-92-)	
TD444W	Anti-roll bar(-74-) bush kit(-86-)	K	Ø15 Complete axle kit(-92-)	
TD602W	Pinch bolt kit(182)	K		
TD892W	Axle bush(-76-)	A B	Front(108)	
TD1194W	Axle bush(-76-)	A B	Rear(187)	

FIESTA V 1.25i, 1.3i, 1.4i, 1.6i, 1.8D Power steering⁽¹⁸⁵⁾ (09/99-04/02)

FIESTA VAN V 1.3i, 1.8D Power steering⁽¹⁸⁵⁾ (09/99-11/02)

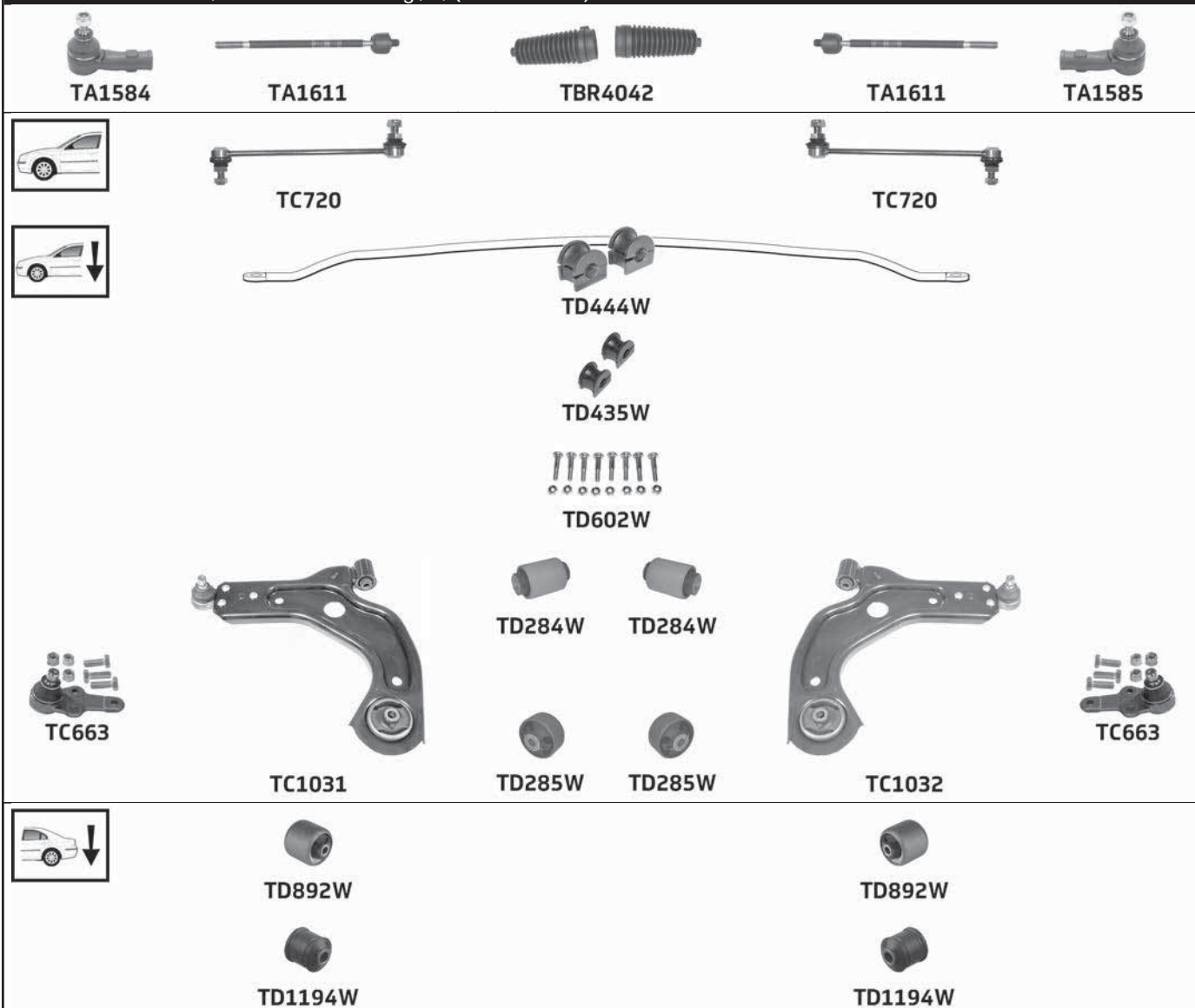

Part No	Description	Pos	Info	Technical
TA1584	Tie rod end (224)	A		M14x2 Female (253) £
TA1585	Tie rod end (224)	B		M14x2 Female (253) £
TA1611	Inner tie rod (123)	A B		M14x2 Male (252) £
TBR4042	Steering rack gaiter kit (213)	K		1 :14x56x56 2 :14x56x56
TC663	Lower ball joint (140)	A B		Pinch Bolt (255) 16.5mm
TC720	Link stabiliser (135)	A B		M10x1.25
TC1031	Lower wishbone (158)	A		Pinch Bolt (255) 16.5mm
TC1032	Lower wishbone (158)	B		Pinch Bolt (255) 16.5mm
TD284W	Lower wishbone bush (159)	A B	Front (108)	
TD285W	Lower wishbone bush (159)	A B	Rear (187)	
TD435W	Anti-roll bar (-74) bush kit (-86)	K	Ø16 Complete axle kit (-92)	
TD444W	Anti-roll bar (-74) bush kit (-86)	K	Ø15 Complete axle kit (-92)	
TD602W	Pinch bolt kit (182)	K		
TD892W	Axle bush (-76)	A B	Front (108)	
TD1194W	Axle bush (-76)	A B	Rear (187)	

... FORD

FIESTA VI 1.25i, 1.3i, 1.4i, 1.4TDCi, 1.6i, 1.6TDCi, 2.0i ST150 (11/01-08/08)

FIESTA VAN VI 1.3i, 1.4TDCi, 1.6TDCi (10/03-12/08)

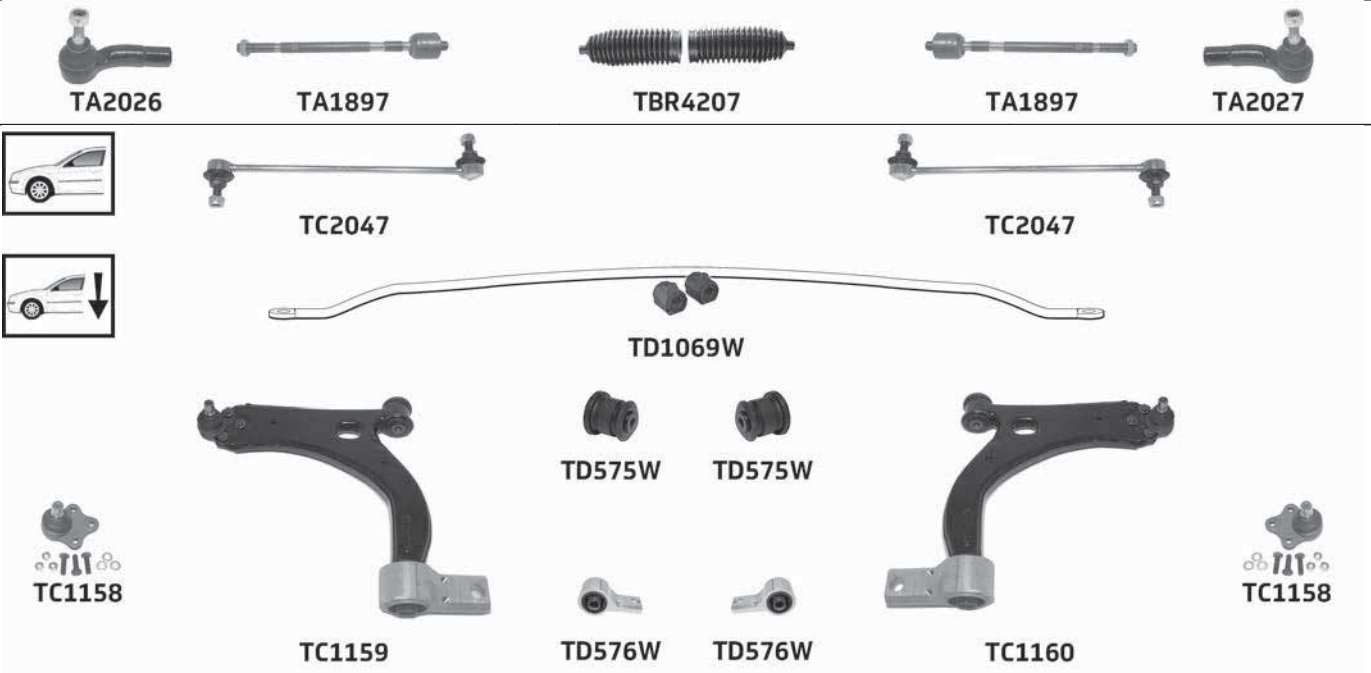

Part No	Description	Pos	Info	Technical
TA1897	Inner tie rod(123)	A B		M14x1.5 Male(252) £
TA2026	Tie rod end(224)	A		M14x1.5 Female(253) £
TA2027	Tie rod end(224)	B		M14x1.5 Female(253) £
TBR4207	Steering rack gaiter kit(213)	K	Thermoplastic(223)	1 :14x54x54 2 :14x54x54
TC1158	Lower ball joint(140)	A B		Pinch Bolt(255) 16.5mm
TC1159	Lower wishbone(158)	A		Pinch Bolt(255) 16.5mm
TC1160	Lower wishbone(158)	B		Pinch Bolt(255) 16.5mm
TC2047	Link stabiliser(135)	A B		M10x1.5
TD575W	Lower wishbone bush(159)	A B	Front(108)	
TD576W	Lower wishbone bush(159)	A B	Rear(187)	
TD911W	Lower hub carrier bush(143)	A B		
TD1069W	Anti-roll bar(-74-) bush kit(-86-)	K	Complete axle kit(-92-)	

FIESTA VII 1.25i, 1.4i, 1.4TDCi, 1.6i, 1.6TDCi (08/08→)

FIESTA VAN VII 1.25i, 1.4TDCi, 1.6TDCi (01/09→)

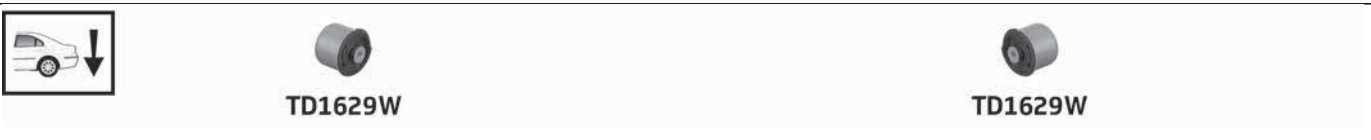

... FIESTA VII 1.25i, 1.4i, 1.4TDCi, 1.6i, 1.6TDCi (08/08→)

... FIESTA VAN VII 1.25i, 1.4TDCi, 1.6TDCi (01/09→)

Part No	Description	Pos	Info	Technical
TA2498	Tie rod end(224)	A		M14x1.5 Female(253) £
TA2499	Tie rod end(224)	B		M14x1.5 Female(253) £
TA2504	Inner tie rod(123)	A B		M14x1.5 Male(252) £
TBR4225	Steering rack gaiter kit(213)	K	Thermoplastic(223)	1 :12x55x55 2 :12x55x55
TC2164	Lower ball joint(140)	A B		Pinch Bolt(255) 17.5mm
TC2184	Lower wishbone(158)	A		Pinch Bolt(255) 17.5mm
TC2185	Lower wishbone(158)	B		Pinch Bolt(255) 17.5mm
TC2562	Link stabiliser(135)	A B		M10x1.5
TD1629W	Axle bush(-76-)	A B		

FIESTA VII 1.0i, 1.25i, 1.4i, 1.5TDCi, 1.6i, 1.6TDCi (07/12→)

FIESTA VAN VII 1.25i, 1.5TDCi (07/12→)

TA2498 TA2504 TBR4225 TA2504 TA2499

TC2562 TC2562

TC2164 TC2184 TC2185 TC2164

TD1629W TD1629W

Part No	Description	Pos	Info	Technical
TA2498	Tie rod end(224)	A		M14x1.5 Female(253) £
TA2499	Tie rod end(224)	B		M14x1.5 Female(253) £
TA2504	Inner tie rod(123)	A B		M14x1.5 Male(252) £
TBR4225	Steering rack gaiter kit(213)	K	Thermoplastic(223)	1 :12x55x55 2 :12x55x55
TC2164	Lower ball joint(140)	A B		Pinch Bolt(255) 17.5mm
TC2184	Lower wishbone(158)	A		Pinch Bolt(255) 17.5mm
TC2185	Lower wishbone(158)	B		Pinch Bolt(255) 17.5mm
TC2562	Link stabiliser(135)	A B		M10x1.5
TD1629W	Axle bush(-76-)	A B		

FIESTA VII 1.6 ST (03/13→)

TA2498 TBR4225 TA2499

TC2562 TC2562

TD1629W TD1629W

Part No	Description	Pos	Info	Technical
TA2498	Tie rod end(224)	A		M14x1.5 Female(253) £
TA2499	Tie rod end(224)	B		M14x1.5 Female(253) £
TBR4225	Steering rack gaiter kit(213)	K	Thermoplastic(223)	1 :12x55x55 2 :12x55x55
TC2562	Link stabiliser(135)	A B		M10x1.5
TD1629W	Axle bush(-76-)	A B		

... FORD

FOCUS I 1.4i, 1.6i, 1.8i, 1.8TD, 1.8TDCi, 2.0i (10/98-12/04)



TA1674



TA1991



TBR4206



TA1991



TA1675



TA1674



TA1758



TA1758



TA1675



TC720



TC720



TC2022



TC2022



TD445W



TC870



TD302W

TD302W



TD303W

TD303W



TC871



TC837



TC837



TD1162W



TC2000



TD1162W



TD1162W



TC2000



TD1162W



TC1056



TC1056



TD446W



TD340W



TD340W



TD1028W



TC2332



TD1030W



TD1030W



TC2332



TD1028W



TD1249W



TC1262



TD1249W



TD1249W



TC1262

























TD1249W

Part No	Description	Pos	Info	Technical
TA1674	Tie rod end(224)	A		M14x2 Female(253) £
TA1675	Tie rod end(224)	B		M14x2 Female(253) £
TA1758	Inner tie rod(123)	A B	R	M14x2 Male(252) £
TA1991	Inner tie rod(123)	A B	L	M14x2 Male(252) £
TBR4206	Steering rack gaiter kit(213)	K	Thermoplastic(223)	1 :13x47x47 2 :13x47x47

... FOCUS I 1.4i, 1.6i, 1.8i, 1.8TD, 1.8TDCi, 2.0i (10/98-12/04)

Part No	Description	Pos	Info	Technical
TC720	Link stabiliser(135)	A B	Metal	M10x1.25
TC837	Lower ball joint(140)	A B		Pinch Bolt(255) 16.5mm
TC870	Lower wishbone(158)	A		Pinch Bolt(255) 16.5mm
TC871	Lower wishbone(158)	B		Pinch Bolt(255) 16.5mm
TC1056	Link stabiliser(135)	A B		
TC1262	Lower trailing arm(156)	A B		
TC2000	Upper trailing arm(245)	A B	(-) 	
TC2022	Link stabiliser(135)	A B	Aluminium(-73-)	M10x1.5
TC2332	Lower track control arm(151)	A B		
TD302W	Lower wishbone bush(159)	A B	Front(108)	
TD303W	Lower wishbone bush(159)	A B	Rear(187)	
TD340W	Knuckle bush(126)	A B		
TD445W	Anti-roll bar(-74-) bush kit(-86-)	K	Complete axle kit(-92-)	
TD446W	Anti-roll bar(-74-) bush kit(-86-)	K	Complete axle kit(-92-)	
TD1028W	Lower track control arm bush(153)	A B	Outer(176)	
TD1030W	Lower track control arm bush(153)	A B	Inner(119)	
TD1162W	Upper trailing arm bush(246)	A B	Outer(176) Inner(119)	
TD1249W	Lower trailing arm bush(157)	A B	Outer(176) Inner(119)	

FOCUS II 1.4i, 1.6i, 1.6TDCi, 1.8i, 1.8TDCi, 2.0i, 2.0TDCi (11/04-02/08)

 TA1989	 TA2093	 TBR4233	 TA2093	 TA1990
 TC1418			 TC1418	
 TC1433	 TC2108	 TD652W	 TD652W	 TC1433
		 TD795W	 TD795W	 TC2109
 TC1971	 TC2252	 TD652W	 TD652W	 TC1971
		 TD795W	 TD795W	 TC2253

... FORD

... FOCUS II 1.4i, 1.6i, 1.6TDCi, 1.8i, 1.8TDCi, 2.0i, 2.0TDCi (11/04-02/08)



TD1162W



TC2000



TD1162W



TD1162W



TC2000



TD1162W



TC1419



TC1419



TC3383



TC3383



TD340W



TD340W



TD1249W



TC1262



TD1249W



TD1249W



TC1262



TD1249W

Part No	Description	Pos	Info	Technical
TA1989	Tie rod end(224)	A		M16x1.5 Female(253) £
TA1990	Tie rod end(224)	B		M16x1.5 Female(253) £
TA2093	Inner tie rod(123)	A B		M16x1.5 Male(252) £
TBR4233	Steering rack gaiter kit(213)	K		1 :15x54x54 2 :15x54x54
TC1262	Lower trailing arm(156)	A B		
TC1418	Link stabiliser(135)	A B		M10x1.5
TC1419	Link stabiliser(135)	A B		M10x1.5
TC1433	Lower ball joint(140)	A B	Cone size(-93-) Ø18mm	M14x1.5
TC1971	Lower ball joint(140)	A B	Cone size(-93-) Ø21mm 27/02/2006→	M14x1.5
TC2000	Upper trailing arm(245)	A B	(-)	
TC2108	Lower wishbone(158)	A	Cone size(-93-) Ø18mm	M14x1.5
TC2109	Lower wishbone(158)	B	Cone size(-93-) Ø18mm	M14x1.5
TC2252	Lower wishbone(158)	A	Cone size(-93-) Ø21mm 27/02/2006→	M14x1.5
TC2253	Lower wishbone(158)	B	Cone size(-93-) Ø21mm 27/02/2006→	M14x1.5
TC3383	Link stabiliser(135)	A B	Bolt fitting(-82-)	
TD340W	Knuckle bush(126)	A B		
TD652W	Lower wishbone bush(159)	A B	Front(108)	
TD795W	Lower wishbone bush(159)	A B	Rear(187)	
TD1162W	Upper trailing arm bush(246)	A B	Outer(176) Inner(119)	
TD1249W	Lower trailing arm bush(157)	A B	Outer(176) Inner(119)	

FOCUS II 1.4i, 1.6i, 1.6TDCi, 1.8i, 1.8TDCi, 2.0i, 2.0TDCi (03/08-07/11)

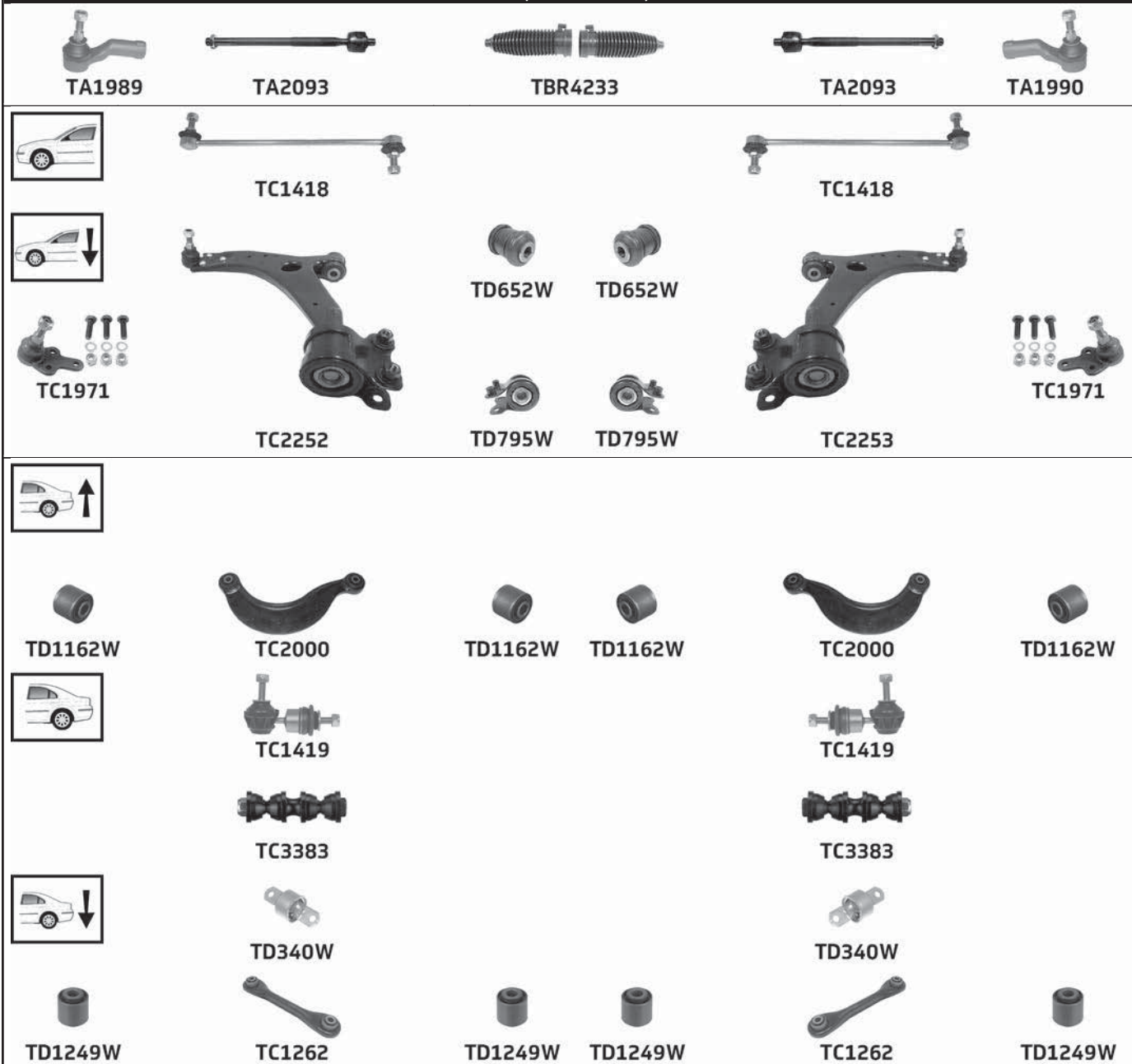

Part No	Description	Pos	Info	Technical
TA1989	Tie rod end(224)	A		M16x1.5 Female(253) £
TA1990	Tie rod end(224)	B		M16x1.5 Female(253) £
TA2093	Inner tie rod(123)	A B		M16x1.5 Male(252) £
TBR4233	Steering rack gaiter kit(213)	K		1 :15x54x54 2 :15x54x54
TC1262	Lower trailing arm(156)	A B		
TC1418	Link stabiliser(135)	A B		M10x1.5
TC1419	Link stabiliser(135)	A B		M10x1.5
TC1971	Lower ball joint(140)	A B	Cone size(-93) Ø21mm	M14x1.5
TC2000	Upper trailing arm(245)	A B	(-)	
TC2252	Lower wishbone(158)	A	Cone size(-93) Ø21mm	M14x1.5
TC2253	Lower wishbone(158)	B	Cone size(-93) Ø21mm	M14x1.5
TC3383	Link stabiliser(135)	A B	Bolt fitting(-82)	
TD340W	Knuckle bush(126)	A B		
TD652W	Lower wishbone bush(159)	A B	Front(108)	
TD795W	Lower wishbone bush(159)	A B	Rear(187)	
TD1162W	Upper trailing arm bush(246)	A B	Outer(176) Inner(119)	
TD1249W	Lower trailing arm bush(157)	A B	Outer(176) Inner(119)	

FORD

... FORD

FOCUS II 2.5i ST (08/05-07/11)



TA1989



TA2093



TBR4233



TA2093



TA1990



TC1418



TC1418



TC2108



TD652W

TD652W



TC2109



TC1433



TC1433



TD795W

TD795W



TC2252



TD652W

TD652W



TC2253



TC1971



TC1971



TD795W

TD795W



TC2000



TC2000



TC3383



TC3383

Part No	Description	Pos	Info	Technical
TA1989	Tie rod end(224)	A		M16x1.5 Female(253) £
TA1990	Tie rod end(224)	B		M16x1.5 Female(253) £
TA2093	Inner tie rod(123)	A B		M16x1.5 Male(252) £
TBR4233	Steering rack gaiter kit(213)	K		1 :15x54x54 2 :15x54x54
TC1418	Link stabiliser(135)	A B		M10x1.5
TC1433	Lower ball joint(140)	A B	Cone size(-93) Ø18mm	M14x1.5
TC1971	Lower ball joint(140)	A B	Cone size(-93) Ø21mm	M14x1.5
TC2000	Upper trailing arm(245)	A B		
TC2108	Lower wishbone(158)	A	Cone size(-93) Ø18mm	M14x1.5
TC2109	Lower wishbone(158)	B	Cone size(-93) Ø18mm	M14x1.5
TC2252	Lower wishbone(158)	A	Cone size(-93) Ø21mm	M14x1.5
TC2253	Lower wishbone(158)	B	Cone size(-93) Ø21mm	M14x1.5
TC3383	Link stabiliser(135)	A B	Bolt fitting(-82)	
TD652W	Lower wishbone bush(159)	A B	Front(108)	
TD795W	Lower wishbone bush(159)	A B	Rear(187)	

FOCUS III 1.0i EcoBoost, 1.6i EcoBoost, 1.6TDCi, 2.0TDCi (04/11-08/14)

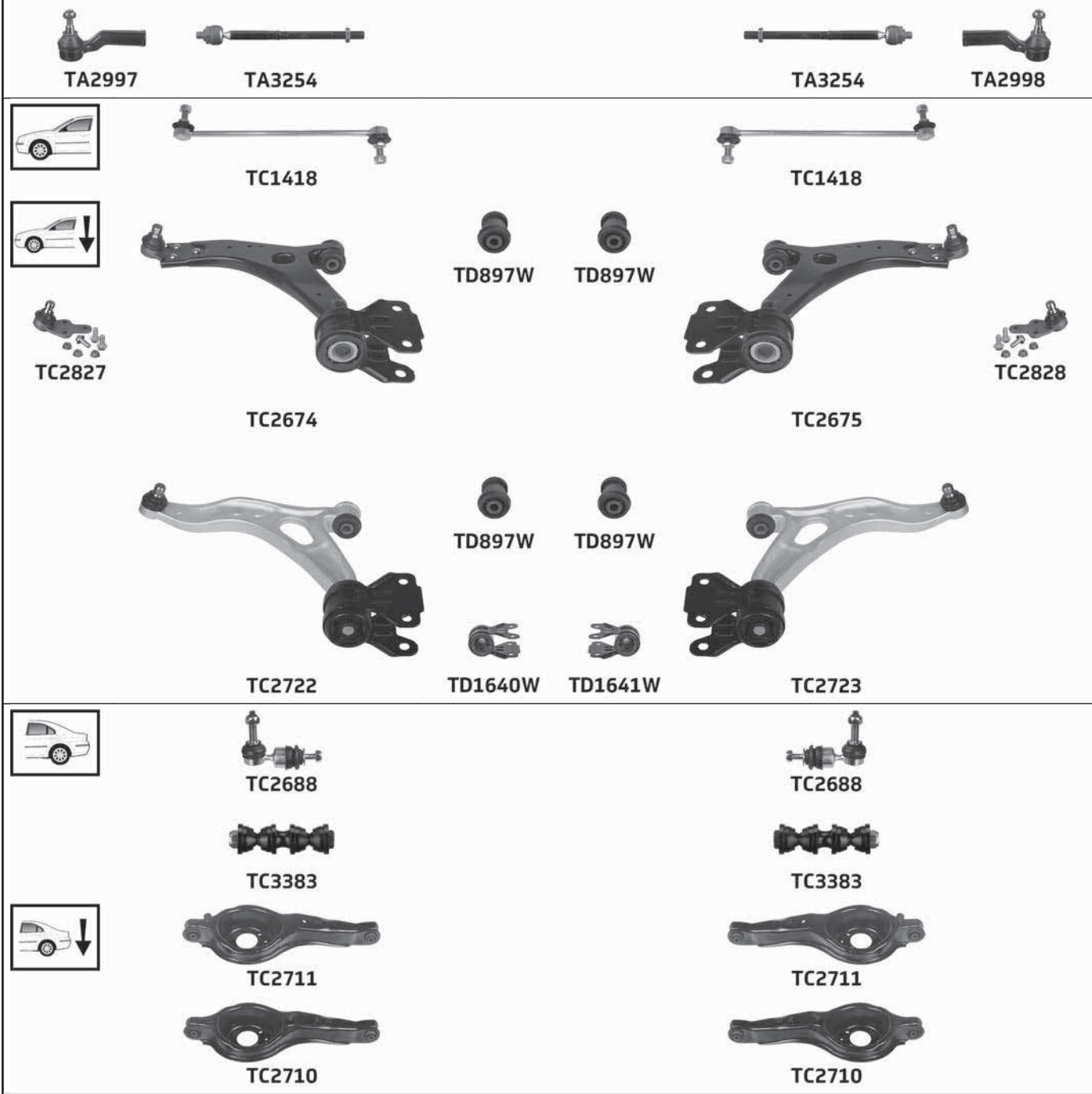

Part No	Description	Pos	Info	Technical
TA2997	Tie rod end(224)	A	Electric(103) Power steering(185)	M16x1.5 Female(253) £
TA2998	Tie rod end(224)	B	Electric(103) Power steering(185)	M16x1.5 Female(253) £
TA3254	Inner tie rod(123)	A B	Electric(103) Power steering(185)	M16x1.5 Male(252) £
TC1418	Link stabiliser(135)	A B		M10x1.5
TC2674	Lower wishbone(158)	A	Sheet steel(201)	Pinch Bolt(255) 21mm
TC2675	Lower wishbone(158)	B	Sheet steel(201)	Pinch Bolt(255) 21mm
TC2688	Link stabiliser(135)	A B		M12x1.75 / M10x1.5
TC2710	Lower track control arm(151)	A B		
TC2711	Lower track control arm(151)	A B		
TC2722	Lower wishbone(158)	A	Aluminium(-73-)	Pinch Bolt(255) 21mm
TC2723	Lower wishbone(158)	B	Aluminium(-73-) for halogen headlamp(106)	Pinch Bolt(255) 21mm
TC2827	Lower ball joint(140)	A		Pinch Bolt(255) 21mm
TC2828	Lower ball joint(140)	B		Pinch Bolt(255) 21mm
TC3383	Link stabiliser(135)	A B	Bolt fitting(-82)	
TD897W	Lower wishbone bush(159)	A B	Front(108)	
TD1640W	Lower wishbone bush(159)	A	Rear(187)	
TD1641W	Lower wishbone bush(159)	B	Rear(187)	

... FORD

FOCUS III 2.0i ST (06/12-10/14)



TA2997



TA3254



TA3254



TA2998



TC1418



TC1418



TC3383



TC3383

Part No	Description	Pos	Info	Technical
TA2997	Tie rod end(224)	A	Electric(103) Power steering(185)	M16x1.5 Female(253) £
TA2998	Tie rod end(224)	B	Electric(103) Power steering(185)	M16x1.5 Female(253) £
TA3254	Inner tie rod(123)	A B	Electric(103) Power steering(185)	M16x1.5 Male(252) £
TC1418	Link stabiliser(135)	A B		M10x1.5
TC3383	Link stabiliser(135)	A B	Bolt fitting(-82)	

FOCUS III 1.6Ti (04/11-08/14)



TA2997



TA3254



TA3254



TA2998



TA1989



TA1990



TC1418



TC1418



TC2674



TD897W



TD897W



TC2675



TC2828



TC2827



TC2722



TD897W



TD897W



TC2723



TD1640W



TD1641W

... FOCUS III 1.6Ti (04/11-08/14)



Part No	Description	Pos	Info	Technical
TA1989	Tie rod end(224)	A	Hydraulic(115) Power steering(185)	M16x1.5 Female(253) £
TA1990	Tie rod end(224)	B	Hydraulic(115) Power steering(185)	M16x1.5 Female(253) £
TA2997	Tie rod end(224)	A	Electric(103) Power steering(185)	M16x1.5 Female(253) £
TA2998	Tie rod end(224)	B	Electric(103) Power steering(185)	M16x1.5 Female(253) £
TA3254	Inner tie rod(123)	A B	Electric(103) Power steering(185)	M16x1.5 Male(252) £
TC1418	Link stabiliser(135)	A B		M10x1.5
TC2674	Lower wishbone(158)	A	Sheet steel(201)	Pinch Bolt(255) 21mm
TC2675	Lower wishbone(158)	B	Sheet steel(201)	Pinch Bolt(255) 21mm
TC2688	Link stabiliser(135)	A B		M12x1.75 / M10x1.5
TC2710	Lower track control arm(151)	A B		
TC2711	Lower track control arm(151)	A B		
TC2722	Lower wishbone(158)	A	Aluminium(-73-)	Pinch Bolt(255) 21mm
TC2723	Lower wishbone(158)	B	Aluminium(-73-) for halogen headlamp(106)	Pinch Bolt(255) 21mm
TC2827	Lower ball joint(140)	A		Pinch Bolt(255) 21mm
TC2828	Lower ball joint(140)	B		Pinch Bolt(255) 21mm
TC3383	Link stabiliser(135)	A B	Bolt fitting(-82-)	
TD897W	Lower wishbone bush(159)	A B	Front(108)	
TD1640W	Lower wishbone bush(159)	A	Rear(187)	
TD1641W	Lower wishbone bush(159)	B	Rear(187)	

FOCUS III 1.0i EcoBoost, 1.5TDCi, 1.6TDCi, 2.0TDCi (09/14→)

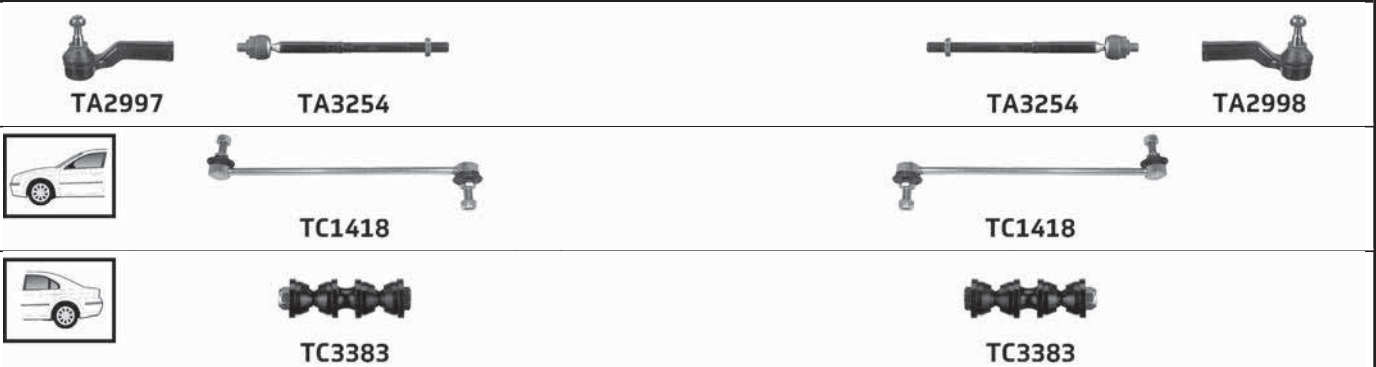

Part No	Description	Pos	Info	Technical
TA2997	Tie rod end(224)	A	Electric(103) Power steering(185)	M16x1.5 Female(253) £
TA2998	Tie rod end(224)	B	Electric(103) Power steering(185)	M16x1.5 Female(253) £
TA3254	Inner tie rod(123)	A B	Electric(103) Power steering(185)	M16x1.5 Male(252) £
TC1418	Link stabiliser(135)	A B		M10x1.5
TC3383	Link stabiliser(135)	A B	Bolt fitting(-82-)	

... FORD

FOCUS III 1.6Ti (09/14→)



Part No	Description	Pos	Info	Technical
TA1989	Tie rod end(224)	A	Hydraulic(115) Power steering(185)	M16x1.5 Female(253) £
TA1990	Tie rod end(224)	B	Hydraulic(115) Power steering(185)	M16x1.5 Female(253) £
TA2997	Tie rod end(224)	A	Electric(103) Power steering(185)	M16x1.5 Female(253) £
TA2998	Tie rod end(224)	B	Electric(103) Power steering(185)	M16x1.5 Female(253) £
TA3254	Inner tie rod(123)	A B	Electric(103) Power steering(185)	M16x1.5 Male(252) £
TC1418	Link stabiliser(135)	A B		M10x1.5
TC3383	Link stabiliser(135)	A B	Bolt fitting(-82)	

FOCUS III 2.0i ST (10/14→)



Part No	Description	Pos	Info	Technical
TA2997	Tie rod end(224)	A	Electric(103) Power steering(185)	M16x1.5 Female(253) £
TA2998	Tie rod end(224)	B	Electric(103) Power steering(185)	M16x1.5 Female(253) £
TA3254	Inner tie rod(123)	A B	Electric(103) Power steering(185)	M16x1.5 Male(252) £
TC1418	Link stabiliser(135)	A B		M10x1.5
TC3383	Link stabiliser(135)	A B	Bolt fitting(-82)	

FOCUS III 2.3i RS (01/16→)



Part No	Description	Pos	Info	Technical
TA2997	Tie rod end(224)	A		M16x1.5 Female(253) £
TA2998	Tie rod end(224)	B		M16x1.5 Female(253) £
TC1418	Link stabiliser(135)	A B		M10x1.5

FOCUS C-MAX 1.6i, 1.6TDCi, 1.8i, 1.8TDCi, 2.0i, 2.0TDCi (06/03-02/05)

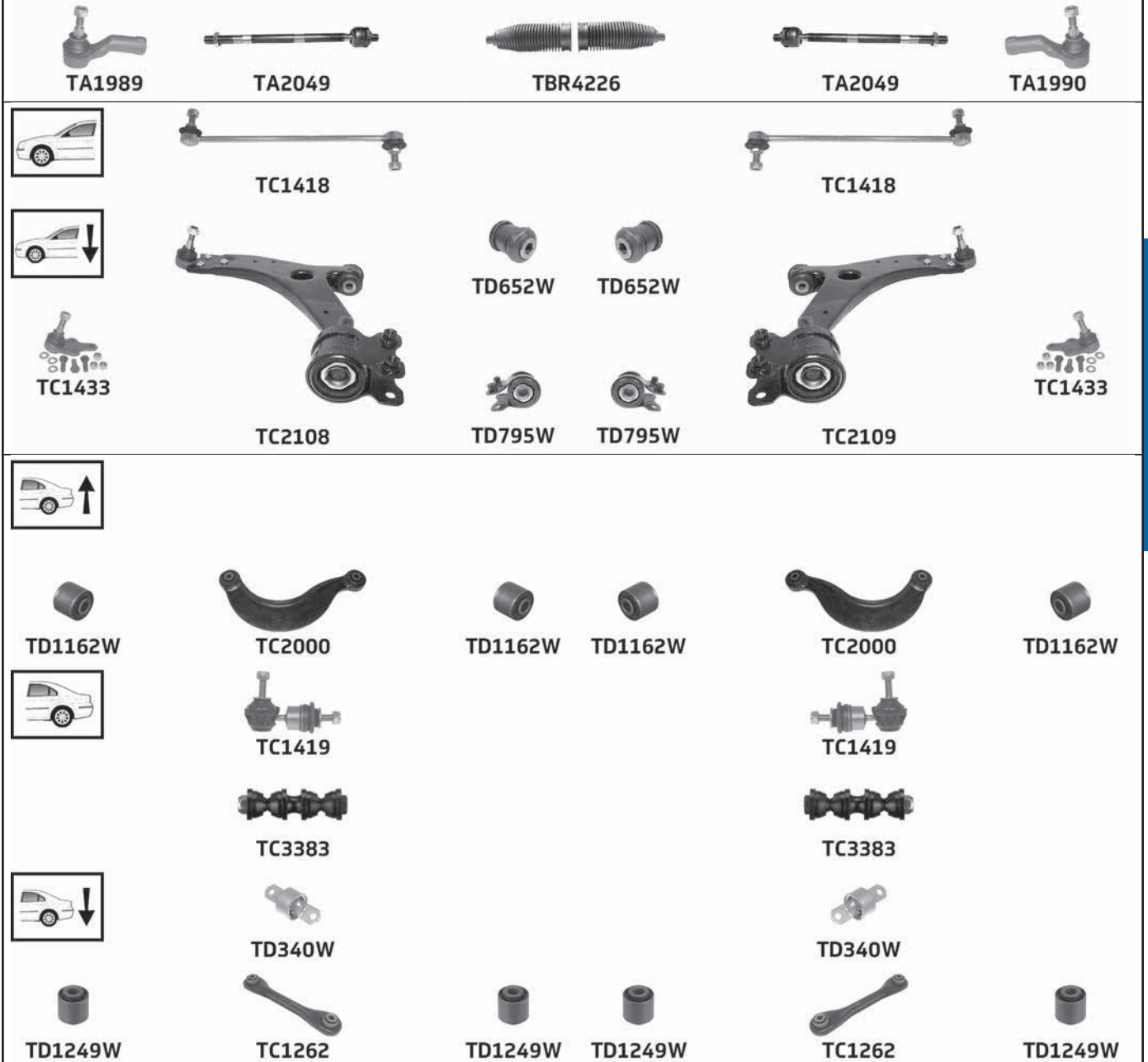

Part No	Description	Pos	Info	Technical
TA1989	Tie rod end(224)	A		M16x1.5 Female(253) £
TA1990	Tie rod end(224)	B		M16x1.5 Female(253) £
TA2049	Inner tie rod(123)	A B		M16x1.5 Male(252) £
TBR4226	Steering rack gaiter kit(213)	K	Thermoplastic(223)	1 :15x54x54 2 :15x54x54
TC1262	Lower trailing arm(156)	A B		
TC1418	Link stabiliser(135)	A B		M10x1.5
TC1419	Link stabiliser(135)	A B		M10x1.5
TC1433	Lower ball joint(140)	A B	Cone size(-93) Ø18mm	M14x1.5
TC2000	Upper trailing arm(245)	A B		
TC2108	Lower wishbone(158)	A	Cone size(-93) Ø18mm	M14x1.5
TC2109	Lower wishbone(158)	B	Cone size(-93) Ø18mm	M14x1.5
TC3383	Link stabiliser(135)	A B	Bolt fitting(-82)	
TD340W	Knuckle bush(126)	A B		
TD652W	Lower wishbone bush(159)	A B	Front(108)	
TD795W	Lower wishbone bush(159)	A B	Rear(187)	
TD1162W	Upper trailing arm bush(246)	A B	Outer(176) Inner(119)	
TD1249W	Lower trailing arm bush(157)	A B	Outer(176) Inner(119)	

... FORD

FOCUS C-MAX 1.6i, 1.6TDCi, 1.8i, 1.8TDCi, 2.0i, 2.0TDCi (02/05-03/07)



Part No	Description	Pos	Info	Technical
TA1989	Tie rod end(224)	A		M16x1.5 Female(253) £
TA1990	Tie rod end(224)	B		M16x1.5 Female(253) £
TA2049	Inner tie rod(123)	A B		M16x1.5 Male(252) £
TBR4226	Steering rack gaiter kit(213)	K	Thermoplastic(223)	1 :15x54x54 2 :15x54x54
TC1262	Lower trailing arm(156)	A B		
TC1418	Link stabiliser(135)	A B		M10x1.5
TC1419	Link stabiliser(135)	A B		M10x1.5
TC1433	Lower ball joint(140)	A B	Cone size(-93-) Ø18mm	M14x1.5
TC1971	Lower ball joint(140)	A B	Cone size(-93-) Ø21mm	M14x1.5
TC2000	Upper trailing arm(245)	A B		
TC2108	Lower wishbone(158)	A	Cone size(-93-) Ø18mm	M14x1.5

FORD

... FOCUS C-MAX 1.6i, 1.6TDCi, 1.8i, 1.8TDCi, 2.0i, 2.0TDCi (02/05-03/07)

Part No	Description	Pos	Info	Technical
TC2109	Lower wishbone(158)	B	Cone size(-93) Ø18mm	M14x1.5
TC2252	Lower wishbone(158)	A	Cone size(-93) Ø21mm	M14x1.5
TC2253	Lower wishbone(158)	B	Cone size(-93) Ø21mm	M14x1.5
TC3383	Link stabiliser(135)	A B	Bolt fitting(-82)	
TD340W	Knuckle bush(126)	A B		
TD652W	Lower wishbone bush(159)	A B	Front(108)	
TD795W	Lower wishbone bush(159)	A B	Rear(187)	
TD1162W	Upper trailing arm bush(246)	A B	Outer(176) Inner(119)	
TD1249W	Lower trailing arm bush(157)	A B	Outer(176) Inner(119)	

FUSION 1.4i, 1.4TDCi, 1.6i, 1.6TDCi (08/02-)

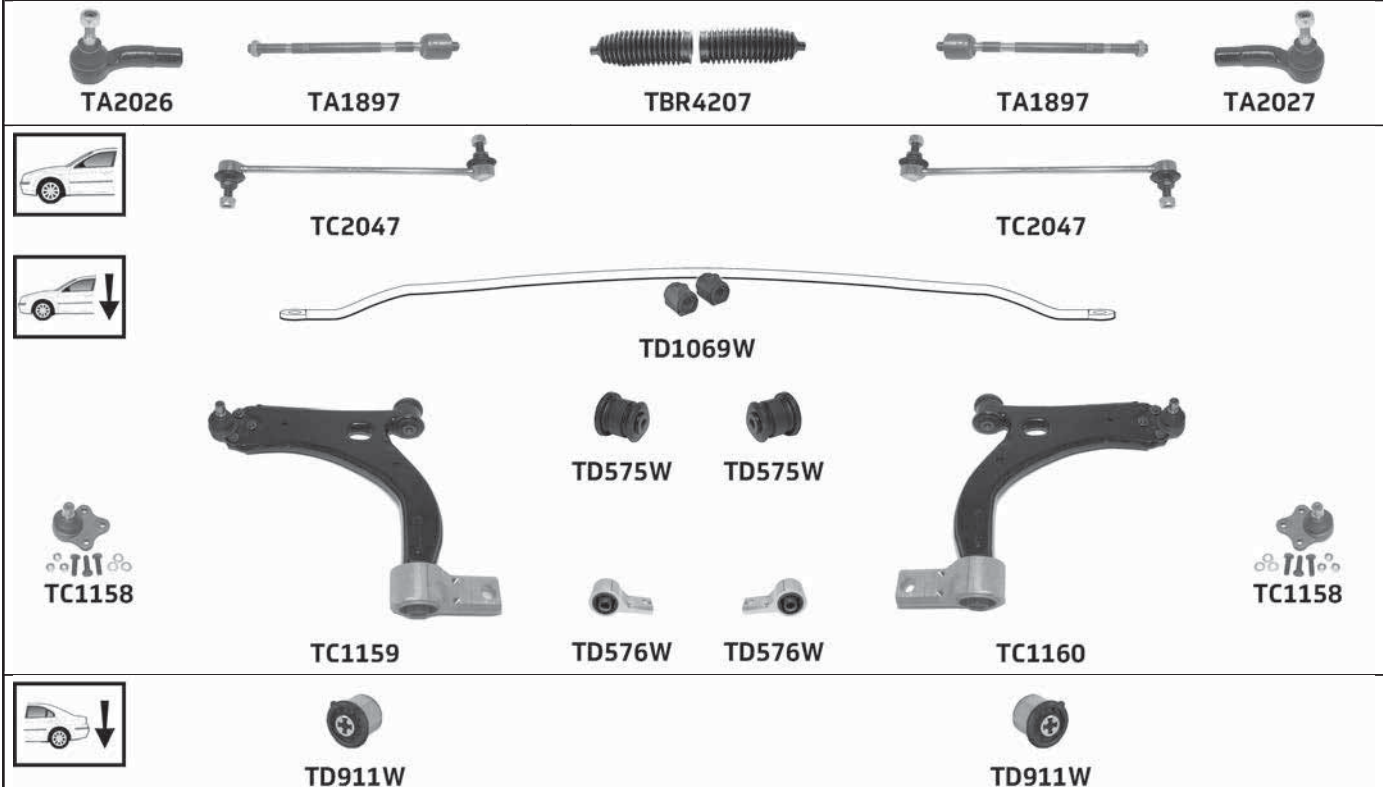

Part No	Description	Pos	Info	Technical
TA1897	Inner tie rod(123)	A B		M14x1.5 Male(252) E
TA2026	Tie rod end(224)	A		M14x1.5 Female(253) E
TA2027	Tie rod end(224)	B		M14x1.5 Female(253) E
TBR4207	Steering rack gaiter kit(213)	K	Thermoplastic(223)	1 :14x54x54 2 :14x54x54
TC1158	Lower ball joint(140)	A B		Pinch Bolt(255) 16.5mm
TC1159	Lower wishbone(158)	A		Pinch Bolt(255) 16.5mm
TC1160	Lower wishbone(158)	B		Pinch Bolt(255) 16.5mm
TC2047	Link stabiliser(135)	A B		M10x1.5
TD575W	Lower wishbone bush(159)	A B	Front(108)	
TD576W	Lower wishbone bush(159)	A B	Rear(187)	
TD911W	Lower hub carrier bush(143)	A B		
TD1069W	Anti-roll bar(-74) bush kit(-86)	K	Complete axle kit(-92)	

... FORD

GALAXY 1.9TDi, 2.0i, 2.3i, 2.8i (03/95-05/06)

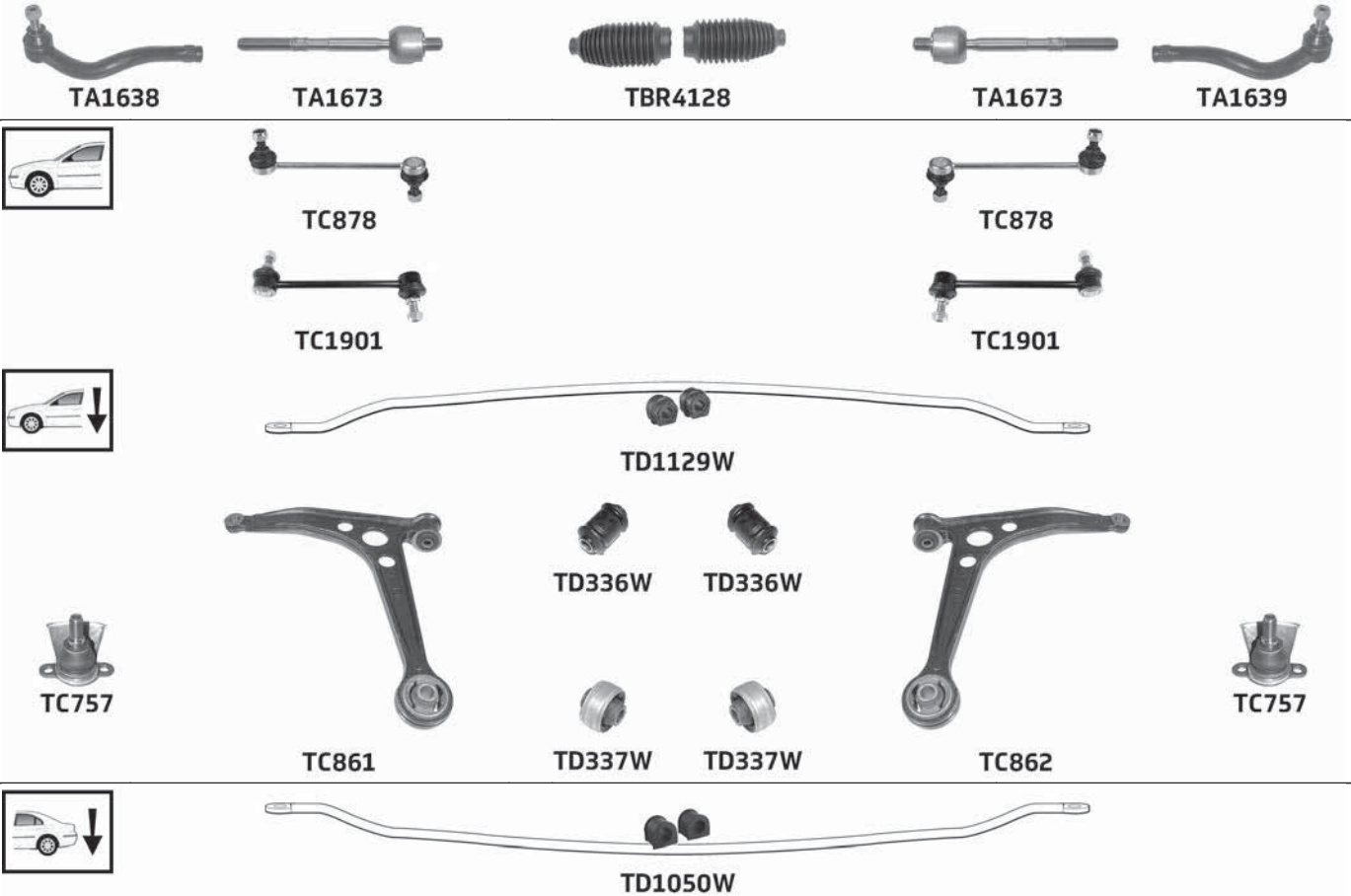

Part No	Description	Pos	Info	Technical
TA1638	Tie rod end(224)	A		M14x1.5 Female(253) £
TA1639	Tie rod end(224)	B		M14x1.5 Female(253) £
TA1673	Inner tie rod(123)	A B		M14x1.5 Male(252) £
TBR4128	Steering rack gaiter kit(213)	K		1 :10x49x49 2 :10x49x49
TC757	Lower ball joint(140)	A B		M14x1.5
TC861	Lower wishbone(158)	A	(-) Ball joint(-11-)	
TC862	Lower wishbone(158)	B	(-) Ball joint(-11-)	
TC878	Link stabiliser(135)	A B	(-) Heavy duty(-17-)	M12x1.5
TC1901	Link stabiliser(135)	A B	Heavy duty(111)	M12x1.5
TD336W	Lower wishbone bush(159)	A B	Front(108)	
TD337W	Lower wishbone bush(159)	A B	Rear(187)	
TD1050W	Anti-roll bar(-74-) bush kit(-86-)	K	Ø20.6 Complete axle kit(-92-) Inner(119)	
TD1129W	Anti-roll bar(-74-) bush kit(-86-)	K	Complete axle kit(-92-)	

GALAXY 1.6TDCi, 1.8TDCi, 2.0i, 2.0TDCi, 2.3i (05/06→)

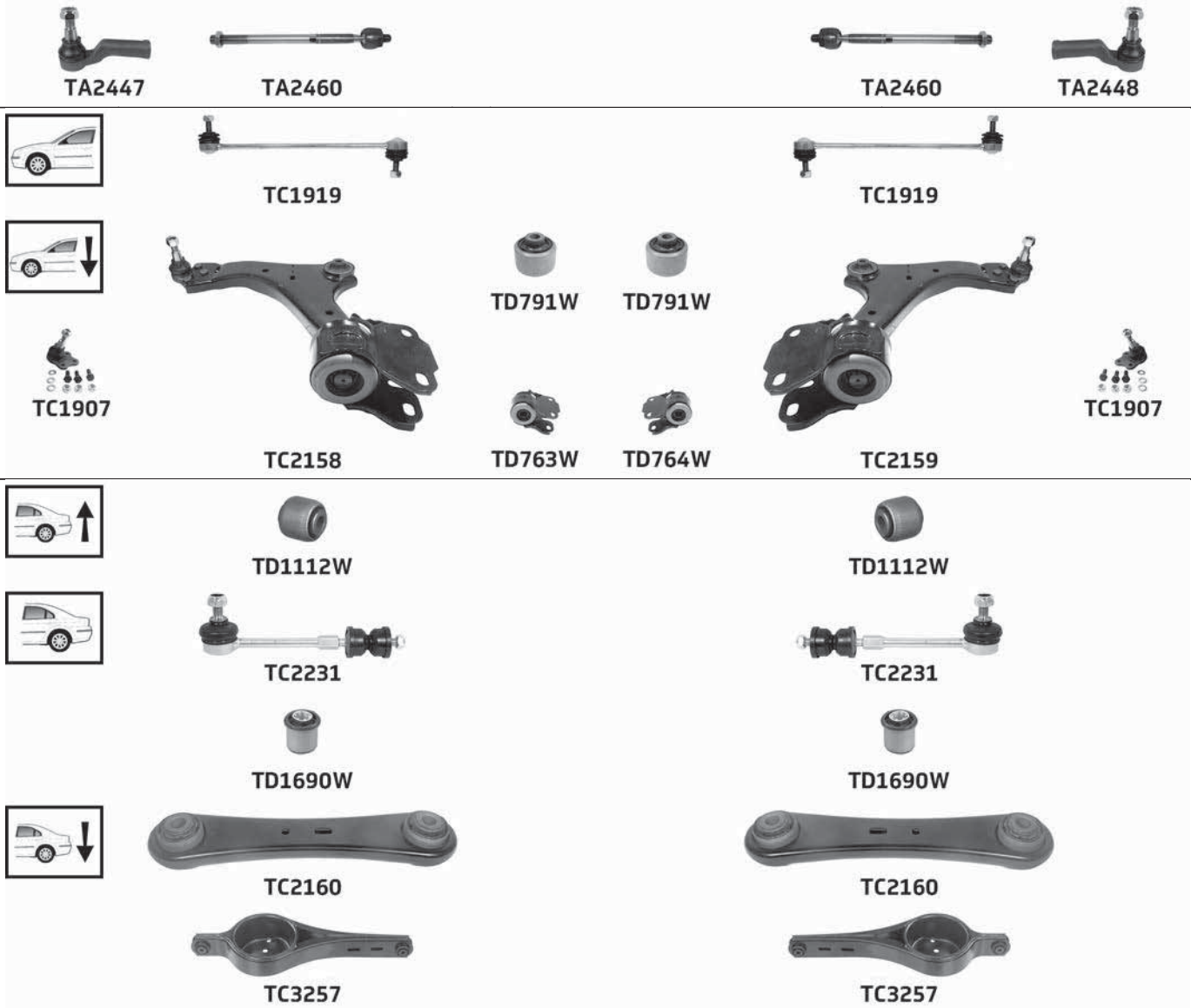

Part No	Description	Pos	Info	Technical
TA2447	Tie rod end(224)	A		M18x1.5 Female(253) £
TA2448	Tie rod end(224)	B		M18x1.5 Female(253) £
TA2460	Inner tie rod(123)	A B		M18x1.5 Male(252) £
TC1907	Lower ball joint(140)	A B		M14x1.5
TC1919	Link stabiliser(135)	A B		M10x1.5
TC2158	Lower wishbone(158)	A		M14x1.5
TC2159	Lower wishbone(158)	B		M14x1.5
TC2160	Lower link arm(144)	A B		
TC2231	Link stabiliser(135)	A B		M10x1.5
TC3257	Lower track control arm(151)	A B		
TD763W	Lower wishbone bush(159)	A	Rear(187) Replace in pairs(192)	
TD764W	Lower wishbone bush(159)	B	Rear(187) Replace in pairs(192)	
TD791W	Lower wishbone bush(159)	A B	Front(108)	
TD1112W	Upper wishbone bush(248)	A B	Outer(176) Inner(119)	
TD1690W	Sub-frame bush(215)	A B	Rear(187)	

... FORD

GRAND C-MAX 1.0i EcoBoost, 1.5i EcoBoost, 1.6i, 1.6Ti, 1.6TDCi, 2.0TDCi (08/10→)

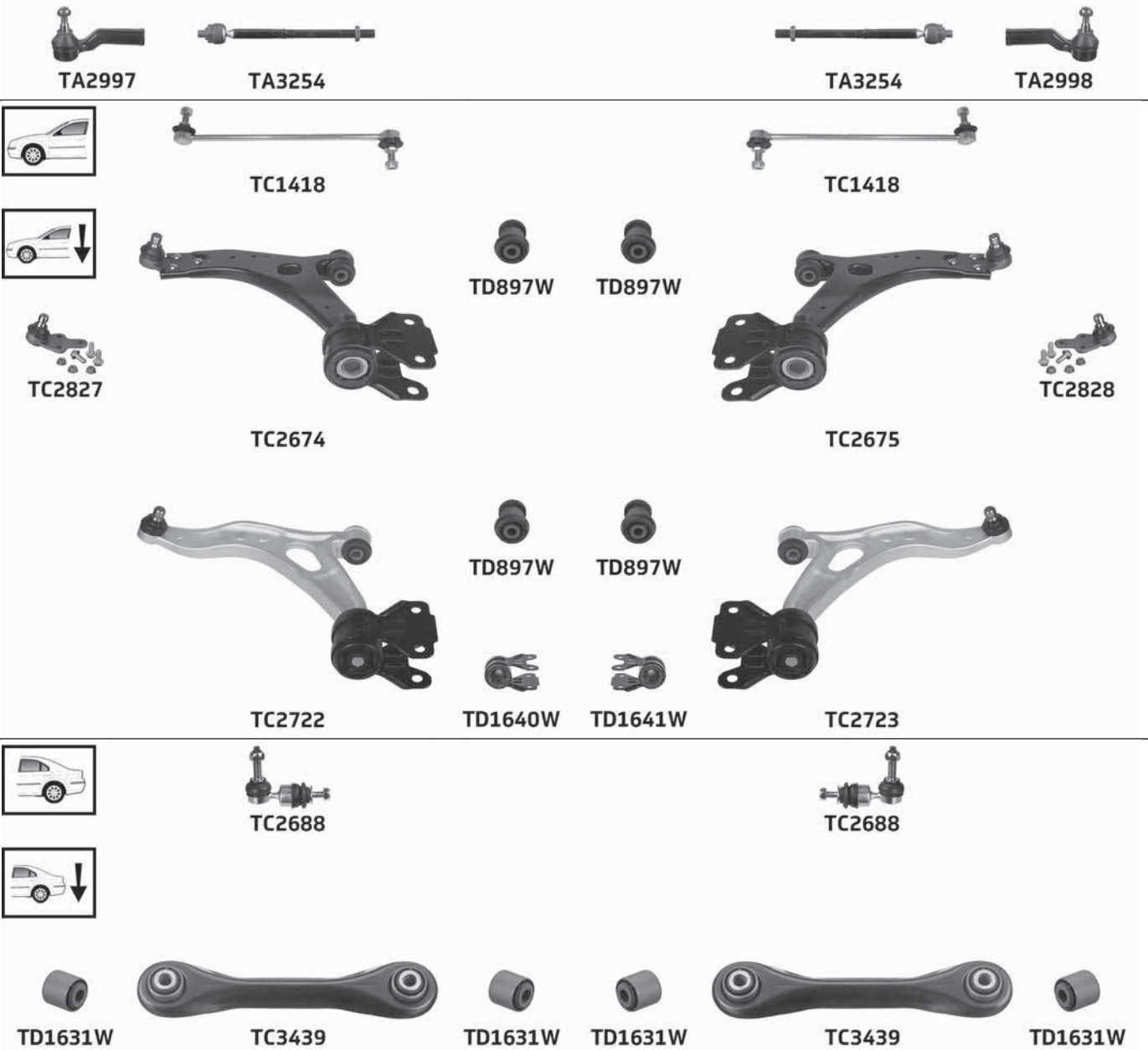

Part No	Description	Pos	Info	Technical
TA2997	Tie rod end(224)	A		M16x1.5 Female(253) E
TA2998	Tie rod end(224)	B		M16x1.5 Female(253) E
TA3254	Inner tie rod(123)	A B		M16x1.5 Male(252) E
TC1418	Link stabiliser(135)	A B		M10x1.5
TC2674	Lower wishbone(158)	A	Sheet steel(201)	Pinch Bolt(255) 21mm
TC2675	Lower wishbone(158)	B	Sheet steel(201)	Pinch Bolt(255) 21mm
TC2688	Link stabiliser(135)	A B		M12x1.75 / M10x1.5
TC2722	Lower wishbone(158)	A	Aluminium(-73-)	Pinch Bolt(255) 21mm
TC2723	Lower wishbone(158)	B	Aluminium(-73-) for halogen headlamp(106)	Pinch Bolt(255) 21mm
TC2827	Lower ball joint(140)	A		Pinch Bolt(255) 21mm
TC2828	Lower ball joint(140)	B		Pinch Bolt(255) 21mm
TC3439	Trailing arm(226)	A B	Front(108)	
TD897W	Lower wishbone bush(159)	A B	Front(108)	
TD1631W	Trailing arm bush(227)	A B	Inner(119) Outer(176)	
TD1640W	Lower wishbone bush(159)	A	Rear(187)	
TD1641W	Lower wishbone bush(159)	B	Rear(187)	

KA 1.3i (09/96-11/08)

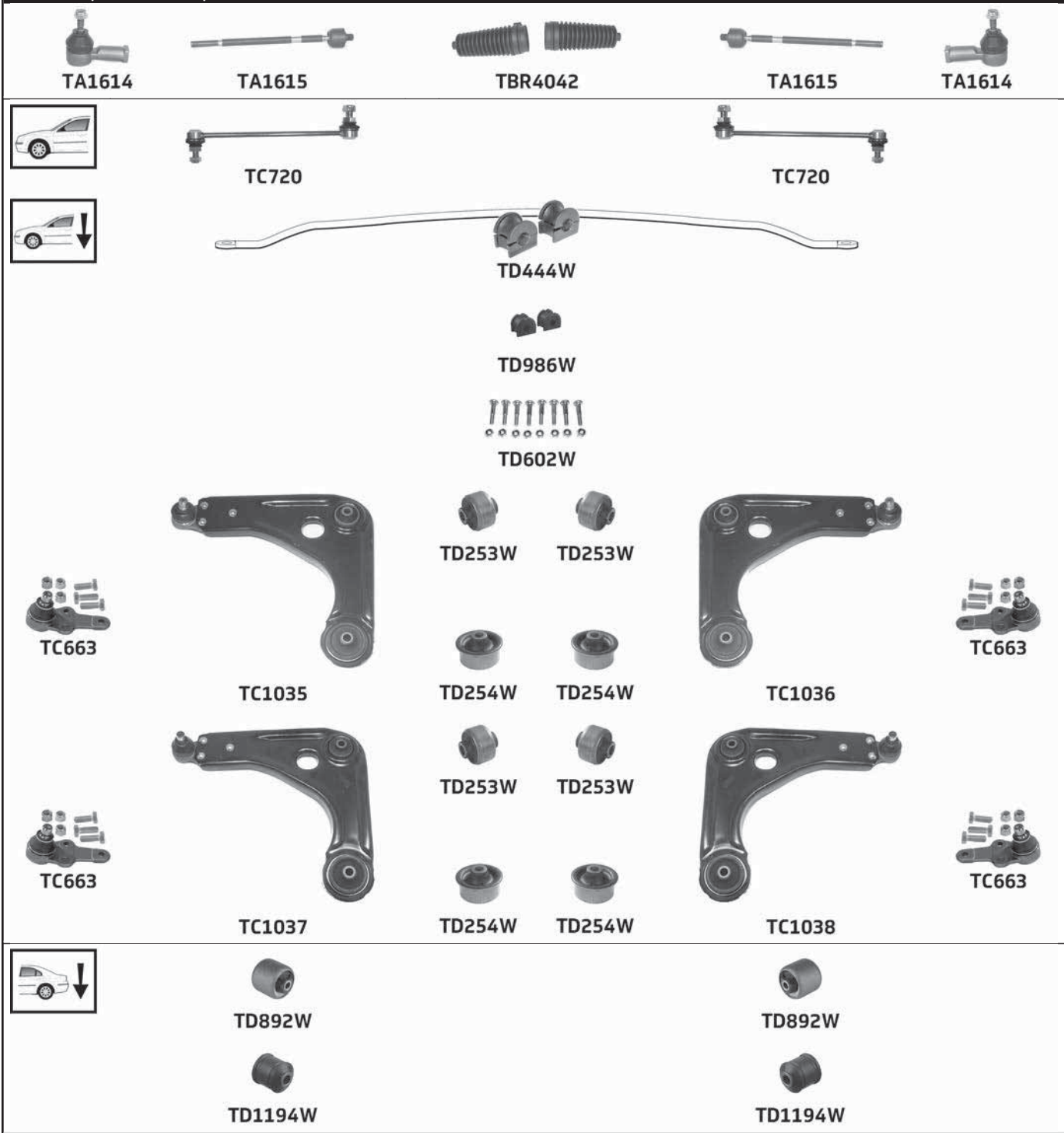

Part No	Description	Pos	Info	Technical
TA1614	Tie rod end(224)	A B		1/2x20 UNF Female(253) £
TA1615	Inner tie rod(123)	A B		1/2x20 UNF Male(252) £
TBR4042	Steering rack gaiter kit(213)	K	Power steering(185)	1 :14x56x56 2 :14x56x56
TC663	Lower ball joint(140)	A B		Pinch Bolt(255) 16.5mm
TC720	Link stabiliser(135)	A B		M10x1.25
TC1035	Lower wishbone(158)	A	Manual steering(170)	Pinch Bolt(255) 16.5mm
TC1036	Lower wishbone(158)	B	Manual steering(170)	Pinch Bolt(255) 16.5mm
TC1037	Lower wishbone(158)	A	Power steering(185)	Pinch Bolt(255) 16.5mm
TC1038	Lower wishbone(158)	B	Power steering(185)	Pinch Bolt(255) 16.5mm
TD253W	Lower wishbone bush(159)	A B	Front(108)	
TD254W	Lower wishbone bush(159)	A B	Rear(187)	
TD444W	Anti-roll bar(-74) bush kit(-86)	K	Ø15 Complete axle kit(-92) → 28/08/2000	
TD602W	Pinch bolt kit(182)	K		
TD892W	Axle bush(-76)	A B	Front(108)	
TD986W	Anti-roll bar(-74) bush kit(-86)	K	Ø13 Complete axle kit(-92) 28/08/2000 →	
TD1194W	Axle bush(-76)	A B	Rear(187)	

... FORD

KA 1.6i (07/03-11/08)



TA1614



TA1614



TC720



TC720



TD602W



TC2607



TD253W



TD253W



TC2608



TD254W



TD254W



TC663



TD892W



TD892W



TD1194W



TD1194W

Part No	Description	Pos	Info	Technical
TA1614	Tie rod end(224)	A B		1/2x20 UNF Female(253) £
TC663	Lower ball joint(140)	A B		Pinch Bolt(255) 16.5mm
TC720	Link stabiliser(135)	A B		M10x1.25
TC2607	Lower wishbone(158)	A		Pinch Bolt(255) 16.5mm
TC2608	Lower wishbone(158)	B		Pinch Bolt(255) 16.5mm
TD253W	Lower wishbone bush(159)	A B	Front(108)	
TD254W	Lower wishbone bush(159)	A B	Rear(187)	
TD602W	Pinch bolt kit(182)	K		
TD892W	Axle bush(-76-)	A B	Front(108)	
TD1194W	Axle bush(-76-)	A B	Rear(187)	

KA 1.2i, 1.3TDCi (11/08→)



TA1967



TA2716



TBR4205



TA2716



TA1968



TC1133



TC1133



TC3433



TD358W



TD358W



TC3434

Part No	Description	Pos	Info	Technical
TA1967	Tie rod end(224)	A		M12x1.5 Female(253) £
TA1968	Tie rod end(224)	B		M12x1.5 Female(253) £
TA2716	Inner tie rod(123)	A B		M12x1.5 Male(252) £
TBR4205	Steering rack gaiter kit(213)	K	Thermoplastic(223)	1 :10.5x54.5x54.5 2 :10.5x54.5x54.5

... KA 1.2i, 1.3TDCi (11/08→)

Part No	Description	Pos	Info	Technical
TC1133	Link stabiliser(135)	A B		M10x1.5
TC3433	Lower wishbone(158)	A		Pinch Bolt (255) 17mm
TC3434	Lower wishbone(158)	B		Pinch Bolt (255) 17mm
TD358W	Lower wishbone bush(159)	A B	Front(108)	

KA 1.2i (06/16→)



Part No	Description	Pos	Info	Technical
TA2498	Tie rod end(224)	A		M14x1.5 Female(253) £
TA2499	Tie rod end(224)	B		M14x1.5 Female(253) £
TA2504	Inner tie rod(123)	A B		M14x1.5 Male(252) £
TC2562	Link stabiliser(135)	A B		M10x1.5

KUGA 2.0TDCi, 2.0TDCi 4x4, 2.5i 4x4 (03/08→)



Part No	Description	Pos	Info	Technical
TA2049	Inner tie rod(123)	A B		M16x1.5 Male(252) £
TA2709	Tie rod end(224)	A		M16x1.5 Female(253) £
TA2710	Tie rod end(224)	B		M16x1.5 Female(253) £
TBR4226	Steering rack gaiter kit(213)	K	Thermoplastic(223)	1 :15x54x54 2 :15x54x54
TC1418	Link stabiliser(135)	A B		M10x1.5
TC2567	Lower wishbone(158)	A		Pinch Bolt (255) 21mm
TC2568	Lower wishbone(158)	B		Pinch Bolt (255) 21mm
TC2601	Link stabiliser(135)	A B		M10x1.5
TC3671	Lower ball joint(140)	A		ø21
TC3672	Lower ball joint(140)	B		ø21
TD340W	Knuckle bush(126)	A B		
TD652W	Lower wishbone bush(159)	A B	Front(108)	
TD795W	Lower wishbone bush(159)	A B	Rear(187)	

... FORD

KUGA II 1.5i, 1.5i 4x4 EcoBoost (03/13→)

KUGA II 1.5TDCi (03/13→)

KUGA II 1.6i, 1.6i 4x4 EcoBoost (03/13→)

KUGA II 2.0TDCi, 2.0TDCi 4x4 (03/13→)



TA2997



TA3254



TA3254



TA2998



TC1418



TC1418



TC2601



TC2601

Part No	Description	Pos	Info	Technical
TA2997	Tie rod end(224)	A		M16x1.5 Female(253) £
TA2998	Tie rod end(224)	B		M16x1.5 Female(253) £
TA3254	Inner tie rod(123)	A B		M16x1.5 Male(252) £
TC1418	Link stabiliser(135)	A B		M10x1.5
TC2601	Link stabiliser(135)	A B		M10x1.5

MONDEO III 1.8i, 2.0i, 2.0Di, 2.0DCi, 2.0TDi, 2.0TDCi, 2.5i V6 (10/00-09/02)



TA1772



TA1813



TBR4208



TA1813



TA1772



TC1154



TC1154



TD694W



TC1017



TD348W

TD348W



TD349W

TD349W



TC1018



TC1016



TC1016

... MONDEO III 1.8i, 2.0i, 2.0Di, 2.0DCi, 2.0TDi, 2.0TDCi, 2.5i V6 (10/00-09/02)



TC1944



TC1944



TC1954



TC1954



TC1171



TC1171



TC1172



TC1172



TD1048W



TC1955



TC1955



TC3028



TC3028



TD688W



TD688W



TD689W



TD689W



TC3275



TC3275

Part No	Description	Pos	Info	Technical
TA1772	Tie rod end(224)	A B		M16x1.5 Female(253) £
TA1813	Inner tie rod(123)	A B		M16x1.5 Male(252) £
TBR4208	Steering rack gaiter kit(213)	K	Thermoplastic(223)	1 :17x55x55 2 :17x55x55
TC1016	Lower ball joint(140)	A B		Pinch Bolt(255) 21mm
TC1017	Lower wishbone(158)	A		Pinch Bolt(255) 21mm
TC1018	Lower wishbone(158)	B		Pinch Bolt(255) 21mm
TC1154	Link stabiliser(135)	A B	Metal	M10x1.5
TC1171	Link stabiliser(135)	A B		M10x1.5
TC1172	Link stabiliser(135)	A B		M10x1.5
TC1944	Trailing arm(226)	A B	Front(108) 550mm	
TC1954	Trailing arm(226)	A B	Rear(187) 600mm	
TC1955	Trailing arm(226)	A B	575mm	
TC3028	Trailing arm(226)	A B	214mm	
TC3275	Lower track control arm(151)	A B		
TD348W	Lower wishbone bush(159)	A B	Front(108)	
TD349W	Lower wishbone bush(159)	A B	Rear(187)	
TD688W	Sub-frame bush(215)	A B	Front(108) V shaped head(249)	
TD689W	Sub-frame bush(215)	A B	Rear(187) Straight head(214)	
TD694W	Anti-roll bar(-74) bush kit(-86-)	K	Ø19 Complete axle kit(-92)	
TD1048W	Anti-roll bar(-74) bush kit(-86-)	K	Complete axle kit(-92) (-)	

... FORD

MONDEO III 1.8i, 2.0i, 2.0Di, 2.0DCi, 2.0TDi, 2.0TDCi, 2.2TDCi, 2.5i V6, 3.0i V6 (09/02-08/07)



TA1772



TA1813



TBR4208



TA1813



TA1772



TC1170



TC1170



TD694W



TC1016



TC1017



TD348W



TD348W



TC1018



TC1016



TD349W



TD349W



TC1944



TC1944



TC1954



TC1954



TC1171



TC1171



TC1172



TC1172

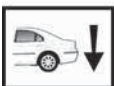

TD1048W



TC1955



TC1955



TC3028



TC3028



TD688W



TD688W



TD689W



TD689W



TC3275



TC3275

Part No	Description	Pos	Info	Technical
TA1772	Tie rod end (224)	A B		M16x1.5 Female (253) E

... MONDEO III 1.8i, 2.0i, 2.0Di, 2.0DCi, 2.0TDi, 2.0TDCi, 2.2TDCi, 2.5i V6, 3.0i V6 (09/02-08/07)

Part No	Description	Pos	Info	Technical
TA1813	Inner tie rod(123)	A B		M16x1.5 Male(252) £
TBR4208	Steering rack gaiter kit(213)	K	Thermoplastic(223)	1 :17x55x55 2 :17x55x55
TC1016	Lower ball joint(140)	A B		Pinch Bolt(255) 21mm
TC1017	Lower wishbone(158)	A		Pinch Bolt(255) 21mm
TC1018	Lower wishbone(158)	B		Pinch Bolt(255) 21mm
TC1170	Link stabiliser(135)	A B	Plastic(184)	M10x1.5
TC1171	Link stabiliser(135)	A B		M10x1.5
TC1172	Link stabiliser(135)	A B		M10x1.5
TC1944	Trailing arm(226)	A B	Front(108) 550mm	
TC1954	Trailing arm(226)	A B	Rear(187) 600mm	
TC1955	Trailing arm(226)	A B	575mm	
TC3028	Trailing arm(226)	A B	214mm	
TC3275	Lower track control arm(151)	A B		
TD348W	Lower wishbone bush(159)	A B	Front(108)	
TD349W	Lower wishbone bush(159)	A B	Rear(187)	
TD688W	Sub-frame bush(215)	A B	Front(108) V shaped head(249)	
TD689W	Sub-frame bush(215)	A B	Rear(187) Straight head(214)	
TD694W	Anti-roll bar(-74) bush kit(-86)	K	Ø19 Complete axle kit(-92)	
TD1048W	Anti-roll bar(-74) bush kit(-86)	K	Complete axle kit(-92) (-)	

MONDEO III 3.0i ST220 (04/02-09/02)

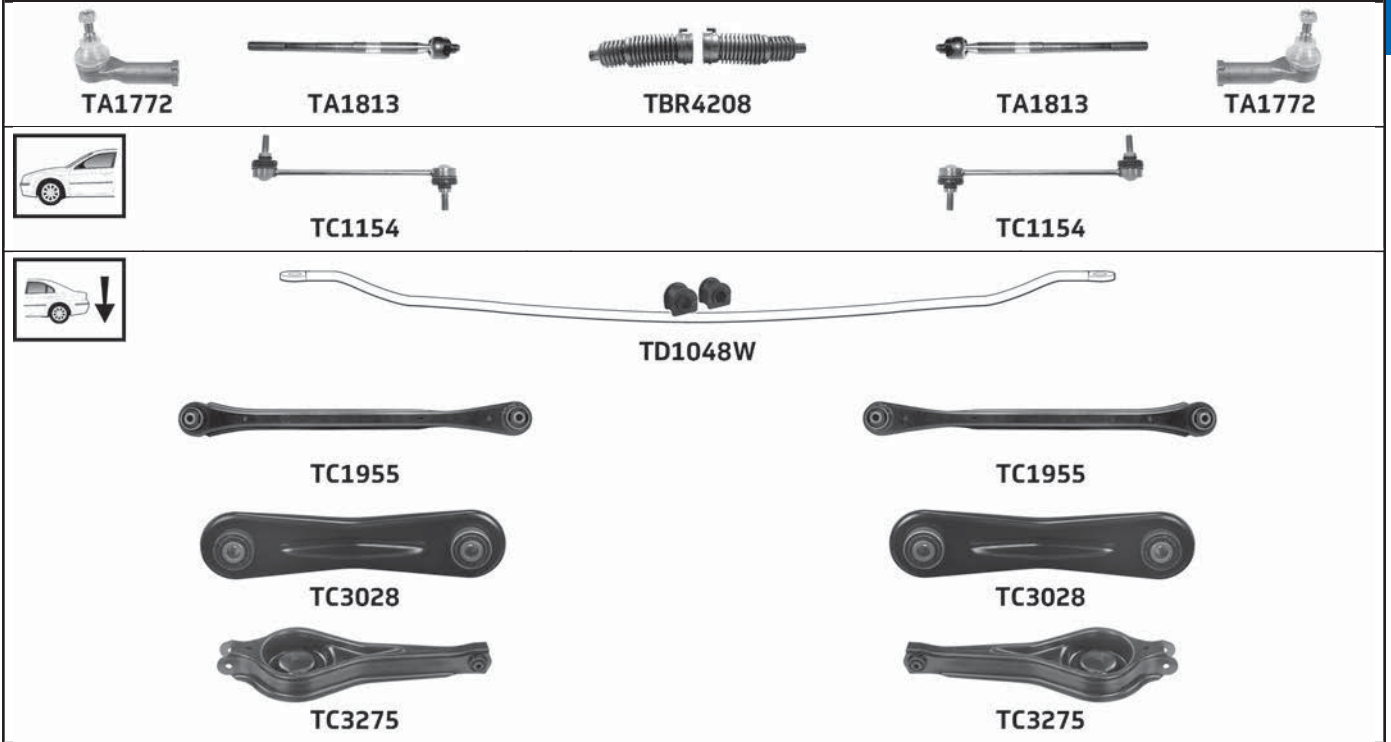

Part No	Description	Pos	Info	Technical
TA1772	Tie rod end(224)	A B		M16x1.5 Female(253) £
TA1813	Inner tie rod(123)	A B		M16x1.5 Male(252) £
TBR4208	Steering rack gaiter kit(213)	K	Thermoplastic(223)	1 :17x55x55 2 :17x55x55
TC1154	Link stabiliser(135)	A B	Metal	M10x1.5
TC1955	Trailing arm(226)	A B	575mm	
TC3028	Trailing arm(226)	A B	214mm	
TC3275	Lower track control arm(151)	A B		
TD1048W	Anti-roll bar(-74) bush kit(-86)	K	Complete axle kit(-92) (-)	

... FORD

MONDEO III 3.0i ST220 (09/02-08/07)



Part No	Description	Pos	Info	Technical
TA1772	Tie rod end(224)	A B		M16x1.5 Female(253) £
TA1813	Inner tie rod(123)	A B		M16x1.5 Male(252) £
TBR4208	Steering rack gaiter kit(213)	K	Thermoplastic(223)	1 :17x55x55 2 :17x55x55
TC1170	Link stabiliser(135)	A B	Plastic(184)	M10x1.5
TC1955	Trailing arm(226)	A B	575mm	
TC3028	Trailing arm(226)	A B	214mm	
TC3275	Lower track control arm(151)	A B		
TD1048W	Anti-roll bar(-74) bush kit(-86-)	K	Complete axle kit(-92-) (-)	

FORD

MONDEO IV 1.6Ti, 2.0i (03/07-)

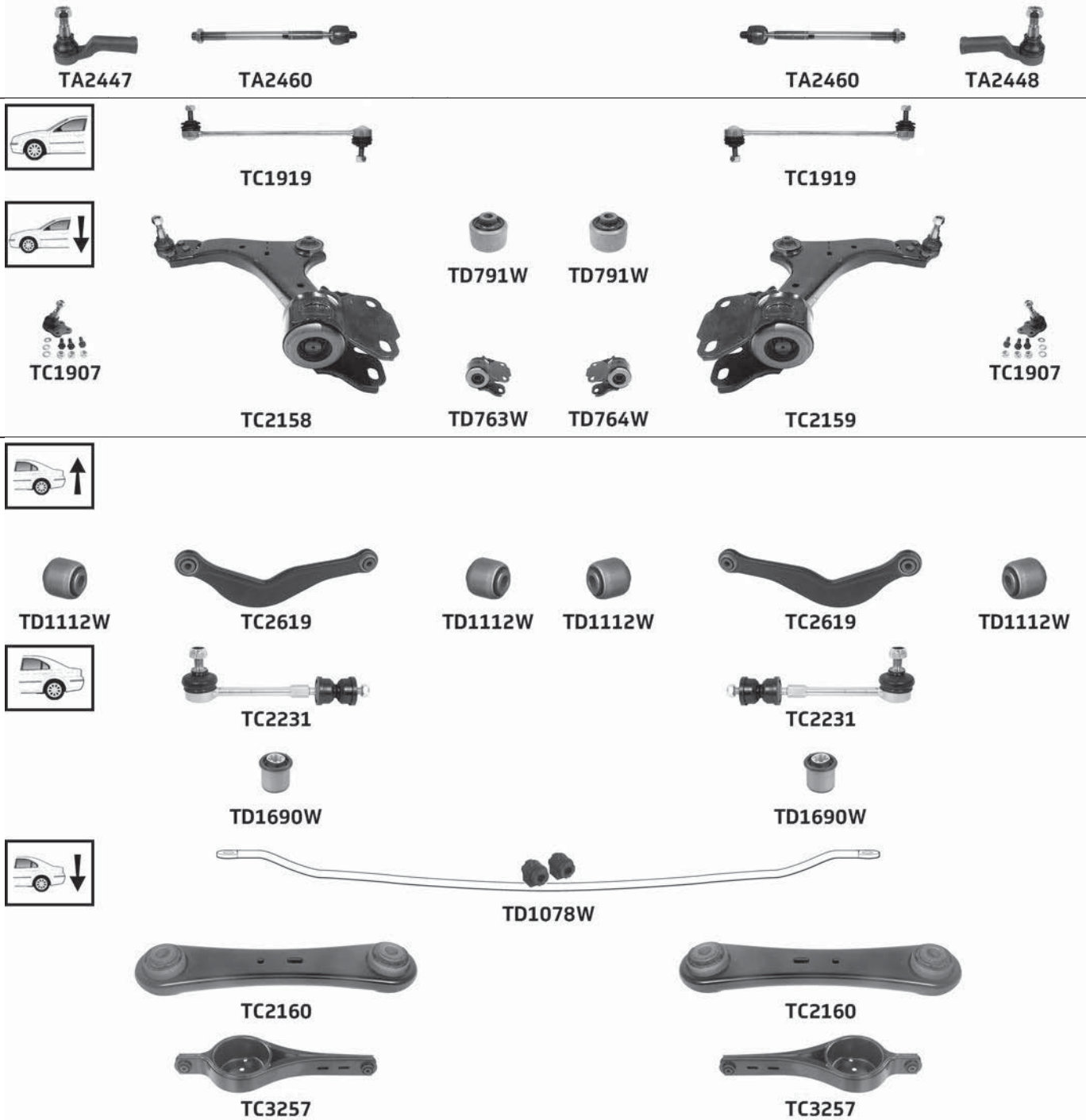

Part No	Description	Pos	Info	Technical
TA2447	Tie rod end (224)	A		M18x1.5 Female(253) £
TA2448	Tie rod end (224)	B		M18x1.5 Female(253) £
TA2460	Inner tie rod (123)	A B		M18x1.5 Male (252) £
TC1907	Lower ball joint (140)	A B		M14x1.5
TC1919	Link stabiliser (135)	A B		M10x1.5
TC2158	Lower wishbone (158)	A		M14x1.5
TC2159	Lower wishbone (158)	B		M14x1.5
TC2160	Lower link arm (144)	A B		
TC2231	Link stabiliser (135)	A B		M10x1.5
TC2619	Upper link arm (239)	A B		
TC3257	Lower track control arm (151)	A B		
TD763W	Lower wishbone bush (159)	A	Rear (187) Replace in pairs(192)	
TD764W	Lower wishbone bush (159)	B	Rear (187) Replace in pairs(192)	
TD791W	Lower wishbone bush (159)	A B	Front (108)	
TD1078W	Anti-roll bar (-74-) bush kit (-86-)	K	Complete axle kit (-92-)	
TD1112W	Upper link arm bush (240)	A B	Outer (176) Inner (119)	
TD1690W	Sub-frame bush (215)	A B	Rear (187)	

... FORD

MONDEO IV 1.6TDCi, 1.8TDCi, 2.0TDCi, 2.2TDCi (03/07→)

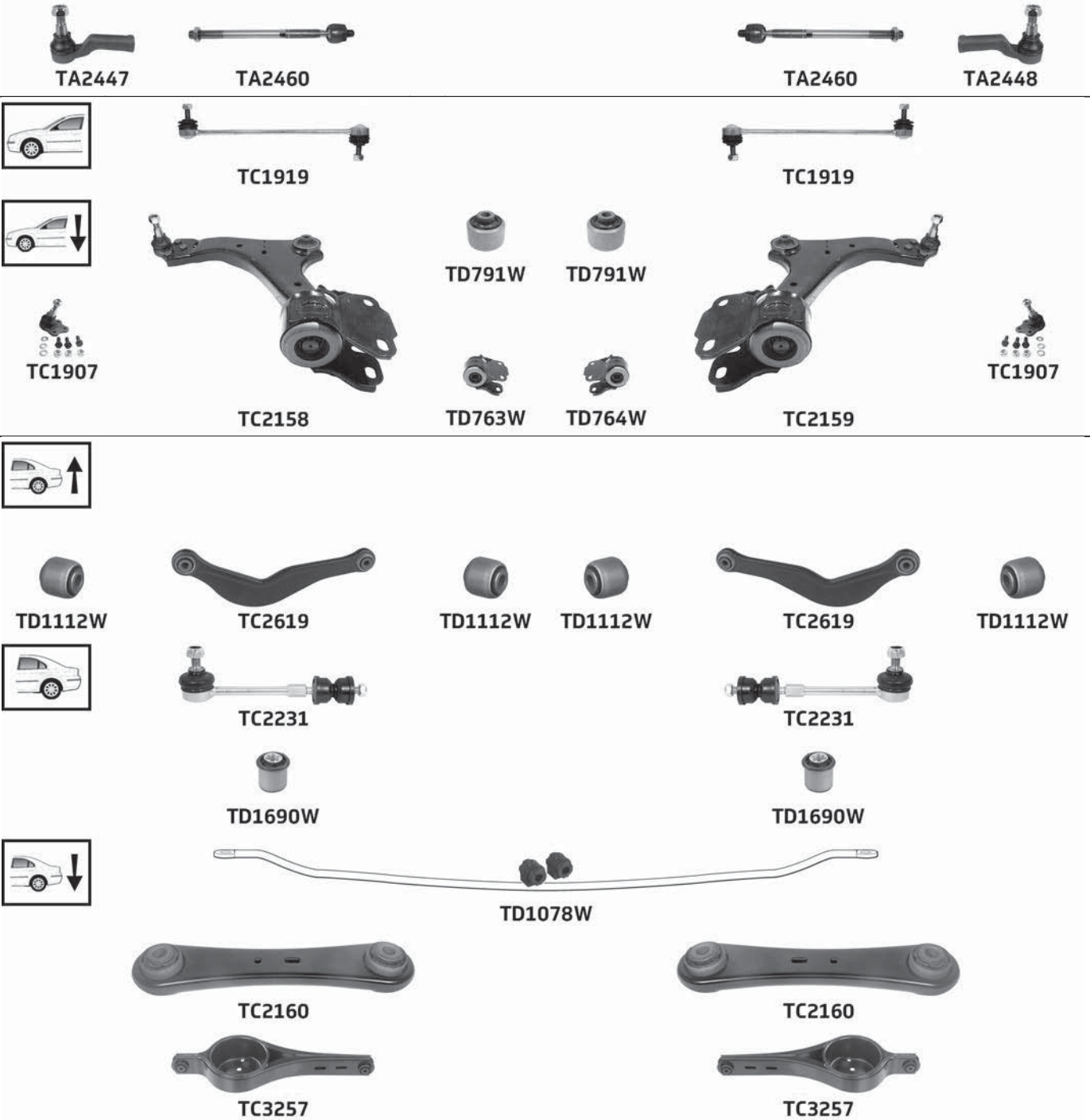

Part No	Description	Pos	Info	Technical
TA2447	Tie rod end(224)	A		M18x1.5 Female(253) £
TA2448	Tie rod end(224)	B		M18x1.5 Female(253) £
TA2460	Inner tie rod(123)	A B		M18x1.5 Male(252) £
TC1907	Lower ball joint(140)	A B		M14x1.5
TC1919	Link stabiliser(135)	A B		M10x1.5
TC2158	Lower wishbone(158)	A		M14x1.5
TC2159	Lower wishbone(158)	B		M14x1.5
TC2160	Lower link arm(144)	A B		
TC2231	Link stabiliser(135)	A B		M10x1.5
TC2619	Upper link arm(239)	A B		
TC3257	Lower track control arm(151)	A B		
TD763W	Lower wishbone bush(159)	A	Rear(187) Replace in pairs(192)	
TD764W	Lower wishbone bush(159)	B	Rear(187) Replace in pairs(192)	
TD791W	Lower wishbone bush(159)	A B	Front(108)	
TD1078W	Anti-roll bar(-74) bush kit(-86-)	K	Complete axle kit(-92) (+)	
TD1112W	Upper link arm bush(240)	A B	Outer(176) Inner(119)	
TD1690W	Sub-frame bush(215)	A B	Rear(187)	

MONDEO IV 2.0SCTi, 2.3i, 2.5i (03/07→)

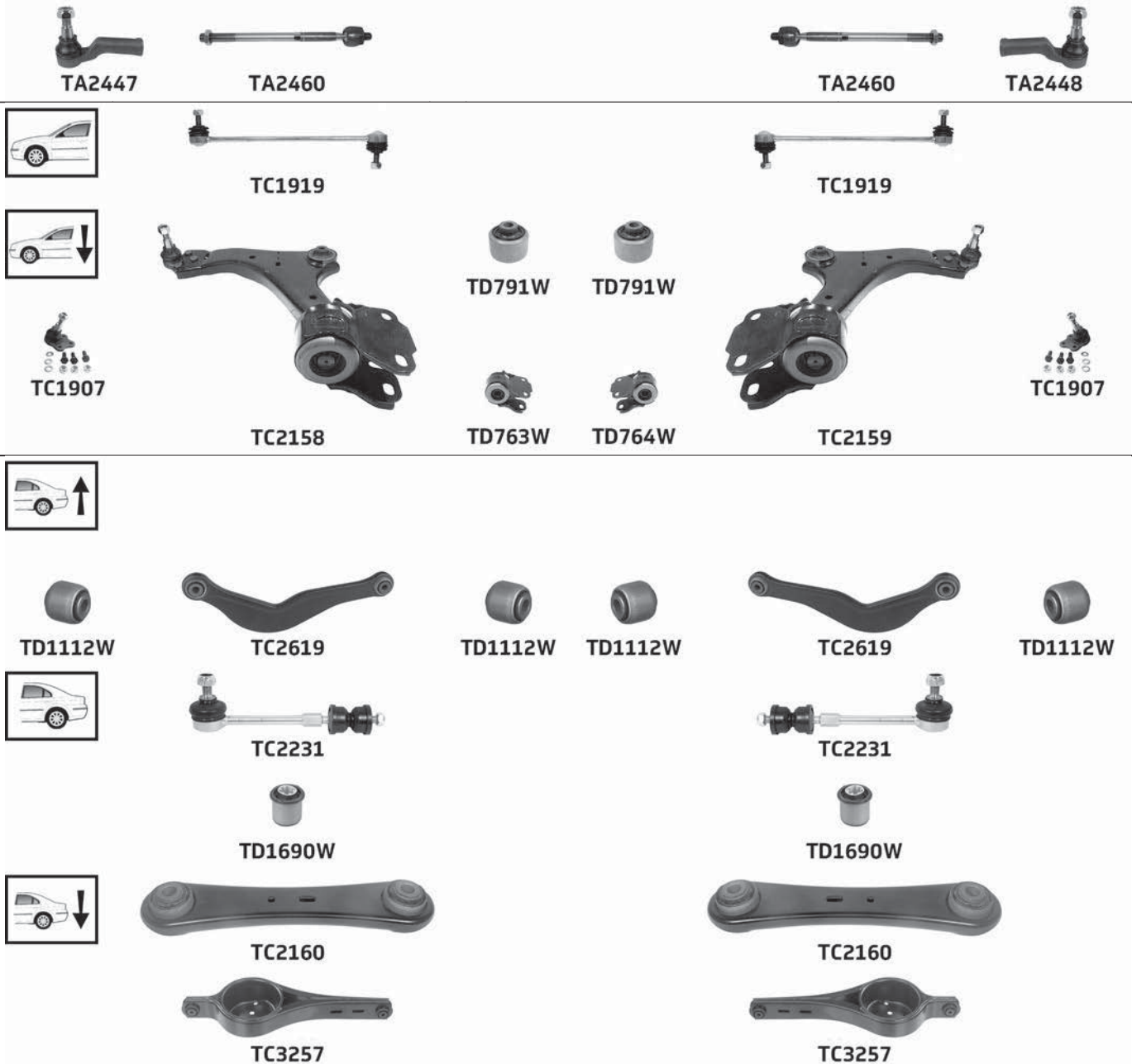

Part No	Description	Pos	Info	Technical
TA2447	Tie rod end (224)	A		M18x1.5 Female (253) £
TA2448	Tie rod end (224)	B		M18x1.5 Female (253) £
TA2460	Inner tie rod (123)	A B		M18x1.5 Male (252) £
TC1907	Lower ball joint (140)	A B		M14x1.5
TC1919	Link stabiliser (135)	A B		M10x1.5
TC2158	Lower wishbone (158)	A		M14x1.5
TC2159	Lower wishbone (158)	B		M14x1.5
TC2160	Lower link arm (144)	A B		
TC2231	Link stabiliser (135)	A B		M10x1.5
TC2619	Upper link arm (239)	A B		
TC3257	Lower track control arm (151)	A B		
TD763W	Lower wishbone bush (159)	A	Rear (187) Replace in pairs (192)	
TD764W	Lower wishbone bush (159)	B	Rear (187) Replace in pairs (192)	
TD791W	Lower wishbone bush (159)	A B	Front (108)	
TD1112W	Upper link arm bush (240)	A B	Outer (176) Inner (119)	
TD1690W	Sub-frame bush (215)	A B	Rear (187)	

... FORD

MONDEO V 1.0i, 1.5i, 1.5TDCi, 1.6TDCi, 2.0i, 2.0DCi (09/14→)

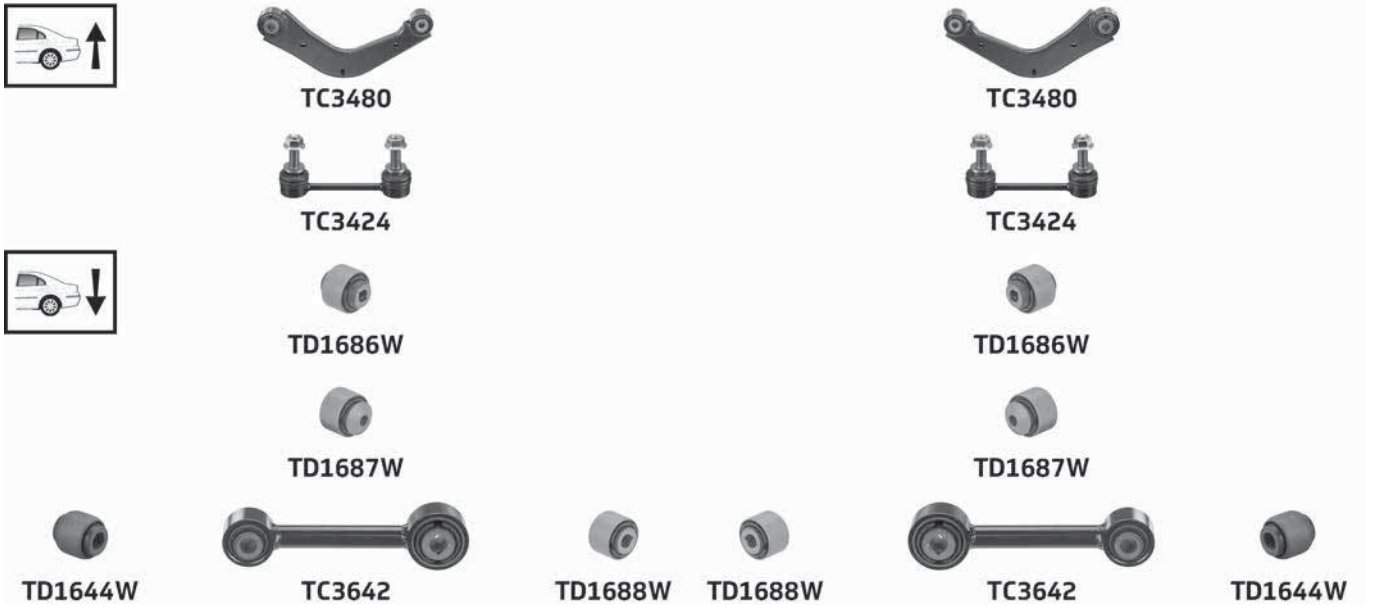

Part No	Description	Pos	Info	Technical
TC3424	Link stabiliser (135)	A B		M12x1.25
TC3480	Upper track control arm (242)	A B	(-) 4X4	
TC3642	Lower link arm (144)	A B	Front (108)	
TD1644W	Lower link arm bush (145)	A B	Front (108) Lower (139)	
TD1686W	Trailing arm bush (227)	A B	Inner (119)	
TD1687W	Trailing arm bush (227)	A B	Outer (176)	
TD1688W	Lower link arm bush (145)	A B	Front (108) Upper (231)	

RANGER 2.5D, 2.5D 4x4, 2.5TD, 2.5TD 4x4 (05/99-06/06)

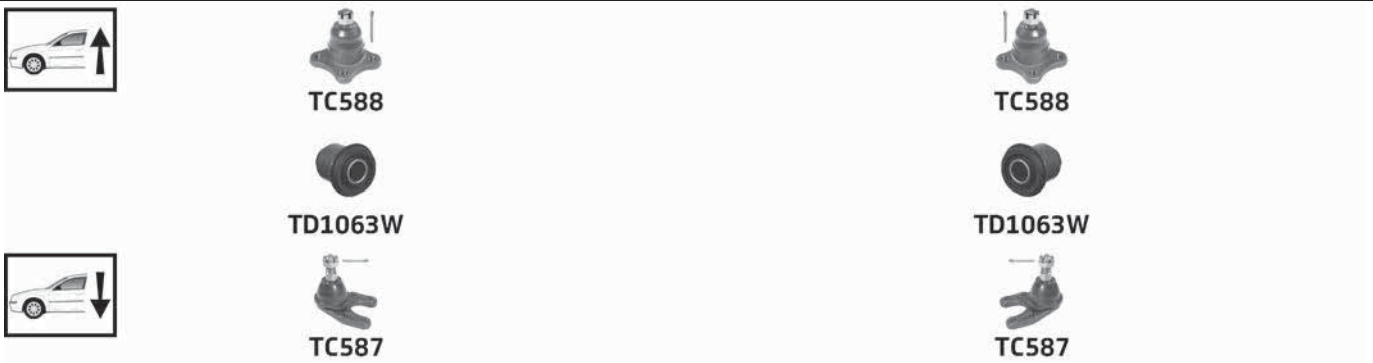

Part No	Description	Pos	Info	Technical
TC587	Lower ball joint (140)	A B	(-) 4x4	M16x1.5
TC588	Upper ball joint (232)	A B		M12x1.25
TD1063W	Upper wishbone bush (248)	A B	Front (108) Rear (187)	

RANGER 2.5TDCi, 2.5TDCi 4x4, 2.5TDDi, 3.0TDCi, 3.0TDCi 4x4 (05/06→)



Part No	Description	Pos	Info	Technical
TC588	Upper ball joint (232)	A B		M12x1.25

RANGER 2.2TDCi, 2.2TDCi 4x4, 2.5i 4x4, 3.2TDCi, 3.2TDCi 4x4 (04/11→)

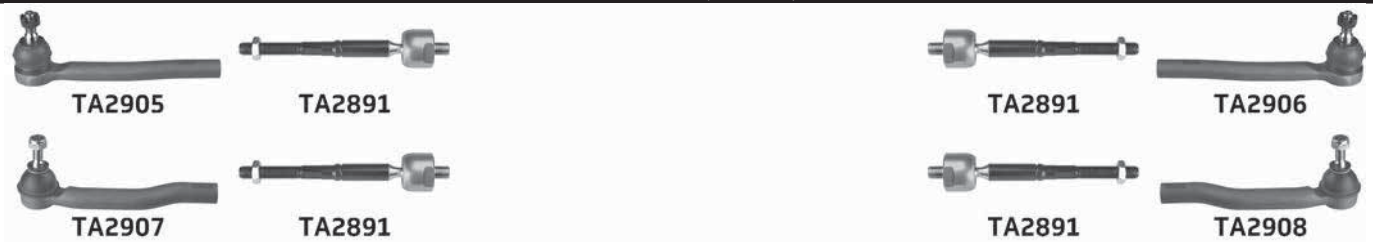

... RANGER 2.2TDCi, 2.2TDCi 4x4, 2.5i 4x4, 3.2TDCi, 3.2TDCi 4x4 (04/11→)



Part No	Description	Pos	Info	Technical
TA2891	Inner tie rod(123)	A B		M14x1.5 Male(252) £
TA2905	Tie rod end(224)	A	(-) Ride height (-25-)	M14x1.5 Female(253) £
TA2906	Tie rod end(224)	B	(-) Ride height (-25-)	M14x1.5 Female(253) £
TA2907	Tie rod end(224)	A	(+) Ride height (-52-)	M12x1.25 Female(253) £
TA2908	Tie rod end(224)	B	(+) Ride height (-52-)	M12x1.25 Female(253) £
TC2679	Link stabiliser(135)	A	(+) Ride height (-52-)	M12x1.75
TC2680	Link stabiliser(135)	B	(+) Ride height (-52-)	M12x1.75
TC2689	Lower ball joint(140)	A B		M16x2

S-MAX 1.6i, 1.6TDCi, 1.8TDCi, 2.0i, 2.0TDCi, 2.2TDCi, 2.3i, 2.5i (05/06→)

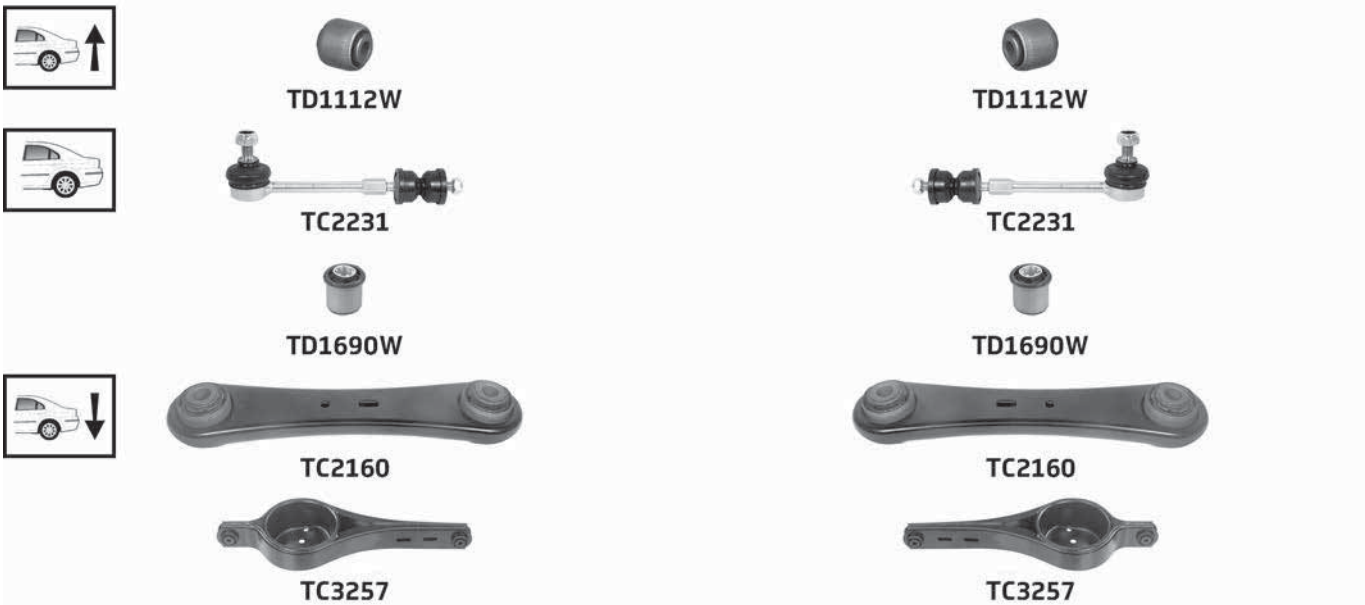
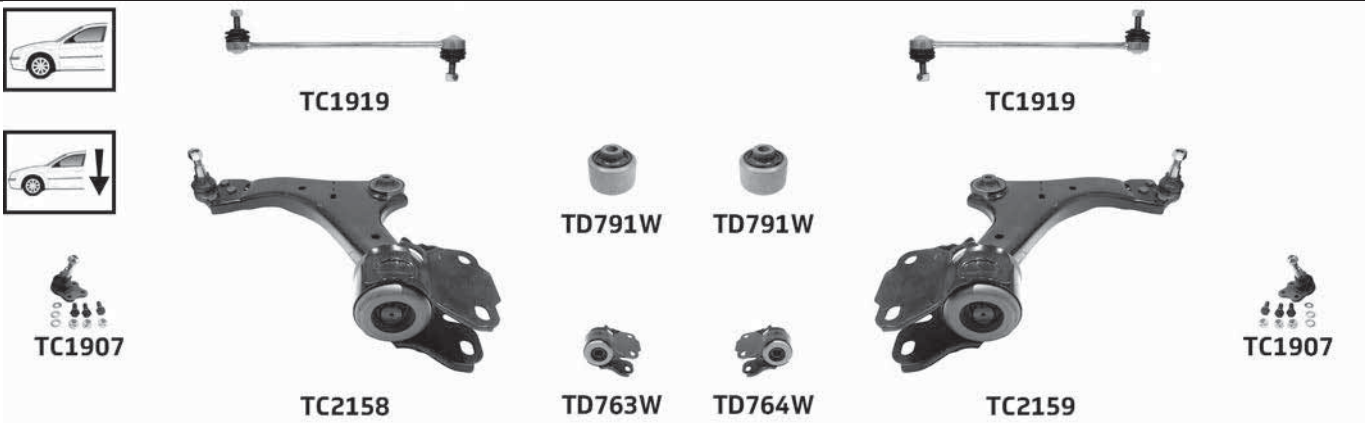

Part No	Description	Pos	Info	Technical
TA2447	Tie rod end(224)	A		M18x1.5 Female(253) £
TA2448	Tie rod end(224)	B		M18x1.5 Female(253) £
TA2460	Inner tie rod(123)	A B		M18x1.5 Male(252) £
TC1907	Lower ball joint(140)	A B		M14x1.5
TC1919	Link stabiliser(135)	A B		M10x1.5

... FORD

... S-MAX 1.6i, 1.6TDCi, 1.8TDCi, 2.0i, 2.0TDCi, 2.2TDCi, 2.3i, 2.5i (05/06→)

Part No	Description	Pos	Info	Technical
TC2158	Lower wishbone(158)	A		M14x1.5
TC2159	Lower wishbone(158)	B		M14x1.5
TC2160	Lower link arm(144)	A B		
TC2231	Link stabiliser(135)	A B		M10x1.5
TC3257	Lower track control arm(151)	A B		
TD763W	Lower wishbone bush(159)	A	Rear(187) Replace in pairs(192)	
TD764W	Lower wishbone bush(159)	B	Rear(187) Replace in pairs(192)	
TD791W	Lower wishbone bush(159)	A B	Front(108)	
TD1112W	Upper wishbone bush(248)	A B	Outer(176) Inner(119)	
TD1690W	Sub-frame bush(215)	A B	Rear(187)	

SPORT KA 1.6i (02/03→)



TA1614



TA1614



TC720



TC720



TD602W



TC2607



TD253W

TD253W



TC2608



TC663



TD892W



TD892W



TD1194W



TD1194W

Part No	Description	Pos	Info	Technical
TA1614	Tie rod end(224)	A B		1/2x20 UNF Female(253) E
TC663	Lower ball joint(140)	A B		Pinch Bolt(255) 16.5mm
TC720	Link stabiliser(135)	A B		M10x1.25
TC2607	Lower wishbone(158)	A		Pinch Bolt(255) 16.5mm
TC2608	Lower wishbone(158)	B		Pinch Bolt(255) 16.5mm
TD253W	Lower wishbone bush(159)	A B	Front(108)	
TD254W	Lower wishbone bush(159)	A B	Rear(187)	
TD602W	Pinch bolt kit(182)	K		
TD892W	Axle bush(-76-)	A B	Front(108)	
TD1194W	Axle bush(-76-)	A B	Rear(187)	

STREET KA 1.6i (05/03-07/05)

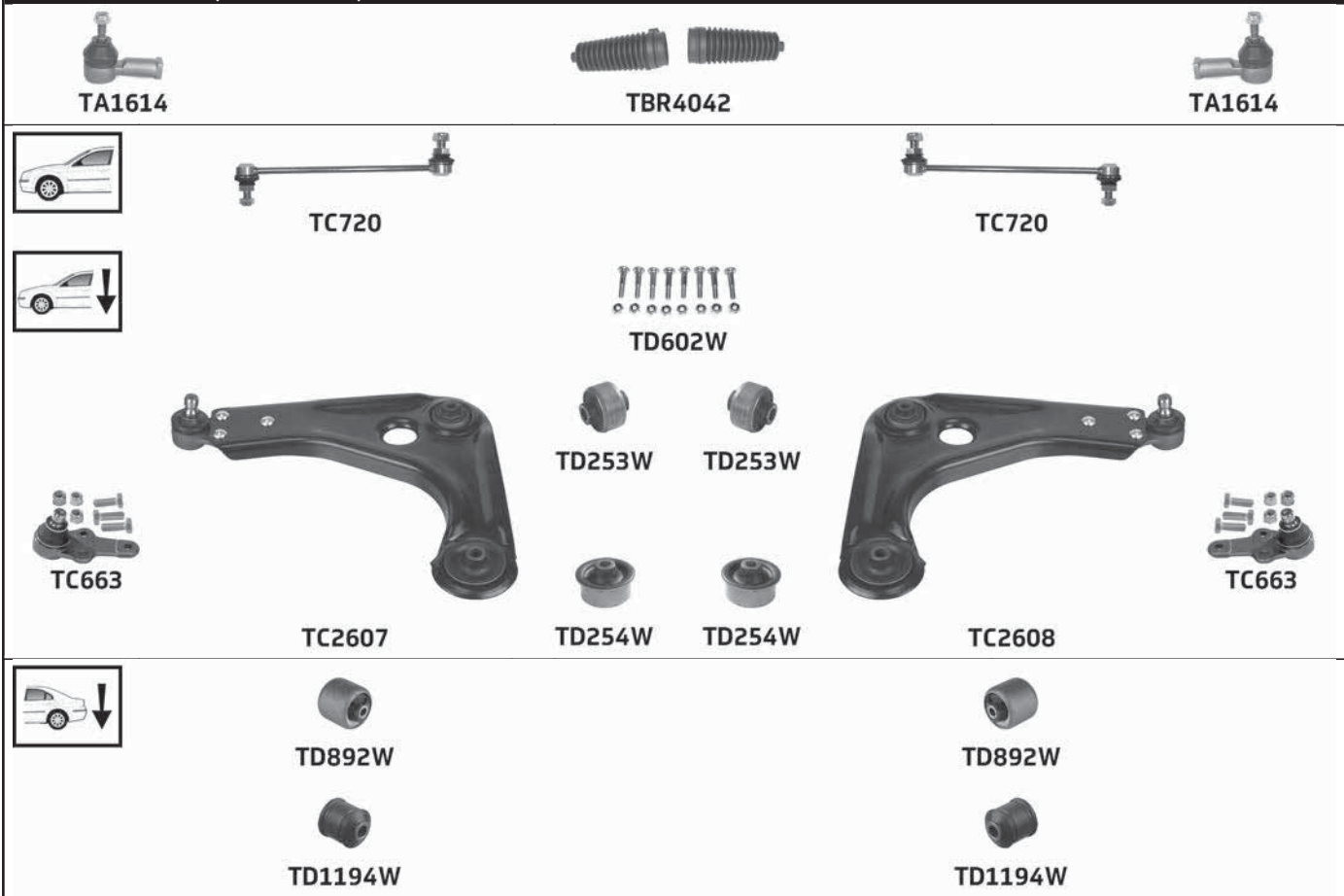

Part No	Description	Pos	Info	Technical
TA1614	Tie rod end (224)	A B		1/2x20 UNF Female (253) £
TBR4042	Steering rack gaiter kit (213)	K		1 :14x56x56 2 :14x56x56
TC663	Lower ball joint (140)	A B		Pinch Bolt (255) 16.5mm
TC720	Link stabiliser (135)	A B		M10x1.25
TC2607	Lower wishbone (158)	A		Pinch Bolt (255) 16.5mm
TC2608	Lower wishbone (158)	B		Pinch Bolt (255) 16.5mm
TD253W	Lower wishbone bush (159)	A B	Front (108)	
TD254W	Lower wishbone bush (159)	A B	Rear (187)	
TD602W	Pinch bolt kit (182)	K		
TD892W	Axle bush (-76-)	A B	Front (108)	
TD1194W	Axle bush (-76-)	A B	Rear (187)	

FORD

... FORD

TOURNEO CONNECT 1.8i, 1.8TDCi, 1.8TDdi (06/02→)

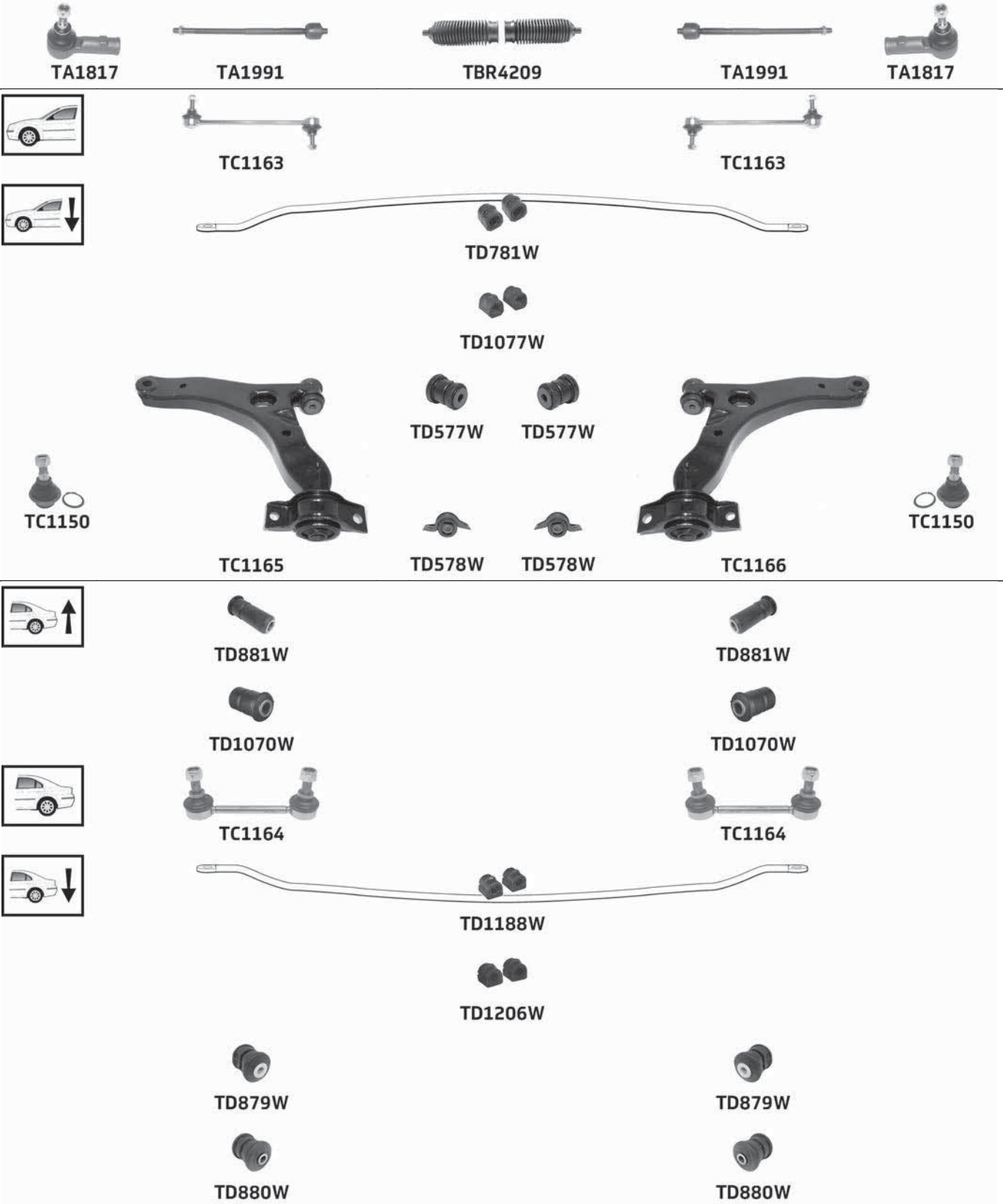

Part No	Description	Pos	Info	Technical
TA1817	Tie rod end(224)	A B		M14x2 Female(253) E
TA1991	Inner tie rod(123)	A B		M14x2 Male(252) E
TBR4209	Steering rack gaiter kit(213)	K	Thermoplastic(223)	1 :14x47x47 2 :14x47x47
TC1150	Lower ball joint(140)	A B		M16x1.5
TC1163	Link stabiliser(135)	A B		M10x1.5
TC1164	Link stabiliser(135)	A B		M12x1.5
TC1165	Lower wishbone(158)	A	(-) Ball joint(-11-)	
TC1166	Lower wishbone(158)	B	(-) Ball joint(-11-)	
TD577W	Lower wishbone bush(159)	A B	Front(108)	

... TOURNEO CONNECT 1.8i, 1.8TDCi, 1.8TDdi (06/02→)

Part No	Description	Pos	Info	Technical
TD578W	Lower wishbone bush(159)	A B	Rear(187)	
TD781W	Anti-roll bar(-74) bush kit(-86)	K	Ø25.5 Complete axle kit(-92) →11/06/2004	
TD879W	Spring eye bush(205)	A B	Front(108)	
TD880W	Spring eye bush(205)	A B	Rear(187)	
TD881W	Spring shackle bush(206)	A B	Inner(119)	
TD1070W	Spring shackle bush(206)	A B	Outer(176)	
TD1077W	Anti-roll bar(-74) bush kit(-86)	K	Ø22 Complete axle kit(-92) 11/06/2004 →	
TD1188W	Anti-roll bar(-74) bush kit(-86)	K	Ø22 Complete axle kit(-92) SWB(221)	
TD1206W	Anti-roll bar(-74) bush kit(-86)	K	Ø24 Complete axle kit(-92) LWB(164)	

TOURNEO CONNECT 1.0i EcoBoost, 1.5TDCi, 1.6TDCi (09/13→)



Part No	Description	Pos	Info	Technical
TA2997	Tie rod end(224)	A		M16x1.5 Female(253) £
TA2998	Tie rod end(224)	B		M16x1.5 Female(253) £
TA3254	Inner tie rod(123)	A B		M16x1.5 Male(252) £
TC1418	Link stabiliser(135)	A B		M10x1.5

TOURNEO COURIER 1.0i EcoBoost (02/14→)

TOURNEO COURIER 1.5TDCi, 1.6TDCi (02/14→)



Part No	Description	Pos	Info	Technical
TA2498	Tie rod end(224)	A		M14x1.5 Female(253) £
TA2499	Tie rod end(224)	B		M14x1.5 Female(253) £
TA2504	Inner tie rod(123)	A B		M14x1.5 Male(252) £
TC2562	Link stabiliser(135)	A B		M10x1.5

TOURNEO CUSTOM 2.2TDCi (12/12→)

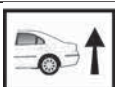

Part No	Description	Pos	Info	Technical
TA2922	Tie rod end(224)	A B		M16x1.5 Female(253) £
TA3186	Inner tie rod(123)	A B		M16x1.5 Male(252) £
TC3024	Lower wishbone(158)	A	(-) Ball joint(-11)	
TC3025	Lower wishbone(158)	B	(-) Ball joint(-11)	
TD1672W	Spring eye bush(205)	A B	Rear(187) Upper(231)	

... FORD

TRANSIT 2.0i, 2.0Di, 2.3i, 2.4Di, 2.4TDi, 2.4TDDi (01/00-05/01)

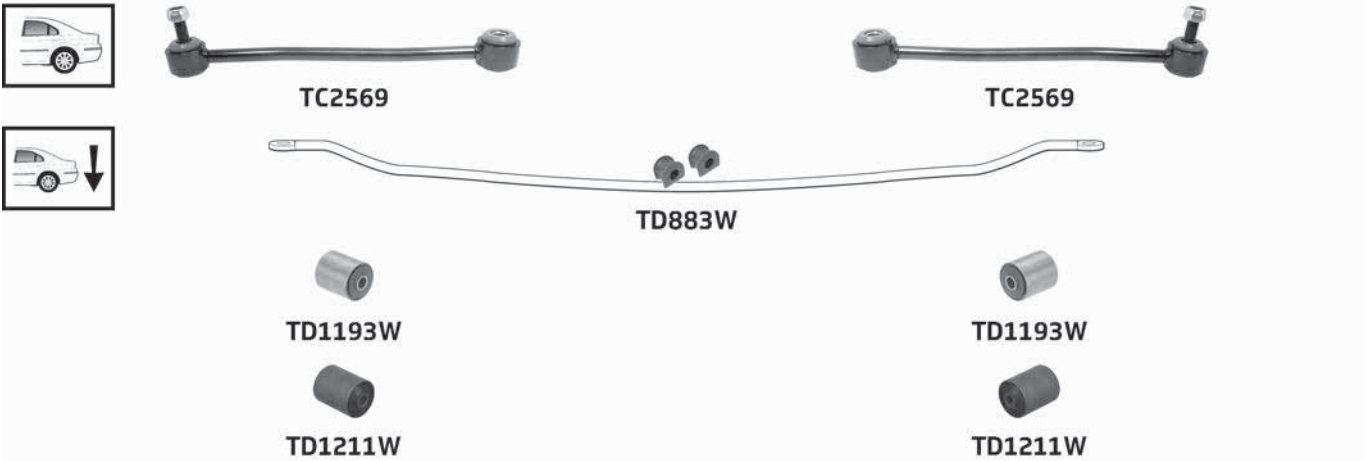
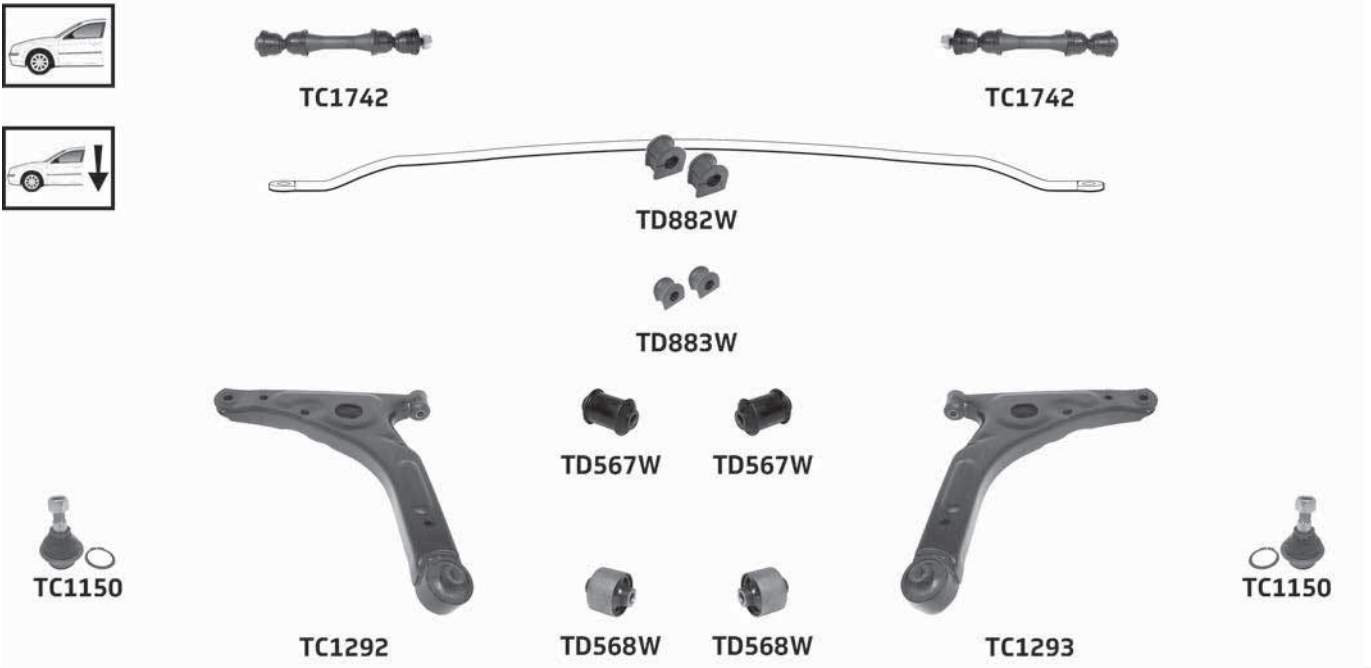

Part No	Description	Pos	Info	Technical
TA1808	Tie rod end(224)	A B		M16x1.5 Female(253) £
TA1809	Inner tie rod(123)	A B	RH(193) L LH(130) R M20 into steering rack(124)	M16x1.5 Male(252) £
TA1810	Inner tie rod(123)	A B	LH(130) L RH(193) R M16 into steering rack(124)	M16x1.5 Male(252) £
TC1150	Lower ball joint(140)	A B		M16x1.5
TC1292	Lower wishbone(158)	A	(-) Ball joint(-11-)	
TC1293	Lower wishbone(158)	B	(-) Ball joint(-11-)	
TC1742	Link stabiliser(135)	A B	RWD(198) FWD 260, 280, 300 Series	
TC2569	Link stabiliser(135)	A B	Twin rear wheels(229) Length(129) 312mm	M12x1.75
TD567W	Lower wishbone bush(159)	A B	Front(108)	
TD568W	Lower wishbone bush(159)	A B	Rear(187)	
TD882W	Anti-roll bar(-74-) bush kit(-86-)	K	Ø23.5 RWD(198) FWD 260, 280, 300 Series Complete axle kit(-92-)	
TD883W	Anti-roll bar(-74-) bush kit(-86-)	K	Ø29 Twin rear wheels(229) Complete axle kit(-92-)	
TD883W	Anti-roll bar(-74-) bush kit(-86-)	K	Ø29 Twin rear wheels(229) Complete axle kit(-92-)	
TD1193W	Leaf spring bush(128)	A B	Front(108) (+) FWD	
TD1193W	Leaf spring bush(128)	A B	Front(108) (+) RWD(198) (-) Chassis Cab	
TD1211W	Leaf spring bush(128)	A B	Rear(187)	

TRANSIT 2.0i, 2.0Di, 2.0TDCi, 2.3i, 2.4Di, 2.4TDi, 2.4TDCi, 2.4TDdi (05/01-05/06)

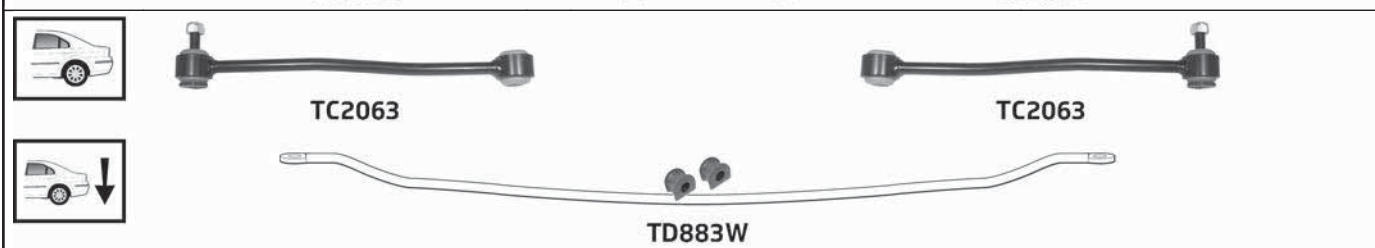
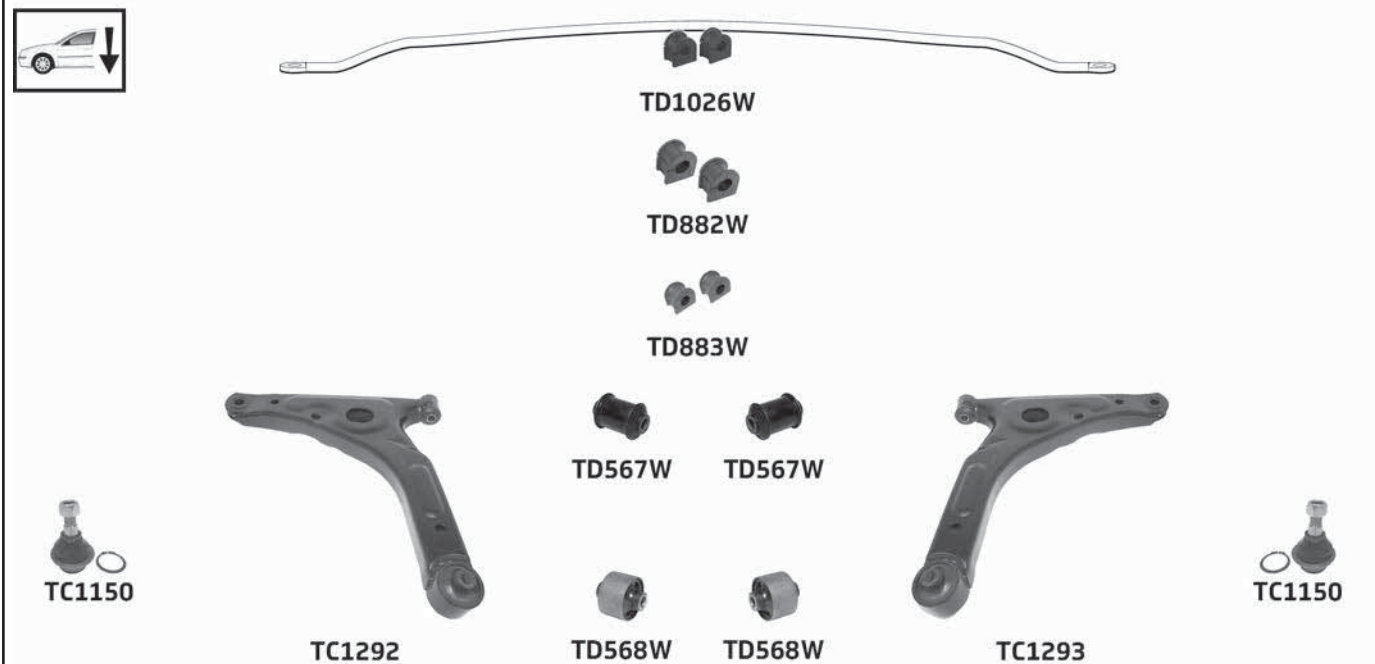
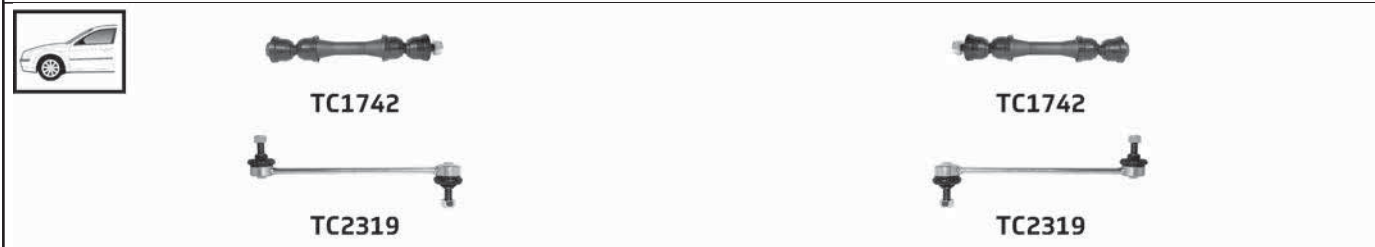
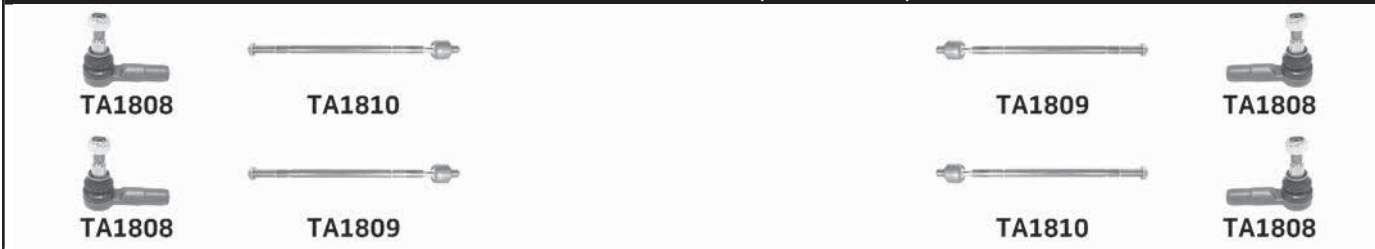

Part No	Description	Pos	Info	Technical
TA1808	Tie rod end (224)	A B		M16x1.5 Female(253) £
TA1809	Inner tie rod(123)	A B	RH(193) L LH(130) R M20 into steering rack(124)	M16x1.5 Male(252) £
TA1810	Inner tie rod(123)	A B	LH(130) L RH(193) R M16 into steering rack(124)	M16x1.5 Male(252) £
TC1150	Lower ball joint(140)	A B		M16x1.5
TC1292	Lower wishbone(158)	A	(-) Ball joint(-11-)	
TC1293	Lower wishbone(158)	B	(-) Ball joint(-11-)	
TC1742	Link stabiliser(135)	A B	RWD(198) FWD 260, 280, 300 Series	
TC2063	Link stabiliser(135)	A B	Twin rear wheels(229) Length(129) 347mm	M12x1.75

FORD

... FORD

... TRANSIT 2.0i, 2.0Di, 2.0TDCi, 2.3i, 2.4Di, 2.4TDi, 2.4TDCi, 2.4TDdi (05/01-05/06)

Part No	Description	Pos	Info	Technical
TC2319	Link stabiliser(135)	A B	FWD 330, 350 Series	M12x1.5
TD567W	Lower wishbone bush(159)	A B	Front(108)	
TD568W	Lower wishbone bush(159)	A B	Rear(187)	
TD882W	Anti-roll bar(-74) bush kit(-86-)	K	Ø23.5 RWD(198) FWD 260, 280, 300 Series Complete axle kit(-92)	
TD883W	Anti-roll bar(-74) bush kit(-86-)	K	Ø29 Twin rear wheels(229) Complete axle kit(-92)	
TD883W	Anti-roll bar(-74) bush kit(-86-)	K	Ø29 Twin rear wheels(229) Complete axle kit(-92)	
TD1026W	Anti-roll bar(-74) bush kit(-86-)	K	Ø20 FWD 330, 350 Series Complete axle kit(-92)	
TD1193W	Leaf spring bush(128)	A B	Front(108) (+) FWD	
TD1193W	Leaf spring bush(128)	A B	Front(108) (+) RWD(198) (-) Chassis Cab	
TD1211W	Leaf spring bush(128)	A B	Rear(187)	

TRANSIT 2.2TDCi, 2.3i, 2.4TDCi, 3.2TDCi (04/06-08/14)

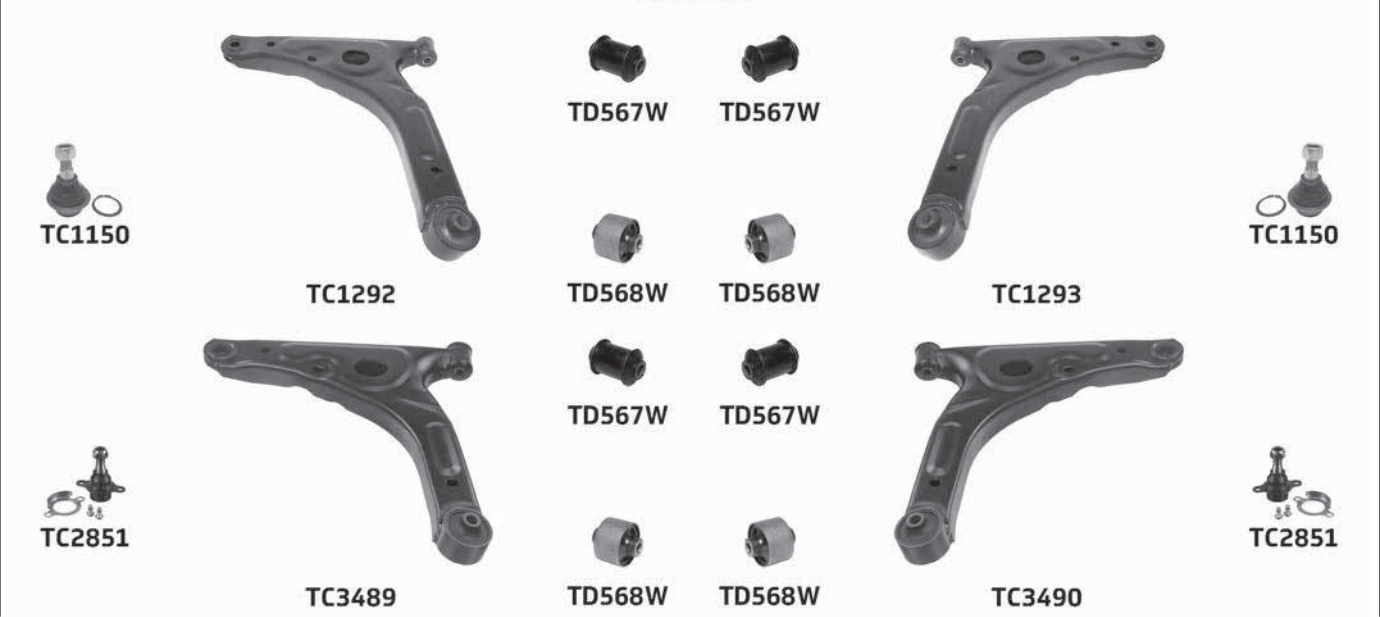

Part No	Description	Pos	Info	Technical
TA1808	Tie rod end(224)	A B		M16x1.5 Female(253) £
TA1809	Inner tie rod(123)	A B	RH(193) L LH(130) R M20 into steering rack(124)	M16x1.5 Male(252) £
TA1810	Inner tie rod(123)	A B	LH(130) L RH(193) R M16 into steering rack(124)	M16x1.5 Male(252) £
TC1150	Lower ball joint(140)	A B	(-) Heavy duty(-17-)	M16x1.5
TC1292	Lower wishbone(158)	A	(-) Heavy duty(111) (-) Ball joint(-11-)	

... TRANSIT 2.2TDCi, 2.3i, 2.4TDCi, 3.2TDCi (04/06-08/14)

Part No	Description	Pos	Info	Technical
TC1293	Lower wishbone(158)	B	(-) Heavy duty(-17-) (-) Ball joint(-11-)	
TC2063	Link stabiliser(135)	A B		M12x1.75
TC2319	Link stabiliser(135)	A B		M12x1.5
TC2851	Lower ball joint(140)	A B	(+) Heavy duty(-46-)	M20.1.5
TC3489	Lower wishbone(158)	A	(+) Heavy duty(111) (-) Ball joint(-11-)	
TC3490	Lower wishbone(158)	B	(+) Heavy duty(111) (-) Ball joint(-11-)	
TD567W	Lower wishbone bush(159)	A B	Front(108)	
TD568W	Lower wishbone bush(159)	A B	Rear(187)	
TD883W	Anti-roll bar(-74-) bush kit(-86-)	K	Ø29 Twin rear wheels(229) Complete axle kit(-92)	
TD1026W	Anti-roll bar(-74-) bush kit(-86-)	K	Complete axle kit(-92)	

TRANSIT 2.2TDCi (01/14→)



TA2922



TA3186



TA3186



TA2922



TC3024



TC3025

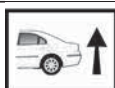

TD1672W



TD1672W

Part No	Description	Pos	Info	Technical
TA2922	Tie rod end(224)	A B		M16x1.5 Female(253) £
TA3186	Inner tie rod(123)	A B		M16x1.5 Male(252) £
TC3024	Lower wishbone(158)	A	(-) Heavy duty(111) (-) Ball joint(-11-)	
TC3025	Lower wishbone(158)	B	(-) Heavy duty(-17-) (-) Ball joint(-11-)	
TD1672W	Spring eye bush(205)	A B	Rear(187) Upper(231) Single Rear Wheels(203)	

... FORD

TRANSIT CONNECT 1.8i, 1.8TDCi, 1.8TDdi (06/02→)

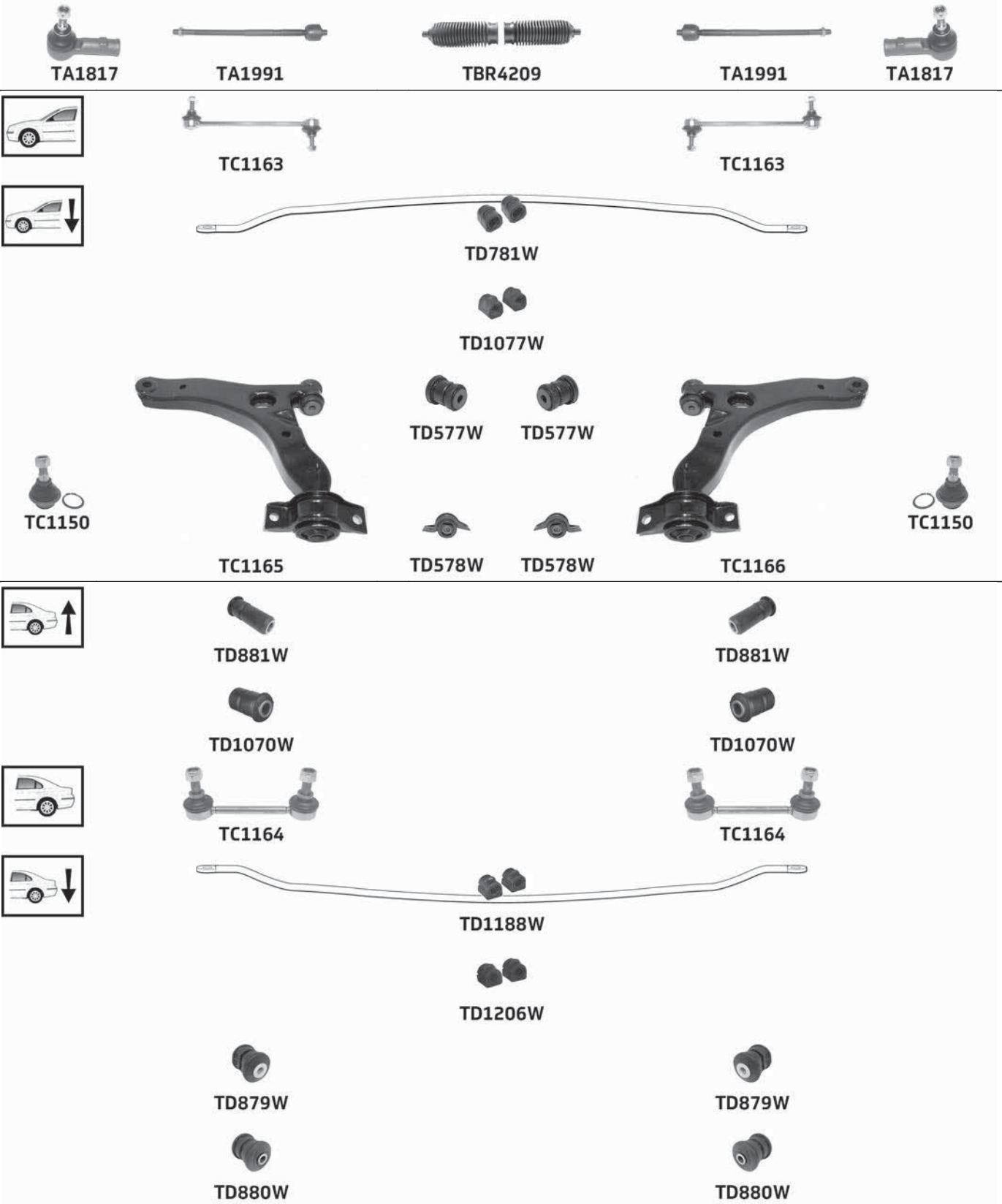

Part No	Description	Pos	Info	Technical
TA1817	Tie rod end(224)	A B		M14x2 Female(253) E
TA1991	Inner tie rod(123)	A B		M14x2 Male(252) E
TBR4209	Steering rack gaiter kit(213)	K	Thermoplastic(223)	1 :14x47x47 2 :14x47x47
TC1150	Lower ball joint(140)	A B		M16x1.5
TC1163	Link stabiliser(135)	A B		M10x1.5
TC1164	Link stabiliser(135)	A B		M12x1.5
TC1165	Lower wishbone(158)	A	(-) Ball joint(-11-)	
TC1166	Lower wishbone(158)	B	(-) Ball joint(-11-)	
TD577W	Lower wishbone bush(159)	A B	Front(108)	

... TRANSIT CONNECT 1.8i, 1.8TDCi, 1.8TDdi (06/02→)

Part No	Description	Pos	Info	Technical
TD578W	Lower wishbone bush(159)	A B	Rear(187)	
TD781W	Anti-roll bar(-74) bush kit(-86)	K	Ø25.5 Complete axle kit(-92) →11/06/2004	
TD879W	Spring eye bush(205)	A B	Front(108)	
TD880W	Spring eye bush(205)	A B	Rear(187)	
TD881W	Spring shackle bush(206)	A B	Inner(119)	
TD1070W	Spring shackle bush(206)	A B	Outer(176)	
TD1077W	Anti-roll bar(-74) bush kit(-86)	K	Ø22 Complete axle kit(-92) 11/06/2004 →	
TD1188W	Anti-roll bar(-74) bush kit(-86)	K	Ø22 Complete axle kit(-92) SWB(221)	
TD1206W	Anti-roll bar(-74) bush kit(-86)	K	Ø24 Complete axle kit(-92) LWB(164)	

TRANSIT CONNECT 1.0i EcoBoost, 1.5TDCi, 1.6TDCi (09/13→)



Part No	Description	Pos	Info	Technical
TA2997	Tie rod end(224)	A		M16x1.5 Female(253) £
TA2998	Tie rod end(224)	B		M16x1.5 Female(253) £
TA3254	Inner tie rod(123)	A B		M16x1.5 Male(252) £
TC1418	Link stabiliser(135)	A B		M10x1.5

TRANSIT COURIER 1.0i EcoBoost, 1.5TDCi, 1.6TDCi (02/14→)



Part No	Description	Pos	Info	Technical
TA2498	Tie rod end(224)	A		M14x1.5 Female(253) £
TA2499	Tie rod end(224)	B		M14x1.5 Female(253) £
TA2504	Inner tie rod(123)	A B		M14x1.5 Male(252) £
TC2562	Link stabiliser(135)	A B		M10x1.5

TRANSIT CUSTOM 2.2TDCi (12/12→)

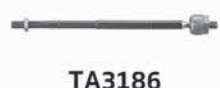

Part No	Description	Pos	Info	Technical
TA2922	Tie rod end(224)	A B		M16x1.5 Female(253) £
TA3186	Inner tie rod(123)	A B		M16x1.5 Male(252) £
TC3024	Lower wishbone(158)	A	(-) Ball joint(-11)	
TC3025	Lower wishbone(158)	B	(-) Ball joint(-11)	
TD1672W	Spring eye bush(205)	A B	Rear(187) Upper(231)	

... FORD

TRANSIT TOURNEO 2.2TDCi (07/06→)

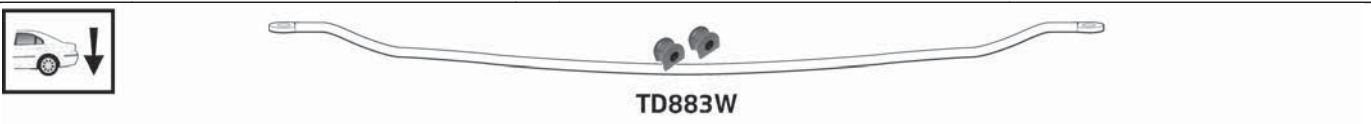

Part No	Description	Pos	Info	Technical
TA1808	Tie rod end(224)	A B		M16x1.5 Female(253) £
TA1809	Inner tie rod(123)	A B	RH(193) L LH(130) R M20 into steering rack(124)	M16x1.5 Male(252) £
TA1810	Inner tie rod(123)	A B	LH(130) L RH(193) R M16 into steering rack(124)	M16x1.5 Male(252) £
TC1150	Lower ball joint(140)	A B	(-) Heavy duty(-17-)	M16x1.5
TC1292	Lower wishbone(158)	A	(-) Heavy duty(111) (-) Ball joint(-11-)	
TC1293	Lower wishbone(158)	B	(-) Heavy duty(-17-) (-) Ball joint(-11-)	
TC2319	Link stabiliser(135)	A B		M12x1.5
TC2851	Lower ball joint(140)	A B	(+) Heavy duty(-46)	M20.1.5
TC3489	Lower wishbone(158)	A	(+) Heavy duty(111) (-) Ball joint(-11-)	
TC3490	Lower wishbone(158)	B	(+) Heavy duty(111) (-) Ball joint(-11-)	
TD567W	Lower wishbone bush(159)	A B	Front(108)	
TD568W	Lower wishbone bush(159)	A B	Rear(187)	
TD883W	Anti-roll bar(-74-) bush kit(-86-)	K	Ø29 Twin rear wheels(229) Complete axle kit(-92-)	
TD1026W	Anti-roll bar(-74-) bush kit(-86-)	K	Complete axle kit(-92-)	

ACCORD 1.6i, 1.8i, 2.0i, 2.2i CG, CH (08/98-02/03)

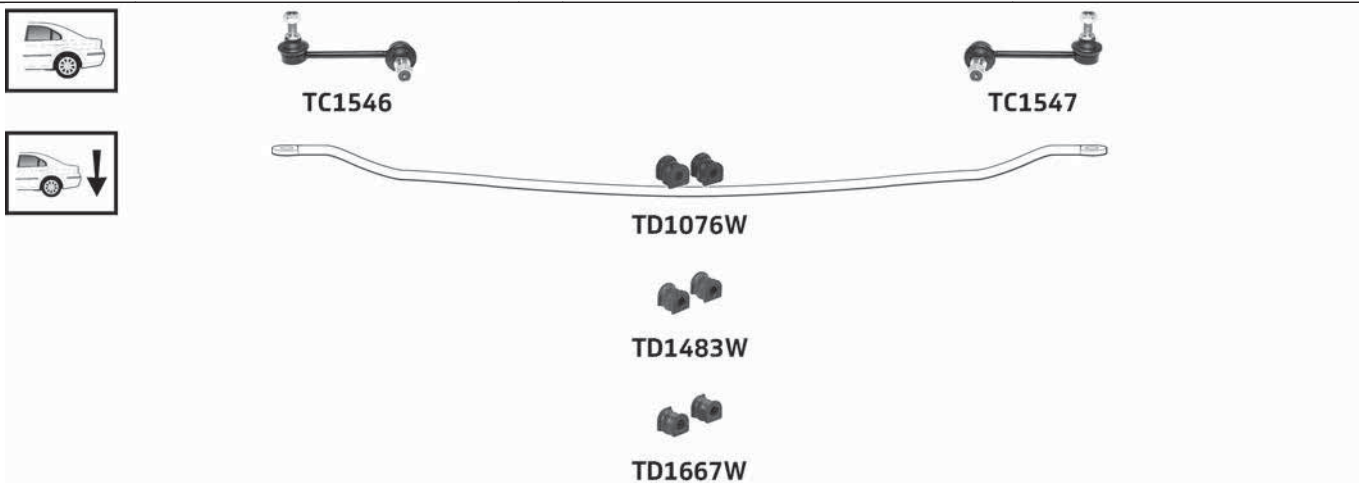
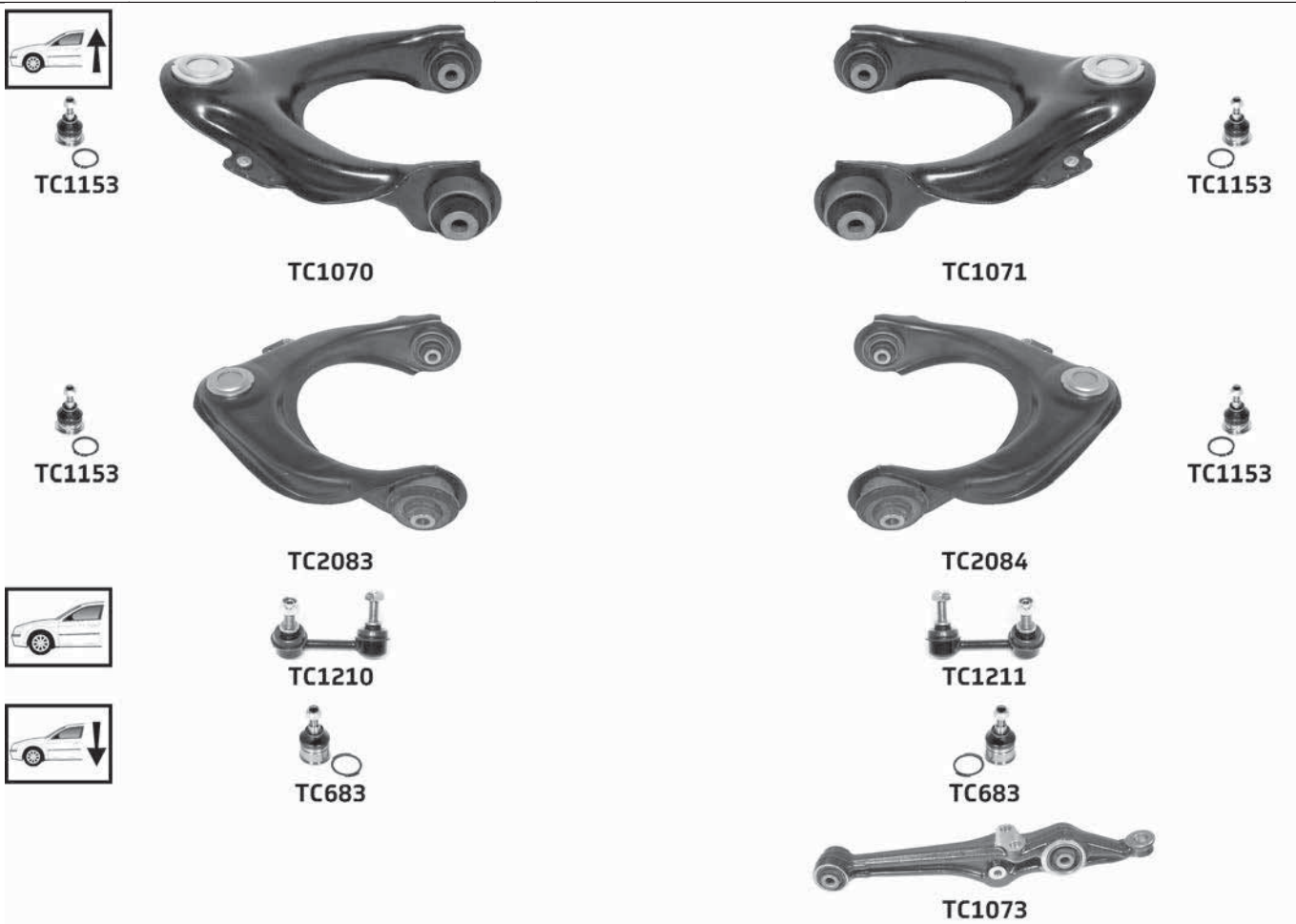

Part No	Description	Pos	Info	Technical
TA1588	Tie rod end (224)	B		M14x1.5 Female (253) £
TA1589	Tie rod end (224)	A		M14x1.5 Female (253) £
TA2112	Inner tie rod (123)	A B		M14x1.5 Male (252) £
TC683	Lower ball joint (140)	A B		M12x1.25
TC1070	Upper wishbone (247)	A	UK Build (230)	M10x1.25
TC1071	Upper wishbone (247)	B	UK Build (230)	M10x1.25
TC1073	Lower track control arm (151)	B	(-) Ball joint (-11-)	
TC1153	Upper ball joint (232)	A B		M10x1.25
TC1210	Link stabiliser (135)	A		M10x1.25
TC1211	Link stabiliser (135)	B		M10x1.25
TC1546	Link stabiliser (135)	A		M10x1.25

(...)

HONDA

... HONDA

... ACCORD 1.6i, 1.8i, 2.0i, 2.2i CG, CH (08/98-02/03)

Part No	Description	Pos	Info	Technical
TC1547	Link stabiliser (135)	B		M10x1.25
TC2083	Upper wishbone (247)	A	Japan Build (125)	M10x1.25
TC2084	Upper wishbone (247)	B	Japan Build (125)	M10x1.25
TD1076W	Anti-roll bar (-74) bush kit (-86-)	K	(-) (-) Type R	
TD1483W	Anti-roll bar (-74) bush kit (-86-)	K	(+) Type R	
TD1667W	Anti-roll bar (-74) bush kit (-86-)	K	(+)	

ACCORD 2.0i, 2.4i CL, CM (02/03-→)

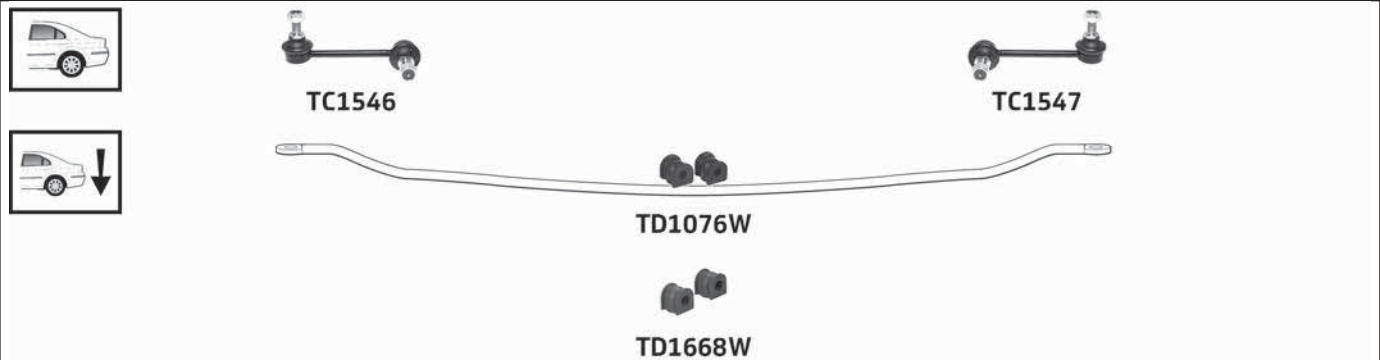
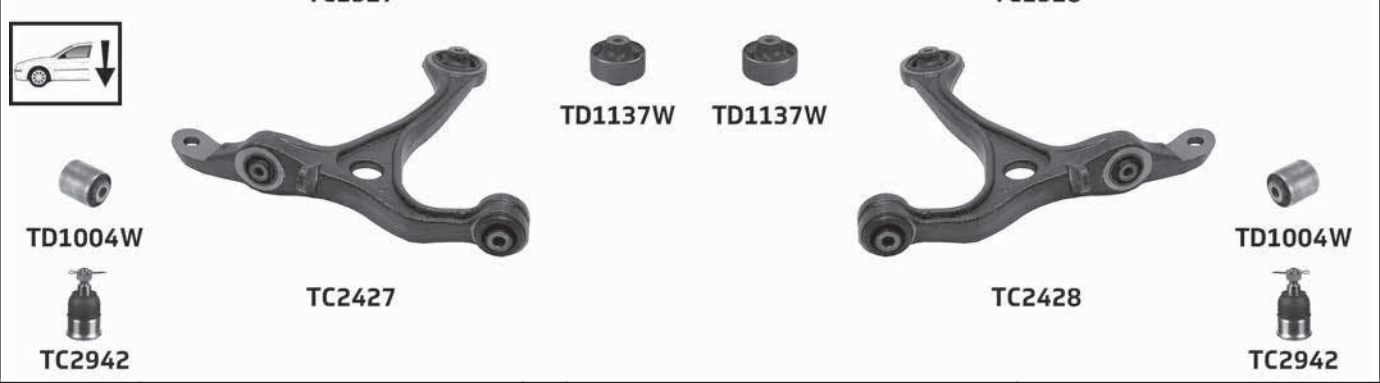

Part No	Description	Pos	Info	Technical
TA2083	Tie rod end (224)	A		M14x1.5 Female (253) E
TA2084	Tie rod end (224)	B		M14x1.5 Female (253) E
TA2111	Inner tie rod (123)	A B		M14x1.5 Male (252) E
TC1153	Upper ball joint (232)	A B		M10x1.25
TC1527	Link stabiliser (135)	A	(-)	M10x1.25
TC1528	Link stabiliser (135)	B	(-)	M10x1.25
TC1546	Link stabiliser (135)	A	(-)	M10x1.25
TC1547	Link stabiliser (135)	B	(-)	M10x1.25
TC2250	Upper wishbone (247)	A		M10x1.25
TC2251	Upper wishbone (247)	B		M10x1.25
TC2427	Lower wishbone (158)	A	(-) Ball joint (-11-)	
TC2428	Lower wishbone (158)	B	(-) Ball joint (-11-)	
TC2942	Lower ball joint (140)	A B		M12x1.25
TD1004W	Lower wishbone bush (159)	A B		

HONDA

... ACCORD 2.0i, 2.4i CL, CM (02/03→)

Part No	Description	Pos	Info	Technical
TD1076W	Anti-roll bar (-74) bush kit (-86)	K	(-)	
TD1137W	Lower wishbone bush (159)	A B	Inner (119) Front (108)	
TD1668W	Anti-roll bar (-74) bush kit (-86)	K	(+)	

ACCORD 2.2CDTi CN (02/03→)

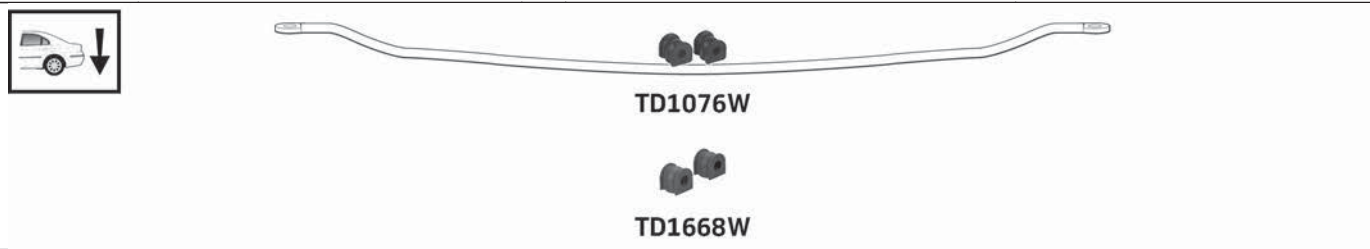
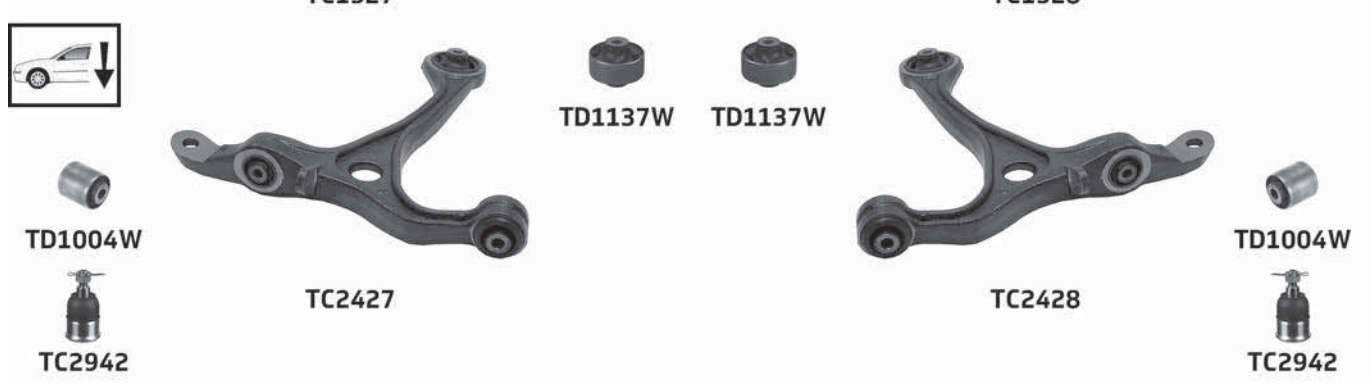
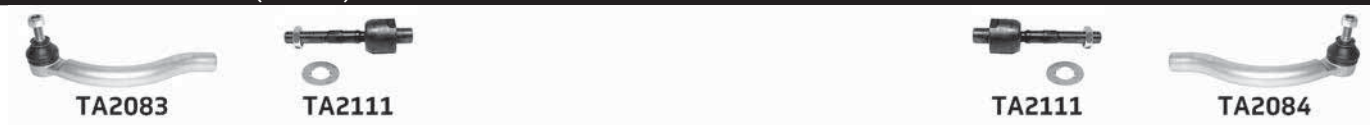

Part No	Description	Pos	Info	Technical
TA2083	Tie rod end (224)	A		M14x1.5 Female (253) £
TA2084	Tie rod end (224)	B		M14x1.5 Female (253) £
TA2111	Inner tie rod (123)	A B		M14x1.5 Male (252) £
TC1153	Upper ball joint (232)	A B		M10x1.25
TC1527	Link stabiliser (135)	A	(-)	M10x1.25
TC1528	Link stabiliser (135)	B	(-)	M10x1.25
TC2250	Upper wishbone (247)	A		M10x1.25
TC2251	Upper wishbone (247)	B		M10x1.25
TC2427	Lower wishbone (158)	A	(-) Ball joint (-11)	
TC2428	Lower wishbone (158)	B	(-) Ball joint (-11)	
TC2942	Lower ball joint (140)	A B		M12x1.25
TD1004W	Lower wishbone bush (159)	A B		
TD1076W	Anti-roll bar (-74) bush kit (-86)	K	(-)	
TD1137W	Lower wishbone bush (159)	A B	Inner (119) Front (108)	
TD1668W	Anti-roll bar (-74) bush kit (-86)	K	(+)	

HONDA

... HONDA

ACCORD 2.0i, 2.2DT, 2.4i CU, CW (07/08→)



TA2783



TA2757



TA2757



TA2784



TC1153



TC1153

TC3633



TC2500

TC3634



TC2501



TC2629



TC3631



TD1098W

TD1098W



TC3632



TC2629



TC2371



TC2372

Part No	Description	Pos	Info	Technical
TA2757	Inner tie rod(123)	A B	M20 into steering rack(124)	M14x1.5 Male(252) £
TA2783	Tie rod end(224)	A		M14x1.5 Female(253) £
TA2784	Tie rod end(224)	B		M14x1.5 Female(253) £
TC1153	Upper ball joint(232)	A B		M10x1.25
TC2371	Link stabiliser(135)	A		M10x1.25
TC2372	Link stabiliser(135)	B		M10x1.25
TC2500	Link stabiliser(135)	A		M10x1.25
TC2501	Link stabiliser(135)	B		M10x1.25
TC2629	Lower ball joint(140)	A B		M14x1.5
TC3631	Lower wishbone(158)	A	(-) Ball joint(-11-)	
TC3632	Lower wishbone(158)	B	(-) Ball joint(-11-)	
TC3633	Upper wishbone(247)	A		
TC3634	Upper wishbone(247)	B		
TD1098W	Lower wishbone bush(159)	A B	Inner(119) Front(108)	

CITY 1.4i GM (09/08→)



TA2879



TA2864



TA2864



TA2880

Part No	Description	Pos	Info	Technical
TA2864	Inner tie rod(123)	A B		M14x1.5 Male(252) £
TA2879	Tie rod end(224)	A		M14x1.5 Female(253) £
TA2880	Tie rod end(224)	B		M14x1.5 Female(253) £

CIVIC 1.6i, 1.7i EM | Coupé (02/01-12/05)

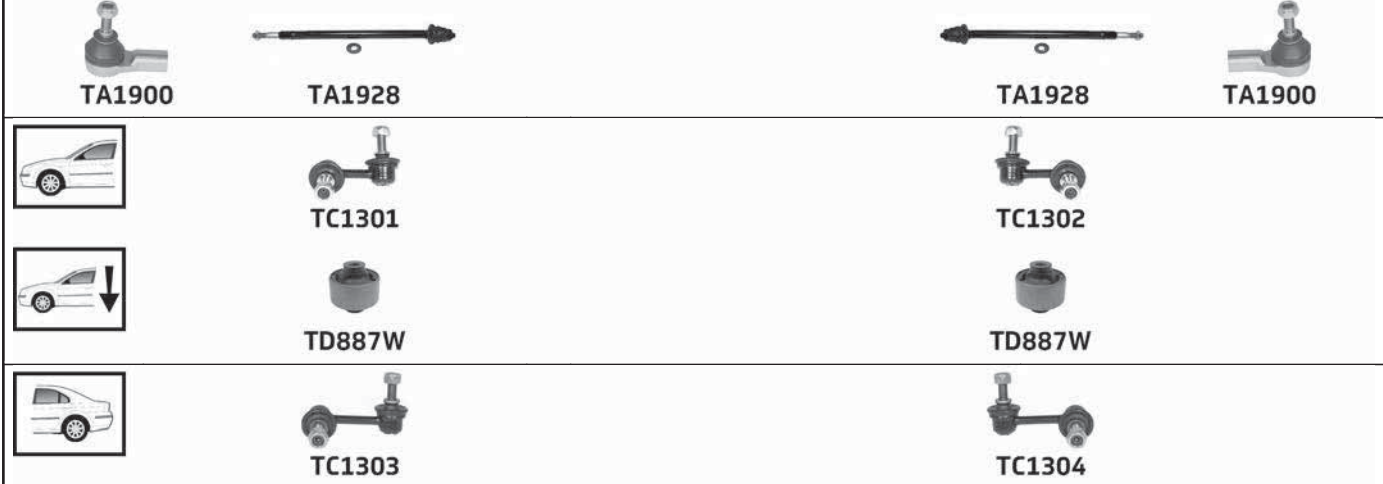

Part No	Description	Pos	Info	Technical
TA1900	Tie rod end(224)	A B		M14x1.5 Female(253) £
TA1928	Inner tie rod(123)	A B		M14x1.5 Male(252) £
TC1301	Link stabiliser(135)	A		M10x1.25
TC1302	Link stabiliser(135)	B		M10x1.25
TC1303	Link stabiliser(135)	A		M10x1.25
TC1304	Link stabiliser(135)	B		M10x1.25
TD887W	Lower wishbone bush(159)	A B	Front(108)	

CIVIC 1.3i, 1.4i, 1.6i, 1.7i ES | Saloon (02/01-12/05)

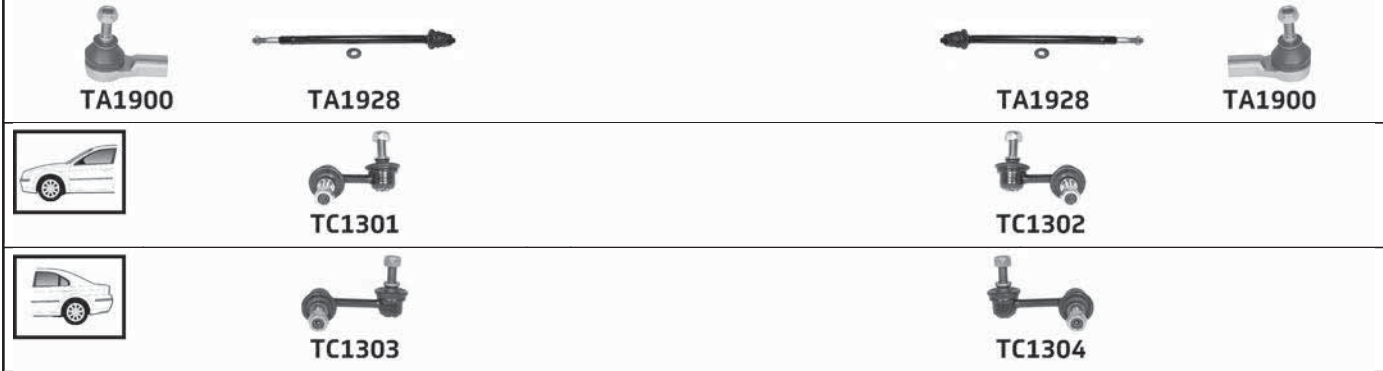

Part No	Description	Pos	Info	Technical
TA1900	Tie rod end(224)	A B		M14x1.5 Female(253) £
TA1928	Inner tie rod(123)	A B		M14x1.5 Male(252) £
TC1301	Link stabiliser(135)	A		M10x1.25
TC1302	Link stabiliser(135)	B		M10x1.25
TC1303	Link stabiliser(135)	A		M10x1.25
TC1304	Link stabiliser(135)	B		M10x1.25

--	--	--	--	--

... HONDA

CIVIC 1.4i, 1.6i EP, EU | Hatchback (02/01-12/05)

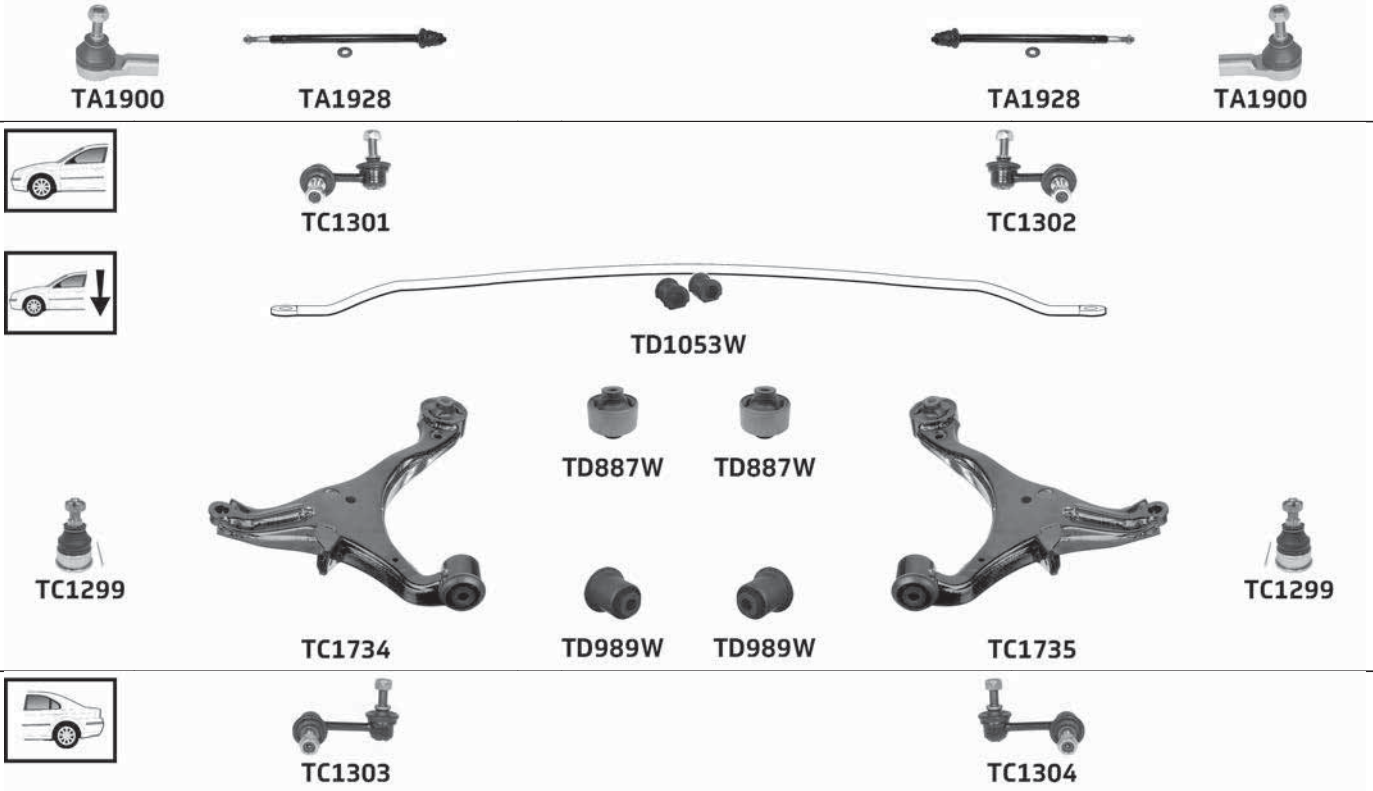

Part No	Description	Pos	Info	Technical
TA1900	Tie rod end(224)	A B		M14x1.5 Female(253) E
TA1928	Inner tie rod(123)	A B		M14x1.5 Male(252) E
TC1299	Lower ball joint(140)	A B		M12x1.25
TC1301	Link stabiliser(135)	A		M10x1.25
TC1302	Link stabiliser(135)	B		M10x1.25
TC1303	Link stabiliser(135)	A		M10x1.25
TC1304	Link stabiliser(135)	B		M10x1.25
TC1734	Lower wishbone(158)	A	(-) Ball joint(-11-)	
TC1735	Lower wishbone(158)	B	(-) Ball joint(-11-)	
TD887W	Lower wishbone bush(159)	A B	Front(108)	
TD989W	Lower wishbone bush(159)	A B	Rear(187)	
TD1053W	Anti-roll bar(-74-) bush kit(-86-)	K		

CIVIC 1.7CTDi EP, EU | Hatchback (02/01-12/05)

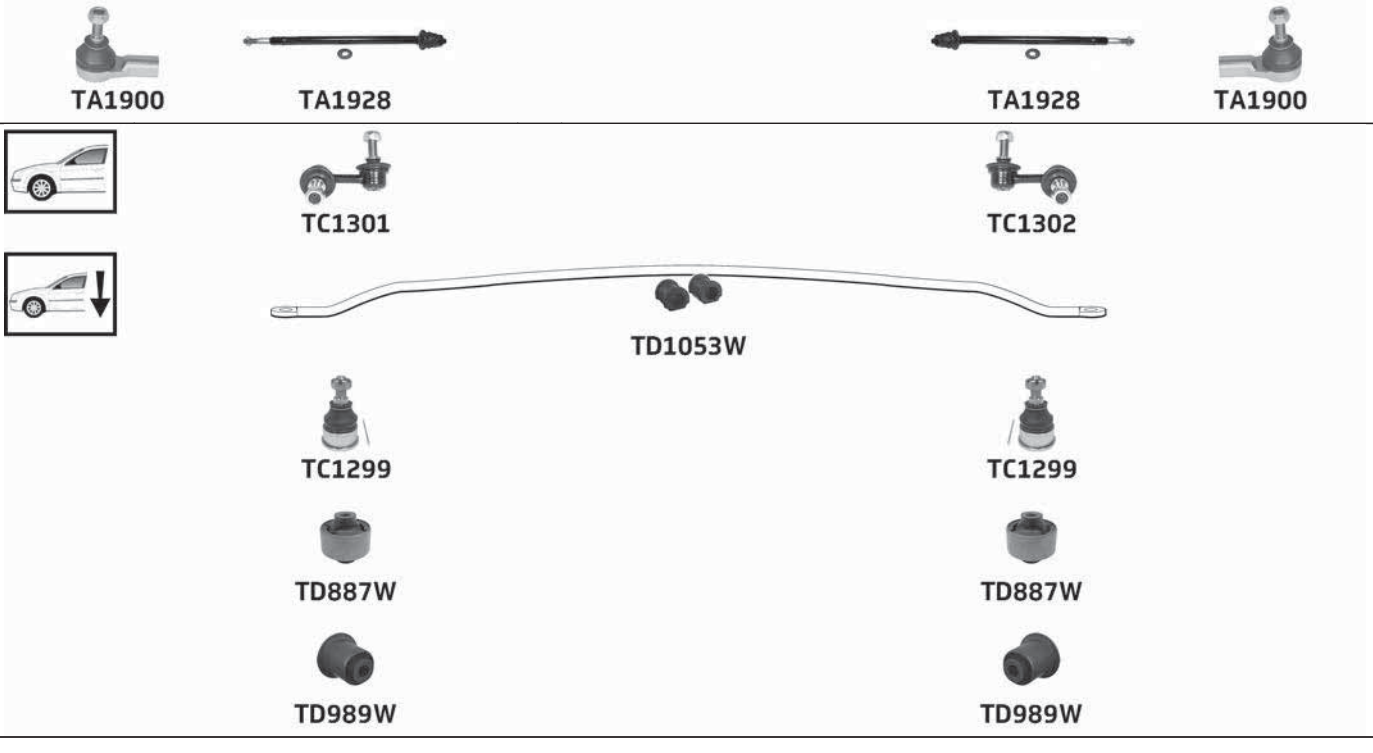

... CIVIC 1.7CTDi EP, EU | Hatchback (02/01-12/05)



Part No	Description	Pos	Info	Technical
TA1900	Tie rod end(224)	A B		M14x1.5 Female(253) £
TA1928	Inner tie rod(123)	A B		M14x1.5 Male(252) £
TC1299	Lower ball joint(140)	A B		M12x1.25
TC1301	Link stabiliser(135)	A		M10x1.25
TC1302	Link stabiliser(135)	B		M10x1.25
TC1303	Link stabiliser(135)	A		M10x1.25
TC1304	Link stabiliser(135)	B		M10x1.25
TD887W	Lower wishbone bush(159)	A B	Front(108)	
TD989W	Lower wishbone bush(159)	A B	Rear(187)	
TD1053W	Anti-roll bar (-74) bush kit (-86-)	K		

CIVIC 2.0i (09/01-09/05)



Part No	Description	Pos	Info	Technical
TA1900	Tie rod end(224)	A B		M14x1.5 Female(253) £
TA1928	Inner tie rod(123)	A B		M14x1.5 Male(252) £
TC1301	Link stabiliser(135)	A		M10x1.25
TC1302	Link stabiliser(135)	B		M10x1.25
TD887W	Lower wishbone bush(159)	A B	Front(108)	
TD989W	Lower wishbone bush(159)	A B	Rear(187)	
TD1053W	Anti-roll bar (-74) bush kit (-86-)	K		

CIVIC 2.0i Type R (09/01-06/06)



Part No	Description	Pos	Info	Technical
TA1900	Tie rod end(224)	A B		M14x1.5 Female(253) £
TA1928	Inner tie rod(123)	A B		M14x1.5 Male(252) £

(...)

... HONDA

... CIVIC 2.0i Type R (09/01-06/06)

Part No	Description	Pos	Info	Technical
TC1301	Link stabiliser (135)	A		M10x1.25
TC1302	Link stabiliser (135)	B		M10x1.25
TD989W	Lower wishbone bush (159)	A B	Rear (187)	
TD1053W	Anti-roll bar (-74) bush kit (-86-)	K		

CIVIC 1.4i, 1.8i, 2.2CTDi FK, FN (09/05→)

TA2640 TA2618 TA2619 TA2641

TC2304 TC2304

TC3290 TC3291

The image shows various suspension components: tie rods (TA2618, TA2619), tie rod ends (TA2640, TA2641), stabilizer links (TC2304), and lower wishbones (TC3290, TC3291). Small icons show the car's wheel and suspension area.

Part No	Description	Pos	Info	Technical
TA2618	Inner tie rod (123)	A		M14x1.5 Male (252) £
TA2619	Inner tie rod (123)	B		M14x1.5 Male (252) £
TA2640	Tie rod end (224)	A		M14x1.5 Female (253) £
TA2641	Tie rod end (224)	B		M14x1.5 Female (253) £
TC2304	Link stabiliser (135)	A B		M10x1.5
TC3290	Lower wishbone (158)	A		M14x2
TC3291	Lower wishbone (158)	B		M14x2

CIVIC 2.0i Type R FN (09/05→)

TA2640 TA2618 TA2619 TA2641

TC2304 TC2304

The image shows various suspension components: tie rods (TA2618, TA2619), tie rod ends (TA2640, TA2641), and stabilizer links (TC2304). A small icon shows the car's wheel and suspension area.

Part No	Description	Pos	Info	Technical
TA2618	Inner tie rod (123)	A		M14x1.5 Male (252) £
TA2619	Inner tie rod (123)	B		M14x1.5 Male (252) £
TA2640	Tie rod end (224)	A		M14x1.5 Female (253) £
TA2641	Tie rod end (224)	B		M14x1.5 Female (253) £
TC2304	Link stabiliser (135)	A B		M10x1.5

CIVIC 1.3i Hybrid FD (09/05-12/12)

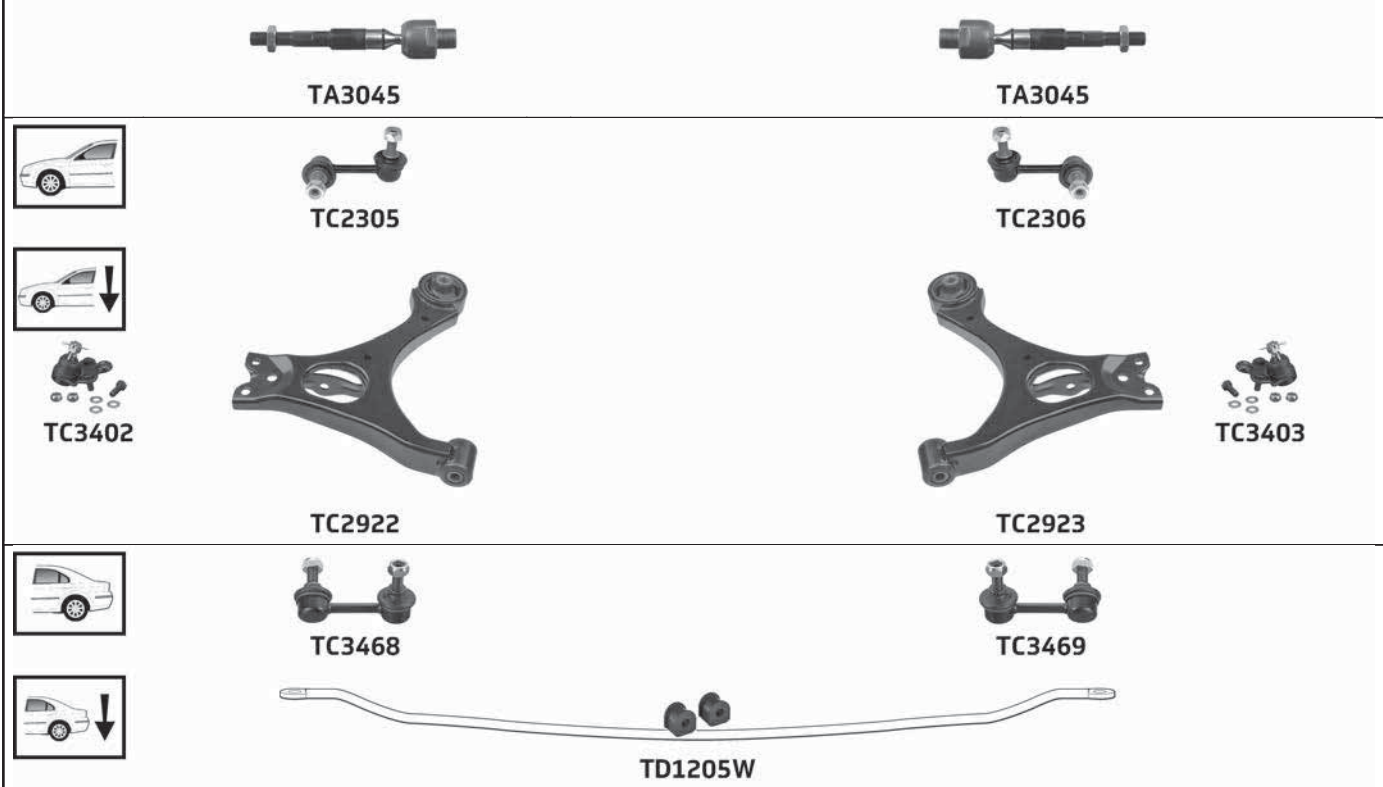

Part No	Description	Pos	Info	Technical
TA3045	Inner tie rod(123)	A B		M14x1.5 Male(252) E
TC2305	Link stabiliser(135)	A		M10x1.25
TC2306	Link stabiliser(135)	B		M10x1.25
TC2922	Lower wishbone(158)	A	(-) Ball joint(-11)	
TC2923	Lower wishbone(158)	B	(-) Ball joint(-11)	
TC3402	Lower ball joint(140)	A		M14x2
TC3403	Lower ball joint(140)	B		M14x2
TC3468	Link stabiliser(135)	A		
TC3469	Link stabiliser(135)	B		
TD1205W	Anti-roll bar(-74) bush kit(-86-)	K		

CIVIC 1.8i FD 4 Door(-70-) (09/05-05/13)

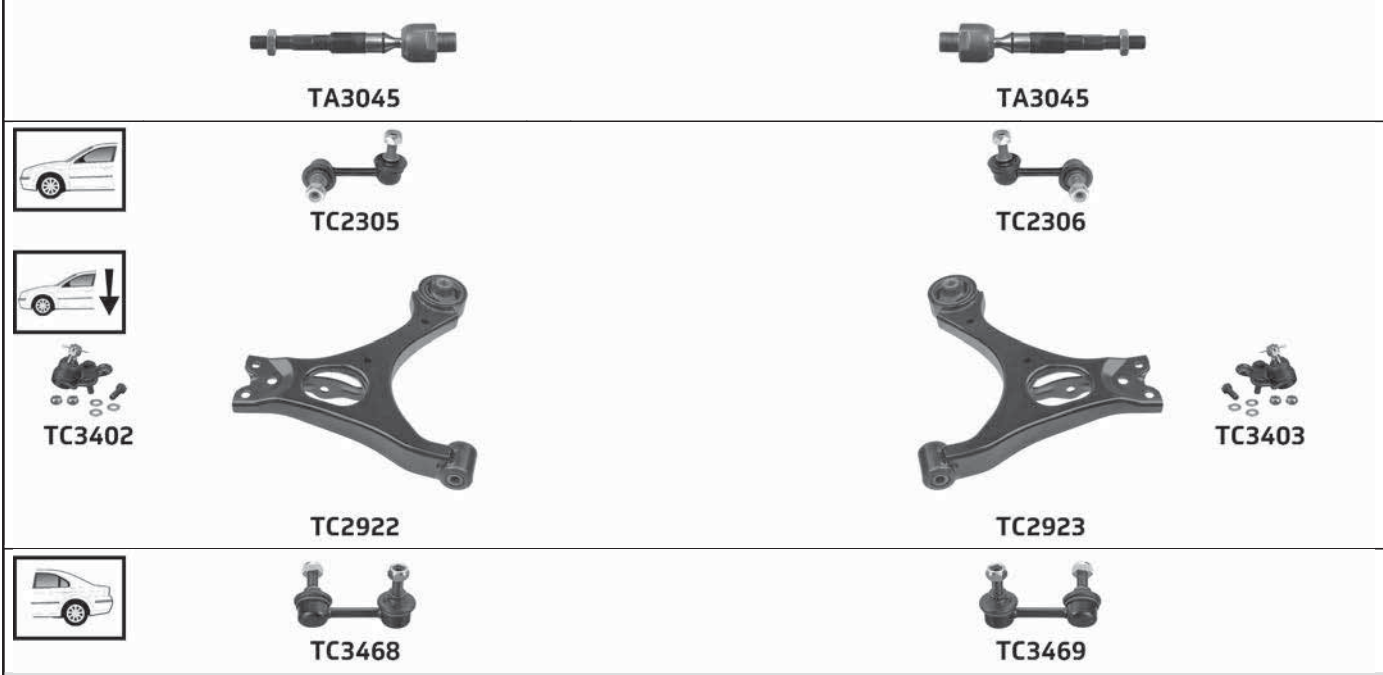

Part No	Description	Pos	Info	Technical
TA3045	Inner tie rod(123)	A B		M14x1.5 Male(252) E
TC2305	Link stabiliser(135)	A		M10x1.25
				(...)

... HONDA

... CIVIC 1.8i FD 4 Door (-70) (09/05-05/13)

Part No	Description	Pos	Info	Technical
TC2306	Link stabiliser(135)	B		M10x1.25
TC2922	Lower wishbone(158)	A	(-) Ball joint (-11-)	
TC2923	Lower wishbone(158)	B	(-) Ball joint (-11-)	
TC3402	Lower ball joint(140)	A		M14x2
TC3403	Lower ball joint(140)	B		M14x2
TC3468	Link stabiliser(135)	A		
TC3469	Link stabiliser(135)	B		

CIVIC 1.4i, 1.6i-DTEC, 1.8i, 2.2i-DTEC FK (02/12-)



Part No	Description	Pos	Info	Technical
TC3679	Lower ball joint(140)	A B		

CR-V I 2.0i RD (10/95-02/02)



TA1962



... CR-V I 2.0i RD (10/95-02/02)



TD1147W



TC2947



TD1148W



TD1148W



TC2948



TD1147W



TC1351



TC1350

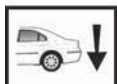

TD1482W



TD263W



TD263W

Part No	Description	Pos	Info	Technical
TA1662	Tie rod end(224)	A		M14x1.5 Female(253) £
TA1663	Tie rod end(224)	B		M14x1.5 Female(253) £
TA1962	Inner tie rod(123)	A B		M14x1.5 Male(252) £
TC836	Lower ball joint(140)	A B	(-) ABS	M12x1.25
TC1190	Link stabiliser(135)	A B		M10x1.25
TC1350	Link stabiliser(135)	B		M10x1.25
TC1351	Link stabiliser(135)	A		M10x1.25
TC2920	Upper wishbone(247)	A		M10x1.25
TC2921	Upper wishbone(247)	B		M10x1.25
TC2947	Upper link arm(239)	A		
TC2948	Upper link arm(239)	B		
TD263W	Trailing arm bush(227)	A B		
TD776W	Lower wishbone bush(159)	A B	Rear(187)	
TD1045W	Lower wishbone bush(159)	A B	Outer(176)	
TD1147W	Upper link arm bush(240)	A B	Outer(176)	
TD1148W	Upper link arm bush(240)	A B	Inner(119)	
TD1195W	Anti-roll bar(-74) bush kit(-86)	K	Ø24.8 Complete axle kit(-92)	
TD1482W	Anti-roll bar(-74) bush kit(-86)	K	Complete axle kit(-92)	

HONDA

... HONDA

CR-V II 2.0i RD (03/02-09/06)

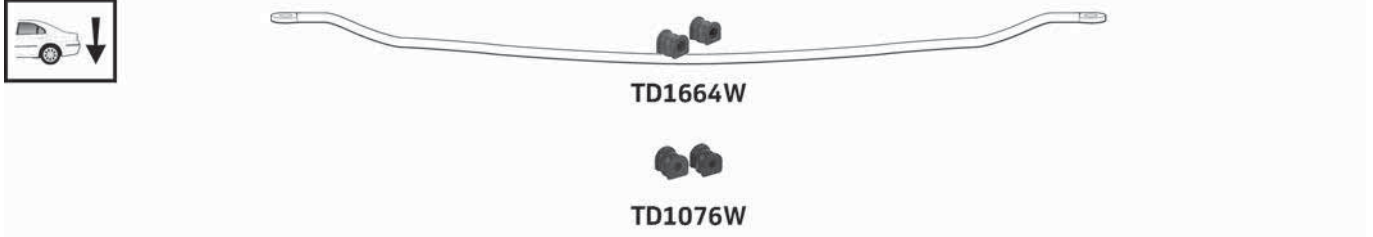
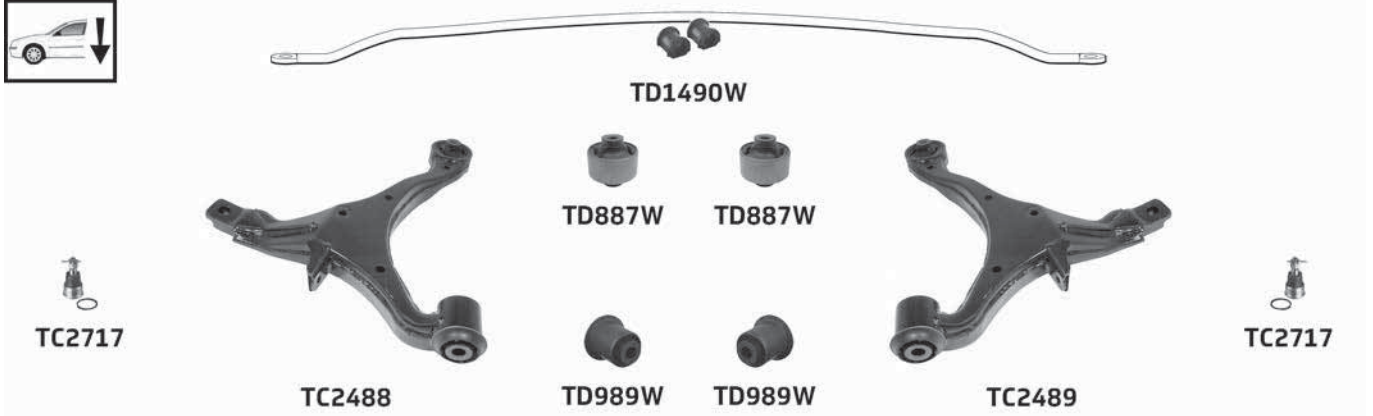

Part No	Description	Pos	Info	Technical
TA1900	Tie rod end(224)	A B		M14x1.5 Female(253) £
TA2344	Inner tie rod(123)	A B		M14x1.5 Male(252) £
TC1301	Link stabiliser(135)	A		M10x1.25
TC1302	Link stabiliser(135)	B		M10x1.25
TC1525	Link stabiliser(135)	A		M10x1.25
TC1526	Link stabiliser(135)	B		M10x1.25
TC2488	Lower wishbone(158)	A	(-) Ball joint(-11-)	
TC2489	Lower wishbone(158)	B	(-) Ball joint(-11-)	
TC2717	Lower ball joint(140)	A B		M12x1.25
TD887W	Lower wishbone bush(159)	A B	Front(108)	
TD989W	Lower wishbone bush(159)	A B	Rear(187)	
TD1076W	Anti-roll bar(-74-) bush kit(-86-)	K	01/05 →	
TD1490W	Anti-roll bar(-74-) bush kit(-86-)	K		
TD1664W	Anti-roll bar(-74-) bush kit(-86-)	K	→01/05	

CR-V II 2.2CTDi RD (03/02-09/06)



HONDA

... CR-V II 2.2CTDi RD (03/02-09/06)

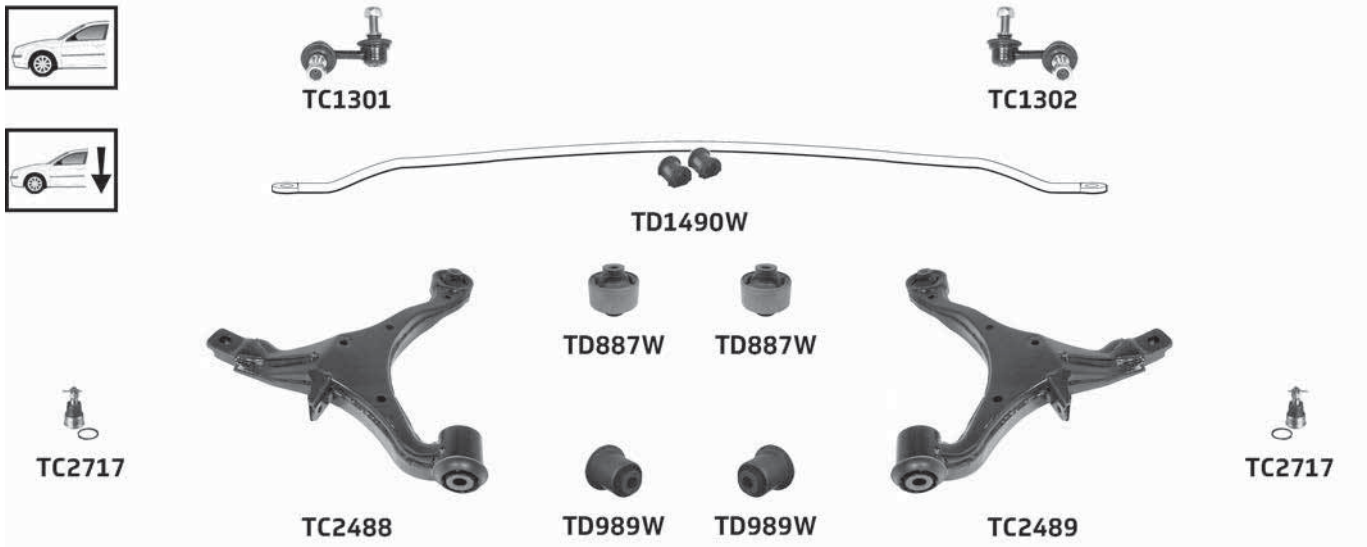

Part No	Description	Pos	Info	Technical
TA2344	Inner tie rod(123)	A B		M14x1.5 Male(252) £
TA3051	Tie rod end(224)	A B		M14x1.5 Female(253) £
TC1301	Link stabiliser(135)	A		M10x1.25
TC1302	Link stabiliser(135)	B		M10x1.25
TC1525	Link stabiliser(135)	A		M10x1.25
TC1526	Link stabiliser(135)	B		M10x1.25
TC2488	Lower wishbone(158)	A	(-) Ball joint(-11)	
TC2489	Lower wishbone(158)	B	(-) Ball joint(-11)	
TC2717	Lower ball joint(140)	A B		M12x1.25
TD887W	Lower wishbone bush(159)	A B	Front(108)	
TD989W	Lower wishbone bush(159)	A B	Rear(187)	
TD1490W	Anti-roll bar(-74) bush kit(-86)	K		

CR-V III 2.0i, 2.4i RE (10/06→)

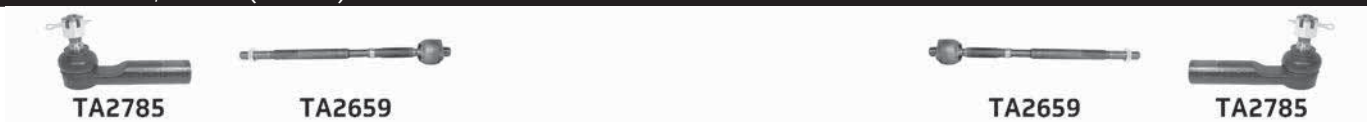

Part No	Description	Pos	Info	Technical
TA2659	Inner tie rod(123)	A B		M14x1.5 Male(252) £

(...)

... HONDA

... CR-V III 2.0i, 2.4i RE (10/06→)

Part No	Description	Pos	Info	Technical
TA2785	Tie rod end(224)	A B		M14x1.5 Female(253) £
TC2271	Link stabiliser(135)	A B		M10x1.25
TC2276	Link stabiliser(135)	A		M10x1.25
TC2277	Link stabiliser(135)	B		M10x1.25
TC2627	Lower ball joint(140)	A B		M14x1.5
TC2871	Lower wishbone(158)	A		M14x2
TC2872	Lower wishbone(158)	B		M14x2
TD1666W	Anti-roll bar(-74) bush kit(-86-)	K		

CR-V III 2.2CTDi RE (10/06→)

TA2785 TA3185 TA3185 TA2785

TC2271 TC2271

TC2627 TC2627

TC2871 TC2872

TC2276 TC2277

TD1666W

Part No	Description	Pos	Info	Technical
TA2785	Tie rod end(224)	A B		M14x1.5 Female(253) £
TA3185	Inner tie rod(123)	A B		M14x1.5 Male(252) £
TC2271	Link stabiliser(135)	A B		M10x1.25
TC2276	Link stabiliser(135)	A		M10x1.25
TC2277	Link stabiliser(135)	B		M10x1.25
TC2627	Lower ball joint(140)	A B		M14x1.5
TC2871	Lower wishbone(158)	A		M14x2
TC2872	Lower wishbone(158)	B		M14x2
TD1666W	Anti-roll bar(-74) bush kit(-86-)	K		

CR-V IV 1.6i-DTEC, 2.0i, 2.2i-DTEC, 2.4i RM (01/12→)

TD1666W

Part No	Description	Pos	Info	Technical
TD1666W	Anti-roll bar(-74) bush kit(-86-)	K		

CR-Z 1.5i ZF (06/10→)

TC2620 TC2620

Part No	Description	Pos	Info	Technical
TC2620	Link stabiliser(135)	A B		M10x1.25

HONDA

FR-V 1.7i, 1.8i, 2.0i, 2.2CTDi BE (06/04→)



TA3060



TA3060



TC1301



TC1302



TD1490W



TD989W



TD989W

Part No	Description	Pos	Info	Technical
TA3060	Inner tie rod(123)	A B		M14x1.5 Male(252) £
TC1301	Link stabiliser(135)	A		M10x1.25
TC1302	Link stabiliser(135)	B		M10x1.25
TD989W	Lower wishbone bush(159)	A B	Rear(187)	
TD1490W	Anti-roll bar(-74) bush kit(-86)	K		

HR-V 1.6i GH (02/99-03/06)



TA1953



TA1954



TA1954



TA1953



TC1378



TC1379



TC2530



TC2531

Part No	Description	Pos	Info	Technical
TA1953	Tie rod end(224)	A B		M12x1.25 Female(253) £
TA1954	Inner tie rod(123)	A B		M12x1.25 Male(252) £
TC1378	Link stabiliser(135)	A		M10x1.25
TC1379	Link stabiliser(135)	B		M10x1.25
TC2530	Link stabiliser(135)	A		M10x1.25
TC2531	Link stabiliser(135)	B		M10x1.25

INSIGHT 1.3i ZE (04/09→)



TA2879



TA2864



TA2864



TA2880



TC2620



TC2620



TC2573



TC2574

Part No	Description	Pos	Info	Technical
TA2864	Inner tie rod(123)	A B		M14x1.5 Male(252) £
TA2879	Tie rod end(224)	A		M14x1.5 Female(253) £

(...)

... HONDA

... INSIGHT 1.3i ZE (04/09→)

Part No	Description	Pos	Info	Technical
TA2880	Tie rod end(224)	B		M14x1.5 Female(253) £
TC2573	Lower wishbone(158)	A		M14x2
TC2574	Lower wishbone(158)	B		M14x2
TC2620	Link stabiliser(135)	A B		M10x1.25

JAZZ 1.2i, 1.4i GD (03/02-12/03)



Part No	Description	Pos	Info	Technical
TA1955	Tie rod end(224)	A		M12x1.25 Female(253) £
TA1956	Tie rod end(224)	B		M12x1.25 Female(253) £
TA1957	Inner tie rod(123)	A		M12x1.25 Male(252) £
TA1958	Inner tie rod(123)	B		M12x1.25 Male(252) £
TC1380	Link stabiliser(135)	A		M10x1.25
TC1381	Link stabiliser(135)	B		M10x1.25
TC1462	Lower wishbone(158)	A		M12x1.25
TC1463	Lower wishbone(158)	B		M12x1.25
TC3420	Lower ball joint(140)	A B		M12x1.25

JAZZ 1.2i, 1.4i GD (01/04-09/08)



Part No	Description	Pos	Info	Technical
TA1955	Tie rod end(224)	A		M12x1.25 Female(253) £
TA1956	Tie rod end(224)	B		M12x1.25 Female(253) £
TA1957	Inner tie rod(123)	A	→12/2004 M16 into steering rack(124)	M12x1.25 Male(252) £
TA1958	Inner tie rod(123)	B	→12/2004 M16 into steering rack(124)	M12x1.25 Male(252) £
TC1462	Lower wishbone(158)	A		M12x1.25
TC1463	Lower wishbone(158)	B		M12x1.25
TC2324	Link stabiliser(135)	A		M10x1.25
TC2325	Link stabiliser(135)	B		M10x1.25
TC3420	Lower ball joint(140)	A B		M12x1.25

HONDA

JAZZ 1.2i, 1.3i, 1.4i GE (07/08→)

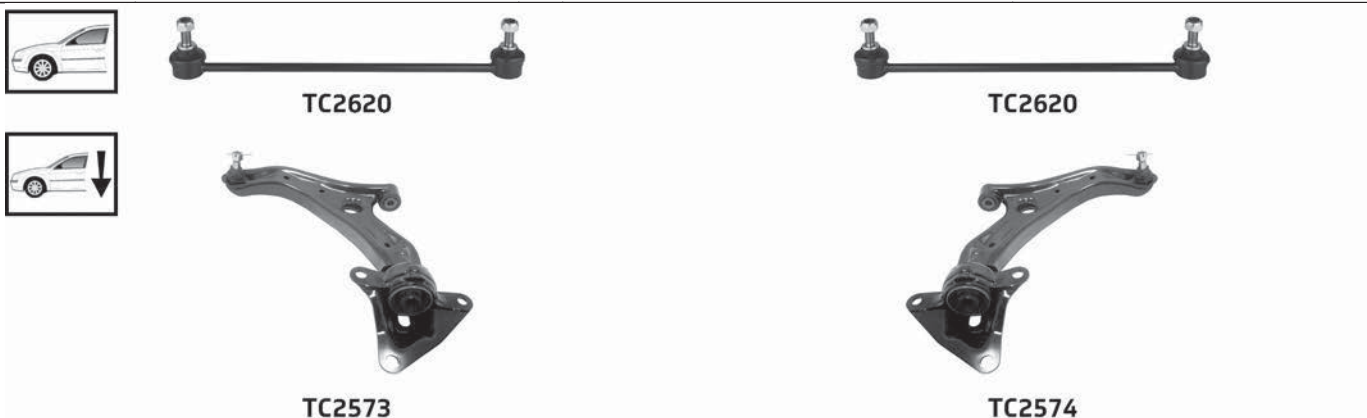

Part No	Description	Pos	Info	Technical
TA2864	Inner tie rod(123)	A B		M14x1.5 Male(252) £
TA2879	Tie rod end(224)	A		M14x1.5 Female(253) £
TA2880	Tie rod end(224)	B		M14x1.5 Female(253) £
TC2573	Lower wishbone(158)	A		M14x2
TC2574	Lower wishbone(158)	B		M14x2
TC2620	Link stabiliser(135)	A B		M10x1.25

LEGEND 3.5i KA9 (02/96-09/04)



Part No	Description	Pos	Info	Technical
TA1923	Inner tie rod(123)	A B		M14x1.5 Male(252) £
TA3043	Tie rod end(224)	A		M14x1.5 Female(253) £
TA3044	Tie rod end(224)	B		M14x1.5 Female(253) £

STREAM 1.7i, 2.0i RN (05/01-12/05)

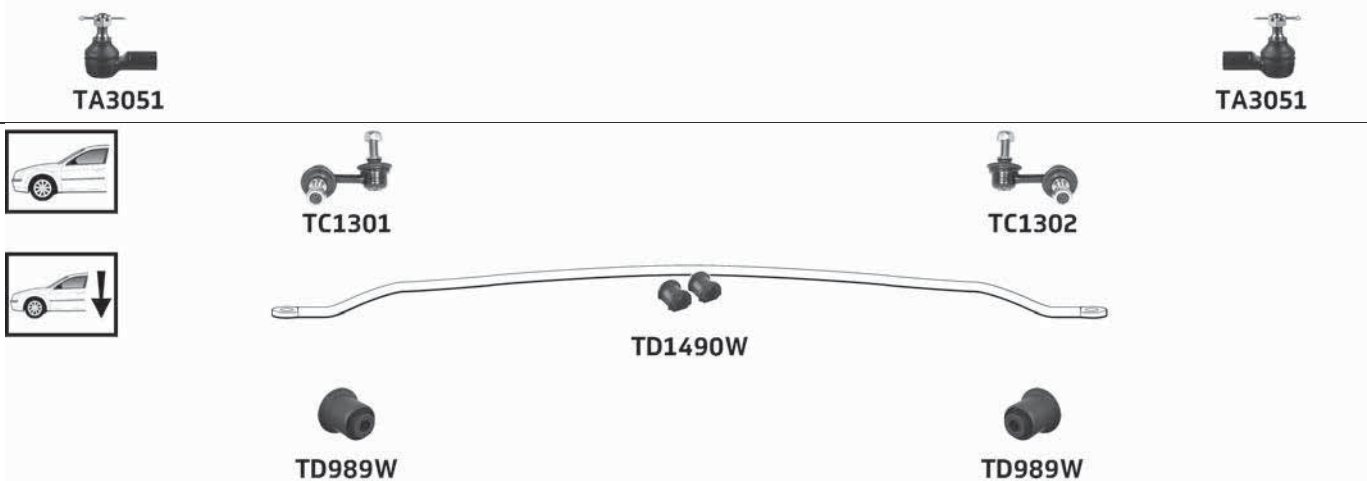

Part No	Description	Pos	Info	Technical
TA3051	Tie rod end(224)	A B		M14x1.5 Female(253) £
TC1301	Link stabiliser(135)	A		M10x1.25
TC1302	Link stabiliser(135)	B		M10x1.25
TD989W	Lower wishbone bush(159)	A B	Rear(187)	
TD1490W	Anti-roll bar(-74) bush kit(-86-)	K		

HYUNDAI

ACCENT 1.3i, 1.5i, 1.5CRDi, 1.6i LC (01/00-11/05)

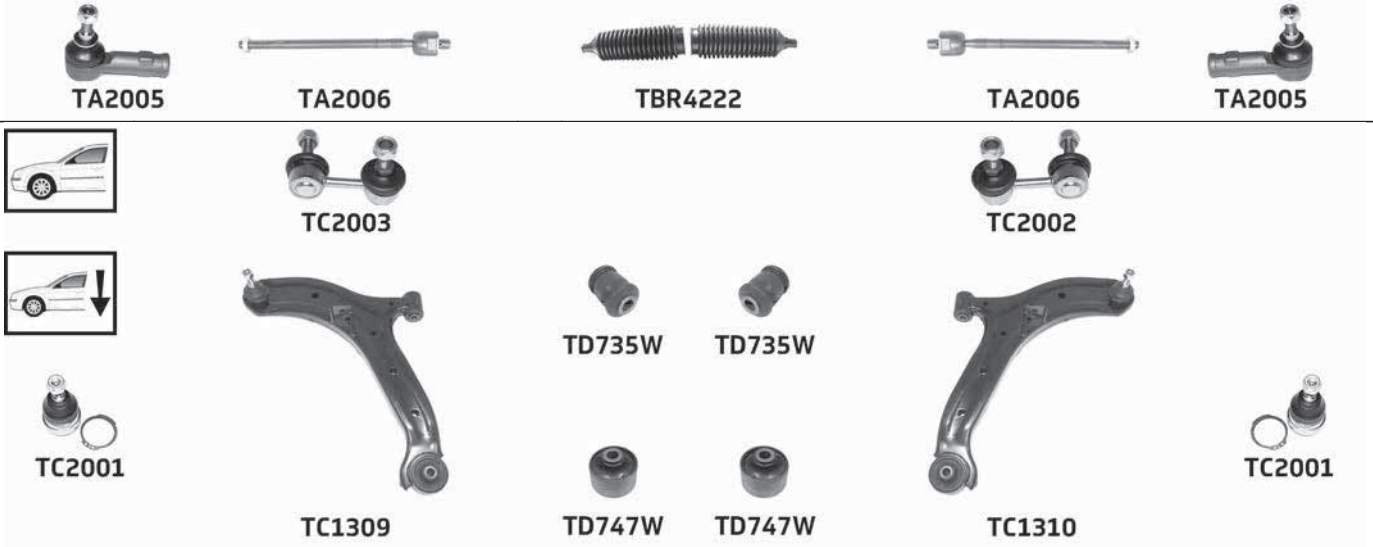

Part No	Description	Pos	Info	Technical
TA2005	Tie rod end(224)	A B		M14x1.5 Female(253) E
TA2006	Inner tie rod(123)	A B	Power steering(185)	M14x1.5 Male(252) E
TBR4222	Steering rack gaiter kit(213)	K	Thermoplastic(223)	1 :15x48x48 2 :15x48x48
TC1309	Lower wishbone(158)	A		M12x1.25
TC1310	Lower wishbone(158)	B		M12x1.25
TC2001	Lower ball joint(140)	A B		M12x1.25
TC2002	Link stabiliser(135)	B		M10x1.25
TC2003	Link stabiliser(135)	A		M10x1.25
TC2004	Link stabiliser(135)	A B		M10x1.25
TD735W	Lower wishbone bush(159)	A B	Front(108)	
TD747W	Lower wishbone bush(159)	A B	Rear(187)	

ACCENT 1.4i, 1.5CRDi, 1.6i MC (11/05→)

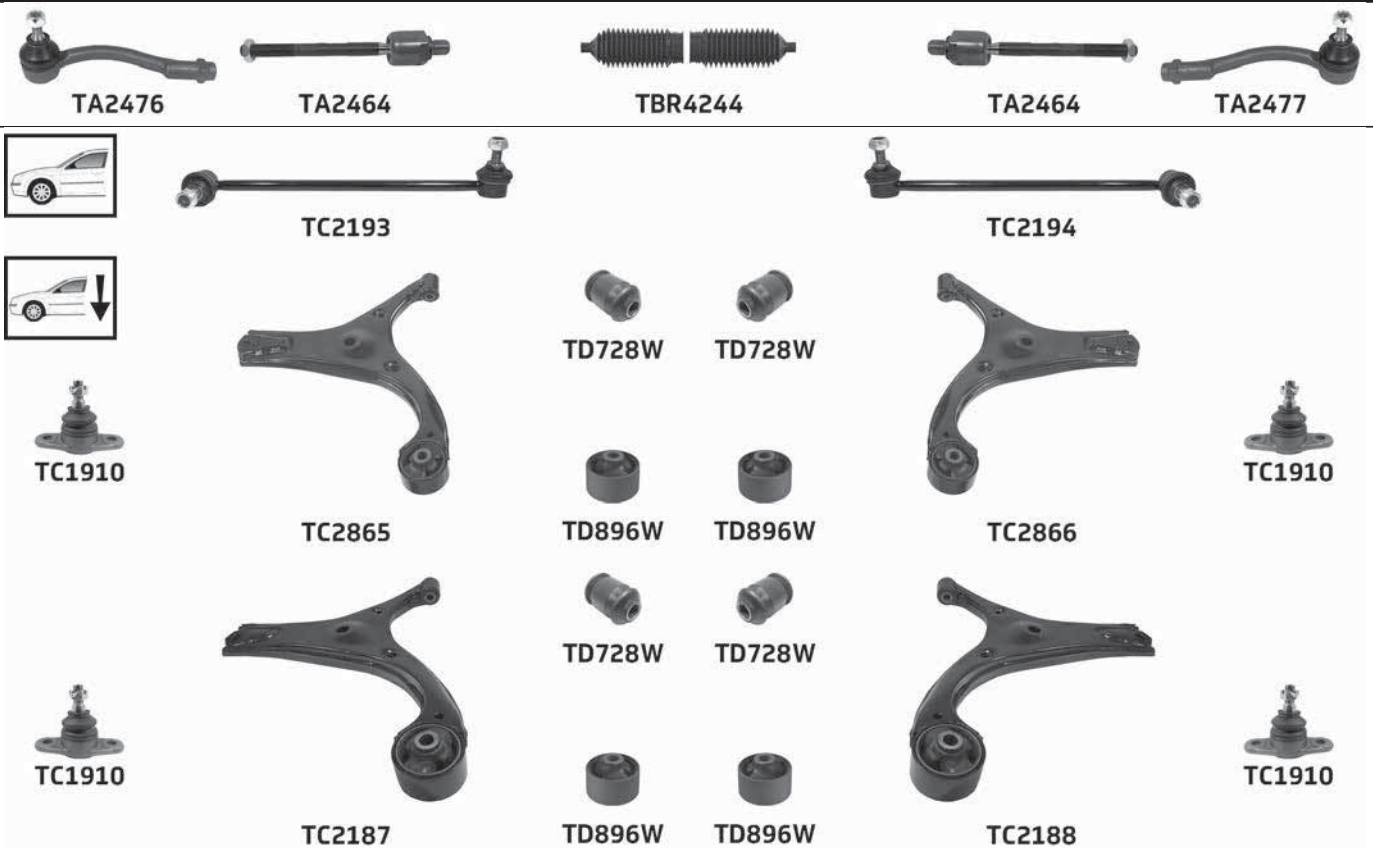

Part No	Description	Pos	Info	Technical
TA2464	Inner tie rod(123)	A B		M14x1.5 Male(252) E

... ACCENT 1.4i, 1.5CRDi, 1.6i MC (11/05→)

Part No	Description	Pos	Info	Technical
TA2476	Tie rod end(224)	A		M14x1.5 Female(253) £
TA2477	Tie rod end(224)	B		M14x1.5 Female(253) £
TBR4244	Steering rack gaiter kit(213)	K	Thermoplastic(223)	1 :14x47x47 2 :14x47x47
TC1910	Lower ball joint(140)	A B		M12x1.25
TC2187	Lower wishbone(158)	A	(-) Bush(-13) Power steering(185)	
TC2188	Lower wishbone(158)	B	(-) Bush(-13) Power steering(185)	
TC2193	Link stabiliser(135)	A		M10x1.25
TC2194	Link stabiliser(135)	B		M10x1.25
TC2865	Lower wishbone(158)	A	(-) Bush(-13) Manual steering(170)	
TC2866	Lower wishbone(158)	B	(-) Bush(-13) Manual steering(170)	
TD728W	Lower wishbone bush(159)	A B	Front(108)	
TD896W	Lower wishbone bush(159)	A B	Rear(187)	

ACCENT BLUE 1.4i, 1.6i, 1.6CRDi (11/10→)



Part No	Description	Pos	Info	Technical
TA2865	Tie rod end(224)	A		M16x1.5 Female(253) £
TA2866	Tie rod end(224)	B		M16x1.5 Female(253) £
TA3204	Inner tie rod(123)	A B		M16x1.5 Male(252) £
TC2663	Link stabiliser(135)	A B		M12x1.25
TC2664	Lower ball joint(140)	A B		M12x1.25
TC2718	Lower wishbone(158)	A		M12x1.25
TC2719	Lower wishbone(158)	B		M12x1.25
TD902W	Lower wishbone bush(159)	A B	Front(108)	

HYUNDAI

... HYUNDAI

AMICA 1.0i, 1.1i (08/99→)

ATOS 1.0i, 1.1i (02/98→)

ATOS PRIME 1.0i, 1.1i (08/99→)

ATOZ 1.0i, 1.1i (05/98→)



TA1516



TA1861



TA1861



TA1516



TA1516



TA1924



TA1924



TA1516



TC1785



TC1785



TC1743



TD777W



TD777W



TC1744



TD733W



TD734W



TC1024



TC1024

Part No	Description	Pos	Info	Technical
TA1516	Tie rod end(224)	A B		M12x1.25 Female(253) £
TA1861	Inner tie rod(123)	A B	Manual steering(170)	M12x1.25 Male(252) £
TA1924	Inner tie rod(123)	A B	Power steering(185)	M12x1.25 Male(252) £
TC1024	Lower ball joint(140)	A B		M10x1.25
TC1743	Lower wishbone(158)	A	(-) Ball joint(-11-)	
TC1744	Lower wishbone(158)	B	(-) Ball joint(-11-)	
TC1785	Link stabiliser(135)	A B		
TD733W	Lower wishbone bush(159)	A	Rear(187)	
TD734W	Lower wishbone bush(159)	B	Rear(187)	
TD777W	Lower wishbone bush(159)	A B	Front(108)	

COUPÉ 1.6i, 2.0i, 2.7i HN (03/02→)



TA2005



TA2108



TA2108



TA2005



TC1569



TC1570



TC1200



TC1200

Part No	Description	Pos	Info	Technical
TA2005	Tie rod end(224)	A B		M14x1.5 Female(253) £
TA2108	Inner tie rod(123)	A B		M14x1.5 Male(252) £
TC1200	Link stabiliser(135)	A B		M10x1.25
TC1569	Link stabiliser(135)	A		M10x1.25
TC1570	Link stabiliser(135)	B		M10x1.25

ELANTRA 1.6i, 1.8i, 2.0i, 2.0CRDi XD (06/00-03/04)



Part No	Description	Pos	Info	Technical
TA2005	Tie rod end(224)	A B		M14x1.5 Female(253) £
TA2108	Inner tie rod(123)	A B		M14x1.5 Male(252) £
TBR4222	Steering rack gaiter kit(213)	K	Thermoplastic(223)	1 :15x48x48 2 :15x48x48
TC1198	Link stabiliser(135)	A B		M10x1.5
TC1200	Link stabiliser(135)	A B		M10x1.25
TC2402	Lower wishbone(158)	A		M12x1.25
TC2403	Lower wishbone(158)	B		M12x1.25

ELANTRA 1.6i, 1.8i, 2.0i, 2.0CRDi XD (04/04-07/06)



Part No	Description	Pos	Info	Technical
TA2005	Tie rod end(224)	A B		M14x1.5 Female(253) £
TA2108	Inner tie rod(123)	A B		M14x1.5 Male(252) £
TC1198	Link stabiliser(135)	A B		M10x1.5
TC1200	Link stabiliser(135)	A B		M10x1.25
TC2402	Lower wishbone(158)	A		M12x1.25
TC2403	Lower wishbone(158)	B		M12x1.25

... HYUNDAI

ELANTRA 1.6CRDi HD (11/05→)

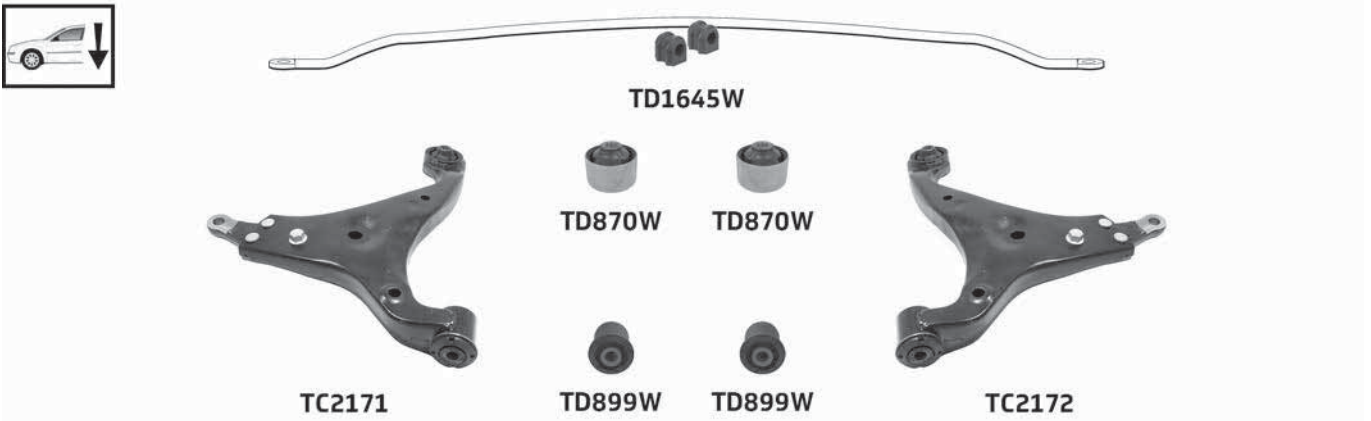

Part No	Description	Pos	Info	Technical
TA2480	Tie rod end(224)	A		M14x1.5 Female(253) £
TA2481	Tie rod end(224)	B		M14x1.5 Female(253) £
TA2492	Inner tie rod(123)	A B		M14x1.5 Male(252) £
TC2152	Link stabiliser(135)	A B		M12x1.25
TC2171	Lower wishbone(158)	A	(-) Ball joint (-11-)	
TC2172	Lower wishbone(158)	B	(-) Ball joint (-11-)	
TC3190	Lower track control arm(151)	A B	Front(108)	M10x1.25
TD870W	Lower wishbone bush(159)	A B	Front(108)	
TD899W	Lower wishbone bush(159)	A B	Rear(187)	
TD1645W	Anti-roll bar(-74-) bush kit(-86-)	K		
TD1656W	Lower hub carrier bush(143)	A B		

ELANTRA 1.6i MD, UD (06/11→)



Part No	Description	Pos	Info	Technical
TA2886	Inner tie rod(123)	A B		M16x1.5 Male(252) £
TA2917	Tie rod end(224)	A		M16x1.5 Female(253) £
TA2918	Tie rod end(224)	B		M16x1.5 Female(253) £

... ELANTRA 1.6i MD, UD (06/11→)

Part No	Description	Pos	Info	Technical
TC2663	Link stabiliser(135)	A B		M12x1.25
TC2737	Lower wishbone(158)	A		M12x1.25
TC2738	Lower wishbone(158)	B		M12x1.25
TD1038W	Lower wishbone bush(159)	A B	Rear (187)	

GETZ 1.1i, 1.3i, 1.4i, 1.5CRDi, 1.6i (08/02-06/09)

TA1965 TA1966 TBR4244 TA1966 TA1965

TC1402 TC1403

TD1277W

TD728W TD728W

TC2001 TC1404 TD710W TD710W TC1405

Part No	Description	Pos	Info	Technical
TA1965	Tie rod end(224)	A B		M14x1.5 Female(253) £
TA1966	Inner tie rod(123)	A B		M14x1.5 Male(252) £
TBR4244	Steering rack gaiter kit(213)	K	Thermoplastic(223)	1 :14x47x47 2 :14x47x47
TC1402	Link stabiliser(135)	A		M10x1.25
TC1403	Link stabiliser(135)	B		M10x1.25
TC1404	Lower wishbone(158)	A		M12x1.25
TC1405	Lower wishbone(158)	B		M12x1.25
TC2001	Lower ball joint(140)	A B		M12x1.25
TD710W	Lower wishbone bush(159)	A B	Rear (187)	
TD728W	Lower wishbone bush(159)	A B	Front(108)	
TD1277W	Anti-roll bar(-74) bush kit(-86-)	K	Complete axle kit(-92) →11/05	

GRAND SANTA FE 2.2CRDi DM (05/13→)

TA3182 TA3198 TA3198 TA3183

TC3356 TC3356

TC2850 TC2850

TD1656W TD1656W

Part No	Description	Pos	Info	Technical
TA3182	Tie rod end(224)	A		M16x1.5 Female(253) £
TA3183	Tie rod end(224)	B		M16x1.5 Female(253) £
TA3198	Inner tie rod(123)	A B		M16x1.5 Male(252) £
TC2850	Lower ball joint(140)	A B		Pinch Bolt(255) 18mm
TC3356	Link stabiliser(135)	A B		M12x1.25
TD1656W	Lower hub carrier bush(143)	A B		

... HYUNDAI

GRANDEUR 2.2CRDi, 3.3i TG (04/05-10/07)



TA2700



TA2658



TA2658



TA2701



TC3486



TC3487



TC2316



TC2316



TC2348



TC2348



TC3484



TC3485



TC2367



TC2367

Part No	Description	Pos	Info	Technical
TA2658	Inner tie rod(123)	A B		M16x1.5 Male(252) £
TA2700	Tie rod end(224)	A		M16x1.5 Female(253) £
TA2701	Tie rod end(224)	B		M16x1.5 Female(253) £
TC2316	Link stabiliser(135)	A B		M12x1.25
TC2348	Lower ball joint(140)	A B		M14x1.5
TC2367	Link stabiliser(135)	A B		M10x1.25
TC3484	Lower wishbone(158)	A	L	
TC3485	Lower wishbone(158)	B	L	
TC3486	Upper wishbone(247)	A		M10 x 1.25
TC3487	Upper wishbone(247)	B		M10 x 1.25

GRANDEUR 2.2CRDi, 3.3i TG (11/07→)



TA2658



TA2658



TC3486



TC3487



TC2316



TC2316



TC2348



TC2348



TC3484



TC3485



TC2367



TC2367

Part No	Description	Pos	Info	Technical
TA2658	Inner tie rod(123)	A B		M16x1.5 Male(252) E
TC2316	Link stabiliser(135)	A B		M12x1.25
TC2348	Lower ball joint(140)	A B		M14x1.5
TC2367	Link stabiliser(135)	A B		M10x1.25
TC3484	Lower wishbone(158)	A	L	
TC3485	Lower wishbone(158)	B	L	
TC3486	Upper wishbone(247)	A		M10 x 1.25
TC3487	Upper wishbone(247)	B		M10 x 1.25

... HYUNDAI

H1 2.4i, 2.5TDi (10/97→)

H1 STAREX 2.4i, 2.5TDi (06/97→)



TA2028



TA2028



TC2049



TC2049



TC2110



TC2110



TC2050



TC2050

Part No	Description	Pos	Info	Technical
TA2028	Inner tie rod(123)	A B		M14x1.5 Male(252) E
TC2049	Link stabiliser(135)	A B		M12x1.5
TC2050	Link stabiliser(135)	A B		M12x1.25
TC2110	Lower ball joint(140)	A B	(-) 4x4	M16x1.5

i10 1.0i, 1.1i, 1.1CRDi, 1.2i (01/08-12/13)



TA2590



TA2591



TA2591



TA2590



TC2242



TC2243



TC2494



TD1643W

TD1643W



TC2495



TC1733

Part No	Description	Pos	Info	Technical
TA2590	Tie rod end(224)	A B		M12x1.25 Female(253) E
TA2591	Inner tie rod(123)	A B		M12x1.25 Male(252) E
TC1733	Lower ball joint(140)	A B		Pinch Bolt(255) 16mm
TC2242	Link stabiliser(135)	A		M10x1.25
TC2243	Link stabiliser(135)	B		M10x1.25
TC2494	Lower wishbone(158)	A		Pinch Bolt(255) 16mm
TC2495	Lower wishbone(158)	B		Pinch Bolt(255) 16mm
TD1643W	Lower wishbone bush(159)	A B	Rear(187)	

i10 1.0i, 1.2i (12/13→)



TC2242



TC2243



TC3404



TC3404

Part No	Description	Pos	Info	Technical
TC2242	Link stabiliser(135)	A		M10x1.25
TC2243	Link stabiliser(135)	B		M10x1.25
TC3404	Lower ball joint(140)	A B		Pinch Bolt(255) 18mm

i20 1.2i, 1.4i, 1.4CRDi, 1.6i, 1.6CRDi (09/08→)



Part No	Description	Pos	Info	Technical
TA2630	Inner tie rod (123)	A B		M16x1.5 Male (252) £
TA2649	Tie rod end (224)	A		M16x1.5 Female (253) £
TA2650	Tie rod end (224)	B		M16x1.5 Female (253) £
TC2001	Lower ball joint (140)	A B		M12x1.25
TC2284	Link stabiliser (135)	A		M10x1.25
TC2285	Link stabiliser (135)	B		M10x1.25
TC2469	Lower wishbone (158)	A		M12x1.25
TC2470	Lower wishbone (158)	B		M12x1.25
TD728W	Lower wishbone bush (159)	A B	Front (108)	

i20 1.0i, 1.1CRDi, 1.2i, 1.4i, 1.4CRDi (11/14→)



Part No	Description	Pos	Info	Technical
TC2664	Lower ball joint (140)	A B		M12x1.25
TC3427	Link stabiliser (135)	A B		
TD1642W	Lower wishbone bush (159)	A B	Front (108)	

... HYUNDAI

i30 1.4i, 1.6i, 1.6CRDi, 2.0i, 2.0CRDi FD (10/07-06/12)

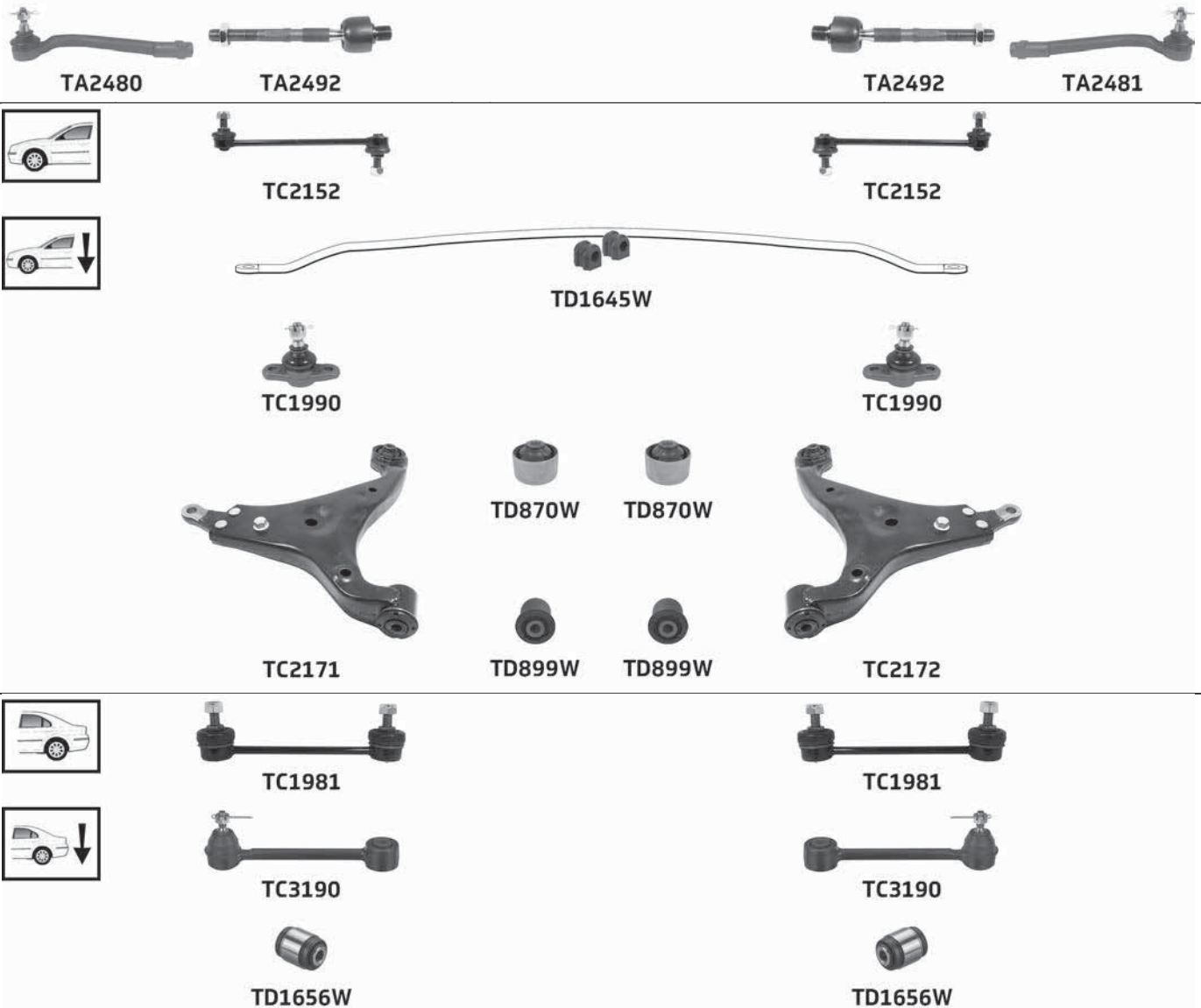

Part No	Description	Pos	Info	Technical
TA2480	Tie rod end(224)	A		M14x1.5 Female(253) £
TA2481	Tie rod end(224)	B		M14x1.5 Female(253) £
TA2492	Inner tie rod(123)	A B		M14x1.5 Male(252) £
TC1981	Link stabiliser(135)	A B		M10x1.25
TC1990	Lower ball joint(140)	A B	Made in South Korea (168)	M12x1.25
TC1990	Lower ball joint(140)	A B	Made in Czech Republic(166) →1/03/2009	M12x1.25
TC2152	Link stabiliser(135)	A B		M12x1.25
TC2171	Lower wishbone(158)	A	(-) Ball joint(-11-)	
TC2172	Lower wishbone(158)	B	(-) Ball joint(-11-)	
TC3190	Lower track control arm(151)	A B	Front(108)	M10x1.25
TD870W	Lower wishbone bush(159)	A B	Front(108)	
TD899W	Lower wishbone bush(159)	A B	Rear(187)	
TD1645W	Anti-roll bar(-74-) bush kit(-86-)	K	(-) 17" Wheels(_1_)	
TD1656W	Lower hub carrier bush(143)	A B		

i30 1.4i, 1.4CRDi, 1.6i, 1.6GDi, 1.6CRDi GD (11/11-12/13)



TC2663



TC2663



TC2850



TC2850



TC2856



TC2857



TC2704



TC2704

Part No	Description	Pos	Info	Technical
TA2917	Tie rod end(224)	A		M16x1.5 Female(253) £
TA2918	Tie rod end(224)	B		M16x1.5 Female(253) £
TA3255	Inner tie rod(123)	A B		M16x1.5 Male(252) £
TC2663	Link stabiliser(135)	A B		M12x1.25
TC2704	Link stabiliser(135)	A B		M12x1.25
TC2850	Lower ball joint(140)	A B		Pinch Bolt(255) 18mm
TC2856	Lower wishbone(158)	A	(-) Xenon light(-31-)	Pinch Bolt(255) 18mm
TC2857	Lower wishbone(158)	B		Pinch Bolt(255) 18mm

i30 1.4i, 1.4CRDi, 1.6i, 1.6GDi, 1.6CRDi GD (01/14→)

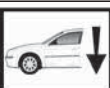

TC2850



TC2850



TC2704



TC2704

Part No	Description	Pos	Info	Technical
TA2917	Tie rod end(224)	A		M16x1.5 Female(253) £
TA2918	Tie rod end(224)	B		M16x1.5 Female(253) £
TA3255	Inner tie rod(123)	A B		M16x1.5 Male(252) £
TC2704	Link stabiliser(135)	A B		M12x1.25
TC2850	Lower ball joint(140)	A B		Pinch Bolt(255) 18mm

... HYUNDAI

i40 1.6GDi, 1.7CRDi, 2.0GDi VF (07/11→)



TA3017



TA3195



TA3195



TA3018



TC3241



TC3242



TC3352



TC3352



TD1656W



TD1656W

Part No	Description	Pos	Info	Technical
TA3017	Tie rod end(224)	A		M16x1.5 Female(253) £
TA3018	Tie rod end(224)	B		M16x1.5 Female(253) £
TA3195	Inner tie rod(123)	A B		M16x1.5 Male(252) £
TC3241	Lower wishbone(158)	A	→ 23/01/2015	M12x1.25
TC3242	Lower wishbone(158)	B	→ 23/01/2015	M12x1.25
TC3352	Link stabiliser(135)	A B		M12x1.25
TD1656W	Lower hub carrier bush(143)	A B		

i800 2.5CRDi (05/08→)



TC3366



TC3366

Part No	Description	Pos	Info	Technical
TC3366	Lower ball joint(140)	A B		Pinch Bolt(255) 20mm

iLOAD 2.5CRDi (02/08→)



TC3366



TC3366

Part No	Description	Pos	Info	Technical
TC3366	Lower ball joint(140)	A B		Pinch Bolt(255) 20mm

iX20 1.4i, 1.4CRDi, 1.6i, 1.6CRDi (11/10→)

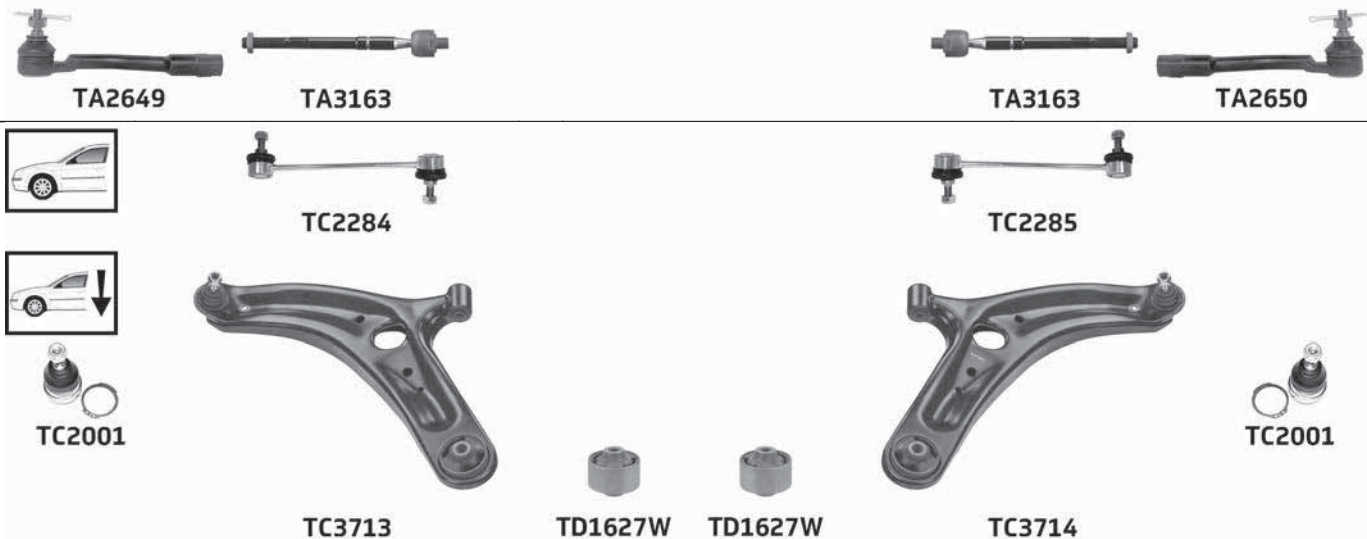

Part No	Description	Pos	Info	Technical
TA2649	Tie rod end(224)	A		M16x1.5 Female(253) £
TA2650	Tie rod end(224)	B		M16x1.5 Female(253) £
TA3163	Inner tie rod(123)	A B		M16x1.5 Male(252) £
TC2001	Lower ball joint(140)	A B		M12x1.25
TC2284	Link stabiliser(135)	A		M10x1.25
TC2285	Link stabiliser(135)	B		M10x1.25
TC3713	Lower wishbone(158)	A		M12x1.25
TC3714	Lower wishbone(158)	B		M12x1.25
TD1627W	Lower wishbone bush(159)	A B	Rear(187)	

iX35 1.6GDi, 1.7CRDi, 2.0i, 2.0CRDi (08/09→)

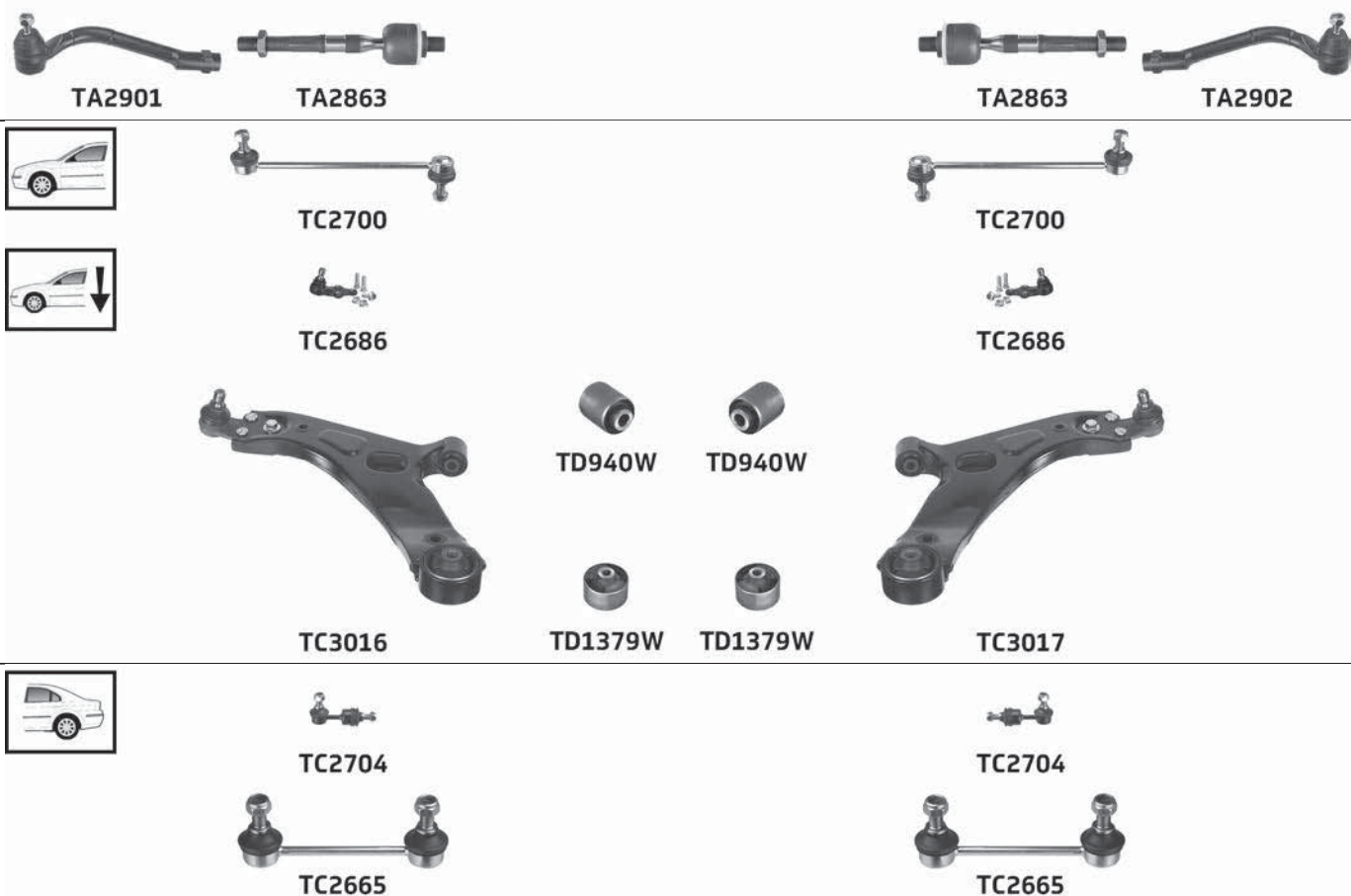

Part No	Description	Pos	Info	Technical
TA2863	Inner tie rod(123)	A B		M16x1.5 Male(252) £
TA2901	Tie rod end(224)	A		M16x1.5 Female(253) £
TA2902	Tie rod end(224)	B		M16x1.5 Female(253) £
TC2665	Link stabiliser(135)	A B	4x4	M12x1.25

(...)

... HYUNDAI

... iX35 1.6GDi, 1.7CRDi, 2.0i, 2.0CRDi (08/09→)

Part No	Description	Pos	Info	Technical
TC2686	Lower ball joint(140)	A B		Pinch Bolt (255) 18mm
TC2700	Link stabiliser(135)	A B		M12x1.25
TC2704	Link stabiliser(135)	A B	(-) 4x4	M12x1.25
TC3016	Lower wishbone(158)	A		Pinch Bolt (255) 18mm
TC3017	Lower wishbone(158)	B		Pinch Bolt (255) 18mm
TD940W	Lower wishbone bush(159)	A B	Front (108)	
TD1379W	Lower wishbone bush(159)	A B	Rear(187)	

iX55 3.0CRDi (09/08→)



TA3197



TA3197



TC2291



TC2292



TC3366



TC3588



TC3589



TC3366



TC2303



TC2303



TD1656W



TD1656W

Part No	Description	Pos	Info	Technical
TA3197	Inner tie rod(123)	A B		M16x1.5 Male(252) E
TC2291	Link stabiliser(135)	A		M12x1.25
TC2292	Link stabiliser(135)	B		M12x1.25
TC2303	Link stabiliser(135)	A B		M12x1.25
TC3366	Lower ball joint(140)	A B		Pinch Bolt (255) 20mm
TC3588	Lower wishbone(158)	A		ø20
TC3589	Lower wishbone(158)	B		ø20
TD1656W	Lower hub carrier bush(143)	A B	Rear(187)	

MATRIX 1.5CRDi, 1.6i, 1.8i FC (06/01-08/10)



Part No	Description	Pos	Info	Technical
TA2005	Tie rod end(224)	A B		M14x1.5 Female(253) £
TA2022	Inner tie rod(123)	A B		M14x1.5 Male(252) £
TBR4244	Steering rack gaiter kit(213)	K	(-) 1.8 Thermoplastic(223)	1 :14x47x47 2 :14x47x47
TC2002	Link stabiliser(135)	B		M10x1.25
TC2003	Link stabiliser(135)	A		M10x1.25
TC2391	Link stabiliser(135)	A B		M10x1.25
TC3218	Lower wishbone(158)	A		M12x1.25
TC3219	Lower wishbone(158)	B		M12x1.25
TC3247	Lower link arm(144)	A B	Rear(187)	
TC3571	Trailing arm(226)	A		
TC3572	Trailing arm(226)	B		
TD1096W	Anti-roll bar(-74) bush kit(-86-)	K	Complete axle kit(-92)	
TD1100W	Anti-roll bar(-74) bush kit(-86-)	K	Complete axle kit(-92)	

HYUNDAI

... HYUNDAI

SANTA FE 2.0i, 2.0CRDi, 2.4i, 2.7i SM (11/00-02/06)



TA1965



TA2101



TA2101



TA1965



TC1529



TC1530



TD1203W



TC2465



TC2466



TC1559



TC1559



TC3582



TC3583



TC1531



TC1532



TC3580



TC3581

Part No	Description	Pos	Info	Technical
TA1965	Tie rod end(224)	A B		M14x1.5 Female(253) E
TA2101	Inner tie rod(123)	A B		M14x1.5 Male(252) E
TC1529	Link stabiliser(135)	A		M12x1.25
TC1530	Link stabiliser(135)	B		M12x1.25
TC1531	Link stabiliser(135)	A		M10x1.25
TC1532	Link stabiliser(135)	B		M10x1.25
TC1559	Lower ball joint(140)	A B		Pinch Bolt(255) 20mm
TC2465	Lower wishbone(158)	A		Pinch Bolt(255) 20mm
TC2466	Lower wishbone(158)	B		Pinch Bolt(255) 20mm
TC3580	Lower track control arm(151)	A	12/2002→	M14 x 1.5 x 26
TC3581	Lower track control arm(151)	B	12/2002→	M14 x 1.5 x 26
TC3582	Upper track control arm(242)	A		M14 x 1.5 x 25
TC3583	Upper track control arm(242)	B		M14 x 1.5 x 25
TD1203W	Anti-roll bar(-74) bush kit(-86-)	K		

SANTA FE 2.2CRDi, 2.7i CM (03/06→)



TC2291



TC2292



TC1559



TC1559



TC3292



TC3293



TC2303



TC2303

Part No	Description	Pos	Info	Technical
TA2617	Inner tie rod(123)	A B		M16x1.5 Male(252) £
TA2679	Tie rod end(224)	A		M16x1.5 Female(253) £
TA2680	Tie rod end(224)	B		M16x1.5 Female(253) £
TC1559	Lower ball joint(140)	A B		Pinch Bolt (255) 20mm
TC2291	Link stabiliser(135)	A		M12x1.25
TC2292	Link stabiliser(135)	B		M12x1.25
TC2303	Link stabiliser(135)	A B		M12x1.25
TC3292	Lower wishbone(158)	A	9/2009→	Pinch Bolt (255) Ø20mm
TC3293	Lower wishbone(158)	B	9/2009→	Pinch Bolt (255) Ø20mm

SANTA FE 2.0CRDi, 2.2CRDi, 2.4i DM (09/12→)



TC3356



TC3356



TC2850



TC2850



TD1656W



TD1656W

Part No	Description	Pos	Info	Technical
TA3182	Tie rod end(224)	A		M16x1.5 Female(253) £
TA3183	Tie rod end(224)	B		M16x1.5 Female(253) £
TA3198	Inner tie rod(123)	A B		M16x1.5 Male(252) £
TC2850	Lower ball joint(140)	A B		Pinch Bolt (255) 18mm
TC3356	Link stabiliser(135)	A B		M12x1.25
TD1656W	Lower hub carrier bush(143)	A B		

... HYUNDAI

SONATA 2.0i, 2.7i EN (10/01-11/04)

HYUNDAI

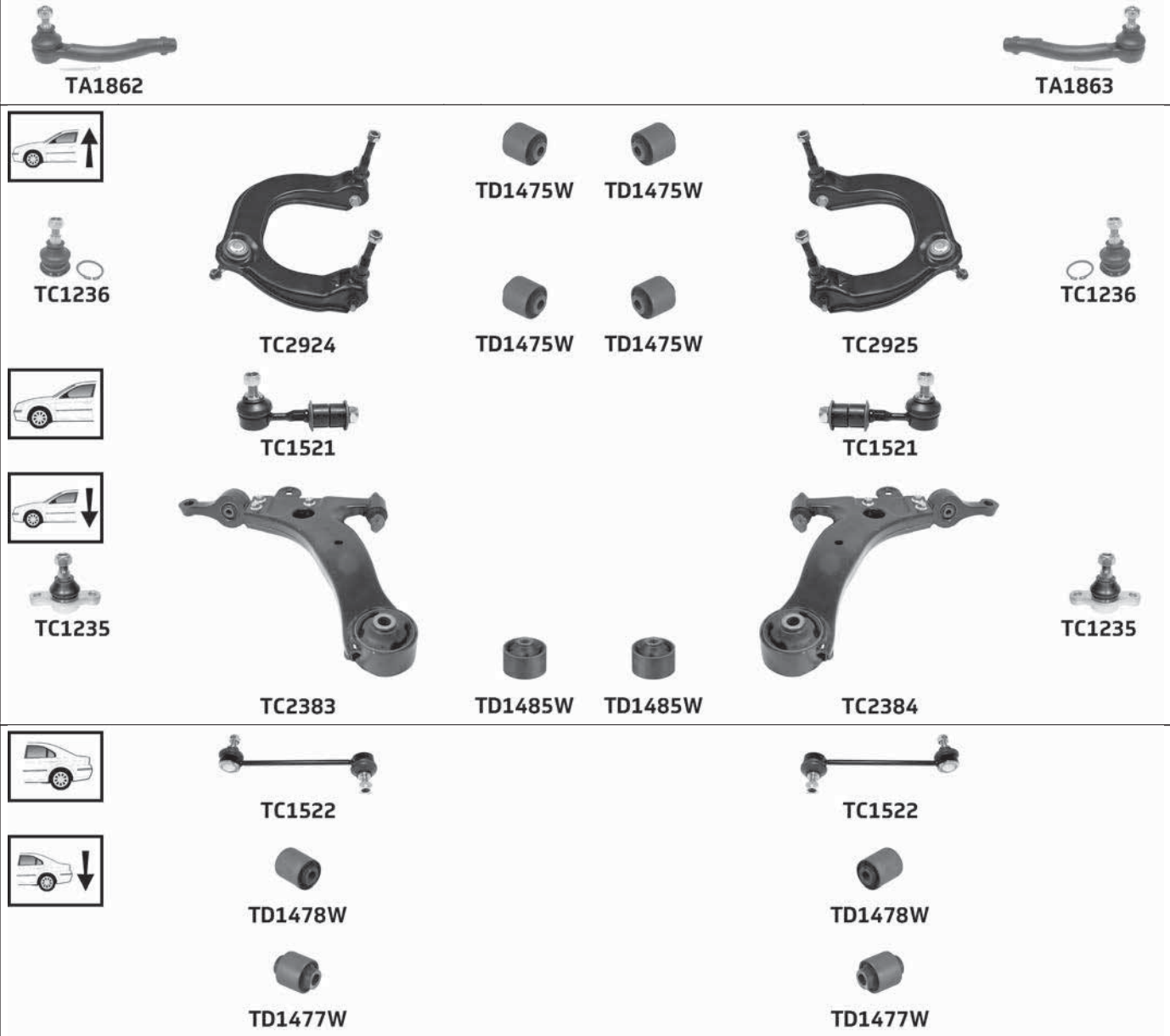

Part No	Description	Pos	Info	Technical
TA1862	Tie rod end(224)	A		M14x1.5 Female(253) £
TA1863	Tie rod end(224)	B		M14x1.5 Female(253) £
TC1235	Lower ball joint(140)	A B		M14x1.5
TC1236	Upper ball joint(232)	A B		M10x1.25
TC1521	Link stabiliser(135)	A B		M10x1.25
TC1522	Link stabiliser(135)	A B		M10x1.25
TC2383	Lower wishbone(158)	A	(-) Ball joint(-11-)	
TC2384	Lower wishbone(158)	B	(-) Ball joint(-11-)	
TC2924	Upper wishbone(247)	A		M10x1.25
TC2925	Upper wishbone(247)	B		M10x1.25
TD1475W	Upper wishbone bush(248)	A B	Front(108) Rear(187)	
TD1477W	Lower hub carrier bush(143)	A B	Front(108) Rear(187)	
TD1478W	Lower track control arm bush(153)	A B		
TD1485W	Lower wishbone bush(159)	A B	Rear(187)	

SONATA 2.0i, 2.0CRDi, 2.4i, 3.3i NF (01/05-12/06)



TC3486



TC3487



TC2316



TC2316



TC2348



TC2348



TC3484



TC3485



TC2367



TC2367

Part No	Description	Pos	Info	Technical
TA2658	Inner tie rod(123)	A B		M16x1.5 Male(252) £
TA2700	Tie rod end(224)	A		M16x1.5 Female(253) £
TA2701	Tie rod end(224)	B		M16x1.5 Female(253) £
TC2316	Link stabiliser(135)	A B		M12x1.25
TC2348	Lower ball joint(140)	A B		M14x1.5
TC2367	Link stabiliser(135)	A B		M10x1.25
TC3484	Lower wishbone(158)	A		
TC3485	Lower wishbone(158)	B		
TC3486	Upper wishbone(247)	A		M10 x 1.25
TC3487	Upper wishbone(247)	B		M10 x 1.25

... HYUNDAI

SONATA 2.0i, 2.0CRDi, 2.4i, 3.3i NF (01/07→)



TA2658



TA2658



TC3486



TC3487



TC2316



TC2316



TC2348



TC2348



TC3484



TC3485



TC2367



TC2367

Part No	Description	Pos	Info	Technical
TA2658	Inner tie rod(123)	A B		M16x1.5 Male(252) E
TC2316	Link stabiliser(135)	A B		M12x1.25
TC2348	Lower ball joint(140)	A B		M14x1.5
TC2367	Link stabiliser(135)	A B		M10x1.25
TC3484	Lower wishbone(158)	A		
TC3485	Lower wishbone(158)	B		
TC3486	Upper wishbone(247)	A		M10 x 1.25
TC3487	Upper wishbone(247)	B		M10 x 1.25

SONATA 2.0i, 2.4i YF (01/09→)



TC2850



TC2850



TC2704



TC2704



TC3236



TC3236

Part No	Description	Pos	Info	Technical
TC2704	Link stabiliser(135)	A B		M12x1.25
TC2850	Lower ball joint(140)	A B		Pinch Bolt(255) 18mm
TC3236	Link Arm(133)	A B		M10x1.25

TERRACAN 2.5TD, 2.9CRDi, 3.5i HP (12/01→)

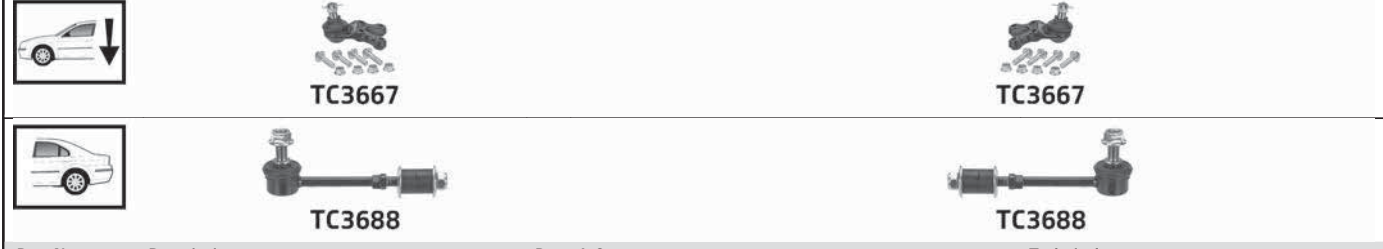

Part No	Description	Pos	Info	Technical
TC3667	Lower ball joint (140)	A B		M16 x 1.5 x 20
TC3688	Link stabiliser (135)	A B		M12 x 1.25 x 23.5

TRAJET 2.0i, 2.0CRDi, 2.7i (03/00-02/04)



Part No	Description	Pos	Info	Technical
TA1965	Tie rod end (224)	A B		M14x1.5 Female (253) £
TA2022	Inner tie rod (123)	A B		M14x1.5 Male (252) £
TC1559	Lower ball joint (140)	A B		Pinch Bolt (255) 20mm
TC1560	Link stabiliser (135)	A		M12x1.25
TC1561	Link stabiliser (135)	B		M12x1.25

TRAJET 2.0i, 2.0CRDi, 2.7i (03/04-07/08)

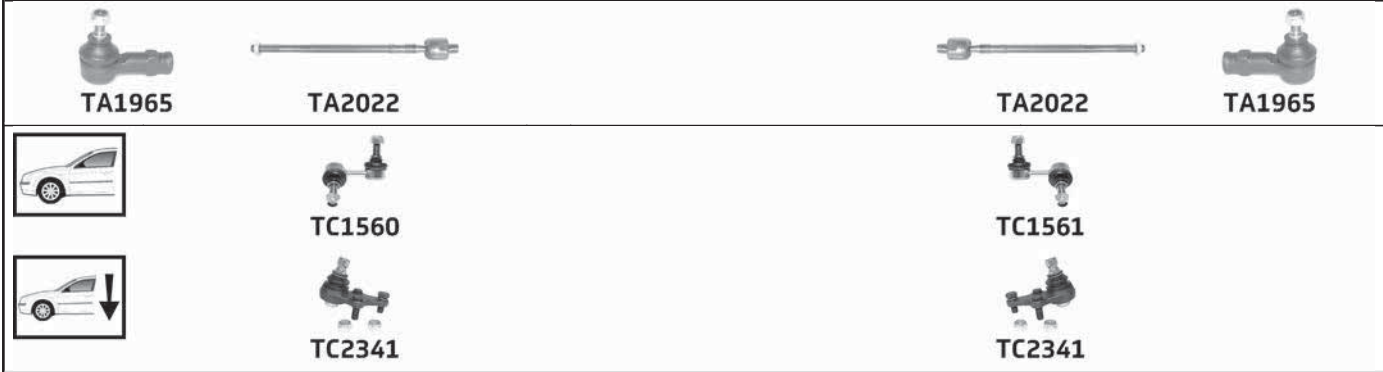

Part No	Description	Pos	Info	Technical
TA1965	Tie rod end (224)	A B		M14x1.5 Female (253) £
TA2022	Inner tie rod (123)	A B		M14x1.5 Male (252) £
TC1560	Link stabiliser (135)	A		M12x1.25
TC1561	Link stabiliser (135)	B		M12x1.25
TC2341	Lower ball joint (140)	A B		Pinch Bolt (255) 20mm

Part No	Description	Pos	Info	Technical

... HYUNDAI

TUCSON 2.0i, 2.0CRDi, 2.7i JM (08/04-03/10)



TA2389



TA2371



TBR4246



TA2371



TA2390



TC1816



TC1816



TC2378



TC2378



TC3199



TD957W



TD957W



TC3200



TC1876



TC1876

Part No	Description	Pos	Info	Technical
TA2371	Inner tie rod(123)	A B		M16x1.5 Male(252) £
TA2389	Tie rod end(224)	A		M16x1.5 Female(253) £
TA2390	Tie rod end(224)	B		M16x1.5 Female(253) £
TBR4246	Steering rack gaiter kit(213)	K	Thermoplastic(223)	1 :16x51x51 2 :16x51x51
TC1816	Link stabiliser(135)	A B		M12x1.25
TC1876	Link stabiliser(135)	A B		M12x1.25
TC2378	Lower ball joint(140)	A B		M12x1.25
TC3199	Lower wishbone(158)	A		
TC3200	Lower wishbone(158)	B		
TD957W	Lower wishbone bush(159)	A B	Front(108)	

VELOSTER 1.6GDi, 2.0CRDi FS (03/11→)



TA2917



TA2886



TA2886



TA2918



TC2663



TC2663



TC2737



TD1038W



TD1038W



TC2738

Part No	Description	Pos	Info	Technical
TA2886	Inner tie rod(123)	A B		M16x1.5 Male(252) £
TA2917	Tie rod end(224)	A		M16x1.5 Female(253) £
TA2918	Tie rod end(224)	B		M16x1.5 Female(253) £
TC2663	Link stabiliser(135)	A B		M12x1.25
TC2737	Lower wishbone(158)	A		M12x1.25
TC2738	Lower wishbone(158)	B		M12x1.25
TD1038W	Lower wishbone bush(159)	A B	Rear(187)	

XG 2.5i, 3.0i (12/98-04/00)

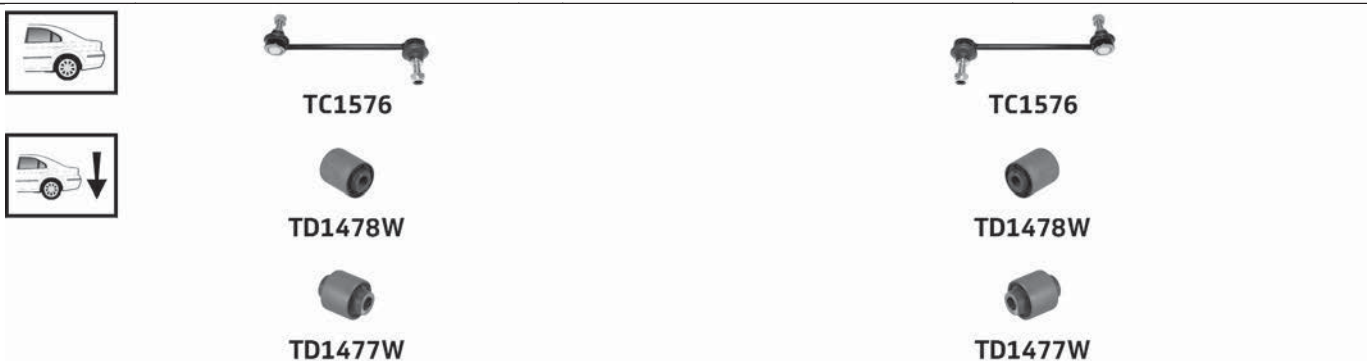
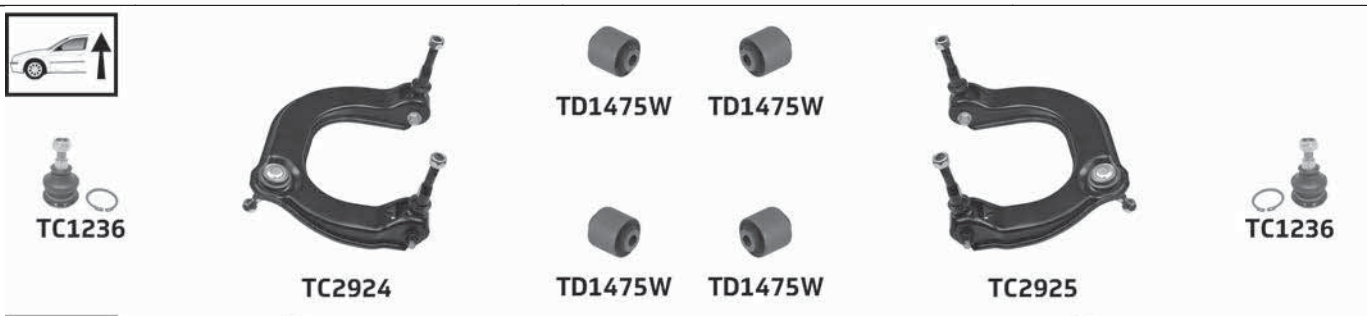

Part No	Description	Pos	Info	Technical
TA1862	Tie rod end(224)	A		M14x1.5 Female(253) £
TA1863	Tie rod end(224)	B		M14x1.5 Female(253) £
TA1981	Inner tie rod(123)	A B		M14x1.5 Male(252) £
TBR4109	Steering rack gaiter kit(213)	K		1 :14x48x48 2 :14x48x48
TC1235	Lower ball joint(140)	A B		M14x1.5
TC1236	Upper ball joint(232)	A B		M10x1.25
TC1521	Link stabiliser(135)	A B		M10x1.25
TC1576	Link stabiliser(135)	A B		M10x1.25
TC2924	Upper wishbone(247)	A		M10x1.25
TC2925	Upper wishbone(247)	B		M10x1.25
TD1475W	Upper wishbone bush(248)	A B	Front(108) Rear(187)	
TD1477W	Lower hub carrier bush(143)	A B	Front(108) Rear(187)	
TD1478W	Lower track control arm bush(153)	A B		
TD1485W	Lower wishbone bush(159)	A B	Rear(187)	

HYUNDAI

... HYUNDAI

XG 2.5i, 3.0i (04/00→)

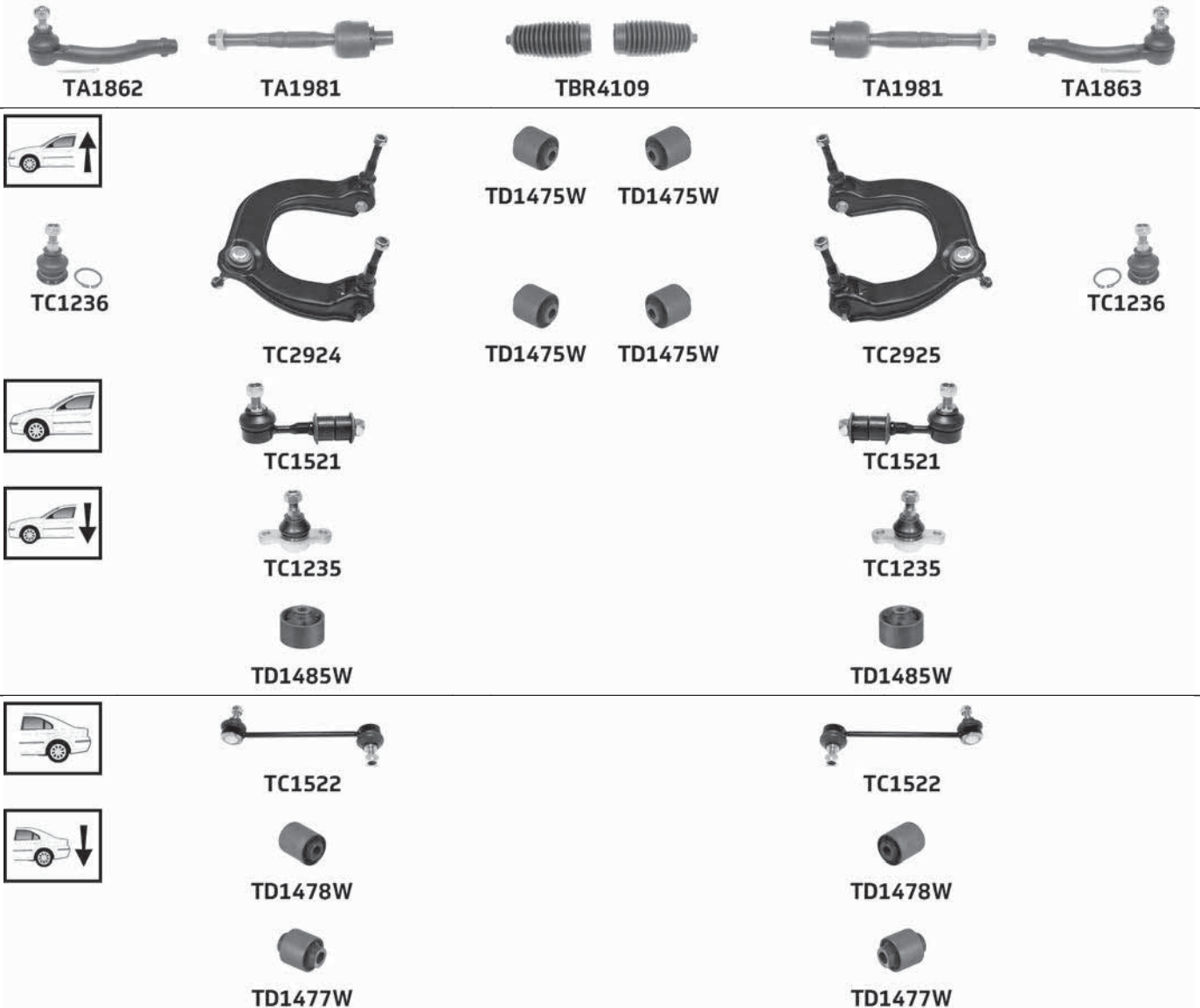

Part No	Description	Pos	Info	Technical
TA1862	Tie rod end(224)	A		M14x1.5 Female(253) £
TA1863	Tie rod end(224)	B		M14x1.5 Female(253) £
TA1981	Inner tie rod(123)	A B		M14x1.5 Male(252) £
TBR4109	Steering rack gaiter kit(213)	K		1 :14x48x48 2 :14x48x48
TC1235	Lower ball joint(140)	A B		M14x1.5
TC1236	Upper ball joint(232)	A B		M10x1.25
TC1521	Link stabiliser(135)	A B		M10x1.25
TC1522	Link stabiliser(135)	A B		M10x1.25
TC2924	Upper wishbone(247)	A		M10x1.25
TC2925	Upper wishbone(247)	B		M10x1.25
TD1475W	Upper wishbone bush(248)	A B	Front(108) Rear(187)	
TD1477W	Lower hub carrier bush(143)	A B	Front(108) Rear(187)	
TD1478W	Lower track control arm bush(153)	A B		
TD1485W	Lower wishbone bush(159)	A B	Rear(187)	

D-MAX 2.5TD (03/12→)



Part No	Description	Pos	Info	Technical
TA3225	Tie rod end (224)	A B		M14x1.5 Female(253) £
TC3644	Lower ball joint (140)	A B		M18x1.5

RODEO 2.5TD, 3.0TD (05/02→)



TC3559

TC3560

Part No	Description	Pos	Info	Technical
TA3225	Tie rod end (224)	A B		M14x1.5 Female(253) £
TC3559	Lower wishbone(158)	A		
TC3560	Lower wishbone(158)	B		
TC3561	Upper wishbone(247)	A		M14 x 1.5 x 24
TC3562	Upper wishbone(247)	B		M14 x 1.5 x 24
TC3644	Lower ball joint (140)	A B		M18x1.5

TROOPER 3.0TD, 3.5i (05/98-08/04)



Part No	Description	Pos	Info	Technical
TC3644	Lower ball joint (140)	A B		M18x1.5

IVECO

DAILY III 2.3TDi, 2.8TDi, 3.0TDi (05/99-05/06)



Part No	Description	Pos	Info	Technical
TA2449	Tie rod end(224)	A B		M16x1.5 Female(253) £
TA2523	Inner tie rod(123)	A B		M16x1.5 Male(252) £
TC1935	Upper wishbone(247)	A		M16x1.5
TC1936	Upper wishbone(247)	B		M16x1.5
TC1937	Lower wishbone(158)	A		M18x1.5
TC1938	Lower wishbone(158)	B		M18x1.5
TC2361	Upper ball joint(232)	A B		M16x1.5
TC2362	Lower ball joint(140)	A B		M18x1.5
TC3386	Link stabiliser(135)	A B	Length(129) 130mm Inner Diameter 1(120) 16mm Inner Diameter 2(121) 18mm	

DAILY IV 2.3TDi, 3.0TDi (05/06-08/11)

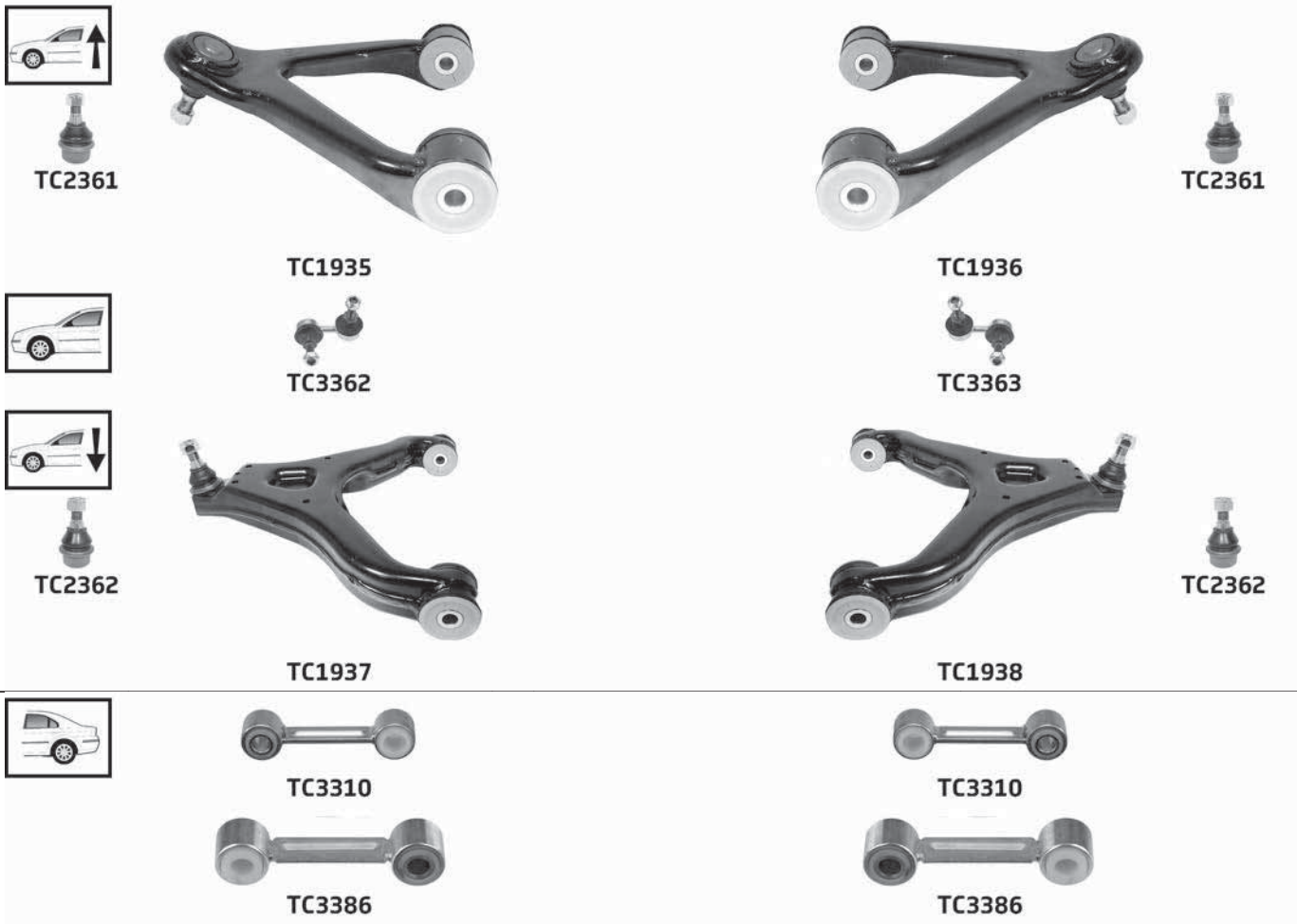

Part No	Description	Pos	Info	Technical
TC1935	Upper wishbone(247)	A		M16x1.5
TC1936	Upper wishbone(247)	B		M16x1.5
TC1937	Lower wishbone(158)	A		M18x1.5
TC1938	Lower wishbone(158)	B		M18x1.5
TC2361	Upper ball joint(232)	A B		M16x1.5
TC2362	Lower ball joint(140)	A B		M18x1.5
TC3310	Link stabiliser(135)	A B	Length(129) 130mm Inner Diameter 1(120) 16mm Inner Diameter 2(121) 22mm	
TC3362	Link stabiliser(135)	A		M10x1.5
TC3363	Link stabiliser(135)	B		M10x1.5
TC3386	Link stabiliser(135)	A B	Length(129) 130mm Inner Diameter 1(120) 16mm Inner Diameter 2(121) 18mm	

JAGUAR

F TYPE 2.0i (07/17→)
F TYPE 3.0i, 5.0i (10/12→)

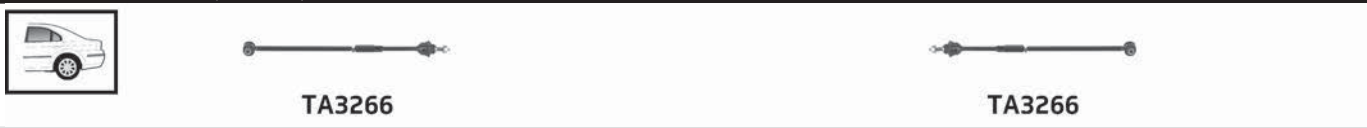

Part No	Description	Pos	Info	Technical
TA3266	Rod assembly(194)	A B		

... JAGUAR

S TYPE 2.5i, 2.7TDi, 3.0i, 4.0i, 4.2i (01/99-10/07)

JAGUAR

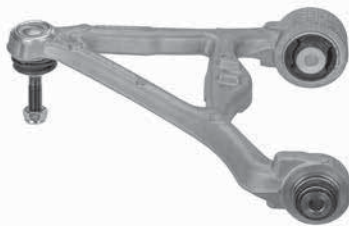

Part No	Description	Pos	Info	Technical
TA2334	Tie rod end(224)	A	Ch. M45255→	M14x1.5 Female(253) E

... S TYPE 2.5i, 2.7TDi, 3.0i, 4.0i, 4.2i (01/99-10/07)

TA2335	Tie rod end(224)	B	Ch. M45255→	M14x1.5 Female(253) £
TA3054	Rod assembly(194)	A B	→Ch. M45254	
TA3256	Inner tie rod(123)	A B	→ 04/02 Length(129) 242mm	M14x1.5 Male(252) £
TA3266	Rod assembly(194)	A B	Ch. M45255→	
TC1797	Link stabiliser(135)	A B	→Ch. M45254	M10x1.5
TC1884	Link stabiliser(135)	A		M10x1.5
TC1885	Link stabiliser(135)	B		M10x1.5
TC2904	Lower ball joint(140)	A B	→Ch. M45254	M14x2
TC3330	Upper wishbone(247)	A	Ch. M45255→	M12 x 1.75 x 30
TC3331	Upper wishbone(247)	B	Ch. M45255→	M12 x 1.75 x 30
TC3546	Upper wishbone(247)	A		M12x1.75
TC3547	Upper wishbone(247)	B		M12x1.75
TC3548	Upper wishbone(247)	A	→Ch. M45254	M12x1.75
TC3549	Upper wishbone(247)	B	→Ch. M45254	M12x1.75
TC3552	Lower track control arm(151)	A B	Front(108) Ch. M45255→	

X TYPE 2.0i, 2.0D, 2.2D, 2.5i, 3.0i (06/01-12/09)

Part No	Description	Pos	Info	Technical
TA1772	Tie rod end(224)	A B		M16x1.5 Female(253) £
TA3161	Inner tie rod(123)	A B		M16x1.5 Male(252) £
TC1016	Lower ball joint(140)	A B		Pinch Bolt(255) 21mm
TC1154	Link stabiliser(135)	A B	→Ch. D14965	M10x1.5
TC1170	Link stabiliser(135)	A B	Ch. D14966→	M10x1.5
TC1520	Link stabiliser(135)	A B		M10x1.5
TD348W	Lower wishbone bush(159)	A B	Front(108)	

... JAGUAR

... X TYPE 2.0i, 2.0D, 2.2D, 2.5i, 3.0i (06/01-12/09)

Part No	Description	Pos	Info	Technical
TD349W	Lower wishbone bush(159)	A B	Rear(187)	
TD996W	Anti-roll bar(-74) bush kit(-86)	K	Ø18 Complete axle kit(-92)	
TD1099W	Anti-roll bar(-74) bush kit(-86)	K	Complete axle kit(-92)	
TD1155W	Lower track control arm bush(153)	A B	Front(108) Outer(176)	

XF 2.2D (04/11-04/15)

XF 2.7TD, 3.0i, 3.0D, 4.2i, 5.0i (03/08-04/15)

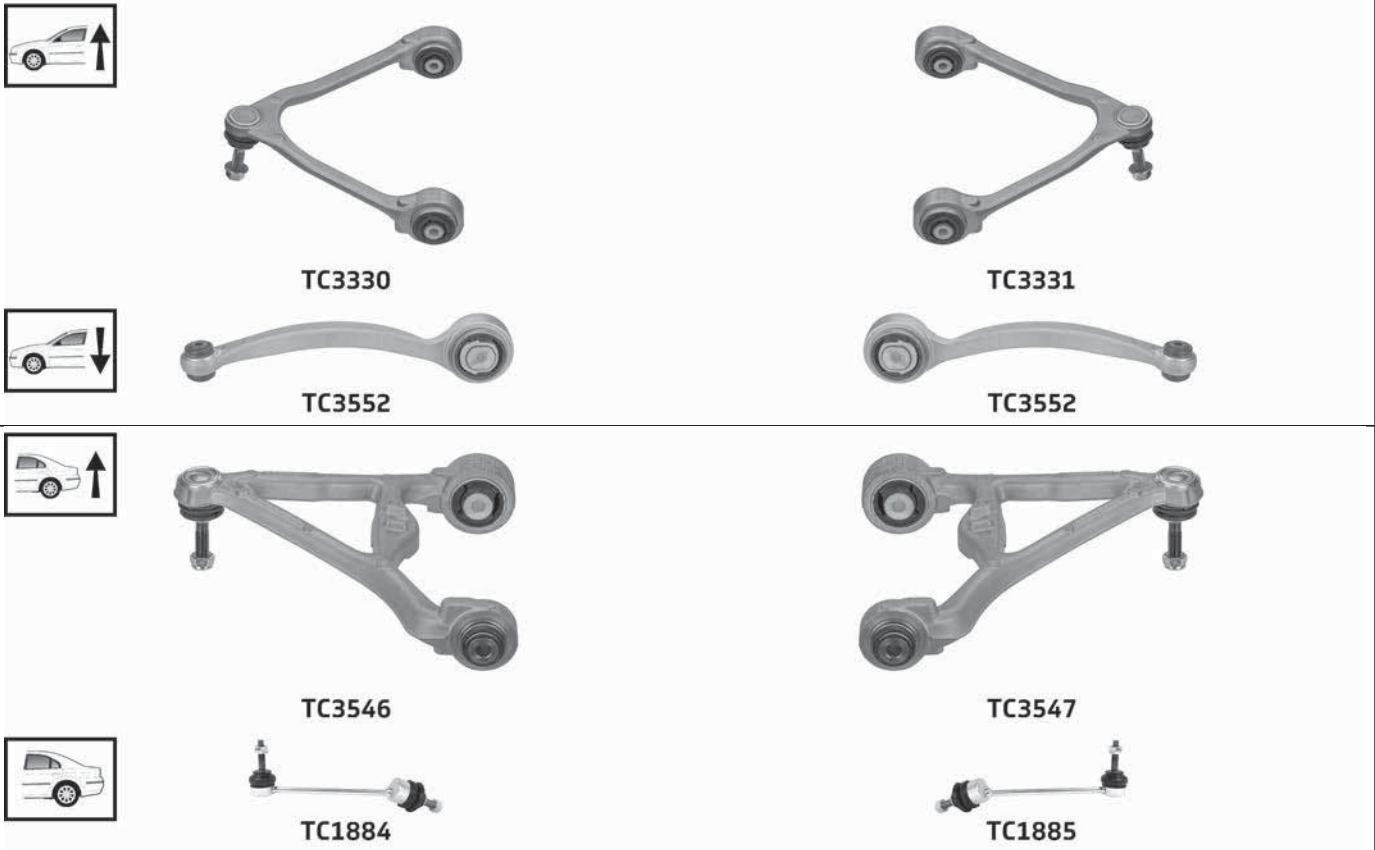

Part No	Description	Pos	Info	Technical
TC1884	Link stabiliser(135)	A		M10x1.5
TC1885	Link stabiliser(135)	B		M10x1.5
TC3330	Upper wishbone(247)	A	(-) AWD	M12 x 1.75 x 30
TC3331	Upper wishbone(247)	B	(-) AWD	M12 x 1.75 x 30
TC3546	Upper wishbone(247)	A		M12x1.75
TC3547	Upper wishbone(247)	B		M12x1.75
TC3552	Lower track control arm(151)	A B	Front(108)	

XJ 2.7D, 3.0i, 3.5i, 4.2i (03/03-10/09)



Part No	Description	Pos	Info	Technical
TA2334	Tie rod end(224)	A		M14x1.5 Female(253) £
TA2335	Tie rod end(224)	B		M14x1.5 Female(253) £
TA3256	Inner tie rod(123)	A B		M14x1.5 Male(252) £
TA3266	Rod assembly(194)	A B		
TC1884	Link stabiliser(135)	A		M10x1.5
TC1885	Link stabiliser(135)	B		M10x1.5

XJ 3.0D, 3.0i, 5.0i (10/09→)



TC3548



TC3549



TC3552



TC3552



TC1884



TC1885



TA3266



TA3266

Part No	Description	Pos	Info	Technical
TA3266	Rod assembly(194)	A B	(-) 3.0D	
TC1884	Link stabiliser(135)	A		M10x1.5
TC1885	Link stabiliser(135)	B		M10x1.5
TC3548	Upper wishbone(247)	A		M12x1.75
TC3549	Upper wishbone(247)	B		M12x1.75
TC3552	Lower track control arm(151)	A B	Front(108)	

XJ8 3.2i, 4.0i (07/97-05/03)



TA1518



TA1518



TC3648



TC3648



TC2887



TC2887

Part No	Description	Pos	Info	Technical
TA1518	Tie rod end(224)	A B		M14x1.5 Female(253) E
TC2887	Link stabiliser(135)	A B	Ch. 853936→	M12x1.75
TC3648	Upper ball joint(232)	A B		M12x1.75

XK8 4.0i, 4.2i (10/96-08/05)

XKR 4.0i, 4.2i (10/96-08/05)



TC3648



TC3648

Part No	Description	Pos	Info	Technical
TC3648	Upper ball joint(232)	A B		M12x1.75

... JAGUAR

XK 4.2i, 5.0i (03/06→)

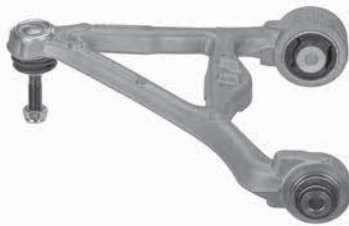

Part No	Description	Pos	Info	Technical
TA2334	Tie rod end(224)	A	→Ch. B32752	M14x1.5 Female(253) £
TA2335	Tie rod end(224)	B	→Ch. B32752	M14x1.5 Female(253) £
TA3266	Rod assembly(194)	A B	(-) 3.0D	
TC1884	Link stabiliser(135)	A		M10x1.5
TC1885	Link stabiliser(135)	B		M10x1.5
TC3546	Upper wishbone(247)	A		M12x1.75
TC3547	Upper wishbone(247)	B		M12x1.75

JEEP

COMPASS 2.0CRD, 2.4i (01/07→)



Part No	Description	Pos	Info	Technical
TA2753	Tie rod end(224)	A B		M14x1.5 Female(253) £
TC3307	Link stabiliser(135)	A B		

GRAND CHEROKEE 2.7CRD WJ, WG, 3.1TD WJ, WG, 4.0i WJ, WG, 4.7i WJ, WG (09/98→)



Part No	Description	Pos	Info	Technical
TC3665	Lower ball joint(140)	A B		W5/8-18

GRAND CHEROKEE 3.0CRD WH, WK, 3.7i WH, WK, 4.7i WH, WK, 5.7i WH, WK, 6.1i WH, WK (06/05→)

	TD1632W	TD1632W
	TC3715	TC3716

Part No	Description	Pos	Info	Technical
TC3715	Lower wishbone(158)	A	(-) SRT8	
TC3716	Lower wishbone(158)	B	(-) SRT8	
TD1632W	Upper wishbone bush(248)	A B	Front(108) Rear(187)	

GRAND CHEROKEE 3.0CRD WK2, 3.6i WK2, 5.7i WK2, 6.4i WK2 (11/10→)

	TC3677	TC3677
	TC3677	TC3677

Part No	Description	Pos	Info	Technical
TC3677	Lower ball joint(140)	A B		M16 x 1.5 x 30
TC3677	Lower ball joint(140)	A B		M16 x 1.5 x 30

COMMANDER 3.0CRD, 3.7i, 4.7i, 5.7i (09/05→)

	TD1632W	TD1632W
	TC3715	TC3716

Part No	Description	Pos	Info	Technical
TC3715	Lower wishbone(158)	A		
TC3716	Lower wishbone(158)	B		
TD1632W	Upper wishbone bush(248)	A B	Front(108) Rear(187)	

PATRIOT 2.0CRD, 2.4i (01/08→)

TA2753	TC3307	TA2753
	TC3307	TC3307

Part No	Description	Pos	Info	Technical
TA2753	Tie rod end(224)	A B		M14x1.5 Female(253) £
TC3307	Link stabiliser(135)	A B		

... JEEP

RENEGADE 1.4i, 1.4i 4X4, 1.6i, 1.6CRD, 2.0CRD 4X4 (07/14→)



TC3454



TC3455

Part No	Description	Pos	Info	Technical
TC3454	Lower wishbone(158)	A	(+) 4x4	Pinch Bolt(255) 19mm
TC3455	Lower wishbone(158)	B	(+) 4x4	Pinch Bolt(255) 19mm

WRANGLER 2.8CRD, 3.8i (04/07→)



TC3665



TC3665

Part No	Description	Pos	Info	Technical
TC3665	Lower ball joint (140)	A B		W5/8-18

KIA

CARENS II 1.6i, 1.8i, 2.0CVVT, 2.0CRDi FJ (07/02-09/06)



TA2623



TA2623



TC2397



TC2398



TD1487W



TD1487W



TD1479W



TD1480W



TC2199



TC2199

Part No	Description	Pos	Info	Technical
TA2623	Inner tie rod(123)	A B		M14x1.5 Male(252) E
TC2199	Link stabiliser(135)	A B		M10x1.25
TC2397	Link stabiliser(135)	A		M10x1.25
TC2398	Link stabiliser(135)	B		M10x1.25
TD1479W	Lower wishbone bush(159)	A	Rear(187) (+) Bracket(-41-)	
TD1480W	Lower wishbone bush(159)	B	Rear(187) (+) Bracket(-41-)	
TD1487W	Lower wishbone bush(159)	A B	Front(108)	

CARENS III 1.6CVVT, 1.6CRDi, 2.0CVVT, 2.0CRDi UN (09/06→)

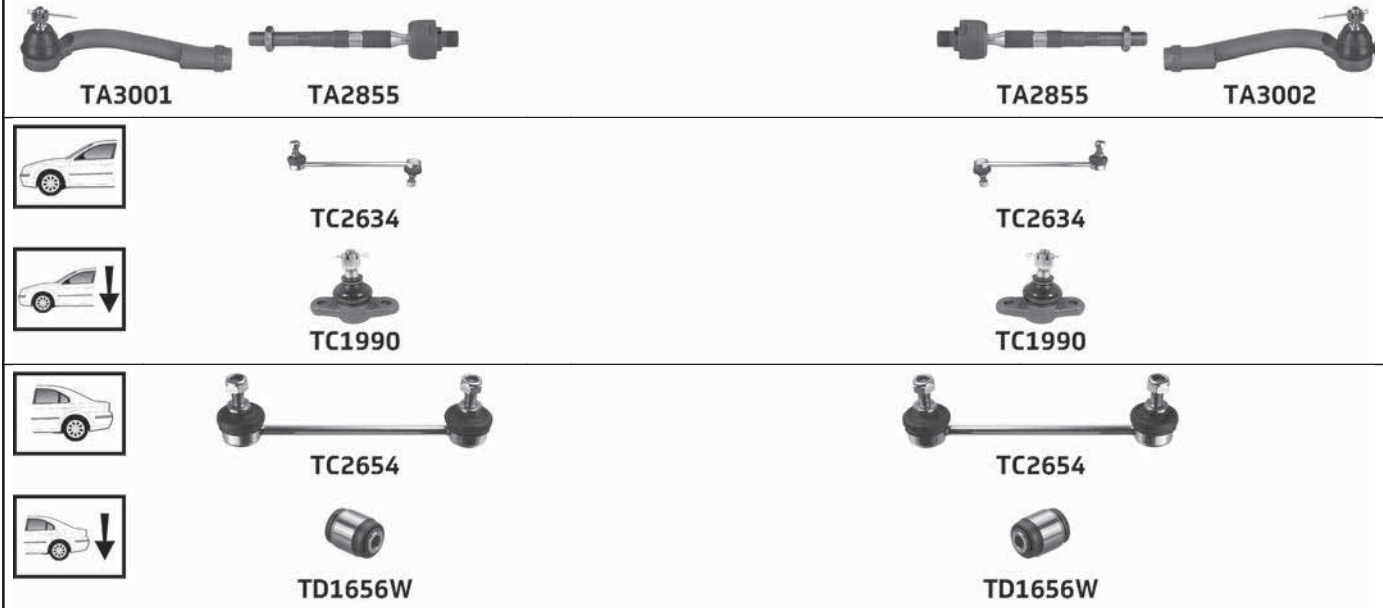

Part No	Description	Pos	Info	Technical
TA2855	Inner tie rod(123)	A B		M16x1.5 Male(252) £
TA3001	Tie rod end(224)	A		M16x1.5 Female(253) £
TA3002	Tie rod end(224)	B		M16x1.5 Female(253) £
TC1990	Lower ball joint(140)	A B		M12x1.25
TC2634	Link stabiliser(135)	A B		M12x1.25
TC2654	Link stabiliser(135)	A B		M10x1.25
TD1656W	Lower hub carrier bush(143)	A B	→17/11/2009	

CARENS IV 1.6, 2.0, 2.0GDi, 1.7CRDi RP (03/13→)

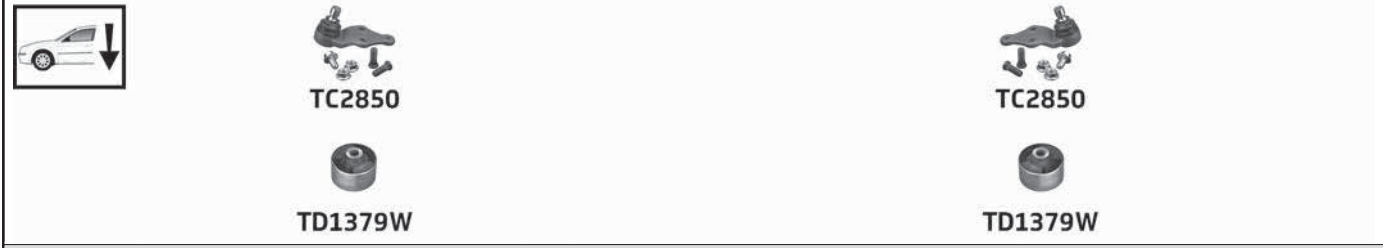

Part No	Description	Pos	Info	Technical
TC2850	Lower ball joint(140)	A B		Pinch Bolt(255) 18mm
TD1379W	Lower wishbone bush(159)	A B	Rear(187)	

CARNIVAL 2.5i, 2.9CRDi, 2.9TD (08/99-10/06)



Part No	Description	Pos	Info	Technical
TA2113	Tie rod end(224)	B		M14x1.5 Female(253) £
TA2114	Tie rod end(224)	A		M14x1.5 Female(253) £
TA2115	Inner tie rod(123)	A		M14x1.5 Male(252) £
TA2116	Inner tie rod(123)	B		M14x1.5 Male(252) £
TC1577	Link stabiliser(135)	A B		M12x1.25
TC1578	Lower track control arm(151)	A		Pinch Bolt(255) 22mm
TC1579	Lower track control arm(151)	B		Pinch Bolt(255) 22mm

--	--	--	--	--

... KIA

CARNIVAL 2.2CRDi, 2.7, 2.9CRDi (11/06→)

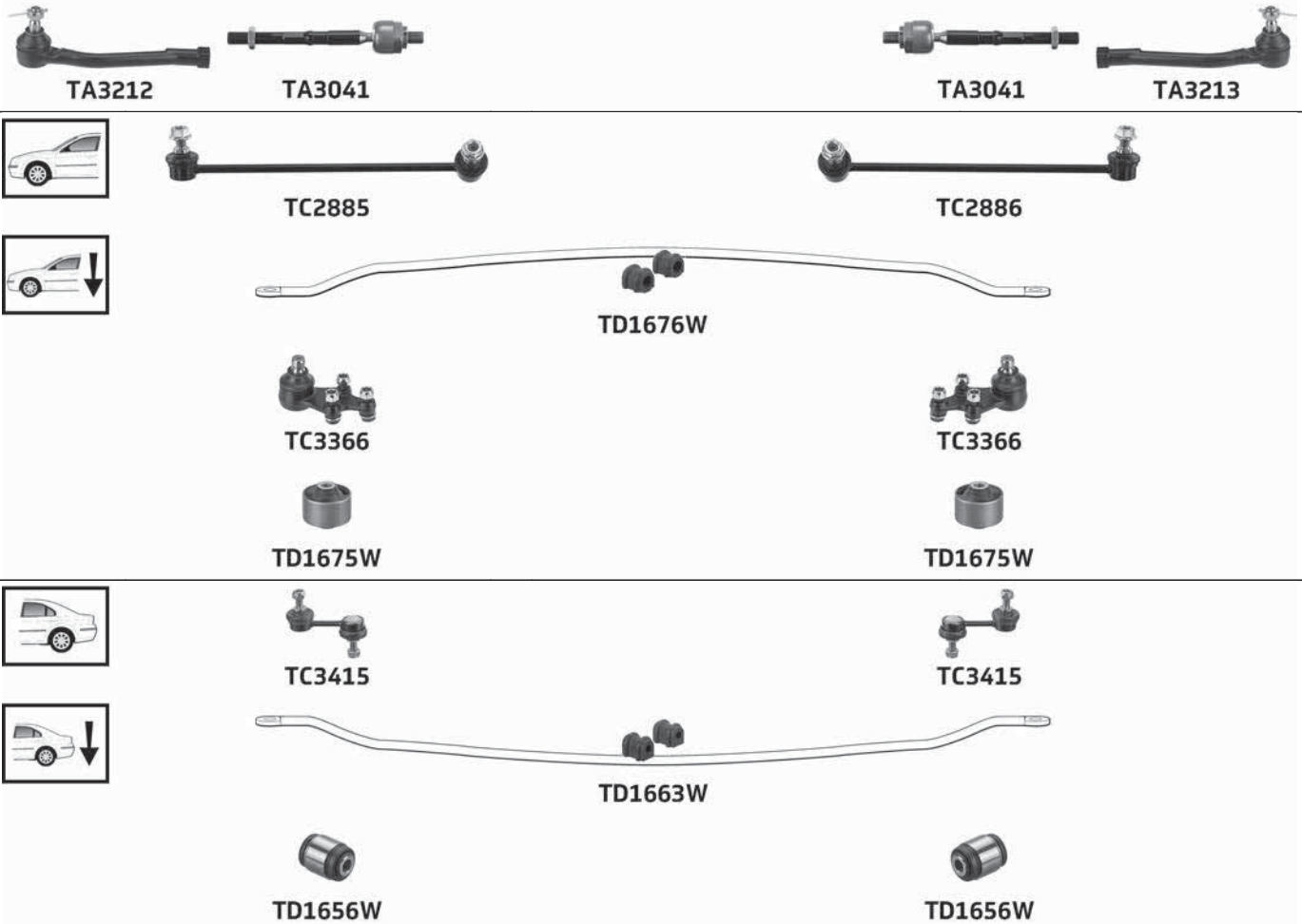

Part No	Description	Pos	Info	Technical
TA3041	Inner tie rod(123)	A B	Non-variable power steering(172)	M16x1.5 Male(252) E
TA3212	Tie rod end(224)	A		
TA3213	Tie rod end(224)	B		
TC2885	Link stabiliser(135)	A		M12x1.25
TC2886	Link stabiliser(135)	B		M12x1.25
TC3366	Lower ball joint(140)	A B		Pinch Bolt(255) 20mm
TC3415	Link stabiliser(135)	A B		
TD1656W	Lower hub carrier bush(143)	A B		
TD1663W	Anti-roll bar(-74) bush kit(-86)	K	Complete axle kit(-92)	
TD1675W	Lower wishbone bush(159)	A B	Front(108)	
TD1676W	Anti-roll bar(-74) bush kit(-86)	K	Ø25 Complete axle kit(-92)	

CEE'D 1.4i, 1.6i ED (12/06-12/12)



Part No	Description	Pos	Info	Technical
TA2480	Tie rod end(224)	A		M14x1.5 Female(253) £
TA2481	Tie rod end(224)	B		M14x1.5 Female(253) £
TA2492	Inner tie rod(123)	A B		M14x1.5 Male(252) £
TC1981	Link stabiliser(135)	A B		M10x1.25
TC1990	Lower ball joint(140)	A B	→ 5/11/2009	M12x1.25
TC2152	Link stabiliser(135)	A B		M12x1.25
TC2171	Lower wishbone(158)	A	(-) Ball joint(-11-)	
TC2172	Lower wishbone(158)	B	(-) Ball joint(-11-)	
TC3190	Lower track control arm(151)	A B	Front(108)	M10x1.25
TD870W	Lower wishbone bush(159)	A B	Front(108)	
TD899W	Lower wishbone bush(159)	A B	Rear(187)	
TD1645W	Anti-roll bar(-74-) bush kit(-86-)	K	→6/9/2011	
TD1656W	Lower hub carrier bush(143)	A B	→1/07/2009	

KIA

... KIA

CEE'D 1.6CRDi, 2.0i ED (12/06-12/12)



Part No	Description	Pos	Info	Technical
TA2480	Tie rod end(224)	A		M14x1.5 Female(253) £
TA2481	Tie rod end(224)	B		M14x1.5 Female(253) £
TA2492	Inner tie rod(123)	A B		M14x1.5 Male(252) £
TC1981	Link stabiliser(135)	A B		M10x1.25
TC1990	Lower ball joint(140)	A B	→ 5/11/2009	M12x1.25
TC2152	Link stabiliser(135)	A B		M12x1.25
TC2171	Lower wishbone(158)	A	(-) Ball joint(-11-)	
TC2172	Lower wishbone(158)	B	(-) Ball joint(-11-)	
TC3190	Lower track control arm(151)	A B	Front(108)	M10x1.25
TD870W	Lower wishbone bush(159)	A B	Front(108)	
TD899W	Lower wishbone bush(159)	A B	Rear(187)	
TD1645W	Anti-roll bar(-74) bush kit(-86-)	K	13/07/2009→ →6/9/2011	
TD1656W	Lower hub carrier bush(143)	A B	→1/07/2009	

CEE'D 2.0CRDi ED (12/06-12/12)



... CEE'D 2.0CRDi ED (12/06-12/12)

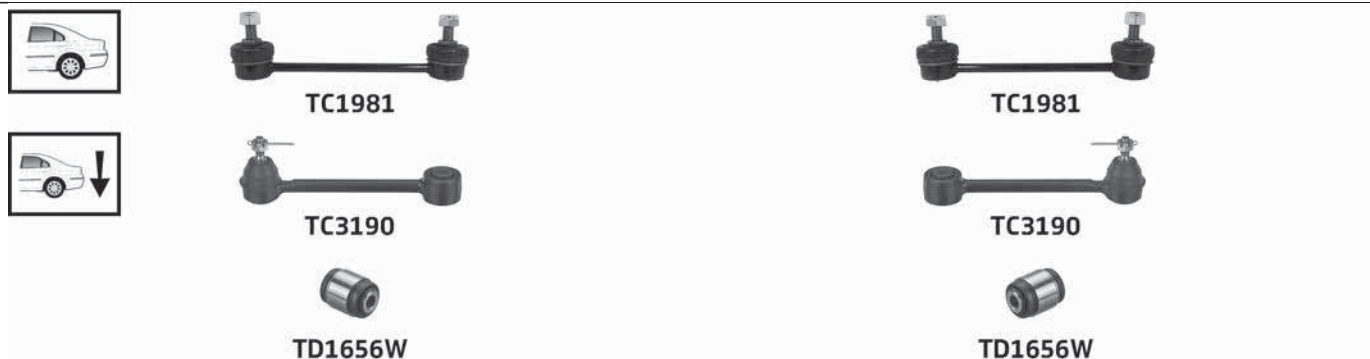
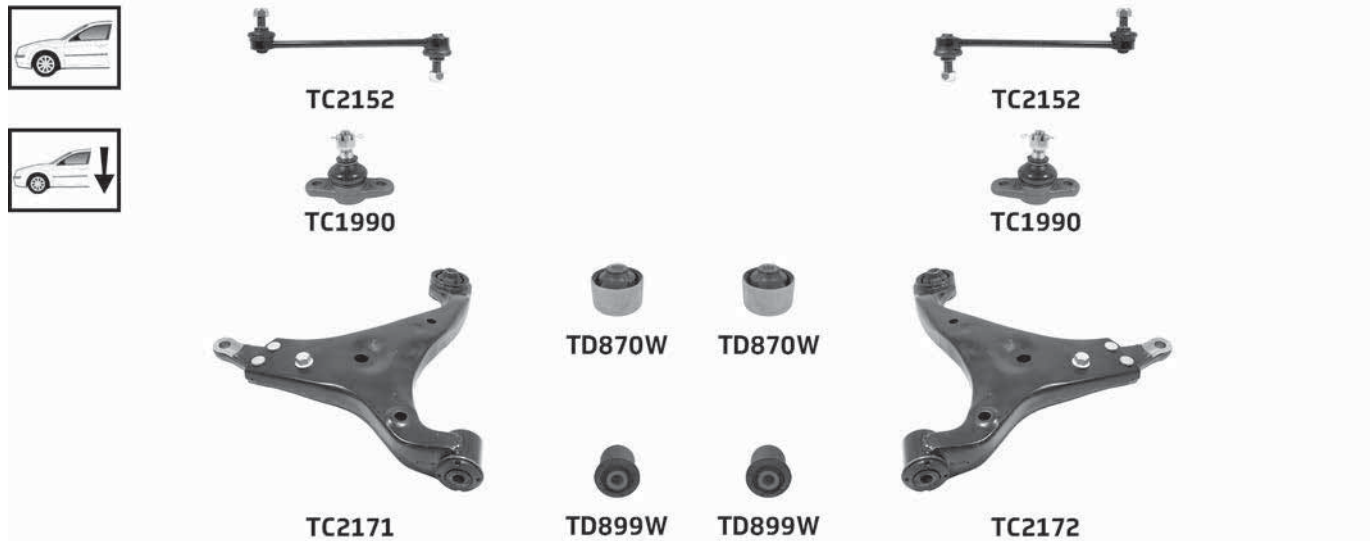

Part No	Description	Pos	Info	Technical
TA2480	Tie rod end(224)	A		M14x1.5 Female(253) £
TA2481	Tie rod end(224)	B		M14x1.5 Female(253) £
TA2492	Inner tie rod(123)	A B		M14x1.5 Male(252) £
TC1981	Link stabiliser(135)	A B		M10x1.25
TC1990	Lower ball joint(140)	A B	→ 5/11/2009	M12x1.25
TC2152	Link stabiliser(135)	A B		M12x1.25
TC2171	Lower wishbone(158)	A	(-) Ball joint(-11-)	
TC2172	Lower wishbone(158)	B	(-) Ball joint(-11-)	
TC3190	Lower track control arm(151)	A B	Front(108)	M10x1.25
TD870W	Lower wishbone bush(159)	A B	Front(108)	
TD899W	Lower wishbone bush(159)	A B	Rear(187)	
TD1656W	Lower hub carrier bush(143)	A B	→1/07/2009	

CEE'D 1.4i, 1.4CRDi, 1.6i, 1.6CRDi JD (05/12-05/14)

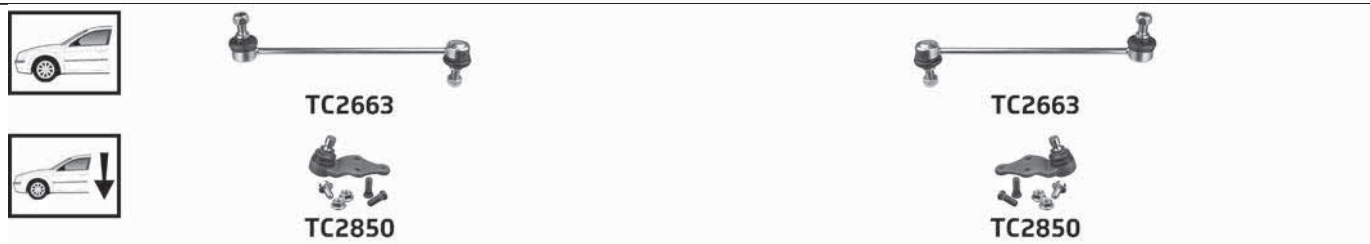

Part No	Description	Pos	Info	Technical
TA2917	Tie rod end(224)	A		M16x1.5 Female(253) £
TA2918	Tie rod end(224)	B		M16x1.5 Female(253) £
TA3255	Inner tie rod(123)	A B		M16x1.5 Male(252) £

(...)

... KIA

... CEE'D 1.4i, 1.4CRDi, 1.6i, 1.6CRDi JD (05/12-05/14)

Part No	Description	Pos	Info	Technical
TC2663	Link stabiliser(135)	A B	→ 09/13	M12x1.25
TC2704	Link stabiliser(135)	A B		M12x1.25
TC2850	Lower ball joint(140)	A B		Pinch Bolt(255) 18mm
TC2856	Lower wishbone(158)	A	(-) Xenon light(-31-)	Pinch Bolt(255) 18mm
TC2857	Lower wishbone(158)	B		Pinch Bolt(255) 18mm

CEE'D 1.4i, 1.4CRDi, 1.6i, 1.6CRDi JD (06/14→)



Part No	Description	Pos	Info	Technical
TA2917	Tie rod end(224)	A	→ 06/15	M16x1.5 Female(253) £
TA2918	Tie rod end(224)	B	→ 06/15	M16x1.5 Female(253) £
TA3255	Inner tie rod(123)	A B		M16x1.5 Male(252) £
TC2704	Link stabiliser(135)	A B		M12x1.25
TC2850	Lower ball joint(140)	A B		Pinch Bolt(255) 18mm

CERATO I 1.5CRDi, 1.6i, 1.6CRDi, 2.0i, 2.0CRDi LD (04/04→)

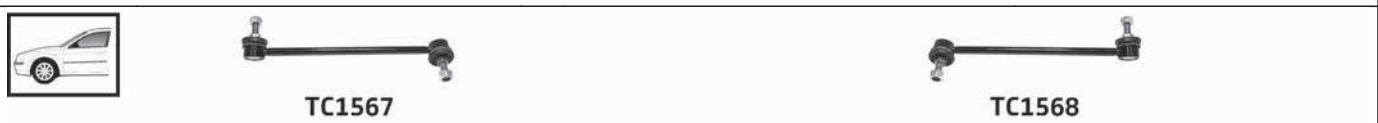
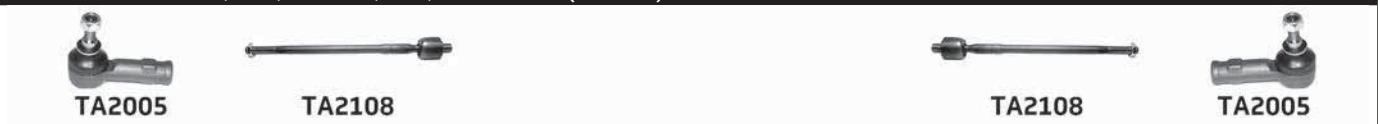

Part No	Description	Pos	Info	Technical
TA2005	Tie rod end(224)	A B		M14x1.5 Female(253) £
TA2108	Inner tie rod(123)	A B		M14x1.5 Male(252) £
TC1567	Link stabiliser(135)	A		M10x1.25
TC1568	Link stabiliser(135)	B		M10x1.25
TC2391	Link stabiliser(135)	A B		M10x1.25
TC3245	Lower wishbone(158)	A		M12x1.25
TC3246	Lower wishbone(158)	B		M12x1.25

CERATO II 1.6i, 2.0i TD (01/09→)

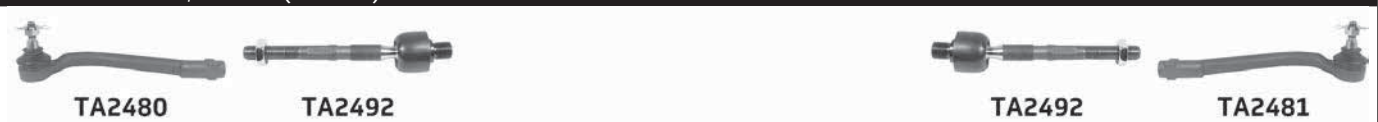

KIA

CERATO II 1.6i, 2.0i TD (01/09→)

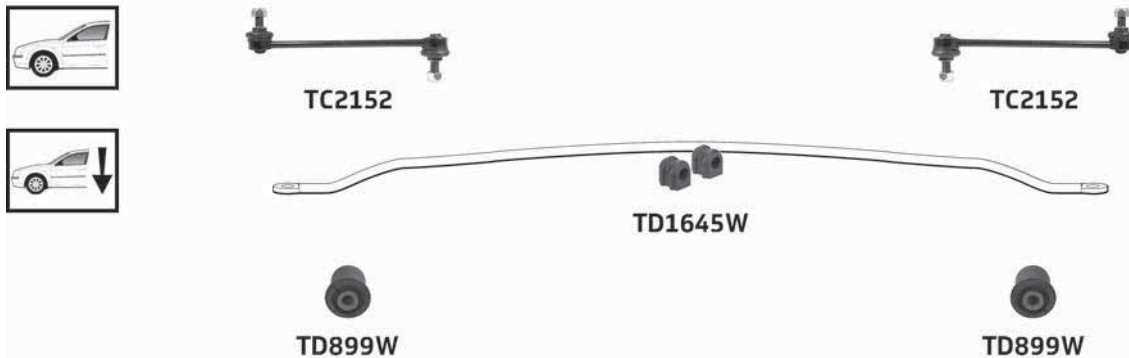

Part No	Description	Pos	Info	Technical
TA2480	Tie rod end (224)	A		M14x1.5 Female (253) £
TA2481	Tie rod end (224)	B	(+) Electric (103) Power steering (185)	M14x1.5 Female (253) £
TA2492	Inner tie rod (123)	A B	(+) Electric (103) Power steering (185)	M14x1.5 Male (252) £
TC2152	Link stabiliser (135)	A B		M12x1.25
TD899W	Lower wishbone bush (159)	A B	Rear (187)	
TD1645W	Anti-roll bar (-74) bush kit (-86)	K	(-)	

MAGENTIS 2.0i, 2.5i GD (05/01→)

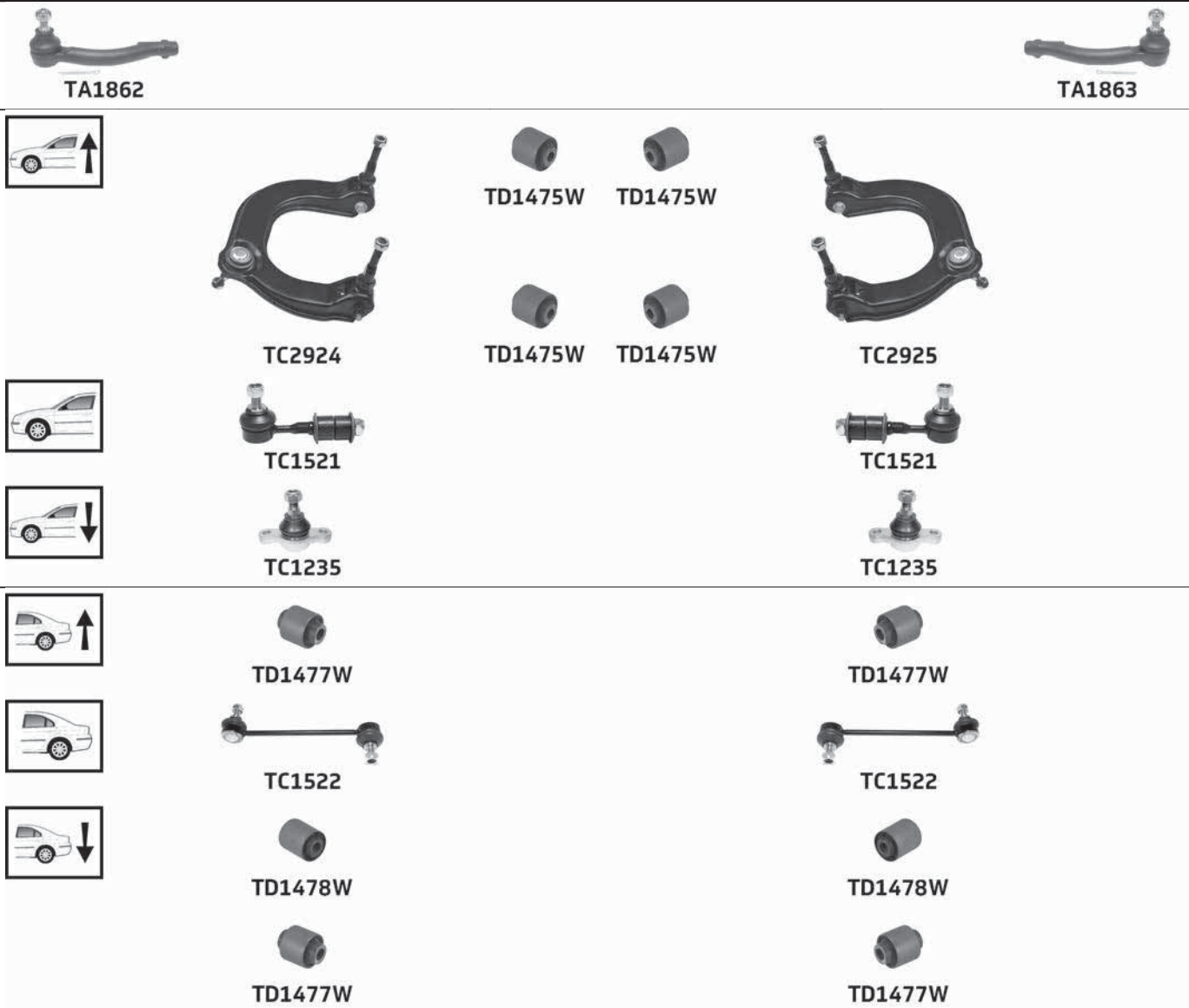

Part No	Description	Pos	Info	Technical
TA1862	Tie rod end (224)	A		M14x1.5 Female (253) £
TA1863	Tie rod end (224)	B		M14x1.5 Female (253) £
TC1235	Lower ball joint (140)	A B		M14x1.5
TC1521	Link stabiliser (135)	A B		M10x1.25
TC1522	Link stabiliser (135)	A B		M10x1.25

... KIA

... MAGENTIS 2.0i, 2.5i GD (05/01→)

















Part No	Description	Pos	Info	Technical
TC2924	Upper wishbone(247)	A		M10x1.25
TC2925	Upper wishbone(247)	B		M10x1.25
TD1475W	Upper wishbone bush(248)	A B	Front(108) Rear(187)	
TD1477W	Lower hub carrier bush(143)	A B		
TD1477W	Upper hub carrier bush(238)	A B		
TD1478W	Lower track control arm bush(153)	A B		

MAGENTIS 2.0i, 2.0CRDi, 2.7i MG (11/05→)

			
TA3001	TA2855	TA2855	TA3002
			
	TC2634	TC2634	
			
	TC1990	TC1990	
			
	TC2637	TC2637	

Part No	Description	Pos	Info	Technical
TA2855	Inner tie rod(123)	A B		M16x1.5 Male(252) £
TA3001	Tie rod end(224)	A		M16x1.5 Female(253) £
TA3002	Tie rod end(224)	B		M16x1.5 Female(253) £
TC1990	Lower ball joint(140)	A B		M12x1.25
TC2634	Link stabiliser(135)	A B		M12x1.25
TC2637	Link stabiliser(135)	A B		M10x1.25

MENTOR II 1.5i FB (05/99-06/01)













		
TA2857	TA2857	
		
	TC1202	TC1202
		
	TC2298	TC2299
		
	TC1228	TC1228
		
	TD1487W	TD1487W
		
	TD1479W	TD1480W
		
	TC2199	TC2199

Part No	Description	Pos	Info	Technical
TA2857	Inner tie rod(123)	A B		M14x1.5 Male(252) £
TC1202	Link stabiliser(135)	A B	→1/1/1999	M10x1.25
TC1228	Lower ball joint(140)	A B		Pinch Bolt(255) 18mm

... MENTOR II 1.5i FB (05/99-06/01)















Part No	Description	Pos	Info	Technical
TC2199	Link stabiliser(135)	A B		M10x1.25
TC2298	Link stabiliser(135)	A	1/1/1999→	M10x1.25
TC2299	Link stabiliser(135)	B	1/1/1999→	M10x1.25
TD1479W	Lower wishbone bush(159)	A	Rear(187) (+) Bracket(-41-)	
TD1480W	Lower wishbone bush(159)	B	Rear(187) (+) Bracket(-41-)	
TD1487W	Lower wishbone bush(159)	A B	Front(108)	

MENTOR II 1.6i FB (06/01-01/03)

 TA2857	 TA2857
  TC2298	  TC2299
  TC1228	  TC1228
 TD1487W	 TD1487W
 TD1479W	 TD1480W
  TC2199	  TC2199

Part No	Description	Pos	Info	Technical
TA2857	Inner tie rod(123)	A B		M14x1.5 Male(252) £
TC1228	Lower ball joint(140)	A B		Pinch Bolt(255) 18mm
TC2199	Link stabiliser(135)	A B		M10x1.25
TC2298	Link stabiliser(135)	A		M10x1.25
TC2299	Link stabiliser(135)	B		M10x1.25
TD1479W	Lower wishbone bush(159)	A	Rear(187) (+) Bracket(-41-)	
TD1480W	Lower wishbone bush(159)	B	Rear(187) (+) Bracket(-41-)	
TD1487W	Lower wishbone bush(159)	A B	Front(108)	

OPIRUS 3.5i GH (07/03-09/06)

 TA1862	 TA1863
  TC1521	  TC1521
  TC1522	  TC1522
  TD1478W	  TD1478W

Part No	Description	Pos	Info	Technical
TA1862	Tie rod end(224)	A		M14x1.5 Female(253) £
TA1863	Tie rod end(224)	B		M14x1.5 Female(253) £
TC1521	Link stabiliser(135)	A B		M10x1.25
TC1522	Link stabiliser(135)	A B		M10x1.25
TD1478W	Lower track control arm bush(153)	A B		

... KIA

OPIRUS 3.8i GH (10/06→)



TA2658



TA2658



TC2367



TC2367

Part No	Description	Pos	Info	Technical
TA2658	Inner tie rod(123)	A B		M16x1.5 Male(252) £
TC2367	Link stabiliser(135)	A B		M10x1.25

OPTIMA 1.7CRDi TF, 2.0i TF, 2.4i TF (06/10→)



TA3017



TA3198



TA3198



TA3018



TC2850



TC2850



TC2704



TC2704



TC3236



TC3236

Part No	Description	Pos	Info	Technical
TA3017	Tie rod end(224)	A		M16x1.5 Female(253) £
TA3018	Tie rod end(224)	B		M16x1.5 Female(253) £
TA3198	Inner tie rod(123)	A B		M16x1.5 Male(252) £
TC2704	Link stabiliser(135)	A B		M12x1.25
TC2850	Lower ball joint(140)	A B		Pinch Bolt(255) 18mm
TC3236	Link Arm(133)	A B		M10x1.25

PICANTO 1.0i, 1.1i, 1.1CRDi BA (04/04-04/11)



TA2085



TA2104



TA2104



TA2085



TC1533



TC1534



TC1733



TC1733



TC2001



TC2001



TC1972



TD717W



TD717W



TD718W



TD718W



TC1973

Part No	Description	Pos	Info	Technical
TA2085	Tie rod end(224)	A B		M12x1.25 Female(253) £

... PICANTO 1.0i, 1.1i, 1.1CRDi BA (04/04-04/11)

Part No	Description	Pos	Info	Technical
TA2104	Inner tie rod(123)	A B		M12x1.25 Male(252) £
TC1533	Link stabiliser(135)	A		M10x1.25
TC1534	Link stabiliser(135)	B		M10x1.25
TC1733	Lower ball joint(140)	A B	→ 4/08/2008	Pinch Bolt(255) 16mm
TC1972	Lower wishbone(158)	A	Power steering(185) → 12/07/2007	Pinch Bolt(255) 16mm
TC1973	Lower wishbone(158)	B	Power steering(185) → 12/07/2007	Pinch Bolt(255) 16mm
TC2001	Lower ball joint(140)	A B	5/08/2008 →	M12x1.25
TD717W	Lower wishbone bush(159)	A B	Front(108)	
TD718W	Lower wishbone bush(159)	A B	Rear(187)	

PICANTO 1.0i, 1.2i TA (05/11→)



Part No	Description	Pos	Info	Technical
TA3228	Tie rod end(224)	A		M14x1.5 Female(253) £
TA3229	Tie rod end(224)	B		M14x1.5 Female(253) £
TBR4244	Steering rack gaiter kit(213)	K	Thermoplastic(223)	1 :14x47x47 2 :14x47x47
TC2284	Link stabiliser(135)	A		M10x1.25
TC2285	Link stabiliser(135)	B		M10x1.25
TC3404	Lower ball joint(140)	A B		Pinch Bolt(255) 18mm
TC3417	Lower wishbone(158)	A		Pinch Bolt(255) Ø18mm
TC3418	Lower wishbone(158)	B		Pinch Bolt(255) Ø18mm

PICANTO 1.0i TA (01/15→)



Part No	Description	Pos	Info	Technical
TA3228	Tie rod end(224)	A		M14x1.5 Female(253) £
TA3229	Tie rod end(224)	B		M14x1.5 Female(253) £
TBR4244	Steering rack gaiter kit(213)	K	(-) ESC Thermoplastic(223)	1 :14x47x47 2 :14x47x47
TC2284	Link stabiliser(135)	A		M10x1.25
TC2285	Link stabiliser(135)	B		M10x1.25
TC3404	Lower ball joint(140)	A B		Pinch Bolt(255) 18mm

(...)

... KIA

... PICANTO 1.0i TA (01/15→)

Part No	Description	Pos	Info	Technical
TC3417	Lower wishbone(158)	A		Pinch Bolt(255) Ø18mm
TC3418	Lower wishbone(158)	B		Pinch Bolt(255) Ø18mm

PRO CEE'D 1.4i, 1.6i ED (02/08-02/13)

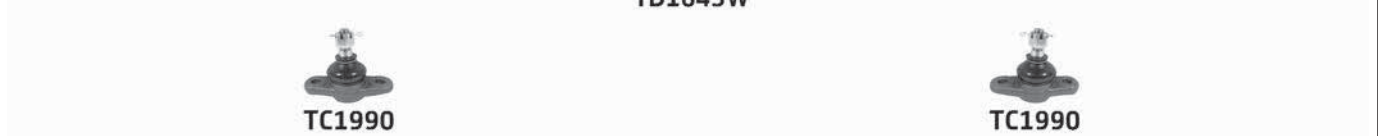

Part No	Description	Pos	Info	Technical
TA2480	Tie rod end(224)	A		M14x1.5 Female(253) £
TA2481	Tie rod end(224)	B		M14x1.5 Female(253) £
TA2492	Inner tie rod(123)	A B		M14x1.5 Male(252) £
TC1981	Link stabiliser(135)	A B		M10x1.25
TC1990	Lower ball joint(140)	A B	→ 5/11/2009	M12x1.25
TC2152	Link stabiliser(135)	A B		M12x1.25
TC2171	Lower wishbone(158)	A	(-) Ball joint(-11-)	
TC2172	Lower wishbone(158)	B	(-) Ball joint(-11-)	
TC3190	Lower track control arm(151)	A B	Front(108)	M10x1.25
TD870W	Lower wishbone bush(159)	A B	Front(108)	
TD899W	Lower wishbone bush(159)	A B	Rear(187)	
TD1645W	Anti-roll bar(-74-) bush kit(-86-)	K	→6/9/2011	
TD1656W	Lower hub carrier bush(143)	A B	→1/07/2009	

KIA

... KIA

PRO CEE'D 1.6CRDi, 2.0i ED (02/08-02/13)

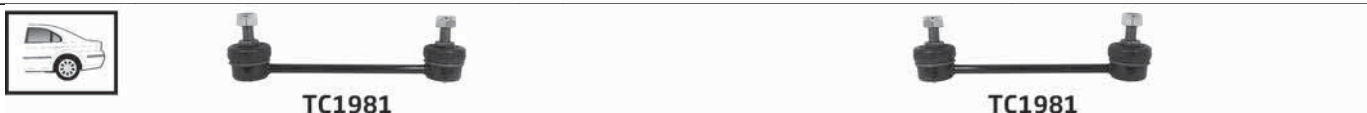

Part No	Description	Pos	Info	Technical
TA2480	Tie rod end(224)	A		M14x1.5 Female(253) £
TA2481	Tie rod end(224)	B		M14x1.5 Female(253) £
TA2492	Inner tie rod(123)	A B		M14x1.5 Male(252) £
TC1981	Link stabiliser(135)	A B		M10x1.25
TC1990	Lower ball joint(140)	A B	→ 5/11/2009	M12x1.25
TC2152	Link stabiliser(135)	A B		M12x1.25
TC2171	Lower wishbone(158)	A	(-) Ball joint(-11-)	
TC2172	Lower wishbone(158)	B	(-) Ball joint(-11-)	
TC3190	Lower track control arm(151)	A B	Front(108)	M10x1.25
TD870W	Lower wishbone bush(159)	A B	Front(108)	
TD899W	Lower wishbone bush(159)	A B	Rear(187)	
TD1645W	Anti-roll bar(-74-) bush kit(-86-)	K	13/07/2009→ →6/9/2011	
TD1656W	Lower hub carrier bush(143)	A B	→1/07/2009	

KIA

... KIA

PRO CEE'D 2.0CRDi ED (02/08-02/13)



Part No	Description	Pos	Info	Technical
TA2480	Tie rod end(224)	A		M14x1.5 Female(253) £
TA2481	Tie rod end(224)	B		M14x1.5 Female(253) £
TA2492	Inner tie rod(123)	A B		M14x1.5 Male(252) £
TC1981	Link stabiliser(135)	A B		M10x1.25
TC1990	Lower ball joint(140)	A B	→ 5/11/2009	M12x1.25
TC2152	Link stabiliser(135)	A B		M12x1.25
TC2171	Lower wishbone(158)	A	(-) Ball joint(-11-)	
TC2172	Lower wishbone(158)	B	(-) Ball joint(-11-)	
TC3190	Lower track control arm(151)	A B	Front(108)	M10x1.25
TD870W	Lower wishbone bush(159)	A B	Front(108)	
TD899W	Lower wishbone bush(159)	A B	Rear(187)	
TD1656W	Lower hub carrier bush(143)	A B	→1/07/2009	

PRO CEE'D 1.4i, 1.4CRDi, 1.6i, 1.6CRDi JD (03/13→)



Part No	Description	Pos	Info	Technical
TC2663	Link stabiliser(135)	A B		M12x1.25
TC2704	Link stabiliser(135)	A B		M12x1.25
TC2850	Lower ball joint(140)	A B		Pinch Bolt(255) 18mm
TC2856	Lower wishbone(158)	A	(-) Xenon light (-31-) → 05/14	Pinch Bolt(255) 18mm
TC2857	Lower wishbone(158)	B	→ 05/14	Pinch Bolt(255) 18mm

RIO I 1.3i, 1.5i DC (08/00-07/02)

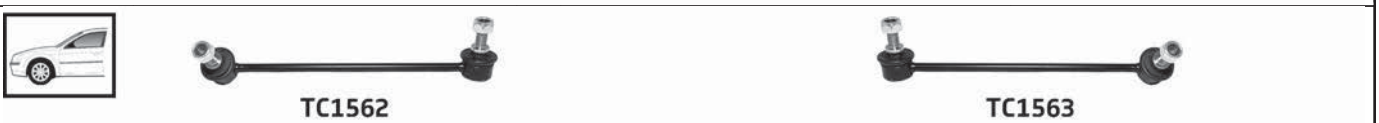

Part No	Description	Pos	Info	Technical
TA2085	Tie rod end(224)	A B		M12x1.25 Female(253) E
TA2102	Inner tie rod(123)	A B	Power steering(185)	M12x1.25 Male(252) E
TC1562	Link stabiliser(135)	A		M10x1.25
TC1563	Link stabiliser(135)	B		M10x1.25

RIO I 1.3i, 1.5i DC (08/02-02/05)



Part No	Description	Pos	Info	Technical
TA2085	Tie rod end(224)	A B		M12x1.25 Female(253) E
TA2102	Inner tie rod(123)	A B	Power steering(185)	M12x1.25 Male(252) E
TC1773	Link stabiliser(135)	A		M10x1.25
TC1774	Link stabiliser(135)	B		M10x1.25
TC2490	Lower track control arm(151)	A		
TC2491	Lower track control arm(151)	B		

... KIA

RIO II 1.4i, 1.5CRDi, 1.6i JB (03/05-10/11)

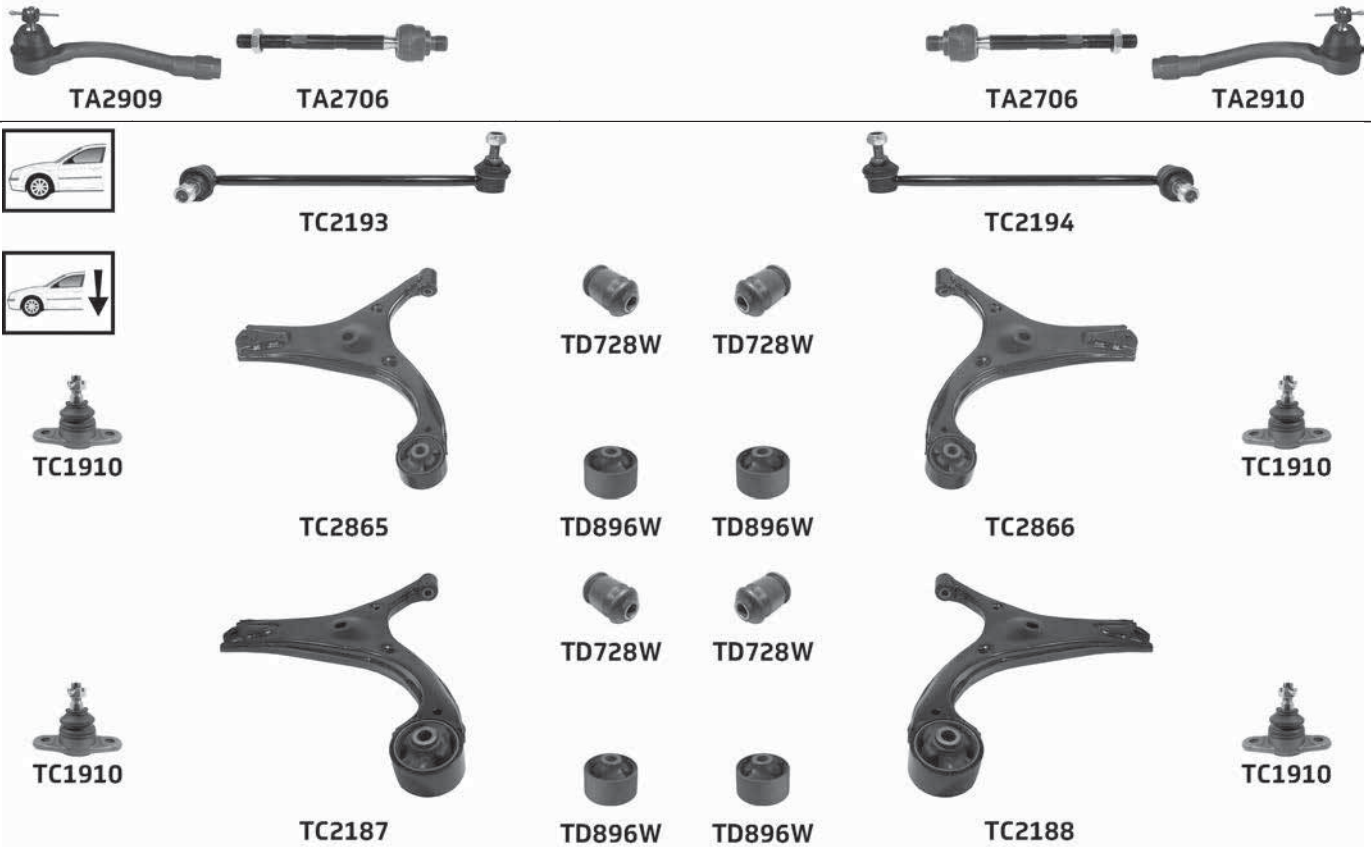

Part No	Description	Pos	Info	Technical
TA2706	Inner tie rod(123)	A B		M14x1.5 Male(252) £
TA2909	Tie rod end(224)	A		M14x1.5 Female(253) £
TA2910	Tie rod end(224)	B		M14x1.5 Female(253) £
TC1910	Lower ball joint(140)	A B		M12x1.25
TC2187	Lower wishbone(158)	A	(-) Bush(-13) Power steering(185)	
TC2188	Lower wishbone(158)	B	(-) Bush(-13) Power steering(185)	
TC2193	Link stabiliser(135)	A		M10x1.25
TC2194	Link stabiliser(135)	B		M10x1.25
TC2865	Lower wishbone(158)	A	(-) Bush(-13) Manual steering(170)	
TC2866	Lower wishbone(158)	B	(-) Bush(-13) Manual steering(170)	
TD728W	Lower wishbone bush(159)	A B	Front(108)	
TD896W	Lower wishbone bush(159)	A B	Rear(187)	

RIO III 1.1CRDi, 1.25i, 1.4i, 1.4CRDi, 1.6i UB (06/11→)



Part No	Description	Pos	Info	Technical
TA3204	Inner tie rod(123)	A B		M16x1.5 Male(252) £
TC2663	Link stabiliser(135)	A B		M12x1.25
TC3404	Lower ball joint(140)	A B		Pinch Bolt(255) 18mm
TC3625	Lower wishbone(158)	A		

... RIO III 1.1CRDi, 1.25i, 1.4i, 1.4CRDi, 1.6i UB (06/11→)

Part No	Description	Pos	Info	Technical
TC3626	Lower wishbone(158)	B		

SEDONA 2.5i, 2.9CRDi, 2.9TD (08/99-10/06)



Part No	Description	Pos	Info	Technical
TA2113	Tie rod end(224)	B		M14x1.5 Female(253) £
TA2114	Tie rod end(224)	A		M14x1.5 Female(253) £
TA2115	Inner tie rod(123)	A		M14x1.5 Male(252) £
TA2116	Inner tie rod(123)	B		M14x1.5 Male(252) £
TC1577	Link stabiliser(135)	A B		M12x1.25
TC1578	Lower track control arm(151)	A		Pinch Bolt(255) 22mm
TC1579	Lower track control arm(151)	B		Pinch Bolt(255) 22mm

SEDONA 2.2CRDi, 2.7i, 2.9CRDi (11/06→)



Part No	Description	Pos	Info	Technical
TA3041	Inner tie rod(123)	A B	Non-variable power steering(172)	M16x1.5 Male(252) £
TA3212	Tie rod end(224)	A		
TA3213	Tie rod end(224)	B		
TC2885	Link stabiliser(135)	A		M12x1.25
TC2886	Link stabiliser(135)	B		M12x1.25
TC3366	Lower ball joint(140)	A B		Pinch Bolt(255) 20mm
TC3415	Link stabiliser(135)	A B		

(...)

... KIA

... SEDONA 2.2CRDi, 2.7i, 2.9CRDi (11/06→)

Part No	Description	Pos	Info	Technical
TD1656W	Lower hub carrier bush(143)	A B		
TD1663W	Anti-roll bar(-74) bush kit(-86-)	K	Complete axle kit(-92-)	
TD1675W	Lower wishbone bush(159)	A B	Front(108)	
TD1676W	Anti-roll bar(-74) bush kit(-86-)	K	Ø25 Complete axle kit(-92-)	

SHUMAILI 1.6i, 1.8i FB (05/01-08/04)

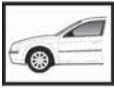

Part No	Description	Pos	Info	Technical
TA2857	Inner tie rod(123)	A B		M14x1.5 Male(252) E
TC1228	Lower ball joint(140)	A B		Pinch Bolt(255) 18mm
TC2199	Link stabiliser(135)	A B		M10x1.25
TC2298	Link stabiliser(135)	A		M10x1.25
TC2299	Link stabiliser(135)	B		M10x1.25
TD1479W	Lower wishbone bush(159)	A	Rear(187) (+) Bracket(-41-)	
TD1480W	Lower wishbone bush(159)	B	Rear(187) (+) Bracket(-41-)	
TD1487W	Lower wishbone bush(159)	A B	Front(108)	

SORENTO 2.4i, 2.5CRDi, 3.5i JC (08/02-04/06)



... SORENTO 2.4i, 2.5CRDi, 3.5i JC (08/02-04/06)

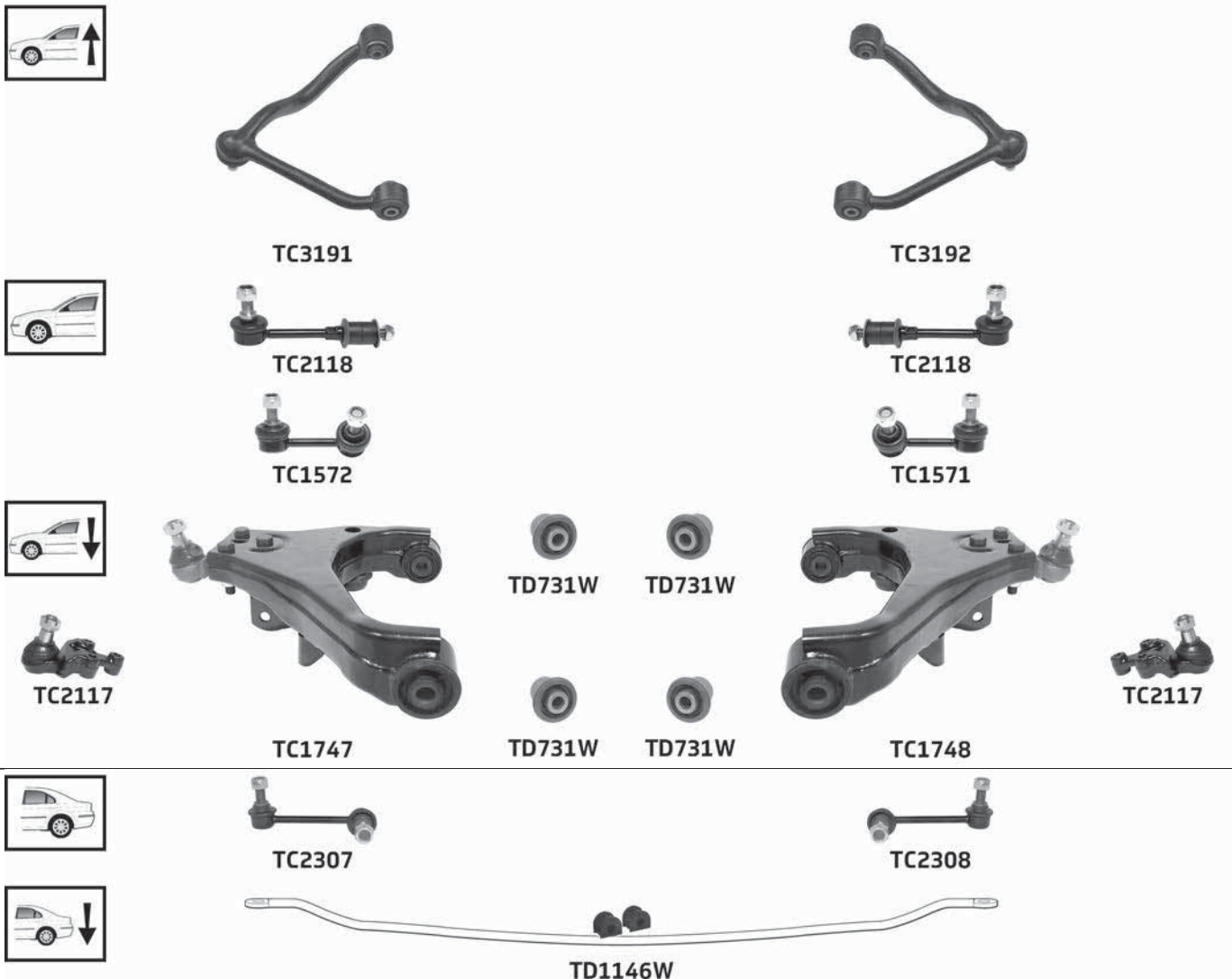

Part No	Description	Pos	Info	Technical
TA2050	Tie rod end (224)	A		M14x1.5 Female (253) £
TA2051	Tie rod end (224)	B		M14x1.5 Female (253) £
TA2053	Inner tie rod (123)	A B		M14x1.5 Male (252) £
TC1571	Link stabiliser (135)	B	02/04→	M12x1.25
TC1572	Link stabiliser (135)	A	02/04→	M12x1.25
TC1747	Lower wishbone (158)	A	→ 12/03	M20x1.5
TC1748	Lower wishbone (158)	B	→ 12/03	M20x1.5
TC2117	Lower ball joint (140)	A B		M20x1.5
TC2118	Link stabiliser (135)	A B	→ 02/04	M12x1.25
TC2307	Link stabiliser (135)	A	02/04→	M12x1.25
TC2308	Link stabiliser (135)	B	02/04→	M12x1.25
TC3191	Upper wishbone (247)	A		Pinch Bolt (255) 16mm
TC3192	Upper wishbone (247)	B		Pinch Bolt (255) 16mm
TD731W	Lower wishbone bush (159)	A B	Front (108) Rear (187)	
TD1146W	Anti-roll bar (-74) bush kit (-86-)	K	Complete axle kit (-92) 02/04→	

SORENTO 2.5CRDi, 3.3i JC (04/06→)









Part No	Description	Pos	Info	Technical
TA2050	Tie rod end (224)	A		M14x1.5 Female (253) £
TA2051	Tie rod end (224)	B		M14x1.5 Female (253) £

... KIA

... SORENTO 2.5CRDi, 3.3i JC (04/06→)









Part No	Description	Pos	Info	Technical
TA2053	Inner tie rod(123)	A B		M14x1.5 Male(252) E
TC2307	Link stabiliser(135)	A		M12x1.25
TC2308	Link stabiliser(135)	B		M12x1.25

SORENTO 2.2CRDi, 2.4i XM (11/09→)

 TA3198	 TA3198
 TC2291	 TC2292
 TC2303	 TC2303



Part No	Description	Pos	Info	Technical
TA3198	Inner tie rod(123)	A B	16/07/12→	M16x1.5 Male(252) E
TC2291	Link stabiliser(135)	A	→07/2012	M12x1.25
TC2292	Link stabiliser(135)	B	→07/2012	M12x1.25
TC2303	Link stabiliser(135)	A B		M12x1.25

SOUL I 1.6i, 1.6CRDi (02/09→)

 TA2649	 TA3163	 TA3163	 TA2650
 TC3353	 TC3354		
 TC3404	 TC3404		

Part No	Description	Pos	Info	Technical
TA2649	Tie rod end(224)	A		M16x1.5 Female(253) E
TA2650	Tie rod end(224)	B		M16x1.5 Female(253) E
TA3163	Inner tie rod(123)	A B		M16x1.5 Male(252) E
TC3353	Link stabiliser(135)	A		M12x1.25
TC3354	Link stabiliser(135)	B		M12x1.25
TC3404	Lower ball joint(140)	A B		Pinch Bolt(255) 18mm

SOUL II 1.6i, 1.6CRDi (01/14→)

 TC2663	 TC2663
--	---

Part No	Description	Pos	Info	Technical
TC2663	Link stabiliser(135)	A B		M12x1.25

SPECTRA II 1.6i, 1.8i FB (05/01-08/04)



TA2857



TA2857



TC2298



TC2299



TC1228



TC1228



TD1487W



TD1487W



TD1479W



TD1480W

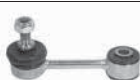

TC2199



TC2199

Part No	Description	Pos	Info	Technical
TA2857	Inner tie rod(123)	A B		M14x1.5 Male(252) £
TC1228	Lower ball joint(140)	A B		Pinch Bolt(255) 18mm
TC2199	Link stabiliser(135)	A B		M10x1.25
TC2298	Link stabiliser(135)	A		M10x1.25
TC2299	Link stabiliser(135)	B		M10x1.25
TD1479W	Lower wishbone bush(159)	A	Rear(187) (+) Bracket(-41)	
TD1480W	Lower wishbone bush(159)	B	Rear(187) (+) Bracket(-41)	
TD1487W	Lower wishbone bush(159)	A B	Front(108)	

SPORTAGE 2.0i, 2.0TD (04/94-08/03)



TL462



TL463



TC3475



TC3475



TC1203



TC1203



TC1229



TC1229

Part No	Description	Pos	Info	Technical
TC1203	Link stabiliser(135)	A B		M16x1.5
TC1229	Lower ball joint(140)	A B		M16x1.5
TC3475	Upper wishbone(247)	A B		
TL462	Rod assembly(194)	A		M12x1.25
TL463	Rod assembly(194)	B		M12x1.25

... KIA

SPORTAGE 2.0i, 2.0CRDi, 2.7i JE / KM (09/04-02/11)



TC1816



TC1816



TC2378



TC2378



TC3199



TD957W

TD957W



TC3200



TC1876



TC1876

Part No	Description	Pos	Info	Technical
TA2371	Inner tie rod(123)	A B		M16x1.5 Male(252) £
TA2389	Tie rod end(224)	A		M16x1.5 Female(253) £
TA2390	Tie rod end(224)	B		M16x1.5 Female(253) £
TBR4246	Steering rack gaiter kit(213)	K	Thermoplastic(223)	1 :16x51x51 2 :16x51x51
TC1816	Link stabiliser(135)	A B		M12x1.25
TC1876	Link stabiliser(135)	A B		M12x1.25
TC2378	Lower ball joint(140)	A B		M12x1.25
TC3199	Lower wishbone(158)	A		
TC3200	Lower wishbone(158)	B		
TD957W	Lower wishbone bush(159)	A B	Front(108)	

SPORTAGE 1.6i, 1.7CRDi, 2.0i, 2.0CRDi SL (07/10→)



TC2700



TC2700



TC2686



TC2686



TC3016



TD940W

TD940W



TD1379W

TD1379W



TC3017

... SPORTAGE 1.6i, 1.7CRDi, 2.0i, 2.0CRDi SL (07/10→)



Part No	Description	Pos	Info	Technical
TA2863	Inner tie rod(123)	A B		M16x1.5 Male(252) £
TA2901	Tie rod end(224)	A		M16x1.5 Female(253) £
TA2902	Tie rod end(224)	B		M16x1.5 Female(253) £
TC2665	Link stabiliser(135)	A B	4x4	M12x1.25
TC2686	Lower ball joint(140)	A B		Pinch Bolt(255) 18mm
TC2700	Link stabiliser(135)	A B		M12x1.25
TC2704	Link stabiliser(135)	A B	(-) 4x4	M12x1.25
TC3016	Lower wishbone(158)	A		Pinch Bolt(255) 18mm
TC3017	Lower wishbone(158)	B		Pinch Bolt(255) 18mm
TD940W	Lower wishbone bush(159)	A B	Front(108)	
TD1379W	Lower wishbone bush(159)	A B	Rear(187)	
TD1656W	Lower hub carrier bush(143)	A B	→4/1/2014	

VENGA 1.4i, 1.4CRDi, 1.6i, 1.6CRDi (02/10→)



TC3713

TD1627W

TD1627W

TC3714

Part No	Description	Pos	Info	Technical
TA2649	Tie rod end(224)	A		M16x1.5 Female(253) £
TA2650	Tie rod end(224)	B		M16x1.5 Female(253) £
TA3163	Inner tie rod(123)	A B		M16x1.5 Male(252) £
TC2001	Lower ball joint(140)	A B	→1/03/2013	M12x1.25
TC2284	Link stabiliser(135)	A		M10x1.25
TC2285	Link stabiliser(135)	B		M10x1.25
TC2664	Lower ball joint(140)	A B	1/03/2013→	M12x1.25
TC3713	Lower wishbone(158)	A	1/03/2013→	M12x1.25
TC3714	Lower wishbone(158)	B	1/03/2013→	M12x1.25
TD1627W	Lower wishbone bush(159)	A B	Rear(187)	

KIA

LADA

KALINA (1117, 1118, 1119) 1.4i, 1.6i (10/04→)



Part No	Description	Pos	Info	Technical
TC583	Lower ball joint (140)	A B		M12x1.25

PRIORA (2170, 2171, 2172) 1.6i (03/07→)



Part No	Description	Pos	Info	Technical
TA1937	Tie rod end (224)	A		M18x1.5 Female (253) ~
TA1938	Tie rod end (224)	B		M18x1.5 Female (253) ~
TA1939	Inner tie rod (123)	A		M18x1.5 Female (253) £
TA1940	Inner tie rod (123)	B		M18x1.5 Female (253) £
TC583	Lower ball joint (140)	A B		M12x1.25

LANCIA

DELTA III 1.4i, 1.6JTD, 1.9JTD, 2.0JTD (09/08→)



Part No	Description	Pos	Info	Technical
TA1806	Tie rod end (224)	A B		M14x1.5 Female (253) £
TA1807	Inner tie rod (123)	A B		M14x1.5 Male (252) £
TC1133	Link stabiliser (135)	A B		M10x1.5
TC2571	Lower wishbone (158)	A		Pinch Bolt (255) 17mm
TC2572	Lower wishbone (158)	B		Pinch Bolt (255) 17mm
TC2946	Lower ball joint (140)	A B		Pinch Bolt (255) 17mm
TD366W	Lower wishbone bush (159)	A B	Rear (187)	
TD1218W	Axle Bush (-76-)	A B		

FLAVIA 2.4i (03/12→)



Part No	Description	Pos	Info	Technical
TC3675	Lower ball joint (140)	A B		

LYBRA 1.6i, 1.8i, 1.9JTD, 2.0i, 2.4JTD (07/99-10/05)

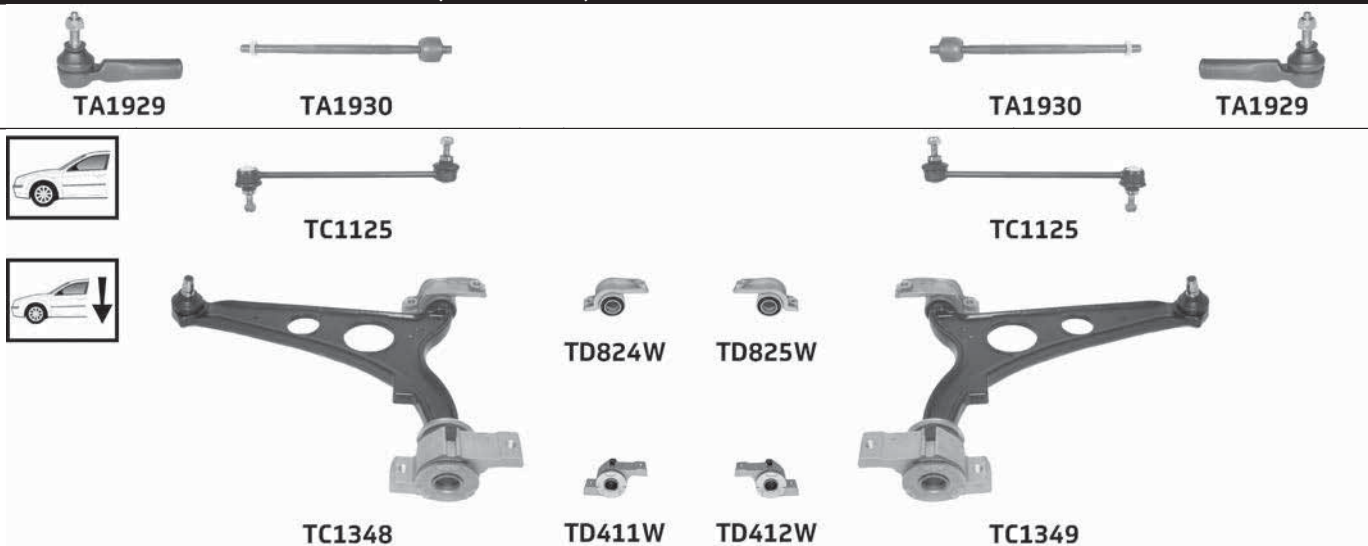

Part No	Description	Pos	Info	Technical
TA1929	Tie rod end(224)	A B		M14x1.5 Female(253) £
TA1930	Inner tie rod(123)	A B		M14x1.5 Male(252) £
TC1125	Link stabiliser(135)	A B		M10x1.25
TC1348	Lower wishbone(158)	A		Pinch Bolt(255) 17mm
TC1349	Lower wishbone(158)	B		Pinch Bolt(255) 17mm
TD411W	Lower wishbone bush(159)	A	Rear(187)	Inner(119) Ø20.9mm
TD412W	Lower wishbone bush(159)	B	Rear(187)	Inner(119) Ø20.9mm
TD824W	Lower wishbone bush(159)	A	Front(108)	
TD825W	Lower wishbone bush(159)	B	Front(108)	

MUSA 1.3JTD, 1.4i, 1.6JTD, 1.9JTD (10/04→)



Part No	Description	Pos	Info	Technical
TA1985	Tie rod end(224)	A B		M14x1.5 Female(253) £
TA1986	Inner tie rod(123)	A B		M14x1.5 Male(252) £
TBR4227	Steering rack gaiter kit(213)	K		1 :12.5x54x54 2 :12.5x54x54
TC1431	Lower wishbone(158)	A		Pinch Bolt(255) 17mm
TC1432	Lower wishbone(158)	B		Pinch Bolt(255) 17mm
TD706W	Lower wishbone bush(159)	A B	Front(108)	
TD707W	Lower wishbone bush(159)	A B	Rear(187)	

... LANCIA

PHEDRA 2.0i, 2.0JTD, 2.2JTD, 3.0i V6 (09/02-06/06)

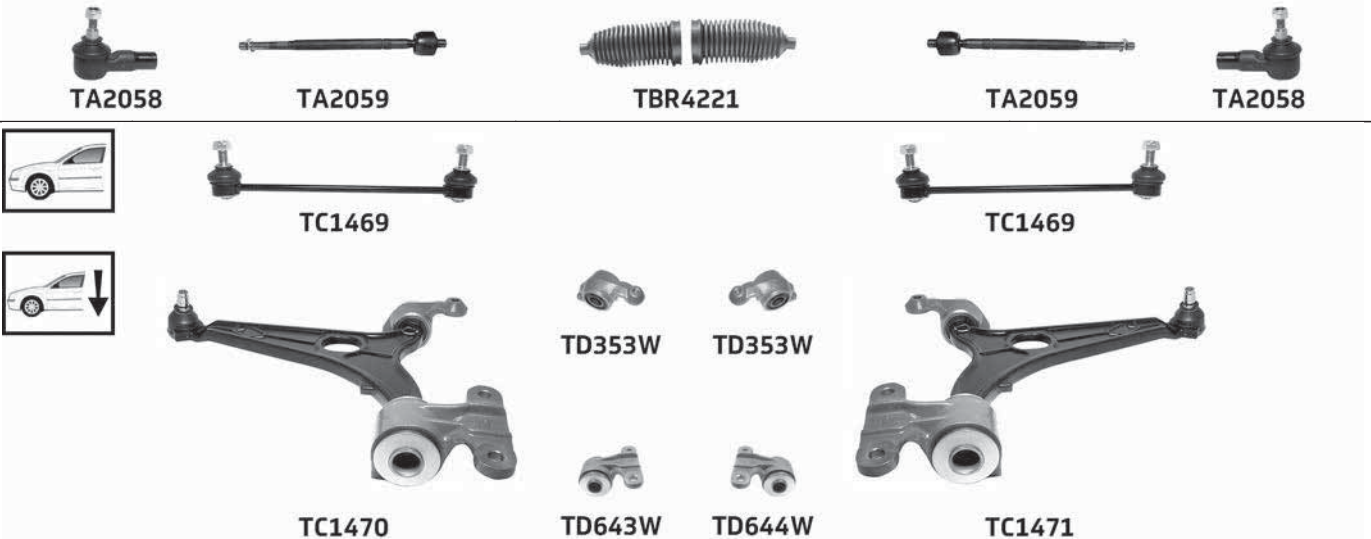

Part No	Description	Pos	Info	Technical
TA2058	Tie rod end(224)	A B		M14x1.5 Female(253) £
TA2059	Inner tie rod(123)	A B		M14x1.5 Male(252) £
TBR4221	Steering rack gaiter kit(213)	K	Thermoplastic(223)	1 :14.5x64x64 2 :14.5x64x64
TC1469	Link stabiliser(135)	A B		M10x1.25
TC1470	Lower wishbone(158)	A		Pinch Bolt(255) 17mm
TC1471	Lower wishbone(158)	B		Pinch Bolt(255) 17mm
TD353W	Lower wishbone bush(159)	A B	Front(108)	
TD643W	Lower wishbone bush(159)	A	Rear(187)	
TD644W	Lower wishbone bush(159)	B	Rear(187)	

PHEDRA 2.0i, 2.0D, 2.0JTD, 2.2D, 2.2JTD, 3.0i V6 (07/06-11/10)

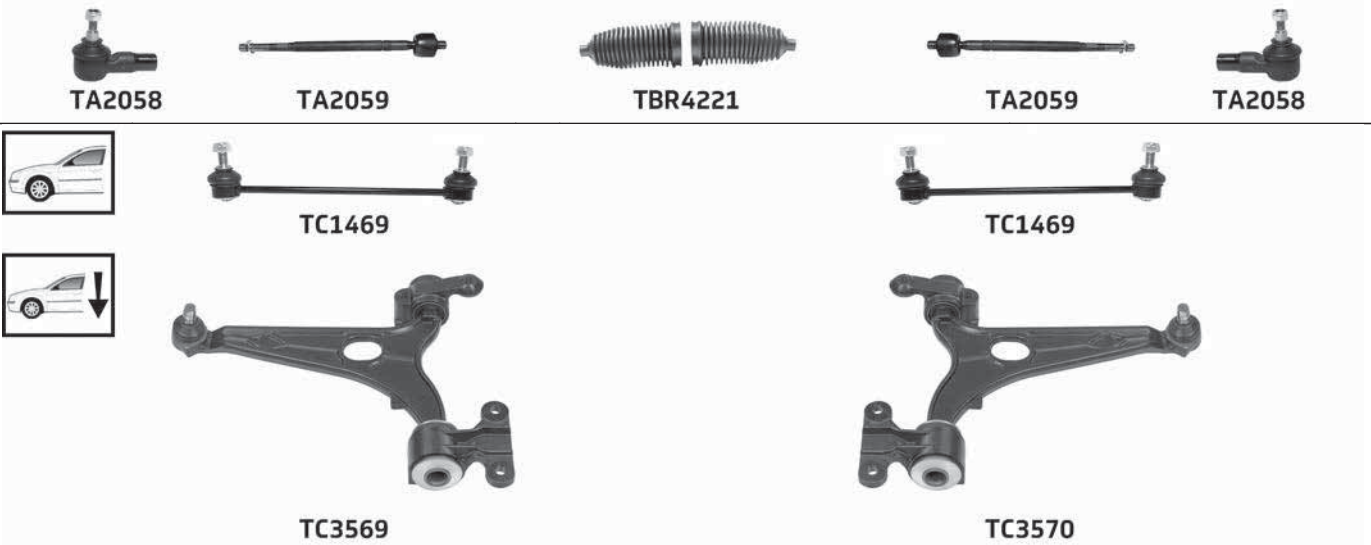

Part No	Description	Pos	Info	Technical
TA2058	Tie rod end(224)	A B		M14x1.5 Female(253) £
TA2059	Inner tie rod(123)	A B		M14x1.5 Male(252) £
TBR4221	Steering rack gaiter kit(213)	K	Thermoplastic(223)	1 :14.5x64x64 2 :14.5x64x64
TC1469	Link stabiliser(135)	A B		M10x1.25
TC3569	Lower wishbone(158)	A		ø16.4
TC3570	Lower wishbone(158)	B		ø16.4

THESIS 2.0i, 2.4i, 2.4JTD, 3.0i, 3.2i (07/02-07/09)



Part No	Description	Pos	Info	Technical
TA1787	Tie rod end(224)	A		M14x1.5 Female(253) £
TA1788	Tie rod end(224)	B		M14x1.5 Female(253) £

Y 1.1i, 1.2i, 1.4i (11/95-09/03)

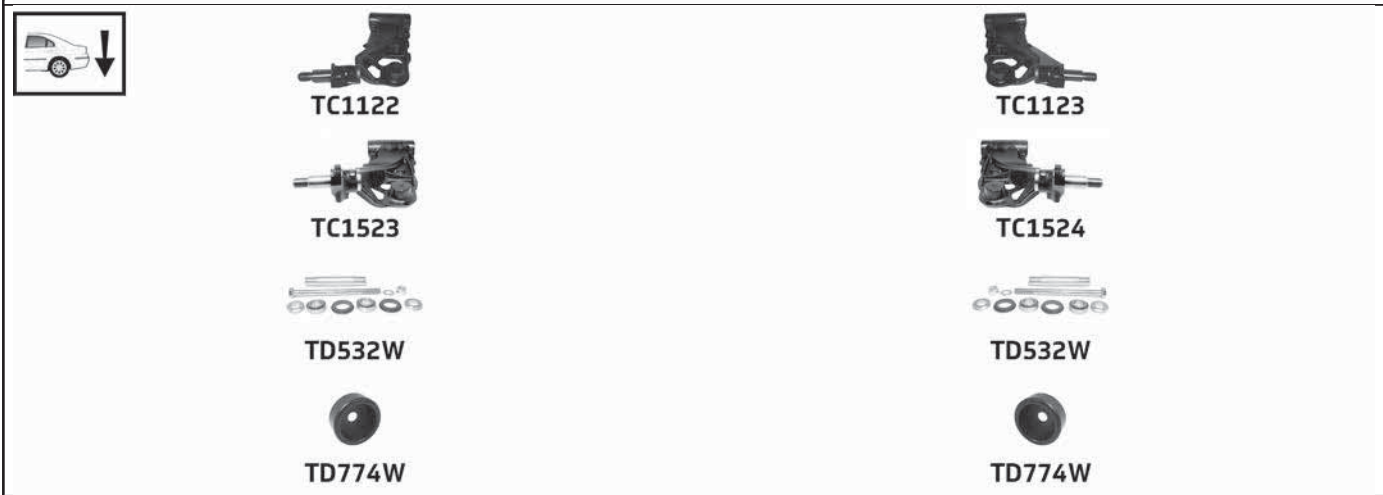

Part No	Description	Pos	Info	Technical
TA1506	Tie rod end (224)	A B		M12x1.5 Female (253) £
TA1507	Inner tie rod (123)	A B	Power steering (185)	M12x1.5 Male (252) £
TA1510	Inner tie rod (123)	A B	Manual steering (170)	M12x1.5 Male (252) £
TBR4040	Steering rack gaiter kit (213)	K	Power steering (185)	1 :10x53x53 2 :10x53x53
TC562	Lower wishbone (158)	B		Pinch Bolt (255) 15mm
TC563	Lower wishbone (158)	A		Pinch Bolt (255) 15mm
TC1122	Lower track control arm (151)	A	(-) ABS	
TC1123	Lower track control arm (151)	B	(-) ABS	
TC1523	Lower track control arm (151)	A	ABS →Ch. 3336902	
TC1524	Lower track control arm (151)	B	ABS →Ch. 3336902	
TD237W	Lower wishbone bush (159)	A B	Front (108)	
TD356W	Lower wishbone bush (159)	A	Rear (187)	
TD357W	Lower wishbone bush (159)	B	Rear (187)	
TD532W	Suspension arm repair kit (218)	A B		
TD774W	Sub-frame bush (215)	A B		

... LANCIA

YPSILON 1.2, 1.3JTD, 1.4 (10/03-05/11)



Part No	Description	Pos	Info	Technical
TA1987	Tie rod end(224)	A B		M12x1.5 Female(253) £
TA1988	Inner tie rod(123)	A B		M12x1.5 Male(252) £
TBR4228	Steering rack gaiter kit(213)	K		1 :10.5x54.5x54.5 2 :10.5x54.5x54.5
TC1431	Lower wishbone(158)	A		Pinch Bolt(255) 17mm
TC1432	Lower wishbone(158)	B		Pinch Bolt(255) 17mm
TD706W	Lower wishbone bush(159)	A B	Front(108)	
TD707W	Lower wishbone bush(159)	A B	Rear(187)	

YPSILON 900cc, 1.2i, 1.3JTD (06/11→)



Part No	Description	Pos	Info	Technical
TA2848	Tie rod end(224)	A B		M12x1.5 Female(253) £
TBR4205	Steering rack gaiter kit(213)	K	Thermoplastic(223)	1 :10.5x54.5x54.5 2 :10.5x54.5x54.5
TC1133	Link stabiliser(135)	A B		M10x1.5

Z(Zeta) 2.0i, 2.0JTD, 2.1TD (08/94-09/02)

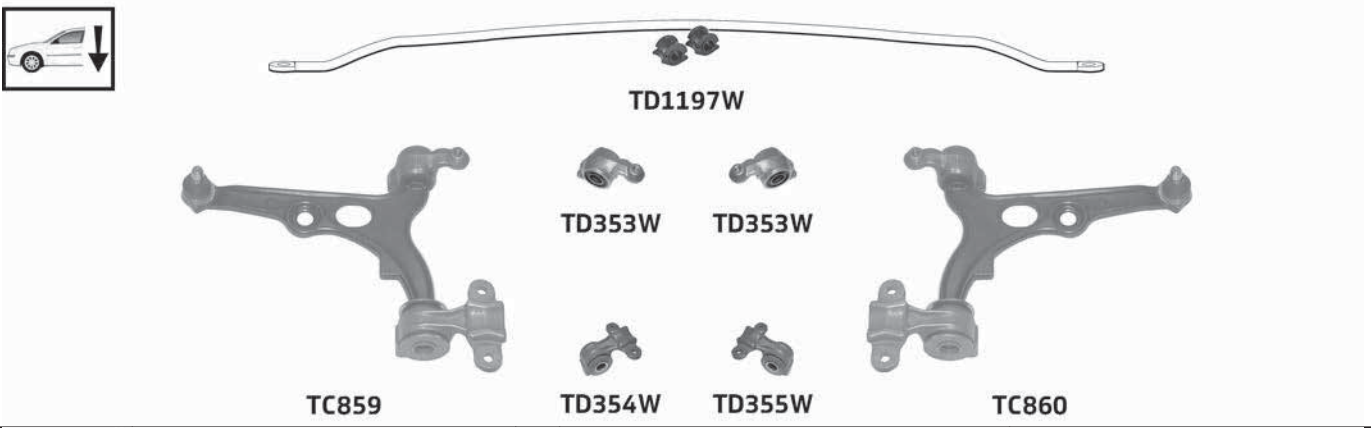

Part No	Description	Pos	Info	Technical
TA1607	Tie rod end(224)	A B		M14x1.5 Female(253) £

LANCIA

Z(Zeta) 2.0i, 2.0JTD, 2.1TD (08/94-09/02)

Part No	Description	Pos	Info	Technical
TA1608	Inner tie rod(123)	A B		M14x1.5 Male(252) £
TBR4121	Steering rack gaiter kit(213)	K		1 :13x62x62 2 :13x62x62
TC859	Lower wishbone(158)	A		Pinch Bolt(255) 17mm
TC860	Lower wishbone(158)	B		Pinch Bolt(255) 17mm
TC1191	Link stabiliser(135)	A B		
TD353W	Lower wishbone bush(159)	A B	Front(108)	
TD354W	Lower wishbone bush(159)	A	Rear(187)	
TD355W	Lower wishbone bush(159)	B	Rear(187)	
TD1126W	Axle Bush(-76-)	A B		
TD1197W	Anti-roll bar(-74-) bush kit(-86-)	K		

LAND ROVER

DEFENDER 90 2.2TD4, 2.4TD4, 2.5, 2.5D, 2.5TD5, 2.5TDi, 3.5, 3.9 (09/90→)

DEFENDER 110 2.2TD4, 2.4TD4, 2.5, 2.5D, 2.5TD5, 2.5TDi, 3.5, 3.9 (09/90→)

DEFENDER 130 2.2TD4, 2.5TD5, 2.5TD, 3.5, 3.9 (09/90→)

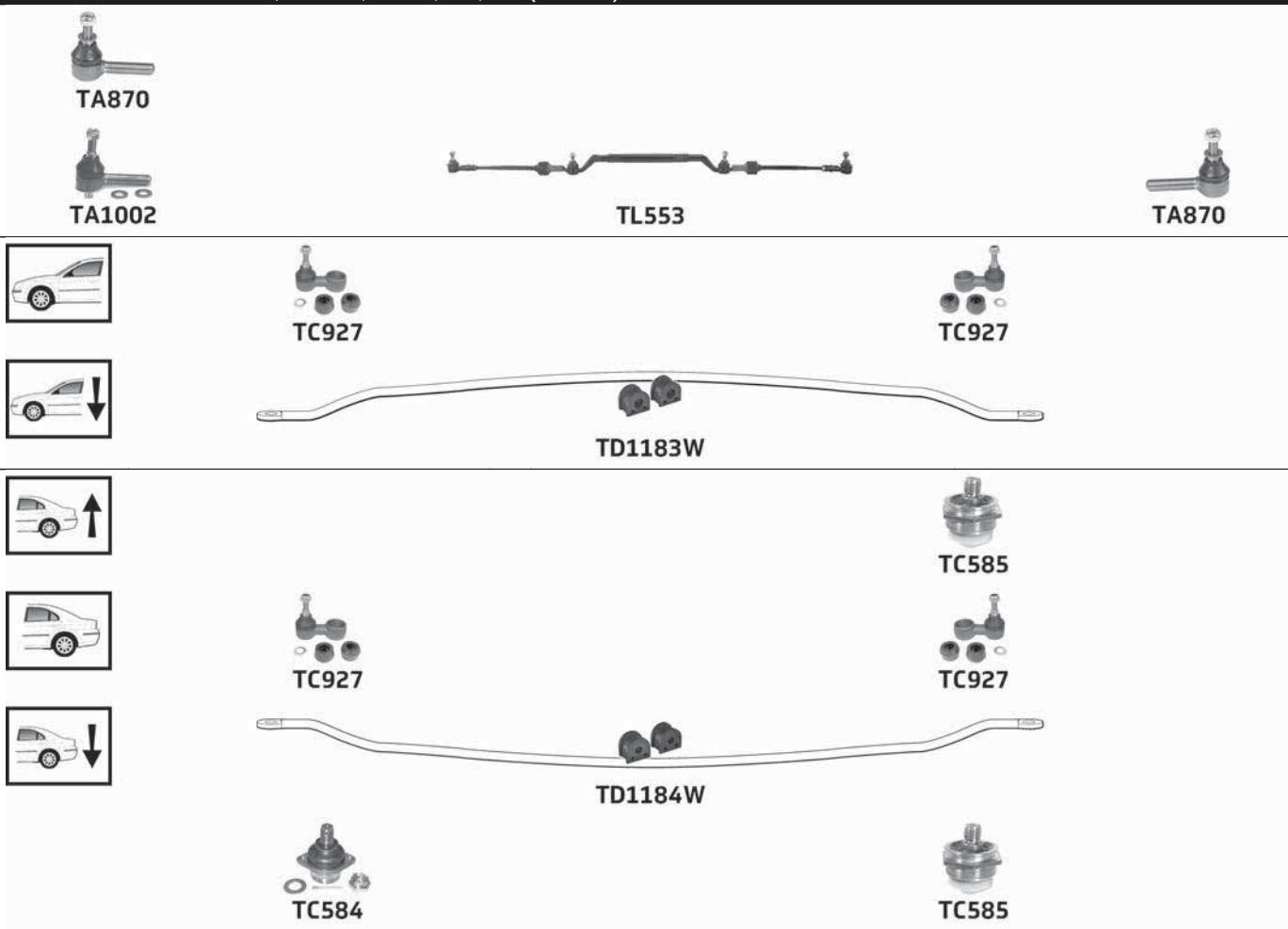

Part No	Description	Pos	Info	Technical
TA870	Drag link end(102) Tie rod end(224)	A B		11/16x16 UNF Male(252) £
TA1002	Tie rod end(224)	A		11/16x16 UNF Male(252) ~
TC584	Ball joint(-78-)	A	Centre top link(-91-)	M20x1.5
TC585	Ball joint(-78-)	B	Self levelling unit(200)	M14x1.75
TC927	Link stabiliser(135)	A B		M12x1.75
TC927	Link stabiliser(135)	A B		M12x1.75
TD1183W	Anti-roll bar(-74-) bush kit(-86-)	K	Ø22 Complete axle kit(-92)	
TD1184W	Anti-roll bar(-74-) bush kit(-86-)	K	Complete axle kit(-92) Defender 90 (-) 50LE →Ch. WA159806	
TL553	Drag link assembly(101)	K		M12x1.5

LAND ROVER

... LAND ROVER

DISCOVERY 2 2.5TD5, 4.0i (11/98-06/04)

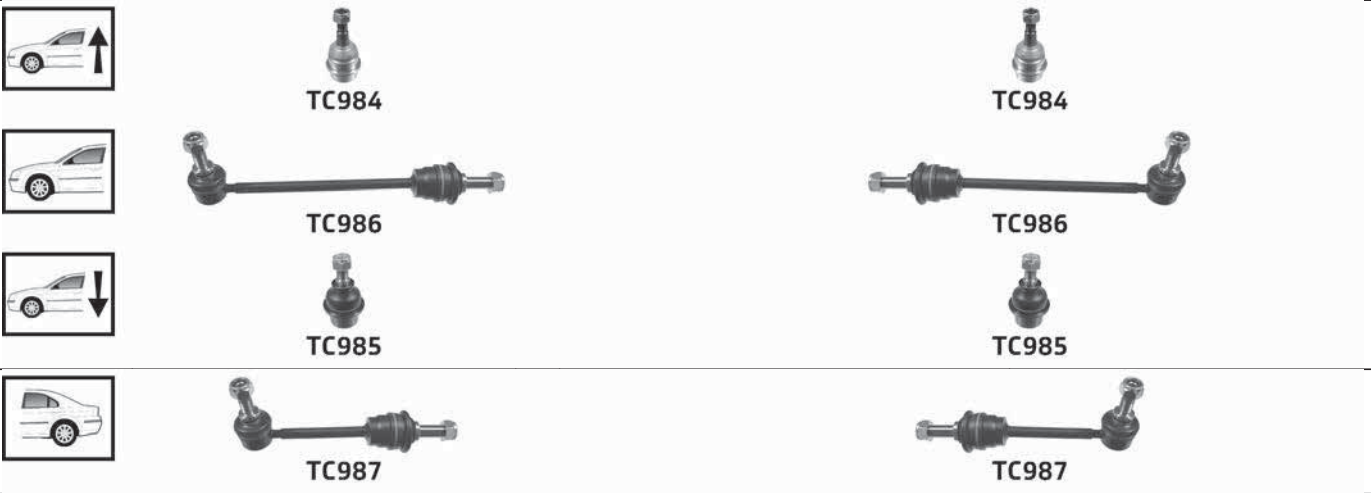

Part No	Description	Pos	Info	Technical
TA1759	Drag link end(102) Tie rod end(224)	A B		M18x1.5 Male(252) -
TA1760	Tie rod end(224)	B		M22x1.5 Female(253) £
TC984	Upper ball joint (232)	A B		M16x1.5
TC985	Lower ball joint (140)	A B		M14x1.5
TC986	Link stabiliser (135)	A B		M12x1.25
TC987	Link stabiliser (135)	A B		M12x1.25
TL516	Drag link assembly(101)	K	L	M12x1.5
TL517	Drag link assembly(101)	K	R	M12x1.5
TL521	Centre rod assembly(-90-)	K		M12x1.5

DISCOVERY 3 2.7TDV6, 4.0i, 4.4i (07/04-09/09)

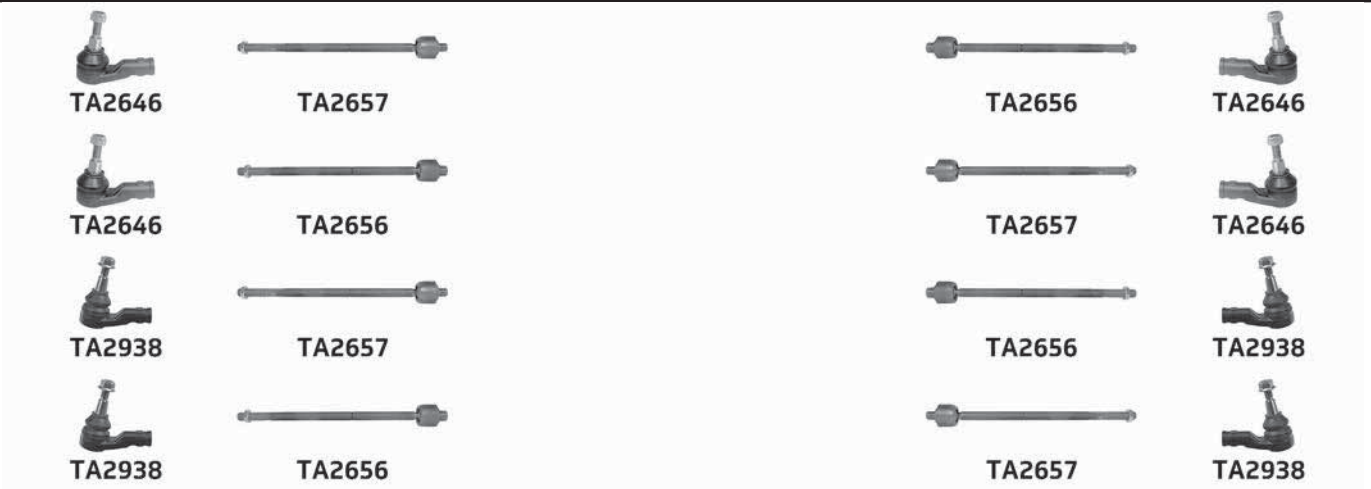

... DISCOVERY 3 2.7TDV6, 4.0i, 4.4i (07/04-09/09)



TC1952



TC3004



TC3005



TC1952



TC2425



TC3026



TD1496W



TD1496W



TC3027



TC2425



TD1496W



TD1496W



TC1818



TC1818



TC1929



TC1930



TD1494W



TD886W



TD886W



TD1135W



TD1135W



TC1963



TC2162



TD936W



TD936W



TC2163



TD1377W



TD1377W



TC1963

... LAND ROVER

... DISCOVERY 3 2.7TDV6, 4.0i, 4.4i (07/04-09/09)



TD1119W



TD1401W



TD1166W



TC1908



TD1495W



TD1120W



TD1117W



TC3029



TD1119W



TD1401W



TD1166W



TC1908



TD1120W



TD1117W



TC3029



TD1238W



TD1238W

Part No	Description	Pos	Info	Technical
TA2646	Tie rod end(224)	A B	→Ch. 9A496359	M16x1.5 Female(253) £
TA2656	Inner tie rod(123)	A B	RH(193) L LH(130) R M20 into steering rack(124)	M16x1.5 Male(252) £
TA2657	Inner tie rod(123)	A B	LH(130) L RH(193) R M16 into steering rack(124)	M16x1.5 Male(252) £
TA2938	Tie rod end(224)	A B	Ch. 9A496360→	M16x1.5 Female(253) £
TC1818	Link stabiliser(135)	A B	(-) Armoured(-10)	M12x1.75
TC1908	Link stabiliser(135)	A B		M12x1.75
TC1929	Link stabiliser(135)	A	(+) Armoured(-38)	M14x2
TC1930	Link stabiliser(135)	B	(+) Armoured(-38)	M14x2
TC1952	Upper ball joint(232)	A B	(-) Armoured(-10)	M12x1.75
TC1963	Lower ball joint(140)	A B		M16x2
TC2162	Lower wishbone(158)	A	(+) Air suspension(-35) (-) Armoured(-10)	M16x2
TC2163	Lower wishbone(158)	B	(+) Air suspension(-35) (-) Armoured(-10)	M16x2
TC2425	Upper ball joint(232)	A B	(+) Armoured(-38)	M12x1.75
TC3004	Upper wishbone(247)	A	(-) Armoured(-10)	M12x1.75
TC3005	Upper wishbone(247)	B	(-) Armoured(-10)	M12x1.75
TC3026	Upper wishbone(247)	A	(+) Armoured(-38)	M12x1.75
TC3027	Upper wishbone(247)	B	(+) Armoured(-38)	M12x1.75
TC3029	Panhard rod(180)	A B		
TD886W	Lower wishbone bush(159)	A B	Front(108) (+) Armoured(-38)	
TD936W	Lower wishbone bush(159)	A B	Front(108) (-) Armoured(-10)	
TD1117W	Lower suspension arm bush(148)	A B	Rear(187)	
TD1119W	Upper track control arm bush(243)	A B	Front(108)	
TD1120W	Lower suspension arm bush(148)	A B	Front(108)	
TD1135W	Lower wishbone bush(159)	A B	Rear(187) (+) Armoured(-38)	
TD1166W	Hub carrier bush(113)	A B	Lower(139)	
TD1238W	Panhard rod bush(181)	A B		
TD1377W	Lower wishbone bush(159)	A B	Rear(187) (-) Armoured(-10)	
TD1401W	Hub carrier bush(113)	A B	Upper(231)	
TD1494W	Anti-roll bar(-74) bush kit(-86)	K	(-) Armoured(-10)	
TD1495W	Anti-roll bar(-74) bush kit(-86)	K	(-) Armoured(-10)	
TD1496W	Upper wishbone bush(248)	A B	Front(108) Rear(187) (+) Armoured(-38)	

DISCOVERY 4 2.7TDV6, 3.0i, 3.0TDV6, 4.0i, 5.0i (09/09→)



TA2938



TA2657



TA2656



TA2938



TA2938



TA2656



TA2657



TA2938



TC3030



TC3031



TC2425



TC2425



TC1818



TC1818



TD1501W



TC1963



TC1963



TD936W



TD936W



TD1377W



TD1377W

... LAND ROVER

... DISCOVERY 4 2.7TDV6, 3.0i, 3.0TDV6, 4.0i, 5.0i (09/09→)

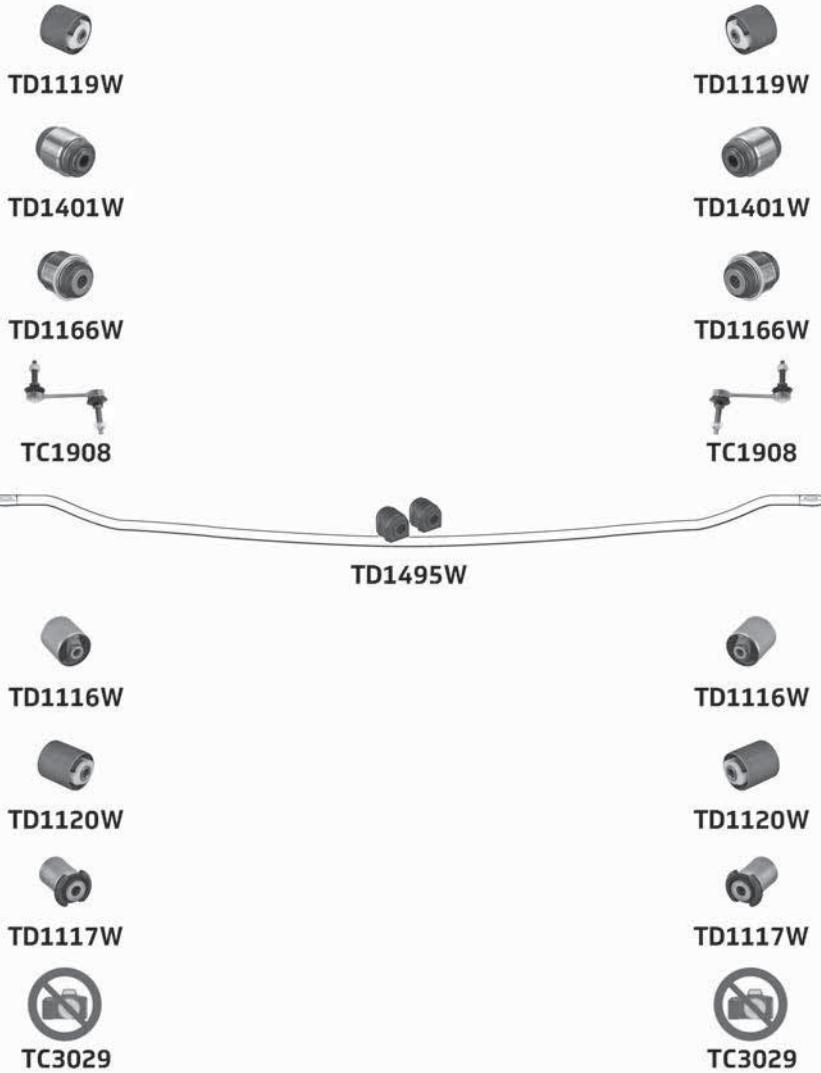

Part No	Description	Pos	Info	Technical
TA2656	Inner tie rod(123)	A B	RH(193) L LH(130) R M20 into steering rack(124)	M16x1.5 Male(252) £
TA2657	Inner tie rod(123)	A B	LH(130) L RH(193) R M16 into steering rack(124)	M16x1.5 Male(252) £
TA2938	Tie rod end(224)	A B		M16x1.5 Female(253) £
TC1818	Link stabiliser(135)	A B		M12x1.75
TC1908	Link stabiliser(135)	A B		M12x1.75
TC1963	Lower ball joint(140)	A B		M16x2
TC2425	Upper ball joint(232)	A B		M12x1.75
TC3029	Panhard rod(180)	A B		
TC3030	Upper wishbone(247)	A		M12x1.75
TC3031	Upper wishbone(247)	B		M12x1.75
TD936W	Lower wishbone bush(159)	A B	Front(108)	
TD1116W	Lower suspension arm bush(148)	A B	Front(108) →Ch. AA518769	
TD1117W	Lower suspension arm bush(148)	A B	Rear(187)	
TD1119W	Upper track control arm bush(243)	A B	Front(108)	
TD1120W	Lower suspension arm bush(148)	A B	Front(108) Ch. AA518770 →	
TD1166W	Hub carrier bush(113)	A B	Lower(139)	
TD1238W	Panhard rod bush(181)	A B		
TD1377W	Lower wishbone bush(159)	A B	Rear(187)	
TD1401W	Hub carrier bush(113)	A B	Upper(231)	
TD1495W	Anti-roll bar(-74) bush kit(-86-)	K		
TD1501W	Anti-roll bar(-74) bush kit(-86-)	K		

DISCOVERY 5 2.0SD4, 3.0Si6i, 3.0TD6 (01/17→)



TC3037



TC3038



TC3041



TC3041



TC3036



TC3036



TC3034



TC3035

Part No	Description	Pos	Info	Technical
TC3034	Link stabiliser (135)	A		M14x2
TC3035	Link stabiliser (135)	B		M14x2
TC3036	Upper track control arm (242)	A B		
TC3037	Upper track control arm (242)	A		Pinch Bolt (255) 19.3mm
TC3038	Upper track control arm (242)	B		Pinch Bolt (255) 19.3mm
TC3041	Link stabiliser (135)	A B		M14x2

DISCOVERY SPORT 2.0i, 2.0TD4, 2.2SD4 (12/14→)



TA2882



TA2888



TA2888



TA2883



TC2666



TC2666

Part No	Description	Pos	Info	Technical
TA2882	Tie rod end (224)	A		M18x1.5 Female (253) £
TA2883	Tie rod end (224)	B		M18x1.5 Female (253) £
TA2888	Inner tie rod (123)	A B		M18x1.5 Male (252) £
TC2666	Link stabiliser (135)	A B		M10x1.5

... LAND ROVER

FREELANDER 1 1.8i, 2.0Di, 2.0TD, 2.0TD4, 2.5i (10/97-10/06)



TA1740



TA2702



TBR4251



TA2703



TA1741



TA1740



TA2702



TBR4252



TA2703



TA1741



TC933



TC933



TC1258



TD647W

TD647W



TD1035W

TD1035W



TC1259



TC1888



TC1888



TD1504W



TD1504W



TD1502W



TC1889



TD1503W



TD1503W



TC1889



TD1502W



TD1502W



TC1890



TD1502W



TD1502W



TC1890



TD1502W

Part No	Description	Pos	Info	Technical
TA1740	Tie rod end(224)	A		M16x1.5 Female(253) ~
TA1741	Tie rod end(224)	B		M16x1.5 Female(253) ~
TA2702	Inner tie rod(123)	A		M16x1.5 Female(253) £
TA2703	Inner tie rod(123)	B		M16x1.5 Female(253) £
TBR4251	Steering rack gaiter kit(213)	K	→Ch. YA999999 Rubber(197)	1 :44x67x67
TBR4252	Steering rack gaiter kit(213)	K	Ch. 1A000001→ Rubber(197)	1 :61x66x66
TC933	Link stabiliser(135)	A B		M12x1.5
TC1258	Lower wishbone(158)	A		M14x1.5
TC1259	Lower wishbone(158)	B		M14x1.5
TC1888	Trailing arm(226)	A B		
TC1889	Lower link arm(144)	A B	Not adjustable(174)	
TC1890	Lower link arm(144)	A B	Adjustable(-72)	
TD647W	Lower wishbone bush(159)	A B	Front(108)	
TD1035W	Lower wishbone bush(159)	A B	Rear(187)	
TD1502W	Lower link arm bush(145)	A B	Inner(119) Outer(176)	
TD1503W	Lower link arm bush(145)	A B	Inner(119)	
TD1504W	Trailing arm bush(227)	A B		

FREELANDER 2 2.0i, 2.2ED4, 2.2SD4, 2.2TD4, 3.2i (10/06→)



TA2447



TA2448



TC2436



TC2436



TD1628W



TC2591



TC2858



TC2859



TC2591



TC2393



TC2393



TC3464



TC3464

Part No	Description	Pos	Info	Technical
TA2447	Tie rod end (224)	A		M18x1.5 Female(253) £
TA2448	Tie rod end (224)	B		M18x1.5 Female(253) £
TC2393	Link stabiliser (135)	A B		M10x1.5
TC2436	Link stabiliser (135)	A B		M10x1.5
TC2591	Lower ball joint (140)	A B		M14x1.5
TC2858	Lower wishbone (158)	A		M14x1.5
TC2859	Lower wishbone (158)	B		M14x1.5
TC3464	Lower link arm (144)	A B	Front (108)	
TD1628W	Anti-roll bar (-74) bush kit (-86)	K	(-) 2.0 240ps	

... LAND ROVER

RANGE ROVER II 2.5TD, 3.9i, 4.0i, 4.6i (05/94-03/02)



Part No	Description	Pos	Info	Technical
TA1759	Drag link end(102) Tie rod end(224)	A B	Drag link end(102) LH(130) L RH(193) R	M18x1.5 Male(252) -
TA1895	Tie rod end(224)	A		M22x1.5 Female(253) E
TA1925	Drag link end(102)	B	L	M22x1.5 Female(253) E
TC984	Upper ball joint(232)	A B		M16x1.5
TC985	Lower ball joint(140)	A B		M14x1.5
TC1208	Link stabiliser(135)	A B		M12x1.25
TD480W	Radius arm bush(186)	A B	Pack of(179) 2	
TL473	Centre rod assembly(-90-)	K		M12x1.5
TL474	Drag link assembly(101)	K	L	M12x1.5
TL543	Drag link assembly(101)	K	R	M12x1.5

LAND ROVER

RANGE ROVER III 3.0TD6, 3.6TDV8, 4.2i, 4.4i, 4.4TDV8, 5.0i (03/02-08/12)

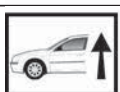
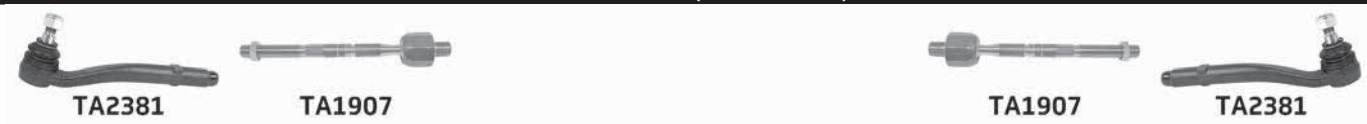

Part No	Description	Pos	Info	Technical
TA1907	Inner tie rod(123)	A B		M16x1.5 Male(252) £
TA2381	Tie rod end(224)	A B		M16x1.5 Female(253) £
TC1795	Link stabiliser(135)	A B		M12x1.5
TC1817	Link stabiliser(135)	A B		M12x1.5
TC1903	Upper track control arm(242)	A	(-) Ball joint(-11-)	
TC1904	Upper track control arm(242)	B	(-) Ball joint(-11-)	
TC1905	Lower track control arm(151)	A B		M14x1.5
TC1951	Upper ball joint(232)	A B		M14x1.5
TC2475	Lower rod assembly(146)	A B		M14x1.5
TD846W	Lower track control arm bush(153)	A B		
TD848W	Upper track control arm bush(243)	A B		
TD869W	Hub carrier bush(113)	A B	Upper(231)	
TD1115W	Lower suspension arm bush(148)	A B	Front(108)	
TD1166W	Hub carrier bush(113)	A B	Lower(139)	

LAND ROVER

... LAND ROVER

RANGE ROVER IV 3.0i, 3.0TDV6, 4.4TDV8, 5.0i (08/12→)



TA2939



TA2940



TA2940



TA2939



TC3145



TC3146



TC3042



TC3043



TC3147



TC3148



TC3037



TC3038



TC3041



TC3041



TC3149



TC3150



TC3456



TD1655W



TD1655W



TC3457

... RANGE ROVER IV 3.0i, 3.0TDV6, 4.4TDV8, 5.0i (08/12→)



TC3036



TC3036



TC3034



TC3035

Part No	Description	Pos	Info	Technical
TA2939	Tie rod end(224)	A B	→Ch. EA9999999	M14.1.5 Female(253) £
TA2940	Inner tie rod(123)	A B	→Ch. EA9999999	M14x1.5 Male(252) £
TC3034	Link stabiliser(135)	A	→Ch. EA9999999	M14x2
TC3034	Link stabiliser(135)	A	Ch. GA000001→ (-) Painted brake caliper(-83) (+) LWB(164) (+) Black brake caliper(-83)	M14x2
TC3035	Link stabiliser(135)	B	→Ch. EA9999999	M14x2
TC3035	Link stabiliser(135)	B	Ch. GA000001→ (-) Painted(-23) brake caliper(-83) (+) LWB(164) (+) Black(-40) brake caliper(-83)	M14x2
TC3036	Upper track control arm(242)	A B		
TC3037	Upper track control arm(242)	A	Autobiography Black Ch. GA000001→	Pinch Bolt(255) 19.3mm
TC3038	Upper track control arm(242)	B	Autobiography Black Ch. GA000001→	Pinch Bolt(255) 19.3mm
TC3041	Link stabiliser(135)	A B		M14x2
TC3042	Upper track control arm(242)	A	Standard(207) Length(129)	Pinch Bolt(255) 19.3mm
TC3043	Upper track control arm(242)	B	Standard(207) Length(129)	Pinch Bolt(255) 19.3mm
TC3145	Upper track control arm(242)	A	(-) 5mm Length(129)	Pinch Bolt(255) 19.3mm
TC3146	Upper track control arm(242)	B	(-) 5mm Length(129)	Pinch Bolt(255) 19.3mm
TC3147	Upper track control arm(242)	A	(+) 5mm Length(129)	Pinch Bolt(255) 19.3mm
TC3148	Upper track control arm(242)	B	(+) 5mm Length(129)	Pinch Bolt(255) 19.3mm
TC3149	Lower track control arm(151)	A	Rear(187) Autobiography Black Ch. GA000001→	M16x1.5
TC3150	Lower track control arm(151)	B	Rear(187) Autobiography Black Ch. GA000001→	M16x1.5
TC3456	Lower track control arm(151)	A	Rear(187)	M16x1.5
TC3457	Lower track control arm(151)	B	Rear(187)	M16x1.5
TD1655W	Lower track control arm bush(153)	A B	Inner(119)	

RANGE ROVER EVOQUE 2.0Si4, 2.2ED4, 2.2SD4, 2.0TD4, 2.2TD4 (06/11→)



TA2882



TA2888



TA2888



TA2883



TC2666



TC2666



TC3032



TC3033



TC2393



TC2393

Part No	Description	Pos	Info	Technical
TA2882	Tie rod end(224)	A		M18x1.5 Female(253) £
TA2883	Tie rod end(224)	B		M18x1.5 Female(253) £
TA2888	Inner tie rod(123)	A B		M18x1.5 Male(252) £
TC2393	Link stabiliser(135)	A B		M10x1.5
TC2666	Link stabiliser(135)	A B		M10x1.5
TC3032	Lower wishbone(158)	A	(-) Heavy duty suspension(-18)	Pinch Bolt(255) 25mm
TC3033	Lower wishbone(158)	B	(-) Heavy duty suspension(-18)	Pinch Bolt(255) 25mm

... LAND ROVER

RANGE ROVER EVOQUE 2.0Si4, 2.0TD4 Cabriolet (02/16→)



Part No	Description	Pos	Info	Technical
TA2882	Tie rod end(224)	A		M18x1.5 Female(253) £
TA2883	Tie rod end(224)	B		M18x1.5 Female(253) £
TA2888	Inner tie rod(123)	A B		M18x1.5 Male(252) £
TC2393	Link stabiliser(135)	A B		M10x1.5
TC2666	Link stabiliser(135)	A B		M10x1.5

RANGE ROVER SPORT 2.7TDV6, 3.6TDV8, 4.2i, 4.4i →Ch. 9A999999 (02/05-03/09)



... RANGE ROVER SPORT 2.7TDV6, 3.6TDV8, 4.2i, 4.4i → Ch. 9A999999 (02/05-03/09)

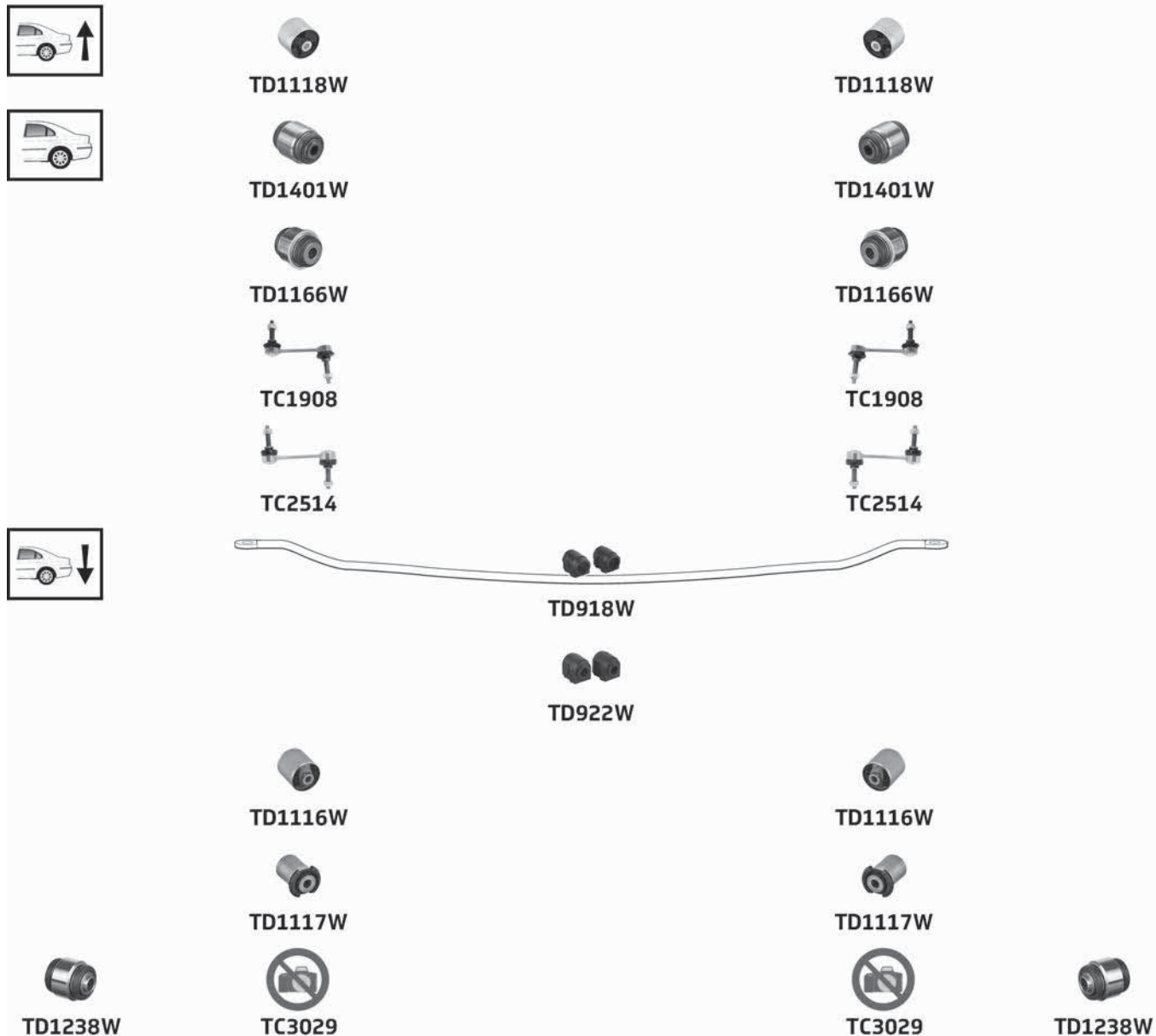

Part No	Description	Pos	Info	Technical
TA2446	Inner tie rod(123)	A B		M16x1.5 Male(252) £
TA2452	Tie rod end(224)	A B	→Ch. 9A191791	M16x1.5 Female(253) £
TA2941	Tie rod end(224)	A B	Ch. 9A191792→	M16x1.5 Female(253) £
TC1908	Link stabiliser(135)	A B	(-) Active stabiliser(_7_)	M12x1.75
TC1929	Link stabiliser(135)	A		M14x2
TC1930	Link stabiliser(135)	B		M14x2
TC1963	Lower ball joint(140)	A B		M16x2
TC2162	Lower wishbone(158)	A	→Ch.9A999999	M16x2
TC2163	Lower wishbone(158)	B	→Ch.9A999999	M16x2
TC2425	Upper ball joint(232)	A B		M12x1.75
TC2514	Link stabiliser(135)	A B	(+) Active stabiliser(-33-)	M12x1.75
TC3026	Upper wishbone(247)	A		M12x1.75
TC3027	Upper wishbone(247)	B		M12x1.75
TC3029	Panhard rod(180)	A B		
TD886W	Lower wishbone bush(159)	A B	Front(108)	
TD918W	Anti-roll bar(-74-) bush kit(-86-)	K	(+) Active stabiliser(-33-)	
TD922W	Anti-roll bar(-74-) bush kit(-86-)	K	(-) Active stabiliser(_7_)	
TD955W	Anti-roll bar(-74-) bush kit(-86-)	K	(-) Active stabiliser(_7_)	
TD956W	Anti-roll bar(-74-) bush kit(-86-)	K	(+) Active stabiliser(-33-)	
TD1116W	Lower suspension arm bush(148)	A B	Front(108)	
TD1117W	Lower suspension arm bush(148)	A B	Rear(187)	
TD1118W	Upper track control arm bush(243)	A B	Front(108)	
TD1135W	Lower wishbone bush(159)	A B	Rear(187)	

(...)

... LAND ROVER

... RANGE ROVER SPORT 2.7TDV6, 3.6TDV8, 4.2i, 4.4i →Ch. 9A999999 (02/05-03/09)

Part No	Description	Pos	Info	Technical
TD1166W	Hub carrier bush(113)	A B	Lower (139)	
TD1238W	Panhard rod bush(181)	A B		
TD1401W	Hub carrier bush(113)	A B	Upper (231)	
TD1496W	Upper wishbone bush(248)	A B	Front (108) Rear (187)	

RANGE ROVER SPORT 2.7TDV6, 3.0TDV6, 3.6TDV8, 4.2i, 4.4i, 5.0i Ch. AA000001→ (04/09-03/13)

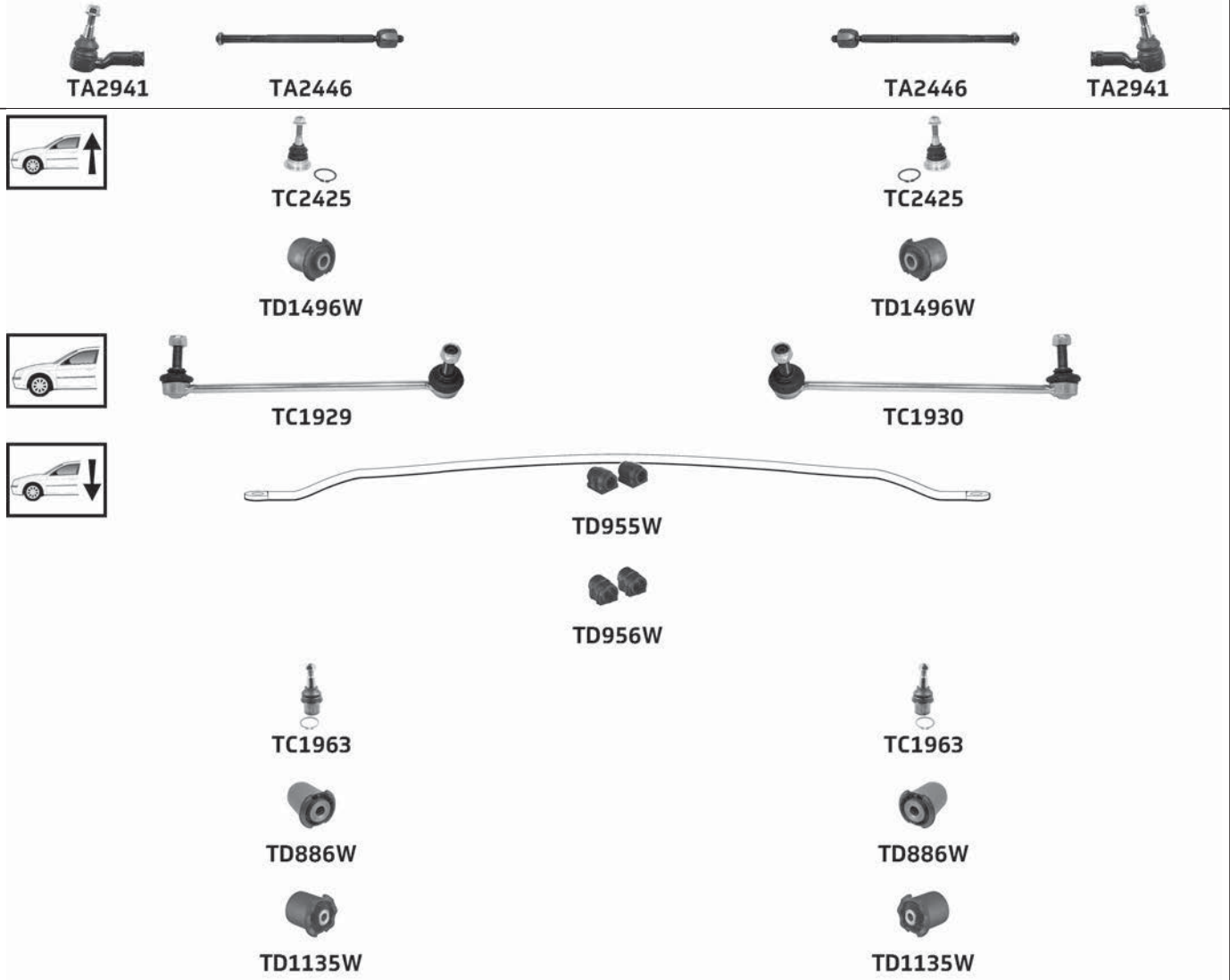

LAND ROVER

... RANGE ROVER SPORT 2.7TDV6, 3.0TDV6, 3.6TDV8, 4.2i, 4.4i, 5.0i Ch. AA000001→ (04/09-03/13)

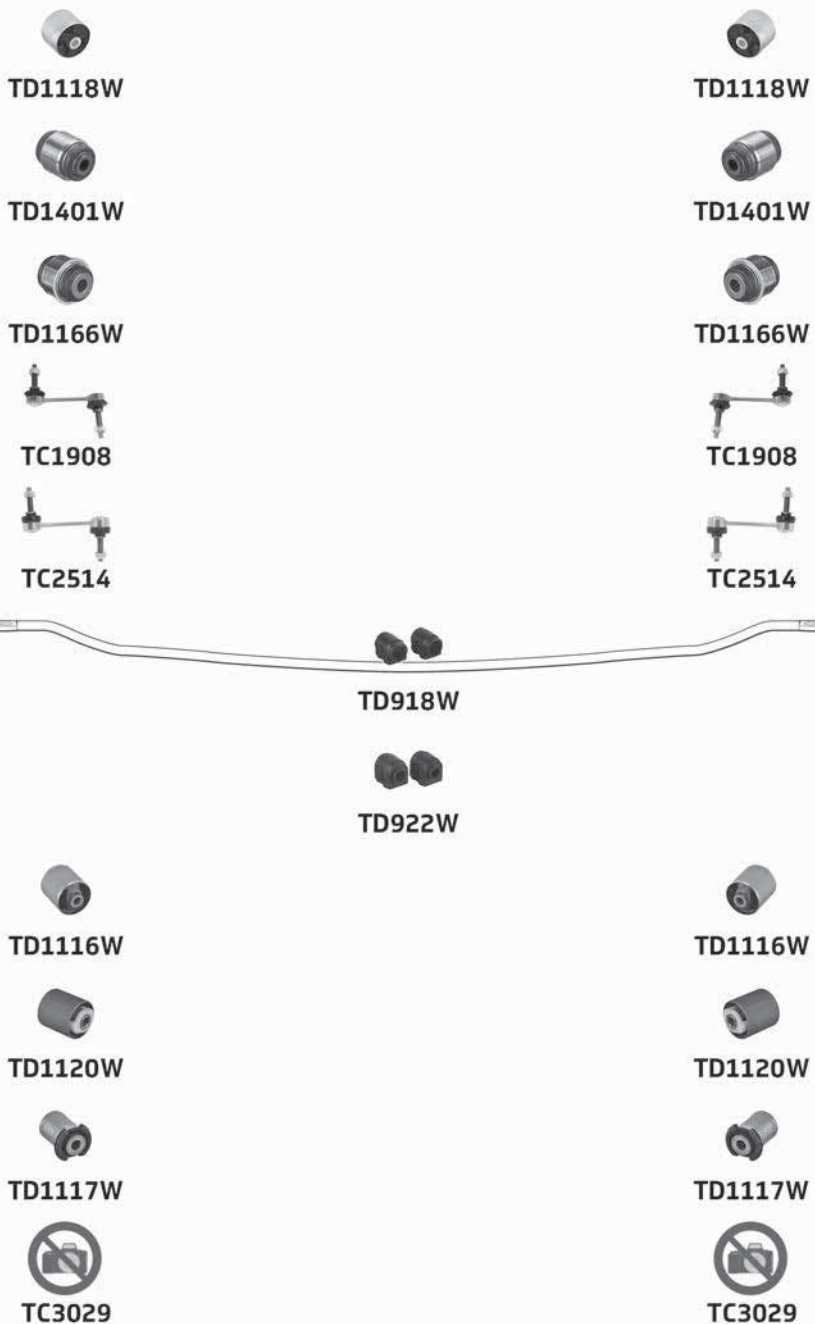

Part No	Description	Pos	Info	Technical
TA2446	Inner tie rod(123)	A B		M16x1.5 Male(252) £
TA2941	Tie rod end(224)	A B		M16x1.5 Female(253) £
TC1908	Link stabiliser(135)	A B	(-) Active stabiliser(_7_)	M12x1.75
TC1929	Link stabiliser(135)	A		M14x2
TC1930	Link stabiliser(135)	B		M14x2
TC1963	Lower ball joint(140)	A B		M16x2
TC2425	Upper ball joint(232)	A B		M12x1.75
TC2514	Link stabiliser(135)	A B	(+) Active stabiliser(-33-)	M12x1.75
TC3029	Panhard rod(180)	A B		
TD886W	Lower wishbone bush(159)	A B	Front(108)	
TD918W	Anti-roll bar(-74-) bush kit(-86-)	K	(+) Active stabiliser(-33-)	
TD922W	Anti-roll bar(-74-) bush kit(-86-)	K	(-) Active stabiliser(_7_)	
TD955W	Anti-roll bar(-74-) bush kit(-86-)	K	(-) Active stabiliser(_7_)	
TD956W	Anti-roll bar(-74-) bush kit(-86-)	K	(+) Active stabiliser(-33-)	
TD1116W	Lower suspension arm bush(148)	A B	Front(108) →Ch. AA222239	
TD1117W	Lower suspension arm bush(148)	A B	Rear(187)	
TD1118W	Upper track control arm bush(243)	A B	Front(108)	
TD1120W	Lower suspension arm bush(148)	A B	Front(108) Ch. AA222240→	
TD1135W	Lower wishbone bush(159)	A B	Rear(187)	

(...)

... LAND ROVER

... RANGE ROVER SPORT 2.7TDV6, 3.0TDV6, 3.6TDV8, 4.2i, 4.4i, 5.0i Ch. AA00001→ (04/09-03/13)

Part No	Description	Pos	Info	Technical
TD1166W	Hub carrier bush(113)	A B	Lower (139)	
TD1238W	Panhard rod bush(181)	A B		
TD1401W	Hub carrier bush(113)	A B	Upper (231)	
TD1496W	Upper wishbone bush(248)	A B	Front (108) Rear (187)	

RANGE ROVER SPORT 3.0i, 3.0TDV6, 4.4TDV8, 5.0i (04/13→)

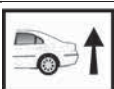

Part No	Description	Pos	Info	Technical
TA2939	Tie Rod End(224)	A B	→Ch. FA619100	M14.1.5 Female(253) £
TA2940	Inner tie rod(123)	A B	→Ch. FA619100	M14x1.5 Male(252) £
TC3036	Upper track control arm(242)	A B		
TC3037	Upper track control arm(242)	A	Standard(207) Length(129)	Pinch Bolt(255) 19.3mm
TC3038	Upper track control arm(242)	B	Standard(207) Length(129)	Pinch Bolt(255) 19.3mm
TC3041	Link stabiliser(135)	A B		M14x2
TC3046	Upper track control arm(242)	A	(-) 5mm Length(129)	Pinch Bolt(255) 19.3mm
TC3047	Upper track control arm(242)	B	(-) 5mm Length(129)	Pinch Bolt(255) 19.3mm
TC3048	Upper track control arm(242)	A	(+) 5mm Length(129)	Pinch Bolt(255) 19.3mm
TC3049	Upper track control arm(242)	B	(+) 5mm Length(129)	Pinch Bolt(255) 19.3mm
TC3149	Lower track control arm(151)	A	Rear(187)	M16x1.5
TC3150	Lower track control arm(151)	B	Rear(187)	M16x1.5

CONVOY 2.4TD, 2.5D, 2.5TD, 3.5i (04/96-04/09)



Part No	Description	Pos	Info	Technical
TA990	Drag link end(102) Tie rod end(224)	K	Front(108)	M20x1.5 Male(252) £
TA990	Drag link end(102) Tie rod end(224)	A		M20x1.5 Male(252) £
TA991	Drag link end(102) Tie rod end(224)	K	Rear(187)	M20x1.5 Male(252) ~
TA991	Drag link end(102) Tie rod end(224)	B		M20x1.5 Male(252) ~

MAXUS 2.5CDi (02/05-12/08)



Part No	Description	Pos	Info	Technical
TC829	Lower ball joint(140)	A B		M18x1.5
TC2638	Link stabiliser(135)	A		M10x1.25
TC2639	Link stabiliser(135)	B		M10x1.25

LEXUS

CT 200h 1.8i ZWA10 (12/10→)



Part No	Description	Pos	Info	Technical
TA3189	Tie rod end(224)	A		M14x1.5 Female(253) £
TA3190	Tie rod end(224)	B		M14x1.5 Female(253) £
TC1920	Link stabiliser(135)	A B		M12x1.25

ES350 3.5i ACV40, GSV40 (05/06-06/12)



Part No	Description	Pos	Info	Technical
TA2853	Inner tie rod(123)	A B		M15x1.5 Male(252) £
TC2653	Link stabiliser(135)	A B		M10x1.25

... LEXUS

GS300 3.0i JZS160 (08/97-03/05)

GS400 4.0i JZS160 (08/97-03/05)

GS430 4.3i UZS161 (08/97-03/05)



TA2844



TA2569



TA2569



TA2845



TC2932



TC2933



TC1769



TC1770



TC2317



TC2318

Part No	Description	Pos	Info	Technical
TA2569	Inner tie rod(123)	A B		M14x1.5 Male(252) £
TA2844	Tie rod end(224)	A		M14x1.5 Female(253) £
TA2845	Tie rod end(224)	B		M14x1.5 Female(253) £
TC1769	Link stabiliser(135)	A		M12x1.25
TC1770	Link stabiliser(135)	B		M12x1.25
TC2317	Lower ball joint(140)	A		M14x1.5
TC2318	Lower ball joint(140)	B		M14x1.5
TC2932	Upper wishbone(247)	A		M12x1.25
TC2933	Upper wishbone(247)	B		M12x1.25

GS300 3.0i GRS190 (04/05→)

GS450H 3.5i GWS191 (04/05→)

GS430 4.3i UZS190 (04/05→)

GS460 4.6i URS190 (04/05→)



TA3208



TA3160



TA3160



TA3209



TC3370



TC3371



TC3062



TC3063



TC3196



TC3196

Part No	Description	Pos	Info	Technical
TA3160	Inner tie rod(123)	A B		M15x1.5 Male(252) £
TA3208	Tie rod end(224)	A		M15x1.5 Female(253) £
TA3209	Tie rod end(224)	B		M15x1.5 Female(253) £
TC3062	Lower ball joint(140)	A		M12x1.25 / M14x1.5
TC3063	Lower ball joint(140)	B		M12x1.25 / M14x1.5
TC3196	Link stabiliser(135)	A B		M12x1.25
TC3370	Link stabiliser(135)	A		M12x1.25
TC3371	Link stabiliser(135)	B		M12x1.25

IS200 2.0i GXE10 (04/99-07/05)

IS300 3.0i JCE10 (04/99-07/05)



TA2846



TA2847



TC2600



TC2600



TC2902



TC2903

Part No	Description	Pos	Info	Technical
TA2846	Tie rod end (224)	A		M14x1.5 Female (253) £
TA2847	Tie rod end (224)	B		M14x1.5 Female (253) £
TC2600	Link stabiliser (135)	A B		M10x1.25 / M12x1.25
TC2902	Lower ball joint (140)	A		M14x1.5
TC2903	Lower ball joint (140)	B		M14x1.5

IS200d 2.2D ALE20 (10/05→)

IS220d 2.2D ALE20 (10/05→)

IS250 2.5i GSE20 (10/05→)

IS250 Cabrio 2.5i GSE20 (10/05→)



TA3208

TA3160



TA3160

TA3209



TC3370



TC3371



TC3062



TC3063



TC3196



TC3196

Part No	Description	Pos	Info	Technical
TA3160	Inner tie rod (123)	A B		M15x1.5 Male (252) £
TA3208	Tie rod end (224)	A		M15x1.5 Female (253) £
TA3209	Tie rod end (224)	B		M15x1.5 Female (253) £
TC3062	Lower ball joint (140)	A		M12x1.25 / M14x1.5
TC3063	Lower ball joint (140)	B		M12x1.25 / M14x1.5
TC3196	Link stabiliser (135)	A B		M12x1.25
TC3370	Link stabiliser (135)	A	08/2008→	M12x1.25
TC3371	Link stabiliser (135)	B	08/2008→	M12x1.25

IS-F 5.0i USE20 (10/05→)



TA3208

TA3160



TA3160

TA3209



TC3062



TC3063



TC3196



TC3196

Part No	Description	Pos	Info	Technical
TA3160	Inner tie rod (123)	A B		M15x1.5 Male (252) £
				(...)

... LEXUS

... IS-F 5.0i USE20 (10/05→)

Part No	Description	Pos	Info	Technical
TA3208	Tie rod end(224)	A		M15x1.5 Female(253) £
TA3209	Tie rod end(224)	B		M15x1.5 Female(253) £
TC3062	Lower ball joint(140)	A		M12x1.25 / M14x1.5
TC3063	Lower ball joint(140)	B		M12x1.25 / M14x1.5
TC3196	Link stabiliser(135)	A B		M12x1.25

IS200t 2.0i ASE30 (08/15→)

IS250 2.5i AVE30, GSE30 (04/13→)

IS300h 2.5i AVE30, GSE30 (04/13→)



TA3208



TA3209



TC3062



TC3063

Part No	Description	Pos	Info	Technical
TA3208	Tie rod end(224)	A		M15x1.5 Female(253) £
TA3209	Tie rod end(224)	B		M15x1.5 Female(253) £
TC3062	Lower ball joint(140)	A		M12x1.25 / M14x1.5
TC3063	Lower ball joint(140)	B		M12x1.25 / M14x1.5

LS460 4.6i USF45, USF46 (04/06→)

LS600h 5.0i UVF45, UVF46 (04/06→)



TC3674



TC3673

Part No	Description	Pos	Info	Technical
TC3673	Lower ball joint(140)	B		M14 x 1.5 x 24
TC3674	Lower ball joint(140)	A		M14 x 1.5 x 24

NX200t 2.0i ZGZ10, ZGZ15 (08/14→)

NX300H 2.5i AYZ10, AYZ15 (08/14→)



TA2626



TBR4248



TA2627



TC1920



TC1920



TC1994



TC3428



TC1994

TC3429



TC2628



TC2628

Part No	Description	Pos	Info	Technical
TA2626	Tie rod end(224)	A		M16x1.5 Female(253) £
TA2627	Tie rod end(224)	B		M16x1.5 Female(253) £
TBR4248	Steering rack gaiter kit(213)	K	Thermoplastic(223)	1 :15x49x49 2 :15x49x49
TC1920	Link stabiliser(135)	A B		M12x1.25
TC1994	Lower ball joint(140)	A B		M14x1.5
TC2628	Link stabiliser(135)	A B		M12x1.25
TC3428	Lower wishbone(158)	A		
TC3429	Lower wishbone(158)	B		

RX300 3.0i MCU15 (10/00-05/03)



Part No	Description	Pos	Info	Technical
TA2078	Tie rod end (224)	A B		M15x1.5 Female (253) £
TA3062	Inner tie rod (123)	A B		M15x1.5 Male (252) £
TC1516	Lower ball joint (140)	A B		M14x1.5
TC1540	Link stabiliser (135)	A		M10x1.25
TC1541	Link stabiliser (135)	B		M10x1.25
TC2919	Link stabiliser (135)	A B		M10x1.25

RX300 3.0i MCU35 (04/03-12/08)

RX330 3.3i MCU38 (04/03-12/08)

RX350 3.5i GSU35 (04/03-12/08)



Part No	Description	Pos	Info	Technical
TA3067	Inner tie rod (123)	A B		M15x1.5 Male (252) £
TC1513	Link stabiliser (135)	A B		M12x1.25
TC1514	Lower ball joint (140)	A		M14x1.5
TC1515	Lower ball joint (140)	B		M14x1.5

RX400h 3.3i MHU33, MHU38 (04/03-12/08)



Part No	Description	Pos	Info	Technical
TC1513	Link stabiliser (135)	A B		M12x1.25
TC1514	Lower ball joint (140)	A		M14x1.5
TC1515	Lower ball joint (140)	B		M14x1.5

... LEXUS

SC430 4.3i UZZ40 (08/01-07/10)



TA2844



TA2845



TC2932



TC2933



TC1769



TC1770

Part No	Description	Pos	Info	Technical
TA2844	Tie rod end(224)	A		M14x1.5 Female(253) £
TA2845	Tie rod end(224)	B		M14x1.5 Female(253) £
TC1769	Link stabiliser(135)	A		M12x1.25
TC1770	Link stabiliser(135)	B		M12x1.25
TC2932	Upper wishbone(247)	A		M12x1.25
TC2933	Upper wishbone(247)	B		M12x1.25

MAZDA

2 1.25i NB, 1.4i NC, 1.4CDi NE, 1.6i ND (04/03-12/07)



TA2026



TA1897



TBR4207



TA1897



TA2027



TC2047



TC2047



TD1069W



TC1159



TD575W



TD575W



TC1160



TC1158



TC1158



TD576W



TD576W

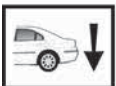

TD911W



TD911W

Part No	Description	Pos	Info	Technical
TA1897	Inner tie rod(123)	A B		M14x1.5 Male(252) £
TA2026	Tie rod end(224)	A		M14x1.5 Female(253) £
TA2027	Tie rod end(224)	B		M14x1.5 Female(253) £
TBR4207	Steering rack gaiter kit(213)	K	Thermoplastic(223)	1 :14x54x54 2 :14x54x54
TC1158	Lower ball joint(140)	A B		Pinch Bolt(255) 16.5mm
TC1159	Lower wishbone(158)	A		Pinch Bolt(255) 16.5mm
TC1160	Lower wishbone(158)	B		Pinch Bolt(255) 16.5mm
TC2047	Link stabiliser(135)	A B		M10x1.5
TD575W	Lower wishbone bush(159)	A B	Front(108)	
TD576W	Lower wishbone bush(159)	A B	Rear(187)	

... 2 1.25i NB, 1.4i NC, 1.4CDi NE, 1.6i ND (04/03-12/07)

Part No	Description	Pos	Info	Technical
TD911W	Lower hub carrier bush(143)	A B		
TD1069W	Anti-roll bar(-74) bush kit(-86)	K	Complete axle kit(-92)	

2 1.3i, 1.4CDi, 1.5i, 1.6CDi DE (10/07→)

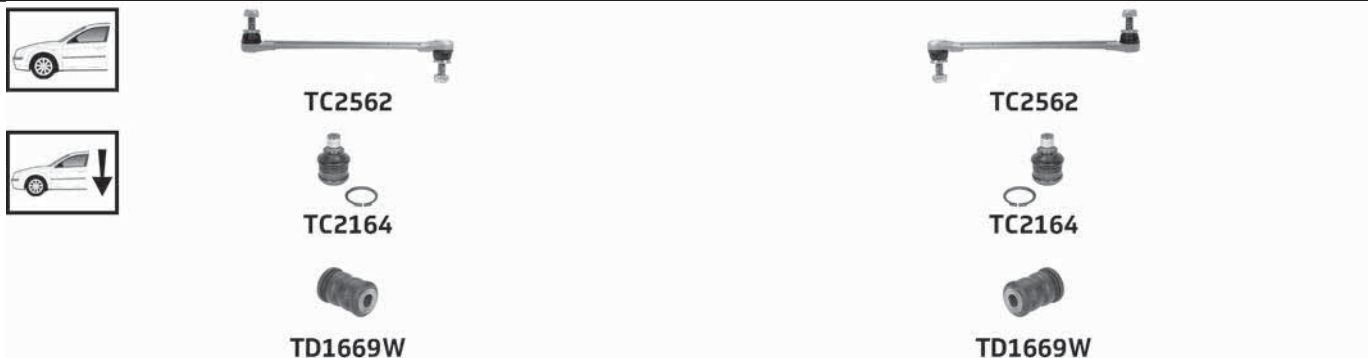

Part No	Description	Pos	Info	Technical
TA2673	Tie rod end(224)	A		M14x1.5 Female(253) £
TA2674	Tie rod end(224)	B		M14x1.5 Female(253) £
TA2675	Inner tie rod(123)	A B		M14x1.5 Male(252) £
TBR4225	Steering rack gaiter kit(213)	K	Thermoplastic(223)	1 :12x55x55 2 :12x55x55
TC2164	Lower ball joint(140)	A B		Pinch Bolt(255) 17.5mm
TC2562	Link stabiliser(135)	A B		M10x1.5
TD1669W	Lower wishbone bush(159)	A B	Front(108)	

3 1.4i, 1.6i, 1.6CDi, 2.0i BK (10/03-06/09)

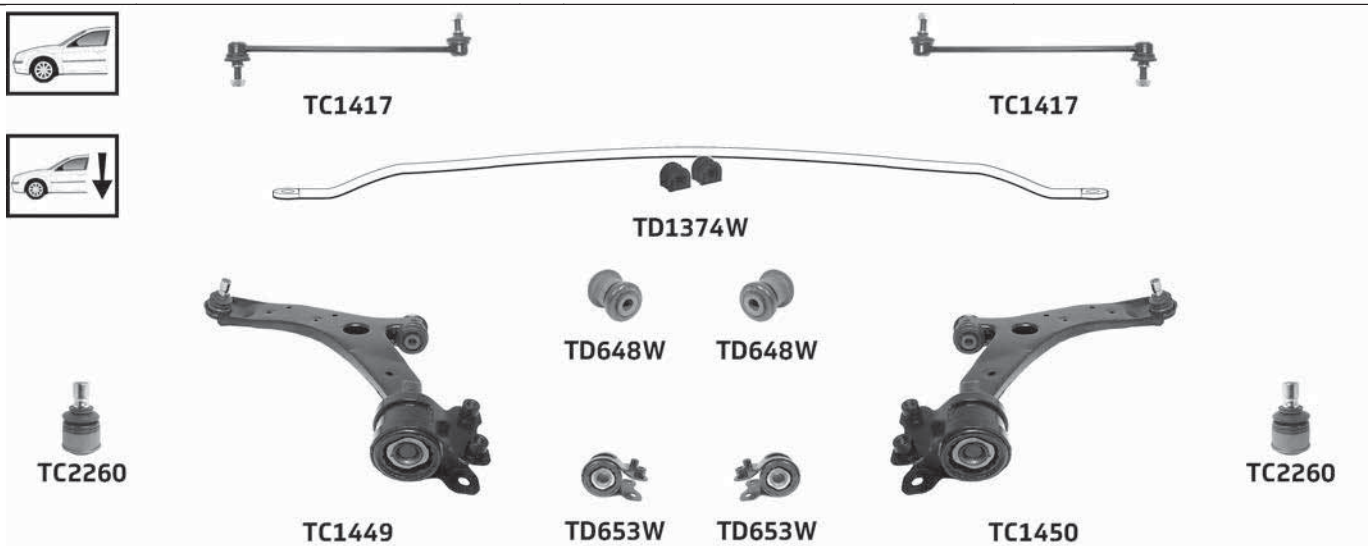
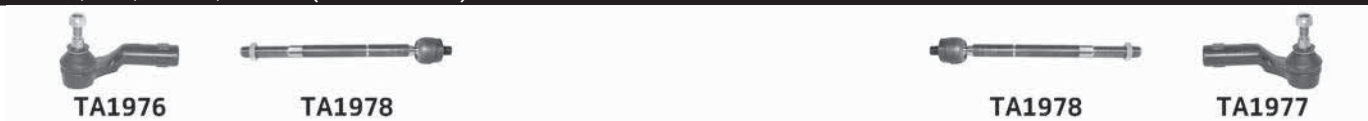

MAZDA

... MAZDA

... 3 1.4i, 1.6i, 1.6CDi, 2.0i BK (10/03-06/09)



Part No	Description	Pos	Info	Technical
TA1976	Tie rod end(224)	A		M17x1.5 Female(253) £
TA1977	Tie rod end(224)	B		M17x1.5 Female(253) £
TA1978	Inner tie rod(123)	A B		M17x1.5 Male(252) £
TC1262	Lower trailing arm(156)	A B		
TC1417	Link stabiliser(135)	A B		M10x1.25
TC1419	Link stabiliser(135)	A B		M10x1.5
TC1449	Lower wishbone(158)	A		Pinch Bolt(255) 18mm
TC1450	Lower wishbone(158)	B		Pinch Bolt(255) 18mm
TC2000	Upper trailing arm(245)	A B		
TC2260	Lower ball joint(140)	A B		Pinch Bolt(255) 18mm
TD340W	Knuckle bush(126)	A B		
TD648W	Lower wishbone bush(159)	A B	Front(108)	
TD653W	Lower wishbone bush(159)	A B	Rear(187)	
TD1162W	Upper trailing arm bush(246)	A B	Outer(176) Inner(119)	
TD1249W	Lower trailing arm bush(157)	A B	Outer(176) Inner(119)	
TD1374W	Anti-roll bar(-74-) bush kit(-86-)	K	Complete axle kit(-92-)	

3 2.3i MPS BK (10/03-06/09)

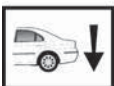

Part No	Description	Pos	Info	Technical
TA1976	Tie rod end(224)	A		M17x1.5 Female(253) £
TA1977	Tie rod end(224)	B		M17x1.5 Female(253) £
TA1978	Inner tie rod(123)	A B		M17x1.5 Male(252) £
TC2000	Upper trailing arm(245)	A B		
TD340W	Knuckle bush(126)	A B		
TD1162W	Upper trailing arm bush(246)	A B	Outer(176) Inner(119)	

MAZDA

3 1.6MZR, 1.6MZR-CD, 2.0MZR, 2.2MZR-CD BL (06/09→)



Part No	Description	Pos	Info	Technical
TA1976	Tie rod end(224)	A		M17x1.5 Female(253) £
TA1977	Tie rod end(224)	B		M17x1.5 Female(253) £
TA1978	Inner tie rod(123)	A B		M17x1.5 Male(252) £
TC2000	Upper trailing arm(245)	A B		
TD1162W	Upper trailing arm bush(246)	A B	Outer(176) Inner(119)	
TD1374W	Anti-roll bar(-74) bush kit(-86-)	K	Complete axle kit(-92)	

3 1.5i, 2.0i, 2.2DT BM (09/13→)

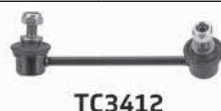
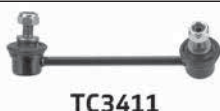

Part No	Description	Pos	Info	Technical
TA3237	Tie rod end(224)	A		
TA3238	Tie rod end(224)	B		
TA3258	Inner tie rod(123)	A B		M14x1.5 Male(252) £ / ~
TC3411	Link stabiliser(135)	A		
TC3412	Link stabiliser(135)	B		
TC3431	Link stabiliser(135)	A		
TC3432	Link stabiliser(135)	B		

... MAZDA

5 1.8i, 2.0i, 2.0CDi CR (03/05→)

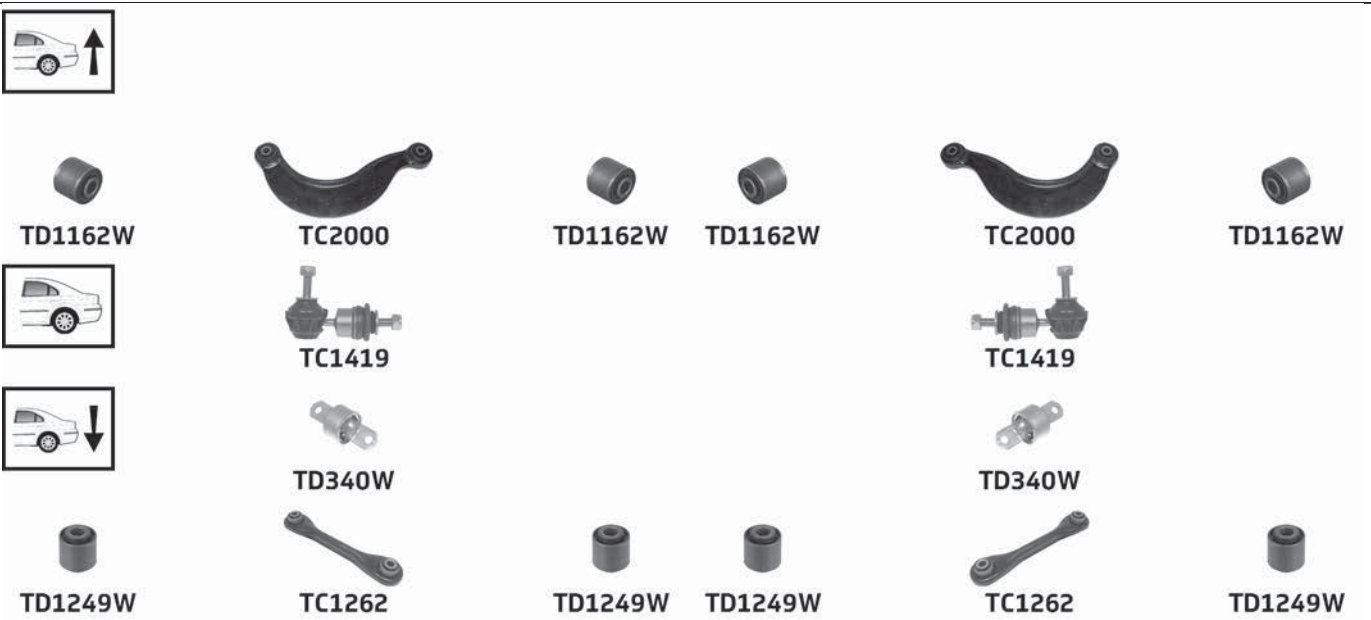
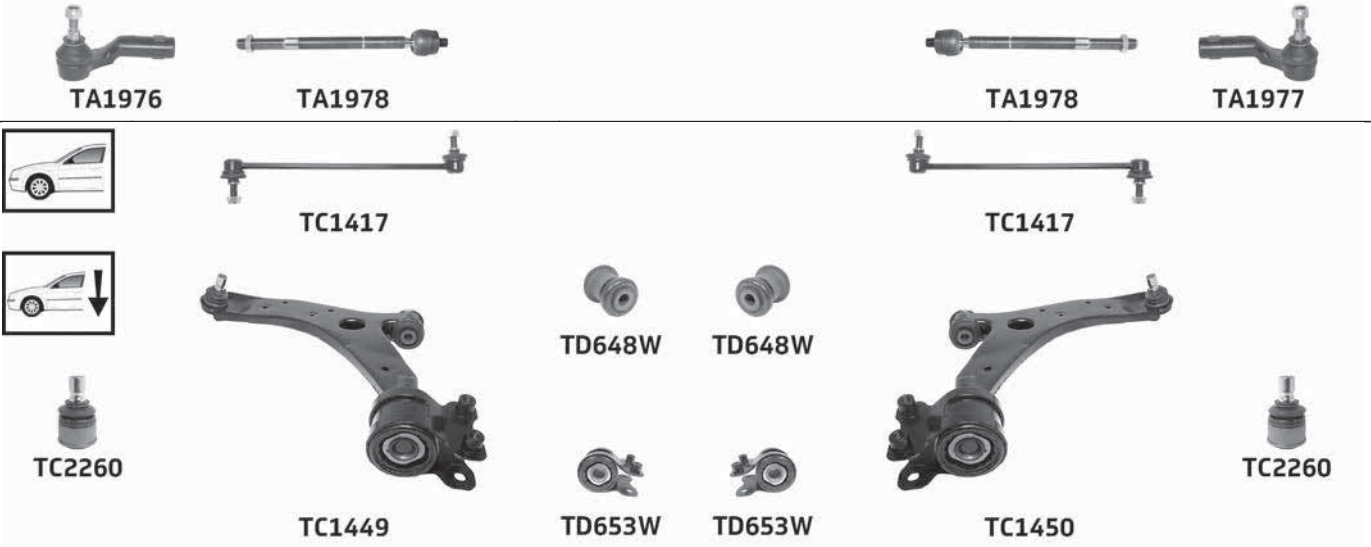

Part No	Description	Pos	Info	Technical
TA1976	Tie rod end(224)	A		M17x1.5 Female(253) £
TA1977	Tie rod end(224)	B		M17x1.5 Female(253) £
TA1978	Inner tie rod(123)	A B		M17x1.5 Male(252) £
TC1262	Lower trailing arm(156)	A B		
TC1417	Link stabiliser(135)	A B		M10x1.25
TC1419	Link stabiliser(135)	A B		M10x1.5
TC1449	Lower wishbone(158)	A		Pinch Bolt(255) 18mm
TC1450	Lower wishbone(158)	B		Pinch Bolt(255) 18mm
TC2000	Upper trailing arm(245)	A B		
TC2260	Lower ball joint(140)	A B		Pinch Bolt(255) 18mm
TD340W	Knuckle bush(126)	A B		
TD648W	Lower wishbone bush(159)	A B	Front(108)	
TD653W	Lower wishbone bush(159)	A B	Rear(187)	
TD1162W	Upper trailing arm bush(246)	A B	Outer(176) Inner(119)	
TD1249W	Lower trailing arm bush(157)	A B	Outer(176) Inner(119)	

5 1.6CDi, 1.8i, 2.0i CW (06/10→)



Part No	Description	Pos	Info	Technical
TD1374W	Anti-roll bar(-74-) bush kit(-86-)	K	Complete axle kit(-92-)	

6 1.8i, 2.0i, 2.0TDi, 2.3i (-) MPS GG, GY (06/02-07/07)

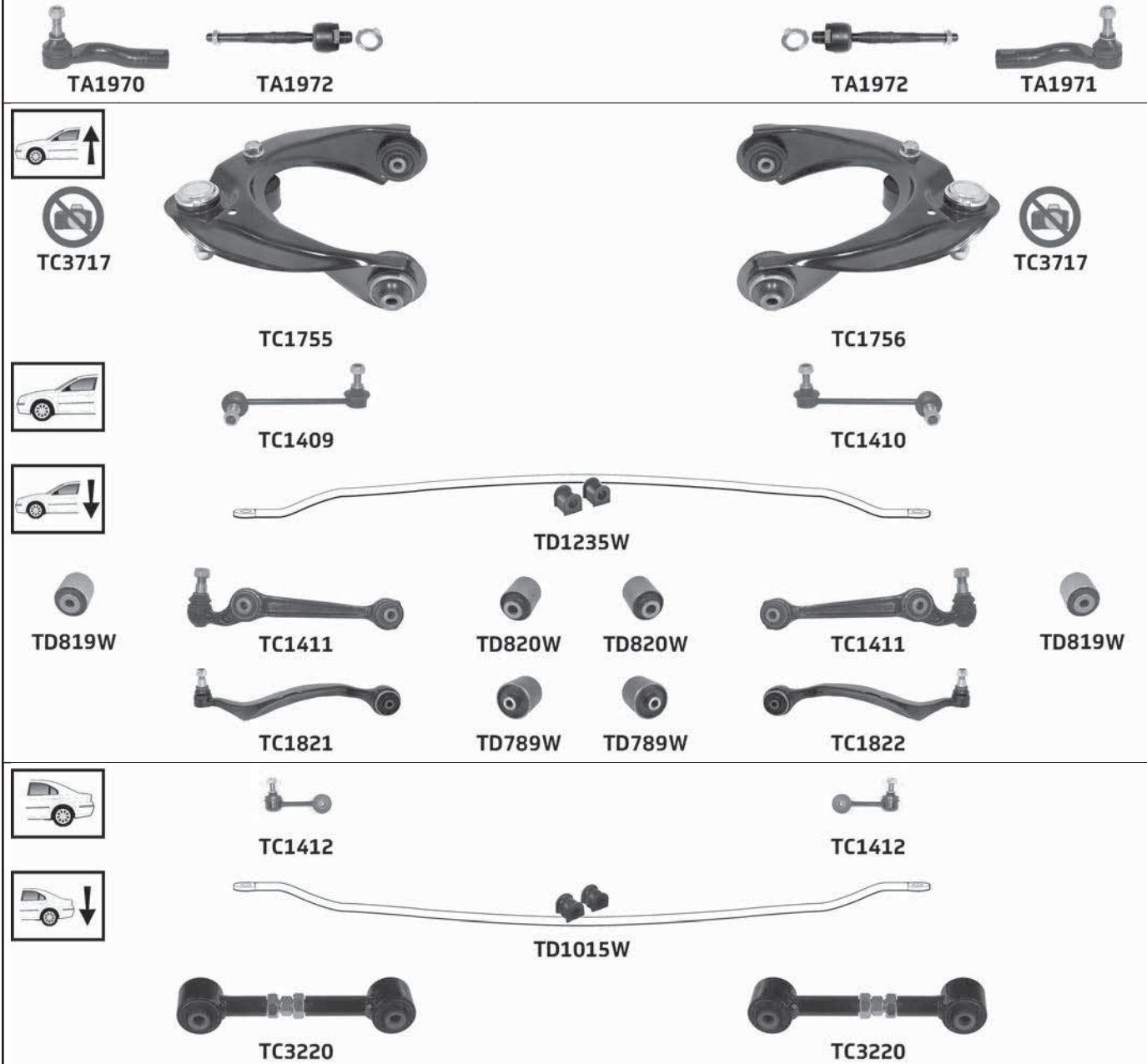

Part No	Description	Pos	Info	Technical
TA1970	Tie rod end (224)	A		M14x1.5 Female (253) £
TA1971	Tie rod end (224)	B		M14x1.5 Female (253) £
TA1972	Inner tie rod (123)	A B		M14x1.5 Male (252) £
TC1409	Link stabiliser (135)	A		M10x1.25
TC1410	Link stabiliser (135)	B		M10x1.25
TC1411	Lower track control arm (151)	A B	Front (108)	M16x1.5
TC1412	Link stabiliser (135)	A B		M10x1.25
TC1755	Upper track control arm (242)	A		M12x1.25
TC1756	Upper track control arm (242)	B		M12x1.25
TC1821	Lower track control arm (151)	A	Rear (187)	M16x1.5
TC1822	Lower track control arm (151)	B	Rear (187)	M16x1.5
TC3220	Connecting link (-95)	A B		
TC3717	Upper ball joint (232)	A B		
TD789W	Lower track control arm bush (153)	A B	Rear (187)	
TD1015W	Anti-roll bar (-74) bush kit (-86)	K	Complete axle kit (-92)	
TD1235W	Anti-roll bar (-74) bush kit (-86)	K	Ø22 Complete axle kit (-92)	

... MAZDA

6 2.3i MPS GG, GY (06/02-07/07)



Part No	Description	Pos	Info	Technical
TA1970	Tie rod end(224)	A		M14x1.5 Female(253) £
TA1971	Tie rod end(224)	B		M14x1.5 Female(253) £
TA1972	Inner tie rod(123)	A B		M14x1.5 Male(252) £
TC1409	Link stabiliser(135)	A		M10x1.25
TC1410	Link stabiliser(135)	B		M10x1.25
TC1411	Lower track control arm(151)	A B	Front(108)	M16x1.5
TC1412	Link stabiliser(135)	A B		M10x1.25

6 1.8i, 2.0i, 2.0MZR-CD, 2.2MZR-CD, 2.5i GH (08/07-12/12)

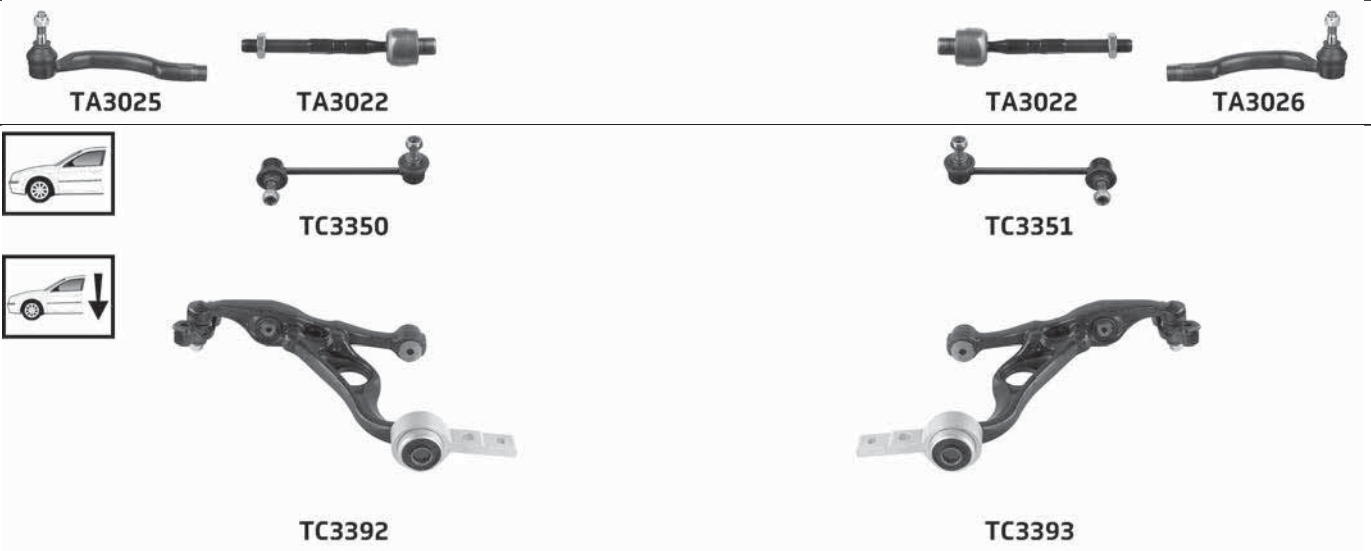

Part No	Description	Pos	Info	Technical
TA3022	Inner tie rod(123)	A B		M14x1.5 Male(252) £
TA3025	Tie rod end(224)	A		M14x1.5 Female(253) £
TA3026	Tie rod end(224)	B		M14x1.5 Female(253) £
TC3350	Link stabiliser(135)	A		M10x1.25
TC3351	Link stabiliser(135)	B		M10x1.25
TC3361	Link stabiliser(135)	A B		M10x1.25
TC3392	Lower wishbone(158)	A		M16x1.5
TC3393	Lower wishbone(158)	B		M16x1.5

6 2.0i, 2.2CITD, 2.5i GJ, GL (10/12→)



TA3237



TA3258



TA3258



TA3238



TC3411



TC3412

Part No	Description	Pos	Info	Technical
TA3237	Tie rod end(224)	A	(-) 4X4	
TA3238	Tie rod end(224)	B		
TA3258	Inner tie rod(123)	A B		M14x1.5 Male(252) £ / ~
TC3411	Link stabiliser(135)	A		
TC3412	Link stabiliser(135)	B		

121 1.25i, 1.3i, 1.8D BA (03/96-04/03)



TA1584



TA1611



TA1611



TA1585



TC720



TC720



TD435W



TC677



TD284W

TD284W



TC678



TC663



TC663



TD285W



TD285W



TD892W



TD892W



TD1194W



TD1194W

Part No	Description	Pos	Info	Technical
TA1584	Tie rod end(224)	A		M14x2 Female(253) £
TA1585	Tie rod end(224)	B		M14x2 Female(253) £
TA1611	Inner tie rod(123)	A B		M14x2 Male(252) £
TC663	Lower ball joint(140)	A B		Pinch Bolt(255) 16.5mm
TC677	Lower wishbone(158)	A		Pinch Bolt(255) 16.5mm
TC678	Lower wishbone(158)	B		Pinch Bolt(255) 16.5mm
TC720	Link stabiliser(135)	A B		M10x1.25
TD284W	Lower wishbone bush(159)	A B	Front(108)	
TD285W	Lower wishbone bush(159)	A B	Rear(187)	
TD435W	Anti-roll bar(-74) bush kit(-86-)	K	Ø16 Complete axle kit(-92)	
TD892W	Axle bush(-76-)	A B	Front(108)	
TD1194W	Axle bush(-76-)	A B	Rear(187)	

MAZDA

... MAZDA

323 1.3i, 1.5i, 1.8i, 2.0TDi BJ (09/98-09/00)

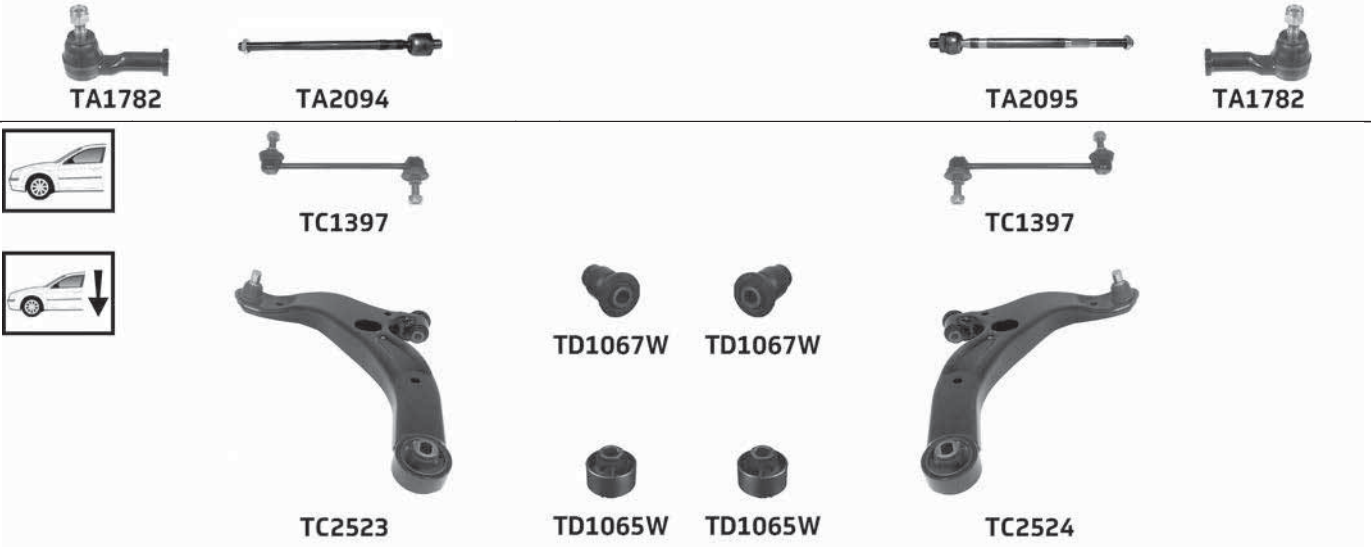

Part No	Description	Pos	Info	Technical
TA1782	Tie rod end(224)	A B		M14x1.5 Female(253) £
TA2094	Inner tie rod(123)	A		M14x1.5 Male(252) £
TA2095	Inner tie rod(123)	B		M14x1.5 Male(252) £
TC1397	Link stabiliser(135)	A B		M10x1.25
TC1398	Link stabiliser(135)	A B		M10x1.25
TC2523	Lower wishbone(158)	A		Pinch Bolt(255) 18mm
TC2524	Lower wishbone(158)	B		Pinch Bolt(255) 18mm
TD1065W	Lower wishbone bush(159)	A B	Rear(187)	
TD1067W	Lower wishbone bush(159)	A B	Front(108)	

323 1.3i, 1.5i, 1.6i, 1.8i, 2.0i, 2.0TDi BJ (10/00-05/04)

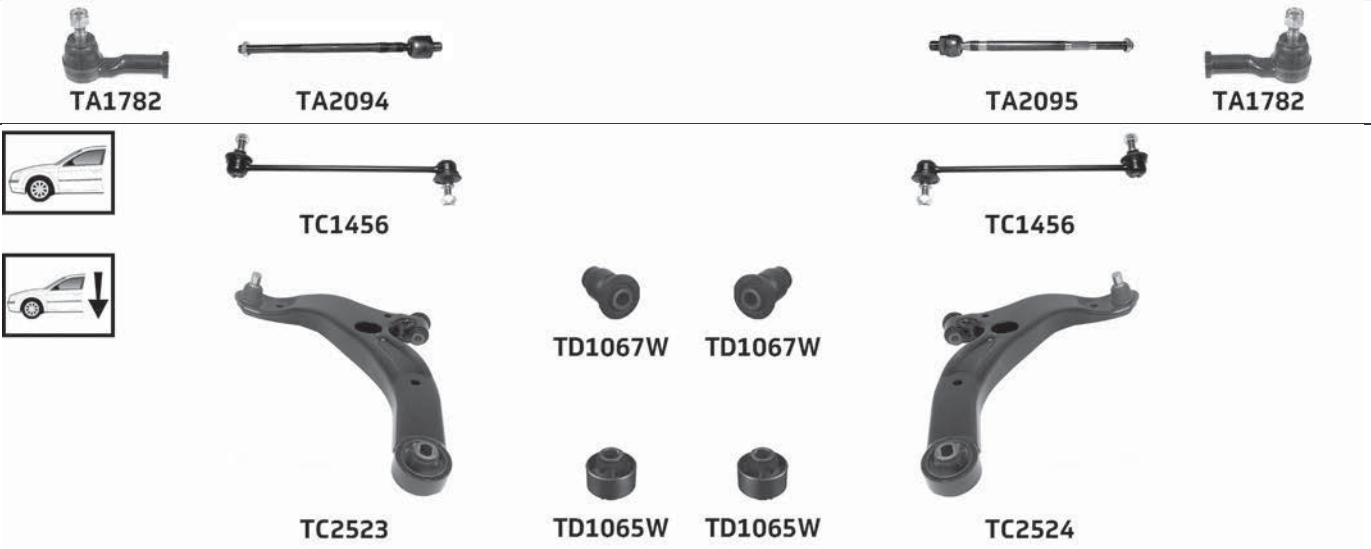

Part No	Description	Pos	Info	Technical
TA1782	Tie rod end(224)	A B		M14x1.5 Female(253) £
TA2094	Inner tie rod(123)	A		M14x1.5 Male(252) £
TA2095	Inner tie rod(123)	B		M14x1.5 Male(252) £
TC1456	Link stabiliser(135)	A B		M10x1.25
TC1457	Link stabiliser(135)	A B		M10x1.25
TC2523	Lower wishbone(158)	A		Pinch Bolt(255) 18mm
TC2524	Lower wishbone(158)	B		Pinch Bolt(255) 18mm
TD1065W	Lower wishbone bush(159)	A B	Rear(187)	
TD1067W	Lower wishbone bush(159)	A B	Front(108)	

MAZDA

B2500 2.5D UN (11/98-06/06)



Part No	Description	Pos	Info	Technical
TD1063W	Upper wishbone bush(248)	A B	Front (108) Rear (187)	

CX-5 2.0i, 2.2D, 2.5i KE (11/11→)

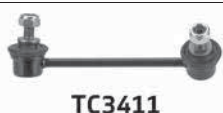

Part No	Description	Pos	Info	Technical
TC3411	Link stabiliser (135)	A		
TC3412	Link stabiliser (135)	B		
TC3687	Lower ball joint (140)	A B		ø20

CX-5 2.0i, 2.2D KF (11/16→)



Part No	Description	Pos	Info	Technical
TC3411	Link stabiliser (135)	A		
TC3412	Link stabiliser (135)	B		

CX-7 2.2CD, 2.3i ER (02/06-08/12)



Part No	Description	Pos	Info	Technical
TA3063	Inner tie rod (123)	A B		M14x1.5 Male (252) £
TA3074	Tie rod end (224)	A		M14x1.5 Female (253) £
TA3075	Tie rod end (224)	B		M14x1.5 Female (253) £
TC3629	Lower wishbone (158)	A		
TC3630	Lower wishbone (158)	B		

CX-9 3.7i TB (01/07→)



Part No	Description	Pos	Info	Technical
TA3074	Tie rod end (224)	A		M14x1.5 Female (253) £
TA3075	Tie rod end (224)	B		M14x1.5 Female (253) £

... MAZDA

DEMIO 1.3i, 1.5i DW (06/98-04/03)



Part No	Description	Pos	Info	Technical
TA1624	Tie rod end(224)	A B		M12x1.25 Female(253) £
TA2588	Inner tie rod(123)	A		M12x1.25 Male(252) £
TA2589	Inner tie rod(123)	B		M12x1.25 Male(252) £
TC1548	Link stabiliser(135)	A B		M10x1.25
TC3286	Lower wishbone(158)	A	Ch. 980601→	Pinch Bolt(255) 16mm
TC3287	Lower wishbone(158)	A B		Pinch Bolt(255) 16mm
TC3287	Lower wishbone(158)	A B	→Ch. 980601	Pinch Bolt(255) 16mm

E2000 2.0i SR (09/99-09/04)

E2200 2.2D SR (09/99-09/04)



Part No	Description	Pos	Info	Technical
TA2612	Inner tie rod(123)	A B		M14x1.5 Male(252) £
TA2644	Tie rod end(224)	A B		M14x1.5 Female(253) £
TC590	Upper ball joint(232)	A B		M16x1.5
TC3365	Lower ball joint(140)	A B		M18x1.5

MPV II 2.0i, 2.0Di, 2.3i LW (09/99-02/06)



Part No	Description	Pos	Info	Technical
TA1782	Tie rod end(224)	A B		M14x1.5 Female(253) £
TA2346	Inner tie rod(123)	A B		M14x1.5 Male(252) £
TC1456	Link stabiliser(135)	A B	→Ch. 109195	M10x1.25
TC2296	Link stabiliser(135)	A B	Ch. 109196→	M10x1.25

MX5 II 1.6i, 1.8i NB (04/98-10/05)



TA1830



TA2124



TBR4132



TA2124



TA1830



TC1399



TC1401



TC1267



TC1267



TC1105



TC1104

Part No	Description	Pos	Info	Technical
TA1830	Tie rod end(224)	A B		M12x1.25 Female(253) £
TA2124	Inner tie rod(123)	A B		M12x1.25 Male(252) £
TBR4132	Steering rack gaiter kit(213)	K	Thermoplastic(223)	1 :13x42x42 2 :13x42x42
TC1104	Link stabiliser(135)	B		M10x1.25
TC1105	Link stabiliser(135)	A		M10x1.25
TC1267	Lower ball joint(140)	A B		M14x1.5
TC1399	Link stabiliser(135)	A		M10x1.25
TC1401	Link stabiliser(135)	B		M10x1.25

MX5 III 1.8i, 2.0i NC (03/05-08/08)



TA2782



TA2782



TC1837



TC1838



TC1791



TC1791

Part No	Description	Pos	Info	Technical
TA2782	Inner tie rod(123)	A B		M14x1.5 Male(252) £
TC1791	Link stabiliser(135)	A B		M10x1.25
TC1837	Link stabiliser(135)	A		M10x1.25
TC1838	Link stabiliser(135)	B		M10x1.25

MX5 III 1.8i, 2.0i NC (09/08→)



TA2782



TA2782



TC1791



TC1791

Part No	Description	Pos	Info	Technical
TA2782	Inner tie rod(123)	A B		M14x1.5 Male(252) £
TC1791	Link stabiliser(135)	A B		M10x1.25

MAZDA

... MAZDA

PREMACY 1.8i, 2.0TDi CP (03/99-08/00)

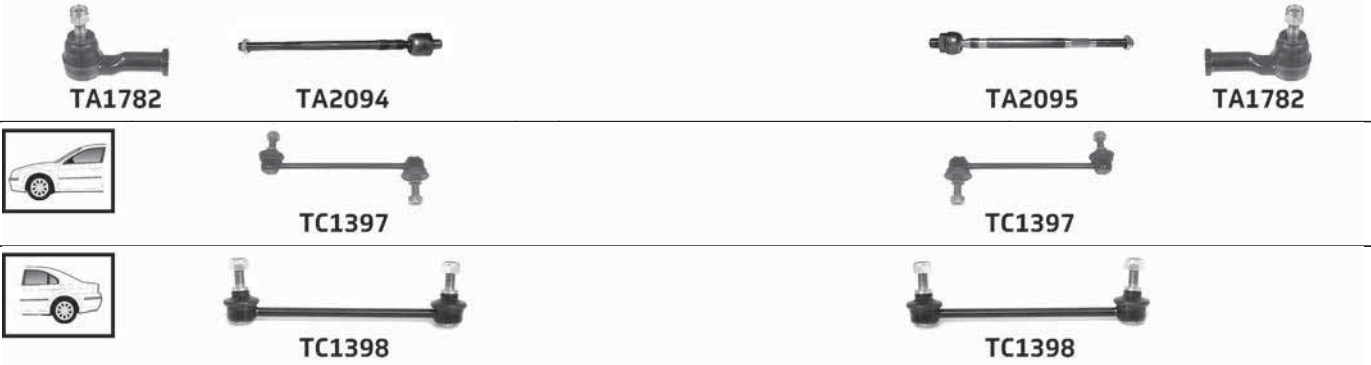

Part No	Description	Pos	Info	Technical
TA1782	Tie rod end(224)	A B		M14x1.5 Female(253) £
TA2094	Inner tie rod(123)	A		M14x1.5 Male(252) £
TA2095	Inner tie rod(123)	B		M14x1.5 Male(252) £
TC1397	Link stabiliser(135)	A B		M10x1.25
TC1398	Link stabiliser(135)	A B		M10x1.25

PREMACY 1.8i, 2.0TDi CP (08/00-07/01)

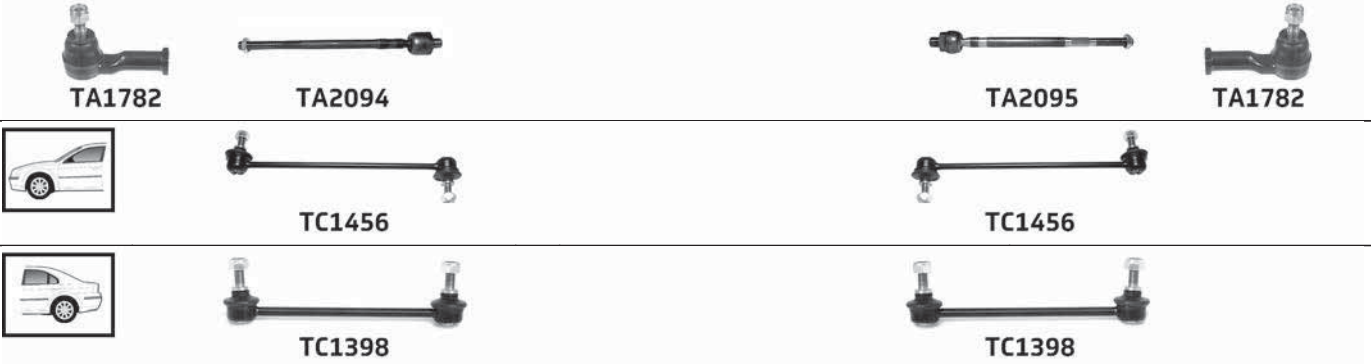

Part No	Description	Pos	Info	Technical
TA1782	Tie rod end(224)	A B		M14x1.5 Female(253) £
TA2094	Inner tie rod(123)	A		M14x1.5 Male(252) £
TA2095	Inner tie rod(123)	B		M14x1.5 Male(252) £
TC1398	Link stabiliser(135)	A B		M10x1.25
TC1456	Link stabiliser(135)	A B		M10x1.25

PREMACY 1.8i, 2.0i, 2.0TDi CP (07/01-03/05)

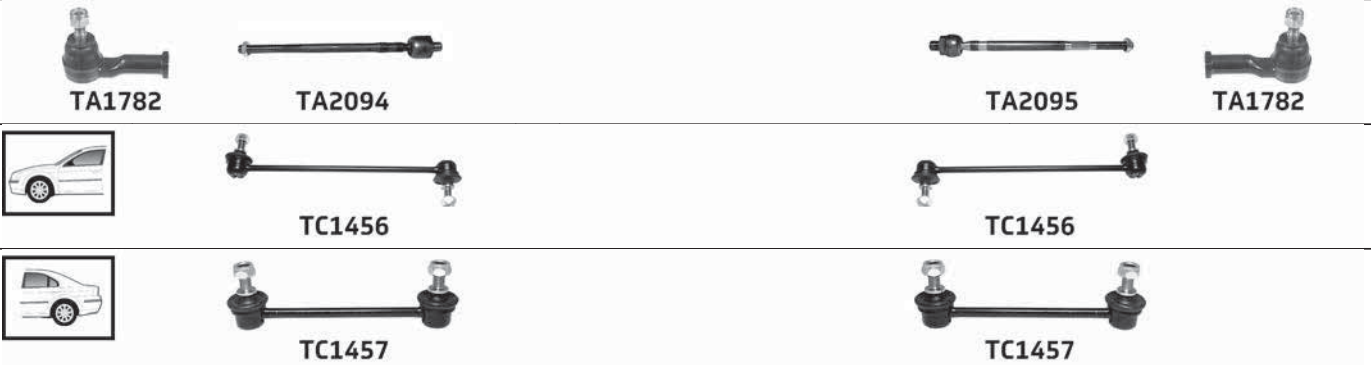

Part No	Description	Pos	Info	Technical
TA1782	Tie rod end(224)	A B		M14x1.5 Female(253) £
TA2094	Inner tie rod(123)	A		M14x1.5 Male(252) £
TA2095	Inner tie rod(123)	B		M14x1.5 Male(252) £
TC1456	Link stabiliser(135)	A B		M10x1.25
TC1457	Link stabiliser(135)	A B		M10x1.25

MAZDA

RX8 2.6i FE (10/03-06/12)



TA2356



TA2382



TA2382



TA2357



TC1837



TC1838



TC1791



TC1791

Part No	Description	Pos	Info	Technical
TA2356	Tie rod end(224)	A		M14x1.5 Female(253) £
TA2357	Tie rod end(224)	B		M14x1.5 Female(253) £
TA2382	Inner tie rod(123)	A B		M14x1.5 Male(252) £
TC1791	Link stabiliser(135)	A B		M10x1.25
TC1837	Link stabiliser(135)	A		M10x1.25
TC1838	Link stabiliser(135)	B		M10x1.25

MERCEDES

A CLASS (168 SERIES) A140 1.4i, A160 1.6i, 1.7CDi, A170 1.7CDi, A190 1.9i, A210 2.1i (07/97-08/04)



TA1750



TA1752



TA1752



TA1751



TC962



TC962



TC1549



TC1549



TC963



TC964



TD383W



TD383W



TD384W



TD384W



TC965



TC963

Part No	Description	Pos	Info	Technical
TA1750	Tie rod end(224)	A		M12x1.5 Female(253) £
TA1751	Tie rod end(224)	B		M12x1.5 Female(253) £
TA1752	Inner tie rod(123)	A B		M12x1.5 Male(252) £
TC962	Link stabiliser(135)	A B	Metal	M10x1.5
TC963	Lower ball joint(140)	A B		M12x1.5
TC964	Lower wishbone(158)	A		M12x1.5
TC965	Lower wishbone(158)	B		M12x1.5
TC1549	Link stabiliser(135)	A B	Plastic(184)	M10x1.5
TD383W	Lower wishbone bush(159)	A B	Front(108)	
TD384W	Lower wishbone bush(159)	A B	Rear(187)	

MERCEDES

... MERCEDES

A CLASS (169 SERIES) A150 1.5i, A160 1.5i, 2.0CDi, A170 1.7i, A180 1.7i, 2.0CDi, A200 2.0i, 2.0CDi (09/04-06/12)



Part No	Description	Pos	Info	Technical
TA1983	Tie rod end(224)	A		M14x1.5 Female(253) £
TA1984	Tie rod end(224)	B		M14x1.5 Female(253) £
TA2056	Inner tie rod(123)	A B	→Ch. J126738	M14x1.5 Male(252) £
TA2123	Inner tie rod(123)	A B	Ch. J126739→	M14x1.5 Male(252) £
TC1429	Link stabiliser(135)	A B		M10x1.5
TC1430	Lower ball joint(140)	A B		M14x1.5
TC1465	Lower wishbone(158)	A		M14x1.5
TC1466	Lower wishbone(158)	B		M14x1.5
TC1766	Link stabiliser(135)	A B	Plastic(184)	M10x1.5
TD704W	Lower wishbone bush(159)	A B	Front(108)	
TD705W	Lower wishbone bush(159)	A B	Rear(187) Pack of(179) 2	

A CLASS (176 SERIES) A160 1.5CDi, 1.6i, A180 1.5CDi, 1.6i, 1.8CDi, A200 1.6i, 1.8CDi, 2.2CDi, 2.2CDi 4-Matic, A220 2.0i 4-Matic, 2.2CDi, 2.2CDi 4-Matic, A250 2.0i, 2.0i 4-Matic (06/12→)



Part No	Description	Pos	Info	Technical
TA2858	Inner tie rod(123)	A B		M14x1.5 Male(252) £
TA2884	Tie rod end(224)	A		M14x1.5 Female(253) £
TA2885	Tie rod end(224)	B		M14x1.5 Female(253) £
TBR4254	Steering rack gaiter kit(213)	K	Thermoplastic(223)	1 :15x58x58 2 :15x58x58
TC3423	Upper camber arm(233)	A B		

A CLASS (176 SERIES) A45 2.0i AMG (06/12→)



Part No	Description	Pos	Info	Technical
TA2858	Inner tie rod(123)	A B		M14x1.5 Male(252) £
TA2884	Tie rod end(224)	A		M14x1.5 Female(253) £
TA2885	Tie rod end(224)	B		M14x1.5 Female(253) £
TBR4254	Steering rack gaiter kit(213)	K	Thermoplastic(223)	1 :15x58x58 2 :15x58x58
TD1658W	Sub-frame bush(215)	K	(+) A45 AMG Rear(187) Centre(-89-)	
TD1658W	Sub-frame bush(215)	A B	Front(108) Inner(119)	

B CLASS (245 SERIES) B150 1.5i, B160 1.5i, B170 1.7i, B170NGT 2.0i, B180 1.7i, B180NGT 2.0i, B180 2.0CDi, B200 2.0i, 2.0CDi (03/05-11/11)



TC1465

TD705W

TD705W

TC1466



TC1766

TC1766

Part No	Description	Pos	Info	Technical
TA1983	Tie rod end(224)	A		M14x1.5 Female(253) £
TA1984	Tie rod end(224)	B		M14x1.5 Female(253) £
TA2123	Inner tie rod(123)	A B		M14x1.5 Male(252) £
TC1429	Link stabiliser(135)	A B	→Ch. J210986 →20/01/2007	M10x1.5
TC1430	Lower ball joint(140)	A B		M14x1.5
TC1465	Lower wishbone(158)	A		M14x1.5
TC1466	Lower wishbone(158)	B		M14x1.5
TC1766	Link stabiliser(135)	A B	Plastic(184)	M10x1.5
TC3654	Link stabiliser(135)	A B	Ch. J210987→ 20/01/2007→	M10x1.5
TD704W	Lower wishbone bush(159)	A B	Front(108)	
TD705W	Lower wishbone bush(159)	A B	Rear(187) Pack of(179) 2	

... MERCEDES

B CLASS (246 SERIES) B160 1.5CDi, B180 1.5CDi, 1.6i, 1.8CDi, B200 1.6i, 1.8CDi, B220 2.0i 4-Matic, 2.2CDi, B250 2.0i (11/11→)



Part No	Description	Pos	Info	Technical
TA2858	Inner tie rod(123)	A B		M14x1.5 Male(252) £
TA2884	Tie rod end(224)	A		M14x1.5 Female(253) £
TA2885	Tie rod end(224)	B		M14x1.5 Female(253) £
TBR4254	Steering rack gaiter kit(213)	K	Thermoplastic(223)	1 :15x58x58 2 :15x58x58
TC3423	Upper camber arm(233)	A B		

C CLASS (203 SERIES) C180 1.8i, 2.0i, C200 1.8i, 2.0i, 2.2CDi, C220 2.2CDi, C230 1.8i, 2.3i, C240 2.6i (-) 4-Matic, C270 2.7CDi, C280 3.0i (-) 4-Matic, C320 3.2i (-) 4-Matic, C350 3.5i (-) 4-Matic (05/00-08/07)



TD1082W



TD1073W



TD767W



TD767W



TC1279



TD758W



TD758W



TC1280



TC1281



TD759W



TD759W



TC1282

... C CLASS (203 SERIES) C180 1.8i, 2.0i, C200 1.8i, 2.0i, 2.2CDi, C220 2.2CDi, C230 1.8i, 2.3i, C240 2.6i (-) 4-Matic, C270 2.7CDi, C280 3.0i (-) 4-Matic, C320 3.2i (-) 4-Matic, C350 3.5i (-) 4-Matic (05/00-08/07)

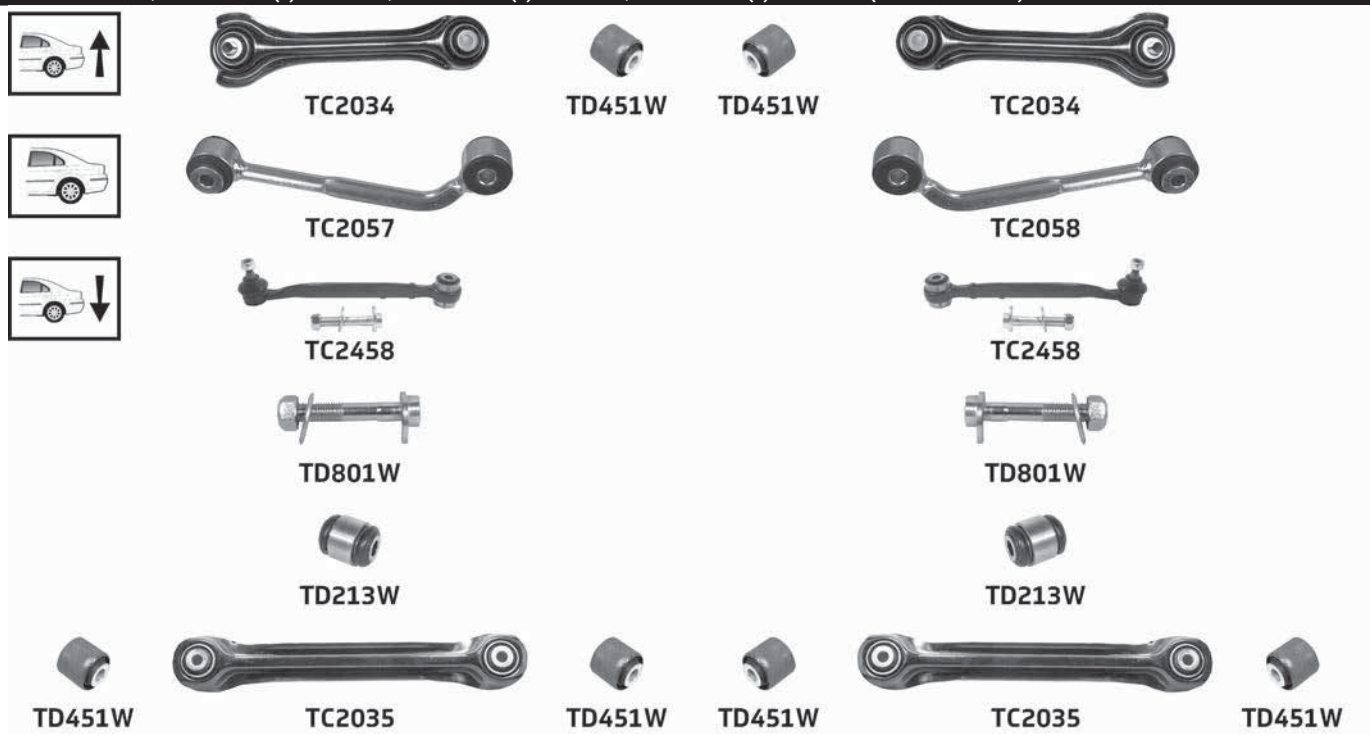

Part No	Description	Pos	Info	Technical
TA2030	Tie rod end(224)	A		M14x1.5 Female(253) £
TA2031	Tie rod end(224)	B		M14x1.5 Female(253) £
TA2032	Inner tie rod(123)	A B		M14x1.5 Male(252) £
TC1279	Lower track control arm(151)	A	Front(108)	M14x1.5
TC1280	Lower track control arm(151)	B	Front(108)	M14x1.5
TC1281	Lower track control arm(151)	A	Rear(187)	M14x1.5
TC1282	Lower track control arm(151)	B	Rear(187)	M14x1.5
TC2034	Upper torque rod(241)	A B		
TC2035	Lower torque rod(149)	A B		
TC2055	Link stabiliser(135)	A B	(-) Sport suspension(-27-)	M10x1.5
TC2057	Link stabiliser(135)	A		
TC2058	Link stabiliser(135)	B		
TC2132	Link stabiliser(135)	A B	Sport suspension(204)	M12x1.5
TC2458	Lower rod assembly(146)	A B		M10x1.5
TD213W	Lower hub carrier bush(143)	A B		
TD451W	Bush(-85-)	A B	Outer(176) Inner(119)	
TD758W	Lower track control arm bush(153)	A B	Front(108)	
TD759W	Lower track control arm bush(153)	A B	Rear(187)	
TD767W	Lower track control arm bolt(152)	A B		
TD801W	Lower rod assembly bolt(147)	A B		
TD1073W	Anti-roll bar(-74-) bush kit(-86-)	K	Ø21 Complete axle kit(-92)	
TD1082W	Anti-roll bar(-74-) bush kit(-86-)	K	Ø20 Complete axle kit(-92)	

MERCEDES

... MERCEDES

C CLASS (203 SERIES) C240 2.6i, C280 3.0i, C320 3.2i, C350 3.5i 4-Matic (07/02-08/07)

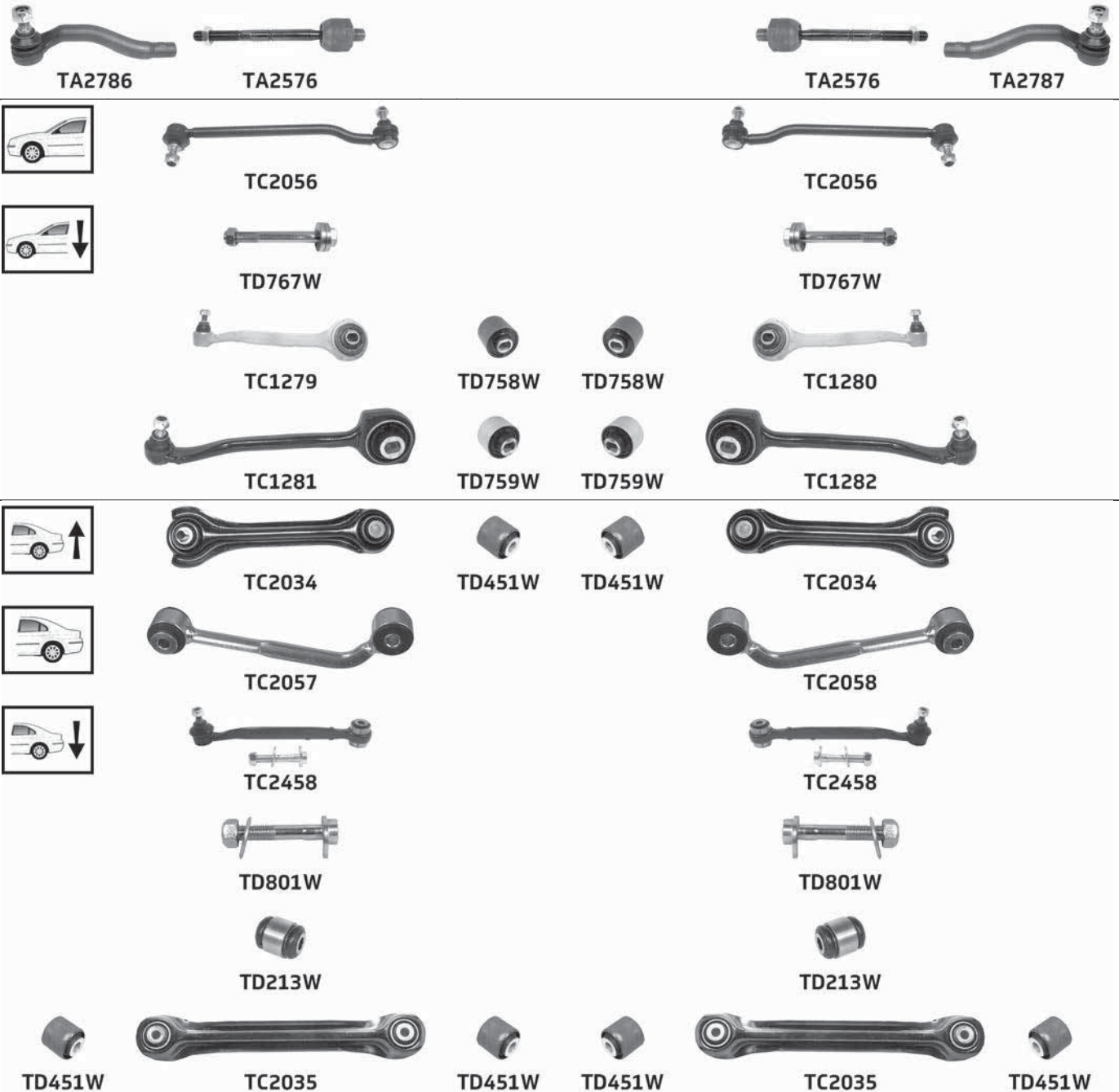

Part No	Description	Pos	Info	Technical
TA2576	Inner tie rod(123)	A B		M14x1.5 Male(252) £
TA2786	Tie rod end(224)	A		M14x1.5 Female(253) £
TA2787	Tie rod end(224)	B		M14x1.5 Female(253) £
TC1279	Lower track control arm(151)	A	Front(108)	M14x1.5
TC1280	Lower track control arm(151)	B	Front(108)	M14x1.5
TC1281	Lower track control arm(151)	A	Rear(187)	M14x1.5
TC1282	Lower track control arm(151)	B	Rear(187)	M14x1.5
TC2034	Upper torque rod(241)	A B		
TC2035	Lower torque rod(149)	A B		
TC2056	Link stabiliser(135)	A B		M10x1.5
TC2057	Link stabiliser(135)	A		
TC2058	Link stabiliser(135)	B		
TC2458	Lower rod assembly(146)	A B		M10x1.5
TD213W	Lower hub carrier bush(143)	A B		
TD451W	Bush(-85-)	A B	Outer(176) Inner(119)	
TD758W	Lower track control arm bush(153)	A B	Front(108)	
TD759W	Lower track control arm bush(153)	A B	Rear(187)	
TD767W	Lower track control arm bolt(152)	A B		
TD801W	Lower rod assembly bolt(147)	A B		

MERCEDES

C CLASS (204 SERIES) C180 1.6i, 1.8i, 1.8CGi, 2.2CDi, C200 1.8i, 1.8CGi, 2.2CDi, C220 2.2CDi, C230 2.5i (-) 4-Matic, C250CGi 1.8CGi, C250 2.2CDi (-) 4-Matic, C280 3.0i (-) 4-Matic, C300 3.0i (-) 4-Matic, C320 3.0CDi (-) 4-Matic, C350 3.0CDi (-) 4-Matic, 3.5i (-) (01/07→)

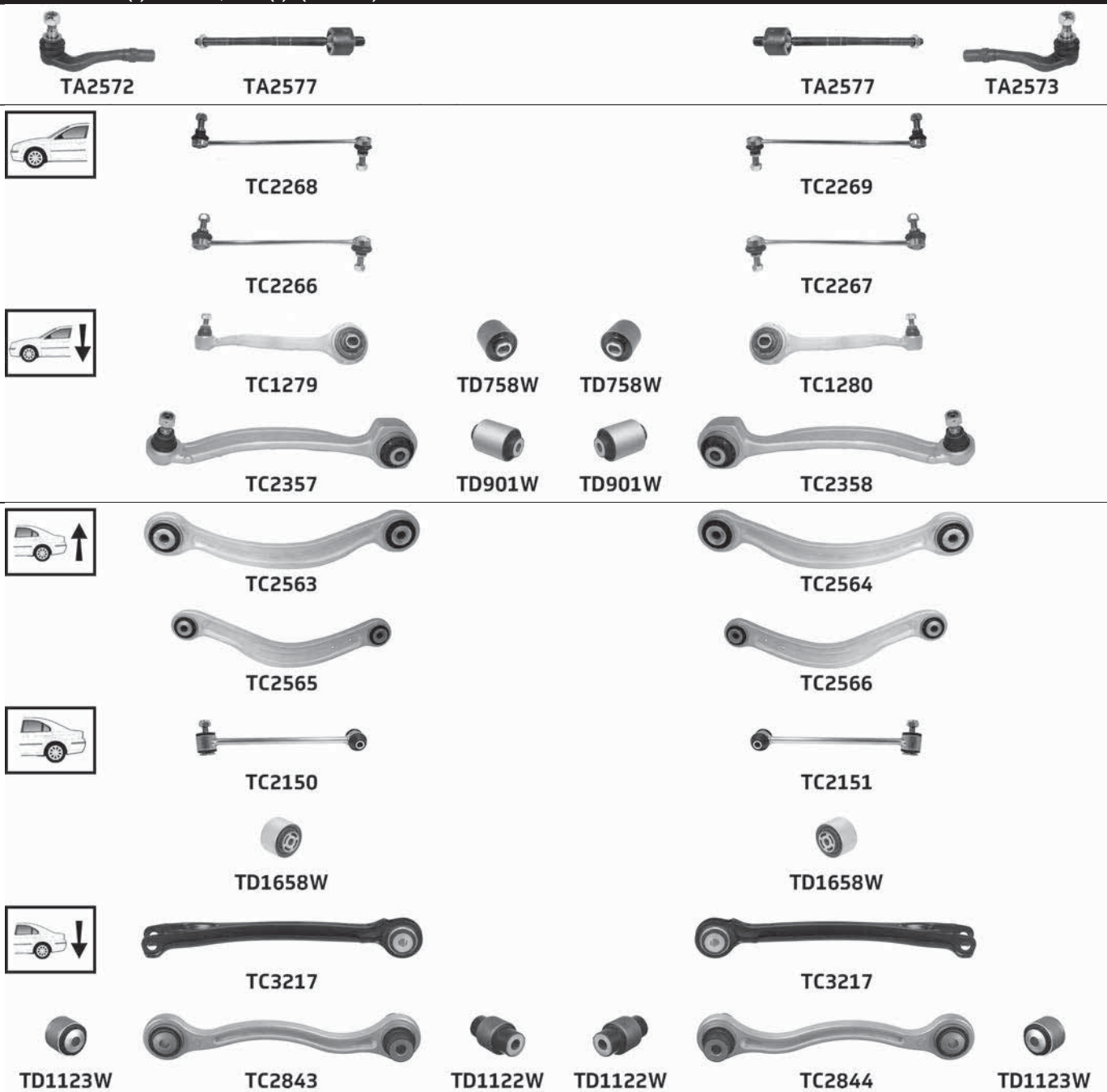

Part No	Description	Pos	Info	Technical
TA2572	Tie rod end(224)	A		M14x1.5 Female(253) £
TA2573	Tie rod end(224)	B		M14x1.5 Female(253) £
TA2577	Inner tie rod(123)	A B		M14x1.5 Male(252) £
TC1279	Lower track control arm(151)	A	Front(108)	M14x1.5
TC1280	Lower track control arm(151)	B	Front(108)	M14x1.5
TC2150	Link stabiliser(135)	A		M10x1.5
TC2151	Link stabiliser(135)	B		M10x1.5
TC2266	Link stabiliser(135)	A	Sport suspension(204)	M12x1.5
TC2267	Link stabiliser(135)	B	Sport suspension(204)	M12x1.5
TC2268	Link stabiliser(135)	A	(-) Sport suspension(-27)	M12x1.5
TC2269	Link stabiliser(135)	B	(-) Sport suspension(-27)	M12x1.5
TC2357	Lower track control arm(151)	A	Rear(187)	M14x1.5
TC2358	Lower track control arm(151)	B	Rear(187)	M14x1.5
TC2563	Upper link arm(239)	A	Front(108)	
TC2564	Upper link arm(239)	B	Front(108)	
TC2565	Upper link arm(239)	A	Rear(187)	
				(...)













MERCEDES

... MERCEDES

... C CLASS (204 SERIES) C180 1.6i, 1.8i, 1.8CGi, 2.2CDi, C200 1.8i, 1.8CGi, 2.2CDi, C220 2.2CDi, C230 2.5i (-) 4-Matic, C250CGi 1.8CGi, C250 2.2CDi (-) 4-Matic, C280 3.0i (-) 4-Matic, C300 3.0i (-) 4-Matic, C320 3.0CDi (-) 4-Matic, C350 3.0CDi (-) 4-Matic, 3.5i (-) (01/07→)











Part No	Description	Pos	Info	Technical
TC2566	Upper link arm(239)	B	Rear(187)	
TC2843	Lower link arm(144)	A	Rear(187)	
TC2844	Lower link arm(144)	B	Rear(187)	
TC3217	Lower link arm(144)	A B	Front(108)	
TD758W	Lower track control arm bush(153)	A B	Front(108)	
TD901W	Lower track control arm bush(153)	A B	Rear(187)	
TD1122W	Lower link arm bush(145)	A B	Rear(187) Inner(119)	
TD1123W	Lower link arm bush(145)	A B	Rear(187) Outer(176)	
TD1658W	Sub-frame bush(215)	A B	Rear(187) Inner(119)	

C CLASS (204 SERIES) C63 6.2i AMG (02/08→)

			
TA2572	TA3248	TA3248	TA2573
			
TC2266	TC2267		
			
TD732W	TD732W		
			
TC2150	TC2151		
			
TD1658W	TD1658W		

Part No	Description	Pos	Info	Technical
TA2572	Tie rod end(224)	A		M14x1.5 Female(253) £
TA2573	Tie rod end(224)	B		M14x1.5 Female(253) £
TA3248	Inner tie rod(123)	A B		M14x1.5 Male(252) £
TC2150	Link stabiliser(135)	A		M10x1.5
TC2151	Link stabiliser(135)	B		M10x1.5
TC2266	Link stabiliser(135)	A		M12x1.5
TC2267	Link stabiliser(135)	B		M12x1.5
TD732W	Lower track control arm bush(153)	A B	Front(108)	
TD1658W	Sub-frame bush(215)	A B	Rear(187) Inner(119)	

C CLASS (204 SERIES) C220 2.2CDi, C230 2.5i, C250 2.2CDi, C280 3.0i, C300 3.0i, 3.0CDi, 3.5i, C320 3.0CDi, C350 3.0CDi, 3.5i 4-Matic (01/07→)

			
TA3047	TA3047		
			
TC3384	TC3385		
			
TC3472	TD758W	TD758W	TC3473
			
TC3394	TC3395		

... C CLASS (204 SERIES) C220 2.2CDi, C230 2.5i, C250 2.2CDi, C280 3.0i, C300 3.0i, 3.0CDI, 3.5i, C320 3.0CDI, C350 3.0CDI, 3.5i 4-Matic (01/07→)

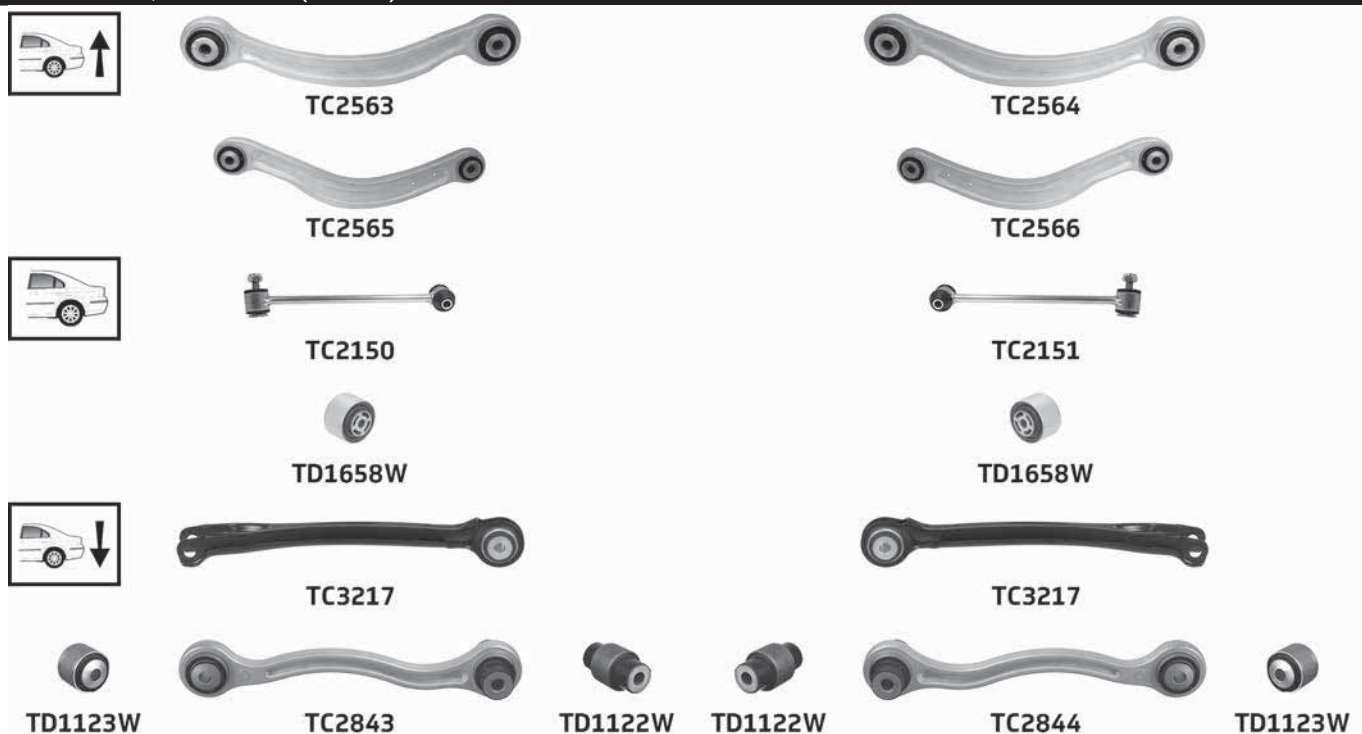

Part No	Description	Pos	Info	Technical
TA3047	Inner tie rod(123)	A B	(-) Electric(103) Power steering(185)	M14x1.5 Male(252) £
TC2150	Link stabiliser(135)	A		M10x1.5
TC2151	Link stabiliser(135)	B		M10x1.5
TC2563	Upper link arm(239)	A	Front(108)	
TC2564	Upper link arm(239)	B	Front(108)	
TC2565	Upper link arm(239)	A	Rear(187)	
TC2566	Upper link arm(239)	B	Rear(187)	
TC2843	Lower link arm(144)	A	Rear(187)	
TC2844	Lower link arm(144)	B	Rear(187)	
TC3217	Lower link arm(144)	A B	Front(108)	
TC3384	Link stabiliser(135)	A		M12x1.5
TC3385	Link stabiliser(135)	B		M12x1.5
TC3394	Lower track control arm(151)	A	Rear(187)	M14x1.5
TC3395	Lower track control arm(151)	B	Rear(187)	M14x1.5
TC3472	Lower track control arm(151)	A	Front(108)	M14x1.5
TC3473	Lower track control arm(151)	B	Front(108)	M14x1.5
TD758W	Lower track control arm bush(153)	A B	Front(108)	
TD1122W	Lower link arm bush(145)	A B	Rear(187) Inner(119)	
TD1123W	Lower link arm bush(145)	A B	Rear(187) Outer(176)	
TD1658W	Sub-frame bush(215)	A B	Rear(187) Inner(119)	

C CLASS (205 SERIES) C160 1.6i, C180 1.6i, 1.6CDi, C200 1.6CDi, 2.0i, C220 2.2CDi, C250CGI 2.0CGi, C250 2.2CDi, C300 2.0i, 2.2CDi, C300h 2.2CDi, C350e 2.0i (02/14→)



Part No	Description	Pos	Info	Technical
TC2563	Upper link arm(239)	A	Front(108)	
TC2564	Upper link arm(239)	B	Front(108)	
TC2843	Lower link arm(144)	A	Rear(187)	

(...)

... MERCEDES

... C CLASS (205 SERIES) C160 1.6i, C180 1.6i, 1.6CDi, C200 1.6CDi, 2.0i, C220 2.2CDi, C250CGI 2.0CGi, C250 2.2CDi, C300 2.0i, 2.2CDi, C300h 2.2CDi, C350e 2.0i (02/14→)

Part No	Description	Pos	Info	Technical
TC2844	Lower link arm(144)	B	Rear(187)	
TC3217	Lower link arm(144)	A B	Front(108)	
TD1122W	Lower link arm bush(145)	A B	Rear(187) Inner(119)	
TD1123W	Lower link arm bush(145)	A B	Rear(187) Outer(176)	

C CLASS (205 SERIES) C200 2.0i, C220 2.2CDi, C250 2.2CDi, C300 2.0i 4-Matic (02/14→)



Part No	Description	Pos	Info	Technical
TC2843	Lower link arm(144)	A	Rear(187)	
TC2844	Lower link arm(144)	B	Rear(187)	
TC3217	Lower link arm(144)	A B	Front(108)	
TD1122W	Lower link arm bush(145)	A B	Rear(187) Inner(119)	
TD1123W	Lower link arm bush(145)	A B	Rear(187) Outer(176)	

CITAN (415 SERIES) 1.5CDI 108, 109, 111 (11/12→)

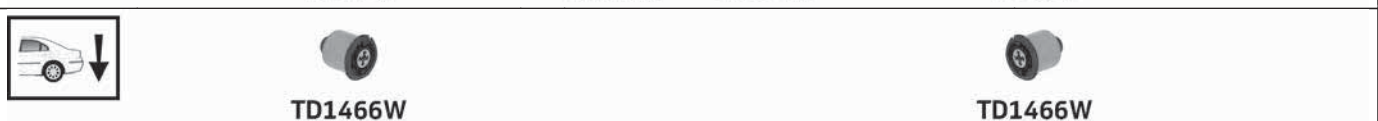

Part No	Description	Pos	Info	Technical
TA2500	Tie rod end(224)	A		M14x1.5 Female(253) £
TA2501	Tie rod end(224)	B		M14x1.5 Female(253) £
TA2502	Inner tie rod(123)	A B		M14x1.5 Male(252) £
TC1362	Link stabiliser(135)	A B		M10x1.5
TC1998	Lower ball joint(140)	A		Pinch Bolt(255) 20mm
TC1999	Lower ball joint(140)	B		Pinch Bolt(255) 20mm
TC2326	Lower wishbone(158)	A		Pinch Bolt(255) 20mm
TC2327	Lower wishbone(158)	B		Pinch Bolt(255) 20mm
TD533W	Lower wishbone bush(159)	A B	Front(108)	
TD534W	Lower wishbone bush(159)	A B	Rear(187)	
TD1466W	Axle Bush(-76-)	A B		

CL CLASS (215 SERIES) CL500 5.0i, CL600 5.5i, 5.8i, CL55 5.4i AMG, CL63 6.3i AMG, CL65 6.0i AMG (03/99-03/06)



MERCEDES

... CL CLASS (215 SERIES) CL500 5.0i, CL600 5.5i, 5.8i, CL55 5.4i AMG, CL63 6.3i AMG, CL65 6.0i AMG (03/99-03/06)



TC1492



TC1493



TD767W



TD767W



TC1382



TC1382



TC1494



TD1618W



TD1618W



TC1495



TC1751



TC1751



TC1752



TC1752

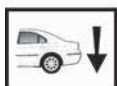

TC1753



TC1753



TC1754



TC1754



TD967W



TD967W



TD1151W



TD1151W

Part No	Description	Pos	Info	Technical
TA1961	Tie rod end(224)	A B		M14x1.5 Female(253) £
TA2032	Inner tie rod(123)	A B		M14x1.5 Male(252) £
TC1382	Lower ball joint(140)	A B	Outer(176)	M14x1.5
TC1492	Upper wishbone(247)	A		M10x1.5
TC1493	Upper wishbone(247)	B		M10x1.5
TC1494	Lower track control arm(151)	A	Front(108)	M14x1.5
TC1495	Lower track control arm(151)	B	Front(108)	M14x1.5
TC1751	Upper track control arm(242)	A B		
TC1752	Upper camber arm(233)	A B		
TC1753	Lower track control arm(151)	A B		
TC1754	Lower rod assembly(146)	A B		M10x1.5
TD767W	Lower track control arm bolt(152)	A B		
TD967W	Control arm bush(-97-)	A B		
TD1151W	Lower hub carrier bush(143)	A B		
TD1618W	Lower track control arm bush(153)	A B		

MERCEDES

... MERCEDES

CL CLASS (216 SERIES) CL500 4.7i (-) 4-Matic, 5.5i (-) 4-Matic, CL600 5.5i, CL63 5.5i AMG, 6.2i AMG, CL65 6.0i AMG (05/06→)

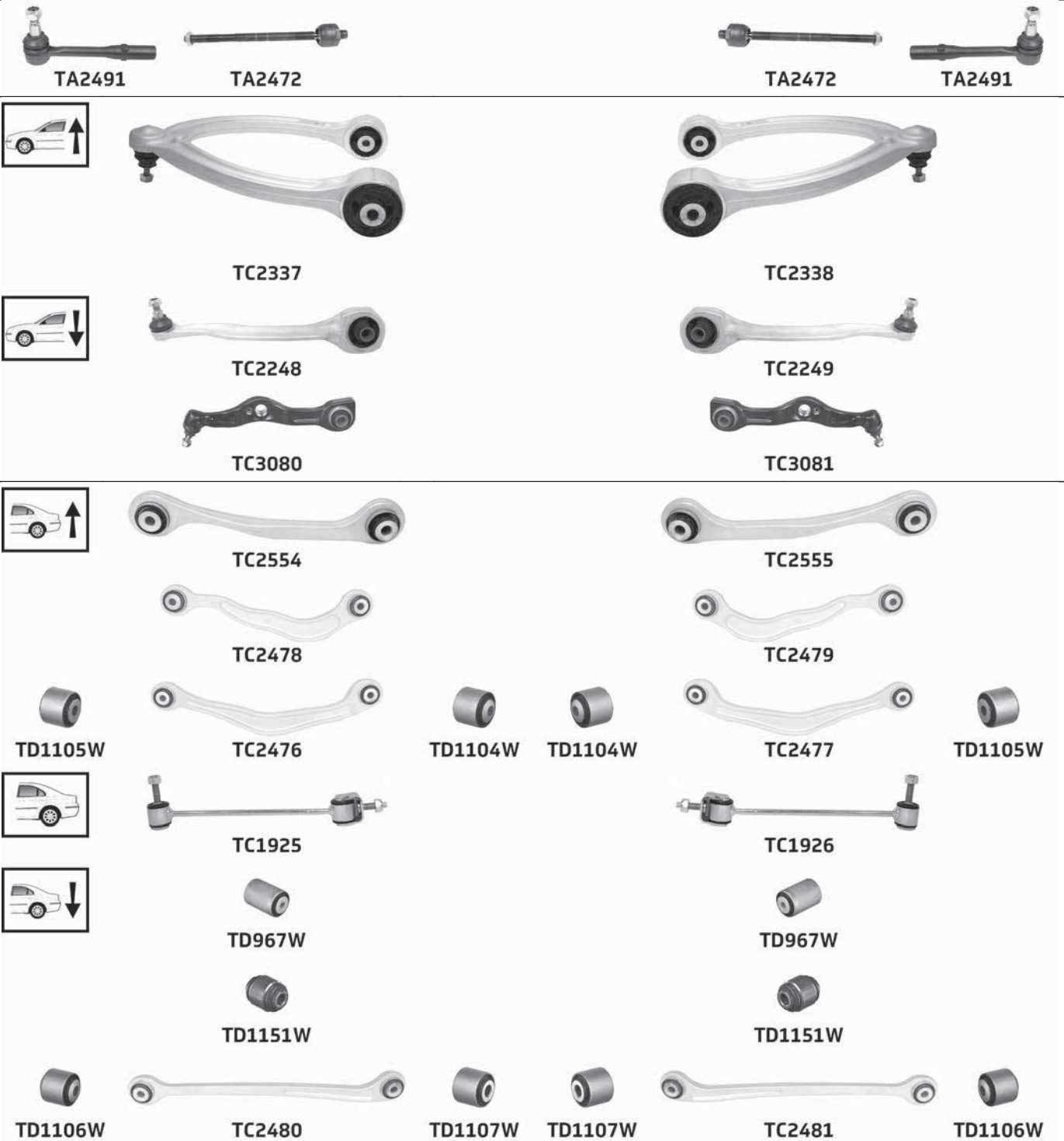

Part No	Description	Pos	Info	Technical
TA2472	Inner tie rod(123)	A B		M14x1.5 Male(252) E
TA2491	Tie rod end(224)	A B		M14x1.5 Female(253) E
TC1925	Link stabiliser(135)	A	(+) Airmatic dual control(-36-)	M10x1.5
TC1926	Link stabiliser(135)	B	(+) Airmatic dual control(-36-)	M10x1.5
TC2248	Lower track control arm(151)	A	Front(108)	M14x1.5
TC2249	Lower track control arm(151)	B	Front(108)	M14x1.5
TC2337	Upper wishbone(247)	A		M10x1.5
TC2338	Upper wishbone(247)	B		M10x1.5
TC2476	Upper link arm(239)	A		
TC2477	Upper link arm(239)	B		
TC2478	Upper camber arm(233)	A		
TC2479	Upper camber arm(233)	B		
TC2480	Lower track control arm(151)	A		
TC2481	Lower track control arm(151)	B		

... CL CLASS (216 SERIES) CL500 4.7i (-) 4-Matic, 5.5i (-) 4-Matic, CL600 5.5i, CL63 5.5i AMG, 6.2i AMG, CL65 6.0i AMG (05/06→)

Part No	Description	Pos	Info	Technical
TC2554	Upper track control arm(242)	A	Front(108)	
TC2555	Upper track control arm(242)	B	Front(108)	
TC3080	Lower track control arm(151)	A	Rear(187)	M14x1.5
TC3081	Lower track control arm(151)	B	Rear(187)	M14x1.5
TD967W	Control arm bush(-97)	A B		
TD1104W	Bush(-85)	A B	Inner(119)	
TD1105W	Bush(-85)	A B	Outer(176)	
TD1106W	Bush(-85)	A B	Outer(176)	
TD1107W	Bush(-85)	A B	Inner(119)	
TD1151W	Lower hub carrier bush(143)	A B	(-) CL500	

CL CLASS (216 SERIES) CL500 4.7i 4-Matic, 5.5i 4-Matic (05/06→)

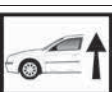

TC2337



TC2338

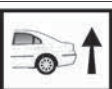

TC2554



TC2555



TC2478



TC2479



TD1105W



TC2476



TD1104W



TD1104W



TC2477



TD1105W



TC1925



TC1926



TD967W



TD967W



TD1106W



TC2480



TD1107W



TD1107W



TC2481



TD1106W

Part No	Description	Pos	Info	Technical
TA3047	Inner tie rod(123)	A B		M14x1.5 Male(252) £
TA3226	Tie rod end(224)	A		M14x1.5 Female(253) £
TA3227	Tie rod end(224)	B		M14x1.5 Female(253) £
TC1925	Link stabiliser(135)	A	(+) Airmatic dual control(-36)	M10x1.5
TC1926	Link stabiliser(135)	B	(+) Airmatic dual control(-36)	M10x1.5
TC2337	Upper wishbone(247)	A		M10x1.5
TC2338	Upper wishbone(247)	B		M10x1.5
TC2476	Upper link arm(239)	A		
TC2477	Upper link arm(239)	B		
TC2478	Upper camber arm(233)	A		
TC2479	Upper camber arm(233)	B		
TC2480	Lower track control arm(151)	A		

(...)

... MERCEDES

... CL CLASS (216 SERIES) CL500 4.7i 4-Matic, 5.5i 4-Matic (05/06→)

Part No	Description	Pos	Info	Technical
TC2481	Lower track control arm(151)	B		
TC2554	Upper track control arm(242)	A	Front(108)	
TC2555	Upper track control arm(242)	B	Front(108)	
TD967W	Control arm bush(-97-)	A B		
TD1104W	Bush(-85-)	A B	Inner(119)	
TD1105W	Bush(-85-)	A B	Outer(176)	
TD1106W	Bush(-85-)	A B	Outer(176)	
TD1107W	Bush(-85-)	A B	Inner(119)	

CLA CLASS (117 SERIES) CLA180 1.5CDi, 1.6i, CLA200 1.6i, 1.8CDi, 2.2CDi, 2.2CDi 4-Matic, CLA220 2.2CDi, 2.2CDi 4-Matic, CLA250 2.0i, 2.0i 4-Matic (01/13→)

CLA CLASS (117 SERIES) CLA45 2.0i AMG (01/13→)



Part No	Description	Pos	Info	Technical
TA2858	Inner tie rod(123)	A B		M14x1.5 Male(252) £
TA2884	Tie rod end(224)	A		M14x1.5 Female(253) £
TA2885	Tie rod end(224)	B		M14x1.5 Female(253) £
TBR4254	Steering rack gaiter kit(213)	K	Thermoplastic(223)	1 :15x58x58 2 :15x58x58
TC3423	Upper camber arm(233)	A B		

CLA CLASS (117 SERIES) CLA45 2.0i AMG (01/13→)



Part No	Description	Pos	Info	Technical
TA2858	Inner tie rod(123)	A B		M14x1.5 Male(252) £
TA2884	Tie rod end(224)	A		M14x1.5 Female(253) £
TA2885	Tie rod end(224)	B		M14x1.5 Female(253) £
TBR4254	Steering rack gaiter kit(213)	K	Thermoplastic(223)	1 :15x58x58 2 :15x58x58
TD1658W	Sub-frame bush(215)	K	(+ CLA45 AMG Rear(187) Centre (-89-)	
TD1658W	Sub-frame bush(215)	A B	Front(108) Inner(119)	

CLC CLASS (203 SERIES) CLC160 1.6i, CLC180 1.8i, CLC200 1.8i, 2.2CDi, CLC220 2.2CDi, CLC230 2.5i, CLC350 3.5i (06/08→)



MERCEDES

... CLC CLASS (203 SERIES) CLC160 1.6i, CLC180 1.8i, CLC200 1.8i, 2.2CDi, CLC220 2.2CDi, CLC230 2.5i, CLC350 3.5i (06/08→)

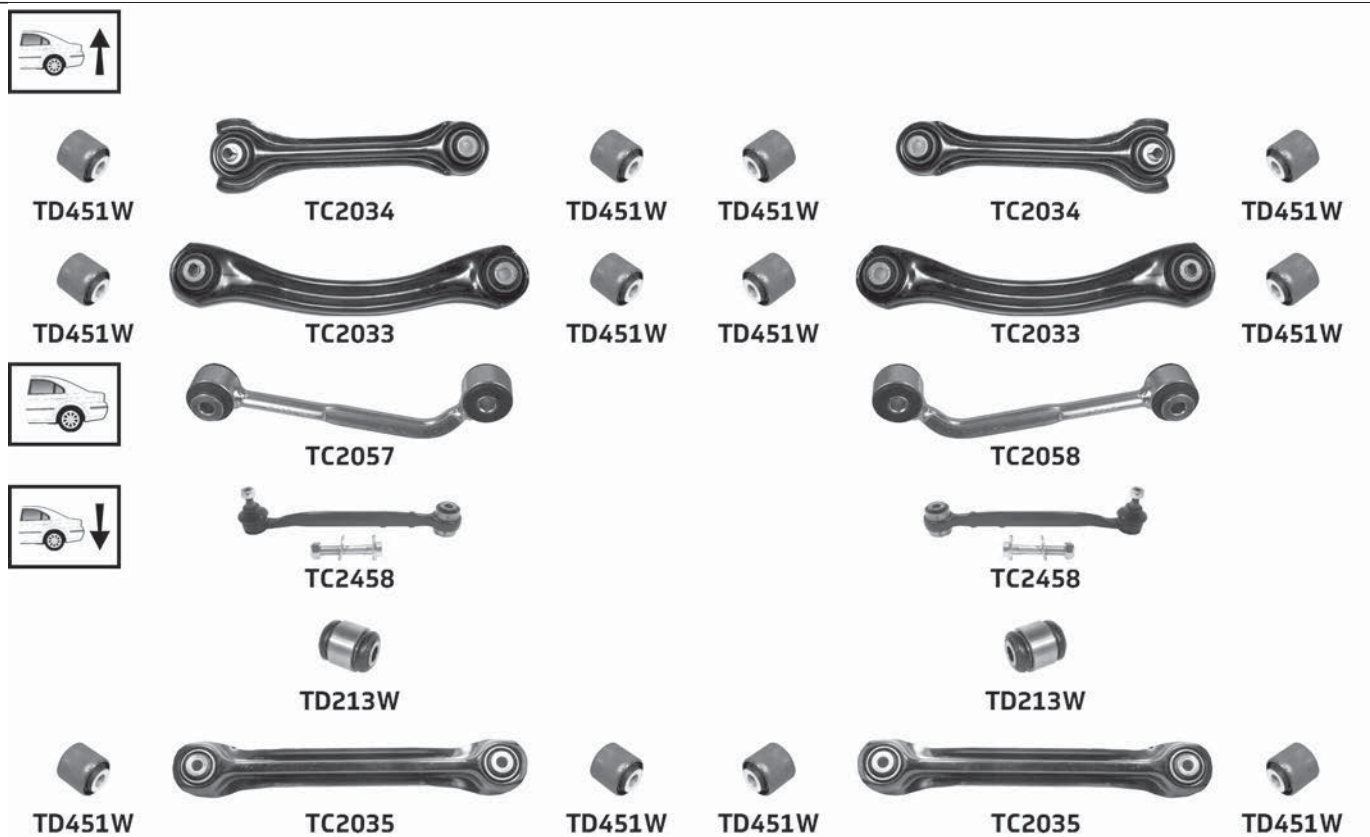
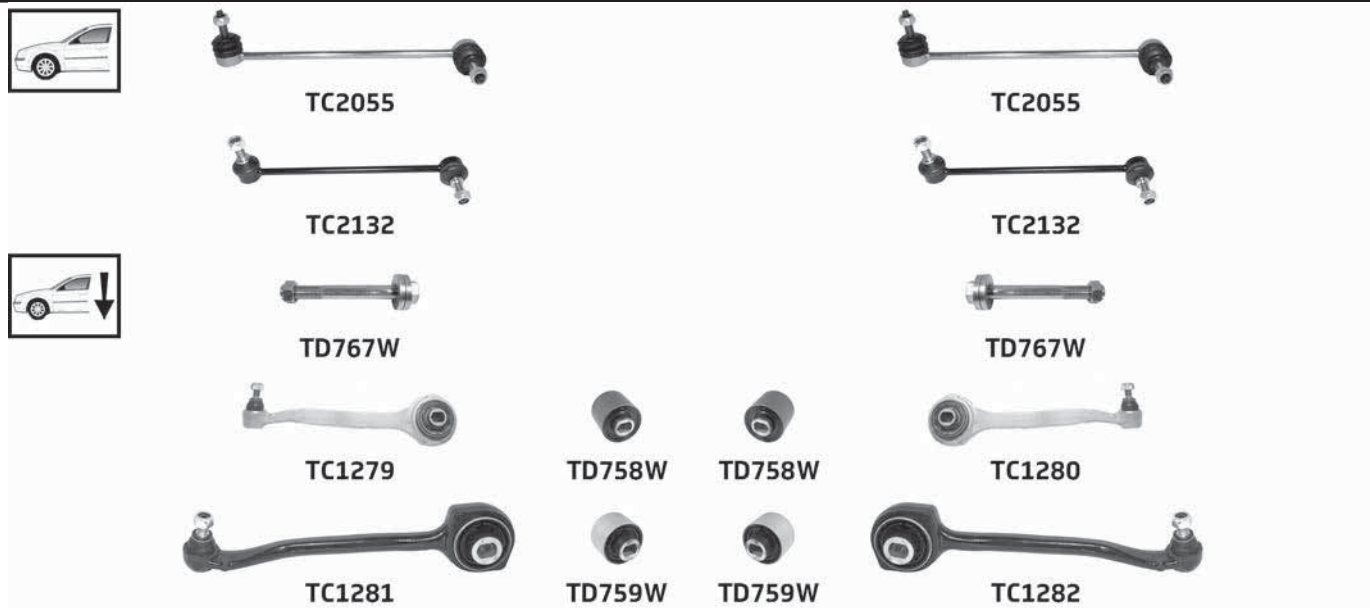

Part No	Description	Pos	Info	Technical
TA2030	Tie rod end(224)	A		M14x1.5 Female(253) £
TA2031	Tie rod end(224)	B		M14x1.5 Female(253) £
TA2032	Inner tie rod(123)	A B		M14x1.5 Male(252) £
TC1279	Lower track control arm(151)	A	Front(108)	M14x1.5
TC1280	Lower track control arm(151)	B	Front(108)	M14x1.5
TC1281	Lower track control arm(151)	A	Rear(187)	M14x1.5
TC1282	Lower track control arm(151)	B	Rear(187)	M14x1.5
TC2033	Upper track rod(244)	A B	Rear(187)	
TC2034	Upper torque rod(241)	A B	Front(108)	
TC2035	Lower torque rod(149)	A B	Front(108)	
TC2055	Link stabiliser(135)	A B	(-) Sport suspension(27-)	M10x1.5
TC2057	Link stabiliser(135)	A		
TC2058	Link stabiliser(135)	B		
TC2132	Link stabiliser(135)	A B	Sport suspension(204)	M12x1.5

MERCEDES

... MERCEDES

... CLC CLASS (203 SERIES) CLC160 1.6i, CLC180 1.8i, CLC200 1.8i, 2.2CDi, CLC220 2.2CDi, CLC230 2.5i, CLC350 3.5i (06/08-)

Part No	Description	Pos	Info	Technical
TC2458	Lower rod assembly(146)	A B	Rear(187)	M10x1.5
TD213W	Lower hub carrier bush(143)	A B		
TD451W	Bush(-85-)	A B	Outer(176) Inner(119)	
TD758W	Lower track control arm bush(153)	A B	Front(108)	
TD759W	Lower track control arm bush(153)	A B	Rear(187)	
TD767W	Lower track control arm bolt(152)	A B		

CLK CLASS (208 SERIES) CLK200 2.0i, CLK230 2.3i (06/97-06/02)



TA1643



TL502



TA1643







TC2043



TD772W



TD772W



TC2044



TD772W



TD772W







TC835



TC835







TC2034



TD451W



TD451W



TC2034



TD451W



TC2033



TD451W



TD451W



TC2033





TD451W





TC1600KIT







TC2031



TC2031



TD801W



TD801W



TD599W



TD599W



TD213W



TD213W



TD451W



TC2035



TD451W



TD451W



TC2035



TD451W



TC389



TD450W



TD450W



TC389

Part No	Description	Pos	Info	Technical
TA1643	Tie rod end(224)	A B		M12x1.5 Male(252) E

... CLK CLASS (208 SERIES) CLK200 2.0i, CLK230 2.3i (06/97-06/02)

Part No	Description	Pos	Info	Technical
TC389	Lower rod assembly(146)	A B		M10x1.25
TC835	Lower ball joint(140)	A B		M14x1.5
TC1600KIT	Suspension kit(220)	K		
TC2031	Link stabiliser(135)	A B	Plastic(184)	M10x1.5
TC2033	Upper track rod(244)	A B		
TC2034	Upper torque rod(241)	A B		
TC2035	Lower torque rod(149)	A B		
TC2043	Upper wishbone(247)	A		M10x1.5
TC2044	Upper wishbone(247)	B		M10x1.5
TD213W	Lower hub carrier bush(143)	A B		
TD450W	Bush(-85-)	A B		
TD451W	Bush(-85-)	A B	Outer(176) Inner(119)	
TD599W	Cross member bush(-99-)	A B	Front(108)	
TD772W	Upper wishbone bush(248)	A B	Front(108) Rear(187)	
TD801W	Lower rod assembly bolt(147)	A B		
TL502	Centre rod assembly(-90-)	K		M12x1.5

CLK CLASS (208 SERIES) CLK320 3.2i, CLK430 4.3i (06/97-06/02)



... MERCEDES

... CLK CLASS (208 SERIES) CLK320 3.2i, CLK430 4.3i (06/97-06/02)



TC2034



TD451W



TD451W



TC2034



TD451W



TC2033



TD451W



TD451W



TC2033



TD451W



TC1600KIT



TC2031



TC2031



TD801W



TD801W



TD599W



TD599W



TD213W



TD213W



TD451W



TC2035



TD451W



TD451W



TC2035



TD451W



TC389



TD450W



TD450W



TC389

Part No	Description	Pos	Info	Technical
TA1643	Tie rod end(224)	A B		M12x1.5 Male(252) E
TC389	Lower rod assembly(146)	A B		M10x1.25
TC835	Lower ball joint(140)	A B		M14x1.5
TC1600KIT	Suspension kit(220)	K		
TC2031	Link stabiliser(135)	A B	Plastic(184)	M10x1.5
TC2033	Upper track rod(244)	A B		
TC2034	Upper torque rod(241)	A B		
TC2035	Lower torque rod(149)	A B		
TC2043	Upper wishbone(247)	A		M10x1.5
TC2044	Upper wishbone(247)	B		M10x1.5
TD213W	Lower hub carrier bush(143)	A B		
TD450W	Bush(-85-)	A B		
TD451W	Bush(-85-)	A B	Outer(176) Inner(119)	
TD599W	Cross member bush(-99-)	A B	Front(108)	
TD772W	Upper wishbone bush(248)	A B	Front(108) Rear(187)	
TD801W	Lower rod assembly bolt(147)	A B		
TL511	Centre rod assembly(-90-)	K		M12x1.5

CLK CLASS (209 SERIES) CLK220 2.2CDi, CLK280 3.0i, CLK320 3.0CDi, CLK350 3.5i (06/02-03/10)

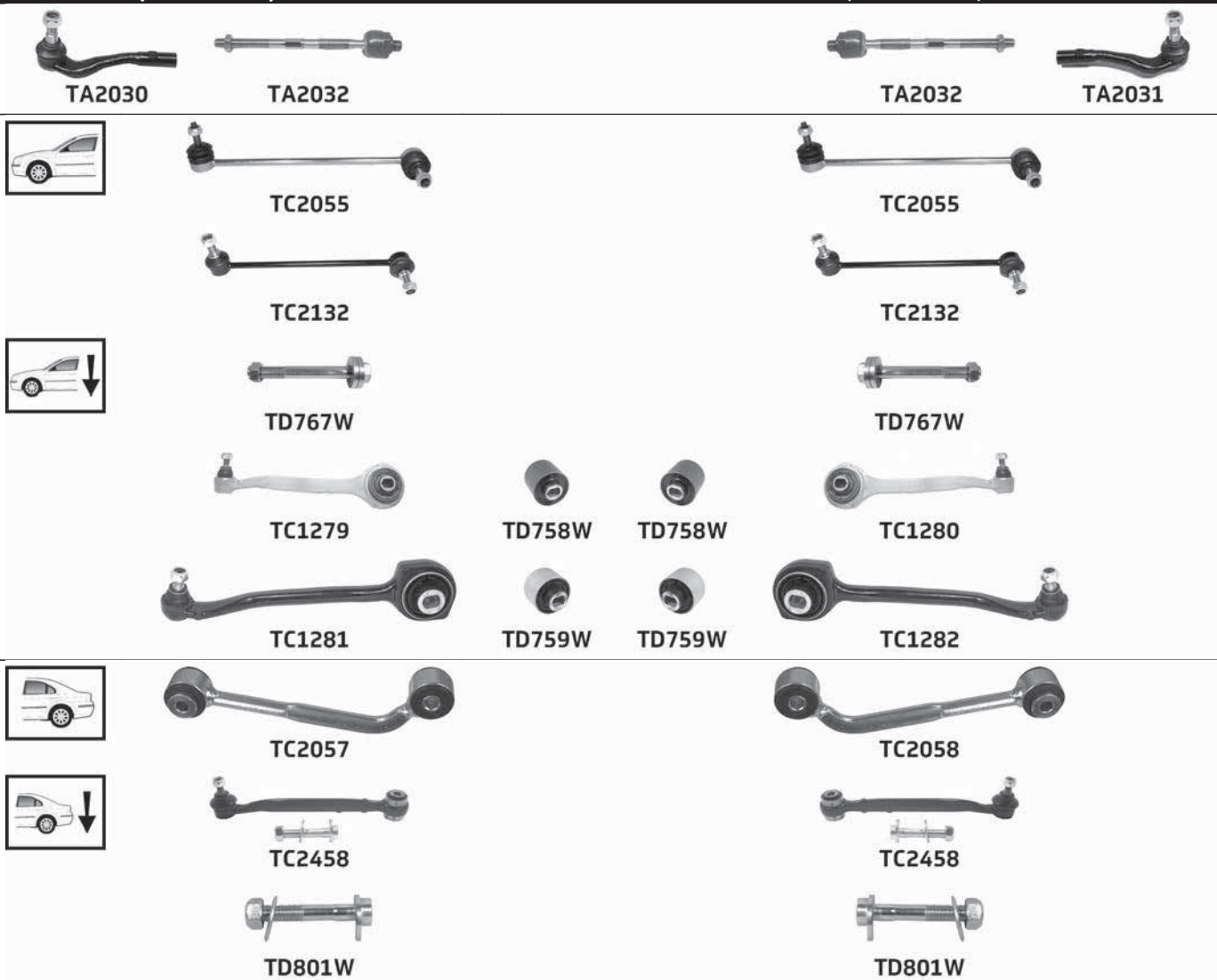

Part No	Description	Pos	Info	Technical
TA2030	Tie rod end(224)	A		M14x1.5 Female(253) £
TA2031	Tie rod end(224)	B		M14x1.5 Female(253) £
TA2032	Inner tie rod(123)	A B		M14x1.5 Male(252) £
TC1279	Lower track control arm(151)	A	Front(108)	M14x1.5
TC1280	Lower track control arm(151)	B	Front(108)	M14x1.5
TC1281	Lower track control arm(151)	A	Rear(187)	M14x1.5
TC1282	Lower track control arm(151)	B	Rear(187)	M14x1.5
TC2055	Link stabiliser(135)	A B	(-) Sport suspension(-27)	M10x1.5
TC2057	Link stabiliser(135)	A		
TC2058	Link stabiliser(135)	B		
TC2132	Link stabiliser(135)	A B	Sport suspension(204)	M12x1.5
TC2458	Lower rod assembly(146)	A B		M10x1.5
TD758W	Lower track control arm bush(153)	A B	Front(108)	
TD759W	Lower track control arm bush(153)	A B	Rear(187)	
TD767W	Lower track control arm bolt(152)	A B		
TD801W	Lower rod assembly bolt(147)	A B		

MERCEDES

... MERCEDES

CLK CLASS (209 SERIES) CLK200 1.8i, 1.8CGi, CLK240 2.6i, CLK270 2.7CDi, CLK320 3.2i, CLK500 5.0i (06/02-03/10)

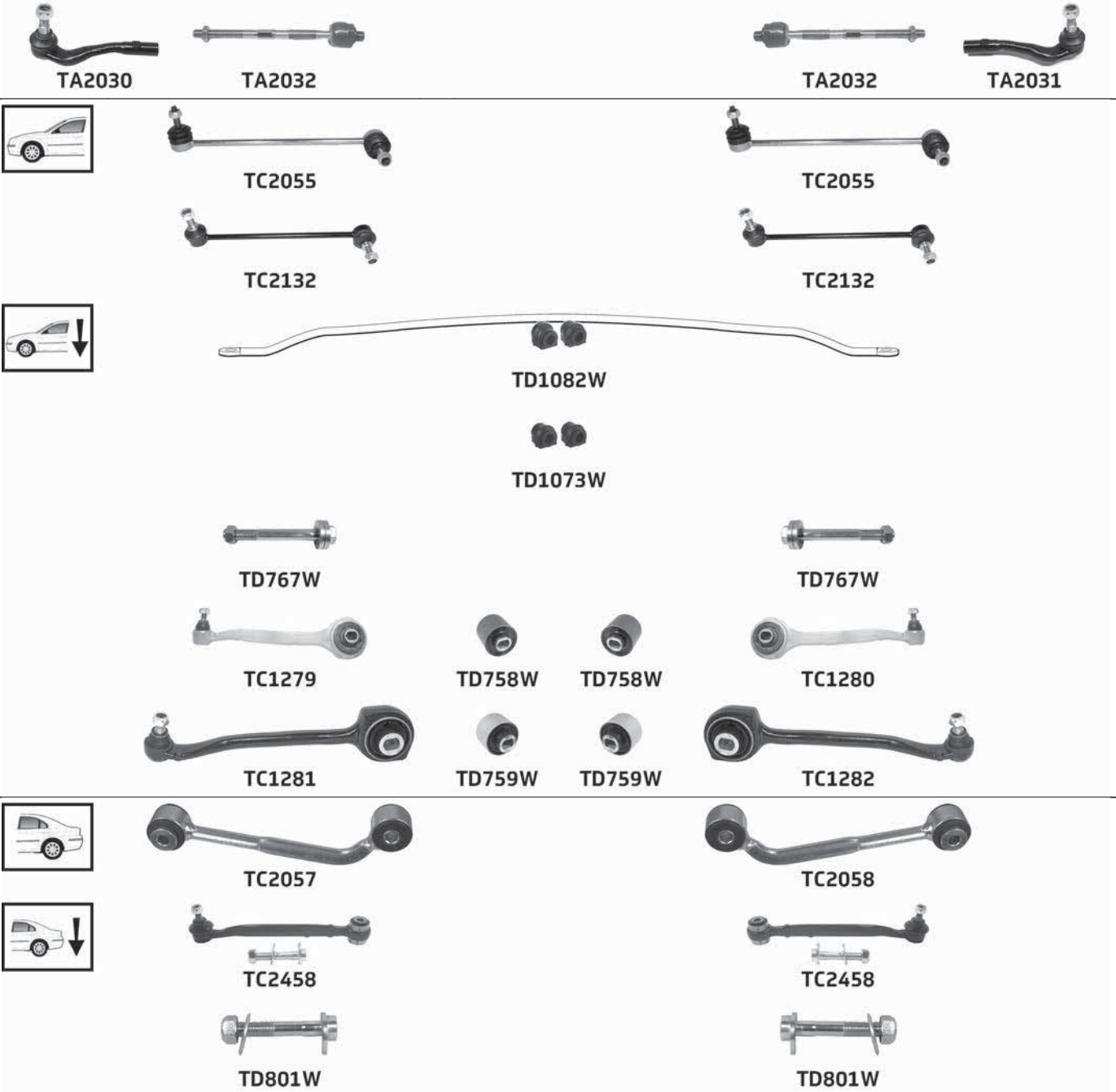

Part No	Description	Pos	Info	Technical
TA2030	Tie rod end(224)	A		M14x1.5 Female(253) £
TA2031	Tie rod end(224)	B		M14x1.5 Female(253) £
TA2032	Inner tie rod(123)	A B		M14x1.5 Male(252) £
TC1279	Lower track control arm(151)	A	Front(108)	M14x1.5
TC1280	Lower track control arm(151)	B	Front(108)	M14x1.5
TC1281	Lower track control arm(151)	A	Rear(187)	M14x1.5
TC1282	Lower track control arm(151)	B	Rear(187)	M14x1.5
TC2055	Link stabiliser(135)	A B	(-) Sport suspension(-27)	M10x1.5
TC2057	Link stabiliser(135)	A		
TC2058	Link stabiliser(135)	B		
TC2132	Link stabiliser(135)	A B	Sport suspension(204)	M12x1.5
TC2458	Lower rod assembly(146)	A B		M10x1.5
TD758W	Lower track control arm bush(153)	A B	Front(108)	
TD759W	Lower track control arm bush(153)	A B	Rear(187)	
TD767W	Lower track control arm bolt(152)	A B		
TD801W	Lower rod assembly bolt(147)	A B		
TD1073W	Anti-roll bar(-74) bush kit(-86-)	K	Ø21 Complete axle kit(-92-) →F 070725 →T 000994	
TD1082W	Anti-roll bar(-74) bush kit(-86-)	K	Ø20 Complete axle kit(-92-) →F 085672	

CLS CLASS (218 SERIES) CLS250 2.2CDI, CLS350 3.0CDI, 3.5i, 3.5CDI (-) 4-Matic, CLS500 4.7i (-) 4-Matic (01/11→)

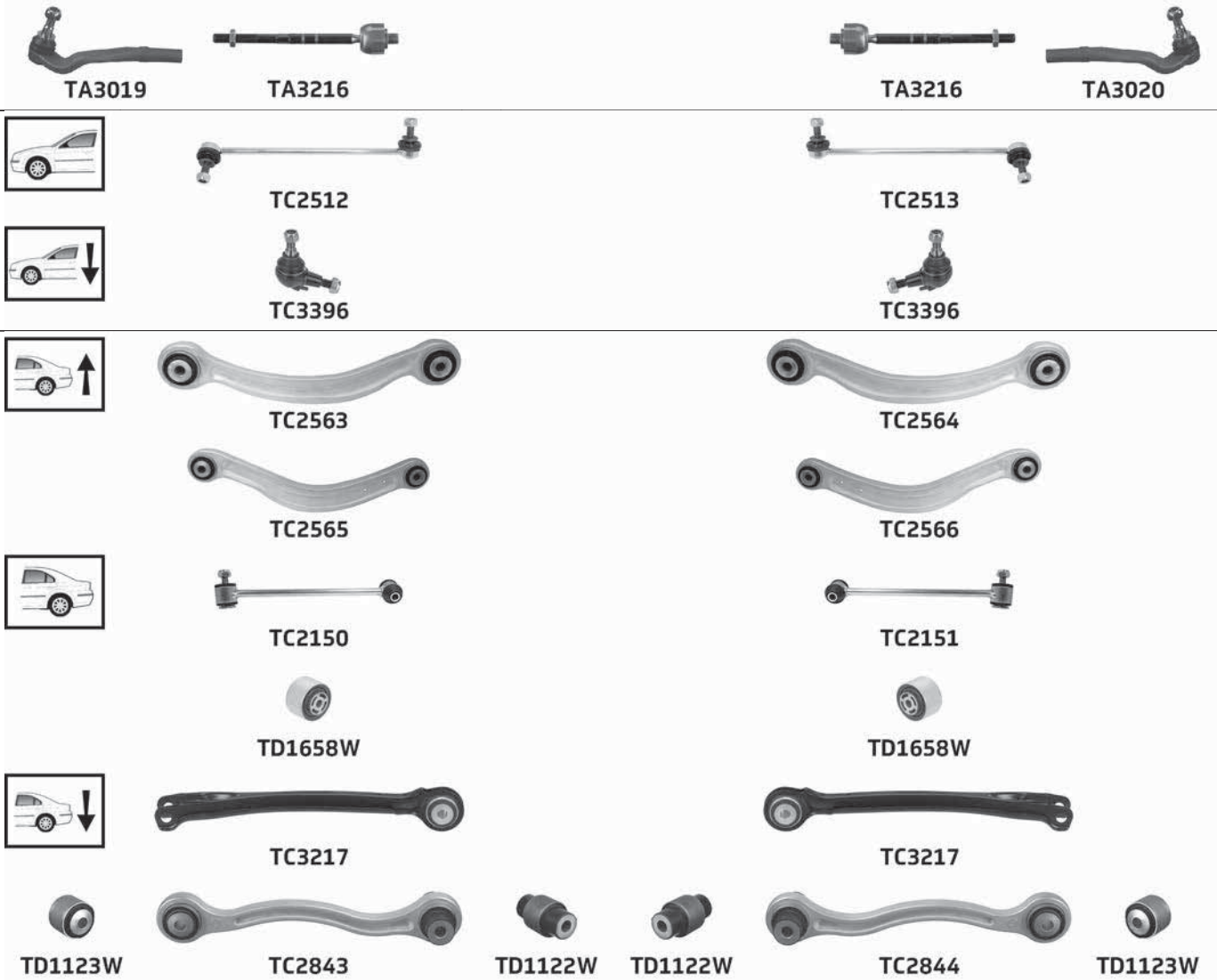

Part No	Description	Pos	Info	Technical
TA3019	Tie rod end (224)	A		M14x1.5 Female (253) £
TA3020	Tie rod end (224)	B		M14x1.5 Female (253) £
TA3216	Inner tie rod (123)	A B		
TC2150	Link stabiliser (135)	A		M10x1.5
TC2151	Link stabiliser (135)	B		M10x1.5
TC2512	Link stabiliser (135)	A		M12x1.5
TC2513	Link stabiliser (135)	B		M12x1.5
TC2563	Upper link arm (239)	A	Front (108)	
TC2564	Upper link arm (239)	B	Front (108)	
TC2565	Upper link arm (239)	A	Rear (187)	
TC2566	Upper link arm (239)	B	Rear (187)	
TC2843	Lower link arm (144)	A	Rear (187)	
TC2844	Lower link arm (144)	B	Rear (187)	
TC3217	Lower link arm (144)	A B	Front (108)	
TC3396	Lower ball joint (140)	A B		M14x1.5
TD1122W	Lower link arm bush (145)	A B	Rear (187) Inner (119)	
TD1123W	Lower link arm bush (145)	A B	Rear (187) Outer (176)	
TD1658W	Sub-frame bush (215)	A B	Rear (187) Inner (119)	

CLS CLASS (218 SERIES) CLS63 5.5i AMG (01/11→)



... MERCEDES

... CLS CLASS (218 SERIES) CLS63 5.5i AMG (01/11→)



Part No	Description	Pos	Info	Technical
TA3216	Inner tie rod(123)	A B		
TC2150	Link stabiliser (135)	A		M10x1.5
TC2151	Link stabiliser (135)	B		M10x1.5
TC2512	Link stabiliser (135)	A		M12x1.5
TC2513	Link stabiliser (135)	B		M12x1.5
TC2563	Upper link arm(239)	A	Front(108)	
TC2564	Upper link arm(239)	B	Front(108)	
TC2565	Upper link arm(239)	A	Rear(187)	
TC2566	Upper link arm(239)	B	Rear(187)	
TD1658W	Sub-frame bush(215)	A B	Rear(187) Inner(119)	

CLS CLASS (218 SERIES) CLS350 3.5CDI, CLS500 4.7i 4-Matic (01/11→)

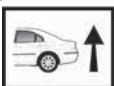

Part No	Description	Pos	Info	Technical
TA3216	Inner tie rod(123)	A B		
TC2150	Link stabiliser (135)	A		M10x1.5
				(...)

MERCEDES

... CLS CLASS (218 SERIES) CLS350 3.5CDI, CLS500 4.7i 4-Matic (01/11→)

Part No	Description	Pos	Info	Technical
TC2151	Link stabiliser(135)	B		M10x1.5
TC2563	Upper link arm(239)	A	Front(108)	
TC2564	Upper link arm(239)	B	Front(108)	
TC2565	Upper link arm(239)	A	Rear(187)	
TC2566	Upper link arm(239)	B	Rear(187)	
TC2651	Link stabiliser(135)	A		M12x1.5
TC2652	Link stabiliser(135)	B		M12x1.5
TC2843	Lower link arm(144)	A	Rear(187)	
TC2844	Lower link arm(144)	B	Rear(187)	
TC3217	Lower link arm(144)	A B	Front(108)	
TD1122W	Lower link arm bush(145)	A B	Rear(187) Inner(119)	
TD1123W	Lower link arm bush(145)	A B	Rear(187) Outer(176)	
TD1658W	Sub-frame bush(215)	A B	Rear(187) Inner(119)	

CLS CLASS (219 SERIES) CLS320 3.0CDi, CLS350 3.5i, CLS500 5.0i (10/04-12/10)



TA1959



TA2032



TA2032



TA1960







TC1995



TC1490



TD740W





TD740W



TC1491









TC2097



TC2098









TC1382



TC1382









TC2254



TC2254









TD767W



TD767W









TC1385



TD765W





TD765W



TC1386









TD741W



TC1383



TD732W



TD732W



TC1384



TD741W

... MERCEDES

... CLS CLASS (219 SERIES) CLS320 3.0CDi, CLS350 3.5i, CLS500 5.0i (10/04-12/10)



TC1947



TC1948



TC1949



TC1950



TC1387



TC1387



TC2226



TC2226



TC2293



TC2294



TD1011W



TD967W



TD967W

Part No	Description	Pos	Info	Technical
TA1959	Tie rod end(224)	A		M14x1.5 Female(253) £
TA1960	Tie rod end(224)	B		M14x1.5 Female(253) £
TA2032	Inner tie rod(123)	A B		M14x1.5 Male(252) £
TC1382	Lower ball joint(140)	A B	Outer(176)	M14x1.5
TC1383	Lower track control arm(151)	A	Rear(187) (-) Ball joint(-11-)	
TC1384	Lower track control arm(151)	B	Rear(187) (-) Ball joint(-11-)	
TC1385	Lower track control arm(151)	A	Front(108)	M14x1.5
TC1386	Lower track control arm(151)	B	Front(108)	M14x1.5
TC1387	Link stabiliser(135)	A B		M10x1.5
TC1490	Upper wishbone(247)	A		M10x1.5
TC1491	Upper wishbone(247)	B		M10x1.5
TC1947	Upper link arm(239)	A	Front(108)	
TC1948	Upper link arm(239)	B	Front(108)	
TC1949	Upper link arm(239)	A	Rear(187)	
TC1950	Upper link arm(239)	B	Rear(187)	
TC1995	Upper ball joint(232)	A B		M10x1.5
TC2097	Link stabiliser(135)	A		
TC2098	Link stabiliser(135)	B		
TC2226	Lower link arm(144)	A B	Front(108)	
TC2254	Lower ball joint(140)	A B	Inner(119)	M14x1.5
TC2293	Lower link arm(144)	A	Rear(187)	
TC2294	Lower link arm(144)	B	Rear(187)	
TD732W	Lower track control arm bush(153)	A B	Rear(187) Inner(119)	
TD740W	Upper wishbone bush(248)	A B	Front(108) Rear(187)	
TD741W	Lower track control arm bush(153)	A B	Rear(187) Outer(176)	
TD765W	Lower track control arm bush(153)	A B	Front(108)	
TD767W	Lower track control arm bolt(152)	A B		
TD967W	Control arm bush(-97-)	A B		
TD1011W	Sub-frame bush(215)	K	Rear(187)	

CLS CLASS (219 SERIES) CLS55 5.4i AMG, CLS63 6.2i AMG (01/05-12/10)



TA1959



TA2032



TA2032



TA1960

... CLS CLASS (219 SERIES) CLS55 5.4i AMG, CLS63 6.2i AMG (01/05-12/10)

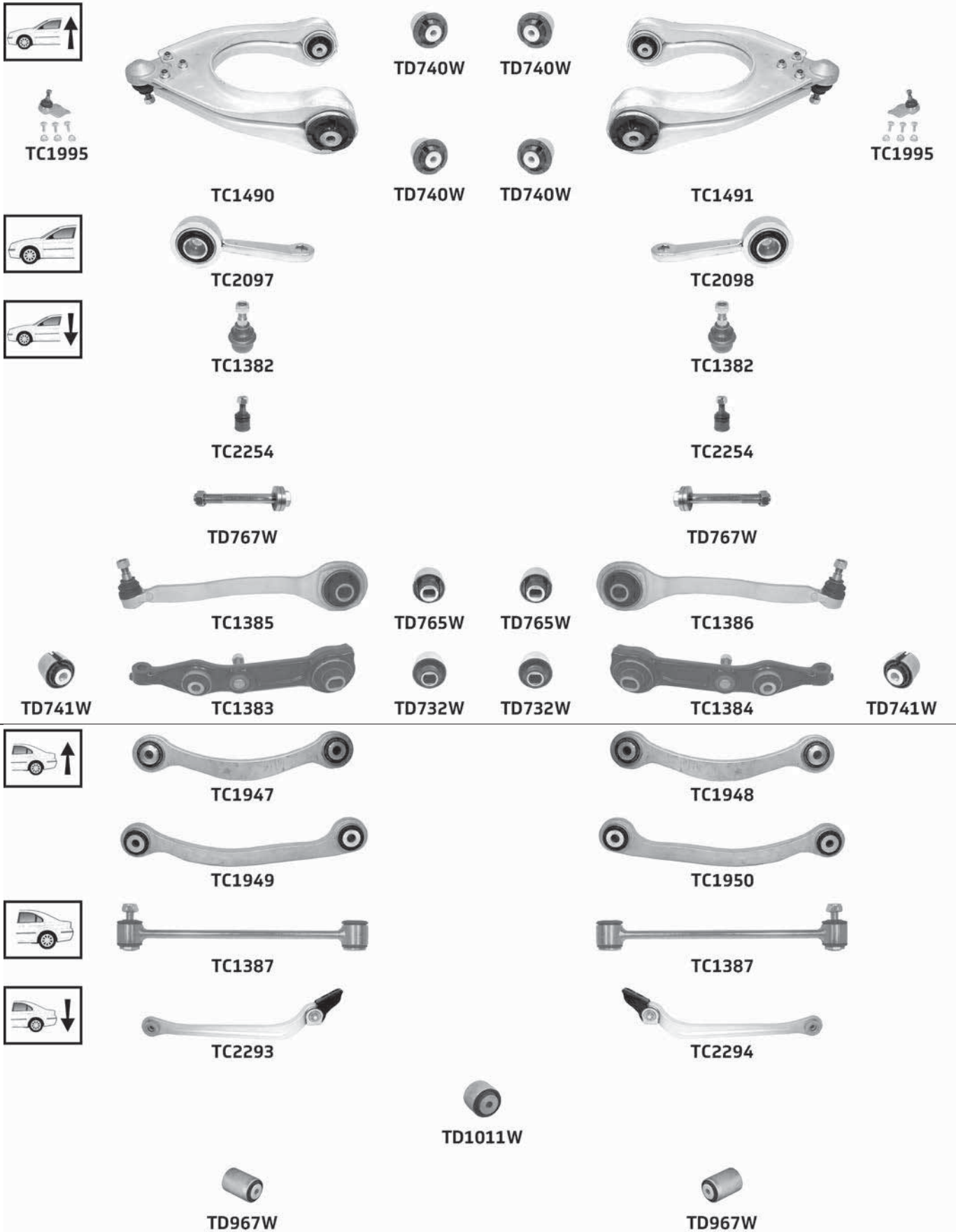

Part No	Description	Pos	Info	Technical
TA1959	Tie rod end(224)	A		M14x1.5 Female(253) £
TA1960	Tie rod end(224)	B		M14x1.5 Female(253) £
TA2032	Inner tie rod(123)	A B		M14x1.5 Male(252) £
TC1382	Lower ball joint(140)	A B	Outer(176)	M14x1.5
				(...)

... MERCEDES

... CLS CLASS (219 SERIES) CLS55 5.4i AMG, CLS63 6.2i AMG (01/05-12/10)

Part No	Description	Pos	Info	Technical
TC1383	Lower track control arm(151)	A	Rear(187) (-) Ball joint(-11-)	
TC1384	Lower track control arm(151)	B	Rear(187) (-) Ball joint(-11-)	
TC1385	Lower track control arm(151)	A	Front(108)	M14x1.5
TC1386	Lower track control arm(151)	B	Front(108)	M14x1.5
TC1387	Link stabiliser(135)	A B		M10x1.5
TC1490	Upper wishbone(247)	A		M10x1.5
TC1491	Upper wishbone(247)	B		M10x1.5
TC1947	Upper link arm(239)	A	Front(108)	
TC1948	Upper link arm(239)	B	Front(108)	
TC1949	Upper link arm(239)	A	Rear(187)	
TC1950	Upper link arm(239)	B	Rear(187)	
TC1995	Upper ball joint(232)	A B		M10x1.5
TC2097	Link stabiliser(135)	A		
TC2098	Link stabiliser(135)	B		
TC2254	Lower ball joint(140)	A B	Inner(119)	M14x1.5
TC2293	Lower link arm(144)	A	Rear(187)	
TC2294	Lower link arm(144)	B	Rear(187)	
TD732W	Lower track control arm bush(153)	A B	Rear(187) Inner(119)	
TD740W	Upper wishbone bush(248)	A B	Front(108) Rear(187)	
TD741W	Lower track control arm bush(153)	A B	Rear(187) Outer(176)	
TD765W	Lower track control arm bush(153)	A B	Front(108)	
TD767W	Lower track control arm bolt(152)	A B		
TD967W	Control arm bush(-97-)	A B		
TD1011W	Sub-frame bush(215)	K	Rear(187)	

E CLASS (207 SERIES) E200 1.8CGI, 2.0i, E220 2.2CDI, E250 1.8CGI, 2.0i, 2.2CDI, E300 3.5i, E350 2.2CDI, 3.0CDI, 3.5i, 3.5CGI, E400 3.0i, E500 4.7i, 5.4i, E550 4.7CGI (01/09→)

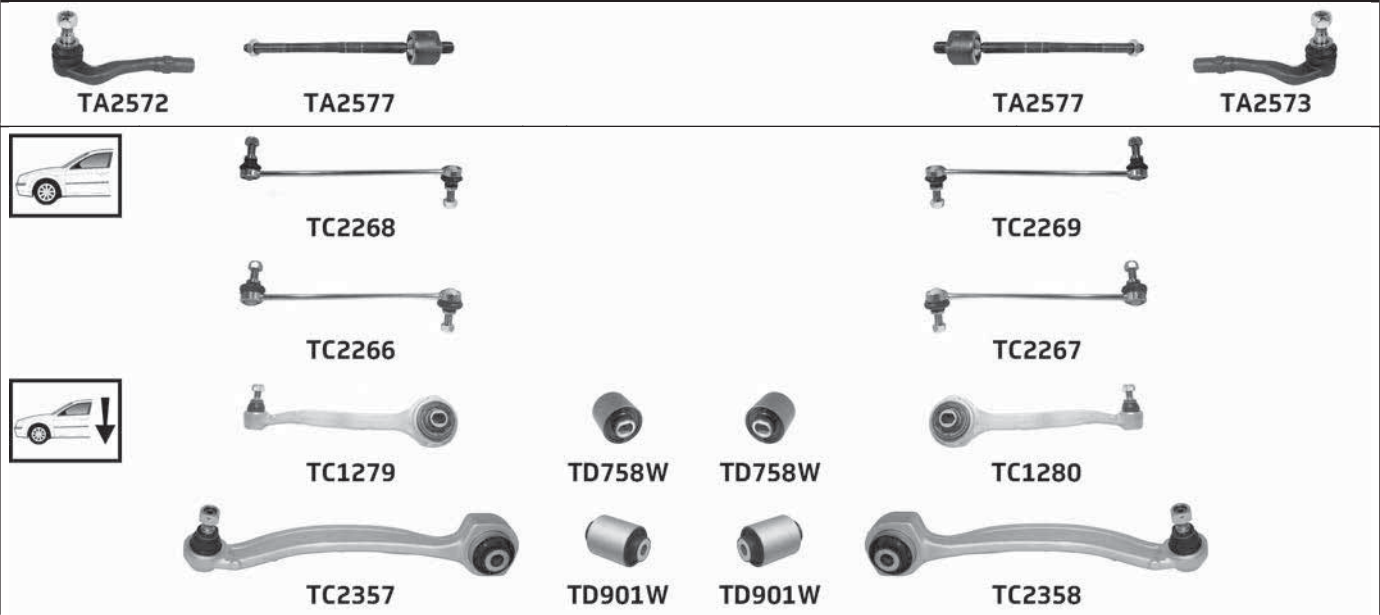

... E CLASS (207 SERIES) E200 1.8CGI, 2.0i, E220 2.2CDI, E250 1.8CGI, 2.0i, 2.2CDI, E300 3.5i, E350 2.2CDI, 3.0CDI, 3.5i, 3.5CGI, E400 3.0i, E500 4.7i, 5.4i, E550 4.7CGI (01/09→)

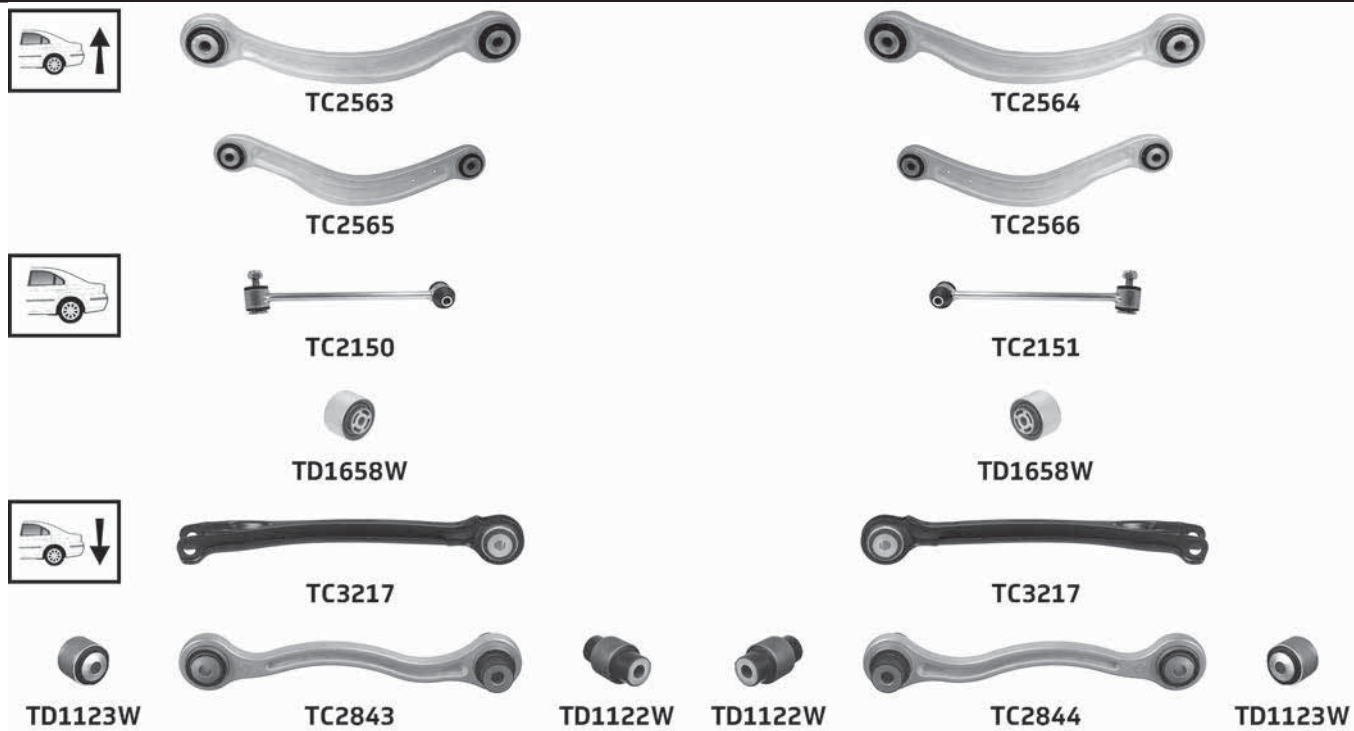

Part No	Description	Pos	Info	Technical
TA2572	Tie rod end(224)	A		M14x1.5 Female(253) £
TA2573	Tie rod end(224)	B		M14x1.5 Female(253) £
TA2577	Inner tie rod(123)	A B		M14x1.5 Male(252) £
TC1279	Lower track control arm(151)	A	Front(108)	M14x1.5
TC1280	Lower track control arm(151)	B	Front(108)	M14x1.5
TC2150	Link stabiliser(135)	A		M10x1.5
TC2151	Link stabiliser(135)	B		M10x1.5
TC2266	Link stabiliser(135)	A	Sport suspension(204)	M12x1.5
TC2267	Link stabiliser(135)	B	Sport suspension(204)	M12x1.5
TC2268	Link stabiliser(135)	A	(-) Sport suspension(-27-)	M12x1.5
TC2269	Link stabiliser(135)	B	(-) Sport suspension(-27-)	M12x1.5
TC2357	Lower track control arm(151)	A	Rear(187)	M14x1.5
TC2358	Lower track control arm(151)	B	Rear(187)	M14x1.5
TC2563	Upper link arm(239)	A	Front(108)	
TC2564	Upper link arm(239)	B	Front(108)	
TC2565	Upper link arm(239)	A	Rear(187)	
TC2566	Upper link arm(239)	B	Rear(187)	
TC2843	Lower link arm(144)	A	Rear(187)	
TC2844	Lower link arm(144)	B	Rear(187)	
TC3217	Lower link arm(144)	A B	Front(108)	
TD758W	Lower track control arm bush(153)	A B	Front(108)	
TD901W	Lower track control arm bush(153)	A B	Rear(187)	
TD1122W	Lower link arm bush(145)	A B	Rear(187) Inner(119)	
TD1123W	Lower link arm bush(145)	A B	Rear(187) Outer(176)	
TD1658W	Sub-frame bush(215)	A B	Rear(187) Inner(119)	

MERCEDES

... MERCEDES

E CLASS (210 SERIES) E200 2.0i, 2.0D, 2.2CDi, E220 2.2CDi, 2.2D, E230 2.3i, E240 2.4i, 2.6i, E250 2.5D, 2.5TD, E270 2.7CDi, E280 2.8i (-) 4-Matic, E290 2.9TD, E300 3.0D, 3.0TD, E320 3.2i (-) 4-Matic, 3.2CDi, E420 4.2i, E430 4.3i (-) 4-Matic (06/95-03/03)



TA1658



TA1660



TA1660



TA1659



TC2043



TD772W



TD772W



TC2044



TD772W



TD772W



TC2053



TC2054



TD1052W



TC835



TC1053



TD385W



TD385W



TC1054



TC835



TD386W



TD386W

... E CLASS (210 SERIES) E200 2.0i, 2.0D, 2.2CDi, E220 2.2CDi, 2.2D, E230 2.3i, E240 2.4i, 2.6i, E250 2.5D, 2.5TD, E270 2.7CDi, E280 2.8i (-) 4-Matic, E290 2.9TD, E300 3.0D, 3.0TD, E320 3.2i (-) 4-Matic, 3.2CDi, E420 4.2i, E430 4.3i (-) 4-Matic (06/95-03/03)

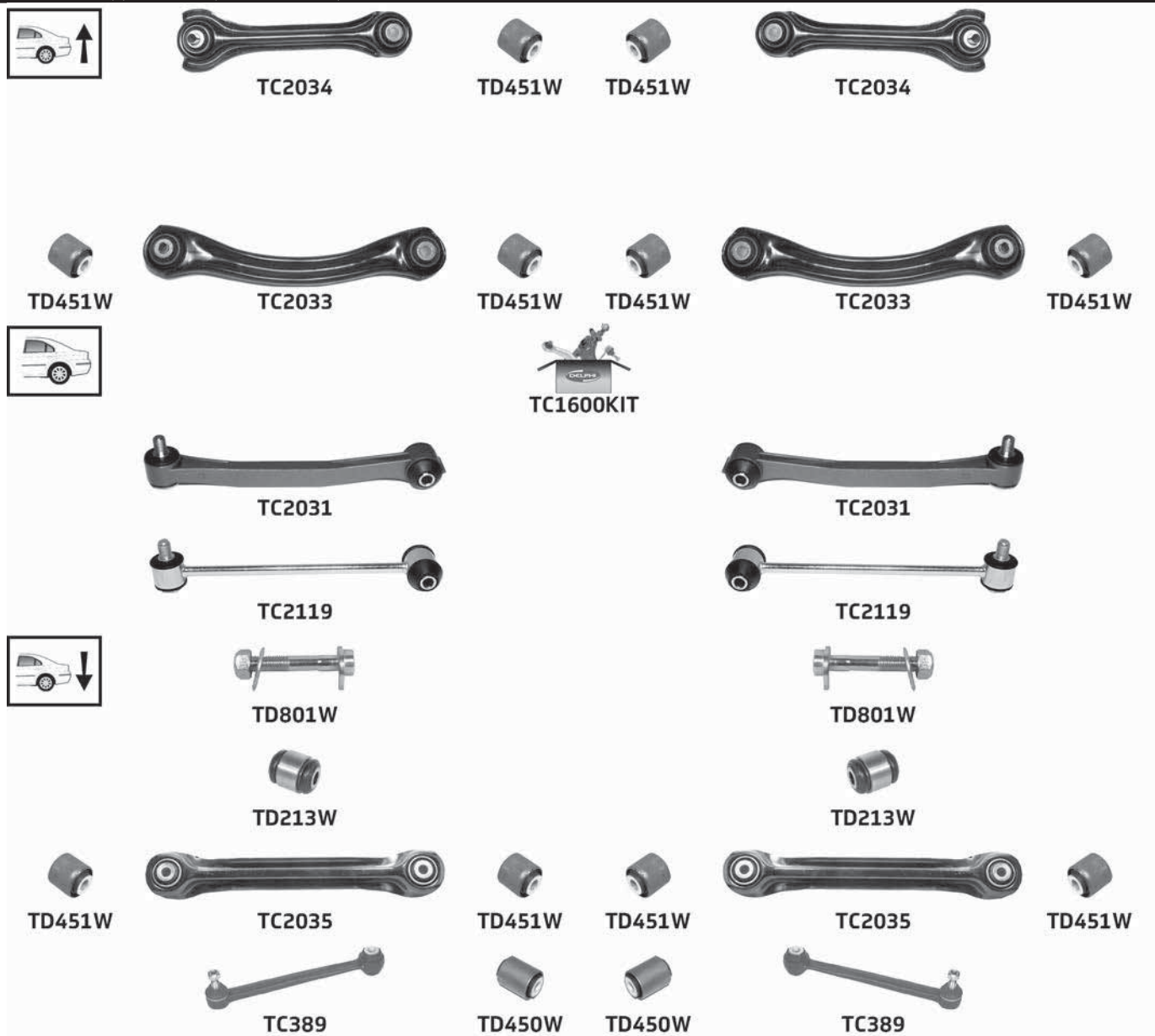

Part No	Description	Pos	Info	Technical
TA1658	Tie rod end(224)	A		M14x1.5 Female(253) £
TA1659	Tie rod end(224)	B		M14x1.5 Female(253) £
TA1660	Inner tie rod(123)	A B		M14x1.5 Male(252) £
TC389	Lower rod assembly(146)	A B		M10x1.25
TC835	Lower ball joint(140)	A B		M14x1.5
TC1053	Lower wishbone(158)	A	(-) Ball joint(-11-)	
TC1054	Lower wishbone(158)	B	(-) Ball joint(-11-)	
TC1600KIT	Suspension kit(220)	K		
TC2031	Link stabiliser(135)	A B	Plastic(184)	M10x1.5
TC2033	Upper track rod(244)	A B		
TC2034	Upper torque rod(241)	A B		
TC2035	Lower torque rod(149)	A B		
TC2043	Upper wishbone(247)	A		M10x1.5
TC2044	Upper wishbone(247)	B		M10x1.5
TC2053	Link stabiliser(135)	A		
TC2054	Link stabiliser(135)	B		
TC2119	Link stabiliser(135)	A B	Metal	M10x1.5
TD213W	Lower hub carrier bush(143)	A B		
TD385W	Lower wishbone bush(159)	A B	Front(108)	
TD386W	Lower wishbone bush(159)	A B	Rear(187) Pack of(179) 2	
TD450W	Bush(-85-)	A B		

(...)

... MERCEDES

... E CLASS (210 SERIES) E200 2.0i, 2.0D, 2.2CDi, E220 2.2CDi, 2.2D, E230 2.3i, E240 2.4i, 2.6i, E250 2.5D, 2.5TD, E270 2.7CDi, E280 2.8i (-) 4-Matic, E290 2.9TD, E300 3.0D, 3.0TD, E320 3.2i (-) 4-Matic, 3.2CDi, E420 4.2i, E430 4.3i (-) 4-Matic (06/95-03/03)

Part No	Description	Pos	Info	Technical
TD451W	Bush(-85-)	A B	Outer(176) Inner(119)	
TD772W	Upper wishbone bush(248)	A B	Front(108) Rear(187)	
TD801W	Lower rod assembly bolt(147)	A B		
TD1052W	Anti-roll bar(-74-) bush kit(-86-)	K	→Ch. A 394035	

E CLASS (210 SERIES) E280 2.8i, E320 3.2i, E430 4.3i 4-Matic (06/95-03/03)

Part No	Description	Pos	Info	Technical
TA2622	Inner tie rod(123)	A B		M14x1.5 Male(252) £
TA2631	Tie rod end(224)	A		M14x1.5 Female(253) £
TA2632	Tie rod end(224)	B		M14x1.5 Female(253) £
TC389	Lower rod assembly(146)	A B		M10x1.25
TC835	Lower ball joint(140)	A B		M14x1.5
TC1600KIT	Suspension kit(220)	K		
TC2031	Link stabiliser(135)	A B	Plastic(184)	M10x1.5

MERCEDES

... E CLASS (210 SERIES) E280 2.8i, E320 3.2i, E430 4.3i 4-Matic (06/95-03/03)

Part No	Description	Pos	Info	Technical
TC2033	Upper track rod(244)	A B		
TC2034	Upper torque rod(241)	A B		
TC2035	Lower torque rod(149)	A B		
TC2119	Link stabiliser (135)	A B	Metal	M10x1.5
TD213W	Lower hub carrier bush(143)	A B		
TD450W	Bush(-85-)	A B		
TD451W	Bush(-85-)	A B	Outer(176) Inner(119)	
TD801W	Lower rod assembly bolt(147)	A B		

E CLASS (211 SERIES) E200 1.8i, 2.2CDi, E220 2.2CDi, E230 2.5i, E240 2.6i (-) 4-Matic, E270 2.7CDi, E280 3.2CDi, E320 3.2i (-) 4-Matic, 3.2CDi, E350 3.5i (-) 4-Matic, E400 4.0CDi, E420 4.0CDi (03/02-07/09)

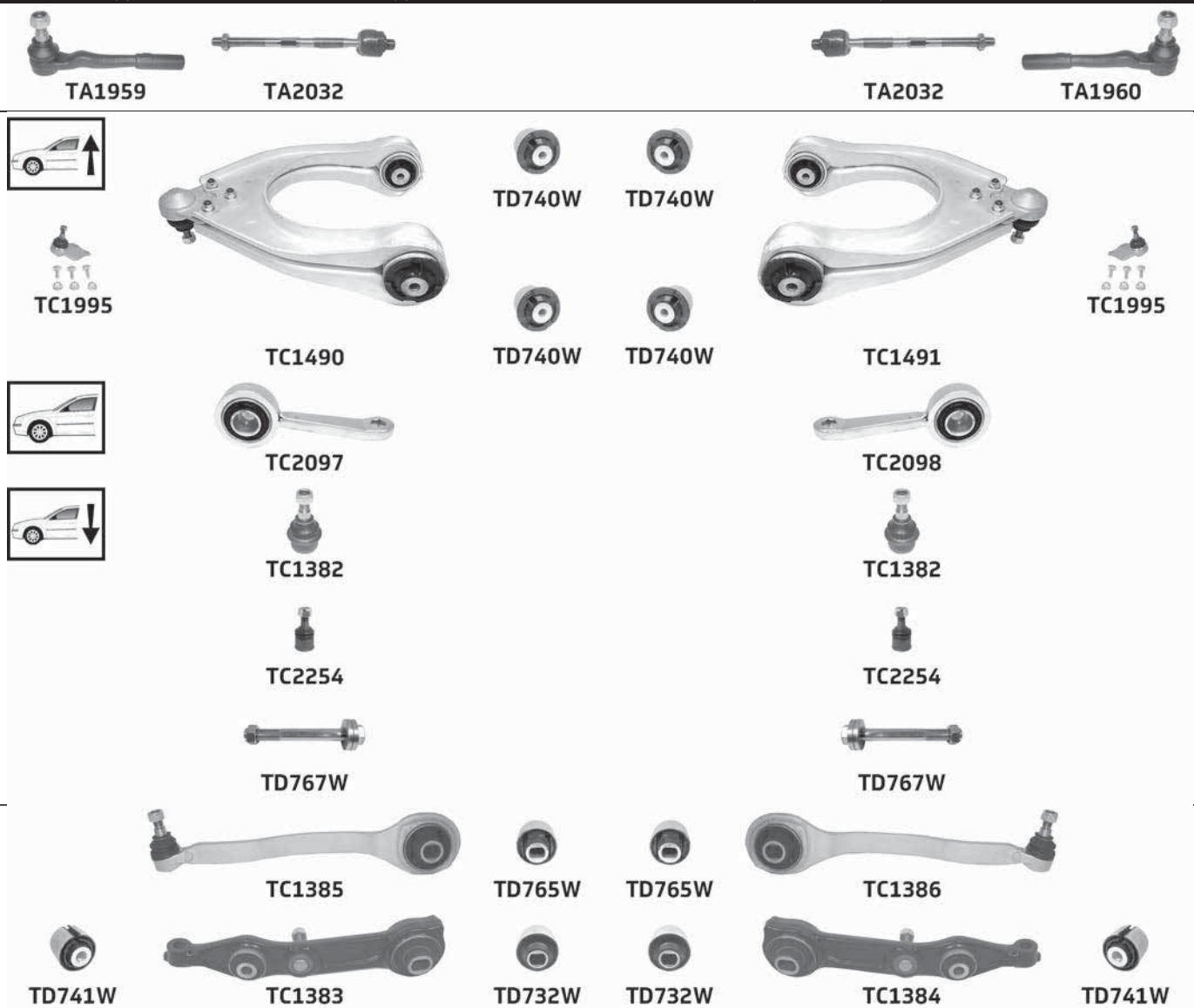

MERCEDES

... MERCEDES

... E CLASS (211 SERIES) E200 1.8i, 2.2CDi, E220 2.2CDi, E230 2.5i, E240 2.6i (-) 4-Matic, E270 2.7CDi, E280 3.2CDi, E320 3.2i (-) 4-Matic, 3.2CDi, E350 3.5i (-) 4-Matic, E400 4.0CDi, E420 4.0CDi (03/02-07/09)



TC1947



TC1948



TC1949



TC1950



TC1387



TC1387



TC2226



TC2226



TC2293



TC2294



TD1010W



TD1010W



TD1011W



TD967W



TD967W

Part No	Description	Pos	Info	Technical
TA1959	Tie rod end(224)	A		M14x1.5 Female(253) £
TA1960	Tie rod end(224)	B		M14x1.5 Female(253) £
TA2032	Inner tie rod(123)	A B		M14x1.5 Male(252) £
TC1382	Lower ball joint(140)	A B	Outer(176)	M14x1.5
TC1383	Lower track control arm(151)	A	Rear(187) (-) Ball joint(-11)	
TC1384	Lower track control arm(151)	B	Rear(187) (-) Ball joint(-11)	
TC1385	Lower track control arm(151)	A	Front(108)	M14x1.5
TC1386	Lower track control arm(151)	B	Front(108)	M14x1.5
TC1387	Link stabiliser(135)	A B		M10x1.5
TC1490	Upper wishbone(247)	A		M10x1.5
TC1491	Upper wishbone(247)	B		M10x1.5
TC1947	Upper link arm(239)	A	Front(108)	
TC1948	Upper link arm(239)	B	Front(108)	
TC1949	Upper link arm(239)	A	Rear(187)	
TC1950	Upper link arm(239)	B	Rear(187)	
TC1995	Upper ball joint(232)	A B		M10x1.5
TC2097	Link stabiliser(135)	A		
TC2098	Link stabiliser(135)	B		
TC2226	Lower link arm(144)	A B	Front(108) (-) Heavy duty suspension(-18)	
TC2254	Lower ball joint(140)	A B	Inner(119)	M14x1.5
TC2293	Lower link arm(144)	A	Rear(187)	
TC2294	Lower link arm(144)	B	Rear(187)	
TD732W	Lower track control arm bush(153)	A B	Rear(187) Inner(119)	
TD740W	Upper wishbone bush(248)	A B	Front(108) Rear(187)	
TD741W	Lower track control arm bush(153)	A B	Rear(187) Outer(176)	
TD765W	Lower track control arm bush(153)	A B	Front(108)	
TD767W	Lower track control arm bolt(152)	A B		
TD967W	Control arm bush(-97-)	A B		
TD1010W	Cross member bush(-99-)	A B	Front(108)	
TD1011W	Sub-frame bush(215)	K	Rear(187)	

E CLASS (211 SERIES) E280 3.0i (-) 4-Matic, 3.0CDi (-) 4-Matic, E320 3.0CDi (-) 4-Matic, E500 5.0i (-) 4-Matic, E55 5.4i AMG, E63 6.2i AMG (03/02-07/09)



TA1959



TA2032



TA2032



TA1960



TC1490



TD740W



TD740W



TC1491



TC1995



TC1995



TD740W



TD740W



TC2097



TC2098



TC1382



TC1382



TC2254



TC2254



TD767W



TD767W



TC1385



TD765W



TD765W



TC1386



TD741W



TC1383



TD732W



TD732W



TC1384



TD741W

... MERCEDES

E CLASS (211 SERIES) E280 3.0i (-) 4-Matic, 3.0CDi (-) 4-Matic, E320 3.0CDi (-) 4-Matic, E500 5.0i (-) 4-Matic, E55 5.4i AMG, E63 6.2i AMG (03/02-07/09)



TC1947



TC1948



TC1949



TC1950



TC1387



TC1387



TC2226



TC2226



TC2293



TC2294



TD1011W



TD967W



TD967W

Part No	Description	Pos	Info	Technical
TA1959	Tie rod end(224)	A		M14x1.5 Female(253) £
TA1960	Tie rod end(224)	B		M14x1.5 Female(253) £
TA2032	Inner tie rod(123)	A B		M14x1.5 Male(252) £
TC1382	Lower ball joint(140)	A B	Outer(176)	M14x1.5
TC1383	Lower track control arm(151)	A	Rear(187) (-) Ball joint(-11-)	
TC1384	Lower track control arm(151)	B	Rear(187) (-) Ball joint(-11-)	
TC1385	Lower track control arm(151)	A	Front(108)	M14x1.5
TC1386	Lower track control arm(151)	B	Front(108)	M14x1.5
TC1387	Link stabiliser(135)	A B		M10x1.5
TC1490	Upper wishbone(247)	A		M10x1.5
TC1491	Upper wishbone(247)	B		M10x1.5
TC1947	Upper link arm(239)	A	Front(108)	
TC1948	Upper link arm(239)	B	Front(108)	
TC1949	Upper link arm(239)	A	Rear(187)	
TC1950	Upper link arm(239)	B	Rear(187)	
TC1995	Upper ball joint(232)	A B		M10x1.5
TC2097	Link stabiliser(135)	A		
TC2098	Link stabiliser(135)	B		
TC2226	Lower link arm(144)	A B	Front(108) (-) Heavy duty suspension(-18-)	
TC2254	Lower ball joint(140)	A B	Inner(119)	M14x1.5
TC2293	Lower link arm(144)	A	Rear(187)	
TC2294	Lower link arm(144)	B	Rear(187)	
TD732W	Lower track control arm bush(153)	A B	Rear(187) Inner(119)	
TD740W	Upper wishbone bush(248)	A B	Front(108) Rear(187)	
TD741W	Lower track control arm bush(153)	A B	Rear(187) Outer(176)	
TD765W	Lower track control arm bush(153)	A B	Front(108)	
TD767W	Lower track control arm bolt(152)	A B		
TD967W	Control arm bush(-97-)	A B		
TD1011W	Sub-frame bush(215)	K	Rear(187)	

E CLASS (211 SERIES) E280 3.0i, 3.0CDi, E320 3.0CDi, E500 5.0i 4-Matic (03/02-07/09)

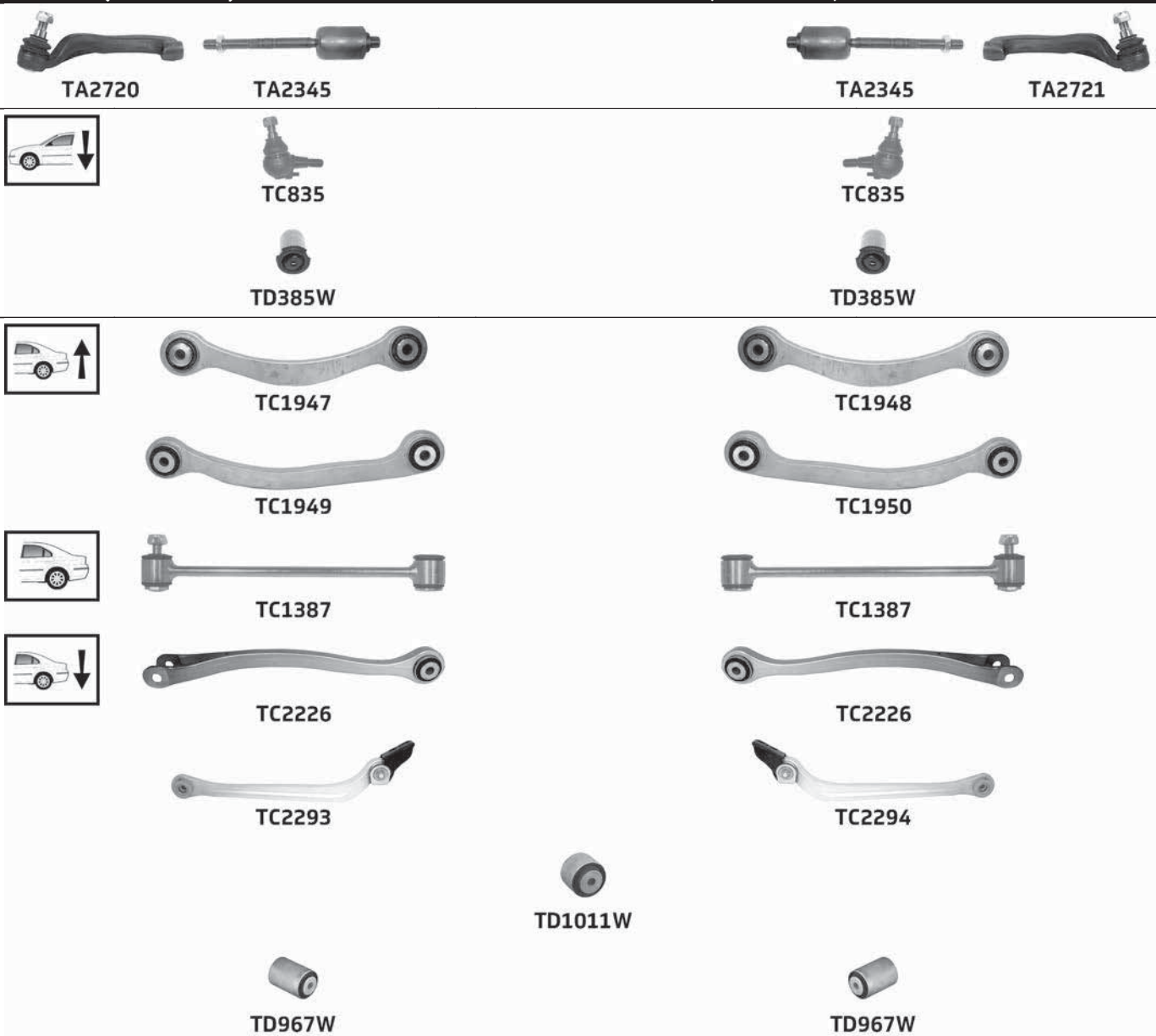

Part No	Description	Pos	Info	Technical
TA2345	Inner tie rod(123)	A B		M14x1.5 Male(252) £
TA2720	Tie rod end(224)	A		M14x1.5 Female(253) £
TA2721	Tie rod end(224)	B		M14x1.5 Female(253) £
TC835	Lower ball joint(140)	A B		M14x1.5
TC1387	Link stabiliser(135)	A B		M10x1.5
TC1947	Upper link arm(239)	A	Front(108)	
TC1948	Upper link arm(239)	B	Front(108)	
TC1949	Upper link arm(239)	A	Rear(187)	
TC1950	Upper link arm(239)	B	Rear(187)	
TC2226	Lower link arm(144)	A B	Front(108) (-) Heavy duty suspension(-18)	
TC2293	Lower link arm(144)	A	Rear(187)	
TC2294	Lower link arm(144)	B	Rear(187)	
TD385W	Lower wishbone bush(159)	A B	Front(108)	
TD967W	Control arm bush(-97-)	A B		
TD1011W	Sub-frame bush(215)	K	Rear(187)	

MERCEDES

... MERCEDES

E CLASS (211 SERIES) E240 2.6i, E320 3.2i, E350 3.5i 4-Matic (03/02-07/09)



Part No	Description	Pos	Info	Technical
TA2345	Inner tie rod(123)	A B		M14x1.5 Male(252) £
TA2720	Tie rod end(224)	A		M14x1.5 Female(253) £
TA2721	Tie rod end(224)	B		M14x1.5 Female(253) £
TC835	Lower ball joint(140)	A B		M14x1.5
TC1387	Link stabiliser(135)	A B		M10x1.5
TC1947	Upper link arm(239)	A	Front(108)	
TC1948	Upper link arm(239)	B	Front(108)	
TC1949	Upper link arm(239)	A	Rear(187)	
TC1950	Upper link arm(239)	B	Rear(187)	
TC2226	Lower link arm(144)	A B	Front(108) (-) Heavy duty suspension(-18-)	
TC2293	Lower link arm(144)	A	Rear(187)	
TC2294	Lower link arm(144)	B	Rear(187)	
TD385W	Lower wishbone bush(159)	A B	Front(108)	
TD967W	Control arm bush(-97-)	A B		
TD1010W	Cross member bush(-99-)	A B	Front(108)	
TD1011W	Sub-frame bush(215)	K	Rear(187)	

MERCEDES

E CLASS (212 SERIES) E200 1.8CGI, 2.0i, 2.2CDI, E220 2.2i (-) 4-Matic, 2.2CDI, E250 1.8CGI, 2.0i, 2.2CDI (-) 4-Matic, E300 Hybrid 2.2CDI, E300 3.0CDI, 3.5i (-) 4-Matic, E350 BlueTec 3.0i, 3.0CDI (-) 4-Matic, 3.5i (-) 4-Matic, 3.5CGI, E500 4.7i (-) 4-Matic, 5.4i (-) 4-Matic (01/09 →)

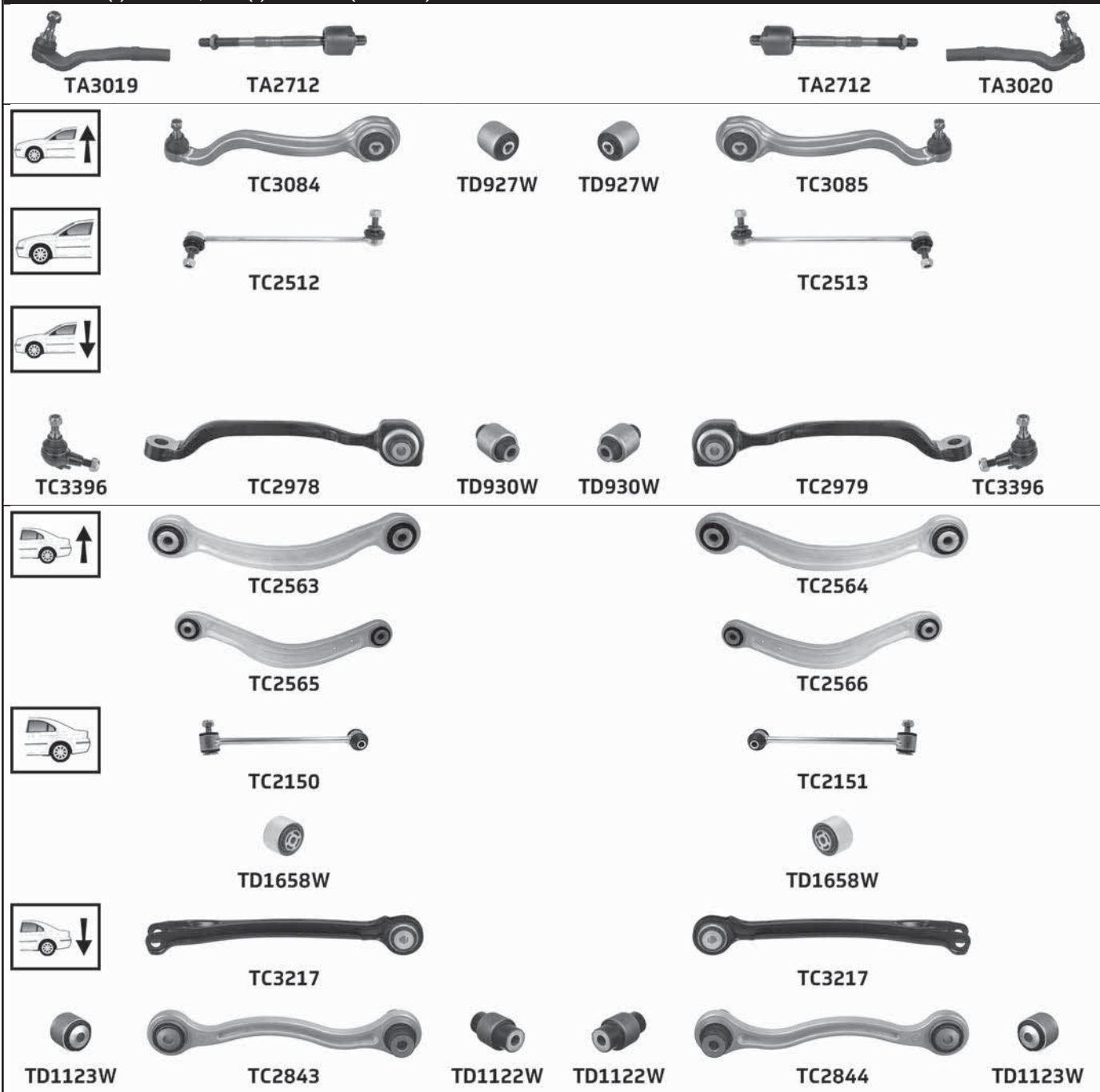

Part No	Description	Pos	Info	Technical
TA2712	Inner tie rod(123)	A B		M14x1.5 Male(252) £
TA3019	Tie rod end(224)	A	→ 17/10/2013	M14x1.5 Female(253) £
TA3020	Tie rod end(224)	B	→ 17/10/2013	M14x1.5 Female(253) £
TC2150	Link stabiliser(135)	A		M10x1.5
TC2151	Link stabiliser(135)	B		M10x1.5
TC2512	Link stabiliser(135)	A		M12x1.5
TC2513	Link stabiliser(135)	B		M12x1.5
TC2563	Upper link arm(239)	A	Front(108)	
TC2564	Upper link arm(239)	B	Front(108)	
TC2565	Upper link arm(239)	A	Rear(187)	
TC2566	Upper link arm(239)	B	Rear(187)	
TC2843	Lower link arm(144)	A	Rear(187)	
TC2844	Lower link arm(144)	B	Rear(187)	
TC2978	Lower track control arm(151)	A	(-) Ball joint(-11-)	
TC2979	Lower track control arm(151)	B	(-) Ball joint(-11-)	
TC3084	Upper track control arm(242)	A		M14x1.5
				(...)

MERCEDES

... MERCEDES

... E CLASS (212 SERIES) E200 1.8CGI, 2.0i, 2.2CDI, E220 2.2i (-) 4-Matic, 2.2CDI, E250 1.8CGI, 2.0i, 2.2CDI (-) 4-Matic, E300 Hybrid 2.2CDI, E300 3.0CDI, 3.5i (-) 4-Matic, E350 BlueTec 3.0i, 3.0CDI (-) 4-Matic, 3.5i (-) 4-Matic, 3.5CGI, E500 4.7i (-) 4-Matic, 5.4i (-) 4-Matic (01/09→)

TC3085	Upper track control arm(242)	B		M14x1.5
TC3217	Lower link arm(144)	A B	Front(108)	
TC3396	Lower ball joint(140)	A B		M14x1.5
TD927W	Upper track control arm bush(243)	A B		
TD930W	Lower track control arm bush(153)	A B		
TD1122W	Lower link arm bush(145)	A B	Rear(187) Inner(119)	
TD1123W	Lower link arm bush(145)	A B	Rear(187) Outer(176)	
TD1658W	Sub-frame bush(215)	A B	Rear(187) Inner(119)	

E CLASS (212 SERIES) E63 5.4i AMG, 6.2i AMG (01/09→)

E CLASS (212 SERIES) E63 6.2i AMG (01/09→)



TA2712



TA2712



TC2512



TC2513



TC3396



TC3396



TC2150



TC2151



TD1658W



TD1658W



TC3217



TC3217

Part No	Description	Pos	Info	Technical
TA2712	Inner tie rod(123)	A B		M14x1.5 Male(252) E
TC2150	Link stabiliser(135)	A		M10x1.5
TC2151	Link stabiliser(135)	B		M10x1.5
TC2512	Link stabiliser(135)	A		M12x1.5
TC2513	Link stabiliser(135)	B		M12x1.5
TC3217	Lower link arm(144)	A B	Front(108)	
TC3396	Lower ball joint(140)	A B		M14x1.5
TD1658W	Sub-frame bush(215)	A B	Rear(187) Inner(119)	

E CLASS (212 SERIES) E63 5.4i AMG 4-Matic (01/09→)



TA3214



TA3047



TA3047



TA3215



TA3214



TA3216



TA3216



TA3215

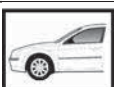

TC2512



TC2513

... E CLASS (212 SERIES) E63 5.4i AMG 4-Matic (01/09→)



Part No	Description	Pos	Info	Technical
TA3047	Inner tie rod(123)	A B	(-) Electric(103) Power steering(185)	M14x1.5 Male(252) £
TA3214	Tie rod end(224)	A		M14x1.5 Female(253) £
TA3215	Tie rod end(224)	B		M14x1.5 Female(253) £
TA3216	Inner tie rod(123)	A B	(+) Electric(103) Power steering(185)	
TC2150	Link stabiliser(135)	A		M10x1.5
TC2151	Link stabiliser(135)	B		M10x1.5
TC2512	Link stabiliser(135)	A		M12x1.5
TC2513	Link stabiliser(135)	B		M12x1.5
TC3217	Lower link arm(144)	A B	Front(108)	

E CLASS (212 SERIES) E220 2.2CDI, E250 2.2CDI, E300 3.5i, E350 3.5i, 3.0CDI, 3.5i, E400 3.0i, E500 4.7i, 5.4i 4-Matic (01/09→)



Part No	Description	Pos	Info	Technical
TA3047	Inner tie rod(123)	A B	(-) Electric(103) Power steering(185)	M14x1.5 Male(252) £
TA3214	Tie rod end(224)	A		M14x1.5 Female(253) £
TA3215	Tie rod end(224)	B		M14x1.5 Female(253) £
TA3216	Inner tie rod(123)	A B	(+) Electric(103) Power steering(185)	
TC2150	Link stabiliser(135)	A		M10x1.5
TC2151	Link stabiliser(135)	B		M10x1.5

(...)

... MERCEDES

... E CLASS (212 SERIES) E220 2.2CDI, E250 2.2CDI, E300 3.5i, E350 3.5i, 3.0CDI, 3.5i, E400 3.0i, E500 4.7i, 5.4i 4-Matic (01/09→)

Part No	Description	Pos	Info	Technical
TC2563	Upper link arm(239)	A	Front(108)	
TC2564	Upper link arm(239)	B	Front(108)	
TC2565	Upper link arm(239)	A	Rear(187)	
TC2566	Upper link arm(239)	B	Rear(187)	
TC2651	Link stabiliser(135)	A		M12x1.5
TC2652	Link stabiliser(135)	B		M12x1.5
TC2843	Lower link arm(144)	A	Rear(187)	
TC2844	Lower link arm(144)	B	Rear(187)	
TC3217	Lower link arm(144)	A B	Front(108)	
TD1122W	Lower link arm bush(145)	A B	Rear(187) Inner(119)	
TD1123W	Lower link arm bush(145)	A B	Rear(187) Outer(176)	
TD1658W	Sub-frame bush(215)	A B	Rear(187) Inner(119)	

GL CLASS (164 SERIES) GL320 3.0CDi, GL350 3.0CDi, GL420 4.0CDi, GL450 4.7i, GL500 5.4i (09/06→)



TC2949



TC2950



TC2220



TC2220



TC2739



TC2740



TC2379



TC2379



TC3281



TC3281



TC3268



TC3269



TC2259



TC2259



TC2380



TC2380

Part No	Description	Pos	Info	Technical
TA2647	Tie rod end(224)	A		M14x1.5 Female(253) £
TA2648	Tie rod end(224)	B		M14x1.5 Female(253) £
TA2697	Inner tie rod(123)	A B		M14x1.5 Male(252) £
TC2220	Link stabiliser(135)	A B		M14x1.5
TC2259	Link stabiliser(135)	A B		M14x1.5

... GL CLASS (164 SERIES) GL320 3.0CDi, GL350 3.0CDi, GL420 4.0CDi, GL450 4.7i, GL500 5.4i (09/06→)

Part No	Description	Pos	Info	Technical
TC2379	Lower ball joint(140)	A B		M16x1.5
TC2380	Lower ball joint(140)	A B		M16x1.5
TC2739	Lower wishbone(158)	A		
TC2740	Lower wishbone(158)	B		
TC2949	Upper track control arm(242)	A		M14x1.5
TC2950	Upper track control arm(242)	B		M14x1.5
TC3268	Upper camber arm(233)	A		
TC3269	Upper camber arm(233)	B		
TC3281	Upper track control arm(242)	A B	Front(108)	

GL CLASS (166 SERIES) GL350 3.0CDI, GL400 3.0i, GL450 4.7i, GL500 4.7i, GL63 5.4i AMG (07/12→)

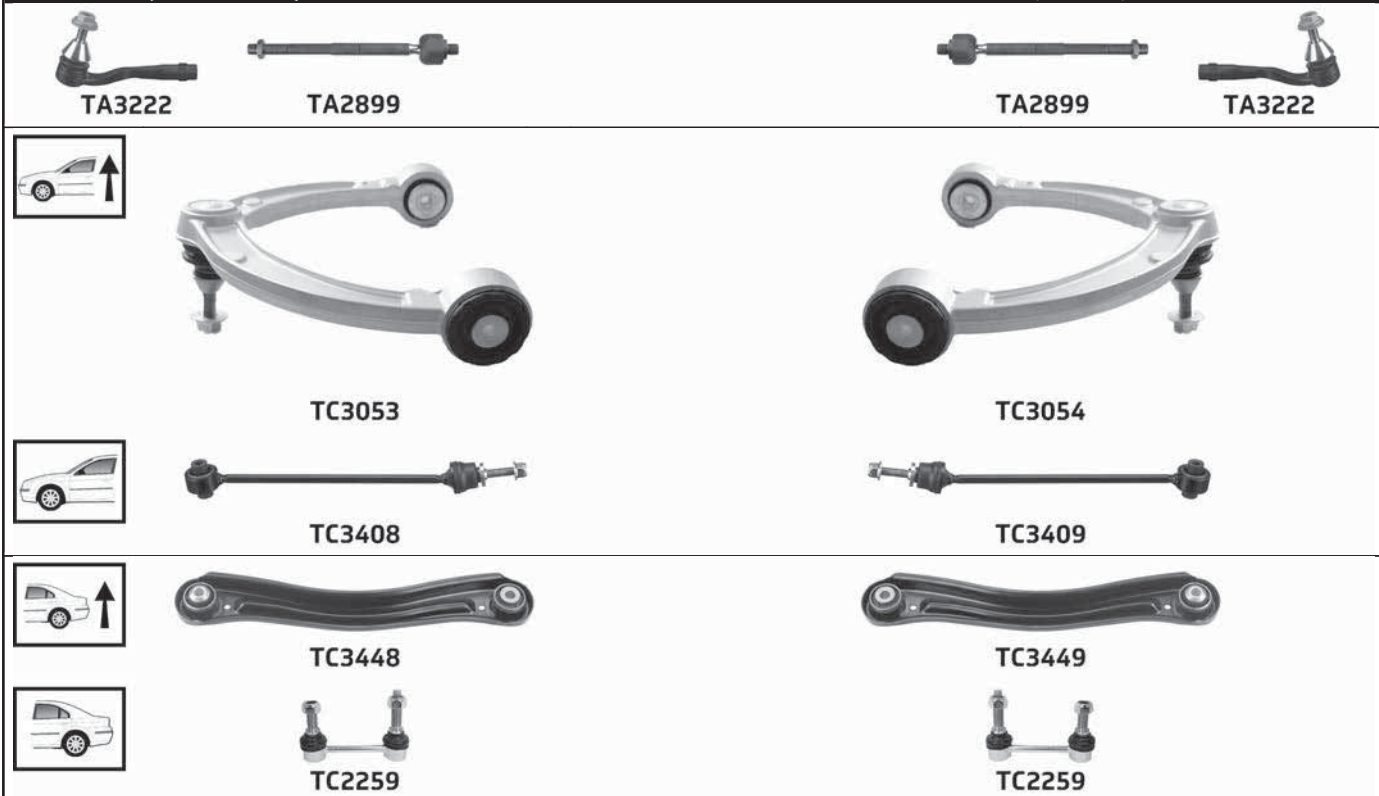

Part No	Description	Pos	Info	Technical
TA2899	Inner tie rod(123)	A B		M16x1.5 Male(252) E
TA3222	Tie rod end(224)	A B		M16x1.5 Female(253) E
TC2259	Link stabiliser(135)	A B		M14x1.5
TC3053	Upper wishbone(247)	A		M14x1.5
TC3054	Upper wishbone(247)	B		M14x1.5
TC3408	Link stabiliser(135)	A		M12x1.5
TC3409	Link stabiliser(135)	B		M12x1.5
TC3448	Upper camber arm(233)	A	Centre(-89)	
TC3449	Upper camber arm(233)	B	Centre(-89)	

MERCEDES

... MERCEDES

GLA CLASS (156 SERIES) GLA180 1.6i, 1.5CDi, GLA200 1.6i, 2.2CDi, 2.2CDi 4-Matic, GLA220 2.2CDi, 2.2CDi 4-Matic, GLA250 2.0i, 2.0i 4-Matic, GLA45 2.0i AMG (12/13→)

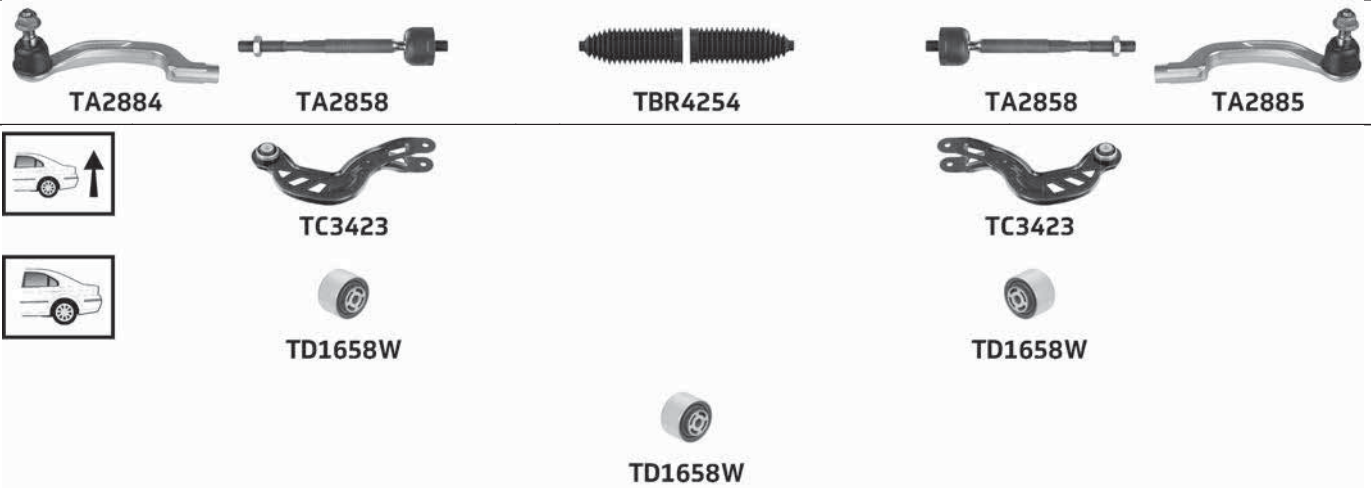

Part No	Description	Pos	Info	Technical
TA2858	Inner tie rod(123)	A B		M14x1.5 Male(252) £
TA2884	Tie rod end(224)	A		M14x1.5 Female(253) £
TA2885	Tie rod end(224)	B		M14x1.5 Female(253) £
TBR4254	Steering rack gaiter kit(213)	K	Thermoplastic(223)	1 :15x58x58 2 :15x58x58
TC3423	Upper camber arm(233)	A B	(-) GLA45 AMG	
TD1658W	Sub-frame bush(215)	K	(+ GLA45 AMG Rear(187) Centre(-89-)	
TD1658W	Sub-frame bush(215)	A B	(+ GLA45 AMG Front(108) Inner(119)	

GLC CLASS (X253 SERIES) GLC220 2.2CDi, 2.2CDi 4-Matic, GLC250 2.0i 4-Matic, 2.2CDi 4-Matic (06/15→)



Part No	Description	Pos	Info	Technical
TC2843	Lower link arm(144)	A	Rear(187)	
TC2844	Lower link arm(144)	B	Rear(187)	
TC3217	Lower link arm(144)	A B	Front(108)	
TD1122W	Lower link arm bush(145)	A B	Rear(187) Inner(119)	
TD1123W	Lower link arm bush(145)	A B	Rear(187) Outer(176)	

GLE CLASS (166 SERIES) GLE250 2.2CDi, GLE350 3.0CDi, GLE400 3.0i, GLE450 3.0i, GLE500 3.0i Hybrid, 4.7i, GLE63 5.4i AMG (04/15→)

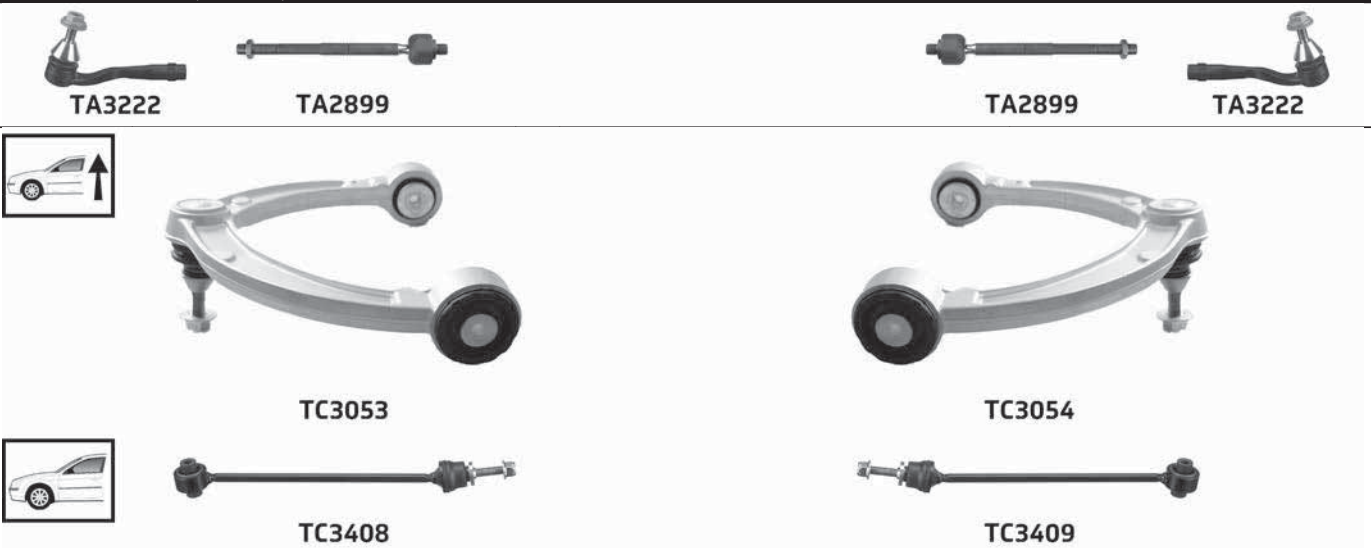

... GLE CLASS (166 SERIES) GLE250 2.2CDi, GLE350 3.0CDi, GLE400 3.0i, GLE450 3.0i, GLE500 3.0i Hybrid, 4.7i, GLE63 5.4i AMG (04/15→)



TC3448



TC3449



TC2259



TC2259

Part No	Description	Pos	Info	Technical
TA2899	Inner tie rod(123)	A B		M16x1.5 Male(252) £
TA3222	Tie rod end(224)	A B		M16x1.5 Female(253) £
TC2259	Link stabiliser(135)	A B		M14x1.5
TC3053	Upper wishbone(247)	A		M14x1.5
TC3054	Upper wishbone(247)	B		M14x1.5
TC3408	Link stabiliser(135)	A		M12x1.5
TC3409	Link stabiliser(135)	B		M12x1.5
TC3448	Upper camber arm(233)	A	Centre(-89)	
TC3449	Upper camber arm(233)	B	Centre(-89)	

GLE CLASS (292 SERIES) GLE350 COUPE 3.0CDi, GLE400 COUPE 3.0i, GLE450 COUPE 3.0i, GLE500 COUPE 4.7i, GLE63 COUPE 5.4i AMG (03/15→)



TA3222



TA2899



TA2899



TA3222



TC3053



TC3054



TC3408



TC3409

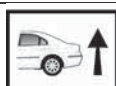

TC3448



TC3449



TC2259



TC2259

Part No	Description	Pos	Info	Technical
TA2899	Inner tie rod(123)	A B		M16x1.5 Male(252) £
TA3222	Tie rod end(224)	A B		M16x1.5 Female(253) £
TC2259	Link stabiliser(135)	A B		M14x1.5
TC3053	Upper wishbone(247)	A		M14x1.5
TC3054	Upper wishbone(247)	B		M14x1.5
TC3408	Link stabiliser(135)	A		M12x1.5
TC3409	Link stabiliser(135)	B		M12x1.5
TC3448	Upper camber arm(233)	A	Centre(-89)	
TC3449	Upper camber arm(233)	B	Centre(-89)	

MERCEDES

... MERCEDES

GLK CLASS (X204 SERIES) GLK200 2.2CDi, GLK220 2.2CDi, 2.2CDi 4-Matic, GLK250 2.0i 4-Matic, 2.2CDi 4-Matic, GLK280 3.0i 4-Matic, GLK300 3.0i 4-Matic, GLK320 3.0CDI 4-Matic, GLK350 3.0CDI 4-Matic, 3.5i 4-Matic (06/08→)



Part No	Description	Pos	Info	Technical
TA3047	Inner tie rod(123)	A B	(-) Electric(103) Power steering(185)	M14x1.5 Male(252) £
TA3214	Tie rod end(224)	A		M14x1.5 Female(253) £
TA3215	Tie rod end(224)	B		M14x1.5 Female(253) £
TA3216	Inner tie rod(123)	A B	(+) Electric(103) Power steering(185)	
TC2150	Link stabiliser(135)	A		M10x1.5
TC2151	Link stabiliser(135)	B		M10x1.5
TC2843	Lower link arm(144)	A	Rear(187)	
TC2844	Lower link arm(144)	B	Rear(187)	
TC3217	Lower link arm(144)	A B	Front(108)	
TC3384	Link stabiliser(135)	A		M12x1.5
TC3385	Link stabiliser(135)	B		M12x1.5
TD1122W	Lower link arm bush(145)	A B	Rear(187) Inner(119)	
TD1123W	Lower link arm bush(145)	A B	Rear(187) Outer(176)	
TD1658W	Sub-frame bush(215)	A B	Rear(187) Inner(119)	

MERCEDES

GLS CLASS (166 SERIES) GLS350 3.0CDI, GLS400 3.0i, GLS500 4.7i, GLS63 5.4i AMG (11/15→)



TA3222



TA2899



TA2899



TA3222



TC3053



TC3054



TC3408



TC3409



TC3448



TC3449



TC2259



TC2259

Part No	Description	Pos	Info	Technical
TA2899	Inner tie rod(123)	A B		M16x1.5 Male(252) E
TA3222	Tie rod end(224)	A B		M16x1.5 Female(253) E
TC2259	Link stabiliser (135)	A B		M14x1.5
TC3053	Upper wishbone(247)	A		M14x1.5
TC3054	Upper wishbone(247)	B		M14x1.5
TC3408	Link stabiliser (135)	A		M12x1.5
TC3409	Link stabiliser (135)	B		M12x1.5
TC3448	Upper camber arm(233)	A	Centre(-89-)	
TC3449	Upper camber arm(233)	B	Centre(-89-)	

... MERCEDES

M CLASS (163 SERIES) ML230 2.3i, ML270 2.7CDi, ML320 3.2i, ML350 3.7i, ML400 4.0CDi, ML430 4.3i, ML500 5.0i (02/98-06/05)

MERCEDES

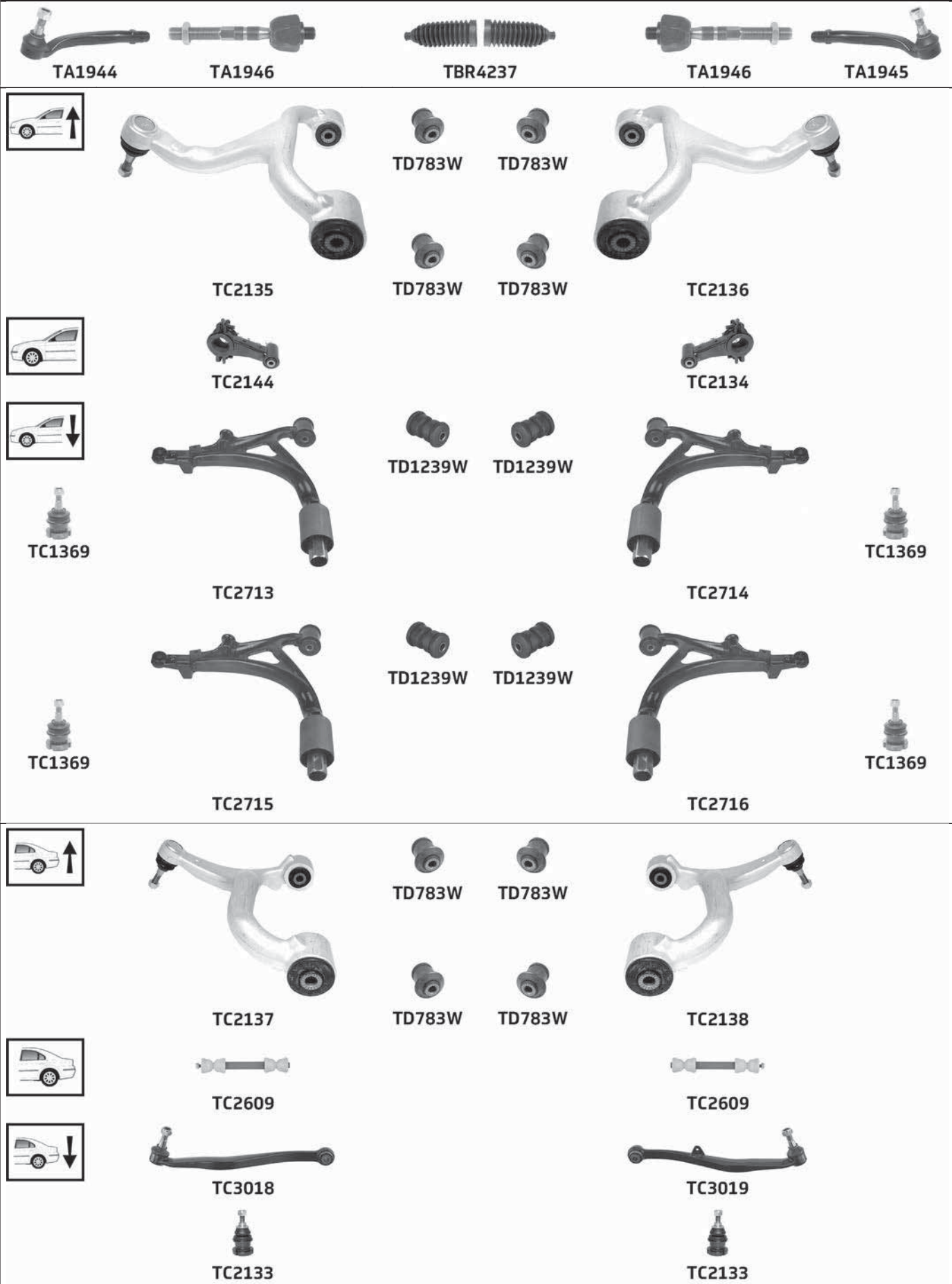

Part No	Description	Pos	Info	Technical
TA1944	Tie rod end(224)	A		M16x1.5 Female(253) E

... M CLASS (163 SERIES) ML230 2.3i, ML270 2.7CDi, ML320 3.2i, ML350 3.7i, ML400 4.0CDi, ML430 4.3i, ML500 5.0i (02/98-06/05)

TA1945	Tie rod end(224)	B		M16x1.5 Female(253) £
TA1946	Inner tie rod(123)	A B		M16x1.5 Male(252) £
TBR4237	Steering rack gaiter kit(213)	K		1 :16.5x64.5x64.5 2 :16.5x64.5x64.5
TC1369	Lower ball joint(140)	A B		M14x1.5
TC2133	Lower ball joint(140)	A B		M14x1.5
TC2134	Link stabiliser(135)	B		
TC2135	Upper track control arm(242)	A		M12x1.5
TC2136	Upper track control arm(242)	B		M12x1.5
TC2137	Upper track control arm(242)	A		M12x1.5
TC2138	Upper track control arm(242)	B		M12x1.5
TC2144	Link stabiliser(135)	A		
TC2609	Link stabiliser(135)	A B		
TC2713	Lower wishbone(158)	A	(-) Bush(-13) →Ch. A 145272, X 707755	
TC2714	Lower wishbone(158)	B	(-) Bush(-13) →Ch. A 145272, X 707755	
TC2715	Lower wishbone(158)	A	(-) Bush(-13) Ch. A 145273, X 707756→	
TC2716	Lower wishbone(158)	B	(-) Bush(-13) Ch. A 145273, X 707756→	
TC3018	Lower link arm(144)	A		M14x1.5
TC3019	Lower link arm(144)	B		M14x1.5
TD783W	Upper track control arm bush(243)	A B	Front(108) Rear(187)	
TD1239W	Lower wishbone bush(159)	A B	Front(108)	

M CLASS (164 SERIES) ML280 3.0CDi, ML300 3.0CDi, ML320 3.0CDi, ML350 3.0CDi, 3.5i, ML420 4.0CDi, ML450 4.0CDi, ML500 5.0i, 5.4i, ML63 6.2i AMG (07/05→)

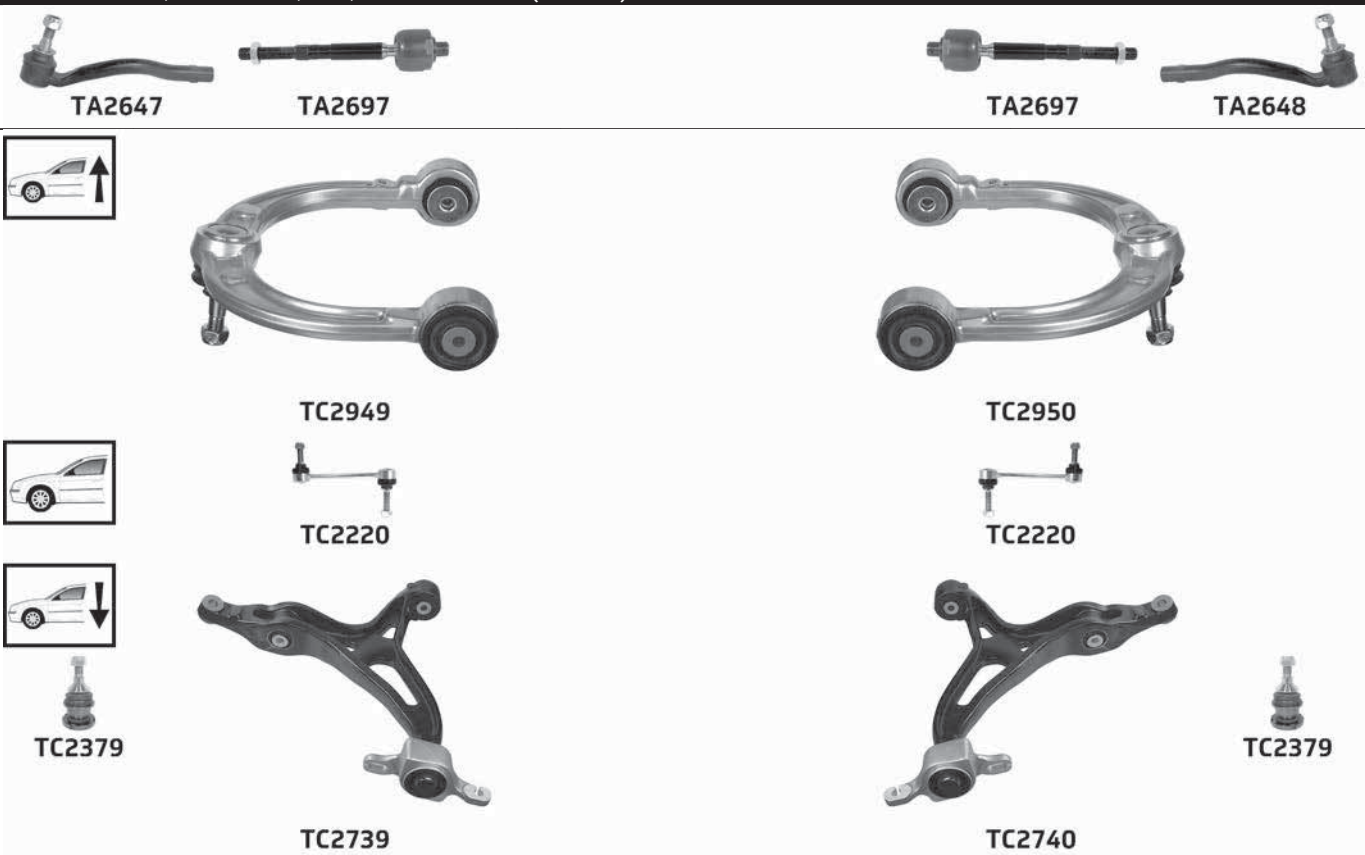

... MERCEDES

... M CLASS (164 SERIES) ML280 3.0CDi, ML300 3.0CDi, ML320 3.0CDi, ML350 3.0CDi, 3.5i, ML420 4.0CDi, ML450 4.0CDi, ML500 5.0i, 5.4i, ML63 6.2i AMG (07/05→)



TC3281



TC3281



TC3268



TC3269



TC2259



TC2259



TC2380



TC2380

Part No	Description	Pos	Info	Technical
TA2647	Tie rod end(224)	A		M14x1.5 Female(253) £
TA2648	Tie rod end(224)	B		M14x1.5 Female(253) £
TA2697	Inner tie rod(123)	A B		M14x1.5 Male(252) £
TC2220	Link stabiliser(135)	A B		M14x1.5
TC2259	Link stabiliser(135)	A B		M14x1.5
TC2379	Lower ball joint(140)	A B		M16x1.5
TC2380	Lower ball joint(140)	A B		M16x1.5
TC2739	Lower wishbone(158)	A		
TC2740	Lower wishbone(158)	B		
TC2949	Upper track control arm(242)	A		M14x1.5
TC2950	Upper track control arm(242)	B		M14x1.5
TC3268	Upper camber arm(233)	A		
TC3269	Upper camber arm(233)	B		
TC3281	Upper track control arm(242)	A B	Front(108)	

M CLASS (166 SERIES) ML250 2.2CDi, ML350 3.0i, 3.0CDi, ML400 3.0i, ML500 4.7i, ML63 5.4 AMG (06/11→)



TA3222



TA2899



TA2899



TA3222



TC3053



TC3054



TC3408



TC3409

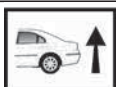

TC3448



TC3449



TC2259



TC2259

Part No	Description	Pos	Info	Technical
TA2899	Inner tie rod(123)	A B		M16x1.5 Male(252) £
TA3222	Tie rod end(224)	A B		M16x1.5 Female(253) £
TC2259	Link stabiliser(135)	A B		M14x1.5
TC3053	Upper wishbone(247)	A		M14x1.5
TC3054	Upper wishbone(247)	B		M14x1.5

... M CLASS (166 SERIES) ML250 2.2CDi, ML350 3.0i, 3.0CDi, ML400 3.0i, ML500 4.7i, ML63 5.4 AMG (06/11→)

Part No	Description	Pos	Info	Technical
TC3408	Link stabiliser(135)	A		M12x1.5
TC3409	Link stabiliser(135)	B		M12x1.5
TC3448	Upper camber arm(233)	A	Centre(-89°)	
TC3449	Upper camber arm(233)	B	Centre(-89°)	

R CLASS (251 SERIES) R280 3.0i, 3.0CDi, R300 3.0i, 3.0CDi, R320 3.0CDi, R350 3.0CDi, 3.5i, R500 5.0i, 5.4i, R63 6.2i AMG (01/06→)

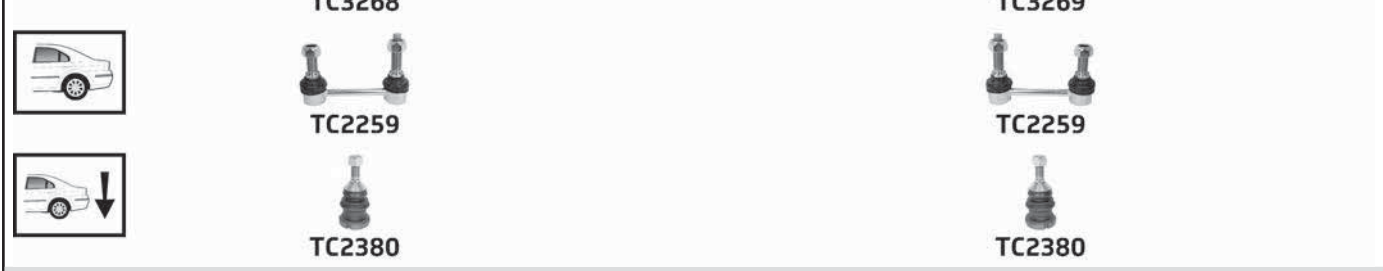
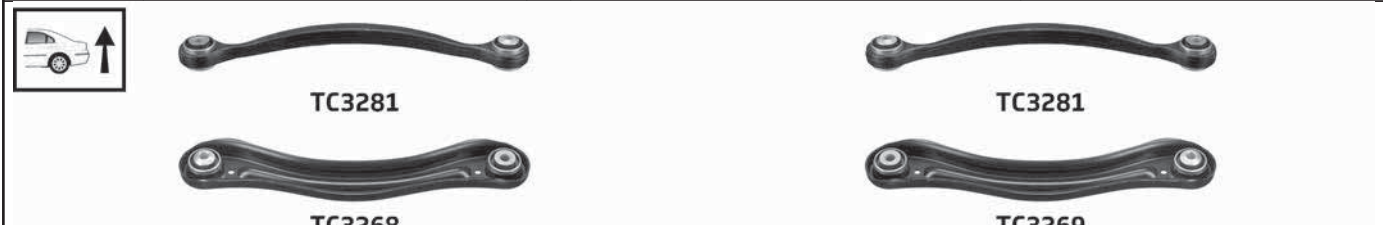
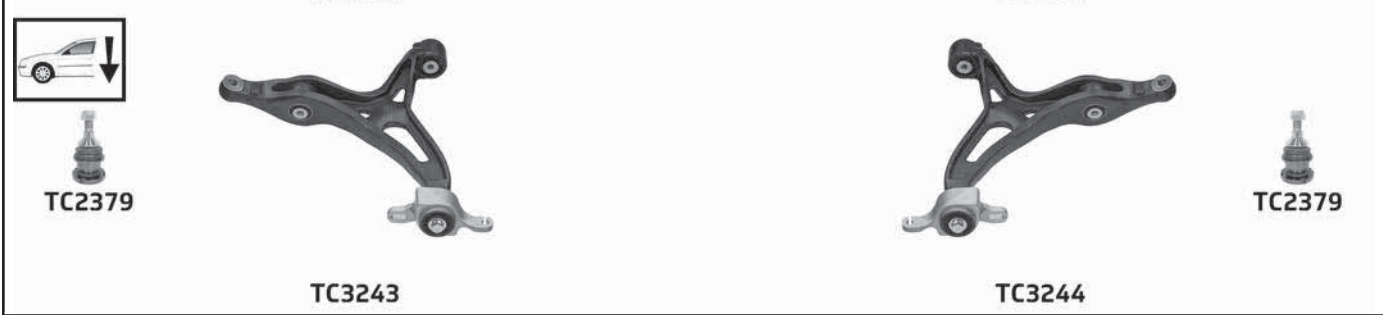
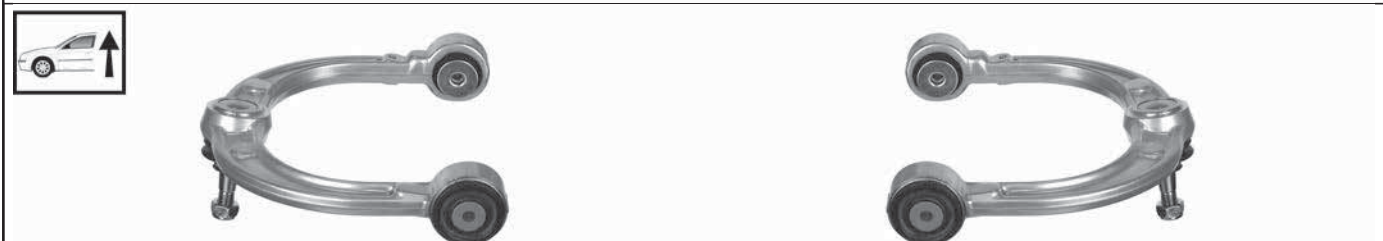

Part No	Description	Pos	Info	Technical
TA2697	Inner tie rod(123)	A B		M14x1.5 Male(252) £
TA2836	Tie rod end(224)	A		M14x1.5 Female(253) £
TA2837	Tie rod end(224)	B		M14x1.5 Female(253) £
TC2220	Link stabiliser(135)	A B		M14x1.5
TC2259	Link stabiliser(135)	A B		M14x1.5
TC2379	Lower ball joint(140)	A B		M16x1.5
TC2380	Lower ball joint(140)	A B		M16x1.5
TC2949	Upper track control arm(242)	A		M14x1.5
TC2950	Upper track control arm(242)	B		M14x1.5
TC3243	Lower wishbone(158)	A	(-) Ball joint(-11)	
TC3244	Lower wishbone(158)	B	(-) Ball joint(-11)	
TC3268	Upper camber arm(233)	A		

... MERCEDES

... R CLASS (251 SERIES) R280 3.0i, 3.0CDi, R300 3.0i, 3.0CDi, R320 3.0CDi, R350 3.0CDi, 3.5i, R500 5.0i, 5.4i, R63 6.2i AMG (01/06→)

Part No	Description	Pos	Info	Technical
TC3269	Upper camber arm(233)	B		
TC3281	Upper track control arm(242)	A B	Front (108)	

S CLASS (220 SERIES) S280 2.8i, S320 3.2i, 3.2CDi, S350 3.7i (-) 4-Matic, S400 4.0CDi, S430 4.3i (-) 4-Matic, S500 5.0i (-) 4-Matic, S600 5.5i, 5.8i (10/98-08/05)



TA1961



TA2032



TA2032



TA1961



TC1492



TC1493



TC1498



TC1499



TC2254



TC2254



TD767W



TD767W



TC1494



TD1618W



TD1618W



TC1495



TC1382



TC1496



TC1497



TC1382

... S CLASS (220 SERIES) S280 2.8i, S320 3.2i, 3.2CDi, S350 3.7i (-) 4-Matic, S400 4.0CDi, S430 4.3i (-) 4-Matic, S500 5.0i (-) 4-Matic, S600 5.5i, 5.8i (10/98-08/05)

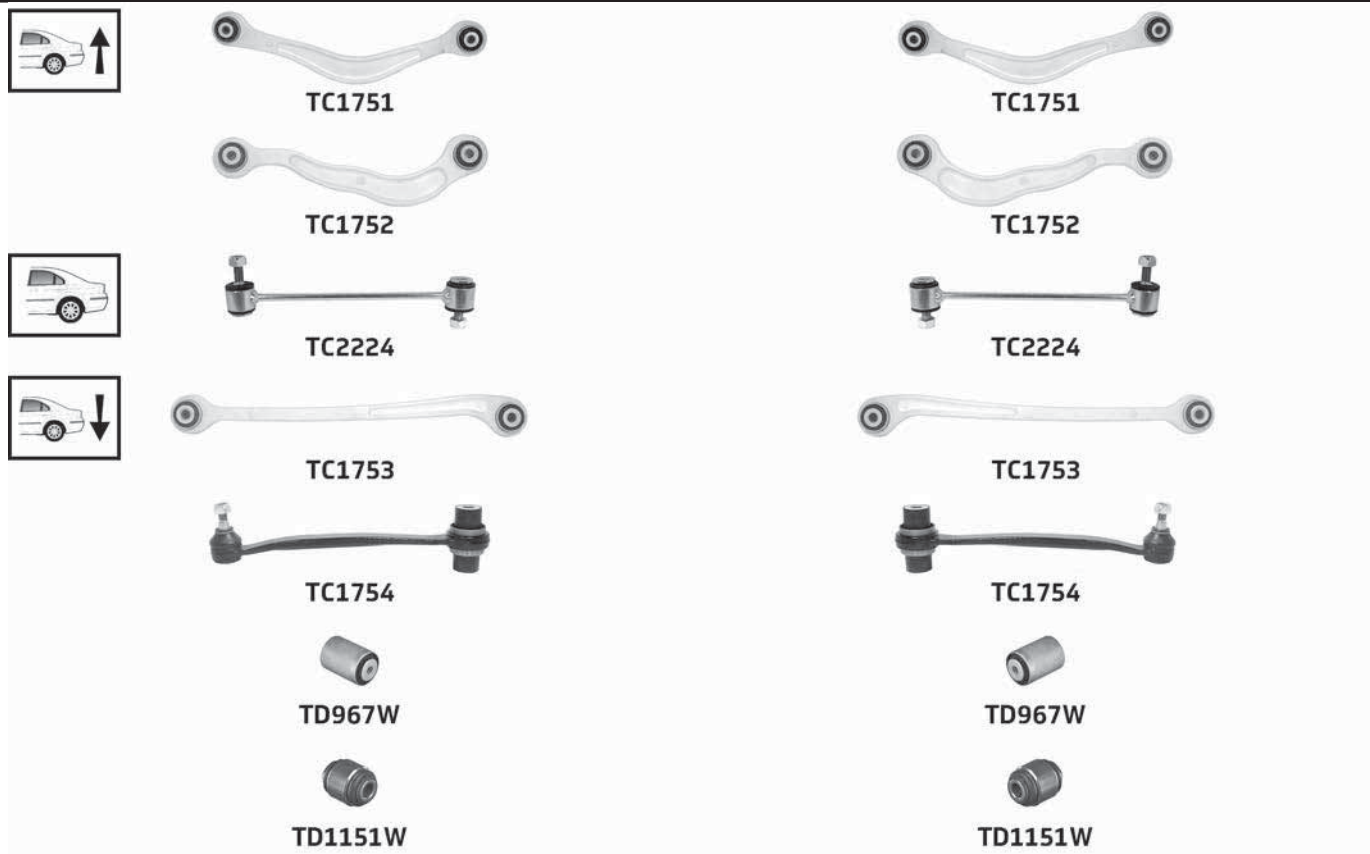

Part No	Description	Pos	Info	Technical
TA1961	Tie rod end(224)	A B		M14x1.5 Female(253) £
TA2032	Inner tie rod(123)	A B		M14x1.5 Male(252) £
TC1382	Lower ball joint(140)	A B	Outer(176)	M14x1.5
TC1492	Upper wishbone(247)	A		M10x1.5
TC1493	Upper wishbone(247)	B		M10x1.5
TC1494	Lower track control arm(151)	A	Front(108)	M14x1.5
TC1495	Lower track control arm(151)	B	Front(108)	M14x1.5
TC1496	Lower track control arm(151)	A	Rear(187) (-) Ball joint(-11-)	
TC1497	Lower track control arm(151)	B	Rear(187) (-) Ball joint(-11-)	
TC1498	Link stabiliser(135)	A		
TC1499	Link stabiliser(135)	B		
TC1751	Upper track control arm(242)	A B		
TC1752	Upper camber arm(233)	A B		
TC1753	Lower track control arm(151)	A B		
TC1754	Lower rod assembly(146)	A B		M10x1.5
TC2224	Link stabiliser(135)	A B		M10x1.5
TC2254	Lower ball joint(140)	A B	Inner(119)	M14x1.5
TD767W	Lower track control arm bolt(152)	A B		
TD967W	Control arm bush(-97-)	A B		
TD1151W	Lower hub carrier bush(143)	A B		
TD1618W	Lower track control arm bush(153)	A B		

MERCEDES

... MERCEDES

S CLASS (220 SERIES) S350 3.7i, S430 4.3i, S500 5.0i 4-Matic (10/98-08/05)



TA2720



TA2668



TA2668



TA2721



TC835



TC835



TD385W



TD385W



TC3348



TC3349



TC1751



TC1751



TC1752



TC1752



TC2224



TC2224



TC1753



TC1753



TC1754



TC1754



TD967W



TD967W



TD1151W



TD1151W

Part No	Description	Pos	Info	Technical
TA2668	Inner tie rod(123)	A B		M14x1.5 Male(252) E
TA2720	Tie rod end(224)	A		M14x1.5 Female(253) E
TA2721	Tie rod end(224)	B		M14x1.5 Female(253) E
TC835	Lower ball joint(140)	A B		M14x1.5
TC1751	Upper track control arm(242)	A B		
TC1752	Upper camber arm(233)	A B		
TC1753	Lower track control arm(151)	A B		
TC1754	Lower rod assembly(146)	A B		M10x1.5
TC2224	Link stabiliser(135)	A B		M10x1.5
TC3348	Link stabiliser(135)	A		M12x1.5
TC3349	Link stabiliser(135)	B		M12x1.5
TD385W	Lower wishbone bush(159)	A B	Front(108)	
TD967W	Control arm bush(-97-)	A B		
TD1151W	Lower hub carrier bush(143)	A B		

S CLASS (221 SERIES) S280 3.0i, S300 3.0i, S320 3.0CDi (-) 4-Matic, S350 3.0CDi (-) 4-Matic, 3.5i (-) 4-Matic, S400 3.5i, S420 4.0CDi, S450 4.7i (-) 4-Matic, S500 4.7i (-) 4-Matic, 5.5i (-) 4-Matic (10/05→)

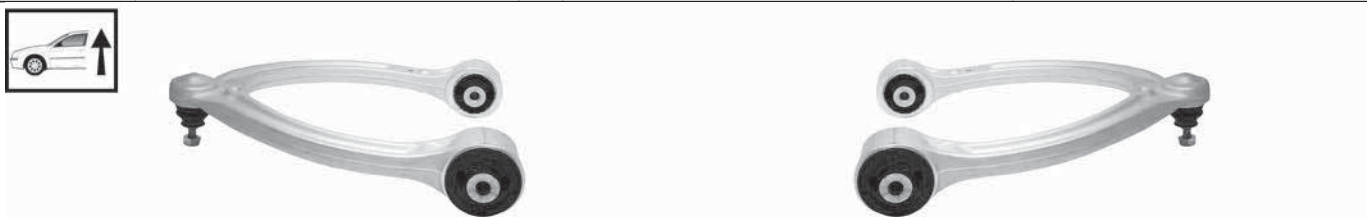
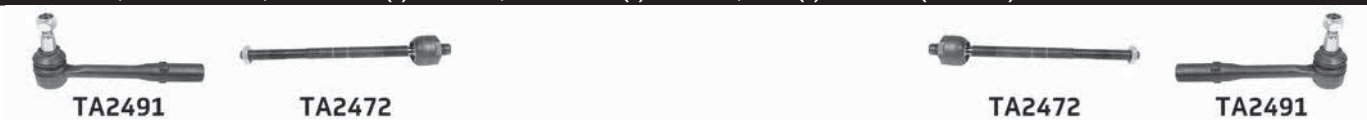

Part No	Description	Pos	Info	Technical
TA2472	Inner tie rod(123)	A B		M14x1.5 Male(252) £
TA2491	Tie rod end(224)	A B		M14x1.5 Female(253) £
TC1925	Link stabiliser(135)	A		M10x1.5
TC1926	Link stabiliser(135)	B		M10x1.5
TC1958	Link stabiliser(135)	A		M12x1.5
TC1959	Link stabiliser(135)	B		M12x1.5
TC2248	Lower track control arm(151)	A	Front(108)	M14x1.5
				(...)

MERCEDES

... MERCEDES

... S CLASS (221 SERIES) S280 3.0i, S300 3.0i, S320 3.0CDi (-) 4-Matic, S350 3.0CDi (-) 4-Matic, 3.5i (-) 4-Matic, S400 3.5i, S420 4.0CDi, S450 4.7i (-) 4-Matic, S500 4.7i (-) 4-Matic, 5.5i (-) 4-Matic (10/05→)

Part No	Description	Pos	Info	Technical
TC2249	Lower track control arm(151)	B	Front(108)	M14x1.5
TC2333	Lower track control arm(151)	A	Rear(187) (-) ABC	M14x1.5
TC2334	Lower track control arm(151)	B	Rear(187) (-) ABC	M14x1.5
TC2337	Upper wishbone(247)	A		M10x1.5
TC2338	Upper wishbone(247)	B		M10x1.5
TC2476	Upper link arm(239)	A		
TC2477	Upper link arm(239)	B		
TC2478	Upper camber arm(233)	A		
TC2479	Upper camber arm(233)	B		
TC2480	Lower track control arm(151)	A		
TC2481	Lower track control arm(151)	B		
TC2554	Upper track control arm(242)	A	Front(108)	
TC2555	Upper track control arm(242)	B	Front(108)	
TC3080	Lower track control arm(151)	A	Rear(187) (+) ABC	M14x1.5
TC3081	Lower track control arm(151)	B	Rear(187) (+) ABC	M14x1.5
TD967W	Control arm bush(-97-)	A B		
TD1104W	Bush(-85-)	A B	Inner(119)	
TD1105W	Bush(-85-)	A B	Outer(176)	
TD1106W	Bush(-85-)	A B	Outer(176)	
TD1107W	Bush(-85-)	A B	Inner(119)	

S CLASS (221 SERIES) S600 5.5i, S63 6.2i AMG (10/05→)

S CLASS (221 SERIES) S65 6.0i AMG Turbo (10/05→)



TA2491



TA2472



TA2472



TA2491



TC2337



TC2338



TC1958



TC1959



TC2248



TC2249



TC2333



TC2334



TC3080



TC3081

... S CLASS (221 SERIES) S600 5.5i, S63 6.2i AMG (10/05→)

... S CLASS (221 SERIES) S65 6.0i AMG Turbo (10/05→)

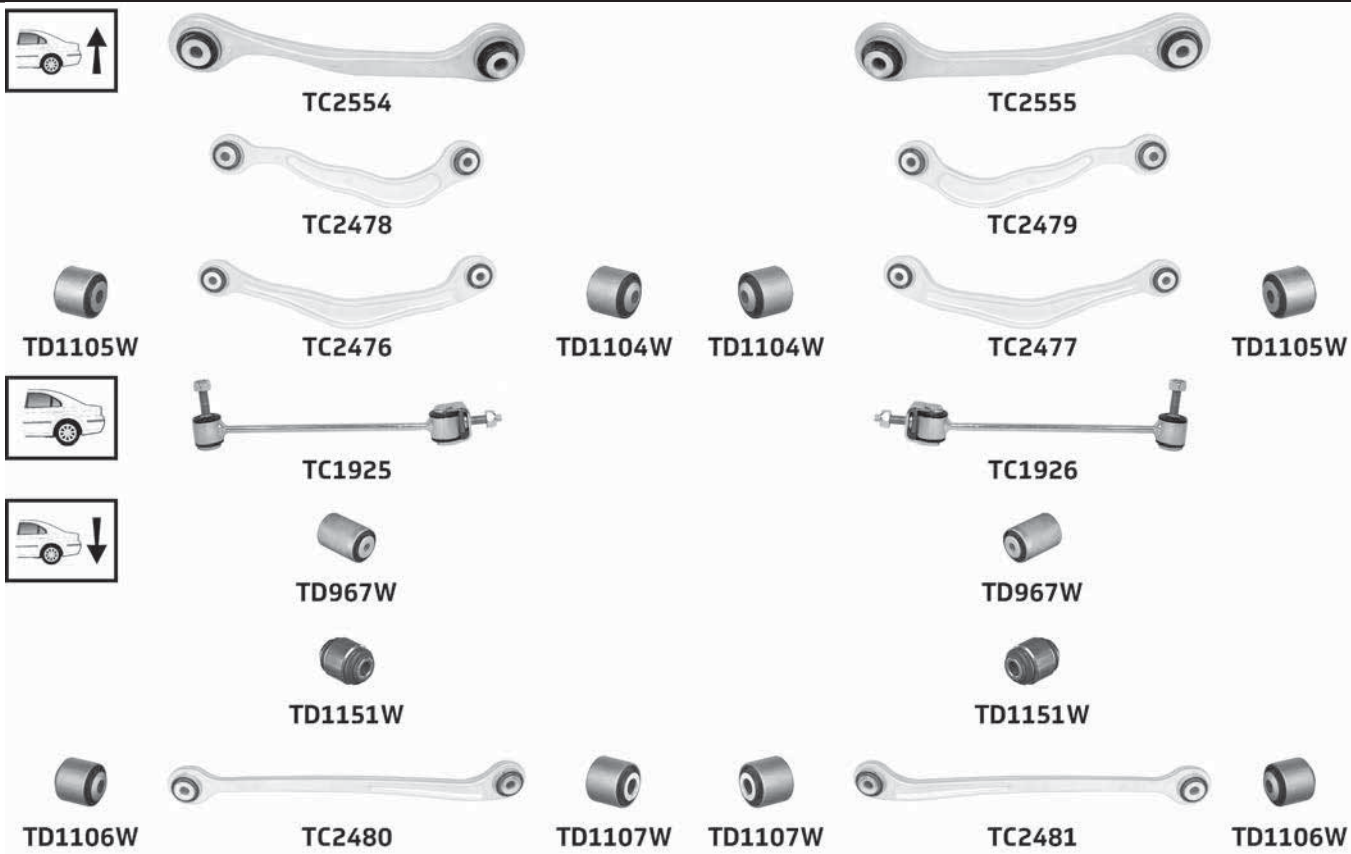

Part No	Description	Pos	Info	Technical
TA2472	Inner tie rod(123)	A B		M14x1.5 Male(252) £
TA2491	Tie rod end(224)	A B		M14x1.5 Female(253) £
TC1925	Link stabiliser(135)	A		M10x1.5
TC1926	Link stabiliser(135)	B		M10x1.5
TC1958	Link stabiliser(135)	A		M12x1.5
TC1959	Link stabiliser(135)	B		M12x1.5
TC2248	Lower track control arm(151)	A	Front(108)	M14x1.5
TC2249	Lower track control arm(151)	B	Front(108)	M14x1.5
TC2333	Lower track control arm(151)	A	Rear(187) (-) ABC	M14x1.5
TC2334	Lower track control arm(151)	B	Rear(187) (-) ABC	M14x1.5
TC2337	Upper wishbone(247)	A		M10x1.5
TC2338	Upper wishbone(247)	B		M10x1.5
TC2476	Upper link arm(239)	A		
TC2477	Upper link arm(239)	B		
TC2478	Upper camber arm(233)	A		
TC2479	Upper camber arm(233)	B		
TC2480	Lower track control arm(151)	A		
TC2481	Lower track control arm(151)	B		
TC2554	Upper track control arm(242)	A	Front(108)	
TC2555	Upper track control arm(242)	B	Front(108)	
TC3080	Lower track control arm(151)	A	Rear(187) (+) ABC	M14x1.5
TC3081	Lower track control arm(151)	B	Rear(187) (+) ABC	M14x1.5
TD967W	Control arm bush(-97-)	A B		
TD1104W	Bush(-85-)	A B	Inner(119)	
TD1105W	Bush(-85-)	A B	Outer(176)	
TD1106W	Bush(-85-)	A B	Outer(176)	
TD1107W	Bush(-85-)	A B	Inner(119)	
TD1151W	Lower hub carrier bush(143)	A B		

MERCEDES

... MERCEDES

S CLASS (221 SERIES) S250 2.2CDi (-) 4-Matic, S320 3.0CDi 4-Matic, S350 3.0CDi 4-Matic, 3.5i 4-Matic, S450 4.7i 4-Matic, S500 4.7i 4-Matic, 5.5i 4-Matic (10/05→)

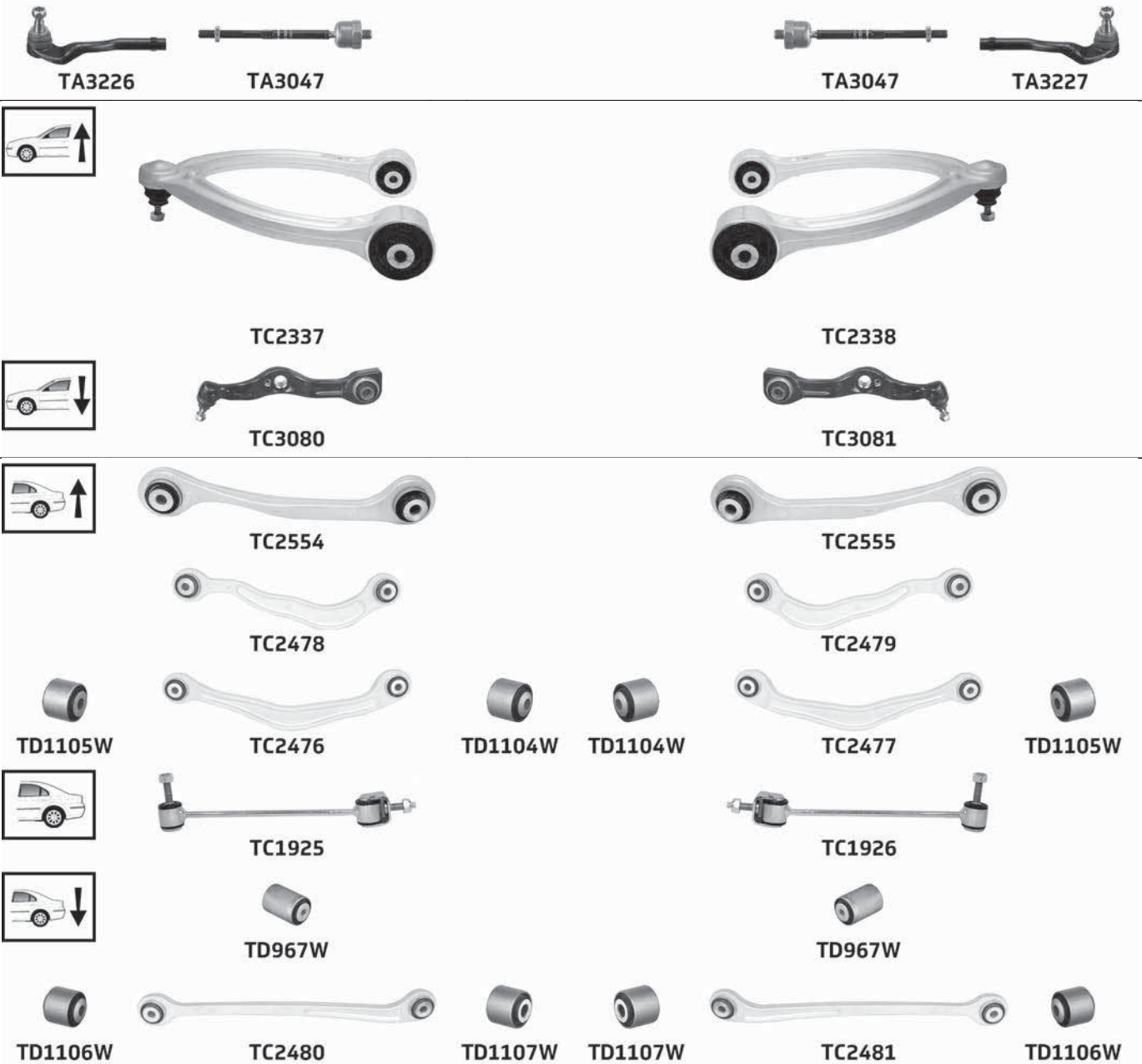

Part No	Description	Pos	Info	Technical
TA3047	Inner tie rod(123)	A B		M14x1.5 Male(252) £
TA3226	Tie rod end(224)	A		M14x1.5 Female(253) £
TA3227	Tie rod end(224)	B		M14x1.5 Female(253) £
TC1925	Link stabiliser(135)	A		M10x1.5
TC1926	Link stabiliser(135)	B		M10x1.5
TC2337	Upper wishbone(247)	A		M10x1.5
TC2338	Upper wishbone(247)	B		M10x1.5
TC2476	Upper link arm(239)	A		
TC2477	Upper link arm(239)	B		
TC2478	Upper camber arm(233)	A		
TC2479	Upper camber arm(233)	B		
TC2480	Lower track control arm(151)	A		
TC2481	Lower track control arm(151)	B		
TC2554	Upper track control arm(242)	A	Front(108)	
TC2555	Upper track control arm(242)	B	Front(108)	
TC3080	Lower track control arm(151)	A	Rear(187) (+) ABC (-) 4-Matic	M14x1.5
TC3081	Lower track control arm(151)	B	Rear(187) (+) ABC (-) 4-Matic	M14x1.5
TD967W	Control arm bush(-97-)	A B		
TD1104W	Bush(-85-)	A B	Inner(119)	
TD1105W	Bush(-85-)	A B	Outer(176)	
TD1106W	Bush(-85-)	A B	Outer(176)	

... S CLASS (221 SERIES) S250 2.2CDi (-) 4-Matic, S320 3.0CDi 4-Matic, S350 3.0CDi 4-Matic, 3.5i 4-Matic, S450 4.7i 4-Matic, S500 4.7i 4-Matic, 5.5i 4-Matic (10/05→)

Part No	Description	Pos	Info	Technical
TD1107W	Bush(-85)	A B	Inner(119)	

S CLASS (222 SERIES) S350 3.0CDii, S400 3.0i, S500 4.7i, S63 5.4i AMG 4-Matic (05/13→)



TA3216



TA3216

Part No	Description	Pos	Info	Technical
TA3216	Inner tie rod(123)	A B		

SL CLASS (230 SERIES) SL280 3.0i, SL300 3.0i, SL350 3.5i, 3.7i, SL500 5.0i, 5.4i, SL600 5.5i (10/01-01/12)

TA1961	TA2032	TA2032	TA1961
	TC1995	TC1995	
	TD767W	TD767W	
	TC1382	TC1382	
	TC2254	TC2254	
TC1385	TD765W	TD765W	TC1386

MERCEDES

... MERCEDES

... SL CLASS (230 SERIES) SL280 3.0i, SL300 3.0i, SL350 3.5i, 3.7i, SL500 5.0i, 5.4i, SL600 5.5i (10/01-01/12)



TC1947



TC1948



TC1949



TC1950



TC1387



TC1387



TC2226



TC2226



TC2293



TC2294



TD1011W



TD967W



TD967W

Part No	Description	Pos	Info	Technical
TA1961	Tie rod end(224)	A B		M14x1.5 Female(253) £
TA2032	Inner tie rod(123)	A B		M14x1.5 Male(252) £
TC1382	Lower ball joint(140)	A B	Outer(176)	M14x1.5
TC1385	Lower track control arm(151)	A	Front(108)	M14x1.5
TC1386	Lower track control arm(151)	B	Front(108)	M14x1.5
TC1387	Link stabiliser(135)	A B		M10x1.5
TC1947	Upper link arm(239)	A	Front(108)	
TC1948	Upper link arm(239)	B	Front(108)	
TC1949	Upper link arm(239)	A	Rear(187)	
TC1950	Upper link arm(239)	B	Rear(187)	
TC1995	Upper ball joint(232)	A B		M10x1.5
TC2226	Lower link arm(144)	A B	Front(108)	
TC2254	Lower ball joint(140)	A B	Inner(119)	M14x1.5
TC2293	Lower link arm(144)	A	Rear(187)	
TC2294	Lower link arm(144)	B	Rear(187)	
TD765W	Lower track control arm bush(153)	A B	Front(108)	
TD767W	Lower track control arm bolt(152)	A B		
TD967W	Control arm bush(-97-)	A B		
TD1011W	Sub-frame bush(215)	K	Rear(187)	

SL CLASS (230 SERIES) SL55 5.4i AMG, SL65 6.0i AMG (10/01-01/12)



TA1961



TA2032



TA2032



TA1961

... SL CLASS (230 SERIES) SL55 5.4i AMG, SL65 6.0i AMG (10/01-01/12)

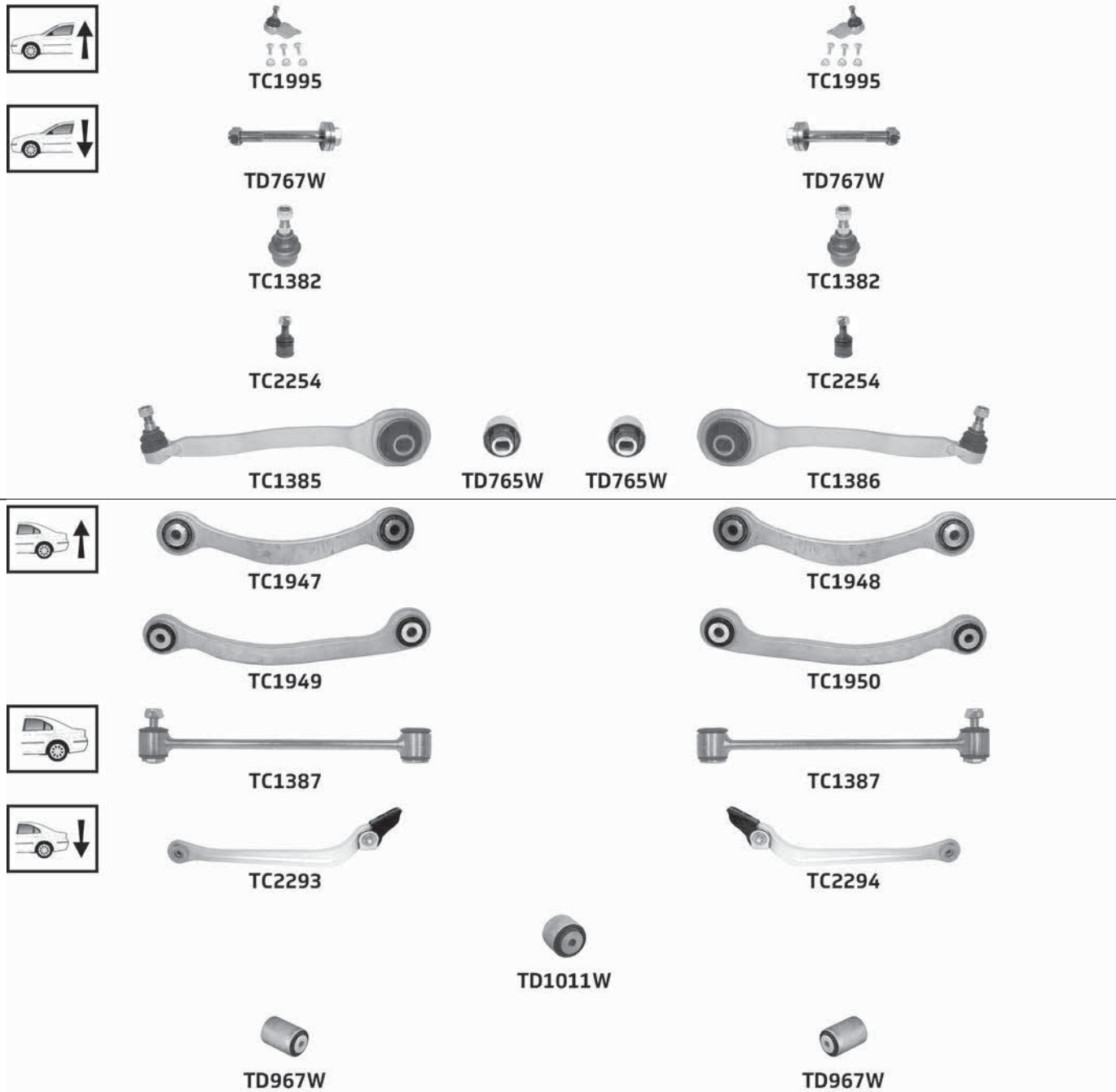

Part No	Description	Pos	Info	Technical
TA1961	Tie rod end(224)	A B		M14x1.5 Female(253) £
TA2032	Inner tie rod(123)	A B		M14x1.5 Male(252) £
TC1382	Lower ball joint(140)	A B	Outer(176)	M14x1.5
TC1385	Lower track control arm(151)	A	Front(108)	M14x1.5
TC1386	Lower track control arm(151)	B	Front(108)	M14x1.5
TC1387	Link stabiliser(135)	A B		M10x1.5
TC1947	Upper link arm(239)	A	Front(108)	
TC1948	Upper link arm(239)	B	Front(108)	
TC1949	Upper link arm(239)	A	Rear(187)	
TC1950	Upper link arm(239)	B	Rear(187)	
TC1995	Upper ball joint(232)	A B		M10x1.5
TC2254	Lower ball joint(140)	A B	Inner(119)	M14x1.5
TC2293	Lower link arm(144)	A	Rear(187)	
TC2294	Lower link arm(144)	B	Rear(187)	
TD765W	Lower track control arm bush(153)	A B	Front(108)	
TD767W	Lower track control arm bolt(152)	A B		
TD967W	Control arm bush(-97-)	A B		
TD1011W	Sub-frame bush(215)	K	Rear(187)	

... MERCEDES

SL CLASS (231 SERIES) SL350 3.5i, SL400 3.0i, SL500 4.7i (02/12→)



Part No	Description	Pos	Info	Technical
TD1658W	Sub-frame bush(215)	A B	Rear(187) Inner(119)	

SLC CLASS (172 SERIES) SLC180 1.6i, SLC200 2.0i, SLC250 2.2CDI, SLC300 2.0i (01/16→)



Part No	Description	Pos	Info	Technical
TA2572	Tie rod end(224)	A		M14x1.5 Female(253) E
TA2573	Tie rod end(224)	B		M14x1.5 Female(253) E
TA3248	Inner tie rod(123)	A B		M14x1.5 Male(252) E
TC1279	Lower track control arm(151)	A	Front(108)	M14x1.5
TC1280	Lower track control arm(151)	B	Front(108)	M14x1.5
TC2357	Lower track control arm(151)	A	Rear(187)	M14x1.5
TC2358	Lower track control arm(151)	B	Rear(187)	M14x1.5
TC3460	Link stabiliser(135)	A B		M10x1.5
TC3461	Lower rod assembly(146)	A B	Rear(187)	M10x1.5
TC3478	Upper camber arm(233)	A	Rear(187)	
TC3479	Upper camber arm(233)	B	Rear(187)	
TD758W	Lower track control arm bush(153)	A B	Front(108)	
TD901W	Lower track control arm bush(153)	A B	Rear(187)	
TD1649W	Lower link arm bush(145)	A B	Front(108) Inner(119)	
TD1649W	Upper camber arm bush(234)	A B	Front(108) Inner(119)	
TD1649W	Upper track control arm bush(243)	A B	Front(108) Inner(119)	

SLC CLASS (172 SERIES) SLC43 3.0i AMG (01/16→)



Part No	Description	Pos	Info	Technical
TA2572	Tie rod end(224)	A		M14x1.5 Female(253) £
TA2573	Tie rod end(224)	B		M14x1.5 Female(253) £
TA3248	Inner tie rod(123)	A B		M14x1.5 Male(252) £
TC3460	Link stabiliser(135)	A B		M10x1.5
TC3461	Lower rod assembly(146)	A B	Rear(187)	M10x1.5
TD732W	Lower track control arm bush(153)	A B	Front(108)	

SLK CLASS (170 SERIES) SLK200 2.0i, SLK230 2.3i (09/96-03/00)



... MERCEDES

... SLK CLASS (170 SERIES) SLK200 2.0i, SLK230 2.3i (09/96-03/00)



TC2034



TD451W



TD451W



TC2034



TD451W



TC2033



TD451W



TD451W



TC2033



TD451W



TC1600KIT



TD801W



TD801W



TD213W



TD213W



TD451W



TC2035



TD451W



TD451W



TC2035



TD451W



TC389



TD450W



TD450W



TC389

Part No	Description	Pos	Info	Technical
TA1643	Tie rod end(224)	A B		M12x1.5 Male(252) E
TC389	Lower rod assembly(146)	A B		M10x1.25
TC835	Lower ball joint(140)	A B		M14x1.5
TC1051	Lower wishbone(158)	A	(-) Ball joint(-11-)	
TC1052	Lower wishbone(158)	B	(-) Ball joint(-11-)	
TC1600KIT	Suspension kit(220)	K		
TC2033	Upper track rod(244)	A B		
TC2034	Upper torque rod(241)	A B		
TC2035	Lower torque rod(149)	A B		
TC2043	Upper wishbone(247)	A		M10x1.5
TC2044	Upper wishbone(247)	B		M10x1.5
TD213W	Lower hub carrier bush(143)	A B		
TD397W	Lower wishbone bush(159)	A B	Front(108) Pack of(179) 2	
TD398W	Lower wishbone bush(159)	A B	Rear(187)	
TD450W	Bush(-85-)	A B		
TD451W	Bush(-85-)	A B	Outer(176) Inner(119)	
TD680W	Anti-roll bar(-74-) bush kit(-86-)	K	Ø18 Outer(176) Complete axle kit(-92)	
TD772W	Upper wishbone bush(248)	A B	Front(108) Rear(187)	
TD801W	Lower rod assembly bolt(147)	A B		
TD839W	Lower wishbone repair kit(163)	A B		
TD1229W	Anti-roll bar(-74-) bush kit(-86-)	K	Ø23 Inner(119) Complete axle kit(-92)	
TL540	Centre rod assembly(-90-)	K	(-) Ch. 170444, 170449	M12x15

SLK CLASS (170 SERIES) SLK200 2.0i, SLK230 2.3i, SLK320 3.2i (03/00-04/04)



TA1643



TL554



TA1643

... SLK CLASS (170 SERIES) SLK200 2.0i, SLK230 2.3i, SLK320 3.2i (03/00-04/04)

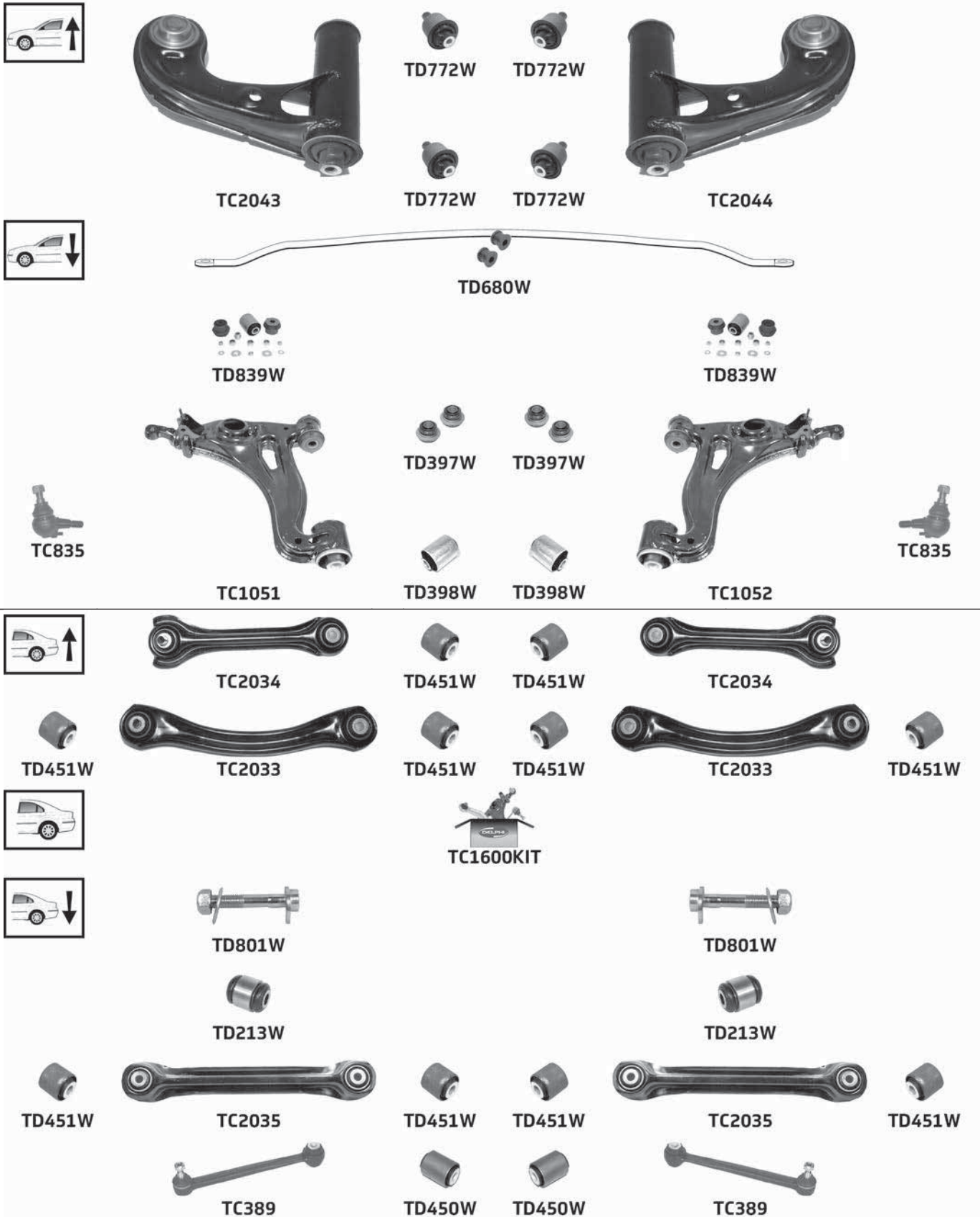

Part No	Description	Pos	Info	Technical
TA1643	Tie rod end(224)	A B		M12x1.5 Male(252) E
TC389	Lower rod assembly(146)	A B		M10x1.25
TC835	Lower ball joint(140)	A B		M14x1.5
TC1051	Lower wishbone(158)	A	(-) Ball joint(-11-)	
TC1052	Lower wishbone(158)	B	(-) Ball joint(-11-)	
TC1600KIT	Suspension kit(220)	K		
				(...)

... MERCEDES

... SLK CLASS (170 SERIES) SLK200 2.0i, SLK230 2.3i, SLK320 3.2i (03/00-04/04)

Part No	Description	Pos	Info	Technical
TC2033	Upper track rod(244)	A B		
TC2034	Upper torque rod(241)	A B		
TC2035	Lower torque rod(149)	A B		
TC2043	Upper wishbone(247)	A		M10x1.5
TC2044	Upper wishbone(247)	B		M10x1.5
TD213W	Lower hub carrier bush(143)	A B		
TD397W	Lower wishbone bush(159)	A B	Front(108) Pack of(179) 2	
TD398W	Lower wishbone bush(159)	A B	Rear(187)	
TD450W	Bush(-85-)	A B		
TD451W	Bush(-85-)	A B	Outer(176) Inner(119)	
TD680W	Anti-roll bar(-74-) bush kit(-86-)	K	Ø18 Outer(176) Complete axle kit(-92-)	
TD772W	Upper wishbone bush(248)	A B	Front(108) Rear(187)	
TD801W	Lower rod assembly bolt(147)	A B		
TD839W	Lower wishbone repair kit(163)	A B		
TL554	Centre rod assembly(-90-)	K		M12x1.5

SLK CLASS (171 SERIES) SLK200 1.8i, SLK280 3.0i, SLK300 3.0i, SLK350 3.5i, SLK55 5.4i AMG (03/04-02/11)

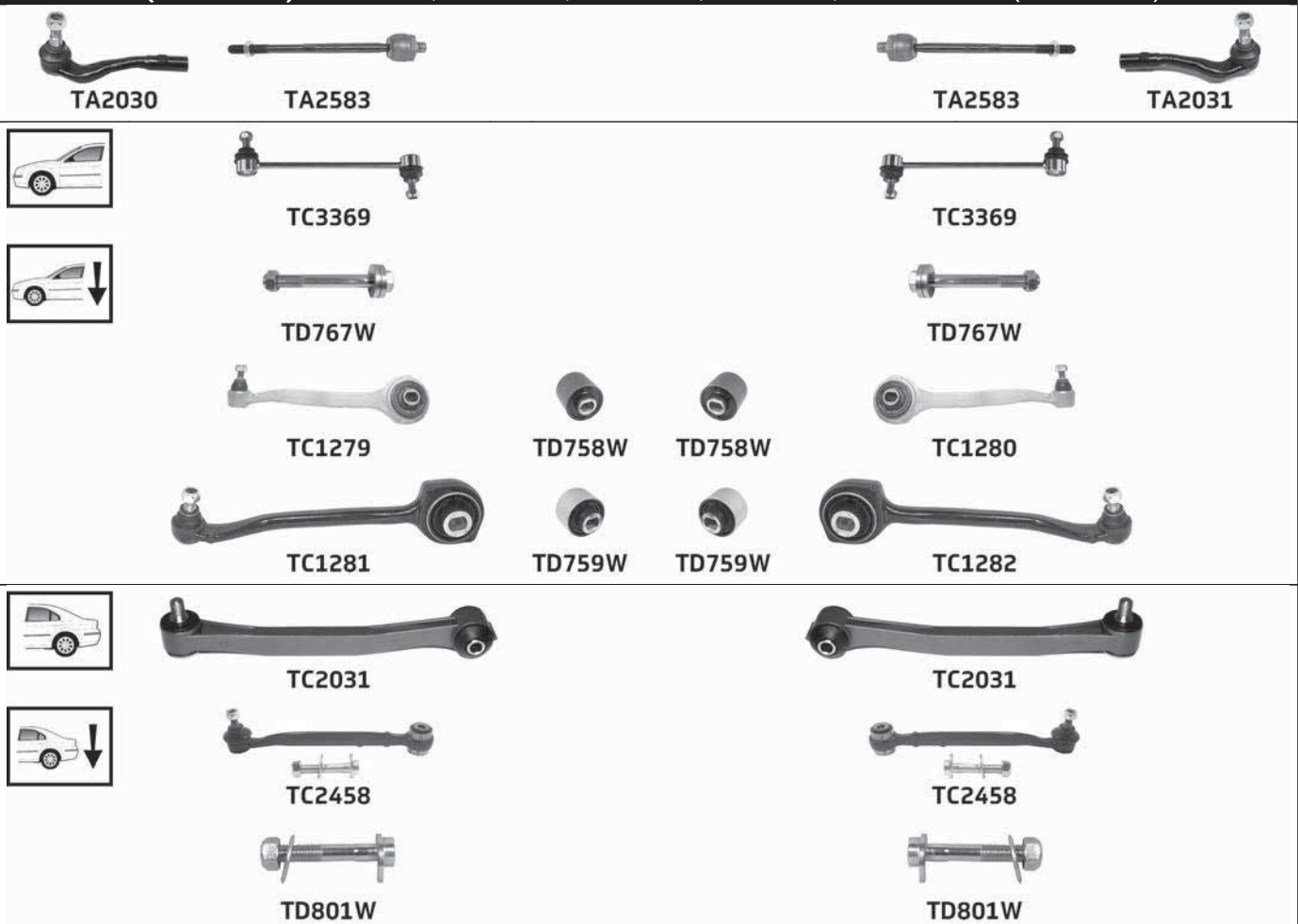

Part No	Description	Pos	Info	Technical
TA2030	Tie rod end(224)	A		M14x1.5 Female(253) £
TA2031	Tie rod end(224)	B		M14x1.5 Female(253) £
TA2583	Inner tie rod(123)	A B		M14x1.5 Male(252) £
TC1279	Lower track control arm(151)	A	Front(108)	M14x1.5
TC1280	Lower track control arm(151)	B	Front(108)	M14x1.5
TC1281	Lower track control arm(151)	A	Rear(187)	M14x1.5
TC1282	Lower track control arm(151)	B	Rear(187)	M14x1.5
TC2031	Link stabiliser(135)	A B	Plastic(184)	M10x1.5
TC2458	Lower rod assembly(146)	A B		M10x1.5
TC3369	Link stabiliser(135)	A B		M12x1.5
TD758W	Lower track control arm bush(153)	A B	Front(108)	
TD759W	Lower track control arm bush(153)	A B	Rear(187)	
TD767W	Lower track control arm bolt(152)	A B		
TD801W	Lower rod assembly bolt(147)	A B		

SLK CLASS (172 SERIES) SLK200 1.8i, SLK250 1.8i, 2.2CDI, SLK350 3.5i (02/11→)

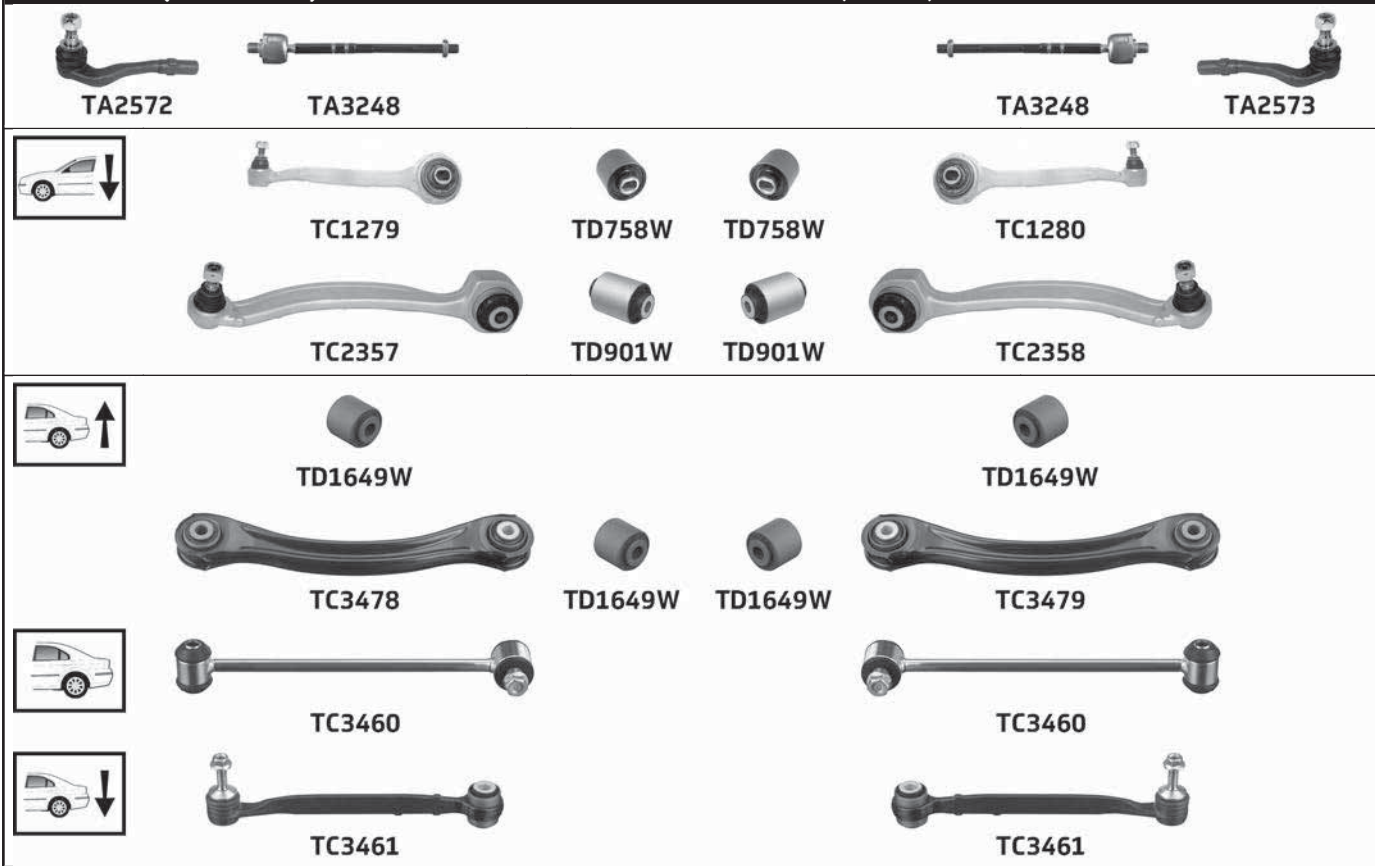

Part No	Description	Pos	Info	Technical
TA2572	Tie rod end(224)	A		M14x1.5 Female(253) £
TA2573	Tie rod end(224)	B		M14x1.5 Female(253) £
TA3248	Inner tie rod(123)	A B		M14x1.5 Male(252) £
TC1279	Lower track control arm(151)	A	Front(108)	M14x1.5
TC1280	Lower track control arm(151)	B	Front(108)	M14x1.5
TC2357	Lower track control arm(151)	A	Rear(187)	M14x1.5
TC2358	Lower track control arm(151)	B	Rear(187)	M14x1.5
TC3460	Link stabiliser(135)	A B		M10x1.5
TC3461	Lower rod assembly(146)	A B	Rear(187)	M10x1.5
TC3478	Upper camber arm(233)	A	Rear(187)	
TC3479	Upper camber arm(233)	B	Rear(187)	
TD758W	Lower track control arm bush(153)	A B	Front(108)	
TD901W	Lower track control arm bush(153)	A B	Rear(187)	
TD1649W	Lower link arm bush(145)	A B	Front(108) Inner(119)	
TD1649W	Upper camber arm bush(234)	A B	Front(108) Inner(119)	
TD1649W	Upper track control arm bush(243)	A B	Front(108) Inner(119)	

MERCEDES

... MERCEDES

SLK CLASS (172 SERIES) SLK55 5.4i AMG (02/11→)

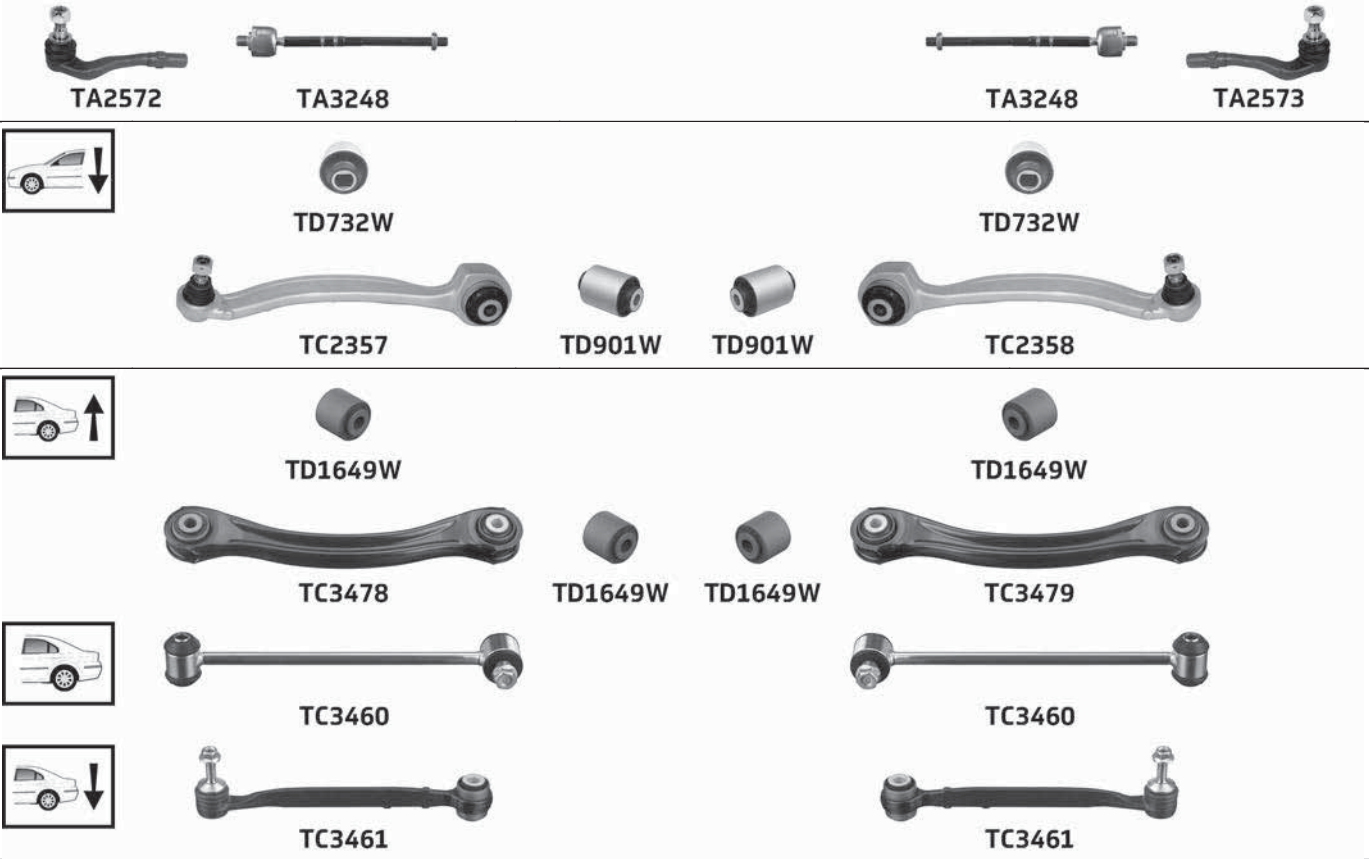

Part No	Description	Pos	Info	Technical
TA2572	Tie rod end(224)	A		M14x1.5 Female(253) £
TA2573	Tie rod end(224)	B		M14x1.5 Female(253) £
TA3248	Inner tie rod(123)	A B		M14x1.5 Male(252) £
TC2357	Lower track control arm(151)	A	Rear(187)	M14x1.5
TC2358	Lower track control arm(151)	B	Rear(187)	M14x1.5
TC3460	Link stabiliser(135)	A B		M10x1.5
TC3461	Lower rod assembly(146)	A B	Rear(187)	M10x1.5
TC3478	Upper camber arm(233)	A	Rear(187)	
TC3479	Upper camber arm(233)	B	Rear(187)	
TD732W	Lower track control arm bush(153)	A B	Front(108)	
TD901W	Lower track control arm bush(153)	A B	Rear(187)	
TD1649W	Lower link arm bush(145)	A B	Front(108) Inner(119)	
TD1649W	Upper camber arm bush(234)	A B	Front(108) Inner(119)	
TD1649W	Upper track control arm bush(243)	A B	Front(108) Inner(119)	

SLS CLASS (197 SERIES) SLS63 6.2i AMG (03/10→)



Part No	Description	Pos	Info	Technical
TA2572	Tie rod end(224)	A		M14x1.5 Female(253) £
TA2573	Tie rod end(224)	B		M14x1.5 Female(253) £

SPRINTER (901, 902, 903 SERIES) 2.2CDi 208, 211, 213, 308, 311, 313, 2.3i 214, 314, 2.3D 208, 308, 2.7CDi 216, 316, 2.9TDi 210, 212, 310, 312 (12/94-05/06)



TA1683



TA1764



TBR4134



TA1764



TA1683



TA3257



TA3257



TC1128



TC1129



TD569W



TD569W



TD779W



TD800W



TC2128



TD744W



TD744W



TC2129



TC888



TC888



TD1622W



TD1622W



TC2127



TC2127



TD1624W



TD1624W



TD1025W



TD745W



TD1025W

Part No	Description	Pos	Info	Technical
TA1683	Tie rod end(224)	A B	(-) 4x4	M16x1.5 Female(253) £
TA1764	Inner tie rod(123)	A B		M16x1.5 Male(252) £
TA3257	Tie rod end(224)	A B	(+) 4x4	M16x1.5 Female(253) £
TBR4134	Steering rack gaiter kit(213)	K		1 :16x49x49 2 :16x49x49
TC888	Lower ball joint(140)	A B		M20x1.5
TC1128	Link stabiliser(135)	A		
TC1129	Link stabiliser(135)	B		
TC2127	Link stabiliser(135)	A B		
TC2128	Lower wishbone(158)	A		M20x1.5
TC2129	Lower wishbone(158)	B		M20x1.5
TD569W	Link stabiliser bush(136)	A B	Pack of (179) 2	

(...)

... MERCEDES

... SPRINTER (901, 902, 903 SERIES) 2.2CDi 208, 211, 213, 308, 311, 313, 2.3i 214, 314, 2.3D 208, 308, 2.7CDi 216, 316, 2.9TDi 210, 212, 310, 312 (12/94-05/06)

Part No	Description	Pos	Info	Technical
TD744W	Lower wishbone bush(159)	A B	Front(108) Rear(187)	
TD745W	Anti-roll bar(-74) bush kit(-86-)	K	Ø23 Complete axle kit(-92-)	
TD779W	Anti-roll bar(-74) bush kit(-86-)	K	Ø22 Complete axle kit(-92-)	
TD800W	Anti-roll bar(-74) bush kit(-86-)	K	Ø25 Complete axle kit(-92-)	
TD1025W	Anti-roll bar(-74) link bush(134)	A B	Lower(139)	
TD1622W	Spring shackle bush(206)	A B	Rear(187)	
TD1624W	Leaf spring bush(128)	A B		

SPRINTER (904 SERIES) 2.2CDi 408, 411, 413, 2.3i 414, 2.3D 408, 2.7CDi 416, 2.9TDi 410, 412 (12/94-05/06)

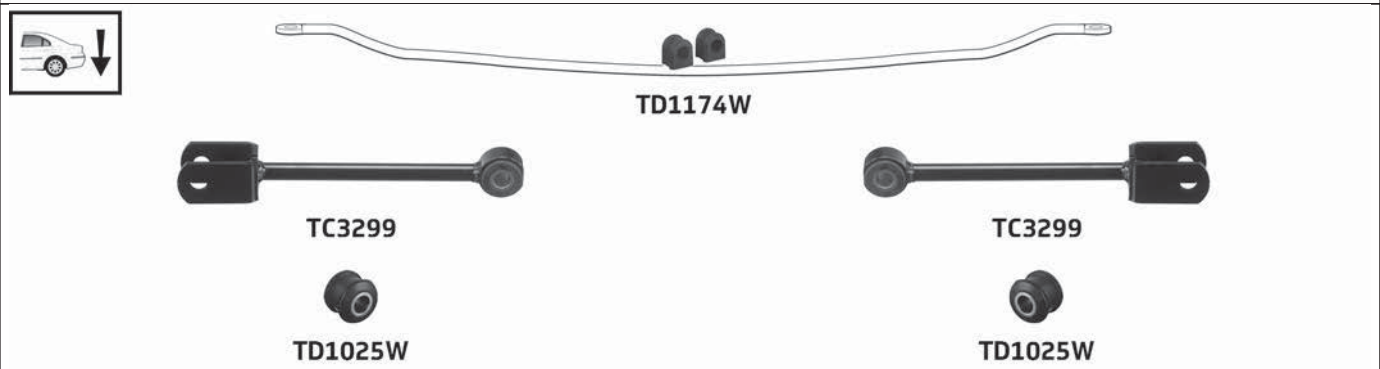
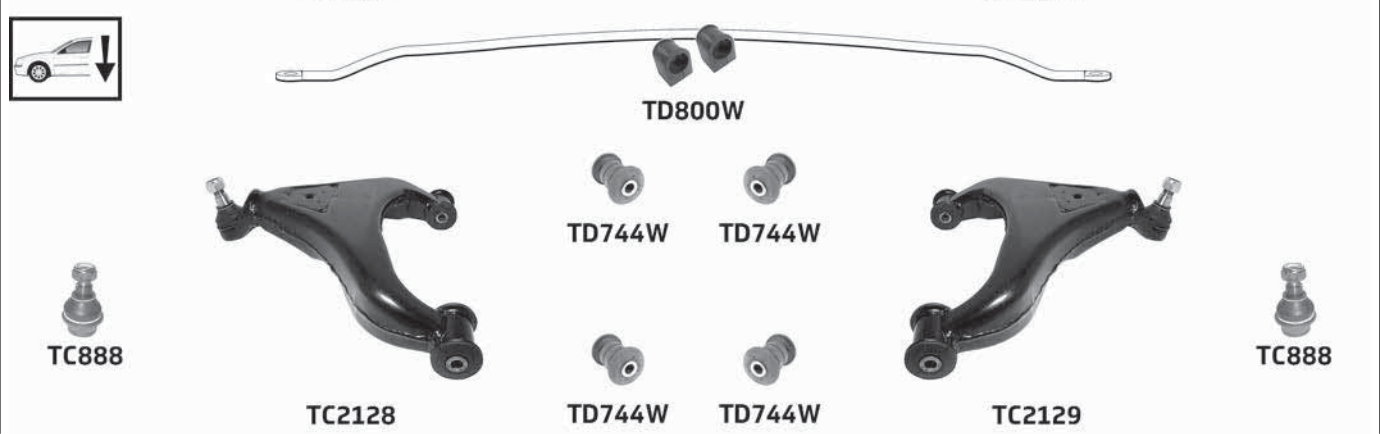
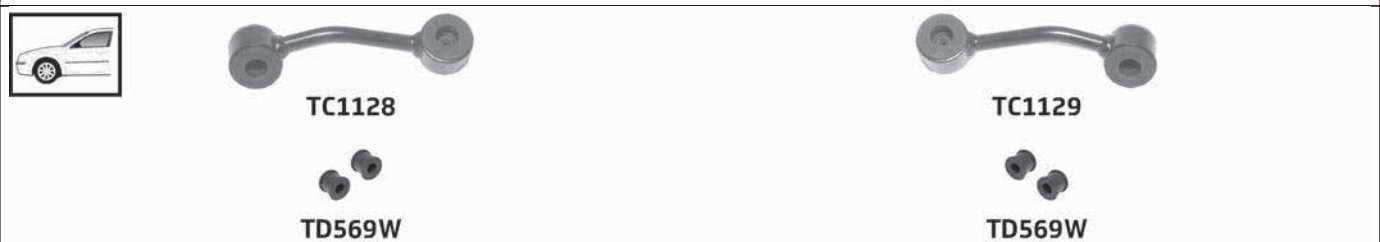

Part No	Description	Pos	Info	Technical
TA1683	Tie rod end(224)	A B	(-) 4x4	M16x1.5 Female(253) £
TA1764	Inner tie rod(123)	A B		M16x1.5 Male(252) £
TA3257	Tie rod end(224)	A B	(+) 4x4	M16x1.5 Female(253) £
TBR4134	Steering rack gaiter kit(213)	K		1 :16x49x49 2 :16x49x49
TC888	Lower ball joint(140)	A B		M20x1.5
TC1128	Link stabiliser(135)	A		
TC1129	Link stabiliser(135)	B		
TC2128	Lower wishbone(158)	A		M20x1.5
TC2129	Lower wishbone(158)	B		M20x1.5
TC3299	Link stabiliser(135)	A B	(-) 4x4	
TD569W	Link stabiliser bush(136)	A B	Pack of(179) 2	
TD744W	Lower wishbone bush(159)	A B	Front(108) Rear(187)	

MERCEDES

... SPRINTER (904 SERIES) 2.2CDi 408, 411, 413, 2.3i 414, 2.3D 408, 2.7CDi 416, 2.9TDi 410, 412 (12/94-05/06)

Part No	Description	Pos	Info	Technical
TD800W	Anti-roll bar(-74) bush kit(-86)	K	Ø25 Complete axle kit(-92)	
TD1025W	Anti-roll bar(-74) link bush(134)	A B	Lower(139)	
TD1174W	Anti-roll bar(-74) bush kit(-86)	K	Ø27 Complete axle kit(-92)	

SPRINTER (905 SERIES) 2.7CDi 616 (04/01→)



TC2130



TC2131

Part No	Description	Pos	Info	Technical
TC2130	Link stabiliser(135)	A		M10x1.5
TC2131	Link stabiliser(135)	B		M10x1.5

SPRINTER (906 SERIES) 1.8i 216, 2.2CDi 209, 210, 211, 213, 215, 216, 3.0CDi 218, 219, 3.5i 224 (06/06→)



TA2461



TA2462



TA2462



TA2461



TC1923



TC1924



TD910W



TC2448



TD847W

TD847W



TC2449



TC2424



TD856W



TD856W



TC2424



TC1961



TC1961



TD1025W



TD1025W

Part No	Description	Pos	Info	Technical
TA2461	Tie rod end(224)	A B		M16x1.5 Female(253) £
TA2462	Inner tie rod(123)	A B		M16x1.5 Male(252) £
TC1923	Link stabiliser(135)	A		M12x1.5
TC1924	Link stabiliser(135)	B		M12x1.5
TC1961	Link stabiliser(135)	A B		
TC2424	Lower ball joint(140)	A B		M20x1.5
TC2448	Lower wishbone(158)	A	(-) Heavy duty suspension(-18)	M20x1.5
TC2449	Lower wishbone(158)	B	(-) Heavy duty suspension(-18)	M20x1.5
TD847W	Lower wishbone bush(159)	A B	Front(108)	
TD856W	Lower wishbone bush(159)	A B	Rear(187)	
TD910W	Anti-roll bar(-74) bush kit(-86)	K	Ø20 Complete axle kit(-92) →07/10 (-) Heavy duty(111) (-) 4x4	
TD1025W	Anti-roll bar(-74) link bush(134)	A B	Lower(139)	

MERCEDES

... MERCEDES

SPRINTER (906 SERIES) 1.8i 316, 2.2CDi 309, 310, 311, 313, 315, 316, 3.0CDi 318, 319, 3.5i 324 (06/06→)

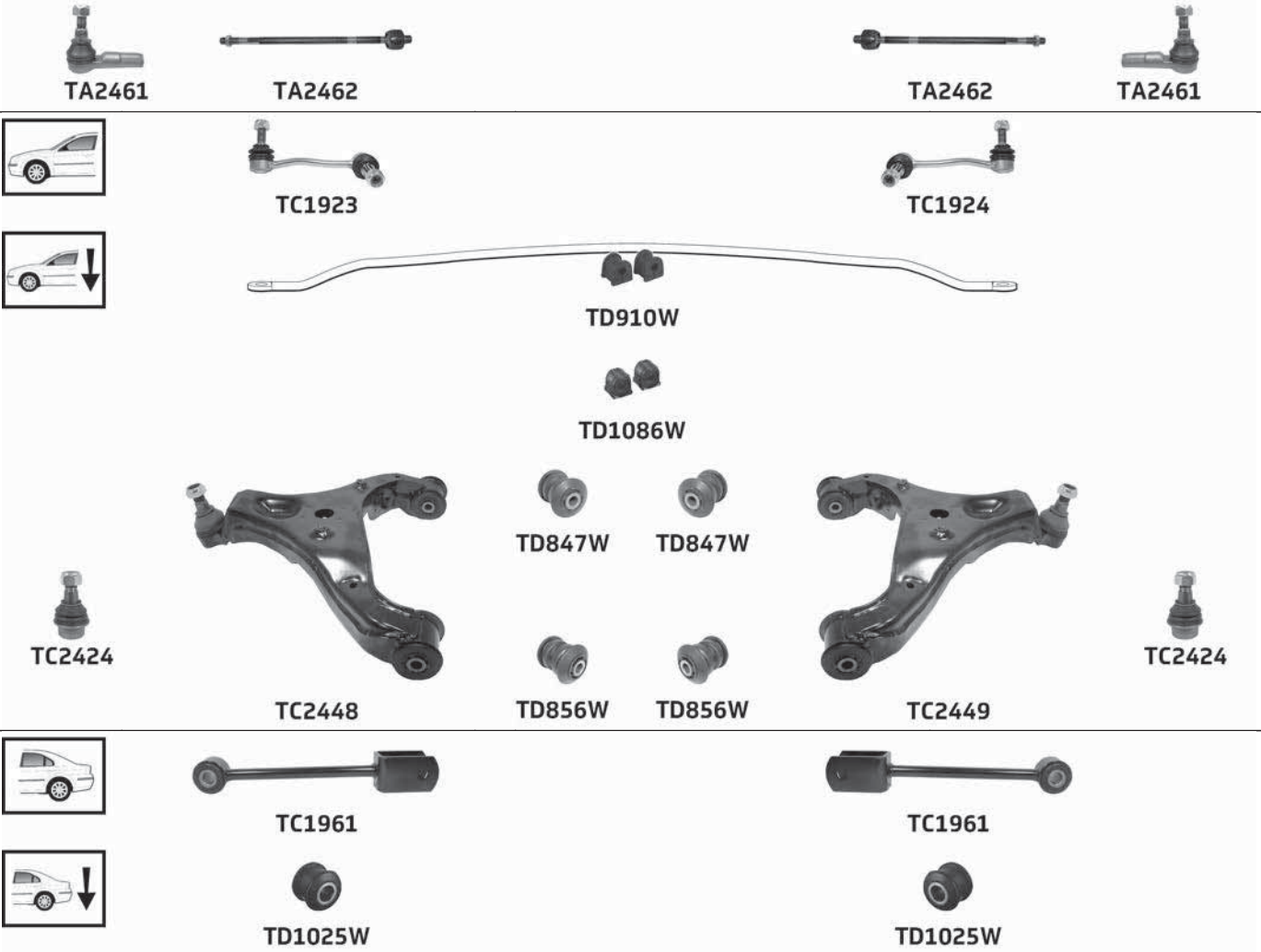

Part No	Description	Pos	Info	Technical
TA2461	Tie rod end(224)	A B		M16x1.5 Female(253) £
TA2462	Inner tie rod(123)	A B		M16x1.5 Male(252) £
TC1923	Link stabiliser(135)	A		M12x1.5
TC1924	Link stabiliser(135)	B		M12x1.5
TC1961	Link stabiliser(135)	A B		
TC2424	Lower ball joint(140)	A B		M20x1.5
TC2448	Lower wishbone(158)	A	(-) Heavy duty suspension(-18-)	M20x1.5
TC2449	Lower wishbone(158)	B	(-) Heavy duty suspension(-18-)	M20x1.5
TD847W	Lower wishbone bush(159)	A B	Front(108)	
TD856W	Lower wishbone bush(159)	A B	Rear(187)	
TD910W	Anti-roll bar(-74) bush kit(-86-)	K	Ø20 Complete axle kit(-92-) →07/10 (-) Heavy duty(111) (-) 4x4	
TD1025W	Anti-roll bar(-74) link bush(134)	A B	Lower(139)	
TD1086W	Anti-roll bar(-74) bush kit(-86-)	K	Ø20 Complete axle kit(-92-) 07/10→ (+) Heavy duty(-46-)	

SPRINTER (906 SERIES) 1.8i 516, 2.2CDi 411, 413, 415, 416, 509, 510, 511, 513, 515, 516, 3.0CDi 418, 419, 518, 519, 3.5i 424, 524 (06/06→)

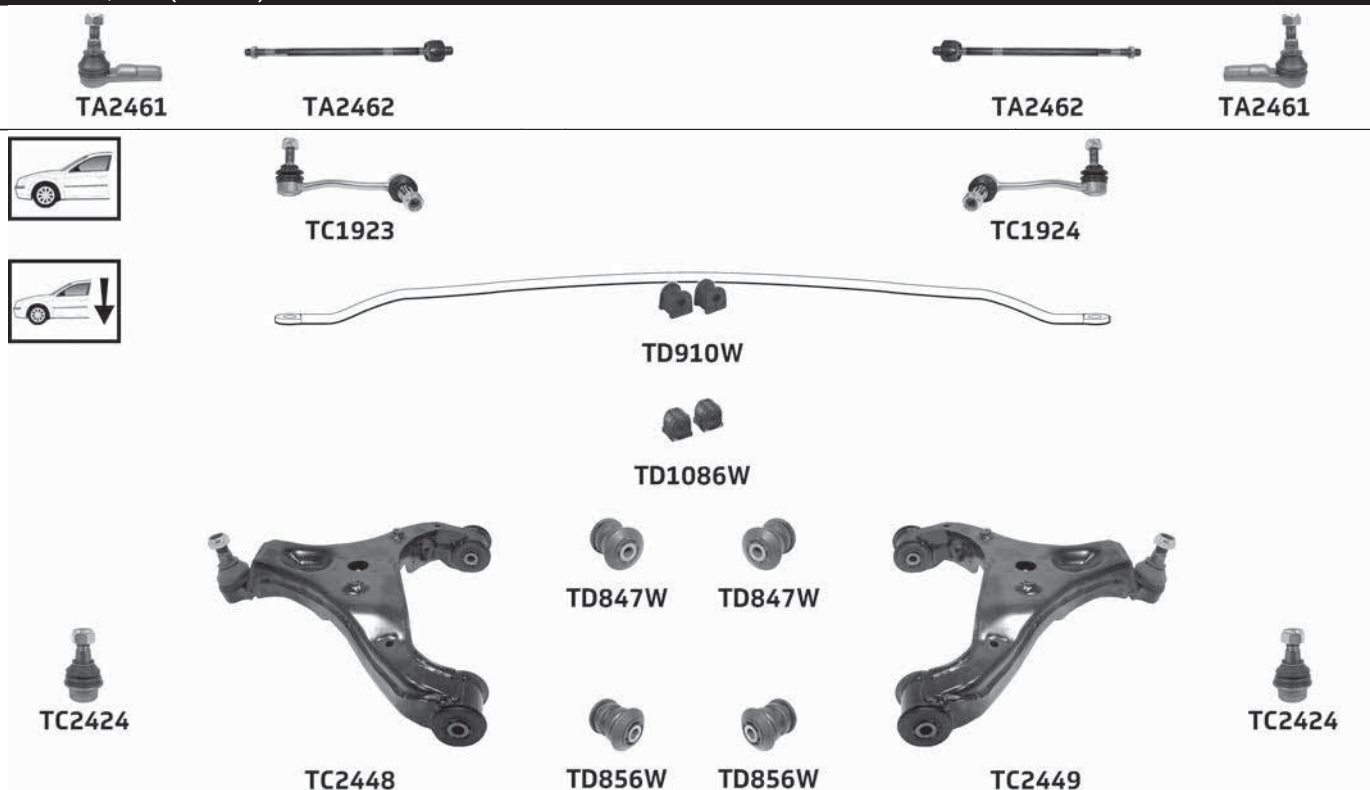

Part No	Description	Pos	Info	Technical
TA2461	Tie rod end(224)	A B		M16x1.5 Female(253) £
TA2462	Inner tie rod(123)	A B		M16x1.5 Male(252) £
TC1923	Link stabiliser(135)	A		M12x1.5
TC1924	Link stabiliser(135)	B		M12x1.5
TC2424	Lower ball joint(140)	A B		M20x1.5
TC2448	Lower wishbone(158)	A	(-) Heavy duty suspension(-18)	M20x1.5
TC2449	Lower wishbone(158)	B	(-) Heavy duty suspension(-18)	M20x1.5
TD847W	Lower wishbone bush(159)	A B	Front(108)	
TD856W	Lower wishbone bush(159)	A B	Rear(187)	
TD910W	Anti-roll bar(-74) bush kit(-86)	K	Ø20 Complete axle kit(-92) →07/10 (-) Heavy duty(111) (-) 4x4	
TD1086W	Anti-roll bar(-74) bush kit(-86)	K	Ø20 Complete axle kit(-92) 07/10→ (+) Heavy duty(-46)	

MERCEDES

... MERCEDES

SPRINTER CLASSIC (909 SERIES) RUSSIAN BUILD 2.2CDi 308, 408 (08/13→)

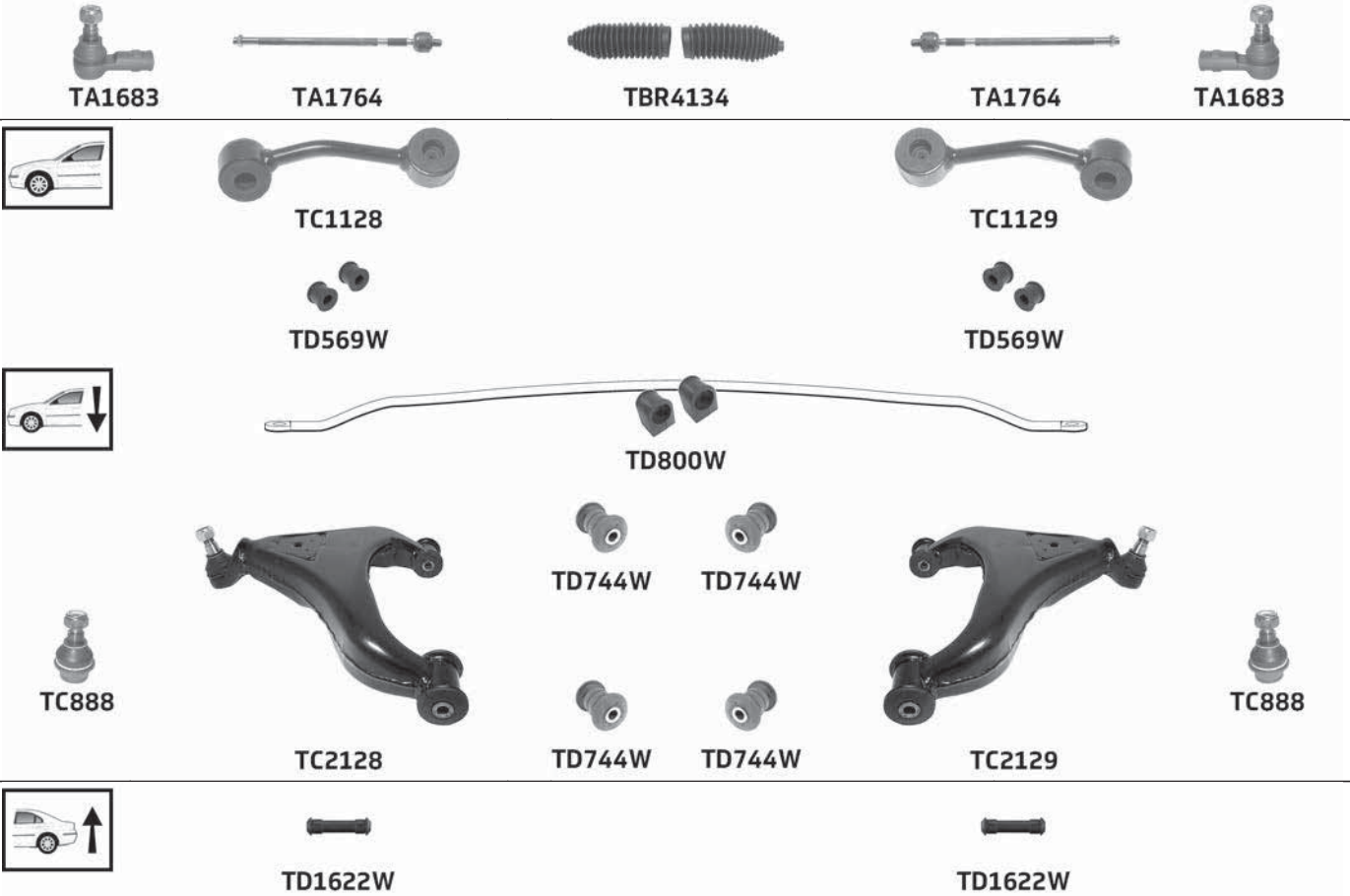

Part No	Description	Pos	Info	Technical
TA1683	Tie rod end(224)	A B		M16x1.5 Female(253) £
TA1764	Inner tie rod(123)	A B		M16x1.5 Male(252) £
TBR4134	Steering rack gaiter kit(213)	K		1 :16x49x49 2 :16x49x49
TC888	Lower ball joint(140)	A B		M20x1.5
TC1128	Link stabiliser(135)	A		
TC1129	Link stabiliser(135)	B		
TC2128	Lower wishbone(158)	A		M20x1.5
TC2129	Lower wishbone(158)	B		M20x1.5
TD569W	Link stabiliser bush(136)	A B	Pack of(179) 2	
TD744W	Lower wishbone bush(159)	A B	Front(108) Rear(187)	
TD800W	Anti-roll bar(-74) bush kit(-86-)	K	Ø25 Complete axle kit(-92-)	
TD1622W	Spring shackle bush(206)	A B	Rear(187) Model 308	

V CLASS (638 SERIES) V200 2.0i, V230 2.3i, 2.3TD, V280 2.8i (08/96-07/03)

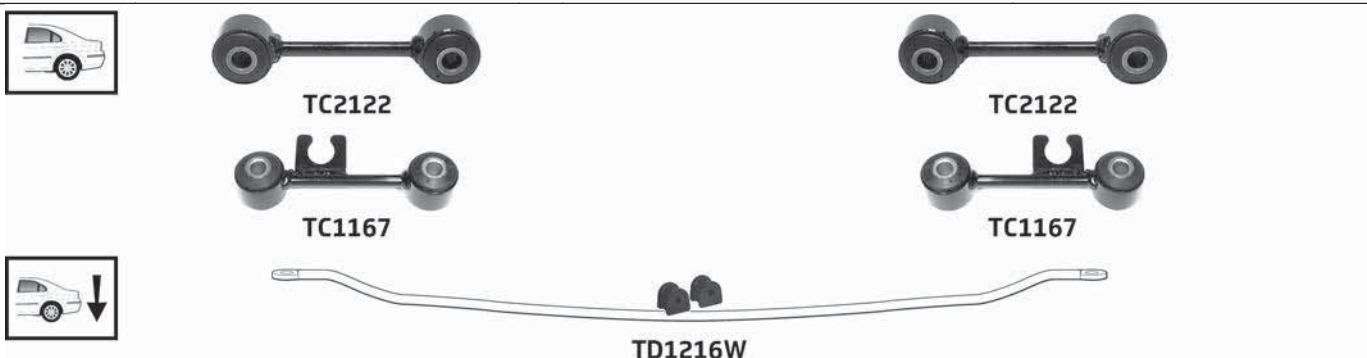
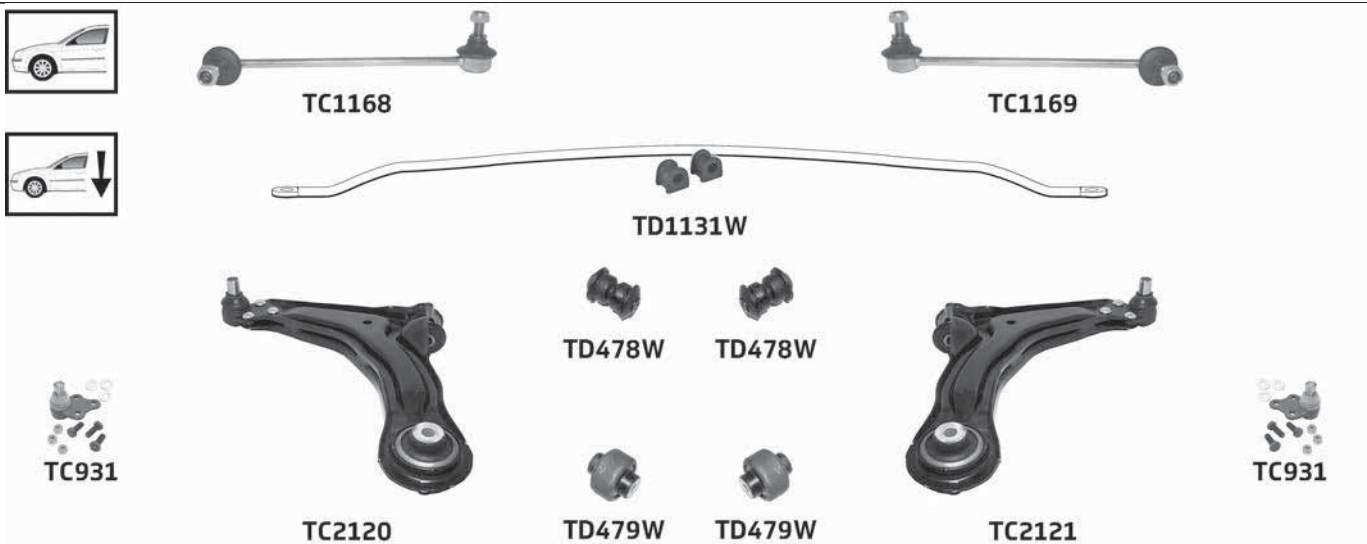

Part No	Description	Pos	Info	Technical
TA1742	Tie rod end(224)	A B		M16x1.5 Female(253) £
TA1765	Inner tie rod(123)	A B		M16x1.5 Male(252) £
TBR4135	Steering rack gaiter kit(213)	K		1 :13x60x60 2 :13x60x60
TC931	Lower ball joint(140)	A B		Pinch Bolt(255) 22mm
TC1167	Link stabiliser(135)	A B	(+) Bracket(-41-)	
TC1168	Link stabiliser(135)	A		M10x1.5
TC1169	Link stabiliser(135)	B		M10x1.5
TC2120	Lower wishbone(158)	A		Pinch Bolt(255) 22mm
TC2121	Lower wishbone(158)	B		Pinch Bolt(255) 22mm
TC2122	Link stabiliser(135)	A B	(-) Bracket(-12-)	
TD478W	Lower wishbone bush(159)	A B	Front(108)	
TD479W	Lower wishbone bush(159)	A B	Rear(187)	
TD1131W	Anti-roll bar(-74-) bush kit(-86-)	K	Complete axle kit(-92-)	
TD1216W	Anti-roll bar(-74-) bush kit(-86-)	K	Complete axle kit(-92-)	
TL477	Rod assembly(194)	A B		M16x1.5

MERCEDES

... MERCEDES

V CLASS (638 SERIES) V200 2.2CDi, V220 2.2CDi (03/99-07/03)

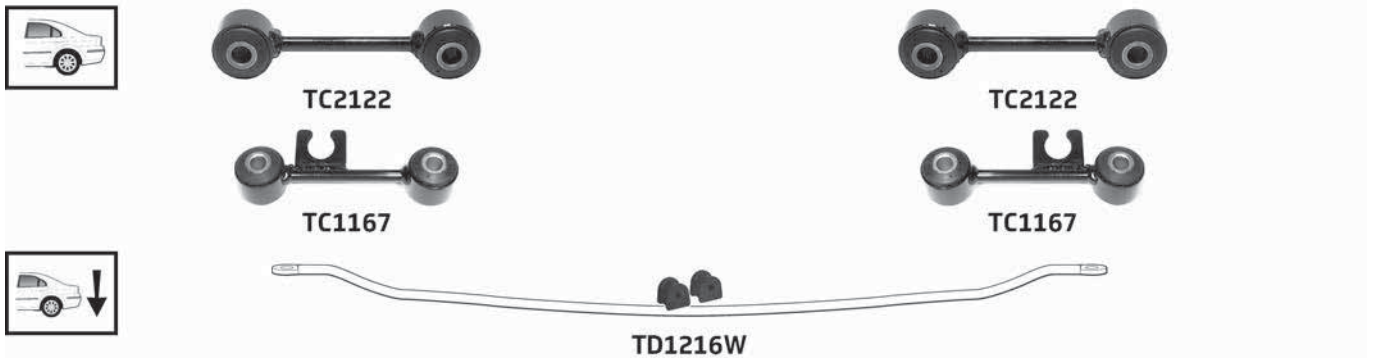
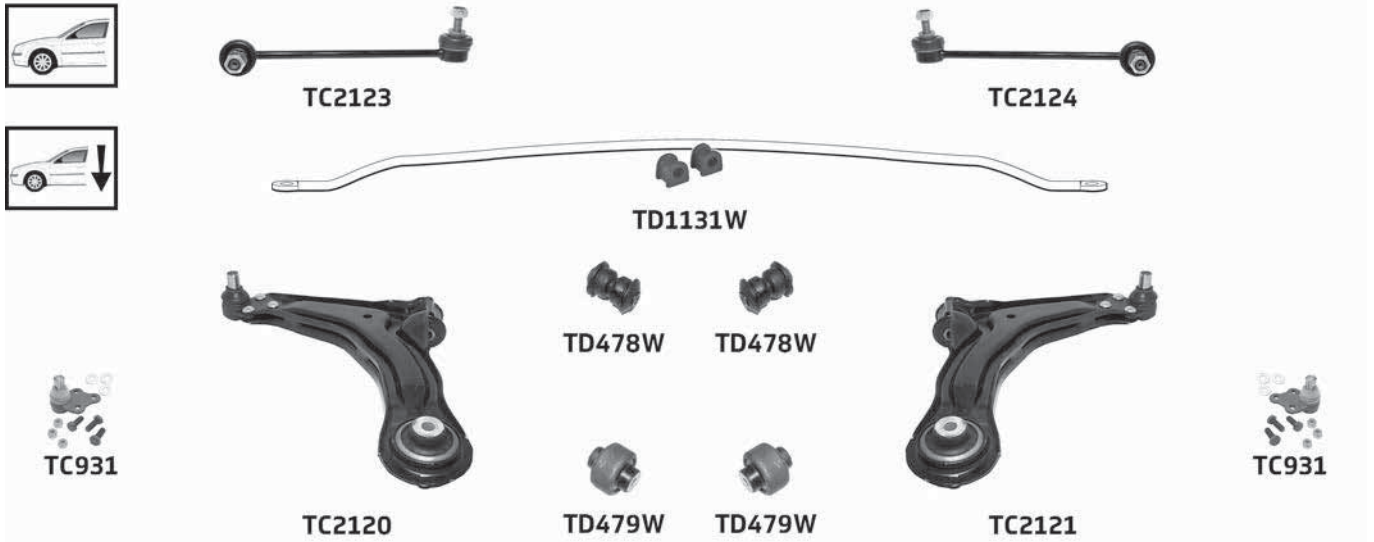

Part No	Description	Pos	Info	Technical
TA1742	Tie rod end(224)	A B		M16x1.5 Female(253) £
TA1765	Inner tie rod(123)	A B		M16x1.5 Male(252) £
TBR4135	Steering rack gaiter kit(213)	K		1 :13x60x60 2 :13x60x60
TC931	Lower ball joint(140)	A B		Pinch Bolt(255) 22mm
TC1167	Link stabiliser(135)	A B	(+) Bracket(-41)	
TC2120	Lower wishbone(158)	A		Pinch Bolt(255) 22mm
TC2121	Lower wishbone(158)	B		Pinch Bolt(255) 22mm
TC2122	Link stabiliser(135)	A B	(-) Bracket(-12)	
TC2123	Link stabiliser(135)	A		M10x1.5
TC2124	Link stabiliser(135)	B		M10x1.5
TD478W	Lower wishbone bush(159)	A B	Front(108)	
TD479W	Lower wishbone bush(159)	A B	Rear(187)	
TD1131W	Anti-roll bar(-74) bush kit(-86-)	K	Complete axle kit(-92)	
TD1216W	Anti-roll bar(-74) bush kit(-86-)	K	Complete axle kit(-92)	
TL477	Rod assembly(194)	A B		M16x1.5

MERCEDES

VANEO (414 SERIES) 1.6i, 1.7CDi, 1.9i (02/02-07/05)

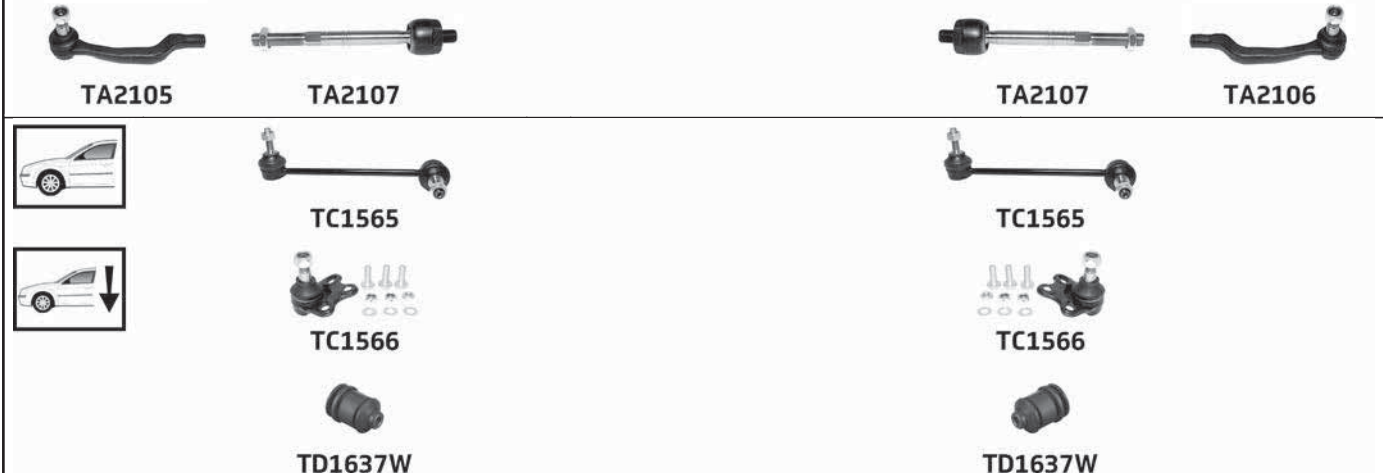

Part No	Description	Pos	Info	Technical
TA2105	Tie rod end(224)	A		M14x1.5 Female(253) £
TA2106	Tie rod end(224)	B		M14x1.5 Female(253) £
TA2107	Inner tie rod(123)	A B		M14x1.5 Male(252) £
TC1565	Link stabiliser(135)	A B		M10x1.5
TC1566	Lower ball joint(140)	A B		M14x1.5
TD1637W	Lower wishbone bush(159)	A B	Front(108)	

VIANO (639 SERIES) 2.2CDi, 3.2i, 3.7i (09/03-)

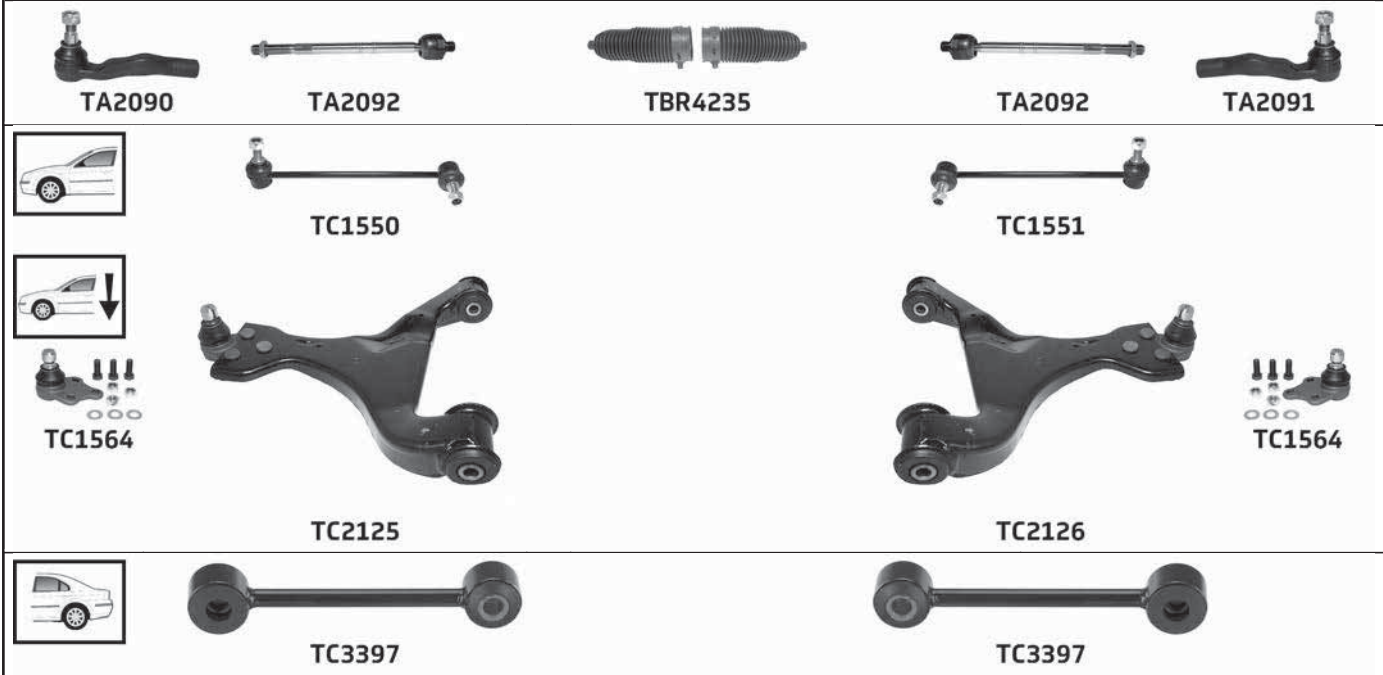

Part No	Description	Pos	Info	Technical
TA2090	Tie rod end(224)	A		M16x1.5 Female(253) £
TA2091	Tie rod end(224)	B		M16x1.5 Female(253) £
TA2092	Inner tie rod(123)	A B		M16x1.5 Male(252) £
TBR4235	Steering rack gaiter kit(213)	K		1 :16x58x58 2 :16x58x58
TC1550	Link stabiliser(135)	A		M12x1.25
TC1551	Link stabiliser(135)	B		M12x1.25
TC1564	Lower ball joint(140)	A B		Pinch Bolt(255) 22mm
TC2125	Lower wishbone(158)	A	→Ch. 3 603471 →31/08/10	Pinch Bolt(255) 22mm
TC2126	Lower wishbone(158)	B	→Ch. 3 603471 →31/08/10	Pinch Bolt(255) 22mm
TC3397	Link stabiliser(135)	A B	(+) Air suspension(-35-) →Ch. 3 603471 →31/08/10	

... MERCEDES

VIANO (639 SERIES) 2.2CDi 109, 111, 113, 115, 116 4-Matic (09/03→)



Part No	Description	Pos	Info	Technical
TA2090	Tie rod end(224)	A		M16x1.5 Female(253) E
TA2091	Tie rod end(224)	B		M16x1.5 Female(253) E
TA2092	Inner tie rod(123)	A B		M16x1.5 Male(252) E
TBR4235	Steering rack gaiter kit(213)	K		1 :16x58x58 2 :16x58x58
TC1564	Lower ball joint(140)	A B		Pinch Bolt(255) 22mm
TC2125	Lower wishbone(158)	A		Pinch Bolt(255) 22mm
TC2126	Lower wishbone(158)	B		Pinch Bolt(255) 22mm

VITO (638 SERIES) 2.0i 113, 2.3i 114, 2.3D 108, 110 (11/95-07/03)

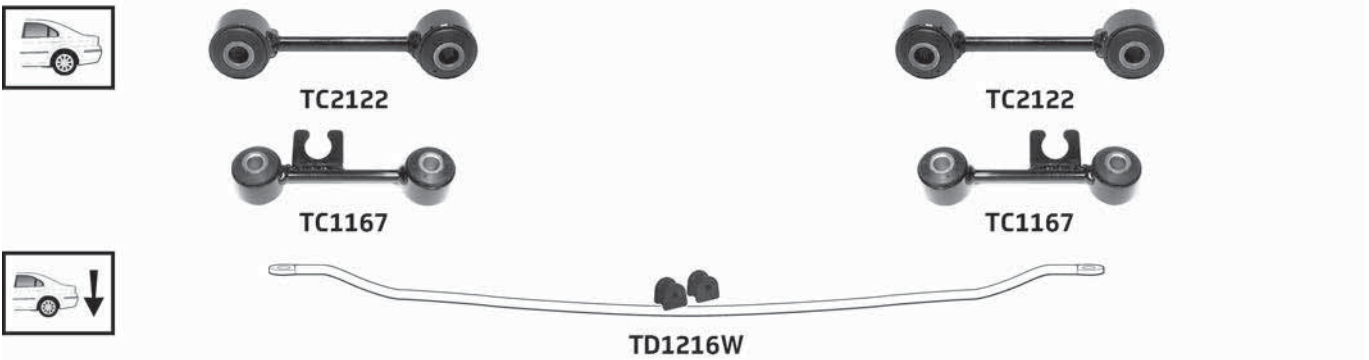
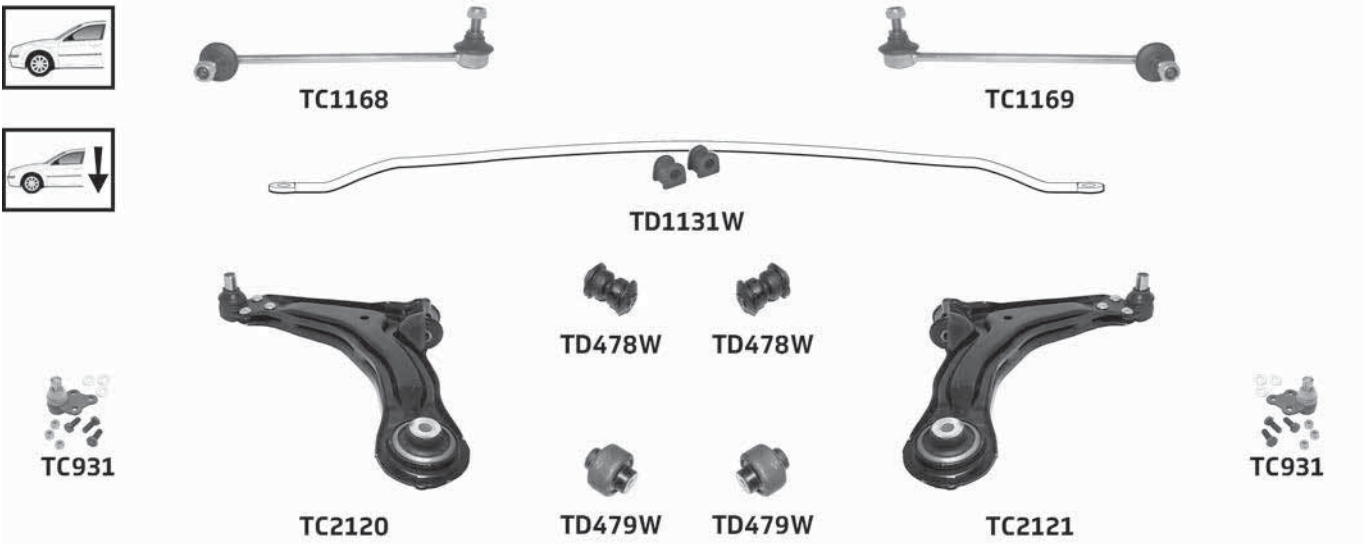

Part No	Description	Pos	Info	Technical
TA1742	Tie rod end(224)	A B		M16x1.5 Female(253) E
TA1765	Inner tie rod(123)	A B		M16x1.5 Male(252) E

MERCEDES

... VITO (638 SERIES) 2.0i 113, 2.3i 114, 2.3D 108, 110 (11/95-07/03)

Part No	Description	Pos	Info	Technical
TBR4135	Steering rack gaiter kit(213)	K		1 :13x60x60 2 :13x60x60
TC931	Lower ball joint(140)	A B		Pinch Bolt(255) 22mm
TC1167	Link stabiliser(135)	A B	(+) Bracket(-41-)	
TC1168	Link stabiliser(135)	A		M10x1.5
TC1169	Link stabiliser(135)	B		M10x1.5
TC2120	Lower wishbone(158)	A		Pinch Bolt(255) 22mm
TC2121	Lower wishbone(158)	B		Pinch Bolt(255) 22mm
TC2122	Link stabiliser(135)	A B	(-) Bracket(-12-)	
TD478W	Lower wishbone bush(159)	A B	Front(108)	
TD479W	Lower wishbone bush(159)	A B	Rear(187)	
TD1131W	Anti-roll bar(-74-) bush kit(-86-)	K	Complete axle kit(-92-)	
TD1216W	Anti-roll bar(-74-) bush kit(-86-)	K	Complete axle kit(-92-)	
TL477	Rod assembly(194)	A B		M16x1.5

VITO (638 SERIES) 2.2CDi 108, 110, 112 (03/99-07/03)

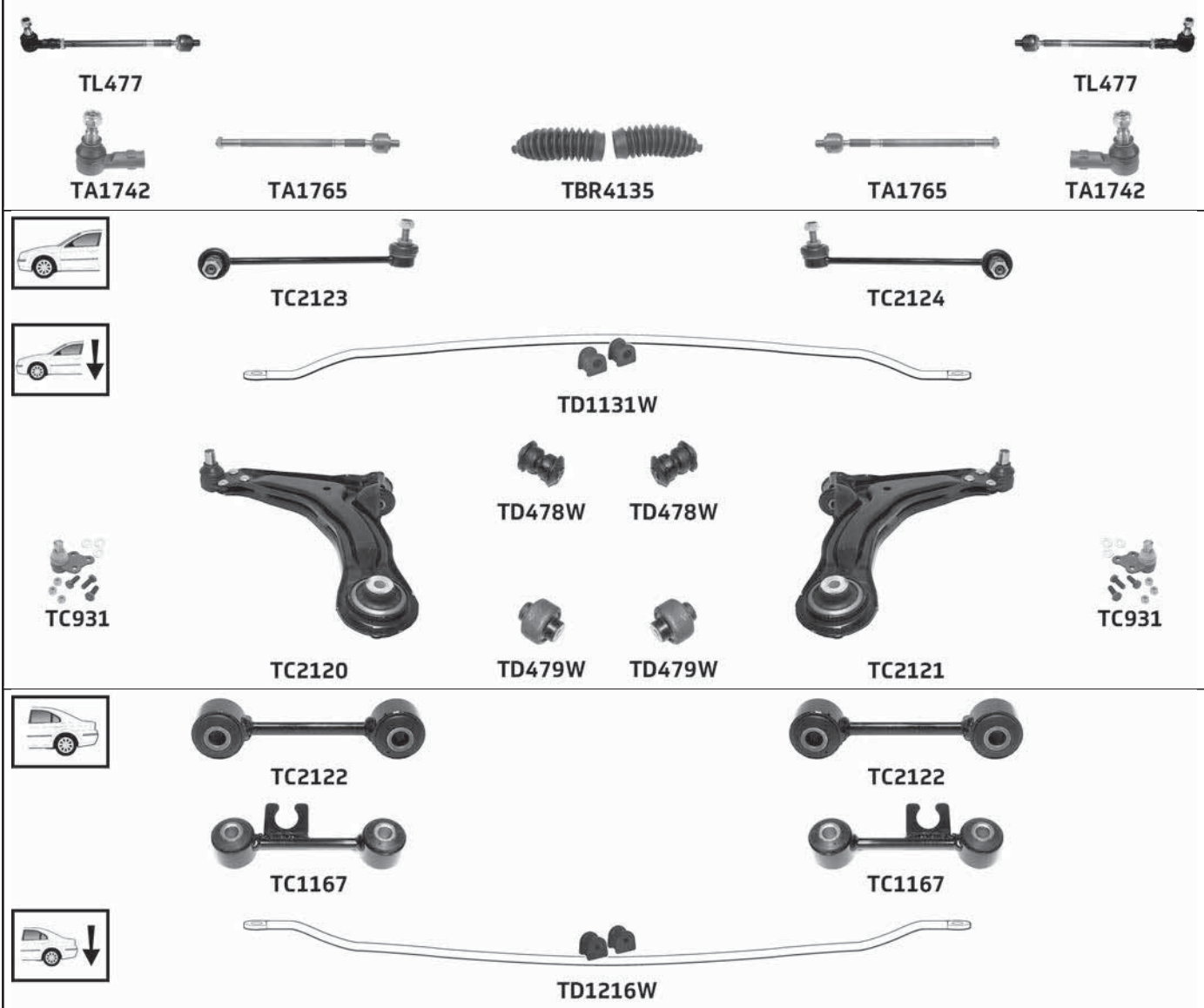

Part No	Description	Pos	Info	Technical
TA1742	Tie rod end(224)	A B		M16x1.5 Female(253) £
TA1765	Inner tie rod(123)	A B		M16x1.5 Male(252) £
TBR4135	Steering rack gaiter kit(213)	K		1 :13x60x60 2 :13x60x60
TC931	Lower ball joint(140)	A B		Pinch Bolt(255) 22mm
TC1167	Link stabiliser(135)	A B	(+) Bracket(-41-)	
TC2120	Lower wishbone(158)	A		Pinch Bolt(255) 22mm
TC2121	Lower wishbone(158)	B		Pinch Bolt(255) 22mm
TC2122	Link stabiliser(135)	A B	(-) Bracket(-12-)	
TC2123	Link stabiliser(135)	A		M10x1.5
TC2124	Link stabiliser(135)	B		M10x1.5

... MERCEDES

... VITO (638 SERIES) 2.2CDi 108, 110, 112 (03/99-07/03)

Part No	Description	Pos	Info	Technical
TD478W	Lower wishbone bush(159)	A B	Front(108)	
TD479W	Lower wishbone bush(159)	A B	Rear(187)	
TD1131W	Anti-roll bar (-74) bush kit(-86-)	K	Complete axle kit(-92)	
TD1216W	Anti-roll bar (-74) bush kit(-86-)	K	Complete axle kit(-92)	
TL477	Rod assembly(194)	A B		M16x1.5

VITO (639 SERIES) 2.2CDi 109, 111, 115, 3.2i 119, 122, 3.7i 123 (09/03→)

Part No	Description	Pos	Info	Technical
TA2090	Tie rod end(224)	A		M16x1.5 Female(253) £
TA2091	Tie rod end(224)	B		M16x1.5 Female(253) £
TA2092	Inner tie rod(123)	A B		M16x1.5 Male(252) £
TBR4235	Steering rack gaiter kit(213)	K		1 :16x58x58 2 :16x58x58
TC1550	Link stabiliser(135)	A		M12x1.25
TC1551	Link stabiliser(135)	B		M12x1.25
TC1564	Lower ball joint(140)	A B		Pinch Bolt(255) 22mm
TC2125	Lower wishbone(158)	A	→Ch. 3 603471 →31/08/10	Pinch Bolt(255) 22mm
TC2126	Lower wishbone(158)	B	→Ch. 3 603471 →31/08/10	Pinch Bolt(255) 22mm
TC3397	Link stabiliser(135)	A B	(+) Air suspension(-35) →Ch. 3 603471 →31/08/10	

VITO (639 SERIES) 2.2CDi 109, 111, 113, 115, 116 4-Matic (09/03→)

Part No	Description	Pos	Info	Technical
TA2090	Tie rod end(224)	A		M16x1.5 Female(253) £
TA2091	Tie rod end(224)	B		M16x1.5 Female(253) £
TA2092	Inner tie rod(123)	A B		M16x1.5 Male(252) £
TBR4235	Steering rack gaiter kit(213)	K		1 :16x58x58 2 :16x58x58
TC1564	Lower ball joint(140)	A B		Pinch Bolt(255) 22mm
TC2125	Lower wishbone(158)	A		Pinch Bolt(255) 22mm
TC2126	Lower wishbone(158)	B		Pinch Bolt(255) 22mm

COOPER 1.6i R50, R53 (04/01-03/02)

ONE 1.6i R50, R53 (04/01-03/02)

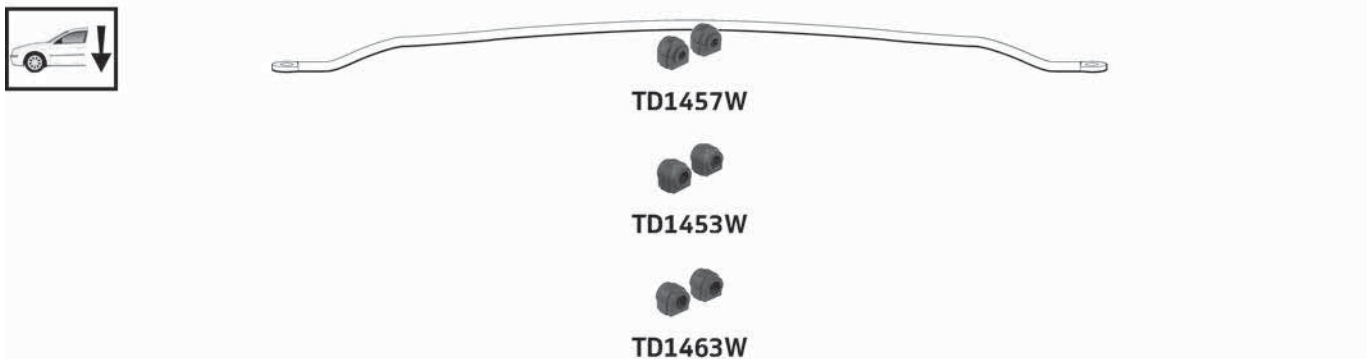

Part No	Description	Pos	Info	Technical
TA1773	Tie rod end(224)	A		M14x1.5 Female(253) £
TA1774	Tie rod end(224)	B		M14x1.5 Female(253) £
TA1775	Inner tie rod(123)	A B		M14x1.5 Male(252) £
TBR4215	Steering rack gaiter kit(213)	K	Thermoplastic(223)	1 :14x47x47 2 :14x47x47
TC1019	Link stabiliser(135)	A B		M10x1.25
TC1020	Link stabiliser(135)	A B		M10x1.25
TC1155	Lower ball joint(140)	A B	Outer part of wishbone(177)	M12x1.5
TC1245	Lower wishbone(158)	A	(-) Ball joint(-11-)	
TC1246	Lower wishbone(158)	B	(-) Ball joint(-11-)	
TC1277	Lower ball joint(140)	A	Inner part of wishbone(122)	M14x1.5
TC1278	Lower ball joint(140)	B	Inner part of wishbone(122)	M14x1.5
TC3225	Lower track control arm(151)	A B		
TC3225	Upper track control arm(242)	A B		
TD664W	Lower wishbone bush(159)	A	Rear(187) (+) Housing(-48-)	
TD665W	Lower wishbone bush(159)	B	Rear(187) (+) Housing(-48-)	
TD750W	Lower wishbone bush(159)	A B	Rear(187) (-) Housing(-19-)	

(...)

... MINI

... COOPER 1.6i R50, R53 (04/01-03/02)

... ONE 1.6i R50, R53 (04/01-03/02)

Part No	Description	Pos	Info	Technical
TD1453W	Anti-roll bar (-74) bush kit (-86)	K	Ø22.5 Complete axle kit (-92) (+) Sport suspension (-53)	
TD1457W	Anti-roll bar (-74) bush kit (-86)	K	Ø16 Complete axle kit (-92) (-) Sport suspension (-27) (-) Cooper	
TD1463W	Anti-roll bar (-74) bush kit (-86)	K	Ø24 Complete axle kit (-92) (+) JCW	

COOPER S 1.6i R50, R53 (04/01-03/02)

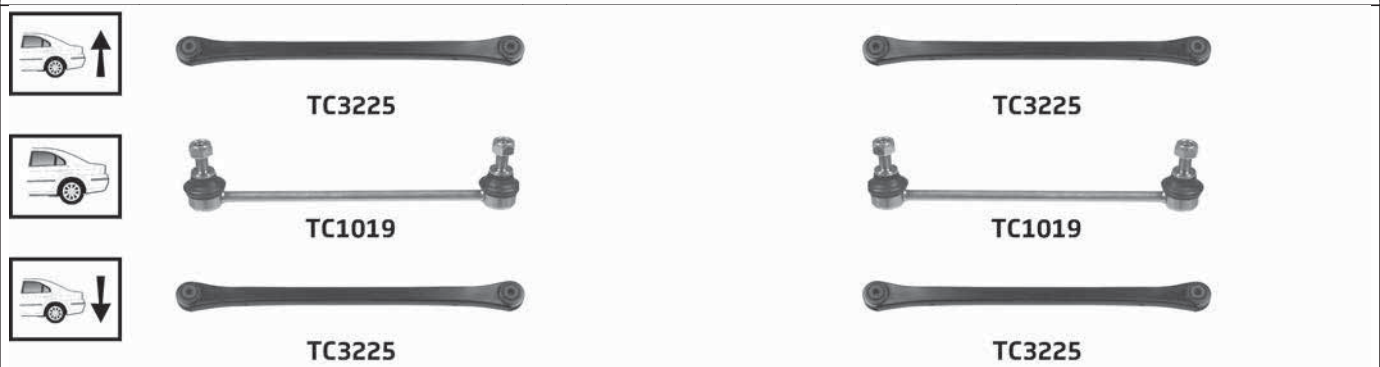
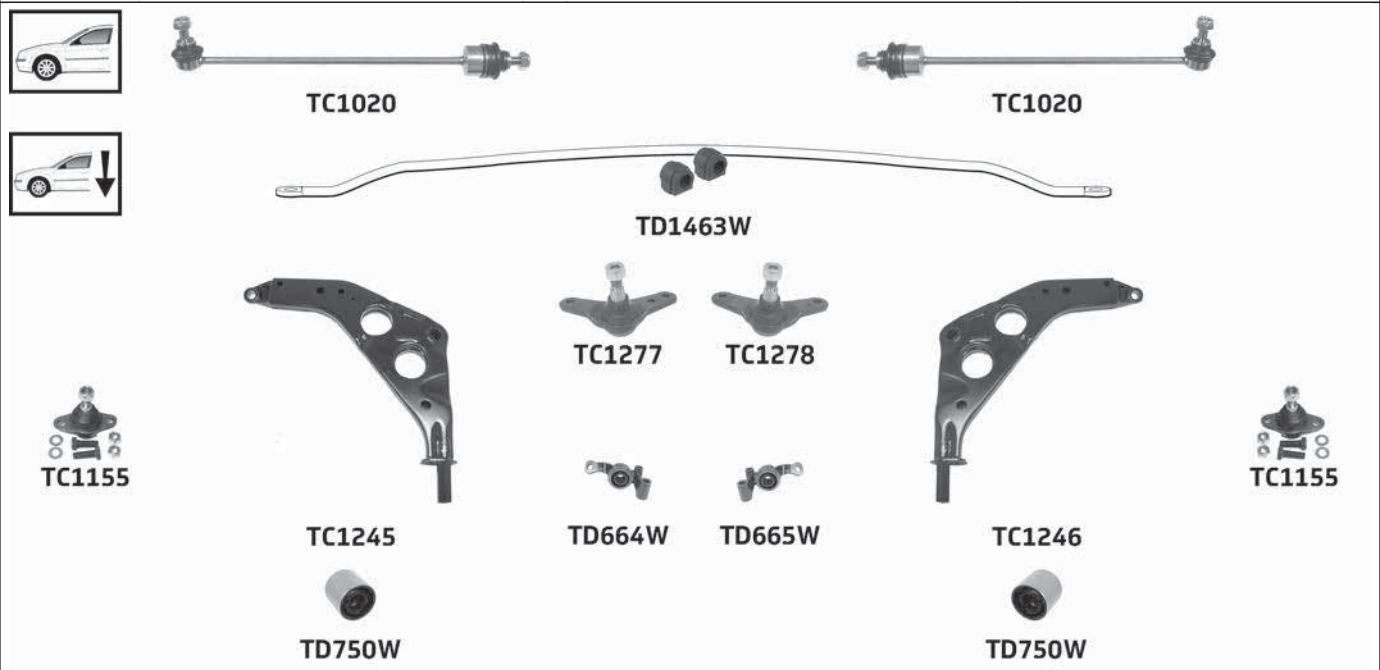

Part No	Description	Pos	Info	Technical
TA1773	Tie rod end (224)	A		M14x1.5 Female (253) £
TA1774	Tie rod end (224)	B		M14x1.5 Female (253) £
TA1775	Inner tie rod (123)	A B		M14x1.5 Male (252) £
TBR4215	Steering rack gaiter kit (213)	K	Thermoplastic (223)	1 :14x47x47 2 :14x47x47
TC1019	Link stabiliser (135)	A B		M10x1.25
TC1020	Link stabiliser (135)	A B		M10x1.25
TC1155	Lower ball joint (140)	A B	Outer part of wishbone (177)	M12x1.5
TC1245	Lower wishbone (158)	A	(-) Ball joint (-11)	
TC1246	Lower wishbone (158)	B	(-) Ball joint (-11)	
TC1277	Lower ball joint (140)	A	Inner part of wishbone (122)	M14x1.5
TC1278	Lower ball joint (140)	B	Inner part of wishbone (122)	M14x1.5
TC3225	Lower track control arm (151)	A B		
TC3225	Upper track control arm (242)	A B		
TD664W	Lower wishbone bush (159)	A	Rear (187) (+) Housing (-48)	
TD665W	Lower wishbone bush (159)	B	Rear (187) (+) Housing (-48)	
TD750W	Lower wishbone bush (159)	A B	Rear (187) (-) Housing (-19)	
TD1463W	Anti-roll bar (-74) bush kit (-86)	K	Ø24 Complete axle kit (-92)	

COOPER 1.6i R50, R53 (03/02-05/03)

ONE 1.6i R50, R53 (03/02-05/03)

ONE D 1.4TD R50, R53 (03/02-05/03)

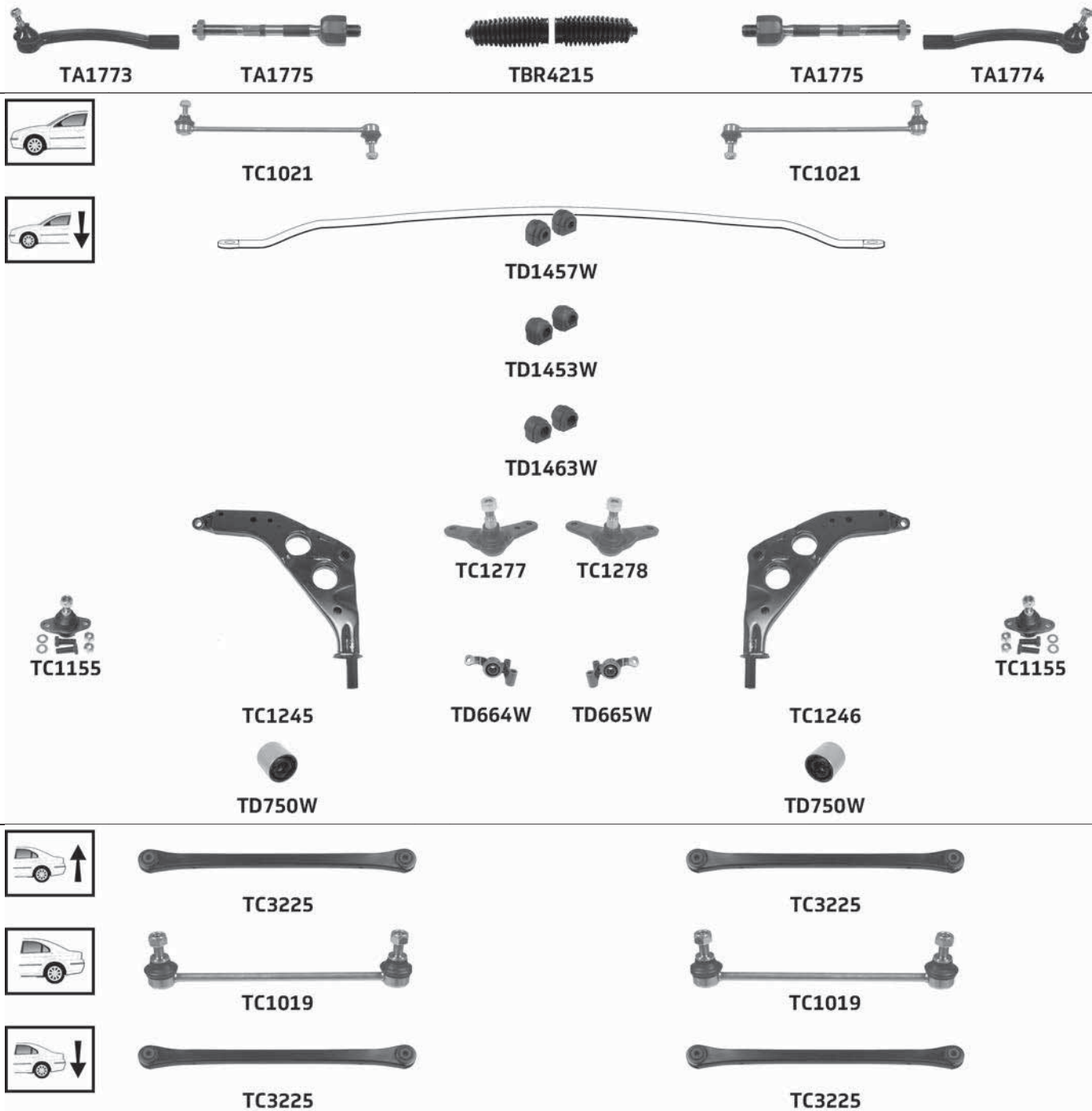

Part No	Description	Pos	Info	Technical
TA1773	Tie rod end(224)	A		M14x1.5 Female(253) £
TA1774	Tie rod end(224)	B		M14x1.5 Female(253) £
TA1775	Inner tie rod(123)	A B		M14x1.5 Male(252) £
TBR4215	Steering rack gaiter kit(213)	K	Thermoplastic(223)	1 :14x47x47 2 :14x47x47
TC1019	Link stabiliser(135)	A B		M10x1.25
TC1021	Link stabiliser(135)	A B		M10x1.25
TC1155	Lower ball joint(140)	A B	Outer part of wishbone(177)	M12x1.5
TC1245	Lower wishbone(158)	A	(-) Ball joint(-11-)	
TC1246	Lower wishbone(158)	B	(-) Ball joint(-11-)	
TC1277	Lower ball joint(140)	A	Inner part of wishbone(122)	M14x1.5
TC1278	Lower ball joint(140)	B	Inner part of wishbone(122)	M14x1.5
TC3225	Lower track control arm(151)	A B		
TC3225	Upper track control arm(242)	A B		
TD664W	Lower wishbone bush(159)	A	Rear(187) (+) Housing(-48-)	
TD665W	Lower wishbone bush(159)	B	Rear(187) (+) Housing(-48-)	

(...)

... MINI

... COOPER 1.6i R50, R53 (03/02-05/03)

... ONE 1.6i R50, R53 (03/02-05/03)

... ONE D 1.4TD R50, R53 (03/02-05/03)

TD750W	Lower wishbone bush(159)	A B	Rear(187) (-) Housing(-19)	
TD1453W	Anti-roll bar(-74) bush kit(-86)	K	Ø22.5 Complete axle kit(-92) (+) Sport suspension(-53)	
TD1457W	Anti-roll bar(-74) bush kit(-86)	K	Ø16 Complete axle kit(-92) (-) Sport suspension(-27) (-) Cooper	
TD1463W	Anti-roll bar(-74) bush kit(-86)	K	Ø24 Complete axle kit(-92) (+) JCW	

COOPER S 1.6i R50, R53 (03/02-05/03)

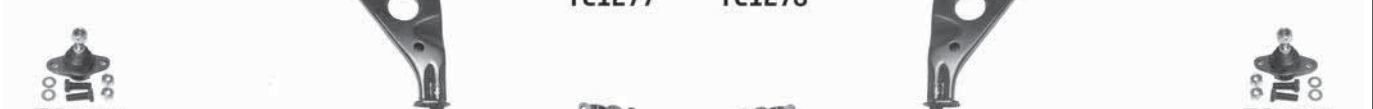

Part No	Description	Pos	Info	Technical
TA1773	Tie rod end(224)	A		M14x1.5 Female(253) £
TA1774	Tie rod end(224)	B		M14x1.5 Female(253) £
TA1775	Inner tie rod(123)	A B		M14x1.5 Male(252) £
TBR4215	Steering rack gaiter kit(213)	K	Thermoplastic(223)	1 :14x47x47 2 :14x47x47
TC1019	Link stabiliser(135)	A B		M10x1.25
TC1021	Link stabiliser(135)	A B		M10x1.25
TC1155	Lower ball joint(140)	A B	Outer part of wishbone(177)	M12x1.5
TC1245	Lower wishbone(158)	A	(-) Ball joint(-11)	
TC1246	Lower wishbone(158)	B	(-) Ball joint(-11)	
TC1277	Lower ball joint(140)	A	Inner part of wishbone(122)	M14x1.5
TC1278	Lower ball joint(140)	B	Inner part of wishbone(122)	M14x1.5
TC3225	Lower track control arm(151)	A B		
TC3225	Upper track control arm(242)	A B		
TD664W	Lower wishbone bush(159)	A	Rear(187) (+) Housing(-48)	
TD665W	Lower wishbone bush(159)	B	Rear(187) (+) Housing(-48)	
TD750W	Lower wishbone bush(159)	A B	Rear(187) (-) Housing(-19)	
TD1463W	Anti-roll bar(-74) bush kit(-86)	K	Ø24 Complete axle kit(-92)	

COOPER 1.6i R50, R53 (05/03-09/06)
 ONE 1.4i R50, R53, 1.6i R50, R53 (05/03-09/06)
 ONE D 1.4TD R50, R53 (05/03-09/06)

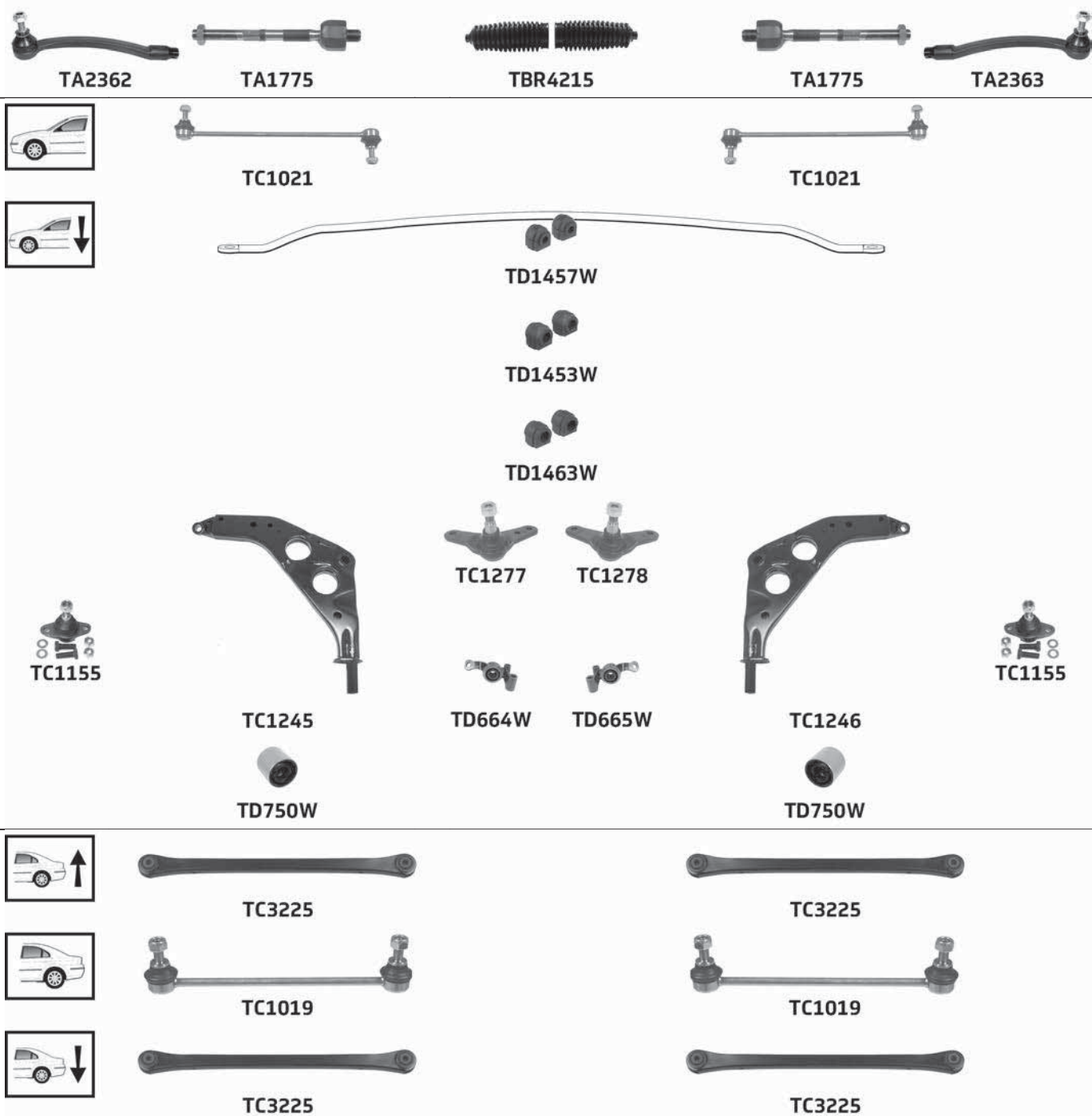

Part No	Description	Pos	Info	Technical
TA1775	Inner tie rod(123)	A B		M14x1.5 Male(252) £
TA2362	Tie rod end(224)	A		M14x1.5 Female(253) £
TA2363	Tie rod end(224)	B		M14x1.5 Female(253) £
TBR4215	Steering rack gaiter kit(213)	K	Thermoplastic(223)	1 :14x47x47 2 :14x47x47
TC1019	Link stabiliser(135)	A B		M10x1.25
TC1021	Link stabiliser(135)	A B		M10x1.25
TC1155	Lower ball joint(140)	A B	Outer part of wishbone(177)	M12x1.5
TC1245	Lower wishbone(158)	A	(-) Ball joint(-11-)	
TC1246	Lower wishbone(158)	B	(-) Ball joint(-11-)	
TC1277	Lower ball joint(140)	A	Inner part of wishbone(122)	M14x1.5
TC1278	Lower ball joint(140)	B	Inner part of wishbone(122)	M14x1.5
TC3225	Lower track control arm(151)	A B		
TC3225	Upper track control arm(242)	A B		
TD664W	Lower wishbone bush(159)	A	Rear(187) (+) Housing(-48-)	
TD665W	Lower wishbone bush(159)	B	Rear(187) (+) Housing(-48-)	

(...)

... MINI

... COOPER 1.6i R50, R53 (05/03-09/06)
... ONE 1.4i R50, R53, 1.6i R50, R53 (05/03-09/06)
... ONE D 1.4TD R50, R53 (05/03-09/06)

TD750W	Lower wishbone bush(159)	A B	Rear(187) (-) Housing(-19)	
TD1453W	Anti-roll bar(-74) bush kit(-86)	K	Ø22.5 Complete axle kit(-92) (+) Sport suspension(-53)	
TD1457W	Anti-roll bar(-74) bush kit(-86)	K	Ø16 Complete axle kit(-92) (-) Sport suspension(-27) (-) Cooper	
TD1463W	Anti-roll bar(-74) bush kit(-86)	K	Ø24 Complete axle kit(-92) (+) JCW	

COOPER S 1.6i R50, R53 (05/03-09/06)



Part No	Description	Pos	Info	Technical
TA1775	Inner tie rod(123)	A B		M14x1.5 Male(252) E
TA2362	Tie rod end(224)	A		M14x1.5 Female(253) E
TA2363	Tie rod end(224)	B		M14x1.5 Female(253) E
TBR4215	Steering rack gaiter kit(213)	K	Thermoplastic(223)	1 :14x47x47 2 :14x47x47
TC1019	Link stabiliser(135)	A B		M10x1.25
TC1021	Link stabiliser(135)	A B		M10x1.25
TC1155	Lower ball joint(140)	A B	Outer part of wishbone(177)	M12x1.5
TC1245	Lower wishbone(158)	A	(-) Ball joint(-11)	
TC1246	Lower wishbone(158)	B	(-) Ball joint(-11)	
TC1277	Lower ball joint(140)	A	Inner part of wishbone(122)	M14x1.5
TC1278	Lower ball joint(140)	B	Inner part of wishbone(122)	M14x1.5
TC3225	Lower track control arm(151)	A B		
TC3225	Upper track control arm(242)	A B		
TD664W	Lower wishbone bush(159)	A	Rear(187) (+) Housing(-48)	
TD665W	Lower wishbone bush(159)	B	Rear(187) (+) Housing(-48)	
TD750W	Lower wishbone bush(159)	A B	Rear(187) (-) Housing(-19)	
TD1463W	Anti-roll bar(-74) bush kit(-86)	K	Ø24 Complete axle kit(-92)	

COOPER 1.6i R52 Convertible (07/04-07/08)

ONE 1.4i R52, 1.6i R52 Convertible (07/04-07/08)

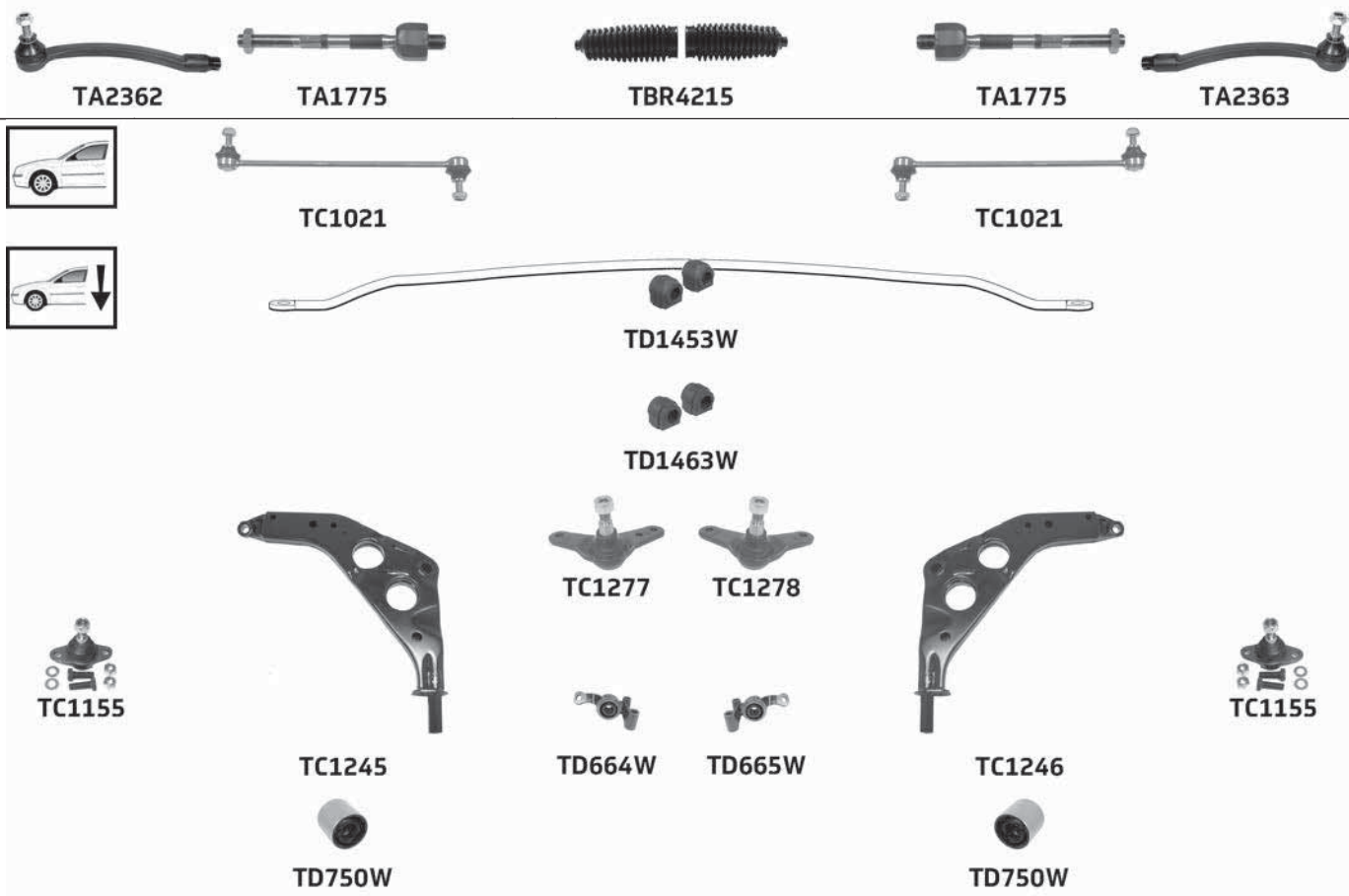

Part No	Description	Pos	Info	Technical
TA1775	Inner tie rod(123)	A B		M14x1.5 Male(252) £
TA2362	Tie rod end(224)	A		M14x1.5 Female(253) £
TA2363	Tie rod end(224)	B		M14x1.5 Female(253) £
TBR4215	Steering rack gaiter kit(213)	K	Thermoplastic(223)	1 :14x47x47 2 :14x47x47
TC1019	Link stabiliser(135)	A B		M10x1.25
TC1021	Link stabiliser(135)	A B		M10x1.25
TC1155	Lower ball joint(140)	A B	Outer part of wishbone(177)	M12x1.5
TC1245	Lower wishbone(158)	A	(-) Ball joint(-11-)	
TC1246	Lower wishbone(158)	B	(-) Ball joint(-11-)	
TC1277	Lower ball joint(140)	A	Inner part of wishbone(122)	M14x1.5
TC1278	Lower ball joint(140)	B	Inner part of wishbone(122)	M14x1.5
TC3225	Lower track control arm(151)	A B		
TC3225	Upper track control arm(242)	A B		
TD664W	Lower wishbone bush(159)	A	Rear(187) (+) Housing(-48-)	
TD665W	Lower wishbone bush(159)	B	Rear(187) (+) Housing(-48-)	
TD750W	Lower wishbone bush(159)	A B	Rear(187) (-) Housing(-19-)	
TD1453W	Anti-roll bar(-74-) bush kit(-86-)	K	Ø22.5 Complete axle kit(-92-) (-) Sport suspension(-27-)	
TD1463W	Anti-roll bar(-74-) bush kit(-86-)	K	Ø24 Complete axle kit(-92-) (+) JCW	

... MINI

COOPER S 1.6i R52 Cabriolet (07/04-07/08)

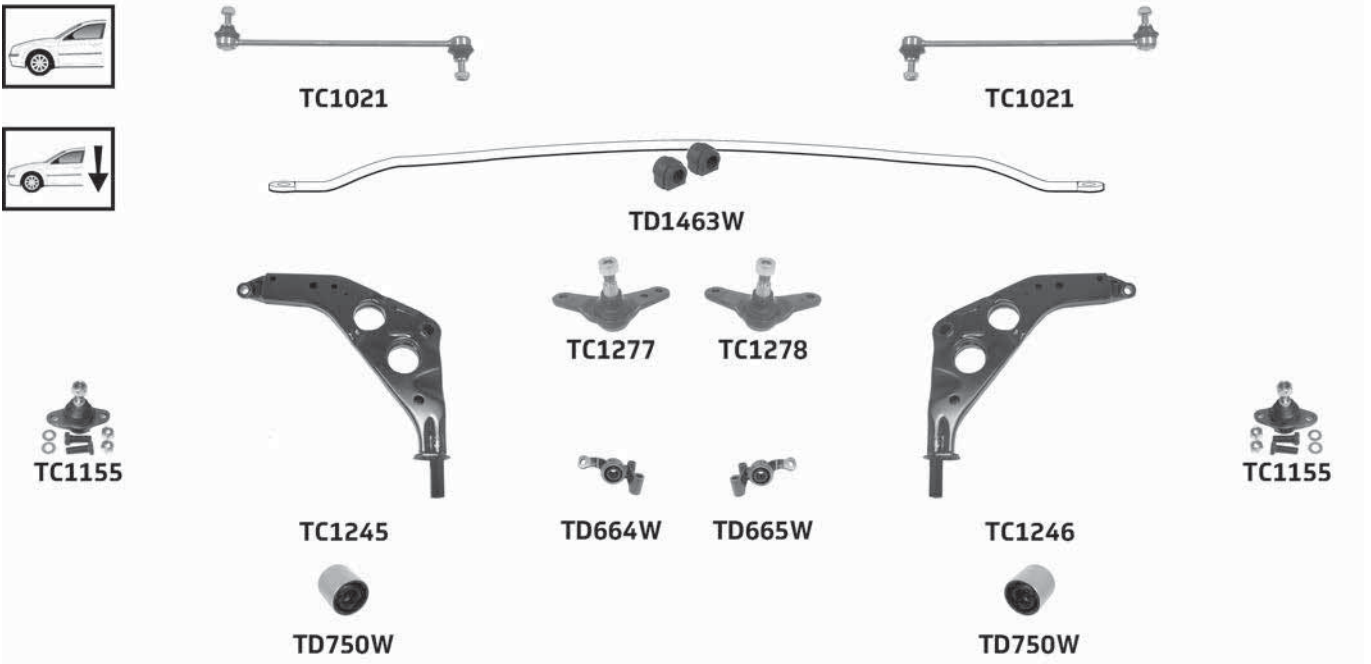

Part No	Description	Pos	Info	Technical
TA1775	Inner tie rod(123)	A B		M14x1.5 Male(252) £
TA2362	Tie rod end(224)	A		M14x1.5 Female(253) £
TA2363	Tie rod end(224)	B		M14x1.5 Female(253) £
TBR4215	Steering rack gaiter kit(213)	K	Thermoplastic(223)	1 :14x47x47 2 :14x47x47
TC1019	Link stabiliser(135)	A B		M10x1.25
TC1021	Link stabiliser(135)	A B		M10x1.25
TC1155	Lower ball joint(140)	A B	Outer part of wishbone(177)	M12x1.5
TC1245	Lower wishbone(158)	A	(-) Ball joint(-11-)	
TC1246	Lower wishbone(158)	B	(-) Ball joint(-11-)	
TC1277	Lower ball joint(140)	A	Inner part of wishbone(122)	M14x1.5
TC1278	Lower ball joint(140)	B	Inner part of wishbone(122)	M14x1.5
TC3225	Lower track control arm(151)	A B		
TC3225	Upper track control arm(242)	A B		
TD664W	Lower wishbone bush(159)	A	Rear(187) (+) Housing(-48-)	
TD665W	Lower wishbone bush(159)	B	Rear(187) (+) Housing(-48-)	
TD750W	Lower wishbone bush(159)	A B	Rear(187) (-) Housing(-19-)	
TD1463W	Anti-roll bar(-74-) bush kit(-86-)	K	Ø24 Complete axle kit(-92-)	