

DAVIS ®

The Spirit of Adventure



31 New Products for the Great Outdoors

ISO 9001 Certified Company



SHOCKLES®

Shock Absorbing Solutions

Shockles are most commonly found around boats. They are often used as shock absorbers on dock lines and anchor lines to reduce loads, minimize chafe, increase safety and generally make life at the dock or at a mooring safer and more comfortable.

On a dock line or mooring line, tensions and loads change as tidal surges, wakes, winds and currents change. Shockles absorb shock loads on mooring lines, making the lines last longer. Putting an end to jarring and snapping at the end of the line makes time aboard more

comfortable, too. Shockles also safely absorb sudden shock loads, such as those at the end of a tow line or loads created by a dinghy tied on deck or held at the stern, suspended by davits.

On land or at sea, the Boeing Insitu ScanEagle drone is retrieved by flying it into a catch-line system. Their drone program utilizes Shockles to diffuse the forces created when retrieving ScanEagle drones.

Shockles are also used by the U.S. Navy to retrieve drones and launch vessels from moving ships. Monterey Bay Aquarium Research Institute uses Shockles while exploring the Monterey Bay National Marine Sanctuary.

SHOCKLES LINE SNUBBER™

**Minimizes stress on ALL lines—
for use on any boat!**



LineSnubber features a patented stretch limiter and progressive tension design to safely and effectively reduce shock loads. Two 316 stainless steel carabiners offer simple and secure attachment. Adjust or remove in seconds. One size fits all—tie a simple clove hitch in line up to 3/4" (19 mm) diameter or use a pair of LineGrabbers for a working line range from 1/2 to 1 inch in diameter (13–25 mm). Use two LineSnubbers side-by-side on very large boats. Available in blue or black.



Progressive tension design means the further LineSnubber stretches, the greater its return force. The result is smooth action and moderated stress. The patented internal line limiter is made from 2500 pound test (1140 kg) nylon webbing. LineSnubber's outer sheath is 3500 pound test (1590 kg) tubular nylon webbing that is UV resistant to protect the internal parts.

For marine applications:

- LineSnubber reduces shock to any line, cleat or ground tackle, including bow rollers and rigging
- Attaches, adjusts or removes quickly; use a simple clove hitch or a pair of Davis #2460 LineGrabbers
- Reduces or eliminates all noise from creaking, groaning dock lines or ground tackle—jarring is minimized, too
- Compensates for tidal surge and chop from wind and waves
- Rigged properly, LineSnubber keeps boats centered in the slip



Docking



Tender Towing



Boom Tie Down



Spinnaker Tack



Boom Preventer



Anchoring

Shockles are strong, but they need to be rigged in-line so they never bear the full load alone. Six to twelve inches (15–30 cm) of in-line slack is recommended. Increase line slack between attachment loops to a maximum of 12" (30 cm) as loads increase. The slack in the line can be wrapped around LineSnubber to "neaten it up" as shown in the docking photo above.



#2400 LineSnubber, blue

011698 01055 4

#2410 LineSnubber, black

011698 01956 1

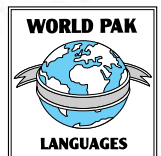

Proud member of . . .



WORLD PAK



LANGUAGES

Look for the World Pak symbol indicating language translations printed on packaging and instructions.

Some of these Davis products feature up to 17 languages in addition to English.

SHOCKLES[®]

LINEGRABBER[™]

NEW

Add a strong attachment point to any line up to 1" diameter (25 mm) with LineGrabber. Made of 1/4" (5 mm) Ultra High Modulus Fiber and holds 2000 lbs. (900 kg). Use a basic Prusik hitch that ties or adjusts in seconds. Make a strong loop to grab a dock cleat, pulpit, handrail or attach LineGrabber. UHMP fiber is tough enough to grab chain and strong enough to help unload a fouled sheet. Very handy to keep aboard!



- Toe rails
- Cleats
- Rail or pulpit
- Vehicle racks

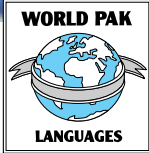

#2460 LineGrabber, PAIR 9" end to end (23 cm)

011698 01079 0

LineGrabber has hundreds of uses onboard:



Create an Attachment



Unload a Sheet



Grab a Railing



Secure a Chain

DOCKSHOCKLE[™]

NEW

DockShockle utilizes the same patented stretch limiter and progressive tension design as LineSnubber to safely absorb shock loads on smaller, lighter boats up to 40 ft. (12 m). Comes with two 316 stainless carabiners, and includes a pair of Mini-LineGrabbers for easy attachment to braided or twisted lines up to 3/4" (19 mm). Webbing is 12" (31 cm) long.



Mini-LineGrabbers create quick, secure attachments using a basic Prusik knot.

#2415 DockShockle, black

011698 01057 8

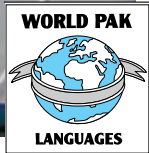

MINISHOCKLE[™]

NEW

These are like bungee cords on steroids! Take MiniShockles boating, camping, biking, motorcycle riding—anywhere you want to be sure your load is held in place solidly, securely, safely. UV resistant nylon webbing is sewn over marine grade elastomer. 316 stainless steel snaps will hold up to 300 pounds (136 kg). That's ten times the capacity of most standard bungee cords. Three sizes available. Black.

A BUNGEE CORD ON STEROIDS!



MiniShockle 12"

Stainless steel wire gate snap

#2430 MiniShockle 12" (31 cm)

011698 01059 2

#2440 MiniShockle 18" (46 cm)

011698 01063 9

#2445 MiniShockle 24" (61 cm)

011698 01067 7

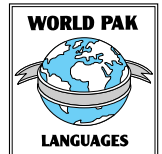

ANCHORSNUBBER[™]

NEW

AnchorSnubber safely absorbs shock loads and helps keep your anchor set. Attaches directly to chain, rope anchor rode, or anchor snubber line. Comes with two 316 stainless captive key pin shackles. Fits most anchor chain. Webbing is 20" (51 cm) long. AnchorSnubber helps your boat ride comfortably at anchor, even in rough anchorages, adverse currents, or strong winds. No more chain noise keeping you awake! **Patented stretch limiter and progressive tension design.**



#2420 AnchorSnubber, black

011698 01058 5

PATENTED

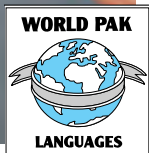

MiniShockles—strong, tough, secure



Sailing



Camping



Fishing



RVs



Adjustable Boat Hooks

The Most Dependable
Twist Lock and Strongest
Boat Hook End

A tough boat hook is a valuable asset when launching, docking, mooring or retrieving your favorite hat. Team telescoping boat hooks adjust to 8' or 12' (240 and 370 cm). The threaded end accepts a deck brush, mop, squeegee and other accessories. A highly visible, soft vinyl orange tip covers the threads and protects the boat's finish when fending off. All Team boat hooks float. The hook of unbreakable Lexan® is lighter than (brittle) metal alloy ends. Durability GUARANTEED to last a lifetime. Don't settle for less!

#5141 BOAT HOOK END ONLY
to replace most 1" (25 mm) boat poles.

011698 00169 9

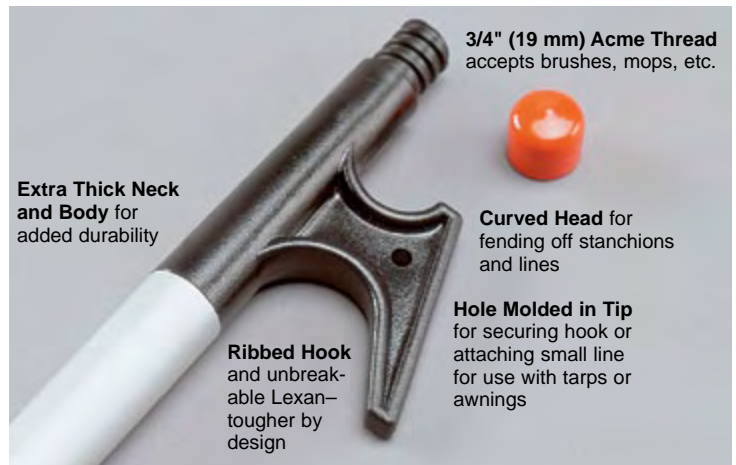

TELESCOPING BOAT HOOKS



#4122	011698 41220 4	Adjusts from 53 in. to 8 ft. (140 to 240 cm)	2 sections: 1" and 1 1/8" (25 and 29 mm) tube diameter
#4132	011698 41320 1	Adjusts from 38 in. to 8 ft. (100 to 240 cm)	3 sections: 1", 1 1/8", and 1 1/4" (25, 29, and 32 mm) tube dia.
#4152	011698 41520 5	Adjusts from 54 in. to 12 ft. (140 to 370 cm)	3 sections: 1", 1 1/8", and 1 1/4" (25, 29, and 32 mm) tube dia.

ADJUSTABLE PADDLES

Paddles are required by law in many states aboard PWCs and small boats. Team adjustable paddles stow easily and telescope to 3'9" (50 to 115 cm). Our Paddle/Boat Hook combination is great to have on board and at the launch ramp. The bright orange paddle end doubles as a signaling device. Made tough for years of hard use.



TELESCOPING PADDLE

#4330	011698 43300 1	Adjusts from 20 in. to 3 ft. 9 in. (50 to 115 cm)	2 sections: 1" and 1 1/8" (25 and 29 mm) tube diameter
--------------	----------------	---	--

PRACTICAL SAILOR Says It Best:

"Davis proves to be the best pole... the best value as well."

"If you often use your boat hook to get a line to a dock or piling, the more complicated hooks (like on the Davis poles) would be preferable." "Some sink like stones. The best floaters are the Davis poles." Out of ten poles tested, "five went without failure up to 500 pounds (of straight line pull force)... two of them Davis Team." "It's rare to find the best product is also the best buy." "They float, they're light to handle, the twist-lock joints withstood a lot of pressure, and we couldn't break the heads."

"Tug Tests Take 10 Boat Hooks to the Limits," *Practical Sailor*



TELESCOPING PADDLE/BOAT HOOK COMBINATION

#4372	011698 43720 7	Adjusts from 32 in. to 5 ft. 6 in. (80 to 170 cm)	2 sections: 1" and 1 1/8" (25 and 29 mm) tube diameter
--------------	----------------	---	--

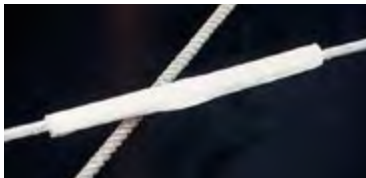

Protect Your Lines

with Removable/Adjustable Chafe Guards

Chafe protection is critical at the dock, at anchor or on a mooring. Davis offers a great solution to prevent chafing over a cleat, cap rail, where two lines cross or at the anchor roller. Dock lines can be expensive—extending their life with good chafe protection is not!

Velcro® hook fasteners along ENTIRE interior grip the line—no need for additional strings or ties

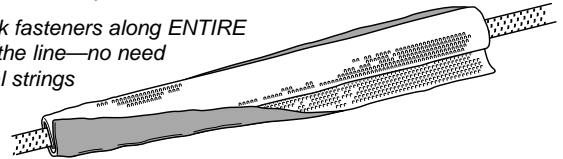

Secure Removable Chafe Guards offer the most flexibility and can be installed anywhere along lines from 3/8 to 7/8" (10 to 22 mm) and some 1" (25 mm) line as well. Great for anchor lines or mooring pennants, where chafing through a line could cost you the boat. Velcro® brand hook fasteners on the inside of the guard grip the line securely. The outside cover is made of marine-tough nylon for years of use.

#395 Secure Removable Chafe Guards, pair

011698 03950 0

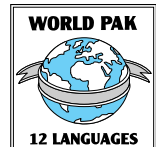

SHOCKLES® **NEW** FENDERFRIEND™

FenderFriend is a fender whip, hanger and adjuster—all in one! Features Shockles® built-in shock absorber to reduce shock loads generated by fenders grinding against the hull and the dock or piling. No more torn fender eyes or bent stanchions and rails!

- Allows anyone to quickly and easily set the fenders
- Stretches when fenders get pinched between the hull and the dock
- Minimizes loads on stanchions, lifelines, rails, cleats
- Attaches almost anywhere: lifelines, stanchions, winches, cleats, grab rails, workboat rails, toe rails, pulpits
- UV resistant strap adjusts from 16 to 72" (0.4–1.8 m)
- Sturdy, marine grade Nexus® nylon buckle makes attaching fenders a snap

FenderFriend keeps fenders in place while docking or when the boat is unattended. Surges and wakes can cause your boat to grind against the dock—a little bit of stretch helps keep fenders in place. Choose from twin-eye or center-tube models. Made of black, UV resistant webbing with Nexus® nylon buckle.

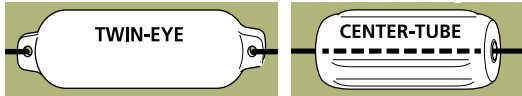

#2450 FenderFriend, Twin-Eye, black

011698 01071 4

#2455 FenderFriend, Center-Tube, black

011698 01075 2



Built-in shock absorber stretches 12 inches (30 cm)!

Tighten or loosen strap to adjust fender height.

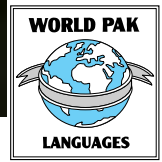

Attaches almost anywhere to almost anything

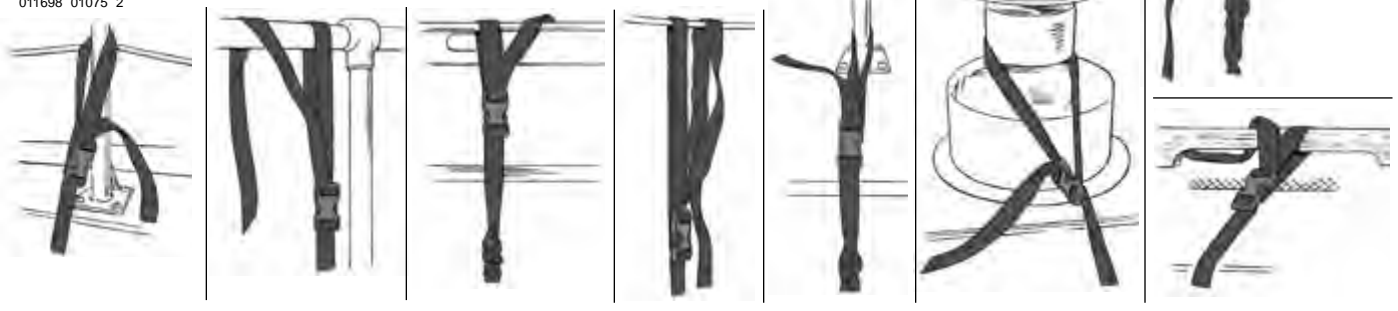

FENDER TENDER II™

The original Fender Tender grips all!

Use this Davis accessory to clip your fenders to rails, lifelines, side wing windows or cleats. Fender Tender II simplifies the handling and relocation of boat fenders. "Railing Lock" firmly grasps rails from 7/8" to 1" (22 to 25 mm) diameter. "Lifeline Lock" provides added safety. Use 1/4" to 3/8" (6 mm to 9 mm) diameter nylon line. Made of tough, sun-resistant plastic for many years of use. Helps tidy up your boat.

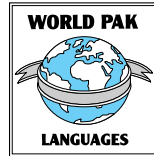
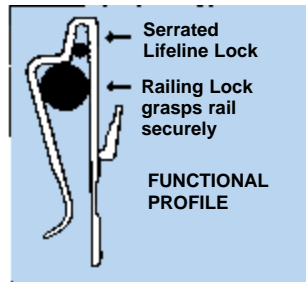

#393 Fender Tender II, PAIR

011698 03930 2

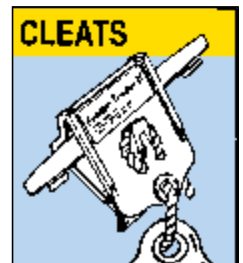
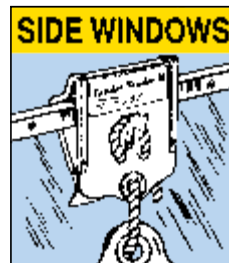
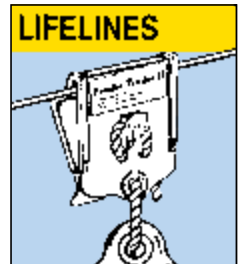
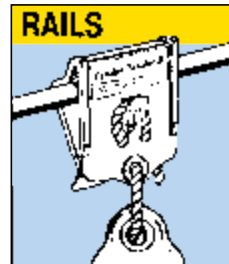

DAVIS

HAPPY TROLLER®

For the Fisherman who thinks he has everything!

Slows even big motors down to that "ever-so-slow" fish tantalizing speed

A significant advancement for the sport of troll fishing, **Happy Troller** mounts on the anti-cavitation plate to allow fine control of trolling speed. Your boat's stability is enhanced at cruising speed, too.



Locks in "down" position for trolling, "up" for cruising

Happy Troller reduces troll speed in "down" position. In "up" position, acts as a stabilizer, smoothing out ride in rough water and reducing porpoising and cavitation. Made of highest quality stainless steel and marine aluminum; with clear anodized aluminum finish. Installs in 15 minutes. Use year-round in all boating activities, salt or fresh water.

Two Models:

Large fits inboard/outboards plus all outboard motors 50 h.p. and larger.

Small fits outboard motors from 20 to 50 h.p.

#460 Large Happy Troller

011698 00635 9

#461 Small Happy Troller

011698 00636 6

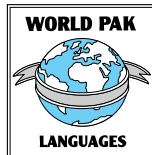

lil' fella™

Trolling Plate

Little brother to the Happy Troller®

- Fits all outboard motors up to and including 25 h.p.
- Locks "down" for trolling, "up" for cruising
- Made of highest quality polycarbonates with stainless steel hardware

#462 Lil' Fella Trolling Plate

011698 00637 3



Precisely Sets Your Trolling Depth!

Turns over and surfaces when fish strikes

Great for SALMON, TROUT, STEELHEAD, WALLEYE, CRAPPIE and STRIPER.

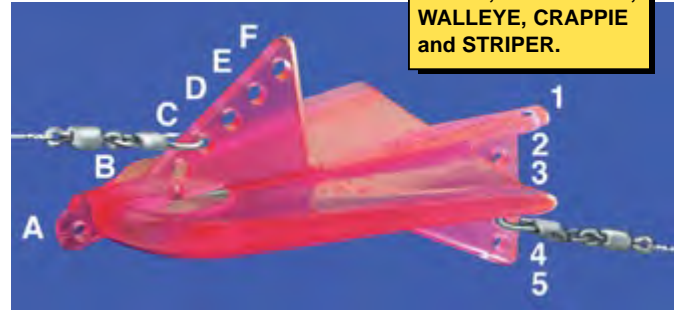

Trolling at 2 MPH with Fish Seeker, you can choose any trolling depth from 5 to 80 feet (1.5 to 25 m). Simply choose the right setting for desired depth, let out enough line and troll at slow speed. For salt or fresh water fishing and 6–25 pound test line. A good replacement for outriggers or heavy lead ball sinkers. Not for use with deep diving lures.

#510 FISH SEEKER, chartreuse
011698 00188 0



#511 FISH SEEKER, hot pink
011698 00189 7



#512 FISH SEEKER, clear
011698 00190 3

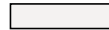

How Fish Seeker's depth is controlled: Using a chart supplied with the product, attach your rod line snap swivel to a lettered hole and your leader snap swivel to a numbered hole. Release the amount of line specified, and Fish Seeker will dive to the desired depth.



Whale Tail XL®

Aluminum Stabilizer and Ski Boat Fin



The **Whale Tail XL** unique hydrodynamic design extends behind the prop to utilize prop wash energy which is normally lost. Whale Tail transforms this energy into lift for immediate response when the throttle is applied. Use Whale Tail XL in fresh or saltwater.

Improves performance in any I/O or outboard motor

- Pops skiers up in less time
- Flattens wake for waterskiing; creates positive, skid-free turns
- Stabilizes bow-light boats
- With bow lowered, visibility and safety are improved
- Smooths out ride in rough water
- Reduces porpoising & cavitation
- Increases top speed and fuel savings in most applications
- Mounts on the anti-cavitation plate of all inboard/outboards and outboards
- Installs in 15 minutes with stainless steel hardware included
- Marine grade aluminum with durable anodized finish

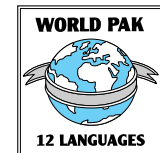

#448 WHALE TAIL XL Stabilizer & Ski Boat Fin

011698 00639 7



Enjoy the ride! 100% Satisfaction Guaranteed

Over three decades of testimonials and 1,000,000 customers agree that Doel-Fin delivers! Fits all motors except Volvo Penta® 280 and 290 outdrives.

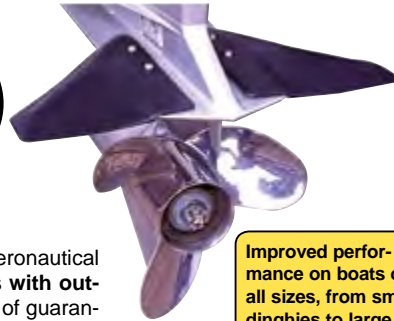

Doel-Fin is the original hydrofoil developed by an aeronautical engineer to improve overall performance on boats with outboard motors or outdrive units. Molded in 2 pieces of guaranteed unbreakable, high-strength plastic, each foil is designed to flex independently to absorb shock. The positive effects include greater stability, consistent planing at lower RPM, faster out-of-the-hole performance, steadier turns, higher top-end speeds and lower bow rise at all speeds.

- Doel-Fin improves overall performance— even on boats with well-designed hulls
- Save up to 30% on fuel consumption
- Faster out-of-the-hole for happier water-skiers
- Maintain lower planing speeds without constant throttle adjustments for wakeboarding, tubing or beginning skiers
- Less bow rise for better visibility and increased safety
- Simple 15-minute installation; hardware included

Doel-Fin is designed for use with small motors, big motors, and inflatable dinghies. Boats with small motors no longer “porpoise” with the bow-up when the throttle is applied and achieve planing at lower engine speeds. Big motors benefit from less stern suction, faster planing times and steadier turns. All these features add up to increased fuel efficiency.

Improved performance on boats of all sizes, from small dinghies to large ocean cruisers!



#440 DOEL-FIN Stabilizer, set of left and right fins, black

011698 00185 9

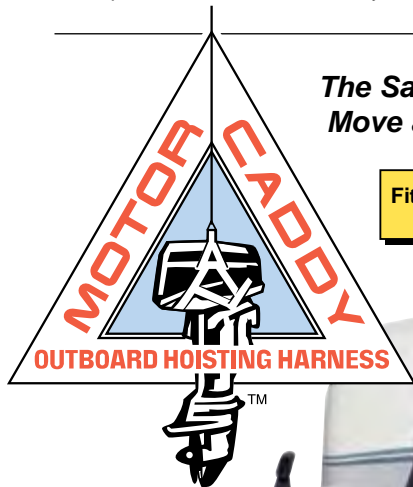
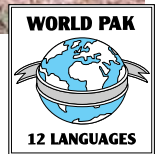

The Safe and Easy Way to Move an Outboard Motor

Fits 4-stroke motors up to 15 h.p.

UPGRADED



Motor Caddy is sized to be quickly attached to most outboards from 2–15 horsepower. This improved design features a longer strap to fit 4-stroke motors and an added security strap for today’s streamlined engine cases. Made of UV resistant materials that will endure the marine environment for those who prefer a semi-permanent installation. Glass filled Nexus® nylon buckles insure easy installation and removal. Makes lifting and moving cumbersome motors safer, simpler.

#430 Motor Caddy Outboard Hoisting Harness

011698 04300 2

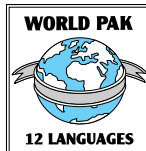

RUDDER POSITION INDICATOR



#385 Rudder Position Indicator

011698 03850 3

Avoid Veering—and Collisions!

Awareness of the rudder angle is a most important safety factor. This is especially true while moving in and out of your berth, drawing alongside another boat, picking up a skier, mooring, or any other “close call” situation. Davis’ Rudder Position Indicator gives instant visual reference of rudder angle. The pointer swings a full 30° with each revolution of the wheel. Mounts easily with its self-adhesive pad directly to your hub. Indicator is approximately 2” (5 cm) in diameter. Rugged, hermetically sealed, weatherproof and sunproof housing ensures long life. No cables, adjustments, or electricity required; gravity power makes it simple and service-free. Suitable for boats with mechanical and single station hydraulic steering systems.

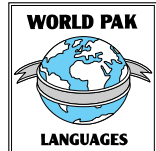

DAVIS ROCKER STOPPER™



A hydrodynamic device scientifically designed to stabilize a boat moored, anchored, or drifting.

The more wind and waves, the better RockerStoppers work!

With engines off or sails down, you feel the sea as you stop for meals, fishing, rest or sleep. Rocker Stopper is the solution—efficiently dampening the effects of waves and wake on a stationary boat. Designed for rugged use.

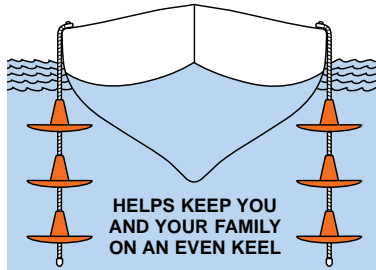

HELPS KEEP YOU AND YOUR FAMILY ON AN EVEN KEEL

Number of Rocker Stopper Units Needed on Each Side of a Boat

Up to 26 feet (0 – 8 m)	3
27 to 36 feet (8 – 11 m)	4
37 to 42 feet (11 – 13 m)	5
43 to 50 feet (13 – 15 m)	8

Length of Boat

For sailboats, powerboats, fishing boats, too!

Lightweight and molded of high-impact, virtually indestructible styrene. Can be deployed or retrieved in seconds. Salt water resistant, gentle to the sides of your boat. Units “nest” within each other, so storage is a breeze.

#352 Rocker Stopper, individual unit

011698 03520 5

14" (36 cm) diameter
Weight 1 lb. (.45 kg)

TIP Rocker Stoppers are excellent for slowing drift while fishing, and can also be used as a dock stabilizer.

SWIM STIRRUP™

The Safe Solution to a Slippery Situation

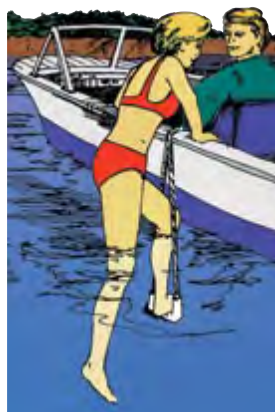

#1466
Swim Stirrup

011698 00649 6

The **Swim Stirrup** provides safe, easy access to small boats for swimmers or water skiers. Durable, reliable design attaches to gunwales, transoms, or open bows.

- Perfect for rowboats, ski boats, dinghies, sailboats
- Adjustable length to fit your boat
- Complete hardware and instructions included
- Easy to install, easy to use—it even floats!

PORTABLE DOCK RING™

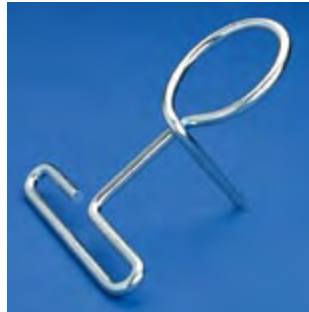

Carry it in your boat!

- Powerboats • Fishing boats
- Sailboats • Seaplanes • Jet skis

No cleat or ring in place? Rings in wrong place? Then use Portable Dock Rings as a convenient way to tie up your boat. Made of heavy duty steel (5/16", 8 mm), tested to hold even in wave action. Zinc plated to resist rust for years.

#387 Portable Dock Ring

011698 03870 1

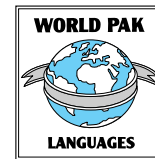

TIP Many boaters carry a Dock Ring and line in their tenders.

It's as easy as 1-2-3:

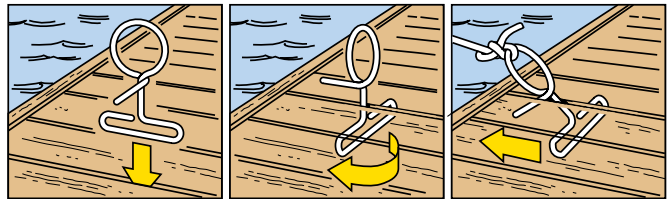

1 Insert between dock planks.

2 Turn 90° to secure under dock.

3 Slide to edge of dock, tie rope.

Line Snubber™

A Shock Absorber for Your Lines



For fishing lines, too!

Line Snubber helps reduce stress and wear on your lines and cleats. They're available in 22" length (56 cm). Molded of highest quality rubber for years of service. Packaged in pairs.

Sailors, fishermen and other boaters will find many uses for Line Snubber, from anchor snubbing to trailering. Using them on parallel lines maximizes their effectiveness. Sailors can use them to lash a tiller, tie down a halyard or rig a boom preventer. Snub docking lines and mooring ropes. Reduce shock on fishing lines, too. Line Snubbers will secure a dinghy in place or keep one steady while being towed. Protect your lines, cleats, boat components and surfaces from wear with Line Snubber.

#1468 Line Snubber 22, PAIR

011698 00651 9

STAINLESS NEW STEEL HARDWARE

Polished 316 stainless steel hardware stands up to the toughest marine and outdoor environments. This is the same hardware used in our Shockles® product line, so volume purchasing allows us to offer our customers very competitive prices.



#2470 Carabiner. Captive, 3/8" stock (10 mm) by 3 7/8" long (10 cm). Safe working load 1200 lbs. (500 kg). 011698 01080 6

#2480 Key Pin Halyard Shackle. Captive, 5/16" stock (8 mm) by 3 1/16" long (8 cm). SWL 1500 lbs. (700 kg). 011698 01081 3

#2490 Wire Gate Snap. 1/4" stock (6 mm) by 2 3/8" long (6 cm). SWL 415 lbs. (188 kg). 011698 01082 0

#2500 Wire Gate Snap. 5/16" stock (8 mm) by 3 1/8" long (8 cm). SWL 968 lbs. (438 kg). 011698 01083 7

SAIL TRACK STOPS

When it's time to lower your sail, you can rely on Davis' SAIL TRACK STOPS to hold your sail and its slides in place on the mast and boom. Large knurled wheels are released with ease. Made of heavy-duty, black anodized aluminum and marine grade nickel plated brass. Flat stops come with lanyard holes.



#2350 ROUND .50" dia. x .875" (13 x 22 mm) 011698 23500 1

#2351 FLAT .42 x 1 x .125" (11 x 25 x 3 mm) 011698 23510 0

#2352 FLAT .75 x 1 x .125" (19 x 25 x 3 mm) 011698 23520 9

UNIVERSAL DECK PLATE KEY

THE RIGHT TOOL!

No more looking for the right tool while refueling or filling a water tank

This handy pocket-sized tool fits **all** deck plate caps: slotted, raised lug, spaced hole, and star (winch handle) type caps. The tool also has common hex sizes: 5/16" (8 mm) for hose clamps and 7/16" (11 mm) for 1/4" (6 mm) bolts. Other designed-in features include a shackle key, a super tough flat screwdriver, and a bottle opener. A wide, flat edge gives good hand leverage when using the shackle key. The hexes are close to the edge for ease of use, and the screwdriver stands out in relief for working in tight places.

Constructed of specially hardened stainless steel. **Will not corrode or break... ever!**

Don't Accept Substitutes! Much stronger and more versatile than all others.

#381 One Key

011698 03810 7

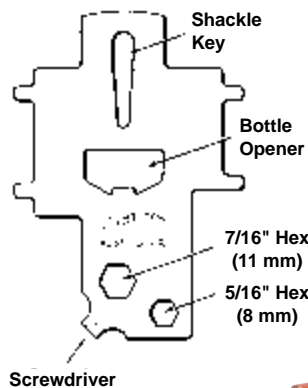

TIP Attach a Key Buoy self-inflating key ring #530 to the shackle key slot to avoid losing your favorite tool!



Look for this display at your favorite retailer

DIS-22
Deck Plate Key countertop easel

FSR™ FIBERGLASS STAIN REMOVER

THE BEST THERE IS! USE ON SHOWERS AND SPAS, TOO.

FSR is a unique stain absorbing gel that serves a variety of purposes both ashore and afloat. It's ideal for removing oil, rust, exhaust, waterline and transom stains, yet it can also be used anywhere else fiberglass stains may crop up—shower stalls, furniture, etc. Use for removing road soil from trailered boats and recreational vehicles. Its non-abrasive quality means that it's safe to use on white painted surfaces as well as on gel-coat. Requires no sanding or compounding. Simply apply with a brush, sponge or cloth. Wait a few minutes and then wipe off or rinse.

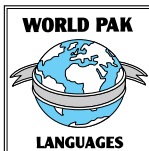

- Great for exhaust and waterline stains
- Removes rust from stainless steel stanchions and railings
- Excellent for removing "rust bleeders" from hull or deck
- Removes road dirt from RVs and trailer boats
- Safe on white painted surfaces

TIP Removes rust stains from clothing, sail cloth, and other fabrics.



Rust stains on fiberglass—gone!

TIP: Test a small area first to be sure FSR will not damage finish.

#790 FSR
16 fl. oz. • 1 pint
0.47 liter
011698 07900 1

#792 FSR Big Job
67.8 fl. oz.
2.0 liters
011698 07920 9

Solar LED Innovation

All SolLight products feature a solar cell and internal battery engineered as a system to capture and store the sun's energy. Makes light available when and where you need it. U.S. designed, rugged enough to survive all outdoor adventures. SolLight units have been to the top and bottom of the world and points in between. Solar LED innovation for everyday use: "Simply brilliant! Why didn't I think of that?"



LIGHTCAP™ 200 **NEW**

Illuminated Water Bottle Cap



2" (51 mm) cap
2.6 oz. (74 g)

Take the light with you!

LightCap 200 turns any 2" (51 mm) bottle into a solar lantern. Four white LEDs light up the night. Built-in light sensor switches cap off during daylight hours while battery charges. A waterproof switch turns light on/off. All electronics are fully sealed for use in the field (not dishwasher safe). Stores up to 15 hours of light on a full charge.

#3400 LightCap 200, 2" (51 mm) bottle cap, red 011698 01084 4

#3410 LightCap 200, 2" (51 mm) bottle cap, smoke 011698 01085 1

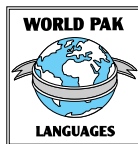

LIGHTCAP™ 300 **NEW**

Solar Lantern and Water Bottle



BPA-free plastic water bottle complete with solar cell and internal storage battery built right into the 3" (76 mm) cap. Automatic light sensor turns unit off in daylight. Manual on/off offers 4 bright white LEDs or a single red LED. The bottle opening is 3" (76 mm) and holds 32 ounces (.94 liter). Bottle shape offers ergonomic grip with two flat sides to prevent rolling. Measures 9.5" tall (24 cm). Weighs just 10.5 oz. (298 g). Bottle doubles as a waterproof storage container for personal items.

#3420 LightCap 300, 3" (76 mm) cap and bottle, red 011698 01086 8

#3430 LightCap 300, 3" (76 mm) cap and bottle, smoke 011698 01087 5



Waterproof storage for important items, and it floats!

RAILLIGHT™ PREMIUM **NEW**

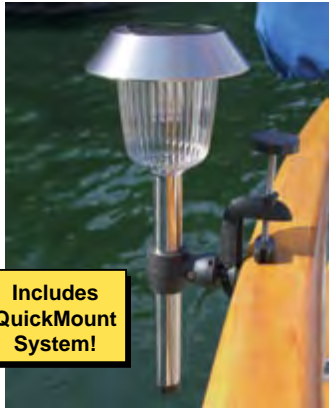

Includes QuickMount System!

RailLight comes in two models, **Premium** and **Mini**. Both feature **FastSolar™** charging system to replenish the internal storage battery. Both switch on automatically at night and off during the day. Manual switch allows RailLight to be turned off when you're not there. Both RailLights are fully marinated and feature stainless steel cap and post, UV resistant polycarbonate lens, nylon mount fittings, waterproof switching and fully sealed electronics. Rail Clamp fits railings from .65–1.25" diameter (17–32 mm).

RailLight Premium has 4 bright white LEDs and can be switched between 2 and 4 LED function. Stands 14" tall (36 cm). Comes complete with the QuickMount System (pictured below), offering several installation options. Stores up to 8 hours of light on a full charge.

Most marine tubing measures either 7/8" or 1" (22 or 25 mm).

FastSolar™ Panel
Sealed epoxy coated, charges in various lighting conditions

Rechargeable, Replaceable Battery
Secured under weatherproof hood

Marine-Grade Stainless Steel
Hood and post resist corrosion

Waterproof Multi-function Switch (under hood)
Three positions: "on high," "on low," "off"
Push once for 4 LEDs, again for 2 LEDs, and once more to turn off
Solar cell continues to charge the battery even in the "off" position

Internal Fresnel Lens
Amplifies light up to 10 times

UV Resistant Polycarbonate
Resists cracking, clouding, yellowing

Sturdy Nylon Post Clamp
1 inch I.D. (25 mm); adjusts up and down for optimum placement

Quick-Release Mount
"Key-type" system snaps together for secure connection or easy removal for storage

Sturdy Nylon Rail Clamp
Pivots 90° for right angle or off-angle mounting; adjusts to rail diameters .65" to 1.25" (17–32 mm) with three shims provided

SPECIFICATIONS

Marine grade construction
Provides up to 8 hours of light on a full charge
1 Watt LED output
1800 mA NiMH storage
200 mAh solar panel output

#3440 RailLight Premium, solar light with 4 LEDs

011698 01088 2



RailLight Premium



RAILLIGHT™ MINI **NEW**



RailLight Mini has 2 bright white LEDs and is 11" tall (28 cm). Includes nylon Rail Clamp that fits .65–1.25" diameter rail (17–32 mm). Sealed on/off switch. Stores up to 8 hours of light on a full charge.

Most marine tubing measures either 7/8" or 1" (22 or 25 mm).

RailLight Mini



#3450 RailLight Mini, solar light with 2 LEDs

011698 01089 9

QuickMount System

Offers three distinct mounting options: Rail Clamp, Threaded C-Clamp, or Wall Mount. Fits RailLight Mini, or use to securely fasten small electronics such as a camera, GPS, GoPro® or monitor. Also ideal to hold a hose, extension cord, rescue buoy, etc. All parts molded of tough, UV resistant nylon.

Included with RailLight Premium.



NEW

#3470 QuickMount System

011698 01091 2



LIGHTSHIP™

Portable Solar/LED Interior Light **NEW**

LightShip is perfect for boats, cars, RVs or home. Three powerful suction cups allow mounting with the solar cell facing the sun. Three bright white LEDs provide enough light for reading. Or switch to one, single red LED for night light function. Unit can also be switched off to store up energy for future use. Built-in light sensor switches LightShip off automatically during daylight hours. Made of tough polycarbonate with clear, molded lens and reflector to maximize LED intensity. For interior use only.

#3460 LightShip

011698 01090 5

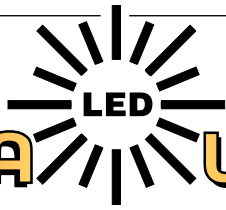

UPGRADED

ENERGY EFFICIENT LIGHTING

NEVER WORRY ABOUT POWER CONSUMPTION AGAIN!

Campers, RVs, fishing boats and sailboats all face the same challenge when nighttime comes: limited battery capacity for general lighting. LEDs developed in recent years provide a solution. Mega-Light uses an energy efficient LED bulb that draws just 30 milliamps (a mere 1/30th of an amp). On a fully charged car battery, Mega-Light could run continuously for 2000 hours or more. Your battery will hardly know it's there!

Both **Mega-Light Utility** and **Mega-Light Masthead** include a light sensor that automatically switches the light on at night and off at dawn. Both models feature a dual-function Fresnel lens that projects light for up to two nautical miles (3.7 km). Hung upside down, the clear top of the lens provides area lighting in the cockpit or around the campsite.

Both **Mega-Lights** now come with two easy-to-change light bulbs. A bayonet-type LED draws 30 milliamps and can be seen for up to two nautical miles (3.7 km). The other bulb, incandescent, is more than twice as bright. It draws 0.32 amp (320 milliamps). Other improvements include 100% waterproof O-ring sealed lens & base, and energy efficient circuit board design.

#3300 Mega-Light Utility

011698 33000 3

#3310 Mega-Light Masthead

011698 33100 0

Mega-Light #3300 components...

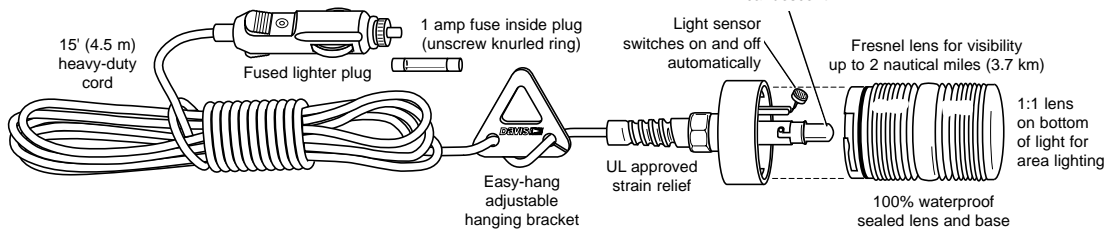

Boating • Fishing • Travel • RVs • Camping



#3300 Mega-Light Utility



#3310 Mega-Light Masthead

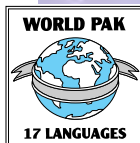

NEW

#3330L Replacement Bulbs for all Mega-Lights.

LED bulb is energy efficient, drawing less than 30 milliamps (1/30 amp). Lasts up to 10,000 hours. Also includes #1893 incandescent bulb to provide "soft" lighting; draws 320 milliamps.

011698 33300 4

Mega-Light Masthead comes mounted to a stainless bracket for easy installation to a masthead, interior wall or bulkhead. Use as a masthead light to mark your boat on a mooring, at anchor, as a nighttime security light or a marker light to light stairways and entryways. Stainless steel bracket with (6) #10 holes and two key-way slots provides multiple installation options. Includes mounting hole for use with Davis Windex® mounting base. Comes with 12" (30 cm) lead wire. On-off switch and fuse holder for hard-wire installation not included.

ECHOMASTER™

Ranked One of the World's Best Radar Reflectors!

Giving ships a chance to see you in fog and low visibility conditions is a must for serious boaters.

Echomaster's full 12.5" (32 cm) diameter circular reflector plates provide 13.2 square yards (12 sq. meters) of maximum effective radar cross section in the X or 3 cm band (9-9.6 GHz frequency), based on optimum orientation between the reflector and radar. Offers equivalent radar cross section of conventional triangular plate reflector with approximate 17" (43 cm) diagonal dimension.

Robust, marine-grade aluminum plates are sufficient thickness to minimize flexing; dimpled to minimize angular distortion. Tough injection-molded, captive corner latches assure minimum angle error. The 1 1/4" (32 mm) windage holes reduce aerodynamic drag and allow assembly of the reflector around a backstay. Easily assembled or demounted. Stows flat.

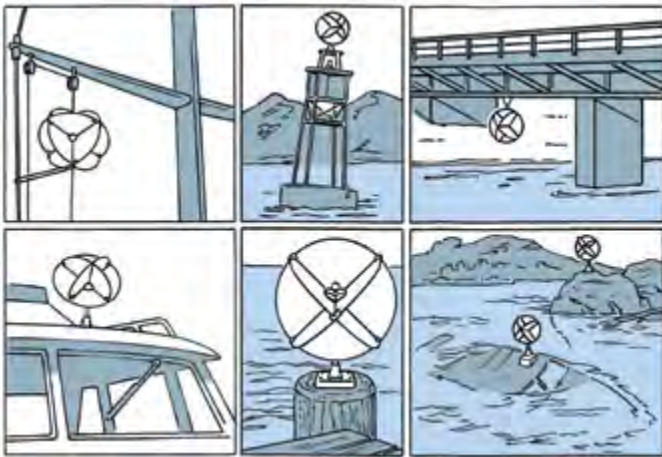

Make your boat visible to other vessels.

Find your way home in less than perfect conditions. Mount a radar reflector on a buoy or piling to help identify your dock or mooring.

Mark hazards to navigation to supplement official channel markings. Install radar reflectors on specific hazards—bridges, rocks, submerged trees, sunken boats.

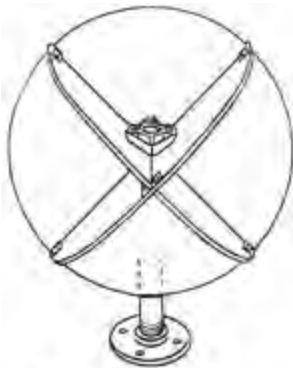

To **SURFACE MOUNT** an Echomaster, use the corner blocks from the #156 Hanging Mount System with five pipe fittings commonly found in hardware stores.

To order the Radar Reflector Booklet separately, contact customer service and ask for #R155E.



UPGRADED

ECHOMASTER with Marine-Grade Anodized Plates

12 square meters of radar cross section. Plates are made of sturdy, stamped 1.3 mm thick aluminum with riveted nylon corner latches for quick assembly or disassembly. Install around a backstay using corner blocks from #156 Mount System, or make your own hanging bridle as described in the 16-page Radar Reflector Booklet included with Echomaster.

#152 011698 01520 7

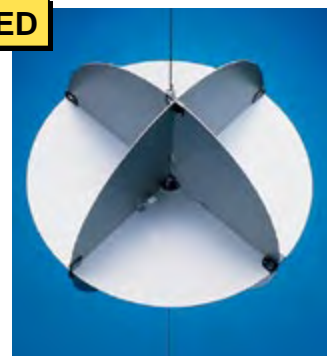

Echomaster meets U.S. Coast Guard requirements for lifeboat and liferaft radar reflectors under SOLAS 74/83.

NEW

HANGING MOUNT SYSTEM (no reflector) Use the hanging mount system to suspend your Echomaster unit from a mast or rigging in the perfect "catch rain" position.

#156 011698 01560 3

Echomaster's proven superiority:

- Ranked one of the best radar reflectors and one of the top ten sailing products by *Practical Sailor*.
- Rated "superior" by SRI after the most rigorous tests ever conducted on radar reflectors, some costing 10 times as much.
- Performance diagrams from the Admiralty weapons test, England, showed Echomaster's high response to incoming radar at all angles:



DAVIS ECHOMASTER #152 DAVIS EMERGENCY RADAR REFLECTOR #151 MOBRI RADAR REFLECTOR FIRDELL BLIPPER RADAR FLAG

Strong peaks, narrow valleys, and 360° returns are desirable.

EMERGENCY RADAR REFLECTOR

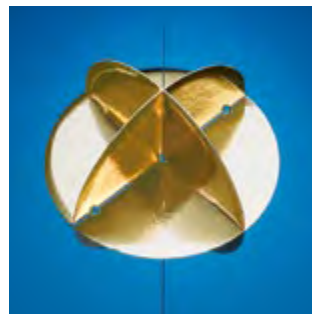

Excellent as a back-up aboard larger vessels or primary reflector on smaller boats that might not normally carry a radar reflector. Made of plastic-metal foil laminate. Opens in seconds and is very lightweight. 11.5" (29 cm) in diameter. Performs almost as well as Echomaster (see performance diagrams above). Economical enough for any boat. Stows flat.

Recommended "Best Buy" by Practical Sailor!

#151
Emergency Radar Reflector

011698 01510 8

Quick Fist™

One Piece Rubber Clamp

Securing your equipment just got a whole lot easier!

Two Sizes Grip Anything from 7/8 to 7 1/2" (22–191 mm)

Quick Fist is a rubber clamp that mounts easily to keep tools and equipment firmly in place. Ideal for boats, off-road trucks, military equipment, ATVs, or any vehicle. Quick Fist clamps are made of heavy duty transportation grade rubber. They're UV resistant and withstand extreme heat or cold. Mount easily with #10 (5 mm) bolts or screws. Terrific for marine use—Quick Fist will not rust or corrode. Available in standard or super sizes. **PATENTED**

#540



#544



Quick Fist

Standard **Quick Fist** is ideal for stowing or transporting tools. Can also be used as a pipe stand-off (do not use on exhaust pipes). Mounts easily with one #10 (5 mm) bolt or screw (not included). Can be mounted with strap facing any direction. To clamp, pull strap through jaw and lock into place. Sold in pairs. Multiple Quick Fists can hold larger tools.

- Holds objects from 7/8–2 1/4" in diameter (22–57 mm)
- Each clamp supports approximately 22 lbs. (10 kg)



#540 Quick Fist Clamp Package includes 2 clamps
Mounting base measures 7/8 x 2 3/4" (22 x 70 mm)

011698 00821 6

SUPER Quick Fist

Super Quick Fist is ideal for holding fire extinguishers, oxygen cylinders, CO₂ tanks, and other equipment. Mounts easily with three #10 (5 mm) bolts or screws (not included). Can be mounted with strap facing any direction. To clamp, pull strap through jaw and lock into place. Strap can be trimmed off for neat installation.

- Holds objects from 2 1/2–7 1/2" in diameter (64–191 mm)
- Each clamp supports approximately 50 lbs. (23 kg)



#544 Super Quick Fist Clamp
1 clamp
Mounting base measures 7/8 x 6" (22 x 152 mm)

011698 00822 3

tiller-tamer™

TILLER STABILIZER & LOCK *Like having an extra crew member!*



Tiller-Tamer maintains cruising course with no hands, in any weather or wind conditions. The tension is smoothly adjustable from fully locked to fully free. Tiller-Tamer gives improved control and feel to the tiller handle. Does not interfere with automatic steering systems. No loss of cockpit space. No need to lash the tiller when boat is moored or trailered. Equally adaptable to inboard rudder tillers, too!

#2205 Tiller-Tamer

011698 22050 2

DECKHAND™

BOATING POUCH



DeckHand is a convenient carrying caddy that attaches to rails, lifelines, or almost any horizontal bar. Simple to install, removable and adjustable. Made of strong, marine-tough polyportex; won't scratch surfaces; sun and mildew resistant. Securely holds drinks, suntan lotion, sunglasses, keys, I.D., pliers, tools, etc. Deck-Hand leaves your hands free.

4 3/4" W x 15 3/4" H
(12 x 40 cm)

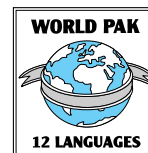

#265 DECKHAND
Boating Pouch

011698 02650 0

AQUA LATHER™ Salt & Fresh Water Body Gel & Shampoo



- Works in all water • Skin pH neutral • Biodegradable

Formulated for salt water, hard water, brackish water, or chlorinated water. Ideal for swimmers, boaters, fishermen, campers, travelers, fitness enthusiasts.



Unique Formulation: Aqua Lather's exclusive blend cleans, freshens, and counteracts salt, sun & wind damage. Works up a rich lather—even in hard water or salt water—that removes all dirt and grease. Leaves skin feeling smooth and hair tangle-free. No annoying curds or residues. Aqua Lather is pH neutral: won't harm hair or skin, no matter how often used. Light, natural fragrance.

Biodegradable: Breaks down into nature's own elements. Leaves no pollution.

Convenient: Dispensing spout flicks open and closed. No lost cap or messy spills. Compact, tuck-away bottle contains the right amount for travel. Great for dishes and clothes, too!

Economical: Each bottle contains enough concentrate for scores of baths and shampoos. You can wash in salt water and follow up with a fresh water final rinse in places where fresh water is scarce.

5 fl. oz. #721
150 ml Aqua Lather

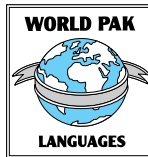

011698 07210 1

SLICK SEAM™ CAULKING COMPOUND



Works Under Water!

(not for use on topsides)

Slick Seam is a remarkable caulking compound made of fine waxes, pure mineral products and silicate fibers. This combination makes Slick Seam not only effective, but easy to use for any **underwater seam application**. It requires neither mixing nor priming. Once in place, Slick Seam stays put no matter how much wood flexes or swells. It adheres to most solid surfaces whether wet, dry, or even oil stained. Applies easily—cleans up fast. Cures ready for painting in half an hour.

Net Weight
16. oz. • 1 lb.
454 g

#730
Slick Seam



011698 07300 9

CABLE COVERS

- Protect sails and sheets from chafe
- Keep sails clean, prevent wear
- Covers split for quick "snap-on"
- Tough, durable plastic with more ultraviolet absorber than other brands—last longer!



Spread end of cable cover and snap cover over cable

CABLE COVERS

Product No.	Fits Cable Size	Cable Cover Length
252	1/8" (3 mm)	6 ft. (180 cm)
253	5/32" (4 mm)	6 ft. (180 cm)
254	3/16" (5 mm)	6 ft. (180 cm)
255	1/4" (6 mm)	6 ft. (180 cm)
256	5/16" (8 mm)	6 ft. (180 cm)
257	3/8" (10 mm)	6 ft. (180 cm)

TURNBUCKLE BOOTS WITH CAPS



- Prevent sails & sheets from catching.
- Give low sheet friction.
- Allow for easy inspection, adjustment and lubrication of turnbuckles.
- Easy to install

Install in three easy steps:

1. Unpin turnbuckle, then slip boot over turnbuckle.
2. Spread cap and snap onto cable.
3. Press cap into boot.

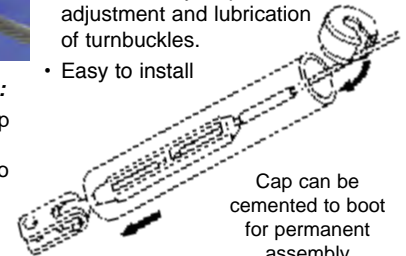

Cap can be cemented to boot for permanent assembly

TURNBUCKLE BOOTS with CAPS

Product No.	Boot Size	Turnbuckle Size
241	3/4" ID x 13" (19 mm x 33 cm)	Barrel
242	1 1/8" ID x 17" (28 mm x 43 cm)	3/8"
243	1 1/2" ID x 20" (38 mm x 51 cm)	1/2"
244	1 3/4" ID x 24" (44 mm x 61 cm)	5/8"

EXTRA TURNBUCKLE BOOT CAPS

245	Fits 3/4" (19 mm) Boot Size
246	Fits 1 1/8" (28 mm) Boot Size
247	Fits 1 1/2" (38 mm) Boot Size
248	Fits 1 3/4" (44 mm) Boot Size

Quick Reference Cards

ACCURATE BOATING INFORMATION WHEN YOU NEED IT

*Make your outing safer,
easier... more fun!*

This complete family of professionally prepared Quick Reference Cards are great for all types of boaters, boat racers, navigators, cruise ship passengers, naturalists, weather buffs, safety-minded sportsmen, electronics owners, school students and classes, or anyone interested in the great outdoors.

All cards feature:

- Full color both sides
- Punched for binder or bulkhead mounting
- Weatherproof high strength plastic
- Full 8 1/2 x 11" (22 x 28 cm) size



U. S. Power Squadrons



U. S. Coast Guard Auxiliary

Look for these displays at your dealer



Dealers: Get free displays with purchase of cards. Your choice:

DIS-15 Display Rack **DIS-15T** Carousel Display

Quick Reference Cards have been designed in close cooperation with the U.S. Coast Guard Auxiliary and U.S. Power Squadrons. They are standard equipment on many U.S. Coast Guard and state boating administration patrol boats.

For quick decisions, get quick answers with Quick Reference Cards!

NAVIGATION RULES



A Must for Safe Boating in an Easy to Use Format

#125
011698 01250 3

A proven navigation tool used by the U.S. Coast Guard, U.S. Power Squadrons, and U.S. Coast Guard Auxiliary. Navigation Rules feature U.S. Buoyage System, inland and international rules, right-of-way, lights, sound signals, and bridge signals. All presented in graphic summary and easy to read. Complete, precise, accurate.

INTERNATIONAL NAV RULES



The Latest Information Covering the Busy Oceans & Waterways of the World

#127
011698 01270 12

A comprehensive guide incorporating the International Maritime Buoyage System and COLREGS. Clarifies differences between Cardinal and Lateral buoyage systems and buoyage regions, key to reducing confusion and danger when entering unfamiliar waters or busy harbors. Complete details on right-of-way, sound signals, entering and clearing a foreign port, lights and day shapes, collision prevention procedures, signal flags.

COASTWISE PILOTING



It's easy to forget the procedures and find yourself lost or in danger!

#126
011698 01260 2

All the piloting information you need at your fingertips: dead reckoning basics, true and magnetic compass relationships, position finding, estimating distance off, current and leeway corrections. Helpful hints on chart reading, preparations and checklists, fog navigation, and depth soundings without a fathometer. Includes time, speed & distance calculator, relative bearing gauge for distance off calculations, common chart symbols.

BOATING GUIDE



Small Craft Seamanship, Vital Boaters' Safety Information

#128
011698 01280 0

Covers all the basic procedures and equipment. Includes predeparture checklist, recommended equipment & spare parts, fueling procedures, engine troubleshooting, radio use, trailering, launching, anchoring, water skiing hand signals. Gives rules of the U.S. Buoyage System and right-of-way. Helps in emergencies by covering distress signals, fire procedures, towing, weather warnings, first aid (hypothermia & CPR).

MARINE ELECTRONICS



Covers Key Modes of Marine Navigation and Communications

#129
011698 01290 9

Comprehensive information. NAVIGATION: GPS, LORANC, RDF, radar, depth sounder. COMMUNICATIONS: VHF, SSB, CB, EPIRB, HAM. Includes procedures, rules, tips, and problem solving. "Marine electronics are vital to the safety and enjoyment of your boat. This card removes any confusion about the proper use of the electronics. Concisely written and easy to understand." — Clyde Kirlin, marine electronics consultant

WEATHER FORECASTING



Practical Methods for Making Marine Forecasts Using Nature's Own Signs

#131
011698 01310 4

Shows the use of wind direction, barometric pressure and cloud type to predict the weather. Includes full listing of radio weather stations for official broadcasts. Has key information on navigation in fog, hazardous wave and surf conditions, storm warnings, hurricane avoidance, and more! "Time tested methods. . . easy to understand. This is a complete guide for becoming 'weather wise.'" —Ken Lilly Jr., CDR. NOAA (ret.), marine meteorologist

CELESTIAL NAVIGATION



Determine Location Using the Sun & Stars

#132
011698 01320 3

A simplified, yet complete Celestial Navigation system. Makes it easy, proving that lengthy instruction is not necessary to master celestial navigation. Includes everything you need: sextant use and corrections, starfinder for 18 stars, data entry form and step-by-step sight reduction and plotting procedures. May be scored and separated; large portion fits in sextant case for quick reference and small part acts as a waterproof data reduction card.

Pocket

Quick Reference Cards

Boating Safety & Procedures Made Simple!



Designed in close cooperation with the U.S. Coast Guard Auxiliary and the U.S. Power Squadrons



U. S. Power Squadrons



U. S. Coast Guard Auxiliary

"These cards are a handy reminder for boaters to rely on in almost any boating situation." — John VanOsdol, director of U.S. Coast Guard Auxiliary's department of education

- | | | |
|--------------------|-------------------|------------------------|
| Predeparture Check | Navigation Lights | Navigation Information |
| Fueling Procedures | Emergencies! | Navigation Rules |
| U.S. Buoyage | Radio Use | Sound Signals |
| Rules of the Road | In Case of Fire! | Hypothermia and CPR |



The set of six 3 x 4" cards (7.6 x 10.2 cm) are easy to read, printed on plastic in full color, and built to withstand the elements. Joined with a steel ring.

#138

011698 00373 0



IT'S EASY TO PREVENT STEERING PROBLEMS!

KEEP WATER & DIRT OUT...

... PUT LUBRICANT IN!

THE ONLY PRODUCT THAT LUBRICATES STEERING CABLE

CABLE BUDDY™

#420

SEALS AND LUBRICATES STEERING ROD

LUBE II™

#425

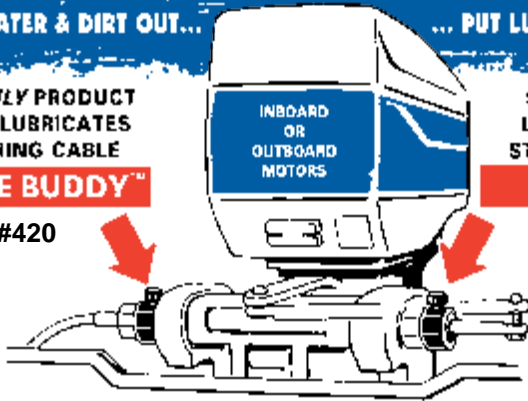

7/8" x 14 pitch threads fit U.S. and Japanese outboard motors



Max-Lube™ oiling-tube method (Lube II shown)

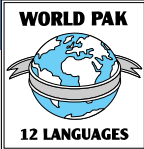

Cable Buddy is a complete steering cable lubrication system. Includes the stainless steel Cable Buddy nut with plug and sealing washer, oiling tube assembly, and Max-Lube, the ideal lubricant for steering cables. Works on inboards, outboards, and inboard/outboard steering cables. Fits all major U.S. and foreign motors (7/8" x 14 pitch threads). Seals moisture out, puts lubricant in. Prevents corrosion and freezing down to -40°F (-40°C). Cable Buddy lubricates and virtually eliminates all wear in the *inner* cable, where *most* problems occur. Easy to install (if you can take the cable off, you can install the Cable Buddy). Install the Cable Buddy now... or deal with the hassle and expense of replacing your steering cable later!

#420 Cable Buddy
with 1 lube nut & Max-Lube
011698 04200 5

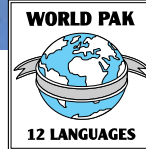

Lube II allows sticky, hard to move steering rods to be properly and easily lubricated for smooth, easy steering action. The system includes a stainless steel lubricating nut with an oil seal and a grease (zerk) fitting. This lubricator's unique design keeps moisture and contaminants *out* while enabling you to pour or pump several types of lubricant *in*. Your choice: (1) Max Lube (#422) synthetic lubricant with high water separation qualities and anti-corrosion protection. This is the best lubricant available for the purpose. (2) A high grade 90w synthetic gear oil. (3) High quality white lithium grease. Lube II helps correct and prevent steering problems. For both mechanical and hydraulic systems. Fits all major U.S. and foreign motors (7/8" x 14 pitch threads). Easy, 10 minute installation. Marine grade stainless steel for salt and fresh water use.

#425 Lube II
011698 04250 0

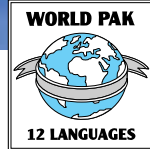

Max-Lube excels under pressure— anywhere oil is required. This proprietary synthetic film has many advantages over other synthetic and premium oils: superior rust and corrosion protection, rapid separation from water, greater stability at temperature extremes, 10-20% reduction in operating temperature, and 5 times greater load carrying. The net result is smoother, quieter, cooler and longer operation. Max-Lube is recommended for steering cables (all boat motors, fresh or salt water), sporting equipment (fishing reels, guns, bike chains), all gears regardless of type or size, and all metals.

#422 Max-Lube
3 fl. oz. • 90 ml
011698 04220 3

SELF-INFLATING KEY BUOY™

Never Lose Keys in the Water Again!

- When keys fall in the water, Key Buoy pops open and its air tube inflates to 14" (36 cm)
- Tube carries keys to the surface for easy retrieval
- Stays afloat for over an hour
- A great gift!

There's nothing like the Davis Key Buoy! Featured in *Time* magazine as a great new outdoor product for the adventurer. Sold worldwide.

PATENTED

Suitable for items weighing up to 2.8 oz. (80 g)

- Key sets
- Small tools
- Deck plate key

The Key Buoy unit measures 2.4 x 1.6 x 0.6" (61 x 41 x 15 mm).

Weight 1.1 ounce (31 g).

Recyclable PP plastic shell and PE plastic tube.

Key Buoy is for single use only. Activator is sodium bicarbonate and tartaric acid, a mild irritant. Not a toy. Prevent contact with eyes and skin; avoid inhalation. Activated product should be promptly disposed.

#530 KEY BUOY self-inflating key ring
011698 00877 3



Winner of the National Marine
Manufacturers Association
Innovation Award

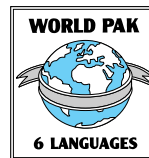

DIS-530
Key Buoy
countertop
display rack

Look for this display
at your favorite retailer



QUEAZ-AWAY™

TRAVELERS' WRISTBANDS



#400
Queaz-Away, PAIR
011698 04000 1

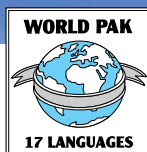

Fight the unpleasant effects of travel!



The "Tummy Tamer"

Queaz-Away is a non-drug aid for active people. Relieves the unpleasant effects of bumpy flights, choppy seas, winding roads, rocking trains, and spinning Ferris wheels. Queaz-Away wristbands exert gentle pressure on points on each wrist to minimize or eliminate the miserable effects of nausea. Made of tough, long-lasting, washable materials. Safe and easy to use. Simply slip onto wrists, position, and enjoy your trip or outing. No complicating buckles or adjustments. One size fits all! Handy carrying case included. Used throughout the world by yachtsmen, pilots, divers, physicians and hospitals.

Look for this display
at your favorite retailer



DIS-34
Queaz-Away
countertop
display rack



Knot-a-Bag
Portable
Plastic Bag Dispenser

The most convenient
plastic bag— anywhere!



GREAT FOR:

- Boating
- Camping
- Food storage
- Wet swimsuits
- Travel
- Car
- Garbage
- Diapers
- Recyclables
- Laundry
- Gardening
- Pets

Roll length
32.5' (10 m).
Bag circumference
24" (61 cm).

Thickness
0.36 mil.



Blend of high
and low density poly-
ethylene for strength.

Dispenser is 4" (10
cm) high and weighs
only 3 oz. (100 g),
roll included.

Just pull it, cut it, knot it, bag it



Knot-a-Bag is absolutely waterproof when tied. Suitable for food storage.
Dispenser clips to belt, backpack, dog leash, wherever needed.

Make plastic bags of any length!

Knot-a-Bag's unique dispenser holds 32.5' (10 m) of tightly wound polyethylene film, yet fits in the palm of your hand. Knot-a-Bag is simple. Pull plastic bag material from center of dispenser, take the length you need, cut with built-in safety cutter, and tie a knot in the end.

PATENTED

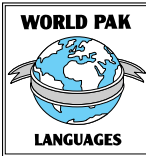

#480 Knot-a-Bag Dispenser.

Dispenser with two 32.5' (10 m) rolls of polyethylene film.

011698 00823 0

#485 Knot-a-Bag Plastic Bag Refills.

Three 32.5' (10 m) rolls of polyethylene film.

011698 00824 7



HANDI-MATE™
Outboard Extension Handle

Handi-Mate extends handle from 30 to 47" (.76 to 1.19 m). Easy to install—tough polycarbonate head quickly clamps over existing handle grip. Does not affect throttle tension adjustment. Depress button & align proper hole for desired length. Non-slip comfort grip, access hole for kill button.

- Lightweight—only 16 oz. (454 grams)
- Turn-locking knob makes securing & removing easy
- Anodized aluminum—no parts to rust or corrode
- Stainless steel hardware

**Fits Virtually All
Twist Grip
Outboard Motors!**

**#1440
Handi-Mate extension handle**
Straight steering unit.

0 11698 00641 0



**Protection for
Propellers and People**



Prop Sox are socks for your prop. They protect your expensive propellers from road kickback when towing. Reflective hot dots alert drivers following too closely behind. People walking by a boat on a trailer can be cut without Prop Sox in place. The bright, molded plastic socks simply slip over each propeller blade and are held in place with a rubber shock cord strap. For use on boats out of water only.

#450 Prop Sox Set of 3

011698 00186 6

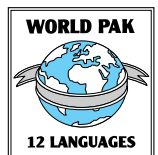

Air-Dryr™

Say Goodbye to Mold, Mildew and Moisture

Air-Dryr is an inexpensive and effective way to fight moisture problems, cold drafts, and corrosion. Designed to operate anywhere, 24 hours a day. Place Air-Dryr on the floor in any damp, enclosed space and plug into a 110/120 volt outlet. Damp air is heated to the point moisture is held in suspension (above dew point), then released through the top vents of the device. As warmed air rises, cooler damp air is drawn in, where it too is heated. Natural convection circulates the air.

Air-Dryr fights the humidity problem with a different (and simpler) strategy than a dehumidifier that drains into the sink—with the same result! Costs no more to operate than burning a light bulb. A thermal cutoff turns the unit off should air flow be impeded.

Features of all **Air-Dryr** models:

- Attractive, neutral beige housing made of polycarbonate for strength and durability
- Slim and stable; can be placed out of the way in confined spaces
- Handle a high volume of air
- Low operating cost; designed to be left on 24 hours a day
- Silent in operation, safe to the touch
- Trouble free—no switch, fan, or thermostat
- Safe for marine use—no components which cause sparking



Air-Dryr 1000

Air-Dryr 500



Use at Home or Office Basements, closets, under desks, storage units, tack rooms, pump rooms, gun cabinets, pianos

Use in RVs and Airplanes Motor homes, trailers, cars, aircraft

Use in Boats Cabins, bilges, engine rooms, V-berths

Two models

#1459 Air-Dryr 500. Handles up to 500 cubic feet of living space. Draws only 0.6 amps, 70 watts. Rectangular unit measures 13.5 x 5.5 x 4.25" high.

#1458 Air-Dryr 1000. Handles up to 1000 cubic feet of living space. Draws only 1.1 amps, 130 watts. Circular unit measures 13.5" in diameter, 4.25" high.

011698 00643 4

011698 00642 7

The Original

Windscoop™ Ventilating Sail

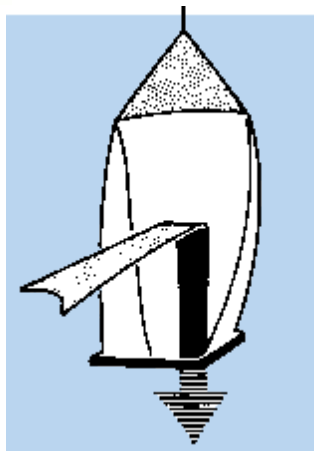

**#291
Windscoop**

011698 00176 7

Put an end to hot, stuffy cabins and sleepless nights. The Windscoop Ventilating Sail is aerodynamically designed to force the slightest breeze into your cabin to keep you cool and comfortable. The versatile Windscoop can be hung from a hal-yard boom or roller furling sheet. Fits any hatch or companion-way up to 4 feet (120 cm) wide. Nothing to install. Since the Windscoop has no tie-downs, once you put it up, it will follow a variable wind. Works with most screens. Colors vary.



Added material and strengthening in stress areas. Two battens are sewn in place. All seams are double-stitched.

Windscoop is packed in its own protective nylon storage bag.

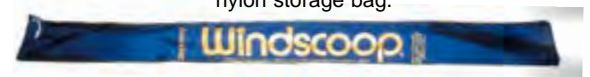

DAVIS CHARTING KIT

Everything
You Need for
Chart Work!

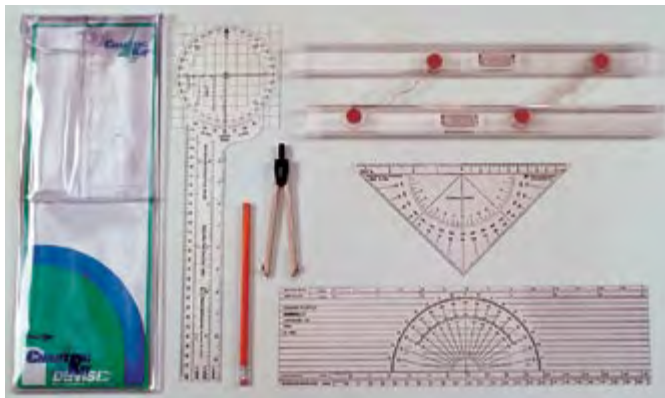

This handy kit makes chart work easy. A choice selection of navigational tools for cruisers and racers as well. Kit includes:

- **One-Arm Protractor**
- **Course Plotter**
- **Protractor Triangle**
- **Parallel Rules**
- **Professional Dividers**
- **Pencil**
- **Instruction Booklet**

All are conveniently organized in a 5³/₄" x 16¹/₄" (15 x 42 cm) heavy gauge plastic carrying case. An excellent gift idea!

#083 Charting Kit

011698 00830 8

**Highest Quality
Printing:**

Davis plotting tools feature sharp printing process, high gloss finish on front and back, and overlamination for durability.

PARALLEL RULES



The most basic plotting instrument

Davis Parallel Rules are completely transparent with a clear optical finish for exact plotting. Each 15" (38 cm) blade features large, easy-to-grip handles. Smooth instrument action, non-slip cork pads. Precision molded for the most accurate straight line plotting money can buy!

#061 Parallel Rules 011698 00610 6

CHART HOLDER

All-Purpose Storage Container

• WEATHERPROOF • DURABLE • FLOATS

LIFETIME
GUARANTEE



Ideal for charts, documents, prints, papers, fishing rods, parts.

40" long x 3" diameter (1.0 m x 7.5 cm). Made of clear, unbreakable polycarbonate for total protection and long life...guaranteed! Tubes are large enough for most marine charts, yet stow easily. Special identification label provided for quick cataloging of contents. Molded end caps ensure maximum security.

#086 Chart Holder 011698 00860 5

TURBO METER™

#271

011698 02710 1

ELECTRONIC WIND SPEED INDICATOR

Measures Wind Speed from 0–99.9 MPH (0–44.8 meters/sec)

Accurate to ±3% of Reading

- Responds to Lightest Winds
- Four Scales
- Easy to Read Day or Night
- Weather and Shock Resistant

The rotation of Turbo Meter's freely turning turbine, suspended on sapphire jewel bearings, is sensed by an infrared light beam. The resulting signal is processed electronically. The display has been made larger, brighter for excellent viewing in full sun or dark conditions. Auto Power-Off. Compact size (2.6 x 4.7 x 1.2", 7 x 12 x 3 cm) and lightweight (3 oz., 85 g). Wrist lanyard, protective case included.



NIST

AVAILABLE

SCALE	RANGE	RESOLUTION	THRESHOLD
Knots	0–87.9	0.1 Knot	0.9 Knot
Feet Per Minute	0–8790	10 FPM	90 FPM
Meters Per Sec.	0–44.8	0.1 m/s	0.5 m/s
Miles Per Hour	0–99.9	0.1 MPH	1 MPH

WORLD PAK



For intermittent use only above 12 MPH (1000 FPM).

Requires 3 AAA alkaline batteries (not included). Redesigned for even longer battery life.

Davis wind speed indicators are useful in many fields

- Yachting • Boating • Windsurfing • Aviation • Sky Diving • Hang Gliding
- Hot Air Ballooning • Track & Field Events • Skiing • Mountaineering
- Archery • Shooting • Model Flying and Sailing • Kite Flying
- Meteorology • Air Flow Testing • Crop Dusting • Ventilation
- Wind Sensitive Construction and Spraying • Anywhere wind is a factor

Wind Wizard™

#281

011698 02810 8

MECHANICAL WIND SPEED INDICATOR

Measures Wind Speed from 0–60 MPH (0–26.8 meters/sec)

- Reads in Miles Per Hour, Meters Per Second, and Beaufort
- Direct reading dial card supported on sapphire jewel bearings
- Sturdy, corrosion-resistant construction
- Unique folding handle makes unit shirt-pocket size
- No batteries required

The Wind Wizard is a rugged, precision instrument. The direct reading dial features sapphire jewel bearings and gold-plated balance spring. A special magnetic damping system uses two rare earth magnets to steady the dial card, greatly reducing the tendency of the readout to "jump around." High impact plastic case; all metals corrosion resistant. Measures 3.6 x 2.9 x 1.0" (9 x 7 x 3 cm) with handle folded. Wrist lanyard and vinyl leather-like carrying case included.



WORLD PAK



Vantage Vue® Wireless Weather Station

Compact. Rugged. Accurate. Reliable.

PRECISION WEATHER INSTRUMENTS

The Vantage Vue weather station combines legendary Davis accuracy and rugged durability into a compact station that's easy to set up and use. Vantage Vue includes a sleek but tough outdoor sensor suite and distinctive LCD console. Its unique Weather Center function provides additional information on each weather variable. In addition, Davis has made the Vantage Vue radio compatible with our flagship Vantage Pro2 stations, so you can mix and match most components.

Sensor suite and console not shown to scale.

#6250 Vantage Vue Station

011698 00912 1



Multiple features affordably priced.

The Vantage Vue's compact outdoor sensor suite measures current weather conditions, including inside/outside temperature, humidity, barometric pressure, wind speed and direction, dew point, and rainfall. Sets up in minutes and starts sending data wirelessly to the indoor console. You'll also get weather forecast icons, moon phase, sunrise/sunset times, graphing of weather trends, alarms and more. The innovative Weather Center button displays additional data for today and over the last 25 days.

The fully-integrated, corrosion-proof sensor suite was subjected to cyclic corrosion tests simulating extreme marine weather environments. Sealed electronics provide protection against the elements. Vantage Vue withstands freezing winters, high winds and blistering sun.

Vantage Vue is perfect for marinas, vacation homes, gardens, schools, universities, businesses, firefighting and emergency response teams.

Features

Displays indoor and outdoor conditions. Temperature and humidity, barometric pressure, wind speed, wind direction, rainfall and more.

Reliable data transmission. Frequency-hopping spread spectrum radio. Radio compatible with Vantage Pro2.

Quick and easy installation. Mounting hardware kit included.

Durability in extreme conditions.

Corrosion-resistant cover on sensor suite; radiation shield on temperature/humidity sensor prevents false readings from radiated and reflected heat.

Bubble level. Allows more accurate installation and better data collection.

Easy-to-read display. Backlit LCD screen measures 3 x 4³/₈" (8 x 11 cm). Glow-in-the-dark keypad for night viewing and domed buttons for better feel.

Graphs. 50 on-screen graphs for comparing current and past weather.

Alarms. 22 alarms to warn of dangers such as high winds, possible flooding and high heat.

Forecast icons. Let you know to expect sun, partly cloudy, clouds, rain or snow.

Optional WeatherLink®. Data logger and software offer extensive weather analysis and data storage. PC, Mac and Internet versions available.

Specifications

Wireless frequency-hopping spread spectrum radio offers transmission up to 1000 ft. (300 m)—three times farther than the competition. Optional repeaters extend the range even more.

Updates every 2.5 seconds—up to ten times faster than the competition.

Outside Temperature readings from -40° to 150° F (-40 to 65° C). Inside temperature readings from 32 to 140° F (0 to 60° C).

Wind Speed as low as 1 mph (1 km/h) and as high as 200 mph (320 km/h).

Wind Direction in compass points or degrees.

Rain Collector measures rainfall with 0.01" resolution or 0.2 mm resolution with metric version.

Barometer's five-position trend arrow shows whether barometric pressure is rising, falling or stable.

Relative Humidity, inside and outside, given in 1–100% range, ±3% accuracy.

Variable display options. See updated variables every 10 seconds for heat index and wind chill to get a better "feel" for the outside environment.

Solar Powered. Lithium battery provides backup when needed.

Compact Console. Size 7¹/₂ x 6 x 4¹/₂" (19 x 15.2 x 11.4 cm). Weighs only 1.2 lbs. (0.5 kg).

Integrated Sensor Suite. Size 13¹/₈ x 6 x 15" (33.4 x 15.2 x 38.1 cm). Weighs 2.2 lbs. (1.0 kg).

Vantage Vue mounts on top of poles 1 to 1³/₄" in diameter (2.54 x 4.45 cm). Pole sold separately. Tripod also available.



Vantage Pro2™ Wireless Weather Stations

Professional and Rugged—Ultimate Versatility and Options

Vantage Pro2 offers the professional weather observer and the serious weather enthusiast rugged performance and a wide range of options and sensors. You'll get your own local forecast, highs and lows, totals or averages, and graphs for virtually all weather variables over the past 24 days, months or years—all without using a PC. Vantage Pro2 uses frequency-hopping spread spectrum radio to transmit and receive data up to 1,000 feet (300 m) line-of-sight. Fast updates every 2.5 seconds (10 times faster than the competition).

Vantage Pro2 is also an excellent choice for emergency professionals, farmers, schools, researchers, municipalities and others to monitor wind and moisture conditions, irrigation requirements and potential flooding. It can be customized with a range of add-on options, such as solar and UV radiation sensors, soil moisture stations and long and short-range repeaters.



Vantage Pro2 features:

- Rainfall.** Measured in 0.01" or 0.2 mm increments.
- Temperature.** Both inside and outside, currently and for each of the last 24 hours.
- Humidity.** Both inside and outside, currently and for each of the last 24 hours.
- Wind Speed.** Up to 200 mph, in 1 mph, 1 knot, 1 km/hr, or 0.1 m/s resolution. Anemometer can be installed separately from rain collector for highest accuracy.
- Wind Direction.** Both current and dominant, shown on compass rose with 16 points.
- Barometric Pressure.** Given by a five-position trend arrow.
- Current and Historical Data.** Records such as highs and lows may be viewed for up to 24 days, months or years.
- Forecast.** Displayed in icons for sun, partly cloudy, clouds, rain or snow. 12-hour icon forecast plus 24–48 hour ticker tape forecast at bottom of screen.
- Moon Phases.** Eight stages shown, from new to full to new.
- Time and Date.** Always on view. Also displays time of sunrise, sunset, time and date of highs and lows.
- Ticker Tape Display.** Provides expanded forecast details and additional information on current conditions.
- Graphing Function.** Shows last 24 hours, days or months of readings or highs and lows. View over 80 graphs, including additional analyses of temperature, rain rate, wind and barometric pressure. Optional WeatherLink® software allows even greater analysis.
- Alarms.** May be set for more than 70 functions.

Vantage Pro2

NIST

AVAILABLE

Choose wireless model for easiest installation, ability to add additional consoles or special-purpose stations, and reduced risk of lightning strikes.

Choose cabled model for most economical installation. For field installations, consider using Vantage Connect (see page 25).

- Cabled version includes console with AC-power adapter and 100' (30 m) cable. No solar power.
- Wireless version includes transmitter (in weather-resistant shelter) and receiver (in console). Range is up to 1000' (300 m) outdoors, line-of-sight. Typical range through walls under most conditions is 200' to 400' (60 to 120 m). Data may be received from more than one transmitter. You can retransmit from one console-receiver to another, allowing viewing of the same weather data in more than one location.

#6152 **Wireless Vantage Pro2**
011698 00722 6

#6152C **Cabled Vantage Pro2**
011698 00755 4

Customize your weather station by adding extra consoles or special-purpose stations. Up to eight wireless transmitters can report to a single console.

Vantage Pro2 Plus

NIST

AVAILABLE

Includes all the features of Vantage Pro2, plus everything you need for reading:

- UV index and dose
- Solar radiation
- Evapotranspiration

UV and solar radiation sensors preinstalled on sensor mounting shelf.

#6162 **Wireless Vantage Pro2 Plus**
011698 00746 2

#6162C **Cabled Vantage Pro2 Plus**
011698 00756 1



Wireless Vantage Pro2 with the optional #7716 Mounting Tripod and #7747 Daytime Fan-Aspirated Radiation Shield.

NIST

Davis Instruments is proud to participate in the National Institute of Standards & Technology (NIST) measurement assurance program. NIST traceability or certification is available for those users who require it.

Vantage Connect™ Brings Remote Weather Stations “Within Range” with Cellular Updates

NEW

Get real-time weather data from remote locations with good cellular coverage right to your smartphone or computer using Vantage Connect.

Vantage Connect combines the weather receiving power of a Vantage Pro2 or Vantage Vue and an integrated data logger with cellular technology to transmit your weather data to a secure page. View the data online or download data to your PC for analysis, archiving and reporting. Vantage Connect can be programmed to send you an immediate email or text message alarm when weather conditions, such as high wind or frost warnings, occur.

Wireless Vantage Connect works with a Vantage Vue or any Vantage Pro2 Integrated Sensor

Suite (ISS) and has a 1000 ft. wireless range (300 m). The cabled Vantage Connect installs using the 100 ft. (30 m) cable from a cabled Vantage Pro2 ISS.

Vantage Connect is a self-contained, weather-resistant, solar-powered unit with battery back-up that comes with mounting hardware, WeatherLink software and your own WeatherLink Network account. Requires an annual service plan and one-time activation fee.

Complete system requirements: Windows XP or above. iPhone and Android compatible.



#6620 Vantage Connect

011698 00989 3

#6620C Cabled Vantage Connect

011698 00995 4

WeatherLink® Data Logger & Software Package

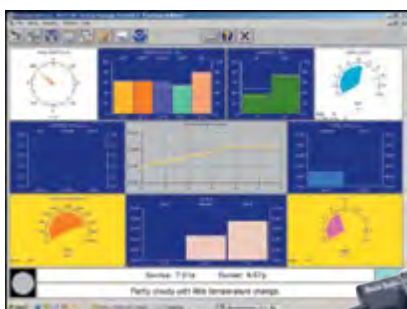

For the ultimate in weather monitoring, add WeatherLink to any of our weather stations. The data logger fits neatly into your console, storing weather data even when it's not connected to your PC. Later, download the data and use the software for detailed analysis and graphing.

With WeatherLink you can:

- See current conditions at a glance on the instant weather bulletin.
- Graph data on an hourly, daily, weekly, monthly, or yearly basis.

- Generate Weather Watcher reports in National Climatic Data Center format.
- Track multiple stations on the same PC using one WeatherLink for each station.
- View data from the same station on two or more PCs with Extra User Licenses.
- Create your own weather website.

Data storage and transfer features:

- Choose a storage interval of 1, 5, 10, 15, 30, 60, or 120 minutes.
- Store up to six months' worth of data, depending on the storage interval.
- Download manually whenever you like, or set the station to download automatically at the same time every day.

Additional features:

- Quick-view weather forecast icons with text messages for expanded details.
- Moon phase icons.
- Wind chill based on the formula adopted by the National Weather Service.
- Expanded temperature measurements and optional sensor reporting.
- Easy participation in the Citizen Weather Observer Program or the international GLOBE Program (Windows version only).

All of the following are included:

Data logger, software on CD, and 8' (2.4 m) cable to connect data logger to your computer.

WeatherLink for Vantage Pro2 and Vantage Vue

#6510USB USB version for Windows® Vista and above

011698 00727 1

#6510SER Serial port version for Windows Vista and above

011698 00726 4

#6510X Extra User License Kit for 6510USB or 6510SER

011698 00334 1

#6520 Mac version for Mac® OS X v 10.1 and above

011698 00735 6

#6520X Extra User License Kit for 6520

011698 00384 6

Windows® is a trademark of Microsoft Corporation in the U.S. and other countries. Macintosh® is a trademark of Apple, Inc., in the U.S. and other countries.

WeatherLink IP™ Data Logger with Internet Delivery

Post your weather data directly to the Internet without a PC!



#6555 WeatherLinkIP

011698 00893 3

It's simple. Plug the data logger into the back of your Vantage Pro2 or Vantage Vue console, and connect the cable to your cable/DSL router. Within minutes, you'll be able to see your weather data live on the web. In addition, WeatherlinkIP lets you:

- Automatically upload data to third-party weather sites, including CWOP (Citizen Weather Observer Program), the GLOBE program, and more.
- Get email alerts of current weather conditions or simple alarm conditions.
- Download the data to your PC for all the same powerful charting, graphing and analysis as our standard WeatherLink.

For more information, ask for our latest Weather Catalog

FREE Weather Catalog!

- Many more weather products and installation accessories
- Detailed specifications and diagrams for all weather stations
- Additional options such as Leaf & Soil Moisture Temperature Station, Fan-Aspirated Radiation Shields, UV Sensors, Solar Radiation Sensors, and special-purpose WeatherLink products.





Sail on the Edge!

BLACK MAX™
Wind Direction Indicator

Tough • Versatile • Sensitive

Black Max is a versatile, high performance wind direction indicator that attaches quickly to masts and booms on most small boats such as Lasers and Sunfish. The tough, high impact plastic vane is designed to withstand years of punishment and the abuse of small boat sailing. The stainless steel mounting arm and set screw, as well as a tough plastic mounting base, add to the system's durability. Wind vane length 8" (20 cm).

#1295 Black Max

011698 12950 8

Unique adjusting system fits masts or booms from 1.5 to 2.5" (38 to 64 mm)

Extra Vane #1452

011698 14520 1

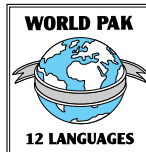

Black Max comes in its own *unbreakable* protective storage tube.

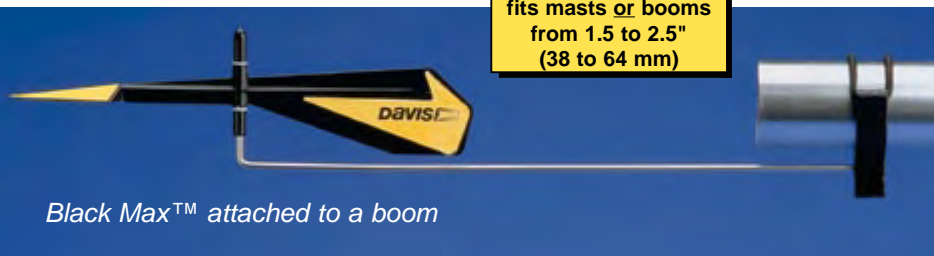

Black Max™ attached to a boom

TELO-CAT™



A must for your Catamaran!



Designed especially for catamarans, the Davis **Telo-Cat** is durable and highly visible. Installs on the headstay bridle in seconds; easily removed for trailering (no tools required). Comes complete with high visibility 8" (20 cm) vane, adjustable tacking arms, and mounting hardware to fit most catamarans. Made of high impact plastic with a stainless steel shaft and tacking arms. The vane rides on a super sensitive nylon bearing system for extreme accuracy in light or heavy weather. Highly visible markings. Adjustable reference arms. Telo-Cat can take the abuse of catamaran sailing.

Wind vane length 8" (20 cm).
Weight 2.9 oz (82 g).

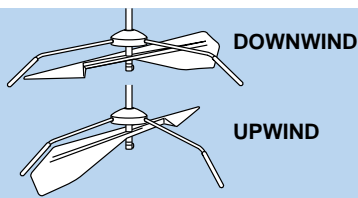

DOWNWIND

UPWIND

#1450 Telo-Cat

011698 14500 3

#1452 Extra Vane

011698 14520 1

Telo-Cat includes complete mounting instructions for the following catamarans: • Hobie 14, 16 • Supercat 15, 17 • Prindle models with turnbuckle forestay adjuster • NACRA 5.2 Telo-Cat will also fit other catamarans using forestay fittings similar to models above.

RIGGING KNIVES

High Quality, Sensible Prices Made entirely of top quality stainless steel, with dura-edged blades. Telo™ Rigging Knives are tools yachtsmen will be proud to own, yet affordable.



#1550 Standard Rigging Knife 011698 15500 2
• Marlin Spike



#1551 Deluxe Rigging Knife 011698 15510 1
• Marlin Spike • Screwdriver
• Shackle Key



#1555 Yachtsman Pocket Knife
• Marlin Spike
• Shackle Key



Why **WINDEX**® is the standard on Most Mastheads around the World...

Windex offers a wide range of masthead wind indicators well suited for racers and cruisers from 15' (4.6 meters) to well over 100' (30 meters). All Windex vanes feature a sapphire jewel suspension bearing, large fin/low inertia vane and easy-to-read, fully adjustable tacking tab system. Reflector tape on the vane and tacking tabs make Windex easy to see at night.

Windex is the perfect choice for all cruising and racing boats from 15 feet and

bigger. Windex vanes are sturdy; they've been tunnel tested to wind speeds of 80 knots! Installed properly, they offer many years of hassle-free use.

You don't have to be an America's Cup skipper or Grand Prix racer to appreciate the sensitive responsiveness, durability and best value of a Windex wind vane. Next time you're on the water, look up and you'll see what most sailors choose... Windex!

- Sapphire suspension system
- Large fin, low inertia vane
- Adjustable tacking tabs
- High visibility reflectors on vane and tabs

On top all over the world

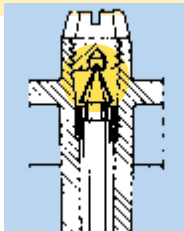
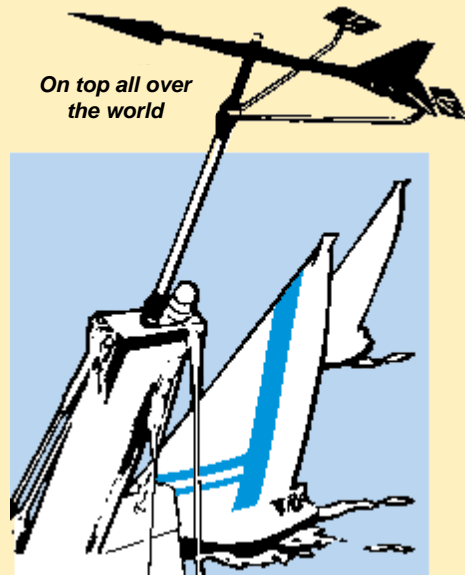

The **sapphire suspension bearing** allows Windex to seek wind direction in winds less than one knot and above. No other wind vane in the world is as sensitive to super light air and small puffs—or as responsive when the breeze picks up.



10" vane #3120

10" WINDEX vane

For Small Boats and Dinghies

Sapphire suspension bearing, 10" vane (25 cm) and adjustable tacking arms with tabs. Vane and tabs feature reflectors for high visibility day and night. Includes glass reinforced polycarbonate J-Base for side, top or front of mast mounting on most dinghies, smaller boats and sport boats. Stands just 9.25" (23.5 cm) tall and weighs 1.2 ounces (31 g).

#3120 Windex 10.Sport
011698 00193 4

#3101 Spare Vane only
011698 31010 4

Windex 10.Sport's J-Base allows mounting on side, top, or front of mast.

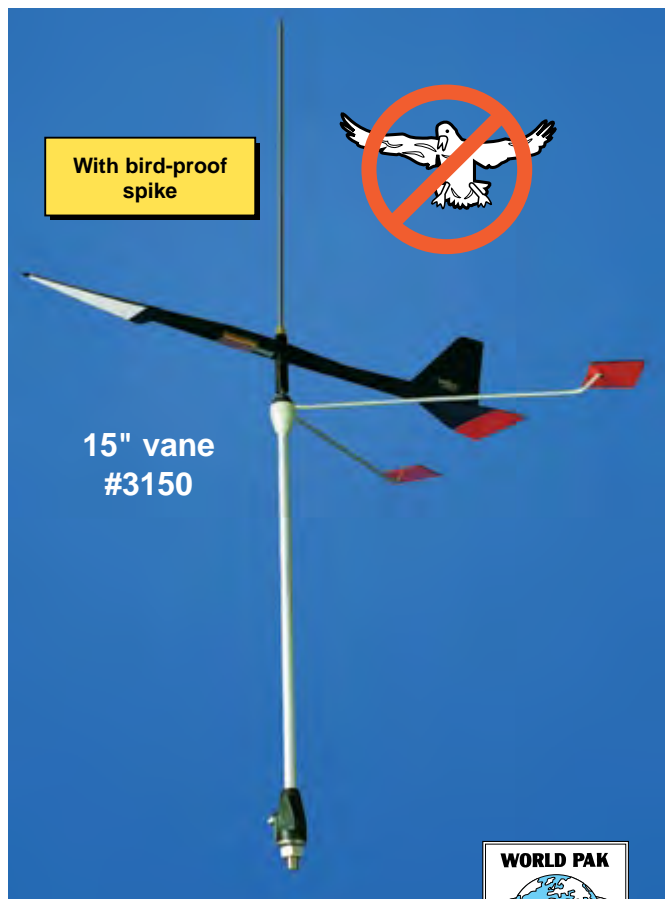
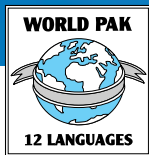

With bird-proof spike



15" vane #3150

15" WINDEX vane

The Choice for Most Sailors

Sapphire suspension bearing, 15" vane (38 cm) and adjustable tacking arms with tabs. Vane and tabs feature reflectors for high visibility day and night. Through-bolt or drill & tap mounting socket; 5/16"-18 stainless stud, washers and nut included. Windex 15 weighs just 3.9 ounces (111 g). Stands 12.75" (32 cm) tall. Bird-proof spike extends above vane to keep birds off your mast. Optional Windex Light #3200.

#3150 Windex 15
011698 31500 0

#3151 Spare Vane only
011698 31510 9

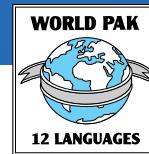



15" vane
with antenna
mounting hardware
#3160

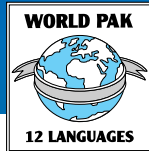

WINDEX AV

For Mounting to Most Whip Antennas

Windex AV™ installs onto most whip antennas, including Metz™ and Shakespeare™ brands, with a whip diameter less than 1/8" (3 mm). Combine two installations into one to reduce masthead clutter, weight and windage aloft. Rides on low-friction Teflon™ bearings. Complete with 15" (38 cm) vane, reflective tacking arms, hardware and instructions for easy installation. Antenna not included.

#3160 Windex AV

011698 31600 7

#3161 Spare Vane only

011698 31610 6

WINDEX LIGHT *For Viewing Windex Indicators at Night*

UPGRADED

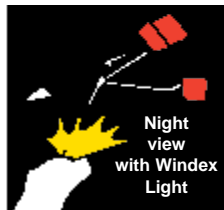

Light up the reflector tabs and vane on your Windex for easy viewing at night with LED Windex Light. Waterproof and non-corroding silver parts give long-life light at less than 100 ma current draw. Fits under Windex 15, Windex 10 or J-Base™ mounting socket.

#3200 Windex Light/LED 011698 32000 4

#R3201L Replacement LED Bulb 011698 00000 0

#R3201 Replacement Incandescent Bulb (G.E. #1447)

011698 00136 1

#R3200B Replacement Dome Lens 011698 00583 3

Some tips for using your Windex:

- Always assemble your Windex with Loctite® or use silicone seal on the threads to eliminate the possibility of the unit unscrewing in use from vibration.
- Prior to unstepping your mast, take your Windex down first.
- Periodically check the assembly screws holding your Windex together.
- Spare parts can be ordered from your local dealer or from Davis; identify which model you have before calling.

UNIVERSAL MASTHEAD MOUNT

Extend your Windex 10.Sport or Windex 15 vane away from masthead obstructions and turbulence. The 13" (33 cm) arm comes with hardware allowing side or top mounting and offset angles up to ±20 degrees. May be attached securely to flat, curved, vertical, horizontal, or inclined surfaces. Gain space aloft and improve mounting position of wind finders and other equipment. Mount on the back of the mast for easier viewing from the cockpit. The mount adapts to virtually every masthead situation.

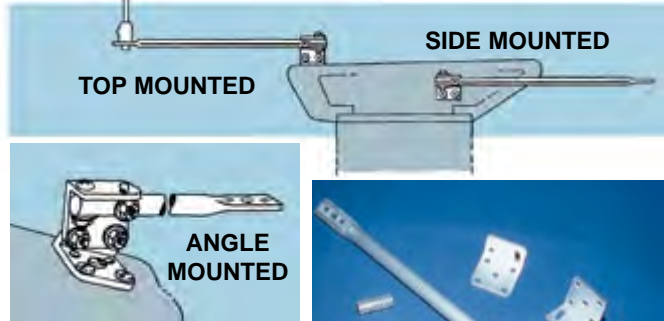

Length 13" (33 cm), weight 3.2 oz (90 g). Boom can be shortened if necessary; complete instructions included. Can be used with Windex Light #3200. Also accommodates Davis J-Base Mounts (using #10 stainless steel screws and nuts, not included).



#1705 Universal Masthead Mount

011698 17050 0

J-BASE™ Versatile Mount for Windex 15 and Windex 10.Sport

Standard with Windex 10.Sport, J-Base can be ordered as an option for Windex 15. Allows for side, top or front mounting on most masts, on big boats or dinghies alike. J-Base is made of glass filled polycarbonate, 2" (5 cm) long. Includes stainless steel set screw and two #10 self-tapping screws. Reduces overall weight by 15 grams when substituted for standard Windex 15 mounting base.

#3155 J-Base for Windex 15

011698 00195 8

#3125 J-Base for Windex 10.Sport

011698 00194 1



- Lubrication is never needed, but years of salt or dirt build-up should be rinsed off with fresh water occasionally.
- Use our Universal Masthead Mount, #1705, for installations requiring more room at the masthead. This mount extends Windex away from the masthead up to 12 inches (30 cm).
- Add an LED Windex Light #3200 for nighttime sailing.

WIND-TELS™ *Fit All Shroud Sizes*



Utilizing port and starboard colored plastic vanes, **Wind-Tels** are ideal for saltwater sailing. The unique method of attachment prevents sliding or fouling of your Wind-Tels on the shrouds. Effective at any angle of heel in the lightest winds. Marine grade metal parts for durability.

#1260 Wind-Tels, 2 Pack 011698 12600 2
 #1261 Extra Wind-Tel Vane Set 011698 12610 1

AIR-FLOW TELS™

You're Sailing Blind Without Them!

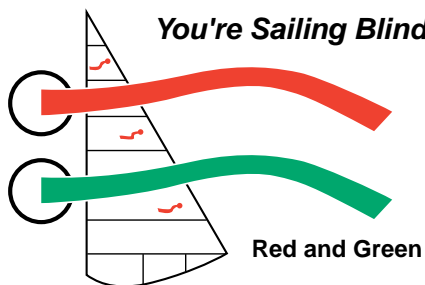

Port and Starboard Colors

#950
 14 TELS
 011698 09500 1

Lightweight, ripstop nylon **Air-Flow Tels** attach to sails with waterproof adhesive locator discs. No holes required. Tels show the air flow across the sails—allowing you to trim sails for maximum performance. Each kit includes 14 Tels and full instructions on where to apply them and how to read them.

The Original SPAR-FLY™



**America's
 Most Popular
 Wind Indicator!**

**Comes equipped with BOTH
 a top mount fitting and a
 quick-release side mount.**

The **Spar-Fly** combines needle bearing balance, high impact plastic, and marine grade metals for unsurpassed sensitivity and durability. Spoiler holes in the vane reduce lift and increase accuracy. Spar-Fly is unaffected by angle of heel. Easily seen from the deck because of its V-shaped silhouette and bright red color. Weighs only 1.25 oz. (35 grams).

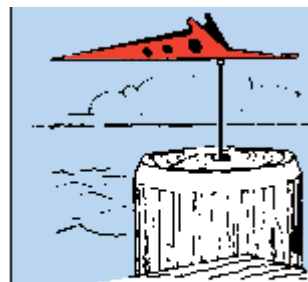

#1310 Spar-Fly™
 011698 13100 6

#1311 Extra Spar-Fly Vane
 011698 13110 5

TIP Knowing wind direction makes docking easier. Install a Spar-Fly near your berth.



HAND BEARING COMPASS

- Yachtsmen
- Racers
- Fishermen
- Position Finding
- Steering

#211, black (standard)
 011698 02110 9

#215, grey (illuminated)
 011698 02150 5

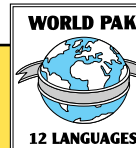

Using these precision marine hand bearing compasses, you can easily obtain quick magnetic bearings on shore or floating objects. Simply align front and rear sights on an object and read off bearing. Uses include quick bearing or position set, determination of angular gain or loss on the competition while racing, checking distance off-shore, establishing lee-bow set while cruising or racing in currents, drift vectoring and plotting a line of position. The stable, liquid-damped compass card is graduated in 5° segments, with bold graduations every 15° for easy reading. Large, contoured handle designed for sure, steady grip and angled forward for added control. Entire instrument is lightweight design for easier bearing. Lanyard and complete instructions included.

FEATURES UNIQUE TO ILLUMINATED MODEL:

- Solid-state LED illumination system floods the compass capsule and sight vane with soft light. The LED will last for the lifetime of the compass. Batteries, which are included, will last up to 10 times longer than with regular bulbs.*
- Positive "push-on" switching action, with vinyl boot water protection. Battery housing has high watertight integrity.
- Made of high impact, grey plastic.

* Based on manufacturer's data, average LED "half-life" is approximately 10 years if operated continuously.

Named "Best Buy" by PRACTICAL SAILOR:

"Both simple and absolutely foolproof, especially when you need an accurate bearing in a hurry." "Proven, simple, cheap, accurate... what a bargain!"



Proven
at the
Equator . . .

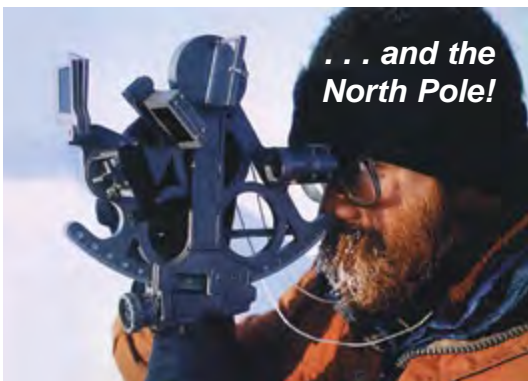

. . . and the
North Pole!

All Davis Master Sextants feature the following professional specifications:

- 7" (18 cm) frame radius. Graduation 120° to -5°
- Index mirror rectangular, 1.98" x 1.49" (50 x 38 mm).
- Precision machined slow travel gear and worm mechanism.
- Highly visible, easy-to-read micrometer drum and vernier allowing readings to 2/10 minute of arc.
- Fully ribbed, three-circle sextant body for platform strength and stability.
- Large, contoured handle designed for sure, steady grip and angled back for added control.
- Seven large sunshades allow complete, independent adjustment of shading density for horizon and index mirrors.
- 3 x 27 mm star telescope with anti-reflective coated glass lenses, plus separate hooded sight tube for glare-free sun shots.
- Neck lanyard frees hand and protects sextant.
- Tough, fully padded, shock-resisting carrying case with compartments for extra batteries and mirror kits.

	Viewing Field	Illuminator	Weight*
MARK 15 #026	Half-Silvered Horizon Mirror 1.64 x 1.14" (42 x 29 mm)	-	14.5 oz. (0.41 kg)
DELUXE MARK 25 #025	Beam Converger 1.61 x 1.16" (43 x 29 mm)	LED on both arc and drum, uses two 1.5 V (AAA) batteries	16.5 oz. (0.47 kg)

*Not including the 1.5 lb. (.68 kg) carrying case.

MARK 15

#026

011698 00260 3



- Large, easily adjusted mirrors using new instrument-quality glass and a special baked on salt-spray resistant backing. Both mirrors have protective housings. Horizon mirror is half-silvered. No adjustment wrenches required.
- Molded of high-impact, weather-resistant plastic.

Extra Mirrors, Spring and Screw Kit #R026H 011698 00271 9

DELUXE MARK 25

with full-field dielectric



#025

011698 00250 4



- Full-field Beam Converger with quartz hardcoat replaces conventional half-silvered mirror. Horizon and astrobody images are combined in a single full-field for easy, reliable sights under the most difficult conditions.
- Special mineral coating is selective for different wavelengths of light. Horizon is transmitted in one color region and the star or sun in another.
- Improved reinforced plastic stiffens frame for greater measurement accuracy.
- High-efficiency LED (solid-state Light Emitting Diode) illumination system, which floods arc and drum with soft light. The LED will last for the lifetime* of the sextant. Batteries, which are included, will last up to 10 times longer than with regular bulbs. This is another Davis first! Positive "push-on" switching action, with vinyl boot water protection. *Average LED half-life is approximately 10 years if operated continuously.



Traditional
half-silvered
horizon mirror sighting



Beam Converger
with full viewing field

Extra Beam Converger and Index Mirror, Spring & Screw Kit #R025F

011698 00272 6

"Highest Recommendation"

"As an experienced open-ocean navigator, I have relied upon my Davis Mark 25 Sextant for over eight years. It has proven to be of the highest quality, both in construction and performance, of any sextant that I have handled. In numerous crossings of the Pacific Ocean, in fair weather and foul and in vessels from 38 to 620 feet, this lightweight plastic sextant has held up where more traditional metal sextants have failed. Calibration is simple, and the full-field view makes it a joy to operate compared to split-screen models. It has my highest recommendation. I simply have nothing bad to say about Davis or their products."

MARINE SEXTANT MARK 3

#011 011698 00110 1



Learn to Navigate

- Full 7" arc (18 cm)
- Four sun shades
- Instantly adjustable
- Corrosion proof

The result of years of practical experience in the manufacture of precision instruments, this plastic sextant has been used as the sole means of navigating both the Atlantic and Pacific oceans. Enabling the yachtman to take a ship to any port of the world, it is used by professional, amateur and student navigators alike. This rugged, full-sized instrument reads to within 2' of arc! Instruction booklet included.

TIP The Celestial Navigation Quick Reference Card (#132, pg. 17) summarizes the use of sextants at a glance!

Sextant Case with Foam Cushion

#R014A 011698 00313 6

Extra Mirrors, Spring and Screw Kit

#R011C 011698 00127 9

ARTIFICIAL HORIZON

Practice navigation without going to sea!



More accurate than a natural horizon...

Answers the need of every sextant user who cannot depend on a natural sea horizon. Use for backyard practice, finding exact position when inland, and making exact sextant shot on foggy mornings. To use, fill with water and read the angle of the reflected sun with your sextant. Half your sextant reading is the sun's angle above the true horizon. Windproof and corrosion resistant, the reflecting surface is completely enclosed.

Comes with two sun shades, a lid and full directions.

Compact 6 x 4 x 1 1/2" (15 10 4 cm).

#144 Artificial Horizon

011698 01440 8

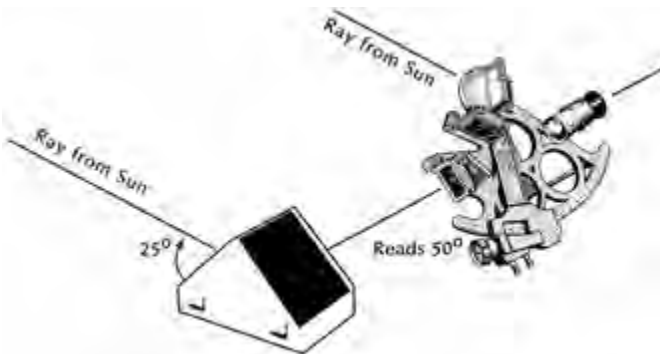

Continuously logs performance behind the wheel and under the hood!



CarChip Pro

Think your teen or employee is a safe driver? Don't wait to find out. Wish you could read your car's mind? Davis has a complete line of vehicle monitoring devices.



CarChip Pro plugs instantly into the OBD II (on-board diagnostics) port in your car or truck, where it continuously logs vehicle and driver performance. Download the data to your PC, and you'll get complete details for each trip, plus information on engine performance. Diagnostic trouble codes can be read when the check engine light comes on. Stores up to 300 hours of driving data. Download the data at any time and clear the memory to start again, or let CarChip automatically overwrite the older data. CarChip software allows analysis, graphing and charting of data. CarChip also has self-setting and audible alarms for speed, hard braking, and quick acceleration.

#8226 CarChip Pro vehicle monitor

011698 00887 2

CarChip Connect

NEW

Manage your vehicles in real time



PATENTED

CarChip Connect is a small GPS telematics device that plugs into the OBD II port. Data is sent using cellular technology to the web-based software, providing GPS fleet tracking in real time anywhere you have internet access. Equipped with a 3-axis accelerometer, the device monitors motion in all directions—forward, backward, sideways, and up and down. Vehicle settings, such as acceleration/deceleration and cornering forces, idle time and geofence locations, are stored directly on the device. You get real-time feedback—not update interval feedback. If a driver exceeds the vehicle settings, an audible beep will immediately alert the driver. Programmable email or text alerts keep you informed, too. Use the powerful web analytic and engine monitoring capabilities to further understand how your vehicles are performing.



CarChip Connect fleet map.

#8351 CarChip Connect telematics device

011698 00948 0

One-time activation fee and choice of service plan required.

CarChip Pro and CarChip Connect can be used in most cars and trucks sold in the USA and Canada, model years 1996 or later.

CHANGE SERVICE REQUESTED

SOLICHARGER-SP™ **NEW**

Solar charger, high output speakers, rugged carrying case—all in one!



Take along stored energy to recharge your cell phone or portable device on the go! You can charge the 2000 mAh internal battery from the sun, from a PC, or by plugging into any type of USB port. SoliCharger's tough Cordura® case also provides protective storage for devices like a Playstation, camera or cell phone. Use the powerful 3-watt stereo speakers to listen to music, enhance games, or make a hands-free conference call. Output rate is 300–500 mA, and you can use your phone or device while it is charging. LED charge indicator tells you how much charge is available.



- Charges any iPhone®, GoPro®, tablet, MP3 player, cell phone, digital camera
- Rich sound from your mobile devices or laptop



Includes adapters for 32 pin Apple®, USB, USB Mini, USB Micro, and USB female for all iPhones 5 and above

#3480 SoliCharger-SP with speakers

011698 01093 6

