

# CROW SAFETY GEAR



Issue #20



## CUSTOMIZE YOUR RESTRAINTS WITH THESE OPTIONS

### Sewn In Harness Pads **(P)**

Racer Net

- Sewn in harness pads can be added to any 2" or 3" harness when ordering, excluding dog bone style.

### Dog Bone Harness **(DB)**

Racer Net

Dog Bone Harness available. Add DB to part number when ordering.

### Black Hardware **(B)**

Racer Net

All restraints available with Black Hardware for an additional ADD B to any part number (aluminum adjusters sold separately).

### Aluminum Harness Adjusters **(PR)**

Racer Net

- Available for 2" or 3" restraints.

### Tension Springs **(TS)**

Racer Net

- Part #11550 for 3" seat belts and harnesses.
- Part #11550A for 2" seat belts and harnesses.
- Sold in sets of 4.

### Pull Up Adjustment **(UP)**

Racer Net

All lap belts other than Quick Adjust are available with a pull-up lap belt adjustment.

### Installation Hardware Options



Bolt-in hardware  
1/2" Diameter Hole



Clip-In



Eyebolts

Bolt-in or Clip-in ends installed with a 3-bar slide can be removed to convert to Wrap-Around



Clip in restraints use eyebolts to mount to the stock lap belt location. The bolt size is 7/16-20 and fits most model cars.

## ENDURO RACING RESTRAINTS



### Part #31004

### QUICK CHANGE 6-POINT ENDURO HARNESS

Racer Net

**NEW!** Quick-Change 6-point Enduro harness: *ideal for quick driver changes.*

- 6-way 2" lap belt with pull down quick adjusters.
- 3" Hans-type harness with aluminum adjusters. (2" X 2" is also available).
- Lap belts clip-in, eyebolts included.
- Harness clip-in with eyebolts or can be changed to wrap around.
- 6-way anti-sub belt clip-in with eyebolts or can be changed to wrap around.
- All black hardware.
- Only available in black webbing.



Clip in restraints use eyebolts to mount to the stock lap belt location. The bolt size is 7/16-20 and fits most model cars.

## STOCK CAR TYPE LATCH & LINK WITH DOG BONE HARNESS BOLT IN MODELS

Restraints for Stock Cars/  
IMCA Modifieds/  
Dwarf Cars/Off Road

### Part #11004DB

Racer Net

- 52" lap belt.
- Dog bone harness tapers from 3" to 2" to accommodate head and neck devices.
- All points bolt in.
- Harness bolt in ends may be removed to change to wrap around.

- 11002DB (Red)
- 11003DB (Blue)
- 11004DB (Black)
- 11005DB (Purple)
- 11006DB (Gray)



### Part #11004

Racer Net

- 52" lap belt.
- Individual harness bolt in.
- All points bolt in.
- Harness bolt in ends may be removed to change to wrap around.

Bolt-in or Clip-in ends installed with a 3-bar slide can be removed to convert to Wrap-Around



SFI APPROVED  
SFI-16.1

SFI APPROVED  
SFI-16.1

- 11002 (Red)
- 11003 (Blue)
- 11004 (Black)
- 11005 (Purple)
- 11006 (Gray)

## LATCH & LINK BOLT IN MODELS

Restraints for Stock Cars/IMCA Modifieds/  
Dwarf Cars/Off Road

### Part #11006B

Racer Net 121.44

- 52" lap belt.
- Individual harness bolt in.
- All points bolt in.
- Harness bolt in ends may be removed to change to wrap around.

- 11002B (Red)
- 11003B (Blue)
- 11004B (Black)
- 11005B (Purple)
- 11006B (Gray)

Dog Bone Harness available. **(DB)**  
Add DB to part number when ordering.

SFI APPROVED  
SFI-16.1

## PRO SERIES

### Part #11002PRB

Racer Net

- 52" lap belt, bolt in.
- Dog bone harness.
- 3" Pro aluminum adjusters.
- Anti-sub belt bolt in.
- Harness bolt in ends may be removed to change to wrap around.

SFI APPROVED  
SFI-16.1

- 11002PRB (Red)
- 11003PRB (Blue)
- 11004PRB (Black)
- 11005PRB (Purple)
- 11006PRB (Gray)



CRAFTED IN THE USA

## STANDARD LATCH & LINK CLIP IN MODELS

Restraints for Off Road Racing/ Stock Car Type

### Part #11044

Racer Net

- 52" lap belt clip in.
- Individual harness clip in.
- Harness clip in ends may be removed to change to wrap around.
- Anti-sub belt bolt in.
- 4 eye bolts included.



Dog Bone Harness available. **DB**  
Add DB to part number when ordering.



- 11042 (Red)
- 11043 (Blue)
- 11044 (Black)
- 11045 (Purple)
- 11046 (Gray)

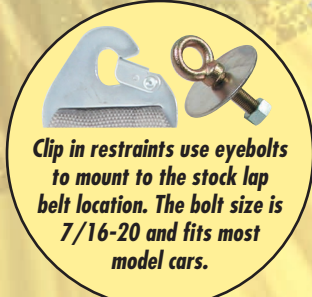

Clip in restraints use eyebolts to mount to the stock lap belt location. The bolt size is 7/16-20 and fits most model cars.

Restraints for Off Road Racing/ Stock Car Type/Jeep

### Part #11046DB

Racer Net

- 52" lap belt clip in.
- Dog bone harness clip in.
- Harness clip in ends may be removed to change to wrap around.
- Anti-sub belt bolt in.
- 4 eye bolts included.



- 11042DB (Red)
- 11043DB (Blue)
- 11044DB (Black)
- 11045DB (Purple)
- 11046DB (Gray)

## LATCH & LINK CLIP IN MODELS

Restraints for Off Road Racing/Stock Car Type

### Part #11044B

Racer Net

- 52" lap belt clip in.
- Individual harness clip in.
- Harness clip in ends may be removed to change to wrap around.
- Anti-sub belt bolt in.
- 4 eye bolts included.



- 11042B (Red)
- 11043B (Blue)
- 11044B (Black)
- 11045B (Purple)
- 11046B (Gray)

## PRO SERIES

### Part #11043PRB

Racer Net

- 52" lap belt clip in.
- Dog bone harness clip in.
- Harness clip in ends may be removed to change to wrap around.
- 3" Pro aluminum adjusters.
- Anti-sub belt bolt in.
- 4 eye bolts included.



- 11042PRB (Red)
- 11043PRB (Blue)
- 11044PRB (Black)
- 11045PRB (Purple)
- 11046PRB (Gray)

# QUICK ADJUST LATCHES WITH ADJUSTERS BUILT INTO THE LATCH & LINK



## Part #11064

Racer Net

- 55" lap belt.
- All points bolt in.
- Harness bolt in ends may be removed to change to wrap around.



**sfi** APPROVED  
SFI-16.1

- 11062 (Red)
- 11063 (Blue)
- 11064 (Black)
- 11065 (Purple)
- 11066 (Gray)

Sewn in pads can be added to any harness, excluding dog bone style.

## Part #11064DB

Racer Net

- 55" lap belt.
- Dog bone harness.
- All points bolt in.
- Harness bolt in ends may be removed to change to wrap around.



**sfi** APPROVED  
SFI-16.1

- 11062DB (Red)
- 11063DB (Blue)
- 11064DB (Black)
- 11065DB (Purple)
- 11066DB (Gray)



Restraints for Stock Cars/  
IMCA Modifieds/  
Dwarf Cars

**sfi** APPROVED  
SFI-16.1

## Part #11062B

Racer Net

- 55" lap belt.
- All points bolt in.
- Harness bolt in ends may be removed to change to wrap around.
- All black hardware.



All harnesses 52" end to end. Special lengths available.

- 11062B (Red)
- 11063B (Blue)
- 11064B (Black)
- 11065B (Purple)
- 11066B (Gray)

Dog Bone Harness available. **DB**  
Add DB to part number when ordering.

## Part #20074

Racer Net

- 40" lap belt.
- All points bolt in.
- Harness bolt in ends may be removed to change to wrap around.



Dog Bone Harness available. **DB**  
Add DB to part number when ordering.

**sfi** APPROVED  
SFI-16.1

- 20072 (Red)
- 20073 (Blue)
- 20074 (Black)
- 20075 (Purple)
- 20076 (Gray)



CRAFTED IN THE USA

## QUICK ADJUST LATCH & LINK WITH BUILT-IN LATCH GUARD

Restraints for Off Road Racing/ Stock Car Type/Jeep

### Part #11053

Racer Net

- 55" lap belt clip in.
- Individual harness clip in.
- Harness clip in ends may be removed to change to wrap around.
- Anti-sub belt bolt in.
- 4 eye bolts included.



**sfi** APPROVED  
SFI-16.1

- 11052 (Red)
- 11053 (Blue)
- 11054 (Black)
- 11055 (Purple)
- 11056 (Gray)

### Part #11054DB

Racer Net

- 55" lap belt clip in.
- Dog bone harness clip in.
- Harness clip in ends may be removed to change to wrap around.
- Anti-sub belt bolt in.
- 4 eye bolts included.

- 11052DB (Red)
- 11053DB (Blue)
- 11054DB (Black)
- 11055DB (Purple)
- 11056DB (Gray)



**sfi** APPROVED  
SFI-16.1



## QUICK ADJUST LATCH & LINK CLIP IN MODELS

Restraints for Sedans/ Drag Racing Door Cars

### Part #11096A

Racer Net

- 55" lap belt clip in.
- V-type harness bolt in.
- Anti-sub belt bolt in.
- 2 eye bolts included.



**sfi** APPROVED  
SFI-16.1

- 11092A (Red)
- 11093A (Blue)
- 11094A (Black)
- 11095A (Purple)
- 11096A (Gray)

## QUICK ADJUST LATCH & LINK BOLT IN MODELS

Restraints for Sedans/ Drag Racing Door Cars

### Part #11085A

Racer Net

- 55" lap belt bolt in.
- V-type harness bolt in.
- Anti-sub belt bolt in.
- Pull down adjustment.



**sfi** APPROVED  
SFI-16.1

- 11082A (Red)
- 11083A (Blue)
- 11084A (Black)
- 11085A (Purple)
- 11086A (Gray)

## STANDARD LATCH & LINK BOLT IN MODELS

Restraints for Sedans/  
Drag Racing Door Cars

### Part #11025A

Racer Net

- 52" lap belt.
- V-type harness bolt in.
- Pull down adjustment.
- All points bolt in.

- 11022A (Red)
- 11023A (Blue)
- 11024A (Black)
- 11025A (Purple)
- 11026A (Gray)

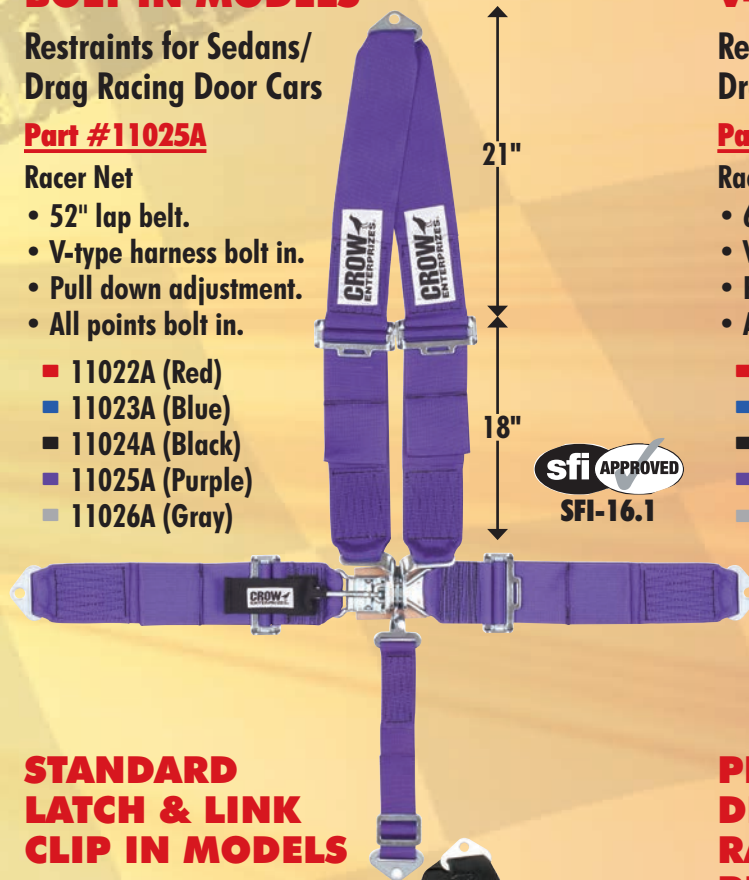

## STANDARD LATCH & LINK V-HARNESS BOLT IN

Restraints for Sedans/  
Drag Racing Door Cars

### Part #20024A

Racer Net

- 60" lap belt.
- V-type harness bolt in.
- Pull up adjustment.
- All bolt in.

- 20022A (Red)
- 20023A (Blue)
- 20024A (Black)
- 20025A (Purple)
- 20026A (Gray)



## STANDARD LATCH & LINK CLIP IN MODELS

Restraints for Sedans/  
Drag Racing Door Cars

### Part #20044A

Racer Net

- 60" lap belt clip in.
- V-type harness clip in.
- Anti-sub belt bolt in.
- Pull up adjustment.
- 2 eye bolts included.

- 20042A (Red)
- 20043A (Blue)
- 20044A (Black)
- 20045A (Purple)
- 20046A (Gray)



## PRO COMP DRAGSTER RACING RESTRAINTS

### Part #11114D

Racer Net

- 60" lap belt.
- All points wrap around.
- Pull up adjustment.

- 11112D (Red)
- 11113D (Blue)
- 11114D (Black)
- 11115D (Purple)
- 11116D (Gray)

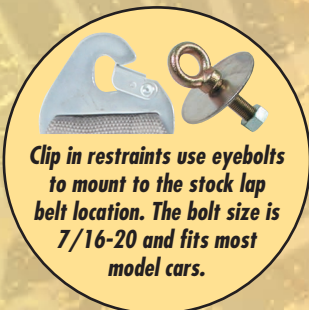

Clip in restraints use eyebolts to mount to the stock lap belt location. The bolt size is 7/16-20 and fits most model cars.



### **Part #11004PS**

#### **Racer Net**

- 52" lap belt, bolt in.
- Individual harness bolt in.
- Springs in harness and lap belt adjusters.
- Anti-sub belt bolt in.
- Harness bolt in ends may be removed to change to wrap around.

- 11002PS (Red)
- 11003PS (Blue)
- 11004PS (Black)
- 11005PS (Purple)
- 11006PS (Gray)



**sfi** APPROVED  
SFI-16.1

### **Part #11042PS**

#### **Racer Net**

- 52" lap belt clip in.
- Individual harness clip in.
- Harness clip in ends may be removed to change to wrap around.
- Springs in harness and lap belt adjusters.
- Anti-sub belt bolt in.
- 4 eye bolts included.

- 11042PS (Red)
- 11043PS (Blue)
- 11044PS (Black)
- 11045PS (Purple)
- 11046PS (Gray)



**sfi** APPROVED  
SFI-16.1



*Clip in restraints use eyebolts to mount to the stock lap belt location. The bolt size is 7/16-20 and fits most model cars.*

### **Part #11064P**

#### **Racer Net**

- 55" Quick Adjust lap belt.
- All points bolt in.
- Harness bolt in ends may be removed to change to wrap around.



**sfi** APPROVED  
SFI-16.1

- 11062P (Red)
- 11063P (Blue)
- 11064P (Black)
- 11065P (Purple)
- 11066P (Gray)

### **Part #11054P**

#### **Racer Net**

- 55" Quick Adjust lap belt clip in.
- Individual harness clip in.
- Harness clip in ends may be removed to change to wrap around.
- Anti-sub belt bolt in.
- 4 eye bolts included.



**sfi** APPROVED  
SFI-16.1

- 11052P (Red)
- 11053P (Blue)
- 11054P (Black)
- 11055P (Purple)
- 11056P (Gray)



## COMPETITION UTV & OFF ROAD SFI 16.1 RESTRAINTS

### **Part #31044**

#### **3X3 UTV Restraint with Standard Latch & Link**

##### **Racer Net**

- 52" lap belt, bolt in.
- Individual harness, aluminum adjusters, sewn-in pads, bolt in.
- Anti-sub belt bolt in.
- Available in black webbing only.



### **Part #31054**

#### **3X3 UTV Restraint with Standard Latch & Link**

##### **Racer Net**

- 52" lap belt, bolt in.
- Individual harness, aluminum adjusters, sewn-in pads, clip in.
- Anti-sub belt bolt in.
- Available in black webbing only.



### **Part #31074**

#### **3X3 UTV Restraint with Quick Adjust Latch & Link**

##### **Racer Net**

- 55" lap belt, bolt in.
- Individual harness, aluminum adjusters, sewn-in pads, bolt in.
- Anti-sub belt bolt in.
- Available in black webbing only.



### **Part #31064**

#### **2X2 UTV Restraint with Standard Latch & Link**

##### **Racer Net**

- 2" lap belt bolt in.
- 2" individual harness, aluminum adjusters, sewn-in pads, bolt in.
- Anti-sub belt bolt in.
- Available in black webbing only.



CRAFTED IN THE USA

# SPRINT CAR/MIDGET/MINI MICROS LATCH & LINK WRAP AROUND MODELS



## Part #11012

Racer Net

- 60" lap belt.
- All 5 points wrap around.



- 11012 (Red)
- 11013 (Blue)
- 11014 (Black)
- 11015 (Purple)
- 11016 (Gray)

Dog Bone  
Harness  
available. **DB**  
Add DB to  
part number  
when ordering.



## Part #11014DB

Racer Net

- 60" lap belt.
- Dog bone harness wrap around.
- All 5 points wrap around.



- 11012DB (Red)
- 11013DB (Blue)
- 11014DB (Black)
- 11015DB (Purple)
- 11016DB (Gray)



## QUICK ADJUST LATCH & LINK WITH BUILT-IN LATCH GUARD

Restraints for  
Sprint Cars/  
Midgets/  
Mini-Micros

Sewn in pads can be added to any harness, excluding dog bone style.

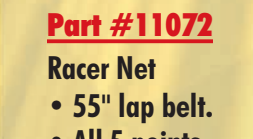

## Part #11072

Racer Net

- 55" lap belt.
- All 5 points wrap around.

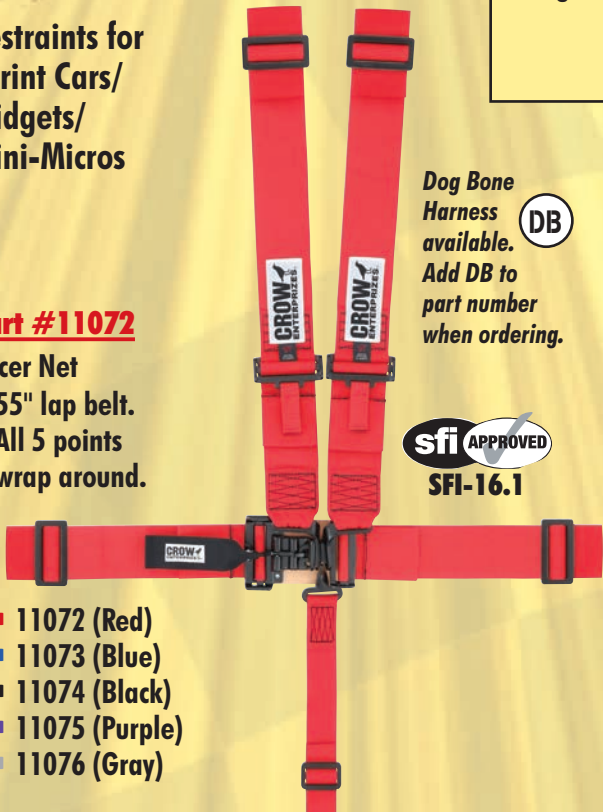

- 11072 (Red)
- 11073 (Blue)
- 11074 (Black)
- 11075 (Purple)
- 11076 (Gray)

Dog Bone  
Harness  
available. **DB**  
Add DB to  
part number  
when ordering.



## Part #20074DB

Racer Net

- 40" lap belt.
- All points bolt in.
- Harness bolt in ends may be removed to change to wrap around.



- 20072DB (Red)
- 20073DB (Blue)
- 20074DB (Black)
- 20075DB (Purple)
- 20076DB (Gray)



## SPECIAL SPRINT CAR & MIDGET LATCH & LINK WRAP AROUND MODELS

### Part #20054

#### Racer Net

- 55" lap belt pull down.
- Adjustment left side only. Latch side stationary.
- All points wrap around.

- 20052 (Red)
- 20053 (Blue)
- 20054 (Black)
- 20055 (Purple)
- 20056 (Gray)



### Part #20054DB

#### Racer Net

- Dog bone harness tapers from 3" to 2" to accommodate head/neck devices.
- Lap belts adjust on left side only. Latch side is stationary.
- 55" lap belt pull down.
- All points are wrap around.

- 20052DB (Red)
- 20053DB (Blue)
- 20054DB (Black)
- 20055DB (Purple)
- 20056DB (Gray)



## LATCH & LINK WRAP AROUND MODELS

### Restraints for Special Sprint Car and Midget

### Part #20055B

#### Racer Net

- 55" lap belt pull down.
- Adjustment left side only. Latch side stationary.
- All points wrap around.

- 20052B (Red)
- 20053B (Blue)
- 20054B (Black)
- 20055B (Purple)
- 20056B (Gray)



## PRO SERIES

### Part #20056PRB

#### Racer Net

- 55" lap belt pull down.
- Adjustment left side only. Latch side stationary.
- Dog bone harness.
- 3" Pro aluminum adjusters.
- All points wrap around.

- 20052PRB (Red)
- 20053PRB (Blue)
- 20054PRB (Black)
- 20055PRB (Purple)
- 20056PRB (Gray)



## LATCH & LINK RATCHET RESTRAINTS WRAP AROUND MODELS

### Part #40064

#### Racer Net

- 3" ratchet sprint car 5-way restraint.
- 52" lap belt.
- Right side of lap belt stationary with ratchet on left side of lap belt.
- Dog bone individual harness, sub belt.
- All wrap around, except left side lap belt bolt in.

# RANK IT UP!

with **CROW**



**sfi APPROVED**  
SFI-16.1

- 40062 (Red)
- 40063 (Blue)
- 40064 (Black)
- 40065 (Purple)
- 40066 (Gray)

(1/4" hand ratchet tool not included.)

### Part #40054

#### Racer Net

- 3" ratchet sprint car 5-way restraint.
- 52" lap belt.
- Right side of lap belt stationary with ratchet on left side of lap belt.
- Individual harness, sub belt.
- All wrap around, except left side lap belt bolt in.



**sfi APPROVED**  
SFI-16.1

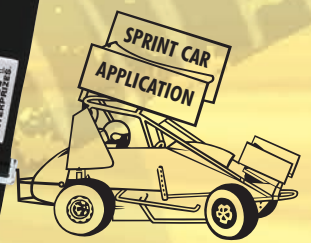

- 40052 (Red)
- 40053 (Blue)
- 40054 (Black)
- 40055 (Purple)
- 40056 (Gray)

(1/4" hand ratchet tool not included.)

## LATCH & LINK RATCHET RESTRAINTS WRAP AROUND MODELS

### Part #40044

#### Racer Net

- 2" ratchet sprint car 5-way restraint.
- 52" lap belt.
- Right side of lap belt stationary with ratchet on left side of lap belt.



**sfi APPROVED**  
SFI-16.1

- Dog bone individual harness, sub belt.
- All wrap around, except left side lap belt bolt in.
- Available in black only.

(1/4" hand ratchet tool not included.)

## LATCH & LINK RATCHET RESTRAINTS BOLT IN MODELS

### Stock Cars/Modifieds/Imports/LeMons/ Drag Sedans

### Part #40074

#### Racer Net

- 3" ratchet 5-way latch & link restraint.
- 52" lap belt.
- Ratchet available on right or left side, opposite side of the lap belt stationary.
- Dog bone individual harness, sub belt.
- All 5 points bolt in.



**sfi APPROVED**  
SFI-16.1



- 40072 (Red)
- 40073 (Blue)
- 40074 (Black)
- 40075 (Purple)
- 40076 (Gray)

(1/4" hand ratchet tool not included.)

## KAM LOCK BOLT IN MODELS

Restraints for  
Stock Car/Sedans

### Part #11102

Racer Net

- 5-way restraint kam lock.
- 52" lap belt.
- All 5 points bolt in.
- Harness & sub belt bolt in ends may be removed to change to wrap around.

- 11102 (Red)
- 11103 (Blue)
- 11104 (Black)
- 11105 (Purple)
- 11106 (Gray)



## KAM LOCK BOLT IN MODELS

Restraints for  
Stock Car/  
Sedans

### Part #11103DB

Racer Net

- 5-way restraint kam lock.
- 52" lap belt.
- Dog bone harness.
- All 5 points bolt in.
- Harness & sub belt bolt in ends may be removed to change to wrap around.

- 11102DB (Red)
- 11103DB (Blue)
- 11104DB (Black)
- 11105DB (Purple)
- 11106DB (Gray)



## KAM LOCK BOLT IN MODELS

Restraints for  
Stock Car/  
Sedans

### Part #11102B

Racer Net

- 5-way kam lock.
- 52" lap belt.
- All 5 points bolt in.
- Harness & sub belt bolt in ends may be removed to change to wrap around.

- 11102B (Red)
- 11103B (Blue)
- 11104B (Black)
- 11105B (Purple)
- 11106B (Gray)

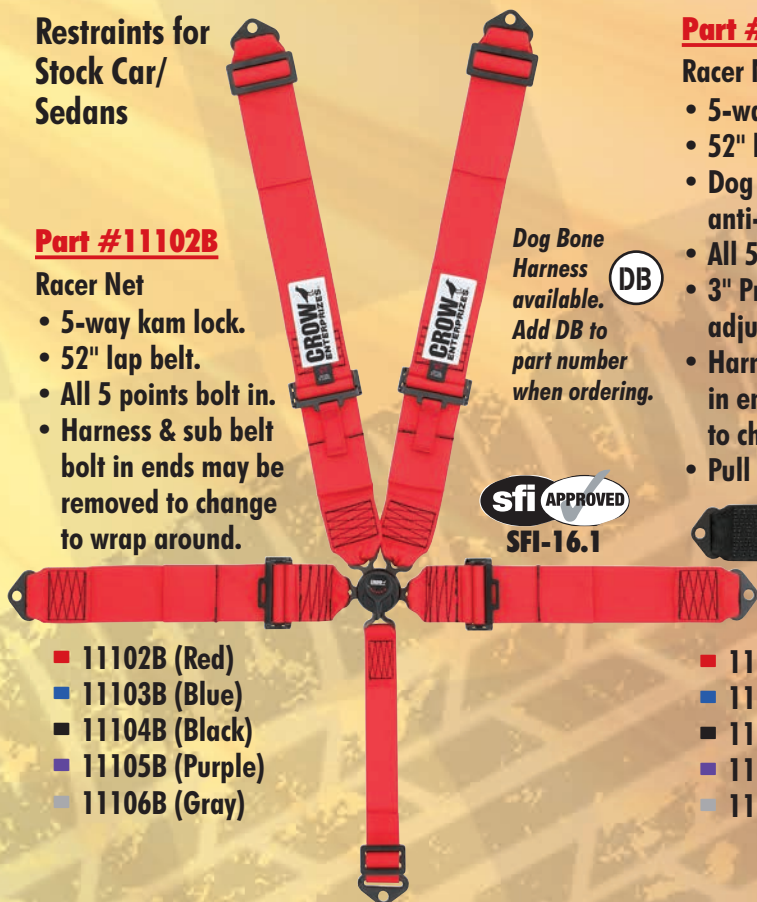

## PRO SERIES

### Part #11104PRB

Racer Net

- 5-way kam lock.
- 52" lap belt.
- Dog bone harness, anti-sub belt.
- All 5 points bolt in.
- 3" Pro aluminum adjusters.
- Harness & sub belt bolt in ends may be removed to change to wrap around.
- Pull down adjustment.

- 11102PRB (Red)
- 11103PRB (Blue)
- 11104PRB (Black)
- 11105PRB (Purple)
- 11106PRB (Gray)



CRAFTED IN THE USA

**Restraints for Stock Cars/Import/Mazda  
Miata/Mustang/Porsche/Corvette**

**Part #11144**

**Racer Net**

- 5-way kam lock.
- 52" clip in lap belt.
- Harness wrap around.
- Anti-sub belt bolt in.

- 11142 (Red)
- 11143 (Blue)
- 11144 (Black)
- 11145 (Purple)
- 11146 (Gray)



*Dog Bone  
Harness  
available.* (DB)  
*Add DB to  
part number  
when ordering.*

**SFI APPROVED**  
**SFI-16.1**

**Part #11142DB**

**Racer Net**

- 5-way kam lock.
- 52" clip in lap belt.
- Dog bone harness wrap around.
- Anti-sub belt bolt in.

- 11142DB (Red)
- 11143DB (Blue)
- 11144DB (Black)
- 11145DB (Purple)
- 11146DB (Gray)



**SFI APPROVED**  
**SFI-16.1**



*Clip in restraints use eyebolts  
to mount to the stock lap  
belt location. The bolt size is  
7/16-20 and fits most  
model cars.*

**KAM LOCK CLIP IN MODELS**

**Restraints for  
Stock Cars/  
Import/Mazda  
Miata/Mustang/  
Porsche/Corvette**

**Part #11143B**

**Racer Net**

- 5-way kam lock.
- 52" lap belt clip in.
- Harness wrap around.
- Anti-sub belt bolt in.

- 11142B (Red)
- 11143B (Blue)
- 11144B (Black)
- 11145B (Purple)
- 11146B (Gray)

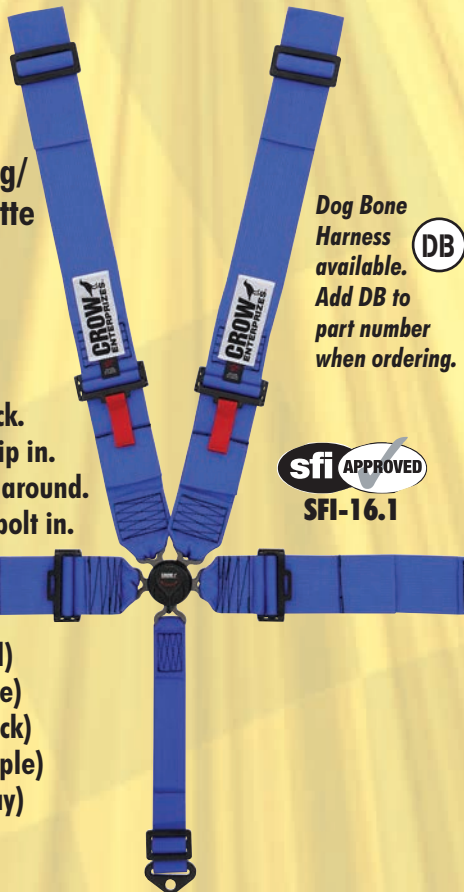

*Dog Bone  
Harness  
available.* (DB)  
*Add DB to  
part number  
when ordering.*

**SFI APPROVED**  
**SFI-16.1**

**Restraints for  
Stock Cars/  
Import/Mazda  
Miata/Mustang/  
Porsche/Corvette**

**Part #11144PRB**

**Racer Net**

- 5-way kam lock.
- 52" lap belt clip in.

- Dog bone harness wrap around.
- Anti-sub belt bolt in.
- 3" Pro aluminum adjusters.
- 2 eye bolts included.

- 11142PRB (Red)
- 11143PRB (Blue)
- 11144PRB (Black)
- 11145PRB (Purple)
- 11146PRB (Gray)



**SFI APPROVED**  
**SFI-16.1**

Restraints for Stock Cars/Import/Mazda  
Miata/Mustang/Porsche/Corvette



**Part #11144-6**

Racer Net

- 52" lap belt clip in.
- Individual harness wrap around.
- 6-way anti-sub belt bolt in.
- 2 eye bolts included.



- 11142-6 (Red)
- 11143-6 (Blue)
- 11144-6 (Black)
- 11145-6 (Purple)
- 11146-6 (Gray)

**Part #11144-6DB**

Racer Net

- 52" lap belt clip in.
- Dog bone harness wrap around.
- 6-way anti-sub belt bolt in.
- 2 eye bolts included.



- 11142-6DB (Red)
- 11143-6DB (Blue)
- 11144-6DB (Black)
- 11145-6DB (Purple)
- 11146-6DB (Gray)

**Part #11144-6B**

Racer Net

- 52" lap belt clip in.
- Individual harness wrap around.
- 6-way anti-sub belt bolt in.
- 2 eye bolts included.
- Black hardware.



- 11142-6B (Red)
- 11143-6B (Blue)
- 11144-6B (Black)
- 11145-6B (Purple)
- 11146-6B (Gray)

**Part #11144-6DBB**

Racer Net

- 52" lap belt clip in.
- Dog bone harness wrap around.
- 6-way anti-sub belt bolt in.
- 2 eye bolts included.



- 11142-6DBB (Red)
- 11143-6DBB (Blue)
- 11144-6DBB (Black)
- 11145-6DBB (Purple)
- 11146-6DBB (Gray)



CRAFTED IN THE USA

## JUNIOR DRAGSTER 2" 5-WAY KAM LOCK BOLT IN MODELS

### Part #11174A

Racer Net

- Kam lock.
- 50" lap belt.
- All points bolt in.
- Bolt in ends with 7/16" hole.
- Bolt in ends may be removed to change to wrap around.

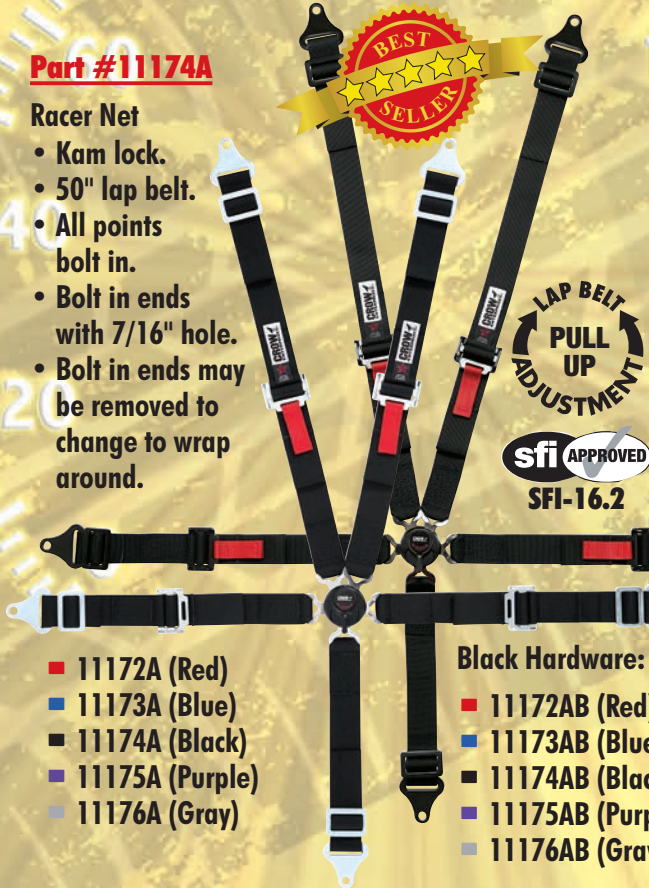

- 11172A (Red)
- 11173A (Blue)
- 11174A (Black)
- 11175A (Purple)
- 11176A (Gray)

Black Hardware:

- 11172AB (Red)
- 11173AB (Blue)
- 11174AB (Black)
- 11175AB (Purple)
- 11176AB (Gray)

## JUNIOR DRAGSTER 2" 5-WAY LATCH & LINK BOLT IN MODELS

### Part #11182A

Racer Net

- Standard latch & link.
- 50" lap belt.
- All points bolt in.
- Bolt in ends with 7/16" hole.
- Bolt in ends may be removed to change to wrap around.



- 11182A (Red)
- 11183A (Blue)
- 11184A (Black)
- 11185A (Purple)
- 11186A (Gray)

Black Hardware:

- 11182AB (Red)
- 11183AB (Blue)
- 11184AB (Black)
- 11185AB (Purple)
- 11186AB (Gray)

## 2020 RULE CHANGE FOR QUARTER MIDGET DRIVERS: (Drivers weighing over 100 lbs. use part 11184C or 11184D)

### Part #11184C

Racer Net

- 2" 5-way latch & link, lap belts pull down adj.
- 2" ind. harness, sub belt.
- All points wrap around.
- SFI 16-1
- Color: black



### Part #11184D

Racer Net

- 2" 5-way latch & link, lap belts pull up adj.
- 2" ind. harness, sub belt.
- All points wrap around.
- SFI 16-1
- Color: black



### Part #11184WA

Racer Net

- 50" lap belt.
- 2" lap belts wrap around.
- Pull up adjustment.

- 2" individual harness wrap around.
- Anti-submarine belt wrap around.



- 11182WA (Red)
- 11183WA (Blue)
- 11184WA (Black)
- 11185WA (Purple)
- 11186WA (Gray)

Black Hardware:

- 11182WAB (Red)
- 11183WAB (Blue)
- 11184WAB (Black)
- 11185WAB (Purple)
- 11186WAB (Gray)

## 1/4" MIDGETS 2" 5-WAY LATCH & LINK WRAP AROUND/BOLT IN MODELS

### Part #11184

Racer Net

- 50" lap belt.
- 2" lap belts wrap around.
- Pull down adjustment.
- 2" individual harness wrap around.
- Anti-submarine belt wrap around.



- 11182 (Red)
- 11183 (Blue)
- 11184 (Black)
- 11185 (Purple)
- 11186 (Gray)

Black Hardware:

- 11182B (Red)
- 11183B (Blue)
- 11184B (Black)
- 11185B (Purple)
- 11186B (Gray)



## UTV-TYPE & SAND CAR RESTRAINTS

Restraints are NOT for competition use. NOT to be used for persons under 70 lbs.

**NOTE: Anti-submarine belts are highly recommended with all 4-way restraints.**

### Part #30184

#### 3X3 UTV Restraint with Standard Latch & Link

##### Racer Net

- 3" lap belt bolt in.
- 3" H-type harness, sewn-in lap belt with harness pads & plastic sternum buckle, all bolt in.
- Black hardware.

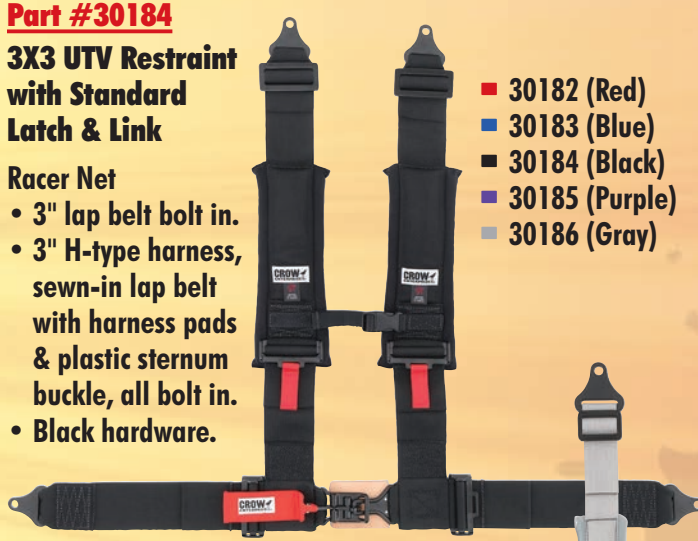

- 30182 (Red)
- 30183 (Blue)
- 30184 (Black)
- 30185 (Purple)
- 30186 (Gray)

### Part #30163

#### 2X2 UTV Restraint with Standard Latch & Link

##### Racer Net

- 2" lap belt bolt in.
- 2" H-type harness, sewn-in lap belt with harness pads & plastic sternum buckle, all bolt in.
- Black hardware.

- 30162 (Red)
- 30163 (Blue)
- 30164 (Black)
- 30165 (Purple)
- 30166 (Gray)

### Part #31016

#### 2X2 UTV Restraint with Standard Latch & Link

##### Racer Net

- 2" 4-way lap belt bolt in.
- 2" individual H-type harness, sewn-in lap belt with harness pads, 2" aluminum adjusters, and plastic sternum buckle, bolt in.
- Black hardware.

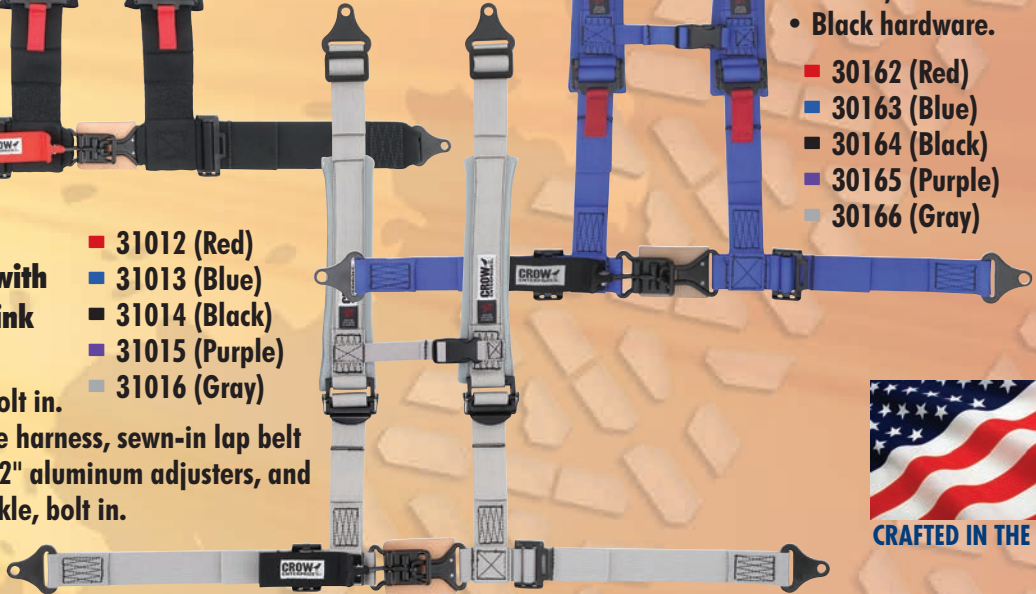

- 31012 (Red)
- 31013 (Blue)
- 31014 (Black)
- 31015 (Purple)
- 31016 (Gray)



### Part #30154

#### 2X2 UTV Restraint with Automotive Buckle

##### Racer Net

- 2" Automotive lap belt bolt in.
- 2" individual H-type harness, sewn-in lap belt, harness pads & plastic sternum buckle, harness wrap around.



- 30152 (Red)
- 30153 (Blue)
- 30154 (Black)
- 30155 (Purple)
- 30156 (Gray)

### Part #30144

#### 2X2 UTV Restraint with Automotive Buckle

\*No photo, same as #30154, no pads.

##### Racer Net

- 2" Automotive lap belt bolt in.
- 2" individual H-type harness, sewn-in lap belt, harness wrap around.

- 30142 (Red)
- 30143 (Blue)
- 30144 (Black)
- 30145 (Purple)
- 30146 (Gray)

### Part #32094

#### 2X2 UTV Restraint with Push Button Side Release

##### Racer Net

- 2" lap belt bolt in.
- 2" individual H-type harness, sewn-in lap belt with harness pads & plastic sternum buckle, harness wrap around.

- 32092 (Red)
- 32093 (Blue)
- 32094 (Black)
- 32095 (Purple)
- 32096 (Gray)

### Part #32084

#### 2X2 UTV Restraint with Push Button Side Release

\*No photo, same as #32094, no pads.

##### Racer Net

- 2" lap belt bolt in.
- 2" individual H-type harness, sewn-in lap belt, harness wrap around.

- 32082 (Red)
- 32083 (Blue)
- 32084 (Black)
- 32085 (Purple)
- 32086 (Gray)

## UTV-TYPE & SAND CAR RESTRAINTS

Restraints are NOT for competition use. NOT to be used for persons under 70 lbs.

**NOTE: Anti-submarine belts are highly recommended with all 4-way restraints.**

### **Part #20132B**

#### **3X3 UTV Restraint with Standard Latch & Link**

##### **Racer Net**

- 3" lap belt bolt in.
- 3" individual harness wrap around.
- Black hardware.

- 20132B (Red)
- 20133B (Blue)
- 20134B (Black)
- 20135B (Purple)
- 20136B (Gray)



### **Part #11204**

#### **Racer Net**

- 3" lap belts bolt in.
- 2" Y-type harness without pads, bolt in.

- 11202 (Red)
- 11203 (Blue)
- 11204 (Black)
- 11205 (Purple)
- 11206 (Gray)



### **Part #11174RP**

#### **Racer Net**

- 2" lap belt bolt in.
- 2" Y-type harness with pads, bolt in.
- Anti-submarine belt bolt in.

- 11172RP (Red)
- 11173RP (Blue)
- 11174RP (Black)
- 11175RP (Purple)
- 11176RP (Gray)

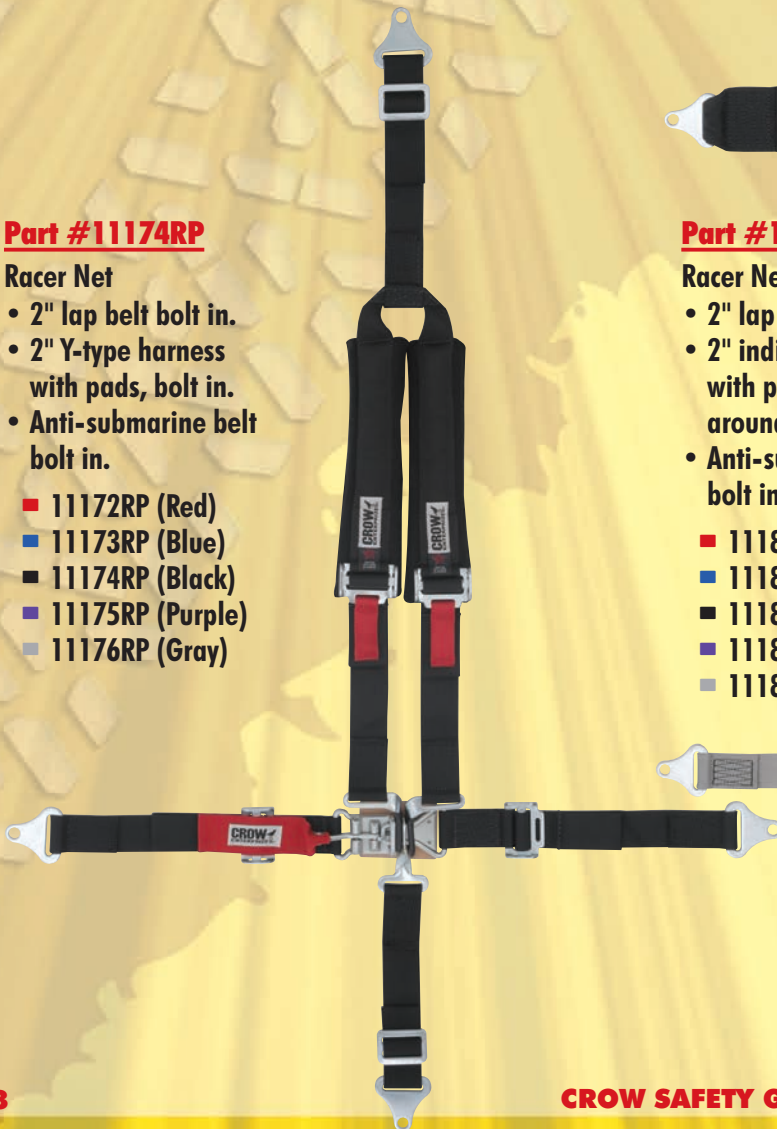

### **Part #11186RP**

#### **Racer Net**

- 2" lap belt bolt in.
- 2" individual harness with pads, wrap around or bolt in.
- Anti-submarine belt bolt in.

- 11182RP (Red)
- 11183RP (Blue)
- 11184RP (Black)
- 11185RP (Purple)
- 11186RP (Gray)

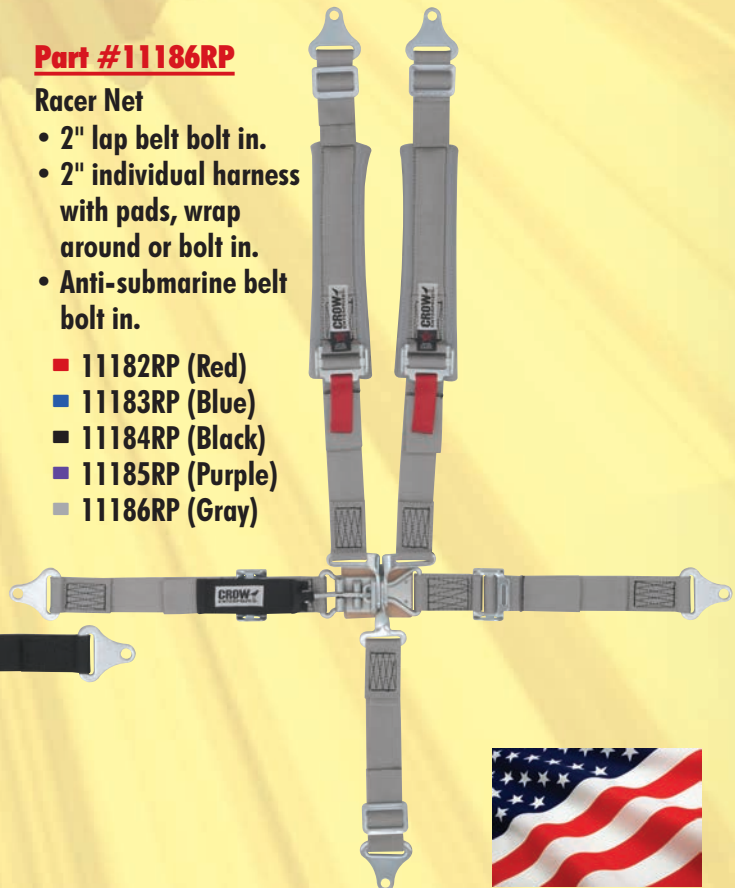

## STANDARD LATCH & LINK INDIVIDUAL LAP BELTS



### Part #11224

Racer Net

- 3" webbing.
- 52" lap belt bolt in.



- 11222 (Red)
- 11223 (Blue)
- 11224 (Black)
- 11225 (Purple)
- 11226 (Gray)



### Part #11243

Racer Net

- 3" webbing.
- 52" lap belt clip in.
- 2 eye bolts included.



- 11242 (Red)
- 11243 (Blue)
- 11244 (Black)
- 11245 (Purple)
- 11246 (Gray)



### Part #11504

Racer Net

- 2" webbing.
- 2" lap belt bolt in.
- 52" lap belt

- 11502 (Red)
- 11503 (Blue)
- 11504 (Black)
- 11505 (Purple)
- 11506 (Gray)



### Part #11512

Racer Net

- 2" Seat Belt Floor Mount.
- 2 Eye Bolts Included.

- 11512 (Red)
- 11513 (Blue)
- 11514 (Black)
- 11515 (Purple)
- 11516 (Gray)

## HARNESSES



### Part #11354

Racer Net

- 3" webbing.
- 51" individual harness, bolt in.



- 11352 (Red)
- 11353 (Blue)
- 11354 (Black)
- 11355 (Purple)
- 11356 (Gray)

## MOUNTING HARDWARE



### Part #11546

Racer Net

- Clip in with eye bolt, nut & washer.
- 1 each per set.

### Part #11547

Racer Net

- 3" 3-bar slide.
- 2 each per set.

### Part #11548

Racer Net

- Eye bolt, nut, washer.
- 2 each per set.
- Thread size 7/16 x 20.

### Part #11549

Racer Net

- Bolt in bracket.
- 2 each per set.

### Part #11549A

Racer Net

- Bolt in bracket.
- 2 each per set.
- Sizes: 1/4", 5/16", 3/8", 7/16", 1/2"

### Part #11551

Racer Net

- 2" 3-bar slide.
- 2 each per set.

## QUICK ADJUST INDIVIDUAL LAP BELTS

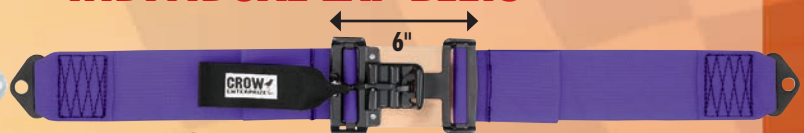

### Part #11255

Racer Net

- 3" webbing.
- Duck bill type
- 55" lap belt bolt in.



- 11252 (Red)
- 11253 (Blue)
- 11254 (Black)
- 11255 (Purple)
- 11256 (Gray)



### Part #11274

Racer Net

- 3" webbing.
- Duck bill type
- 55" lap belt clip in.
- 2 eye bolts included.



- 11272 (Red)
- 11273 (Blue)
- 11274 (Black)
- 11275 (Purple)
- 11276 (Gray)

## 2" ANTI-SUBMARINE BELTS



### Part #11384

Racer Net

- Standard anti-submarine belt.
- Bolt In.

- 11382 (Red)
- 11383 (Blue)
- 11384 (Black)
- 11385 (Purple)
- 11386 (Gray)



### Part #11393

Racer Net

- Adjustable anti-submarine belt.
- Bolt In.

- 11392 (Red)
- 11393 (Blue)
- 11394 (Black)
- 11395 (Purple)
- 11396 (Gray)



### Part #11402

Racer Net

- 6-way dual anti-submarine belt.

- 11402 (Red)
- 11403 (Blue)
- 11404 (Black)
- 11405 (Purple)
- 11406 (Gray)

## LATCH GUARDS



### Part #LG2

Racer Net

- LG2 (Red)
- LG4 (Black)



## QUILTED MULTI-LAYER NOMEX® SUIT

**sfi APPROVED**  
SFI-3.2A/5

**26 TPP**



**sfi APPROVED**  
SFI-3.2A/5

## QUILTED MULTI-LAYER PROBAN® SUITS

**22 TPP**

**sfi APPROVED**  
SFI-3.2A/5

**22 TPP**



**30%  
Lighter &  
Breathable**

### 1-PIECE SUIT

#### Racer Net

- Nomex® exterior with knit Nomex® interior is 30% lighter and breathable.
- Features: box quilting, straight leg cuff with stirrups, inset pockets, high rise collar.
- Back waist gusset and 180° shoulder gussets in back of arms.

Multi-Layer Nomex® 1-Piece Driving Suit (Available in Black ONLY)		
Medium	Large	XL
30014	30024	30034

### 1-PIECE SUIT

#### Racer Net

- Features: box quilting, straight leg cuff with stirrups, inset pockets, high rise collar.
- Back waist gusset and 180° shoulder gussets in back of arms.
- Sizes S-XL (XXL, XXXL available for an additional charge).

### 2-PIECE SUIT: JACKET & PANT

#### JACKET: Racer Net

- Features: box quilting, high rise collar.
- Sizes S-XL (XXL, XXXL available for an additional charge).

#### PANTS: Racer Net

- Feature: box quilting, straight leg cuff with stirrups, inset pockets.
- Sizes S-XL (XXL available for an additional charge).

Driving Suit Measurement Chart						
	Chest	Waist	Inseam	Neck	Height	Weight
Small	30"-34"	26"-30"	31"	14.5"	5'5"-5'7"	115-130
Medium	34"-38"	30"-34"	32"	15.5"	5'7"-5'10"	140-165
Large	38"-44"	34"-38"	33"	16.5"	5'10"-6'2"	175-200
X-Large	44"-46"	38"-40"	34"	17.5"	5'11"+	200-225
XX-Large	46"-48"	40"-42"	35"	18.5"	5'11"+	225-240
XXX-Large	48"-50"	42"-44"	35"	19"+	5'11"+	240-255

2-Layer Proban® 1-Piece Driving Suit						
	Small	Medium	Large	XL	XXL	XXXL
Red	27002	27012	27022	27032	27042	N/A
Blue	27003	27013	27023	27033	27043	N/A
Black	27004	27014	27024	27034	27044	27054

XXX-Large available in black only

2-Layer Proban® 2-Piece Driving Suit: Jacket						
	Small	Medium	Large	XL	XXL	XXXL
Red	28002	28012	28022	28032	28042	N/A
Blue	28003	28013	28023	28033	28043	N/A
Black	28004	28014	28024	28034	28044	28054

2-Layer Proban® 2-Piece Driving Suit: Pants						
	Small	Medium	Large	XL	XXL	XXXL
Red	29002	29012	29022	29032	29042	N/A
Blue	29003	29013	29023	29033	29043	N/A
Black	29004	29014	29024	29034	29044	29054

**NEW!  
LEGACY  
SUIT**

**sfi** APPROVED  
SFI-3.2A/1



**22%  
Lighter**

*To the Limit*

**NEW! LEGACY 1-PIECE SUIT**

Racer Net

*Limited Edition, while supplies last!*

- European styling with high rise collar, 22% lighter and more breathable Proban.®
- Inset pockets, straight leg with inside cuff and stirrup.
- "To the Limit" embroidered on the left inside sleeve.
- SFI 3.2A/1 certified.
- Available in black only.
- Sizes S-XL (XXL, XXXL available for an additional charge).

Single-Layer Proban® Driving Suit Colors/Sizes						
1-Piece Driving Suit						
Size:	Small	Medium	Large	XL	XXL	XXXL
Black	24004L	24014L	24024L	24034L	24044L	24054L



**SINGLE-LAYER  
PROBAN® SUITS**

**sfi** APPROVED  
SFI-3.2A/1



**1-PIECE SUIT**

Racer Net

- Features: straight leg with inside cuff, inset pockets, high rise collar.
- Sizes S-XL (XXL, XXXL available for an additional charge).

Single-Layer Proban® Driving Suit Colors/Sizes						
1-Piece Driving Suit						
Size:	Small	Medium	Large	XL	XXL	XXXL
Red	24002	24012	24022	24032	24042	24052
Blue	24003	24013	24023	24033	24043	24053
Black	24004	24014	24024	24034	24044	24054



**2-PIECE SUIT**

JACKET: Racer Net

- Jacket features: high rise collar.
- Sizes S-XL, (XXL, XXXL available for an additional charge).

PANTS: Racer Net

- Pants feature: straight leg with inside cuff, inset pockets.
- Sizes S-XL (XXL, XXXL available for an additional charge).

Single-Layer Proban® 2-Piece Driving Suit: Jacket						
Size:	Small	Medium	Large	XL	XXL	XXXL
Red	25002	25012	25022	25032	25042	25052
Blue	25003	25013	25023	25033	25043	25053
Black	25004	25014	25024	25034	25044	25054
2-Piece Driving Suit: Pants						
Red	26002	26012	26022	26032	26042	26052
Blue	26003	26013	26023	26033	26043	26053
Black	26004	26014	26024	26034	26044	26054

# FLAME-RETARDANT UNDERWEAR & ACCESSORIES

(Jr. Sizes Not Available)



## HEAD SOCK

Racer Net

- SFI-3.3 approved.
- 29100 One size White

## TURTLE NECK SHIRT

Racer Net

- SFI-3.3 approved.
- 29101 Medium White  
29102 Large White  
29103 XL White  
29104 XXL White

## UNDERWEAR BOTTOMS

Racer Net

- SFI-3.3 approved.
- 29105 Medium White  
29106 Large White  
29107 XL White  
29108 XXL White

## NOMEX® SOCKS

Racer Net

- SFI-3.3 approved.
- 29116 Medium White (6-8½)  
29118 XL White (11½-13½)



## HEAD SOCK

Racer Net

- SFI-3.3 approved.
- 29100B One size Black

## TURTLE NECK SHIRT

Racer Net

- SFI-3.3 approved.
- 29101B Medium Black  
29102B Large Black  
29103B XL Black  
29104B XXL Black

## UNDERWEAR BOTTOMS

Racer Net

- SFI-3.3 approved.
- 29105B Medium Black  
29106B Large Black  
29107B XL Black  
29108B XXL Black

## NOMEX® SOCKS

Racer Net

- SFI-3.3 approved.
- 29116B Medium Black (6-8½)  
29117B Large Black (9-11)  
29118B XL Black (11½-13½)



## JUNIOR DRIVING SUITS

Single-Layer SFI 3.2A/1 Suits  
Child Sizing 6-8, 10-12, 14-16



### 1-PIECE SUIT

Racer Net

- Features straight leg with inside cuff, inset pockets, and high rise collar.

### JUNIOR JACKET

Racer Net

- Features high rise collar.

### JUNIOR PANTS

Racer Net

- Features straight leg with inside cuff and inset pockets.

1-Piece Junior Suit

Size:	6-8	10-12	14-16
Red	24062	24072	24082
Blue	24063	24073	24083
Black	24064	24074	24084

2-Piece Junior Suit: Jacket

Size:	6-8	10-12	14-16
Red	25112	25122	25132
Blue	25113	25123	25133
Black	25114	25124	25134

2-Piece Junior Suit: Pants

Size:	6-8	10-12	14-16
Red	26112	26122	26132
Blue	26113	26123	26133
Black	26114	26124	26134



## JUNIOR RACER ACCESSORIES

### STANDARD DRIVING GLOVES

Racer Net

- Two layers of Nomex®
- Sewn with Nomex® thread.
- Extra padding on palm and knuckle area.
- Junior racer gloves have a shorter finger length than adult sizes.
- Available in black only.
  - 11674 (Medium)
  - 11684 (Large)



See page 25 for glove sizing information and instructions

### JUNIOR MID TOP DRIVING SHOES

Part #22000

Racer Net

- Satin suede with flame-retardant interior.
- Available in sizes 1 through 6. Also available in adult sizes (see page 24).

Colors available:

- Red ■ Blue ■ Black



Junior Shoe Sizing  
Children 6-10 years old

Shoe Size	Inches
1	7
2	7.5
3	8
4	8.5
5	9
6	9.5

### NECK COLLARS

Racer Net

- For neck sizes 12" and under.
- 360° neck collar.
- Manufactured in knitted flame-retardant material.



- 20162K (Red)
- 20163K (Blue)
- 20164K (Black)

### ARM RESTRAINTS

Racer Net

- 2" individual arm restraint.
- Attach around arms with Velcrow closures, vee straps attach via hooks.
- 11574A2 (Black only)



## SHOES

Junior Racer shoes available. See page 23.

### MID TOP DRIVING SHOES

#### Part #22000

Racer Net

- Satin suede with flame-retardant interior.
- Available in sizes 7 through 13 in half-size increments.

Colors available:

- Red ■ Blue ■ Black



### HIGH TOP DRIVING SHOES

#### Part #21000

Racer Net

- Satin suede with flame-retardant interior.
- Available in sizes 7 through 13 in half-size increments.

Colors available:

- Black only



### SPRINT CAR HIGH TOP DRIVING SHOES

#### Part #23000

Racer Net

- Black leather with flame-retardant interior.
- Features covered laces with Velcrow closure.
- Available in sizes 8 through 13 in half-size increments.

Colors available:

- Black only



## HELMET SKIRTS

#### Part #20174

Racer Net

- Proban® Helmet skirt.
- 20174 (Black)



#### Part #20176

Racer Net

- Knitted Nomex® helmet skirt with Velcrow attachment.
- Available in black only.



## NECK COLLARS

#### Part #20162

Racer Net

- 360° neck collar.
- Manufactured in knitted flame-retardant material.
- Junior racer neck collars see page 23.

- 20162 (Red)
- 20163 (Blue)
- 20164 (Black)



## TAPERED NECK SUPPORT

#### Part #20162A

Racer Net

- Manufactured in Proban® flame-retardant material.
- Tapered from 1¾ inches in front to 2¼ inches in back.
- Velcrow closure.

- 20162A (Red)
- 20163A (Blue)
- 20164A (Black)





# GLOVES

## THE NEW ALL-STAR GLOVE, The ULTIMATE Racing Glove



### Racer Net

- Light weight, comfortable double-layer Nomex®.
- Pre-curved fingers with outside seams for comfort and dexterity.
- Palm & fingers reinforced with performance leather grip points.
- Elastic at wrist for a more secure feeling.
- SFI-3.3/5 approved.

### Colors and Sizes Available:

	Small	Medium	Large	Extra Large
■ Red	11802	11812	11822	11832
■ Blue	11803	11813	11823	11833
■ Black	11804	11814	11824	11834



## WINGS GLOVES RACING GLOVE



### Racer Net

- Double layer Nomex®.
- This is a long gauntlet glove.
- Extra padding on palm and knuckle area.
- Adjustable Velcrow wrist closure.
- SFI-3.3/5 approved.

### Color and Sizes Available:

	Large	Extra Large
■ Black	11774	11784



### Glove Sizing

To find glove size, make a loose fist, wrap a tape measure over knuckles around the largest part of hand, excluding thumbs.

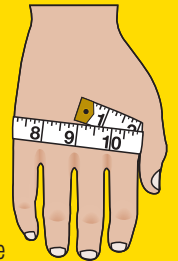

Jr. Medium*	4.5" - 5.5"
Jr. Large*	5.5" - 6.5"
X-Small	6.0" - 6.5"
Small	7.5" - 8.0"
Medium	8.0" - 9.0"
Large	9.5" - 10.5"
X-Large	10.5" - 11.5"

\*Junior gloves have short finger lengths

Junior Racer gloves available. See page 23.

## THE STANDARD RACING GLOVE



### Racer Net

- Double layer Nomex®.
- Extra padding on palm and knuckle area.
- Adjustable Velcrow wrist closure.
- SFI-3.3/5 approved.

### Colors and Sizes Available:

	Extra Small	Small	Medium	Large	Extra Large
■ Red		11702	11712	11722	11732
■ Blue		11703	11713	11723	11733
■ Black	11694	11704	11714	11724	11734



## ARM RESTRAINTS

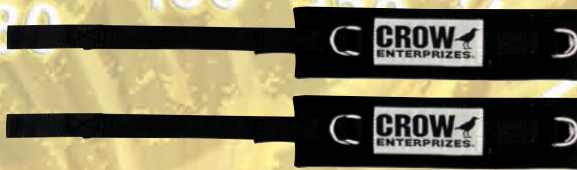

### Part #11574

Racer Net

- 3" arm restraints.
- 11574 (Black only)

### Part #11574A

Racer Net

- 2" individual arm restraint.
- Attach around arms with Velcrow closures, vee straps attach via hooks.
- 11574A (Black only)



### Part #11574SCTA

Racer Net

- 2" individual arm restraint.
- Attach around arms with Velcrow closures.
- 11574SCTA (Black only)



## SAND CAR WRIST RESTRAINTS

Not For Competition Use

### Part #11664

Racer Net

- Attach around wrist with Velcrow closures.
- 11664 (Black only)



### Part #11614

Racer Net

- Sprint car & midget side nets.
- SFI 37.1 approved.

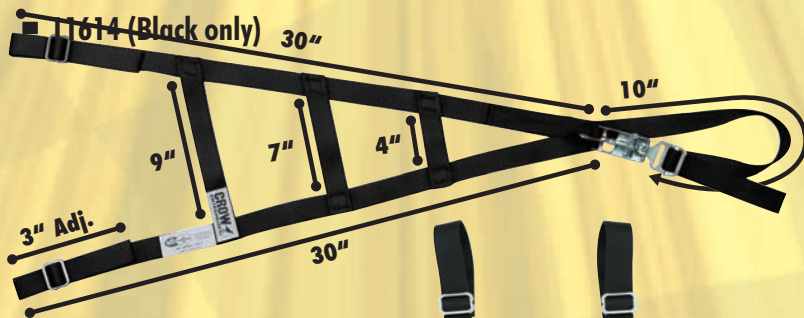

### Part #11654

Racer Net

- Junior dragster leg containment net.
- Black only.



## WINDOW NETS

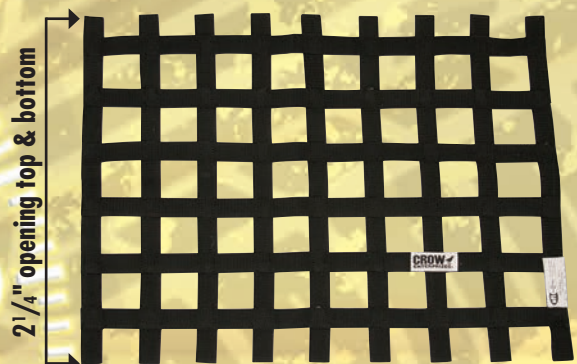

### Part #11624

Racer Net

- Window net 18X24.
- SFI 27.1 approved.
- Available in red, blue and black.

### Part #11634

Racer Net

- Window net 24X24.
- SFI 27.1 approved.
- Available in red, blue and black.

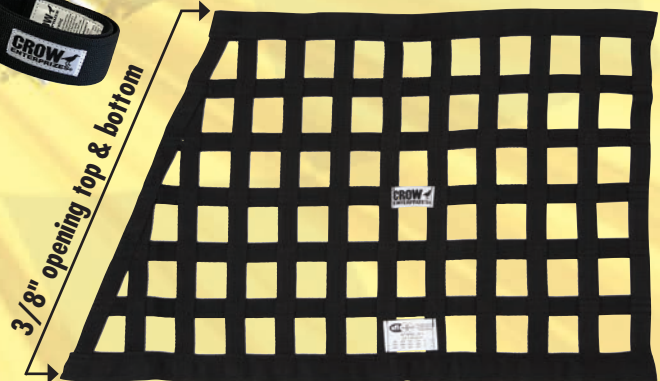

### Part #11649

Racer Net

- Solid mount 18X24x29 window net.
- SFI 27.1 approved.
- Nylon webbing.
- Black only.

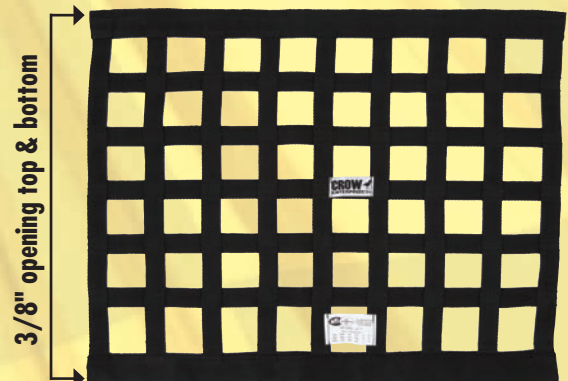

### Part #11648

Racer Net

- Solid mount 18X18 window net.
- SFI 27.1 approved.
- Nylon webbing.
- Black only.

### Part #11650

Racer Net

- Solid mount 18X24 window net.
- SFI 27.1 approved.
- Nylon webbing.
- Black only.

## HARNESS PADS



### Part #11564

Racer Net

- 3" harness pads.
- Attaches with Velcrow.
- Made with Flame-Retardant Material
- 11564 (Black only)



### Part #11564A

Racer Net

- 3" harness pads.
- Attaches with Velcrow.
- Made with Nylon material.
- 11564A (Black only)

### Part #11564A2

Racer Net

- 2" harness pads.
- Attaches with Velcrow.
- Made with Nylon material.
- 11564A2 (Black only)



### Sewn In Harness Pads

Racer Net (3" or 2")

- Sewn in harness pads can be added to any harness when ordering, excluding dog bone style.

## AXLE, DRAG LINK & TOW STRAPS

### Part #11594

Racer Net

- Axle straps 24" long.
- Available in black only.



### Part #11646

Racer Net

- Sprint car drag link strap.



## TOW STRAPS

Tow straps available with a 1/2" or 7/16" bolt-in bracket.

### Part #51012A

Racer Net

- Tow strap with 7/16" bolt-in bracket.

### Part #51012B

Racer Net

- Tow strap with 1/2" bolt-in bracket.



### Part #11645

Racer Net

- 24" end to end.
- 7/16" diameter hole.



## SPRINT CAR TETHERS

### Part #SP-54

Racer Net

- Wing Sprint Car Tethers 54" end-to-end.
- Axel 50" Tether 54".
- Kingpin Stud Kit-2 each.
- 27" Radius Rod Tethers & Heim Kit.

### Part #SP-57

Racer Net

- Non-Wing Sprint Car Tethers 57" end-to-end.
- Axel 52" - 54" Tether 57".
- Kingpin Stud Kit-2 each.
- 27" Radius Rod Tethers & Heim Kit.

**Part #SP-54WA & SP-57WA** Same as Part #SP54-57 but with wrap around ends. (No Picture.)

