



2020



The Classic Accessories Difference

It's not just about protecting your stuff. Sure, that's part of it. But to us, it's also about much more; it's about protecting dreams, adventures and memories, and all the irreplaceable experiences that make your belongings worth protecting. That's why we do what we do. And why we're committed to doing it so well. We know the true value of your belongings doesn't necessarily start with a dollar sign.

With 22 different collections across 12 distinct product categories we have products to hit nearly any price point or application and give your customer the experience they deserve.

Montlake®	Terrazzo®	Encompass™
Ravenna®	Classic Accessories®	Fairway™
Hickory®	SideSlider™	MotoGear®
Mainland™	Porterhouse™	QuadGear®
Madrona®	Elkridge™	SledGear®
Storigami™	Seasons™	WaveGear®
Veranda™	Over Drive®	SkyShield® and ProTop4®

Our expertise and experience in fabric development has led to more than 20 distinct fabric types across our lines. We have fabric technologies suited to nearly any application or weather condition.

FadeSafe®	Stellex™	PermaPRO™
RainProof™	Plus 4™	PolyPRO3™
Gardelle™	DryGuard™	PolyPRO1™
Gardelle One™	Rain-Tite™	PolyPRO™
TwillTek™	ProtekX™	Weather-X™
StormPro™	ProtekX Plus™	Weather10™
Storm-X™	Lunex™	WeatherPRO™

AUTO [002](#)

BOAT [010](#)

GOLF [028](#)

HOME GARAGE [038](#)

HOME PATIO

GRILL COVERS [054](#)

UMBRELLAS [080](#)

HAMMOCKS [081](#)

SLIP COVERS [086](#)

CUSHIONS [088](#)

FURNITURE COVERS [138](#)

HOME STORAGE [230](#)

POWERSPORT [232](#)

RV [244](#)

MARKETING [268](#)

AUTO



PVC Free

PolyPRO™ 3 SUV/ Pickup Cover



Triple-layer material provides heavy-duty protection against dirt, scratches and bad weather

COLOR: CHARCOAL

- Rugged PolyPRO™ 3 triple-layer fabric resists and repels rain and snow
- Superior protection against dirt, pollution and scratches
- Thick, soft fabric won't scratch paint, and shields against scratches and nicks
- Features include zippered driver's side door for easy access, an antenna reinforcement patch, non-scratch tie-down grommets and rope with an elasticized bottom hem for a fast, custom-like fit
- Convenient storage bag

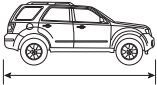
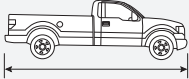

Item/Fit		Examples	Retail Stock No	Case Qty
COMPACT TO MID SIZE		FORD ESCAPE, FORD RANGER	10-018-241001-00	1
FITS SUVS AND PICKUPS UP TO 187"L*				
FULL SIZE		CHEVY SUBURBAN, FORD F150	10-019-261001-00	1
FITS FULL SIZE SUVS AND PICKUPS** 188"-230"L*				

**May not fit extended cab versions of some models.
*Not designed to entirely cover the wheels.

PVC Free

PolyPRO™3 Jeep Cover

Triple-layer material provides heavy-duty protection against dirt, scratches and bad weather

COLOR: CHARCOAL

- Rugged PolyPRO™3 triple-layer fabric resists and repels rain and snow
- Superior protection against dirt, pollution and scratches
- Thick, soft fabric won't scratch paint, and shields against scratches and nicks
- Features include an antenna reinforcement patch, non-scratch tie-down grommets and rope with an elasticized bottom hem for a fast, custom-like fit
- Convenient storage bag



Item/Fit	Examples	Retail Stock No	Case Qty
JEEP FITS JEEP WRANGLERS UP TO 161"L 65"W*		JEEP WRANGLER	10-020-251001-00 1

*Not designed to entirely cover the wheels
Note: Jeep cover does not have zippered access door

PVC Free

PolyPRO™3 Car and Hatchback Car Cover



Triple-layer material provides heavy-duty protection against dirt, scratches and bad weather

COLOR: CHARCOAL

- Rugged PolyPRO™3 triple-layer fabric resists and repels rain and snow
- Superior protection against dirt, pollution and scratches
- Thick, soft fabric won't scratch paint, and shields against scratches and nicks
- Features include zippered driver's side door for easy access, an antenna reinforcement patch, non-scratch tie-down grommets and rope with an elasticized bottom hem for a fast, custom-like fit
- Convenient storage bag



Item/Fit	Examples	Retail Stock No	Case Qty
COMPACT FITS SEDANS UP TO 175"L*	HONDA CIVIC, FORD FOCUS	10-016-241001-00	1
MID SIZE FITS SEDANS 176"-190"L*	HONDA ACCORD**, TOYOTA CAMRY**	10-013-251001-00	1
FULL SIZE FITS SEDANS 191"-210"L*	LEXUS LS 460, MERCEDES S CLASS	10-014-261001-00	1
FULL SIZE FITS HATCHBACKS/WAGONS 169"-183"L*	TOYOTA RAV4	10-120-321001-RT	1

NEW

**Certain models may vary in size from year to year
 *Not designed to entirely cover the wheels.

PVC Free

PolyPRO™ 3 Pickup Truck Cover with RainRelease™

3
YEAR
WARRANTYALL-SEASON
PROTECTION3-PLY
FABRICZIPPERED
ACCESSELASTIC
BOTTOM HEMSTORAGE
BAG

Triple-layer material provides heavy-duty protection, RainRelease™ panel channels water out through the bed

NEW

COLOR: CHARCOAL

- RainRelease™ grid panel channels water across the cover and into the truck bed, releasing tension and preventing pooling
- Rugged PolyPRO™3 triple-layer fabric resists and repels rain and snow
- Superior protection against dirt, pollution and scratches
- Thick, soft fabric won't scratch paint, and shields against scratches and nicks
- Zippered driver's side door for easy access
- Non-scratch tie-down grommets and rope with an elasticized bottom hem for a fast, custom-like fit
- Antenna reinforcement patch
- Convenient storage bag

 RainRelease™
grid panel

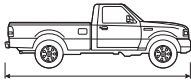
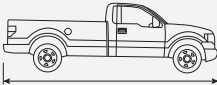
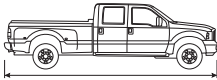
Item/Fit	Examples	Retail Stock No	Case Qty
MID SIZE FITS PICKUP TRUCKS UP TO 232"L*1	 NISSAN TITAN, STANDARD CAB	10-119-251001-RT	1
FULL SIZE FITS PICKUP TRUCKS 233"—249"L*1	 FORD 150, CREW CAB	10-118-261001-RT	1
FULL SIZE FITS CREW CAB PICKUP TRUCKS 250"—264"L*1	 DODGE RAM 2500. 4X4 MEGACAB	10-117-261001-RT	1

**Certain models may vary in size from year to year

*Not designed to entirely cover the wheels. †Actual cover dimensions. Do not include tolerance.

PVC Free

PolyPRO™1 Car Cover



WARRANTY



WEATHER PROTECTION



BREATHABLE FABRIC



ELASTIC BOTTOM HEM



STORAGE BAG



Single-layer protection against dirt, scratches, weather and sun damage

COLOR: BODIESEL

- PolyPRO™1 fabric is water-repellent, yet breathes to reduce mold and mildew
- Soft fabric won't scratch paint
- Protects against dirt and scratches, perfect for storage and moderate weather protection
- Includes an antenna reinforcement patch, non-scratch tie-down grommets and rope with an elasticized bottom hem for a fast, custom-like fit

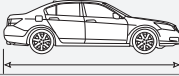
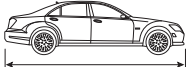

Convenient storage bag

Item/Fit		Examples	Retail Stock No	Case Qty
COMPACT FITS SEDANS UP TO 157"L* ¹	NEW SIZE	 CHEVROLET SPARK	10-115-251001-RT	1
COMPACT FITS SEDANS 158"-170"L* ¹	NEW SIZE	 HONDA FIT	10-116-251001-RT	1
COMPACT FITS SEDANS UP TO 175"L*		 HONDA CIVIC, FORD FOCUS	10-011-241001-00	1
MID SIZE FITS SEDANS 176"-190"L*		 HONDA ACCORD**, TOYOTA CAMRY**	10-012-251001-00	1
FULL SIZE FITS SEDANS 191"-210"L*		 LEXUS LS 460, MERCEDES S CLASS	10-010-051001-00	1

**Certain models may vary in size from year to year

*Not designed to entirely cover the wheels. ¹Actual cover dimensions. Do not include tolerance.



WARRANTY



WEATHER PROTECTION



BREATHABLE FABRIC



ELASTIC BOTTOM HEM



STORAGE BAG

PVC Free

PolyPRO™1 SUV/ Pickup Cover

Single-layer protection against dirt, scratches, weather and sun damage

COLOR: BIODIESEL

- PolyPRO™1 fabric is water-repellent, yet breathes to reduce mold and mildew
- Soft fabric won't scratch paint
- Protects against dirt and scratches, perfect for storage and moderate weather protection
- Includes an antenna reinforcement patch, non-scratch tie-down grommets and rope with an elasticized bottom hem for a fast, custom-like fit



Convenient storage bag

Item/Fit	Examples	Retail Stock No	Case Qty
COMPACT FITS SUVs, PICKUP TRUCKS WITH CANOPIES UP TO 187"L*		FORD ESCAPE, FORD RANGER	10-015-161001-00 1
FULL SIZE FITS SUVs, PICKUP TRUCKS WITH CANOPIES 188"-230"L*		CHEVY SUBURBAN, FORD F150	10-017-241001-00 1
FULL SIZE FITS SUVs, PICKUP TRUCKS WITH CANOPIES 231"-264"L*		DODGE RAM 2500. 4X4 MEGACAB	10-114-261001-RT 1
CREW CAB FITS SUVs, CREW OR EXTENDED CAB PICKUP TRUCKS WITH CANOPIES 231"-262"L*		FORD 350 LONG BED CREW CAB, DODGE RAM LONG BED QUAD CAB	10-021-261001-00 1

**Certain models may vary in size from year to year
 *Not designed to entirely cover the wheels.



PVC Free

PolyPRO™1 Pickup Truck Cover with RainRelease™

Protection against dirt, scratches, weather and sun damage, RainRelease™ panel channels water out through the bed

COLOR: BIODIESEL

NEW

- RainRelease™ grid panel channels water across the cover and into the truck bed, releasing tension and preventing pooling
- PolyPRO™1 fabric is water-repellent, yet breathes to reduce mold and mildew
- Soft fabric won't scratch paint
- Protects against dirt and scratches, perfect for storage and moderate weather protection
- Includes an antenna reinforcement patch, non-scratch tie-down grommets and rope with an elasticized bottom hem for a fast, custom-like fit

RainRelease™ grid panel



Convenient storage bag



Item/Fit	Examples	Retail Stock No	Case Qty	
MID SIZE FITS PICKUP TRUCKS UP TO 232"L*1		NISSAN TITAN, STANDARD CAB	10-112-251001-RT	1
FULL SIZE FITS PICKUP TRUCKS 233"—249"L*1		FORD 150, CREW CAB	10-110-261001-RT	1
FULL SIZE FITS CREW CAB PICKUP TRUCKS 250"—264"L*1		DODGE RAM 2500, 4X4 MEGACAB	10-111-261001-RT	1

**Certain models may vary in size from year to year
 *Not designed to entirely cover the wheels.

BOAT



AS ATTACHED TO YOUR BOAT AS YOU ARE



PVC Free

StormPro™ Boat Cover5
YEAR
WARRANTYHEAVY-DUTY
PROTECTIONUV
PROTECTIONWATER
RESISTANT

AIR VENTS

ELASTIC
HEM CORDCLICK-CLOSE
STRAPS

TRAILERABLE

STORAGE
BAG

Heavy-duty boat cover designed for both long-term storage and highway travel

COLOR: CHARCOAL



- High-strength polyester StormPro™ fabric designed for extra durability and all-weather protection
- Fabric coating technology and heavy-duty fabric for maximum water-resistance and repellency
- Storage bag and trailer straps included
- Integrated buckle and strap system for easy fitting and trailering, adjustable straps snap into quick-release buckles on the cover











- Full-cut to allow extra room for accessories such as bow rails, running lights, etc.
- Elastic cord sewn into bottom hem gives a tight, custom fit
- Support pole included to prevent water from pooling and help preserve the cover
- Dual rear air vents with built-in stiffeners reduce wind pressure during trailering and storms and allow inside moisture to escape

Support pole included



Quick-release buckle & strap system for easy fitting & trailering



	Item/Fit			Retail Stock No	Case Qty	
MODEL AA	12'-14'L BEAM WIDTH TO 68"	 V-HULL FISHING BOATS		88908	1	
MODEL A	14'-16'L BEAM WIDTH TO 75"	 V-HULL FISHING BOATS		88918	1	
MODEL B	14'-16'L BEAM WIDTH TO 90"	 V-HULL RUNABOUTS OUTBOARDS AND I/O	 V-HULL RUNABOUTS OUTBOARDS AND I/O	 ALUMINUM BASS BOATS	88928	1
MODEL C	16'-18.5'L BEAM WIDTH TO 98"	 FISH AND SKI BOATS	 PRO-STYLE BASS BOATS		88938	1
MODEL D	17'-19'L BEAM WIDTH TO 102"	 V-HULL RUNABOUTS OUTBOARDS AND I/O			88948	1
MODEL E	20'-22'L BEAM WIDTH TO 106"	 V-HULL RUNABOUTS OUTBOARDS AND I/O			88958	1
MODEL F	22'-24'L BEAM WIDTH TO 116"	 V-HULL RUNABOUTS OUTBOARDS AND I/O			88968	1

PVC Free

StormPro™ Center Console Boat Cover



Heavy-duty boat cover designed for both long-term storage and highway travel

COLOR: CHARCOAL



- High-strength polyester StormPro™ fabric designed for extra durability and all-weather protection
- Fabric coating technology and heavy-duty fabric for maximum water-resistance and repellency
- Storage bag and trairling straps included
- Integrated buckle and strap system for easy fitting and trailering, adjustable straps snap into quick-release buckles on the cover

- Full-cut to allow extra room for accessories such as bow rails, running lights, etc.
- Elastic cord sewn into bottom hem gives a tight, custom fit
- Support pole included to prevent water from pooling and help preserve the cover
- Dual rear air vents with built-in stiffeners reduce wind pressure during trailering and storms and allow inside moisture to escape
- Includes integrated motor cover

Support pole included



Quick-release buckle & strap system for easy fitting & trailering



	Item/Fit		Retail Stock No	Case Qty
MODEL B	14'-16'L BEAM WIDTH TO 90"	 CENTER CONSOLE BOATS OUTBOARDS	20-301-091001-RT	1
MODEL C	16'-18.5'L BEAM WIDTH TO 98"	 CENTER CONSOLE BOATS OUTBOARDS	20-302-101001-RT	1
MODEL D	17'-19'L BEAM WIDTH TO 102"	 CENTER CONSOLE BOATS OUTBOARDS	20-303-111001-RT	1
MODEL E	20'-22'L BEAM WIDTH TO 106"	 CENTER CONSOLE BOATS OUTBOARDS	20-304-121001-RT	1
MODEL F	22'-24'L BEAM WIDTH TO 116"	 CENTER CONSOLE BOATS OUTBOARDS	20-305-131001-RT	1

PVC Free

StormPro™ Deck Boat Cover



Heavy-duty boat cover designed for both long-term storage and highway travel

COLOR: CHARCOAL



- High-strength polyester StormPro™ fabric designed for extra durability and all-weather protection
- Fabric coating technology and heavy-duty fabric for maximum water-resistance and repellency
- Storage bag and trailering straps included
- Integrated buckle and strap system for easy fitting and trailering, adjustable straps snap into quick-release buckles on the cover





- Full-cut to allow extra room for accessories such as bow rails, running lights, etc.
- Elastic cord sewn into bottom hem gives a tight, custom fit
- Support pole included to prevent water from pooling and help preserve the cover
- Dual rear air vents with built-in stiffeners reduce wind pressure during trailering and storms and allow inside moisture to escape

Support pole included



Quick-release buckle & strap system for easy fitting & trailering



	Item/Fit		Retail Stock No	Case Qty
MODEL C	16'-18.5'L BEAM WIDTH TO 98"	 DECK BOATS INBOARDS	20-297-101001-RT	1
MODEL D	17'-19'L BEAM WIDTH TO 102"	 DECK BOATS INBOARDS	20-298-111001-RT	1
MODEL E	20'-22'L BEAM WIDTH TO 106"	 DECK BOATS INBOARDS	20-299-121001-RT	1
MODEL F	22'-24'L BEAM WIDTH TO 116"	 DECK BOATS INBOARDS	20-300-131001-RT	1

PVC Free

StormPro™ T-Top Boat Cover



Heavy-duty boat cover designed for long-term storage

COLOR: CHARCOAL



- High-strength polyester StormPro™ fabric designed for extra durability and all-weather protection
- Fabric coating technology and heavy-duty fabric for maximum water-resistance and repellency
- Storage bag and straps included
- Integrated buckle and strap system for easy fitting, adjustable straps snap into quick-release buckles on the cover





- Full-cut to allow extra room for accessories such as bow rails, running lights, etc.
- Elastic cord sewn into bottom hem gives a tight, custom fit
- Support pole included to prevent water from pooling and help preserve the cover
- Dual rear air vents with built-in stiffeners reduce wind pressure during storms and allow inside moisture to escape

Support pole included



Quick-release buckle & strap system for easy fitting



	Item/Fit		Retail Stock No	Case Qty
MODEL C	16'-18.5'L BEAM WIDTH TO 98"	 T-TOP BOATS	20-306-101001-RT	1
MODEL D	17'-19'L BEAM WIDTH TO 102"	 T-TOP BOATS	20-307-111001-RT	1
MODEL E	20'-22'L BEAM WIDTH TO 106"	 T-TOP BOATS	20-308-121001-RT	1
MODEL F	22'-24'L BEAM WIDTH TO 116"	 T-TOP BOATS	20-309-131001-RT	1

PVC Free

StormPro™ V-Hull Inboard/Outboard Boat Cover



Heavy-duty boat cover designed for both long-term storage and highway travel

COLOR: CHARCOAL



- High-strength polyester StormPro™ fabric designed for extra durability and all-weather protection
- Fabric coating technology and heavy-duty fabric for maximum water-resistance and repellency
- Storage bag and trairling straps included
- Integrated buckle and strap system for easy fitting and trairling, adjustable straps snap into quick-release buckles on the cover

- Full-cut to allow extra room for accessories such as bow rails, running lights, etc.
- Elastic cord sewn into bottom hem gives a tight, custom fit
- Support pole included to prevent water from pooling and help preserve the cover
- Dual rear air vents with built-in stiffeners reduce wind pressure during trairling and storms and allow inside moisture to escape

Support pole included



Quick-release buckle & strap system for easy fitting & trairling



	Item/Fit		Retail Stock No	Case Qty
MODEL E6	19'6"L-20'6"L BEAM WIDTH TO 96"	 V-HULL BOATS	20-397-120801-RT	1
MODEL E8	19'6"L-20'6"L BEAM WIDTH TO 104"	 V-HULL BOATS	20-398-120801-RT	1
MODEL E9	20'6"-21'6"L BEAM WIDTH TO 96"	 V-HULL BOATS	20-399-120801-RT	1
MODEL E11	20'6"-21'6"L BEAM WIDTH TO 104"	 V-HULL BOATS	20-394-120801-RT	1
MODEL F2	21'6"-22'6"L BEAM WIDTH TO 96"	 V-HULL BOATS	20-400-130801-RT	1
MODEL F3	21'6"-22'6"L BEAM WIDTH TO 104"	 V-HULL BOATS	20-401-130801-RT	1

PVC Free

StormPro™ Tri-Hull Outboard Boat Cover



Heavy-duty boat cover designed for both long-term storage and highway travel

COLOR: CHARCOAL

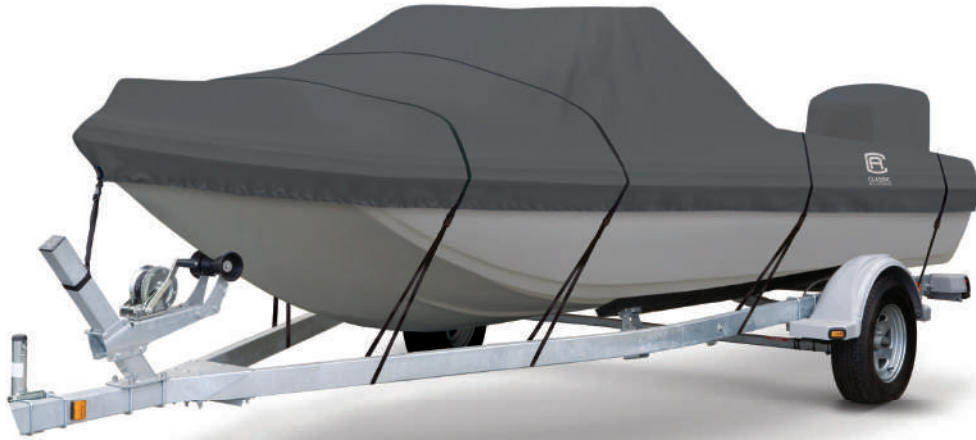

- High-strength polyester StormPro™ fabric designed for extra durability and all-weather protection
- Fabric coating technology and heavy-duty fabric for maximum water-resistance and repellency
- Storage bag and trairling straps included
- Integrated buckle and strap system for easy fitting and trairling, adjustable straps snap into quick-release buckles on the cover





- Full-cut to allow extra room for accessories such as bow rails, running lights, etc.
- Elastic cord sewn into bottom hem gives a tight, custom fit
- Support pole included to prevent water from pooling and help preserve the cover
- Dual rear air vents with built-in stiffeners reduce wind pressure during trairling and storms and allow inside moisture to escape
- Includes integrated motor cover

Support pole included



Quick-release buckle & strap system for easy fitting & trairling



	Item/Fit		Retail Stock No	Case Qty
MODEL B2	13'6"-14'6" BEAM WIDTH TO 73"	 TRI-HULL BOATS	20-386-090801-RT	1
MODEL B3	14'6"-15'6" BEAM WIDTH TO 80"	 TRI-HULL BOATS	20-387-090801-RT	1
MODEL C4	15'6"-16'6" BEAM WIDTH TO 86"	 TRI-HULL BOATS	20-389-100801-RT	1
MODEL C6	16'6"-17'6" BEAM WIDTH TO 87"	 TRI-HULL BOATS	20-391-100801-RT	1
MODEL D3	17'6"-18'6" BEAM WIDTH TO 92"	 TRI-HULL BOATS	20-393-110801-RT	1

PVC Free

StormPro™ Outboard Ski-Boat Cover



Heavy-duty boat cover designed for both long-term storage and highway travel

COLOR: CHARCOAL



- High-strength polyester StormPro™ fabric designed for extra durability and all-weather protection
- Fabric coating technology and heavy-duty fabric for maximum water-resistance and repellency
- Storage bag and trairling straps included
- Integrated buckle and strap system for easy fitting and trairling, adjustable straps snap into quick-release buckles on the cover
- Full-cut to allow extra room for accessories such as bow rails, running lights, etc.

- Elastic cord sewn into bottom hem gives a tight, custom fit
- Support pole included to prevent water from pooling and help preserve the cover
- Dual rear air vents with built-in stiffeners reduce wind pressure during trairling and storms and allow inside moisture to escape
- Includes integrated motor cover

Support pole included



Quick-release buckle & strap system for easy fitting & trairling



	Item/Fit		Retail Stock No	Case Qty
MODEL C6	15'6"-16'6" BEAM WIDTH TO 82"	 OUTBOARD SKI-BOATS	20-388-100801-RT	1
MODEL C5	16'6"-17'6" BEAM WIDTH TO 85"	 OUTBOARD SKI-BOATS	20-390-100801-RT	1
MODEL D2	17'6"-18'6" BEAM WIDTH TO 89"	 OUTBOARD SKI-BOATS	20-392-110801-RT	1
MODEL E2	18'6"-19'6" BEAM WIDTH TO 89"	 OUTBOARD SKI-BOATS	20-395-120801-RT	1
MODEL E5	19'6"-20'6" BEAM WIDTH TO 90"	 OUTBOARD SKI-BOATS	20-396-120801-RT	1

PVC Free

StormPro™ Ski and Wakeboard Tower Boat Cover



Heavy-duty boat cover designed for long-term storage

NEW

COLOR: CHARCOAL



- High-strength StormPro™ polyester fabric designed for extra durability and all-weather protection
- Fabric coating technology and heavy-duty fabric for maximum water-resistance and repellency
- Resistant to UV damage
- Storage bag and straps included
- Zippered access leads to rip-in-grip opening at tower sides for easy installation
- Integrated buckle and strap system for easy fitting; adjustable straps snap into quick-release buckles on the cover

- Full-cut to allow extra room for accessories such as bow rails, running lights, etc.
- Elastic cord sewn into bottom hem gives a tight, custom fit
- Support pole included to prevent water from pooling and help preserve the cover
- Air vents with built-in stiffeners reduce wind pressure during storms and allow inside moisture to escape

Support pole included



Quick-release buckle & strap system for easy fitting & trailering



	Item/Fit		Retail Stock No	Case Qty
MODEL D	17'-19'L* BEAM WIDTH TO 102"	 SKI AND WAKEBOARD TOWER BOAT	20-411-110801-RT	1
MODEL E	20'-22'L* BEAM WIDTH TO 106"	 SKI AND WAKEBOARD TOWER BOAT	20-412-120801-RT	1
MODEL F	22'-24'L* BEAM WIDTH TO 116"	 SKI AND WAKEBOARD TOWER BOAT	20-413-130801-RT	1

* Fits boats with towers near the beam

PVC Free

StormPro™ Pontoon Boat Cover



Heavy-duty trailerable pontoon boat cover

COLOR: CHARCOAL

- High-strength polyester StormPro™ fabric designed for extra durability and all-weather protection
- Integrated buckle and strap system for easy fitting and trailering, adjustable straps snap into quick-release buckles on the cover
- Adjustable transom flap and an elastic cord sewn into the bottom hem provides a tight, custom-like fit
- Dual air vents reduce inside moisture and ballooning of cover at high speeds
- Fabric coating technology and heavy-duty fabric for maximum water-resistance and repellency
- Storage bag, trailering straps, transom flap tie-down rope and two stern-fit elastic cords included



	Item/Fit		Retail Stock No	Case Qty
MODEL A	17'-20'L BEAM WIDTH TO 102"		20-027-080801-00	1
MODEL B	21'-24'L BEAM WIDTH TO 102"		20-028-090801-00	1

PVC Free

StormPro™ Kayak, Canoe and Stand-Up Paddleboard Cover



Heavy-duty boat cover designed for long-term storage

COLOR: CHARCOAL

- High-strength polyester StormPro™ fabric designed for extra durability and all-weather protection
- Fabric coating technology and heavy-duty fabric for maximum water-resistance and repellency
- Full-cut to allow extra room for accessories such as paddles, life vests, etc.
- Handles strategically positioned for easy installation and carrying
- Dual zipper provides fast and easy access to canoes, SUPs or kayaks, and locking feature (lock not included)
- Storage bag included



	Item/Fit		Retail Stock No	Case Qty
MODEL A	FITS UP TO 12'L KAYAKS, CANOES AND STAND-UP PADDLEBOARDS		20-334-140801-RT	2
MODEL B	FITS UP TO 16'L KAYAKS, CANOES AND STAND-UP PADDLEBOARDS		20-335-150801-RT	2

PVC Free

DryGuard™ Waterproof Boat Cover



Strong DryGuard™ fabric with waterproof lamination

COLOR: TAN



- Strong DryGuard™ fabric for durability and tear-resistance to trailering and weather
- Taped seam construction blocks water from entering through the stitching
- Integrated buckle and strap system for easy fitting and trailering, adjustable straps snap into quick-release buckles on the cover
- Dual rear air vents with built-in stiffeners reduce wind pressure during trailering and storms and allow inside moisture to escape









- Reinforcement panels on bow, windshield and stern for additional protection
- Elastic cord in bottom hem gives a tight, custom-like fit
- Full-cut to allow extra room for accessories
- Mesh storage bag and trailering straps included
- Bluesign® approved fabric*

Taped seam construction blocks water from entering through the stitching



Quick-release buckle & strap system for easy fitting & trailering



	Item/Fit			Retail Stock No	Case Qty
MODEL A	14'-16'L BEAM WIDTH TO 75"	 V-HULL FISHING BOATS		20-083-082401-00	1
MODEL B	14'-16'L BEAM WIDTH TO 90"	 V-HULL RUNABOUTS OUTBOARDS AND I/O	 V-HULL RUNABOUTS OUTBOARDS AND I/O	 ALUMINUM BASS BOATS	20-084-092401-00 1
MODEL C	16'-18.5'L BEAM WIDTH TO 98"	 FISH AND SKI BOATS	 PRO-STYLE BASS BOATS		20-085-102401-00 1
MODEL D	17'-19'L BEAM WIDTH TO 102"	 V-HULL RUNABOUTS OUTBOARDS AND I/O			20-086-112401-00 1
MODEL E	20'-22'L BEAM WIDTH TO 106"	 V-HULL RUNABOUTS OUTBOARDS AND I/O			20-087-122401-00 1
MODEL F	22'-24'L BEAM WIDTH TO 116"	 V-HULL RUNABOUTS OUTBOARDS AND I/O			20-088-132401-00 1

*The bluesign® system is the solution for sustainable textile production.

PVC Free

Stellex™ Boat Cover

WARRANTY

ALL-SEASON
PROTECTIONWATER
RESISTANTPROTECTION
UVELASTIC
HEM CORDCLICK-CLOSE
STRAPS

TRAILERABLE

STORAGE
BAG

Light and strong trailerable boat cover

COLOR: BLUE













- Tough polyester Stellex™ fabric designed for durability and weather protection
- Integrated buckle and strap system for easy fitting and trailering, adjustable straps snap into quick-release buckles on the cover
- Full-cut to allow extra room for accessories such as bow rails, running lights, etc.

- Elastic cord sewn into bottom hem for a tight, custom-like fit
- Fabric coating technology resists dirt and stains while providing water-resistance
- Storage bag and trailering straps included

Quick-release buckle & strap system for easy fitting & trailering



	Item/Fit			Retail Stock No	Case Qty	
MODEL AA	12'-14'L BEAM WIDTH TO 68"	 V-HULL FISHING BOATS		20-144-070501-00	1	
MODEL A	14'-16'L BEAM WIDTH TO 75"	 V-HULL FISHING BOATS		20-145-080501-00	1	
MODEL B	14'-16'L BEAM WIDTH TO 90"	 V-HULL RUNABOUTS OUTBOARDS AND I/O	 V-HULL RUNABOUTS OUTBOARDS AND I/O	 ALUMINUM BASS BOATS	20-146-090501-00	1
MODEL C	16'-18.5'L BEAM WIDTH TO 98"	 FISH AND SKI BOATS	 PRO-STYLE BASS BOATS		20-147-100501-00	1
MODEL D	17'-19'L BEAM WIDTH TO 102"	 V-HULL RUNABOUTS OUTBOARDS AND I/O			20-148-110501-00	1
MODEL E	20'-22'L BEAM WIDTH TO 106"	 V-HULL RUNABOUTS OUTBOARDS AND I/O			20-149-120501-00	1
MODEL F	22'-24'L BEAM WIDTH TO 116"	 V-HULL RUNABOUTS OUTBOARDS AND I/O			20-237-130501-00	1

PVC Free

Stellex™ T-Top Boat Cover



Light and strong boat cover

COLOR: BLUE





- Tough polyester Stellex™ fabric designed for durability and weather protection
- Integrated buckle and strap system for easy fitting, adjustable straps snap into quick-release buckles on the cover
- Full-cut to allow extra room for accessories such as bow rails, running lights, etc.

- Elastic cord sewn into bottom hem for a tight, custom-like fit
- Fabric coating technology resists dirt and stains while providing water-resistance
- Zippered access for easy installation
- Storage bag and straps included

Quick-release buckle & strap system for easy fitting



	Item/Fit		Retail Stock No	Case Qty
MODEL E	20'-22'L BEAM WIDTH TO 106"	 T-TOP BOATS	20-404-120501-RT	1
MODEL F	22'-24'L BEAM WIDTH TO 116"	 T-TOP BOATS	20-405-130501-RT	1

PVC Free

Stellex™ Center Console Boat Cover4
YEAR
WARRANTYALL-SEASON
PROTECTIONWATER
RESISTANTUV
PROTECTIONELASTIC
HEM CORDCLICK-CLOSE
STRAPS

TRAILERABLE

STORAGE
BAG

Light and strong trailerable boat cover

COLOR: BLUE





- Tough polyester Stellex™ fabric designed for durability and weather protection
- Integrated buckle and strap system for easy fitting and trailering, adjustable straps snap into quick-release buckles on the cover
- Full-cut to allow extra room for accessories such as bow rails, running lights, etc.

- Elastic cord sewn into bottom hem for a tight, custom-like fit
- Fabric coating technology resists dirt and stains while providing water-resistance
- Resistant to mildew and UV damage
- Storage bag and trailering straps included
- Includes integrated motor cover

Quick-release buckle
& strap system for easy
fitting & trailering



	Item/Fit		Retail Stock No	Case Qty
MODEL D	17'-19'L BEAM WIDTH TO 102"	 CENTER CONSOLE BOATS	20-402-110501-RT	1
MODEL E	20'-22'L BEAM WIDTH TO 106"	 CENTER CONSOLE BOATS	20-403-120501-RT	1



Stellex™ Pontoon Boat Cover

All-season pontoon boat cover

COLOR: BLUE

- Tough Stellex™ fabric designed for durability and weather protection
- Fits most popular pontoon boats
- Rope attaches to rugged non-scratch D-rings, no grommets to pull out or scratch
- Adjustable transom flap and an elastic cord sewn into the bottom hem provides a tight, custom-like fit



	Item/Fit		Retail Stock No	Case Qty
MODEL A	17'-20'L BEAM WIDTH TO 102"		20-150-080501-00	1
MODEL B	21'-24'L BEAM WIDTH TO 102"		20-151-090501-00	1

Stellex™ Kayak, Canoe and Stand-Up Paddleboard Cover



Protects from dirt, sun and weather

COLOR: BLUE

- Tough polyester Stellex™ fabric designed for durability and weather protection
- Fabric coating technology resists dirt and stains while providing water resistance
- Resistant to UV damage
- Storage bag included
- Full-cut to allow extra room for accessories such as paddles, life vests, etc.
- Dual zipper provides fast and easy access to canoes, SUPs, or kayaks, and allows for cable lock for secure storage (lock not included)



Item/Fit		Retail Stock No	Case Qty
MODEL A			
FITS UP TO 12'L KAYAKS, CANOES AND STAND-UP PADDLEBOARDS		20-406-140501-RT	1
MODEL B			
FITS UP TO 16'L KAYAKS, CANOES AND STAND-UP PADDLEBOARDS		20-407-150501-RT	1

PVC Free

Stellex™ Folding Boat Seat & Center Console Cover



Protects folding boat seats and center consoles from dirt, sun and weather

COLOR: BLUE

- Tough polyester Stellex™ fabric designed for durability and weather protection
- Folds easy for storage
- Elastic cord in bottom hem provides a quick and secure fit (Folding Seat Cover)
- Drawstring with cord lock in bottom hem provides a quick and secure fit (Center Console)
- Fabric coating technology resists dirt and stains while providing water-resistance and repellency
- Provides UV protection
- All-season protection

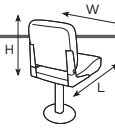
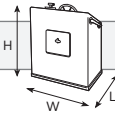

Item/Fit		Retail Stock No	Case Qty
FITS MOST PEDESTAL FOLDING SEATS UP TO 20"W 17.25"L 13"H		20-217-010501-00	6
FITS SMALL CENTER CONSOLES UP TO 36"W 24"L 42"H		20-218-020501-00	6
FITS MEDIUM CENTER CONSOLES UP TO 40"W 30"L 44"H		20-219-030501-00	6
FITS LARGE CENTER CONSOLES UP TO 46"W 40"L 45"H		20-220-040501-00	6

PVC Free

Stellex™ Trailerable Outboard Motor Cover



Protects outboard motors from dirt, sun and weather

COLOR: BLUE

- Covers motor cowling and motor to protect from sun and weather damage
- High-strength Stellex™ fabric engineered for extra durability and maximum weather protection
- Provides UV protection
- Webbing strap and side release buckle on hem cinch cover tightly over the motor
- FOR USE ONLY WHEN MOTOR IS NOT RUNNING

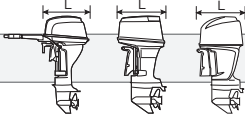

Item/Fit		Retail Stock No	Case Qty
25 TO 50 H.P. 23"L 16"W 17"H		20-269-160501-RT	6
50 TO 115 H.P. 24"L 18"W 23"H		20-270-170501-RT	6
115 TO 225 H.P. 28"L 18"W 27"H		20-271-180501-RT	6

PVC Free

Stellex™ Personal Watercraft Cover



All-season travel cover with an integrated trailering system

COLOR: BLUE

- Tough polyester Stellex™ fabric designed for durability and weather protection
- Provides UV protection
- Integrated trailering system with built-in quick adjusting side-release straps
- Rear air vents reduce inside moisture and wind lofting
- Zippered access door on both sides
- Elastic cord in bottom hem provides a quick and secure fit
- Tension panels tightly secure cover for highway travel
- Built-in strap keepers secure excess strap after tightening
- Integrated storage bag

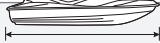

Item/Fit		Retail Stock No	Case Qty
MEDIUM FITS WATERCRAFTS UP TO 133"L		20-208-030501-00	6
LARGE FITS WATERCRAFTS UP TO 140"L		20-209-040501-00	6

PVC Free

Jon Boat Cover



Protects 10'–14' L Jon boats from dirt, sun and weather

COLOR: OLIVE

- Weather Protected™ polyester fabric resists mildew
- Provides UV protection
- Dual air vents reduce inside moisture and air pressure in winds
- Elastic cord in bottom hem provides a quick and secure fit
- Reinforced corners
- Heavy-duty non-scratch D-rings
- Includes a handy storage bag and tie-down rope



Item/Fit		Retail Stock No	Case Qty
MODEL B 14'L JON BOATS, BEAM WIDTH TO 62"		20-213-041401-00	6

Boat Cover Support Pole

Supports boat covers to minimize pooling of water and debris

- Multiple-piece pole fits together to adjust to needed height
- Supports any part of a boat cover
- Made of rust-proof, ABS plastic

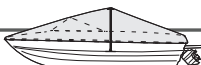

Item/Fit		Retail Stock No	Case Qty
ADJUSTS FROM 12"–54"H		05900-SC	6

GOLF



FOCUS ON YOUR GAME, NOT THE FORECAST



PVC Free

Golf Car Quick-Fit Cover

2
YEAR
WARRANTYHEAVY-DUTY
PROTECTIONWATER
REPELLANTUV
PROTECTION

AIR VENTS



REFLECTIVE

ELASTIC
BOTTOM HEMZIPPERED
ACCESSSTORAGE
BAG

Storage cover with rear access zipper, rear air vents and tie down security points

COLORS: LIGHT KHAKI AND BLACK



Storage bag included

- Weather Protected™ fabric won't shrink or stretch
- Elastic cord in bottom hem for a custom-like fit
- Protects golf cars from sun, weather damage and dirt
- Rear zipper for easy entry and installation
- Rear air vents reduce wind lofting and inside moisture
- Water-repellent fabric
- Reflective piping
- Tie-down straps to prevent blow off
- Integrated storage bag

Rear zippered access



Item/Fit	Colors	Retail Stock No	Case Qty
SHORT ROOF (UP TO 60" L ROOF*) FITS MOST TWO-PERSON GOLF CARS	LIGHT KHAKI	40-040-335801-00	3
	BLACK	40-063-330401-00	3
LONG ROOF (UP TO 80" L ROOF*) FITS MOST FOUR-PERSON GOLF CARS	LIGHT KHAKI	40-041-345801-00	3
	BLACK	40-064-340401-00	3
EXTRA LONG ROOF (UP TO 124" L ROOF*) FITS MOST SIX-PERSON GOLF CARS	LIGHT KHAKI	40-042-345801-00	3
CONVERSION CAR (UP TO 60" L ROOF*) FITS MOST FOUR-PERSON GOLF CARS	LIGHT KHAKI	40-067-015801-RT	3

*Not designed to entirely cover the wheels.

PVC Free

Easy-On Golf Car Cover



Rugged storage cover with rear access zipper and rear air vents

COLOR: TAN

- Weather Protected™ fabric won't shrink or stretch
- Elastic cord in bottom hem for a custom-like fit
- Protects golf cars from dirt and weather damage
- Rear zipper for easy entry and installation
- Rear air vents reduce wind lofting and inside moisture
- Tough water-repellent fabric
- Integrated storage bag



Item/Fit		Retail Stock No	Case Qty
SHORT ROOF (UP TO 60" L ROOF*)		72402	6
FITS MOST TWO-PERSON GOLF CARS			
LONG ROOF (UP TO 80" L ROOF*)		74442	6
FITS MOST FOUR-PERSON GOLF CARS			

*Not designed to entirely cover the wheels.

PVC Free

Golf Car Cover



Protects valuable golf cars against dirt and weather damage

COLOR: LIGHT KHAKI

- Weather Protected™ fabric won't shrink or stretch
- Elastic cord in bottom hem for a custom-like fit
- Protects golf cars from dirt and weather damage
- Structured rear air vents reduce wind lofting and inside moisture
- Tough water-repellent fabric
- Integrated storage bag



Item/Fit		Retail Stock No	Case Qty
SHORT ROOF (UP TO 60" L ROOF*)		40-038-335801-00	3
FITS MOST TWO-PERSON GOLF CARS			
LONG ROOF (UP TO 80" L ROOF*)		40-039-345801-00	3
FITS MOST FOUR-PERSON GOLF CARS			

*Not designed to entirely cover the wheels.

FadeSafe® Club Car® Precedent* Golf Car Enclosure



Custom fit for Club Car® Precedent two and four-person golf cars

COLOR: LIGHT KHAKI



Storage bag included

- FadeSafe® solution-dyed fabric significantly reduces sun bleaching
- Full protection against weather and wind
- Fits over roof and secures with hooks on bottom
- Quick zip-off windshield stores in front pocket
- Keeps golf cars clean and dry
- Super-clear window material with heavy-duty polyester walls and top
- Zippered doors and panels adjust quickly and easily to any weather condition

- Doors can be rolled back or completely removed
- Interior and exterior zipper pulls for quick and easy access to the golf car
- Reflective piping for enhanced safety
- Convenient carrying duffel bag with padded handle included

Dual-sided zipper pulls make getting in and out of the enclosure easy and convenient

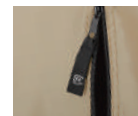

Doors and windows roll open and secure with rip-n-grip straps



Item/Fit	Color	Retail Stock No	Case Qty
SHORT ROOF (UP TO 59" L ROOF) FITS CLUB CAR® PRECEDENT i2 TWO-PERSON GOLF CARS	 LIGHT KHAKI	40-060-335801-00	1



*Precedent is a copyright of Club Car, LLC, a subsidiary of Ingersoll-Rand Plc. Classic Accessories is not affiliated or associated with Club Car, LLC, Ingersoll-Rand Plc. or its products in any way.

FadeSafe® E-Z-Go® Golf Car Enclosure



Custom fit for E-Z-Go® two-person golf cars

COLORS: LIGHT KHAKI AND NAVY NEWS

- FadeSafe® solution-dyed fabric significantly reduces sun bleaching
- Full protection against weather and wind
- Fits over roof and secures with hooks on bottom
- Quick zip-off windshield stores in front pocket
- Keeps golf cars clean and dry
- Super-clear window material with heavy-duty polyester walls and top
- Zippered doors and panels adjust quickly and easily to any weather condition
- Doors can be rolled back or completely removed

- Windshield bumper access points
- Interior and exterior zipper pulls for quick and easy access
- Reflective piping for enhanced safety
- Convenient carrying duffel bag with padded handles included



Item/Fit	Colors	Retail Stock No	Case Qty
SHORT ROOF (UP TO 59" L ROOF)	LIGHT KHAKI	40-058-335801-00	1
FITS E-Z-GO® TXT & RXV TWO-PERSON GOLF CARS	NAVY NEWS	40-059-335501-00	1

*E-Z-Go® is a registered trademark of Textron, Inc. Classic Accessories is not affiliated or associated with Textron, Inc. or its products in any way.

FadeSafe® Yamaha® The Drive² Golf Car Enclosure



Custom fit for The Drive² by Yamaha® two-person golf cars

COLORS: LIGHT KHAKI AND NAVY NEWS

- FadeSafe® solution-dyed fabric significantly reduces sun bleaching
- Full protection against weather and wind
- Fits over roof and secures with hooks on bottom
- Quick zip-off windshield stores in front pocket
- Keeps golf cars clean and dry in storage
- Super-clear window material with heavy-duty polyester walls and top
- Zippered doors and panels adjust quickly and easily to any weather condition
- Doors can be rolled back or completely removed

- Interior and exterior zipper pulls for quick and easy access to the golf car
- Reflective piping for enhanced safety
- Convenient carrying duffel bag with padded handle included



Item/Fit	Colors	Retail Stock No	Case Qty
SHORT ROOF (UP TO 68" L ROOF)	LIGHT KHAKI	40-056-335801-00	1
FITS MOST THE DRIVE ² BY YAMAHA® TWO-PERSON GOLF CARS	NAVY NEWS	40-057-335501-00	1

*The Drive² by Yamaha® is a copyright of Yamaha Golf Car Company, a subsidiary of Yamaha Motor Co. Ltd. Classic Accessories is not affiliated or associated with Yamaha Motor Co. Ltd. or its products in any way.



Deluxe Golf Car Enclosure

Sizes to fit two-, four-, or six-person golf cars

COLORS: LIGHT KHAKI, NAVY NEWS AND BLACK

- Gardelle™ fabric won't shrink or stretch
- Heavy-duty ProtekX6™ fabric with water-resistant backing and exterior coating for maximum weather and abrasion protection
- Full protection against weather and wind
- Fits over roof and secures with hooks on bottom
- Quick zip-off windshield
- Keeps golf cars clean and dry
- Super-clear window material with heavy-duty polyester walls and top
- Zippered doors and panels adjust quickly and easily to any weather condition
- Removable doors
- Interior and exterior zipper pulls for quick and easy access
- Reflective piping for enhanced safety
- Convenient carrying duffel bag with padded handle included



Item/Fit		Colors	Retail Stock No	Case Qty
SHORT ROOF (UP TO 68" L ROOF) FITS MOST TWO-PERSON GOLF CARS		LIGHT KHAKI	40-049-335801-00	1
		BLACK	40-054-330401-00	1
LONG ROOF (UP TO 80" L ROOF) FITS MOST FOUR-PERSON GOLF CARS		LIGHT KHAKI	40-050-345801-00	1
		NAVY NEWS	40-053-345501-00	1
		BLACK	40-055-340401-00	1
EXTRA LONG ROOF (UP TO 124" L ROOF) FITS MOST SIX-PERSON GOLF CARS		LIGHT KHAKI	40-051-345801-00	1

Deluxe 4-Sided Golf Car Enclosure



Sizes to fit two or four person golf cars with or without windshields

COLOR: SAND

- Fits over roof—just roll down sides when bad weather threatens
- Keeps golf cars clean and dry in storage
- Super-clear window material with heavy-duty polyester walls and top
- Roof valance covers rolled up panels
- Six zip-open panels roll up and down independently for quick and easy adjustment to any weather condition
- Carrying case included



Item/Fit		Retail Stock No	Case Qty
FITS MOST TWO-PERSON GOLF CARS: 66" L 53" W ROOF DIMENSIONS: 60" L 47" W		72072	3
FITS MOST FOUR-PERSON GOLF CARS: 94" L 47" W ROOF DIMENSIONS: 79" L 43" W		72472	3

Travel Golf Car Enclosure



Fast and portable protection against wind and rain for two and four-person golf cars

COLORS: LIGHT KHAKI AND NAVY NEWS

- Weather Protected™ fabric won't shrink or stretch
- Fits over roof and secures with hooks on bottom
- Keeps golf cars clean and dry in storage
- Super-clear windows
- Zippered doors open to the side for easy entry
- Rear panel zips open for easy access to clubs
- Interior and exterior zipper pulls for quick and easy access to the golf car
- Reflective piping for enhanced safety
- Folds down to compact size for easy travel and storage
- Convenient carrying duffel bag included



Item/Fit		Colors	Retail Stock No	Case Qty
SHORT ROOF (UP TO 68" L ROOF)		LIGHT KHAKI	40-045-335801-00	1
FITS MOST TWO-PERSON GOLF CARS		NAVY NEWS	40-047-335501-00	1
LONG ROOF (UP TO 80" L ROOF)		LIGHT KHAKI	40-046-345801-00	1
FITS MOST FOUR-PERSON GOLF CARS				

Travel 2 Passenger Golf Car Enclosure



Fast and portable protection against wind and rain

COLOR: TAN

- Weather Protected™ fabric won't shrink or stretch
- Fits over roof and secures with hooks on bottom
- Keeps golf cars clean and dry in storage
- Super-clear windows
- Zippered doors open to the side for easy entry
- Rear panel zips open for easy access to clubs
- Folds down to compact size for easy travel and storage
- Convenient carrying duffel bag included



Item/Fit		Retail Stock No	Case Qty
FITS MOST TWO-PERSON GOLF CARS		72052	6
ROOF DIMENSIONS: 54.5" L 41" W			

Golf Car Neoprene Paneled Seat Cover



COLORS: LIGHT KHAKI/BLACK AND NAVY NEWS/BLACK

- Durable, water-resistant Gardelle™ fabric won't shrink or stretch
- Extends the life of your seats—protects against dirt, sun damage and wear
- Covers and renews older or damaged seats
- Reflective piping for added visibility
- Machine washable
- Elastic hem and click-close strap system provide a custom-like fit
- Fits most golf car seats in minutes



Item/Fit	Colors	Retail Stock No	Case Qty
FITS MOST TWO-PERSON GOLF CAR BENCH SEATS	LIGHT KHAKI/BLACK	40-034-015801-00	3
	NAVY NEWS/BLACK	40-035-015501-00	3



Golf Car Diamond Air Mesh Seat Cover



COLORS: LIGHT KHAKI, NAVY NEWS AND BLACK

- Unique diamond mesh weave allows air circulation, adds comfort and creates a technical, sporty look
- Extends the life of your seats—protects against dirt, sun damage and wear
- Covers and renews older or damaged seats
- Machine washable
- Elastic hem and strap system provide a custom like fit
- Fits most golf car seats in minutes
- Elastic hem and strap system



Item/Fit	Colors	Retail Stock No	Case Qty
FITS MOST TWO-PERSON GOLF CAR BENCH SEATS	LIGHT KHAKI	40-032-015801-00	3
	NAVY NEWS	40-033-015501-00	3
	BLACK	40-031-010401-00	3



PVC Free

Golf Car Terry Cloth Seat Cover



COLORS: LIGHT KHAKI, NAVY NEWS AND BLACK

- Soft terry cloth fabric is comfortable against skin & protects from heat or cold
- Extends the life of your seats—protects against dirt, sun damage and wear
- Covers and renews older or damaged seats
- Machine washable
- Elastic hem and strap system provide a custom-like fit
- Fits most golf car seats in minutes



Item/Fit	Colors	Retail Stock No	Case Qty
FITS MOST TWO-PERSON GOLF CAR BENCH SEATS	LIGHT KHAKI	40-029-015801-00	3
	NAVY NEWS	40-030-015501-00	3
	BLACK	40-028-010401-00	3



PVC Free

Golf Car Seat Blankets



COLORS: LIGHT KHAKI, NAVY NEWS, PERFECT PINK/SILVER SHOT, HERITAGE AND HOUNDSTOOTH

- Instant protection from hot, cold or dirty golf car seats
- Quilted top with plush fleece backing
- Wipe-clean water-resistant heavy-duty fabric
- Quickly secures over golf cart arm rests
- Also great as a lap blanket
- Self-packs for easy transport
- Machine washable
- Exterior pocket offers storage & placement for personalized embroidery
- Reflective piping on Light Khaki, Navy News and Perfect Pink/Silver Shot



Item/Fit	Colors	Retail Stock No	Case Qty
FITS MOST TWO-PERSON GOLF CAR SEATS WITH ARMRESTS	LIGHT KHAKI	40-023-015801-00	3
FITS MOST TWO-PERSON GOLF CAR SEATS WITH ARMRESTS	NAVY NEWS	40-022-015501-00	3
FITS MOST TWO-PERSON GOLF CAR SEATS WITH ARMRESTS	PERFECT PINK / SILVER SHOT	40-024-014401-00	3
FITS MOST TWO-PERSON GOLF CAR SEATS WITH ARMRESTS	HERITAGE	40-015-013701-00	3
FITS MOST TWO-PERSON GOLF CAR SEATS WITH ARMRESTS	HOUNDSTOOTH	40-027-015701-00	3



Deluxe Portable Golf Car Windshield



COLOR: SAND/CLEAR

- Stores in a golf bag and installs in seconds to provide a shield against wind and rain
- Fits in seconds on most popular golf cars
- Attaches quickly and securely with rip-n-grip straps
- Super-clear material rolls up for easy storage in a golf bag



Item/Fit	Retail Stock No	Case Qty
FITS MOST GOLF CARS WITH ROOFS 38"L 29"H	40-001-012401-00	6



Standard Portable Golf Car Windshield



COLOR: WHITE/CLEAR

- Stores in a golf bag and installs in seconds to provide a shield against wind and rain
- Fits most popular golf cars
- Attaches with three elastic cords
- Super-clear material rolls up for easy storage in a golf bag
- Includes storage bag



Item/Fit	Retail Stock No	Case Qty
FITS MOST GOLF CARS WITH ROOFS 47"L 36"H	72033	6



HOME GARAGE



StormPro™ RainProof™ Heavy-Duty Tractor Cover



All-weather, heavy-duty protection for tractors

COLOR: DARK GREY/ MEDIUM GREY

- Durable, water-repellent fabric backed with protective, water-resistant PVC provides protection against rain, snow, sun and dirt and won't crack in cold weather
- Critically seams are taped to help keep rain out and your equipment protected
- Adjustable tension panels with click-close straps provide a quick and customizable fit with exceptional security in windy conditions
- Air vents provide maximum ventilation and minimum condensation
- Elastic hem cord in bottom hem for a quick custom-like fit
- Reflective piping on air vents for safer night-time visibility

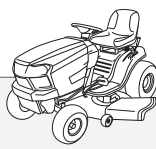
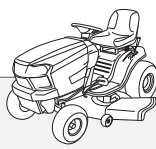

Item/Fit		E-Commerce Stock No	Case Qty
MEDIUM FITS LAWN & GARDEN TRACTORS		52-241-031001-EC	3
UP TO 72"L 44"W 46"H WITH DECKS UP TO 54"W*			
LARGE FITS LAWN & GARDEN TRACTORS		52-240-041001-EC	3
UP TO 82"L 50"W 47"H WITH DECKS UP TO 62"W*			

StormPro™ RainProof™ Heavy-Duty Compact Utility Tractor Cover



All-weather, heavy-duty protection for compact utility tractors

COLOR: DARK GREY/ MEDIUM GREY

- Durable, water-repellent fabric backed with protective, water-resistant PVC provides protection against rain, snow, sun and dirt and won't crack in cold weather
- Critically seams are taped to help keep rain out and your equipment protected
- Adjustable tension panels with click-close straps provide a quick and customizable fit with exceptional security in windy conditions
- Air vents provide maximum ventilation and minimum condensation
- Elastic hem cord in bottom hem for a quick custom-like fit
- Reflective piping on air vents for safer night-time visibility

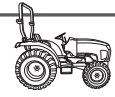

Item/Fit		E-Commerce Stock No	Case Qty
COMPACT UTILITY TRACTOR		52-239-011001-EC	6
FITS COMPACT UTILITY TRACTORS FROM SEATBACK TO COWLING FRONT UP TO 79" L			

*Not designed to entirely cover the wheels.

StormPro™ RainProof™ Heavy-Duty Zero-Turn Mower Cover



All-weather, heavy-duty protection for zero-turn mowers

COLOR: DARK GREY/ MEDIUM GREY

- Durable, water-repellent fabric backed with protective, water-resistant PVC provides protection against rain, snow, sun and dirt and won't crack in cold weather
- Critically seams are taped to help keep rain out and your equipment protected
- Adjustable tension panels with click-close straps provide a quick and customizable fit with exceptional security in windy conditions
- Air vents provide maximum ventilation and minimum condensation
- Elastic hem cord in bottom hem for a quick custom-like fit
- Reflective piping on air vents for safer night-time visibility



Item/Fit	E-Commerce Stock No	Case Qty
MEDIUM ZERO-TURN TRACTOR		
FITS ZERO-TURN MOWERS WITH A DECK UP TO 50"W*	52-233-031001-EC	6
LARGE ZERO-TURN TRACTOR		
FITS ZERO-TURN MOWERS WITH A DECK UP TO 60"W*	52-232-041001-EC	6



StormPro™ RainProof™ Heavy-Duty Lawn Mower Cover



All-weather, heavy-duty protection for lawn mowers

COLOR: DARK GREY/ MEDIUM GREY

- Durable, water-repellent fabric backed with protective, water-resistant PVC provides protection against rain, snow, sun and dirt and won't crack in cold weather
- Critically seams are taped to help keep rain out and your equipment protected
- Adjustable tension panels with click-close straps provide a quick and customizable fit with exceptional security in windy conditions
- Air vents provide maximum ventilation and minimum condensation
- Elastic hem cord in bottom hem for a quick custom-like fit
- Reflective piping on air vents for safer night-time visibility
- Zipper provides easy access and installation



Item/Fit	E-Commerce Stock No	Case Qty
LAWN MOWER		
FITS GAS, ELECTRIC & PUSH REEL MOWERS*	52-234-011001-EC	6



*Not designed to entirely cover the wheels.

StormPro™ RainProof™ Heavy-Duty Log Splitter Cover



All-weather, heavy-duty protection for log splitters

COLOR: DARK GREY/ MEDIUM GREY

- Durable, water-repellent fabric backed with protective, water-resistant PVC provides protection against rain, snow, sun and dirt and won't crack in cold weather
- Critically seams are taped to help keep rain out and your equipment protected
- Adjustable tension panels with click-close straps provide a quick and customizable fit with exceptional security in windy conditions
- Air vents provide maximum ventilation and minimum condensation
- Elastic hem cord in bottom hem for a quick custom-like fit
- Reflective piping on air vents for safer night-time visibility

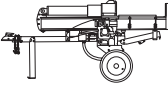

Item/Fit		E-Commerce Stock No	Case Qty
LOG SPLITTER		52-231-011001-EC	6
UP TO 82"L 45" W 34"H*			

StormPro™ RainProof™ Heavy-Duty Log Rack Cover



All-weather, heavy-duty protection for log racks

COLOR: DARK GREY/ MEDIUM GREY

- Durable, water-repellent fabric backed with protective, water-resistant PVC provides protection against rain, snow, sun and dirt and won't crack in cold weather
- Critically seams are taped to help keep rain out and your equipment protected
- Adjustable tension panels with click-close straps provide a quick and customizable fit with exceptional security in windy conditions
- Air vents provide maximum ventilation and minimum condensation
- Elastic hem cord in bottom hem for a quick custom-like fit
- Reflective piping on air vents for safer night-time visibility
- Reinforced top corners for strength and durability
- Full height zippers provide easy access and installation



Item/Fit		E-Commerce Stock No	Case Qty
MEDIUM LOG RACK		52-230-031001-EC	6
FITS 4'L LOG RACKS 48"L 24"W 42"H*			
LARGE LOG RACK		52-229-041001-EC	6
FITS 8'L LOG RACKS 96"L 24"W 42"H*			

*Not designed to entirely cover the wheels.

StormPro™ RainProof™ Heavy-Duty Generator Covers



All-weather, heavy-duty protection for generators

COLOR: DARK GREY/ MEDIUM GREY

- Durable water-repellent fabric backed with protective water resistant PVC provides protection against rain, snow, sun and dirt and won't crack in cold weather
- Critically taped seams help keep rain out and your equipment protected
- Adjustable tension panels with click-close straps provide a quick and customizable fit with exceptional security in windy conditions
- Air vents provide maximum ventilation and minimum condensation
- Elastic hem cord in bottom hem for a quick custom-like fit
- Reflective piping on air vents for safer night-time visibility
- Zippered panels for ease of installation



Item/Fit		E-Commerce Stock No	Case Qty
LARGE GENERATORS			
UP TO 30.25"L 22"W 19.25"H*		52-225-041001-EC	6
X LARGE GENERATORS			
UP TO 34.5"L 22.5"W 25.5"H*		52-226-051001-EC	6
XX LARGE GENERATORS			
UP TO 37"L 27"W 30"H*		52-227-061001-EC	6

StormPro™ RainProof™ Heavy-Duty Snow Thrower Cover



All-weather, heavy-duty protection for snow throwers

COLOR: DARK GREY/ MEDIUM GREY

- Durable water-repellent fabric backed with protective water resistant PVC provides protection against rain, snow, sun and dirt and won't crack in cold weather
- Critically taped seams help keep rain out and your equipment protected
- Adjustable tension panels with click-close straps provide a quick and customizable fit with exceptional security in windy conditions
- Air vents provide maximum ventilation and minimizes condensation
- Elastic hem cord in bottom hem for a quick custom-like fit
- Reflective piping on air vents for safer night-time visibility



Item/Fit		E-Commerce Stock No	Case Qty
SNOW THROWER			
FITS MOST TWO-STAGE SNOW THROWERS*		52-228-011001-EC	6

PVC Free

Heavy-Duty Tractor Cover



All-season, heavy-duty protection for tractors

COLOR: DARK GREY/ MEDIUM GREY

- Durable, water-repellent fabric backed with protective, water-resistant PVC provides protection against rain, snow, sun and dirt and won't crack in cold weather
- Adjustable tension panels with click-close straps provide a quick and customizable fit with exceptional security in windy conditions
- Air vents provide maximum ventilation and minimum condensation
- Elastic hem cord in bottom hem for a quick custom-like fit
- Reflective piping on air vents for safer night-time visibility

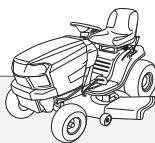

Item/Fit		Retail Stock No	Case Qty
MEDIUM FITS LAWN & GARDEN TRACTORS			
UP TO 72"L 44"W 46"H WITH DECKS UP TO 54"W*		52-148-380301-00	3
LARGE FITS LAWN & GARDEN TRACTORS			
UP TO 82"L 50"W 47"H WITH DECKS UP TO 62"W*		52-149-380401-00	3

PVC Free

Deluxe Tractor Cover



All-season, heavy-duty protection for lawn or garden tractors

COLOR: BLACK

- Storm-X™ fabric with water-repellent outer coating for maximum strength and weather protection
- Heavy-duty protection against UV damage, rain, dirt, birds and tree sap
- Dual air vents let air circulate and help prevent ballooning in wind
- Interior lining protects machinery from scratches
- Heavy-duty fabric won't shrink or stretch
- Elastic shock cord in bottom hem for a quick, custom-like fit
- EasyOn™ side handles and split back for fast fitting and easy access after installation
- Integrated storage bag

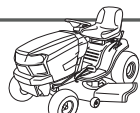

Item/Fit		Retail Stock No	Case Qty
MEDIUM FITS LAWN & GARDEN TRACTORS			
UP TO 72"L 44"W 46"H WITH DECKS UP TO 54"W*		73967	6

PVC Free

Tractor Cover



All-weather protection for lawn or garden tractors

COLORS: BLACK AND OLIVE

- Weather-X™ fabric with water-repellent outer coating for maximum strength and weather protection
- Protects against UV damage, rain, dirt, birds and tree sap
- Reinforced air vent lets air circulate and helps prevent ballooning in winds
- Elastic shock cord in bottom hem for a quick, custom-like fit



Item/Fit	Colors	Retail Stock No	Case Qty
MEDIUM FITS LAWN & GARDEN TRACTORS UP TO 72"L 44"W 46"H WITH DECKS UP TO 54"W*	BLACK	55-081-010401-00	3
	OLIVE	73910**	6
LARGE FITS LAWN & GARDEN TRACTORS UP TO 82"L 50"W 47"H WITH DECKS UP TO 62"W*	BLACK	52-147-040401-00	3



PVC Free

Tractor with Installed Bagger Cover



Weather protection for tractors with installed baggers

COLOR: BLACK

- Weather-X™ fabric with water-resistant backing for extra weather and abrasion protection
- Protects against UV damage, rain, dirt, birds and tree sap
- Elastic shock cord in bottom hem for a quick and custom-like fit
- Reinforced air vent lets air circulate and helps prevent ballooning in the wind



Item/Fit	Retail Stock No	Case Qty
TRACTOR WITH INSTALLED BAGGER STORAGE COVER FITS RLE TRACTORS WITH BAGGER ATTACHMENT INSTALLED	52-221 050401-RT	3



*Not designed to entirely cover the wheels.

PVC Free

Zero-Turn Mower Cover



All-weather protection for lawn or garden tractors

COLOR: BLACK

- Weather-X™ fabric with water-repellent outer coating for maximum strength and weather protection
- Protects against UV damage, rain, dirt, birds and tree sap
- Reinforced air vent lets air circulate and helps prevent ballooning in winds
- Elastic shock cord in bottom hem for a quick, custom-like fit
- Handy storage bag

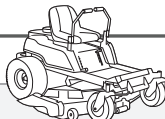

Item/Fit		Retail Stock No	Case Qty
MEDIUM FITS ZERO-TURN MOWERS WITH A DECK UP TO 50"W*		73997	6
LARGE FITS ZERO-TURN MOWERS WITH A DECK UP TO 60"W*		52-150-040401-00	6

Compact Utility Tractor Cover



All-season, heavy-duty protection for compact utility tractors

COLOR: DARK GREY/LIGHT GREY

- Heavy-duty protection against UV damage, rain, dirt, birds and tree sap
- Air vent lets air circulate and help prevent ballooning in wind
- Heavy-duty fabric won't shrink or stretch
- Elastic shock cord in bottom hem for a quick, custom-like fit
- Fits tractors with and without roll over bar
- Protects critical components such as engine mechanics, electronics, and seat



Item/Fit	Examples	Retail Stock No	Case Qty
FITS COMPACT UTILITY TRACTORS WITH SEATBACK TO COWLING FRONT UP TO 79"L	JD 1000® & 2000® CUT, NEW HOLLAND BOOMER®, KUBOTA BX SERIES®, MAHINDRA MAX® & EMAX® AND OTHERS	52-151-380301-RT	3



PVC Free

Tractor Seat Cover



COLOR: BLACK/GREY

- Storm-X™ fabric with water-repellent outer coating for maximum strength and weather protection
- Protects new seats and makes old seats look new
- Cushioned seat for extra comfort
- Convenient back pockets keep tools and gear within reach
- Elastic shock cord in bottom hem for a quick and custom-like fit
- Storage bag included



Item/Fit		Retail Stock No	Case Qty
SMALL FITS BACKRESTS 11.5"–13.5"H WITHOUT ARMRESTS		12314	3
MEDIUM FITS BACKRESTS 14"–16.5"H WITHOUT ARMRESTS		12324	3
LARGE FITS BACKRESTS 16.5"–19"H WITHOUT ARMRESTS		52-152-043201-RT	3

PVC Free

Neoprene Paneled Tractor Seat Cover



COLOR: DARK GREY/GREY

- Storm-X™ fabric with water-repellent outer coating for maximum strength and weather protection
- Protects new seats and makes old seats look new
- Cushioned seat for extra comfort
- Convenient back pockets keep tools and gear within reach
- Elastic shock cord in bottom hem for a quick and custom-like fit
- Reflective piping on pockets
- Interior non-slip panels keep cover in place
- Side openings for seats with or without arm rests
- Contoured neoprene fabric provides better fit on shaped seats



Item/Fit		Retail Stock No	Case Qty
MEDIUM FITS BACKRESTS 14"–16.5"H WITH OR WITHOUT ARMRESTS		52-144-380301-00	3
LARGE FITS BACKRESTS 17"–19"H WITH OR WITHOUT ARMRESTS		52-145-380401-00	3

PVC Free

Lawn Mower Cover



All-weather protection for lawn mowers

COLOR: BLACK

- Weather-X™ fabric with water-repellent outer coating for maximum strength and weather protection
- Protects against UV damage, rain, dirt, birds and tree sap
- Covers both mower and attached catcher on rear discharge mowers
- Elastic shock cord in bottom hem for a quick, custom-like fit
- Click-it closure on back makes installation and removal a snap
- Integrated storage bag

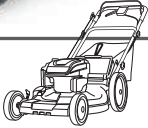

Item/Fit	Retail Stock No	Case Qty
FITS GAS, ELECTRIC AND PUSH REEL MOWERS* 	73117	4

PVC Free

Rototiller Cover



All-weather protection for rototillers

COLOR: BLACK

- Storm-X™ fabric with water-repellent outer coating for maximum strength and weather protection
- Fast protection when storing or on the job
- Protects against UV damage, rain, dirt, birds and tree sap
- Elastic hem cord in bottom hem with adjustable cord-lock for a quick and custom-like fit
- Click-close strap quickly secures cover to rototiller
- Integrated storage bag



Item/Fit	Retail Stock No	Case Qty
FITS MOST ROTOTILLERS UP TO 46"L 22"W 41"H (BACK) 17"H* (FRONT) 	52-040-010401-00	3

*Not designed to entirely cover the wheels.

PVC Free

Generator Cover



Keeps dirt, debris, and weather out of the motor

COLOR: BLACK

- Weather-X™ fabric with water-repellent outer coating for maximum strength and weather protection
- Fast protection when storing at home or on the job
- Protects against UV damage, rain, dirt, birds and tree sap
- Medium size has an elastic hem cord; larger sizes close with rip-n-grip tabs
- Openings for generators with handles (large and x large sizes only)
- Integrated storage bag



Item/Fit		Retail Stock No	Case Qty
MEDIUM FITS GENERATORS TO 3,000 WATTS 22.5"L 16.5"W 16"H*		79527-SC	6
LARGE FITS GENERATORS TO 7,000 WATTS 31.25"L 23"W 19.25"H*		79537	6
X LARGE FITS GENERATORS TO 15,000 WATTS 35.5"L 23.5"W 25.5"H*		79547	6
XX LARGE FITS GENERATORS 38"L 28"W 30"H* TO 17,500 WATTS		79557	3

PVC Free

Pressure Washer Cover



Protects pressure washers against rust, dust, and sun damage

COLOR: BLACK

- Weather-X™ fabric with water-repellent outer coating for maximum strength and weather protection
- Fast protection when storing at home or on the job
- Protects against UV damage, rain, dirt, birds and tree sap
- Elastic shock cord in bottom hem for a quick, custom-like fit
- Covers attached hose reels
- Click-it closure on back makes installation and removal a snap
- Integrated storage bag



Item/Fit		Retail Stock No	Case Qty
FITS VERTICAL OR HORIZONTAL STYLE PRESSURE WASHERS UP TO 48"L 18.5"W 13.5"H*		79507	6

*Not designed to entirely cover the wheels.

PVC Free

Log Splitter Cover



All-weather protection for rototillers

COLOR: BLACK

- Storm-X™ fabric with water-repellent outer coating for maximum strength and weather protection
- Keeps dirt, debris and weather out of the motor
- Fast protection when storing at home or on the job
- Protects against UV damage, rain, dirt, birds and tree sap
- Elastic hem cord in bottom hem for a quick, custom-like fit
- Integrated storage bag



Item/Fit		Retail Stock No	Case Qty
FITS GAS OR ELECTRIC LOG SPLITTERS UP TO 82"L 45"W 34"H*		52-041-010401-00	3

Log Rack Covers



All-weather protection for rototillers

COLOR: BLACK

- Storm-X™ fabric with water-resistant backing for maximum strength, abrasion and weather protection
- Protects firewood from dirt, debris and weather
- Dual air vents circulate air and help prevent ballooning in wind
- Click-close straps to secure cover on the windiest days
- Reinforced corners provide enhanced durability
- Elastic hem cord with non-scratch hooks for extra attachment options



Item/Fit		Retail Stock No	Case Qty
MEDIUM LOG RACK FITS 4'L LOG RACKS 48"L 24"W 42"H*		52-068-020401-00	1
LARGE LOG RACK FITS 8'L LOG RACKS 96"L 24"W 42"H*		52-069-030401-00	1

*Not designed to entirely cover the wheels.

Universal SL Snow Thrower Cab



Mid-sized cab provides protection from weather and snow blow-back

COLOR: BLACK

- Lightweight and easy to install/assemble
- Mid-sized cab provides protection from weather and snow blow-back
- Weather-X™ fabric won't shrink or stretch and resists both water and snow
- Designed to fit most dual stage snow throwers such as Ariens®, Toro®, Cub Cadet®, Honda®, Husqvarna®, and others
- Freeze-resistant, super-clear vinyl windows
- No drilling—quickly installs with standard hand tools
- Rugged, powder-coated steel tube frame
- Triple plate clamping system securely holds cab in place
- Quick release spring pins allow cab to be easily removed for transport and/or storage



13 cubic feet of interior room

Item/Fit	Examples	Retail Stock No	Case Qty
FITS MOST TWO-STAGE SNOW THROWERS WITH OR WITHOUT FOUR-WAY CHUTE CONTROL	ARIENS®, TORO®, CUB CADET®, HONDA®, HUSQVARNA®, AND OTHERS	52-086-010401-00	1

PVC Free

Snow Thrower Cover



All-season protection for snow throwers

COLOR: BLACK

- Weather Protected™ fabric won't shrink or stretch
- Fast slip-on protection
- Protects against rain and snow, sun damage, dust, tree sap and birds
- Elastic shock cord in bottom hem for a quick, custom-like fit
- Integrated storage bag

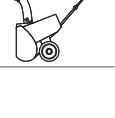

Item/Fit		Retail Stock No	Case Qty
FITS MOST TWO-STAGE SNOW THROWERS*		52-003-040105-00	3
FITS MOST TWO-STAGE SNOW THROWERS WITH TALLER CHUTES*		52-224-040401-RT	3
FITS MOST GAS AND ELECTRIC SINGLE-STAGE SNOW THROWERS*		52-067-010405-00	3

*Not designed to entirely cover the wheels.

Premium Garage Shelf Cover



COLOR: BLACK

- Weather-X™ fabric with water-resistant backing for extra weather and abrasion protection
- Multiple zippers allow easy access to both front and back of the garage shelf
- Rip-n-grip straps help secure cover to your shelf and roll-up back panel
- Reinforced top
- Convenient loops and toggles, allow for multiple ways to hold open cover doors
- Clear PVC windows make interior contents visible



Item/Fit		Retail Stock No	Case Qty
GARAGE SHELF		52-242-010401-RT	3
UP TO 49"W 19"D 72"H*			

Standard Garage Shelf Cover



COLOR: BLACK

- Weather-X™ fabric with water-resistant backing for extra weather and abrasion protection
- Zipper provides easy access to entire shelving unit
- Rip-and-grip tie-backs hold open door panels providing easy access to interior
- Tie-on straps help secure cover to your shelf
- Reinforced top



Item/Fit		Retail Stock No	Case Qty
GARAGE SHELF		52-216-010401-EC	10
UP TO 49"W 19"D 72"H			

*Not designed to entirely cover the wheels.

PVC Free

Bicycle Cover



All-season protection for bicycles

COLOR: BLACK

- Tough fabric with water-proof backing
- Air vents reduce condensation and wind lofting
- Elastic hem cord with toggles on either end
- Adjustable front and back panel with cord lock
- Rip-and-grip lock ports to allow passage of U locks or cables through cover
- Integrated storage bag



Item/Fit		Retail Stock No	Case Qty
1 OR 2 BICYCLES			
UP TO 73"L 35"W 35"H*		52-154-013801-RT	2

*Not designed to entirely cover the wheels.

Mesh Air Conditioner Cover



All-season protection against leaves, twigs and other debris

COLOR: BLACK

- Reinforced corners offer superior, lasting protection
- Four long-lasting bungee cords with metal hooks included for secure attachment

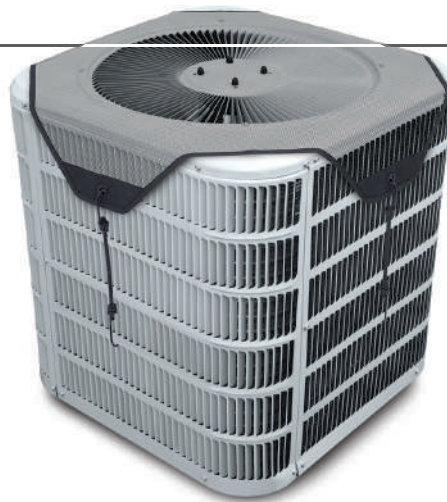

Item/Fit		Retail Stock No	Case Qty
MESH AIR CONDITIONER COVER			
UP TO 36"W 36"H (OPENING FOR FAN AIR DISCHARGE)		52-205-011001-RT	2

PVC Free



Evaporative Cooler Cover Heat Plug

Prevents cool air and drafts from entering through the grill and reduces noise*

COLOR: GREY

- Friction fit for a full and positive seal
- Easy to install
- Removable Hurricane™ fabric cover is easy to clean
- Thick interior insulation



Item/Fit		Retail Stock No	Case Qty
MODEL 0	FITS 14"L 14"W 4"H	52-032-301001-00	6
MODEL 1	FITS 18"L 18"W 4"H	52-033-141001-00	6
MODEL 2	FITS 20"L 20"W 4"H	52-034-151001-00	6

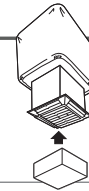

*Not for use when cooler is in operation

PVC Free



Universal Fit Duct Insulator

Prevents cool air and drafts from entering through the grill and reduces noise*

COLOR: GREY

- Friction fit for a full and positive seal
- Easy to install
- Thick interior insulation



Item/Fit		Retail Stock No	Case Qty
FITS 20"L 20"W		52-036-011001-00	6

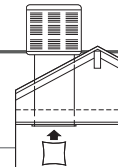

*Not for use when cooler is in operation

PVC Free

Evaporative Cooler Cover Straps

Provides extra security in high winds

COLOR: BLACK

- Includes two heavy-duty straps
- Easy-adjust metal cam buckles



Item/Fit		Retail Stock No	Case Qty
17'L 1"W STRAPS FIT ALL COVERS		52-030-010401-00	6



HOME PATIO | GRILL



SideSlider™ BBQ Grill Covers





COLOR: BLACK/GREY



- Full-height side zipper ensures easy slide-on installation
- PU coated, water resistant coil zipper
- Durable, water-repellent fabric backed with protective water resistant PVC provides protection against rain, snow, sun and dirt and won't crack in cold weather
- Robust, PVC at critical corners provide extra durability and longevity

- Patented WindLock® secure attachment system includes an adjustable belted hem with click-close straps that provide a customizable fit with exceptional security in the windiest conditions
- Air vent provides maximum ventilation and minimum condensation
- Reinforced padded handles provide comfort when installing and removing covers

Item/Fit		E-Commerce Stock No	Case Qty
MEDIUM BBQ GRILL		56-275-041001-EC	4
UP TO 58"L 30"D 48"H*			
LARGE BBQ GRILL		56-274-031001-EC	4
UP TO 64"L 30"D 48"H*			
X LARGE BBQ GRILL		56-276-051001-EC	4
UP TO 70"L 30"D 48"H*			

*Not designed to entirely cover the legs or wheels



Porterhouse™ BBQ Grill Cover



COLOR: LIMESTONE/CORD



- Wrap-tite™ rip-and-grip panels act as cinching mechanisms to keep the cover in place
- Robust, double-layered fabric panels with laminated PVC at critical corners provide extra durability and longevity
- Durable, water-repellent fabric backed with protective water resistant PVC provides protection against rain, snow, sun and dirt and won't crack in cold weather
- Two tie-down straps at opposite corners keep the cover securely in place to prevent blow off
- Air vent provides maximum ventilation and minimum condensation
- Soft, cushioned handles provide comfort in cover handling, installation and removal

Item/Fit		E-Commerce Stock No	Case Qty
MEDIUM BBQ GRILL		56-281-036601-EC	4
UP TO 58"L 30"D 48"H*			
LARGE BBQ GRILL		56-282-046601-EC	4
UP TO 64"L 30"D 48"H*			
X LARGE BBQ GRILL		56-283-056601-EC	4
UP TO 70"L 30"D 48"H*			

*Not designed to entirely cover the legs or wheels



StormPro™ RainProof™ BBQ Grill Cover



COLOR: DARK GREY/MEDIUM GREY



- Durable water-repellent fabric backed with protective water resistant PVC provides protection against rain, snow, sun and dirt and won't crack in cold weather
- Taped seams help keep rain out and your grill protected
- Reinforced corners help prevent tearing
- Adjustable compression panels with click-close straps provide a quick and customizable fit with exceptional security in windy conditions
- Webbing stay loops at the side seams help keep the click-close straps in place for easy access
- Air vent provides maximum ventilation and minimum condensation
- Webbing handles provide ease when installing and removing covers
- Side split panels allow easy-access to grill without taking off cover

Item/Fit		E-Commerce Stock No	Case Qty
MEDIUM BBQ GRILL		56-277-031001-EC	6
UP TO 58"L 30"D 48"H*			
LARGE BBQ GRILL		56-278-041001-EC	6
UP TO 64"L 30"D 48"H*			
X LARGE BBQ GRILL		56-279-051001-EC	6
UP TO 70"L 30"D 48"H*			

*Not designed to entirely cover the legs or wheels

Elkridge™ BBQ Grill Cover



COLOR: OTTER/BLACK





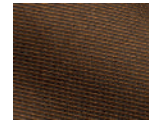

- Durable TwillTek™ fabric backed with protective water resistant PEVA provides protection against rain, snow, sun and dirt and won't crack in cold weather
- CinchLock™ tunnel with cord and cordlocks provide an easy way to quickly secure the cover and achieve a tailored fit

- Air vent provides maximum ventilation and minimum condensation
- Reinforced padded PU leather handles provide comfort when installing and removing covers
- Click-close straps snap around wheels/legs to secure cover on windy days

TwillTek™ fabric detail



Item/Fit		E-Commerce Stock No	Case Qty
MEDIUM BBQ GRILL			
UP TO 58"L 30"D 49"H*		56-270-036601-EC	8
LARGE BBQ GRILL			
UP TO 64"L 30"D 49"H*		56-269-046601-EC	8
X LARGE BBQ GRILL			
UP TO 70"L 30"D 49"H*		56-271-066601-EC	8
LARGE ROUND SMOKER			
WEBER® SMOKEY MOUNTAIN COOKER UP TO 24"DIA 46"H*		56-273-046601-EC	12
LARGE SQUARE SMOKER			
UP TO 21.5"L 16.5"D 39"H*		56-272-046601-EC	12

*Not designed to entirely cover the legs or wheels
 Weber® a trademark of Weber-Stein® Products, LLC



SkyShield™ BBQ Grill Covers



COLOR: BLACK/WHITE/BLACK



- Bonded DuPont™ Tyvek® used at top panel of the cover, is a lightweight fabric, tear resistant, UV and water resistant and easy to wipe clean
- Double-layered, grey PermaPRO™ ripstop fabric at top side panels protects cover from damage due to sharp table edges & heavy duty lower black polyester panel is ideal for high wear areas
- Adjustable compression panels with click-close straps provide a quick and customizable fit with exceptional security in windy conditions
- Webbing stay-loops at the side seams help keep the click-close straps in place for easy access
- Covered mesh air vent reduces wind lofting and inside condensation
- Webbing handles provide ease when installing and removing covers
- Integrated storage bag keeps your cover tidy when not in use

Item/Fit		E-Commerce Stock No	Case Qty
MEDIUM BBQ GRILL			
UP TO 58"L 24"D 48"H*		56-195-033101-EC	8
LARGE BBQ GRILL			
UP TO 64"L 24"D 48"H*		56-196-043101-EC	8
X LARGE BBQ GRILL			
UP TO 70"L 24"D 48"H*		56-197-053101-EC	8

*Not designed to entirely cover the legs or wheels



Montlake® FadeSafe® BBQ Grill Cover

HEAVY-DUTY
PROTECTIONPROTECTION
UVWON'T CRACK
IN THE COLDAIR VENTS
VENTADJUSTABLE
HEM CORDPADDED
HANDLESCLICK-CLOSE
STRAPS

COLORS: HEATHER HENNA



- Montlake® FadeSafe® solution-dyed fabric is both stylish and engineered to resist fading
- Water-repellent backed fabric helps keep rain out and your furniture protected
- Click-close straps snap over legs to secure cover on windy days
- Hooded air vents keep weather out while providing maximum ventilation and minimum condensation
- Conveniently placed reinforced handles for easy installation and removal of cover
- Cord lock closure within specially designed hem tunnel allows easy adjustment resulting in a custom-like fit

Item/Fit		Retail Stock No	Case Qty
MEDIUM BBQ GRILL			
UP TO 58"L 24"D 48"H*		55-847-031001-RT	1
X LARGE BBQ GRILL			
UP TO 70"L 24"D 48"H*		55-848-051001-RT	1

*Not designed to entirely cover the wheels or legs

Ravenna® BBQ Grill Covers



COLOR: DARK TAUPE/MUSHROOM/ESPRESSO



- Gardelle One™ is a durable woven polyester fabric with an added UV-stabilized coating and a water-resistant undercoating
- Patented WindLock® secure attachment system includes an adjustable belted hem with click-close straps that provide a customizable fit with exceptional security in the windiest conditions
- Engineered seams and double top-stitching at the most demanding joints provide strength, durability and style

- Gusseted, self-supporting side vents keeps weather out while providing maximum ventilation and minimum condensation
- Reinforced padded handles provide comfort when installing and removing covers
- Double cord closures within specially designed hem tunnels allow easy adjustment resulting in a custom-like fit







Item/Fit		E-Commerce Stock No	Case Qty
X SMALL BBQ GRILL UP TO 38"L 22"D 44"H*		55-849-365101-EC	8
SMALL BBQ GRILL UP TO 44"L 22"D 44"H*		55-850-025101-EC	8
MEDIUM BBQ GRILL UP TO 58"L 24"D 48"H*		55-140-035101-EC	6
LARGE BBQ GRILL UP TO 64"L 24"D 48"H*		55-141-045101-EC	6
X LARGE BBQ GRILL UP TO 70"L 24"D 48"H*		55-142-055101-EC	4
XX LARGE BBQ GRILL UP TO 72"L 26"D 51"H*		55-193-065101-EC	4
3X LARGE BBQ GRILL UP TO 80"L 26"D 51"H*		55-320-355101-EC	4

*Not designed to entirely cover the legs or wheels



Patio Built-In Grill and Kettle BBQ Grill Covers



COLOR: DARK TAUPE/MUSHROOM/ESPRESSO

Item/Fit		E-Commerce Stock No	Case Qty
X SMALL BUILT-IN GRILL TOP UP TO 32"L 26"D 24"H		55-326-365101-EC	12
SMALL BUILT-IN GRILL TOP UP TO 37"L 27"D 24"H		55-325-025101-EC	12
MEDIUM BUILT-IN GRILL TOP UP TO 45"L 29"D 26"H		55-324-035101-EC	10
LARGE BUILT-IN GRILL TOP UP TO 57"L 29"D 26"H		55-323-045101-EC	10
KETTLE GRILL UP TO 26.5"DIA 38"H*		55-178-015101-EC	18
LARGE KETTLE BBQ GRILL UP TO 30" DIA 43"H* FITS WEBER® PREMIUM 26" GRILL		55-998-045101-EC	12

Weber® is a registered trademark of Weber-Stephen Products LLC



Patio Kamado Ceramic Grill Covers





LARGE KAMADO CERAMIC GRILL UP TO 22"DIA WITH SIDE TABLES 40"H* (LARGE BIG GREEN EGG®)		55-321-045101-EC	12
X LARGE KAMADO CERAMIC GRILL UP TO 27"DIA WITH SIDE TABLES 45"H* (X LARGE BIG GREEN EGG®)		55-322-055101-EC	12
KAMADO CERAMIC GRILL WITH OFFSET TABLE UP TO 60"L 30"D 50"H*		55-420-015101-EC	5

*Not designed to entirely cover the wheels or legs
Big Green Egg is a registered trademark of Big Green Egg Inc. Corporation. Classic Accessories is not affiliated or associated with Big Green Egg Inc. or its products in any way.



Patio BBQ Grill Covers





COLOR: BLACK

Item/Fit		E-Commerce Stock No	Case Qty
MEDIUM BBQ GRILL UP TO 58"L 24"D 48"H*		55-390-030401-EC	6
LARGE BBQ GRILL UP TO 64"L 24"D 48"H*		55-391-040401-EC	6
X LARGE BBQ GRILL UP TO 70"L 24"D 48"H*		55-392-050401-EC	4
XX LARGE BBQ GRILL UP TO 72"L 26"D 51"H*		55-393-060401-EC	4
3X LARGE BBQ GRILL UP TO 80"L 26"D 51"H*		55-394-350401-EC	4

*Not designed to entirely cover the wheels or legs.



Patio Built-In Grill Top and Kamado Ceramic Grill Covers

X SMALL BUILT-IN GRILL TOP UP TO 32"L 26"D 24"H		55-397-360401-EC	12
SMALL BUILT-IN GRILL TOP UP TO 37"L 27"D 24"H		55-398-020401-EC	12
MEDIUM BUILT-IN GRILL TOP UP TO 45"L 29"D 26"H		55-399-030401-EC	10
LARGE KAMADO CERAMIC GRILL UP TO 22"DIA WITH SIDE TABLES 40"H* (LARGE BIG GREEN EGG®)		55-395-040401-EC	12
X LARGE KAMADO CERAMIC GRILL UP TO 27"DIA WITH SIDE TABLES 45"H* (X LARGE BIG GREEN EGG®)		55-396-050401-EC	12

*Not designed to entirely cover the wheels or legs.
Big Green Egg® is a registered trademark of Big Green Egg Inc. Corporation. Classic Accessories is not affiliated or associated with Big Green Egg Inc. or its products in any way.



Hickory® BBQ Grill Cover



COLOR: HICKORY/ANTIQUÉ OAK/MAHOGANY



- WeatherIO™ fabric features a rugged outer layer with a protective water-repellent and wipe-clean undercoating
- Click-close straps snap over legs to secure cover on windy days
- Covered air vent reduces condensation and wind lofting
- Padded handles for easy fitting and removal
- Elastic hem cords with toggle allow adjustment for a tight and custom fit

Item/Fit		E-Commerce Stock No	Case Qty	Retail Stock No	Case Qty
LARGE BBQ GRILL UP TO 64"L 24"D 48"H*				55-042-042401-00	1
X LARGE BBQ GRILL UP TO 70"L 24"D 48"H*				55-043-052401-00	1
XX LARGE BBQ GRILL UP TO 72"L 24"D 51"H*				55-197-062401-00	1



Patio Smoker Cover

LARGE ROUND SMOKER UP TO 24"DIA 46"H*				55-038-042401-00	1
---	---	--	--	------------------	---

*Not designed to entirely cover the wheels or legs
 †Does not fit models with external side controls and bisquette loader attached



Patio Built-In Grill Covers

COLOR: HICKORY/ANTIQUE OAK/MAHOGANY

Item/Fit		E-Commerce Stock No	Case Qty	Retail Stock No	Case Qty
X SMALL BUILT-IN GRILL TOP		55-330-362401-EC	14		
UP TO 32"L 26"D 24"H					
SMALL BUILT-IN GRILL TOP		55-331-022401-EC	14		
UP TO 37"L 27"D 24"H					
MEDIUM BUILT-IN GRILL TOP		55-332-032401-EC	12		
UP TO 45"L 29"D 26"H					

*Not designed to entirely cover the wheels or legs

Mainland™ BBQ Grill Cover



COLOR: FOG/NAVY

NEW

- Mainland™ is a practical and modern collection with a distinctly nautical color palette and a water-resistant, easy-to-clean skirt
- Durable woven polyester fabric with a water-resistant 6P-free PVC laminated backing
- Air vents keep weather out while providing maximum ventilation and minimum condensation
- Uniquely stitched handles with faux leather trim give your cover a coastal look and is a breeze to remove and install
- Patented webbing tunnel allows easy adjustment resulting in a custom-like fit
- Click-Close straps snap around legs to secure cover on windy days
- Protects furniture from harmful UV rays



Item/Fit		E-Commerce Stock No	Case Qty
MEDIUM BBQ GRILL		56-067-034601-EC	6
UP TO 58"W 24"D 48"H*			
LARGE BBQ GRILL		56-066-044601-EC	6
UP TO 64"W 24"D 48"H*			

*Not designed to entirely cover the wheels or legs





Madrona® RainProof™ BBQ Grill Cover



COLOR: DARK COCOA



- Our RainProof™ fabric combines style and durability with taped seam construction to keep rain out so that you're always ready to entertain
- Customized click-close buckles and adjustable designer webbing provide exceptional security in windy conditions
- Critical taped seams help keep rain out and your furniture protected
- Vent hoods are seam taped to keep weather out, providing maximum ventilation and minimum condensation
- Custom designer handles provide ease and comfort when installing and removing cover
- Cord lock closures allow easy access to adjustment points at the hem resulting in a custom-like fit

Item/Fit		E-Commerce Stock No	Case Qty
MEDIUM BBQ GRILL		55-725-016601-RT	3
UP TO 58"W 24"D 48"H*			
LARGE BBQ GRILL		55-726-046601-RT	3
UP TO 64"W 24"D 48"H*			
X LARGE BBQ GRILL		55-727-056601-RT	3
UP TO 70"W 24"D 48"H*			
XX LARGE BBQ GRILL		55-728-061001-RT	3
UP TO 72"W 26"D 51"H*			

Patio Kamado Ceramic Grill Covers

LARGE KAMADO CERAMIC GRILL		55-729-046601-RT	3
UP TO 22"DIA WITH SIDE TABLES 40"H* (LARGE BIG GREEN EGG®)			
X LARGE KAMADO CERAMIC GRILL		55-730-056601-RT	3
UP TO 27"DIA WITH SIDE TABLES 45"H* (X LARGE BIG GREEN EGG®)			

*Not designed to entirely cover the wheels or legs
Big Green Egg is a registered trademark of Big Green Egg Inc. Corporation. Classic Accessories is not affiliated or associated with Big Green Egg Inc. or its products in any way.

Storigami™ BBQ Grill Cover



COLORS: BLACK, GOAT AND MONUMENT

NEW





BLACK

GOAT

MONUMENT

- Stores in ¼ the space: purposeful construction allows the cover to fold down to a neat, manageable size every time
- Folds 2x faster: folds down in half the time of a normal cover; functional design combines the natural flow of fabric with purposeful mountain and valley seams for an intuitive folding experience
- Directional guide arrows highlight key steps to simplify the folding process
- Click-close straps snap around leg/wheels to secure cover on windy days
- Air vents reduce condensation and wind lofting
- Protects furniture from harmful UV rays
- For a step-by-step video, visit a website.

Item/Fit		Color	E-Commerce Stock No	Case Qty
MEDIUM GRILL UP TO 58"W 30"D 48"H*		Monument	56-293-031001-EC	
		Goat	56-296-035801-EC	6
		Black	56-290-030401-EC	
LARGE GRILL UP TO 64"W 30"D 49"H*		Monument	56-294-041001-EC	
		Goat	56-297-045801-EC	6
		Black	56-291-040401-EC	
X LARGE GRILL UP TO 70"W 30"D 49"H*		Monument	56-295-051001-EC	
		Goat	56-298-055801-EC	6
		Black	56-292-050401-EC	

*Not designed to entirely cover the wheels or legs

Veranda™ BBQ Grill Cover













COLOR: PEBBLE/BARK/EARTH



→ Gardelle™ fabric features an elegant, water-repellent fabric top, a protective, water-resistant undercoating, and a dark splash guard skirt

→ Protects furniture from harmful UV rays
 → Click-Close straps snap over legs to secure cover on windy days
 → Air vent reduces condensation and wind lofting

→ Padded handles for easy fitting and removal
 → Elastic hem cord with toggle allows adjustment for a tight and custom fit











Item/Fit		E-Commerce Stock No	Case Qty
SMALL SPACES GRILL UP TO 24"W 23"D 42"H*	NEW 	56-306-011501-EC	8
X SMALL BBQ GRILL UP TO 38"L 22"D 44"H*		55-337-361501-00	8
SMALL BBQ GRILL WEBER® Q® 3200™ UP TO 44"L 17"D 44"H*		73902	6
SMALL BBQ GRILL UP TO 44"L 22"D 44"H*		55-702-021501-00	6
SMALL/MEDIUM BBQ GRILL UP TO 52"L 24"D 44"H*		55-338-371501-00	5
MEDIUM BBQ GRILL UP TO 58"L 24"D 48"H*		73912	6
LARGE BBQ GRILL UP TO 64"L 24"D 48"H*		73922	6
X LARGE BBQ GRILL UP TO 70"L 24"D 48"H*		73942	4
XX LARGE BBQ GRILL UP TO 72"L 26"D 51"H*		73952	4
3X LARGE BBQ GRILL UP TO 80"L 26"D 51"H*		55-339-351501-00	4

*Not designed to entirely cover the wheels or legs



Patio Island Grill Top Covers

COLOR: PEBBLE/BARK/EARTH





Item/Fit		E-Commerce Stock No	Case Qty
EXTRA SMALL ISLAND GRILL TOP UP TO 32"L 26"D 24"H		55-340-361501-00	12
SMALL ISLAND GRILL TOP UP TO 37"L 27"D 24"H		55-053-021501-00	12
MEDIUM ISLAND GRILL TOP UP TO 45"L 29"D 26"H		55-054-031501-00	8
MEDIUM ISLAND GRILL, CENTER GRILL HEAD UP TO 78"L 44"D 48"H*		55-628-031501-00	3
LARGE ISLAND GRILL, CENTER GRILL HEAD UP TO 86"L 44"D 48"H*		55-629-041501-00	3
X LARGE ISLAND GRILL, CENTER GRILL HEAD UP TO 98"L 44"D 48"H*		55-630-051501-00	3
MEDIUM ISLAND GRILL, LEFT OR RIGHT GRILL HEAD UP TO 78"L 44"D 48"H*		55-625-031501-00	3
LARGE ISLAND GRILL, LEFT OR RIGHT GRILL HEAD UP TO 86"L 44"D 48"H*		55-626-041501-00	3
X LARGE ISLAND GRILL, LEFT OR RIGHT GRILL HEAD UP TO 98"L 44"D 48"H*		55-627-051501-00	3
20 LB PROPANE TANK UP TO 7"DIA TOP 13"DIA BOTTOM 19.5"H*		55-707-011501-00	30

*Not designed to entirely cover the wheels or legs





Patio Kamado Ceramic Grill Covers

COLOR: PEBBLE/BARK/EARTH

Item/Fit		E-Commerce Stock No	Case Qty
MEDIUM KAMADO CERAMIC GRILL FITS UP TO 18" TOTAL EXTERIOR DIA W/ SIDE TABLES 40"H* (MEDIUM BIG GREEN EGG®)		55-603-031501-00	12
LARGE KAMADO CERAMIC GRILL FITS UP TO 22" TOTAL EXTERIOR DIA W/ SIDE TABLES 40"H* (LARGE BIG GREEN EGG®)		55-231-041501-00	16
X LARGE KAMADO CERAMIC GRILL FITS UP TO 27" TOTAL EXTERIOR DIA W/ SIDE TABLES 45"H* (X LARGE BIG GREEN EGG®)		55-232-051501-00	12
KAMADO CERAMIC GRILL WITH OFFSET TABLE UP TO 60"L 30"D 50"H*		55-410-011501-00	5
MINI KAMADO CERAMIC GRILL UP TO 21.5"DIA (INCLUDING HANDLES) 27"H*		55-968-011501-00	12

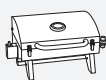

Patio Table Top Grill Covers and Carrying Bags





ROUND TABLE TOP GRILL COVER AND CARRY BAG UP TO 22"DIA 18"H*		55-973-031501-00	12
MEDIUM RECTANGULAR TABLE TOP GRILL COVER AND CARRY BAG UP TO 22"L 18"D 15"H*		55-974-031501-00	12
LARGE RECTANGULAR TABLE TOP GRILL COVER UP TO 29"L 24"D 15"H*		55-975-041501-00	10

*Not designed to entirely cover the wheels or legs
Big Green Egg is a registered trademark of Big Green Egg Inc. Corporation. Classic Accessories is not affiliated or associated with Big Green Egg Inc. or its products in any way.









Patio Flat Top Griddle and Park Style Grill Covers

COLOR: PEBBLE/BARK/EARTH

Item/Fit		E-Commerce Stock No	Case Qty
MEDIUM FLAT TOP GRIDDLE FITS 28" GRIDDLE UP TO 45"L 23"D 25"H*		55-774-035101-00	6
LARGE FLAT TOP GRIDDLE FITS 36" GRIDDLE UP TO 63"L 22"D 36"H*		55-775-045101-00	6
PARK STYLE GRILL UP TO 23"L 24"D 19"H*		55-783-011501-00	12
BISTRO GRILL FITS 30"W 26"D 38"H*		55-993-011501-00	12



Patio Smoker Covers

MEDIUM ROUND SMOKER UP TO 19"DIA 39"H*		73002	20
BARREL SMOKER UP TO 24"DIA 30"H*		55-967-011501-00	12
MEDIUM SQUARE SMOKER UP TO 17"L 14"D 30"H*		73012	18
LARGE SQUARE SMOKER UP TO 26"L 19.5"D 40"H*		55-570-011501-00	12
X LARGE SQUARE SMOKER UP TO 33"L 24.5"D 60"H*		55-857-051501-00	6
OFFSET SMOKER FITS DYNA-GLO 1176 SERIES OFFSET SMOKERS AND OFFSET SMOKERS UP TO 32"W 17"D 40"H* NEW		56-310-011501-EC	8
PK GRILL AND SMOKER* FITS PK GRILL & SMOKER 34.5" W 20" D 35" H*		55-971-011501-00	12







*Not designed to entirely cover the wheels or legs

*Does not fit models with external side controls and bisquette loader attached
PK Grill and Smoker is a registered trademark of Portable Kitchens®, Inc.

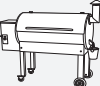

Patio Pellet Grill and Kettle BBQ Grill Covers

COLOR: PEBBLE/BARK/EARTH

Item/Fit		E-Commerce Stock No	Case Qty
MEDIUM PELLETT GRILL UP TO 37"W 18"D 36"H*		55-969-031501-00	8
LARGE PELLETT GRILL UP TO 46"W 26"D 43"H*		55-970-041501-00	8
22 SERIES TRAEGER® GRILLS UP TO 41"W 27"D 49"H*		55-918-011501-00	8
34 SERIES TRAEGER® GRILLS UP TO 53"W 27"D 49"H*		55-919-011501-00	6
WEBER® PERFORMER® GRILL UP TO 40"L 28.5"D 50.25"H* GOLD AND PLATINUM 22" GRILLS		55-411-011501-00	8
WEBER SUMMIT® CHARCOAL GRILL CENTER SUMMIT CHARCOAL, PERFORMER PREMIUM AND PERFORMER DELUXE GRILLS*		55-819-261501-00	6
KETTLE BBQ GRILL UP TO 26.5"DIA 38"H*		73422	18
LARGE KETTLE BBQ GRILL UP TO 30" DIA 43"H* FITS WEBER® PREMIUM 26" GRILL		55-966-041501-00	12

Patio Cowboy Grill and Pizza Oven Covers



COWBOY FIRE PIT GRILL AND ROTISSERIE UP TO 40"DIA 16"H*		55-879-011501-00	8
OUTDOOR PIZZA OVEN UP TO 44.5"L 22.25"W 39.5"H* FITS BLACKSTONE® OUTDOOR PIZZA/PATIO OVEN		55-964-011501-00	10

*Not designed to entirely cover the wheels or legs

*Traeger® pellet grills are a trademark of Traeger Pellet Grills, LLC.

Weber® Summit® and Weber® Performer® are trademarks of Weber-Stephens Products, LLC. Classic Accessories is not affiliated or associated with Weber-Stephens Products, LLC or its products in any way. Blackstone® is a registered trademark of Blackstone Products. Classic Accessories is not affiliated or associated with Weber-Stephens Products, LLC or its products in any way.





Terrazzo® BBQ Grill Cover



COLOR: SAND



- Rain-Tite™ durable woven polyester fabric with a water-repellent outercoating and PVC undercoating that protects your furniture from the elements
- StayOn™ elastic loops fit over legs to keep cover on during high winds and breezy conditions
- Air vents reduce condensation and wind lofting

Item/Fit		E-Commerce Stock No	Case Qty	Retail Stock No	Case Qty
MEDIUM BBQ GRILL					
UP TO 58"L 24"D 48"H*		53912-EC	8	53912	1
LARGE BBQ GRILL					
UP TO 64"L 24"D 48"H*		53922-EC	8	53922	1
X LARGE BBQ GRILL					
UP TO 70"L 24"D 48"H*		53942-EC	6	53942	1
XX LARGE BBQ GRILL					
UP TO 72"L 26"D 51"H*		53952-EC	6	53952	1

*Not designed to entirely cover the wheels or legs

Classic Accessories® BBQ Grill Cover

1
YEAR
WARRANTYWEATHER
PROTECTIONUV
PROTECTIONWON'T CRACK
IN THE COLD









AIR VENTS

ELASTIC
HEM CORDSTAY ON
ELASTIC LOOPS

COLOR: BLACK



- Tough fabric with water-resistant backing protects against rain, snow, sun, dirt and won't crack in the cold
- StayOn™ elastic loops fit over legs to keep cover on during high winds and breezy conditions
- Air vents reduce condensation and wind lofting





Item/Fit		Retail Stock No	Case Qty
X SMALL BBQ GRILL UP TO 38"L 22"D 44"H*		55-303-360401-00	2
SMALL BBQ GRILL UP TO 44"L 22"D 44"H*		55-304-020401-00	2
MEDIUM SMALL BBQ GRILL UP TO 52"L 24"D 44"H*		55-305-370401-00	2
MEDIUM BBQ GRILL UP TO 58"L 26"D 48"H*		55-306-030401-00	2
LARGE BBQ GRILL UP TO 64"L 26"D 48"H*		55-307-040401-00	2
X LARGE BBQ GRILL UP TO 70"L 26"D 48"H*		55-308-050401-00	2
XX LARGE BBQ GRILL UP TO 74"L 26"D 51"H*		55-309-060401-00	2
3X LARGE BBQ GRILL UP TO 80"L 26"D 51"H*		55-310-350401-00	2

*Not designed to entirely cover the wheels or legs



Patio Built-In Grill Top, Kettle BBQ Grill and Smoker Covers

COLOR: BLACK

Item/Fit		E-Commerce Stock No	Retail Stock No	Case Qty
X SMALL BUILT-IN GRILL TOP UP TO 32"W 26"D 24"H			55-311-360401-00	2
KETTLE BBQ GRILL UP TO 26.5"DIA 38"H*			55-315-010401-00	2
LARGE KETTLE BBQ GRILL UP TO 30" DIA 43"H* FITS WEBER® PREMIUM 26" GRILL		55-903-040401-EC		10
MEDIUM ROUND SMOKER UP TO 19"DIA 39"H*			55-318-010401-00	2
MEDIUM SQUARE SMOKER UP TO 20"L 17"W 35.5"H*			55-319-010401-00	2

*Not designed to entirely cover the wheels or legs
 †Does not fit models with external side controls and bisquette loader attached
 Weber® Premium is a trademark of Weber-Stephens Products, LLC. Classic Accessories is not affiliated or associated with Weber-Stephens Products, LLC or its products in any way.

Classic Accessories® BBQ Grill Accessory Set





COLOR: BLACK



Round out your grilling arsenal, or give the perfect gift to your grilling enthusiast, with our select line of grilling accessory sets. Covers protect grills from the elements, shielding them during storms and winter weather. Grill accessories complement the covers, providing everything you need to get the most out of your grill. Select the set that's right for you and your grill, and get grilling today.

Patio BBQ Grill Cover with Grill Tool Set



Item/Fit		E-Commerce Stock No	Case Qty
MEDIUM BBQ GRILL		55-306-TOOL-EC	2
UP TO 58"L 24"D 48"H*			
LARGE BBQ GRILL		55-307-TOOL-EC	2
UP TO 64"L 24"D 48"H*			
X LARGE BBQ GRILL		55-308-TOOL-EC	2
UP TO 70"L 24"D 48"H*			

*Not designed to entirely cover the wheels or legs





Patio BBQ Grill Cover with Grill Brush and Light Set

COLOR: BLACK

Item/Fit		E-Commerce Stock No	Case Qty
MEDIUM BBQ GRILL UP TO 58"L 24"D 48"H*		55-306-BRUSH-EC	2
LARGE BBQ GRILL UP TO 64"L 24"D 48"H*		55-307-BRUSH-EC	2
X LARGE BBQ GRILL UP TO 70"L 24"D 48"H*		55-308-BRUSH-EC	2



Patio Kettle BBQ Grill Cover with Charcoal Chimney Set

KETTLE BBQ GRILL UP TO 26.5"DIA 38"H* (COVER + CHARCOAL CHIMNEY)		55-315-CHIMNY-EC	2
LARGE KETTLE BBQ GRILL UP TO 30" DIA 43"H* FITS WEBER® PREMIUM 26" GRILL (COVER + CHARCOAL CHIMNEY)		55-903-CHIMNY-EC	2

*Not designed to entirely cover the wheels or legs

HOME PATIO | MONTLAKE®



DISCOVER MORE TIME OUTDOORS™





9 ft Bamboo Patio Market Umbrella

UV Protection Factor (UPF) of 50+ blocking 100% of UV penetration (A & B rays)

COLORS: ANTIQUE BEIGE AND HEATHER INDIGO

- Montlake® FadeSafe® water-repellent, solution-dyed fabric is both stylish and engineered to resist fading and retain vibrancy
- 8 bamboo ribs and supporting arms are fitted with high-grade stainless steel bolts and couplings for extra strength
- Stainless steel locking pin secures the umbrella in the open position
- 100% natural bamboo finial top, hub, and ribs provide natural elegance to outdoor decor
- The dual stainless steel pulley system makes operation quick and easy
- Threaded stainless steel pole connector allows for easy installation, breakdown and storage
- **Umbrella fabric: Five-year limited warranty**
Umbrella frame: Three-year limited warranty



Item/Fit		Color	Retail Stock No	Case Qty
BAMBOO PATIO MARKET UMBRELLA		Antique Beige	50-005-030101-RT	1
9' DIA (OPENED) 8.2' H*				
BAMBOO PATIO MARKET UMBRELLA		Heather Indigo	50-008-550101-RT	1
9' DIA (OPENED) 8.2' H*				

*Base not included



9 ft Aluminum Patio Market Umbrella

UV Protection Factor (UPF) of 50+ blocking 100% of UV penetration (A & B rays)

COLORS: ANTIQUE BEIGE AND HEATHER INDIGO

- Montlake® FadeSafe® water-repellent, solution-dyed fabric is both stylish and engineered to resist fading and retain vibrancy
- 8 aluminum ribs provide extra strength and wind resistance, constructed with high-grade 100% virgin aluminum, stainless steel hardware and ABS plastic for lasting durability
- Stainless steel locking pin secures the umbrella in the open position
- Canopy operates with a reinforced ABS plastic crank open system for quick and easy operation
- Quick click-in aluminum center pole allows for easy installation, breakdown and storage
- **Umbrella fabric: Five-year limited warranty**
Umbrella frame: One-year limited warranty



Item/Fit		Colors	Retail Stock No	Case Qty
ALUMINUM PATIO MARKET UMBRELLA		Antique Beige	50-001-030101-RT	1
9' DIA (OPENED) 8.3' H*				
ALUMINUM PATIO MARKET UMBRELLA		Heather Indigo	50-004-550101-RT	1
9' DIA (OPENED) 8.3' H*				

*Base not included



Brazilian Hammock With Steel Stand



Water-repellent, solution-dyed polyester fabric minimizes fading to keep hammock colors strong and vibrant

COLORS: HEATHER FERN STRIPE AND HEATHER INDIGO STRIPE

- Montlake® FadeSafe® water-repellent, solution-dyed polyester fabric minimizes fading to keep hammock colors strong and vibrant
- Unique striping pattern combines several rich colors to stand out on any patio
- Made with high-quality materials such as 8mm polyester ropes and stainless steel cord enclosures
- Powder-coated -gauge stainless steel metal stand, with 2.5 mm tube walls provide added strength
- Uses ergonomic screws for easy setup and break down
- Stainless steel hardware, stainless steel chain and carabiner clips included
- Capable of supporting up to 450 lbs of weight*



Ergonomic screws secure major joints making setup and break down quick and simple

Item/Fit		Color	Retail Stock No	Case Qty
BRAZILIAN HAMMOCK WITH STEEL STAND BED: 82"L 58"W STAND: 177"W 48"D 50"H		Heather Fern Stripe	50-047-HFERN-RT	1
BRAZILIAN HAMMOCK WITH STEEL STAND BED: 82"L 58"W STAND: 177"W 48"D 50"H		Heather Indigo Stripe	50-050-HINDIGO-RT	1

*This product has a maximum weight capacity of 450lbs/200kg. If you combine a hammock with a hammock stand, please defer to the lesser of two weight capacity limits. Never exceed the smaller maximum weight capacity of either the stand or hammock. When calculating the weight to be held by a hammock stand, please account for the weight of the hammock in addition to the weight of the person.



Steel Hammock Stand

COLOR: BLACK STEEL

- Artfully clean lines softened by a cool grey powder coating give this stand a look of simple integrity
- Supports up to 450 lbs of weight
- Ergonomic screws secure major joints making setup and break down quick and simple
- Stainless steel hardware, stainless steel chain and carabiner clips provide structural integrity and reliability



Item/Fit		Material	Retail Stock No	Case Qty
STEEL HAMMOCK STAND 177"W 48"D 50"H		Steel	50-021-011001-RT	1



Quilted Hammock

Water-repellent, solution-dyed polyester fabric minimizes fading to keep hammock colors strong and vibrant

COLORS: HEATHER GREY STRIPE AND HEATHER INDIGO STRIPE

- Montlake® FadeSafe® water-repellent, solution-dyed polyester fabric minimizes fading to keep hammock colors strong and vibrant
- 1.5" thick quilted bed with unique striping pattern combines several rich colors to stand out on any patio and reverses to a solid color
- Custom-colored spreader bar is constructed from shock-absorbent beechwood for strength and durability
- 8mm 100% polyester ropes, stainless steel hardware, and aluminum grommets provide structural integrity and reliability

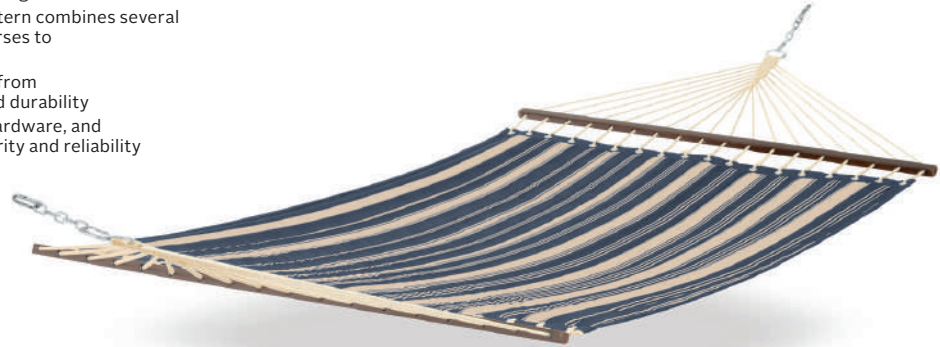

Item/Fit		Color	Retail Stock No	Case Qty
QUILTED HAMMOCK* 81"L 55"W**		Heather Grey Stripe	50-027-011001-RT	1
QUILTED HAMMOCK* 81"L 55"W**		Heather Indigo Stripe	50-029-010501-RT	1

*Stand available separately
**Full length including ropes is 135"

Wood Hammock Stand



COLOR: RUSSIAN LARCH WOOD

- Naturally finished, 100% Russian Larch hardwood is durable, resilient and naturally resistant to decay
- Beautiful arched curves create a dynamic shape that is both comfortable and refined
- Supports up to 450 lbs of weight when combined with a hammock of equal or greater weight capacity"
- Stainless steel hardware, stainless steel chain and carabiner clips provide structural integrity and reliability



Item/Fit		Material	Retail Stock No	Case Qty
WOOD HAMMOCK STAND 163"W 46.5"D 47.2"H		Russian Larch Wood	50-020-016601-RT	1



Quilted Hammock With Wood Stand



Water-repellent, solution-dyed polyester fabric minimizes fading to keep hammock colors strong and vibrant

COLORS: HEATHER HENNA MULTI-STRIPE AND HEATHER INDIGO MULTI-STRIPE

- Naturally finished, 100% Russian Larch hardwood is durable, resilient and naturally resistant to decay
- Beautiful arched curves create a dynamic shape that is both comfortable and refined
- Supports up to 450 lbs of weight when combined with a hammock of equal or greater weight capacity*
- Stainless steel hardware, stainless steel chain and carabiner clips provide structural integrity and reliability
- Water-repellent, solution-dyed polyester fabric minimizes fading to keep hammock colors strong and vibrant
- 1.5" thick quilted bed with unique striping pattern combines several rich colors to stand out on any patio and reverses to a solid color
- Custom-colored spreader bar is constructed from shock-absorbent beechwood for strength and durability
- 8mm 100% polyester ropes, stainless steel hardware, and aluminum grommets provide structural integrity and reliability



Supports up to 450 lbs of weight in combination with a hammock of equal or greater weight capacity*

Item/Fit		Color	Retail Stock No	Case Qty
QUILTED HAMMOCK WITH WOOD STAND BED: 81"L 55"W STAND: 163"W 47"D 47"H		Heather Henna Multi-Stripe	50-022-HHENNA-RT	1
QUILTED HAMMOCK WITH WOOD STAND BED: 81"L 55"W STAND: 163"W 47"D 47"H		Heather Indigo Multi-Stripe	50-023-INDIGO-RT	1

*This product has a maximum weight capacity of 450lbs/200kg. If you combine a hammock with a hammock stand, please defer to the lesser of two weight capacity limits. Never exceed the smaller maximum weight capacity of either the stand or hammock. When calculating the weight to be held by a hammock stand, please account for the weight of the hammock in addition to the weight of the person.

HOME PATIO | RAVENNA™







ConnectCurve™ Quilted Hammock

Water-repellent, solution-dyed polyester fabric minimizes fading to keep hammock colors strong and vibrant

COLORS: DARK TAUPE, EMPIRE BLUE, AND MUSHROOM

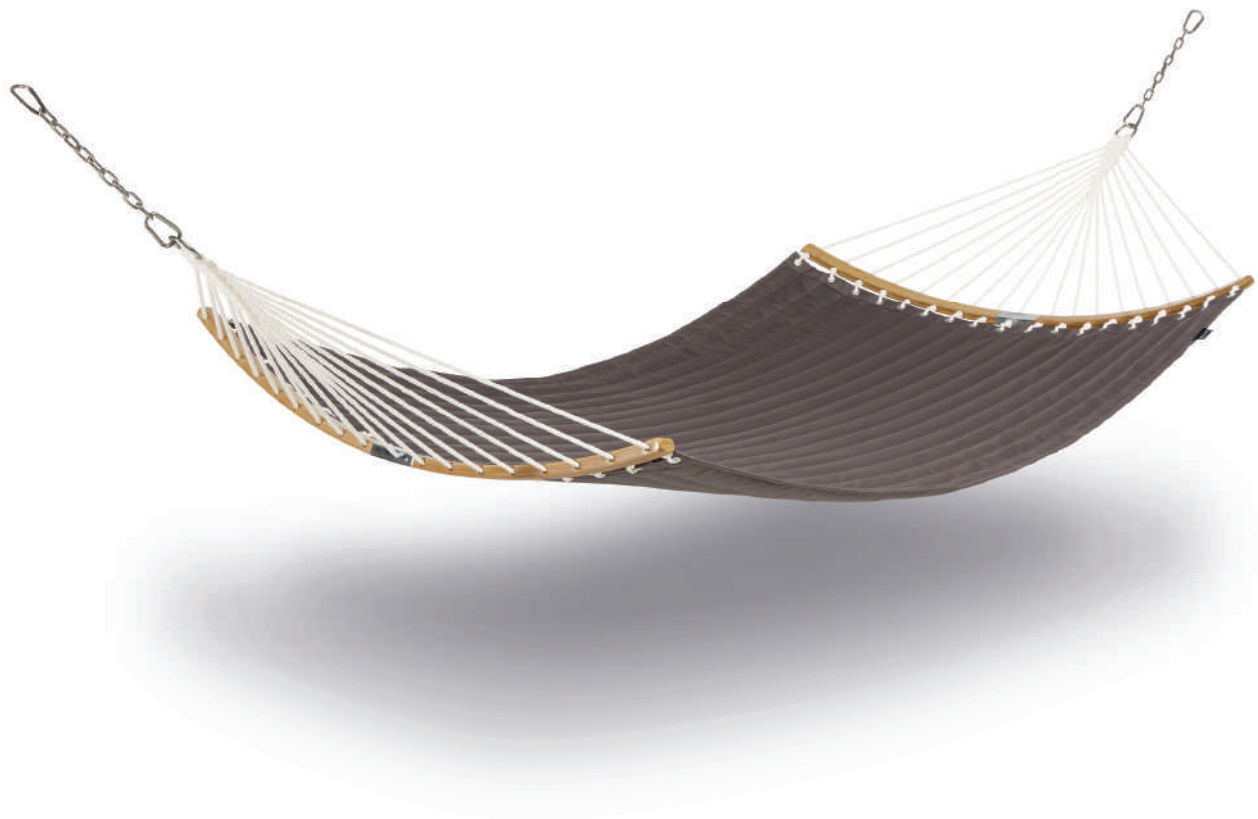
- Curved, folding spreader bars are constructed from 100% bamboo for strength and durability
- Water-repellent, solution-dyed polyester fabric minimizes fading to keep hammock colors strong and vibrant
- Made with high-quality materials including 8mm polyester ropes, stainless steel hardware and aluminum grommets
- Double-bed size is capable of supporting up to 450 lbs of weight**
- Includes stainless steel chain and carabiner clips
- Includes storage bag with shoulder strap

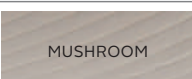

Item/Fit	Color	Retail Stock No	Case Qty
CONNECTCURVE™ QUILTED HAMMOCK* 81"L 55"W**	 DARK TAUPE	50-110-015101-RT	1
CONNECTCURVE™ QUILTED HAMMOCK* 81"L 55"W**	 EMPIRE BLUE	50-111-015501-RT	1
CONNECTCURVE™ QUILTED HAMMOCK* 81"L 55"W**	 MUSHROOM	50-112-016601-RT	1

*Stand available separately, **Full length including ropes is 135", **This product has a maximum weight capacity of 450lbs/200kg. If you combine a hammock with a hammock stand, please defer to the lesser of two weight capacity limits. Never exceed the smaller maximum weight capacity of either the stand or hammock. When calculating the weight to be held by a hammock stand, please account for the weight of the hammock in addition to the weight of the person.

HOME PATIO | MONTLAKE™



Chair and Chaise Slipcovers



COLORS: ANTIQUE BEIGE, HEATHER FERN, HEATHER HENNA, AND HEATHER INDIGO

- Dress up old, worn and stained furniture
- Montlake® FadeSafe® solution-dyed fabric is both stylish and engineered to resist fading
- A water-repellent fabric top and a water-resistant backing help keep rain out and your furniture protected
- Protects furniture from harmful UV rays
- Adjustable belted hem with click-close straps provides a tight, customizable fit to keep your slip cover where you want it
- Elastized back panel provides easy installation, covers worn or unsightly backs and accommodates most chairs/chaises with or without cushions



Item/Fit	Color	E-Commerce Stock No	Retail Stock No	Case Qty
CHAIR	Antique Beige		56-010-010301-RT	12
	Heather Fern		56-014-011101-RT	
UP TO 45"L 20"W	Heather Henna		56-018-016601-RT	12
	Heather Indigo		56-022-015501-RT	



Item/Fit	Color	E-Commerce Stock No	Retail Stock No	Case Qty
STEAMER CHAISE	Antique Beige		56-007-030301-RT	12
	Heather Fern		56-011-031101-RT	
UP TO 69"L 19"W	Heather Henna		56-015-036601-RT	12
	Heather Indigo		56-019-035501-RT	



Item/Fit	Color	E-Commerce Stock No	Retail Stock No	Case Qty	
CHAISE LOUNGE	Antique Beige		56-008-040301-RT	12	
	Heather Fern		56-012-041101-RT		
	UP TO 72"L 21"W	Heather Henna		56-016-046601-RT	12
		Heather Indigo		56-020-045501-RT	
CHAISE LOUNGE	Antique Beige	56-009-050301-RT		12	
	Heather Fern	56-013-051101-RT			
	UP TO 80"L 26"W	Heather Henna	56-017-056601-RT		12
		Heather Indigo	56-021-055501-RT		

HOME PATIO | MONTLAKE®



Montlake® FadeSafe® Cushions and Quilted Cushions



CUSHION COLORS: HEATHER GREY, ANTIQUE BEIGE, HEATHER FERN, LIGHT CHARCOAL, HEATHER HENNA AND HEATHER INDIGO
 QUILTED CUSHION COLORS: CHAMOMILE, GREY, HEATHER FERN, SPICE AND NAVY

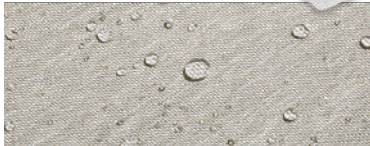

Montlake® FadeSafe® Fabric System

Montlake® FadeSafe® solution-dyed fabric is both stylish and engineered to resist fading



Water-Repellent Coating

Resists stains and helps keep rain out and your cushion foam protected



Patented Attachment System

Patented 9,155,397 B2

Adjustable belted hem with click-close straps provides a tight, customizable fit to keep your cushion where you want it



Durable Stitching

Bound interior seams are engineered to provide strength and durability at the most demanding joints



Locking Zippers Disappear In Garages When Not in Use

Zippers lock to keep a tight closure and are stored in protective garages when closed for a clean, protected look



3-Layered Seat Foam and Solid-Core Back Foam





Designed for comfort and support, outer layers of open-cell foam enclose a high density core that is resilient but conforms to your shape



Patio Quilted Lounge Back Cushion Components

NEW

COLORS: CHAMOMILE, GREY, HEATHER FERN, SPICE AND NAVY



	Cushion Foam Only	Size	Color	E-Commerce Stock No	Case Qty
	FOAM	21"W 20"H 4"Thickness	White	61-024-010924-RT	6
FOAM	25"W 22"H 4"Thickness	White	61-028-010928-RT	6	
	Cushion Cover Only	Size	Color	E-Commerce Stock No	Case Qty
	COVER	21"W 20"H 4"Thickness	Chamomile	60-465-016201-RT	12
COVER	25"W 22"H 4"Thickness	Chamomile	60-466-016201-RT	12	
	COVER	21"W 20"H 4"Thickness	Grey	60-454-011001-RT	12
	COVER	25"W 22"H 4"Thickness	Grey	60-455-011001-RT	12
	COVER	21"W 20"H 4"Thickness	Spice	60-476-012401-RT	12
	COVER	25"W 22"H 4"Thickness	Spice	60-477-012401-RT	12
	COVER	21"W 20"H 4"Thickness	Navy	60-486-015501-RT	12
	COVER	25"W 22"H 4"Thickness	Navy	60-487-015501-RT	12



Patio Quilted Lounge Back Cushion

NEW

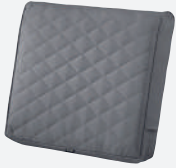
COLORS: CHAMOMILE, GREY, HEATHER FERN, SPICE AND NAVY

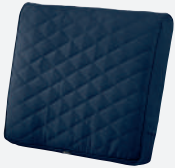



	Cushion Foam & Cover Set	Size	Color	E-Commerce Stock No	Case Qty
	FOAM + COVER	21"W 20"H 4"Thickness	Chamomile	62-024-CREAM-EC	1
	FOAM + COVER	25"W 22"H 4"Thickness	Chamomile	62-028-CREAM-EC	1
	FOAM + COVER	21"W 20"H 4"Thickness	Grey	62-024-GREY-EC	1
	FOAM + COVER	25"W 22"H 4"Thickness	Grey	62-028-GREY-EC	1
	FOAM + COVER	21"W 20"H 4"Thickness	Spice	62-024-GSPICE-EC	1
	FOAM + COVER	25"W 22"H 4"Thickness	Spice	62-028-GSPICE-EC	1
	FOAM + COVER	21"W 20"H 4"Thickness	Navy	62-024-NAVY-EC	1
	FOAM + COVER	25"W 22"H 4"Thickness	Navy	62-028-NAVY-EC	1



Patio Quilted Square/Rectangle Lounge Seat Cushion Components

NEW

COLORS: CHAMOMILE, GREY, HEATHER FERN, SPICE AND NAVY





	Cushion Foam Only	Size	Color	Retail Stock No	Case Qty
	FOAM	25"W 25"D 5"Thickness	White	61-020-010920-RT	6
	FOAM	25"W 27"D 5"Thickness	White	61-021-010921-RT	6
	COVER	25"W 25"D 5"Thickness	Chamomile	60-463-016201-RT	12
	COVER	25"W 27"D 5"Thickness	Chamomile	60-464-016201-RT	12
	COVER	25"W 25"D 5"Thickness	Grey	60-452-011001-RT	12
	COVER	25"W 27"D 5"Thickness	Grey	60-453-011001-RT	12
	COVER	25"W 25"D 5"Thickness	Spice	60-474-012401-RT	12
	COVER	25"W 27"D 5"Thickness	Spice	60-475-012401-RT	12
	COVER	25"W 25"D 5"Thickness	Navy	60-484-015501-RT	12
	COVER	25"W 27"D 5"Thickness	Navy	60-485-015501-RT	12



Patio Quilted Square/Rectangle Lounge Seat Cushion

NEW

COLORS: CHAMOMILE, GREY, HEATHER FERN, SPICE AND NAVY





	Cushion Foam & Cover Set	Size	Color	E-Commerce Stock No	Case Qty
	FOAM + COVER	25"W 25"D 5"Thickness	Chamomile	62-020-CREAM-EC	1
	FOAM + COVER	25"W 27"D 5"Thickness	Chamomile	62-021-CREAM-EC	1
	FOAM + COVER	25"W 25"D 5"Thickness	Grey	62-020-GREY-EC	1
	FOAM + COVER	25"W 27"D 5"Thickness	Grey	62-021-GREY-EC	1
	FOAM + COVER	25"W 25"D 5"Thickness	Spice	62-020-QSPICE-EC	1
	FOAM + COVER	25"W 27"D 5"Thickness	Spice	62-021-QSPICE-EC	1
	FOAM + COVER	25"W 25"D 5"Thickness	Navy	62-020-NAVY-EC	1
	FOAM + COVER	25"W 27"D 5"Thickness	Navy	62-021-NAVY-EC	1



Patio Quilted Rectangle Dining Seat Cushion Components

NEW

COLORS: CHAMOMILE, GREY, HEATHER FERN, SPICE AND NAVY





	Cushion Foam Only	Size	Color	Retail Stock No	Case Qty
	FOAM	21"W 19"D 3"Thickness	White	61-009-010909-RT	6
	Cushion Cover Only	Size	Color	Retail Stock No	Case Qty
	COVER	21"W 19"D 3"Thickness	Chamomile	60-462-016201-RT	12
	COVER	21"W 19"D 3"Thickness	Grey	60-451-011001-RT	12
	COVER	21"W 19"D 3"Thickness	Spice	60-473-012401-RT	12
	COVER	21"W 19"D 3"Thickness	Navy	60-483-015501-RT	12



Patio Quilted Rectangle Dining Seat Cushion

NEW

COLORS: CHAMOMILE, GREY, HEATHER FERN, SPICE AND NAVY



	Cushion Foam & Cover Set	Size	Color	E-Commerce Stock No	Case Qty
	FOAM + COVER	21"W 19"D 3"Thickness	Chamomile	62-009-CREAM-EC	1
	FOAM + COVER	21"W 19"D 3"Thickness	Grey	62-009-GREY-EC	1
	FOAM + COVER	21"W 19"D 3"Thickness	Spice	62-009-QSPICE-EC	1
	FOAM + COVER	21"W 19"D 3"Thickness	Navy	62-009-NAVY-EC	1



Patio Quilted Settee/Bench Seat Cushion Components

NEW

COLORS: CHAMOMILE, GREY, HEATHER FERN, SPICE AND NAVY





	Cushion Foam Only	Size	Color	Retail Stock No	Case Qty
	FOAM	42"W 18"D 3"Thickness	White	61-014-010914-RT	6
	FOAM	48"W 18"D 3"Thickness	White	61-015-010915-RT	6
	FOAM	54"W 18"D 3"Thickness	White	61-044-010944-RT	6
	Cushion Cover Only	Size	Color	Retail Stock No	Case Qty
	COVER	42"W 18"D 3"Thickness	Chamomile	60-458-016201-RT	12
	COVER	48"W 18"D 3"Thickness	Chamomile	60-459-016201-RT	12
	COVER	54"W 18"D 3"Thickness	Chamomile	60-460-016201-RT	12
	COVER	42"W 18"D 3"Thickness	Grey	60-447-011001-RT	12
	COVER	48"W 18"D 3"Thickness	Grey	60-448-011001-RT	12
	COVER	54"W 18"D 3"Thickness	Grey	60-449-011001-RT	12
	COVER	42"W 18"D 3"Thickness	Spice	60-469-012401-RT	12
	COVER	48"W 18"D 3"Thickness	Spice	60-470-012401-RT	12
	COVER	54"W 18"D 3"Thickness	Spice	60-471-012401-RT	12
	COVER	42"W 18"D 3"Thickness	Navy	60-480-015501-RT	12
	COVER	48"W 18"D 3"Thickness	Navy	60-481-015501-RT	12
	COVER	54"W 18"D 3"Thickness	Navy	60-482-015501-RT	12



Patio Quilted Settee/Bench Seat Cushion

NEW

COLORS: CHAMOMILE, GREY, HEATHER FERN, SPICE AND NAVY

	Cushion Foam & Cover Set	Size	Color	E-Commerce Stock No	Case Qty
	FOAM + COVER	42"W 18"D 3"Thickness	Chamomile	62-014-CREAM-EC	1
	FOAM + COVER	48"W 18"D 3"Thickness	Chamomile	62-015-CREAM-EC	1
	FOAM + COVER	54"W 18"D 3"Thickness	Chamomile	62-044-CREAM-EC	1
	FOAM + COVER	42"W 18"D 3"Thickness	Grey	62-014-GREY-EC	1
	FOAM + COVER	48"W 18"D 3"Thickness	Grey	62-015-GREY-EC	1
	FOAM + COVER	54"W 18"D 3"Thickness	Grey	62-044-GREY-EC	1
	FOAM + COVER	42"W 18"D 3"Thickness	Spice	62-014-QSPICE-EC	1
	FOAM + COVER	48"W 18"D 3"Thickness	Spice	62-015-QSPICE-EC	1
	FOAM + COVER	54"W 18"D 3"Thickness	Spice	62-044-QSPICE-EC	1
	FOAM + COVER	42"W 18"D 3"Thickness	Navy	62-014-NAVY-EC	1
	FOAM + COVER	48"W 18"D 3"Thickness	Navy	62-015-NAVY-EC	1
	FOAM + COVER	54"W 18"D 3"Thickness	Navy	62-044-NAVY-EC	1



Patio Quilted Lounge Chaise Cushion Components

NEW

COLORS: CHAMOMILE, GREY, HEATHER FERN, SPICE AND NAVY





	Cushion Foam Only	Size	Color	Retail Stock No	Case Qty
	FOAM	72"L 21"W 3"Thickness	White	61-001-010901-RT	6
	FOAM	80"L 26"W 3"Thickness	White	61-029-010929-RT	6
	Cushion Cover Only	Size	Color	Retail Stock No	Case Qty
	COVER	72"L 21"W 3"Thickness	Chamomile	60-456-016201-RT	12
	COVER	80"L 26"W 3"Thickness	Chamomile	60-457-016201-RT	12
	COVER	72"L 21"W 3"Thickness	Grey	60-445-011001-RT	12
	COVER	80"L 26"W 3"Thickness	Grey	60-446-011001-RT	12
	COVER	72"L 21"W 3"Thickness	Spice	60-467-012401-RT	12
	COVER	80"L 26"W 3"Thickness	Spice	60-468-012401-RT	12
	COVER	72"L 21"W 3"Thickness	Navy	60-478-015501-RT	12
	COVER	80"L 26"W 3"Thickness	Navy	60-479-015501-RT	12



Patio Quilted Lounge Chaise Cushion

NEW

COLORS: CHAMOMILE, GREY, HEATHER FERN, SPICE AND NAVY





	Cushion Foam & Cover Set	Size	Color	E-Commerce Stock No	Case Qty
	FOAM + COVER	72"L 21"W 3"Thickness	Chamomile	62-001-CREAM-EC	1
	FOAM + COVER	80"L 26"W 3"Thickness	Chamomile	62-029-CREAM-EC	1
	FOAM + COVER	72"L 21"W 3"Thickness	Grey	62-001-GREY-EC	1
	FOAM + COVER	80"L 26"W 3"Thickness	Grey	62-029-GREY-EC	1
	FOAM + COVER	72"L 21"W 3"Thickness	Spice	62-001-QSPICE-EC	1
	FOAM + COVER	80"L 26"W 3"Thickness	Spice	62-029-QSPICE-EC	1
	FOAM + COVER	72"L 21"W 3"Thickness	Navy	62-001-NAVY-EC	1
	FOAM + COVER	80"L 26"W 3"Thickness	Navy	62-029-NAVY-EC	1



Patio Lounge Back Cushion Components

COLORS: HEATHER GREY, ANTIQUE BEIGE, HEATHER FERN, LIGHT CHARCOAL, HEATHER HENNA AND HEATHER INDIGO

	Cushion Foam Only	Size	Color	Retail Stock No	Case Qty
	FOAM	19"W 20"H 4"Thickness	White	61-047-010947-RT	6
	FOAM	21"W 20"H 4"Thickness	White	61-024-010924-RT	6
	FOAM	21"W 22"H 4"Thickness	White	61-039-010939-RT	6
	FOAM	23"W 20"H 4"Thickness	White	61-025-010925-RT	6
	FOAM	23"W 22"H 4"Thickness	White	61-040-010940-RT	6
	FOAM	25"W 18"H 4"Thickness	White	61-026-010926-RT	6
	FOAM	25"W 22"H 4"Thickness	White	61-028-010928-RT	6
	COVER	19"W 20"H 4"Thickness	Heather Grey	60-263-011001-RT	6
	COVER	21"W 20"H 4"Thickness	Heather Grey	60-057-011001-RT	6
	COVER	21"W 22"H 4"Thickness	Heather Grey	60-195-011001-RT	6
	COVER	23"W 20"H 4"Thickness	Heather Grey	60-060-011001-RT	6
	COVER	25"W 18"H 4"Thickness	Heather Grey	60-061-011001-RT	6
	COVER	25"W 22"H 4"Thickness	Heather Grey	60-063-011001-RT	6
		COVER	19"W 20"H 4"Thickness	Antique Beige	60-241-010301-RT
COVER		21"W 20"H 4"Thickness	Antique Beige	60-001-010301-RT	6
COVER		21"W 22"H 4"Thickness	Antique Beige	60-171-010301-RT	6
COVER		23"W 20"H 4"Thickness	Antique Beige	60-004-010301-RT	6
COVER		23"W 22"H 4"Thickness	Antique Beige	60-172-010301-RT	6
COVER		25"W 18"H 4"Thickness	Antique Beige	60-005-010301-RT	6
COVER		25"W 22"H 4"Thickness	Antique Beige	60-007-010301-RT	6



	Cushion Cover Only	Size	Color	Retail Stock No	Case Qty
	COVER	19"W 20"H 4"Thickness	Heather Fern	60-252-011101-RT	6
	COVER	21"W 20"H 4"Thickness	Heather Fern	60-029-011101-RT	6
	COVER	21"W 22"H 4"Thickness	Heather Fern	60-183-011101-RT	6
	COVER	23"W 20"H 4"Thickness	Heather Fern	60-032-011101-RT	6
	COVER	25"W 18"H 4"Thickness	Heather Fern	60-033-011101-RT	6
	COVER	25"W 22"H 4"Thickness	Heather Fern	60-035-011101-RT	6
	COVER	19"W 20"H 4"Thickness	Light Charcoal	60-296-010801-RT	6
	COVER	21"W 20"H 4"Thickness	Light Charcoal	60-141-010801-RT	6
	COVER	21"W 22"H 4"Thickness	Light Charcoal	60-231-010801-RT	6
	COVER	23"W 20"H 4"Thickness	Light Charcoal	60-144-010801-RT	6
	COVER	23"W 22"H 4"Thickness	Light Charcoal	60-232-010801-RT	6
	COVER	25"W 18"H 4"Thickness	Light Charcoal	60-145-010801-RT	6
	COVER	25"W 22"H 4"Thickness	Light Charcoal	60-147-010801-RT	6
	COVER	19"W 20"H 4"Thickness	Heather Henna	60-274-016601-RT	6
	COVER	21"W 20"H 4"Thickness	Heather Henna	60-085-016601-RT	6
	COVER	21"W 22"H 4"Thickness	Heather Henna	60-207-016601-RT	6
	COVER	23"W 20"H 4"Thickness	Heather Henna	60-088-016601-RT	6
	COVER	25"W 18"H 4"Thickness	Heather Henna	60-089-016601-RT	6
	COVER	25"W 22"H 4"Thickness	Heather Henna	60-091-016601-RT	6
	COVER	19"W 20"H 4"Thickness	Heather Indigo	60-285-015501-RT	6
	COVER	21"W 20"H 4"Thickness	Heather Indigo	60-113-015501-RT	6
	COVER	21"W 22"H 4"Thickness	Heather Indigo	60-219-015501-RT	6
	COVER	23"W 20"H 4"Thickness	Heather Indigo	60-116-015501-RT	6
	COVER	23"W 22"H 4"Thickness	Heather Indigo	60-220-015501-RT	6
	COVER	25"W 18"H 4"Thickness	Heather Indigo	60-117-015501-RT	6
	COVER	25"W 22"H 4"Thickness	Heather Indigo	60-119-015501-RT	6



Patio Lounge Back Cushion

COLORS: HEATHER GREY, ANTIQUE BEIGE, HEATHER FERN, LIGHT CHARCOAL, HEATHER HENNA AND HEATHER INDIGO

	Cushion Foam & Cover Set	Size	Color	E-Commerce Stock No	Case Qty
	FOAM + COVER	19"W 20"H 4"Thickness	Heather Grey	62-047-HGREY-EC	1
	FOAM + COVER	21"W 20"H 4"Thickness	Heather Grey	62-024-HGREY-EC	1
	FOAM + COVER	21"W 22"H 4"Thickness	Heather Grey	62-039-HGREY-EC	1
	FOAM + COVER	23"W 20"H 4"Thickness	Heather Grey	62-025-HGREY-EC	1
	FOAM + COVER	25"W 18"H 4"Thickness	Heather Grey	62-026-HGREY-EC	1
	FOAM + COVER	25"W 22"H 4"Thickness	Heather Grey	62-028-HGREY-EC	1
	FOAM + COVER	19"W 20"H 4"Thickness	Antique Beige	62-047-BEIGE-EC	1
	FOAM + COVER	21"W 20"H 4"Thickness	Antique Beige	62-024-BEIGE-EC	1
	FOAM + COVER	21"W 22"H 4"Thickness	Antique Beige	62-039-BEIGE-EC	1
	FOAM + COVER	23"W 20"H 4"Thickness	Antique Beige	62-025-BEIGE-EC	1
	FOAM + COVER	23"W 22"H 4"Thickness	Antique Beige	62-040-BEIGE-EC	1
	FOAM + COVER	25"W 18"H 4"Thickness	Antique Beige	62-026-BEIGE-EC	1
	FOAM + COVER	19"W 20"H 4"Thickness	Heather Fern	62-047-HFERN-EC	1
	FOAM + COVER	21"W 20"H 4"Thickness	Heather Fern	62-024-HFERN-EC	1
	FOAM + COVER	21"W 22"H 4"Thickness	Heather Fern	62-039-HFERN-EC	1
	FOAM + COVER	23"W 20"H 4"Thickness	Heather Fern	62-025-HFERN-EC	1
	FOAM + COVER	25"W 18"H 4"Thickness	Heather Fern	62-026-HFERN-EC	1
	FOAM + COVER	25"W 22"H 4"Thickness	Heather Fern	62-028-HFERN-EC	1

	Cushion Foam & Cover Set	Size	Color	E-Commerce Stock No	Case Qty
	FOAM + COVER	19"W 20"H 4"Thickness	Light Charcoal	62-047-LCHARC-EC	1
	FOAM + COVER	21"W 20"H 4"Thickness	Light Charcoal	62-024-LCHARC-EC	1
	FOAM + COVER	21"W 22"H 4"Thickness	Light Charcoal	62-039-LCHARC-EC	1
	FOAM + COVER	23"W 20"H 4"Thickness	Light Charcoal	62-025-LCHARC-EC	1
	FOAM + COVER	23"W 22"H 4"Thickness	Light Charcoal	62-040-LCHARC-EC	1
	FOAM + COVER	25"W 18"H 4"Thickness	Light Charcoal	62-026-LCHARC-EC	1
	FOAM + COVER	25"W 22"H 4"Thickness	Light Charcoal	62-028-LCHARC-EC	1
	FOAM + COVER	19"W 20"H 4"Thickness	Heather Henna	62-047-HHENNA-EC	1
	FOAM + COVER	21"W 20"H 4"Thickness	Heather Henna	62-024-HHENNA-EC	1
	FOAM + COVER	21"W 22"H 4"Thickness	Heather Henna	62-039-HHENNA-EC	1
	FOAM + COVER	23"W 20"H 4"Thickness	Heather Henna	62-025-HHENNA-EC	1
	FOAM + COVER	25"W 18"H 4"Thickness	Heather Henna	62-026-HHENNA-EC	1
	FOAM + COVER	25"W 22"H 4"Thickness	Heather Henna	62-028-HHENNA-EC	1
	FOAM + COVER	19"W 20"H 4"Thickness	Heather Indigo	62-047-INDIGO-EC	1
	FOAM + COVER	21"W 20"H 4"Thickness	Heather Indigo	62-024-INDIGO-EC	1
	FOAM + COVER	21"W 22"H 4"Thickness	Heather Indigo	62-039-INDIGO-EC	1
	FOAM + COVER	23"W 20"H 4"Thickness	Heather Indigo	62-025-INDIGO-EC	1
	FOAM + COVER	23"W 22"H 4"Thickness	Heather Indigo	62-040-INDIGO-EC	1
	FOAM + COVER	25"W 18"H 4"Thickness	Heather Indigo	62-026-INDIGO-EC	1
	FOAM + COVER	25"W 22"H 4"Thickness	Heather Indigo	62-028-INDIGO-EC	1



Patio Lounge Rectangle Seat Cushion Components

COLORS: HEATHER GREY, ANTIQUE BEIGE, HEATHER FERN, LIGHT CHARCOAL, HEATHER HENNA AND HEATHER INDIGO

	Cushion Foam Only	Size	Color	Retail Stock No	Case Qty
	FOAM	21"W 19"D 5"Thickness	White	61-017-010917-RT	6
	FOAM	21"W 25"D 5"Thickness	White	61-018-010918-RT	6
	FOAM	23"W 25"D 5"Thickness	White	61-053-010953-RT	6
	FOAM	25"W 27"D 5"Thickness	White	61-021-010921-RT	6
	Cushion Cover Only	Size	Color	Retail Stock No	Case Qty
	COVER	23"W 25"D 5"Thickness	Heather Grey	60-315-011001-RT	6
	COVER	21"W 19"D 5"Thickness	Antique Beige	60-070-011001-RT	6
	COVER	21"W 25"D 5"Thickness	Antique Beige	60-072-011001-RT	6
	COVER	23"W 25"D 5"Thickness	Antique Beige	60-313-010301-RT	6
	COVER	25"W 27"D 5"Thickness	Antique Beige	60-078-011001-RT	6
	COVER	23"W 25"D 5"Thickness	Heather Fern	60-308-011101-RT	6
	COVER	21"W 19"D 5"Thickness	Light Charcoal	60-154-010801-RT	6
	COVER	21"W 25"D 5"Thickness	Light Charcoal	60-156-010801-RT	6
	COVER	23"W 25"D 5"Thickness	Light Charcoal	60-318-010801-RT	6
	COVER	25"W 27"D 5"Thickness	Light Charcoal	60-162-010801-RT	6
	COVER	23"W 25"D 5"Thickness	Heather Henna	60-316-016601-RT	6
	COVER	21"W 19"D 5"Thickness	Heather Indigo	60-126-015501-RT	6
	COVER	21"W 25"D 5"Thickness	Heather Indigo	60-128-015501-RT	6
	COVER	23"W 25"D 5"Thickness	Heather Indigo	60-317-015501-RT	6
	COVER	25"W 27"D 5"Thickness	Heather Indigo	60-134-015501-RT	6



Patio Lounge Rectangle Seat Cushion



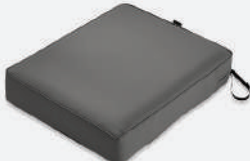



COLORS: HEATHER GREY, ANTIQUE BEIGE, HEATHER FERN, LIGHT CHARCOAL, HEATHER HENNA AND HEATHER INDIGO

	Cushion Foam & Cover Set	Size	Color	E-Commerce Stock No	Case Qty
	COVER + FOAM	23"W 25"D 5"Thickness	Heather Grey	62-053-HGREY-EC	1
	COVER + FOAM	21"W 19"D 5"Thickness	Antique Beige	62-017-BEIGE-EC	1
	COVER + FOAM	21"W 25"D 5"Thickness	Antique Beige	62-018-BEIGE-EC	1
	COVER + FOAM	23"W 25"D 5"Thickness	Antique Beige	62-053-BEIGE-EC	1
	COVER + FOAM	25"W 27"D 5"Thickness	Antique Beige	62-021-BEIGE-EC	1
	COVER + FOAM	23"W 25"D 5"Thickness	Heather Fern	62-053-HFERN-EC	1
	COVER + FOAM	21"W 19"D 5"Thickness	Light Charcoal	62-017-LCHARC-EC	1
	COVER + FOAM	21"W 25"D 5"Thickness	Light Charcoal	62-018-LCHARC-EC	1
	COVER + FOAM	23"W 25"D 5"Thickness	Light Charcoal	62-053-LCHARC-EC	1
	COVER + FOAM	25"W 27"D 5"Thickness	Light Charcoal	62-021-LCHARC-EC	1
	COVER + FOAM	23"W 25"D 5"Thickness	Heather Henna	62-053-HHENNA-EC	1
	COVER + FOAM	21"W 19"D 5"Thickness	Heather Indigo	62-017-INDIGO-EC	1
	COVER + FOAM	21"W 25"D 5"Thickness	Heather Indigo	62-018-INDIGO-EC	1
	COVER + FOAM	23"W 25"D 5"Thickness	Heather Indigo	62-053-INDIGO-EC	1
	COVER + FOAM	25"W 27"D 5"Thickness	Heather Indigo	62-021-INDIGO-EC	1



Patio Lounge Square Seat Cushion Components





COLORS: HEATHER GREY, ANTIQUE BEIGE, HEATHER FERN, LIGHT CHARCOAL, HEATHER HENNA AND HEATHER INDIGO

	Cushion Foam Only	Size	Color	Retail Stock No	Case Qty
	FOAM	21"W 21"D 5"Thickness	White	61-035-010935-RT	6
	FOAM	23"W 23"D 5"Thickness	White	61-019-010919-RT	6
	FOAM	25"W 25"D 5"Thickness	White	61-020-010920-RT	6
	Cushion Cover Only	Size	Color	Retail Stock No	Case Qty
	COVER	21"W 21"D 5"Thickness	Heather Grey	60-202-011001-RT	6
	COVER	23"W 23"D 5"Thickness	Heather Grey	60-076-011001-RT	6
	COVER	25"W 25"D 5"Thickness	Heather Grey	60-077-011001-RT	6
	COVER	21"W 21"D 5"Thickness	Antique Beige	60-178-010301-RT	6
	COVER	23"W 23"D 5"Thickness	Antique Beige	60-020-010301-RT	6
	COVER	25"W 25"D 5"Thickness	Antique Beige	60-021-010301-RT	6
	COVER	21"W 21"D 5"Thickness	Heather Fern	60-255-011101-RT	6
	COVER	23"W 23"D 5"Thickness	Heather Fern	60-048-011101-RT	6
	COVER	25"W 25"D 5"Thickness	Heather Fern	60-049-011101-RT	6
	COVER	21"W 21"D 5"Thickness	Light Charcoal	60-214-016601-RT	6
	COVER	23"W 23"D 5"Thickness	Light Charcoal	60-160-010801-RT	6
	COVER	25"W 25"D 5"Thickness	Light Charcoal	60-161-010801-RT	6
	COVER	21"W 21"D 5"Thickness	Heather Henna	60-226-015501-RT	6
	COVER	23"W 23"D 5"Thickness	Heather Henna	60-104-016601-RT	6
	COVER	25"W 25"D 5"Thickness	Heather Henna	60-105-016601-RT	6
	COVER	21"W 21"D 5"Thickness	Heather Indigo	60-238-010801-RT	6
	COVER	23"W 23"D 5"Thickness	Heather Indigo	60-132-015501-RT	6
	COVER	25"W 25"D 5"Thickness	Heather Indigo	60-133-015501-RT	6

Patio Lounge Square Seat Cushion

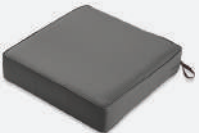

COLORS: HEATHER GREY, ANTIQUE BEIGE, HEATHER FERN, LIGHT CHARCOAL, HEATHER HENNA AND HEATHER INDIGO

	Cushion Foam & Cover Set	Size	Color	E-Commerce Stock No	Case Qty
	FOAM + COVER	21"W 21"D 5"Thickness	Heather Grey	62-035-HGREY-EC	1
	FOAM + COVER	23"W 23"D 5"Thickness	Heather Grey	62-019-HGREY-EC	1
	FOAM + COVER	25"W 25"D 5"Thickness	Heather Grey	62-020-HGREY-EC	1
	FOAM + COVER	21"W 21"D 5"Thickness	Antique Beige	62-035-BEIGE-EC	1
	FOAM + COVER	23"W 23"D 5"Thickness	Antique Beige	62-019-BEIGE-EC	1
	FOAM + COVER	25"W 25"D 5"Thickness	Antique Beige	62-020-BEIGE-EC	1
	FOAM + COVER	21"W 21"D 5"Thickness	Heather Fern	62-035-HFERN-EC	1
	FOAM + COVER	23"W 23"D 5"Thickness	Heather Fern	62-019-HFERN-EC	1
	FOAM + COVER	25"W 25"D 5"Thickness	Heather Fern	62-020-HFERN-EC	1
	FOAM + COVER	21"W 21"D 5"Thickness	Light Charcoal	62-035-LCHARC-EC	1
	FOAM + COVER	23"W 23"D 5"Thickness	Light Charcoal	62-019-LCHARC-EC	1
	FOAM + COVER	25"W 25"D 5"Thickness	Light Charcoal	62-020-LCHARC-EC	1
	FOAM + COVER	21"W 21"D 5"Thickness	Heather Henna	62-035-HHENNA-EC	1
	FOAM + COVER	23"W 23"D 5"Thickness	Heather Henna	62-019-HHENNA-EC	1
	FOAM + COVER	25"W 25"D 5"Thickness	Heather Henna	62-020-HHENNA-EC	1
	FOAM + COVER	21"W 21"D 5"Thickness	Heather Indigo	62-035-INDIGO-EC	1
	FOAM + COVER	23"W 23"D 5"Thickness	Heather Indigo	62-019-INDIGO-EC	1
	FOAM + COVER	25"W 25"D 5"Thickness	Heather Indigo	62-020-INDIGO-EC	1

Patio Lounge Seat and Back Cushion Combo Set



COLORS: HEATHER GREY, ANTIQUE BEIGE, HEATHER FERN, LIGHT CHARCOAL, HEATHER HENNA AND HEATHER INDIGO

	Cushion Foam & Cover Set	Size	Color	E-Commerce Stock No	Case Qty
	SEAT: FOAM + COVER	23"W 23"D 5"Thickness	Heather Grey	62-019-HGREY-SET	1
	BACK: FOAM + COVER	21"W 20"D 4"Thickness			
	SEAT: FOAM + COVER	23"W 23"D 5"Thickness	Antique Beige	62-019-BEIGE-SET	1
	BACK: FOAM + COVER	21"W 20"D 4"Thickness			
	SEAT: FOAM + COVER	23"W 23"D 5"Thickness	Heather Fern	62-019-HFERN-SET	1
	BACK: FOAM + COVER	21"W 20"D 4"Thickness			
	SEAT: FOAM + COVER	23"W 23"D 5"Thickness	Light Charcoal	62-019-LCHARC-SET	1
	BACK: FOAM + COVER	21"W 20"D 4"Thickness			
	SEAT: FOAM + COVER	23"W 23"D 5"Thickness	Heather Henna	62-019-HHENNA-SET	1
	BACK: FOAM + COVER	21"W 20"D 4"Thickness			
	SEAT: FOAM + COVER	23"W 23"D 5"Thickness	Heather Indigo	62-019-INDIGO-SET	1
	BACK: FOAM + COVER	21"W 20"D 4"Thickness			

Patio Lounge Seat and Back Cushion Combo Set



COLORS: HEATHER GREY, ANTIQUE BEIGE, HEATHER FERN, LIGHT CHARCOAL, HEATHER HENNA AND HEATHER INDIGO

	Cushion Foam & Cover Set	Size	Color	E-Commerce Stock No	Case Qty
	SEAT: FOAM + COVER	25"W 25"D 5"Thickness	Heather Grey	62-020-HGREY-SET	1
	BACK: FOAM + COVER	25"W 22"D 4"Thickness			
	SEAT: FOAM + COVER	25"W 25"D 5"Thickness	Antique Beige	62-020-BEIGE-SET	1
	BACK: FOAM + COVER	25"W 22"D 4"Thickness			
	SEAT: FOAM + COVER	25"W 25"D 5"Thickness	Heather Fern	62-020-HFERN-SET	1
	BACK: FOAM + COVER	25"W 22"D 4"Thickness			
	SEAT: FOAM + COVER	25"W 25"D 5"Thickness	Light Charcoal	62-020-LCHARC-SET	1
	BACK: FOAM + COVER	25"W 22"D 4"Thickness			
	SEAT: FOAM + COVER	25"W 25"D 5"Thickness	Heather Henna	62-020-HHENNA-SET	1
	BACK: FOAM + COVER	25"W 22"D 4"Thickness			
	SEAT: FOAM + COVER	25"W 25"D 5"Thickness	Heather Indigo	62-020-INDIGO-SET	1
	BACK: FOAM + COVER	25"W 22"D 4"Thickness			

Patio Lounge Rectangular Bench/Settee Seat Cushion Components









COLORS: HEATHER GREY, ANTIQUE BEIGE, HEATHER FERN, LIGHT CHARCOAL, HEATHER HENNA AND HEATHER INDIGO

	Cushion Foam Only	Size	Color	Retail Stock No	Case Qty
	FOAM	42"W 18"D 3"Thickness	White	61-014-010914-RT	6
	FOAM	48"W 18"D 3"Thickness	White	61-015-010915-RT	6
	FOAM	54"W 18"D 3"Thickness	White	61-044-010944-RT	6
	FOAM	59"W 18"D 3"Thickness	White	61-045-010945-RT	6
	COVER	42"W 18"D 3"Thickness	Heather Grey	60-081-011001-RT	6
	COVER	48"W 18"D 3"Thickness	Heather Grey	60-082-011001-RT	6
	COVER	54"W 18"D 3"Thickness	Heather Grey	60-268-011001-RT	6
	COVER	59"W 18"D 3"Thickness	Heather Grey	60-269-011001-RT	6
	COVER	42"W 18"D 3"Thickness	Antique Beige	60-025-010301-RT	6
	COVER	48"W 18"D 3"Thickness	Antique Beige	60-026-010301-RT	6
	COVER	54"W 18"D 3"Thickness	Antique Beige	60-246-010301-RT	6
	COVER	59"W 18"D 3"Thickness	Antique Beige	60-247-010301-RT	6
	COVER	42"W 18"D 3"Thickness	Heather Fern	60-053-011101-RT	6
	COVER	48"W 18"D 3"Thickness	Heather Fern	60-054-011101-RT	6
	COVER	54"W 18"D 3"Thickness	Heather Fern	60-257-011101-RT	6
	COVER	59"W 18"D 3"Thickness	Heather Fern	60-258-011101-RT	6
	COVER	42"W 18"D 3"Thickness	Light Charcoal	60-165-010801-RT	6
	COVER	48"W 18"D 3"Thickness	Light Charcoal	60-166-010801-RT	6
	COVER	54"W 18"D 3"Thickness	Light Charcoal	60-301-010801-RT	6
	COVER	59"W 18"D 3"Thickness	Light Charcoal	60-302-010801-RT	6
	COVER	42"W 18"D 3"Thickness	Heather Henna	60-109-016601-RT	6
	COVER	48"W 18"D 3"Thickness	Heather Henna	60-110-016601-RT	6
	COVER	54"W 18"D 3"Thickness	Heather Henna	60-279-016601-RT	6
	COVER	59"W 18"D 3"Thickness	Heather Henna	60-280-016601-RT	6
	COVER	42"W 18"D 3"Thickness	Heather Indigo	60-137-015501-RT	6
	COVER	48"W 18"D 3"Thickness	Heather Indigo	60-138-015501-RT	6
	COVER	54"W 18"D 3"Thickness	Heather Indigo	60-290-015501-RT	6
	COVER	59"W 18"D 3" Thickness	Heather Indigo	60-291-015501-RT	6

Patio Lounge Rectangular Bench/Settee Seat Cushion



COLORS: HEATHER GREY, ANTIQUE BEIGE, HEATHER FERN, LIGHT CHARCOAL, HEATHER HENNA AND HEATHER INDIGO

	Cushion Foam & Cover Set	Size	Color	E-Commerce Stock No	Case Qty
	FOAM + COVER	42"W 18"D 3"Thickness	Heather Grey	62-014-HGREY-EC	1
	FOAM + COVER	48"W 18"D 3"Thickness	Heather Grey	62-015-HGREY-EC	1
	FOAM + COVER	54"W 18"D 3"Thickness	Heather Grey	62-044-HGREY-EC	1
	FOAM + COVER	59"W 18"D 3"Thickness	Heather Grey	62-045-HGREY-EC	1
	FOAM + COVER	42"W 18"D 3"Thickness	Antique Beige	62-014-BEIGE-EC	1
	FOAM + COVER	48"W 18"D 3"Thickness	Antique Beige	62-015-BEIGE-EC	1
	FOAM + COVER	54"W 18"D 3"Thickness	Antique Beige	62-044-BEIGE-EC	1
	FOAM + COVER	59"W 18"D 3"Thickness	Antique Beige	62-045-BEIGE-EC	1
	FOAM + COVER	42"W 18"D 3"Thickness	Heather Fern	62-014-HFERN-EC	1
	FOAM + COVER	48"W 18"D 3"Thickness	Heather Fern	62-015-HFERN-EC	1
	FOAM + COVER	54"W 18"D 3"Thickness	Heather Fern	62-044-HFERN-EC	1
	FOAM + COVER	59"W 18"D 3"Thickness	Heather Fern	62-045-HFERN-EC	1
	FOAM + COVER	42"W 18"D 3"Thickness	Light Charcoal	62-014-LCHARC-EC	1
	FOAM + COVER	48"W 18"D 3"Thickness	Light Charcoal	62-015-LCHARC-EC	1
	FOAM + COVER	54"W 18"D 3"Thickness	Light Charcoal	62-044-LCHARC-EC	1
	FOAM + COVER	59"W 18"D 3"Thickness	Light Charcoal	62-045-LCHARC-EC	1
	FOAM + COVER	42"W 18"D 3"Thickness	Heather Henna	62-014-HHENNA-EC	1
	FOAM + COVER	48"W 18"D 3"Thickness	Heather Henna	62-015-HHENNA-EC	1
	FOAM + COVER	54"W 18"D 3"Thickness	Heather Henna	62-044-HHENNA-EC	1
	FOAM + COVER	59"W 18"D 3"Thickness	Heather Henna	62-045-HHENNA-EC	1
	FOAM + COVER	42"W 18"D 3"Thickness	Heather Indigo	62-014-INDIGO-EC	1
	FOAM + COVER	48"W 18"D 3"Thickness	Heather Indigo	62-015-INDIGO-EC	1
	FOAM + COVER	54"W 18"D 3"Thickness	Heather Indigo	62-044-INDIGO-EC	1
	FOAM + COVER	59"W 18"D 3"Thickness	Heather Indigo	62-045-INDIGO-EC	1

Patio Lounge Contoured Back Bench/Settee Seat Cushion Components



COLORS: HEATHER GREY, ANTIQUE BEIGE, HEATHER FERN, LIGHT CHARCOAL, HEATHER HENNA AND HEATHER INDIGO

	Cushion Foam Only	Size	Color	Retail Stock No	Case Qty
	FOAM	41"W 18"D 3"Thickness	White	61-016-010916-RT	6
	Cushion Cover Only	Size	Color	Retail Stock No	Case Qty
	COVER	41"W 18"D 3"Thickness	Heather Grey	60-083-011001-RT	6
	COVER	41"W 18"D 3"Thickness	Antique Beige	60-027-010301-RT	6
	COVER	41"W 18"D 3"Thickness	Heather Fern	60-055-011101-RT	6
	COVER	41"W 18"D 3"Thickness	Light Charcoal	60-167-010801-RT	6
	COVER	41"W 18"D 3"Thickness	Heather Henna	60-111-016601-RT	6
	COVER	41"W 18"D 3"Thickness	Heather Indigo	60-139-015501-RT	6

Patio Lounge Contoured Back Bench/Settee Seat Cushion



COLORS: HEATHER GREY, ANTIQUE BEIGE, HEATHER FERN, LIGHT CHARCOAL, HEATHER HENNA AND HEATHER INDIGO

	Cushion Foam & Cover Set	Size	Color	E-Commerce Stock No	Case Qty
	FOAM + COVER	41"W 18"D 3"Thickness	Heather Grey	62-016-HGREY-EC	1
	FOAM + COVER	41"W 18"D 3"Thickness	Antique Beige	62-016-BEIGE-EC	1
	FOAM + COVER	41"W 18"D 3"Thickness	Heather Fern	62-016-HFERN-EC	1
	FOAM + COVER	41"W 18"D 3"Thickness	Light Charcoal	62-016-LCHARC-EC	1
	FOAM + COVER	41"W 18"D 3"Thickness	Heather Henna	62-016-HHENNA-EC	1
	FOAM + COVER	41"W 18"D 3"Thickness	Heather Indigo	62-016-INDIGO-EC	1



Patio Lounge Chaise Cushion Components







COLORS: HEATHER GREY, ANTIQUE BEIGE, HEATHER FERN, LIGHT CHARCOAL, HEATHER HENNA AND HEATHER INDIGO

	Cushion Foam Only	Size	Color	Retail Stock No	Case Qty
	FOAM	72"L 21"W 3"Thickness	White	61-001-010901-RT	6
	FOAM	74"L 23"W 3"Thickness	White	61-056-010901-RT	6
	FOAM	80"L 26"W 3"Thickness	White	61-029-010929-RT	6
	COVER	72"L 21"W 3"Thickness	Heather Grey	60-084-011001-RT	6
	COVER	74"L 23"W 3"Thickness	Heather Grey	60-441-011001-RT	6
	COVER	80"L 26"W 3"Thickness	Heather Grey	60-204-011001-RT	6
	COVER	72"L 21"W 3"Thickness	Antique Beige	60-028-010301-RT	6
	COVER	74"L 23"W 3"Thickness	Antique Beige	60-439-010301-RT	6
	COVER	80"L 26"W 3"Thickness	Antique Beige	60-180-010301-RT	6
	COVER	72"L 21"W 3"Thickness	Heather Fern	60-056-011101-RT	6
	COVER	74"L 23"W 3"Thickness	Heather Fern	60-440-011101-RT	6
	COVER	80"L 26"W 3"Thickness	Heather Fern	60-192-011101-RT	6
	COVER	72"L 21"W 3"Thickness	Light Charcoal	60-168-010801-RT	6
	COVER	74"L 23"W 3"Thickness	Light Charcoal	60-444-010801-RT	6
	COVER	80"L 26"W 3"Thickness	Light Charcoal	60-240-010801-RT	6
	COVER	72"L 21"W 3"Thickness	Heather Henna	60-112-016601-RT	6
	COVER	74"L 23"W 3"Thickness	Heather Henna	60-442-016601-RT	6
	COVER	80"L 26"W 3"Thickness	Heather Henna	60-216-016601-RT	6
	COVER	72"L 21"W 3"Thickness	Heather Indigo	60-140-015501-RT	6
	COVER	74"L 23"W 3"Thickness	Heather Indigo	60-443-015501-RT	6
	COVER	80"L 26"W 3"Thickness	Heather Indigo	60-228-015501-RT	6



Patio Lounge Chaise Cushion







COLORS: HEATHER GREY, ANTIQUE BEIGE, HEATHER FERN, LIGHT CHARCOAL, HEATHER HENNA AND HEATHER INDIGO

	Cushion Foam & Cover Set	Size	Color	E-Commerce Stock No	Case Qty
	FOAM + COVER	72"L 21"W 3"Thickness	Heather Grey	62-001-HGREY-EC	1
	FOAM + COVER	74"L 23"W 3"Thickness	Heather Grey	62-056-HGREY-EC	1
	FOAM + COVER	80"L 26"W 3"Thickness	Heather Grey	62-029-HGREY-EC	1
	FOAM + COVER	72"L 21"W 3"Thickness	Antique Beige	62-001-BEIGE-EC	1
	FOAM + COVER	74"L 23"W 3"Thickness	Antique Beige	62-056-BEIGE-EC	1
	FOAM + COVER	80"L 26"W 3"Thickness	Antique Beige	62-029-BEIGE-EC	1
	FOAM + COVER	72"L 21"W 3"Thickness	Heather Fern	62-001-HFERN-EC	1
	FOAM + COVER	74"L 23"W 3"Thickness	Heather Fern	62-056-HFERN-EC	1
	FOAM + COVER	80"L 26"W 3"Thickness	Heather Fern	62-029-HFERN-EC	1
	FOAM + COVER	72"L 21"W 3"Thickness	Light Charcoal	62-001-LCHARC-EC	1
	FOAM + COVER	74"L 23"W 3"Thickness	Light Charcoal	62-056-LCHARC-EC	1
	FOAM + COVER	80"L 26"W 3"Thickness	Light Charcoal	62-029-LCHARC-EC	1
	FOAM + COVER	72"L 21"W 3"Thickness	Heather Henna	62-001-HHENNA-EC	1
	FOAM + COVER	74"L 23"W 3"Thickness	Heather Henna	62-056-HHENNA-EC	1
	FOAM + COVER	80"L 26"W 3"Thickness	Heather Henna	62-029-HHENNA-EC	1
	FOAM + COVER	72"L 21"W 3"Thickness	Heather Indigo	62-001-INDIGO-EC	1
	FOAM + COVER	74"L 23"W 3"Thickness	Heather Indigo	62-056-INDIGO-EC	1
	FOAM + COVER	80"L 26"W 3"Thickness	Heather Indigo	62-029-INDIGO-EC	1



Patio Dining Contoured Back Cushion Components

COLORS: HEATHER GREY, ANTIQUE BEIGE, HEATHER FERN, LIGHT CHARCOAL, HEATHER HENNA AND HEATHER INDIGO

	Cushion Foam Only	Size	Color	Retail Stock No	Case Qty
	FOAM	18"W 18"D 2"Thickness	White	61-005-010905-RT	6
	FOAM	20"W 20"D 2"Thickness	White	61-006-010906-RT	6
	COVER	18"W 18"D 2"Thickness	Heather Grey	60-079-011001-RT	6
	COVER	20"W 20"D 2"Thickness	Heather Grey	60-080-011001-RT	6
	COVER	18"W 18"D 2"Thickness	Antique Beige	60-023-010301-RT	6
	COVER	20"W 20"D 2"Thickness	Antique Beige	60-024-010301-RT	6
	COVER	18"W 18"D 2"Thickness	Heather Fern	60-051-011101-RT	6
	COVER	20"W 20"D 2"Thickness	Heather Fern	60-052-011101-RT	6
	COVER	18"W 18"D 2"Thickness	Light Charcoal	60-163-010801-RT	6
	COVER	20"W 20"D 2"Thickness	Light Charcoal	60-164-010801-RT	6
	COVER	18"W 18"D 2"Thickness	Heather Henna	60-107-016601-RT	6
	COVER	20"W 20"D 2"Thickness	Heather Henna	60-108-016601-RT	6
	COVER	18"W 18"D 2"Thickness	Heather Indigo	60-135-015501-RT	6
	COVER	20"W 20"D 2"Thickness	Heather Indigo	60-136-015501-RT	6

Patio Dining Contoured Back Cushion









COLORS: HEATHER GREY, ANTIQUE BEIGE, HEATHER FERN, LIGHT CHARCOAL, HEATHER HENNA AND HEATHER INDIGO

	Cushion Foam & Cover Set	Size	Color	E-Commerce Stock No	Case Qty
	FOAM + COVER	18"W 18"D 2"Thickness	Heather Grey	62-005-HGREY-EC	1
	FOAM + COVER	20"W 20"D 2"Thickness	Heather Grey	62-006-HGREY-EC	1
	FOAM + COVER	18"W 18"D 2"Thickness	Antique Beige	62-005-BEIGE-EC	1
	FOAM + COVER	20"W 20"D 2"Thickness	Antique Beige	62-006-BEIGE-EC	1
	FOAM + COVER	18"W 18"D 2"Thickness	Heather Fern	62-005-HFERN-EC	1
	FOAM + COVER	20"W 20"D 2"Thickness	Heather Fern	62-006-HFERN-EC	1
	FOAM + COVER	18"W 18"D 2"Thickness	Light Charcoal	62-005-LCHARC-EC	1
	FOAM + COVER	20"W 20"D 2"Thickness	Light Charcoal	62-006-LCHARC-EC	1
	FOAM + COVER	18"W 18"D 2"Thickness	Heather Henna	62-005-HHENNA-EC	1
	FOAM + COVER	20"W 20"D 2"Thickness	Heather Henna	62-006-HHENNA-EC	1
	FOAM + COVER	18"W 18"D 2"Thickness	Heather Indigo	62-005-INDIGO-EC	1
	FOAM + COVER	20"W 20"D 2"Thickness	Heather Indigo	62-006-INDIGO-EC	1



Patio Dining Rectangular Seat Cushion Components

COLORS: HEATHER GREY, ANTIQUE BEIGE, HEATHER FERN, LIGHT CHARCOAL, HEATHER HENNA AND HEATHER INDIGO

	Cushion Foam Only	Size	Color	Retail Stock No	Case Qty
	FOAM	21"W 19"D 3"Thickness	White	61-009-010909-RT	6
	Cushion Cover Only	Size	Color	Retail Stock No	Case Qty
	COVER	21"W 19"D 3"Thickness	Heather Grey	60-069-011001-RT	6
	COVER	21"W 19"D 3"Thickness	Antique Beige	60-013-010301-RT	6
	COVER	21"W 19"D 3"Thickness	Heather Fern	60-041-011101-RT	6
	COVER	21"W 19"D 3"Thickness	Light Charcoal	60-153-010801-RT	6
	COVER	21"W 19"D 3"Thickness	Heather Henna	60-097-016601-RT	6
	COVER	21"W 19"D 3"Thickness	Heather Indigo	60-125-015501-RT	6

Patio Dining Rectangular Seat Cushion









COLORS: HEATHER GREY, ANTIQUE BEIGE, HEATHER FERN, LIGHT CHARCOAL, HEATHER HENNA AND HEATHER INDIGO

	Cushion Foam & Cover Set	Size	Color	E-Commerce Stock No	Case Qty
	FOAM + COVER	21"W 19"D 3"Thickness	Heather Grey	62-009-HGREY-EC	1
	FOAM + COVER	21"W 19"D 3"Thickness	Antique Beige	62-009-BEIGE-EC	1
	FOAM + COVER	21"W 19"D 3"Thickness	Heather Fern	62-009-HFERN-EC	1
	FOAM + COVER	21"W 19"D 3"Thickness	Light Charcoal	62-009-LCHARC-EC	1
	FOAM + COVER	21"W 19"D 3"Thickness	Heather Henna	62-009-HHENNA-EC	1
	FOAM + COVER	21"W 19"D 3"Thickness	Heather Indigo	62-009-INDIGO-EC	1



Patio Dining Square Seat Cushion Components







COLORS: HEATHER GREY, ANTIQUE BEIGE, HEATHER FERN, LIGHT CHARCOAL, HEATHER HENNA AND HEATHER INDIGO

	Cushion Foam Only	Size	Color	Retail Stock No	Case Qty
	FOAM	17"W 17"D 3"Thickness	White	61-007-010907-RT	6
	FOAM	19"W 19"D 3"Thickness	White	61-008-010908-RT	6
	FOAM	21"W 21"D 3"Thickness	White	61-010-010910-RT	6
	Cushion Cover Only	Size	Color	Retail Stock No	Case Qty
	COVER	17"W 17"D 3"Thickness	Heather Grey	60-065-011001-RT	6
	COVER	19"W 19"D 3"Thickness	Heather Grey	60-067-011001-RT	6
	COVER	21"W 21"D 3"Thickness	Heather Grey	60-071-011001-RT	6
	COVER	17"W 17"D 3"Thickness	Antique Beige	60-009-010301-RT	6
	COVER	19"W 19"D 3"Thickness	Antique Beige	60-011-010301-RT	6
	COVER	21"W 21"D 3"Thickness	Antique Beige	60-015-010301-RT	6
	COVER	17"W 17"D 3"Thickness	Heather Fern	60-037-011101-RT	6
	COVER	19"W 19"D 3"Thickness	Heather Fern	60-039-011101-RT	6
	COVER	21"W 21"D 3"Thickness	Heather Fern	60-043-011101-RT	6
	COVER	17"W 17"D 3"Thickness	Light Charcoal	60-149-010801-RT	6
	COVER	19"W 19"D 3"Thickness	Light Charcoal	60-151-010801-RT	6
	COVER	21"W 21"D 3"Thickness	Light Charcoal	60-155-010801-RT	6
	COVER	17"W 17"D 3"Thickness	Heather Henna	60-093-016601-RT	6
	COVER	19"W 19"D 3"Thickness	Heather Henna	60-095-016601-RT	6
	COVER	21"W 21"D 3"Thickness	Heather Henna	60-099-016601-RT	6
	COVER	17"W 17"D 3"Thickness	Heather Indigo	60-121-015501-RT	6
	COVER	19"W 19"D 3"Thickness	Heather Indigo	60-123-015501-RT	6
	COVER	21"W 21"D 3"Thickness	Heather Indigo	60-127-015501-RT	6



Patio Dining Square Seat Cushion

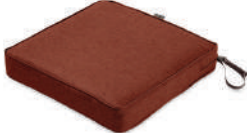

COLORS: HEATHER GREY, ANTIQUE BEIGE, HEATHER FERN, LIGHT CHARCOAL, HEATHER HENNA AND HEATHER INDIGO

	Cushion Foam & Cover Set	Size	Color	E-Commerce Stock No	Case Qty
	FOAM + COVER	17"W 17"D 3"Thickness	Heather Grey	62-007-HGREY-EC	1
	FOAM + COVER	19"W 19"D 3"Thickness	Heather Grey	62-008-HGREY-EC	1
	FOAM + COVER	21"W 21"D 3"Thickness	Heather Grey	62-010-HGREY-EC	1
	FOAM + COVER	17"W 17"D 3"Thickness	Antique Beige	62-007-BEIGE-EC	1
	FOAM + COVER	19"W 19"D 3"Thickness	Antique Beige	62-008-BEIGE-EC	1
	FOAM + COVER	21"W 21"D 3"Thickness	Antique Beige	62-010-BEIGE-EC	1
	FOAM + COVER	17"W 17"D 3"Thickness	Heather Fern	62-007-HFERN-EC	1
	FOAM + COVER	19"W 19"D 3"Thickness	Heather Fern	62-008-HFERN-EC	1
	FOAM + COVER	21"W 21"D 3"Thickness	Heather Fern	62-010-HFERN-EC	1
	FOAM + COVER	17"W 17"D 3"Thickness	Light Charcoal	62-007-LCHARC-EC	1
	FOAM + COVER	19"W 19"D 3"Thickness	Light Charcoal	62-008-LCHARC-EC	1
	FOAM + COVER	21"W 21"D 3"Thickness	Light Charcoal	62-010-LCHARC-EC	1
	FOAM + COVER	17"W 17"D 3"Thickness	Heather Henna	62-007-HHENNA-EC	1
	FOAM + COVER	19"W 19"D 3"Thickness	Heather Henna	62-008-HHENNA-EC	1
	FOAM + COVER	21"W 21"D 3"Thickness	Heather Henna	62-010-HHENNA-EC	1
	FOAM + COVER	17"W 17"D 3"Thickness	Heather Indigo	62-007-INDIGO-EC	1
	FOAM + COVER	19"W 19"D 3"Thickness	Heather Indigo	62-008-INDIGO-EC	1
	FOAM + COVER	21"W 21"D 3"Thickness	Heather Indigo	62-010-INDIGO-EC	1

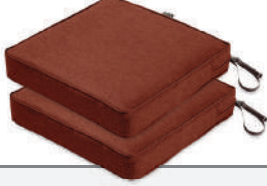

Patio Dining Square Seat Cushion—2 Pack

COLORS: HEATHER GREY, ANTIQUE BEIGE, HEATHER FERN, LIGHT CHARCOAL, HEATHER HENNA AND HEATHER INDIGO

	Cushion Foam & Cover Set	Size	Color	E-Commerce Stock No	Case Qty
	FOAM + COVER	19"W 19"D 3"Thickness	Heather Grey	62-008-HGREY-2PK	1
	FOAM + COVER	19"W 19"D 3"Thickness	Antique Beige	62-008-BEIGE-2PK	1
	FOAM + COVER	19"W 19"D 3"Thickness	Heather Fern	62-008-HFERN-2PK	1
	FOAM + COVER	19"W 19"D 3"Thickness	Light Charcoal	62-008-LCHARC-2PK	1
	FOAM + COVER	19"W 19"D 3"Thickness	Heather Henna	62-008-HHENNA-2PK	1
	FOAM + COVER	19"W 19"D 3"Thickness	Heather Indigo	62-008-INDIGO-2PK	1

Patio Dining Seat and Back Cushion Combo Components



COLORS: HEATHER GREY, ANTIQUE BEIGE, HEATHER FERN, LIGHT CHARCOAL, HEATHER HENNA AND HEATHER INDIGO

	Cushion Foam Only	Size	Color	Retail Stock No	Case Qty
	FOAM	44"L 20"W 3"Thickness	White	61-055-010901-RT	6
	Cushion Cover Only	Size	Color	Retail Stock No	Case Qty
	COVER	44"L 20"W 3"Thickness	Heather Grey	60-435-011001-RT	6
	COVER	44"L 20"W 3"Thickness	Antique Beige	60-433-010301-RT	6
	COVER	44"L 20"W 3"Thickness	Heather Fern	60-434-011101-RT	6
	COVER	44"L 20"W 3"Thickness	Light Charcoal	60-438-010801-RT	6
	COVER	44"L 20"W 3"Thickness	Heather Henna	60-436-016601-RT	6
	COVER	44"L 20"W 3"Thickness	Heather Indigo	60-437-015501-RT	6

Patio Dining Seat and Back Cushion Combo Set









	Cushion Foam & Cover Set	Size	Color	E-Commerce Stock No	Case Qty
	FOAM + COVER	44"L 20"W 3"Thickness	Heather Grey	62-055-HGREY-EC	1
	FOAM + COVER	44"L 20"W 3"Thickness	Antique Beige	62-055-BEIGE-EC	1
	FOAM + COVER	44"L 20"W 3"Thickness	Heather Fern	62-055-HFERN-EC	1
	FOAM + COVER	44"L 20"W 3"Thickness	Light Charcoal	62-055-LCHARC-EC	1
	FOAM + COVER	44"L 20"W 3"Thickness	Heather Henna	62-055-HHENNA-EC	1
	FOAM + COVER	44"L 20"W 3"Thickness	Heather Indigo	62-055-INDIGO-EC	1



Patio Dining Round Seat Cushion Components







COLORS: HEATHER GREY, ANTIQUE BEIGE, HEATHER FERN, LIGHT CHARCOAL, HEATHER HENNA AND HEATHER INDIGO

	Cushion Foam Only	Size	Color	Retail Stock No	Case Qty
	FOAM	15"DIA 2"Thickness	White	61-002-010902-RT	6
	FOAM	18"DIA 2"Thickness	White	61-003-010903-RT	6
	COVER	15"DIA 2"Thickness	Heather Grey	60-064-011001-RT	6
	COVER	18"DIA 2"Thickness	Heather Grey	60-066-011001-RT	6
	COVER	15"DIA 2"Thickness	Antique Beige	60-008-010301-RT	6
	COVER	18"DIA 2"Thickness	Antique Beige	60-010-010301-RT	6
	COVER	15"DIA 2"Thickness	Heather Fern	60-036-011101-RT	6
	COVER	18"DIA 2"Thickness	Heather Fern	60-038-011101-RT	6
	COVER	15"DIA 2"Thickness	Light Charcoal	60-148-010801-RT	6
	COVER	18"DIA 2"Thickness	Light Charcoal	60-150-010801-RT	6
	COVER	15"DIA 2"Thickness	Heather Henna	60-092-016601-RT	6
	COVER	18"DIA 2"Thickness	Heather Henna	60-094-016601-RT	6
	COVER	15"DIA 2"Thickness	Heather Indigo	60-120-015501-RT	6
	COVER	18"DIA 2"Thickness	Heather Indigo	60-122-015501-RT	6

Patio Dining Round Seat Cushion



COLORS: HEATHER GREY, ANTIQUE BEIGE, HEATHER FERN, LIGHT CHARCOAL, HEATHER HENNA AND HEATHER INDIGO

	Cushion Foam & Cover Set	Size	Color	E-Commerce Stock No	Case Qty
	FOAM + COVER	15"DIA 2"Thickness	Heather Grey	62-002-HGREY-EC	1
	FOAM + COVER	18"DIA 2"Thickness	Heather Grey	62-003-HGREY-EC	1
	FOAM + COVER	15"DIA 2"Thickness	Antique Beige	62-002-BEIGE-EC	1
	FOAM + COVER	18"DIA 2"Thickness	Antique Beige	62-003-BEIGE-EC	1
	FOAM + COVER	15"DIA 2"Thickness	Heather Fern	62-002-HFERN-EC	1
	FOAM + COVER	18"DIA 2"Thickness	Heather Fern	62-003-HFERN-EC	1
	FOAM + COVER	15"DIA 2"Thickness	Light Charcoal	62-002-LCHARC-EC	1
	FOAM + COVER	18"DIA 2"Thickness	Light Charcoal	62-003-LCHARC-EC	1
	FOAM + COVER	15"DIA 2"Thickness	Heather Henna	62-002-HHENNA-EC	1
	FOAM + COVER	18"DIA 2"Thickness	Heather Henna	62-003-HHENNA-EC	1
	FOAM + COVER	15"DIA 2"Thickness	Heather Indigo	62-002-INDIGO-EC	1
	FOAM + COVER	18"DIA 2"Thickness	Heather Indigo	62-003-INDIGO-EC	1

HOME PATIO | RAVENNA®



Ravenna® Cushions



COLORS: DARK TAUPE, EMPIRE BLUE, ESPRESSO, MALLARD GREEN, MUSHROOM AND SPICE

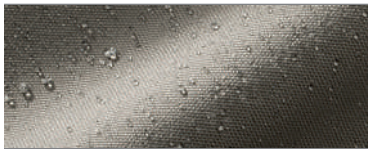

Gardelle One™ Fabric System

Gardelle One™ is a solution-dyed, durable woven polyester fabric with a protective water repellent coating and water-resistant laminated backing



Water-Repellent Coating

Resists stains and helps keep rain out and your cushion foam protected



Patented Attachment System

Patented 9,155,397 B2

Adjustable belted hem with click-close straps provides a tight, customizable fit to keep your cushion where you want it



Durable Stitching

Bound interior seams are engineered to provide strength and durability at the most demanding joints



Locking Zippers

Zippers lock to keep a tight closure and make stuffing the cushion easier









3-Layered Seat Foam and Solid-Core Back Foam

Foam is designed for comfort and support, with outer layers of open-cell foam enclosing a high-density core that is resilient but conforms to your shape



Patio Dining Rectangular Seat Cushion Components

COLORS: DARK TAUPE, EMPIRE BLUE, ESPRESSO, MALLARD GREEN, MUSHROOM AND SPICE

	Cushion Foam Only	Size	Color	Retail Stock No	Case Qty
	FOAM	21"W 19"D 3"Thickness	White	61-009-010909-RT	6
	Cushion Cover Only	Size	Color	Retail Stock No	Case Qty
	COVER	21"W 19"D 3"Thickness	Dark Taupe	60-423-015101-RT	6
	COVER	21"W 19"D 3"Thickness	Empire Blue	60-338-010501-RT	6
	COVER	21"W 19"D 3"Thickness	Espresso	60-355-016601-RT	6
	COVER	21"W 19"D 3"Thickness	Mallard Green	60-372-011101-RT	6
	COVER	21"W 19"D 3"Thickness	Mushroom	60-389-016401-RT	6
	COVER	21"W 19"D 3"Thickness	Spice	60-406-011701-RT	6









Patio Dining Rectangular Seat Cushion

	Cushion Foam & Cover Set	Size	Color	E-Commerce Stock No	Case Qty
	FOAM + COVER	21"W 19"D 3"Thickness	Dark Taupe	62-009-TAUPE-EC	1
	FOAM + COVER	21"W 19"D 3"Thickness	Empire Blue	62-009-EMBLUE-EC	1
	FOAM + COVER	21"W 19"D 3"Thickness	Espresso	62-009-ESPRES-EC	1
	FOAM + COVER	21"W 19"D 3"Thickness	Mallard Green	62-009-MGREEN-EC	1
	FOAM + COVER	21"W 19"D 3"Thickness	Mushroom	62-009-MUSHRM-EC	1
	FOAM + COVER	21"W 19"D 3"Thickness	Spice	62-009-SPICE-EC	1



Patio Dining Square Seat Cushion Components

COLORS: DARK TAUPE, EMPIRE BLUE, ESPRESSO, MALLARD GREEN, MUSHROOM AND SPICE

	Cushion Foam Only	Size	Color	Retail Stock No	Case Qty
	FOAM	19"W 19"D 3"Thickness	White	61-008-010908-RT	6
FOAM	21"W 21"D 3"Thickness	White	61-010-010910-RT	6	
	Cushion Cover Only	Size	Color	Retail Stock No	Case Qty
	COVER	19"W 19"D 3"Thickness	Dark Taupe	60-422-015101-RT	6
COVER	21"W 21"D 3"Thickness	Dark Taupe	60-424-015101-RT	6	
	COVER	19"W 19"D 3"Thickness	Empire Blue	60-337-010501-RT	6
	COVER	21"W 21"D 3"Thickness	Empire Blue	60-339-010501-RT	6
	COVER	19"W 19"D 3"Thickness	Espresso	60-354-016601-RT	6
	COVER	21"W 21"D 3"Thickness	Espresso	60-356-016601-RT	6
	COVER	19"W 19"D 3"Thickness	Mallard Green	60-371-011101-RT	6
	COVER	21"W 21"D 3"Thickness	Mallard Green	60-373-011101-RT	6
	COVER	19"W 19"D 3"Thickness	Mushroom	60-388-016401-RT	6
	COVER	21"W 21"D 3"Thickness	Mushroom	60-390-016401-RT	6
	COVER	19"W 19"D 3"Thickness	Spice	60-405-011701-RT	6
	COVER	21"W 21"D 3"Thickness	Spice	60-407-011701-RT	6

Patio Dining Square Seat Cushion









	Cushion Foam & Cover Set	Size	Color	E-Commerce Stock No	Case Qty
	FOAM + COVER	19"W 19"D 3"Thickness	Dark Taupe	62-008-TAUPE-EC	1
FOAM + COVER	21"W 21"D 3"Thickness	Dark Taupe	62-010-TAUPE-EC	1	
	FOAM + COVER	19"W 19"D 3"Thickness	Empire Blue	62-008-EMBLUE-EC	1
	FOAM + COVER	21"W 21"D 3"Thickness	Empire Blue	62-010-EMBLUE-EC	1
	FOAM + COVER	19"W 19"D 3"Thickness	Espresso	62-008-ESPRES-EC	1
	FOAM + COVER	21"W 21"D 3"Thickness	Espresso	62-010-ESPRES-EC	1
	FOAM + COVER	19"W 19"D 3"Thickness	Mallard Green	62-008-MGREEN-EC	1
	FOAM + COVER	21"W 21"D 3"Thickness	Mallard Green	62-010-MGREEN-EC	1
	FOAM + COVER	19"W 19"D 3"Thickness	Mushroom	62-008-MUSHRM-EC	1
	FOAM + COVER	21"W 21"D 3"Thickness	Mushroom	62-010-MUSHRM-EC	1
	FOAM + COVER	19"W 19"D 3"Thickness	Spice	62-008-SPICE-EC	1
	FOAM + COVER	21"W 21"D 3"Thickness	Spice	62-010-SPICE-EC	1



Patio Dining Rectangular Seat Cushion Components

COLORS: DARK TAUPE, EMPIRE BLUE, ESPRESSO, MALLARD GREEN, MUSHROOM AND SPICE

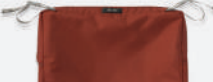
	Cushion Foam Only	Size	Color	Retail Stock No	Case Qty
	FOAM	17"W 15"D 2"Thickness	White	61-030-010930-RT	6
	Cushion Cover Only	Size	Color	Retail Stock No	Case Qty
	COVER	17"W 15"D 2"Thickness	Dark Taupe	60-421-015101-RT	6
	COVER	17"W 15"D 2"Thickness	Empire Blue	60-336-010501-RT	6
	COVER	17"W 15"D 2"Thickness	Espresso	60-353-016601-RT	6
	COVER	17"W 15"D 2"Thickness	Mallard Green	60-370-011101-RT	6
	COVER	17"W 15"D 2"Thickness	Mushroom	60-387-016401-RT	6
	COVER	17"W 15"D 2"Thickness	Spice	60-404-011701-RT	6

Patio Dining Rectangular Seat Cushion





	Cushion Foam & Cover Set	Size	Color	E-Commerce Stock No	Case Qty
	FOAM + COVER	17"W 15"D 2"Thickness	Dark Taupe	62-030-TAUPE-EC	1
	FOAM + COVER	17"W 15"D 2"Thickness	Empire Blue	62-030-EMBLUE-EC	1
	FOAM + COVER	17"W 15"D 2"Thickness	Espresso	62-030-ESPRES-EC	1
	FOAM + COVER	17"W 15"D 2"Thickness	Mallard Green	62-030-MGREEN-EC	1
	FOAM + COVER	17"W 15"D 2"Thickness	Mushroom	62-030-MUSHRM-EC	1
	FOAM + COVER	17"W 15"D 2"Thickness	Spice	62-030-SPICE-EC	1



Patio Lounge Chaise Cushion Components

COLORS: DARK TAUPE, EMPIRE BLUE, ESPRESSO, MALLARD GREEN, MUSHROOM AND SPICE

	Cushion Foam Only	Size	Color	Retail Stock No	Case Qty
	FOAM	72"L 21"W 3"Thickness	White	61-001-010901-RT	6
	Cushion Cover Only	Size	Color	Retail Stock No	Case Qty
	COVER	72"L 21"W 3"Thickness	Dark Taupe	60-431-015101-RT	6
	COVER	72"L 21"W 3"Thickness	Empire Blue	60-346-010501-RT	6
	COVER	72"L 21"W 3"Thickness	Espresso	60-363-016601-RT	6
	COVER	72"L 21"W 3"Thickness	Mallard Green	60-380-011101-RT	6
	COVER	72"L 21"W 3"Thickness	Mushroom	60-397-016401-RT	6
	COVER	72"L 21"W 3"Thickness	Spice	60-414-011701-RT	6









Patio Lounge Chaise Cushion

	Cushion Foam & Cover Set	Size	Color	E-Commerce Stock No	Case Qty
	FOAM + COVER	72"L 21"W 3"Thickness	Dark Taupe	62-001-TAUPE-EC	1
	FOAM + COVER	72"L 21"W 3"Thickness	Empire Blue	62-001-EMBLUE-EC	1
	FOAM + COVER	72"L 21"W 3"Thickness	Espresso	62-001-ESPRES-EC	1
	FOAM + COVER	72"L 21"W 3"Thickness	Mallard Green	62-001-MGREEN-EC	1
	FOAM + COVER	72"L 21"W 3"Thickness	Mushroom	62-001-MUSHRM-EC	1
	FOAM + COVER	72"L 21"W 3"Thickness	Spice	62-001-SPICE-EC	1

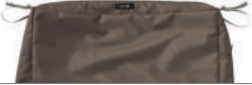





Patio Lounge Rectangular Seat Cushion Components

COLORS: DARK TAUPE, EMPIRE BLUE, ESPRESSO, MALLARD GREEN, MUSHROOM AND SPICE

	Cushion Foam Only	Size	Color	Retail Stock No	Case Qty
	FOAM	21"W 19"D 5"Thickness	White	61-017-010917-RT	6
	Cushion Cover Only	Size	Color	Retail Stock No	Case Qty
	COVER	21"W 19"D 5"Thickness	Dark Taupe	60-416-015101-RT	6
	COVER	21"W 19"D 5"Thickness	Empire Blue	60-331-010501-RT	6
	COVER	21"W 19"D 5"Thickness	Espresso	60-348-016601-RT	6
	COVER	21"W 19"D 5"Thickness	Mallard Green	60-365-011101-RT	6
	COVER	21"W 19"D 5"Thickness	Mushroom	60-382-016401-RT	6
	COVER	21"W 19"D 5"Thickness	Spice	60-399-011701-RT	6









Patio Lounge Rectangular Seat Cushion

	Cushion Foam & Cover Set	Size	Color	E-Commerce Stock No	Case Qty
	FOAM + COVER	21"W 19"D 5"Thickness	Dark Taupe	62-017-TAUPE-EC	1
	FOAM + COVER	21"W 19"D 5"Thickness	Empire Blue	62-017-EMBLUE-EC	1
	FOAM + COVER	21"W 19"D 5"Thickness	Espresso	62-017-ESPRES-EC	1
	FOAM + COVER	21"W 19"D 5"Thickness	Mallard Green	62-017-MGREEN-EC	1
	FOAM + COVER	21"W 19"D 5"Thickness	Mushroom	62-017-MUSHRM-EC	1
	FOAM + COVER	21"W 19"D 5"Thickness	Spice	62-017-SPICE-EC	1

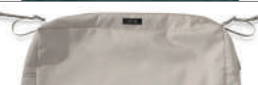

Patio Lounge Square Seat Cushion Components

COLORS: DARK TAUPE, EMPIRE BLUE, ESPRESSO, MALLARD GREEN, MUSHROOM AND SPICE

	Cushion Foam Only	Size	Color	Retail Stock No	Case Qty
		FOAM	23"W 23"D 5"Thickness	White	61-019-010919-RT
	FOAM	25"W 25"D 5"Thickness	White	61-020-010920-RT	6
	Cushion Cover Only	Size	Color	Retail Stock No	Case Qty
	COVER	23"W 23"D 5"Thickness	Dark Taupe	60-418-015101-RT	6
	COVER	25"W 25"D 5"Thickness	Dark Taupe	60-419-015101-RT	6
	COVER	23"W 23"D 5"Thickness	Empire Blue	60-333-010501-RT	6
	COVER	25"W 25"D 5"Thickness	Empire Blue	60-334-010501-RT	6
	COVER	23"W 23"D 5"Thickness	Espresso	60-350-016601-RT	6
	COVER	25"W 25"D 5"Thickness	Espresso	60-351-016601-RT	6
	COVER	23"W 23"D 5"Thickness	Mallard Green	60-367-011101-RT	6
	COVER	25"W 25"D 5"Thickness	Mallard Green	60-368-011101-RT	6
	COVER	23"W 23"D 5"Thickness	Mushroom	60-384-016401-RT	6
	COVER	25"W 25"D 5"Thickness	Mushroom	60-385-016401-RT	6
	COVER	23"W 23"D 5"Thickness	Spice	60-401-011701-RT	6
	COVER	25"W 25"D 5"Thickness	Spice	60-402-011701-RT	6









Patio Lounge Square Seat Cushion

	Cushion Foam & Cover Set	Size	Color	E-Commerce Stock No	Case Qty
		FOAM + COVER	23"W 23"D 5"Thickness	Dark Taupe	62-019-TAUPE-EC
	FOAM + COVER	25"W 25"D 5"Thickness	Dark Taupe	62-020-TAUPE-EC	1
	FOAM + COVER	23"W 23"D 5"Thickness	Empire Blue	62-019-EMBLUE-EC	1
	FOAM + COVER	25"W 25"D 5"Thickness	Empire Blue	62-020-EMBLUE-EC	1
	FOAM + COVER	23"W 23"D 5"Thickness	Espresso	62-019-ESPRES-EC	1
	FOAM + COVER	25"W 25"D 5"Thickness	Espresso	62-020-ESPRES-EC	1
	FOAM + COVER	23"W 23"D 5"Thickness	Mallard Green	62-019-MGREEN-EC	1
	FOAM + COVER	25"W 25"D 5"Thickness	Mallard Green	62-020-MGREEN-EC	1
	FOAM + COVER	23"W 23"D 5"Thickness	Mushroom	62-019-MUSHRM-EC	1
	FOAM + COVER	25"W 25"D 5"Thickness	Mushroom	62-020-MUSHRM-EC	1
	FOAM + COVER	23"W 23"D 5"Thickness	Spice	62-019-SPICE-EC	1
	FOAM + COVER	25"W 25"D 5"Thickness	Spice	62-020-SPICE-EC	1



Patio Lounge Back Cushion Components



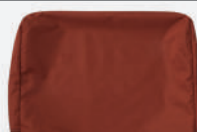



COLORS: DARK TAUPE, EMPIRE BLUE, ESPRESSO, MALLARD GREEN, MUSHROOM AND SPICE

	Cushion Foam Only	Size	Color	Retail Stock No	Case Qty
	FOAM	21"W 20"H 4"Thickness	White	61-024-010924-RT	6
	FOAM	23"W 20"H 4"Thickness	White	61-025-010925-RT	6
	FOAM	25"W 22"H 4"Thickness	White	61-028-010928-RT	6
	Cushion Cover Only	Size	Color	Retail Stock No	Case Qty
	COVER	21"W 20"H 4"Thickness	Dark Taupe	60-425-015101-RT	6
	COVER	23"W 20"H 4"Thickness	Dark Taupe	60-426-015101-RT	6
	COVER	25"W 22"H 4"Thickness	Dark Taupe	60-428-015101-RT	6
	COVER	21"W 20"H 4"Thickness	Empire Blue	60-340-010501-RT	6
	COVER	23"W 20"H 4"Thickness	Empire Blue	60-341-010501-RT	6
	COVER	25"W 22"H 4"Thickness	Empire Blue	60-343-010501-RT	6
	COVER	21"W 20"H 4"Thickness	Espresso	60-357-016601-RT	6
	COVER	23"W 20"H 4"Thickness	Espresso	60-358-016601-RT	6
	COVER	25"W 22"H 4"Thickness	Espresso	60-360-016601-RT	6
	COVER	21"W 20"H 4"Thickness	Mallard Green	60-374-011101-RT	6
	COVER	23"W 20"H 4"Thickness	Mallard Green	60-375-011101-RT	6
	COVER	25"W 22"H 4"Thickness	Mallard Green	60-377-011101-RT	6
	COVER	21"W 20"H 4"Thickness	Mushroom	60-391-016401-RT	6
	COVER	23"W 20"H 4"Thickness	Mushroom	60-392-016401-RT	6
	COVER	25"W 22"H 4"Thickness	Mushroom	60-394-016401-RT	6
	COVER	21"W 20"H 4"Thickness	Spice	60-408-011701-RT	6
	COVER	23"W 20"H 4"Thickness	Spice	60-409-011701-RT	6
	COVER	25"W 22"H 4"Thickness	Spice	60-411-011701-RT	6

Patio Lounge Back Cushion









COLORS: DARK TAUPE, EMPIRE BLUE, ESPRESSO, MALLARD GREEN, MUSHROOM AND SPICE

	Cushion Foam & Cover Set	Size	Color	E-Commerce Stock No	Case Qty
	FOAM + COVER	21"W 20"H 4"Thickness	Dark Taupe	62-024-TAUPE-EC	1
	FOAM + COVER	23"W 20"H 4"Thickness	Dark Taupe	62-025-TAUPE-EC	1
	FOAM + COVER	25"W 22"H 4"Thickness	Dark Taupe	62-028-TAUPE-EC	1
	FOAM + COVER	21"W 20"H 4"Thickness	Empire Blue	62-024-EMBLUE-EC	1
	FOAM + COVER	23"W 20"H 4"Thickness	Empire Blue	62-025-EMBLUE-EC	1
	FOAM + COVER	25"W 22"H 4"Thickness	Empire Blue	62-028-EMBLUE-EC	1
	FOAM + COVER	21"W 20"H 4"Thickness	Espresso	62-024-ESPRES-EC	1
	FOAM + COVER	23"W 20"H 4"Thickness	Espresso	62-025-ESPRES-EC	1
	FOAM + COVER	25"W 22"H 4"Thickness	Espresso	62-028-ESPRES-EC	1
	FOAM + COVER	21"W 20"H 4"Thickness	Mallard Green	62-024-MGREEN-EC	1
	FOAM + COVER	23"W 20"H 4"Thickness	Mallard Green	62-025-MGREEN-EC	1
	FOAM + COVER	25"W 22"H 4"Thickness	Mallard Green	62-028-MGREEN-EC	1
	FOAM + COVER	21"W 20"H 4"Thickness	Mushroom	62-024-MUSHRM-EC	1
	FOAM + COVER	23"W 20"H 4"Thickness	Mushroom	62-025-MUSHRM-EC	1
	FOAM + COVER	25"W 22"H 4"Thickness	Mushroom	62-028-MUSHRM-EC	1
	FOAM + COVER	21"W 20"H 4"Thickness	Spice	62-024-SPICE-EC	1
	FOAM + COVER	23"W 20"H 4"Thickness	Spice	62-025-SPICE-EC	1
	FOAM + COVER	25"W 22"H 4"Thickness	Spice	62-028-SPICE-EC	1



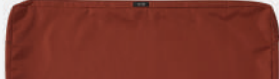

Patio Lounge Rectangle Bench/Settee Seat Cushion Components

COLORS: DARK TAUPE, EMPIRE BLUE, ESPRESSO, MALLARD GREEN, MUSHROOM AND SPICE

	Cushion Foam Only	Size	Color	Retail Stock No	Case Qty
	FOAM	42"W 18"D 3"Thickness	White	61-014-010914-RT	6
	FOAM	48"W 18"D 3"Thickness	White	61-015-010915-RT	6
	Cushion Cover Only	Size	Color	Retail Stock No	Case Qty
	COVER	42"W 18"D 3"Thickness	Dark Taupe	60-429-015101-RT	6
	COVER	48"W 18"D 3"Thickness	Dark Taupe	60-430-015101-RT	6
	COVER	42"W 18"D 3"Thickness	Empire Blue	60-344-010501-RT	6
	COVER	48"W 18"D 3"Thickness	Empire Blue	60-345-010501-RT	6
	COVER	42"W 18"D 3"Thickness	Espresso	60-361-016601-RT	6
	COVER	48"W 18"D 3"Thickness	Espresso	60-362-016601-RT	6
	COVER	42"W 18"D 3"Thickness	Mallard Green	60-378-011101-RT	6
	COVER	48"W 18"D 3"Thickness	Mallard Green	60-379-011101-RT	6
	COVER	42"W 18"D 3"Thickness	Mushroom	60-395-016401-RT	6
	COVER	48"W 18"D 3"Thickness	Mushroom	60-396-016401-RT	6
	COVER	42"W 18"D 3"Thickness	Spice	60-412-011701-RT	6
	COVER	48"W 18"D 3"Thickness	Spice	60-413-011701-RT	6

Patio Lounge Rectangle Bench/Settee Seat Cushion

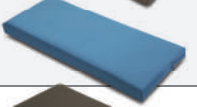

	Cushion Foam & Cover Set	Size	Color	E-Commerce Stock No	Case Qty
	FOAM + COVER	42"W 18"D 3"Thickness	Dark Taupe	62-014-TAUPE-EC	1
	FOAM + COVER	48"W 18"D 3"Thickness	Dark Taupe	62-015-TAUPE-EC	1
	FOAM + COVER	42"W 18"D 3"Thickness	Empire Blue	62-014-EMBLUE-EC	1
	FOAM + COVER	48"W 18"D 3"Thickness	Empire Blue	62-015-EMBLUE-EC	1
	FOAM + COVER	42"W 18"D 3"Thickness	Espresso	62-014-ESPRES-EC	1
	FOAM + COVER	48"W 18"D 3"Thickness	Espresso	62-015-ESPRES-EC	1
	FOAM + COVER	42"W 18"D 3"Thickness	Mallard Green	62-014-MGREEN-EC	1
	FOAM + COVER	48"W 18"D 3"Thickness	Mallard Green	62-015-MGREEN-EC	1
	FOAM + COVER	42"W 18"D 3"Thickness	Mushroom	62-014-MUSHRM-EC	1
	FOAM + COVER	48"W 18"D 3"Thickness	Mushroom	62-015-MUSHRM-EC	1
	FOAM + COVER	42"W 18"D 3"Thickness	Spice	62-014-SPICE-EC	1
	FOAM + COVER	48"W 18"D 3"Thickness	Spice	62-015-SPICE-EC	1

HOME PATIO | MONTLAKE®



Montlake® FadeSafe®



The Montlake® FadeSafe® Collection from Classic Accessories® offers a classic look with solution-dyed technology while being EU REACH¹ compliant, ensuring excellent performance and durability



Montlake® FadeSafe® Fabric System

Montlake® FadeSafe® solution-dyed fabric is both stylish and engineered to resist fading



Water-Repellent Coating

Helps keep rain out and your furniture/grills protected with a water-repellent fabric top and a water resistant laminated backing



Click-Close Straps

Click-close straps snap over legs to secure cover on windy days



Hooded Air Vents

Air vents keep weather out while providing maximum ventilation and minimum condensation



Reinforced Handles

Conveniently placed reinforced handles for easy installation and removal of cover



Adjustable Cord Lock Closure





Single cord lock closure within specially designed hem tunnels allows easy adjustment resulting in a custom-like fit

¹Classic Accessories warrants that this product will be free of defects in material and construction for its life from the date of purchase
¹Meets EU requirements for SVHC (solvents of very high concern)



Patio Chair and Loveseat Covers

COLOR: HEATHER GREY AND HEATHER FERN

Item/Fit			E-Commerce Stock No	Case Qty
STACKABLE 6 CHAIRS UP TO 25.5"L 33.5"D 45"H*	NEW COLOR		56-382-016701-EC Heather Fern	2
ADIRONDACK UP TO 31.5"L 33.5"D 36"H*	NEW COLOR		56-380-016701-EC Heather Fern	2
LOUNGE UP TO 36"L 35"D 31"H*	NEW COLOR		56-381-016701-EC Heather Fern	2
LOUNGE UP TO 36"L 35"D 31"H*			55-675-016701-2PK Heather Grey	1
SMALL LOVESEAT UP TO 58"L 32.5"D 31"H*	NEW COLOR		56-386-026701-EC Heather Fern	2



Patio Cushion and Cover Storage Bag



OVERSIZE CUSHION AND COVER STORAGE BAG FITS CHAIR, BENCH, CHAISE CUSHIONS & COVERS UP TO 45.5"L 13.75"W 20"H	NEW COLOR		56-385-016701-EC Heather Fern	2
---	------------------	--	----------------------------------	---

*Bag not intended for outdoor storage. **Not designed to entirely cover the wheels or legs



Patio Chair and Loveseat Covers

COLOR: HEATHER FERN AND HEATHER HENNA

Item/Fit		E-Commerce Stock No	Case Qty
LARGE RECTANGULAR/OVAL TABLE & 6 STANDARD CHAIRS UP TO 108"L 82"W 23"H*		56-383-046701-EC Heather Fern	2
X LARGE RECTANGULAR/OVAL TABLE & 6 STANDARD CHAIRS UP TO 128"L 82"W 23"H*		56-384-056701-EC Heather Fern	2



Patio BBQ Grill Covers

		Retail Stock No	Case Qty
MEDIUM BBQ GRILL UP TO 58"L 22"D 48"H*		55-847-031001-RT Heather Henna	1
X LARGE BBQ GRILL UP TO 70"L 22"D 48"H*		55-848-051001-RT Heather Henna	1

*Not designed to entirely cover the wheels or legs

HOME PATIO | RAVENNA®



TAILORED TO FIT YOUR LIFE



Ravenna®



The Ravenna® Collection from Classic Accessories® combines a striking style with durability, fade-resistance and convenient features



Gardelle One™ Fabric System

Gardelle One™ is a durable woven polyester fabric with an added fabric treatment to reduce fading and a water-resistant undercoating



Patented WindLock® Secure Attachment System

Patented 9,155,397 B2

Adjustable belted hem with click-close straps provides a customizable fit with exceptional security in the windiest conditions (on many Ravenna products)



Durable Stitching

Engineered seams and double top-stitching at the most demanding joints provide strength, durability and style



Hooded Air Vents

Gusseted self-supporting vents keep weather out while providing maximum ventilation and minimum condensation



Padded Handles

Reinforced padded handles provide comfort when installing and removing covers











Adjustable Cord Closures

Single and double cord closures within specially designed hem tunnels allow easy adjustment resulting in a custom-like fit



Patio Chair Covers

COLOR: DARK TAUPE/MUSHROOM/ESPRESSO



Item/Fit		E-Commerce Stock No	Case Qty
STACKABLE 6 CHAIRS UP TO 25.5"L 33.5"D 45"H*		55-179-015101-EC	8
ADIRONDACK UP TO 31.5"L 33.5"D 36"H*		55-165-015101-EC	10
DOUBLE ADIRONDACK UP TO 66" L 35"D 36"H*		56-263-011501-EC	6
STANDARD BACKREST UP TO 25.5"L 28.5"D 26"H*		55-143-015101-EC	12
HIGH BACK BACKREST UP TO 25.5"L 32.5"D 34"H*		55-144-015101-EC	10
BAR CHAIR UP TO 26"L 28"D 48"H*		55-920-015101-EC	8
MEDIUM ROCKING CHAIR UP TO 27.5"L 32.5"D 39"H*		55-161-015101-EC	10
LOUNGE UP TO 38"L 35"D 31"H*		55-160-015101-EC	8
DEEP LOUNGE UP TO 38"L 40"D 31"H*		55-422-015101-EC	8

*Not designed to entirely cover the wheels or legs







Patio Umbrella Covers

COLOR: DARK TAUPE/MUSHROOM/ESPRESSO

Item/Fit		E-Commerce Stock No	Case Qty
UMBRELLA UP TO 11'DIA ROUND, UP TO 8' SQUARE*		55-159-015101-EC	22
OFFSET UMBRELLA CANOPY UP TO 13'DIA ROUND, UP TO 9' SQUARE*		55-195-015101-EC	15
OFFSET UMBRELLA FRAME AND CANOPY UP TO 13'DIA ROUND, UP TO 9' SQUARE*		55-708-015101-EC	8



Patio Rectangular/Oval Table and Chair Set Covers







MEDIUM RECTANGULAR/OVAL TABLE & 6 STANDARD CHAIRS UP TO 88"L 58"W 23"H*		55-154-035101-EC	4
LARGE RECTANGULAR/OVAL TABLE & 6 STANDARD CHAIRS UP TO 108"L 82"W 23"H*		55-155-045101-EC	4
X LARGE RECTANGULAR/OVAL TABLE & 6 STANDARD CHAIRS UP TO 128"L 82"W 23"H*		55-156-055101-EC	3
LARGE RECTANGULAR/OVAL TABLE W/UMBRELLA HOLE UP TO 108"L 82"W 23"H* (UMBRELLA NOT INCLUDED)		55-801-045101-EC	3

*Not designed to entirely cover the wheels or legs



Patio Round Table and Chair Set Covers

COLOR: DARK TAUPE/MUSHROOM/ESPRESSO

Item/Fit		E-Commerce Stock No	Case Qty
SMALL ROUND TABLE & 4 STANDARD CHAIRS UP TO 60"DIA 23"H*		55-188-025101-EC	6
MEDIUM ROUND TABLE & 6 STANDARD CHAIRS UP TO 70"DIA 23"H*		55-157-035101-EC	6
MEDIUM/LARGE ROUND TABLE & 6 STANDARD CHAIRS UP TO 82"DIA 23"H*		55-709-035101-EC	8
LARGE ROUND TABLE & 6 STANDARD CHAIRS UP TO 94"DIA 23"H*		55-158-045101-EC	3
X LARGE ROUND TABLE & 6 STANDARD CHAIRS UP TO 108"DIA 23"H*		55-778-055101-EC	2
SMALL ROUND TABLE W/ UMBRELLA HOLE UP TO 60"DIA 23"H* (UMBRELLA NOT INCLUDED)		55-800-025101-EC	5



Patio Table Cover Support Pole





Item/Fit		Retail Stock No	Case Qty
TABLE COVER SUPPORT POLE ADJUSTS FROM 12" TO 20"H		55-190-015101-00	1

*Not designed to entirely cover the wheels or legs



Patio Square Table, Bistro Table and Chair Set Covers

COLOR: DARK TAUPE/MUSHROOM/ESPRESSO



Item/Fit		E-Commerce Stock No	Case Qty
MEDIUM/LARGE SQUARE TABLE & 8 CHAIRS UP TO 86"L 86"W 23"H*		55-710-015101-EC	3
LARGE SQUARE TABLE & 8 CHAIRS UP TO 98"L 98"W 23"H*		55-194-015101-EC	3
BISTRO TABLE & 2-4 STANDARD CHAIRS UP TO 52"DIA 23"H*		55-186-015101-EC	6
BISTRO ROUND TABLE & 2 CHAIRS UP TO 40"DIA TABLE 80"L 24"H*		55-196-015101-EC	6

*Not designed to entirely cover the wheels or legs





Patio Tall Round Table and Chair Set Covers

COLOR: DARK TAUPE/MUSHROOM/ESPRESSO

Item/Fit		E-Commerce Stock No	Case Qty
SMALL TALL ROUND TABLE & 4 TALL CHAIRS UP TO 60"DIA 29"H*		55-187-015101-EC	6
MEDIUM TALL ROUND TABLE & 6 TALL CHAIRS UP TO 70"DIA 29"H*		55-776-035101-EC	3
LARGE TALL ROUND TABLE & 6 TALL CHAIRS UP TO 94"DIA 29"H*		55-777-045101-EC	3



Patio Table Covers





LARGE RECTANGULAR/OVAL TABLE UP TO 72"L 44"W 23"H*		56-043-045101-EC	5
X LARGE RECTANGULAR/OVAL TABLE UP TO 84"L 44"W 23"H*		56-044-055101-EC	5
LARGE SQUARE TABLE UP TO 60"L 60"W 23"H*		56-045-045101-EC	6

*Not designed to entirely cover the wheels or legs





Patio Bench and Loveseat Covers

COLOR: DARK TAUPE/MUSHROOM/ESPRESSO

Item/Fit		E-Commerce Stock No	Case Qty
BENCH UP TO 50"L 28.5"D 31"H*		55-164-015101-EC	10
SMALL LOVESEAT UP TO 58"W 32.5"D 32"H*		55-149-025101-EC	7
MEDIUM LOVESEAT UP TO 76"W 32.5"D 34"H*		55-150-035101-EC	6
LARGE LOVESEAT UP TO 88"W 32.5"D 34"H*		55-151-045101-EC	5
X LARGE LOVESEAT/SOFA UP TO 104"W 32.5"D 31"H*		55-328-055101-EC	4

Patio Deep Loveseat Covers



MEDIUM DEEP LOVESEAT UP TO 76"W 40"D 34"H*		55-423-035101-EC	5
LARGE DEEP LOVESEAT UP TO 88"W 40"D 34"H*		55-424-045101-EC	4
X LARGE DEEP LOVESEAT UP TO 104"W 40"D 31"H*		55-425-055101-EC	4

*Not designed to entirely cover the wheels or legs.



Patio Sectional and Modular Covers

COLOR: DARK TAUPE/MUSHROOM/ESPRESSO

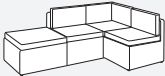
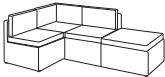
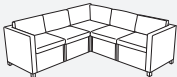

Item/Fit		E-Commerce Stock No	Case Qty
DEEP CORNER SECTIONAL UP TO 40"L 40"W 31"H*		55-426-055101-EC	8
WEDGE ACCENT TABLE UP TO 14"L (FRONT) 24"L (BACK) 32"D 24"H*		55-828-015101-EC	12
CURVED MODULAR SOFA SECTIONAL UP TO 46"(FRONT) 90"(BACK) L 34" D 32" H*		55-827-015101-EC	5
SECTIONAL L-SHAPE LOUNGE SET – RIGHT BACK LENGTHS UP TO 104"L, 83"L 32"D 31"H*		56-030-015101-EC	4
SECTIONAL L-SHAPE LOUNGE SET – LEFT BACK LENGTHS UP TO 83"L, 104"L 32"D 31"H*		56-031-015101-EC	4
SECTIONAL V-SHAPE LOUNGE SET BACK LENGTHS UP TO 100"L, 100"L 33.5"D 31"H*		56-032-015101-EC	3

*Not designed to entirely cover the wheels or legs.



Patio Conversation Set and Furniture Group Covers

COLOR: DARK TAUPE/MUSHROOM/ESPRESSO

Item/Fit		E-Commerce Stock No	Case Qty
LARGE CONVERSATION SET/FURNITURE GROUP UP TO 100"L 70"W 30"H*		55-457-015101-EC	3
X LARGE CONVERSATION SET/FURNITURE GROUP¹ FITS UP TO 140"L 70"W 30"H*		55-908-055101-EC	3



Patio Cushion and Cover Storage Bags

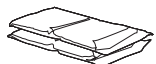
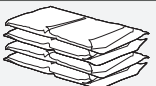







CUSHION & COVER STORAGE BAG FITS CHAIR, BENCH, CHAISE CUSHIONS & COVERS UP TO 45.5"L 13.75"W 20"H		55-180-015101-EC	10
OVERSIZED CUSHION & COVER STORAGE BAG FITS CUSHIONS & COVERS UP TO 60"L 20"W 28"H		55-809-065101-EC	6

*Not designed to entirely cover the wheels or legs.



Patio Chaise Lounge and Day Chaise Covers

COLOR: DARK TAUPE/MUSHROOM/ESPRESSO









Item/Fit		E-Commerce Stock No	Case Qty
MEDIUM CHAISE LOUNGE UP TO 66"L 28"W 27.5"H*		55-145-015101-EC	6
LARGE CHAISE LOUNGE UP TO 86"L 34"W 30"H*		55-712-045101-EC	5
LARGE CHAISE LOUNGE UP TO 86"L 34"W 30"H*		55-712-045101-2PK	1
MEDIUM DAY CHAISE WIDER CHAISES UP TO 66"L 35.5"W 33"H*		55-162-035101-EC	6
LARGE DAY CHAISE WIDER CHAISES UP TO 78"L 35.5"W 33"H*		55-163-045101-EC	6
LARGE DAY CHAISE WIDER CHAISES UP TO 78"L 35.5"W 33"H*		55-163-045101-2PK	1
DOUBLE WIDE CHAISE LOUNGE WIDER CHAISES UP TO 80"L 55"W 33"H*		55-454-015101-EC	4
STACKABLE CHAISE LOUNGE 2 UP TO 75"L 27"W 20"H*		55-430-015101-EC	5
STACKABLE CHAISE LOUNGE 6 UP TO 75"L 27"W 40"H*		55-429-015101-EC	4

*Not designed to entirely cover the wheels or legs.



Patio Ottoman and Coffee Table Covers



COLOR: DARK TAUPE/MUSHROOM/ESPRESSO

Item/Fit		E-Commerce Stock No	Case Qty
SMALL SQUARE OTTOMAN/TABLE UP TO 21"L 21"W 17"H*		55-168-025101-EC	16
LARGE SQUARE OTTOMAN/TABLE UP TO 26"L 26"W 17"H*		55-169-045101-EC	14
SMALL RECTANGULAR OTTOMAN/TABLE UP TO 32"L 22"W 17"H*		55-166-025101-EC	14
LARGE RECTANGULAR OTTOMAN/TABLE UP TO 38"L 28"W 17"H*		55-167-045101-EC	14
COFFEE TABLE UP TO 48"L 25"W 18"H*		55-327-015101-EC	10
SMALL ROUND OTTOMAN/COFFEE TABLE UP TO 24"DIA 20"H*		55-868-025101-EC	12
MEDIUM ROUND OTTOMAN/COFFEE TABLE UP TO 30"DIA 25"H*		55-869-035101-EC	10
LARGE ROUND OTTOMAN/COFFEE TABLE UP TO 34"DIA 28"H*		55-870-045101-EC	10



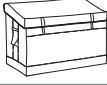

Patio Deck Boxes

COLOR: DARK TAUPE/MUSHROOM/ESPRESSO

Item/Fit		E-Commerce Stock No	Case Qty
MEDIUM DECK BOX, 11.3 CUBIC FEET OF STORAGE	NEW		
ASSEMBLED SIZE 32"L 28"W 30"H*		56-391-035101-EC	1
LARGE DECK BOX, 17.7 CUBIC FEET OF STORAGE	NEW		
ASSEMBLED SIZE 50"L 28"W 30"H*		56-392-045101-EC	1
X-LARGE DECK BOX, 21.6 CUBIC FEET OF STORAGE	NEW		
ASSEMBLED SIZE 61"L 28"W 30"H*		56-393-055101-EC	1



Patio Hot Tub Cover Caps

MEDIUM SQUARE HOT TUB COVER			
UP TO 86"W 86"D 14"H		55-885-035101-EC	4
LARGE SQUARE HOT TUB COVER			
UP TO 94"W 94"D 14"H		55-886-045101-EC	3



Patio Canopy Swing Cover









CANOPY SWING			
UP TO 78"L 60"D 72"H*		55-170-015101-EC	3

*Not designed to entirely cover the wheels or legs



Patio Fire Pit and Chiminea Covers

COLOR: DARK TAUPE/MUSHROOM/ESPRESSO

Item/Fit		E-Commerce Stock No	Case Qty
ROUND FIRE PIT UP TO 44"DIA*		55-147-015101-EC	20
ROUND FIRE PIT UP TO 60"DIA*		55-146-045101-EC	16
SMALL ROUND FULL COVERAGE FIRE PIT UP TO 30"DIA 12"H*		55-484-015101-EC	12
LARGE ROUND FULL COVERAGE FIRE PIT UP TO 36"DIA 12"H*		55-485-015101-EC	12
SQUARE FIRE PIT UP TO 40L" 40"W*		55-148-015101-EC	18
SMALL SQUARE FULL COVERAGE FIRE PIT UP TO 30"L 30"W 12"H*		55-486-015101-EC	12
LARGE SQUARE FULL COVERAGE FIRE PIT UP TO 36"L 36"W 12"H*		55-487-015101-EC	12
MEDIUM CHIMINEA UP TO 22"DIA 52.75"H*		55-813-035101-EC	10



Patio Log Carrier





JUMBO LOG CARRIER HOLDS UP TO 2 STANDARD WOOD BUNDLES 24"L 11.75"W 11.75"H (OPENED)		55-185-015101-EC	24
--	--	------------------	----

*Not designed to entirely cover the wheels or legs

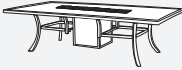
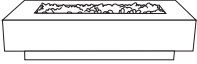

Patio Fire Pit Table and Fire Column Covers

COLOR: DARK TAUPE/MUSHROOM/ESPRESSO

Item/Fit		E-Commerce Stock No	Case Qty
42" ROUND FIRE PIT TABLE UP TO 42"DIA 22"H*		55-455-015101-EC	8
42" SQUARE FIRE PIT TABLE FITS UP TO 42"L 42"W 22"H*		55-417-015101-EC	8
40" RECTANGULAR FIRE PIT TABLE FITS UP TO 40"L 38"W 22"H*		55-711-015101-EC	8
56" RECTANGULAR FIRE PIT TABLE FITS UP TO 56"L 38"W 22"H*		55-598-015101-EC	5
60" RECTANGULAR FIRE PIT TABLE FITS UP TO 60"L 28"W 15"H*		55-811-055101-EC	5
FIRE COLUMN UP TO 20"L 20"W 30"H*		56-262-011501-EC	12



Patio Log Rack Covers







SMALL LOG RACK FITS 4'L LOG RACKS 48"L 24"W 42"H*		55-171-025101-EC	6
LARGE LOG RACK FITS 8'L LOG RACKS 96"L 24"W 42"H*		55-172-045101-EC	4

*Not designed to entirely cover the wheels or legs



Patio BBQ Grill Covers

COLOR: DARK TAUPE/MUSHROOM/ESPRESSO







Item/Fit		E-Commerce Stock No	Case Qty
X SMALL BBQ GRILL UP TO 38"L 22"D 44"H*		55-849-365101-EC	8
SMALL BBQ GRILL UP TO 44"L 22"D 44"H*		55-850-025101-EC	8
MEDIUM BBQ GRILL UP TO 58"L 24"D 48"H*		55-140-035101-EC	6
LARGE BBQ GRILL UP TO 64"L 24"D 48"H*		55-141-045101-EC	6
X LARGE BBQ GRILL UP TO 70"L 24"D 48"H*		55-142-055101-EC	4
XX LARGE BBQ GRILL UP TO 72"L 26"D 51"H*		55-193-065101-EC	4
3X LARGE BBQ GRILL UP TO 80"L 26"D 51"H*		55-320-355101-EC	4

*Not designed to entirely cover the wheels or legs



Patio Built-In Grill and Kettle BBQ Grill Covers

COLOR: DARK TAUPE/MUSHROOM/ESPRESSO



Item/Fit		E-Commerce Stock No	Case Qty
X SMALL BUILT-IN GRILL TOP UP TO 32"L 26"D 24"H		55-326-365101-EC	12
SMALL BUILT-IN GRILL TOP UP TO 37"L 27"D 24"H		55-325-025101-EC	12
MEDIUM BUILT-IN GRILL TOP UP TO 45"L 29"D 26"H		55-324-035101-EC	10
LARGE BUILT-IN GRILL TOP UP TO 57"L 29"D 26"H		55-323-045101-EC	10
KETTLE GRILL UP TO 26.5"DIA 38"H*		55-178-015101-EC	18
LARGE KETTLE BBQ GRILL UP TO 30" DIA 43"H* FITS WEBER® PREMIUM 26" GRILL		55-998-045101-EC	12

*Not designed to entirely cover the wheels or legs
Weber® Summit® and Weber® Performer® are trademarks of Weber-Stephens Products, LLC. Classic Accessories is not affiliated or associated with Weber-Stephens Products, LLC or its products in any way.







Patio Kamado Ceramic Grill Covers

COLOR: DARK TAUPE/MUSHROOM/ESPRESSO

Item/Fit		E-Commerce Stock No	Case Qty
LARGE KAMADO CERAMIC GRILL UP TO 22"DIA WITH SIDE TABLES 40"H* (LARGE BIG GREEN EGG®)		55-321-045101-EC	12
X LARGE KAMADO CERAMIC GRILL UP TO 27"DIA WITH SIDE TABLES 45"H* (X LARGE BIG GREEN EGG®)		55-322-055101-EC	12
KAMADO CERAMIC GRILL WITH OFFSET TABLE UP TO 60"L 30"D 50"H*		55-420-015101-EC	5

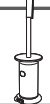

Patio Stand-Up Heater, Pyramid Torch Heater & Air Conditioner Covers

STAND-UP HEATER UP TO 95"H 34"DIA DOME 18.5"DIA ROUND BASE WITH OR WITHOUT ADJUSTABLE TABLE		55-175-015101-EC	7
PYRAMID TORCH HEATER UP TO 21"L 21"W 90"H		55-329-015101-EC	6
ROUND AIR CONDITIONER UP TO 34"DIA 30"H		55-176-015101-EC	14
SQUARE AIR CONDITIONER UP TO 34"L 34"D 30"H		55-189-015101-EC	10





*Not designed to entirely cover the wheels or legs.

Big Green Egg® is a registered trademark of Big Green Egg Inc. Corporation. Classic Accessories is not affiliated or associated with Big Green Egg Inc. or its products in any way.



Patio Smoker and Flat Top Griddle Covers



COLOR: DARK TAUPE/MUSHROOM/ESPRESSO

Item/Fit		E-Commerce Stock No	Case Qty
MEDIUM ROUND SMOKER UP TO 19"DIA 39"H*		55-173-015101-EC	16
LARGE SQUARE SMOKER UP TO 29"L 19.5"D 40"H* ¹		55-852-045101-EC	12
X LARGE SQUARE SMOKER UP TO 33"L 24.5"D 60"H* ¹		55-853-325101-EC	8
LARGE FLAT TOP GRIDDLE FITS BLACKSTONE® 36" GRIDDLE UP TO 63"L 22"D 37"H*		55-997-045101-EC	5

Blackstone® is a registered trademark of Blackstone Products.



Patio Weber Grill Covers

WEBER PERFORMER® GRILL UP TO 40"L 28.5"D 50.25"H* GOLD AND PLATINUM 22" GRILLS		55-421-015101-EC	10
WEBER SUMMIT® CHARCOAL GRILL CENTER SUMMIT CHARCOAL, PERFORMER PREMIUM AND PERFORMER DELUXE GRILLS*		55-787-265101-EC	6
WEBER SUMMIT® CHARCOAL GRILL UP TO 40"L 36"D 46"H*		55-788-015101-EC	8





*Not designed to entirely cover the wheels or legs.

¹Does not fit models with external side controls and bisquette loader attached.
Weber Performer and Weber Summit are registered trademarks of Weber-Stephens Products, LLC.
Classic Accessories is not affiliated or associated with Weber-Stephens Products, LLC or its products in any way.



Patio BBQ Grill Covers

COLOR: BLACK





Item/Fit		E-Commerce Stock No	Case Qty
MEDIUM BBQ GRILL UP TO 58"L 24"D 48"H*		55-390-030401-EC	6
LARGE BBQ GRILL UP TO 64"L 24"D 48"H*		55-391-040401-EC	6
X LARGE BBQ GRILL UP TO 70"L 24"D 48"H*		55-392-050401-EC	4
XX LARGE BBQ GRILL UP TO 72"L 26"D 51"H*		55-393-060401-EC	4
3X LARGE BBQ GRILL UP TO 80"L 26"D 51"H*		55-394-350401-EC	4

*Not designed to entirely cover the wheels or legs.



Patio Built-In Grill Top and Kamado Ceramic Grill Covers

COLOR: BLACK

Item/Fit		E-Commerce Stock No	Case Qty
X SMALL BUILT-IN GRILL TOP UP TO 32"L 26"D 24"H		55-397-360401-EC	12
SMALL BUILT-IN GRILL TOP UP TO 37"L 27"D 24"H		55-398-020401-EC	12
MEDIUM BUILT-IN GRILL TOP UP TO 45"L 29"D 26"H		55-399-030401-EC	10
LARGE KAMADO CERAMIC GRILL UP TO 22"DIA WITH SIDE TABLES 40"H* (LARGE BIG GREEN EGG®)		55-395-040401-EC	12
X LARGE KAMADO CERAMIC GRILL UP TO 27"DIA WITH SIDE TABLES 45"H* (X LARGE BIG GREEN EGG®)		55-396-050401-EC	12

*Not designed to entirely cover the wheels or legs.
Big Green Egg® is a registered trademark of Big Green Egg Inc. Corporation. Classic Accessories is not affiliated or associated with Big Green Egg Inc. or its products in any way.

Hickory®



Weather10™ Fabric System

Weather10™ fabric features a rugged outer layer with a protective, water-repellent and wipe-clean undercoating



Durable Construction

Heavy-duty fabric and tough interlocking seams add strength and durability



Click-Close Straps

Click-close straps snap over legs to secure cover on windy days (on most Hickory products)



Air Vents

Air vents reduce condensation and wind lofting

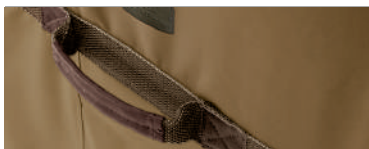

Padded Handles

Padded handles for easy fitting and removal





Adjustable Cord Closures

Elastic hem cord with a toggle allows adjustment for a tight and custom fit







Patio Lounge Chair and Offset Umbrella Covers

COLOR: HICKORY/ANTIQUE OAK/MAHOGANY

Item/Fit		E-Commerce Stock No	Case Qty	Retail Stock No	Case Qty
LOUNGE					
UP TO 38"L 35"D 31"H*		55-206-012401-EC	8		
OFFSET UMBRELLA CANOPY					
UP TO 13'DIA ROUND, SQUARE TO 9'		55-225-012401-EC	12		





Patio BBQ Grill and Smoker Covers

LARGE BBQ GRILL				55-042-042401-00	1
UP TO 64"L 24"D 48"H*					
X LARGE BBQ GRILL				55-043-052401-00	1
UP TO 70"L 24"D 48"H*					
XX LARGE BBQ GRILL				55-197-062401-00	1
UP TO 72"L 26"D 51"H*					
LARGE ROUND SMOKER				55-038-042401-00	1
UP TO 24"DIA 46"H*					



Patio Built-In Grill Covers

X SMALL BUILT-IN GRILL TOP				55-330-362401-EC	14
UP TO 32"L 26"D 24"H					
SMALL BUILT-IN GRILL TOP				55-331-022401-EC	14
UP TO 37"L 27"D 24"H					
MEDIUM BUILT-IN GRILL TOP				55-332-032401-E	12
UP TO 45"L 29"D 26"H					

*Not designed to entirely cover the wheels or legs.

Mainland™



NEW

The Mainland™ Collection from Classic Accessories® features nautical styling and sensibilities, from a distinct colorway that salutes sailing style to an easy-to-clean skirt that focuses on water-resistance, to create a practical, yet modish cover

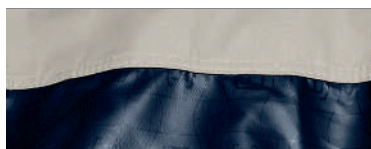

Mainland™ Fabric System

Durable woven polyester fabric with a water-resistant 6P-free PVC laminated backing keep rain out and your furniture/grills protected



Easy Care Skirt

Water-resistant easy-to-clean skirt and nautical styling that make this cover collection both practical and modern



Patented WindLock® Secure Attachment System

Patented 9,155,397 B2

Adjustable belted hem with click-close straps provides a customizable fit with exceptional security in the windiest conditions



Hooded Air Vents

Air vents keep weather out while providing maximum ventilation and minimum condensation



Designer Handles

Uniquely stitched handles with faux leather trim give your cover a coastal look and is a breeze to remove and install



Adjustable Cord Lock Closure







Single cord lock closure within specially designed hem tunnels allows easy adjustment resulting in a custom-like fit

NEW



Patio Chair Covers

COLOR: FOG/NAVY

Item/Fit		E-Commerce Stock No	Case Qty
STACKABLE 6 CHAIRS UP TO 25.5"W 33.5"D 45"H*		56-058-014601-EC	10
ADIRONDACK UP TO 31.5"W 33.5"D 36"H*		56-068-014601-EC	10
HIGH BACK BACKREST UP TO 25.5"W 32.5"D 34"H*		56-060-014601-EC	10
LOUNGE UP TO 38"W 35"D 31"H*		56-070-044601-EC	12
LOUNGE, 2-PACK UP TO 38"W 35"D 31"H*		56-070-044601-2PK	1
DEEP LOUNGE CHAIR UP TO 38"W 40"D 31"H*		56-069-014601-EC	10



*Not designed to entirely cover the wheels or legs

NEW





Patio Table and Chair Set Covers

COLOR: FOG/NAVY

Item/Fit		E-Commerce Stock No	Case Qty
LARGE RECTANGULAR/OVAL TABLE & 6 STANDARD CHAIRS UP TO 108"W 82"D 23"H*		56-061-044601-EC	4
LARGE ROUND TABLE & 6 STANDARD CHAIRS UP TO 94"DIA 23"H*		56-064-044601-EC	5



Patio Day Chaise and Loveseat Covers

LARGE DAY CHAISE WIDER CHAISES UP TO 86"L 34.5"W 30"H*		56-076-044601-EC	6
SMALL LOVESEAT UP TO 58"W 33"D 32"H*		56-075-024601-EC	10
LARGE DEEP LOVESEAT UP TO 38"W 35"D 34"H*		56-071-044601-EC	4



*Not designed to entirely cover the wheels or legs

NEW



Patio BBQ Grill Covers

COLOR: FOG/NAVY

Item/Fit		E-Commerce Stock No	Case Qty
MEDIUM BBQ GRILL		56-067-034601-EC	6
UP TO 58"W 24"D 48"H*			
LARGE BBQ GRILL		56-066-044601-EC	6
UP TO 64"W 24"D 48"H*			

*Not designed to entirely cover the wheels or legs

HOME PATIO | MADRONA®



PROVEN AGAINST THE ELEMENTS



Madrona® RainProof™



The Madrona® RainProof™ Collection by Classic Accessories® keeps your patio furniture safe, giving you peace of mind for years to come. Our RainProof™ fabric combines style and durability with taped seam construction to keep rain and weather out in all conditions



RainProof™ Fabric System

Our RainProof™ fabric combines style and durability with taped seam construction to keep rain out so that you're always ready to entertain



Adjustable Security Straps

Customized click-close buckles and adjustable designer webbing provide exceptional security in windy conditions*



Critical Seams Taped

Critical seams are taped to help keep rain out and your furniture protected

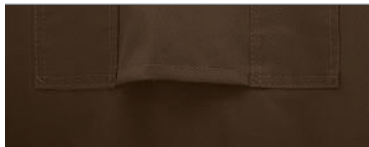

Hooded Air Vents

Vent hoods are seam taped to keep weather out, providing maximum ventilation and minimum condensation



Designer Handles

Custom, designer handles provide ease and comfort when installing and removing covers



Adjustable Cord Lock Closures







Cord lock closures allow easy access to adjustment points at the hem resulting in a custom-like fit

*On many Madrona products



Patio Chair Covers

COLOR: DARK COCOA

Item/Fit		Retail Stock No	Case Qty
ADIRONDACK UP TO 31.5"W 33.5"D 32"H*		55-738-016601-RT	3
STANDARD BACKREST UP TO 25.5"W 28.5"D 26"H*		55-717-016601-RT	3
HIGH BACK BACKREST UP TO 25.5"W 32.5"D 34"H*		55-716-016601-RT	3
BAR CHAIR UP TO 26"W 28"D 48"H*	 NEW	56-315-016601-RT	3
LOUNGE UP TO 38"W 35"D 31"H*		55-742-016601-RT	3
DEEP LOUNGE UP TO 38"W 40"D 31"H*		55-741-016601-RT	3
STACKABLE 6 CHAIRS UP TO 25.5"W 33.5"D 45"H*		55-715-016601-RT	3



Patio Umbrella Covers

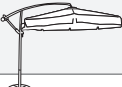



UMBRELLA UP TO 11'DIA ROUND, UP TO 8' SQUARE		55-723-046601-RT	3
OFFSET UMBRELLA CANOPY UP TO 13'DIA ROUND, UP TO 9' SQUARE		55-724-016601-RT	3

*Not designed to entirely cover the wheels or legs







Patio Table and Chair Set Covers

COLOR: DARK COCOA

Item/Fit		Retail Stock No	Case Qty
MEDIUM RECTANGULAR/OVAL TABLE & 6 STANDARD CHAIRS UP TO 88"W 58"D 23"H*		55-718-036601-RT	3
LARGE RECTANGULAR/OVAL TABLE & 6 STANDARD CHAIRS UP TO 108"W 82"D 23"H*		55-719-046601-RT	3
X LARGE RECTANGULAR/OVAL TABLE & 6 STANDARD CHAIRS UP TO 128"W 82"D 23"H*		55-720-056601-RT	3
MEDIUM ROUND TABLE & 6 STANDARD CHAIRS UP TO 70"DIA 23"H*		55-721-036601-RT	3
LARGE ROUND TABLE & 6 STANDARD CHAIRS UP TO 94"DIA 23"H*		55-722-046601-RT	3



Patio Full Coverage General Purpose Covers









FULL COVERAGE CONVERSATION SET/FURNITURE GROUP SMALL UP TO 100"W 80"D 36"H*	NEW		56-319-026601-RT	3
FULL COVERAGE CONVERSATION SET/FURNITURE GROUP MEDIUM UP TO 100"W 100"D 36"H*	NEW		56-320-036601-RT	3
FULL COVERAGE CONVERSATION SET/FURNITURE GROUP LARGE UP TO 125"W 125"D 36"H*	NEW		56-321-046601-RT	3
FULL COVERAGE CONVERSATION SET/FURNITURE GROUP X LARGE UP TO 150"W 150"D 36"H*	NEW		56-322-056601-RT	3

*Not designed to entirely cover the wheels or legs





Patio Coffee Table and Loveseat Covers

COLOR: DARK COCOA

Item/Fit		Retail Stock No	Case Qty
RECTANGULAR COFFEE TABLE UP TO 48"W 25"D 18"H*		55-751-016601-RT	3
SMALL LOVESEAT UP TO 58"W 32.5"D 32"H*		55-746-026601-RT	3
MEDIUM LOVESEAT UP TO 76"W 32.5"D 34"H*		55-747-036601-RT	3
LARGE LOVESEAT UP TO 88"W 32.5"D 34"H*		55-748-046601-RT	3
SMALL DEEP LOVESEAT UP TO 60"W 40"D 32"H*	 NEW	56-317-026601-RT	3
MEDIUM DEEP LOVESEAT UP TO 76"W 40"D 31"H*		55-743-036601-RT	3
LARGE DEEP LOVESEAT UP TO 88"W 40"D 31"H*		55-744-046601-RT	3
X LARGE DEEP LOVESEAT UP TO 104"W 40"D 31"H*		55-745-056601-RT	3



Patio Chaise Lounge and Day Chaise Covers

MEDIUM CHAISE LOUNGE UP TO 66"L 28"W 27.5"H*		55-749-016601-RT	3
DOUBLE WIDE CHAISE LOUNGE WIDER CHAISES UP TO 80"L 55"W 33"H*		55-830-016601-RT	3
LARGE DAY CHAISE WIDER CHAISES UP TO 78"L 35.5"W 33"H*		55-750-046601-RT	3

*Not designed to entirely cover the wheels or legs



Patio Canopy Swing Cover

COLOR: DARK COCOA

Item/Fit		Retail Stock No	Case Qty
CANOPY SWING		55-831-016601-RT	3
UP TO 78"W 60"D 72"H*			



Patio Stand-Up Heater Cover

STAND-UP HEATER UP TO 95"H 34"DIA DOME 18.5"DIA
ROUND BASE WITH OR WITHOUT ADJUSTABLE TABLE







55-737-016601-RT

3



Patio Fire Pit and Fire Pit Table Covers





ROUND FIRE PIT		55-833-046601-RT	3
UP TO 44"DIA*			
ROUND FIRE PIT		55-834-056601-RT	3
UP TO 60"DIA*			
SQUARE FIRE PIT		55-832-036601-RT	3
UP TO 40L" 40"W*			
42" SQUARE FIRE PIT TABLE		55-835-016601-RT	3
UP TO 42"L 42"W 22"H*			

*Not designed to entirely cover the wheels or legs





Patio BBQ Grill Covers

COLOR: DARK COCOA

Item/Fit		Retail Stock No	Case Qty
MEDIUM BBQ GRILL UP TO 58"W 24"D 48"H*		55-725-016601-RT	3
LARGE BBQ GRILL UP TO 64"W 24"D 48"H*		55-726-046601-RT	3
X LARGE BBQ GRILL UP TO 70"W 24"D 48"H*		55-727-056601-RT	3
XX LARGE BBQ GRILL UP TO 72"W 26"D 51"H*		55-728-061001-RT	3



Patio Kamado Ceramic Grill Covers

LARGE KAMADO CERAMIC GRILL UP TO 22"DIA WITH SIDE TABLES 40"H* (LARGE BIG GREEN EGG®)		55-729-046601-RT	3
X LARGE KAMADO CERAMIC GRILL UP TO 27"DIA WITH SIDE TABLES 45"H* (X LARGE BIG GREEN EGG®)		55-730-056601-RT	3

*Not designed to entirely cover the wheels or legs
Big Green Egg is a registered trademark of Big Green Egg Inc. Corporation. Classic Accessories is not affiliated or associated with Big Green Egg Inc. or its products in any way.

HOME PATIO | STORIGAMI™



THE ART OF COVER FOLDING



Storigami™

NEW

The Storigami™ Collection by Classic Accessories® stores in ¼ the space and folds 2x faster than traditional covers. Purposeful construction allows the cover to fold down to a neat, manageable size every time and functional design creates an intuitive folding experience.



Stores in ¼ the Space

Purposeful construction allows the cover to fold down to a neat, manageable size every time



Durable Water-Repellent Fabric

Woven polyester fabric provides all-season protection from the elements, from UV rays to pollen and leaves

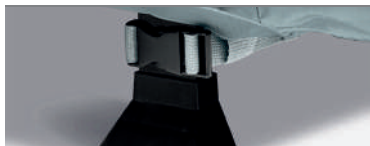

Adjustable Security Straps

Click-close buckles and adjustable webbing provide exceptional security in windy conditions



Loop Handles

Loop handles with guide arrows provide an easy touchpoint for handling



Air Vents

Vent hoods are seam taped to keep weather out, providing maximum ventilation and minimum condensation



Mountain and Valley Seams





Functional seam design combines the natural flow of fabric with purposeful mountain and valley seams for an intuitive folding experience

NEW





Patio Chair Covers

COLOR: MONUMENT

Item/Fit		E-Commerce Stock No	Case Qty
ADIRONDACK UP TO 32"W 34"D 32"H*		56-375-011001-EC	8
HIGH BACK BACKREST UP TO 26"W 33"D 35"H*		56-376-011001-EC	8
LOUNGE UP TO 36"W 35"D 32"H*		56-377-041001-EC	8
LOUNGE (2 PACK) UP TO 36"W 35"D 32"H*		56-377-041001-2PK	4
STACKABLE 6 CHAIRS UP TO 26"W 34"D 47"H*		56-374-011001-EC	8



Patio Day Chaise and Loveseat Covers

LARGE DAY CHAISE WIDER CHAISES UP TO 78"L 34"W 34"H*		56-379-011001-EC	6
SMALL LOVESEAT UP TO 58"W 33"D 32"H*		56-378-021001-EC	6

*Not designed to entirely cover the wheels or legs

NEW



MONUMENT



GOAT

Patio Full Coverage General Purpose Covers

COLORS: MONUMENT AND GOAT

Item/Fit		Color	E-Commerce Stock No	Case Qty
FULL COVERAGE CONVERSATION SET/FURNITURE GROUP LARGE UP TO 100"W 70"D 35"H*		Goat	56-334-042401-EC	2
		Monument	56-329-041001-EC	
FULL COVERAGE CONVERSATION SET/FURNITURE GROUP X LARGE UP TO 140"W 70"D 35"H*		Goat	56-335-052401-EC	2
		Monument	56-330-051001-EC	



GOAT

MONUMENT



GOAT

MONUMENT

Patio Sectional Covers

SECTIONAL V-SHAPE LOUNGE SET BACK LENGTHS UP TO 100"L, 100"L 33.5"D 31"H*		Goat	56-333-012401-EC	3
		Monument	56-328-011001-EC	
SECTIONAL L-SHAPE LOUNGE SET - LEFT BACK LENGTHS UP TO 83"L, 104"L 32"D 31"H*		Goat	56-332-012401-EC	3
		Monument	56-327-011001-EC	
SECTIONAL L-SHAPE LOUNGE SET - RIGHT BACK LENGTHS UP TO 104"L, 83"L 32"D 31"H*		Goat	56-331-012401-EC	3
		Monument	56-326-011001-EC	



*Not designed to entirely cover the wheels or legs

NEW



Patio Table and Chair Set Covers



COLOR: MONUMENT

Item/Fit		Color	E-Commerce Stock No	Case Qty
RECTANGLE/OVAL TABLE & 6 STANDARD CHAIRS		Monument	56-395-041001-EC	3
UP TO 108"L 82" W 23"H*				
ROUND TABLE & 6 STANDARD CHAIRS		Monument	56-394-041001-EC	4
UP TO 94" DIA 23"H*				

Patio BBQ Grill Covers



COLORS: BLACK, GOAT AND MONUMENT

Item/Fit		Color	E-Commerce Stock No	Case Qty
MEDIUM GRILL		Monument	56-293-031001-EC	6
		Goat	56-296-035801-EC	
		Black	56-290-030401-EC	
LARGE GRILL		Monument	56-294-041001-EC	6
		Goat	56-297-045801-EC	
		Black	56-291-040401-EC	
X LARGE GRILL		Monument	56-295-051001-EC	6
		Goat	56-298-055801-EC	
		Black	56-292-050401-EC	

*Not designed to entirely cover the wheels or legs

HOME PATIO | VERANDA™



DURABLE STYLE FOR ANY BACKYARD



Veranda™

3
YEAR
WARRANTYHEAVY-DUTY
PROTECTIONUV
PROTECTIONWATER
REPELLENTWON'T CRACK
IN THE COLD

AIR VENTS

ADJUSTABLE
HEM CORDPADDED
HANDLESCLICK-CLOSE
STRAPS

The Veranda™ Collection from Classic Accessories® is a customer favorite for its fashionable design, durability and numerous sizes



Gardelle™ Fabric System

Gardelle™ fabric features an elegant water-repellent fabric top with a protective, water-resistant 6P-free PVC undercoating and a protective dark splash guard skirt



Click-Close Straps

Click-close straps snap over legs to secure cover on windy days (on many Veranda products)

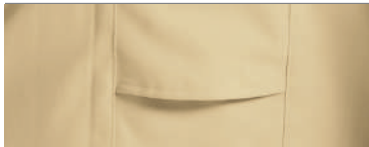

Air Vents

Air vents reduce condensation and wind lofting



Padded Handles

Padded handles for easy fitting and removal















Adjustable Cord Closures

Elastic hem cord with a toggle allows adjustment for a tight and custom fit



Patio Chair Covers

COLOR: PEBBLE/BARK/EARTH







Item/Fit		E-Commerce Stock No	Case Qty
STACKABLE 6 CHAIRS UP TO 25.5"L 33.5"D 45"H*		78972	8
ADIRONDACK UP TO 31.5"L 33.5"D 32"H*		71932	10
ADIRONDACK (2 PACK) UP TO 31.5"L 33.5"D 32"H*	 NEW 2-PACK	71932-2PK	1
DOUBLE ADIRONDACK UP TO 66"L 35"D 32"H*		55-621-011501-00	5
STANDARD BACKREST UP TO 25.5"L 28.5"D 26"H*		78912	14
HIGH BACK BACKREST UP TO 25.5"L 32.5"D 34"H*		78932	12
BAR CHAIR UP TO 26"L 28"D 48"H*		55-642-011501-00	8
MEDIUM LOUNGE CHAIR UP TO 30"L 35"D 31"H*		55-643-011501-00	8
MEDIUM LOUNGE CHAIR (2 PACK) UP TO 30"L 35"D 31"H*	 NEW 2-PACK	55-643-011501-2PK	1
LARGE LOUNGE CHAIR UP TO 38"L 35"D 31"H*		70912	10
LARGE LOUNGE CHAIR (2 PACK) UP TO 38"L 35"D 31"H*	 NEW 2-PACK	70912-2PK	4
LARGE LOUNGE CHAIR (4 PACK) UP TO 38"L 35"D 31"H*	 NEW 4-PACK	70912-4PK	2
DEEP LOUNGE CHAIR UP TO 38"L 40"D 31"H*		55-412-011501-00	8

*Not designed to entirely cover the wheels or legs

Patio Chair Covers







COLOR: PEBBLE/BARK/EARTH

Item/Fit		E-Commerce Stock No	Case Qty
MEDIUM ROCKING CHAIR UP TO 27.5"L 32.5"D 39"H*		70952	12
MEDIUM ROCKING CHAIR (2 PACK) UP TO 27.5"L 32.5"D 39"H*	 NEW 2-PACK	70952-2PK	1
LARGE ROCKING CHAIR UP TO 32"L 40"D 39"H*		55-624-011501-00	6
LARGE ROCKING CHAIR (2 PACK) UP TO 32"L 40"D 39"H*	 NEW 2-PACK	55-624-011501-2PK	1
DOUBLE WIDE ROCKING CHAIR UP TO 50"W 40"D 45"H*		55-874-011501-00	5
2 FOLDED ZERO GRAVITY CHAIRS UP TO 27"W 9"(BOTTOM) 6"(TOP)D 40"H*		55-976-011501-00	12

Patio Umbrella Covers

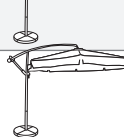









UMBRELLA UP TO 11'DIA ROUND, SQUARE TO 8'*		78902	24
OFFSET UMBRELLA CANOPY UP TO 13'DIA ROUND, SQUARE TO 9'*		55-230-011501-00	16
OFFSET UMBRELLA FRAME AND CANOPY UP TO 13'DIA ROUND, SQUARE TO 9'*		73152	10
OFFSET BANANA FRAME (FOR CURVED FRAMES) UP TO 13'DIA ROUND, SQUARE TO 9'*		55-842-011501-00	10
UMBRELLA STORAGE BAG FITS ANY UMBRELLA UP TO 67" DISASSEMBLED LENGTH		55-929-011501-00	12

*Not designed to entirely cover the wheels or legs.



Patio Table and Chair Set Covers

COLOR: PEBBLE/BARK/EARTH













Item/Fit		E-Commerce Stock No	Case Qty
MEDIUM RECTANGULAR/OVAL TABLE & 6 STANDARD CHAIRS UP TO 88"L 58"W 23"H*		70922	4
LARGE RECTANGULAR/OVAL TABLE & 6 STANDARD CHAIRS UP TO 108"L 82"W 23"H*		70932	4
X LARGE RECTANGULAR/OVAL TABLE & 6 STANDARD CHAIRS UP TO 128"L 82"W 23"H*		70942	3
SMALL ROUND TABLE & 4 STANDARD CHAIRS UP TO 60"DIA 23"H*		71912	6
MEDIUM ROUND TABLE & 6 STANDARD CHAIRS UP TO 70"DIA 23"H*		78922	6
MEDIUM/LARGE ROUND TABLE & 6 STANDARD CHAIRS UP TO 82"DIA 23"H*		55-700-031501-00	4
LARGE ROUND TABLE & 6 STANDARD CHAIRS UP TO 94"DIA 23"H*		78942	3
X LARGE ROUND TABLE & 6 STANDARD CHAIRS UP TO 108"DIA 23"H*		55-782-051501-00	2

*Not designed to entirely cover the wheels or legs.

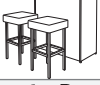

Patio Table and Chair Set Covers

COLOR: PEBBLE/BARK/EARTH









Item/Fit		E-Commerce Stock No	Case Qty
MEDIUM SQUARE TABLE & 4 CHAIRS UP TO 66"L 66"W 23"H*		55-227-011501-00	4
MEDIUM/LARGE SQUARE TABLE & 8 CHAIRS UP TO 86"L 86"W 23"H*		55-701-011501-00	3
LARGE SQUARE TABLE & 8 CHAIRS UP TO 98"L 98"W 23"H*		55-228-011501-00	3
SMALL BISTRO TABLE & 2 STANDARD CHAIRS UP TO 30"DIA TABLE 60"L 23"H*		55-466-021501-00	8
BISTRO TABLE & 2 CHAIRS UP TO 40"DIA TABLE 80"L 24"H*		55-233-011501-00	6
BISTRO TABLE & 2-4 STANDARD CHAIRS UP TO 52"DIA 23"H*		71962	6
STANDARD OUTDOOR BAR SET UP TO 41"L 38"D 40"H*		55-841-011501-00	6
MEDIUM BAR HEIGHT SQUARE TABLE & 4 BAR HEIGHT CHAIRS UP TO 66"L 66"D 34"H*		55-906-031501-00	3
LARGE BAR HEIGHT RECTANGULAR TABLE & 6 BAR HEIGHT CHAIRS UP TO 108"L 82"D 34"H*		55-907-041501-00	3
SMALL TALL ROUND TABLE & 4 TALL CHAIRS UP TO 60"DIA 29"H*		71922	5
MEDIUM TALL ROUND TABLE & 6 TALL CHAIRS UP TO 70"DIA 29"H*		55-780-031501-00	4
LARGE TALL ROUND TABLE & 8 TALL CHAIRS UP TO 94"DIA 29"H*		55-781-041501-00	3

*Not designed to entirely cover the wheels or legs



Patio Table and Chair Set Covers

COLOR: PEBBLE/BARK/EARTH

Item/Fit		E-Commerce Stock No	Case Qty
MEDIUM RECTANGULAR/OVAL TABLE W/ UMBRELLA HOLE UP TO 88"L 58"W 23"H* (UMBRELLA NOT INCLUDED)		55-458-031501-00	4
LARGE RECTANGULAR/OVAL TABLE W/ UMBRELLA HOLE UP TO 108"L 82"W 23"H* (UMBRELLA NOT INCLUDED)		55-459-041501-00	3
SQUARE TABLE AND 4 CHAIRS W/ UMBRELLA HOLE UP TO 66"L 66"W 23"H* (UMBRELLA NOT INCLUDED)		55-463-031501-00	4
SMALL ROUND TABLE W/ UMBRELLA HOLE UP TO 60"DIA 23"H* (UMBRELLA NOT INCLUDED)		55-460-021501-00	4
MEDIUM ROUND TABLE W/ UMBRELLA HOLE UP TO 70"DIA 23"H* (UMBRELLA NOT INCLUDED)		55-461-031501-00	4
LARGE ROUND TABLE W/ UMBRELLA HOLE UP TO 94"DIA 23"H* (UMBRELLA NOT INCLUDED)		55-462-041501-00	3
PICNIC TABLE UP TO 72"L 57"W 30"H*		55-618-031501-00	4
ROUND PICNIC TABLE UP TO 46"DIA (TOP) 80"DIA (BOTTOM) 30"H*		56-305-011501-EC	3







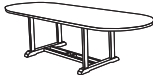

NEW

*Not designed to entirely cover the wheels or legs

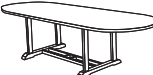

Patio Table and Coffee Table Covers

COLOR: PEBBLE/BARK/EARTH













Item/Fit		E-Commerce Stock No	Case Qty
LARGE RECTANGULAR/OVAL TABLE UP TO 72"L 44"W 23"H*		55-565-011501-00	5
X LARGE RECTANGULAR/OVAL TABLE UP TO 84"L 44"W 23"H*		55-564-011501-00	4
XX LARGE RECTANGULAR/OVAL TABLE UP TO 96"L 44"W 23"H*	 NEW SIZE	56-311-061501-EC	4
MEDIUM SQUARE TABLE UP TO 40"L 40"W 23"H*		55-566-011501-00	8
LARGE SQUARE TABLE UP TO 60"L 60"W 23"H*		55-567-011501-00	5
MEDIUM ROUND TABLE UP TO 36"DIA 23"H*		55-568-011501-00	10
LARGE ROUND TABLE UP TO 50"DIA 23"H*		55-569-011501-00	8
RECTANGULAR COFFEE TABLE UP TO 48"L 25"W 18"H*		55-121-011501-00	8

*Not designed to entirely cover the wheels or legs



Patio Loveseat/Sofa and Bench Covers

COLOR: PEBBLE/BARK/EARTH







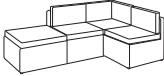
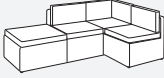

Item/Fit		E-Commerce Stock No	Case Qty
SMALL LOVESEAT UP TO 58"L 32.5"D 32"H*		70982	8
MEDIUM LOVESEAT UP TO 76"L 32.5"D 34"H*		72922	6
LARGE LOVESEAT UP TO 88"L 32.5"D 34"H*		72932	6
X LARGE LOVESEAT/SOFA UP TO 104"L 32.5"D 31"H*		55-226-051501-00	4
DEEP SMALL LOVESEAT UP TO 58" L 40"D 31"H*		55-649-021501-00	5
DEEP MEDIUM LOVESEAT UP TO 76"L 40"D 31"H*		55-413-031501-00	4
DEEP LARGE LOVESEAT UP TO 88"L 40"D 31"H*		55-414-041501-00	4
DEEP LARGE LOVESEAT (2 PACK) UP TO 88"L 40"D 31"H*	 NEW 2-PACK	55-414-041501-2PK	1
DEEP X LARGE LOVESEAT UP TO 104"L 40"D 31"H*		55-415-051501-00	4
SMALL BENCH UP TO 50"L 28.5"D 31"H*		70992	10
MEDIUM BENCH UP TO 60"L 28.5"D 31"H*		55-646-011501-00	6
LARGE BENCH UP TO 75"L 28.5"D 31"H*		55-647-011501-00	5

*Not designed to entirely cover the wheels or legs



Patio Sectional Covers

COLOR: PEBBLE/BARK/EARTH





Item/Fit		Retail Stock No	Case Qty	E-Commerce Stock No	Case Qty
SECTIONAL L-SHAPE LOUNGE SET - RIGHT BACK LENGTHS UP TO 104"L, 83"L 32"D 31"H*		55-880-011501-RT	1		
X LARGE SECTIONAL L-SHAPE LOUNGE SET - RIGHT BACK LENGTHS UP TO 115"L, 83"L 32.5"D 31"H*	 NEW SIZE			56-302-051501-EC	3
SECTIONAL L-SHAPE LOUNGE SET - LEFT BACK LENGTHS UP TO 83"L, 104"L 32"D 31"H*		55-881-011501-RT	1		
X LARGE SECTIONAL L-SHAPE LOUNGE SET - LEFT BACK LENGTHS UP TO 83"L, 115"L 32.5"D 31"H*	 NEW SIZE			56-303-051501-EC	3
SMALL SECTIONAL V-SHAPE LOUNGE SET BACK LENGTHS UP TO 70"L, 70"L 32.5"D 31"H*	 NEW SIZE			56-300-021501-EC	4
MEDIUM SECTIONAL V-SHAPE LOUNGE SET BACK LENGTHS UP TO 85"L, 85"L 32.5"D 31"H*	 NEW SIZE			56-301-031501-EC	3
SECTIONAL V-SHAPE LOUNGE SET BACK LENGTHS UP TO 100"L, 100"L 33.5"D 31"H*		55-882-011501-RT	1		
X LARGE SECTIONAL V-SHAPE LOUNGE SET BACK LENGTHS UP TO 115"L, 115"L 32.5"D 31"H*	 NEW SIZE			56-304-051501-EC	3
CURVED SOFA SECTIONAL FITS UP TO 46"(FRONT) 90"(BACK)L 34"D 32"H*				56-253-011501-00	5

*Not designed to entirely cover the wheels or legs.







Patio Chaise and Steamer Chaise/Deck Chair Covers

COLOR: PEBBLE/BARK/EARTH

Item/Fit		E-Commerce Stock No	Case Qty
MEDIUM CHAISE LOUNGE UP TO 66"L 28"W 30"H*		78952	8
LARGE CHAISE LOUNGE UP TO 86"L 34"W 30"H*		55-623-011501-00	4
DOUBLE WIDE CHAISE LOUNGE WIDER CHAISES UP TO 80"L 55"W 33"H		55-464-011501-00	4
STEAMER CHAISE/DECK CHAIR UP TO 65"L 25"W 37"H*		55-583-141501-00	6

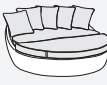

Patio Day Chaise and Circular Daybed Covers









MEDIUM DAY CHAISE WIDER CHAISES UP TO 66"L 35.5"W 33"H*		70962	6
MEDIUM DAY CHAISE (2 PACK) WIDER CHAISES UP TO 66"L 35.5"W 33"H*	 NEW 2-PACK	70962-2PK	1
LARGE DAY CHAISE WIDER CHAISES UP TO 78"L 35.5"W 33"H*		71972	6
SMALL ROUND OUTDOOR DAYBED UP TO 56"DIA 33"H*	 NEW SIZE	56-299-021501-EC	6
MEDIUM/LARGE ROUND OUTDOOR DAYBED UP TO 90"DIA 33"H*		55-872-031501-00	4

*Not designed to entirely cover the wheels or legs



Patio Ottoman/Table Covers

COLOR: PEBBLE/BARK/EARTH







Item/Fit		E-Commerce Stock No	Case Qty
SMALL SQUARE OTTOMAN/TABLE UP TO 21"L 21"W 17"H*		70972	14
LARGE SQUARE OTTOMAN/TABLE UP TO 26"L 26"W 17"H*		71982	16
X LARGE SQUARE OTTOMAN/TABLE UP TO 31"L 31"W 17"H*		55-645-051501-00	12
X SMALL RECTANGLE OTTOMAN/TABLE UP TO 26"L 20"W 17"H*		55-644-361501-00	16
SMALL RECTANGULAR OTTOMAN/TABLE UP TO 32"L 22"W 17"H*		71992	20
LARGE RECTANGULAR OTTOMAN/TABLE UP TO 38"L 28"W 17"H*		72912	14
SMALL ROUND OTTOMAN/COFFEE TABLE UP TO 24"DIA 18"H*		55-854-021501-00	12
MEDIUM ROUND OTTOMAN/COFFEE TABLE UP TO 30"DIA 22"H*		55-855-031501-00	12
LARGE ROUND OTTOMAN/COFFEE TABLE UP TO 34"DIA 25"H*		55-856-041501-00	10

*Not designed to entirely cover the wheels or legs.



Patio Conversation Set/Furniture Group Covers



COLOR: PEBBLE/BARK/EARTH

Item/Fit		E-Commerce Stock No	Case Qty
CONVERSATION SET/FURNITURE GROUP MEDIUM UP TO 80"L 60"W 30"H*		55-578-011501-00	3
CONVERSATION SET/FURNITURE GROUP LARGE UP TO 100"L 70"W 30"H*		55-467-011501-00	3
CONVERSATION SET/FURNITURE GROUP X LARGE UP TO 140"L 70"W 30"H*		55-577-011501-00	3
FULL COVERAGE CONVERSATION SET/FURNITURE GROUP LARGE UP TO 100"L 70"W 35"H*		55-883-041501-00	3
FULL COVERAGE CONVERSATION SET/FURNITURE GROUP X LARGE UP TO 140"L 70"W 35"H*		55-884-051501-00	2
CONVERSATION SET/FURNITURE GROUP ROUND UP TO 128" DIA 30"H*		56-087-011501-00	3

*Not designed to entirely cover the wheels or legs.



Patio Cushion Storage Bags





CUSHION AND COVER STORAGE BAG FITS CHAIR, BENCH, CHAISE CUSHIONS & COVERS UP TO 45.5"L 13.75"W 20"H		78982	12
OVERSIZED CUSHION AND COVER STORAGE BAG FITS CHAIR, BENCH, CHAISE CUSHIONS & COVERS UP TO 60"L 20"W 28"H		55-648-051501-00	5

*Not designed to entirely cover the wheels or legs.



Canopy Swing, A-Frame Swing and Porch Swing Covers

COLOR: PEBBLE/BARK/EARTH

Item/Fit		E-Commerce Stock No	Case Qty
PORCH SWING UP TO 56"W 25"D 32" H		55-972-011501-00	8
A-FRAME SWING UP TO 72"W 55"D 67"H*		55-965-011501-00	3
CANOPY SWING UP TO 78"L 60"W 72"H*		72962	3
3-SEAT CANOPY SWING UP TO 88"L 60"W 72"H*		55-622-011501-00	2



Patio Swing Chair Covers





HAMMOCK CHAIR UP TO 35"W 43"D 75"H*		55-991-041501-00	10
HANGING CHAIR AND STAND UP TO 43"W 35"D 75"H*		55-905-011501-00	4

*Not designed to entirely cover the wheels or legs.



Patio Hot Tub Cover Caps

COLOR: PEBBLE/BARK/EARTH

Item/Fit		E-Commerce Stock No	Case Qty
ROUND HOT TUB UP TO 84"DIA		55-584-011501-00	5
MEDIUM SQUARE HOT TUB UP TO 86"W		55-585-011501-00	4
LARGE SQUARE HOT TUB UP TO 94"W		55-586-011501-00	4
MEDIUM RECTANGULAR HOT TUB UP TO 82"L 69"W		55-587-011501-00	5
LARGE RECTANGULAR HOT TUB UP TO 94"L 84"W		55-588-011501-00	4



Patio ADA Pool Lift Cover

ADA FOLDING POOL LIFT UP TO 22"W 25"D 50"H* FITS MODELS S.R. SMITH® ML300 & MULTILIFT®		55-876-011501-00	10
--	---	------------------	----

*Not designed to entirely cover the base.





*S.R. Smith® and MultiLift® are trademarks of S.R. Smith Inc, LLC.

*Americans with Disabilities Act



Patio TV Dust Covers

COLOR: PEBBLE/BARK/EARTH

Item/Fit		E-Commerce Stock No	Case Qty
TV (WITH OR WITHOUT WALL MOUNT) MODEL 2 UP TO 32"W 4.5"D 23"H		55-789-151501-00	10
TV (WITH OR WITHOUT WALL MOUNT) MODEL 4 UP TO 42"W 4.5"D 26.5"H		55-791-171501-00	10
TV (WITH OR WITHOUT WALL MOUNT) MODEL 5 UP TO 46"W 4.5"D 29"H		55-792-181501-00	10
TV (WITH OR WITHOUT WALL MOUNT) MODEL 6 UP TO 51"W 4.5"D 33"H		55-793-191501-00	8
TV (WITH OR WITHOUT WALL MOUNT) MODEL 8 UP TO 60"W 4.5"D 37"H		55-795-211501-00	8



Patio Fountain Cover



FOUNTAIN: MODEL 2 FITS 48"DIA 68"H*		55-058-151501-00	6
---	--	------------------	---

*Not designed to entirely cover the wheels or legs.



Patio Hammock Covers

COLOR: PEBBLE/BARK/EARTH

Item/Fit		E-Commerce Stock No	Case Qty
WOOD HAMMOCK STAND FITS 13' WOOD STAND AND QUILTED HAMMOCK WITH SPREADER BARS*		55-917-011501-00	2
STEEL HAMMOCK STAND FITS 15' STEEL STAND AND BRAZILIAN HAMMOCK**		55-916-011501-00	2
HAMMOCK AND 15 FT. STEEL STAND STORAGE BAG UP TO 72" DISASSEMBLED LENGTH		55-904-011501-00	12

**Cover cannot accommodate a hammock with spreader bars.



Patio Ping Pong Table and Hose Reel Covers

PING PONG TABLE UP TO 60"W 28"D 63"H*		55-826-011501-00	4
FREE STANDING HOSE REEL FITS ALL 150 FT. HOSE CAPACITY ELEY AND RAPID REEL GARDEN REELS*		55-931-031501-00	12

Trash and Recycling Cart Covers







TRASH CART UP TO 29"L 34"D 46"H FITS STANDARD 96 GALLON TRASH CART		55-785-011501-00	6
RECYCLING CART UP TO 29"L 34"D 46"H FITS STANDARD 96 GALLON RECYCLING CART		55-786-011501-00	6

*Not designed to entirely cover the wheels or legs.



Patio Deck Box, Bar Cart and Rolling Cooler Covers

COLOR: PEBBLE/BARK/EARTH

Item/Fit		E-Commerce Stock No	Case Qty
48" DECK BOX UP TO 48"L 24"W 21"H*		55-705-011501-00	10
55" DECK BOX UP TO 55"L 27"W 24"H*		55-706-011501-00	8
MEDIUM SINGLE HANDLE BAR CART UP TO 30"L 20"D 36"H*		55-798-031501-00	10
LARGE SINGLE HANDLE BAR CART UP TO 36"L 25"D 36"H*		55-797-041501-00	10
DOUBLE HANDLE BAR CART UP TO 40"L 18"D 36"H*		55-799-031501-00	10
80 QT ROLLING DECK COOLER UP TO 32"W 19.8"D 34.5"H*		55-871-041501-00	12



Patio Towel Valet Covers







OUTDOOR TOWEL VALET UP TO 24"W 24"D 70"H*		55-873-011501-00	4
---	---	------------------	---

*Not designed to entirely cover the wheels or legs.





Patio Stand-Up, Pyramid and Table Top Heater Covers

COLOR: PEBBLE/BARK/EARTH

Item/Fit		E-Commerce Stock No	Case Qty
ROUND STAND-UP HEATER UP TO 95"H 34"DIA DOME 18.5"DIA ROUND BASE WITH OR W/O ADJUSTABLE TABLE		73112	8
SQUARE STAND-UP HEATER UP TO 32" SQUARE TOP 87"H		55-582-141501-00	5
PYRAMID TORCH HEATER UP TO 21"L 21"W 90"H		55-341-011501-00	6
ROUND TABLE TOP HEATER UP TO 21"DIA DOME 38"H		55-571-011501-00	14
PYRAMID TABLE TOP HEATER UP TO 11"L 11"W 34"H		55-572-011501-00	14
ROUND STAND-UP PATIO HEATER WITH TABLE FITS ROUND TOP STAND-UP HEATERS W/ 32" DIA TABLE		55-995-015101-00	6
SQUARE STAND-UP PATIO HEATER WITH TABLE FITS SQUARE TOP STAND-UP HEATERS W/ 32"L 32"W TABLE		55-996-015101-00	4











Patio Air Conditioner Covers

ROUND AIR CONDITIONER UP TO 34"DIA 30"H		73122	14
SQUARE AIR CONDITIONER UP TO 34"L 34"W 30"H		73132	10



Patio Fire Pit Covers

COLOR: PEBBLE/BARK/EARTH



Item/Fit		E-Commerce Stock No	Case Qty
ROUND FIRE PIT UP TO 44"DIA*		78992	18
ROUND FIRE PIT UP TO 60"DIA*		72942	12
SQUARE FIRE PIT UP TO 40"L 40"W*		71942	18
X SMALL ROUND FULL COVERAGE FIRE PIT UP TO 24"DIA 12"H*		55-703-011501-00	12
SMALL ROUND FULL COVERAGE FIRE PIT UP TO 30"DIA 12"H*		55-488-011501-00	12
LARGE ROUND FULL COVERAGE FIRE PIT UP TO 36"DIA 12"H*		55-489-011501-00	12
X SMALL SQUARE FULL COVERAGE FIRE PIT UP TO 24"L 24"W 12"H*		55-704-011501-00	12
SMALL SQUARE FULL COVERAGE FIRE PIT UP TO 30"L 30"W 12"H*		55-490-011501-00	12
LARGE SQUARE FULL COVERAGE FIRE PIT UP TO 36"L 36"W 12"H*		55-491-011501-00	12

*Not designed to entirely cover the wheels or legs.





Patio Stand-Up Fire Pit and Fire Column Covers

COLOR: PEBBLE/BARK/EARTH

Item/Fit		E-Commerce Stock No	Case Qty
X-LARGE STAND-UP FIRE PIT UP TO 35.5"L 35.5"W 35"H*		72952	12
X-LARGE TALL OUTDOOR FIREPLACE UP TO 32.5"W 32.5"D 50"H*		55-989-051501-00	8
FIRE COLUMN UP TO 21"L 21"W 30"H*		55-796-031501-00	12

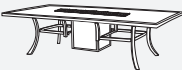
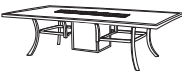
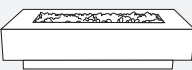

Patio Fire Pit Table Covers

42" ROUND FIRE PIT TABLE UP TO 42"DIA 22"H*		55-465-011501-00	8
42" SQUARE FIRE PIT TABLE UP TO 42"L 42"W 22"H*		55-407-011501-00	8
52" SQUARE FIRE PIT TABLE UP TO 52"L 52"W 22"H*		55-620-011501-00	6
40" RECTANGULAR FIRE PIT TABLE UP TO 40"L 28"W 22"H*		55-619-011501-00	10
56" RECTANGULAR FIRE PIT TABLE UP TO 56"L 38"W 22"H*		55-599-011501-00	5
60" RECTANGULAR FIRE PIT TABLE UP TO 60"L 28"W 15"H*		55-784-051501-00	8

*Not designed to entirely cover the wheels or legs.



Patio Chiminea Covers

COLOR: PEBBLE/BARK/EARTH

Item/Fit		E-Commerce Stock No	Case Qty
MEDIUM CHIMINEA		55-112-011501-00	10
UP TO 22" DIA 52.75"H*			
LARGE CHIMINEA		55-779-041501-00	10
UP TO 25" DIA 65"H*			



Patio Log Rack Covers

SMALL LOG RACK		72972	6
FITS 4'L LOG RACKS 48"L 24"W 42"H*			
LARGE LOG RACK		72982	3
FITS 8'L LOG RACKS 96"L 24"W 42"H*			
X LARGE LOG RACK		55-930-051501-00	2
FITS 12'L LOG RACKS 144"L 24"W 42"H*			



Patio Log Carriers











LOG CARRIER 40"L 25"W (OPENED)		55-056-011501-00	30
SHOULDER STRAP 55" (EXTENDED)			
JUMBO LOG CARRIER HOLDS UP TO 2 STANDARD WOOD BUNDLES 24"L 11.75"W 11.75"H (OPENED)		55-096-011501-00	30

*Not designed to entirely cover the wheels or legs.



Patio BBQ Grill and Propane Tank Covers

COLOR: PEBBLE/BARK/EARTH

Item/Fit			E-Commerce Stock No	Case Qty
SMALL SPACES GRILL UP TO 24"W 23"D 42"H*	NEW		56-306-011501-EC	8
X SMALL BBQ GRILL UP TO 38"L 22"D 44"H*			55-337-361501-00	8
SMALL BBQ GRILL WEBER® Q® 3200™ UP TO 44"L 17"D 44"H*			73902	6
SMALL BBQ GRILL UP TO 44"L 22"D 44"H*			55-702-021501-00	6
SMALL/MEDIUM BBQ GRILL UP TO 52"L 24"D 44"H*			55-338-371501-00	5
MEDIUM BBQ GRILL UP TO 58"L 24"D 48"H*			73912	6
LARGE BBQ GRILL UP TO 64"L 24"D 48"H*			73922	6
X LARGE BBQ GRILL UP TO 70"L 24"D 48"H*			73942	4
XX LARGE BBQ GRILL UP TO 72"L 26"D 51"H*			73952	4
3X LARGE BBQ GRILL UP TO 80"L 26"D 51"H*			55-339-351501-00	4
20 LB PROPANE TANK UP TO 7"DIA TOP 13"DIA BOTTOM 19.5"H*			55-707-011501-00	30









*Not designed to entirely cover the wheels or legs.

Weber Q 3200 is a trademark of Weber-Stephens Products, LLC. Classic Accessories is not affiliated or associated with Weber-Stephens Products, LLC or its products in any way.



Patio Island Grill Top Covers

COLOR: PEBBLE/BARK/EARTH





Item/Fit		E-Commerce Stock No	Case Qty
EXTRA SMALL ISLAND GRILL TOP UP TO 32"L 26"D 24"H		55-340-361501-00	12
SMALL ISLAND GRILL TOP UP TO 37"L 27"D 24"H		55-053-021501-00	12
MEDIUM ISLAND GRILL TOP UP TO 45"L 29"D 26"H		55-054-031501-00	8
MEDIUM ISLAND GRILL, CENTER GRILL HEAD UP TO 78"L 44"D 48"H*		55-628-031501-00	3
LARGE ISLAND GRILL, CENTER GRILL HEAD UP TO 86"L 44"D 48"H*		55-629-041501-00	3
X LARGE ISLAND GRILL, CENTER GRILL HEAD UP TO 98"L 44"D 48"H*		55-630-051501-00	3
MEDIUM ISLAND GRILL, LEFT OR RIGHT GRILL HEAD UP TO 78"L 44"D 48"H*		55-625-031501-00	3
LARGE ISLAND GRILL, LEFT OR RIGHT GRILL HEAD UP TO 86"L 44"D 48"H*		55-626-041501-00	3
X LARGE ISLAND GRILL, LEFT OR RIGHT GRILL HEAD UP TO 98"L 44"D 48"H*		55-627-051501-00	3

*Not designed to entirely cover the wheels or legs.



Patio Kamado Ceramic Grill Covers

COLOR: PEBBLE/BARK/EARTH

Item/Fit		E-Commerce Stock No	Case Qty
MEDIUM KAMADO CERAMIC GRILL			
UP TO 18" TOTAL DIA W/ SIDE TABLES 40"H* (MEDIUM BIG GREEN EGG®)		55-603-031501-00	12
LARGE KAMADO CERAMIC GRILL			
UP TO 22" TOTAL DIA W/ SIDE TABLES 40"H* (LARGE BIG GREEN EGG®)		55-231-041501-00	16
X LARGE KAMADO CERAMIC GRILL			
UP TO 27" DIA W/ SIDE TABLES 45"H* (X LARGE BIG GREEN EGG®)		55-232-051501-00	12
KAMADO CERAMIC GRILL WITH OFFSET TABLE			
UP TO 60"L 30"D 50"H*		55-410-011501-00	5
MINI KAMADO CERAMIC GRILL			
UP TO 21.5"DIA (INCLUDING HANDLES) 27"H*		55-968-011501-00	12





*Not designed to entirely cover the wheels or legs.

Big Green Egg® is a registered trademark of Big Green Egg Inc. Corporation. Classic Accessories is not affiliated or associated with Big Green Egg Inc. or its products in any way.







Patio Flat Top Griddle, Park Style and Bistro Grill Covers

COLOR: PEBBLE/BARK/EARTH

Item/Fit		E-Commerce Stock No	Case Qty
MEDIUM FLAT TOP GRIDDLE FITS 28" GRIDDLE UP TO 45"L 23"D 25"H*		55-774-035101-00	6
LARGE FLAT TOP GRIDDLE FITS 36" GRIDDLE UP TO 63"L 22"D 36"H*		55-775-045101-00	6
PARK STYLE GRILL UP TO 23"L 24"D 19"H*		55-783-011501-00	12
BISTRO GRILL FITS 30"W 26"D 38"H*		55-993-011501-00	12



Patio Prep Table Covers







SMALL PREP TABLE UP TO 30"W 23"D 33"H*			56-308-021501-EC	8
MEDIUM PREP TABLE UP TO 54"W 23"D 33"H*			56-309-031501-EC	8

*Not designed to entirely cover the wheels or legs.



Patio Smoker Covers

COLOR: PEBBLE/BARK/EARTH

Item/Fit		E-Commerce Stock No	Case Qty
MEDIUM ROUND SMOKER UP TO 19" DIA 39"H*		73002	20
BARREL SMOKER UP TO 24" DIA 30"H*		55-967-011501-00	12
MEDIUM SQUARE SMOKER UP TO 17"L 14"D 30"H*		73012	18
LARGE SQUARE SMOKER UP TO 26"L 19.5"D 40"H*		55-570-011501-00	12
X LARGE SQUARE SMOKER UP TO 33"L 24.5"D 60"H*		55-857-051501-00	6
OFFSET SMOKER FITS DYNA-GLO 1176 SERIES OFFSET SMOKERS AND OFFSET SMOKERS UP TO 32"W 17"D 40"H*	 NEW	56-310-011501-EC	8
PK GRILL AND SMOKER* FITS PK GRILL & SMOKER 34.5" W 20" D 35" H*		55-971-011501-00	12







*Not designed to entirely cover the wheels or legs.

*Does not fit models with external side controls and bisquette loader attached.
PK Grill and Smoker is a registered trademark of Portable Kitchens®, Inc.

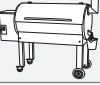

Patio Pellet Grill and Kettle BBQ Grill Covers

COLOR: PEBBLE/BARK/EARTH

Item/Fit		E-Commerce Stock No	Case Qty
MEDIUM PELLETT GRILL UP TO 37"W 18"D 36"H*		55-969-031501-00	8
LARGE PELLETT GRILL UP TO 46"W 26"D 43"H*		55-970-041501-00	8
22 SERIES TRAEGER® GRILLS UP TO 41"W 23"D 49"H*		55-918-011501-00	8
34 SERIES TRAEGER® GRILLS UP TO 53"W 23"D 49"H*		55-919-011501-00	6
WEBER® PERFORMER® GRILL UP TO 40"L 28.5"D 50.25"H* GOLD AND PLATINUM 22" GRILLS		55-411-011501-00	8
WEBER SUMMIT® CHARCOAL GRILL CENTER SUMMIT CHARCOAL, PERFORMER PREMIUM AND PERFORMER DELUXE GRILLS*		55-819-261501-00	6
KETTLE BBQ GRILL UP TO 26.5"DIA 38"H*		73422	18
LARGE KETTLE BBQ GRILL UP TO 30" DIA 43"H* FITS WEBER® PREMIUM 26" GRILL		55-966-041501-00	12

*Not designed to entirely cover the wheels or legs.



*Traeger® pellet grills are a trademark of Traeger Pellet Grills, LLC.

Webster Summit® and Weber® Performer® are trademarks of Weber-Stephens Products, LLC. Classic Accessories is not affiliated or associated with Weber-Stephens Products, LLC or its products in any way. Blackstone® is a registered trademark of Blackstone Products. Classic Accessories is not affiliated or associated with Weber-Stephens Products, LLC or its products in any way.



Patio Cowboy Grill and Pizza Oven Covers

COLOR: PEBBLE/BARK/EARTH

Item/Fit		E-Commerce Stock No	Case Qty
COWBOY FIRE PIT GRILL AND ROTISSERIE UP TO 40"DIA 16"H*		55-879-011501-00	8
OUTDOOR PIZZA OVEN UP TO 44.5"L 22.25"W 39.5"H* FITS BLACKSTONE® OUTDOOR PIZZA/PATIO OVEN		55-964-011501-00	10



Patio Table Top Grill Covers and Carrying Bags

ROUND TABLE TOP GRILL COVER AND CARRY BAG UP TO 22"DIA 18"H*		55-973-031501-00	12
MEDIUM RECTANGULAR TABLE TOP GRILL COVER AND CARRY BAG UP TO 22"L 18"D 15"H*		55-974-031501-00	12
LARGE RECTANGULAR TABLE TOP GRILL COVER UP TO 29"L 24"D 15"H*		55-975-041501-00	10

*Not designed to entirely cover the wheels or legs.
Blackstone® is a registered trademark of Blackstone Products. Classic Accessories is not affiliated or associated with Weber-Stephens Products, LLC or its products in any way.

Terrazzo®



The Terrazzo® Collection from Classic Accessories® has an alluring combination of style and our durable, medium-weight Rain-Tite™ woven polyester fabric

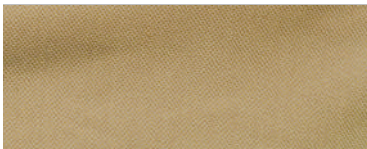

Rain-Tite™ Fabric System

Tough Rain-Tite™ fabric protects against rain, snow, sun and dirt and won't crack in cold weather



Elastic Loops and Elastic Cord

StayOn™ elastic loops fit over legs to keep cover on during high winds and breezy conditions
Elastic cord in the bottom of hem for a fast and custom fit (on many Terrazzo products)













Air Vents

Air vents reduce condensation and wind lofting



Patio Chair and Chaise Lounge Covers

COLOR: SAND





Item/Fit		E-Commerce Stock No	Case Qty	Retail Stock No	Case Qty
ADIRONDACK					
UP TO 33"L 34"D 32"H*		59952-EC	10	59952	1
LOUNGE					
UP TO 36"L 35"D 32"H*		59942-EC	8	59942	1
LOUNGE					
UP TO 36"L 35"D 32"H*		59942-2PK	1		
STANDARD BACKREST					
UP TO 27.5"L 26"D 27"H*		58912-EC	16	58912	1
HIGH BACK BACKREST					
UP TO 27.5"L 26"D 35"H*		58932-EC	16	58932	1
HIGH BACK BACKREST					
UP TO 27.5"L 26"D 35"H*		58932-2PK	1		
STACKABLE 6 CHAIRS					
UP TO 26"L 34"D 47"H*		58972-EC	10	58972	1
MEDIUM CHAISE LOUNGE					
UP TO 66"L 28.5"W 30"H*		58952-EC	10	58952	1
MEDIUM CHAISE LOUNGE					
UP TO 66"L 28.5"W 30"H*		58952-2PK	1		
LARGE CHAISE LOUNGE					
UP TO 86"L 34.5"D 30"H*		55-990-042001-EC	6	55-990-042001-00	1

*Not designed to entirely cover the wheels or legs



Patio Table and Chair Set Covers

COLOR: SAND



Item/Fit		E-Commerce Stock No	Case Qty	Retail Stock No	Case Qty
TABLE COVER SUPPORT POLE ADJUSTS FROM 12" TO 20"H				55-190-015101-00	1
LARGE RECTANGULAR/OVAL TABLE & 6 STANDARD CHAIRS UP TO 106"L 82"W 23"H*		58262-EC	4	58262	1
MEDIUM ROUND TABLE & 6 STANDARD CHAIRS UP TO 69"DIA 23"H*		58212-EC	6	58212	1
LARGE ROUND TABLE & 6 STANDARD CHAIRS UP TO 94"DIA 23"H*		58222-EC	4	58222	1

*Not designed to entirely cover the wheels or legs

Patio Umbrella Covers



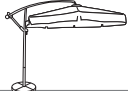

COLOR: SAND



Item/Fit		E-Commerce Stock No	Case Qty	Retail Stock No	Case Qty
UMBRELLA					
UP TO 11'DIA ROUND, SQUARE TO 8'		58902-EC	30	58902	1
OFFSET UMBRELLA CANOPY					
UP TO 13'DIA ROUND, SQUARE TO 9'		59992-EC	12	59992	1
OFFSET UMBRELLA AND FRAME					
UP TO 13' DIA ROUND OR 9'L		56-264-012001-EC	8		

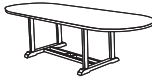

Patio Table, Coffee Table and Conversation Set/Furniture Group Covers

RECTANGULAR/OVAL TABLE					
UP TO 72"L 44"W 23"H*		58242-EC	6	58242	1
LARGE ROUND TABLE					
UP TO 50"DIA 23"H*		58202-EC	10	58202	1
EXTRA LARGE ROUND TABLE					
UP TO 94"DIA 23"H		56-267-052001-EC	3		
RECTANGULAR COFFEE TABLE					
UP TO 48"L 25"W 18"H*		59962-EC	12	59962	1
CONVERSATION SET/ FURNITURE GROUP					
UP TO 80"L 60"W 30"H*		59972-EC	4	59972	1

*Not designed to entirely cover the wheels or legs



Patio Loveseat/Sofa and Sectional Covers

COLOR: SAND





Item/Fit		E-Commerce Stock No	Case Qty	Retail Stock No	Case Qty
SMALL LOVESEAT UP TO 58"L 32.5"D 32"H*		55-914-022001-EC	5		
MEDIUM LOVESEAT UP TO 76"L 32.5"D 34"H*		58272-EC	6	58272	1
LARGE LOVESEAT UP TO 88"L 32.5"D 34"H*				58282	1
X LARGE LOVESEAT/SOFA UP TO 104"L 32.5"D 31"H*		55-915-052001-EC	4		
DEEP SMALL LOVESEAT UP TO 58" L 40"D 34"H*		55-899-022001-EC	5		
DEEP MEDIUM LOVESEAT UP TO 76"L 40"D 34"H*		55-900-032001-EC	4		
DEEP LARGE LOVESEAT UP TO 88"L 40"D 34"H*		55-901-042001-EC	4		
DEEP X LARGE LOVESEAT UP TO 104"L 40"D 31"H*		55-902-052001-EC	4		
SECTIONAL L-SHAPE LOUNGE SET - RIGHT BACK LENGTHS UP TO 104"L, 83"L 32"D 31"H*		56-049-012001-EC	3		
SECTIONAL L-SHAPE LOUNGE SET - LEFT BACK LENGTHS UP TO 83"L, 104"L 32"D 31"H*		56-050-012001-EC	3		
SECTIONAL V-SHAPE LOUNGE SET BACK LENGTHS UP TO 100"L, 100"L 33.5"D 31"H*		56-051-012001-EC	3		

*Not designed to entirely cover the wheels or legs



Patio Ottoman/Table Covers



COLOR: SAND

Item/Fit		E-Commerce Stock No	Case Qty	Retail Stock No	Case Qty
SMALL SQUARE OTTOMAN/TABLE UP TO 21"L 21"W 17"H*		55-910-022001-EC	12		
LARGE SQUARE OTTOMAN/TABLE UP TO 26"L 26"W 17"H*		55-913-042001-EC	12		
SMALL ROUND OTTOMAN/COFFEE TABLE UP TO 24"DIA 18"H*		55-909-022001-EC	12		
MEDIUM ROUND OTTOMAN/COFFEE TABLE UP TO 30"DIA 22"H*		55-911-032001-EC	12		
LARGE ROUND OTTOMAN/COFFEE TABLE UP TO 34"DIA 25"H*		55-912-042001-EC	12		

*Not designed to entirely cover the wheels or legs





Patio Hot Tub Cover Caps

MEDIUM SQUARE HOT TUB UP TO 86"W		55-858-032001-EC	4		
LARGE SQUARE HOT TUB UP TO 94"W		55-859-042001-EC	4		

Patio Cushion and Cover Storage Bags









CUSHION AND COVER STORAGE BAG FITS CHAIR, BENCH, CHAISE CUSHIONS & COVERS UP TO 45.5"L 13.75"W 20"H		58982-EC	14	58982	1
OVERSIZE CUSHION & COVER STORAGE BAG FITS CHAIR, BENCH AND CHAISE CUSHIONS & COVERS UP TO 60"L 20"W 28"H		56-268-012001-EC	6		



Patio Fire Pit and Fire Pit Table Covers

COLOR: SAND

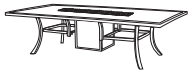

Item/Fit		E-Commerce Stock No	Case Qty	Retail Stock No	Case Qty
ROUND FIRE PIT UP TO 44"DIA*		58992-EC	8	58992	1
SMALL SQUARE FULL COVERAGE FIRE PIT UP TO 30"L 30"W 12"H*				59922	1
LARGE SQUARE FULL COVERAGE FIRE PIT UP TO 36"L 36"W 12"H*		59932-EC	10		
42" ROUND FIRE PIT TABLE UP TO 42"DIA 22"H*		55-823-012001-EC	10		
42" SQUARE FIRE PIT TABLE UP TO 42"L 42"W 22"H*		55-824-022001-EC	10		
52" SQUARE FIRE PIT TABLE UP TO 52"L 52"W 22"H*		55-825-012001-EC	6		
40" RECTANGULAR FIRE PIT TABLE UP TO 40"L 28"W 22"H*		55-821-022001-EC	12		

*Not designed to entirely cover the wheels or legs





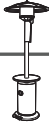

Patio Stand-Up Heater, Fire Column and Chiminea Covers

COLOR: SAND

Item/Fit		E-Commerce Stock No	Case Qty	Retail Stock No	Case Qty
STAND-UP HEATER UP TO 95"H 34"DIA DOME 18.5"DIA ROUND BASE WITH OR W/O ADJUSTABLE TABLE		53112-EC	12	53112	1
FIRE COLUMN UP TO 21"L 21"W 30"H*		56-266-012001-EC	16		
LARGE CHIMINEA UP TO 22" DIA 65"H*		56-265-042001-EC	12		



Patio BBQ Grill Covers

MEDIUM BBQ GRILL UP TO 58"L 24"D 48"H*		53912-EC	8	53912	1
LARGE BBQ GRILL UP TO 64"L 24"D 48"H*		53922-EC	8	53922	1
X LARGE BBQ GRILL UP TO 70"L 24"D 48"H*				53942	1
XX LARGE BBQ GRILL UP TO 72"L 26"D 51"H*		53952-EC	6	53952	1

*Not designed to entirely cover the wheels or legs

HOME PATIO | CLASSIC



Classic Collection



Our Classic Accessories® line is a carefully curated assortment of cover and accessory styles with a focus on simple silhouettes and distilled features. It is a collection that is simply, classic.



StayOn™ Elastic Loops

StayOn™ elastic loops fit over legs to keep cover on during high winds and breezy conditions



Elastic Hem Cord

Elastic cord in the bottom of hem for a fast and custom fit



Air Vents

Air vents reduce condensation and wind lofting



Patio Fire Pit Covers

COLOR: BLACK





Item/Fit		Retail Stock No	Case Qty
30" ROUND FULL COVERAGE FIRE PIT UP TO 30"DIA 12"H*		55-552-010401-00	2
36" ROUND FULL COVERAGE FIRE PIT UP TO 36"DIA 12"H*		55-553-010401-00	2
52" ROUND FIRE PIT TABLE UP TO 52"DIA 22"H*	NEW SIZE	56-313-010401-RT	1

*Not designed to entirely cover the wheels or legs

Patio Fire Pit and Fire Pit Table Covers





COLOR: BLACK

Item/Fit		Retail Stock No	Case Qty
30" SQUARE FULL COVERAGE FIRE PIT UP TO 30"L 30"W 12"H*		55-555-010401-00	2
36" SQUARE FULL COVERAGE FIRE PIT UP TO 36"L 36"W 12"H*		55-556-010401-00	2
42" SQUARE FIRE PIT TABLE UP TO 42"L 42"W 22"H*		55-557-010401-00	2
52" SQUARE FIRE PIT TABLE UP TO 52"L 52"W 22"H*	 NEW <small>SIZE</small>	56-314-010401-RT	1



Patio Log Rack and Stand-Up Heater Covers

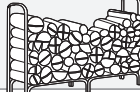

STAND-UP HEATER UP TO 95"H 34"DIA DOME 18.5"DIA ROUND BASE WITH OR WITHOUT ADJUSTABLE TABLE		55-558-010401-00	2
PYRAMID TORCH HEATER UP TO 21"L 21"W 90"H		55-560-010401-00	2
SMALL LOG RACK FITS 4'L LOG RACKS 48"L 24"W 42"H*		52-068-020401-00	1
LARGE LOG RACK FITS 8'L LOG RACKS 96"L 24"W 42"H*		52-069-030401-00	1

*Not designed to entirely cover the wheels or legs





Patio Built-In Grill Top and Kettle BBQ Grill Covers

COLOR: BLACK

Item/Fit		Retail Stock No	Case Qty
X SMALL BUILT-IN GRILL TOP UP TO 32"W 26"D 24"H		55-311-360401-00	2
KETTLE BBQ GRILL UP TO 26.5"DIA 38"H*		55-315-010401-00	2
LARGE KETTLE BBQ GRILL UP TO 30" DIA 43"H* FITS WEBER® PREMIUM 26" GRILL		55-903-040401-00	12



Patio Smoker Covers

MEDIUM ROUND SMOKER UP TO 19"DIA 39"H*		55-318-010401-00	2
MEDIUM SQUARE SMOKER UP TO 20"L 17"W 35.5"H* ¹		55-319-010401-00	2



*Not designed to entirely cover the wheels or legs
¹Does not fit models with external side controls and bisquette loader attached
 Weber® Premium is a trademark of Weber-Stephens Products, LLC. Classic Accessories is not affiliated or associated with Weber-Stephens Products, LLC or its products in any way.

Classic Accessories® BBQ Grill Accessory Set



Round out your grilling arsenal, or give the perfect gift to your grilling enthusiast, with our select line of grilling accessory sets. Covers protect grills from the elements, shielding them during storms and winter weather. Grill accessories complement the covers, providing everything you need to get the most out of your grill. Select the set that's right for you and your grill, and get grilling today.

Patio BBQ Grill Cover with Grill Tool Set



Item/Fit		E-Commerce Stock No	Case Qty
MEDIUM BBQ GRILL UP TO 58"L 24"D 48"H*		55-306-TOOL-EC	2
LARGE BBQ GRILL UP TO 64"L 24"D 48"H*		55-307-TOOL-EC	2
X LARGE BBQ GRILL UP TO 70"L 24"D 48"H*		55-308-TOOL-EC	2

*Not designed to entirely cover the wheels or legs





Patio BBQ Grill Cover with Grill Brush and Light Set

COLOR: BLACK

Item/Fit		E-Commerce Stock No	Case Qty
MEDIUM BBQ GRILL UP TO 58"L 24"D 48"H*		55-306-BRUSH-EC	2
LARGE BBQ GRILL UP TO 64"L 24"D 48"H*		55-307-BRUSH-EC	2
X LARGE BBQ GRILL UP TO 70"L 24"D 48"H*		55-308-BRUSH-EC	2



Patio Kettle BBQ Grill Cover with Charcoal Chimney Set









KETTLE BBQ GRILL UP TO 26.5"DIA 38"H* (COVER + CHARCOAL CHIMNEY)		55-315-CHIMNY-EC	2
LARGE KETTLE BBQ GRILL UP TO 30" DIA 43"H* FITS WEBER® PREMIUM 26" GRILL (COVER + CHARCOAL CHIMNEY)		55-903-CHIMNY-EC	2

*Not designed to entirely cover the wheels or legs



Patio BBQ Grill and Flat Top Griddle Covers

COLOR: BLACK

Item/Fit		E-commerce Stock No	Retail Stock No	Case Qty
X SMALL BBQ GRILL UP TO 38"L 22"D 44"H*			55-303-360401-00	2
SMALL BBQ GRILL UP TO 44"L 22"D 44"H*			55-304-020401-00	2
MEDIUM SMALL BBQ GRILL UP TO 52"L 24"D 44"H*			55-305-370401-00	2
MEDIUM BBQ GRILL UP TO 58"L 24"D 48"H*			55-306-030401-00	2
LARGE BBQ GRILL UP TO 64"L 24"D 48"H*			55-307-040401-00	2
X LARGE BBQ GRILL UP TO 70"L 24"D 48"H*			55-308-050401-00	2
XX LARGE BBQ GRILL UP TO 74"L 26"D 51"H*			55-309-060401-00	2
3X LARGE BBQ GRILL UP TO 80"L 26"D 51"H*			55-310-350401-00	2
LARGE FLAT TOP GRIDDLE FITS BLACKSTONE® 36" GRIDDLE UP TO 63"L 22"D 36"H*		55-992-040401-EC		8

*Not designed to entirely cover the wheels or legs.
Blackstone® is a registered trademark of Blackstone Products.



Patio Umbrella Sun Shade

COLOR: BLACK

- Sunshade screen fabric provides protection from direct sun
- Clip system attaches to any patio umbrella
- Mesh fabric creates shade while allowing breeze to pass through
- Weighted hem holds screen in place in breezy conditions



Sun shade rotated

Item/Fit		Retail Stock No	Case Qty
UMBRELLA SUN SHADE		55-606-012401-RT	2
FITS ALL UMBRELLAS			



Patio Umbrella Mosquito Net Canopy

COLOR: BLACK

- Turns your umbrella into a mosquito-free screen house
- Magnetic door closes easily behind you and will not snag or tear mosquito mesh
- Ties allow canopy to be retracted when not in use
- Weighted hem keeps netting in place



Canopy retracted

Item/Fit		Retail Stock No	Case Qty
UMBRELLA MOSQUITO NET CANOPY		55-605-012801-RT	2
FITS 7' TO 9'DIA UMBRELLAS			

HOME STORAGE



Wrapping Supplies Organizer & Storage Duffel



Keeps wrapping paper, ribbons and other supplies organized and ready for instant use

COLOR: CRANBERRY

- Holds (18"L-36"W) wrapping paper in lid with elastic straps
- Two large 18"L 1.5"W interior bottom sections with elastic straps secure boxes, paper, bows and other supplies
- Easy-view window lid with dual zippers for easy access
- Convenient top carrying handles with comfort pad
- Clear ID sleeve



HOLDS WRAPPING SUPPLIES UP TO 36"
36"L 12"W 6"H

57-006-014301-00 1

Wreath Storage Bag



Stores and protects artificial wreaths

COLOR: CRANBERRY

- Interior adjustable strap secures a variety of wreath sizes
- Easy-view window lid with dual zippers for easy access
- Convenient top carrying handles with comfort pad
- Zipper closure
- Clear ID sleeve



LARGE FITS ARTIFICIAL WREATHS UP TO 35"DIA 9.5"H

Retail Stock No Case Qty

57-002-044301-00 1

Holiday Tree Rolling Storage Duffel



Sturdy rolling duffel holds and protects artificial trees

COLOR: CRANBERRY

- 58"L 17.5"W 17.5"H duffel holds sectional artificial trees 6 to 9 feet tall (Tree must break down into sections no larger than 57")
- Interior sling with adjustable straps and quick-release buckles secures trees and tree sections of all sizes
- Easy-view window lid with dual zippers for easy access
- Convenient rear wheels for effortless transport
- Interior tree stand pocket
- Convenient end handles and large top carrying handles with comfort pad
- Clear ID sleeve



Retail
Stock No

Case
Qty

HOLDS SECTIONAL ARTIFICIAL TREES 6' TO 9' TALL

ASSEMBLED SIZE 58"L 17.5"W 17.5"H

57-004-014301-00

1

Holiday Lights Storage Duffel



Stores and organizes a variety of decorative lights on four light winders

COLOR: CRANBERRY

- Includes four sturdy black plastic board winders, 11"L .25"W 11.75"H
- Winders have handles on both ends for easy winding
- Each winder can hold up to 150 feet of mini lights or 100 feet of large lights
- Three movable padded dividers with rip-n-grip secure tabs
- Easy-view window lid with dual zippers for easy access
- Convenient top carrying handles with comfort pad
- Clear ID sleeve



Retail
Stock No

Case
Qty

HOLDS UP TO 600 FT OF MINI LIGHTS OR 400 FT OF LARGE LIGHTS

DUFFEL: 24"L 12"W 12"H

57-007-014301-00

1

Ornament Organizer & Storage Bin



Stores and organizes up to 60 ornaments in three trays with modular dividers

COLOR: CRANBERRY

- Holds three sturdy corrugated trays with up to 20 3"L 3"W 3.75"H removable sections
- Corrugated tray sections can be removed and configured to hold a wide variety of ornament sizes
- Trays have ribbon handles for easy moving and stacking
- Easy-view window lid with dual zippers for easy access
- Convenient top carrying handles with comfort pad
- Clear ID sleeve



Retail
Stock No

Case
Qty

HOLDS UP TO 60 ORNAMENTS, ORGANIZER 16"L 13"W 12"H

INCLUDES 3 ORNAMENT TRAYS EACH WITH 20, 3"L 3"W 3.75"H REMOVABLE SECTIONS

57-005-014301-00

1

POWERSPORT | ATV



PVC Free

ATV Storage Cover



Great weather and abrasion protection

COLOR: OLIVE DRAB

- Durable ProtekX2™ fabric with water-resistant backing and exterior coating for great weather and abrasion protection
- Elastic cord hem for a fast, tight fit
- Storage bag included



Item/Fit	Retail Stock No	Case Qty
LARGE FITS ATVS UP TO 80"L 44"W 45"H*	15-055-041404-00	2
X LARGE FITS ATVS UP TO 84"L 48"W 50"H*	15-056-051404-00	2
XX LARGE FITS ATVS UP TO 88"L 48"W 48"H*	15-057-061404-00	2



*Not designed to entirely cover the wheels.

PVC Free

ATV Deluxe Seat Cover



Thick, padded stretch EVA seat top for comfort and durability

COLOR: BLACK

- Durable ProtekX2™ fabric with water-resistant backing and exterior coating for great weather and abrasion protection
- Thick, padded stretch EVA seat top for comfort and durability
- Keeps seat clean and dry
- Protects seat against fading and other sun damage
- Quickly fits to seat with adjustable click-close bottom straps
- Elasticized hem for a quick and close fit
- Machine washable



Item/Fit	Retail Stock No	Case Qty
FITS MOST ATV SEATS	15-098-013801-00	2



PVC Free

ATV Seat Cover



All-season protection

COLOR: PRECISE WOODS™

- ProtekX™ fabric
- Keeps seats clean and dry
- Protects seat against fading and other sun damage
- Quickly fits to seat with adjustable click-close bottom straps
- Elasticized hem for a quick and close fit
- Machine washable



Item/Fit	Retail Stock No	Case Qty
FITS MOST ATV SEATS	15-116-015901-00	6



POWERSPORT | UTV



ADVENTURE RULES



UTV Deluxe Storage Cover



Rugged all-weather protection for UTVs

COLOR: BLACK/GREY



Tension panels tightly secure cover for travel





Air vents reduce inside moisture and wind lofting



Reinforced slots for transport tie-down straps**



- Heavy-duty ProtekX3[®] fabric with a water-repellent exterior coating for extra weather protection
- Integrated trailering system with quick adjusting straps and buckles
- Tension panels tightly secure cover for travel
- Slots in front and sides for transport tie-down straps**
- Dual air vents reduce inside moisture and wind lofting
- Elastic cord hem for a fast, tight fit
- Integrated storage bag included

Item/Fit		Retail Stock No	Case Qty
FITS MIDSIZE 2 PASSENGER UTVS UP TO 113"L 60"W 70"H*		18-064-043801-00	2
FITS LARGER 2-3 PASSENGER UTVS UP TO 125"L 64"W 70"H*		18-065-053801-00	2
FITS CREW CAB UTVS UP TO 150"L 66"W 75"H*		18-066-063801-00	2

*Not designed to entirely cover the wheels.
 **Transport tie-down straps not included

PVC Free

UTV Storage Cover



Rugged all-weather protection for UTVs



COLOR: BLACK

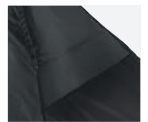

- Heavy-duty ProtekX2[®] fabric with a water-repellent exterior coating for extra weather protection
- Dual air vents reduce condensation and wind lofting
- Elastic cord hem for a fast, tight fit
- Storage bag included

Air vents reduce inside moisture and wind lofting



Item/Fit		Retail Stock No	Case Qty
FITS MIDSIZE 2 PASSENGER UTVS UP TO 113"L 60"W 70"H*		18-070-040401-00	2
FITS LARGER 2-3 PASSENGER UTVS UP TO 125"L 64"W 70"H*		18-071-050401-00	2

*Not designed to entirely cover the wheels.

UTV Cab Enclosure



Provides heavy-duty protection in all weather conditions

COLORS: BLACK AND NEXT VISTA G1™ CAMO



next
VISTA

- Heavy-duty ProtekX6™ fabric with water-resistant backing and exterior coating for maximum weather and abrasion protection
- Keeps the cab clean and dry in storage
- Large ultra-clear windshield material, doors, and back window for excellent visibility
- Doors can be rolled back or completely removed for easy cab access and ventilation in warmer weather
- Mounts to the roll cage with click-close straps and rip-n-grip tabs
- Enhanced venting system for added circulation
- Includes adhesive backed rip-n-grip to further secure enclosure to your UTV

Item/Fit		Colors	Retail Stock No	Case Qty
FITS KAWASAKI® MULE 600, 610, 610 4x4, 610 4x4 XC		BLACK	18-113-010401-00	1
FITS KAWASAKI® TERYX 750 F1		BLACK	18-020-010401-00	3
FITS POLARIS® RANGER '02-'08		BLACK	18-115-010401-00	1
		NEXT VISTA G1	18-116-016001-00	1
FITS POLARIS® RANGER MIDSIZE 400, 570 EFI, 800 EFI, EV UP TO AND INCL. MODEL YEAR 2014		BLACK	18-117-010401-00	1
FITS POLARIS® RANGER MIDSIZE 400, 570, 800 MODEL YEAR 2015+		BLACK	18-156-010401-RT	1
FITS POLARIS® RANGER 900 XP		BLACK	18-119-010401-00	1
FITS POLARIS® RANGER 800 FULL SIZE, 6x6 800, DIESEL		BLACK	18-122-010401-00	1
FITS YAMAHA® RHINO (WITH HALF DOORS)		BLACK	18-124-010401-00	1
		NEXT VISTA G1	18-125-016001-00	1

UTV Bench and Bucket Seat Covers



Quick-fit covers keep seats clean and dry

COLORS: BLACK AND NEXT VISTA G1™ CAMO



next VISTA

- Heavy-duty ProtekX6™ fabric with water-resistant backing and exterior coating for maximum weather and abrasion protection
- Protects new seats and renews the look of old seats
- Includes bottom and back seat covers (also includes separate head rests when applicable)
- Elasticized hem and attachment system provides a quick and custom-like fit
- Stretchy foam panels for an improved custom-like fit
- Bucket seat covers include two sets

Item/Fit		Colors	Retail Stock No	Case Qty
FITS KAWASAKI® MULE 600, 610, 610 4x4, 610 4x4 XC		BLACK	18-135-010403-00	6
FITS KAWASAKI® MULE 4000, 4010 4x4, 4010 4x4 DIESEL		BLACK	18-033-010401-00	6
FITS POLARIS® RANGER '02-'08		BLACK	78377	6
FITS POLARIS® RANGER MIDSIZE 400, 570 EFI, 800 EFI, EV, 500-570 CREW		NEXT VISTA G1	18-141-016003-00	6
FITS POLARIS® RANGER 6x6 800, 800 FULL SIZE, CREW 800, 900 XP, CREW 900, DIESEL		BLACK	18-026-010401-00	6
		NEXT VISTA G1	18-142-016003-00	6
FITS YAMAHA® RHINO*		BLACK	18-144-010403-00	6
		NEXT VISTA G1	18-145-016003-00	6

*Bucket seats



UTV Front Windshield

Instantly shields against wind and rain

COLOR: BLACK

- Ultra-clear window material framed with heavy-duty ProtekX™ fabric
- Attaches in seconds to the roll cage of UTVs with cinch-tight straps and rip-n-grip closure tabs
- Rolls up for easy storage



Item/Fit		Retail Stock No	Case Qty
FITS KAWASAKI® MULE 600, 610, 610 4x4, 610 4x4 XC		18-094-010401-00	6
FITS POLARIS® RANGER '02 - '08		78627	6



UTV Rear Window

Instantly shields against wind and rain

COLOR: BLACK

- Ultra-clear window material framed with heavy-duty ProtekX6™ fabric
- Attaches in seconds to the roll cage of UTVs with cinch-tight straps and rip-n-grip closure tabs
- Rolls up for easy storage



Item/Fit		Retail Stock No	Case Qty
FITS POLARIS® RANGER '02 - '08		78657	6
FITS POLARIS® RANGER 6x6 800, 800 FULL SIZE, CREW 800, CREW DIESEL		18-029-010401-00-SC	6
FITS YAMAHA® RHINO		78637	6

UTV Double Bow Case



Keeps two compound bows protected and readily accessible on most UTV roll cages

COLOR: NEXT VISTA G1™ CAMO

- Heavy-duty ProtekX6™ fabric with water-resistant backing and exterior coating for maximum weather and abrasion protection
- Holds two large compound bows
- Mounts to rear of UTV roll cage or rear rack of ATV
- Interior bow pockets contain a thick protective padding
- Two additional exterior zippered pockets for tools, broadheads and accessories
- One quiver case pocket with easy access from both ends of case
- Water-resistant exterior fabric
- Durable, weather-resistant zippers



Item/Fit	Retail Stock No	Case Qty
FITS MOST UTV ROLL CAGES	18-127-016001-00	1
BOW CASE SIZE: 42"W 12"D 16.25"H		

Note: Not for overnight storage

UTV Double Gun Carrier



Keeps two rifles protected and readily accessible on most UTV roll cages

COLORS: BLACK AND NEXT VISTA G1™ CAMO

- Heavy-duty ProtekX6™ fabric with water-resistant backing and exterior coating for maximum weather and abrasion protection
- One rifle or shotgun fits in each side
- Three large gear pockets for extra shells or other items
- Attaches securely to the back of UTV roll cages with heavy-duty straps and quick-release buckles
- Bottom D-rings provide additional lash points
- Extra-thick padding keeps rifles protected



Item/Fit	Retail Stock No	Case Qty
FITS MOST UTV ROLL CAGES	18-129-010401-00	3
GUN CARRIER SIZE: 53"W 4"D 17"H	18-130-016001-00	

Note: Not for overnight storage

UTV Roll Cage Organizer—Large



COLORS: BLACK AND NEXT VISTA G1™ CAMO

next VISTA™

- Heavy-duty ProtekX6™ fabric with water-resistant backing and exterior coating for maximum weather and abrasion protection
- Non-scratch padded binocular or camera pouch, seven zippered gear pockets and two fast-access end pockets for radios or cell phones
- Stow essentials across the front or back of UTV roll cages
- Quickly attaches to the front or rear of UTV roll cages with rip-n-grip tabs and adjustable straps
- Protective foam base



Item/Fit		Retail Stock No	Case Qty
FITS MOST FULL SIZE UTVS		18-131-010401-00	6
47"W 2"D 7.5"H		18-132-016001-00	

Note: Not for overnight storage

UTV Roll Cage Organizer—Medium



COLOR: BLACK

- Heavy-duty ProtekX6™ fabric with water-resistant backing and exterior coating for maximum weather and abrasion protection
- Non-scratch padded binocular or camera pouch, four zippered gear pockets and one fast-access end pockets for radios or cell phones
- Stow essentials across the front or back of UTV roll cages
- Quickly attaches to the front or rear of UTV roll cages with rip-n-grip tabs and adjustable straps
- Protective foam base



Item/Fit		Retail Stock No	Case Qty
FITS MOST UTVS SUCH AS THE KAWASAKI® 610, POLARIS® MID, POLARIS® RZR		18-128-010401-00	6
29.5"W 3.5"D 8"H			

Note: Not for overnight storage

UTV Hand Holds



COLOR: BLACK

- Heavy-duty ProtekX™ Extreme fabric
- Convenient handles make it easy to enter or exit UTV
- Adjustable straps fit most UTV roll cages
- Textured grip handles
- **Two hand holds included in each package**



Item/Fit		Retail Stock No	Case Qty
FITS MOST UTV ROLL CAGES UP TO 1.75" DIA		77777	6

PVC Free

Deluxe Snowmobile Travel Cover



Heavy-duty travel cover with integrated trailering strap system and fuel tank access flap

COLOR: BLACK/GREY

- Heavy-duty ProtekX™ Extreme fabric
- Elastic hem cord for a fast and tight fit
- Integrated trailering system with built-in quick adjusting straps
- Tension panels tightly secure cover for highway travel
- Non-scratch hood liner
- Fuel tank access door
- Reflective rear safety markings
- Integrated storage bag



Fuel tank access flap

Item/Fit		Retail Stock No	Case Qty
LARGE FITS SNOWMOBILES 101"–118"L		71837	2
X LARGE FITS SNOWMOBILES 119"–127"L		71847	2

PVC Free

Snowmobile Storage Cover



All-weather protection

COLOR: BLACK

- Tough ProtekX™ Plus fabric
- Three sizes fit most snowmobiles
- Elastic hem cord for a fast and tight fit
- Dual air vents reduce moisture and wind lofting
- Non-scratch hood liner
- Integrated storage bag
- Attachment straps included



Item/Fit		Retail Stock No	Case Qty
MEDIUM FITS SNOWMOBILES UP TO 100"L		71527	2
LARGE FITS SNOWMOBILES 101"–118"L		71537	2
X LARGE FITS SNOWMOBILES 119"–127"L		71547	2

RV



PROTECTING ROAD TRIPS SINCE 1983



Encompass™ Class C RV Cover



Strong and lightweight ripstop fabric is enhanced by the included SoftGuard™ foams to prevent tears

NEW

COLOR: CINDER/MAGNET



Ripstop Fabric

100% WOVEN POLYESTER RIPSTOP

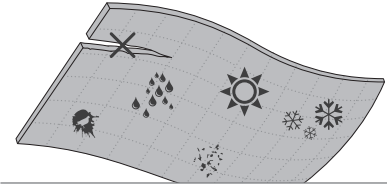

- Tear-resistant
- Water-repellent
- Bird droppings protection
- Dirt, dust and scratch protection
- UV protection
- Snow protection



Includes SoftGuard™ sharp edge protectors

- Extra-strength ripstop fabric repels water and protects against dirt and sun damage
- Air vent system and quick drying fabric combine to reduce wind stress and vent inside moisture
- Adjustable tension panels and elasticized hem corners provide a custom-like fit
- Zippered panels allow access to the RV doors and storage compartments
- Long zipper pulls reduce the need for a ladder

- Integrated strap attachment and weighted toss bag system eliminates crawling under the RV to install tension straps
- Tension panels reduce cover stress when tightening the straps
- Includes SoftGuard™ foam inserts to help protect your cover from sharp edges
- Includes a reinforcement patch kit
- Storage bag included

Convenient storage bag

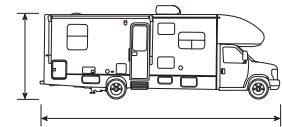

Item/Fit	Cover Width Dimension	Retail Stock No	Case Qty
MODEL 2	FITS CLASS C RVS 20'–23'L, 122"MAX H**	105"	80-495-152401-RT 1
MODEL 3	FITS CLASS C RVS 23'–26'L, 122"MAX H**	105"	80-496-162401-RT 1
MODEL 4	FITS CLASS C RVS 26'–29'L, 122"MAX H**	105"	80-497-172401-RT 1
MODEL 5	FITS CLASS C RVS 29'–32'L, 122"MAX H**	105"	80-498-182401-RT 1

*Classic Accessories warrants that this product will be free of defects in material and construction for its life from the date of purchase.
 **Height is maximum recommended measurement from ground to roofline. Not designed to entirely cover the wheels.

Encompass™ Travel Trailer Cover



COLOR: CINDER/MAGNET

NEW

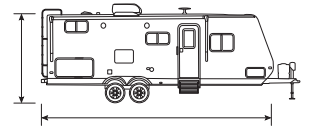

Item/Fit	Cover Width Dimension	Retail Stock No	Case Qty
MODEL 1 FITS TRAVEL TRAILERS 18'–20'L, 118"MAX H*	102"	80-485-142401-RT	1
MODEL 2 FITS TRAVEL TRAILERS 20'–22'L, 118"MAX H*	102"	80-486-152401-RT	1
MODEL 3 FITS TRAVEL TRAILERS 22'–24'L, 118"MAX H*	102"	80-487-162401-RT	1
MODEL 4 FITS TRAVEL TRAILERS 24'–27'L, 118"MAX H*	102"	80-488-172401-RT	1
MODEL 5 FITS TRAVEL TRAILERS 27'–30'L, 118"MAX H*	102"	80-489-182401-RT	1
MODEL 6 FITS TRAVEL TRAILERS 30'–33'L, 118"MAX H*	102"	80-490-192401-RT	1

*FIT DIMENSIONS include only the Trailer Body, tow hitch not included. Not designed to entirely cover the wheels.

Encompass™ 5th Wheel Cover



COLOR: CINDER/MAGNET

NEW

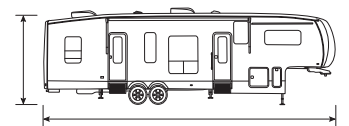

Item/Fit	Cover Width Dimension	Retail Stock No	Case Qty
MODEL 4T FITS 5TH WHEELS 29'–33'L, 135"MAX H*	102"	80-491-172401-RT	1
MODEL 5T FITS 5TH WHEELS 33'–37'L, 135"MAX H*	102"	80-492-182401-RT	1
XT MODEL 6 FITS 5TH WHEELS 37'–41'L, 140"MAX H*	102"	80-493-192401-RT	1
XT MODEL 7 FITS 5TH WHEELS 41'–44'L, 140"MAX H*	102"	80-494-202401-RT	1

*FIT DIMENSIONS include only the Trailer Body, tow hitch not included. Not designed to entirely cover the wheels.

PVC Free

PermaPRO™ Class A RV Cover**Ripstop fabric is lightweight and packable, yet strong, repelling water and protecting against dirt and sun damage**

COLOR: GREY

PermaPRO™ Fabric

100% WOVEN POLYESTER RIPSTOP

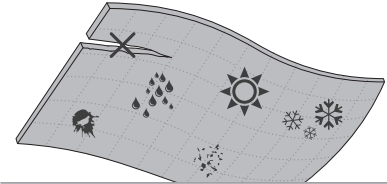

- Tear-resistant
- Water-repellent
- Bird dropping protection
- Dirt, dust and scratch protection
- UV protection
- Snow protection



- Extra-strength PermaPRO™ ripstop fabric repels water and protects against dirt and sun damage
- Air vent system and quick drying PermaPRO™ fabric combine to reduce wind stress and vent inside moisture
- Includes 3 air vents on each side
- Adjustable front and rear tension panels and elasticized hem corners provide a custom-like fit
- Zippered panels allow access to the RV doors, hood and storage compartments

- Long zipper pulls reduce the need for a ladder
- Integrated undercarriage strap system with click-close straps, 5 connection points on each side and weighted toss bag system eliminates crawling under the RV to install the cover.
- Tension panels reduce cover stress when tightening the strap
- Zippered storage bag expands for easy packing

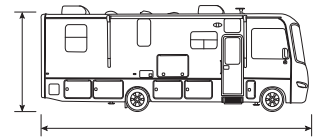
Zippered storage bag
22"L 10"W 10"H
expands to 15"H

Item/Fit	Cover Width Dimension	Retail Stock No	Case Qty
MODEL 3T FITS CLASS A RVS 24'-28'L, 125"MAX H**	105"	80-328-161001-RT	1
MODEL 4T FITS CLASS A RVS 28'-30'L, 130"MAX H**	105"	80-329-171001-RT	1
MODEL 5T FITS CLASS A RVS 30'-33'L, 130"MAX H**	105"	80-330-181001-RT	1
MODEL 6T FITS CLASS A RVS 33'-37'L, 135"MAX H**	105"	80-331-191001-RT	1
XT MODEL 7 FITS CLASS A RVS 37'-40'L, 140"MAX H**	105"	80-184-201001-OO	1
XT MODEL 8 FITS CLASS A RVS 40'-42'L, 140"MAX H**	105"	80-333-211001-RT	1

*Classic Accessories warrants that this product will be free of defects in material and construction for its life from the date of purchase.
 **Height is maximum recommended measurement from ground to roofline. Not designed to entirely cover the wheels.

PVC Free

PermaPRO™ Class B RV Cover



Extra-strength ripstop fabric repels water, protects against dirt and sun damage

COLOR: GREY

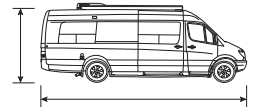

Item/Fit		Cover Width Dimension	Retail Stock No	Case Qty
MODEL 1	FITS CLASS B RVS UP TO 20'L, 117"MAX H*	58.5"FRONT, 85" BACK	80-411-141001-RT	1
MODEL 2	FITS CLASS B RVS 20'-23'L, 117"MAX H*	60"FRONT, 85" BACK	80-412-151001-RT	1
MODEL 3	FITS CLASS B RVS 23'-25'L, 117"MAX H *	60"FRONT, 85" BACK	80-413-161001-RT	1
MODEL 4	FITS CLASS B RVS 25'-27'L, 117"MAX H*	60"FRONT, 85" BACK	80-414-171001-RT	1
MODEL 3T	FITS CLASS B PLUS RVS 23'-25'L, 128"MAX H*	60"FRONT, 100" BACK	80-415-161001-RT	1
MODEL 4T	FITS CLASS B PLUS RVS 25'-27'L, 128"MAX H*	60"FRONT, 100" BACK	80-416-171001-RT	1

*Height is maximum recommended measurement from ground to roofline. Not designed to entirely cover the wheels.

PVC Free

PermaPRO™ Class C RV Cover



Extra-strength ripstop fabric repels water, protects against dirt and sun damage

COLOR: GREY

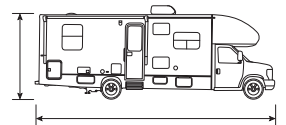

Item/Fit		Cover Width Dimension	Retail Stock No	Case Qty
MODEL 3	FITS CLASS C RVS 23'-26'L, 122"MAX H*	105"	80-129-161001-00	1
MODEL 5	FITS CLASS C RVS 29'-32'L, 122"MAX H*	105"	80-131-181001-00	1
MODEL 6T	FITS CLASS C RVS 32'-35'L, 125"MAX H*	105"	80-314-191001-RT	1

*Height is maximum recommended measurement from ground to roofline. Not designed to entirely cover the wheels.

PVC Free

PermaPRO™ Travel Trailer and Toy Hauler Cover



COLOR: GREY

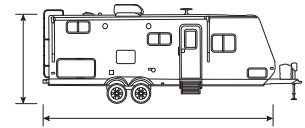

Item/Fit		Cover Width Dimension	Retail Stock No	Case Qty
MODEL 0	FITS TRAVEL TRAILERS 15'-18'L, 114"MAX H*	102"	80-321-301001-RT	1
MODEL 1	FITS TRAVEL TRAILERS 18'-20'L, 118"MAX H*	102"	80-134-141001-00	1
MODEL 2	FITS TRAVEL TRAILERS 20'-22'L, 118"MAX H*	102"	80-135-151001-00	1
MODEL 3	FITS TRAVEL TRAILERS 22'-24'L, 118"MAX H*	102"	80-136-161001-00	1
MODEL 4	FITS TRAVEL TRAILERS 24'-27'L, 118"MAX H*	102"	80-137-171001-00	1
MODEL 5	FITS TRAVEL TRAILERS 27'-30'L, 118"MAX H*	102"	80-138-181001-00	1
MODEL 6	FITS TRAVEL TRAILERS 30'-33'L, 118"MAX H*	102"	80-139-191001-00	1
MODEL 7T	FITS TRAVEL TRAILERS 33'-35'L, 124"MAX H*	102"	80-325-201001-RT	1
MODEL 8T	FITS TRAVEL TRAILERS 35'-38'L, 124"MAX H*	102"	80-326-211001-RT	1
MODEL 9T	FITS TRAVEL TRAILERS 38'-40'L, 124"MAX H*	102"	80-327-221001-RT	1

PVC Free

PermaPRO™ 5th Wheel Cover



COLOR: GREY

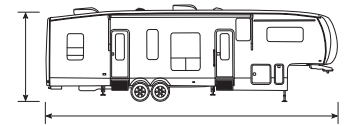

Item/Fit		Cover Width Dimension	Retail Stock No	Case Qty
MODEL 1	FITS 5TH WHEELS 20'-23'L, 122"MAX H*	102"	80-121-141001-00	1
MODEL 3T	FITS 5TH WHEELS 26'-29'L, 130"MAX H*	102"	80-317-161001-RT	1
MODEL 4T	FITS 5TH WHEELS 29'-33'L, 135"MAX H*	102"	80-318-171001-RT	1
MODEL 5T	FITS 5TH WHEELS 33'-37'L, 135"MAX H*	102"	80-319-181001-RT	1
XT MODEL 6	FITS 5TH WHEELS 37'-41'L, 140"MAX H*	102"	80-187-191001-00	1
XT MODEL 7	FITS 5TH WHEELS 41'-44'L, 140"MAX H*	102"	80-299-203101-RT	1

*Height is maximum recommended measurement from ground to roofline. Not designed to entirely cover the wheels.

PVC Free

PermaPRO™ R•POD™ Cover



Extra-strength ripstop fabric repels water, protects against dirt and sun damage

COLOR: GREY

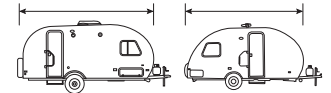

Item/ Fit	Length of Trailer Body	Cover Width Dimension	Retail Stock No	Case Qty
MODEL 2 FITS: RP-176, RP-176T UNTIL 2016, RP-171, RP-172, RP-177	UP TO 16' 2" L*	78"	80-255-151001-00	1
MODEL 3 FITS: RP-178, RP-181G, RP-182G(DOOR IN FRONT), RP-183G, RP-176, RP-176T 2017+	UP TO 17' 7" L*	78"	80-256-161001-00	1
MODEL 4 FITS: RP-179 (DOOR IN BACK), RP-180, RP-189, RP-190, RP-191	UP TO 17' 7" L*	78"	80-257-171001-00	1

* Height is maximum recommended measurement from ground to roofline. Not designed to entirely cover the wheels. **R•POD is a brand name of Forest River Inc.

FIT DIMENSIONS include only the Trailer Body, tow hitch not included

PVC Free

PermaPRO™ Camper Cover



Extra-strength ripstop fabric repels water, protects against dirt and sun damage

COLOR: GREY

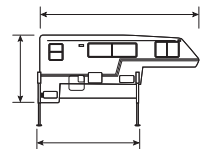

Item/Fit	Cover Width Dimension	Retail Stock No	Case Qty
MODEL 1 FITS CAMPERS 8'-10'L 212"L(TOP) 126"L(BOTTOM) 102"W 92"H*	106"	80-258-141001-00	1
MODEL 2 FITS CAMPERS 10'-12'L INCLUDING LANCE** 1172 AND 1191 236"L(TOP) 150"L(BOTTOM) 102"W 99"H*	106"	80-259-151001-00	1

* Height is maximum recommended measurement from ground to roofline. Not designed to entirely cover the wheels.
**Lance is a brand name of Lance Camper Manufacturing Corporation

PermaPRO™ Teardrop Trailer Cover



Extra-strength ripstop fabric repels water, protects against dirt and sun damage

COLOR: GREY

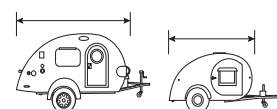

Item/Fit		Retail Stock No	Case Qty
MODEL 1	FITS TEARDROP TRAILERS UP TO 8'L 5'W* TRAILER BODY	80-397-141001-RT	1
MODEL 2	FITS TEARDROP TRAILERS 8'-10'L 5'W* TRAILER BODY	80-398-151001-RT	1
MODEL 3	FITS T@B ¹ & CLAM SHELL TEARDROP TRAILERS 10'-12'L 6'W* TRAILER BODY	80-399-161001-RT	1

*FIT DIMENSIONS include only the Trailer Body, tow hitch not included. Not designed to entirely cover the wheels.

¹T@B is a registered trademark of Pleasant Valley Teardrop trailers

PVC Free

PermaPRO™ Molded Fiberglass Travel Trailer Cover



Extra-strength ripstop fabric repels water, protects against dirt and sun damage

COLOR: GREY

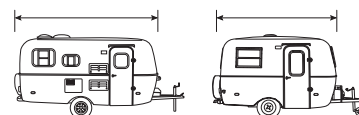

Item/Fit		Cover Width Dimension	Retail Stock No	Case Qty
MODEL 1	FITS MOLDED FIBERGLASS TRAVEL TRAILER BODIES 8'-10'L*	80"	80-407-141001-RT	1
MODEL 2	FITS MOLDED FIBERGLASS TRAVEL TRAILER BODIES 10'1"-13'L*	80"	80-408-151001-RT	1
MODEL 3	FITS MOLDED FIBERGLASS TRAVEL TRAILER BODIES 13'1"-16'L*	NEW SIZE 80"	80-479-161001-RT	1

*FIT DIMENSIONS include only the Trailer Body, tow hitch not included. Not designed to entirely cover the wheels.

PVC Free

PermaPRO™ Folding Camping Trailer Cover



Extra-strength ripstop fabric repels water, protects against dirt and sun damage

COLOR: GREY



Item/Fit	Cover Width Dimension	Retail Stock No	Case Qty
MODEL 0 FITS TRAILERS UP TO 8' 6"L*	88"	80-400-301001-RT	1
MODEL 1 FITS TRAILERS 8'-10'L*	88"	80-401-141001-RT	1
MODEL 2 FITS TRAILERS 10'-12'L*	88"	80-402-151001-RT	1
MODEL 3 FITS TRAILERS 12'-14'L*	88"	80-403-161001-RT	1
MODEL 4 FITS TRAILERS 14'-16'L*	88"	80-404-171001-RT	1
MODEL 5 FITS TRAILERS 16'-18'L*	88"	80-405-181001-RT	1
MODEL 6 FITS TRAILERS 18'-20'L*	88"	80-406-191001-RT	1

*FIT DIMENSIONS include only the Trailer Body, tow hitch not included. Not designed to entirely cover the wheels.

PVC Free

PermaPRO™ General Purpose Furniture Cover



COLOR: GREY

- Extra-strength PermaPRO™ ripstop fabric repels water and protects against dirt and sun damage
- Extra long tie-down straps tie around furniture legs to secure covers on windy days
- Air vents keep weather out while providing ventilation and minimizing condensation
- Adjustable drawstring cord closure within lightweight hem tunnel allow easy adjustment resulting in a custom-like fit
- Integrated storage bag



Cover folds neatly into integrated storage bag when not in use



Item/Fit	E-Commerce Stock No	Case Qty
LARGE CONVERSATION SET/FURNITURE GROUP UP TO 100"L 70"W 30"H*	80-410-041001-RT	8



*Not designed to entirely cover the wheels or legs

PVC Free

PolyPRO™3 Class A RV Cover



Triple-ply top with breathable single-ply sides for all-season protection

COLOR: GREY/SNOW WHITE



PolyPRO™3 Fabric (top of cover) 3-PLY / NON-WOVEN POLYPROPYLENE

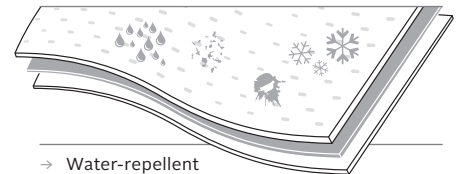

- Water-repellent
- Bird dropping protection
- Dirt, dust and scratch protection
- UV block protection
- Snow protection

PolyPRO™1 Fabric (sides of cover) 1-PLY / NON-WOVEN POLYPROPYLENE

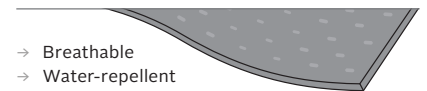

- Breathable
- Water-repellent
- Bird dropping protection
- Dirt, dust and scratch protection

- Thick, triple-ply PolyPRO™3 top with breathable single-ply PolyPRO™1 sides protects against rain, snow, dirt, nicks and scratches for all-season protection
- An integrated air vent system combined with quick drying PolyPRO™1 sides reduces wind stress and vents inside moisture
- Includes three air vents on each side (Class B has two vents)

- Adjustable front and rear tension panels and elasticized hem corners provide a custom-like fit
- Integrated rope attachment system with 4 connection points on each side to secure cover
- A provided toss bag helps reduce crawling under the RV
- Storage bag, ladder cap and tie-down rope included



Convenient storage bag

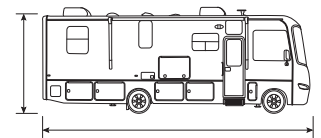

Item/Fit	Cover Width Dimension	Retail Stock No	Case Qty
MODEL 4T FITS CLASS A RVS 28'–30'L, 130"MAX H*	105"	80-335-173101-RT	1
MODEL 5T FITS CLASS A RVS 30'–33'L, 130"MAX H*	105"	80-336-183101-RT	1
MODEL 6T FITS CLASS A RVS 33'–37'L, 135"MAX H*	105"	80-337-193101-RT	1
XT MODEL 7 FITS CLASS A RVS 37'–40'L, 140"MAX H*	105"	77763	1

*Height is maximum recommended measurement from ground to roofline. Not designed to entirely cover the wheels.

PVC Free

PolyPRO™ 3 Class B RV Cover



Triple-ply top with breathable single-ply sides for all-season protection

COLOR: GREY/SNOW WHITE

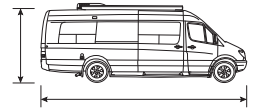

Item/Fit		Cover Width Dimension	Retail Stock No	Case Qty
MODEL 1	FITS CLASS B RVS UP TO 20'L, 117"MAX H*	60"FRONT, 85" BACK	80-103-141001-00	1
MODEL 2	FITS CLASS B RVS 20'-23'L, 117"MAX H*	60"FRONT, 85" BACK	80-104-151001-00	1
MODEL 3	FITS CLASS B RVS 23'-25'L, 117"MAX H *	60"FRONT, 85" BACK	80-105-161001-00	1
MODEL 4	FITS CLASS B RVS 25'-27'L, 117"MAX H *	60"FRONT, 85" BACK	80-106-171001-00	1
MODEL 3T	FITS CLASS B PLUS RVS 23'-25'L, 128"MAX H*	60"FRONT, 100" BACK	80-394-163101-RT	1
MODEL 4T	FITS CLASS B PLUS RVS 25'-27'L, 128"MAX H*	60"FRONT, 100" BACK	80-395-173101-RT	1

*Height is maximum recommended measurement from ground to roofline. Not designed to entirely cover the wheels.

PVC Free

PolyPRO™ 3 Class C RV Cover



Triple-ply top with breathable single-ply sides for all-season protection

COLOR: GREY/SNOW WHITE

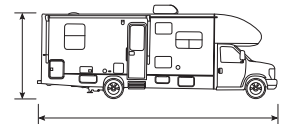

Item/Fit		Cover Width Dimension	Retail Stock No	Case Qty
MODEL 2	FITS CLASS C RVS 20'-23'L, 122"MAX H*	105"	79263	1
MODEL 3	FITS CLASS C RVS 23'-26'L, 122"MAX H*	105"	79363	1
MODEL 4	FITS CLASS C RVS 26'-29'L, 122"MAX H*	105"	79463	1
MODEL 5	FITS CLASS C RVS 29'-32'L, 122"MAX H*	105"	79563	1
MODEL 6T	FITS CLASS C RVS 32'-35'L, 125"MAX H*	105"	80-344-193101-RT	1

*Height is maximum recommended measurement from ground to roofline. Not designed to entirely cover the wheels.

PVC Free

PolyPRO™ 3 Travel Trailer and Toy Hauler Cover



Triple-ply top with breathable single-ply sides for all-season protection

COLOR: GREY/SNOW WHITE



- Thick, triple-ply PolyPRO™ 3 top with breathable single-ply PolyPRO™ 1 sides protects against rain, snow, dirt, nicks and scratches for all-season protection
- An integrated air vent system combined with quick drying PolyPRO™ 1 sides reduces wind stress and vents inside moisture
- Includes two air vents on each side

- Adjustable front and rear tension panels and elasticized hem corners provide a custom-like fit
- Integrated rope attachment system with 4 connection points on each side to secure cover
- A provided toss bag helps reduce crawling under the RV
- Storage bag, ladder cap and tie-down rope included

Convenient storage bag

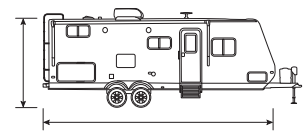

Item/Fit	Cover Width Dimension	Retail Stock No	Case Qty
MODEL 0	FITS TRAVEL TRAILERS 15'-18'L, 114"MAX H*	102"	80-351-303101-RT 1
MODEL 1	FITS TRAVEL TRAILERS 18'-20'L, 118"MAX H*	102"	73163 1
MODEL 2	FITS TRAVEL TRAILERS 20'-22'L, 118"MAX H*	102"	73263 1
MODEL 3	FITS TRAVEL TRAILERS 22'-24'L, 118"MAX H*	102"	73363 1
MODEL 4	FITS TRAVEL TRAILERS 24'-27'L, 118"MAX H*	102"	73463 1
MODEL 5	FITS TRAVEL TRAILERS 27'-30'L, 118"MAX H*	102"	73563 1
MODEL 6	FITS TRAVEL TRAILERS 30'-33'L, 118"MAX H*	102"	73663 1
MODEL 7T	FITS TRAVEL TRAILERS 33'-35'L, 124"MAX H*	102"	80-355-203101-RT 1
MODEL 8T	FITS TRAVEL TRAILERS 35'-38'L, 124"MAX H*	102"	80-356-213101-RT 1
MODEL 9T	FITS TRAVEL TRAILERS 38'-40'L, 124"MAX H*	102"	80-357-223101-RT 1

*FIT DIMENSIONS include only the Trailer Body, tow hitch not included. Height is maximum recommended measurement from ground to roofline. Not designed to entirely cover the wheels.

PVC Free

PolyPRO™ 3 5th Wheel Cover



Triple-ply top with breathable single-ply sides for all-season protection

COLOR: GREY/SNOW WHITE

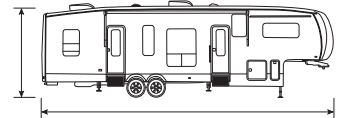

Item/Fit	Cover Width Dimension	Retail Stock No	Case Qty
MODEL 1 FITS 5TH WHEELS 20'-23'L, 122"MAX H*	102"	75263	1
MODEL 2 FITS 5TH WHEELS 23'-26'L, 122"MAX H*	102"	75363	1
MODEL 3T FITS 5TH WHEELS 26'-29'L, 130"MAX H*	102"	80-347-163101-RT	1
MODEL 4T FITS 5TH WHEELS 29'-33'L, 135"MAX H*	102"	80-348-173101-RT	1
MODEL 5T FITS 5TH WHEELS 33'-37'L, 135"MAX H*	102"	80-349-183101-RT	1
XT MODEL 6 FITS 5TH WHEELS 37'-41'L, 140"MAX H*	102"	75063	1
XT MODEL 7 FITS 5TH WHEELS 41'-44'L, 140"MAX H*	102"	80-300-203101-RT	1

PVC Free

PolyPRO™ 3 R•POD™ and Sloped Travel Trailer Cover



Triple-ply top with breathable single-ply sides for all-season protection

COLOR: GREY/SNOW WHITE

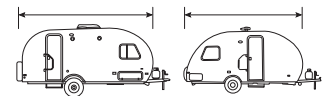

Item/ Fit	Length of Trailer Body	Cover Width Dimension	Retail Stock No	Case Qty
MODEL 1 FITS: RP-151	UP TO 13' 7"L*	78"	80-198-141001-00	1
MODEL 2 FITS: RP-176, RP-176T UNTIL 2016, RP-171, RP-172, RP-177	UP TO 16' 2"L*	78"	80-199-151001-00	1
MODEL 3 FITS: RP-178, RP-181G, RP-182G (DOOR IN FRONT), RP 183G, RP-176, RP-176T 2017+	UP TO 17' 7"L*	78"	80-200-161001-00	1
MODEL 4 FITS: RP-179 (DOOR IN BACK), RP-180, RP 189, RP 190, RP-191	UP TO 17' 7"L*	78"	80-197-171001-00	1
MODEL 5 FITS SLOPED TRAVEL TRAILERS	NEW 17'-19'L*	105"	80-483-183101-RT	1
MODEL 6 FITS SLOPED TRAVEL TRAILERS	NEW 19'-21'L*	105"	80-484-193101-RT	1

*FIT DIMENSIONS include only the Trailer Body, tow hitch not included. Height is maximum recommended measurement from ground to roofline. Not designed to entirely cover the wheels.
 **R•POD is a brand name of Forest River Inc.

PVC Free

PolyPRO™ 3 Camper Cover



Triple-ply top with breathable single-ply sides for all-season protection

COLOR: GREY/SNOW WHITE

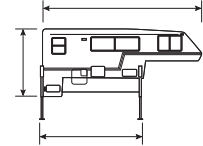

Item/Fit	Cover Width Dimension	Retail Stock No	Case Qty
MODEL 0 FITS CAMPERS 6'-8'L 188"L(TOP) 102"L(BOTTOM) 102"W 85"H*	100"	80-396-301001-RT	1
MODEL 1 FITS CAMPERS 8'-10'L 212"L(TOP) 126"L(BOTTOM) 102"W 92"H*	106"	80-036-143101-00	1
MODEL 2 FITS CAMPERS 10'-12'L INCLUDING LANCE** 1172 AND 1191 236"L(TOP) 150"L(BOTTOM) 102"W 99"H*	106"	80-037-153101-00	1

*Not designed to entirely cover the legs.

**Lance is a brand name of Lance Camper Manufacturing Corporation

PVC Free

PolyPRO™ 3 Folding Camping Trailer Cover



Triple-ply top with breathable single-ply sides for all-season protection

COLOR: GREY/SNOW WHITE



Item/Fit	Cover Width Dimension	Retail Stock No	Case Qty
MODEL 0 FITS TRAILERS UP TO 8' 6"L*	88"	80-209-303101-00	1
MODEL 1 FITS TRAILERS 8'-10'L*	88"	80-038-143106-00	1
MODEL 2 FITS TRAILERS 10'-12'L*	88"	80-039-153106-00	1
MODEL 3 FITS TRAILERS 12'-14'L*	88"	80-040-163106-00	1
MODEL 4 FITS TRAILERS 14'-16'L*	88"	80-041-173106-00	1
MODEL 5 FITS TRAILERS 16'-18'L*	88"	80-042-183106-00	1
MODEL 6 FITS TRAILERS 18'-20'L*	88"	80-043-193106-00	1

*FIT DIMENSIONS include only the Trailer Body, tow hitch not included. Not designed to entirely cover the wheels.

PVC Free

PolyPRO™ 3 Teardrop Trailer Cover



Triple-ply top with breathable single-ply sides for all-season protection

COLOR: GREY/SNOW WHITE

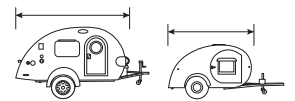

Item/Fit		Retail Stock No	Case Qty
MODEL 1	FITS TEARDROP TRAILERS UP TO 8'L 5'W* TRAILER BODY	80-296-143101-RT	1
MODEL 2	FITS TEARDROP TRAILERS 8'L-10'L 5'W* TRAILER BODY	80-297-153101-RT	1
MODEL 3	FITS TAB & CLAM SHELL TEARDROP TRAILERS 10'L-12'L 6'W* TRAILER BODY	80-298-163101-RT	1
MODEL 4	FITS TEARDROP TRAILERS 12'L-15'L 7'W* TRAILER BODY	NEW SIZE 80-480-173101-RT	1

*FIT DIMENSIONS include only the Trailer Body, tow hitch not included. Not designed to entirely cover the wheels.

PVC Free

PolyPRO™ 3 Molded Fiberglass Travel Trailer Cover



Triple-ply top with breathable single-ply sides for all-season protection

COLOR: GREY/SNOW WHITE

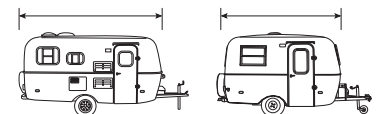

Item/Fit		Cover Width Dimension	Retail Stock No	Case Qty
MODEL 1	FITS MOLDED TRAILERS WITH BODIES 8'L-10'L*	80"	80-294-143101-RT	1
MODEL 2	FITS MOLDED TRAILERS WITH BODIES 10'1"L-13'L*	80"	80-295-153101-RT	1
MODEL 3	FITS MOLDED TRAILERS WITH BODIES 13'1"L-16'L*	80"	80-409-161001-RT	1

*FIT DIMENSIONS include only the Trailer Body, tow hitch not included. Not designed to entirely cover the wheels.

RV Windshield Cover





Provides privacy and keeps interior cool and protected from sun damage

COLOR: SNOW WHITE

- Internal, non-scratch magnets ensure a custom-like fit—no tools necessary
- Fast, easy fit—lays over windshield and secures to doors
- Security strap slides over side window
- Rugged wipe-clean vinyl with a soft non-scratch backing
- Side mirror cut-outs on models 6 and 8
- Handy storage bag
- UV protection



Item/Fit		Retail Stock No	Case Qty
MODEL 6	FITS FORD® '04–2015	 78634	6
MODEL 8	FITS DODGE®, MERCEDES® SPRINTER® '06–CURRENT	 80-035-212307-00	6
MODEL 9	FITS FORD® TRANSIT WINDSHIELDS '06–CURRENT	 80-418-222801-RT	6

RV Mirror and Wiper Blade Covers



COLOR: SNOW WHITE

- Fast, easy fit—no tools necessary
- Rugged wipe-clean vinyl with a soft non-scratch backing
- UV protection



Item/Fit		Retail Stock No	Case Qty
FITS CLASS A AND C RVS WIPER BLADES UP TO 31"	 	80-420-012801-RT	4

RV Deluxe Wheel Covers



Protects tires and wheels against sun damage

COLOR: SNOW WHITE

- Multiple sizes for a custom-like fit
- Fast and easy slip-on fit
- Folds up for easy storage
- Wipe-clean vinyl material with a soft non-scratch black backing
- Elasticized back panel for secure fit
- Two rear eyelets on each cover to secure bottom flap for a neat look (rope included)
- Handy storage bag
- UV protection
- **Four wheel covers in each package**



Item/Fit		Retail Stock No	Case Qty
MODEL 0	FITS 18"-21" WHEEL DIAMETER, 6.75" TIRE WIDTH	80-219-302302-00	2
MODEL 1	FITS 21"-24" WHEEL DIAMETER, 8.25" TIRE WIDTH	80-220-142302-00	2
MODEL 2	FITS 24"-27" WHEEL DIAMETER, 8.5" TIRE WIDTH	80-221-152302-00	2
MODEL 3	FITS 27"-30" WHEEL DIAMETER, 8.75" TIRE WIDTH	80-222-162302-00	2
MODEL 4	FITS 30"-33" WHEEL DIAMETER, 9" TIRE WIDTH	80-223-172302-00	2
MODEL 5	FITS 33"-36" WHEEL DIAMETER, 9" TIRE WIDTH	80-224-182302-00	2
MODEL 6	FITS 37"-41" (BUS) WHEEL DIAMETER, 9.25" TIRE WIDTH	80-225-192302-00	2



RV Wheel Covers

Protects tires and wheels against sun damage

COLORS: SNOW WHITE, GREY AND BLACK

- Multiple sizes for a custom-like fit
- Fast and easy slip-on fit
- Folds up for easy storage
- Wipe-clean vinyl material with a soft non-scratch backing
- Elasticized back panel for secure fit
- UV protection of tires
- **Two wheel covers in each package**



Item/Fit	Colors	Retail Stock No	Case Qty
MODEL 0 18"–21" WHEEL DIAMETER, 6.75" TIRE WIDTH	SNOW WHITE	76220	2
	GREY	80-098-301001-00	2
	BLACK	80-235-300402-00	2
MODEL 1 21"–24" WHEEL DIAMETER, 8.25" TIRE WIDTH	SNOW WHITE	76230	2
	GREY	80-082-141001-00	2
	BLACK	80-236-140402-00	2
MODEL 2 24"–27" WHEEL DIAMETER, 8.5" TIRE WIDTH	SNOW WHITE	76240	2
	GREY	80-083-151001-00	2
	BLACK	80-237-150401-00	2
MODEL 3 27"–30" WHEEL DIAMETER, 8.75" TIRE WIDTH	SNOW WHITE	76250	2
	GREY	80-084-161001-00	2
	BLACK	80-238-160402-00	2
MODEL 4 30"–33" WHEEL DIAMETER, 9.0" TIRE WIDTH	SNOW WHITE	76260	2
	GREY	80-085-171001-00	2
	BLACK	80-239-170402-00	2
MODEL 5 33"–36" WHEEL DIAMETER, 9.0" TIRE WIDTH	SNOW WHITE	76280	2
	GREY	80-086-181001-00	2
	BLACK	80-240-180402-00	2
MODEL 6 37"–41" (BUS) WHEEL DIAMETER, 9.25" TIRE WIDTH	SNOW WHITE	76270	2
	GREY	80-087-191001-00	2
	BLACK	80-241-190402-00	2



RV Dual Axle Wheel Covers

Protects tires and wheels against sun damage

COLORS: SNOW WHITE, GREY AND BLACK

- Three sizes fit most wheels on the market
- Fast and easy slip-on fit
- Two rear eyelets secure the bottom flaps for a neat look (rope not included)
- Elasticized back panel for a secure fit
- Wipe-clean vinyl with soft, non-scratch backing
- UV protection of tires
- **One dual axle wheel cover in each package**



Item/Fit	Colors	Retail Stock No	Case Qty
SMALL UP TO 27" WHEEL DIAMETER, 8" TIRE WIDTH	SNOW WHITE	80-109-022801-00	2
	GREY	80-107-021001-00	2
	BLACK	80-242-020402-00	2
LARGE 27"-30" WHEEL DIAMETER, 8" TIRE WIDTH	SNOW WHITE	80-110-042801-00	2
	GREY	80-108-041001-00	2
	BLACK	80-243-040402-00	2
X LARGE 30"-33" WHEEL DIAMETER, 8" TIRE WIDTH	SNOW WHITE	80-211-052801-00	2
	GREY	80-210-051001-00	2
	BLACK	80-244-050402-00	2



Custom Fit Spare Tire Cover

Attractive protection for spare tires on RVs, vans or trucks

COLOR: SNOW WHITE

- Tire sizes are listed on back of package so customers can determine sizing without measuring tires
- Elasticized back hem for a fast and adjustable fit
- Wipe-clean vinyl with soft, non-scratch backing
- UV protection of tires



Item/Fit	Retail Stock No	Case Qty
MODEL 1 21"–22" WHEEL DIAMETER	75100	6
MODEL 2 24"–25" WHEEL DIAMETER	75110	6
MODEL 3 25.5"–26.5" WHEEL DIAMETER	75120	6
MODEL 4 26.75"–27.75" WHEEL DIAMETER	75130	6
MODEL 5 28"–29" WHEEL DIAMETER	75140	6
MODEL 6 29"–29.75" WHEEL DIAMETER	75150	6
MODEL 7 30"–30.75" WHEEL DIAMETER	75160	6
MODEL 8 31"–31.75" WHEEL DIAMETER	75170	6



Universal Fit Spare Tire Cover

Affordable all-weather protection for spare tires on RVs, vans or trucks

COLORS: SNOW WHITE AND BLACK

- Tire sizes are listed on back of package so customers can determine sizing without measuring tires
- Wipe-clean vinyl with soft, non-scratch backing
- Elasticized back hem with quick-connect clips for a fast & adjustable fit
- UV protection of tires



Item/Fit	Retail Stock No	Case Qty
SMALL 26.75"–29.75" WHEEL DIAMETER	SNOW WHITE 80-217-022301-00	6
	BLACK 75347	6
LARGE 30"–33" WHEEL DIAMETER	SNOW WHITE 80-218-042301-00	6
	BLACK 75387	6

RV AC Cover



Keeps weather and debris out of RV air conditioners

COLORS: SNOW WHITE, GREY AND BLACK

- Wipe-clean vinyl with soft, non-scratch backing
- Elasticized bottom for a fast and secure fit
- Board insert for additional stiffness across the top of double tanks
- Slip-on fit
- UV protection



Item/Fit		Retail Stock No	Case Qty
MODEL 1 COLEMAN® MACH I, II, III, MACH 3 PLUS, MACH 15, ROUGHNECK & TSR	SNOW WHITE	77410	6
	BLACK	80-231-140401-00	6
MODEL 2 FITS DUO-THERM® BRISKAIR & QUICK COOL	SNOW WHITE	77420	6
	SNOW WHITE	80-226-192301-00	6
MODEL 6 FITS DOMETIC BRISK II®	GREY	80-227-191001-00	6
	BLACK	80-234-190401-00	6
MODEL 8 FITS COLEMAN® MACH 8	SNOW WHITE	80-251-212801-00	6





RV Tank Cover

Protects tanks from dirt, weather and debris*

COLORS: SNOW WHITE AND GREY

- Wipe-clean vinyl with soft, non-scratch backing
- Draw cord along bottom for a fast and secure fit
- UV protection



Item/Fit		Colors	Retail Stock No	Case Qty
MODEL 2 FITS DOUBLE 20/5 GALLON		SNOW WHITE	79720	6
		GREY	80-099-141001-00	6
MODEL 3 FITS DOUBLE 30/7.5 GALLON		SNOW WHITE	79730	6
		GREY	80-100-151001-00	6

*Storage or parking use—not for use while trailering



Toy Hauler Screen

COLOR: GREY

- Heavy-duty screen material lets in air, keeps bugs out and provides shade
- Width and height adjustable for a custom-like fit
- Includes detachable grey PolyPRO™ privacy screens that can be quickly attached to the inside of the screened panels with rip-n-grip strips
- Zipper door closure
- Top of the screen attaches with rip-n-grip strips, screen sides attach with rip-n-grip strips or magnets* depending on model



Item/Fit		Retail Stock No	Case Qty
FITS TOY HAULERS WITH REAR OPENING UP TO 90.5" H COMPATIBLE WITH FIBERGLASS OR ALUMINUM FRAMES	RIP-N-GRIP ATTACHMENT	79984	3
FITS TOY HAULERS WITH REAR OPENING UP TO 90.5" H COMPATIBLE WITH STEEL FRAMES	MAGNETIC ATTACHMENT	79994	3

*Positively Unique, You-Nique Magnetic RV Screen, Patented 6,257,307.

RV Captain Seat Cover



COLORS: ALDER/NATURAL AND GREY

- Semi-custom fit for RV captain-style seats
- Access hole for seat adjustment lever
- Protects new seats and renews the look of old seats
- Elasticized hem provides a quick, custom-like fit
- Integrated stabilizer tubes secure cover to seat bottom
- Includes armrest covers
- Machine wash, air dry



Item/Fit	Colors	Retail Stock No	Case Qty
FITS MOST RV CAPTAIN-STYLE SEATS	TAN	80-112-012401-00	2
	GREY	80-421-011002-RT	1

RV Sway Bar Hitch Tote



COLOR: BLACK

- Easy-to-carry fabric case stores draw bars and protects vehicles from dents
- Heavy-duty water and abrasion-resistant fabric case
- Carrying handles and convenient extra long shoulder straps
- Big and easy-access zippered opening



Item/Fit	Retail Stock No	Case Qty
FITS SWAY BAR KITS UP TO 36"L 11"W 8"H	80-113-010401-00	3

RV 5th Wheel Hitch Cover



COLORS: BLACK AND GREY

- Easy-to-attach cover protects hitch from dirt, weather and debris
- Elasticized hem on two sides for a tight fit
- Four metal hooks to secure cover

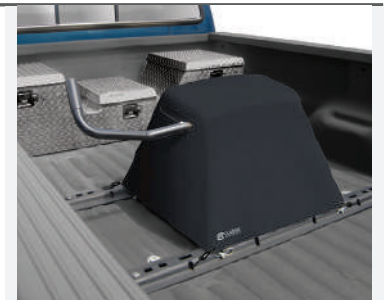

Item/Fit	Colors	Retail Stock No	Case Qty
PUCK STYLE HITCHES 24"W 24"D	BLACK	80-116-010401-00	3

Dedicated Product Videos

We provide over 200 product videos for our products so your customers can easily see how to get the most out of the features and benefits of the great products you sell them.



Online Support Tools

Our online support helps you improve your game. Our web portal gives you access to product information, sales sheets, product manuals and images that will improve sales, while our fit information makes for happy customers and fewer returns.

We provide more opportunities than ever to reach your customers. We help by optimizing website content for mobile applications, by spreading the word through positive consumer reviews, and helping those reviews reach buyers by syndicating them to your website.

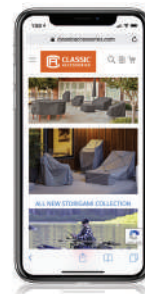
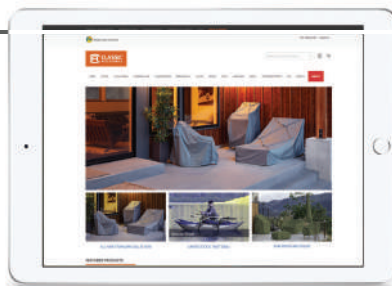

Direct Ship and Retail Packaging

The patio products are offered in both direct ship packaging for online sales as well as retail box packaging for your store.

Direct ship packaging will save shipping and packaging costs while the full color box will create an instant merchandising story on your sales floor.



Merchandising Solutions

From planograms to signs and fixtures, we have resources to help you put your best foot forward at your in-store Point-of-Sale. Our end-cap toppers are show-stoppers and our product hangtags are notorious for encouraging add-on sales and getting product to move.



POP Displays

We know that good Point-of-Purchase displays help sell product for you. That's why we invest in displays that are easy to set up, don't eat valuable floor space and provide valuable information to help convert shoppers into buyers.



Merchandising Fit Guides

We know that one of your biggest challenges is helping clients get the right fit. That's why we've created easy-to-read "Fit Guides" for every product category, available for in-store display or online.

FIT GUIDE	
<p>Always read the instructions to the right. Please read the fitting guide to help you with the proper fit. The height of the cover has not been designed for compatibility with the table.</p>	
<p>Patio Umbrella Covers</p> <p>Model: 10-0110</p> <p>Model: 10-0110</p>	<p>Model: 10-0110</p> <p>Model: 10-0110</p>
<p>Patio Chair Covers</p> <p>Model: 10-0110</p> <p>Model: 10-0110</p>	<p>Model: 10-0110</p> <p>Model: 10-0110</p>

Glossary of Symbols

Warranty Information



The Classic Accessories product line features warranties from one to five years and a limited lifetime

Weather Protection Levels



WEATHER PROTECTION: Good



ALL SEASON PROTECTION: Better



HEAVY DUTY PROTECTION: Best

Fabric Details



3-PLY FABRIC: Water-repellent and water-resistant



BREATHABLE: Breathes to let inside moisture and condensation out



UV PROTECTION: Shields the contents or covered object from harmful rays of the sun



RIPSTOP FABRIC: Reinforced technique to make fabric highly durable and tear resistant



WATERPROOF: Taped seams block water from entering through stitching



WON'T CRACK IN THE COLD: Treated to stay flexible in freezing conditions

Product Features



ADJUSTABLE CUSTOM FIT: Feature allows adjustment for a custom fit



ADJUSTABLE HEM CORD: Elastic hem cord with a toggle allows adjustment for a tight and custom fit



AIR VENTS: Reduces inside condensation and wind lofting



ANCHOR SYSTEM: Keeps pontoon boats from drifting



ANTENNA PATCH: Adhesive backed reinforcement for antenna hole on cover



BACKPACK STRAPS: Backpack straps for convenient carrying



CLICK-CLOSE STRAPS: Secures with fast and adjustable quick-release buckles



COMPRESSION STUFF SACK: Allows compression of the cover to reduce storage space



CONTENTS WINDOW: Clear panel for easy viewing of contents



CUSHIONED: Thick cushioning for added comfort



ELASTIC BOTTOM HEM: Elastic sewn into the hem for a snug fit



ELASTIC HEM CORD: Elastic cord sewn into the hem for a strong and tight fit



FLEECE LINED: Fleece lined for warmth and comfort



HANDLES: Found on many products for easy carrying



HEAT SHIELD: Reflective or heat resistant fabric for hot areas



INSULATED: Protects against cold



LOCK INCLUDED: Security feature included on some covers



MACHINE WASHABLE: Can be washed and dried (machine dry on air or lowest setting)



MAGNETIC LATCHES: Latches fasten magnetically for a quick, one-handed opening and closing



MOTOR MOUNT: Attachment point on pontoon boats for small electric motors



NO TOOLS REQUIRED: No tools are required for assembly



PORTABLE: Specially designed to be carried or transported



PRODUCT ID TAG: Card in clear sleeve lets you label bag contents



PROTECTIVE LINING: Protects against scratches



PROTECTIVE PADDING: Cushions contents against bumps and breakage



REFLECTIVE: Light enhancing elements for safety in dark conditions



RIP-N-GRIP CLOSURE: Fabric tabs for product attachment



SELF-ZIP CASE: Folds and zips into its own storage and carrying case



STAY-ON ELASTIC LOOPS: Fit over legs to keep the cover on in windy conditions



STAY-ON STRAPS: Wrap-around straps secure covers during windy days



STORAGE BAG: Storage bag included



TIE-ON STRAPS: Elastic corners and straps tie around legs to secure cover on windy days



TRAILERABLE: Can be used during transport on a trailer



TRANSPORT WHEEL: Fits onto pontoon boats for easy transportation to and from the water



ZIPPERED ACCESS: Provides quick and easy access to interior



WATER RESISTANT OR REPELLENT: Protects against water penetration and/or spray

Check out the collection of custom car covers we offer.