



PRODUCT GUIDE

MODEL | MODÈLE | MODELO
463436214

Classic C-453

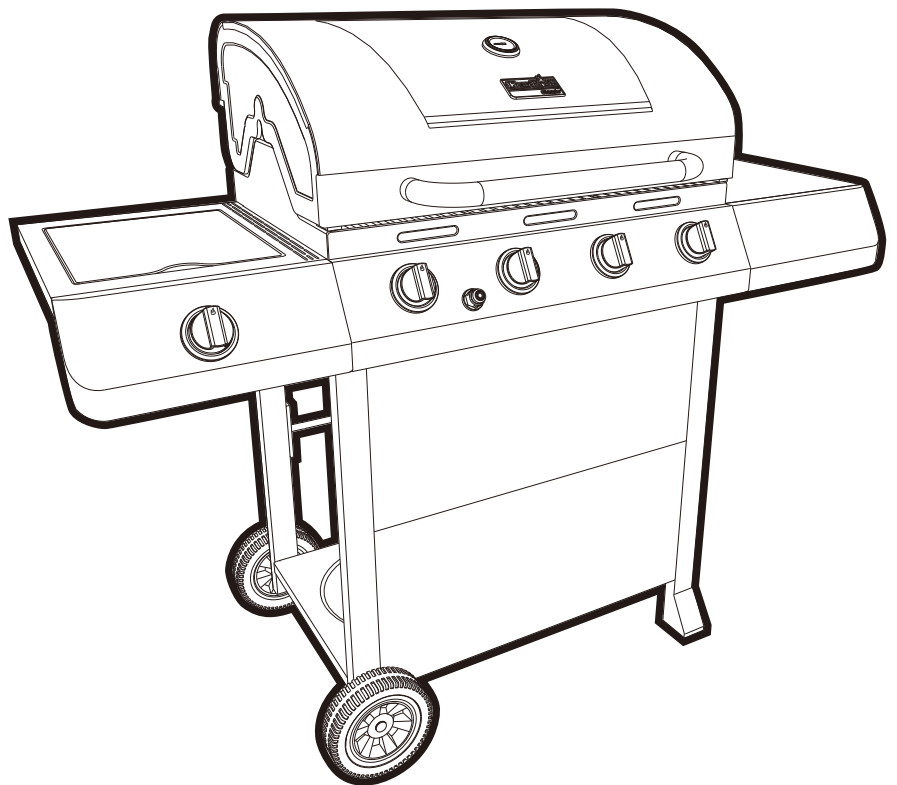

TABLE OF CONTENTS

For Your Safety	2
Grilling Guide	3-4
Use and Care	5-7
Limited Warranty	8
Parts List	23
Parts Diagram	26
Assembly	27-36
Troubleshooting	37-38
Registration Card	43

Safety Symbols

The symbols and boxes shown below explain what each heading means. Read and follow all of the messages found throughout the manual.

⚠
CAUTION
⚠

CAUTION: Indicates a potentially hazardous situation or unsafe practice which, if not avoided, may result in minor or moderate injury.

⚠
WARNING
⚠

WARNING: Indicates a potentially hazardous situation which, if not avoided, could result in death or serious injury.

⚠
DANGER
⚠

DANGER: Indicates an imminently hazardous situation which, if not avoided, will result in death or serious injury.

INSTALLER/ASSEMBLER:

Leave this manual with consumer.

CONSUMER:

Keep this manual for future reference.

⚠
DANGER
⚠

If you smell gas:

1. Shut off gas to the appliance
2. Extinguish any open flame.
3. Open lid.
4. If odor continues, keep away from the appliance and immediately call your gas supplier or your fire department.

⚠
WARNING
⚠

1. Do not store or use gasoline or other flammable liquids or vapors in the vicinity of this or any other appliance.
2. An LP cylinder not connected for use shall not be stored in the vicinity of this or any other appliance.

THIS GRILL IS FOR OUTDOOR USE ONLY.

⚠
WARNING
⚠

Failure to follow all manufacturer's instructions could result in serious personal injury and/or property damage.

⚠
CAUTION
⚠

For residential use only. Do not use for commercial cooking.

⚠
CAUTION
⚠

Read and follow all safety statements, assembly instructions, and use and care directions before attempting to assemble and cook.

⚠
CAUTION
⚠

Some parts may contain sharp edges. Wear protective gloves if necessary.

⚠
WARNING
⚠

CALIFORNIA PROPOSITION 65

1. Combustible by-products produced when using this product contains chemicals known to the State of California to cause cancer, birth defects, or other reproductive harm.
2. This product contains chemicals, including lead and lead compounds, known to the State of California to cause cancer, birth defects or other reproductive harm.

Wash your hands after handling this product.

⚠
WARNING
⚠

Do not attempt to repair or alter the hose/valve/regulator for any "assumed" defect. Any modification to this assembly will void your warranty and create the risk of a gas leak and fire. Use only authorized replacement parts supplied by manufacturer.

Installation Safety Precautions

- Use grill, as purchased, only with LP (propane) gas and the regulator/valve assembly supplied. If your grill is Dual Fuel ready, a conversion kit must be purchased for use with natural gas.
- Grill installation must conform with local codes, or in their absence of local codes, with either the *National Fuel Gas Code, ANSI Z223.1/NFPA 54, Natural Gas and Propane Installation Code, CSA B149.1, or Propane Storage and Handling Code, B149.2.*
- All electrical accessories (such as rotisserie) must be electrically grounded in accordance with local codes, or *National Electrical Code, ANSI/NFPA 70 or Canadian Electrical Code, CSA C22.1.* Keep any electrical cords and/or fuel supply hoses away from any hot surfaces.
- This grill is safety certified for use in the United States and/or Canada only. Do not modify for use in any other location. Modification will result in a safety hazard.

⚠
CAUTION
⚠

Grease Fires

- Putting out grease fires by closing the lid is not possible. Grills are well ventilated for safety reasons.
- Do not use water on a grease fire. Personal injury may result. If a grease fire develops, turn knobs and LP tank off.
- If grill has not been regularly cleaned, a grease fire can occur that may damage the product. Pay close attention while preheating or burning off food residue to insure that a grease fire does not develop. Follow instructions on General Grill Cleaning and Cleaning The Burner Assembly to prevent grease fires.
- The best way to prevent grease fires is regular cleaning of the grill.

⚠
CAUTION
⚠

Using pots larger than 6 quarts in capacity could exceed weight limit of the side burner shelf or side shelf, resulting in failure of grill cart components.

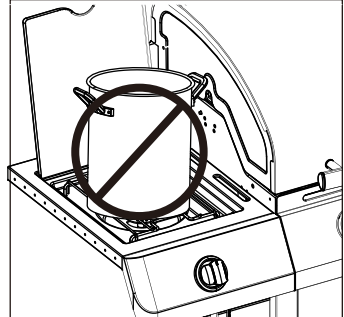

⚠
DANGER
⚠

- NEVER store a spare LP cylinder under or near the appliance or in an enclosed area.

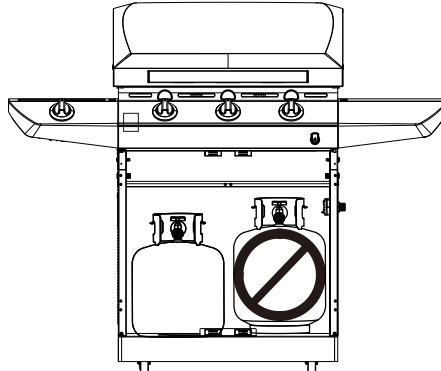

- Never fill a cylinder beyond 80% full.
- An over filled or improperly stored cylinder is a hazard due to possible gas release from the safety relief valve. This could cause an intense fire with risk of property damage, serious injury or death.
- If you see, smell or hear gas escaping, immediately get away from the LP cylinder/appliance and call your fire department.

GRILLING GUIDE – Getting Started

First Time Use

Read your Assembly Manual and ensure the grill is put together properly. Remove all Point-of-Purchase advertising material from all grill surfaces before first use. We recommend operating your grill on its highest setting for 15-20 minutes prior to your first use. This aids in removing the oils used during manufacturing.

Lava Rock / Briquettes

This gas grill has been designed, engineered, and tested to be used with heat tents to provide more even heating, improve the cleaning process, and reduce flare-ups. The addition of after market lava rocks, charcoal, or briquettes of any type will cause poor combustion and increase the likelihood of a grease fire, and is not recommended. Using briquettes, lava rock, or charcoal in this grill will void your warranty. For extra smoke flavor, we recommend using a smoker box with wood chips.



Temperature - Convective Grills ONLY.

The temperature gauge in the hood of your new grill measures air temperature. The air temperature inside your grill will never be as hot as the temperature at the cooking surface.

Note: Since 1995, all regulators (the part that attaches to the gas tank to regulate the flow of gas) have included a safety feature that restricts gas flow in the event of a gas leak. You can inadvertently activate this safety feature without having a gas leak. This typically occurs when you turn on the gas using the grill control knob before you turn on the LP tank valve. If the gas regulator safety feature activates, the grill will only reach temperatures between 250°F and 300°F even with all burners on the high setting.

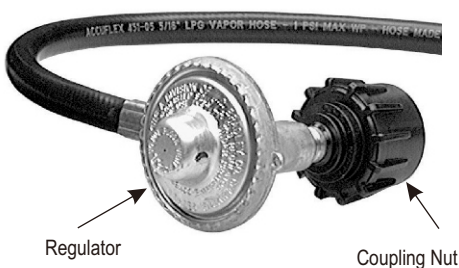

If your grill is not getting hotter than 250°F to 300°F these steps should be taken first to reset the gas regulator safety device:

1. Open the grill lid.
2. Turn off all knobs on the control panel in front.
3. Turn off the tank knob.
4. Disconnect the regulator from the LP tank.
5. Wait 30 seconds.
6. Reconnect the regulator to the LP tank.
7. Slowly open the LP tank knob all the way. Do not put excessive force on the valve at the full open position to avoid damaging the valve.
8. Turn on the appropriate control knob and light the grill per the instructions.

An illustration of this process is included in this Product Guide. See Troubleshooting section for additional information.

Pre-Heating Your Grill

Just like your home oven, your grill should be pre-heated to provide optimum performance. Pre-heat the grill on high for 10-15 minutes – longer if weather conditions require. Please refer to the lighting instructions inside the Product Guide if you have questions about how to light your grill. A match-light chain and hole is provided for your convenience.

Outdoor grilling is really quite simple. You'll succeed with burgers, dogs, or steaks usually on your very first try. With experience, you will learn how to work with your grill, creating more imaginative meals all the time. This knowledge makes up the art of grilling. Before you start grilling, organize your food according to cooking technique and required cooking time, and optimize the use of your grilling area.

Direct Cooking

Direct cooking involves grilling your meat directly over high heat. It is perfect for searing steaks, chops, and other smaller pieces of meat and vegetables that quickly make their way to the table.

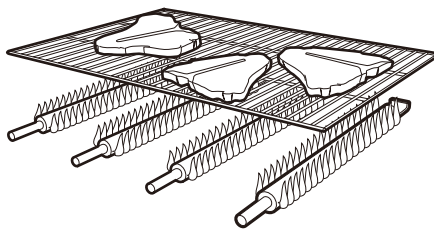

Indirect Cooking

Indirect cooking utilizes select burners to circulate heat throughout the grill, without direct contact between the meat and the flame. The meat is placed over the burner that is 'off'. This method is generally used to slow cook large cuts of meat and poultry. A pan can be placed underneath the meat to catch grease and food drippings, and helps minimize clean-up.

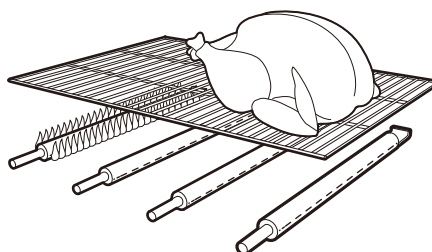
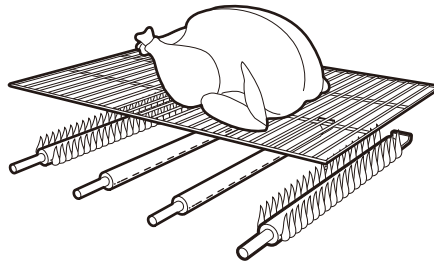

Rotisserie Cooking

Rotisserie cooking is best for 'round' meat, such as large roasts, whole poultry, and pork. It generally requires an accessory motor and spit rod that allows the meat to be turned at a constant speed. Rotisserie cooking is best done in front of a special rotisserie burner, or utilizing an indirect cooking burner arrangement. A pan can be placed underneath the meat to catch grease and food drippings, and helps minimize clean-up.

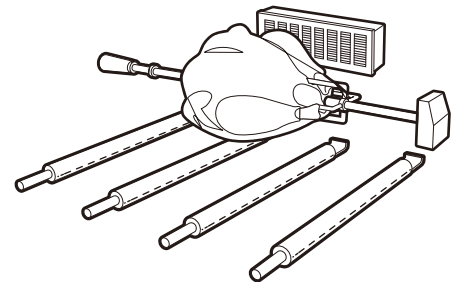
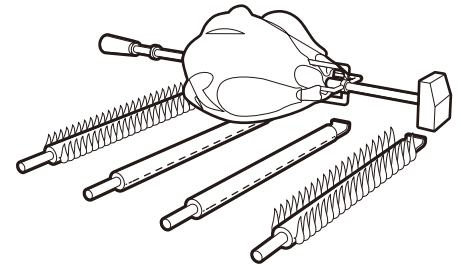

Food Safety

Food safety is a very important part of enjoying the outdoor cooking experience. To keep food safe from harmful bacteria, follow these four basic steps:

Clean: Wash hands, utensils, and surfaces with hot soapy water before and after handling raw meat.

Separate: Separate raw meats from ready-to-eat foods to avoid cross contamination. Use a clean platter and utensils when removing cooked foods.

Cook: Cook meat and poultry thoroughly to kill bacteria. Use a thermometer to ensure proper internal food temperatures.

Chill: Refrigerate prepared foods and leftovers promptly.

GRILLING GUIDE – Tips & Tricks

Cooking on your new grill is a hands-on experience, and it is recommended to remain outside with your grill while cooking. Grilling can be affected by many external conditions. In cold weather, you will need more heat to reach an ideal cooking temperature, and grilling may take longer. The meat's internal temperature and thickness can also affect cooking times. Cold and thicker meats will take longer to cook.

Internal Meat Temperatures

Meat cooked on a grill often browns very fast on the outside. Therefore, use a meat thermometer to ensure it has reached safe internal temperatures.

USDA Recommended Safe Minimum Internal Temperatures	
Beef, Veal, Lamb, Steak, Roasts, & Whole Pork (with a 3 minute rest time)	145° F
Fish	145° F
Beef, Veal, Lamb, and Pork - Ground	160° F
Egg Dishes	160° F
Turkey, Chicken & Duck Whole, Pieces & Ground	165° F

Sauces

Sauces containing sugars and fats can cause flare-ups, and your food may burn. In general, apply these sauces during the final 10 minutes of cooking. Keep in mind, use of excessive sauces or glazes will also require extra cleaning afterwards.

Marinades and Rubs

To enhance the flavor of grilled foods, a liquid marinade or dry rub can be used prior to cooking. Meat can be either soaked or injected with liquid marinade up to 24 hours prior to grilling. Dry rubs can be applied directly to the meat immediately before grilling.



Wood Chips

For extra smoke flavor when grilling, try adding wood chips. Soak the chips in water for approximately 30 minutes before adding to a smoke box or pan. Place smoke box or pan on top of the cooking grate above the flame. Turn grill on high until the wood starts to smoke. Reduce heat to desired temperature for cooking, and place food on cooking grate as desired. Close lid to retain more smoke. Hardwood varieties that work particularly well with grilled foods include Alder, Apple, Cherry, Hickory, Mesquite, and Pecan.



Skewers

Metal skewers should be flat, with long handles. Round skewers allow food to roll when turned, so it may not cook as evenly. Use metal skewers when cooking meat kabobs. Wooden skewers should be soaked in water for an hour before use, and are best used for quick cooking foods such as vegetables and fruits.



Utensils

Use tongs or a spatula to handle the food instead of a fork, and don't turn the food too often. Piercing the food with a fork will release juices that you want in the meat, and may cause flare-ups.



GRILLING GUIDE – Cleaning Your Grill

Why Clean?

We've all heard the saying 'An ounce of prevention is worth a pound of cure'. This is great advice when it comes to keeping your grill clean.

Routine Care

Periodic cleaning of this grill is necessary, as grill fires can occur when grease and food debris collect in the bottom of the grill. After each use, remove any remaining food particles from the cooking grate and inside of the grill using a grill brush. Do this after the grill has cooled down. This grill is not designed to be 'burned off' by closing the lid and turning the burners on High for an extended time. The excessive heat generated can cause leftover grease to catch fire, and can cause permanent damage to your grill.

General Cleaning

Plastic parts: Wash with warm soapy water and wipe dry. Do not use abrasive cleaners, degreasers or a concentrated grill cleaner on plastic parts. Damage to and failure of parts can result.

Porcelain surfaces: Because of glass-like composition, most residue can be wiped away with baking soda/water solution or glass cleaner. Use non-abrasive scouring powder for stubborn stains.

Painted surfaces: Wash with mild detergent or non-abrasive cleaner and warm water. Wipe dry with a soft non-abrasive cloth.

Stainless steel surfaces: Stainless steel can rust under certain conditions. This can be caused by environmental conditions such as chlorine or salt water, or improper cleaning tools such as wire or steel wool. It can also discolor due to heat, chemicals, or grease build-up. To maintain your grill's high quality appearance, wash with mild detergent and warm water, or use a stainless steel grill cleaner. Baked-on grease deposits may require the use of an abrasive plastic cleaning pad. Use only in direction of brushed finish to avoid damage. Do not use abrasive pad on areas with graphics.



Cooking surfaces: Ensure no loose bristles remain on cooking surfaces prior to grilling. It is not recommended to clean cooking surfaces while grill is hot.

Storing Your Grill

- Clean cooking grates.
- Store grill in dry location.
- When LP cylinder is connected to grill, store outdoors in a well ventilated space and out of reach of children.
- Cover grill if stored outdoors. Choose from a variety of grill covers offered by manufacturer.
- Store grill indoors ONLY if LP cylinder is turned off, disconnected, and removed from grill. Never store LP cylinder indoors.
- When removing grill from storage, follow the 'Cleaning the Burner Assembly' instructions in the Use and Care section of the Product Guide.

Critters

Spiders like to make their homes in the venturi tubes of grills. These must be inspected and cleaned regularly to ensure there are no blockages. Refer to the Use and Care portion of this Product Guide for complete information.

GEARTRAX™

The Char-Broil® grill is equipped with Gear Trax™, which allow for the easy mounting of our unique line of Gear Trax accessories. Please visit charbroil.com for a complete list of Gear Trax accessories. *Available on most models.



VISIT CHARBROIL.COM FOR ALL YOUR GRILLING NEEDS!

USE AND CARE

LP Cylinder Removal, Transport and Storage

- Turn OFF all control knobs and LP cylinder valve. Turn coupling nut counterclockwise by hand only - do not use tools to disconnect. Loosen cylinder screw beneath bottom shelf or disconnect other retention means, then lift LP cylinder up and out of cart. Install safety cap onto LP cylinder valve. Always use cap and strap supplied with valve. **Failure to use safety cap as directed may result in serious personal injury and/or property damage.**
- A disconnected LP cylinder in storage or being transported must have a safety cap installed (as shown). Do not store an LP cylinder in enclosed spaces such as a carport, garage, porch, covered patio or other building. Never leave an LP cylinder inside a vehicle which may become overheated by the sun.
- Do not store an LP cylinder in an area where children play.

LP Cylinder Valve

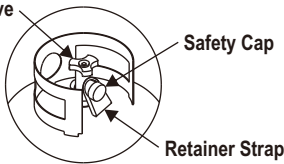

LP Cylinder

- The LP cylinder used with your grill must meet the following requirements:

- Use LP cylinders only with these required measurements: 12" (30.5cm) (diameter) x 18" (45.7 cm) (tall) with 20 lb. (9 kg.) capacity maximum.
- LP cylinders must be constructed and marked in accordance with specifications for LP cylinders of the U.S. Department of Transportation (DOT) or for Canada, CAN/CSA-B339, cylinders, spheres and tubes for transportation of dangerous goods, Transport Canada (TC). See LP cylinder collar for marking.
- LP cylinder valve must have:
 - Type 1 outlet compatible with regulator or grill.
 - Safety relief valve.
 - UL listed Overfill Protection Device (OPD). This OPD safety feature is identified by a unique triangular hand wheel. **Use only LP cylinders equipped with this type of valve.**
- LP cylinder must be arranged for vapor withdrawal and include collar to protect LP cylinder valve. Always keep LP cylinders in upright position during use, transit or storage.



OPD Hand Wheel

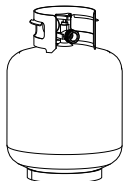

LP cylinder in upright position for vapor withdrawal

LP (Liquefied Petroleum Gas)

- LP gas is nontoxic, odorless and colorless when produced. **For Your Safety**, LP gas has been given an odor (similar to rotten cabbage) so that it can be smelled.
- LP gas is highly flammable and may ignite unexpectedly when mixed with air.

LP Cylinder Filling

- Use only licensed and experienced dealers.
- LP dealer **must purge new cylinder** before filling.
- Dealer should **NEVER** fill LP cylinder more than 80% of LP cylinder volume. Volume of propane in cylinder will vary by temperature.
- A frosty regulator indicates gas overfill. Immediately close LP cylinder valve and call local LP gas dealer for assistance.
- Do not release liquid propane (LP) gas into the atmosphere. This is a hazardous practice.
- To remove gas from LP cylinder, contact an LP dealer or call a local fire department for assistance. Check the telephone directory under "Gas Companies" for nearest certified LP dealers.

LP Cylinder Exchange

- Many retailers that sell grills offer you the option of replacing your empty LP cylinder through an exchange service. Use only those reputable exchange companies that inspect, precision fill, test and certify their cylinders. **Exchange your cylinder only for an OPD safety feature-equipped cylinder as described in the "LP Cylinder" section of this manual.**
- Always keep new and exchanged LP cylinders in upright position during use, transit or storage.

- **Leak test new and exchanged LP cylinders BEFORE connecting to grill.**

- Place safety cap on cylinder valve outlet whenever the cylinder is not in use. Only install the type of safety cap on the cylinder valve outlet that is provided with the cylinder valve. Other types of caps or plugs may result in leakage of propane.

LP Cylinder Leak Test

For your safety

- Leak test must be repeated each time LP cylinder is exchanged or refilled.
- Do not smoke during leak test.
- Do not use an open flame to check for gas leaks.
- Grill must be leak tested outdoors in a well-ventilated area, away from ignition sources such as gas fired or electrical appliances. During leak test, keep grill away from open flames or sparks.
- Use a clean paintbrush and a 50/50 mild soap and water solution. Brush soapy solution onto areas indicated by arrows in figure below.
- ▲ **Do not use household cleaning agents.** Damage to gas train components can result.

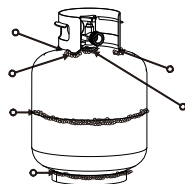

WARNING

If "growing" bubbles appear do not use or move the LP cylinder. Contact an LP gas supplier or your fire department!

Connecting Regulator to the LP Cylinder

1. LP cylinder must be properly secured onto grill. (Refer to assembly section.)
2. Turn all control knobs to the OFF position.
3. Turn LP cylinder OFF by turning hand-wheel clockwise to a **full stop**.
4. Remove the safety cap from LP cylinder valve. Always use cap and strap supplied with valve.

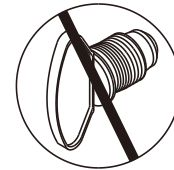
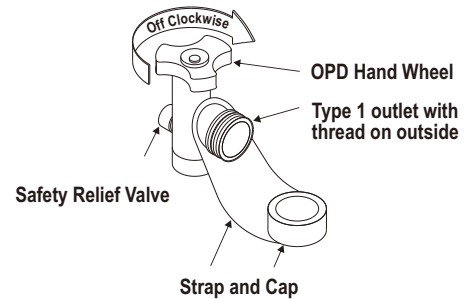

Do not use a POL transport plug (plastic part with external threads)! It will defeat the safety feature of the valve.

5. Hold regulator and insert nipple into LP cylinder valve. Hand-tighten the coupling nut, holding regulator in a straight line with LP cylinder valve so as not to cross-thread the connection.

Nipple has to be centered into the LP cylinder valve.

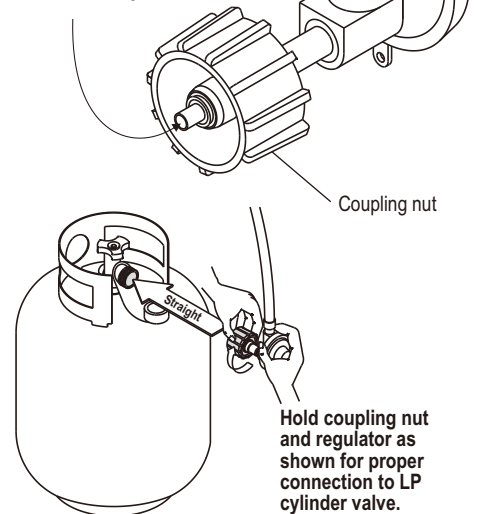

6. Turn the coupling nut clockwise and tighten to a full stop. The regulator will seal on the back-check feature in the LP cylinder valve, resulting in some resistance. **An additional one-half to three-quarters turn is required to complete the connection. Tighten by hand only – do not use tools.**

NOTE:

If you cannot complete the connection, disconnect regulator and repeat steps 5 and 6. If you are still unable to complete the connection, **do not use this regulator!**



DANGER

- Do not insert any tool or foreign object into the valve outlet or safety relief valve. You may damage the valve and cause a leak. Leaking propane may result in explosion, fire, severe personal injury, or death.

WARNING

- Do not use grill until leak-tested.
- If a leak is detected at any time, STOP!
- If you cannot stop a gas leak by closing the LP cylinder valve leave area and call your fire department!

Leak Testing Valves, Hose and Regulator

- Turn all grill control knobs to OFF.
- Be sure regulator is tightly connected to LP cylinder.
- Completely open LP cylinder valve by turning hand wheel counterclockwise. If you hear a *rushing sound*, turn gas off immediately. There is a major leak at the connection. **Correct before proceeding.**
- Brush soapy solution onto areas circled below, or other similar fittings on your grill.

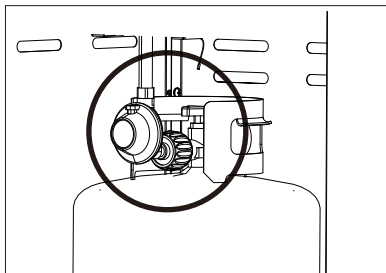

NOTE: Sideburner shelf fascia and other parts not shown for clarity.

NOTE: Your grill may NOT be equipped with a sideburner.

- If “growing” bubbles appear, there is a leak. Close LP cylinder valve immediately and retighten connections. **If leaks cannot be stopped do not try to repair.** Call for replacement parts.
- Always close LP cylinder valve after performing leak test by turning hand wheel clockwise.

WARNING

- Outdoor gas appliance is not intended to be installed in or on a boat.
- Outdoor gas appliance is not intended to be installed in or on an RV.
- Never attempt to attach this grill to the self-contained LP gas system of a camper trailer or motor home.

Safety Tips

- Before opening LP cylinder valve, check the coupling nut for tightness.
- When grill is not in use, turn off all control knobs and LP cylinder valve.
- Never move grill while in operation or still hot.
- Some surfaces will be hot during use. Use long-handled barbecue utensils and oven mitts to avoid burns and splatters.
- Maximum load for sideburner and side shelf is 10 lbs.
- The grease tray or cup **must** be installed during use and emptied after each use. Do not remove grease tray or cup until grill has completely cooled.
- Clean grill often, preferably after each cookout. If a bristle brush is used to clean any of the grill cooking surfaces, ensure no loose bristles remain on cooking surfaces prior to grilling. It is not recommended to clean cooking surfaces while grill is hot.

- If you notice grease or other hot material dripping from grill onto valve, hose or regulator, turn off gas supply at once. Determine the cause, correct it, then clean and inspect valve, hose and regulator before continuing. Perform a leak test.
- Keep ventilation openings in cylinder enclosure (grill cart) free and clear of debris.
- Do not store objects or materials inside the grill cart enclosure that would block the flow of combustion air to the underside of either the control panel or the firebox bowl.
- The regulator may make a humming or whistling noise during operation. This will not affect safety or use of grill.
- If you have a grill problem see the “Troubleshooting” Section.
- If the regulator frosts, turn off grill and LP cylinder valve immediately. This indicates a problem with the cylinder and it should not be used on any product. Return to supplier!

WARNING

For Safe Use of Your Grill and to Avoid Serious Injury:

- Do not let children operate or play near grill.
- Keep grill area clear and free from materials that burn.
- Do not block holes in sides or back of grill.
- Check burner flames regularly.
- Use grill only in well-ventilated space. NEVER use in enclosed space such as carport, garage, porch, covered patio, or under an overhead structure of any kind.
- Do not use charcoal or ceramic briquets in a gas grill.
- Do not cover grates with aluminum foil or any other material. This will block burner ventilation and create a potentially dangerous condition resulting in property damage and/or personal injury.
- Use grill at least 3 ft. from any wall or surface.** Maintain 10 ft. clearance to objects that can catch fire or sources of ignition such as pilot lights on water heaters, live electrical appliances, etc.

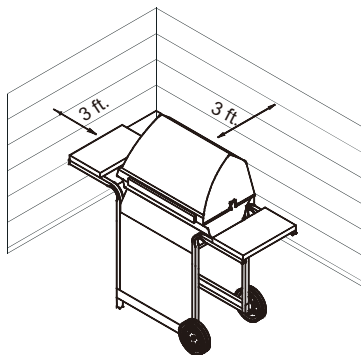

- NEVER attempt to light burner with lid closed. A buildup of non-ignited gas inside a closed grill is hazardous.**
- Never operate grill with LP cylinder out of correct position specified in assembly instructions.**
- Always close LP cylinder valve and remove coupling nut before moving LP cylinder from specified operation position.**
- Apartment Dwellers:**
Check with management to learn the requirements and fire codes for using an LP gas grill in your apartment complex. If allowed, use outside on the ground floor with a three (3) foot clearance from walls or rails. Do not use on or under balconies.

Ignitor Lighting

- Do not lean over grill while lighting.**
- Turn **OFF** gas burner control valves.
 - Turn **ON** gas at LP cylinder.
 - Open lid during lighting.**
 - To ignite, push and turn **IGNITION BURNER** knob to **HIGH**.
 - Immediately, push and hold **ELECTRONIC IGNITION** button until the burner lights.
 - If ignition does NOT occur in 5 seconds, turn the burner controls **OFF**, wait 5 minutes and repeat the lighting procedure. If ignitor does not work, follow match lighting instructions.
 - To ignite remaining burners, turn knob to the **HIGH** position starting with the burners closest to **IGNITION BURNER** first.
 - For grills equipped with ELECTRONIC IGNITION at each burner:**
Repeat steps 4 through 6 to light each burner.
 - Once each burner has ignited, turn knobs to desired setting.

WARNING

Turn controls and gas source or tank **OFF** when not in use.

CAUTION

If ignition does NOT occur in 5 seconds, turn the burner controls **OFF**, wait 5 minutes and repeat the lighting procedure. If the burner does not ignite with the valve open, gas will continue to flow out of the burner and could accidentally ignite with risk of injury.

Match-Lighting

- Do not lean over grill while lighting.**
- Turn **OFF** gas burner control valves.
 - Turn **ON** gas at LP cylinder.
 - Open lid during lighting.**
 - Place match into match holder (hanging from side panel of grill). Light match; then light burner by placing match through the match light hole on side of grill.
 - Push in and turn burner knob to the **HIGH** position. Be sure burner lights and stays lit.
 - Light adjacent burners in sequence by pushing knobs in and turning to the **HIGH** position.

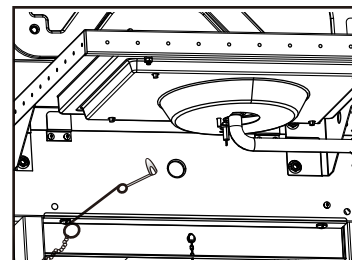

NOTE: Your grill may NOT be equipped with a Sideburner!

Sideburner Ignitor Lighting

- Do not lean over grill while lighting.
- 1. Turn **OFF** gas burner control valves.
- 2. Turn **ON** gas at LP cylinder.
- 3. Open sideburner lid.
- 4. Turn sideburner knob to the **HIGH** position, push and hold **ELECTRONIC IGNITOR** button.
- 5. If sideburner does NOT light within 5 seconds, turn knob to **OFF**, wait 5 minutes, then repeat lighting procedure.

Sideburner Match Lighting

- Do not lean over grill while lighting.
- 1. Turn **OFF** gas burner control valves.
- 2. Turn **ON** gas at LP cylinder.
- 3. Open sideburner lid.
- 4. Place lit match near burner.
- 5. Turn sideburner knob to the **HIGH** position. Be sure burner lights and stays lit.

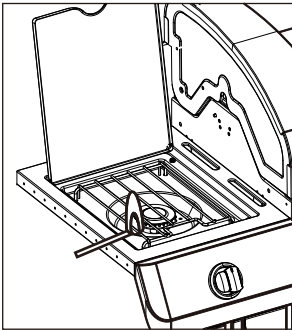

Burner Flame Check

- Remove cooking grates and heat tents. Light burners, rotate knobs from **HIGH** to **LOW**. You should see a smaller flame in **LOW** position than seen on **HIGH**. Perform burner flame check on side burner, also. Always check flame prior to each use. If only low flame is seen refer to "Sudden drop or low flame" in the *Troubleshooting* Section.

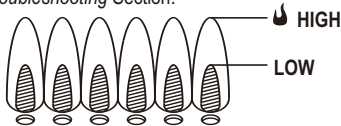

Turning Grill Off

- Turn all knobs to the **OFF** position. Turn LP cylinder **OFF** by turning hand-wheel clockwise to a full stop.

Ignitor Check

- Turn gas off at LP cylinder. Press and hold electronic ignitor button. "Click" should be heard and spark seen each time in each collector box or between burner and electrode. See *"Troubleshooting"* if no click or spark.

Valve Check

- **Important: Make sure gas is off at LP cylinder before checking valves.** Knobs lock in **OFF** position. To check valves, first push in knobs and release, knobs should spring back. If knobs do not spring back, replace valve assembly before using grill. Turn knobs to **LOW** position then turn back to **OFF** position. Valves should turn smoothly.

Hose Check

- Before each use, check to see if hoses are cut or worn or kinked. Replace damaged hoses before using grill. Use only valve/hose/regulator specified by manufacturer.



SPIDER ALERT! SPIDER AND WEBS INSIDE BURNER



If your grill is getting hard to light or the flame is weak, check and clean the venturis and burners.

Spiders or small insects are known to create "flashback" problems by building nests and laying eggs in the barbecue's venturi or burner, obstructing the flow of gas. The back-up gas can ignite behind the control panel. This flashback can damage your barbecue and cause injury. To prevent flashbacks and ensure good performance the burner and venturi tube assembly should be removed and cleaned whenever the barbecue has been idle for an extended period of time.

General Grill Cleaning

- Do not mistake brown or black accumulation of grease and smoke for paint. Interiors of gas grills are not painted at the factory (**and should never be painted**). Apply a strong solution of detergent and water or use a grill cleaner with scrub brush on insides of grill lid and bottom. Rinse and allow to completely air dry. **Do not apply a caustic grill/oven cleaner to painted surfaces.**
- **Plastic parts:** Wash with warm soapy water and wipe dry.
 - Do not use citrisol, abrasive cleaners, degreasers or a concentrated grill cleaner on plastic parts. Damage to and failure of parts can result.
- **Porcelain surfaces:** Because of glass-like composition, most residue can be wiped away with baking soda/water solution or specially formulated cleaner. Use nonabrasive scouring powder for stubborn stains.
- **Painted surfaces:** Wash with mild detergent or nonabrasive cleaner and warm soapy water. Wipe dry with a soft nonabrasive cloth.
- **Stainless steel surfaces:** To maintain your grill's high quality appearance, wash with mild detergent and warm soapy water and wipe dry with a soft cloth after each use. Baked-on grease deposits may require the use of an abrasive plastic cleaning pad. Use only in direction of brushed finish to avoid damage. Do not use abrasive pad on areas with graphics.
- **Cooking surfaces:** If a bristle brush is used to clean any of the grill cooking surfaces, ensure no loose bristles remain on cooking surfaces prior to grilling. It is NOT recommended to clean cooking surfaces while grill is hot.

Storing Your Grill

- Clean cooking grates.
- Store in dry location.
- When LP cylinder is connected to grill, store outdoors in a well-ventilated space and out of reach of children.
- Cover grill if stored outdoors. Choose from a variety of grill covers offered by manufacturers.
- Store grill indoors ONLY if LP cylinder is turned off and disconnected, removed from grill and stored outdoors.
- When removing grill from storage, follow *"Cleaning the Burner Assembly"* instructions before starting grill.

Cleaning the Burner Assembly

Follow these instructions to clean and/or replace parts of burner assembly or if you have trouble igniting grill.

1. Turn gas **OFF** at control knobs and LP cylinder.
2. Remove cooking grates and heat tents.
3. Remove carryover tubes and hardware securing burners.
4. Detach electrode from burner.

NOTE: Removal/Detachment method will depend on the burner configuration. See different configurations in illustrations below.

5. Carefully lift each burner up and away from valve openings.

We suggest three ways to clean the burner tubes. Use the one easiest for you.

- (A) Bend a stiff wire (a light weight coat hanger works well) into a small hook. Run the hook through each burner tube several times.



- (B) Use a narrow bottle brush with a flexible handle (do not use a brass wire brush). Run the brush through each burner tube several times.

- (C) **Wear eye protection:** Use an air hose to force air into the burner tube and out the burner ports. Check each port to make sure air comes out each hole.

6. Wire brush entire outer surface of burner to remove food residue and dirt.

7. Clean any blocked ports with a stiff wire such as an open paper clip.

8. Check burner for damage due to normal wear and corrosion, some holes may become enlarged. If any large cracks or holes are found, replace burner.

VERY IMPORTANT: Burner tubes must reengage valve openings. See illustrations at right.

Correct burner-to-valve engagement

9. Attach electrode to burner.
10. Carefully replace burners.
11. Attach burners to brackets on firebox.
12. Reposition carryover tubes and attach to burners. Replace heat tents and cooking grates.
13. Before cooking again on grill, perform a "Leak Test" and "Burner Flame Check".

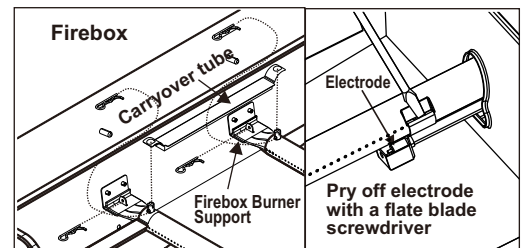
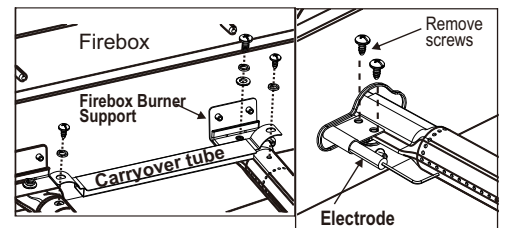

LIMITED WARRANTY

This warranty only applies to units purchased from an authorized retailer. Manufacturer warrants to the **original consumer-purchaser** only that this product shall be free from defects in workmanship and materials after correct assembly and under normal and reasonable home use for the periods indicated below beginning on the date of purchase*. The manufacturer reserves the right to require that defective parts be returned, postage and or freight pre-paid by the consumer for review and examination.

<u>SCOPE OF COVERAGE</u>	<u>PERIOD OF COVERAGE</u>	<u>TYPE OF FAILURE COVERAGE</u>
Stainless Burner	5 years from date of purchase*	PERFORATION, MANUFACTURING, AND MATERIAL DEFECTS ONLY
Firebox and Lid	2 years from date of purchase*	
All Other Parts	1 year from date of purchase*	

*Note: A dated sales receipt WILL be required for warranty service.

The original consumer-purchaser will be responsible for all shipping charges for parts replaced under the terms of this limited warranty.

This limited warranty is applicable in the United States and Canada only, is only available to the original owner of the product and is not transferable. **Manufacturer requires proof of your date of purchase. Therefore, you should retain your sales slip or invoice.** Registering your product is not a substitute for proof of purchase and the manufacturer is not responsible for or required to retain proof of purchase records.

This limited warranty applies to the functionality of the product ONLY and does not cover cosmetic issues such as scratches, dents, corruptions or discoloring by heat, abrasive and chemical cleaners or any tools used in the assembly or installation of the appliance, surface rust, or the discoloration of stainless steel surfaces. Paint is not warranted and will require touch up. **RUST is not considered a manufacturing or materials defect.**

This limited warranty will not reimburse you for the cost of any inconvenience, food, personal injury or property damage.

ITEMS MANUFACTURER WILL NOT PAY FOR:

1. Shipping cost, standard or expedited, for warranty and replacement parts
2. Service calls to your home.
3. Repairs when your product is used for other than normal, single-family household or residential use.
4. Damage, failures, or operating difficulties resulting from accident, alteration, careless handling, misuse, abuse, fire, flood, acts of God, improper installation or maintenance, installation not in accordance with electrical or plumbing codes, or use of products not approved by the manufacturer.
5. Any food loss due to product failures or operating difficulties.
6. Replacement parts or repair labor costs for units operated outside the United States or Canada.
7. Pickup and delivery of your product.
8. Repairs to parts or systems resulting from unauthorized modifications made to the product.
9. The removal and/or reinstallation of your product.

DISCLAIMER OF IMPLIED WARRANTIES and LIMITATION OF REMEDIES

Repair or replacement of defective parts is your exclusive remedy under the terms of this limited warranty. In the event of parts availability issues, the manufacturer reserves the right to substitute like or similar parts that are equally functional.

Manufacturer will not be responsible for any consequential or incidental damages arising from the breach of either this limited warranty or any applicable implied warranty, or for failure or damage resulting from acts of God, improper care and maintenance, grease fire, accident, alteration, replacement of parts by anyone other than Manufacturer, misuse, transportation, commercial use, abuse, hostile environments (inclement weather, acts of nature, animal tampering), improper installation or installation not in accordance with local codes or printed manufacturer instructions.

THIS LIMITED WARRANTY IS THE SOLE EXPRESS WARRANTY GIVEN BY THE MANUFACTURER. NO PRODUCT PERFORMANCE SPECIFICATION OR DESCRIPTION WHEREVER APPEARING IS WARRANTED BY MANUFACTURER EXCEPT TO THE EXTENT SET FORTH IN THIS LIMITED WARRANTY. ANY IMPLIED WARRANTY PROTECTION ARISING UNDER THE LAWS OF ANY STATE, INCLUDING IMPLIED WARRANTY OF MERCHANTABILITY OR FITNESS FOR A PARTICULAR PURPOSE OR USE, IS HEREBY LIMITED IN DURATION TO THE DURATION OF THIS LIMITED WARRANTY.

Neither dealers nor the retail establishment selling this product has any authority to make any additional warranties or to promise remedies in addition to or inconsistent with those stated above. Manufacturer's **maximum liability**, in any event, shall not exceed the purchase price of the product paid by the original consumer.

NOTE: Some states do not allow an exclusion or limitation of incidental or consequential damages, so some of the above limitations or exclusions may not apply to you. This limited warranty gives you specific legal rights as set forth herein. You may also have other rights which vary from state to state. In the state of California only, if refinishing or replacement of the product is not commercially practicable, the retailer selling this product or the Manufacturer will refund the purchase price paid for the product, less the amount directly attributable to use by the original consumer-purchaser prior to discovery of the nonconformity. In addition, in the state of California only, you may take the product to the retail establishment selling this product in order to obtain performance under this limited warranty.