

CAMCO

# RV ACCESSORIES



# About Camco

Camco started in 1966 with one product and one employee. Don Caine and his wife Teresa, his one employee, mixed the antifreeze by hand in a 55 gallon drum with a big two by four plank. Lots of hard work, love and dedication have made Camco into the business it is today. Competitive pricing, superior service, quality products and customer satisfaction are the foundations upon which Camco operates.

Camco has always held a commitment to its employees and its country. It boasts over 1,000 employees and six separate manufacturing facilities in the United States, where it creates and assembles many of its 4,000+ products. By working with inventors, entrepreneurs and small businesses, Camco has been able to bring and keep products in the market. Camco takes pride in meeting the ever changing demands of a challenging marketplace while maintaining its strong reputation of quality products and customer satisfaction.

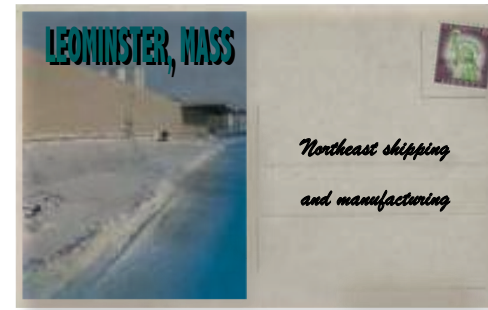
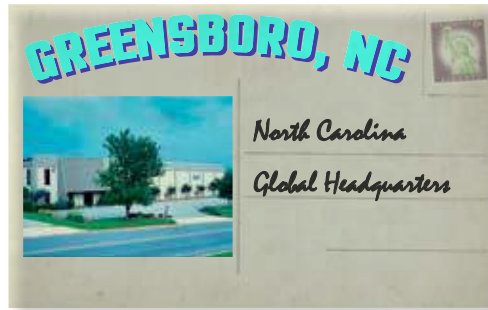

- 02** New Products
- 20** Awning & Outdoor
- 56** Camping
- 76** Grills & Accessories
- 82** RV Covers
- 88** Housewares
- 106** Hardware
- 116** LP Gas
- 126** Appliances
- 136** Winterizing
- 142** Fresh Water
- 154** Sanitation
- 180** Cleaning & Care
- 186** RV Towing
- 206** Leveling & Stabilization
- 218** Electrical
- 236** Index
- 242** Numeric Index
- 256** Black Boar ATV/UTV Implements
- 260** Hydro Life Hydroponics Filters



**CAMCO**





New Products

**CURRITUCK TAILGATING COOLERS** Currituck's Premium Coolers feature an ultra-durable design with stainless steel hardware and impact modified polypropylene resin. A consistent wall thickness and freezer-grade seal help allow up to 10 days of ice retention. Included are rope handles with ergonomic grip, (6) tie-down points, (2) bottle openers, and (1) storage tray. Also includes built-in slots for Currituck cup holders, fishing rod holders, dry baskets and divider accessories. Made in the USA.

- 51741 50 qt, Red 186/White
- 51742 50 qt, Red 200/Gray 424
- 51744 50 qt, Green 356/Yellow 107
- 51745 50 qt, Red 200/White
- 51746 50 qt, Orange 1595/Purple 268
- 51747 50 qt, Orange 151/White
- 51751 30 qt, Red 186/White
- 51752 30 qt, Red 200/Gray 424
- 51754 30 qt, Green 356/Yellow 107
- 51755 30 qt, Red 200/White
- 51756 30 qt, Orange 1595/Purple 268
- 51757 30 qt, Orange 151/White



**CURRITUCK COOLERS** Currituck's Premium Coolers feature an ultra-durable design with stainless steel hardware and impact modified polypropylene resin. A consistent wall thickness and freezer-grade seal help allow up to 10 days of ice retention. Included are rope handles with ergonomic grip, (6) tie-down points, (2) bottle openers, and (1) storage tray. Also includes built-in slots for Currituck cup holders, fishing rod holders, dry baskets and divider accessories. Made in the USA.

- 51705 50 qt, Raspberry/White
- 51715 30 qt, Raspberry/White



**CURRITUCK STAINLESS STEEL THREADED TUMBLER** Currituck Insulated Twist Top Tumblers offer superior heat and ice retention. They feature double-wall vacuum insulation and are constructed of durable, kitchen-grade 18/8 stainless steel. A BPA-free lid attachment locks into place for a longer period of heat retention and a no-spill experience. A BPA-free lid with sealing gasket further helps prevent temperature loss.

- 53073 30 oz, Black
- 53074 30 oz, Raspberry
- 53075 30 oz, Orange
- 53076 30 oz, Seafoam
- 53077 30 oz, Stainless Steel
- 53078 20 oz, Black
- 53079 20 oz, Raspberry
- 53080 20 oz, Orange
- 53081 20 oz, Seafoam
- 53082 20 oz, Stainless Steel



**SUPERIOR**  
  
**ICE RETENTION**



All prices listed are manufacturer's suggested retail

## CURRITUCK STAINLESS STEEL BOTTLES AND FOOD CONTAINERS

Currituck Stainless Steel Bottles and Food Containers feature double-wall, copper-lined vacuum insulation that maintains hot or cold temperatures for hours on end. They are constructed of durable, kitchen grade 18/8 stainless steel that won't impart a metal taste in your beverages. A BPA-free lid with sealing gasket further helps prevent temperature loss.

- 51985** Bottle, 36 oz, Wide Mouth, Stainless Steel
- 51986** Bottle, 24 oz, Wide Mouth, Stainless Steel
- 51987** Bottle, 20 oz, Stan. Mouth, Stainless Steel
- 51988** Bottle, 12 oz, Stan. Mouth, Stainless Steel
- 51957** Food Container, 12 oz, Stainless Steel
- 51989** Food Container, 18 oz, Stainless Steel



**OUTDOOR MAT, 9' X 12'** The Camco Outdoor Mat is perfect for putting by your RV, campsite or patio. It features a double-sided reversible pattern made from resilient material that is mold and mildew-resistant. Simple to clean and lightweight to carry, the outdoor mat requires little maintenance and folds easily for storage. Measures 9' x 12'.

- 42864** Stripe, Dark Green/Light Green/White
- 42865** Stripe, Dark Blue/Light Blue/White
- 42866** Zig Zag/Diamond, Blue/Blue/White

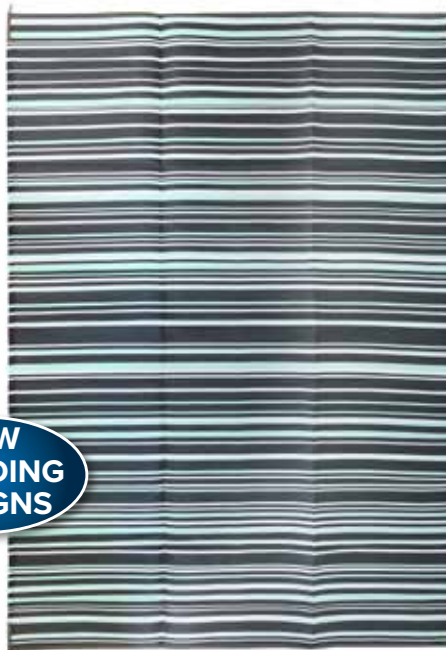

**NEW TRENDING DESIGNS**



**HANDY MAT W/ STRAP** The Camco Handy Mat is perfect to take with you wherever you go. It's great for picnics, beaches, RVing and outings. Includes built-in handles and convenient pockets on both sides to accommodate personal items. Features a reversible blue, white and yellow striped pattern. Folds out to 9' x 12' and folds to a compact 19" x 17 5/8" for easy storage. Made of durable, UV-stabilized polypropylene that is mold and mildew-resistant. Easily cleans with soap and water. Weighs 6 lb.

- 42816** 9' x 12', Blue/Green Asym.
- 42817** 9' x 12', Lt. Blue/Orange/Navy Asym.



**COOLER CART KIT** Camco's Cooler Cart kit allows you to roll your cooler, rather than having to carry it. The cart fits different sized hard coolers with widths of up to 17.5" (adjusts approximately 15.5"–17.5"). Its large, 12" wheels provide easy toting over different terrain and the cart comes equipped with a powder-coated steel frame on zinc-plated steel axles and polyester straps.

**51798** Cooler Cart Kit



**ADIRONDACK TABLES** This lightweight, easy to set-up and easy to store Adirondack table creates a convenient table top in any situation. It's a perfect addition to your campsite, patio, pool or home. Use it as a side table for drinks, snacks and keys, as a footrest or as extra countertop space.

**51680** Small, Aqua, Canada Item

**51681** Small, Green, Canada Item

**51682** Small, Gray, Canada Item

**51683** Small, Navy, Canada Item

**51684** Small, Red, Canada Item

**51685** Small, White, Canada Item

**51690** Large, Aqua, Canada Item

**51691** Large, Green, Canada Item

**51692** Large, Gray, Canada Item

**51693** Large, Navy, Canada Item

**51694** Large, Red, Canada Item

**51695** Large, White, Canada Item



**OUTDOOR GLOBE LIGHTS** The Outdoor Globe Light Set makes any outdoor setting more festive. These durable, weather resistant lights are perfect for your RV awning or patio. The light assemblies have integrated RV awning track hangers and also include S-hooks for hanging.

**42740** 6 Globe, White Cord, Multicolor

**42741** 6 Globe, White Cord, Bronze

**42742** 6 Globe, White Cord, Clear

**42743** 6 Globe, White Cord, Patriotic

**42744** 6 Globe, White Cord, White

**42750** 10 Globe, White Cord, Multicolor

**42751** 10 Globe, White Cord, Bronze

**42752** 10 Globe, White Cord, Clear

**42753** 10 Globe, White Cord, Patriotic

**42754** 10 Globe, White Cord, White

**42760** 6 Globe, Black Cord, Multicolor

**42761** 6 Globe, Black Cord, Bronze

**42762** 6 Globe, Black Cord, Clear

**42763** 6 Globe, Black Cord, Patriotic

**42764** 6 Globe, Black Cord, White

**42770** 10 Globe, Black Cord, Multicolor

**42771** 10 Globe, Black Cord, Bronze

**42772** 10 Globe, Black Cord, Clear

**42773** 10 Globe, Black Cord, Patriotic

**42774** 10 Globe, Black Cord, White



**6 & 10 GLOBE AVAILABLE**

**LED compatible**





## AWNING CLIP FOR ROPE

**LIGHTS** Camco's RV Awning Rope Light Clips allow you to accessorize your RV with rope lights wherever you go. Slide the clips into your awning track to display up to 2 rope lights at a time. With two hook sizes, the clips can be used for awning support and hanging rope lights. Patented.

**42708** Awning Clip for Rope Lights, Canada Item



## PORTABLE FOLDING

**ARMCHAIR** Camco's Portable Folding Armchair is perfect for stadium bleachers, benches, outdoor concerts, picnics, camping, the beach, etc. Its fold flat design and adjustable backpack straps make it convenient to carry on your back. It includes a convenient large zippered rear storage compartment. Integrated armrests provide additional comfort and can be inverted to increase the seat width to 20".

**53095** Portable Folding Armchair, Blue

**53096** Portable Folding Armchair, Red



**FLYING INSECT SCREEN** Wasps, mud daubers and rodents pose a serious threat to the refrigerator vents on your RV. Camco's Flying Insect RV Refrigerator Screen (Model RS 900) fits Dometic/Atwood RV refrigerators, which have 19 3/8" long louver openings. These screens will help ensure that your vents stay free from costly pest invasions.

**42157** Flying Insect Screen, RS 900



**LED ROPE LIGHTS** Outline your awning, windows, doorways, or campsite for a more spirited camping atmosphere. Camco's LED Rope Lights are the perfect festive addition to your RV or campsite. The Rope Lights are clear with alternating blue and white lights for a crisp, clean glow. The 16' long strand has a slim diameter of 6 mm with narrow, capped ends to fit seamlessly inside most RV's awning roller bar channel.

**53094** Blue/White, 16', Canada Item

**53100** White, 16', Canada Item



## LIFE IS BETTER AT THE CAMPSITE

**WRAPPING PAPER** Camco's Life is Better at the Campsite Wrapping Paper comes in a 3pk and are RV-themed for the camping enthusiast. The white-colored roll is thick enough to not show items with colorful packaging. Their multiple patterns make them great to wrap presents for the holidays as well as other special occasions.

**53239** LIBATC Wrapping Paper, 3pk

**3 PACK**



## LIFE IS BETTER AT THE CAMPSITE

**TOTE BAG** The Camco Life Is Better at the Campsite Tote is a stylish addition to your trip. Use it for carrying groceries, hauling gear or as an everyday bag. It has durable, double-stitched handles, a zippered interior pocket, a fully lined interior and a magnetic closure. Measures 16.25" x 18".

**53268** LIBATC Tote Bag, Sunrise on Beige

**53269** LIBATC Tote Bag, RV Sketch Pattern on Teal



**LIFE IS BETTER  
at the  
CAMPSITE®**

**LIFE IS BETTER AT THE CAMPSITE SHIRTS**

Show off your love of the campsite in style, everywhere you go! These shirts provide softer comfort and a non-restrictive fit.



**PATRIOTIC PRINT, CHARCOAL** Made from 50% cotton and 50% polyester. 3/4" rib knit collar for better wear and durability. Taped neck and shoulder seams for comfort and fit retention.

- 53272** Patriotic Print, Charcoal, S
- 53273** Patriotic Print, Charcoal, M
- 53274** Patriotic Print, Charcoal, L
- 53275** Patriotic Print, Charcoal, XL
- 53276** Patriotic Print, Charcoal, XXL

**SUNRISE SKETCH PRINT, TERRACOTTA V-NECK** This V-neck shirt is made from 100% ringspun cotton. Twill taped neck and shoulder seams for comfort and fit retention.

- 53277** Sunrise Sketch Print, Terracotta V-Neck, S
- 53278** Sunrise Sketch Print, Terracotta V-Neck, M
- 53279** Sunrise Sketch Print, Terracotta V-Neck, L
- 53280** Sunrise Sketch Print, Terracotta V-Neck, XL
- 53281** Sunrise Sketch Print, Terracotta V-Neck, XXL

**TRAILER PRINT, SLATE BLUE** Made from 100% pre-shrunk cotton. 3/4" rib knit collar for better wear and durability. Taped neck and shoulder seams for comfort and fit retention

- 53282** Trailer Print, Slate Blue, S
- 53283** Trailer Print, Slate Blue, M
- 53284** Trailer Print, Slate Blue, L
- 53285** Trailer Print, Slate Blue, XL
- 53286** Trailer Print, Slate Blue, XXL

**AMERICAN FLAG CAMPER, ATHLETIC GRAY** Made from 60% combed ring-spun cotton and 40% polyester. Features soft CVC jersey fabric and a crew neck. Side seamed.

- 53330** American Flag Camper, Athletic Gray, S
- 53331** American Flag Camper, Athletic Gray, M
- 53332** American Flag Camper, Athletic Gray, L
- 53333** American Flag Camper, Athletic Gray, XL
- 53334** American Flag Camper, Athletic Gray, XXL

**PALM TREE, ICE BLUE** Made from 60% combed ring-spun cotton and 40% polyester. Features soft CVC jersey fabric and a crew neck. Side seamed.

- 53335** Palm Tree, Ice Blue, S
- 53336** Palm Tree, Ice Blue, M
- 53337** Palm Tree, Ice Blue, L
- 53338** Palm Tree, Ice Blue, XL
- 53339** Palm Tree, Ice Blue, XXL

**GRAFFITI RV, OLIVE** Made from 60% combed ring-spun cotton and 40% polyester. Features soft CVC jersey fabric and a crew neck. Side seamed.

- 53340** Graffiti RV, Olive, S
- 53341** Graffiti RV, Olive, M
- 53342** Graffiti RV, Olive, L
- 53343** Graffiti RV, Olive, XL
- 53344** Graffiti RV, Olive, XXL



**NEW  
DESIGNS  
& COLORS**



## LIFE IS BETTER AT THE CAMPSITE SUNGLASS STRAPS

Camco's Life is Better at the Campsite Sunglass Straps secure your sunglasses to your face or nest around your neck, preventing you from losing your sunglasses. It features a unique RV camping-themed design and is made out of soft, durable neoprene material. Measures 16" long.

**53242** LIBATC Sunglass Straps, Navy RV Pattern

**53243** LIBATC Sunglass Straps, Teal Teardrop



## LIFE IS BETTER AT THE CAMPSITE LICENSE PLATE

Camco's Life is Better at the Campsite Novelty Front License Plate allows you to personalize your vehicle. It is perfect for camping and outdoors enthusiasts. The license plate measures a standard 6" x 12".

**53250** LIBATC License Plate, Navy

**53251** LIBATC License Plate, Teal Logo



## LIFE IS BETTER AT THE CAMPSITE SPARE TIRE COVER

Camco's Life is Better at the Campsite Spare Tire Cover is made of durable vinyl. The cover keeps dirt, rain and sun away from your spare tire. An elastic hem provides a snug fit and durable thread ensures weatherproofing at the seams. It includes a vibrant, printed RV camping design that resists fading.

**53290** LIBATC Spare Tire Cover, 27", Sunrise 2-Color

**53291** LIBATC Spare Tire Cover, 29", Sunrise 2-Color

**53292** LIBATC Spare Tire Cover, 27", Sketch 3-Color

**53293** LIBATC Spare Tire Cover, 29", Sketch 3-Color



## LIFE IS BETTER AT THE CAMPSITE ENAMEL PINS

Camco's Life is Better at the Campsite Enamel Pins are decorative and great for RV enthusiasts. The pins are the perfect accessory to put on your clothing, backpack, purse, hat and more. Made out of durable zinc die cast and coated in enamel.

**53261** LIBATC Enamel Pin, Red Teardrop Heart

**53262** LIBATC Enamel Pin, GoOutsiding Trees

**53263** LIBATC Enamel Pin, Navy RV Heart

**53264** LIBATC Enamel Pin, Sleeping Bag

**53265** LIBATC Enamel Pin, Sunrise



## LIFE IS BETTER AT THE CAMPSITE KEYCHAIN

Camco's Life is Better at the Campsite Keychain is decorative and great for RV enthusiasts. The keychain is the perfect accessory for your keys. Made out of durable zinc die cast and coated in enamel.

**53287** LIBATC Keychain, Red Teardrop Heart

**53288** LIBATC Keychain, Navy RV Heart

**53289** LIBATC Keychain, Sunrise



## LIFE IS BETTER AT THE CAMPSITE STICKER

Show your love for RVing with Camco's Life is Better at the Campsite Decal. It is the perfect decoration to personalize your laptop, car, luggage and more. The sticker is made of 3.5 mil white vinyl and includes protective UV-coating so that it lasts a long time.

**53252** LIBATC Sticker, RV Destination

**53253** LIBATC Sticker, Red Seal

**53254** LIBATC Sticker, Multi-Color Sunrise

**53255** LIBATC Sticker, Teal Teardrop



## LIFE IS BETTER AT THE CAMPSITE FLYING DISC

Camco's Life is Better at the Campsite Flying Disc makes any disc game fun and exhilarating. RV-themed, it is made out of durable polypropylene, which makes it easy to catch and throw accurately. The flying disc weighs 173 grams and is for outdoor use only.

**53256** LIBATC Flying Disc, Navy



## LIFE IS BETTER AT THE CAMPSITE HANDY MAT

This Handy Mat is perfect to take with you wherever you go and can comfortably seat up to four adults. It's ideal for picnics, beaches, RVing and outings. Includes built-in handles and convenient pockets on both sides to accommodate personal items. Features a reversible RV-pattern print. Folds out to 60" x 78" and folds to a compact 10.5" x 15".

**53266** LIBATC Handy Mat, 60" x 78"



**LIFE IS BETTER AT THE CAMPSITE**

**CAN HOLDERS** Camco's Life is Better at the Campsite Can Holder is perfect for RV enthusiasts. It keeps your drink cold while keeping your hand warm and free of condensation. The sleeve is made of soft, resilient neoprene that is easy to grip. For 12 oz cans.

- 53247 LIBATC Can Holder, Navy and Yellow Seal
- 53248 LIBATC Can Holder, Burgundy Sunrise
- 53249 LIBATC Can Holder, Teal Logo



**LIFE IS BETTER AT THE CAMPSITE WATER BOTTLES**

Stay hydrated on the go with Camco's Life is Better at the Campsite Water Bottle. It's perfect for outdoor activities, traveling and sports. The water bottle body is made of safe and durable Tritan™, a BPA-free plastic. The screw on lid, made of resilient polypropylene, features a silicone gasket that prevents leakage. Holds 32 oz/1,000 ml.

- 53270 LIBATC Water Bottle, Opaque Teal
- 53271 LIBATC Water Bottle, Opaque Red



**LIFE IS BETTER AT THE CAMPSITE**

**APRON** Camco's Life is Better at the Campsite Apron is perfect for RV enthusiasts. It protects clothing, making it great for baking, cooking and grilling. One size-fits all and is made of 100% cotton. Machine washable.

- 53257 LIBATC Apron, RV Multi-Patterned
- 53258 LIBATC Apron, Teal



**LIFE IS BETTER AT THE CAMPSITE OVEN MITT AND POT HOLDER**

Camco's Life is Better at the Campsite Oven Mitt and Pot Holder are heat resistant to protect your hands from hot foods, making them great for handling food from the oven, microwave or campfire. Ideal for RV enthusiasts, the mitt and pot holder feature a decorative RV camping-themed design. They are made out of 100% cotton.

- 53259 RV Multi-Color Oven Mitt w/ Red Pot Holder
- 53260 Red Oven Mitt w/ RV Multi-Color Pot Holder



**LIFE IS BETTER AT THE CAMPSITE**

**DINNERWARE SET** The Life is Better at the Campsite Dishware Set comes in a set of 12: (4) large dinner plates, (4) small salad plates and (4) bowls. The durable dinnerware set is virtually unbreakable and is great for boats, RVs, and camping. Each piece is easy to clean and is top rack dishwasher safe, and BPA free. Do not use in the microwave.

- 53294 12pc Set, RV/Tree Pattern
- 53295 12pc Set, Multi RV Pattern



**BPA FREE**

**CABINET MOUNT TRASH CAN** Camco's RV Cabinet Mount Trash Can is perfect for tight spaces in an RV. The trash can features a swing-top lid and measures 13" tall x 8.5" wide. It mounts inside your cabinet to help save space and stay in place while traveling. Easy to install, it can be screwed directly to your cabinet or wall or be mounted with a durable, double-sided adhesive. Installation hardware and double-sided adhesive are included.

**43962** 5 qt, Canada Item



**MOUNTABLE SPICE RACK** Camco's Spice Rack provides the perfect location to store your spice bottles. It can be mounted to the wall or inside your cabinet and measures 13" (W) x 3 1/2" (D) x 3 1/2" (H). Made of durable wood construction, it features an oak-look. All mounting hardware is included.

**53099** Spice Rack, Mountable



**PRO-TEC RV COVER MINI** Protect your investment with Camco's Pro-Tec Mini Travel Trailer Cover. The cover's sides, front and back are made of three-layer non-woven polypropylene, while the top is a three-layer material made of DuPont Tyvek and non-woven polypropylene. Not only are these materials extremely durable, they are also breathable, water resistant and offer UV protection. A zipper entry door provides easy access during covered storage. Covered air vents help stop trapped moisture and mold. The air vents also help keep the unit cooler as well as prevent the cover from billowing in high winds. To fit your RV properly, the front and rear cinching straps reduce loose fabric and an underbelly strap system further secures the cover.

**56370** Up to 13'7"

**56371** Up to 16'2"

**56372** Up to 17'7", Front Door

**56373** Up to 17'7", Rear Door

## SUCTION CUP UTENSIL

**HOLDER** Keep your kitchen utensils from moving around on your RV's or boat's counter during travel with Camco's Mechanical Suction Cup Utensil Holder. It's specifically designed for compact spaces and is perfect for RVs and boats. The utensil holder suction cups tightly with a mechanical suction cup design, securing your kitchen utensils while your RV or boat is in motion. Patent pending.

**43816** Suction Cup Utensil Holder, Gray



## LIFE IS BETTER AT THE CAMPSITE RV BAMBOO CUTTING BOARD

Camco's Life is Better at the Campsite RV Shaped Bamboo Cutting Board is made of durable, premium quality bamboo construction. It is perfect for cutting vegetables, fruits, meats and cheese and its RV-shaped design also makes for a great decorating accessory for your kitchen. Measures 17.25" (H) x 10.10" (W) with a usable surface space of 12" (H) x 7.25" (W)

**53089** LIBATC RV Bamboo Cutting Board



**ICE CUBE TRAYS** Camco's Water Bottle Ice Cube Trays make whiskey cubes, tubed and cubed-shaped ice cubes, designed to fit inside different bottle styles. Each tray makes 16, which can be easily removed. Comes in a pack of two and are made in the USA.

**44101** Water Bottle/Multi-Size, Canada Item



## LIFE IS BETTER AT THE CAMPSITE PET BOWL

Camco's Life is Better at the Campsite Pet Bowl is the perfect accessory for your pet. It's stylish RV camping-themed design will look great in your home, RV or while you are out camping. The durable, ceramic bowl holds up to 3 cups of food or water. Measures 6" Dia. x 3" H. Multi-colored pattern.

**53237** LIBATC Pet Bowl, Teal

**53238** LIBATC Pet Bowl, RV Design



**PRO-TEC RV COVERS** Sun, rain, sleet and snow can damage your RV's exterior. Protect your investment with Camco's Pro-Tec Premium RV Cover. The cover's sides, front and back are made of three-layer non-woven polypropylene, while the top is a three-layer material made of non-woven polypropylene and DuPont Tyvek. These materials are extremely durable, breathable, water-resistant and offer UV protection.

- 56300** Pro-Tec RV Cover, Class A, 25'–28'
- 56302** Pro-Tec RV Cover, Class A, 28'–31'
- 56304** Pro-Tec RV Cover, Class A, 31'–34'
- 56306** Pro-Tec RV Cover, Class A, 34'–37'
- 56308** Pro-Tec RV Cover, Class A, 37'–40'
- 56310** Pro-Tec RV Cover, Class A, 40'–43'
- 56312** Pro-Tec RV Cover, Class C, 20'–23'
- 56314** Pro-Tec RV Cover, Class C, 23'–26'
- 56316** Pro-Tec RV Cover, Class C, 26'–29'
- 56318** Pro-Tec RV Cover, Class C, 29'–32'6"
- 56320** Pro-Tec RV Cover, Travel Trailer, Up to 15'
- 56322** Pro-Tec RV Cover, Travel Trailer, 15'–18'
- 56324** Pro-Tec RV Cover, Travel Trailer, 18'–20'
- 56326** Pro-Tec RV Cover, Travel Trailer, 20'–22'
- 56328** Pro-Tec RV Cover, Travel Trailer, 22'–24'
- 56330** Pro-Tec RV Cover, Travel Trailer, 24'–26'
- 56332** Pro-Tec RV Cover, Travel Trailer, 26'–28'6"
- 56334** Pro-Tec RV Cover, Travel Trailer, 28'6"–31'6"
- 56336** Pro-Tec RV Cover, Travel Trailer, 31'6"–34'
- 56338** Pro-Tec RV Cover, Travel Trailer, 34'–37'
- 56340** Pro-Tec RV Cover, Fifth Wheel, Up to 23'
- 56342** Pro-Tec RV Cover, Fifth Wheel, 23'–25'6"
- 56344** Pro-Tec RV Cover, Fifth Wheel, 25'6"–28'
- 56346** Pro-Tec RV Cover, Fifth Wheel, 28'–31'
- 56348** Pro-Tec RV Cover, Fifth Wheel, 31'–34'
- 56350** Pro-Tec RV Cover, Fifth Wheel, 34'–37'
- 56352** Pro-Tec RV Cover, Fifth Wheel, 37'–40'
- 56354** Pro-Tec RV Cover, Fifth Wheel, 40'–44'
- 56356** Pro-Tec RV Cover, Toy Hauler, Up to 20'
- 56358** Pro-Tec RV Cover, Toy Hauler, 20'–24'
- 56360** Pro-Tec RV Cover, Toy Hauler, 24'–28'
- 56362** Pro-Tec RV Cover, Toy Hauler, 28'–30'
- 56364** Pro-Tec RV Cover, Toy Hauler, 30'–33'6"
- 56366** Pro-Tec RV Cover, Toy Hauler, 33'6"–37'
- 56368** Pro-Tec RV Cover, Toy Hauler, 37'–40'



Air vents help keep unit cooler and prevent billowing in high winds

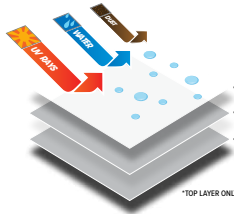

**TYVEK®**

This product uses Dupont™ Tyvek® material.

SPUN BOND POLYPROPYLENE

SPUN BOND POLYPROPYLENE

\*TOP LAYER ONLY



Reinforcement in corners and other high-wear areas for extra durability



Zipper entry doors for easy access during covered storage



Front and rear cinching straps reduce loose fabric for a perfect fit



Underbelly strap system for a tight, secure fit



100% breathable material and covered air vents help prevent trapped moisture and mold

**PRO-TEC**



## GAS LIFT SPRINGS, STAINLESS

**STEEL** Camco's Stainless Steel Gas Springs are ideal for corrosive environments, making them perfect for marine use. Nitrogen charged, it makes lifting and lowering doors and hatches easier and more controllable.

- 53001 7.7" Extended, 5.3" Compressed, 20 lb
- 53002 7.7" Extended, 5.3" Compressed, 40 lb
- 53003 9.8" Extended, 6.3" Compressed, 20 lb
- 53004 9.8" Extended, 6.3" Compressed, 40 lb
- 53005 10" Extended, 6.4" Compressed, 40 lb
- 53006 12.5" Extended, 7.8" Compressed, 30 lb
- 53007 12.6" Extended, 7.7" Compressed, 20 lb
- 53008 12.6" Extended, 7.7" Compressed, 30 lb
- 53009 12.6" Extended, 7.7" Compressed, 50 lb
- 53010 15" Extended, 9.5" Compressed, 10 lb
- 53011 15" Extended, 9.5" Compressed, 20 lb
- 53012 15" Extended, 9.5" Compressed, 25 lb
- 53013 15" Extended, 9.5" Compressed, 30 lb
- 53014 15" Extended, 9.5" Compressed, 40 lb
- 53015 15" Extended, 9.5" Compressed, 60 lb
- 53016 17" Extended, 10.2" Compressed, 20 lb
- 53017 17" Extended, 10.2" Compressed, 30 lb
- 53018 17" Extended, 10.2" Compressed, 35 lb
- 53019 17" Extended, 10.2" Compressed, 40 lb
- 53020 17" Extended, 10.2" Compressed, 60 lb
- 53021 17" Extended, 10.2" Compressed, 90 lb
- 53022 20" Extended, 11.8" Compressed, 20 lb
- 53023 20" Extended, 11.8" Compressed, 30 lb
- 53024 20" Extended, 11.8" Compressed, 40 lb
- 53025 20" Extended, 11.8" Compressed, 60 lb
- 53026 20" Extended, 11.8" Compressed, 80 lb
- 53027 20" Extended, 11.8" Compressed, 90 lb
- 53028 20" Extended, 11.8" Compressed, 120 lb



## GAS LIFT SPRING REPLACEMENT

**SOCKET END** Camco's Gas Lift Spring Replacement Socket End is a replacement part for damaged gas lift springs. Gas lift springs are ideal when lifting and lowering doors and hatches. They are nitrogen charged, providing both control and ease of lift. This replacement part provides female sockets for each end of the gas spring to attach to the ball. Compatible with 10mm diameter balls and M6 threaded shafts.

- 53040 Gas Lift Spring Replacement Socket End



## GAS LIFT SPRINGS, CARBON

**STEEL** Camco's Carbon Steel Gas Springs are ideal when lifting and lowering doors and hatches. They are nitrogen charged, providing both control and ease.

- 53029 17" Extended, 10.2" Compressed, 20 lb
- 53030 17" Extended, 10.2" Compressed, 30 lb
- 53031 17" Extended, 10.2" Compressed, 35 lb
- 53032 17" Extended, 10.2" Compressed, 40 lb
- 53033 17" Extended, 10.2" Compressed, 60 lb
- 53034 20" Extended, 11.8" Compressed, 20 lb
- 53035 20" Extended, 11.8" Compressed, 30 lb
- 53036 20" Extended, 11.8" Compressed, 40 lb
- 53037 20" Extended, 11.8" Compressed, 60 lb
- 53038 20" Extended, 11.8" Compressed, 80 lb
- 53039 20" Extended, 11.8" Compressed, 120 lb
- 53042 13.8" Extended, 8.3" Compressed, 25 lb
- 53044 20" Extended, 11.8" Compressed, 45 lb
- 53045 20" Extended, 11.8" Compressed, 90 lb
- 53046 17" Extended, 10.2" Compressed, 80 lb
- 53047 36" Extended, 19.6" Compressed, 40 lb



## GAS LIFT SPRING 90° MOUNTING CONNECTOR

Camco's Gas Lift Spring 90° RV Mounting Brackets connect each end of your gas lift spring: one to the door/hatch; the other to the fixed surface. Gas lift springs are nitrogen charged, making lifting and lowering doors and hatches easier and more controllable. These brackets are for 90-degree angle mounting and are compatible with 10mm ball sockets.

- 53041 90° Mounting Connector



## GAS LIFT SPRING FLAT MOUNTING CONNECTOR

Camco's Gas Lift Spring Flat RV Mounting Brackets connect each end of your gas lift spring: one to the door/hatch; the other to the fixed surface. Gas lift springs are nitrogen charged, making lifting and lowering doors and hatches easier and more controllable. These brackets are for flat surface mounting and are compatible with 10mm ball sockets.

- 53043 Flat Mounting Connector



## VACUUM BREAKER ASSEMBLY

Camco's Vacuum Breaker Assembly provides protection against pollutants or contaminants from entering the potable water supply due to backsiphonage. Made out of a strong, durable thermoplastic polymer, it has 1/2" NPT male threads on both the inlet and outlet. Has a maximum pressure of 125 PSI and is listed to ASSE 1001 and IAPMO TS8.

- 40395 Vacuum Breaker Assembly, Bagged



## TASTEPURE MALE-TO-MALE DRINKING WATER HOSE COUPLING

Camco's TastePURE Male-to-Male Drinking Water Hose Coupling is a fitting that allows the connection between two female water hose couplings by converting any garden hose female thread to a male thread. It is compatible with any standard garden hose and garden hose equipment. The coupling is made of nickel-plated, low lead brass and is drinking water safe.

- 22705 Male-to-Male, Bulk



## STRAIGHT, BRASS WATER HOSE VALVE

Camco's Straight, Brass Water Hose Valve has a solid brass housing with non-corrosive stainless-steel quarter-turn shut-off valves. It features easy-grip valve handles and hose connection.

- 20223 Straight, Brass Water Hose Valve, Canada Item



**COILED HOSE AND SPRAY NOZZLE KIT**

Camco's Coiled Hose and Spray Nozzle Kit is a complete wash kit that is ideal for marine use, general cleaning, car washing and daily gardening. The coiled hose features a strain relief to help prevent kinking. Included in the kit is an adjustable spray tip nozzle with thumb lever for flow control as well as a quick connect fitting.

**41980** Coiled Hose and Spray Nozzle Kit, 20'

**41982** Coiled Hose and Spray Nozzle Kit, 40'



**INCLUDES STORAGE BAG**

**HAND LEVER SPRAY NOZZLE**

Camco's Hand Lever Spray Nozzle features an easy-to-use hand lever that lets you turn the nozzle on or off with ease. With an adjustable spray pattern, the water flows from a light shower to a powerful jet. Soft rubber comfort grip for a relaxed hold. Fits any standard water hose.

**41987** Coil Hose, Nozzle, Hand Lever



**THUMB LEVER SPRAY NOZZLE**

Camco's Thumb Lever Spray Nozzle features an easy-to-use thumb control knob that lets you adjust the nozzle's spray pattern with ease. Soft rubber comfort grip for a relaxed hold. Spray adjusts from a light shower to a powerful jet. Fits any standard water hose.

**41986** Coil Hose, Nozzle, Thumb Lever



**COILED HOSE** Camco's Coiled Hose is ideal for marine use, as well as general cleaning, car washing and daily gardening. It features a strain relief to help prevent kinking. Brass hose fittings are both durable and rust resistant. The hose self-coils for easy storage.

**41983** Coiled Hose, 20'

**41985** Coiled Hose, 40'



**EASY STORAGE**

**TST MAX DROP-INS**

Camco's TST Drop-Ins help control unwanted odors and break down waste and tissue in your black water holding tank. These Drop-Ins contain surfactant oils that trap unwanted odors in your tank, making your camping experience more enjoyable. They do not contain formaldehyde, pesticides or biocides and are safe for all septic tanks.

**41553** Drop-Ins, Lavender, 30/bucket

**41577** Drop-Ins, Lemon, 30/bucket

**41604** Drop-Ins, Hibiscus Breeze, 30/bucket



**NEW SCENTS IN 30 PACKS**

**PRO-TEC CLEANER FOR RV TPO ROOFS**

Pro-Tec RV TPO Roof Cleaner is specially formulated to deep clean dirt and grime from your RV's TPO roof. Its professional strength formula is a blend of surfactants and conditioners. One application is all that is needed to remove black streaks and road film build up to help extend the life of your TPO roof.

**41069** Pro-Tec TPO Roof Cleaner, 1 gal



**TRAVEL TOILET REPLACEMENT LID & SEAT**

The Camco Travel Toilet Replacement Lid and Seat is a replacement part for Camco Travel Toilets 41535, 41544, and 41545. Travel toilets are perfect for camping, hunting and other remote activities. The replacement lid and seat are elongated in shape for additional comfort. It has a smooth finish for easy cleaning. Lid and seat are made of durable ABS.

**41536** Toilet Seat & Lid, Replacement



**TOILET SEAT W/ LID AND BAGS FOR 5 GAL BUCKET**

Camco's Bucket Toilet Seat transforms most standard 5 gal buckets into a portable toilet. Easy to attach, the seat snaps securely onto the rim of your bucket. Perfect for camping, hunting and other remote activities. Camco's Toilet Bucket Bags maintain the cleanliness of your bucket toilet and feature an absorbent gel that converts liquids to solids for easy disposal. 3 bucket bags per pack.

**41546** Toilet Seat w/ Lid & 3 Bags for 5 gal Bucket

**41547** Toilet Bags for 5 gal Bucket, 3pk



**REPLACEMENT CAP FOR TRAVEL TOILET**

Camco's Travel Toilet Replacement Cap is a replacement part for Camco's portable toilets. The cap is compatible with both Camco's 2.6 gal Portable Toilet (41531) and Camco's 5.3 gal Portable Toilet (41541).

**41532** Replacement Fill Cap for Travel Toilet

**41533** Replacement Dump Cap for Travel Toilet





## WASTE VALVE EXTENSION ROD KIT

The Camco RV Waste Valve Extension Rod Kit is essential to make sure your RV sanitation system is working properly. The kit extends the handle of your waste valve an additional 6" to 8" or 9" to 11". Compatible with all Camco Waste Valves and other standard waste gate valves. Includes a UV-stabilized handle and mounting bracket.

**39509** 6"-8" & 9"-11", Canada Item



## 3" RV WASTE VALVE W/ FLEXIBLE 72" CABLE EXTENSION KIT

Camco's 3" RV Waste Valve with Flexible 72" Cable Extension Kit is essential to make sure your RV sanitation system is working properly. The extension kit makes it easier to grasp hard to reach valve handles by extending the handle of your waste valve to a more accessible location.

**39519** Waste Valve w/ Flex. Cable Ext. Kit, Bi.



## WASTE VALVE W/ METAL HANDLE

The Camco Waste Valve w/ Metal Handle is essential to make sure your RV sanitation system is working properly. The Waste Valve w/ Metal Handle is the ideal valve replacement for your RV's grey water tank. Includes valve body, metal handle, 4 nuts and 4 bolts.

**39501** 1 1/2", Canada Item

**39511** 3", Canada Item



## REPLACEMENT WASTE VALVE HANDLE

The Camco Replacement Waste Valve Handle is essential to make sure your RV sanitation system is working properly. It works with your RV's black and grey water tank valves. Compatible with any 1 1/2" or 3" gate valves. Can be used with 1/4" thread waste valve tubes and easily attaches to the valve rod.

**39507** Replacement Metal Waste Valve Handle

**39508** Replacement Plastic Waste Valve Handle



## RHINOEXTREME FLEXIBLE 3-IN-1 SEWER HOSE SEAL & HANDLE

The Rhino Sewer Hose Adapter Flexible Drain is designed to connect your RV sewer hose to sewer drains with hard-to-reach angles. The 3-in-1 flexible seal is easy to push in and can fit in 3", 3 1/2" or 4" inlets. Includes a pre-assembled Rhino Extreme hose with a 360-degree swivel bayonet fitting, a 3-in-1 seal adapter and a pull handle. Patent pending.

**39319** Flexible 3-in-1 Sewer Hose Seal and Handle



**SEAL KIT** The Camco Replacement Seal Kit is essential to make sure your RV sanitation system is working properly. This seal kit provides 2 replacement valve seals (one for each side of your waste valve) and hardware for waste valves. Made out of flexible rubber to create a tight seal to prevent leaks.

**39500** Seal Kit, 1 1/2", Canada Item

**39510** Seal Kit, 3", Canada Item



## TOILET FLUSH VALVE PROP

The Camco Toilet Flush Valve Prop easily installs around the body of your RV waste tank rinser and props open the toilet waste valve while you clean. It makes it easier to clean the waste tank without having to hold down on a foot pedal, and also helps prevent damage to the waste valve.

**40075** Toilet Flush Valve Prop, Canada Item



**VENTED WASTE VALVE CAP** Camco's Vented RV Waste Valve Cap is essential to make sure your RV sanitation system is working properly. It helps keep your RV waste tanks dry and odor-free during storage. Great for winterization or when your RV isn't in frequent use. Fits 3" gate valves and is comprised of one molded piece with a gasket. Fits with the storage of sewer hoses inside a 4" square bumper.

**39934** Vented Waste Valve Cap, Canada Item



**REVOLUTION 360 WYE** Camco's Revolution Wye RV Sewer Fitting allows two sewer hoses with lug fittings to be connected to the same dump station—perfect for RVs with tandem holding tanks. It has built-in gaskets for odor tight connections. All three ends swivel 360 degrees for ease of use. Patented.

**39629** Revolution 360 Wye



**MAGNETIC BUMPER CAP W/ 4-IN-1 STORAGE** Camco's Magnetic Bumper Cap for 4-in-1 Adapter allows you to store your 4-in-1 adapter onto your RV's bumper. The base stays securely in place using high-strength neodymium magnets, allowing you to transport your 4-in-1 adapter externally. While in storage, the vented cap provides your 4-in-1 adapter with air flow, helping reduce the build-up of moisture and mold. Patent pending.

**40335** Magnetic Bumper Cap w/ 4-in-1 Storage

# MAG-CAP



## RHINO BUMPER MOUNT TOTE

**TANK HOLDER** The Rhino Bumper Mount Tote Tank Holder securely holds your Rhino Tote Tank onto standard RV bumpers and fits both 4" and 4 1/2" bumpers. It's perfect for RVs without ladders. Holds all four Rhino Tote Tank sizes (15, 21, 28 and 36 gal) and is also compatible with most portable waste holding tanks on the market.

**39010** Bumper Mount Tote Tank Holder



**RV SLIDE OUT INDICATOR** Park with confidence with Camco's AccuPark RV Slide-out Indicator. The provided suction cup with rod attaches securely to the side of your RV. Simply trim the indicator length of the rod to match the size of your slide-out and you'll park with confidence every time. Features 44" of slide-out clearance with a highly visible orange flag. Patent pending.

**42205** RV Slide Out Indicator



**RV STEERING WHEEL CHECK BANDS** Camco's RV Steering Wheel Check Bands help remind you to perform various RV tasks before you travel to prevent avoidable damage to your rig. Simply snap the band onto the wheel to remember a specific task and remove when it's completed. The pack includes (9) steering wheel check bands (7 pre-labeled and 2 blank).

**53098** RV Steering Wheel Check Bands



**EAZ-LIFT KINGPIN COLLAR LOCK**

**LOCK** Eaz-Lift's Kingpin Collar Lock helps avoid RV theft by preventing your kingpin from connecting to a trailer hitch while it's in storage. The collar lock fits over standard 2" kingpins and is easy to install and lock. It is made out of durable, zinc-plated steel to ensure your RV's maximum protection. Padlock and keys are included.

**48856** Eaz-Lift Kingpin Collar Lock



**EAZ-LIFT SCISSOR JACK DRILL ATTACHMENT**

The Eaz-Lift Scissor Jack Drill Attachments aid in raising and lowering your RV's scissor jacks. They are compatible only with manual scissor jacks and are made of durable, zinc-plated construction. These 8" attachments fit all 3/8" drills and are quick and easy to use.

**48861** 3/4" Hex Jack Socket Extension

**48862** Slotted Jack Drive Extension



**EAZ-LIFT LOCKING HITCH PIN**

The Eaz-Lift Trailer Locking Hitch Pin locks your hitch to prevent theft. It is compatible with Class I & II hitches. Made of durable zinc-plated steel, the locking hitch pin features a weather-resistant cap that protects the keyhole from dirt and moisture. Includes 2 keys.

**48477** 1/2"

**48478** 5/8"



**EAZ-LIFT FORGED, EXTRA HI-LOW SHANK**

Camco's Eaz-Lift Shank is designed to provide excellent towing and smooth adjustability. It allows you to modify the vertical height of your ball mount. Designed to fit a 2.5" x 2.5" receiver and has an effective length of 12" with a drop of 5.75" and a rise of 8.75". Rated for 15,000 lb.

**48652** Shank, 5.75" Drop, 8.75" Rise



**R3/R6 HITCH BALL W/ SPACER**

The R3/R6 Ball Kit provides a 2" ball that is compatible with both the R3 and R6 hitches. It includes (1) 2" hitch ball, (1) spacer (to be used on the R3), (1) lock washer and (1) nut. The hitch ball is made of steel and has a tow rating of 8,000 lb. Features a 7.5" length shank with a 1 1/4" diameter.

**48780** 2" dia., 7.5" Shank w/ R3 Spacer, 8000 lb Rating



**EAZ-LIFT HITCH BALL**

The Eaz-Lift Hitch Ball allows for easy installation and can be used with any standard ball mount. Made of resilient chrome-plated 1045 steel, you can ensure that the RV or boat you have in tow is hitched with maximum safety and strength.

**48222** 2" x 1" x 2 1/8", 5000 lb Rating

**48223** 2" x 3/4" x 2 1/8", 3500 lb Rating

**48224** 2 5/16" x 1" x 2 1/8", 7500 lb Rating

**48226** 2" x 1 1/4" x 2 1/2", 8000 lb Rating



**EAZ-LIFT BUMPER MOUNT SPARE TIRE CARRIER**

Camco's Eaz-Lift Bumper Mount Spare Tire Carrier easily mounts to your RV bumper to create an exterior spare tire location. It fits 4" RV bumpers that are hinged, so it doesn't limit access to your storage areas. Compatible with the following wheels: 4 lug x 4", 5 lug x 4.5" and 5 lug x 4.75".

**48476** Bumper Mount Spare Tire Carrier, Canada Item



**BLACK BOAR ATV SNOW PLOW POLYMER WEAR BLADE**

Camco's Black Boar Replacement Polymer ATV Snow Plow Wear Blade replaces your original hardened steel wear blade in order to prevent damaging your concrete driveway or street. Made of a heavy-duty, high-density polyethylene that can withstand incimate weather conditions. It's compatible with Camco's Black Boar Snow Plow (66016) and is designed for ATV use only.

**66028** Polymer Wear Blade, Canada Item



**BLACK BOAR ATV WINDSHIELD**

Camco's Black Boar ATV Windshield deflects wind, rain, mud, rocks and insects as you ride through all different terrain. Easy to install, it mounts directly to your handlebars. With a wrap-around design, your hands will be protected from anything in your path. Made of durable, clear acrylic plastic for optimum visibility. Includes all hardware.

**66031** ATV Windshield



**DOUBLE SUPER WHEEL CHOCK W/ ROPE** Camco's RV Double Super Wheel Chock with Rope is designed to keep your trailer in place and allows you to re-hitch with confidence. Two Super Wheel Chocks are connected by a rope with handle, which makes removing the chocks from the wheel safe and easy. Fits tires up to 29". Made in the USA.

**44477** Double Super Wheel Chock w/ Rope, Bulk



**SUPER TRI-LEVELER** Camco's RV Super Tri-Leveler is designed to raise your RV up 2", 3.5" or 5" on any tire for a more level position. The tri-leveler helps your RV's appliances and tanks to operate more efficiently. It has a load capacity of 10,000 lb and is easy to use. Includes a built-in handle for easy carrying. Patent pending.

**44575** Super Tri-Leveler, Yellow

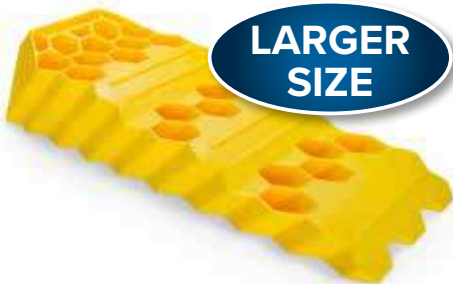

**RECESSED MOTORCYCLE WHEEL CHOCK** Camco's Recessed Motorcycle Wheel Chock helps keep your motorcycle secured upright during transit and is designed for trailers with 16" cross member spacing. It accommodates most tire sizes with widths of up to 6.25" and is constructed of durable, powder-coated steel. Includes all mounting hardware. Measures 17.5" x 9.75" x 2" deep. Must be used with straps (not included).

**66101** Recessed Motorcycle Wheel Chock



**DOUBLE END-TO-END BATTERY BOX** Camco's Double Battery Box safely stores automotive, RV and marine batteries. Made of heavy-duty, corrosion-resistant polypropylene, it holds (2) 6V Group GC2 batteries or (2) 12V Group 24/24M batteries. The box's inner dimensions measure 21.5-inches (L) x 7.4-inches (W) x 11.2-inches (H). Includes (2) straps and (4) strap clamps with screws. The Double Battery Box meets U.S. Coast Guard CFR 183.420 and ABYC E-10.7 specifications when used with (2) 6V Group GC2 batteries.

**55374** Double End-to-End



**CAMPFIRE NIGHTLIGHT** Bring a piece of camping indoors with Camco's Campfire Nightlight. This nightlight makes a fun room décor accent that will brighten any room with its warm, soft glow. Its 120V LED bulb is energy efficient and is controlled by an on/off switch. Features a 360-degree swivel base. For indoor use only.

**53087** Campfire Nightlight, Canada Item



**RV UTILITY COIL BAG** Camco's RV Equipment Storage Bag compactly stores your fresh water drinking hose, grey water hose or electrical cords. It comes with 3 convenient identification tags for organization—1 fresh water tag, 1 electrical tag and 1 sanitation tag. The bag measures 16" in diameter x 10" tall and features a lined interior with breathable mesh top as well as a barrel lock clasp on a draw cord.

**53097** RV Utility Coil Bag



**PREMIUM RV STORAGE BAG**

The Camco All-Purpose RV Storage Bag securely holds RV equipment, such as items for stabilization, electrical and more. Made of heavy-duty material, the bag includes a padded interior, (1) internal zippered compartment, (2) inside pockets and an exterior double zipper. Measures 25.5" (W) x 12" (H) x 13" (D) and is easy to carry with (2) top carrying handles.

**53246** Premium RV Storage Bag



**CAMCO**



-  **BLACK**
-  **BLUE**
-  **BROWN**
-  **GRAY**





# Awning & Outdoor

**CURRITUCK COOLERS** The Currituck Cooler offers superior ice retention up to 10 days, ultra-durable design with stainless steel hardware, FDA-compliant impact modified polypropylene resin and silicone freezer seal. It features rope handle with ergonomic grip, reversible feet that slide or stay put, built-in bottle opener, lockable, leak proof drain plug that is designed to connect to a garden hose to divert draining water. The Currituck Cooler offers six points for secure tie down that keep the cooler firmly in place while allowing access to cooler interior. Designed and made in the US.

- 51700 50 qt, White/Gray
- 51710 30 qt, White/Gray
- 51701 50 qt, White/Cyan
- 51711 30 qt, White/Cyan
- 51702 50 qt, Cyan/Gray
- 51712 30 qt, Cyan/Gray
- 51703 50 qt, Gray/Magenta
- 51713 30 qt, Gray/Magenta
- 51704 50 qt, Olive/Orange
- 51714 30 qt, Olive/Orange



**CURRITUCK SOFT SIDED COOLER**

The Currituck Soft-Sided Cooler is a lightweight option when you need to keep things chilled on the go. The closed cell foam insulation provides all day cold without all the bulk. Sealing zipper prevents spills and allows for better loading and access to cooler contents. The Soft-Sided Cooler has three different carrying options: the handle grips on each side, the tote straps in the middle, and a long shoulder strap that is removable when you don't want it. The rugged, waterproof shell is constructed of PU coated 840D nylon material. Reinforced with double-stitching for strength and durability.

- 51913 33 qt
- 51984 22 qt



**CURRITUCK COOLER DRY BASKET**

The Currituck Cooler Dry Basket helps keep items that need to stay cold but dry in your cooler away from ice and will easily hang.

- 51796 30 qt
- 51797 50 qt



**CURRITUCK COOLER DIVIDERS**

The Currituck Cooler Divider creates a barrier between two sides of the cooler. It easily slides into one of three sets of interior grooves to stay in place. They are durable and UV-resistant.

- 51792 30 qt
- 51793 50 qt



**CURRITUCK ROD HOLDER**

The Currituck Cooler Fishing Rod Holder Attachment creates a convenient spot to place your fishing rod. It can easily attach to the tie-down slot on the side of your Currituck Cooler. It is durable and UV-resistant.

- 51790 Rod Holder



**CURRITUCK COLD PACKS** Currituck Cold Packs fit into your Currituck Cooler to help keep food and beverages cold without the use of ice and thus increasing the room for use. The casing is ultra-durable and features an open core design. The Cold Packs engage adjacent packs and all sizes fit together, so you can piece together as many packs as you need for your application.

- 51978 Small (6 1/4" x 5 3/4")
- 51979 Medium (8" x 5 3/4")
- 51980 Large (8" x 11 1/2")



**SUPERIOR**



**ICE RETENTION**

**CURRITUCK COOLER CUTTING BOARDS**

The Currituck Cooler Cutting Board Attachment attaches easily and is durable. It includes 19" markers to easily measure length.

- 51794 30 qt
- 51795 50 qt



**CURRITUCK CUP HOLDER**

The Currituck Cooler Cup Holder Attachment creates a convenient spot to hold your can, bottle cup or tumbler. It can easily attach to the tie-down slot on the side of your Currituck Cooler and drainage holes prevent water or condensation from pooling in the cup holder. It is durable and UV-resistant.

- 51791 Cup Holder





# CURRITUCK COOLERS

**10** DAYS OF ICE RETENTION  
\*environmental factors may apply

## AVAILABLE ATTACHMENTS

CUP HOLDER



ROD HOLDER



CUTTING BOARD



COOLER DIVIDER



**CAMCO**



# CURRITUCK®

**NOW AVAILABLE!**  
IN A VARIETY OF COLORS

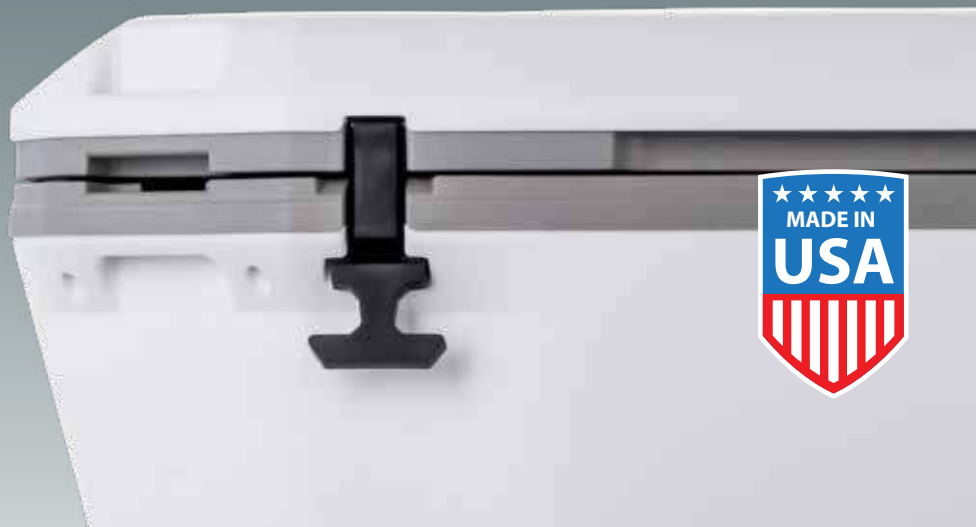



**CURRITUCK TUMBLER** Currituck Tumblers offer superior heat and ice retention. They are constructed of durable, kitchen-grade 18/8 stainless steel and come with a BPA free lid. The double wall vacuum insulation and built-in gasket help prevent heat transfer, meaning your ice stays solid longer and your cup won't sweat. Fits in most cup holders. The lid is dishwasher safe, tumbler should be hand washed.

- 51860 Currituck Tumbler, 12 oz
- 51861 Currituck Tumbler, 20 oz
- 51862 Currituck Tumbler, 30 oz
- 51863 Currituck Can Cooler

**REPLACEMENT SLIDER LIDS**

- 51848 Slider Lid, Currituck, 12 & 20 oz
- 51849 Slider Lid, Currituck, 30 oz

**REPLACEMENT SEALS**

- 51846 Replacement Seal, Currituck, 12 & 20 oz
- 51847 Replacement Seal, Currituck, 30 oz



**Superior Ice Retention**

Currituck Tumblers are made of durable, high quality, kitchen-grade 18/8 stainless steel with vacuum insulation. The layer of vacuum insulation between the walls provides superior ice retention, and ensures that the tumbler won't sweat, no matter how cold your drink and how hot the day. The vacuum insulation is also great for keeping hot drinks hot. These tumbler walls don't let heat out or in, perfectly maintaining the desired temperature of your drink. The Eastman Tritan BPA-free lid has a built-in gasket that helps prevent temperature loss and leaks, and all sizes fit in most standard cup holders.

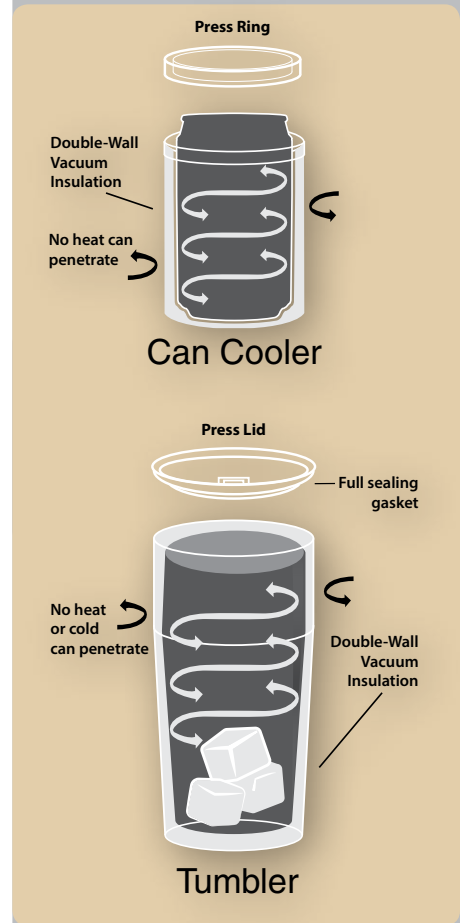

**How it Works**

Currituck Tumbler has a double-wall, vacuum insulated design that creates a vacuum in between two walls of high quality, kitchen grade stainless steel. That vacuum helps prevent heat from getting in or out, meaning that you can keep your drink at the desired temperature- hot or cold- for much longer than standard tumblers or cups. The lid is constructed of Eastman Tritan BPA-free material and has a built-in gasket that helps seal in temperature and prevent leaks from around the edges of your cup.

**CURRITUCK TUMBLER HANDLES**

These colorful handles easily slide onto the bottom of your 20 oz or 30 oz tumbler and creates an ergonomic handle for better grip. The lightweight and durable handle comes in four colors: orange, pink, blue and black.

- 51919 Black Tumbler Handle, 20 oz
- 51920 Pink Tumbler Handle, 20 oz
- 51921 Blue Tumbler Handle, 20 oz
- 51922 Orange Tumbler Handle, 20 oz
- 51923 Black Tumbler Handle, 30 oz
- 51924 Pink Tumbler Handle, 30 oz
- 51925 Blue Tumbler Handle, 30 oz
- 51926 Orange Tumbler Handle, 30 oz
- 51969 Black Tumbler Handle, 12 oz
- 51970 Pink Tumbler Handle, 12 oz
- 51971 Blue Tumbler Handle, 12 oz
- 51972 Orange Tumbler Handle, 12 oz



**ERGONOMIC  
HANDLE  
—  
BETTER GRIP**



# CURRITUCK BOTTLES

DOUBLE-WALL  
VACUUM INSULATED

WIDE MOUTH &  
STANDARD MOUTH

SUPERIOR



ICE RETENTION

SUPERIOR



HEAT RETENTION

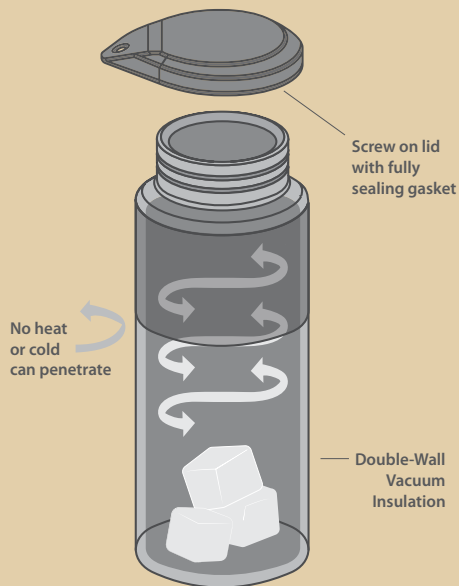

**CAMCO**



# CURRITUCK®



Item#	Description
51943	24 oz, Wide Mouth, Orange
51944	24 oz, Wide Mouth, Raspberry
51945	24 oz, Wide Mouth, Seafoam
51946	24 oz, Wide Mouth, Charcoal
51986	24 oz, Wide Mouth, Stainless Steel
51947	36 oz, Wide Mouth, Orange
51948	36 oz, Wide Mouth, Raspberry
51949	36 oz, Wide Mouth, Seafoam
51950	36 oz, Wide Mouth, Charcoal
51985	36 oz, Wide Mouth, Stainless Steel

Item#	Description
51935	12 oz, Standard Mouth, Orange
51936	12 oz, Standard Mouth, Raspberry
51937	12 oz, Standard Mouth, Seafoam
51938	12 oz, Standard Mouth, Charcoal
51988	12 oz, Standard Mouth, Stainless Steel
51939	20 oz, Standard Mouth, Orange
51940	20 oz, Standard Mouth, Raspberry
51941	20 oz, Standard Mouth, Seafoam
51942	20 oz, Standard Mouth, Charcoal
51987	20 oz, Standard Mouth, Stainless Steel

\* all come in case quantity of 12

**CURRITUCK BOTTLES** Currituck Stainless Steel Bottles feature double-wall, copper-lined vacuum insulation that retains hot or cold temperatures for hours on end. They are constructed of durable, kitchen grade 18/8 stainless steel that won't impart a metal taste in your beverages. A BPA-free lid with sealing gasket further helps prevent temperature loss, and features a loop on the top for straps or carabiners. Gray silicone wrap provides a comfortable, secure grip.



**CURRITUCK BOTTLE, 12 OZ, STANDARD MOUTH**

- 51935 Orange
- 51936 Raspberry
- 51937 Seafoam
- 51938 Charcoal



**CURRITUCK BOTTLE, 20 OZ, STANDARD MOUTH**

- 51939 Orange
- 51940 Raspberry
- 51941 Seafoam
- 51942 Charcoal



**CURRITUCK BOTTLE, 24 OZ, WIDE MOUTH**

- 51943 Orange
- 51944 Raspberry
- 51945 Seafoam
- 51946 Charcoal



**CURRITUCK BOTTLE, 36 OZ, WIDE MOUTH**

- 51947 Orange
- 51948 Raspberry
- 51949 Seafoam
- 51950 Charcoal



See the New Products section for stainless steel bottle prices.

**CURRITUCK FOOD CONTAINER**

Currituck Food Containers feature double-wall, copper-lined vacuum insulation that retains hot or cold temperatures for hours on end. They are constructed of durable, kitchen grade 18/8 stainless steel that won't impart a metal taste in your food or beverages. A BPA-free lid with sealing gasket further helps prevent temperature loss, and the wide mouth design makes cleaning easier. Gray silicone wrap provides a comfortable, secure grip. 12/18 oz.

- 51927 12 oz Orange
- 51928 12 oz Seafoam
- 51929 12 oz Raspberry
- 51930 12 oz Charcoal
- 51931 18 oz Orange
- 51932 18 oz Seafoam
- 51933 18 oz Raspberry
- 51934 18 oz Charcoal



**CURRITUCK GROWLER 64 OZ**

Currituck Growlers feature double-wall, copper-lined vacuum insulation that retains hot or cold temperatures for hours on end. They are constructed of durable, kitchen grade 18/8 stainless steel that won't impart a metal taste in your beverages. A BPA-free lid with sealing gasket further helps prevent temperature loss. 64 oz.

- 51956 Growler



**AWNING ANCHOR KIT** Sturdy strap and springs provide even distribution of tension and make securing your awning easy. Extra holding power of spiral stakes works well in all kinds of soil and makes this unit ideal for use in sandy soil. Perfect for use at the beach. Kit stores compactly and fits all awning sizes.

**42593** Anchor Kit



**AWNING STABILIZER KIT** Secure your awning economically. Spiral stakes work well in all kinds of soil and are ideal for securing in sandy soil. Tension units keep ropes securely taut. Easy-to-use kit stores compactly and fits all awning sizes.

**42563** Stabilizer Kit



**2 PACK**



**RV AWNING HOLD DOWN STRAP KIT** Secure awnings in breezy conditions through evenly distributed tension. Sturdy strap is wrinkle resistant with triangle rings to hold it flat and neat. Fits awnings up to 25'. Includes two steel 15" awning stakes. Once assembled, the unit is easily stored with no danger of lost parts.

**42514** Awning Hold Down Strap Kit



**AWNING STAKE AND AWNING**

**SPRING** 7" spring replaces worn or corroded awning springs or stake frame canopy springs. Sturdy awning stakes secure your awning hold down strap. Made of durable steel. Zinc-plated for corrosion resistance.

**42532** 7" spring

**42522** 15" stake



All prices listed are manufacturer's suggested retail

## POWER HOOK™ AWNING

**TENSIONER** Reduce the noise of flapping fabric without stakes or anchors. Tensioner pulls awning roller taut. Easy installation requires no tools and attaches to all existing awning hardware.

**42013** Power Hook



**DE-FLAPPER™** Protect your RV awning from costly rips and tears while preventing noisy wind flapping. De-Flapper holds securely with hook-and-loop fastener straps. Made of durable nylon with UV stabilizers, chemically resistant and rust proof. Universal fit. Soft, non-marring grippers protect awning fabric. Can be used with screen room in place.

**42061** 2/pack

**42083** 13" replacement straps 2/pack



**DE-FLAPPER™ MAX** This larger version of the original DeFlapper with wider grippers keeps awnings even more stable in wind or rain.

**42251** 2/pack

**42243** Replacement straps 2/pack



**AWNING ARM ANCHOR** Awning arms stay securely on the ground in carport position with Awning Arm Anchors. Holds awning arm in carport position more securely than regular stakes. Rust-resistant zinc-coated steel.

**42021** Awning Arm Anchor

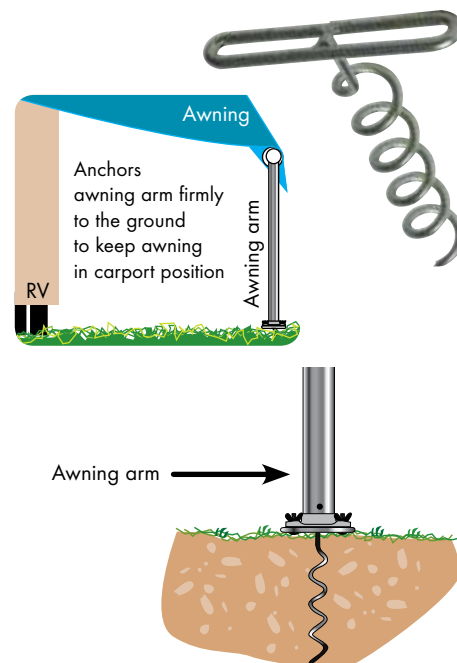

**RV GRAB HANDLE** This handle is a simple, efficient way to make entering and exiting your RV safer. After the one-time, easy installation, the Grab Handle provides a secure hand-hold on the left or right side of your RV door. When not in use, the Grab Handle easily lifts and rotates to lay flat against the side of the RV. The durable aluminum construction with UV resistant plastic brackets is built to last. Replace your old or broken Grab Handle, or install it on an RV that has never had one. All installation hardware is included.

**STANDARD SIZE**

- 42175 Black
- 42176 White
- 42177 Aluminum

**SHORT**

- 42197 Black
- 42198 White



**Black**

**White**

**Aluminum**

**AWNING GUTTER** Helps keep your campsite dry. Easily attaches to awning tube, and adapts to either side of awning. Hose channels water up to 20' away. Adapter included to fit most awning brands.

42010 Awning Gutter



**CHANNELS WATER UP TO 20' AWAY**



**RV AWNING-CLAMP™** This was developed by a team of engineers to overcome the inherent problem of awnings unfurling during travel. By clamping the middle of the awning, you take away the power developed by strong micro-bursts of air and keep your awning securely in place. The adjustable links ensure a perfect fit on any awning. RV Awning-Clamp allows you to travel without worry. Latch and unlatch your awning in seconds using a standard awning wand. Adjustable links for a perfect fit on all awnings. Three RV mounting options: roof, wall or radius mount.

42551 White

42552 White, Canada Item

42556 Black

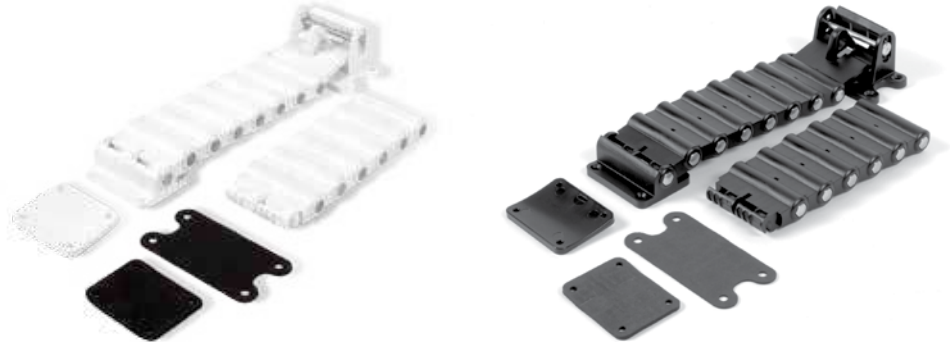

**RV AWNING PULL STRAPS** Open awnings with ease. RV Awning Pull Strap slides into your RV awning's channel and can stay there for storage to have an easy way to roll your awning out or retract every time.

42504 Window Awning Straps, 2pk

42505 Patio Awning Strap



**TELESCOPING RV EASY REACH AWNING OPENER**

Easily extend your awning with this handy tool with an extended length of up to 47". Easy to store: telescopes down to 12". Stainless steel.

42543 RV Awning Opener, 6/ctn

42544 RV Awning Opener, 20/ctn



**AWNING DOOR ROLLER™** Open your door without the worry of damaging your awning. Camco's RV Awning Door Roller mounts directly on your door to protect your awning from wear and tear. Innovative roller-ball design rotates 360° to follow the arch of the door. Includes Screen Door Slider. Patented.

**42005** Awning Roller Ball



**SCREEN DOOR AWNING SAVERS**

Snap the plastic Awning Saver on the corner of the screen door to help prevent ruined awnings. Snaps on quickly and easily without tools.

**42073** 2/pack

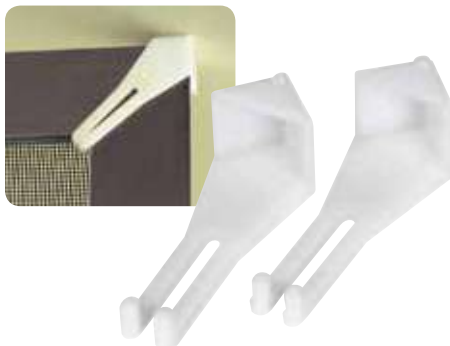

**SCREEN DOOR GRILLES** Sturdy Screen Door Grilles protect your RV screen door. Adds a sturdy feel to your door and saves repairs to screens. Helps prevent children and pets from pushing through screen. Deluxe Grille adjusts from 20"–32"; Standard Grille adjusts from 20"–29". Easy installation, hardware included.

**43991** Deluxe Grille, Aluminum

**43997** Deluxe Grille, White

**43993** Deluxe Grille, Black

**43980** Standard Grille, Aluminum

**Deluxe**



**Standard**



**REPLACEMENT AWNING KNOBS**

Exact replacements for Faulkner, A&E or Carefree awnings.

**42303** Faulkner/A&E, 2/card

**42363** Carefree, 2/card



**Faulkner / A&E**

**Carefree**

**AWNING STRAPS** Replace worn or lost awning straps. For use on awning arms. 12" lengths. Hook and Loop straps with pull-through buckles. Also useful for securing all sorts of items around your RV.

**42503** 2/card



**AWNING LOCKING PINS** A universal fit for Carefree, A&E and Omni brands. Beveled for easy insertion.

**42403** 2/card

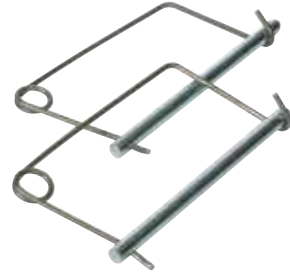

**RV SCREEN DOOR CLOSER KIT**

Keep your screen door shut with the RV Screen Door Closer Kit. Dual spring action pulls door closed with evenly distributed tension. Installs easily on standard (square corner), radius corner (such as Winnebago) or fold-down tent camper doors. Patented.

**44133** Screen Door Closer Kit



## SCREEN DOOR CROSS BAR

**DELUXE** It not only makes your screen door feel sturdier, but it also helps protect your screen from being torn and punctured by providing an easier grip for exiting. Extends 21 5/8" to 28 5/8" to fit most RV screen doors. Also includes a mounting template and all the hardware needed to help with installation. Once installed, it is durable enough to stay in place and truly last. Patented.

**42188** Black

**42189** White

**DELUXE**



**SCREEN DOOR CROSS BAR** Allows for easier exit and protection of your RV screen door. Adds a sturdy feel to your door and saves repairs to screens. Aluminum bar with black or white molded handles. Easy installation, hardware included. Adjusts from 21 1/4" to 28 3/8". Patented.

**42183** Screen Door Cross Bar, Black

**42186** Screen Door Cross Bar, White



**SCREEN DOOR PUSH BAR** Sturdy Push Bar used alone or with a Screen Door Grill allows for easier exit and protection of your RV screen door. Adds a sturdy feel to your door and saves repairs to screens. Helps prevent pushing through screen. Adjusts from 20"–32". Easy installation, hardware included.

**43971** Push Bar, Aluminum

**43976** Push Bar, Black

**43977** Push Bar, White



**SCREEN DOOR HANDLES** For easy access in and out of your screen door, use this top or bottom mounted Screen Door Handle. Designed to fit between the RV door and the screen door. Made of molded plastic. Two-sided tape is provided for attaching to the most convenient location on your door. 2pk.

**45551** White, Limited Quantities



**SCREEN DOOR SLIDE SETS** 12" sets include Slide and Stationary Piece.

- 45581** 12" x 24", Clear
- 45583** 12" x 24", White
- 45591** 12" x 28", Clear



**12" SCREEN DOOR STOPS** Designed to fit Camco 12" Screen Door Slides. A screen door "Stop" is required to block the opening between the slide and door frame. Buy this Stop when purchasing 12" slide or 12" slide set. Not needed on all doors.

- 45542** Clear
- 45543** White
- 45544** Black\*



**SCREEN DOOR SLIDES** Replace your missing or damaged screen door slide.

- 45511** 12" x 11.5", Beige\*
- 45512** 12" x 11.5", Clear
- 45513** 12" x 11.5", White



**SCREEN DOOR OPENER** Install this handy time-saver using just a drill. Now you can open the screen door, keep the slide closed and keep the bugs outside. Just pull up to open the screen door. Patented.

- 43953** Screen Door Opener



## CLAMP-N-CARRY™ CHAIR AND BIKE RACK

Securely hold four or more chairs (depending on chair style) on most standard 1" and 7/8" diameter ladders (adapters included). Glass-filled nylon construction with UV protectants and zinc-plated hardware. Lockable rack won't rust or corrode, and swings out of the way quickly for ladder access. Includes an adjustable strap to stabilize chairs while traveling.

51430 Clamp-N-Carry

**HOLDS 4+ CHAIRS**



**CHAIR AND BIKE RACK** Sturdy vinyl-covered steel construction. Easy to install to create more external storage. Fits all RV ladders and holds up to four folding lawn chairs.

51490 Chair and Bike Rack



**SPIRAL ANCHOR** Secure your pet outside. Works well in all kinds of soil; ideal for securing in sandy areas. Swivel ring helps prevent your pet's chain from becoming wrapped around the stake.

42572 Spiral Anchor



**RV AWNING REPAIR TAPE** Permanent repair for rips and punctures. Aggressive adhesive; resists tearing in any direction. Use for RV awnings, boat sails, canvas, tents, rain wear, backpacks, pool covers and liners, seat covers, auto soft tops, pop-up campers and more.

42613 Awning Repair Tape, 3" x 15'

42623 Awning Repair Tape, 5" x 15'



**NON-SLIP TAPE FOR RV STEPS** Help prevent slips and falls with this self-adhesive tape. Use for added safety on steps, ladders and walkways. Available in black or black/yellow safety stripe. 2" x 15'.

25401 Non-Slip Tape, Black

25405 Non-Slip Tape, Black & Yellow



**RV LADDER MOUNT BIKE RACK**

The Camco RV Ladder Mount Bike Rack easily installs onto standard RV ladders, and holds up to two bikes. The form fit cradles securely hold your bikes, and the straps provide added security. The Bike Rack has soft grip handles and locking pins to keep it in place. Folds for easy storage.

**51492** Bike Rack



**FOLDS FOR EASY STORAGE**



**EAZ-LIFT HITCH MOUNTED BIKE RACK**

The Eaz-Lift Hitch Mounted Bike Rack easily mounts to any 2" hitch receiver and creates storage space for up to four bikes. The rack pivots back after installation to allow better access to the rear of the vehicle, so you won't have to uninstall the rack to get something out of your trunk. Simply release the pivot by removing a locking pin. The base joint on the pivoting rack tightens to help prevent excessive wobbling, and the arms of the rack fully fold down to reduce the effective vehicle length, which helps with backing up and maneuvering your vehicle. The rack also fully folds in the opposite direction. This combined with the folding arms allows you to fold up for compact storage. The Hitch Mounted Bike Rack features reflectors for added visibility, and it is constructed of durable, powder-coated steel. Maximum weight should not exceed 35 lbs per bike.

**51493** Hitch Mount Bike Rack, 4 Bikes

**eaz lift**  
SINCE 1952



**RV WRAP AROUND STEP RUG** For manual or electric RV steps. Adjusts to fit almost any RV step. Just wrap around existing step and hook springs into the holes that fit your step. No screws, glue or tools needed. Helps to keep your RV clean by cutting down on tracked-in dirt. 18" wide.

- 42921** Brown
- 42923** Green
- 42924** Blue
- 42925** Gray

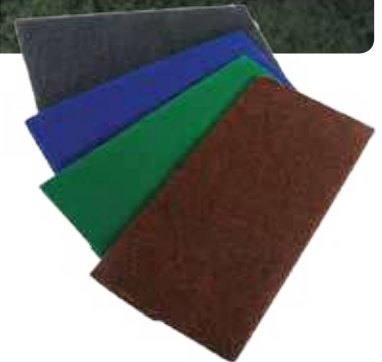

**STEP RUG XL** Designed to fit larger manual or electric RV steps. 23" wide.

- 42935** Gray
- 42931** Brown
- 42933** Green
- 42934** Blue





**Premium Scrub Rug**



**Double Rib**



**Single Rib**



**Artificial Turf**



**Artificial Turf**

## PREMIUM WRAP AROUND RV STEP RUGS

Premium TPE backing helps keep the rug in place. Easy to clean — weather and mildew resistant. Simple installation.

**PREMIUM SCRUB RUG** Traps dirt and debris and won't hold water. Provides a cushioned step.

42962 Black, 17.5" x 18"

42963 Brown, 17.5" x 18"

42964 Gray, 17.5" x 18"

42966 Black, 22" x 23"

42967 Brown, 22" x 23"

42968 Gray, 22" x 23"

**DOUBLE RIB** Design has larger ridges to help keep dirt and debris outside and provide more grip.

42953 Black, 18" x 23"

42954 Blue, 18" x 23"

42955 Brown, 18" x 23"

42956 Gray, 18" x 23"

**SINGLE RIB** Design helps keep dirt and debris outside and provides a non-slip surface.

42904 Black, 17.5" x 18"

42905 Blue, 17.5" x 18"

42906 Brown, 17.5" x 18"

42907 Gray, 17.5" x 18"

42909 Black, 22" x 23"

42910 Blue, 22" x 23"

42911 Brown, 22" x 23"

42912 Gray, 22" x 23"

## ARTIFICIAL TURF

42915 Black, 17.5" x 18"

42916 Blue, 17.5" x 18"

42917 Brown, 17.5" x 18"

42918 Gray, 17.5" x 18"

42936 Black, 22" x 20"

42937 Blue, 22" x 20"

42938 Brown, 22" x 20"

42939 Gray, 22" x 20"

42942 Black, 22" x 23"

42943 Blue, 22" x 23"

42944 Brown, 22" x 23"

42945 Gray, 22" x 23"

## ARTIFICIAL TURF (RADIUS)

Material brushes off debris as you enter your RV or trailer. Accommodates rounded steps.

42947 Black, 22"

42948 Blue, 22"

42949 Brown, 22"

42950 Gray, 22"

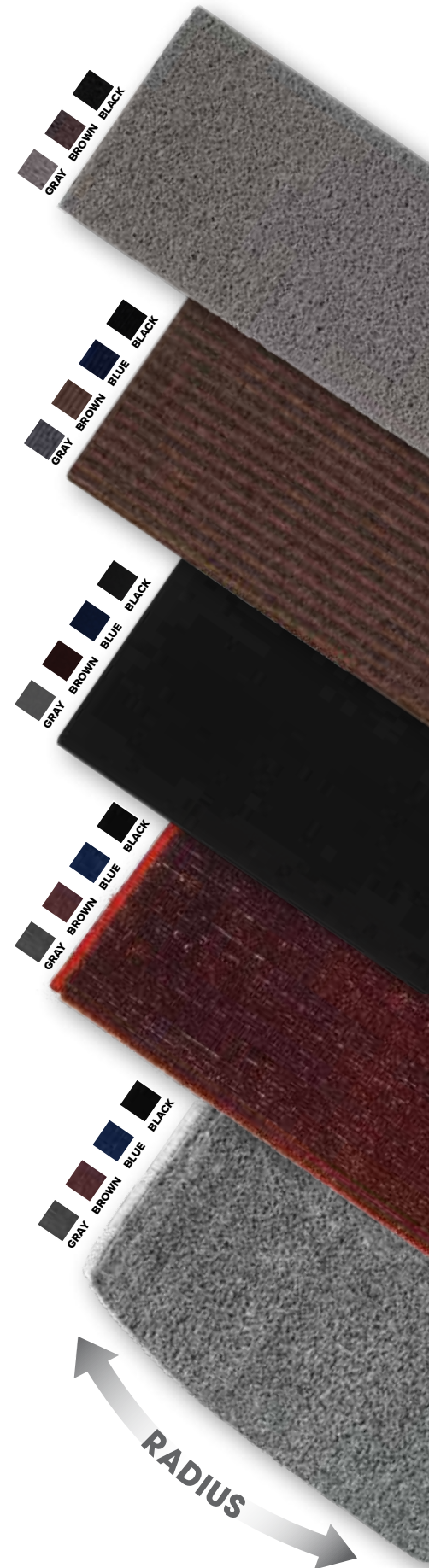

**OPEN AIR™ OUTDOOR MATS** Reversible, lightweight and easy to clean. Mold and mildew resistant; perfect for putting by your RV, at your campsite or on your patio. Four styles, available in green, blue, burgundy or charcoal. Mats fold easily for storage.

- 42870 Green Stripe, 6' x 9'
- 42871 Blue Stripe, 6' x 9'
- 42872 Burgundy Stripe, 6' x 9'
- 42873 Charcoal Stripe, 6' x 9'
- 42850 Green Oriental, 9' x 12'
- 42851 Blue Oriental, 9' x 12'
- 42852 Burgundy Oriental, 9' x 12'
- 42853 Charcoal Oriental, 9' x 12'
- 42830 Green Botanical, 8' x 20'
- 42831 Blue Botanical, 8' x 20'
- 42832 Burgundy Botanical, 8' x 20'
- 42833 Charcoal Botanical, 8' x 20'
- 42840 Green Swirl, 8' x 16'
- 42841 Blue Swirl, 8' x 16'
- 42842 Burgundy Swirl, 8' x 16'
- 42843 Charcoal Swirl, 8' x 16'



6' x 9'

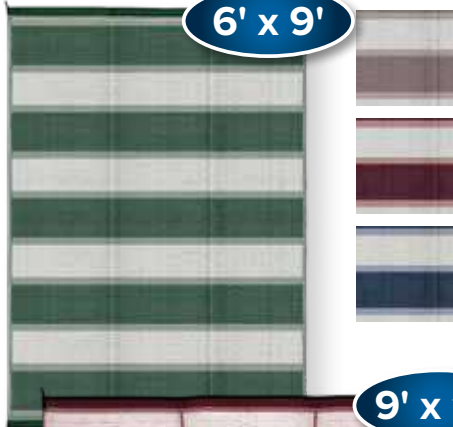

8' x 20'



9' x 12'



8' x 16'





## PATTERNS OPEN AIR™ OUTDOOR

**MATS** Lightweight Open Air Outdoor Mats are now available in eight new patterns.

- 42884 Checkered, 6' x 9'
- 42827 Checkered, 9' x 12'
- 42886 Camouflage, 6' x 9'
- 42825 Camouflage, 9' x 12'
- 42875 Brown/Tan leaf, 6' x 9'
- 42855 Brown/Tan leaf, 9' x 12'
- 42876 Blue Lattice, 6' x 9'
- 42856 Blue Lattice, 9' x 12'
- 42857 Brown/Tan Lattice, 9' x 12'
- 42877 Brown/Tan Lattice, 6' x 9'
- 42878 Blue Chevron, 6' x 9'
- 42858 Blue Chevron, 9' x 12'
- 42879 Green Chevron, 6' x 9'
- 42859 Green Chevron, 9' x 12'
- 42860 Texas Flag, 9' x 12'
- 42861 Football Field Mat, 9' x 12'
- 42862 Football Field Mat, 8' x 16'

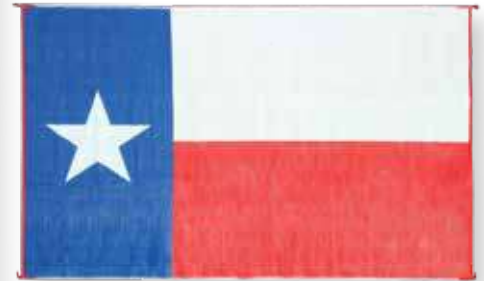
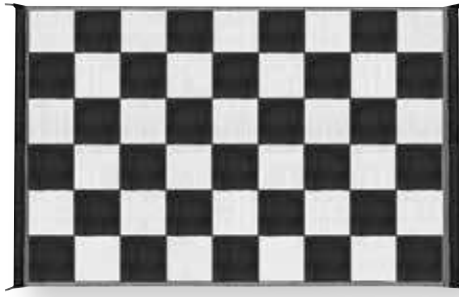

**PREMIUM QUALITY AWNING & LEISURE MAT**

This attractive 7' x 15' mat is made from a heavy-duty woven polymeric material which allows snow and rain to drain through. Reinforced corners with rust resistant grommets provide an easy way to secure it using included ground stakes. Helps keep dirt from being tracked into your RV. Easily cleaned with soap and water. Comes with heavy canvas bag for storage and transport.

- 42811** Brown, 7' x 15'
- 42812** Gray, 7' x 15'



**7' X 15'**



**AWNING MAT** Cleans easily with soap and water. Made of durable, mildew resistant materials, with rust resistant grommets and ground stakes included. Woven design allows snow and rain to drain through mat. Helps keep dirt from being tracked into your RV. Also useful for picnics and beach outings. 6' x 9' or 9' x 12'.

- 42880** Green, 6' x 9'
- 42881** Blue, 6' x 9'
- 42882** Burgundy, 6' x 9'
- 42820** Green, 9' x 12'
- 42821** Blue, 9' x 12'



**AWNING MAT ANCHORS** Keep your awning mat flat with Awning Mat Anchors. Get rid of the rocks that you've been using to keep your awning mat from "bunching up" or blowing away. 4pk of white plastic clips with hold-down nails will keep the awning mat flat on the ground. Low profile molded plastic.

- 45631** Awning Mat Anchors, 4pk



**PICNIC BLANKET** This blanket is easy to carry; it expands to 57" x 57" and folds to 15" x 11" x 4" with hook-and-loop fastener to keep the blanket folded for storage. It features a water-resistant bottom so you stay dry and a soft top for sitting, lounging and relaxing. When you're done, fold it up, secure the flap, and carry it with the handy adjustable shoulder strap. It even has a convenient side pocket for other essentials. Machine washable.

42809 Aqua

42808 Chartreuse

42807 Teal



**ADJUSTABLE  
SHOULDER  
STRAP**



**HANDY MAT** This Handy Mat is perfect to take with you wherever you go. Includes built-in handles and convenient pockets on both sides. Smaller size folds out to 60" x 78" and folds to a compact 10.5" x 15". Larger size folds out to 72" x 108", and folds down to 14.5" x 18". Perfect for picnics, beaches, RVing and outings. Durable polypropylene is weather-proof and mold- and mildew-resistant. UV stabilized for years of use. Easily cleans with soap and water.

**42805** Blue/Green/Yellow/orange, 60" x 78"

**42806** Blue/turquoise/Green, 60" x 78"

**42813** Green/White/Red, 60" x 78"

**42814** Blue/Green, 72" x 108"



**PICNIC BLANKETS** Great for picnics, tailgating, camping or an emergency blanket in your RV or car. Durable waterproof backing with foam cushioning adds comfort and insulation. Folds compactly and hook-and-loop fastener keeps blanket folded for storage. Soft, insulated surface is easy to clean. Acrylic face; expanded PE foam inner liner; PVA back face. 51" x 59".

**42800** Black/Yellow

**42801** Red/White



**ALUMINUM STEP PLATFORMS** With adjustable or fixed-height legs, each stool has a 19" x 14 1/2" platform. Easy to set up; supports up to 1000 pounds. Strong and sturdy construction with non-slip rubber feet. Legs fold for easy storage (storage height: 2 3/4"). Adjustable-leg stool adjusts between 7" and 8 1/2" tall. Fixed-height stool is 8" tall.

**43676** Step Platform, Adjustable Legs

**43677** Step Platform, Fixed Legs



**STEP STOOLS** Small stool supports up to 300 lb. Large stool supports up to 400 lb. Patent Pending. Platform dimensions: Small: 9" x 9 7/8" x 15 7/8", Large: 9 1/4" x 10 7/8" x 17 3/8".

**43460** Stool, Plastic, Small

**43470** Stool, Plastic, Large



**SUPPORTS UP TO 400 LB**

**RV EXTRA STEP** Heavy-duty steel-frame stool. Folding legs lock open to 7" height. Extra-wide 8" x 19" platform with angled legs to provide stability. Non-slip gripper strips on platform. Folds to only 2" wide for storage. Supports up to 300 lb.

**43675** RV Extra Step



**SUPPORTS UP TO 300 LB**

**RV FOLDING STEP STOOL** You'll find dozens of uses inside and outside your RV for this versatile stool. When not in use, it folds up neatly to tuck into a 2" wide space. Opens to a generous 11" x 12.5" x 9" stool that's sturdy enough to support 300 lb.

**43635** RV Folding Step Stool, Silver

**43637** RV Folding Step Stool, Yellow/Black

**43638** RV Folding Step Stool, Tan/Black



**SUPPORTS UP TO 300 LB**



**FOLD-AWAY STEP STOOL** This small, sturdy stool is perfect for all those little jobs around the RV. Opens to 11 1/2" tall. Lightweight aluminum construction. Supports up to 300 lb.

**43672** Folding Stool



**SUPPORTS UP TO 300 LB**

**POP-UP XL CONTAINER** XL Container is ideal for storage, yard work and more. Extra handle at bottom for easy lifting. Includes toggles for a secure close. Heavy duty canvas construction with padded handles and durable liner. Fits 39 gal trash bags. Stands 28" tall and 22" in diameter. Stores 2.5" high.

**42895** Pop-Up XL Container



**POP-UP RECYCLE CONTAINER**

Features three compartments labeled bottles, cans and paper for your convenience. Collapses to 2.5" high with padded handles, durable liner and zipper lid. Includes storage bag and stake.

**42983** Pop-Up Recycle Container



**RV COLLAPSIBLE BUCKETS** The perfect size for RVing, camping, fishing, boating and more. 3 gal (11 L) capacity. Opens easily to 9.25" (23.5 cm) tall and folds to less than 2" (3.5 cm) for compact storage. Zippered storage bag included.

**42993** Bucket, Blue

**42994** Bucket, Camouflage



**POP-UP UTILITY CONTAINER** A sturdy frame for 30 gal bags that can be easily moved around to accommodate needs inside or out. Features a durable liner, padded handles, a lid that zips closed, and a stake to secure it in place against wind, pets and people. Constructed for rugged, heavy duty use, this tear resistant container is lightweight and flexible. Stands 2' tall, and collapses in seconds to store at just 2-1/2" high in its zippered storage bag.

**42893** Pop-Up Utility Container



**MINI POP-UP UTILITY CONTAINER**

Collapses to 2-1/2" high with built-in storage strap. Hook-and-loop tape on base to help hold in place.

**42903** Mini Pop-Up Utility Container



**POP-UP COOLER** Water resistant interior prevents leaks, spills and condensation. Insulated access hatch allows you to retrieve food and beverages while minimizing cold loss. Features a zippered lid, carry handles, and buckle strap to keep flat when not in use. Bottle opener included.

51995 Blue w/ Bottle Opener

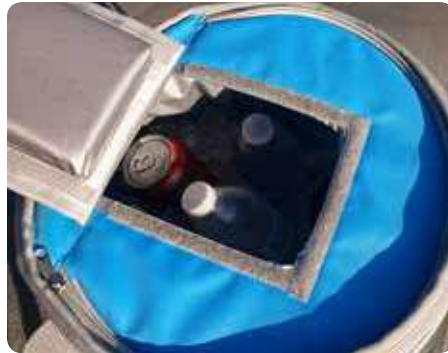

**POP-UP CONTAINERS, 18" X 24"** The Camco Pop-Up Utility Container is a lightweight option that springs open for use and collapses flat for storage, making it a great option for small spaces or traveling. The Utility Container features a durable liner, padded carrying handles, a zipper lid and includes a stake and storage bag. Two tie down loops keep the container flat when not in use. Holds 30 gal trash bags. Measures 24" tall with a 18" diameter when open, and 2.5" tall with a 18" diameter when flat. Red white and blue or RV patterned.

51993 Blue and Red w/ Stars

42986 Life is Better at the Campsite



**FOLDING RAKE** Keep your campsite neat with this full-size compact-able rake. Opens to 60" long with a 22" wide rake end. Folds down to 29" x 8" to easily fit in a storage compartment.

42171 Folding Rake

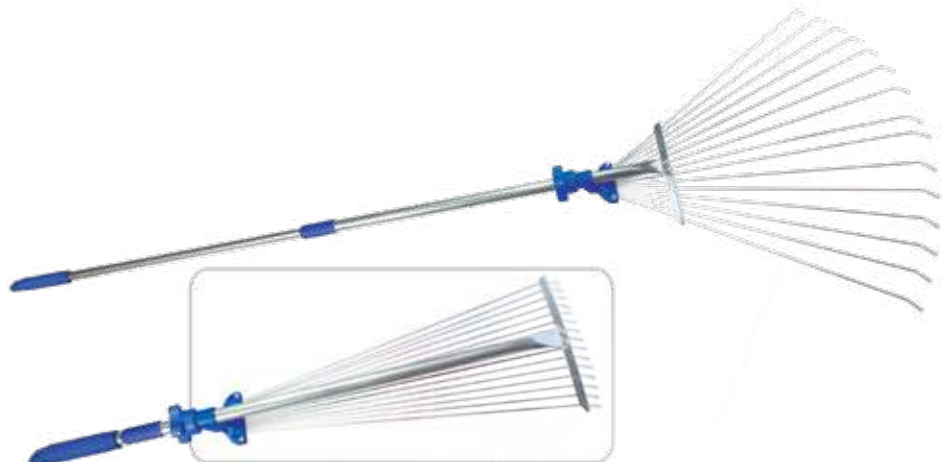

**FITS-ALL™ RV PARTY LIGHT HOLDERS**

Hang party lights, signs, plants and more from your awning roller bar. The Fits-All RV party light holders slide easily into roller bar channel, and each hanger can support up to 15 lb. Each holder has two sizes of channel insets; fits all automatic roll out awning roller bar channels.

**42693** Fits-All RV Party Light Holders, 7pk



**RV PARTY LIGHT HOLDERS** Hang party lights quickly and easily. Strong, flexible vinyl holders slide securely into the awning roller bar channel. Seven 8" plastic lanyards with metal hooks included in each pack to allow party lights to hang below RV awning valance.

**42703** RV Party Light Holders, 7pk



**FABRIC PARTY LIGHT HOLDERS**

Sturdy sewn fabric tabs with grommets slide easily into your roller bar channel to hold lights, wind chimes and more. When storing awning, just remove the hooks; tabs can be left in place. Includes 7 tabs and hooks.

**42733** Fabric Party Light Holders, 7pk



**RV AWNING HANGER CLIPS** Hang lights, flags, banners and more from your RV's awning channel with Camco's Awning Hangers. Our innovative design allows two hangers to clip together giving you even more hanging options. 8 pk. Patented.

**42720** RV Awning Hanger Clips, 8pk



**LANTERN SNAPS** Attach patio lights, screens, canvas or poly film to your awning quickly and easily. Open one end, snap to awning fabric, then snap the other end to the lights, or push the flexible tabs into the awning roller bar channel and attach the snaps to the tabs. Durable metal construction.

**42713** Lantern Snaps, 4pk





**PARTY LIGHTS** Add a festive glow to your outdoor living area with these Party Light sets. Each 8' strand contains 10 lights and a connector for hooking strands together. Includes two spare bulbs and a spare fuse. These 120 V Light Sets with overload protection are UL certified for indoor and outdoor use.

- 42654 Retro Motorhomes
- 42655 Retro Travel Trailer, LED
- 42656 Stars, LED
- 42657 Flags and Ribbons
- 42659 Chili & Cactus
- 42662 Flamingos and Palm Trees



**U.S. FLAG** A fabric, full detail printed flag, mounted on a 1/4" wooden staff with gilded spear. Finished edges. 12" x 18".

**45491** US Flag



**RV SINGLE FLAG HOLDER** For small staffs. Holds on windy days. Installs to any existing screw on your rig. Durable plastic with tapered 2" shaft. 2pk.

**45501** Flag Holders, 2pk, White



**SCREW-IN TRIPLE FLAG HOLDER**

Holds flags with 3/8" or smaller staffs. Durable plastic. Screws are provided for easy installation. 3" x 5".

**45504** Triple Flag Holder, White

**45505** Triple Flag Holder, Black



**SUCTION CUP FLAG HOLDERS** Easy to use; no drilling. Each suction cup holds up to three pounds. When moistened, suction cups stick to any smooth, clean nonporous surface. Remove before traveling. 3-hole style, 3" x 5" holds flags with staffs up to 3/8". ABS plastic.

**45502** 3-Flag Holder, White

**45506** 3-Flag Holder, Black



**HITCH-MOUNT FLAGPOLE HOLDER**

Fits standard 2" hitch receivers. Holds flagpoles up to 2 11/32" in diameter, and includes thumbscrew to hold pole in place. Durable power-coated finish.

**51611** Hitch-Mount Flagpole Holder



**20' TELESCOPING FLAGPOLE WITH CAR-FOOT FLAG HOLDER**

Fly your flag anywhere you park your RV. Rust-proof anodized aluminum pole extends to 20' (6 m) and collapses to 64" (162 cm). Hardware allows you to fly up to two flags at once, or fly a flag at half mast. Both include tire-anchored flag holder, storage bag and bonus 3' x 5' American Flag. 51605 also includes permanent residential mount.

**51600** Flagpole w/ Car Foot

**51605** Flagpole w/ Car Foot & Residential Mount

**51602** Replacement Car Foot



**FIBERGLASS FLAGPOLE** Fly your flag anywhere you park your RV. Unlike aluminum poles, fiberglass flagpoles will not conduct electricity. Extends to 16' (4.8 m) and collapses to 48" (122 cm) for storage. Hardware allows you to fly up to two flags at once, or fly a flag at half mast. Includes a durable tire stand, residential mount and storage bag.

**51606** Fiberglass Flagpole



**TIPSY STIX** Holds a variety of beverages and snacks. Beverage holders lock in two ways for standard size beverages. Bonus snack holder holds bowls and plates. Great for outdoor parties and activities. Patented.

**51463** Tippy Stix



The perfect anytime campfire.

# Little Red CAMPFIRE®



#### Realistic Logs

Natural looking logs for a realistic fire.

#### Self-Storing Carrying Case

Attractive lid with built-in handle and latches for easy transport and storage.

#### Large Burner Ring

Full burner ring allows for even distribution of gas and flame.

#### Heat Resistant Base & Tray

Elevates fire and keeps the base cool.

#### 8' Hose & Adjustable Regulator

Allows easy control of desired fire size up to 65,000 BTUs per hour. For propane use only.

and the new larger size...

# Big Red CAMPFIRE®



## LITTLE AND BIG RED CAMPFIRES

Take your fire with you! Our Portable Campfires are great for campsites with restrictions against in-ground fires. Take it tailgating, or put it on the patio. . . its size is convenient for wherever you need a fire. Realistic log set and full 9 1/2" diameter ring burner help create the natural look and ambiance of from-scratch campfires. Sturdy lid and security latches make it safe and easy to transport. Little Red Campfire includes 8' propane hose and Big Red Campfire includes 10' propane hose for use with standard LP gas cylinders. RV campground approved. Little Red Campfire has a 11 1/4" fire tray diameter and Big Red Campfire has a 13 1/4" fire tray diameter. 65,000 BTU/HR.

- 58031** Little Red Campfire®
- 58032** Little Red Replacement Log set
- 58034** 8' LP Hose w/ Regulator
- 58035** Big Red Campfire®
- 58037** Big Red Replacement Log set
- 58036** 10 ft LP Hose w/ Regulator



## PORTABLE PROPANE CAMPFIRE

Features like an elevated fire tray and heat resistant base make this Portable Campfire perfect for use in campgrounds with fire restrictions; great for residential porch and patio use as well. Large 14 1/2" burner ring allows for even distribution of gas and flame. 8' hose and adjustable regulator allows easy control of desired fire size up to 65,000 BTUs per hour with no ash, no mess and no smoke. Includes two bags of lava rocks. Legs fold completely under to fit into included storage bag.

- 58041** Propane Campfire



**PORTABLE FIRE RING** Safely contain your campfire with Camco's Portable Campfire Ring. The large, 27" wide steel ring will accommodate your natural wood-burning fire. Six-piece hinged design unfolds and assembles easily with no tools required. Tree cut-outs create a captivating ambiance. Folds flat for storage. Includes a zippered bag for easy transportation.

- 51091** Portable Fire Ring



## LITTLE RED AND BIG RED

**CAMPFIRE COOK TOPS** Now you can cook with your Little Red or Big Red Campfire. Unfold the legs of the Campfire Cook Top to create a cooking platform for pots and pans at the perfect height. Legs fold for convenient storage in the included bag.

- 58033** Little Red Campfire Cook Top
- 58038** Big Red Campfire Cook Top



## CAMPFIRE PROPANE ADAPTER

Safely and easily installs to one of Camco's propane connection kits (59103, 59123 or 59143) to use the on-board propane supply to fuel your Campfire. Can also be used to convert any appliance from a Type I ACME to a 1"-20 Throwaway connection for use with a disposable 1 lb bottle of LP gas.

- 59213** Propane Adapter



**TELESCOPING ROASTER** The perfect tool for cooking marshmallows, hot dogs or sausages over an open fire. Stainless steel—Extends up to 34". The roaster is intended for use over an open wood fire.

- 44014** Telescoping Roaster



**ADIRONDACK TABLES** Sturdy molded plastic tables fold for easy transport and storage. Available in taupe, sage, charcoal, and mocha. Folding Side Table: 15 x 12 x 14". Folding Table: 19.5 x 18 x 15".

**SIDE TABLES**

- 51883 Side Table, Taupe
- 51880 Side Table, Sage
- 51881 Side Table, Charcoal
- 51882 Side Table, Mocha

**TABLES**

- 51887 Table, Taupe
- 51884 Table, Sage
- 51885 Table, Charcoal
- 51886 Table, Mocha



**ALUMINUM FOLDING TABLES**

Lightweight materials combined with a durable design. Perfect for RVing, camping, tailgating or out on the porch or patio. Tables set up without tools in seconds and folds to only 2" wide for compact storage. Small table has a 12" x 10" top, opens to 16.5" tall and supports up to 130 lb. Folded dimensions: 18.5" x 12" x 2". Large table has a 19.5" x 19" top, opens to 23.7" tall and supports up to 110 lb. Folded dimensions: 28.25 x 19.5 x 2".

- 51890 Folding Side Table, 12" x 10"
- 51891 Folding Table, 19.5" x 19"



# Adirondack Tables

Weather-resistant; will not rust or rot.

UV-stabilized resin resists fading.

When expanded, top snaps in place for added stability.



Perfect for:

- ✓ the beach
- ✓ picnics
- ✓ RVing
- ✓ camping
- ✓ patio use
- ✓ poolside
- ✓ indoor use



More colors available in the new products section!



**BAMBOO FOLDING TABLE** Adjustable-height table with attractive bamboo top folds flat for easy storage. Convenient carrying handle makes transport easy. Lightweight telescoping aluminum legs have adjustable leveling knobs. Folded size: 23.6" x 18" x 1.63". Tabletop is 34.1" x 23.6". 110 lb load rating.

**51893** Bamboo Folding Table



**BAMBOO COMPACT FOLDING TABLE** Adjustable-height table is great for picnicking, tailgates and camping. Attractive natural bamboo top gives an "at home" feel anywhere you go. Aluminum legs fold flat for transportation, and telescope out to 18" or 25-1/2" when in use. Folds and unfolds in just seconds. Each leg securely clicks into place when fully extended and features an adjustable leveling knob foot. The included storage bag makes it easy to transport and the overall design is lightweight for added portability. Folded dimensions are 26-1/2" L x 4-1/2" W x 6-1/2" H. Supports up to 85 lbs.

**51895** Bamboo Compact Folding Table



**ALUMINUM ROLL-UP TABLE** Lightweight functional design makes this table portable, easy to set-up and break down with storage bag included. Hollow, aluminum slat top attaches easily to cross-support bars and segmented legs. Seats 4-6 people. No tools required. The roll-top feature makes the table and bag compact for easy storage.

**51892** Roll-Up Table w/ Carrying Bag







**ZERO GRAVITY RECLINERS** Stylish and comfortable. The frame is constructed of powder coated steel. The fabric is weather-resistant and UV protected to provide years of use. They feature a dual locking system so that you can stay in the position that is most comfortable for you. These Zero Gravity Recliners also fold to 5" for easy storage and transport.

- 51810 Black Swirl
- 51811 Green Swirl
- 51812 Tan Fern
- 51813 Red Swirl



**ZERO GRAVITY CHAIR** Stretch Cord Repair Kit. Contains four cords.

51809 Stretch Cord Chair Repair Kit



**ZERO GRAVITY WIDE RECLINERS**

The same quality and style as our regular recliners, plus 4" of extra width for added comfort.

51831 Green Swirl



**ZERO GRAVITY CHAIR TRAY** The

Camco Zero Gravity Chair Tray easily attaches to your Zero Gravity Chair to provide a convenient place to set snacks and drinks. It is designed with two cup holders, one of which is compatible with stemmed drinkware such as wine, margarita and martini glasses. The top of the tray is textured, to help prevent items from sliding around, and the drainage holes in each cup holder prevent condensation from pooling under your cold drinks. An integrated hook is great for hanging bags or cameras. The tray is made of lightweight polypropylene and has UV protection to help prevent fading over time.

51834 Chair Tray



CAMCO





**LIFE IS BETTER AT THE CAMPSITE SCRUB MATS** Stylish Life Is Better At The Campsite door mats are great for home, outdoors, under a pet bowl or camping! Use them to help trap dirt and debris to prevent bigger messes. Looped PVC material dries quickly, provides a cushioned step and is easy to clean. Mat comes in blue or gray, measures 29"x17-1/4".

- 53200 Grey/White Scrub Mat
- 53201 Blue/Orange Scrub Mat



**LIFE IS BETTER AT THE CAMPSITE COASTERS** Show off your love for camping whether you're at home or outdoors! Drink coasters help prevent rings and water marks on your furniture. Neoprene, 2pk / Cork coasters, 2pk

- 53228 Cork, Truck & Trailer
- 53229 Cork, Camper
- 53230 Neoprene, Camper
- 53231 Neoprene, RV Design



**LIFE IS BETTER AT THE CAMPSITE MUGS** Drink your coffee or tea from this mug to show your love of the campsite whether you're home or outdoors! These ceramic mugs are microwave and dishwasher safe. 12 oz/16 oz.

- 53232 Teal
- 53233 Gray
- 53234 RV Print
- 53235 Speckled



**LIFE IS BETTER AT THE CAMPSITE WINE TUMBLER SET** Camco's Wine Tumblers are a great addition to any campsite, tailgate or party! These ultra-durable tumblers are made with kitchen grade 18/8 stainless steel and the double walls vacuum insulate your beverage, keeping it hot or cold longer. The tumblers have a flat bottom, so they can be used with or without the colorful stems. The stems can be used to color code drinks, and help keep track of whose drink is whose! The lid is BPA free and has a fully sealing gasket to help maintain beverage temperature and prevent spills. Hand wash only. 2- 8 oz tumblers: green and yellow. 2- 8 oz tumblers: pink and blue.

- 51915 Blue/Pink
- 51916 Green/Yellow



**2 PACK**

**LIFE IS BETTER AT THE CAMPSITE DINNERWARE** The Life is Better at the Campsite Dish Set is white with a multi-color RV and truck design. The durable Dish Set is great for boats, RVs, and camping. The Life is Better at the Campsite Dish Set is easy to clean and is top rack dishwasher safe, and BPA free. Do not use in the microwave.

- 53222 Bowl, RV Pattern
- 53223 Salad Plate, RV Pattern
- 53224 Dinner Plate, RV Pattern
- 53225 Bowl, Trailer/Tree Pattern
- 53226 Salad Plate, Trailer/Tree Pattern
- 53227 Dinner Plate, Trailer/Tree Pattern

**BPA FREE**



Look for new 12pk sets in New Products section!

**LIFE IS BETTER AT THE CAMPSITE PAINTED TUMBLERS** The Life is Better at the Campsite Painted Tumblers offer superior heat and ice retention. They are constructed of durable, kitchen-grade 18/8 stainless steel and come with a BPA free lid. The double wall vacuum insulation and built-in gasket help prevent heat transfer, meaning your ice stays solid longer and your cup won't sweat. Fits in most cup holders.

- 53057 Cool Blue, 20 oz
- 53058 Cool Blue, 30 oz
- 53059 Yellow, 20 oz
- 53060 Yellow, 30 oz
- 53061 Coral Pink, 20 oz
- 53062 Coral Pink, 30 oz
- 53063 Green, 20 oz
- 53064 Green, 30 oz



**DOUBLE WALL VACUUM INSULATED**



**LIFE IS BETTER AT THE CAMPSITE**

**TOTE BAGS** The Camco Life Is Better At The Campsite Tote is a stylish addition to your trip. Use it for carrying groceries, hauling gear or as an everyday bag. It has durable, double-stitched handles, a zippered interior pocket and a magnetic closure.

53202 Logo

53203 RV Design



**LIFE IS BETTER AT THE CAMPSITE**

**HATS** Stylish baseball style hat has an adjustable strap with snap. One size fits most.

53204 Hat, Blue

53205 Hat, Red

53206 Hat, Teal



**ADJUSTABLE STRAP**



**LIFE IS BETTER AT THE CAMPSITE**

**SHIRTS** Show off your love of the campsite in style, everywhere you go! This shirt provides soft comfort and a non-restrictive fit. Rib at neck for better wear and durability.

53207 Shirt, Gray, S

53208 Shirt, Gray, M

53209 Shirt, Gray, L

53210 Shirt, Gray, XL

53211 Shirt, Gray, XXL

53212 Shirt, Navy, S

53213 Shirt, Navy, M

53214 Shirt, Navy, L

53215 Shirt, Navy, XL

53216 Shirt, Navy, XXL

53217 Shirt, Teal, S

53218 Shirt, Teal, M

53219 Shirt, Teal, L

53220 Shirt, Teal, XL

53221 Shirt, Teal, XXL



NEW

LIFE  
is better at the  
CAMPSITE



A lifestyle brand designed and curated by Camco...

**Stylish, comfortable and fun. Show your love for the campsite wherever you go.**

When fun patterns and practical durability meet, products will fly off the shelves.



CAMCO



# T2.6 and T5.3 TRAVEL TOILETS

Durable parts and seals  
Long-term use

Flush nozzle and slick interior surface  
Helps keep the bowl clean

Sturdy construction  
Long-lasting

Easy dumping elbow

Detachable holding tank  
Seals in odors and won't leak



**T 2.6**

41535 2.6 gal



**T 5.3**

41545 5.3 gal

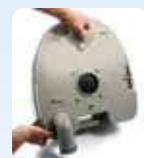

## MORE FEATURES!



**T2.6 AND T5.3 TRAVEL TOILETS** A durable, comfortable option for camping, hunting, road trips and boat trips. Larger seat size and bowl size than most brands. Pump flush action effectively rinses the bowl. Detachable holding tank seals firmly to prevent escaping leaks and odors. The holding tank's slick interior surface makes waste removal easier and more efficient. Remove the flush tank one handed by toggling a single spring-loaded locking latch. Features a latchable lid for easier transport. Lid can be completely removed for cleaning. Made of durable ABS resin.

**41535** Travel Toilet, Canada Item, 2.6 gal

**41545** Travel Toilet, Canada Item, 5.3 gal



**CAMPING TOILET TISSUE** Stay-clean dispenser packs are easy to carry and great for camping. Keep a spare mini-roll or two in the glove compartment for travel. Two rolls per pack; 259 x 4.3" per roll. Biodegradable.

**51358** Camping Toilet Tissue, Canada Item



**PORTABLE TOILETS** For camping, RVing, boating or other recreational activities. Sturdy polyethylene construction is compact and lightweight. The detachable holding tank includes a sealing slide valve to lock in odors and protect against leakage. Two side latches secure the tank to the toilet and a carrying handle makes transport easy. The toilet employs an easy-to-use bellow-type flush and pull slide valve for easy flushing. Includes a packet of Camco's TST biodegradable toilet chemical. 2.6 gal (12.5"H x 16.25"W x 14.5"D); 5.3 gal (16.38"H x 13.75"W x 16.13"D)

**41531** 2.6 gal, Canada Item

**41541** 5.3 gal, Canada Item



**CAMPING COOK SET** Anodized aluminum nesting set with folding handles includes travel bag. Contains pot, saucepan, frying pan, three plastic bowls, a plastic spoon, plastic scoop with folding handle and a scrubber.

**51312** Camping Cook Set, Canada Item



**CAMP STOVE TOASTER RACK** Foldable compact design. Great for use with gas camping stoves. Toast up to 4 slices of bread at one time. 19" x 22".

**51035** Toaster Rack, Canada Item



**TRIPOD GRILL AND LANTERN HOLDER** Cook over an open fire with handy tripod grill. 17" diameter chrome-plated grilling surface is height-adjustable for better control of cooking temperatures. Or use it to hold your lantern for hands-free light. Fast and easy setup; compact storage.

**51079** Tripod Grill and Lantern Holder, Canada Item



**CAN OPENERS** Compact, lightweight can openers are easy to use, and fold down to fit in a pocket. Nickel-plated hardened carbon steel stays sharp for many years. 2pk.

**51041** Can Openers, 2pk, Canada Item



**KNIFE SHARPENER** Molded of sturdy ABS with special ceramic sharpening surfaces to quickly and easily reshape a dull blade. Small enough to fit on a key chain.

**51029** Knife Sharpener, Canada Item



**CAMP GRIDDLE** Non-stick-coated aluminum griddle is perfect for making breakfast under the open sky. 10" x 16.5".

**51049** Camp Griddle, Canada Item



**SAFETY FORK** 41" long safety fork with stay-cool wooden handle has the tines turned inward. This helps prevent accidental injuries, and helps keep the food from sliding off into the fire.

51308 Safety Fork, Canada Item

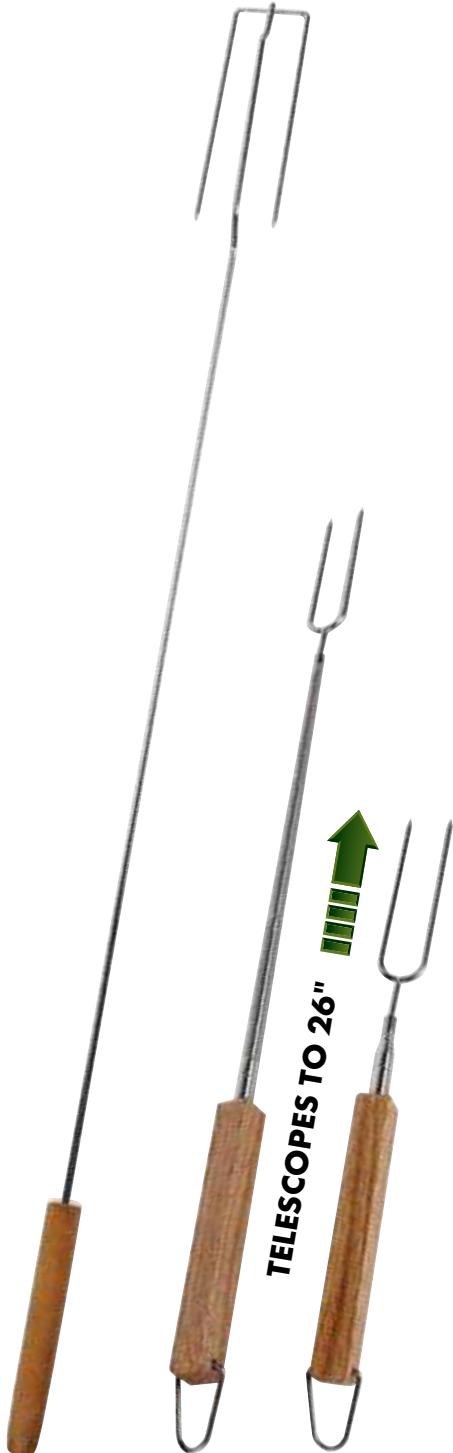

**TELESCOPING FORK** The perfect portable tool for roasting hot dogs or marshmallows over an open wood campfire. Extends out to 26", telescopes down to a compact 13" for easy carrying.

51304 Telescoping Fork, Canada Item

**CUTTING BOARD** With built-in handle. BPA-free; made of FDA-compliant materials. Cutting Surface: 6-1/2 x 8-3/8". Top-shelf dishwasher-safe. Polypropylene.

51300 Cutting Board, Canada Item



**EXPANDABLE WATER CARRIER WITH SPIGOT** Camping water carrier holds 8 L (2.1 gal) of water. Screw-on spigot cap allows easy filling and controlled dispensing. Built-in handle for easy carrying. Great for camping or tailgating.

51085 Water Carrier with tap, Canada Item



**EXPANDABLE WATER CARRIERS** Available in 5 L and 10 L capacity, these BPA-free drinking water carriers have a built-in reinforced handle and a wide pour spout.

51092 5 L Water Carrier, Canada Item

51093 10 L Water Carrier, Canada Item



**CAMPERS' SALT AND PEPPER SHAKER** Convenient travel size. All-in-one design is moisture-proof and spill-proof. Unscrew ends to fill, unscrew from center to use.

51057 Salt and Pepper, Canada Item



**FUEL FUNNEL** Fuel funnel with built-in screen for use with camp stoves and lanterns. 2.5" diameter.

51051 Fuel Funnel, Canada Item



**FOOD COVER** Tight mesh cover opens like an umbrella to keep your picnic safe from bothersome flies and insects. Cover measures 12 x 12" when open.

51302 Food Cover, Canada Item



**EGG CARRIERS** These clean, compact and unbreakable egg carriers help prevent eggs from breaking.  
**51013** Holds 6 Eggs, Canada Item  
**51015** Holds 12 Eggs, Canada Item



**SEWING KIT** 50 yards (45.7 m) assorted thread, 5 needles, needle tube, needle threader, thimble, 8 buttons, 2 snaps, 5 safety pins, 2 straight pins, measuring tape and scissors in a travel-size plastic box.  
**51053** Sewing Kit, Canada Item



**LANTERN HANGER** Campground-approved lantern hanger won't damage trees. Helps keep bugs up and away from campsite, and works on trees or posts up to 20" in diameter.  
**51055** Lantern Hanger, Canada Item



**TABLECLOTHS** Red & White Vinyl Available as tablecloth (52" x 84") only or tablecloth (54" x 84") with two bench covers (18" x 84"). Vinyl material makes for easy cleanup.  
**51021** Tablecloth w/ Bench Covers, Canada Item  
**51019** Tablecloth, Canada Item



**FOLDING SCISSORS** Compact folding scissors tuck easily into your pocket, purse or pack. Ideal for fishing, camping or travel.  
**51061** Folding Scissors, Canada Item



**TABLECLOTH CLAMPS** Hold tablecloths securely under the windiest conditions. Red plastic clamps won't rust or corrode. Use on tables from 1/2" to 2" thick.  
**44003** 4/card



**DELUXE TABLECLOTH CLAMPS** Spring loaded for a more secure hold. Tablecloth clamps fit picnic- or patio tables up to 1.5" thick. 4pk.  
**51077** Deluxe Tablecloth Clamps, Bilingual



**DITTY BAG SET** Great for organizing camping or home items. Made of water-repellent nylon and features a push-button draw string. Set contains 3 sizes: 6 x 12.5", 5 x 11", 4.25 x 9"  
**51009** Ditty Bag Set, Nylon, 3pk, Canada Item



**MULTI-FUNCTION TOOL** Stainless steel tool folds up to fit in pocket or pack. Includes three knife blades, two screwdrivers, can opener, bottle opener, mini-saw, grip teeth, pliers, wire cutters and two rulers. Includes carrying case.

51081 Multi-Function Tool, Canada Item



**CAMP SAW** 10" triple-edge blade makes this an ideal saw for camping or home. Cuts natural and synthetic wood, plywood, drywall, PVC pipe and more.

51027 Saw w/ Sheath, Canada Item



**FOLDING SAW** Folding saw with triple-edge blade offers high-quality performance. Features comfortable ergonomic handle and a two-position locking blade for safety.

51352 Folding Saw, Canada Item



**POCKET SAW** Handy wire saw is over 20" long, but rolls up easily to fit in a pocket. Strong enough to cut through wood, bone, plastic and soft metals. Wire length: 20.75"

51354 Pocket Saw, Canada Item



**CAMP AXE** A durable camp axe is a must-have tool for every campsite. Use while camping, hiking, backpacking or in the yard. This durable, heavy-duty axe has a drop-forged steel head, a steel shaft and non-slip, ergonomically designed handle for superior grip. Use the blade to split firewood or help clear areas for camping. Use the blunt side to help drive tent stakes. The included plastic sheath makes it safe to transport when not in use.

51083 Camp Axe, Canada Item



**WATERPROOF SAFETY MATCHES**

Wooden matches work even when damp. Four boxes of 40 each. Strike on box.

51334 Wooden Safety Matches



**LIGHTER FLINTS** Replacement flints for lantern lighter or camp stove. Packaged in a resealable storage bag.

51025 Lighter Flints, 10pk, Canada Item



**MAGNESIUM FIRE STARTER** Scrape off magnesium shavings, mix with tinder and strike the fire-steel with the attached sparker. The shavings will burn hot, even when damp, making fire-starting in wet conditions much easier. Compact starter is fireproof when solid.

51332 Magnesium Fire Starter



**FIRESTARTER STICKS** Quick and safe way to start fires. Burn completely without odor. Non-toxic and waterproof. Easy to carry and store.

51017 Firestarter Sticks, 12pk, Canada Item



**ULTRALIGHT TENT STAKES** Corrosion-resistant lightweight aluminum stakes with cord for easier removal.

- 51089 9", 6pk, Canada Item
- 51106 12", 6pk, Canada Item
- 51104 9", 100/bulk, Canada Item
- 51105 12", 50/bulk, Canada Item



**TENT PEG MALLET WITH BUILT-IN PULLER** Heavy-duty plastic mallet for use with plastic tent pegs only. 12.5" long.

51094 Tent Peg Mallet



**METAL TENT STAKES** Made of heavy-duty steel with durable plastic T-stopper.

- 51011 10", 2pk, Canada Item
- 51086 10", 100/bulk, Canada Item



**PLASTIC TENT PEGS** For tents, awnings, sports nets and more. Made of tough ABS plastic with large non-slip hook. High-visibility color. 6pk of 9" or 12" pegs.

- 51045 Tent Pegs, 9", 6pk, Canada Item
- 51102 Tent Pegs, 9", 100/bulk, Canada Item
- 51043 Tent Pegs, 12", 6pk, Canada Item
- 51103 Tent Pegs, 12", 50/bulk, Canada Item

**TENT STAKE PULLER** Plated-steel tent peg puller with comfortable grip allows easy removal of tent pegs.

51059 Tent Peg Puller, Canada Item



**MOSQUITO COIL HOLDER** Securely holds burning mosquito coils and keeps the ash contained. Can be hung up or placed flat on a table. Uses standard mosquito coils, not included.

51063 Mosquito Coil Holder, Canada Item



**CITRONELLA CANDLE** Citronella candle in a convenient metal container with lid for easy storage and transport. Helps keep the bugs away from your camping area.

51023 Citronella Candle, Canada Item



**WATERPROOF POUCHES** Triple-fold pouch tops with hook-and-loop closure and handy strap keep the water out so your valuables stay dry. Three sizes to accommodate everything from cell phones and keys to books and maps. 10.5 x 13.5, 6.75 x 10 and 4.75 x 7".

**51340** Waterproof Pouches, 3pk, Canada Item



**FOLDABLE CAMP SHOVEL** Foldable shovel with heavy-duty steel blade. Features serrated edge and locking collar. Folds compactly to carry along in its own storage pouch.

**51075** Camp Shovel, Canada Item



**TICK REMOVER** Remove ticks easily and safely with this tool. Special design holds securely with minimum risk of damaging tick during removal.

**51316** Tick Remover



**50' ROPE** Sturdy polypropylene braided rope for medium-duty camping use. Great around the house as well.

**51350** 50' Rope, Canada Item



**VINYL REPAIR TAPE** For quick repair of rubber or vinyl gear, ground sheets, waders, rain gear and more. Contains four pieces of self-adhesive vinyl. One each: 3 x 6"; 3 x 7"; 3 x 8" and 3 x 9"

**51326** Vinyl Repair Tape, Canada Item



**MULTI-PURPOSE SCISSORS**

Multi-purpose scissors are the ideal tool for camping or home. Detachable stainless steel blades and a variety of useful tools; scissors, screwdriver, can opener, wrench, fish scaler, nutcracker, jar wrench, wire stripper, wire cutter, bottle opener and knife.

**51039** Multipurpose Scissors, Canada Item



**TENT WHISK WITH DUST PAN**

Travel-sized tent whisk snaps into dustpan to keep them together for convenience.

**51033** Whisk w/ Dust Pan, Canada Item



**TILTING UMBRELLA** Camco 9' Tilting Umbrella is a large, durable outdoor umbrella that helps provide shade and relief from the sun. It is a multi-use umbrella that can be used with patio sets, beach sets and Camco's Hitch Mounted Umbrella Holder (#51958). The pole of the umbrella is constructed of durable, corrosion-resistant steel and has a 1.5" diameter. The fabric is durable, water-resistant and fade-resistant. The umbrella easily cranks open for use, the umbrella tilts via a push button to angle it in the desired direction, and then easily cranks closed when you're done using it.

**51959** 9', Tilting, Beige

**HITCH MOUNT UMBRELLA HOLDER**

Mount a patio umbrella to your hitch to provide extra shade while tailgating, camping, fishing, or for days at the beach or park.

**51958** Umbrella Holder





**PROPANE DISTRIBUTION POST WITH STORAGE BAG** Use up to three propane appliances simultaneously—with just one tank! Lantern, Portable Campfire, Grill, Camp Stove/Griddle, Heater and more. Includes: One 15" Propane Distribution Post: Excess Flow, Soft-Nose P.O.L. Propane Tank Connection and THREE—1"-20 Male Throwaway Cylinder—Appliance connections and one 15" Propane Distribution Post Extension: 1"-20 Male/Female Throwaway Cylinder Threads. All outlets feature auto-shutoff.

**51096** Propane Distribution Post, Canada Item

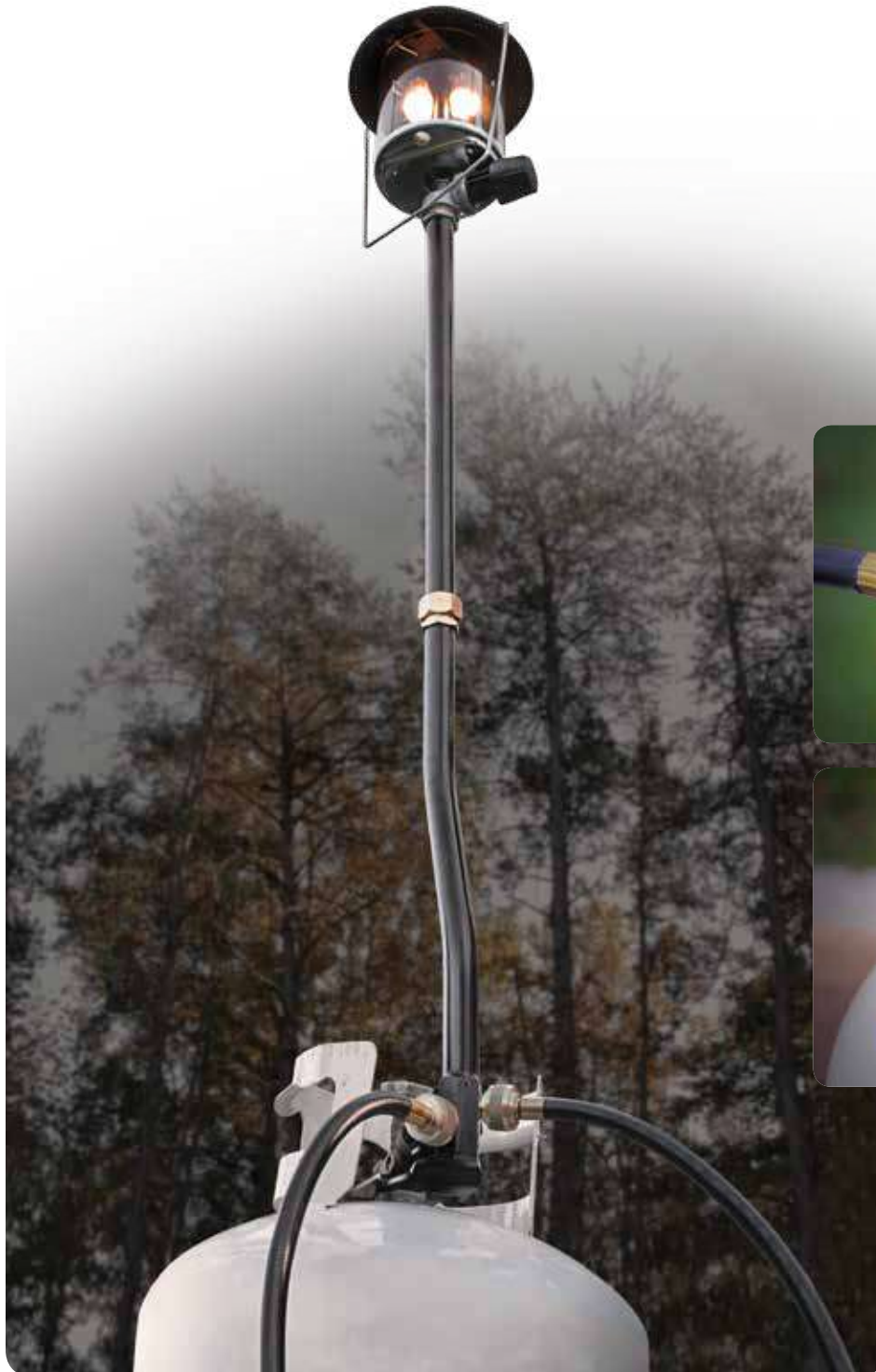

**METAL GROMMET KIT** includes heavy duty punch, anvil and 20 sets of 1/2" weather-resistant metal grommets. Great for repairing tarps, tents and awnings. Replacement grommet bag includes 20 sets.

**51372** Metal Grommet Kit, Canada Item

**51328** Grommets, 20 sets, Canada Item



**TARP CLIPS** Two-piece clips work on tarps, plastic sheeting, tents and awnings to create an extra tie-down point without punching a hole in the fabric.

**51344** Tarp Clips, 4pk, Canada Item



**CARABINERS** Aluminum biner clips with key rings. 2pk of 3" clips in assorted colors. Perfect for attaching light equipment to your backpack or belt. Not for climbing.

**51346** Carabiners, 2pk, Canada Item



**UTILITY CLIPS** 8pk of clips with protective coating. Permanently string clips onto your 3/16" (4.8 mm) or smaller clothes line, so they won't get lost. Can also be used to hang patio lights, or as snack bag clips.

**51037** Utility Clips, 8pk, Canada Item



**SNAP FASTENER KIT** Comes with a flaring tool and setting base. Everything you need to add or replace snap fasteners. For tarps, tents, car or boat covers, awnings and more.

**51007** Snap Fastener Kit, 10 Sets, Canada Item



**BRAIDED POLY CORD** Polypropylene shell with polyester core. Wound around a reusable plastic spool.

**51005** Braided Poly Cord, 50', Green, Canada Item



**UTILITY STRAPS** Durable 1" wide polypropylene straps are ideal for camping or outdoor use. Attached buckle for securing the straps.

**51067** Utility Strap, 4', Canada Item

**51069** Utility Strap, 6', Canada Item

**51071** Utility Strap, 8', Canada Item

**51073** Utility Strap, 10', Canada Item



**SLEEPING BAG STRAPS** 2pk of durable 4', 3/4" wide polypropylene straps are ideal for securing sleeping bags, tents and other camping equipment. Attached buckle for fastening the straps.

**51348** Sleeping Bag Straps, Canada Item



**50" STRETCH CORD** Ideal for camping and outdoor use. Coated hardened-steel hooks. Flexible rubber core. Weather-resistant outer layer. 50" long.

**51001** Stretch Cord, 50", 1pk, Canada Item



**LIGHT STICKS** 6pk: One each of pink, red, blue, orange, yellow and green. Provide a long-lasting glow in any weather condition; they even work under water. Safe and easy to use; light sticks don't heat up and don't attract insects. Sticks are non-toxic and nonflammable; individually foil wrapped for light/moisture protection.

**51336** Light Sticks, Canada Item



**6 PACK**



**20" STRETCH CORDS** 2pk of durable stretch cords. Ideal for camping and outdoor use. Weather-resistant outer layer. Coated hardened-steel hooks and flexible rubber core.

**51342** Stretch Cords, 20", 2pk, Canada Item



**LED LANTERN/FLASHLIGHT** Ultra-bright LED with three modes: ultra-bright, bright and flashing. Lantern telescopes for 360° illumination and has a metal C-ring for hanging; flashlight has adjustable-focus light beam. Powered by three AAA batteries (not included).

**51374** LED Lantern/Flashlight, Canada Item



**MINI STRETCH CORDS** 4pk of mini cords; ideal for camping and outdoor use. Hardened-steel hooks. Flexible rubber core. Weather-resistant outer layer.

**51003** Mini Stretch Cords, 10", 4pk, Canada Item



**MULTI-FUNCTIONAL LED LANTERN**

Ultra-bright: up to 120 lumens. Can be set up as a tabletop- or hanging lantern, a spotlight or a lantern/spotlight combo. Lightweight and weather-resistant light has three brightness settings, and is powered by three AAA batteries (not included).

**51378** Multi-functional LED Lantern, Canada Item



**RAIN PONCHO** Roomy one-size-fits-all poncho with hood has molded-in side snaps. Reversible; storage bag included. (200 x 127 cm).

**51360** Rain Poncho, Canada Item



**SURVIVAL PONCHO** This compact, lightweight poncho reflects and helps maintain body heat. Wind- and water-proof poncho can help keep you warm and dry in adverse conditions.

**51320** Survival Poncho, Canada Item



**WIND & WATER PROOF**

**EMERGENCY BLANKET** Waterproof and windproof reflective mylar blanket helps retain body heat. Opens to 52 x 84", folds down small enough to fit in a pocket.

**51322** Emergency Blanket, Canada Item



**LENSATIC COMPASS** Don't get lost while camping! Use this handy compass to find your position using a map and three landmarks.

**51362** Lensatic Compass, Canada Item



**6-FUNCTION SURVIVAL WHISTLE** Includes a safety whistle, magnifier, compass, ultra-bright LED, signal mirror and Fahrenheit/Celsius thermometer, all in one compact, easy to carry tool.

**51364** Survival Whistle, Canada Item



**LAUNDRY REEL** Lightweight, compact laundry reel is easy to set up. Contains 21' of laundry line and two hooks for easy mounting. Wind-up reel for easy storage.

**51065** Laundry Reel, Canada Item



**LAUNDRY BAG** Lightweight fabric laundry bag with mesh vent has a side pocket that doubles as a zippered pouch to hold the bag when its not in use.

**51338** Laundry Bag, Canada Item



**MOSQUITO NET** Fine polyester net (400 holes per square inch) helps protect against flying insects. Net has four sewn-in hanging cords and comes with storage bag. Sized to fit a standard camping cot or adult-size sleeping bag. 31 x 78 x 59".

**51366** Mosquito Net, Single



**SOAP DISH** Covered soap dish with a securely snapping lid closure and vent holes in the bottom.

**51356** Soap Dish, Canada Item



**SOLAR CAMP SHOWER** Enjoy a warm shower, even while camping far from civilization. 5 gal/ 20 L capacity. Holds enough water for 3 or 4 showers. Includes flexible tube, tab, 2 m hanging cord and mini-showerhead. Made of non-toxic UV-Resistant PVC material. With on-off valves at fill cap and at showerhead.

**51368** Camp Shower, Canada Item



**ON-OFF VALVES**



**HOLDS  
5 GAL**

**DUNK BAG** Nylon mesh Dunk Bag will not rot or retain odors. Handy all-purpose bag with sewn-in drawstring is great for laundry or storage. 19" x 22".

**51031** Dunk Bag, Canada Item



**CAMCO**





# Grills & Accessories

# PREMIUM GRILLS

**Olympian™**

Olympian grills are designed specifically for RVing, tailgating and patio or deck grilling.

- RV mountable
- Quality materials
- Quick-Connect available



## THE OLYMPIAN 4500 GRILL:

An outstanding grill that offers premium-quality construction and convenient portability.

**HIGH PRESSURE GAS** Designed specifically for RVing, tailgating as well as patio or deck grilling, the Olympian 4500 Grill features a spacious 160-square-inch grilling surface, which is perfect for a family of 4 to 5. The 4500's latching lid and stay-cool handle make it easy to transport. Integrated fold-away legs enable easy grilling on any flat surface or, with the Olympian RV Mounting Bracket (sold separately), it can be mounted to your existing RV mounting rail.

**57251** Olympian 4500 Gas



**RV GRILL MOUNT** Designed to mount your grill to the existing RV Mounting Rail. Thumbscrews make the mount easy to install. Rubber feet help prevent scratches. Fits Olympian 5500 (2014 and later), and Olympian 3500-C, 4500 and 6500, and all Kuuma Brand Grills. Made of durable stainless steel and anodized aluminum for a lasting finish.

**58090** Universal Grill Mount



**Grill not included.**





**THE OLYMPIAN 6500 GRILL:**

Designed specifically for RVing, and tailgating as well as patio or deck grilling—ideal for the grilling enthusiast on the go.

**LP VALVE/QUICK-CONNECT** The Olympian 6500 Grill is the top of the line and features all of the best Olympian has to offer. The Olympian 6500 offers a 316-square-inch cooking surface for full-size grilling power in a convenient, compact size. Features a simple control knob for precise heat control and integrated fold-away legs enable easy grilling on any flat surface. Additional features include removable warming rack, built-in thermometer, push-button igniter, removable Lift-and-Clean™ liner, grease tray, latching lid and stay-cool handle. Quick-Connect hose and valve included to use the propane supply on an RV or trailer that has a built-in low-pressure quick-connect propane connection. Includes RV Grill Mounting Bracket.

57245 w/ LP Valve and Quick-Connect Hose

**INCLUDES MOUNTING BRACKET****OLYMPIAN 5500 STAINLESS STEEL**

**RV GRILL** Designed for RV and outdoor use, this high quality lightweight stainless steel barbecue increases flavor without flare-ups. Grilling on any flat surface is easy with the integrated fold-away legs, or it can be mounted to your RV mounting rail with the Olympian RV mounting rail bracket (sold separately). Smoker plate is designed to offer the fullest flavor while minimizing grease fires. Includes Quick-Connect hose and valve to use the propane supply on an RV or trailer that has a built-in low pressure Quick-Connect propane connection. Quick and easy to assemble.

57305 Olympian 5500 SS RV Grill

**Cast Iron Smoker Plate**

- No ashes or mess
- Replaces lava rock
- More-even heat distributon



**RV MOUNTING RAIL** Used for hanging portable grills or other accessories on the side of your RV. This support must be installed by a qualified RV dealer.

57268 Mounting Rail



**FISH BASKET** Features a flexible wire design that adjusts to hold a variety of food shapes and sizes; it won't crush or disfigure your food. It is ideal for preventing delicate foods from flaking and falling apart on the grill. The Fish Basket features snaps to keep it closed while in use, and the whole fish basket is made from durable stainless steel that resists rust and corrosion—there are no wooden handles to burn or char. It is easy to clean and dishwasher safe.

**58387** Fish Basket



**CAST ALUMINUM GRIDDLE** With built-in handles. Two-sided for smooth or raised-rib surface. For use with all Olympian brand grills. Reversible. 16" x 8".

**58390** Cast Aluminum Griddle



**OLYMPIAN GRILL BAG** Heavy-Duty weather resistant polyester grill bag provides long lasting protection in every storage environment. Keeps grill free from dust, dirt and scratches.

**57632** Olympian Grill Bag



**SKEWER SET** 4pk of 18" long skewers. Square shaft keeps food from slipping when the skewers are turned on the grill. Ring handle for easy turning, and to hang on grilling table or tray. Stainless steel.

**58384** Skewers, 4pk



**PREMIUM FISH & VEGGIE GRILL TRAY** With removable handle. Dishwasher-safe stainless-steel tray is perfect for delicate foods. Handle can be attached on any side of tray. Fits all Olympian brand grills. 8" x 10".

**58380** Fish/Veggie Tray



**DELUXE FOLDING GRILL TABLE**

Spacious grill table has a lightweight, high strength steel frame and aluminum table top. Quick and easy to set up. Great for picnics, camping, sporting events and backyards. 57.75" w x 19" d x 32" h. Folds to fit durable carrying case (37" x 20" x 6" - included).

**57293** Deluxe Folding Grill Table



**DELUXE GRILLING TABLE W/ INJECTION MOLDED SIDE TABLES**

The Deluxe Folding Grilling Table is a must-have accessory for any tailgate, party or camping trip. This spacious grilling table has a lightweight, high strength steel frame and an aluminum table top. The heat-resistant aluminum top surface accommodates your portable grill and sturdy, improved side tables are weather resistant, have integrated cup holders and fold out to hold condiments and utensils. The table is quick and easy to set-up. Includes carrying case.

**57295** Grill Table



**GM9 GASMATCHES™** Great for barbecues, fireplaces, pilot lights, kerosene heaters and candles. 11" long. Safety lock, CPSC certified, adjustable flame, fuel viewing window. Refillable with butane lighter fluid. Packaged two per card.

**57473** Olympian GM9 GasMatch



**GM4 GASMATCH™** Our most popular mid-sized model. Piezo electric ignition, fully adjustable flame, safety lock, fuel viewing window, thousands of lights. CPSC certified. Refillable with butane lighter fluid. 11" long.

**57453** Olympian GM4 GasMatch



**GM3 GASMATCHES™** The GM3 GasMatch sets the standard for top-of-the-line features. The continuous ignition system means that the flame will never blow out. Long slender design gets at hard-to-reach places with total safety. Features safety lock, fully adjustable flame and fuel viewing window. 10,000 starts. Refillable with butane lighter fluid. Uses one AA battery, included. CPSC certified.

**57433** GM3 - 14 3/4"

**57543** GM3X - 26" (15" flex extender)

**57684** GM3XE - 40 3/4" (26" flex extender)



### GM12 CONTINUOUS IGNITION

**MULTI-SPARKER** This handy igniter is the one designed exclusively for igniting gas appliances. No butane to refill. The continuous electric sparker assures a large and immediate continuous spark. The automatic illumination micro-light and curved nozzle make tough lighting jobs easy. Uses one C battery (included).

**57533** GM12 - 13" long (7" pipe)

**57561** GM12X - 26" long (20" pipe)



**BUTANE REFILLS** Multi-fill injectors in 78 gram and 165 gram sizes.

**57416** 78 gram butane fuel

**57496** 165 gram butane fuel



### FEMALE QUICK-CONNECT TO ACME PROPANE HOSE

Hook up a quick-connect grill valve to a 5 lb or 20 lb propane cylinder. Designed to be used only with low-pressure gas appliances (i.e. 14" w.c.) such as our 5500 Grill. Six-foot regulator hose with shut-off valve. Gas bottle not included.

**57629** Hose - Quick-Connect to Acme



**BARBECUE ADAPTER HOSE** No more disposable cylinders. High-pressure hose with adapter for use with Olympian 4100 and 5100 Elite Gas Grills. Male P.O.L. x 1"-20 Throwaway Cylinder Thread. Allows you to connect a full size propane gas bottle to your portable grill.

**57636** 5' High-Pressure LP Hose

**59833** 12' High-Pressure LP Hose



### LP GAS CONTROL VALVE WITH QUICK-CONNECT

Replacement part for 5500 SS RV Grill. For using propane supply on an RV or trailer that has a built-in Quick-Connect propane connection. Rated for 14" w.c. (0.5 psi max.) of inlet pressure.

**57274** LP Gas Control Valve



### 4100 LOW PRESSURE CONVERSION KIT

Convert an Olympian 4100 grill to work with on-board low pressure LP Quick Connect gas supply. Kit is rated for 14" w.c. (0.5 psi max.) of inlet pressure. Includes Quick-Connect grill valve and 10' hose.

**57638** Low Pressure Conversion Kit



### QUICK-CONNECT TO QUICK-CONNECT LP GAS HOSE

For using propane supply on an RV or trailer that has a built-in Quick-Connect propane connection. Rated for 14" w.c. (0.5 psi max.) of inlet pressure. Replacement part for 5500 SS RV Grill.

**57280** Quick-Connect Hose, 39"

**57282** Quick-Connect Hose, 10'



**CAMCO**





# RV Covers

# ULTRAGUARD™

- Recommended for cold, snowy regions
- Triple layer SFS top panel beads water on contact providing maximum resistance to rainfall and snow
- Heavy duty polypropylene fabric around sides
- Tough interlocking seams
- Storage bag included

## CLASS A COVERS

- 45730 28'
- 45731 30'
- 45732 32'
- 45733 34'
- 45734 36'
- 45735 38'
- 45736 40'
- 45737 42'



## CLASS C/TRAVEL TRAILER COVERS

- 45740 22'
- 45741 24'
- 45742 26'
- 45743 28'
- 45744 30'
- 45745 32'
- 45746 34'
- 45747 36'



## 5TH WHEEL COVERS

- 45750 24'
- 45751 26'
- 45752 28'
- 45753 30'
- 45754 32'
- 45755 34'
- 45756 36'
- 45757 38'
- 45758 40'
- 45759 42'



**2 YEAR LIMITED WARRANTY**

## 3 HIGH-TECH LAYER PROTECTION

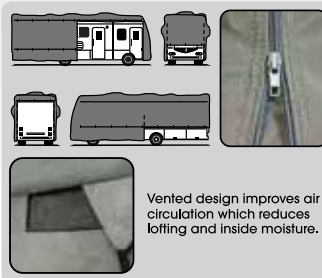
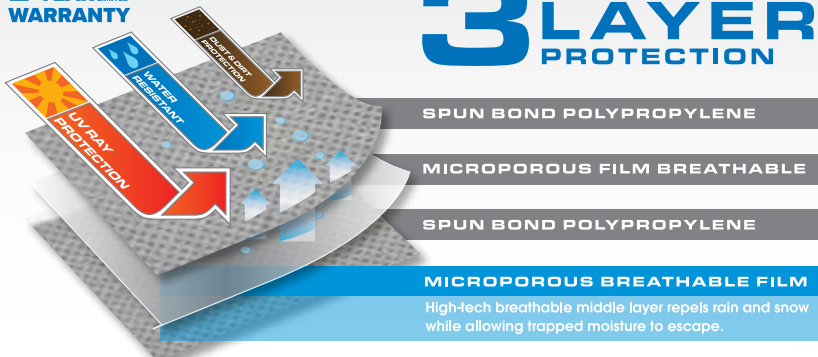

**HEAVY DUTY ZIPPERS**  
**Integrated zippers for easy access to doors and storage with cover in place!**

### SLIDE-IN CAMPER COVERS

- 45770 18'
- 45771 16.5'
- 45773 19.5'



### POP-UP CAMPER COVERS

- 45760 6' to 8'
- 45761 8' to 10'
- 45762 10' to 12'
- 45763 12' to 14'
- 45764 14' to 16'
- 45765 16' to 18'



### VAN COVERS

- 45780 Standard: to 18'
- 45781 Extended: to 22'
- 45782 HiTop: to 19'



**ULTRAGUARD PATCH KIT** Repair your UltraGuard RV Cover with these 9" x 6' self-adhesive patch kits.

- 45791 SFS for Top
- 45795 Polypropylene for Sides



**VINYL WINDSHIELD COVERS** White leather-grained vinyl cover ensures privacy and provides shade. Easy no-drill installation; anti-theft tabs lock in doors.

**ARCTIC WHITE**

- 45232 Ford thru '91
- 45233 Chevy/GMC '73-96

**COLONIAL WHITE**

- 45243 Chevy/GMC '73-96
- 45244 Chevy/GMC '97-Present
- 45245 Dodge '93-Present



**LADDER COVER FOR ULTRAGUARD**

- Not shown.
- 45796 Ladder Cover

**VINYL TIRE PROTECTORS** Vinyl covers protect your tires and wheels from sun, dirt, corrosion and all types of weather while your vehicle is parked. 2pk.

**ARCTIC WHITE**

- 45321 24-26"
- 45322 27-29"
- 45323 30-32"
- 45324 33-35"
- 45325 36-39"
- 45326 40-42"

**COLONIAL WHITE**

- 45331 24-26"
- 45332 27-29"
- 45333 30-32"
- 45334 33-35"
- 45335 36-39"
- 45336 40-42"

**BLACK**

- 45246 24-26"
- 45247 27-29"
- 45248 30-32"
- 45249 33-35"
- 45250 36-39"
- 45251 40-42"



**VINYL AC COVERS** Vinyl covers protect your air conditioner from dirt, leaves and weather. Locking draw cord ensures a perfect fit. Helps keep out cold drafts.

**COLEMAN MACH I, II AND III TSR MODELS** except model #7100 (includes aerodynamic shroud)

- 45391 Arctic White
- 45393 Colonial White
- 45262 Black

**DOMETIC AND BRISK AIR MODELS** 57912, 57915, 58915, 58935, 59016, 59036, 59046 — Manufactured after 6/1/90

- 45392 Arctic White
- 45398 Colonial White
- 45263 Black

**DUOTHERM 54608, 54612, 57915; BRISK AIR: 10.5" High/55908, 12.5" High/55912, 12.5" High/55915**

- 45394 Colonial White
- 45264 Black

**DOMETIC SL SERIES, EMERSON EQK 1100 & 1350\***

- 45265 Black

**DUOTHERM PENGUIN "I" & "II" DOMETIC LOW PROFILE CA SERIES**

- 45396 Colonial White
- 45266 Black

**COLEMAN MINI AND SUPER MACH**

- 45397 Colonial White
- 45267 Black

**DOMETIC BRISK II**

- 45399 Arctic White
- 45269 Black





**VINYL SPARE TIRE COVERS** Vinyl cover helps keep dirt, rain and sun away from spare tire. Heavy nylon thread helps ensure weatherproofing of seams.

### ARCTIC WHITE

- 45340 A - 34" Diameter
- 45341 B - 32 1/4" Diameter
- 45342 C - 31 1/4" Diameter
- 45343 E - 29 3/4" Diameter
- 45344 F - 29" Diameter
- 45345 I - 28" Diameter
- 45346 J - 27" Diameter
- 45347 L - 25 1/2" Diameter
- 45348 N - 24" Diameter
- 45349 O - 21 1/2" Diameter

### COLONIAL WHITE

- 45350 A - 34" Diameter
- 45351 B - 32 1/4" Diameter
- 45352 C - 31 1/4" Diameter
- 45353 E - 29 3/4" Diameter
- 45354 F - 29" Diameter
- 45355 I - 28" Diameter
- 45356 J - 27" Diameter
- 45357 L - 25 1/2" Diameter
- 45358 N - 24" Diameter
- 45359 O - 21 1/2" Diameter

### BLACK

- 45252 A - 34" Diameter
- 45253 B - 32 1/4" Diameter
- 45254 C - 31 1/4" Diameter
- 45255 E - 29 3/4" Diameter
- 45256 F - 29" Diameter
- 45257 I - 28" Diameter
- 45258 J - 27" Diameter
- 45259 L - 25 1/2" Diameter
- 45260 N - 24" Diameter
- 45261 O - 21 1/2" Diameter



### REFLECTIVE WINDOW COVERS

Protect the interior of your coach from UV rays and assist with temperature control. Air-filled cells encapsulated in lightweight, flexible polypropylene between two layers of reflective film. Collapses for storage and attaches with hook-and-loop fasteners for simple installation.

### WINDOW COVERS

- 45161 50" x 26"
- 45162 50" x 30"
- 45163 62" x 26"
- 45164 62" x 30"

### WINDOW COVERS, BULK

- 45165 24" x 120"
- 45166 48" x 120"

### WINDOW COVERS FOR DOORS

- 45167 16 1/4" x 25 1/4"

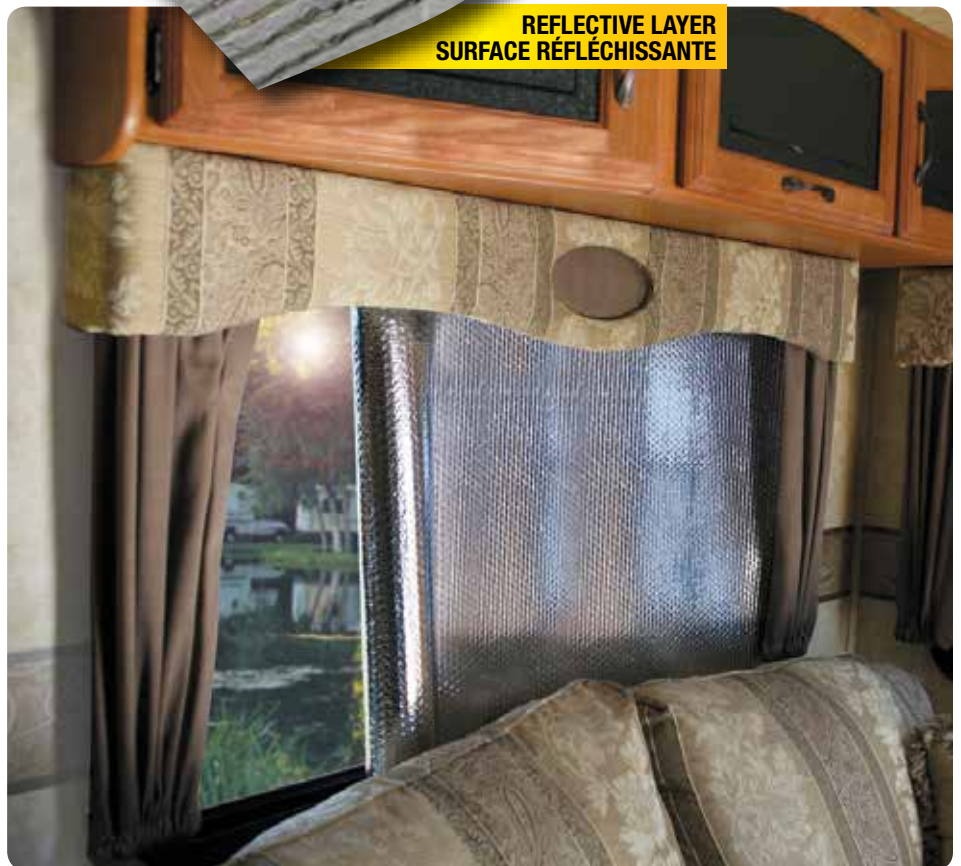

**CAMCO**





# Housewares

# Nesting Cookware Sets

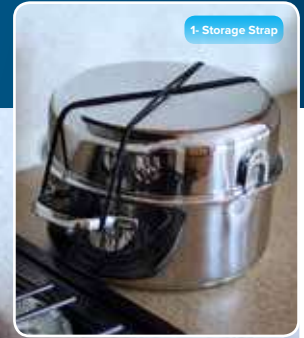

## NESTING COOKWARE SETS

Attractive stainless steel is low maintenance, rust-resistant and non-reactive. Dishwasher safe, compatible with induction cooking and can even be used in the oven when the removable handles are not attached. Nesting cookware conveniently saves valuable space by storing in less than a ½ cubic foot area. High quality 18/10 stainless steel with an aluminum core.

**43920** 7 piece, Stainless

**43921** 10 piece, Stainless

**43929** Replacement Handle



**BREAK-RESISTANT BEVERAGE**

**SETS** No more broken glassware! BPA-free acrylic glasses have the look and feel of real glass, and the advantage of being shatter-resistant. Available in wine, pilsner, pint, juice, tumbler, martini and margarita styles. Sold in boxed pairs. Top shelf dishwasher safe.

**WINE GLASS** 9 oz. 2pk.

43861 Wine

**PILSNER GLASS** 22 oz. 2pk.

43891 Pilsner

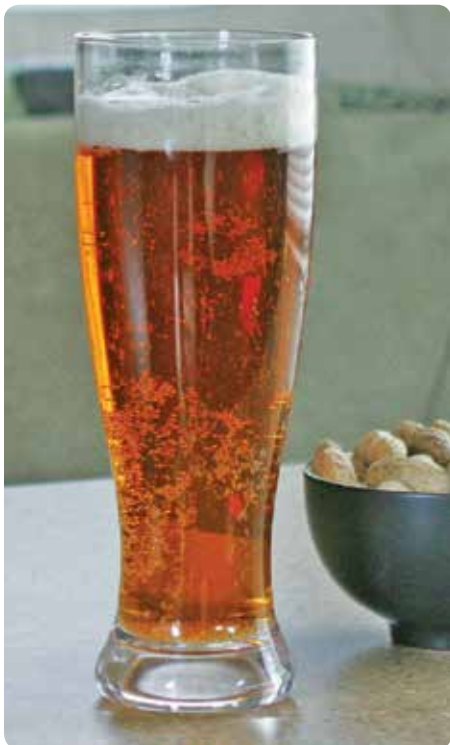
**JUICE GLASS** 7 oz. 2pk.

43881 Juice

**TUMBLER** 7 oz. 2pk.

43871 Tumbler

**MARTINI GLASS** 10 oz. 2pk.

43901 Martini

**MARGARITA GLASS** 12 oz. 2pk.

43902 Margarita

**PINT GLASSES** 16 oz. 2pk.

43865 Pint



**OAK ACCENTS™ COUNTERTOP**

**EXTENSION** Add an extra 12" to your counter top. Solid oak-finish hardwood extension mounts to your existing countertop with a metal piano hinge. Pulls up easily and is secured by a metal drop-leaf table brace. Folds down when not in use. Super-hard, non-toxic gloss finish. Mounting hardware included. (12" x 13 1/2" x 3/4")

**43421** Countertop Extension



**OAK ACCENTS™ ORGANIZER** Organize papers, remote controls, mail, maps or anything you need to keep neat and at hand. Mounts easily on almost any surface. Solid oak-finish hardwood. (8 3/8" x 4 5/8" x 2 13/16")

**43483** Organizer



**OAK ACCENTS™ REMOTE HOLDER**

Have remote controls and other items near at hand with this easily installed, wall-mounted holder. Solid oak-finish hardwood complements any decor. (5" x 4" x 1 3/4")

**43533** Remote Holder

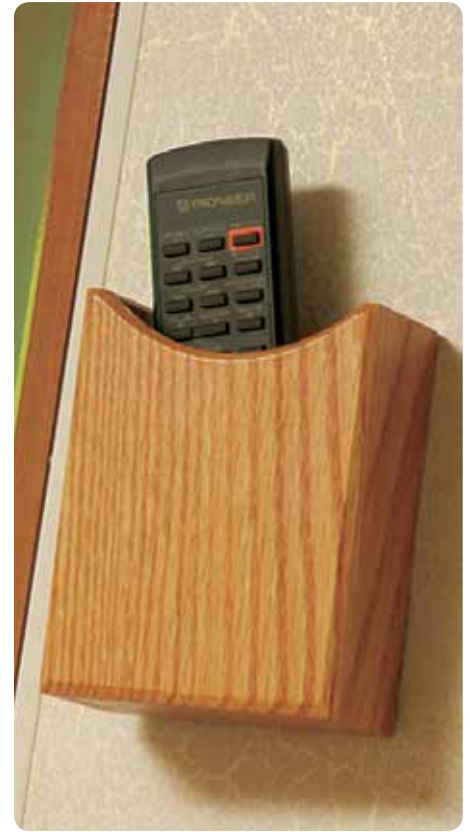

**OAK ACCENTS™ SINK COVER**

Add more counter space with the sink cover that comes with a lifetime warranty. Super-hard, non-toxic gloss finish for extra moisture protection. Solid oak-finish hardwood. Board size is 13" x 15". Stabilized with adjustable rubber feet to fit sinks 10" x 14", 11" x 13 1/4" and 12" x 14".

**43431** Sink Cover



**BORDEAUX SINK COVER** With lifetime warranty. Super-hard, non-toxic gloss finish for extra moisture protection. Solid hardwood with a rich bordeaux finish. Board size is 13" x 15". Stabilized with adjustable rubber feet to fit sinks 10" x 14", 11" x 13 1/4" and 12" x 14".

**43436** Bordeaux Sink Cover



**BAMBOO SINK COVER** Add more counter space with this sustainable, naturally anti-bacterial bamboo sink cover. Can also be used as a cutting board. Board size is 13" x 15". Stabilized with adjustable rubber feet to fit sinks 10" x 14", 11" x 13 1/4" and 12" x 14".

**43437** Bamboo Sink Cover



**UNIVERSAL SILENT TOP™** Silence annoying stovetop rattles while adding valuable counter space to your RV. Bamboo or solid hardwood in oak- or bordeaux- finish. Stovetop cover hides and protects burners. Non-toxic gloss finish for extra moisture protection. (19 5/8" x 17 1/2") Patented. Includes bonus Flexible Cutting Mat.

**43521** Oak Accents Silent Top

**43526** Bordeaux Silent Top

**43571** Bamboo Silent Top



**RV UNIVERSAL FIT STOVE TOP COVER**

Protect and hide burners and add counter space in your RV. Cover acts as a splash guard between burners and wall when folded back. Flip up one side to use two burners or fold and store it away compactly when you need all four burners. 20-gage steel with powder-coated finish.

43559 Almond

43554 Black

43557 White



**STOWAWAY FLEXIBLE CUTTING MAT**

Protect RV countertops from nicks, cuts and stains. Natural-colored mat eliminates spills by bending for easy pouring. Made of sturdy, lightweight recyclable plastic. Bend or roll for compact storage. Non-toxic and dishwasher safe. 11 1/2" x 15".

43770 Flexible Cutting Mat



**RV HARDWOOD STOVE TOPPER/ CUTTING BOARD**

Hide burners, eliminate rattles, and add an attractive cutting board to your RV kitchen. Board doubles as a serving tray. Won't nick or dull knives. Non-skid backing holds board in place. Selected hardwoods are treated to preserve and enhance natural wood beauty. Built-in juice groove. Fits 3 or 4 burner stoves. Patented. (17" x 19 1/2" x 3/4") Includes bonus Flexible Cutting Mat.

43753 Hardwood Stove Topper





**DECOR-MATE STOVE TOPPER**

Quiet stovetop rattle and add much-needed counter space in your RV kitchen. Sits directly on stovetop grates or over an existing stove cover. Stays firmly in place with non-skid backing. Durable polyethylene—cleans easily with soap and water. (17" x 19 1/2" x 1/2")

**43704** Black

**43707** White

**43709** Almond

**SINK MATE CUTTING BOARD**

Increase kitchen work space with a sturdy polyethylene cutting board. Ideal for cleaning, carving and chopping. Fits right on RV sink; adjustable feet adapt to sink size. Won't nick or dull knives. With cut corner for scraps and built-in juice groove. Measures 12 1/2" x 14 1/2"; Fits sinks 10" x 14", 11" x 13 1/4" and 12" x 14". Patented.

**43857** White

**43859** Almond

**MICROWAVE COOKING COVERS**

Prevent spattering and reduce cooking time while venting steam automatically. Dishwasher safe. 2pk includes one 7" x 7" and one 9" x 9".

**43790** 2pk

**MAGIC CHEF® GROMMETS**

Rubberized silicone grommets protect your stove top from scratches caused by the grate. Specially sized for Magic Chef brand grates.

**43614** 4pk

**GAS STOVE BURNER LINERS**

Keep RV stovetop burners clean and hide pitted or rusted burner wells. Liners make clean-up easier. Fits Wedgewood, Magic Chef and most other RV gas stoves. Easy installation. 7 1/2" diameter.

**43800** 4pk



**CUTTING BOARD SET** 3 Piece Cutting Board

Set is great for camping, RVs, boats, dorm rooms or any kitchen. It includes a cutting board, 4" paring knife with sheath and a peeler. The cutting board is food safe, non-porous and easy to clean. The paring knife has a 4" blade with sheath and is made of durable high carbon stainless steel. The peeler is also made of high carbon stainless steel and has an ergonomic grip. Together the utensils and board are perfect for cutting and preparing vegetables and other foods.

**51954** 3 Piece, Green



**FOLDABLE CUTTING BOARD**

The Camco Foldable Cutting Board is a paddle-shaped board with a convenient fold down the middle to make pouring diced food easier. The cutting board is thin for easy storage in a drawer or tight space if needed. The non-slip backing helps secure the cutting board while in use, helping to make cutting safer. It is food safe and has a built in hanging loop on the handle.

**51301** Plastic, Green



**CAR SEAT-WEDGE CUP HOLDER**

Designed to fit in between your car seat and center console in order to create extra space to put drinks and other items. Features two cup holders, plus an extra space for your wallet, sunglasses or change. Easy to remove and clean. Compatible with most car seats and consoles.

**53050** Car Seat Cup Holder, Black, Holds 2 cups



**BAMBOO PIZZA PEEL/ CHARCUTERIE BOARD**

The Camco Bamboo Pizza Peel/Charcuterie Board is an attractive, paddle shaped bamboo board that is great for cutting or serving. Bamboo is a renewable resource that has natural antibacterial properties. It is stronger than maple, but won't dull knives. The Pizza Peel features a convenient handle with a hole at the top that can be used for hanging if desired. Serving area measures 11 5/8" x 11 3/4", plus a 7 5/8" long handle.

**53000** Pizza Peel, Bulk



**RV & MARINE SINK MAT** Cushion and

protect glassware and dishes. Small size vinyl mat is specifically engineered for RV & Marine sinks. Multiple drain holes allow water to flow freely through mat. Mildew resistant. 10" x 11 3/4".

**43720** Sink Mat, White

**43721** Sink Mat, Black



**RV SINK-SHOWER STRAINERS**

Help prevent clogs with these stainless steel strainers. These strainers easily fit into your drain to keep food out of your plumbing. Bonus 3pk for both sink and shower drains.

**42273** Sink Strainers

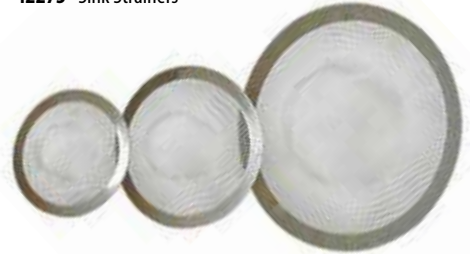

**ADJUSTABLE DRINK HOLDERS**

Adjustable Drink Holders help prevent spills and mount quickly and easily in RVs, cars, vans, trucks as well as boats. Holders feature arms that easily adjust to hold almost any size bottle, can or mug. Folds up for compact storage. Easily mountable with tape or screws.

**44040** White

**44041** Gray

**44042** Khaki



**MICROFIBER DISH DRYING PAD**

Absorbs and contains water drips from your drying dishes, and wicks moisture away from the dishes to keep them dry. It's great for delicate stemware and china, because it is padded to protect against chips and scratches. Microfiber is capable of absorbing several times its weight in water, helping to keep the countertop beneath the pad dry. Machine washable.

**43577** Microfiber Dish Drying Pad



**RV/MARINE SINK KIT** Makes doing dishes in your RV a breeze. Holds full sized plates, cups and utensils for up to six people. Sloped tray helps excess water run off into your sink and doubles as a lid. The dish pan and sink mat all nest together with the dish drainer for compact storage. Perfect for small sinks with limited counter space.

**43517** White

**43518** Black



**MINI DISH DRAINER** Fits most RV sinks, and is sized just right for limited counter space. Sloped drainer tray keeps counters dry. Drain tray snaps on top of rack for handy storage. Durable heavy-duty construction.

**43511** Mini Dish Drainer, White

**43512** Mini Dish Drainer, Black



**RV/MARINE MINI DISHPAN** Designed to fit most RV sinks. Durable translucent polypropylene with easy-lift handles. Holds nine quarts. Camco's Mini Dish Drainer (sold separately) fits perfectly inside for easy storage. Fits 10 1/2" x 12 3/4" and larger sinks.

**43516** Mini Dishpan, Natural

**43515** Mini Dishpan, Black



**POP-A-TOWEL** Keep paper towels clean and conveniently located. Holder can be permanently mounted on cabinet door, wall or under cabinet. Slides off the mounting bracket to stand alone or carry as needed.

- 57111 White
- 57113 Black



**POP-A-TISSUE** Keep facial tissues handy in wall- or cabinet-mounted dispenser. Installs easily with screws or double-sided tape. Can dispense upward or downward. Fits most boutique tissue brands.

- 57101 Clear



**POP-A-PLATE** Save space and store 9" paper or plastic plates under your cabinet or shelf. Mounts easily.

- 57001 White
- 57006 Black



**POP-A-BAG** Store grocery bags, trash bags and dryer sheets efficiently. Plastic bag holder/dispenser mounts easily on wall or inside cabinet with screws or double-sided tape. Holds up to 25 grocery bags.

- 57061 White
- 57065 Black



**POP-A BAG HANGER** Create a wastebasket anywhere. A great way to re-use your plastic grocery bags and save money on trash bags. Install inside a cabinet door, on a wall or workbench area. Pop-A-Bag Hanger comes with double sided tape for easy installation. 2pk.

- 43593 Pop-a Bag Hanger



**POP-A-NAPKIN** Keep napkins handy and clean. Napkin dispenser installs easily under cabinet or shelf. Easy to refill.

- 57041 White
- 57042 Black



**POP-A-BOWL** Save space by storing 6" disposable bowls or plates under your cabinet or shelf or next to the microwave. Mounts easily with screws (included).

- 57211 White
- 57213 Black



**Pop • A® Products**

All prices listed are manufacturer's suggested retail

# dehumidifier

## M o i s t u r e   A b s o r b e r

- Removes moisture from air in confined areas
- Fragrance free
- Easy to use — Remove foil to activate!

### MOISTURE ABSORBER HANGERS

The Camco Hanging Dehumidifier is an easy way to reduce humidity in small, tight spaces such as closets or storage areas. The double packet of moisture-absorbing media features a convenient hanger on top for hooks or clothing racks. The moisture-absorbing agent acts fast to trap humidity and the fragrance-free beads do not impart any scent. One packet of media will absorb up to three times its weight in water and lasts up to one month. Contains two hanging dehumidifiers.

**44286** Moisture Absorber Hangers



### MOISTURE ABSORBER

The Camco Moisture Absorber is an easy way to reduce humidity in your basement, closet, bathroom, boat, RV or any confined area! The moisture-absorbing agent acts fast to trap humidity and lavender-scented fragrance beads keep the air smelling fresh. One container of media will absorb up to three times its weight in water, and when it's done you can safely empty and refill it over and over again.

**44280** 10.5 oz, Refillable, Lavender

**44284** 42 oz Refill, Lavender



LAVENDER  
SCENTED

### MOISTURE ABSORBER, 5 LB BUCKET

The Camco Moisture Absorber Bucket is an easy way to reduce humidity in your basement, closet, bathroom, boat, RV or any confined area! The moisture-absorbing agent acts fast to trap humidity and the fragrance-free beads do not impart any scent. One container of media will absorb up to three times its weight in water, and when it's done you can safely empty the bucket. One bucket lasts up to six months.

**44282** Moisture Absorber, 5 lb



### MINI DEHUMIDIFIER

Compact moisture absorber reduces moisture which could lead to odors. Works to remove dampness from the air, helping to reduce mildew, mold and musty odors.

**44195** Mini Dehumidifier

**REFRIGERATOR BARS** Keep order in your RV refrigerator during travel. Spring loaded bars keep items in place. Refrigerator bars extend from 16"–28". Wide Refrigerator Bars extend from 19"–34".

**REFRIGERATOR**

- 43823 Refrigerator 3pk, 16"–28", Oak-Look
- 44053 Refrigerator 3pk, 16"–28", White
- 44055 Refrigerator 3pk, 16"–28", Gray
- 44056 Refrigerator 3pk, 16"–28", Brown

**DOUBLE REFRIGERATOR**

- 44073 Double Refrigerator, 16"–28", White
- 44075 Double Refrigerator, 16"–28", Gray
- 44077 Double Refrigerator, 16"–28", Brown

**DOUBLE WIDE REFRIGERATOR**

- 44074 Double Wide Refrigerator, 19"–34", White
- 44076 Double Wide Refrigerator, 19"–34", Gray
- 44078 Double Wide Refrigerator, 19"–34", Brown



**CUPBOARD BARS** Keep order in your RV cupboards during travel. Spring loaded bars keep items in place. Cupboard bars extend from 10"–17".

**CUPBOARD**

- 43833 Cupboard 3pk, 10"–17", Oak-Look
- 44063 Cupboard 3pk, 10"–17", White
- 44065 Cupboard 3pk, 10"–17", Gray
- 44066 Cupboard 3pk, 10"–17", Brown

**DOUBLE CUPBOARD**

- 44093 Double Cupboard, 10"–17", White
- 44095 Double Cupboard, 10"–17", Gray
- 44096 Double Cupboard, 10"–17", Brown



**GREASE BIN** Here's an easy way to dispose of cooking grease and fat, and save your drains from nasty clogs. Hot cooking grease can be poured directly into the foil-lined bag. Container keeps odors in so you can use the bag until it's full, and then just toss it out with the trash. Includes three foil liner bags. 5pk of replacement bags also available. Patented.

- 42281 Grease Bin
- 42282 Grease Bin, Canada Item
- 42285 Replacement Bags, 5pk
- 42286 Replacement Bags, Canada Item



**FRIDGE BRACE™** Keep food from sliding as you go down the road. Helps keep cartons upright to reduce the risk of messy spills. 2pk. Patented.

44033 Fridge Brace



**MINI ICE CUBE TRAYS** Small trays fit perfectly into RV, marine or dorm freezers. Provides small size cubes for quick freezing. 2pk. (9" x 4" x 1")

44100 2/bag



**FRIDGE DOOR STAY** Keeps your refrigerator door held open during storage. Improves air circulation and helps prevent mold and odor build-up.

**45641** Door Stay



**FRIDGE AIRATOR™** Cool your RV fridge evenly and keep food fresher. High-volume air circulator absorbs odors with replaceable activated charcoal filter. Battery operated. Features an on/off switch. Batteries not included.

**44124** Fridge Airator Deluxe

**42093** 3pk Replacement Charcoal Filters



**DELUXE - WITH ON/OFF SWITCH**



### CAMCO RV FRIDGE DOOR BLOCK

Holds your fridge and freezer door open during storage to promote airflow and prevent mildew and odors; prevents the door from swinging open if your RV or trailer is uneven. The unique drawstring design adjusts to accommodate doors thick and thin. A high strength neodymium magnet attaches to the inside of the fridge to hold the block in place, and the drawstring can tighten to the thickness of the door, holding the door open but preventing it from opening further. Sticks to the outside of the refrigerator for storage.

**44105** Fridge Door Block



### REFRIGERATOR/FREEZER/DRY STORAGE THERMOMETER

The Camco Refrigerator/Freezer Thermometer helps you monitor the inside temperatures of your fridge or freezer. The durable, stainless steel thermometer has a built-in base that allows it to stand self-supported on any flat surface. It can also hook or hang onto a wire rack. An easy to read dial measures from -20° F/-29° C to 80° F/27° C.

**42114** Thermometer



**SLIP STOP®** Keep everything safe and secure by preventing slipping and sliding. Washable, easily trimmed material works in tool boxes, rugs, van floors, shelves, dash boards or anywhere things slide around or rattle in your RV. Use as a liner between plates, cups and appliances.

**43277** Cream 1' x 12' roll

**43278** Slate Blue 1' x 12' roll



**FRIDGE ODOR ABSORBER** The Camco Fridge Odor Absorber is an easy, space-saving way to help trap unpleasant odors in your refrigerator. It can either hang or sit on your refrigerator rack, and it swivels with airflow to help maximize contact with air and trap more odors. The inner charcoal bag is replaceable.

**44180** Blue



**WALL-MOUNT TRASH CAN** Compact trash can mounts to wall or inside cabinet. Features swing-top lid. Patented.

**43961** Wall-Mount Trash Can



**DUST PAN AND WHISK BROOM**

Small size makes it easy to keep this handy duo close at hand. Whisk broom snaps into dustpan when not in use. Hanger-hole for convenient storage.

**43945** Dust Pan and Whisk Broom



**RV/MARINE BROOM AND DUSTPAN** Full size (52" long) broom telescopes down to just 24" for compact storage. Soft-bristled head adjusts to different angles for maximum cleaning power. Handle length is adjustable, too! Handy dustpan clips onto broom handle for storage. Patented.

**43623** Broom



**POP-A-TOOTHBRUSH** Protect and store toothbrushes with this easily-installed holder that guards against dust and germs. Cover opens automatically when toothbrush is pulled forward. Vented for quick drying. Double-sided tape allows for permanent mounting.

**2 BRUSH**

**57202** 2 Brush, Black

**57203** 2 Brush, White

**4 BRUSH**

**57204** 4 Brush, White

**57207** 4 Brush, Black





**RV/MARINE SHOWERHEAD**

Enjoy longer showers with this ergonomically designed, hand-held showerhead. Handy on/off switch allows you to pause water flow while shampooing, greatly reducing the amount of water used. No more rushing your shower to conserve water. Choice of four spray patterns from a drenching rain to a gentle massage; you can personalize your shower with your favorite comfort settings. Heavy-duty construction. Washers included.

**43710** Chrome

**43711** White

**43712** Off-White

**43763** Showerhead Gasket, 10pk

**RV/MARINE SHOWERHEAD KIT**

The same showerhead described on the left, packaged with a flexible 60" shower hose. Kit includes showerhead, flex hose, washers, wall mount and hardware. Shower Flex Hose features built-in connectors for easy installation to a standard 1/2" shower arm and reinforced construction to eliminate hose kinking. Heavy-duty construction.

**43713** Chrome

**43714** White

**43715** Off-White

**RV/MARINE SHOWER FLEX HOSE**

Flexible 60" replacement hose with built-in connectors for easy installation to a standard 1/2" shower arm. Reinforced construction eliminates hose kinking. Washers included.

**43716** Chrome

**43717** White



**OUTDOOR SHOWERHEAD** Easy-to-install showerhead fits in RV's outdoor shower area. This high flow showerhead has a convenient on-off switch to help conserve water.

**44023** Outdoor Showerhead

**SHOWERHEAD MOUNTS**

Adjustable chrome showerhead wall mount gives you great flexibility in positioning your showerhead. Two-position chrome showerhead wall mount gives you a choice of two angles for your showerhead. Hardware included.

**43718** Two-Position

**43719** Adjustable



**SHOWER CADDY** The Camco Shower Caddy mesh bag is a convenient, lightweight option for carrying toiletries to campsite bathrooms. The caddy features a versatile design equipped with multiple pockets for storage of different items and its mesh material won't retain water or liquids. It's high quality, durable mesh structure can carry hefty items while maintaining its sleek and compact design. This caddy also comes with a sturdy, flexible handle that enables simple hanging and will not rip or break. Although resilient, this handle is very comfortable to carry.

**51997** Shower Caddy



**HOSE AND CORD CARRY STRAP**

The Camco Hose and Cord Carry Strap is a simple, easy to use way to hang, organize and store cords, hoses and ropes. The carry strap will adjust to accommodate most hose, cord and rope sizes and lengths, and the handle doubles as a hanger for easy storage. An integrated slit on the carry strap can be used to hold and keep track of the ends on your rope or extension cord so that they don't get lost in the coil. The durable polyethylene hanger makes a great addition to any garage or shed.

**20165** Carry Strap



**RV WALL CLOCK** Bracket mounts securely to the wall of RV. Clock slides into bracket and locks in place. It won't rattle or fall during travel, and slides off easily for battery change. Quartz movement; solid wood frame with brushed metal trim. Uses one AAA battery; not included. Patented.

**43781** RV Wall Clock



**MULTI-PURPOSE SHOE TRAY**

Camco Multi-Purpose Shoe Trays help protect your floor from messes. Place them in the entryway of your home, in your car trunk, under pet food bowls, in your laundry room, garage, kitchen or by your fireplace! The durable trays with contoured, ridged edging is perfect for keeping dirt and debris contained. They feature built-in handles and an anti-slip pattern, and they're easy to hose off when they get dirty. Small tray measures 19 3/4" L x 15" D. Large tray measures 29 3/4" L x 15" D.

**42894** Small

**42896** Large



**POP-UP LAUNDRY HAMPER** The Camco Pop-Up Laundry Hamper is the perfect for RVs, camping, boating, dorm rooms, or any other area that space may be limited. It is a wire and mesh design that pops-up for use, and collapses flat for storage. The durable handles allow you to easily carry it when full, and the mesh sides allow for ventilation. When collapsed, the hamper has a button-and-loop design that keeps it collapsed.

**51977** Hamper

**POP-UP**



**COLLAPSIBLE LAUNDRY BASKET**

The Camco Collapsible Utility basket is great for laundry or extra storage, and it collapses flat to hide when you don't need it. The simple pop-open and collapse-down design is easy to use and versatile for anywhere. The entire basket is waterproof for easy clean-up, making it perfect for dirty jobs.

**51951** Small, White/Taupe

**51902** Small, Gray/Teal

**51903** Large, White/Gray



**FOLDING IRONING BOARD** Tabletop ironing board with pressed-board top and quality fabric cover is small and easy to use. Features sturdy chrome-wire iron rest. Measures 32" x 12" when set up. Legs fold under and board folds to 16" x 12" for easy storage.

**43904** Ironing Board



**STURDY**

**CAMCO**



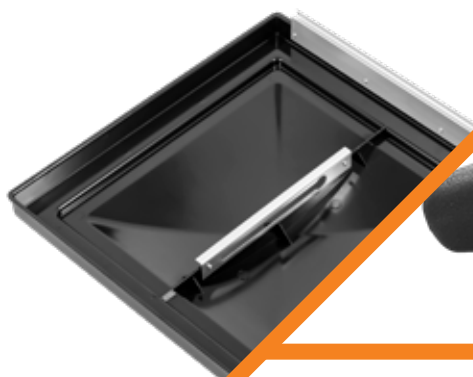

# XLT



**Long lasting**

Fused with hindered-amine light stabilizers for ultimate UV protection.

**Works with high-powered fans**



The high profile of the vent allows for increased air circulation from inside the RV to the outside, and vice versa.



**Opens for cleaning**

The XLT grate opens for full access to the interior of the vent, making cleaning easier.

**High-flow louvers**



High flow louvers in the grate of the XLT provide maximum air flow for running fans.

**XLT ROOF VENT COVER** The new, streamlined Vent Cover XLT features an aerodynamic design and a durable construction. The oversized vent cover is UV resistant and allows more air flow than standard vent covers. It also allows more room to open and close your RV vent lid. Works great with fan powered vents. Camco Vent Cover XLT has pivoting louvers on the grate which allow for easy access to the inside of the cover, making it easy to clean. Fits most mounting brackets. Patented.

**40446** XLT Roof Vent Cover, White

**40456** XLT Roof Vent Cover, Black

**40448** XLT Roof Vent Cover, Replacement Louver





**CAMCO VENT COVER** Leave your vent open rain or shine. The Camco Vent Cover offers high-flow ventilation in an aerodynamic design. Removable louvers for easy cleaning. Mounts to existing 14" x 14" roof vents. UV stabilized resin for years of rugged use. Replacement Screen available in white only.

- 40431 White, 10/ctn
- 40433 White, 5/ctn
- 40439 Replacement Screen, White
- 40443 Black, 5/ctn
- 40453 Smoke, 5/ctn
- 40463 Champagne, 5/ctn
- 40473 Silver, 5/ctn

**Replacement Screen**



**White**



**Black**



**Smoke**



**Champagne**



**Silver**

**Opens for cleaning**



**30% More Open Vent Area**



**AERO-FLO RV ROOF VENT COVER**

Get high-flow fresh air ventilation and light into your RV, rain or shine. Streamlined cover has 30% more open vent area than other brands. Swing-open design makes cleaning easy. Made of rugged UV stabilized resin. Instructions and hardware included. Installs easily by mounting to existing 14" x 14" roof vent. Installed size is 22.5" l x 20" w x 9" h.

- 40421 White



**Easy Access for Cleaning**



**Works great with high-powered fans**

**ROOF VENT KIT** One-piece seamless frame vent kit is leak resistant and weather tight. Built-in screen allows air through and keeps insects out. UV-resistant translucent lid.

**40480** RV Roof Vent Kit



**UV-RESISTANT**

**POLYPROPYLENE REPLACEMENT VENT LIDS**

Impact-resistant vent lids come pre-assembled and include all mounting hardware for quick, easy installation on all 14" x 14" RV vents. Hardware is rust resistant. Replaces models as shown

**WHITE**

- 40151** Ventline, Starting w/ 2008
- 40153** Jensen for Metal Vent, 1994 Up
- 40154** Jensen, Pin Hinge, Pre-1994
- 40155** Ventline: Pre-2008, Elixir: 1994 Up
- 40156** Elixir, Pre-1994
- 40182** Ventline, Starting w/ 2008, PDQ
- 40183** Jensen for Metal Vent, 1994 Up, PDQ
- 40184** Jensen, Pin Hinge, Pre-1994, PDQ
- 40185** Ventline: Pre-2008, Elixir: 1994 Up, PDQ
- 40186** Elixir, Pre-1994, PDQ



**SMOKE**

- 40145** Jensen, Pin Hinge, Pre-1994
- 40146** Ventline: Pre-2008, Elixir: Starting w/ 1994
- 40165** Elixir, Pre-1994



**BLACK**

- 40170** Elixir, Pre-1994
- 40173** Jensen, Metal Base, 1994 Up
- 40174** Jensen, Pin, Pre-1994
- 40176** Ventline, 2008 Up
- 40177** Ventline: Pre 2008, Elixir: 1994 Up

**UNBREAKABLE POLYCARBONATE VENT LIDS**

Unbreakable 14" x 14" vent lids are pre-assembled and include rust-resistant mounting hardware for quick, easy installation. Five-year warranty. Replaces models as shown.

**WHITE**

- 40160** Jensen, Pin Hinge, Pre-1994
- 40161** Ventline: Pre-2008, Elixir: Starting w/ 1994
- 40162** Elixir, Pre-1994
- 40187** Ventline: Pre-2008, Elixir: 1994 Up, PDQ

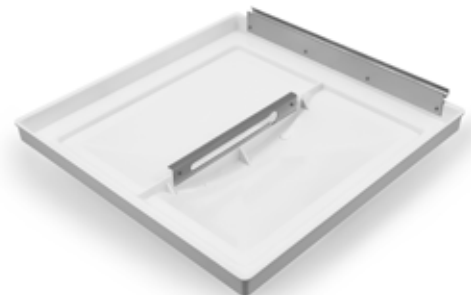

**BLACK**

- 40172** Elixir, Pre-1994
- 40175** Jensen, Pin, Pre-1994
- 40178** Ventline: Pre-2008, Elixir: 1994 Up
- 40188** Ventline: Pre-2008, Elixir: 1994 Up, PDQ

**UNBREAKABLE**



**LIGHTS OUT™ VENT SHADE** Prevent light from shining into RV sleeping quarters. Easily mounts to ceiling and retracts into the space-efficient housing to allow light inside. Opens to 14 1/8" x 19". Durable, lightweight vinyl's reflective finish reflects heat to keep RV cool.

42913 Lights Out



### INSULATED DUAL VENT COVER

Lets air in or blocks it off. It will disperse air in four directions, reducing draft. Catches condensation, rain and outside dust when the vent is left open. Reflective surface blocks 100% of the sun's damaging rays. Dual clips and screws install into existing vent mounting holes. Fits 14" x 14" vents.

45651 Dual Vent Cover



**RV VENT COVER** Increase your RV's AC and heating efficiency. Reflective surfaces block 100% of the sun's damaging rays, helping to keep your RV cooler in summer and warmer in winter. Reflective thermal barrier mounts securely with hook-and-loop strips. 16" x 16"

45191 RV Vent Cover



**RV VENT INSULATOR** Fits snugly in vent opening to help stop heat transfer, keeping your RV cooler in summer and warmer in winter. Fits standard 14" vents. Removable synthetic fleece cover.

45192 Insulator w/ Reflective (not shown)

45195 Insulator



### PRO-TEC RUBBER ROOF PATCH KIT

The fast, easy way to mend your rubber roof. Just peel and seal for a permanent no-leak repair. A quick fix that will last for years! Also for metal and vinyl surfaces.

41461 Rubber Roof Patch Kit



### UNIVERSAL VENT INSTALLATION KITS

Replace or install roof vents, side mount vents, plumbing stacks and refrigerator vents. 3/4" x 8' kits include screws (24 #8 x 1" slotted hex and 4 #6 x 1/2" Phillips) and instructions.

25003 Kit, Gray Putty Tape for Metal Roofs

25013 Kit, White Butyl Tape for Rubber Roofs



**FULL KIT**

**VINYL TRIM INSERT** Replace cracked and stained trim inserts with easy-to-install inserts for aluminum roof edge, trim molding and truck camper shells. (Not for windows, entry doors, compartment doors or vents). UV inhibitors for longer life.

**1" X 25'**

- 25093 Beige
- 25103 White
- 25113 Black
- 25123 Colonial White
- 25133 Brown
- 25134 Light Gray

**3/4" X 25'**

- 25143 Colonial White
- 25153 Beige
- 25163 White
- 25173 Black

**1" X 100'**

- 25192 Beige
- 25202 White
- 25212 Black
- 25222 Colonial White
- 25232 Brown
- 25233 Light Gray

**3/4" X 100'**

- 25242 Colonial White
- 25252 Beige
- 25262 White
- 25272 Black

**1" X 1000'**

- 25302 White
- 25312 Black
- 25322 Colonial White



**BAGGAGE DOOR CATCHES** Durable ABS plastic. Keep baggage compartments open while loading and unloading for easy access. Easily mounts directly on RV.

- 44160 Black, 2pk
- 44163 Colonial White, 2pk
- 44173 Polar White, 2pk



**CAM LOCKS** Keep your storage compartments secure. Ideal for new or replacement installations on RVs. Easy-turn thumb operated or key-locking styles. Each contains one offset and one straight cam.

- 44323 7/8" Thumb Operated
- 44333 5/8" Thumb Operated
- 44340 5/8" Baggage Lock
- 44353 7/8" Baggage Lock
- 44363 1 1/8" Baggage Lock
- 44368 1 3/8" Baggage Lock
- 44303 7/8" ACE Key Baggage Lock
- 44293 5/8" ACE Key Baggage Lock



**LOCKING T-HANDLE** Replaces most garage door, camper and RV locking handles.

- 44393 Locking T-Handle



**CABINET CATCHES** Barrel-style replacement catches. Screws included.

- 44203 Side Mount, 6pk



**COAXIAL CABLE** 75 ohm, 18 AWG center conductor cable for use with Satellite or cable TV and cable modems.

- 64761 50' cable



**MOVABLE TARP CLIPS** Two-piece snap-together grommets work on plastic sheeting, tarps, tents and awnings to create an extra tie-down point without punching a hole in the fabric.

- 45462 Tarp Clips, 4pk, Canada Item



**CAMPER MOUNTING TAPE** Self-Adhesive vinyl foam. 30' roll: Enough to install a large camper or canopy. Seals out dust, drafts and water; cushions to quiet rattles and vibrations. 30' L x 1 1/4" W x 3/16" thick.

**25084** Camper Mounting Tape



**GUTTER EXTENSIONS** Contains 2 each left and right extensions. Direct rain water runoff away from the sides of your RV to help prevent black streaks. Extensions clip onto your existing RV gutters. Patented.

**42123** White, 4pk

**42120** White, 4pk, Canada Item

**42110** Black, 4pk, Canada Item



Clips onto existing spouts

**SLIDE-OUT CORNER GUARDS** A simple solution to the danger posed by sharp corners on your slide-outs. Place these soft, flexible guards on each exterior corner of your slide-out to provide a cushion zone. Constructed of advanced UV stabilized resin for long life. Installation is quick and easy—no tools required. Patented.

**42193** White

**42194** White, Canada Item

**42203** Black

**42204** Black, Canada Item

**GUTTER SPOUTS WITH EXTENSIONS** Replace shorter or worn OEM rain spouts, or can be used on RVs that do not have existing gutters on the drip rail. Help prevent black streaks by directing rain water runoff away from the sides of your RV. Patented.

**42134** White, 4pk

**42323** Black, 4pk



Replaces damaged or missing spouts



**WIDE/LONG GUTTER SPOUTS WITH EXTENSIONS** Replace shorter or worn OEM rain spouts, or can be used on RVs that do not have existing gutters on the drip rail. Help prevent black streaks by directing rain water runoff away from the sides of your RV. Patented.

**42462** White, 4pk

**42452** Black, 4pk



Replaces damaged or missing spouts



**A/C CEILING VENT WITH LOUVERS**

**40419** Ceiling Vent, A/C, Open/Close, White



**A/C CEILING VENT**

**40411** Ceiling Vent, A/C, Beige

**40413** Ceiling Vent, A/C, White

**40416** Ceiling Vent, A/C, Black



**ROUND ATTIC VENT ASSEMBLY**

**40403** Attic Vent Assembly, Round, White

**40406** Attic Vent Assembly, Round, Black



**SLIDE-OUT CORNER PLATES**

**42216** Slide Out Corner Plate, 4pk, White

**42217** Slide Out Corner Plate, 4pk, Tan

**42218** Slide Out Corner Plate, 4pk, Gray

**42219** Slide Out Corner Plate, 4pk, Black

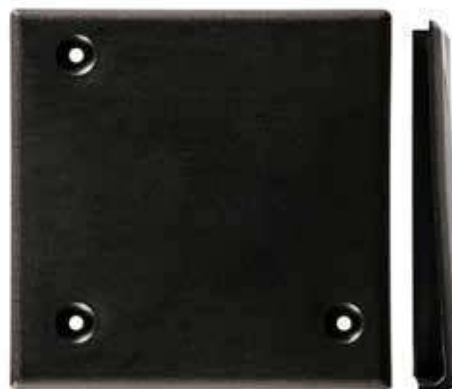

**90° DOOR HOLDER KITS**

**42373** Door Holder Kit, 90°, White

**42376** Door Holder Kit, 90°, Black



**STRAIGHT DOOR HOLDER KITS**

**42383** Door Holder Kit, 3.5", White

**42386** Door Holder Kit, 3.5", Black

**42393** Door Holder Kit, 6", White

**42396** Door Holder Kit, 6", Black



**ELECTRICAL CABLE HATCHES**

**55053** Electric Cable Hatch w/ back, White

**55056** Electric Cable Hatch w/ back, Black

**55063** Electric Cable Hatch w/o back, White

**55066** Electric Cable Hatch w/o back, Black



**SINGLE COAXIAL CABLE PLATES**

55033 Coaxial Cable Plate w/ Cap, Single, White

55036 Coaxial Cable Plate w/ Cap, Single, Black

**SINGLE LARGE-CAP COAXIAL CABLEPLATES**

55073 Coaxial Cable Plate w/ Large Cap, Single, White

5076 Coaxial Cable Plate w/ Large Cap, Single, Black

**DUAL COAXIAL CABLE PLATES**

55043 Coaxial Cable Plate w/ Cap, Dual, White

55046 Coaxial Cable Plate w/ Cap, Dual, Black

**DUAL LARGE-CAP COAXIAL CABLE PLATES**

55083 Coaxial Cable Plate w/ Large Cap, Dual, White

5086 Coaxial Cable Plate w/ Large Cap, Dual, Black



**CAMCO**





# FUMES STAY UP HERE

Vent dangerous generator exhaust above the roof line



**Gen-turi™**  
RV generator exhaust system

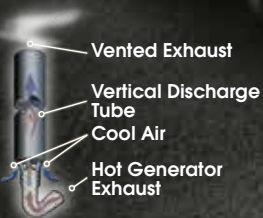

**CAMCO**

## GEN-TURI AIR-COOLED VENTURI GENERATOR EXHAUST SYSTEM

Close quarters at rallies and tailgate parties create a need for noise and exhaust fume reduction. Gen-turi diverts nasty fumes away from the ground, so they won't be inhaled by neighboring RVers. Be a good neighbor. Weighing only nine pounds, Gen-turi installs easily and disconnects quickly. Includes storage bag. Patented.

**44461** Gen-turi



**Sturdy Construction**



**Lightweight**



**Storage Bag Included**



**GEN-TURI TRANSFER KIT** If you need to move your Gen-turi from one motorhome to another, this kit contains all the hardware you'll need.

**44881** Gen-turi Transfer Kit



## GEN-TURI SUCTION CUP MOUNTS

Designed to quickly secure your Gen-turi exhaust system to your RV with the twist of a knob and keep it there until you're ready for it to come down. No need for drilling holes in your RV or potentially damaging the exterior. Mounts can be removed at any time, and can go with you if you ever decide to move RVs.

**44850** Gen-turi Suction Cup Mounts



## GEN-TURI REPLACEMENT PARTS

(not shown)

- 44802** 30" EMT Straight
- 44812** 30" EMT 90° Bend
- 44822** 1 1/2" Muffer Clamp
- 44842** 1 5/8" Coupler
- 44845** 1 3/4" Coupler w/ Clamp
- 44848** 2" Coupler w/ Clamp
- 44852** 1" Split Bushing
- 44862** 8" 30° EMT
- 44872** 18" Extension w/ Coupler
- 44892** Aluminum Hooks w/ Rivets, 2pk
- 44894** Bungee w/ S-Hooks

All prices listed are manufacturer's suggested retail



**HEAVY DUTY PROPANE TANK COVER**

**COVER** Heavy duty polypropylene cover protects propane gas bottles from flying debris while streamlining the look of your rig. Slip the custom molded, assembled unit over bottles for a safe, secure fit and UV protection against sun damage. Updated design provides easier access to gas valves and changeover valves. Patented.

**FITS 20 LB OR 30 LB STEEL DOUBLE TANKS**

(will not fit 30 lb aluminum tanks)

- 40532 Colonial White
- 40542 Polar White
- 40530 Bronze
- 40531 Champagne
- 40539 Black

**FITS 20 LB STEEL DOUBLE TANKS**

- 40523 Polar White
- 40525 Colonial White
- 40568 Black

**FITS 20 LB STEEL SINGLE TANKS**

- 40564 Polar White
- 40565 Black

**CAP REPLACEMENT KITS FOR TANK COVERS**

- 40533 Colonial White
- 40543 Polar White
- 40548 Bronze
- 40549 Black
- 40550 Champagne
- 40534 Old-Style, Colonial White
- 40544 Old-Style, Polar White

**REPLACEMENT PARTS**

- 40547 Thumbscrews, 2pk
- 40586 Thumbscrews and Nuts, 2pk
- 40519 Bungee Cord for LP Covers



**CYLINDER STABILIZING BASE**

Help prevent accidental tipping of your propane cylinder, especially during transport. For use with 20 or 30 lb propane tanks. Impact resistant base easily attaches to tank to keep cylinder in place during storage or travel. Patented.

- 57236 Cylinder Base

Cylinder not included



# Find the Propane Connection Kit that best fits your needs.

## BRASS TEE WITH THREE PORTS AND 12' HOSE

Mounts in-line between supply and regulator on a motorhome to allow connection of an additional propane appliance such as a tabletop grill, camp stove or lantern. Provides excess flow protection in case of broken gas line. Includes propane tee (Female P.O.L./Male Acme Thread x excess flow soft nose P.O.L. x 1"-20 male throwaway cylinder thread) and 12 ft extension hose with male x female swivel 1"-20 female throwaway cylinder threads.

**59103** 3-Port Tee and Hose

**59093** 3-Port Tee Only



## BRASS TEE WITH FOUR PORTS, 5' HOSE AND 12' HOSE

Mounts in-line between supply and regulator on a motorhome to allow hook-up of an auxiliary propane cylinder and the connection of an additional propane appliance such as a tabletop grill, camp stove or lantern. Provides excess flow protection in case of broken gas line. Includes propane tee (Female P.O.L./Male Acme Thread x excess flow soft nose P.O.L. x 1"-20 male throwaway cylinder thread x 1/4" inverted flare), 12' extension hose with male x female swivel 1"-20 female throwaway cylinder threads and 5' supply hose with excess flow soft nose P.O.L. x 1/4" inverted male flare connections.

**59123** 4-Port Tee and Hoses

**59113** 4-Port Tee Only

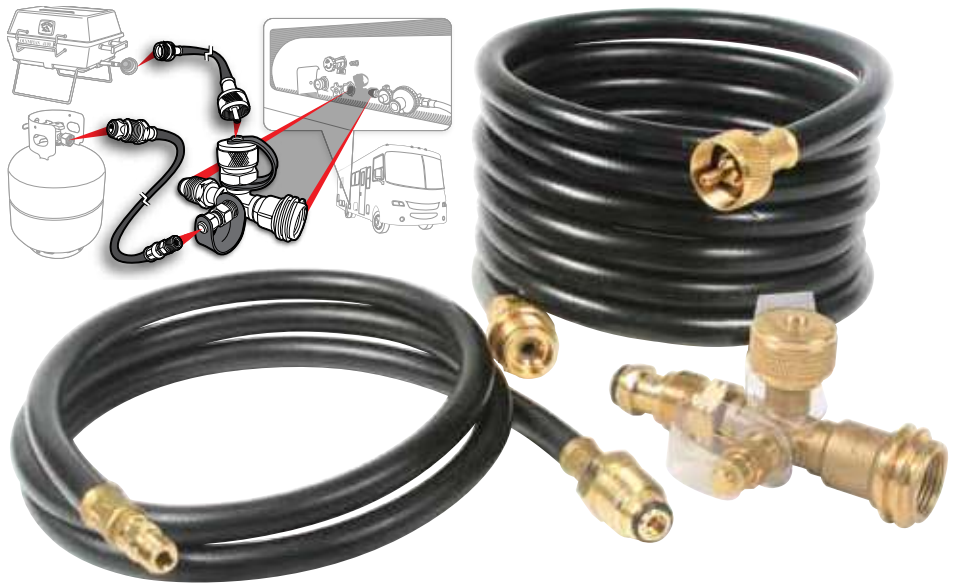

## BRASS TEE WITH FOUR PORTS AND 5' HOSE

Mounts in-line between supply and regulator on a motorhome to allow hook-up of an auxiliary propane cylinder. Provides excess flow protection in case of broken gas line. Includes propane tee (Female P.O.L./Male Acme Thread x excess flow soft nose P.O.L. x 1"-20 male throwaway cylinder thread x 1/4" inverted flare), and 5' supply hose with excess flow soft nose P.O.L. x 1/4" inverted male flare connections. (Allows connection of an additional propane appliance that requires a high-pressure source with the addition of a 59043 or 59045 propane extension hose - sold separately).

**59125** 4-Port Tee with 5' hose



## 90° PROPANE TEE WITH 12' HOSE

Connects to camper or trailer propane cylinder to allow connection of an additional propane appliance such as a tabletop grill, camp stove or lantern. Provides thermal protection in case of fire and excess flow protection in case of broken gas line. Includes propane tee (Type 1 Acme nut x female P.O.L. and male acme thread x 1"-20 male throwaway cylinder thread) and 12' extension hose with male x female swivel 1"-20 female throwaway cylinder threads.

59143 90° Tee and Hose

59133 90° Tee Only

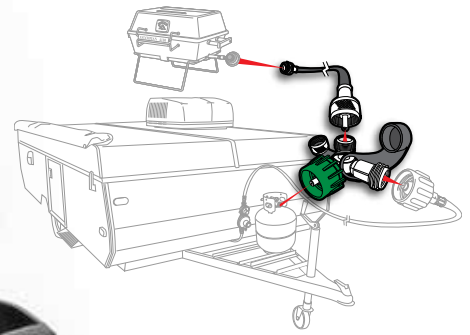

**Connects to Acme (new style) and P.O.L. (old style) connections**

**PROPANE SUPPLY HOSE** Replacement for hose in Propane Kits 59123 and 59125. Excess Flow Soft Nose P.O.L. x 1/4" Inverted Male Flare. Connects a propane cylinder to any device that has a 1/4" inverted female flare connection.

59033 5'

59035 12'

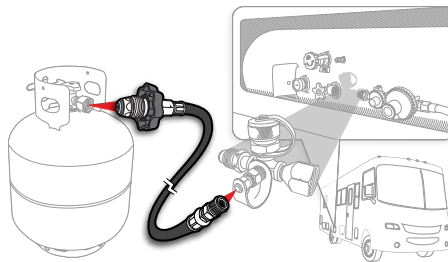

**PROPANE HOSE ASSEMBLY** For use with an existing gas supply to connect an appliance equipped with a 3/8" male flare. 3/8" female flare x 3/8" female flare.

59913 3'

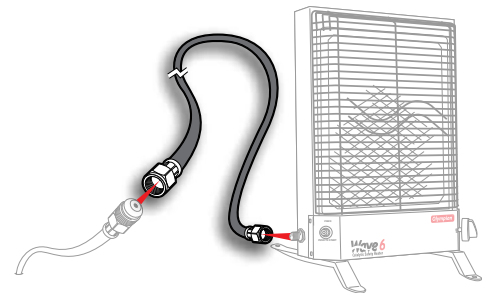

## PROPANE EXTENSION HOSE

Replacement for 12' hose in the following Propane Connection Kits: 59123 (4-Port Tee with 12' Hose and 5' Hose) 59103 (3-Port Tee with 12' Hose) 59143 (90° 4-Port Tee with 12' Hose) M x F swivel 1"-20 female throwaway cylinder threads.

59045 5'

59043 12'

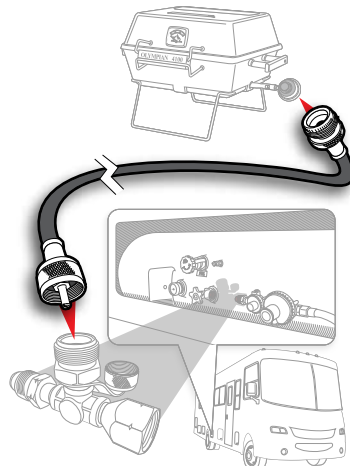

**PIGTAIL PROPANE HOSE CONNECTORS WITH MALE INVERTED FLARE**

For connecting propane cylinder to RV or trailer propane regulator. Rated for 200,000 BTUs per hour. Provides thermal protection in case of fire and excess flow protection in case of broken gas line. Type 1 ACME nut x 1/4" inverted male flare.

- 59053 12" Pigtail Connector
- 59065 15" Pigtail Connector
- 59073 20" Pigtail Connector
- 59153 24" Pigtail Connector
- 59163 30" Pigtail Connector
- 59173 36" Pigtail Connector
- 59183 48" Pigtail Connector
- 59193 60" Pigtail Connector

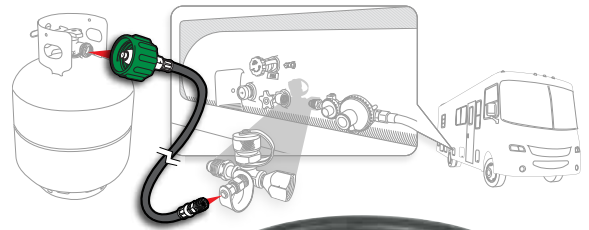
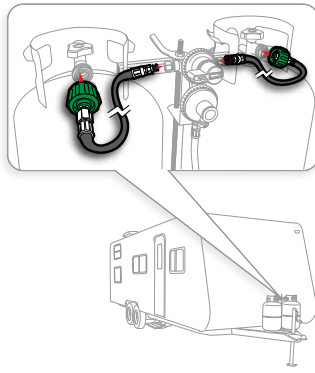

**PIGTAIL PROPANE HOSE CONNECTOR WITH MALE NPT**

For connecting a 20 or 30 lb refillable propane tank to the regulator on a camper. Provides thermal protection in case of fire and excess flow protection in case of broken gas line. Type 1 ACME nut x 1/4" Male NPT.

- 59843 20" Pigtail Connector

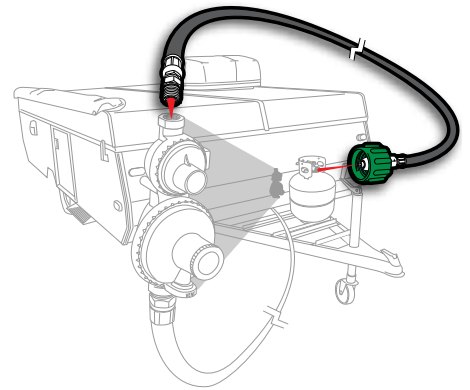

**PROPANE HOSE ASSEMBLY**

High-pressure hose with easy-grip Acme nut for connecting an appliance designed to use a 1 lb disposable cylinder to a 20 or 30 lb refillable propane tank. Provides thermal protection in case of fire and excess flow protection in case of broken gas line.

- 59823 5'
- 59825 12'

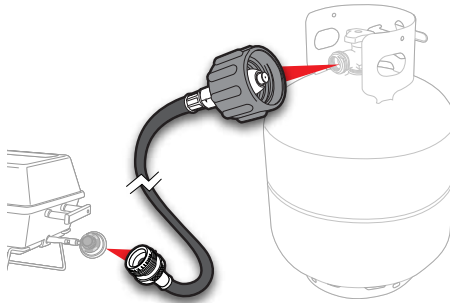

**PROPANE APPLIANCE EXTENSION HOSE**

For use on a 20 or 30 lb refillable propane tank to provide an extension for portable propane appliances. 1/4" Male NPT x 1/4" Female NPSM.

- 59883 5'

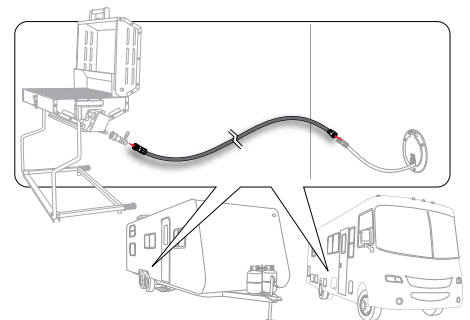

**AUTOMATIC CHANGEOVER TWO-STAGE REGULATOR**

For RVs with dual propane tank hookup. Regulator maintains constant gas pressure and automatically changes from empty tank to full one. Allows removal of empty cylinder for refill without interrupting propane supply. Inlet: 1/4" SAE inverted flare. Outlet: 3/8" NPT female. BTU rating: service cylinder: 210,000 BTU/hr; reserve cylinder: 130,000 BTU/hr.

59005 Automatic Changeover Regulator

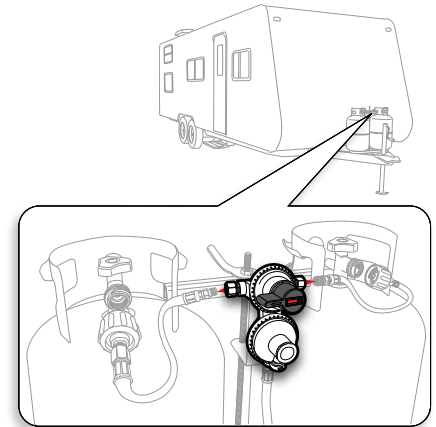

**SINGLE STAGE PROPANE REGULATOR**

For connecting a free-standing gas bottle to a grill or other low-pressure gas appliance. Maintains a constant 11" w.c. propane pressure. 200,000 BTU/HR.

59013 Single Stage Regulator

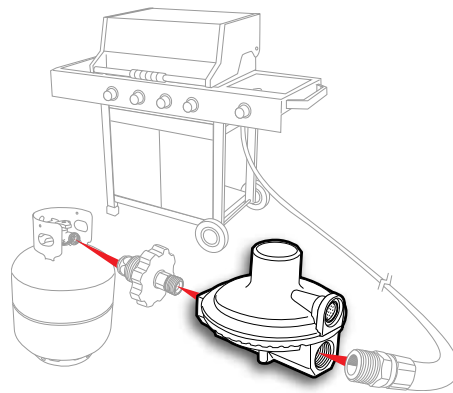

**TWO STAGE PROPANE REGULATOR**

Integral first and second stages ensure a smoother, more consistent flow of gas to all appliances. CSA Listed. Inlet: 1/4" NPT. Outlet: 3/8" NPT. Outlet pressure: 11" WC. BTU Capacity (propane): 160,000 BTU/HR.

59313 Vertical Mount

59323 Horizontal Mount

59333 Horizontal Mount with P.O.L.

59344 Covers for Two-Stage Regulators, 2pk

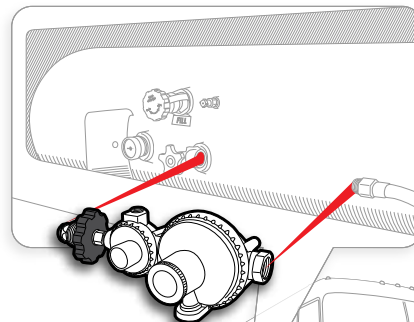
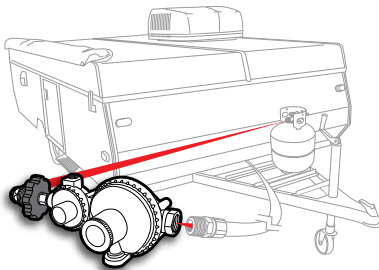
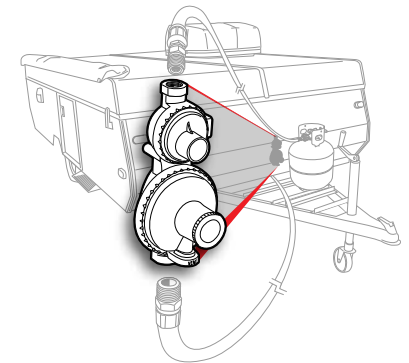

**PROPANE DISTRIBUTION POST WITH STORAGE BAG**

Use up to three propane appliances simultaneously—with just one tank! Lantern, Portable Campfire, Grill, Camp Stove/Griddle, Heater and more. Includes: One 15" Propane Distribution Post; Excess Flow, Soft-Nose P.O.L. Propane Tank Connection and THREE—1"-20 Male Throwaway Cylinder—Appliance connections and one 15" Propane Distribution Post Extension: 1"-20 Male/Female Throwaway Cylinder Threads. All outlets feature auto-shutoff.

**51096** Propane Distribution Post



**PROPANE QUICK-CONNECT KIT**

For use in low-pressure propane systems to add a convenient connect/disconnect method or to add an additional safety shut-off. Valve: 1/4" Female NPT x Female Quick Connect; Full Flow Plug: 1/4" Male NPT x Male Quick-Connect.

**59853** Quick-Connect Kit

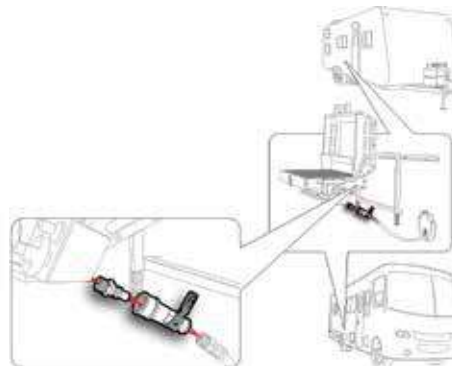

**QUICK-CONNECT FULL-FLOW PLUG**

For use in low-pressure propane systems to add a convenient connect/disconnect method. 1/4" Male NPT x Male Quick-Connect.

**59903** Full-Flow Quick-Connect Plug

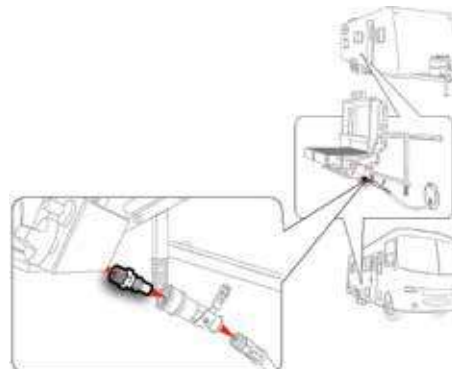

**GREEN PROPANE ACME NUT** 200,000 BTU/hour. For use on a 20 or 30 lb refillable propane tank to connect to a regulator/hose assembly. Provides thermal protection in case of fire and excess flow protection in case of broken gas line. Acme nut x 1/4" NPT.

**59923** 200,000 BTU Acme Nut

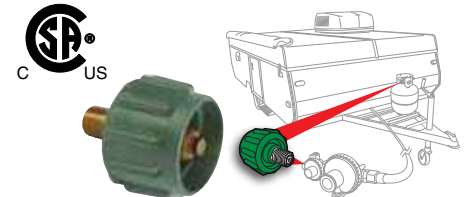

**BLACK PROPANE GRILL ACME NUT** 70,000 BTU/hour. For use on a 20 or 30 lb refillable propane tank to connect to a regulator/hose assembly. Provides thermal protection in case of fire and excess flow protection in case of broken gas line. Acme nut x 1/4" NPT.

**59933** 70,000 BTU Acme Nut



**PROPANE FITTINGS** For use on some regulators to allow connection of a propane pigtail with 1/4" inverted flare connection to a regulator that has female 1/4" NPT port(s). 1/4" Male NPT x 1/4" Female Inverted Flare.

**59953** NPT 1/4" Fitting

**59954** NPT 1/4" Fitting w/ Check Valve

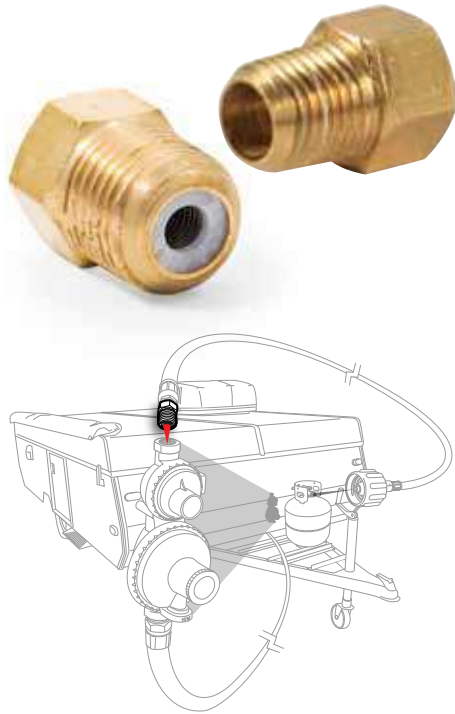

## PROPANE CYLINDER ADAPTER

For use with any appliance designed to use a 1 lb throwaway cylinder. With this handy adapter, you can power your small LP appliance directly from a 20 or 30 lb refillable tank. Provides excess flow protection in case of broken gas line. Soft Nose P.O.L. x 1"-20 Male Throwaway Cylinder Thread.

**59943** Propane Cylinder Adapter



## PROPANE Y ADAPTER WITH HANDWHEEL

For use on a 20 or 30 lb refillable propane tank. Allows you to operate two appliances such as a Campfire and a grill at once from the same cylinder. Provides excess flow protection in case of broken gas line. Male Soft-Nose P.O.L. x Two 1"-20 Male Throwaway Cylinder Thread Connections.

**59893** Propane Y Adapter

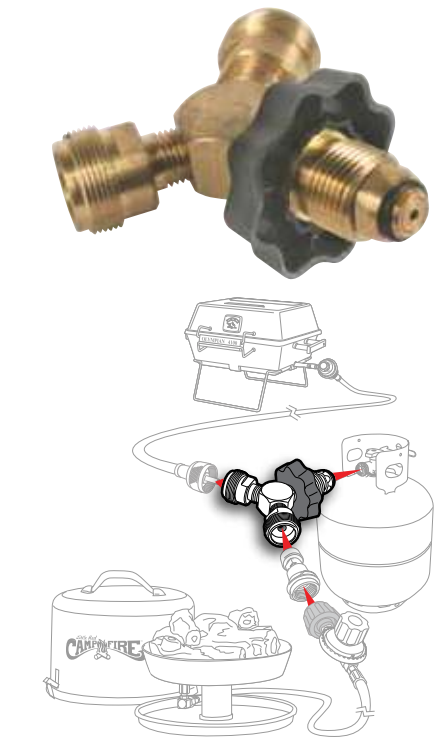

**P.O.L. PLUG ADAPTER** For use on a 20 or 30 lb refillable tank to connect cylinder to regulator. Converts 1/4" NPT to female P.O.L. Provides excess flow protection in case of broken gas line. Soft Nose P.O.L. x 1/4" Male NPT.

**59203** P.O.L. Plug Adapter

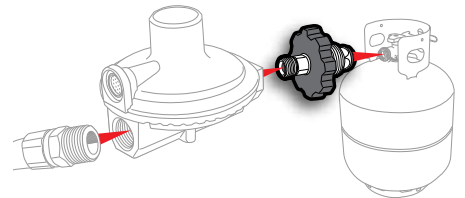

**GAS GAUGE/LEAK DETECTOR** See at a glance when your propane pressure level is low. Type 1 for gas grills, RVs and boats. Fits all propane tanks manufactured after 1995. Provides thermal protection in case of fire and excess flow protection in case of broken gas line. Acme Nut x Acme Thread and Female P.O.L.

**59023** Gas Leak Detector

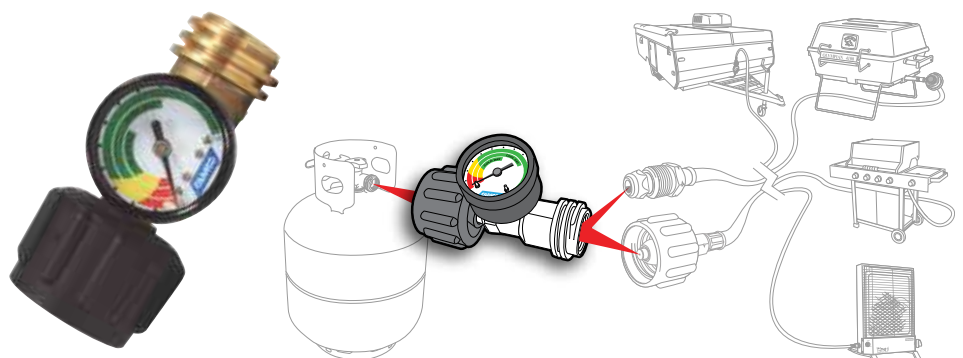

**CAMCO**







Appliances

**OLYMPIAN CATALYTIC HEATING ELEMENT** Features a high porosity spongy texture which allows for perfect transport of the oxygen needed for combustion. The catalytic heating element is evenly impregnated with platinum, guaranteeing optimal oxidation of gas and elimination of the mix of dangerous gas emissions.

**Platinum Catalytic heating system  
for all Wave Heater models**

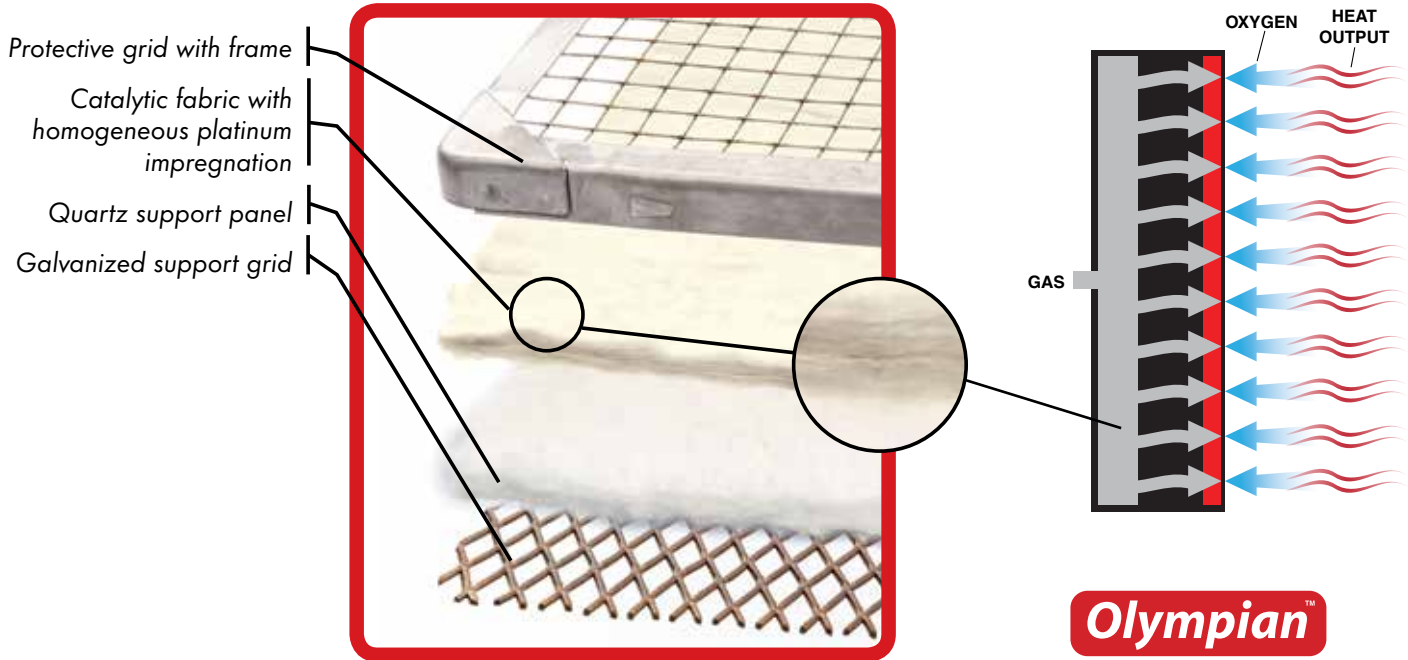

**CHOOSE THE WAVE HEATER THAT'S RIGHT FOR YOU**

	WAVE 3	WAVE 6	WAVE 8
Low pressure LP gas	•	•	•
BTU Output	1600 to 3000	3200 to 6000	4200 to 8000
Fuel Consumption at maximum output	1/8 lb/hr.	1/4 lb/hr.	1/3 lb/hr.
Gas Connection	3/8" SAE Flare	3/8" SAE Flare	3/8" SAE Flare
Height	11-3/4"	17-7/8"	21-1/4"
Width	10-1/4"	12-13/16"	15"
Depth	3-1/2"	4"	4"
Weight	6 lbs.	12 lbs.	14 lbs.
Typical RV Size*	up to 12'	up to 18'	up to 23'
Room Area Heated*	100 sq. ft.	200 sq. ft.	290 sq. ft.
Ignition	Piezo Spark	Piezo Spark	Piezo Spark
Vertical Wall Hung	•	•	•
Horizontal Wall Hung		•	•
Vertical Recessed		•	•
Horizontal Recessed		•	•
Portable Leg Stands	•	•	•
Warranty	1 year	1 year	1 year

\*The heated areas depends greatly on insulation R-Factor and outside temperature. All "heated area" specifications were based on outside temperature of 35°F and R17 interior insulation. If camping in cooler temperatures, or if RV is not well insulated, a larger heater should be installed.

**Flame-type heaters waste up to 45% of all heat produced. Catalytic heating is over 96% efficient, resulting in efficient, low-cost heat. Refer to the chart on the previous page to choose the correct size heater for your RV.**

## OLYMPIAN WAVE CATALYTIC SAFETY HEATERS

An ideal primary or secondary heating source. Wave heaters operate on low pressure LP gas, and can be wall mounted or used as portables. Equipped with an integral safety shut-off valve to help prevent accidental non-ignition fuel discharge. The built-in Piezo electric spark starter will last for 20,000 starts. No electrical drain or battery connection. Leg stands not included.

**57331** Olympian Wave 3, Adj. 1600–3000 BTUs

**57341** Olympian Wave 6, Adj. 3200–6000 BTUs

**57351** Olympian Wave 8, Adj. 4200–8000 BTUs

**PORTABLE OR WALL MOUNTED**



## CUSTOM FITTED DUST COVERS

**57706** Wave 3/3100 Dust Cover

**57713** Wave 6/6100 Dust Cover

**57715** Wave 8/8100 Dust Cover

**57722** Wave 3 Dust Cover, Portable

**57723** Wave 6 Dust Cover, Portable

**57724** Wave 8 Dust Cover, Portable



## LEG STANDS FOR WAVE HEATERS

**57701** Black, 2pk



**Olympian™**

**90° CONNECTOR ELBOW** 3/8" swivel flare female x 3/8" flare male.

**57633** Elbow w/ Full 360° Swivel

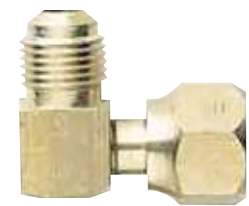

## LP GAS REGULATOR WITH HOSE

For use with all Olympian LP gas fired heaters.

**57703** Regulator w/ 6' Hose

**57704** Regulator w/ 8' Hose

**57721** Regulator w/ 12' Hose

**59863** Regulator w/ 22" Hose



**FLYING INSECT SCREENS** Wasps, mud daubers, birds and rodents pose a serious threat to your RV appliances when they enter through vents and openings, building nests that interfere with air flow. Protect your valuable investment by purchasing and installing Camco's Flying Insect Screens. These easy-to-install screens will help ensure that your vents stay free from costly invasion by unwanted pests. All except Refrigerator Screens and FUR200 include installation tool.

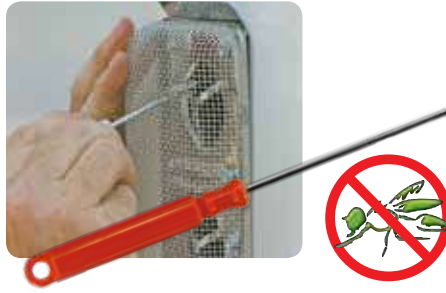

**PL100** For 4-prong type plumbing vents.

**42152** PL100 for Plumbing Vents



**WH200** For Suburban furnace vents; models 8535, 8531, 8525, 8940 DC, and 8940 AC, Suburban louvered water heater vents as well as most battery vents.

**42150** WH200 Insect Screen



**WH400** For Suburban 6 gal Flush Mount water heater vents.

**42151** WH400 for Water Heater Vents



**WH500** For Atwood 6 and 10 gal, Suburban 6 gal water heater vents.

**42145** WH500 for Water Heater Vents



**WH600** For Suburban 10 to 16 gal water heater vents.

**42146** WH600 for Water Heater Vents



**ST500** For louver-type RV stove vents.

**42147** ST500 for RV Stove Vents



**RS500** For RV refrigerator vents with 19 3/4" louver openings - except Dometic.

**42148** RS500 for RV Refrigerator Vents

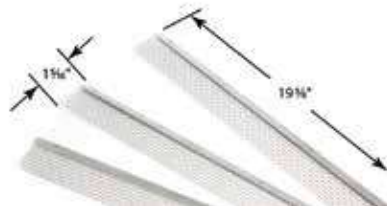

**RS600** For Dometic RV refrigerator vents with 20" louver openings.

**42149** RS600 for RV Refrigerator Vents



**RS700** For Norcold refrigerator vents with 27.5" louver openings.

**42153** RS700 for Refrigerator Vents, 3pk

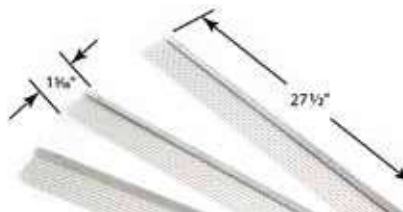

**RS800** For Dometic refrigerator vents with 8.13" louver openings.

**42154** RS800 for Refrigerator Vents, 6pk

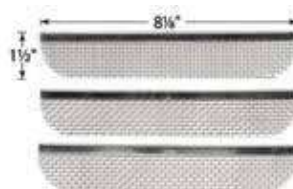

**RS900** Fits Norcold refrigerator with 620505PW louvers.

**42156** RS900 for Refrigerator Vents



**FUR100** For Sol-Aire, Coleman, Hydroflame and Suburban furnace vents.

**42140** FUR100 for Furnace Vents



**FUR200** For Duo-Therm and Suburban furnace vents.

**42141** FUR200 for Furnace Vents



**FUR300** For Hydroflame series furnace vents.

**42142** FUR300 for Furnace Vents



**FUR400** For Suburban DD Series furnace vents.

**42143** FUR400 for Furnace Vents



**FUR500** For Atwood / Hydroflame water heater vents with no access door.

**42144** FUR500 for Furnace Vents



**FUR600** For Atwood AFMD model furnace vents.

**42155** FUR 600 for Furnace Vents



## RV REFRIGERATOR VENT COVER

Fits Dometic, Camco and newer Norcold bases. Made from UV stabilized, durable polypropylene plastic. Cap mounts to base with included hardware. Patented.

### WHITE

42160 Vent only

42161 Vent Base only

### BLACK

42163 Vent only

42164 Vent Base only



## UNIVERSAL ROOF AIR CONDITIONER GASKET KIT

Install a roof AC with confidence with this 14" x 14" kit, the best available. Includes a self-adhesive picture frame gasket and two self-adhesive foam leveling pads (7/8" x 1 7/16" x 18" and 5/16" x 1 7/16" x 18") for a universal fit.

25071 AC Gasket Kit



## WALL THERMOSTATS

09221 Heat & Cool Thermostat, Single Stage Only (Not designed for multi-speed air conditioners.)



09231 Heat Only Thermostat



## RV WATER HEATER HYBRID HEAT™

Easily converts any RV LP gas water heater to 120V electricity on demand, helping to conserve propane. Stainless steel heating cartridge heats the water to temperatures ranging from 90° to 150° F. Includes power switch with mounting bracket and adjustable thermostat. Factory preset to 120° F. All necessary power cords and color-coded wire assemblies are included. 15 A/120 V electrical service required for use.

11673 6 gal w/ 425 Watt Element

11773 10 gal w/ 625 Watt Element

11674 6 gal Replacement Element

11774 10 gal Replacement Element

## REPLACEMENT BUSHING WITH FLOW-THRU ANODE ROD

11641 Replacement Bushing, 1/2" NPT

11645 Replacement Bushing, 3/4" NPT

Switch from propane to 120 V electric any time with the RV Water Heater Hybrid Heat.

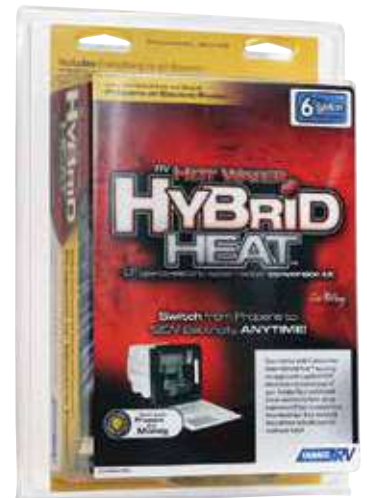
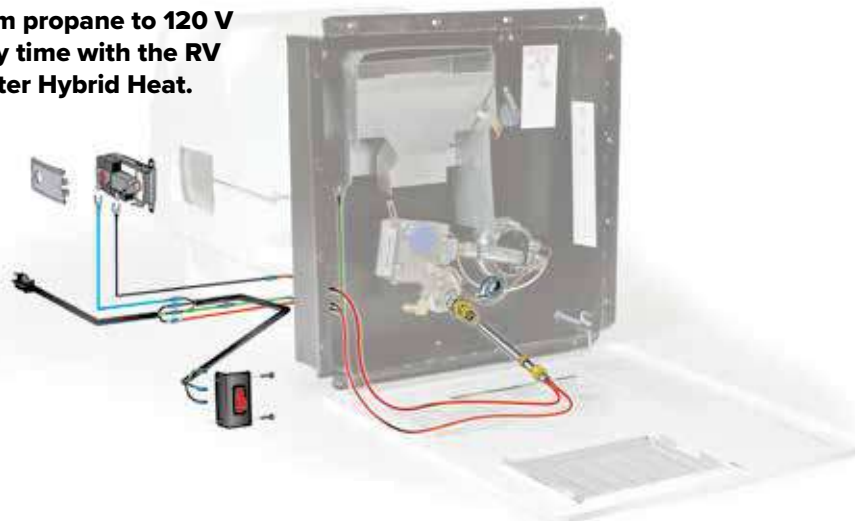

**SCREW-IN ELEMENT WRENCH**

Remove and replace screw-in elements with ease. Zinc-plated element wrench goes where other wrenches can't. Works with your screwdriver and fits all standard screw-in type elements and 1 1/2" nuts.

**09883** Element Wrench



**PROFESSIONAL ELEMENT SOCKET**

Fits standard 1/2" socket drive to make easy work of replacing screw-in water heater elements. Chrome-plated.

**09951** Element Socket, Card

**09953** Element Socket, Clamshell



**CAM LOCKS** Replace broken door latches quickly and easily. Cam Locks replace water heater door latch assemblies or gas bottle cover access door latches.

**09203** Plastic Cam Locks, 2/card

**09213** Steel Cam Locks, 2/card

**09214** Stainless Steel Cam Locks, 2/card



**WATER HEATER REPLACEMENT ELEMENTS**

Replace the heating element in your RV water heater with a UL recognized HWD replacement kit. Detailed instructions included.

**02103** Screw-In Element, 1000W-120V

**02143** Screw-In Element, 1500W-120V

**04363** Universal Element, 1500W-120V



**WATER HEATER CONTINUITY TESTER**

Test your water heater elements and circuits with ease.

**10023** Water Heater Continuity Tester



**RV WATER HEATER DRAIN PLUG KIT**

Specifically designed for use with RV water heater drain plugs. Angled design conveniently fits in tight spaces and includes prongs for rusted drain valves. Fits both 7/8" and 15/16" drain plugs. Includes two replacement 1/2-14 NPT drain plugs and Teflon® tape.

**11630** Water Heater Drain Plugs, 2pk

**11632** Water Heater Drain Plug, 50/box

**11633** Water Heater Drain Plug Kit

**11634** Water Heater Drain Plug, 1 vent. & 1 stan.



**WATER HEATER TANK RINSER**

Helps extend the life of your water heater. Water Heater Tank Rinsers lift sediment that collects at the bottom of your water heater and washes it out of your water heater tank.

**11691** Water Heater Tank Rinsers



**WATER HEATER THERMOSTAT**

Replacement Therm-O-Disc style single element thermostat with High Limit Control.

**08143** TOD Single Element Thermostat



**TEMPERATURE AND PRESSURE RELIEF VALVES** Protect your RV water heater from excessive temperature and water pressure with corrosion-resistant metal T & P valves. Epoxy-coated probes help prevent corrosion buildup. Factory set at 150 PSI and 210° F.

- 10423** 1/2" Valve w/ 4" Probe 4/ctn
- 10421** 1/2" Valve w/ 4" Probe, Bulk
- 10463** 3/4" Valve w/ 1" Probe 12/ctn
- 10473** 3/4" Valve w/ 4" Probe 12/ctn
- 10471** 3/4" Valve w/ 4" Probe, Bulk



**WATER HEATER DRAIN VALVE WRENCH** Open or close stubborn water heater drain valves without scraping your knuckles. Heavy duty, high-impact plastic wrench has an adjustable handle that lets you get at hard-to-reach valves with leverage to loosen stubborn valves. Open handle allows hot water to flow to front of heater, preventing pooling.

- 11653** Drain Valve Wrench



**UNIVERSAL T & P VALVE REMOVER** Replace T & P valves faster and more safely. Valve Remover gives you better access to the water heater housing, reducing injuries. Fits Atwood and Suburban (Mor-Flo) water heaters.

- 10552** T & P Valve Remover



**ANODE RODS** Anode rods extend the life of a water heater by attracting corrosive elements in the water, protecting your tank and elements from corrosion.

- 11553** Magnesium, For Atwood 1/2" NPT 1/2" Dia. 4 1/2" Long, Patented
- 11552** Magnesium, For Atwood, Bulk
- 11593** Magnesium, For 10 gal Atwood 1/2" NPT .6" Dia. 9 1/2" Long, Patented
- 11563** Aluminum, For Suburban (Mor-Flo) 3/4" NPT 3/4" Dia. 9 1/2" Long
- 11562** For Suburban (Mor-Flo), Bulk



**WATER HEATER DRAIN VALVES** Replace water heater valves with sturdy, easily-installed durable brass replacements.

- 11663** 1/4" NPT Drain Valve
- 11683** 3/8" NPT Drain Valve
- 11703** 1/2" NPT Drain Valve



**RV WATER HEATER ANODE ROD WITH DRAIN** Patented magnesium anode rod for aluminum water heaters (Atwood style) preserves the life of your water heater by corroding itself so your water heater tank doesn't. Replace your 1/2" pipe thread drain plug with the Camco RV Water Heater Anode Rod to extend the life of your RV's water heater. Internal drain valve allows you to drain your water heater without tools.

- 11533** Anode Rod with drain, 1/2 NPT



**GAS CONTROL REPLACEMENTS** Camco's gas controls are designed specifically for use on recreational vehicles. Custom made for use with LP gas to an 11" water column. All are adjustable from 120° to 160° F.

- 08601** (3/8" Inv. Flare x 3/8" Female NPT) RV-50A
- 08631** (3/8" Inv. Flare x 3/8" Inv. Flare) RV-50D
- 08641** (3/8" Inv. Flare x 3/8" Inv. Flare) RV-50G
- 08651** (3/8" x 3/8" Female NPT) RV-50J



**GAS CONTROL WRENCH** Install gas controls with a durable, universal gas control wrench. Has a case-hardened adjustable screw for durability.

- 09963** Gas Control Wrench



**THERMOCOUPLES** Replace your thermocouple with confidence. Universal thermocouple kits with positioning adapters fit RV gas water heaters and furnaces.

- 09253** 12" Universal Kit
- 09273** 18" Universal Kit
- 09293** 24" Universal Kit
- 09313** 30" Universal Kit
- 09333** 36" Universal Kit
- 09353** 48" Universal Kit



**RV GAS PILOT ASSEMBLIES**

Direct factory replacements with complete step-by-step instructions.

- 08763** 9" Mor-Flo/Suburban
- 08773** 9" Atwood
- 08783** 11 1/2" Atwood



**GAS PRESSURE TEST KIT** Test your gas system for leaks and system pressure, at an appliance or at the gas controls. Easy-to-read gauge comes mounted in a durable case with a 30" hose and a brass pressure tap fitting.

- 10389** Test Kit
- 10399** Replacement Nipple for Kit
- 10409** Replacement Hose for Kit





# Boiler Antifreeze Concentrate

Recommended for  
~~Aqua-Hot™~~  
~~Hydro-Hot®~~  
Systems

**ANTIFREEZE FOR HYDRONIC HEATING & COOLING SYSTEMS  
WITH SPECIAL CORROSION INHIBITORS ADDED**

- **PREMIUM** heat transfer fluid
- **EASY TO STORE** size
- **EASY TO MIX** — Dilution chart included
- **PROTECTS** to -100° F
- **RECOMMENDED** for use in RV  
**Aqua-Hot** and **Hydra-Hot Systems**



**BOILER ANTIFREEZE -100°** A premium heat transfer fluid with special corrosion inhibitors. For use in traditional boilers and closed boiler and solar systems. Can be used with Aqua-Hot and Hydra-Hot systems.

- 30027** 1 gal
- 30029** 5 gal
- 30028** 55 gal
- 35116** Concentrate, 32 oz

## ANTIFREEZE PH TEST STRIPS

Test the pH of your antifreeze solution to indicate the level of corrosion protection.

- 36011** pH Test Strips

## BOILER ANTIFREEZE AL (not shown)

Same great features as our regular Boiler Antifreeze, with an advanced formula that's safe for aluminum containing systems.

- 33116** 3.5 gal
- 33119** 5 gal
- 33118** 55 gal



**GAS LEAK DETECTOR** Help protect your RV from gas leaks. Gas Leak Detector bubbles at the problem area when gas is escaping.

- 10324** w/ Sprayer 8 oz Bottle
- 10325** w/ Dauber 8 oz Bottle
- 10367** 1 gal Bottle (not shown)
- 10368** 55 gal Drum (not shown)



**CAMCO**





# Winterizing

Camco offers a complete line of by-pass kits for a lifetime of durable performance. By-pass kits save antifreeze by allowing your water heater to be bypassed when winterizing.

**QUICK-TURN PERMANENT**

**BY-PASS KIT** Save on antifreeze when you winterize with this easily-installed water heater by-pass kit. Sturdy, brass backflow preventer and 100% shut-off valve lets you bypass the water heater with a single turn. Patented.

35983 Quick-Turn Kit

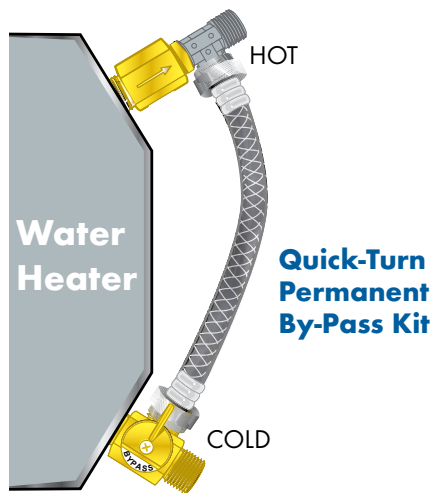

**SUPREME PERMANENT**

**BY-PASS KIT** Simple, permanent installation of this kit reduces the amount of antifreeze required to winterize by bypassing your RV water heater. Save gallons of antifreeze by not filling your water heater with antifreeze when you winterize. Brass valves provide non-restrictive flow. Comes with kink-resistant nylon reinforced hose.

35953 w/ 8" Hose for 6 gal Tank

35963 w/ 12" Hose for 10 gal Tank

37463 By-Pass Valve Replacement

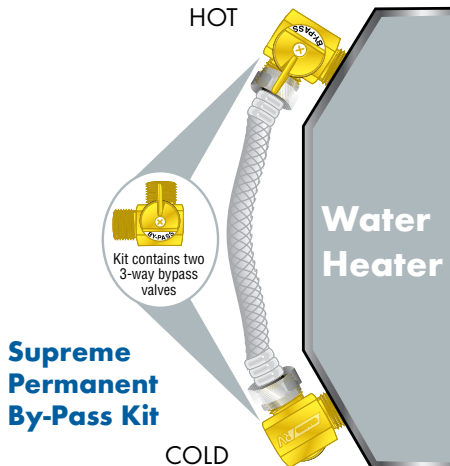

**SEASONAL BY-PASS KIT** This temporary by-pass kit allows you to hook up in the fall for winterizing and remove in the spring for reconnecting the system. Comes with kink-resistant nylon reinforced hose.

35713 Seasonal By-Pass Kit

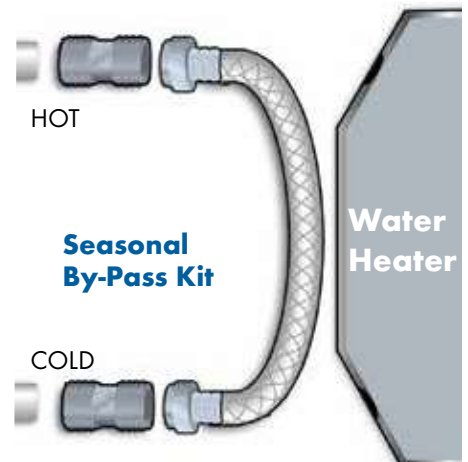

## BANFROST 2000® MARINE ENGINE ANTIFREEZE

Low toxicity biodegradable engine protection. Use for winter storage of raw water cooled engines and as a permanent antifreeze/coolant for fresh water cooled systems. Replaces ethylene glycol; safer for people, pets and wildlife. All season/all purpose propylene glycol formula with CAM-3 inhibitor package offers superior corrosion protection.

**30627** 1 gal

**30628** 55 gal

**RV & MARINE ANTIFREEZE** Protect your RV's potable water system from freeze damage. Camco antifreezes inhibit fouling and corrosion while helping to lubricate pumps and valves throughout the system. Choose a temperature-specific product designed for your winterizing needs. Safe and tasteless.

**30626** Premium Ban Frost 2000, 32 oz

**30767** Freeze Ban -50, 1 gal

**30769** Freeze Ban -50, 5 gal

**30768** Freeze Ban -50, 55 gal

**30787** Winter Ban -100, 1 gal

**30788** Winter Ban -100, 55 gal

**30647** Winter Ban -50, 1 gal

**BOILER ANTIFREEZE -100°** Premium heat transfer fluid with special corrosion inhibitors. For use in traditional boilers and closed boiler and solar systems. Can be used with Aqua-Hot and Hydra-Hot systems.

**30027** 1 gal

**30029** 5 gal

**30028** 55 gal

**35116** Concentrate, 32 oz



**ANTIFREEZE PH TEST STRIPS** Test the pH of your Boiler Antifreeze solution to indicate the level of corrosion protection.

**36011** Bottle of 50 Strips

## FREEZE CHECK REFRACTOMETER

An economical, highly accurate instrument for testing the point at which antifreeze solutions begin to solidify. No charts, graphs or conversions. Eliminates guesswork, reassuring the user that the system is protected to the desired level. Saves money by eliminating over-use of antifreeze and verifying proper protection. Recommended for use with winterization methods where propylene glycol based antifreezes are used.

**65401** Refractometer



## BOILER ANTIFREEZE AL (not shown)

Advanced formula is safe for aluminum containing systems. A premium heat transfer fluid with special corrosion inhibitors for multi-metal corrosion protection. For use in traditional boilers and closed boiler and solar systems. Can be used with Aqua-Hot and Hydra-Hot systems.

**33118** Boiler Antifreeze AL, 55 gal

**HAND PUMP KIT WITH HOSE**

Pump antifreeze directly into your RV waterlines and supply tanks. Kit includes flexible connecting line with city water connection.

**36003** Hand Pump Kit



**PUMP CONVERTER**

**WINTERIZING KIT** Winterize your RV annually with ease. This permanent kit installs with an adjustable wrench and comes complete with brass valve, siphon hose, Teflon tape and pump adapters. Patented.

**36543** Pump Converter



**BLOW-OUT PLUGS** Completely clear your water lines with RV blow-out plugs. Screw the plug into the city water inlet, open all drains and faucets, attach and activate oil-less compressor until all lines are clear.

**36103** 6/ctn, Plastic, White

**36104** 50/ctn, Plastic, White

**36153** w/ Schrader Valve, Brass

**36133** w/ Schrader Valve, Plastic, Black

**36143** Quick-Connect Style, Brass, Patented



**WINTERIZING YOUR RV WATER SYSTEM**

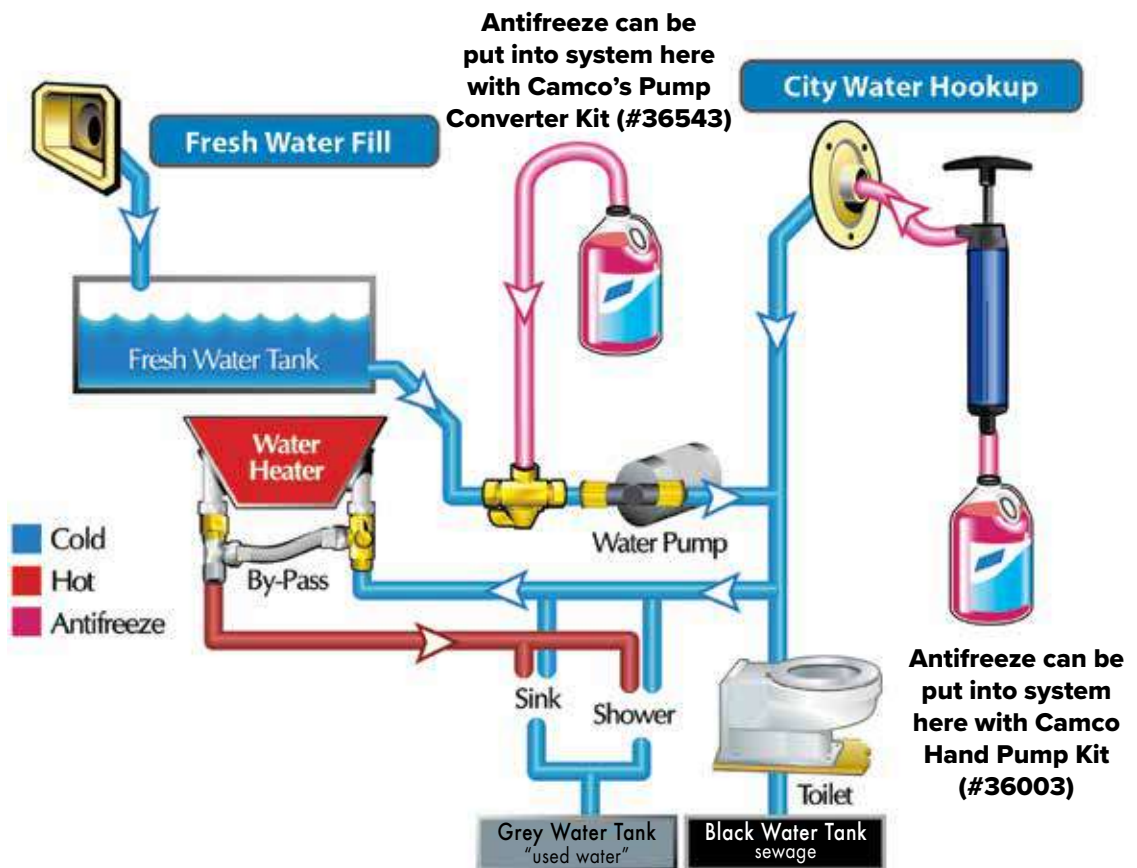

**DIY BOAT WINTERIZER** Quickly and efficiently service inboard/outboard marine engines. The Do-It-Yourself Winterizer allows flushing and preparation of boat engine for winter storage with just five gallons of antifreeze and your flusher. Save time and money season after season. Great for technicians, too. For front mounted raw water pump systems use the Flush Adapter, sold separately.

**65501** DIY Winterizer

**65493** Flush Adapter (call for availability)

**65502** Replacement Ball Valve



**RV WINTER READINESS KIT** The Camco RV Winter Readiness Kit helps you prepare your RV for long-term or winter storage. The Blow Out Plug allows you to use your oil-less air compressor to completely clear your water lines before winterizing. The Hand Pump Kit makes adding antifreeze to your water lines easier and less messy, and the Ban Frost Antifreeze Concentrate, which you can dilute in the included bucket, helps to protect your RV's plumbing from bursting in the cold winter months. Meanwhile, the Mini Dehumidifier, Dehumidifier, Hanging Dehumidifier and Fridge Door Stay keep the air in your RV from becoming musty. Included in the kit is a step-by-step RV Winterizing Guide to make the winterizing process as simple as possible.

**36190** RV Winter Readiness Kit



**FULL KIT**

**CAMCO**







# Fresh Water

**HYDRO LIFE HL-170 QC UNDER COUNTER FILTER KIT** The Hydro Life Water Filter Under Counter Kit is perfect for the icemaker, kitchen or bathroom faucet on your boat or RV. It installs on the cold water line for use with your existing faucets. The kit fits under the counter, completely hidden and occupies minimal space. After the kit is installed, the filter is easily replaced annually without tools. The Hydro Life filter utilizes KDF media in conjunction with granular activated carbon (GAC) to provide superior filtration and protection from many contaminants. Fine mesh activated carbon provides safer, cleaner, better tasting water by filtering contaminants including those that cause bad odor and taste. The EPA approved filter media, KDF, controls bacteria growth that may occur in standard carbon filters. Working pressure range: 20-100 PSI. Maximum flow rate: 1 GPM

- 52103** HL 170 QC Under Counter Filter Kit
- 52101** HL 170 QC Replacement Filter



**HYDRO LIFE HL-170 TF REPLACEMENT UNDER COUNTER FILTER** The Hydro Life filter utilizes KDF media in conjunction with granular activated carbon (GAC) to provide superior filtration and protection from many contaminants. Fine mesh activated carbon provides safer, cleaner, better tasting water by filtering out contaminants including those that cause bad odor and taste. The EPA approved filter media, KDF, controls bacteria growth that may occur in standard carbon filters. Easily replace your threaded under counter water filter kit. Working pressure range: 20-100 PSI. Maximum flow rate: 1 GPM

- 52117** HL 170 TF Replacement Filter



**HYDRO LIFE HL-170 PP REPLACEMENT UNDER COUNTER FILTER** The Hydro Life filter utilizes KDF media in conjunction with granular activated carbon (GAC) to provide superior filtration and protection from many contaminants. Fine mesh activated carbon provides safer, cleaner, better tasting water by filtering out contaminants including those that cause bad odor and taste. The EPA approved filter media, KDF, controls bacteria growth that may occur in standard carbon filters. Easily replace your push/pull under counter water filter kit without the use of tools. Working pressure range: 20-100 PSI. Maximum flow rate: 1 GPM

- 52073** HL 170 PP Replacement Filter



# INTERIOR FILTRATION



## EXTERIOR FILTRATION



**HYDRO LIFE EXTERIOR WATER FILTER HOLDER** Keeps filter clean, safe, and out the way. It is easily installed with only a Phillips head screwdriver, and includes two mounting brackets: one for the outside of the coach and one for the storage area to travel. Save money by reducing stress on hose and fittings.

**52001** Exterior Water Filter Holder

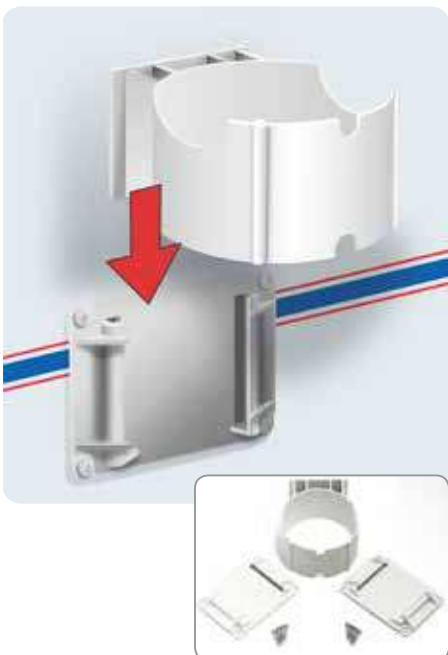

**HYDRO LIFE HL-180 INLINE HOSE FILTER** The Hydro Life Inline Hose Water Filter is ideal for trailers, RVs and boats with an exterior water hook up. It installs quickly and easily without tools and filters all the water coming into your RV or boat. The filter is small and compact and can be used in conjunction with the Hydro Life under counter filter kit for even greater performance and extended life. The Hydro Life filter utilizes KDF media in conjunction with granular activated carbon (GAC) to provide superior filtration and protection from many contaminants. Fine mesh activated carbon provides safer, cleaner, better tasting water by filtering out contaminants including those that cause bad odor and taste. The EPA approved filter media, KDF, controls bacteria growth that may occur in standard carbon filters. Working pressure range: 20-100 PSI. Maximum flow rate: 2.5 GPM

**52133** HL 180 Hose Filter



**HYDRO LIFE C-2471 REPLACEMENT CARTRIDGE** Hydro Life's radial flow Carbon Block Cartridge has several advantages. Water touches the entire surface area of filter, increasing the dirt-holding capacity and performance. No carbon particles are released into the water as it is filtered. It has a high flow rate (2.5 GPM), since water contacts the entire exterior surface area of filter and percolates from the outside in. Carbon Block Cartridge virtually eliminates chlorine and potentially dangerous micro-organisms as well as turbidity. It is also effective in reducing many other contaminants. Working pressure range: 20-100 PSI. Fits most 10" filter housings.

**52418** C 2471 Replacement Cartridge



**HYDRO LIFE HL-200 EXTERIOR FILTER KIT** The Hydro Life Water Filter Exterior kit is ideal for RVs, trailers or boats with an exterior water hook up. This high volume Hydro Life filter connects easily with standard garden hose fittings, filtering the water before entering your fresh water system while virtually eliminating chlorine and lead. This filter is adaptable for permanent installation. After the kit is installed, the cartridge is easily replaced without tools. The Hydro Life filter utilizes KDF media in conjunction with granular activated carbon (GAC) to provide superior filtration and protection from many contaminants. Fine mesh activated carbon provides safer, cleaner, better tasting water by filtering out contaminants including those that cause bad odor and taste. The EPA approved filter media, KDF, controls bacteria growth that may occur in standard carbon filters. Working pressure range: 20-100 PSI. Maximum flow rate: 2.5 GPM

**52141** HL 200 External Filter Kit w/C 2063 Ctg

**52412** C 2063 Replacement Cartridge



**HYDRO LIFE**  
WATER FILTRATION SYSTEMS

**EVO PREMIUM WATER FILTER WITH REPLACEABLE CARTRIDGE**

Reduces bad taste, odors, sediments, bacteria, chlorine and much more. Includes filter housing, one extension hose and one replaceable premium spun polypropylene filter cartridge. Filtration begins with water traveling through a porous shell with openings no greater than 5 microns in diameter. Filtered water then passes through a bed of KDF® and GAC (Granulated Activated Carbon) for further filtration and bacteria control. The result is fresh, clean, great tasting drinking water straight from your tap. For exterior use.

- 40631 Evo Premium Water Filter
- 40621 Evo Spun PP Cartridge
- 40635 Evo Mounting Bracket (not pictured)

**Filter Stand sold separately.**



**TASTEPURE KDF/CARBON WATER FILTER**

Larger capacity filter lasts an entire season. Greatly reduces bad taste, odor, chlorine and sediment in drinking water with a 20 micron filter. Durable in-line, exterior filter has a wider body to increase flow. Includes flexible hose protector to reduce strain on connections and minimize kinking that impedes water flow.

- 40043 Filter w/ Hose Protector
- 40045 2pk (Filters only)



**METAL WATER FILTER STAND**

Hold your water filter upright and off the ground. Foot bar makes it easier to secure the stand in the ground. Lightweight. Zinc coated to inhibit rust.

- 40772 Water Filter Stand, Metal



**TASTEPURE KDF/CARBON XL WATER FILTER**

XL RV Water Filter easily installs in-line and filters two times more water than our standard size filter. It greatly reduces bad taste, odors, chlorine and sediment in drinking water. The XL RV Water Filter High-flow carbon filter also includes 50% more KDF to help prevent bacteria growth. Includes flexible hose protector to reduce strain on connection and minimize kinking that impedes water flow.

- 40019 XL Water Filter



**TASTEPURE RV & MARINE WATER FILTER**

Improve the taste and smell of your drinking water for up to 120 days. Filters down to 20 microns.

- 40645 Water Filter
- 40646 Water Filter, Canada Item



**EVO PREMIUM WATER FILTER VOC REPLACEMENT CARTRIDGE**

Designed as a replacement cartridge for Camco's Evo Water Filter housing. Filtration begins with water traveling through a porous shell with openings no greater than 5 microns in diameter. Filtered water then passes through a bed of KDF® and GAC (Granulated Activated Carbon) for further filtration and bacteria control. Contains premium carbon with a high microporosity level for absorbing harmful VOCs (Volatile Organic Compounds). The result is fresh, clean, safe, great tasting drinking water straight from your tap.

- 40624 Evo VOC Water Filter Cartridge



**PLASTIC WATER FILTER STAND**

Universal fit water filter stand is secure on most terrain, keeping the water filter upright and helping to prevent the water hose from kinking.

- 40775 Water Filter Stand, Plastic





# XL

## Water Filter

*Safe Water Matters*

TastePURE®

# 2x

## Water Filtration

**2x Protection Against:**  
bad taste, odors, sediment,  
bacteria, chlorine and much MORE!



Camco  
Water Filter, 40043



Camco XL  
Water Filter, 40019

**HIGH-FLOW**  
*Longer Life!*



# Now available in 2 sizes!

# SAFE WATER MATTERS!



## Premium Drinking Water Hoses

- ✓ Drinking Water Safe
- ✓ Lead Free\*
- ✓ BPA Free
- ✓ Phthalate Free
- ✓ Made of NSF approved materials

\* as defined in the Reduction of Lead in Water Act of 2011



### PREMIUM DRINKING WATER HOSES

Heavy duty reinforced 5/8" ID drinking water hoses are 20% thicker than our standard hoses. Anti-kink design features machined fittings and strain-relief ends for added durability. Lead-free, drinking water safe. BPA-free, phthalate-free formulation. No strong plastic taste is imparted to the drinking water. UV-stabilized for long life. Made with NSF-61 certified hose. Made in USA.

- 22823 10' Premium Water Hose
- 22833 25' Premium Water Hose
- 22843 35' Premium Water Hose
- 22853 50' Premium Water Hose
- 22813 4' Premium Water Hose
- 22857 75' Premium Water Hose



### DRINKING WATER HOSES

Reinforced hoses for maximum kink resistance. Made with NSF-61 certified hose. Lead-free, drinking water safe. BPA-free, phthalate-free formulation. No strong plastic taste is imparted to the drinking water. UV-stabilized for long life. Made in USA.

- 22763 4' Fresh Water Hose (1/2" ID)
- 22743 10' Fresh Water Hose (1/2" ID)
- 22733 25' Fresh Water Hose (1/2" ID)
- 22753 50' Fresh Water Hose (1/2" ID)
- 22783 25' Fresh Water Hose (5/8" ID)
- 22793 50' Fresh Water Hose (5/8" ID)
- 22803 75' Fresh Water Hose (5/8" ID)



### HEATED DRINKING WATER HOSE WITH THERMOSTAT

Made with an NSF 61 certified, 5/8" I.D. drinking water safe hose that is BPA, phthalate and lead free. Won't leach harmful chemicals into water or leave it tasting like plastic. Energy saving thermostat only heats as needed, saving money on the electric bill. Fittings are heavy duty machined and plated for maximum corrosion resistance and the durable exterior jacket protects water hose and electrical components from damage or exposure. Protects to -20° F.

- 22910 12' Heated Drinking Water Hose
- 22911 25' Heated Drinking Water Hose
- 22912 50' Heated Drinking Water Hose



### PREMIUM HEATED DRINKING WATER HOSE

Keep your water supply flowing even in freezing temperatures. Camco's Heated Water Hose combines a drinking-water-safe hose with a self-regulating heat source which is encapsulated in an all-weather, PVC jacket for durability. Features machined and Nickel-plated fittings for maximum corrosion protection. Includes a female-to-male adapter for connection of the water source to either end of the hose; depending on the location of your electrical connection. Made with an NSF 61 certified, 5/8" I.D. drinking water safe hose that is BPA, phthalate and lead free. Protects to -40° F.

- 22920 12' Heated Drinking Water Hose
- 22922 25' Heated Drinking Water Hose
- 22924 50' Heated Drinking Water Hose



All prices listed are manufacturer's suggested retail

**90° WATER FAUCET** Get an extra outside water source right at your RV's side with this lightweight plastic faucet. Lets your fresh water hose hang without kinking. Use as a pressure release valve during disconnection.  
**22463** 90° Water Faucet

**Connects to RV  
at fresh water inlet**  
to provide an outside water faucet at the RV.

**WATER DIVERTER** Provides an extra faucet at your water source. Threaded faucet attaches to a standard garden hose, allowing you to use the hose without disconnecting the RV water hook-up. Also acts as a pressure release during disconnection.  
**22475** Water Diverter

**Connects to faucet  
at fresh water supply**  
to provide an outside water faucet  
while RV is connected to water source.

**WATER BANDIT** Hook this 3 1/4" connector to any standard-size, unthreaded faucet or one with stripped threads and attach your garden hose. Stop wasting water due to poor connections.  
**22484** Water Bandit

**SPRING FRESH™** One-step, no-measure solution requires no mixing or preparation. Good for periodic cleaning, freshening and deodorizing. Clean and deodorize or dewinterize RV fresh water systems with this safe, biodegradable formula. 1 gal cleans and freshens up to a 100 gal tank.  
**40207** 1 gal

**TASTEPURE DRINKING WATER FRESHENER** Eliminate algae and slime buildup from drinking water tanks. Just one ounce helps remove bad smells and taste from 20 gallons of water.  
**40206** 16 oz

**STOP LEAK CONNECTOR** Connect bent hose ends. This versatile connector includes a built-in, one-piece, flow-through, flexible washer. Recommended for connecting damaged hose couplings and for new hoses to protect hose threads. Fits male or female end of a 3/4" garden hose.  
**20213** 6/ctn

**HOSE ELBOWS** Prevent hose kinking and strain, and extend hose life. 90° and 45° elbows eliminate unnecessary stress and strain on all RV water intake hose fittings. Perfect for RVs, or just around the house. Made of brass for years of trouble-free use.  
**22505** 90° Hose Elbow  
**22605** 45° Hose Elbow

**FLEXIBLE HOSE PROTECTOR WITH EASY GRIPPER** Coiled attachment eliminates hose kinking at the faucet. Comes complete with Easy Gripper for effortless attachment to the faucet.  
**22703** Hose Protector

**BACKFLOW PREVENTERS** Allows fluid to only flow in one direction. Prevents backflow. Heavy duty brass body with stainless spring. 1/2" or 3/4" (Male x Female NPT).  
**23303** 1/2", Skinpack, 6/ctn  
**23402** 3/4", Bulk, 50/ctn

**QUICK HOSE CONNECTS** Attach hoses quickly and easily for RV or residential hook-up. Choose a solid brass model with automatic shut-off when disconnected, or a sturdy plastic model with convenient built-in shut-off valve.

**20103** Plastic Connector w/ Shut-Off

**20135** Brass Connector w/ Auto Shut-Off

**20143** Brass Connector, Flow-Through



**QUICK HOSE CONNECT VALUE**

**PACK** Includes two extra male connectors. Connect/ Disconnect quickly between water hose and multiple attachments such as spray nozzle, sprinkler, water hose, pressure washer and many more! Shuts off automatically when disconnected. Use at your home, RV, boat or campsite—anywhere with a standard water hose hookup! Solid brass construction provides years of service.

**20136** Quick Hose Connect Value Pack

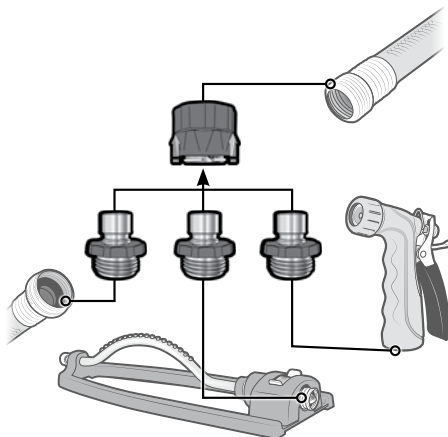

**WATER PRESSURE REGULATORS**

Stop damage to your RV water hose, pump or internal lines from inconsistent water pressure in campgrounds. Reduce water pressure to a safe, consistent 40–50 PSI of operational pressure. Protects equipment and prevents hose failure, helping to prolong equipment life. Available in durable ABS plastic or brass. (3/4" Male x Female Garden Hose Threads) Patented.

**40143** Plastic Regulator, 3/4", 6/ctn

**40055** Brass Regulator, 3/4", 6/ctn

**40052** Brass Regulator, 3/4", Bulk



**WATER PRESSURE REGULATOR WITH GAUGE**

Helps protect RV plumbing and hoses from damage that can be caused by high-pressure city water. Attaches easily with convenient 3/4" garden hose threads. Easy-to-read dial. Pressure is factory pre-set at 40-50 PSI. Patented.

**40064** Regulator w/ Gauge





**HOSE WASHERS** Stop your garden hose from leaking at the faucet and hose connections.

20153 10/card



**FILTER WASHERS** Filter trash and debris from your water system. Washer fits any standard garden hose female coupling. Stainless steel 40 x 40 mesh traps dirt particles before they enter your RV system. Ideal for washing machine hookup at home.

20183 1" Washers, 3/card



**ADJUSTABLE WATER PRESSURE REGULATOR**

Helps to protect plumbing and hoses from damage caused by high-pressure water. Regulator may be set to desired pressure using adjustment screw in cap. Factory preset to 45 psi. Protects equipment and prevents hose failure, helping to prolong equipment life. Durable lead-free brass construction. (FGH x MGH).

40058 Adjustable Brass Water Pressure Regulator



**SHUT-OFF VALVES** Control water flow with a quarter-turn pressure seated valve. Y-style converts a single-line hose to two directions. Each side is valve controlled to easily adjust flow and pressure. Made of resilient plastic; wye also available in metal.

20113 Metal Y-valve

20073 Plastic Y-valve

20003 Plastic Straight Valve



**BRASS SHUT-OFF VALVES** Solid brass housing with non-corrosive stainless-steel quarter-turn pressure seated shut-off valves. Features easy-grip valve handles and hose connection.

20123 Brass Y-Valve

20173 Brass 45° Valve



**FLEXIBLE CAMPER DRAIN**

Complete rust-proof drain system designed especially for campers and RVs. Drain trap is made of durable, chemical resistant polypropylene, evacuation flange is made of durable ABS construction with UV stabilizers. Includes 25" of 3/4" ID hose.

37420 Flexible Camper Drain



**EVACUATION FLANGE** Durable ABS construction with UV stabilizers; won't rust. Barbed for 3/4" ID hose. Use with camper drain trap for a complete drain system.

37271 Polar White



**CAMPER DRAIN TRAP** Designed especially for campers and RVs. Made of durable, chemical resistant polypropylene; won't rust. Barbed for 3/4" ID hose.

37262 Black



**DUAL SIZE DRAIN VALVES** Easily drain your RV fresh water tank. Available with or without flange, each valve is graduated for use with 1/2" or 3/4" vinyl tubing. Durable plastic construction.

**22243** W/o Flange, 3/8" or 1/2" Male NPT Thread

**22223** W/ Flange, 3/8" or 1/2" Barb



**LANYARDS** Help prevent lost caps and plugs. Use with male or female plugs or dust cap.

**22062** Snap-Fit Lanyard, Clear

**22072** New Style Lanyard, Clear

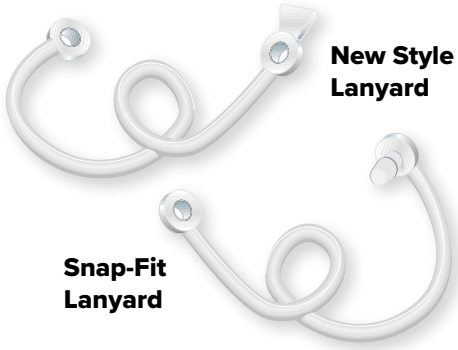

**FILL SPOUT WITH DOOR** Fill spout with door is designed with a loop and slot for pin or lock to ensure secure closure. Colonial white. Door is spring-loaded snap-shut design.

**37102** 25/ctn

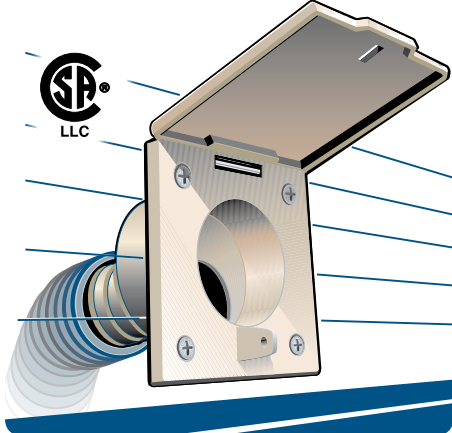

**WATER TANK FILLERS** Fill your water tank in a fraction of the usual time and eliminate "bubble-back." Large 5/8" fill tube allows you to fill your camper, trailer or motorhome water tank at or near full pressure while minimizing line backflow. Quarter-turn pressure-sealed valve allows you to selectively control water flow.

**40003** Filler w/ Shut-Off Valve



**REPLACEMENT HOSE PLUGS AND CAPS**

Replacement 3/4" hose plugs and caps keep dust and dirt out of your water system. Each comes with an easily attached lanyard to help prevent the loss of your cap or plug.

**22103** Male Plug w/ Lanyard

**22204** Female Dust Cap w/ Lanyard



**REPLACEMENT RECESSED WATER FILL**

Replace your cracked or broken RV water fill with an original replacement part. Durable white plastic construction—will not rust or corrode.

**37221** 25/ctn

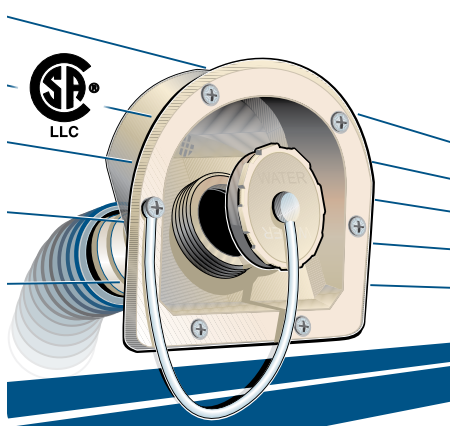

**FLUSH MOUNT FILL SPOUT** Flush mount fill spout is designed to mount flush with RV side. Top-fill door is secured with sliding lock. Colonial white.

**37002** 25/bulk

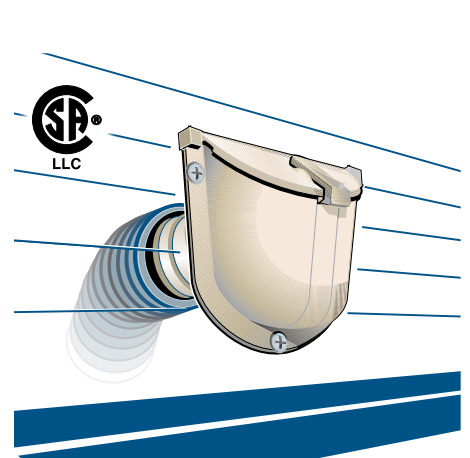

## HOSE AND CORD CARRY STRAP

The Camco Hose and Cord Carry Strap is a simple, easy to use way to hang, organize and store cords, hoses and ropes. The carry strap will adjust to accommodate most hose, cord and rope sizes and lengths, and the handle doubles as a hanger for easy storage. An integrated slit on the carry strap can be used to hold and keep track of the ends on your rope or extension cord so that they don't get lost in the coil. The durable polyethylene hanger makes a great addition to any garage or shed.

**20165** Carry Strap



**PLASTIC WATER FILL HOSE** 10' hose for connecting a fill spout or city water fill to a water tank. 1-1/4" diameter. FDA non-toxic formulation, IAPMO® TSC 31-90 and TSC 7-90 compliant, IAPMO® listed file No. T-3334. Will not kink.

**36601** Water Fill Hose



## RECESSED CITY WATER FILL, PLASTIC

**37023** Recessed Fill, City-Plastic, White

**37026** Recessed Fill, City-Plastic, Black



## FLUSH CITY WATER FILL, PLASTIC

**37053** Flush Fill, City, Plastic, White

**37056** Flush Fill, City, Plastic, Black



## RECESSED GRAVITY & CITY WATER FILL, PLASTIC

**37063** Gravity & City, Plastic, White

**37066** Gravity & City, Plastic, Black



## RECESSED GRAVITY WATER FILL

**37013** Recessed Fill, Gravity, White

**37016** Recessed Fill, Gravity, Black



**CAMCO**



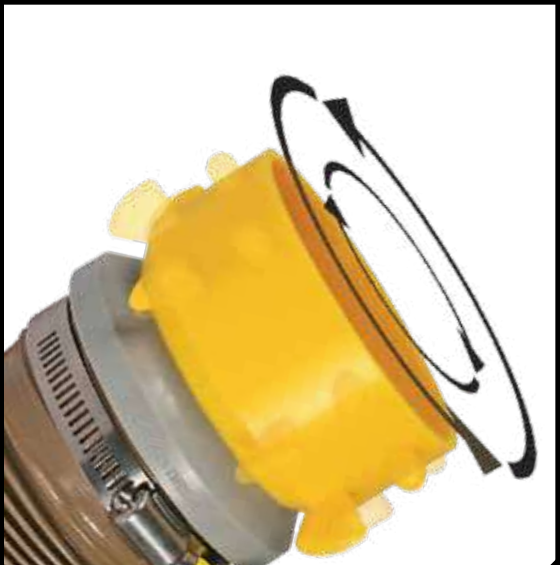

# The toughest odor stopper!



15 pack  
*more value*



## Also Available

- Breaks down waste and tissue
- Stops odors up to 7 days
- No harmful formaldehyde, pesticides or biocides



lemon

hibiscus

lavender

fresh

enzyme

**CAMCO**

**TST TOILET TREATMENT** TST Single-dose treatments require no mixing or measuring. Each 4 oz bottle treats 40 gal. 8pk. TST Liquid eliminates odors and lubricates sensors. Safe for all septic tanks. TST Drop-INs are handy, convenient individual dose pouches that come in an easy-to-use resealable bag or tub. One Drop-IN treats an entire tank. Dissolves instantly, eliminates odors on contact.

For over 40 years RVers have trusted the odor-stopping power of TST. The name TST still guarantees the highest quality in sanitation treatments that contain no formaldehyde, are non-staining and are safe for septic tanks. 100% biodegradable and environmentally safe.

### TST FRESH SCENT

- 40221 Singles, 8pk
- 40225 Liquid, 64 oz
- 40226 Liquid, 32 oz
- 40227 Liquid, 1 gal
- 40236 Liquid, 32 oz, Canada Item
- 40260 Drop-INs, 15/bag, Canada Item
- 40262 Drop-INs, 30/tub, Canada Item
- 40263 Drop-INs, 30/tub
- 40264 Drop-INs, 15/bag



### TST ULTRA-CONCENTRATED CITRUS SCENT

- 41191 Singles, 8pk
- 41198 Singles, 8pk, Canada Item
- 41190 Liquid, 32 oz, Canada Item
- 41192 Liquid, 32 oz
- 41195 Liquid, 64 oz
- 41197 Liquid, 1 gal
- 41199 Liquid, 1 gal, Canada Item
- 41178 Drop-INs, 10/bag, Canada Item
- 41180 Drop-INs, 15/bag, Canada Item
- 41182 Drop-INs, 30/tub, Canada Item
- 41183 Drop-INs, 30/tub
- 41189 Drop-INs, 15/bag



### TST ULTRA-CONCENTRATED LAVENDER SCENT

- 41551 Singles, 8pk
- 41552 Liquid, 32 oz
- 41555 Liquid, 64 oz
- 41557 Liquid, 1 gal
- 41556 Drop-INs, 10/bag, Canada Item
- 41559 Drop-INs, 15/bag





SAFE FOR SEPTIC TANKS

**TST ULTRA-CONCENTRATED LEMON SCENT**

- 41571 Singles, 8pk
- 41572 Liquid, 32 oz
- 41575 Liquid, 64 oz
- 41570 Drop-Ins, 15/bag
- 41573 Drop-Ins, 10/bag, Canada Item



**TST ULTRA-CONCENTRATED HIBISCUS BREEZE**

- 41601 Singles, 8pk
- 41602 Liquid, 32 oz
- 41605 Liquid, 64 oz
- 41600 Drop-Ins, 15/bag
- 41603 Drop-Ins, 10/bag, Canada Item



**ENZYME**

**TST ENZYME**

- 41500 Singles, 8pk, Canada Item
- 41501 Singles, 8pk
- 41502 Liquid, 32 oz
- 41503 Liquid, 32 oz, Canada Item
- 41506 Liquid, 64 oz
- 41507 Liquid, 1gal
- 41520 Drop-Ins, 10/bag, Canada Item
- 41529 Drop-Ins, 10/bag





**TST GREY WATER ODOR CONTROL**

**CONTROL** Remove grease buildup in your grey water tank, sink and shower drain lines with this concentrated treatment. Only 4 oz per 40 gal eliminates foul odors, leaving a fresh lemon scent.

40252 32 oz

40256 64 oz

40250 32 oz, Canada Item



**STOPS SINK ODORS**



**TST TABS** Deodorize black and grey water tanks with these compact tablets. One tab treats up to 40 gal. Use in portable and RV toilets and grey water tanks.

41152 6pk



**TST DRAIN VALVE LUBE** Lubricate plumbing lines while you drive. Prevents sticking valves with coconut oil, making equipment last longer. Recommended for all applications: waste holding tanks, black and grey water systems.

40246 16 oz

40247 16 oz, Canada Item



**TST PROBE CLEANER** Restore accurate sensor readings with a super-concentrated formula that attacks residue on probes. Works in black and grey water tanks.

41146 32 oz

41147 32 oz, Canada Item



**RHINO HOLDING TANK CLEANER**

**DROP-INS** Camco's Rhino Holding Tank Cleaner is a powerful enzyme that helps clean your holding tank and remove waste from tank walls in less than 24 hours. Simply flush one drop-in per 40 gallons of holding tank capacity down your RV toilet and fill  $\frac{3}{4}$  of the way with water, then let the drop-in do the rest of the work. Regular cleaning of your holding tank helps sensors function efficiently and keep unwanted smells at bay. The easy to use drop-in is pre-measured and safe for septic tanks. For best results, use one drop-in every three months.

- 41560 6/bag
- 41561 6/bag, Canada Item



**24/H**  
CLEANS  
TANK & SENSORS  
in less than 24 hours

**RHINO ENZYME RV HOLDING TANK TREATMENT**

Features a Bacteria/Enzyme formula to digest waste and break down tissue for easy biodegradation. Natural formulation digests waste, tissue, fats and proteins. Activates only in the presence of material requiring digestion. Advanced formula is stable, with a long shelf life and is not temperature sensitive. Also contains a buffering agent to prevent acid formation and septic odors. This product harnesses the natural process by which nature digests waste. Environmentally friendly and biodegradable. Fresh pine scent. 2 oz treats 40 gal.

- 41512 16 oz
- 41513 32 oz
- 41514 64 oz



**RHINO ENZYME DROP-INS**

Handy, convenient individual dose Drop-INS come in an easy-to-use resealable bag. One Drop-IN treats an entire tank. Dissolves instantly, eliminates odors on contact. Contains 10 treatments.

- 41519 Rhino Drop-INS, 10/bag



**RHINO ENZYME SINGLES** Single-dose treatments require no mixing or measuring. Each 4 oz bottle treats 40 gal. 8pk.

- 41511 8pk, 4 oz Singles
- 41515 1pk, 4 oz Single



## LIVEWELL/COOLER CLEANER

The Camco Livewell/Cooler Cleaner is any easy to use tab that simply dissolves in your livewell, baitwell or cooler to clean, deodorize and remove slime. The cleaning tabs are effective on livewells and coolers up to 40 gallons in size, and also help remove stains and impart a fresh scent. Each tab is 100% biodegradable and formaldehyde free, so it is safe for discharge in any environment. Includes 6 tabs.

**50054** Livewell/Cooler Cleaner



## RV SANITATION REUSABLE

**GLOVES** Instead of using disposable plastic gloves every time you empty your RV's black and grey water tanks, invest in Camco's heavy duty, reusable RV Sanitation Gloves. They protect your hands during dirty jobs, and aren't as wasteful as disposable options. These gloves are made of thick, durable PVC that grips well in wet and dry conditions. The RV Sanitation Gloves are latex free and one size fits most people. 1 pair.

**40287** Reusable Sanitation Gloves



## RV SANITATION DISPOSABLE

**GLOVES** With mountable dispenser. Keep your hands clean from the messy tasks of RVing. These durable all-purpose gloves are perfect for everything from sanitation hose connections to messy clean-ups and pet care. Made of latex-free and powder-free material that grips in wet or dry conditions. Disposable, one size fits all. Patented.

**40285** Sanitation Gloves, Green

**40286** Nitrile Sanitation Gloves, Orange



## RV & MARINE TOILET TISSUE

Fast-dissolving, clog-resistant toilet tissue is biodegradable and septic tank safe. Contains no dyes or perfumes. 1 or 2 ply.

**40276** 1 Ply/4 per bag, 280 sheets/roll

**40274** 2 Ply/4 per bag, 500 sheets/roll

 **Biodegradable**



**STANDARD RV SEWER HOSE** 12 mils of black HTS™ vinyl, created for the occasional RVer. The 10' hose compresses to 14"; the 20' hose to 27 1/2" for storage.

**39601** 10'

**39611** 20'

**Standard RV Sewer Hose**



For occasional camping  
With 12 mils of HTS™ vinyl  
Contains more wire and vinyl  
than other standard sewer hoses



**HEAVY DUTY RV SEWER HOSE** 15 mils of brown HTS™ vinyl, created for the seasonal RVer who makes weekend trips during the summer camping season. The 10' hose compresses to 16"; the 15' to 26"; and the 20' hose to 32" for storage.

**39621** 10'

**39661** 15'

**39631** 20'

**Heavy Duty RV Sewer Hose**



For seasonal camping  
With 15 mils of HTS™ vinyl  
Contains 25% more vinyl than  
other heavy duty sewer hoses



**SUPER HEAVY DUTY RV SEWER HOSE** 18 mils of gray HTS™ vinyl, created for the full-time RVer who lives on the road. The 10' hose compresses to 25"; the 20' hose compresses to 52" for storage.

**39641** 10'

**39651** 20'

**Super Heavy Duty RV Sewer Hose**



For full time camping  
The ultimate collapsible hose —  
18 mils of UV stabilized HTS vinyl.



**RHINO EXTREME RV SEWER KITS** Improved design for better performance.

**New features include:**

- An exoskeleton design that bears the brunt of abrasion, protecting the sewer hose from pinholes and helping to prevent leaks
- A hose that is both crushproof and collapsible
- Improved compression ratio for storage over the previous RhinoEXTREME design

All of the features that RVers are looking for in a complete kit. The RhinoEXTREME hose features new exoskeleton reinforcement, which protects the hose from pinholes and leaks by bearing the brunt of abrasion from use. The exoskeleton reinforcement also makes the hose crush-proof and collapsible so that it maintains its shape and is easy to store. Hose stays flexible in below-freezing temperatures and contains UV-inhibitors to help prolong the life of the hose, even when it is out in the sun. RhinoEXTREME kits now feature clear sewer elbows rather than translucent ones, to better see when waste tanks are empty. Along with the clear elbows, the kits feature pre-attached Rhino swivel fittings, a 4-in-1 dump station fitting and storage caps. When the 4-in-1 adapter is removed, the sewer hose and fittings can be stored in most 4" square bumpers. Ready to use! Patented.

**39861** RhinoEXTREME 15' Kit

**39867** RhinoEXTREME 20' Kit



**RHINO EXTREME SEWER HOSE EXTENSIONS** Extend the reach of your RhinoEXTREME with this handy kit. Includes 5' or 10' RhinoEXTREME hose with pre-attached swivel lug and bayonet fitting. Fits in 4" square RV bumper.

**39865** RhinoEXTREME 5' Extension

**39863** RhinoEXTREME 10' Extension

**39866** RhinoEXTREME 10' Extension, Canada Item

**Camco HTS™ sewer hoses are made from a high tensile strength formula vinyl to minimize pinholes and other leaks caused by the rough scrapes and abrasions of everyday use and transportation. Designed to stand up to hot and cold weather for trouble-free camping. Three wraps of vinyl and a steel-wire core offer the best protection for the price, with the convenience of collapsible storage.**

**SELF-CLAMPING™ RV SEWER HOSE**

Designed for quick, simple hookup with all types of sewer hose adapters. Fittings slip on easily and clamp securely. This 15' super heavy duty hose is tough enough to stand up to all kinds of weather conditions. Built-in clamp keeps fittings securely in place. Compresses to 34" for storage. Patented.

**39901** 15'



**HEAVY DUTY RV SEWER HOSE WITH PRE-ATTACHED FITTING**

Heavy duty 15' sewer hose comes with attached bayonet fitting for easy, convenient hookup. Compresses to 27" for storage.

**39691** 15'





# The World's Toughest Sewer Hoses



## RHINO<sup>®</sup> EXTREME



### COMPLETE KIT FEATURES:



Transparent elbow



Swivel fittings



24 mils of Thermoplastic  
Elastomer (TPE) over a  
polypropylene core



Crush-resistant  
sewer hose



Storage caps



Exoskeleton reinforcement

Available in 15' & 20' kits as well as 5' and 10' extensions.



**RHINOFLEX RV SEWER KITS** With pre-attached fittings At the RV end of the hose, there is a super-tough bayonet fitting with 4 bayonets for a more secure fit. At the dump-station end we've added a clear elbow that separates from the 4-in-1 adapter for easy storage. These are ready-to-use kits made with the toughest hose you can buy. Pre-attached swivel fittings feature locking rings so that your fittings stay secured. Bayonet cap and elbow also included. Patented.

- 39761** RhinoFLEX Sewer Kit, 15'
- 39741** RhinoFLEX Sewer Kit, 20'

**RHINOFLEX EXTENSION KITS**

Extend the reach of your RhinoFLEX or other\* sewer hose with this handy kit. Includes RhinoFLEX hose with pre-attached swivel lug and bayonet fitting. Patented. \*Works with any sewer hose that has a bayonet fitting.

- 39765** Extension Kit, 5'
- 39764** Extension Kit, 10'
- 39767** Extension Kit, 10', Canada Item

**RHINOFLEX RV SEWER HOSE**

The world's toughest sewer hose retains its shape once it's set until unhooked and stored. Made with 23 mils of heavy duty polyolefin reinforced with steel wire. 10' hose compresses to 32" and the 15' hose compresses to 45" for storage.

- 39671** 10'
- 39681** 15'

**RHINO FITTING WRENCHES** Disconnect sewer fittings with ease with the RhinoFLEX Sewer Fitting Wrench. Compatible with any Rhino, Revolution or Easy Slip bayonet or lug fitting. Simply attach the wrench to the fitting and turn to loosen or connect. Great for hard-to-turn fittings.

- 39758** Rhino Fitting Wrenches, 2pk



**The World's Toughest Sewer Hose™**



**Camco RhinoFLEX hoses are made of heavy-duty polyolefin reinforced with steel wire.**

**RHINOFLEX LOCKING RINGS**

Reusable locking rings work with new and original RhinoFLEX Elbow, Bayonet, Lug or Coupler fittings, allowing fittings to be moved to a new RhinoFLEX hose. Patented.

- 39803** Locking Rings



**RhinoFLEX sewer hose fittings are designed to work with the RhinoFLEX hose. Made with UV stabilized resin for long life.**

**RHINOFLEX WYE** Allows two hoses with lug fittings to be connected to the same dump station. Perfect for a motorhome that has two separate holding tank valves. Patented.

- 39812** RhinoFLEX Wye



**RHINOFLEX RV SEWER HOSE SWIVEL BAYONET FITTING**

Designed with four sturdy prongs that lock into position. Easy-grip wings for quick connect and disconnect. Built-in gasket for an odortight connection without hose clamps. Stores in 4" square bumper. Complete with reusable locking ring. Patented. RhinoFLEX hose not included.

- 39783** RhinoFLEX Bayonet



**RHINOFLEX RV SEWER HOSE**

**SWIVEL COUPLER** The easiest way to connect two RhinoFLEX hoses. It provides a secure odortight connection without hose clamps. Stores in 4" square bumper. Patented.

**39821** RhinoFLEX Coupler

**RHINOFLEX RV SEWER HOSE**

**SWIVEL LUG** Allows you to connect your RhinoFLEX hose to any sewer hose that has a bayonet fitting. Reusable locking ring provides a secure odortight connection without hose clamps. Stores in 4" square bumper. Patented. RhinoFLEX hose not included.

**39773** RhinoFLEX Lug

**RHINOFLEX RV SEWER HOSE SWIVEL ELBOW FITTING WITH 4-IN-1 ADAPTER**

Takes the trouble out of connecting to the dump station. Elbow locks and seals into adapter for a secure and odortight connection, and still swivels when connected. Clear elbow detaches from 4-in-1 adapter to store with hose in 4" bumper. Complete with reusable locking ring. Patent pending. RhinoFLEX hose not included.

**39733** RhinoFLEX Elbow

**RHINOFLEX SWIVEL FITTINGS**

Transparent or semi-translucent fittings connect sewer hose to waste valve fitting. Features swivel lug and bayonet fittings for a secure connection. Available in 45° or 90° style. Patented.

**39842** 45° Translucent Fitting

**39852** 90° Translucent Fitting

**39847** 45° Clear Fitting

**39857** 90° Clear Fitting

**SEWER HOSE FITTING ORGANIZER**

Camco's RV Sewer Fitting Organizer helps keep your sewer fittings organized in one place, and it works with any bayonet style fitting or 4-in-1 adapter. The bayonet style fitting twists onto the lugs located on the outside of the organizer, and the 4-in-1 adapter presses into it. The durable organizer is easy to mount with installation hardware included: all you need is a Phillips head screwdriver.

**39747** Sewer Hose Fitting Organizer



**RHINOEXTREME 2' COMPARTMENT HOSE**

The Camco Rhino Compartment Sewer Hose is great for use in tight RV sewer compartments when attaching to your waste outlet can be difficult. Instead, leave the Compartment Sewer Hose connected to your waste outlet and connect your sewer hose to the lug fitting on the end of the Compartment Hose. The Rhino Compartment Hose has an exoskeleton design that bears the brunt of abrasion, helping to prevent pinholes and leaks. You can bend or crush the hose and it will maintain its shape, or only extend as much as you need and the hose will stay compressed. The attached fittings swivel for easy connection, and the assembly measures two feet extended. Patented.

**39855** 2' Compartment Hose



**RHINOFLEX ELBOW & 4-IN-1 ADAPTER**

Sewer elbow adapter fits securely into four sizes of dump station inlets. Clear elbow fitting rotates 360 degrees. Works with any lug fitting. Bayonet-style elbow detaches from 4-in-1 adapter to fit into RV bumper. Patented **39736** RhinoFLEX Elbow & Adapter



**RHINO GREY/BLACK WATER HOSE**

If you are flushing your black and grey water tanks or cleaning out a tote tank, then you need to use a separate hose so that you don't risk cross-contamination with a drinking water hose. The Camco Rhino 25 ft Grey Water Hose is made of durable PVC and is bright orange so that you don't mix it up with your drinking water hoses by accident. The ends are compatible with standard garden hose threads.

**22990** 25', 5/8" ID

**22991** 25', 5/8" ID, Canada Item



**READY-TO-USE RV SEWER KIT**

This complete sewer kit comes assembled with everything you'll need for a quick, reliable sewer hook up. Non-restrictive for free flow and faster dumping. Includes 10' HTS™ sewer hose, bayonet straight hose adapter and sewer elbow with 4-in-1 adapter. Patented.

**39551** Ready-To-Use Sewer Kit



**SUPERKIT 20' RV SEWER HOSE KIT**

Camco's SUPER Kit 20' RV Sewer Hose Kit with the Super Hose and Swivel Fittings is a ready-to-use kit with two 10' hose assemblies. The hoses are made of super heavy duty 18 mil HTS vinyl. This kit features two sections each with a lug fitting and bayonet fitting with four prongs for a more secure fit. Included is a clear elbow with an easily detachable 4-in-1 adapter for connecting to 3" slip or 3", 3 1/2" and 4" NPT threaded sewer connection. The fittings swivel 360° for easy connecting. The hose and fittings compress for storage, and once the 4-in-1 adapter is removed you can store the hose in standard 4" square bumpers. Includes a bonus clear extender so you can see when your tank is empty, plus 2 bayonet and 2 lug end caps for storage. Patented.

**39659** 20' SuperKit

**39662** 5' Extension

**39663** 10' Extension





**TOW**   
Tow adapter  
tow or roll



**HANG**   
Ladder hook  
hangs on RV ladder



**The World's  
Toughest  
Tote Tanks!**



WITH BUILT-IN  
**GATE VALVE**  
FOR EFFORTLESS  
EMPTYING



28 AND 36 GALLON ONLY



LARGE WHEELS  
with bearings



TOW ADAPTER  
roll or tow



LADDER HOOK  
hangs on RV ladder



SUPERIOR  
DURABILITY



TANK RINSER  
for easy cleaning

**COMPLETE KITS INCLUDE:**



RHINO Extreme  
Sewer Hose



RHINO  
Clean Out Hose



Clear Elbow



Storage caps  
with lanyards



Clear Elbow  
with 4-in-1



Steel Tow  
Adapter

**RHINO PORTABLE HOLDING TANKS** Transport waste from your RV or trailer to a dump station when you're parked too far away for a sewer hose. Ready-to-use kit includes everything needed for use, storage and maintenance. Heavy-duty, no-flat wheels with bearings make transport smooth and easy. Integrated tank rinser makes cleaning easy. Constructed of extremely durable blow molded, UV stabilized HDPE that won't leak or deteriorate in the sun. Removable steel tow adapter allows you to easily roll the tote tank like a suitcase, or tow it slowly behind a golf cart or vehicle. Integrated ladder hook hangs on RV ladder when not in use and features grooves to securely strap it in place. 2 year warranty.

- 39000 15 gal
- 39002 21 gal

- 39004 28 gal
- 39006 36 gal

**TOTE TANK ADAPTER** Designed for use with RV Tote Tanks. Low profile 90° elbow for maximum drainage. Each end features four bayonet prongs that create a positive locking action to secure to the lug fitting. Odortight connection. UV stabilized resin.

39485 Tote Tank Adapter



**TOTE TANK KIT** Connects your portable waste tank to any lug sewer fitting. Assembled kit is 3' long extended; 19" compressed. Includes 90° translucent elbow with bayonet swivel fitting to provide a secure, odor tight connection. Includes two storage caps.

39768 Tote Tank Kit





**REVOLUTION SWIVEL RV SEWER KIT**

The complete hose kit that comes with everything you need for a quick, reliable hook-up. Features new pre-attached fittings that rotate 360 degrees. Includes two 10' heavy duty vinyl sewer hoses with pre-attached swivel lug and swivel bayonet fittings and 4 storage caps. Other features include translucent elbow and wire guards to protect your hands. Patented. Also available: 10' Extension with pre-attached swivel lug and swivel bayonet fittings.

**39625** Revolution Kit

**39623** Revolution 10' Extension

**Hose Support not included**



**SEWER HOSE STORAGE CAPS** 2pk; one each for bayonet and elbow fittings. Can be used with Revolution, Easy Slip and RhinoFLEX fittings. Patented.

**39753** Sewer Hose Storage Caps



# revolution

## with SWIVEL FITTINGS

Providing a quick, reliable  
RV sewer hook up.



10' Extension

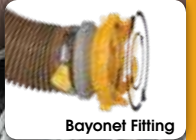

Bayonet Fitting



4-in-1 Elbow



Lug Fitting



### PRODUCT FEATURES:



15 mils of heavy duty vinyl with steel wire



Swivel Fittings



Translucent Elbow



Storage Caps

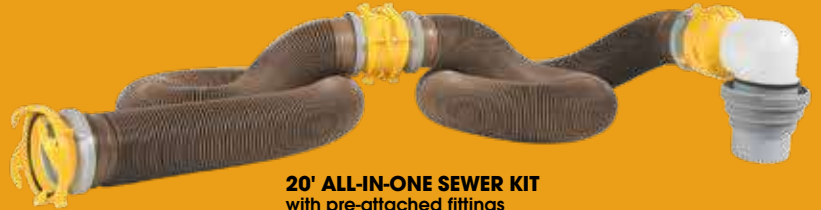

**20' ALL-IN-ONE SEWER KIT**  
with pre-attached fittings  
includes storage caps

### REVOLUTION SWIVEL FITTINGS

Add a 360° swivel to any RV sewer hose. Bayonet fitting and Lug fitting include a Twist-It™ clamp for securing fitting to hose. Patented.

39471 Elbow w/ 4-in-1 Adapter

39481 Bayonet Fitting w/ Twist-it Clamp

39491 Lug Fitting w/ Twist-it Clamp

#### Elbow w/4-in-1 Adapter



#### Lug Fitting



#### Bayonet Fitting





**Easy Slip sewer hose fittings are the most user-friendly fittings available today. Camco's Easy Slip fittings are made in the USA of engineering-grade resins for strength and durability.**

**All Easy Slip fittings have Camco's Spin-Lock™ rings that rotate directly onto sewer hose wire for a secure hold. Just pull hose onto the fitting, turn the Spin-Lock™ rings around the hose to tighten, and you have a secure, airtight seal that eliminates odors and leaks. There's no need for clamps or tools. No other fitting gives you the ease, convenience and security you get every time you hook up with Spin-Lock.**

**No clamps or tools needed!**

**EASY SLIP 4-IN-1 SEWER ADAPTER WITH ELBOW**

Connects hose to dump station. The elbow's tapered end accepts all 3" hoses and slip-over fittings. Adapter fits into 3" slip or 3", 3 1/2" and 4" threaded pipe. Larger inside diameter allows for faster dumping. Elbow separates from adapter for storage in bumper. Patented.

**39144** 4-in-1 Elbow



**REPLACE-ALL PLUMBING VENT CAP**

Separate cap fits up to a 2" pipe. Features spring tension attachment, which eliminates the need to replace the entire vent just because of a lost cap top.

**40134** Beige, 6/ctn

**40034** Polar White, 6/ctn

**40137** Black, 6/ctn



**REPLACE-ALL PLUMBING VENT KIT**

Replace damaged plumbing vents with quality original factory replacement vents. Kit fits 1" to 2 3/8" O.D. pipe and includes vent plus all hardware and putty tape needed for installation.

**40133** Beige, 3/ctn

**40033** Polar White, 3/ctn

**40138** Black, 3/ctn

**40132** Vent Only, Beige, 72/bulk

**40032** Vent Only, Polar White, 72/bulk

**40139** Vent Only, Black, 72/bulk



**EASY SLIP GREY WATER DRAIN**

**ADAPTER** Connect your garden hose between the dump valve and this adapter to drain your grey water tank, or attach it to the sewer hose to rinse hose out. Adapter with Easy Gripper provides airtight odor and leak seal. Fits Camco 4-in-1 threaded sewer adapters or standard sponge ring.

**39111** Grey Water Drain Adapter



**GREY WATER SEAL** Get an airtight odor and leak seal when you drain grey water into campground sewer system. With Easy Gripper.

**39322** Grey Water Seal

**EASY SLIP RV STRAIGHT HOSE**

**ADAPTER** Connect hose to RV quickly with an airtight odor and leak seal. Tapered ends accept all 3" sewer hoses. Stores with hose in standard 4" bumper. Non-restrictive, allows free flow.

**39172** 6/ctn, Bulk

**39173** Clamshell



**SEWER T ADAPTER** Connects two sewer kits to one dump station. The Sewer T has four tabs that twist securely into any Camco 4-in-1 adapter, plus a washer for an odor tight seal. Each side of the T is compatible with any Camco sewer hose elbow style fitting. No clamps or tools are needed. Made of durable, UV-stabilized resin that will last through many camping seasons.

**39734** Sewer T Adapter

**EASY SLIP RV INTERNAL HOSE**

**COUPLER** Connects two sewer hoses together. Tapered ends accept all 3" sewer hoses and slip-over fittings. Allows for quick, secure and airtight connection. Stores with hose in standard 4" bumper. Non-restrictive, allows free flow.

**39162** 6/ctn, Bulk

**39163** Clamshell

**RV SEWER HOSE FITTING GASKETS**

Get an odortight connection every time with fitting gaskets. Works with all Camco elbow and bayonet fittings. Includes two bayonet and two elbow gaskets.

**39834** Gaskets





# T2.6 and T5.3 TRAVEL TOILETS

A durable, comfortable option for camping, hunting, road trips and boat trips. Features a larger seat size than most brands, and a larger bowl. Pump flush action effectively rinses the bowl. Detachable holding tank seals firmly to prevent escaping leaks and odors. The holding tank's slick interior surface makes waste removal easier and more efficient. Remove the flush tank one handed by toggling a single spring-loaded locking latch. Features a latchable lid for easier transport. Lid can be completely removed for cleaning. Made of durable ABS resin.

Durable parts and seals  
Long-term use

Flush nozzle and slick interior surface  
Helps keep the bowl clean

Sturdy construction  
Long-lasting

Easy dumping elbow

Detachable holding tank  
Seals in odors and won't leak



41535 2.6 gal

41545 5.3 gal

**T 2.6**

**T 5.3**



## MORE FEATURES!

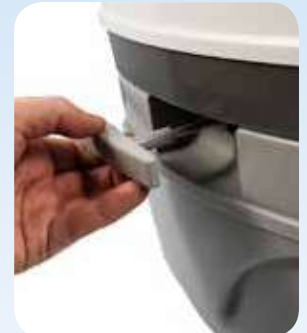

## T2.6 AND T5.3 TRAVEL TOILETS

A durable, comfortable option for camping, hunting, road trips and boat trips. Larger seat size and bowl size than most brands. Pump flush action effectively rinses the bowl. Detachable holding tank seals firmly to prevent escaping leaks and odors. The holding tank's slick interior surface makes waste removal easier and more efficient. Remove the flush tank one handed by toggling a single spring-loaded locking latch. Features a latchable lid for easier transport. Lid can be completely removed for cleaning. Made of durable ABS resin.

**41535** Travel Toilet, Canada Item, 2.6 gal

**41545** Travel Toilet, Canada Item, 5.3 gal



**TOILET BUCKET KIT** The Camco Toilet Bucket is a simple and easy to use toilet for camping, hunting and other remote activities. The five gallon bucket comes with a seat and lid attachment that snaps securely onto the rim of the bucket. The bucket has a smooth interior, making it easy to empty and clean. It is lightweight and the bucket features an attached carry handle. Lid and seat are made of durable, UV-resistant polypropylene.

**41549** Toilet Bucket w/ Seat

**41548** Replacement Bags, 10pk



**CYCLONE™ PLUMBING VENT** Use the power of the wind to draw holding tank odors out of your RV. Even a gentle breeze works with the dynamically engineered shape of the Cyclone to create a powerful vortex that pulls odors up and away. Attaches easily to any RV plumbing vent. Patented.

**40594** Cyclone, White, Canada Item

**40595** Cyclone, PDQ Pack, White

**40597** Cyclone, PDQ Pack, Black



**PORTABLE TOILETS** For camping, RVing, boating or other recreational activities. Sturdy polyethylene construction is compact and lightweight. The detachable holding tank includes a sealing slide valve to lock in odors and protect against leakage. Two side latches secure the tank to the toilet and a carrying handle makes transport easy. The toilet employs an easy-to-use bellow-type flush and pull slide valve for easy flushing. Includes a packet of Camco's TST biodegradable toilet chemical. 2.6 gal (12.5"H x 16.25"W x 14.5"D); 5.3 gal (16.38"H x 13.75"W x 16.13"D)

**41531** 2.6 gal, Canada Item

**41541** 5.3 gal, Canada Item



**TORNADO™ ROTARY TANK RINSER**

Reach every area of your holding tank. This permanent tank rinser with a 360° rotating head and ten high-pressure nozzles is the easiest, most sanitary way to clean your holding tank. No need for hoses through the windows or devices stuck down toilets. Has a built-in backflow preventer and a vacuum breaker. Kit comes with an exterior access hose for quick hose connection with no mess.

**40126** Tornado Kit w/ 6' Hose



**SEWER HOSE RINSE CAP**

Thoroughly rinse your sewer hose before storing. Locks onto bayonet fitting securely, and connects to a garden hose. Fits Easy Slip, RhinoFLEX and standard sewer fittings. Can be left in place as a hose cap during storage.

**39533** Sewer Hose Rinse Cap

**39534** Sewer Hose Rinse Cap, Canada Item



**C-DO2™ 45° HOSE ADAPTER** Know when your system is clean with this see-through hose adapter made of break-resistant polycarbonate.

**39432** 45° Hose Adapter



**RV SWIVEL STIK™ TANK RINSERS**

Patented holding tank rinsers with shut-off valves dislodge and flush stubborn waste deposits and odor-causing particles left after holding tank is emptied. Powerful rotary cleaning action reaches corners and walls of tank. One-quarter turn shut-off valve at your fingertips. All brass moving parts. Flexible Swivel Stik has a flexible 55 1/2" reach for basement holding tanks.

**40094** Swivel Stik

**40074** Flexible Swivel Stik



**QUICKIE FLUSH™** Thoroughly flush your holding tank without bringing a hose through the window. Permanently installed built-in backflow preventer keeps sewage from contaminating water line. Just hook garden hose to the connection (outside RV).

**40123** w/ 8' Hose



**HOLDING TANK RINSERS** Completely flush out your holding tank. Easy grip handle and quarter-turn pressure-sealed valve allow complete control of water flow. Side jets clean and rinse the smallest, hard to reach places. Rinser kit includes holding tank rinser plus a 8" hose and Faucet Adapter. Patented.

**40103** Rinser w/ Valve

**40113** Rinser Kit

**40083** Faucet Adapter Only, Carded





**DUAL FLUSH™ PRO** Clean your entire septic system with this reverse flush valve. Forces water back up into plumbing lines to break up clogs in pipes. Allows you to backfill and flush black and grey water tanks, then reverse valve and flush sewer drain hose. Anti-siphon valve and complete valve assembly included. Patented.

**39062** Dual Flush PRO

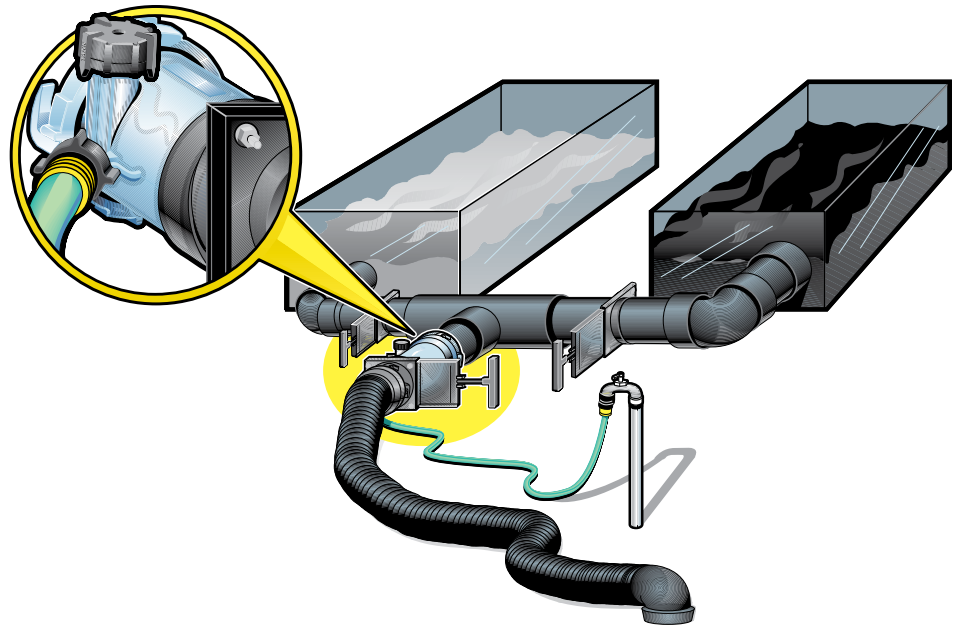

### **RHINO BLASTER PRO TANK RINSER**

Creates a high flow blast of water into your RV's sewer discharge pipe, cleaning the black or gray water tanks. The 45° angle allows the water to flow up the center of the pipes and directly to the tank, and the gate valve allows you to backfill and flush black and grey water tanks, then reverse valve and flush sewer drain hose. The high flow rate allows for rapid tank flushing. The Rhino Blaster Pro attaches directly to the RV's sewer drainage pipe, so there is no need for sanitation equipment to be brought inside the RV, or brought back out after use. The vacuum breaker prevents backflow into the fresh water supply. Additional features include a 4-prong bayonet fitting that easily and securely attaches to the RV's sewer outlet, and a swivel lug fitting to connect to your sewer hose.

**39085** Rhino Blaster Pro



### **RHINO BLASTER TANK RINSER**

Creates a high flow blast of water into your RV's sewer discharge pipe, cleaning the black or gray water tanks. The 45° angle allows the water to flow up the center of the pipes and directly to the tank to help reduce unwanted odors and the clogging and helps keep sensor clean to ensure accurate reading. Attaches directly to the RV's sewer drainage pipe, so there is no need for sanitation equipment to be brought inside the RV. A vacuum breaker prevents backflow into the fresh water supply. Four-prong bayonet swivel fitting easily and securely attaches to the RV's sewer outlet; swivel lug fitting connects to your sewer hose.

**39080** Rhino Blaster



**DUAL FLUSH™** Sprays water into lines to clear out clogged pipes. Get two-way jet cleaning action with this unique holding tank and sewer hose rinser. Transparent 5" long polycarbonate fitting attaches between sewer hose and RV, then hooks to any standard water hose to create a powerful spray that helps reduce odors and malfunctions in RV holding tanks and hoses.

**39072** Dual Flush

**39073** Dual Flush, Canada Item





# WINDING SEWER HOSE SUPPORT



- **Ultra-flexible sewer hose support carries hose over rough terrain**
- **Sturdy, light-weight design with deep cradles**
- **No staples to rust**
- **Convenient carry handle**
- **Available in 10', 15', 20' and NEW 30' lengths**



\* 30' Sidewinder has strap instead of handle



## SIDEWINDER SEWER HOSE

**SUPPORT** Sidewinder Sewer Hose Supports were designed to go around any obstacle and allow proper drainage. Sturdy, lightweight plastic support with strong snap-fit hinges has deep cradles to hold sewer hose in place without straps. No staples to rust. Easily positions around obstacles and stays where you put it. Won't creep closed. Patented. Sewer hose and fittings not included.

- 43031** Holds 10' Hose
- 43041** Holds 15' Hose
- 43051** Holds 20' Hose
- 43061** Holds 30' Hose



## RHINO ADJUSTABLE SEWER HOSE

**CRADLE KIT** The Rhino Adjustable Sewer Hose Support Kit is an adaptable sewer hose support that elevates your sewer hose to keep waste moving downhill. It features 6 independent troughs that cradle the sewer hose to keep it in place, can be adjusted for height, and can be set up to make turns to avoid an obstacle or go over a curb. The legs of the Rhino™ Adjustable Sewer Hose Cradle Kit can be staked into the ground for added stability, but they don't need to be staked- they can also work on hard surfaces like concrete. The troughs measure 30" long and nest for easy storage when not in use. Provides support for up to 20 feet of sewer hose length.

- 43071** Adjustable Sewer Hose Cradle Kit



## ALUMINUM FOLDING SEWER HOSE

**SUPPORT** Lightweight all-aluminum stand keeps sewer hose secure over the most uneven terrain. This durable support has been sold for over twenty years, and has more than a million satisfied users. Telescopes to 6'; folds to 6" for easy, compact storage. Provides stability for trouble-free drainage. Set up and storage take just seconds. Rust resistant. Solid brass rivets. Includes strap kit to hold hose securely in place. Lifetime warranty. Sewer hose and fittings not included.

- 40351** Sewer Hose Support 10'
- 40353** Sewer Hose Support 15'



## RHINOFLEX SEWER CLEANOUT

**PLUG WRENCH** Universal wrench allows you to loosen and remove any cleanout plug with ease. Works with any Camco 4-in-1 adapter. Patented.

**39755** Sewer Cleanout Wrench



## RV SEWER HOSE TWIST-IT™

**CLAMPS** Make fast work of connecting sewer hoses with easy-to-use Twist-It Clamps. No tools required—just position the clamp and twist the convenient thumb grip to tighten! Durable construction features 3" rust-resistant clamps and UV stabilized resin thumb grips.

**39553** 2pk



**RV TWIST CONNECT KIT** Connect two hoses quickly and easily for added length. Fits all 3" sewer hoses.

**39543** Twist Connect Kit



## 3-IN-1 FLEXIBLE SEWER HOSE SEAL

The Camco 3-in-1 Flexible Sewer Adapter is a black, flexible fitting that makes connection to a sewer inlet easier and less hands-on, even when the inlet threading is stripped or dirty. Instead of twisting the 4-in-1 adapter into the threading on the dump station, put the 3-in-1 adapter on the bottom of the 4-in-1 and simply press it into the dump station. The ridges on 3-in-1 will keep the sewer assembly firmly in place. The 3-in-1 can also be used without the 4-in-1 adapter, by placing the sewer hose directly in the 3-in-1. Adapter is compatible with 3" NPT, 3 1/2" NPT, and 4" NPT sewer inlets and features wings for easy removal, with holes in the wings to attach a rope if desired. Patent Pending.

**39318** 3-in-1 Flexible Sewer Hose Seal



**MULTI-CLAMP™** Secure objects of almost any shape or size with no tools. Each clamp holds objects between 1/2" and 4" in diameter. Made of flexible hardened plastic with UV inhibitors. Won't rust; resistant to most chemicals. Join two or more together for larger jobs.

**39103** Multi-Clamp



**BUMPER CAPS WITH INSECT**

**SCREENS** Replace lost or damaged RV bumper caps with Camco's RV Bumper Caps featuring vent holes and squeeze grip for easy installation and removal. Holes allow ventilation while keeping flying insects out. Constructed of durable polyethylene. Patented.

- 40322 Bulk
- 40324 Single Cap w/ Saver
- 40325 2pk



**BUMPER CAPS** RV 4" bumper caps have vented hole for air circulation and easy removal. Durable lifetime polyethylene construction.

- 40303 2pk
- 40302 288/bulk



**MAGNETIC BUMPER CAP** Bayonet end of sewer hose locks onto the cap, pulling out the sewer hose when you remove it and preventing hose from sliding around in the bumper. Fits on the end of most metal 4" square bumpers, lugs compatible with any Camco bayonet-style sewer hose fitting. High-strength Neodymium magnets keep the bumper cap in place. Features small holes for airflow and doubles as an insect screen. Bumper Cap set includes additional No-Insect Bumper Cap. Patented.

- 40311 Magnetic w/ Lug Fitting
- 40310 Set, 1 Magnetic w/ Lugs & 1 Insect Screen



**4-IN-1 SEWER EXTENSION** Ideal for reaching recessed dump stations to keep everything flowing smoothly. By elevating the sewer elbow out of a recessed sewer inlet, the 4-in-1 Sewer Extension streamlines the hose, reducing unwanted kinks and bends. The 4-in-1 Sewer Extension fits between the 4-in-1 Adapter and the elbow. Sewer Extension is clear, allowing you to see when the tank is empty. It locks securely to help prevent spills, and is compatible with any Camco 4-in-1 Adapter.

- 39735 4-in-1 Sewer Extension

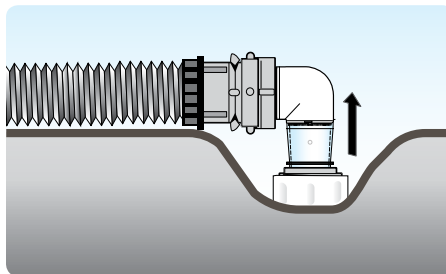

**RV SEWER HOSE STORAGE CAPS**

Camco's RV Sewer Hose Storage Caps allow you to seal both ends of your sewer hose before storing. One cap fits on the bayonet end of your sewer hose and the other fits on the lug end. Works with RhinoFLEX, RhinoEXTREME, Revolution, and Easy Slip sewer hose fittings. Comes in a 2pk.

- 39752 Sewer Hose Storage Caps



**CLEAR SEWER HOSE EXTENDERS**

Straight hose adapters attach directly to your RV's sewer connection, allowing you to extend your sewer hose outlet for easier, more convenient hose connection. Because they are clear, they help during tank cleaning by letting you to see when your system is fully rinsed.

- 39562 3 1/2" Straight Adapter, Canada Item
- 39572 5" Straight Adapter
- 39573 5" Straight Adapter, Canada Item
- 39582 7" Straight Adapter
- 39592 9" Straight Adapter



## 3" PERMANENT PLUMBING

**ADAPTER** Allows hookup of standard RV bayonet connection to 3" threaded plumbing pipe.

**39422** Permanent Plumbing Adapter



**3" SEWER HOSE WYE** Allows connection of two hoses to the same dump station.

**39272** Sewer Hose Wye



## 90° SEWER HOSE SPLICER ELBOW

For joining two hoses to go around a corner.

**39232** 90° Splicer Elbow



**RV SEWER HOSE SEAL** 4" x 3" sponge ring works with the grey water seal or directly on sewer hose for an odor proof connection to dump station.

**39313** Sewer Hose Seal

**39312** Sewer Hose Seal, 24/bulk



**RV SEWER CAPS** Cap your sewer connection to prevent leaks. Cap with hose connection allows you to drain grey water tank easily.

**39452** Cap, 24/bulk

**39463** Cap w/ Hose Connection

**39462** Cap w/ Hose Connection, 24/bulk



## 3" RV WASTE VALVE

**39513** Waste Valve



**RV 45° HOSE ADAPTER** Connects sewer hose to RV.

**39403** 45° Hose Adapter

**39402** 45° Hose Adapter, 24/bulk



## RV STRAIGHT HOSE ADAPTER

Connects sewer hose to RV.

**39413** Straight Hose Adapter

**39412** Straight Hose Adapter, 24/bulk



## RV INTERNAL HOSE COUPLER

Connects two sewer hoses together.

**39203** Internal Hose Coupler

**39202** Internal Hose Coupler, 24/bulk



CAMCO





# Cleaning & Care

**BLACK STREAK REMOVER** Power away stubborn black streaks caused by window and door sealant and roof coatings. Great for interior cleaning too.

- 41008 32 oz
- 41007 1 gal
- 41000 32 oz, Canada Item
- 41006 1 gal, Canada Item



**RV AWNING CLEANER** Remove mold stains, mildew stains, dirt, tree sap and road grime with the industrial strength formula that's safe for all awning fabrics.

- 41024 32 oz
- 41028 1 gal
- 41020 32 oz, Canada Item

**RUBBER ROOF CLEANER & CONDITIONER** Deep clean and condition your rubber roof to extend its life. One application of this blend of surfactants and conditioners gets rid of black streaks, oxidation and road grime.

- 41063 32 oz
- 41060 32 oz, Canada Item

**PRO-TEC™ RV RUBBER ROOF CARE SYSTEM** This innovative 2-step Roof Care System is a must-have for every RV owner! Protects your rubber roof against the elements to reduce roof chalking and minimize maintenance. Contains a gallon of Pro-Tec Rubber Roof Cleaner and a gallon of Pro-Tec Rubber Roof Protectant.

- 41453 RV Rubber Roof Care System
- 41452 RV Rubber Roof Care System, Canada Item

**ALSO AVAILABLE SEPARATELY:**

- 41068 Rubber Roof Cleaner, 1 gal
- 41448 Rubber Roof Protectant, 1 gal
- 41066 Rubber Roof Cleaner, 32 oz
- 41443 Rubber Roof Protectant, 32 oz

**TRAILER GLITTER™** Bring back the luster to those dull exteriors and clean all the surfaces in your RV—metal, wood, plastic, fiberglass, paint—with just one product.

- 40603 32 oz
- 40608 1 gal



**RV WASH & WAX** Give your RV a clean finish and a hand-polished look without buffing.

- 40493 32 oz
- 40498 1 gal
- 40490 32 oz, Canada Item

**RV MILDEW STAIN REMOVER**

Just spray on to remove mildew stains on contact! Perfect for renewing the look of awnings, headliners, vinyl covers, chair cushions and more without scrubbing.

- 41093 32 oz
- 41090 32 oz, Canada Item



**ALUMINUM CARE WASH** Renews the sheen on dull exterior surfaces. Use on RVs, horse trailers, siding, wheels, canoes and more. Cleans metal, plastic, fiberglass and painted surfaces.

- 40613 Aluminum Care Wash, 32 oz, Canada Item



**WASH SPONGE** Curved shape for an easy grip while washing your RV. 7" x 4.5" x 2".

- 44710 RV Wash Sponge



**HAND BRUSH** Ergonomic shape and non-slip handle make this brush ideal for many RV and household cleaning tasks.

- 43631 Hand Brush





**210® PLUS PLASTIC SCRATCH REMOVER** Remove surface scratches and blemishes. One-step formula is an extremely mild abrasive compound with anti-static and anti-fog properties. Water soluble and easy to use with superior results.

**40944** 210 Plus, 15 oz

**210® PLASTIC CLEANER/POLISH**

The professionals' choice for protecting and maintaining in glass, plexiglas and vinyl. Seals the pores in all plastics, leaving a protective coating with UV inhibitors to prevent browning and hardening. Anti-static, anti-fog and non-streaking. Provides plastics with a clear, lustrous look.

**40931** 210, 7 oz Aerosol

**40934** 210, 14 oz Aerosol



**ARMADA® AQUABLOCK™ WATERPROOFER & STAIN REPELLENT**

Contains UV and mildew resistant agents. Most fabric manufacturers, including Sunbrella®, apply a fluorocarbon polymer to the cloth at the factory for waterproofing and stain repellency. This is the most durable and effective waterproofing technology currently known. A polymer is like Teflon® for cloth. Armada AquaBlock uses virtually the same fluorocarbon technology as the fabric manufacturers do to last an entire season. Application is therefore more effective, durable and easier to use than a less compatible agent. AquaBlock has been independently laboratory tested against the three leading waterproofing products in the marine industry and was found superior.

**40914** AquaBlock, 22 oz



\*Sunbrella® is a registered trademark of Glen Raven Inc.

**RV WASH PODS** Camco's easy to use RV Wash Drop-Ins help wash away years of built up dirt and grime on your RV. One convenient, pre-measured drop-in dissolves in 3 gallons of water that can then be used to scrub away at your RV. The resealable bag of 6 drop-ins is more lightweight than most liquid or gel cleaners, making it easy to take with you on the road. Cleaner is biodegradable, fragrance-, phosphate- and SLS-free and contains no added dyes.

**41580** RV Wash Pods



**ARMADA® CARNAUBA WASH & WAX**

Cleans, Shines & Protects in one easy step! This non-toxic and biodegradable wash & wax is a premium grade cleaner for fiberglass, metal and painted surfaces and is the only boat soap available with real carnauba wax. Replenish your wax while you wash so that your sparkling shine lasts in between washings and reduces the frequency that waxing is needed.

**40922** 32 oz

**40927** 1 gal



**RV AWNING WATERPROOFER**

Waterproofs and protects fabrics. Also great for outdoor furniture, pop-up campers, RV covers and tents. Restores water repellent qualities to fabric; lasts through several washings.

**41072** 22 oz



**BLAST-OUT PRESSURE WASHER**

Concentrate Powerful pressure-washer cleaner specially formulated for RV and boat cleaning. Removes dirt, oil, grease and mildew stain. Use with a pressure washer or clean manually with a cloth, sponge or soft brush. Phosphate-free; contains no bleach or ammonia.

**41867** Boat/RV Wash



**SLIDE OUT LUBE & PROTECTANT**

Help slide outs operate smoothly without sticking. Spray-on lube leaves a dry film to repel dirt and grime and protect against rust and corrosion.

**41105** 15 oz Aerosol

**41104** 15 oz Aerosol, Canada Item

**SLIDE OUT RUBBER SEAL**

**CONDITIONER** Protect and condition the seals on your slide outs. Shield against UV rays, decrease friction. Help rubber seals last longer.

**41135** 16 oz Aerosol

**41130** 16 oz Aerosol, Canada Item



**WASH BRUSH W/ PUSH BUTTON HANDLE** The Camco Wash Brush is a great asset for cleaning your car, truck, boat or RV. Soft bristles effectively lift grime and wash away residue, but won't scratch your vehicle. Telescoping handle easily adjusts to fit your needs. The handle is a lightweight aluminum construction and teardrop shaped. The wash brush attaches to any standard garden hose and water flows through the handle, controlled by a convenient, easy-to-reach on/off switch. Best of all, the wash head attaches to the handle with a square peg, eliminating aggravating swiveling while in use. Patented.

**41960** Wash Brush w/ Push Button Handle



**ADJUSTABLE RV WASH BRUSH** Adjusts from 43" up to 71" long. Built-in ON/OFF switch provides full water control. Versatile brush features an 11" wide cleaning head with two types of bristles for maximum cleaning power: white bristles lift dirt and gray bristles brush it away!

**43633** Wash Brush

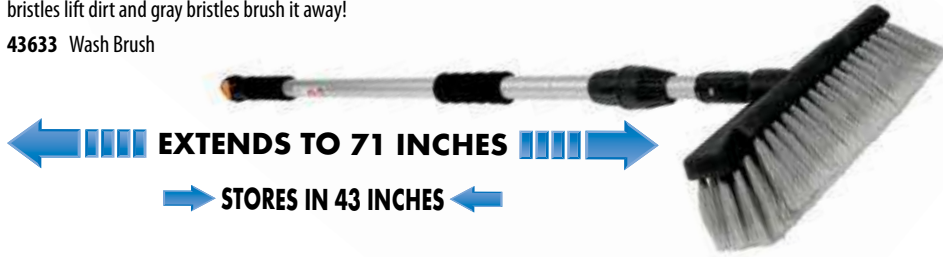

**21" WIDE ULTIMATE SQUEEGEE** Strong, lightweight, flexible squeegee won't scratch RV finish. Acid-resistant, non-corroding polypropylene frame. Features a splash guard and 4" black twin foam rubber blade.

**43733** Ultimate Squeegee w/ handle

**43742** Ultimate Squeegee w/o handle

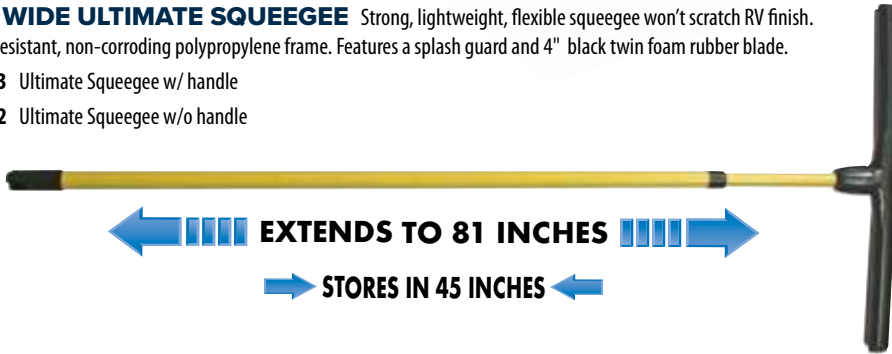

**ADJUSTABLE MULTI-PURPOSE HANDLE** Teardrop profile. Anodized aluminum construction. Two TPE hand grips. Patented.

**41910** 2'-4'

**41912** 3'-6'

**41914** 5'-9'

**41916** 6'-11'

**FIXED-LENGTH MULTI-PURPOSE HANDLE**

**41900** 2'

**41902** 4'



**XL COLLAPSIBLE BUCKET** Over 18" wide for ease of use with large wash brushes. Collapses to 2 3/4" tall to fit in its own easy-to-carry storage bag (included). Made with durable watertight fabric. Extra-large 18 1/4" x 9 1/2" x 10 1/2" bucket has a 5 gal capacity.

**42973** XL Collapsible Bucket



**SYNTHETIC CHAMOIS** Super absorbent, large 26" x 17" chamois great for quick and easy drying. Ideal for washing cars, cleaning up spills and toweling off, this synthetic chamois is durable enough to be reused hundreds of times, but soft enough for safe use with delicate surfaces. The Camco Synthetic Chamois leaves lint-free and streak-free drying results on any surface.

**43575** Synthetic Chamois



# CAMCO'S PREMIUM CLEANING BRUSHES AND ACCESSORIES

## Telescoping Handles

Teardrop profile. Anodized aluminum construction. Two TPE hand grips.



**Easy to grip**  
Tear-drop handle for increased rigidity and better grip

**Click-n-Go**



**Locking head**  
Wash head won't loosen while in use

**Floats!**

Designed to float in water if dropped.



## Multi-Purpose Handle Brush Head Attachments

7" wide brush head. Rubber perimeter bumper. Available in 4 textures.



### MULTI-PURPOSE HANDLE ACCESSORY ATTACHMENTS

#### WASH HEAD WITH SYNTHETIC WOOL PAD

41930 Wash Head w/ Pad

41932 Replacement Pad

#### WASH HEAD WITH MICROFIBER PAD

41948 Wash Head w/ Pad

41950 Replacement Pad

#### PVA MOP HEAD

41934 Mop Head

#### SQUEEGEE

41936 Squeegee, Patented

41938 Squeegee Adapter



### MULTI-PURPOSE HANDLE BRUSH HEAD ATTACHMENTS

7" wide brush head. Rubber perimeter bumper. Available in 4 textures.

41920 Extra Soft, Light Blue

41922 Soft, Dark Blue

41924 Medium, Yellow

41926 Stiff, White



All prices listed are manufacturer's suggested retail

**CAMCO**





# R3

# RECURVE

WDH

WDH with Adjustable Sway Technology®

**RECURVE R3** A weight distribution hitch that features adjustable sway technology. By simply adjusting the clamp, you can decide how much sway control is exerted on the trailer. The ReCurve R3 will distribute the weight of your trailer evenly across the axles of the tow vehicle and provide as much sway control as you choose. Or, turn the sway control completely off in dangerous or icy road conditions. Its top-loading spring bars give it more ground clearance than other hitches, and the streamlined design makes the hitch and the trailer move as one, while creating a sleek look. Hitch ball included.

**48750** Hitch Kit, 400 lb

**48751** Hitch Kit, 600 lb

**48752** Hitch Kit, 1,000 lb

**48753** Hitch Kit, 1,200 lb

**48770** Hitch Kit 400 lb, 2" Ball

**48771** Hitch Kit 600 lb, 2" Ball

Sway control can be disengaged for easier hookup and safer towing in dangerous road conditions.



Thumbscrew makes it easier to set proper head angle of hitch.



Top-loading spring bars. Simply drop in.



One bolt adjustable sway control.

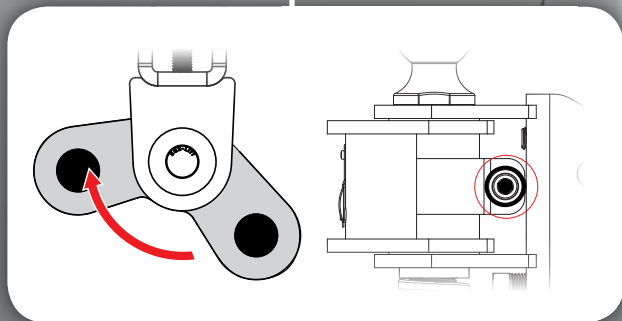
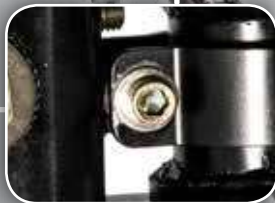

# R3

Weight Distribution Just Got Better

Sway control • No need to grease bars

Easier hook-up • Quiet operation



# RECURVE<sup>®</sup>

WDH with Adaptive Sway Technology<sup>®</sup> WDH

**RECURVE R6** Our most user friendly weight distribution hitch, and it features premium adaptive sway technology. With other sway control hitches, turning can be an even bigger hassle than it usually is with a trailer because the sway control “locks” the trailer straight. With the ReCurve R6, the hitch will control your sway for normal driving, but when you turn, the sway control will automatically disengage, making maneuvering smoother and easier on the driver. The sway control can easily be turned completely off in dangerous or icy road conditions. Its top-loading spring bars give it more ground clearance than other weight distribution hitches, and the streamlined design makes the hitch and the trailer move as one, while creating a sleek and subtle look. Hitch ball included.

- 48731 600 lb Hitch Kit
- 48733 1,000 lb Hitch Kit
- 48734 1,200 lb Hitch Kit
- 48779 600 lb Hitch Kit, 2" Ball

Sway resistance is increased as needed and automatically disengages for turning and maneuvering.



Thumbscrew makes it easier to set proper head angle of hitch.



Top-loading spring bars. Simply drop in.



Simple on/off sway control.

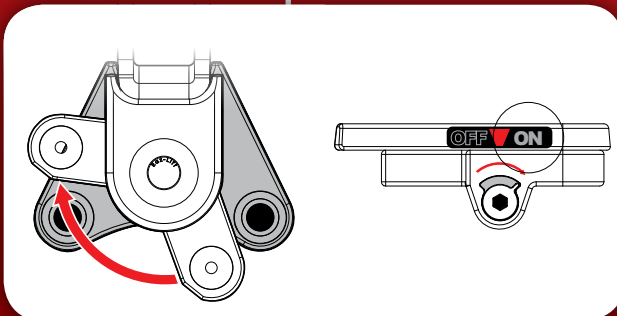

**Weight Distribution Just Got Better**

Sway control • No need to grease bars  
Easier hook-up • Quiet operation

# Trekker



## Innovative Weight Distributing Hitch with Adaptive Sway Technology

- Adaptive sway resistance
- Noise suppressed



### Easy On/Off Sway Control

- Distribution bars are easy to move into place
- Turns off quickly for dangerous road conditions

### Automatic Sway Control Disengagement

- Disengages for tight maneuvering
- Decreases wear

Eaz-Lift's Trekker hitch is designed with Adaptive Sway Technology

Sway resistance is instant when driving on the highway. Trekker reacts and increases resistance as needed when challenged with wind gusts and passing trucks. When taking sharper turns or tight maneuvering where sway control is unnecessary, Trekker disengages sway for improved handling.

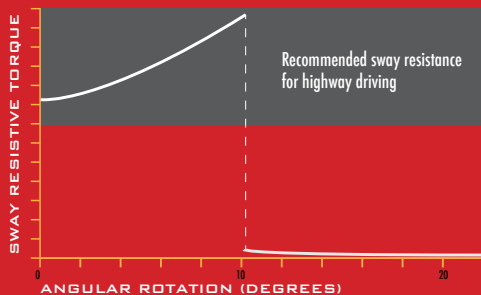

**EAZ-LIFT TREKKER** The perfect combination of premium weight distribution and sway control in an easy-to-install hitch. Trekker utilizes adaptive sway technology which goes above and beyond that of the competitors' weight distribution hitches. When towing and challenged with wind gusts and passing trucks, the Trekker reacts and increases resistance as needed! During sharp turns and maneuvering, when sway control is unnecessary, the Trekker disengages sway control completely for improved handling. When towing in dangerous conditions, such as slippery or icy roads, sway control is unwanted. Trekker's easy on/off sway control makes it a breeze to manually disengage. This feature also comes in handy when hooking-up and unhooking. Includes High-Low Shank.

**48701** Trekker Hitch, 600 lb

**48703** Trekker Hitch, 1,000 lb

**48704** Trekker Hitch, 1,200 lb

**eaz  
lift**  
Since 1952



**eaz  
lift**  
Since 1952®

## INNOVATIVE & CONVENIENT TOWING SOLUTIONS.



### EAZ-LIFT GOOSENECK BALL PLATE

The Eaz-Lift Gooseneck Ball Plate for Fifth Wheel Rails mounts to industry standard in-bed fifth wheel rails and allows you to easily tow gooseneck trailers with fifth wheel equipped trucks. It is rated to 30,000 lb Max GTWR (7,500 lb Tongue Weight) and features a 2-5/16" hitch ball that is 2" offset from center plus safety chain attachment slots on both ends of the hitch. Constructed of durable, powder coated steel.

**48554** for 5th Wheel Rails



**EAZ-LIFT GOOSENECK ADAPTERS** Converts most standard fifth-wheel trailers to a gooseneck trailer. This allows you to have the convenience of towing two types of trailers with only one truck. You will also enjoy towing a fifth-wheel trailer without having a large hitch taking up the bed of your truck. Eaz-Lift's Gooseneck adapters feature an automatic latching coupler for a simple hookup and disconnect. They have a 30,000 lb tow rating. Easy to install and each adapter comes with all of the parts and hardware needed for installation.

**48490** 17" Gooseneck Adapter

**48500** 12" Gooseneck Adapter

**48501** 15" Gooseneck Adapter

**48572** Bolt Pack for Gooseneck Adapter

### Gooseneck System

- Adapts 5th wheel trailer to fit gooseneck trailer hitch
- Rated up to 30,000 lb
- Available in 12", 15" and 17" heights
- Easy to install
- Tow a 5th wheel trailer without a large hitch taking up the bed of your truck



**eaz**  
**lift**  
Since 1952

**16K**  
5th Wheel Hitch

**18K**  
5th Wheel Hitch

**22K**  
5th Wheel Hitch



#### 16K 5TH WHEEL HITCH

48626 16K 5th Wheel Stationary Hitch

#### 18K 5TH WHEEL HITCH

48624 18K 5th Wheel Stationary Hitch

#### 22K 5TH WHEEL HITCH

48628 22K 5th Wheel Stationary Hitch

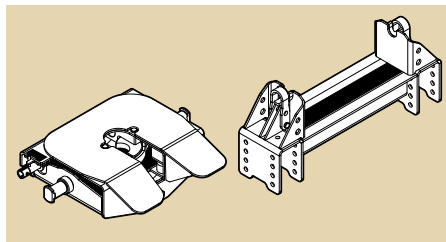
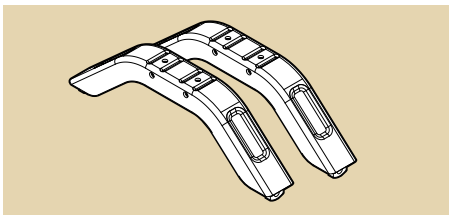

Stationary hitches include head, crossmember, bolt pack and two stationary legs. (Legs are packed in a separate carton for shipping.)

#### EAZ-LIFT FIFTH WHEEL HITCHES

Eaz-Lift quality on a standard base-rail-style bracket system. The Stationary- and Slider- Fifth Wheel Hitches' universal design allows them to be mounted to any existing base rails or to Eaz-Lift's heavy-duty rails. Ideal for a truck with a short bed, the 16KS, 18KS and 22KS models utilize the slider system to avoid truck and trailer damage by allowing additional turning clearance.

16K(S) and 18K(S) may being mounted on any existing rails. 22K(S) must be mounted on Eaz Lift 22K rated rails (48630)

#### 16K, 18K and 22K Features:

- Mounts to industry standard 4- and 10-bolt bed rails
- 11 degree side-to-side pivot w/ urethane cushions
- 32 degree, front-to-back pivot
- Automatic locking jaws
- Durable, powder-coated finish
- Secondary handle lock to ensure jaws have been locked closed
- Adjustable height from 14.5" to 18"
- 16K : 4000 lb vertical
- 18K : 4500 lb vertical
- 22K : 5500 lb vertical

#### ADAPTER KITS AND INSTALL KITS FOR USE WITH SLIDER OR STATIONARY HITCHES

##### 4-BOLT FIFTH WHEEL ADAPTER KITS

48595 Dodge 1500, '09-'15, Bracket/Hardware

48594 Dodge 1500, '02-'08, Brackets

48593 Ford F-150, '04-'14, Bracket/Hardware

48592 Ford F-250/350/450, '04-'16 Brackets/Hdw

##### FIFTH WHEEL INSTALL KITS

48630 Brackets/Hardware/Bed Rails

4- & 10-Bolt Pattern Rails for 16K/18K/22K

48631 Bed Rails / Hardware Only

4- & 10-Bolt Pattern Rails for 16K/18K/22K



# 16KS

5th Wheel Hitch **Slider**

# 18KS

5th Wheel Hitch **Slider**

# 22KS

5th Wheel Hitch **Slider**



## 16KS 5TH WHEEL HITCH SLIDER

48625 16K 5th Wheel Slider Hitch

## 18KS 5TH WHEEL HITCH SLIDER

48623 18K 5th Wheel Slider Hitch

## 22KS 5TH WHEEL HITCH SLIDER

48627 22K 5th Wheel Slider Hitch

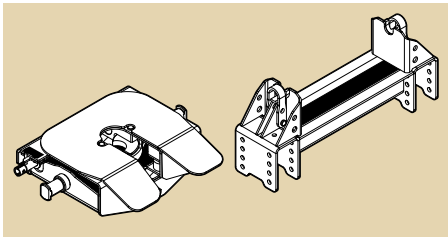

Slider hitches include head, cross-member, bolt pack and two sliders. (Sliders are packed in a separate carton for shipping.)

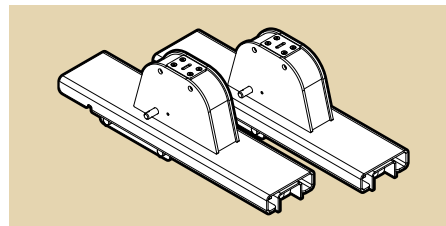

## EAZ-LIFT FIFTH WHEEL RAIL ADAPTER

48555 for 5th Wheel Rails



## 16KS, 18KS and 22KS Features:

- Mounts to industry standard 4- and 10-bolt bed rails
- 11 degree side-to-side pivot w/ urethane cushions
- 32 degree, front-to-back pivot
- Automatic locking jaws
- Durable, powder-coated finish
- Secondary handle lock to ensure jaws have been locked closed
- Adjustable height from 17.5" to 21"
- Displaces hitch 9" toward tailgate for tight maneuvering
- Visible flag on each rail to show the slider has locked in either towing or maneuvering positions
- Secondary lock pin ensures primary locking mechanism is fully secured
- Fully enclosed rollers and locking mechanism to minimize debris build-up
- 16KS : 4000 lb vertical
- 18KS : 4500 lb vertical
- 22KS : 5500 lb vertical

## EAZ-LIFT NO DRILL INSTALL KIT

(Not shown.) Install a fifth wheel hitch in the bed of your truck.

48596 RAM 2500 2014–2019

48597 Ford 150 2015–2019

48598 RAM 3500 2013–2018

48599 Chevy/GMC 2500/3500 2011–2019

48604 Ford F250/F350/F450 2011–2016

48605 Ford F250/F350/F450 2019

# Ready to Tow Hitch Kits

Pre-installed components save installation time



**Round Bar WDH  
with Shank  
+  
SWAY CONTROL  
+  
Hitch Ball  
=  
Quicker Set-up**

## ROUND BAR WEIGHT DISTRIBUTING READY-TO-TOW HITCH KITS

Part #	Description	Maximum Tongue Weight	Maximum Gross Weight Rating
48056	Elite Hitch Kit – 600 lb	800 lb	8,000 lb
48057	Elite Hitch Kit – 800 lb	1000 lb	10,000 lb
48058	Elite Hitch Kit – 1000 lb	1200 lb	12,000 lb
48069	Elite Hitch Kit – 1200 lb	1400 lb	14,000 lb

**Do not overload any part of your towing system.  
Consult the vehicle manual for towing recommendations and limitations.**

**ROUND BAR WEIGHT DISTRIBUTING HITCHES** Over five decades ago, Eaz-lift became the first patented weight distributing system in North America. Designed with fewer parts, forge-tapered round spring steel bars provide a smoother ride with interchangeable bars that have positive latching action for operation. Eaz-Lift has a broad selection of weight distributing hitches that include right and left hand sway control mounts and bolt together ball mounts providing adjustability of ball height and ball mount angle. Each hitch includes hook-up brackets, spring bars, chains, ball mount, shank and hitch pin, clip and bolt package for adjustable hitches.



## WEIGHT DISTRIBUTING HITCHES W/ BOLT-TOGETHER ADJUSTABLE SHANK

Part #	Descr.	Max Tongue Weight	Max Gross Weight Rating
48051	600 lb	800 lb	8,000 lb
48052	800 lb	1000 lb	10,000 lb
48053	1000 lb	1200 lb	12,000 lb
48059	1200 lb	1400 lb	14,000 lb

## REPLACEMENT PARTS

	Part	Description
1	48081	Ball Mount, Adjustable for 2" square size shank (hitch bar) (600-800-1000-1200)
2	48021	Hitch Pin 5/8"
3	48023	Bushing 1-1/4" to 1"
4	48091	Spring Bar 600 Rating
	48092	Spring Bar 800 Rating
	48093	Spring Bar 1000 Rating
	48097	Spring Bar 1200 Rating
5	48028	Hook-Up Wire Clip for 48029 (2 pk)
6	48029	Quick Hook-Up
7	48100	Set Screw - (for Quick Hook-Up 48029)
8	48031	Lever Bar 18"
9	48101	Bolt Package for Adjustable Ball Mount 600-800-1000-1200
10	48103	Set Screw for Adjustable Ball Mount 600-800-1000-1200
11	48104	Spring Bar Locking Device Repair Kit Contains two each pins, retainers and screws
11	48113	Spring Bar Locking Device Repair Kit Contains one each pins, retainers and screws
12	48110	Elite Ball Mount Kit for 600,800,1000,1200

**eaz lift**  
Since 1952

**elite**

## Why Eaz-Lift Sway Controls are better than cam-action type sway controls:

- Eaz-Lift Sway Controls do not create noise problems as does the cam-action type.
- Eaz-Lift Sway Controls do not reduce road clearance.
- Eaz-Lift Sway Controls are easily released when road conditions do not warrant their use...unlike cam-action type sway controls that depend upon hitch weight to operate and cannot be released on icy and oily road conditions where straight line action would possibly impair driving control.
- Eaz-Lift Sway Controls do not lose sway control ability during turns.

**EAZ-LIFT SWAY CONTROLS** Sway Controls minimize sway caused by passing trucks and sudden wind gusts, and do not lose control ability during turns. Double friction pads provide constant sway abatement. Eaz-Lift Sway Controls attach with easy socket and spring clip connectors remove for easy storage. **NOT FOR USE ON TRAILERS WITH SURGE BRAKES.** Trailers over 25' long or smaller broad-sided trailers may require two Sway Controls. Use left hand Sway Control part number 48381.

**48380** Sway Control, Right-Mounted Pass. Side

**48381** Sway Control, Left-Mounted Driver Side (includes one 48390 Ball Mount Bar)



**Note: some vehicles require custom base plates.**

NOTE: THIS TOW BAR IS TO BE INSTALLED BY A PROFESSIONAL INSTALLER/FABRICATOR EXPERIENCED IN SELECTING VEHICLE ATTACHMENT AREAS WITH ADEQUATE STRENGTH.

**TOW BAR** Rated at 5,000 lb GVW for towing pick-ups, cars and multi-purpose vehicles. Designed and constructed for universal fit, with adjustable arms that extend from 24" to 41". The Tow Bar comes with all zinc-plated hardware. The quick disconnect pull pins allow for easy removal and the collapsing side arms afford trunk storage. A 2" ball is required. The Tow Bar is boxed, completely assembled.

**48350** Tow Bar w/o Cables

**48372** Tow Bar U-Joint Assembly

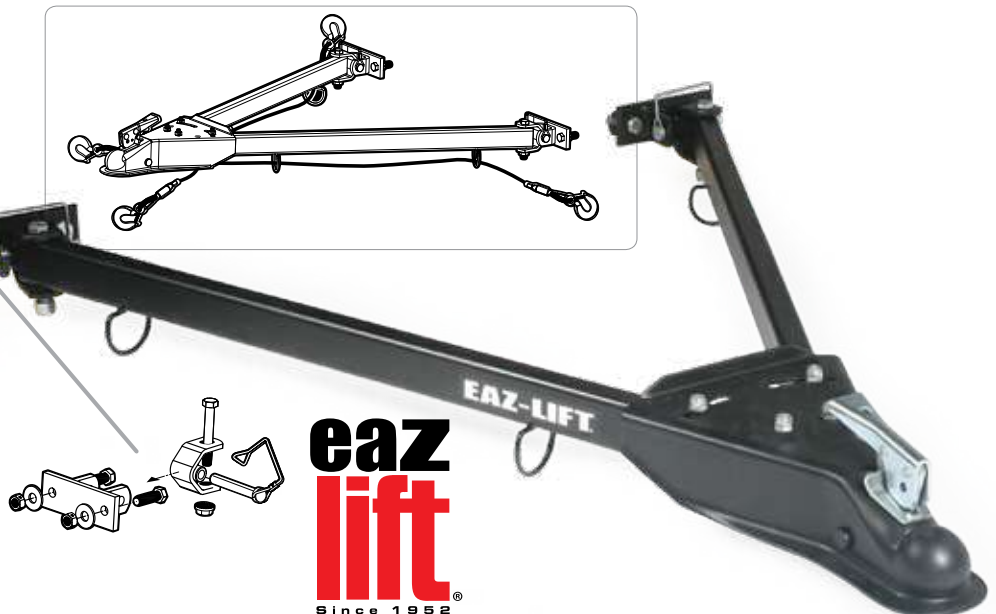

## SWAY CONTROL ADAPTER

Bolt-together adapter fits most 2" ball mounts with 1" ball shank hole. Can be used on left or right side. Durable powder coat finish (Except on balls and utility ball mounts).

**48386** Left or Right Ball Mount Adapter, 2"



## CLAMP-ON SWAY CONTROL ADAPTER

Bolt-together adapter with no-weld installation prevents damage to wiring enclosed in framework. May be used on right or left side of 2 x 3" "A-frame" trailers. **NOT FOR USE ON TRAILERS WITH SURGE BRAKES.**

**48385** Sway Control Adapter



**SWAY CONTROL PARTS** Replacement parts for Eaz-Lift 48380 and 48381.

- 1 **48388** Trailer Tongue Ball Plate
- 2 **48389** Self Tap Screw 3/8" x 1 (6pk)
- 2 **48114** Self Tap Screw 3/8" x 1
- 3 **48028** Hook-Up Wire Clips - 2pk
- 4 **48390** Ball Mount Bar
- 5 **48391** Slide Bar 3/8" (48380 & 48381)
- 6 **48404** Ball, Washer, Nut

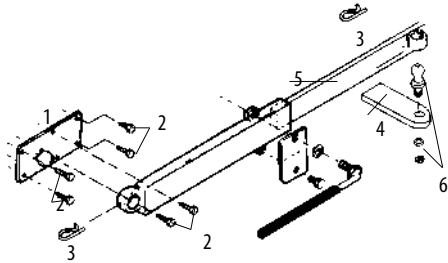

**CHAIN LOOP** Safety chain for use with fabricated receiver and hitches. Large Loops for Class III and IV.

**48181** Large



**5TH WHEEL LUBE PLATES** Cushions vibrations and helps protect your 5th Wheel against friction and wear. Constructed from high-density wear-resistant plastic. No drilling or tools required for installation.

- 44664** 10", Canada Item
- 44665** 10", PDQ Display Packaging, Canada Item
- 44668** 10", Premium, Red w/ PTFE, Canada Item
- 44674** 12", Canada Item
- 44675** 12", PDQ Display Packaging, Canada Item
- 44678** 12", Premium, Red w/PTFE, Canada Item



**CHROME-PLATED STEEL HITCH BALL**

**BALL** Made of solid, machined steel. To choose the correct hitch ball for your towing need, check the inside of your coupler and the desired length of the shank on the ball needed. Hitch ball is marked with size and rating; it is important to match coupler size with hitch ball size. 2 5/16" ball diameter; 1 1/4" shank diameter; 2 1/2" shank length; 10,000 lb gross weight limit

**48213** 2 5/16" diameter hitch ball



**COMBO BAR** 2" x 2" x 1/4" wall with collared tube, used to create under-car receivers for vehicles where standard or frame hitches are not available. Can be bolted or welded to vehicles undercarriage. Sized and punched to fit all common weight distributing hitch ball mounts or utility ball mounts. \*Wt. Dist. only with 24" to 48" combo bar when properly installed. Fits 2"x2" receiver.

- 48170** 6" Shank
- 48171** 10" Shank
- 48172** 12" Shank
- \***48173** 24" Shank
- \***48174** 36" Shank
- \***48175** 48" Shank



**MAGNETIC HITCH ALIGNMENT KIT**

Camco's Magnetic Hitch Alignment Kit is designed for one-person hook-up on the first try every time. Easily visible balls take the guesswork out of linking up your hitch. Attach one guide to the tow vehicle and one to the trailer. Guides extend to 50" for easy viewing, and a swivel base allows the guides to be positioned directly above hitch and receiver. This system works with virtually any tow vehicle and any trailer: gooseneck trailers, fifth wheel trailers, horse trailers and boat trailers.

**44603** Hitch Alignment Kit

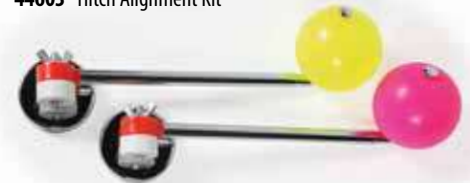

**EAZ-LIFT TOWING KIT**

The Eaz-Lift Towing Kit is a ready to use hitch mount designed for 2" hitch receivers. Includes a convenient no-mess storage case for all included parts. The heavy-duty tow kit has a 5000 lb towing capacity and is designed for use with Class III Trailers.

**51952** 2" Ball and 5/8" Pin w/ Plastic Case



**BALL MOUNTS** Ball mounts are 2" x 2" and are used to convert a receiver from a weight distributing hitch to a weight carrying hitch. Ball mounts create a ball platform for attaching a hitch ball. The ball mounts or utility hitch bar length are determined by measuring from the center of the pull pin to the center of the hitch ball hole. The drop or rise is determined by measuring from the top of the mount to the top of the tongue. All 2" x 2" ball mount shank holes are 1", except 48282, which has a 3/4" hole.

(Not reversible)



**A**



**B**



**C**



**D**



**E**



**F**



**G**



**H**

**STRAIGHT & ANGLE, DROP/RISE, REVERSIBLE BALL MOUNTS**

Fits 2" X 2" Receiver, Rated MGTWR/MTW 6000/600 All ball mounts are unboxed. Hitch ball not included. Call for pricing.

	Part #	Length	Drop	Lift
A*	<b>48282</b>	8-3/4"	-	-
B	<b>48286</b>	9"	2"	3/4"
	<b>48290</b>	13"	2"	3/4"
C	<b>48292</b>	9"	4"	2-3/4"
	<b>48294</b>	11"	4"	2-3/4"
D	<b>48296</b>	13"	4"	2-3/4"
	<b>48298</b>	9"	7"	5-3/4"
E	<b>48300</b>	11"	7"	5-3/4"
	<b>48312</b>	13"	2"	3/4"
F	<b>48314</b>	8"	2"	3/4"
	<b>48326</b>	10-1/2"	2"	3/4"
G	<b>48304</b>	10-1/2"	3-1/4"	2
	<b>48316</b>	7"	3-1/4"	2"
H	<b>48306</b>	11-1/2"	6"	4-3/4"
	<b>48318</b>	9"	5-1/4"	4"
	<b>48320</b>	10-1/2"	5-1/4"	4"

\*Rated MGTWR/MTW 3500/350—NOT REVERSIBLE



**48386**  
Left & Right Sway Control Adapter



## ADJUSTABLE BALL MOUNT SHANKS

Used in either the up or down position to match the ball mount to any coupler height. Long hi/low shanks provide the extra length sometimes needed to obtain clearance from bumper interference. Fits 2"x2" Receiver.

### A1. HI/LOW SHANK 2 1/2" Drop, 5 1/2" Rise

- 48650 12" Shank, Forged
- 48121 14" Shank
- 48122 16" Shank
- 48123 18" Shank



### A2. EXTRA HI/LOW SHANK

5 3/4" Drop, 8 3/4" Rise

- 48653 12" Shank, Forged
- 48131 14" Shank
- 48133 16" Shank



### A3. EXTRA LOW SHANK 9 1/2" Drop

(Ball mount and shank to be used in the low position only)

- 48132 12" Shank



**Extra Low Ball Mount and Shank to be used in low position ONLY.**

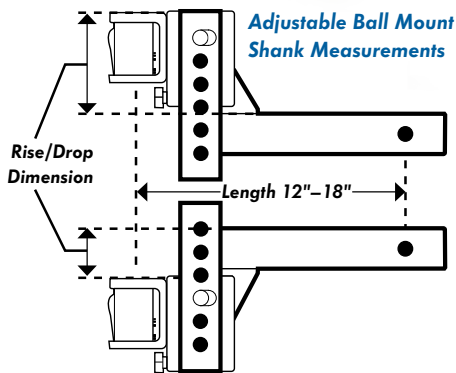

**DUAL HITCH EXTENSION** Allows use of hitch-mounted accessories such as bike racks, chair carriers, etc. while towing a trailer. 3500 lb gross trailer weight capacity and a 350 lb combined tongue weight capacity. Constructed of durable steel with a powder coat finish that resists rust and corrosion, and is weather resistant. Both receivers are 2" receiver openings.

- 48472 Dual Hitch Extension



**SQUARE BUMPER HITCH** Clamps on to your 4" square RV bumper, creating a hitch receiver without drilling or permanent installation. The 2" hitch receiver is ideal for lightweight applications, such as bike and cargo racks. The heavy duty, durable powder-coated steel is corrosion resistant and built to last. **RV BUMPER HITCH IS NOT DESIGNED FOR TOWING.**

- 48473 Square Bumper Hitch



**RECEIVER ADAPTER** Easily adapts a 1 1/4" receiver into a 2" receiver. The adapter has a 6" extension and has a 3500 lb gross trailer weight rating. The durable steel with powder coat finish resists rust and corrosion and is weather resistant.

- 48471 Receiver Adapter



## ADJUSTABLE UTILITY BALL MOUNT AND SHANK

Ideal for those who have more than one trailer or tow vehicle. Rated for trailer weights up to 5,000 lb. and tongue weights up to 500 lb. Powder coat baked-on finish. 1" Ball Hole, 8 1/2" Drop, 7 1/4" Rise, Fits 2"x2" receiver.

- 48270 14" Shank

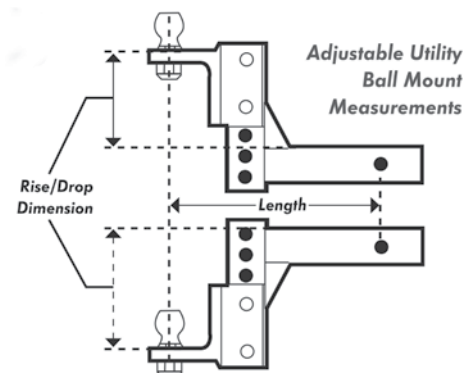

- 1 Drive your good tire onto the Trailer-Aid. This will lift your flat tire off the ground.



- 2 Remove your flat tire and mount your spare tire.



- 3 Drive off the Trailer-Aid and you're on your way.



**Trailer-Aid is a fast, safe, easy way to change your trailer's flat tire without having to unload your trailer.**

A flat tire never happens at a good time, usually when you are by yourself on a busy highway, with a full trailer. Trailer-Aid allows anyone to change a flat tire anywhere, anytime—without help, without a jack and without unloading.

Trailer-Aid can withstand weights up to 15,000 lb, and is waterproof and rustproof. Trailer-Aid is made from a high-tech polymer which is both lightweight and strong as steel.

The front holes and rear slot allow for easy handling and access. Small and lightweight (only 5 lb), Trailer-Aid stores easily and unobtrusively. It is light enough to be carried on the finger tips, and has clean edges that won't snag clothing or hurt your hands.

Trailer-Aid PLUS is engineered specifically for recreational trailers. It gives your tire an extra 1" lift for performing maintenance on brakes, wheels and axles.

Both styles of Trailer-Aid come with a lifetime guarantee.



## TOW CAR WINDSHIELD

**PROTECTOR** Helps protect windshield from chips and cracks. Fast and easy installation and removal with no hardware required. Simply place vinyl cover on windshield, open doors, put end flaps inside car and close doors. Buckle straps hold cover firmly in place. Universal cover fits most windshields.

**45401** Windshield Protector



## EAZ-LIFT SPARE TIRE MOUNT

The Camco Eaz-Lift Spare Tire Mount is an easy way to create an exterior spare tire location on your trailer. The durable, powder-coated steel mount easily attaches to your trailer with included zinc-plated hardware without the need for drilling. Spare Tire Mount fits trailer tongues up to 6" tall and is compatible with 4 lug X 4" diameter hole pattern, 5 lug X 4.5" diameter hole pattern, and 5 lug X 4.75" diameter hole pattern.

**48474** Spare Tire Mount

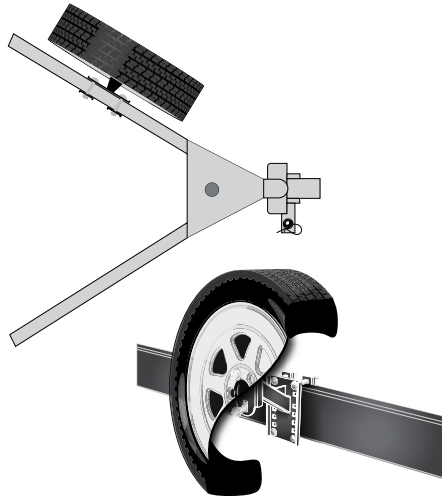

**TRAILER-AID HOLDER** Secure your Trailer-Aid or Trailer-Aid PLUS with this metal holder. Designed to mount on the wall of your trailer.

**55** Trailer-Aid Holder

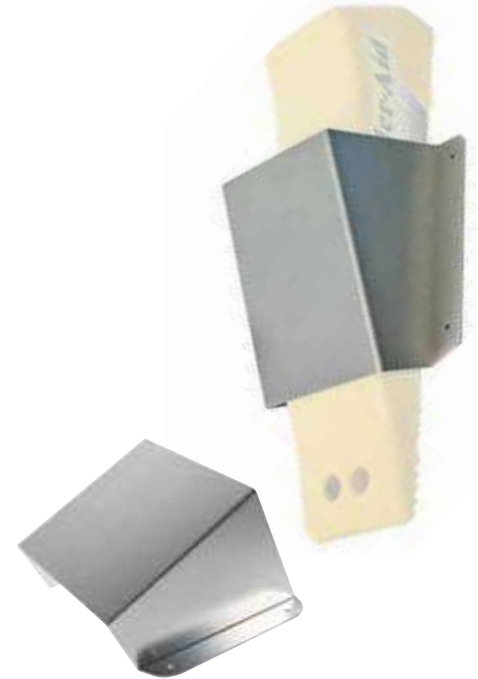

**TRAILER-AID** Trailer-Aid is the fast, safe and easy way to change a trailer's flat tire. Made from lightweight super strong polymer, Trailer-Aid is easy to travel with and makes changing your trailer tire simple, even if you're alone.

**21** Yellow

**22** Black

**44487** Yellow, Canada Item



**TRAILER-AID PLUS** Trailer-Aid PLUS is designed specifically for recreational trailers and gives an additional 1" lift. The extra 1" lift makes Trailer-Aid PLUS handy when performing maintenance on brakes, wheels, and axles.

**23** Yellow

**24** Black



**TRAILER ADAPTER, HEAVY DUTY  
BLADE 7-WAY TO 4-WAY FLAT**

**TRAILER ADAPTER** 7-way male end plugs into your existing female end and converts it to a standard 4-way flat female connector.

64786 1/card

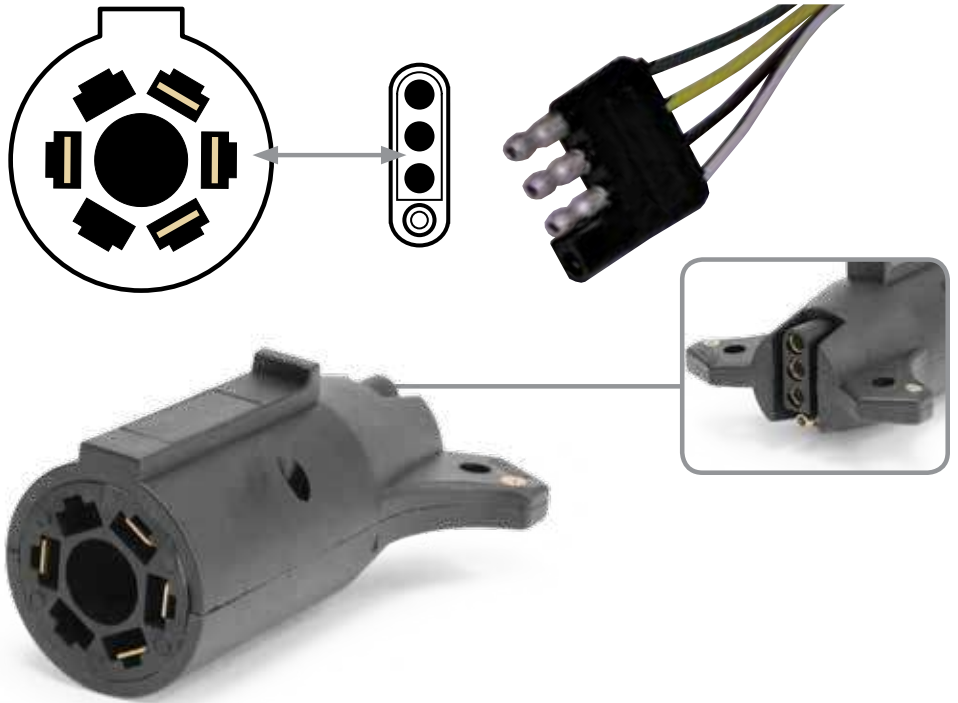

**TRAILER CABLE BLACK PVC  
JACKET**

	Multi-Gage - 7 Conductor 2-10, 1-12, 4-14 Ga. Diameter .69; Copper wires color coded for RV: 2-10 ga—black and white, 1-12 ga—blue, 4-14 ga—yellow, red, green and brown.
--	---------------------------------------------------------------------------------------------------------------------------------------------------------------------------------------

Package	
25' Spool	<b>64673</b>
50' Spool	<b>64674</b>
100' Spool	<b>64675</b>



**BATTERY CABLE** Polyvinyl chloride insulated with bare copper conductors. Made to meet SAE J1127 standards and is rated at 80° C. Resistant to abrasions, acids, and oil.

**64685** 25' Spool / 4-Gage Red



## TRAILER CONNECTORS, COMPLETE Male and Female Ends.

### 2-WAY, FLAT 18 GA WIRE, 12" LONG

64858 1/bag

### 3-WAY, FLAT 18 GA WIRE, 12" LONG

64859 1/bag

### 4-WAY, FLAT 18 GA WIRE, 12" LONG

64834 Bulk

64835 1/bag

### 5-WAY, FLAT 18 GA WIRE, 60" LONG

64856 1/bag

### 6-WAY, SQUARE 16 GA WIRE, 12" LONG

64860 1/bag



## 7-WAY RV BLADE HARDWARE KIT

Make your vehicle trailer-ready with this complete kit. Comes complete with pre-wired plastic 7-Way Trailer Connector bracket, circuit breakers, electrical connectors, wire, nuts, bolts, washer and even cable ties. Enjoy the convenience of having everything you need to finish the job right at your fingertips.

63938 7-Way RV Blade Hardware Kit



**4-WAY TRAILER TEST LIGHT** Trailer light problems are easily identified by plugging this tester into your existing car-end connector. Also helps to properly install a 4-way connector without a trailer attached.

64776 1/bag



## 4-WAY WISHBONE TRAILER HARNESS - TRAILER END

1/bag. Male/Plug.

64839 12"

64841 24"

64843 36"

64845 48"

64837 25'

64847 30'



## 4-WAY TOW VEHICLE END

Female/Socket

64849 12" Pigtail, Bulk

64850 12" Pigtail, 1/bag

64852 48" Wishbone Harness, 1/bag

64853 60" Bonded Harness, Bulk

64854 60" Bonded Harness, 1/bag



**CLIP-ON TOWING MIRRORS** The Camco Clip-On Tow Mirror gives you more visibility when towing, making driving while towing safer and giving you peace of mind. The Clip-On Mirror features 360 degree ball and socket adjustment and an aerodynamic design that reduces vibrations. Installation is easy- there are no tools required. The adjustable rubber straps provide a universal fit.

**25650** Single Towing Mirror

**25653** Dual Towing Mirror



**EAZ-LIFT CARGO CARRIER, HITCH MOUNT**

The Camco Hitch Mounted Cargo Mount is an easy way to add extra storage space when traveling. The Cargo Carrier is compatible with any 2" hitch receiver and easily attaches and detaches with included hitch pin. The heavy duty steel basket has a 500 lb. weight capacity and a powder coated finish. Measures 51 1/2" x 17 1/2" x 3 1/4".

**48475** Cargo Carrier



**ELECTRIC TONGUE JACK HEAD COVER**

The Camco Electric Tongue Jack Cover helps protect your electric tongue jack when it is not in use and in storage. The durable 3-layer spun bond polypropylene provides protection from harmful UV rays, excess moisture and dirt and debris. Tongue Jack Cover accommodates most styles and brands of Electric Tongue Jacks, and measures 18" tall x 7 1/2" wide x 8 1/2" deep.

**48356** 18"H x 7.5"W x 8"D



## TOW-N-SEE™ POWER MIRROR

**EXTENDER** Don't spend money on expensive aftermarket power mirror extensions. Tow-N-See Mirror moves along with your power mirrors so you can adjust your view while sitting in the driver's seat. Installs in just seconds with a twist of the knob, leaving no marks and making it easy to transfer from one vehicle to the next. Tow-N-See...The one that works! Patented.

**25668** Convex, Passenger Side

**25663** Flat, Driver Side



**CONVEX BLIND SPOT MIRROR** Can be installed on either side view mirror to help eliminate blind spots. 4" x 5.5"

**25603** Convex Mirror



**BLIND SPOT MIRRORS** Convex wide angle mirrors can be installed on rearview or side-view mirrors to help eliminate blind spots. Adjustable 360° mirror rotates for different driving positions. Large 2" diameter mirror surface effectively increases viewing angles.

**25593** 2pk



**CONVEX BLIND SPOT MIRROR** Can be installed on either side view mirror to help eliminate blind spots. 3.75" Round.

**25613** Convex Round Mirror



**XTRA VIEW MIRROR** Can be mounted on top of driver's or passenger's side mirror to help eliminate blind spots. Patented.

**25633** Xtra View Mirror



## WIDE ANGLE BLIND SPOT MIRROR

Can be installed on either side view mirror to help eliminate blind spots. 3.25" x 3.25"

**25623** Wide Angle Mirror



**CAMCO**







# Leveling & Stabilization

# Fasten™

## LEVELING

## BLOCKS

### EXCLUSIVE CARRY HANDLE

- TWIST to secure
- PULL UP to carry



3



6



10

3  
sizes  
available

- Customize your levels: stack interlocking blocks to desired height
- Safe and easy to use
- Strong and durable

**CAMCO**

**FASTEN LEVELING BLOCKS** Allows you to stack the interlocking blocks to the desired height for safe and easy leveling. Each block adds a full inch to stack height. Can be used with single wheels, double wheels, hydraulic jacks, tongue jacks, stabilizer jacks, 5th wheel jacks and tandem axles. The convenient carrying handle easily pulls up for carrying, or twists down to secure blocks together for storage. Strong, durable construction; engineered with a patent-pending design to optimize both strength and weight. UV stabilized resin; built to last even with extended exposure to sunlight. Sold in sets of 10.

- 44512 2 x 2, Yellow
- 44521 2 x 2, Brown
- 44515 4 x 2, Yellow
- 44525 4 x 2, Brown



**FASTEN XL HEAVY DUTY LEVELING BLOCKS** The Camco FasTen XL Leveling Blocks allow you to stack the interlocking blocks to the desired height for safe and easy leveling. The new, larger size has an increased weight capacity of blocks individually and in a stack, and also provides more surface area for leveling. Each block adds a full inch to stack height. Camco's FasTen XL Leveling Blocks can be used with single wheels, dual wheels, hydraulic jacks, tongue jacks, stabilizer jacks, 5th wheel jacks and tandem axles. The convenient carrying handle secures blocks together for storage and easily pulls up for carrying, or pushes down for more compact storage. Individual block measures: 10.5" x 10.5" x 1.5". Stack height should not exceed 4 1/2".

- 44527 Leveling Blocks



**FASTEN FOOTPATH** A great asset in your campsite, garden or backyard. Can be a sturdy, solid stepping stone at the entry to your RV, beside your camping water source, in that perpetually muddy corner or a designated footpath through a garden. Stack and use as a step stool, or to create levels amongst your potted plants. Durable, UV-resistant polypropylene has a cut out design, making it easy to clean—simply hose off any mud, dirt or debris. Set of ten stepping blocks has an integrated FasTen handle that goes through the center of the stacked pads when they are all nested and twists into the threaded bottom pad to hold the set together, then telescopes down for compact storage.

- 44530 FasTen Footpath, Charcoal
- 44533 FasTen Footpath, Green
- 44534 FasTen Footpath, Tan

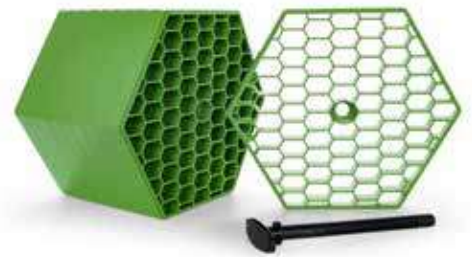

**LEVELING BLOCK CAPS** Securely join a single layer of Leveling Blocks, or create a flat surface on top of a larger stack. Use with regular or FasTen Leveling Blocks. Patented.

- 44500 Leveling Block Caps, 4pk

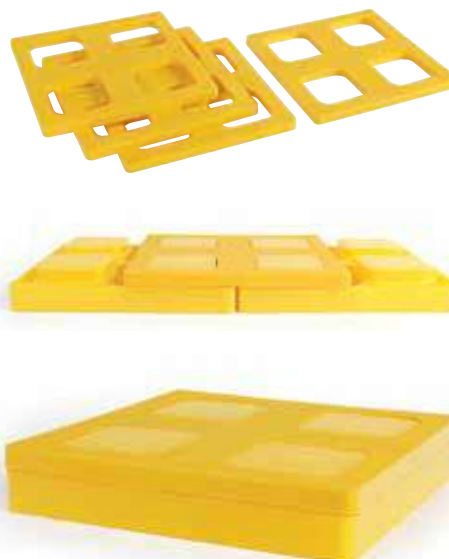

**LEVELING BLOCKS** Heavy duty blocks are safe and easy to use. They offer many options for leveling single wheels, dual wheels, hydraulic jacks, tongue jacks, stabilizer jacks, 5th wheel jacks and tandem axles. Customize your levels: Stack interlocking blocks to desired height. Strong and durable blocks are available in a ten-block set and a four-block build-up set. Patented.

- 44503 10-Block Set
- 44501 4-Block Set



**TRI-LEVELER™** Raise your RV up to 3 7/8" on any tire for a more level position. Helps appliances and tanks operate more efficiently. Lightweight, durable resin has a non-slip surface. Each Tri-Leveler has a load capacity of 4000 lb. Patented.

**44573** Tri-Leveler

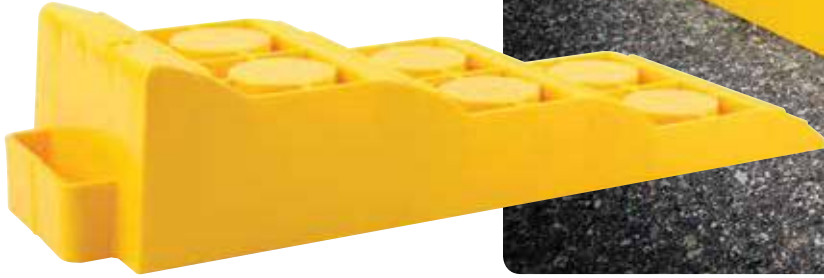

**WHEEL DOCK™** Prevent your trailer tongue wheel from rolling on the pavement or sinking into soft ground. Heavy duty, durable dock is easy to store and transport.

**44632** Wheel Dock

**44630** Wheel Dock, Canada Item



**STABILIZER JACK PADS** Specifically designed for use with stack jacks, fifth wheel stabilizers, swing down stabilizers and awning arms to keep them from sinking into soft ground. Interlocking for convenient storage with handy strap. Built-in handle for ease of use. Solidly constructed of durable polypropylene with UV inhibitors. Patented.

**44595** Small 6.5" x 9" pad, 4pk

**44541** Large, 14" x 11.7" pad, 2pk

**44543** Large, w/ Extension Handle



**BIG BAG™ STABILIZATION KIT** A 14 piece kit that includes everything you need to stabilize your trailer set up, with a convenient storage duffel included. Each stabilization piece is made of durable, UV-stabilized resin and is easy to use. The kit includes 2 Tri-Levelers for customizable leveling, 2 Wheel Chocks to help keep your trailer in place, 4 Regular and 2 Large Stabilizing Jack Pads that help prevent jacks from sinking into soft ground, 2 Wheel Stops that secure tandem tires to prevent movement while parked or re-hitching and 1 Tongue Jack Stand to evenly distribute the weight of the tongue.

**44550** Stabilization Kit

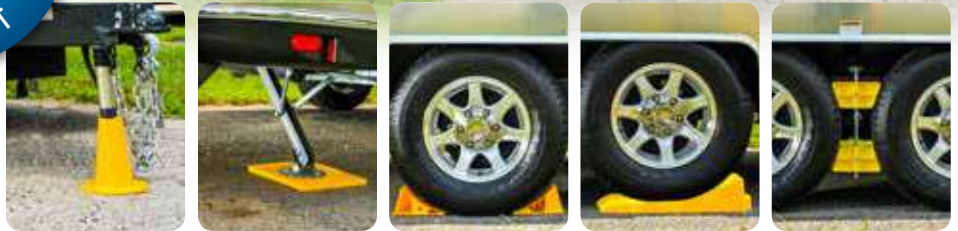

**STABILIZER JACK SUPPORT** The Camco Stabilizer Jack Support is a 7" tall leveler that is great for use with stabilizer jacks that don't reach the ground. It can also be used with tongue jacks equipped with a footpad, or as a step stool if not otherwise in use. The Stabilizer Jack Support is constructed of durable UV-stabilized polypropylene, and nests for storage if you own more than one. Patent Pending.

**44424** Stabilizer Jack Support



**STABILIZER JACK PADS** The Camco recycled rubber stabilizer jack pads help prevent jacks and stabilizers from sinking into soft ground. The flexible material is great for use on uneven surfaces such as gravel, tree roots, and rough earth because it absorbs uneven pressure instead of cracking or wobbling. Recycled rubber stabilizer jack pads are UV resistant, weather-proof, and constructed of recycled materials. Nests perfectly with most stack jacks. Each pad measures 6.5" x 9" X .75".

**44591** Rubber, 6.2" x 6.2" pad, 4pk



**UNIVERSAL FLEX PADS** The Leveling Block Non Slip Pad works well underneath Camco and FasTen brand leveling blocks, other brand leveling blocks, or on its own to help prevent jacks and stabilizers from sinking into soft ground. The flexible material is great for use on uneven surfaces such as gravel, tree roots and rough earth to help create a more even surface. It also helps prevent the leveling blocks from cracking due to uneven stress. Non Slip Pads are UV resistant, weather-proof, and constructed of recycled materials. 2pk.

**44600** 2 x 2

**44601** 4 x 2



# Curved RV Leveler

**NEW!**

Compact length makes  
leveler ideal for  
tandem wheel  
spacing

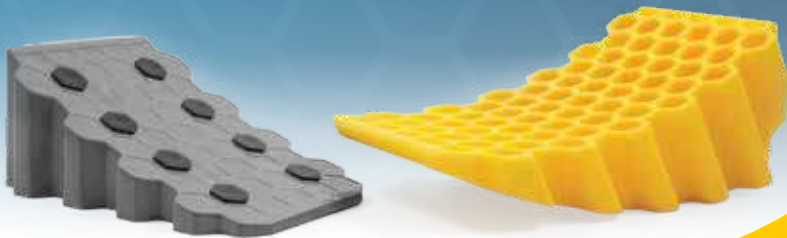

**CAMCO**

## **CURVED LEVELER & LEVELER**

**CHOCK** The Camco Curved Leveler is a simple way to level your vehicle by giving a tire up to 4 extra inches of lift. The honeycomb design makes the leveler lightweight but durable. The drive-on curved design allows you to only drive on to as much height as needed, then chock the leveler at the exact right height. The included clock has non-slip rubber grippers on the bottom. Patent Pending

**44423** Curved Leveler and Leveler Chock

**44425** 2pk



**BIG YELLOW CHOCK** Camco's Big Yellow Wheel Chock is compatible with tires up to 30" in diameter and is designed to keep your trailer in place so that you can re-hitch with confidence. The large wheel chock has a honeycomb design that provides extra strength and durability. It is constructed of durable hard plastic with UV inhibitors and has a built-in handle to make it easy to use. Patent Pending

**44419** 30" Wheel Chock

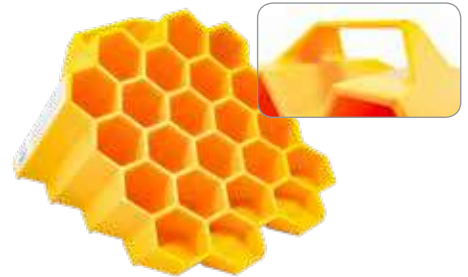

**NESTING WHEEL CHOCKS** Camco's RV Nesting Wheel Chocks are designed to keep your trailer in place so that you can re-hitch with confidence. The convenient nesting pair reduces space needed for storage. They are constructed of durable plastic with UV inhibitors and are easy to use and effective. Meets SAE J348 for tires up to 26" in diameter. 2pk.

**44418** Dark Gray Nested Chocks



All prices listed are manufacturer's suggested retail

**WHEEL CHOCK** Chocks keep your trailer in place so you can re-hitch with confidence. Solidly constructed of durable hard plastic with UV inhibitors. Also sold with rope for convenient placement and removal from the wheel.

**44412** 6/ctn

**44432** 36/ctn

**44472** Wheel Chock w/ Rope



**SUPER WHEEL CHOCK** Keep your vehicle and trailer from moving. Keep your trailer in place and re-hitch with confidence. Solidly constructed of durable polypropylene with UV inhibitors.

**44492** Super Wheel Chock

**44475** Super Wheel Chock w/ Rope



**TONGUE JACK STAND** Heavy duty, durable way to stabilize your tongue without the need for heavy cinder blocks or wood. Sturdy base has a weight capacity of 5,000 pounds, but is lightweight and easy to store. The recessed dock supports the weight of the tongue, preventing it from slipping and evenly distributing the weight, helping it to not sink into soft ground. UV stabilized resin for many years of use. The Jack Stand is not designed for use with a wheel-equipped tongue jack.

**44635** Tongue Jack Stand



**TANDEM WHEEL CHOCK** Camco's Tandem Axle Trailer Wheel Chock is designed to secure your tandem-axle trailer against both forward and backward motion. Durable polymer construction with UV inhibitors. Wheel Chock can also be used as a tongue jack stand with a 400 lb. max tongue weight.

**44435** Tandem Wheel Chock



**LEVELING BLOCK WHEEL CHOCKS**

Make stabilizing and centering wheels easier; connect to Camco's Leveling Blocks to level and chock simultaneously. Sized for larger vehicle wheels. Ideal for RVs, trucks and trailers; helps eliminate dangerous wheel movement. Exclusively for use with Camco's Leveling Blocks. Patented.

**44401** 2pk



**KING PIN 5TH WHEEL STABILIZING JACK**

Major height adjustments are made by simply moving the adjustable foot pads inward or outward; minor adjustments are made at the screw level with the provided stabilizing adjusting lever. Designed for use with 5th wheel trailers whose coaches have a king pin height of 39" to 50". Fully assembled with steel tube construction and zinc-plated chain. Lockable for added security. Designed to allow use of padlock to secure Stabilizing Jack to trailer. 5000 lb maximum load capacity.

**48855** King Pin Stabilizing Jack

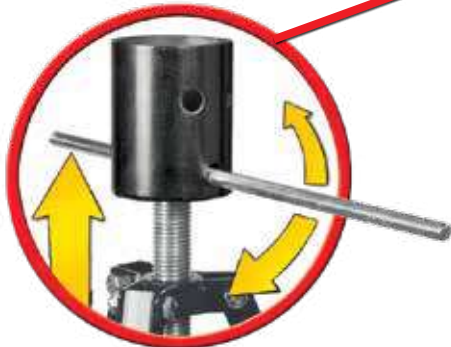

**GOOSENECK STABILIZER JACK**

Reduces movement on trailer; works with horse trailers and 5th wheel trailers with gooseneck adapter installed. Heavy duty steel construction; powder coated for maximum rust protection. Features zinc-plated chain and large foot pads. Hooks up to Gooseneck Adapter (sold separately). Adjustable from 30 to 44". Maximum load: 7500 lb.

**48850** Gooseneck Stabilizer Jack



**ADJUSTABLE STABILIZER** 6" x 6" HD

Use under front or rear of trailer for greater stability. Large reinforced base for better ground contact. 5000 lb capacity. Adjusts from 9 to 14".

**44531** Adjustable Stabilizer



**SAV-A-STEP BRACE** Place under RV entry steps for safety. Stabilizes steps and helps keep the coach from rocking. Helps prevent sag and wear. Heavy-gage steel with a 3/4" solid metal screw thread. 1000 lb limit.

**43681** 4 5/8"-8"

**43691** 7 5/8"-14"



**SELF-STOR STEP SUPPORT** Mount

under RV entry steps for safety. Swings up and stores securely under RV Step. Stabilizes steps and helps keep the coach from rocking. Helps prevent sag and wear. Heavy-gage steel with a 3/4" solid metal screw thread. 1000 lb limit.

**43671** Self-Stor Step Support





**SLIDE-OUT SUPPORTS** Help protect your RV's slide out mechanism by providing support to your slide out room when it is in use for prolonged periods. The universal fit top will support any slide out rail, and the space saving handle and tethered pin make the support easy to use and store. The Eaz-Lift Slide Out Support adjusts from 19" to 47", with incremental locked positions, plus minute adjustment that extends an additional 14". These durable supports are constructed of rust-resistant steel and support up to 5,000 lb each.

**48866** Slide Out Supports, Pair

**48867** Slide Out Support, Single



## TELESCOPIC STABILIZING JACKS

Zinc-plated inner tube and screw assembly. Adjustable from 16" to 30". Sturdy steel construction, powder coated for maximum rust protection. 6000 lb load capacity.

**48860** Telescopic Jack, 2pk



**LEVELING SCISSOR JACKS** Fits pop-ups and trailers and allows for either bolt-on or weld-on installation. Powder coated for maximum rust protection. See listing below for load capacities.

**48800** 20", 5000 lb, 2pk

**48810** 24", 5000 lb, 1pk

**48820** 24", 5000 lb, 2pk

**48830** 24", 7500 lb, 2pk

**48840** 30", 5000 lb, 2pk

**57874** Crank Handle



**STABILIZING TRAILER JACKS** Features include a heavy duty non-corroding cast aluminum base with steel screw assembly and a permanent handle. Adjustable from 11" to 17". 6000 lb load capacity.

**44561** Aluminum Jack Stands, 2pk

**44560** Aluminum Jack Stands, 4pk



## SCISSOR JACK SOCKET DRILL ADAPTERS 3/4"

**57363** Standard Socket

**57364** Quick-Connect Socket



## EAZ-LIFT SCISSOR JACK DRILL EXTENSIONS

The Eaz-Lift Scissor Jack Drill Extensions aid in raising and lowering your RV's scissor jacks. It is compatible only with manual scissor jacks and is made of durable, zinc-plated construction.

**48861** 3/4" Hex Jack Socket Extension

**48862** Slotted Jack Drive Extension



## STABILIZER BASE PADS

For use with most cross-frame or "T" type stabilizing jacks. Wide pad construction for greater stability. Installation hardware and anti-rattle rubber grommet included.

**57883** Stabilizer Base Pads, 4pk



**RV EZLEVEL™** Just place our factory-calibrated RV EzLevel in the center of the RV for fast, accurate and easy leveling of the entire RV, ensuring not only a level refrigerator but a good night's sleep. Built with solid state electronics to level both axes simultaneously. Easy to stow.  
**25505** RV EzLevel



**ACCULEVEL™** Mounts with screws to the front of the trailer and can be seen in mirrors. Large ball indicates side-to-side leveling, with second level for front-to-back. Brackets for mounting to fifth wheel pin boxes sold separately.

**25563** AccuLevel

**25583** Brackets for AccuLevel



**TRAILER LEVEL** Mounts with screws to the front of the trailer and can be seen in mirrors. Large ball indicates side-to-side leveling, with second level for front-to-back. Lightweight plastic construction. Patented.

**25533** Trailer Level



**STANDARD LEVELS** Screw-mounted level for front-to-back or side-to-side leveling.

**25523** 2/card



**T LEVEL** Screw-mounted level provides front-to-back and side-to-side leveling.

**25543** 1/card



**PRECISION CURVED BALL LEVELS**

Screw-mountable level has graduated markings for accurate leveling.

**25553** 2/card



**BULLSEYE LEVEL** Round domed level reads 360° at once.

**25573** 1/card



**UTILITY TRAILER LEVELS** Mount with screws or self-adhesive tape. Graduated markings help you to determine how much to adjust your vehicle. Patented.

**25503** Utility Trailer Levels, 2/card



## METAL LOCKING WHEEL STOP W/ WRENCH

Prevent tandem-tire shift using just one piece of equipment—Eaz-Lift's Premium Metal Wheel Stop. Zinc-plated for corrosion resistance, has raised ribs on the contact surface for increased traction which helps prevent tire shift/slippage between tandem tires spaced from 3–10" apart. It also includes a comfort-grip ratchet wrench for easy installation and a lock to keep it secure.

44662 10", Canada Item

44663 18", Canada Item



**WHEEL STOP™** Secure tandem tires to prevent movement while parked or re-hitching. Fits 26" to 30" diameter tires with tire spacing of 3 1/2" to 5 1/2". Patented.

44622 Wheel Stop



**SMALL WHEEL STOP™** A smaller version of the Wheel Stop, designed to fit 26" to 30" diameter tires with tire spacing of 1 1/2" to 3 1/2". Patented.

44652 Small Wheel Stop



## LOCKING WHEEL STOP™ W/ PADLOCK

Locking model with padlock included. Fits 26" to 30" diameter tires with tire spacing of 3 1/2" to 5 1/2". Patented.

44642 Locking Wheel Stop



**CAMCO**

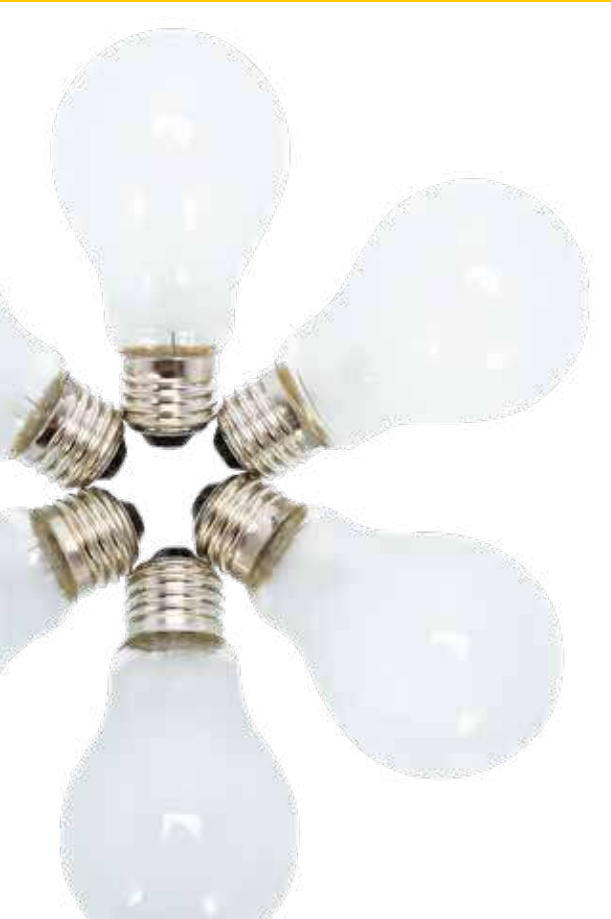





**SUPERIOR  
QUALITY**

COMES IN

**BLACK**



**—AND—**

**YELLOW**

Look for the trademark **BLACK & YELLOW** for superior quality RV electrical accessories.



**POWER GRIP DOGBONE ADAPTERS**

**30 AMP MALE TO 15 AMP FEMALE**

125V-1875W. NEMA TT-30P/5-15R - 12"

55155 30A Male to 15A Female



55153 30A Male to 15A Female, Carded

**15 AMP MALE TO 30 AMP FEMALE**

125V-1875W. NEMA 5-15P/TT-30R - 12"

55165 15A Male to 30A Female



55163 15A Male to 30A Female, Carded

**50 AMP MALE TO 30 AMP FEMALE**

125V-3750W. NEMA 14-50P/TT-30R - 18"

55175 50A Male to 30A Female



55173 50A Male to 30A Female, Carded

**30 AMP MALE TO 50 AMP FEMALE**

125V-3750W. NEMA TT30P/14-50R - 18"

55185 30A Male to 50A Female



55183 30A Male to 50A Female, Carded

**15 AMP MALE TO 50 AMP FEMALE**

125V-1875W. NEMA 5-15P/14-50R - 12"

55168 15A Male to 50A Female



55170 15A Male to 50A Female, Carded

Patented



**POWER GRIP DOGBONE**

**EXTENDERS** Connect extenders to your RV power cord and enjoy the ease and convenience of our Power Grip handles when connecting to a matching amperage outlet box. Extenders are 18" long. Patented.

55205 30A, 125V/3750W, NEMA TT-30P/TT-30R

55215 50A, 125-250V/12500W, NEMA 14-50P/14-50R



**POWER GRIP ELECTRICAL**

**ADAPTERS** With contoured shape for easy removal from outlet.

**15 AMP MALE TO 30 AMP FEMALE**

125V-1875W. NEMA 5-15P/TT-30R.

55223 15A Male to 30A Female

55222 15A Male to 30A Female, Bulk

**30 AMP MALE TO 15 AMP FEMALE**

125V-1875W. NEMA TT-30P/5-15R

55233 30A Male to 15A Female

55232 30A Male to 15A Female, Bulk

**15 AMP MALE TO 30 AMP FEMALE, 90°**

125V-1875W. NEMA 5-15P/TT-30R.

55325 15A Male to 30A Female



Patented



**POWER GRIP GENERATOR DOGBONE ADAPTERS**

**30 AMP** 12" adapters for connecting a generator with a L5-30 or L14-30 locking receptacle to a recreational vehicle that uses a standard 30A RV cord set (NEMA TT-30). 125V/3750W. Patented.

55272 3-prong for L5-30 Locking

55382 4-prong for L14-30 Locking

55384 4-prong for L14-30 Locking, Carded

**30 TO 50 AMP** 12" adapters for connecting a generator with a L5-30 or L14-30 locking receptacle to a recreational vehicle that uses a standard 50A RV cord set (NEMA 14-50). Patented.

55412 3-prong for L5-30 Locking

55422 4-prong for L14-30 Locking



**POWER GRIP POWER**

**MAXIMIZER** Get up to 45 amps combined power. When connecting to your RV's 50 amp power cord, don't be limited to just 15 or 30 amps. Camco's Power Grip Power Maximizer draws the combined power from a 15 and a 30 amp outlet, which allows your RV to receive up to 45 amps. Will not work when plugged into GFI type outlets and must be used in conjunction with properly sized circuit breakers. NEMA TT-30P + 5-15P/14-50R. Patented.

55025 Power Maximizer



**POWER GRIP GENERATOR ELECTRICAL ADAPTER**

For connecting a generator with a L5-30 or L14-30 locking receptacle to a recreational vehicle that uses a standard RV cord set (NEMA TT-30). 125V/3750W. Patented.

55333 3-Prong Generator Adapter

55338 4-Prong Generator Adapter



**POWER GRIP Y GENERATOR**

**ADAPTERS** Adapt a 30 amp generator receptacle to two 15 amp receptacles. Models available for 3 and 4 prong 30 amp generator plug. 125V/3750W.

55433 3 Prong - L5-30/5-15(2)

55438 4 Prong L14-30/ 5-15(2)



**POWER GRIP VOLTAGE**

**PROTECTOR** Helps protect your RV from damaging low/high voltage levels and power spikes and surges. Camco's Voltage Protectors monitor incoming power, automatically disconnecting it when dangerous voltage levels are detected and automatically reconnecting once it stabilizes between 102–132 VAC. Reconnect Delay protects sensitive equipment, such as AC units, by not rapidly cycling power. Includes diagnostic lights for visual indication of faults. Water resistant unit incorporates integrated multilevel surge protection and diagnostic lights for visual indication of faults. Available in 30 and 50 AMP.

**55301** 30A, NEMA TT-30P/TT-30R

**55306** 50A, NEMA 14-50P/14-50R



**POWER GRIP UNIVERSAL**

**POWERLOCK™** The Camco Power Lock is an innovative solution to secure cables and adapters. The spherical design protects your valuable cables by encasing two connected plug-ends deterring theft and tampering. The Power Lock also helps keep plug-ends off the ground, and features holes to drain water in case of rain or condensation. The durable high density polyethylene is UV-stabilized for many years of use. Works with 30 amp or 50 amp plugs. Padlock and key included.

**55000** Power Lock Cord Protector



**POWER GRIP CABLE LOCK**

Allows you to lock power cables with handles to the power box to help prevent theft. You can also lock handled cables together. Use with Camco's Power Grip Dog bones, power cords, Power Defenders or other brand handled power cables. The Power Grip Cable Lock features a 60" long braided steel wire rope with a durable vinyl coating. The lock head end has a retractable key hole cover and securely locks onto the locking pin. The other end of the Power Grip Cable Lock is looped to secure the locking head. The Camco Power Grip Cable Lock is weather resistant and comes with two keys.

**44290** Cable Lock





**POWER GRIP EXTENSION CORDS** 50 or 30 amp styles. All cords feature the patented Power Grip handles for ease of use. Each cord (except 55191) also includes a convenient carrying strap. Patented.

**30 AMP** NEMA TT30P/TT-30R. 125V-3750W.

A1 55191 25', 10 Ga, Grounded STW

A2 55197 50', 10 Ga, Grounded STW

**50 AMP** NEMA 14-50P/14-50R. 125V/250V 12500W.

A3 55194 15', 6/8 Ga

A4 55195 30', 6/3 + 8/1 STW



A1



A2



A3



A4

**POWER GRIP LOCKING EXTENSION CORDS** Camco's 30 & 50 amp male (NEMA TT-30P & NEMA 14-50P) 30 & 50 amp female locking adapter (NEMA L5-30R & SS2-50R) extension cords allow you to connect your marine-style 30 & 50 amp RV power inlets to standard 30 & 50 amp RV power pedestals. Heavy duty locking extension cord features 90 degree connections for improved strain relief. The threaded locking ring creates a weatherproof connection.

55524 25' 30 Amp w/90F Locking Adapter

55525 50' 30 Amp w/90F Locking Adapter

55574 25' 50 amp w/90F Locking Adapter



**RV OUTDOOR 15 AMP EXTENSION CORD** For RV, mobile home and household use. Heavy-duty. 14-Gauge wire construction. Polarized cord set with ground. 15 Amps / 125 Volts / 1875W stw jacket. NEMA 5-15P/5-15R.

55142 30' Extension Cord

55143 50' Extension Cord (not shown)



**ELECTRICAL CORD STORAGE HANDLE** Carry and store power cords easily. Keeps your power cord neatly coiled, and makes it easier to carry.

55001 Cord Storage Handle



**POWER GRIP LOCKING DOGBONE ADAPTERS & EXTENSION CORDS**

For hooking your marine-style 30 or 50 amp RV power inlet to a RV power pedestal. Power Grip handle for easy removal. Threaded locking ring helps to create a weatherproof connection. Patented.

- A1 55501 30A, NEMA TT-30P/L5-30R, 25'
- A2 55512 30A, NEMA TT-30P/L5-30R, 18"
- A3 55542 50A, NEMA 14-50P/SS2-50R, 25'
- A4 55552 50A, NEMA 14-50P/SS2-50R, 18"



**POWER GRIP LOCKING DOGBONE ADAPTERS**

Female locking to male standard Power Grip. For hooking your marine-style 30 or 50 amp RV power inlet to a RV power pedestal. 90° connector reduces strain on the cord and allows easier connection in tight places. Threaded locking ring helps to create a weatherproof connection. Patented.

- B1 55522 30A, NEMA TT-30P/L5-30R, 18"
- B2 55562 50A, NEMA 14-50P/SS2-50R, 18"



**POWER GRIP 90° 30A/50A LOCKING ADAPTER**

For hooking your marine-style 50 amp RV power inlet to a standard 30 amp RV power pedestal. 90° head reduces strain on the RV connection and allows easier connection in tight places. Simply lock the 50 amp head onto the power inlet of the RV and connect the 30 amp plug to a standard 30 amp power cord. Threaded locking ring helps to create a weatherproof connection. Patented.

- 55582 Adapter, NEMA TT-30P/SS2-50R, 18"



**POWER GRIP LOCKING DOGBONE ADAPTERS**

For hooking your marine-style 30 or 50 amp RV power inlet to a marine-style power source. 90° connector reduces strain on the cord and allows easier connection in tight places. Threaded locking ring helps to create a weatherproof connection. 18". Patented.

- C1 55532 30A, NEMA L5-30P/L5-30R, 18"
- C2 55572 50A, NEMA SS2-50P/SS2-50R, 18"



**POWER GRIP REPLACEMENT LOCKING RINGS**

For use with Power Grip Locking Adapters to help protect against moisture.

- 55537 Replacement Locking Ring, 30 A
- 55577 Replacement Locking Ring, 50 A



**120 VOLT LINE MONITOR** Designed to plug into any 120V wall receptacle and provide a continuous, accurate reading of the AC line voltage.

**55263** 120V Line Monitor, 5-15P



**POWER GRIP DOGBONE LOCKING ADAPTER** Camco's Power Grip Dogbone with Locking Adapter allows you to connect your RV's marine-style inlet to your everyday 15 Amp power receptacle. The 90-degree outlet connection reduces strain on the cord and allows for easier connection in tight places, while the patented Power Grip handle design provides a solid grip, making for a hassle-free connection. 15 amp male/30 amp female features STW cable with 10AWG 3-wire, NEMA L5-30R & NEMA 5-15P connections (max: 15Amps, 125Volts and 1875Watts). 15 amp male/50 amp female features STW cable with 10AWG 3-wire, NEMA SS2-50R & NEMA 5-15P connections (max: 15Amps, 125Volts and 1875Watts). Threaded locking ring creates a weatherproof connection.

**55636** 15 amp M/ 30 amp F, Locking,

**55637** 15 amp M/ 30 amp F, Locking, 1/card

**55638** 15 amp M/ 50 amp F, Locking



**POWER GRIP REPLACEMENT**

**PLUGS** Replace your power cord plugs and receptacles using the Power Grip replacements with handle for ease of use. Patented.

**55245** 30A, NEMA TT-30P

**55242** 30A, NEMA TT-30P - Bulk

**55255** 50A, NEMA 14-50P

**55252** 50A, NEMA 14-50P - Bulk

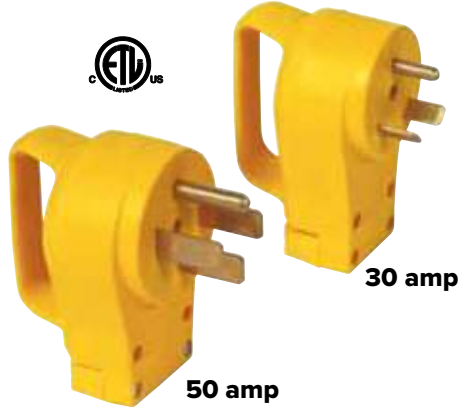

**POWER GRIP REPLACEMENT**

**RECEPTACLES** Replace your receptacles using the Power Grip replacements with handle for ease of use. Patented.

**55343** 30A, NEMA TT-30R

**55353** 50A, NEMA 14-50R



**POWER GRIP 30 AMP MINI POWER**

**GRIP PLUG** Replacement plug fits completely inside RV's cord cable hatch, so door can be closed during travel. Sturdy handle makes it easy to remove plug from power outlet. Patented.

**55283** 30A Mini, NEMA TT-30P



**POWER GRIP ELECTRICAL**

**PROTECTANT & LUBE** Use on any electrical connector to improve conductivity and protect from oxidation. Also helps make connectors easier to insert and remove. Perfect for use with Camco's Power Grip Adapters and Extension Cords.

**55013** Electrical Protectant & Lube



**POWER GRIP DOGBONE CIRCUIT ANALYZERS**

Help protect your RV from improperly wired electrical boxes. Diagnostic lights indicate electrical wiring faults before you connect your electrical cord. Also includes integrated surge protection.

**55312** 30 Amp, NEMA TT-30P & NEMA TT-30R

**55313** 50 Amp, NEMA 14-50P & NEMA 14-50R



**POWER GRIP 30 AMP CIRCUIT**

**ANALYZER** Help protect your RV from improperly wired electrical boxes. Diagnostic lights indicate electrical wiring faults before you connect your electrical cord. Also includes integrated surge protection.

**55310** 30 Amp, NEMA TT-30P



**POWER GRIP ELECTRICAL ACCESSORY BAG** High quality duffel bag stores Power Grip extension cords and accessories. The large main compartment is big enough for a 50' extension cord, and the bottom compartment has separate, padded areas to protect accessories. The easy to carry duffel has two handles on the top, or a long, removable shoulder strap that attaches end to end. Duffel is made of heavy duty material and stitching.

**55014** W/ Adapter Storage (Bag Only)



**REPLACEMENT LED DOME LIGHTS** Replaces OEM dome lights in marine and recreational vehicles. Single housing comes with 1 dome cover and 1 light bulb (160 lumens), double housing comes with 2 dome covers and 2 light bulbs (320 lumens total, 160 lumens per bulb). 12-Volt Warm white light.

**41321** Double LED Dome Light

**41331** Single LED Dome Light

**54646** Replacement Bulb



**REPLACEMENT DOME LIGHTS** 12V replacement dome lights in double or single style. Double light measures 12" x 4.25" x 1.5" (l x w x h). Single light measures 7" x 4.25" x 1.5" (l x w x h). Instructions and bulbs included.

**41320** Double Replacement Dome Light

**41330** Single Replacement Dome Light



**BATTERY BOXES** Lightweight, heavy-duty, corrosion-resistant polypropylene boxes are designed to secure and protect your battery. Both sizes include lift-off lid, durable woven hold-down strap, foot clamps and stainless steel screws. Choose small for group size 24 batteries or large for group sizes 27, 30 and 31. Both boxes meet USCG CFR 183.420 and ABYC E-010.7 specifications. Inside dimensions with lid (l x w x h) Small: 11.33" x 7.84" x 9.9"; Large: 13.87" x 7.87" x 10.9". Patented.

**55362** Standard

**55372** Large

**55364** Replacement Strap



**BATTERY HOLD-DOWN TRAYS**

Made from heavy duty acid resistant plastic with stainless steel hardware. Meets USCG CFR 183.420 and ABYC E-10.7 specifications. Patented.

**55394** Standard

**55404** Large

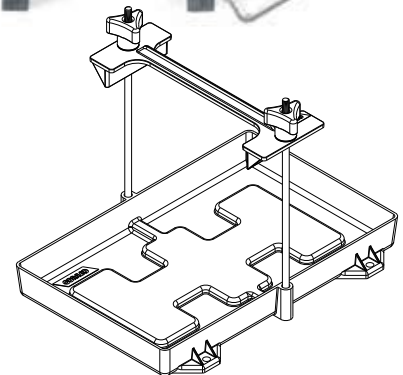



Figure 1



Figure 2



Figure 3



Figure 4



Figure 5

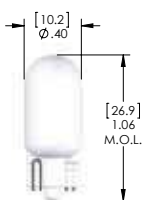

Figure 6

**LIGHT BULBS**

Camco offers both clamshell and bulk packages and we are committed to providing you a well designed product that has been developed through rigid adherence to product specifications. The nominal voltage for most of our bulbs is 12.0.

- DESIGN VOLTS:** The voltage at which the lamp is designed for rated amperage, candlepower and life characteristics.
- CANDLEPOWER:** The average value of total light output of miniature lamps at design volts.
- LIFE HOURS:** The rated average life to be expected when operated at design volts. Actual service life can vary depending upon application.
- SERVICE DESC.:** The major applications for each bulb. In most cases they can be used in many other applications.
- FIG. NUMBER:** Refers to the diagrams on page sides.



Fig #	Part #	Description	Design Volts	Amps	Watts	Candle Power	Life Hrs	Package
1	54710	53 Auto Instrument	14.4	.12	1.7	1	1000	10/box
	54711	53 Auto Instrument	14.4	.12	1.7	1	1000	2pk
2	54712	55 Auto Instrument	7	.41	2.87	2	200	10/box
	54714	57 Auto Instrument	14	.24	3.4	2	500	10/box
	54715	57 Auto Instrument	14	.24	3.4	2	500	2pk
	54836	1895 Auto Instrument	14	.27	3.78	2	2000	10/box
	54837	1895 Auto Instrument	14	.27	3.78	2	2000	2pk
3	54717	63 Auto Instrument	7	.63	4.41	3	1000	2pk
	54720	67 Auto License	13.5	.59	7.97	4	5000	10/box
	54721	67 Auto License	13.5	.59	7.97	4	5000	2pk
	54727	89 Auto Interior	13	.58	7.54	6	750	2pk
4	54722	68 Auto/Marine	13.5	.59	7.97	4	5000	10/box
	54723	68 Auto/Marine	13.5	.59	7.97	4	5000	2pk
	54728	90 Auto/Marine Interior	13	.58	7.5	6	750	10/box
	54729	90 Auto/Marine Interior	13	.58	7.5	6	750	2pk
5	54830	1816 Aviation/Auto Instrument	13	.33	4.29	3	1000	10/box
	54834	1893 HD Auto Instrument	14	.33	4.62	2	7500	10/box
	54835	1893 HD Auto Instrument	14	.33	4.62	2	7500	2pk
6	54750	194 HD Auto Instrument	14	.27	3.8	2	2500	10/box
	54751	194/158 HD Auto Instrument	14/14	.27/.24	3.78/3.36	2	2500/500	2pk
	54752	194A Auto Side Marker	14	.27	3.78	1.5	2500	10/box
	54753	194A Auto Side Marker	14	.27	3.78	1.5	2500	2pk



**Figure 7**



**Figure 8**



**Figure 9**



**Figure 10**



**Figure 11**



**Figure 12**

Fig #	Part #	Description	Design Volts	Amps	Watts	Candle Power	Life Hrs	Package
7	<b>54762</b>	906 Auto/RV Interior	13.5	.69	9.3	6	1000	10/box
	<b>54763</b>	906 Auto/RV Interior	13.5	.69	9.3	6	1000	2pk
	<b>54766</b>	912 Auto/RV/Marine Interior	12.8	1	12.8	12	1000	10/box
	<b>54767</b>	912 Auto/RV/Marine Interior	12.8	1	12.8	12	1000	2pk
	<b>54768</b>	921 Auto 3rd Brake Lamp	12.8	1.41	18.048	21	1000	10/box
	<b>54769</b>	921 Auto 3rd Brake Lamp	12.8	1.41	18.048	21	1000	2pk

8	<b>54772</b>	1003 Auto/RV Interior	12.8	.94	12.03	15	200	10/box
	<b>54773</b>	1003 Auto/RV Interior	12.8	.94	12.03	15	200	2pk

9	<b>54774</b>	1004 Auto/RV Interior	12.8	.94	12.03	15	200	10/box
	<b>54775</b>	1004 Auto/RV Interior	12.8	.94	12.03	15	200	2pk

10	<b>54730</b>	93 Auto	12.8	1.04	13.31	15	700	10/box
	<b>54731</b>	93 Auto	12.8	1.04	13.31	15	700	2pk
	<b>54788</b>	1141 Auto/RV Back Up	12.8	1.44	18.43	21	1000	10/box
	<b>54789</b>	1141 Auto/RV Back Up	12.8	1.44	18.43	21	1000	2pk
	<b>54791</b>	1141F Inside Frosted	12.8	1.44	18.43	21	1000	2pk
	<b>54793</b>	1141NA Auto/RV/Marine Exterior	12.8	1.44	18.43	-	1000	2pk
	<b>54802</b>	1156 Auto Back Up	12.8	2.1	26.9	32	1200	10/box
	<b>54803</b>	1156 Auto Back Up	12.8	2.1	26.9	32	1200	2pk
	<b>54829</b>	1651 Lantern 4F Cells - Clear	5	.6	3	3	20	2pk

11	<b>54798</b>	1154 Auto Park/Tail/Signal	6.3/7	2.63/.75	16.57/5.25	21/3	200/1000	10/box
	<b>54799</b>	1154 Auto Park/Tail/Signal	6.3/7	2.63/.75	16.57/5.25	21/3	200/1000	2pk
	<b>54806</b>	1157 Auto Park/Tail/Signal	12.8/14.0	2.1/.59	26.88/8.26	32/3	1200/5000	10/box
	<b>54807</b>	1157 Auto Park/Tail/Signal	12.8/14.0	2.1/.59	26.88/8.26	32/3	1200/5000	2pk
	<b>54838</b>	2057 Auto Park/Tail/Signal	12.8/14.0	2.1/0.48	26.88/6.72	32/2	1200/5000	10/box
	<b>54839</b>	2057 Auto Park/Tail/Signal	12.8/14.0	2.1/0.48	26.88/6.72	32/2	1200/5000	2pk
	<b>54841</b>	2057NA Auto Park/Tail/Signal	12.8/14.0	2.1/0.48	26.88/6.72	24/1.5	1200/5000	2pk

12	<b>54733</b>	94 Auto/Marine	12.8	1.04	13.31	15	700	2pk
	<b>54794</b>	1142 Auto/RV/Marine Exterior	12.8	1.44	18.432	21	1000	10/box
	<b>54795</b>	1142 Auto/RV/Marine Exterior	12.8	1.44	18.432	21	1000	2pk
	<b>54780</b>	1076 Auto/RV/Marine Signal	12.8	1.8	23.04	32	200	10/box
	<b>54781</b>	1076 Auto/RV/Marine Signal	12.8	1.8	23.04	32	200	2pk
	<b>54812</b>	1176 Stop/Tail/Park	12.8/14	1.34/.59	17.15/8.26	21/6	300/1500	10/box
	<b>54813</b>	1176 Stop/Tail/Park	12.8/14	1.34/.59	17.15/8.26	21/6	300/1500	2pk



Figure 13



Figure 14



Figure 15

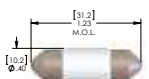

Figure 16

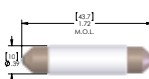

Figure 17



Figure 18



Figure 19



Fig #	Part #	Description	Design Voltage	Amps	Watts	Candle Power	Life Hours	Package
13	54786	1139IF RV/Marine/Truck Interior	12.8	1.04	13.3	15	700	10/box
	54787	1139IF RV/Marine/Truck Interior	12.8	1.04	13.3	15	700	2pk
	54796	1143IF RV/Marine Inside Frosted	12.5	1.98	24.75	2.5/32	400	10/box
	54797	1143IF RV/Marine Inside Frosted	12.5	1.98	24.75	2.5/32	400	2pk

14	54820	1383 Auto/RV Reading	13	1.5	19.5	-	300	1/box
	54822	1383TF Auto/RV Reading S	13	1.5	19.5	-	300	1/box
	54823	1383TF Auto/RV Reading S	13	1.5	19.5	-	300	1pk

S 1383TF bulbs are shatter-resistant

15	54706	20-99 RV Cosmetic Frosted	12	1.08	12.96	-	300	10/box
	54707	20-99 RV Cosmetic Frosted	12	1.08	12.96	-	300	1pk
	54708	20-99 RV Cosmetic Clear	12	1.08	12.96	-	300	10/box
	54709	20-99 RV Cosmetic Clear	12	1.08	12.96	-	300	1pk

16	54858	3175 Auto Interior	12	.83	9.96	9.5	400	10/box
	54859	3175 Auto Interior	12	.83	9.96	9.5	400	2pk

17	54754	211-2 Auto Interior	12.8	.97	12.41	12	1000	10/box
	54755	211-2 Auto Interior	12.8	.97	12.41	12	1000	2pk
	54756	212-2 Auto/Marine	13.5	.74	10	6	2000	10/box
	54757	212-2 Auto/Marine	13.5	.74	10	6	2000	2pk
	54758	214-2 RV Refrig/Auto Interior	13.5	.52	7	4	1000	10/box
	54759	214-2 RV Refrig/Auto Interior	13.5	.52	7	4	1000	2pk

18	54704	C7 1/2 Clear Patio Decor	120	.056	7	3.2	3000	10/box
	54705	C7 1/2 Clear Patio Decor	120	.056	7	3.2	3000	2pk

19	54827	1416 Marine	12.8	.8	10.24	8	1000	2pk
----	-------	-------------	------	----	-------	---	------	-----



**Figure 20**

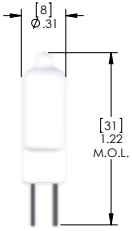

**Figure 21**

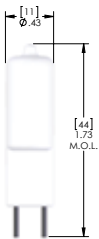

**Figure 22**



Fig #	Part #	Description	Design Volts	Amps	Watts	Candle Power	Life Hours	Package
20	<b>54847</b>	3057 Auto Park/Tail/Signal	12.8/14	2.1/.48	26.88/6.72	32/2	1200/5000	2pk
	<b>54849</b>	3057NA Auto Park/Tail/Signal	12.8/14	2.1/.48	26.88/6.72	24/1.5	1200/5000	2pk
	<b>54850</b>	3156 Auto	12.8	2.1	26.88	32	1200	10/box
	<b>54854</b>	3157 Auto Park/Tail/Signal	12.8/14	2.1/.59	26.88/8.26	32/3	1200/5000	10/box
	<b>54855</b>	3157 Auto Park/Tail/Signal	12.8/14	2.1/.59	26.88/8.26	32/3	1200/5000	2pk
	<b>54857</b>	3157NA Auto Park/Tail/Signal	12.8/14	2.1/.59	26.88/8.26	24/2.2	1200/5000	2pk
21	<b>54702</b>	JC-10 Halogen Fog/Driving	12	.83	9.96	9.5	2000	1/box
	<b>54902</b>	JC-10 Halogen Fog/Driving	12	.83	9.96	9.5	2000	2pk
22	<b>54703</b>	JC-35 Halogen, 12V 35W	12	2.92	35	47.7	2000	1/box
	<b>54903</b>	JC-35 Halogen, 12V 35W	12	2.92	35	47.7	2000	2pk

**LED BULBS - BRIGHT WHITE**

Part #	Description
<b>54601</b>	1003 (BA15S) 13-LED 160lm (1pk)
<b>54605</b>	1156/1141/1073/93 (BA15S) 27-LED 285lm (1pk)
<b>54607</b>	1156/1141/1073/93 (BA15S) 27-LED 285lm (6pk)
<b>54617</b>	1383 (BA15s) 3-LED 150lm (1pk)
<b>54621</b>	194/906 (T10 Wedge) 5-LED 60lm (1pk)
<b>54623</b>	912/921/922 (T10 Wedge) 9-LED 95lm (1pk)
<b>54627</b>	JC10 Bi-Pin (G4 Chip) 12-LED 165lm (1pk)
<b>54631</b>	1076 (BA15D) 27-LED 285lm (1pk)
<b>54637</b>	211/211-2/212-2 (Festo), 2-LED 25lm (1pk)
<b>54648</b>	1004 (BA15D) 13-LED 160lm (1pk)
<b>54650</b>	1157/1016 (BAY15D-Index) 13-LED 140lm (1pk)

**54605**



**54631**



**54607**



**54627**



**54601**



**54623**



**12 VOLT FLASHER** Two terminal 552/536 (short) flasher. Flashes 2 to 3 standard or long-life turn signal lamps and 2 to 6 hazard lamps.

**65260** 12V Flasher



**54650**



**54637**



**54621**



**54648**







**SEALED BEAM BULB**

Part #	Description	Design Voltage	Amps	Watts	Life Hrs	Pkg
54870	Bulb 4411	12.8	2.73	34.94	300	1 kit

**SCREW-BASE 12V BULBS**



House Type



Oven Type

Part #	Description	Type	Wattage	Life Hours	Package
54890	A-15 15W/12V Oven Type	Oven	15		1pk
54892	A-19 25W/12V House Type	House	25		2pk
54894	A-19 50W/12V House Type	House	50		2pk

**12V FLUORESCENT BULB** Fits standard screw-in socket. Perfect for use with solar-power panels. Save energy—15W Fluorescent bulb delivers the lighting power of a 60W incandescent.



Part #	Package
41313	1pk

**FLUORESCENT REPLACEMENT TUBES**



Part #	Description	Length	Wattage	Life Hours	Package
54877	F15T8/CW 15 Watt - 18"	18"	15	7500	Bulk
54878	F15T8/CW 15 Watt - 18"	18"	15	7500	2pk
54879	F8T5/CW 8 Watt - 12"	12"	8	7500	Bulk
54880	F8T5/CW 8 Watt - 12"	12"	8	7500	2pk
54881	F13T5/CW 13 Watt - 21"	21"	13	7500	Bulk
54882	F13T5/CW 13 Watt - 21"	21"	13	7500	2pk
54896	F4T5/CW 4 Watt - 6"	6"	4	6500	2pk
54898	F6T5/CW 6 Watt - 9"	9"	6	7500	2pk

**RV/MARINE DC FLUORESCENT REPLACEMENT TUBES** 22W, Cool-White, 4-pin style FC8T9 with circular tube. 12000 Life Hours.



Part #	Package
54875	Bulk
54876	1pk

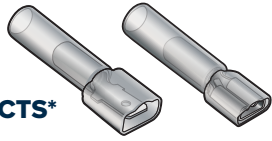

Insulated  
**DISCONNECTS\***

Part #	AWG	Gender	Ins.	Pkg.
63711	16-14	M	Nylon	4
63721	12-10	M	Nylon	3
63726	12-10	F	Nylon	3



Insulated  
**RING TERMINALS\***

Part #	AWG	Stud	Ins.	Pkg.
63124	22-18	1/4 in	Vinyl	100/Bag
63126	22-18	1/4 in	Nylon	5/Card
63171	16-14	#10	Nylon	6/Card
63181	16-14	1/4 in	Nylon	5/Card
63191	16-14	5/16 in	Nylon	5/Card
63221	12-10	1/4 in	Nylon	4/Card



Heavy Duty, Insulated  
**BUTT CONNECTORS**

Part #	AWG	Ins.	Pkg.
63522	8	Vinyl	25
63525	6	Vinyl	25



Insulated  
**BUTT CONNECTORS**

Part #	AWG	Ins.	Pkg.
63477	22-18	Vinyl	25
63479	22-18	Vinyl	100
63487	16-14	Vinyl	25
63489	16-14	Vinyl	100
63497	12-10	Vinyl	25
63499	12-10	Vinyl	100
63481	22-18	Nylon	5
63482	22-18	Nylon	25
63484	22-18	Nylon	100
63491	16-14	Nylon	5
63492	16-14	Nylon	25
63494	16-14	Nylon	100
63501	12-10	Nylon	5
63502	12-10	Nylon	25
63504	12-10	Nylon	100

1. Non-skid ridge — tool slides to end for proper crimp.
2. Beveled leading edge for easy wire entry.
3. FUNNEL BARREL CONSTRUCTION for positive and easy wire insertion.
4. Crimp ridge for centering and locating tool on terminal barrel.
5. INJECTION MOLDED, 105° C RATED insulation of electrical grade vinyl plastic for uniform wall thickness and interface.
6. Multiple "V" grooves in #22 AWG to #4 AWG for maximum holding power and current flow.
7. Barrel-to-pad transition designed to maximize strength and minimize bending.
8. One piece, burr-free construction for maximum electrical conductivity. Electro-tin plating for maximum corrosion resistance.

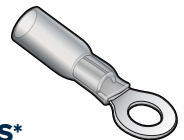
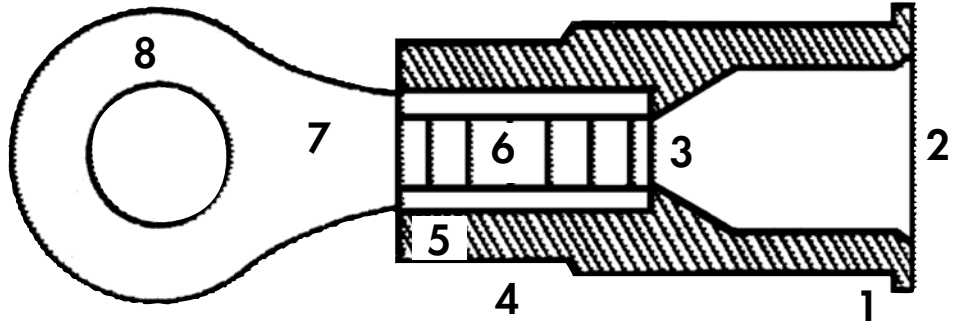

Heat Shrink  
**RING TERMINALS\***

Part #	AWG	Stud	Ins.	Pkg.
63875	16-14	#10	Heat Shrink	100



Heat Shrink  
**BUTT CONNECTORS**

Part #	AWG	Ins.	Pkg.
63868	22-18	Heat Shrink	3
63892	12-10	Heat Shrink	3
63895	12-10	Heat Shrink	100



Insulated  
**PIGGYBACK SLIP-ONS\***

Part #	AWG	Ins.	Pkg.
63686	16-14	Vinyl	100

**BLACK SPLIT LOOM\***

Corrugated polyethylene tubing. Holds groups of wires together. Guards wires against abrasion and crushing. Tubing is slit for easy insertion of wires.

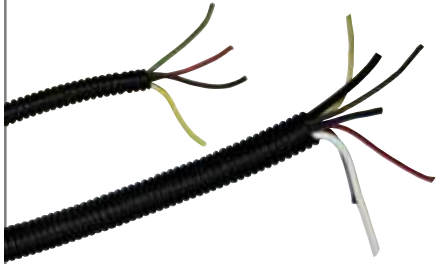

	3/4"	1"
100'	64984	64987

**SELF-ADJUSTING WIRE STRIPPER\***

Cuts and strips 26 to 10 AWG wire and crimps insulated and uninsulated terminals. Strips multi-lead trailer wire in one motion without harming strands.



63924 1/card

**QUICKEE CIRCUIT TESTER\***

One-hand operation to test circuits in hard-to-reach areas. Works two ways—captures and pierces wire with unique hook design or it can be used as an "ice pick" type tester.



63928 1/card

**BONDED WIRE\***

General purpose thermoplastic wire made with bare copper conductors and polyvinyl chloride insulation to SAE J1128 standards. Rated at 80° C, 90V. Two, three, or four wires extruded side by side. Colors: Two Conductor - Red and Black;



Bonded Wire	Two Conductor 12 Gage
100' spool	64534

**RATCHETING CRIMPER TOOL\***

Crimps 22 to 18, 16 to 14 and 12 to 10 Gage terminals in three separate crimping nests. Makes two crimps—electrical and weather resistant—all in one motion.



63929 1/card

**ALL-PURPOSE HANDTOOL\***

Standard duty construction. Crimps and strips 22 to 10 Gage wire. Also features wire and bolt cutters.

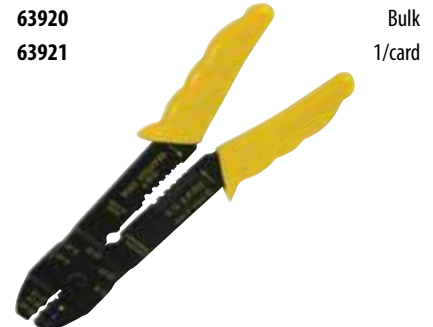

63920 Bulk  
63921 1/card

**HEAT SHRINK TUBING**

125° C flexible polyolefin tubing. Recovers to 50% of its original diameter when heated. Use for splices, wire bundling, markets, harnessing, stress relief, terminations, etc. Provides excellent resistance to chemicals, corrosion, oil, and heat. 6" length, 12 pieces per header bag.



1/4" 12-10 Ga Yellow	3/8" 14-18 Ga Clear
65003	65009

**COPPER LUGS** Made from 95% copper.

Package	8 Gage			6 Gage		4 Gage		2 Gage		1 Gage	1/0 Gage	2/0 Gage
	#10	#5/16	#3/8	#1/4	#3/8	#5/16	#3/8	#5/16	#3/8	#3/8	#3/8	#3/8
25/bag	65800	65823	65824	65801	65822	65803	65804	65806	65807	65820	65809	65812

**TIN PLATED COPPER LUGS**

Package	8 Gage		6 Gage		4 Gage		2 Gage		1 Gage		1/0 Gage	2/0 Gage		
	#5/16	#3/8	#1/4	#5/16	#3/8	#5/16	#3/8	#1/2	#5/16	#3/8	#5/16	#5/16	#3/8	#1/2
25/bag	65849	65848	65828	65829	65830	65832	65833	65836	65851	65846	65834	65837	65838	65839



**GLASS FUSES**

AGU Glass Fuses  
2pk

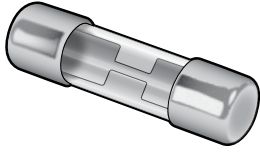

30

**65176**

**BLADE FUSES**

Mini-Blade Fuses



ATC/ATO Blade Fuses

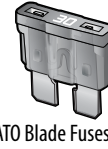

Max-Blade Fuses

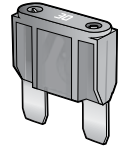

AMP	5	7.5	10	25	3	7.5	25	20	30	50	60
Color	Tan	Brown	Red	Clear	Violet	Brown	Clear	Yellow	Green	Red	Blue
2pk	<b>65141</b>	<b>65143</b>	<b>65145</b>	<b>65151</b>	<b>65121</b>	<b>65125</b>	<b>65133</b>	<b>65161</b>	<b>65163</b>	<b>65167</b>	<b>65169</b>

**BLADE TERMINALS**

Heavy duty replacement for ATO and ATC blade type fuses. Special snap off feature provides three lengths from .30-.75 long.



AMP	10	25
1pk	<b>65231</b>	<b>65239</b>

**ATC FUSE TAP ADAPTER**

Tap the hot side of flat automotive fuse blocks to easily create an additional circuit for a radio or other add-on accessory.  
**65186** 2pk



**AGC/GLASS FUSE HOLDER**

6" wire (Fuse included)



	12 AWG / 30 AMP	10 AWG / 30 AMP
1/card	<b>65246</b>	<b>65248</b>

**MINIATURE / INTERMEDIATE CABLE TIES**



	4" Length x .10" Width - 1/16" to 7/8" Bundle Dia. - 18 lbs tensile strength	5.5" Length x .13" Width - 1/16" to 1-1/4" Bundle Dia. - 30 lbs tensile strength
	Black	Natural
100 count	<b>64880</b>	<b>64883</b>

**MOUNTING CABLE TIES**



	6" L - .14" W - #8 Stud - 1/16" to 1-1/4" Bundle Dia. - 40 lbs tensile strength	14.5" L - .187" W - #10 Stud - 1/16" to 4" Bundle Dia. - 50 lbs tensile strength
	Natural	Black
100 count	<b>64939</b>	<b>64942</b>
		Black
		<b>64960</b>

**NYLON CLAMPS**

Package	1/4"	1/2"
25/Header Bag	<b>65057</b>	<b>65063</b>



**RUBBER-COATED METAL CLAMPS**

Package	5/16" ID 3/8" Stud	1" ID 3/8" Stud
25/Header Bag	<b>65042</b>	<b>65048</b>



**FRAME CLIPS**

Package	Medium - 1/4" ID
100 ct	<b>65072</b>



**LEAD BATTERY TERMINALS**

Made with lead alloy, composed of antimony. Tensile strength and hardness will meet your heavy electrical demands. Tin is added to prevent corrosion and oxidation.



Package	Universal Emergency Recessed staked-in zinc plated nuts.	Marine Universal Zinc plated to resist corrosion.
2/card	<b>65276</b>	<b>65280</b>

**MOUNTING BASES FOR CABLE TIES**

Molded nylon. Adhesive backed with screw mount. Natural color.

**64966** Mounting Bases, 100 count





# RHINO<sup>®</sup> TOTE TANKS

*The world's toughest tote tanks!*

LARGE WHEELS  
with bearings



TANK RINSER  
for easy cleaning



SUPERIOR  
DURABILITY



TOW ADAPTER  
roll or tow



LADDER HOOK  
hangs on RV ladder

## Complete Kits



Available in four sizes!  
15, 21, 28, & 36 gallon





# BLACK BOAR<sup>®</sup>

## ATV/UTV IMPLEMENTS

BASE

### MOTORIZED IMPLEMENT LIFT

- Ready to mount any Black Boar implement
- Includes motorized actuator and wiring harness with control switch

**66000** Motorized Implement Lift

Ergonomic Actuator Control Grip can be hand held or mounted to handlebar



Box Dimensions: 53" x 17 1/4" x 10 3/4" | Boxed Weight: 60 lbs

### MANUAL IMPLEMENT LIFT

- Ready to mount any Black Boar implement
- Manually lift and lower implements with handle or remove handle and actuate using a drill and socket

**66013** Manual Implement Lift



a Camco brand.

\*SOLD SEPARATELY

### DISC HARROW

- For breaking up hard ground and leveling
- Each side adjusts 0, 15 or 30 degrees in both directions to help break up tough ground

**66001** Disc Harrow



Box Dimensions: 35 1/2" x 20" x 13 3/4" | Boxed Weight: 105 lbs

### LANDSCAPING RAKE

- For removal of rock, grass clumps and debris as well as prep for seeding
- Super rigid design utilizes entire length of rake, tines are removable to achieve desired tine spacing

**66002** Landscaping Rake



Box Dimensions: 30" x 17" x 4" | Boxed Weight: 50 lbs

### CHISEL PLOW

- Breaks up hard ground with 6 independently adjustable chisels

**66003** Chisel Plow



Box Dimensions: 30" x 17" x 4" | Boxed Weight: 45 lbs

### SCRAPE BLADE

- Adjusts 0, 7.5 or 15 degrees either direction

**66005** Scrape Blade



Box Dimensions: 50 1/2" x 15" x 11" | Boxed Weight: 65 lbs

IMPLEMENTS



# GROUND BREAKING DESIGN

\*SOLD SEPARATELY

## S-TINE CULTIVATOR

- Great for new ground preparation or re-tilling

66007 S-Tine Cultivator



Box Dimensions: 34" x 24 1/2" x 6 1/2" | Boxed Weight: 45 lbs

## PLUGGER

- Aerates ground by removing plugs, allowing for increased air flow, water flow and nutrient absorption

66008 Plugger



Box Dimensions: 33" x 14" x 8" | Boxed Weight: 75 lbs

## CULTIPACKER

- Breaks up clods, packs down loose soil and forces seeds into the seed bed for better water and nutrient absorption
- Frame and axle constructed of durable steel, cultipacker wheels constructed of impact resistant polymer

66009 Cultipacker



Box Dimensions: 49" x 13" x 9"  
Boxed Weight: 38 lbs

## SNOW PLOW

- Adjustable tension safety trip springs protect vehicle from blade impacts and overloading
- Round, angled push tube assembly with optimized winch connection provides maximum plow lift range

66016 Snow Plow



Box Dimensions: 49" x 13" x 23"  
Boxed Weight: 110 lbs

IMPLEMENTS



- Superior range of lift motion
- Adjust full range of implement depth on the fly
- Streamlined ease of use - no stopping to adjust implements



- Optimal angle of attack at any height
- Provides more control and better handling
- Parallel linkage design consistently maintains accurate implement angle



- Simple, optimized design
- Efficient use of steel produces streamlined and robust implements
- Easy, one-person installation



- Constructed of durable powder-coated steel
- Fewer joints provides a more rigid design
- Smart, minimalist design provides a stronger implement lift and implements

## ALSO AVAILABLE

### STORAGE BOXES FOR ATVs



- Convenient storage solutions mountable on your ATV
- Durable polymer construction
- Includes all installation hardware
- No drilling required on your ATV

#### ATV FRONT BOX

- Lockable
- Durable double-wall design
- Rotomolded polymer construction
- Perfect storage for your equipment and supplies

Dimensions: 35.5" x 17" x 10" | Weight: 14.5 lbs

66011 ATV Front Box



#### ATV LOUNGER

- Comfortable padded lounger
- Lockable storage is easily accessible
- Rotomolded polymer construction

Dimensions: 42" x 26" x 16" | Weight: 26.5 lbs

66010 ATV Lounger



# BETTER FROM THE GROUND UP

CAMCO



# BLACK BOAR<sup>®</sup>

## ATV/UTV IMPLEMENTS

### WEIGHT BASKET

- Addition of weight on the implement bar provides more downward force on the implement, driving it deeper into the ground
- Designed to fit two cinderblocks and has mounting holes to accept tie down straps
- Made of durable, black powder-coated steel
- Mounting hardware included

**Box Dimensions:** 23.5" x 19.5" x 8.75"

**Box Weight:** 13 lb

**66006** Weight Basket



### ATV FOOT PEDESTALS

- Secure place to rest feet when sitting in a rear lounger
- Constructed of durable, powder coated cast aluminum that is corrosion-resistant
- Securely mounts to any ATV foot board

**Box Dimensions:** 8.25" x 5.5" x 9"

**Boxed Weight:** 15.5 lbs

**66017** ATV Foot Pedestals, 2pk



### ATV GUN CASE

- Stores and protects most rifles - including scoped guns with high mounts and up to 50mm objectives
- Integrated carry-handle and included soft-side inner gun case
- All mounting hardware included
- Dust and water resistant

**Box Dimensions:** 5.5" x 53.75" x 15"

**Boxed Weight:** 8 lbs

**66012** ATV Gun Case



### SUSPENSION LOCK (ATV ONLY)

- Locks ATVs rear suspension
- Adapters included to fit most brands

**Box Dimensions:** 13.75" x 3" x 4.25"

**Boxed Weight:** 10 lbs

**66004** Suspension Lock



### ATV/UTV BALL MOUNTS

- Provides hitch ball, winch strap loop and pin hole for yard work equipment, utility trailers and other towable accessories
- Hitch ball has a 2" rise to give sufficient ground clearance in most applications
- Constructed of durable, powder-coated steel
- Hitch ball rated for up to 2,000 lbs, Winch Strap Loop rated for up to 5,000 lbs

**Box Dimensions:** 2.75" x 11" x 7.25"

**Boxed Weight:** 8 lbs

**66024** 2" Ball, 1 1/4" Shank

**66025** 2" Ball, 2" Shank

**66026** 1 7/8" Ball, 1 1/4" Shank

**66027** 1 7/8" Ball, 2" Shank





**ALSO AVAILABLE**

**COVERS  
FOR ATVs & UTVS**



- Protects from rain, snow, dirt, debris and damaging UV rays while in storage
- Durable 210 D polyester with polyurethane coating is waterproof and UV-resistant to help prevent weather related damage



**ATV COVERS**

- Secure fit with three sewn-in, buckling straps: two transverse straps and one longitudinal strap.
- On each corner, there are slots to accommodate tie-down straps so that the cover can be used while trailering.

**Dimensions:**

Large - 82" x 48" x 31.5"

X-Large - 86.5" x 49" x 33.5"

**66018** Olive, Up to 450cc, Large

**66019** Jungle Camo, Up to 450cc, Large

**66021** Jungle Camo, 450cc and up, X-Large

**66020** Olive, 450cc and up, X-Large



**UTV COVERS**

- Reinforced grommets to tie cover in place if desired (bungees not included)
- Vents on sides of cover help provide airflow to prevent trapped moisture and billowing with wind
- Cover fits most UTVs, including those with cabins
- Storage bag included

**66022** Olive

**66023** Jungle Wood Camo



HYDROPONIC FILTRATION

# HYDRO LIFE®

GARDEN WATER FILTRATION

## Promotes healthy plant growth

- A must-have filter for organic gardeners
- Reduces chlorine and chloramine compounds
- Improves the health of your plants and soil
- Attaches to standard garden hose threads

**AVAILABLE!**

6-pack  
Countertop Display  
or  
Single Pack with Garden  
Hose Protector



52701



52700

## Effectively Reduces

- Chlorine and chloramines
- Chemicals
- Salts and heavy metals
- Sediment
- Rust flakes (iron)
- Organic matter



HYDROPONIC FILTRATION

## HYDRO LIFE®

GARDEN WATER FILTRATION



52710

### TWIN Water Filter System

Working pressure: 20–100 PSI non-shock  
(1.4–6.9 Bar)

Operating temp.: 35°–100° F (2–38° C)

Output: 2.5 GPM (9.46 LPM)

## Improve your garden and your soil by improving the quality of the water you use

The Hydro Life Hydroponics Twin Filtration System is perfect for urban gardens, organic veggies and flowers. The two step filter system includes a 25 micron pre-filter and Catalytic Carbon filter with KDF 85 media. The pre-filter is a sacrificial filter that removes heavy sediment from water, helping to extend the life of the KDF 85 filter. The KDF 85 filter has Catalytic Carbon filtration to provide you with safer, cleaner water from any potable source and KDF 85 to help prevent bacteria growth when the filter is not in use. Removing chlorine and other contaminants from your irrigation water promotes larger and faster root growth, which translates to larger and faster plant growth and larger yields.

### Effectively Reduces

- Bacteria
- Chlorine and chloramines
- Harmful chemicals
- Salts and heavy metals
- Sediment
- Rust flakes (iron)
- Organic matter
- Sulfur

## THE ULTIMATE IN HYDROPONIC FILTRATION



52715

### Reverse Osmosis 100 Water Filter System

Working pressure: 20–100 PSI non-shock  
(1.4–6.9 Bar)

Operating temp.: 35°–100° F (2–38° C)

Output: 100 GPD (378.5 LPD)

## Get the most from your expensive nutrients by starting with pure water

Growing with pure water and adding nutrients at the grower's discretion makes growing more predictable. The Hydro Life Hydroponics RO 100 Filter System removes 99% of all contamination in water through reverse osmosis. This three step system includes a 25 micron pre-filter, premium Catalytic Carbon filter with KDF 85 media and hydron membrane. This RO 100 system removes the same contaminants as the Twin filter system but the addition of the hydron membrane, which rejects everything but water molecules, leaves a final product that has 99% reduction in parts per million contaminants in water. The RO 100 Water Filter System is easy to install and includes garden hose connector, mounting bracket, blue RO filtered water line, black wastewater line, white inlet line and filter wrench, all preinstalled and ready to go.

### Effectively Reduces

- Bacteria
- Pesticides
- Chlorine and chloramines
- Harmful chemicals
- Salts and heavy metals
- Sediment
- Rust flakes (iron)
- Organic matter
- Sulfur