

BOLT[®]
BREAKTHROUGH ONE-KEY LOCK TECHNOLOGY



















ONE KEY

CONVENIENT SECURITY!



2020

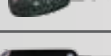
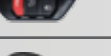

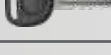
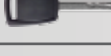
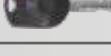
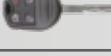
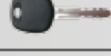
	5/8" RECEIVER LOCK	P - 4
	1/2" RECEIVER LOCK	P - 4
	COLLAR - KING PIN LOCKING SYSTEM	P - 5
	OFF VEHICLE COUPLER LOCK	P - 6
	COUPLER PIN LOCK	P - 7
	LOCKING RECOVERY HOOK	P - 8
	PADLOCK	P - 9
	CABLE LOCK	P - 9
	BOLT CYLINDER	P - 10
	BOLT CYLINDER NUT	P - 10
	GM TAILGATE HANDLE	P - 10
	TOOLBOX LATCH RETRO FIT KIT	P - 11
	JEEP HOOD LOCK	P - 12
	J-MOUNT	P - 13
	JEEP SPARE TIRE LOCK	P - 14
	DODGE/ JEEP/ RAM	P - 15
	JEEP CENTER CUT	P - 15
	GM EARLY	P - 16
	GM LATE	P - 16
	GM CENTER CUT	P - 17
	FORD	P - 18
	FORD SIDE CUT	P - 18
	TOYOTA	P - 19
	NISSAN	P - 19



JEEP SPARE TIRE LOCK

RECEIVER LOCK



JEEP HOOD LOCK



CABLE LOCK

PADLOCK

J-MOUNT

RECEIVER LOCK

- Stainless Steel Pin for Durability
- Weather Proof
- Auto Return Spring Locks Automatically when Key is Removed
- Double Ball Bearing Locking-Mechanism
- Plate Tumbler Sidebar to Prevent Picking and Bumping
- Stainless Steel Lock Shutter to Keep Out Dirt and Moisture
- Limited Lifetime Warranty



5/8" PIN FITS 2.5" and 3" SQUARE RECEIVERS

Note: All dimensions are in inches



5/8" RECEIVER LOCK

Part Number	Description
7018448	5/8" Receiver Lock Dodge/Jeep/Ram
7032290	5/8" Receiver Lock Jeep Center Cut
7018447	5/8" Receiver Lock Ford
7023585	5/8" Receiver Lock Ford Side Cut
7018445	5/8" Receiver Lock GM Early Model
7018446	5/8" Receiver Lock GM Late Model
7023582	5/8" Receiver Lock GM Center Cut
7023583	5/8" Receiver Lock Nissan
7023584	5/8" Receiver Lock Toyota

5/8" Diameter Stainless Steel Pins for Class III, IV & V Receivers

1/2" RECEIVER LOCK

Part Number	Description
7019344	1/2" Receiver Lock Dodge/Jeep/Ram
7032293	1/2" Receiver Lock Jeep Center Cut
7019343	1/2" Receiver Lock Ford
7023630	1/2" Receiver Lock Ford Side Cut
7019341	1/2" Receiver Lock GM Early Model
7019342	1/2" Receiver Lock GM Late Model
7023627	1/2" Receiver Lock GM Center Cut
7023628	1/2" Receiver Lock Nissan
7023629	1/2" Receiver Lock Toyota

1/2" Diameter Stainless Steel Pins for Class I + II Receivers (1.5" Square Receiver)

** The BOLT 5/8" Receiver Lock is compatible with the Ford Super Duty 3" hitch. Size variations have been observed with a select number of hitches, please contact BOLT Locks if you experience any issues with fit. **

COLLAR - KINGPIN LOCKING SYSTEM

- Secures your Fifth Wheel King Pin
- Visible Off-Vehicle Theft Deterrent
- Powder Coated, Hardened Steel Collar Resists Corrosion
- Heavy Duty Collar Resists Tampering
- Works with any BOLT 5/8" Receiver Lock
- Limited Lifetime Warranty

Part Number	Description
7032039	Collar - Kingpin Locking System



* Receiver Lock sold separately

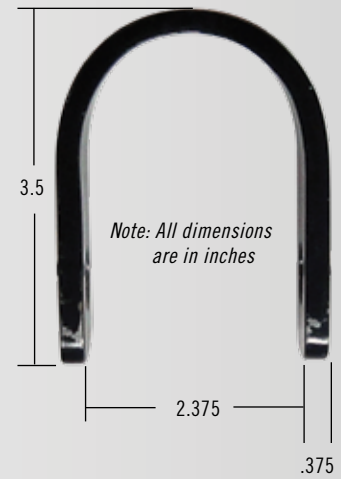

OFF-VEHICLE COUPLER LOCK

- Works with 1 7/8", 2" and 2 5/16" Couplers
- Hardened Steel Hardware for Extra Security
- Maximum Protection for Unattended Trailers
- Corrosion Resistant
- Plate Tumbler Sidebar to Prevent Picking and Bumping
- Limited Lifetime Warranty
- Powder Coated in Red for Visible Theft Deterrent

Part Number	Description
7032492	Off-Vehicle Coupler Lock Dodge/Jeep/Ram
7032497	Off-Vehicle Coupler Lock Jeep Center Cut
7032491	Off-Vehicle Coupler Lock Ford
7032496	Off-Vehicle Coupler Lock Ford Side Cut
7032489	Off-Vehicle Coupler Lock GM Early Model
7032490	Off-Vehicle Coupler Lock GM Late Model
7032493	Off-Vehicle Coupler Lock GM Center Cut
7032494	Off-Vehicle Coupler Lock Nissan
7032495	Off-Vehicle Coupler Lock Toyota

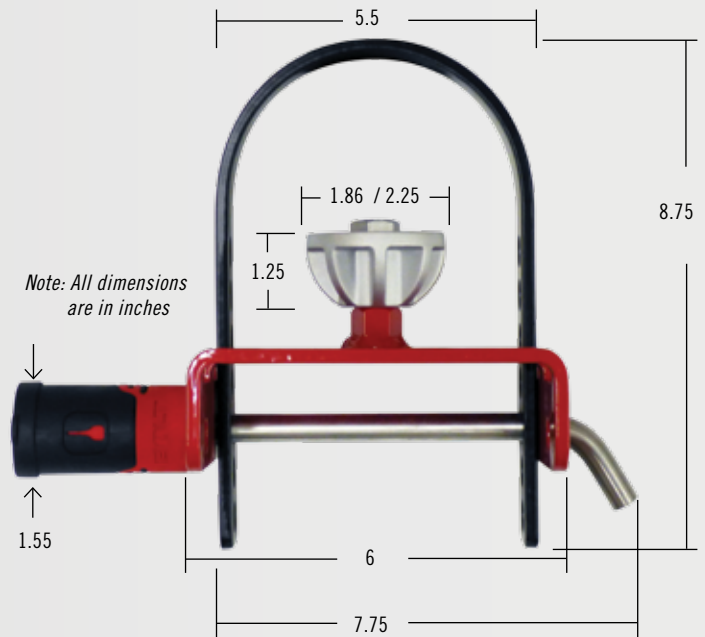

COUPLER PIN LOCK

- Stainless Steel Pin for Durability
- Fits Couplers from 1/2" to 3 3/8" and any Size in Between
- Lock Slides Back and Forth Along Pin for Ease of Use
- 1/8" Incremental Adjustments Allows for Snug Fit
- Stainless Steel Lock Shutter to Keep Out Dirt and Moisture
- Plate Tumbler Sidebar to Prevent Picking and Bumping
- Weather Proof
- Limited Lifetime Warranty



Part Number	Description
7025286	Coupler Lock Dodge/Jeep/Ram
7032299	Coupler Lock Jeep Center Cut
7025285	Coupler Lock Ford
7025290	Coupler Lock Ford Side Cut
7025283	Coupler Lock GM Early Model
7025284	Coupler Lock GM Late Model
7025287	Coupler Lock GM Center Cut
7025288	Coupler Lock Nissan
7025289	Coupler Lock Toyota

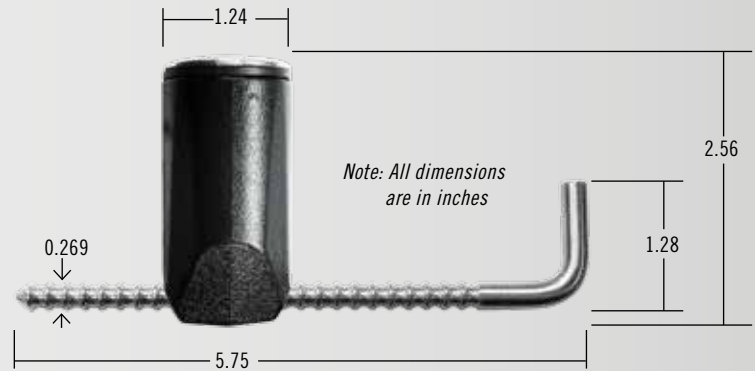

LOCKING RECOVERY HOOK

- Provides for Safe and Secure Recovery Ability
- Rated at 10,000 lbs
- Hook can Swivel 160 Degrees
- Made of Aircraft Grade Aluminum
- Secures Standard 7/8" Bumper Tabs, Winches, and Recovery Ropes
- Stainless Steel Lock Shutter to Keep out Dirt and Moisture
- Limited Lifetime Warranty



Part Number	Description
7039049	Locking Recovery Hook Dodge/Jeep/Ram
7039055	Locking Recovery Hook Jeep Center Cut
7039048	Locking Recovery Hook Ford
7039054	Locking Recovery Hook Ford Side Cut
7039046	Locking Recovery Hook GM Early Model
7039047	Locking Recovery Hook GM Late Model
7039050	Locking Recovery Hook GM Center Cut
7039051	Locking Recovery Hook Nissan
7039052	Locking Recovery Hook Toyota



CABLE LOCK

- 6' Long 1/4" Black Vinyl Coated Coiled Cable
- Weather Proof
- Auto Return Spring Locks Automatically when Key is Removed
- Double Ball Bearing Locking-Mechanism
- Plate Tumbler Sidebar to Prevent Picking and Bumping
- Stainless Steel Lock Shutter to Keep Out Dirt and Moisture
- Limited Lifetime Warranty



Part Number	Description
7018452	6' Cable Lock Dodge/Jeep/Ram
7032295	6' Cable Lock Jeep Center Cut
7018451	6' Cable Lock Ford
7023722	6' Cable Lock Ford Side Cut
7018449	6' Cable Lock GM Early Model
7018450	6' Cable Lock GM Late Model
7023719	6' Cable Lock GM Center Cut
7023720	6' Cable Lock Nissan
7023721	6' Cable Lock Toyota



PADLOCK

- 2" Chrome Plated 5/16" Dia. Hardened Steel Shackle
- Weather Proof
- Double Ball Bearing Locking Mechanism
- Plate Tumbler Sidebar to Prevent Picking and Bumping
- Stainless Steel Lock Shutter to Keep Out Dirt and Moisture
- Limited Lifetime Warranty

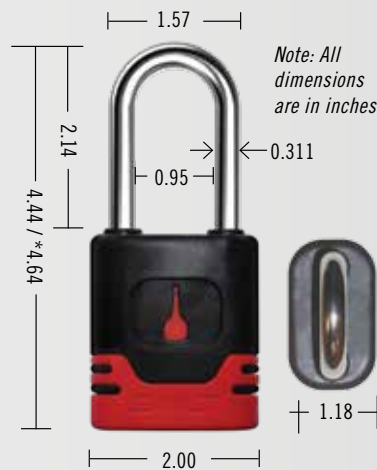

Designed to Work with Deeze Padlock Toolbox

Part Number	Description
7018520	Padlock Dodge/Jeep/Ram
7032288	Padlock Jeep Center Cut
7018519	Padlock Ford
7023540	Padlock Ford Side Cut
7018517	Padlock GM Early Model
7018518	Padlock GM Late Model
7023537	Padlock GM Center Cut *
7023538	Padlock Nissan *
7023539	Padlock Toyota *



BOLT CYLINDER

- Automotive Grade Quality
- Weather Proof
- Plate Tumbler Sidebar to Prevent Picking and Bumping
- Stainless Steel Lock Shutter to Keep Out Dirt and Moisture
- Limited Lifetime Warranty

Part Number	Description
692916	BOLT Cylinder Dodge/Jeep/Ram
692917	BOLT Cylinder Ford
7025636	BOLT Cylinder Ford Side Cut
692918	BOLT Cylinder GM Early Model
692915	BOLT Cylinder GM Late Model
7023480	BOLT Cylinder GM Center Cut *
7023481	BOLT Cylinder Nissan *
7023482	BOLT Cylinder Toyota *



CYLINDER RETAINING NUT

Part Number	Description
4306752	Retaining Nut



GM TAILGATE HANDLE

- Original Factory Handle
- Included BOLT Cylinder
- Weather Proof
- Plate Tumbler Sidebar to Prevent Picking and Bumping
- Stainless Steel Lock Shutter to Keep Out Dirt and Moisture
- Limited Lifetime Warranty
- Official GM Licensed Product



Part Number	Description
5922987	GM Tailgate Handle (includes lock cylinder)
709231	Tailgate Lock Cylinder

GM 16TM001
General Motors Trademarks are used under license to STRATTEC Security Corporation.
OFFICIAL LICENSED PRODUCT

2007-2013 CHEVROLET SILVERADO
2007-2014 CHEVROLET SILVERADO HD
2007-2013 GMC SIERRA
2007-2014 GMC SIERRA HD

TOOLBOX LATCH RETRO FIT KIT

- Original Factory Handle with Included BOLT Cylinder
- Weather Proof
- Plate Tumbler Sidebar to Prevent Picking and Bumping
- Stainless Steel Lock Shutter to Keep Out Dirt and Moisture
- Limited Lifetime Warranty



WORKS WITH DEEZEE, UWS AND OTHER LEADING MAKERS OF TOOLBOXES

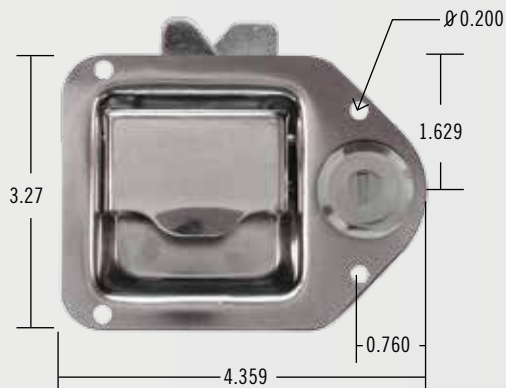

Note: All dimensions are in inches



Part Number	Description
7022699	Toolbox Latch Dodge/Jeep/Ram
7022698	Toolbox Latch Ford
7023550	Toolbox Latch Ford Side Cut
7022696	Toolbox Latch GM Early Model
7022697	Toolbox Latch GM Late Model
7023547	Toolbox Latch GM Center Cut
7023548	Toolbox Latch Nissan
7023549	Toolbox Latch Toyota

JK HOOD LOCK

- Fits 2007-2018 Jeep JK's
- Rivets into Existing Holes
- Secures Underhood Items from Theft
- Plate Tumbler Sidebar to Prevent Picking and Bumping
- Stainless Steel Lock Shutter to Keep Out Dirt and Moisture
- Limited Lifetime Warranty

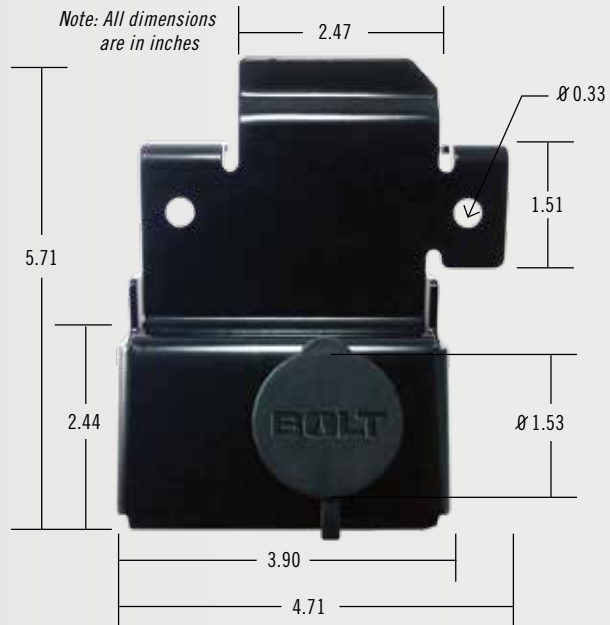

Part Number	Description
7026128	JK Hood Lock

JL HOOD LOCK

- Fits 2018+ Jeep JL's
- Rivets into Existing Holes
- Comes with Replacement Grille Insert
- Secures Underhood Items from Theft
- Plate Tumbler Sidebar to Prevent Picking and Bumping
- Stainless Steel Lock Shutter to Keep Out Dirt and Moisture
- Limited Lifetime Warranty



Part Number	Description
7032303	JL Hood Lock

J-MOUNT

- Fits 1997-2018 Jeep TJ's & JK's
- Secure Your High Lift Jack With Your Jeep Key
- High Lift Jack Held Securely in Place With 2 Knobs
- Easy to Remove and Mount Your High Lift Jack
- Auto Return Spring Locks Automatically When Key is Removed
- Plate Tumbler Sidebar to Prevent Picking and Bumping
- Easy to Install, Bolts into Existing Holes No Drilling Required!
- Weather Proof
- Limited Lifetime Warranty

Part Number	Description
7028648	J-Mount - Driver Side, Black
7028649	J-Mount - Passenger Side, Black

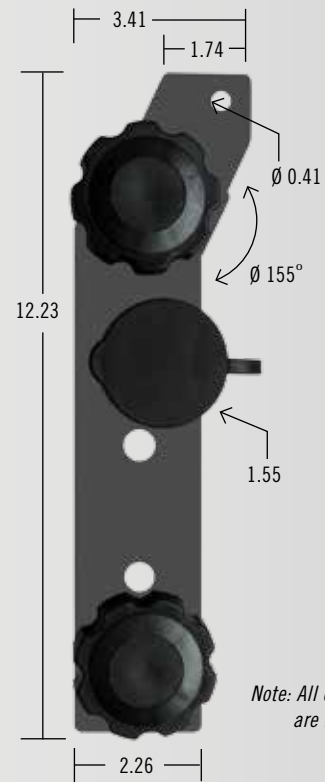

JEEP JK SPARE TIRE LOCK

- Fits 1997-2018 Jeep TJ's & JK's
- Replaces One Lug Nut on Spare Wheel
- Weather Proof
- Double Ball Bearing Locking-Mechanism
- Plate Tumbler Sidebar to Prevent Picking and Bumping
- Stainless Steel Lock Shutter to Keep Out Dirt and Moisture
- Auto Return Spring Locks Automatically When Key is Removed
- Limited Lifetime Warranty

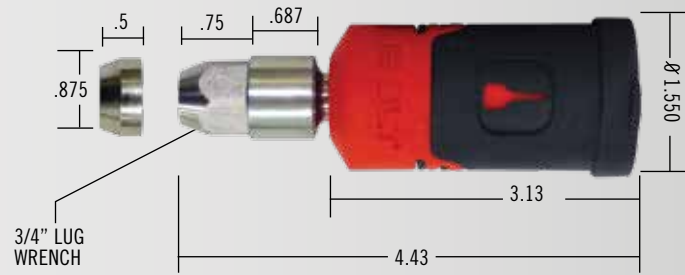

Note: All dimensions are in inches

Part Number	Description
5922986	Jeep Spare Tire Lock

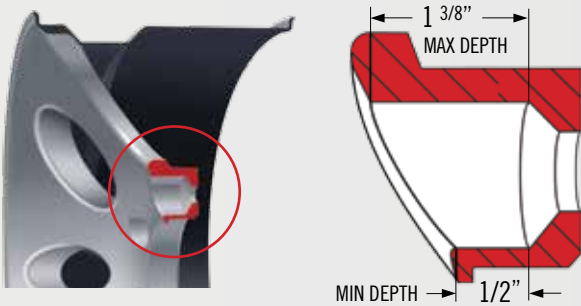

JEEP JL SPARE TIRE LOCK

- Fits 2018+ Jeep JL's
- Replaces One Lug Nut on Spare Wheel
- Weather Proof
- Double Ball Bearing Locking-Mechanism
- Plate Tumbler Sidebar to Prevent Picking and Bumping
- Stainless Steel Lock Shutter to Keep Out Dirt and Moisture
- Auto Return Spring Locks Automatically When Key is Removed
- Limited Lifetime Warranty

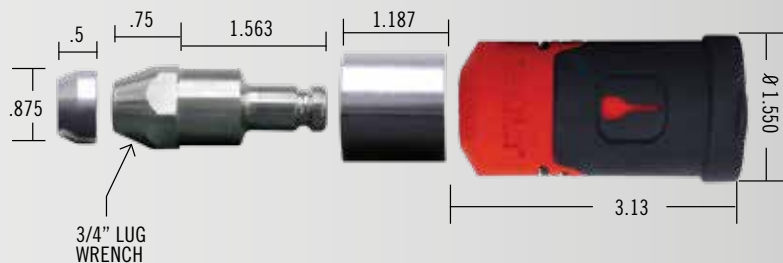

Note: All dimensions are in inches

Part Number	Description
7032301	Jeep JL Spare Tire Lock



DODGE / JEEP / RAM / VEHICLE APPLICATIONS



GROOVE ON BOTTOM

MAKE	MODEL	YEAR
CHRYSLER	300 (All)	1999 - 2020
	Aspen	2007 - 2009
	Pacifica	2004 - 2020
	PT Cruiser	2001 - 2011
	Town and Country Van	1991 - 2016
	Voyager	2001 - 2004
JEEP	Cherokee	1991 - 2020
	Commander	2005 - 2010
	Compass	2007 - 2017
	Grand Cherokee	1992 - 2020
	Liberty	2002 - 2014
	Patriot	2007 - 2017
	Wrangler	1991 - 2018
DODGE	Caliber	2006 - 2012
	Caravan, Grand Caravan	1991 - 2020
	Dakota	1990 - 2012
	Dart	1990 - 2017
	Durango	1998 - 2020
	Journey	2009 - 2020
	Nitro	2007 - 2011
RAM	Ram Pickup, Chassis	1990 - 2020
	Ram CV Tradesman	2012 - 2015



Part Number	BOLT Product
7019344	1/2" Receiver
7018448	5/8" Receiver
7018452	Cable Lock
7025286	Coupler Pin Lock
7028648	J-Mount - Driver Side, Black (1997+)
7028649	J-Mount - Passenger Side, Black (1997+)
5922986	Jeep Spare Tire Lock (1997 +)
7026128	JK Hood Lock (2007 +)
692916	Lock Cylinder
7039049	Locking Recovery Hook
7032492	Off-Vehicle Coupler Lock
7018520	Padlock
7022699	Toolbox Latch



JEEP CENTER CUT APPLICATIONS



CENTER CUT

FIAT	500	2011 - 2019
	500L	2013 - 2019
	500X	2016 - 2019
JEEP	Renegade	2015 - 2018
	Compass	2018 - 2020
	Wrangler JL	2018 - 2020
	Gladiator	2020
RAM	Promaster	2014 - 2020
	Promaster City	2014 - 2020



Part Number	BOLT Product
7032293	1/2" Receiver
7032290	5/8" Receiver
7032295	Cable Lock
7032299	Coupler Pin Lock
7032303	JL Hood Lock
7032301	JL Spare Tire Lock
7039055	Locking Recovery Hook
7032497	Off-Vehicle Coupler Lock
7032288	Padlock

GM EARLY VEHICLE APPLICATIONS



MAKE	MODEL	YEAR
BUICK CADILLAC	Ranier	2004 - 2007
	Rendezvous	2001 - 2007
	Terraza	2005 - 2007
	Escalade	1999 - 2005
OLDSMOBILE PONTIAC	Bravada	1996 - 2005
	Silhouette	1997 - 2004
	Aztek	2001 - 2006
	Montana	1999 - 2006
	SV6	2007 - 2008
GMC HUMMER	Transport	1997 - 1998
	Envoy	2002 - 2009
	Jimmy	1995 - 2005
	Safari	1995 - 2005
	Savana Van	1996 - 2007
	Sierra	1995 - 2006
	Sierra Classic	1995 - 2009
	Sonoma	1995 - 2005
	Top Kick	2003 - 2005
	Yukon	1995 - 2006
H2	2003 - 2007	

CHEVROLET

MAKE	MODEL	YEAR
	Astro	1996 - 2005
	Avalanche	2002 - 2006
	Express Van	1996 - 2007
	Impala	2000 - 2005
	Kodiak	2003 - 2005
	S10 Blazer & Pickup	1995 - 2005
	Silverado	1995 - 2006
	Silverado Classic	1995 - 2009
	Suburban	1995 - 2006
	Tahoe	1995 - 2006
	Trailblazer	2002 - 2009
	Uplander	2005 - 2009
	Venture Van	1999 - 2005

Part Number	BOLT Product
7019341	1/2" Receiver
7018445	5/8" Receiver
7018449	Cable Lock
7025283	Coupler Pin Lock
692918	Lock Cylinder

7039046	Locking Recovery Hook
7032489	Off-Vehicle Coupler Lock
7018517	Padlock
7022696	Toolbox Latch



GM LATE VEHICLE APPLICATIONS



BUICK CADILLAC	Enclave	2007 - 2017
	Escalade	2006 - 2014
	SRX	2005 - 2013
PONTIAC SATURN	Torrent	2007 - 2010
	Outlook	2007 - 2010
	Vue	2007
GMC HUMMER	Acadia	2007 - 2016
	Savana Van	2008 - 2014
	Sierra	2007 - 2013
	Sierra HD	2007 - 2014
	Yukon	2006 - 2014
CHEVROLET	H2	2008 - 2009
	Avalanche	2007 - 2013
	Equinox	2007 - 2009

CHEVROLET

Express Van	2008 - 2014
HHR Impala	2006 - 2011
Silverado	2006 - 2013
Silverado HD	2007 - 2013
Suburban	2007 - 2014
Tahoe	2006 - 2014
Traverse	2006 - 2014

Part Number	BOLT Product
7019342	1/2" Receiver
7018446	5/8" Receiver
7018450	Cable Lock
7025284	Coupler Pin Lock
692915	Lock Cylinder
7039047	Locking Recovery Hook
7032490	Off-Vehicle Coupler Lock
7018518	Padlock

5922987	GM Tailgate Handle <i>(Includes Lock Cylinder)</i>
709231	Tailgate Lock Cylinder
7022697	Toolbox Latch

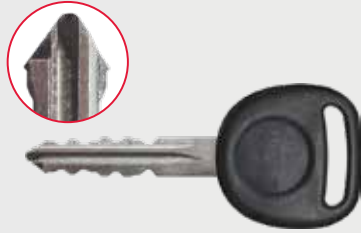

GM CENTER CUT APPLICATIONS



MAKE	MODEL	YEAR	MAKE	MODEL	YEAR
BUICK CADILLAC	Enclave	2018 - 2020	CHEVROLET	Colorado *	2015 - 2020
	Envision	2017 - 2020		Cruze	2011 - 2019
	Encore	2014 - 2020		Equinox	2010 - 2020
	Escalade	2015 - 2019		Express Van	2015 - 2020
	SRX	2014 - 2017		Impala	2014 - 2019
GMC	Acadia	2017 - 2020		Malibu	2014 - 2020
	Canyon *	2015 - 2020		Silverado	2014 - 2020
	Savana Van	2015 - 2020		Silverado HD	2015 - 2020
	Sierra	2014 - 2020		Sonic	2012 - 2017
	Sierra HD	2015 - 2020		Suburban	2015 - 2020
	Terrain	2010 - 2020		Tahoe	2015 - 2020
	Yukon	2015 - 2020	Traverse	2017 - 2020	

Part Number	BOLT Product
7023627	1/2" Receiver
7023582	5/8" Receiver
7023719	Cable Lock
7025287	Coupler Pin Lock
7023480	Lock Cylinder
7039050	Locking Recovery Hook
7032493	Off-Vehicle Coupler Lock
*7023537	Padlock
7023547	Toolbox Latch



* To Ensure Proper Compatibility on the Padlocks Look For Packaging That States "Now Works With 2015 + Chevrolet Colorado, GMC Canyon."

HOW IT WORKS

YOUR IGNITION KEY

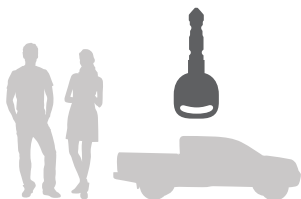

TURN ONCE

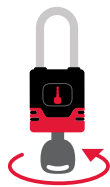

IT PERMANENTLY
LEARNS **YOUR** KEY

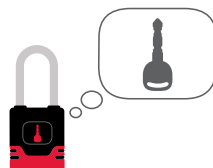

OPENS ALL **YOUR** LOCKS



FORD VEHICLE APPLICATIONS



MAKE	MODEL	YEAR
FORD	Bronco	1996 - 1999
	Econoline Van/Chassis	1996 - 2020
	Edge	2007 - 2015
	Escape	2001 - 2012
	Expedition	1997 - 2017
	Explorer	1996 - 2015
	Explorer Sport Trac	2001 - 2011
	Flex	2009 - 2017
	Freestar	2004 - 2008
	Freestyle	2004 - 2007
	F-150 Pickup	1996 - 2014
	F-Series Super Duty	1996 - 2016
	Ranger	1995 - 2012
	Taurus	1997 - 2016
	MERCURY	Mariner
Monterey		2004 - 2007
Mountaineer		1997 - 2011



MAKE	MODEL	YEAR
LINCOLN	Mark LT	2005 - 2014
	MKT	2011 - 2020
	MKX	2006 - 2015
	Navigator	1998 - 2017

Part Number	BOLT Product
7019343	1/2" Receiver
7018447	5/8" Receiver
7018451	Cable Lock
7025285	Coupler Pin Lock
692917	Lock Cylinder
7039048	Locking Recovery Hook
7032491	Off-Vehicle Coupler Lock
7018519	Padlock
7022698	Toolbox Latch



FORD SIDE CUT APPLICATIONS



FORD	Edge *	2016 - 2020
	Escape	2013 - 2020
	Expedition	2018 - 2020
	Explorer *	2016 - 2020
	F-150 Pickup *	2015 - 2020
	F-Series Super Duty	2017 - 2020
	Focus	2011 - 2019
	Ranger	2020
	Transit	2015 - 2020
	Transit Connect	2015 - 2020
LINCOLN	MKC *	2015 - 2019
	MKX *	2016 - 2019
	Navigator	2018 - 2020
LAND ROVER	LR2	2007 - 2012
	LR3	2005 - 2009
	LR4	2010 - 2016
	Range Rover	2007 - 2016
	Range Rover Sport	2007 - 2016

Part Number	BOLT Product
7023630	1/2" Receiver
7023585	5/8" Receiver
7023722	Cable Lock
7025290	Coupler Pin Lock
7025636	Lock Cylinder
7039054	Locking Recovery Hook
7032496	Off-Vehicle Coupler Lock
7023540	Padlock
7023550	Toolbox Latch

* For Proper Coding of Push Button Start Vehicles, Please Use the Glovebox Key To Program Your BOLT Lock.



TOYOTA VEHICLE APPLICATIONS



MAKE

MODEL

YEAR

TOYOTA

4-Runner *	1996 - 2018
Corolla *	1993 - 2020
FJ Cruiser	2006 - 2014
Highlander *	2001 - 2020
Landcruiser	1998 - 2007
Prius	2001 - 2014
RAV-4 *	1996 - 2018

MAKE

MODEL

YEAR

TOYOTA

Sequoia	2001 - 2019
Sienna	1998 - 2019
Tacoma (All) *	1995 - 2016
Tacoma (SR/SR5 models ONLY) *	2017 - 2020
Tundra	2000 - 2020
Venza	2009 - 2016



* BOLT Locks Do Not Support Toyota Center Cut Keys

Part Number	BOLT Product
7023629	1/2" Receiver
7023584	5/8" Receiver
7023721	Cable Lock
7025289	Coupler Pin Lock
7023482	Lock Cylinder
7039052	Locking Recovery Hook
7032495	Off-Vehicle Coupler Lock
7023539	Padlock
7023549	Toolbox Latch

NISSAN VEHICLE APPLICATIONS



NISSAN

Altima	1999 - 2018
Armada	2004 - 2017
Cube	2009 - 2017
Frontier P/Up	1998 - 2020
Juke	2011 - 2018
Murano	2003 - 2020

NISSAN

Pathfinder	1996 - 2020
Quest	2004 - 2018
Rogue	2008 - 2020
Sentra	2000 - 2018
Titan	2004 - 2020
X-Terra	2002 - 2015



* For Proper Coding and Operation, Please Use the Key That Works in The Glove Box With Your BOLT Lock.



Part Number	BOLT Product
7023628	1/2" Receiver
7023583	5/8" Receiver
7023720	Cable Lock
7025288	Coupler Pin Lock
7023481	Lock Cylinder
7039051	Locking Recovery Hook
7032494	Off-Vehicle Coupler Lock
7023538	Padlock
7023548	Toolbox Latch