



INSTALLATION INSTRUCTIONS

PART#: BB080800\BB080800A
2" CITY BAR FOR JEEP PATRIOT 4X4 & 4X2 08-09



PARTS LIST:

1	City Bar	2	12-1.75mm x 50mm Hex Head Bolts
1	Center Tube Bracket	4	12-1.75mm x 35mm Hex Head Bolts
1	Driver/Left Mounting Bracket	4	12mm Hex Nuts
1	Passenger/Right Mounting Bracket	6	12mm Lock Washers
3	10mm Nut Plates (4x2 models)	10	12mm ID x 32mm OD x 3mm Flat Washers
3	38mm OD x 27mm Long - Tube Spacers	3	10-1.50mm x 70mm Hex Head Bolts
1	6mmx25mm Button Head Bolts	3	10mm Lock Washers
1	6mm Flat Washer	3	10mm ID x 27mm OD x 3mm Flat Washers
1	6mm Lock Washer		

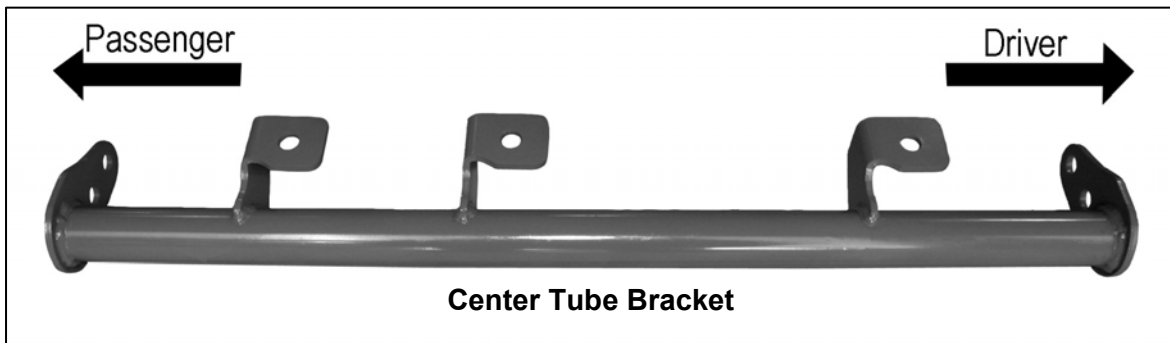

PROCEDURE:

1. REMOVE CONTENTS FROM BOX. VERIFY ALL PARTS ARE PRESENT. READ INSTRUCTIONS CAREFULLY BEFORE STARTING INSTALLATION.

4x4 Models – Center Tube Bracket Installation

2. Remove the three 10mm hex head bolts from lower part of the bumper that secures the front end of the factory skid plate to vehicle (**Figure 1**).
3. Line up the holes in the Center Tube Bracket with factory holes in the skid plate. Partially hang Center Tube Bracket to vehicle by replacing the factory bolts with the included (3) 10-1.50mm x 70mm Hex Head Bolts, (3) 10mm Lock Washers, and (3) 10mm Flat Washers (**Figure 2**).

4x2 Models – Center Tube Bracket Installation

4. Remove all 10mm hex head bolts from the lower part of the bumper that secures plastic shroud to the vehicle. Place the plastic shroud on a clean working area and cut the marked area shown in **Figure 3**. **NOTE:** You will not be re-installing the two outer mounting locations in the plastic shroud.
5. Locate the three rectangular holes in the back side of the front cross member and insert one of the 10mm Nut Plates into each of them. Orient Nut Plates to the holes in the bottom of the front cross member (**Figure 4**).
6. Position Center Tube Bracket to the vehicle and line up the holes in the bracket with already inserted Nut Plates. Starting on the center mounting location of the Tube Bracket, place one of the Tube Spacers between the cross member and the Tube Bracket and attach them using the included (1) 10mm x 70mm Hex Head Bolt, (1) 10mm Lock Washer, and (1) 10mm Flat Washer (**Figure 5**). Repeat this step for the two outer mounting locations in the Tube Bracket.
7. Reinstall plastic shroud at this time using the factory hardware.

4x4 & 4x2 Models – Mounting Brackets Installation

8. Locate passenger and driver Mounting Brackets and partially attach them to Center Tube Bracket by using the included (4) 12mm x 35mm Hex Head Bolts, (4) 12mm Lock Washers, (4) 12mm Flat Washers, and (4) 12mm Hex Nuts (**Figure 6**).
9. With help attach the City Bar to Mounting Brackets by using the included (2) 12mm x 50mm Hex Head Bolts, (2) 12mm Lock Washers, and (2) 12mm Flat Washers (**Figure 7**).
10. Attach Top Bracket to vehicle using the factory license plate screws. Use the included (1) 6mm x 25mm Allen Bolt, (1) 6mm Lock Washer, and (1) 6mm Flat Washer to attach City Bar to Top Bracket (**Figure 8**). **NOTE:** Top Bracket can be mounted in front or behind license plate.
11. Level and adjust City Bar properly; and then tighten all hardware at this time.
12. Do periodic inspections to the installation to make sure that all hardware is secure and tight.

To protect your investment, wax this product after installing. Regular waxing is recommended to add a protective layer over the finish. Do not use any type of polish or wax that may contain abrasives that could damage the finish.

For stainless steel: Aluminum polish may be used to polish small scratches and scuffs on the finish. Mild soap may be used also to clean the City Bar.

For gloss black finishes: Mild soap may be used to clean the City Bar.

2" CITY BAR FOR JEEP PATRIOT 4X4 & 4X2 08-09

4x4 Model Shown

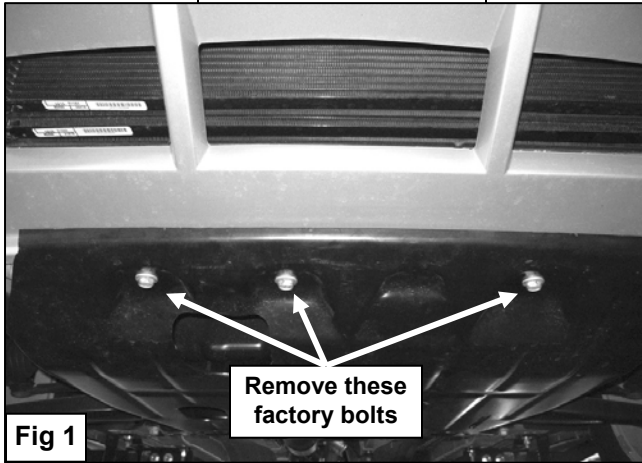

4x4 Model Shown

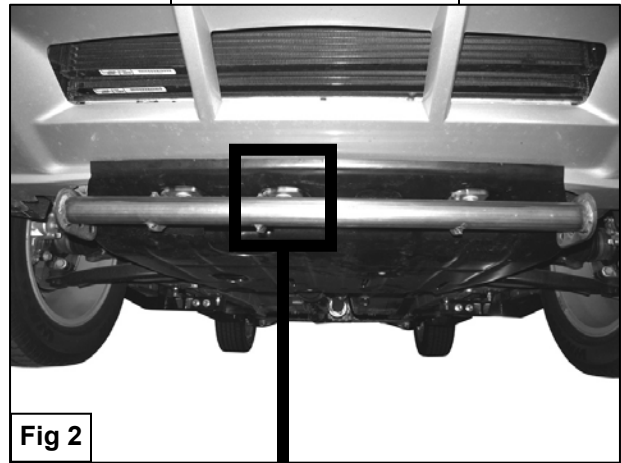

10mm x 70mm Hex Bolt
10mm Lock Washers
10mm Flat Washers

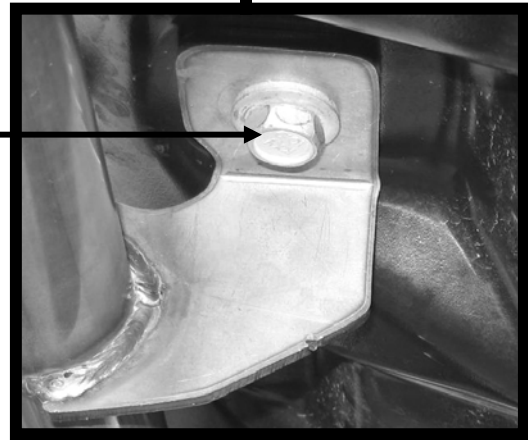

4x2 Model Shown

Cut a 3 1/2" gap here

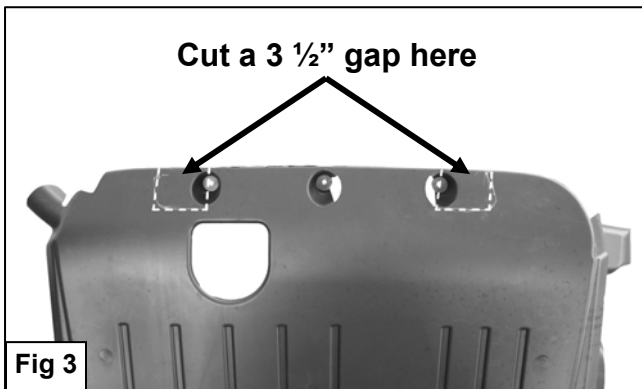

10mm Nut Plate

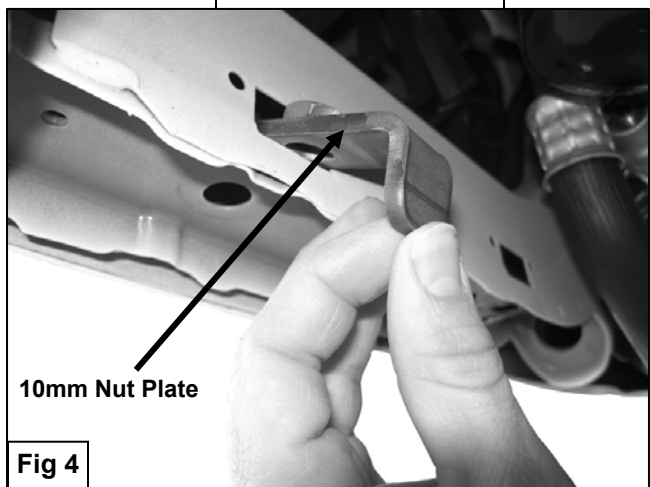

4x2 Model Shown

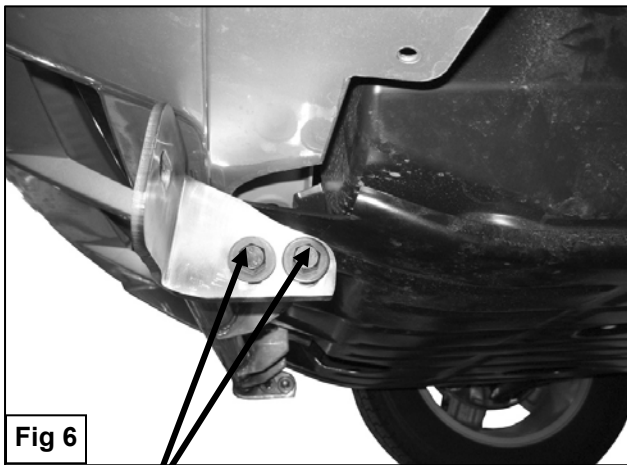
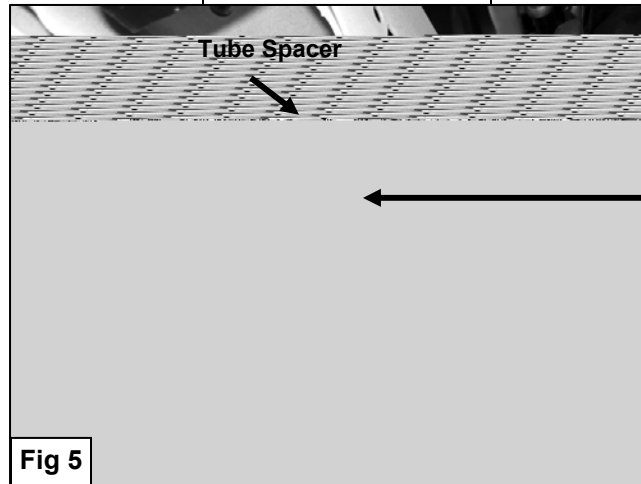

12mm x 35mm Hex Bolts
12mm Lock Washers
12mm Flat Washers
12mm Hex Nuts

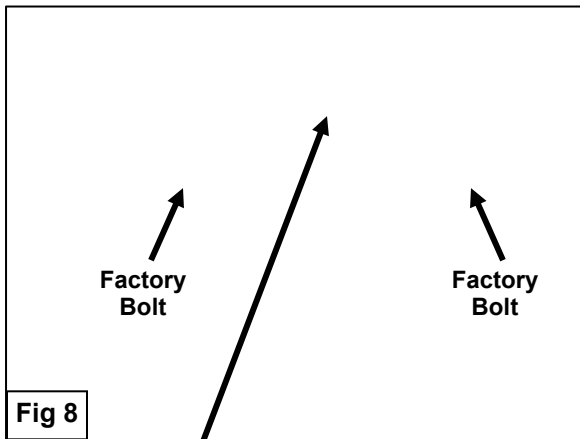
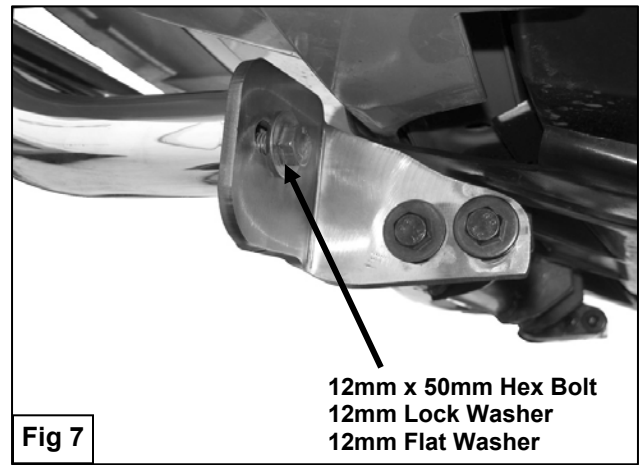

6mm x 25mm Button Head Bolt
6mm Lock Washer
6mm Flat Washer

