



# *BilletSpecialties*

Driving Style Since 1985



**VOL #31**

# TABLE OF CONTENTS

## ENGINE ACCESSORIES

<b>Tru Trac Serpentine Systems</b>	
Chevrolet® SB, BB, 348/409, LS	3-18
LSA	COMING SOON
LT4	12
Ford SB, BB, FE	19-26
Chrysler SB, BB, HEMI	27-32
Pontiac SB, BB	33-36
Upgrades & Add-ons	37-38
<b>V-Trac Pulley Systems</b>	
Chevrolet® SB, BB	39-40
Upgrades, Add-ons, & Accessories	41
<b>Tru Trac &amp; V-Trac Recommended Accessories</b>	42
<b>Sport Trac</b>	
<b>Serpentine Accessory Drive Kit for LS</b>	43-44
<b>LS Accessories</b>	45-46
<b>Serpentine Conversion Kits</b>	47-50
<b>Accessory Brackets</b>	51-52
<b>Independent Mount Brackets</b>	53-56
<b>Serpentine Pulleys</b>	57
<b>V-Groove Pulleys</b>	58-59
<b>Power Steering Components</b>	60-62
<b>Air Cleaners</b>	63-68
<b>Valve Covers</b>	69-76
<b>Oil Fill Caps</b>	76
<b>Engine Dress-Up Accessories</b>	
Breathers & PCV Breathers	77-78
Ignition Wire Organization	79-80
Engine Block Accessories	81-82
Cooling Components	83-84
Hose and Line Management	85-86
Battery Accessories	87
Hardware	88
<b>Hood and Deck Hinges</b>	89-92

## INTERIOR & EXTERIOR ACCESSORIES

<b>Pedals &amp; Pedal Kits</b>	93-98
<b>Door Panel Accessories</b>	99-101
<b>Dash Panel Accessories</b>	102
<b>Shift &amp; Column Accessories</b>	103
<b>Shifters &amp; Shifter Boot Rings</b>	104
<b>Half-Wrap Steering Wheels</b>	105-116
<b>Horn Buttons &amp; Adapters</b>	117-118
<b>Mirrors</b>	119-121
<b>Interior Lighting</b>	122
<b>Exterior Accessories</b>	123-124
<b>Exterior Lighting</b>	125
<b>Tools</b>	126

General Motors Trademarks used under license to Billet Specialties, Inc.



PERFORMANCE  
OFFICIAL LICENSED PRODUCT

### Proposition 65 Compliance Statement;



It is the responsibility of Billet Specialties to warn its customers that some products sold in this catalog contain chemicals known to the state of California to cause cancer, birth defects, or other reproductive harm. These products are identified with the above warning label in the catalog and on the product.

To find out more information about Prop 65.

Billet Specialties is not responsible for misprints. Prices are subject to change without notice. Prices do not include shipping, taxes, duties or customs charges.



"Lakeside Rods uses Billet Specialties products on every car we build. Precision quality and fit every time"

- ROGER BURMAN - LAKESIDE RODS & RIDES

- 2012 Goodguys Muscle Machine of the Year
- 2007 America's Most Beautiful Roadster
- 2006 Ridler Award
- 2015 Good Guys Street Rod d'Elegance
- 2015 Good Guys Truck of the Year-Late
- 2017 Good Guys Truck of the Year-Late



**AMERICAN MADE QUALITY** first and foremost. Billet Specialties has been on the forefront of manufacturing Billet aluminum wheels and accessories since 1985. With the most diverse lineup of products in the industry, Billet Specialties has become the go-to manufacturer that top builders use and trust. This recognition comes from years of experience, enthusiasm and innovation conceived into each and every product, instruction sheet and product package.



*"Every time I come up here, I challenge these guys and every time I challenge them - it comes out better. Everything is done in house, from concept to reality. Their quality and design is irreplaceable and that is why I choose Billet Specialties"*

**- Troy Trepanier - RAD RIDES BY TROY**

- 2004 Goodguys Street Rod of the Year
- 2002, 2004 & 2012 Mothers Shine Award
- 2002 & 2012 SEMA GM Design Award
- 2007 Grand National Roadster Show Builder of the Year
- 2014 America's most beautiful roadster
- 2014 Detroit Autorama builder of the year
- 2015 SEMA Design Award
- 2017 SEMA Battle of the Builders



2013 Goodguys Street Machine of the Year



*"Our cars are built to drive coast to coast. We have been relying on Billet Specialties quality for over 15 years. Everything they make performs as good as it looks!"*

**-Roy Brizio**

- 2012 Good Guys Hot Rod of the Year
- 2013 America's Most Beautiful Roadster



*"Stance, tires and wheels define the trademark Alloway look. Billet Specialties is the go to manufacturer of choice, their quality and delivery is second to none"*



*"Billet Specialties attention to detail is unmatched in the industry. With over 40 years in the racing engine business, Billet Specialties products are some of the very few that do not need to be re-machined or re-engineered to make everything work"*

**- JON KAASE – KAASE RACING ENGINES**



*"Customer service and quality of parts every time, and the only serpentine kits offered that truly bolt on, fit and work perfect!"*

**- SCOTT BONOWSKI – HOT RODS & HOBBIES**

- 2006 & 2009 Worlds Most Beautiful Custom - Fresno Autorama
- 2011 Grand National Roadster Show Builder of the Year
- 2009 Triple Gun of Excellence Award Grand National Roadster Show
- 2018 America's Most Beautiful Roadster





# CHEVROLET® TRU TRAC KITS

SMALL BLOCK, BIG BLOCK, 348/409



"Top notch hardware, Quality components, compact design and professional engineering. You cannot beat the Tru Trac"

- RAD RIDES BY TROY

## BILLET A/C MANIFOLD

Kits with AC include our Billet aluminum AC manifold, engineered not only to provide an efficient attachment point for the AC hoses, but to look good as well. In fact, so good and efficient we patented it!

## BILLET TENSIONER

Our Billet aluminum tensioner optimizes belt and accessory life with constant and correct tension; eliminating belt-slip while minimizing parasitic horsepower loss. Every modern car has a tensioner—so should your classic.

## DURABILITY

Pulleys that are in contact with the back of the belt are subject to high wear. Billet Specialties hard coat anodizes these areas to eliminate wear altogether. Hard coat anodized aluminum actually provides a harder surface than stock steel pulleys!

## STAINLESS STANDOFFS

Our stainless stand-offs provide the most rigid platform in the industry, while maintaining perfect alignment between the accessories. Machined from 303 stainless steel to provide corrosion resistance and double the surface area while adding ease of assembly.



## FASTENERS

Tru Trac kits are assembled with 18-8 stainless steel fasteners, offering not only corrosion resistance, but professional appearance and high tensile strength. ARP 12pt. fasteners also match many other Billet Specialties accessories.

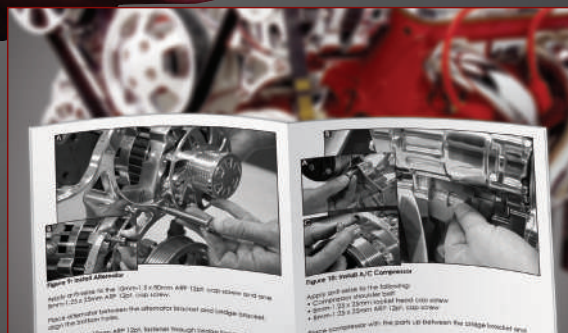

## EASE OF INSTALLATION

With our comprehensive instruction booklet and pre-installed alternator and power steering pulleys, installing a Tru Trac is easy. See for yourself, visit Billetspecialties, select the Tru Trac for your application and download a copy of the instructions





## THE BEST BRANDS INCLUDED!



Designed and cast in the USA, Edelbrock water pumps provide maximum flow, maximum pressure and equal distribution to both sides of the block within 1%. Featuring Edelbrock's industry leading precision powdered metal impeller with modern vane design that is larger than other high-performance pumps along with the precision machined computer designed A-356 cast pump housing.

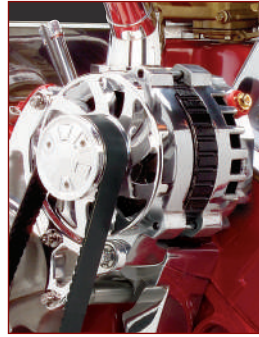

Billet Specialties supplies a new 170 amp Powermaster alternator in every Tru Trac kit. Each Powermaster alternator is 100% new. With a high amp output at idle, internally regulated architecture and internal fan with a gold plated battery post. Each 170 amp alternator is pre-tested and includes a proof of performance tag showing output at idle and at highway speeds. Best of all, Powermaster alternators are made right here in the USA.



Sanden manufactures and supplies compressors for some of the largest automotive manufacturers in the world. The SD-7 is a high efficiency modern compact compressor ensuring better performance and aesthetics over early 508 compressors while keeping you cool and comfortable.

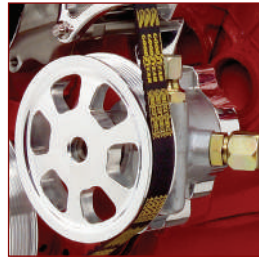

Kits with power steering feature modern TC style pumps, used by OEM manufacturers and various applications from NASCAR, Off Road and Road Racing. We supply the pumps with -10AN supply and -6AN pressure nipples installed. Featuring a sealed front bearing and precision internals, each high performance pump is calibrated to 1200 PSI and flows at 3.5 GPM.

## STANDARD POLISHED AND BLACK ANODIZED KITS INCLUDE:



**Natural Finish Water Pump**  
The traditional look of performance for decades, the natural cast look easily matches your cast intake manifold and power steering pump.



**Polished 170 amp Alternator**  
Powermaster USA made quality, precision cast and polished case with the best internal components in the industry.



**Natural Finish Power Steering Pump**  
Matches the natural finish Edelbrock water pump and we pre-install the pulley for ease of installation.

## PREMIUM POLISHED KITS INCLUDES:



**EnduraShine™ Water Pump**  
EnduraShine is a bright chrome like vacuum metallized finish that matches our polished Billet aluminum components.



**Optional Billet Aluminum 170 amp Alternator**  
Truly the crown jewel of the Premium kit. The precision machined 6061-T6 Billet case makes this the ultimate alternator.

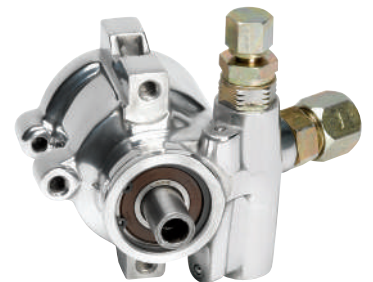

**Polished Power Steering Pump**  
Show quality polish and pre-installed pulley for ease of installation.

# CHEVROLET® SMALL BLOCK

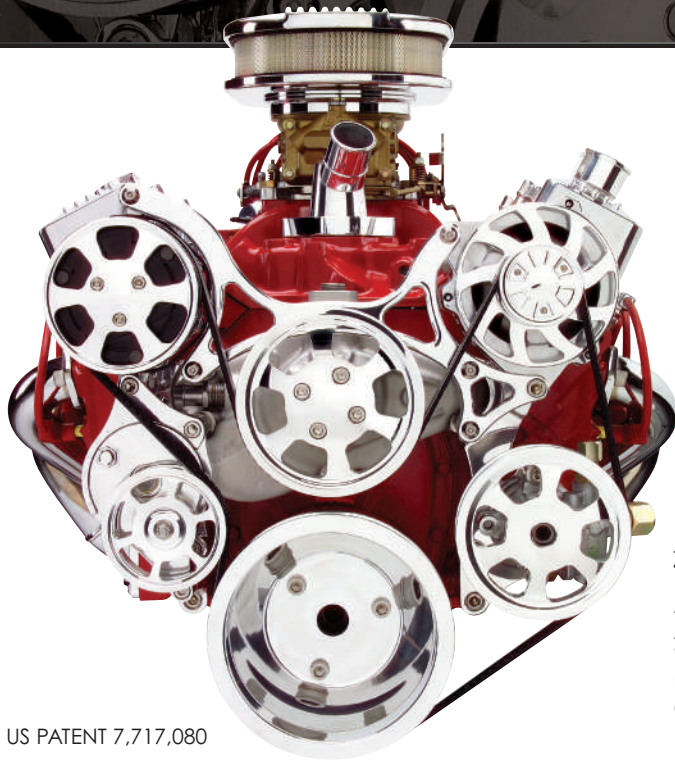

US PATENT 7,717,080

### All Kits Feature:

- Exclusive Billet aluminum tensioner
- Polished ARP 12-point stainless steel fasteners
- Hard-coat anodizing for durability in high-wear areas
- Continental Elite serpentine belt
- Comprehensive instruction manual

\*Tru Trac systems are not designed for use with hydroboost brake systems\*

## BIG STYLE FOR YOUR SMALL BLOCK

The Tru Trac for small block Chevrolet® patented design mounts between the water pump and the engine block via positive O-ring seal. It works with all cylinder head configurations. Early model, late model, or Vortec™ - Tru Trac fits them all.

Featuring the best brands in aftermarket performance:



## DIMENSIONS - SMALL BLOCK CHEVY™

To Front Face Of	From Block Face
AC Compressor Cover	7.437"
Alternator Pulley	6.500"
Water Pump Pulley	7.000"
Power Steering Pulley	6.312"
Crankshaft Pulley	6.187"

A: 8.375"	D: 7.000"
B: 8.750"	E: 9.000"
C: 6.625"	

\* Check Clearances Before Ordering \*

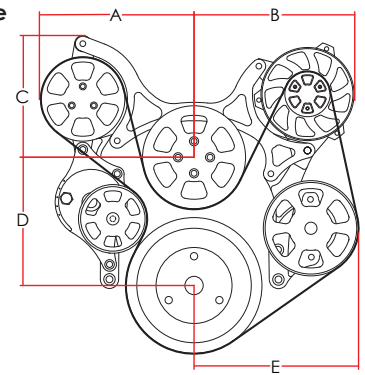

## STANDARD POLISHED KITS

Standard polished Small Block Chevrolet® Tru Trac includes the following:

- Polished aluminum pulleys & brackets
- Polished billet tensioner (Tru Trac exclusive)
- Polished 170 amp Powermaster 1-wire alternator
- Natural finish Edelbrock reverse rotation water pump

### Kits with AC Include:

- Polished Sanden SD-7 compressor
- Polished AC clutch cover
- Patented polished Billet compressor manifold

### Kits with power steering include:

- Natural finish power steering pump with AN nipples
- Polished power steering pulley installed

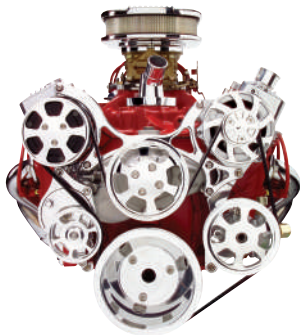

With AC  
With Power Steering  
13220



With AC  
Without Power Steering  
13120

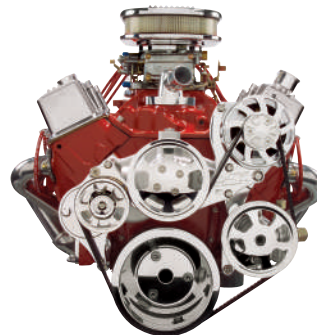

Without AC  
With Power Steering  
13225



Without AC  
Without Power Steering  
13125



# PREMIUM POLISHED KITS



Premium Small Block Chevrolet® Tru Trac includes the following:

- Polished aluminum pulleys & brackets
- Polished billet tensioner (Tru Trac exclusive)
- Polished 170 amp Powermaster 1-wire alternator or polished Billet machined case 170 amp alternator
- EnduraShine™ Edelbrock reverse rotation water pump

**Kits with AC include:**

- Polished Sanden SD-7 compressor
- Polished AC clutch cover
- Patented polished Billet compressor manifold

**Kits with power steering include:**

- Polished finish power steering pump with AN nipples
- Polished power steering pulley installed

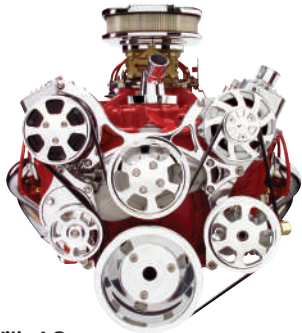

**With AC  
With Power Steering**

Includes EnduraShine™ Water Pump & Polished P/S Pump  
**13220WP**

Includes EnduraShine™ Water Pump & Polished P/S Pump  
Polished 170 amp Billet Alternator  
**13220WPA**



**With AC  
Without Power Steering**

Includes EnduraShine™ Water Pump  
**13120W**

Includes EnduraShine™ Water Pump & Polished 170 amp Billet Alternator  
**13120WA**

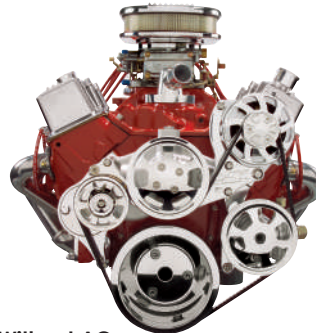

**Without AC  
With Power Steering**

Includes EnduraShine™ Water Pump & Polished P/S Pump  
**13225WP**

Includes EnduraShine™ Water Pump, Polished P/S Pump & Polished 170 amp Billet Alternator  
**13225WPA**



**Without AC  
Without Power Steering**

Includes EnduraShine™ Water Pump  
**13125W**

Includes EnduraShine™ Water Pump & Polished 170 amp Billet Alternator  
**13125WA**

# PREMIUM BLACK ANODIZED KITS

Includes EnduraShine™ Water Pump & Polished P/S Pump  
**BLK13220WP**

Includes EnduraShine™ Water Pump, Polished P/S Pump, & Polished 170 amp Billet Alternator  
**BLK13220WPA**

*\* Includes all the upgrades from the premium kits above, with black anodized pulleys, brackets, and tensioner\**

# BLACK ANODIZED KITS

Black anodized Small Block Chevrolet® Tru Trac includes the following:

- Black anodized aluminum pulleys & brackets
- Black anodized billet tensioner (Tru Trac exclusive)
- Polished 170 amp Powermaster 1-wire alternator
- Natural finish Edelbrock reverse rotation water pump

**Kits with AC include:**

- Polished Sanden SD-7 compressor
- Black anodized AC clutch cover
- Patented black anodized Billet compressor manifold

**Kits with power steering include:**

- Natural finish power steering pump with AN nipples
- Black anodized power steering pulley installed



**With AC  
With Power Steering**  
**BLK13220**



**With AC  
Without Power Steering**  
**BLK13120**



**Without AC  
With Power Steering**  
**BLK13225**



**Without AC  
Without Power Steering**  
**BLK13125**

# CHEVROLET® BIG BLOCK

## THE BEST YOUR BIG BLOCK HAS EVER LOOKED...

There is no substitute for big block horsepower and torque - the efficiency of a Tru Trac system ensures you get the most out of your motor. Engineered to fit any cylinder head and manifold configuration, the big block Tru Trac's exclusive Billet aluminum tensioner keeps constant even tension allowing the 170 amp alternator and Edelbrock water pump to run at full potential without fear of belt slip. The compact design fits easily into the tightest engine compartments truly making it the ultimate serpentine system.

Featuring the best brands in aftermarket performance:



## DIMENSIONS - BIG BLOCK CHEVY™

To Front Face Of	From Block Face
AC Compressor Cover	7.562"
Alternator Pulley	6.625"
Water Pump Pulley	7.125"
Power Steering Pulley	6.437"
Crankshaft Pulley	6.375"

A: 9.125"	D: 7.125"
B: 9.250"	E: 9.500"
C: 7.250"	

\* Check Clearances Before Ordering \*

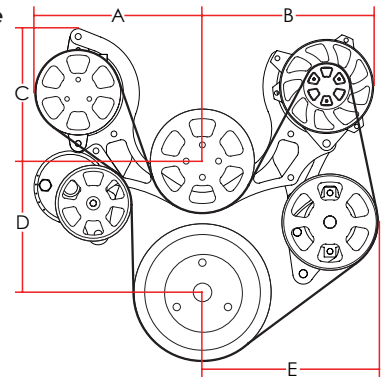

US PATENT 7,717,080

### All Kits Feature:

- Exclusive Billet aluminum tensioner
- Polished ARP 12-point stainless steel fasteners
- Hard-coat anodizing for durability in high-wear areas
- Continental Elite serpentine belt
- Comprehensive instruction manual

\*Tru Trac systems are not designed for use with hydroboost brake systems\*

## STANDARD POLISHED KITS

Standard polished Big Block Chevrolet® Tru Trac includes the following:

- Polished aluminum pulleys & brackets
- Polished Billet Tensioner (Tru Trac exclusive)
- Polished 170 amp Powermaster 1-wire alternator
- Natural finish Edelbrock reverse rotation water pump

### Kits with AC Include:

- Polished Sanden SD-7 compressor
- Polished AC clutch cover
- Patented polished Billet compressor manifold

### Kits with power steering include:

- Natural finish power steering pump with AN nipples
- Polished power steering pulley installed



With AC  
With Power Steering  
14220



With AC  
Without Power Steering  
14120

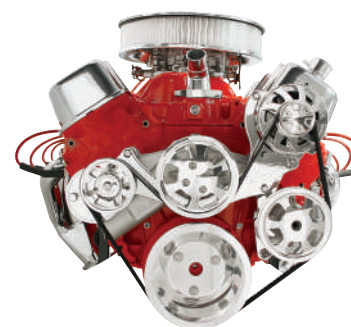

Without AC  
With Power Steering  
14225

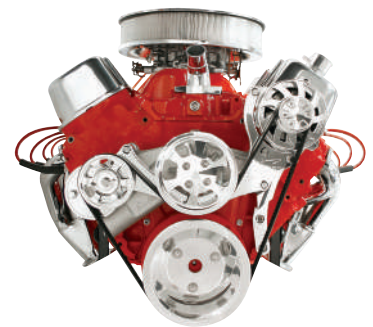

Without AC  
Without Power Steering  
14125



## PREMIUM POLISHED KITS

Premium Big Block Chevrolet® Tru Trac includes the following:

- Polished aluminum pulleys & brackets
- Polished billet tensioner (Tru Trac exclusive)
- Polished 170 amp Powermaster 1-wire alternator or polished Billet machined case 170 amp alternator
- EnduraShine™ Edelbrock reverse rotation water pump

**Kits with AC include:**

- Polished Sanden SD-7 compressor
- Polished AC clutch cover
- Patented polished Billet compressor manifold

**Kits with power steering include:**

- Polished finish power steering pump with AN nipples
- Polished power steering pulley installed

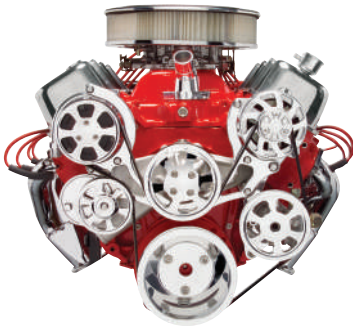

**With AC  
With Power Steering**

Includes EnduraShine™ Water Pump & Polished P/S Pump  
**14220WP**

Includes EnduraShine™ Water Pump & Polished P/S Pump  
Polished 170 amp Billet Alternator  
**14220WPA**



**With AC  
Without Power Steering**

Includes EnduraShine™ Water Pump  
**14120W**

Includes EnduraShine™ Water Pump & Polished 170 amp Billet Alternator  
**14120WA**

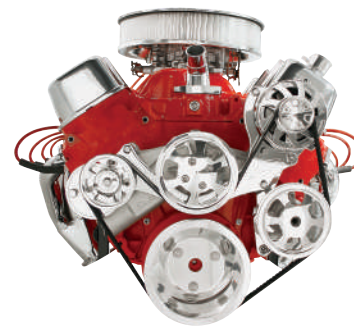

**Without AC  
With Power Steering**

Includes EnduraShine™ Water Pump & Polished P/S Pump  
**14225WP**

Includes EnduraShine™ Water Pump, Polished P/S Pump & Polished 170 amp Billet Alternator  
**14225WPA**

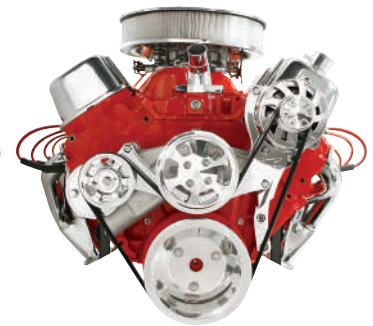

**Without AC  
Without Power Steering**

Includes EnduraShine™ Water Pump  
**14125W**

Includes EnduraShine™ Water Pump & Polished 170 amp Billet Alternator  
**14125WA**

## PREMIUM BLACK ANODIZED KITS

Includes EnduraShine™ Water Pump & Polished P/S Pump  
**BLK14220WP**

Includes EnduraShine™ Water Pump, Polished P/S Pump, & Polished 170 amp Billet Alternator  
**BLK14220WPA**

*\* Includes all the upgrades from the premium kits above, with black anodized pulleys, brackets, and tensioner.*

## BLACK ANODIZED KITS

Black anodized Big Block Chevrolet® Tru Trac includes the following:

- Black anodized aluminum pulleys & brackets
- Black anodized billet tensioner (Tru Trac exclusive)
- Polished 170 amp Powermaster 1-wire alternator
- Natural finish Edelbrock reverse rotation water pump

**Kits with AC include:**

- Polished Sanden SD-7 compressor
- Black anodized AC clutch cover
- Patented black anodized Billet compressor manifold

**Kits with power steering include:**

- Natural finish power steering pump with AN nipples
- Black anodized power steering pulley installed



**With AC  
With Power Steering**  
**BLK14220**



**With AC  
Without Power Steering**  
**BLK14120**

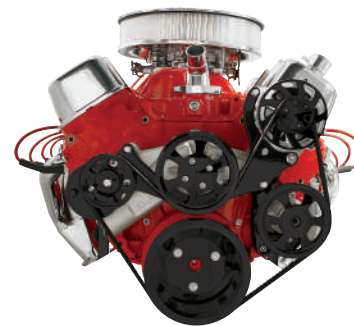

**Without AC  
With Power Steering**  
**BLK14225**

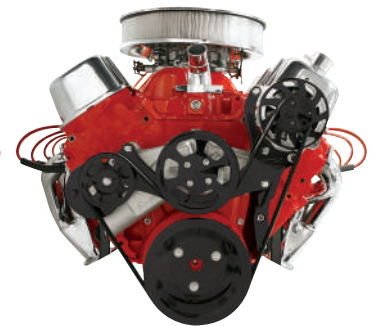

**Without AC  
Without Power Steering**  
**BLK14125**

# CHEVROLET® 348/409

BilletSpecialties

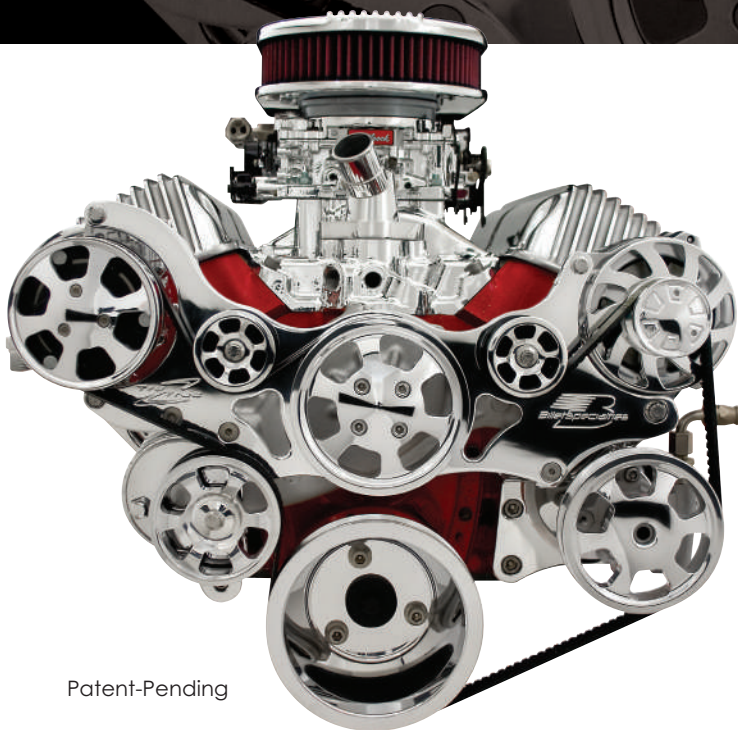

Patent-Pending

### All Kits Feature:

- Exclusive Billet aluminum tensioner
- Polished ARP 12-point stainless steel fasteners
- Hard-coat anodizing for durability in high-wear areas
- Continental Elite serpentine belt
- Comprehensive instruction manual

\*Tru Trac systems are not designed for use with hydroboost brake systems\*

## A LEGEND GETS A FACELIFT

It was feared on the drag strips and boulevards across America. Its monster torque punished the asphalt. It was the first production big block. It was immortalized in a song, and in only seven years of production the 348/409 became a legend. Take your legend to the next level with a Tru Trac kit featuring modern true serpentine performance, compact profile and timeless style.

Featuring the best brands in aftermarket performance:



NOW 170 amp!



## DIMENSIONS - 348/409 CHEVY™

To Front Face Of	From Block Face
AC Compressor Cover	7.625"
Alternator Pulley	6.750"
Water Pump Pulley	7.125"
Power Steering Pulley	6.625"
Crankshaft Pulley	6.500"

- A: 11.25"
- B: 11.75"
- C: 6.25"
- D: 7.125"
- E: 11.125"

\* Check Clearances Before Ordering \*

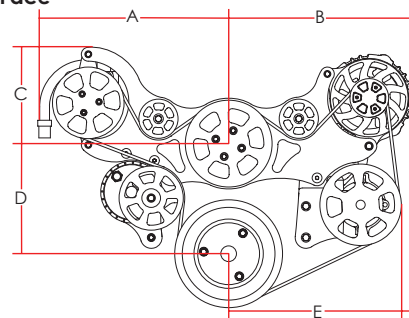

Note: Some 348 blocks do not have the lower bosses threaded and may require modification. Please check your engine block before ordering.

## STANDARD POLISHED KITS

Standard polished 348/409 Chevrolet® Tru Trac includes the following:

- Polished aluminum pulleys & brackets
- Polished billet tensioner (Tru Trac exclusive)
- Polished 170 amp Powermaster 1-wire alternator
- Natural finish Edelbrock reverse rotation water pump

### Kits with AC Include:

- Polished Sanden SD-7 compressor
- Polished AC clutch cover
- Patented polished Billet compressor manifold

### Kits with power steering include:

- Natural finish power steering pump with AN nipples
- Polished power steering pulley installed

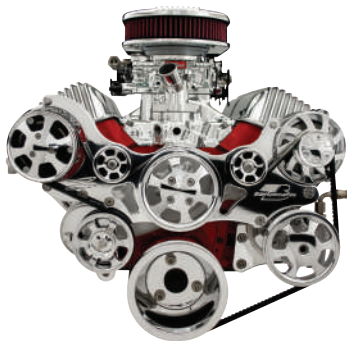

With AC  
With Power Steering  
14400



With AC  
Without Power Steering  
14420



Without AC  
With Power Steering  
14405



Without AC  
Without Power Steering  
14425



# PREMIUM POLISHED KITS



Premium 348/409 Chevrolet® Tru Trac includes the following:

- Polished aluminum pulleys & brackets
- Polished billet tensioner (Tru Trac exclusive)
- Polished 170 amp Powermaster 1-wire alternator or polished Billet machined case 170 amp alternator
- EnduraShine™ Edelbrock standard rotation water pump

**Kits with AC include:**

- Polished Sanden SD-7 compressor
- Polished AC clutch cover
- Patented polished Billet compressor manifold

**Kits with power steering include:**

- Polished finish power steering pump with AN nipples
- Polished power steering pulley installed



**With AC  
With Power Steering**

Includes EnduraShine™ Water Pump & Polished P/S Pump

**14400WP**

Includes EnduraShine™ Water Pump & Polished P/S Pump  
Polished 170 amp Billet Alternator

**14400WPA**



**With AC  
Without Power Steering**

Includes EnduraShine™ Water Pump

**14420W**

Includes EnduraShine™ Water Pump & Polished 170 amp Billet Alternator

**14420WA**



**Without AC  
With Power Steering**

Includes EnduraShine™ Water Pump & Polished P/S Pump

**14405WP**

Includes EnduraShine™ Water Pump, Polished P/S Pump & Polished 170 amp Billet Alternator

**14405WPA**



**Without AC  
Without Power Steering**

Includes EnduraShine™ Water Pump

**14425W**

Includes EnduraShine™ Water Pump & Polished 170 amp Billet Alternator

**14425WA**

# PREMIUM BLACK ANODIZED KITS

Includes EnduraShine™ Water Pump & Polished P/S Pump  
**BLK14400WP**

Includes EnduraShine™ Water Pump, Polished P/S Pump, & Polished 170 amp Billet Alternator  
**BLK14400WPA**

*\* Includes all the upgrades from the premium kits above, with black anodized pulleys, brackets, and tensioner\**

# BLACK ANODIZED KITS

Black anodized 348/409 Chevrolet® Tru Trac includes the following:

- Black anodized aluminum pulleys & brackets
- Black anodized billet tensioner (Tru Trac exclusive)
- Polished 170 amp Powermaster 1-wire alternator
- Natural finish Edelbrock standard rotation water pump

**Kits with AC include:**

- Polished Sanden SD-7 compressor
- Black anodized AC clutch cover
- Patented black anodized Billet compressor manifold

**Kits with power steering include:**

- Natural finish power steering pump with AN nipples
- Black anodized power steering pulley installed



**With AC  
With Power Steering**  
**BLK14400**



**With AC  
Without Power Steering**  
**BLK14420**



**Without AC  
With Power Steering**  
**BLK14405**



**Without AC  
Without Power Steering**  
**BLK14425**

# CHEVROLET® LT4 TRU TRAC



"The front drive for our custom engine builds is a key feature; we choose Billet Specialties for their unmatched form and function in creating the perfect platform for style and performance."

-Don Hardy

## DURABILITY

Separate Supercharger and accessory drive belts prolong accessory bearing life; over tension on the accessories will cause premature failure of their bearings. Pulleys that are in contact with the back of the belt are subject to high wear. Billet Specialties hard coat anodizes these areas to eliminate wear altogether. Alternator pulley diameter is optimized for proper amperage at idle.

## OEM TENSIONERS

The LT4 Tru Trac utilizes OEM Supercharger and accessory drive tensioners for constant and correct tension like GM engineered it; ensuring no slip of the supercharger belt or over tension on the accessory bearings. Ease of replacement is another benefit.

## BILLET A/C MANIFOLD

Kits with AC include our Billet aluminum AC manifold, engineered not only to provide an efficient attachment point for the AC hoses, but to look good as well.

## DYNO TEST

The LT4 Tru Trac is Dyno Tested ensuring proper operation at all RPM's for worry free operation.

## FASTENERS

Tru Trac kits are assembled with 18-8 stainless steel fasteners, offering not only corrosion resistance, but professional appearance and high tensile strength. ARP 12pt. fasteners also match many other Billet Specialties accessories.

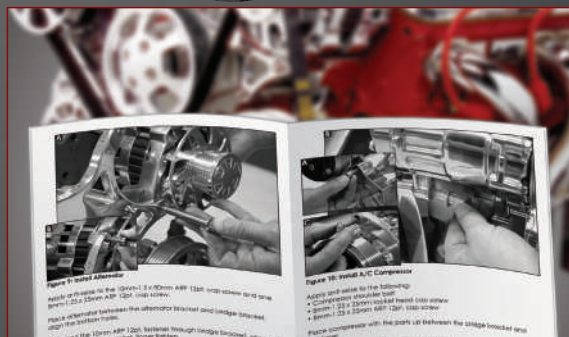

## EASE OF INSTALLATION

With our comprehensive instruction booklet and pre-installed alternator and power steering pulleys, installing a Tru Trac is easy. See for yourself, visit Billetspecialties, select the Tru Trac for your application and download a copy of the instructions



# CHEVROLET® LT4 TRU TRAC

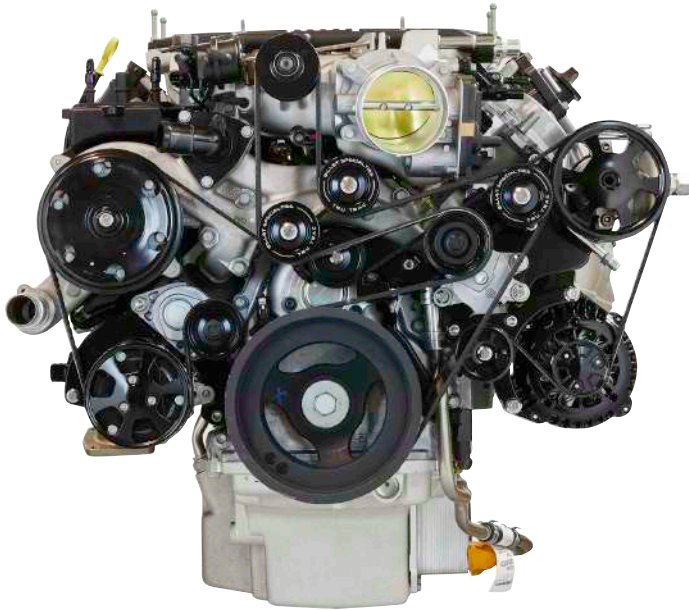

Patent-Pending

**\*Tru Trac systems are not designed for use with hydroboost brake systems\***



## HIGH TECH. HIGH PERFORMANCE.

Billet Specialties new LT4 Tru Trac is the perfect accessory upgrade for GM's supercharged high-tech horsepower. Known for our style, fit and finishes – the new LT4 Tru Trac features precision machined brackets and pulleys giving you perfect alignment with optimal belt wrap. Billet specialties has worked with the nation's top chassis manufacturers to verify compatibility and fit. Adding hydraulic power steering is just one of the many advantages of the new LT4 Tru Trac. With Billet Specialties' 15 years of experience manufacturing front drive systems and partnering with the best brands in automotive aftermarket components delivers you a product offering reliable, worry-free miles.

Featuring the best brands in aftermarket performance:



### Features:

- Hard coat anodizing for durability in high belt wear areas
- Precision machined black anodized pulleys, brackets and covers
- Stainless steel hardware used throughout for corrosion resistance
- Compressor manifold included
- Power steering hardline included
- Retains the factory supercharger tensioner
- Pre-installed power steering and alternator pulleys
- 15 years of accessory drive experience used by the nation's top builders.

## BLACK ANODIZED KIT

Black anodized Chevrolet® LT4 Tru Trac includes the following:

- Powermaster 170 amp one-wire alternator
- Genuine Sanden SD7 AC compressor
- Tuff Stuff power steering pump
- ARP fasteners
- Continental Poly-V serpentine belts



With AC  
With Power Steering  
BLK13500

## DIMENSIONS - LT4

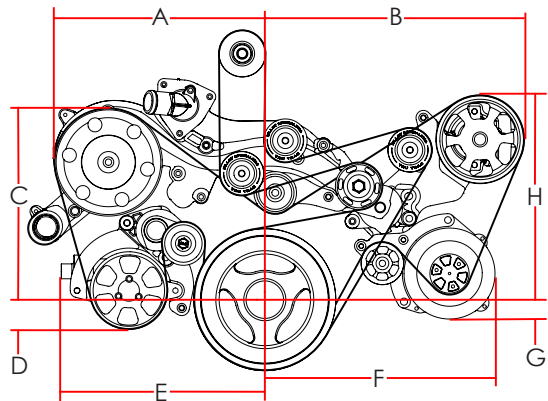

To Front Face Of	From Block Face
AC Compressor Cover	5.434"
Alternator Pulley	4.721"
Water Pump Pulley	5.507"
Power Steering Pulley	4.537"
Crankshaft Pulley	6.209"
Supercharger Pulley	6.968"

A: 12.010"	D: 13.535"
B: 14.997"	E: 11.960"
C: 12.09"	F: .944"

\* Check Clearances Before Ordering \*

# CHEVROLET® TRU TRAC KITS

LS 1, 2, 3, 6, 7

**LSA COMING SOON!**

## BILLET A/C MANIFOLD

Kits with AC include our Billet aluminum AC manifold, engineered not only to provide an efficient attachment point for the AC hoses, but to look good as well. In fact, so good and efficient we patented it!

## DURABILITY

Pulleys that are in contact with the back of the belt are subject to high wear. Billet Specialties hard coat anodizes these areas to eliminate wear altogether. Hard coat anodized aluminum actually provides a harder surface than stock steel pulleys!

## BILLET TENSIONER

Our Billet aluminum tensioner optimizes belt and accessory life with constant and correct tension; eliminating belt-slip while minimizing parasitic horsepower loss. Every modern car has a tensioner—so should your classic.

## STAINLESS STANDOFFS

Our stainless stand-offs provide the most rigid platform in the industry, while maintaining perfect alignment between the accessories. Machined from 303 stainless steel to provide corrosion resistance and double the surface area while adding ease of assembly.

## FASTENERS

Tru Trac Kits are assembled with 18-8 stainless steel fasteners, offering not only corrosion resistance, but professional appearance and high tensile strength. ARP 12pt. fasteners also match many other Billet Specialties accessories.

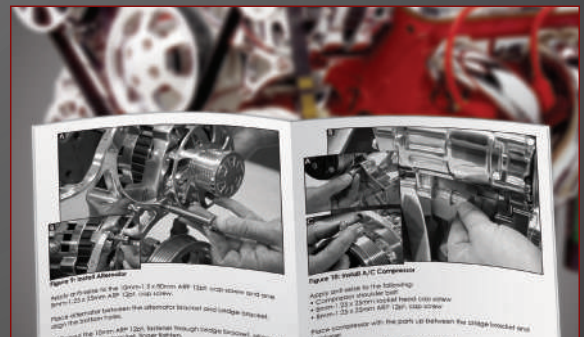
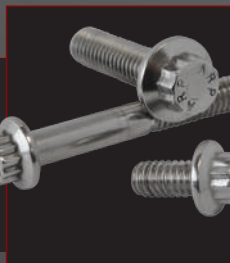
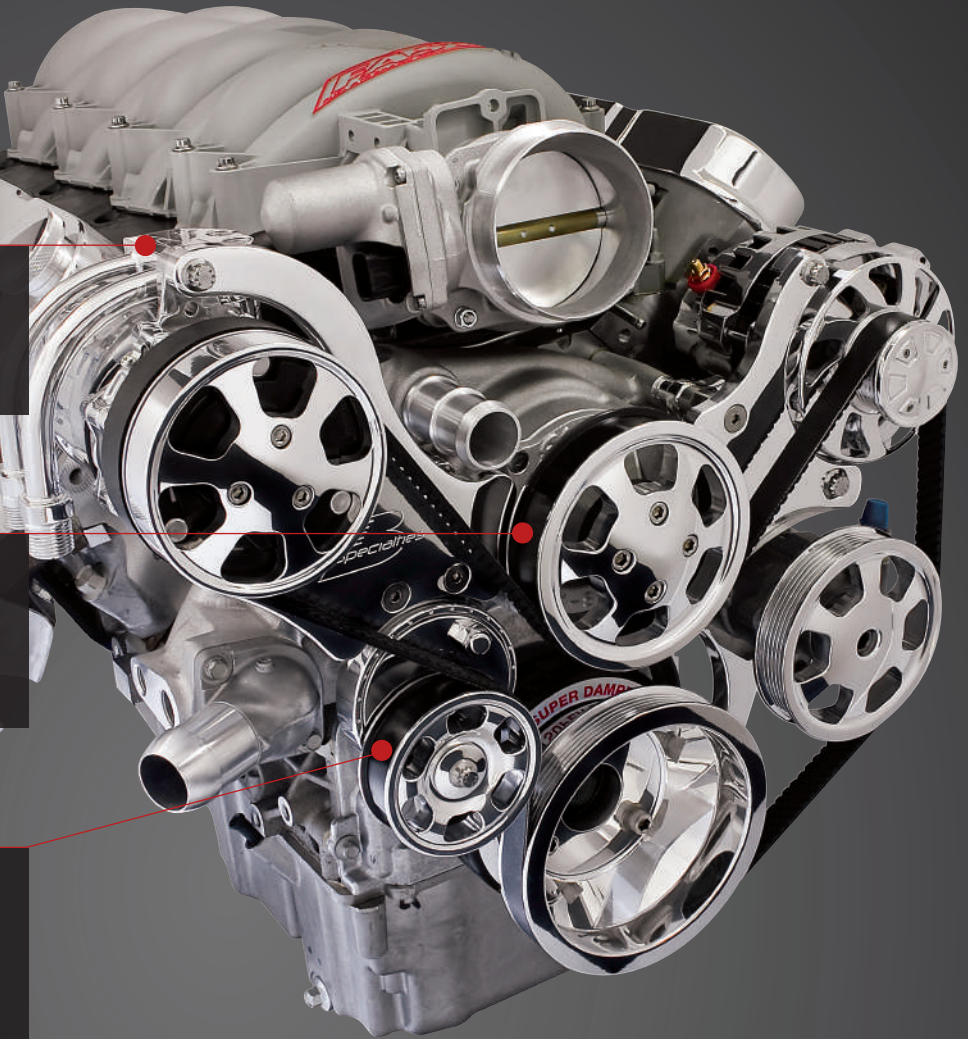

## EASE OF INSTALLATION

With our comprehensive instruction booklet and pre-installed alternator and power steering pulleys, installing a Tru Trac is easy. See for yourself, visit Billetspecialties, select the Tru Trac for your application and download a copy of the instructions



## THE BEST BRANDS INCLUDED!



Designed and cast in the USA, Edelbrock water pumps provide maximum flow, maximum pressure and equal distribution to both sides of the block within 1%. Featuring Edelbrock's industry leading precision powered metal impeller with modern vane design that is larger than other high-performance pumps along with the precision machined computer designed A-356 Cast pump housing.

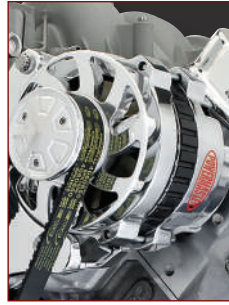

Billet Specialties supplies a new 170 amp Powermaster alternator in every Tru Trac kit. Each Powermaster alternator is 100% new. With a high amp output at idle, internally regulated architecture and internal fan with a gold plated battery post. Each 170 amp alternator is pre-tested and includes a proof of performance tag showing output at idle and at highway speeds. Best of all, Powermaster alternators are made right here in the USA.



Sanden manufactures and supplies compressors for some of the largest automotive manufacturers in the world. The SD-7 is a high efficiency modern compact compressor ensuring better performance and aesthetics over early 508 compressors while keeping you cool and comfortable.

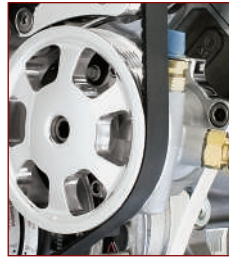

Kits with power steering feature modern TC style pumps, used by OEM manufacturers and various applications from NASCAR, Off Road and Road Racing. We supply the pumps with -10AN supply and -6AN pressure nipples installed. Featuring a sealed front bearing and precision internals, each high performance pump is calibrated to 1200 PSI and flows at 3.5 GPM.



LS kits include an ATI Super Damper, ATI has been manufacturing quality products for over 50 years and can be found on race winning vehicles worldwide and on GM performance crate motors. The ATI damper exceeds SFI 18.1 specs while eliminating torsional crankshaft vibrations.

## STANDARD POLISHED AND BLACK ANODIZED KITS INCLUDE:

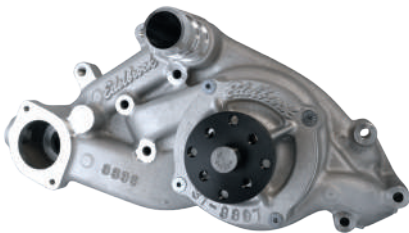

### Natural Finish Water Pump

The traditional look of performance for decades, the natural cast look easily matches your cast intake manifold and power steering pump.



### Polished 170 amp Alternator

Powermaster USA made quality, precision cast and polished case with the best internal components in the industry.



### Natural Finish Power Steering Pump

Matches the natural finish Edelbrock water pump and we pre-install the pulley for ease of installation.

## PREMIUM POLISHED KITS INCLUDES:

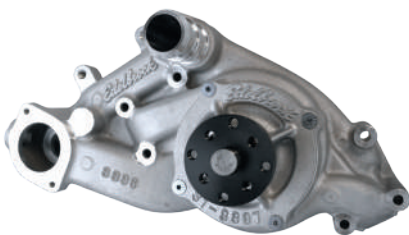

### Natural Finish Water Pump

The traditional look of performance for decades, the natural cast look easily matches your cast intake manifold and power steering pump.

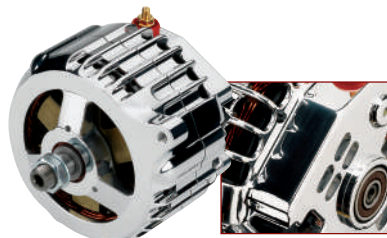

### Optional Billet Aluminum 170 amp Alternator

Truly the crown jewel of the Premium kit. The precision machined 6061-T6 Billet case makes this the ultimate alternator.



### Polished Power Steering Pump

Show quality polish and pre-installed pulley for ease of installation.

# CHEVROLET® LS1, 2, 3, 6, LSX

## LSA COMING SOON!

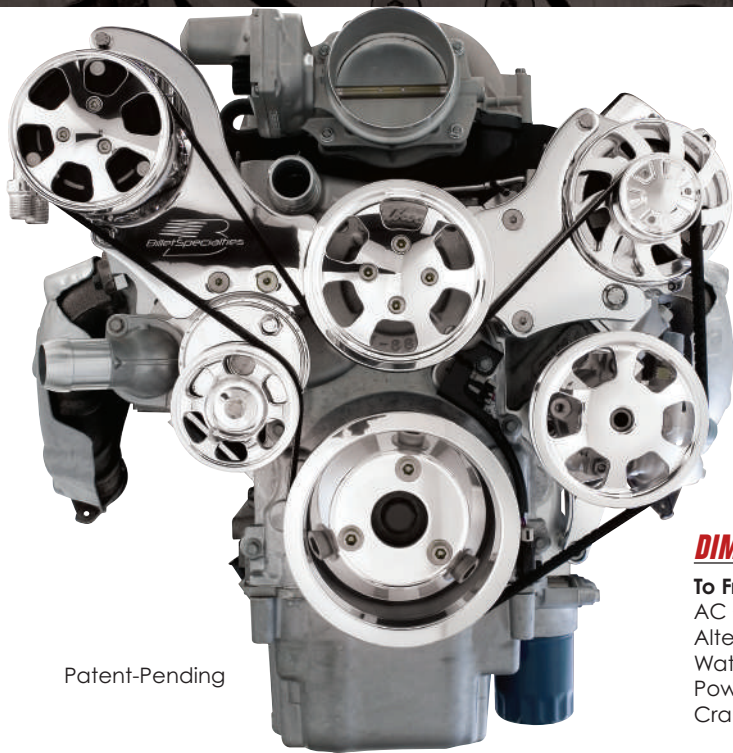

Patent-Pending

### All Kits Feature:

- Exclusive Billet aluminum tensioner
- Polished ARP 12-point stainless steel fasteners
- Hard-coat anodizing for durability in high-wear areas
- Continental Elite serpentine belt
- Comprehensive instruction manual

\*Tru Trac systems are not designed for use with hydroboost brake systems\*

### HIGH TECH. HIGH PERFORMANCE.

The LS platform has become the go-to engine for Chevy enthusiasts and keeping pace is Billet Specialties Top Mount LS Tru Trac. Engineered to clear cross members and steering boxes of muscle cars all the while keeping a slim profile, the LS top mount kit includes all the essentials for a complete engine accessory drive. The Tru Trac's exclusive Billet aluminum tensioner keeps constant even tension allowing the 170 amp alternator and Edelbrock water pump to run at full potential without fear of belt slippage.

Featuring the best brands in aftermarket performance:



### DIMENSIONS - TOP MOUNT LS CHEVY™

To Front Face Of	From Block Face
AC Compressor Cover	7.625"
Alternator Pulley	6.750"
Water Pump Pulley	7.000"
Power Steering Pulley	6.625"
Crankshaft Pulley	6.500"

A: 12.00"	D: 9.125"
B: 10.50"	E: 5.00"
C: 7.75"	

- \* Will not work with VVT engines \*
- \* Check Clearances Before Ordering \*

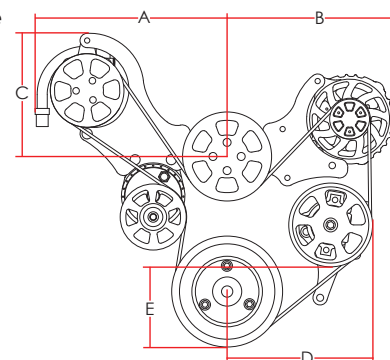

## STANDARD POLISHED KITS

Standard polished Top Mount LS1, 2, 3, 6, LSX Chevrolet® Tru Trac includes the following:

- Polished aluminum pulleys & brackets
- Polished billet tensioner (Tru Trac exclusive)
- Polished 170 amp Powermaster 1-wire alternator
- Natural finish Edelbrock reverse rotation water pump

### Kits with AC Include:

- Polished Sanden SD-7 compressor
- Polished AC clutch cover
- Patented polished Billet compressor manifold

### Kits with power steering include:

- Natural finish power steering pump with AN nipples
- Polished power steering pulley installed



With AC  
With Power Steering  
13450



With AC  
Without Power Steering  
13470



Without AC  
With Power Steering  
13455

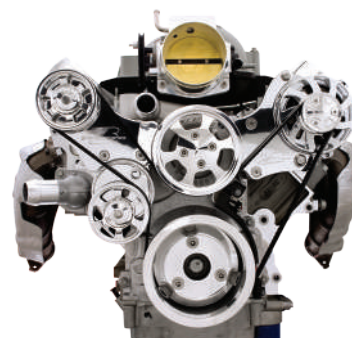

Without AC  
Without Power Steering  
13475



# PREMIUM POLISHED KITS



Premium Top Mount LS1, 2, 3, 6, LSX Chevrolet® Tru Trac includes the following:

- Polished aluminum pulleys & brackets
- Polished billet tensioner (Tru Trac exclusive)
- Polished 170 amp Powermaster 1-wire alternator or polished Billet machined case 170 amp alternator
- Natural finish Edelbrock reverse rotation water pump

**Kits with AC include:**

- Polished Sanden SD-7 compressor
- Polished AC clutch cover
- Patented polished Billet compressor manifold

**Kits with power steering include:**

- Polished finish power steering pump with AN nipples
- Polished power steering pulley installed



**With AC  
With Power Steering**

Includes Polished P/S Pump

**13450P**

Includes Polished P/S Pump & Polished 170 amp Billet Alternator

**13450PA**



**With AC  
Without Power Steering**

Includes Polished 170 amp Billet Alternator

**13470A**



**Without AC  
With Power Steering**

Includes Polished P/S Pump

**13455P**

Includes Polished P/S Pump & Polished 170 amp Billet Alternator

**13455PA**

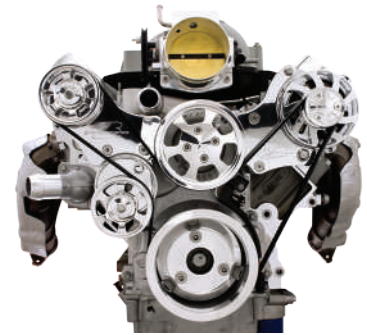

**Without AC  
Without Power Steering**

Includes Polished 170 amp Billet Alternator

**13475A**

# PREMIUM BLACK ANODIZED KITS

Includes Polished P/S Pump

**BLK13450P**

Includes Polished P/S Pump & Polished 170 amp Billet Alternator

**BLK13450PA**

*\* Includes all the upgrades from the premium kits above, with black anodized pulleys, brackets, and tensioner\**



## NEW BLACK ANODIZED KIT – NATURAL FINISH ACCESSORIES

Looking for an OEM style, un-polished look with all the performance a Tru Trac can offer? Billet Specialties now offers the LS Tru Trac with a natural finish accessories.

**Natural Finish LS1, 2, 3, 6 LSX Chevrolet® Tru Trac includes the following:**

- Black anodized aluminum pulleys & brackets
- Black anodized BILLET TENSIONER (Tru Trac exclusive)
- Natural finish 170 amp Powermaster 1-wire alternator
- Natural finish Edelbrock reverse rotation water pump
- Natural finish Sanden SD-7 compressor
- Black anodized AC clutch cover
- Patented black anodized Billet compressor manifold
- Natural finish power steering pump
- Black anodized power steering pulley installed

**BLK13450NA**

# BLACK ANODIZED KITS

Black anodized Top Mount LS1, 2, 3, 6, LSX Chevrolet® Tru Trac includes the following:

- Black anodized aluminum pulleys & brackets
- Black anodized billet tensioner (Tru Trac exclusive)
- Polished 170 amp Powermaster 1-wire alternator
- Natural finish Edelbrock reverse rotation water pump

**Kits with AC include:**

- Polished Sanden SD-7 compressor
- Black anodized AC clutch cover
- Patented black anodized Billet compressor manifold

**Kits with power steering include:**

- Natural finish power steering pump with AN nipples
- Black anodized power steering pulley installed



**With AC  
With Power Steering**

**BLK13450**

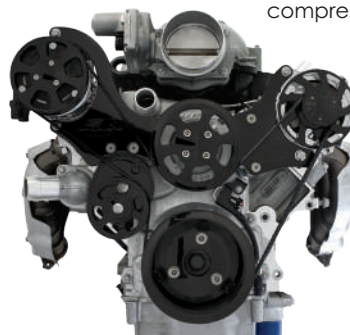

**With AC  
Without Power Steering**

**BLK13470**

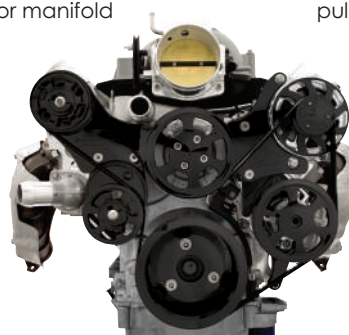

**Without AC  
With Power Steering**

**BLK13455**



**Without AC  
Without Power Steering**

**BLK13475**



# CHEVROLET® LS7

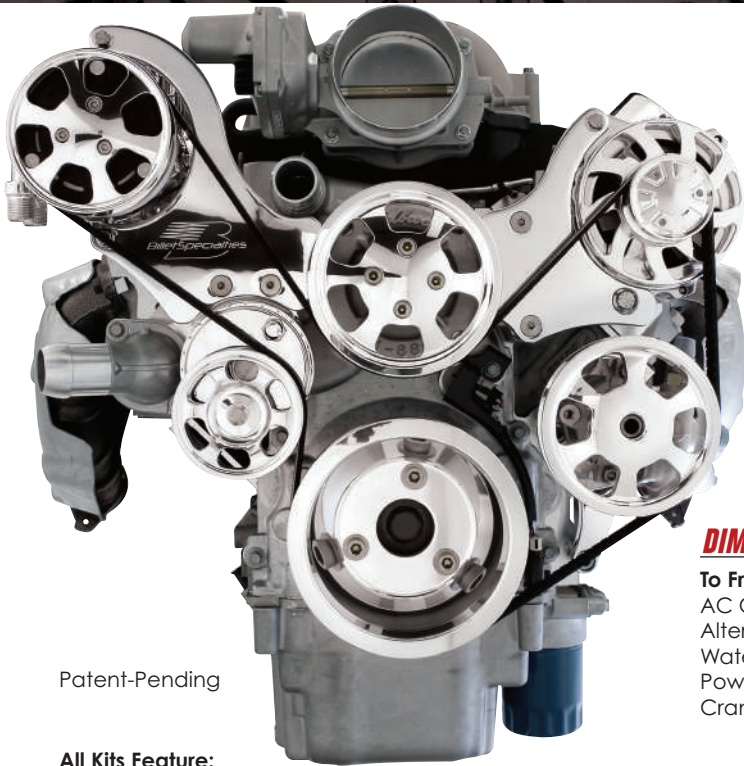

Patent-Pending

### All Kits Feature:

- Exclusive Billet aluminum tensioner
- Polished ARP 12-point stainless steel fasteners
- Hard-coat anodizing for durability in high-wear areas
- Continental Elite serpentine belt
- Comprehensive instruction manual

\*Tru Trac systems are not designed for use with hydroboost brake systems\*

## BIG ON STYLE. BIG ON PERFORMANCE.

The LS platform is becoming the go-to engine for Chevy enthusiasts and keeping pace is Billet Specialties Top mount LS Tru Trac. Engineered to clear cross members and steering boxes of muscle cars all the while keeping a slim profile, the LS top mount kit includes all the essentials for a complete engine accessory drive. The Tru Trac's exclusive Billet aluminum tensioner keeps constant even tension allowing the 170 amp alternator and Edelbrock water pump to run at full potential without fear of belt slip.

Featuring the best brands in aftermarket performance:



## DIMENSIONS - TOP MOUNT LS CHEVY™

To Front Face Of	From Block Face
AC Compressor Cover	7.625"
Alternator Pulley	6.750"
Water Pump Pulley	7.000"
Power Steering Pulley	6.625"
Crankshaft Pulley	6.500"

A: 12.00"	D: 9.125"
B: 10.50"	E: 5.00"
C: 7.75"	

- \* Will not work with VVT engines \*
- \* Check Clearances Before Ordering \*

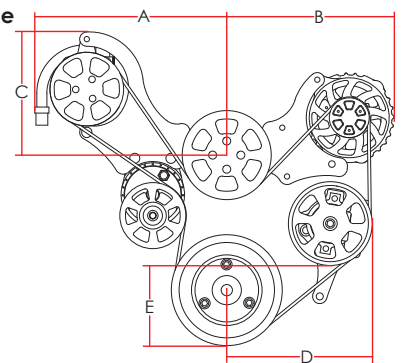

Engineered to work with LS 7 Motors that have a dry sump system & 2 stage oil pumps.

## STANDARD POLISHED KITS

Standard polished Top Mount LS7 Chevrolet® Tru Trac includes the following:

- Polished aluminum pulleys & brackets
- Polished billet tensioner (Tru Trac exclusive)
- Polished 170 amp Powermaster 1-wire alternator
- Natural finish Edelbrock reverse rotation water pump

### Kits with AC Include:

- Polished Sanden SD-7 compressor
- Polished AC clutch cover
- Patented polished Billet compressor manifold

### Kits with power steering include:

- Natural finish power steering pump with AN nipples
- Polished power steering pulley installed



With AC  
With Power Steering  
13460



With AC  
Without Power Steering  
13490



Without AC  
With Power Steering  
13465

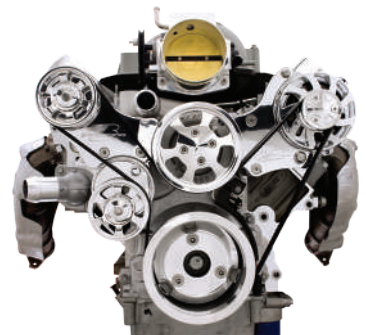

Without AC  
Without Power Steering  
13495



# PREMIUM POLISHED KITS



Premium Top Mount LS7 Chevrolet® Tru Trac includes the following:

- Polished aluminum pulleys & brackets
- Polished billet tensioner (Tru Trac exclusive)
- Polished 170 amp Powermaster 1-wire alternator or polished Billet machined case 170 amp alternator
- Natural finish Edelbrock reverse rotation water pump

**Kits with AC include:**

- Polished Sanden SD-7 compressor
- Polished AC clutch cover
- Patented polished Billet compressor manifold

**Kits with power steering include:**

- Polished finish power steering pump with AN nipples
- Polished power steering pulley installed



**With AC  
With Power Steering**

Includes Polished P/S Pump

**13460P**

Includes Polished P/S Pump & Polished 170 amp Billet Alternator  
**13460PA**



**With AC  
Without Power Steering**

Includes Polished 170 amp Billet Alternator

**13490A**



**Without AC  
With Power Steering**

Includes Polished P/S Pump

**13465P**

Includes Polished P/S Pump Polished 170 amp Billet Alternator  
**13465PA**



**Without AC  
Without Power Steering**

Includes Polished 170 amp Billet Alternator

**13495A**

# PREMIUM BLACK ANODIZED KITS

With Polished P/S Pump

**BLK13460P**

With Polished P/S Pump & Polished 170 amp Billet Alternator

**BLK13460PA**

*\* Includes all the upgrades from the premium kits above, with black anodized pulleys, brackets, and tensioner\**

# BLACK ANODIZED KITS

Black anodized Top Mount LS7 Chevrolet® Tru Trac includes the following:

- Black anodized aluminum pulleys & brackets
- Black anodized billet tensioner (Tru Trac exclusive)
- Polished 170 amp Powermaster 1-wire alternator
- Natural finish Edelbrock reverse rotation water pump

**Kits with AC include:**

- Polished Sanden SD-7 compressor
- Black anodized AC clutch cover
- Patented black anodized Billet compressor manifold

**Kits with power steering include:**

- Natural finish power steering pump with AN nipples
- Black anodized power steering pulley installed

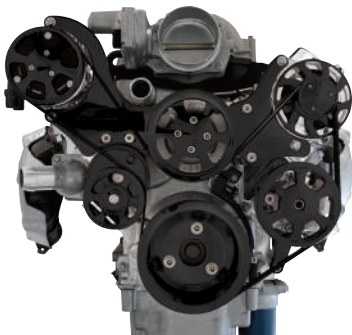

**With AC  
With Power Steering**

**BLK13460**



**With AC  
Without Power Steering**

**BLK13490**

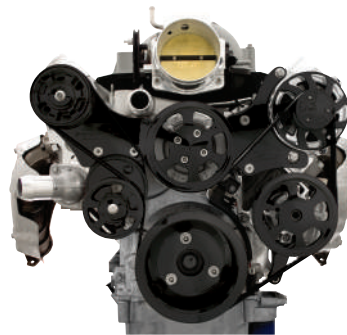

**Without AC  
With Power Steering**

**BLK13465**



**Without AC  
Without Power Steering**

**BLK13495**

# FORD TRU TRAC

**SMALL BLOCK, BIG BLOCK, FE**

**ROUSH** -ROUSH  
"We were truly impressed with the performance and reliability of the Tru Trac on the dyno. This is the only way to go for a front accessory drive system"

## **BILLET A/C MANIFOLD**

Kits with AC include our Billet aluminum AC manifold, engineered not only to provide an efficient attachment point for the AC hoses, but to look good as well. In fact, so good and efficient we patented it!

## **DURABILITY**

Pulleys that are in contact with the back of the belt are subject to high wear. Billet Specialties hard coat anodizes these areas to eliminate wear altogether. Hard coat anodized aluminum actually provides a harder surface than stock steel pulleys!

## **BILLET TENSIONER**

Our Billet aluminum tensioner optimizes belt and accessory life with constant and correct tension; eliminating belt-slip while minimizing parasitic horsepower loss. Every modern car has a tensioner—so should your classic.

## **STAINLESS STANDOFFS**

Our stainless stand-offs provide the most rigid platform in the industry, while maintaining perfect alignment between the accessories. Machined from 303 stainless steel to provide corrosion resistance and double the surface area while adding ease of assembly.

## **FASTENERS**

Tru Trac kits are assembled with 18-8 stainless steel fasteners, offering not only corrosion resistance, but professional appearance and high tensile strength. ARP 12pt. fasteners also match many other Billet Specialties accessories.

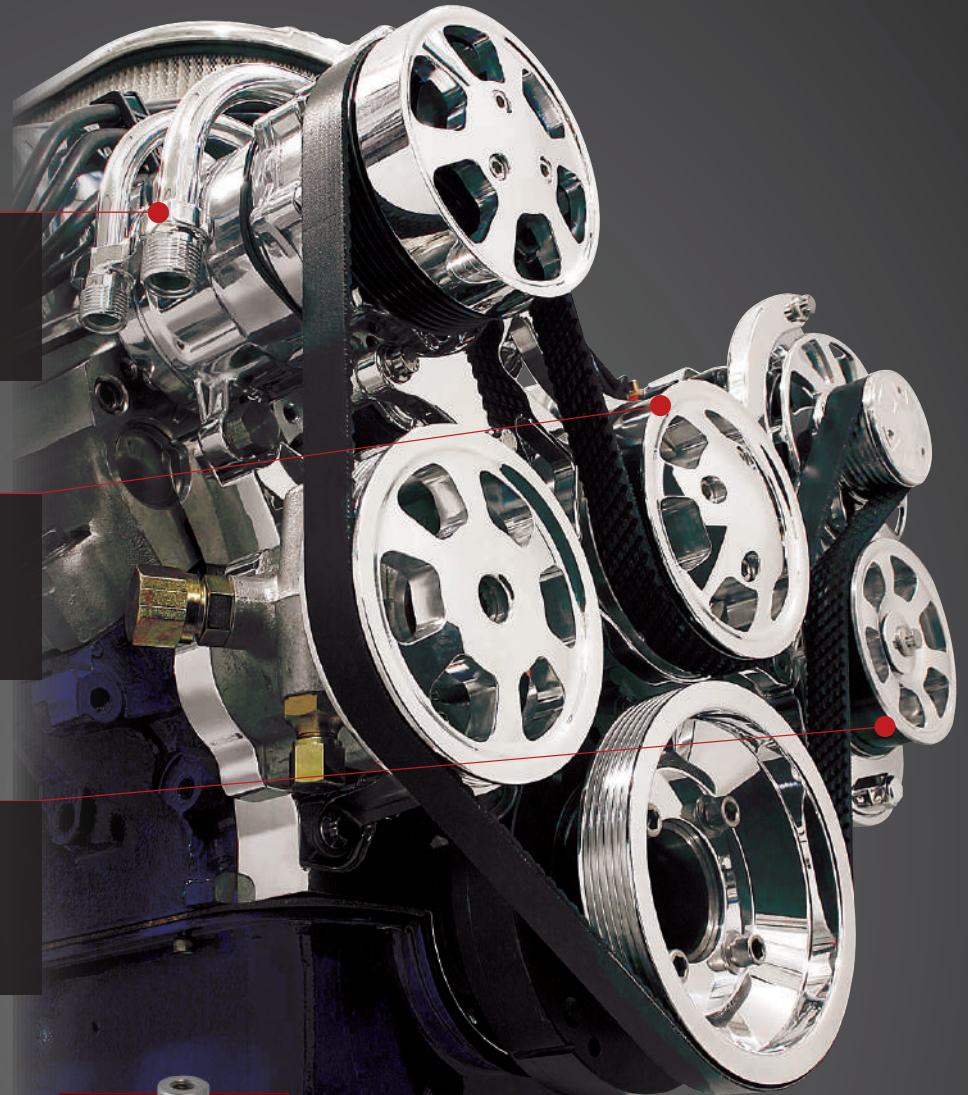

## **BILLET TIMING COVER**

True innovation. Our Small Block and Big Block kits feature our exclusive 100% Billet aluminum timing cover. This machining marvel supports the components for rock-solid stability while bringing them closer to the block for overall engine clearance.



## THE BEST BRANDS INCLUDED!



The quality water pump included in the small block kits provides superior cooling so your car's operating temperature stays constant.



Edelbrock water pumps provide maximum cooling, utilizing state of the art racing technology. Edelbrock water pumps ensure greater cooling efficiency and reliability for your Big Block 429/460 or FE Tru Trac kit.

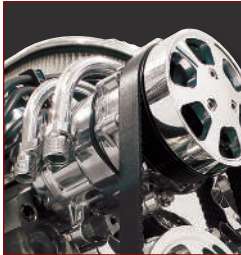

Sanden manufactures and supplies compressors for some of the largest automotive manufacturers in the world. The SD-7 is a high efficiency modern compact compressor ensuring better performance and aesthetics over early 508 compressors while keeping you cool and comfortable.

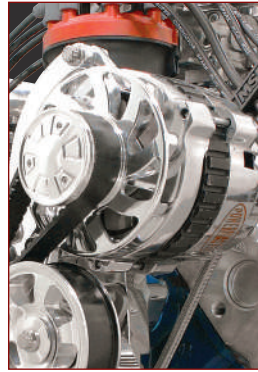

Billet Specialties supplies a new 170 amp Powermaster alternator in every Tru Trac kit. Each Powermaster alternator is 100% new. With a high amp output at idle, internally regulated architecture and internal fan with a gold plated battery post. Each 170 amp alternator is pre-tested and includes a proof of performance tag showing output at idle and at highway speeds. Best of all, Powermaster alternators are made right here in the USA.



Kits with power steering feature modern TC style pumps, used by OEM manufacturers and various applications from NASCAR, Off Road and Road Racing. We supply the pumps with -10AN supply and -6AN pressure nipples installed. Featuring a sealed front bearing and precision internals, each high performance pump is calibrated to 1200 PSI and flows at 3.5 GPM.

## STANDARD POLISHED AND BLACK ANODIZED KITS INCLUDE:

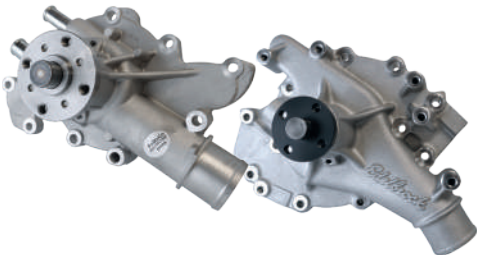

### Natural Finish Water Pump

The traditional look of performance for decades, the natural cast look easily matches your cast intake manifold and power steering pump.



### Polished 170 amp Alternator

Powermaster USA made quality, precision cast and polished case with the best internal components in the industry.



### Natural Finish Power Steering Pump

Matches the natural finish Edelbrock water pump and we pre-install the pulley for ease of installation.

## PREMIUM POLISHED KITS INCLUDE:

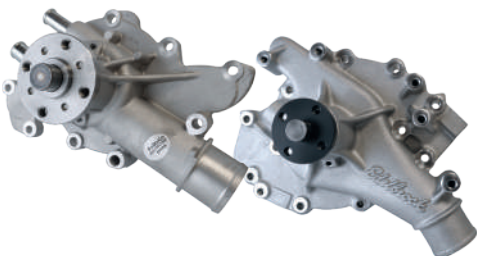

### Natural Finish Water Pump

The traditional look of performance for decades, the natural cast look easily matches your cast intake manifold and power steering pump.



### Optional Billet Aluminum 170 amp Alternator

Truly the crown jewel of the Premium kit. The precision machined 6061-T6 Billet case makes this the ultimate alternator.

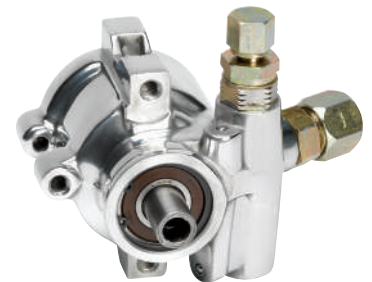

### Polished Power Steering Pump

Show quality polish and pre-installed pulley for ease of installation.

# FORD SMALL BLOCK

289/302/351W

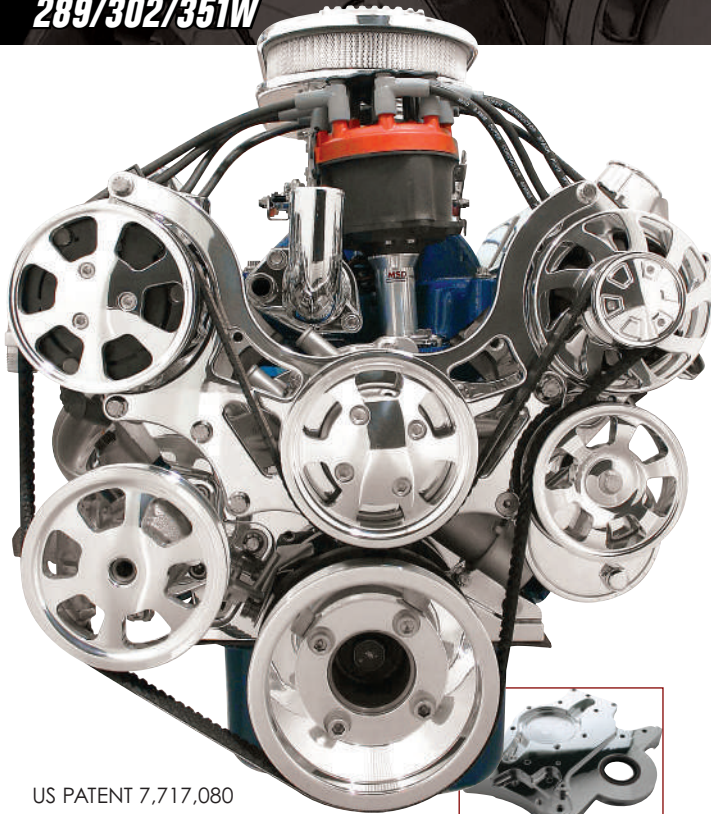

US PATENT 7,717,080

**All Kits Feature:**

- Exclusive Billet aluminum tensioner
- 100% Billet aluminum timing cover
- Polished ARP 12-point stainless steel fasteners
- Hard-coat anodizing for durability in high-wear areas
- Continental Elite serpentine belt
- Comprehensive instruction manual



Includes: Billet Timing Cover

## TRU TRAC: THE ULTIMATE SERPENTINE SYSTEM

Our exclusive design features a 100% precision machined Billet aluminum timing cover that supports all components. There is no need to tap into the block. The Tru Trac serpentine system fits 289, 302, and 351W motors.

The Tru Trac for small block Ford fits in the tightest engine bays. Perfect for muscle cars and street rods! The Tru Trac's OE styling gives your motor a clean, professional look.

Featuring the best brands in aftermarket performance:



NOW 170 amp!

## DIMENSIONS - SMALL BLOCK FORD

To Front Face Of	From Block Face
AC Compressor Cover	7.750"
Alternator Pulley	6.375"
Water Pump Pulley	7.375"
Power Steering Pulley	6.750"
Crankshaft Pulley	6.500"

- A: 9.250"
- B: 9.125"
- C: 6.625"
- D: 6.250"
- E: 7.875"

\* Check Clearances Before Ordering \*

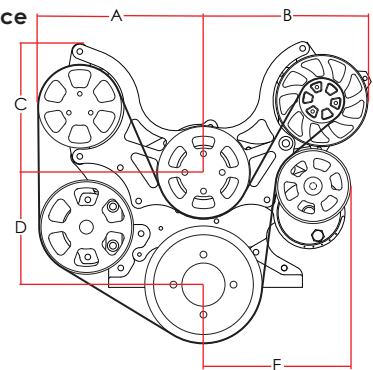

**IMPORTANT - THIS KIT REQUIRES:**  
4-Bolt - 6.4" Dia. crank damper and an electric fuel pump

## STANDARD POLISHED KITS

Standard polished 289/302/351W Ford Tru Trac includes the following:

- Polished aluminum pulleys & brackets
- Polished billet tensioner (Tru Trac exclusive)
- Polished 170 amp Powermaster 1-wire alternator
- Natural finish reverse rotation water pump

**Kits with AC Include:**

- Polished Sanden SD-7 compressor
- Polished AC clutch cover
- Patented polished Billet compressor manifold

**Kits with power steering include:**

- Natural finish power steering pump with AN nipples
- Polished power steering pulley installed



With AC  
With Power Steering  
13600



With AC  
Without Power Steering  
13620

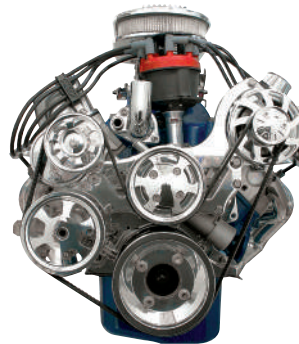

Without AC  
With Power Steering  
13605



Without AC  
Without Power Steering  
13625

Front Sump Oil Pan Dipstick - 40150

\* For use with front sump oil pans only - see page 38 for details, \*



# PREMIUM POLISHED KITS



Premium 289/302/351W Ford Tru Trac includes the following:

- Polished aluminum pulleys & brackets
- Polished billet tensioner (Tru Trac exclusive)
- Polished 170 amp Powermaster 1-wire alternator or polished Billet machined case 170 amp alternator
- Natural finish reverse rotation water pump

**Kits with AC include:**

- Polished Sanden SD-7 compressor
- Polished AC clutch cover
- Patented polished Billet compressor manifold

**Kits with power steering include:**

- Polished finish power steering pump with AN nipples
- Polished power steering pulley installed



**With AC  
With Power Steering**

Includes Polished P/S Pump

**13600P**

Includes Polished P/S Pump & Polished 170 amp Billet Alternator  
**13600PA**

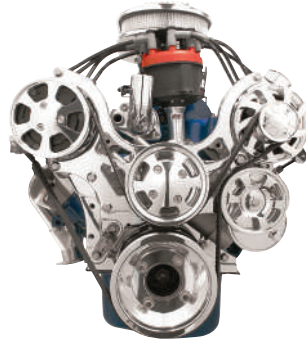

**With AC  
Without Power Steering**

Includes Polished 170 amp Billet Alternator

**13620A**



**Without AC  
With Power Steering**

Includes Polished P/S Pump

**13605P**

Includes Polished P/S Pump & Polished 170 amp Billet Alternator  
**13605PA**



**Without AC  
Without Power Steering**

Includes Polished 170 amp Billet Alternator

**13625A**

# PREMIUM BLACK ANODIZED KITS

Includes Polished P/S Pump

**BLK13600P**

Includes Polished P/S Pump & Polished 170 amp Billet Alternator

**BLK13600PA**

*\* Includes all the upgrades from the premium kits above, with black anodized pulleys, brackets, and tensioner\**

# BLACK ANODIZED KITS

Black anodized 289/302/351W Ford Tru Trac includes the following:

- Black anodized aluminum pulleys & brackets
- Black anodized billet tensioner (Tru Trac exclusive)
- Polished 170 amp Powermaster 1-wire alternator
- Natural finish reverse rotation water pump
- Black anodized timing cover

**Kits with AC include:**

- Polished Sanden SD-7 compressor
- Black anodized AC clutch cover
- Patented black anodized Billet compressor manifold

**Kits with power steering include:**

- Natural finish power steering pump with AN nipples
- Black anodized power steering pulley



**With AC  
With Power Steering  
BLK13600**



**With AC  
Without Power Steering  
BLK13620**



**Without AC  
With Power Steering  
BLK13605**



**Without AC  
Without Power Steering  
BLK13625**

# FORD BIG BLOCK

429/460



Patent-Pending

### All Kits Feature:

- Exclusive Billet aluminum tensioner
- 100% Billet aluminum timing cover
- Polished ARP 12-point stainless steel fasteners
- Hard-coat anodizing for durability in high-wear areas
- Continental Elite serpentine belt
- Comprehensive instruction manual

Includes: Billet Timing Cover

\*Tru Trac systems are not designed for use with hydroboost brake systems\*

## EVERYTHING YOU NEED IS RIGHT HERE

Superior design, performance and style. Based on the successful and proven small block design, Billet Specialties big block Ford Tru Trac serpentine system answers the call for performance and style in one compact package. True innovation is the key here, from our patented Billet aluminum timing cover and our exclusive Billet Tensioner specifically engineered for the system right down to the smallest details such as stainless hardware.

Featuring the best brands in aftermarket performance:



## DIMENSIONS - BIG BLOCK FORD

To Front Face Of	From Block Face
AC Compressor Cover	8.125"
Alternator Pulley	7.125"
Water Pump Pulley	8.250"
Power Steering Pulley	7.250"
Crankshaft Pulley	7.000"

A: 10.25"	D: 7.375"
B: 9.75"	E: 11.00"
C: 5.75"	

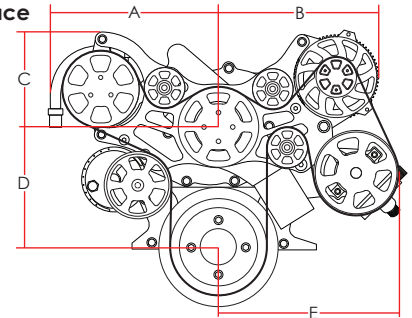

\* Check Clearances Before Ordering \*



### IMPORTANT - THIS KIT REQUIRES:

- Use of an electric fuel pump
- Oil pan with dipstick provision

## STANDARD POLISHED KITS

Standard polished 429/460 Ford Tru Trac includes the following:

- Polished aluminum pulleys & brackets
- Polished billet tensioner (Tru Trac exclusive)
- Polished 170 amp Powermaster 1-wire alternator
- Natural finish Edelbrock standard rotation water pump

### Kits with AC Include:

- Polished Sanden SD-7 compressor
- Polished AC clutch cover
- Patented polished Billet compressor manifold

### Kits with power steering include:

- Natural finish power steering pump with AN nipples
- Polished power steering pulley installed



With AC  
With Power Steering  
14600

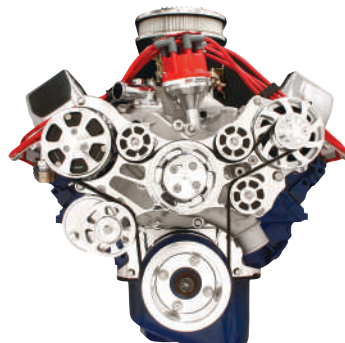

With AC  
Without Power Steering  
14620

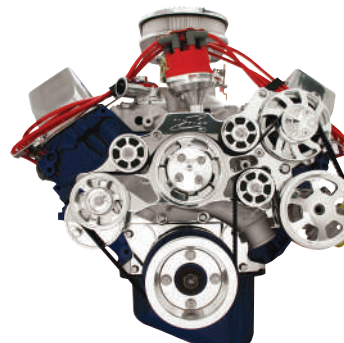

Without AC  
With Power Steering  
14605

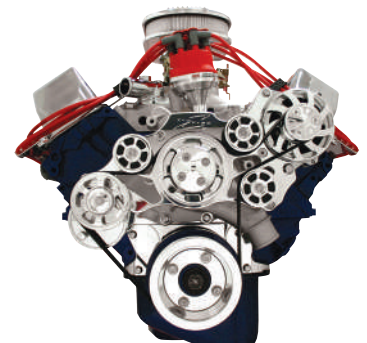

Without AC  
Without Power Steering  
14625

"Our cars are built to drive coast to coast. Take it from a long-time Ford guy..."

Billet Specialties Tru Trac Serpentine System for Ford is truly a work of art that PERFORMS!™

- ROY BRIZIO





## PREMIUM POLISHED KITS



Premium 429/460 Ford Tru Trac includes the following:

- Polished aluminum pulleys & brackets
- Polished billet tensioner (Tru Trac exclusive)
- Polished 170 amp Powermaster 1-wire alternator or polished Billet machined case 170 amp alternator
- Natural finish Edelbrock standard rotation water pump

**Kits with AC include:**

- Polished Sanden SD-7 compressor
- Polished AC clutch cover
- Patented polished Billet compressor manifold

**Kits with power steering include:**

- Polished finish power steering pump with AN nipples
- Polished power steering pulley installed



**With AC  
With Power Steering**

Includes Polished P/S Pump

**14600P**

Includes Polished P/S Pump  
Polished 170 amp  
Billet Alternator  
**14600PA**



**With AC  
Without Power Steering**

Includes Polished 170 amp  
Billet Alternator

**14620A**

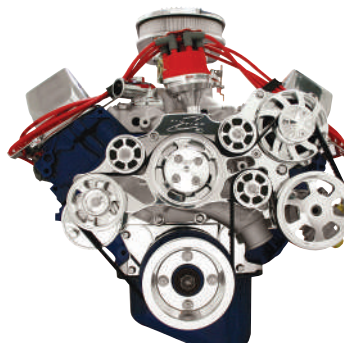

**Without AC  
With Power Steering**

Includes Polished P/S Pump

**14605P**

Includes Polished P/S Pump  
Polished 170 amp  
Billet Alternator  
**14605PA**

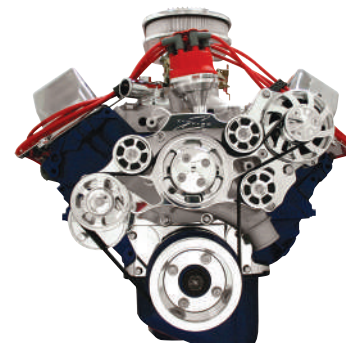

**Without AC  
Without Power Steering**

Includes Polished 170 amp  
Billet Alternator

**14625A**

## PREMIUM BLACK ANODIZED KITS

Includes Polished P/S Pump

**BLK14600P**

Includes Polished P/S Pump &  
Polished 170 amp Billet Alternator

**BLK14600PA**

*\* Includes all the upgrades from the premium kits above, with black anodized pulleys, brackets, and tensioner\**

## BLACK ANODIZED KITS

Black anodized 429/460 Ford Tru Trac includes the following:

- Black anodized aluminum pulleys & brackets
- Black anodized billet tensioner (Tru Trac exclusive)
- Polished 170 amp Powermaster 1-wire alternator
- Natural finish Edelbrock standard rotation water pump
- Black anodized timing cover

**Kits with AC include:**

- Polished Sanden SD-7 compressor
- Black anodized AC clutch cover
- Patented black anodized Billet compressor manifold

**Kits with power steering include:**

- Natural finish power steering pump with AN nipples
- Black anodized power steering pulley installed



**With AC  
With Power Steering**  
**BLK14600**



**With AC  
Without Power Steering**  
**BLK14620**

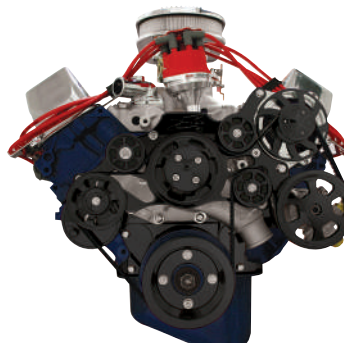

**Without AC  
With Power Steering**  
**BLK14605**

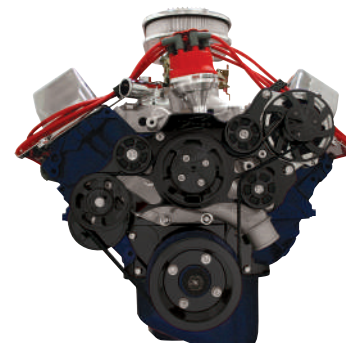

**Without AC  
Without Power Steering**  
**BLK14625**

# FORD FE

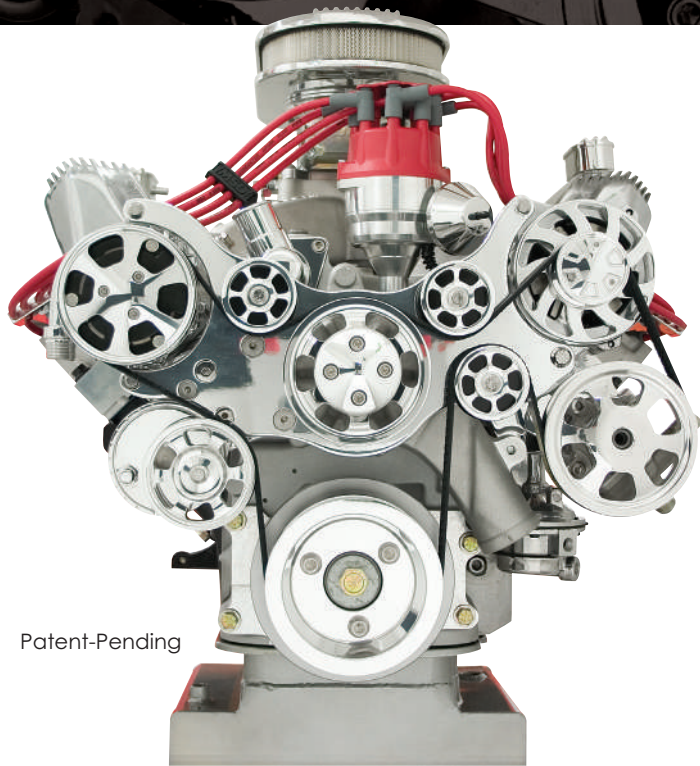

Patent-Pending

### All Kits Feature:

- Exclusive Billet aluminum tensioner
- Polished ARP 12-point stainless steel fasteners
- Hard-coat anodizing for durability in high-wear areas
- Continental Elite serpentine belt
- Comprehensive instruction manual

\*Tru Trac systems are not designed for use with hydroboost brake systems\*

## A LEGEND GETS A NEW LOOK

From LeMans to Daytona, the Ford FE has become a legend in the automotive world. Combining Billet Specialties' innovative design, precision machined aluminum brackets and pulleys, along with top components from Edelbrock, Powermaster, and Goodyear, the Tru Trac for Ford FE is sure to become a legend all its own.

Featuring the best brands in aftermarket performance:



### DIMENSIONS - FE FORD

To Front Face Of	From Block Face
AC Compressor Cover	7.875"
Alternator Pulley	7.500"
Water Pump Pulley	8.500"
Power Steering Pulley	7.250"
Crankshaft Pulley	7.125"

A: 11.00"	D: 7.00"
B: 10.50"	E: 11.50"
C: 6.00"	

\* Check Clearances Before Ordering \*

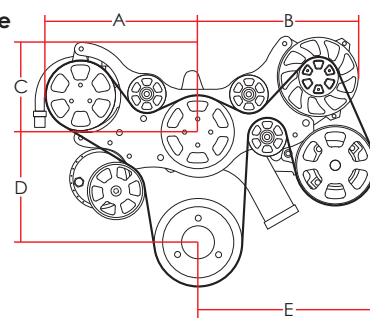

### IMPORTANT - THIS KIT REQUIRES:

- Early FE motors require the use of a crank damper (not included)

## STANDARD POLISHED KITS

Standard polished FE Ford Tru Trac includes the following:

- Polished aluminum pulleys & brackets
- Polished billet tensioner (Tru Trac exclusive)
- Polished 170 amp Powermaster 1-wire alternator
- Natural finish Edelbrock standard rotation water pump

### Kits with AC Include:

- Polished Sanden SD-7 compressor
- Polished AC clutch cover
- Patented polished Billet compressor manifold

### Kits with power steering include:

- Natural finish power steering pump with AN nipples
- Polished power steering pulley installed



With AC  
With Power Steering  
14700



With AC  
Without Power Steering  
14720



Without AC  
With Power Steering  
14705

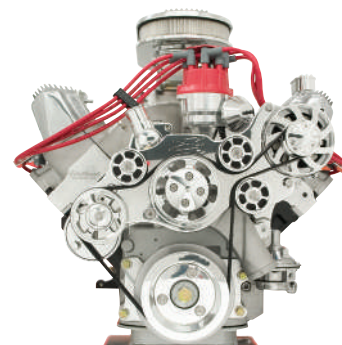

Without AC  
Without Power Steering  
14725



# PREMIUM POLISHED KITS



Premium FE Ford Tru Trac includes the following:

- Polished aluminum pulleys & brackets
- Polished billet tensioner (Tru Trac exclusive)
- Polished 170 amp Powermaster 1-wire alternator or polished Billet machined case 170 amp alternator
- Natural finish Edelbrock standard rotation water pump

**Kits with AC include:**

- Polished Sanden SD-7 compressor
- Polished AC clutch cover
- Patented polished Billet compressor manifold

**Kits with power steering include:**

- Polished finish power steering pump with AN nipples
- Polished power steering pulley installed



**With AC  
With Power Steering**

Includes Polished P/S Pump

**14700P**

Includes Polished P/S Pump  
Polished 170 amp  
Billet Alternator  
**14700PA**



**With AC  
Without Power Steering**

Includes Polished 170 amp  
Billet Alternator

**14720A**



**Without AC  
With Power Steering**

Includes Polished P/S Pump

**14705P**

Includes Polished P/S Pump  
Polished 170 amp  
Billet Alternator  
**14705PA**



**Without AC  
Without Power Steering**

Includes Polished 170 amp  
Billet Alternator

**14725A**

# PREMIUM BLACK ANODIZED KITS

Includes Polished P/S Pump

**BLK14700P**

Includes Polished P/S Pump &  
Polished 170 amp Billet Alternator

**BLK14700PA**

*\* Includes all the upgrades from the premium kits above, with black anodized pulleys, brackets, and tensioner\**

# BLACK ANODIZED KITS

Black anodized FE Ford Tru Trac includes the following:

- Black anodized aluminum pulleys & brackets
- Black anodized billet tensioner (Tru Trac exclusive)
- Polished 170 amp Powermaster 1-wire alternator
- Natural finish Edelbrock standard rotation water pump

**Kits with AC include:**

- Polished Sanden SD-7 compressor
- Black anodized AC clutch cover
- Patented black anodized Billet compressor manifold

**Kits with power steering include:**

- Natural finish power steering pump with AN nipples
- Black anodized power steering pulley installed



**With AC  
With Power Steering**

**BLK14700**

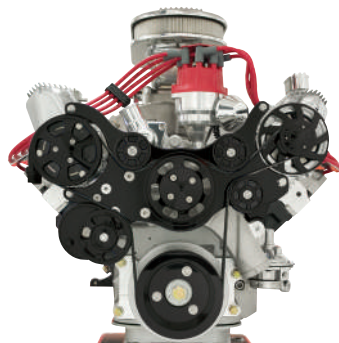

**With AC  
Without Power Steering**

**BLK14720**

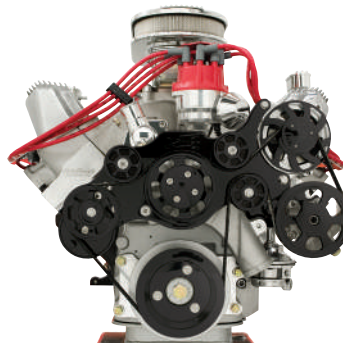

**Without AC  
With Power Steering**

**BLK14705**

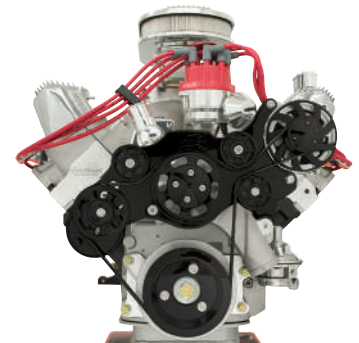

**Without AC  
Without Power Steering**

**BLK14725**

# CHRYSLER TRU TRAC

**SMALL BLOCK, BIG BLOCK, HEMI**



"The Tru Trac's reliability, style and performance definitely makes a statement under the hood"

-BOBBY ALLOWAY

## BILLET A/C MANIFOLD

Kits with AC include our Billet aluminum AC manifold, engineered not only to provide an efficient attachment point for the AC hoses, but to look good as well. In fact, so good and efficient we patented it!

## BILLET TENSIONER

Our Billet aluminum tensioner optimizes belt and accessory life with constant and correct tension; eliminating belt-slip while minimizing parasitic horsepower loss. Every modern car has a tensioner—so should your classic.

## DURABILITY

Pulleys that are in contact with the back of the belt are subject to high wear. Billet Specialties hard coat anodizes these areas to eliminate wear altogether. Hard coat anodized aluminum actually provides a harder surface than stock steel pulleys!

## STAINLESS STANDOFFS

Our stainless stand-offs provide the most rigid platform in the industry, while maintaining perfect alignment between the accessories. Machined from 303 stainless steel to provide corrosion resistance and double the surface area while adding ease of assembly.



## FASTENERS

Tru Trac kits are assembled with 18-8 stainless steel fasteners, offering not only corrosion resistance, but professional appearance and high tensile strength. ARP 12pt. fasteners also match many other Billet Specialties accessories.

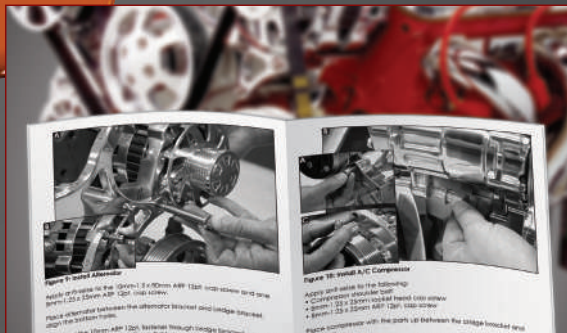

## EASE OF INSTALLATION

With our comprehensive instruction booklet and pre-installed alternator and power steering pulleys, installing a Tru Trac is easy. See for yourself, visit [Billetspecialties.com](http://Billetspecialties.com), select the Tru Trac for your application and download a copy of the instructions





## THE BEST BRANDS INCLUDED!



Big block and HEMI Tru Tracs include a new natural cast finish aluminum water pump housing and Mopar Performance water pump. The eight-blade impeller will keep your engine temp in check on those hot summer days.



Edelbrock water pumps provide maximum cooling, utilizing state of the art racing technology. Edelbrock water pumps ensure greater cooling efficiency and reliability for your small block Chrysler Tru Trac kit.

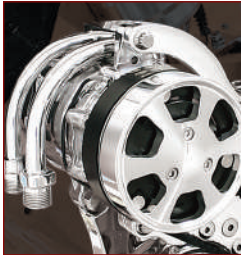

Sanden manufactures and supplies compressors for some of the largest automotive manufacturers in the world. The SD-7 is a high efficiency modern compact compressor ensuring better performance and aesthetics over early 508 compressors while keeping you cool and comfortable.



Billet Specialties supplies a new 170 amp Powermaster alternator in every Tru Trac kit. Each Powermaster alternator is 100% new. With a high amp output at idle, internally regulated architecture and internal fan with a gold plated battery post. Each 170 amp alternator is pre-tested and includes a proof of performance tag showing output at idle and at highway speeds. Best of all, Powermaster alternators are made right here in the USA.

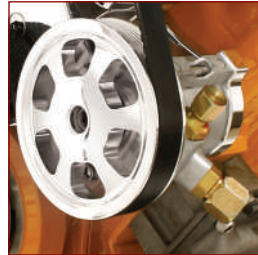

Kits with power steering feature modern TC style pumps, used by OEM manufacturers and various applications from NASCAR, Off Road and Road Racing. We supply the pumps with -10AN supply and -6AN pressure nipples installed. Featuring a sealed front bearing and precision internals, each high performance pump is calibrated to 1200 PSI and flows at 3.5 GPM.

## STANDARD POLISHED AND BLACK ANODIZED KITS INCLUDE:



### Natural Finish Water Pump

The traditional look of performance for decades, the natural cast look easily matches your cast intake manifold and power steering pump.



### Polished 170 amp Alternator

Powermaster USA made quality, precision cast and polished case with the best internal components in the industry.

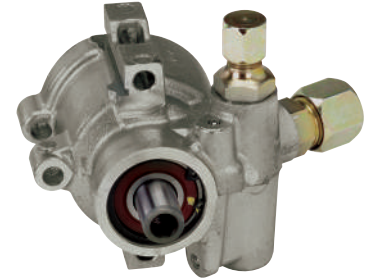

### Natural Finish Power Steering

Matches the natural finish Edelbrock water pump and we pre-install the pulley for ease of installation.

## PREMIUM POLISHED KITS INCLUDES:



### Natural Finish Water Pump

The traditional look of performance for decades, the natural cast look easily matches your cast intake manifold and power steering pump.



### Optional Billet Aluminum 170 amp Alternator

Truly the crown jewel of the Premium kit. The precision machined 6061-T6 Billet case makes this the ultimate alternator.

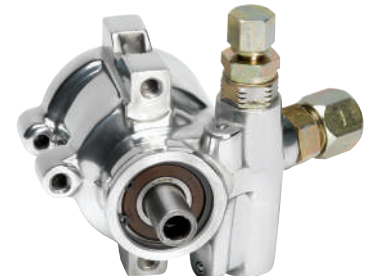

### Polished Power Steering Pump

Show quality polish and pre-installed pulley for ease of installation.

# CHRYSLER SMALL BLOCK

318/340/360



Patent-Pending

#### All Kits Feature:

- Exclusive Billet aluminum tensioner
- Polished ARP 12-point stainless steel fasteners
- Hard-coat anodizing for durability in high-wear areas
- Continental Elite serpentine belt
- Comprehensive instruction manual

\*Tru Trac systems are not designed for use with hydroboost brake systems\*

### TIME TO SHOW OFF

The small block LA series motor that has proven its performance and reliability over the years as Chrysler's best selling engine is about to get the ultimate upgrade. Using the same successful formula as the rest of the Tru Trac family, the small block Chrysler Tru Trac stands alone as the most complete and efficient accessory drive system on the market.

Featuring the best brands in aftermarket performance:



### DIMENSIONS - SMALL BLOCK CHRYSLER

To Front Face Of	From Block Face
AC Compressor Cover	8.125"
Alternator Pulley	7.625"
Water Pump Pulley	9.125"
Power Steering Pulley	7.375"
Crankshaft Pulley	7.375"

- A: 9.75"
- B: 10.25"
- C: 7.25"
- D: 6.875"
- E: 10.00"

\* Check Clearances Before Ordering \*

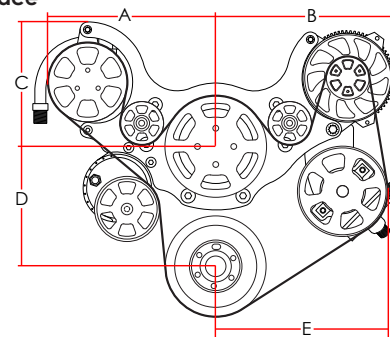

## STANDARD POLISHED KITS

Standard polished 318/340/360 Chrysler Tru Trac includes the following:

- Polished aluminum pulleys & brackets
- Polished billet tensioner (Tru Trac exclusive)
- Polished 170 amp Powermaster 1-wire alternator
- Natural finish Edelbrock standard rotation water pump

#### Kits with AC Include:

- Polished Sanden SD-7 compressor
- Polished AC clutch cover
- Patented polished Billet compressor manifold

#### Kits with power steering include:

- Natural finish power steering pump with AN nipples
- Polished power steering pulley installed

### IMPORTANT - THIS KIT REQUIRES:

- Use of an electric fuel pump



With AC  
With Power Steering  
13800



With AC  
Without Power Steering  
13820

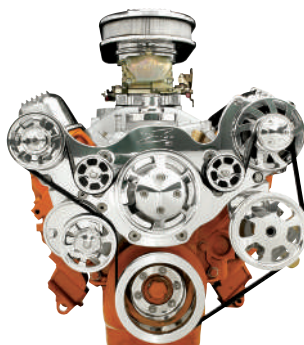

Without AC  
With Power Steering  
13805

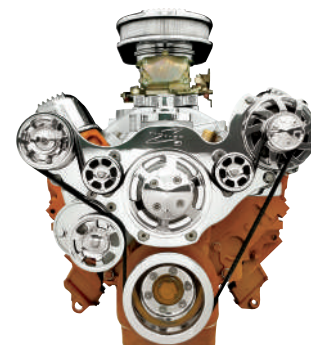

Without AC  
Without Power Steering  
13825



# PREMIUM POLISHED KITS



Premium 318/340/360 Chrysler Tru Trac includes the following:

- Polished aluminum pulleys & brackets
- Polished billet tensioner (Tru Trac exclusive)
- Polished 170 amp Powermaster 1-wire alternator or polished Billet machined case 170 amp alternator
- Natural finish Edelbrock standard rotation water pump

**Kits with AC include:**

- Polished Sanden SD-7 compressor
- Polished AC clutch cover
- Patented polished Billet compressor manifold

**Kits with power steering include:**

- Polished finish power steering pump with AN nipples
- Polished power steering pulley installed



**With AC  
With Power Steering**

Includes Polished P/S Pump

**13800P**

Includes Polished P/S Pump & Polished 170 amp Billet Alternator  
**13800PA**



**With AC  
Without Power Steering**

Includes Polished 170 amp Billet Alternator  
**13820A**



**Without AC  
With Power Steering**

Includes Polished P/S Pump  
**13805P**

With Polished P/S Pump & Polished 170 amp Billet Alternator  
**13805PA**

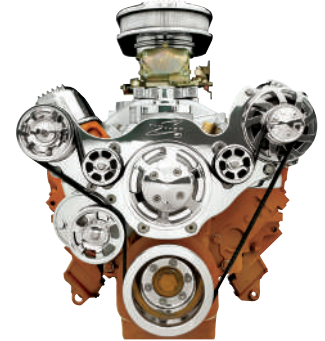

**Without AC  
Without Power Steering**

Includes Polished 170 amp Billet Alternator  
**13825A**

# PREMIUM BLACK ANODIZED KITS

Includes Polished P/S Pump

**BLK13800P**

Includes Polished P/S Pump & Polished 170 amp Billet Alternator

**BLK13800PA**

*\* Includes all the upgrades from the premium kits above, with black anodized pulleys, brackets, and tensioner\**

# BLACK ANODIZED KITS

Black anodized 318/340/360 Chrysler Tru Trac includes the following:

- Black anodized aluminum pulleys & brackets
- Black anodized billet tensioner (Tru Trac exclusive)
- Polished 170 amp Powermaster 1-wire alternator
- Natural finish Edelbrock standard rotation water pump

**Kits with AC include:**

- Polished Sanden SD-7 compressor
- Black anodized AC clutch cover
- Patented black anodized Billet compressor manifold

**Kits with power steering include:**

- Natural finish power steering pump with AN nipples
- Black anodized power steering pulley installed



**With AC  
With Power Steering**  
**BLK13800**



**With AC  
Without Power Steering**  
**BLK13820**



**Without AC  
With Power Steering**  
**BLK13805**

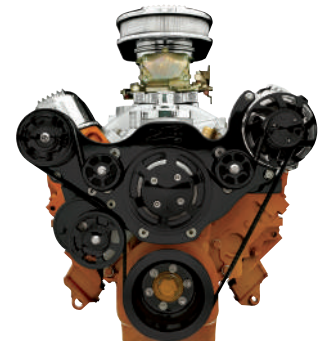

**Without AC  
Without Power Steering**  
**BLK13825**

# CHRYSLER HEMI/BIG BLOCK

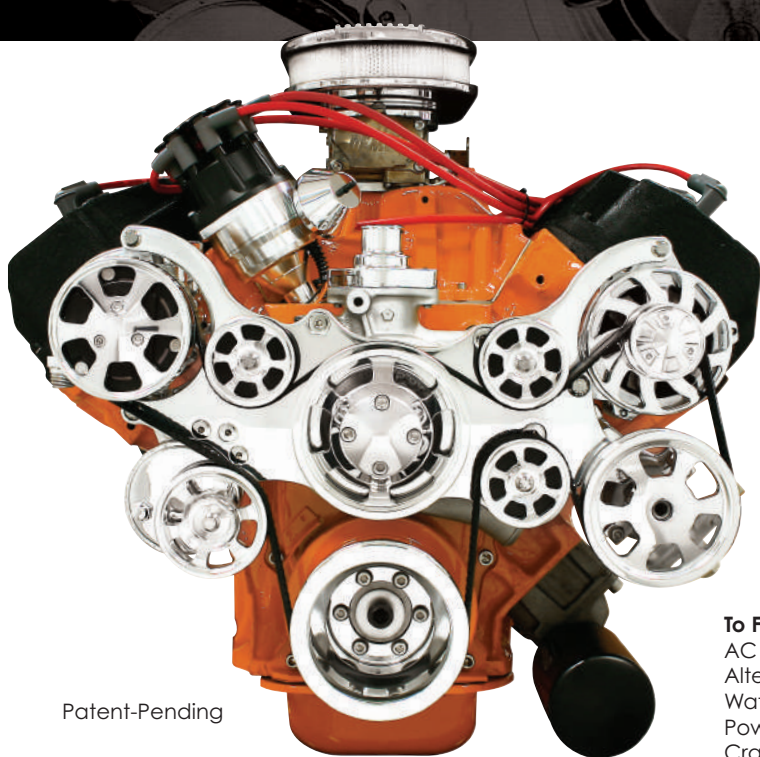

Patent-Pending

### All Kits Feature:

- Exclusive Billet aluminum tensioner
- Polished ARP 12-point stainless steel fasteners
- Hard-coat anodizing for durability in high-wear areas
- Continental Elite serpentine belt
- Comprehensive instruction manual

\*Tru Trac systems are not designed for use with hydroboost brake systems\*

## 383/440 B/RB, '66 & UP 426 HEMI 426/472/528 HEMI CRATE TRU TRAC SYSTEM

Attitude, Style & Performance for the legendary Hemi motor is here right now. Billet Specialties' Tru Trac is the answer for the ultimate accessory drive system for your HEMI. Everything you need is right here: pulleys, brackets, A/C compressor, alternator, power steering pump, water pump & housing. All in one, ready to bolt on kit. Billet Specialties' innovative mounting system allows the use of any type of cylinder head.

Featuring the best brands in aftermarket performance:



### DIMENSIONS - HEMI/BIG BLOCK CHRYSLER

To Front Face Of	From Block Face
AC Compressor Cover	7.375"
Alternator Pulley	6.250"
Water Pump Pulley	8.125"
Power Steering Pulley	6.000"
Crankshaft Pulley	5.875"

- A: 11.75"      D: 6.875"
- B: 12.00"      E: 11.875"
- C: 6.625"

\* Check Clearances Before Ordering \*

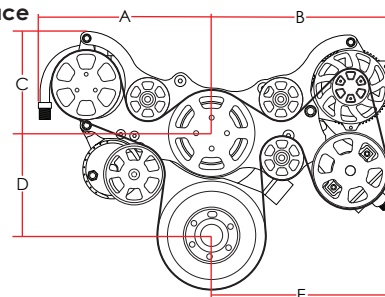

### IMPORTANT - THIS KIT REQUIRES:

- Use of a thin style damper

## STANDARD POLISHED KITS

Standard polished HEMI/Big Block Chrysler Tru Trac includes the following:

- Polished aluminum pulleys & brackets
- Polished billet tensioner (Tru Trac exclusive)
- Polished 170 amp Powermaster 1-wire alternator
- Natural finish Mopar water pump

### Kits with AC Include:

- Polished Sanden SD-7 compressor
- Polished AC clutch cover
- Patented polished Billet compressor manifold

### Kits with power steering include:

- Natural finish power steering pump with AN nipples
- Polished power steering pulley installed



With AC  
With Power Steering  
14800



With AC  
Without Power Steering  
14820



Without AC  
With Power Steering  
14805



Without AC  
Without Power Steering  
14825



# PREMIUM POLISHED KITS



Premium HEMI/Big Block Chrysler Tru Trac includes the following:

- Polished aluminum pulleys & brackets
- Polished billet tensioner (Tru Trac exclusive)
- Polished 170 amp Powermaster 1-wire alternator or polished Billet machined case 170 amp alternator
- Natural finish Mopar water pump

**Kits with AC include:**

- Polished Sanden SD-7 compressor
- Polished AC clutch cover
- Patented polished Billet compressor manifold

**Kits with power steering include:**

- Polished finish power steering pump with AN nipples
- Polished power steering pulley installed



**With AC  
With Power Steering**

Includes Polished P/S Pump

**14800P**

Includes Polished P/S Pump  
Polished 170 amp  
Billet Alternator  
**14800PA**

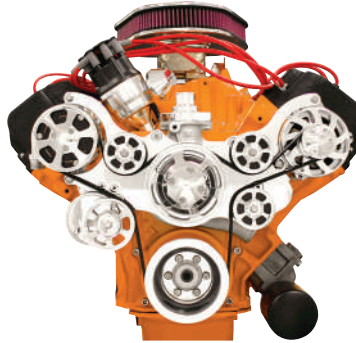

**With AC  
Without Power Steering**

Includes Polished 170 amp  
Billet Alternator

**14820A**



**Without AC  
With Power Steering**

Includes Polished P/S Pump

**14805P**

Includes Polished P/S Pump  
Polished 170 amp  
Billet Alternator  
**14805PA**



**Without AC  
Without Power Steering**

Includes Polished 170 amp  
Billet Alternator

**14825A**

# PREMIUM BLACK ANODIZED KITS

Includes Polished P/S Pump

**BLK14800P**

Includes Polished P/S Pump &  
Polished 170 amp Billet Alternator

**BLK14800PA**

*\* Includes all the upgrades from the premium kits above, with black anodized pulleys, brackets, and tensioner\**

# BLACK ANODIZED KITS

Black anodized HEMI/Big Block Chrysler Tru Trac includes the following:

- Black anodized aluminum pulleys & brackets
- Black anodized billet tensioner (Tru Trac exclusive)
- Polished 170 amp Powermaster 1-wire alternator
- Natural finish Mopar water pump

**Kits with AC include:**

- Polished Sanden SD-7 compressor
- Black anodized AC clutch cover
- Patented black anodized Billet compressor manifold

**Kits with power steering include:**

- Natural finish power steering pump with AN nipples
- Black anodized power steering pulley installed



**With AC  
With Power Steering**  
**BLK14800**

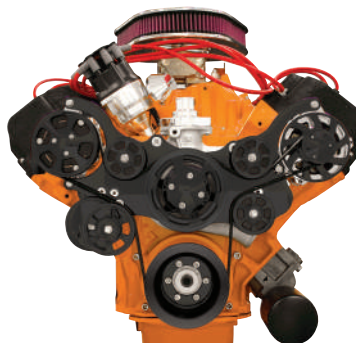

**With AC  
Without Power Steering**  
**BLK14820**



**Without AC  
With Power Steering**  
**BLK14805**



**Without AC  
Without Power Steering**  
**BLK14825**

# PONTIAC TRU TRAC KITS

326/455

## BILLET A/C MANIFOLD

Kits with AC include our Billet aluminum AC manifold, engineered not only to provide an efficient attachment point for the AC hoses, but to look good as well. In fact, so good and efficient we patented it!

## BILLET TENSIONER

Our Billet aluminum tensioner optimizes belt and accessory life with constant and correct tension; eliminating belt-slip while minimizing parasitic horsepower loss. Every modern car has a tensioner—so should your classic.

## DURABILITY

Pulleys that are in contact with the back of the belt are subject to high wear. Billet Specialties hard coat anodizes these areas to eliminate wear altogether. Hard coat anodized aluminum actually provides a harder surface than stock steel pulleys!

## STAINLESS STANDOFFS

Our stainless stand-offs provide the most rigid platform in the industry, while maintaining perfect alignment between the accessories. Machined from 303 stainless steel to provide corrosion resistance and double the surface area while adding ease of assembly.



## FASTENERS

Tru Trac kits are assembled with 18-8 stainless steel fasteners, offering not only corrosion resistance, but professional appearance and high tensile strength. ARP 12pt. fasteners also match many other Billet Specialties accessories.

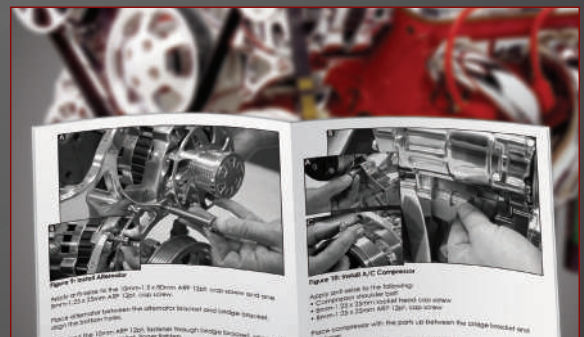

## EASE OF INSTALLATION

With our comprehensive instruction booklet and pre-installed alternator and power steering pulleys, installing a Tru Trac is easy. See for yourself, visit [Billetspecialties.com](http://Billetspecialties.com), select the Tru Trac for your application and download a copy of the instructions.



## THE BEST BRANDS INCLUDED!



Designed and cast in the USA, Edelbrock water pumps provide maximum flow, maximum pressure and equal distribution to both sides of the block within 1%. Featuring Edelbrock's industry leading precision powered metal impeller with modern vane design that is larger than other high-performance pumps along with the precision machined computer designed A-356 Cast pump housing.



Billet Specialties supplies a new 170 amp Powermaster alternator in every Tru Trac kit. Each Powermaster alternator is 100% new. With a high amp output at idle, internally regulated architecture and internal fan with a gold plated battery post. Each 170 amp alternator is pre-tested and includes a proof of performance tag showing output at idle and at highway speeds. Best of all, Powermaster alternators are made right here in the USA.

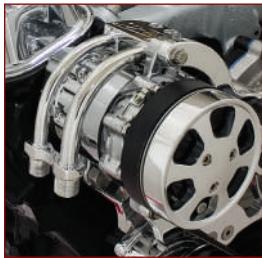

Sanden manufactures and supplies compressors for some of the largest automotive manufacturers in the world. The SD-7 is a high efficiency modern compact compressor ensuring better performance and aesthetics over early 508 compressors while keeping you cool and comfortable.



Kits with power steering feature modern TC style pumps, used by OEM manufacturers and various applications from NASCAR, Off Road and Road Racing. We supply the pumps with -10AN supply and -6AN pressure nipples installed. Featuring a sealed front bearing and precision internals, each high performance pump is calibrated to 1200 PSI and flows at 3.5 GPM.

## STANDARD POLISHED AND BLACK ANODIZED KITS INCLUDE:



**Natural Finish Water Pump**  
The traditional look of performance for decades, the natural cast look easily matches your cast intake manifold and power steering pump.



**Polished 170 amp Alternator**  
Powermaster USA made quality, precision cast and polished case with the best internal components in the industry.

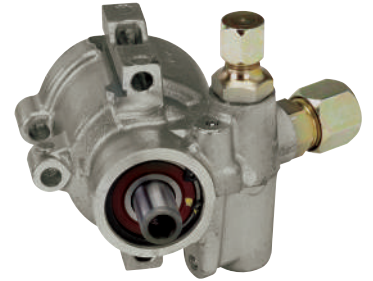

**Natural Finish Power Steering Pump**  
Matches the natural finish Edelbrock water pump and we pre-install the pulley for ease of installation.

## PREMIUM POLISHED KITS INCLUDE:



**Natural Finish Water Pump**  
The traditional look of performance for decades, the natural cast look easily matches your cast intake manifold and power steering pump.



**Optional Billet Aluminum 170 amp Alternator**  
Truly the crown jewel of the Premium kit. The precision machined 6061-T6 Billet case makes this the ultimate alternator.

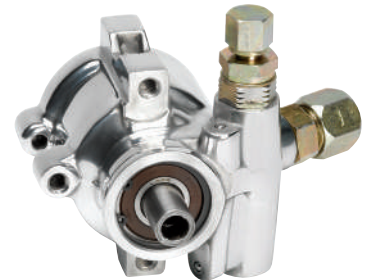

**Polished Power Steering Pump**  
Show quality polish and pre-installed pulley for ease of installation.

# PONTIAC 326-455

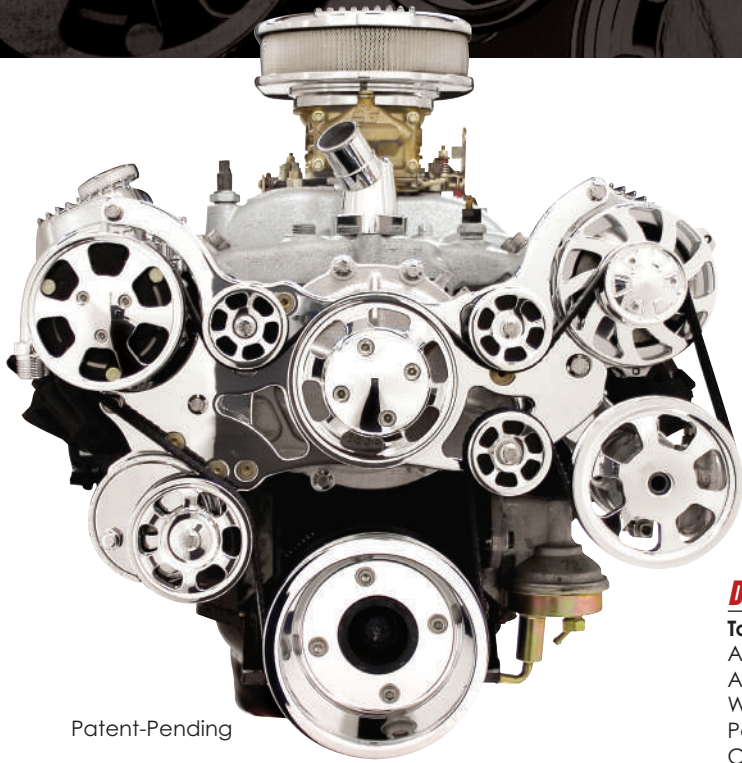

Patent-Pending

### All Kits Feature:

- Exclusive Billet aluminum tensioner
- Polished ARP 12-point stainless steel fasteners
- Hard-coat anodizing for durability in high-wear areas
- Continental Elite serpentine belt
- Comprehensive instruction manual

\*Tru Trac systems are not designed for use with hydroboost brake systems\*

## PONTIAC'S TURN IN THE SPOTLIGHT

It's Game On for Pontiac power plants as the void in performance accessory drives has been filled. Billet Specialties has answered your requests with the Tru Trac for the 326/455 Pontiac. Using the proven Tru Trac formula of quality, ease of assembly, the best name brand components & superior engineering the Tru Trac for Pontiac is sure to be a hit from Woodward to Van Nuys.

Featuring the best brands in aftermarket performance:



## DIMENSIONS - 326-455 PONTIAC

To Front Face Of	From Block Face
AC Compressor Cover	7.250"
Alternator Pulley	6.875"
Water Pump Pulley	8.125"
Power Steering Pulley	6.500"
Crankshaft Pulley	6.625"

A: 10.25"	D: 8.00"
B: 10.50"	E: 11.125"
C: 5.50"	

\* Check Clearances Before Ordering \*

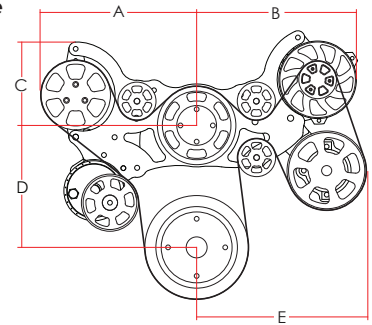

## STANDARD POLISHED KITS

Standard polished 326-455 Pontiac Tru Trac includes the following:

- Polished aluminum pulleys & brackets
- Polished billet tensioner (Tru Trac exclusive)
- Polished 170 amp Powermaster 1-wire alternator
- Natural finish Edelbrock standard rotation water pump

### Kits with AC Include:

- Polished Sanden SD-7 compressor
- Polished AC clutch cover
- Patented polished Billet compressor manifold

### Kits with power steering include:

- Natural finish power steering pump with AN nipples
- Polished power steering pulley

## IMPORTANT - THIS KIT REQUIRES:

- 1969-1977 11-Bolt Timing Cover



With AC  
With Power Steering  
14900



With AC  
Without Power Steering  
14920



Without AC  
With Power Steering  
14905



Without AC  
Without Power Steering  
14925



# PREMIUM POLISHED KITS



Premium 326–455 Pontiac Tru Trac includes the following:

- Polished aluminum pulleys & brackets
- Polished billet tensioner (Tru Trac exclusive)
- Polished 170 amp Powermaster 1-wire alternator or polished Billet machined case 170 amp alternator
- Natural finish Edelbrock standard rotation water pump

**Kits with AC include:**

- Polished Sanden SD-7 compressor
- Polished AC clutch cover
- Patented polished Billet compressor manifold

**Kits with power steering include:**

- Polished finish power steering pump with AN nipples
- Polished power steering pulley



**With AC  
With Power Steering**

Includes Polished P/S Pump

**14900P**

Includes Polished P/S Pump  
Polished 170 amp  
Billet Alternator  
**14900PA**



**With AC  
Without Power Steering**

Includes Polished 170 amp  
Billet Alternator

**14920A**



**Without AC  
With Power Steering**

Includes Polished P/S Pump

**14905P**

Includes Polished P/S Pump  
Polished 170 amp  
Billet Alternator  
**14905PA**



**Without AC  
Without Power Steering**

Includes Polished 170 amp  
Billet Alternator

**14925A**

# PREMIUM BLACK ANODIZED KITS

Includes Polished P/S Pump

**BLK14900P**

Includes Polished P/S Pump &  
Polished 170 amp Billet Alternator

**BLK14900PA**

*\* Includes all the upgrades from the premium kits above, with black anodized pulleys, brackets, and tensioner\**

# BLACK ANODIZED KITS

Black anodized 326–455 Pontiac Tru Trac includes the following:

- Black anodized aluminum pulleys & brackets
- Black anodized billet tensioner (Tru Trac exclusive)
- Polished 170 amp Powermaster 1-wire alternator
- Natural finish Edelbrock standard rotation water pump

**Kits with AC include:**

- Polished Sanden SD-7 compressor
- Black anodized AC clutch cover
- Patented black anodized Billet compressor manifold

**Kits with power steering include:**

- Natural finish power steering pump with AN nipples
- Black anodized power steering pulley



**With AC  
With Power Steering**  
**BLK14900**



**With AC  
Without Power Steering**  
**BLK14920**



**Without AC  
With Power Steering**  
**BLK14905**



**Without AC  
Without Power Steering**  
**BLK14925**



# TRU TRAC UPGRADES & ADD-ONS

## 170 AMP BILLET ALUMINUM ALTERNATOR

Truly the crown jewel of alternators, Billet Specialties 3D machines the entire alternator case from 6061-T6 Billet aluminum optimizing airflow for cooling while adding our unmistakable style. Each alternator is then assembled with quality new Powermaster internals and dyno tested to ensure superior performance. Available in polished or black anodized finish.

### Product Features:

- 170 amp 1-wire hook-up
- Proof-of-Performance tag included
- Gold plated terminal post

### Designed for use with:

- Billet Specialties Tru Trac serpentine kits

### Not for use with:

- V-Trac Pulley Systems
- FM brackets or bracket kits
- Independent brackets



12050 Polished  
BLK12050 Black Anodized

170 AMP

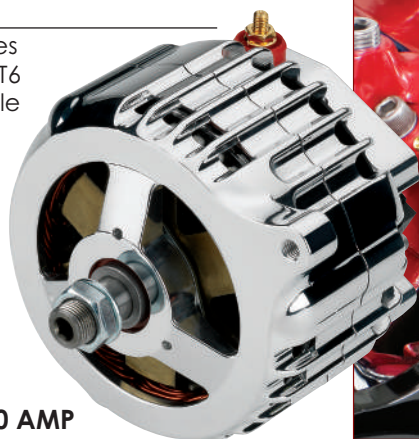

## REPLACEMENT POWERMASTER ALTERNATOR

### Product Features:

- 170 amp 1-wire hook-up
- Polished Powermaster alternator
- Gold-plated terminal post

### Designed for use with:

- Billet Specialties Tru Trac serpentine kits

### Not for use with:

- V-Trac Pulley Systems
- FM brackets or bracket kits
- Independent brackets



12045 Polished  
\* Pulley not included \*

170 AMP

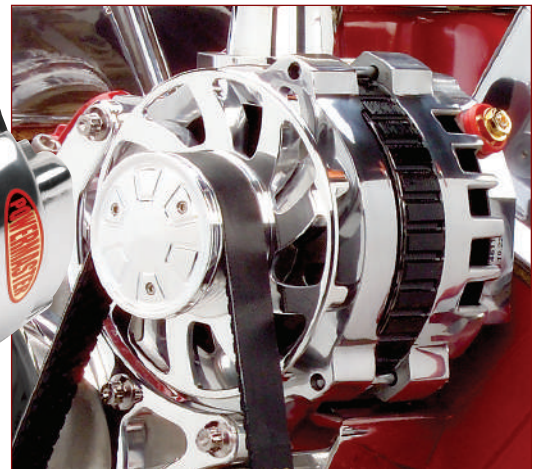
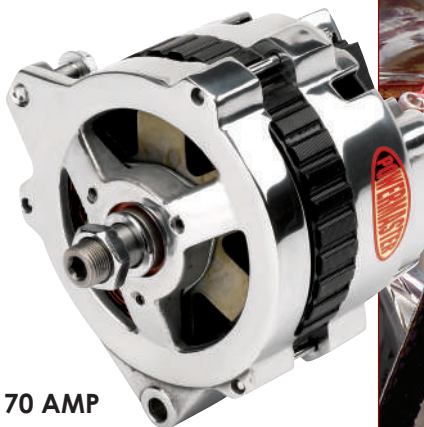

## EDELBRÖCK ENDURASHINE™ WATER PUMP

### What is EnduraShine™?

It's an amazing finish that has the brilliance of chrome or a well-polished piece, without the maintenance or the high price tag. This revolutionary new coating won't fade or oxidize and cleans up easily with soap and water.

### Designed for use with:

- Chevrolet® Tru Trac Serpentine Kits
- For Small / Big Block & 348/409 kits only

12030 Small Block Chevy\*  
12035 Big Block Chevy\*  
12037 348/409 Chevy\*

\* Reverse rotation water pump for Tru Trac only \*





## POWER STEERING ADD-ON KITS FOR TRU TRAC SERPENTINE KITS



### Designed for use with:

- Billet Specialties Tru Trac Serpentine Kits

### Not for use with:

- V-Trac Pulley Systems
- FM or Independent brackets

### Kits Include:

- Natural finish power steering pump
- Polished Billet aluminum power steering pulley (installed)
- Polished Billet aluminum bracket
- Continental Elite serpentine belt
- Stainless mounting hardware



CHEVROLET®		
Engine Type	Tru Trac	P/S Add-On
Small Block	w AC 13120	13320
Small Block	w/o AC 13125	13325
Big Block	w AC 14120	14320
Big Block	w/o AC 14125	14325
348/409	w AC 14420	14430
348/409	w/o AC 14425	14435
LS - Top Mount	w AC 13470	13480
LS - Top Mount	w/o AC 13475	13485
LS7 - Top Mount	w AC 13490	13480
LS7 - Top Mount	w/o AC 13495	13485

FORD		
Engine Type	Tru Trac	P/S Add-On
Small Block	w AC 13620	13630
Big Block	w AC 14620	14630
Big Block	w/o AC 14625	14635
FE	w AC 14720	14730
FE	w/o AC 14725	14735

CHRYSLER		
Engine Type	Tru Trac	P/S Add-On
Small Block	w AC 13820	13830
Small Block	w/o AC 13825	13835
Big Block/HEMI	w AC 14820	14830
Big Block/HEMI	w/o AC 14825	14835

PONTIAC		
Engine Type	Tru Trac	P/S Add-On
326-455	w AC 14920	14930
326-455	w/o AC 14925	14935



\* Only works with SB-BBC Tru Trac, V-Trac & FM Serpentine Conversion Kits \*

### PUMP MOUNT BILLET RESERVOIR

Billet Specialties pump mount Billet reservoir is a machining marvel with innovative features such as threaded double O-ring reservoir and hose attachments providing secure leak free service. Precision machined internal baffling eliminates foaming and is topped off with a vented notch grip cap to match our other accessories.

### Product Features:

- Precision 3D Machined
- Vented fill cap with dipstick
- 6061-T6 Billet aluminum
- High fluid capacity

77930  
BLK77930

Polished  
Black



### GM TYPE II P/S FLOW CONTROL VALVE

Solves quick or "twitchy" steering by replacing the supplied valve and reducing the flow of GM type II power steering pumps from 3.5 GPM to 2 GPM which is recommended for Mustang II rack & pinion steering.

RP1300



### FORD SMALL BLOCK BILLET DIPSTICK & BRACKET ASSEMBLY FOR USE WITH FRONT SUMP OIL PANS ONLY



Designed for use with the Tru Trac Ford Billet timing cover only. Features easy to read level markings and stainless steel braided cover with Teflon inner tube.

40150



**FOR ADDITIONAL TRU TRAC ACCESSORIES, SEE PAGE 42**

# V-TRAC PULLEY SYSTEMS

CHEVROLET®

## V-Trac: The Most Complete V-Belt Pulley System Available

The V-Trac offers quality components and ease of installation in a compact package. We take the guesswork out of assembling an engine accessory drive by providing an all inclusive kit that includes all the components, brackets and hardware from some of the best brands in the automotive aftermarket. The V-Trac works with any cylinder head and manifold combination while allowing installation in the most compact engine compartments. Best of all, the V-Trac features Billet Specialties quality.

## BILLET A/C MANIFOLD

Kits with AC include our Billet aluminum AC manifold, engineered not only to provide an efficient attachment point for the AC hoses, but to look good as well. In fact, so good and efficient we patented it!



## EDELBROCK WATER PUMP

Designed and cast in the USA, Edelbrock water pumps provide maximum pressure and equal distribution to both sides of the block within 1%.

## STAINLESS STANDOFFS

Our stainless stand-offs provide the most rigid platform in the industry, while maintaining perfect alignment between the accessories. Machined from 303 stainless steel to provide corrosion resistance and double the surface area while adding ease of assembly.



## FASTENERS

V-Trac kits are assembled with 18-8 stainless steel fasteners, offering not only corrosion resistance, but professional appearance and high tensile strength. ARP 12pt. fasteners also match many other Billet Specialties accessories.

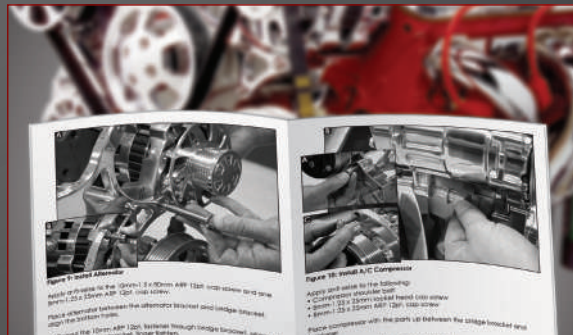
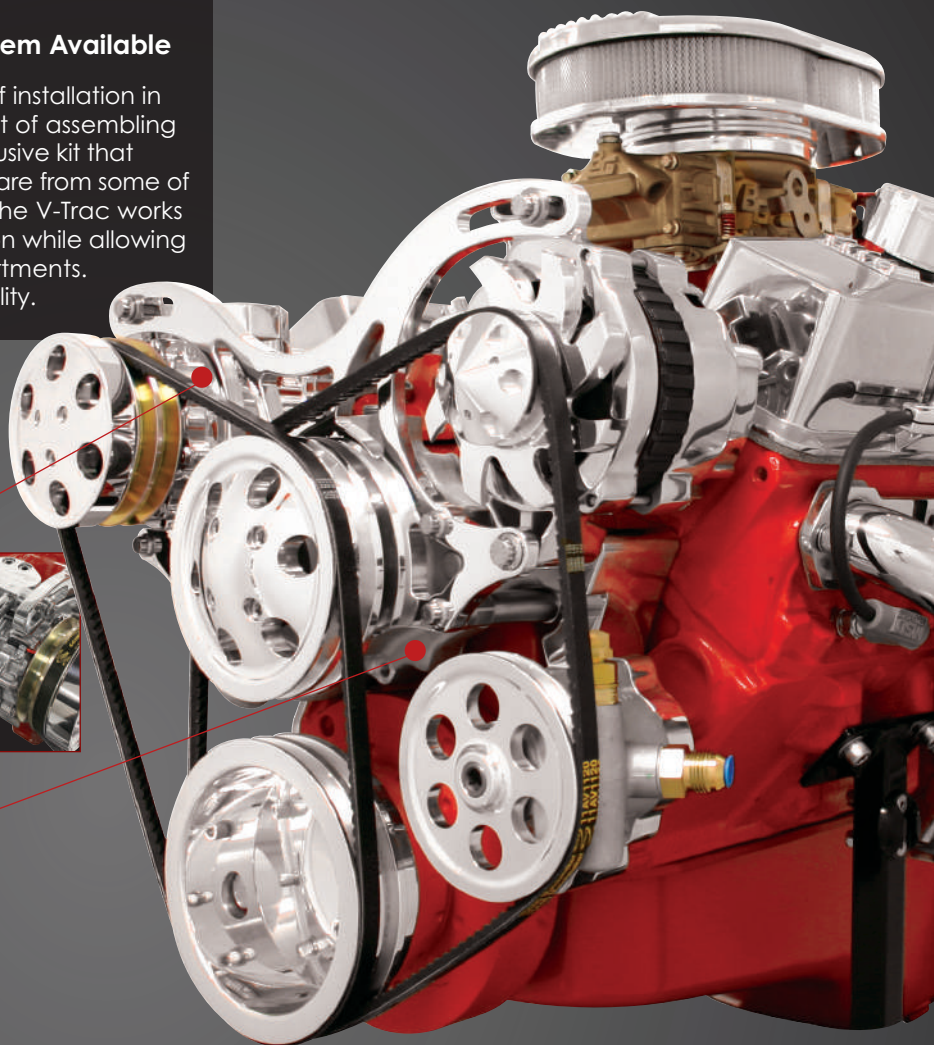
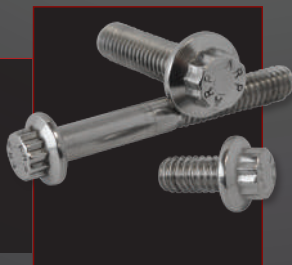

## EASE OF INSTALLATION

With our comprehensive instruction booklet and pre-installed alternator and power steering pulleys, installing a V-Trac is easy. See for yourself, visit [Billetspecialties.com](http://Billetspecialties.com), select the V-Trac for your application and download a copy of the instructions.



Featuring the best brands in aftermarket performance:



## SMALL BLOCK CHEVROLET®

Standard polished Small Block Chevrolet® V-Trac includes the following:

- Polished aluminum pulleys & brackets
- Polished 140 amp 1-wire alternator
- Natural finish Edelbrock water pump
- Continental Elite Poly V-belts

- Polished Sanden SD-7 compressor
- Polished AC clutch cover
- Patented polished Billet compressor manifold

**Kits with power steering include:**

- Natural finish power steering pump with AN nipples
- Polished power steering pulley



With AC  
With Power Steering  
V3220



With AC  
Without Power Steering  
V3120

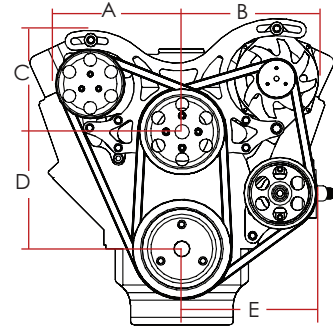

**Dimensions - Small Block Chevy™**

To Front Face Of	From Block Face
AC Compressor Cover	7.500"
Alternator Pulley	6.500"
Water Pump Pulley	7.000"
Power Steering Pulley	6.325"
Crankshaft Pulley	6.250"

\* Check Clearances Before Ordering \*  
Replacement O-Ring Kit Available - RP1320 For Small Block Chevy Tru Trac & V-Trac

A: 9.50" D: 7.00"  
B: 9.00" E: 9.00"  
C: 7.75"



## BIG BLOCK CHEVROLET®

Standard polished Big Block Chevrolet® V-Trac includes the following:

- Polished aluminum pulleys & brackets
- Polished 140 amp 1-wire alternator
- Natural finish Edelbrock water pump
- Continental Elite Poly V-belts

- Polished Sanden SD-7 compressor
- Polished AC clutch cover
- Patented polished Billet compressor manifold

**Kits with power steering include:**

- Natural finish power steering pump with AN nipples
- Polished power steering pulley

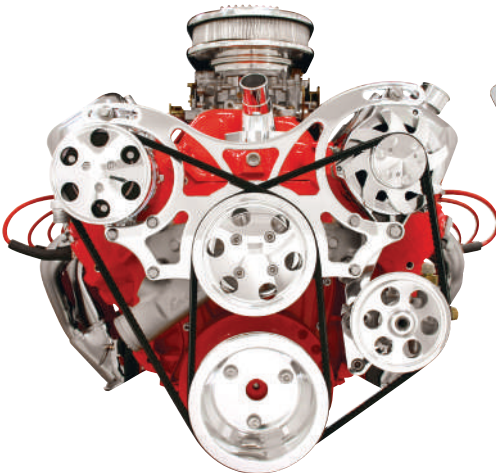

With AC  
With Power Steering  
V4220



With AC  
Without Power Steering  
V4120

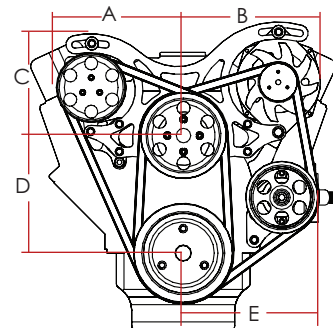

**Dimensions - Big Block Chevy™**

To Front Face Of	From Block Face
AC Compressor Cover	7.625"
Alternator Pulley	6.625"
Water Pump Pulley	7.125"
Power Steering Pulley	6.500"
Crankshaft Pulley	6.375"

\* Check Clearances Before Ordering \*  
\*V-Trac systems are not designed for use with hydroboost brake systems\*  
Replacement O-Ring Kit Available - RP1420 For Big Block Chevy Tru Trac & V-Trac

A: 10.00" D: 7.125"  
B: 9.00" E: 9.50"  
C: 8.50"



# V-TRAC UPGRADES & ADD-ONS

## FOR V-TRAC PULLEY SYSTEMS

Designed for use with:

- V-Trac Pulley systems

Not for use with:

- Tru Trac Serpentine Kits
- FM or Independent brackets

Kits Include:

- Natural finish power steering pump
- Polished Billet aluminum power steering pulley (installed)
- Polished Billet aluminum bracket
- Continental Elite Poly V-belts
- Stainless mounting hardware

V3320 Small Block Chevy  
V4320 Big Block Chevy



We pre-installed the pulley for you!

## REPLACEMENT V-TRAC ALTERNATOR



Product Features:

- 140 amp 1-wire hook-up
- Gold plated terminal post
- GM 10SI/12SI Case
- New - not rebuilt case and internals

For use with:

- Billet Specialties V-Trac Pulley System

Also will work with:

- FM Brackets or FM Serpentine Conversion Kits
- Independent Alternator Brackets

V0105 Polished



## REPLACEMENT POWER STEERING PUMPS

Product Features:

- Flow rate: 3.5GPM @ 1200PSI
- Cad plated AN fittings pre-installed
- New pump (not remanufactured)

12020 Natural  
12025 Polished

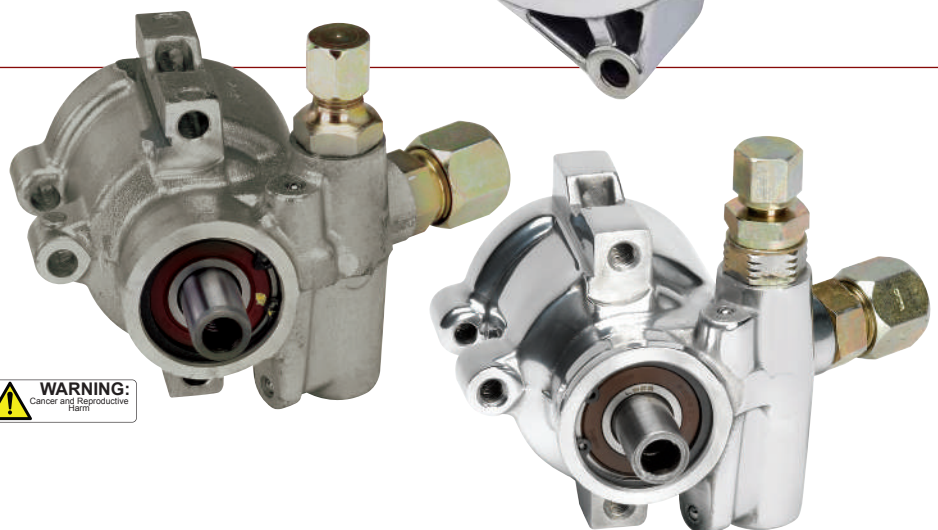



# RECOMMENDED ACCESSORIES

## FOR V-TRAC & TRU TRAC



### PUMP MOUNT BILLET RESERVOIR

Billet Specialties pump mount Billet reservoir is a machining marvel with innovative features such as threaded double O-ring reservoir and hose attachments providing secure leak free service. Precision machined internal baffling eliminates foaming and is topped off with a vented notch grip cap to match our other accessories.

77930 Polished  
BLK77930 Black



\* Only works with SB-BBC, LS & LT4 Tru Trac, V-Trac & FM Serpentine Conversion Kits \*  
Replacement O-Ring Kit Available - RP7793



### REMOTE POWER STEERING RESERVOIR

The double O-ring sealed breathable cap relieves positive and negative pressure while keeping your engine compartment clean. Forget foaming and fluid turbulence with our innovative internal return tube. Includes male AN fittings on the bottom of the reservoir. Our exclusive bracket design clamps to the reservoir with an internal lock. The mounting hardware is completely hidden!

77910 Smooth  
BLK77910 Black



### POWER STEERING HOSE KIT FOR PUMP MOUNT RESERVOIR



77905

The perfect accessory to our pump mount reservoir takes the guesswork out of power steering lines. All this in one kit includes hose, fittings and adapters for the most popular power steering racks and boxes.



### POWER STEERING HOSE KIT FOR REMOTE RESERVOIR



77900

The perfect accessory to our remote reservoir takes the guesswork out of power steering lines. All this in one kit includes hose, fittings and adapters for the most popular power steering racks and boxes.



### POWER STEERING ADAPTER KIT

#### Applications:

- '77-'78 Mustang II rack & pinion
- Up to '88 T-Bird rack & pinion
- Maval Mfg. rack & pinion
- Saginaw 600 steering gear box

77901



### RESERVOIR TIGHT FIT KIT

Kit includes -6 & -10 90° AN fittings for use with our Billet remote reservoirs when available space does not allow for the use of straight fittings.

77902



### 2GPM FLOW CONTROL VALVE

Reduce the flow of GM type II power steering pumps from 3.5 GPM to 2 GPM which is recommended for Mustang II rack & pinion steering.

RP1300



# SPORT TRAC



## SERPENTINE ACCESSORY DRIVE KIT FOR CHEVY LS

### BILLET A/C MANIFOLD

Kits with AC include our Billet aluminum AC manifold, engineered not only to provide an efficient attachment point for the AC hoses, but to look good as well. In fact, so good and efficient we patented it!

### OEM TENSIONER

The LS Sport Trac utilizes an OEM tensioner for constant and correct tension like GM engineered it for. Ease of service and replacement along with cost savings are additional benefits. The plastic tensioner pulley is replaced with a sealed bearing billet pulley for performance and appearance.

### DURABILITY

Pulleys that are in contact with the back of the belt are subject to high wear. Billet Specialties hard coat anodizes these areas to eliminate wear altogether. The 170 amp Powermaster Alternator provides proper amperage for your vehicle at low idle rpm that the LS motors operate at. The quality genuine Sanden AC compressor offers years of worry free service over lesser import copies.

### PERFECT FOR LS SWAPS

The LS Sport Trac was engineered to work in multiple platforms. Billet Specialties took the time to research multiple vehicles from X frame cars to classic trucks. For each application consideration was taken for suspension, cross members, exhaust, inner fender panels, steering boxes and racks to ensure proper clearance while keeping a tight and low profile installation across all.

### FASTENERS

The LS Sport Trac kits are assembled with quality stainless steel fasteners that offer not only superior corrosion resistance but professional appearance and high tensile strength.

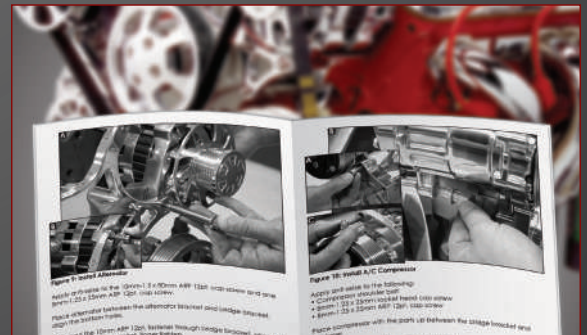
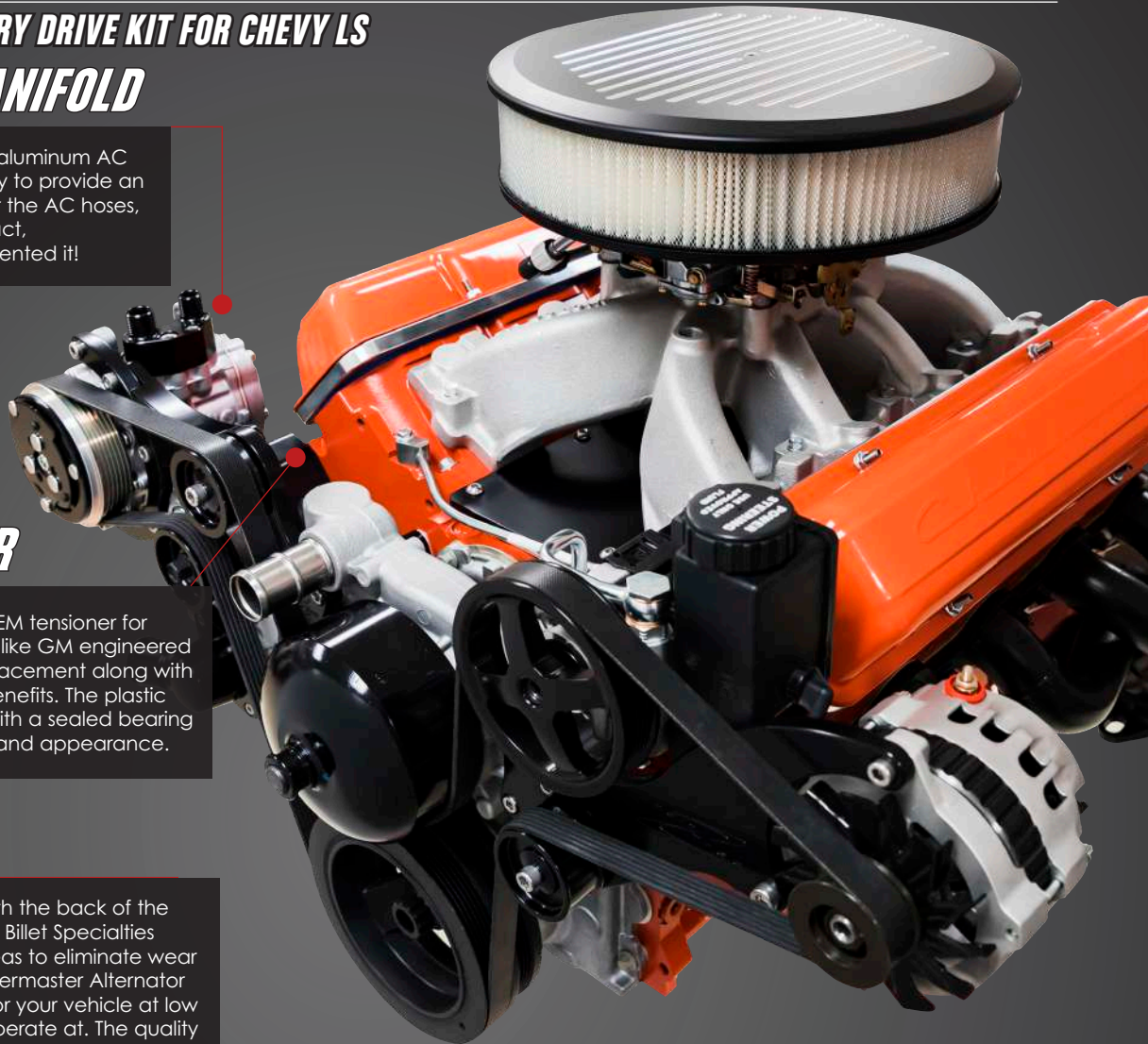

### EASE OF INSTALLATION

With our comprehensive instruction booklet and pre-installed alternator and power steering pulleys, installing a LS Sport Trac kit is easy.



# CHEVROLET® LS1, 2, 3, 6



Patent-Pending

**\*Sport Trac systems are not designed for use with hydroboost brake systems\***

### SPORT TRAC ACCESSORY DRIVE KIT FOR CHEVY LS:

- 170 amp Powermaster one-wire alternator
- Tuff Stuff Performance new aluminum power steering pump and reservoir
- Power steering hard line for pressure side
- OEM Tensioner
- 6-rib serpentine belt
- Precision Machined Brackets and pulleys
- Pre-installed Alternator and Power Steering Pulleys
- Black Powder Coated Brackets
- Black hard coat anodized Tensioner and Idler pulleys to resist wear
- Stainless hardware for superior corrosion resistance

**\* Requires the use of - F-Body water pump & Damper (not included)**



### HIGH TECH. HIGH PERFORMANCE.

The new Billet Specialties Sport Trac for the LS engine platform brings value, style and quality to your engine compartment. Starting off with a strong foundation ensures quality - featuring precision machined brackets for flex free operation, laser straight belt alignment and ease of installation. Each bracket is finished in a satin black powder coat finish for a classic look while the pulleys are hard coat black anodized for durability. Quality stainless hardware is used throughout for superior corrosion protection. Topped off with the best components for reliability and long life, each kit includes a 170 amp Power Master alternator, genuine Sanden SD-7 A/C compressor and a new Tuff Stuff Performance power steering pump with reservoir. Billet Specialties Made in the USA quality, maximum value with top of the line components and classic style - all in the new Sport Trac for LS.

Featuring the best brands in aftermarket performance:



NOW 170 amp!

### DIMENSIONS - LS SPORT TRAC

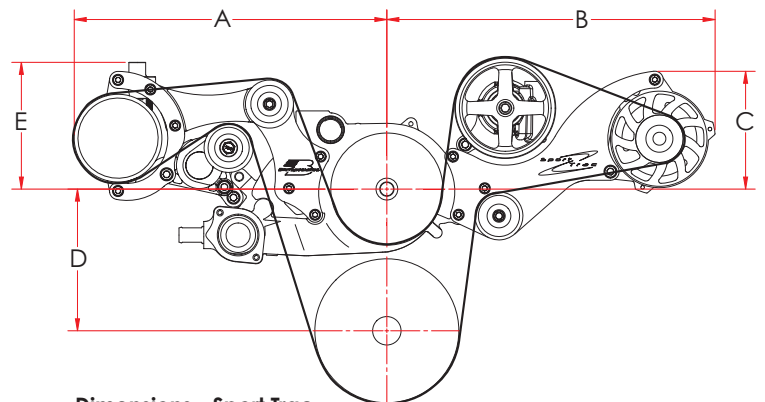

#### Dimensions - Sport Trac

To Front Face Of	From Block Face	A: 16.285	D: 7.382"
AC Compressor Cover	5.132"	B: 17.092"	E: 6.600"
Alternator Pulley	4.931"	C: 6.136"	
Water Pump Pulley	7.806"		
Power Steering Pulley	5.067"		
Crankshaft Pulley	4.900"		

**\* Check Clearances Before Ordering \***



**With AC  
With Power Steering  
12500**

Includes genuine Sanden SD-7 A/C compressor and Precision machined A/C compressor manifold



**Without AC  
With Power Steering  
12525**



### REPLACEMENT AC MANIFOLD

Precision machined A/C compressor manifold  
RPB1264

# LS ACCESSORIES

## LS MODULAR VALVE COVERS DETAILS ON PG.69

True innovation with features like the coil packs and oil fill cap hidden under the ribbed and vented top cover, ARP 12 pt. stainless hardware and two finish options. Our LS modular valve covers clean up your engine and add aggressive styling - get a pair today.



LS3 Modular Chevrolet® Script  
P95480 Polished  
P95485 Black



LS3 Modular Smooth  
P95471 Polished  
P95476 Black



LS3 Modular Ribbed  
P95470 Polished  
P95475 Black

## LS SHORT VALVE COVERS DETAILS ON PG.70

Billet Specialties LS valve covers are the perfect way to top off your LS motor. Select from seven styles with multiple finishes.



CAST



LS Chevrolet® Black Short  
BLK95423



CAST

BILLET

Short LS Streamline  
95424 BLK/POL  
95424RTF Ready to Finish



LS Ribbed Short  
P95450



BILLET

LS Plain Short P95459

## LS VALVE COVER CONVERSION KITS DETAILS ON PG.69

Coils are Ugly! Hide them and give your modern LS classic style with Billet Specialties LS valve cover conversion kits. Each kit allows the use of perimeter style Chevrolet valve covers on an LS motor while hiding the coils underneath for a classic clean look. Recessed wire channels drop the wires where you need them for ease of installation.

### HIDES THE FACTORY LS COILS & WIRING



LS Valve Cover Conversion Kit - Small Block  
96037



LS Valve Cover Conversion Kit - Big Block  
96037

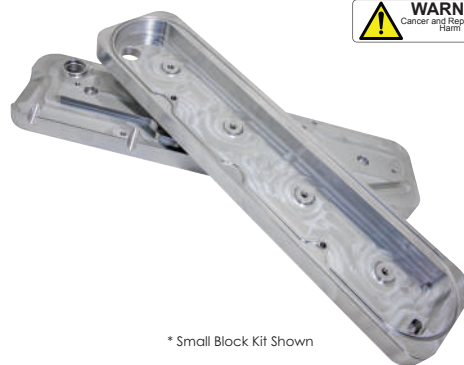

\* Small Block Kit Shown



Retains OEM LS Gasket Channel



NPT Breather Port





## LS VALLEY COVERS

DETAILS ON PG.81

Billet Specialties LS Valley Covers are available in three styles. Select from polished classic ribbed style or no frills plain in either black or machine finish.

- 95050 Ribbed/Polished
- 95059 Machine Finish
- BLK95059 Black Anodized



## LS SWAP MOTOR MOUNTS

DETAILS ON PG.81

Billet Specialties LS Motor Swap Mounts make it easy to put a LS motor in your classic. Multiple mount points allow the bellhousing to be located in the same position as the small block in the frame as well increments of 1/2", 1-3/4" and 2-1/4" forward for more firewall clearance if needed. Precision machined from 6061-t6 aluminum for strength. Select from machine finish or black anodized. Sold in pairs.

- 11600 Machine Finish
- 11605 Black Anodized



## LS THERMOSTAT HOUSINGS

DETAILS ON PG.83

Billet Specialties thermostat housings accept the OEM style two piece thermostats for correct factory cooling just like GM engineered it. Select from straight up or 15 degree swivel for street cars and AN style for race applications.



Straight-Up  
90134  
BLK90134

15-Degree  
90334  
BLK90334

Machine Finish  
- 16 AN  
90900  
BLK90900

-20 AN  
90920  
BLK90920



## LS VALVE COVER ADAPTERS

DETAILS ON PG.70

Billet Specialties Valve Cover Adapters make your LS look like a classic small block by allowing you to install a small block Chevrolet or a small block Ford set of valve covers on your modern LS. Precision machined from 6061-t6 aluminum for strength, each adapter uses the OEM LS gasket on the bottom and the standard small block cork gasket on the top for leak free operation. Coil relocation is required.

### SMALL BLOCK CHEVROLET



SMALL BLOCK CHEVY VALVE COVER TO LS ADAPTERS  
95030

### SMALL BLOCK FORD



SMALL BLOCK FORD VALVE COVER TO LS ADAPTERS  
95032

# SERPENTINE CONVERSION KITS

## SMALL BLOCK CHEVROLET® - TOP MOUNT

### SMALL BLOCK CHEVROLET®

#### Top Mount - Alternator Only Kit

##### Designed for use with:

- Long water pump
- GM 10SI / 12SI alternator

✓ Pulley Nose Cones - Included!

✓ Stainless Hardware - Included!

Top mount passenger side alternator bracket, alternator pulley with fan and nose cone. Water pump pulley with nose cone and crank pulley. Stainless steel hardware is included.

FM2110PC  
BLKFM2110

Top Mount-Alt Only Polished  
Top Mount-Alt Only Black

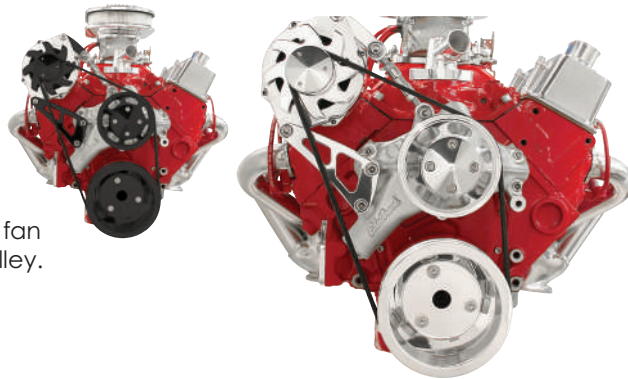

### SMALL BLOCK CHEVROLET®

#### Top Mount - Alternator & Power Steering Kit

##### Designed for use with

- Long water pump
- GM 10SI / 12SI alternator
- Saginaw power steering pump

✓ Pulley Nose Cones - Included!

✓ Stainless Hardware - Included!

Top mount passenger side alternator bracket, alternator pulley with fan and nose cone. Water pump pulley with nose cone and crank pulley. Power steering pump bracket and pulley. Stainless steel hardware included.

FM2111PC  
FM2112PC  
BLKFM2111  
BLKFM2112

Keyway Shaft Power Steering Pump Polished  
Press-on Shaft Power Steering Pump Polished  
Keyway Shaft Power Steering Pump Black  
Press-on Shaft Power Steering Pump Black

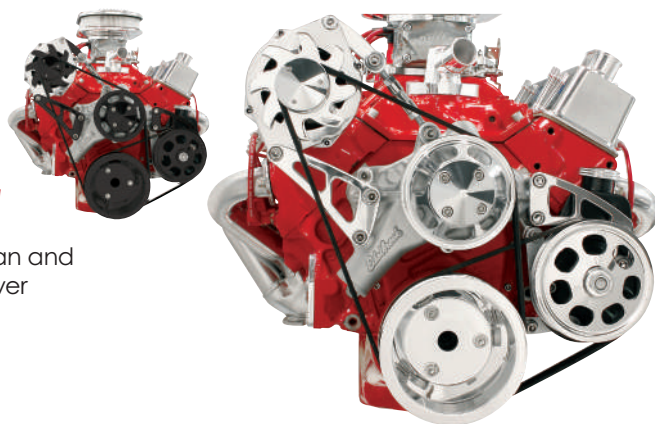

### SMALL BLOCK CHEVROLET® A/C ADD-ON KIT

#### For Top or Mid-Mount - Alternator, AC & Power Steering Kit

In an effort to simplify things while providing the ability to add A/C to an existing kit purchased without A/C Bracket. Billet specialties now offers the A/C add-on kit separately.

Includes: Alternator Bracket, Turn Buckle, Idler Pulley and Compressor Clutch cover

FM1320PC  
BLKFM1320

Serpentine Conversion Kit - SBC A/C Add-On Polished  
Serpentine Conversion Kit - SBC A/C Add-On Black

##### Fits the following part numbers:

FM2111PC & FM2112PC Top Mount-Alternator & Power Steering Kit  
FM2121PC & FM2122PC Mid Mount-Alternator & Power Steering Kit

Important: This kit only works with above listed kits



### KNOW THE DIFFERENCE...

Our Serpentine Conversion Kits give you much more for less money. All with genuine Billet Specialties quality!

#### Billet Specialties Serpentine Conversion Kits:

- Mirror Polished Finish
- Stainless Steel Hardware Included
- Polished Stainless Steel Turnbuckles
- Nose Cones included on Alternator, Water Pump, & Idler Pulleys
- Comprehensive Installation Instructions
- CNC machined Billet stylized pulley design - At No Extra Charge
- Exclusive dual idler pulley system for A/C kits to keep belt tension

#### Their Bracket Kits:

- Machine Finish
- Zinc Plated Steel Hardware
- Raw Stainless Finish Turnbuckles
- Nose Cones Sold Separately
- Single Diagram
- Blank, plain-faced pulleys
- Single idler pulley allows belt slacking



# SERPENTINE CONVERSION KITS

## SMALL BLOCK CHEVROLET® - MID MOUNT

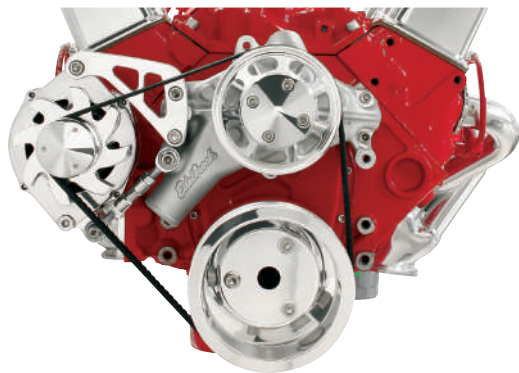

### SMALL BLOCK CHEVROLET®

#### Mid Mount - Alternator Only Kit

- ✓ Pulley Nose Cones - Included!
- ✓ Stainless Hardware - Included!

- Designed for use with:
- Long water pump
  - GM 10SI / 12SI alternator

Mid mount passenger side alternator bracket, alternator pulley with fan and nose cone. Water pump pulley with nose cone and crank pulley. Stainless steel hardware is included.

FM2120PC  
BLKFM2120

Mid Mount-Alt Only Polished  
Mid Mount-Alt Only Black

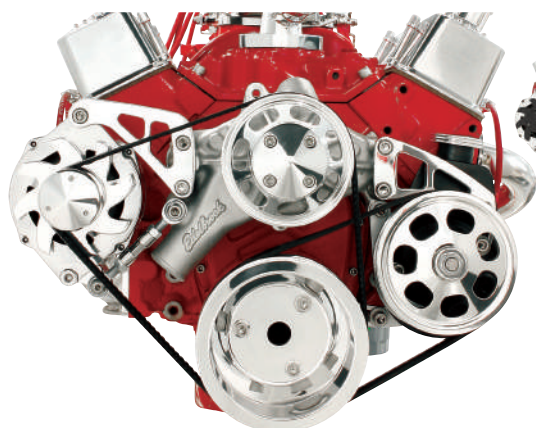

### SMALL BLOCK CHEVROLET®

#### Mid Mount - Alternator & Power Steering Kit

- ✓ Pulley Nose Cones - Included!
- ✓ Stainless Hardware - Included!

- Designed for use with:
- Long water pump
  - GM 10SI / 12SI alternator
  - Saginaw power steering pump

Mid mount passenger side alternator bracket, alternator pulley with fan and nose cone. Water pump pulley with nose cone and crank pulley. Power steering pump bracket and pulley. Stainless steel hardware included.

FM2121PC  
FM2122PC  
BLKFM2121  
BLKFM2122

Keyway Shaft Power Steering Pump Polished  
Press-on Shaft Power Steering Pump Polished  
Keyway Shaft Power Steering Pump Black  
Press-on Shaft Power Steering Pump Black

### TECH TIP: STAINLESS VS. ZINC PLATED

Billet Specialties knows why you replace the factory accessories on your car. We'll help you improve your style and performance with the highest quality components available. We never skimp on the details and that's why you get stainless steel hardware with every Billet Specialties pulley and bracket kit.

Even new vehicles are equipped with stainless hardware. The fact is - zinc-plated steel doesn't stand up to vehicle manufacturer's tests for strength and durability. Stainless steel beats zinc hands down in looks, performance and quality. Billet Specialties supplies the best because you demand it!



Small Block Chevrolet®  
Mid Mount - Alternator & Power Steering Kit



### DON'T FORGET THIS!

#### Power Steering Cap Cover

Easy to install, attaches to factory cap with a set-screw. 1.94" I.D.

89120

# SERPENTINE CONVERSION KITS

## BIG BLOCK CHEVROLET® - TOP MOUNT

### BIG BLOCK CHEVROLET®

#### Top Mount - Alternator Only Kit

##### Designed for use with:

- Long water pump
  - GM 10SI / 12SI alternator
- ✓ Pulley Nose Cones - Included!  
✓ Stainless Hardware - Included!

Top mount passenger side alternator bracket, alternator pulley with fan and nose cone. Water pump pulley with nose cone and crank pulley. Stainless steel hardware is included.

FM2210PC  
BLKFM2210

Top Mount-Alt Only Polished  
Top Mount-Alt Only Black

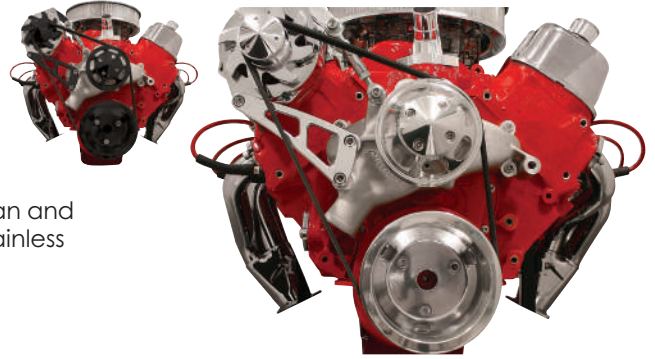

### BIG BLOCK CHEVROLET®

#### Top Mount - Alternator & Power Steering Kit

##### Designed for use with:

- Long water pump
  - GM 10SI / 12SI alternator
  - Saginaw power steering pump
- ✓ Pulley Nose Cones - Included!  
✓ Stainless Hardware - Included!

Top mount passenger side alternator bracket, alternator pulley with fan and nose cone. Water pump pulley with nose cone and crank pulley. Power steering pump bracket and pulley. Stainless steel hardware included.

FM2211PC  
FM2212PC  
BLKFM2211  
BLKFM2212

Keyway Shaft Power Steering Pump Polished  
Press-on Shaft Power Steering Pump Polished  
Keyway Shaft Power Steering Pump Black  
Press-on Shaft Power Steering Pump Black

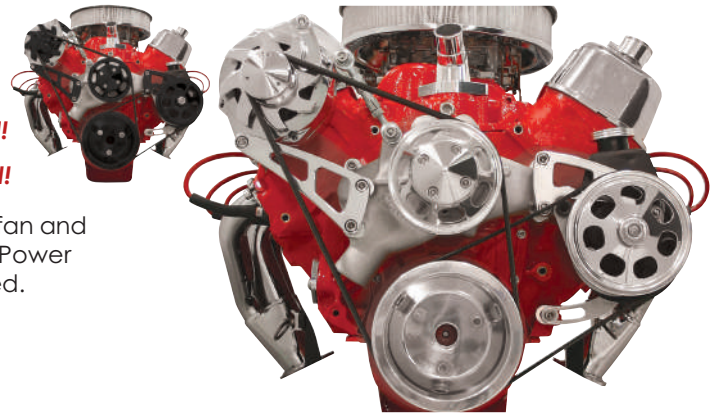

### BIG BLOCK CHEVROLET® A/C add-on Kit

#### For Top or Mid-Mount - Alternator, AC & Power Steering Kit

In an effort to simplify things while providing the ability to add A/C to an existing kit purchased without A/C Bracket. Billet specialties now offers the A/C add-on kit separately.

Includes: Alternator Bracket, Turn Buckle, Idler Pulley and Compressor Clutch cover

FM1325PC  
BLKFM1325

Serpentine Conversion Kit - BBC A/C Add-On Polished  
Serpentine Conversion Kit - BBC A/C Add-On Black

##### Fits the following part numbers:

FM2211PC & FM2212PC Top Mount-Alternator & Power Steering Kit  
FM2221PC & FM2222PC Mid Mount-Alternator & Power Steering Kit

Important: This kit only works with above listed kits

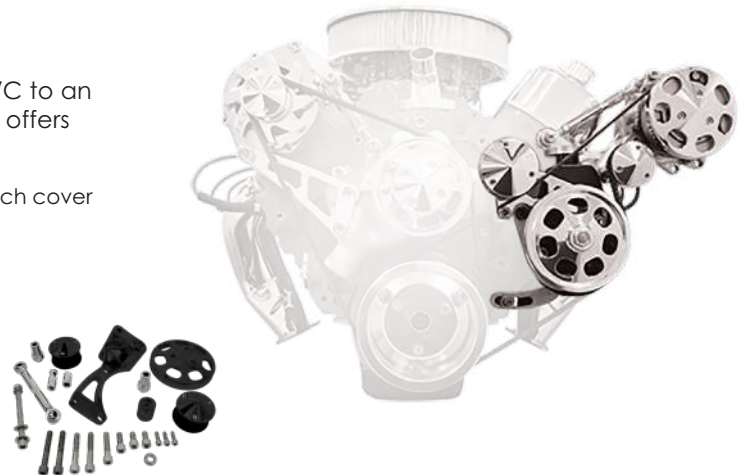

### DON'T FORGET THIS!

#### POWER STEERING PUMPS - KEYWAY or PRESS-ON?

Billet Specialties serpentine conversion kits and FM brackets are designed to work with the following Saginaw power steering pumps.

#### Saginaw Power Steering Pump:

- 1/8" Keyway Shaft: Up to 1975
- Press-On Shaft: 1975 & up



# SERPENTINE CONVERSION KITS

**BIG BLOCK CHEVROLET® - MID MOUNT**

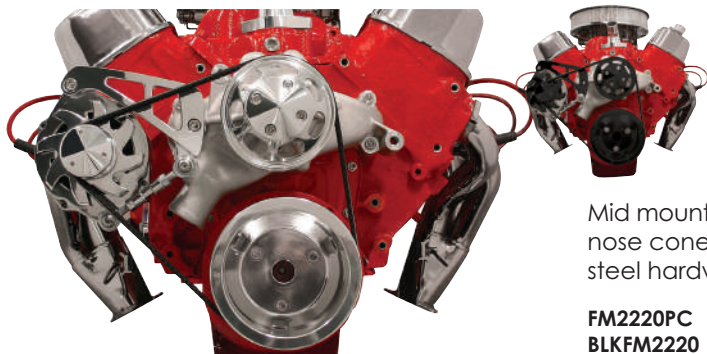

- ✓ Pulley Nose Cones - Included!
- ✓ Stainless Hardware - Included!

Mid mount passenger side alternator bracket, alternator pulley with fan and nose cone. Water pump pulley with nose cone and crank pulley. Stainless steel hardware is included.

FM2220PC  
BLKFM2220

Mid Mount-Alt Only Polished  
Mid Mount-Alt Only Black

**BIG BLOCK CHEVROLET®**

Mid Mount - Alternator Only Kit

Designed for use with:

- Long water pump
- GM 10SI / 12SI alternator

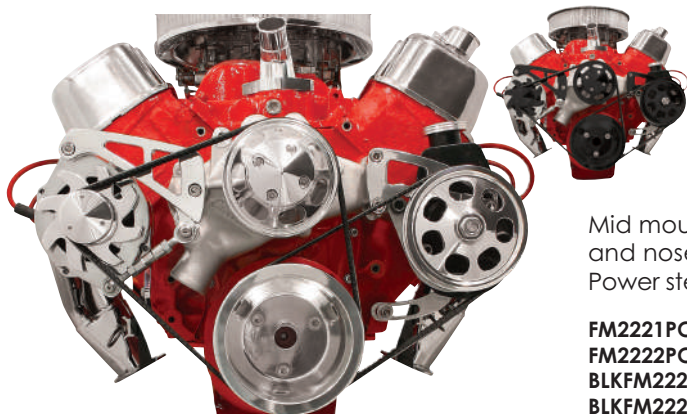

- ✓ Pulley Nose Cones - Included!
- ✓ Stainless Hardware - Included!

Mid mount passenger side alternator bracket, alternator pulley with fan and nose cone. Water pump pulley with nose cone and crank pulley. Power steering pump bracket and pulley. Stainless steel hardware included.

FM2221PC  
FM2222PC  
BLKFM2221  
BLKFM2222

Keyway Shaft Power Steering Pump Polished  
Press-on Shaft Power Steering Pump Polished  
Keyway Shaft Power Steering Pump Black  
Press-on Shaft Power Steering Pump Black

**BIG BLOCK CHEVROLET®**

Mid Mount - Alternator & Power Steering Kit

Designed for use with:

- Long water pump
- GM 10SI / 12SI alternator
- Saginaw power steering pump

## DO IT RIGHT!

All Billet Specialties Tru Trac, V-Trac and Serpentine Conversion kits are designed for the most rigid final assembly in the industry. Here is why:

### STRENGTH

By using solid stainless stand-offs and threaded block mounting studs - rather than long bolts through a saw-cut tubing spacer - flex, fatigue and failure are non-existent

### PRECISION

Our stand-offs are designed for precise positioning and alignment of components, not just "spacing". Each stand-off is CNC machined within .002" - a tolerance that cannot be met with saw-cut tubing.

### DOUBLE THE SURFACE AREA

Stand-offs have over twice the contact surface area compared to a cut piece of tubing. With two times more thread engagement, stand-offs ensure greater clamping force.

### CORROSION RESISTANCE

Stainless steel stand-offs and hardware resist corrosion compared to mild steel and zinc plated fasteners.

### EASE OF ASSEMBLY

Stand-offs enable straight forward assembly allowing you to install the water pump before the accessory bracket. Each piece goes together in a logical order. No component / bracket / fastener juggling or balancing acts required.

**BILLET SPECIALTIES**  
STAINLESS STAND-OFF

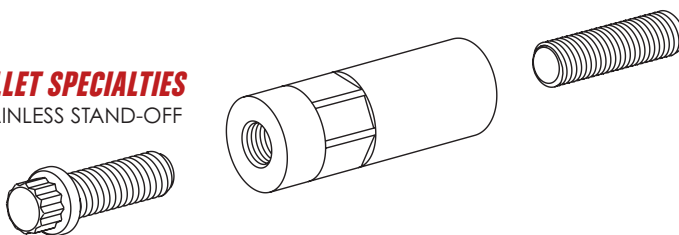

**VS.**

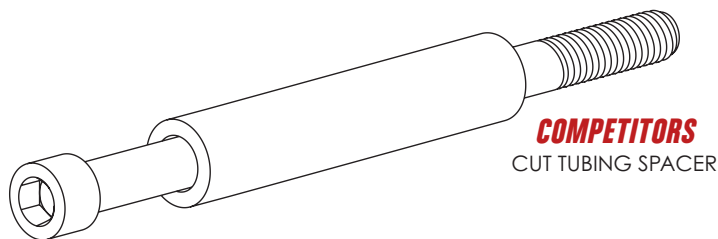

**COMPETITORS**  
CUT TUBING SPACER

**ABSOLUTELY THE STRONGEST, MOST RIGID METHOD. PERIOD.**

# ACCESSORY BRACKETS

## SMALL BLOCK CHEVROLET® - (LONG WATER PUMP)

### SMALL BLOCK CHEVROLET®

#### Top Mount - Alternator Only Bracket

##### Designed for use with:

- Long water pump
- GM 10SI / 12SI alternator
- V-groove pulleys (See pages 58-59) or Serpentine pulleys (See page 57)

##### Kit Includes:

Top mount passenger side alternator bracket & stainless steel hardware.

FM0109PC

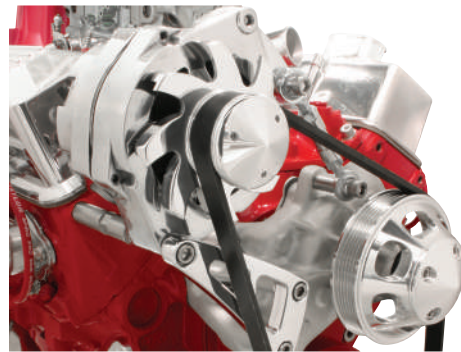

### SMALL BLOCK CHEVROLET®

#### Mid Mount - Alternator Only Bracket

##### Designed for use with:

- Long water pump
- GM 10SI / 12SI alternator
- V-groove pulleys (See pages 58-59) or Serpentine pulleys (See page 57)

##### Kit Includes:

Mid mount passenger side alternator bracket & stainless steel hardware.

FM0107PC



### SMALL BLOCK CHEVROLET®

#### Saginaw Power Steering Pump Bracket

##### Designed for use with:

- Long water pump
- Saginaw power steering pump
- V-groove pulleys (pages 58-59) or Serpentine pulleys (page 57)

##### Kit Includes:

Driver side power steering pump bracket & stainless steel hardware.

FM0130PC

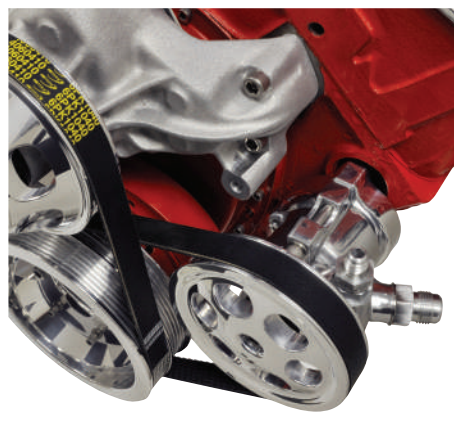

### SMALL BLOCK CHEVROLET®

#### GM Type II Power Steering Bracket & Pulley kit

##### Designed for use with:

- Long water pump
- External reservoir or Billet Specialties pump mount reservoir

##### Kit Includes:

New polished 1200psi GM type II pump. Pre-installed power steering pulley with AN fittings, bracket & stainless steel hardware.

FM1220PC



### FOR SHORT WATER PUMP ONLY

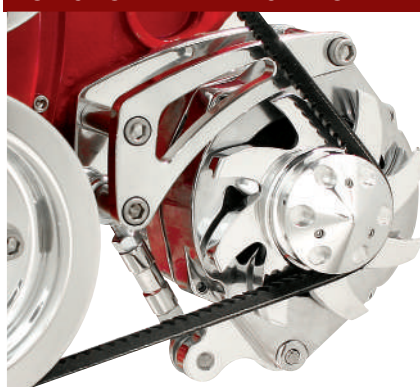

### SMALL BLOCK CHEVROLET®

#### Low Mount - Alternator Only Bracket

##### Designed for use with:

- Short water pump
- GM 10SI / 12SI alternator
- V-groove pulleys (See page 58-59)

##### Kit Includes:

Low mount driver side alternator bracket & stainless steel hardware.

FM0105PC



# ACCESSORY BRACKETS

## BIG BLOCK CHEVROLET® - (LONG WATER PUMP)

### BIG BLOCK CHEVROLET®

#### Top Mount - Alternator Only Bracket

##### Designed for use with:

- Long water pump
- GM 10SI / 12SI alternator
- V-groove pulleys (See pages 58-59) or Serpentine pulleys (See page 57)

##### Kit Includes:

Top mount passenger side alternator bracket & stainless steel hardware.

FM0209PC

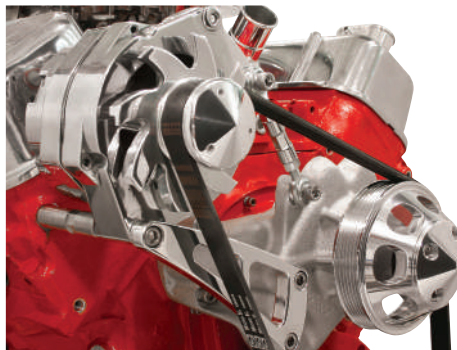

### BIG BLOCK CHEVROLET®

#### Mid Mount - Alternator Only Bracket

##### Designed for use with:

- Long water pump
- GM 10SI / 12SI alternator
- V-groove pulleys (See pages 58-59) or Serpentine pulleys (See page 57)

##### Kit Includes:

Mid mount passenger side alternator bracket & stainless steel hardware.

FM0207PC

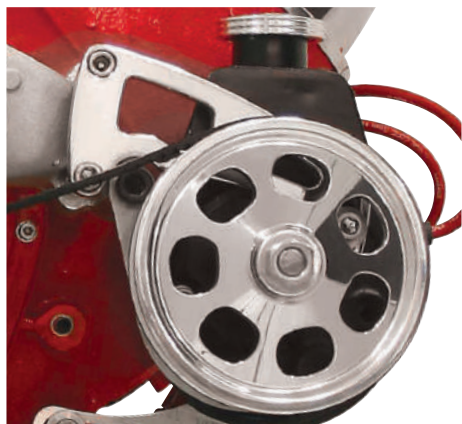
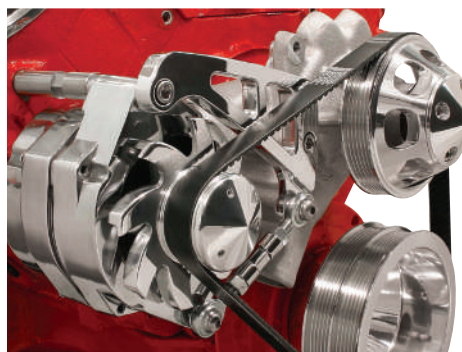

### BIG BLOCK CHEVROLET®

#### Saginaw Power Steering Pump Bracket

##### Designed for use with:

- Long water pump
- Saginaw power steering pump
- V-groove pulleys (pages 58-59) or Serpentine pulleys (page 57)

##### Kit Includes:

Driver side power steering pump bracket & stainless steel hardware.

FM0230PC

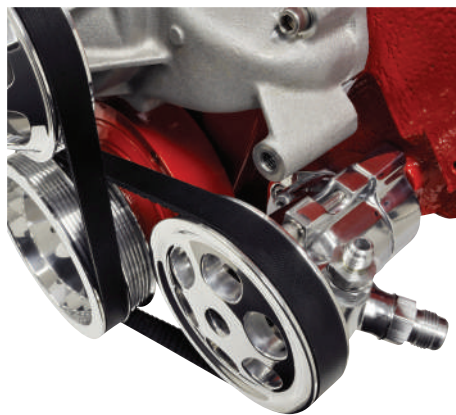

### BIG BLOCK CHEVROLET®

#### GM Type II Power Steering Bracket & Pulley kit

##### Designed for use with:

- Long water pump
- External reservoir or Billet Specialties pump mount reservoir

##### Kit Includes:

New polished 1200psi GM type II pump. Pre-installed power steering pulley with AN fittings, bracket & stainless steel hardware.

FM1225PC



### FOR SHORT WATER PUMP ONLY

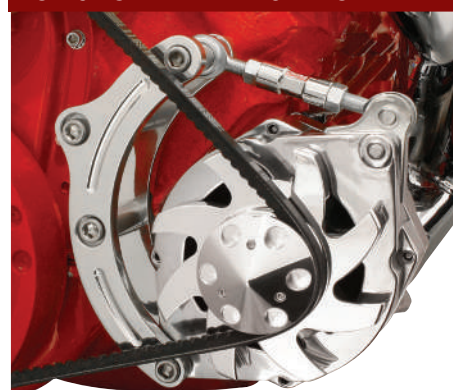

### BIG BLOCK CHEVROLET®

#### Low Mount - Alternator Only Bracket

##### Designed for use with:

- Short water pump
- GM 10SI / 12SI alternator
- V-groove pulleys (See page 58-59)

##### Kit Includes:

Low mount driver side alternator bracket & stainless steel hardware.

FM0205PC



# INDEPENDENT MOUNT BRACKETS

**SMALL BLOCK CHEVROLET® - (SHORT WATER PUMP)**

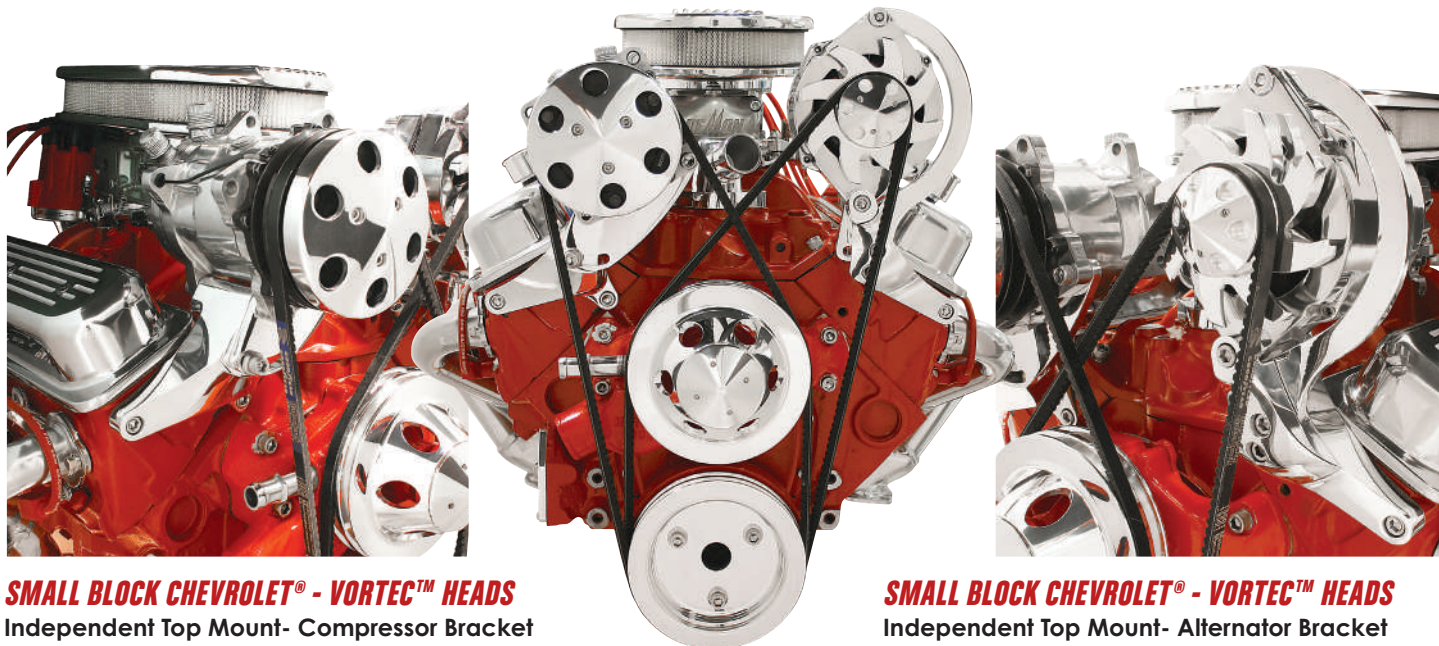

**SMALL BLOCK CHEVROLET® - VORTEC™ HEADS**  
Independent Top Mount- Compressor Bracket

Designed for use with:

- Short water pump
- Sanden 508 AC compressor
- V-groove pulleys (Pages 58-59)

Mounts to the passenger side of the motor and positions the compressor to the inside of the passenger side valve cover. Independently adjustable.

10721

**SMALL BLOCK CHEVROLET® - VORTEC™ HEADS**  
Independent Top Mount- Alternator Bracket

Designed for use with:

- Short water pump
- GM 10SI / 12SI alternators
- V-groove pulleys (Pages 58-59)

Mounts to the driver side of the motor and positions the alternator to the inside of the driver side valve cover. Independently adjustable.

10720



## NEED AN ALTERNATOR?

**140 AMP GM 10SI/12SI ALTERNATOR**

10SI/12SI Alternator For Independent Brackets

Product Features:

- 140 amp 1-wire hook-up
- Gold plated terminal
- GM 10SI/12SI Case
- New - not rebuilt case and internals

V0105

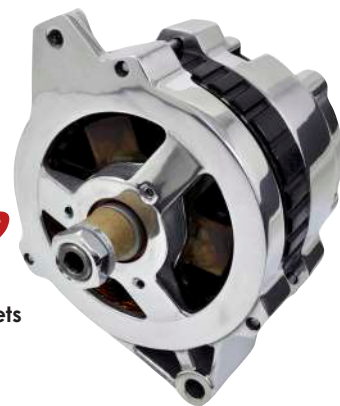



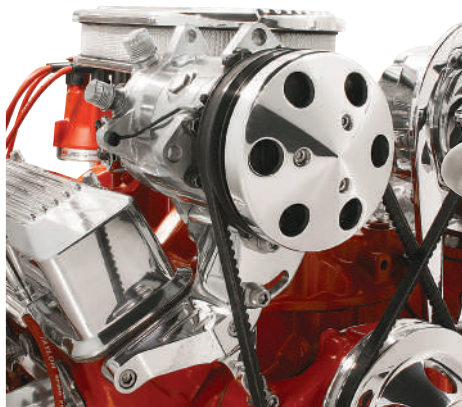

**SMALL BLOCK CHEVROLET® - STANDARD HEADS**  
Independent Top Mount- Compressor Bracket

**Designed for use with:**

- Short water pump
- Sanden 508 AC compressor
- V-groove pulleys (Pages 58-59)

Mounts to the passenger side of the motor and positions the compressor to the inside of the passenger side valve cover. Independently adjustable.

10221

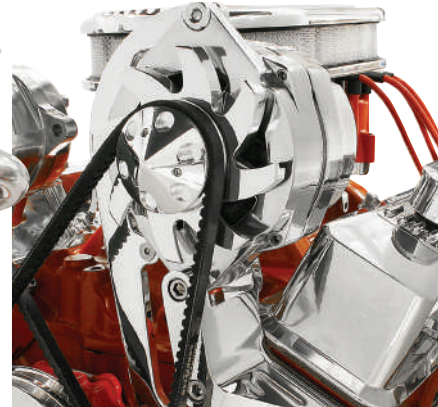
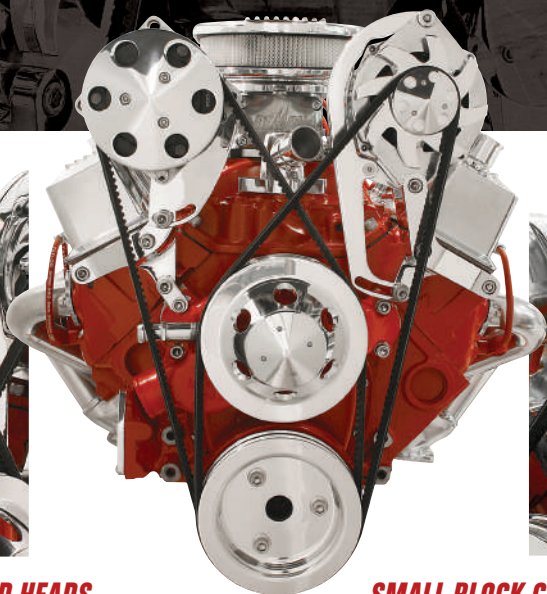

**SMALL BLOCK CHEVROLET® - STANDARD HEADS**  
Independent Top Mount- Alternator Bracket

**Designed for use with:**

- Short water pump
- GM 10SI / 12SI alternators
- V-groove pulleys (Pages 58-59)

Mounts to the driver side of the motor and positions the alternator to the inside of the driver side valve cover. Independently adjustable.

10220

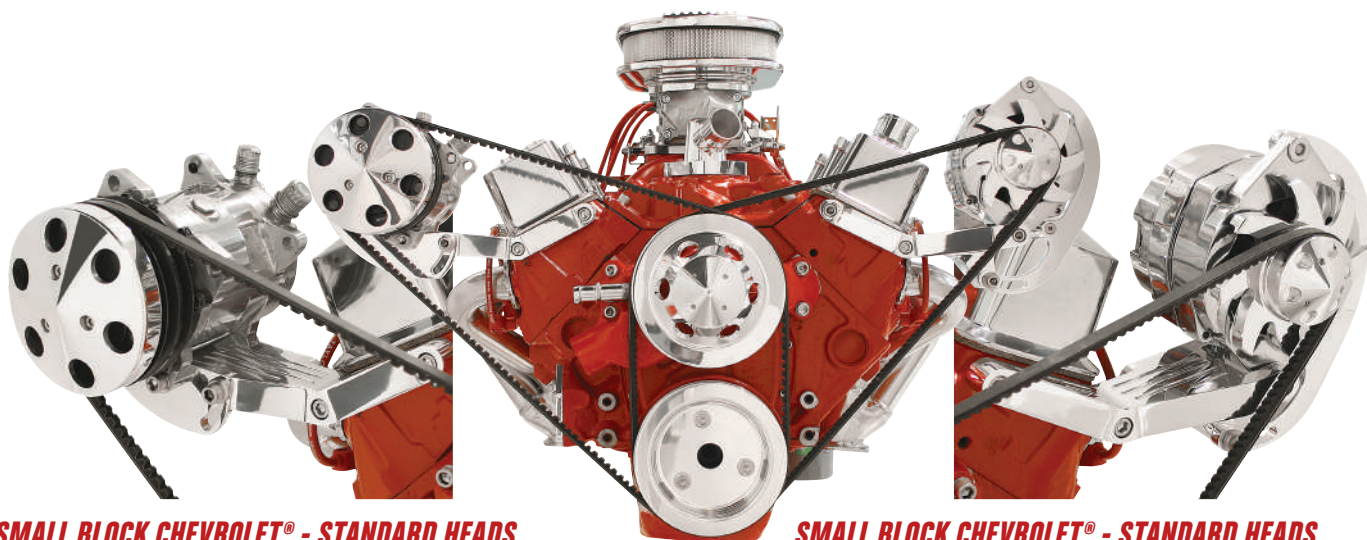

**SMALL BLOCK CHEVROLET® - STANDARD HEADS**  
Independent Side Mount- Compressor Bracket

**Designed for use with:**

- Short water pump
- Sanden 508 AC compressor
- V-groove pulleys (Pages 58-59)

Dual-point mounting to the passenger side of the motor positions the compressor to the outside of the passenger side valve cover. Independently adjustable.

10421

**SMALL BLOCK CHEVROLET® - STANDARD HEADS**  
Independent Side Mount- Alternator Bracket

**Designed for use with:**

- Short water pump
- GM 10SI / 12SI alternators
- V-groove pulleys (Pages 58-59)

Dual-point mounting to the driver side of the motor positions the alternator to the outside of the driver side valve cover. Independently adjustable.

10420



# INDEPENDENT MOUNT BRACKETS

## SMALL BLOCK CHEVROLET® - (LONG WATER PUMP)

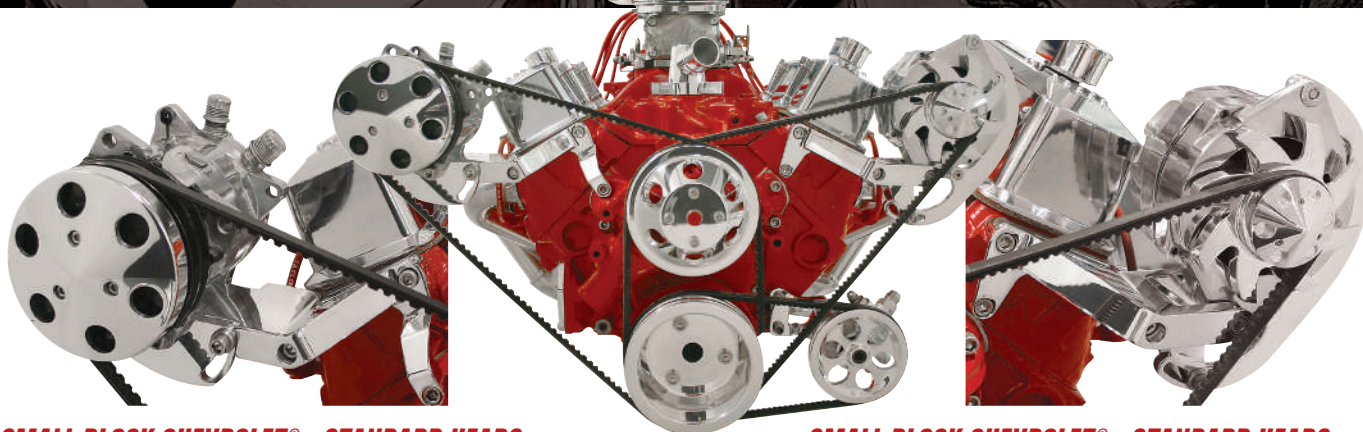

### SMALL BLOCK CHEVROLET® - STANDARD HEADS

#### Independent Side Mount- Compressor Bracket

##### Designed for use with:

- Long water pump
- Sanden 508 AC compressor
- V-groove pulleys (Pages 58-59)

3-point mounting and one piece construction for extra stability. Bracket positions the compressor to the outside of the passenger side valve cover. Independently adjustable.

11421

### SMALL BLOCK CHEVROLET® - STANDARD HEADS

#### Independent Side Mount- Alternator Bracket

##### Designed for use with:

- Long water pump
- GM 10SI / 12SI alternators
- V-groove pulleys (Pages 58-59)

3-point mounting and one piece construction for extra stability. Bracket positions the alternator to the outside of the driver side valve cover. Independently adjustable.

11420

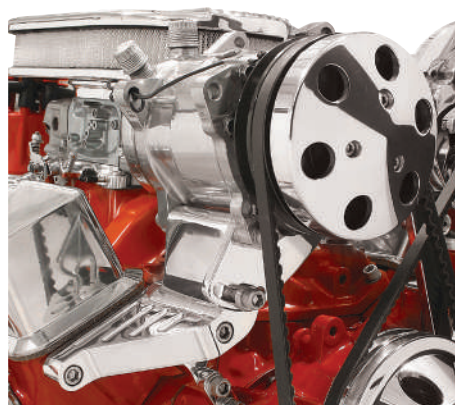

### SMALL BLOCK CHEVROLET® - STANDARD HEADS

#### Independent Top Mount- Compressor Bracket

##### Designed for use with:

- Long water pump
- Sanden 508 AC compressor
- V-groove pulleys (Pages 58-59)

3-point mounting to the head and water pump position the compressor to the inside of the passenger side valve cover. Independently adjustable.

11221

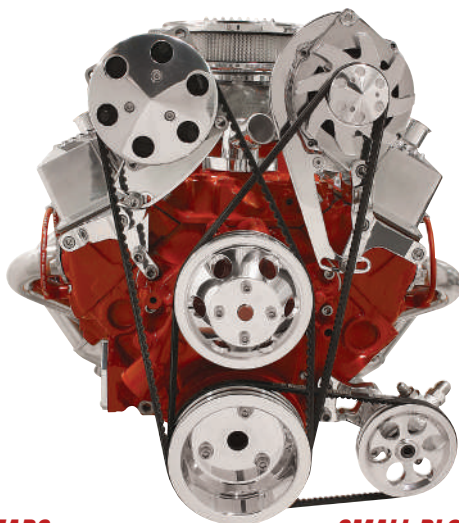

### SMALL BLOCK CHEVROLET® - STANDARD HEADS

#### Independent Top Mount- Alternator Bracket

##### Designed for use with:

- Long water pump
- GM 10SI / 12SI alternators
- V-groove pulleys (Pages 58-59)

3-point mounting to the head positions the alternator to the inside of the driver side valve cover. Independently adjustable.

11220



# INDEPENDENT MOUNT BRACKETS

**BIG-BLOCK CHEVROLET® - (SHORT WATER PUMP)**



## **BIG BLOCK CHEVROLET® - STANDARD HEADS**

**Independent Side Mount- Compressor Bracket**

### **Designed for use with:**

- Cylinder heads with 7/16" accessory bolt holes
- Short water pump
- Sanden 508 AC compressor
- V-groove pulleys (Pages 58-59)

Dual-point mounting and one piece construction for extra stability. Bracket positions the compressor to the outside of the passenger side valve cover. Independently adjustable.

10621

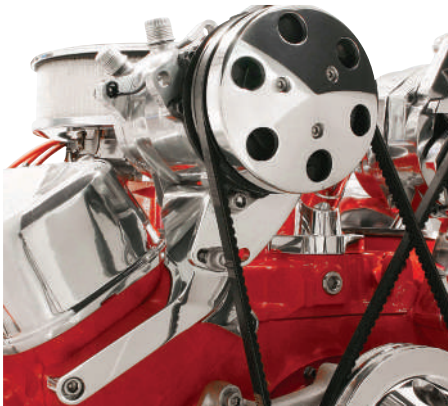

## **BIG BLOCK CHEVROLET® - STANDARD HEADS**

**Independent Top Mount- Compressor Bracket**

### **Designed for use with:**

- Cylinder heads with 7/16" accessory bolt holes
- Short water pump
- Sanden 508 AC compressor
- V-groove pulleys (Pages 58-59)

Dual-point mounting to the passenger side of the motor positioning the compressor to the inside of the passenger side valve cover. Independently adjustable.

10521

## **BIG BLOCK CHEVROLET® - STANDARD HEADS**

**Independent Side Mount- Alternator Bracket**

### **Designed for use with:**

- Cylinder heads with 3/8" bolt holes
- Short water pump
- GM 10SI / 12SI alternators
- V-groove pulleys (Pages 58-59)

Dual-point mounting and one piece construction for extra stability. Bracket positions the alternator to the outside of the driver side valve cover. Independently adjustable.

10620

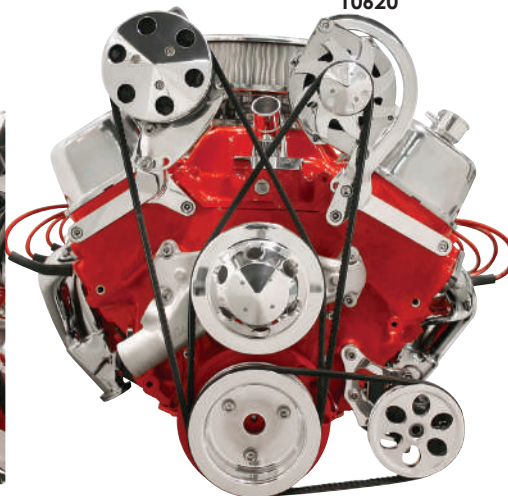

## **BIG BLOCK CHEVROLET® - STANDARD HEADS**

**Independent Top Mount- Alternator Bracket**

### **Designed for use with:**

- Cylinder heads with 3/8" accessory bolt holes
- Short water pump
- GM 10SI / 12SI alternators
- V-groove pulleys (Pages 58-59)

Dual-point mounting to the driver side of the motor positioning the alternator to the inside of the driver side valve cover. Independently adjustable.

10520





# BILLET PULLEYS & PULLEY KITS

## SERPENTINE

Precision machined & polished to a mirror finish, these pulleys are engineered to work with our accessory brackets. 6061-T6 construction means they are perfectly balanced and true unlike cast pulleys on the market. Stainless steel hardware is included.

### SERPENTINE PULLEY KIT FOR FM BRACKETS - LONG WATER PUMP

#### Designed for use with:

- Long water pump
- GM 10SI / 12SI alternator

#### Kit Includes:

- Alternator pulley with Fan & Nose Cone
- Water Pump Pulley with Nose Cone
- Crank Pulley
- Stainless Hardware

#### Small Block Chevrolet®

FM3110PC Serpentine Pulley Kit

#### Big Block Chevrolet®

FM3210PC Serpentine Pulley Kit

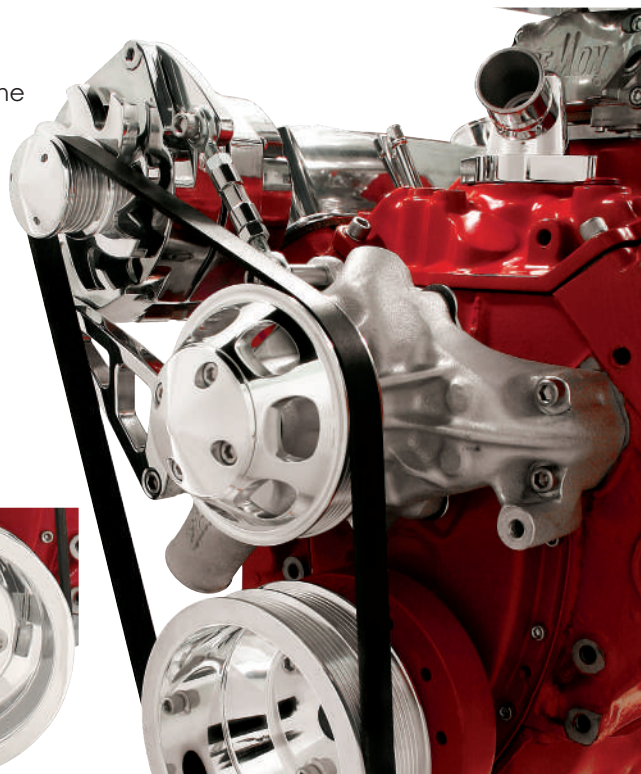

### KIT INCLUDES...

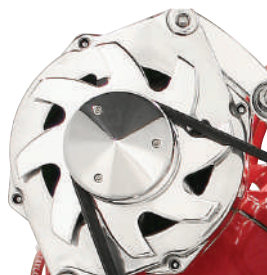

1PC. ALTERNATOR PULLEY  
W/ FAN & NOSE CONE



WATER PUMP PULLEY  
W/ NOSE CONE



CRANKSHAFT PULLEY

Brackets Available On Pages 51-52

### SERPENTINE POWER STEERING PULLEY FOR SAGINAW STYLE PUMP

#### Designed for use with:

- Long water pump
- 6-rib serpentine belt
- Billet Specialties power steering brackets (pages 51-52)

FM1030PC 1/8" Keyway Pump Shaft (up to '75)

FM1035PC Press-on Pump Shaft ('75 & up)

**Pulley Diameter: 5.875"**



### WHY BUY A BILLET PULLEY?

The benefit of a Billet aluminum pulley over a cast pulley is equal density. With a cast pulley, the aluminum is poured into a mold and then allowed to cool. This process can create variations in density throughout the pulley. Dense areas are heavier than the more porous areas causing the pulley to vibrate at high RPM. Our Billet pulleys are equally dense throughout; equal weight translates to a true and balanced pulley drive system.



# BILLET PULLEYS

## V-GROOVE

### ALTERNATOR PULLEYS

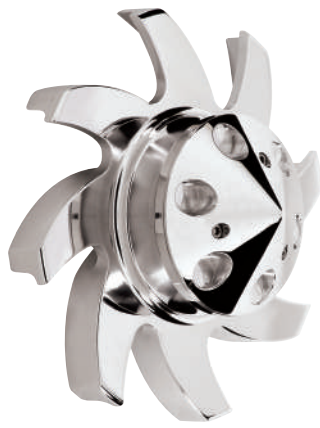

### 1PC. ALTERNATOR PULLEY WITH FAN - 2.5" DIAMETER

Billet Specialties manufactures the most balanced alternator pulley & fan combo in the industry by machining the unit out of one solid piece of aluminum. This 1-piece pulley and fan combo features a bolt on nose cone to hide the alternator nut and washer, stainless hardware included. Fits most GM, Delco, & Ford alternators.

85220



### ALTERNATOR PULLEY - 2.5" DIAMETER

Machined in the USA from 6061-T6 Billet aluminum this Billet Specialties one piece alternator pulley features a bolt on nose cone to hide the alternator nut and washer. Fits most GM, Delco, and Ford alternators.

85120

### A/C CLUTCH COVERS

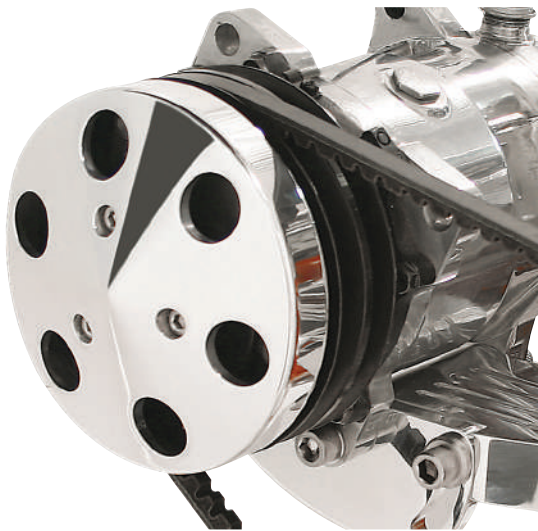

### SANDEN 508

Machined from solid Billet aluminum, this cover bolts directly to the Sanden 508 clutch with stainless hardware and is polished to a mirror finish.

87120

### KNOW THE DIFFERENCE

Beware of the term "Billet Style". In most cases this is a sign of cast aluminum imitations that offer inferior quality and finish.



# BILLET PULLEYS

## V-GROOVE

### WATER PUMP PULLEYS



SHORT WATER PUMP



LONG WATER PUMP

SMALL BLOCK CHEVROLET®		BIG BLOCK CHEVROLET®		SMALL/BIG BLOCK CHEVROLET®	
<b>SHORT WATER PUMP</b> - 6-7/16" Diameter		<b>SHORT WATER PUMP</b> - 6-7/16" Diameter		<b>LONG WATER PUMP</b> - 6" Diameter	
80120	1-Groove	82120	1-Groove	78110	1-Groove
80220	2-Groove	82220	2-Groove	78120	2-Groove
84120	Nose Cone	84120	Nose Cone	84220	Nose Cone
RP8020	Repl. Bolts	RP8020	Repl. Bolts		

### CRANKSHAFT PULLEYS



SHORT WATER PUMP



LONG WATER PUMP

SMALL BLOCK CHEVROLET®		BIG BLOCK CHEVROLET®	
<b>SHORT WATER PUMP</b> - 6.4" Diameter		<b>SHORT WATER PUMP</b> - 6.4" Diameter	
81120	1-Groove	83120	1-Groove
81220	2-Groove	83220	2-Groove
81320	3-Groove	83320	3-Groove
<b>LONG WATER PUMP</b> - 6.4" Diameter		<b>LONG WATER PUMP</b> - 6.4" Diameter	
78210	1-Groove	79210	1-Groove
78220	2-Groove	79220	2-Groove
78230	3-Groove	79230	3-Groove

### WHY BUY A BILLET PULLEY?

The benefit of a Billet aluminum pulley over a cast pulley is equal density. With a cast pulley, the aluminum is poured into a mold and then allowed to cool. This process can create variations in density throughout the pulley. Dense areas are heavier than the more porous areas causing the pulley to vibrate at high RPM. Our Billet pulleys are equally dense throughout; equal weight translates to a true and balanced pulley drive system.



# POWER STEERING PULLEYS & COMPONENTS

## POWER STEERING PULLEYS - 6" Diameter



### V-GROOVE POWER STEERING PULLEY 1966 - 1974 POWER STEERING PULLEY

Designed for use with:

- Long or short water pump
- '66-'74 Saginaw power steering pump
- Power steering pump with attached reservoir
- 1/8" keyway pump shaft

86120 1-groove  
86220 2-groove



### V-GROOVE POWER STEERING PULLEY 1975 & UP POWER STEERING PUMP

Designed for use with:

- Long water pump
- '75 & up Saginaw power steering pump
- Power steering pump with attached reservoir
- Press-on pump shaft

86420 1-groove  
86520 2-groove

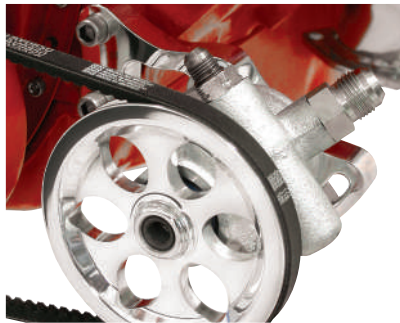

Short Water Pump



Long Water Pump



### POWER STEERING BRACKET & PULLEY KIT

Engineered to work with GM type II remote power steering pumps. Billet Specialties power steering bracket and pulley is precision machined from 6061-T6 Billet aluminum and mounts low on the driver's side of the motor.

**\*Requires a 3-Groove Crank Pulley\***

Dimensions:

From center of crank pulley to outside of power steering pulley:

- Small Block Chevy™ - 11.00"
- Big Block Chevy™ - 10.75"
- Pulley Diameter: 4.75"

### SMALL BLOCK CHEVROLET®

12120 Short Water Pump

12220 Long Water Pump

### BIG BLOCK CHEVROLET®

12320 Short Water Pump

**\*Check for clearance before ordering\***

# POWER STEERING COMPONENTS

## REMOTE POWER STEERING RESERVOIR

In your choice of Smooth or Ribbed styles, our remote power steering reservoirs are much more than empty cans. The double O-ring sealed breathable cap relieves positive and negative pressure while keeping your engine compartment clean. Forget foaming and fluid turbulence with our innovative internal return tube. Includes male AN fittings on the bottom of the reservoir.

Our exclusive bracket design clamps to the reservoir with an internal lock. The mounting hardware is completely hidden!

### Note:

- Bracket must be installed at center of reservoir as shown
- Not for use with Hydroboost systems

77910	Smooth Reservoir w/ Bracket Polished
BLK77910	Smooth Reservoir w/ Bracket Black
RP7701	-8AN Power Steering Supply Fitting
RP7791	Replacement O-Ring Kit

## TECH TIP



For optimal performance always mount the remote power steering reservoir higher than the power steering pump.

## PUMP MOUNT RESERVOIR

Billet Specialties pump mount Billet reservoir is a machining marvel with innovative features such as threaded double O-ring reservoir and hose attachments providing secure leak free service. Precision machined internal baffling eliminates foaming and is topped off with a vented notch grip cap to match our other accessories.

### Product Features:

- Precision 3D Machined
- 6061-T6 Billet aluminum
- Vented fill cap with dipstick
- High fluid capacity

77930	Polished
BLK77930	Black Anodized

\* Only works with SB, BBC, LS & LT4 Tru Trac, V-Trac & FM Serpentine Conversion Kits \*



Replacement O-Ring Kit Available - RP7793



## QUALITY INSIDE AND OUT!

- Internally baffled and O-ring sealed cap to prevent splash over
- Vented cap eliminates positive & negative pressure which leads to foaming
- Innovative internal return tube greatly reduces fluid turbulence & foaming
- Extra capacity of up to 15 oz. of fluid in a compact design
- Sleek mounting bracket with internal key lock design hides all hardware
- -6 & -10 AN male AN fittings are included and pre-installed
- 100% Billet aluminum construction - polished to a mirror finish
- Overall dimensions: 2-7/8" O.D. x 8-3/4"H (Cap: 3" O.D.)



Matching Overflow Tanks, see page 79 for details!



### SAGINAW STYLE POWER STEERING PUMP WITH RESERVOIR KEYWAY SHAFT

The GM Saginaw style pump features all new components including reservoir and pump assembly. Includes new chrome cap, new dip stick, and hardware. Pumps are 1200 PSI rated to work with most gearbox systems.

#### Applications:

Bracket Kits and Brackets;

- Small Block Chevrolet  
FM2111PC, BLKFM2111PC, FM2121PC, BLKFM2121PC, & FM0130PC
- Big Block Chevrolet  
FM2211PC, BLKFM2211PC, FM2221PC, BLKFM2221PC, & FM0230PC

Power Steering Pulley;

- FM1030PC



12010 Black

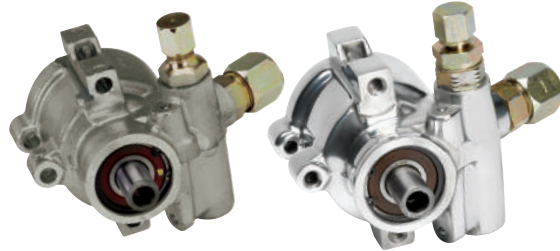

### POWER STEERING PUMPS

#### Product Features:

- Flow rate: 3.5GPM @ 1200PSI
- Cad plated AN fittings pre-installed
- New pump (not remanufactured)

12025 Polished  
12020 Natural



### POWER STEERING HOSE KITS

We take the guesswork out of power steering hoses to save you time and money. Each kit is supplied with enough adapters to cover most popular GM boxes and Ford type racks. Quality fittings and hose from Russell Performance are used exclusively to ensure reliability. Included -6 fittings match our pump mount power steering reservoirs and the GM Type II pumps used in Tru Trac & V-Trac pulley systems.

#### HOSE KITS FOR PUMP MOUNT RESERVOIR

##### Features:

- 2 - 3ft sections - 6 Powerflex High Pressure Hose
- 5 - 6 AN Endura Hose Ends
- Adapters to fit most Rack & Steering Boxes
- Comprehensive Instructions

77905



#### HOSE KIT FOR REMOTE RESERVOIR

##### Applications:

- '65-'78 GM 800 steering gear box (Metric & SAE)
- '74-'77 Ford Mustang II rack & pinion
- CPP GM 500 steering gear box
- GM rack & pinion
- Flaming River rack & pinion
- Dodge Omni rack & pinion

77900



#### POWER STEERING HARDLINE KIT FOR GM TYPE 2 PUMP

Billet Specialties Type 2 Power Steering Pump Hardline Kit routes the pressure line connection below the pump for a tidy and clean look. Attaches to the power steering pump with a simple Banjo Bolt and terminates at the hose with a -6AN fitting.



77908



#### POWER STEERING ADAPTER KIT

##### Applications:

- '77-'78 Mustang II rack & pinion
- Up to '88 T-Bird rack & pinion
- Maval Mfg. rack & pinion
- Saginaw 600 steering gear box

77901



#### RESERVOIR TIGHT FIT KIT

Kit includes -6 & -10 90° AN fittings for use with our Billet remote reservoirs when available space does not allow for the use of straight fittings.

77902



#### 2GPM FLOW CONTROL VALVE

Reduce the flow of GM type II power steering pumps from 3.5 GPM to 2 GPM which is recommended for Mustang II rack & pinion steering.

RP1300



# STREAMLINE AIR CLEANERS

## OVAL STREAMLINE - BLACK

Billet Specialties Streamline air cleaners offer a fresh new look for Hot Rod Custom car air cleaners. Precision Machined Billet aluminum tops capped off with a 3D machined wing nut and single raised rib complement any exterior trim cues.

### Available finishes include:

- Satin black powder coat with a polished trim strip and wing nut.
- Ready to Finish bead blasted surface ready to be powder coated or primed and painted with a polished trim strip and wing nut.

### Product Features:

- Includes integrated wing nut easily replaceable filter element
- Stainless steel mounting hardware
- Fits Standard 4-Barrel Carburetors (Not for use with Dominator carburetors)

15324 Small Oval  
15424 Large Oval



**WE PREPPED IT, YOU PAINT IT!**



## OVAL STREAMLINE - READY TO FINISH

15324RTF Small Oval  
15424RTF Large Oval



### Dimensions:

Small Oval: 11-7/8"L x 8-3/8"W x 3-3/4"H  
Large Oval: 15"L x 8-1/2"W x 3-3/4"H  
Round: 14" Overall Diameter / 3-3/4" Tall



## 14" ROUND STREAMLINE

15824RTF Ready to Finish  
15824 Black



## DEMON CARB?

For proper installation of a Billet Specialties air cleaner you'll need a Demon Carb Stud Kit RP1516



# RIBBED AIR CLEANERS

## ROUND 14" PROFILE

Billet Specialties Profile accessories are something special. Each product is a progression of styling and machining precision. Our Profile 14" air cleaner is no exception, featuring a 3D machined top with Billet perimeter posts retaining a K&N filter for performance - all on top of a fully machined carb base and clamp. Polished to perfection the 14" Profile air cleaner will be the centerpiece of your engine compartment.



P15840 14" Round



**K&N Lifetime Filter Included!**



## DUAL QUAD

By using adjustable mounting plates, dual quad air cleaners will fit carburetors with a minimum spacing of 6-3/8" to a maximum spacing of 8-13/16" measured from center to center of each carb. Some applications may require trimming of mounting plates.

**15650 Polished**  
**BLK15650 Black Powder Coat**



Dual Quad Adjustable Base. Fits carburetors with a minimum spacing of 6-3/8" to a maximum spacing of 8-13/16" measured from center to center of each carb.



**K&N Lifetime Filter Included!**

## OVAL RIBBED

Traditional Hot Rod Style is reflected in our Ribbed Air Cleaners. Machined raised ribs rise from the mirror polished surface via thousands of lines of programming code, each radius matches other ribbed accessories for consistency. Truly in a class by themselves, Billet Specialties air cleaners are the best quality air cleaner you can buy.

### Product Features:

- High quality, industry leading mirror finish polish
- Easily replaceable filter element
- Stainless steel mounting hardware
- Fits standard 4-barrel carburetors (Not for use with Dominator carburetors)

**15630 Polished Small Oval**  
**BLK15630 Black Small Oval**

**15640 Polished Large Oval**  
**BLK15640 Black Large Oval**

### Dimensions:

Small Oval: 11-7/8"L x 8-3/8"W x 3"H

Large Oval: 15"L x 8-1/2"W x 3"H

Dual Quad: 17-1/2"L x 9-3/8"W x 3-1/4"H

Round: 14.5" Overall Diameter / 3-1/4" Tall



# PLAIN AIR CLEANERS

When simple says more, our plain air cleaners say it the best with mirror finished perfection. Plainly put, you will not find a better quality air cleaner anywhere. Precision machined from 6061-T6 aluminum and supplied with stainless hardware and common easy to replace filter elements make Billet Specialties air cleaners stand out from the crowd.

**Product Features:**

- High quality, industry leading mirror finish polish
- Easily replaceable filter element
- Stainless steel mounting hardware
- Fits standard 4-barrel carburetors  
(Not for use with Dominator carburetors)

**Dimensions:**

Small Oval: 11-7/8"L x 8-3/8"W x 3"H  
 Large Oval: 15"L x 8-1/2"W x 3"H  
 Dual Quad: 17-1/2"L x 9-3/8"W x 3-1/4"H  
 Round: Overall Height 3"  
 Triangle: 14-7/8"L x 13-1/2"W x 3-1/8"H

15329 Small Oval  
 15429 Large Oval



15529 Dual Quad Plain



  
 STEEL BROSSELOPS HOUSING AND PRESSEDS  
**K&N Lifetime Filter  
 Included!**



15729 Triangle Plain



6-3/8" Round Plain  
 15129

  
 STEEL BROSSELOPS HOUSING AND PRESSEDS  
**K&N Lifetime Filter  
 Included!**



10" Round Plain  
 15229



15829 14" Round Plain Polished  
 BLK15829 14" Round Plain Black  
 Includes 1" steel drop base





# BALL MILLED AIR CLEANERS



Classic Billet Specialties Ball Milled air cleaners will stand the test of time and have set today's standards of design. Precision machined from 6061-T6 aluminum then polished to a mirror finish, Billet Specialties Ball Milled air cleaners feature stainless hardware and standard size air filters for ease of service and long life. Stand out in the crowd with a Billet Specialties Ball Milled air cleaner.

**Product Features:**

- High quality, industry leading mirror finish polish
- Easily replaceable filter element
- Stainless steel mounting hardware
- Fits standard 4-barrel carburetors  
(Not for use with Dominator carburetors)

15320 Small Oval  
15420 Large Oval



**K&N**  
STEEL BRIDGELAPS BERRY AIR SYSTEMS  
K&N Lifetime Filter  
Included!

15720 Triangle Ball Milled



15520 Dual Quad Ball Milled



15820 14" Round Ball Milled Polished  
BLK15820 14" Round Ball Milled Black  
Includes 1" steel drop base



10" Round Ball Milled  
15220



**K&N**  
STEEL BRIDGELAPS BERRY AIR SYSTEMS  
K&N Lifetime Filter  
Included!

6-3/8" Round Ball Milled  
15120





# 14" ROUND AIR CLEANERS

Billet Specialties' Classic and Vintage air cleaners offer a modern alternative from the decade's old standard of stamped steel air cleaners. Stand out from the crowd with three versions to choose from, Vintage polished or black powder coated for the 50-60's style and the Classic for your muscle car – high horsepower fix. Precision machined top features a unique Billet wing nut on top of a quality element and 1" steel drop base for hood clearance.

## Product Features:

- 14" Round diameter
- 3" Overall height
- 1" Drop base
- Stainless hardware
- Fits standard 4-barrel carburetors
- Paper element



15837  
BLK15830  
15830

Polished Classic  
Black Vintage  
Polished Vintage



Polished Classic



Black Vintage



Polished Vintage



MACHINED BILLET WINGNUT



# CROSS FLAG AIR CLEANERS



Classic 60's cross flag styling is machined right into the Billet aluminum top for a look that cast aluminum air cleaners cannot match. Billet Specialties unmistakable mirror finish guarantees the attention your engine compartment deserves. Includes stainless hardware for long life and easy to find common size elements for easy replacement.

#### Product Features:

- High quality, industry leading mirror finish polish
- Stainless steel mounting hardware
- Fits standard 4-barrel carburetors (Not for use with Dominator carburetors)

#### Dimensions:

Small Oval: 11-7/8"L x 8-3/8"W x 3"H  
Large Oval: 15"L x 8-1/2"W x 3"H

15327 Small Oval  
15427 Large Oval



## REPLACEMENT ELEMENT GUIDE

### Oval Air Cleaner Elements

Available at most automotive stores

	Brand	Dimensions (in)	Part
<b>SMALL OVAL</b>			
Stock	Group 7	11.5 x 8.125 x 2	VA-3138
Aftermarket	K&N	11.5 x 8.125 x 2	E-3505
<b>LARGE OVAL</b>			
Stock	Group 7	14.625 x 7.75 x 2	VA-3193
Aftermarket	K&N	14.625 x 7.75 x 2	E-3515

### Dual Quad/Triangle Air Cleaner Elements

Available at most automotive stores

	Brand	Dimensions (in)	Part
<b>DUAL QUAD/TRIANGLE</b>			
Stock	K&N	14 OD x 12 ID x 2.31	E-3740

### Round Air Cleaner Elements

Available at most automotive stores

	Brand	Dimensions (in)	Part
<b>ROUND 6-3/8"</b>			
Stock	K&N	6.125 OD x 5.125 ID x 2	E-3330
<b>ROUND 10"</b>			
Stock	Purolator	9.75 OD x 8 ID x 2.25	A30045
Aftermarket	K&N	9.75 OD x 7.875 ID x 2	E-2740
<b>ROUND 14"</b>			
Stock	Purolator	14 OD x 11.675 ID x 3	A60074
Aftermarket	K&N	14 OD x 12 ID x 2.3125	E-3740

## REPLACEMENT PARTS

RP1500	Air Cleaner Stud Kit
RP1516	5/16" Demon Carb Stud Kit
RP1508	14" Round Air Cleaner - Flat Base



2.5" Tall Spacer Ring for Dual Quad & Triangle Air Cleaners

15500-905

# BILLET VALVE COVERS

## PROFILE COLLECTION

### LS MODULAR VALVE COVERS

True innovation with features like the coil packs and oil fill cap hidden under the ribbed and vented top cover, ARP 12 pt. stainless hardware and two finish options. Our LS modular valve covers clean up your engine and add aggressive styling - get a pair today.

#### Product Features:

- 6061-T6 Billet aluminum construction
- Hidden Billet aluminum screw-in oil fill cap included
- Polished ARP 12-point stainless fastening hardware included
- Mirror polished or Black Anodized finishes match other Billet Specialties engine accessories



**Important-Requires OEM Coil**  
LS3 Coils GM P/N 12611424



LS3 Modular Chevrolet® Script  
P95480 Polished  
P95485 Black



LS3 Modular Smooth  
P95471 Polished  
P95476 Black



LS3 Modular Ribbed  
P95470 Polished  
P95475 Black

\* Not for use with OEM Corvette accessory drives

### LS VALVE COVER CONVERSION KITS

Coils are Ugly! Hide them and give your modern LS classic style with Billet Specialties LS valve cover conversion kits. Each kit allows the use of perimeter style Chevrolet valve covers on an LS motor while hiding the coils underneath for a classic clean look. Recessed wire channels drop the wires where you need them for ease of installation.

#### Product Features:

- Precision Machined from 6061-T6 Billet Aluminum
- Small Block Chevrolet works with large LS3 coils (AC Delco D14A)
- Big Block Chevrolet works with either Round LS3 coils (AC Delco D14A) or Flat LS3 coils (AC Delco D510C)
- Recessed wire channels
- Made in the USA
- Retains the factory LS gasket for a leak free seal
- Hidden oil fill cap (1 Each Side)
- Stainless Mounting Hardware



### HIDES THE FACTORY LS COILS & WIRING



LS Valve Cover Conversion Kit - Small Block  
95037



LS Valve Cover Conversion Kit - Big Block  
96037

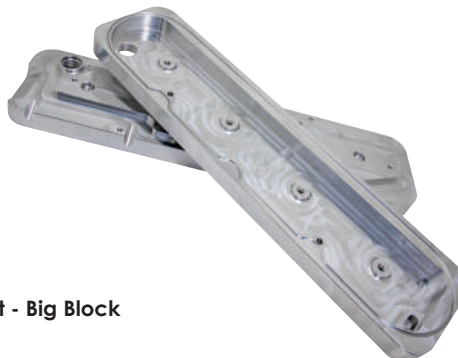

\* Small Block Kit Shown



Retains OEM LS Gasket Channel



NPT Breather Port



## BILLET LS VALVE COVERS



Billet Specialties Profile Collection billet valve covers for the LS are precision machined from a solid block of aluminum to create the ultimate valve cover. Featuring ARP hardware and billet machined cap. Utilizes OEM style gasket for leak free operation. Select from ribbed or plain styles. Requires coil relocation.

### Product Features:

- Precision machined from 6061-t6 aluminum
- Mirror polished finish matches other Billet Specialties accessories
- ARP 12-point stainless fasteners included
- Billet machined screw-in oil fill cap



P95450 Ribbed

\* Valve Covers do not have a provision for coil mounts P95459 Plain

## CAST LS VALVE COVERS

Billet Specialties cast valve covers for the LS offer maximum style for the price. Select from Classic Chevrolet script machined into the covers or Streamline to complement our other Streamline accessories. Requires coil relocation.

### Product Features:

- Precision die cast construction
- Includes gaskets and mounting hardware
- Screw in aluminum oil cap
- Streamline available in satin black or ready to finish



95424 LS Streamline BLK/POL  
95424RTF LS Streamline RTF

BLK95423

LS Chevrolet® Black Short



## LS VALVE COVER ADAPTERS

Billet Specialties Valve Cover Adapters make your LS look like a classic small block by allowing you to install a small block Chevrolet or a small block Ford set of valve covers on your modern LS. Precision machined from 6061-t6 aluminum for strength, each adapter uses the OEM LS gasket on the bottom and the standard small block cork gasket on the top for leak free operation. Coil relocation is required.

### Product Features:

- Precision machined from 6061-t6 aluminum
- Retains OEM LS gasket on the bottom and cork gasket on the top
- Hardware included
- Made in the USA

### SMALL BLOCK CHEVROLET



SMALL BLOCK CHEVY VALVE COVER TO LS ADAPTERS  
95030

### SMALL BLOCK FORD



SMALL BLOCK FORD VALVE COVER TO LS ADAPTERS  
95032

# VALVE COVERS

## SMALL BLOCK CHEVROLET®

Our CNC milled aluminum valve covers are guaranteed to draw attention to your engine compartment. Available in short and tall heights with a 1-1/4" diameter breather hole positioned between the rockers to reduce oil splash. Valve covers are produced from a high-grade aluminum that is polished to Billet Specialties standards and each design is CNC machined in the USA. Use tall style valve covers if using roller rockers and stud girdles. All Valve Covers sold in pairs.

### Product Features:

- Includes metal baffles
- Includes grommets
- Accepts 1-1/4" breathers (pgs 77-78)
- Short valve covers: 2-3/4"H
- Tall valve covers: 3-3/4"H



BLK95121 Bowtie Black Short  
BLK95221 Bowtie Black Tall



BLACK POWDER COAT

BLK95123 Chevrolet Black Short  
BLK95223 Chevrolet Black Tall

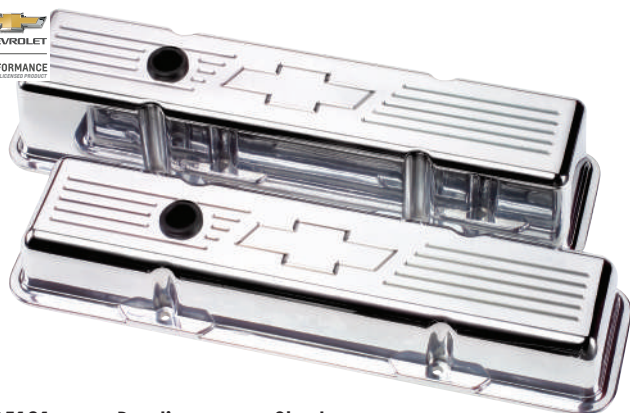

95121 Bowtie Short  
95221 Bowtie Tall



95123 Chevrolet Short  
95223 Chevrolet Tall



95122 Chevy Power Short  
95222 Chevy Power Tall



95129 Plain Short  
95229 Plain Tall

### REPLACEMENT PARTS

For replacement parts see page 74



## STREAMLINE VALVE COVERS

Billet Specialties Streamline Valve Covers offer a fresh new look in valve cover choices. The precision machined Billet aluminum trim strip complements our Streamline Air Cleaners. Available in two finishes; Satin black powder coat with a polished Billet aluminum trim strip or Ready to Finish that has a bead blasted surface ready to be powder coated or primed and painted with a polished trim strip. Includes stainless hardware and baffles.



95124 Streamline Black Short  
95224 Streamline Black Tall

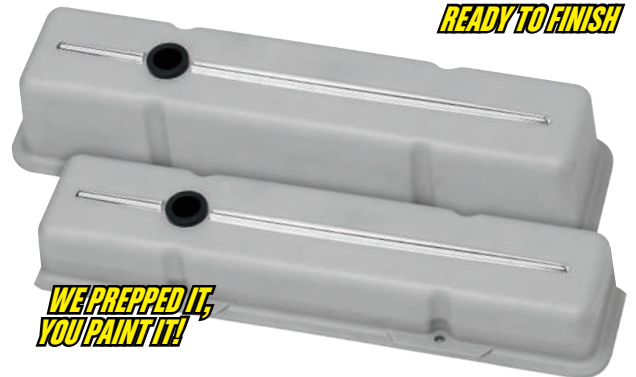

**READY TO FINISH**

**WE PREPPED IT,  
YOU PAINT IT!**

95124RTF Streamline RTF Short  
95224RTF Streamline RTF Tall



95120 Ball Milled Short  
95220 Ball Milled Tall



95127 Cross Flags Short  
95227 Cross Flags Tall

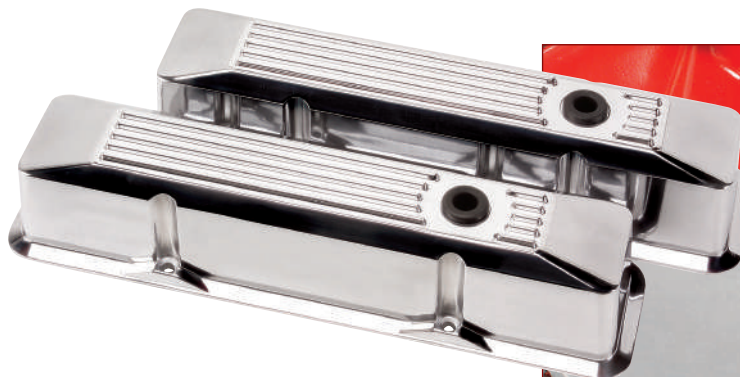

### Ribbed

Machined "fins" sit above the mirror finished surface of these valve covers.

95620 Ribbed Tall



### TECH TIP

For the best seal, Billet Specialties recommends the use of a cork gasket with all of the valve covers we sell.



# VALVE COVERS

## BIG BLOCK CHEVROLET®

Our CNC milled aluminum valve covers are guaranteed to draw attention to your engine compartment. Available in short and tall heights with a 1-1/4" diameter breather hole positioned between the rockers to reduce oil splash. Valve covers are produced from a high-grade aluminum that is polished to Billet Specialties standards and each design is CNC machined in the USA. Use tall style valve covers if using roller rockers and stud girdles. All Valve Covers sold in pairs.

### Product Features:

- Includes metal baffles
- Includes grommets
- Accepts 1-1/4" breathers (pgs 77-78)
- Short valve covers: 2-3/4"H
- Tall valve covers: 3-3/4"H

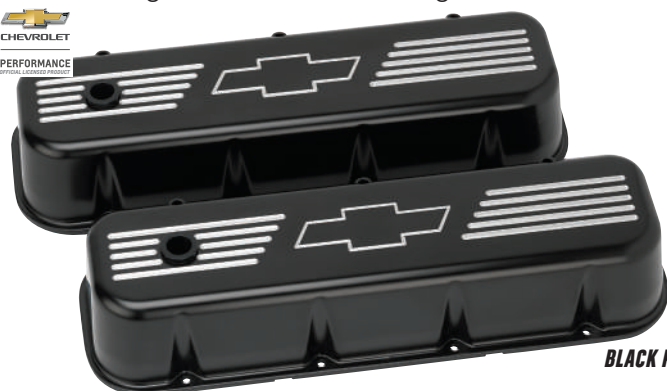

BLK96121 Bowtie Black Tall



BLACK POWDER COAT

BLK96123 Chevrolet Black Tall



96021 Bowtie Short  
96121 Bowtie Tall



96023 Chevrolet Short  
96123 Chevrolet Tall



96022 Chevy Power Short  
96122 Chevy Power Tall



96029 Plain Short  
96129 Plain Tall



# VALVE COVERS & HOLD DOWNS

## STREAMLINE VALVE COVERS

Billet Specialties Streamline Valve Covers offer a fresh new look in valve cover choices. The precision machined Billet aluminum trim strip complements our Streamline Air Cleaners. Available in two finishes; Satin black powder coat with a polished Billet aluminum trim strip or Ready to Finish that has a bead blasted surface ready to be powder coated or primed and painted with a polished trim strip. Includes stainless hardware and baffles.



96124 Streamline Black Tall

## READY TO FINISH



96124RTF Streamline RTF Tall



96020 Ball Milled Short  
96120 Ball Milled Tall



96027 Cross Flags Short  
96127 Cross Flags Tall

## VALVE COVER HOLD DOWNS

Each hold down is 2-7/8" tall with 1/4-20 threaded stud and can only be used on the exhaust side of tall big block valve covers.

- 95011 Acorn
- 95013 Hex

Long studs are required when using our Billet wire looms.

RP9510 Long Stud Kit



## REPLACEMENT PARTS

- 95002 Grommet (1-1/4" Valve Cover Hole)
- RP956033 Baffles - Small Block Tall
- RP956034 Baffles - SB/Short - BB/Tall
- RP956035 Baffles - Big Block Short



# VALVE COVERS

## CENTER BOLT CHEVROLET®

Our CNC milled aluminum valve covers are guaranteed to draw attention to your engine compartment. Available in short and tall heights with a 1-1/4" diameter breather hole positioned between the rockers to reduce oil splash. Valve covers are produced from a high-grade aluminum that is polished to Billet Specialties standards and each design is CNC machined in the USA. All Valve Covers sold in pairs.

### Product Features:

- Includes stainless bolts
- Includes grommets
- Accepts 1-1/4" breathers (pages 77-78)
- Short valve covers: 2-3/4"H
- Tall valve covers: 3-3/4"H



95829	Plain	Short
95729	Plain	Tall



Tall Style



95820	Ball Milled	Short
95720	Ball Milled	Tall

Tall Style



95827	Cross Flags	Short
95727	Cross Flags	Tall

Tall Style

### REPLACEMENT PARTS

- |           |   |
|-----------|---|
| 95002     | Grommet (1-1/4" Valve Cover Hole)       |
| 95800-802 | Center Bolt Screw Kit - 8pc/set - Short |
| 95700-802 | Center Bolt Screw Kit - 8pc/set - Tall  |
| RP956034  | Baffles - Center Bolt                   |
| RP9570    | Gasket - Center bolt Valve Cover        |



### TECH TIP

Not for use with stud girdles. Center bolt valve covers should be run with one breather and one PCV valve or PCV breather for proper air circulation.



# VALVE COVERS

## SMALL BLOCK FORD

### STREAMLINE VALVE COVERS SMALL BLOCK FORD

Billet Specialties Streamline Valve Covers offer a fresh new look in valve cover choices. The precision machined Billet aluminum trim strip complements our Streamline Air Cleaners. Available in two finishes; Satin black powder coat with a polished billet aluminum trim strip or Ready to Finish that has a bead blasted surface ready to be powder coated or primed and painted with a polished trim strip. Includes stainless hardware and baffles.



95324 Streamline Black Tall



**READY TO FINISH**

**WE PREPPED IT,  
YOU PAINT IT!**

95324RTF Streamline RTF Tall

### PRECISION CAST SMALL BLOCK FORD

#### Product Features:

- Polished finish
- Tall style design
- 1-1/4" breather hole  
(see pages 77-78 for breathers)

#### Dimensions:

- Interior: 4"W x 3.5625"T
- Overall Height: 3.875"

95320 Tall



# OIL FILL CAPS

Precision machined from 6061-T6 Billet aluminum. Billet Specialties oil fill caps fit a variety of applications. Weld in bung is 1-5/8" diameter and can be used by welding bung to valve covers, aluminum tanks, etc.

#### Product Features:

- Knurled edge for positive grip
- Buna N® O-ring for no-leak operation



Screw-On  
23320



Push-On (1-1/4" Hole)  
23120



Aluminum Weld-In  
24110



Twist-On  
23220

# BREATHERS

Billet Specialties breathers are precision machined in the USA from 6061-T6 Billet aluminum and feature a unique 2 pc. design with a positive O-ring seal. They are easily maintained with a washable filter element. The PCV breather features a common replaceable PCV valve with a barbed fitting for 3/8" hose. Available for 1" or 1-1/4" diameter valve cover holes.

## RETRO BREATHERS

Time for a fresh new look in aftermarket valve cover breathers. Retro Breathers feature classic styling and a two piece design for easy maintenance.



Retro Chevrolet® Script  
 20923 Breather Polished  
 21923 PCV Breather Polished



**BLACK POWDER COAT**  
 Retro Chevrolet® Script  
 BLK20923 Breather Black  
 BLK21923 PCV Breather Black



Retro Plain  
 20939 Breather Polished  
 21939 PCV Breather Polished



**BLACK POWDER COAT**  
 Retro Plain Black  
 BLK20939 Breather Black  
 BLK21939 PCV Breather Black

## TECH TIP

Valve covers should be run with one breather and one PCV valve or PCV breather for proper air circulation.



## BILLET PCV VALVE

Engineered to be used with Billet Specialties valve covers and supplied with a grommet for 1-1/4" VC holes. Uses a replaceable PCV valve found at any auto parts store. Will fit O.E. valve covers by using the factory grommet (not supplied).



22120 PCV Valve Polished



## REPLACEMENT PARTS

- 95001 Grommet for 22120
- 95002 Grommet (1-1/4" Valve Cover Hole)
- 95003 Grommet w/ baffle (1-1/4" Valve Cover Hole)
- RP2010 Breather Filter - Round
- RP2011 Breather Filter - Oval

Breathers feature a 2 pc. design with a positive O-ring seal and washable filter element.





**CROSS FLAGS**

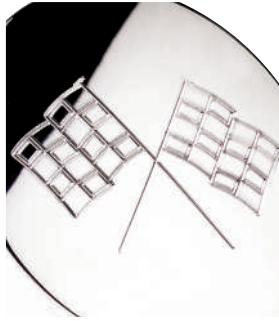

- 20720 1-1/4" VC Hole
- 21720 1-1/4" - PCV - VC Hole



**BOWTIE**



- 20220 1-1/4" VC Hole
- 21220 1-1/4" - PCV - VC Hole



**BLACK POWDER COAT**



- BLK20220 1-1/4" VC Hole
- BLK21220 1-1/4" - PCV - VC Hole

**PLAIN**



- 20120 1-1/4" VC Hole
- 20125 1" VC Hole



**ROUND BALL MILLED**



- 21120 1-1/4" - PCV - VC Hole
- 21125 1" - PCV - VC Hole

- 20820 1-1/4" VC Hole
- 20825 1" VC Hole



**BLACK POWDER COAT**



- BLK20120 1-1/4" VC Hole
- BLK21120 1-1/4" - PCV VC Hole



**OVAL BALL MILLED**



- 20920 1-1/4" VC Hole
- 21920 1-1/4" - PCV - VC Hole



**OVAL PLAIN**



- 20929 1-1/4" VC Hole
- 21929 1-1/4" - PCV - VC Hole



**OVAL RIBBED**



- 20950 1-1/4" VC Hole
- 21950 1-1/4" - PCV - VC Hole



# IGNITION WIRE ORGANIZATION

## UNIVERSAL WIRE LOOMS



Our unique two-piece design fits all big block and small block Chevrolet® and Ford engines. The wire looms mount to the base of the valve cover with adjustable tabs. Sold in Pairs.

### Product Features:

- Fits up to 9mm wires
- Precision machined from 6061-T6 Billet aluminum
- Industry leading mirror finish polish or black powder coat
- Stainless steel hardware

Dimensions: 14-3/4" L X 2-1/4" W

## REPLACEMENT PARTS

RP6900 Wire Loom Screw Kit W/ Wrench



**NOW AVAILABLE  
IN BLACK**

69520 Ball Milled-Polished  
BLK69520 Ball Milled-Black Powder Coat



**NOW AVAILABLE  
IN BLACK**

69523 Bowtie-Polished  
BLK69523 Bowtie-Black Powder Coat



**NOW AVAILABLE  
IN BLACK**

69529 Plain-Polished  
BLK69529 Plain-Black Powder Coat



## LATE MODEL BRACKET KIT

Brackets attach to cylinder heads between exhaust ports. Providing a mounting location for wire looms.

\* Some headers may require modification to access mount holes.

69600 Wire Loom Bracket Kit





### **BILLET PLUG WIRE SEPARATORS - FOR 8.5 MM WIRES**

Billet Specialties wire separators offer a clean, efficient solution to the ignition wire dilemma by routing the wires in a simple straight-forward fashion. Utilizing stainless fasteners and 6061-T6 aluminum construction Billet Specialties wire separators will make your motor stand out while keeping the wires safely off the hot exhaust. Your specific needs can be custom tailored for your type of motor and routing. Easy snap-in wire retention makes service and installation a breeze. Sold in Pairs.



#### **VALVE COVER MOUNTS**

1-Wire Polished  
69701

2-Wire Polished  
69702

3-Wire Polished  
69703

4-Wire Polished  
69704

1-Wire Black Anodized  
69781

2-Wire Black Anodized  
69782

3-Wire Black Anodized  
69783

4-Wire Black Anodized  
69784

### **STAINLESS HARDWARE INCLUDED!**



#### **CYLINDER HEAD MOUNT**

4-Wire Polished  
69604

4-Wire Black Anodized  
69684



#### **FLOATING CLIPS**

2-Wire Polished  
69602

2-Wire Black Anodized  
69682



4-Wire Polished  
69601

4-Wire Black Anodized  
69681

# ENGINE BLOCK ACCESSORIES

## LS RIBBED VALLEY COVERS

Is that stock valley cover standing out like a sore thumb on your carbureted LS? Billet Specialties' LS Valley Cover has the cure with a precision machined replacement that compliments our other LS products featuring matching ARP quality hardware and ribbed design.

### Features:

- For use with Carbureted applications.
- 2 1/8" NPT ports for use with breather.
- Stainless ARP hardware included.
- Accepts OEM gasket.

### Engineered To Fit:

- LS2, LS3, LS7 & LSX blocks.

\* Will not work with D.O.D Blocks

95050



\* Accepts OEM breather



## LS PLAIN VALLEY COVERS

The Billet Specialties LS Plain Valley Cover offers a simple no frills approach to the top of your Gen IV LS Engine Block.

### Product Features:

- Precision Machined from 6061-T6 Billet Aluminum
- Works with the OEM LS gasket for a leak free seal
- Stainless Fasteners included
- Made in the USA

95059 Machine Finish  
BLK95059 Black Anodized

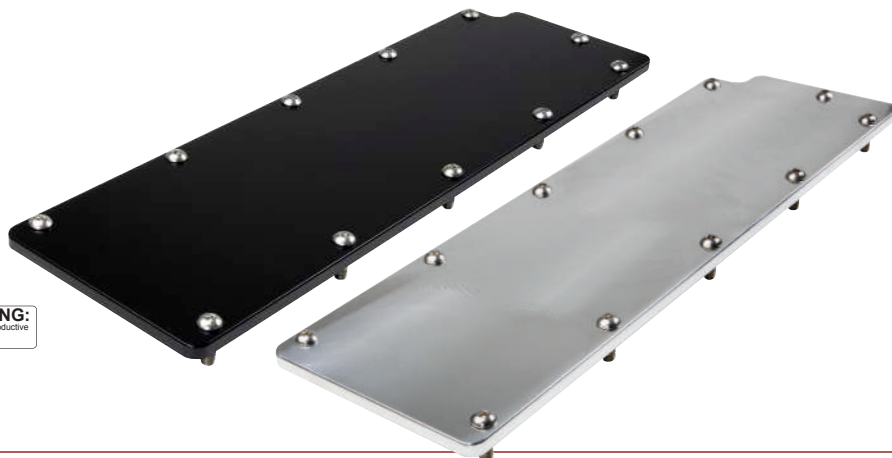

Polished



Black Anodized



Machine Finish



Black Anodized

## DISTRIBUTOR CLAMP

Precision machined from 6061-T6 Billet aluminum. Available polished or black anodized.

### Product Features:

- Unique No-Mar ball seat pivot design
- Positive lock down eliminates slipping
- Works with small & big block Chevrolet® engines
- Stainless hardware included

65920 Polished  
BLK65920 Black Anodized

## LS SWAP MOTOR MOUNTS

Billet Specialties LS Motor Swap Mounts make it easy to put a LS motor in your classic. Adjustable mount points allow the bellhousing to be located in the same position as the small block in the frame as well increments of 1/2", 1-3/4" and 2-1/4" forward for more firewall clearance if needed. Select from machine finish or black anodized. Sold in pairs.

### Product Features:

- 6061-T6 Billet Aluminum
- Quality hardware
- Multiple mount points

11600 Machine Finish  
11605 Black Anodized



## FUEL BLOCK OFF

Available for big and small block Chevrolet®, Ford & Chrysler motors.

### Product Features:

- Machined from 6061-T6 Billet aluminum
- Polished finish
- Stainless hardware included



**Chevrolet®**

Small Block  
**41120**  
Also fits the  
348/409



Big Block  
**41220**



**Chrysler**

Small Block  
**41820**



Big Block  
**41825**



**Ford**

Small Block: 289/302/351W  
Big Block: 429/460  
Ford FE blocks  
**41620**

## SMALL BLOCK CHEVY™ DIPSTICK

Billet Specialties dipstick fits directly into the block on small block Chevrolet® motors up to 1979 and replaces the factory driver side dipstick tube for a clean look.

**40120**



## BILLET FUEL FILTERS

Billet Specialties new in-line fuel filters offers a 40 micron screen element that can be cleaned or replaced. Available in a Polished or Black Anodized finish and your choice of 3/8" hose barbed ends or -6AN fittings. For use on both carbureted or fuel injected systems. Mounting bracket sold separately.

### Product Features:

- 3/8" Barbed or -6AN fitting
- 6061-t6 Billet Aluminum
- Serviceable 40 micron screen element
- Works with carbureted or fuel injection



**Dimensions:** 4-1/2"L x 1-3/8" diameter

**42130** Polished 3/8" Barbed  
**BLK42130** Black 3/8" Barbed

**42230** Polished -6 AN  
**BLK42230** Black -6 AN

**42520** Mounting Bracket  
**BLK42520** Black Bracket



Mounting Bracket  
(Sold Separately)

# COOLING COMPONENTS

## BILLET THERMOSTAT HOUSINGS

Billet Specialties thermostat housings are precision machined from 6061-T6 Billet aluminum. Available polished or black anodized.

- Swivels for proper hose angle
- Stainless steel mounting hardware included



### CHEVROLET® LS



Straight-Up  
90134  
BLK90134



15-Degree  
90334  
BLK90334



Machine  
Finish

-20 AN  
90920  
BLK90920



Machine  
Finish

-16 AN  
90900  
BLK90900

### CHEVROLET® SMALL/BIG BLOCK

\*Not for use with Tuned Port or Ram Jet applications\*



0-Degree  
90220  
BLK90220



15-Degree  
90320  
BLK90320



Straight-Up  
90120  
BLK90120



45-Degree  
90420  
BLK90420

### CHRYSLER SMALL/BIG BLOCK & HEMI TO 1978



Straight-Up  
90820

### CHEVROLET® SMALL/BIG BLOCK



-16 AN Straight-up  
90116  
BLK90116

Machine  
Finish

-20 AN Straight-up  
90119  
BLK90119

### FORD SMALL BLOCK

289, 302, 351W



0-Degree  
90620  
BLK90620

### FORD BIG BLOCK



0-Degree  
90720



15-Degree  
90725

### FORD FE



0-Degree  
90730



## RADIATOR CAPS

Mirror polished or black anodized Billet top & quality Stant® radiator cap come unassembled to allow for proper positioning of the logo.

7 lb radiator caps are intended for use with pre-1966 radiators.



**Bowtie**  
75320 16 lb  
76320 7 lb



**V8**  
75420 16 lb  
76420 7 lb



**Circle**  
75220 16 lb



**Notch Grip**  
75125 16 lb  
BLK75125 16 lb



**Plain**  
75120 16 lb  
76120 7 lb  
BLK75120 16 lb

## 8.75" BILLET OVERFLOW TANKS

- 100% Billet aluminum construction
- Mirror polished finish or high-gloss black anodized finish
- Fluid capacity: 15oz.

**Dimensions:** 2-7/8" O.D. x 8-3/4"H (Cap: 3" O.D.)

Our exclusive bracket design clamps to the tank with an internal lock. The mounting hardware is completely hidden!

**Note:** Bracket must be installed at center of reservoir as shown.

**77109** Smooth Polished Tank w/ Bracket  
**BLK77109** Black Anodized Tank w/ Bracket

Matching Power Steering Reservoir, see page 61 for details!



**BLACK ANODIZED**

## BILLET OVERFLOW TANKS

Looking for the best overflow tank on the market? Look no further - they're right here! Billet Specialties overflow tanks are machined from 6061-T6 Billet aluminum and include two adjustable Billet mounting brackets to ensure proper positioning. Choose from either ribbed or smooth designs to match our engine accessories. Tanks are 2" in diameter and available in three lengths measured from bottom of cap to base of tube.

### Product Features:

- Knurled O-ring cap for a no-leak seal
- Industry leading mirror finish polish
- Stainless hardware included
- Internal return tube
- Aluminum push-on fittings included



**77113** 13" Smooth Overflow 10oz.  
**77115** 15" Smooth Overflow 13oz.  
**77117** 17" Smooth Overflow 16oz.

# HOSE & LINE MANAGEMENT

## BILLET HEATER & A/C BULKHEADS

Billet Specialties heat and AC bulkheads are engineered to work with 5/8" heater hose and one 6 and one 10 AC line.

- Hose Fittings Not Included
- Push-on for heater side only
- Stainless heater hose applications require a male tube O-ring To AN adapter

### Product Features:

- Precision machined 6061-T6 aluminum
- Industry leading mirror finish polish or black anodized
- Offset design allows clear access to lines
- Uniform hose routing in a minimum space

**NOW AVAILABLE  
IN BLACK**



AC & Heater Combo (Push-On\*)  
66925  
BLK66925

\* Heater Side Only



AC Bulkhead  
66720  
BLK66720



AC & Heater Combo  
66920  
BLK66920



AC & Heater In-Line (Push-On\*)  
66935  
BLK66935

\* Heater Side Only



Heater Bulkhead  
66820  
BLK66820



Heater Bulkhead (Push-On)  
66825  
BLK66825

## POLISHED BILLET HOSE ENDS

Billet Specialties has the answer for unsightly hose clamps and loud anodized colors - polished Billet hose ends! Available in popular sizes for rubber and braided hoses from 5/16" to 1-3/4".



Billet Hose Ends – Fuel

- 67025 5/16" Braided
- 67225 3/8" Rubber
- 67325 3/8" Braided

Billet Hose Ends – Heater

- 67425 5/8" Rubber
- 67525 5/8" Braided
- 67625 3/4" Rubber
- 67725 3/4" Braided

Billet Hose Ends – Radiator\*

- 67825 1-1/2" Rubber  
O.D. - 2.00"
- 67925 1-3/4" Rubber  
O.D. - 2.25"

\* Not for use on water pump outlets



### Product Features:

- CNC machined aluminum
- Mirror polished finish
- Hose clamp included



## BILLET HOSE SEPARATORS

Billet Specialties hose separators are precision machined from 6061-T6 Billet aluminum and are available in many popular combinations and sizes. Sold individually.

### Product Features:

- Industry leading mirror finish polish or black anodized
- Stainless bolt

	Hose O.D.		Hose O.D.		Hose O.D.
68020	.440 x .540	68320	.625 x .625	68625	.890 x .969
BLK68020	.440 x .540	BLK68320	.625 x .625	BLK68625	.890 x .969
68025	.440 x .630	68325	.625 x .781	68720	.906 x .906
BLK68025	.440 x .630	BLK68325	.625 x .781	BLK68720	.906 x .906
68120	.500 x .500	68420	.734 x .890	68725	.906 x 1.015
BLK68120	.500 x .500	BLK68420	.734 x .890	BLK68725	.906 x 1.015
68125	.540 x .630	68425	.734 x .969	68729	.906 x 1.125
BLK68125	.540 x .630	BLK68425	.734 x .969	BLK68729	.906 x 1.125
68220	.562 x .562	68520	.781 x .781	68820	1.015 x 1.015
BLK68220	.562 x .562	BLK68520	.781 x .781	BLK68820	1.015 x 1.015
68225	.562 x .625	68525	.781 x .906		
BLK68225	.562 x .625	BLK68525	.781 x .906		



### TECH TIP

A hose's listed size is always in reference to the inside diameter of that hose. Example, a 5/8" heater hose has an inside diameter (I.D.) of 5/8" while the outside diameter (O.D.) is 29/32" or .906. The O.D. is the dimension needed when purchasing hose separators.

### HOSE SEPARATOR TECHNICAL DATA – Decimal/Fraction = Outside Diameter

BRAIDED AC HOSE DIAMETER			AC HOSE DIAMETER			BRAIDED AN LINE DIAMETER			HEATER HOSE DIAMETER		
Hose	Decimal	Fraction	Hose	Decimal	Fraction	Size	Decimal	Fraction	Size	Decimal	Fraction
6	.440	7/16"	6	.734	47/64"	-6	.562	9/16"	5/8	.906	29/32"
8	.540	35/64"	8	.890	57/64"	-8	.625	5/8"	3/4	1.015	1-1/64"
10	.630	5/8"	10	.969	31/32"	-10	.781	25/32"			
						-12	.906	29/32"			
						-16	1.125	1-1/8"			

### HOSE SEPARATOR SIZING CHART

Figures represent hose outside diameter measured in inches. These numbers match the available hose separator sizes.

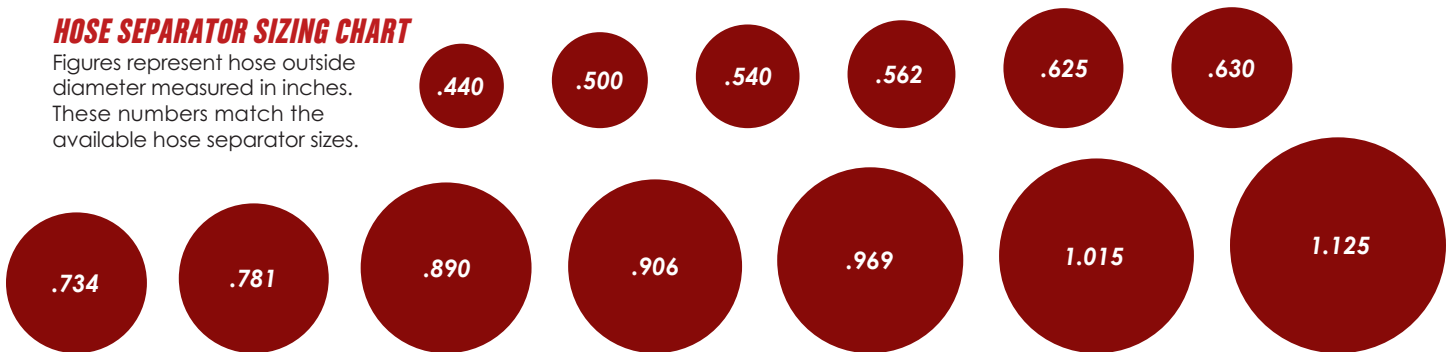

### THRU-FRAME FITTINGS

Machined from 303-stainless steel. Available for 2" & 2-3/8" wide frame rails. 9/16" Dia. Sold in pairs.

66210	-3AN x 1/8" NPT Short (2")
66310	-3AN x 1/8" NPT Long (2-3/8")



### BILLET LINE CLAMPS

- Stainless bolts included
- Machined step to prevent twisting
- 3/16" & 1/4" include 8-32 x 5/8" bolts
- 5/16", 3/8" & 1/2" include 10-32 x 3/4" bolts
- Natural Aluminum Finish

65110	3/16" Clamp
65210	1/4" Clamp
65310	5/16" Clamp
65410	3/8" Clamp
65510	1/2" Clamp

# BATTERY ACCESSORIES

Billet Specialties battery mounts secure your high performance battery with style. Machined from 6061-T6 Billet aluminum for strength our battery mounts hold the battery firmly in place and provide a rigid base to mount to the vehicle. Billet Specialties offers an Optima and XS Power design each with two finish options.

## OPTIMA STYLE BATTERY MOUNTS

### Product Features:

- Stainless hardware Included
- Recessed bottom tray locks battery in place
- Fits Red or Yellow top Optima (Group 34/78)
  - Red Top P/N 8004-003
  - Yellow Top P/N 8014-045

248910 Black/Clear Anodized  
248915 Fully Polished

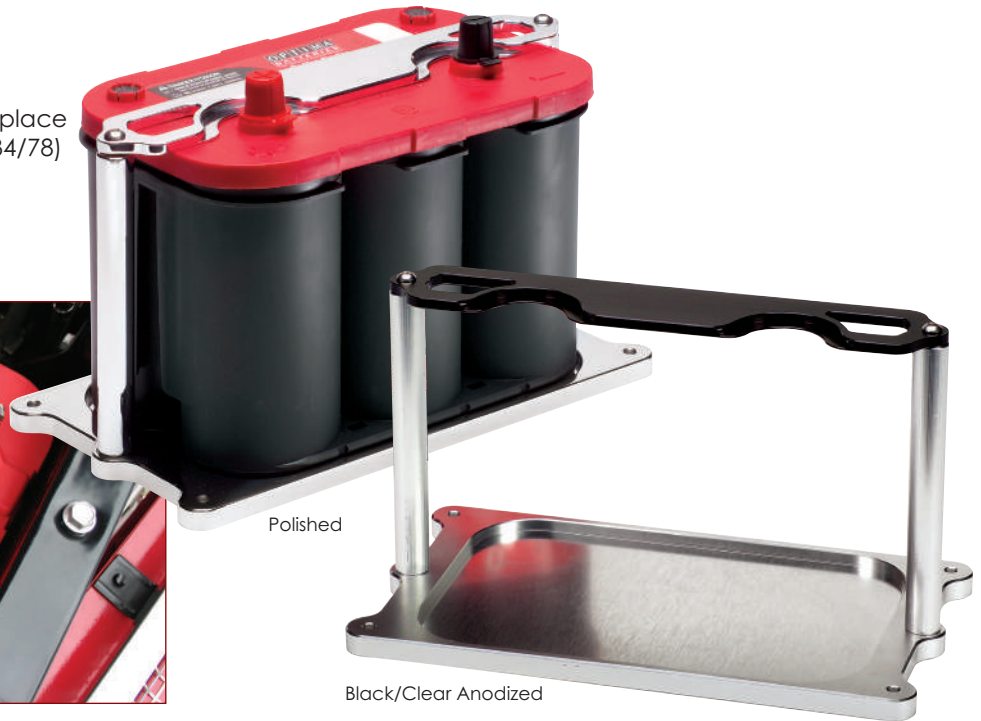

## BATTERY MOUNTS

### Product Features:

- Stainless hardware Included
- Recessed bottom tray locks battery in place

Dimensions: 10.25"L x 6.4375" W x 7.24"H

248920 Black/Clear Anodized  
248925 Fully Polished





# HARDWARE

## STAINLESS PRO BOLTS

Developed by Rad Rides by Troy, these stainless fender washers were designed to avoid paint distortion during assembly and add style to your engine compartment.

### Product Features:

- Stainless hardware Included
- Sold in pairs

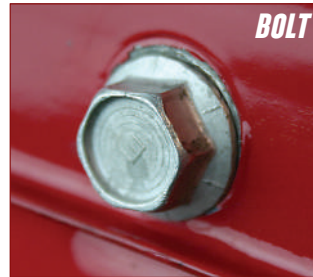

## BLACK

Part	Bolt Size	Washer O.D.
BLK66110	5/16-18 x 1"	3/4"
BLK66120	3/8-16 x 1"	7/8"
BLK66130	1/4-20 x 1"	1 1/16"
BLK66140	10-24 x 1"	9/16"
BLK66115	5/16-18 x 1"	1"

## BRUSHED

Part	Bolt Size	Washer O.D.
66110	5/16-18 x 1"	3/4"
66120	3/8-16 x 1"	7/8"
66130	1/4-20 x 1"	1 1/16"
66140	10-24 x 1"	9/16"
66115	5/16-18 x 1"	1"



"For over 20 years Walden Speed Shop has trusted Billet Specialties Quality and Finish."

- Bobby Walden  
Walden Speed Shop



# BILLET HOOD HINGES

'55-'56 CHEVROLET®

Billet Specialties hood hinges for the 55-56 Chevy feature precision 3D machining and look great at any angle. Available in three finish options of Raw Machined, Black Anodized and Full Polished, these hinges feature stainless hardware and precision bearings ensuring smooth operation. Sold in Pairs. Made in the USA.



**BILLET SPECIALTIES HOOD HINGES - TWO MORE REASONS TO KEEP YOUR HOOD OPEN!**

## Product Features:

- Follows OE Firewall Contours
- Precision 3D Machined
- Hood Closes Flush With Cowl
- Stainless Hardware & Sealed Precision Bearings
- Includes Gas Springs



Polished Finish  
Includes Polished Gas Spring  
**873512**



Black Anodized Finish  
Includes Polished Gas Spring  
**BLK873512**



Raw Machined Finish  
Includes Polished Gas Spring  
**N873512**



Looks great at any angle!





# BILLET HOOD HINGES

'65-'67 CHEVELLE-EL CAMINO

Style from any angle -Billet Specialties Billet hood hinges for the Chevelle/El Camino are the perfect upgrade to your engine compartment. The Billet hinges feature precision 3D machining, premium stainless hardware to match other Billet Specialties accessories and precision bearings for smooth operation. Sold in Pairs.



## Product Features:

- 6061-T6 aluminum construction
- Precision sealed bearings
- Stainless hardware
- Multiple finishes available
- Made in the USA
- Includes Gas Springs
- \* Will not work on cars with factory A/C



Polished Finish  
Includes Polished Gas Spring  
873612



Black Anodized Finish  
Includes Polished Gas Spring  
BLK873612



Raw Machined Finish  
Includes Polished Gas Spring  
N873612

## REPLACEMENT POLISHED STAINLESS HD GAS SPRINGS

3610HDSS	325 LB
3612HDSS	400 LB
3614HDSS	500 LB



## HOOD HINGE SPACERS FOR '66-'67 NOVA

Allows the use of Billet Specialties Camaro/Chevelle Hinges on 66-67 Nova's with aftermarket front clip and inner fender panels. Machined from 6061-T6 aluminum the spacers mount seamlessly between the aftermarket inner fender and the hinge. Sold in pairs.

## Product Features:

- 6061-T6 Billet Aluminum
- Stainless hardware
- Made in the USA



Polished Finish  
874410



Black Anodized Finish  
BLK874410



Raw Machined Finish  
N874410

# BILLET HOOD HINGES

'67-'69 CAMARO™

Billet Specialties leaves no detail unattended. Each hood hinge is precision 3D machined on both sides of the arms for style from any angle. Stainless hardware secure the precision bearing pivots. Stainless button head fasteners

**Product Features:**

- 6061-T6 aluminum construction
- Precision sealed bearings
- Stainless hardware
- Multiple finishes available
- Made in the USA
- Includes Gas Springs



Polished Finish  
Includes Polished Gas Spring  
873612



Black Anodized Finish  
Includes Polished Gas Spring  
BLK873612



Raw Machined Finish  
Includes Polished Gas Spring  
N873612

## BILLET DECK LID HINGES - '67-'69 CAMARO™

Add the finishing touch to the trunk area of your 67-69 Camaro, Billet Specialties Billet deck lid hinges steal the show with 3D machining on both sides of the hinge and our exclusive hidden hardware to complete the smooth hi-tech look.



**Product Features:**

- 6061-T6 aluminum construction
- Machined Billet cover to hide hardware
- Delrin® pivot bushings
- Multiple finishes available
- Made in the USA
- \* *Black Gas Springs Included*



Polished Finish  
Black Gas Spring Included  
875610



Black Anodized Finish  
Black Gas Spring Included  
BLK875610

Stainless hardware & Delrin® bushings

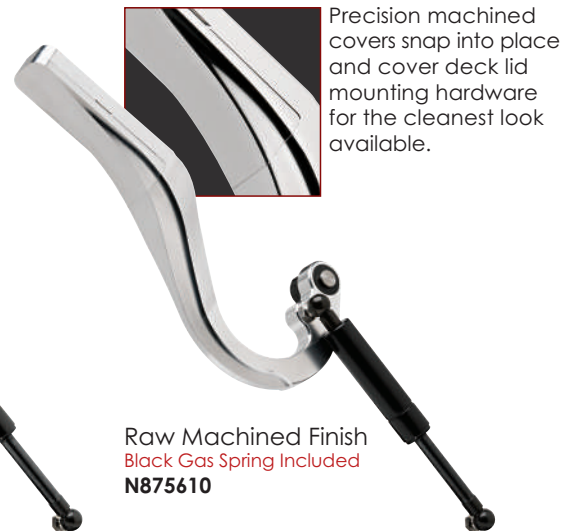

Raw Machined Finish  
Black Gas Spring Included  
N875610



Precision machined covers snap into place and cover deck lid mounting hardware for the cleanest look available.



# BILLET HOOD HINGES

'70-'81 CAMARO™

Billet hood hinges done right - Billet Specialties unique knife edge styling looks great from any angle. Each hinge component is precision machined to not only look great but perform as well. Quality hardware including precision bearings for smooth operation as well as stainless fasteners ensure years of trouble free operation. Billet Specialties hood hinges, just another two reasons to keep your hood open. Sold in pairs.

## Product Features:

- 6061-T6 aluminum construction
- Precision sealed bearings
- Stainless hardware
- Multiple finishes available
- Made in the USA
- Includes Gas Springs



Polished Finish  
Includes Polished Gas Spring  
873622



Black Anodized Finish  
Includes Polished Gas Spring  
BLK873622



Raw Machined Finish  
Includes Polished Gas Spring  
N873622

## FENDER BRACES- '67-'69 CAMARO™

Billet Specialties Fender Braces add high tech styling to your engine compartment while complementing the other Billet Accessories. Machined from 6061-T6 aluminum each brace kit includes aluminum mounting brackets and stainless hardware. Sold in pairs.

## Product Features:

- Precision 3D Machined surfaces
- Stainless hardware
- 6061-T6 aluminum construction
- Made in the USA



872610  
BLK872610  
N872610

Polished  
Black Anodized Finish  
Raw Machined Finish



# GAS, BRAKE & CLUTCH PEDALS

'67-'69 CAMARO™/FIREBIRD

## Product Features:

- Gas pedal attaches directly to factory linkage location
- 1:1 Arm ratio for full range throttle operation
- Spring loaded gas pedal offers two mounting height options
- Stainless Hardware
- Gas pedal requires the use of a cable style linkage (not included)

**CONVERTS TO CABLE STYLE LINKAGE**



Pedestal attaches in factory firewall location.

CNC machined non-slip surface

### **GAS PEDAL ASSEMBLY**

- 199160 Polished
- 199165 Black Anodized
- \*Throttle Cable Not Included

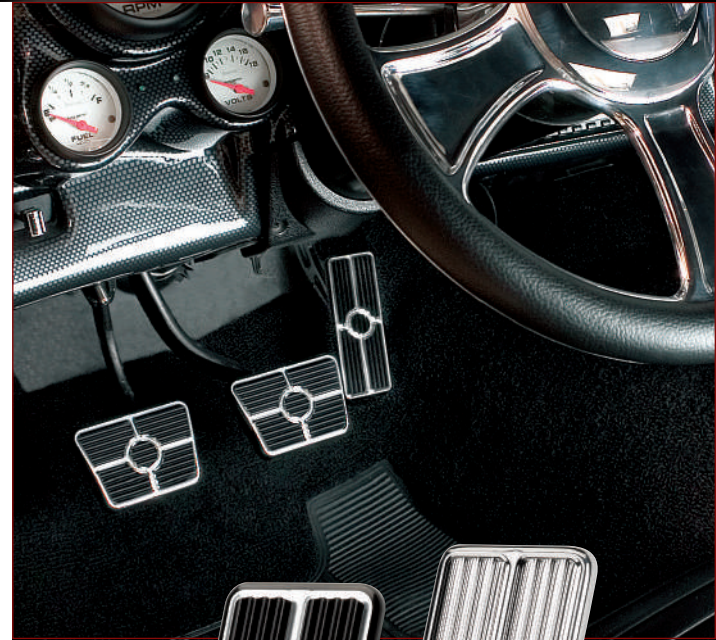

### **GAS PEDAL PAD**

- Replaces Factory Pedal
- 199260 Polished
- 199265 Black Anodized



### **E-BRAKE PAD**

- 199660 Polished
- 199665 Black Anodized

Dimensions: 2-5/16" W x 2-1/8" H

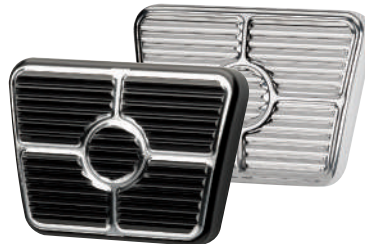

### **BRAKE/CLUTCH PAD**

- 199360 Polished
- 199365 Black Anodized

Dimensions: 3-7/8" W x 2-3/4" H

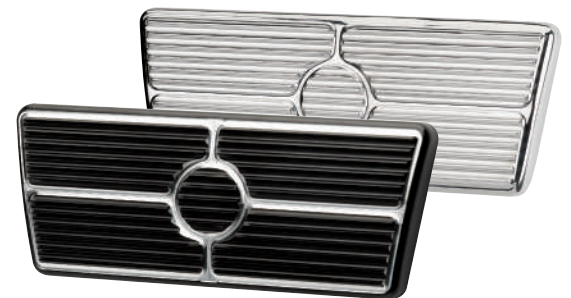

### **BRAKE PAD**

- 199460 Polished
- 199465 Black Anodized

Dimensions: 7" W x 2-11/16" H

**FITS OTHER APPLICATIONS - CALL!**



# TRI-FIVE CHEVY™ PEDALS

Add the finishing touch to the driver's compartment of your Chevy™ with these beauties. Gas, brake/clutch and dimmer are available in either durable black anodized or polished finishes.



## FLOOR MOUNT TRI-FIVE GAS PEDAL

199250 Polished  
199255 Black Anodized

### 1-2-3 E-Z INSTALL

1. REMOVE BOLTS
  2. REMOVE STOCK PEDAL
  3. BOLT IN NEW PEDAL
- YOU'RE DONE!**



**CONVERTS TO CABLE STYLE LINKAGE**

## GAS PEDAL ASSEMBLY

Our Billet gas pedal assembly converts your old throttle linkage to a more modern cable style linkage for extra firewall clearance and smooth operation.

### Product Features:

- Installs in factory firewall location with existing hardware
- Taller throttle arm improves engine clearance and cable angle
- Gas pedal pad has two mounting height options for added comfort
- Gas pedal includes aluminum washers to offset the throttle cable
- 1:1 pedal ratio - Works with all carburetors for full throttle range
- Spring loaded gas pedal - Just like late model OE
- CNC machined non-slip surface
- Stainless hardware included

## GAS PEDAL ASSEMBLY FOR CABLE STYLE LINKAGE

Gas Pedal Assembly for Cable Style Linkage

199150 Polished  
199155 Black Anodized

*\*Throttle Cable Not Included*



## DIMMER SWITCH COVER

199870 Polished  
199875 Black Anodized

Dimensions: .875" I.D.

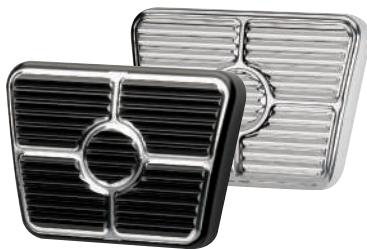

## BRAKE/CLUTCH PAD

199350 Polished  
199355 Black Anodized

Dimensions: 3-7/8" W x 2-3/4" H

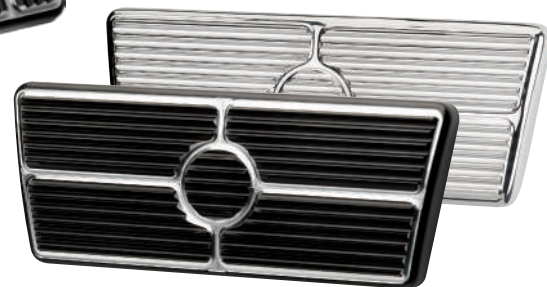

Dimensions: 7" W x 2-11/16" H

## POWER BRAKE PAD

199450 Polished  
199455 Black Anodized

## NON-POWER BRAKE PAD\*

199550 Polished  
199555 Black Anodized

*\*Non-power brake pad sizes match the power brake pad size for added safety.*



# FULL SIZE CHEVY™ PEDALS

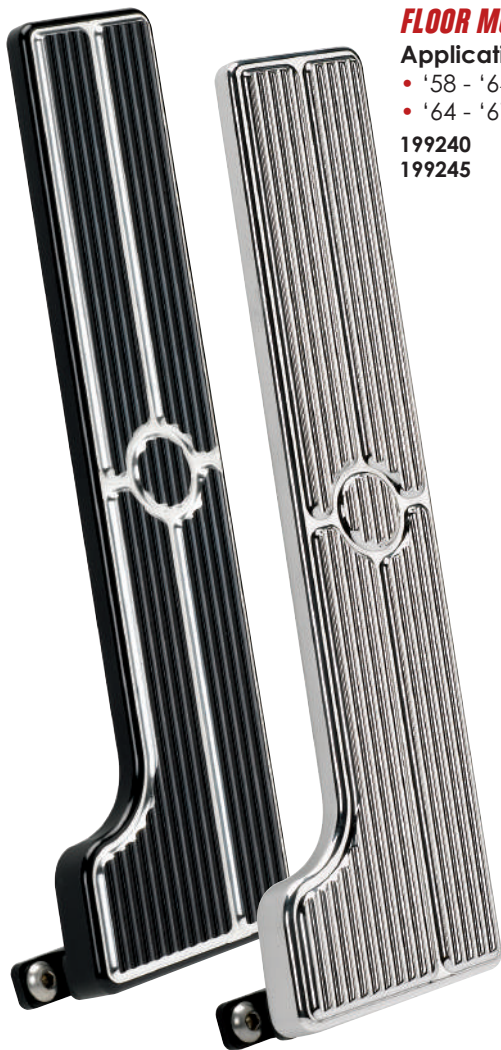

## FLOOR MOUNT FULL SIZE GAS PEDAL PAD

### Applications:

- '58 - '64 Bel Air™, Biscayne, Impala™
- '64 - '67 Nova®, Chevelle™, El Camino®

199240 Polished  
199245 Black Anodized

## 1-2-3 E-Z INSTALL

1. REMOVE BOLTS
2. REMOVE STOCK PEDAL
3. BOLT IN NEW PEDAL

**YOU'RE DONE!**



## DIMMER SWITCH COVER

199870 Polished  
199875 Black Anodized  
Dimensions: .875" I.D.



## E-BRAKE PAD

### Applications:

- '58 - '64 Bel Air™, Biscayne, Impala™

199640 Polished  
199645 Black Anodized

Dimensions: 2-7/8" W x 2-1/2" H

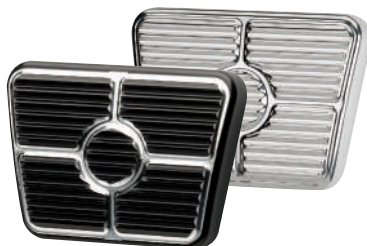

## BRAKE/CLUTCH PAD

### Applications:

- '58 - '65 Bel Air™, Biscayne, Impala™
- '63 - '67 Nova®, Chevelle™, El Camino®

199340 Polished  
199345 Black Anodized

Dimensions: 3-7/8" W x 2-3/4" H

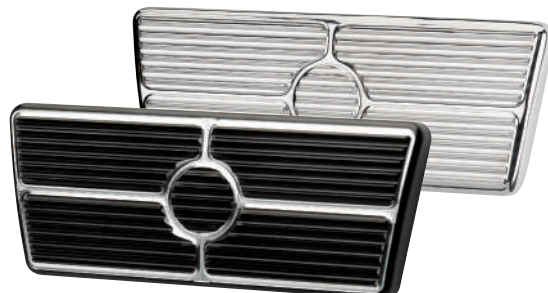

## BRAKE PAD

### Applications:

- '58 - '64 Bel Air™, Biscayne, Impala™
- '63 - '67 Nova®

199450 Polished  
199455 Black Anodized

Dimensions: 7" W x 2-11/16" H

**FITS OTHER APPLICATIONS - CALL!**



# STREET ROD PEDALS

Reversible arm for extra floor clearance



Base offers left or right mounting positions

Fully adjustable



## RECTANGLE GAS PEDAL

199110 Polished

199115 Black Anodized

Dimensions: Pedal = 2.085"W x 4"H

Arm - Straight = 6 5/8

Arm - Curved = 6 3/4

## OVAL GAS PEDAL

199130 Polished

199135 Black Anodized

Dimensions: Pedal = 3.5"W x 2"H

Arm - Straight = 6 5/8

Arm - Curved = 6 3/4

## BRAKE/CLUTCH PADS

### Product Features:

- Backside offers two mounting positions Center or Offset
- 1/2-20 stud included for use with popular brake assemblies
- CNC machined non-slip surface



199310 Rectangle Polished

199315 Rectangle Black Anodized

Dimensions: 3-11/32" W x 1-15/16" H



199870 Polished

199875 Black Anodized

Dimensions: .875" I.D.

## BILLET DIMMER SWITCH COVERS

### Product Features:

- Machined non-slip surface
- Stainless steel set-screw design
- Fits Chevy™ & Ford applications



Oval pedals can be mounted vertical or horizontal

199330 Oval Polished

199335 Oval Black Anodized

Dimensions: 4" W x 1-11/16" H

# PROFILE PEDALS - UNIVERSAL

## BILLET GAS PEDAL ASSEMBLY

The ultimate pedals for your car! Billet Specialties Universal Profile Pedals are ideal for many applications that are not covered with our other pedals. The gas pedal's wide base ensures smooth, stable operation and fully adjustable arms allow precise throttle control and pedal height for multiple mounting situations. The brake, clutch and E-brake pedals include a steel base plate for welding to your pedal arms or use the included template to drill your existing pedal. Choose from either a polished or durable black anodized finish.

### Product Features:

- Modular design allows for custom backgrounds
- Embossed carbon vinyl insert included
- Wider mounting base for added stability
- 1:1 Arm Ratio for full range throttle operation
- Dual Delrin® bushings for smooth operation
- 3D CNC machined surface
- Spring loaded pedal
- Stainless hardware included
- Requires cable style throttle linkage (not included)



Base offers left or right mounting positions



Universal Profile Gas Pedal  
**199172 Polished**  
 Dimensions: 2" W x 5 1/2" H



Universal Profile Gas Pedal  
**199177 Black Anodized**  
 Dimensions: 2" W x 5 1/2" H

## UNIVERSAL PROFILE BRAKE & CLUTCH PEDALS

### Product Features:

- Modular design allows for custom backgrounds
- Embossed carbon vinyl insert included
- 3D CNC machined surface
- Includes steel mounting plates for installation
- Stainless mounting hardware included



**199860 Polished**  
**199865 Black Anodized**

## PROFILE BILLET DIMMER SWITCH COVERS

### Product Features:

- CNC machined aluminum
- Stainless steel set-screw design
- Fits Chevy™ & Ford applications

Dimensions: .875" I.D.



Universal Profile Brake Pad  
**199472 Polished**  
**199477 Black Anodized**  
 Dimensions: 7.5" W x 3" H



Universal Profile Brake/Clutch Pad  
**199372 Polished**  
**199377 Black Anodized**  
 Dimensions: 4 1/4" W x 3" H



Universal Profile E-Brake Pad  
**199672 Polished**  
**199677 Black Anodized**  
 Dimensions: 2 5/8" W x 2 1/2" H



# UNIVERSAL PEDALS

## UNIVERSAL FLOOR MOUNT GAS PEDAL

Our universal floor mount pedal adds style and functional clearance for cramped engine compartments. Featuring adjustable pedal mount angle, pedal stop and pedal travel, this pedal works where others do not. Combine with matching pedals from our other applications to complete the set. Requires cable style throttle and appropriate carb linkage (not included). 1/2" pedal spacers available for added clearance.

### Product Features:

- 2-1/4" of travel
- Machined from 6061-T6 Billet Aluminum
- Polished or Black anodized finish
- Double nickel-plated cable bracket
- Stainless hardware and instructions included

199270 Polished

199275 Black Anodized

199800 1/2" Spacer Polished

199805 1/2" Spacer Black Anodized

Dimensions: 6 1/2" L x 2 1/2" W



## BILLET UNIVERSAL GAS PEDALS

### Product Features:

- Wider mounting base for added stability
- 1:1 Arm Ratio for full range throttle operation
- Dual Delrin® bushings for smooth operation
- CNC machined non-slip surface
- Spring loaded pedal
- Stainless hardware (included)
- Requires cable style throttle linkage (not included)

Universal Rectangle Gas Pedal

199170 Polished

199175 Black Anodized

Dimensions: 2" W x 5 1/2" H

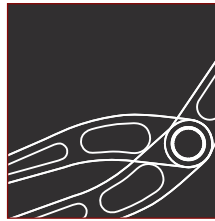

Reversible arm for extra floor clearance



Infinitely adjustable



Matching Brake & Clutch Pedals, See Page 88

## UNIVERSAL PEDAL KITS

Our 3pc. Billet aluminum pedal covers add that finishing touch to the driver's compartment. Easy to use drill templates are included along with stainless hardware for a secure installation. Kits include covers for gas, brake and parking brake.

### Applications:

'73-'04 Dodge, Ford, & GM 1/2 & 3/4-ton trucks

### Dimensions:

Gas Pedal: 2.87"W x 6.18"H

Brake Pedal: 5.88"W x 2.92"H

Parking Brake: 2.23"W x 2.79"H

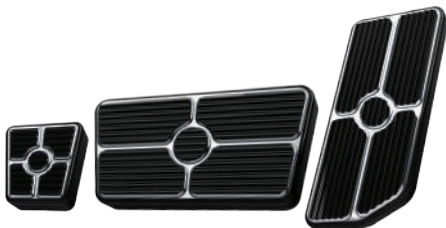

198625 Grooved Black Anodized



198622 Grooved Polished

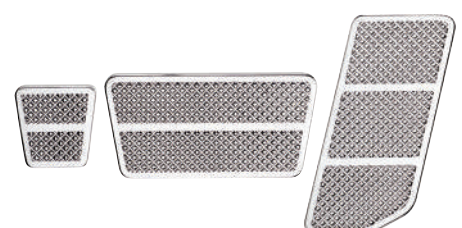

198620 Diamond Cut

# DOOR HANDLES & WINDOW CRANKS

## BILLET DOOR HANDLES & WINDOW CRANKS

Dress up your door panels with our Billet aluminum door handles and window cranks. Easy installation and fully adjustable to any angle. Sold in pairs.

### Product Features:

- Installs in minutes
- Precision machined from 6061-T6 Billet aluminum
- Industry leading mirror finish polish
- Steel splines & two set screws for secure installation



### RP4505 Replacement End Caps



### Door Handles - 3-3/4" L

Polished

- 45320 Ford to '48
- 45420 GM to '48
- 45520 GM/Ford '49 & Up

### Window Cranks - 3-3/4" L

Polished

- 46320 Ford to '48
- 46420 GM to '48
- 46520 GM/Ford '49 & Up

### Vent Cranks - 2-9/16" L

Polished

- 47320 Ford to '48
- 47420 GM to '48
- 47520 GM/Ford '49 & Up

## RAIL DOOR HANDLES & WINDOW CRANKS

CNC 3-D machined from Billet aluminum for both strength and style, the Rail door handles and window cranks add a touch of style to any interior. Sold in pairs.

### Product Features:

- Installs in minutes
- Precision machined from 6061-T6 Billet aluminum
- Industry leading mirror finish polish
- Steel splines & two set screws ensure secure installation



### Door Handles - 4-13/32" L

Polished

- 45328 Ford to '48
- 45428 GM to '48
- 45528 GM/Ford '49 & Up

### Window Cranks - 4-13/32" L

Polished

- 46328 Ford to '48
- 46428 GM to '48
- 46528 GM/Ford '49 & Up

### Vent Cranks - 3-5/32" L

Polished

- 47328 Ford to '48
- 47428 GM to '48
- 47528 GM/Ford '49 & Up

\*Tri-Five Chevy™ door panel trim will not allow proper functioning of vent window crank.

## SPLINE IDENTIFICATION

Lengths are measured from center of spline to end of handle/crank.

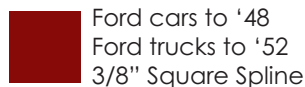



## BALL MILLED DOOR HANDLES & WINDOW CRANKS

Ball milled handles feature an aggressive design for a high-tech look and an award winning polished or black anodized finish. Sold in pairs.

### Product Features:

- Installs in minutes
- Precision machined from 6061-T6 Billet aluminum
- Industry leading mirror finish polish
- Steel splines & two set screws ensure secure installation



### Door Handles - 4-13/32"L

Polished

- 45325 Ford to '48
- 45425 GM to '48
- 45525 GM/Ford '49 & Up

### Window Cranks - 4-13/32"L

Polished

- 46325 Ford to '48
- 46425 GM to '48
- 46525 GM/Ford '49 & Up

### Vent Cranks - 3-5/32"L

Polished

- 47325 Ford to '48
- 47425 GM to '48
- 47525 GM/Ford '49 & Up

\*Tri-Five Chevy™ door panel trim will not allow proper functioning of vent window crank.

## KNOW THE DIFFERENCE

Billet Specialties' exclusive steel splined inserts are engineered to provide the most secure and durable attachment in the industry. Each steel insert offers precision machined splines to eliminate unnecessary play in the handle and is securely locked in position with two set screws. This is another great example of how far Billet Specialties goes to manufacture the best components for your car.

### Ours:

- High quality steel
- Precision machined
- Two set screws

### Theirs:

- Soft aluminum
- Stamped splines
- One set screw



**BLACK ANODIZED**



### Door Handles - 4-13/32"L

Black Anodized

- BLK45525 GM/Ford '49 & Up

### Window Cranks - 4-13/32"L

Black Anodized

- BLK46525 GM/Ford '49 & Up

### Vent Cranks - 3-5/32"L

Black Anodized

- BLK47525 GM/Ford '49 & Up

\*Tri-Five Chevy™ door panel trim will not allow proper functioning of vent window crank.

# DOOR PANEL ACCESSORIES

## '68-'69 CAMARO™ DOOR JAMB VENTS

Replace those plastic door vents on your 68-69 Camaro with a set of precision machined Billet aluminum vents from Billet Specialties. Our Billet vents feature a 3D machined design with a stainless mesh insert for cutting edge style. Includes stainless hardware.

### Product Features:

- Precision machined from 6061-T6 Billet aluminum
- Polished, Black Anodized & Raw Machined finishes
- Made in the USA

171100 Polished  
 BLK171100 Black Anodized  
 N171100 Machined Finish



## BILLET DOOR LOCK KNOBS

Machined from 6061-T6 Billet aluminum and sold in pairs.

45910 Smooth  
 BLK45910 Smooth  
 Dimensions: 1-5/8" Tall Thread: 10-24

45930 Tri-Five  
 BLK45930 Tri-Five  
 '55-'57, '59 & '60 Chevy™  
 Dimensions: 1-5/8" Tall Thread: 6-40



## GRAB HANDLE/DOOR PULL

Great for muscle cars with flat door panels. Also a direct replacement for GM truck grab handles.

Dimensions: 8-1/2"L x 1-1/2"W  
 Holes are 6-3/4" center to center



### Direct Replacement For:

- '94-'03 S-Series trucks
- '95-'03 S-Series Blazer®
- '88-'03 F/S Chevy™ trucks

### Product Features:

- Universal Billet aluminum design
- Mirror polished finish
- Stainless hardware included

271020



# DASH PANEL ACCESSORIES

## TRIM STYLE DASH PANELS

The Trim Style's universal design allows the dash panel to be mounted with the machined ribs on the top or the bottom as shown. Accepts 3-3/8" dia. Tach or Speedo and 2-1/16" or 2-1/8" dia. gauges.

Compatible with gauges from:

- Autometer®
- Classic Instruments®
- Stewart Warner
- VDO
- Ford Motorsport



**Trim Style - 5 Gauge Panel**  
15-1/4"W x 4-7/8"H x 3/8"D

36525



**Trim Style - 6 Gauge Panel**  
19-1/4"W x 6"H x 3/8"D

36535

## BILLET A/C VENTS

Fully adjustable machined vent rotates smoothly within a Billet bezel.



### Product Features:

- Precision machined from 6061-T6 Billet aluminum
- Polished to an industry leading mirror finish

### Dimensions:

Dash Opening: 2-1/2"

Hose Size: 2-1/2"

Outer Bezel: 2-3/4"

Mounting Depth: 1-7/8"

38220 Silhouette

38320 Slotted

Also available is a more economical air conditioning vent with Billet aluminum bezel and plastic vent louvers.

38110 Billet Bezel

**Note:** AC vents do not have a closed position to stop air flow.



Silhouette



Slotted



Billet Bezel

## BILLET DASH KNOBS

Universal dash knobs work great to add that extra touch to your dash.

### Product Features:

- Precision machined from 6061-T6 Billet aluminum
- Polished to a mirror finish
- 3/16" bore with set screw

26002 Classic

26003 Smooth



Classic



Smooth

# SHIFT & COLUMN ACCESSORIES

## **BILLET SHIFT ARM**

Billet Specialties shift arms are designed to fit a wide range of GM vehicles. (Not for use with van columns)

### **Product Features:**

- Easy installation
- Precision machined from 6061-T6 Billet aluminum
- Industry leading mirror finish polish
- Heat treated case hardened shaft end

267320 '73-'94 Passenger Car

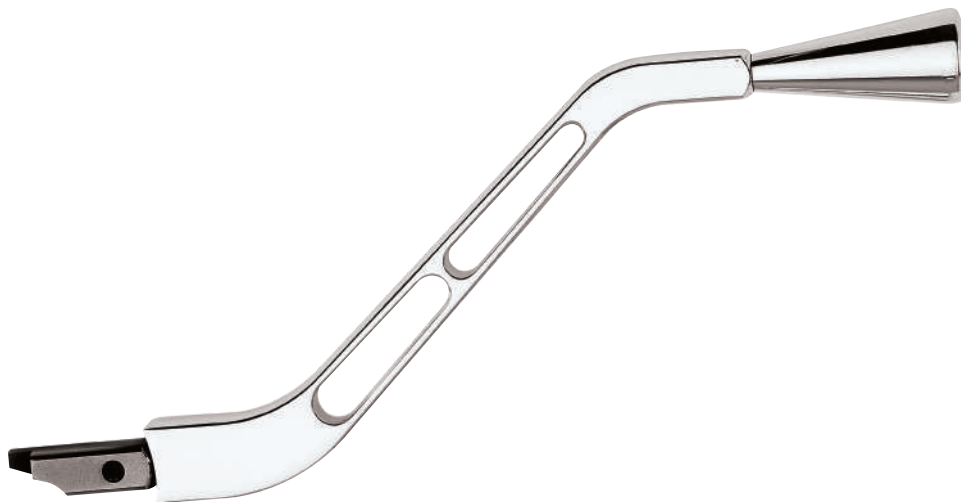
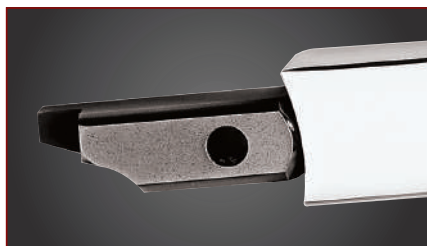

## **COLUMN DRESS-UP KITS & COMPONENTS**

Billet Specialties dress-up kits are a great way to detail your column. Featuring easy installation, precision machined 6061-T6 Billet aluminum, polished or black anodized knob and polished stainless steel shafts.



Early Model Kit  
• Dimmer on floor  
**BLK26120 Black**



Early Model Kit  
• Dimmer on floor  
**26120 Polished**



# SHIFTERS & SHIFTER BOOT RINGS

## BILLET SHIFT LEVERS

Billet Shift Levers are precision machined from 6061-T6 aluminum. Engineered as a direct bolt on for Tremec TKO500, TKO600 & Borg Warner T-56 Transmissions.

### Product Features:

- Precision machined from 6061-t6 aluminum
- Select polished or black anodized
- Available in two lengths 8" & 10"



### GRID

- 264840 8" Straight Grid Polished
- 266140 10" Straight Grid Polished
- 264845 8" Straight Grid Black
- 266145 10" Straight Grid Black
- 264820 8" Bent Grid Polished
- 266120 10" Bent Grid Polished
- 264825 8" Bent Grid Black
- 266125 10" Bent Grid Black



### OUTLAW

- 264830 8" Straight Outlaw Polished
- 266130 10" Straight Outlaw Polished
- 264835 8" Straight Outlaw Black
- 266135 10" Straight Outlaw Black
- 264810 8" Bent Outlaw Polished
- 266110 10" Bent Outlaw Polished
- 264815 8" Bent Outlaw Black
- 266115 10" Bent Outlaw Black

## BILLET SHIFTER BOOT RING

Billet Specialties shifter boot rings take style to the next level. The rings are precision machined from 6061-t6 aluminum and are available in two styles; recessed and smooth. Select the style and finish that complements your interior best. Includes mounting hardware and fits leather or rubber shift boots (not included).

- Outside Dimensions: 5.75 x 7.125"
- Inside Dimensions: 4.125 x 5.5"



Smooth  
279312  
BLK279312

Polished  
Black Anodized



Recessed  
279310  
BLK279310

Polished  
Black Anodized

# HALF-WRAP

## BILLET STEERING WHEELS

We are the worldwide leader in Billet steering wheels for many reasons. We offer the widest selection of styles, top grain leather colors, outstanding quality and fast delivery. Our relentless attention to detail is apparent both front and back on these works of automotive art.

The face of each half-wrap steering wheel boasts a custom front steering ring that is available in your choice of a wide array of leather colors, simulated burl wood or carbon fiber finishes. The backside of each wheel features milled finger notches for an ultra-comfortable grip. Designs are available in 14" & 15.5" diameter and will fit in most any vehicle imaginable.



# 4 PARTS ARE REQUIRED FOR EVERY STEERING WHEEL PACKAGE...

### STEERING WHEEL



Choose a half-wrap Billet steering wheel style

### HALF-WRAP RING



Choose a leather or simulated finish half-wrap

### HORN BUTTON



Choose a horn button that fits your style

### COLUMN ADAPTER



Choose an adapter that fits your application





# STEERING WHEEL CONFIGURATOR



## STEERING WHEEL CONFIGURATOR

### SEE WHAT IT LOOKS LIKE BEFORE YOU BUY IT!

Our steering wheel configurator lets you build your own kit online:

1. SELECT YOUR STEERING WHEEL
2. SELECT YOUR HALF WRAP
3. SELECT YOUR HORN BUTTON
4. SELECT YOUR COLUMN ADAPTER

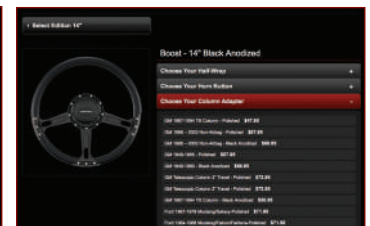

**CHOOSE FROM OVER 40 STEERING WHEEL DESIGNS**  
**TOP GRAIN LEATHER HALF-WRAPS PLUS SIMULATED FINISHES**

**MULTIPLE HORN BUTTON STYLES AVAILABLE**

**POLISHED AND BLACK ANODIZED FINISHES**

## FLAT OUT 14" BILLET STEERING WHEEL

Traditional style for traditional columns, our Flat Out Steering Wheels are a direct bolt-on to early steering columns via 3 stainless fasteners hidden under an O-ring button cap. Select one of our top grain leather half wraps to finish the wheel off or have a plain ring wrapped to match your interior.

### Features:

- 14" diameter
- 3-hole mount fits traditional steering columns
- 6061-T6 Billet aluminum
- Half-wrap design with milled finger grips
- Includes button cap

**\*Requires the use of 14" half wrap\***

**\*Flat Out Steering Wheels fit 3-hole traditional steering columns only\***

Sprint  
29540



# D-SHAPED

## 14" BILLET STEERING WHEELS

D-Shaped steering wheels offer race inspired design matching today's trends with Billet Specialties quality. Each wheel is precision 3D machined from 6061-T6 aluminum with milled finger notches and aggressive style. Each wheel includes both black and polished rivets allowing you to customize the final look. Select from four top grain leather choices plus simulated Carbon Fiber or wrap your own with a blank wrap to match your interior.

**Features:**

- Race inspired D-shaped design
- Precision 3D machined
- Milled finger notches
- Polished or black hard anodized finish

\* See Pro Style horn buttons located on page 117



Hairpin - Polished  
29414



Hydro - Polished  
29435



Prism - Polished  
29475



Hairpin - Black Anodized  
BLK29414



Hydro - Black Anodized  
BLK29435



Prism - Black Anodized  
BLK29475

### D-SHAPED HALF-WRAPS

Precision machined from 6061-T6 Billet aluminum then covered in top grain leather or Embossed Carbon Vinyl. Each piece precisely fits into place and is secured with stainless hardware.



Tan  
28702

Light Gray  
28703

Red  
28705

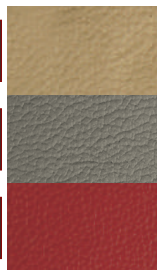

Black  
28708

Embossed Carbon Vinyl  
28713

Blank - No Leather  
28700



# D-SHAPED

## 14" BILLET STEERING WHEELS



Formula - Contrast Cut  
BC29409



Camber - Polished  
29402



Formula - Black Anodized  
BLK29409



Camber - Black Anodized  
BLK29402



Formula - Polished  
29409

**INCLUDES:**  
Both Polished & Black Rivets!



### D-SHAPED STEERING WHEEL KITS

Billet Specialties new D-Shaped Steering kits available in the Prism & Formula styles offer two finish options Gunmetal Matte and Bronze Matte. Steering wheel kits include a color matched smooth/black logo Pro Style horn button. Finish off with the package by selecting from 6 half wraps and adapter (not included).



Prism Kit with Horn Button  
294751 Gunmetal Matte  
294753 Bronze Matte



Formula Kit with Horn Button  
294091 Gunmetal Matte  
294093 Bronze Matte

# SELECT EDITION

## 14" BILLET STEERING WHEELS

Once again Billet Specialties leads the way with the Select Edition line of steering wheels. Precision machined from 6061-T6 Billet aluminum, each wheel features segmented half wraps for an aggressive style. The Boost, Throttle and Draft include polished and black rivets allowing you to customize your steering wheel to achieve your own unique look.

Select Edition. Truly Custom.



Throttle - Black Anodized  
BLK29299



Throttle  
29299



Draft - Black Anodized  
BLK29263



Draft  
29263



Boost - Black Anodized  
BLK29244



Boost  
29244

**PRICE SHOWN IS FOR STEERING WHEEL ONLY**  
Half wraps for Select Edition available to the right





### PRO STYLE HORN BUTTONS



Six styles to compliment the Select Edition steering wheels as well as our other steering wheels. The Pro Style horn buttons feature either a smooth elegant style or more aggressive riveted look that includes both polished and black rivets you install to customize your look even further.



Monaco 29315



Octane 29308



Riveted / Polished Logo 32710

Riveted / Black Logo 32715

Riveted / Black Anodized 32719



Smooth / Polished Logo 32720

Smooth / Black Logo 32725

Smooth / Black Anodized 32729

**\*Pro Style horn buttons are not for use with Stiletto, Rail or Rat Tail Profile Steering wheels.**

### SELECT EDITION HALF-WRAPS



Precision machined from 6061-T6 Billet aluminum then covered in top grain leather or Embossed Carbon Vinyl. Each piece precisely fits into place and is secured with stainless hardware.

Tan 28602

Light Gray 28603

Red 28605

Black 28608

Embossed Carbon Vinyl 28613

Blank – No Leather 28600

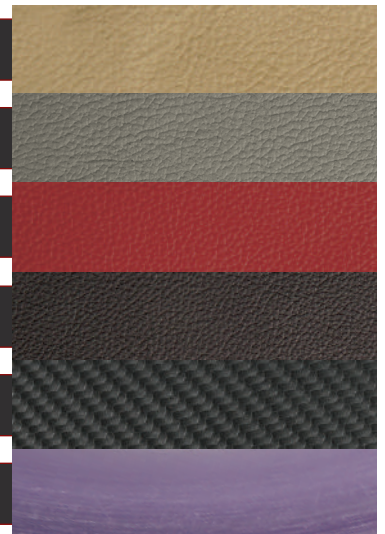

# PROFILE COLLECTION

## BILLET STEERING WHEELS

The Profile collection brings forth a revolutionary take on steering wheel design. Each of these wheels feature a half-wrapped and fully polished aluminum wheel with milled finger notches on the backside and a premium leather front. Polished Billet aluminum accent pieces raise up from each spoke and flow out over the leather half-wrap ring and horn button for a bold new look that will add award winning detail to your ride's interior.

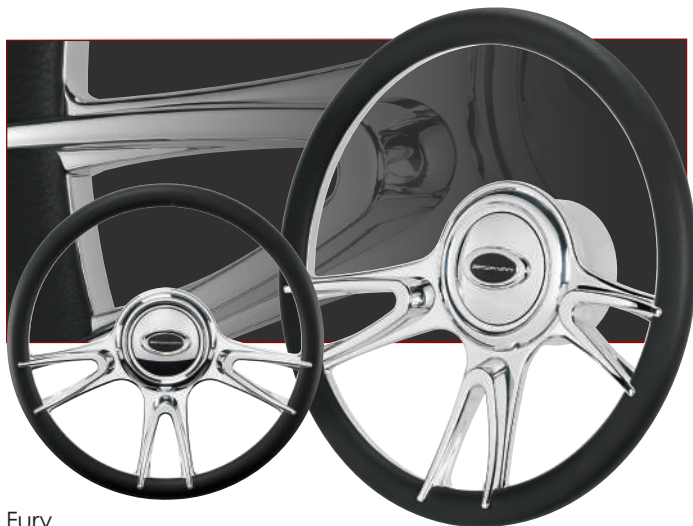

Fury  
P30017 14" Diameter

\*All Billet Specialties horn buttons work with this steering wheel

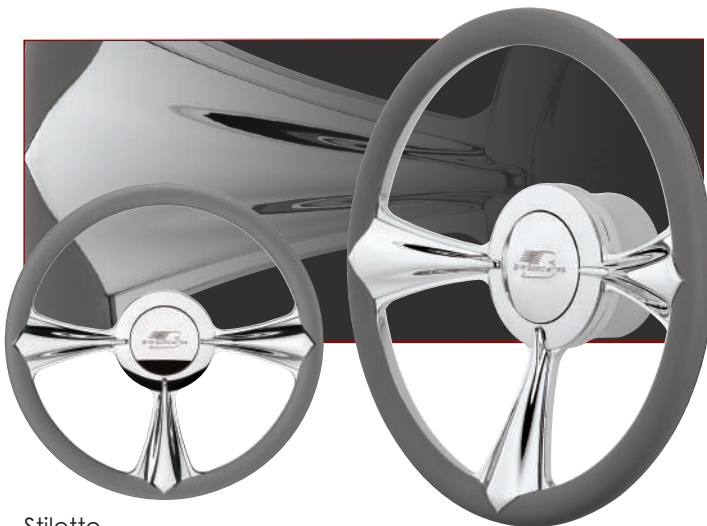

Stiletto  
P30092 14" Diameter  
P34092 15.5" Diameter

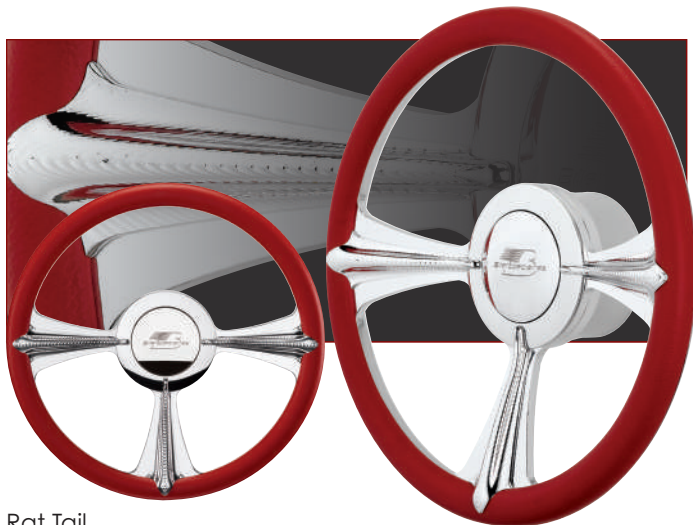

Rat Tail  
P30097 14" Diameter  
P34097 15.5" Diameter

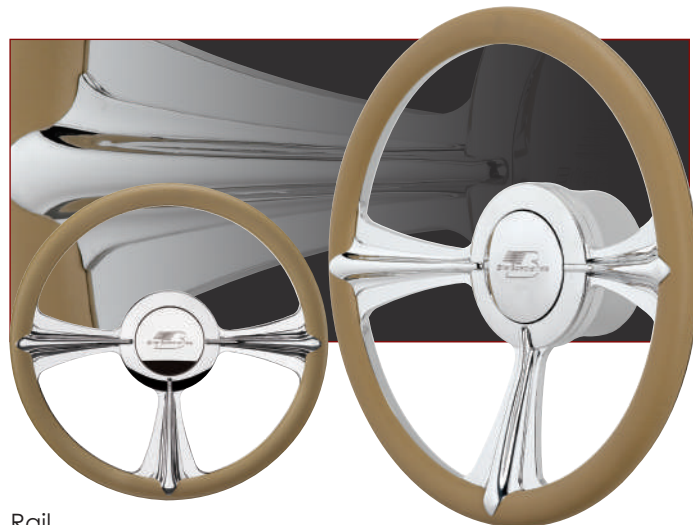

Rail  
P30096 14" Diameter  
P34096 15.5" Diameter



Large Billet Logo



Large Bowtie



Large Plain

Profile steering wheels are engineered to work with Billet Specialties large horn buttons, leather half-wraps, and steering column adapters. Not for use with simulated burl wood half-wrap rings.

**PRICE SHOWN IS FOR STEERING WHEEL ONLY**

Steering wheels require the purchase of a half-wrap, horn button, & adapter. See pages 117-118.



# STANDARD 14"

BILLET STEERING WHEELS

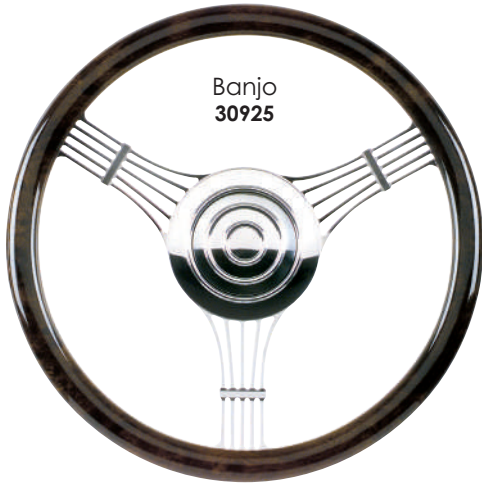

Banjo  
30925



Split Spoke  
30137



Interceptor  
30595



Rival  
30735



Street Lite - Black  
BLK30103



Street Lite  
30103

**PRICE SHOWN IS FOR STEERING WHEEL ONLY**  
Steering wheels require the purchase of a half-wrap, horn button, & adapter. See pages 117-118.

# STANDARD 14"

**BILLET STEERING WHEELS**



**PRICE SHOWN IS FOR STEERING WHEEL ONLY**

Steering wheels require the purchase of a half-wrap, horn button, & adapter. See pages 117-118.





GTX01  
30935



Fast Lane  
30175



Vintec  
30425



Eagle  
29825



Sniper  
30955



Steering Wheel Accessories  
see page 117-118

**PRICE SHOWN IS FOR STEERING WHEEL ONLY**

*Steering wheels require the purchase of a half-wrap, horn button, & adapter. See pages 117-118.*

# STANDARD 15.5"

## BILLET STEERING WHEELS

Take control of your muscle car or classic with our 15-1/2" diameter steering wheels from Billet Specialties. Designed for proper proportion and leverage needed with larger vehicles, our precision machined steering wheels feature milled finger notches and leather front rings just like our best selling 14" wheels.

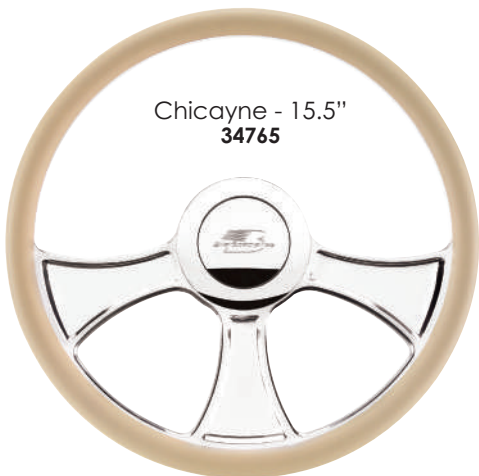
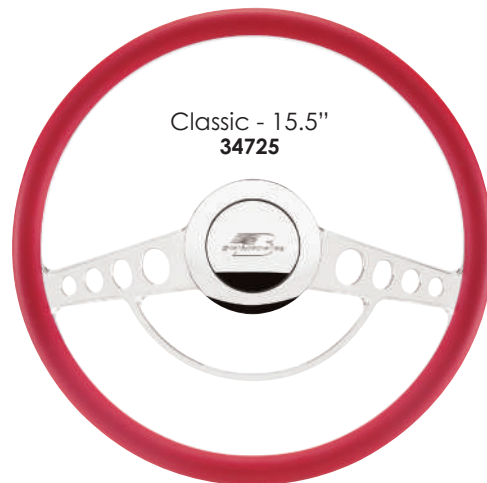

**PRICE SHOWN IS FOR STEERING WHEEL ONLY**

Steering wheels require the purchase of a half-wrap, horn button, & adapter. See pages 117-118.



# BLVD 15.5"

**BILLET STEERING WHEELS**



BLVD75 - 15.5"  
34075

**PRICE SHOWN IS FOR STEERING WHEEL ONLY**  
Steering wheels require the purchase of a half-wrap, horn button, & adapter. See pages 117-118.

# HORN BUTTONS, HALF WRAPS & ADAPTERS

## PRO STYLE HORN BUTTONS



Six styles to compliment the Select Edition steering wheels as well as our other steering wheels. The Pro Style horn buttons feature either a smooth elegant style or more aggressive riveted look that includes both polished and black rivets you install to customize your look even further.

Not for use with Rail, Rat Tail or Stiletto steering wheels

### Product Features:

- Precision machined 6061-T6 Billet aluminum
- Durable polished and black anodized finishes available
- Stainless internal hardware
- Riveted horn buttons include polished and black rivets

INCLUDES:  
Both Polished & Black Rivets!



Riveted - Polished Logo  
32710



Riveted - Black Logo  
32715



Riveted - Black Anodized  
32719



Smooth - Polished Logo  
32720



Smooth - Black Logo  
32725



Smooth - Black Anodized  
32729

## STANDARD HALF-WRAP RINGS

Wrap up the details with genuine leather half-wrap rings for Billet Specialties steering wheels.



\*Leather photos shown may differ from actual color.

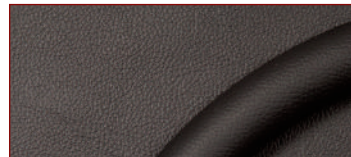

Black Leather  
14" 29008  
15.5" 33008

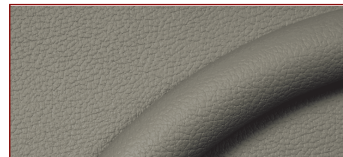

Light Gray Leather  
14" 29003  
15.5" 33003

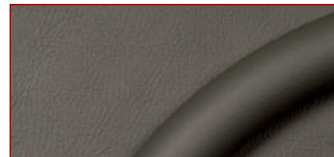

Dark Gray Leather  
14" 29004  
15.5" 33004

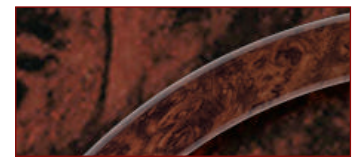

Simulated Burl Wood  
14" 29012  
15.5" 33012



Tan Leather  
14" 29002  
15.5" 33002

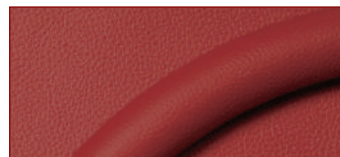

Red Leather  
14" 29005  
15.5" 33005

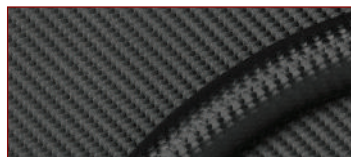

Embossed Carbon Vinyl  
14" 29013  
15.5" 33013



Blank - No Leather  
14" 29000  
15.5" 33000

For Custom Wrap Applications



## BILLET HORN BUTTONS



Billet Specialties dome style horn buttons fit our Billet steering wheels and other aftermarket 9-hole steering wheels. Standard size horn buttons leave the steering wheel mounting screws exposed while the large horn buttons cover them up.

### Product Features:

- Precision machined 6061-T6 Billet aluminum
- Industry leading polished finish
- Stainless internal hardware

\* Some Ford applications require a dual contact horn button. Call For Applications.

### NOTE:

Profile Steering wheels require the use of a LARGE horn button, shown below.



Standard - Billet Logo  
32620



Standard - Bowtie  
32320



Standard - Plain  
32120  
32121\*



Large - Banjo  
32925



Large - Billet Logo  
32625



Large - Bowtie  
32325



Large - Plain  
32125

### Replacement Horn Wire Lead RP2510

Some aftermarket steering columns do not include this wire

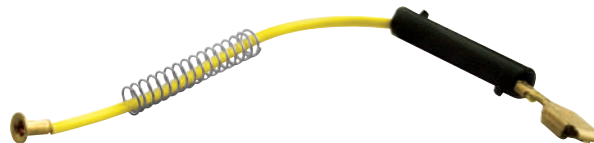

## BILLET STEERING WHEEL ADAPTERS



Engineered to fit most GM applications.

### Product Features:

- Precision machined from 6061-T6 Billet aluminum
- Industry leading mirror finish polish or Black Anodized Finish
- Polished stainless steel mount screws (8/32" x 5/8")
- '49-'66 adapter includes cancel cam for '55-'56 columns



**CALL FOR OTHER APPLICATIONS**

\* Telescoping adapters are designed for steering columns with a telescoping function. Telescopic adapters do not add this function to a steering column.

Part	Column Type	
31120	GM 1967-1994 Ididit & F. River	Most Applications
31126	GM 1996-2003	Non-Air Bag
31322	GM 1949-1966	Most Applications
31324	GM Telescopic*	2" Travel
31323	GM Telescopic*	3" Travel
31120	Flaming River	
BLK31120	GM 1967-1994 Flaming River	Black Anodized
BLK31126	GM 1996-2003	Black Anodized
BLK31322	GM 1949-1966	Black Anodized
LC22400	F24 FORD	Polished
LC22404	F24D Ford	Polished
31000-900	Replacement Adapter Screw Kit	

# PROFILE MIRROR KITS

Add timeless style with Billet Specialties forged 6061-T6 aluminum Profile Mirror Kits. Forged for ultimate strength, 3-D machined and mirror polished for style. Profile mirror arms feature multiple mounting holes for a secure fit and can be used for top or bottom mount applications.

## Product Features:

- Precision machined from forged 6061-T6 aluminum
- Industry leading mirror finish polish
- High quality glass for distortion free viewing
- Stainless steel swivel with a nylon bushing for smooth positive adjustment
- Stainless steel 10-24 button head screws included

Multiple mount options



## Dimensions:

- Base: 1-1/2"W x 21/32"H
- Profile mirror overall arm length 6"
- From mounting surface out to pivot point 4"



**Oblique  
Mirror Heads**

74820 Oblique



**Offset Round  
Mirror Heads**

74720 4" Offset Round





**TECH TIP**

Offset mirrors allow for increased angle of adjustment. Mirror arms can be used as top or bottom mounts by switching driver and passenger mounting positions.



**Offset Oval  
Mirror Heads**



**74920 Offset Oval**



**Oval  
Mirror Heads**



**74520 Oval**



**Round  
Mirror Heads**



**74120 3-1/8" Round**



# INTERIOR MIRRORS

## INTERIOR MIRRORS & MOUNTS

Complement your interior with a Billet aluminum rear view mirror from Billet Specialties. Rectangle or our classic oval design mirrors are available along with two interior mirror mounts. *Glue on mirror mount is designed for vertical or slightly angled windshields only.*

### Product Features:

- Precision machined from 6061-T6 Billet aluminum
- Top quality glass for clear viewing
- Stainless steel swivel with nylon inserts for smooth accurate adjustments
- Industry leading polished finish



- |       |   |
|-------|---|
| 73420 | Rectangle                                   |
| 73520 | Oval  |
| 72220 | Bolt-on mirror mount                        |
| 72120 | Glue-on mirror mount<br>(Adhesive Included) |



- 1.75" Tall
- Holes are 2" center to center



### Mirror Head Dimensions

- Rectangle 1-3/4" x 5-1/4"
- Oval 2-5/16" x 4-3/16"

## BILLET REAR VIEW MIRRORS

Our rear view mirrors are an easy bolt on replacement for the factory windshield mounted mirrors in most vehicles. These rearview mirrors have a universal mount that simply slips over the factory glued-on windshield mount.

### Approximate Dimensions:

9-3/8" W x 2-7/16" H



257330 Ball Milled



257340 Bowtie



# INTERIOR LIGHTING

## **BILLET INTERIOR LIGHTS**

Billet Specialties interior lights provide ample light for use in consoles and headliners.

### **Product Features:**

- Machined from 6061-T6 Billet aluminum
- Mirror polished Billet bezel
- Easy Installation



### **Dimensions:**

Rectangle Lights: 1-1/4"H x 3-5/8"W x 1-1/16"D

Elliptical Lights: 2"H x 4"W x 1-1/2"D

60320 Elliptical - Interior Light

60120 Rectangle - Interior Light

RP6413 Replacement Bulb 5-watt



Elliptical Interior Light



Rectangle Interior Light

## **BILLET DOOR LIGHTS**

### **Product Features:**

- Machined from 6061-T6 Billet aluminum
- Mirror polished Billet bezel
- Easy Installation



### **Dimensions:**

Rectangle Lights: 1-1/4"H x 3-5/8"W x 1-1/16"D

Elliptical Lights: 2"H x 4"W x 1-1/2"D

60420 Elliptical - Door Light

60220 Rectangle - Door Light

RP6413 Replacement Bulb 5-watt



Elliptical Door Light

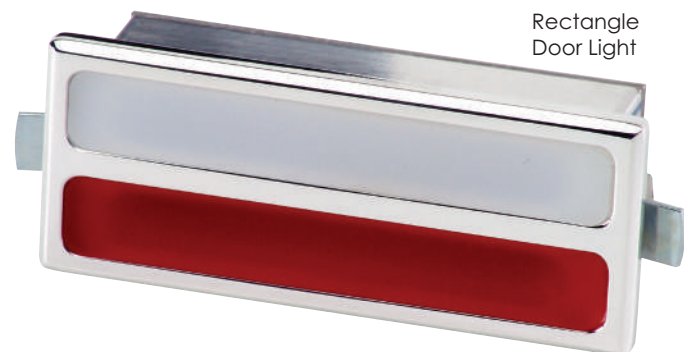

Rectangle Door Light

# EXTERIOR ACCESSORIES



## **BILLET RECESSED LICENSE PLATE FRAME**

Machined on both sides from 6061-T6 Billet aluminum our Billet license plate frames are the perfect measure of form and function. Each frame is given a polished, mirror-like finish and includes stainless hardware.

Recessed frames sit around the license plate for a smooth look.

- 55120** Plain - Recessed
- 55623** Bowtie - Recessed

**Dimensions:** 12-5/8" W x 6-7/8" H



## **LIGHTED RECESSED FRAMES**

Lighted Billet Specialties recessed license frames illuminate your plate with style

- 55220** Lighted - Plain Recessed
- 55520** Lighted - 3rd Brake Recessed
- 55320** Lighted - Bowtie Recessed

**Dimensions:** 12-5/8" W x 6-7/8" H



## **POLISHED SLIM LINE FRAME**

Billet Specialties Slim Line license frame match the outside dimensions of a standard license plate and fits well in tight spaces, including GM front license plate mounts. This frame is not recessed.

**Dimensions:** 12-3/8" W x 6-5/8" H

- 55020** Polished - Slim Line
- BLK55020** Black - Slim Line



**POLISHED OR BLACK POWDER COATED FINISH**



## '68-'69 CAMARO SS HOOD VENTS

Billet Specialties SS hood vents are the perfect match to our other great Camaro accessories. Precision 3D Machined from billet aluminum on multi axis CNC equipment, each hood vent features stainless mesh grill and drain holes. Includes stainless hardware and is ready to install.

Sold in Pairs

### Product Features:

- 6061-T6 Billet Aluminum
- Stainless Hardware & Mesh Grills
- Made in the USA

#876610 Polished

### 3D MACHINING



## WINDSHIELD WIPER POST COVERS

Not running wiper arms? Cover those posts with our polished Billet wiper post covers. Sold in pairs.

### Applications:

11/16"  
.6875

Set-screw design  
uses 11/16" or smaller shaft

- 248810 Bullet Style / Post Style
- 248815 Ribbed Style / Post Style



## BILLET TRAILER HITCH COVER

The face plates of our hitch covers are CNC machined from 6061-T6 aluminum and polished to a mirror finish, the back piece is 2" square steel tube. Installation takes a matter of seconds to make your truck's detail complete all the way around. *Pin Not Included.*



General Motors Trademarks  
used under license to  
Billet Specialties, Inc.



210120 Bowtie Cutout

# EXTERIOR LIGHTING

## UNIVERSAL LED TAILLIGHTS

Billet Specialties taillights feature either Vintage or Smooth styling in a clean easy to install package. Billet aluminum bezels are precision machined from 6061-T6 aluminum and polished to perfection. One piece safety lenses and steel housings complete the package. Each pair of tail lights includes two 1157 LED bulbs for safety. Sold in pairs.

### Product Features:

- LED bulbs
- 1 pc. Safety Lens
- 6061-T6 Billet Aluminum
- Made in the USA



61330 Vintage Polished Bezel  
61340 Smooth Polished Bezel



## BILLET BEZEL TAILLIGHTS

Billet Specialties taillights offer a custom look and safety for the back end of your hot rod. One piece safety lenses and steel housings complete the package. Each pair of tail lights includes two 1157 LED bulbs for safety. Sold in pairs.

### Product Features:

- Machined bezels from 6061-T6 Billet aluminum
- 3-3/4" deep steel housing
- Industry leading mirror finish polish
- Includes LED 1157 bulb



61225 Open Bezel/Pair  
61000-900 Taillight Lenses/Pair

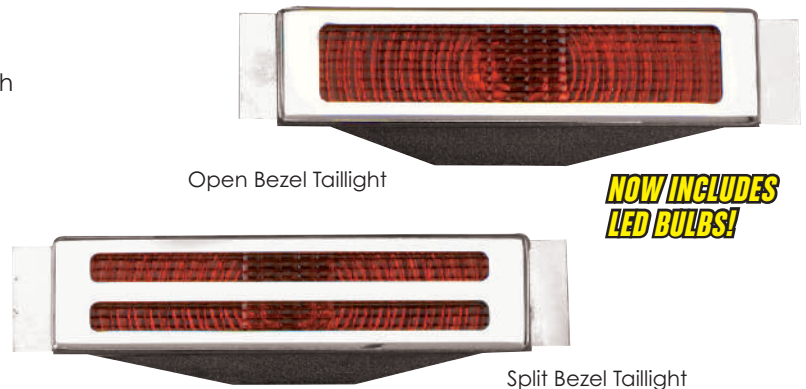

**NOW INCLUDES LED BULBS!**

## OVAL THIRD BRAKE LIGHT

### Product Features:

- Precision machined from 6061-T6 Billet aluminum
- Industry leading mirror finish polish
- Swivel base for proper angle adjustment

Dimensions: 7"W x 1-3/4"H x 9/16"D

Mounting Surface: 2"W x 1/2"D



62220 Oval Third Brake Light  
RP6211 Third Brake Light Lens w/ Screws  
RP6411 Replacement 10w bulb 2-pack



## 1969 CAMARO RS FLUSH TAILLIGHT BEZELS

Different from our recessed taillights, our flush mount bezels offer a smooth clean look for the back of your Camaro. Each tail light is precision machined from 6061-T6 Billet aluminum for a High-Tech look. Two styles are available; traditional slotted and segmented tri-panel. Made in the USA. Sold in pairs.

### Product Features:

- Precision Machined Bezel
- Stainless Hardware
- 1 pc. Cast Acrylic Lens
- 6061-T6 Billet Aluminum

Slotted Polished Bezel  
61737





## **BILLET AN HOSE END WRENCH KITS**

Billet Specialties AN Hose End wrench kits are made from 6061-t6 aluminum then anodized to provide a mar-free installation. Short handles offer a comfortable grip while avoiding over-tightening. Each Handle is stamped with the wrench size for easy identification. Select from a 5pc or 7pc kit



- 5pc Kit includes;**
- -6AN
  - -8AN
  - -10AN
  - -12AN
  - -16AN

**67005 5PC AN HOSE END WRENCH KIT**



- 7pc Kit includes;**
- -3AN
  - -4AN
  - -6AN
  - -8AN
  - -10AN
  - -12AN
  - -16AN

**67007 7PC AN HOSE END WRENCH KIT**

## **BACKSPACE/OFFSET MEASURING TOOL**

Finally a professional and easy way to measure backspace in 1/8" increments or offset in 2mm increments on wheels with or without a tire mounted. Works with 14" thru 32" diameter wheels up to 15" in width.

### **Product Features:**

- Easy to read engraved scale
- Precision 6061-T6 billet aluminum construction
- Black anodized finish

**999510 Backspace/Offset Measurement Tool**

