

Spark plugs - Glow plugs - Ignition coils

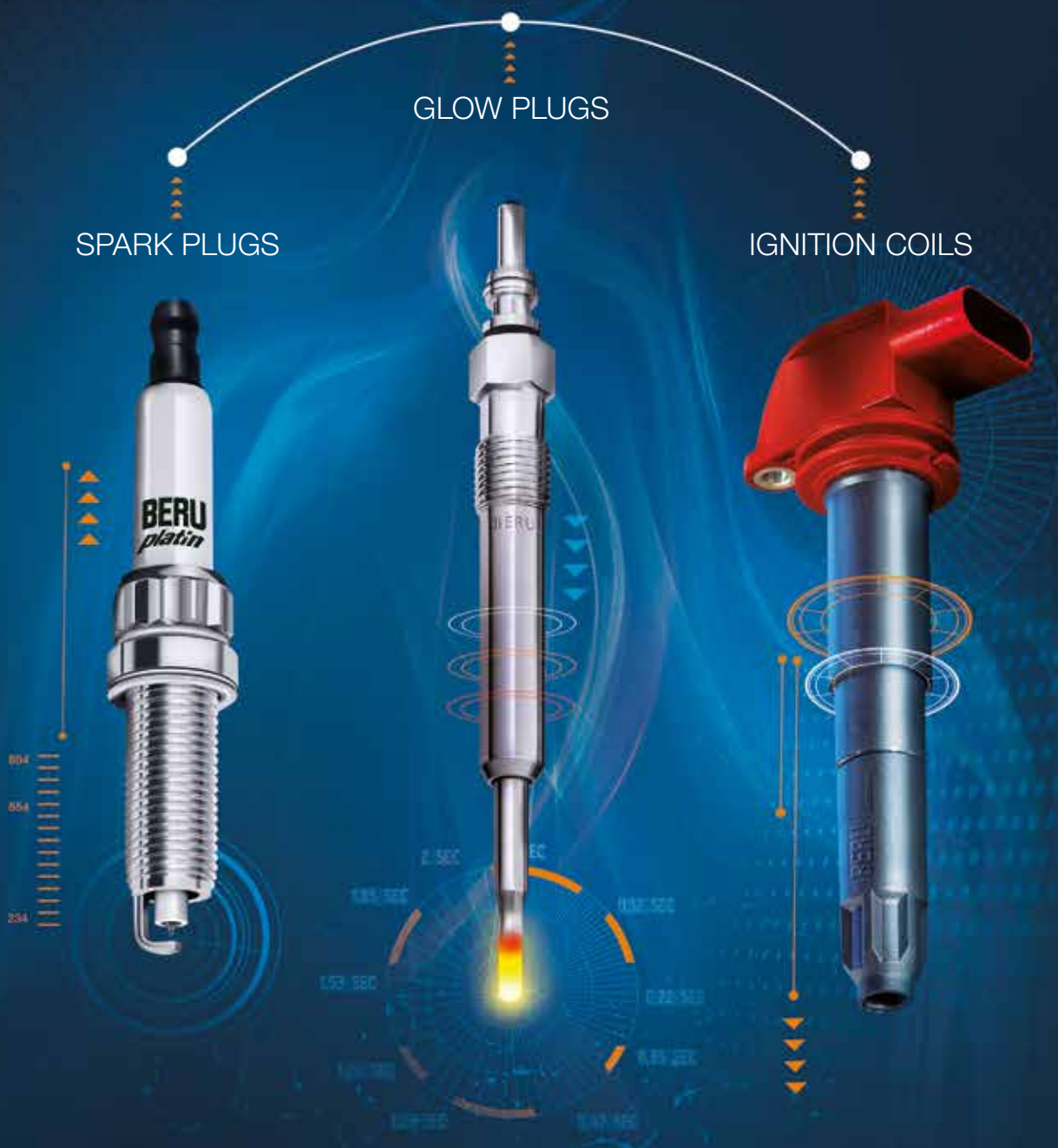

2015 - 2016
CATBU1501

IGNITION STARTS WITH BERU



THE MOST COMPREHENSIVE IGNITION CATALOGUE EVER

This BERU catalogue contains the most complete OE product range, from spark plugs and glow plugs to ignition coils. It provides you with all the answers to your ignition questions.

It's new. It's leading. It's BERU. Perfection built in.

Perfection
built in





Table of content

| | | |
|------------|--|--|
| | | |
| NEW | | |
| | | |
| | | |
| | | |
| | | |



THE QUEST FOR PERFECTION IT'S IN OUR DNA

BERU founders Julius **Behr** and Albert **Ruprecht**'s company creed is ever relevant: perfection is in the continuous desire for self-improvement. You can always count on BERU to offer highly technological solutions to meet the ignition demands of today and tomorrow. **The quest for perfection: it's simply in our DNA.**

THE FUTURE OF OE IS OURS



BERU not only develops OE innovations to tune in on the future of ignition technology, we are a part of the future. Vehicle manufacturers have relied on us for award-winning solutions such as the Pressure Sensor Glow Plug to meet emission limits or the revolutionary bowl connector to address the challenges in engine design. And they will continue to build on this trusted partnership in the many years to come.



Yesterday, today and tomorrow. It's perfection built in.

Partners

95%
COVERAGE



**PARTNER UP WITH THE EUROPEAN
GLOW PLUG MARKET LEADER**

BERU glow plugs are not only market leading for the European diesel car parc, covering 95%, but also leading in OE supply. So there's a high chance that a car is fitted with BERU when it enters your shop for servicing. And that applies to our solutions for the entire ignition train and diesel cold-start technology.

Yesterday, today and tomorrow. It's perfection built in.

Quality

WHY THE BERU BLACK TIP?

Meeting the highest quality standards is our biggest concern. That's why we test every single plug before it leaves the workshop. The result: the characteristic BERU black tip. It's our quality guarantee, certifying that your plug has been tested before use.

Our 100% OE quality guarantee.

It's the foundation of perfection built in.



Perfection
built in













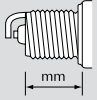

| | | | | | | | | | | | |
|-------------------------|---|-----------------|--------|-------------|-------------------------------------|--|--|-----|--------------------------|--|--|
| | | | | | | | | | | | |
| ... BMW | | | | | | | | | | | |
| 5 /Touring (E34) | | | | | | | | | | | |
| 1.8 518 i | 4 | M43 B18 (184E2) | 85/114 | 08/89→01/97 | Z14 | | | 0.9 | UXT1 / UXT3 ZS307 | | |
| 1.8 518 i LPG | 4 | M43 B18 (184E2) | 85/114 | 08/89→01/97 | Z116 | | | 0.8 | UXT5 | | |
| 2.5 525 td | 6 | M51 D25 (256T1) | 85/114 | 03/93→01/97 | GN013 <small>(21222)</small> | | | 11V | | | |
| | | | | | GV719 | | | 11V | | | |

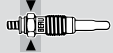

EN

- | | | |
|-----------------------|------------------------|-------------------------------|
| Model | Spark plug | Ultra X Titan |
| Cylinders | Glow plug | Ignition coil |
| Engine code | Glow plug control unit | Ignition module |
| KiloWatt / Horsepower | Voltage | Connectors for ignition coils |
| Model year | Electrode Gap | |

NEW TO RANGE

| |  |  |  |  |  |
|-------------|---|---|---|---|--|
| Z306 | 12F-HPURW | 16 | M 12x1,25 | 0,9 | Audi/VW |
| Z354 | 14FR-5LPUOX | 16 | M 14x1,25 | 1,1 | Honda |
| Z359 | 12F-5NPUR2T | 16 | M 12x1,25 | 0,8 | Mercedes-Benz |

| |  |  |  |  | |  | |  |
|---------------|---|---|---|---|----|--|---------|---|
| | | | |  | Nm |  | Nm max. | |
| GE117 | 137,1 | 24 | M 10x1,25 | 10 mm | 18 | 4 mm | - | Opel/Vauxhall |
| GE121A | 112 | 28 | M 8x1,0 | 8 mm | 10 | 4 mm | - | Citroen |
| GE122 | 148,5 | 35,5 | M 10x1,0 | 10 mm | 15 | M4 | 2 | Ford |
| GE123 | 134 | 28 | M 8x1,0 | 8 mm | 10 | 4 mm | - | Volvo |
| GE124 | 162,7 | 26 | M 10x1,0 | 10 mm | 15 | 4 mm | - | Renault |
| GE125 | 92,7 | 29,5 | M 8x1,0 | 8 mm | 10 | 4 mm | - | Opel/Vauxhall |
| GE126 | 146 | 31,4 | M 10x1,0 | 10 mm | 15 | 4 mm | - | Opel/Vauxhall |
| PSG005 | 158,35 | 31,4 | M 10x1,0 | 12 mm | 12 | - | - | Opel/Vauxhall |
| PSG006 | 179,95 | 35 | M 9x1,0 | 12 mm | 11 | - | - | Opel/Vauxhall |

|  |  |
|---|---|
| GR081 | Audi |
| GSE114 | Mercedes-Benz |
| GSE116 | Mercedes-Benz |
| GSE140 | Mercedes-Benz |
| GSE141 | Mercedes-Benz |
| GSE142 | Opel/Vauxhall |
| GSE143 | Opel/Vauxhall |
| GSE144 | Opel/Vauxhall |
| GSE145 | Opel/Vauxhall |

NEW TO RANGE

|  |  |
|---|---|
| ZS445 | Toyota |
| ZS446 | Volvo |
| ZS447A | Chevrolet |
| ZS452 | Jeep |
| ZS453 | Chrysler / Fiat |
| ZS454 | Renault |
| ZS455 | Chrysler |
| ZS456 | Chrysler |
| ZS469 | Rover |
| ZS470 | Chrysler |
| ZS474 | Kia, Hyundai |
| ZS475 | Kia, Hyundai |
| ZS476 | Kia |
| ZS477 | Kia |
| ZS478 | Hyundai, Kia |
| ZS479 | Hyundai |
| ZS480 | Hyundai |
| ZS481 | Hyundai, Kia |
| ZS482 | Hyundai, Kia |
| ZS483 | Kia |
| ZS485 | Hyundai |
| ZS486 | Kia |
| ZS487 | Kia |
| ZS538 | BMW-Mini Cooper |

|  |  |
|---|---|
| ZSE089 | Ford |
| ZSE093 | Mercedes-Benz |
| ZSE094 | Mercedes-Benz |
| ZSE154 | Audi, Skoda, VW |
| ZSE155 | VW - Only for Export South America |
| ZSE156 | Nissan |
| ZSE157 | Infiniti |
| ZSE158 | Nissan |
| ZSE159 | Cadillac |
| ZSE161 | Renault |
| ZSE164 | Toyota |
| ZSE165 | Toyota |
| ZSE166 | Honda |
| ZSE167 | Toyota |
| ZSE168 | Toyota |
| ZSE169 | Honda |
| ZSE170 | Honda |
| ZSE171 | Toyota |
| ZSE172 | Lexus, Toyota |
| ZSE173 | Lexus, Toyota |
| ZSE174 | Alfa Romeo, Cadillac, Opel, Saab, Vauxhall |
| ZSE175 | Honda |
| ZSE176 | Honda |
| ZSE177 | Chevrolet |



kW/BHP

**ACURA****INTEGRA**

| | | | | | | | | | | |
|-------|---|--------------|--------|-------------|--|--|--|--|--|-----------|
| 1.6 | 4 | D16A1, D16A3 | 74/99 | 01/85→12/90 | | | | | | ZS276 [1] |
| 1.6 i | 4 | D16A8 | 88/118 | 01/85→12/90 | | | | | | ZS276 [1] |
| 1.8 | 4 | F18A2 | 77/103 | 10/90→09/93 | | | | | | ZS278 |

LEGEND II

| | | | | | | | | | | |
|---------|---|-------------|---------|-------------|------|--|--|-----|-------|--|
| 3.2 | 6 | C32A, C32A2 | 151/202 | 08/91→08/96 | Z16 | | | 1.1 | UXT11 | |
| 3.2 LPG | 6 | C32A, C32A2 | 151/202 | 08/91→08/96 | Z340 | | | 0.7 | UXT12 | |

LEGEND III

| | | | | | | | | | | |
|---------|---|-------|---------|--------|------------|--|--|-----|-------|--|
| 3.5 | 6 | C35A2 | 151/202 | 08/96→ | Z228 | | | 1.0 | UXT11 | |
| 3.5 LPG | 6 | C35A2 | 151/202 | 08/96→ | Z221 [168] | | | 1.0 | UXT14 | |

SLX

| | | | | | | | | | | |
|-------------|---|------|---------|-------------|------|--|--|-----|-------|--|
| 3.2 4WD | 6 | 6VD1 | 140/188 | 11/95→09/99 | Z343 | | | 1.1 | UXT11 | |
| 3.2 4WD LPG | 6 | 6VD1 | 140/188 | 11/95→09/99 | Z206 | | | 0.7 | UXT10 | |

ALFA ROMEO**6**

| | | | | | | | | | | |
|----------|---|--------------|---------|-------------|-------------------------------------|-----------------|--|-----|-----------------------|--|
| 2.0 | 6 | AR 01932 | 99/133 | 07/81→12/86 | Z11 09/83→ | | | 0.8 | UXT2 / UXT6 09/83→ | |
| 2.5 i.e. | 6 | AR 01928 | 110/148 | 10/83→12/86 | Z11 | | | 0.8 | UXT2 / UXT6 | |
| 2.5 i.e. | 6 | AR 01928 | 116/156 | 04/79→06/84 | Z1 →08/83 Z11 [168] 09/83→ | | | 0.7 | UXT2 / UXT6 →08/83 | |
| 2.5 TD | 5 | VM-HR 588 HT | 77/103 | 07/81→05/86 | GV657 06/83→ | GR066 06/83→ | | 11V | | |

33

| | | | | | | | | | | |
|----------|---|---------------------------------|--------|-------------|--------------------------------|--|--|-----|---|---------------------|
| 1.2 | 4 | AR 30585 | 50/67 | 06/83→12/89 | Z42 →03/88 | | | 0.8 | UX56 →03/88 | |
| 1.3 | 4 | AR 30502, AR 30586 | 55/74 | 06/83→12/89 | Z22 →03/88 Z42 04/88→ | | | 0.7 | UX56 →03/88 | ZS283 |
| 1.3 | 4 | AR 30502 | 58/78 | 05/83→12/89 | Z42 | | | 0.8 | UX56 | ZS283 |
| 1.3 | 4 | AR 30168, AR 30587 | 63/84 | 10/84→12/89 | Z42 | | | 0.8 | UX56 | ZS283 |
| 1.4 | 4 | AR 30587 | 66/89 | 01/84→12/88 | Z51 | | | 0.8 | UX56 | ZS283 |
| 1.4 i.e. | 4 | AR 30753, AR 30755 | 65/87 | 06/91→09/94 | Z42 →12/91 Z12 01/92→ | | | 0.8 | UX56 →12/91 UXT2 / UXT6 01/92→ | ZS283 |
| 1.4 i.e. | 4 | AR 30753, AR 30755 | 66/89 | 06/91→09/94 | Z12 | | | 0.8 | UXT2 / UXT6 | ZS283 |
| 1.5 | 4 | AR 30143 | 62/83 | 06/83→12/85 | Z11 →10/84 | | | 0.8 | UXT2 / UXT6 →10/84 | |
| 1.5 | 4 | AR 30504 | 62/83 | 06/83→12/85 | Z11 →10/84 | | | 0.8 | UXT2 / UXT6 →10/84 | ZM001 |
| 1.5 4WD | 4 | AR 30504 | 62/83 | 11/83→12/84 | Z11 | | | 0.8 | UXT2 / UXT6 | ZS115 [1][11] ZM001 |
| 1.5 | 4 | AR 30520 | 66/89 | 06/83→12/86 | Z42 11/84→ | | | 0.8 | UX56 11/84→ | ZM001 |
| 1.5 | 4 | AR 30520 | 66/89 | 09/84→12/86 | Z42 | | | 0.8 | UX56 | |
| 1.5 4WD | 4 | AR 30520 | 66/89 | 09/84→12/86 | Z11 | | | 0.8 | UXT2 / UXT6 | ZS115 [1][11] |
| 1.5 4WD | 4 | AR 30520 | 66/89 | 01/85→09/86 | Z42 | | | 0.8 | UX56 | ZM001 |
| 1.5 | 4 | AR 30182, AR 30514 | 70/94 | 05/83→12/93 | Z42 | | | 0.8 | UX56 | |
| 1.5 | 4 | AR 30588 | 75/101 | 07/86→12/89 | Z42 | | | 0.8 | UX56 | |
| 1.5 | 4 | AR 30588 | 75/101 | 12/86→12/89 | Z51 | | | 0.8 | UX56 | |
| 1.5 4WD | 4 | AR 30588 | 75/101 | 12/86→12/89 | | | | | | ZS115 [1][11] |
| 1.5 | 4 | AR 30146, AR 30588, AR 30734 | 77/103 | 12/86→04/93 | Z51 | | | 0.8 | UX56 | |
| 1.5 | 4 | AR 30508 | 77/103 | 12/86→12/89 | Z51 | | | 0.8 | UX56 | ZM001 03/88→ |

ALFA ROMEO



kW/BHP

**... ALFA ROMEO****... 33**

| | | | | | | | | | | |
|--------------|---|----------------------|---------|-------------|--|--|-----|--|---------------------|------------------------|
| 1.5 | 4 | AR30508 | 77/103 | 01/90→04/93 | | | | | | ZM003 |
| 1.5 4WD | 4 | AR 30146 | 77/103 | 09/86→12/89 | Z42 | | 0.8 | UX56 | ZS115 (1111) | |
| 1.5 4WD | 4 | AR 30508 | 77/103 | 12/86→03/89 | Z42 | | 0.8 | UX56 | | ZM001 03/88→ |
| 1.5 4WD | 4 | AR 30588 | 77/103 | 09/86→12/89 | Z42 | | 0.8 | UX56 | ZS115 (1111) | ZM003 09/88→ |
| 1.5 i.e | 4 | AR 30751 | 71/95 | 01/90→09/94 | Z42 →03/92 Z22 04/92→ | | 0.8 | UX56 →03/92 0.7 UX56 04/92→ | | |
| 1.5 i.e. | 4 | AR 30750 | 74/99 | 07/90→08/91 | Z51 | | 0.8 | UX56 | | ZM001 |
| 1.5 QV | 4 | AR 30146, AR 30588 | 77/103 | 06/84→12/89 | Z42 →08/86 Z51 09/86→ | | 0.8 | UX56 →08/86 0.8 UX56 09/86→ | | |
| 1.5 QV | 4 | AR 30508 | 77/103 | 06/84→12/89 | Z42 →08/86 Z51 09/86→ | | 0.8 | UX56 →08/86 0.8 UX56 09/86→ | | ZM003 09/88→ |
| 1.7 | 4 | AR 30550 | 87/117 | 01/86→12/89 | Z51 | | 0.8 | UX56 | | |
| 1.7 | 4 | AR 30550 | 87/117 | 03/88→12/89 | | | | | | ZM001 |
| 1.7 | 4 | AR 30550 | 95/127 | 01/86→12/89 | Z42 | | 0.8 | UX56 | | |
| 1.7 16V | 4 | AR 30747 | 95/127 | 01/90→09/94 | Z130 | | 1.0 | UXT14 | | |
| 1.7 16V | 4 | AR 30747 | 97/130 | 01/90→09/94 | Z130 | | 1.0 | UXT14 | | |
| 1.7 16V | 4 | AR 30746 | 101/135 | 01/90→09/94 | Z188 | | 0.7 | UXT10 | | |
| 1.7 i.e. | 4 | AR 30558 | 77/103 | 09/88→12/89 | Z42 | | 0.8 | UX56 | | ZM003 |
| 1.7 i.e. | 4 | AR 30737, AR 30737 A | 77/103 | 04/92→09/94 | Z22 | | 0.7 | UX56 | | ZM026 |
| 1.7 i.e. 4WD | 4 | AR 30558, AR 30737 | 77/103 | 09/88→12/89 | Z47 | | 0.8 | UX56 | | ZM003 |
| 1.7 i.e. | 4 | AR 30736, AR 30737 | 79/106 | 01/90→09/94 | Z42 | | 0.8 | UX56 | | |
| 1.7 i.e. | 4 | AR 30736, AR 30737 | 79/106 | 01/90→03/92 | | | | | ZS115 (1111) | ZM001 |
| 1.7 i.e. 4WD | 4 | AR 30736, AR 30737 | 79/106 | 01/90→03/92 | Z51 | | 0.8 | UX56 | | ZM001 |
| 1.7 QV | 4 | AR 30550 | 84/113 | 03/88→12/89 | Z51 | | 0.8 | UX56 | | |
| 1.8 TD | 3 | VM 82 A | 54/72 | 01/86→06/90 | GV657 02/90→ | | 11V | | | |
| 1.8 TD | 3 | VM 96 A | 62/83 | 01/86→12/89 | GV657 | | 11V | | | |
| 1.8 TD | 3 | VM 96 A | 62/83 | 07/90→09/94 | GV657 →03/94 | | 11V | | | |

75

| | | | | | | | | | | |
|----------------|---|--------------------|---------|-------------|--------------|--|-----|--------------------|---------------------|------------------------|
| 1.6 | 4 | AR 61101 | 76/102 | 05/85→09/89 | Z42 | | 0.8 | UX56 | | |
| 1.6 | 4 | AR 06100 | 81/109 | 05/85→09/89 | Z42 | | 0.8 | UX56 | | ZM001 |
| 1.6 | 4 | AR 61101 | 81/109 | 05/89→02/92 | Z42 | | 0.8 | UX56 | ZS115 (1111) | |
| 1.8 | 4 | AR 06202 | 85/114 | 09/85→06/89 | Z42 | | 0.8 | UX56 | | ZM001 |
| 1.8 | 4 | AR 06168, AR 61102 | 88/118 | 09/88→02/92 | Z42 | | 0.8 | UX56 | | |
| 1.8 | 4 | AR 61201 | 90/121 | 08/89→02/92 | Z42 | | 0.8 | UX56 | | |
| 1.8 | 4 | AR 67101 | 95/127 | 08/89→02/92 | Z42 | | 0.8 | UX56 | | |
| 1.8 Turbo | 4 | AR 06134 | 110/148 | 09/86→02/92 | Z22 | | 0.7 | UX56 | | ZM001 →01/90 |
| 1.8 Turbo i.e. | 4 | AR 06158 | 114/153 | 02/86→01/90 | Z22 | | 0.7 | UX56 | | |
| 2.0 | 4 | AR 06212 | 94/126 | 05/85→10/88 | Z42 | | 0.8 | UX56 | | ZM001 |
| 2.0 T.S. | 4 | AR 06166, AR 06224 | 107/143 | 01/87→02/92 | Z29 | | 0.8 | UXT5 | | ZM037 |
| 2.0 T.S. | 4 | AR 06224 | 109/146 | 05/85→02/92 | Z29 | | 0.8 | UXT5 | | ZM037 |
| 2.0 TD | 4 | VM 80 A | 70/94 | 05/85→09/92 | GV657 | | 11V | | | |
| 2.4 TD | 4 | VM 81 A | 82/110 | 01/89→02/92 | GV657 | | 11V | | | |
| 2.5 V6 | 6 | AR 01648 | 113/152 | 09/86→04/89 | Z11 | | 0.8 | UXT2 / UXT6 | | |
| 2.5 V6 | 6 | AR 01646 | 115/154 | 05/85→08/86 | Z11 | | 0.8 | UXT2 / UXT6 | | |
| 2.5 V6 | 6 | AR 01911 | 115/154 | 05/85→08/86 | Z11 | | 0.8 | UXT2 / UXT6 | | ZM001 02/86→ |
| 3.0 V6 | 6 | AR 06120 | 136/182 | 01/87→12/90 | Z11 | | 0.8 | UXT2 / UXT6 | ZS115 (1111) | ZM001 |
| 3.0 V6 | 6 | AR 06124 | 136/182 | 01/87→02/92 | Z11 | | 0.8 | UXT2 / UXT6 | | ZM001 |

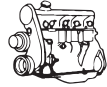

kW/BHP

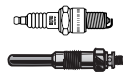

... ALFA ROMEO



... 75

| | | | | | | | | | | |
|--------|---|----------|---------|-------------|-----|--|-----|------|--|--|
| 3.0 V6 | 6 | AR 61503 | 141/189 | 02/90→02/92 | Z42 | | 0.8 | UX56 | | |
|--------|---|----------|---------|-------------|-----|--|-----|------|--|--|

90

| | | | | | | | | | | |
|----------|---|----------|--------|-------------|-----------------|-----------------|-----|-------------|---------------|--|
| 1.8 | 4 | AR 06202 | 85/114 | 10/84→07/87 | Z42 | | 0.8 | UX56 | ZS115 [1][11] | |
| 1.8 | 4 | AR 06202 | 89/119 | 10/84→07/87 | Z42 | | 0.8 | UX56 | | |
| 2.0 i.e. | 4 | AR 01713 | 94/126 | 10/84→07/87 | Z11 | | 0.8 | UXT2 / UXT6 | | |
| 2.0 i.e. | 4 | AR 06212 | 94/126 | 10/84→07/87 | Z42 | | 0.8 | UX56 | | |
| 2.0 i.e. | 6 | AR 06210 | 97/130 | 10/84→07/87 | Z11 | | 0.8 | UXT2 / UXT6 | | |
| 2.4 TD | 4 | VM 81 A | 81/109 | 10/84→07/87 | GV657 →01/87 | GR066 →01/87 | 11V | | | |

| | | | | | | | | | | |
|-------------|---|----------|---------|-------------|-----|--|-----|-------------|-----------------|--|
| 2.5 i.e. V6 | 6 | AR 01646 | 110/148 | 10/84→07/87 | Z11 | | 0.8 | UXT2 / UXT6 | ZM001 →01/87 | |
|-------------|---|----------|---------|-------------|-----|--|-----|-------------|-----------------|--|

| | | | | | | | | | | |
|-------------|---|----------|---------|-------------|-----|--|-----|-------------|-----------------|--|
| 2.5 i.e. V6 | 6 | AR 01911 | 110/148 | 10/84→07/87 | Z11 | | 0.8 | UXT2 / UXT6 | ZM001 02/86→ | |
|-------------|---|----------|---------|-------------|-----|--|-----|-------------|-----------------|--|

| | | | | | | | | | | |
|-------------|---|--------------------|---------|-------------|-----|--|-----|-------------|--|--|
| 2.5 i.e. V6 | 6 | AR 01646, AR 01911 | 114/153 | 10/84→07/87 | Z11 | | 0.8 | UXT2 / UXT6 | | |
|-------------|---|--------------------|---------|-------------|-----|--|-----|-------------|--|--|

145

| | | | | | | | | | | |
|-------------------|---|--------------------|--------|-------------|------------------------|--|------------|------|-------|------------------|
| 1.4 i.e. | 4 | AR 33501 | 66/89 | 07/94→12/96 | Z51 | | 0.8 | UX56 | ZS283 | |
| 1.4 i.e. LPG | 4 | AR 33501 | 66/89 | 07/94→12/96 | Z42 | | 0.8 | UX56 | | |
| 1.4 i.e. 16V T.S. | 4 | AR 33503, AR 38501 | 76/102 | 12/96→01/01 | Z237 (IN) Z210 (EX) | | 1.6 0.6 | | | ZLE288 02/99→ |

| | | | | | | | | | | |
|-------------------|---|-----------------|--------|-------------|--|--|--|--|-----------------|--|
| 1.4 i.e. 16V T.S. | 4 | AR 33503<W3 M1> | 76/102 | 12/96→01/01 | | | | | ZS309 02/99→ | |
|-------------------|---|-----------------|--------|-------------|--|--|--|--|-----------------|--|

| | | | | | | | | | | |
|----------|---|----------|--------|-------------|-----|--|-----|------|-------|--|
| 1.6 i.e. | 4 | AR 33201 | 76/102 | 10/94→12/96 | Z51 | | 0.8 | UX56 | ZS234 | |
|----------|---|----------|--------|-------------|-----|--|-----|------|-------|--|

| | | | | | | | | | | |
|--------------|---|----------|--------|-------------|-----|--|-----|------|--|--|
| 1.6 i.e. LPG | 4 | AR 33201 | 76/102 | 10/94→12/96 | Z42 | | 0.8 | UX56 | | |
|--------------|---|----------|--------|-------------|-----|--|-----|------|--|--|

| | | | | | | | | | | |
|-------------------|---|--------------|--------|-------------|--|--|--|--|---------------------------------|--|
| 1.6 i.e. 16V T.S. | 4 | 67601<W3 M5> | 88/118 | 12/96→01/01 | | | | | ZS309 02/99→ ch. 3174688→ | |
|-------------------|---|--------------|--------|-------------|--|--|--|--|---------------------------------|--|

| | | | | | | | | | | |
|-------------------|---|--------------------|--------|-------------|------------------------|--|------------|--|--|------------------|
| 1.6 i.e. 16V T.S. | 4 | AR 38201, AR 67601 | 88/118 | 12/96→01/01 | Z237 (IN) Z210 (EX) | | 1.6 0.6 | | | ZLE288 02/99→ |
|-------------------|---|--------------------|--------|-------------|------------------------|--|------------|--|--|------------------|

| | | | | | | | | | | |
|--------------|---|----------|--------|-------------|------|--|-----|-------|-------|--|
| 1.7 i.e. 16V | 4 | AR 33401 | 95/127 | 10/94→12/96 | Z188 | | 0.7 | UXT10 | ZS234 | |
|--------------|---|----------|--------|-------------|------|--|-----|-------|-------|--|

| | | | | | | | | | | |
|------------------|---|----------|--------|-------------|------|--|-----|-------|--|--|
| 1.7 i.e. 16V LPG | 4 | AR 33401 | 95/127 | 10/94→12/96 | Z340 | | 0.7 | UXT12 | | |
|------------------|---|----------|--------|-------------|------|--|-----|-------|--|--|

| | | | | | | | | | | |
|--------------|---|----------|---------|-------------|------------------------|--|------------|--|--|------------------|
| 1.8 i.e. 16V | 4 | AR 32201 | 106/142 | 03/98→01/01 | Z237 (IN) Z210 (EX) | | 1.6 0.6 | | | ZLE288 02/99→ |
|--------------|---|----------|---------|-------------|------------------------|--|------------|--|--|------------------|

| | | | | | | | | | | |
|--------------|---|------------------|---------|-------------|--|--|--|--|-----------------|--|
| 1.8 i.e. 16V | 4 | AR 32201<W3 M10> | 106/142 | 03/98→01/01 | | | | | ZS309 02/99→ | |
|--------------|---|------------------|---------|-------------|--|--|--|--|-----------------|--|

| | | | | | | | | | | |
|-------------------|---|---------------------------------|---------|-------------|------------------------|--|------------|--|--|--|
| 1.8 i.e. 16V T.S. | 4 | AR 38401, AR 67106, AR 67199 | 103/138 | 12/96→12/98 | Z237 (IN) Z210 (EX) | | 1.6 0.6 | | | |
|-------------------|---|---------------------------------|---------|-------------|------------------------|--|------------|--|--|--|

| | | | | | | | | | | |
|---------|---|----------|--------|-------------|--|--|------------|--|--|--|
| 1.9 JTD | 4 | AR 32302 | 77/103 | 02/99→01/01 | GN017 →eng. 1716459 GN041 eng. 1716460→ | | 11V 11V | | | |
|---------|---|----------|--------|-------------|--|--|------------|--|--|--|

| | | | | | | | | | | |
|--------|---|--------------------|-------|-------------|-------------------------|--|------------|--|--|--|
| 1.9 TD | 4 | AR 33601, AR 67501 | 66/89 | 10/94→02/99 | GN013 [2][222] GN908 | | 11V 11V | | | |
|--------|---|--------------------|-------|-------------|-------------------------|--|------------|--|--|--|

| | | | | | | | | | | |
|----------------------|---|----------|---------|-------------|------------------------|--|------------|--|-------|--------|
| 2.0 16V Quadrifoglio | 4 | AR 32301 | 114/153 | 03/98→01/01 | Z237 (IN) Z210 (EX) | | 1.6 0.6 | | ZS309 | ZLE288 |
|----------------------|---|----------|---------|-------------|------------------------|--|------------|--|-------|--------|

| | | | | | | | | | | |
|--------------|---|----------|---------|-------------|------------------------|--|------------|--|--|--------|
| 2.0 16V T.S. | 4 | AR 67204 | 110/148 | 10/95→01/01 | Z237 (IN) Z210 (EX) | | 1.6 0.6 | | | ZLE288 |
|--------------|---|----------|---------|-------------|------------------------|--|------------|--|--|--------|

146

| | | | | | | | | | | |
|----------|---|----------|-------|-------------|-----|--|-----|------|-------|--|
| 1.4 i.e. | 4 | AR 33501 | 66/89 | 12/94→12/96 | Z51 | | 0.8 | UX56 | ZS283 | |
|----------|---|----------|-------|-------------|-----|--|-----|------|-------|--|

| | | | | | | | | | | |
|--------------|---|----------|-------|-------------|-----|--|-----|------|--|--|
| 1.4 i.e. LPG | 4 | AR 33501 | 66/89 | 12/94→12/96 | Z42 | | 0.8 | UX56 | | |
|--------------|---|----------|-------|-------------|-----|--|-----|------|--|--|

| | | | | | | | | | | |
|-------------------|---|--------------------|--------|-------------|------------------------|--|------------|--|--|------------------|
| 1.4 i.e. 16V T.S. | 4 | AR 33503, AR 38501 | 76/102 | 11/96→01/01 | Z237 (IN) Z210 (EX) | | 1.6 0.6 | | | ZLE288 02/99→ |
|-------------------|---|--------------------|--------|-------------|------------------------|--|------------|--|--|------------------|

| | | | | | | | | | | |
|-------------------|---|-----------------|--------|-------------|--|--|--|--|-----------------|--|
| 1.4 i.e. 16V T.S. | 4 | AR 33503<W4 M1> | 76/102 | 11/96→01/01 | | | | | ZS309 02/99→ | |
|-------------------|---|-----------------|--------|-------------|--|--|--|--|-----------------|--|

| | | | | | | | | | | |
|----------|---|----------|--------|-------------|-----|--|-----|------|-------|--|
| 1.6 i.e. | 4 | AR 33201 | 76/102 | 12/94→12/96 | Z51 | | 0.8 | UX56 | ZS234 | |
|----------|---|----------|--------|-------------|-----|--|-----|------|-------|--|

| | | | | | | | | | | |
|--------------|---|----------|--------|-------------|-----|--|-----|------|--|--|
| 1.6 i.e. LPG | 4 | AR 33201 | 76/102 | 12/94→12/96 | Z42 | | 0.8 | UX56 | | |
|--------------|---|----------|--------|-------------|-----|--|-----|------|--|--|

| | | | | | | | | | | |
|-------------------|---|--------------------|--------|-------------|------------------------|--|------------|--|--|------------------|
| 1.6 i.e. 16V T.S. | 4 | AR 38201, AR 67601 | 88/118 | 11/96→01/01 | Z237 (IN) Z210 (EX) | | 1.6 0.6 | | | ZLE288 02/99→ |
|-------------------|---|--------------------|--------|-------------|------------------------|--|------------|--|--|------------------|

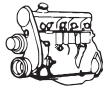

kW/BHP

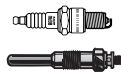

... ALFA ROMEO



... 146

| | | | | | | | | | |
|----------------------|---|--------------------|---------|-------------|--|------------|-------|-----------------|------------------|
| 1.6 i.e. 16V T.S. | 4 | AR 67601<W4 M5> | 88/118 | 11/96→01/01 | | | | ZS309 02/99→ | |
| 1.7 i.e. 16V | 4 | AR 33401 | 95/127 | 12/94→12/96 | Z188 | 0.7 | UXT10 | ZS234 | |
| 1.7 i.e. 16V LPG | 4 | AR 33401 | 95/127 | 12/94→12/96 | Z340 | 0.7 | UXT12 | | |
| 1.8 i.e. 16V T.S. | 4 | AR 38401, AR 67106 | 103/138 | 11/96→01/01 | Z237 (IN) Z210 (EX) | 1.6 0.6 | | ZS309 | |
| 1.8 i.e. 16V T.S. | 4 | AR 32201 | 106/142 | 03/98→01/01 | Z237 (IN) Z210 (EX) | 1.6 0.6 | | ZS309 02/99→ | ZLE288 03/99→ |
| 1.9 JTD | 4 | AR 32302 | 77/103 | 02/99→01/01 | GN017 →eng. 1716459 GN041 eng. 1716460→ | 11V 11V | | | |
| 1.9 TD | 4 | AR 33601, AR 67501 | 66/89 | 12/94→02/99 | GN013 [2][222] GN908 | 11V 11V | | | |
| 2.0 16V Quadrifoglio | 4 | AR 32301 | 114/153 | 03/98→01/01 | Z237 (IN) Z210 (EX) | 1.6 0.6 | | ZS309 02/99→ | ZLE288 02/99→ |
| 2.0 16V T.S. | 4 | AR 67204 | 110/148 | 10/95→01/01 | Z237 (IN) Z210 (EX) | 1.6 0.6 | | | ZLE288 |

147

| | | | | | | | | | |
|---------------------|---|------------|---------|-------------|------------------------------------|------------|-------|-------|--|
| 1.6 16V T.SPARK | 4 | AR 32104 | 88/118 | 01/01→03/10 | Z237 (IN) Z210 (EX) | 1.6 0.6 | | ZS361 | |
| 1.6 16V T.SPARK ECO | 4 | AR 37203 | 77/103 | 01/01→03/10 | Z304 (IN) Z341 (EX) | 0.8 0.7 | | ZS361 | |
| 1.9 JTD | 4 | 182 B9.000 | 74/99 | 06/03→03/10 | GN041 | 11V | | | |
| 1.9 JTD | 4 | AR 37101 | 81/109 | 11/00→09/04 | GN041 [76][219] GN097 [79][220] | 11V 11V | | | |
| 1.9 JTD | 4 | 937 A2.000 | 85/114 | 04/01→03/10 | GN041 | 11V | | | |
| 1.9 JTD 16V | 4 | 937 A4.000 | 93/125 | 09/03→09/04 | GN059 | 11V | | | |
| 1.9 JTD 16V | 4 | 192 B1.000 | 100/134 | 10/04→03/10 | GN059 | 11V | | | |
| 1.9 JTD 16V | 4 | 192 A5.000 | 103/138 | 11/02→03/10 | GN059 | 11V | | | |
| 1.9 JTD M | 4 | 939 A7.000 | 85/114 | 10/04→03/10 | GN097 | 11V | | | |
| 1.9 JTD M 8V | 4 | 937 A3.000 | 88/118 | 07/05→03/10 | GN097 | 11V | | | |
| 1.9 JTD M 16V | 4 | 937 A5.000 | 110/148 | 09/04→03/10 | GN059 | 11V | | | |
| 1.9 JTD M 16V | 4 | 937 A6.000 | 125/168 | 06/08→03/10 | GN069 | 11V | | | |
| 2.0 16V T.SPARK | 4 | AR 32310 | 110/148 | 01/01→03/10 | Z237 (IN) Z210 (EX) | 1.6 0.6 | | ZS361 | |
| 3.2 GTA | 6 | 932 A.000 | 184/247 | 02/03→03/10 | Z188 | 0.7 | UXT10 | ZS428 | |

155

| | | | | | | | | | |
|-----------------------|---|--------------------|---------|-------------|-------------------------|------------|------|-------|--|
| 1.6 16V T.S. | 4 | AR 67601 | 88/118 | 05/96→12/97 | Z237 (IN) Z210 (EX) | 1.6 0.6 | | | |
| 1.7 T.S. | 4 | AR 67103 | 83/111 | 04/93→04/96 | Z29 | 0.8 | UXT5 | ZS234 | |
| 1.7 T.S. | 4 | AR 67105 | 85/114 | 04/93→04/96 | Z29 | 0.8 | UXT5 | ZS234 | |
| 1.7 T.S. 16V | 4 | AR 67106 | 103/138 | 05/96→12/97 | Z237 (IN) Z210 (EX) | 1.6 0.6 | | | |
| 1.8 T.S. | 4 | AR 67402 | 77/103 | 02/92→12/97 | Z29 [168] | 0.8 | UXT5 | ZS234 | |
| 1.8 T.S. | 4 | AR 67101 | 95/127 | 02/92→06/93 | Z29 | 0.8 | UXT5 | ZS234 | |
| 1.8 T.S. Sport | 4 | AR 67101, AR 67102 | 93/125 | 01/92→12/96 | Z29 | 0.8 | UXT5 | ZS234 | |
| 1.9 TD | 4 | AR 67501 | 66/89 | 04/93→12/97 | GN013 [2][222] GN908 | 11V 11V | | | |
| 2.0 16V Turbo 4WD | 4 | AR 67203 | 137/184 | 01/92→12/97 | Z51 | 0.8 | UX56 | ZS283 | |
| 2.0 16V Turbo 4WD | 4 | AR 67203 | 140/188 | 01/92→12/97 | | | | ZS283 | |
| 2.0 16V Turbo 4WD LPG | 4 | AR 67203 | 137/184 | 01/92→12/97 | Z42 | 0.8 | UX56 | | |
| 2.0 T.S. | 4 | AR 67202 | 104/139 | 02/92→02/95 | Z29 | 0.8 | UXT5 | ZS234 | |
| 2.0 T.S. | 4 | AR 67201 | 106/142 | 02/92→04/93 | Z29 | 0.8 | UXT5 | ZS234 | |
| 2.0 T.S. 16V | 4 | AR 67204, AR 67299 | 110/148 | 03/95→12/97 | Z237 (IN) Z210 (EX) | 1.6 0.6 | | | |

ALFA ROMEO



kW/BHP

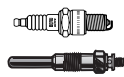

... ALFA ROMEO



... 155

| | | | | | | | | |
|--------|---|--------------------|---------|-------------|--|---------------------------|-------------|--------------|
| 2.5 TD | 4 | VM 07 B, VM 31 B | 92/123 | 04/93→12/97 | GN013 [222] →04/95 GN908 →04/95 GN007 05/95→ | 11V 11V 11V | | |
| 2.5 V6 | 6 | AR 67302, AR 67303 | 120/161 | 10/92→12/97 | Z42 | 0.8 | UX56 | ZS230 |
| 2.5 V6 | 6 | AR 67301 | 121/162 | 02/92→09/96 | Z42 | 0.8 | UX56 | ZS230 |

156

| | | | | | | | | |
|-----------------|---|---|---------|-------------|--|----------------|--------------------|--|
| 1.6 16V T.SPARK | 4 | AR 32102 | 82/110 | 01/00→09/05 | Z237 (IN) Z210 (EX) | 1.6 0.6 | | |
| 1.6 16V T.SPARK | 4 | AR 32102, AR 32103, AR 32104, AR 67601 | 88/118 | 09/97→05/06 | Z237 (IN) Z210 (EX) | 1.6 0.6 | | |
| 1.6 16V T.SPARK | 4 | AR 32102, AR 32103, AR 32104, AR 67601 | 88/118 | 09/97→09/05 | | | | ZS309 →09/00 ZS361 [276] 09/00→ |
| 1.6 16V T.SPARK | 4 | AR 32102, AR 32103, AR 32104, AR 67601 | 88/118 | 05/00→05/06 | | | | ZS361 |
| 1.8 16V T.SPARK | 4 | AR 32205 | 103/138 | 10/00→05/06 | Z237 (IN) Z210 (EX) | 1.6 0.6 | | ZS361 |
| 1.8 16V T.SPARK | 4 | AR 32201 | 106/142 | 09/97→10/00 | Z237 (IN) Z210 (EX) | 1.6 0.6 | | ZS361 ZLE288 |
| 1.9 JTD | 4 | AR 32302 | 77/103 | 09/97→10/00 | GN017 →eng. 1713819 GN041 eng. 1713820→ | 11V 11V | | |
| 1.9 JTD | 4 | AR 37101 | 81/109 | 10/00→05/01 | GN041 | 11V | | |
| 1.9 JTD | 4 | 937 A2.000 | 85/114 | 05/01→05/06 | GN041 | 11V | | |
| 1.9 JTD | 4 | 937 A4.000 | 93/125 | 11/03→05/06 | GN059 | 11V | | |
| 1.9 JTD | 4 | 192 B1.000 | 100/134 | 11/02→11/04 | GN059 | 11V | | |
| 1.9 JTD | 4 | 937 A5.000 | 110/148 | 07/04→05/06 | GN059 | 11V | | |
| 1.9 JTD 16V | 4 | 192 A5.000 | 103/138 | 11/02→05/06 | GN059 | 11V | | |
| 1.9 JTD 16V 4WD | 4 | 937 A5.000 | 110/148 | 07/04→05/06 | GN059 | 11V | | |
| 2.0 | 4 | 932 A2.000 | 119/160 | 03/02→05/06 | Z193 | 0.9 | UXT1 / UXT3 | ZSE148 |
| 2.0 LPG | 4 | 932 A2.000 | 119/160 | 03/02→05/06 | Z340 | 0.7 | UXT12 | |
| 2.0 16V T.SPARK | 4 | AR 32310 | 110/148 | 10/00→03/02 | Z237 (IN) Z210 (EX) | 1.6 0.6 | | ZS361 |
| 2.0 16V T.SPARK | 4 | AR 32301 | 114/153 | 09/97→06/02 | Z237 (IN) Z210 (EX) | 1.6 0.6 | | |
| 2.0 16V T.SPARK | 4 | AR 32301 | 114/153 | 09/97→10/00 | | | | ZS309 ZLE288 |
| 2.0 16V T.SPARK | 4 | AR 32301 | 114/153 | 05/00→06/02 | | | | ZS361 |
| 2.0 JTS | 4 | 937 A1.000 | 122/164 | 03/02→05/06 | Z237 | 1.6 | | ZSE148 |
| 2.0 JTS LPG | 4 | 937 A1.000 | 122/164 | 03/02→05/06 | Z340 | 0.7 | UXT12 | |
| 2.0 Twin Spark | 4 | AR 32303 | 118/158 | 11/97→04/00 | Z237 (IN) Z210 (EX) | 1.6 0.6 | | ZS309 |
| 2.4 JTD | 5 | AR 32501 | 100/134 | 09/97→09/03 | GN017 | 11V | | |
| 2.4 JTD | 5 | 839 A6.000 | 103/138 | 10/00→05/06 | GN041 | 11V | | |
| 2.4 JTD | 5 | 841 C000 | 110/148 | 03/02→05/06 | GN041 | 11V | | |
| 2.4 JTD | 5 | 841 M.000, 841 N.000 | 120/161 | 06/03→05/06 | GN059 | 11V | | |
| 2.4 JTD | 5 | 841 G.000 | 129/173 | 10/03→05/06 | GN059 | 11V | | |
| 2.5 V6 24V | 6 | AR 32401, AR 32402 | 140/188 | 09/97→08/03 | Z188 | 0.7 | UXT10 | ZS428 |
| 2.5 V6 24V | 6 | AR 32405 | 141/189 | 10/00→05/06 | Z188 | 0.7 | UXT10 | ZS428 |
| 2.5 V6 24V LPG | 6 | AR 32401, AR 32402 | 140/188 | 09/97→08/03 | Z340 | 0.7 | UXT12 | |
| 2.5 V6 24V LPG | 6 | AR 32405 | 141/189 | 10/00→05/06 | Z340 | 0.7 | UXT12 | |
| 3.2 GTA | 6 | 932 A.000 | 184/247 | 03/02→05/06 | Z188 | 0.7 | UXT10 | ZS428 |
| 3.2 GTA LPG | 6 | 932 A.000 | 184/247 | 03/02→09/05 | Z340 | 0.7 | UXT12 | |

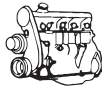

kW/BHP

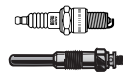

... ALFA ROMEO



159

| | | | | | | | | |
|--------------|---|------------------------|---------|-------------|---|------|-------|--------|
| 1.8 MPI | 4 | 939 A4.000 | 103/138 | 03/07→11/11 | Z203 | 0.9 | | ZS427 |
| 1.8 MPI LPG | 4 | 939 A4.000 | 103/138 | 03/07→11/11 | Z206 [168] | 0.7 | UXT10 | |
| 1.8 Tbi | 4 | 939 B1.000 | 147/197 | 05/09→11/11 | | | | ZS427 |
| 1.9 JTDM 8V | 4 | 937 A7.000, 939 A7.000 | 85/114 | 09/05→11/11 | GN041 →09/06 GN097 10/06→12/08 | 11V | | |
| 1.9 JTDM 8V | 4 | 939 A1.000 | 88/118 | 09/05→11/11 | GN097 | 11V | | |
| 1.9 JTDM 16V | 4 | 937 A8.000, 939 A8.000 | 100/134 | 09/05→11/11 | GN059 | 11V | | |
| 1.9 JTDM 16V | 4 | 939 A2.000 | 110/148 | 09/05→11/11 | GN059 | 11V | | |
| 1.9 JTS | 4 | 939 A6.000 | 118/158 | 09/05→11/11 | Z240 | 1.0 | UXT9 | ZSE148 |
| 2.0 JTDM | 4 | 939 B4.000 | 100/134 | 06/10→11/11 | GE114 | 4.4V | | |
| 2.0 JTDM | 4 | 844 A2.000 | 120/161 | 05/09→11/11 | GE114 | 4.4V | | |
| 2.0 JTDM | 4 | 939 B3.000 | 125/168 | 05/09→11/11 | GE114 | 4.4V | | |
| 2.2 JTS | 4 | 939 A5.000 | 136/182 | 09/05→11/11 | Z240 | 1.0 | UXT9 | ZSE149 |
| 2.2 JTS LPG | 4 | 939 A5.000 | 136/182 | 09/05→11/11 | Z206 | 0.7 | UXT10 | |
| 2.4 JTDM | 5 | 939 A3.000 | 147/197 | 09/05→11/11 | GN059 | 11V | | |
| 2.4 JTDM | 5 | 939 A9.000 | 154/207 | 05/07→11/11 | GN069 | 11V | | |
| 3.2 JTS | 6 | 939 A.000 | 191/256 | 12/05→11/11 | Z356 | 1.1 | UXT8 | ZSE174 |

164

| | | | | | | | | |
|-----------------|---|---|---------|-------------|---|-----|-------------|-------------|
| 2.0 | 4 | AR 06416 | 102/137 | 06/87→09/98 | Z29 | 0.8 | UXT5 | |
| 2.0 T.S. | 4 | AR 06416 | 105/141 | 06/87→09/92 | Z29 | 0.8 | UXT5 | |
| 2.0 T.S. | 4 | AR 64103 | 106/142 | 09/92→09/98 | Z29 | 0.8 | UXT5 | ZS234 |
| 2.0 T.S. | 4 | AR 06420 | 109/146 | 06/87→12/90 | Z29 | 0.8 | UXT5 | |
| 2.0 Turbo | 4 | AR 06476 | 128/172 | 10/87→09/98 | Z27 [168] | 0.8 | UX56 | |
| 2.0 Turbo | 4 | AR 06476 | 129/173 | 02/88→10/92 | Z27 | 0.8 | UX56 | |
| 2.0 Turbo LPG | 4 | AR 06476 | 128/172 | 10/87→09/98 | Z47 [168] | 0.8 | UX56 | |
| 2.0 Turbo LPG | 4 | AR 06476 | 129/173 | 02/88→10/92 | Z47 | 0.8 | UX56 | |
| 2.0 V6 Turbo | 6 | AR 64102 | 148/198 | 09/92→09/98 | Z42 | 0.8 | UX56 | ZS122 ZM035 |
| 2.0 V6 Turbo | 6 | AR 64101 | 150/201 | 03/91→09/92 | Z42 | 0.8 | UX56 | ZS122 |
| 2.5 TD | 4 | VM 84 A | 84/113 | 06/87→09/92 | GV657 | 11V | | |
| 2.5 TD | 4 | VM 08 B, VM 32 B | 92/123 | 09/92→09/98 | GN013 [222] →04/95 GN908 →04/95 GN007 05/95→ | 11V | | |
| 2.5 V6 | 6 | AR 66201 | 120/161 | 09/92→09/98 | Z20 | 0.8 | UXT2 / UXT6 | ZS428 |
| 2.5 V6 LPG | 6 | AR 66201 | 120/161 | 09/92→09/98 | Z27 [168] | 0.8 | UX56 | |
| 3.0 | 6 | AR 06410 | 138/185 | 11/87→09/91 | Z42 | 0.8 | UX56 | |
| 3.0 | 6 | AR 64399 | 145/194 | 10/94→08/97 | | | | ZS428 |
| 3.0 | 6 | AR 66306 | 157/211 | 03/95→10/97 | | | | ZS428 |
| 3.0 | 6 | AR 64304 | 168/225 | 04/93→02/95 | Z188 | 0.7 | UXT10 | ZS428 |
| 3.0 | 6 | AR 64304 | 170/228 | 03/95→08/97 | | | | ZS428 |
| 3.0 LPG | 6 | AR 64304 | 168/225 | 04/93→02/95 | Z340 | 0.7 | UXT12 | |
| 3.0 24V | 6 | AR 66302 | 154/207 | 03/95→10/97 | | | | ZS428 |
| 3.0 24V | 6 | AR 64306, AR 66302 | 155/208 | 09/92→09/98 | | | | ZS428 |
| 3.0 24V | 6 | AR 66301 | 155/208 | 09/92→09/98 | Z188 | 0.7 | UXT10 | ZS428 |
| 3.0 24V 4WD | 6 | AR 64307, AR 64308 | 170/228 | 02/94→09/98 | Z188 | 0.7 | UXT10 | ZS428 |
| 3.0 24V LPG | 6 | AR 66301 | 155/208 | 09/92→09/98 | Z340 | 0.7 | UXT12 | |
| 3.0 24V 4WD LPG | 6 | AR 64307, AR 64308 | 170/228 | 02/94→09/98 | Z340 | 0.7 | UXT12 | |
| 3.0 24V QV | 6 | AR 64304 | 171/229 | 09/92→09/98 | Z188 | 0.7 | UXT10 | ZS428 |
| 3.0 24V QV 4WD | 6 | AR 64304, AR 64307 | 171/229 | 11/92→10/97 | | | | ZS428 |
| 3.0 24V QV LPG | 6 | AR 64304 | 171/229 | 09/92→09/98 | Z340 | 0.7 | UXT12 | |
| 3.0 i.e. QV | 6 | AR 06430, AR 64301 | 147/197 | 09/90→09/92 | Z27 [168] | 0.8 | UX56 | |
| 3.0 V6 | 6 | AR 64303, AR 64305, AR 64399, AR 66303 | 132/177 | 09/92→09/98 | Z27 [168] | 0.8 | UX56 | ZS230 |
| 3.0 V6 | 6 | AR 06412 | 135/181 | 06/87→09/92 | Z42 | 0.8 | UX56 | |
| 3.0 V6 | 6 | AR 06410 | 141/189 | 06/87→09/92 | Z42 | 0.8 | UX56 | |

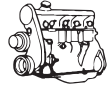

kW/BHP

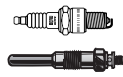
**... ALFA ROMEO****... 164**

| | | | | | | | | |
|------------|---|---|---------|-------------|-----------|-----|------|--|
| 3.0 V6 LPG | 6 | AR 64303, AR 64305, AR 64399, AR 66303 | 132/177 | 09/92→09/98 | Z47 [168] | 0.8 | UX56 | |
|------------|---|---|---------|-------------|-----------|-----|------|--|

166

| | | | | | | | | |
|----------------|---|----------------------|---------|-------------|------------------------|------------|-------|--------------|
| 2.0 T.SPARK | 4 | AR 36301 | 110/148 | 10/00→06/07 | Z237 (IN) Z210 (EX) | 1.6 0.6 | | ZS361 |
| 2.0 T.SPARK | 4 | AR 34103 | 114/153 | 09/98→10/00 | Z237 (IN) Z210 (EX) | 1.6 0.6 | | ZS309 ZLE288 |
| 2.0 V6 | 6 | AR 34102 | 151/202 | 09/98→10/00 | Z47 | 0.8 | UX56 | ZS230 |
| 2.4 JTD | 5 | AR 34202 | 100/134 | 09/98→10/00 | GN017 | 11V | | |
| 2.4 JTD | 5 | 839 A6.000 | 103/138 | 10/00→06/07 | GN041 | 11V | | |
| 2.4 JTD | 5 | 841 C000 | 110/148 | 04/02→06/07 | GN041 | 11V | | |
| 2.4 JTD | 5 | 841 M.000, 841 N.000 | 120/161 | 10/03→06/07 | GN059 | 11V | | |
| 2.4 JTD | 5 | 841 G.000, 841 H.000 | 129/173 | 10/03→06/07 | GN059 | 11V | | |
| 2.4 JTD | 5 | 841 M.000 | 132/177 | 07/06→06/07 | GN059 | 11V | | |
| 2.4 JTD | 5 | 841 M.000 | 136/182 | 07/05→06/07 | GN059 | 11V | | |
| 2.5 V6 24V | 6 | AR 36201 | 138/185 | 10/00→06/07 | Z188 | 0.7 | UXT10 | ZS428 |
| 2.5 V6 24V | 6 | AR 34201 | 140/188 | 09/98→10/00 | Z188 | 0.7 | UXT10 | ZS428 |
| 2.5 V6 24V LPG | 6 | AR 34201 | 140/188 | 09/98→10/00 | Z340 | 0.7 | UXT12 | |
| 3.0 V6 24V | 6 | AR 36101 | 162/217 | 10/00→06/07 | Z188 | 0.7 | UXT10 | ZS428 |
| 3.0 V6 24V | 6 | AR 34301, AR 34302 | 166/223 | 09/98→10/00 | Z188 | 0.7 | UXT10 | ZS428 |
| 3.0 V6 24V LPG | 6 | AR 34301, AR 34302 | 166/223 | 09/98→10/00 | Z340 | 0.7 | UXT12 | |
| 3.2 V6 24V | 6 | 936 A.000 | 176/236 | 10/03→06/07 | Z188 | 0.7 | UXT10 | ZS428 |
| 3.2 V6 24V LPG | 6 | 936 A.000 | 176/236 | 10/03→06/07 | Z340 | 0.7 | UXT12 | |

1750-2000

| | | | | | | | | |
|----------|---|----------|--------|-------------|---------------|-----|-----------------------|----------------------|
| 1.7 | 4 | AR 10525 | 80/107 | 04/68→11/71 | Z47 | 0.8 | UX56 | |
| 1.8 1750 | 4 | AR 00548 | 83/111 | 03/68→10/72 | Z42 | 0.8 | UX56 | |
| 2.0 2000 | 4 | AR 10520 | 97/130 | 10/71→12/83 | Z11 →12/77 | 0.8 | UXT2 / UXT6 →12/77 | ZS106 [11] →12/77 |

1900

| | | | | | | | | |
|--------------|---|--|--------|-------------|-----|-----|------|--|
| 1.9 | 4 | | 59/79 | 10/50→01/54 | Z47 | 0.8 | UX56 | |
| 1.9 Super | 4 | | 66/89 | 01/54→09/59 | Z47 | 0.8 | UX56 | |
| 1.9 ti | 4 | | 74/99 | 01/54→09/59 | Z47 | 0.8 | UX56 | |
| 1.9 ti Super | 4 | | 85/114 | 01/54→09/59 | Z47 | 0.8 | UX56 | |

2300

| | | | | | | | | |
|--------|---|--|---------|-------------|-----|-----|-------------|--|
| 2.3 | 4 | | 104/139 | 03/74→10/80 | Z20 | 0.8 | UXT2 / UXT6 | |
| 2.3 TI | 4 | | 109/146 | 11/76→10/80 | Z20 | 0.8 | UXT2 / UXT6 | |

ALFASUD

| | | | | | | | | |
|--------|---|------------|-------|-------------|-------------------------------------|------------|---|---------------------------|
| 1.2 | 4 | AR 30102 S | 44/59 | 03/80→09/84 | Z38 →06/83 | 0.4 | | ZS106 [11] →04/82 |
| 1.2 | 4 | AR 30102 | 46/62 | 06/72→09/84 | Z11 →02/80 Z38 03/80→06/83 | 0.8 0.4 | UXT2 / UXT6 →02/80 | ZS106 [11] 01/80→04/82 |
| 1.2 | 4 | AR 30102 | 46/62 | 01/78→12/81 | Z11 →02/80 | 0.8 | UXT2 / UXT6 →02/80 | ZS106 [11] →02/80 |
| 1.2 ti | 4 | AR 30104 | 50/67 | 11/73→09/84 | Z38 →12/77 | 0.4 | | ZS106 [11] 03/80→06/83 |
| 1.3 | 4 | AR 30180 | 48/64 | 01/78→07/79 | Z22 | 0.7 | UX56 | ZS106 [11] |
| 1.3 | 4 | AR 30180 | 50/67 | 01/78→02/80 | Z22 →12/78 Z11 01/79→ | 0.7 0.8 | UX56 →12/78 UXT2 / UXT6 01/79→ | ZS106 [11] |
| 1.3 | 4 | AR 30160 | 51/68 | 03/80→12/81 | Z11 | 0.8 | UXT2 / UXT6 | ZS106 [11] |
| 1.3 | 4 | AR 30184 | 55/74 | 09/76→12/81 | Z42 →04/78 Z11 05/78→ | 0.8 0.8 | UX56 →04/78 UXT2 / UXT6 05/78→ | ZS106 [11] 09/77→04/78 |

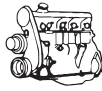

kW/BHP

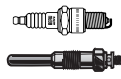
**... ALFA ROMEO****... ALFASUD**

| | | | | | | | | | | |
|-----------------|---|----------|--------|-------------|-------------|--|-----|-------------|-----------------------|--|
| 1.3 SC/ti Super | 4 | AR 30164 | 55/74 | 09/77→09/84 | Z11 | | 0.8 | UXT2 / UXT6 | ZS106 ⁽¹¹⁾ | |
| | | | | | 03/80→06/83 | | | 03/80→06/83 | →04/78 | |
| 1.3 Super | 4 | AR 30160 | 51/68 | 01/79→09/84 | Z11 | | 0.8 | UXT2 / UXT6 | ZS106 ⁽¹¹⁾ | |
| | | | | | 03/80→06/83 | | | 03/80→06/83 | →12/81 | |
| 1.3 ti | 4 | AR 30184 | 55/74 | 09/77→09/84 | Z11 | | 0.8 | UXT2 / UXT6 | ZS106 ⁽¹¹⁾ | |
| | | | | | 03/80→06/83 | | | 03/80→06/83 | →04/78 | |
| 1.3 ti | 4 | AR 30168 | 63/84 | 03/80→12/84 | Z42 | | 0.8 | UX56 | ZS106 ⁽¹¹⁾ | |
| | | | | | | | | | →09/81 | |
| 1.4 | 4 | AR 30164 | 55/74 | 05/78→02/80 | Z11 | | 0.8 | UXT2 / UXT6 | ZS106 ⁽¹¹⁾ | |
| 1.4 | 4 | AR 30168 | 63/84 | 07/79→12/89 | Z42 | | 0.8 | UX56 | ZS106 ⁽¹¹⁾ | |
| | | | | | | | | | 03/80→09/81 | |
| 1.5 | 4 | AR 30124 | 61/82 | 05/78→12/81 | Z42 | | 0.8 | UX56 | ZS106 ⁽¹¹⁾ | |
| 1.5 | 4 | AR 30128 | 70/94 | 07/79→01/87 | Z42 | | 0.8 | UX56 | ZS106 ⁽¹¹⁾ | |
| | | | | | | | | | 03/80→09/81 | |
| 1.5 | 4 | AR 30146 | 77/103 | 01/83→12/87 | Z42 | | 0.8 | UX56 | | |
| 1.5 ti | 4 | AR 30124 | 61/82 | 01/79→09/84 | Z22 | | 0.7 | UX56 | ZS106 ⁽¹¹⁾ | |
| | | | | | | | | | →02/80 | |
| 1.5 ti | 4 | AR 30128 | 70/94 | 03/80→12/84 | Z42 | | 0.8 | UX56 | ZS106 ⁽¹¹⁾ | |
| | | | | | | | | | →09/81 | |
| 1.5 ti Sprint | 4 | AR 30146 | 77/103 | 01/83→12/84 | Z42 | | 0.8 | UX56 | | |
| 1.5 Veloce | 4 | AR 30146 | 75/101 | 01/80→12/87 | Z42 | | 0.8 | UX56 | | |
| 1.7 | 4 | AR 30550 | 87/117 | 03/87→12/89 | Z42 | | 0.8 | UX56 | | |
| 1.7 i.e. | 4 | AR 30558 | 77/103 | 10/87→12/89 | Z42 | | 0.8 | UX56 | | |

ALFETTA

| | | | | | | | | | | |
|--------|---|--------------------|--------|-------------|-------|-------|-----|-------------|---------------------------|--------|
| 1.6 | 4 | AR 01600 | 79/106 | 01/75→12/84 | Z11 | | 0.8 | UXT2 / UXT6 | ZS106 ⁽¹¹⁾ | |
| | | | | | | | | | →12/82 | |
| 1.8 | 4 | AR 01608 X | 85/114 | 07/74→12/77 | Z11 | | 0.8 | UXT2 / UXT6 | ZS106 ⁽¹¹⁾ | |
| 1.8 | 4 | AR 01608 | 89/119 | 10/79→12/84 | Z11 | | 0.8 | UXT2 / UXT6 | ZS115 ⁽¹¹⁾⁽¹¹⁾ | |
| 1.8 | 4 | AR 01678 | 90/121 | 10/79→12/84 | Z11 | | 0.8 | UXT2 / UXT6 | ZS106 ⁽¹¹⁾ | |
| | | | | | | | | | →12/82 | |
| 2.0 | 4 | AR 01623 | 89/119 | 03/77→02/80 | Z11 | | 0.8 | UXT2 / UXT6 | ZS115 ⁽¹¹⁾ | |
| 2.0 | 4 | AR 01655 | 97/130 | 07/78→12/84 | Z11 | | 0.8 | UXT2 / UXT6 | ZS106 ⁽¹¹⁾ | ZM001 |
| | | | | | | | | | →09/81 | 10/81→ |
| 2.0 | 4 | AR 01713, AR 10520 | 97/130 | 07/78→12/84 | Z11 | | 0.8 | UXT2 / UXT6 | ZS106 ⁽¹¹⁾ | |
| | | | | | | | | | →09/81 | |
| 2.0 TD | 4 | VM4HT/2 | 60/80 | 10/79→03/83 | GV657 | GR066 | 11V | | | |
| 2.4 TD | 4 | VM4HT 2.4 | 70/94 | 04/83→12/84 | GV657 | GR066 | 11V | | | |

ALFETTA GT

| | | | | | | | | | | |
|-----|---|------------|--------|-------------|--------|--|-----|-------------|-----------------------|--|
| 1.6 | 4 | AR 01600 | 79/106 | 01/76→09/82 | Z11 | | 0.8 | UXT2 / UXT6 | ZS106 ⁽¹¹⁾ | |
| | | | | | →12/80 | | | →12/80 | →09/81 | |
| 1.8 | 4 | AR 01608 X | 85/114 | 01/74→12/76 | Z11 | | 0.8 | UXT2 / UXT6 | ZS106 ⁽¹¹⁾ | |
| | | | | | | | | | 07/74→ | |
| 1.8 | 4 | AR 01608 | 89/119 | 01/74→12/76 | Z11 | | 0.8 | UXT2 / UXT6 | ZS106 ⁽¹¹⁾ | |
| | | | | | | | | | 07/74→ | |
| 2.0 | 4 | AR 01623 | 89/119 | 07/78→01/86 | Z11 | | 0.8 | UXT2 / UXT6 | ZS115 ⁽¹¹⁾ | |
| 2.0 | 4 | AR 01655 | 96/129 | 06/77→12/84 | Z11 | | 0.8 | UXT2 / UXT6 | ZS106 ⁽¹¹⁾ | |
| | | | | | | | | | 07/78→09/81 | |

ARNA

| | | | | | | | | | | |
|--------|---|----------|-------|-------------|-----|--|-----|------|-----------------------|-------------|
| 1.2 | 4 | AR 31000 | 44/59 | 01/85→12/86 | Z42 | | 0.8 | UX56 | ZS106 ⁽¹¹⁾ | ZM005 |
| 1.2 | 4 | AR 30102 | 46/62 | 03/83→12/86 | Z42 | | 0.8 | UX56 | ZS106 ⁽¹¹⁾ | ZM005 |
| 1.2 | 4 | AR 30500 | 50/67 | 01/85→12/86 | Z42 | | 0.8 | UX56 | ZS106 ⁽¹¹⁾ | ZM005 |
| 1.3 | 4 | AR 30100 | 58/78 | 01/85→12/86 | Z42 | | 0.8 | UX56 | ZS106 ⁽¹¹⁾ | |
| 1.3 TI | 4 | AR 30168 | 63/84 | 03/83→12/86 | Z42 | | 0.8 | UX56 | | |
| 1.3 TI | 4 | AR 31010 | 63/84 | 03/83→12/86 | Z42 | | 0.8 | UX56 | | ZM001 |
| | | | | | | | | | | 09/83→12/84 |
| 1.5 | 4 | AR 30182 | 70/94 | 01/85→12/86 | Z47 | | 0.8 | UX56 | ZS106 ⁽¹¹⁾ | |

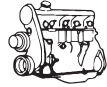

kW/BHP

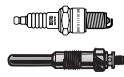

... ALFA ROMEO



BRERA

| | | | | | | | | |
|--------------|---|------------|---------|--------|-------|------|------|--------|
| 2.0 JTDM | 4 | 844 A2.000 | 120/161 | 03/08→ | GE114 | 4.4V | | |
| 2.0 JTDM | 4 | 939 B3.000 | 125/168 | 05/09→ | GE114 | 4.4V | | |
| 2.2 JTS | 4 | 939 A5.000 | 136/182 | 01/06→ | Z240 | 1.0 | UXT9 | ZSE149 |
| 2.4 JTDM 20V | 5 | 939 A3.000 | 147/197 | 01/06→ | GN059 | 11V | | |
| 2.4 JTDM 20V | 5 | 939 A9.000 | 154/207 | 05/07→ | GN069 | 11V | | |
| 3.2 JTS | 6 | 939 A.000 | 191/256 | 01/06→ | Z356 | 1.1 | UXT8 | ZSE174 |

GIULIA

| | | | | | | | | |
|----------------|---|----------|--------|-------------|-------|-----|-------------|------------|
| 1.3 1300 Super | 4 | AR 00530 | 64/86 | 01/74→12/78 | Z22 | 0.7 | UX56 | |
| 1.3 1300 TI | 4 | | 62/83 | 04/69→07/75 | Z11 | 0.8 | UXT2 / UXT6 | |
| 1.6 1600 Super | 4 | AR 00526 | 71/95 | 06/64→08/69 | Z42 | 0.8 | UX56 | ZS106 [11] |
| 1.6 1600 Super | 4 | AR 00526 | 76/102 | 01/74→12/78 | Z42 | 0.8 | UX56 | ZS106 [11] |
| 1.8 D | 4 | 4.108 | 38/51 | 06/76→12/78 | GV657 | 11V | | |

GIULIETTA

| | | | | | | | | |
|------------|---|------------------------|---------|-------------|--------------------------------|------------|----------------------|--|
| 1.3 | 4 | AR 00500 | 37/50 | 01/55→12/62 | Z42 | 0.8 | UX56 | |
| 1.3 | 4 | AR 00504 | 39/52 | 01/58→12/62 | Z42 | 0.8 | UX56 | |
| 1.3 | 4 | AR 00502 | 46/62 | 01/61→12/62 | Z42 | 0.8 | UX56 | |
| 1.3 | 4 | AR 00501 | 48/64 | 01/54→12/62 | Z42 | 0.8 | UX56 | |
| 1.3 | 4 | AR 00508 | 59/79 | 01/58→12/62 | Z42 | 0.8 | UX56 | |
| 1.3 | 4 | AR 00510 | 66/89 | 01/56→12/62 | Z42 | 0.8 | UX56 | |
| 1.3 | 4 | AR 01644 | 66/89 | 10/77→06/83 | Z11 | 0.8 | UXT2 / UXT6 | ZS106 [11] ZM001 10/81→ |
| 1.3 | 4 | AR 00514 | 74/99 | 01/58→12/61 | Z42 | 0.8 | UX56 | |
| 1.3 ti | 4 | AR 00502 | 48/64 | 01/57→12/60 | Z42 | 0.8 | UX56 | |
| 1.3 ti | 4 | AR 00502 | 55/74 | 01/61→12/62 | Z42 | 0.8 | UX56 | |
| 1.4 BiFuel | 4 | 198 A4.000 | 88/118 | 12/11→ | Z338 | 0.8 | | ZS095 |
| 1.4 TB | 4 | 940 B1.000, 940 B8.000 | 77/103 | 04/11→ | Z338 | 0.8 | | ZS095 |
| 1.4 TB | 4 | 940 A6.000 | 85/114 | 04/10→ | Z338 | 0.8 | | ZS095 |
| 1.4 TB | 4 | 198 A4.000, 940 B7.000 | 88/118 | 04/10→ | Z338 | 0.8 | | ZS095 |
| 1.4 TB | 4 | 940 A2.000 | 125/168 | 04/10→ | Z338 | 0.8 | | |
| 1.6 | 4 | AR 01600 | 79/106 | 10/77→04/85 | Z11 | 0.8 | UXT2 / UXT6 | ZS106 [11] ZM005 →09/81 01/81→ |
| 1.6 JTDM | 4 | 940 A3.000 | 77/103 | 04/10→ | GE114 | 4.4V | | |
| 1.8 | 4 | AR 01678 | 90/121 | 04/79→04/85 | Z11 | 0.8 | UXT2 / UXT6 | ZS106 [11] ZM005 →09/81 01/81→ ZM001 10/81→ |
| 1.8 Turbo | 4 | AR 01354 | 110/148 | 01/84→12/85 | Z11 | 0.8 | UXT2 / UXT6 | ZM005 →04/85 |
| 2.0 | 4 | AR 01655, AR 11671 | 96/129 | 06/80→04/85 | Z11 →09/82 Z42 10/82→ | 0.8 0.8 | UXT2 / UXT6 UX56 | ZS106 [11] ZM005 →09/82 →09/81 01/81→ 10/82→ |
| 2.0 JTDM | 4 | 940 A8.000, 940 B6.000 | 100/134 | 04/10→ | GE114 | 4.4V | | |
| 2.0 JTDM | 4 | 940 A5.000 | 103/138 | 04/10→ | GE114 | 4.4V | | |
| 2.0 JTDM | 4 | 940 B5.000 | 110/148 | 08/13→ | GE114 | 4.4V | | |
| 2.0 JTDM | 4 | 940 A7.000 | 120/161 | 04/10→ | GE114 | 4.4V | | |
| 2.0 JTDM | 4 | 940 A4.000 | 125/168 | 04/10→ | GE114 | 4.4V | | |
| 2.0 JTDM | 4 | 940 B4.000 | 129/173 | 11/13→ | GE114 | 4.4V | | |
| 2.0 TD | 4 | VM 4 HT | 61/82 | 01/83→12/85 | GV657 | 11V | GR066 03/83→04/85 | |
| 2.0 Turbo | 4 | AR 01699 | 125/168 | 07/83→06/84 | Z38 [168] | 0.4 | | ZM005 |

GT

| | | | | | | | | |
|-----------------|---|------------|--------|-------------|-----|-----|------|------------|
| 1.3 1300 Junior | 4 | AR 00530 | 64/86 | 01/66→12/77 | Z22 | 0.7 | UX56 | ZS106 [11] |
| 1.6 1600 | 4 | AR 00526 S | 75/101 | 03/63→12/66 | Z42 | 0.8 | UX56 | |
| 1.6 1600 | 4 | AR 00526 S | 76/102 | 09/72→12/77 | Z22 | 0.7 | UX56 | ZS106 [11] |
| 1.6 1600 | 4 | AR 00536 | 80/107 | 01/66→12/68 | Z42 | 0.8 | UX56 | |
| 1.6 1600 | 4 | AR 00536 | 80/107 | 01/66→12/77 | | | | ZS106 [11] |
| 1.6 1600 | 4 | AR 00536 | 80/107 | 06/71→12/77 | Z22 | 0.7 | UX56 | |



kW/BHP

**... ALFA ROMEO****... GT**

| | | | | | | | | |
|-------------|---|------------------------|---------|-------------|------------------------|------------|-------------|-----------------------|
| 1.6 A 1600 | 4 | AR 10538 | 83/111 | 01/65→12/70 | Z42 | 0.8 | UX56 | ZS106 ⁽¹¹⁾ |
| 1.7 | 4 | AR 10525 | 80/107 | 04/68→11/71 | Z42 | 0.8 | UX56 | |
| 1.8 V 1750 | 4 | AR 00548 | 83/111 | 01/67→12/72 | Z42 | 0.8 | UX56 | ZS106 ⁽¹¹⁾ |
| 1.8 TS | 4 | AR 32205 | 103/138 | 11/03→09/10 | Z237 (IN) Z210 (EX) | 1.6 0.6 | | ZS361 |
| 1.9 V 2000 | 4 | AR 10527 | 96/129 | 01/71→12/77 | Z11 | 0.8 | UXT2 / UXT6 | ZS106 ⁽¹¹⁾ |
| 1.9 JTD | 4 | 937 A5.000 | 110/148 | 11/03→09/10 | GN059 | 11V | | |
| 1.9 JTD | 4 | 937 A6.000 | 125/168 | 05/08→09/10 | GN069 | 11V | | |
| 2.0 JTS | 4 | 932 A2.000 | 119/160 | 12/06→09/10 | Z237 | 1.6 | | ZSE148 |
| 2.0 JTS | 4 | 932 A2.000 | 121/162 | 11/03→09/10 | Z193 | 0.9 | UXT1 / UXT3 | ZSE148 |
| 2.0 JTS | 4 | 937 A1.000 | 121/162 | 11/03→09/10 | Z237 | 1.6 | | ZSE148 |
| 2.0 JTS LPG | 4 | 932 A2.000 | 119/160 | 12/06→09/10 | Z340 | 0.7 | UXT12 | |
| 2.0 JTS LPG | 4 | 932 A2.000, 937 A1.000 | 121/162 | 11/03→09/10 | Z340 | 0.7 | UXT12 | |
| 3.2 GTA | 6 | 936 A.000 | 176/236 | 11/03→09/10 | Z188 | 0.7 | UXT10 | ZS428 |

GTA

| | | | | | | | | |
|------------|---|----------|---------|-------------|---------------|-----|----------------|--|
| 1.3 Junior | 4 | AR 10531 | 81/109 | 05/68→12/76 | Z42 →09/71 | 0.8 | UX56 →09/71 | |
| 1.3 Junior | 4 | AR 10534 | 117/157 | 05/68→12/76 | Z42 →09/71 | 0.8 | UX56 →09/71 | |

GTV

| | | | | | | | | |
|-----------------|---|--------------------|---------|-------------|------------------------|------------|-------------|-----------------------|
| 1.8 16V | 4 | AR 32201 | 106/142 | 05/98→10/05 | Z237 (IN) Z210 (EX) | 1.6 0.6 | | ZS309 ZLE288 |
| 2.0 | 4 | AR 06212 | 94/126 | 01/85→12/85 | Z42 | 0.8 | UX56 | ZS115 ⁽¹¹⁾ |
| 2.0 | 4 | AR 01655, AR 06212 | 96/129 | 07/78→01/86 | Z42 | 0.8 | UX56 | ZS115 ⁽¹¹⁾ |
| | | | | 12/82→06/83 | Z11 | 0.8 | UXT2 / UXT6 | |
| 2.0 JTS | 4 | 937 A1.000 | 121/162 | 04/03→10/05 | Z237 | 1.6 | | ZSE148 |
| 2.0 JTS LPG | 4 | 937 A1.000 | 121/162 | 04/03→10/05 | Z340 | 0.7 | UXT12 | |
| 2.0 T.SPARK 16V | 4 | 16201 | 110/148 | 06/95→10/05 | | | | ZS309 →04/98 |
| 2.0 T.SPARK 16V | 4 | 32310 | 110/148 | 06/95→10/05 | | | | ZS361 |
| 2.0 T.SPARK 16V | 4 | AR 16201, AR 32310 | 110/148 | 06/95→10/05 | Z237 (IN) Z210 (EX) | 1.6 0.6 | | ZLE288 |
| 2.0 T.SPARK 16V | 4 | AR 32301 | 114/153 | 05/98→08/00 | Z237 (IN) Z210 (EX) | 1.6 0.6 | | ZS309 ZLE288 |
| 2.0 Turbodelta | 4 | AR 11642 | 111/149 | 01/78→12/80 | Z11 ^[168] | 0.8 | UXT2 / UXT6 | |
| 2.0 V6 Turbo | 6 | AR 16202 | 148/198 | 06/95→09/98 | Z42 | 0.8 | UX56 | ZS122 ZM035 |
| 2.5 6 | 6 | AR 01646 | 116/156 | 11/80→02/87 | Z11 ^[168] | 0.8 | UXT2 / UXT6 | ZS115 ⁽¹¹⁾ |
| 3.0 V6 24V | 6 | AR 16105 | 160/215 | 10/00→10/05 | Z188 | 0.7 | UXT10 | ZS428 |
| 3.0 V6 24V | 6 | AR 16102 | 162/217 | 10/96→10/00 | Z188 | 0.7 | UXT10 | ZS428 |
| 3.0 V6 24V LPG | 6 | AR 16105 | 160/215 | 10/00→10/05 | Z340 | 0.7 | UXT12 | |
| 3.0 V6 24V LPG | 6 | AR 16102 | 162/217 | 10/96→10/00 | Z340 | 0.7 | UXT12 | |
| 3.2 V6 24V | 6 | 936 A6.000 | 176/236 | 04/03→10/05 | | | | ZS428 |

MITO

| | | | | | | | | |
|----------------|---|------------------------|---------|--------|-------|------|--|-------|
| 1.3 JTDM | 4 | 199 B4.000 | 62/83 | 01/11→ | GE112 | 4.4V | | |
| 1.3 JTDM | 4 | 199 A3.000 | 66/89 | 09/08→ | GN053 | 11V | | |
| 1.3 JTDM | 4 | 199 B1.000 | 70/94 | 10/09→ | GE112 | 4.4V | | |
| 1.4 | 4 | 955 A9.000 | 51/68 | 05/11→ | Z293 | 1.05 | | ZS079 |
| 1.4 | 4 | 350 A1.000, 955 A1.000 | 57/76 | 03/11→ | Z293 | 1.05 | | ZS322 |
| 1.4 | 4 | 955 A1.000 | 58/78 | 09/08→ | Z293 | 1.05 | | ZS322 |
| 1.4 | 4 | 199 A6.000 | 70/94 | 09/08→ | Z293 | 1.05 | | ZS322 |
| 1.4 | 4 | 955 A6.000 | 77/103 | 08/10→ | Z234 | 0.9 | | |
| 1.4 | 4 | 198 A4.000 | 88/118 | 09/08→ | Z338 | 0.8 | | ZS095 |
| 1.4 Bifuel LPG | 4 | 198 A4.000 | 88/118 | 07/11→ | Z338 | 0.8 | | ZS095 |
| 1.4 TB | 4 | 955 A2.000 | 99/133 | 10/09→ | Z338 | 0.8 | | |
| 1.4 TB | 4 | 199 A8.000 | 114/153 | 09/08→ | Z338 | 0.8 | | ZS095 |
| 1.4 TB | 4 | 955 A8.000 | 120/161 | 10/09→ | Z338 | 0.8 | | |
| 1.4 TB | 4 | 940 A2.000 | 125/168 | 10/09→ | Z338 | 0.8 | | |

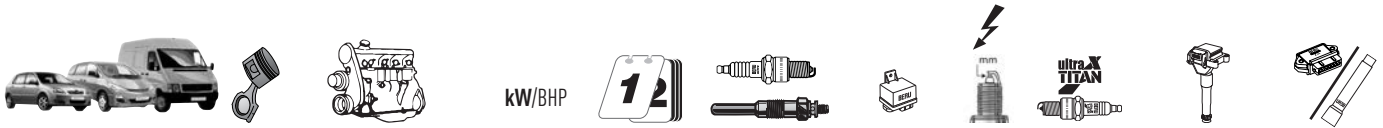

| ... ALFA ROMEO | | | | | | | | | |
|-----------------|---|------------------------|---------|-------------|------------------------|--|------------|-------------|--|
| ... MITO | | | | | | | | | |
| 1.4 Turbo | 4 | 198 A1.000 | 110/148 | 09/08→ | | | | | ZS095 |
| 1.6 JTDM | 4 | 955 A4.000 | 85/114 | 09/08→ | GE114 | | 4.4V | | |
| 1.6 JTDM | 4 | 198 A2.000, 955 A3.000 | 88/118 | 09/08→ | GE114 | | 4.4V | | |
| MONTREAL | | | | | | | | | |
| 2.6 | 8 | AR 10832 | 143/192 | 12/72→03/79 | Z42 | | 0.8 | UX56 | |
| | | | | | →12/75 | | | →12/75 | |
| RZ | | | | | | | | | |
| 3.0 V6 Zagato | 6 | AR 61501 | 152/204 | 01/92→12/94 | Z42 | | 0.8 | UX56 | |
| SPIDER | | | | | | | | | |
| 1.3 1300 | 4 | AR 00530 | 64/86 | 01/68→12/77 | Z42 | | 0.8 | UX56 | ZS106 [11] |
| 1.6 1600 | 4 | AR 00526 | 76/102 | 03/76→12/90 | Z42 | | 0.8 | UX56 | ZS106 [11] |
| | | | | | 11/79→ | | | 11/79→ | |
| 1.6 1600 | 4 | AR 01563 | 79/106 | 01/90→12/93 | Z42 | | 0.8 | UX56 | |
| 1.6 1600 | 4 | AR 00526, AR 01600 | 80/107 | 03/66→12/68 | Z47 | | 0.8 | UX56 | ZS106 [11] |
| 1.6 1600 | 4 | AR 00536 | 80/107 | 03/66→12/68 | Z47 | | 0.8 | UX56 | |
| 1.6 1600 | 4 | AR 00536 | 80/107 | 03/66→12/79 | | | | | ZS106 [11] |
| 1.6 1600 | 4 | AR 00536 | 80/107 | 03/71→12/79 | Z42 | | 0.8 | UX56 | |
| 1.7 | 4 | AR 10525 | 80/107 | 04/68→11/71 | Z47 | | 0.8 | UX56 | |
| 1.8 16V | 4 | AR 32201 | 106/142 | 05/98→04/05 | Z237 (IN) Z210 (EX) | | 1.6 0.6 | | ZS309 ZLE288 |
| 1.8 1750 | 4 | AR 00548 | 83/111 | 01/67→12/71 | Z42 | | 0.8 | UX56 | ZS106 [11] |
| | | | | | 12/69→ | | | 12/69→ | |
| 2.0 2000 | 4 | AR 01544 | 85/114 | 08/86→12/90 | Z11 | | 0.8 | UXT2 / UXT6 | |
| 2.0 2000 | 4 | AR 01588 | 88/118 | 01/90→12/93 | Z11 | | 0.8 | UXT2 / UXT6 | |
| 2.0 2000 | 4 | AR 00515 | 92/123 | 08/86→12/90 | Z11 | | 0.8 | UXT2 / UXT6 | ZS106 [11] |
| 2.0 2000 | 4 | AR 00512 | 96/129 | 01/71→12/77 | Z11 | | 0.8 | UXT2 / UXT6 | ZS106 [11] |
| 2.0 2000 Veloce | 4 | AR 00515, AR 01590 | 93/125 | 01/77→12/93 | Z11 | | 0.8 | UXT2 / UXT6 | |
| 2.0 JTDM | 4 | 844 A2.000 | 120/161 | 04/09→ | GE114 | | 4.4V | | |
| 2.0 JTDM | 4 | 939 B3.000 | 125/168 | 05/09→ | GE114 | | 4.4V | | |
| 2.0 JTS | 4 | 937 A1.000 | 121/162 | 04/03→04/05 | Z237 | | 1.6 | | ZSE148 |
| 2.0 JTS LPG | 4 | 937 A1.000 | 121/162 | 04/03→04/05 | Z340 | | 0.7 | UXT12 | |
| 2.0 T.SPARK 16V | 4 | AR 16201 | 110/148 | 06/95→04/05 | Z237 (IN) Z210 (EX) | | 1.6 0.6 | | ZS309 →04/98 ZS361 [276] 08/00→ |
| 2.0 T.SPARK 16V | 4 | AR 32310 | 110/148 | 06/95→04/05 | Z237 (IN) Z210 (EX) | | 1.6 0.6 | | ZS361 08/00→ |
| 2.0 T.SPARK 16V | 4 | AR 32301 | 114/153 | 05/98→08/00 | Z237 (IN) Z210 (EX) | | 1.6 0.6 | | ZS309 ZLE288 |
| 2.0 V6 Turbo | 6 | AR 16202 | 148/198 | 05/98→04/05 | Z47 | | 0.8 | UX56 | ZS122 |
| | | | | | →12/00 | | | →12/00 | →12/00 |
| 2.2 JTS | 4 | 939 A5.000 | 136/182 | 09/06→ | Z240 | | 1.0 | UXT9 | ZSE149 |
| 2.2 JTS LPG | 4 | 939 A5.000 | 136/182 | 09/06→ | Z206 | | 0.7 | UXT10 | |
| 2.4 JTDM | 5 | 939 A3.000 | 147/197 | 04/07→ | GN059 | | 11V | | |
| 2.4 JTDM | 5 | 939 A3.000 | 154/207 | 03/08→ | GN059 | | 11V | | |
| 3.0 V6 | 6 | AR 16101 | 141/189 | 06/95→04/05 | Z27 | | 0.8 | UX56 | ZS230 |
| 3.0 V6 | 6 | AR 16105 | 160/215 | 09/94→08/00 | Z188 | | 0.7 | UXT10 | ZS428 |
| 3.0 V6 24V | 6 | AR 16102 | 162/217 | 01/99→10/03 | Z188 | | 0.7 | UXT10 | ZS428 |
| 3.0 V6 24V LPG | 6 | AR 16102 | 162/217 | 01/99→10/03 | Z340 | | 0.7 | UXT12 | |
| 3.2 JTS | 6 | 939 A.000 | 191/256 | 09/06→ | Z356 | | 1.1 | UXT8 | ZSE174 |
| 3.2 V6 24V | 6 | 936 A6.000 | 176/236 | 04/03→04/05 | | | | | ZS428 |

ALFA ROMEO

ALFA ROMEO

| | | | | | | | | | |
|-------------|---|-------------|-------|-------------|-------------------------|--|-----|--|--|
| AR 6 | | | | | | | | | |
| 1.9 D | 4 | 160 D100 | 51/68 | 04/85→12/89 | GN013 [2][222] GN908 | | 11V | | |
| 2.4 D | 4 | 8144.61.200 | 53/71 | 04/85→02/86 | GN909 [2][222] GV602 | | 11V | | |

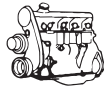

kW/BHP

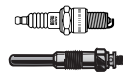

... ALFA ROMEO



... AR 6

| | | | | | | | |
|--------|---|-------------|-------|-------------|-------|------|--|
| 2.4 TD | 4 | 8144.21.220 | 68/91 | 09/86→12/89 | GF683 | 9.5V | |
| 2.5 D | 4 | 8144.67.220 | 55/74 | 03/86→12/89 | GF683 | 9.5V | |

AR 8

| | | | | | | | |
|--------|---|------------------|-------|-------------|-------------------------|------------|--|
| 2.4 D | 4 | 8140.61.200 | 53/71 | 04/78→08/86 | GN909 [2][222] GV602 | 11V 11V | |
| 2.4 TD | 4 | 8140.21.200 D.I. | 68/91 | 04/85→12/89 | GF683 | 9.5V | |
| 2.5 D | 4 | 8144.67.220 | 55/74 | 09/86→12/89 | GN909 [2][222] GV642 | 11V 11V | |

ALPINA



B3

| | | | | | | | |
|-----------|---|--|---------|-------------|-----------|-----|-------------|
| 2.7 | 6 | | 150/201 | 09/87→06/92 | Z20 [168] | 0.8 | UXT2 / UXT6 |
| 3.2 | 6 | | 195/261 | 04/96→04/99 | Z14 | 0.9 | UXT1 / UXT3 |
| 3.3 | 6 | | 206/276 | 05/99→01/05 | Z237 | 1.6 | |
| 3.3 LPG | 6 | | 206/276 | 05/99→01/05 | Z340 | 0.7 | UXT12 |
| 3.4 S | 6 | | 224/300 | 08/02→ | Z237 | 1.6 | |
| 3.4 S LPG | 6 | | 224/300 | 08/02→ | Z340 | 0.7 | UXT12 |

B6

| | | | | | | | |
|-----|---|--|---------|-------------|-----------|-----|-------------|
| 2.8 | 6 | | 147/197 | 03/78→08/81 | Z20 [168] | 0.8 | UXT2 / UXT6 |
| 2.8 | 6 | | 154/207 | 11/83→07/86 | Z20 [168] | 0.8 | UXT2 / UXT6 |
| 2.8 | 6 | | 160/215 | 09/81→03/83 | Z20 [168] | 0.8 | UXT2 / UXT6 |
| 3.5 | 6 | | 187/251 | 08/86→12/90 | Z20 [168] | 0.8 | UXT2 / UXT6 |
| 3.5 | 6 | | 192/257 | 08/84→07/87 | Z20 [168] | 0.8 | UXT2 / UXT6 |

B7

| | | | | | | | |
|-----|---|-----------|---------|-------------|------|-----|-------|
| 3.0 | 6 | | 221/296 | 12/78→07/87 | Z104 | 0.6 | |
| 3.5 | 6 | | 235/315 | 08/86→06/88 | Z104 | 0.6 | |
| 3.5 | 6 | | 243/326 | 11/81→08/87 | Z104 | 0.6 | |
| 4.4 | 8 | N62B44A19 | 368/493 | 12/03→06/08 | | | ZS324 |

B8

| | | | | | | | |
|-----|---|-----------|---------|-------------|-----|-----|-------------|
| 4.6 | 8 | M 62 B 46 | 245/329 | 01/95→03/98 | Z14 | 0.9 | UXT1 / UXT3 |
|-----|---|-----------|---------|-------------|-----|-----|-------------|

B9

| | | | | | | | |
|---------|---|--|---------|-------------|-----------|-----|-------------|
| 3.0 4WD | 6 | | 180/241 | 11/81→12/85 | Z11 [168] | 0.8 | UXT2 / UXT6 |
| 3.5 | 6 | | 180/241 | 07/82→12/85 | Z11 [168] | 0.8 | UXT2 / UXT6 |

B10

| | | | | | | | |
|-------------|---|--|---------|-------------|-----------|-----|-------------|
| 3.2 | 8 | | 191/256 | 08/97→12/98 | Z14 | 0.9 | UXT1 / UXT3 |
| 3.3 | 6 | | 206/276 | 01/99→10/03 | Z237 | 1.6 | |
| 3.3 LPG | 6 | | 206/276 | 01/99→10/03 | Z340 | 0.7 | UXT12 |
| 3.5 | 6 | | 187/251 | 04/88→12/92 | Z11 [168] | 0.8 | UXT2 / UXT6 |
| 3.5 Biturbo | 6 | | 265/355 | 01/89→06/93 | Z104 | 0.6 | |
| 4.6 V8 | 8 | | 250/335 | 12/96→10/98 | Z14 | 0.9 | UXT1 / UXT3 |
| 4.6 V8 | 8 | | 255/342 | 10/98→09/02 | Z237 | 1.6 | |
| 4.6 V8 LPG | 8 | | 255/342 | 10/98→09/02 | Z340 | 0.7 | UXT12 |

B11

| | | | | | | | |
|-----|---|--|---------|-------------|-----------|-----|-------------|
| 3.5 | 6 | | 177/237 | 07/87→09/87 | Z11 [168] | 0.8 | UXT2 / UXT6 |
| 3.5 | 6 | | 184/247 | 01/87→09/87 | Z11 [168] | 0.8 | UXT2 / UXT6 |
| 3.5 | 6 | | 187/251 | 10/87→12/93 | Z11 [168] | 0.8 | UXT2 / UXT6 |

B12

| | | | | | | | |
|---------|----|--|---------|-------------|------|-----|-------------|
| 5.7 | 12 | | 285/382 | 12/95→09/98 | Z14 | 0.9 | UXT1 / UXT3 |
| 6.0 | 12 | | 316/424 | 07/99→07/01 | Z237 | 1.6 | |
| 6.0 LPG | 12 | | 316/424 | 07/99→07/01 | Z340 | 0.7 | UXT12 |

C1

| | | | | | | | |
|-----|---|----------|---------|-------------|-----------|-----|-------------|
| 2.3 | 6 | C1, C1/1 | 125/168 | 03/80→11/85 | Z11 [168] | 0.8 | UXT2 / UXT6 |
| 2.5 | 6 | | 140/188 | 10/86→06/88 | Z20 [168] | 0.8 | UXT2 / UXT6 |

→07/87

→07/87

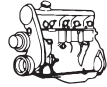

kW/BHP

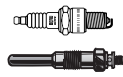
**... ALPINA****C2**

| | | | | | | | | |
|-----|---|--|---------|-------------|-----------|-----|-------------|--|
| 2.5 | 6 | | 136/182 | 07/85→03/88 | Z11 [168] | 0.8 | UXT2 / UXT6 | |
| 2.7 | 6 | | 150/201 | 03/87→08/87 | Z20 [168] | 0.8 | UXT2 / UXT6 | |
| 2.7 | 6 | | 154/207 | 02/86→07/87 | Z20 [168] | 0.8 | UXT2 / UXT6 | |

D10

| | | | | | | | | |
|---------------|---|--|---------|-------------|-------|-----|--|--|
| 3.0 D Biturbo | 6 | | 180/241 | 04/00→10/03 | GN025 | 11V | | |
|---------------|---|--|---------|-------------|-------|-----|--|--|

ROADSTER

| | | | | | | | | |
|------------|---|--|---------|-------------|------|-----|-------|-------|
| 4.8 V8 | 8 | | 280/375 | 06/02→10/03 | Z237 | 1.6 | | ZS302 |
| 4.8 V8 LPG | 8 | | 280/375 | 06/02→10/03 | Z340 | 0.7 | UXT12 | |

ROADSTER S

| | | | | | | | | |
|---------|---|----------|---------|-------------|------|-----|-------|--|
| 3.3 | 6 | S54327S7 | 221/296 | 07/03→12/05 | Z237 | 1.6 | | |
| 3.3 LPG | 6 | S54327S7 | 221/296 | 07/03→12/05 | Z340 | 0.7 | UXT12 | |

ARO**10**

| | | | | | | | | |
|----------------|---|--------------|-------|-------------|---------------|-----|--|--|
| 1.3 1,3 4WD | 4 | 810-02 | 40/54 | 06/80→11/86 | Z10 | 0.8 | | |
| 1.4 1,4 4WD | 4 | IAP 810-R-99 | 46/62 | 06/84→10/99 | Z10 09/88→ | 0.8 | | |
| 1.9 1.9 D 4WD | 4 | F8QA6 | 48/64 | 09/92→10/06 | GN959 | 11V | | |
| 1.9 1.9 TD 4WD | 4 | F8QT | 69/93 | 06/97→10/06 | GN959 | 11V | | |

240-244

| | | | | | | | | |
|------------|---|-----------|-------|-------------|-------------------------|------------|--|--|
| 2.5 4WD | 4 | Aro L25 | 59/79 | 04/78→12/98 | Z19 [168] | 0.8 | | |
| 2.5 4WD | 4 | Aro L25 | 60/80 | 01/80→12/98 | Z68 | 0.6 | | |
| 2.5 D 4WD | 4 | XD3P | 52/70 | 01/83→12/98 | GN909 [2][222] GV636 | 11V 11V | | |
| 2.5 TD 4WD | 4 | XD3TP | 70/94 | 01/92→12/06 | GN909 [2][222] GV636 | 11V 11V | | |
| 2.5 TD 4WD | 4 | VM-425HLT | 74/99 | 01/92→12/06 | GV636 | 11V | | |
| 2.7 D 4WD | 4 | | 50/67 | 09/89→12/98 | GN909 [2][222] GV636 | 11V 11V | | |
| 2.7 D 4WD | 4 | Aro L-27D | 52/70 | 04/85→12/98 | GN909 [2][222] GV636 | 11V 11V | | |
| 2.7 D 4WD | 4 | Aro L-27D | 60/80 | 01/83→12/98 | GV636 | 11V | | |
| 3.0 4WD | 4 | Aro L30 | 70/94 | 01/92→12/06 | Z57 | 0.6 | | |

ASTON MARTIN**DB6**

| | | | | | | | | |
|-----|---|-----|---------|-------------|-----|-----|-------------|--|
| 4.0 | 6 | AJ6 | 210/282 | 10/64→12/70 | Z20 | 0.8 | UXT2 / UXT6 | |
|-----|---|-----|---------|-------------|-----|-----|-------------|--|

DB7

| | | | | | | | | |
|---------|----|-------|---------|-------------|-----------|-----|------|-------|
| 3.2 | 6 | AJ6HT | 250/335 | 01/94→10/03 | Z24 | 0.8 | UXT5 | ZM047 |
| 3.2 | 6 | AJ6HT | 250/335 | 01/96→10/03 | Z30 | 0.8 | UXT5 | |
| 3.2 LPG | 6 | AJ6HT | 250/335 | 01/94→10/03 | Z30 [168] | 0.8 | UXT5 | |
| 5.9 | 12 | AM2 | 309/414 | 03/99→10/03 | | | | ZM047 |

DB9

| | | | | | | | | |
|---------|----|-------|---------|-------------|--|--|--|-------|
| 4.2 V8 | 8 | AM6U5 | 283/380 | 06/05→ | | | | ZS389 |
| 6.0 | 12 | | 331/444 | 04/04→07/12 | | | | ZS426 |
| 6.0 V12 | 12 | | 331/444 | 01/04→ | | | | ZS426 |

DBS

| | | | | | | | | |
|-----|---|-----|---------|-------------|-----|-----|-------------|-------------------------------------|
| 4.0 | 6 | AJ6 | 210/282 | 01/66→12/72 | Z20 | 0.8 | UXT2 / UXT6 | ZS106 [1][11][254] ZS109 [1][15] |
|-----|---|-----|---------|-------------|-----|-----|-------------|-------------------------------------|

LAGONDA I

| | | | | | | | | |
|-----|---|--------------|---------|-------------|--|------------|----------------------------|---------------------|
| 5.3 | 8 | 40HCA, 40HES | 228/306 | 01/76→12/97 | Z11 [167] →12/85 Z20 [167] 01/86→ | 0.8 0.8 | UXT2 / UXT6 UXT2 / UXT6 | ZS117 [1] 01/86→ |
|-----|---|--------------|---------|-------------|--|------------|----------------------------|---------------------|

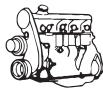

kW/BHP



... ASTON MARTIN



... LAGONDA I

| | | | | | | | | | | |
|---------|---|--------------|---------|-------------|---------------------|-----|------|--|--|--|
| 5.3 LPG | 8 | 40HCA, 40HES | 228/306 | 01/76→12/97 | Z27 [168] 01/86→ | 0.8 | UX56 | | | |
|---------|---|--------------|---------|-------------|---------------------|-----|------|--|--|--|

V8

| | | | | | | | | | | |
|-----|---|-------|---------|-------------|-----|-----|-------------|-----------|-----------|--|
| 5.3 | 8 | 40HCA | 250/335 | 01/69→12/89 | | | | | ZS117 [1] | |
| 5.3 | 8 | 40HCD | 276/370 | 01/78→12/89 | Z20 | 0.8 | UXT2 / UXT6 | ZS117 [1] | | |
| 5.3 | 8 | 40HE | 376/504 | 01/69→12/89 | | | | ZS117 [1] | | |

VIRAGE

| | | | | | | | | | | |
|---------|---|--------------|---------|-------------|------|-----|-------------|--|--|-------|
| 5.3 | 8 | 40HTA, 40HTE | 246/330 | 10/88→12/95 | Z15 | 0.8 | UXT1 / UXT3 | | | |
| 5.3 | 8 | 40HTE | 246/330 | 09/90→12/95 | | | | | | ZM047 |
| 5.3 | 8 | 40HTE | 246/330 | 01/93→12/95 | Z250 | 0.7 | UXT1 / UXT3 | | | |
| 5.3 | 8 | 40HTE | 410/550 | 10/92→10/00 | Z250 | 0.7 | UXT1 / UXT3 | | | ZM047 |
| 5.3 LPG | 8 | 40HTA, 40HTE | 246/330 | 10/88→12/95 | Z340 | 0.7 | UXT12 | | | |
| 5.3 LPG | 8 | 40HTE | 410/550 | 10/92→10/00 | Z340 | 0.7 | UXT12 | | | |
| 6.3 | 8 | 63TK4 | 246/330 | 01/95→12/95 | | | | | | ZM047 |
| 6.3 | 8 | 63TK4 | 373/500 | 09/90→12/95 | | | | | | ZM047 |

VIRAGE Limited Edition

| | | | | | | | | | | |
|-----|---|-------|---------|-------------|--|--|--|--|--|-------|
| 5.3 | 8 | 40HTE | 246/330 | 01/95→12/95 | | | | | | ZM047 |
|-----|---|-------|---------|-------------|--|--|--|--|--|-------|

ZAGATO

| | | | | | | | | | | |
|-----|---|-------|---------|-------------|-----|-----|-------------|--|--|--|
| 5.3 | 8 | | 228/306 | 01/86→12/89 | Z21 | 1.1 | UXT2 / UXT6 | | | |
| 5.3 | 8 | 40HCD | 322/432 | 01/86→12/89 | Z27 | 0.8 | UX56 | | | |

AUDI



50

| | | | | | | | | | | |
|-----|---|----|-------|-------------|-----|-----|-------------|-----------|--|--|
| 0.8 | 4 | HE | 25/34 | 01/76→07/78 | Z22 | 0.7 | UX56 | ZS115 [1] | | |
| 1.1 | 4 | HB | 37/50 | 08/74→07/78 | Z11 | 0.8 | UXT2 / UXT6 | ZS106 [1] | | |
| 1.1 | 4 | HC | 44/59 | 08/74→07/77 | Z22 | 0.7 | UX56 | ZS115 [1] | | |
| 1.3 | 4 | HJ | 43/58 | 01/77→07/78 | Z22 | 0.7 | UX56 | ZS115 [1] | | |
| 1.3 | 4 | HH | 44/59 | 08/77→07/78 | Z11 | 0.8 | UXT2 / UXT6 | ZS115 [1] | | |

60

| | | | | | | | | | | |
|-----|---|----------|-------|-------------|-----|-----|-------------|-----------|--|--|
| 1.5 | 4 | 10, 8910 | 40/54 | 09/68→08/72 | Z11 | 0.8 | UXT2 / UXT6 | ZS115 [1] | | |
|-----|---|----------|-------|-------------|-----|-----|-------------|-----------|--|--|

75

| | | | | | | | | | | |
|-----|---|----|-------|-------------|-----|-----|-------------|-----------|--|--|
| 1.7 | 4 | ZG | 55/74 | 09/68→08/72 | Z11 | 0.8 | UXT2 / UXT6 | ZS115 [1] | | |
|-----|---|----|-------|-------------|-----|-----|-------------|-----------|--|--|

80

| | | | | | | | | | | |
|-----|---|--------|-------|-------------|-----|-----|-------------|--|--|----------------------------|
| 1.3 | 4 | FY | 40/54 | 09/78→07/81 | Z11 | 0.8 | UXT2 / UXT6 | ZS106 [1] | | ZM002 08/80→ |
| 1.3 | 4 | ZA | 40/54 | 05/72→07/78 | Z11 | 0.8 | UXT2 / UXT6 | ZS106 [1] | | |
| 1.3 | 4 | EP | 44/59 | 09/78→07/86 | Z2 | 1.0 | UXT2 / UXT6 | ZS106 [1] | | ZM002 08/81→ |
| 1.3 | 4 | FZ | 44/59 | 09/78→07/81 | Z11 | 0.8 | UXT2 / UXT6 | ZS115 [1] →07/84 ZS124 08/84→07/85 | | |
| 1.3 | 4 | ZF | 44/59 | 05/72→07/78 | Z11 | 0.8 | UXT2 / UXT6 | ZS106 [1] →ch. 81A 0300 000 | | |
| 1.4 | 4 | SE | 48/64 | 08/86→07/88 | Z2 | 1.0 | UXT2 / UXT6 | | | |
| 1.5 | 4 | YJ | 55/74 | 05/72→08/75 | Z11 | 0.8 | UXT2 / UXT6 | ZS106 [1] | | |
| 1.5 | 4 | ZB | 55/74 | 05/72→08/75 | Z22 | 0.7 | UX56 | ZS106 [1] | | |
| 1.5 | 4 | ZC | 63/84 | 05/72→07/76 | Z42 | 0.8 | UX56 | ZS106 [1] | | |
| 1.6 | 4 | PP | 51/68 | 08/87→09/91 | Z93 | 1.0 | UXT2 / UXT6 | ZS124 | | ZM012 |
| 1.6 | 4 | YT, YY | 51/68 | 08/78→07/81 | Z11 | 0.8 | UXT2 / UXT6 | ZS106 [1] | | ZM002 08/80→ |
| 1.6 | 4 | ABM | 52/70 | 09/91→12/94 | Z92 | 0.8 | UXT2 / UXT6 | ZSE001 01/92→07/92 ZSE005 08/92→08/94 | | |
| 1.6 | 4 | FS | 53/71 | 01/76→07/78 | Z61 | 0.7 | UXT2 / UXT6 | ZS115 [1] | | |
| 1.6 | 4 | SA | 54/72 | 02/86→07/86 | Z2 | 1.0 | UXT2 / UXT6 | ZS124 | | ZM002 →ch. 81-F-220 000 |

ASTON MARTIN



kW/BHP

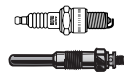

... AUDI



... 80

| | | | | | | | | | | | |
|---------------------|---|--------|--------|-------------|--------------------------------|-------|--|------------|--|---------------------------------|---|
| 1.6 | 4 | DT | 55/74 | 08/78→07/86 | Z2 | | | 1.0 | UXT2 / UXT6 | ZS124 06/84→07/85 | ZM002 08/83→ |
| 1.6 | 4 | RN | 55/74 | 09/86→08/91 | Z93 →04/89 Z92 05/89→ | | | 1.0 0.8 | UXT2 / UXT6 →04/89 UXT2 / UXT6 05/89→ | | |
| 1.6 | 4 | WV | 55/74 | 08/78→07/86 | Z11 Z61 | | | 0.8 0.7 | UXT2 / UXT6 | | |
| 1.6 | 4 | YN | 55/74 | 09/75→07/78 | Z11 | | | 0.8 | UXT2 / UXT6 | ZS115 [11] | |
| 1.6 | 4 | YN | 55/74 | 08/78→07/86 | Z11 Z61 | | | 0.8 0.7 | UXT2 / UXT6 | ZS115 [11] →ch. 81A 0300 000 | |
| 1.6 | 4 | YP | 63/84 | 09/75→02/83 | Z11 | | | 0.8 | UXT2 / UXT6 | | |
| 1.6 | 4 | YP | 63/84 | 09/75→07/78 | | | | | | ZS115 [11] | |
| 1.6 | 4 | YP | 63/84 | 08/78→02/83 | | | | | | ZS106 [11] | ZM002 08/80→ |
| 1.6 | 4 | ABB | 75/101 | 08/90→10/91 | Z20 | | | 0.8 | UXT2 / UXT6 | | |
| 1.6 D | 4 | CR, JK | 40/54 | 08/80→08/91 | GN857 | GR001 | | 11V | | | |
| 1.6 E | 4 | ADA | 74/99 | 06/93→01/96 | Z91 | | | 0.8 | UXT2 / UXT6 | ZSE005 →07/95 | |
| 1.6 E | 4 | ADA | 74/99 | 06/93→12/94 | | | | | | ZSE005 | |
| 1.6 E LPG | 4 | ADA | 74/99 | 06/93→01/96 | Z27 [168] | | | 0.8 | UX56 | | |
| 1.6 GLE | 4 | 780 | 81/109 | 01/79→12/86 | | | | | | ZS106 [11] | |
| 1.6 GLE | 4 | YZ | 81/109 | 01/79→12/86 | Z42 | | | 0.8 | UX56 | | ZM002 08/80→ |
| 1.6 GT | 4 | XX | 74/99 | 09/73→07/76 | Z42 | | | 0.8 | UX56 | ZS106 [11] | |
| 1.6 GTE | 4 | YS | 81/109 | 01/76→07/78 | Z42 | | | 0.8 | UX56 | ZS106 [11] | |
| 1.6 TD | 4 | CY | 51/68 | 08/81→05/86 | GN857 | GR001 | | 11V | | | |
| 1.6 TD | 4 | RA, SB | 59/79 | 09/86→08/91 | GN857 | GR001 | | 11V | | | |
| 1.8 | 4 | RU | 55/74 | 10/86→01/90 | Z93 | | | 1.0 | UXT2 / UXT6 | ZS124 | |
| 1.8 | 4 | SF | 65/87 | 02/86→07/86 | Z91 | | | 0.8 | UXT2 / UXT6 | ZS124 →ch. 81-F-220 000 | ZM002 |
| 1.8 | 4 | DS, JV | 66/89 | 01/83→08/86 | Z12 | | | 0.8 | UXT2 / UXT6 | ZS124 06/84→07/85 | ZM002 |
| 1.8 | 4 | JN | 68/91 | 08/83→08/86 | Z91 | | | 0.8 | UXT2 / UXT6 | ZS124 →07/85 | ZM002 |
| 1.8 | 4 | SD | 83/111 | 09/86→07/88 | Z91 | | | 0.8 | UXT2 / UXT6 | | ZM002 09/87→ |
| 1.8 LPG | 4 | JN | 68/91 | 08/83→08/86 | Z27 [168] | | | 0.8 | UX56 | | |
| 1.8 4WD Quattro | 4 | SD | 83/111 | 09/86→08/90 | Z91 | | | 0.8 | UXT2 / UXT6 | | ZM002 →07/87 ZM012 08/87→08/88 |
| 1.8 CC 4WD Quattro | 4 | JV, NE | 66/89 | 08/84→08/86 | Z12 | | | 0.8 | UXT2 / UXT6 | ZS124 →07/85 | ZM002 |
| 1.8 CC 4WD Quattro | 4 | JN | 68/91 | 08/85→08/86 | Z91 | | | 0.8 | UXT2 / UXT6 | ZS124 →ch. 81-F-220 000 | ZM002 |
| 1.8 E | 4 | DZ | 82/110 | 06/86→08/91 | Z12 Z91 | | | 0.8 0.8 | UXT2 / UXT6 | | ZM002 |
| 1.8 E 4WD Quattro | 4 | DZ | 82/110 | 09/86→08/91 | Z12 | | | 0.8 | UXT2 / UXT6 | | ZM002 →07/87 ZM012 08/87→ |
| 1.8 GTE | 4 | PV | 81/109 | 08/85→07/86 | Z12 | | | 0.8 | UXT2 / UXT6 | ZS124 →ch. 81-F-220 000 | ZM002 |
| 1.8 GTE | 4 | DZ | 82/110 | 10/84→08/86 | Z12 | | | 0.8 | UXT2 / UXT6 | ZS124 →07/85 | ZM002 |
| 1.8 GTE 4WD Quattro | 4 | PV | 81/109 | 03/85→08/86 | Z12 | | | 0.8 | UXT2 / UXT6 | ZS124 →07/85 | ZM002 |

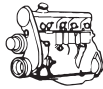

kW/BHP

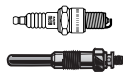

... AUDI



... 80

| | | | | | | | | | | |
|-----------------------|---|--------|---------|-------------|----------------------|-------|------------|-------------|--|------------------------------------|
| 1.8 GTE 4WD Quattro | 4 | DZ | 82/110 | 08/84→08/86 | Z12 | | 0.8 | UXT2 / UXT6 | ZS124 →07/85 | ZM002 |
| 1.8 S | 4 | SF | 65/87 | 09/86→12/90 | Z91 | | 0.8 | UXT2 / UXT6 | | ZM002 |
| 1.8 S | 4 | JN | 66/89 | 09/86→10/91 | Z91 | | 0.8 | UXT2 / UXT6 | | ZM002 |
| 1.8 S | 4 | NE | 66/89 | 09/86→10/91 | Z12 | | 0.8 | UXT2 / UXT6 | | ZM002 |
| 1.8 S | 4 | PM | 66/89 | 09/86→10/91 | Z91 | | 0.8 | UXT2 / UXT6 | ZSE005 ch. BA-M-000001→ | ZM002 |
| 1.8 S 4WD Quattro | 4 | SF | 65/87 | 09/86→07/90 | Z91 | | 0.8 | UXT2 / UXT6 | | ZM002 →07/87 ZM012 08/87→ |
| 1.8 S 4WD Quattro | 4 | JN, PM | 66/89 | 09/86→09/91 | Z91 | | 0.8 | UXT2 / UXT6 | | ZM002 →07/87 ZM012 08/87→ |
| 1.8 S 4WD Quattro | 4 | NE | 66/89 | 09/86→09/91 | Z12 Z91 | | 0.8 0.8 | UXT2 / UXT6 | | ZM002 →07/87 ZM012 08/87→ |
| 1.9 CD-5S | 5 | WN | 85/114 | 09/81→07/83 | Z44 | | 0.8 | UX56 | | ZM002 |
| 1.9 D | 4 | 1Y | 50/67 | 08/89→08/91 | GN857 | GR001 | 11V | | | |
| 1.9 TD | 4 | AAZ | 55/74 | 09/91→12/94 | GN857 | | 11V | | | |
| 1.9 TDI | 4 | 1Z | 66/89 | 09/91→01/96 | GN855 | | 12V | | | |
| 2.0 | 4 | ABT | 66/89 | 09/91→01/96 | Z91 | | 0.8 | UXT2 / UXT6 | | |
| 2.0 | 4 | ABT | 66/89 | 09/91→12/94 | | | | | ZSE001 →07/92 ZSE005 08/92→ | |
| 2.0 | 4 | ABT | 66/89 | 07/92→01/96 | | | | | ZSE001 | |
| 2.0 | 4 | AAD | 82/110 | 10/90→08/91 | Z91 | | 0.8 | UXT2 / UXT6 | | ZM012 |
| 2.0 | 5 | HP, JS | 85/114 | 10/83→09/84 | Z12 | | 0.8 | UXT2 / UXT6 | | |
| 2.0 LPG | 4 | ABT | 66/89 | 07/92→01/96 | Z27 ^[168] | | 0.8 | UX56 | | |
| 2.0 4WD Quattro | 4 | ADW | 79/106 | 11/93→01/96 | Z91 | | 0.8 | UXT2 / UXT6 | | |
| 2.0 4WD Quattro | 4 | 3A | 82/110 | 08/88→07/90 | Z91 | | 0.8 | UXT2 / UXT6 | ZSE005 | |
| 2.0 4WD Quattro | 4 | AAD | 82/110 | 08/88→07/90 | | | | | | ZM012 |
| 2.0 4WD Quattro | 4 | AAD | 85/114 | 10/90→08/91 | Z91 | | 0.8 | UXT2 / UXT6 | ZSE005 | ZM012 |
| 2.0 4WD Quattro | 5 | JS | 85/114 | 10/83→09/84 | Z12 | | 0.8 | UXT2 / UXT6 | | ZM002 |
| 2.0 E | 4 | 3A | 83/111 | 08/88→10/90 | Z91 | | 0.8 | UXT2 / UXT6 | ZSE005 | |
| 2.0 E | 4 | AAD | 83/111 | 08/88→10/90 | | | | | | ZM012 |
| 2.0 E | 4 | ABK | 85/114 | 09/91→01/96 | Z91 | | 0.8 | UXT2 / UXT6 | | |
| 2.0 E | 4 | ABK | 85/114 | 09/91→12/94 | | | | | ZSE001 →07/92 ZSE005 08/92→ | |
| 2.0 E | 4 | ABK | 85/114 | 07/92→01/96 | | | | | ZSE005 08/92→07/95 ZSE001 ^{[175][217]} [254] | |
| 2.0 E LPG | 4 | ABK | 85/114 | 09/91→01/96 | Z27 ^[168] | | 0.8 | UX56 | | |
| 2.0 E 4WD Quattro | 4 | 3A | 83/111 | 08/88→09/90 | Z91 | | 0.8 | UXT2 / UXT6 | ZSE005 | |
| 2.0 E 4WD Quattro | 4 | AAD | 83/111 | 08/88→09/90 | | | | | | ZM012 |
| 2.0 E 4WD Quattro | 4 | ABK | 85/114 | 09/91→12/94 | Z91 | | 0.8 | UXT2 / UXT6 | ZSE001 →07/93 →ch. BC.P.300000 ZSE005 08/93→ ch. BC.R.300001→ | ZM001 |
| 2.0 E 4WD LPG Quattro | 4 | 3A | 83/111 | 08/88→09/90 | Z27 ^[168] | | 0.8 | UX56 | | |
| 2.0 E 16V | 4 | ACE | 103/138 | 08/92→01/96 | Z89 | | 0.8 | UXT5 | | ZM031 |

AUDI



kW/BHP



... AUDI



... 80

| | | | | | | | | | | |
|---------------------------|---|--------|---------|-------------|--------------------------------|-------|------------|--|------------------|--|
| 2.0 E 16V LPG | 4 | ACE | 103/138 | 02/93→01/96 | Z30 [168] | | 0.8 | UXT5 | | |
| 2.0 E 16V 4WD Quattro | 4 | ACE | 103/138 | 04/92→07/95 | Z89 | | 0.8 | UXT5 | | |
| 2.0 E 16V 4WD Quattro | 4 | ACE | 103/138 | 04/92→12/94 | | | | | | ZM031 07/92→ |
| 2.0 E 16V 4WD Quattro | 4 | ACE | 103/138 | 12/92→07/95 | | | | | | ZM031 |
| 2.0 E 16V 4WD LPG Quattro | 4 | ACE | 103/138 | 12/92→07/95 | Z30 [168] | | 0.8 | UXT5 | | |
| 2.2 | 5 | WE | 85/114 | 10/80→07/83 | Z11 | | 0.8 | UXT2 / UXT6 | | |
| 2.2 4WD Quattro | 5 | KL | 96/129 | 08/82→07/84 | Z51 | | 0.8 | UX56 | | ZM002 |
| 2.2 4WD Quattro | 5 | KK | 100/134 | 08/82→07/84 | Z42 [169] | | 0.8 | UX56 | | ZM002 |
| 2.2 RS2 4WD Quattro | 5 | ADU | 232/311 | 03/94→05/95 | | | | | ZS043 | ZLE233 ZM063 |
| 2.2 S2 4WD Quattro | 5 | ABY | 169/227 | 02/93→07/95 | | | | | ZS043 | ZLE233 ZM027 →12/94 ZM063 [175] |
| 2.2 S2 4WD Quattro | 5 | ABY | 169/227 | 02/93→12/94 | | | | | | ZLE233 ZM063 |
| 2.3 4WD Quattro | 5 | NG | 98/131 | 10/87→07/89 | Z75 | | 1.2 | UXT2 / UXT6 | ZSE005 | ZM002 |
| 2.3 E | 5 | NG | 98/131 | 09/91→01/96 | Z75 →07/93 Z94 08/93→ | | 1.2 0.8 | UXT2 / UXT6 →07/93 UXT2 / UXT6 08/93→ | | |
| 2.3 E | 5 | NG | 98/131 | 09/91→12/94 | | | | | ZSE005 07/94→ | ZM031 |
| 2.3 E | 5 | NG | 98/131 | 07/92→01/96 | | | | | ZSE005 | ZM031 →11/94 |
| 2.3 E LPG | 5 | NG | 98/131 | 07/92→01/96 | Z20 [168] 08/93→ | | 0.8 | UXT2 / UXT6 08/93→ | | |
| 2.3 E 4WD Quattro | 5 | NG | 98/131 | 09/91→12/94 | Z75 →07/93 Z94 08/93→ | | 1.2 0.8 | UXT2 / UXT6 →07/93 UXT2 / UXT6 08/93→ | ZSE005 07/94→ | ZM031 |
| 2.3 E 4WD Quattro | 5 | NG | 98/131 | 09/91→11/94 | | | | | ZSE005 | |
| 2.6 | 6 | ABC | 110/148 | 07/92→01/96 | Z90 | | 1.0 | UXT1 / UXT3 | ZSE007 | ZM027 [188] ZM063 [175] |
| 2.6 LPG | 6 | ABC | 110/148 | 07/92→01/96 | Z340 | | 0.7 | UXT12 | | |
| 2.6 4WD Quattro | 6 | ABC | 110/148 | 06/92→07/95 | Z90 | | 1.0 | UXT1 / UXT3 | ZSE007 | ZM027 [188] ZM063 [175] |
| 2.6 4WD LPG Quattro | 6 | ABC | 110/148 | 07/92→07/95 | Z340 | | 0.7 | UXT12 | | |
| 2.8 | 6 | AAH | 128/172 | 09/91→01/96 | Z90 | | 1.0 | UXT1 / UXT3 | ZSE007 | ZM027 [188] ZM063 [175] |
| 2.8 LPG | 6 | AAH | 128/172 | 09/91→01/96 | Z340 | | 0.7 | UXT12 | | |
| 2.8 4WD Quattro | 6 | AAH | 128/172 | 09/91→07/95 | Z90 | | 1.0 | UXT1 / UXT3 | ZSE007 | ZM027 [188] ZM063 [175] |
| 2.8 4WD LPG Quattro | 6 | AAH | 128/172 | 08/92→07/95 | Z340 | | 0.7 | UXT12 | | |
| 90 | | | | | | | | | | |
| 1.6 TD | 4 | CY | 51/68 | 10/85→01/87 | GN857 | GR001 | 11V | | | |
| 1.6 TD | 4 | RA, SB | 59/79 | 04/87→09/91 | GN857 | GR001 | 11V | | | |
| 2.0 | 5 | SK | 83/111 | 03/86→03/87 | Z12 | | 0.8 | UXT2 / UXT6 | | |
| 2.0 | 5 | HP, JS | 85/114 | 10/84→03/87 | Z12 | | 0.8 | UXT2 / UXT6 | ZS124 →07/85 | ZM002 |
| 2.0 | 5 | PS | 85/114 | 07/88→09/91 | Z91 | | 0.8 | UXT2 / UXT6 | ZSE005 | ZM002 |
| 2.0 4WD Quattro | 4 | 6A | 101/135 | 08/89→07/90 | Z89 | | 0.8 | UXT5 | | |
| 2.0 4WD Quattro | 5 | JS | 85/114 | 08/84→08/86 | Z12 | | 0.8 | UXT2 / UXT6 | ZS124 →07/85 | ZM002 |
| 2.0 20 V | 5 | NM | 118/158 | 08/89→07/91 | Z52 | | 0.8 | UXT5 | ZSE005 | |
| 2.0 20 V 4WD Quattro | 5 | NM | 118/158 | 08/88→09/91 | Z52 | | 0.8 | UXT5 | ZSE005 | |
| 2.2 | 5 | KX | 85/114 | 01/85→03/87 | Z12 | | 0.8 | UXT2 / UXT6 | ZS124 →07/85 | ZM002 |

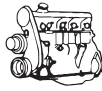

kW/BHP

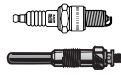

... AUDI



... 90

| | | | | | | | | | | |
|-----------------------|---|--------|---------|-------------|-----|--|-----|-------------|--|------------------------------------|
| 2.2 | 5 | HY, KV | 100/134 | 10/84→03/87 | Z51 | | 0.8 | UX56 | ZS124 →07/85 | ZM002 |
| 2.2 E | 5 | KV | 100/134 | 04/87→07/91 | Z51 | | 0.8 | UX56 | | ZM012 |
| 2.2 E 4WD Quattro | 5 | JT | 88/118 | 08/85→03/87 | Z12 | | 0.8 | UXT2 / UXT6 | ZS124 | |
| 2.2 E 4WD Quattro | 5 | KV | 100/134 | 11/84→09/91 | Z51 | | 0.8 | UX56 | | |
| 2.2 E 4WD Quattro | 5 | KV | 100/134 | 11/84→03/87 | | | | | ZS124 →07/85 | ZM002 |
| 2.2 E 4WD Quattro | 5 | KV | 100/134 | 04/87→09/91 | | | | | | ZM012 |
| 2.3 E | 5 | NG | 98/131 | 04/87→09/91 | Z75 | | 1.2 | UXT2 / UXT6 | ZSE005 | |
| 2.3 E | 5 | NG | 100/134 | 04/87→07/91 | Z75 | | 1.2 | UXT2 / UXT6 | ZSE005 | ZM002 |
| 2.3 E 4WD Quattro | 5 | NG | 98/131 | 04/87→09/91 | Z75 | | 1.2 | UXT2 / UXT6 | ZSE005 | ZM002 |
| 2.3 E 4WD Quattro | 5 | NG | 100/134 | 04/87→07/91 | Z75 | | 1.2 | UXT2 / UXT6 | ZSE005 | ZM002 |
| 2.3 E 20V | 5 | 7A | 123/165 | 04/90→07/91 | Z89 | | 0.8 | UXT5 | ZSE005 | |
| 2.3 E 20V | 5 | 7A | 125/168 | 08/88→07/91 | Z89 | | 0.8 | UXT5 | ZSE005 | |
| 2.3 E 20V 4WD Quattro | 5 | 7A | 123/165 | 04/90→09/91 | Z89 | | 0.8 | UXT5 | ZSE005 | |
| 2.3 E 20V 4WD Quattro | 5 | 7A | 125/168 | 06/88→09/91 | Z89 | | 0.8 | UXT5 | ZSE005 | |
| 100 | | | | | | | | | | |
| 1.6 | 4 | YM, YV | 63/84 | 01/75→02/83 | Z11 | | 0.8 | UXT2 / UXT6 | ZS115 ⁽¹¹⁾ | |
| 1.6 | 4 | YV | 63/84 | 08/76→07/82 | | | | | | ZM002 08/80→ |
| 1.6 | 4 | YV | 63/84 | 07/77→02/83 | | | | | | ZM002 →07/82 |
| 1.8 | 4 | DR | 55/74 | 08/82→12/87 | Z2 | | 1.0 | UXT2 / UXT6 | ZS124 04/84→07/85 ZS124 06/84→07/85 | ZM002 →09/86 ZM012 10/86→ |
| 1.8 | 4 | RS | 55/74 | 08/82→12/87 | Z93 | | 1.0 | UXT2 / UXT6 | | ZM002 →09/86 ZM012 10/86→ |
| 1.8 | 4 | ZV | 59/79 | 11/68→11/71 | Z42 | | 0.8 | UX56 | | |
| 1.8 | 4 | ZU | 63/84 | 09/71→07/74 | Z22 | | 0.7 | UX56 | ZS115 ⁽¹¹⁾ | |
| 1.8 | 4 | SH | 65/87 | 02/86→07/90 | Z91 | | 0.8 | UXT2 / UXT6 | ZS124 →ch. 44-F-300 000 | ZM002 →09/86 ZM012 10/86→ |
| 1.8 | 4 | 4B, PH | 66/89 | 03/85→11/90 | Z91 | | 0.8 | UXT2 / UXT6 | ZSE001 ⁽¹⁷⁵⁾⁽²⁵⁴⁾ ZS124 →ch. 44-F-300 000 | ZM012 |
| 1.8 | 4 | DS | 66/89 | 08/83→07/89 | Z12 | | 0.8 | UXT2 / UXT6 | ZS124 08/84→07/85 | ZM002 →09/86 ZM012 10/86→ |
| 1.8 | 4 | JW | 66/89 | 08/83→07/89 | Z12 | | 0.8 | UXT2 / UXT6 | ZS124 08/84→07/85 | ZM002 →09/86 ZM012 10/86→ |
| 1.8 | 4 | NP | 66/89 | 08/83→07/89 | Z12 | | 0.8 | UXT2 / UXT6 | | ZM002 →09/86 ZM012 10/86→ |
| 1.8 | 4 | ZX | 66/89 | 11/68→11/71 | Z22 | | 0.7 | UX56 | | |
| 1.8 | 4 | ZZ | 74/99 | 10/70→07/76 | Z22 | | 0.7 | UX56 | ZS115 ⁽¹¹⁾ 09/71→ | |
| 1.8 4WD Quattro | 4 | SH | 65/87 | 08/86→07/90 | Z91 | | 0.8 | UXT2 / UXT6 | ZS124 →ch. 44-F-300 000 | ZM002 →09/86 ZM012 10/86→ |



kW/BHP

**... AUDI****... 100**

| | | | | | | | | | |
|-----------------------|---|----------|---------|-------------|-------|-----|-------------|---|------------------------------------|
| 1.8 4WD Quattro | 4 | 4B, PH | 66/89 | 08/85→11/90 | Z91 | 0.8 | UXT2 / UXT6 | ZS124 →ch. 44-F-300 000 | ZM012 →07/88 |
| 1.8 4WD Quattro | 4 | 4B, PH | 66/89 | 08/85→10/90 | | | | | ZM012 |
| 1.8 4WD Quattro | 4 | JW, NP | 66/89 | 10/84→07/88 | Z12 | 0.8 | UXT2 / UXT6 | ZS124 →ch. 44-F-300 000 | ZM002 →09/86 ZM012 10/86→ |
| 1.9 | 4 | ZJ | 82/110 | 08/71→12/76 | Z42 | 0.8 | UX56 | ZS115 [11] | |
| 1.9 | 4 | ZP | 85/114 | 07/70→07/71 | Z42 | 0.8 | UX56 | | |
| 1.9 | 5 | WH | 74/99 | 08/80→07/84 | Z22 | 0.7 | UX56 | | |
| 1.9 | 5 | WH | 74/99 | 08/80→07/82 | | | | | ZM002 |
| 1.9 | 5 | WH | 74/99 | 08/82→07/84 | | | | ZS124 ch. 44-E-220 001→ | ZM002 |
| 2.0 | 4 | AAE | 74/99 | 12/90→06/94 | Z91 | 0.8 | UXT2 / UXT6 | ZSE001 [11]175[254] ZSE036 [11]88[254] | |
| 2.0 | 4 | WA | 85/114 | 06/76→07/80 | Z42 | 0.8 | UX56 | ZS115 [11] | |
| 2.0 | 5 | SL | 83/111 | 08/86→11/87 | Z12 | 0.8 | UXT2 / UXT6 | | ZM002 →09/86 ZM012 10/86→ |
| 2.0 | 5 | KP | 85/114 | 08/84→12/87 | Z12 | 0.8 | UXT2 / UXT6 | ZS124 | ZM002 →09/86 ZM012 10/86→ |
| 2.0 | 5 | RT | 85/114 | 01/88→11/90 | Z91 | 0.8 | UXT2 / UXT6 | ZSE005 ch. 44-K-000001→ | ZM012 |
| 2.0 D | 5 | CN | 51/68 | 08/78→11/90 | GN857 | 11V | | | |
| 2.0 D Turbo | 5 | DE | 64/86 | 08/82→02/88 | GN857 | 11V | | | |
| 2.0 D Turbo | 5 | NC | 74/99 | 03/88→11/90 | GN857 | 11V | | | |
| 2.0 E | 4 | AAE | 74/99 | 09/91→06/94 | Z91 | 0.8 | UXT2 / UXT6 | ZSE001 [11]175[254] ZSE036 [11]88[254] | |
| 2.0 E | 4 | AAD, ABK | 85/114 | 12/90→06/94 | Z91 | 0.8 | UXT2 / UXT6 | ZSE036 | |
| 2.0 E | 5 | KP | 85/114 | 01/85→12/87 | Z12 | 0.8 | UXT2 / UXT6 | ZS124 | ZM002 →09/86 ZM012 10/86→ |
| 2.0 E | 5 | RT | 85/114 | 01/88→11/90 | Z91 | 0.8 | UXT2 / UXT6 | ZSE005 ch. 44-K-000001→ | ZM012 |
| 2.0 E 4WD Quattro | 4 | AAD | 85/114 | 12/90→07/92 | Z91 | 0.8 | UXT2 / UXT6 | ZSE036 | |
| 2.0 E 16V | 4 | ACE | 103/138 | 01/92→06/94 | Z89 | 0.8 | UXT5 | ZSE036 | ZM031 |
| 2.0 E 16V 4WD Quattro | 4 | ACE | 103/138 | 07/92→06/94 | Z89 | 0.8 | UXT5 | ZSE036 | ZM031 |
| 2.0 TD | 5 | DE | 64/86 | 03/83→10/87 | GN857 | 11V | | | |
| 2.0 TD | 5 | NC | 74/99 | 03/88→11/90 | GN857 | 11V | | | |
| 2.1 | 5 | WB, WE | 85/114 | 07/77→02/83 | Z11 | 0.8 | UXT2 / UXT6 | ZS115 [11] | |
| 2.1 | 5 | WB, WE | 85/114 | 10/77→07/82 | | | | | ZM002 08/80→ |
| 2.1 | 5 | KF | 96/129 | 08/82→07/84 | Z51 | 0.8 | UX56 | ZS124 ch. 44-E-220 001→ | |
| 2.1 | 5 | WC | 100/134 | 03/77→07/84 | Z51 | 0.8 | UX56 | | |
| 2.1 | 5 | WC | 100/134 | 08/82→07/84 | | | | ZS124 ch. 44-E-220 001→ | ZM002 |
| 2.1 | 5 | WG | 100/134 | 03/77→02/83 | Z22 | 0.7 | UX56 | | |
| 2.2 | 5 | WU | 79/106 | 08/82→07/84 | Z20 | 0.8 | UXT2 / UXT6 | ZS124 ch. 44-E-220 001→ | |
| 2.2 | 5 | KZ | 85/114 | 10/84→09/86 | Z12 | 0.8 | UXT2 / UXT6 | ZS124 →07/85 | ZM002 [175] |
| 2.2 | 5 | KF | 96/129 | 08/82→07/84 | Z51 | 0.8 | UX56 | ZS124 ch. 44-E-220 001→ | |
| 2.2 | 5 | HX | 101/135 | 06/89→11/90 | Z51 | 0.8 | UX56 | ZS124 | ZM012 |

AUDI

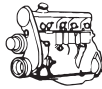

kW/BHP

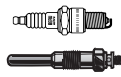

... AUDI



... 100

| | | | | | | | | | |
|---------------------------|---|----------|---------|-------------|---------------|------|-------------|-----------------------------|--|
| 2.2 | 5 | KU | 101/135 | 08/84→11/90 | Z51 | 0.8 | UX56 | | |
| 2.2 | 5 | KU | 101/135 | 08/84→12/88 | | | | ZS124 →07/85 | ZM002 →09/86 ZM012 10/86→ |
| 2.2 | 5 | KU | 101/135 | 06/89→11/90 | | | | ZS124 | ZM012 |
| 2.2 4WD Quattro | 5 | HX | 101/135 | 06/89→11/90 | Z51 | 0.8 | UX56 | ZS124 | ZM012 |
| 2.2 4WD Quattro | 5 | KU | 101/135 | 08/84→11/90 | Z51 | 0.8 | UX56 | | |
| 2.2 4WD Quattro | 5 | KU | 101/135 | 08/84→12/88 | | | | ZS124 →07/85 | ZM002 →09/86 ZM012 10/86→ |
| 2.2 4WD Quattro | 5 | KU | 101/135 | 06/89→11/90 | | | | ZS124 | ZM012 |
| 2.2 E 4WD Quattro | 5 | PX | 88/118 | 08/85→07/86 | Z12 | 0.8 | UXT2 / UXT6 | ZS109 ^[15] | ZM002 |
| 2.2 E Turbo 4WD Quattro | 5 | MC | 121/162 | 08/86→11/90 | Z12 | 0.8 | UXT2 / UXT6 | ZSE005 | |
| 2.2 S4 Turbo 4WD Quattro | 5 | AAN | 169/227 | 08/91→06/94 | Z317 | 0.85 | UXT12 | ZS043 | ZLE233 ZM063 ZLE233 |
| 2.2 S4 Turbo 4WD Quattro | 5 | AAN | 169/227 | 09/91→06/94 | | | | | |
| 2.2 Turbo | 5 | MC | 121/162 | 08/86→11/90 | Z12 | 0.8 | UXT2 / UXT6 | ZSE005 | |
| 2.2 Turbo 4WD Quattro | 5 | MC | 121/162 | 08/86→11/90 | Z12 | 0.8 | UXT2 / UXT6 | ZSE005 ch. F44-J-250001→ | |
| 2.3 | 5 | NF | 98/131 | 03/90→11/90 | Z94 | 0.8 | UXT2 / UXT6 | ZSE005 | |
| 2.3 | 5 | NF | 100/134 | 08/86→11/90 | Z12 | 0.8 | UXT2 / UXT6 | ZSE005 | |
| 2.3 4WD Quattro | 5 | NF | 98/131 | 01/90→11/90 | Z94 | 0.8 | UXT2 / UXT6 | ZSE005 | |
| 2.3 E | 5 | AAR | 98/131 | 12/90→06/94 | Z94 | 0.8 | UXT2 / UXT6 | ZSE036 ^[1] | ZM031 |
| 2.3 E | 5 | AAR | 98/131 | 09/91→06/94 | | | | ZSE036 | |
| 2.3 E | 5 | NF | 98/131 | 01/90→11/90 | Z94 | 0.8 | UXT2 / UXT6 | ZSE005 | |
| 2.3 E | 5 | NF | 100/134 | 10/86→11/90 | Z12 | 0.8 | UXT2 / UXT6 | ZSE005 | |
| 2.3 E 4WD Quattro | 5 | AAR | 98/131 | 12/90→06/94 | Z94 | 0.8 | UXT2 / UXT6 | ZSE036 | ZM031 |
| 2.3 E 4WD Quattro | 5 | NF | 100/134 | 08/86→11/90 | Z12 | 0.8 | UXT2 / UXT6 | ZSE036 | |
| 2.4 D | 5 | 3D, AAS | 60/80 | 08/89→06/94 | GN857 | 11V | | | |
| 2.5 TDI | 5 | AAT, ABP | 85/114 | 12/90→06/94 | GN855 | 12V | | | |
| 2.5 TDI | 5 | 1T | 88/118 | 01/90→11/90 | GN855 | 12V | | | |
| 2.6 | 6 | ACZ | 102/137 | 07/93→06/94 | Z90 | 1.0 | UXT1 / UXT3 | ZSE007 | |
| 2.6 | 6 | ABC | 110/148 | 03/92→06/94 | Z90 | 1.0 | UXT1 / UXT3 | ZSE007 | ZM027 ^[188] ZM063 ^[175] |
| 2.6 4WD Quattro | 6 | ABC | 110/148 | 04/92→06/94 | Z90 | 1.0 | UXT1 / UXT3 | ZSE007 | ZM027 ^[188] ZM063 ^[175] |
| 2.6 E 4WD Quattro | 6 | ACZ | 102/137 | 08/93→07/94 | Z90 | 1.0 | UXT1 / UXT3 | ZSE007 | |
| 2.8 E | 6 | AAH | 128/172 | 12/90→06/94 | Z90 | 1.0 | UXT1 / UXT3 | ZSE007 | ZM027 ^[188] ZM063 ^[175] |
| 2.8 E 4WD Quattro | 6 | AAH | 128/172 | 12/90→06/94 | Z90 | 1.0 | UXT1 / UXT3 | ZSE007 | ZM027 ^[188] ZM063 ^[175] |
| 4.2 S4 V8 4WD Quattro | 8 | ABH | 206/276 | 10/92→06/94 | Z127 | 1.6 | UXT4 | ZSE036 | |
| 200 | | | | | | | | | |
| 2.1 5E | 5 | WC | 100/134 | 10/79→07/84 | Z51 | 0.8 | UX56 | | ZM002 |
| 2.1 5E | 5 | WC | 100/134 | 08/83→07/84 | | | | ZS280 | |
| 2.1 5T | 5 | WJ | 125/168 | 10/79→08/82 | Z44 | 0.8 | UX56 | | ZM002 |
| 2.1 Turbo | 5 | KG | 134/180 | 08/83→01/88 | Z44 | 0.8 | UX56 | | |
| | | | | | →07/85 Z51 | 0.8 | UX56 | →07/85 | |
| | | | | | 08/85→ | | | 08/85→ | |
| 2.1 Turbo 4WD Quattro | 5 | JY, KG | 134/180 | 08/83→01/88 | Z44 | 0.8 | UX56 | →07/85 | |
| | | | | | →07/85 Z51 | 0.8 | UX56 | →07/85 | |
| | | | | | 08/85→ | | | 08/85→ | |
| 2.2 | 5 | KU | 101/135 | 08/84→07/85 | Z51 | 0.8 | UX56 | ZS280 | ZM002 |
| 2.2 20V Turbo 4WD Quattro | 5 | 3B | 162/217 | 03/89→12/90 | | | | ZSE005 | ZM012 |
| 2.2 Turbo | 5 | MC | 121/162 | 08/85→09/91 | Z12 | 0.8 | UXT2 / UXT6 | ZSE005 | |

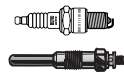

kW/BHP

**... AUDI****... 200**

| | | | | | | | | | |
|-----------------------|---|----|---------|-------------|-----|--|-----|-------------|------------------|
| 2.2 Turbo | 5 | 2B | 140/188 | 02/88→12/90 | Z12 | | 0.8 | UXT2 / UXT6 | ZSE005 |
| 2.2 Turbo | 5 | 1B | 147/197 | 02/88→12/90 | Z12 | | 0.8 | UXT2 / UXT6 | ZSE005 |
| 2.2 Turbo 4WD Quattro | 5 | MC | 121/162 | 09/83→12/91 | Z12 | | 0.8 | UXT2 / UXT6 | ZSE036 |
| | | | | | | | | | ch. 44-K-000001→ |
| 2.2 Turbo 4WD Quattro | 5 | 1B | 147/197 | 02/88→12/91 | Z12 | | 0.8 | UXT2 / UXT6 | ZSE005 |
| 2.3 | 5 | NF | 100/134 | 11/86→09/91 | Z12 | | 0.8 | UXT2 / UXT6 | ZSE005 |

A1

| | | | | | | | | | |
|----------------------|---|------------------|---------|--------|-----------------|--|--------------|-------|-----------------------|
| 1.2 TFSI | 4 | CBZA | 63/84 | 05/10→ | | | | | ZSE003 |
| 1.4 TDI | 3 | CUSB | 66/89 | 11/14→ | GE115 PSG002 | | 4.4V 4.4V | | |
| 1.4 TFSI | 4 | CAXA, CNVA | 90/121 | 05/10→ | Z349 | | 0.9 | | ZSE030 →01/12 |
| 1.4 TFSI | 4 | CAXA, CNVA | 90/121 | 11/11→ | | | | | ZSE030 |
| 1.4 TFSI | 4 | CPTA | 103/138 | 04/12→ | | | | | ZSE067 ^[1] |
| 1.4 TFSI | 4 | CAVG, CTHG, CTJA | 136/182 | 01/11→ | Z349 →02/11 | | 0.9 | | ZSE030 →01/12 |
| 1.4 TFSI | 4 | CAVG, CTHG | 136/182 | 11/11→ | | | | | ZSE030 |
| 1.6 TDI | 4 | CAYB | 66/89 | 03/11→ | GE115 | | 4.4V | | |
| 1.6 TDI | 4 | CAYC | 77/103 | 05/10→ | GE115 | | 4.4V | | |
| 1.6 TDI | 4 | CXMA | 85/114 | 11/14→ | GE115 PSG002 | | 4.4V 4.4V | | |
| 2.0 TDI | 4 | CFHB | 100/134 | 05/12→ | GE115 | | 4.4V | | |
| 2.0 TDI | 4 | CFHD | 105/141 | 09/11→ | GE115 | | 4.4V | | |
| 2.0 TFSI 4WD Quattro | 4 | CDLH | 188/252 | 03/12→ | Z347 | | 0.7 | UXT12 | ZSE033 |

A2

| | | | | | | | | | |
|---------|---|----------|--------|-------------|-------|--------|------|-------------|--------|
| 1.2 TDI | 3 | ANY | 45/60 | 03/01→08/05 | GN046 | | 12V | | |
| 1.4 | 4 | AUA | 55/74 | 02/00→08/05 | Z90 | | 1.0 | UXT1 / UXT3 | ZSE003 |
| 1.4 | 4 | BBY | 55/74 | 02/00→08/05 | Z90 | | 1.0 | UXT1 / UXT3 | ZSE030 |
| 1.4 LPG | 4 | AUA, BBY | 55/74 | 02/00→08/05 | Z340 | | 0.7 | UXT12 | |
| 1.4 TDI | 3 | AMF, BHC | 55/74 | 02/00→08/05 | GN046 | | 12V | | |
| 1.4 TDI | 3 | ATL | 66/89 | 11/03→08/05 | GE100 | GSE100 | 5V | | |
| 1.6 FSI | 4 | BAD | 81/109 | 05/02→08/05 | Z300 | | 1.35 | | ZSE030 |

A3

| | | | | | | | | | |
|----------|---|---------------------------|---------|-------------|-----------------------|--|------------|----------------------|--|
| 1.2 TFSI | 4 | CBZB | 77/103 | 03/10→05/13 | | | | | ZSE003 |
| 1.2 TFSI | 4 | CJZA | 77/103 | 02/13→ | | | | | ZSE067 ^{[42][174]} ZSE126 ^{[43][182]} |
| 1.2 TFSI | 4 | CJZA | 77/103 | 05/13→ | | | | | ZSE067 ^[42] ZSE126 ^[43] |
| 1.2 TSI | 4 | CBZB | 77/103 | 04/10→03/13 | | | | | ZSE003 |
| 1.4 TFSI | 4 | CMBA, CXSA | 90/121 | 04/12→ | | | | | ZSE067 ^{[42][174]} ZSE126 ^{[43][182]} |
| 1.4 TFSI | 4 | CMBA, CXSA | 90/121 | 09/12→ | | | | | ZSE067 ^[42] ZSE126 ^[43] |
| 1.4 TFSI | 4 | CAXC, CMSA | 92/123 | 09/07→03/13 | Z349 | | 0.9 | | ZSE030 |
| 1.4 TFSI | 4 | CAXC | 92/123 | 02/11→05/13 | | | | | ZSE030 →01/12 |
| 1.4 TFSI | 4 | CPTA | 103/138 | 03/13→ | | | | | ZSE067 ^{[1][42][174]} ZSE126 ^{[1][43][182]} |
| 1.4 TFSI | 4 | CPTA | 103/138 | 05/13→ | | | | | ZSE067 ^{[1][42]} ZSE126 ^{[1][43]} |
| 1.4 TFSI | 4 | CPTA | 103/138 | 10/13→ | | | | | ZSE068 |
| 1.6 | 4 | AEH, AKL, APF | 74/99 | 09/96→05/03 | Z90 | | 1.0 | UXT1 / UXT3 | ZSE003 |
| 1.6 | 4 | AVU | 75/101 | 08/00→05/03 | Z188 Z90 | | 0.7 1.0 | UXT10 UXT1 / UXT3 | ZSE003 |
| 1.6 | 4 | BFQ | 75/101 | 08/00→05/03 | Z188 | | 0.7 | UXT10 | ZSE003 |
| 1.6 | 4 | BGU, BSE, BSF, CCSA, CMXA | 75/101 | 05/03→03/13 | Z90 | | 1.0 | UXT1 / UXT3 | ZSE003 |
| 1.6 LPG | 4 | AEH, AKL, APF | 74/99 | 09/96→05/03 | Z340 ^[168] | | 0.7 | UXT12 | |

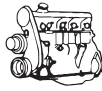

kW/BHP

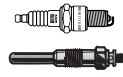

... AUDI



... A3

| | | | | | | | | | | |
|------------------------|---|-------------------------------------|---------|-------------|-------------|-------|------|-------------|---------------------|--------|
| 1.6 LPG | 4 | AVU, BFQ, BGU, BSE, BSF, CCSA, CMXA | 75/101 | 08/00→03/13 | Z340 | | 0.7 | UXT12 | | |
| 1.6 E-Power | 4 | CMXA | 75/101 | 01/11→03/13 | Z90 | | 1.0 | UXT1 / UXT3 | ZSE003 | |
| 1.6 E-Power LPG | 4 | CMXA | 75/101 | 01/11→03/13 | Z340 | | 0.7 | UXT12 | | |
| 1.6 FSI | 4 | BAG, BLF, BLP | 85/114 | 08/03→09/07 | Z300 | | 1.35 | | ZSE030 | |
| 1.6 TDI | 4 | CAYB | 66/89 | 05/09→03/13 | GE115 | | 4.4V | | | |
| 1.6 TDI | 4 | CAYC, CLHA | 77/103 | 05/09→ | GE115 | | 4.4V | | | |
| 1.6 TDI | 4 | CRKB | 81/109 | 09/13→ | GE115 | | 4.4V | | | |
| | | | | | PSG002 [29] | | 4.4V | | | |
| 1.8 | 4 | AGN, APG | 92/123 | 09/96→05/03 | Z90 | | 1.0 | UXT1 / UXT3 | ZSE003 | |
| 1.8 LPG | 4 | AGN, APG | 92/123 | 09/96→05/03 | Z340 | | 0.7 | UXT12 | | |
| 1.8 S3 4WD Quattro | 4 | AMK, AUL | 154/207 | 03/99→04/02 | Z188 | | 0.7 | UXT10 | ZSE009 | |
| | | | | | | | | | →2000 | ZSE043 |
| | | | | | | | | | 2001→ | |
| 1.8 S3 4WD Quattro | 4 | APY | 154/207 | 03/99→04/02 | Z188 | | 0.7 | UXT10 | ZSE009 | |
| | | | | | | | | | →2000 | ZSE043 |
| 1.8 S3 4WD Quattro | 4 | BAM | 165/221 | 10/01→05/03 | Z188 | | 0.7 | UXT10 | ZSE043 | |
| 1.8 S3 4WD LPG Quattro | 4 | AMK, APY, AUL | 154/207 | 03/99→04/02 | Z340 | | 0.7 | UXT12 | | |
| 1.8 S3 4WD LPG Quattro | 4 | BAM | 165/221 | 10/01→05/03 | Z340 | | 0.7 | UXT12 | | |
| 1.8 T | 4 | AGU | 110/148 | 12/96→05/03 | Z188 | | 0.7 | UXT10 | ZS016 | ZLE276 |
| | | | | | →2000 | | | →2000 | →2000 | →07/98 |
| | | | | | Z90 | | 1.0 | UXT1 / UXT3 | ZSE043 | ZM062 |
| | | | | | 2001→ | | | 2001→ | 2001→ | |
| 1.8 T | 4 | AQA, ARZ | 110/148 | 12/96→05/03 | Z188 | | 0.7 | UXT10 | ZSE009 | |
| 1.8 T | 4 | AUM | 110/148 | 12/96→05/03 | Z188 | | 0.7 | UXT10 | ZSE043 | |
| 1.8 T | 4 | AJQ, APP | 132/177 | 12/98→05/03 | Z188 | | 0.7 | UXT10 | ZSE009 | |
| 1.8 T | 4 | ARY, AUQ | 132/177 | 12/98→05/03 | Z188 | | 0.7 | UXT10 | ZSE043 | |
| 1.8 T LPG | 4 | AGU, AQA, ARZ, AUM | 110/148 | 12/96→05/03 | Z340 [168] | | 0.7 | UXT12 | | |
| 1.8 T LPG | 4 | AJQ, APP, ARY, AUQ | 132/177 | 12/98→05/03 | Z340 | | 0.7 | UXT12 | | |
| 1.8 T 4WD Quattro | 4 | AGU | 110/148 | 12/96→05/03 | Z188 | | 0.7 | UXT10 | ZS016 | ZLE276 |
| | | | | | →2000 | | | →2000 | →2000 | →07/98 |
| | | | | | Z90 | | 1.0 | UXT1 / UXT3 | ZSE043 | ZM062 |
| | | | | | 2001→ | | | 2001→ | 2001→ | |
| 1.8 T 4WD Quattro | 4 | AQA | 110/148 | 12/96→05/03 | Z188 | | 0.7 | UXT10 | ZSE009 | |
| | | | | | | | | | →2000 | |
| 1.8 T 4WD Quattro | 4 | ARX | 110/148 | 12/96→05/03 | Z188 | | 0.7 | UXT10 | ZSE043 | |
| 1.8 T 4WD Quattro | 4 | AJQ | 132/177 | 10/98→05/03 | Z188 | | 0.7 | UXT10 | ZSE009 | |
| 1.8 T 4WD Quattro | 4 | ARY | 132/177 | 10/98→05/03 | Z188 | | 0.7 | UXT10 | ZSE043 | |
| 1.8 T 4WD LPG Quattro | 4 | AGU, AQA, ARX | 110/148 | 12/96→05/03 | Z340 | | 0.7 | UXT12 | | |
| 1.8 T 4WD LPG Quattro | 4 | AJQ, ARY | 132/177 | 10/98→05/03 | Z340 [168] | | 0.7 | UXT12 | | |
| 1.8 TFSI | 4 | BYT | 118/158 | 11/06→03/13 | Z347 | | 0.7 | UXT12 | ZSE033 [1] | |
| 1.8 TFSI | 4 | BZB, CDAA | 118/158 | 11/06→05/13 | Z347 | | 0.7 | UXT12 | | |
| 1.8 TFSI | 4 | BZB | 118/158 | 11/06→03/13 | | | | | ZSE033 [1] | |
| 1.8 TFSI | 4 | BZB, CDAA | 118/158 | 04/08→05/13 | | | | | ZSE033 [47] | |
| | | | | | | | | | ZSE142 [48] | |
| 1.8 TFSI | 4 | CDAA | 118/158 | 11/06→03/13 | | | | | ZSE142 [1] | |
| | | | | | | | | | →07/12 | |
| | | | | | | | | | ZSE033 [1][47][182] | |
| 1.8 TFSI | 4 | CJSA, CJSB | 132/177 | 04/12→ | Z348 | | 0.8 | | ZSE068 | |
| 1.8 TFSI 4WD Quattro | 4 | CDAA | 118/158 | 07/08→03/13 | Z347 | | 0.7 | UXT12 | ZSE142 [1] | |
| | | | | | | | | | →07/12 | |
| | | | | | | | | | ZSE033 [1][47][182] | |
| 1.8 TFSI 4WD Quattro | 4 | CDAA | 118/158 | 07/08→08/12 | | | | | ZSE033 [1][47] | |
| | | | | | | | | | ZSE142 [1][48] | |
| 1.8 TFSI 4WD Quattro | 4 | CJSB | 132/177 | 08/12→ | Z348 | | 0.8 | | ZSE068 | |
| 1.9 TDI | 4 | AGR, ALH | 66/89 | 09/96→07/01 | GN855 | GR081 | 12V | | | |



kW/BHP

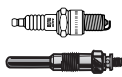

... AUDI



... A3

| | | | | | | | | | |
|---------------------|---|--------------------|---------|-------------|---|--|------|--------------|--|
| 1.9 TDI | 4 | ATD | 74/99 | 10/00→05/03 | GN855 →ch. 8L-2-037 877 GN046 ch. 8L-2-037 878→ | GR081 | 12V | | |
| 1.9 TDI | 4 | AXR | 74/99 | 10/00→05/03 | GN046 ch. 8L-2-037 878→ | GR081 | 12V | | |
| 1.9 TDI | 4 | BKC, BXE | 77/103 | 05/03→05/10 | GE100 | GSE100 →ch. 8P-5A200 000; 8P-5B080 000 | 5V | | |
| 1.9 TDI | 4 | BKC, BXE | 77/103 | 09/04→05/10 | | GSE100 →ch. 8P-5A2000 000; 8P-5B080 000 | | | |
| 1.9 TDI | 4 | BLS | 77/103 | 05/03→05/10 | GE100 | | 5V | | |
| 1.9 TDI | 4 | BLS | 77/103 | 04/08→10/09 | | GSE100 | | | |
| 1.9 TDI | 4 | AHF, ASV | 81/109 | 08/97→07/01 | GN855 | GR081 | 12V | | |
| 1.9 TDI | 4 | ASZ | 96/129 | 08/00→05/03 | GN855 →ch. 8L-2-037 877 GN046 ch. 8L-2-037 878→ | GR081 | 12V | | |
| 1.9 TDI 4WD Quattro | 4 | ASZ | 96/129 | 08/00→05/03 | GN855 →ch. 8L-2-037 877 GN046 ch. 8L-2-037 878→ | GR081 | 12V | | |
| 2.0 FSI | 4 | AXW, BLR, BLX, BVY | 110/148 | 05/03→06/08 | Z236 | | 1.0 | | ZSE033 |
| 2.0 FSI | 4 | BLY, BMB | 110/148 | 05/03→06/08 | Z228 | | 1.0 | UXT11 | ZSE033 |
| 2.0 FSI | 4 | BVZ | 110/148 | 05/03→06/08 | Z228 Z236 2008→ | | 1.0 | UXT11 | ZSE033 |
| 2.0 FSI | 4 | BVZ | 110/148 | 09/04→06/08 | Z228 | | 1.0 | UXT11 | |
| 2.0 FSI LPG | 4 | BLY, BMB, BVZ | 110/148 | 05/03→06/08 | Z221 [168] | | 1.0 | UXT14 | |
| 2.0 S3 4WD Quattro | 4 | BZC | 188/252 | 02/07→08/12 | Z347 | | 0.7 | UXT12 | ZSE033 [1] |
| 2.0 S3 4WD Quattro | 4 | CDLC | 188/252 | 02/07→03/13 | Z347 | | 0.7 | UXT12 | ZSE033 [1][47][182] ZSE142 [1][48][175] |
| 2.0 S3 4WD Quattro | 4 | BHZ, CDLA | 195/261 | 11/06→03/13 | Z347 | | 0.7 | UXT12 | ZSE033 [1][47][182] ZSE142 [1][48][175] |
| 2.0 S3 4WD Quattro | 4 | CJXB | 206/276 | 02/13→ | Z348 | | 0.8 | | ZSE068 |
| 2.0 S3 4WD Quattro | 4 | CJXC | 221/296 | 11/12→ | Z348 | | 0.8 | | ZSE068 |
| 2.0 TDI | 4 | CRFA | 81/109 | 01/13→ | GE115 | | 4.4V | | |
| 2.0 TDI | 4 | AZV | 100/134 | 05/03→03/13 | GE101 | GSE100 | 4.4V | | |
| 2.0 TDI | 4 | CBAA, CFFA, CRBD | 100/134 | 05/03→ | GE115 | | 4.4V | | |
| 2.0 TDI | 4 | CRLC | 100/134 | 10/13→ | GE115 PSG002 [29] | | 4.4V | | |
| 2.0 TDI | 4 | BMM | 103/138 | 06/05→06/08 | CGP002 →ch. 8P-6A138 000; 8P-6B019 000 GE100 [1] ch. 8P-6A138 001; 8P-6B019 001→ | | 7V | | |
| 2.0 TDI | 4 | CBAB, CFFB | 103/138 | 04/08→05/13 | GE115 | | 4.4V | | |
| 2.0 TDI | 4 | CRFC | 105/141 | 09/12→ | GE115 | | 4.4V | | |
| 2.0 TDI | 4 | CRBC | 110/148 | 04/12→ | GE115 | | 4.4V | | |
| 2.0 TDI | 4 | CRLB | 110/148 | 04/12→ | GE115 PSG002 [29] | | 4.4V | | |
| 2.0 TDI | 4 | CRUA | 110/148 | 04/12→ | PSG002 | | 4.4V | | |
| 2.0 TDI | 4 | BUY | 120/161 | 06/06→06/08 | CGP003 | | 7V | | |
| 2.0 TDI | 4 | BMN | 125/168 | 03/06→03/13 | CGP003 | | 7V | | |
| 2.0 TDI | 4 | CBBB, CFGB | 125/168 | 03/06→03/13 | GE115 | | 4.4V | | |
| 2.0 TDI | 4 | CUNA | 135/181 | 05/13→ | GE115 PSG002 [29] | | 4.4V | | |

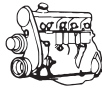

kW/BHP

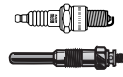

... AUDI



... A3

| | | | | | | | | | |
|-------------------------|---|---------------------------|---------|-------------|------------------------------------|--------|------|-------------|--|
| 2.0 TDI 4WD Quattro | 4 | AZV | 100/134 | 05/03→06/08 | GE101 | GSE100 | 4.4V | | |
| 2.0 TDI 4WD Quattro | 4 | BMM | 103/138 | 01/06→06/08 | CGP002 | | 7V | | |
| | | | | | →ch. 8P-6A138 000; 8P-6B019 000 | | | | |
| | | | | | GE100 [1] | | 5V | | |
| | | | | | ch. 8P-6A138 001; 8P-6B019 001→ | | | | |
| 2.0 TDI 4WD Quattro | 4 | CRBC | 110/148 | 10/12→ | GE115 | | 4.4V | | |
| 2.0 TDI 4WD Quattro | 4 | CRLB | 110/148 | 02/13→ | GE115 | | 4.4V | | |
| | | | | | PSG002 [29] | | 4.4V | | |
| 2.0 TDI 4WD Quattro | 4 | BMN | 125/168 | 03/06→03/13 | CGP003 | | 7V | | |
| 2.0 TDI 4WD Quattro | 4 | CBBB, CFGB | 125/168 | 03/06→03/13 | GE115 | | 4.4V | | |
| 2.0 TDI 4WD Quattro | 4 | CUNA | 135/181 | 12/12→ | GE115 | | 4.4V | | |
| | | | | | PSG002 [29] | | 4.4V | | |
| 2.0 TDI 16V | 4 | BKD | 103/138 | 05/03→03/13 | GE101 | GSE100 | 4.4V | | |
| 2.0 TDI 16V | 4 | CBAB, CFFB, CLJA | 103/138 | 05/03→03/13 | GE115 | | 4.4V | | |
| 2.0 TDI 16V 4WD Quattro | 4 | BKD | 103/138 | 08/04→03/13 | GE101 | GSE100 | 4.4V | | |
| 2.0 TDI 16V 4WD Quattro | 4 | CBAB, CFFB | 103/138 | 08/04→03/13 | GE115 | | 4.4V | | |
| 2.0 TFSI | 4 | AXX, BPY, BWA, CAWB, CCZA | 147/197 | 09/04→05/13 | Z347 | | 0.7 | UXT12 | ZSE033 [1][47][182] ZSE142 [1][48][175] |
| 2.0 TFSI | 4 | CBFA | 147/197 | 09/04→03/13 | | | | | ZSE033 [1][47][182] ZSE142 [1][48][175] |
| 2.0 TFSI 4WD Quattro | 4 | AXX, BWA, CCZA | 147/197 | 09/04→03/13 | Z347 | | 0.7 | UXT12 | ZSE033 [1][47][182] ZSE142 [1][48][175] |
| 2.0 TFSI 4WD Quattro | 4 | AXX, BWA, CCTA, CCZA | 147/197 | 09/04→08/12 | | | | | ZSE033 [1][47] ZSE142 [1][48] |
| 2.0 TFSI 4WD Quattro | 4 | BPY | 147/197 | 09/04→03/13 | Z347 | | 0.7 | UXT12 | ZSE033 [1][47][182] ZSE142 [1][48][175] |
| | | | | | 04/05→09/08 | | | 04/05→09/08 | |
| 2.5 RS3 4WD Quattro | 5 | CEPA | 250/335 | 01/11→12/12 | Z339 | | 0.7 | | ZSE033 |
| 3.2 V6 4WD Quattro | 6 | BDB, BMJ, BUB | 184/247 | 07/03→05/09 | Z306 | | 0.9 | | ZSE044 |

A4

| | | | | | | | | | |
|---------------------|---|--------------------|---------|-------------|------------|--|-----|-------------|-----------------|
| 1.6 | 4 | ADP | 74/99 | 11/94→09/01 | Z90 | | 1.0 | UXT1 / UXT3 | ZSE006 |
| 1.6 | 4 | AHL, ANA, ARM | 74/99 | 11/94→09/01 | Z90 | | 1.0 | UXT1 / UXT3 | |
| | | | | | | | | | ZSE003 |
| 1.6 | 4 | ALZ | 75/101 | 07/00→06/08 | Z90 | | 1.0 | UXT1 / UXT3 | ZSE003 |
| 1.6 LPG | 4 | ADP, AHL, ANA, ARM | 74/99 | 11/94→09/01 | Z340 | | 0.7 | UXT12 | |
| 1.6 LPG | 4 | ALZ | 75/101 | 07/00→11/00 | Z340 [168] | | 0.7 | UXT12 | |
| 1.6 LPG | 4 | ALZ | 75/101 | 07/00→06/08 | Z340 | | 0.7 | UXT12 | |
| 1.8 | 4 | AFY | 85/114 | 04/95→09/01 | Z90 | | 1.0 | UXT1 / UXT3 | ZSE162 |
| 1.8 | 4 | AFY | 85/114 | 04/95→11/00 | | | | | ZLE276 |
| 1.8 | 4 | ADR, APT, ARG, AVV | 92/123 | 01/95→09/01 | Z90 | | 1.0 | UXT1 / UXT3 | |
| 1.8 | 4 | ADR, APT, ARG, AVV | 92/123 | 01/95→11/00 | | | | | ZSE162 |
| 1.8 | 4 | ADR, APT, ARG | 92/123 | 02/96→09/01 | | | | | ZSE162 |
| | | | | | | | | | →07/99 |
| 1.8 | 4 | ADR | 95/127 | 01/95→11/00 | Z90 | | 1.0 | UXT1 / UXT3 | ZSE162 |
| 1.8 | 4 | AMB | 125/168 | 05/00→09/00 | Z188 | | 0.7 | UXT10 | |
| 1.8 LPG | 4 | AFY | 85/114 | 04/95→09/01 | Z340 | | 0.7 | UXT12 | |
| 1.8 LPG | 4 | ADR, APT, ARG, AVV | 92/123 | 01/95→09/01 | Z340 | | 0.7 | UXT12 | |
| 1.8 4WD Quattro | 4 | AFY | 85/114 | 07/95→09/01 | Z90 | | 1.0 | UXT1 / UXT3 | ZSE162 |
| 1.8 4WD Quattro | 4 | AFY | 85/114 | 07/95→11/00 | | | | | ZLE276 |
| 1.8 4WD Quattro | 4 | ADR, APT, ARG | 92/123 | 01/95→09/01 | Z90 | | 1.0 | UXT1 / UXT3 | ZSE162 |
| | | | | | | | | | ZLE276 |
| 1.8 4WD LPG Quattro | 4 | AFY | 85/114 | 07/95→09/01 | Z340 | | 0.7 | UXT12 | |
| 1.8 4WD LPG Quattro | 4 | ADR, APT, ARG | 92/123 | 01/95→09/01 | Z340 | | 0.7 | UXT12 | |
| 1.8 T | 4 | AEB, ARK | 110/148 | 01/95→09/01 | Z188 | | 0.7 | UXT10 | ZS016 |
| | | | | | | | | | ZLE276 ZM062 |

01/97→



kW/BHP

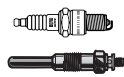

... AUDI



... A4

| | | | | | | | | | | |
|-----------------------|---|------------------------------|---------|-------------|------|--|-----|-------|--|--|
| 1.8 T | 4 | ANB, APU | 110/148 | 01/95→09/01 | Z188 | | 0.7 | UXT10 | | ZLE276 ZM062 01/97→ |
| | | | | | | | | | ZS016 | |
| 1.8 T | 4 | AVJ | 110/148 | 11/00→07/02 | Z188 | | 0.7 | UXT10 | ZSE043 | |
| 1.8 T | 4 | AVJ | 110/148 | 09/01→07/02 | | | | | ZSE043 | ch. 8E-1-000 001→ →ch. 8E-5-400 000 |
| 1.8 T | 4 | AWT | 110/148 | 01/95→09/01 | Z188 | | 0.7 | UXT10 | | ZM062 01/97→ |
| 1.8 T | 4 | AWT | 110/148 | 01/95→11/00 | | | | | ZSE043 06/00→ | |
| 1.8 T | 4 | AWT | 110/148 | 03/96→09/01 | | | | | ZSE043 | |
| 1.8 T | 4 | BFB | 120/161 | 07/02→03/09 | Z188 | | 0.7 | UXT10 | ZSE043 | |
| 1.8 T | 4 | AMB | 125/168 | 07/01→10/05 | Z188 | | 0.7 | UXT10 | | |
| 1.8 T | 4 | AMB | 125/168 | 07/01→12/04 | | | | | ZSE043 | |
| 1.8 T | 4 | AJL | 132/177 | 12/97→09/01 | Z188 | | 0.7 | UXT10 | ZS016 | ZM062 →12/98 |
| 1.8 T | 4 | AJL | 132/177 | 12/97→11/00 | | | | | | ZLE276 ZM062 →12/98 |
| 1.8 T | 4 | BEX | 140/188 | 11/02→12/04 | Z188 | | 0.7 | UXT10 | ZSE043 | |
| 1.8 T LPG | 4 | AEB, ANB, APU, ARK, AVJ, AWT | 110/148 | 01/95→07/02 | Z340 | | 0.7 | UXT12 | | |
| 1.8 T LPG | 4 | BFB | 120/161 | 07/02→03/09 | Z340 | | 0.7 | UXT12 | | |
| 1.8 T LPG | 4 | AJL | 132/177 | 12/97→09/01 | Z340 | | 0.7 | UXT12 | | |
| 1.8 T LPG | 4 | BEX | 140/188 | 11/02→12/04 | Z340 | | 0.7 | UXT12 | | |
| 1.8 T 4WD Quattro | 4 | AEB, ANB, APU | 110/148 | 01/95→09/01 | Z188 | | 0.7 | UXT10 | ZS016 | ZLE276 ZM062 01/97→ |
| 1.8 T 4WD Quattro | 4 | ARK | 110/148 | 01/95→09/01 | Z188 | | 0.7 | UXT10 | | ZLE276 ZM062 01/97→ |
| 1.8 T 4WD Quattro | 4 | ARK, ARX | 110/148 | 01/95→09/01 | | | | | ZS016 | |
| 1.8 T 4WD Quattro | 4 | AVJ | 110/148 | 11/00→07/02 | Z188 | | 0.7 | UXT10 | ZSE043 | |
| 1.8 T 4WD Quattro | 4 | AWT | 110/148 | 01/95→09/01 | Z188 | | 0.7 | UXT10 | | ZM062 01/97→ |
| 1.8 T 4WD Quattro | 4 | BFB | 120/161 | 07/02→03/09 | Z188 | | 0.7 | UXT10 | | |
| 1.8 T 4WD Quattro | 4 | BFB | 120/161 | 07/02→06/08 | | | | | ZSE043 | |
| 1.8 T 4WD Quattro | 4 | BFB | 120/161 | 05/03→03/09 | | | | | ZSE051 | |
| 1.8 T 4WD Quattro | 4 | AMB | 125/168 | 07/01→12/04 | Z188 | | 0.7 | UXT10 | ZSE043 | |
| 1.8 T 4WD Quattro | 4 | AJL | 132/177 | 12/97→09/01 | Z188 | | 0.7 | UXT10 | ZS016 | ZM062 →12/98 |
| 1.8 T 4WD Quattro | 4 | AJL | 132/177 | 12/97→11/00 | | | | | | ZLE276 ZM062 →12/98 |
| 1.8 T 4WD Quattro | 4 | BEX | 140/188 | 11/02→12/04 | Z188 | | 0.7 | UXT10 | ZSE043 | |
| 1.8 T 4WD LPG Quattro | 4 | AEB, ANB, APU, ARK, AVJ, AWT | 110/148 | 01/95→07/02 | Z340 | | 0.7 | UXT12 | | |
| 1.8 T 4WD LPG Quattro | 4 | BFB | 120/161 | 07/02→03/09 | Z340 | | 0.7 | UXT12 | | |
| 1.8 T 4WD LPG Quattro | 4 | AJL | 132/177 | 12/97→09/01 | Z340 | | 0.7 | UXT12 | | |
| 1.8 T 4WD LPG Quattro | 4 | BEX | 140/188 | 11/02→12/04 | Z340 | | 0.7 | UXT12 | | |
| 1.8 TFSI | 4 | CABA, CDHA | 88/118 | 01/08→ | Z347 | | 0.7 | UXT12 | ZSE033 (1)(X47)(182) ZSE142 (1)(X48)(175) | |
| 1.8 TFSI | 4 | CABB, CDHB | 118/158 | 11/07→ | Z347 | | 0.7 | UXT12 | ZSE033 (1)(X47)(182) ZSE142 (1)(X48)(175) | |
| 1.8 TFSI | 4 | CJEB | 125/168 | 11/11→ | Z348 | | 0.8 | | ZSE068 ZSE137 | |
| 1.8 TFSI 4WD Quattro | 4 | CDHB | 118/158 | 09/08→ | Z347 | | 0.7 | UXT12 | ZSE033 (1)(X47)(182) ZSE142 (1)(X48)(175) | |

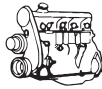

kW/BHP

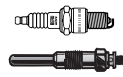

... AUDI



... A4

| | | | | | | | | | |
|----------------------|---|------------------------|---------|-------------|-----------------------------|-------------------|------|-------|------------------|
| 1.8 TFSI 4WD Quattro | 4 | CJEB | 125/168 | 11/11→ | Z348 | | 0.8 | | ZSE068 ZSE137 |
| 1.9 DUO | 4 | AHU | 66/89 | 03/98→09/01 | GN855 | | 12V | | |
| 1.9 TDI | 4 | AFF | 55/74 | 12/95→09/01 | GN855 | | 12V | | |
| 1.9 TDI | 4 | 1Z, AHH, AHU | 66/89 | 01/95→09/01 | GN855 | | 12V | | |
| 1.9 TDI | 4 | AVB | 74/99 | 05/01→12/04 | GN855 | | 12V | | |
| 1.9 TDI | 4 | AFN, AVG | 81/109 | 10/95→09/01 | GN855 | | 12V | | |
| 1.9 TDI | 4 | AJM | 85/114 | 03/00→09/01 | GN855 | | 12V | | |
| 1.9 TDI | 4 | BKE | 85/114 | 06/04→06/08 | GE100 | GSE100 | 5V | | |
| | | | | | ch. 8E-5-070 251→ | ch. 8E-5-070-251→ | | | |
| 1.9 TDI | 4 | BRB | 85/114 | 11/04→06/08 | CGP002 | | 7V | | |
| | | | | | ch. 8E-5-400 001→ | | | | |
| 1.9 TDI | 4 | AVF, AWX | 96/129 | 11/00→12/04 | GN855 | | 12V | | |
| | | | | | →ch. 8E-2-148 697 | | | | |
| | | | | | GN046 | | 12V | | |
| | | | | | ch. 8E-2-148 698→ | | | | |
| 1.9 TDI 4WD Quattro | 4 | AFN, AVG | 81/109 | 09/96→09/01 | GN855 | | 12V | | |
| 1.9 TDI 4WD Quattro | 4 | AJM, ATJ | 85/114 | 03/00→09/01 | GN855 | | 12V | | |
| 1.9 TDI 4WD Quattro | 4 | AVF | 96/129 | 11/01→12/04 | GN855 | | 12V | | |
| | | | | | →ch. 8E-2-148 697 | | | | |
| | | | | | GN046 | | 12V | | |
| | | | | | ch. 8E-2-148 698→ | | | | |
| 2.0 | 4 | ALT | 96/129 | 11/00→06/08 | Z121 | | 1.0 | UXT9 | |
| 2.0 | 4 | ALT | 96/129 | 11/00→12/05 | | | | | ZSE051 |
| 2.0 | 4 | ALT | 96/129 | 11/04→06/08 | | | | | ZSE043 |
| 2.0 LPG | 4 | ALT | 96/129 | 11/00→06/08 | Z206 | | 0.7 | UXT10 | |
| 2.0 FSI | 4 | AWA | 110/148 | 07/02→12/04 | Z236 | | 1.0 | | ZSE032 |
| | | | | | ch. 8E-1-000 001→ | | | | |
| | | | | | →ch. 8E-5-400 000 | | | | |
| 2.0 TDI | 4 | CAGC, CJCC | 88/118 | 06/08→ | GE115 | | 4.4V | | |
| 2.0 TDI | 4 | BVG | 89/119 | 09/05→09/06 | CGP003 | | 7V | | |
| 2.0 TDI | 4 | BVF | 93/125 | 11/05→11/06 | CGP003 | | 7V | | |
| 2.0 TDI | 4 | BNA | 100/134 | 11/04→06/08 | GE101 | GSE100 | 4.4V | | |
| | | | | | ch. 8E-5-400 001→ | | | | |
| 2.0 TDI | 4 | BRC | 100/134 | 01/06→03/09 | CGP002 | | 7V | | |
| 2.0 TDI | 4 | BRF | 100/134 | 11/04→06/08 | CGP003 | | 7V | | |
| | | | | | ch. 8E-5-400 001→ | | | | |
| 2.0 TDI | 4 | CAGB, CJCB | 100/134 | 11/07→ | GE115 | | 4.4V | | |
| 2.0 TDI | 4 | BPW | 103/138 | 11/04→03/09 | CGP002 | | 7V | | |
| 2.0 TDI | 4 | CAGA, CJCA, CMEA, CMFA | 105/141 | 11/07→ | GE115 | | 4.4V | | |
| 2.0 TDI | 4 | CJCD, CMFB | 110/148 | 05/13→ | GE115 ^[228] | | 4.4V | | |
| | | | | | PSG002 ^{[29][228]} | | 4.4V | | |
| 2.0 TDI | 4 | BVA | 120/161 | 06/06→06/08 | CGP003 | | 7V | | |
| 2.0 TDI | 4 | CAHB, CGLD | 120/161 | 08/08→ | GE115 | | 4.4V | | |
| 2.0 TDI | 4 | BRD | 125/168 | 06/06→06/08 | CGP003 | | 7V | | |
| 2.0 TDI | 4 | CAHA | 125/168 | 01/08→ | GE115 | | 4.4V | | |
| 2.0 TDI | 4 | CGLC, CMGB | 130/174 | 11/11→ | GE115 | | 4.4V | | |
| 2.0 TDI | 4 | CNHA | 140/188 | 09/13→ | GE115 ^[228] | | 4.4V | | |
| | | | | | PSG002 ^{[29][228]} | | 4.4V | | |
| 2.0 TDI 4WD Quattro | 4 | BPW | 103/138 | 01/06→06/08 | CGP002 | | 7V | | |
| 2.0 TDI 4WD Quattro | 4 | CAGA, CJCA | 105/141 | 04/08→ | GE115 | | 4.4V | | |
| 2.0 TDI 4WD Quattro | 4 | CJCD | 110/148 | 05/13→ | GE115 ^[228] | | 4.4V | | |
| | | | | | PSG002 ^{[29][228]} | | 4.4V | | |
| 2.0 TDI 4WD Quattro | 4 | BVA | 120/161 | 06/06→06/08 | CGP003 | | 7V | | |
| 2.0 TDI 4WD Quattro | 4 | BRD | 125/168 | 06/06→06/08 | CGP003 | | 7V | | |
| 2.0 TDI 4WD Quattro | 4 | CAHA | 125/168 | 01/08→ | GE115 | | 4.4V | | |
| 2.0 TDI 4WD Quattro | 4 | CGLC | 130/174 | 11/11→ | GE115 | | 4.4V | | |
| 2.0 TDI 4WD Quattro | 4 | CNHA | 140/188 | 09/13→ | GE115 ^[228] | | 4.4V | | |
| | | | | | PSG002 ^{[29][228]} | | 4.4V | | |



kW/BHP



... AUDI



... A4

| | | | | | | | | | |
|------------------------------------|---|-------------------------|---------|-------------|--|--------|------|-------------|--|
| 2.0 TDI 16V | 4 | BLB | 103/138 | 11/04→06/08 | GE101 <small>ch. 8E-5-400 001→</small> | GSE100 | 4.4V | | |
| 2.0 TDI 16V | 4 | BRE | 103/138 | 11/04→06/08 | CGP003 <small>ch. 8E-5-400 001→</small> | | 7V | | |
| 2.0 TFSI | 4 | BPJ | 125/168 | 10/06→06/08 | Z347 | | 0.7 | UXT12 | ZSE142 |
| 2.0 TFSI | 4 | BYK | 125/168 | 10/06→06/08 | | | | | ZSE142 |
| 2.0 TFSI | 4 | CAEA, CONB, CFKA | 132/177 | 06/08→ | Z347 | | 0.7 | UXT12 | ZSE033 (1)(47)(182) ZSE142 (1)(48)(175) |
| 2.0 TFSI | 4 | BGB, BWE | 147/197 | 11/04→06/08 | Z347 | | 0.7 | UXT12 | ZSE033 |
| 2.0 TFSI | 4 | BPG, BWT | 147/197 | 11/04→06/08 | | | | | ZSE033 |
| 2.0 TFSI | 4 | CAEB | 155/208 | 06/08→ | | | | | ZSE033 (1)(47)(182) ZSE142 (1)(48)(175) |
| 2.0 TFSI | 4 | CDNC | 155/208 | 06/08→ | Z347 | | 0.7 | UXT12 | ZSE033 (1)(47)(182) ZSE142 (1)(48)(175) |
| 2.0 TFSI | 4 | BUL | 162/217 | 06/05→06/08 | Z347 | | 0.7 | UXT12 | ZSE033 (1) |
| 2.0 TFSI | 4 | CAED | 162/217 | 05/13→ | Z347 | | 0.7 | UXT12 | ZSE033 |
| 2.0 TFSI | 4 | CNCD | 165/221 | 05/13→ | Z348 | | 0.8 | | ZSE068 |
| 2.0 TFSI 4WD Quattro | 4 | BGB, BWE | 147/197 | 11/04→06/08 | Z347 | | 0.7 | UXT12 | ZSE033 |
| 2.0 TFSI 4WD Quattro | 4 | BPG, BWT | 147/197 | 11/04→03/09 | | | | | ZSE033 |
| 2.0 TFSI 4WD Quattro | 4 | CAEB, CDNC | 155/208 | 06/08→ | Z347 | | 0.7 | UXT12 | ZSE033 (1)(47)(182) ZSE142 (1)(48)(175) |
| 2.0 TFSI 4WD Quattro | 4 | CPMA | 155/208 | 06/08→ | Z347 | | 0.7 | UXT12 | |
| 2.0 TFSI 4WD Quattro | 4 | BUL | 162/217 | 06/05→06/08 | Z347 | | 0.7 | UXT12 | ZSE033 |
| 2.0 TFSI 4WD Quattro | 4 | CAED, CPMB | 162/217 | 05/13→ | Z347 | | 0.7 | UXT12 | ZSE033 (1) |
| 2.0 TFSI 4WD Quattro | 4 | CNCD | 165/221 | 05/13→ | Z348 | | 0.8 | | ZSE068 |
| 2.0 TFSI 16V | 4 | BWE | 147/197 | 01/06→03/09 | Z347 | | 0.7 | UXT12 | ZSE033 (47) ZSE142 (48) |
| 2.0 TFSI 16V | 4 | BWT | 147/197 | 01/06→03/09 | | | | | ZSE033 (47) ZSE142 (48) |
| 2.0 TFSI flexible fuel | 4 | CFKA | 132/177 | 11/09→ | Z347 | | 0.7 | UXT12 | ZSE033 (1)(47)(182) ZSE142 (1)(48)(175) |
| 2.0 TFSI flexible fuel 4WD Quattro | 4 | CFKA | 132/177 | 11/09→ | Z347 | | 0.7 | UXT12 | ZSE033 (1)(47)(182) ZSE142 (1)(48)(175) |
| 2.4 | 6 | AFM | 110/148 | 07/95→07/97 | Z90 | | 1.0 | UXT1 / UXT3 | |
| 2.4 | 6 | AJG, AMM, APZ | 120/161 | 08/97→12/05 | Z145 | | 1.6 | | ZSE154 |
| 2.4 | 6 | AGA, ALF, AML, APS, ARJ | 121/162 | 03/97→09/01 | Z145 | | 1.6 | | ZSE154 |
| 2.4 | 6 | BDV | 125/168 | 09/01→12/05 | Z145 | | 1.6 | | ZSE154 |
| 2.4 4WD Quattro | 6 | APZ | 120/161 | 08/97→09/01 | Z145 | | 1.6 | | ZSE154 |
| 2.4 4WD Quattro | 6 | AGA, ALF, AML, APS, ARJ | 121/162 | 03/97→09/01 | Z145 | | 1.6 | | ZSE154 |
| 2.5 TDI | 6 | AFB, AKN | 110/148 | 09/97→09/01 | GN008 | | 12V | | |
| 2.5 TDI | 6 | AYM | 114/153 | 08/01→07/02 | GN008 | | 12V | | |
| 2.5 TDI | 6 | BCZ, BDG, BFC | 120/161 | 07/02→05/06 | GN008 | | 12V | | |
| 2.5 TDI | 6 | AKE | 132/177 | 10/00→05/03 | GN008 | | 12V | | |
| 2.5 TDI 4WD Quattro | 6 | AFB, AKN | 110/148 | 09/97→09/01 | GN008 | | 12V | | |
| 2.5 TDI 4WD Quattro | 6 | AKE, BAU, BDH | 132/177 | 11/00→12/04 | GN008 | | 12V | | |
| 2.6 | 6 | ACZ | 102/137 | 01/96→07/97 | Z90 | | 1.0 | UXT1 / UXT3 | ZSE008 |
| 2.6 | 6 | ABC | 110/148 | 01/95→09/01 | Z90 | | 1.0 | UXT1 / UXT3 | ZSE008 |
| | | | | | | | | | ZM027 (188) ZM063 (175) |
| 2.6 LPG | 6 | ABC | 110/148 | 01/95→09/01 | Z340 | | 0.7 | UXT12 | |
| 2.6 4WD Quattro | 6 | ABC | 110/148 | 01/95→09/01 | Z90 | | 1.0 | UXT1 / UXT3 | ZSE008 |
| | | | | | | | | | ZM027 (188) ZM063 (175) |
| 2.6 4WD LPG Quattro | 6 | ABC | 110/148 | 01/95→09/01 | Z340 | | 0.7 | UXT12 | |
| 2.7 Bi Turbo 4WD Quattro | 6 | APB | 187/251 | 08/98→12/98 | | | | | ZSE154 |
| 2.7 RS4 4WD Quattro | 6 | ASJ, AZR | 280/375 | 05/00→09/01 | Z317 | | 0.85 | UXT12 | ZS016 |
| 2.7 S4 4WD Quattro | 6 | AGB, AZB | 195/261 | 09/97→09/01 | Z188 | | 0.7 | UXT10 | ZS016 |
| 2.7 S4 4WD LPG Quattro | 6 | AGB, AZB | 195/261 | 09/97→09/01 | Z340 | | 0.7 | UXT12 | ZLE276 |
| 2.7 TDi | 6 | BSG, CAMB, CGKB | 120/161 | 11/05→ | GE115 | | 4.4V | | |
| 2.7 TDI | 6 | PPP | 132/177 | 01/06→03/09 | GE115 | | 4.4V | | |
| 2.7 TDI | 6 | CAMA, CGKA | 140/188 | 11/07→ | GE115 | | 4.4V | | |

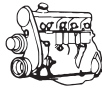

kW/BHP

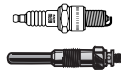

... AUDI



... A4

| | | | | | | | | | | |
|-----------------------|---|-------------------------|---------|-------------|-----------------------------|--|------|-------------|--------|--|
| 2.7 Turbo 4WD Quattro | 6 | AJK | 169/227 | 02/99→09/00 | | | | ZSE154 | | |
| 2.8 | 6 | AAH | 128/172 | 09/95→07/97 | Z90 | | 1.0 | UXT1 / UXT3 | ZSE008 | ZM027 ^[188] ZM063 ^[175] |
| 2.8 | 6 | ATX | 140/188 | 03/99→09/00 | Z145 | | 1.6 | | ZSE154 | |
| 2.8 | 6 | ACK, ALG, AMX, APR, AQD | 142/190 | 10/96→09/01 | Z145 | | 1.6 | | ZSE154 | |
| 2.8 | 6 | AHA | 142/190 | 10/96→07/99 | | | | | ZSE154 | |
| 2.8 LPG | 6 | AAH | 128/172 | 09/95→07/97 | Z340 | | 0.7 | UXT12 | | |
| 2.8 4WD Quattro | 6 | AAH | 128/172 | 01/95→07/97 | Z90 | | 1.0 | UXT1 / UXT3 | ZSE008 | ZM027 ^[188] ZM063 ^[175] |
| 2.8 4WD Quattro | 6 | ATX | 140/188 | 03/99→09/00 | Z145 | | 1.6 | | | |
| 2.8 4WD Quattro | 6 | ACK, ALG, AMX, AQD | 142/190 | 10/96→09/01 | Z145 | | 1.6 | | ZSE154 | |
| 2.8 4WD Quattro | 6 | APR | 142/190 | 10/96→09/01 | Z145 | | 1.6 | | | |
| 2.8 4WD Quattro | 6 | APR, ARP | 142/190 | 10/96→09/01 | | | | | ZSE154 | |
| 2.8 4WD LPG Quattro | 6 | AAH | 128/172 | 01/95→07/97 | Z340 | | 0.7 | UXT12 | | |
| 3.0 | 6 | BBJ | 160/215 | 04/01→05/06 | Z145 | | 1.6 | | ZSE051 | |
| 3.0 | 6 | ASN | 162/217 | 11/00→12/05 | Z145 | | 1.6 | | ZSE051 | |
| 3.0 | 6 | AVK | 162/217 | 11/00→12/04 | | | | | ZSE051 | |
| 3.0 4WD Quattro | 6 | BBJ | 160/215 | 04/01→07/06 | Z145 | | 1.6 | | ZSE051 | |
| 3.0 4WD Quattro | 6 | ASN | 162/217 | 11/00→12/05 | Z145 | | 1.6 | | ZSE051 | |
| 3.0 4WD Quattro | 6 | AVK | 162/217 | 11/00→12/04 | | | | | ZSE051 | |
| 3.0 S4 4WD Quattro | 6 | CAKA | 245/329 | 11/08→ | Z347 | | 0.7 | UXT12 | ZSE032 | |
| | | | | | 03/09→09/12 Z347 | | 0.7 | UXT12 | | |
| 3.0 S4 4WD Quattro | 6 | CCBA | 245/329 | 11/08→ | Z347 | | 0.7 | UXT12 | ZSE032 | |
| 3.0 S4 4WD Quattro | 6 | CGWC, CGXC, CTUB | 245/329 | 11/08→ | | | | | ZSE032 | |
| 3.0 TDI | 6 | CLAB | 150/201 | 11/11→ | GE115 | | 4.4V | | | |
| 3.0 TDI 4WD Quattro | 6 | BKN | 150/201 | 11/04→03/09 | GE115 | | 4.4V | | | |
| 3.0 TDI 4WD Quattro | 6 | CCWB | 155/208 | 06/08→ | GE115 | | 4.4V | | | |
| 3.0 TDI 4WD Quattro | 6 | ASB | 171/229 | 01/06→03/09 | GE115 | | 4.4V | | | |
| 3.0 TDI 4WD Quattro | 6 | CAPA, CCWA | 176/236 | 11/07→ | GE115 | | 4.4V | | | |
| 3.0 TDI 4WD Quattro | 6 | CCLA | 176/236 | 11/07→ | GE115 | | 4.4V | | | |
| | | | | | PSG002 ^[28] | | 4.4V | | | |
| 3.0 TDI 4WD Quattro | 6 | CDUC | 180/241 | 11/11→ | GE115 | | 4.4V | | | |
| 3.0 TDI 4WD Quattro | 6 | CKVB, CKVC | 180/241 | 11/11→ | GE115 | | 4.4V | | | |
| | | | | | PSG002 ^[25] | | 4.4V | | | |
| 3.0 TFSI 4WD Quattro | 6 | CMUA | 200/268 | 02/12→ | | | | | ZSE032 | |
| 3.2 FSI | 6 | AUK | 188/252 | 01/05→03/09 | Z295 | | 0.8 | | ZSE032 | |
| 3.2 FSI | 6 | CALA | 195/261 | 09/08→ | Z321 | | 1.0 | UXT9 | ZSE032 | |
| 3.2 FSI 4WD Quattro | 6 | AUK | 188/252 | 01/05→03/09 | Z295 | | 0.8 | | ZSE032 | |
| 3.2 FSI 4WD Quattro | 6 | BKH | 188/252 | 01/05→06/08 | | | | | ZSE032 | |
| 3.2 FSI 4WD Quattro | 6 | CALA | 195/261 | 11/07→ | Z321 | | 1.0 | UXT9 | ZSE032 | |
| 4.2 RS4 4WD Quattro | 8 | BNS | 309/414 | 09/05→06/08 | Z295 | | 0.8 | | | |
| | | | | | Z347 | | 0.7 | UXT12 | | |
| 4.2 RS4 4WD Quattro | 8 | BNS | 309/414 | 09/05→03/09 | | | | | ZSE142 | |
| 4.2 RS4 4WD Quattro | 8 | BNS | 309/414 | 06/06→03/09 | Z347 | | 0.7 | UXT12 | | |
| 4.2 RS4 4WD Quattro | 8 | CFSA | 331/444 | 05/12→ | Z347 | | 0.7 | UXT12 | ZSE033 | |
| 4.2 S4 4WD Quattro | 8 | BBK | 253/339 | 03/03→03/09 | Z239 | | 1.6 | | ZSE061 | |
| 4.2 S4 4WD Quattro | 8 | BHF | 253/339 | 11/04→06/08 | Z239 | | 1.6 | | | |
| A4 Allroad | | | | | | | | | | |
| 2.0 TDI 4WD Quattro | 4 | CAGB, CJC | 100/134 | 09/09→ | GE115 ^[233] | | 4.4V | | | |
| 2.0 TDI 4WD Quattro | 4 | CAGA, CICA | 105/141 | 09/09→ | GE115 ^[233] | | 4.4V | | | |
| 2.0 TDI 4WD Quattro | 4 | CJCD | 110/148 | 05/13→ | GE115 ^[228] | | 4.4V | | | |
| | | | | | PSG002 ^{[25][228]} | | 4.4V | | | |
| 2.0 TDI 4WD Quattro | 4 | CAHB, CGLD | 120/161 | 04/09→ | GE115 ^[233] | | 4.4V | | | |
| 2.0 TDI 4WD Quattro | 4 | CAHA | 125/168 | 04/09→ | GE115 ^[233] | | 4.4V | | | |
| 2.0 TDI 4WD Quattro | 4 | CGLC | 130/174 | 11/11→ | GE115 ^[233] | | 4.4V | | | |
| 2.0 TDI 4WD Quattro | 4 | CNHA | 140/188 | 09/13→ | GE115 ^[228] | | 4.4V | | | |
| | | | | | PSG002 ^{[25][228]} | | 4.4V | | | |

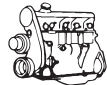

kW/BHP

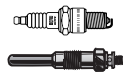

... AUDI



... A4 Allroad

| | | | | | | | | |
|----------------------|---|------------|---------|--------|----------------------------------|--------------|-------|--|
| 2.0 TFSI 4WD Quattro | 4 | CDNC, CPMA | 155/208 | 04/09→ | Z347 | 0.7 | UXT12 | ZSE033 (1) [47] [182] ZSE142 (1) [48] [175] |
| 2.0 TFSI 4WD Quattro | 4 | CPMB | 162/217 | 05/13→ | Z347 | 0.7 | UXT12 | ZSE033 (1) [47] [182] ZSE142 (1) [48] [175] |
| 2.0 TFSI 4WD Quattro | 4 | CNCD | 165/221 | 05/13→ | Z348 | 0.8 | | ZSE068 |
| 3.0 TDI 4WD Quattro | 6 | CCWA | 176/236 | 04/09→ | GE115 [230] | 4.4V | | |
| 3.0 TDI 4WD Quattro | 6 | CDUC | 180/241 | 01/12→ | GE115 [230] | 4.4V | | |
| 3.0 TDI 4WD Quattro | 6 | CKVB, CKVC | 180/241 | 01/12→ | GE115 [232] PSG002 [25] [232] | 4.4V 4.4V | | |

A5

| | | | | | | | | |
|----------------------|---|------------------------------|---------|--------|----------------------------------|--------------|-----------------|--|
| 1.8 TFSI | 4 | CDHB | 118/158 | 05/09→ | Z347 | 0.7 | UXT12 | ZSE033 (1) [47] [182] ZSE142 (1) [48] [175] |
| 1.8 TFSI | 4 | CABD | 125/168 | 10/07→ | Z347 | 0.7 | UXT12 | ZSE033 (1) [47] [182] ZSE142 (1) [48] [175] |
| 1.8 TFSI | 4 | CJEB | 125/168 | 10/07→ | Z348 | 0.8 | | |
| 1.8 TFSI | 4 | CJEB | 125/168 | 08/11→ | Z348 [1] | 0.8 | | |
| 1.8 TFSI | 4 | CJEB | 125/168 | 10/11→ | | | | ZSE137 [1] |
| 2.0 TDI | 4 | CAGB, CJCB | 100/134 | 09/09→ | GE115 [233] | 4.4V | | |
| 2.0 TDI | 4 | CAGA, CJCA, CMEA, CMFA | 105/141 | 09/09→ | GE115 [233] | 4.4V | | |
| 2.0 TDI | 4 | CJCD | 110/148 | 05/13→ | GE115 [228] PSG002 [25] [228] | 4.4V 4.4V | | |
| 2.0 TDI | 4 | CAHB, CGLD | 120/161 | 08/08→ | GE115 [233] | 4.4V | | |
| 2.0 TDI | 4 | CAHA | 125/168 | 08/08→ | GE115 | 4.4V | | |
| 2.0 TDI | 4 | CGLC | 130/174 | 10/11→ | GE115 [233] | 4.4V | | |
| 2.0 TDI | 4 | CNHA | 140/188 | 09/13→ | GE115 [228] PSG002 [25] [228] | 4.4V 4.4V | | |
| 2.0 TDI 4WD Quattro | 4 | CAHA | 125/168 | 08/08→ | GE115 | 4.4V | | |
| 2.0 TDI 4WD Quattro | 4 | CGLC | 130/174 | 12/11→ | GE115 [233] | 4.4V | | |
| 2.0 TDI 4WD Quattro | 4 | CNHA | 140/188 | 09/13→ | GE115 [228] PSG002 [25] [228] | 4.4V 4.4V | | |
| 2.0 TFSI | 4 | CAEA | 132/177 | 03/09→ | Z347 | 0.7 | UXT12 | ZSE033 (1) [47] [182] ZSE142 (1) [48] [175] |
| 2.0 TFSI | 4 | CDNB | 132/177 | 11/08→ | Z347 | 0.7 | UXT12 | ZSE033 [47] ZSE142 [48] |
| 2.0 TFSI | 4 | CDNB | 132/177 | 03/09→ | | | | ZSE033 (1) [47] [182] ZSE142 (1) [48] [175] |
| 2.0 TFSI | 4 | CAEB | 155/208 | 03/09→ | Z347 | 0.7 | UXT12 | ZSE033 (1) [47] [182] ZSE142 (1) [48] [175] |
| 2.0 TFSI | 4 | CDNC | 155/208 | 06/08→ | Z347 | 0.7 | UXT12 | ZSE033 [47] ZSE142 [48] |
| 2.0 TFSI | 4 | CDNC | 155/208 | 03/09→ | | | | ZSE033 (1) [47] [182] ZSE142 (1) [48] [175] |
| 2.0 TFSI | 4 | CNCD | 165/221 | 05/13→ | Z348 | 0.8 | | ZSE068 |
| 2.0 TFSI 4WD Quattro | 4 | CAEB, CDNC | 155/208 | 06/08→ | Z347 | 0.7 | UXT12 | ZSE033 (1) [47] [182] ZSE142 (1) [48] [175] |
| 2.0 TFSI 4WD Quattro | 4 | CDNC | 155/208 | 09/09→ | | | | ZSE033 [47] ZSE142 [48] |
| 2.0 TFSI 4WD Quattro | 4 | CNCD | 165/221 | 05/13→ | Z348 | 0.8 | | ZSE068 |
| 2.7 TDI | 6 | CAMB, CGKB | 120/161 | 09/07→ | GE115 | 4.4V | | |
| 2.7 TDI | 6 | CAMA, CGKA | 140/188 | 06/07→ | GE115 | 4.4V | | |
| 3.0 S5 4WD Quattro | 6 | CAKA, CCBA | 245/329 | 06/09→ | Z321 →2011 | 1.0 | UXT9 →2011 | ZSE032 |
| 3.0 S5 4WD Quattro | 6 | CAKA | 245/329 | 01/10→ | Z347 →03/12 | 0.7 | UXT12 →03/12 | |
| 3.0 S5 4WD Quattro | 6 | CGWC, CGXC, CREC, CTDA, CTUB | 245/329 | 06/09→ | | | | ZSE032 |
| 3.0 TDI | 6 | CLAB | 150/201 | 10/11→ | GE115 [230] | 4.4V | | |
| 3.0 TDI 4WD Quattro | 6 | CCWB | 155/208 | 03/08→ | GE115 | 4.4V | | |
| 3.0 TDI 4WD Quattro | 6 | CAPA, CCWA | 176/236 | 06/07→ | GE115 | 4.4V | | |
| 3.0 TDI 4WD Quattro | 6 | CDUC | 180/241 | 10/11→ | GE115 [230] | 4.4V | | |

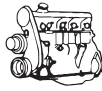

kW/BHP

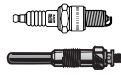

... AUDI



... A5

| | | | | | | | | |
|----------------------|---|------|---------|--------|---------------------------------|--------------|--------|--------|
| 3.0 TDI 4WD Quattro | 6 | CKVB | 180/241 | 10/11→ | GE115 [232] PSG002 [25][232] | 4.4V 4.4V | | |
| 3.0 TFSI 4WD Quattro | 6 | CMUA | 200/268 | 11/11→ | | | ZSE032 | |
| 3.2 FSI | 6 | CALA | 195/261 | 06/07→ | Z321 | 1.0 | UXT9 | ZSE032 |
| 3.2 FSI 4WD Quattro | 6 | CALA | 195/261 | 06/07→ | Z321 | 1.0 | UXT9 | ZSE032 |
| 4.2 RS 5 4WD Quattro | 8 | CFSA | 331/444 | 03/10→ | Z347 | 0.7 | UXT12 | ZSE033 |
| 4.2 S5 4WD Quattro | 8 | CAUA | 260/349 | 06/07→ | Z295 | 0.8 | | ZSE033 |

A6

| | | | | | | | | | |
|---------------------|---|-------------------------|---------|-------------|------|-----|-------------|--------------------------------|---------------------------|
| 1.8 | 4 | AFY | 85/114 | 05/97→01/05 | Z90 | 1.0 | UXT1 / UXT3 | ZSE162 →12/00 | |
| 1.8 | 4 | ADR | 92/123 | 12/95→12/97 | Z90 | 1.0 | UXT1 / UXT3 | ZSE162 | |
| 1.8 | 4 | ADR | 92/123 | 12/95→10/97 | | | | | ZLE276 |
| 1.8 | 4 | AJP | 92/123 | 07/97→01/05 | Z90 | 1.0 | UXT1 / UXT3 | ZSE009 12/97→07/99 | |
| 1.8 | 4 | AJP | 92/123 | 12/97→01/05 | | | | ZSE009 →07/99 | |
| 1.8 | 4 | AQE, ARH | 92/123 | 07/97→01/05 | Z90 | 1.0 | UXT1 / UXT3 | ZSE009 01/99→04/01 | |
| 1.8 LPG | 4 | AFY | 85/114 | 05/97→01/05 | Z340 | 0.7 | UXT12 | | |
| 1.8 LPG | 4 | ADR, AJP, AQE, ARH | 92/123 | 12/95→01/05 | Z340 | 0.7 | UXT12 | | |
| 1.8 4WD Quattro | 4 | ADR | 92/123 | 12/95→12/97 | Z90 | 1.0 | UXT1 / UXT3 | ZSE162 | |
| 1.8 4WD LPG Quattro | 4 | ADR | 92/123 | 12/95→12/97 | Z340 | 0.7 | UXT12 | | |
| 1.8 T | 4 | AEB, ANB | 110/148 | 01/97→01/05 | Z188 | 0.7 | UXT10 | ZS016 →04/01 | ZLE276 ZM062 08/98→ |
| 1.8 T | 4 | AEB, ANB, ARK | 110/148 | 12/97→01/05 | | | | ZS016 | |
| 1.8 T | 4 | APU | 110/148 | 01/97→01/05 | Z188 | 0.7 | UXT10 | ZSE162 11/98→04/01 | ZLE276 ZM062 08/98→ |
| 1.8 T | 4 | APU | 110/148 | 12/97→01/05 | | | | ZSE162 11/98→05/01 ZS016 | |
| 1.8 T | 4 | ARK | 110/148 | 01/97→01/05 | Z188 | 0.7 | UXT10 | | ZLE276 ZM062 08/98→ |
| 1.8 T | 4 | APU, ARK | 110/148 | 01/97→01/05 | | | | ZS016 →04/01 | |
| 1.8 T | 4 | AWL | 110/148 | 01/97→01/05 | | | | | ZM062 08/98→ |
| 1.8 T | 4 | AWT | 110/148 | 01/97→01/05 | Z188 | 0.7 | UXT10 | ZSE043 06/00→ | ZM062 08/98→ |
| 1.8 T | 4 | AJL | 132/177 | 12/97→01/05 | Z188 | 0.7 | UXT10 | ZS016 | ZLE276 ZM062 08/98→ |
| 1.8 T | 4 | AJL | 132/177 | 04/99→01/05 | | | | | ZLE276 ZM062 |
| 1.8 T LPG | 4 | AEB, ANB, APU, ARK, AWT | 110/148 | 01/97→01/05 | Z340 | 0.7 | UXT12 | | |
| 1.8 T LPG | 4 | AJL | 132/177 | 12/97→01/05 | Z340 | 0.7 | UXT12 | | |
| 1.8 T 4WD Quattro | 4 | AEB, ANB, ARK | 110/148 | 02/97→01/05 | Z188 | 0.7 | UXT10 | ZS016 | ZLE276 ZM062 08/98→ |
| 1.8 T 4WD Quattro | 4 | APU | 110/148 | 02/97→01/05 | Z188 | 0.7 | UXT10 | ZSE162 11/98→05/01 ZS016 | ZLE276 ZM062 08/98→ |
| 1.8 T 4WD Quattro | 4 | APU | 110/148 | 12/97→01/05 | | | | ZS016 | |
| 1.8 T 4WD Quattro | 4 | AWT | 110/148 | 02/97→01/05 | Z188 | 0.7 | UXT10 | ZSE043 06/00→ | ZM062 08/98→ |

AUDI



kW/BHP



... AUDI



... A6

| | | | | | | | | | | |
|-------------------------|---|-------------------------|---------|-------------|--|--------|--------------|-------------|--|---------------------------|
| 1.8 T 4WD Quattro | 4 | AJL | 132/177 | 12/97→01/05 | Z188 | | 0.7 | UXT10 | ZS016 | ZLE276 ZM062 08/98→ |
| 1.8 T 4WD LPG Quattro | 4 | AEB, ANB, APU, ARK, AWT | 110/148 | 02/97→01/05 | Z340 | | 0.7 | UXT12 | | |
| 1.8 T 4WD LPG Quattro | 4 | AJL | 132/177 | 12/97→01/05 | Z340 | | 0.7 | UXT12 | | |
| 1.9 TDI | 4 | 1Z, AHU | 66/89 | 06/94→12/97 | GN855 | | 12V | | | |
| 1.9 TDI | 4 | AFN, AVG | 81/109 | 04/97→04/01 | GN855 | | 12V | | | |
| 1.9 TDI | 4 | AJM | 85/114 | 07/00→01/05 | GN855 | | 12V | | | |
| 1.9 TDI | 4 | AVF, AWX | 96/129 | 08/01→01/05 | GN046 | | 12V | | | |
| 2.0 | 4 | AAE | 74/99 | 06/94→12/97 | Z91 | | 0.8 | UXT2 / UXT6 | | |
| 2.0 | 4 | AAE | 74/99 | 06/94→10/97 | | | | | ZSE036 →08/96 | |
| 2.0 | 4 | ADW | 79/106 | 08/95→07/96 | Z91 | | 0.8 | UXT2 / UXT6 | | |
| 2.0 | 4 | ABK | 85/114 | 06/94→12/97 | Z91 | | 0.8 | UXT2 / UXT6 | ZSE036 | |
| 2.0 | 4 | ALT | 96/129 | 08/01→01/05 | Z121 | | 1.0 | UXT9 | ZSE043 | |
| 2.0 LPG | 4 | AAE | 74/99 | 06/94→12/97 | Z27 [168] | | 0.8 | UX56 | | |
| 2.0 LPG | 4 | ABK | 85/114 | 06/94→12/97 | Z27 [168] | | 0.8 | UX56 | | |
| 2.0 LPG | 4 | ALT | 96/129 | 08/01→01/05 | Z206 | | 0.7 | UXT10 | | |
| 2.0 16V | 4 | ACE | 103/138 | 06/94→12/97 | Z89 | | 0.8 | UXT5 | ZSE036 | |
| 2.0 16V LPG | 4 | ACE | 103/138 | 06/94→12/97 | Z30 [168] | | 0.8 | UXT5 | | |
| 2.0 16V 4WD Quattro | 4 | ACE | 103/138 | 06/94→12/97 | Z89 | | 0.8 | UXT5 | ZSE036 | |
| 2.0 16V 4WD LPG Quattro | 4 | ACE | 103/138 | 06/94→12/97 | Z30 [168] | | 0.8 | UXT5 | | |
| 2.0 TDI | 4 | BVG | 89/119 | 09/05→06/06 | CGP003 | | 7V | | | |
| 2.0 TDI | 4 | BNA | 100/134 | 07/04→08/11 | GE101 | GSE100 | 4.4V | | | |
| 2.0 TDI | 4 | BRF | 100/134 | 07/04→08/11 | CGP003 | | 7V | | | |
| 2.0 TDI | 4 | CAGB | 100/134 | 07/04→08/11 | GE115 | | 4.4V | | | |
| 2.0 TDI | 4 | CGLE | 100/134 | 01/12→ | GE115 PSG002 | | 4.4V 4.4V | | | |
| | | | | 05/14→ | | | | | | |
| 2.0 TDI | 4 | BLB | 103/138 | 07/04→10/08 | GN046 →ch. 4B-5-050-000 GE101 ch. 4F-5-000 001→ | | 12V 4.4V | | | |
| 2.0 TDI | 4 | BRE | 103/138 | 07/04→10/08 | CGP003 ch. 4F-5-000 001→ | | 7V | | | |
| 2.0 TDI | 4 | CSUD | 110/148 | 09/14→ | GE115 [228] PSG002 [29][228] | | 4.4V 4.4V | | | |
| 2.0 TDI | 4 | CAHB | 120/161 | 04/09→08/11 | GE115 | | 4.4V | | | |
| 2.0 TDI | 4 | CGLD | 120/161 | 03/11→ | GE115 [233] PSG002 | | 4.4V 4.4V | | | |
| | | | | 05/14→ | | | | | | |
| 2.0 TDI | 4 | CAHA | 125/168 | 10/08→08/11 | GE115 | | 4.4V | | | |
| 2.0 TDI | 4 | CGLC, CMGB | 130/174 | 03/11→ | GE115 [233] PSG002 | | 4.4V 4.4V | | | |
| | | | | 05/14→ | | | | | | |
| 2.0 TDI | 4 | CNHA | 140/188 | 11/13→ | GE115 [228] PSG002 [29][228] | | 4.4V 4.4V | | | |
| 2.0 TFSI | 4 | BPJ | 125/168 | 06/05→08/11 | Z347 | | 0.7 | UXT12 | ZSE033 | |
| 2.0 TFSI | 4 | BYK | 125/168 | 06/05→03/11 | | | | | ZSE033 | |
| 2.0 TFSI | 4 | CDNB | 132/177 | 05/11→ | Z347 | | 0.7 | UXT12 | ZSE033 (1)[47][182] ZSE142 (1)[48][175] | |
| 2.0 TFSI | 4 | CAEB | 155/208 | 03/11→05/13 | Z347 | | 0.7 | UXT12 | ZSE033 (1)[47][182] ZSE142 (1)[48][175] | |
| 2.0 TFSI | 4 | CAED | 162/217 | 05/13→ | Z347 | | 0.7 | UXT12 | ZSE033 (1)[47][182] ZSE142 (1)[48][175] | |
| 2.0 TFSI 4WD Quattro | 4 | CAEB | 155/208 | 05/12→05/13 | Z347 | | 0.7 | UXT12 | ZSE033 (1)[47][182] ZSE142 (1)[48][175] | |
| 2.0 TFSI 4WD Quattro | 4 | CAED | 162/217 | 05/13→ | Z347 | | 0.7 | UXT12 | ZSE033 (1)[47][182] ZSE142 (1)[48][175] | |

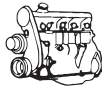

kW/BHP

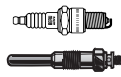

... AUDI



... A6

| | | | | | | | | | |
|--------------------------|---|-------------------------|---------|-------------|-----------|--|------|-------------|--|
| 2.0 TFSI hybrid | 4 | CHJA | 155/208 | 11/11→ | | | | | ZSE033 [1][47][182] ZSE142 [1][48][175] |
| 2.2 S6 Turbo 4WD Quattro | 5 | AAN | 169/227 | 06/94→12/97 | | | | ZS043 | ZLE233 |
| 2.3 | 5 | AAR | 98/131 | 06/94→12/95 | Z94 | | 0.8 | UXT2 / UXT6 | ZSE036 |
| 2.3 LPG | 5 | AAR | 98/131 | 06/94→12/95 | Z20 [168] | | 0.8 | UXT2 / UXT6 | |
| 2.3 4WD Quattro | 5 | AAR | 98/131 | 06/94→12/95 | Z94 | | 0.8 | UXT2 / UXT6 | |
| 2.3 4WD LPG Quattro | 5 | AAR | 98/131 | 06/94→12/95 | Z20 [168] | | 0.8 | UXT2 / UXT6 | |
| 2.4 | 6 | ALW, ARN, ASM | 100/134 | 07/98→01/05 | Z145 | | 1.6 | | ZSE154 |
| 2.4 | 6 | APC | 115/154 | 02/97→01/05 | Z145 | | 1.6 | | ZSE154 |
| 2.4 | 6 | AJG, AMM, APZ | 120/161 | 02/97→01/05 | Z145 | | 1.6 | | ZSE154 |
| 2.4 | 6 | AGA, ALF, AML, APS, ARJ | 121/162 | 02/97→01/05 | Z145 | | 1.6 | | ZSE154 |
| 2.4 | 6 | BDV | 125/168 | 08/01→01/05 | Z145 | | 1.6 | | ZSE154 |
| 2.4 | 6 | BDW | 130/174 | 05/04→10/08 | Z321 | | 1.0 | UXT9 | ZSE032 |
| 2.4 4WD Quattro | 6 | APC | 115/154 | 08/98→05/01 | Z145 | | 1.6 | | |
| 2.4 4WD Quattro | 6 | AJG, APZ | 120/161 | 02/97→01/05 | Z145 | | 1.6 | | ZSE154 |
| 2.4 4WD Quattro | 6 | AGA, ALF, AML, APS, ARJ | 121/162 | 02/97→01/05 | Z145 | | 1.6 | | ZSE154 |
| 2.4 4WD Quattro | 6 | BDV | 125/168 | 08/01→01/05 | Z145 | | 1.6 | | ZSE154 |
| 2.4 4WD Quattro | 6 | BDW | 130/174 | 01/05→10/08 | Z321 | | 1.0 | UXT9 | ZSE032 |
| 2.5 TDI | 5 | AAT | 84/113 | 01/95→12/97 | GN855 | | 12V | | |
| 2.5 TDI | 5 | AAT | 85/114 | 06/94→12/97 | GN855 | | 12V | | |
| 2.5 TDI | 5 | AEL | 103/138 | 08/94→12/97 | GN855 | | 12V | | |
| 2.5 TDI | 6 | AFB, AKN | 110/148 | 07/97→01/05 | GN008 | | 12V | | |
| 2.5 TDI | 6 | AYM | 114/153 | 08/01→01/05 | GN008 | | 12V | | |
| 2.5 TDI | 6 | BCZ, BDG, BFC | 120/161 | 07/02→01/05 | GN008 | | 12V | | |
| 2.5 TDI | 6 | AKE, BAU, BDH, BND | 132/177 | 02/00→01/05 | GN008 | | 12V | | |
| 2.5 TDI 4WD Quattro | 5 | AEL | 103/138 | 07/95→12/97 | GN855 | | 12V | | |
| 2.5 TDI 4WD Quattro | 6 | AFB, AKN | 110/148 | 07/97→01/05 | GN008 | | 12V | | |
| 2.5 TDI 4WD Quattro | 6 | AKE, BAU, BDH | 132/177 | 02/00→01/05 | GN008 | | 12V | | |
| 2.6 | 6 | ACZ | 102/137 | 06/94→10/97 | Z90 | | 1.0 | UXT1 / UXT3 | |
| 2.6 | 6 | ABC | 110/148 | 06/94→12/97 | Z90 | | 1.0 | UXT1 / UXT3 | ZSE007 ZM027 [188] ZM063 [175] |
| 2.6 LPG | 6 | ACZ | 102/137 | 06/94→10/97 | Z340 | | 0.7 | UXT12 | |
| 2.6 LPG | 6 | ABC | 110/148 | 06/94→12/97 | Z340 | | 0.7 | UXT12 | |
| 2.6 4WD Quattro | 6 | ABC | 110/148 | 06/94→12/97 | Z90 | | 1.0 | UXT1 / UXT3 | ZSE007 ZM027 [188] ZM063 [175] |
| 2.6 4WD LPG Quattro | 6 | ABC | 110/148 | 06/94→12/97 | Z340 | | 0.7 | UXT12 | |
| 2.7 T | 6 | AJK | 169/227 | 02/99→01/05 | Z188 | | 0.7 | UXT10 | ZS016 ZLE276 |
| 2.7 T LPG | 6 | AJK | 169/227 | 02/99→01/05 | Z340 | | 0.7 | UXT12 | |
| 2.7 T 4WD Quattro | 6 | AJK | 169/227 | 12/97→01/05 | Z188 | | 0.7 | UXT10 | ZS016 ZLE276 |
| 2.7 T 4WD Quattro | 6 | AZA | 169/227 | 12/97→01/05 | Z188 | | 0.7 | UXT10 | ZS016 ZLE276 |
| 2.7 T 4WD Quattro | 6 | ARE | 184/247 | 08/01→01/05 | Z188 | | 0.7 | UXT10 | ZS016 ZLE276 |
| 2.7 T 4WD Quattro | 6 | BES | 184/247 | 08/01→01/05 | Z188 | | 0.7 | UXT10 | ZSE043 |
| 2.7 T 4WD LPG Quattro | 6 | AJK, AZA | 169/227 | 12/97→01/05 | Z340 | | 0.7 | UXT12 | |
| 2.7 T 4WD LPG Quattro | 6 | ARE, BES | 184/247 | 08/01→01/05 | Z340 | | 0.7 | UXT12 | |
| 2.7 TDI | 6 | BSG, CANB | 120/161 | 11/04→08/11 | GE115 | | 4.4V | | |
| 2.7 TDI | 6 | BPP | 132/177 | 11/04→10/08 | GE115 | | 4.4V | | |
| 2.7 TDI | 6 | CANA | 140/188 | 10/08→08/11 | GE115 | | 4.4V | | |
| 2.7 TDI 4WD Quattro | 6 | BSG, CAND | 120/161 | 06/05→08/11 | GE115 | | 4.4V | | |
| 2.7 TDI 4WD Quattro | 6 | BPP | 132/177 | 11/04→10/08 | GE115 | | 4.4V | | |
| 2.7 TDI 4WD Quattro | 6 | CANC | 140/188 | 10/08→08/11 | GE115 | | 4.4V | | |
| 2.8 | 6 | AAH | 128/172 | 06/94→12/97 | Z90 | | 1.0 | UXT1 / UXT3 | ZSE007 ZM027 [188] ZM063 [175] |
| 2.8 | 6 | AEJ | 128/172 | 06/94→12/97 | Z79 | | 0.8 | UXT1 / UXT3 | ZM027 [188] ZM063 [175] |
| 2.8 | 6 | AEJ | 128/172 | 06/94→10/97 | | | | ZSE007 | |
| 2.8 | 6 | AFC | 128/172 | 06/94→10/97 | | | | | ZM027 [188] ZM063 [175] |
| 2.8 | 6 | AGE | 132/177 | 10/97→05/00 | Z145 | | 1.6 | | ZSE154 |
| 2.8 | 6 | ATX | 140/188 | 07/99→01/05 | Z145 | | 1.6 | | ZSE154 |



kW/BHP

**... AUDI****... A6**

| | | | | | | | | |
|----------------------|---|-------------------------|---------|-------------|---------------------------------|--------------|-------------|--|
| 2.8 | 6 | BBG | 140/188 | 07/99→01/05 | Z145 | 1.6 | | |
| 2.8 | 6 | ACK, ALG, AMX, APR, AQD | 142/190 | 12/95→01/05 | Z145 | 1.6 | | ZSE154 |
| 2.8 | 6 | AHA | 142/190 | 02/97→01/05 | Z145 | 1.6 | | |
| 2.8 LPG | 6 | AAH | 128/172 | 06/94→12/97 | Z340 | 0.7 | UXT12 | |
| 2.8 4WD Quattro | 6 | AAH | 128/172 | 06/94→12/97 | Z90 | 1.0 | UXT1 / UXT3 | ZSE007 ZM027 ^[188] ZM063 ^[175] |
| 2.8 4WD Quattro | 6 | AEJ | 128/172 | 06/94→12/97 | Z79 | 0.8 | UXT1 / UXT3 | ZM027 ^[188] ZM063 ^[175] |
| 2.8 4WD Quattro | 6 | AGE | 132/177 | 01/98→04/00 | Z145 | 1.6 | | |
| 2.8 4WD Quattro | 6 | ATX | 140/188 | 07/99→05/01 | Z145 | 1.6 | | ZSE154 |
| 2.8 4WD Quattro | 6 | ACK, ALG, AMX, APR, AQD | 142/190 | 12/95→01/05 | Z145 | 1.6 | | ZSE154 |
| 2.8 4WD Quattro | 6 | AHA | 142/190 | 02/97→01/05 | Z145 | 1.6 | | |
| 2.8 4WD LPG Quattro | 6 | AAH | 128/172 | 06/94→12/97 | Z340 | 0.7 | UXT12 | |
| 2.8 FSI | 6 | CCDA | 140/188 | 10/08→08/11 | Z321 | 1.0 | UXT9 | ZSE032 |
| 2.8 FSI | 6 | CHVA | 150/201 | 03/11→ | | | | ZSE032 |
| 2.8 FSI | 6 | BDX | 154/207 | 11/06→10/08 | Z321 | 1.0 | UXT9 | ZSE032 |
| 2.8 FSI | 6 | CCEA | 162/217 | 10/08→08/11 | Z321 | 1.0 | UXT9 | ZSE032 |
| 2.8 FSI 4WD Quattro | 6 | CCDA | 140/188 | 10/08→08/11 | Z321 | 1.0 | UXT9 | ZSE032 |
| 2.8 FSI 4WD Quattro | 6 | CHVA | 150/201 | 03/11→ | | | | ZSE032 |
| 2.8 FSI 4WD Quattro | 6 | BDX | 154/207 | 06/07→10/08 | Z321 | 1.0 | UXT9 | ZSE032 |
| 2.8 FSI 4WD Quattro | 6 | CCEA | 162/217 | 10/08→08/11 | Z321 | 1.0 | UXT9 | ZSE032 |
| 3.0 | 6 | BBJ | 160/215 | 08/04→05/06 | Z145 | 1.6 | | |
| 3.0 | 6 | BBJ | 160/215 | 03/05→05/06 | Z145 | 1.6 | | ZSE051 |
| 3.0 | 6 | ASN | 162/217 | 08/01→01/05 | Z145 | 1.6 | | ZSE051 |
| 3.0 4WD Quattro | 6 | BBJ | 160/215 | 06/01→05/06 | Z145 | 1.6 | | ZSE051 |
| 3.0 4WD Quattro | 6 | ASN | 162/217 | 08/01→01/05 | Z145 | 1.6 | | ZSE051 |
| 3.0 TDI | 6 | CLAB | 150/201 | 11/10→ | GE115 ^[230] | 4.4V | | |
| 3.0 TDI | 6 | CTCB | 155/208 | 09/14→ | GE115 | 4.4V | | |
| 3.0 TDI | 6 | CTCC | 160/215 | 09/14→ | GE115 | 4.4V | | |
| 3.0 TDI | 6 | ASB | 171/229 | 06/06→08/11 | GE115 | 4.4V | | |
| 3.0 TDI 4WD Quattro | 6 | CLAA | 150/201 | 03/11→ | GE115 ^[230] | 4.4V | | |
| 3.0 TDI 4WD Quattro | 6 | BNG, CDYB | 155/208 | 05/04→08/11 | GE115 | 4.4V | | |
| 3.0 TDI 4WD Quattro | 6 | CRTF | 155/208 | 09/14→ | GE115 ^[239] | 4.4V | | |
| 3.0 TDI 4WD Quattro | 6 | CRTE | 160/215 | 09/14→ | GE115 ^[239] | 4.4V | | |
| 3.0 TDI 4WD Quattro | 6 | BMK | 165/221 | 05/04→05/06 | GE115 | 4.4V | | |
| 3.0 TDI 4WD Quattro | 6 | ASB | 171/229 | 06/06→10/08 | GE115 | 4.4V | | |
| 3.0 TDI 4WD Quattro | 6 | CDYA, CDYC | 176/236 | 10/08→08/11 | GE115 | 4.4V | | |
| 3.0 TDI 4WD Quattro | 6 | CPNB | 176/236 | 05/13→ | GE115 PSG002 ^[25] | 4.4V 4.4V | | |
| 3.0 TDI 4WD Quattro | 6 | CDUC, CDUD | 180/241 | 03/11→ | GE115 ^[230] | 4.4V | | |
| 3.0 TDI 4WD Quattro | 6 | CKVB, CKVC | 180/241 | 03/11→ | GE115 PSG002 ^[25] | 4.4V 4.4V | | |
| 3.0 TDI 4WD Quattro | 6 | CRTD | 200/268 | 09/14→ | GE115 ^[239] | 4.4V | | |
| 3.0 TDI 4WD Quattro | 6 | CGQB | 230/308 | 11/11→ | GE115 ^[231] | 4.4V | | |
| 3.0 TDI 4WD Quattro | 6 | CVUA | 235/315 | 09/14→ | GE115 ^[239] | 4.4V | | |
| 3.0 TDI 4WD Quattro | 6 | CVUB | 240/322 | 09/14→ | GE115 ^[239] | 4.4V | | |
| 3.0 TFSI 4WD Quattro | 6 | CAJA | 213/286 | 10/08→08/11 | Z347 | 0.7 | UXT12 | ZSE032 |
| 3.0 TFSI 4WD Quattro | 6 | CCAA | 220/295 | 10/08→08/11 | | | | ZSE032 |
| 3.0 TFSI 4WD Quattro | 6 | CGWB | 220/295 | 11/10→05/12 | Z347 | 0.7 | UXT12 | ZSE032 |
| 3.0 TFSI 4WD Quattro | 6 | CGWD, CGXB, CTUA | 228/306 | 03/11→ | | | | ZSE032 |
| 3.2 FSI | 6 | AUK | 188/252 | 05/04→05/09 | Z295 | 0.8 | | ZSE032 |
| 3.2 FSI | 6 | BKH | 188/252 | 05/04→05/09 | Z321 | 1.0 | UXT9 | ZSE032 |
| 3.2 FSI | 6 | CALA | 195/261 | 05/09→03/11 | Z321 | 1.0 | UXT9 | ZSE032 |
| 3.2 FSI 4WD Quattro | 6 | BYU | 183/245 | 09/06→10/08 | | | | ZSE032 |
| 3.2 FSI 4WD Quattro | 6 | AUK | 188/252 | 05/04→10/08 | Z295 | 0.8 | | ZSE032 |

AUDI

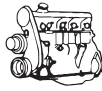

kW/BHP

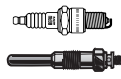

... AUDI



... A6

| | | | | | | | | |
|----------------------------|----|------|---------|-------------|--------------------|------|-------|-----------------------|
| 3.2 FSI 4WD Quattro | 6 | BKH | 188/252 | 05/04→10/08 | | | | ZSE032 |
| 3.7 | 8 | AQG | 191/256 | 03/99→01/05 | Z237 | 1.6 | | ZSE009 |
| 3.7 LPG | 8 | AQG | 191/256 | 03/99→01/05 | Z340 | 0.7 | UXT12 | |
| 3.7 4WD Quattro | 8 | AQG | 191/256 | 03/99→01/05 | Z237 | 1.6 | | ZSE009 |
| 3.7 4WD LPG Quattro | 8 | AQG | 191/256 | 03/99→01/05 | Z340 | 0.7 | UXT12 | |
| 4.0 RS6 4WD Quattro | 8 | CRDB | 412/552 | 01/13→ | Z345 | 0.7 | | |
| 4.0 S6 4WD Quattro | 8 | CEUC | 309/414 | 02/12→ | Z345 | 0.7 | | |
| | | | | | ch. 4H-A-000 001→ | | | |
| 4.2 4WD Quattro | 8 | ARS | 220/295 | 11/98→01/05 | Z239 | 1.6 | | ZSE009 04/99→05/01 |
| 4.2 4WD Quattro | 8 | ASG | 220/295 | 11/98→01/05 | Z239 | 1.6 | | ZSE009 06/00→ |
| 4.2 4WD Quattro | 8 | AWN | 220/295 | 11/98→01/05 | Z239 | 1.6 | | |
| 4.2 4WD Quattro | 8 | BAT | 246/330 | 05/04→05/06 | Z239 | 1.6 | | ZSE061 |
| 4.2 FSI 4WD Quattro | 8 | BJV | 257/345 | 06/06→08/11 | Z295 | 0.8 | | ZSE032 |
| | | | | | ch. F4F-7-000 001→ | | | |
| 4.2 RS6 4WD Quattro | 8 | BCY | 331/444 | 07/02→01/05 | Z317 | 0.85 | UXT12 | ZSE009 |
| 4.2 RS6 plus 4WD Quattro | 8 | BRV | 353/473 | 04/04→01/05 | Z317 | 0.85 | UXT12 | ZSE009 |
| 4.2 S6 4WD Quattro | 8 | ANK | 250/335 | 09/99→01/05 | Z129 | 1.6 | | ZSE009 09/00→ |
| 4.2 S6 4WD Quattro | 8 | AQJ | 250/335 | 09/99→01/05 | Z129 | 1.6 | | ZSE009 →05/01 |
| 4.2 S6 4.2 4WD Quattro | 8 | AEC | 213/286 | 06/94→12/97 | Z127 | 1.6 | UXT4 | |
| 4.2 S6 4.2 4WD LPG Quattro | 8 | AEC | 213/286 | 06/94→12/97 | Z144 | 1.6 | | |
| 4.2 S6 Plus 4WD Quattro | 8 | AHK | 240/322 | 04/96→12/97 | Z144 | 1.6 | | |
| 5.0 RS6 4WD Quattro | 10 | BUH | 426/571 | 04/08→08/10 | | | | ZSE032 |
| 5.2 S6 4WD Quattro | 10 | BXA | 320/429 | 03/06→08/11 | Z295 | 0.8 | | ZSE032 |

A6 Allroad

| | | | | | | | | |
|----------------------|---|------------|---------|-------------|-------------|------|-------|--------|
| 2.7 TDI 4WD Quattro | 6 | BSG, CAND | 120/161 | 05/06→08/11 | GE115 | 4.4V | | |
| 2.7 TDI 4WD Quattro | 6 | BPP | 132/177 | 05/06→10/08 | GE115 | 4.4V | | |
| 2.7 TDI 4WD Quattro | 6 | CANC | 140/188 | 10/08→08/11 | GE115 | 4.4V | | |
| 3.0 TDI 4WD Quattro | 6 | CLAA | 150/201 | 01/12→ | GE115 [230] | 4.4V | | |
| 3.0 TDI 4WD Quattro | 6 | BNG, CDYB | 155/208 | 05/06→08/11 | GE115 | 4.4V | | |
| 3.0 TDI 4WD Quattro | 6 | CRTE | 155/208 | 09/14→ | GE115 [239] | 4.4V | | |
| 3.0 TDI 4WD Quattro | 6 | CRTE | 160/215 | 09/14→ | GE115 [239] | 4.4V | | |
| 3.0 TDI 4WD Quattro | 6 | ASB | 171/229 | 05/06→10/08 | GE115 | 4.4V | | |
| 3.0 TDI 4WD Quattro | 6 | CDYA, CDYC | 176/236 | 10/08→08/11 | GE115 | 4.4V | | |
| 3.0 TDI 4WD Quattro | 6 | CDUD | 180/241 | 01/12→ | GE115 [230] | 4.4V | | |
| 3.0 TDI 4WD Quattro | 6 | CKVC | 180/241 | 01/12→ | GE115 | 4.4V | | |
| | | | | | PSG002 [25] | 4.4V | | |
| 3.0 TDI 4WD Quattro | 6 | CRTD | 200/268 | 09/14→ | GE115 [239] | 4.4V | | |
| 3.0 TDI 4WD Quattro | 6 | CGQB | 230/308 | 01/12→ | GE115 [231] | 4.4V | | |
| 3.0 TDI 4WD Quattro | 6 | CVUA | 235/315 | 01/12→ | GE115 [239] | 4.4V | | |
| 3.0 TFSI 4WD Quattro | 6 | CAJA | 213/286 | 10/08→08/11 | Z347 | 0.7 | UXT12 | ZSE032 |
| 3.0 TFSI 4WD Quattro | 6 | CGWD | 228/306 | 01/12→ | | | | ZSE032 |
| 3.2 FSI 4WD Quattro | 6 | AUK | 188/252 | 05/06→10/08 | Z295 | 0.8 | | ZSE032 |
| 4.2 FSI 4WD Quattro | 8 | BJV | 257/345 | 05/06→12/10 | Z295 | 0.8 | | ZSE032 |

A7

| | | | | | | | | |
|---------------------|---|------------|---------|--------|-------------|------|--|--------|
| 2.8 FSI | 6 | CHVA | 150/201 | 02/11→ | | | | ZSE032 |
| 2.8 FSI 4WD Quattro | 6 | CHVA, CNYA | 150/201 | 10/10→ | | | | ZSE032 |
| 3.0 TDI | 6 | CLAB | 150/201 | 11/10→ | GE115 [230] | 4.4V | | |
| 3.0 TDI | 6 | CTCC | 160/215 | 07/14→ | GE115 | 4.4V | | |
| 3.0 TDI 4WD Quattro | 6 | CLAA | 150/201 | 12/10→ | GE115 [230] | 4.4V | | |
| 3.0 TDI 4WD Quattro | 6 | CRTE, CTCB | 155/208 | 07/14→ | GE115 | 4.4V | | |
| 3.0 TDI 4WD Quattro | 6 | CRTE | 160/215 | 07/14→ | GE115 [239] | 4.4V | | |
| 3.0 TDI 4WD Quattro | 6 | CPNB | 176/236 | 05/13→ | GE115 | 4.4V | | |
| | | | | | PSG002 [25] | 4.4V | | |
| 3.0 TDI 4WD Quattro | 6 | CDUC, CDUD | 180/241 | 10/10→ | GE115 [230] | 4.4V | | |

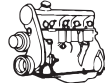

kW/BHP



... AUDI



... A7

| | | | | | | | | | |
|----------------------|---|-------------------------|---------|-------------|---|--------------|-----------------|--|--|
| 3.0 TDI 4WD Quattro | 6 | CKVB, CKVC | 180/241 | 10/10→ | GE115 PSG002 ^[25] | 4.4V 4.4V | | | |
| 3.0 TDI 4WD Quattro | 6 | CRTD | 200/268 | 05/14→ | GE115 ^[239] | 4.4V | | | |
| 3.0 TDI 4WD Quattro | 6 | CGQB | 230/308 | 11/11→ | GE115 ^[231] | 4.4V | | | |
| 3.0 TDI 4WD Quattro | 6 | CVUA | 235/315 | 05/14→ | GE115 ^[239] | 4.4V | | | |
| 3.0 TDI 4WD Quattro | 6 | CVUB | 240/322 | 09/14→ | GE115 ^[239] | 4.4V | | | |
| 3.0 TFSI 4WD Quattro | 6 | CGWB | 220/295 | 10/10→ | Z347 →01/11 | 0.7 | UXT12 →01/11 | ZSE032 | |
| 3.0 TFSI 4WD Quattro | 6 | CHMA | 220/295 | 10/10→ | | | | ZSE032 | |
| 3.0 TFSI 4WD Quattro | 6 | CGWD, CGXB, CTA, CTUA | 228/306 | 01/11→ | Z347 | 0.7 | UXT12 | ZSE032 | |
| 4.0 S7 4WD Quattro | 8 | CEUC | 309/414 | 02/12→ | Z345 | 0.7 | | | |
| A8 | | | | | | | | | |
| 2.0 TFSI hybrid | 4 | CHJA | 155/208 | 02/12→ | | | | ZSE033 | |
| 2.5 TDI | 6 | AFB, AKN | 110/148 | 01/97→04/00 | GN008 | 12V | | | |
| 2.5 TDI | 6 | AKE | 132/177 | 09/00→09/02 | GN008 | 12V | | | |
| 2.5 TDI 4WD Quattro | 6 | AFB, AKN | 110/148 | 07/97→04/00 | GN008 | 12V | | | |
| 2.5 TDI 4WD Quattro | 6 | AKE | 132/177 | 09/00→09/02 | GN008 | 12V | | | |
| 2.5 TFSI | 6 | CPAA | 150/201 | 07/12→ | | | | ZSE032 | |
| 2.8 | 6 | AEJ | 120/161 | 07/95→03/96 | Z79 | 0.8 | UXT1 / UXT3 | ZSE008 | |
| 2.8 | 6 | AAH | 128/172 | 03/94→03/96 | Z90 | 1.0 | UXT1 / UXT3 | ZSE008 | |
| 2.8 | 6 | ACK, ALG, AMX, APR, AQD | 142/190 | 04/96→09/02 | Z145 | 1.6 | | ZSE154 | |
| 2.8 LPG | 6 | AAH | 128/172 | 03/94→03/96 | Z340 | 0.7 | UXT12 | | |
| 2.8 4WD Quattro | 6 | AEJ | 120/161 | 07/95→03/96 | Z79 | 0.8 | UXT1 / UXT3 | ZSE008 | |
| 2.8 4WD Quattro | 6 | AAH | 128/172 | 03/94→03/96 | Z90 | 1.0 | UXT1 / UXT3 | ZSE008 | |
| 2.8 4WD Quattro | 6 | ACK, AMX, APR, AQD | 142/190 | 04/96→09/02 | Z145 | 1.6 | | ZSE154 | |
| 2.8 4WD Quattro | 6 | ALG | 142/190 | 04/96→09/02 | Z145 | 1.6 | | | |
| 2.8 4WD LPG Quattro | 6 | AAH | 128/172 | 03/94→03/96 | Z340 | 0.7 | UXT12 | | |
| 2.8 FSI | 6 | BDX | 154/207 | 08/07→07/10 | | | | ZSE032 | |
| 3.0 | 6 | BBJ | 160/215 | 07/03→05/06 | Z145 | 1.6 | | ZSE051 | |
| 3.0 | 6 | ASN | 162/217 | 07/03→05/05 | Z145 | 1.6 | | ZSE051 | |
| 3.0 TDI | 6 | CLAB | 150/201 | 09/11→ | GE115 | 4.4V | | | |
| 3.0 TDI 4WD Quattro | 6 | BNG | 155/208 | 11/03→07/10 | GE115 <small>ch. 4E-5-003 301→</small> | 4.4V | | | |
| 3.0 TDI 4WD Quattro | 6 | CDTB | 155/208 | 08/10→ | GE115 | 4.4V | | | |
| 3.0 TDI 4WD Quattro | 6 | ASB | 171/229 | 08/03→07/10 | GE115 <small>ch. 4E-5-003 301→</small> | 4.4V | | | |
| 3.0 TDI 4WD Quattro | 6 | CPNA | 176/236 | 11/12→ | GE115 PSG002 ^[25] | 4.4V 4.4V | | | |
| 3.0 TDI 4WD Quattro | 6 | CDTA | 184/247 | 07/10→ | GE115 | 4.4V | | | |
| 3.0 TDI 4WD Quattro | 6 | CMHA | 184/247 | 07/10→ | GE115 PSG002 ^[25] | 4.4V 4.4V | | | |
| 3.0 TDI 4WD Quattro | 6 | CTBA | 190/255 | 10/13→ | GE115 | 4.4V | | | |
| 3.0 TFSI 4WD Quattro | 6 | CGWA | 213/286 | 07/10→ | | | | ZSE032 | |
| 3.0 TFSI 4WD Quattro | 6 | CGWD | 228/306 | 11/11→ | | | | ZSE032 | |
| 3.0 TFSI 4WD Quattro | 6 | CGXC, CMDA, CTUB | 245/329 | 06/10→ | | | | ZSE032 | |
| 3.2 FSI | 6 | BPK | 191/256 | 06/05→07/10 | Z295 | 0.8 | | ZSE032 | |
| 3.2 FSI 4WD Quattro | 6 | BPK | 191/256 | 06/05→07/10 | Z295 | 0.8 | | ZSE032 | |
| 3.3 TDI 4WD Quattro | 8 | AKF | 165/221 | 06/00→09/02 | GN008 | 12V | | | |
| 3.7 | 8 | AEW | 169/227 | 07/95→12/98 | Z127 | 1.6 | UXT4 | ZS016 ^[1] ZS017 ^[1] | |
| 3.7 | 8 | AKC, AQQ | 191/256 | 11/98→09/02 | Z237 | 1.6 | | | |
| 3.7 LPG | 8 | AEW | 169/227 | 07/95→12/98 | Z144 | 1.6 | | | |
| 3.7 4WD Quattro | 8 | AEW, AKJ | 169/227 | 07/95→11/98 | Z127 | 1.6 | UXT4 | ZS016 ^[1] ZS017 ^[1] | |
| 3.7 4WD Quattro | 8 | AKC, AQQ | 191/256 | 11/98→09/02 | Z237 | 1.6 | | ZSE009 | |
| 3.7 4WD Quattro | 8 | BFL | 206/276 | 10/02→05/06 | Z239 | 1.6 | | ZSE061 | |
| 3.7 4WD LPG Quattro | 8 | AEW, AKJ | 169/227 | 07/95→11/98 | Z144 | 1.6 | | | |



kW/BHP



... AUDI



... A8

| | | | | | | | | | |
|---------------------|----|------------|---------|-------------|------------------------------------|------|------|--|--------------------------------------|
| 4.0 S8 4WD Quattro | 8 | CGTA | 382/512 | 04/12→ | Z345 ch. 4H-A-000 001→ →2013 | 0.7 | | | |
| 4.0 TDI 4WD Quattro | 8 | ASE | 202/271 | 05/03→07/05 | GN008 | 12V | | | |
| 4.2 4WD Quattro | 8 | ARU | 175/235 | 02/99→04/00 | Z172 | 1.6 | | ZSE009 | |
| 4.2 4WD Quattro | 8 | AEM | 180/241 | 03/94→07/96 | Z127 | 1.6 | UXT4 | ZS016 ch. 4D-T-000 221→ | ZM062 |
| 4.2 4WD Quattro | 8 | ABZ, AKG | 220/295 | 03/94→11/98 | Z127 | 1.6 | UXT4 | ZS016 ^[1] ch. 4D-T-000 221→ ZS017 ^[1] ch. 4D-T-000 221→ | ZLE277 ZM062 |
| 4.2 4WD Quattro | 8 | AQF | 228/306 | 11/98→09/02 | Z239 | 1.6 | | ZSE009 →02/01 | |
| 4.2 4WD Quattro | 8 | AUW, AUX | 228/306 | 11/98→09/02 | Z239 | 1.6 | | | |
| 4.2 4WD Quattro | 8 | BFM | 246/330 | 10/02→07/10 | Z239 | 1.6 | | ZSE061 | |
| 4.2 4WD LPG Quattro | 8 | ARU | 175/235 | 02/99→04/00 | Z129 | 1.6 | | | |
| 4.2 4WD LPG Quattro | 8 | AEM | 180/241 | 03/94→07/96 | Z144 | 1.6 | | | |
| 4.2 4WD LPG Quattro | 8 | ABZ, AKG | 220/295 | 03/94→11/98 | Z144 | 1.6 | | | |
| 4.2 FSI 4WD Quattro | 8 | BJV | 257/345 | 06/06→07/10 | Z295 ch. FAF-7-000 001→ | 0.8 | | ZSE032 | |
| 4.2 FSI 4WD Quattro | 8 | CDRA | 273/366 | 11/09→ | Z295 | 0.8 | | ZSE032 | |
| 4.2 S 8 4WD Quattro | 8 | AHC, AKH | 250/335 | 07/96→06/99 | Z144 | 1.6 | | ZS016 ch. 4D-T-000 221→ | ZLE276 ch. 4D-T-000 221→ ZM062 |
| 4.2 S 8 4WD Quattro | 8 | AQH | 265/355 | 06/99→09/02 | Z129 | 1.6 | | ZSE009 →02/01 | |
| 4.2 S 8 4WD Quattro | 8 | AVP | 265/355 | 06/99→09/02 | Z129 | 1.6 | | ZSE009 09/00→ | |
| 4.2 TDI 4WD Quattro | 8 | BMC | 235/315 | 01/05→06/05 | GE115 | 4.4V | | | |
| 4.2 TDI 4WD Quattro | 8 | BVN | 240/322 | 07/05→07/10 | GE115 | 4.4V | | | |
| 4.2 TDI 4WD Quattro | 8 | CDSB | 258/346 | 11/09→ | GE115 | 4.4V | | | |
| 4.2 TDI 4WD Quattro | 8 | CTEC | 283/380 | 10/13→ | GE115 | 4.4V | | | |
| 5.2 S8 4WD Quattro | 10 | BSM | 331/444 | 06/06→07/10 | Z295 | 0.8 | | ZSE032 | |
| 6.0 W12 4WD Quattro | 12 | AZC | 309/414 | 01/01→09/02 | Z176 | 1.1 | | ZSE031 | |
| 6.0 W12 4WD Quattro | 12 | BHT, BTE | 331/444 | 12/03→07/10 | Z176 | 1.1 | | ZSE031 | |
| 6.0 W12 4WD Quattro | 12 | BSB | 331/444 | 12/03→07/10 | | | | ZSE031 | |
| 6.3 W12 4WD Quattro | 12 | CEJA, CTNA | 368/493 | 01/11→ | | | | ZSE138 | |

ALLROAD

| | | | | | | | | | |
|-----------------------|---|----------|---------|-------------|-------|-----|-------|--------|--------|
| 2.5 TDI 4WD Quattro | 6 | BCZ | 120/161 | 05/03→08/05 | GN008 | 12V | | | |
| 2.5 TDI 4WD Quattro | 6 | AKE, BAU | 132/177 | 05/00→08/05 | GN008 | 12V | | | |
| 2.7 T 4WD Quattro | 6 | ARE | 184/247 | 05/00→08/05 | Z188 | 0.7 | UXT10 | ZS016 | ZLE276 |
| 2.7 T 4WD Quattro | 6 | BES | 184/247 | 05/00→08/05 | Z188 | 0.7 | UXT10 | | |
| 2.7 T 4WD LPG Quattro | 6 | ARE, BES | 184/247 | 05/00→08/05 | Z340 | 0.7 | UXT12 | | |
| 4.2 V8 4WD Quattro | 8 | BAS | 220/295 | 07/02→08/05 | Z239 | 1.6 | | ZSE062 | |

CABRIOLET

| | | | | | | | | | |
|-------------|---|---------|---------|-------------|--------------------------------|------------|----------------------------|------------------|-------|
| 1.8 | 4 | ADR | 92/123 | 01/97→08/00 | Z90 | 1.0 | UXT1 / UXT3 | ZSE162 | ZM063 |
| 1.8 LPG | 4 | ADR | 92/123 | 01/97→08/00 | Z340 | 0.7 | UXT12 | | |
| 1.9 TDI | 4 | 1Z, AHU | 66/89 | 06/95→08/00 | GN855 | 12V | | | |
| 2.0 16V | 4 | ACE | 103/138 | 06/95→07/96 | Z89 | 0.8 | UXT5 | | |
| 2.0 16V LPG | 4 | ACE | 103/138 | 06/95→07/96 | Z30 ^[168] | 0.8 | UXT5 | | |
| 2.0 E | 4 | ABK | 85/114 | 01/93→07/98 | Z91 | 0.8 | UXT2 / UXT6 | ZSE001 | |
| 2.0 E LPG | 4 | ABK | 85/114 | 01/93→07/98 | Z27 ^[168] | 0.8 | UX56 | | |
| 2.3 E | 5 | NG | 98/131 | 05/91→07/94 | Z75 →07/93 Z94 08/93→ | 1.2 0.8 | UXT2 / UXT6 UXT2 / UXT6 | ZSE005 →07/93 | |
| 2.6 | 6 | ACZ | 102/137 | 05/95→08/00 | Z90 | 1.0 | UXT1 / UXT3 | | |
| 2.6 | 6 | ABC | 110/148 | 06/93→08/00 | Z90 | 1.0 | UXT1 / UXT3 | ZSE007 | ZM063 |
| 2.6 LPG | 6 | ACZ | 102/137 | 05/95→08/00 | Z340 | 0.7 | UXT12 | | |

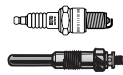

kW/BHP

**... AUDI****... CABRIOLET**

| | | | | | | | | | |
|----------------------|---|----------|---------|-------------|--|------------|--------------|--------|------------------------------------|
| 2.6 LPG | 6 | ABC | 110/148 | 06/93→08/00 | Z340 | 0.7 | UXT12 | | |
| 2.8 | 6 | AAH | 128/172 | 11/92→08/00 | Z90 [169] | 1.0 | UXT1 / UXT3 | ZSE007 | ZM063 |
| 2.8 LPG | 6 | AAH | 128/172 | 11/92→08/00 | Z340 | 0.7 | UXT12 | | |
| COUPE | | | | | | | | | |
| 1.6 | 4 | YN | 55/74 | 07/80→08/81 | Z11 | 0.8 | UXT2 / UXT6 | | |
| 1.8 | 4 | DD | 55/74 | 08/81→07/83 | Z11 | 0.8 | UXT2 / UXT6 | | ZM002 |
| 1.8 | 4 | DZ | 82/110 | 08/89→07/91 | Z12 | 0.8 | UXT2 / UXT6 | | ZM012 |
| 1.8 GT | 4 | SF | 65/87 | 04/86→10/88 | Z91 | 0.8 | UXT2 / UXT6 | | ZM002 →09/86 ZM012 10/86→ |
| 1.8 GT | 4 | DS | 66/89 | 09/82→10/88 | Z2 | 1.0 | UXT2 / UXT6 | | ZM012 |
| 1.8 GT | 4 | JV | 66/89 | 09/82→10/88 | Z12 | 0.8 | UXT2 / UXT6 | | ZM012 |
| 1.8 GT | 4 | JN | 68/91 | 01/85→07/88 | Z91 | 0.8 | UXT2 / UXT6 | | ZM002 →09/86 ZM012 10/86→ |
| 1.8 GT | 4 | PV | 79/106 | 08/86→10/87 | Z12 | 0.8 | UXT2 / UXT6 | | ZM002 →09/86 ZM012 10/86→ |
| 1.8 GT | 4 | DZ | 82/110 | 08/86→10/88 | Z12 | 0.8 | UXT2 / UXT6 | | ZM002 →09/86 ZM012 10/86→ |
| 1.8 GT 4WD Quattro | 4 | DZ | 82/110 | 12/84→10/88 | Z91 | 0.8 | UXT2 / UXT6 | | |
| 1.9 | 5 | WN | 85/114 | 08/80→07/83 | Z42 [169] | 0.8 | UX56 | | ZM002 |
| 2.0 | 4 | 3A | 82/110 | 03/90→07/90 | Z91 | 0.8 | UXT2 / UXT6 | | |
| 2.0 | 4 | 3A | 83/111 | 05/89→03/90 | Z91 | 0.8 | UXT2 / UXT6 | | |
| 2.0 | 4 | AAD | 85/114 | 05/89→12/96 | Z91 | 0.8 | UXT2 / UXT6 | ZSE005 | ZM012 |
| 2.0 | 4 | ABK | 85/114 | 05/89→12/96 | Z91 | 0.8 | UXT2 / UXT6 | ZSE001 | ZM012 |
| 2.0 | 5 | SK | 83/111 | 03/86→04/88 | Z12 | 0.8 | UXT2 / UXT6 | | ZM002 →09/86 ZM012 10/86→ |
| 2.0 | 5 | HP, JS | 85/114 | 09/83→07/86 | Z12 | 0.8 | UXT2 / UXT6 | | ZM002 |
| 2.0 LPG | 4 | AAD, ABK | 85/114 | 05/89→12/96 | Z27 [168] | 0.8 | UX56 | | |
| 2.0 16 V | 4 | ACE | 103/138 | 08/92→12/96 | Z89 | 0.8 | UXT5 | | ZM031 →12/95 |
| 2.0 16 V LPG | 4 | ACE | 103/138 | 08/92→12/96 | Z30 [168] | 0.8 | UXT5 | | |
| 2.0 20 V | 5 | NM | 118/158 | 08/89→07/91 | Z24 | 0.8 | UXT5 | ZSE005 | |
| 2.0 20 V 4WD Quattro | 5 | NM | 118/158 | 08/89→07/91 | Z52 | 0.8 | UXT5 | ZSE005 | |
| 2.1 GT | 5 | WE | 79/106 | 01/81→07/83 | Z11 | 0.8 | UXT2 / UXT6 | | |
| 2.1 GT | 5 | KE | 96/129 | 09/82→10/87 | Z22 →ch. 85-C-250 000 Z42 ch. 85-C-250 001→ | 0.7 0.8 | UX56 UX56 | | ZM002 |
| 2.1 GT | 5 | KL | 96/129 | 09/82→10/87 | Z51 | 0.8 | UX56 | | ZM002 |
| 2.2 4WD Quattro | 5 | JT | 88/118 | 08/85→10/88 | Z12 | 0.8 | UXT2 / UXT6 | ZS124 | ZM002 →09/86 ZM012 10/86→ |
| 2.2 4WD Quattro | 5 | KV | 100/134 | 10/84→07/91 | Z51 | 0.8 | UX56 | | |



kW/BHP

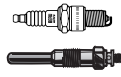

... AUDI



... COUPE

| | | | | | | | | | |
|-------------------------|---|------------|---------|-------------|--------------------------------|--|----------------------|----------------------------|---|
| 2.2 4WD Quattro | 5 | KV | 100/134 | 10/84→10/88 | | | | ZS124 →07/85 | ZM002 →09/86 ZM012 10/86→ |
| 2.2 4WD Quattro | 5 | KV | 100/134 | 11/88→07/91 | | | | | ZM012 |
| 2.2 GT | 5 | KX | 85/114 | 07/81→10/87 | Z12 | | 0.8 | UXT2 / UXT6 | ZM002 01/84→09/86 ZM012 10/86→ |
| 2.2 GT | 5 | HY, KV | 100/134 | 09/84→10/88 | Z51 | | 0.8 | UX56 | ZS124 →07/85 ZM002 →09/86 ZM012 10/86→ |
| 2.2 S2 4WD Quattro | 5 | 3B | 162/217 | 09/90→09/92 | | | | ZSE005 | ZM012 |
| 2.2 S2 4WD Quattro | 5 | ABY | 169/227 | 10/92→12/96 | | | | ZS043 | ZLE233 ZM063 |
| 2.3 | 5 | NG | 98/131 | 03/90→12/96 | Z94 | | 0.8 | UXT2 / UXT6 | ZSE005 |
| 2.3 | 5 | NG | 100/134 | 01/87→10/88 | Z92 | | 0.8 | UXT2 / UXT6 | |
| 2.3 | 5 | NG | 100/134 | 01/87→07/94 | | | | ZSE005 | |
| 2.3 | 5 | NG | 100/134 | 10/88→07/94 | Z75 →07/93 Z94 08/93→ | | 1.2 →07/93 0.8 | UXT2 / UXT6 UXT2 / UXT6 | |
| 2.3 LPG | 5 | NG | 98/131 | 03/90→12/96 | Z20 [168] | | 0.8 | UXT2 / UXT6 | |
| 2.3 4WD Quattro | 5 | NG | 98/131 | 05/90→12/96 | Z75 →07/93 Z94 08/93→ | | 1.2 →07/93 0.8 | UXT2 / UXT6 UXT2 / UXT6 | ZSE005 |
| 2.3 4WD Quattro | 5 | NG | 100/134 | 01/87→10/88 | Z92 | | 0.8 | UXT2 / UXT6 | |
| 2.3 4WD Quattro | 5 | NG | 100/134 | 01/87→12/92 | | | | ZSE005 | |
| 2.3 4WD Quattro | 5 | NG | 100/134 | 11/88→12/92 | Z75 | | 1.2 | UXT2 / UXT6 | |
| 2.3 4WD LPG Quattro | 5 | NG | 98/131 | 05/90→12/96 | Z20 [168] 08/93→ | | 0.8 | UXT2 / UXT6 | |
| 2.3 20V | 5 | 7A | 123/165 | 08/90→07/91 | Z89 | | 0.8 | UXT5 | ZSE005 |
| 2.3 20V | 5 | 7A | 125/168 | 08/89→07/91 | Z89 | | 0.8 | UXT5 | ZSE005 |
| 2.3 20V 4WD Quattro | 5 | 7A | 123/165 | 05/90→12/96 | Z89 | | 0.8 | UXT5 | ZSE005 →07/91 |
| 2.3 20V 4WD Quattro | 5 | 7A | 125/168 | 11/88→07/91 | Z89 | | 0.8 | UXT5 | ZSE005 |
| 2.3 20V 4WD LPG Quattro | 5 | 7A | 123/165 | 05/90→12/96 | Z30 [168] | | 0.8 | UXT5 | |
| 2.6 | 6 | ABC | 110/148 | 08/92→12/96 | Z90 | | 1.0 | UXT1 / UXT3 | ZSE007 ZM027 [188] ZM063 [175] |
| 2.6 LPG | 6 | ABC | 110/148 | 08/92→12/96 | Z340 | | 0.7 | UXT12 | |
| 2.6 4WD Quattro | 6 | ABC | 110/148 | 08/92→12/96 | Z90 | | 1.0 | UXT1 / UXT3 | ZSE007 ZM027 [188] ZM063 [175] |
| 2.6 4WD LPG Quattro | 6 | ABC | 110/148 | 08/92→12/96 | Z340 | | 0.7 | UXT12 | |
| 2.8 | 6 | AAH | 128/172 | 09/91→12/96 | Z90 | | 1.0 | UXT1 / UXT3 | ZSE007 ZM027 [188] ZM063 [175] |
| 2.8 LPG | 6 | AAH | 128/172 | 09/91→12/96 | Z340 | | 0.7 | UXT12 | |
| 2.8 4WD Quattro | 6 | AAH | 128/172 | 08/91→12/96 | Z90 | | 1.0 | UXT1 / UXT3 | ZSE007 ZM027 [188] ZM063 [175] |
| 2.8 4WD LPG Quattro | 6 | AAH | 128/172 | 08/91→12/96 | Z340 | | 0.7 | UXT12 | |
| Q3 | | | | | | | | | |
| 2.0 TDI | 4 | CFFA | 100/134 | 09/11→ | GE115 PSG002 [1][29] | | 4.4V 4.4V | | |
| 2.0 TDI | 4 | CFFB, CLJA | 103/138 | 09/11→ | GE115 PSG002 [1][29] | | 4.4V 4.4V | | |
| 2.0 TDI | 4 | CFGC | 130/174 | 05/13→ | GE115 PSG002 [1][29] | | 4.4V 4.4V | | |

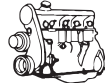

kW/BHP



... AUDI



... Q3

| | | | | | | | | |
|----------------------|---|------------|---------|--------|-------------------------|--------------|-------|--|
| 2.0 TDI 4WD Quattro | 4 | CFFB | 103/138 | 01/12→ | GE115 PSG002 [1][29] | 4.4V 4.4V | | |
| 2.0 TDI 4WD Quattro | 4 | CFGD | 120/161 | 06/11→ | GE115 PSG002 [1][29] | 4.4V 4.4V | | |
| 2.0 TDI 4WD Quattro | 4 | CFGC, CLLB | 130/174 | 06/11→ | GE115 PSG002 [1][29] | 4.4V 4.4V | | |
| 2.0 TFSI 4WD Quattro | 4 | CCZC | 125/168 | 06/11→ | Z347 | 0.7 | UXT12 | ZSE033 [1][47][182] ZSE142 [1][48][175] |
| 2.0 TFSI 4WD Quattro | 4 | CPSA | 155/208 | 06/11→ | Z347 | 0.7 | UXT12 | ZSE033 [1][47][182] ZSE142 [1][48][175] |
| 2.5 RS 4WD Quattro | 5 | CTSA | 228/306 | 10/13→ | | | | ZSE033 [1][47][182] ZSE142 [1][48][175] |

Q5

| | | | | | | | | |
|-----------------------------|---|------------------|---------|--------|---------------------------------|--------------|-------|--|
| 2.0 TDI | 4 | CJCB | 100/134 | 11/10→ | GE115 [233] | 4.4V | | |
| 2.0 TDI | 4 | CJCA | 105/141 | 11/10→ | GE115 [233] | 4.4V | | |
| 2.0 TDI | 4 | CJCD | 110/148 | 05/13→ | GE115 [228] PSG002 [25][228] | 4.4V 4.4V | | |
| 2.0 TDI 4WD Quattro | 4 | CAGB, CJCB | 100/134 | 08/09→ | GE115 [233] | 4.4V | | |
| 2.0 TDI 4WD Quattro | 4 | CAGA, CJCA | 105/141 | 08/09→ | GE115 | 4.4V | | |
| 2.0 TDI 4WD Quattro | 4 | CJCD | 110/148 | 05/13→ | GE115 [228] PSG002 [25][228] | 4.4V 4.4V | | |
| 2.0 TDI 4WD Quattro | 4 | CAHB, CGLA, CGLD | 120/161 | 11/08→ | GE115 [233] | 4.4V | | |
| 2.0 TDI 4WD Quattro | 4 | CAHA, CGLB, CMGA | 125/168 | 11/08→ | GE115 | 4.4V | | |
| 2.0 TDI 4WD Quattro | 4 | CGLC, CMGB | 130/174 | 06/12→ | GE115 [233] | 4.4V | | |
| 2.0 TDI 4WD Quattro | 4 | CNHA | 140/188 | 11/13→ | GE115 [228] PSG002 [25][228] | 4.4V 4.4V | | |
| 2.0 TFSI 4WD Quattro | 4 | CDNB | 132/177 | 08/09→ | Z347 | 0.7 | UXT12 | ZSE033 [1][47][182] ZSE142 [1][48][175] |
| 2.0 TFSI 4WD Quattro | 4 | CNCB | 132/177 | 08/09→ | Z348 | 0.8 | | ZSE033 [1][47][182] ZSE142 [1][48][175] |
| 2.0 TFSI 4WD Quattro | 4 | CAEB, CDNC | 155/208 | 11/08→ | Z347 | 0.7 | UXT12 | ZSE033 [1][47][182] ZSE142 [1][48][175] |
| 2.0 TFSI 4WD Quattro | 4 | CPMA | 155/208 | 11/08→ | Z347 | 0.7 | UXT12 | |
| 2.0 TFSI 4WD Quattro | 4 | CPMB | 162/217 | 05/13→ | Z347 | 0.7 | UXT12 | ZSE033 |
| 2.0 TFSI 4WD Quattro | 4 | CNCD | 165/221 | 06/12→ | Z348 | 0.8 | | |
| 2.0 TFSI hybrid 4WD Quattro | 4 | CHJA | 155/208 | 06/11→ | | | | ZSE033 [1][47][182] ZSE142 [1][48][175] |
| 3.0 SQ5 TDI 4WD Quattro | 6 | CGQB | 230/308 | 12/12→ | GE115 | 4.4V | | |
| 3.0 TDI 4WD Quattro | 6 | CCWB | 155/208 | 11/08→ | GE115 | 4.4V | | |
| 3.0 TDI 4WD Quattro | 6 | CCWA | 176/236 | 11/08→ | GE115 | 4.4V | | |
| 3.0 TDI 4WD Quattro | 6 | CDUD | 180/241 | 06/12→ | GE115 | 4.4V | | |
| 3.0 TDI 4WD Quattro | 6 | CTBC | 184/247 | 06/12→ | GE115 | 4.4V | | |
| 3.0 TDI 4WD Quattro | 6 | CTBA | 190/255 | 11/13→ | GE115 | 4.4V | | |
| 3.0 TFSI 4WD Quattro | 6 | CTUC, CTVA | 200/268 | 06/12→ | | | | ZSE032 |
| 3.2 FSI 4WD Quattro | 6 | CALB | 199/267 | 11/08→ | Z321 | 1.0 | UXT9 | ZSE032 |

Q7

| | | | | | | | | |
|-------------|---|------------|---------|-------------|---------------------------------|--------------|--|--|
| 3.0 TDI 4WD | 6 | CJGC, CJMA | 150/201 | 05/10→ | GE115 [230] | 4.4V | | |
| 3.0 TDI 4WD | 6 | BUN, CASB | 155/208 | 03/06→05/10 | GE115 [226] | 4.4V | | |
| 3.0 TDI 4WD | 6 | CATA | 165/221 | 06/09→05/12 | GE115 [229] PSG002 [28][229] | 4.4V 4.4V | | |
| 3.0 TDI 4WD | 6 | BUG | 171/229 | 03/06→05/08 | GE115 | 4.4V | | |
| 3.0 TDI 4WD | 6 | CASA, CJGA | 176/236 | 11/07→ | GE115 [227] | 4.4V | | |
| 3.0 TDI 4WD | 6 | CCMA | 176/236 | 11/07→ | GE115 [229] PSG002 [28][229] | 4.4V 4.4V | | |
| 3.0 TDI 4WD | 6 | CNRB | 176/236 | 11/07→ | GE115 [232] PSG002 [232] | 4.4V 4.4V | | |
| 3.0 TDI 4WD | 6 | CJGD, CRCA | 180/241 | 05/11→ | GE115 [230] | 4.4V | | |
| 3.0 TDI 4WD | 6 | CLZB | 180/241 | 05/11→ | GE115 [232] PSG002 [232] | 4.4V 4.4V | | |

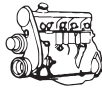

kW/BHP

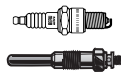

... AUDI



... Q7

| | | | | | | | | | |
|--------------|----|-----------------------|---------|-------------|-------|--|------|--------|--|
| 3.0 TFSI 4WD | 6 | CJTC, CJWC | 200/268 | 05/10→ | | | | ZSE032 | |
| 3.0 TFSI 4WD | 6 | CJWE, CTWB | 206/276 | 05/11→ | | | | ZSE032 | |
| 3.0 TFSI 4WD | 6 | CJTB, CJWB, CNA, CTWA | 245/329 | 05/10→ | | | | ZSE032 | |
| 3.6 FSI 4WD | 6 | BHK | 206/276 | 08/06→05/10 | | | | ZSE041 | |
| 4.2 FSI 4WD | 8 | BAR | 257/345 | 03/06→05/10 | Z295 | | 0.8 | ZSE032 | |
| 4.2 TDI 4WD | 8 | BTR | 240/322 | 03/07→06/09 | GE115 | | 4.4V | | |
| 4.2 TDI 4WD | 8 | CCFA, CCFC | 250/335 | 05/09→ | GE115 | | 4.4V | | |
| 6.0 TDI 4WD | 12 | CCGA | 368/493 | 09/08→ | GE115 | | 4.4V | | |

QUATTRO

| | | | | | | | | | |
|-----------------------|---|--------|---------|-------------|-----|--|-----------------|--------|-------|
| 2.1 Turbo 4WD | 5 | GV, WR | 147/197 | 07/80→07/87 | | | | ZS120 | ZM002 |
| 2.1 Turbo 4WD Quattro | 5 | WX | 119/160 | 02/82→07/89 | Z47 | | 0.8 UX56 | | |
| 2.2 4WD Quattro | 5 | JT | 89/119 | 12/84→07/87 | Z20 | | 0.8 UXT2 / UXT6 | | |
| 2.2 4WD Quattro | 5 | HY, KV | 100/134 | 12/84→07/87 | Z51 | | 0.8 UX56 | | |
| 2.2 20V Turbo 4WD | 5 | RR | 162/217 | 08/89→07/91 | | | | ZSE036 | |
| 2.2 Turbo 4WD | 5 | MB | 147/197 | 08/87→07/89 | Z20 | | 0.8 UXT2 / UXT6 | ZSE036 | |

R8

| | | | | | | | | | |
|---------------------|----|-----------|---------|-------------|------|--|-----------|--------|--|
| 4.2 FSI 4WD Quattro | 8 | BYH | 309/414 | 04/07→09/10 | Z295 | | 0.8 | ZSE032 | |
| 4.2 FSI 4WD Quattro | 8 | CNDA | 316/424 | 07/10→ | Z295 | | 0.8 | ZSE032 | |
| 5.2 FSI 4WD Quattro | 10 | BUJ, CTYA | 386/518 | 04/09→ | Z347 | | 0.7 UXT12 | ZSE032 | |
| | | | | 09/10→ | | | 0.7 | | |
| 5.2 FSI 4WD Quattro | 10 | CTPA | 404/542 | 05/12→ | | | | ZSE032 | |
| 5.2 FSI 4WD Quattro | 10 | CMPA | 412/552 | 11/10→ | | | | ZSE033 | |

SUPER 90

| | | | | | | | | | |
|-----|---|----------|-------|-------------|-----------|--|----------|-------------|--|
| 1.8 | 4 | 21, 8921 | 66/89 | 09/66→08/71 | Z42 [169] | | 0.8 UX56 | ZS115 [111] | |
|-----|---|----------|-------|-------------|-----------|--|----------|-------------|--|

TT

| | | | | | | | | | |
|-------------------|---|------------------------------|---------|-------------|------------|--|-----------|-------------------|--------|
| 1.8 T | 4 | AUM | 110/148 | 01/01→06/06 | Z188 | | 0.7 UXT10 | ZSE043 | |
| | | | | | | | | 01/03→ | |
| 1.8 T | 4 | AUM | 110/148 | 09/02→06/06 | | | | ZSE043 | |
| | | | | | | | | 01/03→ | |
| | | | | | | | | ch. 8N-1-010001→ | |
| 1.8 T | 4 | BVP | 120/161 | 09/05→06/06 | Z188 | | 0.7 UXT10 | ZSE043 | |
| 1.8 T | 4 | AJQ | 132/177 | 10/98→06/06 | Z188 | | 0.7 UXT10 | ZSE009 | ZLE276 |
| 1.8 T | 4 | APP | 132/177 | 10/98→06/06 | Z188 | | 0.7 UXT10 | ZSE009 | |
| 1.8 T | 4 | APP | 132/177 | 10/99→06/06 | | | | ZSE009 | |
| | | | | | | | | →09/00 | |
| | | | | | | | | ch. 8N-1-010 001→ | |
| 1.8 T | 4 | ARY, AUQ | 132/177 | 10/98→06/06 | Z188 | | 0.7 UXT10 | ZSE043 | |
| | | | | | | | | 01/03→ | |
| 1.8 T | 4 | ATC, AWP | 132/177 | 10/98→06/06 | Z188 | | 0.7 UXT10 | | |
| 1.8 T | 4 | AUQ | 132/177 | 10/99→06/06 | | | | ZSE009 | |
| | | | | | | | | 09/00→ | |
| | | | | | | | | →ch. 8N-1-010 000 | |
| | | | | | | | | ZSE043 | |
| | | | | | | | | 01/03→ | |
| 1.8 T | 4 | BVR | 140/188 | 09/05→06/06 | Z188 | | 0.7 UXT10 | ZSE043 | |
| 1.8 T LPG | 4 | AUM | 110/148 | 01/01→06/06 | Z340 | | 0.7 UXT12 | | |
| 1.8 T LPG | 4 | AUM | 110/148 | 09/02→06/06 | Z340 [168] | | 0.7 UXT12 | | |
| 1.8 T LPG | 4 | BVP | 120/161 | 09/05→06/06 | Z340 | | 0.7 UXT12 | | |
| 1.8 T LPG | 4 | AJQ, APP, ARY, ATC, AUQ, AWP | 132/177 | 10/98→06/06 | Z340 | | 0.7 UXT12 | | |
| 1.8 T 4WD Quattro | 4 | AJQ | 132/177 | 10/98→06/06 | Z188 | | 0.7 UXT10 | ZSE009 | ZLE276 |
| 1.8 T 4WD Quattro | 4 | AJQ | 132/177 | 02/00→06/06 | | | | ZS016 | |
| 1.8 T 4WD Quattro | 4 | ARY | 132/177 | 10/98→06/06 | Z188 | | 0.7 UXT10 | ZSE043 | |
| | | | | | | | | 01/03→ | |
| 1.8 T 4WD Quattro | 4 | ATC, AWP | 132/177 | 10/98→06/06 | Z188 | | 0.7 UXT10 | | |
| 1.8 T 4WD Quattro | 4 | BVR | 140/188 | 09/05→06/06 | Z188 | | 0.7 UXT10 | ZSE043 | |
| 1.8 T 4WD Quattro | 4 | AMU, APX | 165/221 | 10/99→06/06 | Z188 | | 0.7 UXT10 | | |

AUDI



kW/BHP

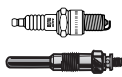

... AUDI



... TT

| | | | | | | | | | |
|-------------------------|---|--------------------|---------|-------------|---|------|--------------------|--|--|
| 1.8 T 4WD Quattro | 4 | APX, BAM | 165/221 | 10/98→06/06 | Z90 →ch. 8N-X-015 500 eng. APX,BAM→ Z188 ch. 8N-X-015 501→ eng. APX,BAM→ | 1.0 | UXT1 / UXT3 | ZSE009 09/00→ →ch. 8N-1-010 000 | |
| 1.8 T 4WD Quattro | 4 | BAM | 165/221 | 10/99→06/06 | Z188 | 0.7 | UXT10 | ZSE043 01/03→ ch. 8N-1-010 001→ | |
| 1.8 T 4WD Quattro | 4 | BFV | 176/236 | 03/05→06/06 | Z188 | 0.7 | UXT10 | ZSE043 01/03→ | |
| 1.8 T 4WD LPG Quattro | 4 | AJQ, ARY, ATC, AWP | 132/177 | 10/98→06/06 | Z340 | 0.7 | UXT12 | | |
| 1.8 T 4WD LPG Quattro | 4 | AMU, APX, BAM | 165/221 | 10/98→06/06 | Z340 | 0.7 | UXT12 | | |
| 1.8 T 4WD LPG Quattro | 4 | BFV | 176/236 | 03/05→06/06 | Z340 | 0.7 | UXT12 | | |
| 1.8 TFSI | 4 | CDA | 118/158 | 06/08→ | Z347 | 0.7 | UXT12 | ZSE033 (1)(47)(182) ZSE142 (1)(48)(175) | |
| 2.0 4WD Quattro | 4 | CDLA, CDMA | 195/261 | 05/08→ | Z347 | 0.7 | UXT12 | ZSE033 (1)(47)(182) ZSE142 (1)(48)(175) | |
| 2.0 TDI | 4 | CUNA | 135/181 | 09/14→ | GE115 PSG002 (29) | 4.4V | | | |
| 2.0 TDI 4WD Quattro | 4 | CBBB, CFGB | 125/168 | 06/08→ | GE115 | 4.4V | | | |
| 2.0 TFSI | 4 | BPY, BWA, CCTA | 147/197 | 08/06→06/10 | Z347 | 0.7 | UXT12 | ZSE033 (1)(47)(182) ZSE142 (1)(48)(175) | |
| 2.0 TFSI | 4 | BPY, BWA, CCTA | 147/197 | 03/07→06/10 | | | | ZSE033 (47) ZSE142 (48) | |
| 2.0 TFSI | 4 | CESA | 155/208 | 05/10→ | Z347 | 0.7 | UXT12 | ZSE033 (1)(47)(182) ZSE142 (1)(48)(175) | |
| 2.0 TFSI 4WD Quattro | 4 | BWA | 147/197 | 06/08→06/10 | | | | ZSE033 (1)(47)(182) ZSE142 (1)(48)(175) | |
| 2.0 TFSI 4WD Quattro | 4 | CCZA | 147/197 | 06/08→06/10 | Z347 | 0.7 | UXT12 | ZSE033 (1)(47)(182) ZSE142 (1)(48)(175) | |
| 2.0 TFSI 4WD Quattro | 4 | CESA, CETA | 155/208 | 05/10→ | Z347 | 0.7 | UXT12 | ZSE033 (1)(47)(182) ZSE142 (1)(48)(175) | |
| 2.0 TFSI 4WD Quattro | 4 | CDLB | 200/268 | 05/08→ | Z347 | 0.7 | UXT12 | ZSE033 (1)(47)(182) ZSE142 (1)(48)(175) | |
| 2.5 TFSI RS 4WD Quattro | 5 | CEPA | 250/335 | 07/09→ | Z339 | 0.7 | | ZSE033 | |
| 2.5 TFSI RS 4WD Quattro | 5 | CEPB | 265/355 | 05/11→ | Z339 | 0.7 | | ZSE033 | |
| 3.2 V6 4WD Quattro | 6 | BUB | 184/247 | 08/06→06/10 | Z306 | 0.9 | | ZSE044 | |
| 3.2 V6 4WD Quattro | 6 | BUB | 184/247 | 03/07→06/10 | | | | ZSE044 (1) | |
| 3.2 VR6 4WD Quattro | 6 | BHE, BPF | 184/247 | 07/03→06/06 | Z306 | 0.9 | | ZSE044 (1)(199) | |
| V8 | | | | | | | | | |
| 3.6 4WD Quattro | 8 | PT | 180/241 | 04/93→02/94 | Z127 | 1.6 | UXT4 | ZSE036 | |
| 3.6 4WD Quattro | 8 | PT | 184/247 | 10/88→02/94 | Z127 | 1.6 | UXT4 | ZSE036 | |
| 4.2 4WD Quattro | 8 | ABH | 206/276 | 10/91→02/94 | Z127 | 1.6 | UXT4 | ZSE036 | |

AUSTIN



1000-Series MK II

| | | | | | | | | | |
|----------------|---|-------|-------|-------------|------------|-----|--------------------|-------------------|--|
| 1.1 1100 | 4 | | 32/43 | 01/70→12/74 | Z11 | 0.8 | UXT2 / UXT6 | | |
| 1.3 1300 | 4 | | 39/52 | 01/70→12/74 | Z11 | 0.8 | UXT2 / UXT6 | ZS106 (11) | |
| 1.3 1300 GT | 4 | | 50/67 | 01/70→12/74 | Z11 | 0.8 | UXT2 / UXT6 | ZS106 (11) | |
| ALLEGRO | | | | | | | | | |
| 1.1 | 4 | 10 H | 33/44 | 05/73→10/81 | Z11 | 0.8 | UXT2 / UXT6 | ZS106 (11) | |
| 1.1 | 4 | 10 H | 36/48 | 01/75→10/79 | Z20 | 0.8 | UXT2 / UXT6 | ZS106 (11) | |
| 1.3 | 4 | 12 H | 40/54 | 05/73→03/82 | Z11 | 0.8 | UXT2 / UXT6 | ZS106 (11) | |
| 1.3 | 4 | 12 L | 43/58 | 01/75→03/82 | Z20 | 0.8 | UXT2 / UXT6 | | |
| 1.3 | 4 | 12 L | 43/58 | 08/75→03/82 | | | | ZS106 (11) | |
| 1.3 | 4 | 12 H | 46/62 | 01/79→12/84 | | | | ZS106 (11) | |
| 1.5 Super | 4 | 14 H | 50/67 | 05/73→03/82 | Z11 | 0.8 | UXT2 / UXT6 | ZS106 (11) | |
| 1.8 1750 | 4 | 17 LA | 67/90 | 01/75→10/79 | Z20 | 0.8 | UXT2 / UXT6 | ZS106 (11) | |

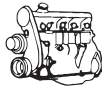

kW/BHP

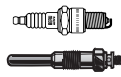
**... AUSTIN****AMBASSADOR**

| | | | | | | | |
|---------|---|-------|--------|-------------|-----------|-----|-------|
| 1.7 | 4 | 17 HL | 62/83 | 03/82→02/84 | Z25 | 0.8 | UXK56 |
| 2.0 | 4 | 20 H | 69/93 | 03/82→10/84 | Z25 | 0.8 | UXK56 |
| 2.0 | 4 | 20 H | 75/101 | 03/82→10/84 | Z25 | 0.8 | UXK56 |
| 2.0 LPG | 4 | 20 H | 75/101 | 03/82→10/84 | Z31 [168] | 0.8 | UXK56 |

MAESTRO

| | | | | | | | |
|-----------------|---|-------------------------------|--------|-------------|-----|-----|-------------|
| 1.3 | 4 | 12 H, 12 H999AA, 12 HC32 | 46/62 | 03/83→08/85 | Z11 | 0.8 | UXT2 / UXT6 |
| 1.3 LS | 4 | 12 H | 49/66 | 03/83→08/90 | Z11 | 0.8 | UXT2 / UXT6 |
| 1.6 | 4 | 16 H956AK | 59/79 | 03/83→10/84 | Z22 | 0.7 | UX56 |
| 1.6 Mayfair HLS | 4 | 16 HC37 | 61/82 | 03/83→08/90 | Z63 | 0.8 | UXT1 / UXT3 |
| 1.6 MG | 4 | 16 HA03AL | 72/97 | 03/83→08/85 | Z22 | 0.7 | UX56 |
| 1.6 MG | 4 | 16 HA35AL | 73/98 | 03/83→08/90 | Z22 | 0.7 | UX56 |
| 2.0 Efi | 4 | 20 HA50AA, 20 HC51AA, 20 HC81 | 83/111 | 10/84→08/90 | Z27 | 0.8 | UX56 |

MAXI

| | | | | | | | |
|-------------|---|-------|-------|-------------|-----|-----|------------------------|
| 1.5 1500 | 4 | 14 H | 50/67 | 04/69→07/80 | Z11 | 0.8 | UXT2 / UXT6 |
| 1.7 1750 | 4 | 17 H | 53/71 | 04/69→10/80 | Z11 | 0.8 | UXT2 / UXT6 ZS109 [15] |
| 1.7 1750 HL | 4 | 17 LA | 66/89 | 10/72→10/80 | Z11 | 0.8 | UXT2 / UXT6 ZS109 [15] |

METRO

| | | | | | | | |
|--------------|---|-----------|-------|-------------|-----|-----|---------------------------|
| 1.0 | 4 | 99 H | 30/40 | 10/80→04/90 | Z20 | 0.8 | UXT2 / UXT6 ZS109 [1][15] |
| 1.0 | 4 | 99 H | 33/44 | 10/80→04/90 | Z20 | 0.8 | UXT2 / UXT6 ZS109 [1][15] |
| 1.0 Surf HLE | 4 | 99 HA65P | 35/47 | 10/80→04/90 | Z20 | 0.8 | UXT2 / UXT6 ZS109 [1][15] |
| 1.3 | 4 | 12 HL | 46/62 | 10/80→12/83 | | | ZS109 [1][15] |
| 1.3 | 4 | 12 HA83AA | 51/68 | 10/80→04/90 | Z20 | 0.8 | UXT2 / UXT6 ZS109 [1][15] |
| 1.3 | 4 | 12 H996AA | 52/70 | 10/80→12/85 | Z20 | 0.8 | UXT2 / UXT6 |
| 1.3 L,HLE,S | 4 | 12 H | 44/59 | 10/80→04/90 | Z11 | 0.8 | UXT2 / UXT6 |
| | | | | | Z20 | 0.8 | |
| 1.3 Surf | 4 | 12 HC21AA | 44/59 | 11/85→04/90 | Z11 | 0.8 | UXT2 / UXT6 |
| 1.3 Turbo | 4 | 12 HA85AA | 66/89 | 10/83→04/90 | Z27 | 0.8 | UX56 ZS115 [1][11] |

MINI

| | | | | | | | |
|------------------------|---|------------------------------|-------|-------------|-----------|-----|---------------------------|
| 0.8 850 | 4 | BMC Serie A | 25/34 | 01/67→08/79 | Z11 | 0.8 | UXT2 / UXT6 ZS106 [11] |
| 1.0 | 4 | | 44/59 | 09/62→08/69 | | | ZS106 [11] |
| 1.0 1000 | 4 | | 26/35 | 10/67→09/84 | Z11 | 0.8 | UXT2 / UXT6 ZS106 [1][11] |
| | | | | →12/81 | Z20 [167] | 0.8 | UXT2 / UXT6 ZS115 [1][11] |
| | | | | 01/82→ | | | 01/69→12/81 |
| 1.0 1000 | 4 | 99 H | 29/39 | 10/67→09/84 | Z11 [167] | 0.8 | UXT2 / UXT6 ZS106 [1][11] |
| 1.0 1000 Mayfair | 4 | 99 H997P, 99 HA53P, 99 HC20P | 31/42 | 08/82→06/93 | Z20 [167] | 0.8 | UXT2 / UXT6 ZS106 [11] |
| | | | | | | | 08/83→08/88 |
| 1.0 1000 Mayfair Sport | 4 | 99 HD81 | 30/40 | 09/88→06/93 | Z11 [167] | 0.8 | UXT2 / UXT6 ZS109 [1][15] |
| 1.1 1100 Special | 4 | 10 H | 33/44 | 01/76→08/81 | Z20 | 0.8 | UXT2 / UXT6 ZS106 [11] |
| 1.3 | 4 | 12 H | 48/64 | 04/74→09/80 | | | ZS106 [11] |
| 1.3 | 4 | 12 HC | 53/71 | 09/69→09/80 | | | ZS106 [11] |
| 1.3 | 4 | | 57/76 | 09/62→08/69 | | | ZS106 [11] |
| 1.3 1275 GT | 4 | | 39/52 | 10/69→08/80 | Z20 | 0.8 | UXT2 / UXT6 ZS106 [11] |

MONTEGO

| | | | | | | | |
|-------------|---|--------------|---------|-------------|-----|-----|----------------------------|
| 1.6 LS | 4 | 16 HC37 | 61/82 | 10/84→08/88 | Z63 | 0.8 | UXT1 / UXT3 ZS109 [15] |
| | | | | | | | ch. 247735→ →ch. 389194 |
| 1.6 LS,HL | 4 | 16 HC37 | 61/82 | 04/84→08/88 | Z63 | 0.8 | UXT1 / UXT3 ZS109 [15] |
| | | | | | | | ch. 247735→ →ch. 389194 |
| 2.0 | 4 | 20 H, 20 HSC | 74/99 | 04/84→08/91 | Z21 | 1.1 | UXT2 / UXT6 |
| 2.0 HLI | 4 | 20 H | 83/111 | 10/84→08/88 | Z27 | 0.8 | UX56 |
| 2.0 Mayfair | 4 | 20 H(EFI) | 83/111 | 04/84→08/88 | Z27 | 0.8 | UX56 |
| 2.0 Turbo | 4 | 20 HC85 | 110/148 | 04/84→08/88 | Z22 | 0.7 | UX56 |

PRINCESS

| | | | | | | | |
|--------------|---|------|--------|-------------|-----|-----|------------------------|
| 1.8 1800 HL | 4 | 18 H | 60/80 | 04/76→09/78 | Z11 | 0.8 | UXT2 / UXT6 ZS106 [11] |
| 2.2 2200 HLS | 6 | 22 H | 81/109 | 04/76→09/78 | Z11 | 0.8 | UXT2 / UXT6 ZS106 [11] |

AUSTIN



kW/BHP

**... AUSTIN****PRINCESS 2**

| | | | | | | | | |
|----------|---|-------|--------|-------------|--|--|--|------------|
| 1.7 1700 | 4 | 17 HL | 65/87 | 10/78→10/82 | | | | ZS106 [11] |
| 2.0 2000 | 4 | 20 H | 69/93 | 10/78→10/82 | | | | ZS106 [11] |
| 2.2 2200 | 6 | 22 H | 82/110 | 10/78→10/82 | | | | ZS106 [11] |

AUTOBIANCHI**A 111**

| | | | | | | | | |
|-----|---|--------------|-------|-------------|-----|--|-----|------------------------|
| 1.4 | 4 | Fiat BLC.000 | 51/68 | 08/69→11/72 | Z20 | | 0.8 | UXT2 / UXT6 ZS106 [11] |
|-----|---|--------------|-------|-------------|-----|--|-----|------------------------|

A 112

| | | | | | | | | |
|------------------|---|-------------------------|-------|-------------|-----|--|-----|------------------------|
| 0.9 | 4 | A112A 5.000 | 32/43 | 10/69→12/72 | Z20 | | 0.8 | UXT2 / UXT6 ZS106 [11] |
| 0.9 | 4 | A112A 5.000 | 33/44 | 01/76→12/78 | Z20 | | 0.8 | UXT2 / UXT6 ZS106 [11] |
| 0.9 E | 4 | A112A 5.000 | 34/46 | 01/73→12/77 | Z20 | | 0.8 | UXT2 / UXT6 ZS106 [11] |
| 0.9 Junior | 4 | A112A 5.000, A112B2.000 | 31/42 | 07/75→12/85 | Z20 | | 0.8 | UXT2 / UXT6 ZS106 [11] |
| 1.0 Abarth | 4 | A112A1.000 | 43/58 | 09/71→12/75 | Z27 | | 0.8 | UX56 |
| 1.0 Abarth | 4 | A112A2.000 | 51/68 | 01/74→12/84 | Z27 | | 0.8 | UX56 |
| 1.0 E, Elite, LX | 4 | A112B1.000 | 35/47 | 11/77→12/85 | Z20 | | 0.8 | UXT2 / UXT6 |

ZM005
01/79→02/84
ZM005
01/79→02/84

Y10

| | | | | | | | | |
|-----------------|---|----------------------|-------|-------------|-----------|--|-----|-------------|
| 1.0 | 4 | 156A2.000, 156A2.246 | 33/44 | 03/85→10/95 | Z15 [168] | | 0.8 | UXT1 / UXT3 |
| 1.0 4WD | 4 | 156A3.000 | 37/50 | 12/86→10/95 | Z15 [168] | | 0.8 | UXT1 / UXT3 |
| 1.0 | 4 | 156A.000 | 41/55 | 03/85→10/95 | Z20 | | 0.8 | UXT2 / UXT6 |
| 1.0 LPG | 4 | 156A2.000, 156A2.246 | 33/44 | 03/85→10/95 | Z340 | | 0.7 | UXT12 |
| 1.0 4WD LPG | 4 | 156A3.000 | 37/50 | 12/86→10/95 | Z340 | | 0.7 | UXT12 |
| 1.0 LPG | 4 | 156A.000 | 41/55 | 03/85→10/95 | Z27 [168] | | 0.8 | UX56 |
| 1.1 | 4 | 156C.000 | 42/56 | 06/89→10/95 | Z15 [168] | | 0.8 | UXT1 / UXT3 |
| 1.1 LPG | 4 | 156C.000 | 42/56 | 06/89→10/95 | Z340 | | 0.7 | UXT12 |
| 1.1 i.e. | 4 | 156C.046 | 42/56 | 09/90→10/95 | Z247 | | 0.9 | UXT1 / UXT3 |
| 1.1 i.e. LPG | 4 | 156C.046 | 42/56 | 09/90→10/95 | Z340 | | 0.7 | UXT12 |
| 1.3 i.e. GT | 4 | 146A5.046 | 54/72 | 06/89→10/95 | Z20 | | 0.8 | UXT2 / UXT6 |
| 1.3 i.e. GT | 4 | 156B.000 | 57/76 | 06/89→10/95 | Z20 | | 0.8 | UXT2 / UXT6 |
| 1.3 i.e. GT LPG | 4 | 146A5.046 | 54/72 | 06/89→10/95 | Z27 [168] | | 0.8 | UX56 |
| 1.3 i.e. GT LPG | 4 | 156B.000 | 57/76 | 06/89→10/95 | Z27 [168] | | 0.8 | UX56 |

BEDFORD**ASTRAMAX**

| | | | | | | | | |
|-------|---|-------|-------|-------------|----------------|-------|-----|--|
| 1.6 D | 4 | 16 D | 40/54 | 09/85→08/88 | GV636 | | 11V | |
| 1.6 D | 4 | 16 DA | 42/56 | 09/85→08/88 | GN909 [2][222] | GR064 | 11V | |
| | | | | | GV636 | | 11V | |

ASTRA VAN

| | | | | | | | | |
|-------|---|-------|-------|-------------|----------------|--------|-----|--|
| 1.6 D | 4 | 16 D | 40/54 | 07/82→08/88 | GV636 | | 11V | |
| 1.6 D | 4 | 16 DA | 42/56 | 09/87→08/89 | GN909 [2][222] | GR064 | 11V | |
| | | | | | GV636 | →01/89 | 11V | |

CHEVANNE

| | | | | | | | | |
|-----|---|-----|-------|-------------|--|--|--|---------------|
| 1.3 | 4 | | 39/52 | 06/76→02/80 | | | | ZS109 [1][15] |
| 1.3 | 4 | LW4 | 40/54 | 03/80→12/82 | | | | ZS109 [1][15] |

RASCAL

| | | | | | | | | |
|---------|---|----|-------|-------------|--|--|--|---------------|
| 1.0 4WD | 3 | CB | 34/46 | 07/86→06/90 | | | | ZS109 [1][15] |
|---------|---|----|-------|-------------|--|--|--|---------------|

BEDFORD**BLITZ**

| | | | | | | | | |
|-------|---|--------|-------|-------------|----------------|--|-----|--|
| 1.8 | 4 | N18Z | 49/66 | 08/69→10/87 | Z49 | | 0.8 | |
| 2.0 | 4 | 20 N | 56/75 | 02/85→10/87 | Z19 [168] | | 0.8 | |
| 2.0 D | 4 | 20 DTr | 44/59 | 10/80→10/83 | GN013 [2][222] | | 11V | |
| | | | | | GN954 | | 11V | |
| 2.1 D | 4 | 21D | 44/59 | 09/81→10/87 | GN927 [2][222] | | 11V | |
| | | | | | GV604 | | 11V | |



kW/BHP

**... BEDFORD****... BLITZ**

| | | | | | | | |
|-------|---|-----|-------|-------------|--|----------------|--|
| 2.3 D | 4 | 23D | 46/62 | 01/73→10/87 | GN013 [222] 09/80→ GN954 09/80→ | 11V 11V | |
|-------|---|-----|-------|-------------|--|----------------|--|

MIDI

| | | | | | | | |
|-------|---|------|-------|-------------|--------------|-----|--|
| 2.2 D | 4 | 4FD1 | 45/60 | 09/84→08/92 | GV947 | 11V | |
|-------|---|------|-------|-------------|--------------|-----|--|

RASCAL

| | | | | | | | |
|---------|---|-------|-------|-------------|------------------|-----|----------------------|
| 1.0 4WD | 3 | CB | 34/46 | 07/86→06/90 | | | ZS109 [1][15] |
| 1.0 | 4 | FA10A | 34/46 | 07/86→06/90 | Z20 [168] | 0.8 | UXT2 / UXT6 |

BENTLEY**ARNAGE**

| | | | | | | | |
|--------------|---|--|---------|-------------|-------------------|-----|--------------|
| 6.8 V8 T | 8 | | 336/451 | 02/02→10/09 | Z228 | 1.0 | UXT11 |
| 6.8 V8 T LPG | 8 | | 336/451 | 02/02→10/09 | Z221 [168] | 1.0 | UXT14 |

CONTINENTAL

| | | | | | | | |
|----------------|----|-------|---------|--------|--|--|---------------|
| 6.0 4WD | 12 | MTBHT | 412/552 | 06/03→ | | | ZSE031 |
| 6.0 4WD | 12 | MTBHT | 449/602 | 08/07→ | | | ZSE031 |
| 6.0 4WD | 12 | MTBHT | 463/621 | 03/10→ | | | ZSE031 |
| 6.0 CS ISR 4WD | 12 | | 471/632 | 03/11→ | | | ZSE031 |

CONTINENTAL FLYING SPUR

| | | | | | | | |
|---------|----|-------|---------|--------|--|--|---------------|
| 6.0 4WD | 12 | MTBHT | 412/552 | 03/05→ | | | ZSE031 |
| 6.0 4WD | 12 | | 449/602 | 09/08→ | | | ZSE031 |

BMW**1 (E81)**

| | | | | | | | |
|-----------|---|-----------|---------|-------------|-------------|-----|---|
| 1.6 116 i | 4 | N43 B16 A | 85/114 | 03/07→09/12 | | | ZSE144 |
| 1.6 116 i | 4 | N45 B16 A | 85/114 | 03/07→09/12 | Z239 | 1.6 | ZS324 →06/09 ZSE143 07/09→ |
| 1.6 116 i | 4 | N43 B16 A | 90/121 | 03/07→09/12 | | | ZSE144 |
| 1.6 116 i | 4 | N45 B16 A | 90/121 | 03/07→09/12 | Z239 | 1.6 | ZS324 →06/09 ZSE143 07/09→ |
| 2.0 116 i | 4 | N43 B20 A | 90/121 | 11/08→09/12 | | | ZSE144 03/09→12/11 |
| 2.0 118 i | 4 | N43 B20 A | 100/134 | 09/06→09/12 | | | ZSE144 |
| 2.0 118 i | 4 | N46 B20 B | 100/134 | 09/06→09/12 | Z301 | 1.1 | ZS324 →06/09 ZSE143 07/09→ |
| 2.0 118 i | 4 | N43 B20 A | 105/141 | 09/06→09/12 | | | ZSE144 05/07→12/11 |
| 2.0 120 i | 4 | N43 B20 A | 115/154 | 09/06→09/12 | | | ZSE144 |
| 2.0 120 i | 4 | N46 B20 | 115/154 | 09/06→09/12 | Z301 | 1.1 | ZS324 →06/09 ZSE143 07/09→ |
| 2.0 120 i | 4 | N43 B20 A | 120/161 | 09/06→09/12 | | | ZSE144 05/07→12/11 |
| 2.0 120 i | 4 | N46 B20 | 120/161 | 09/06→09/12 | Z301 | 1.1 | ZS324 →09/09 ZSE143 07/09→ |
| 2.0 120 i | 4 | N43 B20 A | 125/168 | 09/06→09/12 | | | ZSE144 05/07→12/11 |

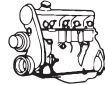

kW/BHP

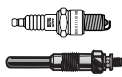
**... BMW****... 1 (E81)**

| | | | | | | | | |
|-----------|---|-----------------------|---------|-------------|----------------|--|-----|-------------------------------------|
| 2.0 120 i | 4 | N46 B20 | 125/168 | 09/06→09/12 | Z301 | | 1.1 | ZS324 →06/09 ZSE143 07/09→ |
| 3.0 130 i | 6 | N52 B30 A | 190/255 | 09/06→09/12 | Z235 | | 1.0 | ZSE143 09/09→12/11 |
| 3.0 130 i | 6 | N52 B30 B, N52 B30 BF | 190/255 | 09/06→09/12 | Z235 | | 1.0 | |
| 3.0 130 i | 6 | N52 B30 A | 195/261 | 09/06→09/12 | Z235 →09/09 | | 1.0 | ZSE143 11/07→08/09 |
| 3.0 130 i | 6 | N52 B30 B, N52 B30 BF | 195/261 | 09/06→09/12 | Z235 →09/09 | | 1.0 | |

1 Coupe (E82)

| | | | | | | | | |
|-----------|---|-----------|---------|-------------|----------------|--|-----|------------------|
| 2.0 120 i | 4 | N46 B20 B | 115/154 | 09/09→ | Z301 | | 1.1 | ZSE143 |
| 2.0 120 i | 4 | N43 B20 A | 125/168 | 09/09→ | | | | ZSE144 →02/12 |
| 2.0 120 i | 4 | N46 B20 B | 125/168 | 09/09→ | Z301 | | 1.1 | ZSE143 |
| 3.0 125 i | 6 | N52 B30 A | 160/215 | 10/07→ | Z235 →09/09 | | 1.0 | ZSE143 03/08→ |
| 3.0 135 i | 6 | N54 B30 A | 225/302 | 10/07→ | | | | ZSE143 |
| 3.0 M | 6 | N54 B30 A | 250/335 | 04/11→06/12 | | | | ZSE143 |

1 (E87)

| | | | | | | | | |
|-----------|---|--|---------|-------------|------------------------|--------|-----|-------------------------------------|
| 1.6 116 i | 4 | N43 B16 A | 85/114 | 11/03→09/12 | | | | ZSE144 |
| 1.6 116 i | 4 | N45 B16 A | 85/114 | 11/03→09/12 | Z239 | | 1.6 | ZS324 →06/09 ZSE143 07/09→ |
| 1.6 116 i | 4 | N43 B16 A | 90/121 | 11/03→09/12 | | | | ZSE144 |
| 1.6 116 i | 4 | N45 B16 A | 90/121 | 11/03→09/12 | Z239 | | 1.6 | ZS324 →06/09 ZSE143 07/09→ |
| 2.0 116 i | 4 | N43 B20 A | 90/121 | 11/03→09/12 | | | | ZSE144 |
| 2.0 118 d | 4 | M47 | 90/121 | 11/03→09/12 | GE102 | GSE101 | 5V | |
| 2.0 118 d | 4 | M47 D20 (204D4) | 100/134 | 11/03→09/12 | GE102 ⁽²⁶⁸⁾ | GSE101 | 5V | |
| 2.0 118 d | 4 | M47 D20 (204D4) | 105/141 | 11/03→09/12 | GE102 ⁽²⁶⁸⁾ | GSE101 | 5V | |
| 2.0 118 i | 4 | N43 B20 A | 95/127 | 07/04→09/12 | | | | ZSE144 |
| 2.0 118 i | 4 | N46 B20 B | 95/127 | 07/04→09/12 | Z301 | | 1.1 | ZS324 →06/09 ZSE143 07/09→ |
| 2.0 118 i | 4 | N43 B20 A | 105/141 | 07/04→09/12 | | | | ZSE144 |
| 2.0 118 i | 4 | N46 B20 A | 105/141 | 07/04→09/12 | Z301 | | 1.1 | ZS324 →06/09 ZSE143 07/09→ |
| 2.0 120 d | 4 | M47 | 120/161 | 11/03→09/12 | GE102 | GSE101 | 5V | |
| 2.0 120 d | 4 | M47 | 130/174 | 11/03→09/12 | GE102 | GSE101 | 5V | |
| 2.0 120 i | 4 | N43 B20 A | 110/148 | 11/03→09/12 | | | | ZSE144 |
| 2.0 120 i | 4 | N46 B20 B, N46 B20 BD, N46 B20 C, N46 B20 CC, N46 B20 CD | 110/148 | 11/03→09/12 | Z301 | | 1.1 | ZS324 →06/09 ZSE143 07/09→ |
| 2.0 120 i | 4 | N43 B20 A | 115/154 | 11/03→09/12 | | | | ZSE144 |
| 2.0 120 i | 4 | N46 B20 B, N46 B20 BD, N46 B20 C, N46 B20 CC, N46 B20 CD | 115/154 | 11/03→09/12 | Z301 | | 1.1 | ZS324 →06/09 ZSE143 07/09→ |
| 2.0 120 i | 4 | N43 B20 A | 120/161 | 11/03→09/12 | | | | ZSE144 |

BMW



kW/BHP

**... BMW****... 1 (E87)**

| | | | | | | | |
|-----------|---|--|---------|-------------|----------------|-----|---|
| 2.0 120 i | 4 | N46 B20 B, N46 B20 BD, N46 B20 C, N46 B20 CC, N46 B20 CD | 120/161 | 11/03→09/12 | Z301 | 1.1 | ZS324 →06/09 ZSE143 07/09→ |
| 2.0 120 i | 4 | N43 B20 A | 125/168 | 11/03→09/12 | | | ZSE144 |
| 2.0 120 i | 4 | N46 B20 B, N46 B20 BD, N46 B20 C, N46 B20 CC, N46 B20 CD | 125/168 | 11/03→09/12 | | | ZS324 →06/09 ZSE143 07/09→ |
| 3.0 130 i | 6 | N52 B30 A, N52 B30 B | 190/255 | 03/05→09/12 | Z235 →12/09 | 1.0 | ZSE143 09/09→06/11 |
| 3.0 130 i | 6 | N52 B30 A, N52 B30 B | 195/261 | 03/05→09/12 | Z235 →12/09 | 1.0 | ZSE145 →04/06 ZSE143 04/06→08/09 |

1 Convertible (E88)

| | | | | | | | |
|-----------|---|----------------------|---------|--------|----------------|-----|------------------|
| 2.0 118 i | 4 | N46 B20 B | 100/134 | 09/08→ | Z301 | 1.1 | ZSE143 |
| 2.0 118 i | 4 | N43 B20 A | 105/141 | 03/08→ | | | ZSE144 →02/12 |
| 2.0 120 i | 4 | N46 B20 B, N46 B20 C | 115/154 | 03/08→ | Z301 | 1.1 | ZSE143 |
| 2.0 120 i | 4 | N43 B20 A | 120/161 | 03/08→ | | | ZSE144 →02/12 |
| 2.0 120 i | 4 | N43 B20 A | 125/168 | 03/08→ | | | ZSE144 →02/12 |
| 3.0 125 i | 6 | N52 B30 A | 160/215 | 03/08→ | Z235 →09/09 | 1.0 | ZSE143 |
| 3.0 135 i | 6 | N54 B30 A | 225/302 | 03/08→ | | | ZSE143 |

1 (F20)

| | | | | | | | |
|-----------|---|-----------|---------|--------|------|-----|--------|
| 1.6 114 i | 4 | N13 B16 A | 75/101 | 11/11→ | Z332 | 0.7 | ZSE143 |
| 1.6 116 i | 4 | N13 B16 A | 100/134 | 12/10→ | Z332 | 0.7 | ZSE143 |
| 1.6 118 i | 4 | N13 B16 A | 125/168 | 11/10→ | Z332 | 0.7 | ZSE143 |

1 (F21)

| | | | | | | | |
|-----------|---|-----------|---------|--------|------|-----|--------|
| 1.6 114 i | 4 | N13 B16 A | 75/101 | 12/11→ | Z332 | 0.7 | ZSE143 |
| 1.6 116 i | 4 | N13 B16 A | 100/134 | 12/11→ | Z332 | 0.7 | ZSE143 |
| 1.6 118 i | 4 | N13 B16 A | 125/168 | 07/12→ | Z332 | 0.7 | ZSE143 |

2 Active Tourer (F45)

| | | | | | | | |
|-----------|---|-----------|---------|--------|--|--|-------|
| 1.5 218 i | 3 | B38 A15 A | 100/134 | 09/14→ | | | ZS538 |
| 2.0 225 i | 4 | B48 A20 B | 170/228 | 09/14→ | | | ZS538 |

02 Touring (E6)

| | | | | | | | |
|--------------|---|---------|--------|-------------|--------------------------------|------------|--|
| 1.6 1600 | 4 | M10 B16 | 63/84 | 05/71→04/73 | Z22 | 0.7 | UX56 |
| 1.8 1802 | 4 | M10 B18 | 66/89 | 05/71→07/75 | Z22 | 0.7 | UX56 |
| 2.0 2002 | 4 | M10 B20 | 74/99 | 05/71→07/75 | Z22 →07/72 Z11 08/72→ | 0.7 0.8 | UX56 ZS106 ⁽¹¹⁾ →07/72 UXT2 / UXT6 08/72→ |
| 2.0 2002 Tii | 4 | M10 B20 | 96/129 | 01/71→07/75 | Z22 →08/72 Z11 09/72→ | 0.7 0.8 | UX56 ZS106 ⁽¹¹⁾ →08/72 UXT2 / UXT6 09/72→ |

02 (E10)

| | | | | | | | |
|-------------|---|---------|--------|-------------|-----|-----|---|
| 1.6 1502 | 4 | M10 B16 | 55/74 | 01/75→07/77 | Z1 | 0.7 | UXT2 / UXT6 ZS106 ⁽¹¹⁾ |
| 1.6 1600/2 | 4 | M10 B16 | 63/84 | 12/67→12/71 | Z22 | 0.7 | UX56 |
| 1.6 1600 Ti | 4 | M10 B16 | 77/103 | 09/67→11/69 | Z22 | 0.7 | UX56 |
| 1.6 1602 | 4 | M10 B16 | 63/84 | 04/71→07/75 | Z22 | 0.7 | UX56 ZS106 ⁽¹¹⁾ 06/73→ |
| 1.8 1802 | 4 | M10 B18 | 66/89 | 05/71→07/75 | Z22 | 0.7 | UX56 ZS106 ⁽¹¹⁾ 06/73→ |

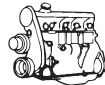

kW/BHP

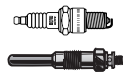
**... BMW****... 02 (E10)**

| | | | | | | | | |
|----------------|---|-----------------|---------|-------------|--------------------------------------|---|------------|--|
| 2.0 2002 | 4 | M10 B20 | 74/99 | 02/68→07/75 | Z22 →08/72 Z11 09/72→ | 0.7 UX56 →08/72 0.8 UXT2 / UXT6 09/72→ | | |
| 2.0 2002 Ti | 4 | M10 B20 | 88/118 | 06/68→04/72 | Z22 | 0.7 UX56 | ZS106 [11] | |
| 2.0 2002 Tii | 4 | M10 B20 | 96/129 | 05/71→07/75 | Z22 →08/72 Z11 [168] 09/72→ | 0.7 UX56 →08/72 0.8 UXT2 / UXT6 09/72→ | ZS106 [11] | |
| 2.0 2002 Turbo | 4 | M10 B20 (Turbo) | 125/168 | 01/74→07/75 | Z22 | 0.7 UX56 | ZS109 [15] | |

02 /Convertible (E10)

| | | | | | | | | |
|----------|---|---------|-------|-------------|--|--|------------|--|
| 2.0 2002 | 4 | M10 B20 | 74/99 | 02/68→07/75 | | | ZS106 [11] | |
|----------|---|---------|-------|-------------|--|--|------------|--|

02 Convertible (E10)

| | | | | | | | | |
|------------|---|---------|-------|-------------|--------------------------------------|---|--|--|
| 1.6 1600-2 | 4 | M10 B16 | 63/84 | 12/67→10/71 | Z51 [167] | 0.8 UX56 | | |
| 2.0 2002 | 4 | M10 B20 | 74/99 | 05/71→07/75 | Z22 →08/72 Z11 [168] 09/72→ | 0.7 UX56 →08/72 0.8 UXT2 / UXT6 09/72→ | | |

3 (E21)

| | | | | | | | | |
|-----------|---|--------------------------|---------|-------------|-----|-----------------|---|----------------------------|
| 1.6 315 | 4 | M10 B16 (164VB) | 55/74 | 03/81→03/84 | Z1 | 0.7 UXT2 / UXT6 | | ZM001 |
| 1.6 316 | 4 | M10 B16, M10 B16 (164VA) | 66/89 | 08/75→08/80 | Z1 | 0.7 UXT2 / UXT6 | ZS106 [11] | |
| 1.8 316 | 4 | M10 B18 (184VC) | 66/89 | 09/80→08/82 | Z1 | 0.7 UXT2 / UXT6 | | ZM001 [175] ZM038 [175] |
| 1.8 318 | 4 | M10 B18 (184VA) | 72/97 | 08/75→08/80 | Z1 | 0.7 UXT2 / UXT6 | ZS106 [11] | |
| 1.8 318 i | 4 | M10 B18 (184VA) | 77/103 | 11/79→08/82 | Z1 | 0.7 UXT2 / UXT6 | ZS106 [11] →08/80 ZM001 09/80→ | ZM038 [175] |
| 2.0 320 | 4 | M10 B20 | 80/107 | 08/75→08/77 | Z1 | 0.7 UXT2 / UXT6 | ZS106 [11] | |
| 2.0 320/6 | 6 | M20 B20, M20 B20 (206VA) | 90/121 | 09/77→08/82 | Z1 | 0.7 UXT2 / UXT6 | ZS115 [11] →07/78 ZS400 [11] 08/78→08/80 | ZM001 |
| 2.0 320 i | 4 | M10 B20 | 92/123 | 06/75→08/82 | Z11 | 0.8 UXT2 / UXT6 | ZS106 [11] | |
| 2.3 323 i | 6 | M20 B23 (236EA) | 105/141 | 01/78→08/82 | Z1 | 0.7 UXT2 / UXT6 | ZS400 [11] →07/80 | ZM001 |

3 (E30)

| | | | | | | | | |
|---------------------|---|-----------------|---------|-------------|------------------------------|--|-----------------|------------------------------------|
| 1.6 315 | 4 | M10 B16 | 55/74 | 09/82→12/91 | Z1 | 0.7 UXT2 / UXT6 | | ZM001 |
| 1.6 316 i | 4 | M40 B16 (164E1) | 73/98 | 09/87→06/91 | Z1 →08/88 Z4 09/88→ | 0.7 UXT2 / UXT6 →08/88 0.7 UXT1 / UXT3 09/88→ | ZS121 09/88→ | |
| 1.6 316 i | 4 | M40 B16 (164E1) | 75/101 | 07/88→06/91 | Z4 | 0.7 UXT1 / UXT3 | | |
| 1.8 316 | 4 | M10 B18 (184VC) | 66/89 | 09/82→12/87 | Z1 | 0.7 UXT2 / UXT6 | | ZM001 |
| 1.8 316 (Ecotronic) | 4 | M10 B18 | 66/89 | 09/83→12/90 | Z1 | 0.7 UXT2 / UXT6 | | |
| 1.8 316 i | 4 | M10 B18 (184KA) | 75/101 | 08/87→08/88 | Z1 | 0.7 UXT2 / UXT6 | | |
| 1.8 318 i | 4 | M10 B18 (184KA) | 75/101 | 12/84→08/88 | Z1 | 0.7 UXT2 / UXT6 | | ZM038 01/85→ |
| 1.8 318 i | 4 | M10 B18 (184EA) | 77/103 | 09/82→08/87 | Z1 | 0.7 UXT2 / UXT6 | | ZM038 |
| 1.8 318 i | 4 | M40 B18 | 85/114 | 09/87→06/91 | Z4 | 0.7 UXT1 / UXT3 | ZS122 | |
| 1.8 318 is | 4 | M42 B18 (184S1) | 100/134 | 09/89→08/91 | Z14 | 0.9 UXT1 / UXT3 | | |
| 2.0 320 i | 6 | M20 B20 (206EB) | 92/123 | 09/82→12/85 | Z1 | 0.7 UXT2 / UXT6 | | ZM001 →08/83 ZM038 09/84→ |
| 2.0 320 i | 6 | M20 B20 (206KA) | 95/127 | 12/85→06/91 | | | ZS122 04/89→ | ZM038 12/86→11/90 |
| 2.0 320 i | 6 | M20 B20 (206KA) | 110/148 | 12/85→06/90 | Z14 | 0.9 UXT1 / UXT3 | | |
| 2.0 320 is | 4 | S14 204 EA | 141/189 | 05/88→12/90 | | | ZS122 | |

BMW

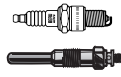

kW/BHP

**... BMW****... 3 (E30)**

| | | | | | | | | | |
|-------------------------------------|---|---|---------|-------------|------------------------------------|------------|-----------------------|-----------------|-----------------|
| 2.3 323 i | 6 | M20 B23 | 102/137 | 09/82→08/83 | Z1 | 0.7 | UXT2 / UXT6 | ZM001 | |
| 2.3 323 i | 6 | M20 B23 | 110/148 | 09/83→08/86 | Z1 | 0.7 | UXT2 / UXT6 | ZM001 | |
| 2.3 M3 | 4 | S14 B23 (234S1), S14 B23 (234S2) | 143/192 | 07/86→06/91 | | | | ZS122 | |
| 2.3 M3 | 4 | S14 B23 (234S2) | 147/197 | 02/87→05/89 | | | | ZS122 | |
| 2.3 M3 | 4 | S14 B23 | 158/212 | 06/89→06/91 | | | | ZS122 | |
| 2.3 M3 EVO I | 4 | S14 B23 (EVO I) | 162/217 | 10/88→10/90 | | | | ZS122 | |
| 2.4 324 d | 6 | M21 D24 W | 63/84 | 09/85→08/91 | GN909 ^{[2][222]} GV636 | 11V 11V | | | |
| 2.5 325 i | 6 | M20 B25 (256E1) | 125/168 | 12/86→06/91 | Z3 | 0.7 | UXT2 / UXT6 | ZS122 | |
| 2.5 325 i 4WD | 6 | M20 B25 (256E1), M20 B25 (256E2), M20 B25 (256EX) | 125/168 | 12/86→08/91 | Z3 | 0.7 | UXT2 / UXT6 | | |
| 2.5 325 i | 6 | M20 B25 (256E2) | 126/169 | 09/83→11/89 | | | | ZS122 09/85→ | |
| 2.5 325 i 4WD | 6 | M20 B25 (256E1), M20 B25 (256E2), M20 B25 (256EX), M20 B25 (256K1) | 126/169 | 03/86→12/87 | Z3 12/86→ | 0.7 | UXT2 / UXT6 12/86→ | ZS122 | |
| 2.5 M3 EVO II | 4 | S14 B25 (254S1) | 175/235 | 01/90→01/92 | | | | ZS122 | |
| 2.7 325 e | 6 | M20 B27 (276KA), M20 B27 (276KB) | 90/121 | 10/83→12/88 | Z3 12/86→ | 0.7 | UXT2 / UXT6 12/86→ | ZS122 01/85→ | |
| 2.7 325 e | 6 | M20 B27 (276KB) | 95/127 | 01/85→08/87 | Z3 12/86→ | 0.7 | UXT2 / UXT6 12/86→ | ZS122 | |
| 3 /Convertible (E30) | | | | | | | | | |
| 1.8 318 i | 4 | M40 B18 (184E1) | 83/111 | 09/87→10/93 | Z4 | 0.7 | UXT1 / UXT3 | | |
| 2.3 M3 | 4 | S14 B23 (234EA) | 143/192 | 07/86→06/91 | | | | ZS122 | |
| 2.5 325 i | 6 | M20 B25 (256E2), M20 B25 (256EX) | 125/168 | 12/86→10/93 | Z3 | 0.7 | UXT2 / UXT6 | ZS122 | |
| 2.5 325 i | 6 | M20 B25 (256E2) | 126/169 | 09/83→11/89 | Z3 12/86→ | 0.7 | UXT2 / UXT6 12/86→ | | |
| 3 /Convertible/Touring (E30) | | | | | | | | | |
| 1.8 318 i | 4 | M40 B18 (184E1) | 83/111 | 09/87→06/94 | | | | ZS122 | ZM038 |
| 2.0 320 i | 6 | M20 B20 (206KA) | 95/127 | 12/85→10/93 | Z3 | 0.7 | UXT2 / UXT6 | | |
| 2.5 325 i | 6 | M20 B25 (256K1) | 125/168 | 12/86→10/93 | Z3 | 0.7 | UXT2 / UXT6 | ZS122 | |
| 3 /Touring (E30) | | | | | | | | | |
| 1.8 318 i | 4 | M40 B18 | 85/114 | 09/87→06/91 | | | | | ZM038 →11/90 |
| 2.4 324 td | 6 | M21 D24 (246TB) | 85/114 | 09/87→06/93 | GN013 ^{[2][222]} GV719 | 11V 11V | | | |
| 2.5 325 i 4WD | 6 | M20 B25 (256K1) | 125/168 | 12/86→10/93 | Z3 | 0.7 | UXT2 / UXT6 | | |
| 3 Convertible (E30) | | | | | | | | | |
| 1.8 318 i | 4 | M40 B18 C | 103/138 | 06/88→02/92 | Z14 | 0.9 | UXT1 / UXT3 | | |
| 2.5 325 i | 6 | M20 B25 (256E2) | 126/169 | 12/85→12/87 | | | | ZS122 | |
| 3 Convertible/Touring (E30) | | | | | | | | | |
| 2.0 320 i | 6 | M20 B20 (206KA) | 95/127 | 04/86→10/93 | | | | ZS122 | ZM038 →11/89 |
| 3 Touring (E30) | | | | | | | | | |
| 1.6 316 i | 4 | M40 B16 (164E1) | 73/98 | 09/91→06/94 | Z4 | 0.7 | UXT1 / UXT3 | | |
| 1.6 316 i | 4 | M40 B16 | 75/101 | 09/91→06/94 | Z4 | 0.7 | UXT1 / UXT3 | ZS122 | |
| 1.8 318 i | 4 | M40 B18 (184E1) | 83/111 | 04/89→06/94 | Z4 →12/93 | 0.7 | UXT1 / UXT3 →12/93 | | |
| 1.8 318 i | 4 | M40 B18 | 85/114 | 09/87→06/91 | | | | ZS122 04/89→ | |
| 2.5 325 i 4WD | 6 | M20 B25 (256K1) | 125/168 | 06/88→10/93 | | | | ZS122 | |

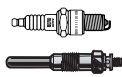

kW/BHP

**... BMW**

| | | | | | | | | | |
|---|---|---|---------|-------------|-------------------------|------------|-------------|--------------------------|--------|
| 3 (E36) | | | | | | | | | |
| 1.6 316 i | 4 | M40 B16 (164E1) | 73/98 | 09/90→09/93 | Z14 | 0.9 | UXT1 / UXT3 | ZS122 | |
| 1.6 316 i | 4 | M43 B16 | 75/101 | 09/90→09/93 | | | | ZS307 | |
| 1.8 318 i | 4 | M40 B18 (184E1) | 83/111 | 12/90→10/93 | Z14 | 0.9 | UXT1 / UXT3 | ZS122 | |
| 2.0 320 i | 6 | M50B (20 6 S1), M50B (20 6 S2) Vanos | 110/148 | 09/90→02/98 | | | | ZS014 →12/95 | |
| 2.0 320 i | 6 | M50 B20 (206S1), M50 B20 (206S2), M52 B20 (206S3) | 110/148 | 09/90→02/98 | Z14 Z237 | 0.9 1.6 | UXT1 / UXT3 | | |
| 2.5 325 i | 6 | M 50 B 25 | 141/189 | 09/90→09/95 | | | | ZS014 | ZLE232 |
| 2.5 325 td | 6 | M51 D25 (256T1) | 85/114 | 09/91→02/98 | GN013 [2][222] GV719 | 11V 11V | | | |
| 3 /Compact/Coupe/Touring (E36) | | | | | | | | | |
| 1.6 316 i | 4 | M43 B16 (164E2) | 75/101 | 09/90→08/00 | Z14 | 0.9 | UXT1 / UXT3 | | |
| 1.6 316 i | 4 | M43 B16 (164E2) | 75/101 | 07/93→08/00 | | | | ZS307 | |
| 1.6 316 i LPG | 4 | M43 B16 (164E2) | 75/101 | 07/93→08/00 | Z116 | 0.8 | UXT5 | | |
| 3 /Compact/Touring (E36) | | | | | | | | | |
| 1.7 318 tds | 4 | M41 D17 (174T1) | 66/89 | 01/95→08/00 | GN013 [2][222] GV719 | 11V 11V | | | |
| 3 /Convertible (E36) | | | | | | | | | |
| 3.0 M3 | 6 | S50 B30 | 210/282 | 01/94→10/95 | | | | ZS014 | |
| 3.2 M3 | 6 | S50 B32 (326S1) | 236/316 | 09/95→04/99 | | | | ZS302 | |
| 3 /Convertible/Coupe (E36) | | | | | | | | | |
| 2.0 320 i | 6 | M50 B20 (206S2),) M52 B20 (206S3) | 110/148 | 09/90→04/99 | | | | | ZLE232 |
| 2.0 320 i | 6 | M52B (20 6 S3) Vanos | 110/148 | 09/90→04/99 | | | | ZS302 09/94→ | |
| 2.0 320 i LPG | 6 | M50 B20 (206S2) | 110/148 | 09/90→04/99 | Z116 | 0.8 | UXT5 | | |
| 2.5 325 i | 6 | M50 B25 (256S2) | 141/189 | 09/90→04/99 | Z14 | 0.9 | UXT1 / UXT3 | | |
| 2.5 325 i LPG | 6 | M50 B25 (256S2) | 141/189 | 09/90→04/99 | Z116 | 0.8 | UXT5 | | |
| 3 /Convertible/Coupe/Touring (E36) | | | | | | | | | |
| 2.0 320 i LPG | 6 | M52 B20 (206S3) | 110/148 | 09/90→10/99 | Z116 | 0.8 | UXT5 | | |
| 2.5 323 i | 6 | M52 B25 (256S3) | 125/168 | 03/95→10/99 | Z14 | 0.9 | UXT1 / UXT3 | ZS302 | |
| 2.5 323 i LPG | 6 | M52 B25 (256S3) | 125/168 | 03/95→10/99 | Z116 | 0.8 | UXT5 | | |
| 2.8 328 i | 6 | M52 B28 (286S1) | 142/190 | 01/95→10/99 | Z14 | 0.9 | UXT1 / UXT3 | ZS302 | |
| 2.8 328 i LPG | 6 | M52 B28 (286S1) | 142/190 | 01/95→10/99 | Z116 | 0.8 | UXT5 | | |
| 3 /Convertible/Touring (E36) | | | | | | | | | |
| 1.8 318 i | 4 | M43 B18 (184E2) | 85/114 | 10/93→10/99 | Z14 | 0.9 | UXT1 / UXT3 | ZS307 | |
| 1.8 318 i LPG | 4 | M43 B18 (184E2) | 85/114 | 10/93→10/99 | Z116 | 0.8 | UXT5 | | |
| 3 /Coupe (E36) | | | | | | | | | |
| 1.8 318 is | 4 | M42 B18 (184S1) | 103/138 | 03/92→02/98 | Z14 | 0.9 | UXT1 / UXT3 | ZS014 →09/93 ZS307 | |
| 1.8 318 is LPG | 4 | M42 B18 (184S1) | 103/138 | 03/92→02/98 | Z116 | 0.8 | UXT5 | | |
| 1.9 318 is | 4 | M44 B19 (194S1) | 103/138 | 09/95→04/99 | Z14 | 0.9 | UXT1 / UXT3 | ZS307 | |
| 1.9 318 is LPG | 4 | M44 B19 (194S1) | 103/138 | 09/95→04/99 | Z116 | 0.8 | UXT5 | | |
| 2.0 320 i | 6 | M50 B20 (206S1) | 110/148 | 09/90→04/99 | | | | | ZLE232 |
| 2.0 320 i LPG | 6 | M50 B20 (206S1) | 110/148 | 09/90→04/99 | Z116 | 0.8 | UXT5 | | |
| 2.5 325 i | 6 | M50 B25 (256S1) | 141/189 | 09/90→04/99 | Z14 | 0.9 | UXT1 / UXT3 | | |
| 2.5 325 i LPG | 6 | M50 B25 (256S1) | 141/189 | 09/90→04/99 | Z116 | 0.8 | UXT5 | | |
| 3 /Touring (E36) | | | | | | | | | |
| 2.5 325 tds | 6 | M51 D25 (256T1) | 105/141 | 05/93→10/99 | GN013 [2][222] GV719 | 11V 11V | | | |
| 3 Compact (E36) | | | | | | | | | |
| 1.6 316 g | 4 | M43 B16 (164E2) | 75/101 | 03/94→08/00 | Z14 | 0.9 | UXT1 / UXT3 | ZS307 | |
| 1.6 316 g LPG | 4 | M43 B16 (164E2) | 75/101 | 03/94→08/00 | Z116 | 0.8 | UXT5 | | |
| 1.8 318 ti | 4 | M42 B18 | 103/138 | 11/94→08/95 | Z14 | 0.9 | UXT1 / UXT3 | ZS307 | |
| 1.8 318 ti LPG | 4 | M42 B18 | 103/138 | 11/94→08/95 | Z116 | 0.8 | UXT5 | | |



kW/BHP

**... BMW****... 3 Compact (E36)**

| | | | | | | | |
|----------------|---|-----------------|---------|-------------|------|-----|-------------------|
| 1.9 316 i | 4 | M43 B19 (194E1) | 77/103 | 12/98→08/00 | Z237 | 1.6 | ZS307 |
| 1.9 318 ti | 4 | M44 B19 (194S1) | 103/138 | 07/95→08/00 | Z14 | 0.9 | UXT1 / UXT3 ZS307 |
| 1.9 318 ti LPG | 4 | M44 B19 (194S1) | 103/138 | 07/95→08/00 | Z116 | 0.8 | UXT5 |
| 2.5 323 ti | 6 | M52 B25 (256S3) | 125/168 | 08/97→08/00 | Z14 | 0.9 | UXT1 / UXT3 ZS302 |
| 2.5 323 ti LPG | 6 | M52 B25 (256S3) | 125/168 | 08/97→08/00 | Z116 | 0.8 | UXT5 |

3 Convertible (E36)

| | | | | | | | |
|-----------|---|-----------------|---------|-------------|--|--|--------------|
| 2.5 325 i | 6 | M50 B25 (256S2) | 141/189 | 03/93→03/95 | | | ZS014 ZLE232 |
|-----------|---|-----------------|---------|-------------|--|--|--------------|

3 Convertible/Coupe (E36)

| | | | | | | | |
|-----------|---|-----------------|---------|-------------|-----|-----|-----------------|
| 2.0 320 i | 6 | M50 B | 110/148 | 03/92→04/99 | | | ZS014 →12/95 |
| 2.0 320 i | 6 | M50 B20 (206S2) | 110/148 | 03/92→04/99 | Z14 | 0.9 | UXT1 / UXT3 |

3 Convertible/Coupe/Touring (E36)

| | | | | | | | |
|-----------|---|-----------------|---------|-------------|-----|-----|-------------|
| 2.0 320 i | 6 | M52 B20 (206S3) | 110/148 | 03/92→10/99 | Z14 | 0.9 | UXT1 / UXT3 |
|-----------|---|-----------------|---------|-------------|-----|-----|-------------|

3 Coupe (E36)

| | | | | | | | |
|------------|---|-------------------------------------|---------|-------------|-----|-----|-------------------------------|
| 1.8 318 is | 4 | M42 B18 (184S1) | 103/138 | 03/92→10/95 | | | ZLE232 →09/93 |
| 2.0 320 i | 6 | M50 B20 (206S1) | 110/148 | 03/92→04/99 | Z14 | 0.9 | UXT1 / UXT3 |
| 2.5 325 i | 6 | M50 B25 (256S1), M50 B25 (256S2) | 141/189 | 03/92→04/99 | | | ZS014 ZLE232 →12/95 →12/95 |
| 3.0 M3 | 6 | S50 B30 (306S1) | 210/282 | 10/92→01/95 | | | ZS014 |
| 3.0 M3 | 6 | S50 B30 (306S1) | 217/291 | 01/95→10/95 | | | ZS014 |
| 3.2 M3 3.2 | 6 | S50 B32 (326S1) | 236/316 | 10/95→04/99 | | | ZS302 |

3 Touring (E36)

| | | | | | | | |
|-----------|---|-----------------|---------|-------------|--|--|-------|
| 2.0 320 i | 6 | M52 B20 (206S3) | 110/148 | 01/95→10/99 | | | ZS302 |
|-----------|---|-----------------|---------|-------------|--|--|-------|

3 (E46)

| | | | | | | | |
|---------------|---|---------------------|---------|-------------|------------------------------------|-----------|-----------------|
| 1.6 316 i | 4 | M43 B16 (164E3) | 77/103 | 04/00→02/05 | Z237 | 1.6 | ZS307 |
| 1.6 316 i | 4 | N45 B16, N45 B16 A | 85/114 | 06/02→02/05 | Z301 | 1.1 | ZS324 |
| 1.6 316 i LPG | 4 | M43 B16 (164E3) | 77/103 | 04/00→02/05 | Z340 | 0.7 | UXT12 |
| 1.6 316 i LPG | 4 | N45 B16, N45 B16 A | 85/114 | 06/02→02/05 | Z116 | 0.8 | UXT5 |
| 1.8 316 i | 4 | N42 B18 | 85/114 | 02/02→02/05 | Z237 →03/04 | 1.6 | |
| 1.8 316 i LPG | 4 | N42 B18 | 85/114 | 02/02→02/05 | Z340 →03/04 | 0.7 | UXT12 →03/04 |
| 1.9 316 i | 4 | M43 B19 (194E1) | 77/103 | 09/98→02/05 | Z237 | 1.6 | ZS307 |
| 1.9 316 i LPG | 4 | M43 B19 (194E1) | 77/103 | 09/98→02/05 | Z340 | 0.7 | UXT12 |
| 2.0 318 i | 4 | N42 B20 | 105/141 | 09/01→02/05 | Z237 →03/04 | 1.6 | ZS324 03/03→ |
| 2.0 318 i LPG | 4 | N42 B20 | 105/141 | 09/01→02/05 | Z340 →03/04 | 0.7 | UXT12 →03/04 |
| 2.0 320 d | 4 | M47 D20 (204D1) | 95/127 | 02/98→04/05 | GN024 →09/01 GE102 09/01→ | 11V 5V | |
| 2.0 320 d | 4 | M47 D20 (204D4) | 110/148 | 09/01→02/05 | GSE101 →09/04 | | |
| 2.2 320 i | 6 | M54 B22, M54 226 S1 | 125/168 | 09/00→02/05 | | | ZS324 10/02→ |
| 2.2 320 i | 6 | M54 B22 (226S1) | 125/168 | 09/00→02/05 | | | ZS302 →09/02 |
| 2.5 323 i | 6 | M52 B25 (256S4) | 125/168 | 03/98→09/00 | Z237 | 1.6 | ZS302 |
| 2.5 323 i LPG | 6 | M52 B25 (256S4) | 125/168 | 03/98→09/00 | Z340 | 0.7 | UXT12 |

3 /Touring (E46)

| | | | | | | | |
|---------------|---|--------------------|--------|-------------|------|-----|-----------------|
| 1.8 316 i | 4 | N42 B18 | 85/114 | 02/02→02/05 | | | ZS324 03/03→ |
| 1.8 316 i | 4 | N46 B18, N46 B18 A | 85/114 | 02/02→02/05 | Z301 | 1.1 | ZS324 |
| 1.8 316 i LPG | 4 | N46 B18, N46 B18 A | 85/114 | 02/02→02/05 | Z116 | 0.8 | UXT5 |
| 1.9 318 i | 4 | M43 B19 (194E1) | 87/117 | 02/98→09/01 | Z237 | 1.6 | ZS307 |

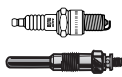

kW/BHP

**... BMW****... 3 /Touring (E46)**

| | | | | | | | | | |
|--------------------|---|--------------------|---------|-------------|---------------------------------|------------------|-----------|-------|------------------------------------|
| 1.9 318 i LPG | 4 | M43 B19 (194E1) | 87/117 | 02/98→09/01 | Z340 | | 0.7 | UXT12 | |
| 2.0 318 d | 4 | M47 D20 (204D1) | 85/114 | 09/01→02/05 | GE102 ⁽²⁷⁷⁾ GN024 | GSE101 | 5V 11V | | |
| 2.0 318 d | 4 | M47 D20 (204D4) | 85/114 | 03/03→02/05 | GE102 ⁽²⁷⁷⁾ | GSE101 | 5V | | |
| 2.0 318 i | 4 | N46 B20, N46 B20 A | 105/141 | 09/01→02/05 | Z301 | | 1.1 | | ZS324 |
| 2.0 318 i LPG | 4 | N46 B20, N46 B20 A | 105/141 | 09/01→02/05 | Z116 | | 0.8 | UXT5 | |
| 2.0 320 d | 4 | M47 D20 (204D1) | 100/134 | 04/98→09/01 | GN024 | | 11V | | |
| 2.0 320 d | 4 | M47 D20 (204D4) | 110/148 | 09/01→02/05 | GE102 | | 5V | | |
| 2.0 320 i | 6 | M52 B20 (206S4) | 110/148 | 03/98→09/00 | Z237 | | 1.6 | | ZS302 |
| 2.0 320 i LPG | 6 | M52 B20 (206S4) | 110/148 | 03/98→09/00 | Z340 | | 0.7 | UXT12 | |
| 2.2 320 i | 6 | M54 B22 (226S1) | 125/168 | 09/00→02/05 | Z237 | | 1.6 | | |
| 2.2 320 i LPG | 6 | M54 B22 (226S1) | 125/168 | 09/00→02/05 | Z340 | | 0.7 | UXT12 | |
| 2.5 325 i | 6 | M54 B25 (256S5) | 141/189 | 09/00→02/05 | Z237 | | 1.6 | | ZS302 →09/02 ZS324 10/02→ |
| 2.5 325 i LPG | 6 | M54 B25 (256S5) | 141/189 | 09/00→02/05 | Z340 | | 0.7 | UXT12 | |
| 2.5 325 xi 4WD | 6 | M54 B25 (256S5) | 141/189 | 09/00→02/05 | Z237 | | 1.6 | | ZS302 →09/02 ZS324 10/02→ |
| 2.5 325 xi 4WD LPG | 6 | M54 B25 (256S5) | 141/189 | 09/00→02/05 | Z340 | | 0.7 | UXT12 | |
| 2.8 328 i | 6 | M52 B28 (286S2) | 142/190 | 02/98→06/00 | Z237 | | 1.6 | | ZS302 |
| 2.8 328 i LPG | 6 | M52 B28 (286S2) | 142/190 | 02/98→06/00 | Z340 | | 0.7 | UXT12 | |
| 3.0 330 d | 6 | M 57 | 135/181 | 10/99→02/05 | GN024 | | 11V | | |
| 3.0 330 d | 6 | M57 D30 (306D2) | 150/201 | 03/03→02/05 | GE102 | GSE102 →09/04 | 5V | | |
| 3.0 330 i | 6 | M54 B30 (306S3) | 170/228 | 06/00→02/05 | Z237 | | 1.6 | | ZS302 →09/02 ZS324 10/02→ |
| 3.0 330 i LPG | 6 | M54 B30 (306S3) | 170/228 | 06/00→02/05 | Z340 | | 0.7 | UXT12 | |
| 3.0 330 xi 4WD | 6 | M54 B30 (306S3) | 170/228 | 06/00→02/05 | Z237 | | 1.6 | | ZS302 →09/02 ZS324 10/02→ |
| 3.0 330 xi 4WD LPG | 6 | M54 B30 (306S3) | 170/228 | 06/00→02/05 | Z340 | | 0.7 | UXT12 | |
| 3.0 330 xd 4WD | 6 | M57 D30 | 135/181 | 06/00→02/05 | GN024 | | 11V | | |
| 3.0 330 xd 4WD | 6 | M57 D30 (306D2) | 150/201 | 03/03→02/05 | GE102 | GSE102 →09/04 | 5V | | |

3 Compact (E46)

| | | | | | | | | | |
|----------------|---|-----------------|---------|-------------|----------------|------------------|-----|-----------------|-----------------|
| 1.6 316 ti | 4 | N40 B16 A | 85/114 | 06/02→02/05 | | | | | ZS324 |
| 1.6 316 ti | 4 | N45 B16 A | 85/114 | 06/02→02/05 | Z301 | | 1.1 | | ZS324 |
| 1.6 316 ti LPG | 4 | N45 B16 A | 85/114 | 06/02→02/05 | Z116 | | 0.8 | UXT5 | |
| 1.8 316 ti | 4 | N42 B18 | 85/114 | 06/01→02/05 | Z237 →03/04 | | 1.6 | | ZS324 03/03→ |
| 1.8 316 ti | 4 | N46 B18 A | 85/114 | 06/01→02/05 | Z301 | | 1.1 | | ZS324 |
| 1.8 316 ti LPG | 4 | N42 B18 | 85/114 | 06/01→02/05 | Z340 →03/04 | | 0.7 | UXT12 →03/04 | |
| 1.8 316 ti LPG | 4 | N46 B18 A | 85/114 | 06/01→02/05 | Z116 | | 0.8 | UXT5 | |
| 2.0 318 td | 4 | M47 D20 (204D4) | 85/114 | 03/03→02/05 | GE102 | GSE101 →09/04 | 5V | | |
| 2.0 318 ti | 4 | N42 B20 | 105/141 | 09/01→02/05 | Z237 | | 1.6 | | ZS324 03/03→ |
| 2.0 318 ti | 4 | N46 B20 A | 105/141 | 09/01→02/05 | Z301 | | 1.1 | | ZS324 |
| 2.0 318 ti LPG | 4 | N42 B20 | 105/141 | 09/01→02/05 | Z340 | | 0.7 | UXT12 | |
| 2.0 318 ti LPG | 4 | N46 B20 A | 105/141 | 09/01→02/05 | Z116 | | 0.8 | UXT5 | |
| 2.0 320 td | 4 | M47 D20 (204D1) | 100/134 | 10/01→12/02 | GE102 | | 5V | | |
| 2.0 320 td | 4 | M47 D20 (204D4) | 110/148 | 09/01→02/05 | GE102 | | 5V | | |

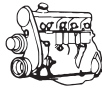

kW/BHP

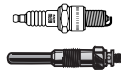
**... BMW****... 3 Compact (E46)**

| | | | | | | | | |
|----------------|---|-----------------|---------|-------------|------|--|-----|------------------------------------|
| 2.5 325 ti | 6 | M54 B25 (256S5) | 141/189 | 06/01→02/05 | Z237 | | 1.6 | ZS302 →09/02 ZS324 10/02→ |
| 2.5 325 ti LPG | 6 | M54 B25 (256S5) | 141/189 | 06/01→02/05 | Z340 | | 0.7 | UXT12 |

3 Convertible (E46)

| | | | | | | | | |
|----------------|---|-----------------|---------|-------------|------|--------|-----|-----------------|
| 2.0 318 Ci | 4 | N46 B20 B | 110/148 | 02/05→ | Z301 | | 1.1 | ZS324 →06/09 |
| 2.0 318 Ci LPG | 4 | N46 B20 B | 110/148 | 02/05→ | Z116 | | 0.8 | UXT5 |
| 2.0 320 Cd | 4 | M47 D20 (204D4) | 110/148 | 02/05→ | | GSE101 | | |
| 2.2 320 Ci | 6 | M54 B22 (226S1) | 120/161 | 01/06→12/07 | | | | ZSE143 |
| 3.0 330 Cd | 6 | M57 D30 (306D2) | 150/201 | 08/05→ | | GSE102 | | |
| 3.0 330 Ci | 6 | M54 B30 (306S3) | 170/228 | 06/00→ | Z237 | | 1.6 | |
| 3.0 330 Ci LPG | 6 | M54 B30 (306S3) | 170/228 | 06/00→ | Z340 | | 0.7 | UXT12 |

3 Convertible/Coupe (E46)

| | | | | | | | | |
|----------------|---|-----------------|---------|-------------|-------|--|-----|---|
| 2.0 318 Ci | 4 | N42 B20 | 105/141 | 09/01→ | Z237 | | 1.6 | ZS324 03/03→06/09 |
| 2.0 318 Ci | 4 | N46 B20 | 105/141 | 09/01→ | Z301 | | 1.1 | ZS324 →06/09 |
| 2.0 318 Ci | 4 | N46 B20 A | 110/148 | 02/05→ | Z301 | | 1.1 | |
| 2.0 318 Ci LPG | 4 | N42 B20 | 105/141 | 09/01→ | Z340 | | 0.7 | UXT12 |
| 2.0 318 Ci LPG | 4 | N46 B20 | 105/141 | 09/01→ | Z116 | | 0.8 | UXT5 |
| 2.0 318 Ci LPG | 4 | N46 B20 A | 110/148 | 02/05→ | Z116 | | 0.8 | UXT5 |
| 2.0 320 Cd | 4 | M47 D20 (204D4) | 110/148 | 11/03→ | GE102 | | 5V | |
| 2.2 320 Ci | 6 | M54 B22 (226S1) | 125/168 | 09/00→ | Z237 | | 1.6 | ZS302 →09/02 ZS324 10/02→06/09 |
| 2.2 320 Ci LPG | 6 | M54 B22 (226S1) | 125/168 | 09/00→ | Z340 | | 0.7 | UXT12 |
| 2.5 323 Ci | 6 | M52 B25 (256S4) | 125/168 | 04/99→09/00 | Z237 | | 1.6 | ZS302 |
| 2.5 323 Ci LPG | 6 | M52 B25 (256S4) | 125/168 | 04/99→09/00 | Z340 | | 0.7 | UXT12 |
| 2.5 325 Ci | 6 | M54 B25 (256S5) | 141/189 | 09/00→ | Z237 | | 1.6 | ZS302 →09/02 ZS324 10/02→06/09 |

| | | | | | | | | |
|----------------|---|-----------------|---------|--------|-------|--|-----|---|
| 2.5 325 Ci LPG | 6 | M54 B25 (256S5) | 141/189 | 09/00→ | Z340 | | 0.7 | UXT12 |
| 3.0 330 Cd | 6 | M57 D30 (306D2) | 150/201 | 03/03→ | GE102 | | 5V | |
| 3.0 330 Ci | 6 | M54 B30 (306S3) | 170/228 | 06/00→ | | | | ZS302 →09/02 ZS324 10/02→06/09 |
| 3.2 M3 3.2 | 6 | S54 B32 (326S4) | 252/338 | 06/00→ | | | | ZS324 →06/09 |

3 Coupe (E46)

| | | | | | | | | |
|----------------|---|-----------------|---------|-------------|------|------------------|-----|---------------------------|
| 1.6 316 Ci | 4 | M43 B16 (164E3) | 77/103 | 04/00→ | Z237 | | 1.6 | ZS307 |
| 1.6 316 Ci | 4 | N45 B16 A | 85/114 | 06/02→ | Z239 | | 1.6 | ZS324 →06/09 |
| 1.6 316 Ci LPG | 4 | M43 B16 (164E3) | 77/103 | 04/00→ | Z340 | | 0.7 | UXT12 |
| 1.9 318 Ci | 4 | M43 B19 (194E1) | 87/117 | 11/99→09/01 | Z237 | | 1.6 | ZS307 |
| 1.9 318 Ci LPG | 4 | M43 B19 (194E1) | 87/117 | 11/99→09/01 | Z340 | | 0.7 | UXT12 |
| 2.0 318 Ci | 4 | N46 B20 A | 110/148 | 03/05→ | | | | ZS324 →06/09 ZSE143 |
| 2.0 320 Cd | 4 | M47 D20 (204D4) | 110/148 | 11/03→ | | GSE101 →09/04 | | |
| 2.0 320 Ci | 6 | M52 B20 (206S4) | 110/148 | 08/99→09/00 | Z237 | | 1.6 | ZS302 |
| 2.0 320 Ci LPG | 6 | M52 B20 (206S4) | 110/148 | 08/99→09/00 | Z340 | | 0.7 | UXT12 |
| 2.8 328 Ci | 6 | M52 B28 (286S2) | 142/190 | 04/99→06/00 | Z237 | | 1.6 | ZS302 |



kW/BHP

**... BMW****... 3 Coupe (E46)**

| | | | | | | | | | |
|--------------------|---|----------------------|---------|-------------|----------------|------------------|-----|-------|-----------------|
| 2.8 328 Ci LPG | 6 | M52 B28 (28652) | 142/190 | 04/99→06/00 | Z340 | | 0.7 | UXT12 | |
| 3.0 330 Cd | 6 | M57 D30 (306D2) | 150/201 | 03/03→ | | GSE102 →09/04 | | | |
| 3.0 330 Ci | 6 | M54 B30 (30653) | 170/228 | 06/00→ | Z237 →05/06 | | 1.6 | | |
| 3.0 330 xi 4WD | 6 | M54 306 S3 | 170/228 | 06/00→ | Z237 | | 1.6 | | ZS302 →09/02 |
| 3.0 330 xi 4WD LPG | 6 | M54 306 S3 | 170/228 | 06/00→ | Z340 | | 0.7 | UXT12 | |
| 3.2 M3 CSL | 6 | S54 B32, S54N 326 S4 | 265/355 | 06/03→ | | | | | ZS324 →06/09 |

3 Touring (E46)

| | | | | | | | | | |
|---------------|---|--------------------|---------|-------------|------|--------|-----|-------|------------------------------------|
| 1.6 316 i | 4 | N45 B16, N45 B16 A | 85/114 | 06/02→02/05 | Z239 | | 1.6 | | ZSE143 ⁽¹⁾ |
| 1.8 316 i | 4 | N42 B18 | 85/114 | 03/02→02/05 | Z237 | | 1.6 | | |
| 1.8 316 i LPG | 4 | N42 B18 | 85/114 | 03/02→02/05 | Z340 | | 0.7 | UXT12 | |
| 1.9 318 i | 4 | M43 B19 (194E1) | 85/114 | 10/99→09/01 | | | | | ZS307 |
| 2.0 318 i | 4 | N42 B20 | 105/141 | 09/01→02/05 | Z237 | | 1.6 | | |
| 2.0 318 i LPG | 4 | N42 B20 | 105/141 | 09/01→02/05 | Z340 | | 0.7 | UXT12 | |
| 2.0 320 d | 4 | M47 D20 (204D4) | 110/148 | 09/01→02/05 | | GSE101 | | | |
| 2.2 320 i | 6 | M54 B22 (22651) | 125/168 | 09/00→02/05 | | | | | ZS302 →09/02 ZS324 10/02→ |

3 (E90)

| | | | | | | | | | |
|---------------|---|------------------------------------|---------|-------------|----------------|--------|------|------|--------------------------------------|
| 1.6 316 i | 4 | N45 B16, N45 B16 A, N45 B16 TU2 | 85/114 | 02/06→12/11 | Z239 | | 1.6 | | ZS324 →06/09 ZSE143 07/09→ |
| 1.6 316 i | 4 | N43 B16 A | 90/121 | 09/07→12/11 | | | | | ZSE144 |
| 2.0 316 d | 4 | N 47 N | 85/114 | 07/09→12/11 | CGP001 | | 5.4V | | |
| 2.0 318 d | 4 | M47 D20 (204D4) | 90/121 | 09/05→12/11 | GE102 | GSE101 | 5V | | |
| 2.0 318 i | 4 | N46 B20 B | 95/127 | 09/05→03/07 | Z301 | | 1.1 | | ZS324 |
| 2.0 318 i | 4 | N43 B20 A | 105/141 | 09/07→12/11 | | | | | ZSE144 |
| 2.0 318 i LPG | 4 | N46 B20 B | 95/127 | 09/05→03/07 | Z116 | | 0.8 | UXT5 | |
| 2.0 320 d | 4 | M47 D20 (204D4) | 110/148 | 09/05→12/11 | GE102 | GSE101 | 5V | | |
| 2.0 320 d | 4 | M47 D20 (204D4), N47 D20 C | 120/161 | 01/05→12/11 | GE102 | | 5V | | |
| 2.0 320 i | 4 | N46 B20 A, N46 B20 B, N46 B20 C | 110/148 | 01/05→03/07 | Z301 | | 1.1 | | ZS324 |
| 2.0 320 i | 4 | N43 B20 A, N46 B20 B | 115/154 | 03/07→12/11 | Z301 | | 1.1 | | ZS324 →06/09 ZSE143 07/09→ |
| 2.0 320 i | 4 | N43 B20 A | 125/168 | 09/07→12/11 | | | | | ZSE144 |
| 2.0 320 i LPG | 4 | N46 B20 A, N46 B20 B, N46 B20 C | 110/148 | 01/05→03/07 | Z116 | | 0.8 | UXT5 | |
| 2.0 320 si | 4 | N45 B20 A | 127/170 | 05/06→12/11 | | | | | ZS324 →06/09 ZSE143 07/09→ |
| 2.5 323 i | 6 | N52 B25 A, N52N B25 A | 130/174 | 04/06→12/11 | Z235 | | 1.0 | | ZSE145 →04/06 |
| 2.5 323 i | 6 | N52 B25 A | 140/188 | 03/08→12/11 | Z235 →12/09 | | 1.0 | | ZSE143 |
| 2.5 325 i | 6 | N52 B25 A | 155/208 | 01/06→ | Z235 →12/09 | | 1.0 | | ZSE143 05/06→ |
| 2.5 325 i | 6 | N52 B25 A | 160/215 | 01/05→12/11 | Z235 →12/09 | | 1.0 | | ZSE145 →04/06 ZSE143 05/06→ |

BMW

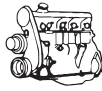

kW/BHP

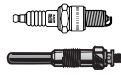
**... BMW****... 3 (E90)**

| | | | | | | | | |
|------------------------|---|---------------------------|---------|-------------|------------------|--------|------|---|
| 2.5 325 xi 4WD | 6 | N52 B25 A | 160/215 | 01/05→12/11 | Z235 →12/09 | | 1.0 | ZSE145 09/05→04/06 ZSE143 04/06→ |
| 3.0 325 d | 6 | M57 D30 (306D3) | 145/194 | 09/06→12/11 | GE102 | GSE102 | 5V | |
| 3.0 325 i | 6 | N53 B30, N53 B30 A | 160/215 | 09/07→12/11 | | | | ZSE144 |
| 3.0 325 xi 4WD | 6 | N53 B30 A | 160/215 | 09/07→12/11 | | | | ZSE144 |
| 3.0 330 d | 6 | M57 306 D3 | 170/228 | 09/05→12/11 | GE102 | | 5V | |
| 3.0 330 d | 6 | M57 D30 (306D3) | 170/228 | 09/05→12/11 | | GSE102 | | |
| 3.0 330 i | 6 | N52 B30 A | 190/255 | 01/05→12/11 | Z235 →12/09 | | 1.0 | ZSE145 →04/06 ZSE143 05/06→ |
| 3.0 330 i | 6 | N53 B30 A | 200/268 | 09/07→12/11 | | | | ZSE144 |
| 3.0 330 i xDrive 4WD | 6 | N53 B30 A | 200/268 | 09/08→12/11 | | | | ZSE144 |
| 3.0 330 xi 4WD | 6 | N52 B30 A | 190/255 | 01/05→12/11 | Z235 →12/09 | | 1.0 | ZSE145 09/05→04/06 ZSE143 05/06→ |
| 3.0 330 xi 4WD | 6 | N53 B30 A | 200/268 | 09/07→12/11 | | | | ZSE144 →08/08 |
| 3.0 330 xd 4WD | 6 | M57 306 D3 | 170/228 | 09/05→12/11 | GE102 | | 5V | |
| 3.0 330 xd 4WD | 6 | M57 D30 (306D3) | 170/228 | 09/05→12/11 | | GSE102 | | |
| 3.0 335 d | 6 | M57 D30 (306D5) | 210/282 | 09/06→12/11 | GE102 | GSE102 | 5V | |
| 3.0 335 i | 6 | N54 B30 A | 220/295 | 10/06→12/11 | | | | ZSE143 |
| 3.0 335 i | 6 | N54 B30 A | 225/302 | 09/06→12/11 | | | | ZSE143 |
| 3.0 335 i xDrive 4WD | 6 | N54 B30 A | 225/302 | 09/08→12/11 | | | | ZSE143 |
| 3.0 335 xi 4WD | 6 | N54 B30 A | 225/302 | 09/07→12/11 | | | | ZSE143 |
| 3 Touring (E91) | | | | | | | | |
| 1.6 316 i | 4 | N43 B16 A | 90/121 | 05/08→05/12 | | | | ZSE144 09/08→02/12 |
| 2.0 316 d | 4 | N 47 N | 85/114 | 09/09→ | CGP001 →02/11 | | 5.4V | |
| 2.0 318 d | 4 | M47 D20 (204D4) | 90/121 | 09/05→ | GE102 | GSE101 | 5V | |
| 2.0 318 d | 4 | N 47 N | 105/141 | 09/07→ | CGP001 →02/11 | | 5.4V | |
| 2.0 318 i | 4 | N46 B20 | 95/127 | 01/06→ | | | | ZS324 →06/09 |
| 2.0 318 i | 4 | N46 B20 B | 95/127 | 01/06→ | Z301 | | 1.1 | ZS324 →06/09 |
| 2.0 318 i | 4 | N43 B20 A, N46 B20 B | 100/134 | 09/07→ | Z301 | | 1.1 | ZS324 →06/09 ZSE143 07/09→ |
| 2.0 318 i | 4 | N43 B20 A | 105/141 | 09/07→ | | | | ZSE144 →02/12 |
| 2.0 318 i LPG | 4 | N46 B20 B | 95/127 | 01/06→ | Z116 | | 0.8 | UXT5 |
| 2.0 320 d | 4 | M47N 204 D4 | 110/148 | 09/05→ | GE102 | GSE101 | 5V | |
| 2.0 320 d | 4 | 12217786821, M47 N 204 D5 | 120/161 | 09/05→ | | GSE101 | | |
| 2.0 320 d | 4 | M47N 204 D5 | 120/161 | 09/05→ | GE102 | | 5V | |
| 2.0 320 i | 4 | N46 B20 A, N46 B20 C | 110/148 | 09/05→ | Z301 | | 1.1 | ZS324 →06/09 |
| 2.0 320 i | 4 | N43 B20 A | 125/168 | 09/07→ | | | | ZSE144 →02/12 |
| 2.0 320 i LPG | 4 | N46 B20 A, N46 B20 C | 110/148 | 09/05→ | Z116 | | 0.8 | UXT5 |
| 2.5 323 i | 6 | N52N B25 A | 130/174 | 04/06→06/07 | Z235 | | 1.0 | ZSE143 ZSE145 |



kW/BHP

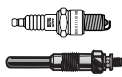

... BMW



... 3 Touring (E91)

| | | | | | | | | | |
|----------------------|---|-----------------------|---------|-------------|------------------------|------------------|-----|------|--------------------------------------|
| 2.5 325 i | 6 | N52 B25 | 160/215 | 09/05→ | | | | | ZSE145 →04/06 ZSE143 11/07→ |
| 2.5 325 i | 6 | N52 B25 A | 160/215 | 09/05→ | Z235 →09/09 | | 1.0 | | ZSE145 →04/06 ZSE143 11/07→ |
| 2.5 325 i | 6 | N52 B25 C | 160/215 | 09/05→ | Z235 →09/09 | | 1.0 | | |
| 2.5 325 xi 4WD | 6 | N52 B25 A, N52 B25 C | 160/215 | 09/05→ | Z235 | | 1.0 | | ZSE145 →06/06 ZSE143 05/06→ |
| 3.0 325 d | 6 | M57 306 D3 | 145/194 | 09/06→ | GE102 | GSE102 | 5V | | |
| 3.0 325 d | 6 | M57N2 306 D3 | 150/201 | 04/10→ | GE102 | | 5V | | |
| 3.0 325 i | 6 | N53 B30 A | 155/208 | 01/12→ | | | | | ZSE144 |
| 3.0 325 i | 6 | N53 B30 A | 160/215 | 09/07→ | | | | | ZSE144 →02/12 |
| 3.0 325 i xDrive 4WD | 6 | N51 B30 A, N53 B30 A | 160/215 | 09/08→ | | | | | ZSE144 →02/12 |
| 3.0 325 xi 4WD | 6 | N53 B30 A | 160/215 | 09/07→ | | | | | ZSE144 →08/08 |
| 3.0 330 d | 6 | M57 306 D3 | 170/228 | 09/05→ | GE102 | GSE102 | 5V | | |
| 3.0 330 d | 6 | N57 D30 A | 180/241 | 01/09→ | GE102 ⁽²⁶⁸⁾ | | 5V | | |
| 3.0 330 i | 6 | N52 B30 A | 190/255 | 09/05→ | Z235 →09/09 | | 1.0 | | ZSE145 →04/06 ZSE143 11/07→ |
| 3.0 330 i | 6 | N52 B30 A, N53 B30 A | 200/268 | 09/07→ | | | | | ZSE144 →02/12 |
| 3.0 330 i xDrive 4WD | 6 | N53 B30 A | 200/268 | 09/08→ | | | | | ZSE144 →02/12 |
| 3.0 330 xi 4WD | 6 | N52 B30 A | 190/255 | 09/05→ | Z235 | | 1.0 | | ZSE145 →04/06 |
| 3.0 330 xi 4WD | 6 | N53 B30 A | 200/268 | 09/07→ | | | | | ZSE144 →08/08 |
| 3.0 330 xd 4WD | 6 | M57 D30 (306D3) | 170/228 | 09/05→ | GE102 →08/08 | GSE102 →08/08 | 5V | | |
| 3.0 335 d | 6 | M57 D30 (306D5) | 210/282 | 09/06→ | GE102 | GSE102 | 5V | | |
| 3.0 335 i | 6 | N54 B30 A | 225/302 | 09/06→ | | | | | ZSE143 |
| 3.0 335 i xDrive 4WD | 6 | N54 B30 A | 225/302 | 09/08→ | | | | | ZSE143 |
| 3.0 335 xi 4WD | 6 | N54 B30 A | 225/302 | 09/07→ | | | | | ZSE143 |
| 3 Coupe (E92) | | | | | | | | | |
| 1.6 316 i | 4 | N43 B16 A | 90/121 | 09/07→ | | | | | ZSE144 |
| 2.0 318 i | 4 | N43 B20 A | 105/141 | 03/10→ | | | | | ZSE144 →02/12 |
| 2.0 320 i | 4 | N46 B20 A, N46N B20 B | 110/148 | 11/06→06/07 | Z301 | | 1.1 | | ZS324 |
| 2.0 320 i | 4 | N43 B20 A | 115/154 | 06/07→ | | | | | ZSE144 |
| 2.0 320 i | 4 | N43 B20 A | 120/161 | 01/07→ | | | | | ZSE144 |
| 2.0 320 i | 4 | N43 B20 A | 125/168 | 03/07→ | | | | | ZSE144 →02/12 |
| 2.0 320 i LPG | 4 | N46 B20 A, N46N B20 B | 110/148 | 11/06→06/07 | Z116 | | 0.8 | UXT5 | |
| 2.5 323 i | 6 | N52N B25 A | 130/174 | 06/06→ | | | | | ZSE143 |
| 2.5 325 i | 6 | N52 B25 | 160/215 | 09/06→ | | | | | ZSE143 11/07→ |
| 2.5 325 i | 6 | N52 B25 A | 160/215 | 09/06→ | Z235 | | 1.0 | | ZSE143 11/07→ |
| 2.5 325 i | 6 | N52 B25 C | 160/215 | 09/06→ | Z235 | | 1.0 | | |



kW/BHP

**... BMW****... 3 Coupe (E92)**

| | | | | | | | | |
|----------------------|---|----------------------|---------|-------------|-------------|--------|-----|--|
| 2.5 325 xi 4WD | 6 | N52 B25 A | 160/215 | 09/06→ | Z235 | | 1.0 | ZSE143 11/07→08/08 |
| 2.5 325 xi 4WD | 6 | N52 B25 C | 160/215 | 09/06→ | Z235 | | 1.0 | |
| 3.0 325 d | 6 | M57 D30 (306D3) | 145/194 | 03/07→ | | GSE102 | | |
| 3.0 325 d | 6 | M57 D30 TU2 | 145/194 | 03/07→ | GE102 | | 5V | |
| 3.0 325 d | 6 | M57N2 306 D3 | 150/201 | 04/10→ | GE102 [268] | | 5V | |
| 3.0 325 d | 6 | M57 D30 (306D3) | 155/208 | 01/07→12/09 | GE102 [268] | | 5V | |
| 3.0 325 i | 6 | N53 B30 A | 155/208 | 07/07→ | | | | ZSE144 |
| 3.0 325 i | 6 | N51 B30 A, N53 B30 A | 160/215 | 09/07→ | | | | ZSE144 →02/12 |
| 3.0 325 xi 4WD | 6 | N53 B30 A | 160/215 | 09/07→ | | | | ZSE144 →08/08 |
| 3.0 330 d | 6 | M57 D30 (306D3) | 170/228 | 09/06→ | GE102 | GSE102 | 5V | |
| 3.0 330 d | 6 | M57N2 306 D3 | 180/241 | 01/09→ | GE102 [268] | | 5V | |
| 3.0 330 i | 6 | N52 B30 A | 190/255 | 09/06→ | Z235 | | 1.0 | ZSE143 11/07→08/12 |
| 3.0 330 i | 6 | N52 B30 A, N53 B30 A | 200/268 | 09/06→ | | | | ZSE143 09/07→02/12 ZSE144 09/07→02/12 |
| 3.0 330 i xDrive 4WD | 6 | N53 B30 A | 200/268 | 09/08→ | | | | ZSE144 →02/12 |
| 3.0 330 xi 4WD | 6 | N52 B30 A | 190/255 | 09/06→ | Z235 | | 1.0 | ZSE143 |
| 3.0 330 xi 4WD | 6 | N52 B30 A, N53 B30 A | 200/268 | 09/06→ | Z235 | | 1.0 | ZSE143 |
| 3.0 330 xd 4WD | 6 | M57 D30 (306D3) | 170/228 | 09/06→ | GE102 | GSE102 | 5V | |
| 3.0 330 xd 4WD | 6 | M57N2 306 D3 | 180/241 | 01/09→ | GE102 [268] | | 5V | |
| 3.0 335 d | 6 | M57 D30 (306D5) | 210/282 | 09/06→ | GE102 | GSE102 | 5V | |
| 3.0 335 i | 6 | N54 B30 A | 225/302 | 09/06→ | | | | ZSE143 →02/10 |
| 3.0 335 i xDrive 4WD | 6 | N54 B30 A | 225/302 | 09/08→ | | | | ZSE143 |
| 3.0 335 xi 4WD | 6 | N54 B30 A | 225/302 | 09/06→ | | | | ZSE143 |

3 Convertible (E93)

| | | | | | | | | |
|---------------|---|---------------------------------|---------|-------------|-------------|--|-----|--|
| 2.0 318 i | 4 | N43 B20 A | 105/141 | 03/10→ | | | | ZSE144 →02/12 |
| 2.0 320 i | 4 | N46 B20, N46N B20 B | 110/148 | 03/07→08/07 | Z301 | | 1.1 | ZS324 |
| 2.0 320 i | 4 | N43 B20 A | 115/154 | 03/07→ | | | | ZSE144 |
| 2.0 320 i | 4 | N46 B20 B | 115/154 | 03/07→ | | | | ZS324 →06/09 ZSE143 07/09→09/13 |
| 2.0 320 i | 4 | N43 B20 A | 120/161 | 01/07→ | | | | ZSE144 |
| 2.0 320 i | 4 | N43 B20 A | 125/168 | 03/07→ | | | | ZSE144 →02/12 |
| 2.0 320 i LPG | 4 | N46 B20, N46N B20 B | 110/148 | 03/07→08/07 | Z116 | | 0.8 | UXT5 |
| 2.5 323 i | 6 | N52N B25 A | 130/174 | 03/07→ | | | | ZSE143 |
| 2.5 325 i | 6 | N52 B25 A | 160/215 | 03/07→ | Z235 | | 1.0 | ZSE143 11/07→ |
| 3.0 325 d | 6 | M57 D30 (306D3) | 145/194 | 03/07→ | GE102 | | 5V | |
| 3.0 325 d | 6 | N57 D30 A | 150/201 | 02/10→ | GE102 [268] | | 5V | |
| 3.0 325 d | 6 | M57 D30 (306D3) | 155/208 | 01/07→12/09 | GE102 [268] | | 5V | |
| 3.0 325 i | 6 | N51 B30 A, N53 B30 A | 160/215 | 03/07→ | | | | ZSE144 →02/12 |
| 3.0 330 d | 6 | M57 D30 (306D3), M57 D30 TU2 | 170/228 | 03/07→ | GE102 [268] | | 5V | |
| 3.0 330 d | 6 | M57N2 306 D3 | 180/241 | 01/09→ | GE102 [268] | | 5V | |
| 3.0 330 i | 6 | N52 B30 A, N52N B30 B | 190/255 | 03/07→ | | | | ZSE143 11/07→01/13 |



kW/BHP

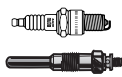

... BMW



... 3 Convertible (E93)

| | | | | | | | | |
|-----------|---|----------------------|---------|--------|--|--|--|--------------------------------------|
| 3.0 330 i | 6 | N52 B30 A, N53 B30 A | 200/268 | 03/07→ | | | | ZSE143 →02/12 ZSE144 →02/12 |
| 3.0 335 i | 6 | N54 B30 A, N54 B30 B | 225/302 | 03/07→ | | | | ZSE143 →02/10 |

3 (F30, F35, F80)

| | | | | | | | | |
|----------------------|---|-----------|---------|--------|--------|--|------|------------------|
| 1.6 316 i | 4 | N13 B16 A | 100/134 | 10/12→ | Z332 | | 0.7 | ZSE143 |
| 2.0 320 i | 4 | N13 B16 A | 125/168 | 02/12→ | | | | ZSE143 |
| 2.0 316 d | 4 | N47 D20 C | 85/114 | 02/12→ | CGP001 | | 5.4V | |
| 2.0 318 d | 4 | N47 D20 C | 100/134 | 02/12→ | CGP001 | | 5.4V | |
| 2.0 318 d | 4 | N47 D20 C | 105/141 | 02/12→ | CGP001 | | 5.4V | |
| 2.0 320 d | 4 | N47 D20 C | 120/161 | 10/11→ | CGP001 | | 5.4V | |
| 2.0 320 d | 4 | N47 D20 C | 135/181 | 10/11→ | CGP001 | | 5.4V | |
| 2.0 320 d xDrive 4WD | 4 | N47 D20 C | 135/181 | 10/11→ | CGP001 | | 5.4V | |
| 2.0 325 d | 4 | N47 D20 D | 160/215 | 10/11→ | CGP001 | | 5.4V | |
| 3.0 330 d | 6 | N57 D30 A | 190/255 | 01/12→ | CGP001 | | 5.4V | |
| 3.0 335 i | 6 | N55 B30 A | 225/302 | 10/11→ | | | | ZSE143 →05/13 |
| 3.0 335 i xDrive 4WD | 6 | N55 B30 A | 225/302 | 10/11→ | | | | ZSE143 →05/13 |

3 Touring (F31)

| | | | | | | | | |
|-----------|---|-----------|---------|--------|------|--|-----|--------|
| 1.6 316 i | 4 | N13 B16 A | 100/134 | 03/13→ | Z332 | | 0.7 | ZSE143 |
|-----------|---|-----------|---------|--------|------|--|-----|--------|

3 GRAN TURISMO (F34)

| | | | | | | | | |
|-----------|---|-----------|---------|--------|--------|--|------|--|
| 2.0 318 d | 4 | N47 D20 C | 105/141 | 03/13→ | CGP001 | | 5.4V | |
| 2.0 320 d | 4 | | 120/161 | 03/13→ | CGP001 | | 5.4V | |
| 2.0 320 d | 4 | N47 D20 C | 135/181 | 03/13→ | CGP001 | | 5.4V | |
| 2.0 325 d | 4 | N47 D20 D | 155/208 | 07/13→ | CGP001 | | 5.4V | |
| 2.0 325 d | 4 | N47 D20 D | 160/215 | 03/13→ | CGP001 | | 5.4V | |

4 Coupe (F32, F82)

| | | | | | | | | |
|-----------|---|-----------|---------|--------|--------|--|------|--|
| 2.0 420 d | 4 | N47 D20 C | 135/181 | 07/13→ | CGP001 | | 5.4V | |
|-----------|---|-----------|---------|--------|--------|--|------|--|

4 Convertible (F33, F83)

| | | | | | | | | |
|-----------|---|-----------|---------|--------|--------|--|------|--|
| 2.0 420 d | 4 | N47 D20 C | 135/181 | 10/13→ | CGP001 | | 5.4V | |
|-----------|---|-----------|---------|--------|--------|--|------|--|

5 (E12)

| | | | | | | | | | | |
|-----------|---|-----------------|---------|-------------|-------------------------------|--|-----|-----------------------|--|-----------------|
| 1.8 518 | 4 | M10 B18 (184VB) | 66/89 | 07/74→05/81 | Z22 →07/75 Z1 08/75→ | | 0.7 | UX56 →07/75 | ZS106 [11] →03/81 | ZM001 08/75→ |
| 1.8 518 i | 4 | | 75/101 | 08/79→08/81 | Z1 | | 0.7 | UXT2 / UXT6 | | |
| 2.0 518 i | 4 | M10 B20 | 92/123 | 08/77→09/79 | Z11 | | 0.8 | UXT2 / UXT6 | | |
| 2.0 520 | 4 | M10 B20 | 85/114 | 08/72→08/77 | Z11 | | 0.8 | UXT2 / UXT6 | ZS106 [11] | |
| 2.0 520/6 | 6 | M20 B20 (206VA) | 90/121 | 09/77→05/81 | Z1 | | 0.7 | UXT2 / UXT6 | ZS115 [11] →07/78 ZS400 [11] 08/78→ | |
| 2.0 520 i | 4 | M10 B20 | 92/123 | 10/75→05/77 | Z11 | | 0.8 | UXT2 / UXT6 | ZS106 [11] | |
| 2.0 520 i | 4 | M10 B20 | 96/129 | 08/72→10/75 | Z11 | | 0.8 | UXT2 / UXT6 | ZS115 [11] 06/73→12/74 | |
| 2.5 525 | 6 | M30 B25 | 107/143 | 08/73→10/76 | Z11 | | 0.8 | UXT2 / UXT6 | ZS115 [11] 09/75→ | |
| 2.5 525 | 6 | M30 B25 (256VA) | 110/148 | 08/76→05/81 | Z11 →08/77 Z1 09/77→ | | 0.8 | UXT2 / UXT6 →08/77 | ZS115 [11] →07/78 | |
| | | | | | | | 0.7 | UXT2 / UXT6 09/77→ | ZS400 [11] 08/78→ | |
| 2.8 528 | 6 | M30 B28 | 121/162 | 01/75→08/77 | Z11 | | 0.8 | UXT2 / UXT6 | ZS115 [11] 09/75→ | |
| 2.8 528 | 6 | M30 B28 | 125/168 | 01/75→08/77 | Z11 | | 0.8 | UXT2 / UXT6 | ZS115 [11] 09/75→ | |

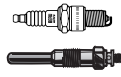

kW/BHP

**... BMW****... 5 (E12)**

| | | | | | | | | | |
|-----------|---|--------------------------|---------|-------------|----|-----|-------------|--|--|
| 2.8 528 i | 6 | M30 B28 | 130/174 | 04/77→05/81 | Z1 | 0.7 | UXT2 / UXT6 | | |
| 2.8 528 i | 6 | M30 B28 | 135/181 | 04/77→05/81 | Z1 | 0.7 | UXT2 / UXT6 | | |
| 3.4 M | 6 | M30 B35 (Motronic,9.3:1) | 160/215 | 06/80→08/81 | Z1 | 0.7 | UXT2 / UXT6 | | |

5 (E28)

| | | | | | | | | | |
|--------------------|---|---|---------|-------------|------------------------|------------|-------------|-----------------|------------------------------------|
| 1.8 518 | 4 | M10 B18 (184VC), M10 B18 (184VD) | 66/89 | 06/81→08/84 | Z1 | 0.7 | UXT2 / UXT6 | | ZM001 →12/83 ZM038 01/84→ |
| 1.8 518 i | 4 | M10 B18 (184EB) | 77/103 | 09/83→12/87 | Z1 | 0.7 | UXT2 / UXT6 | | ZM001 →08/84 ZM038 09/84→ |
| 2.0 520 i | 6 | M20 B20 (206EA) | 92/123 | 06/81→12/87 | Z119 | 0.8 | UXT2 / UXT6 | | ZM001 →08/84 ZM038 09/84→ |
| 2.0 520 i | 6 | M20 B20 (206KA) | 95/127 | 08/85→12/87 | Z1 | 0.7 | UXT2 / UXT6 | ZS122 12/86→ | ZM038 |
| 2.0 520 i | 6 | | 110/148 | 12/86→12/87 | Z3 | 0.7 | UXT2 / UXT6 | | |
| 2.4 524 d | 6 | M21 D24 (246DA) | 63/84 | 03/86→12/87 | GN909 (2 222) GV636 | 11V 11V | | | |
| 2.4 524 td | 6 | M21 D24 (246TA) | 85/114 | 09/83→12/87 | GN909 (2 222) GV636 | 11V 11V | | | |
| 2.5 525 i | 6 | M30 B25 (256EA) | 110/148 | 06/81→12/87 | Z1 | 0.7 | UXT2 / UXT6 | | ZM001 |
| 2.7 525 e | 6 | M20 B27 (276EB), M20 B27 (276KA), M20 B27 (276KB) | 90/121 | 09/81→12/87 | Z3 | 0.7 | UXT2 / UXT6 | ZS122 | |
| 2.7 525 e | 6 | M20 B27 (276EA) | 92/123 | 05/83→12/87 | Z1 | 0.7 | UXT2 / UXT6 | ZS122 | |
| 2.7 525 e | 6 | M20 B27 (276KB) | 95/127 | 12/84→12/87 | Z3 | 0.7 | UXT2 / UXT6 | ZS122 | |
| 2.8 528 i | 6 | M30 B28 | 135/181 | 06/81→12/87 | Z1 | 0.7 | UXT2 / UXT6 | | |
| 3.4 535 i, M 535 i | 6 | M30 B34 (346KA) | 136/182 | 01/85→12/87 | Z1 | 0.7 | UXT2 / UXT6 | ZS122 | |
| 3.4 535 i, M 535 i | 6 | M30 B35 (Motronic) | 141/189 | 01/85→12/87 | Z1 | 0.7 | UXT2 / UXT6 | ZS122 | |
| 3.4 535 i, M 535 i | 6 | M30 B34 (346EC) | 160/215 | 01/85→12/87 | Z1 | 0.7 | UXT2 / UXT6 | ZS122 | |
| 3.5 M | 6 | S38 B35 (356ED) | 211/283 | 08/85→12/87 | | | | ZS122 | |

5 (E34)

| | | | | | | | | | |
|------------------------|---|-------------------------------------|---------|-------------|------------------------|------------|-------------|-------|--------|
| 1.8 518 i | 4 | M40 B18 (184E1) | 83/111 | 08/89→09/95 | Z14 | 0.9 | UXT1 / UXT3 | ZS122 | |
| 1.8 518 i LPG | 4 | M40 B18 (184E1) | 83/111 | 08/89→09/95 | Z116 | 0.8 | UXT5 | | |
| 2.0 520 i | 6 | M20 B20 (206KA) | 95/127 | 01/88→08/91 | Z3 | 0.7 | UXT2 / UXT6 | ZS122 | |
| 2.0 520 i 24V | 6 | M50 B20 (206S1), M50 B20 (206S2) | 110/148 | 09/89→09/95 | Z14 | 0.9 | UXT1 / UXT3 | ZS014 | |
| 2.0 520 i 24V LPG | 6 | M50 B20 (206S1), M50 B20 (206S2) | 110/148 | 09/89→09/95 | Z116 | 0.8 | UXT5 | | |
| 2.4 524 td | 6 | M21 D24 (246TB) | 85/114 | 03/88→09/95 | GN013 (2 222) GV719 | 11V 11V | | | |
| 2.5 525 i | 6 | M20 B25 (256K1) | 125/168 | 01/88→08/91 | Z3 | 0.7 | UXT2 / UXT6 | ZS122 | |
| 2.5 525 i 24V | 6 | M50 B25 (256S2) | 141/189 | 09/89→09/95 | Z14 | 0.9 | UXT1 / UXT3 | ZS014 | |
| 2.5 525 i 24V LPG | 6 | M50 B25 (256S2) | 141/189 | 09/89→09/95 | Z116 | 0.8 | UXT5 | | |
| 2.5 525 iX 24V 4WD | 6 | M50 B25 (256S1), M50 B25 (256S2) | 141/189 | 10/91→09/95 | Z14 | 0.9 | UXT1 / UXT3 | ZS014 | ZLE232 |
| 2.5 525 iX 24V 4WD LPG | 6 | M50 B25 (256S1), M50 B25 (256S2) | 141/189 | 10/91→09/95 | Z116 | 0.8 | UXT5 | | |
| 2.5 525 tds | 6 | M51 D25 (256T1) | 105/141 | 09/91→09/95 | GN013 (2 222) GV719 | 11V 11V | | | |
| 3.0 530 i | 6 | M30 B30 (306KA) | 138/185 | 01/88→08/91 | Z3 | 0.7 | UXT2 / UXT6 | ZS122 | |
| 3.0 530 i V8 | 8 | M60 B30 (308S1) | 160/215 | 09/92→09/95 | | | | ZS014 | ZLE232 |
| 3.4 535 i | 6 | M30 B34 (346KB) | 155/208 | 01/88→09/95 | Z3 →04/93 | 0.7 | UXT2 / UXT6 | ZS122 | |
| 4.0 540 i V8 | 8 | M60 B40 (408S1) | 210/282 | 09/92→09/95 | Z14 | 0.9 | UXT1 / UXT3 | ZS014 | ZLE232 |
| 4.0 540 i V8 LPG | 8 | M60 B40 (408S1) | 210/282 | 09/92→09/95 | Z116 | 0.8 | UXT5 | | |



kW/BHP



... BMW



5 /Touring (E34)

| | | | | | | | | |
|------------------|---|-----------------|---------|-------------|------------------------------------|------------|-------------|-------|
| 1.8 518 i | 4 | M43 B18 (184E2) | 85/114 | 08/89→01/97 | Z14 | 0.9 | UXT1 / UXT3 | ZS307 |
| 1.8 518 i LPG | 4 | M43 B18 (184E2) | 85/114 | 08/89→01/97 | Z116 | 0.8 | UXT5 | |
| 2.5 525 td | 6 | M51 D25 (256T1) | 85/114 | 03/93→01/97 | GN013 ^{[2][222]} GV719 | 11V 11V | | |
| 3.0 530 i V8 | 8 | M60 B30 (308S1) | 160/215 | 09/92→01/97 | Z14 | 0.9 | UXT1 / UXT3 | |
| 3.0 530 i V8 LPG | 8 | M60 B30 (308S1) | 160/215 | 09/92→01/97 | Z116 | 0.8 | UXT5 | |
| 3.8 M | 6 | S38 B38 (386S1) | 250/335 | 03/92→01/97 | | | | ZS014 |

5 Touring (E34)

| | | | | | | | | |
|--------------------|---|-------------------------------------|---------|-------------|------------------------------------|------------|-----------------------------------|-------------------------------------|
| 1.8 518 g | 4 | M43 B18 (184E2) | 85/114 | 11/95→06/96 | Z14 | 0.9 | UXT1 / UXT3 | ZS307 |
| 1.8 518 g LPG | 4 | M43 B18 (184E2) | 85/114 | 11/95→06/96 | Z116 | 0.8 | UXT5 | |
| 1.8 518 i | 4 | M43 B18 (184E2) | 83/111 | 03/93→09/94 | Z14 | 0.9 | UXT1 / UXT3 | ZS122 |
| 2.0 520 i | 6 | M50 B20 (206S1), M50 B20 (206S2) | 110/148 | 11/91→01/97 | Z14 | 0.9 | UXT1 / UXT3 | ZS014 →12/96 |
| 2.0 520 i LPG | 6 | M50 B20 (206S1), M50 B20 (206S2) | 110/148 | 11/91→01/97 | Z116 | 0.8 | UXT5 | |
| 2.5 525 i | 6 | M50 B25 (256S1), M50 B25 (256S2) | 141/189 | 11/91→01/97 | Z14 | 0.9 | UXT1 / UXT3 | ZS014 →12/96 |
| 2.5 525 i LPG | 6 | M50 B25 (256S1), M50 B25 (256S2) | 141/189 | 11/91→01/97 | Z116 | 0.8 | UXT5 | |
| 2.5 525 ix 4WD | 6 | M50 B25 (256S1), M50 B25 (256S2) | 141/189 | 02/92→01/97 | Z14 | 0.9 | UXT1 / UXT3 | ZS014 →12/96 |
| 2.5 525 ix 4WD LPG | 6 | M50 B25 (256S1), M50 B25 (256S2) | 141/189 | 02/92→01/97 | Z116 ^[168] | 0.8 | UXT5 | |
| 2.5 525 tds | 6 | M51 D25 (Inter.) | 105/141 | 12/91→01/97 | GN013 ^{[2][222]} GV719 | 11V 11V | | |
| 3.0 530 i V8 | 8 | M60 B30 (308S1) | 160/215 | 09/92→01/97 | | | | ZS014 →12/96 ZLE232 →12/96 |
| 4.0 540 i | 8 | M60 B40 (408S1) | 210/282 | 09/93→01/97 | Z14 | 0.9 | UXT1 / UXT3 | ZS014 →12/96 ZLE232 →12/96 |
| 4.0 540 i LPG | 8 | M60 B40 (408S1) | 210/282 | 09/93→01/97 | Z116 | 0.8 | UXT5 | |
| 5 (E39) | | | | | | | | |
| 2.0 520 i | 6 | M52 B20 (206S3) | 110/148 | 01/96→09/00 | Z14 →09/98 Z237 10/98→ | 0.9 1.6 | UXT1 / UXT3 →09/98 | |
| 2.0 520 i LPG | 6 | M52 B20 (206S3) | 110/148 | 01/96→09/00 | Z116 →09/98 Z340 10/98→ | 0.8 0.7 | UXT5 →09/98 UXT12 10/98→ | |
| 2.5 525 td | 6 | M51 D25 (256T1) | 85/114 | 01/97→06/03 | GN013 ^{[2][222]} GV719 | 11V 11V | | |
| 2.5 525 tds | 6 | M51 D25 (Inter.) | 105/141 | 01/96→06/03 | GN013 ^{[2][222]} GV719 | 11V 11V | | |
| 2.8 528 i | 6 | M52 B28 (286S1), M52 B28 (286S2) | 142/190 | 11/95→09/00 | Z14 | 0.9 | UXT1 / UXT3 | |
| 2.8 528 i LPG | 6 | M52 B28 (286S1), M52 B28 (286S2) | 142/190 | 11/95→09/00 | Z116 | 0.8 | UXT5 | |
| 3.5 535 i | 8 | M62 B35 (358S1), M62 B35 (358S2) | 173/232 | 04/96→03/99 | Z14 →08/98 Z237 09/98→ | 0.9 1.6 | UXT1 / UXT3 →08/98 | ZS302 |
| 3.5 535 i | 8 | M62 B35 (358S2) | 180/241 | 04/99→06/03 | Z237 | 1.6 | | ZS302 |
| 3.5 535 i LPG | 8 | M62 B35 (358S1), M62 B35 (358S2) | 173/232 | 04/96→03/99 | Z116 →08/98 Z340 09/98→ | 0.8 0.7 | UXT5 →08/98 UXT12 09/98→ | |
| 3.5 535 i LPG | 8 | M62 B35 (358S2) | 180/241 | 04/99→06/03 | Z340 | 0.7 | UXT12 | |

BMW

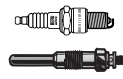

kW/BHP

**... BMW****... 5 (E39)**

| | | | | | | | | | |
|---------------|---|-------------------------------------|---------|-------------|--|------------|---|--------------|---------------|
| 4.4 540 i | 8 | M62 B44 (448S1), M62 B44 (448S2) | 210/282 | 04/96→06/03 | Z14 →09/98 Z237 10/98→ | 0.9 1.6 | UXT1 / UXT3 →09/98 | | |
| 4.4 540 i LPG | 8 | M62 B44 (448S1), M62 B44 (448S2) | 210/282 | 04/96→06/03 | Z116 →09/98 Z340 10/98→ | 0.8 0.7 | UXT5 →09/98 UXT12 10/98→ | | |
| 4.9 M | 8 | S38 B49 | 294/394 | 10/98→06/03 | Z237 | 1.6 | | ZS302 | ZLE232 |
| 4.9 M LPG | 8 | S38 B49 | 294/394 | 10/98→06/03 | Z340 [168] | 0.7 | UXT12 | | |

5 /Touring (E39)

| | | | | | | | | | |
|---------------|---|-------------------------------------|---------|-------------|--|------------|---|--|--|
| 2.0 520 d | 4 | M47 D20 (204D1) | 100/134 | 02/00→09/03 | GN024 | 11V | | | |
| 2.0 520 i | 6 | M52 B20 (206S3) | 100/134 | 04/99→05/04 | Z237 | 1.6 | | ZS302 | |
| 2.0 520 i | 6 | M52 B20 (206S3) | 110/148 | 01/96→09/00 | | | | ZS302 | |
| 2.0 520 i LPG | 6 | M52 B20 (206S3) | 100/134 | 04/99→05/04 | Z340 | 0.7 | UXT12 | | |
| 2.2 520 i | 6 | M54 B22 (226S1) | 125/168 | 09/00→05/04 | Z237 | 1.6 | | ZS302 →09/02 ZS324 10/02→ | |
| 2.2 520 i LPG | 6 | M54 B22 (226S1) | 125/168 | 09/00→05/04 | Z340 | 0.7 | UXT12 | | |
| 2.5 523 i | 6 | M52 B25 (256S3) | 125/168 | 11/95→09/00 | Z14 →08/98 Z237 09/98→ | 0.9 1.6 | UXT1 / UXT3 →08/98 | ZS302 | |
| 2.5 523 i LPG | 6 | M52 B25 (256S3) | 125/168 | 11/95→09/00 | Z116 →08/98 Z340 09/98→ | 0.8 0.7 | UXT5 →08/98 UXT12 09/98→ | | |
| 2.5 525 d | 6 | M57 D25 (256D1) | 120/161 | 02/00→05/04 | GN024 | 11V | | | |
| 2.5 525 i | 6 | M54 B25 (256S5) | 141/189 | 09/00→05/04 | Z237 | 1.6 | | ZS302 →09/02 | |
| 2.5 525 i LPG | 6 | M54 B25 (256S5) | 141/189 | 09/00→05/04 | Z340 | 0.7 | UXT12 | | |
| 2.8 528 i | 6 | M52 B28 (286S1), M52 B28 (286S2) | 142/190 | 11/95→09/00 | | | | ZS302 | |
| 3.0 530 d | 6 | M57 D30 (306D1) | 135/181 | 08/98→09/00 | GN024 | 11V | | | |
| 3.0 530 d | 6 | M57 D30 (306D1) | 142/190 | 09/00→05/04 | GN024 | 11V | | | |
| 3.0 530 i | 6 | M54 B30 (306S3) | 170/228 | 09/00→05/04 | Z237 | 1.6 | | ZS302 →09/02 ZS324 10/02→ | |
| 3.0 530 i LPG | 6 | M54 B30 (306S3) | 170/228 | 09/00→05/04 | Z340 | 0.7 | UXT12 | | |
| 4.4 540 i | 8 | M62 B44 (448S1), M62 B44 (448S2) | 210/282 | 04/96→05/04 | | | | ZS302 | |

5 Touring (E39)

| | | | | | | | | | |
|---------------|---|-------------------------------------|---------|-------------|--|------------|---|--|---------------|
| 2.0 520 i | 6 | M52 B20 (206S3) | 110/148 | 01/97→09/00 | Z14 →08/98 Z237 09/98→ | 0.9 1.6 | UXT1 / UXT3 →08/98 | | |
| 2.0 520 i LPG | 6 | M52 B20 (206S3) | 110/148 | 01/97→09/00 | Z116 →08/98 Z340 09/98→ | 0.8 0.7 | UXT5 →08/98 UXT12 09/98→ | | |
| 2.5 525 tds | 6 | M51 D25 (256T1) | 105/141 | 03/97→05/04 | GN013 [2][222] GV719 | 11V 11V | | | |
| 2.8 528 i | 6 | M52 B28 (286S1), M52 B28 (286S2) | 142/190 | 01/97→09/00 | Z237 | 1.6 | | | ZLE232 |
| 2.8 528 i LPG | 6 | M52 B28 (286S1), M52 B28 (286S2) | 142/190 | 01/97→09/00 | Z340 | 0.7 | UXT12 | | |

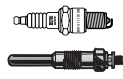

kW/BHP

**... BMW****... 5 Touring (E39)**

| | | | | | | | | |
|---------------|---|-------------------------------------|---------|-------------|--|--|---|--|
| 4.4 540 i | 8 | M62 B44 (448S1), M62 B44 (448S2) | 210/282 | 01/97→05/04 | Z14 →08/98 Z237 09/98→ | | 0.9 UXT1 / UXT3 →08/98 1.6 | |
| 4.4 540 i LPG | 8 | M62 B44 (448S1), M62 B44 (448S2) | 210/282 | 01/97→05/04 | Z116 →08/98 Z340 09/98→ | | 0.8 UXT5 →08/98 0.7 UXT12 09/98→ | |

5 (E60)

| | | | | | | | | |
|----------------|---|-------------------------------------|---------|-------------|-----------------------|-------------------------|-----|--|
| 2.0 520 d | 4 | M47 D20 (204D4) | 110/148 | 09/05→03/10 | GE102 | GSE101 | 5V | |
| 2.0 520 d | 4 | M47 | 120/161 | 07/05→03/10 | GE102 | GSE101 | 5V | |
| 2.0 520 d | 4 | M47 D20 (204D4) | 130/174 | 09/07→03/10 | GE102 | GSE101 | 5V | |
| 2.0 520 i | 4 | N46 B20 B | 115/154 | 04/06→12/09 | Z301 | | 1.1 | ZS324 →06/09 ZSE143 07/09→ |
| 2.0 520 i | 4 | N43 B20 A | 120/161 | 12/06→03/10 | | | | ZSE143 |
| 2.0 520 i | 4 | N43 B20 A | 125/168 | 09/07→03/10 | | | | ZSE144 |
| 2.2 520 i | 6 | M54 B22, M54 226 S1 | 125/168 | 07/03→03/10 | | | | ZS324 →06/09 |
| 2.2 520 i | 6 | M54 B22 (226S1) | 125/168 | 07/03→03/10 | Z237 | | 1.6 | |
| 2.2 520 i LPG | 6 | M54 B22 (226S1) | 125/168 | 07/03→03/10 | Z340 | | 0.7 | UXT12 |
| 2.5 523 i | 6 | N52 B25 A | 130/174 | 07/05→03/10 | Z235 →09/09 | | 1.0 | ZSE145 →04/06 ZSE143 11/07→ |
| 2.5 523 i | 6 | N52 B25 A | 140/188 | 01/07→03/10 | Z235 →12/09 | | 1.0 | ZSE144 |
| 2.5 525 d | 6 | M57 D25 (256D1) | 120/161 | 12/04→03/10 | GE102 | GSE102 | 5V | |
| 2.5 525 d | 6 | M57 D25 TU, M57N 256 D4 | 130/174 | 06/04→03/10 | GE102 | GSE102 | 5V | |
| 2.5 525 i | 6 | M54 B25, M54 256 S5 | 141/189 | 09/03→03/10 | Z237 | | 1.6 | ZS324 →06/09 |
| 2.5 525 i | 6 | N52 B25 A | 160/215 | 07/05→03/10 | Z235 →12/09 | | 1.0 | ZSE145 →04/06 ZSE143 04/06→ |
| 2.5 525 i LPG | 6 | M54 B25, M54 256 S5 | 141/189 | 09/03→03/10 | Z340 | | 0.7 | UXT12 |
| 2.5 525 xi 4WD | 6 | N52 B25 A | 160/215 | 07/05→03/10 | Z235 →12/09 | | 1.0 | ZSE145 →04/06 ZSE143 04/06→ |
| 3.0 525 d | 6 | M57 D30 (306D3) | 145/194 | 01/07→03/10 | GE102 | GSE102 | 5V | |
| 3.0 525 i | 6 | N53 B30 A | 160/215 | 01/07→03/10 | | | | ZSE144 |
| 3.0 525 xi 4WD | 6 | N53 B30 A | 160/215 | 01/07→03/10 | | | | ZSE144 →12/08 |
| 3.0 525 xd 4WD | 6 | M57 D30 (306D3) | 145/194 | 01/07→03/10 | GE102 | GSE102 | 5V | |
| 3.0 530 d | 6 | M57 D30 (306D2), M57 D30 (306D3) | 155/208 | 07/03→03/10 | GE102 | GSE102 | 5V | |
| 3.0 530 d | 6 | M57 D30 (306D2) | 160/215 | 07/03→03/10 | GE102 | GSE102 →09/04 | 5V | |
| 3.0 530 d | 6 | M57 306 D3 | 170/228 | 07/03→03/10 | GE102 | GSE102 | 5V | |
| 3.0 530 d | 6 | M57 D30 (306D3) | 173/232 | 01/07→03/10 | GE102 | GSE102 | 5V | |
| 3.0 530 i | 6 | M54 B30, M54 306 S3 | 170/228 | 07/03→03/10 | Z237 | | 1.6 | ZS324 →06/09 |
| 3.0 530 i | 6 | N52 B30 A | 190/255 | 07/05→03/10 | Z235 →12/09 | | 1.0 | ZSE145 →04/06 ZSE143 04/06→ |
| 3.0 530 i | 6 | N52 B30 A, N53 B30 A | 200/268 | 01/07→03/10 | | | | ZSE144 |

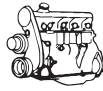

kW/BHP

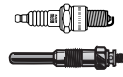
**... BMW****... 5 (E60)**

| | | | | | | | | | |
|------------------------|---|-------------------------|---------|-------------|----------------|------------------|-----|-------|---|
| 3.0 530 i LPG | 6 | M54 B30, M54 306 S3 | 170/228 | 07/03→03/10 | Z340 | | 0.7 | UXT12 | |
| 3.0 530 xi 4WD | 6 | N52 B30 A | 190/255 | 07/05→03/10 | Z235 | | 1.0 | | ZSE145 →04/06 ZSE143 11/07→08/08 |
| 3.0 530 xi 4WD | 6 | N52 B30 A, N53 B30 A | 200/268 | 01/07→03/10 | | | | | ZSE144 →08/08 |
| 3.0 530 xd 4WD | 6 | M57 306 D3 | 170/228 | 07/05→03/10 | GE102 | GSE102 | 5V | | |
| 3.0 530 xd 4WD | 6 | M57 D30 (306D3) | 173/232 | 01/07→03/10 | GE102 | GSE102 | 5V | | |
| 3.0 535 d | 6 | M57 D30 (306D4) | 200/268 | 09/04→03/10 | GE102 | GSE102 | 5V | | |
| 3.0 535 d | 6 | M57 D30 (306D5) | 210/282 | 01/07→03/10 | GE102 | GSE102 | 5V | | |
| 3.0 540 i | 6 | N54 B30 A | 225/302 | 08/05→03/10 | | | | | ZS324 →06/09 ZSE143 |
| 4.0 540 i | 8 | N62 B40 A | 225/302 | 07/05→03/10 | Z301 | | 1.1 | | ZS324 →06/09 ZSE143 |
| 4.0 540 i LPG | 8 | N62 B40 A | 225/302 | 07/05→03/10 | Z116 | | 0.8 | UXT5 | |
| 4.4 545 i | 8 | N62 B44 A | 245/329 | 09/03→03/10 | Z237 | | 1.6 | | ZS324 →06/09 ZSE143 [53] |
| 4.4 545 i LPG | 8 | N62 B44 A | 245/329 | 09/03→03/10 | Z340 | | 0.7 | UXT12 | |
| 4.8 550 i | 8 | N62 B48 A, N62 B48 B | 270/362 | 07/05→03/10 | Z301 | | 1.1 | | ZS324 →06/09 ZSE143 [53] |
| 4.8 550 i LPG | 8 | N62 B48 A, N62 B48 B | 270/362 | 07/05→03/10 | Z116 | | 0.8 | UXT5 | |
| 5 Touring (E61) | | | | | | | | | |
| 2.0 520 d | 4 | M47 D20 (204D4) | 110/148 | 09/05→ | GE102 | GSE101 | 5V | | |
| 2.0 520 d | 4 | M47 D20 (204D4) | 120/161 | 07/05→ | GE102 | GSE101 | 5V | | |
| 2.0 520 i | 4 | N43 B20 A | 120/161 | 07/07→08/10 | | | | | ZSE144 |
| 2.0 520 i | 4 | N43 B20 A | 125/168 | 09/07→ | | | | | ZSE144 →08/10 |
| 2.5 523 i | 6 | N52 B25 A | 130/174 | 07/05→ | Z235 →09/09 | | 1.0 | | ZSE145 →04/06 ZSE143 11/07→08/10 |
| 2.5 523 i | 6 | N52 B25 A, N53 B25 A | 140/188 | 01/07→ | Z235 | | 1.0 | | ZSE144 →08/10 |
| 2.5 525 d | 6 | M57N 256 D4 | 120/161 | 12/04→ | GE102 | GSE102 | 5V | | |
| 2.5 525 d | 6 | M57 D25 TU, M57N 256 D4 | 130/174 | 06/04→ | GE102 | GSE102 →08/05 | 5V | | |
| 2.5 525 i | 6 | M54 B25 (256S5) | 141/189 | 06/04→ | Z237 | | 1.6 | | ZS324 →06/09 |
| 2.5 525 i | 6 | N52 B25 A | 160/215 | 07/05→ | Z235 | | 1.0 | | ZSE145 →04/06 ZSE143 11/07→08/10 |
| 2.5 525 i LPG | 6 | M54 B25 (256S5) | 141/189 | 06/04→ | Z340 | | 0.7 | UXT12 | |
| 2.5 525 xi 4WD | 6 | N52 B25 A | 160/215 | 07/05→ | Z235 →03/07 | | 1.0 | | ZSE145 →04/06 |
| 3.0 525 d | 6 | M57 D30 (306D3) | 145/194 | 01/07→ | GE102 | GSE102 | 5V | | |
| 3.0 525 d xDrive 4WD | 6 | M57 D30 (306D3) | 145/194 | 09/08→ | GE102 | GSE102 | 5V | | |
| 3.0 525 i | 6 | N53 B30 A | 160/215 | 01/07→ | | | | | ZSE144 →08/10 |
| 3.0 525 i xDrive 4WD | 6 | N53 B30 A | 160/215 | 09/08→ | | | | | ZSE144 →08/10 |
| 3.0 525 xi 4WD | 6 | N52 B30 A, N53 B30 A | 160/215 | 01/07→ | | | | | ZSE144 →08/08 |
| 3.0 525 xd 4WD | 6 | M57 D30 (306D3) | 145/194 | 01/07→ | GE102 | GSE102 | 5V | | |

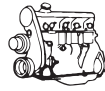

kW/BHP

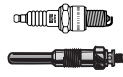
**... BMW****... 5 Touring (E61)**

| | | | | | | | | | |
|------------------------|---|----------------------|---------|--------|-------------------|------------------|------|-------|---|
| 3.0 530 d | 6 | M57 D30 (306D2) | 160/215 | 06/04→ | GE102 | GSE102 →09/04 | 5V | | |
| 3.0 530 d | 6 | M57 306 D3 | 170/228 | 07/05→ | GE102 | GSE102 | 5V | | |
| 3.0 530 d | 6 | M57 D30 (306D3) | 173/232 | 01/07→ | GE102 | GSE102 | 5V | | |
| 3.0 530 i | 6 | N52 B30 A | 190/255 | 07/05→ | Z235 →09/09 | | 1.0 | | ZSE145 →04/06 ZSE143 11/07→08/10 |
| 3.0 530 i | 6 | N53 B30 A | 200/268 | 01/07→ | | | | | ZSE143 →08/10 ZSE144 →08/10 |
| 3.0 530 i xDrive 4WD | 6 | N52 B30 A, N53 B30 A | 200/268 | 09/08→ | | | | | ZSE144 →08/10 |
| 3.0 530 xi 4WD | 6 | N52 B30 A | 190/255 | 07/05→ | Z235 | | 1.0 | | ZSE145 →04/06 ZSE143 11/07→08/08 |
| 3.0 530 xi 4WD | 6 | N52 B30 A, N53 B30 A | 200/268 | 01/07→ | | | | | ZSE144 →08/08 |
| 3.0 530 xd 4WD | 6 | M57 306 D3 | 170/228 | 07/05→ | GE102 | GSE102 | 5V | | |
| 3.0 530 xd 4WD | 6 | M57 D30 (306D3) | 173/232 | 01/07→ | GE102 | GSE102 | 5V | | |
| 3.0 535 d | 6 | M57 D30 (306D4) | 200/268 | 09/04→ | GE102 | GSE102 | 5V | | |
| 3.0 535 d | 6 | M57 D30 (306D5) | 210/282 | 01/07→ | GE102 | GSE102 | 5V | | |
| 4.4 545 i | 8 | N62 B44 A | 245/329 | 06/04→ | Z237 | | 1.6 | | ZS324 →06/09 |
| 4.4 545 i LPG | 8 | N62 B44 A | 245/329 | 06/04→ | Z340 | | 0.7 | UXT12 | |
| 4.8 550 i | 8 | N62 B48 A, N62 B48 B | 270/362 | 07/05→ | Z301 | | 1.1 | | ZS324 →06/09 |
| 4.8 550 i LPG | 8 | N62 B48 A, N62 B48 B | 270/362 | 07/05→ | Z116 | | 0.8 | UXT5 | |
| 5 (F10, F18) | | | | | | | | | |
| 2.5 523 i | 6 | N52 B25 A | 150/201 | 03/10→ | | | | | ZSE143 |
| 3.0 523 i | 6 | N53 B30 A | 150/201 | 03/10→ | | | | | ZSE144 →08/11 |
| 3.0 528 i | 6 | N53 B30 A | 190/255 | 03/10→ | | | | | ZSE143 →08/11 ZSE144 →08/11 |
| 3.0 530 d | 6 | N 57 N | 180/241 | 03/10→ | CGP001 →01/12 | | 5.4V | | |
| 3.0 530 d 4WD | 6 | N57 D30 A | 190/255 | 09/11→ | CGP001 →01/12 | | 5.4V | | |
| 3.0 530 i | 6 | N53 B30 A | 200/268 | 09/11→ | | | | | ZSE144 →02/12 |
| 3.0 535 d | 6 | N57 D30 B | 220/295 | 09/10→ | CGP001 [267][278] | | 5.4V | | |
| 3.0 535 d | 6 | N57 D30 B, N 57 Z | 230/308 | 09/11→ | CGP001 | | 5.4V | | |
| 3.0 M 550 d 4WD | 6 | N57 D30 C | 280/375 | 01/12→ | CGP001 | | 5.4V | | |
| 4.4 550 i | 8 | N63 B44 A | 300/402 | 03/10→ | | | | | ZSE143 |
| 4.4 550 i | 8 | N63 B44 B | 330/443 | 05/13→ | | | | | ZSE143 |
| 4.4 M5 | 8 | S63 B44 B | 412/552 | 06/11→ | | | | | ZSE143 |
| 5 Touring (F11) | | | | | | | | | |
| 3.0 523 i | 6 | N53 B30 A | 150/201 | 09/10→ | | | | | ZSE144 →08/11 |
| 3.0 528 i | 6 | N53 B30 A | 190/255 | 09/10→ | | | | | ZSE143 →08/11 ZSE144 →08/11 |
| 3.0 530 d | 6 | N 57 N | 180/241 | 09/10→ | CGP001 →01/12 | | 5.4V | | |

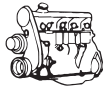

kW/BHP

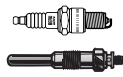

... BMW



... 5 Touring (F11)

| | | | | | | | | |
|-----------------|---|-----------|---------|--------|-----------------------------------|------|------------------|--|
| 3.0 530 d 4WD | 6 | N57 D30 A | 190/255 | 09/11→ | CGP001 ^[268] →01/12 | 5.4V | | |
| 3.0 530 i | 6 | N53 B30 A | 200/268 | 09/11→ | | | ZSE144 →02/12 | |
| 3.0 535 d | 6 | N57 D30 B | 230/308 | 09/11→ | CGP001 ^{[268][278]} | 5.4V | | |
| 3.0 535 d 4WD | 6 | N57 D30 B | 230/308 | 09/11→ | CGP001 ^[268] | 5.4V | | |
| 3.0 M 550 d 4WD | 6 | N57 D30 C | 280/375 | 01/12→ | CGP001 | 5.4V | | |
| 4.4 550 i | 8 | N63 B44 A | 300/402 | 09/10→ | | | ZSE143 | |
| 4.4 550 i | 8 | N63 B44 B | 330/443 | 05/13→ | | | ZSE143 | |

5 GRAN TURISMO (F07)

| | | | | | | | | |
|----------------------|---|-----------|---------|--------|------------------------------|------|------------------|--|
| 3.0 535 d | 6 | N57 D30 B | 220/295 | 09/10→ | CGP001 ^{[267][278]} | 5.4V | | |
| 3.0 535 d 4WD | 6 | N57 D30 B | 220/295 | 09/10→ | CGP001 ^[267] | 5.4V | | |
| 3.0 535 d | 6 | N57 D30 B | 230/308 | 02/12→ | CGP001 ^{[267][278]} | 5.4V | | |
| 4.4 550 i | 8 | N63 B44 A | 300/402 | 10/09→ | | | ZSE143 →06/12 | |
| 4.4 550 i | 8 | N63 B44 B | 330/443 | 05/12→ | | | ZSE143 | |
| 4.4 550 i xDrive 4WD | 8 | N63 B44 B | 330/443 | 05/12→ | | | ZSE143 | |

6 (E24)

| | | | | | | | | | |
|---------------|---|---|---------|-------------|------------------------------|-----|-------------|---|-----------------|
| 2.8 628 CSi | 6 | M30 B28 | 135/181 | 09/79→08/87 | Z1 | 0.7 | UXT2 / UXT6 | ZS400 ^[11] →05/81 | ZM001 05/82→ |
| 3.0 630 CS | 6 | M30 B30 | 135/181 | 04/76→08/79 | Z1 | 0.7 | UXT2 / UXT6 | ZS115 ^[11] →07/78 ZS400 ^[11] 08/78→ | |
| 3.0 630 CS | 6 | M30 B30 | 136/182 | 04/76→08/79 | Z1 | 0.7 | UXT2 / UXT6 | ZS115 ^[11] →07/78 ZS400 ^[11] 08/78→ | |
| 3.2 633 CSi | 6 | M30 B32 | 145/194 | 09/78→08/84 | Z1 | 0.7 | UXT2 / UXT6 | ZS400 ^[11] →08/79 | |
| 3.2 633 CSi | 6 | | 147/197 | 04/76→09/78 | Z1 | 0.7 | UXT2 / UXT6 | ZS400 ^[11] | |
| 3.4 635 CSi | 6 | M30 B34 (346KA) | 136/182 | 01/85→05/89 | Z3 06/87→ | 0.7 | UXT2 / UXT6 | ZS122 06/87→ | |
| 3.4 635 CSi | 6 | M30 B35 | 141/189 | 04/85→09/90 | Z3 | 0.7 | UXT2 / UXT6 | ZS122 | |
| 3.4 635 CSi | 6 | M30 B34 (346KB) | 155/208 | 08/87→05/89 | Z3 | 0.7 | UXT2 / UXT6 | ZS122 | |
| 3.4 635 CSi | 6 | M30 B35 (L-Jetronic, 10:1), M30 B35 (Motronic, 10:1), M30 B35 (Motronic, 9.3:1) | 160/215 | 06/78→08/88 | Z1 →05/87 Z3 06/87→ | 0.7 | UXT2 / UXT6 | ZS400 ^{[11][254]} ZS122 →05/87 0.7 UXT2 / UXT6 09/84→ 06/87→ | |
| 3.4 M 635 CSi | 6 | S38 B35 | 211/283 | 03/84→05/89 | | | | ZS122 | |
| 3.5 M 635 CSi | 6 | S38 B35 (356ED) | 191/256 | 10/86→10/88 | | | | ZS122 | |

6 (E63)

| | | | | | | | | | |
|----------------|---|-----------------------|---------|--------|---------------------------------|-----|-----------------|---|--|
| 3.0 630 i | 6 | N52 B30, N52 B30 A | 190/255 | 09/04→ | Z235 →09/09 | 1.0 | | ZSE145 →04/06 ZSE143 11/07→07/10 | |
| 3.0 630 i | 6 | N52 B30 A, N52 B30 BF | 200/268 | 07/07→ | | | | ZSE144 →07/10 | |
| 3.0 635 d | 6 | M57 D30 (306D5) | 210/282 | 07/07→ | GE102 | 5V | | | |
| 4.4 645 Ci | 8 | N62 B44 A | 245/329 | 01/04→ | Z237 →09/05 | 1.6 | | ZS324 →06/09 | |
| 4.4 645 Ci LPG | 8 | N62 B44 A | 245/329 | 01/04→ | Z340 ^[168] →09/05 | 0.7 | UXT12 →09/05 | | |
| 4.8 650 i | 8 | N62 B48 B | 270/362 | 07/05→ | Z301 | 1.1 | | ZS324 →06/09 | |
| 4.8 650 i LPG | 8 | N62 B48 B | 270/362 | 07/05→ | Z116 | 0.8 | UXT5 | | |

BMW

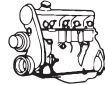

kW/BHP

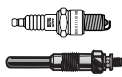

... BMW

**6 Convertible (E64)**

| | | | | | | | | |
|----------------|---|-------------------------------------|---------|--------|----------------|--------|-----|---|
| 3.0 630 i | 6 | N52 B30 A | 190/255 | 09/04→ | Z235 →09/09 | | 1.0 | ZSE145 →04/06 ZSE143 11/07→07/10 ZSE144 →07/10 |
| 3.0 630 i | 6 | N52 B30 A, N52 B30 B, N52 B30 BF | 200/268 | 07/07→ | | | | |
| 3.0 635 d | 6 | M57 D30 (306D5) | 210/282 | 07/07→ | GE102 | GSE102 | 5V | |
| 4.4 645 Gi | 8 | N62 B44 A | 245/329 | 04/04→ | Z237 →09/05 | | 1.6 | ZS324 →06/09 |
| 4.4 645 Gi LPG | 8 | N62 B44 A | 245/329 | 04/04→ | Z340 →09/05 | | 0.7 | UXT12 →09/05 |
| 4.8 650 i | 8 | N62 B48 B | 270/362 | 07/05→ | Z301 | | 1.1 | ZS324 →06/09 |
| 4.8 650 i LPG | 8 | N62 B48 B | 270/362 | 07/05→ | Z116 | | 0.8 | UXT5 |

6 Convertible (F12)

| | | | | | | | | |
|---------------|---|----------------------|---------|--------|--------|--|------|------------------|
| 3.0 640 d | 6 | N57 D30 B | 230/308 | 09/11→ | CGP001 | | 5.4V | |
| 4.4 650 i | 8 | N63 B44 A | 300/402 | 03/11→ | | | | ZSE143 →06/12 |
| 4.4 650 i 4WD | 8 | N63 B44 A | 300/402 | 06/11→ | | | | ZSE143 |
| 4.4 650 i | 8 | N63 B44 A, N63 B44 B | 330/443 | 10/11→ | | | | ZSE143 |
| 4.4 M6 | 8 | S63 B44 B | 412/552 | 01/12→ | | | | ZSE143 |

6 Coupe (F13)

| | | | | | | | | |
|---------------|---|-----------|---------|--------|--------|--|------|--------|
| 3.0 640 d | 6 | N57 D30 B | 230/308 | 11/10→ | CGP001 | | 5.4V | |
| 4.4 650 i | 8 | N63 B44 A | 300/402 | 11/10→ | | | | ZSE143 |
| 4.4 650 i 4WD | 8 | N63 B44 A | 300/402 | 06/11→ | | | | ZSE143 |
| 4.4 650 i | 8 | N63 B44 B | 330/443 | 10/11→ | | | | ZSE143 |
| 4.4 M6 | 8 | S63 B44 B | 412/552 | 01/12→ | | | | ZSE143 |

6 Gran Coupe (F06)

| | | | | | | | | |
|-----------|---|-----------|---------|--------|--------|--|------|--------|
| 3.0 640 d | 6 | N57 D30 B | 230/308 | 09/11→ | CGP001 | | 5.4V | |
| 4.4 650 i | 8 | N63 B44 B | 330/443 | 11/11→ | | | | ZSE143 |
| 4.4 M6 | 8 | S63 B44 B | 412/552 | 12/12→ | | | | ZSE143 |

7 (E23)

| | | | | | | | | |
|-----------|---|--|---------|-------------|----|--|-----|--|
| 2.8 728 | 6 | M30 B28 | 125/168 | 05/77→08/79 | Z1 | | 0.7 | UXT2 / UXT6 ZS115 [11] →07/78 ZS400 [11] 08/78→ |
| 2.8 728 i | 6 | M30 B28 | 135/181 | 07/78→08/86 | Z1 | | 0.7 | UXT2 / UXT6 ZS400 [11] ZM001 09/79→05/81 06/81→ |
| 3.0 730 | 6 | M30 B30 | 135/181 | 05/77→08/79 | Z1 | | 0.7 | UXT2 / UXT6 ZS115 [11] →07/78 ZS400 [11] 08/78→ |
| 3.2 733 i | 6 | M30 B32 | 145/194 | 05/77→08/86 | Z1 | | 0.7 | UXT2 / UXT6 ZS122 |
| 3.2 745 i | 6 | M30 B32 (326TA) | 185/248 | 04/80→04/83 | Z1 | | 0.7 | UXT2 / UXT6 ZS400 [11] |
| 3.4 735 i | 6 | M30 B34 (346KA) | 136/182 | 01/85→08/86 | Z3 | | 0.7 | UXT2 / UXT6 ZS122 |
| 3.4 735 i | 6 | M30 B35 (Motronic) | 141/189 | 04/85→08/86 | Z3 | | 0.7 | UXT2 / UXT6 ZS122 |
| 3.4 735 i | 6 | M30 B35 (Motronic, 10:1), M30 B35 (Motronic, 9.3:1) | 160/215 | 09/79→08/86 | Z1 | | 0.7 | UXT2 / UXT6 ZS400 [11] →09/80 ZS122 [214][254] |
| 3.4 745 i | 6 | M30 B35 | 185/248 | 05/83→08/86 | Z1 | | 0.7 | UXT2 / UXT6 ZS122 |

7 (E32)

| | | | | | | | | |
|------------------|----|---------------------------|---------|-------------|-----|--|-----|--------------------------|
| 3.0 730 i,iL | 6 | M30 B30 (306KA) | 138/185 | 12/86→09/94 | Z3 | | 0.7 | UXT2 / UXT6 ZS122 |
| 3.0 730 i,iL V8 | 6 | M30 B30 (306EA) | 145/194 | 12/86→09/94 | Z3 | | 0.7 | UXT2 / UXT6 ZS122 |
| 3.0 730 i,iL V8 | 8 | M60 B30 (308S1) | 160/215 | 04/92→09/94 | Z14 | | 0.9 | UXT1 / UXT3 ZS014 |
| 3.4 735 i,iL | 6 | M30 B34 (346KB) | 155/208 | 09/86→09/92 | Z3 | | 0.7 | UXT2 / UXT6 ZS122 |
| 3.4 735 i,iL | 6 | M30 B35 (Motronic, 9.2:1) | 162/217 | 09/86→12/87 | Z3 | | 0.7 | UXT2 / UXT6 ZS122 |
| 4.0 740 i,iL V8 | 8 | M60 B40 (408S1) | 210/282 | 04/92→09/94 | Z14 | | 0.9 | UXT1 / UXT3 ZS014 ZLE232 |
| 5.0 750 i,iL V12 | 12 | M70 B50 (5012A) | 220/295 | 09/87→09/94 | Z4 | | 0.7 | UXT1 / UXT3 |



kW/BHP

**... BMW****7 (E38)**

| | | | | | | | | |
|------------------|----|-------------------------------------|---------|-------------|--|------------|---|------------------------|
| 2.5 725 tds | 6 | M51 D25 (Inter.) | 105/141 | 04/96→11/01 | GN013 ^{[2][222]} GV719 | 11V 11V | | |
| 2.8 728i 4WD | 6 | M52 B28 GG, M52 B28 TU | 142/190 | 11/95→09/01 | Z237 09/98→ | 1.6 | ZS302 | |
| 2.8 728 i,iL | 6 | M52 B28 (286S1), M52 B28 (286S2) | 142/190 | 08/95→11/01 | Z14 | 0.9 | UXT1 / UXT3 | ZS302 |
| 2.8 728 i,iL LPG | 6 | M52 B28 (286S1), M52 B28 (286S2) | 142/190 | 08/95→11/01 | Z116 | 0.8 | UXT5 | |
| 3.0 730 d | 6 | M57 D30 (306D1) | 135/181 | 08/98→04/00 | GN024 | 11V | | |
| 3.0 730 d | 6 | M57 D30 (306D1) | 142/190 | 04/00→11/01 | GN024 | 11V | | |
| 3.0 730 i,iL | 8 | M60 B30 | 155/208 | 10/94→11/01 | Z14 →08/98 Z237 09/98→ | 0.9 1.6 | UXT1 / UXT3 →08/98 | ZS014 →12/96 |
| 3.0 730 i,iL | 8 | M60 B30 (308S1) | 160/215 | 10/94→11/01 | Z14 →08/98 Z237 09/98→ | 0.9 1.6 | UXT1 / UXT3 →08/98 | ZS014 →12/96 |
| 3.0 730 i,iL LPG | 8 | M60 B30 | 155/208 | 10/94→11/01 | Z116 →08/98 Z340 09/98→ | 0.8 0.7 | UXT5 →08/98 UXT12 09/98→ | |
| 3.0 730 i,iL LPG | 8 | M60 B30 (308S1) | 160/215 | 10/94→11/01 | Z116 →08/98 Z340 09/98→ | 0.8 0.7 | UXT5 →08/98 UXT12 09/98→ | |
| 3.5 735 i,iL | 8 | M62 B35 (358S1) | 173/232 | 01/96→11/01 | Z14 →08/98 Z237 09/98→ | 0.9 1.6 | UXT1 / UXT3 →08/98 | ZS302 |
| 3.5 735 i,iL LPG | 8 | M62 B35 (358S1) | 173/232 | 01/96→11/01 | Z116 →08/98 Z340 09/98→ | 0.8 0.7 | UXT5 →08/98 UXT12 09/98→ | |
| 3.9 740 d | 8 | M67 D39 (398D1) | 180/241 | 05/99→11/01 | GN025 | 11V | | |
| 4.0 740 i,iL | 8 | M60 B40 (408S1) | 210/282 | 10/94→11/01 | Z14 →08/98 Z237 09/98→ | 0.9 1.6 | UXT1 / UXT3 →08/98 | ZS014 →06/96 |
| 4.0 740 i,iL LPG | 8 | M60 B40 (408S1) | 210/282 | 10/94→11/01 | Z116 →08/98 Z340 09/98→ | 0.8 0.7 | UXT5 →08/98 UXT12 09/98→ | |
| 4.4 740 i,iL | 8 | M62 B44 (448S1), M62 B44 (448S2) | 210/282 | 01/96→11/01 | Z14 →08/98 Z237 09/98→ | 0.9 1.6 | UXT1 / UXT3 →08/98 | ZS302 |
| 4.4 740 i,iL LPG | 8 | M62 B44 (448S1), M62 B44 (448S2) | 210/282 | 01/96→11/01 | Z116 →08/98 Z340 09/98→ | 0.8 0.7 | UXT5 →08/98 UXT12 09/98→ | |
| 5.4 750 i,iL | 12 | M73 B54 (54121), M73 B54 (54122) | 240/322 | 12/94→11/01 | Z237 | 1.6 | | ZS302 |
| 5.4 750 i,iL LPG | 12 | M73 B54 (54121), M73 B54 (54122) | 240/322 | 12/94→11/01 | Z340 | 0.7 | UXT12 | |

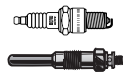

kW/BHP

**... BMW****7 (E65, E66, E67)**

| | | | | | | | | | |
|-------------------|----|---------------------------------|---------|-------------|--------|--------|-----|--------|-------------|
| 3.0 730 d | 6 | M57 D30 (306D3) | 155/208 | 10/02→ | GE102 | GSE102 | 5V | | |
| 3.0 730 d | 6 | M57 D30 (306D2) | 160/215 | 10/02→ | GE102 | GSE102 | 5V | | |
| | | | | | | | | →09/04 | |
| 3.0 730 i, Li | 6 | M54 B30 (306S3) | 170/228 | 03/03→ | Z237 | | 1.6 | | ZS324 |
| | | | | | →03/05 | | | | →06/09 |
| 3.0 730 i, Li | 6 | N52 B30 A | 184/247 | 03/05→ | Z235 | | 1.0 | | ZSE145 |
| | | | | | | | | | →03/06 |
| | | | | | | | | | ZSE143 |
| | | | | | | | | | 04/06→ |
| 3.0 730 i, Li | 6 | N52 B30 A | 190/255 | 03/05→ | Z235 | | 1.0 | | ZSE145 |
| | | | | | | | | | →04/06 |
| | | | | | | | | | ZSE143 |
| | | | | | | | | | 11/07→10/08 |
| 3.0 730 i, Li LPG | 6 | M54 B30 (306S3) | 170/228 | 03/03→ | Z340 | | 0.7 | UXT12 | |
| | | | | | →03/05 | | | →03/05 | |
| 3.0 730 Ld | 6 | M57 306 D3 | 170/228 | 07/05→ | GE102 | GSE102 | 5V | | |
| | | | | | | | | | →08/05 |
| 3.6 735 i, Li | 8 | N62 B36 | 200/268 | 11/01→ | Z237 | | 1.6 | | ZS324 |
| | | | | | | | | | →06/09 |
| 3.6 735 i, Li LPG | 8 | N62 B36 | 200/268 | 11/01→ | Z340 | | 0.7 | UXT12 | |
| 3.9 740 d | 8 | M67 D39 (398D1) | 190/255 | 10/02→ | GE103 | GSE103 | 5V | | |
| | | | | | | | | | →09/04 |
| 4.0 735 i | 8 | N62 B40 A | 225/302 | 03/05→ | | | | | ZSE143 |
| 4.0 740 i, Li | 8 | N62 B40 A | 225/302 | 07/05→ | Z301 | | 1.1 | | ZS324 |
| | | | | | | | | | →06/09 |
| 4.0 740 i, Li LPG | 8 | N62 B40 A | 225/302 | 07/05→ | Z116 | | 0.8 | UXT5 | |
| 4.4 745 d | 8 | M67 D44 (448D1) | 220/295 | 03/05→08/05 | GE103 | GSE103 | 5V | | |
| 4.4 745 d | 8 | M67 D44 (448D1), N67N 448 D2 | 242/325 | 07/05→ | GE103 | GSE103 | 5V | | |
| 4.4 745 i, Li | 8 | N62 B44 A | 245/329 | 11/01→ | Z237 | | 1.6 | | ZS324 |
| | | | | | | | | | →06/09 |
| 4.4 745 i, Li LPG | 8 | N62 B44 A | 245/329 | 11/01→ | Z340 | | 0.7 | UXT12 | |
| 4.8 750 i, Li | 8 | N62 B48 B | 270/362 | 07/05→ | Z301 | | 1.1 | | ZS324 |
| | | | | | | | | | →06/09 |
| 4.8 750 i, Li LPG | 8 | N62 B48 B | 270/362 | 07/05→ | Z116 | | 0.8 | UXT5 | |
| 6.0 760 i, Li | 12 | N73 B60 A | 327/439 | 01/03→ | Z237 | | 1.6 | | ZS324 |
| | | | | | | | | | →06/09 |
| 6.0 760 i, Li LPG | 12 | N73 B60 A | 327/439 | 01/03→ | Z340 | | 0.7 | UXT12 | |

7 (F01, F02, F03, F04)

| | | | | | | | | | |
|------------------|----|-----------------------|---------|--------|--------|--|------|--|--------|
| 3.0 730 d | 6 | N57 D30 A | 155/208 | 07/09→ | CGP001 | | 5.4V | | |
| | | | | | →01/12 | | | | |
| 3.0 730 d | 6 | N57 D30 A | 180/241 | 10/08→ | CGP001 | | 5.4V | | |
| | | | | | →01/12 | | | | |
| 3.0 730 i | 6 | N52 B30 A, N52 B30 BF | 190/255 | 06/08→ | Z235 | | 1.0 | | ZSE143 |
| | | | | | →12/09 | | | | |
| 3.0 740 d | 6 | N57 D30 B | 225/302 | 09/09→ | CGP001 | | 5.4V | | |
| 3.0 740 d | 6 | N57 D30 B | 230/308 | 07/12→ | CGP001 | | 5.4V | | |
| 3.0 740 i | 6 | N54 B30 A | 240/322 | 10/08→ | | | | | ZSE143 |
| | | | | | | | | | →06/12 |
| 3.0 750 d 4WD | 6 | N57 D30 C | 280/375 | 07/12→ | CGP001 | | 5.4V | | |
| 4.4 750 i | 8 | N63 B44 A, N63 B44 B | 300/402 | 10/08→ | | | | | ZSE143 |
| | | | | | | | | | →06/12 |
| 4.4 750 i | 8 | N63 B44 B | 330/443 | 10/12→ | | | | | ZSE143 |
| 4.4 ActiveHybrid | 8 | N63 B44 A | 330/443 | 10/10→ | | | | | ZSE143 |
| | | | | | | | | | →06/12 |
| 4.4 ActiveHybrid | 8 | N63 B44 A | 342/459 | 10/10→ | | | | | ZSE143 |
| | | | | | | | | | →06/12 |
| 6.0 760 i | 12 | N74 B60 A | 400/536 | 09/09→ | | | | | ZSE143 |

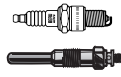

kW/BHP

**... BMW****8 (E31)**

| | | | | | | | | |
|-----------------|----|-----------------|---------|-------------|------------|-----|-------------|-------|
| 4.0 840 i | 8 | M60 B40 (408S1) | 210/282 | 02/93→02/96 | Z14 | 0.9 | UXT1 / UXT3 | ZS014 |
| 4.0 840 i LPG | 8 | M60 B40 (408S1) | 210/282 | 02/93→02/96 | Z116 | 0.8 | UXT5 | |
| 4.4 840 Ci | 8 | M62 B44 (448S1) | 210/282 | 01/96→12/99 | Z14 | 0.9 | UXT1 / UXT3 | ZS302 |
| 4.4 840 Ci LPG | 8 | M62 B44 (448S1) | 210/282 | 01/96→12/99 | Z116 | 0.8 | UXT5 | |
| 5.0 850 i,Ci | 12 | M70 B50 (5012A) | 220/295 | 04/90→10/94 | Z4 | 0.7 | UXT1 / UXT3 | |
| 5.4 850 Ci | 12 | M73 B54 (54121) | 240/322 | 09/94→12/99 | Z237 | 1.6 | | ZS302 |
| 5.4 850 Ci LPG | 12 | M73 B54 (54121) | 240/322 | 09/94→12/99 | Z340 | 0.7 | UXT12 | |
| 5.6 850 Csi | 12 | S70 B56 (56121) | 280/375 | 04/93→12/96 | Z4 | 0.7 | UXT1 / UXT3 | |
| 5.6 850 Csi LPG | 12 | S70 B56 (56121) | 280/375 | 04/93→12/96 | Z158 [168] | 1.1 | | |

503 Convertible

| | | | | | | | | |
|-----|---|--|---------|-------------|--------------------------|-----|--|--|
| 3.2 | 8 | | 103/138 | 01/57→05/61 | Z40 [170] →eng. 30643 | 0.6 | | |
|-----|---|--|---------|-------------|--------------------------|-----|--|--|

600 (111)

| | | | | | | | | |
|---------|---|--|-------|-------------|-----|-----|--|------------|
| 0.6 0.6 | 2 | | 15/20 | 12/57→05/61 | Z38 | 0.4 | | ZS105 [11] |
|---------|---|--|-------|-------------|-----|-----|--|------------|

700 (107)

| | | | | | | | | |
|-------|---|--|-------|-------------|-----|-----|--|--|
| 0.7 | 2 | | 22/30 | 01/59→11/66 | Z38 | 0.4 | | |
| 0.7 A | 2 | | 24/32 | 01/59→11/66 | Z38 | 0.4 | | |

700 Coupe

| | | | | | | | | |
|-------|---|--|-------|-------------|-----|-----|--|--|
| 0.7 | 2 | | 24/32 | 08/59→04/64 | Z38 | 0.4 | | |
| 0.7 S | 2 | | 29/39 | 08/59→04/64 | Z38 | 0.4 | | |

1500-2000 (115, 116, 118, 121)

| | | | | | | | | |
|---------------------|---|---------|--------|-------------|-----|-----|-------------|----------------------|
| 1.5 1500 | 4 | M10 B15 | 59/79 | 10/62→07/66 | Z11 | 0.8 | UXT2 / UXT6 | |
| 1.6 1500 | 4 | M10 B16 | 59/79 | 09/63→07/66 | Z11 | 0.8 | UXT2 / UXT6 | |
| 1.6 1600 | 4 | M10 B16 | 61/82 | 04/64→04/68 | Z11 | 0.8 | UXT2 / UXT6 | |
| 1.8 1800 | 4 | M10 B18 | 66/89 | 08/63→09/71 | Z11 | 0.8 | UXT2 / UXT6 | |
| 2.0 2000 | 4 | M10 B20 | 74/99 | 09/68→07/72 | Z22 | 0.7 | UX56 | ZS106 [11] |
| 2.0 2000 Tii | 4 | M10 B20 | 96/129 | 12/69→07/72 | Z22 | 0.7 | UX56 | ZS106 [11] |
| 2.0 2000 Ti / Tilux | 4 | M10 B20 | 88/118 | 01/66→07/72 | Z22 | 0.7 | UX56 | ZS106 [11] →04/71 |

1600 GT Coupe

| | | | | | | | | |
|-----|---|---------|--------|-------------|-----|-----|-------------|--|
| 1.6 | 4 | M10 B16 | 77/103 | 10/67→05/69 | Z11 | 0.8 | UXT2 / UXT6 | |
|-----|---|---------|--------|-------------|-----|-----|-------------|--|

2000-3.2 Coupe (E9)

| | | | | | | | | |
|---------------|---|----------------------|---------|-------------|-----|-----|-------------|------------|
| 2.0 2000 C/CA | 4 | M10 B20 | 74/99 | 10/65→06/70 | Z22 | 0.7 | UX56 | |
| 2.0 2000 CS | 4 | M10 B20 | 88/118 | 10/65→06/70 | Z22 | 0.7 | UX56 | |
| 2.5 CS | 6 | M30 B25 | 110/148 | 09/74→03/76 | Z11 | 0.8 | UXT2 / UXT6 | ZS115 [11] |
| 2.8 2800 CS | 6 | M30 B28 | 125/168 | 01/69→04/71 | Z11 | 0.8 | UXT2 / UXT6 | ZS115 [11] |
| 3.0 CS | 6 | M30 B30 | 132/177 | 05/71→03/76 | Z11 | 0.8 | UXT2 / UXT6 | ZS115 [11] |
| 3.0 Csi | 6 | M30 B30 | 147/197 | 07/71→03/76 | Z11 | 0.8 | UXT2 / UXT6 | ZS115 [11] |
| 3.2 CSL | 6 | M30 B32 (L-Jetronic) | 152/204 | 01/74→12/75 | Z11 | 0.8 | UXT2 / UXT6 | ZS115 [11] |

2500-3.3 (E3)

| | | | | | | | | |
|----------|---|----------------------|---------|-------------|-----|-----|-------------|------------------------------------|
| 2.5 2500 | 6 | M30 B25 | 110/148 | 10/68→04/77 | Z11 | 0.8 | UXT2 / UXT6 | ZS115 [11] |
| 2.8 2800 | 6 | M30 B28 | 125/168 | 10/68→07/75 | Z11 | 0.8 | UXT2 / UXT6 | ZS115 [11] |
| 2.8 L | 6 | M30 B28 | 125/168 | 02/75→04/77 | Z11 | 0.8 | UXT2 / UXT6 | ZS115 [11] |
| 3.0 L | 6 | M30 B30 | 132/177 | 02/75→04/77 | Z11 | 0.8 | UXT2 / UXT6 | ZS115 [11] |
| 3.0 S | 6 | M30 B30 | 132/177 | 05/71→04/77 | Z11 | 0.8 | UXT2 / UXT6 | ZS115 [11] |
| 3.0 Si | 6 | M30 B30 | 143/192 | 10/75→04/77 | Z11 | 0.8 | UXT2 / UXT6 | ZS115 [11] |
| 3.0 Si | 6 | M30 B30 | 147/197 | 07/71→09/75 | Z11 | 0.8 | UXT2 / UXT6 | ZS115 [11] |
| 3.2 Li | 6 | | 147/197 | 10/75→04/77 | Z11 | 0.8 | UXT2 / UXT6 | ZS115 [11] ZS400 [11] 09/76→ |
| 3.3 L | 6 | M30 B33 (35/40 INAT) | 140/188 | 01/74→09/76 | Z11 | 0.8 | UXT2 / UXT6 | ZS115 [11] |

ISETTA (100, 101, 102, 103)

| | | | | | | | | |
|---------|---|--|-------|-------------|-----|-----|--|--|
| 0.3 250 | 1 | | 9/12 | 01/56→12/62 | Z39 | 0.4 | | |
| 0.3 300 | 1 | | 10/13 | 05/58→11/63 | Z39 | 0.4 | | |



kW/BHP

**... BMW**

| X1 (E84) | | | | | | | | | |
|---------------------|---|---------------------------------|---------|--------|------------------|------------------|------|-------|-----------------------|
| 2.0 sDrive 18 i | 4 | N46 B20 B | 100/134 | 03/09→ | | | | | ZSE143 |
| 2.0 sDrive 18 i | 4 | N46 B20 B | 110/148 | 01/10→ | Z301 | | 1.1 | | ZSE143 |
| 2.0 sDrive 18 i LPG | 4 | N46 B20 B | 110/148 | 01/10→ | Z116 | | 0.8 | UXT5 | |
| 3.0 xDrive 25 i 4WD | 6 | N52 B30 A | 160/215 | 01/10→ | Z235 | | 1.0 | | ZSE143 |
| 3.0 xDrive 28 i 4WD | 6 | N52 B30 A | 190/255 | 10/09→ | Z235 | | 1.0 | | ZSE143 →08/11 |
| X3 (E83) | | | | | | | | | |
| 2.0 d 4WD | 4 | M47 D20 (204D4) | 110/148 | 10/04→ | GE102 | GSE101 | 5V | | |
| 2.0 i 4WD | 4 | N46 B20, N46 B20 A | 110/148 | 07/05→ | | | | | ZS324 →06/09 |
| 2.0 i 4WD | 4 | N46 B20 B | 110/148 | 07/05→ | Z301 | | 1.1 | | |
| 2.0 i 4WD LPG | 4 | N46 B20 B | 110/148 | 07/05→ | Z116 | | 0.8 | UXT5 | |
| 2.0 xDrive 20 i 4WD | 4 | N46 B20 B | 110/148 | 09/08→ | Z301 | | 1.1 | | ZSE143 |
| 2.5 i 4WD | 6 | M54 B25, M54 256 S5 | 141/189 | 01/04→ | | | | | ZS324 →06/09 |
| 2.5 i 4WD | 6 | M54 B25 (256S5) | 141/189 | 01/04→ | Z237 | | 1.6 | | |
| 2.5 i 4WD LPG | 6 | M54 B25 (256S5) | 141/189 | 01/04→ | Z340 | | 0.7 | UXT12 | |
| 2.5 si 4WD | 6 | N52 B25 A | 160/215 | 09/06→ | Z235 | | 1.0 | | ZSE143 11/07→08/08 |
| 2.5 xDrive 25 i 4WD | 6 | N52 B25 A | 160/215 | 09/08→ | Z235 →12/09 | | 1.0 | | ZSE143 →08/10 |
| 3.0 d 4WD | 6 | M57 D30 (306D2) | 150/201 | 01/04→ | GE102 | GSE102 →09/04 | 5V | | |
| 3.0 d 4WD | 6 | M57 D30 (306D3) | 160/215 | 01/04→ | GE102 | GSE102 | 5V | | |
| 3.0 i 4WD | 6 | M54 B30, M54 306 S3 | 170/228 | 01/04→ | | | | | ZS324 →06/09 |
| 3.0 i 4WD | 6 | M54 B30 (306S3) | 170/228 | 01/04→ | Z237 | | 1.6 | | |
| 3.0 i 4WD LPG | 6 | M54 B30 (306S3) | 170/228 | 01/04→ | Z340 | | 0.7 | UXT12 | |
| 3.0 sd 4WD | 6 | M57 D30 (306D5) | 210/282 | 09/06→ | GE102 | GSE102 | 5V | | |
| 3.0 si 4WD | 6 | N52 B30 A | 200/268 | 09/06→ | Z235 | | 1.0 | | ZSE143 11/07→08/08 |
| 3.0 xDrive 30 d 4WD | 6 | M57 D30 (306D3) | 155/208 | 09/08→ | GE102 | | 5V | | |
| 3.0 xDrive 30 d 4WD | 6 | M57 D30 (306D3) | 160/215 | 09/08→ | GE102 | | 5V | | |
| 3.0 xDrive 30 i 4WD | 6 | N52 B30 A | 200/268 | 09/08→ | Z235 | | 1.0 | | ZSE143 →08/10 |
| 3.0 xDrive 35 d 4WD | 6 | M57 D30 (306D5) | 210/282 | 09/08→ | GE102 | | 5V | | |
| X3 (F25) | | | | | | | | | |
| 3.0 xDrive 28 i 4WD | 6 | N52 B30 A | 190/255 | 04/11→ | Z235 | | 1.0 | | ZSE143 →03/12 |
| 3.0 xDrive 30 d 4WD | 6 | N57 D30 A | 190/255 | 05/11→ | CGP001 →01/12 | | 5.4V | | |
| 3.0 xDrive 35 d 4WD | 6 | N57 D30 B | 230/308 | 09/11→ | CGP001 | | 5.4V | | |
| X5 (E53) | | | | | | | | | |
| 3.0 d 4WD | 6 | M57 D30 (306D1) | 135/181 | 05/01→ | GN024 | | 11V | | |
| 3.0 d 4WD | 6 | M57 D30 (306D2) | 155/208 | 08/04→ | GE102 | GSE102 | 5V | | |
| 3.0 d 4WD | 6 | M57 D30 (306D2), M57N 306 D4 | 160/215 | 12/03→ | GE102 | GSE102 →09/04 | 5V | | |
| 3.0 i 4WD | 6 | M54 306 S3 | 163/219 | 05/00→ | Z237 | | 1.6 | | ZS302 →10/02 |
| 3.0 i 4WD | 6 | M54 B30 (306S3) | 170/228 | 05/00→ | Z237 | | 1.6 | | ZS324 10/02→06/09 |
| 3.0 i 4WD LPG | 6 | M54 306 S3 | 163/219 | 05/00→ | Z340 | | 0.7 | UXT12 | |
| 3.0 i 4WD LPG | 6 | M54 B30 (306S3) | 170/228 | 05/00→ | Z340 | | 0.7 | UXT12 | |
| 4.4 i 4WD | 8 | M62 B44 (448S2) | 210/282 | 05/00→ | Z237 | | 1.6 | | ZS302 |
| 4.4 i 4WD | 8 | N62 B44, N62 B44 A | 235/315 | 12/03→ | Z237 | | 1.6 | | ZS324 →06/09 |
| 4.4 i 4WD LPG | 8 | M62 B44 (448S2) | 210/282 | 05/00→ | Z340 | | 0.7 | UXT12 | |
| 4.4 i 4WD LPG | 8 | N62 B44, N62 B44 A | 235/315 | 12/03→ | Z340 | | 0.7 | UXT12 | |

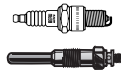

kW/BHP

**... BMW****... X5 (E53)**

| | | | | | | | | | |
|----------------|---|-----------------|---------|--------|------|--|-----|-------|-----------------|
| 4.6 is 4WD | 8 | M62 B46 (468S1) | 255/342 | 02/02→ | Z237 | | 1.6 | | ZS302 |
| 4.6 is 4WD LPG | 8 | M62 B46 (468S1) | 255/342 | 02/02→ | Z340 | | 0.7 | UXT12 | |
| 4.8 is 4WD | 8 | N62 B48 A | 265/355 | 04/04→ | Z301 | | 1.1 | | ZS324 →06/09 |
| 4.8 is 4WD LPG | 8 | N62 B48 A | 265/355 | 04/04→ | Z116 | | 0.8 | UXT5 | |

X5 (E70)

| | | | | | | | | | |
|---------------------|---|-----------------|---------|-------------|--------|--------|------|------|------------------|
| 3.0 d 4WD | 6 | M57 D30 (306D3) | 155/208 | 02/07→09/08 | GE102 | GSE102 | 5V | | |
| 3.0 d 4WD | 6 | M57 D30 (306D3) | 173/232 | 02/07→09/08 | GE102 | GSE102 | 5V | | |
| 3.0 M 50 d 4WD | 6 | N57 D30 C | 280/375 | 08/11→ | CGP001 | | 5.4V | | |
| 3.0 sd 4WD | 6 | M57 D30 (306D5) | 210/282 | 09/07→02/09 | GE102 | GSE102 | 5V | | |
| 3.0 si 4WD | 6 | N52 B30 A | 200/268 | 02/07→09/08 | Z235 | | 1.0 | | ZSE143 11/07→ |
| 3.0 xDrive 30 d 4WD | 6 | N57 D30 A | 173/232 | 09/08→ | GE102 | GSE102 | 5V | | |
| 3.0 xDrive 30 i 4WD | 6 | N52 B30 A | 200/268 | 09/08→03/10 | Z235 | | 1.0 | | ZSE143 |
| 3.0 xDrive 35 d 4WD | 6 | M57 D30 (306D5) | 210/282 | 09/08→ | GE102 | | 5V | | |
| 4.4 M 4WD | 8 | S63 B44 A | 408/547 | 09/09→ | | | | | ZSE143 |
| 4.4 xDrive 50 i 4WD | 8 | N63 B44 A | 300/402 | 06/10→ | | | | | ZSE143 |
| 4.8 i 4WD | 8 | N62 B48 B | 261/350 | 02/07→09/08 | Z301 | | 1.1 | | ZS324 |
| 4.8 i 4WD LPG | 8 | N62 B48 B | 261/350 | 02/07→09/08 | Z116 | | 0.8 | UXT5 | |
| 4.8 xDrive 48 i 4WD | 8 | N62 B48 B | 261/350 | 09/08→ | | | | | ZSE143 |

X5 (F15)

| | | | | | | | | | |
|---------------------|---|-----------|---------|--------|--|--|--|--|--------|
| 4.4 xDrive 50 i 4WD | 8 | N63 B44 B | 330/443 | 11/12→ | | | | | ZSE143 |
|---------------------|---|-----------|---------|--------|--|--|--|--|--------|

X6 (E71, E72)

| | | | | | | | | | |
|----------------------|---|-----------------|---------|--------|--------|--------|------|--|------------------|
| 3.0 30 d 4WD | 6 | M57N2 306 D3 | 173/232 | 05/08→ | GE102 | | 5V | | |
| 3.0 35 d 4WD | 6 | M57 D30 (306D5) | 210/282 | 05/08→ | GE102 | GSE102 | 5V | | |
| 3.0 35 i 4WD | 6 | N54 B30 A | 225/302 | 05/08→ | | | | | ZSE143 →03/10 |
| 3.0 M 50 d 4WD | 6 | N57 D30 C | 280/375 | 08/11→ | CGP001 | | 5.4V | | |
| 3.0 xDrive 35 d 4WD | 6 | M57 D30 (306D5) | 210/282 | 09/08→ | GE102 | | 5V | | |
| 3.0 xDrive 35 i 4WD | 6 | N54 B30 A | 225/302 | 09/08→ | | | | | ZSE143 →03/10 |
| 4.4 50 i 4WD | 8 | N63 B44 A | 300/402 | 05/08→ | | | | | ZSE143 |
| 4.4 ActiveHybrid 4WD | 8 | N63 B44 A | 357/479 | 10/10→ | | | | | ZSE143 →10/11 |
| 4.4 M 4WD | 8 | S63 B44 A | 408/547 | 09/09→ | | | | | ZSE143 |
| 4.4 xDrive 50 i 4WD | 8 | N63 B44 A | 300/402 | 09/08→ | | | | | ZSE143 |

Z1

| | | | | | | | | | |
|-----|---|-----------------|---------|-------------|----|--|-----|-------------|-------|
| 2.5 | 6 | M20 B25 (256K1) | 125/168 | 06/88→06/91 | Z3 | | 0.7 | UXT2 / UXT6 | ZS122 |
|-----|---|-----------------|---------|-------------|----|--|-----|-------------|-------|

Z3 (E36)

| | | | | | | | | | |
|---------|---|-----------------|---------|-------------|--------------------------|--|-----|-------------|-----------------|
| 1.8 | 4 | M43 B18 (184E2) | 85/114 | 10/95→10/98 | Z14 | | 0.9 | UXT1 / UXT3 | ZS307 |
| 1.8 LPG | 4 | M43 B18 (184E2) | 85/114 | 10/95→10/98 | Z116 | | 0.8 | UXT5 | |
| 1.9 | 4 | M43 B19 (194E1) | 85/114 | 01/99→01/03 | Z237 | | 1.6 | | ZS307 |
| 1.9 | 4 | M43 B19 (194E1) | 87/117 | 07/98→01/03 | Z237 | | 1.6 | | ZS307 |
| 1.9 | 4 | M44 B19 (194S1) | 103/138 | 10/95→03/99 | Z14 | | 0.9 | UXT1 / UXT3 | ZS307 |
| 1.9 LPG | 4 | M43 B19 (194E1) | 85/114 | 01/99→01/03 | Z340 | | 0.7 | UXT12 | |
| 1.9 LPG | 4 | M43 B19 (194E1) | 87/117 | 07/98→01/03 | Z340 | | 0.7 | UXT12 | |
| 1.9 LPG | 4 | M44 B19 (194S1) | 103/138 | 10/95→03/99 | Z116 | | 0.8 | UXT5 | |
| 2.0 | 6 | M52 B20 (206S4) | 110/148 | 04/99→01/03 | Z237 | | 1.6 | | ZS302 |
| 2.0 LPG | 6 | M52 B20 (206S4) | 110/148 | 04/99→01/03 | Z340 | | 0.7 | UXT12 | |
| 2.2 | 6 | M54 B22 (226S1) | 125/168 | 08/00→01/03 | Z237 | | 1.6 | | ZS302 →09/02 |
| 2.2 LPG | 6 | M54 B22 (226S1) | 125/168 | 08/00→01/03 | Z340 | | 0.7 | UXT12 | |
| 2.8 | 6 | M52 B28 (286S1) | 141/189 | 04/97→06/00 | Z14 | | 0.9 | UXT1 / UXT3 | ZS302 |
| | | | | | →08/98 Z237 09/98→ | | 1.6 | →08/98 | |

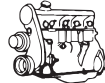

kW/BHP

**... BMW****... Z3 (E36)**

| | | | | | | | |
|---------|---|----------------------------|---------|-------------|----------------------------------|---|-----------------|
| 2.8 LPG | 6 | M52 B28 (286S1) | 141/189 | 04/97→06/00 | Z116 →08/98 Z340 09/98→ | 0.8 UXT5 →08/98 0.7 UXT12 09/98→ | |
| 3.0 | 6 | M54 B30 (306S3) | 170/228 | 06/00→01/03 | Z237 | 1.6 | ZS302 →12/02 |
| 3.0 LPG | 6 | M54 B30 (306S3) | 170/228 | 06/00→01/03 | Z340 | 0.7 | UXT12 |
| 3.2 M | 6 | S50 B32 (326S1) | 236/316 | 03/97→06/01 | | | ZS302 →12/00 |
| 3.2 M | 6 | S54 B32, S54 B32 (32 6 S4) | 239/320 | 06/01→01/03 | | | ZS324 |

Z3 Coupe (E36)

| | | | | | | | |
|---------|---|---------------------|---------|-------------|------|-----|-----------------|
| 2.8 | 6 | M52 B28 (286S1) | 141/189 | 07/97→06/00 | Z237 | 1.6 | ZS302 |
| 2.8 LPG | 6 | M52 B28 (286S1) | 141/189 | 07/97→06/00 | Z340 | 0.7 | UXT12 |
| 3.0 | 6 | M54 B30 (306S3) | 170/228 | 06/00→06/03 | Z237 | 1.6 | ZS302 →12/02 |
| 3.0 LPG | 6 | M54 B30 (306S3) | 170/228 | 06/00→06/03 | Z340 | 0.7 | UXT12 |
| 3.2 M | 6 | S50 B32 | 236/316 | 02/98→06/01 | | | ZS302 →12/00 |
| 3.2 M | 6 | S54 B32, S54 326 S4 | 239/320 | 06/01→06/03 | | | ZS324 |

Z4 (E85)

| | | | | | | | |
|-----------|---|----------------------|---------|--------|----------------|-----|---|
| 2.0 i | 4 | N46 B20 | 110/148 | 04/05→ | | | ZS324 →06/09 |
| 2.0 i | 4 | N46 B20 A | 110/148 | 04/05→ | Z301 | 1.1 | ZS324 →06/09 |
| 2.0 i | 4 | N46 B20 B | 110/148 | 04/05→ | Z301 | 1.1 | |
| 2.0 i LPG | 4 | N46 B20 A, N46 B20 B | 110/148 | 04/05→ | Z116 | 0.8 | UXT5 |
| 2.2 i | 6 | M54 B22, M54 226 S1 | 125/168 | 10/03→ | | | ZS324 →06/09 |
| 2.2 i | 6 | M54 B22 (226S1) | 125/168 | 10/03→ | Z237 →10/05 | 1.6 | |
| 2.2 i LPG | 6 | M54 B22 (226S1) | 125/168 | 10/03→ | Z340 →10/05 | 0.7 | UXT12 →10/05 |
| 2.5 i | 6 | N52 B25 A | 130/174 | 01/06→ | Z235 | 1.0 | ZSE145 →04/06 ZSE143 11/07→02/09 |
| 2.5 i | 6 | M54 B25, M54 256 S5 | 141/189 | 02/03→ | | | ZS324 →06/09 |
| 2.5 i | 6 | M54 B25 (256S5) | 141/189 | 02/03→ | Z237 | 1.6 | |
| 2.5 i LPG | 6 | M54 B25 (256S5) | 141/189 | 02/03→ | Z340 | 0.7 | UXT12 |
| 2.5 si | 6 | N52 B25 A | 160/215 | 01/06→ | Z235 | 1.0 | ZSE145 →04/06 ZSE143 11/07→03/09 |
| 3.0 i | 6 | M54 B30 (306S3) | 170/228 | 02/03→ | Z237 | 1.6 | ZS324 →06/09 |
| 3.0 i LPG | 6 | M54 B30 (306S3) | 170/228 | 02/03→ | Z340 | 0.7 | UXT12 |
| 3.0 si | 6 | N52 B30 A | 195/261 | 01/06→ | Z235 | 1.0 | ZSE145 →04/06 ZSE143 11/07→08/08 |
| 3.2 M | 6 | S54 B32, S54 326 S4 | 252/338 | 03/06→ | | | ZS324 →06/09 |

Z4 (E89)

| | | | | | | | |
|-----------------|---|-----------|---------|--------|----------------|-----|------------------|
| 2.5 sDrive 23 i | 6 | N52 B25 A | 150/201 | 05/09→ | Z235 →12/09 | 1.0 | ZSE143 →08/11 |
| 3.0 sDrive 30 i | 6 | N52 B30 A | 190/255 | 05/09→ | Z235 | 1.0 | ZSE143 →08/11 |

BMW

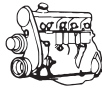

kW/BHP

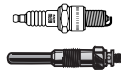
**... BMW****... Z4 (E89)**

| | | | | | | | | |
|------------------|---|-----------|---------|--------|--|--|--|--------|
| 3.0 sDrive 35 i | 6 | N54 B30 A | 225/302 | 05/09→ | | | | ZSE143 |
| 3.0 sDrive 35 is | 6 | N54 B30 A | 250/335 | 09/10→ | | | | ZSE143 |

Z4 Coupe (E86)

| | | | | | | | | |
|--------|---|---------------------|---------|--------|------|--|-----|--|
| 3.0 si | 6 | N52 B30 A | 195/261 | 03/06→ | Z235 | | 1.0 | ZSE145 →04/06 ZSE143 11/07→08/08 ZS324 →06/09 |
| 3.2 M | 6 | S54 B32, S54 326 S4 | 252/338 | 03/06→ | | | | ZS324 →06/09 |

Z8 (E52)

| | | | | | | | | |
|-----|---|-----------------|---------|-------------|------|--|-----|-------|
| 4.9 | 8 | S62 B50 | 294/394 | 06/00→06/03 | Z237 | | 1.6 | |
| 4.9 | 8 | S62 B50 (508S1) | 294/394 | 06/00→06/03 | | | | ZS302 |

CHEVROLET**ALERO**

| | | | | | | | | |
|-----|---|-----|---------|-------------|------|--|-----|--|
| 2.2 | 4 | L61 | 104/139 | 12/01→09/04 | Z305 | | 1.0 | |
|-----|---|-----|---------|-------------|------|--|-----|--|

ASTRA

| | | | | | | | | |
|-------------|---|----------|---------|-------------|-----------|--|-----|-------------|
| 2.0 DTi | 4 | Y 20 DTH | 74/99 | 08/02→ | GN033 [1] | | 11V | |
| 2.0 DTi GLS | 4 | Y 20 DTH | 74/99 | 08/02→12/11 | GN033 [1] | | 11V | |
| 2.0 GLS | 4 | C 20 SEL | 100/134 | 08/02→12/11 | Z74 | | 1.0 | UXT1 / UXT3 |

AVALANCHE

| | | | | | | | | |
|-------------------|---|-----|---------|--------|--|--|--|--------|
| 5.3 Flex-Fuel 4WD | 8 | | 227/304 | 01/07→ | | | | ZSE159 |
| 5.3 Flex-Fuel | 8 | LY5 | 235/315 | 01/07→ | | | | ZSE159 |

AVEO

| | | | | | | | | |
|---------|---|----------------------|--------|-------------|------------|--|------|--------------------|
| 1.2 | 4 | A 12 XEL | 51/68 | 03/11→ | Z203 | | 0.9 | |
| 1.2 | 4 | F12S3, LQ5 | 53/71 | 03/06→ | Z9 | | 1.15 | UXT2 / UXT6 ZS447A |
| 1.2 | 4 | B12D1 | 55/74 | 01/08→ | | | | ZS447A |
| 1.2 | 4 | B12D1, LMU | 55/74 | 04/08→ | Z234 | | 0.9 | ZS447A |
| 1.2 | 4 | B12D1 | 62/83 | 01/08→ | Z358 | | 0.8 | ZS447A |
| 1.2 | 4 | B12D1, LMU | 62/83 | 04/08→ | | | | ZS447A |
| 1.2 | 4 | LMU | 62/83 | 01/08→ | Z358 | | 0.8 | |
| 1.2 | 4 | A 12 XER | 63/84 | 03/11→ | Z203 | | 0.9 | |
| 1.2 LPG | 4 | F12S3, LQ5 | 53/71 | 03/06→12/07 | Z20 [168] | | 0.8 | UXT2 / UXT6 |
| 1.2 LPG | 4 | B12D1, LMU | 62/83 | 01/08→ | Z291 [168] | | 0.9 | |
| 1.2 LPG | 4 | B12D1, LMU | 62/83 | 04/08→ | Z291 | | 0.9 | ZS447A |
| 1.3 D | 4 | LDV | 55/74 | 07/11→ | GE112 | | 4.4V | |
| 1.3 D | 4 | LSF | 70/94 | 07/11→ | GE112 | | 4.4V | |
| 1.4 | 4 | F14D3, L14 | 69/93 | 03/06→12/07 | Z16 | | 1.1 | UXT11 ZS447A |
| 1.4 | 4 | A 14 XER, F14D4, LDT | 74/99 | 04/08→ | Z203 | | 0.9 | ZS447A |
| 1.4 | 4 | F14D4 | 74/99 | 09/08→ | Z16 | | 1.1 | UXT11 |
| 1.4 LPG | 4 | F14D3, L14 | 69/93 | 03/06→12/07 | Z340 | | 0.7 | UXT12 |
| 1.5 | 4 | F15S3, LX6 | 62/83 | 05/05→ | Z20 | | 0.8 | UXT2 / UXT6 ZS447A |
| 1.6 | 4 | F16D4 | 85/114 | 03/11→ | Z203 | | 0.9 | ZS447A |

BERETTA

| | | | | | | | | |
|-------------|---|-----|---------|-------------|------|--|-----|-------|
| 2.2 | 4 | LN2 | 71/95 | 01/91→12/96 | | | | ZS355 |
| 2.2 | 4 | LN2 | 82/110 | 10/91→09/92 | | | | ZS355 |
| 2.2 | 4 | LN2 | 87/117 | 10/92→09/96 | | | | ZS355 |
| 2.3 16V | 4 | L60 | 130/174 | 09/90→12/96 | Z73 | | 1.1 | UXT11 |
| 2.3 16V LPG | 4 | L60 | 130/174 | 09/90→12/96 | Z206 | | 0.7 | UXT10 |
| 3.1 | 6 | L82 | 110/148 | 10/93→09/96 | | | | ZS355 |
| 3.1 LT | 6 | LHO | 103/138 | 10/92→09/93 | | | | ZS355 |
| 3.1 V6 | 6 | LHO | 104/139 | 04/87→12/96 | | | | ZS355 |
| 3.1 Z26 | 6 | L82 | 119/160 | 10/93→09/96 | | | | ZS355 |

CAMARO

| | | | | | | | | |
|--------|---|-----|---------|-------------|--|--|--|-------|
| 3.4 | 6 | L32 | 119/160 | 10/92→09/95 | | | | ZS355 |
| 3.4 V6 | 6 | L32 | 119/160 | 12/92→07/98 | | | | ZS355 |
| 3.8 | 6 | L36 | 142/190 | 07/98→12/02 | | | | ZS355 |



kW/BHP

**... CHEVROLET****... CAMARO**

| | | | | | | | | |
|--------|---|-----|---------|-------------|--|--|--|--------|
| 3.8 | 6 | L36 | 149/200 | 10/95→09/97 | | | | ZS355 |
| 3.8 V6 | 6 | L36 | 142/190 | 07/98→12/02 | | | | ZS355 |
| 5.7 | 8 | LS1 | 212/284 | 07/98→12/02 | | | | ZS355 |
| 6.2 | 8 | L99 | 298/400 | 09/09→ | | | | ZSE159 |
| 6.2 | 8 | LS3 | 318/426 | 09/09→ | | | | ZSE159 |

CAPTIVA

| | | | | | | | | |
|---------|---|----------|---------|--------|------------------------------|------------|-------------|--------|
| 2.0 D | 4 | Z 20 S | 93/125 | 10/06→ | GE125 | 4.4V | | |
| 2.0 D | 4 | Z 20 S | 110/148 | 10/06→ | GE125 | 4.4V | | |
| 2.4 | 4 | Z 24 SED | 100/134 | 06/06→ | Z190 ^[282] Z74 | 1.2 1.0 | UXT1 / UXT3 | ZS447A |
| 2.4 LPG | 4 | Z 24 SED | 100/134 | 06/06→ | Z206 | 0.7 | UXT10 | ZS447A |
| 2.4 LPG | 4 | Z 24 SED | 100/134 | 01/07→ | | | | ZS447A |
| 3.2 4WD | 6 | 10 HM | 169/227 | 06/06→ | Z356 | 1.1 | UXT8 | |

CAVALIER

| | | | | | | | | |
|--------|---|-----|---------|-------------|--|--|--|-------|
| 2.2 | 4 | LN2 | 90/121 | 10/91→12/94 | | | | ZS355 |
| 2.2 RS | 4 | LN2 | 90/121 | 10/91→09/96 | | | | ZS355 |
| 3.1 | 6 | LHO | 103/138 | 10/89→09/94 | | | | ZS355 |

CORSICA

| | | | | | | | | |
|-----|---|-----|---------|-------------|--|--|--|-------|
| 2.2 | 4 | LN2 | 82/110 | 01/94→12/96 | | | | ZS355 |
| 2.3 | 4 | LGO | 134/180 | 10/89→09/92 | | | | ZS355 |
| 2.8 | 6 | LB6 | 93/125 | 02/87→09/89 | | | | ZS355 |
| 3.1 | 6 | L82 | 95/127 | 10/92→09/96 | | | | ZS355 |
| 3.1 | 6 | LHO | 104/139 | 04/87→12/96 | | | | ZS355 |
| 3.1 | 6 | LHO | 106/142 | 10/89→09/92 | | | | ZS355 |
| 3.1 | 6 | L82 | 110/148 | 10/92→09/96 | | | | ZS355 |
| 3.1 | 6 | L82 | 119/160 | 10/92→09/96 | | | | ZS355 |

CORVETTE

| | | | | | | | | |
|---------|---|------------|---------|-------------|--|--|--|--------|
| 5.7 | 8 | LT1 (5.7L) | 207/278 | 10/91→09/97 | | | | ZS355 |
| 5.7 | 8 | LT1 (5.7L) | 224/300 | 10/91→04/97 | | | | ZS355 |
| 5.7 | 8 | LT5 | 246/330 | 10/95→04/97 | | | | ZS355 |
| 6.0 | 8 | LS2 | 298/400 | 09/04→ | | | | ZSE159 |
| 6.2 | 8 | LS3 | 321/430 | 02/08→ | | | | ZSE159 |
| 6.2 ZR1 | 8 | LS9 (6,2L) | 476/638 | 09/08→ | | | | ZSE159 |
| 7.0 Z06 | 8 | LS7 | 371/498 | 03/06→ | | | | ZSE159 |
| 7.0 Z06 | 8 | LS3, LS7 | 377/506 | 03/06→ | | | | ZSE159 |

CRUZE

| | | | | | | | | |
|---------|---|-------------------|---------|--------|-------|------|-------|--------|
| 1.6 | 4 | F16D3, LXT, LXV | 80/107 | 05/09→ | Z16 | 1.1 | UXT11 | ZS447A |
| 1.6 | 4 | LXT | 80/107 | 01/12→ | | | | ZS447A |
| 1.6 | 4 | F16D4 | 83/111 | 05/09→ | Z158 | 1.1 | | ZS447A |
| 1.6 | 4 | F16D4, LDE | 91/122 | 05/09→ | Z158 | 1.1 | | ZS447A |
| 1.8 | 4 | 2HO, F18D4 | 104/139 | 05/09→ | Z158 | 1.1 | | ZS508 |
| 2.0 CDI | 4 | Z 20 S1 | 90/121 | 05/09→ | GE125 | 4.4V | | |
| 2.0 CDI | 4 | Z 20 S1 | 92/123 | 05/09→ | GE125 | 4.4V | | |
| 2.0 CDI | 4 | Z 20 DMH, Z 20 S1 | 110/148 | 05/09→ | GE125 | 4.4V | | |

EPICA

| | | | | | | | | |
|---------|---|----------|---------|-------------|----------------------|------------|-------|-----------------------|
| 2.0 | 4 | C 20 SED | 94/126 | 01/05→12/06 | | | | ZS447A ⁽¹⁾ |
| 2.0 | 6 | X 20 D1 | 105/141 | 06/06→ | Z313 Z304 | 1.1 0.8 | UXT14 | |
| 2.0 LPG | 6 | X 20 D1 | 105/141 | 06/06→ | Z30 ^[168] | 0.8 | UXT5 | |
| 2.0 D | 4 | Z 20 S | 110/148 | 01/07→ | GE125 | 4.4V | | |
| 2.5 | 6 | LF4 | 115/154 | 06/06→ | Z313 Z304 | 1.1 0.8 | UXT14 | |
| 2.5 LPG | 6 | LF4 | 115/154 | 06/06→ | Z30 ^[168] | 0.8 | UXT5 | |

EVANDA

| | | | | | | | | |
|-----|---|----------|--------|--------|-----|-----|-------------|--------|
| 2.0 | 4 | X 20 SED | 96/129 | 03/05→ | Z74 | 1.0 | UXT1 / UXT3 | ZS447A |
|-----|---|----------|--------|--------|-----|-----|-------------|--------|

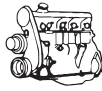

kW/BHP

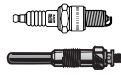
**... CHEVROLET****IMPALA**

| | | | | | | | | |
|--------|---|-----|---------|-------------|--|--|--|-------|
| 3.4 V6 | 6 | LA1 | 134/180 | 01/99→12/05 | | | | ZS355 |
| 3.8 V6 | 6 | L36 | 149/200 | 01/99→12/05 | | | | ZS355 |

KALOS

| | | | | | | | | |
|-------------|---|--------------|-------|--------|-----------|------|-------------|--------|
| 1.2 | 4 | B12S1, F12S3 | 53/71 | 03/05→ | Z9 | 1.15 | UXT2 / UXT6 | ZS447A |
| 1.2 LPG | 4 | F12S3 | 53/71 | 03/05→ | Z20 [168] | 0.8 | UXT2 / UXT6 | |
| 1.4 | 4 | F14S3 | 61/82 | 03/05→ | Z20 | 0.8 | UXT2 / UXT6 | ZS447A |
| 1.4 LPG | 4 | F14S3 | 61/82 | 03/05→ | Z27 [168] | 0.8 | UX56 | |
| 1.4 16V | 4 | F14D3 | 69/93 | 03/05→ | Z16 | 1.1 | UXT11 | ZS447A |
| 1.4 16V LPG | 4 | F14D3 | 69/93 | 03/05→ | Z340 | 0.7 | UXT12 | |

LACETTI

| | | | | | | | | |
|-------------|---|--------|--------|--------|--------|-----|-------|--------|
| 1.4 16V | 4 | F14D3 | 70/94 | 03/05→ | Z16 | 1.1 | UXT11 | |
| 1.4 16V LPG | 4 | F14D3 | 70/94 | 03/05→ | Z340 | 0.7 | UXT12 | |
| 1.6 | 4 | F16D3 | 80/107 | 03/05→ | Z16 | 1.1 | UXT11 | |
| 1.6 LPG | 4 | F16D3 | 80/107 | 03/05→ | Z340 | 0.7 | UXT12 | |
| 1.8 | 4 | F18D3 | 89/119 | 08/05→ | Z304 | 0.8 | | ZS447A |
| | | | | | 01/06→ | | | |
| 1.8 | 4 | T18SED | 90/121 | 03/05→ | Z304 | 0.8 | | ZS447A |
| | | | | | 01/06→ | | | →02/06 |
| | | | | | | | | ZS508 |
| | | | | | | | | 02/06→ |

| | | | | | | | | |
|-------|---|---------|--------|--------|-------|------|--|--|
| 2.0 D | 4 | Z 20 DM | 89/119 | 01/07→ | GE125 | 4.4V | | |
|-------|---|---------|--------|--------|-------|------|--|--|

LANOS

| | | | | | | | | |
|-----|---|--------|-------|--------|-----|-----|-------------|--------|
| 1.5 | 4 | A15SMS | 63/84 | 11/05→ | Z20 | 0.8 | UXT2 / UXT6 | ZS447A |
|-----|---|--------|-------|--------|-----|-----|-------------|--------|

LUMINA

| | | | | | | | | |
|---------|---|-----|---------|-------------|--|--|--|-------|
| 2.5 | 4 | LR8 | 82/110 | 10/89→09/92 | | | | ZS355 |
| 3.1 | 6 | LHO | 103/138 | 10/89→09/94 | | | | ZS355 |
| 3.1 | 6 | L82 | 110/148 | 10/94→09/97 | | | | ZS355 |
| 3.1 LS | 6 | L82 | 119/160 | 10/94→09/97 | | | | ZS355 |
| 3.4 | 6 | LQ1 | 157/211 | 10/89→09/94 | | | | ZS355 |
| 3.4 Z34 | 6 | LQ1 | 149/200 | 10/89→09/94 | | | | ZS355 |

LUMINA APV

| | | | | | | | | |
|---------|---|-----|---------|-------------|------|-----|-------|-------|
| 2.3 | 4 | LD2 | 101/135 | 10/93→07/96 | | | | ZS355 |
| 2.3 | 4 | LD2 | 108/145 | 12/92→07/96 | Z247 | | | ZS355 |
| 2.3 LPG | 4 | LD2 | 108/145 | 12/92→07/96 | Z340 | 0.7 | UXT12 | |
| 3.1 | 6 | LG6 | 90/121 | 08/89→07/96 | | | | ZS355 |
| 3.1 | 6 | L82 | 119/160 | 01/94→07/96 | | | | ZS355 |
| 3.4 | 6 | LA1 | 134/180 | 10/95→07/96 | | | | ZS355 |
| 3.8 | 6 | L27 | 123/165 | 10/91→09/95 | | | | ZS355 |
| 3.8 | 6 | L27 | 129/173 | 12/92→07/96 | Z117 | 1.0 | UXT4 | ZS355 |

MALIBU

| | | | | | | | | |
|-----|---|-----|---------|-------------|-----|-----|--|-------|
| 2.4 | 4 | LD9 | 112/150 | 08/96→09/02 | | | | ZS355 |
| 3.1 | 6 | L82 | 116/156 | 08/96→09/99 | | | | ZS355 |
| 3.1 | 6 | LG8 | 126/169 | 10/99→09/03 | | | | ZS355 |
| 5.0 | 8 | LG4 | 110/148 | 01/80→12/83 | Z49 | 0.8 | | |

MATIZ

| | | | | | | | | |
|---------|---|-------|-------|--------|-----------|------|-------------|--------|
| 0.8 | 3 | F8CV | 38/51 | 03/05→ | Z9 | 1.15 | UXT2 / UXT6 | |
| 0.8 LPG | 3 | F8CV | 38/51 | 03/05→ | Z20 [168] | 0.8 | UXT2 / UXT6 | |
| | | | | | Z9 | 1.15 | | |
| | | | | | →12/10 | | | |
| 1.0 | 4 | B10S | 47/63 | 03/05→ | Z9 | 1.15 | UXT2 / UXT6 | ZS447A |
| 1.0 | 4 | B10S1 | 49/66 | 03/05→ | Z20 | 0.8 | UXT2 / UXT6 | ZS447A |
| 1.0 LPG | 4 | B10S1 | 49/66 | 03/05→ | Z9 | 1.15 | UXT2 / UXT6 | ZS447A |
| | | | | | →12/10 | | | →12/10 |

NIVA

| | | | | | | | | |
|---------|---|--|-------|--------|-----|-----|-------------|-------|
| 1.7 4WD | 4 | | 59/79 | 09/02→ | Z20 | 0.8 | UXT2 / UXT6 | ZS395 |
| 1.7 4WD | 4 | | 61/82 | 01/10→ | Z20 | 0.8 | UXT2 / UXT6 | |

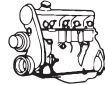

kW/BHP

**... CHEVROLET****NUBIRA**

| | | | | | | | | |
|---------|---|--------|--------|--------|----------------|-----|-------|---------------------------------|
| 1.4 | 4 | F14D3 | 69/93 | 01/05→ | Z16 | 1.1 | UXT11 | |
| 1.6 | 4 | F16D3 | 80/107 | 03/05→ | Z16 | 1.1 | UXT11 | |
| 1.6 LPG | 4 | F16D3 | 80/107 | 03/05→ | Z340 | 0.7 | UXT12 | |
| 1.8 | 4 | F18D3 | 89/119 | 08/05→ | Z304 01/06→ | 0.8 | | ZS447A |
| 1.8 | 4 | F18D3 | 89/119 | 01/06→ | Z304 | 0.8 | | ZS447A |
| 1.8 | 4 | T18SED | 90/121 | 03/05→ | Z304 01/06→ | 0.8 | | ZS447A →02/06 ZS508 [123] |

| | | | | | | | | |
|-------|---|-----------------|--------|--------|-------|------|--|--|
| 2.0 D | 4 | Z 20 DM, Z 20 S | 89/119 | 01/05→ | GE125 | 4.4V | | |
|-------|---|-----------------|--------|--------|-------|------|--|--|

OPTRA

| | | | | | | | | |
|---------|---|----------|--------|-------------|--|--|--|------------|
| 1.8 | 4 | T18SED | 90/121 | 08/03→12/08 | | | | ZS508 |
| 1.8 SRV | 4 | T18SED | 90/121 | 06/06→ | | | | ZS508 |
| 2.0 | 4 | X 20 SED | 98/131 | 06/99→07/03 | | | | ZS447A [1] |

ORLANDO

| | | | | | | | | |
|-----|---|------------|---------|--------|------|-----|--|--|
| 1.8 | 4 | 2H0, F18D4 | 104/139 | 02/11→ | Z158 | 1.1 | | |
|-----|---|------------|---------|--------|------|-----|--|--|

REZZO

| | | | | | | | | |
|---------|---|--------|--------|--------|------|-----|-------------|--------|
| 1.6 | 4 | A16DMS | 77/103 | 03/05→ | Z16 | 1.1 | UXT11 | ZS447A |
| 1.6 | 4 | A16DMS | 79/106 | 08/05→ | Z16 | 1.1 | UXT11 | ZS447A |
| 1.6 LPG | 4 | A16DMS | 79/106 | 08/05→ | Z340 | 0.7 | UXT12 | |
| 2.0 | 4 | T20SED | 89/119 | 03/05→ | Z74 | 1.0 | UXT1 / UXT3 | ZS447A |
| 2.0 | 4 | T20SED | 90/121 | 08/05→ | Z74 | 1.0 | UXT1 / UXT3 | ZS447A |

S10

| | | | | | | | | |
|-----|---|-----|--------|-------------|--|--|--|-------|
| 2.2 | 4 | L43 | 84/113 | 10/94→12/04 | | | | ZS355 |
| 2.2 | 4 | LN2 | 90/121 | 10/94→09/98 | | | | ZS355 |

SILVERADO 1500

| | | | | | | | | |
|------------------|---|--|---------|--------|--|--|--|--------|
| 5.3 4WD | 8 | | 232/311 | 01/07→ | | | | ZSE159 |
| 5.3 FlexFuel 4WD | 8 | | 232/311 | 01/07→ | | | | ZSE159 |

SILVERADO 2500 HD

| | | | | | | | | |
|------------|---|-----|---------|--------|-----------------|------|--|--|
| 6.6 Di | 8 | LMM | 224/300 | 10/01→ | GE109 01/09→ | 4.7V | | |
| 6.6 TD 4WD | 8 | | 268/359 | 01/07→ | GE109 | 4.7V | | |

SPARK

| | | | | | | | | |
|--------|---|------------|-------|--------|------|------|-------------|--------|
| 0.8 | 3 | F8CV | 37/50 | 05/05→ | Z21 | 1.1 | UXT2 / UXT6 | |
| 1.0 | 4 | B10D1 | 50/67 | 03/10→ | Z291 | 0.9 | | ZS447A |
| 1.0 SX | 4 | B10S1 | 49/66 | 05/05→ | Z9 | 1.15 | UXT2 / UXT6 | ZS447A |
| 1.2 | 4 | B12D1, LMU | 60/80 | 03/10→ | Z291 | 0.9 | | ZS447A |

TRAILBLAZER

| | | | | | | | | |
|---------|---|-----|---------|-------------|-----|-----|------|------------------|
| 4.2 4WD | 6 | LL8 | 201/270 | 09/01→09/08 | Z97 | 1.0 | UXT8 | ZSE133 01/06→ |
| 4.2 4WD | 6 | LL8 | 217/291 | 08/05→09/08 | | | | ZSE133 01/06→ |
| 5.3 4WD | 8 | L59 | 213/286 | 08/02→09/08 | | | | ZSE159 01/05→ |
| 6.0 4WD | 8 | LS2 | 295/396 | 08/05→09/08 | | | | ZSE159 |

VECTRA

| | | | | | | | | |
|-----|---|-----------------|--------|-------------|-----|-----|-------------|--|
| 2.0 | 4 | 20 NEJ, C 20 NE | 81/109 | 03/96→12/05 | Z74 | 1.0 | UXT1 / UXT3 | |
|-----|---|-----------------|--------|-------------|-----|-----|-------------|--|

VIVA

| | | | | | | | | |
|-----|---|---------|--------|-------------|------|-----|--|--|
| 1.8 | 4 | Z 18 XE | 90/121 | 09/03→03/08 | Z203 | 0.9 | | |
|-----|---|---------|--------|-------------|------|-----|--|--|

VIVANT

| | | | | | | | | |
|-----|---|----------|--------|--------|--|--|--|------------|
| 2.0 | 4 | X 20 SED | 89/119 | 08/00→ | | | | ZS447A [1] |
|-----|---|----------|--------|--------|--|--|--|------------|

CHEVROLET**EXPRESS**

| | | | | | | | | |
|---------------|---|-----|---------|--------|--|--|--|--------|
| 5.3 Flex-Fuel | 8 | L59 | 216/290 | 01/07→ | | | | ZSE159 |
|---------------|---|-----|---------|--------|--|--|--|--------|

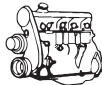

kW/BHP

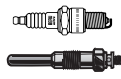
**CHRYSLER****300 C**

| | | | | | | | | |
|-----|---|------------|---------|-------------|--|--|--|------------------------------------|
| 2.7 | 6 | EES | 130/174 | 01/07→12/10 | | | | ZS453 |
| 2.7 | 6 | EES | 130/174 | 01/07→11/12 | | | | ZS453 ^[1] |
| 2.7 | 6 | 2.7FX, EER | 142/190 | 09/04→11/12 | | | | ZS431 →12/05 ZS453 01/06→ |

| | | | | | | | | |
|------------|---|------|---------|-------------|-------|--|------|--|
| 3.0 CRD | 6 | M664 | 160/215 | 09/05→11/12 | GE105 | | 4.4V | |
| 3.0 V6 CRD | 6 | EXL | 155/208 | 11/10→11/12 | GE105 | | 4.4V | |

| | | | | | | | | |
|-----|---|-------------|---------|-------------|--|--|--|---|
| 3.5 | 6 | 3.5CSP, EEG | 183/245 | 09/04→12/10 | | | | ZS432 ZS453 ^[1] 01/06→ |
|-----|---|-------------|---------|-------------|--|--|--|---|

| | | | | | | | | |
|-----|---|--------|---------|-------------|--|--|--|--|
| 3.5 | 6 | 3.5CSP | 183/245 | 09/04→11/12 | | | | ZS453 ^[1] 08/05→01/08 ZS432 |
|-----|---|--------|---------|-------------|--|--|--|--|

| | | | | | | | | |
|-----|---|---------------|---------|-------------|------|--|-----|--|
| 5.7 | 8 | EZB, EZD, EZH | 250/335 | 09/04→12/10 | Z216 | | 1.3 | |
|-----|---|---------------|---------|-------------|------|--|-----|--|

300 M

| | | | | | | | | |
|------------|---|-----|---------|-------------|--|--|--|-------|
| 2.7 V6 24V | 6 | EER | 149/200 | 11/98→08/00 | | | | ZS431 |
| 2.7 V6 24V | 6 | EER | 150/201 | 08/00→09/04 | | | | ZS431 |
| 3.5 V6 24V | 6 | EGG | 185/248 | 08/00→09/04 | | | | ZS432 |
| 3.5 V6 24V | 6 | EGG | 187/251 | 07/98→08/00 | | | | ZS432 |

CIRRUS

| | | | | | | | | |
|------------|---|-----|---------|-------------|------|--|-----|-------------------|
| 2.0 LX | 4 | ECB | 96/129 | 05/94→09/97 | Z15 | | 0.8 | UXT1 / UXT3 ZS379 |
| 2.0 LX | 4 | ECB | 98/131 | 10/97→09/00 | Z15 | | 0.8 | UXT1 / UXT3 ZS379 |
| 2.0 LX LPG | 4 | ECB | 96/129 | 05/94→09/97 | Z340 | | 0.7 | UXT12 |
| 2.0 LX LPG | 4 | ECB | 98/131 | 10/97→09/00 | Z340 | | 0.7 | UXT12 |
| 2.4 LX | 4 | EDZ | 103/138 | 05/94→09/00 | | | | ZS379 |
| 2.5 LX | 6 | EEB | 120/161 | 10/94→09/00 | Z312 | | 1.0 | UXT9 |

CONCORDE

| | | | | | | | | |
|---------------------|---|-----|---------|-------------|--|--|--|-------|
| 2.7 LX | 6 | EER | 149/200 | 10/97→09/03 | | | | ZS431 |
| 3.3 LX | 6 | EGB | 120/161 | 10/92→09/97 | | | | ZS406 |
| 3.5 LX | 6 | EWZ | 174/233 | 10/97→09/03 | | | | ZS432 |
| 3.5 LX Supercharged | 6 | EWZ | 186/249 | 10/97→09/03 | | | | ZS432 |

CROSSFIRE

| | | | | | | | | |
|-----------|---|-----|---------|-------------|------|--|-----|------------|
| 3.2 | 6 | EGX | 160/215 | 07/03→12/07 | Z170 | | 1.0 | UXT9 ZS297 |
| 3.2 LPG | 6 | EGX | 160/215 | 07/03→12/07 | Z340 | | 0.7 | UXT12 |
| 3.2 SRT-6 | 6 | EGZ | 246/330 | 09/04→12/07 | | | | ZS297 |

DAYTONA

| | | | | | | | | |
|-------------|---|-----|---------|-------------|-----|--|-----|-------------------|
| 2.2 i Turbo | 4 | EDR | 130/174 | 10/87→10/92 | Z82 | | 0.7 | UXT2 / UXT6 ZS394 |
| 2.5 i Turbo | 4 | EDT | 110/148 | 01/89→10/92 | | | | ZS394 |

DELTA

| | | | | | | | | |
|----------------|---|------------|---------|--------|-------|--|------|--|
| 1.6 D Multijet | 4 | 198 A2.000 | 88/118 | 08/11→ | GE114 | | 4.4V | |
| 2.0 D Multijet | 4 | 198 A5.000 | 121/162 | 08/11→ | GE114 | | 4.4V | |

GRAND VOYAGER V

| | | | | | | | | |
|-----|---|-----|---------|--------|--|--|--|-------|
| 3.3 | 6 | EGV | 125/168 | 01/08→ | | | | ZS455 |
| 3.8 | 6 | EGL | 142/190 | 10/07→ | | | | ZS455 |

LE BARON

| | | | | | | | | |
|-------------|---|-----|---------|-------------|-----|--|-----|-------------|
| 2.2 i | 4 | | 69/93 | 09/86→12/94 | Z82 | | 0.7 | UXT2 / UXT6 |
| 2.2 i Turbo | 4 | | 109/146 | 09/86→12/90 | Z82 | | 0.7 | UXT2 / UXT6 |
| 2.2 i Turbo | 4 | EDR | 130/174 | 09/86→01/91 | Z82 | | 0.7 | UXT2 / UXT6 |
| 2.5 i Turbo | 4 | EDT | 112/150 | 01/89→12/93 | Z82 | | 0.7 | UXT2 / UXT6 |
| 2.5 i Turbo | 4 | EDT | 112/150 | 01/89→12/94 | Z82 | | 0.7 | UXT2 / UXT6 |

| | | | | | | | | |
|----------|---|-----------|---------|-------------|-----|--|-----|-------------|
| 3.0 i V6 | 6 | 6G72, EFA | 105/141 | 01/90→12/96 | Z82 | | 0.7 | UXT2 / UXT6 |
|----------|---|-----------|---------|-------------|-----|--|-----|-------------|

NEON

| | | | | | | | | |
|-------------|---|------|--------|-------------|------|--|-----|-------------------|
| 1.8 16V | 4 | EBD | 85/114 | 09/97→08/99 | Z15 | | 0.8 | UXT1 / UXT3 |
| 1.8 16V LPG | 4 | EBD | 85/114 | 09/97→08/99 | Z340 | | 0.7 | UXT12 |
| 2.0 16V | 4 | 420H | 98/131 | 05/94→08/99 | Z15 | | 0.8 | UXT1 / UXT3 ZS379 |

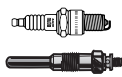

kW/BHP

**... CHRYSLER****... NEON**

| | | | | | | | | |
|-------------|---|------|---------|-------------|------|-----|-------------|-------|
| 2.0 16V | 4 | ECC | 107/143 | 06/94→08/99 | Z72 | 0.8 | UXT1 / UXT3 | ZS379 |
| 2.0 16V | 4 | 420T | 109/146 | 04/96→08/99 | Z72 | 0.8 | UXT1 / UXT3 | ZS379 |
| 2.0 16V LPG | 4 | 420H | 98/131 | 05/94→08/99 | Z340 | 0.7 | UXT12 | |
| 2.0 16V LPG | 4 | ECC | 107/143 | 06/94→08/99 | Z206 | 0.7 | UXT10 | |
| 2.0 16V LPG | 4 | 420T | 109/146 | 04/96→08/99 | Z206 | 0.7 | UXT10 | |

NEON II

| | | | | | | | | |
|-------------|---|-----------|---------|-------------|------|-----|-------------|------------------------------------|
| 1.6 | 4 | EJD | 85/114 | 11/01→12/06 | | | | ZS392 |
| 2.0 16V | 4 | ECB | 97/130 | 10/02→12/06 | | | | ZS380 →12/03 ZS379 01/04→ |
| 2.0 16V | 4 | 420H, ECB | 98/131 | 08/99→12/06 | Z15 | 0.8 | UXT1 / UXT3 | ZS379 |
| 2.0 16V LPG | 4 | 420H, ECB | 98/131 | 08/99→12/06 | Z340 | 0.7 | UXT12 | |
| 2.0 16V R/T | 4 | ECH | 110/148 | 10/01→12/06 | | | | ZS380 →12/03 ZS379 01/04→ |

NEW YORKER

| | | | | | | | | |
|-----------|---|-----|---------|-------------|------|-----|--|-------|
| 3.5 i 24V | 6 | F01 | 155/208 | 04/93→09/98 | Z152 | 0.7 | | ZS406 |
|-----------|---|-----|---------|-------------|------|-----|--|-------|

PACIFICA

| | | | | | | | | |
|---------|---|-----|---------|-------------|--|--|--|------------------------|
| 3.5 | 6 | EGN | 186/249 | 08/03→09/08 | | | | ZS432 |
| 3.5 4WD | 6 | EGN | 186/249 | 08/03→09/08 | | | | ZS432 [1] ZS453 [1] |

PT CRUISER

| | | | | | | | | |
|---------|---|-----|---------|-------------|-------|-------|--|------------------------------------|
| 1.6 | 4 | EJD | 85/114 | 11/01→12/10 | | | | ZS392 |
| 2.0 | 4 | ECC | 100/134 | 10/04→12/10 | | | | ZS379 |
| 2.0 | 4 | ECC | 104/139 | 06/00→12/10 | | | | ZS380 |
| 2.2 CRD | 4 | EDJ | 89/119 | 03/02→12/10 | GN003 | 11.5V | | |
| 2.2 CRD | 4 | EDJ | 110/148 | 08/05→12/10 | GN003 | 11.5V | | |
| 2.4 | 4 | EDZ | 105/141 | 03/04→03/08 | Z216 | 1.3 | | |
| 2.4 | 4 | EDZ | 105/141 | 03/04→12/10 | | | | ZS380 |
| 2.4 | 4 | EDZ | 110/148 | 06/00→12/10 | | | | ZS380 |
| 2.4 | 4 | EDV | 169/227 | 09/04→12/10 | | | | ZS379 |
| 2.4 GT | 4 | EDV | 164/220 | 08/03→12/10 | | | | ZS379 →01/04 ZS380 12/03→ |
| 2.4 GT | 4 | EDV | 164/220 | 03/04→03/08 | Z216 | 1.3 | | ZS379 |

SARATOGA

| | | | | | | | | |
|---------|---|------|---------|-------------|-----------|------|-------------|--|
| 3.0 | 6 | 6G72 | 105/141 | 09/89→12/95 | Z9 | 1.15 | UXT2 / UXT6 | |
| 3.0 LPG | 6 | 6G72 | 105/141 | 09/89→12/95 | Z20 [168] | 0.8 | UXT2 / UXT6 | |

SEBRING

| | | | | | | | | |
|------------|---|----------|---------|-------------|----------------|------|----------------|-----------|
| 2.0 | 4 | ECC | 104/139 | 04/01→06/07 | Z216 | 1.3 | | ZS380 |
| 2.0 CRD | 4 | ECD | 103/138 | 07/07→12/10 | GE101 | 4.4V | | |
| 2.4 | 4 | EDZ | 105/141 | 04/01→06/07 | | | | ZS379 |
| 2.4 | 4 | EDZ | 112/150 | 04/01→06/07 | | | | ZS379 |
| 2.5 LE | 6 | EED | 120/161 | 05/95→09/00 | Z312 →08/00 | 1.0 | UXT9 →08/00 | |
| 2.7 | 6 | EER | 137/184 | 07/07→12/10 | | | | ZS453 [1] |
| 2.7 V6 24V | 6 | EER, EES | 149/200 | 04/01→06/07 | | | | ZS431 |
| 2.7 VVT | 6 | EER | 137/184 | 07/07→09/10 | | | | ZS453 [1] |

STRATUS

| | | | | | | | | |
|-------------|---|-----------|---------|-------------|------|-----|-------------|-------|
| 2.0 16V | 4 | ECB | 98/131 | 12/95→04/01 | Z15 | 0.8 | UXT1 / UXT3 | ZS379 |
| 2.0 16V LPG | 4 | ECB | 98/131 | 12/95→04/01 | Z340 | 0.7 | UXT12 | |
| 2.0 LE | 4 | 420X, COO | 96/129 | 12/95→04/01 | Z15 | 0.8 | UXT1 / UXT3 | ZS380 |
| 2.0 LE LPG | 4 | 420X, COO | 96/129 | 12/95→04/01 | Z340 | 0.7 | UXT12 | |
| 2.4 16 V | 4 | EDZ | 103/138 | 12/95→04/01 | Z73 | 1.1 | UXT11 | |

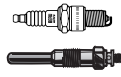

kW/BHP

**... CHRYSLER****... STRATUS**

| | | | | | | | | |
|---------------|---|------|---------|-------------|------------|-----|-------|-------|
| 2.4 16V | 4 | EDZ | 112/150 | 12/95→04/01 | Z73 [172] | 1.1 | UXT11 | ZS379 |
| 2.4 16 V LPG | 4 | EDZ | 103/138 | 12/95→04/01 | Z206 | 0.7 | UXT10 | |
| 2.4 16V LPG | 4 | EDZ | 112/150 | 12/95→04/01 | Z206 | 0.7 | UXT10 | |
| 2.5 LX | 6 | 625H | 120/161 | 04/96→04/01 | Z228 | 1.0 | UXT11 | |
| 2.5 LX LPG | 6 | 625H | 120/161 | 04/96→04/01 | Z221 [168] | 1.0 | UXT14 | |
| 2.5 LX V6 | 6 | H00 | 120/161 | 12/95→04/01 | Z73 | 1.1 | UXT11 | |
| 2.5 LX V6 LPG | 6 | H00 | 120/161 | 12/95→04/01 | Z206 | 0.7 | UXT10 | |
| 2.5 V6 | 6 | H00 | 125/168 | 12/95→04/01 | Z73 [172] | 1.1 | UXT11 | |
| 2.5 V6 LPG | 6 | H00 | 125/168 | 12/95→04/01 | Z206 | 0.7 | UXT10 | |

TOWN & COUNTRY

| | | | | | | | | |
|---------|---|-----|---------|-------------|--|--|--|-----------------|
| 3.3 | 6 | EGM | 128/172 | 10/00→08/07 | | | | ZS455 01/01→ |
| 3.8 4WD | 6 | EGH | 160/215 | 10/00→08/07 | | | | ZS455 01/01→ |

VIPER

| | | | | | | | | |
|---------|----|-----|---------|-------------|----------------|-----|--|--|
| 8.0 | 10 | EPD | 282/378 | 07/98→12/98 | Z248 | 0.8 | | |
| 8.0 | 10 | EPA | 290/389 | 08/92→12/98 | Z152 →12/96 | 0.7 | | |
| 8.0 LPG | 10 | EPD | 282/378 | 07/98→12/98 | Z225 [168] | 1.1 | | |

VOYAGER I

| | | | | | | | | |
|-----|---|-----|---------|-------------|--|--|--|-------|
| 3.3 | 6 | EGA | 112/150 | 10/89→09/90 | | | | ZS405 |
|-----|---|-----|---------|-------------|--|--|--|-------|

VOYAGER II

| | | | | | | | | |
|-----------|---|-----------|---------|-------------|---|-------------------|-------------|-------|
| 2.5 i | 4 | K00 | 72/97 | 01/91→09/95 | Z82 | 0.7 | UXT2 / UXT6 | |
| 2.5 i | 4 | K | 74/99 | 08/90→09/95 | Z82 | 0.7 | UXT2 / UXT6 | ZS394 |
| 2.5 TD | 4 | 09B, M00 | 87/117 | 01/92→09/95 | GN013 [222] →04/95 GN954 →04/95 GN007 05/95→ | 11V 11V 11V | | |
| 3.0 i | 6 | 6G72, 300 | 108/145 | 01/91→09/95 | Z8 [171] | 0.8 | UXT2 / UXT6 | |
| 3.0 i LPG | 6 | 6G72, 300 | 108/145 | 01/91→09/95 | Z20 [168] | 0.8 | UXT2 / UXT6 | |
| 3.3 i | 6 | EGA | 110/148 | 08/90→09/95 | Z285 | 1.3 | | ZS405 |
| 3.3 i 4WD | 6 | EGA | 110/148 | 08/90→09/95 | | | | ZS405 |
| 3.3 i | 6 | EGA, R00 | 120/161 | 08/90→09/95 | | | | ZS405 |

VOYAGER III

| | | | | | | | | |
|--------------|---|------------------|---------|-------------|---|-------------------|-------------|--|
| 2.0 i | 4 | C00 | 98/131 | 01/95→03/01 | Z15 08/96→12/00 | 0.8 | UXT1 / UXT3 | ZS380 08/96→12/00 |
| 2.0 i LPG | 4 | C00 | 98/131 | 01/95→03/01 | Z340 08/96→12/00 | 0.7 | UXT12 | 08/96→12/00 |
| 2.4 i | 4 | B00 | 111/149 | 01/95→03/01 | Z73 01/96→ | 1.1 | UXT11 | ZS380 01/96→ |
| 2.4 i LPG | 4 | B00 | 111/149 | 01/95→03/01 | Z206 01/96→ | 0.7 | UXT10 | 01/96→ |
| 2.5 TD | 4 | 425 CLIRS/X, ENC | 85/114 | 01/95→03/01 | GN013 [222] →04/95 GN954 →04/95 GN007 05/95→ | 11V 11V 11V | | |
| 2.5 TDiC 4WD | 4 | ENC | 85/114 | 10/95→03/01 | GN007 | 11V | | |
| 3.3 i | 6 | R00 | 116/156 | 01/95→03/01 | Z285 | 1.3 | | ZS405 [1] →12/98 ZS470 [1] 01/99→12/00 ZS455 [1] 01/01→ |

CHRYSLER

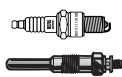

kW/BHP

**... CHRYSLER****... VOYAGER III**

| | | | | | | | |
|-----------|---|-----|---------|-------------|------|-----|-------|
| 3.8 i 4WD | 6 | L00 | 122/164 | 01/95→03/01 | Z285 | 1.3 | ZS470 |
| 3.8 i 4WD | 6 | EGH | 131/176 | 01/95→03/01 | Z285 | 1.3 | ZS470 |

VOYAGER IV

| | | | | | | | |
|---------|---|-----|---------|-------------|-------|-----|--|
| 2.4 | 4 | EDZ | 108/145 | 02/00→12/08 | Z216 | 1.3 | ZS380 |
| 2.5 CRD | 4 | EDK | 88/118 | 08/05→12/08 | GN055 | 11V | |
| 2.5 CRD | 4 | ENC | 105/141 | 02/00→12/08 | GN055 | 11V | |
| 2.8 CRD | 4 | ENR | 110/148 | 06/04→12/08 | GN055 | 11V | |
| 3.3 | 6 | EGA | 128/172 | 02/00→12/08 | | | ZS470 [1] →12/00 ZS455 [1] 01/01→ |

| | | | | | | | |
|---------------|---|-----|---------|-------------|--|--|--|
| 3.3 Flex-Fuel | 6 | EGM | 128/172 | 02/00→12/08 | | | ZS470 [1] →12/00 ZS455 [1] 01/01→ |
| 3.8 | 6 | EGH | 160/215 | 02/00→12/08 | | | ZS470 [1] |

YPSILON

| | | | | | | | |
|--------------|---|------------|-------|--------|-------|------|--|
| 0.9 Twinair | 2 | 312 A2.000 | 63/84 | 05/11→ | Z357 | 0.7 | |
| 1.3 Multijet | 4 | 199 B1.000 | 70/94 | 05/11→ | GE112 | 4.4V | |

CITROËN**2 CV**

| | | | | | | | |
|-------|---|------------------|-------|-------------|-----|-----|--|
| 0.4 4 | 2 | A 53 | 12/16 | 03/63→02/70 | Z57 | 0.6 | |
| 0.4 4 | 2 | A79/1 (AYA2) | 17/23 | 01/70→12/75 | Z40 | 0.6 | |
| 0.6 6 | 2 | M28/1 (AK2) | 18/24 | 09/75→06/81 | Z40 | 0.6 | |
| 0.6 6 | 2 | A06/664 | 20/27 | 08/79→07/90 | Z40 | 0.6 | |
| 0.6 6 | 2 | A06/635, A06/664 | 21/28 | 02/70→10/85 | Z40 | 0.6 | |

AMI

| | | | | | | | |
|--------------|---|-----------|-------|-------------|-----|-----|---------------------------------|
| 0.6 6 | 2 | M4 (AM) | 18/24 | 01/63→05/68 | Z40 | 0.6 | |
| 0.6 6 | 2 | M28 (AM2) | 24/32 | 05/68→07/69 | Z40 | 0.6 | |
| 0.6 8 | 2 | M28 (AM2) | 24/32 | 07/69→12/77 | Z40 | 0.6 | |
| 1.0 10 Super | 4 | G10 | 40/54 | 03/73→12/77 | Z22 | 0.7 | UX56 ZS110 [1][15] →06/76 |

AX

| | | | | | | | |
|------------|---|------------------|-------|-------------|------|-----|--|
| 1.0 10 | 4 | C1A | 32/43 | 09/86→06/92 | Z193 | 0.9 | UXT1 / UXT3 ZS247 ZM003 |
| 1.0 10 | 4 | CDY (TU9M) | 33/44 | 07/86→12/98 | Z193 | 0.9 | UXT1 / UXT3 ZS247 →12/90 ZS249 01/91→ ZS231 01/92→ |
| 1.0 10 | 4 | CDZ (TU9M) | 37/50 | 02/87→12/98 | Z193 | 0.9 | UXT1 / UXT3 ZS231 01/93→ |
| 1.0 10 LPG | 4 | CDY (TU9M) | 33/44 | 07/86→12/98 | Z340 | 0.7 | UXT12 |
| 1.0 10 LPG | 4 | CDZ (TU9M) | 37/50 | 02/87→12/98 | Z340 | 0.7 | UXT12 |
| 1.0 10 E | 4 | C3A | 30/40 | 12/86→12/88 | Z193 | 0.9 | UXT1 / UXT3 ZS247 ZM003 |
| 1.1 11 | 4 | H1A, H1B | 40/54 | 12/86→04/94 | Z193 | 0.9 | UXT1 / UXT3 ZS247 →04/91 ZS249 05/91→ |
| 1.1 11 | 4 | H1A, HAZ (TU1CP) | 40/54 | 09/88→07/92 | Z193 | 0.9 | UXT1 / UXT3 ZS247 ZM003 |

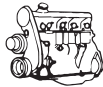

kW/BHP

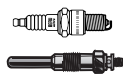

... CITROËN



... AX

| | | | | | | | | | | |
|----------------|---|--|-------|-------------|------------------------------------|-------|------------|---|---|---|
| 1.1 11 | 4 | H1B, HDZ (TU1M) | 44/59 | 09/86→12/97 | Z193 | | 0.9 | UXT1 / UXT3 | ZS247 →12/90 ZS249 01/91→ →eng. 5656 ZS231 01/91→ eng. 5657→ | ZM003 →04/92 |
| 1.1 11 LPG | 4 | H1B, HDZ (TU1M) | 44/59 | 09/86→12/97 | Z340 | | 0.7 | UXT12 | | |
| 1.3 Sport | 4 | M4A | 70/94 | 04/87→12/88 | Z29 | | 0.8 | UXT5 | ZS247 | ZM003 |
| 1.4 4WD | 4 | K2A | 62/83 | 09/86→07/92 | | | | | ZS249 ^[1] | |
| 1.4 14 | 4 | KAY (TU3CP) | 44/59 | 12/86→12/88 | Z193 | | 0.9 | UXT1 / UXT3 | ZS247 | ZM003 |
| 1.4 14 | 4 | K1F | 49/66 | 06/88→12/89 | Z193 | | 0.9 | UXT1 / UXT3 | ZS247 | ZM003 |
| 1.4 14 | 4 | K1G | 51/68 | 01/89→12/91 | | | | | ZS247 →04/91 ZS249 05/91→ | |
| 1.4 14 | 4 | KDX (TU3M/Z), KDY (TU3FM), KDY (TU3M), KDZ (TU3M/Z) | 55/74 | 04/87→04/97 | Z193 | | 0.9 | UXT1 / UXT3 | ZS247 | ZM001 ^[175] ZM003 ^{[175][181]} |
| 1.4 14 4WD | 4 | KDX (TU3M/Z), KDY (TU3FM), KDY (TU3M), KDZ (TU3M/Z) | 55/74 | 08/91→12/96 | Z193 →06/95 Z123 07/95→ | | 0.9 1.0 | UXT1 / UXT3 →06/95 UXT9 07/95→ | ZS247 | |
| 1.4 14 | 4 | K2A | 61/82 | 01/88→12/92 | | | | | ZS247 →04/91 ZS249 05/91→ | |
| 1.4 14 | 4 | K2A, K2B | 62/83 | 01/88→12/92 | Z24 | | 0.8 | UXT5 | ZS247 →12/90 | ZM003 |
| 1.4 14 LPG | 4 | KDX (TU3M/Z), KDY (TU3FM), KDY (TU3M), KDZ (TU3M/Z) | 55/74 | 04/87→04/97 | Z340 | | 0.7 | UXT12 | | |
| 1.4 14 4WD LPG | 4 | KDX (TU3M/Z), KDY (TU3FM), KDY (TU3M), KDZ (TU3M/Z) | 55/74 | 08/91→12/96 | Z340 →06/95 Z129 07/95→ | | 0.7 1.6 | UXT12 →06/95 | | |
| 1.4 14 D | 4 | K9Y (TUD3Y) | 37/50 | 08/91→12/97 | GN927 ^{[2][222]} GV661 | | 11V | | | |
| 1.4 14 D | 4 | K9A (TUD3) | 38/51 | 09/88→06/92 | GN927 ^{[2][222]} GV661 | GR065 | 11V | | | |
| 1.4 14 GT | 4 | KDZ (TU3M/Z) | 59/79 | 01/89→12/91 | | | | | ZS247 →04/91 ZS249 05/91→ | |
| 1.4 D 4WD | 4 | K9A (TUD3) | 39/52 | 06/91→07/92 | GV661 | | 11V | | | |
| 1.4 GTi | 4 | KFY (TU3FJ2) | 66/89 | 08/91→12/96 | Z60 | | 1.2 | | ZS231 01/92→ | |
| 1.4 GTi | 4 | KFZ (TU3FJ2) | 69/93 | 06/91→12/96 | Z60 | | 1.2 | | ZS231 01/92→ | ZM026 |
| 1.4 GTi | 4 | KFZ (TU3FJ2) | 74/99 | 06/91→12/92 | Z193 | | 0.9 | UXT1 / UXT3 | ZS231 | |
| 1.5 15 D | 4 | VJY (TUD5) | 40/54 | 08/94→12/97 | GN016 ^{[2][222]} GN912 | GR054 | 11V | | | |
| 1.5 15 D | 4 | VJZ (TUD5) | 43/58 | 08/94→12/97 | GN016 ^{[2][222]} GN912 | GR054 | 11V | | | |
| AXEL | | | | | | | | | | |
| 1.1 11 | 4 | G11/631 | 42/56 | 01/84→03/91 | Z25 | | 0.8 | UXK56 | | |
| 1.3 11 | 4 | | 45/60 | 01/84→03/91 | Z25 | | 0.8 | UXK56 | ZS115 ^{[1][11]} | |



kW/BHP

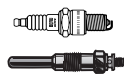

... CITROËN



BERLINGO

| | | | | | | | | | |
|----------------|---|-----------------------------------|--------|-------------|------------------------------------|------------|-----------------|---|-------|
| 1.1 i | 4 | HDZ | 44/59 | 07/96→ | | | | ZS341 [1] →12/02 | |
| 1.1 i | 4 | HDZ (TU1M), HFX (TU1JP) | 44/59 | 07/96→ | Z123 | 1.0 | UXT9 | | ZM026 |
| 1.1 i | 4 | HFX | 44/59 | 07/96→ | | | | ZSE047 [1][13] 01/01→08/05 | |
| 1.1 i LPG | 4 | HDZ (TU1M), HFX (TU1JP) | 44/59 | 07/96→ | Z129 | 1.6 | | | |
| 1.4 | 4 | KFW (TU3JP) | 53/71 | 11/02→10/05 | | | | ZSE047 [13] | |
| 1.4 bivalent | 4 | KFW (TU3JP) | 48/64 | 11/02→ | Z15 | 0.8 | UXT1 / UXT3 | ZSE048 [10] | |
| 1.4 Hybrid | 4 | KFW (TU3JP) | 54/72 | 05/05→ | | | | ZSE047 [13] | |
| 1.4 i | 4 | KFW | 55/74 | 07/96→ | | | | ZSE047 [1][13] →03/10 | |
| 1.4 i | 4 | KFW (TU3JP), KFX (TU3JP) | 55/74 | 07/96→ | Z123 | 1.0 | UXT9 | | ZM003 |
| 1.4 i | 4 | KFX | 55/74 | 07/96→ | | | | ZS341 [1] →05/98 ZS381 [1] 06/98→11/02 | |
| 1.4 i LPG | 4 | KFW (TU3JP), KFX (TU3JP) | 55/74 | 07/96→ | Z129 | 1.6 | | | |
| 1.4 i bivalent | 4 | KFW | 55/74 | 04/03→ | | | | ZSE047 [13] →03/10 | |
| 1.4 i bivalent | 4 | KFW (TU3JP) | 55/74 | 04/03→ | Z206 | 0.7 | UXT10 | | |
| 1.6 | 4 | NFR (TU5JP4B) | 66/89 | 04/08→ | Z184 | 0.9 | UXT13 | ZSE045 | |
| 1.6 | 4 | NFU (TU5JP4) | 80/107 | 04/08→ | Z184 | 0.9 | UXT13 | ZSE045 | |
| 1.6 LPG | 4 | NFR (TU5JP4B) | 66/89 | 04/08→ | Z226 [168] | 0.8 | | | |
| 1.6 LPG | 4 | NFU (TU5JP4) | 80/107 | 04/08→ | Z226 [168] | 0.8 | | | |
| 1.6 16V | 4 | NFU (TU5JP4) | 80/107 | 10/00→ | Z184 →11/02 | 0.9 | UXT13 →11/02 | ZSE045 | |
| 1.6 16V LPG | 4 | NFU (TU5JP4) | 80/107 | 10/00→ | Z226 [168] →11/02 | 0.8 | | | |
| 1.6 HDi 75 | 4 | 9HN (DV6ETED4), 9HT (DV6BTED4) | 55/74 | 04/08→ | GN056 | 11V | | | |
| 1.6 HDi 75 | 4 | 9HW (DV6ETED), DV6B | 55/74 | 07/05→ | GN047 →05/06 GN056 06/06→ | 11V 11V | | | |
| 1.6 HDi 90 | 4 | 9HX (DV6ATED4) | 66/89 | 07/05→ | GN047 →02/06 GN056 03/06→ | 11V 11V | | | |
| 1.6 HDi 90 | 4 | 9HX (DV6ATED4) | 66/89 | 04/08→ | GN056 | 11V | | | |
| 1.6 HDi 90 | 4 | 9HX (DV6ATED4) | 68/91 | 07/10→ | GE121A | 5V | | | |
| 1.6 HDi 110 | 4 | 9HZ (DV6TED4) | 80/107 | 08/05→ | GN047 | 11V | | | |
| 1.6 HDi 110 | 4 | 9HZ (DV6TED4) | 80/107 | 04/08→ | GN056 | 11V | | | |
| 1.6 HDi 110 | 4 | 9HL (DV6C), 9HR (DV6C) | 82/110 | 07/10→ | GE121A | 5V | | | |
| 1.6 HDi 115 | 4 | 9HR (DV6C) | 84/113 | 07/10→ | GE121A | 5V | | | |
| 1.6 VTi 95 | 4 | 5FK (EP6CB) | 72/97 | 07/10→ | Z332 | 0.7 | | ZSE143 | |
| 1.6 VTi 120 | 4 | 5FS (EP6C) | 88/118 | 11/09→ | Z332 | 0.7 | | ZSE143 | |
| 1.8 D | 4 | A9A (XUD7) | 43/58 | 07/98→ | GN013 | 11V | | | |
| 1.8 i | 4 | LFX (XU7JB) | 66/89 | 05/97→ | Z193 | 0.9 | UXT1 / UXT3 | ZS341 | |
| 1.8 i 4WD | 4 | LFX (XU7JB) | 66/89 | 04/97→ | Z193 | 0.9 | UXT1 / UXT3 | ZS341 [1] | |
| 1.8 i LPG | 4 | LFX (XU7JB) | 66/89 | 04/97→ | Z340 | 0.7 | UXT12 | | |
| 1.9 D | 4 | D9B (XUD9A/L), DJY (XUD9A) | 50/67 | 07/96→ | GN099 →08/98 GN013 09/98→ | 11V 11V | GR054 →08/98 | | |
| 1.9 D | 4 | DJY (XUD9A) | 51/68 | 07/96→10/99 | GN013 | 11V | | | |
| 1.9 D | 4 | WJY (DW8B), WJZ (DW8) | 51/68 | 07/98→ | GN016 | 11V | | | |
| 2.0 HDi 4WD | 4 | RHY (DW10TD) | 66/89 | 11/02→10/05 | GN027 | 11V | | | |
| 2.0 HDi 90 | 4 | RHY (DW10TD) | 66/89 | 12/99→ | GN027 | 11V | | | |

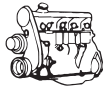

kW/BHP

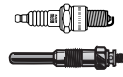

... CITROËN



BX

| | | | | | | | | | |
|----------|---|--------------------------|-------|-------------|--------------------------------|------------|---------------|---|-------|
| 1.1 11 | 4 | HDZ (TU1M) | 40/54 | 10/88→06/92 | Z247 | 0.9 | UXT1 / UXT3 | ZS247 | |
| 1.1 11 | 4 | HTA | 42/56 | 10/86→06/92 | Z31 | 0.8 | UXK56 | ZS247 ^[1] | |
| 1.4 | 4 | | 44/59 | 01/87→01/92 | | | | ZS247 ^[1] | |
| 1.4 | 4 | 150C | 52/70 | 01/87→01/92 | Z95 ^[167] | 0.7 | UXT4 | ZS115 ^[11] →04/88 ZS247 05/88→ | ZM003 |
| 1.4 14 | 4 | K1H (TU3A) | 47/63 | 01/89→12/89 | Z13 ^[170] Z247 | 0.8 0.9 | UXT1 / UXT3 | ZS247 | |
| 1.4 14 | 4 | 150C | 53/71 | 01/86→02/93 | Z17 | 0.8 | UXT4 | ZS247 ^[1] | |
| 1.4 14 | 4 | KDY, KDZ | 55/74 | 01/89→02/93 | Z193 | 0.9 | UXT1 / UXT3 | | |
| 1.4 14 | 4 | KDY (TU3M) | 55/74 | 01/89→02/93 | Z247 | 0.9 | UXT1 / UXT3 | ZS247 | |
| 1.4 14 | 4 | KDZ (TU3M/Z) | 55/74 | 01/89→02/93 | | | | ZS247 | |
| 1.4 14 E | 4 | 150A | 45/60 | 10/82→06/88 | Z17 | 0.8 | UXT4 | ZS115 ^[11] →04/88 ZS247 05/88→ | ZM003 |
| 1.4 14 E | 4 | 150F | 49/66 | 09/85→02/93 | Z95 ^[167] | 0.7 | UXT4 | ZS115 ^[11] →04/88 ZS247 05/88→ | ZM003 |
| 1.4 14 E | 4 | 150C, K1G | 52/70 | 04/83→07/89 | Z95 ^[167] | 0.7 | UXT4 | ZS115 ^[11] →04/88 ZS247 05/88→ | ZM003 |
| 1.4 14 E | 4 | 150C | 53/71 | 04/83→02/93 | Z95 ^[167] | 0.7 | UXT4 | ZS115 ^[11] →04/88 ZS247 05/88→ | ZM003 |
| 1.4 14 E | 4 | | 59/79 | 10/85→05/89 | Z95 ^[167] | 0.7 | UXT4 | | |
| 1.6 15 | 4 | B1E (XU51C) | 59/79 | 10/87→05/92 | Z247 | 0.9 | UXT1 / UXT3 | ZS115 ^{[1][11]} →07/89 ZS257 ^[1] 08/89→ | |
| 1.6 16 | 4 | B1E (XU51C) | 53/71 | 01/87→12/94 | Z247 | 0.9 | UXT1 / UXT3 | | ZM003 |
| 1.6 16 | 4 | B1E (XU51C) | 53/71 | 01/87→02/93 | | | | ZS257 04/88→ | |
| 1.6 16 | 4 | B1E (XU51C) | 53/71 | 09/88→12/94 | | | | ZS257 →06/93 | |
| 1.6 16 | 4 | BAY (XU5CP), BAZ (XU5CP) | 55/74 | 09/88→12/94 | Z13 ^[170] Z247 | 0.8 0.9 | UXT1 / UXT3 | ZS257 ^[1] 02/89→12/93 | |
| 1.6 16 | 4 | BAY (XU5CP), BAZ (XU5CP) | 55/74 | 09/88→02/93 | | | | ZS257 ^[1] 02/89→ | |
| 1.6 16 | 4 | B1A (XU51C/K) | 58/78 | 09/87→02/93 | Z31 | 0.8 | UXK56 | ZS341 | |
| 1.6 16 | 4 | 171D | 64/86 | 07/85→02/93 | Z25 →06/87 Z24 07/87→ | 0.8 0.8 | UXK56 UXT5 | | |
| 1.6 16 | 4 | 171D | 64/86 | 07/85→12/94 | Z25 →03/88 Z24 04/88→ | 0.8 0.8 | UXK56 UXT5 | | ZM003 |
| 1.6 16 | 4 | BDY (XU5M) | 65/87 | 05/89→12/94 | Z13 ^[170] Z247 | 0.8 0.9 | UXT1 / UXT3 | ZS341 ^[1] 04/91→06/94 ZS232 ^[1] 07/94→ | ZM003 |
| 1.6 16 | 4 | BDZ (XU5M) | 65/87 | 05/89→12/94 | Z13 ^[170] Z247 | 0.8 0.9 | UXT1 / UXT3 | ZS257 ^[1] →03/91 | ZM003 |



kW/BHP

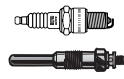

... CITROËN



... BX

| | | | | | | | | | | |
|----------------|---|-------------------------------------|---------|-------------|---------------------------------------|-----------------|-----|----------------------|------------------------------------|--------------------------------|
| 1.6 16 | 4 | 171A, 171B, 171C | 66/89 | 10/82→06/88 | Z25 07/84→06/87 Z24 06/87→ | | 0.8 | UXK56 07/84→06/87 | ZS257 [1] 03/88→ | ZM003 |
| 1.6 16 | 4 | 171A, 171B, 171C | 66/89 | 06/85→06/88 | Z247 | | 0.9 | UXT1 / UXT3 | | |
| 1.6 16 | 4 | 171C | 68/91 | 04/83→01/92 | | | | | ZS257 [1] 03/88→ | |
| 1.6 16 | 4 | XU52C | 68/91 | 10/82→12/92 | Z25 →06/84 | | 0.8 | UXK56 →06/84 | ZS257 [1] 03/88→ | |
| 1.6 16 | 4 | 180Z | 76/102 | 03/86→12/94 | Z26 [167] →06/87 Z247 07/87→ | | 0.7 | UXK56 →06/87 | ZS115 [1][11] →11/89 | ZM003 |
| 1.6 16 E | 4 | BDY (XU5M) | 65/87 | 05/89→02/93 | Z13 [170] Z247 | | 0.8 | UXT1 / UXT3 | ZS341 [1] 04/91→ | ZM003 |
| 1.6 16 E | 4 | BDZ (XU5M) | 65/87 | 05/89→02/93 | Z13 [170] Z247 | | 0.8 | UXT1 / UXT3 | ZS257 [1] →03/91 | ZM003 |
| 1.8 18 D | 4 | 161A (XUD7) | 44/59 | 10/85→09/93 | GN909 [2][222] GV636 | GR065 | 11V | | | |
| 1.8 D | 4 | 161 (XUD7) | 44/59 | 10/85→09/93 | GN909 [2][222] GV636 | GR065 →01/93 | 11V | | | |
| 1.8 TRD Turbo | 4 | A8A (XUD7TE), AJZ (XUD7TE) | 66/89 | 03/88→12/94 | GN909 [2][222] GV636 | GR065 | 11V | | | |
| 1.9 19 | 4 | D2C (XU92C) | 70/94 | 09/86→11/89 | Z25 →06/89 Z247 07/89→ | | 0.8 | UXK56 →06/89 | | ZM003 |
| 1.9 19 | 4 | D2C (XU92C) | 70/94 | 09/86→12/89 | | | | | ZS257 eng. 4579→ | |
| 1.9 19 | 4 | D2C (XU92C) | 70/94 | 12/87→12/89 | Z247 | | 0.9 | UXT1 / UXT3 | | |
| 1.9 19 | 4 | 159A | 75/101 | 07/86→05/89 | Z25 | | 0.8 | UXK56 | ZS341 | ZM001 |
| 1.9 19 | 4 | D2A (XU92C) | 75/101 | 07/86→12/94 | Z25 | | 0.8 | UXK56 | ZS341 | ZM003 |
| 1.9 19 | 4 | DFZ (XU9J1) | 75/101 | 07/86→12/94 | Z95 [167] →06/87 Z193 07/87→ | | 0.7 | UXT4 →06/87 | ZS247 | ZM001 |
| 1.9 19 | 4 | D2A (XU92C) | 77/103 | 07/86→05/89 | Z247 | | 0.9 | UXT1 / UXT3 | ZS257 [1] | |
| 1.9 19 4WD | 4 | D2E | 78/105 | 06/89→05/91 | | | | | ZS257 [1] | |
| 1.9 19 | 4 | DDZ (XU9M) | 80/107 | 06/88→12/94 | Z193 | | 0.9 | UXT1 / UXT3 | ZS341 | |
| 1.9 19 4WD | 4 | DDZ (XU9M) | 80/107 | 10/90→05/91 | Z13 [170] Z247 | | 0.8 | UXT1 / UXT3 | ZS341 | |
| 1.9 19 | 4 | DKZ (XU9JA) | 88/118 | 06/88→12/94 | Z13 [170] Z247 | | 0.8 | UXT1 / UXT3 | ZS257 [175][181][254] | ZM003 |
| 1.9 19 D | 4 | 162 (XUD9), D9A (XUD9), DJZ (XUD9Y) | 47/63 | 09/83→11/94 | GN909 [2][222] GV636 | GR065 | 11V | | | |
| 1.9 19 D | 4 | D9B (XUD9A/U) | 51/68 | 03/87→12/94 | GN909 [2][222] GV636 | GR065 | 11V | | | |
| 1.9 19 E | 4 | DDZ (XU9M) | 80/107 | 06/88→02/93 | Z193 | | 0.9 | UXT1 / UXT3 | ZS341 | ZM003 |
| 1.9 19 E 4WD | 4 | D2F | 80/107 | 04/89→02/93 | Z247 | | 0.9 | UXT1 / UXT3 | ZS341 [87][180] ZS257 04/90→ | |
| 1.9 19 GTi | 4 | DKZ (XU9JA) | 88/118 | 06/88→02/93 | Z13 [170] Z247 | | 0.8 | UXT1 / UXT3 | ZS257 [175][181][254] | |
| 1.9 19 GTi | 4 | D6A (XU9J2) | 90/121 | 07/86→02/93 | Z24 | | 0.8 | UXT5 | ZS257 | ZM003 [175] ZM026 04/90→ |
| 1.9 19 GTi 16V | 4 | DFW (XU9J4) | 108/145 | 03/88→02/93 | Z60 | | 1.2 | | ZS257 | ZM003 |
| 1.9 19 GTi 16V | 4 | D6C (XU9J4) | 116/156 | 09/87→12/88 | Z24 | | 0.8 | UXT5 | ZS257 | ZM001 |

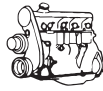

kW/BHP

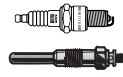

... CITROËN



... BX

| | | | | | | | |
|------------|---|--|-------|-------------|-------|-----|--|
| 1.9 D | 4 | | 52/70 | 01/87→01/92 | GN954 | 11V | |
| 1.9 RD 4WD | 4 | | 52/70 | 01/87→01/92 | GN954 | 11V | |

C1

| | | | | | | | |
|---------|---|-------------------|-------|--------|-------|-----|--------|
| 1.0 | 3 | 1KR-FE | 50/67 | 06/05→ | Z273 | 1.1 | ZSE164 |
| 1.4 HDi | 4 | 8HT (DV4TD), DV4D | 40/54 | 06/05→ | GN056 | 11V | |

C2

| | | | | | | | | |
|---------|---|--------------------------|--------|--------|------------------------------------|----------------|-----------------|--|
| 1.1 | 4 | HFX (TU1JP) | 44/59 | 09/03→ | Z193 | 0.9 | UXT1 / UXT3 | ZSE045 [1] →10/05 ZSE048 [1][10] 11/05→ |
| 1.1 LPG | 4 | HFX (TU1JP) | 44/59 | 09/03→ | Z340 | 0.7 | UXT12 | |
| 1.4 | 4 | KFV (TU3JP) | 54/72 | 09/03→ | Z193 →08/05 | 0.9 | UXT1 / UXT3 | ZSE047 [13] →02/05 |
| 1.4 | 4 | KFV (TU3JP) | 55/74 | 10/06→ | | | | ZSE047 [13] |
| 1.4 LPG | 4 | KFV (TU3JP) | 54/72 | 09/03→ | Z340 →08/05 | 0.7 | UXT12 →08/05 | |
| 1.4 16V | 4 | KFU | 65/87 | 06/06→ | Z243 | 0.9 | | |
| 1.4 16V | 4 | KFU (ET3J4) | 65/87 | 06/06→ | | | | ZS472 |
| 1.4 HDi | 4 | 8HX (DV4TD), 8HZ (DV4TD) | 50/67 | 09/03→ | GN047 | 11V | | |
| 1.6 | 4 | NFU (TU5JP4) | 80/107 | 09/03→ | Z184 | 0.9 | UXT13 | ZSE045 |
| 1.6 LPG | 4 | NFU (TU5JP4) | 80/107 | 09/03→ | Z226 [168] | 0.8 | | |
| 1.6 HDi | 4 | 9HZ (DV6TED4) | 80/107 | 09/05→ | GN047 →06/07 GN056 07/07→ | 11V 11V | | |
| 1.6 VTS | 4 | NFS (TU5JP4S) | 90/121 | 01/05→ | | | | ZSE045 |

C3

| | | | | | | | | |
|------------|---|--------------|--------|--------|----------------------------|------------|-----------------|---------------------------------|
| 1.4 | 4 | KFV (TU3JP) | 54/72 | 05/03→ | Z193 →08/05 | 0.9 | UXT1 / UXT3 | ZSE047 [13] →08/05 →10/12 |
| 1.4 LPG | 4 | KFV (TU3JP) | 54/72 | 05/03→ | Z340 →08/05 | 0.7 | UXT12 →08/05 | |
| 1.4 HDi | 4 | 8HX (DV4TD) | 50/67 | 04/04→ | GN047 [246] GN056 [163] | 11V 11V | | |
| 1.4 Hybrid | 4 | KFV (TU3JP) | 54/72 | 05/05→ | | | | ZSE047 [13] |
| 1.6 | 4 | NFU (TU5JP4) | 80/107 | 05/03→ | Z184 →08/05 | 0.9 | UXT13 →08/05 | ZSE045 |
| 1.6 LPG | 4 | NFU (TU5JP4) | 80/107 | 05/03→ | Z226 [168] →08/05 | 0.8 | | |

C3 I

| | | | | | | | | |
|----------------|---|-------------------------|-------|--------|----------------------------|------------|-----------------------|--|
| 1.1 i | 4 | HFX (TU1JP) | 44/59 | 02/02→ | Z193 | 0.9 | UXT1 / UXT3 | ZSE047 [13] →10/05 ZSE048 [10] 11/05→ |
| 1.1 i LPG | 4 | HFX (TU1JP) | 44/59 | 02/02→ | Z340 | 0.7 | UXT12 | |
| 1.4 16V | 4 | KFU (ET3J4) | 65/87 | 12/03→ | Z243 | 0.9 | | ZS472 |
| 1.4 16V HDi | 4 | 8HY (DV4TED4) | 66/89 | 02/02→ | GN047 | 11V | | |
| 1.4 HDi | 4 | 8HX (DV4TD) | 50/67 | 02/02→ | GN047 [247] GN056 [164] | 11V 11V | | |
| 1.4 HDi | 4 | | 52/70 | 07/03→ | GN056 | 11V | | |
| 1.4 HDi | 4 | | 55/74 | 05/05→ | GN056 | 11V | | |
| 1.4 i | 4 | KFV (TU3A), KFV (TU3JP) | 54/72 | 02/02→ | Z193 →08/05 | 0.9 | UXT1 / UXT3 →08/05 | ZSE047 [13] →10/05 ZSE048 [10] 11/05→ |
| 1.4 i LPG | 4 | KFV (TU3A), KFV (TU3JP) | 54/72 | 02/02→ | Z340 →08/05 | 0.7 | UXT12 →08/05 | |
| 1.4 i Bivalent | 4 | KFV (TU3JP) | 54/72 | 02/02→ | Z193 →08/05 | 0.9 | UXT1 / UXT3 →08/05 | ZSE047 [13] |

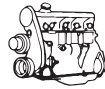

kW/BHP

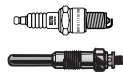
**... CITROËN****... C3 I**

| | | | | | | | | |
|-------------|---|----------------|--------|--------|----------------------------|-----|-----------------|--------|
| 1.6 16V | 4 | NFU (TU5JP4) | 80/107 | 02/02→ | Z184 →08/05 | 0.9 | UXT13 →08/05 | ZSE045 |
| 1.6 16V LPG | 4 | NFU (TU5JP4) | 80/107 | 02/02→ | Z226 [168] →08/05 | 0.8 | | |
| 1.6 16V HDi | 4 | 9HX (DV6ATED4) | 66/89 | 10/05→ | GN047 [249] GN056 [158] | 11V | | |
| 1.6 16V HDi | 4 | 9HZ (DV6TED4) | 80/107 | 09/05→ | GN047 [249] GN056 [158] | 11V | | |
| 1.6 Bioflex | 4 | | 83/111 | 06/05→ | | | | ZSE045 |

C3 II

| | | | | | | | | |
|----------------|---|-------------------------|--------|--------|------------|-----|-------------|------------------------|
| 1.1 | 4 | HFX (TU1JP) | 44/59 | 11/09→ | | | | ZSE048 ⁽¹⁰⁾ |
| 1.4 | 4 | KFT (TU3A), KFY (TU3A) | 54/72 | 11/09→ | Z193 | 0.9 | UXT1 / UXT3 | ZSE048 ⁽¹⁰⁾ |
| 1.4 LPG | 4 | KFT (TU3A), KFY (TU3A) | 54/72 | 11/09→ | Z340 | 0.7 | UXT12 | |
| 1.4 HDi 70 | 4 | 8HR (DV4C), 8HZ (DV4TD) | 50/67 | 11/09→ | GN056 | 11V | | |
| 1.4 VTi 95 | 4 | 8FP (EP3) | 70/94 | 11/09→ | Z320 | 1.0 | | ZSE143 |
| 1.4 VTi 95 LPG | 4 | 8FP (EP3) | 70/94 | 11/09→ | Z320 [168] | 1.0 | | |
| 1.6 HDi | 4 | 9HP (DV6DTED) | 68/91 | 11/09→ | GE121A | 5V | | |
| 1.6 HDi 90 | 4 | 9HX (DV6ATED4) | 66/89 | 11/09→ | GN056 | 11V | | |
| 1.6 HDi 110 | 4 | 9HR (DV6C) | 82/110 | 11/09→ | GE121A | 5V | | |
| 1.6 HDi 115 | 4 | | 84/113 | 09/12→ | GE121A | 5V | | |
| 1.6 VTi 120 | 4 | 5FS (EP6C) | 88/118 | 11/09→ | Z332 | 0.7 | | ZSE143 |

C3 Picasso

| | | | | | | | | |
|----------------|---|---------------------------------|--------|--------|------------|-----|--|--------|
| 1.4 VTi 95 | 4 | 8FN (EP3), 8FP (EP3), 8FS (EP3) | 70/94 | 02/09→ | Z320 | 1.0 | | ZSE143 |
| 1.4 VTi 95 LPG | 4 | 8FN (EP3), 8FP (EP3), 8FS (EP3) | 70/94 | 02/09→ | Z320 [168] | 1.0 | | |
| 1.6 HDi | 4 | 9HX (DV6ATED4) | 66/89 | 02/09→ | GN056 | 11V | | |
| 1.6 HDi | 4 | 9HZ (DV6TED4) | 80/107 | 02/09→ | GN056 | 11V | | |
| 1.6 HDi 90 | 4 | 9HP (DV6DTED) | 68/91 | 07/10→ | GE121A | 5V | | |
| 1.6 HDi 110 | 4 | 9HR (DV6C) | 82/110 | 05/10→ | GE121A | 5V | | |
| 1.6 HDi 115 | 4 | 9HD (DV6C) | 84/113 | 01/13→ | GE121A | 5V | | |
| 1.6 VTi 120 | 4 | 5FS (EP6C) | 88/118 | 02/09→ | | | | ZSE143 |
| 1.6 VTi 120 | 4 | 5FW (EP6) | 88/118 | 02/09→ | Z332 | 0.7 | | ZSE143 |

C4

| | | | | | | | | |
|-------------|---|---------------------------------|---------|--------|----------------------------|-----|-------|------------------|
| 1.4 16V | 4 | KFU (ET3J4) | 65/87 | 11/04→ | Z243 | 0.9 | | ZS472 |
| 1.6 16V | 4 | NFU (TU5JP4) | 80/107 | 11/04→ | Z184 | 0.9 | UXT13 | ZSE045 |
| 1.6 16V LPG | 4 | NFU (TU5JP4) | 80/107 | 11/04→ | Z226 [168] | 0.8 | | |
| 1.6 HDi | 4 | 9HX (DV6ATED4) | 66/89 | 11/04→ | GN047 | 11V | | |
| 1.6 HDi | 4 | 9HY (DV6TED4), 9HZ (DV6TED4) | 80/107 | 11/04→ | GN047 [249] GN056 [158] | 11V | | |
| 1.6 HDi | 4 | 9HY (DV6TED4), 9HZ (DV6TED4) | 80/107 | 07/06→ | GN047 [249] GN056 [250] | 11V | | |
| 1.6 THP 150 | 4 | 5FX (EP6DT) | 110/148 | 07/08→ | Z332 | 0.7 | | ZSE143 |
| 1.6 VTi 120 | 4 | 5FW (EP6) | 88/118 | 07/08→ | Z332 | 0.7 | | ZSE143 →07/10 |
| 2.0 16V | 4 | RFN (EW10J4) | 100/134 | 11/04→ | Z183 | 0.9 | UXT13 | ZS348 |
| 2.0 16V | 4 | RFJ (EW10A) | 103/138 | 07/06→ | Z223 | 0.9 | UXT13 | ZS352 |
| 2.0 16V | 4 | RFK (EW10J4S) | 130/174 | 11/04→ | Z184 | 0.9 | UXT13 | ZS351 |
| 2.0 16V LPG | 4 | RFN (EW10J4) | 100/134 | 11/04→ | Z184 [168] | 0.9 | UXT13 | |
| 2.0 16V LPG | 4 | RFK (EW10J4S) | 130/174 | 11/04→ | Z226 [168] | 0.8 | | |
| 2.0 HDi | 4 | RHR (DW10BTD4) | 100/134 | 11/04→ | GN054 | 11V | | |
| 2.0 HDi | 4 | RHF (DW10BTD4) | 103/138 | 07/08→ | GN054 | 11V | | |

C4 I

| | | | | | | | | |
|----------------------|---|----------------|--------|--------|------------|-----|-------|--------|
| 1.4 16V | 4 | KFU (ET3J4) | 65/87 | 11/04→ | Z243 | 0.9 | | ZS472 |
| 1.6 16V | 4 | NFU (TU5JP4) | 80/107 | 11/04→ | Z184 | 0.9 | UXT13 | ZSE045 |
| 1.6 16V LPG | 4 | NFU (TU5JP4) | 80/107 | 11/04→ | Z226 [168] | 0.8 | | |
| 1.6 16V Bio-Flex | 4 | NFU (TU5JP4) | 80/107 | 09/07→ | Z184 | 0.9 | UXT13 | ZSE045 |
| 1.6 16V Bio-Flex LPG | 4 | NFU (TU5JP4) | 80/107 | 09/07→ | Z226 [168] | 0.8 | | |
| 1.6 Flex | 4 | | 81/109 | 02/09→ | | | | ZSE045 |
| 1.6 HDi | 4 | 9HX (DV6ATED4) | 66/89 | 11/04→ | GN047 | 11V | | |



kw/BHP

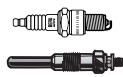

... CITROËN



... C4 I

| | | | | | | | |
|-------------|---|---------------------------------|---------|--------|--|------------|------------------|
| 1.6 HDi | 4 | 9HY (DV6TED4), 9HZ (DV6TED4) | 80/107 | 11/04→ | GN047 ^[249] GN056 ^[158] | 11V 11V | |
| 1.6 THP 140 | 4 | 5FT (EP6DT) | 103/138 | 07/08→ | Z332 | 0.7 | ZSE143 |
| 1.6 THP 150 | 4 | 5FX (EP6DT) | 110/148 | 07/08→ | Z332 | 0.7 | ZSE143 |
| 1.6 VTi 120 | 4 | 5FW (EP6) | 88/118 | 07/08→ | Z332 | 0.7 | ZSE143 →09/10 |
| 2.0 16V | 4 | RFN (EW10J4) | 100/134 | 11/04→ | Z183 | 0.9 | UXT13 ZS348 |
| 2.0 16V | 4 | RFJ (EW10A) | 103/138 | 11/04→ | Z223 | 0.9 | UXT13 ZS352 |
| 2.0 16V | 4 | RFK (EW10J4S) | 130/174 | 11/04→ | Z184 | 0.9 | UXT13 ZS351 |
| 2.0 16V LPG | 4 | RFN (EW10J4) | 100/134 | 11/04→ | Z184 ^[168] | 0.9 | UXT13 |
| 2.0 16V LPG | 4 | RFK (EW10J4S) | 130/174 | 11/04→ | Z226 ^[168] | 0.8 | |
| 2.0 HDi | 4 | RHR (DW10BTD4) | 100/134 | 11/04→ | GN054 | 11V | |
| 2.0 HDi | 4 | RHF (DW10BTD4) | 103/138 | 07/08→ | GN054 | 11V | |

C4 II

| | | | | | | | |
|-----------------|---|-----------------|---------|--------|--------|-----|------------------|
| 1.4 VTi 95 | 4 | 8FP (EP3) | 70/94 | 11/09→ | Z332 | 0.7 | ZSE143 09/10→ |
| 1.6 HDi 90 | 4 | 9HP (DV6DTE) | 68/91 | 11/09→ | GE121A | 5V | |
| 1.6 HDi 110 | 4 | 9HR (DV6C) | 82/110 | 11/09→ | GE121A | 5V | |
| 1.6 HDi 115 | 4 | 9HR (DV6C) | 84/113 | 07/12→ | GE121A | 5V | |
| 1.6 THP 155 | 4 | 5FV (EP6CDT) | 115/154 | 11/09→ | Z332 | 0.7 | ZSE143 |
| 1.6 VTi 120 | 4 | 5FS (EP6C) | 88/118 | 11/09→ | Z332 | 0.7 | ZSE143 09/10→ |
| 1.6 VTi 120 LPG | 4 | 5FS (EP6C) | 88/118 | 09/11→ | | | ZSE143 |
| 2.0 HDi 150 | 4 | RHE (DW10CTED4) | 110/148 | 11/09→ | GE121A | 5V | |

C4 AIRCROSS

| | | | | | | | |
|-------------|---|------------|--------|--------|--------|----|--|
| 1.6 HDi 115 | 4 | 9HL (DV6C) | 84/113 | 04/12→ | GE121A | 5V | |
|-------------|---|------------|--------|--------|--------|----|--|

C4 CACTUS

| | | | | | | | |
|------------|---|--|-------|--------|--------|----|--|
| 1.6 HDi 90 | 4 | | 68/91 | 09/14→ | GE121A | 5V | |
|------------|---|--|-------|--------|--------|----|--|

C4 Grand Picasso I

| | | | | | | | |
|-------------|---|---------------------------------|---------|--------|--------|-----|-------------|
| 1.6 16V | 4 | 5FT (EP6DT) | 103/138 | 07/08→ | | | ZSE143 |
| 1.6 16V | 4 | 5FX (EP6DT) | 110/148 | 10/08→ | Z332 | 0.7 | ZSE143 |
| 1.6 HDi | 4 | 9HY (DV6TED4), 9HZ (DV6TED4) | 80/107 | 10/06→ | GN056 | 11V | |
| 1.6 HDi 110 | 4 | 9HL (DV6C), 9HR (DV6C) | 82/110 | 09/10→ | GE121A | 5V | |
| 1.6 THP 155 | 4 | 5FV (EP6CDT) | 115/154 | 09/10→ | Z332 | 0.7 | ZSE143 |
| 1.6 VTi 120 | 4 | 5FW (EP6) | 88/118 | 07/08→ | | | ZSE143 |
| 1.8 i 16V | 4 | 6FY (EW7A) | 92/123 | 10/06→ | | | ZS352 |
| 2.0 HDi 138 | 4 | RHR (DW10BTD4) | 100/134 | 10/06→ | GN027 | 11V | |
| 2.0 HDi 150 | 4 | RHE (DW10CTED4) | 110/148 | 07/09→ | GE121A | 5V | |
| 2.0 HDi 165 | 4 | RHH (DW10CTED4) | 120/161 | 09/10→ | GE121A | 5V | |
| 2.0 i 16V | 4 | RFJ (EW10A) | 103/138 | 10/06→ | Z223 | 0.9 | UXT13 ZS352 |

C4 Grand Picasso II

| | | | | | | | |
|-----------------|---|--------------|---------|--------|--------|----|--|
| 1.6 HDi 90 | 4 | 9HP (DV6DTE) | 68/91 | 09/13→ | GE121A | 5V | |
| 1.6 HDi 115 | 4 | | 85/114 | 09/13→ | GE121A | 5V | |
| 2.0 BlueHDi 150 | 4 | | 110/148 | 09/13→ | GE121A | 5V | |

C4 Picasso I

| | | | | | | | |
|-------------|---|-----------------------------------|---------|--------|--------|-----|--------|
| 1.6 16V | 4 | 5FX (EP6DT) | 110/148 | 07/08→ | Z332 | 0.7 | ZSE143 |
| 1.6 HDi | 4 | 9HY (DV6TED4), 9HZ (DV6TED4) | 80/107 | 02/07→ | GN056 | 11V | |
| 1.6 HDi 110 | 4 | 9HR (DV6C) | 82/110 | 09/10→ | GE121A | 5V | |
| 1.6 THP 140 | 4 | 5FT (EP6DT) | 103/138 | 07/08→ | | | ZSE143 |
| 1.6 THP 155 | 4 | 5FV (EP6CDT) | 115/154 | 09/10→ | Z332 | 0.7 | ZSE143 |
| 1.6 VTi 120 | 4 | 5FW (EP6) | 88/118 | 07/08→ | Z332 | 0.7 | ZSE143 |
| 1.8 i 16V | 4 | 6FY (EW7A) | 92/123 | 02/07→ | | | ZS352 |
| 2.0 HDi 138 | 4 | RHJ (DW10BTD4), RHR (DW10BTD4) | 100/134 | 02/07→ | GN054 | 11V | |
| 2.0 HDi 150 | 4 | RHE (DW10CTED4) | 110/148 | 07/09→ | GE121A | 5V | |
| 2.0 HDi 165 | 4 | RHH (DW10CTED4) | 120/161 | 09/10→ | GE121A | 5V | |

CITROËN



kW/BHP

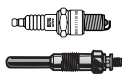

... CITROËN



... C4 Picasso I

| | | | | | | | | |
|-----------|---|-------------|---------|--------|------|-----|-------|-------|
| 2.0 i 16V | 4 | RFJ (EW10A) | 103/138 | 02/07→ | Z223 | 0.9 | UXT13 | ZS352 |
|-----------|---|-------------|---------|--------|------|-----|-------|-------|

C4 Picasso II

| | | | | | | | | |
|-----------------|---|---------------|---------|--------|--------|----|--|--|
| 1.6 HDi 90 | 4 | 9HP (DV6DTEd) | 68/91 | 02/13→ | GE121A | 5V | | |
| 1.6 HDi 115 | 4 | | 85/114 | 02/13→ | GE121A | 5V | | |
| 2.0 BlueHDi 150 | 4 | | 110/148 | 09/13→ | GE121A | 5V | | |

C5 I

| | | | | | | | | |
|--------------|---|-----------------------------------|---------|-------------|-------------------------------|------------|-------|-------|
| 1.8 16V | 4 | 6FZ (EW7J4) | 85/114 | 03/01→08/04 | Z223 | 0.9 | UXT13 | ZS348 |
| 2.0 16V | 4 | RFN (EW10J4) | 100/134 | 03/01→08/04 | Z183 | 0.9 | UXT13 | ZS348 |
| 2.0 16V LPG | 4 | RFN (EW10J4) | 100/134 | 03/01→08/04 | Z184 [168] | 0.9 | UXT13 | |
| 2.0 16V HPI | 4 | RLZ (EW10D) | 103/138 | 03/01→08/04 | Z242 | 1.0 | | ZS348 |
| 2.0 HDi | 4 | RHY (DW10TD) | 66/89 | 03/01→08/04 | GN027 | 11V | | |
| 2.0 HDi | 4 | RHS (DW10ATED), RHZ (DW10ATED) | 79/106 | 03/01→08/04 | GN027 | 11V | | |
| 2.0 HDi | 4 | RHZ (DW10ATED) | 80/107 | 03/01→08/04 | GN027 | 11V | | |
| 2.2 HDi | 4 | 4HX (DW12TED4/FAP) | 98/131 | 03/01→08/04 | GN027 [82] GN054 [83][187] | 11V 11V | | |
| 3.0 Carlsson | 6 | | 173/232 | 09/03→08/04 | | | | ZS347 |
| 3.0 V6 | 6 | XFJ (ES9J4S) | 152/204 | 03/01→08/04 | Z211 | 1.4 | | ZS347 |

C5 II

| | | | | | | | | |
|---------|---|-------------------------------------|---------|--------|----------------------------|------------|-------|-------|
| 1.6 HDi | 4 | 9HY (DV6TED4), 9HZ (DV6TED4) | 80/107 | 09/04→ | GN047 [249] GN056 [158] | 11V 11V | | |
| 1.8 16V | 4 | 6FZ (EW7J4) | 85/114 | 09/04→ | Z223 | 0.9 | UXT13 | ZS348 |
| 2.0 16V | 4 | RFJ (EW10A) | 103/138 | 09/04→ | Z223 | 0.9 | UXT13 | ZS352 |
| 2.0 HDi | 4 | RHR (DW10BTEd4) | 100/134 | 09/04→ | GN054 | 11V | | |
| 2.2 HDi | 4 | 4HX (DW12TED4/FAP) | 98/131 | 09/04→ | GN027 [82] GN054 [83] | 11V 11V | | |
| 2.2 HDi | 4 | 4HP (DW12BTEd4), 4HR (DW12BTEd4) | 120/161 | 05/06→ | GN063 | 11V | | |
| 2.2 HDi | 4 | DW12BTEd4 | 125/168 | 04/06→ | GN063 | 11V | | |
| 3.0 | 6 | | 173/232 | 09/04→ | | | | ZS347 |
| 3.0 V6 | 6 | XFU (ES9A), XFX (ES9J4S) | 152/204 | 09/04→ | Z211 | 1.4 | | ZS347 |

C5 III

| | | | | | | | | |
|-----------------|---|-------------------------------------|---------|--------|--------|-----|-------|--------|
| 1.6 HDi | 4 | 9HZ (DV6TED4) | 80/107 | 02/08→ | GN056 | 11V | | |
| 1.6 HDi 110 | 4 | 9HR (DV6C) | 82/110 | 07/10→ | GE121A | 5V | | |
| 1.6 HDi 115 | 4 | 9HR (DV6C) | 84/113 | 01/12→ | GE121A | 5V | | |
| 1.6 THP 155 | 4 | 5FV (EP6CDT), 5FV (EP6DT) | 115/154 | 04/09→ | Z332 | 0.7 | | ZSE143 |
| 1.6 VTi 120 | 4 | 5FS (EP6C) | 88/118 | 07/10→ | Z332 | 0.7 | | ZSE143 |
| 2.0 16V | 4 | RFJ (EW10A) | 103/138 | 02/08→ | Z223 | 0.9 | UXT13 | ZS352 |
| 2.0 16V BioFlex | 4 | RFJ (EW10A) | 103/138 | 02/08→ | Z223 | 0.9 | UXT13 | ZS352 |
| 2.0 HDi | 4 | RHF (DW10BTEd4), RHR (DW10BTEd4) | 100/134 | 02/08→ | GN054 | 11V | | |
| 2.0 HDi 140 | 4 | RHF (DW10BTEd4) | 103/138 | 04/09→ | GN054 | 11V | | |
| 2.0 HDi 150 | 4 | RHE (DW10CTED4) | 110/148 | 04/09→ | GE121A | 5V | | |
| 2.0 HDi 165 | 4 | RHH (DW10CTED4) | 120/161 | 04/09→ | GE121A | 5V | | |
| 2.2 HDi | 4 | 4HT (DW12BTEd4) | 125/168 | 02/08→ | GN063 | 11V | | |
| 2.2 HDi 165 | 4 | 4HP (DW12BTEd4) | 120/161 | 02/08→ | GN063 | 11V | | |
| 2.7 HDi | 6 | DT17ED4, UHZ (DT17BTEd4) | 150/201 | 02/08→ | GN045 | 11V | | |
| 3.0 V6 | 6 | XFU (ES9A) | 155/208 | 02/08→ | | | | ZS347 |

C6

| | | | | | | | | |
|---------|---|--------------------------|---------|--------|-------|-----|--|-------|
| 2.2 HDi | 4 | 4HP (DW12BTEd4) | 120/161 | 06/06→ | GN063 | 11V | | |
| 2.2 HDi | 4 | DW12BTEd4 | 125/168 | 06/06→ | GN063 | 11V | | |
| 2.7 HDi | 6 | DT17ED4, UHZ (DT17BTEd4) | 150/201 | 09/05→ | GN045 | 11V | | |
| 3.0 V6 | 6 | XFV (ES9A) | 155/208 | 09/05→ | Z211 | 1.4 | | ZS347 |
| 3.0 V6 | 6 | XFJ (ES9J4S) | 155/208 | 09/05→ | | | | ZS347 |

12/05→

ZS347

12/05→

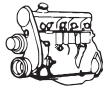

kw/BHP

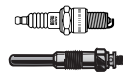

... CITROËN



C8

| | | | | | | | | |
|-------------|---|--|---------|--------|------------------------------------|------------|-------|-------|
| 2.0 | 4 | RFN (EW10J4) | 100/134 | 07/02→ | Z183 | 0.9 | UXT13 | ZS348 |
| 2.0 LPG | 4 | RFN (EW10J4) | 100/134 | 07/02→ | Z184 [168] | 0.9 | UXT13 | |
| 2.0 16V | 4 | RFJ (EW10A) | 103/138 | 09/05→ | Z223 | 0.9 | UXT13 | ZS352 |
| 2.0 HDi | 4 | RHM (DW10ATED4), RHT (DW10ATED4) | 79/106 | 07/02→ | GN027 [82] GN054 [83] | 11V 11V | | |
| 2.0 HDi | 4 | RHW (DW10ATED4) | 80/107 | 07/02→ | GN027 [245] GN054 [162] | 11V 11V | | |
| 2.0 HDi | 4 | RHK (DW10UTED4) | 88/118 | 02/07→ | GN054 | 11V | | |
| 2.0 HDi 135 | 4 | RHD (DW10CB), RHD (DW10CTED4), RHR (DW10BTED4) | 100/134 | 03/06→ | GN054 | 11V | | |
| 2.0 HDi 165 | 4 | RHE (DW10CTED4), RHH (DW10CTED4) | 120/161 | 03/06→ | GE121A | 5V | | |
| 2.2 | 4 | 3FZ (EW12J4) | 116/156 | 07/02→ | Z223 | 0.9 | UXT13 | ZS351 |
| 2.2 HDi | 4 | 4HW (DW12TED4) | 94/126 | 07/02→ | GN027 →04/03 GN054 05/03→ | 11V 11V | | |
| 2.2 HDi | 4 | 4HP (DW12BTED4), 4HR (DW12BTED4) | 120/161 | 06/07→ | GN063 | 11V | | |
| 2.2 HDi | 4 | 4HT (DW12BTED4) | 125/168 | 06/06→ | GN063 | 11V | | |
| 3.0 V6 | 6 | XFX (ES9J4S) | 150/201 | 07/02→ | Z211 | 1.4 | | ZS347 |

C15

| | | | | | | | | |
|---------|---|-------------|-------|-------------|---|-------------------|--|--------------------------------------|
| 1.1 | 4 | HDZ (TU1M) | 44/59 | 08/88→07/96 | Z247 →06/95 Z123 07/95→ | 0.9 1.0 | UXT1 / UXT3 →06/95 UXT9 07/95→ | ZS247 [175][254] ZS247 [181][254] |
| 1.1 LPG | 4 | HDZ (TU1M) | 44/59 | 08/88→07/96 | Z340 →06/95 Z129 07/95→ | 0.7 1.6 | UXT12 →06/95 | |
| 1.4 | 4 | 150D (XY7) | 44/59 | 05/87→10/92 | Z25 | 0.8 | UXK56 | ZM001 |
| 1.4 | 4 | KDY (TU3M) | 55/74 | 05/91→07/96 | Z13 [170] →06/95 Z247 →06/95 Z123 07/95→ | 0.8 0.9 1.0 | UXT1 / UXT3 →06/95 UXT1 / UXT3 →06/95 UXT9 07/95→ | ZS247 ZM003 |
| 1.4 LPG | 4 | 150D (XY7) | 44/59 | 05/87→10/92 | Z31 [168] | 0.8 | UXK56 | |
| 1.4 LPG | 4 | KDY (TU3M) | 55/74 | 05/91→07/96 | Z340 →06/95 Z129 07/95→ | 0.7 1.6 | UXT12 →06/95 | |
| 1.8 D | 4 | 161A (XUD7) | 44/59 | 04/87→08/00 | GN954 | 11V | | |

C35

| | | | | | | | | |
|-------|---|--------|-------|-------------|----------------------|-----|--|-------------------------|
| 2.0 | 4 | B20614 | 65/87 | 11/73→01/94 | | | | ZS110 [1][15] →12/92 |
| 2.2 D | 4 | B22615 | 45/60 | 11/73→01/80 | GV636 | 11V | | |
| 2.5 D | 4 | B25637 | 51/68 | 02/80→01/94 | GN909 07/81→12/92 | 11V | | |

C-CROSSER

| | | | | | | | | |
|-------------|---|-----------------|---------|--------|-------|-----|--|--|
| 2.2 HDi 4WD | 4 | 4HN (DW12MTED4) | 115/154 | 02/07→ | GN063 | 11V | | |
|-------------|---|-----------------|---------|--------|-------|-----|--|--|

C-ELYSEE

| | | | | | | | | |
|------------|---|--|-------|--------|--------|----|--|--|
| 1.6 HDi 92 | 4 | | 68/91 | 11/12→ | GE121A | 5V | | |
|------------|---|--|-------|--------|--------|----|--|--|

CX I

| | | | | | | | | |
|----------|---|---------|--------|-------------|-----|-----|------|----------------------|
| 2.0 2000 | 4 | M20-616 | 75/101 | 09/74→05/79 | Z41 | 0.8 | | |
| 2.0 2000 | 4 | 829 A5 | 78/105 | 06/79→08/85 | Z17 | 0.8 | UXT4 | ZS115 [11] →06/82 |
| | | | | | | | | ZM001 →07/82 |

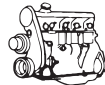

kW/BHP

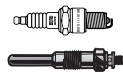
**... CITROËN****... CX I**

| | | | | | | | | | |
|--------------------|---|----------|---------|-------------|---|-----------------|--------------------|--------------------|-------|
| 2.2 2200 | 4 | M22-617 | 82/110 | 09/74→07/76 | Z41 | | 0.8 | ZS110 [1][15] | |
| 2.2 2200 | 4 | J6T A500 | 85/114 | 06/81→08/85 | | | | ZS106 [1][11][254] | |
| | | | | | | | | ZS115 [1][11] | |
| 2.2 2200 D | 4 | M22-621 | 49/66 | 10/75→02/79 | GV130 | | 9.5V | | |
| 2.3 2400 | 4 | M23-623 | 85/114 | 08/76→06/80 | Z41 | | 0.8 | ZS110 [15] | |
| 2.3 2400 | 4 | M23-639 | 88/118 | 05/80→05/82 | Z41 | | 0.8 | ZS110 [1][15] | |
| | | | | | | | | →12/81 | |
| 2.3 2400 GTi | 4 | M23-622 | 94/126 | 06/77→06/83 | Z41 | | 0.8 | | |
| 2.3 2400 GTi | 4 | M23-622 | 94/126 | 06/77→06/82 | | | | ZS106 [11] | |
| 2.3 2400 GTi | 4 | M23-622 | 94/126 | 07/82→06/83 | | | | ZS110 [15] | ZM005 |
| 2.3 2400 GTi | 4 | M23-622 | 96/129 | 06/77→06/82 | Z41 | | 0.8 | ZS106 [11] | |
| 2.5 25 D Turbo | 4 | M25-648 | 70/94 | 04/83→08/85 | GN909 [2][222] GV602 | GR059 | 11V 11V | | |
| 2.5 25 GTi Turbo 2 | 4 | M25-662 | 122/164 | 06/84→08/85 | | | | ZS115 [1][11] | |
| 2.5 25 TRi | 4 | M25-659 | 100/134 | 07/83→08/85 | | | | ZS115 [1][11] | |
| 2.5 2500 D | 4 | M25-629 | 55/74 | 02/78→08/85 | GV130 →07/79 GN909 [222] 08/79→ GV602 08/79→ | GR059 08/79→ | 9.5V 11V 11V | | |
| 2.5 2500 D Turbo | 4 | M25-648 | 70/94 | 04/83→08/85 | GN909 [2][222] GV602 | GR059 | 11V 11V | | |

CX II

| | | | | | | | | | |
|--------------------|---|----------|---------|-------------|-------------------------|-------|------------|-------|-------------------------------------|
| 2.0 20 | 4 | 829 A5 | 78/105 | 08/85→08/86 | Z17 | | 0.8 | UXT4 | ZS106 [1][11][254] ZS115 [1][11] |
| 2.0 20 RE | 4 | 829 A5 | 78/105 | 08/85→12/92 | Z17 | | 0.8 | UXT4 | ZS106 [1][11][254] ZS115 [1][11] |
| | | | | | | | | | ZM001 |
| 2.2 22 TRS | 4 | J6T A500 | 83/111 | 07/85→12/92 | Z25 | | 0.8 | UXK56 | ZS106 [1][11][254] ZS115 [1][11] |
| 2.2 22 TRS | 4 | J6T A500 | 85/114 | 07/85→07/89 | | | | | ZS106 [1][11][254] ZS115 [1][11] |
| 2.5 25 D | 4 | M25-660 | 54/72 | 08/85→12/92 | GN909 [2][222] GV602 | GR059 | 11V 11V | | |
| 2.5 25 D Turbo | 4 | M25-648 | 70/94 | 08/85→12/86 | GN909 [2][222] GV602 | GR059 | 11V 11V | | |
| 2.5 25 D Turbo | 4 | M25-669 | 88/118 | 01/87→12/92 | GN909 [2][222] GV602 | GR059 | 11V 11V | | |
| 2.5 25 D Turbo 2 | 4 | M25-669 | 88/118 | 01/87→12/92 | GN909 [2][222] GV602 | GR059 | 11V 11V | | |
| 2.5 25 GTi | 4 | M25-668 | 89/119 | 05/86→12/92 | Z41 | | 0.8 | | ZS115 [1][11] |
| 2.5 25 GTi Turbo 2 | 4 | M25-667 | 115/154 | 09/86→12/92 | Z41 | | 0.8 | | ZS115 [1][11] |
| 2.5 25 GTi Turbo 2 | 4 | M25-662 | 122/164 | 08/85→12/92 | Z41 | | 0.8 | | ZS115 [1][11] |
| 2.5 25 i | 4 | M25-668 | 89/119 | 05/86→12/92 | Z41 | | 0.8 | | ZS115 [1][11] |
| 2.5 25 TRi | 4 | M25-659 | 100/134 | 08/85→12/92 | Z41 | | 0.8 | | ZS115 [1][11] |
| | | | | | | | | | ZM001 |
| 2.5 2500 D Turbo | 4 | M25-648 | 70/94 | 08/85→12/86 | GN909 [2][222] GV602 | | 11V 11V | | |

DS

| | | | | | | | | | |
|--------|---|--------|---------|-------------|-----------|--|-----|--|------------|
| 1.9 19 | 4 | | 59/79 | 05/59→04/66 | Z48 | | 0.8 | | |
| 1.9 19 | 4 | | 61/82 | 08/56→12/65 | Z48 | | 0.8 | | |
| 2.0 19 | 4 | B20700 | 62/83 | 04/66→10/72 | Z48 | | 0.8 | | |
| 2.0 20 | 4 | | 66/89 | 11/68→10/72 | Z41 | | 0.8 | | |
| 2.0 20 | 4 | B20744 | 72/97 | 07/68→07/75 | Z41 | | 0.8 | | ZS106 [11] |
| 2.0 20 | 4 | B20704 | 73/98 | 09/72→07/75 | Z41 | | 0.8 | | |
| 2.2 | 4 | B22627 | 102/137 | 02/69→06/72 | Z19 [168] | | 0.8 | | |
| 2.2 21 | 4 | B22644 | 74/99 | 04/68→03/69 | Z57 | | 0.6 | | |
| 2.2 21 | 4 | B22644 | 76/102 | 09/65→08/72 | Z57 | | 0.6 | | ZS106 [11] |
| 2.2 21 | 4 | B22644 | 78/105 | 04/69→07/75 | Z57 | | 0.6 | | |
| 2.2 21 | 4 | B22627 | 88/118 | 12/69→08/75 | Z19 [168] | | 0.8 | | |



kW/BHP

**... CITROËN****... DS**

| | | | | | | | | |
|--------|---|--|--------|-------------|-----|--|-----|---|
| 2.3 | 4 | | 93/125 | 07/72→06/74 | | | | ZS110 ^{(1)[15]} ZS115 ^{(1)[11]} |
| 2.3 23 | 4 | | 81/109 | 09/72→07/75 | Z41 | | 0.8 | ZS106 ^{(1)[1254]} ZS115 ^{(1)[1]} |
| 2.3 23 | 4 | | 93/125 | 09/72→07/75 | Z41 | | 0.8 | ZS115 ^{(1)[1]} |

DS3

| | | | | | | | | |
|----------------|---|---------------------------|---------|--------|-----------------------|--|-----|--------|
| 1.4 HDi 70 | 4 | 8HR (DV4C) | 50/67 | 04/10→ | GE121A | | 5V | |
| 1.4 VTi 95 | 4 | 8FP (EP3) | 70/94 | 04/10→ | Z320 | | 1.0 | ZSE143 |
| 1.4 VTi 95 LPG | 4 | 8FP (EP3) | 70/94 | 04/10→ | Z320 ⁽¹⁶⁸⁾ | | 1.0 | |
| 1.6 HDi 90 | 4 | 9HP (DV6DTED) | 68/91 | 11/09→ | GE121A | | 5V | |
| 1.6 HDi 90 | 4 | 9HP (DV6DTED) | 69/93 | 01/13→ | GE121A | | 5V | |
| 1.6 HDi 100 | 4 | | 73/98 | 07/14→ | GE121A | | 5V | |
| 1.6 HDi 110 | 4 | 9HR (DV6C) | 82/110 | 11/09→ | GE121A | | 5V | |
| 1.6 HDi 115 | 4 | 9HL (DV6C) | 84/113 | 08/12→ | GE121A | | 5V | |
| 1.6 HDi 115 | 4 | BHX (DV6FC) | 85/114 | 10/13→ | GE121A | | 5V | |
| 1.6 HDi 120 | 4 | BHZ (DV6FC) | 88/118 | 10/13→ | GE121A | | 5V | |
| 1.6 THP 155 | 4 | 5FR (EP6DT), 5FV (EP6CDT) | 115/154 | 04/10→ | Z332 | | 0.7 | ZSE143 |
| 1.6 VTi 120 | 4 | 5FS (EP6C) | 88/118 | 04/10→ | Z332 | | 0.7 | ZSE143 |

DS4

| | | | | | | | | |
|-------------|---|-----------------|---------|--------|--------|--|-----|--------|
| 1.6 HDi 90 | 4 | 9HP (DV6DTED) | 68/91 | 05/11→ | GE121A | | 5V | |
| 1.6 HDi 110 | 4 | | 81/109 | 04/11→ | GE121A | | 5V | |
| 1.6 HDi 110 | 4 | 9HR (DV6C) | 82/110 | 04/11→ | GE121A | | 5V | |
| 1.6 HDi 115 | 4 | 9HL (DV6C) | 84/113 | 08/12→ | GE121A | | 5V | |
| 1.6 THP 155 | 4 | 5FV (EP6CDT) | 115/154 | 04/11→ | Z332 | | 0.7 | |
| 1.6 VTi 120 | 4 | 5FS (EP6C) | 88/118 | 04/11→ | Z332 | | 0.7 | ZSE143 |
| 2.0 HDi 135 | 4 | | 100/134 | 09/11→ | GE121A | | 5V | |
| 2.0 HDi 165 | 4 | RHH (DW10CTED4) | 120/161 | 04/11→ | GE121A | | 5V | |

DS5

| | | | | | | | | |
|-------------------------|---|-----------------|---------|--------|--------|--|-----|--|
| 1.6 HDi | 4 | | 85/114 | 11/13→ | GE121A | | 5V | |
| 1.6 HDi 110 | 4 | 9HR (DV6C) | 82/110 | 11/11→ | GE121A | | 5V | |
| 1.6 HDi 115 | 4 | | 84/113 | 06/12→ | GE121A | | 5V | |
| 1.6 HDi 120 | 4 | | 88/118 | 07/14→ | GE121A | | 5V | |
| 1.6 THP 155 | 4 | 5FV (EP6CDT) | 115/154 | 11/11→ | Z332 | | 0.7 | |
| 2.0 BlueHdi 150 | 4 | | 110/148 | 07/14→ | GE121A | | 5V | |
| 2.0 HDi 135 | 4 | | 100/134 | 11/11→ | GE121A | | 5V | |
| 2.0 HDi 135 Hybrid4 4WD | 4 | | 100/134 | 12/11→ | GE121A | | 5V | |
| 2.0 HDi 150 Hybrid | 4 | AHX (DW10FD) | 110/148 | 11/11→ | GE121A | | 5V | |
| 2.0 HDi 165 | 4 | RHH (DW10CTED4) | 120/161 | 11/11→ | GE121A | | 5V | |
| 2.0 HDi 165 Hybrid4 4WD | 4 | RHC (DW10CTED4) | 120/161 | 12/11→ | GE121A | | 5V | |
| 2.0 HDi 180 | 4 | | 133/178 | 08/13→ | GE121A | | 5V | |
| 2.0 HDi 200 Hybrid4 | 4 | | 147/197 | 12/11→ | GE121A | | 5V | |

DYANE

| | | | | | | | | |
|-------|---|--------------|-------|-------------|-----|--|-----|--|
| 0.4 4 | 2 | A79/0 (AYA) | 13/17 | 08/67→03/68 | Z40 | | 0.6 | |
| 0.4 4 | 2 | A79/1 (AYA2) | 17/23 | 04/68→07/75 | Z40 | | 0.6 | |
| 0.6 6 | 2 | M28 (AM2) | 21/28 | 12/68→10/84 | Z40 | | 0.6 | |
| 0.6 6 | 2 | M28/1 (AK2) | 24/32 | 05/72→12/80 | Z40 | | 0.6 | |

EVASION

| | | | | | | | | |
|---------|---|-----------------------------------|--------|-------------|------------------------------------|--|-----|-------------------|
| 1.8 | 4 | LFZ (XU7JP) | 73/98 | 05/97→07/02 | Z247 | | 0.9 | UXT1 / UXT3 ZS341 |
| 1.8 LPG | 4 | LFZ (XU7JP) | 73/98 | 05/97→07/02 | Z340 | | 0.7 | UXT12 |
| 1.9 TD | 4 | D8B (XUD9TF), DHX (XUD9TF/BTF) | 66/89 | 11/94→07/02 | GN909 →08/98 GN013 09/98→ | | 11V | |
| 1.9 TD | 4 | D8B (XUD9TF) | 68/91 | 10/95→12/98 | GN909 | | 11V | |
| 2.0 | 4 | RFU (XU10J2/C) | 89/119 | 06/94→07/02 | Z193 | | 0.9 | UXT1 / UXT3 ZS341 |
| 2.0 LPG | 4 | RFU (XU10J2/C) | 89/119 | 06/94→07/02 | Z340 | | 0.7 | UXT12 |
| 2.0 16V | 4 | RFV (XU10J4R) | 97/130 | 05/98→04/00 | Z193 | | 0.9 | UXT1 / UXT3 ZS349 |

10/98→



kW/BHP

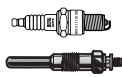

... CITROËN



... EVASION

| | | | | | | | | | |
|--------------------|---|-----------------|---------|-------------|-----------------|-----|-------------|-------|-------|
| 2.0 16V | 4 | RFN (EW10J4) | 100/134 | 05/00→07/02 | Z183 | 0.9 | UXT13 | ZS348 | |
| 2.0 16V LPG | 4 | RFV (XU10J4R) | 97/130 | 05/98→04/00 | Z340 | 0.7 | UXT12 | | |
| 2.0 16V LPG | 4 | RFN (EW10J4) | 100/134 | 05/00→07/02 | Z184 [168] | 0.9 | UXT13 | | |
| 2.0 HDI | 4 | RHZ (DW10ATED) | 80/107 | 08/99→07/02 | GN027 | 11V | | | |
| 2.0 HDI 16V | 4 | RHW (DW10ATED4) | 80/107 | 09/99→07/02 | GN027 | 11V | | | |
| 2.0 Turbo C.I. | 4 | RGX (XU10J2TE) | 108/145 | 06/94→07/02 | Z193 | 0.9 | UXT1 / UXT3 | ZS341 | ZM026 |
| 2.0 Turbo C.I. LPG | 4 | RGX (XU10J2TE) | 108/145 | 06/94→07/02 | Z340 | 0.7 | UXT12 | | |
| 2.1 TD | 4 | P8C (XUD11BTE) | 80/107 | 05/96→07/02 | GN909 | 11V | | | |
| | | | | | →08/98 GN013 | 11V | | | |
| | | | | | 09/98→ | | | | |

GS

| | | | | | | | | | |
|---------------|---|------------------|--------|-------------|-----------|-----|-------------|---------------|-------|
| 1.0 | 4 | G10, G10/612 | 40/54 | 09/70→09/77 | Z22 | 0.7 | UX56 | ZS110 [1][15] | |
| 1.1 | 4 | G11/631 | 40/54 | 09/77→06/80 | Z22 | 0.7 | UX56 | ZS110 [1][15] | |
| 1.1 | 4 | G11/631 | 42/56 | 09/77→07/81 | Z22 | 0.7 | UX56 | ZS110 [15] | |
| 1.1 A Spezial | 4 | G11/631 | 42/56 | 07/80→05/82 | Z22 | 0.7 | UX56 | | |
| 1.2 | 4 | G12/611, G12/612 | 43/58 | 04/73→06/79 | Z22 | 0.7 | UX56 | ZS115 [11] | |
| | | | | →07/74 | Z11 [168] | 0.8 | UXT2 / UXT6 | | |
| | | | | 08/74→ | | | | | |
| 1.2 A | 4 | G12/611, G12/612 | 43/58 | 04/73→06/79 | Z22 | 0.7 | UX56 | ZS115 [11] | |
| | | | | →07/74 | Z11 [168] | 0.8 | UXT2 / UXT6 | | |
| | | | | 08/74→ | | | | | |
| 1.2 X 2 | 4 | G12/619 | 46/62 | 09/75→07/79 | Z22 | 0.7 | UX56 | ZS110 [1][15] | |
| 1.3 A | 4 | G13/625, G13/646 | 48/64 | 09/79→07/86 | Z22 | 0.7 | UX56 | ZS115 [11] | ZM001 |
| | | | | | Z25 [191] | 0.8 | UXK56 | | |
| 2.0 Birotor | 2 | | 78/105 | 09/73→10/75 | Z108 | 0.7 | | | |

ID

| | | | | | | | | | |
|----------------|---|--------|--------|-------------|-----|-----|--|--|--|
| 1.9 19 | 4 | | 52/70 | 08/56→12/65 | Z57 | 0.6 | | | |
| 1.9 19 F | 4 | | 59/79 | 03/65→10/72 | Z48 | 0.8 | | | |
| 1.9 19 P | 4 | | 51/68 | 08/59→09/64 | Z48 | 0.8 | | | |
| 1.9 19 P | 4 | | 54/72 | 09/64→09/69 | Z48 | 0.8 | | | |
| 2.0 19 B | 4 | | 57/76 | 09/64→08/75 | Z48 | 0.8 | | | |
| 2.0 19 B | 4 | | 66/89 | 11/71→08/75 | Z48 | 0.8 | | | |
| 2.0 19 F | 4 | B20700 | 62/83 | 01/66→10/72 | Z48 | 0.8 | | | |
| 2.0 19 F Super | 4 | B20700 | 62/83 | 01/66→10/72 | Z48 | 0.8 | | | |
| 2.0 20 | 4 | | 66/89 | 01/69→08/75 | Z48 | 0.8 | | | |
| 2.0 20 | 4 | B20744 | 72/97 | 11/71→08/75 | Z48 | 0.8 | | | |
| 2.0 20 F | 4 | | 66/89 | 02/69→10/72 | Z48 | 0.8 | | | |
| 2.0 20 F | 4 | B20744 | 72/97 | 11/71→08/75 | Z10 | 0.8 | | | |
| 2.2 21 F | 4 | B22604 | 74/99 | 04/66→11/72 | Z57 | 0.6 | | | |
| 2.2 21 F | 4 | B22644 | 76/102 | 02/69→11/72 | Z57 | 0.6 | | | |

JUMPY

| | | | | | | | | | |
|----------------|---|---------------------------|-------|-------------|-----------------|-----|------|-------|--|
| 1.6 | 4 | 220 A2.000, 1580 SPI | 58/78 | 10/95→ | Z24 [168] | 0.8 | UXT5 | ZS234 | |
| 1.6 LPG | 4 | 220 A2.000, 1580 SPI | 58/78 | 10/95→ | Z30 [168] | 0.8 | UXT5 | | |
| 1.6 HDi 90 8V | 4 | 9HH (DV6DUM), 9HM (DV6UC) | 66/89 | 01/07→ | GE121A | 5V | | | |
| 1.6 HDi 90 16V | 4 | 9HU (DV6UTED4) | 66/89 | 01/07→ | GN056 | 11V | | | |
| 1.9 D | 4 | D9B (XUD9A/U) | 51/68 | 10/95→04/98 | GN013 | 11V | | | |
| 1.9 D 70 | 4 | WJZ (DW8) | 51/68 | 04/98→ | GN016 | 11V | | | |
| 1.9 TD | 4 | DHX (XUD9TF/BTF) | 66/89 | 10/95→ | GN909 | 11V | | | |
| | | | | | →08/98 GN013 | 11V | | | |
| | | | | | 09/98→ | | | | |
| 1.9 TD | 4 | D8B (XUD9TF) | 68/91 | 04/96→ | GN909 | 11V | | | |
| | | | | | →08/98 GN013 | 11V | | | |
| | | | | | 09/98→ | | | | |



kW/BHP

**... CITROËN****... JUMPY**

| | | | | | | | | | |
|---------------|---|------------------------------------|---------|-------------|------------|--|-----|-------|-----------------|
| 2.0 | 4 | RFN (EW10J4) | 100/134 | 04/00→12/06 | Z183 | | 0.9 | UXT13 | ZS348 09/00→ |
| 2.0 LPG | 4 | RFN (EW10J4) | 100/134 | 04/00→12/06 | Z184 [168] | | 0.9 | UXT13 | |
| 2.0 HDi 95 | 4 | RHX (DW10BTD) | 69/93 | 10/99→ | GN027 | | 11V | | |
| 2.0 HDi 95 | 4 | | 72/97 | 07/11→ | GE121A | | 5V | | |
| 2.0 HDi 110 | 4 | RHW (DW10ATED4), RHZ (DW10ATED) | 80/107 | 03/00→ | GN027 | | 11V | | |
| 2.0 HDi 120 | 4 | RHK (DW10UTED4) | 88/118 | 01/07→ | GN054 | | 11V | | |
| 2.0 HDi 125 | 4 | | 94/126 | 07/11→ | GE121A | | 5V | | |
| 2.0 HDi 140 | 4 | RHR (DW10BTD4) | 100/134 | 01/07→ | GN054 | | 11V | | |
| 2.0 HDi 165 | 4 | RHH (DW10CTED4) | 120/161 | 07/10→ | GE121A | | 5V | | |
| 2.0 i | 4 | RFH (EW10A) | 103/138 | 01/07→ | Z223 | | 0.9 | UXT13 | ZS352 |
| 2.0 i 16V | 4 | | 102/137 | 03/00→ | Z183 | | 0.9 | UXT13 | ZS348 01/04→ |
| 2.0 i 16V LPG | 4 | | 102/137 | 03/00→ | Z184 [168] | | 0.9 | UXT13 | |

LNA

| | | | | | | | | | |
|-----|---|------------------|-------|-------------|-----------|--|-----|-------|------------------|
| 0.6 | 2 | R06 627 | 24/32 | 11/76→07/79 | Z40 | | 0.6 | | |
| 0.6 | 2 | V06 644 | 25/34 | 07/82→04/85 | Z25 | | 0.8 | UXK56 | |
| 0.6 | 2 | V06 630, V06 644 | 26/35 | 11/78→07/86 | Z25 | | 0.8 | UXK56 | |
| 1.0 | 4 | T08C | 33/44 | 07/84→10/86 | Z95 [167] | | 0.7 | UXT4 | ZS115 [1][11] |
| 1.1 | 4 | T09/5E | 37/50 | 07/82→04/85 | Z17 | | 0.8 | UXT4 | ZS115 [11] ZM001 |

MEHARI

| | | | | | | | | | |
|-------------|---|----------------------|-------|-------------|-----|--|-----|--|--|
| 0.6 | 2 | M28/1 (AK2) | 19/25 | 05/68→10/79 | Z40 | | 0.6 | | |
| 0.6 | 2 | A06/635, M28/1 (AK2) | 21/28 | 10/79→10/87 | Z40 | | 0.6 | | |
| 0.6 4x4 4WD | 2 | A06/635 | 21/28 | 10/79→10/87 | Z40 | | 0.6 | | |

NEMO

| | | | | | | | | | |
|------------|---|------------------------|-------|--------|-------|--|------|-------------|-------------|
| 1.3 HDi 75 | 4 | FHZ (F13DTE5) | 55/74 | 10/10→ | GE112 | | 4.4V | | |
| 1.4 | 4 | KFT (TU3A), KFV (TU3A) | 54/72 | 04/09→ | Z193 | | 0.9 | UXT1 / UXT3 | ZSE048 [10] |
| 1.4 LPG | 4 | KFT (TU3A), KFV (TU3A) | 54/72 | 04/09→ | Z340 | | 0.7 | UXT12 | |
| 1.4 HDi | 4 | 8HS (DV4TED) | 50/67 | 04/09→ | GN056 | | 11V | | |

SAXO

| | | | | | | | | | |
|--------------|---|--------------------------|-------|-------------|-------------------------|-------|-----|-------------|---|
| 1.0 X | 4 | CDZ (TU9M) | 33/44 | 05/96→11/98 | Z193 | | 0.9 | UXT1 / UXT3 | ZS341 |
| 1.0 X | 4 | CDZ (TU9M) | 37/50 | 05/98→06/03 | Z193 | | 0.9 | UXT1 / UXT3 | ZS341 |
| 1.0 X LPG | 4 | CDZ (TU9M) | 33/44 | 05/96→11/98 | Z340 | | 0.7 | UXT12 | |
| 1.0 X LPG | 4 | CDZ (TU9M) | 37/50 | 05/98→06/03 | Z340 | | 0.7 | UXT12 | |
| 1.1 X,SX | 4 | HDZ (TU1M) | 40/54 | 05/96→09/03 | Z193 | | 0.9 | UXT1 / UXT3 | ZS341 →05/97 ZS381 06/97→05/00 ZSE047 [13] 06/00→12/02 |
| 1.1 X,SX | 4 | HDZ (TU1M) | 44/59 | 05/96→09/03 | Z193 | | 0.9 | UXT1 / UXT3 | ZS341 →08/00 |
| 1.1 X,SX | 4 | HFX (TU1JP) | 44/59 | 05/96→09/03 | Z193 | | 0.9 | UXT1 / UXT3 | ZSE047 [13] 09/00→ |
| 1.1 X,SX LPG | 4 | HDZ (TU1M) | 40/54 | 05/96→09/03 | Z24 | | 0.8 | UXT5 | |
| 1.1 X,SX LPG | 4 | HDZ (TU1M), HFX (TU1JP) | 44/59 | 05/96→09/03 | Z24 | | 0.8 | UXT5 | |
| 1.4 VTS | 4 | KFW (TU3JP) | 55/74 | 05/96→06/03 | Z123 | | 1.0 | UXT9 | ZS381 02/98→05/00 ZSE047 [13] 06/00→ |
| 1.4 VTS | 4 | KFX (TU3JP) | 55/74 | 05/96→06/03 | Z123 | | 1.0 | UXT9 | ZS341 →01/98 |
| 1.4 VTS LPG | 4 | KFW (TU3JP), KFX (TU3JP) | 55/74 | 05/96→06/03 | Z129 | | 1.6 | | |
| 1.5 D | 4 | VJY (TUD5) | 40/54 | 09/96→09/03 | GN016 [2][222] GN912 | GR054 | 11V | | |
| 1.5 D | 4 | VJZ (TUD5) | 42/56 | 09/96→06/01 | GN016 [2][222] GN912 | GR054 | 11V | | |

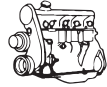

kW/BHP

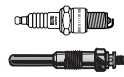

... CITROËN



... SAXO

| | | | | | | | | | |
|-----------------|---|--------------|--------|-------------|-------|--|-----|-------------|---|
| 1.5 D | 4 | | 43/58 | 07/01→04/04 | GN016 | | 11V | | |
| 1.6 | 4 | NFZ (TU5JP) | 66/89 | 02/96→06/03 | Z247 | | 0.9 | UXT1 / UXT3 | ZS341 [87][180][251] ZS381 06/98→ |
| 1.6 | 4 | NFT | 74/99 | 02/01→04/04 | Z193 | | 0.9 | UXT1 / UXT3 | ZSE047 [13] |
| 1.6 | 4 | NFX (TU5JP4) | 88/118 | 02/96→04/04 | Z123 | | 1.0 | UXT9 | ZS241 [38][86] ZSE046 [89] |
| 1.6 LPG | 4 | NFZ (TU5JP) | 66/89 | 02/96→06/03 | Z340 | | 0.7 | UXT12 | |
| 1.6 LPG | 4 | NFT | 74/99 | 02/01→04/04 | Z340 | | 0.7 | UXT12 | |
| 1.6 LPG | 4 | NFX (TU5JP4) | 88/118 | 02/96→04/04 | Z129 | | 1.6 | | |
| 1.6 VTL,VTR | 4 | NFZ (TU5JP) | 65/87 | 05/96→06/03 | Z247 | | 0.9 | UXT1 / UXT3 | ZS341 [87][180][251] ZS381 06/98→ |
| 1.6 VTL,VTR LPG | 4 | NFZ (TU5JP) | 65/87 | 05/96→06/03 | Z340 | | 0.7 | UXT12 | |
| 1.6 VTS | 4 | NFT | 72/97 | 09/00→09/03 | Z193 | | 0.9 | UXT1 / UXT3 | ZSE047 [13] |
| 1.6 VTS | 4 | NFX (TU5JP4) | 87/117 | 06/96→09/03 | Z123 | | 1.0 | UXT9 | ZS241 →12/00 ZSE046 01/01→ |
| 1.6 VTS LPG | 4 | NFT | 72/97 | 09/00→09/03 | Z340 | | 0.7 | UXT12 | |
| 1.6 VTS LPG | 4 | NFX (TU5JP4) | 87/117 | 06/96→09/03 | Z129 | | 1.6 | | |

SM

| | | | | | | | | | |
|---------------|---|---------|---------|-------------|-----------|--|-----|-------------|--|
| 2.7 Injection | 6 | C114-03 | 129/173 | 06/72→12/74 | Z11 [168] | | 0.8 | UXT2 / UXT6 | |
|---------------|---|---------|---------|-------------|-----------|--|-----|-------------|--|

VISA

| | | | | | | | | | |
|----------------|---|------------------|--------|-------------|-------------------------|-----------------|------------|-------|---------------------|
| 0.6 | 2 | V06/665 | 24/32 | 07/82→03/91 | Z17 | | 0.8 | UXT4 | |
| 0.6 | 2 | V06 630, V06 644 | 25/34 | 09/78→06/88 | Z17 | | 0.8 | UXT4 | |
| 1.0 | 4 | XV8 | 33/44 | 09/84→06/88 | Z17 | | 0.8 | UXT4 | ZS115 [1][11] |
| 1.1 11 E | 4 | 109K | 35/47 | 09/78→06/88 | Z25 | | 0.8 | UXK56 | ZS115 [1][11] ZM001 |
| 1.1 11 E | 4 | 109/SF | 37/50 | 07/82→03/91 | Z25 | | 0.8 | UXK56 | ZS115 [1][11] ZM001 |
| 1.1 11 E | 4 | 109/5 | 42/56 | 09/78→03/91 | Z25 | | 0.8 | UXK56 | ZS106 [11] |
| 1.1 11 RE | 4 | 109/SF | 37/50 | 03/83→10/88 | Z25 [168] | | 0.8 | UXK56 | ZS115 [1][11] ZM001 |
| 1.2 II Super X | 4 | 129/5 | 47/63 | 07/80→06/82 | Z25 | | 0.8 | UXK56 | |
| 1.4 14 | 4 | 150D (XY7) | 44/59 | 07/84→03/91 | Z17 | | 0.8 | UXT4 | ZS115 [11] ZM001 |
| 1.4 14 GT | 4 | 150B (XY8) | 55/74 | 03/82→03/87 | Z17 | | 0.8 | UXT4 | ZS115 [1][11] |
| 1.4 14 GT | 4 | 150B (XY8) | 58/78 | 03/82→03/91 | Z17 | | 0.8 | UXT4 | ZS115 [11] ZM001 |
| 1.6 16 GTI | 4 | 180A (XU5J) | 76/102 | 01/85→06/86 | Z26 [167] | | 0.7 | UXK56 | ZS115 [11] ZM001 |
| 1.6 16 GTI | 4 | B6D | 83/111 | 06/86→03/91 | Z25 | | 0.8 | UXK56 | ZS115 [1][11] ZM001 |
| 1.8 17 D | 4 | 161A (XUD7) | 44/59 | 04/84→03/91 | GN909 [2][222] GV636 | GR065 →01/89 | 11V 11V | | |

XANTIA

| | | | | | | | | | |
|---------------|---|--------------|--------|-------------|-------------------------|-------|------------|-------------|------------------------------------|
| 1.6 i | 4 | BFZ (XU5JP) | 65/87 | 03/93→01/98 | Z193 | | 0.9 | UXT1 / UXT3 | ZS341 |
| 1.6 i LPG | 4 | BFZ (XU5JP) | 65/87 | 03/93→01/98 | Z340 | | 0.7 | UXT12 | |
| 1.8 i | 4 | LFX (XU7JB) | 66/89 | 04/97→04/03 | Z247 | | 0.9 | UXT1 / UXT3 | |
| 1.8 i | 4 | LFX (XU7JB) | 66/89 | 04/97→01/98 | | | | | ZS341 [1][87][180] |
| 1.8 i | 4 | LFX (XU7JB) | 66/89 | 01/98→04/03 | | | | | ZS341 |
| 1.8 i | 4 | LFZ (XU7JP) | 74/99 | 03/93→01/98 | Z193 | | 0.9 | UXT1 / UXT3 | ZS341 |
| 1.8 i LPG | 4 | LFX (XU7JB) | 66/89 | 04/97→04/03 | Z340 | | 0.7 | UXT12 | |
| 1.8 i LPG | 4 | LFZ (XU7JP) | 74/99 | 03/93→01/98 | Z340 | | 0.7 | UXT12 | |
| 1.8 i 16V | 4 | LFY (XU7JP4) | 81/109 | 06/95→04/03 | Z193 | | 0.9 | UXT1 / UXT3 | |
| 1.8 i 16V | 4 | LFY (XU7JP4) | 81/109 | 06/95→01/98 | | | | | ZS256 [84][243] ZS349 [85][160] |
| 1.8 i 16V | 4 | LFY (XU7JP4) | 81/109 | 01/98→04/03 | | | | | ZS349 |
| 1.8 i 16V LPG | 4 | LFY (XU7JP4) | 81/109 | 06/95→04/03 | Z340 | | 0.7 | UXT12 | |
| 1.9 D | 4 | DJZ (XUD9Y) | 50/67 | 06/94→01/98 | GN909 [2][222] GV636 | GR054 | 11V 11V | | |

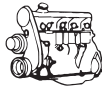

kW/BHP

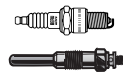
**... CITROËN****... XANTIA**

| | | | | | | | | | |
|-----------------|---|--|---------|-------------|--|--------------|-----|--------------------|--|
| 1.9 D | 4 | D9B (XUD9A/L) | 51/68 | 06/94→01/98 | GV636 →05/95 GN909 06/95→ | GR054 | 11V | | |
| | | | | | | | 11V | | |
| 1.9 SD | 4 | DHW (XUD9SD) | 55/74 | 02/96→01/98 | GN909 | | 11V | | |
| 1.9 SD | 4 | DHW (XUD9SD) | 55/74 | 01/98→04/03 | GN909 →08/98 GN013 09/98→ | | 11V | | |
| 1.9 Turbo D | 4 | D8B (XUD9TF), DHX (XUD9TF/BTF), DHY (XUD9TE/Y) | 66/89 | 10/94→01/98 | GN909 | | 11V | | |
| 1.9 Turbo D | 4 | D8B (XUD9TF), DHX (XUD9TF/BTF), DHY (XUD9TE/Y) | 66/89 | 10/94→04/03 | | GR054 | | | |
| 1.9 Turbo D | 4 | D8B (XUD9TF), DHX (XUD9TF/BTF), DHY (XUD9TE/Y) | 66/89 | 01/98→04/03 | GN909 →08/98 GN013 09/98→ | | 11V | | |
| | | | | | | | 11V | | |
| 2.0 HDI 90 | 4 | RHY (DW10TD) | 66/89 | 03/99→04/03 | GN027 | | 11V | | |
| 2.0 HDI 109 | 4 | RHZ (DW10ATED) | 80/107 | 02/99→04/03 | GN027 | | 11V | | |
| 2.0 i | 4 | RFX (XU10J2C) | 89/119 | 03/93→04/03 | Z193 | | 0.9 | UXT1 / UXT3 | ZS341 |
| 2.0 i | 4 | RFX (XU10J2C) | 89/119 | 01/98→04/03 | | | | | ZM026 |
| 2.0 i LPG | 4 | RFX (XU10J2C) | 89/119 | 03/93→04/03 | Z340 | | 0.7 | UXT12 | |
| 2.0 i 16V | 4 | RFV (XU10J4R) | 97/130 | 06/95→04/03 | Z247 | | 0.9 | UXT1 / UXT3 | |
| 2.0 i 16V | 4 | RFV (XU10J4R) | 97/130 | 06/95→01/98 | | | | | ZS341 →02/97 ZS323 03/97→ ZS349 |
| 2.0 i 16V | 4 | RFV (XU10J4R) | 97/130 | 01/98→04/03 | | | | | ZS341 →02/97 ZS323 03/97→ ZS349 |
| 2.0 i 16V | 4 | RFT (XU10J4/Z) | 110/148 | 06/94→01/98 | Z24 | | 0.8 | UXT5 | ZM026 |
| | | | | | | | | | ZS341 →02/97 ZS323 03/97→ ZS349 |
| 2.0 i 16V | 4 | RFY (XU10J4/Z) | 112/150 | 03/93→01/98 | Z247 | | 0.9 | UXT1 / UXT3 | ZS341 →05/95 ZS323 06/95→ |
| | | | | | | | | | ZM026 |
| 2.0 i 16V LPG | 4 | RFV (XU10J4R) | 97/130 | 06/95→04/03 | Z340 | | 0.7 | UXT12 | |
| 2.0 i 16V LPG | 4 | RFT (XU10J4/Z) | 110/148 | 06/94→01/98 | Z30 [168] | | 0.8 | UXT5 | |
| 2.0 i 16V LPG | 4 | RFY (XU10J4/Z) | 112/150 | 03/93→01/98 | Z340 | | 0.7 | UXT12 | |
| 2.0 Turbo | 4 | RGX (XU10J2TE) | 108/145 | 06/95→04/03 | Z193 | | 0.9 | UXT1 / UXT3 | ZS341 |
| 2.0 Turbo LPG | 4 | RGX (XU10J2TE) | 108/145 | 06/95→04/03 | Z340 | | 0.7 | UXT12 | |
| 2.1 Turbo D 12V | 4 | P8C (XUD11BTE) | 80/107 | 06/95→01/98 | GN909 | | 11V | | |
| 2.1 Turbo D 12V | 4 | P8C (XUD11BTE) | 80/107 | 06/95→02/99 | | GR034 | | | |
| 2.1 Turbo D 12V | 4 | P8C (XUD11BTE) | 80/107 | 01/98→02/99 | GN909 →08/98 GN013 09/98→ | | 11V | | |
| | | | | | | | 11V | | |
| 3.0 i 24V | 6 | XFZ (ES9J4) | 140/188 | 01/97→01/98 | Z123 | | 1.0 | UXT9 | ZS343 |
| 3.0 i 24V LPG | 6 | XFZ (ES9J4) | 140/188 | 01/97→01/98 | Z129 | | 1.6 | | |
| 3.0 V6 | 6 | XFZ (ES9J4) | 140/188 | 01/98→04/03 | Z123 | | 1.0 | UXT9 | ZS343 |
| 3.0 V6 LPG | 6 | XFZ (ES9J4) | 140/188 | 01/98→04/03 | Z129 | | 1.6 | | |
| XM | | | | | | | | | |
| 2.0 | 4 | | 84/113 | 05/89→04/94 | Z13 [170] | | 0.8 | UXT1 / UXT3 | ZS249 |
| 2.0 | 4 | R6A | 94/126 | 05/89→06/94 | | | | | ZS249 |



kW/BHP

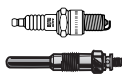

... CITROËN 

... XM

| | | | | | | | | | | |
|---------------|---|---|---------|-------------|------------------------------------|-------|-----|-------------|--|------------------------------------|
| 2.0 i | 4 | RDZ (XU10MZ) | 79/106 | 05/89→04/94 | | | | | ZS249 [1] →06/90 ZS341 [1] 06/90→ | |
| 2.0 i | 4 | RDZ (XU10MZ) | 79/106 | 11/91→04/94 | Z247 | | 0.9 | UXT1 / UXT3 | ZS341 | |
| 2.0 i | 4 | XU102C | 79/106 | 11/91→04/94 | Z247 | | 0.9 | UXT1 / UXT3 | ZS258 | |
| 2.0 i | 4 | RFZ (XU10J2) | 89/119 | 05/89→06/94 | Z193 | | 0.9 | UXT1 / UXT3 | ZS341 | ZM001 →05/90 ZM026 05/90→ |
| 2.0 i | 4 | RFZ (XU10J2) | 89/119 | 11/91→04/94 | | | | | | ZM026 |
| 2.0 i 16V | 4 | RFV (XU10J4R) | 97/130 | 05/94→10/00 | Z247 | | 0.9 | UXT1 / UXT3 | ZS256 →08/97 ZS349 09/97→ | |
| 2.0 i 16V LPG | 4 | RFV (XU10J4R) | 97/130 | 05/94→10/00 | Z340 | | 0.7 | UXT12 | | |
| 2.0 i Turbo | 4 | RGY (XU10J2TE/Z) | 104/139 | 09/92→06/94 | Z193 | | 0.9 | UXT1 / UXT3 | ZS341 | |
| 2.0 Turbo | 4 | RGY (XU10J2TE/Z) | 104/139 | 09/92→04/94 | Z193 | | 0.9 | UXT1 / UXT3 | ZS341 | ZM026 |
| 2.0 Turbo | 4 | RGX (XU10J2TE) | 108/145 | 05/94→10/00 | Z193 | | 0.9 | UXT1 / UXT3 | ZS341 | ZM026 |
| 2.0 Turbo | 4 | RGY (XU10J2TE/Z) | 108/145 | 05/94→10/00 | Z193 | | 0.9 | UXT1 / UXT3 | ZS341 | |
| 2.0 Turbo LPG | 4 | RGX (XU10J2TE), RGY (XU10J2TE/Z) | 108/145 | 05/94→10/00 | Z340 | | 0.7 | UXT12 | | |
| 2.1 D12 | 4 | P9A (XUD11A) | 60/80 | 07/94→06/96 | GN909 [2][222] GV636 | | 11V | | | |
| 2.1 D 12V | 4 | P9A (XUD11A) | 60/80 | 05/89→06/94 | GN909 [2][222] GV636 | | 11V | | | |
| 2.1 D12 VSX | 4 | P9A (XUD11A) | 60/80 | 03/96→08/96 | GN013 | | 11V | | | |
| 2.1 TD 12V | 4 | P8A (XUD11ATE), P8C (XUD11BTE), PHZ (XUD11ATE), PJZ (XUD11ATE) | 80/107 | 05/89→06/94 | GN909 | | 11V | | | |
| 2.1 TD 12V | 4 | P8A (XUD11ATE), P8C (XUD11BTE), PHZ (XUD11ATE), PJZ (XUD11ATE) | 80/107 | 05/94→10/00 | GN909 →08/98 GN013 09/98→ | | 11V | | | |
| 2.1 TD 12V | 4 | XUD11BTE | 80/107 | 11/91→10/00 | | GR034 | | | | |
| 2.5 TD | 4 | THY (DK5ATE) | 95/127 | 05/94→10/00 | GN909 | | 11V | | | |
| 3.0 V6 | 6 | SFZ (ZPJ/Z), UFZ (ZPJ/Z) | 123/165 | 05/89→10/00 | Z60 | | 1.2 | | | |
| 3.0 V6 | 6 | SFZ (ZPJ/Z), UFZ (ZPJ/Z) | 123/165 | 05/89→06/94 | | | | | | ZM015 |
| 3.0 V6 | 6 | ES9J4/L3 | 140/188 | 04/97→10/00 | | | | | ZS343 →07/97 | |
| 3.0 V6 24V | 6 | SKZ (ZPJ4/Z), UKZ (ZPJ4/Z) | 147/197 | 07/90→10/00 | Z60 | | 1.2 | | | |
| 3.0 V6 24V | 6 | SKZ (ZPJ4/Z), UKZ (ZPJ4/Z) | 147/197 | 07/90→06/94 | | | | | | ZM015 |

XSARA

| | | | | | | | | | | |
|---------|---|-------------|-------|-------------|-------|--|-----|-------------|--|--|
| 1.4 HDi | 4 | 8HX (DV4TD) | 50/67 | 01/03→08/05 | GN047 | | 11V | | | |
| 1.4 i | 4 | KFW (TU3JP) | 55/74 | 04/97→08/05 | Z98 | | 0.8 | UXT1 / UXT3 | ZSE047 [13] 09/00→ | |
| 1.4 i | 4 | KFW (TU3JP) | 55/74 | 03/98→03/05 | Z193 | | 0.9 | UXT1 / UXT3 | | |
| 1.4 i | 4 | KFX (TU3JP) | 55/74 | 04/97→08/05 | Z98 | | 0.8 | UXT1 / UXT3 | | |
| 1.4 i | 4 | KFX (TU3JP) | 55/74 | 04/97→03/05 | | | | | ZS232 07/97→06/98 ZS381 07/98→08/00 | |
| 1.4 i | 4 | KFX (TU3JP) | 55/74 | 10/97→08/05 | | | | | ZS232 04/98→06/98 ZS381 07/98→08/00 | |

CITROËN

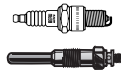

kW/BHP

**... CITROËN****... XSARA**

| | | | | | | | | | |
|----------------|---|--------------------------|---------|-------------|------------|-------|-----|-------------|---|
| 1.4 i | 4 | KFX (TU3JP) | 55/74 | 03/98→03/05 | Z193 | | 0.9 | UXT1 / UXT3 | ZS232 →06/98 ZS381 07/98→08/00 |
| 1.4 i LPG | 4 | KFW (TU3JP), KFX (TU3JP) | 55/74 | 04/97→08/05 | Z116 | | 0.8 | UXT5 | |
| 1.4 i LPG | 4 | KFW (TU3JP), KFX (TU3JP) | 55/74 | 03/98→03/05 | Z340 | | 0.7 | UXT12 | |
| 1.5 D | 4 | VJZ (TUD5) | 42/56 | 04/97→09/00 | GN013 | GR054 | 11V | | |
| 1.6 16V | 4 | NFU (TU5JP4) | 80/107 | 09/00→08/05 | Z184 | | 0.9 | UXT13 | ZSE045 |
| 1.6 16V LPG | 4 | NFU (TU5JP4) | 80/107 | 09/00→08/05 | Z226 [168] | | 0.8 | | |
| 1.6 i | 4 | NFZ (TU5JP) | 65/87 | 04/97→09/00 | Z247 | | 0.9 | UXT1 / UXT3 | ZS232 07/97→06/98 ZS381 07/98→ |
| 1.6 i | 4 | NFZ (TU5JP) | 65/87 | 10/97→09/00 | | | | | ZS232 →06/98 ZS381 07/98→ |
| 1.6 i LPG | 4 | NFZ (TU5JP) | 65/87 | 04/97→09/00 | Z340 | | 0.7 | UXT12 | |
| 1.8 D | 4 | 161A (XUD7), A9A (XUD7) | 43/58 | 04/97→09/00 | GN013 | GR054 | 11V | | |
| 1.8 i | 4 | LFX (XU7JB) | 66/89 | 04/97→09/00 | Z123 | | 1.0 | UXT9 | ZS341 |
| 1.8 i | 4 | LFX (XU7JB) | 66/89 | 02/98→09/00 | Z247 | | 0.9 | UXT1 / UXT3 | |
| 1.8 i | 4 | LFZ (XU7JP) | 74/99 | 02/98→09/00 | | | | | ZS232 |
| 1.8 i LPG | 4 | LFX (XU7JB) | 66/89 | 04/97→09/00 | Z129 | | 1.6 | | |
| 1.8 i LPG | 4 | LFX (XU7JB) | 66/89 | 02/98→09/00 | Z340 | | 0.7 | UXT12 | |
| 1.8 i 16V | 4 | LFY (XU7JP4) | 81/109 | 04/97→09/00 | Z193 | | 0.9 | UXT1 / UXT3 | ZS349 |
| 1.8 i 16V | 4 | LFY (XU7JP4) | 81/109 | 10/97→09/00 | | | | | ZS349 03/98→ |
| 1.8 i 16V | 4 | LFY (XU7JP4) | 81/109 | 02/98→09/00 | Z247 | | 0.9 | UXT1 / UXT3 | |
| 1.8 i 16V LPG | 4 | LFY (XU7JP4) | 81/109 | 04/97→09/00 | Z340 | | 0.7 | UXT12 | |
| 1.8 i Aut. | 4 | LFZ (XU7JP) | 74/99 | 04/97→09/00 | Z193 | | 0.9 | UXT1 / UXT3 | ZS341 |
| 1.8 i Aut. LPG | 4 | LFZ (XU7JP) | 74/99 | 04/97→09/00 | Z340 | | 0.7 | UXT12 | |
| 1.8 TD | 4 | | 66/89 | 10/97→09/00 | GN013 | GR054 | 11V | | |
| 1.9 D | 4 | DJY (XUD9A) | 50/67 | 04/97→09/00 | GN013 | GR054 | 11V | | |
| 1.9 D | 4 | WJY (DW8B), WJZ (DW8) | 51/68 | 07/98→08/05 | GN016 | | 11V | | |
| 1.9 D | 4 | DHV (XUD9BSD) | 55/74 | 01/98→09/00 | GN013 | | 11V | | |
| 1.9 SD | 4 | DHV (XUD9BSD) | 55/74 | 01/98→09/00 | GN013 | | 11V | | |
| 1.9 TD | 4 | DHY (XUD9TE/Y) | 66/89 | 04/97→09/00 | GN013 | GR034 | 11V | | |
| 2.0 16V | 4 | RFV (XU10J4R) | 97/130 | 07/98→09/00 | Z193 | | 0.9 | UXT1 / UXT3 | ZS349 |
| 2.0 16V | 4 | RFN (EW10J4) | 100/134 | 09/00→08/05 | Z183 | | 0.9 | UXT13 | ZS348 |
| 2.0 16V | 4 | RFS (XU10J4RS) | 120/161 | 04/97→09/00 | Z98 | | 0.8 | UXT1 / UXT3 | ZS346 |
| 2.0 16V LPG | 4 | RFV (XU10J4R) | 97/130 | 07/98→09/00 | Z340 | | 0.7 | UXT12 | |
| 2.0 16V LPG | 4 | RFN (EW10J4) | 100/134 | 09/00→08/05 | Z184 [168] | | 0.9 | UXT13 | |
| 2.0 16V LPG | 4 | RFS (XU10J4RS) | 120/161 | 04/97→09/00 | Z116 | | 0.8 | UXT5 | |
| 2.0 HDi 90 | 4 | RHY (DW10TD) | 66/89 | 02/99→08/05 | GN027 | | 11V | | |
| 2.0 HDi 109 | 4 | RHZ (DW10ATED) | 80/107 | 05/01→08/05 | GN027 | | 11V | | |
| 2.0 i 16V | 4 | RFS (XU10J4RS) | 120/161 | 02/98→03/05 | Z98 | | 0.8 | UXT1 / UXT3 | ZS346 |
| 2.0 i 16V LPG | 4 | RFS (XU10J4RS) | 120/161 | 02/98→03/05 | Z116 | | 0.8 | UXT5 | |

XSARA PICASSO

| | | | | | | | | | |
|-------------|---|--------------|--------|-------------|------------|--|-----|-------------|--|
| 1.6 | 4 | NFZ (TU5JP) | 65/87 | 12/99→ | Z247 | | 0.9 | UXT1 / UXT3 | ZS381 |
| 1.6 | 4 | | 67/90 | 06/02→ | Z15 | | 0.8 | UXT1 / UXT3 | ZS381 |
| 1.6 | 4 | NFV (TU5JP) | 70/94 | 12/99→ | Z247 | | 0.9 | UXT1 / UXT3 | ZS381 01/00→04/10 ZSE047 [13] 01/00→04/10 |
| 1.6 LPG | 4 | NFZ (TU5JP) | 65/87 | 12/99→ | Z340 | | 0.7 | UXT12 | |
| 1.6 LPG | 4 | NFV (TU5JP) | 70/94 | 12/99→ | Z340 | | 0.7 | UXT12 | |
| 1.6 16V | 4 | NFU (TU5JP4) | 80/107 | 09/05→ | Z184 | | 0.9 | UXT13 | ZSE045 |
| 1.6 16V LPG | 4 | NFU (TU5JP4) | 80/107 | 09/05→ | Z226 [168] | | 0.8 | | |
| 1.6 Chrono | 4 | | 74/99 | 04/01→10/04 | | | | | ZSE047 [13] |

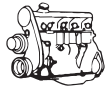

kW/BHP

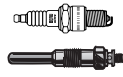

... CITROËN



... XSARA PICASSO

| | | | | | | | | |
|-------------|---|----------------|---------|-------------|--|-----|--------------|--------------|
| 1.6 HDi | 4 | 9HX (DV6ATED4) | 66/89 | 09/05→ | GN047 →02/06 GN056 03/06→ | 11V | | |
| 1.6 HDi | 4 | 9HZ (DV6TED4) | 80/107 | 05/04→ | GN047 →02/06 GN056 03/06→ | 11V | | |
| 1.8 16V | 4 | 6FZ (EW7J4) | 85/114 | 02/00→ | Z223 | 0.9 | UXT13 | ZS348 |
| 1.8 16V LPG | 4 | 6FZ (EW7J4) | 85/114 | 02/00→ | Z184 [168] | 0.9 | UXT13 | |
| 1.8 SX | 4 | | 76/102 | 06/00→08/05 | | | | ZS341 |
| 2.0 16V | 4 | RFN (EW10J4) | 100/134 | 01/03→ | Z183 | 0.9 | UXT13 | ZS348 |
| 2.0 16V LPG | 4 | RFN (EW10J4) | 100/134 | 01/03→ | Z184 [168] | 0.9 | UXT13 | |
| 2.0 HDi | 4 | RHY (DW10TD) | 66/89 | 12/99→ | GN027 | 11V | | |
| 2.0 HDi | 4 | RHZ (DW10ATED) | 80/107 | 12/99→ | GN027 | 11V | | |

ZX

| | | | | | | | | | |
|---------|---|---------------------------|-------|-------------|--|-------------------|---|---|--------------|
| 1.1 | 4 | HDZ (TU1M) | 44/59 | 03/91→06/97 | Z193 | 0.9 | UXT1 / UXT3 | ZS249 →03/94 | ZM003 |
| 1.1 LPG | 4 | HDZ (TU1M) | 44/59 | 03/91→06/97 | Z340 | 0.7 | UXT12 | | |
| 1.1 1,1 | 4 | H1A, H1B | 40/54 | 03/91→08/93 | | | | ZS249 | ZM003 |
| 1.4 | 4 | KDZ (TU3M/Z) | 55/74 | 03/91→06/97 | Z13 [170] →06/95 Z247 →06/95 Z123 07/95→ | 0.8 0.9 1.0 | UXT1 / UXT3 →06/95 UXT1 / UXT3 →06/95 UXT9 07/95→ | ZS249 →12/95 | ZM003 |
| 1.4 LPG | 4 | KDZ (TU3M/Z) | 55/74 | 03/91→06/97 | Z340 →06/95 Z129 07/95→ | 0.7 1.6 | UXT12 →06/95 | | |
| 1.4 D | 4 | K9Y (TUD3Y) | 37/50 | 07/94→10/97 | GV661 | 11V | | | |
| 1.4 i | 4 | KDX (TU3M/Z) | 55/74 | 03/91→06/97 | Z13 [170] →06/95 Z247 →06/95 Z123 07/95→ | 0.8 0.9 1.0 | UXT1 / UXT3 →06/95 UXT1 / UXT3 →06/95 UXT9 07/95→ | ZS249 →08/92 ZS231 08/92→08/96 | |
| 1.4 i | 4 | KDX (TU3M/Z), KFX (TU3JP) | 55/74 | 03/91→10/97 | | | | | ZM003 |
| 1.4 i | 4 | KDX (TU3M/Z) | 55/74 | 10/93→10/97 | | | | ZS231 [159] ZS249 [175][181][254] | |
| 1.4 i | 4 | KDY (TU3M) | 55/74 | 10/93→10/97 | Z193 | 0.9 | UXT1 / UXT3 | ZS231 [159] ZS249 [175][181][254] | ZM003 |
| 1.4 i | 4 | KDZ (TU3M/Z) | 55/74 | 03/91→06/97 | Z13 [170] →06/95 Z247 →06/95 Z123 07/95→ | 0.8 0.9 1.0 | UXT1 / UXT3 →06/95 UXT1 / UXT3 →06/95 UXT9 07/95→ | ZS249 →08/92 | ZM003 |
| 1.4 i | 4 | KFX (TU3JP) | 55/74 | 03/91→06/97 | Z13 [170] →06/95 Z247 →06/95 Z123 07/95→ | 0.8 0.9 1.0 | UXT1 / UXT3 →06/95 UXT1 / UXT3 →06/95 UXT9 07/95→ | ZS249 →08/92 | |
| 1.4 i | 4 | KFX (TU3JP) | 55/74 | 10/93→10/97 | Z193 | 0.9 | UXT1 / UXT3 | ZS231 [159] ZS249 [175][181][254] | |

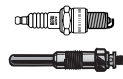

kW/BHP

**... CITROËN****... ZX**

| | | | | | | | | | |
|---------------|---|--|---------|-------------|------------------------------------|------------|-----------------|---|-------|
| 1.4 i LPG | 4 | KDX (TU3M/Z), KDZ (TU3M/Z), KFX (TU3JP) | 55/74 | 03/91→06/97 | Z340 →06/95 Z129 07/95→ | 0.7 1.6 | UXT12 →06/95 | | |
| 1.4 i LPG | 4 | KDY (TU3M), KFX (TU3JP) | 55/74 | 10/93→10/97 | Z340 | 0.7 | UXT12 | | |
| 1.6 | 4 | | 66/89 | 07/94→10/97 | | | | ZS341 | |
| 1.6 i | 4 | BDY (XU5M), BFZ (XU5JP) | 65/87 | 03/91→10/97 | Z193 | 0.9 | UXT1 / UXT3 | ZS341 | |
| 1.6 i LPG | 4 | BDY (XU5M), BFZ (XU5JP) | 65/87 | 03/91→10/97 | Z340 | 0.7 | UXT12 | | |
| 1.8 | 4 | LFY (XU7JP4) | 82/110 | 04/96→10/97 | Z13 [170] Z247 | 0.8 0.9 | UXT1 / UXT3 | ZS256 [84][243] ZS349 [85][160] | |
| 1.8 LPG | 4 | LFY (XU7JP4) | 82/110 | 04/96→10/97 | Z340 | 0.7 | UXT12 | | |
| 1.8 D | 4 | 161A (XUD7) | 44/59 | 06/93→10/97 | GN909 [2][222] GV636 | 11V 11V | | | |
| 1.8 i | 4 | LFZ (XU7JP) | 74/99 | 07/92→10/97 | Z193 | 0.9 | UXT1 / UXT3 | ZS341 | |
| 1.8 i LPG | 4 | LFZ (XU7JP) | 74/99 | 07/92→06/97 | Z340 →06/95 | 0.7 | UXT12 →06/95 | | |
| 1.8 i LPG | 4 | LFZ (XU7JP) | 74/99 | 10/93→10/97 | Z340 | 0.7 | UXT12 | | |
| 1.8 i 16V | 4 | LFY (XU7JP4) | 81/109 | 01/96→02/98 | Z13 [170] Z247 | 0.8 0.9 | UXT1 / UXT3 | ZS256 [84][243] ZS349 [85][160] | |
| 1.8 i 16V LPG | 4 | LFY (XU7JP4) | 81/109 | 01/96→02/98 | Z340 | 0.7 | UXT12 | | |
| 1.9 | 4 | | 96/129 | 03/91→09/93 | | | | ZS249 | |
| 1.9 D | 4 | DJZ (XUD9Y) | 47/63 | 03/91→10/97 | GV636 →04/94 GN909 05/94→ | 11V 11V | | | |
| 1.9 D | 4 | D9B (XUD9A/U), DJY (XUD9A) | 50/67 | 07/93→10/97 | GV636 →05/95 GN909 06/95→ | 11V 11V | | | |
| 1.9 DT | 4 | | 65/87 | 07/94→10/97 | GN013 | 11V | | | |
| 1.9 DT | 4 | | 68/91 | 06/92→06/94 | GN013 | 11V | | | |
| 1.9 i | 4 | DKZ (XU9JA) | 88/118 | 03/91→06/97 | Z193 | 0.9 | UXT1 / UXT3 | ZS341 | ZM001 |
| 1.9 i LPG | 4 | DKZ (XU9JA) | 88/118 | 03/91→06/97 | Z340 | 0.7 | UXT12 | | |
| 1.9 TD | 4 | DHY (XUD9TE/Y) | 66/89 | 07/92→10/97 | GN909 | 11V | | | GR034 |
| 2.0 | 4 | RFS (XU10J4RS) | 122/164 | 09/96→10/97 | | | | ZS341 | |
| 2.0 i | 4 | REF (XU10J2C) | 89/119 | 07/92→06/97 | Z193 | 0.9 | UXT1 / UXT3 | ZS341 | |
| 2.0 i LPG | 4 | REF (XU10J2C) | 89/119 | 07/92→06/97 | Z340 | 0.7 | UXT12 | | |
| 2.0 i 16V | 4 | RFT (XU10J4/Z) | 110/148 | 06/94→06/97 | Z24 | 0.8 | UXT5 | ZS323 | ZM026 |
| 2.0 i 16V | 4 | RFT, RFY | 112/150 | 07/92→10/94 | | | | ZS341 [1][87][180] ZS323 [1] 10/92→ | |
| 2.0 i 16V | 4 | RFT (XU10J4/Z), RFY (XU10J4/Z) | 112/150 | 07/92→10/94 | Z24 | 0.8 | UXT5 | | ZM026 |
| 2.0 i 16V | 4 | RFS (XU10J4RS) | 120/161 | 05/96→06/97 | Z193 | 0.9 | UXT1 / UXT3 | ZS346 | |
| 2.0 i 16V LPG | 4 | RFT (XU10J4/Z) | 110/148 | 06/94→06/97 | Z30 [168] | 0.8 | UXT5 | | |
| 2.0 i 16V LPG | 4 | RFT (XU10J4/Z), RFY (XU10J4/Z) | 112/150 | 07/92→10/94 | Z30 [168] | 0.8 | UXT5 | | |
| 2.0 i 16V LPG | 4 | RFS (XU10J4RS) | 120/161 | 05/96→06/97 | Z340 | 0.7 | UXT12 | | |

CITROËN**ACADIANE**

| | | | | | | | | | |
|-------|---|-----------|-------|-------------|-----|-----|--|--|--|
| 0.6 6 | 2 | M28 (AM2) | 22/30 | 08/78→10/88 | Z40 | 0.6 | | | |
| 0.6 6 | 2 | M28 (AM2) | 23/31 | 08/78→10/88 | Z40 | 0.6 | | | |

BERLINGO

| | | | | | | | | | |
|-------|---|-------------------------|-------|--------|------|-----|------|---------------------|-------|
| 1.1 i | 4 | HDZ | 44/59 | 07/96→ | | | | ZS341 [1] →01/02 | |
| 1.1 i | 4 | HDZ (TU1M), HFX (TU1JP) | 44/59 | 07/96→ | Z123 | 1.0 | UXT9 | | ZM026 |



kW/BHP



... CITROËN



... BERLINGO

| | | | | | | | | | |
|----------------------|---|------------------------------------|--------|-------------|------------------------------------|-----------------|-----|---|--|
| 1.1 i | 4 | HFX | 44/59 | 07/96→ | | | | ZSE047 [1][13] 01/01→08/05 | |
| 1.1 i LPG | 4 | HDZ (TU1M), HFX (TU1JP) | 44/59 | 07/96→ | Z129 | | 1.6 | | |
| 1.4 bivalent | 4 | KFW (TU3JP) | 48/64 | 11/02→ | | | | ZSE047 [1][13] →03/10 | |
| 1.4 i | 4 | KFW | 55/74 | 07/96→ | | | | ZSE047 [1][13] →03/10 | |
| 1.4 i | 4 | KFW (TU3JP), KFX (TU3JP) | 55/74 | 07/96→ | Z123 | | 1.0 | UXT9 | |
| 1.4 i | 4 | KFX | 55/74 | 07/96→ | | | | ZS341 [1] →05/98 ZS381 [1] 06/98→11/02 | |
| 1.4 i LPG | 4 | KFW (TU3JP), KFX (TU3JP) | 55/74 | 07/96→ | Z129 | | 1.6 | | |
| 1.4 i bivalent | 4 | KFW | 55/74 | 04/03→ | | | | ZSE047 [13] →03/10 | |
| 1.4 i bivalent | 4 | KFW (TU3JP) | 55/74 | 04/03→ | Z206 | | 0.7 | UXT10 | |
| 1.6 | 4 | NFR (TU5JP4B) | 66/89 | 04/08→ | Z184 | | 0.9 | UXT13 | |
| 1.6 | 4 | NFU (TU5JP4) | 80/107 | 04/08→ | Z184 | | 0.9 | UXT13 | |
| 1.6 LPG | 4 | NFR (TU5JP4B) | 66/89 | 04/08→ | Z226 [168] | | 0.8 | | |
| 1.6 LPG | 4 | NFU (TU5JP4) | 80/107 | 04/08→ | Z226 [168] | | 0.8 | | |
| 1.6 16V | 4 | NFU (TU5JP4) | 80/107 | 10/00→ | Z184 →11/02 | | 0.9 | UXT13 →11/02 | |
| 1.6 16V LPG | 4 | NFU (TU5JP4) | 80/107 | 10/00→ | Z226 [168] →11/02 | | 0.8 | 12/02→ | |
| 1.6 HDi 75 | 4 | 9HN (DV6ETED4), 9HT (DV6BUTED4) | 55/74 | 04/08→ | GN056 | | 11V | | |
| 1.6 HDi 75 | 4 | 9HW (DV6ETED), DV6B | 55/74 | 07/05→ | GN047 →05/06 GN056 07/06→ | | 11V | | |
| 1.6 HDi 90 | 4 | 9HS (DV6TED4BU), 9HX (DV6ATED4) | 66/89 | 04/08→ | GN056 | | 11V | | |
| 1.6 HDi 90 | 4 | 9HX (DV6ATED4) | 66/89 | 07/05→ | GN047 →02/06 GN056 03/06→ | | 11V | | |
| 1.6 HDi 90 | 4 | 9HP (DV6DTED) | 68/91 | 07/10→ | GE121A | | 5V | | |
| 1.6 HDi 110 | 4 | 9HZ (DV6TED4) | 80/107 | 04/08→ | GN056 | | 11V | | |
| 1.6 HDi 110 | 4 | 9HL (DV6C), 9HR (DV6C) | 82/110 | 07/10→ | GE121A | | 5V | | |
| 1.6 HDi 115 | 4 | 9HL (DV6C) | 84/113 | 07/10→ | GE121A | | 5V | | |
| 1.6 VTi 95 | 4 | 5FK (EP6CB) | 72/97 | 07/10→ | Z332 | | 0.7 | ZSE143 | |
| 1.8 D | 4 | A9A (XUD7) | 43/58 | 07/96→ | GN909 →08/98 GN013 09/98→ | | 11V | | |
| 1.8 i | 4 | LFX (XU7JB) | 66/89 | 08/99→10/02 | | | | ZS341 | |
| 1.9 D | 4 | DJY (XUD9A) | 51/68 | 07/96→ | GN909 →08/98 GN013 09/98→ | GR054 →08/98 | 11V | | |
| 1.9 D 70 | 4 | WJY (DW8B), WJZ (DW8) | 51/68 | 07/98→ | GN016 | | 11V | | |
| 2.0 HDi 90 | 4 | RHY (DW10TD) | 66/89 | 12/99→ | GN027 | | 11V | | |
| C2 ENTERPRISE | | | | | | | | | |
| 1.4 HDi | 4 | 8HX (DV4TD) | 50/67 | 04/09→ | GN047 | | 11V | | |

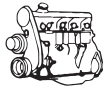

kW/BHP



... CITROËN



C15

| | | | | | | | | | |
|-----------|---|-------------------------|-------|-------------|--|-------|--|--------------------------------|-----------------|
| 1.0 | 4 | TU9, XV8 | 33/44 | 10/84→12/97 | | | | ZS247 ^[1] 07/88→ | |
| 1.1 | 4 | 109K | 35/47 | 10/84→12/96 | Z25 →07/87 Z63 08/87→07/88 | | 0.8 UXX56 →07/87 0.8 UXT1 / UXT3 08/87→07/88 | | ZM001 →07/88 |
| 1.1 | 4 | E1A | 35/47 | 10/84→12/96 | Z25 →07/87 Z63 08/87→07/88 | | 0.8 UXX56 →07/87 0.8 UXT1 / UXT3 08/87→07/88 | ZS257 | ZM001 →07/88 |
| 1.1 | 4 | H1A | 40/54 | 11/88→07/96 | | | | ZS247 | |
| 1.1 LPG | 4 | 109K, E1A | 35/47 | 10/84→12/96 | Z31 ^[168] →07/87 | | 0.8 UXX56 →07/87 | | |
| 1.1 i | 4 | HDZ (TU1M) | 44/59 | 07/88→12/96 | Z247 →06/95 Z123 07/95→ | | 0.9 UXT1 / UXT3 →06/95 1.0 UXT9 07/95→ | ZS247 | |
| 1.1 i LPG | 4 | HDZ (TU1M) | 44/59 | 07/88→12/96 | Z340 →06/95 Z129 07/95→ | | 0.7 UXT12 →06/95 1.6 | | |
| 1.3 | 4 | G1A | 47/63 | 07/87→05/88 | | | | ZS257 | |
| 1.4 | 4 | K1H (TU3A) | 49/66 | 07/87→12/96 | Z13 ^[170] Z247 | | 0.8 UXT1 / UXT3 0.9 | ZS247 | ZM003 |
| 1.4 LPG | 4 | K1H (TU3A) | 49/66 | 07/87→12/96 | Z340 | | 0.7 UXT12 | | |
| 1.4 E | 4 | K3A | 40/54 | 07/87→12/96 | | | | ZS247 ^[1] | |
| 1.4 E | 4 | 150D (XY7) | 44/59 | 05/87→12/96 | Z25 | | 0.8 UXX56 | | ZM001 |
| 1.4 E LPG | 4 | 150D (XY7) | 44/59 | 05/87→12/96 | Z31 ^[168] | | 0.8 UXX56 | | |
| 1.4 i | 4 | KDY (TU3FM), KDY (TU3M) | 55/74 | 05/91→12/96 | Z13 ^[170] →06/95 Z247 →06/95 Z123 07/95→ | | 0.8 UXT1 / UXT3 →06/95 0.9 UXT1 / UXT3 →06/95 1.0 UXT9 07/95→ | ZS247 | ZM003 |
| 1.4 i LPG | 4 | KDY (TU3FM), KDY (TU3M) | 55/74 | 05/91→12/96 | Z340 →06/95 Z129 07/95→ | | 0.7 UXT12 →06/95 1.6 | | |
| 1.8 D | 4 | 161A (XUD7) | 44/59 | 07/86→12/00 | GN909 ^{[2][222]} GV636 | GR065 | 11V 11V | | |
| 1.9 D | 4 | DW 8 | 44/59 | 12/00→12/05 | GN016 | | 11V | | |

C25

| | | | | | | | | | |
|------------|---|--------------------------|-------|-------------|--|-------|-----------------|--------------------------|-------|
| 1.8 | 4 | 169 (XM7T) | 50/67 | 11/81→01/94 | | | | ZS115 ^{[1][11]} | |
| 1.8 E | 4 | 169 (XM7T) | 51/68 | 07/87→02/94 | Z11 ^[167] | | 0.8 UXT2 / UXT6 | ZS115 ^[11] | ZM001 |
| 1.9 D | 4 | D9B (XUD9A/U) | 51/68 | 07/87→02/94 | GN909 ^{[2][222]} GV636 | GR065 | 11V 11V | | |
| 1.9 D 1400 | 4 | DJY (XUD9A) | 51/68 | 01/88→01/94 | GN013 | | 11V | | |
| 1.9 DT | 4 | | 60/80 | 10/91→01/94 | GV636 | | 11V | | |
| 1.9 TD | 4 | M705 | 60/80 | 04/92→02/94 | GN909 | | 11V | | |
| 2.0 | 4 | | 57/76 | 11/81→12/86 | | | | ZS115 ^{[1][11]} | |
| 2.0 | 4 | 170C (XN1T) | 62/83 | 01/87→03/94 | Z20 | | 0.8 UXT2 / UXT6 | | ZM001 |
| 2.0 E | 4 | 170A (XN1T), 170B (XN1T) | 58/78 | 09/81→03/94 | Z11 ^[167] | | 0.8 UXT2 / UXT6 | ZS115 ^{[1][11]} | ZM001 |
| 2.5 D | 4 | CRD93L (U25-661) | 54/72 | 10/85→02/94 | GN909 ^{[2][222]} GV602 | GR059 | 11V 11V | | |
| 2.5 D | 4 | | 55/74 | 11/81→01/94 | GN909 →ch. 00241462 GN013 ch. 00241462→ | | 11V 11V | | |



kW/BHP

**... CITROËN****... C25**

| | | | | | | | | | |
|-------------|---|-------------------|-------|-------------|-------------------------|-------|------------|--|--|
| 2.5 D | 4 | CRD93L (U25-661) | 55/74 | 11/81→01/94 | GN909 [2][222] GV602 | GR059 | 11V 11V | | |
| 2.5 D 4WD | 4 | | 55/74 | 11/83→12/86 | GV602 | | 11V | | |
| 2.5 DT | 4 | CRD93LS (U25-673) | 70/94 | 01/87→01/94 | GN909 [2][222] GV602 | GR059 | 11V 11V | | |
| 2.5 D Turbo | 4 | CRD93LS (U25-673) | 70/94 | 08/87→02/94 | GN909 [2][222] GV602 | GR059 | 11V 11V | | |

C35

| | | | | | | | | | |
|-------|---|--------|-------|-------------|-------------------------|--|------------|--|-------------------------|
| 2.0 | 4 | B20614 | 65/87 | 11/73→01/94 | | | | | ZS110 [1][15] →12/92 |
| 2.2 D | 4 | B22615 | 45/60 | 11/73→01/80 | GV130 | | 9.5V | | |
| 2.5 D | 4 | B25637 | 51/68 | 02/80→01/94 | GN909 [2][222] GV602 | | 11V 11V | | |

C-CROSSER ENTERPRISE

| | | | | | | | | | |
|-------------|---|-----------------|---------|--------|-------|--|-----|--|--|
| 2.2 HDi 4WD | 4 | 4HN (DW12MTED4) | 115/154 | 01/09→ | GN063 | | 11V | | |
|-------------|---|-----------------|---------|--------|-------|--|-----|--|--|

JUMPER

| | | | | | | | | | |
|--------------|---|------------------------------------|---------|-------------|------------------------------------|-------|------------|-------------|--------------------|
| 1.9 D | 4 | XUD9AU | 50/67 | 07/99→04/02 | GN013 | | 11V | | |
| 1.9 D | 4 | D9B (XUD9A/U) | 51/68 | 02/94→04/02 | GN909 →08/98 GN013 09/98→ | | 11V 11V | | |
| 1.9 D | 4 | D9B (XUD9A/U) | 51/68 | 01/99→04/02 | GN013 | | 11V | | |
| 1.9 TD | 4 | D8C (XUD9UTF), DHX (XUD9TF/BTF) | 66/89 | 03/94→04/02 | GN909 →08/98 GN013 09/98→ | | 11V 11V | | |
| 1.9 TD | 4 | D8C (XUD9UTF) | 68/91 | 02/94→04/02 | GN909 →08/98 GN013 09/98→ | | 11V 11V | | |
| 2.0 | 4 | RFW (XU10J2U) | 80/107 | 02/94→04/02 | Z247 | | 0.9 | UXT1 / UXT3 | ZS341 |
| 2.0 | 4 | XU10J2 | 81/109 | 04/02→ | Z193 | | 0.9 | UXT1 / UXT3 | ZS341 [1][87][180] |
| 2.0 LPG | 4 | RFW (XU10J2U) | 80/107 | 02/94→04/02 | Z340 | | 0.7 | UXT12 | |
| 2.0 LPG | 4 | XU10J2 | 81/109 | 04/02→ | Z340 | | 0.7 | UXT12 | |
| 2.0 bivalent | 4 | XU10J2 | 81/109 | 02/03→ | Z193 | | 0.9 | UXT1 / UXT3 | ZS341 |
| 2.0 HDi | 4 | RHV (DW10TD), DHX (XUD9TF/BTF) | 62/83 | 11/01→ | GN027 | | 11V | | |
| 2.2 HDi | 4 | 4HY (DW12UTED) | 74/99 | 02/02→ | GN027 →04/03 GN054 05/03→ | | 11V 11V | | |
| 2.2 HDi 100 | 4 | 4HV (P22DTE) | 74/99 | 04/06→ | GN939 | | 11.5V | | |
| 2.2 HDi 120 | 4 | 4HU (P22DTE) | 88/118 | 04/06→ | GN939 | | 11.5V | | |
| 2.5 D | 4 | T9A (DJ5) | 63/84 | 03/94→04/02 | GN909 | GR054 | 11V | | |
| 2.5 DT 4WD | 4 | | 76/102 | 10/96→08/97 | GN013 | | 11V | | |
| 2.5 TD | 4 | T8A (DJ5T) | 76/102 | 03/94→04/02 | GN909 →08/96 GN013 09/96→ | GR054 | 11V 11V | | |
| 2.5 TD 4WD | 4 | T8A (DJ5T) | 76/102 | 08/96→04/02 | GN909 GN013 09/96→ | GR054 | 11V 11V | | |
| 2.5 TDi | 4 | THX (DJ5TED) | 79/106 | 12/96→04/02 | GN964 | GR054 | 11V | | |
| 2.8 D | 4 | 8140.63 (F28D) | 64/86 | 01/99→02/02 | GN012 | | 11V | | |
| 2.8 HDi | 4 | 8140.43S | 93/125 | 10/00→01/02 | GN012 | | 11V | | |
| 2.8 HDi | 4 | 8140.43S, F28TDCR | 94/126 | 09/00→ | GN012 | | 11V | | |
| 2.8 HDi | 4 | 8140.43N | 107/143 | 05/04→ | GN012 | | 11V | | |
| 3.0 HDi 145 | 4 | F1CE3481N | 107/143 | 07/10→ | GN037 | | 11V | | |

CITROËN

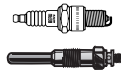

kW/BHP

**... CITROËN****... JUMPER**

| | | | | | | | | |
|-------------|---|-------------------|---------|--------|-------|-----|--|--|
| 3.0 HDi 155 | 4 | F1CE0481D (F30DT) | 115/154 | 07/10→ | GN037 | 11V | | |
| 3.0 HDi 160 | 4 | F1CE0481D (F30DT) | 116/156 | 09/06→ | GN037 | 11V | | |
| 3.0 HDi 180 | 4 | | 130/174 | 07/11→ | GN037 | 11V | | |

JUMPY

| | | | | | | | | |
|-----------------|---|------------------------------------|---------|-------------|------------|-----|-------|-------|
| 1.6 HDi 90 8V | 4 | 9HH (DV6DUM), 9HM (DV6UC) | 66/89 | 01/07→ | GE121A | 5V | | |
| 1.6 HDi 90 16V | 4 | 9HU (DV6UTED4) | 66/89 | 01/07→ | GN056 | 11V | | |
| 1.6 i | 4 | 220 A2.000, 1580 SPI | 58/78 | 10/95→ | Z252 | 0.9 | UXT5 | ZS234 |
| 1.6 i LPG | 4 | 220 A2.000, 1580 SPI | 58/78 | 10/95→ | Z30 [168] | 0.8 | UXT5 | |
| 1.9 D | 4 | D9B (XUD9A/U) | 51/68 | 10/95→08/98 | GN016 | 11V | | |
| 1.9 D 70 | 4 | WJY (DW8B), WJZ (DW8) | 51/68 | 04/98→ | GN016 | 11V | | |
| 1.9 DT | 4 | | 65/87 | 10/95→08/00 | GN013 | 11V | | |
| 1.9 TD | 4 | DHX (XUD9TF/BTF) | 66/89 | 10/95→ | GN909 | 11V | | |
| | | | | | →08/98 | | | |
| | | | | | GN013 | 11V | | |
| | | | | | 09/98→ | | | |
| 1.9 TD | 4 | D8B (XUD9TF) | 68/91 | 10/99→ | GN013 | 11V | | |
| 2.0 | 4 | RFN (EW10J4) | 100/134 | 12/03→10/06 | Z183 | 0.9 | UXT13 | ZS348 |
| 2.0 LPG | 4 | RFN (EW10J4) | 100/134 | 12/03→10/06 | Z184 [168] | 0.9 | UXT13 | |
| 2.0 HDi 95 | 4 | RHX (DW10BTED) | 69/93 | 10/99→ | GN027 | 11V | | |
| 2.0 HDi 95 | 4 | | 72/97 | 07/11→ | GE121A | 5V | | |
| 2.0 HDi 110 | 4 | RHW (DW10ATED4), RHZ (DW10ATED) | 80/107 | 01/02→ | GN027 | 11V | | |
| 2.0 HDi 110 16V | 4 | RHZ (DW10ATED) | 80/107 | 12/03→10/06 | GN027 | 11V | | |
| 2.0 HDi 120 | 4 | RHK (DW10UTED4) | 88/118 | 01/07→ | GN054 | 11V | | |
| 2.0 HDi 125 | 4 | | 94/126 | 07/11→ | GE121A | 5V | | |
| 2.0 HDi 140 | 4 | RHR (DW10BTED4) | 100/134 | 01/07→ | GN054 | 11V | | |
| 2.0 HDi 165 | 4 | RHH (DW10CTED4) | 120/161 | 07/10→ | GE121A | 5V | | |
| 2.0 i | 4 | RFH (EW10A) | 103/138 | 01/07→ | Z223 | 0.9 | UXT13 | ZS352 |
| 2.0 i 16V | 4 | | 102/137 | 03/00→ | Z183 | 0.9 | UXT13 | ZS348 |
| 2.0 i 16V LPG | 4 | | 102/137 | 03/00→ | Z184 [168] | 0.9 | UXT13 | |

NEMO

| | | | | | | | | |
|------------|---|---------------|-------|--------|-------|------|-------------|-------------|
| 1.3 HDi 75 | 4 | FHZ (F13DTE5) | 55/74 | 10/10→ | GE112 | 4.4V | | |
| 1.4 | 4 | KFV (TU3A) | 54/72 | 02/08→ | Z193 | 0.9 | UXT1 / UXT3 | ZSE048 [10] |
| 1.4 LPG | 4 | KFV (TU3A) | 54/72 | 02/08→ | Z340 | 0.7 | UXT12 | |
| 1.4 HDi | 4 | 8HS (DV4TED) | 50/67 | 02/08→ | GN056 | 11V | | |

XSARA

| | | | | | | | | |
|---------|---|--------------|-------|-------------|-------|-----|--|--|
| 2.0 HDi | 4 | RHY (DW10TD) | 66/89 | 09/00→03/05 | GN027 | 11V | | |
|---------|---|--------------|-------|-------------|-------|-----|--|--|

DACIA**1210**

| | | | | | | | | |
|-----|---|--|-------|-------------|-----|-----|--|------------|
| 1.2 | 4 | | 36/48 | 06/83→12/94 | Z19 | 0.8 | | ZS106 [11] |
|-----|---|--|-------|-------------|-----|-----|--|------------|

1300

| | | | | | | | | |
|-----|---|------------|-------|-------------|-----|-----|--|----------------------|
| 1.3 | 4 | 810-02/-99 | 40/54 | 12/72→05/83 | Z10 | 0.8 | | ZS106 [11] 01/76→ |
|-----|---|------------|-------|-------------|-----|-----|--|----------------------|

1309

| | | | | | | | | |
|-----|---|--|-------|-------------|-----|-----|--|-------|
| 1.6 | 4 | | 53/71 | 12/94→08/01 | Z19 | 0.8 | | ZS234 |
|-----|---|--|-------|-------------|-----|-----|--|-------|

1310

| | | | | | | | | |
|-------------|---|------------|-------|-------------|--------|-----|--|----------------------|
| 1.3 | 4 | 810-02/-99 | 40/54 | 05/83→07/04 | Z10 | 0.8 | | ZS106 [11] →12/98 |
| 1.4 | 4 | | 46/62 | 01/95→07/04 | Z118 | 0.9 | | ZS106 [11] →12/96 |
| 1.4 | 4 | | 48/64 | 09/85→12/94 | Z19 | 0.8 | | ZS106 [11] |
| | | | | | 01/94→ | | | |
| 1.4 Classic | 4 | | 46/62 | 01/95→07/04 | Z118 | 0.9 | | ZS106 [11] →12/96 |



kW/BHP



... DACIA



... 1310

| | | | | | | | |
|-----|---|-------|-------------|---|-----|---|--------------|
| 1.5 | 4 | 46/62 | 01/95→07/04 | Z193 →eng. 050425 Z257 [185] eng. 050425→ Z14 [204] eng. 050425;140325→ | 0.9 | UXT1 / UXT3 | ZS354 |
| | | | | | 0.9 | UXT1 / UXT3 eng. 050425→ | |
| | | | | | 0.9 | UXT1 / UXT3 eng. 050425;140325→ | |

1410

| | | | | | | | |
|-----|---|-------|-------------|----------------------|-----|--|--------------|
| 1.4 | 4 | 48/64 | 09/85→12/98 | Z19 | 0.8 | | ZS354 |
| 1.4 | 4 | 48/64 | 06/94→12/98 | Z19 →12/96 | 0.8 | | |

DOKKER

| | | | | | | | |
|---------|---|---------|-------|--------|-------------------|------|--------------|
| 1.5 dCi | 4 | K9K 612 | 55/74 | 11/12→ | GE110 [37] | 4.4V | |
| 1.5 dCi | 4 | | 66/89 | 11/12→ | GE110 [37] | 4.4V | |
| 1.6 16V | 4 | | 61/82 | 11/12→ | | | ZS354 |
| 1.6 LPG | 4 | | 61/82 | 11/13→ | | | ZS354 |

DUSTER

| | | | | | | | |
|-----------------|---|---------------------------|--------|--------|--|-------------|---------------------------------|
| 1.5 dCi | 4 | K9K 796 | 63/84 | 04/10→ | GN018 | 11V | |
| 1.5 dCi | 4 | K9K 892, K9K 894 | 66/89 | 10/10→ | GE110 [16][37] GN018 [14] | 4.4V 11V | |
| 1.5 dCi | 4 | K9K 896, K9K 898 | 79/106 | 06/10→ | GE110 [1][16][37] GN018 [1][14] | 4.4V 11V | |
| 1.5 dCi | 4 | K9K 856, K9K 858 | 80/107 | 08/13→ | GE110 [1][16][37] GN018 [1][14] | 4.4V 11V | |
| 1.5 dCi 4WD | 4 | K9K 898 | 81/109 | 10/10→ | GE110 [1][16][37] GN018 [1][14] | 4.4V 11V | |
| 1.6 16V | 4 | K4M 606, K4M 690, K4M 696 | 77/103 | 04/10→ | Z15 | 0.8 | UXT1 / UXT3 ZS052 |
| 1.6 16V LPG | 4 | K4M 606, K4M 690, K4M 696 | 77/103 | 04/10→ | Z340 | 0.7 | UXT12 |
| 1.6 16V Hi-Flex | 4 | K4M 696 | 77/103 | 08/10→ | | | ZS052 |
| 1.6 16V LPG | 4 | K4M 696 | 77/103 | 04/11→ | Z193 | 0.9 | UXT1 / UXT3 ZS052 |

LODGY

| | | | | | | | |
|---------|---|---------|--------|--------|-------------------|------|---------------------------------|
| 1.2 TCe | 4 | H5F 402 | 85/114 | 03/12→ | | | ZSE131 |
| 1.5 dCi | 4 | | 66/89 | 03/12→ | GE110 [37] | 4.4V | |
| 1.5 dCi | 4 | | 79/106 | 01/13→ | GE110 [37] | 4.4V | |
| 1.6 | 4 | K7MA8 | 61/82 | 03/12→ | Z14 | 0.9 | UXT1 / UXT3 ZS354 |
| 1.6 LPG | 4 | K7MA8 | 61/82 | 03/12→ | Z116 | 0.8 | UXT5 |
| 1.6 LPG | 4 | | 61/82 | 11/13→ | | | ZS354 |

LOGAN

| | | | | | | | |
|-------------------|---|------------------|--------|--------|--|-------------|---|
| 1.2 16V | 4 | D4F 732 | 55/74 | 02/06→ | Z243 | 0.9 | |
| 1.4 | 4 | K7J 710 | 55/74 | 09/04→ | Z15 | 0.8 | UXT1 / UXT3 ZS354 |
| 1.4 | 4 | K7J 710 | 55/74 | 01/09→ | Z98 | 0.8 | UXT1 / UXT3 |
| 1.4 LPG | 4 | K7J 710 | 55/74 | 09/04→ | Z340 | 0.7 | UXT12 |
| 1.4 LPG | 4 | K7J 710 | 55/74 | 01/09→ | Z116 | 0.8 | UXT5 |
| 1.4 MPI LPG | 4 | K7J 710, K7J 714 | 55/74 | 02/06→ | Z340 | 0.7 | UXT12 ZS354 |
| 1.5 dCi | 4 | K9K 790 | 48/64 | 09/05→ | GN018 | 11V | |
| 1.5 dCi | 4 | K9K 792 | 50/67 | 01/06→ | GN018 | 11V | |
| 1.5 dCi | 4 | K9K 892 | 55/74 | 05/10→ | GE110 [1][16][37] GN018 [1][14] | 4.4V 11V | |
| 1.5 dCi | 4 | K9K 796 | 63/84 | 09/07→ | GN018 | 11V | |
| 1.5 dCi | 4 | K9K 892 | 65/87 | 05/10→ | GE110 [1][16][37] GN018 [1][14] | 4.4V 11V | |
| 1.6 | 4 | K7M 710 | 64/86 | 09/04→ | Z15 | 0.8 | UXT1 / UXT3 ZS354 |
| 1.6 LPG | 4 | K7M 710 | 64/86 | 09/04→ | Z340 | 0.7 | UXT12 |
| 1.6 16V | 4 | K4M 690, K4M 696 | 77/103 | 02/06→ | Z15 | 0.8 | UXT1 / UXT3 ZS052 |
| 1.6 16V LPG | 4 | K4M 690, K4M 696 | 77/103 | 02/06→ | Z340 | 0.7 | UXT12 |
| 1.6 16V Flexifuel | 4 | K4M 696 | 77/103 | 07/10→ | | | ZS052 |
| 1.6 Bifuel | 4 | K7M 718, K7M 800 | 62/83 | 05/10→ | Z257 11/10→ | 0.9 | UXT1 / UXT3 ZS354 11/10→ |

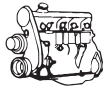

kw/BHP

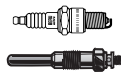

... DACIA



... LOGAN

| | | | | | | | | |
|------------|---|---------|-------|--------|---|-------------------|--|----------------------------------|
| 1.6 MPI 85 | 4 | K7M 800 | 62/83 | 05/10→ | Z193 →eng. 050425 Z257 [185] eng. 050425→ Z14 [204] eng. 050425;140325→ | 0.9 0.9 0.9 | UXT1 / UXT3 UXT1 / UXT3 UXT1 / UXT3 | ZS354 ZS354 |
|------------|---|---------|-------|--------|---|-------------------|--|----------------------------------|

LOGAN II

| | | | | | | | | |
|---------|---|---------|-------|--------|-----------------------|------|--|--|
| 1.2 | 4 | | 55/74 | 10/12→ | | | | ZS325 [157] ZS375 [156] |
| 1.2 LPG | 4 | D4F 734 | 55/74 | 10/12→ | | | | ZS325 [157] ZS375 [156] |
| 1.5 dCi | 4 | | 55/74 | 10/12→ | GE110 [16][37] | 4.4V | | |
| 1.5 dCi | 4 | K9K 612 | 66/89 | 10/12→ | GE110 [16][37] | 4.4V | | |

LOGAN MCV

| | | | | | | | | |
|-----------------|---|------------------|--------|--------|--|-------------|--|----------------------------------|
| 1.4 | 4 | K7J 710 | 55/74 | 02/07→ | Z15 | 0.8 | UXT1 / UXT3 | ZS354 |
| 1.4 LPG | 4 | K7J 710 | 55/74 | 02/07→ | Z340 | 0.7 | UXT12 | |
| 1.5 dCi | 4 | K9K 792 | 50/67 | 02/07→ | GN018 | 11V | | |
| 1.5 dCi | 4 | K9K 892 | 55/74 | 05/10→ | GE110 [1][16][37] GN018 [1][14] | 4.4V 11V | | |
| 1.5 dCi | 4 | K9K 796 | 63/84 | 09/07→ | GN018 | 11V | | |
| 1.5 dCi | 4 | K9K 892 | 65/87 | 05/10→ | GE110 [1][16][37] GN018 [1][14] | 4.4V 11V | | |
| 1.6 | 4 | K7M 710 | 64/86 | 02/07→ | Z15 | 0.8 | UXT1 / UXT3 | ZS354 |
| 1.6 LPG | 4 | K7M 710 | 64/86 | 02/07→ | Z340 | 0.7 | UXT12 | |
| 1.6 16V | 4 | K4M 690, K4M 696 | 77/103 | 02/07→ | Z15 | 0.8 | UXT1 / UXT3 | ZS052 |
| 1.6 16V LPG | 4 | K4M 690, K4M 696 | 77/103 | 02/07→ | Z340 | 0.7 | UXT12 | |
| 1.6 16V Hi-Flex | 4 | K4M 690, K4M 694 | 77/103 | 11/09→ | Z340 | 0.7 | UXT12 | ZS052 |
| 1.6 Bifuel | 4 | K7M 710 | 64/86 | 11/08→ | Z98 | 0.8 | UXT1 / UXT3 | ZS354 |
| 1.6 Bifuel LPG | 4 | K7M 710 | 64/86 | 11/08→ | Z116 | 0.8 | UXT5 | |
| 1.6 MPI 85 | 4 | K7M 800 | 62/83 | 05/10→ | Z14 [204] eng. 050425;140325→ Z257 [185] 11/10→ eng. 050425→ | 0.9 0.9 | UXT1 / UXT3 UXT1 / UXT3 | ZS354 ZS354 |

LOGAN MCV II

| | | | | | | | | |
|---------|---|---------|-------|--------|-----------------------|------|--|--|
| 1.5 dCi | 4 | K9K 612 | 55/74 | 02/13→ | GE110 [16][37] | 4.4V | | |
| 1.5 dCi | 4 | K9K 612 | 66/89 | 02/13→ | GE110 [16][37] | 4.4V | | |

NOVA

| | | | | | | | | |
|-----|---|--|-------|-------------|-----------|-----|--------------------|--------------|
| 1.6 | 4 | | 53/71 | 04/96→03/03 | Z8 | 0.8 | UXT2 / UXT6 | ZS234 |
|-----|---|--|-------|-------------|-----------|-----|--------------------|--------------|

SANDERO

| | | | | | | | | |
|--------------------|---|---------------------------|--------|--------|-------------------|------|--------------------|---|
| 1.2 16V | 4 | D4F 732 | 55/74 | 11/08→ | Z243 | 0.9 | | ZS325 [157] ZS375 [156] |
| 1.2 16V LPG | 4 | D4F 732 | 55/74 | 11/08→ | | | | ZS325 [157][266] ZS375 [156] |
| 1.4 | 4 | K7J 710 | 55/74 | 06/08→ | Z98 | 0.8 | UXT1 / UXT3 | ZS354 |
| 1.4 MPI LPG | 4 | K7J 714 | 53/71 | 01/09→ | Z340 | 0.7 | UXT12 | ZS354 |
| 1.5 dCi | 4 | K9K 792 | 50/67 | 11/08→ | GN018 | 11V | | |
| 1.5 dCi | 4 | K9K 892 | 55/74 | 05/10→ | GE110 [37] | 4.4V | | |
| 1.5 dCi | 4 | K9K 796 | 63/84 | 11/08→ | GN018 | 11V | | |
| 1.5 dCi | 4 | K9K 892 | 65/87 | 05/10→ | GE110 [37] | 4.4V | | |
| 1.6 | 4 | K7M 710 | 64/86 | 06/08→ | Z98 | 0.8 | UXT1 / UXT3 | ZS354 |
| 1.6 16V | 4 | K4M 690 | 77/103 | 07/11→ | Z193 | 0.9 | UXT1 / UXT3 | ZS052 |
| 1.6 16V Bifuel | 4 | K4M 690, K4M 694 | 77/103 | 01/11→ | Z15 | 0.8 | UXT1 / UXT3 | |
| 1.6 16V Bifuel | 4 | K4M 696 | 77/103 | 01/11→ | Z15 | 0.8 | UXT1 / UXT3 | ZS052 |
| 1.6 16V Bifuel LPG | 4 | K4M 690, K4M 694, K4M 696 | 77/103 | 01/11→ | Z340 | 0.7 | UXT12 | |

DACIA

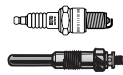

kW/BHP

**... DACIA****... SANDERO**

| | | | | | | | | |
|------------|---|---------|-------|--------|---|-----|---|--------------|
| 1.6 MPI 85 | 4 | K7M 800 | 62/83 | 05/10→ | Z193 →eng. 050425 Z257 [185] eng. 050425→ Z14 [204] eng. 050425;140325→ | 0.9 | UXT1 / UXT3 →eng. 050425 | ZS354 |
| | | | | | | 0.9 | UXT1 / UXT3 eng. 050425→ | |
| | | | | | | 0.9 | UXT1 / UXT3 eng. 050425;140325→ | |

SANDERO II

| | | | | | | | | |
|---------|---|---------|-------|--------|-----------------------|------|--|---|
| 1.2 | 4 | D4F 732 | 55/74 | 10/12→ | | | | ZS325 [157][266] ZS375 [156] |
| 1.2 LPG | 4 | | 55/74 | 10/12→ | | | | ZS325 [157][266] ZS375 [156] |
| 1.5 dCi | 4 | K9K 612 | 55/74 | 10/12→ | GE110 [16][37] | 4.4V | | |
| 1.5 dCi | 4 | K9K 612 | 66/89 | 10/12→ | GE110 [16][37] | 4.4V | | |

SOLENZA

| | | | | | | | | |
|-------|---|---------|-------|--------|----------------------|-----|------------------------------|--|
| 1.4 | 4 | K7J 710 | 55/74 | 02/03→ | Z98 →03/05 | 0.8 | UXT1 / UXT3 →03/05 | |
| 1.9 D | 4 | F8Q 630 | 46/62 | 02/03→ | GN019 | 11V | | |

DACIA**1307**

| | | | | | | | | |
|-----|---|--|-------|-------------|------------|-----|--|--|
| 1.4 | 4 | | 48/64 | 06/84→11/94 | Z19 | 0.8 | | |
|-----|---|--|-------|-------------|------------|-----|--|--|

1309

| | | | | | | | | |
|-----|---|--|-------|-------------|------------|-----|--|--|
| 1.4 | 4 | | 48/64 | 09/90→11/94 | Z19 | 0.8 | | |
|-----|---|--|-------|-------------|------------|-----|--|--|

DOKKER Express

| | | | | | | | | |
|---------|---|---------|-------|--------|-------------------|------|--|--------------|
| 1.5 dCi | 4 | K9K 612 | 55/74 | 12/12→ | GE110 [37] | 4.4V | | |
| 1.5 dCi | 4 | | 66/89 | 12/12→ | GE110 [37] | 4.4V | | |
| 1.6 16V | 4 | | 61/82 | 12/12→ | | | | ZS354 |
| 1.6 LPG | 4 | | 61/82 | 11/13→ | | | | ZS354 |

LOGAN

| | | | | | | | | |
|------------|---|---------|-------|--------|--|-------------|------------------------------|--------------|
| 1.4 | 4 | K7J 710 | 55/74 | 03/09→ | Z15 | 0.8 | UXT1 / UXT3 | ZS354 |
| 1.4 LPG | 4 | K7J 710 | 55/74 | 03/09→ | Z340 | 0.7 | UXT12 | |
| 1.5 dCi | 4 | K9K 792 | 50/67 | 03/09→ | GE110 [16][37] GN018 [14] | 4.4V 11V | | |
| 1.5 dCi | 4 | K9K 892 | 55/74 | 05/10→ | GE110 [1][16][37] GN018 [1][14] | 4.4V 11V | | |
| 1.5 dCi | 4 | K9K 796 | 63/84 | 03/09→ | GN018 | 11V | | |
| 1.5 dCi | 4 | K9K 892 | 65/87 | 05/10→ | GE110 [1][16][37] GN018 [1][14] | 4.4V 11V | | |
| 1.6 | 4 | K7M 710 | 64/86 | 03/09→ | Z15 | 0.8 | UXT1 / UXT3 | ZS354 |
| 1.6 LPG | 4 | K7M 710 | 64/86 | 03/09→ | Z340 | 0.7 | UXT12 | |
| 1.6 MPI 85 | 4 | K7M 800 | 62/83 | 05/10→ | Z257 11/10→ | 0.9 | UXT1 / UXT3 11/10→ | ZS354 |

DAEWOO**CIELO**

| | | | | | | | | |
|-----|---|------|-------|-------------|------------|-----|--------------------|--|
| 1.5 | 4 | V15L | 66/89 | 06/94→07/98 | Z20 | 0.8 | UXT2 / UXT6 | |
|-----|---|------|-------|-------------|------------|-----|--------------------|--|

ESPERO

| | | | | | | | | |
|-------------|---|-------|--------|-------------|------------------|-----|--------------------|--|
| 1.5 16V | 4 | A15MF | 65/87 | 10/93→09/94 | Z16 | 1.1 | UXT11 | |
| 1.5 16V | 4 | A15MF | 66/89 | 02/95→06/99 | Z16 | 1.1 | UXT11 | |
| 1.5 16V LPG | 4 | A15MF | 66/89 | 02/95→06/99 | Z340 | 0.7 | UXT12 | |
| 1.8 | 4 | C18LE | 66/89 | 02/95→09/99 | Z8 | 0.8 | UXT2 / UXT6 | |
| 1.8 | 4 | C18LE | 70/94 | 02/95→06/99 | Z8 | 0.8 | UXT2 / UXT6 | |
| 1.8 LPG | 4 | C18LE | 66/89 | 02/95→09/99 | Z20 [168] | 0.8 | UXT2 / UXT6 | |
| 1.8 LPG | 4 | C18LE | 70/94 | 02/95→06/99 | Z20 [168] | 0.8 | UXT2 / UXT6 | |
| 2.0 | 4 | C20LZ | 74/99 | 10/91→09/93 | Z82 | 0.7 | UXT2 / UXT6 | |
| 2.0 | 4 | C20LE | 77/103 | 02/95→06/99 | Z82 | 0.7 | UXT2 / UXT6 | |

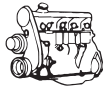

kW/BHP

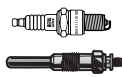

... DAEWOO



EVANDA

| | | | | | | | | |
|-----|---|----------|--------|--------|--|--|--|--------|
| 2.0 | 4 | X 20 SED | 96/129 | 08/02→ | | | | ZS447A |
|-----|---|----------|--------|--------|--|--|--|--------|

KALOS

| | | | | | | | | |
|-------------|---|--------------|-------|-------------|---------------------|------|-----------------------|--------|
| 1.2 | 4 | B12S1, F12S3 | 53/71 | 04/03→ | Z9 →01/05 | 1.15 | UXT2 / UXT6 →01/05 | ZS447A |
| 1.2 LPG | 4 | B12S1, F12S3 | 53/71 | 04/03→ | Z20 [168] →01/05 | 0.8 | UXT2 / UXT6 →01/05 | |
| 1.4 | 4 | F14S3 | 61/82 | 09/02→ | Z20 | 0.8 | UXT2 / UXT6 | ZS447A |
| 1.4 | 4 | F14D3 | 69/93 | 05/03→12/04 | Z16 | 1.1 | UXT11 | ZS447A |
| 1.4 LPG | 4 | F14S3 | 61/82 | 09/02→ | Z27 [168] | 0.8 | UX56 | |
| 1.4 LPG | 4 | F14D3 | 69/93 | 05/03→12/04 | Z340 | 0.7 | UXT12 | |
| 1.4 16V | 4 | F14D3 | 69/93 | 04/03→ | Z16 →01/05 | 1.1 | UXT11 →01/05 | ZS447A |
| 1.4 16V LPG | 4 | F14D3 | 69/93 | 04/03→ | Z340 →01/05 | 0.7 | UXT12 →01/05 | |
| 1.5 | 4 | F15S | 62/83 | 11/02→12/04 | Z20 | 0.8 | UXT2 / UXT6 | |

KORANDO

| | | | | | | | | |
|-----------------|---|----------------|---------|--------|-------|-------|-------------|-------|
| 2.0 16V 4WD | 4 | M 161.950 | 94/126 | 02/99→ | Z100 | 0.8 | UXT1 / UXT3 | ZS340 |
| 2.0 16V 4WD LPG | 4 | M 161.950 | 94/126 | 02/99→ | Z206 | 0.7 | UXT10 | |
| 2.3 4WD | 4 | M 161.970 | 105/141 | 01/99→ | Z100 | 0.8 | UXT1 / UXT3 | ZS340 |
| 2.3 4WD LPG | 4 | M 161.970 | 105/141 | 01/99→ | Z206 | 0.7 | UXT10 | |
| 2.9 D 4WD | 5 | MB-OM 662 | 72/97 | 01/99→ | GN858 | 11.5V | | |
| 2.9 TD 4WD | 5 | MB-OM 601 29TD | 88/118 | 01/99→ | GN858 | 11.5V | | |
| 3.2 4WD | 6 | M 104.995 | 156/209 | 01/99→ | Z100 | 0.8 | UXT1 / UXT3 | ZS340 |
| 3.2 4WD LPG | 6 | M 104.995 | 156/209 | 01/99→ | Z206 | 0.7 | UXT10 | |

LACETTI

| | | | | | | | | |
|---------|---|----------|--------|-------------|------|-----|-------|-------------------------------------|
| 1.4 | 4 | F14D3 | 70/94 | 02/04→ | Z16 | 1.1 | UXT11 | |
| 1.4 LPG | 4 | F14D3 | 70/94 | 02/04→ | Z340 | 0.7 | UXT12 | |
| 1.6 | 4 | F16D3 | 80/107 | 02/04→ | Z16 | 1.1 | UXT11 | |
| 1.6 LPG | 4 | F16D3 | 80/107 | 02/04→ | Z340 | 0.7 | UXT12 | |
| 1.8 | 4 | T18SED | 90/121 | 02/04→ | | | | ZS447A →02/06 ZS508 02/06→ |
| 1.8 CDX | 4 | F18D2 | 67/90 | 08/03→12/04 | | | | ZS508 |
| 1.8 CDX | 4 | T18SED | 90/121 | 08/03→12/04 | | | | ZS508 |
| 2.0 | 4 | X 20 SED | 98/131 | 04/97→07/03 | | | | ZS447A [1] |

LANOS

| | | | | | | | | |
|-------------|---|--------|--------|-------------|---------------------|-----|-----------------------|-----------------------|
| 1.4 | 4 | A14SMS | 55/74 | 05/97→ | Z8 | 0.8 | UXT2 / UXT6 | ZS447A ch. 590906→ |
| 1.4 LPG | 4 | A14SMS | 55/74 | 05/97→ | Z20 [168] | 0.8 | UXT2 / UXT6 | |
| 1.5 | 4 | A15SMS | 63/84 | 05/97→ | Z8 →09/03 | 0.8 | UXT2 / UXT6 →09/03 | ZS447A ch. 590906→ |
| 1.5 | 4 | A15SMS | 73/98 | 10/97→06/99 | | | | ZS447A |
| 1.5 LPG | 4 | A15SMS | 63/84 | 05/97→ | Z20 [168] →09/03 | 0.8 | UXT2 / UXT6 →09/03 | |
| 1.6 16V | 4 | A16DMS | 78/105 | 05/97→ | Z16 | 1.1 | UXT11 | ZS447A [1] |
| 1.6 16V LPG | 4 | A16DMS | 78/105 | 05/97→ | Z340 | 0.7 | UXT12 | |

LEGANZA

| | | | | | | | | |
|-------------|---|----------|---------|-------------|------|-----|-------------|------------|
| 2.0 16V | 4 | T20SED | 93/125 | 07/00→04/04 | Z74 | 1.0 | UXT1 / UXT3 | ZS447A [1] |
| 2.0 16V | 4 | X 20 SED | 98/131 | 06/97→12/02 | Z193 | 0.9 | UXT1 / UXT3 | ZS447A [1] |
| 2.0 16V LPG | 4 | T20SED | 93/125 | 07/00→04/04 | Z206 | 0.7 | UXT10 | |
| 2.0 16V LPG | 4 | X 20 SED | 98/131 | 06/97→12/02 | Z340 | 0.7 | UXT12 | |
| 2.2 16V | 4 | T22SED | 100/134 | 04/99→12/02 | Z74 | 1.0 | UXT1 / UXT3 | ZS447A [1] |
| 2.2 16V LPG | 4 | T22SED | 100/134 | 04/99→12/02 | Z206 | 0.7 | UXT10 | |

MAGNUS

| | | | | | | | | |
|-----|---|----------|--------|--------|--|--|--|------------|
| 2.0 | 4 | X 20 SED | 96/129 | 07/99→ | | | | ZS447A [1] |
|-----|---|----------|--------|--------|--|--|--|------------|

DAEWOO



kW/BHP



... DAEWOO



MATIZ

| | | | | | | | | |
|---------|---|------|-------|--------|-----------|------|-------------|--------|
| 0.8 | 3 | F8CV | 38/51 | 09/98→ | Z9 | 1.15 | UXT2 / UXT6 | |
| 0.8 LPG | 3 | F8CV | 38/51 | 09/98→ | Z20 [168] | 0.8 | UXT2 / UXT6 | |
| 1.0 | 4 | B10S | 47/63 | 01/03→ | Z9 | 1.15 | UXT2 / UXT6 | ZS447A |
| 1.0 LPG | 4 | B10S | 47/63 | 01/03→ | Z20 [168] | 0.8 | UXT2 / UXT6 | |

MUSSO

| | | | | | | | | |
|-------------|---|----------------|---------|-------------|-------|-------|-------------|-------|
| 2.2 TD 4WD | 4 | MB OM 601 | 74/99 | 09/99→ | GN858 | 11.5V | | |
| 2.3 4WD | 4 | M 111.970 | 103/138 | 01/99→ | Z100 | 0.8 | UXT1 / UXT3 | ZS340 |
| 2.3 4WD LPG | 4 | M 111.970 | 103/138 | 01/99→ | Z206 | 0.7 | UXT10 | |
| 2.9 D 4WD | 5 | MB-OM 662 | 73/98 | 01/99→09/99 | GN858 | 11.5V | | |
| 2.9 TD 4WD | 5 | MB-OM 601 29TD | 88/118 | 01/99→ | GN858 | 11.5V | | |
| 3.2 4WD | 6 | M 104.992 | 162/217 | 01/99→ | Z100 | 0.8 | UXT1 / UXT3 | ZS340 |
| 3.2 4WD LPG | 6 | M 104.992 | 162/217 | 01/99→ | Z206 | 0.7 | UXT10 | |

NEXIA

| | | | | | | | | |
|-------------|---|-------|--------|-------------|-----------|-----|-------------|--|
| 1.5 | 4 | G15MF | 44/59 | 08/96→08/97 | Z20 | 0.8 | UXT2 / UXT6 | |
| 1.5 | 4 | G15MF | 52/70 | 02/95→08/97 | Z16 | 1.1 | UXT11 | |
| 1.5 | 4 | G15MF | 55/74 | 02/95→08/97 | Z8 | 0.8 | UXT2 / UXT6 | |
| 1.5 | 4 | Y15L | 59/79 | 07/08→ | Z20 | 0.8 | UXT2 / UXT6 | |
| 1.5 LPG | 4 | G15MF | 44/59 | 08/96→08/97 | Z27 [168] | 0.8 | UX56 | |
| 1.5 LPG | 4 | G15MF | 52/70 | 02/95→08/97 | Z340 | 0.7 | UXT12 | |
| 1.5 LPG | 4 | G15MF | 55/74 | 02/95→08/97 | Z20 [168] | 0.8 | UXT2 / UXT6 | |
| 1.5 16V | 4 | A15MF | 66/89 | 02/95→08/97 | Z16 | 1.1 | UXT11 | |
| 1.5 16V LPG | 4 | A15MF | 66/89 | 02/95→08/97 | Z340 | 0.7 | UXT12 | |
| 1.6 | 4 | F16D3 | 80/107 | 07/08→ | Z16 | 1.1 | UXT11 | |

NUBIRA

| | | | | | | | | |
|-------------|---|----------|--------|-------------|----------------|------------|-----------------------|---------------------------------|
| 1.4 | 4 | F14D3 | 69/93 | 10/03→12/04 | Z16 | 1.1 | UXT11 | |
| 1.4 LPG | 4 | F14D3 | 69/93 | 10/03→12/04 | Z340 | 0.7 | UXT12 | |
| 1.6 | 4 | F16D3 | 80/107 | 07/03→ | Z16 | 1.1 | UXT11 | |
| 1.6 LPG | 4 | F16D3 | 80/107 | 07/03→ | Z340 | 0.7 | UXT12 | |
| 1.6 16V | 4 | | 66/89 | 06/97→ | | | | ZS447A [1] |
| 1.6 16V | 4 | A16DMS | 76/102 | 12/00→ | | | | ZS447A |
| 1.6 16V | 4 | A16DMS | 78/105 | 05/97→ | Z16 | 1.1 | UXT11 | ZS447A [1] |
| 1.6 16V LPG | 4 | A16DMS | 78/105 | 05/97→ | Z340 | 0.7 | UXT12 | |
| 1.8 | 4 | C18LE | 70/94 | 06/04→ | Z8 | 0.8 | UXT2 / UXT6 | |
| 1.8 | 4 | T18SED | 90/121 | 07/03→ | | | | ZS447A →02/06 ZS508 [123] |
| 1.8 LPG | 4 | C18LE | 70/94 | 06/04→ | Z20 [168] | 0.8 | UXT2 / UXT6 | |
| 2.0 | 4 | C20SED | 81/109 | 06/99→07/03 | | | | ZS447A [1] |
| 2.0 16V | 4 | T20SED | 93/125 | 12/00→ | Z74 →01/05 | 1.0 | UXT1 / UXT3 →01/05 | ZS447A |
| 2.0 16V | 4 | X 20 SED | 98/131 | 05/97→ | Z193 Z74 | 0.9 1.0 | UXT1 / UXT3 | ZS447A [1] ch. 642921→ |
| 2.0 16V | 4 | Z20L | 98/131 | 05/97→ | | | | ZS447A [1] |
| 2.0 16V LPG | 4 | T20SED | 93/125 | 12/00→ | Z206 →01/05 | 0.7 | UXT10 →01/05 | |
| 2.0 16V LPG | 4 | X 20 SED | 98/131 | 05/97→ | Z206 Z340 | 0.7 0.7 | UXT10 UXT12 | |

REXTON

| | | | | | | | | |
|----------------|---|------------|---------|--------|-------|-------|-------------|-------|
| 2.9 TD 4WD | 5 | OM 662.983 | 88/118 | 04/02→ | GN858 | 11.5V | | |
| 3.2 V6 4WD | 6 | M 162.992 | 162/217 | 04/02→ | Z100 | 0.8 | UXT1 / UXT3 | ZS340 |
| 3.2 V6 4WD LPG | 6 | M 162.992 | 162/217 | 04/02→ | Z206 | 0.7 | UXT10 | |

REZZO

| | | | | | | | | |
|---------|---|--------|--------|--------|--------------------|-----|-----------------------|--------|
| 1.6 | 4 | A16DMS | 77/103 | 09/00→ | Z73 | 1.1 | UXT11 | ZS447A |
| 1.6 LPG | 4 | A16DMS | 77/103 | 09/00→ | Z206 | 0.7 | UXT10 | |
| 1.8 | 4 | F18D2 | 67/90 | 09/00→ | | | | ZS447A |
| 1.8 | 4 | A18DMS | 72/97 | 09/00→ | | | | ZS447A |
| 1.8 | 4 | F18S2 | 74/99 | 09/00→ | Z8 [168] →01/05 | 0.8 | UXT2 / UXT6 →01/05 | ZS447A |

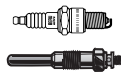

kW/BHP

**... DAEWOO****... REZZO**

| | | | | | | | | |
|---------|---|----------|--------|--------|---------------------|-----|-----------------------|--------|
| 1.8 LPG | 4 | F18S2 | 74/99 | 09/00→ | Z20 [168] →01/05 | 0.8 | UXT2 / UXT6 →01/05 | |
| 2.0 | 4 | X 20 SED | 89/119 | 09/01→ | | | ZS447A | |
| 2.0 | 4 | T20SED | 94/126 | 09/00→ | Z74 →01/05 | 1.0 | UXT1 / UXT3 →01/05 | ZS447A |
| 2.0 LPG | 4 | T20SED | 94/126 | 09/00→ | Z206 →01/05 | 0.7 | UXT10 →01/05 | |

TICO

| | | | | | | | | |
|---------|---|------|-------|-------------|-----------|------|-------------|--|
| 0.8 | 3 | F8C | 35/47 | 02/95→12/00 | Z9 | 1.15 | UXT2 / UXT6 | |
| 0.8 | 3 | F8CV | 38/51 | 01/96→12/00 | Z21 | 1.1 | UXT2 / UXT6 | |
| 0.8 LPG | 3 | F8C | 35/47 | 02/95→12/00 | Z20 [168] | 0.8 | UXT2 / UXT6 | |

TOSCA

| | | | | | | | | |
|----------|---|----------|---------|--------|-------|------|--|--|
| 2.0 TDCi | 4 | Z 20 DMH | 110/148 | 02/06→ | GE125 | 4.4V | | |
|----------|---|----------|---------|--------|-------|------|--|--|

WINSTORM

| | | | | | | | | |
|---------|---|----------|---------|--------|-------------------|------------|-------------|--|
| 2.4 | 4 | Z 24 XED | 104/139 | 12/06→ | Z190 [282] Z74 | 1.2 1.0 | UXT1 / UXT3 | |
| 2.4 LPG | 4 | Z 24 XED | 104/139 | 12/06→ | Z206 | 0.7 | UXT10 | |

DAIHATSU**APPLAUSE I**

| | | | | | | | | |
|-------------|---|------|--------|-------------|------|-----|-------|-----------------|
| 1.6 16V | 4 | HD | 66/89 | 06/89→07/97 | Z16 | 1.1 | UXT11 | |
| 1.6 16V | 4 | HD-E | 77/103 | 06/89→07/97 | Z16 | 1.1 | UXT11 | ZM053 01/90→ |
| 1.6 16V LPG | 4 | HD | 66/89 | 06/89→07/97 | Z340 | 0.7 | UXT12 | |
| 1.6 16V LPG | 4 | HD-E | 77/103 | 06/89→07/97 | Z340 | 0.7 | UXT12 | |

APPLAUSE II

| | | | | | | | | |
|-------------|---|------|-------|-------------|------|-----|-------|--|
| 1.6 16V | 4 | HD-E | 73/98 | 07/97→05/00 | Z16 | 1.1 | UXT11 | |
| 1.6 16V LPG | 4 | HD-E | 73/98 | 07/97→05/00 | Z340 | 0.7 | UXT12 | |

CERIA

| | | | | | | | | |
|----------|---|-------|-------|--------|------|-----|--|--|
| 1.0 DWVT | 3 | EJ-VE | 43/58 | 06/05→ | Z324 | 0.9 | | |
|----------|---|-------|-------|--------|------|-----|--|--|

CHARADE

| | | | | | | | | |
|---------|---|--------|-------|--------|------|-----|--------|--|
| 1.0 | 3 | EJ-VE | 43/58 | 03/03→ | Z324 | 0.9 | | |
| 1.3 16V | 4 | TNR-FE | 73/98 | 05/11→ | | | ZSE172 | |

CHARADE I

| | | | | | | | | |
|-----|---|--------------|-------|-------------|----|-----|-------------|------------|
| 1.0 | 3 | CB 20 | 37/50 | 10/77→02/81 | Z8 | 0.8 | UXT2 / UXT6 | ZS109 [15] |
| 1.0 | 3 | CB 20, CB 22 | 38/51 | 02/81→02/83 | Z8 | 0.8 | UXT2 / UXT6 | ZS109 [15] |

CHARADE II

| | | | | | | | | |
|-----------|---|--------------|-------|-------------|-------|-----|-------------|---------------|
| 1.0 | 3 | CB 20, CB 22 | 38/51 | 10/83→03/87 | Z8 | 0.8 | UXT2 / UXT6 | ZS109 [15] |
| 1.0 D | 3 | CL 10 | 27/36 | 10/83→03/87 | GV886 | 7V | | |
| 1.0 TD | 3 | CL 60 | 34/46 | 02/85→03/87 | GV886 | 7V | | |
| 1.0 Turbo | 3 | CB 60 | 50/67 | 10/83→03/87 | Z20 | 0.8 | UXT2 / UXT6 | ZS109 [1][15] |

CHARADE III

| | | | | | | | | |
|-----------|---|-----------|-------|-------------|---------------|------|-----------------|------------|
| 1.0 | 3 | CB 23 | 38/51 | 03/87→12/92 | Z9 | 1.15 | UXT2 / UXT6 | |
| 1.0 | 3 | CB 90 | 40/54 | 11/90→12/92 | Z9 | 1.15 | UXT2 / UXT6 | |
| 1.0 | 3 | CB 90 | 41/55 | 04/89→12/92 | Z9 | 1.15 | UXT2 / UXT6 | |
| 1.0 D | 3 | CL 11 | 27/36 | 03/87→12/92 | GV967 | 11V | | |
| 1.0 GTi | 3 | CB 80 T | 74/99 | 03/87→12/92 | Z99 [172] | 1.0 | UXT5 | |
| 1.0 TD | 3 | CL, CL 61 | 35/47 | 03/87→12/92 | GV967 | 11V | | |
| 1.0 Turbo | 3 | CB 61 | 50/67 | 03/87→10/90 | Z20 | 0.8 | UXT2 / UXT6 | ZS109 [15] |
| 1.3 | 4 | HCE | 66/89 | 11/90→02/93 | Z16 →12/92 | 1.1 | UXT11 →12/92 | |
| 1.3 i | 4 | HCE | 66/89 | 06/88→01/93 | Z16 | 1.1 | UXT11 | |
| 1.3 i LPG | 4 | HCE | 66/89 | 06/88→01/93 | Z340 | 0.7 | UXT12 | |

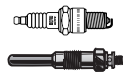

kW/BHP

**... DAIHATSU****CHARADE IV**

| | | | | | | | | |
|---------------|---|-----------|--------|-------------|--------------------------------|------|-------------|-----------------------|
| 1.0 | 3 | CB 22 | 38/51 | 09/94→03/96 | Z9 →10/95 | 1.15 | UXT2 / UXT6 | ZS109 ^[15] |
| 1.0 LPG | 3 | CB 22 | 38/51 | 09/94→03/96 | Z20 ^[168] →10/95 | 0.8 | UXT2 / UXT6 | |
| 1.3 | 4 | HC | 44/59 | 09/96→11/99 | Z16 | 1.1 | UXT11 | |
| 1.3 LPG | 4 | HC | 44/59 | 09/96→11/99 | Z340 | 0.7 | UXT12 | |
| 1.3 16V | 4 | HCE | 55/74 | 05/96→11/99 | Z16 | 1.1 | UXT11 | |
| 1.3 16V LPG | 4 | HCE | 55/74 | 05/96→11/99 | Z340 | 0.7 | UXT12 | |
| 1.3 i 16V | 4 | HC, HCE | 62/83 | 01/93→09/00 | Z16 | 1.1 | UXT11 | |
| 1.3 i 16V LPG | 4 | HC, HCE | 62/83 | 01/93→09/00 | Z340 | 0.7 | UXT12 | |
| 1.5 16V | 4 | HEE | 55/74 | 10/94→ | Z16 | 1.1 | UXT11 | |
| 1.5 16V LPG | 4 | HEE | 55/74 | 10/94→ | Z340 | 0.7 | UXT12 | |
| 1.5 i 16V | 4 | HEE, HEEG | 66/89 | 08/94→ | Z16 | 1.1 | UXT11 | |
| 1.5 i 16V LPG | 4 | HEE, HEEG | 66/89 | 08/94→ | Z340 | 0.7 | UXT12 | |
| 1.6 GTi | 4 | HD-E | 77/103 | 03/93→11/99 | Z16 | 1.1 | UXT11 | |
| 1.6 GTi LPG | 4 | HD-E | 77/103 | 03/93→11/99 | Z340 | 0.7 | UXT12 | |

CHARMANT

| | | | | | | | | |
|-----|---|----|-------|-------------|-----|-----|-------------|-----------------------|
| 1.3 | 4 | 4K | 48/64 | 11/81→07/87 | Z82 | 0.7 | UXT2 / UXT6 | ZS110 ^[15] |
| 1.6 | 4 | 2T | 55/74 | 12/81→09/84 | Z8 | 0.8 | UXT2 / UXT6 | |
| 1.6 | 4 | 4A | 57/76 | 09/85→07/87 | Z8 | 0.8 | UXT2 / UXT6 | |
| 1.6 | 4 | 4A | 60/80 | 05/86→07/87 | Z8 | 0.8 | UXT2 / UXT6 | |
| 1.6 | 4 | 4A | 61/82 | 08/83→07/87 | Z8 | 0.8 | UXT2 / UXT6 | |

COO

| | | | | | | | | |
|-----|---|-------|-------|--------|------|-----|--|--|
| 1.0 | 3 | EJ-VE | 43/58 | 10/06→ | Z324 | 0.9 | | |
|-----|---|-------|-------|--------|------|-----|--|--|

COPEN

| | | | | | | | | |
|-----|---|-------|-------|--------|------|-----|-------|--|
| 1.3 | 4 | K3-VE | 64/86 | 03/06→ | Z157 | 1.1 | UXT11 | |
|-----|---|-------|-------|--------|------|-----|-------|--|

CUORE I

| | | | | | | | | |
|-----|---|-------|-------|-------------|-----|-----|-------------|-----------------------|
| 0.5 | 2 | AB 30 | 20/27 | 10/80→09/85 | Z20 | 0.8 | UXT2 / UXT6 | ZS109 ^[15] |
| 0.6 | 2 | AD 10 | 22/30 | 08/82→09/85 | Z20 | 0.8 | UXT2 / UXT6 | ZS109 ^[15] |

CUORE II

| | | | | | | | | |
|-----|---|-------|-------|-------------|-----|-----|-------------|-----------------------|
| 0.8 | 3 | ED 10 | 29/39 | 11/89→12/90 | Z20 | 0.8 | UXT2 / UXT6 | ZS109 ^[15] |
| 0.8 | 3 | ED 10 | 32/43 | 09/85→06/90 | Z20 | 0.8 | UXT2 / UXT6 | ZS109 ^[15] |

CUORE III

| | | | | | | | | |
|-----|---|---------|-------|-------------|-----|-----|-------------|-----------------------|
| 0.8 | 3 | ED 10 K | 30/40 | 10/90→12/94 | Z20 | 0.8 | UXT2 / UXT6 | ZS109 ^[15] |
|-----|---|---------|-------|-------------|-----|-----|-------------|-----------------------|

CUORE IV

| | | | | | | | | |
|---------|---|-------|-------|-------------|----------------------|-----|-------------|--|
| 0.8 | 3 | ED 20 | 32/43 | 01/95→11/96 | Z20 | 0.8 | UXT2 / UXT6 | |
| 0.8 LPG | 3 | ED 20 | 32/43 | 01/95→11/96 | Z27 ^[168] | 0.8 | UX56 | |

CUORE V

| | | | | | | | | |
|---------|---|-------|-------|-------------|----------------------|-----|-------------|--|
| 0.8 | 3 | ED 20 | 31/42 | 11/96→10/98 | Z20 | 0.8 | UXT2 / UXT6 | |
| 0.8 LPG | 3 | ED 20 | 31/42 | 11/96→10/98 | Z27 ^[168] | 0.8 | UX56 | |

CUORE VI

| | | | | | | | | |
|-----------|---|--------------|-------|-------------|------|-----|-------|--|
| 1.0 DVVT | 3 | EJ-VE | 43/58 | 10/00→02/03 | Z324 | 0.9 | | |
| 1.0 i | 3 | EJ-DE, EJ-VE | 41/55 | 10/98→05/03 | Z73 | 1.1 | UXT11 | |
| 1.0 i LPG | 3 | EJ-DE, EJ-VE | 41/55 | 10/98→05/03 | Z206 | 0.7 | UXT10 | |

CUORE VII

| | | | | | | | | |
|-----|---|-------|-------|--------|------|-----|--|--|
| 1.0 | 3 | EJ-VE | 43/58 | 05/03→ | Z324 | 0.9 | | |
|-----|---|-------|-------|--------|------|-----|--|--|

CUORE VIII

| | | | | | | | | |
|-----|---|--------|-------|--------|------|-----|--|--------|
| 1.0 | 3 | 1KR-FE | 51/68 | 04/07→ | Z235 | 1.0 | | ZSE164 |
|-----|---|--------|-------|--------|------|-----|--|--------|

FEROZA Hard Top

| | | | | | | | | |
|-------------------|---|------|-------|-------------|------|-----|-------|--|
| 1.6 16V 4WD | 4 | HDC | 63/84 | 10/88→12/99 | Z16 | 1.1 | UXT11 | |
| 1.6 16V 4WD LPG | 4 | HDC | 63/84 | 10/88→12/99 | Z340 | 0.7 | UXT12 | |
| 1.6 i 16V 4WD | 4 | HD-E | 70/94 | 10/88→12/99 | Z16 | 1.1 | UXT11 | |
| 1.6 i 16V 4WD LPG | 4 | HD-E | 70/94 | 10/88→12/99 | Z340 | 0.7 | UXT12 | |

FEROZA Soft Top

| | | | | | | | | |
|-----------------|---|-----|-------|-------------|------|-----|-------|--|
| 1.6 16V 4WD | 4 | HDC | 63/84 | 10/88→12/99 | Z16 | 1.1 | UXT11 | |
| 1.6 16V 4WD LPG | 4 | HDC | 63/84 | 10/88→12/99 | Z340 | 0.7 | UXT12 | |



kW/BHP

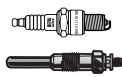

... DAIHATSU



... FERROZA Soft Top

| | | | | | | | |
|-------------------|---|------|-------|-------------|------|-----|-------|
| 1.6 i 16V 4WD | 4 | HD-E | 70/94 | 10/88→12/99 | Z16 | 1.1 | UXT11 |
| 1.6 i 16V 4WD LPG | 4 | HD-E | 70/94 | 10/88→12/99 | Z340 | 0.7 | UXT12 |

GRAN MOVE

| | | | | | | | |
|-------------|---|------|-------|-------------|------|-----|-------|
| 1.5 16V | 4 | HEEG | 66/89 | 10/96→07/98 | Z16 | 1.1 | UXT11 |
| 1.5 16V LPG | 4 | HEEG | 66/89 | 10/96→07/98 | Z340 | 0.7 | UXT12 |
| 1.6 16V | 4 | HDEP | 67/90 | 05/98→ | Z16 | 1.1 | UXT11 |
| 1.6 16V LPG | 4 | HDEP | 67/90 | 05/98→ | Z340 | 0.7 | UXT12 |

MATERIA

| | | | | | | | |
|-----------------|---|--------|--------|--------|-----------------------|------|--|
| 1.0 DVVT | 3 | EJ-VE | 43/58 | 10/06→ | Z324 | 0.9 | |
| 1.5 | 4 | 3SZ-VE | 76/102 | 10/06→ | Z234 | 0.9 | |
| 1.5 LPG | 4 | 3SZ-VE | 76/102 | 10/06→ | Z292 ^[168] | 1.05 | |
| 1.5 ECO 4WD | 4 | 3SZ-VE | 76/102 | 10/06→ | Z234 | 0.9 | |
| 1.5 ECO 4WD LPG | 4 | 3SZ-VE | 76/102 | 10/06→ | Z292 ^[168] | 1.05 | |

MOVE

| | | | | | | | |
|-----------|---|-------|-------|--------|----------------------|-----|-------------|
| 0.8 | 3 | ED 20 | 31/42 | 10/96→ | Z21 | 1.1 | UXT2 / UXT6 |
| 0.8 LPG | 3 | ED 20 | 31/42 | 10/96→ | Z27 ^[168] | 0.8 | UX56 |
| 1.0 i | 3 | EJ-DE | 41/55 | 10/98→ | Z16 | 1.1 | UXT11 |
| | | | | →09/00 | | | →09/00 |
| 1.0 i LPG | 3 | EJ-DE | 41/55 | 10/98→ | Z340 | 0.7 | UXT12 |
| | | | | →09/00 | | | →09/00 |

ROCKY Hard Top

| | | | | | | | |
|------------|---|--------------|--------|-------------|-------|-----|-----------------------------------|
| 2.0 4WD | 4 | 3Y | 65/87 | 02/85→04/93 | Z8 | 0.8 | UXT2 / UXT6 ZS109 ^[15] |
| 2.8 D 4WD | 4 | DL | 54/72 | 02/85→12/98 | GV886 | 7V | |
| 2.8 TD 4WD | 4 | DL 51 | 67/90 | 12/87→04/93 | GV886 | 7V | |
| 2.8 TD 4WD | 4 | DL 52, DLT-C | 72/97 | 05/93→12/98 | GV886 | 7V | |
| 2.8 TD 4WD | 4 | DL 52, DLT | 75/101 | 09/91→12/98 | GV886 | 7V | |
| | | | | →04/93 | | | |

ROCKY Soft Top

| | | | | | | | |
|------------|---|-------|--------|-------------|-------|-----|-----------------------------------|
| 2.0 4WD | 4 | 3Y | 65/87 | 02/85→04/93 | Z8 | 0.8 | UXT2 / UXT6 ZS109 ^[15] |
| 2.8 D 4WD | 4 | DL | 54/72 | 02/85→12/98 | GV886 | 7V | |
| 2.8 TD 4WD | 4 | DL 51 | 67/90 | 12/87→04/93 | GV886 | 7V | |
| 2.8 TD 4WD | 4 | DL 52 | 75/101 | 09/91→12/98 | GV886 | 7V | |
| | | | | →04/93 | | | |

RUGGER

| | | | | | | | |
|-----------|---|----|-------|-------------|-------|----|--|
| 2.8 D 4WD | 4 | DL | 54/72 | 04/84→04/93 | GV886 | 7V | |
|-----------|---|----|-------|-------------|-------|----|--|

SIRION

| | | | | | | | |
|--------------|---|--------|--------|-------------|-----------------------|------|--------|
| 1.0 | 3 | 1KR-FE | 51/68 | 01/05→ | Z273 | 1.1 | ZSE164 |
| 1.0 DVVT 4WD | 3 | 1KR-FE | 51/68 | 04/05→ | Z273 | 1.1 | |
| 1.0 i | 3 | EJ-DE | 41/55 | 04/98→09/00 | Z16 | 1.1 | UXT11 |
| 1.0 i | 3 | EJ-VE | 43/58 | 09/00→01/05 | Z324 | 0.9 | |
| 1.0 i LPG | 3 | EJ-DE | 41/55 | 04/98→09/00 | Z340 | 0.7 | UXT12 |
| 1.3 | 4 | K3-VE | 64/86 | 01/05→ | Z157 | 1.1 | UXT11 |
| 1.3 4WD | 4 | K3-VE | 64/86 | 04/05→ | Z157 | 1.1 | UXT11 |
| | | | | →06/07 | | | →06/07 |
| 1.3 Sport | 4 | K3-VE2 | 75/101 | 08/00→03/05 | Z360 | 1.0 | |
| 1.5 | 4 | 3SZ-VE | 76/102 | 03/08→ | Z234 | 0.9 | |
| 1.5 LPG | 4 | 3SZ-VE | 76/102 | 03/08→ | Z292 ^[168] | 1.05 | |

SKYWING

| | | | | | | | |
|---------|---|--------------|-------|-------------|----------------------|------|-------------|
| 1.0 | 3 | CB 22, CB 23 | 38/51 | 02/87→02/93 | Z9 | 1.15 | UXT2 / UXT6 |
| 1.0 LPG | 3 | CB 22, CB 23 | 38/51 | 02/87→02/93 | Z20 ^[168] | 0.8 | UXT2 / UXT6 |

Taft

| | | | | | | | |
|--------------|---|----|-------|-------------|-------|----|--|
| 2.8 D 4WD | 4 | DL | 51/68 | 08/82→02/85 | GV886 | 7V | |
| 2.8 D 4WD | 4 | DL | 54/72 | 05/93→11/95 | GV886 | 7V | |
| 2.8 TDic 4WD | 4 | | 72/97 | 07/96→06/01 | GV886 | 7V | |



kW/BHP



... DAIHATSU



TERIOS

| | | | | | | | |
|---------------|---|--------|--------|-------------|------------|------|-------------|
| 1.3 4WD | 4 | HC-EJ | 61/82 | 10/97→10/00 | Z98 | 0.8 | UXT1 / UXT3 |
| 1.3 | 4 | K3-VE | 63/84 | 09/01→10/05 | Z257 | 0.9 | UXT1 / UXT3 |
| 1.3 4WD | 4 | K3-VE | 63/84 | 10/00→10/05 | Z360 | 1.0 | |
| 1.3 4WD LPG | 4 | HC-EJ | 61/82 | 10/97→10/00 | Z116 | 0.8 | UXT5 |
| 1.3 LPG | 4 | K3-VE | 63/84 | 09/01→10/05 | Z116 | 0.8 | UXT5 |
| 1.3 VVT-i 4WD | 4 | K3-VE | 63/84 | 11/05→ | Z157 | 1.1 | UXT11 |
| 1.5 4WD | 4 | 3SZ-VE | 77/103 | 05/06→ | Z234 | 0.9 | |
| 1.5 4WD LPG | 4 | 3SZ-VE | 77/103 | 05/06→ | Z292 [168] | 1.05 | |
| 1.5 VVT-i | 4 | 3SZ-VE | 77/103 | 11/05→ | Z234 | 0.9 | |
| 1.5 VVT-i LPG | 4 | 3SZ-VE | 77/103 | 11/05→ | Z292 [168] | 1.05 | |

TREVIS

| | | | | | | | |
|-----|---|-------|-------|--------|------|-----|--|
| 1.0 | 3 | EJ-VE | 43/58 | 06/06→ | Z324 | 0.9 | |
|-----|---|-------|-------|--------|------|-----|--|

WILDCAT/ROCKY

| | | | | | | | |
|------------|---|-------|-------|-------------|-------|----|--|
| 2.8 D 4WD | 4 | DL | 54/72 | 02/85→03/87 | GV886 | 7V | |
| 2.8 TD 4WD | 4 | DL 50 | 65/87 | 09/85→04/87 | GV886 | 7V | |

YRV

| | | | | | | | |
|-----|---|-------|-------|--------|------|-----|--|
| 1.0 | 3 | EJ-VE | 43/58 | 02/01→ | Z324 | 0.9 | |
| 1.3 | 4 | K3-VE | 64/86 | 02/01→ | Z360 | 1.0 | |

DAIHATSU



EXTOL

| | | | | | | | |
|-----|---|-------|-------|--------|------|-----|--|
| 1.3 | 4 | K3-VE | 63/84 | 07/00→ | Z360 | 1.0 | |
|-----|---|-------|-------|--------|------|-----|--|

HIJET

| | | | | | | | |
|---------------|---|------|-------|-------------|-----------|------|-------------|
| 0.8 | 3 | CD | 29/39 | 06/86→12/89 | Z8 | 0.8 | UXT2 / UXT6 |
| 1.0 | 3 | CB | 33/44 | 06/86→12/89 | Z8 | 0.8 | UXT2 / UXT6 |
| 1.0 | 3 | CB41 | 33/44 | 12/92→05/98 | Z20 | 0.8 | UXT2 / UXT6 |
| 1.0 LPG | 3 | CB41 | 33/44 | 12/92→05/98 | Z27 [168] | 0.8 | UX56 |
| 1.0 i | 3 | CB42 | 35/47 | 07/94→05/98 | Z9 | 1.15 | UXT2 / UXT6 |
| 1.0 i LPG | 3 | CB42 | 35/47 | 07/94→05/98 | Z20 [168] | 0.8 | UXT2 / UXT6 |
| 1.3 i 16V | 4 | HCE | 48/64 | 05/98→ | Z16 | 1.1 | UXT11 |
| 1.3 i 16V LPG | 4 | HCE | 48/64 | 05/98→ | Z340 | 0.7 | UXT12 |

SPARCAR

| | | | | | | | |
|-----|---|----|-------|-------------|-----|-----|-------------|
| 0.8 | 3 | CD | 29/39 | 09/83→05/86 | Z20 | 0.8 | UXT2 / UXT6 |
| 1.0 | 3 | CB | 33/44 | 09/83→05/86 | Z8 | 0.8 | UXT2 / UXT6 |

FIAT



124

| | | | | | | | |
|----------------|---|------------|--------|-------------|-----|-----|-----------------|
| 1.2 1200 | 4 | 124 A.000 | 44/59 | 07/66→10/73 | Z22 | 0.7 | UX56 |
| 1.2 1200 | 4 | 124 A.000 | 48/64 | 02/73→07/75 | Z22 | 0.7 | UX56 |
| 1.2 1200 | 4 | 124 A.000 | 48/64 | 05/73→03/75 | Z27 | 0.8 | UX56 |
| 1.4 1400 | 4 | 124 B2.000 | 51/68 | 12/68→12/72 | Z22 | 0.7 | UX56 |
| 1.4 1400 Sport | 4 | 124 AC.000 | 66/89 | 06/67→10/72 | Z22 | 0.7 | UX56 |
| 1.4 1500 | 4 | 124 B2.000 | 55/74 | 01/73→07/75 | Z22 | 0.7 | UX56 |
| 1.4 1500 | 4 | 124 AC.000 | 59/79 | 01/71→07/75 | Z22 | 0.7 | UX56 |
| 1.4 1500 Sport | 4 | 124 AC.000 | 66/89 | 01/66→12/72 | Z22 | 0.7 | UX56 ZS106 [11] |
| 1.6 1600 | 4 | | 70/94 | 01/73→07/75 | Z22 | 0.7 | UX56 |
| 1.6 1600 | 4 | | 74/99 | 11/71→10/73 | Z22 | 0.7 | UX56 |
| 1.6 1600 | 4 | | 81/109 | 04/70→10/73 | Z22 | 0.7 | UX56 |
| 1.6 1600 Sport | 4 | 132 AC.000 | 74/99 | 11/69→08/73 | Z22 | 0.7 | UX56 ZS106 [11] |
| 1.6 1600 Sport | 4 | 132 AC.000 | 76/102 | 01/69→12/75 | Z27 | 0.8 | UX56 |
| 1.6 1600 Sport | 4 | 132 AC.000 | 80/107 | 01/69→12/74 | Z22 | 0.7 | UX56 ZS106 [11] |
| 1.6 1600 Sport | 4 | 132 AC.000 | 80/107 | 08/72→12/75 | Z27 | 0.8 | UX56 |
| 1.6 1600 Sport | 4 | | 82/110 | 11/69→08/73 | Z27 | 0.8 | UX56 |



kW/BHP



... FIAT



... 124

| | | | | | | | | | |
|-----------------------|---|-------------|--------|-------------|-----|--|-----|-------------|-----------------------|
| 1.7 1800 Rally Abarth | 4 | | 94/126 | 09/72→07/75 | Z42 | | 0.8 | UX56 | |
| 1.7 1800 Sport | 4 | | 82/110 | 01/73→07/75 | Z20 | | 0.8 | UXT2 / UXT6 | |
| 1.7 1800 Sport | 4 | | 87/117 | 01/73→02/76 | Z22 | | 0.7 | UX56 | |
| 1.8 1800 Sport | 4 | 132 AC1.000 | 87/117 | 01/72→12/77 | Z20 | | 0.8 | UXT2 / UXT6 | ZS106 ⁽¹¹⁾ |

125

| | | | | | | | | | |
|-----|---|-----------|-------|-------------|--------|--|-----|--------|-----------------------|
| 1.6 | 4 | 125 A.000 | 66/89 | 07/67→03/74 | Z22 | | 0.7 | UX56 | ZS106 ⁽¹¹⁾ |
| | | | | | →12/72 | | | →12/72 | |
| 1.6 | 4 | 125 B.000 | 74/99 | 05/69→10/73 | Z42 | | 0.8 | UX56 | |
| | | | | | →12/72 | | | →12/72 | |

126

| | | | | | | | | | |
|-------------|---|------------------------|-------|-------------|----------------------|--|-----|-------------|-----------------------|
| 0.6 600 | 2 | 126 A.000 | 17/23 | 09/72→06/77 | Z10 | | 0.8 | | ZS106 ⁽¹¹⁾ |
| | | | | | Z22 | | 0.7 | UX56 | |
| 0.6 650 | 2 | 126 A1.000, 126 A1.048 | 17/23 | 07/77→09/87 | Z10 | | 0.8 | | ZS106 ⁽¹¹⁾ |
| | | | | | Z22 | | 0.7 | UX56 | |
| 0.7 650 | 2 | 126 A1.048 | 18/24 | 07/81→09/00 | Z20 | | 0.8 | UXT2 / UXT6 | ZS106 ⁽¹¹⁾ |
| | | | | | 01/87→12/99 | | | 01/87→12/99 | |
| 0.7 700 | 2 | 126 A2.000, 126 A2.048 | 19/25 | 09/87→06/96 | Z20 | | 0.8 | UXT2 / UXT6 | |
| 0.7 700 LPG | 2 | 126 A2.000, 126 A2.048 | 19/25 | 09/87→06/96 | Z27 ^[168] | | 0.8 | UX56 | |

127

| | | | | | | | | | |
|------------|---|------------|-------|-------------|---------------------------|--|-----|-------------|-----------------------|
| 0.9 | 4 | 100 GL.048 | 29/39 | 06/71→05/83 | Z20 | | 0.8 | UXT2 / UXT6 | ZS106 ⁽¹¹⁾ |
| 0.9 | 4 | 100 GL.000 | 33/44 | 06/71→05/83 | Z20 | | 0.8 | UXT2 / UXT6 | ZS106 ⁽¹¹⁾ |
| 1.0 | 4 | 127 A.000 | 37/50 | 01/77→12/86 | Z20 | | 0.8 | UXT2 / UXT6 | |
| 1.0 | 4 | 127 A.000 | 37/50 | 04/77→12/86 | | | | | ZS106 ⁽¹¹⁾ |
| 1.0 Sport | 4 | 127 A1.000 | 51/68 | 07/78→02/82 | Z27 | | 0.8 | UX56 | ZS106 ⁽¹¹⁾ |
| 1.3 D | 4 | 127 A5.000 | 33/44 | 06/81→12/86 | GN909 ^{[2][222]} | | 11V | | |
| | | | | | GV663 | | 11V | | |
| 1.3 Diesel | 4 | 127 A5.000 | 33/44 | 04/81→12/86 | GN909 ^{[2][222]} | | 11V | | |
| | | | | | GV663 | | 11V | | |
| 1.3 Sport | 4 | 127 A3.000 | 55/74 | 12/81→05/83 | Z27 | | 0.8 | UX56 | ZS106 ⁽¹¹⁾ |

128

| | | | | | | | | | |
|----------------|---|-------------|-------|-------------|-----|--|-----|-------------|-----------------------|
| 1.1 | 4 | 128 A.048 | 33/44 | 02/75→09/81 | Z20 | | 0.8 | UXT2 / UXT6 | ZS106 ⁽¹¹⁾ |
| 1.1 | 4 | 128 A.000 | 40/54 | 03/69→12/84 | Z20 | | 0.8 | UXT2 / UXT6 | ZS106 ⁽¹¹⁾ |
| 1.1 | 4 | 128 AC5.000 | 47/63 | 03/72→02/81 | Z20 | | 0.8 | UXT2 / UXT6 | |
| 1.1 | 4 | 128 AC5.000 | 48/64 | 08/75→02/81 | Z20 | | 0.8 | UXT2 / UXT6 | |
| 1.3 | 4 | 128 A1.000 | 44/59 | 12/74→10/82 | Z20 | | 0.8 | UXT2 / UXT6 | |
| 1.3 | 4 | 128 AC.000 | 55/74 | 03/72→12/79 | Z20 | | 0.8 | UXT2 / UXT6 | |
| 1.3 Berlinetta | 4 | 128 AC.000 | 54/72 | 06/75→12/79 | Z20 | | 0.8 | UXT2 / UXT6 | ZS106 ⁽¹¹⁾ |
| 1.3 Rally | 4 | 128 AR.000 | 49/66 | 09/71→02/76 | Z8 | | 0.8 | UXT2 / UXT6 | |
| 1.3 Sport | 4 | 128 A1.000 | 44/59 | 08/74→12/84 | Z20 | | 0.8 | UXT2 / UXT6 | ZS106 ⁽¹¹⁾ |

130

| | | | | | | | | | |
|-----|---|-----------|---------|-------------|----------------------|--|-----|-------------|--|
| 3.2 | 6 | 130 B.000 | 121/162 | 10/71→03/78 | Z11 ^[168] | | 0.8 | UXT2 / UXT6 | |
|-----|---|-----------|---------|-------------|----------------------|--|-----|-------------|--|

131

| | | | | | | | | | |
|---------------------|---|-----------------------|---------|-------------|---------------------------|-------|-----|-------------|-----------------------------|
| 1.3 Mirafiori | 4 | 131 A6.000 | 40/54 | 10/74→09/81 | Z11 ^[168] | | 0.8 | UXT2 / UXT6 | ZS106 ⁽¹¹⁾ |
| 1.3 Mirafiori | 4 | 131 A.000 | 48/64 | 10/74→12/82 | Z11 ^[167] | | 0.8 | UXT2 / UXT6 | ZS106 ⁽¹¹⁾ |
| | | | | | →12/80 | | | →12/80 | |
| 1.3 Mirafiori | 4 | 131 A.000 | 48/64 | 03/75→03/82 | Z20 | | 0.8 | UXT2 / UXT6 | |
| 1.3 Super Mirafiori | 4 | 131 B.000 | 57/76 | 03/78→12/80 | Z11 ^[168] | | 0.8 | UXT2 / UXT6 | ZS106 ⁽¹¹⁾ |
| 1.4 Mirafiori | 4 | 131 C.000, 131 C1.000 | 51/68 | 11/80→01/84 | Z11 ^[168] | | 0.8 | UXT2 / UXT6 | ZS106 ⁽¹¹⁾ |
| 1.4 Super Mirafiori | 4 | 131 C1.000 | 55/74 | 04/81→12/83 | Z20 | | 0.8 | UXT2 / UXT6 | |
| 1.6 | 4 | 131 A1.000 | 55/74 | 10/74→09/81 | Z20 | | 0.8 | UXT2 / UXT6 | ZS106 ⁽¹¹⁾ |
| 1.6 | 4 | 131 C2.000 | 63/84 | 11/76→04/85 | Z20 | | 0.8 | UXT2 / UXT6 | ZS106 ⁽¹¹⁾ |
| 1.6 CL | 4 | 131 A1.000 | 55/74 | 03/75→12/78 | Z11 ^[168] | | 0.8 | UXT2 / UXT6 | |
| 1.6 Super | 4 | 131 C3.000 | 71/95 | 03/78→01/84 | Z20 | | 0.8 | UXT2 / UXT6 | ZS106 ⁽¹¹⁾ |
| 1.6 Super Mirafiori | 4 | 131 B1.000 | 72/97 | 03/79→03/82 | Z20 | | 0.8 | UXT2 / UXT6 | |
| 2.0 Abarth Rally | 4 | 131 B2.000 | 103/138 | 01/76→07/80 | Z47 | | 0.8 | UX56 | |
| 2.0 D | 4 | 8144.65 | 44/59 | 07/78→08/84 | GN909 ^{[2][222]} | GR065 | 11V | | |
| | | | | | GV642 | | 11V | | |
| 2.0 Racing | 4 | 131 B2.000 | 85/114 | 06/78→12/81 | Z22 | | 0.7 | UX56 | ZS106 ⁽¹¹⁾ ZM005 |



kW/BHP

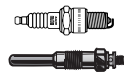

... FIAT



... 131

| | | | | | | | | | |
|------------------|---|------------|--------|-------------|----------------|-------|-----|-------------|------------|
| 2.0 Super | 4 | 131 C4.000 | 83/111 | 01/81→12/84 | Z11 [168] | | 0.8 | UXT2 / UXT6 | ZS106 [11] |
| 2.5 D | 4 | 8144.61 | 53/71 | 06/78→02/84 | GN909 [2][222] | GR065 | 11V | | |
| | | | | | GV642 | | 11V | | |
| 2.5 Super Diesel | 4 | 8144.61 | 53/71 | 03/79→12/84 | GN909 [2][222] | GR065 | 11V | | |
| | | | | | GV642 | | 11V | | |

132

| | | | | | | | | | |
|-------------|---|-------------|--------|-------------|----------------|--|-----|-------------|------------|
| 1.6 | 4 | 132 C.000 | 65/87 | 05/77→09/82 | Z27 | | 0.8 | UX56 | |
| | | | | | →06/79 | | | →06/79 | |
| | | | | | Z20 [168] | | 0.8 | UXT2 / UXT6 | |
| | | | | | 07/79→ | | | 07/79→ | |
| 1.6 | 4 | 132 C6.000 | 66/89 | 03/77→12/81 | Z27 | | 0.8 | UX56 | |
| 1.6 | 4 | 132 BB 0A 0 | 72/97 | 04/72→01/76 | Z27 | | 0.8 | UX56 | |
| 1.6 | 4 | 132 C.000 | 72/97 | 01/76→12/82 | Z22 | | 0.7 | UX56 | |
| | | | | | →06/79 | | | →06/79 | |
| | | | | | Z11 [168] | | 0.8 | UXT2 / UXT6 | |
| | | | | | 07/79→ | | | 07/79→ | |
| 1.7 GLS | 4 | 132 B1.000 | 79/106 | 04/74→12/75 | Z22 | | 0.7 | UX56 | |
| 1.7 GLS | 4 | 132 B1.000 | 82/110 | 11/75→01/77 | Z27 | | 0.8 | UX56 | |
| 1.7 Special | 4 | 132 B1.000 | 77/103 | 04/72→01/74 | Z22 | | 0.7 | UX56 | |
| 2.0 | 4 | 132 C2.000 | 82/110 | 05/77→06/81 | Z22 | | 0.7 | UX56 | ZS106 [11] |
| | | | | | →06/79 | | | →06/79 | |
| | | | | | Z11 [168] | | 0.8 | UXT2 / UXT6 | ZM005 |
| | | | | | 07/79→ | | | 07/79→ | |
| 2.0 D | 4 | 8144.65 | 44/59 | 07/78→07/82 | GN909 [2][222] | | 11V | | |
| | | | | | GV642 | | 11V | | |
| 2.0 i.e. | 4 | 132 C3.000 | 90/121 | 01/80→12/82 | Z11 [168] | | 0.8 | UXT2 / UXT6 | |
| 2.5 D | 4 | 8144.61 | 53/71 | 07/78→07/82 | GN909 [2][222] | | 11V | | |
| | | | | | GV642 | | 11V | | |

147

| | | | | | | | | | |
|-------|---|------------|-------|-------------|----------------|--|-----|--|--|
| 1.3 D | 4 | 127 A5.000 | 33/44 | 07/82→06/84 | GN909 [2][222] | | 11V | | |
| | | | | | GV602 | | 11V | | |
| 1.3 D | 4 | | 36/48 | 10/80→10/95 | GN909 [2][222] | | 11V | | |
| | | | | | GV602 | | 11V | | |

500

| | | | | | | | | | |
|-------------------------|---|--------------------|---------|-------------|------------|--|------|--|------------|
| 0.5 | 2 | 120.000 | 11/15 | 01/57→12/66 | Z57 | | 0.6 | | |
| 0.5 | 2 | 110 F.000, 120.000 | 13/17 | 01/65→12/75 | Z10 | | 0.8 | | ZS106 [11] |
| 0.6 | 2 | | 13/17 | 05/73→01/76 | Z10 | | 0.8 | | ZS106 [11] |
| 0.9 | 2 | 312 A4.000 | 48/64 | 09/12→ | Z357 | | 0.7 | | ZS090 |
| 0.9 | 2 | 312 A2.000 | 63/84 | 07/10→ | Z357 | | 0.7 | | ZS090 |
| 1.2 | 4 | 169 A4.000 | 51/68 | 10/07→ | Z293 | | 1.05 | | ZS079 |
| 1.2 LPG | 4 | 169 A4.000 | 51/68 | 12/10→ | Z293 | | 1.05 | | ZS079 |
| 1.3 D Multijet | 4 | 169 A1.000 | 55/74 | 10/07→ | GN053 | | 11V | | |
| 1.3 D Multijet | 4 | 199 B1.000 | 70/94 | 12/09→ | GE112 | | 4.4V | | |
| 1.4 | 4 | 169 A3.000 | 74/99 | 10/07→ | Z292 | | 1.05 | | ZS322 |
| 1.4 LPG | 4 | 169 A3.000 | 74/99 | 10/07→ | Z291 [168] | | 0.9 | | |
| 1.4 Abarth | 4 | 312 A1.000 | 99/133 | 08/08→ | Z338 | | 0.8 | | ZS322 |
| 1.4 Abarth | 4 | 312 A3.000 | 103/138 | 05/10→ | Z292 | | 1.05 | | ZS322 |
| 1.4 Abarth | 4 | 312 A3.000 | 132/177 | 08/08→ | Z338 | | 0.8 | | ZS095 |
| 1.4 Abarth Asseto Corse | 4 | 198 A.1000 | 140/188 | 08/08→ | Z338 | | 0.8 | | |
| 1.4 Abarth Asseto Corse | 4 | 312 A1.000 | 140/188 | 08/08→ | | | | | ZS322 |

500 C

| | | | | | | | | | |
|----------------|---|------------|---------|--------|-------|--|------|--|-------|
| 0.9 | 2 | 312 A4.000 | 48/64 | 09/12→ | Z357 | | 0.7 | | ZS090 |
| 0.9 | 2 | 312 A2.000 | 63/84 | 09/09→ | Z357 | | 0.7 | | ZS090 |
| 1.2 | 4 | 169 A4.000 | 51/68 | 09/09→ | Z293 | | 1.05 | | ZS079 |
| 1.3 D Multijet | 4 | 169 A1.000 | 55/74 | 09/09→ | GN053 | | 11V | | |
| 1.3 D Multijet | 4 | 199 B1.000 | 70/94 | 09/09→ | GE112 | | 4.4V | | |
| 1.4 | 4 | 169 A3.000 | 74/99 | 09/09→ | Z292 | | 1.05 | | ZS322 |
| 1.4 Abarth | 4 | 312 A3.000 | 103/138 | 09/09→ | Z338 | | 0.8 | | |



kW/BHP

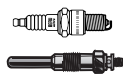

... FIAT



... 500 C

| | | | | | | | |
|------------|---|------------|---------|--------|------|------|-------|
| 1.4 Abarth | 4 | 312 A1.000 | 118/158 | 05/11→ | Z292 | 1.05 | ZS322 |
| 1.4 Abarth | 4 | 312 A3.000 | 132/177 | 09/09→ | Z292 | 1.05 | ZS322 |

500L

| | | | | | | | |
|-------------------|---|------------|--------|--------|-------|------|-------|
| 0.9 | 2 | 199 B6.000 | 77/103 | 09/12→ | Z357 | 0.7 | ZS090 |
| 0.9 Natural Power | 2 | 312 A2.000 | 63/84 | 03/13→ | Z357 | 0.7 | ZS090 |
| 1.3 D Multijet | 4 | 199 B4.000 | 62/83 | 09/12→ | GE112 | 4.4V | |
| 1.4 | 4 | 843 A1.000 | 70/94 | 09/12→ | Z292 | 1.05 | ZS322 |
| 1.6 D Multijet | 4 | 199 B5.000 | 77/103 | 09/12→ | GE114 | 4.4V | |
| 1.6 D Multijet | 4 | 955 A3.000 | 88/118 | 09/13→ | GE114 | 4.4V | |

600

| | | | | | | | |
|-----|---|--|-------|-------------|-----|-----|--|
| 0.6 | 2 | | 15/20 | 03/55→05/61 | Z40 | 0.6 | |
| 0.8 | 4 | | 17/23 | 10/60→02/71 | Z40 | 0.6 | |

850

| | | | | | | | |
|-------------|---|------------|-------|-------------|-----|-----|------|
| 0.8 | 4 | 100 G.000 | 25/34 | 07/64→10/72 | Z22 | 0.7 | UX56 |
| 0.8 | 4 | 100 G.002 | 27/36 | 07/64→10/72 | Z22 | 0.7 | UX56 |
| 0.8 Special | 4 | 100 GB.000 | 35/47 | 03/68→10/72 | Z27 | 0.8 | UX56 |
| 0.9 Sport | 4 | 100 GL.040 | 38/51 | 02/68→12/72 | Z42 | 0.8 | UX56 |

900 T/E Panorama

| | | | | | | | |
|-----|---|------------|-------|-------------|--|--|-----------------------|
| 0.9 | 4 | 100 GF 000 | 26/35 | 01/78→01/86 | | | ZS106 ⁽¹¹⁾ |
|-----|---|------------|-------|-------------|--|--|-----------------------|

900 T/E Pulmino

| | | | | | | | |
|-----|---|------------|-------|-------------|------------|------------|----------------------------|
| 0.9 | 4 | 100 GF 000 | 26/35 | 01/78→01/86 | Z15 Z20 | 0.8 0.8 | UXT1 / UXT3 UXT2 / UXT6 |
|-----|---|------------|-------|-------------|------------|------------|----------------------------|

1000er-Serie

| | | | | | | | |
|----------|---|--|-------|-------------|------|-----|-------------|
| 1.1 1100 | 4 | | 29/39 | 07/53→06/61 | Z40 | 0.6 | |
| 1.2 1200 | 4 | | 38/51 | 02/59→03/62 | Z40 | 0.6 | |
| 1.5 1500 | 4 | | 49/66 | 11/61→03/69 | Z100 | 0.8 | UXT1 / UXT3 |

1500

| | | | | | | | |
|-----|---|-----------|-------|-------------|-----|-----|-------------|
| 1.5 | 4 | | 49/66 | 06/64→10/67 | Z62 | 0.8 | UXT2 / UXT6 |
| 1.5 | 4 | 115 C.005 | 55/74 | 06/64→10/67 | Z62 | 0.8 | UXT2 / UXT6 |

1500-2300

| | | | | | | | |
|------------|---|--|--------|-------------|-----|-----|-------------|
| 1.5 1500 L | 4 | | 55/74 | 10/63→12/70 | Z62 | 0.8 | UXT2 / UXT6 |
| 2.3 2300 | 6 | | 75/101 | 07/62→03/69 | Z62 | 0.8 | UXT2 / UXT6 |

ARGENTA

| | | | | | | | |
|----------------------|---|------------------------|--------|-------------|------------------------------------|------------|-----------------------|
| 1.6 1600 | 4 | 132 D.000 | 72/97 | 04/81→12/85 | Z11 ^[168] | 0.8 | UXT2 / UXT6 |
| 1.6 1600 i.e | 4 | | 66/89 | 04/81→12/85 | | | ZS106 ⁽¹¹⁾ |
| 2.0 2000 | 4 | 132 C2.000, 132 D1.000 | 83/111 | 06/78→12/85 | Z11 ^[168] | 0.8 | UXT2 / UXT6 |
| 2.0 2000 i.e. | 4 | 132 C3.000 | 90/121 | 06/81→07/86 | Z11 ^[168] | 0.8 | UXT2 / UXT6 |
| 2.0 2000 Volumex | 4 | | 99/133 | 06/84→07/85 | | | ZM005 →05/83 |
| 2.4 2500 Turbodiesel | 4 | 8144.61.500.81 | 66/89 | 07/83→08/85 | GN909 ^{[2][222]} GV642 | 11V 11V | ZM061 |
| 2.5 2500 Diesel | 4 | 8144.61 | 53/71 | 06/81→11/85 | GN909 ^{[2][222]} GV642 | 11V 11V | |

BARCETTA

| | | | | | | | |
|-------------|---|------------|--------|-------------|------------------------------|------------|--------------------------------------|
| 1.8 16V | 4 | 183 A1.000 | 96/129 | 04/95→05/05 | Z116 Z98 | 0.8 0.8 | UXT5 UXT1 / UXT3 |
| 1.8 16V | 4 | 188 A6.000 | 96/129 | 04/95→05/05 | Z116 →eng. 1945438 Z98 | 0.8 | UXT5 →eng. 1945438 UXT1 / UXT3 |
| | | | | | Z255 →eng. 1945438 | 0.9 | UXT1 / UXT3 |
| | | | | | eng. 1945439→ | | eng. 1945439→ |
| 1.8 16V LPG | 4 | 183 A1.000 | 96/129 | 04/95→05/05 | Z116 | 0.8 | UXT5 |
| 1.8 16V LPG | 4 | 188 A6.000 | 96/129 | 04/95→05/05 | Z116 Z206 | 0.8 0.7 | UXT5 UXT10 |
| | | | | | eng. 1945439→ | | eng. 1945439→ |

FIAT

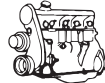

kW/BHP

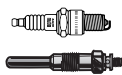

... FIAT

| BRAVA | | | | | | | | |
|----------------|---|------------|---------|-------------|-----------------------|--|------|-------------------|
| 1.2 16V | 4 | 182 B2.000 | 64/86 | 12/98→12/02 | Z234 | | 0.9 | ZS234 |
| 1.2 16V LPG | 4 | 182 B2.000 | 64/86 | 12/98→12/02 | Z292 [168] | | 1.05 | |
| 1.2 16V 80 | 4 | 188 A5.000 | 59/79 | 10/00→10/01 | Z234 | | 0.9 | ZS234 |
| 1.2 16V 80 | 4 | 182 B2.000 | 60/80 | 12/98→12/02 | Z234 | | 0.9 | ZS234 |
| | | | | | →eng. 1945437 Z291 | | 0.9 | |
| | | | | | eng. 1945438→ | | | |
| 1.2 16V 80 LPG | 4 | 188 A5.000 | 59/79 | 10/00→10/01 | Z292 [168] | | 1.05 | |
| 1.2 16V 80 LPG | 4 | 182 B2.000 | 60/80 | 12/98→12/02 | Z292 [168] | | 1.05 | |
| | | | | | →eng. 1945437 | | | |
| 1.4 | 4 | 182 A5.000 | 55/74 | 10/95→10/01 | Z98 | | 0.8 | UXT1 / UXT3 ZS234 |
| | | | | | →10/98 | | | →10/98 |
| 1.4 LPG | 4 | 182 A5.000 | 55/74 | 10/95→10/01 | Z116 | | 0.8 | UXT5 |
| | | | | | →10/98 | | | →10/98 |
| 1.4 12 V | 4 | 182 A3.000 | 59/79 | 10/95→08/98 | Z98 | | 0.8 | UXT1 / UXT3 ZS234 |
| 1.4 12 V LPG | 4 | 182 A3.000 | 59/79 | 10/95→08/98 | Z116 | | 0.8 | UXT5 |
| 1.6 16V | 4 | 182 A6.000 | 66/89 | 10/95→10/01 | Z98 | | 0.8 | UXT1 / UXT3 ZS029 |
| | | | | | →10/98 | | | →10/98 |
| 1.6 16V | 4 | 182 A4.000 | 76/102 | 02/96→10/01 | Z98 | | 0.8 | UXT1 / UXT3 ZS029 |
| | | | | | →10/98 | | | →10/98 |
| | | | | | Z255 | | 0.9 | UXT1 / UXT3 |
| | | | | | 11/98→ | | | 11/98→ |
| 1.6 16V | 4 | 182 B6.000 | 76/102 | 01/99→12/02 | Z255 | | 0.9 | UXT1 / UXT3 ZS029 |
| 1.6 16V LPG | 4 | 182 A6.000 | 66/89 | 10/95→10/01 | Z116 | | 0.8 | UXT5 |
| | | | | | →10/98 | | | →10/98 |
| 1.6 16V LPG | 4 | 182 A4.000 | 76/102 | 02/96→10/01 | Z116 | | 0.8 | UXT5 |
| | | | | | →10/98 | | | →10/98 |
| | | | | | Z206 | | 0.7 | UXT10 |
| | | | | | 11/98→ | | | 11/98→ |
| 1.6 16V LPG | 4 | 182 B6.000 | 76/102 | 01/99→12/02 | Z206 | | 0.7 | UXT10 |
| 1.8 GT 16V | 4 | 182 A2.000 | 83/111 | 10/95→10/01 | Z98 | | 0.8 | UXT1 / UXT3 |
| | | | | | →07/99 | | | →07/99 |
| | | | | | →eng. 1945438 | | | →eng. 1945438 |
| | | | | | Z255 | | 0.9 | UXT1 / UXT3 |
| | | | | | 08/99→ | | | 08/99→ |
| | | | | | eng. 1945439→ | | | eng. 1945439→ |
| 1.8 GT 16V LPG | 4 | 182 A2.000 | 83/111 | 10/95→10/01 | Z116 | | 0.8 | UXT5 |
| | | | | | →07/99 | | | →07/99 |
| | | | | | →eng. 1945438 | | | →eng. 1945438 |
| | | | | | Z206 | | 0.7 | UXT10 |
| | | | | | 08/99→ | | | 08/99→ |
| | | | | | eng. 1945439→ | | | eng. 1945439→ |
| 1.9 D | 4 | 160 A7.000 | 48/64 | 10/95→10/01 | GN909 [222] | | 11V | |
| | | | | | →10/96 | | | |
| | | | | | GV663 | | 11V | |
| | | | | | →10/96 | | | |
| 1.9 JTD | 4 | 182 B9.000 | 74/99 | 09/00→10/01 | GN041 | | 11V | |
| 1.9 JTD | 4 | 182 B4.000 | 79/106 | 01/01→12/02 | GN017 | | 11V | |
| | | | | | GN041 [2] | | 11V | |
| 1.9 JTD 105 | 4 | 182 B4.000 | 77/103 | 12/98→10/01 | GN017 | | 11V | |
| | | | | | →10/99 | | | |
| | | | | | →eng. 1716458 | | | |
| | | | | | GN041 | | 11V | |
| | | | | | 11/99→ | | | |
| | | | | | eng. 1716459→ | | | |
| 1.9 TD 75 S | 4 | 182 A8.000 | 55/74 | 03/96→10/01 | GN970 | | 11V | |
| 1.9 TD 100 S | 4 | 182 A7.000 | 74/99 | 03/96→10/01 | GN970 | | 11V | |
| 2.0 | 5 | 182 B7.000 | 113/152 | 09/98→08/00 | Z98 | | 0.8 | UXT1 / UXT3 ZS311 |
| 2.0 LPG | 5 | 182 B7.000 | 113/152 | 09/98→08/00 | Z116 | | 0.8 | UXT5 |

FIAT



kW/BHP



... FIAT



BRAVO I

| | | | | | | | |
|-----------------|---|------------|---------|-------------|--|------------|--|
| 1.2 16V 80 | 4 | 188 A5.000 | 59/79 | 10/00→10/01 | Z234 | 0.9 | ZS234 |
| 1.2 16V 80 | 4 | 182 B2.000 | 60/80 | 12/98→10/00 | Z234 →eng. 1945437 Z291 eng. 1945438→ | 0.9 | ZS234 |
| 1.2 16V 80 | 4 | 182 B2.000 | 64/86 | 12/98→10/01 | Z234 | 0.9 | ZS234 |
| 1.2 16V 80 LPG | 4 | 188 A5.000 | 59/79 | 10/00→10/01 | Z292 [168] | 1.05 | |
| 1.2 16V 80 LPG | 4 | 182 B2.000 | 60/80 | 12/98→10/00 | Z292 [168] →eng. 1945437 | 1.05 | |
| 1.4 | 4 | 182 A5.000 | 55/74 | 10/95→10/01 | Z98 →10/98 | 0.8 | UXT1 / UXT3 ZS234 →10/98 |
| 1.4 | 4 | 182 A3.000 | 59/79 | 10/95→10/01 | Z98 →10/98 | 0.8 | UXT1 / UXT3 ZS234 →10/98 |
| 1.4 LPG | 4 | 182 A5.000 | 55/74 | 10/95→10/01 | Z116 →10/98 | 0.8 | UXT5 →10/98 |
| 1.4 LPG | 4 | 182 A3.000 | 59/79 | 10/95→10/01 | Z116 | 0.8 | UXT5 |
| 1.6 | 4 | 182 B6.000 | 76/102 | 09/00→02/02 | Z255 | 0.9 | UXT1 / UXT3 ZS029 |
| 1.6 LPG | 4 | 182 B6.000 | 76/102 | 09/00→02/02 | Z206 | 0.7 | UXT10 |
| 1.6 16V | 4 | 182 A6.000 | 66/89 | 10/95→10/01 | Z98 →10/98 | 0.8 | UXT1 / UXT3 ZS029 →10/98 |
| 1.6 16V | 4 | 182 A4.000 | 76/102 | 03/96→10/01 | Z98 →10/98 Z255 11/98→ | 0.8 0.9 | UXT1 / UXT3 ZS029 →10/98 UXT1 / UXT3 11/98→ |
| 1.6 16V LPG | 4 | 182 A6.000 | 66/89 | 10/95→10/01 | Z116 →10/98 | 0.8 | UXT5 →10/98 |
| 1.6 16V LPG | 4 | 182 A4.000 | 76/102 | 03/96→10/01 | Z116 →10/98 Z206 11/98→ | 0.8 0.7 | UXT5 →10/98 UXT10 11/98→ |
| 1.8 GT | 4 | 182 A2.000 | 83/111 | 10/95→10/01 | Z98 →07/99 →eng. 1945438 Z255 08/99→ eng. 1945439→ | 0.8 0.9 | UXT1 / UXT3 →07/99 →eng. 1945438 UXT1 / UXT3 08/99→ eng. 1945439→ |
| 1.8 GT LPG | 4 | 182 A2.000 | 83/111 | 10/95→10/01 | Z116 →07/99 →eng. 1945438 Z206 08/99→ eng. 1945439→ | 0.8 0.7 | UXT5 →07/99 →eng. 1945438 UXT10 08/99→ eng. 1945439→ |
| 1.9 D | 4 | 160 A7.000 | 48/64 | 10/95→10/01 | GN909 [222] →10/96 GV663 →10/96 | 11V 11V | |
| 1.9 JTD | 4 | 182 B9.000 | 74/99 | 09/00→10/01 | GN041 | 11V | |
| 1.9 JTD 105 | 4 | 182 B4.000 | 77/103 | 12/98→10/01 | GN017 →10/99 →eng. 1716458 GN041 11/99→ eng. 1716459→ | 11V 11V | |
| 1.9 TD 75 S | 4 | 182 A8.000 | 55/74 | 03/96→10/01 | GN970 | 11V | |
| 1.9 TD 100 S | 4 | 182 A7.000 | 74/99 | 03/96→10/01 | GN970 | 11V | |
| 2.0 HGT 20V | 5 | 182 A1.000 | 108/145 | 10/95→07/98 | Z98 | 0.8 | UXT1 / UXT3 ZS310 |
| 2.0 HGT 20V | 5 | 182 B7.000 | 113/152 | 07/98→10/01 | Z98 | 0.8 | UXT1 / UXT3 ZS311 |
| 2.0 HGT 20V LPG | 5 | 182 A1.000 | 108/145 | 10/95→07/98 | Z116 | 0.8 | UXT5 |
| 2.0 HGT 20V LPG | 5 | 182 B7.000 | 113/152 | 07/98→10/01 | Z116 | 0.8 | UXT5 |



kW/BHP



... FIAT



BRAVO II

| | | | | | | | |
|----------------|---|------------------------|---------|-------------|-----------------|------|-----------|
| 1.4 | 4 | 192 B2.000 | 66/89 | 04/07→ | Z292 | 1.05 | ZS322 |
| 1.4 LPG | 4 | 192 B2.000 | 66/89 | 04/07→ | Z291 [168] | 0.9 | |
| 1.4 16V | 4 | 198 A7.000 | 103/138 | 03/08→ | Z338 | 0.8 | ZS322 (1) |
| 1.4 LPG | 4 | 192 B2.000 | 66/89 | 11/09→ | Z292 | 1.05 | ZS322 |
| 1.4 T-Jet | 4 | 198 A4.000 | 88/118 | 09/07→ | Z338 | 0.8 | ZS095 |
| 1.4 T-Jet | 4 | 198 A1.000 | 110/148 | 09/07→ | Z338 | 0.8 | ZS095 |
| 1.6 D Multijet | 4 | 198 A6.000 | 66/89 | 03/08→ | GE114 | 4.4V | |
| 1.6 D Multijet | 4 | 198 A3.000 | 77/103 | 03/08→ | GE114 | 4.4V | |
| 1.6 D Multijet | 4 | 955 A4.000 | 85/114 | 11/08→ | GE114 | 4.4V | |
| 1.6 D Multijet | 4 | 198 A2.000 | 88/118 | 03/08→ | GE114 | 4.4V | |
| 1.9 D Multijet | 4 | 192 B5.000 | 66/89 | 04/07→12/08 | GN097 | 11V | |
| 1.9 D Multijet | 4 | 192 A1.000, 192 B4.000 | 85/114 | 11/06→ | GN097 →12/09 | 11V | |
| 1.9 D Multijet | 4 | 192 A8.000 | 88/118 | 04/07→ | GN097 | 11V | |
| 1.9 D Multijet | 4 | 937 A5.000 | 110/148 | 04/07→ | GN059 | 11V | |
| 2.0 D Multijet | 4 | 844 A2.000 | 120/161 | 09/08→ | GE114 | 4.4V | |
| 2.0 D Multijet | 4 | 198 A5.000 | 121/162 | 09/08→ | GE114 | 4.4V | |

CAMPAGNOLA

| | | | | | | | |
|-----------|---|---------------|-------|-------------|--|-----|-----------------------|
| 2.0 4WD | 4 | 6132 AZ 2.000 | 59/79 | 06/74→10/89 | Z20 →10/86 | 0.8 | UXT2 / UXT6 →10/86 |
| 2.4 D 4WD | 4 | 8144.61.200 | 53/71 | 06/74→10/89 | GN909 [222] →10/86 GV602 →10/86 | 11V | |

CINQUECENTO

| | | | | | | | |
|------------------|---|--------------------------|-------|-------------|-----------|-----|-----------------------------|
| 0.7 | 2 | 170 A.000 | 23/31 | 12/91→01/96 | Z20 | 0.8 | UXT2 / UXT6 ZS283 01/92→ |
| 0.7 LPG | 2 | 170 A.000 | 23/31 | 12/91→01/96 | Z27 [168] | 0.8 | UX56 |
| 0.7 i | 2 | 170 A.046 | 22/30 | 07/94→01/98 | Z20 | 0.8 | UXT2 / UXT6 ZS283 |
| 0.7 i LPG | 2 | 170 A.046 | 22/30 | 07/94→01/98 | Z27 [168] | 0.8 | UX56 |
| 0.9 | 4 | 170 A1.000 | 30/40 | 07/91→12/93 | Z20 | 0.8 | UXT2 / UXT6 ZS283 |
| 0.9 i.e. | 4 | 170 A1.046 | 30/40 | 07/91→12/93 | Z20 | 0.8 | UXT2 / UXT6 ZS283 |
| 0.9 i.e. S | 4 | 1170 A1.000, 1170 A1.046 | 29/39 | 07/91→07/99 | Z20 | 0.8 | UXT2 / UXT6 ZS283 |
| 0.9 i.e. S LPG | 4 | 1170 A1.000, 1170 A1.046 | 29/39 | 07/91→07/99 | Z27 [168] | 0.8 | UX56 |
| 1.1 Sporting | 4 | 176 B2.000 | 40/54 | 10/94→01/98 | Z193 | 0.9 | UXT1 / UXT3 ZS283 |
| 1.1 Sporting LPG | 4 | 176 B2.000 | 40/54 | 10/94→01/98 | Z340 | 0.7 | UXT12 |

COUPE

| | | | | | | | |
|-------------------|---|------------|---------|-------------|-----------|-----|-------------------|
| 1.8 16V | 4 | 183 A1.000 | 96/129 | 03/96→08/00 | Z98 | 0.8 | UXT1 / UXT3 |
| 1.8 16V LPG | 4 | 183 A1.000 | 96/129 | 03/96→08/00 | Z116 | 0.8 | UXT5 |
| 2.0 16V | 4 | 836 A3.000 | 102/137 | 11/93→08/96 | Z27 [170] | 0.8 | UX56 |
| 2.0 16V LPG | 4 | 836 A3.000 | 102/137 | 11/93→08/96 | Z47 [168] | 0.8 | UX56 |
| 2.0 16V Turbo | 4 | 175 A1.000 | 140/188 | 11/93→08/96 | Z27 [170] | 0.8 | UX56 ZS283 |
| 2.0 16V Turbo LPG | 4 | 175 A1.000 | 140/188 | 11/93→08/96 | Z47 [168] | 0.8 | UX56 |
| 2.0 20V | 5 | 182 A1.000 | 108/145 | 08/96→04/98 | Z98 | 0.8 | UXT1 / UXT3 ZS310 |
| 2.0 20V | 5 | 182 B3.000 | 113/152 | 04/98→08/00 | Z98 | 0.8 | UXT1 / UXT3 ZS311 |
| 2.0 20V LPG | 5 | 182 A1.000 | 108/145 | 08/96→04/98 | Z116 | 0.8 | UXT5 |
| 2.0 20V LPG | 5 | 182 B3.000 | 113/152 | 04/98→08/00 | Z116 | 0.8 | UXT5 |
| 2.0 20V Turbo | 5 | 175 A3.000 | 162/217 | 08/96→08/00 | | | ZS310 |

CROMA

| | | | | | | | |
|-----------------------|---|------------|---------|-------------|------------|-----|-------|
| 1.6 1600 | 4 | 154 A.048 | 61/82 | 12/85→12/90 | Z27 [168] | 0.8 | UX56 |
| 1.8 16V | 4 | 939 A4.000 | 103/138 | 12/05→ | Z203 | 0.9 | ZS427 |
| 1.8 16V LPG | 4 | 939 A4.000 | 103/138 | 12/05→ | Z206 [168] | 0.7 | UXT10 |
| 1.9 1900 Turbo D i.d. | 4 | 154 C6.000 | 66/89 | 05/89→10/92 | GV730 | 11V | |
| 1.9 1900 Turbo D i.d. | 4 | 154 D1.000 | 69/93 | 11/92→12/96 | GV730 | 11V | |

FIAT

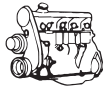

kW/BHP

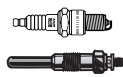

... FIAT



... CROMA

| | | | | | | | | | |
|-------------------------|---|-------------------------------------|---------|-------------|---|-----|-------------|-------------------|--------------|
| 1.9 D Multijet | 4 | 939 A7.000 | 85/114 | 06/05→ | GN041 →08/06 →eng. 5115898 GN097 09/06→ | 11V | | | |
| 1.9 D Multijet | 4 | 939 A1.000 | 88/118 | 06/05→ | GN097 →09/06 GN041 08/06→ | 11V | | | |
| 1.9 D Multijet | 4 | 939 A8.000 | 100/134 | 12/05→ | GN059 | 11V | | | |
| 1.9 D Multijet | 4 | 939 A2.000 | 110/148 | 06/05→ | GN059 | 11V | | | |
| 2.0 2000 16V | 4 | 154 E1.000 | 101/135 | 08/92→08/96 | Z27 [170] | 0.8 | UX56 | ZS234 | |
| 2.0 2000 16V LPG | 4 | 154 E1.000 | 101/135 | 08/92→08/96 | Z47 [168] | 0.8 | UX56 | | |
| 2.0 2000 CHT | 4 | 154 A1.000 | 66/89 | 12/85→02/89 | Z27 [168] | 0.8 | UX56 | ZS248 | ZM005 |
| 2.0 2000 CHT | 4 | | 74/99 | 01/91→09/92 | Z27 [168] | 0.8 | UX56 | | ZM005 |
| 2.0 2000 i.e. | 4 | 834 B.048 | 83/111 | 03/86→09/90 | Z27 [168] | 0.8 | UX56 | | |
| 2.0 2000 i.e. | 4 | 154 C3.046, 834 B.146 | 85/114 | 10/87→08/96 | Z27 [170] | 0.8 | UX56 | | |
| 2.0 2000 i.e. | 4 | 154 C3.000, 834 B.000 | 88/118 | 03/87→09/92 | Z27 [168] | 0.8 | UX56 | | |
| 2.0 2000 i.e. LPG | 4 | 154 C3.046, 834 B.146 | 85/114 | 10/87→08/96 | Z47 [168] | 0.8 | UX56 | | |
| 2.0 2000 i.e. Turbo | 4 | 154 C4.046, 834 C.146 | 110/148 | 06/87→08/96 | Z27 [170] | 0.8 | UX56 | | ZM061 |
| 2.0 2000 i.e. Turbo | 4 | 834 C.146 | 111/149 | 11/86→11/88 | Z27 [170] | 0.8 | UX56 | | ZM061 |
| 2.0 2000 i.e. Turbo | 4 | 154 A2.000 | 114/153 | 12/85→06/90 | Z27 [168] | 0.8 | UX56 | ZS115 [11] | ZM061 |
| 2.0 2000 i.e. Turbo LPG | 4 | 154 C4.046, 834 C.146 | 110/148 | 06/87→08/96 | Z47 [168] | 0.8 | UX56 | | |
| 2.2 16V | 4 | 194 A1.000 | 108/145 | 06/05→ | Z222 | 1.1 | | | |
| 2.4 2500 TD | 4 | 8144.91.2000 | 74/99 | 12/85→08/89 | GN909 (2)(222) GV642 | 11V | | | |
| 2.4 D Multijet | 5 | 939 A3.000 | 147/197 | 06/05→ | GN059 | 11V | | | |
| 2.5 2500 D | 4 | 8144.67 | 55/74 | 12/85→12/89 | GN909 (2)(222) GV663 | 11V | | | |
| 2.5 2500 V6 | 6 | 834 G.000 | 119/160 | 06/93→08/96 | Z27 [168] | 0.8 | UX56 | ZS230 | |
| 2.5 2500 V6 LPG | 6 | 834 G.000 | 119/160 | 06/93→08/96 | Z47 [168] | 0.8 | UX56 | | |
| 2.5 2500 TD | 4 | 8144.97, 8144.97.2400, 8144.97 Y | 85/114 | 05/89→08/96 | GN013 (2)(222) GN925 | 11V | | | |
| 2.5 2500 TDE | 4 | 8144.97 S | 77/103 | 12/91→08/96 | GN909 (2)(222) GV642 | 11V | | | |

DOBLO

| | | | | | | | | | |
|-------------------|---|------------------------|--------|-------------|--|------|--------------------|--------------|--|
| 1.2 | 4 | 223 A5.000 | 48/64 | 03/01→ | Z255 | 0.9 | UXT1 / UXT3 | ZS283 | |
| 1.2 LPG | 4 | 223 A5.000 | 48/64 | 03/01→ | Z206 | 0.7 | UXT10 | | |
| 1.3 D Multijet | 4 | 223 A9.000 | 62/83 | 10/05→ | GN053 | 11V | | | |
| 1.3 D Multijet | 4 | 199 A3.000, 263 A2.000 | 66/89 | 02/10→ | GE112 [80] GN053 [78] | 4.4V | | | |
| 1.3 JTD | 4 | 199 A2.000 | 55/74 | 05/05→ | GN053 | 11V | | | |
| 1.3 JTD 16V | 4 | 188 A9.000 | 51/68 | 12/04→05/05 | GN053 | 11V | | | |
| 1.4 | 4 | 350 A1.000 | 57/76 | 10/05→ | Z293 | 1.05 | | ZS079 | |
| 1.4 | 4 | 843 A1.000 | 70/94 | 02/10→ | Z292 | 1.05 | | ZS322 | |
| 1.4 | 4 | 198 A4.000 | 88/118 | 10/11→ | | | | ZS095 | |
| 1.4 LPG | 4 | 843 A1.000 | 70/94 | 02/10→ | Z291 [168] | 0.9 | | | |
| 1.4 Natural Power | 4 | 198 A4.000 | 88/118 | 02/10→ | Z338 | 0.8 | | ZS095 | |
| 1.6 | 4 | 182 B6.000 | 68/91 | 09/02→ | | | | ZS029 | |
| 1.6 16V | 4 | 182 B6.000 | 76/102 | 10/01→ | Z255 | 0.9 | UXT1 / UXT3 | ZS320 | |
| 1.6 16V LPG | 4 | 182 B6.000 | 76/102 | 10/01→ | Z206 | 0.7 | UXT10 | | |
| 1.6 D Multijet | 4 | 263 A4.000 | 66/89 | 02/10→ | GE114 | 4.4V | | | |
| 1.6 D Multijet | 4 | 198 A3.000 | 77/103 | 02/10→ | GE114 | 4.4V | | | |
| 1.6 Natural Power | 4 | 182 B6.000 | 76/102 | 09/02→ | Z98 | 0.8 | UXT1 / UXT3 | ZS029 | |
| 1.9 D | 4 | 223 A6.000 | 46/62 | 03/01→ | GN030 | 11V | | | |
| 1.9 D Multijet | 4 | 186 A9.000 | 88/118 | 10/05→ | GN097 | 11V | | | |
| 1.9 JTD | 4 | 182 B9.000, 223 B2.000 | 74/99 | 10/01→ | GN041 | 11V | | | |
| 1.9 JTD | 4 | 223 A7.000, 223 B1.000 | 77/103 | 07/03→ | GN041 | 11V | | | |
| 2.0 D Multijet | 4 | 263 A1.000 | 99/133 | 02/10→ | GE114 | 4.4V | | | |



kW/BHP



... FIAT

**DUNA**

| | | | | | | | | | |
|--------|---|------------|-------|-------------|-------------------------|------------|-------------|-------|-------|
| 1.1 60 | 4 | 146 A6.000 | 43/58 | 01/87→12/91 | Z20 | 0.8 | UXT2 / UXT6 | ZS248 | ZM009 |
| 1.3 70 | 4 | 146 A5.000 | 49/66 | 01/87→12/91 | Z20 | 0.8 | UXT2 / UXT6 | ZS248 | ZM009 |
| 1.7 DS | 4 | 149 B3.000 | 44/59 | 01/87→12/91 | GN909 [2][222] GV663 | 11V 11V | | | |

ELBA

| | | | | | | | | | |
|-------|---|------------|-------|-------------|-------------------------|------------|--|--|--|
| 1.3 D | 4 | 127 A5.000 | 33/44 | 04/86→10/92 | GN909 [2][222] GV636 | 11V 11V | | | |
| 1.7 D | 4 | 146 B2.000 | 43/58 | 04/89→12/96 | GV663 | 11V | | | |

FIORINO Pick up

| | | | | | | | | | |
|---------|---|------------------------|-------|-------------|-------------------------|------------|-------------|-------|--|
| 1.0 | 4 | | 37/50 | 10/82→10/87 | Z20 | 0.8 | UXT2 / UXT6 | | |
| 1.1 | 4 | 156 A.000 | 41/55 | 09/87→12/88 | Z20 | 0.8 | UXT2 / UXT6 | | |
| 1.3 | 4 | 146 A5.000 | 49/66 | 01/88→12/94 | Z20 | 0.8 | UXT2 / UXT6 | ZS248 | |
| | | | | | →08/93 | | →08/93 | | |
| 1.3 D | 4 | 127 A5.000 | 33/44 | 05/84→12/88 | GN909 [2][222] GV663 | 11V 11V | | | |
| 1.4 | 4 | 146 D5.000 | 49/66 | 05/94→05/01 | Z15 [168] | 0.8 | UXT1 / UXT3 | ZS234 | |
| 1.4 LPG | 4 | 146 D5.000 | 49/66 | 05/94→05/01 | Z340 | 0.7 | UXT12 | | |
| 1.6 | 4 | 146 C6.000 | 55/74 | 01/94→05/01 | Z27 [170] | 0.8 | UX56 | | |
| 1.6 | 4 | 146 D6.000 | 55/74 | 01/94→05/01 | Z27 [170] | 0.8 | UX56 | ZS234 | |
| 1.6 LPG | 4 | 146 C6.000, 146 D6.000 | 55/74 | 01/94→05/01 | Z47 [168] | 0.8 | UX56 | | |
| 1.7 D | 4 | 146 B2.000 | 42/56 | 10/93→10/99 | GN909 [2][222] GV663 | 11V 11V | | | |
| 1.7 D | 4 | 149 B3.000 | 44/59 | 05/88→10/99 | GN909 [2][222] GV663 | 11V 11V | | | |
| 1.7 TD | 4 | 146 D7.000 | 46/62 | 01/97→05/01 | GN013 [2][222] GN908 | 11V 11V | | | |

FREEMONT

| | | | | | | | | | |
|---------|---|------------------------|---------|--------|-------|------|--|-------|--|
| 2.0 JTD | 4 | 939 B5.000 | 100/134 | 08/11→ | GE114 | 4.4V | | | |
| 2.0 JTD | 4 | 939 B5.000, 940 A5.000 | 103/138 | 08/11→ | GE114 | 4.4V | | | |
| 2.0 JTD | 4 | 939 B5.000 | 120/161 | 08/11→ | GE114 | 4.4V | | | |
| 2.0 JTD | 4 | 939 B5.000 | 125/168 | 08/11→ | GE114 | 4.4V | | | |
| 3.6 | 6 | ERB | 206/276 | 08/11→ | | | | ZS453 | |

IDEA

| | | | | | | | | | |
|----------------|---|------------|--------|--------|------------|------|--|-------|--|
| 1.2 16V | 4 | 188 A5.000 | 59/79 | 01/04→ | Z292 | 1.05 | | ZS322 | |
| 1.2 16V LPG | 4 | 188 A5.000 | 59/79 | 01/04→ | Z291 [168] | 0.9 | | | |
| 1.3 D Multijet | 4 | 199 A3.000 | 66/89 | 10/05→ | GN053 | 11V | | | |
| 1.3 D Multijet | 4 | 199 B1.000 | 70/94 | 05/08→ | GE112 [37] | 4.4V | | | |
| 1.3 JTD | 4 | 188 A9.000 | 51/68 | 01/04→ | GN053 | 11V | | | |
| 1.4 | 4 | 350 A1.000 | 57/76 | 10/05→ | Z293 | 1.05 | | ZS079 | |
| 1.4 | 4 | 192 B2.000 | 66/89 | 12/03→ | Z292 | 1.05 | | ZS322 | |
| 1.4 LPG | 4 | 192 B2.000 | 66/89 | 12/03→ | Z291 [168] | 0.9 | | | |
| 1.4 16V | 4 | 843 A1.000 | 70/94 | 01/04→ | Z292 | 1.05 | | ZS322 | |
| 1.4 16V LPG | 4 | 843 A1.000 | 70/94 | 01/04→ | Z291 [168] | 0.9 | | | |
| 1.4 LPG | 4 | 350 A1.000 | 57/76 | 03/09→ | | | | ZS079 | |
| 1.6 D Multijet | 4 | 350 A2.000 | 88/118 | 05/08→ | GE114 | 4.4V | | | |
| 1.9 JTD | 4 | 188 B2.000 | 74/99 | 01/04→ | GN041 | 11V | | | |

JAGST

| | | | | | | | | | |
|---------|---|--|-------|-------------|-----|-----|--|------------|--|
| 0.8 770 | 4 | | 17/23 | 03/68→02/71 | Z57 | 0.6 | | ZS106 [11] | |
|---------|---|--|-------|-------------|-----|-----|--|------------|--|

LINEA

| | | | | | | | | | |
|----------------|---|------------|--------|--------|-------|------|--|-------|--|
| 1.3 D Multijet | 4 | 199 A3.000 | 66/89 | 06/07→ | GN053 | 11V | | | |
| 1.3 D Multijet | 4 | 199 A3.000 | 70/94 | 09/09→ | GN053 | 11V | | | |
| 1.4 | 4 | 350 A1.000 | 57/76 | 06/07→ | Z293 | 1.05 | | ZS079 | |
| 1.4 T-Jet | 4 | 198 A4.000 | 88/118 | 09/07→ | Z338 | 0.8 | | ZS095 | |
| 1.6 D Multijet | 4 | 198 A3.000 | 77/103 | 06/09→ | GE114 | 4.4V | | | |



kW/BHP



... FIAT



MAREA

| | | | | | | | |
|---------------------|---|------------------------|---------|-------------|--|------------|-------------------|
| 1.2 16V | 4 | 182 B2.000 | 60/80 | 10/98→05/02 | Z234 Z291 | 0.9 0.9 | ZS234 |
| 1.2 16V LPG | 4 | 182 B2.000 | 60/80 | 10/98→05/02 | Z292 [168] | 1.05 | |
| 1.4 80 12V | 4 | 182 A3.000 | 59/79 | 09/96→05/02 | Z98 →03/99 | 0.8 | UXT1 / UXT3 ZS234 |
| 1.4 80 12V LPG | 4 | 182 A3.000 | 59/79 | 09/96→05/02 | Z116 →03/99 | 0.8 | UXT5 |
| 1.6 | 4 | 182 B6.000 | 76/102 | 09/00→08/02 | Z255 | 0.9 | UXT1 / UXT3 ZS029 |
| 1.6 LPG | 4 | 182 B6.000 | 76/102 | 09/00→08/02 | Z206 | 0.7 | UXT10 |
| 1.6 16V | 4 | 185 A3.000 | 75/101 | 04/97→02/99 | Z98 | 0.8 | UXT1 / UXT3 ZS029 |
| 1.6 100 16V | 4 | 182 A4.000 | 76/102 | 09/96→05/02 | Z98 →03/99 Z255 04/99→ | 0.8 0.9 | UXT1 / UXT3 ZS029 |
| 1.6 100 16V LPG | 4 | 182 A4.000 | 76/102 | 09/96→05/02 | Z116 →03/99 Z206 04/99→ | 0.8 0.7 | UXT5 UXT10 |
| 1.6 100 16V Bipower | 4 | 185 A3.000, 186 A4.000 | 76/102 | 04/99→05/02 | Z206 | 0.7 | UXT10 ZS029 |
| 1.8 115 16V | 4 | 182 A2.000 | 83/111 | 09/96→05/02 | Z98 →07/99 →eng. 1945438 Z255 08/99→ eng. 1945439→ | 0.8 0.9 | UXT1 / UXT3 |
| 1.8 115 16V LPG | 4 | 182 A2.000 | 83/111 | 09/96→05/02 | Z116 →07/99 →eng. 1945438 Z206 08/99→ eng. 1945439→ | 0.8 0.7 | UXT5 UXT10 |
| 1.9 JTD | 4 | | 79/106 | 01/01→12/07 | GN041 | 11V | |
| 1.9 JTD 105 | 4 | 182 B4.000 | 77/103 | 04/99→05/02 | GN017 →10/99 →eng. 1713818 GN041 11/99→ eng. 1713819→ | 11V 11V | |
| 1.9 JTD 110 | 4 | 186 A6.000 | 81/109 | 01/01→05/02 | GN041 | 11V | |
| 1.9 TD 75 | 4 | 182 A8.000 | 55/74 | 09/96→05/02 | GN970 | 11V | |
| 1.9 TD 100 | 4 | 182 A7.000, 182 B9.000 | 74/99 | 09/96→05/02 | GN970 | 11V | |
| 2.0 150 20V | 5 | 182 A1.000 | 108/145 | 09/96→04/99 | Z98 | 0.8 | UXT1 / UXT3 ZS310 |
| 2.0 150 20V | 5 | 185 A8.000 | 110/148 | 01/01→05/02 | Z98 | 0.8 | UXT1 / UXT3 ZS311 |
| 2.0 150 20V LPG | 5 | 182 A1.000 | 108/145 | 09/96→04/99 | Z116 | 0.8 | UXT5 |
| 2.0 150 20V LPG | 5 | 185 A8.000 | 110/148 | 01/01→05/02 | Z116 | 0.8 | UXT5 |
| 2.0 155 20V | 5 | 182 B7.000 | 113/152 | 04/99→02/03 | Z98 | 0.8 | UXT1 / UXT3 ZS311 |
| 2.0 155 20V LPG | 5 | 182 B7.000 | 113/152 | 04/99→02/03 | Z116 | 0.8 | UXT5 |
| 2.4 JTD 130 | 5 | 185 A6.000, 839 A5.000 | 96/129 | 04/99→05/02 | GN017 →10/99 →eng. 1713818 GN041 11/99→ eng. 1713819→ | 11V 11V | |
| 2.4 TD 125 | 5 | 185 A2.000 | 91/122 | 09/96→04/99 | GN970 | 11V | |

MULTIPLA

| | | | | | | | |
|---------|---|------------|--------|-------------|------|-----|-------------------|
| 1.6 | 4 | 182 B6.000 | 68/91 | 05/04→08/05 | | | ZS029 |
| 1.6 | 4 | 182 B6.000 | 74/99 | 03/01→08/05 | | | ZS029 |
| 1.6 | 4 | 182 B6.000 | 76/102 | 09/00→06/10 | Z255 | 0.9 | UXT1 / UXT3 ZS029 |
| 1.6 LPG | 4 | 182 B6.000 | 76/102 | 09/00→06/10 | Z206 | 0.7 | UXT10 |

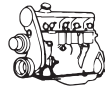

kW/BHP

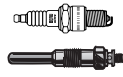

... FIAT



... MULTIPLA

| | | | | | | | | |
|------------------|---|------------------------|--------|-------------|--|------------|-------------|-------|
| 1.6 16V | 4 | 182 B6.000 | 70/94 | 04/02→06/10 | Z255 | 0.9 | UXT1 / UXT3 | ZS029 |
| 1.6 16V Bipower | 4 | 182 B6.000, 186 A4.000 | 76/102 | 04/99→06/10 | Z255 | 0.9 | UXT1 / UXT3 | ZS029 |
| 1.6 16V Blupower | 4 | 186 A3.000 | 70/94 | 04/99→06/10 | Z255 | 0.9 | UXT1 / UXT3 | ZS029 |
| 1.6 100 16V | 4 | 182 A4.000 | 76/102 | 04/99→06/10 | Z255 | 0.9 | UXT1 / UXT3 | ZS029 |
| 1.6 100 16V LPG | 4 | 182 A4.000 | 76/102 | 04/99→06/10 | Z206 | 0.7 | UXT10 | |
| 1.9 JTD | 4 | 186 A9.000 | 88/118 | 04/02→06/10 | GN041 →09/05 GN097 10/05→ | 11V 11V | | |
| 1.9 JTD 105 | 4 | 182 B4.000 | 77/103 | 04/99→06/10 | GN017 →10/99 →eng. 1692990 GN041 11/99→ eng. 1692991→ | 11V 11V | | |
| 1.9 JTD 110 | 4 | 186 A6.000 | 81/109 | 03/01→07/02 | GN041 | 11V | | |
| 1.9 JTD 115 | 4 | 186 A8.000 | 85/114 | 07/02→06/10 | GN041 [263] GN097 [264] | 11V 11V | | |

PALIO

| | | | | | | | | |
|-------------|---|---------------------------------------|--------|-------------|-------------------------|------------|-------------|-------|
| 1.0 | 4 | | 45/60 | 04/96→ | Z15 [168] | 0.8 | UXT1 / UXT3 | ZS283 |
| 1.0 LPG | 4 | | 45/60 | 04/96→ | Z340 | 0.7 | UXT12 | |
| 1.2 | 4 | 178 B7.045, 178 C4.066, 188 A4.000 | 44/59 | 07/97→ | | | | ZS283 |
| 1.2 | 4 | 178 C4.066, 188 A4.000 | 44/59 | 02/01→ | Z255 | 0.9 | UXT1 / UXT3 | |
| 1.2 | 4 | 188 A4.000 | 44/59 | 07/97→08/02 | Z292 | 1.05 | | |
| 1.2 | 4 | 178 E2.000 | 50/67 | 06/99→10/00 | Z255 | 0.9 | UXT1 / UXT3 | |
| 1.2 | 4 | 178 E2.000 | 50/67 | 06/99→10/02 | Z98 | 0.8 | UXT1 / UXT3 | ZS283 |
| 1.2 | 4 | 176 A8.000, 178 B5.000, 178 E2.000 | 54/72 | 04/96→ | Z98 | 0.8 | UXT1 / UXT3 | ZS283 |
| 1.2 | 4 | 188 A5.000 | 59/79 | 09/01→ | Z291 | 0.9 | | ZS234 |
| 1.2 LPG | 4 | 178 C4.066, 188 A4.000 | 44/59 | 02/01→ | Z206 | 0.7 | UXT10 | |
| 1.2 LPG | 4 | 188 A4.000 | 44/59 | 07/97→08/02 | Z291 [168] | 0.9 | | |
| 1.2 LPG | 4 | 178 E2.000 | 50/67 | 06/99→10/02 | Z116 | 0.8 | UXT5 | |
| 1.2 LPG | 4 | 176 A8.000, 178 B5.000, 178 E2.000 | 54/72 | 04/96→ | Z116 | 0.8 | UXT5 | |
| 1.2 Flex | 4 | 188 A4.000 | 44/59 | 07/97→08/02 | | | | ZS283 |
| 1.2 LPG | 4 | 188 A4.000 | 44/59 | 07/97→08/02 | | | | ZS283 |
| 1.4 | 4 | 178 B2.000, 178 B2.016 | 51/68 | 04/96→ | Z74 | 1.0 | UXT1 / UXT3 | ZS283 |
| 1.4 LPG | 4 | 178 B2.000, 178 B2.016 | 51/68 | 04/96→ | Z206 | 0.7 | UXT10 | |
| 1.5 | 4 | 178 E5.022 | 62/83 | 02/02→ | | | | ZS283 |
| 1.5 | 4 | 178 E5.022 | 62/83 | 06/04→ | Z15 Z247 | 0.8 0.9 | UXT1 / UXT3 | |
| 1.6 | 4 | 178 C7.098, 178 D2.011 | 68/91 | 07/97→10/03 | | | | ZS029 |
| 1.6 16V | 4 | 178 B3.000 | 74/99 | 04/96→ | Z255 | 0.9 | UXT1 / UXT3 | ZS029 |
| 1.6 16V | 4 | 182 B6.000 | 76/102 | 02/01→ | Z255 | 0.9 | UXT1 / UXT3 | ZS029 |
| 1.6 16V LPG | 4 | 178 B3.000 | 74/99 | 04/96→ | Z206 | 0.7 | UXT10 | |
| 1.6 16V LPG | 4 | 182 B6.000 | 76/102 | 02/01→ | Z206 | 0.7 | UXT10 | |
| 1.7 TD | 4 | 176 A3.000 | 51/68 | 04/96→03/01 | GN013 [2][222] GN908 | 11V 11V | | |
| 1.9 D | 4 | 223 A6.000 | 46/62 | 03/01→ | GN030 | 11V | | |
| 1.9 JTD | 4 | 188 A2.000 | 59/79 | 09/01→ | GN041 | 11V | | |

PANDA

| | | | | | | | | | |
|-------------|---|------------------------|-------|-------------|-----------|-----|-------------|-------------|--------------------------------|
| 0.8 750 | 4 | 141 B.000 | 25/34 | 01/86→01/95 | Z20 | 0.8 | UXT2 / UXT6 | ZS106 [111] | ZM009 |
| 0.8 750 | 4 | 156 A4.000 | 25/34 | 01/86→01/95 | Z15 [168] | 0.8 | UXT1 / UXT3 | ZS106 [111] | ZM009 [193] ZM017 01/88→ |
| 0.8 750 | 4 | 156 A4.048 | 25/34 | 01/95→10/03 | Z15 [168] | 0.8 | UXT1 / UXT3 | ZS248 | ZM009 [193] ZM017 [213] |
| 0.8 750 LPG | 4 | 156 A4.000, 156 A4.048 | 25/34 | 01/86→10/03 | Z340 | 0.7 | UXT12 | | |



kW/BHP



... FIAT



... PANDA

| | | | | | | | | | |
|---------------------------|---|------------------------|-------|-------------|---|------|------------------------------|---------------------------------|---|
| 0.8 800 | 4 | 100 GL6.000 | 25/34 | 02/81→12/85 | Z20 | 0.8 | UXT2 / UXT6 | ZS106 ^[11] | |
| 0.9 | 2 | 312 A4.000 | 48/64 | 02/12→ | Z234 | 0.9 | | ZS283 | |
| 0.9 | 2 | 312 A2.000 | 57/76 | 02/12→ | Z357 | 0.7 | | ZS090 | |
| 0.9 | 2 | 312 A2.000 | 63/84 | 02/12→ | Z357 | 0.7 | | ZS090 | |
| 0.9 900 | 4 | 1170 A1.046 | 29/39 | 04/92→12/96 | Z20 →10/95 Z255 11/95→ | 0.8 | UXT2 / UXT6 →10/95 | ZS283 | |
| 0.9 900 | 4 | 100 GL3.000, 146 A.000 | 33/44 | 10/80→06/94 | Z20 | 0.8 | UXT2 / UXT6 | ZS106 ^[11] | |
| 0.9 900 LPG | 4 | 1170 A1.046 | 29/39 | 04/92→12/96 | Z27 ^[168] →10/95 Z206 11/95→ | 0.8 | UX56 →10/95 | | |
| 0.9 950 | 4 | A 112 B1.054 | 35/47 | 09/82→08/83 | | | | ZS106 ^[11] | |
| 0.9 Fire S 4WD | 4 | 146 A.048 | 33/44 | 10/80→04/86 | | | | ZS106 ^[11] | |
| 0.9 Natural Power | 2 | 312 A2.000 | 63/84 | 07/12→ | Z357 | 0.7 | | | |
| 1.0 950 4WD | 4 | A 112 B1.054 | 35/47 | 09/83→12/86 | Z20 →12/85 | 0.8 | UXT2 / UXT6 →12/85 | ZS106 ^[11] →12/85 | |
| 1.0 1000 | 4 | 156 A2.100 | 32/43 | 01/86→04/92 | Z15 08/90→ | 0.8 | UXT1 / UXT3 08/90→ | ZS106 ^[11] | ZM009 ^[193] ZM017 01/88→ |
| 1.0 1000 4WD | 4 | 156 A2.100, 156 A3.100 | 32/43 | 01/86→07/89 | Z15 ^[168] | 0.8 | UXT1 / UXT3 | ZS248 | ZM009 ^[193] ZM017 01/88→ |
| 1.0 1000 4WD | 4 | 141 C2.000, 156 A2.246 | 33/44 | 05/86→12/94 | Z193 | 0.9 | UXT1 / UXT3 | ZS248 | ZM009 ^[193] ZM017 01/88→ |
| 1.0 1000 | 4 | 156 A3.000 | 37/50 | 01/85→12/92 | Z20 | 0.8 | UXT2 / UXT6 | ZS106 ^[11] | ZM009 ^[193] ZM017 01/88→ |
| 1.0 1000 4WD | 4 | 156 A3.000 | 37/50 | 01/86→12/92 | Z15 ^[168] | 0.8 | UXT1 / UXT3 | ZS106 ^[11] →06/90 | ZM009 ^[193] ZM017 01/88→ |
| 1.0 1000 i.e. | 4 | 141 C2.000, 156 A2.246 | 33/44 | 10/87→08/98 | Z193 | 0.9 | UXT1 / UXT3 | ZS106 ^[11] | ZM009 ^[193] ZM017 01/88→ |
| 1.0 1000 i.e. LPG | 4 | 141 C2.000, 156 A2.246 | 33/44 | 10/87→08/98 | Z340 | 0.7 | UXT12 | | |
| 1.1 | 4 | 187 A1.000 | 40/54 | 09/03→ | Z255 →eng. 2533528 Z234 eng. 2533529→ | 0.9 | UXT1 / UXT3 →eng. 2533528 | ZS283 | |
| 1.1 LPG | 4 | 187 A1.000 | 40/54 | 09/03→ | Z206 →eng. 2533528 Z292 ^[168] eng. 2533529→ | 0.7 | UXT10 →eng. 2533528 | | |
| 1.1 1100 | 4 | 156 C.046 | 37/50 | 05/91→12/99 | Z193 | 0.9 | UXT1 / UXT3 | ZS283 01/93→ | |
| 1.1 1100 | 4 | 176 B2.000, 187 A1.000 | 40/54 | 02/95→07/04 | Z193 | 0.9 | UXT1 / UXT3 | ZS283 | |
| 1.1 1100 LPG | 4 | 156 C.046 | 37/50 | 05/91→12/99 | Z340 | 0.7 | UXT12 | | |
| 1.1 1100 LPG | 4 | 176 B2.000, 187 A1.000 | 40/54 | 02/95→07/04 | Z340 | 0.7 | UXT12 | | |
| 1.1 1100 Trekking 4WD | 4 | 156 C.046 | 37/50 | 10/91→07/04 | Z193 | 0.9 | UXT1 / UXT3 | ZS283 01/93→ | |
| 1.1 1100 Trekking 4WD LPG | 4 | 156 C.046 | 37/50 | 10/91→07/04 | Z340 | 0.7 | UXT12 | | |
| 1.2 | 4 | 188 A4.000 | 44/59 | 09/03→ | Z255 →eng. 2533528 Z234 eng. 2533529→ | 0.9 | UXT1 / UXT3 →eng. 2533528 | ZS283 | |
| 1.2 | 4 | 169 A4.000 | 51/68 | 11/09→ | Z293 | 1.05 | | ZS079 | |
| 1.2 | 4 | 169 A4.000 | 51/68 | 02/12→ | Z234 | 0.9 | | | |

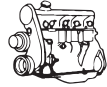

kW/BHP

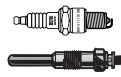

... FIAT



... PANDA

| | | | | | | | | |
|------------------------------|---|------------------------------------|-------|-------------|--|---------------------------|--|--------------|
| 1.2 LPG | 4 | 188 A4.000 | 44/59 | 09/03→ | Z206 → eng. 2533528 Z292 [168] eng. 2533529→ | 0.7 1.05 | UXT10 → eng. 2533528 | |
| 1.2 Bi-Power / Natural Power | 4 | 188 A4.000 | 44/59 | 01/07→ | Z255 → eng. 2533528 Z234 eng. 2533529→ | 0.9 0.9 | UXT1 / UXT3 → eng. 2533528 | ZS283 |
| 1.2 LPG | 4 | 188 A4.000 | 44/59 | 04/09→ | Z206 → eng. 2533528 Z255 → eng. 2533528 Z234 eng. 2533529→ Z292 [168] eng. 2533529→ | 0.7 0.9 0.9 1.05 | UXT10 → eng. 2533528 UXT1 / UXT3 → eng. 2533528 | ZS283 |
| 1.2 LPG | 4 | 169 A4.000 | 51/68 | 11/10→ | Z292 | 1.05 | | ZS283 |
| 1.3 1300 D | 4 | 156 A5.000 | 27/36 | 04/86→12/92 | GN909 | 11V | | |
| 1.3 D Multijet | 4 | 188 A8.000, 188 A9.000 | 51/68 | 09/03→ | GN053 | 11V | | |
| 1.3 D Multijet | 4 | 169 A1.000, 169 A5.000 | 55/74 | 06/06→ | GN053 | 11V | | |
| 1.3 D Multijet | 4 | 169 A1.000, 199 A1.000, 199 A9.000 | 55/74 | 09/10→ | GE112 | 4.4V | | |
| 1.4 | 4 | 169 A3.000 | 74/99 | 10/06→ | Z292 | 1.05 | | ZS322 |
| 1.4 LPG | 4 | 169 A3.000 | 74/99 | 10/06→ | Z291 [168] | 0.9 | | |
| 1.4 Bi-Power / Natural Power | 4 | 350 A1.000 | 57/76 | 09/10→ | | | | ZS079 |

PUNTO

| | | | | | | | | |
|-------------------|---|------------------------|-------|-------------|---|-------------|--------------------------------------|--------------|
| 0.9 Bifuel LPG | 2 | 312 A2.000 | 63/84 | 03/12→ | Z357 | 0.7 | | |
| 0.9 Twinair Turbo | 2 | 312 A2.000 | 63/84 | 03/12→ | Z357 | 0.7 | | ZS090 |
| 1.1 55 | 4 | 176 A6.000, 176 B2.000 | 40/54 | 09/93→09/99 | Z193 | 0.9 | UXT1 / UXT3 | ZS283 |
| 1.1 55 LPG | 4 | 176 A6.000, 176 B2.000 | 40/54 | 09/93→09/99 | Z340 | 0.7 | UXT12 | |
| 1.2 | 4 | 169 A4.000 | 51/68 | 03/12→ | Z293 | 1.05 | | ZS079 |
| 1.2 16V | 4 | 176 B9.000 | 63/84 | 04/97→09/99 | Z234 | 0.9 | | ZS283 |
| 1.2 16V LPG | 4 | 176 B9.000 | 63/84 | 04/97→09/99 | Z292 [168] | 1.05 | | |
| 1.2 16V 80 | 4 | 188 A5.000 | 59/79 | 09/99→ | Z291 | 0.9 | | ZS234 |
| 1.2 60 | 4 | 176 A7.000 | 43/58 | 01/94→06/00 | Z193 | 0.9 | UXT1 / UXT3 | ZS283 |
| 1.2 60 | 4 | 176 B1.000, 176 B4.000 | 44/59 | 03/94→06/00 | Z193 | 0.9 | UXT1 / UXT3 | ZS283 |
| 1.2 60 | 4 | 188 A4.000 | 44/59 | 09/99→ | Z255 → eng. 2533528 Z234 eng. 2533529→ | 0.9 0.9 | UXT1 / UXT3 → eng. 2533528 | ZS283 |
| 1.2 60 LPG | 4 | 176 A7.000 | 43/58 | 01/94→06/00 | Z340 | 0.7 | UXT12 | |
| 1.2 60 LPG | 4 | 176 B1.000, 176 B4.000 | 44/59 | 03/94→06/00 | Z340 | 0.7 | UXT12 | |
| 1.2 60 LPG | 4 | 188 A4.000 | 44/59 | 09/99→ | Z206 → eng. 2533528 Z292 [168] eng. 2533529→ | 0.7 1.05 | UXT10 → eng. 2533528 | |
| 1.2 75 | 4 | 176 A8.000 | 54/72 | 10/93→09/99 | Z193 | 0.9 | UXT1 / UXT3 | ZS283 |
| 1.2 75 LPG | 4 | 176 A8.000 | 54/72 | 10/93→09/99 | Z340 | 0.7 | UXT12 | |
| 1.2 85 16V | 4 | 176 B9.000 | 63/84 | 04/97→06/00 | Z234 | 0.9 | | ZS283 |
| 1.2 85 16V LPG | 4 | 176 B9.000 | 63/84 | 04/97→06/00 | Z292 [168] | 1.05 | | |
| 1.2 Bifuel | 4 | 188 A4.000 | 44/59 | 08/07→ | | | | ZS283 |
| 1.2 Natural Power | 4 | 188 A4.000 | 44/59 | 09/03→ | Z255 → eng. 2533528 Z234 eng. 2533529→ | 0.9 0.9 | UXT1 / UXT3 → eng. 2533528 | ZS283 |
| 1.3 D Multijet | 4 | 199 A2.000, 199 A9.000 | 55/74 | 03/12→ | GE112 [37] GN053 [36] | 4.4V 11V | | |
| 1.3 D Multijet | 4 | 199 B4.000 | 62/83 | 03/12→ | GE112 [37] GN053 [36] | 4.4V 11V | | |

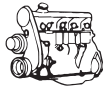

kW/BHP

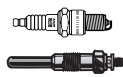

... FIAT



... PUNTO

| | | | | | | | | |
|-------------------|---|------------------------|--------|-------------|--------------------------|-------------|-------------|-------------|
| 1.3 D Multijet | 4 | 199 B1.000 | 70/94 | 03/12→ | GE112 [37] GN053 [36] | 4.4V 11V | | |
| 1.3 JTD 16V | 4 | 188 A9.000 | 51/68 | 06/03→ | GN053 | 11V | | |
| 1.4 | 4 | 199 A7.000 | 55/74 | 03/12→ | Z292 [1] Z338 [1] | 1.05 0.8 | | |
| 1.4 | 4 | 350 A1.000 | 57/76 | 03/12→ | Z293 [36] | 1.05 | ZS079 | |
| 1.4 | 4 | 843 A1.000 | 70/94 | 09/03→ | Z292 | 1.05 | ZS322 | |
| 1.4 LPG | 4 | 843 A1.000 | 70/94 | 09/03→ | Z291 [168] | 0.9 | | |
| 1.4 GT Turbo | 4 | 176 B6.000 | 96/129 | 09/96→09/99 | Z24 | 0.8 | UXT5 | ZS234 ZM026 |
| 1.4 GT Turbo | 4 | 176 A4.000 | 98/131 | 01/94→09/96 | Z24 | 0.8 | UXT5 | ZS234 |
| 1.4 Multi Air | 4 | 955 A6.000 | 77/103 | 03/12→ | Z292 | 1.05 | | |
| 1.4 Multi Air LPG | 4 | 955 A6.000 | 77/103 | 03/12→ | Z338 [1] | 0.8 | | |
| 1.4 Natural Power | 4 | 350 A1.000 | 57/76 | 03/12→ | | | | ZS079 |
| 1.6 | 4 | 176 A9.000 | 65/87 | 01/94→04/97 | Z252 | 0.9 | UXT5 | ZS234 |
| 1.6 LPG | 4 | 176 A9.000 | 65/87 | 01/94→04/97 | Z30 [168] | 0.8 | UXT5 | |
| 1.6 90 | 4 | 176 A9.000 | 65/87 | 04/94→04/97 | Z252 | 0.9 | UXT5 | |
| 1.6 90 LPG | 4 | 176 A9.000 | 65/87 | 04/94→04/97 | Z30 [168] | 0.8 | UXT5 | |
| 1.7 D | 4 | 176 B3.000 | 42/56 | 04/94→09/97 | GN013 [2][222] GN908 | 11V 11V | | |
| 1.7 TD | 4 | 176 B7.000 | 46/62 | 09/96→09/99 | GN013 [2][222] GN908 | 11V 11V | | |
| 1.7 TD | 4 | 176 A3.000 | 51/68 | 01/94→09/99 | GN013 [2][222] GN908 | 11V 11V | | |
| 1.7 TD | 4 | 176 A5.000 | 52/70 | 01/94→09/99 | GN013 [2][222] GN908 | 11V 11V | | |
| 1.8 130 HGT | 4 | 183 A1.000, 188 A6.000 | 96/129 | 09/99→ | Z255 | 0.9 | UXT1 / UXT3 | |
| 1.8 130 HGT LPG | 4 | 183 A1.000, 188 A6.000 | 96/129 | 09/99→ | Z206 | 0.7 | UXT10 | |
| 1.9 DS 60 | 4 | 188 A3.000 | 44/59 | 09/99→ | GN030 | 11V | | |
| 1.9 JTD | 4 | 188 A7.000 | 63/84 | 10/01→ | GN041 →09/05 GN097 | 11V 11V | | |
| 1.9 JTD | 4 | 188 B2.000 | 74/99 | 06/03→ | GN041 →09/05 GN097 | 11V 11V | | |
| 1.9 JTD 80 | 4 | 188 A2.000 | 59/79 | 09/99→ | GN041 | 11V | | |

PUNTO EVO

| | | | | | | | | |
|-------------------|---|------------------------|---------|-------------|--------------------------|-------------|-------|-------|
| 1.2 | 4 | 199 A4.000 | 48/64 | 10/09→02/12 | Z293 | 1.05 | ZS079 | |
| 1.2 | 4 | 169 A4.000 | 51/68 | 10/09→02/12 | Z293 | 1.05 | ZS079 | |
| 1.3 D Multijet | 4 | 199 B2.000 | 51/68 | 07/08→02/12 | GE112 [80] GN053 [78] | 4.4V 11V | | |
| 1.3 D Multijet | 4 | 199 A2.000, 199 A9.000 | 55/74 | 10/09→02/12 | GE112 [37] GN053 [36] | 4.4V 11V | | |
| 1.3 D Multijet | 4 | 199 B4.000, 223 A9.000 | 62/83 | 10/09→02/12 | GE112 | 4.4V | | |
| 1.3 D Multijet | 4 | 199 A3.000 | 66/89 | 10/09→02/12 | GN053 | 11V | | |
| 1.3 D Multijet | 4 | 199 B1.000 | 70/94 | 10/09→02/12 | GE112 | 4.4V | | |
| 1.4 | 4 | 199 A7.000 | 55/74 | 07/09→02/12 | Z234 | 0.9 | ZS079 | |
| 1.4 | 4 | 350 A1.000 | 57/76 | 10/09→02/12 | Z293 | 1.05 | ZS079 | |
| 1.4 16V | 4 | 955 A6.000 | 77/103 | 10/09→02/12 | Z293 | 1.05 | | |
| 1.4 16V | 4 | 955 A2.000 | 99/133 | 10/09→02/12 | Z338 | 0.8 | | |
| 1.4 Abarth | 4 | 955 A8.000 | 120/161 | 10/09→ | Z338 | 0.8 | | |
| 1.4 LPG | 4 | 350 A1.000 | 57/76 | 06/09→02/12 | | | | ZS079 |
| 1.4 Natural Power | 4 | 350 A1.000 | 57/76 | 10/09→02/12 | Z234 | 0.9 | | ZS079 |
| 1.6 D Multijet | 4 | 955 A3.000 | 88/118 | 10/09→02/12 | GE114 | 4.4V | | |

PUNTO / GRANDE PUNTO

| | | | | | | | | |
|-----|---|------------|-------|-------------|------|------|-------|--|
| 1.2 | 4 | 188 A4.000 | 44/59 | 10/05→12/11 | Z293 | 1.05 | ZS283 | |
| 1.2 | 4 | 199 A4.000 | 48/64 | 10/05→ | Z293 | 1.05 | ZS079 | |
| 1.2 | 4 | 169 A4.000 | 51/68 | 09/10→ | Z293 | 1.05 | ZS079 | |

FIAT



kW/BHP

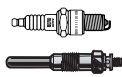

... FIAT



... PUNTO / GRANDE PUNTO

| | | | | | | | | |
|-------------------|---|------------|---------|-------------|--------------------------|-------------|--|-------|
| 1.2 LPG | 4 | 188 A4.000 | 44/59 | 10/05→12/11 | Z292 | 1.05 | | |
| 1.3 D Multijet | 4 | 199 B2.000 | 51/68 | 07/08→ | GE112 [80] GN053 [78] | 4.4V 11V | | |
| 1.3 D Multijet | 4 | 199 A2.000 | 55/74 | 10/05→ | GN053 | 11V | | |
| 1.3 D Multijet | 4 | 199 A2.000 | 56/75 | 06/09→ | GE112 | 4.4V | | |
| 1.3 D Multijet | 4 | 199 B4.000 | 62/83 | 04/10→ | GE112 | 4.4V | | |
| 1.3 D Multijet | 4 | 223 A9.000 | 62/83 | 04/10→ | GN053 | 11V | | |
| 1.3 D Multijet | 4 | 199 A3.000 | 66/89 | 10/05→ | GN053 | 11V | | |
| 1.4 | 4 | 199 A7.000 | 55/74 | 06/06→ | Z234 | 0.9 | | ZS079 |
| 1.4 | 4 | 350 A1.000 | 57/76 | 10/05→ | Z293 | 1.05 | | ZS079 |
| 1.4 16V | 4 | 199 A6.000 | 70/94 | 10/05→ | Z293 | 1.05 | | ZS322 |
| 1.4 Abarth | 4 | 199 A8.000 | 114/153 | 12/07→ | Z338 | 0.8 | | ZS095 |
| 1.4 Abarth | 4 | 199 A8.000 | 132/177 | 12/07→ | Z338 | 0.8 | | ZS095 |
| 1.4 Abarth | 4 | 955 A8.000 | 132/177 | 12/07→ | | | | ZS095 |
| 1.4 LPG | 4 | 350 A1.000 | 57/76 | 12/08→ | | | | ZS079 |
| 1.4 Natural Power | 4 | 350 A1.000 | 57/76 | 07/08→ | Z234 | 0.9 | | ZS079 |
| 1.4 T-Jet | 4 | 198 A4.000 | 88/118 | 09/07→ | Z338 | 0.8 | | ZS095 |
| 1.6 D Multijet | 4 | 955 A3.000 | 88/118 | 07/08→ | GE114 | 4.4V | | |
| 1.9 D Multijet | 4 | 939 A7.000 | 85/114 | 06/06→ | GN097 | 11V | | |
| 1.9 D Multijet | 4 | 939 A1.000 | 88/118 | 10/05→ | GN097 | 11V | | |
| 1.9 D Multijet | 4 | 199 A5.000 | 96/129 | 10/05→ | GN097 | 11V | | |

QUBO

| | | | | | | | | |
|-------------------|---|------------|-------|--------|--------------------------|-------------|-------------|-------------|
| 1.3 D Multijet | 4 | 199 A9.000 | 55/74 | 02/08→ | GE112 [37] GN053 [36] | 4.4V 11V | | |
| 1.3 D Multijet | 4 | 199 B1.000 | 70/94 | 07/10→ | GE112 | 4.4V | | |
| 1.4 | 4 | KFT, KFV | 54/72 | 02/08→ | Z193 | 0.9 | UXT1 / UXT3 | ZSE048 [10] |
| 1.4 LPG | 4 | KFT, KFV | 54/72 | 02/08→ | Z340 | 0.7 | UXT12 | |
| 1.4 Natural Power | 4 | 350 A1.000 | 57/76 | 10/09→ | Z234 | 0.9 | | ZS079 |

REGATA

| | | | | | | | | |
|-----------------|---|------------------------|-------|-------------|--------------------------------|------------|-------------------------------|---|
| 1.3 70 | 4 | 149 A3.000, 149 A7.000 | 48/64 | 09/83→07/89 | Z20 | 0.8 | UXT2 / UXT6 | ZS248 07/88→ |
| 1.3 70 | 4 | 138 B2.000 | 50/67 | 09/83→07/86 | Z20 04/85→ | 0.8 | UXT2 / UXT6 | ZS106 [11] 04/85→ |
| 1.3 70 | 4 | 138 B2.000 | 50/67 | 01/84→07/89 | Z20 | 0.8 | UXT2 / UXT6 | ZS106 [11] →09/85 ZS248 10/85→ |
| 1.5 75 | 4 | 138 B3.048, 138 C3.048 | 55/74 | 12/83→12/87 | Z27 →03/85 Z20 04/85→ | 0.8 0.8 | UX56 →03/85 UXT2 / UXT6 | |
| 1.5 75 | 4 | 138 B3.048, 138 C3.048 | 55/74 | 12/83→07/89 | | | | ZS248 |
| 1.5 75 | 4 | 138 B3.048, 138 C3.048 | 55/74 | 09/84→07/89 | Z20 | 0.8 | UXT2 / UXT6 | |
| 1.5 75 1.5 i.e. | 4 | 138 C2.048 | 55/74 | 12/86→07/89 | Z20 | 0.8 | UXT2 / UXT6 | ZS248 |
| 1.5 75 i.e. | 4 | 138 C2.048, 149 C1.000 | 55/74 | 07/85→07/89 | Z20 | 0.8 | UXT2 / UXT6 | ZS248 |
| 1.5 85 | 4 | 149 A5.000 | 58/78 | 05/85→12/87 | Z27 [168] | 0.8 | UX56 | ZM005 |
| 1.5 85 | 4 | 138 B3.000 | 60/80 | 01/84→04/89 | Z27 [168] | 0.8 | UX56 | ZS106 [11] →04/85 ZM005 |
| 1.5 85 Super | 4 | 138 B3.000 | 60/80 | 09/83→04/85 | Z27 [168] | 0.8 | UX56 | ZS106 [11] ZM005 |
| 1.6 85 | 4 | 149 A.000 | 60/80 | 10/83→06/90 | Z27 [168] | 0.8 | UX56 | ZS106 [11] |
| 1.6 90 i.e. | 4 | 149 C2.000 | 66/89 | 01/87→07/89 | Z20 | 0.8 | UXT2 / UXT6 | ZM005 |
| 1.6 100 | 4 | 149 A4.000 | 74/99 | 09/84→12/86 | Z27 [168] | 0.8 | UX56 | ZS248 ZM043 06/86→ |
| 1.6 100 i.e. | 4 | 149 C3.000 | 74/99 | 01/87→12/90 | Z27 [168] | 0.8 | UX56 | ZS248 ZM043 |
| 1.6 100 Super | 4 | 149 C3.000 | 70/94 | 10/83→07/89 | | | | ZM043 06/86→ |

FIAT

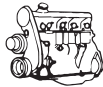

kw/BHP

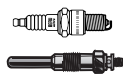

... FIAT



... REGATA

| | | | | | | | | |
|---------------------|---|------------------------|-------|-------------|--|---|-------|-----------------|
| 1.6 100 Super | 4 | 149 A2.000, 149 A4.000 | 74/99 | 10/83→12/90 | Z20 [168] →11/84 Z27 [168] 12/84→ | 0.8 UXT2 / UXT6 →11/84 0.8 UX56 12/84→ | ZS248 | ZM043 06/86→ |
| 1.7 60 Diesel | 4 | 138 B6.000 | 43/58 | 09/83→12/86 | GN909 (2)(222) GV663 | 11V 11V | | |
| 1.7 60 Diesel | 4 | 149 B3.000 | 44/59 | 05/85→03/89 | GN909 (2)(222) GV663 | 11V 11V | | |
| 1.7 60 Diesel 1.7 | 4 | 149 B3.000 | 44/59 | 01/84→12/89 | GN909 (2)(222) GV663 | 11V 11V | | |
| 1.9 65 Diesel | 4 | 149 A1.000 | 48/64 | 04/84→07/89 | GN909 (2)(222) GV663 | 11V 11V | | |
| 1.9 80 Turbo Diesel | 4 | 831 D1.000 | 59/79 | 05/86→07/89 | GN909 (2)(222) GV663 | 11V 11V | | |

RITMO

| | | | | | | | | |
|--------|---|------------|-------|-------------|-----------|----------|-----------------------|--|
| 1.3 50 | 4 | 138 B2.000 | 50/67 | 10/85→12/87 | | | ZS106 (111) →12/86 | |
| 1.5 85 | 4 | 138 B3.000 | 60/80 | 03/83→12/86 | Z27 [168] | 0.8 UX56 | ZS248 | |
| 1.5 85 | 4 | 138 A4.000 | 63/84 | 01/80→07/89 | Z27 [168] | 0.8 UX56 | ZS106 (111) →09/82 | |

RITMO I

| | | | | | | | | |
|-------------------|---|------------------------|--------|-------------|-------------------------|-----------------|--------------------------------|--|
| 1.0 60 | 4 | 127 A6.000 | 44/59 | 09/78→09/82 | Z20 | 0.8 UXT2 / UXT6 | ZS106 (111) | |
| 1.3 65 | 4 | 138 A1.000 | 48/64 | 01/78→09/82 | Z20 | 0.8 UXT2 / UXT6 | ZS106 (111) | |
| 1.3 70 | 4 | 149 A3.000, 149 A7.000 | 48/64 | 11/83→08/85 | Z20 | 0.8 UXT2 / UXT6 | ZS106 (11)(254) ZS248 (254) | |
| 1.3 75 | 4 | 138 A3.000 | 55/74 | 01/81→09/82 | Z27 [168] | 0.8 UX56 | ZS106 (111) | |
| 1.5 75 | 4 | 138 A2.000, 138 C3.048 | 55/74 | 01/78→10/82 | | | ZS106 (111) | |
| 1.5 75 i.e. | 4 | 138 C2.048, 149 C1.000 | 55/74 | 10/85→05/87 | Z20 | 0.8 UXT2 / UXT6 | ZS248 eng. 6114921→ | |
| 1.5 85 | 4 | 138 A4.000 | 63/84 | 01/81→05/87 | Z27 [168] | 0.8 UX56 | ZS106 (111) | |
| 1.6 90 i.e. | 4 | 149 C2.000 | 66/89 | 09/85→12/87 | Z20 | 0.8 UXT2 / UXT6 | | |
| 1.6 105 Sport | 4 | 138 AR.000 | 77/103 | 05/81→12/82 | Z20 | 0.8 UXT2 / UXT6 | ZS106 (111) | |
| 1.7 55 Diesel | 4 | 138 A5.000 | 40/54 | 10/79→09/82 | GN909 (2)(222) GV602 | 11V 11V | | |
| 1.7 55 Diesel | 4 | 138 A5.000 | 43/58 | 10/79→09/82 | GN909 (2)(222) GV602 | 11V 11V | | |
| 2.0 125 TC Abarth | 4 | 138 AR1.000 | 92/123 | 11/81→09/82 | Z27 [168] | 0.8 UX56 | | |

RITMO II

| | | | | | | | | |
|---------------------|---|--------------------------------------|--------|-------------|-------------------------|-----------------|------------------------|--|
| 1.1 60 | 4 | 138 B.000, 138 B1.000, 138 C1.000 | 40/54 | 10/82→12/87 | Z20 | 0.8 UXT2 / UXT6 | ZS106 (111) | |
| 1.1 60 | 4 | 146 A4.048 | 43/58 | 04/85→12/87 | Z20 | 0.8 UXT2 / UXT6 | ZS106 (111) | |
| 1.3 70 | 4 | 138 B2.000 | 50/67 | 01/83→04/85 | Z20 | 0.8 UXT2 / UXT6 | ZS106 (111) | |
| 1.5 75 | 4 | 138 A2.000 | 55/74 | 09/85→12/88 | Z27 [168] | 0.8 UX56 | | |
| 1.5 75 | 4 | 138 C2.048, 149 C1.000 | 55/74 | 09/85→12/88 | Z27 [168] | 0.8 UX56 | ZS248 eng. 6114921→ | |
| 1.5 85 | 4 | 149 A5.000 | 58/78 | 08/85→05/87 | Z27 [168] | 0.8 UX56 | | |
| 1.5 85 | 4 | 138 B3.000 | 60/80 | 01/83→12/87 | Z27 [168] 05/85→ | 0.8 UX56 | ZS106 (111) | |
| 1.6 90 1.6 i.e. | 4 | 138 AR.000 | 66/89 | 12/85→12/87 | Z20 | 0.8 UXT2 / UXT6 | | |
| 1.6 100 | 4 | 149 A4.000 | 74/99 | 01/83→12/87 | Z27 [168] | 0.8 UX56 | | |
| 1.6 105 | 4 | 138 AR.000 | 77/103 | 01/83→12/87 | Z20 | 0.8 UXT2 / UXT6 | | |
| 1.7 60 Diesel | 4 | 138 B6.000 | 43/58 | 10/82→10/85 | GN909 (2)(222) GV663 | 11V 11V | | |
| 1.7 60 Diesel | 4 | 138 C.000, 149 B3.000 | 44/59 | 05/85→12/87 | GN909 (2)(222) GV663 | 11V 11V | | |
| 1.9 80 Turbo Diesel | 4 | 831 D1.000 | 59/79 | 12/85→12/87 | GN909 (2)(222) GV663 | 11V 11V | | |
| 2.0 130 TC Abarth | 4 | 138 AR2.000 | 96/129 | 04/83→12/87 | Z47 | 0.8 UX56 | | |

FIAT



kW/BHP

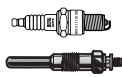

... FIAT



SCUDO

| | | | | | | | | |
|----------------|---|-----------------|---------|-------------|-----------------|-----|-------|-------|
| 1.6 | 4 | 220 A 2.000 | 58/78 | 02/96→12/06 | Z24 | 0.8 | UXT5 | ZS234 |
| 1.6 LPG | 4 | 220 A 2.000 | 58/78 | 02/96→12/06 | Z30 [168] | 0.8 | UXT5 | |
| 1.6 D Multijet | 4 | 9HU | 66/89 | 01/07→ | GN056 | 11V | | |
| 1.9 D | 4 | D9B | 51/68 | 02/96→04/98 | GN909 | 11V | | |
| 1.9 D | 4 | WJZ (DW8) | 51/68 | 04/98→12/06 | GN016 | 11V | | |
| 1.9 TD | 4 | D8B | 68/91 | 02/96→12/06 | GN909 | 11V | | |
| | | | | | →08/98 GN013 | 11V | | |
| | | | | | 09/98→ | | | |
| 1.9 TD Eco | 4 | DHX (XUD9TF/L) | 66/89 | 02/96→12/06 | GN909 | 11V | | |
| | | | | | →08/98 GN013 | 11V | | |
| | | | | | 09/98→ | | | |
| 2.0 16V | 4 | RFN (EW10J4) | 100/134 | 06/00→12/06 | Z183 | 0.9 | UXT13 | ZS348 |
| 2.0 16V LPG | 4 | RFN (EW10J4) | 100/134 | 06/00→12/06 | Z184 [168] | 0.9 | UXT13 | |
| 2.0 D Multijet | 4 | RHK | 88/118 | 01/07→ | GN054 | 11V | | |
| 2.0 D Multijet | 4 | RH02 | 94/126 | 04/11→ | GN054 | 11V | | |
| 2.0 D Multijet | 4 | RHR | 100/134 | 01/07→ | GN054 | 11V | | |
| 2.0 D Multijet | 4 | RHH | 120/161 | 07/10→ | GN054 | 11V | | |
| 2.0 JTD | 4 | RHX | 69/93 | 01/04→12/06 | GN027 | 11V | | |
| 2.0 JTD | 4 | RHZ | 80/107 | 12/99→12/06 | GN027 [124] | 11V | | |
| | | | | | GN054 [125] | 11V | | |
| 2.0 JTD 16V | 4 | RHW (DW10ATED4) | 80/107 | 05/99→12/06 | GN027 [124] | 11V | | |
| | | | | | GN054 [125] | 11V | | |

SEDICI

| | | | | | | | | |
|----------------|---|-------|--------|--------|-------|------|-------------|--|
| 1.6 16V 4WD | 4 | M16A | 79/106 | 06/06→ | Z193 | 0.9 | UXT1 / UXT3 | |
| 1.9 D Multijet | 4 | D19AA | 88/118 | 06/06→ | GN041 | 11V | | |
| 2.0 D Multijet | 4 | D20AA | 99/133 | 06/06→ | GE114 | 4.4V | | |

SEICENTO

| | | | | | | | | |
|---------|---|-------------|-------|-------------|--------------------------------|-----|------------------------|-------|
| 0.9 | 4 | 1170 A1.046 | 29/39 | 01/98→01/10 | Z20 | 0.8 | UXT2 / UXT6 | ZS283 |
| 0.9 LPG | 4 | 1170 A1.046 | 29/39 | 01/98→01/10 | Z27 [168] | 0.8 | UX56 | |
| 1.1 | 4 | 176 B2.000 | 40/54 | 01/98→01/10 | Z193 | 0.9 | UXT1 / UXT3 | ZS283 |
| 1.1 | 4 | 187 A1.000 | 40/54 | 01/98→01/10 | Z255 | 0.9 | UXT1 / UXT3 | ZS283 |
| | | | | | →eng. 2543170 →2004 Z234 | 0.9 | →eng. 2543170 →2004 | |
| | | | | | eng. 2543171→ 2004→ | | | |
| 1.1 LPG | 4 | 176 B2.000 | 40/54 | 01/98→01/10 | Z340 | 0.7 | UXT12 | |
| 1.1 LPG | 4 | 187 A1.000 | 40/54 | 01/98→01/10 | Z206 | 0.7 | UXT10 | |
| | | | | | →eng. 2543170 →2004 | | →eng. 2543170 →2004 | |

SIENA

| | | | | | | | | |
|---------|---|------------|-------|--------|------------|------|-------------|-------------|
| 1.0 | 4 | | 45/60 | 09/98→ | | | | ZS283 |
| | | | | | | | | 01/99→08/00 |
| 1.2 | 4 | 178 C4.066 | 44/59 | 09/01→ | | | | ZS283 |
| 1.2 | 4 | 188 A4.000 | 44/59 | 09/01→ | Z292 | 1.05 | | |
| 1.2 | 4 | 178 B5.000 | 54/72 | 09/98→ | Z255 | 0.9 | UXT1 / UXT3 | ZS283 |
| 1.2 | 4 | 188 A5.000 | 59/79 | 09/01→ | Z234 | 0.9 | | ZS234 |
| 1.2 LPG | 4 | 188 A4.000 | 44/59 | 09/01→ | Z291 [168] | 0.9 | | |
| 1.2 LPG | 4 | 178 B5.000 | 54/72 | 09/98→ | Z206 | 0.7 | UXT10 | |
| 1.3 JTD | 4 | 188 A9.000 | 51/68 | 09/03→ | GN053 | 11V | | |
| 1.4 | 4 | 178 B2.000 | 51/68 | 04/96→ | Z247 | 0.9 | UXT1 / UXT3 | ZS283 |
| | | | | | | | | 03/00→06/01 |
| 1.4 | 4 | 178 B2.016 | 51/68 | 04/96→ | Z74 | 1.0 | UXT1 / UXT3 | ZS283 |
| | | | | | | | | 05/98→06/01 |
| 1.4 | 4 | | 57/76 | 01/07→ | Z293 | 1.05 | | |
| 1.4 | 4 | | 57/76 | 11/07→ | Z234 | 0.9 | | |

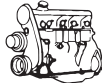

kW/BHP

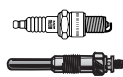

... FIAT



... SIENA

| | | | | | | | | |
|-------------|---|------------|--------|--------|-------|-----|-------------|-------|
| 1.4 LPG | 4 | 178 B2.000 | 51/68 | 04/96→ | Z340 | 0.7 | UXT12 | |
| 1.6 | 4 | 182 B6.000 | 76/102 | 11/00→ | Z255 | 0.9 | UXT1 / UXT3 | ZS029 |
| 1.6 LPG | 4 | 182 B6.000 | 76/102 | 11/00→ | Z206 | 0.7 | UXT10 | |
| 1.6 16V | 4 | 178 B3.000 | 78/105 | 09/98→ | Z255 | 0.9 | UXT1 / UXT3 | ZS029 |
| 1.6 16V LPG | 4 | 178 B3.000 | 78/105 | 09/98→ | Z206 | 0.7 | UXT10 | |
| 1.7 TD | 4 | 176 A3.000 | 51/68 | 02/06→ | GN908 | 11V | | |
| 1.9 D | 4 | 223 A6.000 | 46/62 | 11/00→ | GN030 | 11V | | |

STILO

| | | | | | | | | |
|----------------|---|------------------------|---------|-------------|---|------|-------------|-----------------|
| 1.2 16V | 4 | 188 A5.000 | 59/79 | 02/02→11/06 | Z291 →12/03 | 0.9 | | ZS322 |
| 1.4 16V | 4 | 192 B2.000 | 66/89 | 03/05→08/08 | Z292 | 1.05 | | ZS322 |
| 1.4 16V | 4 | 843 A1.000 | 70/94 | 01/04→08/08 | Z292 | 1.05 | | ZS322 |
| 1.4 16V LPG | 4 | 192 B2.000 | 66/89 | 03/05→08/08 | Z291 [168] | 0.9 | | |
| 1.4 16V LPG | 4 | 843 A1.000 | 70/94 | 01/04→08/08 | Z291 [168] | 0.9 | | |
| 1.6 16V | 4 | 182 B6.000 | 76/102 | 10/01→08/08 | Z255 | 0.9 | UXT1 / UXT3 | ZS320 |
| 1.6 16V | 4 | 192 B3.000 | 77/103 | 03/05→12/07 | Z203 | 0.9 | | ZS427 |
| 1.6 16V LPG | 4 | 182 B6.000 | 76/102 | 10/01→08/08 | Z206 | 0.7 | UXT10 | |
| 1.8 16V | 4 | 192 A4.000 | 98/131 | 10/01→08/08 | Z255 | 0.9 | UXT1 / UXT3 | |
| 1.8 16V LPG | 4 | 192 A4.000 | 98/131 | 10/01→08/08 | Z206 | 0.7 | UXT10 | |
| 1.9 D | 4 | 192 B5.000 | 66/89 | 09/04→08/08 | GN041 →09/05 GN097 10/05→12/07 | 11V | | |
| 1.9 D Multijet | 4 | 192 A9.000 | 74/99 | 09/05→08/08 | GN041 | 11V | | |
| 1.9 D Multijet | 4 | 192 A8.000 | 88/118 | 09/05→08/08 | GN041 [77] GN097 [79] | 11V | | |
| 1.9 D Multijet | 4 | 937 A5.000 | 110/148 | 09/05→08/08 | GN059 | 11V | | |
| 1.9 JTD | 4 | 192 A3.000 | 59/79 | 02/02→08/08 | GN041 | 11V | | |
| 1.9 JTD | 4 | 192 B5.000 | 66/89 | 09/04→11/06 | GN097 | 11V | | |
| 1.9 JTD | 4 | 192 A1.000, 937 A7.000 | 85/114 | 10/01→08/08 | GN041 [77] GN097 [79] | 11V | | |
| 1.9 JTD | 4 | 937 A4.000 | 93/125 | 09/03→08/08 | GN059 | 11V | | |
| 1.9 JTD | 4 | 192 B1.000 | 100/134 | 04/04→08/08 | GN059 | 11V | | |
| 1.9 JTD | 4 | 192 A5.000 | 103/138 | 01/04→08/08 | GN059 | 11V | | |
| 2.4 20V | 5 | 192 A2.000 | 125/168 | 10/01→11/06 | Z98 | 0.8 | UXT1 / UXT3 | ZS321 →12/03 |
| 2.4 20V LPG | 5 | 192 A2.000 | 125/168 | 10/01→11/06 | Z116 | 0.8 | UXT5 | |

STRADA

| | | | | | | | | |
|----------------|---|------------|-------|--------|-------------------------|------|--|-------|
| 1.2 | 4 | 188 A4.000 | 44/59 | 04/03→ | Z292 | 1.05 | | ZS283 |
| 1.2 | 4 | 178 B5.000 | 54/72 | 06/99→ | | | | ZS283 |
| 1.2 LPG | 4 | 188 A4.000 | 44/59 | 04/03→ | Z291 [168] | 0.9 | | |
| 1.3 D Multijet | 4 | 223 A9.000 | 62/83 | 05/06→ | GN053 | 11V | | |
| 1.3 D Multijet | 4 | 199 B1.000 | 70/94 | 10/10→ | GN053 | 11V | | |
| 1.7 TD | 4 | 176 A3.000 | 51/68 | 06/99→ | GN013 [2][222] GN954 | 11V | | |
| 1.9 D | 4 | 223 A6.000 | 46/62 | 12/00→ | GN030 | 11V | | |
| 1.9 JTD | 4 | 188 A2.000 | 59/79 | 04/03→ | GN041 | 11V | | |

TEMPRA

| | | | | | | | | |
|----------|---|------------------------|-------|-------------|---------------------------------|-----|-----------------------|-----------------|
| 1.4 i.e. | 4 | 160 A1.046 | 51/68 | 03/92→08/96 | Z20 →03/95 Z193 03/95→ | 0.8 | UXT2 / UXT6 →03/95 | ZS244 →03/93 |
| 1.4 i.e. | 4 | 160 A1.046, 836 A4.000 | 51/68 | 10/92→08/96 | | 0.9 | UXT1 / UXT3 03/95→ | ZS234 |
| 1.4 i.e. | 4 | 836 A4.000 | 51/68 | 03/92→08/96 | Z20 →03/95 Z193 03/95→ | 0.8 | UXT2 / UXT6 →03/95 | ZS234 03/95→ |
| | | | | | | 0.9 | UXT1 / UXT3 03/95→ | |

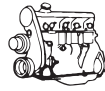

kW/BHP

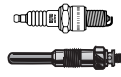

... FIAT



... TEMPRA

| | | | | | | | | | |
|--------------|---|------------------------|--------|-------------|--|------------|-----------------------------------|---|--|
| 1.4 i.e. | 4 | 159 A2.000 | 57/76 | 03/91→08/96 | Z27 | 0.8 | UX56 | ZS234 ZS244 ^[254] | ZM009 |
| 1.4 i.e. LPG | 4 | 160 A1.046, 836 A4.000 | 51/68 | 03/92→08/96 | Z27 ^[168] →03/95 Z340 03/95→ | 0.8 0.7 | UX56 →03/95 UXT12 03/95→ | | |
| 1.4 i.e. LPG | 4 | 159 A2.000 | 57/76 | 03/91→08/96 | Z47 ^[168] | 0.8 | UX56 | | |
| 1.6 | 4 | 159 A3.048 | 51/68 | 04/90→06/93 | Z27 06/92→ | 0.8 | UX56 06/92→ | | |
| 1.6 | 4 | 159 A3.000 | 63/84 | 03/90→04/93 | Z27 ^[170] | 0.8 | UX56 | | ZM009 |
| 1.6 i.e. | 4 | 159 A3.048, 835 C1.000 | 55/74 | 06/92→08/96 | Z252 | 0.9 | UXT5 | ZS234 | |
| 1.6 i.e. | 4 | 159 A3.046, 835 C1.000 | 57/76 | 06/90→08/96 | Z27 ^[170] | 0.8 | UX56 | | |
| 1.6 i.e. | 4 | 159 B9.000 | 63/84 | 06/94→08/96 | Z252 | 0.9 | UXT5 | | |
| 1.6 i.e. | 4 | 159 B9.000 | 66/89 | 06/94→08/96 | Z252 | 0.9 | UXT5 | ZS234 | |
| 1.6 i.e. LPG | 4 | 159 A3.048, 835 C1.000 | 55/74 | 06/92→08/96 | Z30 ^[168] | 0.8 | UXT5 | | |
| 1.6 i.e. LPG | 4 | 159 A3.046, 835 C1.000 | 57/76 | 10/90→08/96 | Z47 ^[168] | 0.8 | UX56 | | |
| 1.6 i.e. LPG | 4 | 159 B9.000 | 63/84 | 06/94→08/96 | Z30 ^[168] | 0.8 | UXT5 | | |
| 1.6 i.e. LPG | 4 | 159 B9.000 | 66/89 | 06/94→08/96 | Z30 ^[168] | 0.8 | UXT5 | | |
| 1.8 i.e. | 4 | 835 C4.000 | 66/89 | 09/93→08/96 | Z27 ^[170] | 0.8 | UX56 | ZS283 | |
| 1.8 i.e. | 4 | 836 A5.000 | 74/99 | 10/94→08/96 | Z27 ^[170] | 0.8 | UX56 | ZS283 | |
| 1.8 i.e. | 4 | 835 C2.000 | 76/102 | 09/93→08/96 | Z27 ^[170] | 0.8 | UX56 | ZS283 | |
| 1.8 i.e. | 4 | 159 A4.046 | 77/103 | 03/92→08/96 | Z27 ^[170] | 0.8 | UX56 | ZS283 | |
| 1.8 i.e. | 4 | 159 A4.000 | 81/109 | 03/90→08/96 | Z27 ^[170] | 0.8 | UX56 | ZS283 | |
| 1.8 i.e. LPG | 4 | 835 C4.000 | 66/89 | 09/93→08/96 | Z47 ^[168] | 0.8 | UX56 | | |
| 1.8 i.e. LPG | 4 | 836 A5.000 | 74/99 | 10/94→08/96 | Z47 ^[168] | 0.8 | UX56 | | |
| 1.8 i.e. LPG | 4 | 835 C2.000 | 76/102 | 09/93→08/96 | Z47 ^[168] | 0.8 | UX56 | | |
| 1.8 i.e. LPG | 4 | 159 A4.046 | 77/103 | 03/92→08/96 | Z47 ^[168] | 0.8 | UX56 | | |
| 1.8 i.e. LPG | 4 | 159 A4.000 | 81/109 | 03/90→08/96 | Z47 ^[168] | 0.8 | UX56 | | |
| 1.9 D | 4 | 160 A7.000 | 48/64 | 07/91→08/96 | GN013 ^{[2][222]} GN908 | 11V 11V | | | |
| 1.9 TD | 4 | 160 B6.046 | 59/79 | 03/92→08/96 | GN013 ^{[2][222]} GN908 | 11V 11V | | | |
| 1.9 TD | 4 | 160 A6.000, 160 D1.000 | 66/89 | 05/90→08/96 | GN013 ^{[2][222]} GN908 | 11V 11V | | | |
| 2.0 i.e. | 4 | 159 A6.046 | 83/111 | 10/90→08/96 | Z27 ^[170] | 0.8 | UX56 | | |
| 2.0 i.e. LPG | 4 | 159 A6.046 | 83/111 | 10/90→08/96 | Z47 ^[168] | 0.8 | UX56 | | |
| TIPO | | | | | | | | | |
| 1.1 | 4 | 160 A3.000 | 41/55 | 01/88→10/91 | Z15 ^[168] | 0.8 | UXT1 / UXT3 | ZS244 | ZM017 01/89→ |
| 1.4 | 4 | 160 A1.000, 160 A1.048 | 52/70 | 07/87→12/89 | Z20 | 0.8 | UXT2 / UXT6 | ZS244 | ZM017 01/89→ |
| 1.4 i.e. | 4 | 160 A1.046, 836 A4.000 | 51/68 | 05/89→04/95 | Z20 | 0.8 | UXT2 / UXT6 | ZS244 →03/93 ZS248 ^[254] | ZM017 |
| 1.4 i.e. | 4 | 159 A2.000 | 57/76 | 05/89→04/95 | Z27 ^[170] | 0.8 | UX56 | ZS244 | |
| 1.4 i.e. LPG | 4 | 160 A1.046, 836 A4.000 | 51/68 | 05/89→04/95 | Z27 ^[168] | 0.8 | UX56 | | |
| 1.4 i.e. LPG | 4 | 159 A2.000 | 57/76 | 05/89→04/95 | Z47 ^[168] | 0.8 | UX56 | | |
| 1.6 | 4 | | 56/75 | 03/93→10/95 | | | | ZS234 | |
| 1.6 | 4 | 160 A2.000 | 61/82 | 01/88→10/91 | Z20 | 0.8 | UXT2 / UXT6 | | ZM017 01/89→ |
| 1.6 i.e. | 4 | 159 A3.048 | 55/74 | 10/92→04/95 | Z252 | 0.9 | UXT5 | | ZM009 ^[193] ZM017 ^[213] |
| 1.6 i.e. | 4 | 835 C1.000 | 55/74 | 10/92→04/95 | Z252 | 0.9 | UXT5 | ZS234 03/93→ | ZM009 ^[193] ZM017 ^[213] |
| 1.6 i.e. | 4 | 159 A3.046 | 57/76 | 07/90→01/93 | Z27 ^[170] | 0.8 | UX56 | ZS248 →eng. 8327193 | ZM017 |
| 1.6 i.e. | 4 | 149 C2.046 | 66/89 | 02/88→05/91 | Z20 | 0.8 | UXT2 / UXT6 | | |
| 1.6 i.e. LPG | 4 | 159 A3.048, 835 C1.000 | 55/74 | 10/92→04/95 | Z30 ^[168] | 0.8 | UXT5 | | |

FIAT

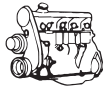

kw/BHP

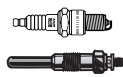

... FIAT



... TIPO

| | | | | | | | | | |
|------------------------|---|---------------------------------------|---------|-------------|--|------------|---|-------|-------|
| 1.7 D | 4 | 149 B4.000 | 43/58 | 01/88→10/94 | GN909 ^{[2][222]} GV663 | 11V 11V | | | |
| 1.7 D | 4 | 149 B4.000 | 45/60 | 01/88→10/95 | GN909 ^{[2][222]} GV663 | 11V 11V | | | |
| 1.8 i.e | 4 | 836 A5.000 | 71/95 | 03/93→04/95 | | | | | ZS283 |
| 1.8 i.e. | 4 | 835 C4.000 | 66/89 | 09/93→04/95 | Z27 ^[170] | 0.8 | UX56 | | ZS283 |
| 1.8 i.e. | 4 | 159 A4.000, 836 A5.000 | 74/99 | 10/94→10/95 | Z27 ^[168] | 0.8 | UX56 | | ZS283 |
| 1.8 i.e. | 4 | 835 C2.000 | 76/102 | 04/93→04/95 | Z27 ^[170] | 0.8 | UX56 | | ZS283 |
| 1.8 i.e. | 4 | 159 A4.046 | 77/103 | 10/90→06/93 | Z27 ^[170] | 0.8 | UX56 | | ZS283 |
| 1.8 i.e. | 4 | 159 A4.000 | 81/109 | 10/90→06/93 | Z27 →03/92 | 0.8 | UX56 →03/92 | | |
| 1.8 i.e. LPG | 4 | 835 C4.000 | 66/89 | 09/93→04/95 | Z47 ^[168] | 0.8 | UX56 | | |
| 1.8 i.e. LPG | 4 | 159 A4.000, 836 A5.000 | 74/99 | 10/94→10/95 | Z47 ^[168] | 0.8 | UX56 | | |
| 1.8 i.e. LPG | 4 | 835 C2.000 | 76/102 | 04/93→04/95 | Z47 ^[168] | 0.8 | UX56 | | |
| 1.8 i.e. 16V Sport | 4 | 160 A5.000 | 100/134 | 11/89→06/92 | | | | | ZM061 |
| 1.9 D | 4 | 160 A7.000 | 48/64 | 07/91→08/96 | GN909 ^{[2][222]} GV663 | 11V 11V | | | |
| 1.9 TD | 4 | 160 B6.046 | 59/79 | 03/92→06/93 | GN909 ^{[2][222]} GV663 | 11V 11V | | | |
| 1.9 TD | 4 | 160 A6.000, 160 A6.046, 160 D1.000 | 66/89 | 09/90→04/95 | GN013 ^{[2][222]} GN908 | 11V 11V | | | |
| 2.0 16V | 4 | 160 A8.046 | 107/143 | 07/91→04/95 | Z27 ^[170] | 0.8 | UX56 | | |
| 2.0 16V LPG | 4 | 160 A8.046 | 107/143 | 07/91→04/95 | Z47 ^[168] | 0.8 | UX56 | | |
| 2.0 i.e. | 4 | 159 A5.046 | 80/107 | 06/90→03/92 | Z27 ^[168] | 0.8 | UX56 | | |
| 2.0 i.e. | 4 | 159 A6.046 | 83/111 | 03/90→04/95 | Z27 ^[170] | 0.8 | UX56 | | |
| 2.0 i.e. LPG | 4 | 159 A6.046 | 83/111 | 03/90→04/95 | Z47 ^[168] | 0.8 | UX56 | | |
| 2.0 i.e. 16V Sport | 4 | 836 A3.000 | 102/137 | 03/93→04/95 | Z27 ^[170] | 0.8 | UX56 | | |
| 2.0 i.e. 16V Sport LPG | 4 | 836 A3.000 | 102/137 | 03/93→04/95 | Z47 ^[168] | 0.8 | UX56 | | |
| ULYSSE | | | | | | | | | |
| 1.8 | 4 | LFW | 73/98 | 05/97→08/02 | Z193 | 0.9 | UXT1 / UXT3 | ZS341 | |
| 1.8 LPG | 4 | LFW | 73/98 | 05/97→08/02 | Z340 | 0.7 | UXT12 | | |
| 1.9 TD | 4 | DHX (XUD9TF/L) | 66/89 | 02/95→08/02 | GN013 | 11V | | | |
| 2.0 | 4 | RFU (XU10J2C) | 89/119 | 06/94→08/02 | Z193 | 0.9 | UXT1 / UXT3 | ZS341 | |
| 2.0 | 4 | RFN (EW10J4) | 100/134 | 08/02→06/11 | Z183 | 0.9 | UXT13 | ZS348 | |
| 2.0 LPG | 4 | RFU (XU10J2C) | 89/119 | 06/94→08/02 | Z340 | 0.7 | UXT12 | | |
| 2.0 LPG | 4 | RFN (EW10J4) | 100/134 | 08/02→06/11 | Z184 ^[168] | 0.9 | UXT13 | | |
| 2.0 16V | 4 | RFV | 97/130 | 05/98→09/00 | Z193 | 0.9 | UXT1 / UXT3 | ZS349 | |
| 2.0 16V | 4 | RFN (EW10J4) | 100/134 | 09/00→08/02 | Z183 | 0.9 | UXT13 | ZS348 | |
| 2.0 16V LPG | 4 | RFV | 97/130 | 05/98→09/00 | Z340 | 0.7 | UXT12 | | |
| 2.0 16V LPG | 4 | RFN (EW10J4) | 100/134 | 09/00→08/02 | Z184 ^[168] | 0.9 | UXT13 | | |
| 2.0 D Multijet | 4 | RHK | 88/118 | 05/06→06/11 | GN027 ^[124] GN054 ^[125] | 11V 11V | | | |
| 2.0 D Multijet | 4 | RHR | 100/134 | 05/06→06/11 | GN054 ^[125] | 11V | | | |
| 2.0 JTD | 4 | RHM (DW10ATED4) | 79/106 | 05/03→08/06 | GN027 ^[124] GN054 ^[125] | 11V 11V | | | |
| 2.0 JTD | 4 | RHW (DW10ATED4) | 80/107 | 08/02→08/06 | GN027 ^[124] GN054 ^[125] | 11V 11V | | | |
| 2.0 JTD | 4 | RHZ | 80/107 | 10/99→08/02 | GN027 | 11V | | | |
| 2.0 JTD 16V | 4 | RHW (DW10ATED4) | 80/107 | 05/99→08/02 | GN027 ^[124] GN054 ^[125] | 11V 11V | | | |
| 2.0 Turbo | 4 | RGX (XU10J2CTE) | 108/145 | 06/94→08/02 | Z252 →06/95 Z193 07/95→ | 0.9 0.9 | UXT5 →06/95 UXT1 / UXT3 07/95→ | ZS341 | ZM026 |
| 2.0 Turbo LPG | 4 | RGX (XU10J2CTE) | 108/145 | 06/94→08/02 | Z30 ^[168] →06/95 Z340 07/95→ | 0.8 0.7 | UXT5 →06/95 UXT12 07/95→ | | |
| 2.1 TD | 4 | P8C | 80/107 | 03/96→10/99 | GN908 | 11V | | | |



kW/BHP

**... FIAT****... ULYSSE**

| | | | | | | | | |
|----------------|---|----------------------|---------|-------------|----------------------------|------------|-------|-------|
| 2.2 D Multijet | 4 | 4HS, 4HT (DW12BTED4) | 125/168 | 03/08→06/11 | GN063 | 11V | | |
| 2.2 JTD | 4 | 4HW (DW12ATED4) | 94/126 | 08/02→08/06 | GN027 [124] GN054 [125] | 11V 11V | | |
| 2.2 JTD | 4 | 4HP, 4HR | 120/161 | 03/08→06/11 | GN063 | 11V | | |
| 3.0 | 6 | XFW | 150/201 | 08/02→06/11 | Z219 | 1.1 | UXT13 | ZS347 |
| 3.0 LPG | 6 | XFW | 150/201 | 08/02→06/11 | Z184 [168] | 0.9 | UXT13 | |

UNO

| | | | | | | | | | |
|------------------|---|------------------------|--------|-------------|------------------------------------|------------|----------------------------|---|-----------------|
| 0.9 45 | 4 | 146 A.000, 146 A1.000 | 33/44 | 03/83→09/92 | Z20 | 0.8 | UXT2 / UXT6 | ZS106 [111] | ZM017 01/89→ |
| 1.0 | 4 | 156 A2.000 | 31/42 | 06/89→02/92 | Z15 Z247 | 0.8 0.9 | UXT1 / UXT3 | ZS244 | |
| 1.0 45 | 4 | 156 A2.048, 156 A2.100 | 32/43 | 06/86→12/93 | Z15 [168] | 0.8 | UXT1 / UXT3 | ZS248 01/87→12/87 ZS244 01/88→ | ZM009 |
| 1.0 45 i.e. | 4 | 156 A2.246 | 33/44 | 04/84→10/95 | Z193 | 0.9 | UXT1 / UXT3 | ZS248 01/87→12/87 ZS244 01/88→ | |
| 1.0 55 | 4 | 146 C4.011 | 41/55 | 11/93→08/00 | Z20 | 0.8 | UXT2 / UXT6 | ZS248 | |
| 1.0 iE | 4 | 156 A2.246 | 34/46 | 05/98→08/00 | | | | ZS244 | |
| 1.1 | 4 | 160 A3.000 | 41/55 | 01/92→06/06 | Z24 | 0.8 | UXT5 | ZS244 | |
| 1.1 | 4 | | 43/58 | 10/88→06/06 | | | | ZS248 →01/90 ZS244 12/89→ | |
| 1.1 50 | 4 | 146 A4.044 | 37/50 | 01/86→12/89 | Z247 | 0.9 | UXT1 / UXT3 | ZS244 | |
| 1.1 50 | 4 | 156 C.046 | 37/50 | 01/90→12/93 | Z247 | 0.9 | UXT1 / UXT3 | ZS244 | ZM009 |
| 1.1 50 i.e. | 4 | 146 C3.000 | 36/48 | 06/92→12/93 | Z247 | 0.9 | UXT1 / UXT3 | ZS244 | ZM009 |
| 1.1 55 | 4 | 138 B.000 | 40/54 | 01/83→08/89 | Z20 →04/85 | 0.8 | UXT2 / UXT6 | ZS106 [111] →04/85 | |
| 1.1 60 | 4 | 160 A3.000 | 42/56 | 04/89→12/92 | Z227 | 0.8 | UXT10 | ZS244 | ZM009 |
| 1.1 60 | 4 | 146 A4.048 | 43/58 | 05/85→08/89 | Z20 | 0.8 | UXT2 / UXT6 | ZS248 | ZM009 |
| 1.3 70 | 4 | 149 A7.000 | 48/64 | 05/85→08/89 | Z20 | 0.8 | UXT2 / UXT6 | ZS248 | |
| 1.3 70 | 4 | 138 B2.000 | 50/67 | 01/83→04/85 | Z20 | 0.8 | UXT2 / UXT6 | ZS106 [111] | |
| 1.3 Super Diesel | 4 | 127 A5.000, 146 B1.000 | 33/44 | 06/83→03/92 | GN909 [2][222] GV663 | 11V 11V | | | |
| 1.3 Turbo i.e. | 4 | 146 A2.246 | 74/99 | 09/89→03/91 | | | | | ZM061 |
| 1.3 Turbo i.e. | 4 | 146 A2.000 | 77/103 | 04/85→08/89 | Z52 | 0.8 | UXT5 | | ZM061 |
| 1.4 70 i.e. | 4 | 160 A1.046 | 51/68 | 09/89→12/93 | Z20 | 0.8 | UXT2 / UXT6 | ZS248 | |
| 1.4 70 i.e. | 4 | 146 C1.000 | 53/71 | 09/89→12/93 | Z20 | 0.8 | UXT2 / UXT6 | | |
| 1.4 70 S | 4 | 160 A1.048 | 52/70 | 09/89→10/92 | Z15 Z20 | 0.8 0.8 | UXT1 / UXT3 UXT2 / UXT6 | | |
| 1.4 70 TD | 4 | 146 B.000, 146 B3.000 | 52/70 | 10/86→10/90 | GN909 [2][222] GV663 | 11V 11V | | | |
| 1.4 Turbo i.e. | 4 | 146 A8.046 | 82/110 | 09/89→09/93 | Z24 | 0.8 | UXT5 | | |
| 1.4 Turbo i.e. | 4 | 146 A8.000 | 87/117 | 12/89→12/96 | Z24 →09/92 Z8 03/94→12/95 | 0.8 0.8 | UXT5 UXT2 / UXT6 | →09/92 03/94→12/95 | |
| 1.5 75 i.e. | 4 | 138 C2.048 | 55/74 | 10/85→12/93 | Z20 [168] | 0.8 | UXT2 / UXT6 | ZS244 →12/88 ZS248 01/89→ | |
| 1.5 75 i.e. | 4 | 149 C1.000 | 55/74 | 10/85→12/93 | Z27 [170] | 0.8 | UX56 | ZS244 →12/88 ZS248 01/89→ | |

FIAT

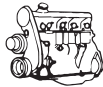

kW/BHP

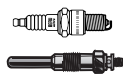

... FIAT



... UNO

| | | | | | | | | |
|---------------|---|------------|-------|-------------|------------------------------------|------------|--|--|
| 1.7 60 Diesel | 4 | 146 B2.000 | 42/56 | 09/89→12/93 | GN909 ^{[2][222]} GV663 | 11V 11V | | |
| 1.7 60 Diesel | 4 | 149 B3.000 | 44/59 | 07/86→08/89 | GN909 ^{[2][222]} GV663 | 11V 11V | | |
| 1.7 D | 4 | 146 B2.000 | 43/58 | 11/94→08/00 | GV663 | 11V | | |
| 1.9 D | 4 | 149 B5.046 | 44/59 | 09/89→03/94 | GN909 ^{[2][222]} GV663 | 11V 11V | | |

X 1/9

| | | | | | | | | |
|-----|---|------------|-------|-------------|----------------------|-----|------|-----------------------|
| 1.3 | 4 | 128 A5.000 | 54/72 | 10/75→06/78 | Z27 ^[168] | 0.8 | UX56 | ZS110 ^[15] |
| 1.3 | 4 | 128 A5.000 | 55/74 | 05/73→12/79 | Z27 ^[168] | 0.8 | UX56 | ZS110 ^[15] |
| 1.5 | 4 | 138 B5.031 | 56/75 | 06/85→12/89 | Z27 ^[168] | 0.8 | UX56 | |
| 1.5 | 4 | 138 A5.000 | 63/84 | 11/78→12/89 | Z27 ^[168] | 0.8 | UX56 | ZS106 ^[11] |

FIAT



238-SERIE

| | | | | | | | | |
|-----|---|------------|-------|-------------|-----|-----|-------------|--|
| 1.4 | 4 | 131 AZ.000 | 34/46 | 09/66→06/76 | Z20 | 0.8 | UXT2 / UXT6 | |
|-----|---|------------|-------|-------------|-----|-----|-------------|--|

242-SERIE

| | | | | | | | | |
|-------|---|----------|-------|-------------|------------------------------------|------------|--|--|
| 2.2 D | 4 | | 46/62 | 10/75→08/80 | GV130 →01/78 | 9.5V | | |
| 2.5 D | 4 | B 25.637 | 52/70 | 08/80→07/82 | GN909 ^{[2][222]} GV642 | 11V 11V | | |

BRAVO Van

| | | | | | | | | |
|----------------|---|------------|--------|--------|-------|------|--|--|
| 1.6 D Multijet | 4 | 198 A3.000 | 77/103 | 03/08→ | GE114 | 4.4V | | |
|----------------|---|------------|--------|--------|-------|------|--|--|

DOBLO

| | | | | | | | | |
|----------------------|---|------------------------|--------|-------------|--|-------------|-------------|-------|
| 1.2 | 4 | 223 A5.000 | 48/64 | 03/01→ | Z255 | 0.9 | UXT1 / UXT3 | ZS283 |
| 1.2 LPG | 4 | 223 A5.000 | 48/64 | 03/01→ | Z206 | 0.7 | UXT10 | |
| 1.3 D Multijet | 4 | 199 A2.000 | 55/74 | 10/05→01/10 | GN053 | 11V | | |
| 1.3 D Multijet | 4 | 199 A3.000, 263 A2.000 | 66/89 | 02/10→ | GE112 ^[80] GN053 ^[78] | 4.4V 11V | | |
| 1.3 JTD 16V | 4 | 188 A8.000, 188 A9.000 | 51/68 | 05/04→12/06 | GN053 | 11V | | |
| 1.3 JTD 16V Multijet | 4 | 223 A9.000 | 62/83 | 08/06→ | GN053 | 11V | | |
| 1.4 | 4 | 350 A1.000 | 57/76 | 10/05→ | Z293 | 1.05 | | ZS079 |
| 1.4 | 4 | 843 A1.000 | 70/94 | 02/10→ | Z292 | 1.05 | | ZS322 |
| 1.4 | 4 | 198 A4.000 | 88/118 | 10/11→ | Z234 Z292 | 0.9 1.05 | | ZS322 |
| 1.4 LPG | 4 | 843 A1.000 | 70/94 | 02/10→ | Z291 ^[168] | 0.9 | | |
| 1.4 Natural Power | 4 | 198 A4.000 | 88/118 | 06/10→ | Z338 | 0.8 | | ZS095 |
| 1.6 16V | 4 | 182 B6.000 | 76/102 | 10/01→ | Z255 | 0.9 | UXT1 / UXT3 | ZS320 |
| 1.6 16V LPG | 4 | 182 B6.000 | 76/102 | 10/01→ | Z206 | 0.7 | UXT10 | |
| 1.6 D Multijet | 4 | 263 A4.000 | 66/89 | 02/10→ | GE114 | 4.4V | | |
| 1.6 D Multijet | 4 | 263 A3.000 | 74/99 | 02/10→ | GE114 | 4.4V | | |
| 1.6 D Multijet | 4 | 198 A3.000 | 77/103 | 02/10→ | GE114 | 4.4V | | |
| 1.6 Natural Power | 4 | 182 B6.000 | 76/102 | 09/02→ | Z98 | 0.8 | UXT1 / UXT3 | ZS029 |
| 1.9 D | 4 | 223 A6.000 | 46/62 | 03/01→ | GN030 | 11V | | |
| 1.9 JTD | 4 | 182 B9.000 | 74/99 | 10/01→ | GN041 | 11V | | |
| 1.9 JTD | 4 | 223 A7.000, 223 B1.000 | 77/103 | 07/03→ | GN041 | 11V | | |
| 1.9 JTD Multijet | 4 | 186 A9.000 | 88/118 | 12/06→ | GN097 →12/10 | 11V | | |
| 2.0 D Multijet | 4 | 263 A1.000 | 99/133 | 02/10→ | GE114 | 4.4V | | |

DUCATO

| | | | | | | | | |
|-------|---|-----------------------|-------|-------------|------------------------------------|------------|-------------|--------------------------------|
| 1.8 | 4 | 169 B | 49/66 | 01/82→10/88 | Z11 ^[168] | 0.8 | UXT2 / UXT6 | ZS115 ^{[1][11]} ZM001 |
| 1.8 | 4 | XM7T | 51/68 | 07/82→12/88 | | | | ZS115 ^{[1][11]} |
| 1.9 D | 4 | D9B, D9B (XUD9A), DJY | 50/67 | 04/98→04/02 | GN013 | 11V | | |
| 1.9 D | 4 | 230 A2.000 | 51/68 | 03/94→04/02 | GN013 ^{[2][222]} GN917 | 11V 11V | | |
| 1.9 D | 4 | 149 B1.000 | 52/70 | 02/87→03/94 | GN909 ^{[2][222]} GV663 | 11V 11V | | |

FIAT



kW/BHP

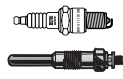

... FIAT



... DUCATO

| | | | | | | | | | |
|----------------------------|---|---|---------|-------------|-------------------------|-------|------------|-----------------------|---------------------|
| 1.9 D Combinato | 4 | 230 A2.000 | 51/68 | 06/95→04/02 | GN013 [2][222] GN917 | | 11V 11V | | |
| 1.9 TD | 4 | 230 A3.000 | 60/80 | 03/94→04/02 | GN013 [2][222] GN917 | | 11V 11V | | |
| 1.9 TD | 4 | 280 A1.000 | 60/80 | 03/89→03/94 | GV663 | | 11V | | |
| 1.9 TD | 4 | DHX (XUD9TF/L) | 66/89 | 04/98→04/02 | GN013 [2][222] GN908 | | 11V 11V | | |
| 1.9 TD CAT | 4 | 230 A4.000 | 59/79 | 08/94→04/02 | GN013 [2][222] GN908 | | 11V 11V | | |
| 1.9 TD Combinato | 4 | 230 A4.000 | 59/79 | 08/94→04/02 | GN013 [2][222] GN908 | | 11V 11V | | |
| 1.9 TD Panorama/Combinato | 4 | 230 A3.000 | 60/80 | 03/94→04/02 | GN013 [2][222] GN917 | | 11V 11V | | |
| 2.0 | 4 | 170 B | 55/74 | 07/85→08/90 | Z11 [168] | | 0.8 | UXT2 / UXT6 | ZS115 [1][11] ZM001 |
| 2.0 | 4 | 170BXN1T/ 170DXN1TA | 55/74 | 07/85→08/90 | Z11 01/86→ | | 0.8 | UXT2 / UXT6 01/86→ | |
| 2.0 | 4 | XN 1T | 58/78 | 01/82→08/90 | Z11 [168] | | 0.8 | UXT2 / UXT6 | ZS115 [1][11] ZM001 |
| 2.0 | 4 | 170 D | 62/83 | 09/88→08/90 | Z11 [168] | | 0.8 | UXT2 / UXT6 | |
| 2.0 | 4 | 170 D | 62/83 | 07/90→03/94 | Z11 [168] | | 0.8 | UXT2 / UXT6 | |
| 2.0 | 4 | 170 D | 63/84 | 06/90→05/94 | Z20 | | 0.8 | UXT2 / UXT6 | |
| 2.0 | 4 | RFW | 80/107 | 03/94→04/02 | Z247 | | 0.9 | UXT1 / UXT3 | ZS341 |
| 2.0 | 4 | RFW | 80/107 | 06/98→04/02 | Z193 | | 0.9 | UXT1 / UXT3 | |
| 2.0 4WD | 4 | RFW | 80/107 | 11/94→11/01 | | | | | ZS232 |
| 2.0 | 4 | RFL | 81/109 | 04/02→ | Z193 | | 0.9 | UXT1 / UXT3 | ZS232 |
| 2.0 LPG | 4 | RFW | 80/107 | 03/94→04/02 | Z340 | | 0.7 | UXT12 | |
| 2.0 LPG | 4 | RFL | 81/109 | 04/02→ | Z340 | | 0.7 | UXT12 | |
| 2.0 115 Multijet 2,0 D | 4 | 250 A1.000 | 85/114 | 06/11→ | GE114 | | 4.4V | | |
| 2.0 Bipower | 4 | RFL | 81/109 | 11/02→ | Z193 [168] | | 0.9 | UXT1 / UXT3 | ZS232 |
| 2.0 JTD | 4 | RHV (DW10) | 62/83 | 07/01→ | GN027 | | 11V | | |
| 2.0 Panorama/Combinato | 4 | RFW | 80/107 | 03/94→04/02 | Z247 | | 0.9 | UXT1 / UXT3 | ZS341 |
| 2.0 Panorama/Combinato LPG | 4 | RFW | 80/107 | 03/94→04/02 | Z340 | | 0.7 | UXT12 | |
| 2.2 100 Multijet 2,2 D | 4 | 4HV | 74/99 | 07/06→ | GN939 | | 11.5V | | |
| 2.3 110 Multijet 2,3 D | 4 | F1AE3481G | 83/111 | 10/11→ | GN037 | | 11V | | |
| 2.3 120 Multijet 2,3 D | 4 | F1AE0481D | 88/118 | 07/06→ | GN037 | | 11V | | |
| 2.3 130 Multijet 2,3 D | 4 | F1AE0481T | 93/125 | 08/06→ | GN037 | | 11V | | |
| 2.3 130 Multijet 2,3 D | 4 | F1AE0481N, F1AE3481D | 96/129 | 01/07→ | GN037 | | 11V | | |
| 2.3 150 Multijet 2,3 D | 4 | F1AE3481E | 109/146 | 06/11→ | GN037 | | 11V | | |
| 2.3 JTD | 4 | F1AE0481C | 81/109 | 04/02→ | GN037 | | 11V | | |
| 2.4 D | 4 | 8144.61 | 53/71 | 01/82→08/90 | GN909 | GR065 | 11V | | |
| 2.5 D | 4 | 8140.61, 8144.61, 8144.67, CRD93L (U25-661) | 55/74 | 01/82→05/94 | GN908 | GR065 | 11V | | |
| 2.5 D | 4 | 8140.67 | 62/83 | 03/94→04/02 | GN927 | GR065 | 11V | | |
| 2.5 D Combinato | 4 | 8140.67 | 62/83 | 08/94→04/02 | GN927 | GR065 | 11V | | |
| 2.5 TD | 4 | 8144.21, 8144.21.220 | 68/91 | 01/86→08/90 | GN908 | GR065 | 11V | | |
| 2.5 TD | 4 | 8140.27 | 70/94 | 09/86→03/94 | GN908 | GR065 | 11V | | |
| 2.5 TD | 4 | 8140.47 | 80/107 | 06/94→08/98 | GF984 | | 11V | | |
| 2.5 TD | 4 | 8140.47 | 85/114 | 06/94→04/98 | GF984 | | 11V | | |
| 2.5 TDI | 4 | 8140.47R | 80/107 | 03/94→04/02 | GF984 | | 11V | | |
| 2.5 TDI | 4 | 8140.47 | 85/114 | 03/94→04/02 | GF984 | | 11V | | |
| 2.5 TDI Panorama/Combinato | 4 | 8140.47R | 80/107 | 07/94→04/02 | GF984 | | 11V | | |
| 2.5 TDI Panorama/Combinato | 4 | 8140.47 | 85/114 | 03/94→04/02 | GF984 | | 11V | | |
| 2.8 D | 4 | 8140.63 | 64/86 | 02/98→04/02 | GN012 | | 11V | | |
| 2.8 iDTD 4WD | 4 | 8140.43 | 90/121 | 05/98→09/01 | GN012 | | 11V | | |
| 2.8 JTD | 4 | 8140.43S | 94/126 | 11/00→ | GN012 | | 11V | | |
| 2.8 JTD | 4 | 8140.43N | 107/143 | 04/04→07/06 | GN012 | | 11V | | |
| 2.8 JTD Power | 4 | 8140.43N | 107/143 | 05/04→ | GN012 | | 11V | | |
| 2.8 TD 4WD | 4 | 8140.63 | 64/86 | 05/98→11/01 | GN012 | | 11V | | |
| 2.8 TD 4WD | 4 | 8140.43 | 90/121 | 05/98→09/01 | GN012 | | 11V | | |
| 2.8 TDI | 4 | 8140.43 | 90/121 | 10/97→04/02 | GN012 | | 11V | | |

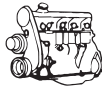

kW/BHP

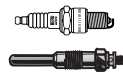

... FIAT



... DUCATO

| | | | | | | | | |
|------------------------|---|----------------------|---------|--------|-------|-----|--|-------|
| 3.0 140 Natural Power | 4 | F1CE0441A | 100/134 | 04/09→ | | | | ZS322 |
| 3.0 150 Multijet 3,0 D | 4 | F1CE3481N | 107/143 | 04/10→ | GN037 | 11V | | |
| 3.0 160 Multijet 3,0 D | 4 | F1CE0481D, F1CE3481M | 115/154 | 07/06→ | GN037 | 11V | | |
| 3.0 160 Multijet 3,0 D | 4 | F1CE0481D | 116/156 | 07/06→ | GN037 | 11V | | |
| 3.0 D Multijet | 4 | F1CE3481E | 130/174 | 06/11→ | GN037 | 11V | | |

FIORINO

| | | | | | | | | |
|----------------|---|------------------------|-------|-------------|---------------------------|------|-------------|------------------------|
| 0.9 900 | 4 | 100 GL.000 | 33/44 | 10/77→12/84 | Z20 | 0.8 | UXT2 / UXT6 | ZS106 ^[11] |
| 1.0 | 4 | 127 A.000 | 37/50 | 01/80→12/87 | Z20 | 0.8 | UXT2 / UXT6 | ZS106 ^[11] |
| 1.0 | 4 | 156 A.000 | 41/55 | 12/86→04/88 | Z20 | 0.8 | UXT2 / UXT6 | |
| 1.0 1050 | 4 | 127 A.000 | 37/50 | 01/80→12/87 | Z20 | 0.8 | UXT2 / UXT6 | |
| 1.1 60 | 4 | 146 A9.000 | 40/54 | 11/86→12/93 | Z20 | 0.8 | UXT2 / UXT6 | |
| 1.1 60 | 4 | 146 A9.000 | 40/54 | 05/88→12/93 | | | | ZS248 |
| 1.3 | 4 | 146 A5.000 | 49/66 | 12/87→08/93 | Z20 | 0.8 | UXT2 / UXT6 | ZS248 |
| | | | | | | | | ZM009 |
| | | | | | | | | 01/89→ |
| 1.3 70 | 4 | 146 A5.000 | 49/66 | 01/88→12/94 | Z20 | 0.8 | UXT2 / UXT6 | ZS248 |
| 1.3 D | 4 | 127 A5.000 | 33/44 | 03/82→12/87 | GV602 | 11V | | |
| | | | | | →10/82 | | | |
| | | | | | GN909 ^{[2][222]} | 11V | | |
| | | | | | GV663 | 11V | | |
| | | | | | 11/82→ | | | |
| 1.3 D Multijet | 4 | 199 A9.000 | 55/74 | 11/07→ | GE112 ^[37] | 4.4V | | |
| | | | | | GN053 ^[36] | 11V | | |
| 1.3 D Multijet | 4 | 199 B1.000 | 70/94 | 07/09→ | GE112 | 4.4V | | |
| 1.4 | 4 | KFT, KFV | 54/72 | 11/07→ | Z193 | 0.9 | UXT1 / UXT3 | ZSE048 ^[10] |
| 1.4 LPG | 4 | KFT, KFV | 54/72 | 11/07→ | Z340 | 0.7 | UXT12 | |
| 1.4 70 i.e. | 4 | 146 C5.000, 146 D5.000 | 49/66 | 05/94→05/01 | Z20 | 0.8 | UXT2 / UXT6 | ZS248 |
| | | | | | | | | →05/95 |
| | | | | | | | | ZS234 |
| | | | | | | | | 06/95→ |

| | | | | | | | | |
|-------------------|---|------------------------|-------|-------------|---------------------------|-----|-------------|-----------------------|
| 1.4 70 i.e. LPG | 4 | 146 C5.000, 146 D5.000 | 49/66 | 05/94→05/01 | Z27 ^[168] | 0.8 | UX56 | |
| 1.4 Natural Power | 4 | 350 A1.000 | 57/76 | 10/09→ | Z234 | 0.9 | | ZS079 |
| 1.5 | 4 | 149 C1.000 | 55/74 | 01/88→08/93 | Z20 ^[168] | 0.8 | UXT2 / UXT6 | ZS248 |
| 1.5 75 i.e. | 4 | 149 C1.000 | 55/74 | 05/88→12/93 | Z20 ^[168] | 0.8 | UXT2 / UXT6 | ZS106 ^[11] |
| 1.6 75 i.e. | 4 | 146 C6.000, 146 D6.000 | 55/74 | 10/93→05/01 | Z252 | 0.9 | UXT5 | ZS234 |
| | | | | | | | | 06/95→ |
| 1.6 75 i.e. LPG | 4 | 146 C6.000, 146 D6.000 | 55/74 | 10/93→05/01 | Z30 ^[168] | 0.8 | UXT5 | |
| 1.7 60 1.7 D | 4 | 146 B2.000 | 42/56 | 05/88→10/96 | GN909 ^{[2][222]} | 11V | | |
| | | | | | GV663 | 11V | | |
| 1.7 60 1.7 D | 4 | 149 B3.000 | 44/59 | 05/88→05/00 | GN909 ^{[2][222]} | 11V | | |
| | | | | | GV663 | 11V | | |
| 1.7 65 1.7 TD | 4 | 146 D7.000 | 46/62 | 01/97→05/01 | GN013 ^{[2][222]} | 11V | | |
| | | | | | GN908 | 11V | | |
| 1.7 D | 4 | 149 B2.000 | 42/56 | 01/88→10/93 | GN909 ^{[2][222]} | 11V | | |
| | | | | | GV663 | 11V | | |
| 1.7 D | 4 | 146 B2.000 | 44/59 | 01/88→10/99 | GV663 | 11V | | |
| 1.7 D | 4 | 149 B3.000 | 44/59 | 12/87→12/90 | GN909 ^{[2][222]} | 11V | | |
| | | | | | GV663 | 11V | | |
| 1.7 TD | 4 | 146 D7.000 | 46/62 | 11/96→05/00 | GN908 | 11V | | |

PANDA

| | | | | | | | | |
|----------|---|------------------------|-------|-------------|----------------------|-----|-------------|------------------------|
| 0.8 750 | 4 | 141 B.000 | 25/34 | 01/86→07/92 | Z20 | 0.8 | UXT2 / UXT6 | ZS106 ^[11] |
| | | | | | | | | ZM009 ^[193] |
| | | | | | | | | ZM017 |
| | | | | | | | | 01/88→ |
| 1.0 1000 | 4 | 156 A2.100, 156 A3.100 | 32/43 | 01/86→02/92 | Z15 ^[168] | 0.8 | UXT1 / UXT3 | ZS106 ^[11] |
| | | | | | | | | ZM001 ^[175] |
| | | | | | | | | ZM009 ^[193] |
| | | | | | | | | ZM017 |
| | | | | | | | | 01/88→ |

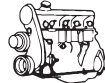

kW/BHP

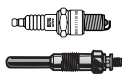
**... FIAT****... PANDA**

| | | | | | | | | | |
|-----------------------|---|------------------------------------|-------|-------------|------------------------------------|------------|--|-------|-------|
| 1.0 1000 i.e | 4 | 156 A2.246 | 33/44 | 08/92→02/04 | Z193 | 0.9 | UXT1 / UXT3 | ZS283 | ZM009 |
| 1.0 1000 i.e LPG | 4 | 156 A2.246 | 33/44 | 08/92→02/04 | Z340 | 0.7 | UXT12 | | |
| 1.1 | 4 | 187 A1.000 | 40/54 | 09/00→02/04 | Z255 | 0.9 | UXT1 / UXT3 | | |
| 1.1 | 4 | 187 A1.000 | 40/54 | 09/00→ | | | | ZS283 | |
| 1.1 | 4 | 187 A1.000 | 40/54 | 09/04→ | Z255 →12/09 →eng. 2533528 | 0.9 | UXT1 / UXT3 →12/09 →eng. 2533528 | | |
| | | | | | Z234 →12/09 eng. 2533529→ | 0.9 | | | |
| 1.2 | 4 | 188 A4.000 | 44/59 | 09/04→ | Z255 →eng. 2533528 | 0.9 | UXT1 / UXT3 | ZS283 | |
| | | | | | Z292 eng. 2533529→ | 1.05 | | | |
| 1.2 4WD | 4 | 169 A4.000 | 51/68 | 09/10→ | Z293 | 1.05 | | | |
| 1.2 LPG | 4 | 188 A4.000 | 44/59 | 09/04→ | Z206 →eng. 2533528 | 0.7 | UXT10 | | |
| | | | | | | | | | |
| 1.3 JTD | 4 | 188 A8.000, 188 A9.000 | 51/68 | 03/04→ | GN053 | 11V | | | |
| 1.3 JTD | 4 | 169 A1.000 | 55/74 | 01/06→ | GN053 | 11V | | | |
| 1.3 Multijet 4WD | 4 | 169 A1.000 | 55/74 | 01/06→ | GN053 →12/09 | 11V | | | |
| | | | | | GE112 01/10→ | 4.4V | | | |
| 1.4 Natural Power | 4 | 350 A1.000 | 57/76 | 10/09→ | Z292 | 1.05 | | ZS322 | |
| 1.4 Natural Power LPG | 4 | 350 A1.000 | 57/76 | 10/09→ | Z291 [168] | 0.9 | | | |
| PENNY | | | | | | | | | |
| 1.7 D | 4 | 149 B3.000 | 44/59 | 01/86→12/90 | GN954 | 11V | | | |
| PUNTO | | | | | | | | | |
| 1.1 | 4 | 176 B2.000 | 40/54 | 04/96→02/00 | Z193 | 0.9 | UXT1 / UXT3 | ZS283 | |
| 1.1 LPG | 4 | 176 B2.000 | 40/54 | 04/96→02/00 | Z340 | 0.7 | UXT12 | | |
| 1.2 60 | 4 | 188 A4.000 | 44/59 | 02/00→10/09 | Z255 →eng. 2533528 | 0.9 | UXT1 / UXT3 | ZS283 | |
| | | | | | Z234 eng. 2533529→ | 0.9 | | | |
| 1.2 60 LPG | 4 | 188 A4.000 | 44/59 | 02/00→10/09 | Z206 →eng. 2533528 | 0.7 | UXT10 | | |
| | | | | | Z292 [168] eng. 2533529→ | 1.05 | | | |
| 1.3 D Multijet | 4 | 188 A9.000, 199 A2.000, 199 A9.000 | 55/74 | 02/05→ | GN053 | 11V | | | |
| 1.3 D Multijet | 4 | 199 B4.000 | 62/83 | 03/12→ | GE112 | 4.4V | | | |
| 1.3 D Multijet | 4 | 199 A3.000 | 66/89 | 01/10→02/12 | GN053 | 11V | | | |
| 1.3 D Multijet | 4 | 199 B1.000 | 70/94 | 03/09→ | GE112 | 4.4V | | | |
| 1.3 JTD | 4 | 188 A9.000 | 51/68 | 06/03→10/05 | GN053 | 11V | | | |
| 1.4 | 4 | 350 A1.000 | 57/76 | 04/08→ | Z293 | 1.05 | | ZS079 | |
| 1.7 D | 4 | 176 B3.000 | 42/56 | 04/96→02/00 | GN013 [23][222] GN908 | 11V 11V | | | |
| 1.7 TD | 4 | 176 B7.000 | 46/62 | 09/96→09/99 | GN908 | 11V | | | |
| 1.7 TD | 4 | 176 A5.000 | 52/70 | 04/96→02/00 | GN013 [23][222] GN908 | 11V 11V | | | |
| 1.9 D 60 | 4 | 188 A3.000 | 44/59 | 02/00→10/09 | GN030 | 11V | | | |
| 1.9 JTD | 4 | 188 A7.000 | 63/84 | 02/00→10/09 | GN041 →07/07 GN097 08/07→ | 11V 11V | | | |
| SCUDO | | | | | | | | | |
| 1.6 | 4 | 220 A 2.000 | 58/78 | 02/96→12/06 | Z24 | 0.8 | UXT5 | ZS234 | |
| 1.6 LPG | 4 | 220 A 2.000 | 58/78 | 02/96→12/06 | Z30 [168] | 0.8 | UXT5 | | |

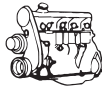

kW/BHP

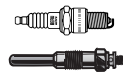

... FIAT



... SCUDO

| | | | | | | | | |
|----------------|---|-----------------|---------|-------------|------------------------------------|-----|-------|-------|
| 1.6 D Multijet | 4 | 9HU | 66/89 | 01/07→ | GN056 | 11V | | |
| 1.9 D | 4 | D9B | 51/68 | 02/96→12/06 | GN909 | 11V | | |
| 1.9 D | 4 | WJZ (DW8) | 51/68 | 04/98→12/06 | GN016 | 11V | | |
| 1.9 TD | 4 | DHX (XUD9TF/L) | 66/89 | 02/96→12/06 | GN909 →08/98 GN013 09/98→ | 11V | | |
| 1.9 TD | 4 | D8B | 68/91 | 02/98→12/06 | GN909 →08/98 GN013 09/98→ | 11V | | |
| 2.0 | 4 | RFN (EW10J4) | 100/134 | 05/00→12/06 | Z183 | 0.9 | UXT13 | ZS348 |
| 2.0 LPG | 4 | RFN (EW10J4) | 100/134 | 05/00→12/06 | Z184 [168] | 0.9 | UXT13 | |
| 2.0 D Multijet | 4 | RHK | 88/118 | 01/07→ | GN054 | 11V | | |
| 2.0 D Multijet | 4 | RH02 | 94/126 | 05/11→ | GN054 | 11V | | |
| 2.0 D Multijet | 4 | DW10BTED4, RHR | 100/134 | 01/07→ | GN054 | 11V | | |
| 2.0 D Multijet | 4 | RHH | 120/161 | 07/10→ | GN054 | 11V | | |
| 2.0 JTD | 4 | RHX | 69/93 | 12/99→12/06 | GN027 | 11V | | |
| 2.0 JTD | 4 | RHZ | 80/107 | 12/02→12/06 | GN027 | 11V | | |
| 2.0 JTD 16V | 4 | RHW (DW10ATED4) | 80/107 | 05/99→12/06 | GN027 [124] GN054 [125] | 11V | | |

SEICENTO

| | | | | | | | | |
|---------|---|-------------|-------|-------------|-----------|-----|-------------|-------|
| 0.9 | 4 | 1170 A1.046 | 29/39 | 01/98→01/10 | Z20 | 0.8 | UXT2 / UXT6 | ZS283 |
| 0.9 LPG | 4 | 1170 A1.046 | 29/39 | 01/98→01/10 | Z27 [168] | 0.8 | UX56 | |
| 1.1 | 4 | 176 B2.000 | 40/54 | 01/98→01/10 | Z193 | 0.9 | UXT1 / UXT3 | ZS283 |
| 1.1 LPG | 4 | 176 B2.000 | 40/54 | 01/98→01/10 | Z340 | 0.7 | UXT12 | |

TALENTO

| | | | | | | | | |
|-------|---|------------|-------|-------------|-------------------------|-----|-------------|---------------|
| 1.9 D | 4 | 149 B1.000 | 52/70 | 03/89→03/94 | GN909 [2][222] GV663 | 11V | | |
| 2.0 | 4 | 170 B | 55/74 | 03/89→03/94 | Z20 07/90→ | 0.8 | UXT2 / UXT6 | ZS115 [1][11] |

UNO

| | | | | | | | | |
|--------|---|------------------------|-------|-------------|-------|-----|--|---------------------------|
| 0.9 45 | 4 | 146 A.000, 146 A1.000 | 33/44 | 02/88→07/96 | | | | ZS106 [11] 09/89→03/94 |
| 1.7 D | 4 | 146 B2.000, 149 B4.046 | 43/58 | 02/88→02/92 | GV663 | 11V | | |

FORD



B-MAX

| | | | | | | | | |
|----------|---|------|--------|--------|--------|----|--|-------|
| 1.4 | 4 | SPJD | 66/89 | 10/12→ | | | | ZS387 |
| 1.5 TDCi | 4 | UGJC | 55/74 | 10/12→ | GE121A | 5V | | |
| 1.6 TDCi | 4 | T3JB | 70/94 | 10/12→ | GE121A | 5V | | |
| 1.6 Ti | 4 | IQJA | 77/103 | 10/12→ | | | | ZS387 |

CAPRI

| | | | | | | | | |
|-------------|---|------------------|-------|-------------|-----------|-----|-------------|------------|
| 1.3 1300 | 4 | | 35/47 | 01/69→12/70 | Z22 [167] | 0.7 | UX56 | ZS106 [11] |
| 1.3 1300 | 4 | EV 13 L | 37/50 | 12/68→12/72 | Z11 [167] | 0.8 | UXT2 / UXT6 | ZS106 [11] |
| 1.3 1300 | 4 | KL 13 L | 38/51 | 01/69→12/70 | Z22 [167] | 0.7 | UX56 | ZS106 [11] |
| 1.3 1300 | 4 | EV 13 H, KL 13 L | 39/52 | 01/71→12/73 | Z22 [167] | 0.7 | UX56 | ZS106 [11] |
| 1.3 1300 | 4 | | 40/54 | 10/72→12/73 | Z32 [167] | 0.7 | | ZS106 [11] |
| 1.3 1300 | 4 | KL 13 L | 41/55 | 01/71→12/73 | Z22 [167] | 0.7 | UX56 | ZS106 [11] |
| 1.3 1300 | 4 | | 43/58 | 01/73→12/73 | Z22 [167] | 0.7 | UX56 | ZS106 [11] |
| 1.3 1300 | 4 | KL 13 H | 48/64 | 01/69→12/70 | Z22 [167] | 0.7 | UX56 | ZS106 [11] |
| 1.3 1300 | 4 | KL 13 HC | 53/71 | 01/72→12/72 | Z32 [167] | 0.7 | | ZS106 [11] |
| 1.5 1500 | 4 | EX | 44/59 | 12/68→02/74 | Z11 [167] | 0.8 | UXT2 / UXT6 | ZS106 [11] |
| 1.5 1500 | 4 | | 48/64 | 12/68→02/74 | Z22 [167] | 0.7 | UX56 | ZS106 [11] |
| 1.6 1600 | 4 | OHCT L 16 H | 53/71 | 08/72→02/74 | Z32 [167] | 0.7 | | ZS106 [11] |
| 1.6 1600 | 4 | LE | 65/87 | 08/72→02/74 | Z33 [167] | 0.7 | | ZS106 [11] |
| 1.6 1600 GT | 4 | | 60/80 | 01/69→10/72 | Z22 [167] | 0.7 | UX56 | ZS106 [11] |

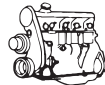

kW/BHP

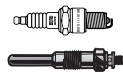

... FORD



... CAPRI

| | | | | | | | | |
|-------------|---|---------|---------|-------------|-----------|-----|-------------|------------|
| 1.7 1700 | 4 | TV 17 H | 55/74 | 12/68→08/72 | Z22 [167] | 0.7 | UX56 | ZS106 [11] |
| 2.0 2000 | 6 | NX | 63/84 | 02/69→06/71 | Z11 [167] | 0.8 | UXT2 / UXT6 | ZS106 [11] |
| 2.0 2000 | 6 | NY | 66/89 | 02/69→02/74 | Z22 [167] | 0.7 | UX56 | ZS106 [11] |
| 2.0 2000 | 6 | | 69/93 | 02/69→02/74 | Z22 [167] | 0.7 | UX56 | ZS106 [11] |
| 2.3 2300 | 6 | TV 23 H | 79/106 | 02/69→02/74 | Z22 [167] | 0.7 | UX56 | ZS106 [11] |
| 2.3 2300 | 6 | | 92/123 | 08/69→02/74 | Z22 [167] | 0.7 | UX56 | ZS106 [11] |
| 2.5 2600 | 6 | UY | 92/123 | 08/70→02/74 | Z42 [167] | 0.8 | UX56 | |
| 2.6 2600 RS | 6 | OZ | 110/148 | 08/70→02/74 | Z42 | 0.8 | UX56 | ZS115 [11] |
| 3.0 3000 | 6 | TV30LY | 94/126 | 01/70→12/71 | Z22 [167] | 0.7 | UX56 | ZS115 [11] |
| 3.0 3000 | 6 | | 101/135 | 01/72→12/72 | Z22 [167] | 0.7 | UX56 | ZS115 [11] |
| 3.0 3000 | 6 | | 103/138 | 01/73→12/73 | Z22 [167] | 0.7 | UX56 | ZS115 [11] |
| 3.0 3000 | 6 | HY | 103/138 | 08/72→02/74 | Z22 [167] | 0.7 | UX56 | |

CAPRI II

| | | | | | | | | |
|-----|---|-------------|---------|-------------|-----------|-----|-------------|------------|
| 1.3 | 4 | J1E | 40/54 | 02/74→08/77 | Z20 [167] | 0.8 | UXT2 / UXT6 | ZS115 [11] |
| 1.3 | 4 | J1E | 42/56 | 02/74→08/77 | Z20 [167] | 0.8 | UXT2 / UXT6 | ZS115 [11] |
| 1.6 | 4 | LAC | 50/67 | 09/74→12/77 | Z32 | 0.7 | | |
| 1.6 | 4 | LCE | 53/71 | 02/74→12/77 | Z33 | 0.7 | | |
| 1.6 | 4 | LEC | 65/87 | 02/74→12/77 | Z33 [167] | 0.7 | | ZS109 [15] |
| 2.0 | 4 | OHC TL 20 H | 72/97 | 04/74→12/77 | Z32 | 0.7 | | ZS109 [15] |
| 2.0 | 6 | NWN, NYL | 66/89 | 04/76→12/77 | Z27 [168] | 0.8 | UX56 | ZS109 [15] |
| 2.3 | 6 | YYE | 79/106 | 02/74→12/77 | Z47 [168] | 0.8 | UX56 | ZS109 [15] |
| 3.0 | 6 | HYF | 101/135 | 02/74→12/77 | Z27 [167] | 0.8 | UX56 | |

CAPRI III

| | | | | | | | | |
|---------------------|---|------------------|---------|-------------|-----------|-----|-------------|------------|
| 1.3 | 4 | J1E | 40/54 | 01/78→06/85 | Z20 [167] | 0.8 | UXT2 / UXT6 | ZS115 [11] |
| 1.6 | 4 | LCN | 54/72 | 01/78→04/87 | Z33 | 0.7 | | |
| 2.0 | 4 | | 64/86 | 01/78→12/85 | Z33 | 0.7 | | ZS109 [15] |
| 2.0 | 4 | NEN, OHC TL 20 H | 74/99 | 01/78→12/85 | Z33 | 0.7 | | ZS109 [15] |
| 2.0 | 6 | NYL | 66/89 | 01/78→12/82 | Z27 [168] | 0.8 | UX56 | ZS109 [15] |
| 2.3 Super | 6 | YYN | 84/113 | 06/79→12/85 | Z47 [168] | 0.8 | UX56 | ZS109 [15] |
| 2.8 Super Injection | 6 | PRN | 118/158 | 01/81→04/87 | Z47 [168] | 0.8 | UX56 | |
| 3.0 | 6 | HYF | 101/135 | 01/78→12/81 | Z27 [167] | 0.8 | UX56 | |

C-MAX

| | | | | | | | | |
|---------------|---|------------------------------|---------|--------|-------------------------------------|-----------|-------|-----------------|
| 1.6 | 4 | HWDA, HWDB, SHDA, SHDB, SHDC | 74/99 | 02/07→ | Z177 | 1.3 | UXT7 | ZS387 →07/10 |
| 1.6 TDCi | 4 | HHDA, HHDB | 66/89 | 02/07→ | GN056 | 11V | | |
| 1.6 TDCi | 4 | G8DC, MTDA | 74/99 | 02/07→ | GN056 →07/10 GE121A 08/10→ | 11V 5V | | |
| 1.6 TDCi | 4 | G8DA, G8DB, G8DD | 80/107 | 02/07→ | GN056 | 11V | | |
| 1.8 | 4 | QQDC | 90/121 | 02/07→ | Z230 →07/10 | 1.3 | | ZS408 |
| 1.8 | 4 | QQDA, QQDB | 92/123 | 02/07→ | Z230 | 1.3 | | ZS408 |
| 1.8 Flexifuel | 4 | Q7DA | 92/123 | 02/07→ | Z209 | 1.3 | UXT15 | ZS408 |
| 1.8 TDCi | 4 | KKDA | 85/114 | 02/07→ | GN993 | 10V | | |
| 2.0 | 4 | AODA, AODB, AODE, SYDA | 107/143 | 02/07→ | Z230 | 1.3 | | ZS408 |
| 2.0 CNG | 4 | SYDA | 107/143 | 04/09→ | Z209 | 1.3 | UXT15 | ZS408 |
| 2.0 LPG | 4 | SYDA | 107/143 | 06/08→ | Z209 | 1.3 | UXT15 | ZS408 |
| 2.0 TDCi | 4 | IXDA | 81/109 | 02/08→ | GN054 | 11V | | |
| 2.0 TDCi | 4 | G6DC, G6DE, G6DF | 98/131 | 02/07→ | GN054 | 11V | | |
| 2.0 TDCi | 4 | G6DA, G6DB, G6DD, G6DG | 100/134 | 02/07→ | GN054 | 11V | | |

C-MAX II

| | | | | | | | | |
|--------------|---|------------|---------|--------|--------|-----|------|-----------------|
| 1.6 EcoBoost | 4 | JQDA, JQDB | 110/148 | 12/10→ | | | | ZS387 |
| 1.6 EcoBoost | 4 | JTDA, JTDB | 134/180 | 12/10→ | | | | ZS387 |
| 1.6 TDCi | 4 | T3DA, T3DB | 70/94 | 12/10→ | GE121A | 5V | | |
| 1.6 TDCi | 4 | T1DA, T1DB | 85/114 | 12/10→ | GE121A | 5V | | |
| 1.6 Ti | 4 | IQDA, IQDB | 77/103 | 12/10→ | Z177 | 1.3 | UXT7 | ZS387 →05/11 |

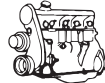

kW/BHP

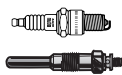

... FORD



ESCORT

| | | | | | | | | |
|----------|---|------|-------|--------|--------|----|--|--|
| 1.5 TDCi | 4 | UGJE | 66/89 | 10/13→ | GE121A | 5V | | |
|----------|---|------|-------|--------|--------|----|--|--|

ESCORT I

| | | | | | | | | |
|-------------|---|---------|-------|-------------|-----|-----|-------------|---------------|
| 1.0 950 | 4 | | 25/34 | 08/68→08/74 | Z22 | 0.7 | UX56 | |
| 1.0 950 | 4 | | 26/35 | 08/68→08/74 | Z22 | 0.7 | UX56 | |
| 1.1 1100 | 4 | KL11 | 29/39 | 06/68→06/71 | Z11 | 0.8 | UXT2 / UXT6 | ZS109 [1][15] |
| 1.1 1100 | 4 | G1 | 32/43 | 01/68→02/76 | Z11 | 0.8 | UXT2 / UXT6 | ZS109 [1][15] |
| | | | | →09/73 | Z20 | 0.8 | UXT2 / UXT6 | |
| | | | | 10/73→ | | | | |
| 1.1 1100 | 4 | G1 | 33/44 | 06/68→06/71 | Z11 | 0.8 | UXT2 / UXT6 | ZS109 [1][15] |
| 1.1 1100 | 4 | G2 | 35/47 | 06/70→02/76 | Z11 | 0.8 | UXT2 / UXT6 | ZS109 [1][15] |
| | | | | →09/73 | Z20 | 0.8 | UXT2 / UXT6 | |
| | | | | 10/73→ | | | | |
| 1.3 1300 | 4 | | 35/47 | 06/68→06/71 | Z11 | 0.8 | UXT2 / UXT6 | ZS109 [1][15] |
| 1.3 1300 | 4 | | 38/51 | 06/68→06/71 | Z11 | 0.8 | UXT2 / UXT6 | ZS109 [1][15] |
| 1.3 1300 | 4 | J1F | 40/54 | 09/73→02/76 | Z20 | 0.8 | UXT2 / UXT6 | |
| 1.3 1300 | 4 | J2 | 42/56 | 06/70→02/76 | Z11 | 0.8 | UXT2 / UXT6 | |
| | | | | →09/73 | Z20 | 0.8 | UXT2 / UXT6 | |
| | | | | 10/73→ | | | | |
| 1.3 1300 | 4 | J3D | 53/71 | 06/70→02/76 | Z47 | 0.8 | UX56 | |
| 1.3 1300 GT | 4 | KL 13 H | 47/63 | 06/68→06/71 | Z11 | 0.8 | UXT2 / UXT6 | ZS109 [1][15] |
| 1.6 Mexico | 4 | KL 16 R | 63/84 | 01/70→10/75 | | | | ZS109 [15] |

ESCORT II

| | | | | | | | | |
|-------------|---|--------------|---------|-------------|-----------|-----|-------------|---------------|
| 1.1 | 4 | G1 | 32/43 | 12/74→08/80 | Z20 | 0.8 | UXT2 / UXT6 | ZS109 [15] |
| 1.1 | 4 | G1 | 32/43 | 04/75→08/80 | | | | ZS115 [1][11] |
| 1.1 | 4 | G1 | 34/46 | 06/75→08/80 | Z20 | 0.8 | UXT2 / UXT6 | ZS109 [15] |
| 1.1 | 4 | G2 | 35/47 | 12/74→08/80 | Z20 | 0.8 | UXT2 / UXT6 | ZS109 [15] |
| 1.1 | 4 | G2 | 35/47 | 04/75→08/80 | | | | ZS115 [1][11] |
| 1.3 | 4 | J1F, KL 13 H | 40/54 | 12/74→07/81 | Z20 | 0.8 | UXT2 / UXT6 | ZS109 [15] |
| 1.3 | 4 | J2 | 42/56 | 12/74→08/80 | Z27 [168] | 0.8 | UX56 | ZS109 [15] |
| 1.3 | 4 | J2 | 42/56 | 04/75→08/80 | | | | ZS115 [1][11] |
| 1.3 | 4 | J2 | 44/59 | 03/79→08/80 | Z27 [168] | 0.8 | UX56 | ZS109 [15] |
| 1.3 | 4 | J3 | 51/68 | 12/74→08/80 | Z27 [168] | 0.8 | UX56 | ZS109 [15] |
| 1.6 RS | 4 | LC | 62/83 | 12/74→08/80 | Z27 [168] | 0.8 | UX56 | ZS109 [15] |
| 1.8 | 4 | | 115/154 | 12/74→08/80 | | | | ZS109 [15] |
| 1.8 RS 1800 | 4 | KL 18 S | 92/123 | 03/75→08/77 | | | | ZS109 [15] |
| 2.0 RS | 4 | | 73/98 | 03/73→02/77 | Z33 | 0.7 | | ZS109 [15] |
| 2.0 RS | 4 | NE | 80/107 | 08/75→08/80 | Z33 | 0.7 | | ZS109 [15] |

ESCORT III

| | | | | | | | | | |
|-------|---|----------|-------|-------------|-------------------------|--------------|------|------------|-------------|
| 1.1 | 4 | GSE | 37/50 | 08/83→12/85 | Z95 | 0.7 | UXT4 | ZS109 [15] | ZM003 |
| 1.1 | 4 | GLB, GMA | 40/54 | 09/80→08/83 | Z24 [168] | 0.8 | UXT5 | ZS109 [15] | ZM003 |
| 1.1 | 4 | GPA | 43/58 | 09/80→08/83 | Z30 | 0.8 | UXT5 | ZS109 [15] | ZM003 |
| 1.3 | 4 | JPA | 51/68 | 09/80→12/85 | Z24 | 0.8 | UXT5 | ZS126 | ZM003 |
| 1.3 | 4 | JPA | 51/68 | 09/83→12/85 | Z24 [168] | 0.8 | UXT5 | | |
| 1.6 | 4 | CVH | 58/78 | 09/80→12/85 | | | | | ZM020 |
| | | | | | | | | | 01/85→ |
| 1.6 | 4 | LPI, LPA | 58/78 | 09/80→12/85 | Z30 | 0.8 | UXT5 | ZS126 | ZM008 |
| | | | | | | | | | →01/85 |
| | | | | | | | | | ZM003 [175] |
| | | | | | | | | | 02/85→ |
| 1.6 | 4 | LPI, LPA | 58/78 | 09/83→12/85 | Z30 [168] | 0.8 | UXT5 | | |
| 1.6 | 4 | CVH | 71/95 | 09/80→10/82 | | | | | ZM020 |
| 1.6 | 4 | LUA | 71/95 | 09/80→10/82 | Z30 [168] | 0.8 | UXT5 | ZS126 | ZM008 |
| 1.6 D | 4 | LTA | 40/54 | 02/84→12/85 | GN927 [2][222] GV631 | 11V 11.5V | | | |
| 1.6 i | 4 | CVH | 66/89 | 07/85→12/85 | | | | | ZM020 |

FORD



kW/BHP



... FORD



... ESCORT III

| | | | | | | | | | |
|--------------|---|----------|--------|-------------|-----------|-----|------|-----------------|------------------------------------|
| 1.6 i | 4 | L4B | 66/89 | 07/85→12/85 | Z24 [168] | 0.8 | UXT5 | ZS126 08/85→ | ZM003 |
| 1.6 i | 4 | LR1, LRA | 77/103 | 09/83→12/85 | Z30 | 0.8 | UXT5 | ZS126 | ZM003 |
| 1.6 RS 1600i | 4 | LUAE | 85/114 | 05/82→12/85 | Z30 | 0.8 | UXT5 | ZS126 →07/83 | |
| 1.6 RS Turbo | 4 | LNA | 97/130 | 11/84→12/85 | | | | ZS126 | ZM003 |
| 1.6 XR3i | 4 | LR1, LRA | 77/103 | 10/82→12/85 | Z30 [168] | 0.8 | UXT5 | ZS126 | ZM008 →01/85 ZM003 02/85→ |

ESCORT IV

| | | | | | | | | | |
|-----|---|---------------|-------|-------------|--------------------------------------|------------|---------------|--|----------------------------|
| 1.1 | 4 | GSG | 37/50 | 10/85→09/90 | Z95 | 0.7 | UXT4 | ZS126 01/86→ | ZM003 08/87→ |
| 1.1 | 4 | GSG | 37/50 | 12/85→07/90 | | | | ZS126 →09/88 | |
| 1.3 | 4 | CVH | 44/59 | 01/86→07/90 | | | | | ZM020 |
| 1.3 | 4 | JBB | 44/59 | 01/86→07/90 | Z67 | 1.1 | UXT4 | ZS126 [1][214][254] →07/88 ZS281 [1] 08/88→ | ZM003 |
| 1.3 | 4 | JLA, JLB | 44/59 | 01/86→07/90 | Z95 | 0.7 | UXT4 | ZS126 [1][214][254] →07/88 ZS281 [1] 08/88→ | ZM003 |
| 1.3 | 4 | CVH | 46/62 | 07/88→10/90 | | | | | ZM020 |
| 1.3 | 4 | JBA | 46/62 | 07/88→10/90 | Z67 | 1.1 | UXT4 | ZS238 ZS281 | |
| 1.3 | 4 | | 51/68 | 11/86→07/88 | Z24 | 0.8 | UXT5 | | |
| 1.3 | 4 | CVH | 51/68 | 11/86→07/88 | | | | | ZM020 |
| 1.4 | 4 | CVH | 51/68 | 10/85→10/90 | | | | | ZM020 [192] 01/89→ |
| 1.4 | 4 | FUAA | 51/68 | 10/85→10/90 | Z24 Z27 [168] | 0.8 0.8 | UXT5 UX56 | ZS126 [1] 01/86→07/90 ZS281 [1] | |
| 1.4 | 4 | CVH | 54/72 | 01/86→07/90 | | | | | ZM020 |
| 1.4 | 4 | F6B, F6D | 54/72 | 01/86→07/90 | Z99 →07/88 Z16 [171] 08/88→ | 1.0 1.1 | UXT5 UXT11 | ZS126 [1] →07/88 ZS281 [1] 01/89→ | ZM003 [175] ZM020 [192] |
| 1.4 | 4 | F6B, F6D, FUC | 54/72 | 02/87→07/90 | | | | ZS126 [1][214][254] ZS281 [1] 01/89→ | ZM003 |
| 1.4 | 4 | FUC | 54/72 | 01/86→07/90 | Z253 | 1.0 | UXT5 | ZS126 [1] 01/87→ ZS281 [1] 01/89→ | ZM003 [175] ZM020 [192] |
| 1.4 | 4 | CVH | 55/74 | 01/86→07/90 | | | | | ZM020 |
| 1.4 | 4 | FUA | 55/74 | 01/86→07/90 | Z24 | 0.8 | UXT5 | ZS126 [1][214][254] →10/89 ZS281 [1] 10/89→ | ZM003 |
| 1.6 | 4 | CVH | 58/78 | 01/86→07/90 | | | | | ZM020 |
| 1.6 | 4 | LP2 | 58/78 | 01/86→12/87 | Z30 | 0.8 | UXT5 | | |
| 1.6 | 4 | LP2 | 58/78 | 01/86→07/90 | Z24 | 0.8 | UXT5 | ZS126 [1][214][254] ZS281 [1] | ZM015 |
| 1.6 | 4 | LPA | 58/78 | 01/86→12/87 | Z30 | 0.8 | UXT5 | ZS126 [1][214][254] ZS281 [1] | ZM015 |
| 1.6 | 4 | CVH | 65/87 | 04/89→07/90 | | | | | ZM020 |



kW/BHP

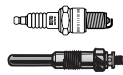

... FORD



... ESCORT IV

| | | | | | | | | | | |
|--------------|---|----------|--------|-------------|-------------------------|--|--------------|------|----------------------------------|----------------------------|
| 1.6 | 4 | LUG | 65/87 | 04/89→07/90 | Z24 | | 0.8 | UXT5 | ZS126 [1][214][254] ZS281 [1] | ZM015 |
| 1.6 D | 4 | LTC | 40/54 | 01/86→01/89 | GN927 [2][222] GV631 | | 11V 11.5V | | | |
| 1.6 i | 4 | CVH | 66/89 | 01/86→07/90 | | | | | | ZM020 |
| 1.6 i | 4 | L4B | 66/89 | 01/86→07/90 | Z24 | | 0.8 | UXT5 | ZS126 [1][214][254] ZS281 [1] | ZM003 [175] ZM015 [175] |
| 1.6 i | 4 | L4B | 66/89 | 01/86→05/90 | | | | | ZS281 | |
| 1.6 i | 4 | CVH | 75/101 | 08/89→07/90 | | | | | | ZM020 |
| 1.6 i | 4 | LJB | 75/101 | 08/89→07/90 | Z99 | | 1.0 | UXT5 | ZS281 | ZM003 [175] ZM015 [175] |
| 1.6 Turbo RS | 4 | CVH | 97/130 | 01/86→07/90 | | | | | | ZM020 |
| 1.6 Turbo RS | 4 | LNB | 97/130 | 01/86→07/90 | | | | | ZS281 | ZM015 |
| 1.6 XR3i | 4 | LR2, LRB | 77/103 | 01/86→07/90 | Z30 | | 0.8 | UXT5 | ZS281 | ZM003 [175] ZM015 [175] |
| 1.8 D | 4 | RTA, RTB | 44/59 | 01/89→07/90 | GN927 [2][222] GV666 | | 11V 11.5V | | | |

ESCORT V

| | | | | | | | | | | |
|--------------|---|--------------------------|---------|-------------|-------------------------|--|--------------|-------|----------------------------------|-------|
| 1.3 | 4 | J4B | 44/59 | 07/90→09/92 | Z67 | | 1.1 | UXT4 | ZS238 [1] ZS281 [1] | |
| 1.3 | 4 | J4B, J6A | 44/59 | 09/91→09/92 | | | | | ZS238 ZS281 | |
| 1.3 | 4 | J6A | 44/59 | 07/90→09/92 | Z67 | | 1.1 | UXT4 | ZS238 [1] ZS281 [1] | ZM003 |
| 1.4 | 4 | F6F, F6G | 52/70 | 07/90→12/92 | Z16 [171] | | 1.1 | UXT11 | ZS126 [1][214][254] ZS281 [1] | |
| 1.6 | 4 | CVH 2 VHC, CVH HL 16 EFI | 66/89 | 07/90→08/92 | | | | | ZS281 [1] | |
| 1.6 | 4 | LUJ, LUK | 66/89 | 07/90→08/92 | Z30 | | 0.8 | UXT5 | ZS126 [1][214][254] ZS281 | |
| 1.6 | 4 | LJF | 77/103 | 07/90→12/92 | Z99 | | 1.0 | UXT5 | ZS126 [1] →09/92 ZS281 [1] | |
| 1.6 | 4 | LJF | 77/103 | 07/90→09/92 | | | | | ZS126 [1][214][254] ZS281 [1] | |
| 1.8 16V | 4 | RDA | 77/103 | 02/92→12/92 | Z97 | | 1.0 | UXT8 | ZS281 | |
| 1.8 16V XR3i | 4 | RDA | 77/103 | 02/92→12/92 | Z97 | | 1.0 | UXT8 | ZS281 | |
| 1.8 16V XR3i | 4 | RQB | 96/129 | 02/92→12/92 | Z97 | | 1.0 | UXT8 | ZS281 | |
| 1.8 D | 4 | RTE, RTF, RTH | 44/59 | 07/90→12/92 | GN927 [2][222] GV666 | | 11V 11.5V | | | |
| 1.8 TD | 4 | | 55/74 | 05/91→12/92 | GV666 | | 11.5V | | | |
| 2.0 RS 2000 | 4 | N7A | 110/148 | 05/91→12/92 | Z99 | | 1.0 | UXT5 | ZS308 | |

ESCORT VI

| | | | | | | | | | | |
|---------|---|----------|-------|-------------|-------------------|--|------------|---------------|----------------------------------|-------|
| 1.3 | 4 | J4B | 44/59 | 09/92→01/95 | Z67 | | 1.1 | UXT4 | ZS238 ZS281 | |
| 1.3 | 4 | J6A | 44/59 | 09/92→01/95 | Z67 | | 1.1 | UXT4 | ZS238 ZS281 | ZM003 |
| 1.3 LPG | 4 | J4B, J6A | 44/59 | 09/92→01/95 | Z26 | | 0.7 | UXK56 | | |
| 1.4 | 4 | F6F, F6G | 52/70 | 09/92→01/95 | Z16 [171] | | 1.1 | UXT11 | ZS126 [1][214][254] ZS281 [1] | |
| 1.4 | 4 | F4B | 55/74 | 08/93→01/95 | Z16 | | 1.1 | UXT11 | ZS281 | |
| 1.4 | 4 | F4B, FUH | 55/74 | 01/94→01/95 | | | | | ZS126 [1][214][254] ZS281 [1] | ZM003 |
| 1.4 | 4 | FUH | 55/74 | 08/93→01/95 | Z24 | | 0.8 | UXT5 | ZS281 | |
| 1.4 LPG | 4 | F6F, F6G | 52/70 | 09/92→01/95 | Z340 | | 0.7 | UXT12 | | |
| 1.4 LPG | 4 | F4B | 55/74 | 08/93→01/95 | Z340 | | 0.7 | UXT12 | | |
| 1.4 LPG | 4 | F4B | 55/74 | 01/94→01/95 | Z30 [168] Z340 | | 0.8 0.7 | UXT5 UXT12 | | |
| 1.4 LPG | 4 | FUH | 55/74 | 08/93→01/95 | Z30 [168] | | 0.8 | UXT5 | | |
| 1.4 i | 4 | F4B | 55/74 | 07/93→08/98 | Z16 [171] | | 1.1 | UXT11 | | |

FORD



kW/BHP

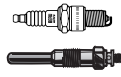

... FORD



... ESCORT VI

| | | | | | | | | | |
|---------------------|---|---------------|---------|-------------|------------------------------------|--|--------------|-------|---|
| 1.4 i | 4 | F4B | 55/74 | 07/93→01/95 | | | | | ZS281 01/94→ |
| 1.4 i LPG | 4 | F4B | 55/74 | 07/93→01/95 | Z340 | | 0.7 | UXT12 | |
| 1.6 16V XR3i | 4 | L1E | 66/89 | 12/92→01/95 | Z97 | | 1.0 | UXT8 | ZS281 |
| 1.6 i 16V | 4 | L1H | 65/87 | 01/94→01/95 | Z97 | | 1.0 | UXT8 | ZS281 |
| 1.6 i 16V | 4 | L1E, L1K | 66/89 | 09/92→02/99 | Z97 | | 1.0 | UXT8 | ZS281 |
| 1.8 16V XR3i | 4 | RDA | 77/103 | 12/92→01/95 | Z97 | | 1.0 | UXT8 | ZS281 |
| 1.8 16V XR3i | 4 | RQB | 96/129 | 09/92→01/95 | Z97 | | 1.0 | UXT8 | ZS281 |
| 1.8 D | 4 | RTE, RTE, RTH | 44/59 | 09/92→01/95 | GN927 ^{[2][222]} GV666 | | 11V 11.5V | | |
| 1.8 i 16V | 4 | RDA | 77/103 | 09/92→08/95 | Z97 | | 1.0 | UXT8 | |
| 1.8 i 16V | 4 | RDA | 77/103 | 09/92→01/95 | | | | | ZS239 ^[119] ZS281 |
| 1.8 i 16V | 4 | RQB | 96/129 | 02/93→01/95 | Z97 | | 1.0 | UXT8 | ZS281 |
| 1.8 TD | 4 | RFD, RFK | 66/89 | 02/93→01/95 | GN927 ^{[2][222]} GV666 | | 11V 11.5V | | |
| 1.8 TD | 4 | RFS | 66/89 | 02/93→01/95 | GN022 | | 10V | | |
| 1.8 XR3i 16V 4WD | 4 | RDA | 77/103 | 08/93→01/95 | Z97 | | 1.0 | UXT8 | ZS281 |
| 1.8 XR3i 16V 4WD | 4 | RQB | 96/129 | 08/93→01/95 | Z97 | | 1.0 | UXT8 | ZS281 |
| 2.0 RS 2000 | 4 | N7A | 110/148 | 09/92→01/95 | Z99 | | 1.0 | UXT5 | ZS308 |
| 2.0 RS 2000 LPG | 4 | N7A | 110/148 | 09/92→01/95 | Z30 ^[168] | | 0.8 | UXT5 | |
| 2.0 RS Cosworth 4WD | 4 | N5F | 162/217 | 09/92→01/95 | | | | | ZS126 ^[1] →05/94 ZS360 ^{[1][201]} |

ESCORT VII

| | | | | | | | | | |
|---------------------|---|---------------|---------|-------------|------------------------------------|--|--------------|-------|---|
| 1.3 | 4 | J4B, J6A | 44/59 | 01/95→02/99 | Z67 | | 1.1 | UXT4 | ZS238 →08/98 ZS281 →08/98 ZS350 09/98→ |
| 1.3 | 4 | J4B, J6A | 44/59 | 01/95→01/99 | | | | | ZM003 |
| 1.3 LPG | 4 | J4B, J6A | 44/59 | 01/95→02/99 | Z26 | | 0.7 | UXK56 | |
| 1.4 | 4 | F4B | 55/74 | 01/95→02/99 | Z16 | | 1.1 | UXT11 | ZS281 |
| 1.4 | 4 | FUH | 55/74 | 01/95→02/99 | Z24 | | 0.8 | UXT5 | ZS281 |
| 1.4 LPG | 4 | F4B | 55/74 | 01/95→02/99 | Z340 | | 0.7 | UXT12 | |
| 1.4 LPG | 4 | FUH | 55/74 | 01/95→02/99 | Z30 ^[168] | | 0.8 | UXT5 | |
| 1.6 16V XR3i | 4 | L1H | 65/87 | 02/95→12/96 | Z97 | | 1.0 | UXT8 | ZS281 |
| 1.6 16V XR3i | 4 | L1E | 66/89 | 02/95→09/99 | Z97 | | 1.0 | UXT8 | ZS281 |
| 1.6 i 16V | 4 | L1H | 65/87 | 01/95→08/95 | Z97 | | 1.0 | UXT8 | ZS281 |
| 1.6 i 16V | 4 | L1E, L1K | 66/89 | 01/95→02/99 | Z97 | | 1.0 | UXT8 | ZS281 |
| 1.8 16V | 4 | RDA | 77/103 | 01/95→08/95 | | | | | ZS281 |
| 1.8 16V | 4 | RKC | 85/114 | 01/95→02/99 | Z97 | | 1.0 | UXT8 | ZS281 |
| 1.8 16V | 4 | RKC | 85/114 | 01/95→10/98 | | | | | ZS238 |
| 1.8 16V XR3i | 4 | RDA | 77/103 | 02/95→08/98 | Z97 | | 1.0 | UXT8 | ZS281 |
| 1.8 16V XR3i | 4 | RKC | 85/114 | 10/95→08/98 | Z97 | | 1.0 | UXT8 | ZS281 |
| 1.8 16V XR3i | 4 | RQB | 96/129 | 02/95→08/00 | Z97 | | 1.0 | UXT8 | ZS281 |
| 1.8 D | 4 | RTE, RTE, RTH | 44/59 | 01/95→02/99 | GN927 ^{[2][222]} GV666 | | 11V 11.5V | | |
| 1.8 TD | 4 | RFD, RFK | 66/89 | 01/95→02/99 | GN927 ^{[2][222]} GV666 | | 11V 11.5V | | |
| 1.8 Turbo D | 4 | RVA | 51/68 | 12/95→08/99 | GN022 | | 10V | | |
| 2.0 RS 2000 | 4 | N7A | 110/148 | 02/95→10/98 | Z99 | | 1.0 | UXT5 | ZS308 →08/96 |
| 2.0 RS 2000 LPG | 4 | N7A | 110/148 | 02/95→10/98 | Z30 ^[168] | | 0.8 | UXT5 | |
| 2.0 RS Cosworth 4WD | 4 | N5F | 162/217 | 02/95→10/98 | | | | | ZS360 |



kW/BHP

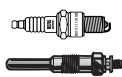

... FORD



ESCORT CLASSIC

| | | | | | | | | | |
|---------|---|----------|-------|-------------|-------------------------|--------------|------|-------|--|
| 1.6 16V | 4 | L1E | 66/89 | 10/98→07/00 | Z97 | 1.0 | UXT8 | ZS281 | |
| 1.8 TD | 4 | RFD, RFK | 66/89 | 10/98→07/00 | GN927 [2][222] GV666 | 11V 11.5V | | | |

FIESTA I

| | | | | | | | | | |
|---------|---|----------|-------|-------------|-----|-----|------|----------------------|--|
| 0.9 | 4 | TKA, TKW | 29/39 | 05/76→08/83 | Z95 | 0.7 | UXT4 | ZS109 [15] | |
| 0.9 | 4 | TLA | 33/44 | 05/76→08/83 | Z95 | 0.7 | UXT4 | ZS109 [15] | |
| 1.1 | 4 | GLA | 39/52 | 05/76→08/83 | Z95 | 0.7 | UXT4 | ZS109 [15] | |
| 1.1 | 4 | GLW | 40/54 | 02/81→08/83 | Z95 | 0.7 | UXT4 | ZS109 [15] | |
| 1.3 | 4 | J3E | 49/66 | 08/77→08/83 | Z30 | 0.8 | UXT5 | ZS109 [15] →09/81 | |
| 1.6 XR2 | 4 | L3E | 62/83 | 08/81→08/83 | Z30 | 0.8 | UXT5 | | |

FIESTA II

| | | | | | | | | | |
|---------|---|----------|-------|-------------|--------------------------------------|--------------------------------|-------------------------|----------------------------------|--------------------------------|
| 1.0 | 4 | TKB | 33/44 | 09/83→02/89 | Z95 | 0.7 | UXT4 | ZS126 | ZM003 05/86→ |
| 1.0 | 4 | TLB | 33/44 | 09/83→11/89 | Z67 | 1.1 | UXT4 | | |
| 1.1 | 4 | GSH | 36/48 | 05/86→02/89 | Z95 | 0.7 | UXT4 | ZS126 [1] | ZM003 |
| 1.1 | 4 | GLC, GSF | 37/50 | 09/83→02/89 | Z95 | 0.7 | UXT4 | ZS126 | |
| 1.3 | 4 | JPC | 51/68 | 09/83→01/87 | Z24 | 0.8 | UXT5 | ZS126 →12/85 | |
| 1.4 | 4 | FUBA | 51/68 | 09/83→01/87 | Z24 | 0.8 | UXT5 | ZS126 | |
| 1.4 | 4 | F6A, F6C | 52/70 | 10/86→02/89 | Z99 →07/88 Z16 [171] 08/88→ | 1.0 →07/88 1.1 08/88→ | UXT5 →01/88 UXT11 | ZS126 [1] →01/88 ZS237 [1] | ZM020 |
| 1.4 | 4 | FUD | 54/72 | 02/87→02/89 | Z99 | 1.0 | UXT5 | ZS126 [1] | ZM020 |
| 1.4 | 4 | FUB | 55/74 | 10/85→11/89 | Z24 | 0.8 | UXT5 | ZS126 01/86→02/89 | ZM020 →02/89 ZM003 [175] |
| 1.6 D | 4 | LTB | 40/54 | 04/84→02/89 | GN927 [2][222] GV631 | 11V 11.5V | | | |
| 1.6 XR2 | 4 | LUD | 70/94 | 03/84→02/89 | Z24 | 0.8 | UXT5 | ZS126 | ZM020 01/86→ |
| 1.6 XR2 | 4 | LUB | 71/95 | 04/84→02/89 | Z24 [7] Z30 [6] | 0.8 0.8 | UXT5 | ZS126 | ZM020 01/86→ |

FIESTA III

| | | | | | | | | | |
|---------|---|------------|-------|-------------|---------------|---------------|-------|---|-------|
| 1.0 | 4 | TLB | 33/44 | 03/89→12/95 | Z67 | 1.1 | UXT4 | ZS281 | |
| 1.0 LPG | 4 | TLB | 33/44 | 03/89→12/95 | Z26 | 0.7 | UXK56 | | |
| 1.1 | 4 | G6A | 37/50 | 03/89→12/95 | Z67 | 1.1 | UXT4 | ZS238 →12/91 ZS281 ZS237 01/92→ | ZM047 |
| 1.1 | 4 | GUD, GUE | 40/54 | 03/89→12/95 | Z67 | 1.1 | UXT4 | ZS238 ZS281 | ZM047 |
| 1.1 LPG | 4 | G6A | 37/50 | 03/89→12/95 | Z26 | 0.7 | UXK56 | | |
| 1.1 LPG | 4 | GUD, GUE | 40/54 | 03/89→12/95 | Z26 | 0.7 | UXK56 | | |
| 1.3 | 4 | | 44/59 | 03/89→12/95 | Z67 06/91→ | 1.1 06/91→ | UXT4 | ZS237 | |
| 1.3 | 4 | J6B | 44/59 | 05/91→01/97 | Z67 | 1.1 | UXT4 | ZS238 ZS281 01/92→ | |
| 1.3 | 4 | JBC | 44/59 | 03/89→12/92 | Z67 | 1.1 | UXT4 | ZS281 | |
| 1.3 LPG | 4 | J6B | 44/59 | 05/91→01/97 | Z26 | 0.7 | UXK56 | | |
| 1.4 | 4 | CVH CF ILC | 52/70 | 03/89→12/95 | | | | ZS281 | |
| 1.4 | 4 | F6E | 52/70 | 03/89→12/95 | Z16 [171] | 1.1 | UXT11 | | ZM020 |
| 1.4 | 4 | CVH CF ILC | 54/72 | 03/89→12/95 | | | | ZS281 [1] | |

FORD



kW/BHP

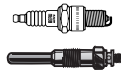

... FORD



... FIESTA III

| | | | | | | | | | | |
|------------------|---|--------------------------------------|--------|-------------|-------------------------|--|--------------|-------|---|-----------------|
| 1.4 | 4 | F4A | 54/72 | 03/89→12/95 | Z16 [171] | | 1.1 | UXT11 | ZS126 [1] →12/93 ZS281 [1] 01/94→ | |
| 1.4 | 4 | FUG | 54/72 | 03/89→12/95 | Z99 | | 1.0 | UXT5 | ZS126 [1] | |
| 1.4 | 4 | FUJ | 54/72 | 03/89→12/95 | Z24 | | 0.8 | UXT5 | ZS126 [1] | |
| 1.4 LPG | 4 | F6E | 52/70 | 03/89→12/95 | Z340 | | 0.7 | UXT12 | | |
| 1.4 LPG | 4 | F4A | 54/72 | 03/89→12/95 | Z340 | | 0.7 | UXT12 | | |
| 1.4 LPG | 4 | FUG, FUJ | 54/72 | 03/89→12/95 | Z30 [168] | | 0.8 | UXT5 | | |
| 1.6 | 4 | LUH | 65/87 | 01/89→01/94 | Z24 | | 0.8 | UXT5 | ZS281 [1] ZS126 [1] 03/89→ | ZM020 →07/90 |
| 1.6 | 4 | LUH | 66/89 | 03/89→12/92 | Z24 | | 0.8 | UXT5 | ZS126 [1][214][254] ZS281 [1] | |
| 1.6 i 16V | 4 | L1G | 65/87 | 01/94→12/95 | Z177 | | 1.3 | UXT7 | ZS239 [119] ZS281 | |
| 1.6 Turbo | 4 | LHA | 96/129 | 03/90→10/92 | | | | | ZS281 [1] ZS126 [1] 07/90→ | |
| 1.6 XR2i | 4 | LJD | 76/102 | 03/89→03/93 | Z99 | | 1.0 | UXT5 | ZS126 [1][214][254] ZS281 [1] | |
| 1.6 XR2i | 4 | LJC | 81/109 | 03/89→01/94 | Z99 | | 1.0 | UXT5 | ZS126 | |
| 1.8 16V | 4 | RDB | 77/103 | 02/92→12/95 | Z177 | | 1.3 | UXT7 | ZS239 [119] ZS281 | |
| 1.8 D | 4 | RTC, RTD, RTG | 44/59 | 03/89→12/95 | GN927 [2][222] GV666 | | 11V 11.5V | | | |
| 1.8 TD | 4 | RFL | 55/74 | 03/93→12/95 | GV666 | | 11.5V | | | |
| 1.8 XR2i 16V | 4 | RQC | 96/129 | 02/92→12/95 | Z177 | | 1.3 | UXT7 | ZS281 →12/93 | |
| FIESTA IV | | | | | | | | | | |
| 1.3 1.25 i 16V | 4 | DHA, DHB, DHC, DHD, DHE, DHE, DHG | 55/74 | 08/95→01/02 | Z177 | | 1.3 | UXT7 | ZS238 →04/98 ZS281 →04/98 ZS350 05/98→ | |
| 1.3 i | 4 | JJA, JJM | 37/50 | 08/95→01/02 | Z67 | | 1.1 | UXT4 | ZS281 →08/98 | |
| 1.3 i | 4 | JJC, JJE, JJJ, JJK | 37/50 | 08/95→01/02 | | | | | ZS281 →08/98 | |
| 1.3 i | 4 | | 44/59 | 04/96→08/99 | Z67 | | 1.1 | UXT4 | ZS281 ZS422 | |
| 1.3 i | 4 | J4C, J4T | 44/59 | 08/95→01/02 | Z67 | | 1.1 | UXT4 | ZS281 →08/98 | |
| 1.3 i | 4 | J4J, J4L, J4Q, J4R, JBC | 44/59 | 08/95→01/02 | | | | | ZS281 →08/98 | |
| 1.3 i LPG | 4 | JJA, JJM | 37/50 | 08/95→01/02 | Z26 | | 0.7 | UXK56 | | |
| 1.3 i LPG | 4 | J4C, J4T | 44/59 | 08/95→01/02 | Z26 | | 0.7 | UXK56 | | |
| 1.4 i 16V | 4 | FHA, FHE | 66/89 | 04/96→01/02 | Z177 | | 1.3 | UXT7 | ZS238 →04/98 ZS281 →04/98 ZS350 05/98→ | |
| 1.6 16V Sport | 4 | L1T, L1V | 76/102 | 02/00→01/02 | Z177 | | 1.3 | UXT7 | ZS281 | |
| 1.8 D | 4 | RTJ, RTK | 44/59 | 08/95→04/00 | GN022 | | 10V | | | |
| 1.8 DI | 4 | RTN, RTP, RTQ | 55/74 | 04/00→01/02 | GN993 | | 10V | | | |



kW/BHP

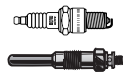

... FORD



FIESTA V

| | | | | | | | | |
|-----------|---|------------|---------|-------------|------------------------------------|-----|-------|------------------------------------|
| 1.3 | 4 | BAJA | 44/59 | 11/01→06/08 | Z177 | 1.3 | UXT7 | ZS350 [1] |
| 1.3 | 4 | A9JA, A9JB | 51/68 | 11/01→06/08 | Z177 | 1.3 | UXT7 | ZS350 [1] |
| 1.3 16V | 4 | M7JA, M7JB | 51/68 | 03/03→06/08 | Z177 | 1.3 | UXT7 | ZS387 03/05→ |
| 1.3 16V | 4 | FUJA, FUJB | 55/74 | 05/02→06/08 | Z177 | 1.3 | UXT7 | ZS422 →02/05 ZS387 03/05→ |
| 1.4 16V | 4 | FXJA, FXJB | 59/79 | 11/01→06/08 | Z177 | 1.3 | UXT7 | ZS350 →02/05 ZS387 03/05→ |
| 1.4 TDCi | 4 | F6JA, F6JB | 50/67 | 11/01→06/08 | GN047 →10/04 GN056 11/04→ | 11V | | |
| 1.6 16V | 4 | FYJA | 74/99 | 11/01→06/08 | Z177 | 1.3 | UXT7 | ZS350 →02/05 ZS387 03/05→ |
| 1.6 16V | 4 | FYJB | 74/99 | 11/01→06/08 | | | | ZS350 →02/05 ZS387 03/05→ |
| 1.6 TDCi | 4 | HHJA, HHJB | 66/89 | 11/04→06/08 | GN047 →05/06 GN056 06/06→ | 11V | | |
| 2.0 ST150 | 4 | N4JB | 110/148 | 03/05→06/08 | Z209 | 1.3 | UXT15 | |

FIESTA VI

| | | | | | | | | |
|----------|---|------------------|--------|--------|--------|-----|------|-------|
| 1.3 | 4 | STJA, STJB | 44/59 | 06/08→ | Z177 | 1.3 | UXT7 | ZS387 |
| 1.3 | 4 | SNJA, SNJB | 60/80 | 06/08→ | Z177 | 1.3 | UXT7 | ZS387 |
| 1.4 | 4 | SPJA, SPJC | 71/95 | 06/08→ | Z177 | 1.3 | UXT7 | ZS387 |
| 1.4 LPG | 4 | RTJA, RTJB | 68/91 | 01/09→ | | | | ZS387 |
| 1.4 LPG | 4 | RTJA, RTJB | 71/95 | 01/09→ | Z177 | 1.3 | UXT7 | ZS387 |
| 1.4 TDCi | 4 | F6JB | 50/67 | 01/09→ | GN056 | 11V | | |
| 1.4 TDCi | 4 | F6JD | 51/68 | 07/10→ | GN056 | 11V | | |
| 1.5 TDCi | 4 | UGJC | 55/74 | 09/12→ | GE121A | 5V | | |
| 1.6 TDCi | 4 | HHJF, UBJA | 55/74 | 06/08→ | GN056 | 11V | | |
| 1.6 TDCi | 4 | HHJC, HHJD, HHJE | 66/89 | 06/08→ | GN056 | 11V | | |
| 1.6 TDCi | 4 | TZJA, TZJB | 70/94 | 02/10→ | GE121A | 5V | | |
| 1.6 Ti | 4 | HXJA, HXJB | 88/118 | 06/08→ | Z177 | 1.3 | UXT7 | ZS387 |
| 1.6 Ti | 4 | U5JA | 99/133 | 12/10→ | | | | ZS387 |

FOCUS

| | | | | | | | | |
|-------------------|---|------------------------------|--------|-------------|-------------|------------|--------------|-----------------|
| 1.4 16V | 4 | FXDA, FXDB, FXDC, FXDD | 55/74 | 10/98→11/04 | Z177 | 1.3 | UXT7 | ZS350 |
| 1.6 16V | 4 | FYDA, FYDB, FYDC, FYDD | 74/99 | 10/98→11/04 | Z177 | 1.3 | UXT7 | ZS350 |
| 1.6 16V | 4 | FYDA, FYDB, FYDC, FYDD, FYDH | 74/99 | 02/99→11/04 | | | | ZS350 →07/04 |
| 1.6 16V | 4 | FYDH | 74/99 | 10/98→11/04 | | | | ZS350 |
| 1.6 16V Flexifuel | 4 | FYDA, FYDH | 75/101 | 01/02→11/04 | Z177 | 1.3 | UXT7 | |
| 1.8 16V | 4 | EYDB, EYDC, EYDD, EYDE, EYDF | 85/114 | 10/98→11/04 | Z97 | 1.0 | UXT8 | ZS350 →07/04 |
| 1.8 16V | 4 | EYDB, EYDC, EYDD, EYDE, EYDF | 85/114 | 02/99→11/04 | Z177 Z97 | 1.3 1.0 | UXT7 UXT8 | |
| 1.8 16V | 4 | EYDG, EYDI, EYDJ, EYDL | 85/114 | 10/98→11/04 | | | | ZS350 →07/04 |
| 1.8 16V | 4 | EYDG, EYDI, EYDJ, EYDL | 85/114 | 02/99→11/04 | Z177 | 1.3 | UXT7 | |
| 1.8 DI / TDDi | 4 | BHDA, BHDB | 55/74 | 08/99→11/04 | GN993 | 10V | | |
| 1.8 TDCi | 4 | FFDA | 74/99 | 08/02→11/04 | GN993 | 10V | | |

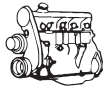

kW/BHP

**... FORD****... FOCUS**

| | | | | | | | | |
|---------------------|---|------------------------|---------|-------------|-------|-----|------|-----------------|
| 1.8 TDCi | 4 | F9DA, F9DB | 85/114 | 03/01→11/04 | GN993 | 10V | | |
| 1.8 Turbo DI / TDDi | 4 | BHDA, BHDB | 55/74 | 08/01→03/05 | GN993 | 10V | | |
| 1.8 Turbo DI / TDDi | 4 | 9DC, C9DA, C9DB, C9DC | 66/89 | 10/98→11/04 | GN993 | 10V | | |
| 2.0 16V | 4 | EDDB, EDDC, EDDD, EDDF | 96/129 | 10/98→11/04 | Z97 | 1.0 | UXT8 | ZS350 →07/04 |
| 2.0 RS | 4 | HMDA | 158/212 | 10/02→11/04 | Z177 | 1.3 | UXT7 | ZS350 |
| 2.0 ST170 | 4 | ALDA | 127/170 | 03/02→11/04 | Z315 | 1.3 | | ZS350 |

FOCUS II

| | | | | | | | | |
|---------------|---|------------------------------|---------|--------|--|------------|-----------------|------------------------------------|
| 1.4 | 4 | ASDA, ASDB | 59/79 | 11/04→ | Z177 | 1.3 | UXT7 | ZS387 03/05→ |
| 1.4 | 4 | ASDA, ASDB | 59/79 | 04/05→ | | | | ZS387 |
| 1.6 | 4 | HWDA, HWDB, SHDA, SHDB, SHDC | 74/99 | 11/04→ | Z177 | 1.3 | UXT7 | ZS387 03/05→ |
| 1.6 | 4 | HWDA, HWDB, SHDA, SHDB, SHDC | 74/99 | 04/05→ | | | | ZS387 |
| 1.6 | 4 | HWDA, HWDB, SHDA, SHDB, SHDC | 74/99 | 10/06→ | | | | ZS387 →10/09 |
| 1.6 LPG | 4 | SIDA | 85/114 | 10/09→ | | | | ZS387 |
| 1.6 TDCi | 4 | GPDA, GPDC, HHDA, HHDB | 66/89 | 11/04→ | GN047 ^{[1][73]} GN056 ^{[1][74]} | 11V | | |
| 1.6 TDCi | 4 | G8DC, MTDA | 74/99 | 11/04→ | GN047 ^[73] →03/06 GN056 ^[74] 04/06→ | 11V | | |
| 1.6 TDCi | 4 | G8DC, MTDA | 74/99 | 04/05→ | GN047 ^[73] GN056 ^[74] | 11V 11V | | |
| 1.6 TDCi | 4 | G8DA, G8DB, G8DD, G8DE, G8DF | 80/107 | 11/04→ | GN047 →05/06 GN056 06/06→ | 11V 11V | | |
| 1.6 TDCi | 4 | G8DA | 81/109 | 12/07→ | GN047 ^[73] GN056 ^[74] | 11V 11V | | |
| 1.6 Ti | 4 | HXDA, HXDB | 85/114 | 11/04→ | Z177 | 1.3 | UXT7 | ZS422 →02/05 ZS387 03/05→ |
| 1.6 Ti | 4 | HXDA, HXDB | 85/114 | 04/05→ | | | | ZS387 |
| 1.8 | 4 | Q7DA, QQDB | 92/123 | 03/06→ | Z209 | 1.3 | UXT15 | ZS408 |
| 1.8 Flexifuel | 4 | Q7DA | 92/123 | 01/06→ | Z209 →01/08 | 1.3 | UXT15 →01/08 | ZS408 |
| 1.8 Flexifuel | 4 | QQDD | 96/129 | 12/05→ | Z209 | 1.3 | UXT15 | |
| 1.8 TDCi | 4 | KKDA, KKDB | 85/114 | 11/04→ | GN993 | 10V | | |
| 2.0 | 4 | AODA, AODB | 107/143 | 11/04→ | Z209 | 1.3 | UXT15 | ZS408 |
| 2.0 CNG | 4 | SYDA | 107/143 | 04/09→ | Z209 | 1.3 | UXT15 | ZS408 |
| 2.0 LPG | 4 | SYDA | 107/143 | 06/08→ | Z209 | 1.3 | UXT15 | ZS408 |
| 2.0 TDCi | 4 | IXDA | 81/109 | 02/08→ | GN054 | 11V | | |
| 2.0 TDCi | 4 | G6DE, G6DF | 98/131 | 11/04→ | GN054 | 11V | | |
| 2.0 TDCi | 4 | G6DA, G6DB, G6DD | 100/134 | 11/04→ | GN054 | 11V | | |
| 2.5 RS | 5 | JZDA | 224/300 | 01/09→ | | | | ZSE055 →07/11 |
| 2.5 RS 500 | 5 | JZDA | 257/345 | 05/10→ | | | | ZSE055 →07/11 |
| 2.5 ST | 5 | HYDA | 166/223 | 10/05→ | Z326 →01/08 | 0.7 | | ZSE055 |
| 2.5 ST LPG | 5 | HYDA | 166/223 | 10/05→ | Z226 ^[168] →01/08 | 0.8 | | |

FOCUS III

| | | | | | | | | |
|---------------|---|------------|--------|--------|--------|----|--|-------|
| 1.6 Flexifuel | 4 | MUDA | 88/118 | 05/11→ | | | | ZS387 |
| 1.6 TDCi | 4 | T3DA, T3DB | 70/94 | 04/11→ | GE121A | 5V | | |



kW/BHP



... FORD



... FOCUS III

| | | | | | | | | |
|-------------------|---|------------|---------|--------|--------|-----|------|-------|
| 1.6 TDCi | 4 | T1DA, T1DB | 85/114 | 04/11→ | GE121A | 5V | | |
| 1.6 TDCi ECONetic | 4 | NGDA | 77/103 | 05/12→ | GE121A | 5V | | |
| 1.6 Ti | 4 | XTDA | 63/84 | 08/11→ | | | | ZS387 |
| 1.6 Ti | 4 | IQDB | 77/103 | 04/11→ | Z177 | 1.3 | UXT7 | ZS387 |
| 1.6 Ti | 4 | PNDA | 92/123 | 04/11→ | | | | ZS387 |
| 2.0 TDCi | 4 | TYDA | 85/114 | 04/11→ | GE121A | 5V | | |
| 2.0 TDCi | 4 | UKDB | 100/134 | 04/11→ | GE121A | 5V | | |
| 2.0 TDCi | 4 | UFDB | 103/138 | 04/11→ | GE121A | 5V | | |
| 2.0 TDCi | 4 | TXDB | 120/161 | 04/11→ | GE121A | 5V | | |

FOCUS C-MAX

| | | | | | | | | |
|---------------|---|------------------------|---------|-------------|------------------------------------|-----|-------|-----------------|
| 1.6 | 4 | HWDA, HWDB | 74/99 | 10/03→03/07 | Z177 | 1.3 | UXT7 | ZS387 03/05→ |
| 1.6 TDCi | 4 | HHDA, HHDB | 66/89 | 02/05→03/07 | GN047 →05/06 GN056 06/06→ | 11V | | |
| 1.6 TDCi | 4 | G8DA, G8DB | 80/107 | 10/03→03/07 | GN047 →05/06 GN056 06/06→ | 11V | | |
| 1.6 Ti | 4 | HXDA, SIDA | 85/114 | 08/04→03/07 | Z177 | 1.3 | UXT7 | ZS387 03/05→ |
| 1.8 | 4 | CSDA, CSDB | 88/118 | 10/03→03/07 | Z209 | 1.3 | UXT15 | ZS408 |
| 1.8 | 4 | QQDC | 90/121 | 09/05→03/07 | | | | ZS408 |
| 1.8 | 4 | Q7DA, QQDA, QQDB | 92/123 | 04/04→03/07 | Z209 | 1.3 | UXT15 | ZS408 |
| 1.8 Flexifuel | 4 | Q7DA | 92/123 | 01/06→03/07 | Z209 | 1.3 | UXT15 | ZS408 |
| 1.8 TDCi | 4 | KKDA | 85/114 | 01/05→03/07 | GN993 | 10V | | |
| 2.0 | 4 | AODA, AODB, SYDA | 107/143 | 03/04→03/07 | Z209 | 1.3 | UXT15 | ZS408 |
| 2.0 TDCi | 4 | G6DC, G6DE, G6DF | 98/131 | 10/03→03/07 | GN054 | 11V | | |
| 2.0 TDCi | 4 | G6DA, G6DB, G6DD, G6DG | 100/134 | 10/03→03/07 | GN054 | 11V | | |

FUSION

| | | | | | | | | |
|----------|---|------------|-------|--------|------------------------------------|-----|------|------------------------------------|
| 1.3 | 4 | FUJA, FUJB | 55/74 | 08/04→ | Z177 | 1.3 | UXT7 | ZS387 03/05→ |
| 1.4 | 4 | FXJA, FXJB | 59/79 | 08/02→ | Z177 | 1.3 | UXT7 | ZS387 03/05→ |
| 1.4 | 4 | FXJC | 59/79 | 08/02→ | | | | ZS387 03/05→ |
| 1.4 LPG | 4 | UTJA | 59/79 | 01/10→ | | | | ZS387 →06/12 |
| 1.4 TDCi | 4 | F6JA, F6JB | 50/67 | 08/02→ | GN047 →10/04 GN056 11/04→ | 11V | | |
| 1.6 | 4 | FYJA | 74/99 | 08/02→ | Z177 | 1.3 | UXT7 | ZS350 →02/05 ZS387 03/05→ |
| 1.6 | 4 | FYJB | 74/99 | 08/02→ | | | | ZS350 →02/05 ZS387 03/05→ |
| 1.6 TDCi | 4 | HHJA, HHJB | 66/89 | 11/04→ | GN047 | 11V | | |

GALAXY

| | | | | | | | | |
|----------|---|--------------|--------|-------------|---------------------------------|-----|--|--|
| 1.6 TDCi | 4 | T1WA, T1WB | 85/114 | 02/11→ | GE121A | 5V | | |
| 1.8 TDCi | 4 | FFWA | 74/99 | 05/06→ | GN993 | 10V | | |
| 1.8 TDCi | 4 | QYWA | 92/123 | 05/06→ | GN993 | 10V | | |
| 1.9 TDI | 4 | 1Z, AHU, ANU | 66/89 | 03/95→05/06 | GN046 [1][58] GN855 [1][122] | 12V | | |

FORD

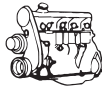

kW/BHP

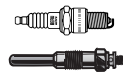

... FORD



... GALAXY

| | | | | | | | | |
|---------------|---|------------------|---------|-------------|-----------------|-------|-------|--------|
| 1.9 TDI | 4 | AFN, AVG | 81/109 | 08/97→04/00 | GN855 | 12V | | |
| 1.9 TDI | 4 | AUY | 85/114 | 04/00→05/06 | GN855 | 12V | | |
| | | | | | →10/01 GN046 | 12V | | |
| | | | | | 11/01→ | | | |
| 1.9 TDI | 4 | ASZ | 96/129 | 02/03→05/06 | GN046 | 12V | | |
| 1.9 TDI | 4 | BTB | 110/148 | 05/05→05/06 | GN046 | 12V | | |
| 2.0 | 4 | AOWA, AOWB | 107/143 | 05/06→ | Z230 | 1.3 | | ZS408 |
| 2.0 Flexifuel | 4 | TBWA, TBWB | 107/143 | 05/06→ | | | | ZS408 |
| 2.0 i | 4 | NSE, ZVSA | 85/114 | 11/95→05/06 | Z130 | 1.0 | UXT14 | ZS422 |
| | | | | | | | | 01/01→ |
| 2.0 TDCi | 4 | KLWA | 85/114 | 11/07→ | GN054 | 11V | | |
| | | | | | →02/10 | | | |
| 2.0 TDCi | 4 | TYWA | 85/114 | 11/07→ | GE121A | 5V | | |
| | | | | | 03/10→ | | | |
| 2.0 TDCi | 4 | AZWA | 96/129 | 05/06→ | GN054 | 11V | | |
| 2.0 TDCi | 4 | AZWC | 100/134 | 05/06→ | GN054 | 11V | | |
| 2.0 TDCi | 4 | UKWA | 100/134 | 05/06→ | GE121A | 5V | | |
| | | | | | 03/10→ | | | |
| 2.0 TDCi | 4 | QXWA, QXWB, QXWC | 103/138 | 05/06→ | GN939 | 11.5V | | |
| 2.0 TDCi | 4 | UFWA | 103/138 | 05/06→ | GE121A | 5V | | |
| 2.0 TDCi | 4 | TXWA | 120/161 | 03/10→ | GE121A | 5V | | |
| 2.2 TDCi | 4 | Q4BA, Q4WA | 129/173 | 03/08→ | GN063 | 11V | | |
| 2.3 | 4 | SEWA | 118/158 | 07/07→ | Z342 | 1.3 | UXT7 | |
| 2.3 16V | 4 | ESSB | 103/138 | 09/01→05/06 | Z159 | 1.1 | UXT14 | ZS422 |
| 2.3 16V | 4 | ESSA, Y5B | 107/143 | 01/97→05/06 | Z159 | 1.1 | UXT14 | ZS422 |
| | | | | | | | | 04/00→ |
| 2.3 16V LPG | 4 | ESSB | 103/138 | 09/01→05/06 | Z30 [168] | 0.8 | UXT5 | |
| 2.3 16V LPG | 4 | ESSA, Y5B | 107/143 | 01/97→05/06 | Z30 [168] | 0.8 | UXT5 | |
| 2.8 i V6 | 6 | AAA, AMY | 128/172 | 11/95→04/00 | Z173 | 1.6 | | ZSE004 |
| 2.8 i V6 LPG | 6 | AAA, AMY | 128/172 | 11/95→04/00 | Z172 | 1.6 | | |
| 2.8 V6 | 6 | AYL | 150/201 | 04/00→05/06 | Z176 | 1.1 | | ZSE089 |

GRANADA

| | | | | | | | | |
|-------|---|------------------|--------|-------------|----------------|-------|-------------|--|
| 1.6 | 4 | LCK | 55/74 | 07/81→08/85 | Z33 | 0.7 | | |
| 1.7 | 4 | LC | 48/64 | 03/72→02/75 | Z11 | 0.8 | UXT2 / UXT6 | |
| 1.7 | 4 | MWB, TV 17 LC | 51/68 | 12/74→05/82 | Z20 | 0.8 | UXT2 / UXT6 | |
| 1.7 | 4 | MY, MYE | 54/72 | 08/77→07/81 | Z27 [168] | 0.8 | UX56 | |
| 1.7 | 4 | TV 17 H | 55/74 | 03/72→02/75 | Z27 [168] | 0.8 | UX56 | |
| 1.9 D | 4 | | 40/54 | 08/77→08/82 | GV107 | 10.5V | | |
| | | | | | →02/79 | | | |
| | | | | | GN909 [222] | 11V | | |
| | | | | | 03/79→ | | | |
| | | | | | GV602 | 11V | | |
| | | | | | 03/79→ | | | |
| 2.0 | 4 | OHC LC, TL 20 LC | 64/86 | 01/76→07/79 | Z32 | 0.7 | | |
| 2.0 | 4 | TL 20 LC | 70/94 | 01/76→07/77 | Z32 | 0.7 | | |
| 2.0 | 4 | TL 20 LC | 73/98 | 03/72→12/75 | Z32 | 0.7 | | |
| 2.0 | 4 | NEP | 74/99 | 08/79→08/85 | Z32 | 0.7 | | |
| | | | | | Z32 [169] | 0.7 | | |
| 2.0 | 4 | NEK | 77/103 | 08/81→08/85 | Z32 | 0.7 | | |
| 2.0 | 6 | NY | 66/89 | 01/75→08/77 | Z27 [168] | 0.8 | UX56 | |
| 2.0 | 6 | NYP | 66/89 | 08/77→08/85 | Z20 | 0.8 | UXT2 / UXT6 | |
| 2.1 D | 4 | WTA | 46/62 | 08/77→08/82 | GN909 [2][222] | 11V | | |
| | | | | | GV602 | 11V | | |
| 2.3 | 6 | YYH | 79/106 | 01/72→06/79 | Z27 [168] | 0.8 | UX56 | |
| 2.3 | 6 | YYU | 82/110 | 06/81→08/85 | Z20 | 0.8 | UXT2 / UXT6 | |
| 2.3 | 6 | YYP | 84/113 | 06/79→08/85 | Z20 | 0.8 | UXT2 / UXT6 | |
| 2.5 D | 4 | STP | 51/68 | 08/82→08/85 | GN909 | 11V | | |
| 2.6 | 6 | TV 26 L | 79/106 | 12/75→08/77 | Z27 [168] | 0.8 | UX56 | |



kW/BHP



... FORD



... GRANADA

| | | | | | | | | |
|-------|---|---------|---------|-------------|----------------------|-----|-------------|-------|
| 2.6 | 6 | UY | 92/123 | 01/72→02/76 | Z27 ^[168] | 0.8 | UX56 | |
| 2.8 | 6 | PYU | 97/130 | 06/81→08/85 | Z20 | 0.8 | UXT2 / UXT6 | |
| 2.8 | 6 | PYA | 99/133 | 08/77→08/85 | Z20 | 0.8 | UXT2 / UXT6 | |
| 2.8 i | 6 | PRD | 108/145 | 08/77→08/85 | Z20 | 0.8 | UXT2 / UXT6 | |
| 2.8 i | 6 | PRC | 110/148 | 10/82→08/85 | Z20 | 0.8 | UXT2 / UXT6 | |
| 2.8 i | 6 | PRB | 118/158 | 08/77→08/81 | Z27 ^[168] | 0.8 | UX56 | ZS126 |
| 3.0 | 6 | EV 30 H | 101/135 | 01/72→02/76 | Z27 ^[168] | 0.8 | UX56 | |

GRAND C-MAX

| | | | | | | | | |
|--------------|---|------------|---------|--------|--------|-----|------|-----------------|
| 1.6 EcoBoost | 4 | JQDA, JQDB | 110/148 | 12/10→ | | | | ZS387 |
| 1.6 EcoBoost | 4 | JTDA, JTDB | 134/180 | 12/10→ | | | | ZS387 |
| 1.6 TDGi | 4 | T3DA, T3DB | 70/94 | 12/10→ | GE121A | 5V | | |
| 1.6 TDGi | 4 | T1DA, T1DB | 85/114 | 12/10→ | GE121A | 5V | | |
| 1.6 Ti | 4 | IQDA, IQDB | 77/103 | 12/10→ | Z177 | 1.3 | UXT7 | ZS387 →05/11 |
| 1.6 Ti | 4 | PNDA | 92/123 | 12/10→ | | | | ZS387 →05/11 |
| 2.0 TDGi | 4 | TYDA | 85/114 | 02/11→ | GE121A | 5V | | |
| 2.0 TDGi | 4 | UKDB | 100/134 | 02/11→ | GE121A | 5V | | |
| 2.0 TDGi | 4 | UFDB | 103/138 | 02/11→ | GE121A | 5V | | |
| 2.0 TDGi | 4 | TXDB | 120/161 | 12/10→ | GE121A | 5V | | |

GT

| | | | | | | | | |
|-----|---|--|---------|--------|--|--|--|-------|
| 5.4 | 8 | | 368/493 | 06/03→ | | | | ZS369 |
|-----|---|--|---------|--------|--|--|--|-------|

KA

| | | | | | | | | |
|-----------|---|------------------------------|-------|-------------|-----------------------|------|-----------------|---|
| 1.0 i | 4 | ZH10JRB | 38/51 | 07/97→09/99 | Z67 | 1.1 | UXT4 | |
| 1.0 i | 4 | | 48/64 | 09/99→11/08 | Z67 | 1.1 | UXT4 | |
| 1.0 i LPG | 4 | ZH10JRB | 38/51 | 07/97→09/99 | Z26 | 0.7 | UXK56 | |
| 1.0 i LPG | 4 | | 48/64 | 09/99→11/08 | Z26 | 0.7 | UXK56 | |
| 1.2 | 4 | FP4 | 51/68 | 10/08→ | Z293 | 1.05 | | ZS079 |
| 1.2 LPG | 4 | FP4 | 51/68 | 10/08→ | Z291 ^[168] | 0.9 | | |
| 1.3 i | 4 | JJD, JJF, JJG, JJH, JJJ | 36/48 | 06/98→11/08 | Z67 | 1.1 | UXT4 | ZS237 →09/98 ZS281 →09/98 ZS350 09/98→ |
| 1.3 i | 4 | JJB | 37/50 | 09/96→10/02 | Z67 | 1.1 | UXT4 | ZS237 →09/98 ZS281 →09/98 ZS350 09/98→ |
| 1.3 i | 4 | BAA | 44/59 | 09/96→11/08 | Z177 10/02→ | 1.3 | UXT7 10/02→ | ZS281 →08/98 ZS350 09/98→ |
| 1.3 i | 4 | J4D, J4K, J4M, J4N, J4P, J4S | 44/59 | 09/96→11/08 | Z67 →10/02 | 1.1 | UXT4 →10/02 | ZS281 →08/98 ZS350 09/98→ |
| 1.3 i | 4 | A9A, A9B | 51/68 | 08/02→11/08 | Z177 | 1.3 | UXT7 | ZS350 →02/07 |
| 1.3 i LPG | 4 | JJD, JJF, JJG, JJH, JJJ | 36/48 | 06/98→11/08 | Z26 | 0.7 | UXK56 | |
| 1.3 i LPG | 4 | JJB | 37/50 | 09/96→10/02 | Z26 | 0.7 | UXK56 | |
| 1.3 i LPG | 4 | J4D, J4K, J4M, J4N, J4P, J4S | 44/59 | 09/96→11/08 | Z26 →10/02 | 0.7 | UXK56 →10/02 | |

FORD



kW/BHP

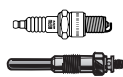

... FORD



... KA

| | | | | | | | | |
|----------|---|-----|-------|--------|--|-------------|--|--|
| 1.3 TDCi | 4 | FD4 | 55/74 | 10/08→ | GN053 →10/10 GE112 11/10→ | 11V 4.4V | | |
|----------|---|-----|-------|--------|--|-------------|--|--|

| | | | | | | | | |
|-------|---|-----|-------|-------------|--|--|--|--|
| 1.6 i | 4 | CCA | 70/94 | 07/03→11/08 | | | | ZS350 →07/07 ZS387 08/07→ |
|-------|---|-----|-------|-------------|--|--|--|--|

| | | | | | | | | |
|-------|---|----------|-------|-------------|-------------|-----|-------------|--|
| 1.6 i | 4 | CDB, CDC | 70/94 | 07/03→11/08 | Z177 | 1.3 | UXT7 | ZS350 →07/07 ZS387 08/07→ |
|-------|---|----------|-------|-------------|-------------|-----|-------------|--|

KUGA I

| | | | | | | | | |
|----------|---|------|---------|--------|--------------|-----|--|--|
| 2.0 TDCi | 4 | G6DG | 100/134 | 03/08→ | GN054 | 11V | | |
|----------|---|------|---------|--------|--------------|-----|--|--|

| | | | | | | | | |
|----------|---|------|---------|--------|-------------------------|----|--|--|
| 2.0 TDCi | 4 | UKDA | 100/134 | 03/08→ | GE121A 05/10→ | 5V | | |
|----------|---|------|---------|--------|-------------------------|----|--|--|

| | | | | | | | | |
|----------|---|------|---------|--------|---------------|----|--|--|
| 2.0 TDCi | 4 | UFDA | 103/138 | 03/10→ | GE121A | 5V | | |
|----------|---|------|---------|--------|---------------|----|--|--|

| | | | | | | | | |
|--------------|---|------|---------|--------|---------------|----|--|--|
| 2.0 TDCi 4WD | 4 | TXDA | 120/161 | 03/10→ | GE121A | 5V | | |
|--------------|---|------|---------|--------|---------------|----|--|--|

| | | | | | | | | |
|---------|---|-----------------|---------|--------|--|--|--|---------------|
| 2.5 4WD | 5 | DuratecST-Motor | 147/197 | 03/09→ | | | | ZSE055 |
|---------|---|-----------------|---------|--------|--|--|--|---------------|

KUGA II

| | | | | | | | | |
|----------|---|------|---------|--------|---------------|----|--|--|
| 2.0 TDCi | 4 | UKMA | 100/134 | 03/13→ | GE121A | 5V | | |
|----------|---|------|---------|--------|---------------|----|--|--|

| | | | | | | | | |
|----------|---|------|---------|--------|---------------|----|--|--|
| 2.0 TDCi | 4 | UFMA | 103/138 | 03/13→ | GE121A | 5V | | |
|----------|---|------|---------|--------|---------------|----|--|--|

| | | | | | | | | |
|--------------|---|------|---------|--------|---------------|----|--|--|
| 2.0 TDCi 4WD | 4 | TXDA | 120/161 | 03/13→ | GE121A | 5V | | |
|--------------|---|------|---------|--------|---------------|----|--|--|

MAVERICK

| | | | | | | | | |
|-------------|---|----|--------|--------|----------------------------|-----|----------------------------|--------------|
| 2.0 16V 4WD | 4 | YF | 91/122 | 02/01→ | Z177 07/01→12/03 | 1.3 | UXT7 07/01→12/03 | ZS350 |
|-------------|---|----|--------|--------|----------------------------|-----|----------------------------|--------------|

| | | | | | | | | |
|-------------|---|----|---------|--------|-------------|-----|--------------|--------------|
| 2.3 16V 4WD | 4 | GZ | 110/148 | 03/04→ | Z209 | 1.3 | UXT15 | ZS408 |
|-------------|---|----|---------|--------|-------------|-----|--------------|--------------|

| | | | | | | | | |
|-----------|---|-------|--------|-------------|-------------|-----|--|--------------|
| 2.4 i 4WD | 4 | KA-24 | 85/114 | 09/96→04/98 | Z225 | 1.1 | | ZS277 |
|-----------|---|-------|--------|-------------|-------------|-----|--|--------------|

| | | | | | | | | |
|-----------|---|-------|--------|-------------|-------------|-----|--|--------------|
| 2.4 i 4WD | 4 | KA-24 | 87/117 | 09/96→04/98 | Z225 | 1.1 | | ZS277 |
|-----------|---|-------|--------|-------------|-------------|-----|--|--------------|

| | | | | | | | | |
|-----------|---|--------|--------|-------------|-------------|-----|--|--------------|
| 2.4 i 4WD | 4 | KA24-E | 91/122 | 02/93→08/96 | Z225 | 1.1 | | ZS277 |
|-----------|---|--------|--------|-------------|-------------|-----|--|--------------|

| | | | | | | | | |
|------------|---|------|-------|-------------|--------------|-----|--|--|
| 2.7 TD 4WD | 4 | TD27 | 74/99 | 02/93→08/96 | GN854 | 11V | | |
|------------|---|------|-------|-------------|--------------|-----|--|--|

| | | | | | | | | |
|------------|---|-------|--------|-------------|--------------|-----|--|--|
| 2.7 TD 4WD | 4 | TD27E | 92/123 | 09/96→04/98 | GN994 | 11V | | |
|------------|---|-------|--------|-------------|--------------|-----|--|--|

| | | | | | | | | |
|----------------|---|----|---------|--------|--|--|--|--------------|
| 3.0 V6 24V 4WD | 6 | AJ | 145/194 | 02/01→ | | | | ZS410 |
|----------------|---|----|---------|--------|--|--|--|--------------|

MONDEO I

| | | | | | | | | |
|-----------|---|-----|-------|-------------|------------|-----|-------------|---|
| 1.6 i 16V | 4 | L1J | 65/87 | 07/94→08/96 | Z97 | 1.0 | UXT8 | ZS239 ⁽¹¹⁹⁾ ZS281 |
|-----------|---|-----|-------|-------------|------------|-----|-------------|---|

| | | | | | | | | |
|-----------|---|-----|-------|-------------|------------|-----|-------------|---|
| 1.6 i 16V | 4 | L1F | 66/89 | 02/93→08/96 | Z97 | 1.0 | UXT8 | ZS239 ⁽¹¹⁹⁾ ZS281 |
|-----------|---|-----|-------|-------------|------------|-----|-------------|---|

| | | | | | | | | |
|-----------|---|-----|--------|-------------|------------|-----|-------------|---|
| 1.8 i 16V | 4 | RKB | 82/110 | 01/94→08/96 | Z97 | 1.0 | UXT8 | ZS239 ⁽¹¹⁹⁾ ZS281 |
|-----------|---|-----|--------|-------------|------------|-----|-------------|---|

| | | | | | | | | |
|-----------|---|-----|--------|-------------|------------|-----|-------------|---|
| 1.8 i 16V | 4 | RKA | 85/114 | 02/93→08/96 | Z97 | 1.0 | UXT8 | ZS239 ⁽¹¹⁹⁾ ZS281 |
|-----------|---|-----|--------|-------------|------------|-----|-------------|---|

| | | | | | | | | |
|--------|---|----------|-------|-------------|--|--------------|--|--|
| 1.8 TD | 4 | RFM, RFN | 65/87 | 06/93→08/96 | GN927 ⁽²⁾⁽²²²⁾ GV666 | 11V 11.5V | | |
|--------|---|----------|-------|-------------|--|--------------|--|--|

| | | | | | | | | |
|--------|---|----------|-------|-------------|--|--------------|--|--|
| 1.8 TD | 4 | RFM, RFN | 66/89 | 10/95→08/96 | GN927 ⁽²⁾⁽²²²⁾ GV666 | 11V 11.5V | | |
|--------|---|----------|-------|-------------|--|--------------|--|--|

| | | | | | | | | |
|-----------|---|-----|--------|-------------|------------|-----|-------------|--------------|
| 2.0 i 16V | 4 | NGA | 97/130 | 01/93→08/96 | Z97 | 1.0 | UXT8 | ZS239 |
|-----------|---|-----|--------|-------------|------------|-----|-------------|--------------|

| | | | | | | | | |
|---------------|---|-----|--------|-------------|------------|-----|-------------|---|
| 2.0 i 16V 4WD | 4 | NGA | 97/130 | 12/94→08/96 | Z97 | 1.0 | UXT8 | ZS239 ⁽¹¹⁹⁾ ZS281 |
|---------------|---|-----|--------|-------------|------------|-----|-------------|---|

| | | | | | | | | |
|-----------|---|-----|---------|-------------|------------|-----|-------------|---|
| 2.0 i 16V | 4 | NGA | 100/134 | 02/93→08/96 | Z97 | 1.0 | UXT8 | ZS239 ⁽¹¹⁹⁾ ZS281 |
|-----------|---|-----|---------|-------------|------------|-----|-------------|---|

| | | | | | | | | |
|-----------|---|---------------------|---------|-------------|-------------|-----|--------------|--------------|
| 2.5 i 24V | 6 | LCBD, SEA, SEB, SEC | 125/168 | 07/94→11/00 | Z148 | 1.3 | UXT15 | ZS371 |
|-----------|---|---------------------|---------|-------------|-------------|-----|--------------|--------------|

| | | | | | | | | |
|---------------|---|-----|---------|-------------|------------|-----|-------------|--|
| 2.5 i 24V LPG | 6 | SEA | 125/168 | 07/94→08/96 | Z95 | 0.7 | UXT4 | |
|---------------|---|-----|---------|-------------|------------|-----|-------------|--|



kW/BHP

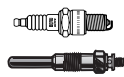

... FORD



MONDEO II

| | | | | | | | | | |
|----------------|---|-------------------------|---------|-------------|-------|--|-----|-------|------------------------------------|
| 1.6 i | 4 | LIJ | 66/89 | 09/96→11/00 | Z97 | | 1.0 | UXT8 | ZS281 →08/98 ZS350 09/98→ |
| 1.6 i 16V | 4 | LIL, LIN, LIQ | 70/94 | 05/98→11/00 | Z97 | | 1.0 | UXT8 | ZS281 →08/98 ZS350 09/98→ |
| 1.8 i | 4 | RKB, RKF, RKH, RKJ, RKK | 85/114 | 09/96→11/00 | Z97 | | 1.0 | UXT8 | ZS281 →08/98 ZS350 09/98→ |
| 1.8 TD | 4 | RFN | 66/89 | 09/96→11/00 | GN022 | | 10V | | |
| 2.0 i | 4 | NGA, NGB, NGC, NGD | 96/129 | 09/96→11/00 | Z97 | | 1.0 | UXT8 | ZS281 →08/98 ZS350 09/98→ |
| 2.5 2.5 ST 200 | 6 | SGA | 151/202 | 05/99→11/00 | Z209 | | 1.3 | UXT15 | ZS371 |
| 2.5 24V LPG | 6 | LCBD, SEA, SEB, SEC | 125/168 | 09/96→11/00 | Z95 | | 0.7 | UXT4 | |

MONDEO III

| | | | | | | | | | |
|--------------------------|---|------------------------|---------|-------------|------------------------|--|-------|-----------------|-----------------|
| 1.8 16V | 4 | CGBA, CGBB | 81/109 | 11/00→08/07 | Z209 | | 1.3 | UXT15 | ZS422 →02/05 |
| 1.8 16V | 4 | CHBA, CHBB | 92/123 | 11/00→08/07 | Z209 | | 1.3 | UXT15 | ZS422 →02/05 |
| 1.8 SCi | 4 | CFBA | 96/129 | 06/03→08/07 | Z309 | | 1.6 | | ZS422 →02/05 |
| 2.0 16V | 4 | CJBA, CJBB | 107/143 | 11/00→08/07 | Z209 | | 1.3 | UXT15 | ZS422 →02/05 |
| 2.0 16V DI / TDDi / TDCi | 4 | D5BA | 66/89 | 11/00→08/07 | GN939 | | 11.5V | | |
| 2.0 16V TDDi / TDCi | 4 | D6BA, HJBA, HJBB, HJBC | 85/114 | 11/00→08/07 | GN939 | | 11.5V | | |
| 2.0 TDCi | 4 | FMBA, N7BA | 96/129 | 10/01→08/07 | GN939 | | 11.5V | | |
| 2.2 TDCi | 4 | QJBC, QJBD | 110/148 | 09/04→08/07 | GN939 | | 11.5V | | |
| 2.2 TDCi | 4 | QJBA, QJBB | 114/153 | 09/04→08/07 | GN939 | | 11.5V | | |
| 2.5 V6 24V | 6 | LCBD | 125/168 | 11/00→08/07 | Z148 | | 1.3 | UXT15 | ZS372 |
| 3.0 ST220 | 6 | MEBA | 166/223 | 04/02→08/07 | Z296 →03/07 Z209 | | 1.3 | UXT15 →03/07 | ZS372 ZSE167 |
| 3.0 ST220 LPG | 6 | MEBA | 166/223 | 04/02→08/07 | Z209 [168] →03/07 | | 1.3 | UXT15 →03/07 | |
| 3.0 V6 24V | 6 | REBA | 150/201 | 09/04→08/07 | Z209 | | 1.3 | UXT15 | ZS372 |

MONDEO IV

| | | | | | | | | | |
|---------------|---|------------------|---------|--------|------------------|--|-----|------|-----------------|
| 1.6 TDCi | 4 | T1BA, T1BB, T1BC | 85/114 | 12/10→ | GE121A | | 5V | | |
| 1.6 Ti | 4 | RHBA | 81/109 | 03/07→ | Z177 | | 1.3 | UXT7 | ZS387 →08/10 |
| 1.6 Ti | 4 | KGBA | 88/118 | 07/10→ | Z177 | | 1.3 | UXT7 | ZS387 |
| 1.6 Ti | 4 | PNBA | 92/123 | 03/07→ | Z177 | | 1.3 | UXT7 | ZS387 →08/10 |
| 1.8 TDCi | 4 | FFBA | 74/99 | 03/07→ | GN993 | | 10V | | |
| 1.8 TDCi | 4 | KHBA, QYBA | 92/123 | 06/07→ | GN993 | | 10V | | |
| 2.0 | 4 | AOBA, AOBC, TBBA | 107/143 | 03/07→ | Z230 | | 1.3 | | ZS408 |
| 2.0 Flexifuel | 4 | TBBA, TBBB | 107/143 | 03/09→ | Z230 | | 1.3 | | ZS408 |
| 2.0 LPG | 4 | TBBA | 107/143 | 07/09→ | | | | | ZS408 |
| 2.0 TDCi | 4 | KLBA, LPBA | 85/114 | 11/07→ | GN054 | | 11V | | |
| 2.0 TDCi | 4 | TYBA | 85/114 | 11/07→ | GE121A 03/10→ | | 5V | | |
| 2.0 TDCi | 4 | AZBA | 96/129 | 03/07→ | GN054 | | 11V | | |
| 2.0 TDCi | 4 | AZBC | 100/134 | 03/07→ | GN054 →02/10 | | 11V | | |



kW/BHP



... FORD



... MONDEO IV

| | | | | | | | | | |
|----------|---|------------------|---------|--------|------------------|-----|------|--------|--|
| 2.0 TDCi | 4 | UKBA | 100/134 | 03/07→ | GE121A 03/10→ | 5V | | | |
| 2.0 TDCi | 4 | QXBA, QXBB, UFBA | 103/138 | 03/07→ | GE121A | 5V | | | |
| 2.0 TDCi | 4 | TXBA | 120/161 | 03/10→ | GE121A | 5V | | | |
| 2.2 TDCi | 4 | Q4BA | 129/173 | 03/08→ | GN063 | 11V | | | |
| 2.3 | 4 | SEBA | 118/158 | 07/07→ | Z342 | 1.3 | UXT7 | | |
| 2.5 | 5 | HUBA | 162/217 | 03/07→ | Z326 | 0.7 | | ZSE055 | |
| 2.5 LPG | 5 | HUBA | 162/217 | 03/07→ | Z226 [168] | 0.8 | | | |

ORION I

| | | | | | | | | | |
|-------|---|----------|--------|-------------|-------------------------|--------------|------|----------------------|---|
| 1.3 | 4 | JPA | 51/68 | 07/83→03/86 | Z24 | 0.8 | UXT5 | ZS126 09/83→12/85 | ZM008 [209] 09/83→ ZM020 [192] 08/84→ ZM003 [175] 02/85→ |
| 1.6 | 4 | LPT, LPA | 58/78 | 07/83→03/86 | Z30 | 0.8 | UXT5 | ZS126 09/83→12/85 | ZM008 [209] 09/83→ ZM020 [192] 08/84→ ZM003 [175] 02/85→ |
| 1.6 D | 4 | LTA | 40/54 | 02/84→03/86 | GN927 [2][222] GV631 | 11V 11.5V | | | |
| 1.6 i | 4 | LR1, LRA | 77/103 | 07/83→03/86 | Z30 | 0.8 | UXT5 | ZS126 09/83→12/85 | ZM008 [209] 09/83→ ZM003 [175] 02/85→ ZM015 [175] 09/85→ |

ORION II

| | | | | | | | | | |
|-----|---|----------|-------|-------------|--------------------------------------|------------|-----------------------------------|--|-------|
| 1.3 | 4 | JBB | 44/59 | 12/85→07/90 | Z67 | 1.1 | UXT4 | ZS238 03/86→ ZS281 03/86→ | ZM003 |
| 1.3 | 4 | JLA, JLB | 44/59 | 12/85→07/90 | Z95 | 0.7 | UXT4 | ZS238 03/86→ ZS281 03/86→ | ZM003 |
| 1.3 | 4 | CVH | 51/68 | 11/86→07/88 | | | | | ZM020 |
| 1.3 | 4 | JPA | 51/68 | 11/86→07/88 | | | | | ZM003 |
| 1.4 | 4 | CVH | 52/70 | 03/86→07/90 | | | | | ZM020 |
| 1.4 | 4 | FUAA | 52/70 | 03/86→07/90 | Z99 →07/88 Z16 [171] 08/88→ | 1.0 1.1 | UXT5 →07/88 UXT11 08/88→ | ZS126 10/87→ | ZM003 |
| 1.4 | 4 | CVH | 54/72 | 01/86→07/90 | | | | | ZM020 |
| 1.4 | 4 | F6B, F6D | 54/72 | 02/87→07/90 | Z99 →07/88 Z16 [171] 08/88→ | 1.0 1.1 | UXT5 →07/88 UXT11 08/88→ | ZS126 10/87→ | ZM003 |
| 1.4 | 4 | FUC | 54/72 | 01/86→07/90 | Z99 | 1.0 | UXT5 | ZS126 02/87→ | ZM003 |
| 1.4 | 4 | CVH | 55/74 | 12/85→07/90 | | | | | ZM020 |
| 1.4 | 4 | FUA | 55/74 | 12/85→07/90 | Z24 | 0.8 | UXT5 | ZS126 04/86→ | ZM003 |
| 1.6 | 4 | CVH | 66/89 | 12/85→07/90 | | | | | ZM020 |
| 1.6 | 4 | LUC | 66/89 | 12/85→07/90 | Z24 | 0.8 | UXT5 | ZS126 [1][214][254] ZS281 [1] 03/89→ | ZM003 |

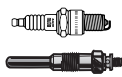

kW/BHP

**... FORD****... ORION II**

| | | | | | | | | |
|-------|---|----------|--------|-------------|------------------------------------|--------------|------|---|
| 1.6 D | 4 | LTC | 40/54 | 12/85→01/89 | GN927 ^{[2][222]} GV631 | 11V 11.5V | | |
| 1.6 i | 4 | CVH | 66/89 | 03/86→07/90 | | | | ZM020 |
| 1.6 i | 4 | L4B | 66/89 | 03/86→07/90 | Z24 | 0.8 | UXT5 | ZS126 ^{[1][214][254]} ZS281 ^[1] ZM003 |
| 1.6 i | 4 | CVH | 75/101 | 08/89→07/90 | | | | ZM020 |
| 1.6 i | 4 | LJB | 75/101 | 08/89→07/90 | Z99 | 1.0 | UXT5 | ZS281 |
| 1.6 i | 4 | LRB | 77/103 | 03/86→07/90 | Z30 | 0.8 | UXT5 | ZS126 ZM003 ^[175] ZM015 ^[175] |
| 1.8 D | 4 | RTA, RTB | 44/59 | 01/89→07/90 | GN927 ^{[2][222]} GV666 | 11V 11.5V | | |

ORION III

| | | | | | | | | |
|-----------|---|---------------|--------|-------------|------------------------------------|--------------|-------|--|
| 1.3 | 4 | J4B, J6A | 44/59 | 07/90→12/93 | Z67 | 1.1 | UXT4 | ZS237 ZS238 ZS281 |
| 1.4 | 4 | F6F, F6G | 52/70 | 07/90→12/93 | Z16 ^[171] | 1.1 | UXT11 | ZS126 |
| 1.4 | 4 | FUH | 54/72 | 07/90→12/93 | Z24 | 0.8 | UXT5 | ZS126 ^{[1][214][254]} ZS281 ^[1] |
| 1.6 | 4 | LUJ, LUK | 66/89 | 07/90→12/92 | Z24 | 0.8 | UXT5 | ZS126 ^{[1][214][254]} ZS281 ^[1] |
| 1.6 i | 4 | LJF | 77/103 | 07/90→09/92 | Z99 | 1.0 | UXT5 | ZS281 |
| 1.6 i 16V | 4 | L1E, L1K | 66/89 | 07/92→12/93 | Z97 | 1.0 | UXT8 | ZS239 ^[119] ZS281 |
| 1.8 D | 4 | RTE, RTF, RTH | 44/59 | 11/90→12/93 | GN927 ^{[2][222]} GV666 | 11V 11.5V | | |
| 1.8 i 16V | 4 | RDA | 77/103 | 02/92→12/93 | Z97 | 1.0 | UXT8 | ZS239 ^[119] ZS281 |
| 1.8 i 16V | 4 | RQB | 96/129 | 01/92→12/93 | Z97 | 1.0 | UXT8 | ZS281 →07/93 ZS239 ^[119] |
| 1.8 TD | 4 | RFD, RFK | 66/89 | 03/92→12/93 | GN927 ^{[2][222]} GV666 | 11V 11.5V | | |

P 100 I

| | | | | | | | | |
|-----|---|-----|-------|-------------|--|--|--|-----------------------|
| 1.6 | 4 | LCR | 54/72 | 04/82→09/87 | | | | ZS109 ^[15] |
|-----|---|-----|-------|-------------|--|--|--|-----------------------|

P 100 II

| | | | | | | | | |
|--------|---|-----|-------|-------------|------------------------------------|--------------|--|-------|
| 1.8 TD | 4 | RFA | 55/74 | 10/87→12/92 | GN927 ^{[2][222]} GV666 | 11V 11.5V | | |
| 2.0 | 4 | NAE | 57/76 | 10/87→12/92 | | | | ZS126 |

PUMA

| | | | | | | | | |
|---------|---|----------|--------|-------------|------|-----|------|------------------------------------|
| 1.4 16V | 4 | FHD, FHF | 66/89 | 11/97→10/00 | Z177 | 1.3 | UXT7 | ZS281 →04/98 ZS350 05/98→ |
| 1.6 16V | 4 | L1W | 76/102 | 08/00→06/02 | Z177 | 1.3 | UXT7 | ZS350 |
| 1.7 16V | 4 | MHA, MHB | 92/123 | 03/97→06/02 | Z177 | 1.3 | UXT7 | ZS281 →04/98 ZS350 05/98→ |

RANGER

| | | | | | | | | |
|--------------|---|---------|---------|-------------|-----------------|------|--|--|
| 2.2 TDCi | 4 | GBVAJPF | 88/118 | 04/11→ | GE122 | 4.4V | | |
| 2.2 TDCi | 4 | GBVAJQW | 92/123 | 04/11→ | GE122 | 4.4V | | |
| 2.2 TDCi | 4 | GBVAJQJ | 110/148 | 04/11→ | GE122 | 4.4V | | |
| 2.5 D | 4 | WL | 57/76 | 10/99→04/02 | GN005 →09/01 | 11V | | |
| 2.5 TD 4WD | 4 | WL-T | 80/107 | 10/99→06/06 | GN005 →09/01 | 11V | | |
| 2.5 TDCi 4WD | 4 | WLAA | 105/141 | 05/06→ | GN005 | 11V | | |
| 2.5 TDCi | 4 | WLAA | 105/141 | 05/06→ | GN005 | 11V | | |



kW/BHP

**... FORD****... RANGER**

| | | | | | | | | | |
|--------------|---|------|---------|-------------|-------|--|------|--|--|
| 2.9 D | 4 | | 70/94 | 06/99→02/02 | GN005 | | 11V | | |
| 3.2 TDCi 4WD | 5 | SAFA | 147/197 | 04/11→ | GE122 | | 4.4V | | |

SCORPIO I

| | | | | | | | | | |
|---------------|---|---------------|---------|-------------|-----------------------|-------|------------|-------------|---|
| 1.8 | 4 | REC | 66/89 | 04/85→02/92 | Z33 | | 0.7 | | ZS126 |
| 1.8 | 4 | REC | 66/89 | 01/86→10/88 | Z24 Z33 | | 0.8 0.7 | UXT5 | |
| 2.0 | 4 | N8D | 77/103 | 04/85→08/89 | Z15 | | 0.8 | UXT1 / UXT3 | ZS126 ZM019 →07/87 |
| 2.0 | 4 | NEL | 77/103 | 04/85→08/89 | Z32 | | 0.7 | | ZS126 ZM019 →07/87 |
| 2.0 | 4 | N8A | 80/107 | 11/88→10/92 | | | | | ZS126 05/89→01/92 |
| 2.0 i | 4 | NRC | 74/99 | 10/85→12/90 | Z32 | | 0.7 | | ZS126 ZM019 →07/87 |
| 2.0 i | 4 | N9F | 85/114 | 09/91→09/94 | Z24 | | 0.8 | UXT5 | ZS126 02/92→07/94 |
| 2.0 i | 4 | N9F, NRA, NRI | 85/114 | 02/92→09/94 | | | | | ZS126 →07/94 |
| 2.0 i | 4 | NRA, NRI | 85/114 | 04/85→09/94 | Z32 | | 0.7 | | |
| 2.0 i | 4 | NRA, NRI | 85/114 | 04/85→02/92 | | | | | ZS126 ZM019 →07/87 |
| 2.0 i | 4 | N9D | 88/118 | 05/89→09/94 | Z24 | | 0.8 | UXT5 | ZS126 →01/92 |
| 2.0 i | 4 | N9B | 92/123 | 05/89→02/92 | Z24 | | 0.8 | UXT5 | |
| 2.4 i | 6 | ARD | 92/123 | 10/88→10/94 | Z67 | | 1.1 | UXT4 | ZS126 →01/92 ZM019 →07/89 |
| 2.4 i | 6 | ARD | 92/123 | 10/88→02/92 | | | | | ZS126 |
| 2.4 i | 6 | ARC | 96/129 | 09/86→09/88 | Z15 | | 0.8 | UXT1 / UXT3 | ZS126 ZM019 |
| 2.5 D | 4 | STR | 51/68 | 12/85→12/94 | GN909 | GR064 | 11V | | |
| 2.5 TD | 4 | SFA, SFB | 68/91 | 06/88→07/93 | GN909 | | 11V | | |
| 2.5 TD | 4 | SCB | 85/114 | 08/93→09/94 | GN909 | | 11V | | |
| 2.8 i | 6 | PRE | 110/148 | 04/85→11/86 | Z20 | | 0.8 | UXT2 / UXT6 | ZS126 ZM019 |
| 2.9 24V | 6 | BOA | 143/192 | 08/93→09/94 | Z284 | | 1.1 | UXT14 | ZS126 ^{[1][214][254]} ZS371 ^[1] |
| 2.9 24V LPG | 6 | BOA | 143/192 | 08/93→09/94 | Z130 ^[168] | | 1.0 | UXT14 | |
| 2.9 i | 6 | BRD, BRE, BRF | 107/143 | 09/86→12/94 | Z117 | | 1.0 | UXT4 | ZS126 →01/92 ZM019 →07/89 |
| 2.9 i | 6 | BRD, BRE, BRF | 107/143 | 09/86→09/94 | | | | | ZS126 ZM019 |
| 2.9 i 4WD | 6 | BRD, BRE, BRF | 107/143 | 05/88→10/94 | Z117 | | 1.0 | UXT4 | |
| 2.9 i 4WD | 6 | BRD, BRE, BRF | 107/143 | 05/88→02/93 | | | | | ZS126 ^{[214][254]} 02/92→ →07/89 ZM019 ^[211] |
| 2.9 i 4WD | 6 | BRD, BRE, BRF | 107/143 | 12/89→10/94 | | | | | ZS126 →01/92 ZM019 |
| 2.9 i | 6 | BRC | 110/148 | 09/86→09/94 | Z15 | | 0.8 | UXT1 / UXT3 | ZS126 →01/92 ZM019 |
| 2.9 i 24V | 6 | BOA | 143/192 | 04/91→09/94 | Z284 | | 1.1 | UXT14 | ZS371 ZM019 |
| 2.9 i 24V LPG | 6 | BOA | 143/192 | 04/91→09/94 | Z130 ^[168] | | 1.0 | UXT14 | |

SCORPIO II

| | | | | | | | | | |
|---------------|---|-----|---------|-------------|----------------------|--|-----|-------|--------------------------|
| 2.0 i | 4 | NSD | 85/114 | 10/94→08/98 | Z159 | | 1.1 | UXT14 | |
| 2.0 i LPG | 4 | NSD | 85/114 | 10/94→08/98 | Z30 ^[168] | | 0.8 | UXT5 | |
| 2.0 i 16V | 4 | N3A | 100/134 | 10/94→08/98 | Z159 | | 1.1 | UXT14 | ZS308 →04/96 |
| 2.0 i 16V LPG | 4 | N3A | 100/134 | 10/94→08/98 | Z30 ^[168] | | 0.8 | UXT5 | |
| 2.3 i 16V | 4 | YSA | 108/145 | 06/96→08/98 | Z159 | | 1.1 | UXT14 | ZS308 |
| 2.3 i 16V LPG | 4 | YSA | 108/145 | 06/96→08/98 | Z30 ^[168] | | 0.8 | UXT5 | |
| 2.5 TD | 4 | SCC | 85/114 | 10/94→08/98 | GN007 | | 11V | | |
| 2.5 TD | 4 | VM | 92/123 | 09/96→08/98 | GN007 | | 11V | | |
| 2.9 i | 6 | BRG | 110/148 | 02/95→08/98 | Z16 | | 1.1 | UXT11 | ZS126 →08/96 ZM019 |



kW/BHP

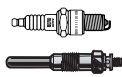

... FORD



... SCORPIO II

| | | | | | | | | | |
|--------------------------|---|---------------|---------|-------------|---------------------------|-------|-------------|--------------------------------|-------|
| 2.9 i LPG | 6 | BRG | 110/148 | 02/95→08/98 | Z340 | 0.7 | UXT12 | | |
| 2.9 i 24V | 6 | BOB | 152/204 | 10/94→08/98 | Z284 | 1.1 | UXT14 | ZS371 | ZM019 |
| 2.9 i 24V LPG | 6 | BOB | 152/204 | 10/94→08/98 | Z130 ^[168] | 1.0 | UXT14 | | |
| SIERRA | | | | | | | | | |
| 1.3 | 4 | JCT | 44/59 | 08/82→12/86 | Z32 | 0.7 | | ZS126 | |
| 1.6 | 4 | LSF | 53/71 | 01/88→02/93 | Z32 | 0.7 | | ZS126 | |
| 1.6 | 4 | LCS, LCT, LSD | 55/74 | 08/82→12/86 | Z32 | 0.7 | | ZS126 | |
| 1.6 | 4 | LSE | 55/74 | 01/87→02/93 | Z32 | 0.7 | | ZS126 ^{[1][214][254]} | |
| | | | | | | | | ZS281 ^[1] | |
| | | | | | | | | 08/90→ | |
| 1.6 | 4 | LSD | 58/78 | 08/84→12/86 | Z17 | 0.8 | UXT4 | | |
| 1.6 i | 4 | L6B | 59/79 | 10/89→02/93 | Z16 | 1.1 | UXT11 | ZS281 | |
| 1.8 | 4 | RED, REF | 59/79 | 10/87→05/88 | Z32 | 0.7 | | ZS126 | |
| | | | | | Z33 | 0.7 | | | |
| 1.8 | 4 | RED, REF | 59/79 | 10/87→09/89 | Z32 | 0.7 | | ZS126 | |
| | | | | | | | | →05/88 | |
| 1.8 | 4 | R2C | 64/86 | 05/88→02/93 | Z16 | 1.1 | UXT11 | ZS126 ^{[1][214][254]} | |
| | | | | | | | | ZS281 ^[1] | |
| | | | | | | | | 09/92→ | |
| 1.8 | 4 | R6A | 64/86 | 05/88→02/93 | Z16 | 1.1 | UXT11 | ZS281 ^[1] | |
| | | | | | | | | 09/92→ | |
| 1.8 | 4 | R2A, REB, RED | 66/89 | 10/84→05/88 | Z32 | 0.7 | | ZS126 | |
| | | | | | Z33 | 0.7 | | | |
| 1.8 TD | 4 | RFA, RFB, RFL | 55/74 | 08/88→02/93 | GN927 ^{[2][222]} | 11V | | | |
| | | | | | GV666 | 11.5V | | | |
| 2.0 | 4 | NRD | 74/99 | 10/85→12/86 | Z32 | 0.7 | | ZS126 | |
| 2.0 | 4 | N8C, NES, NET | 77/103 | 08/82→02/93 | Z32 | 0.7 | | ZS126 | |
| 2.0 | 4 | NR2, NRB | 85/114 | 03/85→12/86 | Z33 | 0.7 | | ZS126 | |
| 2.0 4WD | 4 | N9C | 88/118 | 01/90→03/93 | Z24 | 0.8 | UXT5 | ZS126 | |
| 2.0 4WD | 4 | N9C | 92/123 | 05/89→02/93 | Z24 | 0.8 | UXT5 | ZS126 | |
| 2.0 | 6 | NYT | 66/89 | 08/82→10/84 | Z20 | 0.8 | UXT2 / UXT6 | ZS126 | |
| 2.0 16V Cosworth 4WD | 4 | N5C | 162/217 | 01/90→02/93 | Z284 | 1.1 | UXT14 | ZS126 | |
| | | | | | Z313 | 1.1 | | | |
| 2.0 16V Cosworth 4WD | 4 | N5D | 162/217 | 01/90→02/93 | Z284 | 1.1 | UXT14 | ZS126 | |
| 2.0 16V Cosworth 4WD LPG | 4 | N5C | 162/217 | 01/90→02/93 | Z130 ^[168] | 1.0 | UXT14 | | |
| | | | | | Z30 ^[168] | 0.8 | UXT5 | | |
| 2.0 16V Cosworth 4WD LPG | 4 | N5D | 162/217 | 01/90→02/93 | Z130 ^[168] | 1.0 | UXT14 | | |
| 2.0 i | 4 | N4B | 74/99 | 01/87→02/93 | Z32 | 0.7 | | ZS126 | |
| 2.0 i | 4 | NE5, NEJ | 74/99 | 01/87→02/93 | Z32 | 0.7 | | ZS126 ^{[214][254]} | |
| | | | | | | | | 10/87→ | |
| 2.0 i | 4 | NE5, NEJ | 74/99 | 01/87→12/89 | | | | ZS126 | |
| | | | | | | | | 10/87→ | |
| 2.0 i | 4 | N8A | 80/107 | 06/89→02/93 | Z15 | 0.8 | UXT1 / UXT3 | ZS126 | |
| 2.0 i | 4 | N4A, N4I | 85/114 | 01/87→02/93 | Z32 | 0.7 | | ZS126 | |
| | | | | | Z33 | 0.7 | | | |
| 2.0 i | 4 | NR2, NRB | 85/114 | 03/85→12/86 | Z33 | 0.7 | | ZS126 | ZM019 |
| 2.0 i | 4 | N9C | 88/118 | 05/89→02/93 | Z24 | 0.8 | UXT5 | ZS126 | |
| 2.0 i | 4 | N9B | 92/123 | 06/89→02/93 | Z24 | 0.8 | UXT5 | | |
| 2.0 i | 4 | N9C | 92/123 | 05/89→02/93 | Z24 | 0.8 | UXT5 | ZS126 | |
| 2.0 i DOHC | 4 | N9E | 85/114 | 12/91→02/93 | Z24 | 0.8 | UXT5 | ZS126 | |
| 2.0 RS Cosworth | 4 | N5B | 150/201 | 01/87→12/90 | | | | ZS126 | |
| 2.3 | 6 | YIT | 84/113 | 08/82→12/86 | Z20 | 0.8 | UXT2 / UXT6 | ZS126 | |
| 2.3 D | 4 | YTR, YTT | 49/66 | 08/82→02/93 | GN909 | 11V | | | |
| 2.8 4WD | 6 | PRG | 110/148 | 01/87→08/88 | Z20 | 0.8 | UXT2 / UXT6 | ZS126 | ZM019 |
| 2.8 i | 6 | PR8 | 105/141 | 01/87→02/93 | Z20 | 0.8 | UXT2 / UXT6 | | |
| 2.8 i | 6 | PR8 | 105/141 | 08/87→02/93 | | | | ZS126 | |
| | | | | | | | | →12/88 | |
| 2.8 i 4WD | 6 | PR6 | 105/141 | 08/82→12/86 | Z20 | 0.8 | UXT2 / UXT6 | ZS126 | |
| 2.8 i | 6 | PR7 | 107/143 | 01/87→02/93 | Z20 | 0.8 | UXT2 / UXT6 | | |

FORD

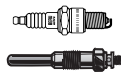

kW/BHP

**... FORD****... SIERRA**

| | | | | | | | | | |
|--------------|---|----------|---------|-------------|---------------------|-----|-------------|--------|-------|
| 2.8 i 4WD | 6 | PR6 | 107/143 | 08/82→12/86 | Z20 | 0.8 | UXT2 / UXT6 | ZS126 | |
| 2.8 i 4WD | 6 | PR7 | 107/143 | 01/87→02/93 | Z20 | 0.8 | UXT2 / UXT6 | ZS126 | |
| | | | | | | | | →12/88 | |
| 2.8 i XR 4WD | 6 | PR5, PR6 | 107/143 | 09/83→12/86 | | | | ZS126 | |
| 2.8 i XR 4WD | 6 | PR7 | 107/143 | 01/87→02/93 | Z20 | 0.8 | UXT2 / UXT6 | ZS126 | |
| | | | | | | | | →12/88 | |
| 2.8 i XR 4WD | 6 | PRG | 110/148 | 01/87→08/88 | Z20 | 0.8 | UXT2 / UXT6 | ZS126 | ZM019 |
| 2.8 XR 4WD | 6 | PRT | 110/148 | 02/85→12/86 | Z20 | 0.8 | UXT2 / UXT6 | ZS126 | |
| 2.8 XR4i | 6 | PR6 | 105/141 | 08/82→12/86 | Z20 | 0.8 | UXT2 / UXT6 | ZS126 | |
| 2.8 XR4i | 6 | PR5 | 107/143 | 08/82→12/86 | Z20 | 0.8 | UXT2 / UXT6 | ZS126 | |
| 2.8 XR4i | 6 | PRT | 110/148 | 08/82→12/86 | Z20 | 0.8 | UXT2 / UXT6 | ZS126 | |
| | | | | | | | | →02/85 | |
| 2.9 | 6 | B4B, B4C | 107/143 | 08/88→02/93 | Z117 | 1.0 | UXT4 | ZS126 | ZM019 |
| 2.9 4WD | 6 | B4B, B4C | 107/143 | 08/88→02/93 | Z117 ^[6] | 1.0 | UXT4 | ZS126 | ZM019 |
| 2.9 4WD | 6 | B4B, B4C | 110/148 | 08/88→02/93 | Z117 ^[6] | 1.0 | UXT4 | ZS126 | |
| 2.9 i | 6 | B4B, B4C | 107/143 | 08/88→02/93 | Z117 | 1.0 | UXT4 | ZS126 | ZM019 |
| 2.9 i | 6 | B4B, B4C | 110/148 | 08/88→02/93 | Z117 | 1.0 | UXT4 | ZS126 | |
| 2.9 i XR 4WD | 6 | B4B, B4C | 107/143 | 08/88→02/93 | Z117 | 1.0 | UXT4 | ZS126 | ZM019 |
| 2.9 i XR 4WD | 6 | B4A | 110/148 | 08/88→02/93 | Z15 | 0.8 | UXT1 / UXT3 | ZS126 | ZM019 |

S-MAX

| | | | | | | | | | |
|---------------|---|------------------------|---------|--------|------------------------|-----|------|--------|--|
| 1.6 TDCi | 4 | T1WA, T1WB | 85/114 | 02/11→ | GE121A | 5V | | | |
| 1.8 TDCi | 4 | FFWA | 74/99 | 01/07→ | GN993 | 10V | | | |
| 1.8 TDCi | 4 | QYWA | 92/123 | 05/06→ | GN993 ^[265] | 10V | | | |
| 2.0 | 4 | AOWA, AOWB | 107/143 | 05/06→ | Z230 | 1.3 | | ZS408 | |
| 2.0 EcoBoost | 4 | TNWA | 149/200 | 03/10→ | | | | ZS408 | |
| 2.0 Flexifuel | 4 | TBWA, TBWB | 107/143 | 05/06→ | Z230 | 1.3 | | ZS408 | |
| 2.0 TDCi | 4 | KLWA | 85/114 | 11/07→ | GN054 | 11V | | | |
| | | | | | →02/10 | | | | |
| 2.0 TDCi | 4 | TYWA | 85/114 | 11/07→ | GE121A | 5V | | | |
| | | | | | 03/10→ | | | | |
| 2.0 TDCi | 4 | AZWA | 96/129 | 05/06→ | GN054 | 11V | | | |
| 2.0 TDCi | 4 | AZWC | 100/134 | 05/06→ | GN054 | 11V | | | |
| | | | | | →02/10 | | | | |
| 2.0 TDCi | 4 | UKWA | 100/134 | 05/06→ | GE121A | 5V | | | |
| | | | | | 03/10→ | | | | |
| 2.0 TDCi | 4 | QXWA, QXWB, QXWC, UFWA | 103/138 | 05/06→ | GE121A | 5V | | | |
| 2.0 TDCi | 4 | TXWA | 120/161 | 03/10→ | GE121A | 5V | | | |
| 2.2 TDCi | 4 | Q4WA | 129/173 | 03/08→ | GN063 | 11V | | | |
| 2.3 | 4 | SEWA | 118/158 | 07/07→ | Z342 | 1.3 | UXT7 | | |
| 2.5 ST | 5 | HUWA | 162/217 | 05/06→ | Z326 | 0.7 | | ZSE055 | |
| 2.5 ST LPG | 5 | HUWA | 162/217 | 05/06→ | Z226 ^[168] | 0.8 | | | |

STREET KA

| | | | | | | | | | |
|-----|---|------------|-------|-------------|------|-----|------|----------------------|--|
| 1.6 | 4 | CDRA, CDRB | 70/94 | 05/03→07/05 | Z177 | 1.3 | UXT7 | ZS350 ^[1] | |
|-----|---|------------|-------|-------------|------|-----|------|----------------------|--|

TAUNUS

| | | | | | | | | | |
|----------|---|--------|--------|-------------|----------------------|-----|------|--------------------------|--|
| 1.3 | 4 | JAC | 40/54 | 05/75→07/79 | Z32 | 0.7 | | | |
| 1.3 | 4 | OHC HC | 40/54 | 05/75→07/79 | Z33 | 0.7 | | | |
| 1.3 | 4 | JAC | 43/58 | 05/75→07/79 | Z32 | 0.7 | | | |
| 1.3 1300 | 4 | OHC HC | 40/54 | 01/70→02/76 | Z33 | 0.7 | | | |
| 1.3 1300 | 4 | JAC | 40/54 | 01/70→05/75 | Z32 | 0.7 | | ZS115 ^{[1][11]} | |
| 1.6 | 4 | LAD | 50/67 | 05/75→07/79 | Z33 | 0.7 | | | |
| 1.6 | 4 | LCJ | 53/71 | 05/75→07/79 | Z33 | 0.7 | | | |
| 1.6 | 4 | LE | 65/87 | 08/76→07/79 | Z33 | 0.7 | | | |
| 1.6 1600 | 4 | LAD | 50/67 | 01/74→05/75 | Z33 | 0.7 | | | |
| 1.6 1600 | 4 | LCJ | 53/71 | 01/70→02/76 | Z33 | 0.7 | | | |
| 1.6 1600 | 4 | | 65/87 | 08/70→02/76 | Z33 | 0.7 | | | |
| 2.0 | 6 | NYR | 66/89 | 05/75→07/79 | Z27 ^[168] | 0.8 | UX56 | | |
| 2.3 | 6 | YYF | 79/106 | 05/75→07/79 | Z27 ^[168] | 0.8 | UX56 | | |

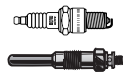

kW/BHP

**... FORD**

| ... FORD | | | | | | | | | |
|-------------------|---|----------|--------|-------------|-----------|--|--|-----|----------------------------------|
| TAUNUS '51 | | | | | | | | | |
| 1.2 | 4 | | 25/34 | 01/51→08/53 | Z57 | | | 0.6 | |
| TAUNUS '80 | | | | | | | | | |
| 1.3 | 4 | JCC | 43/58 | 07/79→07/82 | Z33 | | | 0.7 | |
| 1.3 | 4 | | 46/62 | 07/79→07/82 | Z33 | | | 0.7 | |
| 1.6 | 4 | LAR | 51/68 | 07/79→07/82 | Z33 | | | 0.7 | |
| 1.6 | 4 | LCJ | 54/72 | 07/79→07/82 | Z33 | | | 0.7 | |
| 1.6 | 4 | LE | 65/87 | 07/79→07/82 | Z33 | | | 0.7 | |
| 2.0 | 4 | NER | 74/99 | 07/79→07/82 | Z32 | | | 0.7 | |
| 2.0 | 6 | NWR | 66/89 | 07/79→07/82 | Z27 [168] | | | 0.8 | UX56 ZS126 08/81→ |
| 2.3 | 6 | YYR | 84/113 | 07/79→07/82 | Z27 [168] | | | 0.8 | UX56 ZS126 |
| TAUNUS 12M | | | | | | | | | |
| 1.2 | 4 | | 28/38 | 12/51→02/63 | Z57 | | | 0.6 | |
| 1.2 | 4 | | 29/39 | 07/62→04/67 | Z40 | | | 0.6 | ZS106 [11] |
| 1.2 | 4 | | 31/42 | 09/58→08/62 | | | | | ZS106 [11] |
| 1.2 | 4 | | 33/44 | 08/66→06/71 | Z48 | | | 0.8 | ZS115 [1][11] |
| 1.3 | 4 | KL 13 L | 37/50 | 08/66→06/71 | Z11 | | | 0.8 | UXT2 / UXT6 |
| 1.3 | 4 | TV 13 L | 37/50 | 08/66→06/71 | Z11 | | | 0.8 | UXT2 / UXT6 ZS106 [11] |
| 1.5 | 4 | | 37/50 | 07/62→04/67 | Z40 | | | 0.6 | ZS106 [11] |
| 1.5 | 4 | | 40/54 | 07/59→02/63 | Z57 | | | 0.6 | ZS106 [11] |
| 1.5 | 4 | TV 15 H | 40/54 | 08/66→06/71 | Z22 | | | 0.7 | UX56 ZS115 [1][11] |
| 1.5 TS | 4 | | 37/50 | 12/62→04/67 | Z40 | | | 0.6 | ZS106 [11] |
| 1.5 TS | 4 | | 40/54 | 12/62→04/67 | Z40 | | | 0.6 | ZS115 [1][11] |
| 1.5 TS | 4 | | 48/64 | 12/62→04/67 | Z40 | | | 0.6 | ZS106 [11][254] ZS115 [1][11] |
| TAUNUS 15M | | | | | | | | | |
| 1.5 | 4 | | 40/54 | 12/54→09/58 | Z57 | | | 0.6 | |
| 1.5 | 4 | TV 15 H | 40/54 | 08/66→07/71 | Z22 | | | 0.7 | UX56 |
| 1.5 | 4 | TV 15 HC | 48/64 | 08/66→06/71 | Z22 | | | 0.7 | UX56 |
| 1.5 XL/RS | 4 | TV 15 H | 40/54 | 01/68→06/71 | Z11 | | | 0.8 | UXT2 / UXT6 |
| 1.5 XL/RS | 4 | TV 15 HC | 48/64 | 08/66→06/71 | Z41 | | | 0.8 | |
| 1.7 | 4 | TV 17 H | 51/68 | 01/68→06/71 | Z22 | | | 0.7 | UX56 |
| 1.7 | 4 | TV 17 HC | 55/74 | 07/68→06/71 | Z22 | | | 0.7 | UX56 |
| 1.7 XL/RS | 4 | TV 17 H | 51/68 | 01/68→06/71 | Z11 | | | 0.8 | UXT2 / UXT6 |
| 1.7 XL/RS | 4 | TV 17 HC | 55/74 | 07/68→06/71 | Z11 | | | 0.8 | UXT2 / UXT6 |
| TAUNUS 17M | | | | | | | | | |
| 1.5 | 4 | | 40/54 | 09/60→01/65 | Z57 [169] | | | 0.6 | |
| 1.5 | 4 | | 44/59 | 09/64→10/68 | Z57 [169] | | | 0.6 | |
| 1.5 | 4 | | 44/59 | 07/67→04/74 | Z11 | | | 0.8 | UXT2 / UXT6 ZS106 [11] |
| 1.7 | 4 | | 44/59 | 08/57→11/60 | Z57 [169] | | | 0.6 | |
| 1.7 | 4 | | 44/59 | 09/57→08/58 | | | | | ZS106 [11] |
| 1.7 | 4 | | 48/64 | 09/64→10/68 | Z40 [169] | | | 0.6 | |
| 1.7 | 4 | | 48/64 | 09/64→04/74 | | | | | ZS106 [11] |
| 1.7 | 4 | | 48/64 | 07/67→04/74 | Z11 | | | 0.8 | UXT2 / UXT6 |
| 1.7 | 4 | | 51/68 | 09/64→10/68 | Z40 [169] | | | 0.6 | |
| 1.7 | 4 | | 51/68 | 09/64→04/74 | | | | | ZS106 [11] |
| 1.7 | 4 | | 51/68 | 07/67→04/74 | Z22 | | | 0.7 | UX56 |
| 1.7 | 4 | | 55/74 | 12/67→04/74 | Z22 | | | 0.7 | UX56 |
| 1.7 S | 4 | | 48/64 | 09/60→01/65 | Z57 [169] | | | 0.6 | ZS106 [11] |
| 1.7 S | 4 | | 55/74 | 11/61→01/65 | Z57 [169] | | | 0.6 | |
| 1.8 | 6 | | 60/80 | 12/67→04/74 | Z22 | | | 0.7 | UX56 |
| 2.0 | 6 | | 63/84 | 12/67→04/74 | Z11 | | | 0.8 | UXT2 / UXT6 |
| 2.0 | 6 | | 66/89 | 12/67→04/74 | Z22 | | | 0.7 | UX56 |
| TAUNUS 20M | | | | | | | | | |
| 2.0 | 6 | | 63/84 | 11/64→04/74 | Z11 | | | 0.8 | UXT2 / UXT6 |
| 2.0 | 6 | | 66/89 | 07/67→04/74 | Z11 | | | 0.8 | UXT2 / UXT6 |
| | | | | | Z41 | | | 0.8 | |
| 2.0 TS | 6 | | 66/89 | 11/64→10/68 | Z11 | | | 0.8 | UXT2 / UXT6 |

FORD



kW/BHP

**... FORD****... TAUNUS 20M**

| | | | | | | | | |
|-----|---|--|--------|-------------|-----|-----|-------------|--|
| 2.3 | 6 | | 79/106 | 07/67→04/74 | Z11 | 0.8 | UXT2 / UXT6 | |
|-----|---|--|--------|-------------|-----|-----|-------------|--|

TAUNUS 20M XL

| | | | | | | | | |
|-----|---|--|--------|-------------|-----|-----|-------------|--|
| 2.0 | 6 | | 63/84 | 01/68→04/74 | Z11 | 0.8 | UXT2 / UXT6 | |
| 2.0 | 6 | | 66/89 | 07/67→04/74 | Z11 | 0.8 | UXT2 / UXT6 | |
| 2.3 | 6 | | 79/106 | 07/67→04/74 | Z11 | 0.8 | UXT2 / UXT6 | |

TAUNUS 26M XL

| | | | | | | | | |
|-----|---|---------|--------|-------------|-----|-----|------|--|
| 2.5 | 6 | TV 26 H | 92/123 | 10/69→04/74 | Z22 | 0.7 | UX56 | |
|-----|---|---------|--------|-------------|-----|-----|------|--|

TOURNEO CONNECT

| | | | | | | | | |
|--------------|---|--|--------|--------|--------|-----|------|-------|
| 1.6 TDCi | 4 | UBGA | 55/74 | 09/13→ | GE121A | 5V | | |
| 1.6 TDCi | 4 | TZGA, TZGB | 70/94 | 09/13→ | GE121A | 5V | | |
| 1.6 TDCi | 4 | T1GA | 85/114 | 09/13→ | GE121A | 5V | | |
| 1.8 16V | 4 | EYPA, EYPC, EYPD | 85/114 | 06/02→ | Z97 | 1.0 | UXT8 | ZS350 |
| 1.8 Di | 4 | BHPA, P7PA, P7PB, R2PA | 55/74 | 06/02→ | GN993 | 10V | | |
| 1.8 TDCi | 4 | RWPA, RWPC, RWPD | 81/109 | 08/06→ | GN993 | 10V | | |
| 1.8 Turbo Di | 4 | HCPA, HCPB, P9PA, P9PB, P9PC, P9PD, R3PA, RWPE, RWPF | 66/89 | 06/02→ | GN993 | 10V | | |

TOURNEO COURIER

| | | | | | | | | |
|----------|---|------------|-------|--------|--------|----|--|--|
| 1.5 TDCi | 4 | | 55/74 | 02/14→ | GE121A | 5V | | |
| 1.6 TDCi | 4 | T3CA, T3CB | 70/94 | 02/14→ | GE121A | 5V | | |

TRANSIT CONNECT

| | | | | | | | | |
|----------|---|------------|--------|--------|--------|----|--|--|
| 1.6 TDCi | 4 | UBGA | 55/74 | 09/13→ | GE121A | 5V | | |
| 1.6 TDCi | 4 | TZGA, TZGB | 70/94 | 09/13→ | GE121A | 5V | | |
| 1.6 TDCi | 4 | T1GA | 85/114 | 09/13→ | GE121A | 5V | | |

TRANSIT COURIER

| | | | | | | | | |
|----------|---|--|-------|--------|--------|----|--|--|
| 1.5 TDCi | 4 | | 55/74 | 02/14→ | GE121A | 5V | | |
| 1.6 TDCi | 4 | | 70/94 | 02/14→ | GE121A | 5V | | |

ZEPHYR III

| | | | | | | | | |
|-----|---|---------|-------|-------------|--|--|--|------------|
| 1.7 | 4 | | 41/55 | 12/62→10/66 | | | | ZS106 (11) |
| 1.7 | 4 | EL 17 L | 44/59 | 03/62→03/68 | | | | ZS106 (11) |
| 1.7 | 4 | EL 17 L | 48/64 | 03/62→03/68 | | | | ZS106 (11) |
| 2.5 | 6 | | 65/87 | 03/62→03/68 | | | | ZS106 (11) |
| 2.5 | 6 | EL 25 L | 68/91 | 03/62→03/68 | | | | ZS106 (11) |

ZEPHYR IV

| | | | | | | | | |
|-----|---|---------|--------|-------------|--|--|--|------------|
| 2.0 | 4 | EV 20 A | 57/76 | 03/68→10/72 | | | | ZS106 (11) |
| 2.0 | 4 | EV 20 B | 61/82 | 03/68→10/72 | | | | ZS106 (11) |
| 2.5 | 6 | EV 25 B | 73/98 | 03/68→10/72 | | | | ZS115 (11) |
| 2.5 | 6 | EV 25 L | 76/102 | 03/68→10/72 | | | | ZS115 (11) |
| 3.0 | 6 | EV 30 A | 88/118 | 03/68→10/72 | | | | ZS115 (11) |
| 3.0 | 6 | | 94/126 | 03/68→10/72 | | | | ZS115 (11) |

ZODIAC

| | | | | | | | | |
|-----|---|----------|--------|-------------|--|--|--|------------|
| 2.5 | 6 | EL 25 LV | 73/98 | 03/66→10/72 | | | | ZS115 (11) |
| 2.5 | 6 | EL 25 HV | 78/105 | 03/66→10/72 | | | | ZS115 (11) |
| 3.0 | 6 | | 94/126 | 03/67→10/72 | | | | ZS115 (11) |

ZODIAK

| | | | | | | | | |
|-----|---|----------|--------|-------------|--|--|--|------------|
| 2.5 | 6 | EL 25 LV | 73/98 | 03/62→10/72 | | | | ZS115 (11) |
| 2.5 | 6 | EL 25 HV | 78/105 | 03/62→10/72 | | | | ZS115 (11) |
| 3.0 | 6 | | 94/126 | 03/67→10/72 | | | | ZS115 (11) |

FORD**ECONOVAN**

| | | | | | | | | |
|-------|---|----|-------|-------------|-------|-----|-------------|--|
| 1.4 | 4 | UC | 48/64 | 03/86→03/92 | Z8 | 0.8 | UXT2 / UXT6 | |
| 2.0 D | 4 | RF | 41/55 | 03/86→03/92 | GV705 | 7V | | |

ESCORT '81

| | | | | | | | | |
|-----|---|-----|-------|-------------|-----|-----|------|------------|
| 1.1 | 4 | GLB | 37/50 | 03/81→02/86 | Z95 | 0.7 | UXT4 | ZS109 (15) |
|-----|---|-----|-------|-------------|-----|-----|------|------------|



kW/BHP

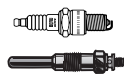

... FORD



... ESCORT '81

| | | | | | | | | | | |
|-------|---|-----|-------|-------------|-------------------------|--|--------------|------|-----------------|------------------------------------|
| 1.3 | 4 | JPA | 51/68 | 03/81→02/86 | Z24 | | 0.8 | UXT5 | ZS126 →12/85 | ZM008 →01/85 ZM003 02/85→ |
| 1.6 D | 4 | LTA | 40/54 | 02/84→02/86 | GN927 [2][222] GV631 | | 11V 11.5V | | | |

ESCORT '86

| | | | | | | | | | | |
|-------|---|----------|-------|-------------|--------------------------------------|--|--------------|---------------|---------------------------|-------|
| 1.1 | 4 | GSG | 37/50 | 05/86→07/90 | Z95 | | 0.7 | UXT4 | ZS281 | ZM003 |
| 1.3 | 4 | JBB | 44/59 | 02/86→07/90 | Z67 | | 1.1 | UXT4 | ZS281 [1] 08/88→ | |
| 1.3 | 4 | JLA, JLB | 44/59 | 02/86→07/90 | Z95 | | 0.7 | UXT4 | ZS281 [1] 08/88→ | |
| 1.3 | 4 | JBA | 46/62 | 07/88→07/90 | Z67 | | 1.1 | UXT4 | ZS281 | |
| 1.4 i | 4 | F6B, F6D | 54/72 | 02/86→07/90 | Z99 →07/88 Z16 [171] 08/88→ | | 1.0 1.1 | UXT5 UXT11 | ZS126 →07/88 08/88→ | |
| 1.4 i | 4 | FUC | 54/72 | 02/86→07/90 | Z253 | | 1.0 | UXT5 | ZS126 | |
| 1.6 | 4 | LUC | 60/80 | 02/86→07/90 | | | | | ZS281 | |
| 1.6 D | 4 | LTA | 40/54 | 02/86→07/90 | GN927 [2][222] GV631 | | 11V 11.5V | | | |
| 1.8 D | 4 | RTA, RTB | 44/59 | 07/88→07/90 | GN927 [2][222] GV666 | | 11V 11.5V | | | |

ESCORT '91

| | | | | | | | | | | |
|-------|---|----------|-------|-------------|-------------------------|--|--------------|------|---------------------|-------|
| 1.3 | 4 | JBD | 46/62 | 07/90→12/94 | Z67 | | 1.1 | UXT4 | ZS238 | ZM003 |
| 1.4 | 4 | F6F, F6G | 52/70 | 07/90→12/94 | | | | | ZS281 [1] 08/90→ | |
| 1.8 D | 4 | RTH | 44/59 | 07/90→12/94 | GN927 [2][222] GV666 | | 11V 11.5V | | | |

ESCORT '95

| | | | | | | | | | | |
|-------------|---|----------|-------|-------------|-------------------------|--|--------------|-------|-------|--|
| 1.4 | 4 | F4B | 54/72 | 01/95→ | Z16 [171] | | 1.1 | UXT11 | ZS281 | |
| 1.4 LPG | 4 | F4B | 54/72 | 01/95→ | Z340 | | 0.7 | UXT12 | | |
| 1.8 D | 4 | RTF, RTH | 44/59 | 01/95→ | GN927 [2][222] GV666 | | 11V 11.5V | | | |
| 1.8 TD | 4 | RFD, RFK | 66/89 | 01/95→ | GV666 | | 11.5V | | | |
| 1.8 TD | 4 | RFS | 66/89 | 01/95→ | GN022 | | 10V | | | |
| 1.8 Turbo D | 4 | RVA | 51/68 | 12/95→06/01 | GN022 | | 10V | | | |

FIESTA

| | | | | | | | | | | |
|---------|---|------------|-------|-------------|------|--|-----|-------|------------------------------------|-----------------|
| 1.0 | 4 | TKA | 29/39 | 10/77→11/86 | Z95 | | 0.7 | UXT4 | ZS109 [15] | ZM047 04/84→ |
| 1.0 | 4 | TKB | 33/44 | 08/83→11/89 | Z95 | | 0.7 | UXT4 | ZS126 | ZM047 04/84→ |
| 1.1 | 4 | GL1, GLA | 39/52 | 10/77→11/86 | Z95 | | 0.7 | UXT4 | ZS109 [15] | ZM047 04/84→ |
| 1.3 | 4 | J4C | 44/59 | 02/96→ | Z67 | | 1.1 | UXT4 | ZS281 →08/98 ZS350 09/98→ | |
| 1.3 | 4 | J6B | 44/59 | 09/91→02/96 | Z67 | | 1.1 | UXT4 | ZS238 ZS281 01/92→ | |
| 1.3 | 4 | A9JA, A9JB | 51/68 | 10/03→ | Z177 | | 1.3 | UXT7 | ZS350 [1] | |
| 1.3 | 4 | SNJA, SNJB | 60/80 | 01/09→ | | | | | ZS387 | |
| 1.3 LPG | 4 | J4C, J6B | 44/59 | 09/91→ | Z26 | | 0.7 | UXK56 | | |
| 1.4 i | 4 | FHA | 66/89 | 04/96→10/99 | Z177 | | 1.3 | UXT7 | ZS281 | |

FORD



kW/BHP

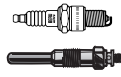

... FORD



... FIESTA

| | | | | | | | | |
|----------|---|------------------|-------|-------------|--|--------------|--|--|
| 1.4 TDCi | 4 | F6JA, F6JB | 50/67 | 10/03→ | GN047 [1] →08/04 GN056 [1] 09/04→ | 11V | | |
| 1.4 TDCi | 4 | F6JB | 50/67 | 01/09→ | GN056 | 11V | | |
| 1.4 TDCi | 4 | F6JD | 51/68 | 07/10→ | GN056 | 11V | | |
| 1.5 TDCi | 4 | UGJC | 55/74 | 10/12→ | GE121A | 5V | | |
| 1.6 D | 4 | LTB | 40/54 | 09/83→09/89 | GV631 | 11.5V | | |
| 1.6 TDCi | 4 | HHJC, HHJD, HHJE | 66/89 | 01/09→ | GN056 | 11V | | |
| 1.6 TDCi | 4 | TZJA, TZJB | 70/94 | 02/10→ | GE121A | 5V | | |
| 1.8 D | 4 | RTC, RTD, RTG | 43/58 | 03/89→12/95 | GN927 [2][222] GV666 | 11V 11.5V | | |
| 1.8 D | 4 | RTC, RTD, RTG | 44/59 | 09/91→02/96 | GN927 [2][222] GV666 | 11V 11.5V | | |
| 1.8 D | 4 | RTJ, RTK | 44/59 | 02/96→ | GN022 | 10V | | |
| 1.8 DI | 4 | RTN, RTP | 55/74 | 09/00→ | GN993 →12/02 | 10V | | |
| 1.8 TD | 4 | RTN, RTP, RTQ | 55/74 | 03/00→ | GN993 →12/02 | 10V | | |

KA Van

| | | | | | | | | |
|-------|---|-------------------------|-------|-------------|-------------|-----|-------------|--|
| 1.3 i | 4 | BAA | 44/59 | 05/02→05/05 | Z177 | 1.3 | UXT7 | |
| 1.3 i | 4 | J4D, J4K, J4M, J4P, J4S | 44/59 | 05/02→05/05 | Z67 | 1.1 | UXT4 | |

TOURNEO CUSTOM

| | | | | | | | | |
|----------|---|------------------|---------|--------|--------------|------|--|--|
| 2.2 TDCi | 4 | DRF4, DRFF, DRFG | 74/99 | 12/12→ | GE122 | 4.4V | | |
| 2.2 TDCi | 4 | CYF4, CYFF | 92/123 | 12/12→ | GE122 | 4.4V | | |
| 2.2 TDCi | 4 | CVFF | 114/153 | 12/12→ | GE122 | 4.4V | | |

TRANSIT

| | | | | | | | | |
|------------------|---|--------|-------|-------------|--|-----|------------------------------|-----------------------------|
| 1.5 | 4 | EX | 44/59 | 01/71→05/73 | Z48 →03/71 Z11 04/71→ | 0.8 | UXT2 / UXT6 04/71→ | |
| 1.5 900 | 4 | | 44/59 | 11/65→08/69 | Z48 | 0.8 | | |
| 1.5 900 | 4 | | 44/59 | 11/65→05/73 | Z48 →03/71 Z11 04/71→ | 0.8 | UXT2 / UXT6 04/71→ | |
| 1.5 1000 | 4 | | 44/59 | 12/68→05/73 | Z48 →08/69 Z11 08/69→ | 0.8 | UXT2 / UXT6 08/69→ | |
| 1.5 1100 | 4 | | 44/59 | 11/65→07/71 | Z48 →08/69 Z11 09/69→ | 0.8 | UXT2 / UXT6 09/69→ | |
| 1.6 | 4 | LAT | 46/62 | 09/85→09/92 | Z33 | 0.7 | | ZS126 01/86→07/91 |
| 1.6 | 4 | LAT | 46/62 | 12/85→01/89 | | | | ZS126 |
| 1.6 | 4 | 4RB, B | 48/64 | 11/77→10/86 | Z32 | 0.7 | | ZS126 08/83→12/85 |
| 1.7 | 4 | | 48/64 | 01/71→05/73 | Z48 | 0.8 | | |
| 1.7 900 | 4 | | 48/64 | 02/71→06/71 | Z48 | 0.8 | | |
| 1.7 1000 | 4 | | 48/64 | 01/71→05/73 | Z48 | 0.8 | | |
| 1.7 1300 | 4 | | 48/64 | 01/66→07/73 | Z48 | 0.8 | | |
| 1.7 1300 Feuerw. | 4 | | 48/64 | 11/65→05/73 | Z48 | 0.8 | | |
| 1.7 FT 100 | 4 | EY | 48/64 | 04/71→03/78 | Z11 | 0.8 | UXT2 / UXT6 | |
| 2.0 | 4 | 4RC | 43/58 | 11/77→07/82 | Z32 | 0.7 | | |
| 2.0 | 4 | 4RC | 55/74 | 11/77→10/86 | Z32 | 0.7 | | ZS126 08/83→12/85 |



kW/BHP

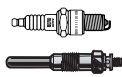

... FORD



... TRANSIT

| | | | | | | | | |
|--------------|---|--|---------|-------------|-----------------|-------|-------|-------------|
| 2.0 | 4 | 4RC | 57/76 | 11/77→10/86 | Z32 | 0.7 | ZS126 | 08/83→12/85 |
| 2.0 | 4 | N6T | 57/76 | 11/85→09/92 | Z32 | 0.7 | ZS126 | 10/88→07/91 |
| 2.0 | 4 | NAT, NAV | 57/76 | 09/85→09/92 | Z32 | 0.7 | ZS126 | 01/86→07/91 |
| 2.0 | 4 | NAT, NAV | 57/76 | 01/86→09/92 | | | ZS126 | →07/91 |
| 2.0 | 4 | NBA | 66/89 | 09/91→09/94 | Z32 | 0.7 | ZS126 | |
| 2.0 | 4 | NCA | 72/97 | 09/91→08/94 | Z32 | 0.7 | ZS126 | |
| 2.0 | 4 | NSF, NSG | 84/113 | 06/94→03/00 | Z130 | 1.0 | UXT14 | |
| 2.0 CNG | 4 | NSH | 84/113 | 06/94→03/00 | Z159 | 1.1 | UXT14 | |
| 2.0 DI | 4 | D3FA | 55/74 | 08/00→05/06 | GN939 | 11.5V | | |
| 2.0 DI | 4 | F3FA | 63/84 | 08/00→05/06 | GN939 | 11.5V | | |
| 2.0 DI | 4 | ABFA | 74/99 | 08/00→05/06 | GN939 | 11.5V | | |
| 2.0 i | 4 | NCA | 72/97 | 09/91→07/94 | Z32 | 0.7 | ZS126 | |
| 2.0 TDCi | 4 | F1FA | 92/123 | 08/02→05/06 | GN939 | 11.5V | | |
| 2.2 TDCi | 4 | P8FA, P8FB | 63/84 | 04/06→ | GN939 | 11.5V | | |
| 2.2 TDCi | 4 | DRFA, DRFB, DRFC, DRFD, DRFE, DRRA, DRRB, DRRC | 74/99 | 10/11→ | GE122 | 4.4V | | |
| 2.2 TDCi | 4 | QVFA | 81/109 | 04/06→ | GN939 | 11.5V | | |
| 2.2 TDCi | 4 | SRFA, SRFB, SRFC, SRFD, SRFE | 85/114 | 10/08→ | GN939 | 11.5V | | |
| 2.2 TDCi | 4 | CYFA, CYFB, CYFC, CYFD, CYRA, CYRB, CYRC | 92/123 | 10/11→ | GE122 | 4.4V | | |
| 2.2 TDCi | 4 | QWFA | 96/129 | 04/06→ | GN939 | 11.5V | | |
| 2.2 TDCi | 4 | USRA, USRB | 100/134 | 09/11→ | GE122 | 4.4V | | |
| 2.2 TDCi | 4 | PGFA, PGFB, UHFA, UHFB, UHFC | 103/138 | 10/07→ | GN939 | 11.5V | | |
| 2.2 TDCi | 4 | CVRA, CVRB, CVRC | 114/153 | 10/11→ | GE122 | 4.4V | | |
| 2.3 | 4 | E5FC | 105/141 | 03/01→03/06 | | | ZS308 | |
| 2.3 | 4 | E5FA | 107/143 | 03/01→03/06 | | | ZS308 | |
| 2.3 16V | 4 | E5FA, E5FC | 107/143 | 08/00→05/06 | Z24 | 0.8 | UXT5 | ZS308 |
| 2.3 16V | 4 | GZFA, GZFC | 107/143 | 04/06→ | Z148 | 1.3 | UXT15 | ZS408 |
| 2.3 16V LPG | 4 | E5FA, E5FC | 107/143 | 08/00→05/06 | Z30 [168] | 0.8 | UXT5 | |
| 2.3 D FT 100 | 4 | | 46/62 | 11/71→09/78 | GH760 | 11V | | |
| | | | | 04/78→05/78 | GN927 [222] | 11V | | |
| | | | | 06/78→ | GV604 | 11V | | |
| | | | | 06/78→ | | | | |
| 2.4 D | 4 | 4AA | 46/62 | 11/77→10/86 | GN927 [21][222] | 11V | | |
| | | | | | GV604 | 11V | | |
| 2.4 DI | 4 | F4FA | 55/74 | 01/00→05/06 | GN939 | 11.5V | | |
| 2.4 DI | 4 | D2FA, D2FB, D2FE | 66/89 | 01/00→05/06 | GN939 | 11.5V | | |
| 2.4 DI | 4 | D4FA | 88/118 | 01/00→05/06 | GN939 | 11.5V | | |
| 2.4 TD | 4 | F4FA | 55/74 | 08/00→08/03 | GN939 | 11.5V | | |
| 2.4 TDCi | 4 | PHFA, PHFC | 74/99 | 04/06→ | GN939 | 11.5V | | |
| 2.4 TDCi | 4 | JXFA, JXFC | 85/114 | 04/06→ | GN939 | 11.5V | | |
| 2.4 TDCi | 4 | H9FA | 101/135 | 03/04→05/06 | GN939 | 11.5V | | |
| 2.4 TDCi | 4 | H9FB, H9FD | 103/138 | 04/06→ | GN939 | 11.5V | | |
| 2.4 TDDi | 4 | D2FE | 66/89 | 10/01→03/06 | GN939 | 11.5V | | |
| 2.4 TDDi | 4 | D4FA | 88/118 | 08/00→08/03 | GN939 | 11.5V | | |
| 2.4 TDE | 4 | FXFA | 85/114 | 03/04→05/06 | GN939 | 11.5V | | |
| 2.4 TDE | 4 | DOFA | 92/123 | 07/01→05/06 | GN939 | 11.5V | | |
| 2.5 D | 4 | 4AB | 50/67 | 10/83→09/91 | GF859 | 8V | | |
| 2.5 D | 4 | 4AB, 4BA, 4CA | 52/70 | 09/88→09/92 | GF859 | 8V | | |
| 2.5 DI | 4 | 4BC, 4CC, 4FA | 51/68 | 05/91→08/94 | GF859 | 8V | | |
| 2.5 DI | 4 | 4FA, 4FB, 4FC, 4FD, FB, FC, FD | 51/68 | 06/94→03/00 | GF983 | 8V | | |
| 2.5 DI | 4 | 4BA, 4CA | 52/70 | 09/88→09/92 | GF859 | 8V | | |
| 2.5 DI | 4 | 4HB, 4HC | 56/75 | 06/94→03/00 | GF982-B | 8V | | |

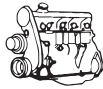

kW/BHP

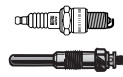
**... FORD****... TRANSIT**

| | | | | | | | | |
|----------|---|------------------------------|---------|-------------|--------------------------|-------|-------------|----------------------|
| 2.5 DI | 4 | 4DA | 59/79 | 05/91→08/94 | GF859 | 8V | | |
| 2.5 DI | 4 | 4GA | 63/84 | 10/92→06/94 | GF859 | 8V | | |
| 2.5 DI | 4 | 4ED | 85/114 | 08/97→03/00 | GF982-B | 8V | | |
| 2.5 TD | 4 | 4HA, 4HD | 55/74 | 08/94→07/00 | GF982-B | 8V | | |
| 2.5 TD | 4 | 4GA, 4GB, 4GC | 63/84 | 10/92→08/94 | GF859 | 8V | | |
| 2.5 TD | 4 | 4GA, 4GB, 4GC, 4GD, 4GE, 4GF | 63/84 | 06/94→03/00 | GF982-B ^[253] | 8V | | |
| | | | | | GF983 ^[251] | 8V | | |
| 2.5 TD | 4 | 4EA | 74/99 | 05/91→08/94 | GF859 | 8V | | |
| 2.5 TD | 4 | 4EB, 4EC | 74/99 | 07/94→03/00 | GF982-B | 8V | | |
| 2.5 TDI | 4 | 4EB, 4EC | 74/99 | 06/94→03/00 | GF982-B | 8V | | |
| 2.9 i | 6 | BRT | 107/143 | 01/91→09/94 | Z15 →07/94 | 0.8 | UXT1 / UXT3 | ZS126 08/91→07/94 |
| 3.2 TDCi | 5 | SAFA, SAFB | 147/197 | 09/07→ | GN939 | 11.5V | | |

TRANSIT '55-

| | | | | | | | | |
|------------------------|---|--|-------|-------------|-----|-----|--|--|
| 1.5 1250 S-2 Klein-LKW | 4 | | 40/54 | 10/57→07/67 | Z48 | 0.8 | | |
| 1.5 K-40 | 4 | | 40/54 | 04/55→04/67 | Z48 | 0.8 | | |

TRANSIT CONNECT

| | | | | | | | | |
|-------------|---|--|--------|--------|--------|-----|------|-------|
| 1.6 TDCi | 4 | UBGA | 55/74 | 09/13→ | GE121A | 5V | | |
| 1.6 TDCi | 4 | TZGA, TZGB | 70/94 | 09/13→ | GE121A | 5V | | |
| 1.6 TDCi | 4 | T1GA | 85/114 | 09/13→ | GE121A | 5V | | |
| 1.8 16V | 4 | EYPA, EYPC, EYPD | 85/114 | 06/02→ | Z97 | 1.0 | UXT8 | ZS365 |
| 1.8 16V LPG | 4 | EYPC | 85/114 | 06/02→ | Z97 | 1.0 | UXT8 | ZS281 |
| 1.8 Di | 4 | BHPA, P7PA, P7PB, R2PA | 55/74 | 06/02→ | GN993 | 10V | | |
| 1.8 TDCi | 4 | HCPA, HCPB, P9PA, P9PB, P9PC, P9PD, R3PA, RWPE, RWPF | 66/89 | 06/02→ | GN993 | 10V | | |
| 1.8 TDCi | 4 | RWPA, RWPC, RWPD | 81/109 | 08/06→ | GN993 | 10V | | |

TRANSIT COURIER

| | | | | | | | | |
|----------|---|--|-------|--------|--------|----|--|--|
| 1.5 TDCi | 4 | | 55/74 | 02/14→ | GE121A | 5V | | |
| 1.6 TDCi | 4 | | 70/94 | 02/14→ | GE121A | 5V | | |

TRANSIT CUSTOM

| | | | | | | | | |
|----------|---|------------------|---------|--------|-------|------|--|--|
| 2.2 TDCi | 4 | DRF4, DRFF, DRFG | 74/99 | 12/12→ | GE122 | 4.4V | | |
| 2.2 TDCi | 4 | CYF4, CYFF | 92/123 | 12/12→ | GE122 | 4.4V | | |
| 2.2 TDCi | 4 | CVFF | 114/153 | 12/12→ | GE122 | 4.4V | | |

TRANSIT TOURNEO

| | | | | | | | | |
|----------|---|------------------------------|---------|-------------|--------------------------|-------|-------|--|
| 2.0 | 4 | NSH | 84/113 | 11/94→12/00 | Z130 | 1.0 | UXT14 | |
| 2.2 TDCi | 4 | QVFA | 81/109 | 07/06→ | GN993 | 10V | | |
| 2.2 TDCi | 4 | SRFA, SRFB, SRFC, SRFD, SRFE | 85/114 | 10/08→ | GN939 | 11.5V | | |
| 2.2 TDCi | 4 | QWFA | 96/129 | 07/06→ | GN993 | 10V | | |
| 2.2 TDCi | 4 | PGFA, PGFB | 103/138 | 10/07→ | GN939 | 11.5V | | |
| 2.5 DI | 4 | 4FA, 4FB, 4FC, 4FD | 51/68 | 11/94→12/00 | GF983 | 8V | | |
| 2.5 DI | 4 | 4HA, 4HB, 4HC | 56/75 | 11/94→12/00 | GF982-B | 8V | | |
| 2.5 TD | 4 | 4GA, 4GB, 4GC | 63/84 | 11/94→12/00 | GF982-B ^[253] | 8V | | |
| | | | | | GF983 ^[251] | 8V | | |
| 2.5 TD | 4 | 4EB, 4EC | 74/99 | 04/98→12/00 | GF982-B | 8V | | |

F50**125P**

| | | | | | | | | |
|-----|---|-----------|-------|-------------|----------------------|-----|-------------|---------------------------------------|
| 1.3 | 4 | 116 C 076 | 47/63 | 10/67→08/92 | Z11 ^[167] | 0.8 | UXT2 / UXT6 | ZS106 ^[11] |
| 1.5 | 4 | 115 C 076 | 55/74 | 10/67→08/92 | Z11 ^[167] | 0.8 | UXT2 / UXT6 | ZS106 ^[11] ZM005 01/71→ |

FORD



kW/BHP

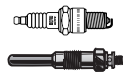

... FSO



| 126P | | | | | | | | | |
|-------------|---|------------|--------|-------------|----------------|--|-----|-------------|-------------|
| 0.6 | 2 | | 17/23 | 07/72→07/77 | Z41 | | 0.8 | ZS106 [11] | |
| | | | | | | | | 12/72→ | |
| 0.6 | 2 | 126 A1.048 | 22/30 | 07/77→12/91 | Z41 [168] | | 0.8 | | |
| 0.7 650 | 2 | 126 A1.048 | 18/24 | 07/81→09/00 | Z11 | | 0.8 | UXT2 / UXT6 | |
| | | | | | →12/82 | | | →12/82 | |
| 127P | | | | | | | | | |
| 0.9 | 4 | | 33/44 | 10/69→10/76 | Z42 | | 0.8 | UX56 | |
| 132P | | | | | | | | | |
| 1.6 | 4 | | 72/97 | 01/74→09/78 | Z20 | | 0.8 | UXT2 / UXT6 | |
| 1.8 | 4 | | 79/106 | 07/75→09/78 | Z27 [170] | | 0.8 | UX56 | |
| LANOS | | | | | | | | | |
| 1.4 | 4 | | 55/74 | 05/04→10/08 | Z20 | | 0.8 | UXT2 / UXT6 | |
| 1.6 16V | 4 | A16DMS | 78/105 | 05/04→10/08 | Z16 | | 1.1 | UXT11 | |
| POLONEZ I | | | | | | | | | |
| 1.3 | 4 | | 48/64 | 01/78→12/80 | Z11 [168] | | 0.8 | UXT2 / UXT6 | |
| 1.5 | 4 | AA | 55/74 | 10/77→08/88 | Z22 [167] | | 0.7 | UX56 | ZM005 |
| | | | | | 05/78→ | | | 05/78→ | 01/83→12/86 |
| 1.5 | 4 | | 60/80 | 01/78→08/88 | | | | ZS106 [11] | ZM005 |
| | | | | | | | | | 01/83→12/86 |
| 1.6 | 4 | CB | 64/86 | 08/86→08/88 | Z11 [168] | | 0.8 | UXT2 / UXT6 | ZS106 [11] |
| | | | | | 05/87→ | | | 05/87→ | ZM005 |
| POLONEZ II | | | | | | | | | |
| 1.5 | 4 | AA | 55/74 | 08/88→08/92 | Z11 [168] | | 0.8 | UXT2 / UXT6 | ZS106 [11] |
| 1.5 i | 4 | | 55/74 | 08/88→08/92 | | | | ZS106 [11] | |
| 1.6 | 4 | CB | 64/86 | 08/88→08/92 | | | | ZS106 [11] | |
| 1.9 D | 4 | XUD 9A | 51/68 | 08/88→08/92 | GN909 [2][222] | | 11V | | |
| | | | | | GV642 | | 11V | | |
| POLONEZ III | | | | | | | | | |
| 1.6 i | 4 | | 57/76 | 09/92→03/02 | | | | ZS234 | |
| 1.9 D | 4 | XUD 9A | 51/68 | 09/92→03/02 | GN909 [2][222] | | 11V | | |
| | | | | | GV636 | | 11V | | |

HONDA



ACCORD I

| | | | | | | | | | |
|----------|---|--------|-------|-------------|--------|--|-----|-------------|--------|
| 1.6 L/EX | 4 | EG, EL | 59/79 | 01/78→09/83 | Z59 | | 0.8 | | ZM054 |
| | | | | | →12/78 | | | | |
| | | | | | Z8 | | 0.8 | UXT2 / UXT6 | |
| | | | | | 01/79→ | | | 01/79→ | |
| 1.6 L/EX | 4 | EL | 59/79 | 01/79→09/83 | Z8 | | 0.8 | UXT2 / UXT6 | ZM054 |
| | | | | | | | | | →12/80 |

ACCORD II

| | | | | | | | | | |
|--------|---|-----|-------|-------------|-----|--|-----|-------------|-----------------|
| 1.6 EX | 4 | EZ | 65/87 | 09/83→10/85 | Z21 | | 1.1 | UXT2 / UXT6 | ZS106 [11][254] |
| | | | | | | | | | ZS110 [15] |
| | | | | | | | | | →12/84 |
| | | | | | | | | | ZM016 [209] |
| | | | | | | | | | ZM056 |
| | | | | | | | | | 01/85→ |
| 1.8 EX | 4 | ET1 | 74/99 | 09/83→10/85 | Z21 | | 1.1 | UXT2 / UXT6 | ZM016 [209] |
| | | | | | | | | | ZM056 |
| | | | | | | | | | 01/85→ |

ACCORD III

| | | | | | | | | | |
|--------|---|-------|--------|-------------|-----|--|------|-------------|--------|
| 1.6 L | 4 | A16A1 | 65/87 | 11/85→12/89 | Z21 | | 1.1 | UXT2 / UXT6 | ZM056 |
| 2.0 EX | 4 | A20A1 | 75/101 | 11/85→12/89 | Z9 | | 1.15 | UXT2 / UXT6 | ZM056 |
| | | | | | | | | | 01/86→ |
| 2.0 EX | 4 | A20A1 | 75/101 | 10/87→12/89 | | | | | ZM056 |
| 2.0 EX | 4 | A20A1 | 76/102 | 11/85→12/89 | Z9 | | 1.15 | UXT2 / UXT6 | ZM056 |
| | | | | | | | | | 01/86→ |



kW/BHP

**... HONDA****... ACCORD III**

| | | | | | | | | | | |
|-----------|---|-------|---------|-------------|-----|--|------|-------------|--|--------|
| 2.0 EX | 4 | A20A1 | 76/102 | 10/87→12/89 | | | | | | ZM056 |
| 2.0 EX | 4 | A20A2 | 78/105 | 11/85→05/89 | Z9 | | 1.15 | UXT2 / UXT6 | | ZM056 |
| | | | | | | | | | | 01/86→ |
| 2.0 EXi | 4 | A20A3 | 85/114 | 01/86→12/89 | Z9 | | 1.15 | UXT2 / UXT6 | | ZM056 |
| 2.0 EXi | 4 | A20A4 | 90/121 | 11/85→12/87 | Z21 | | 1.1 | UXT2 / UXT6 | | ZM056 |
| 2.0 i 16V | 4 | B20A8 | 98/131 | 10/87→12/89 | Z16 | | 1.1 | UXT11 | | ZM016 |
| 2.0 i 16V | 4 | B20A2 | 101/135 | 01/87→12/87 | Z16 | | 1.1 | UXT11 | | ZM016 |

ACCORD IV

| | | | | | | | | | | |
|---------------------|---|---------------------|---------|-------------|------|--|-----|------|---------------------------|----------------------|
| 2.0 16V | 4 | F20A6 | 66/89 | 01/90→03/93 | Z158 | | 1.1 | | | |
| 2.0 16V | 4 | F20A2, F20A3 | 81/109 | 01/90→03/93 | Z158 | | 1.1 | | ZS275 | |
| 2.0 16V LPG | 4 | F20A6 | 66/89 | 01/90→03/93 | Z116 | | 0.8 | UXT5 | | |
| 2.0 i 16V | 4 | F20A4, F20A7, F20A8 | 98/131 | 01/90→09/93 | Z158 | | 1.1 | | ZS275 | |
| 2.0 i 16V | 4 | F20Z3 | 98/131 | 03/93→12/93 | Z158 | | 1.1 | | ZS275 | ZM023 |
| 2.2 i 16V | 4 | F22A8 | 108/145 | 01/91→12/93 | Z158 | | 1.1 | | ZS275 | |
| 2.2 i 16V | 4 | F22A3 | 110/148 | 01/90→03/93 | Z158 | | 1.1 | | ZS275 ^{(1)[254]} | ZS419 ⁽¹⁾ |
| 2.2 i 16V | 4 | F22A7 | 110/148 | 01/91→12/93 | Z158 | | 1.1 | | ZS275 | |
| 2.2 i 16V Automatik | 4 | F22A3 | 108/145 | 01/90→03/93 | Z158 | | 1.1 | | ZS275 | |

ACCORD V

| | | | | | | | | | | |
|------------------|---|-------|---------|-------------|-------|--|-----|------|-------|-------|
| 1.9 i | 4 | F18A3 | 85/114 | 02/96→10/98 | Z158 | | 1.1 | | ZS532 | |
| 1.9 i LPG | 4 | F18A3 | 85/114 | 02/96→10/98 | Z116 | | 0.8 | UXT5 | | |
| 2.0 | 4 | F20B3 | 100/134 | 09/93→12/97 | Z158 | | 1.1 | | ZS275 | |
| 2.0 LPG | 4 | F20B3 | 100/134 | 09/93→12/97 | Z116 | | 0.8 | UXT5 | | |
| 2.0 i | 4 | F20Z2 | 85/114 | 03/93→01/96 | Z158 | | 1.1 | | ZS275 | ZM023 |
| 2.0 i LPG | 4 | F20Z2 | 85/114 | 03/93→01/96 | Z116 | | 0.8 | UXT5 | | |
| 2.0 i LS | 4 | F20Z1 | 96/129 | 02/96→10/98 | Z158 | | 1.1 | | ZS532 | |
| 2.0 i LS LPG | 4 | F20Z1 | 96/129 | 02/96→10/98 | Z116 | | 0.8 | UXT5 | | |
| 2.0 i LS 16V | 4 | F20B3 | 100/134 | 09/93→02/98 | Z158 | | 1.1 | | ZS275 | |
| 2.0 i LS 16V LPG | 4 | F20B3 | 100/134 | 09/93→02/98 | Z116 | | 0.8 | UXT5 | | |
| 2.0 i S | 4 | F20Z1 | 96/129 | 03/93→01/96 | Z158 | | 1.1 | | ZS275 | ZM023 |
| 2.0 i S LPG | 4 | F20Z1 | 96/129 | 03/93→01/96 | Z116 | | 0.8 | UXT5 | | |
| 2.0 TDi | 4 | 20T2N | 77/103 | 04/96→10/98 | GN999 | | 11V | | | |
| 2.2 | 4 | F22Z2 | 103/138 | 04/96→12/97 | | | | | ZS532 | |
| 2.2 | 4 | F22B1 | 107/143 | 09/95→06/96 | | | | | ZS275 | |
| 2.2 i ES | 4 | F22B5 | 110/148 | 09/93→02/98 | Z158 | | 1.1 | | ZS275 | |
| 2.2 i ES LPG | 4 | F22B5 | 110/148 | 09/93→02/98 | Z116 | | 0.8 | UXT5 | | |
| 2.2 i VTEC | 4 | F22Z2 | 110/148 | 02/96→10/98 | Z158 | | 1.1 | | ZS532 | |
| 2.2 i VTEC LPG | 4 | F22Z2 | 110/148 | 02/96→10/98 | Z116 | | 0.8 | UXT5 | | |
| 2.3 i SR | 4 | H23A3 | 116/156 | 03/93→01/96 | Z158 | | 1.1 | | ZS275 | |
| 2.3 i SR LPG | 4 | H23A3 | 116/156 | 03/93→01/96 | Z116 | | 0.8 | UXT5 | | |

ACCORD VI

| | | | | | | | | | | |
|----------------|---|-------|---------|-------------|-------|--|-----|------|-------|-------|
| 1.6 i | 4 | D16B6 | 85/114 | 10/98→12/02 | Z158 | | 1.1 | | | |
| 1.6 i LPG | 4 | D16B6 | 85/114 | 10/98→12/02 | Z116 | | 0.8 | UXT5 | | |
| 1.8 i | 4 | F18B2 | 100/134 | 10/98→12/02 | Z158 | | 1.1 | | ZS532 | ZM045 |
| 1.8 i LPG | 4 | F18B2 | 100/134 | 10/98→12/02 | Z116 | | 0.8 | UXT5 | | |
| 2.0 | 4 | F20B7 | 107/143 | 11/99→10/02 | | | | | ZS532 | |
| 2.0 | 4 | F20B6 | 108/145 | 12/99→12/02 | | | | | ZS532 | |
| 2.0 i | 4 | F20B6 | 108/145 | 10/98→01/01 | Z158 | | 1.1 | | ZS532 | |
| 2.0 i LPG | 4 | F20B6 | 108/145 | 10/98→01/01 | Z116 | | 0.8 | UXT5 | | |
| 2.0 i 16V | 4 | F20B5 | 108/145 | 02/98→06/03 | Z158 | | 1.1 | | ZS275 | |
| 2.0 i 16V | 4 | F20B7 | 108/145 | 02/98→06/03 | | | | | ZS275 | |
| 2.0 i 16V LPG | 4 | F20B5 | 108/145 | 02/98→06/03 | Z116 | | 0.8 | UXT5 | | |
| 2.0 TDi | 4 | 20T2N | 77/103 | 12/99→10/00 | GN905 | | 11V | | | |
| 2.0 Turbo DI | 4 | 20T2N | 77/103 | 02/99→12/02 | GN905 | | 11V | | | |
| 2.2 Type-R | 4 | H22A7 | 156/209 | 02/99→12/02 | Z158 | | 1.1 | | ZS275 | |
| 2.2 Type-R LPG | 4 | H22A7 | 156/209 | 02/99→12/02 | Z116 | | 0.8 | UXT5 | | |
| 2.3 | 4 | F23A1 | 113/152 | 01/01→06/03 | Z158 | | 1.1 | | ZS532 | |
| 2.3 | 4 | F23Z5 | 113/152 | 11/00→06/03 | | | | | ZS532 | |

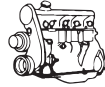

kW/BHP

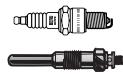

... HONDA



... ACCORD VI

| | | | | | | | | |
|----------------|---|--------------|---------|-------------|------|-----|------|--------|
| 2.3 | 4 | F23Z5 | 113/152 | 01/01→06/03 | Z158 | 1.1 | | |
| 2.3 LPG | 4 | F23A1, F23Z5 | 113/152 | 01/01→06/03 | Z116 | 0.8 | UXT5 | |
| 3.0 V6 24V | 6 | J30A1 | 147/197 | 02/98→06/03 | Z158 | 1.1 | | ZSE166 |
| 3.0 V6 24V LPG | 6 | J30A1 | 147/197 | 02/98→06/03 | Z116 | 0.8 | UXT5 | |

ACCORD VII

| | | | | | | | | |
|------------|---|-------------|---------|-------------|-------|-----|------|--------|
| 2.0 | 4 | K20A6 | 114/153 | 02/03→ | Z299 | 1.0 | | ZSE169 |
| 2.0 4WD | 4 | K20A6 | 114/153 | 02/03→ | Z299 | 1.0 | | ZSE169 |
| 2.0 LPG | 4 | K20A6 | 114/153 | 02/03→ | Z116 | 0.8 | UXT5 | |
| 2.2 i-CTDi | 4 | N22A1 | 103/138 | 01/04→ | GN073 | 11V | | |
| 2.4 | 4 | K24A, K24A3 | 140/188 | 02/03→ | Z354 | 1.1 | | ZSE169 |
| 3.0 | 6 | J30A4 | 177/237 | 09/06→ | | | | ZSE166 |
| 3.0 | 6 | J30A5 | 182/244 | 04/06→05/08 | | | | ZSE166 |

ACCORD VIII

| | | | | | | | | |
|-------|---|-------|---------|-------------|----------------|-----|--------|--|
| 2.0 i | 4 | R20A3 | 115/154 | 07/08→ | Z354 | 1.1 | | |
| 2.4 | 4 | K24Z3 | 148/198 | 06/08→12/08 | Z354 | 1.1 | | |
| 2.4 i | 4 | K24Z3 | 148/198 | 07/08→ | Z297 | 1.1 | UXT11 | |
| | | | | | →12/10 Z354 | 1.1 | →12/10 | |

CITY

| | | | | | | | | |
|-------------|---|-------|-------|-------------|------|-----|-------|--|
| 1.3 4WD | 4 | L13A1 | 63/84 | 09/01→10/04 | Z16 | 1.1 | UXT11 | |
| 1.3 SES | 4 | L13A1 | 63/84 | 05/03→09/05 | Z16 | 1.1 | UXT11 | |
| 1.4 i-V TEC | 4 | L13Z1 | 73/98 | 09/08→ | Z354 | 1.1 | | ZSE175 ^{[15][18]} ZSE176 ^{[10][20]} |

CIVIC I

| | | | | | | | | |
|------------|---|----------|-------|-------------|-----|-----|-------------|-----------------------|
| 1.2 1200 | 4 | EB1, EB2 | 40/54 | 07/72→12/80 | Z11 | 0.8 | UXT2 / UXT6 | |
| 1.2 1200 | 4 | EB3 | 44/59 | 09/77→12/80 | Z11 | 0.8 | UXT2 / UXT6 | ZS110 ^[15] |
| 1.3 1300 L | 4 | EN2 | 33/44 | 09/80→09/83 | Z8 | 0.8 | UXT2 / UXT6 | |
| 1.3 1300 L | 4 | EN1 | 44/59 | 09/80→09/83 | Z8 | 0.8 | UXT2 / UXT6 | |
| 1.3 1300 S | 4 | EN4 | 52/70 | 10/79→12/84 | Z8 | 0.8 | UXT2 / UXT6 | ZM054 |
| 1.5 | 4 | EW2 | 63/84 | 10/83→10/87 | Z21 | 1.1 | UXT2 / UXT6 | |

CIVIC II

| | | | | | | | | |
|-------------------|---|-------|--------|-------------|------|-----|-------------|--------------------------|
| 1.3 1300 | 4 | EN1 | 44/59 | 09/79→09/83 | Z8 | 0.8 | UXT2 / UXT6 | |
| 1.3 1300 L | 4 | EN1 | 44/59 | 09/79→09/83 | Z8 | 0.8 | UXT2 / UXT6 | |
| 1.5 i 16V | 4 | D15B2 | 69/93 | 01/88→11/91 | Z99 | 1.0 | UXT5 | ZS276 ZM023 →08/89 |
| 1.6 i 16V 4WD | 4 | D16A6 | 80/107 | 01/88→12/89 | Z16 | 1.1 | UXT11 | ZS276 ZM023 |
| 1.6 i 16V 4WD | 4 | D16A6 | 81/109 | 01/88→02/95 | Z16 | 1.1 | UXT11 | ZS276 ZM023 →08/92 |
| 1.6 i 16V 4WD LPG | 4 | D16A6 | 81/109 | 01/88→02/95 | Z340 | 0.7 | UXT12 | |

CIVIC III

| | | | | | | | | |
|---------|---|------------|-------|-------------|-----|-----|-------------|---|
| 1.2 | 4 | D12B1, ZA2 | 40/54 | 01/84→10/87 | Z21 | 1.1 | UXT2 / UXT6 | ZM056 |
| 1.3 | 4 | EV2 | 52/70 | 10/83→10/87 | Z21 | 1.1 | UXT2 / UXT6 | ZM056 01/84→ |
| 1.5 GL | 4 | EW2 | 63/84 | 10/83→10/87 | Z21 | 1.1 | UXT2 / UXT6 | ZS276 ^[1] ZM056 01/84→ |
| 1.5 GT | 4 | EW3 | 74/99 | 01/85→10/87 | Z21 | 1.1 | UXT2 / UXT6 | ZM056 |
| 1.5 GTi | 4 | EW4 | 66/89 | 03/86→10/87 | Z21 | 1.1 | UXT2 / UXT6 | ZS276 ^[1] ZM056 |

CIVIC IV

| | | | | | | | | |
|-----------|---|-------|-------|-------------|-----|-----|-------|--------------------------|
| 1.2 | 4 | D12B1 | 41/55 | 01/88→12/91 | Z16 | 1.1 | UXT11 | |
| 1.3 | 4 | D13B1 | 55/74 | 10/87→12/89 | Z16 | 1.1 | UXT11 | |
| 1.3 16 V | 4 | D13B2 | 55/74 | 09/89→09/91 | Z16 | 1.1 | UXT11 | |
| 1.4 L | 4 | D14A1 | 66/89 | 10/87→12/89 | Z16 | 1.1 | UXT11 | |
| 1.5 i 16V | 4 | D15B2 | 66/89 | 10/87→09/91 | Z16 | 1.1 | UXT11 | ZS276 ZM023 →08/89 |
| 1.5 i 16V | 4 | D15B2 | 66/89 | 10/88→09/91 | | | | ZS278 |
| 1.5 i 16V | 4 | D15B2 | 69/93 | 10/87→09/91 | Z99 | 1.0 | UXT5 | ZS276 ZM023 01/90→ |

HONDA

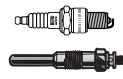

kW/BHP

**... HONDA****... CIVIC IV**

| | | | | | | | | | | |
|--------------------|---|-------|---------|-------------|-----------|--|-----|-------|--------------------------------|-------|
| 1.5 i 16V | 4 | D15B2 | 69/93 | 10/88→09/91 | | | | ZS278 | | |
| 1.6 i 16V | 4 | D16A6 | 80/107 | 10/87→09/91 | Z16 | | 1.1 | UXT11 | ZS276 01/89→12/89 | ZM023 |
| 1.6 i 16V | 4 | D16A6 | 80/107 | 11/87→09/91 | | | | | ZS276 | |
| 1.6 i 16V 4WD | 4 | D16A6 | 80/107 | 10/89→09/91 | Z16 | | 1.1 | UXT11 | ZS276 12/89→ | ZM023 |
| 1.6 i 16V | 4 | D16Z2 | 81/109 | 10/87→09/91 | Z99 [172] | | 1.0 | UXT5 | ZS278 [254] ZS276 01/90→ | ZM023 |
| 1.6 i 16V | 4 | D16A7 | 96/129 | 09/87→09/91 | Z16 | | 1.1 | UXT11 | ZS276 [1] | ZM023 |
| 1.6 i 16V | 4 | D16A9 | 96/129 | 09/87→09/91 | Z16 | | 1.1 | UXT11 | | ZM023 |
| 1.6 i 16V Vtec | 4 | B16A1 | 110/148 | 10/89→09/91 | Z16 | | 1.1 | UXT11 | ZS276 | ZM023 |
| 1.6 i 16V Vtec LPG | 4 | B16A1 | 110/148 | 10/89→09/91 | Z340 | | 0.7 | UXT12 | | |

CIVIC V

| | | | | | | | | | | |
|------------------|---|--------------|---------|-------------|------|--|-----|-------|----------------------------|-----------------------|
| 1.3 16V | 4 | D13B2 | 55/74 | 10/91→11/95 | Z16 | | 1.1 | UXT11 | ZS275 | |
| 1.3 16V LPG | 4 | D13B2 | 55/74 | 10/91→11/95 | Z340 | | 0.7 | UXT12 | | |
| 1.5 i 16V | 4 | D15B2 | 66/89 | 10/91→11/95 | Z16 | | 1.1 | UXT11 | | |
| 1.5 i 16V | 4 | D15Z2 | 66/89 | 10/91→11/95 | Z16 | | 1.1 | UXT11 | ZS275 | |
| 1.5 i 16V | 4 | D15B2 | 69/93 | 10/91→11/95 | Z16 | | 1.1 | UXT11 | ZS275 | ZM045 [188] 01/93→ |
| 1.5 i 16V | 4 | D15Z1 | 69/93 | 10/91→11/95 | Z158 | | 1.1 | | ZS275 | ZM045 [188] 01/93→ |
| 1.5 i 16V LPG | 4 | D15B2, D15Z2 | 66/89 | 10/91→11/95 | Z340 | | 0.7 | UXT12 | | |
| 1.5 i 16V LPG | 4 | D15B2 | 69/93 | 10/91→11/95 | Z340 | | 0.7 | UXT12 | | |
| 1.5 i 16V LPG | 4 | D15Z1 | 69/93 | 10/91→11/95 | Z116 | | 0.8 | UXT5 | | |
| 1.5 i LSi | 4 | D15B7 | 74/99 | 08/93→11/95 | Z158 | | 1.1 | | ZS275 | |
| 1.5 i LSi LPG | 4 | D15B7 | 74/99 | 08/93→11/95 | Z116 | | 0.8 | UXT5 | | |
| 1.6 4WD | 4 | D16Z7 | 92/123 | 01/92→10/95 | | | | | ZS275 | |
| 1.6 16V Vtec | 4 | D16Z6 | 92/123 | 10/91→11/95 | Z16 | | 1.1 | UXT11 | ZS275 [254] 01/92→12/93 | ZM045 01/93→ |
| 1.6 16V Vtec | 4 | D16Z7 | 92/123 | 10/91→11/95 | Z16 | | 1.1 | UXT11 | ZS275 | ZM045 01/93→ |
| 1.6 16V Vtec LPG | 4 | D16Z6, D16Z7 | 92/123 | 10/91→11/95 | Z340 | | 0.7 | UXT12 | | |
| 1.6 i | 4 | D16Y7 | 77/103 | 01/94→11/95 | Z16 | | 1.1 | UXT11 | | |
| 1.6 i | 4 | D16Y7 | 77/103 | 01/94→04/99 | | | | | ZS275 | |
| 1.6 i LPG | 4 | D16Y7 | 77/103 | 01/94→11/95 | Z340 | | 0.7 | UXT12 | | |
| 1.6 i Vtec | 4 | D16Y6 | 92/123 | 01/94→03/96 | | | | | ZS532 | ZM045 |
| 1.6 i Vtec | 4 | D16Z9 | 92/123 | 01/94→03/96 | Z16 | | 1.1 | UXT11 | | ZM045 |
| 1.6 i Vtec | 4 | B16A2 | 118/158 | 01/94→11/95 | Z16 | | 1.1 | UXT11 | ZS275 | ZM045 |
| 1.6 i Vtec LPG | 4 | D16Z9 | 92/123 | 01/94→03/96 | Z340 | | 0.7 | UXT12 | | |
| 1.6 i Vtec LPG | 4 | B16A2 | 118/158 | 01/94→11/95 | Z340 | | 0.7 | UXT12 | | |
| 1.6 VTi | 4 | B16A2 | 118/158 | 10/91→11/95 | Z16 | | 1.1 | UXT11 | ZS275 01/92→12/93 | ZM045 11/95→ |
| 1.6 VTi LPG | 4 | B16A2 | 118/158 | 10/91→11/95 | Z340 | | 0.7 | UXT12 | | |
| 1.6 VTi 16V | 4 | B16A2 | 118/158 | 10/91→11/95 | Z16 | | 1.1 | UXT11 | ZS275 01/92→12/93 | ZM045 01/93→ |
| 1.6 VTi 16V LPG | 4 | B16A2 | 118/158 | 10/91→11/95 | Z340 | | 0.7 | UXT12 | | |

CIVIC VI

| | | | | | | | | | | |
|-------------|---|----------------------------|-------|-------------|------|--|-----|-------|-----------------|--|
| 1.4 16V | 4 | D14A7 | 55/74 | 04/98→02/01 | Z158 | | 1.1 | | | |
| 1.4 16V | 4 | D14A8 | 66/89 | 04/98→02/01 | Z158 | | 1.1 | | ZS275 | |
| 1.4 16V LPG | 4 | D14A7 | 55/74 | 04/98→02/01 | Z116 | | 0.8 | UXT5 | | |
| 1.4 16V LPG | 4 | D14A8 | 66/89 | 04/98→02/01 | Z116 | | 0.8 | UXT5 | | |
| 1.4 i | 4 | D14A3 | 55/74 | 11/95→02/01 | Z16 | | 1.1 | UXT11 | ZS275 | |
| 1.4 i | 4 | D14A5, D14A7, D14Z3 | 55/74 | 09/95→02/01 | Z16 | | 1.1 | UXT11 | ZS532 01/96→ | |
| 1.4 i | 4 | D14Z1 | 55/74 | 11/95→02/01 | Z158 | | 1.1 | | ZS275 | |
| 1.4 i | 4 | D14A2, D14A6, D14A8, D14Z4 | 66/89 | 09/94→02/01 | Z16 | | 1.1 | UXT11 | ZS532 01/96→ | |
| 1.4 i | 4 | D14A4 | 66/89 | 11/95→02/01 | Z16 | | 1.1 | UXT11 | | |



kW/BHP



... HONDA



... CIVIC VI

| | | | | | | | | | | |
|------------------|---|-----------------------------------|---------|-------------|--------|--|-----|-------------|--------|-------|
| 1.4 i | 4 | D14Z2 | 66/89 | 11/95→02/01 | | | | | ZS275 | |
| | | | | | | | | | 12/98→ | |
| 1.4 i LPG | 4 | D14A3, D14A5, D14A7, D14Z3 | 55/74 | 09/95→02/01 | Z340 | | 0.7 | UXT12 | | |
| 1.4 i LPG | 4 | D14A2, D14A4, D14A6, D14A8, D14Z4 | 66/89 | 09/94→02/01 | Z340 | | 0.7 | UXT12 | | |
| 1.4 i S | 4 | D14A4 | 66/89 | 11/95→02/01 | Z16 | | 1.1 | UXT11 | ZS275 | |
| 1.4 i S | 4 | D14Z2, D14Z4 | 66/89 | 11/95→02/01 | | | | | ZS275 | |
| 1.4 i S LPG | 4 | D14A4 | 66/89 | 11/95→02/01 | Z340 | | 0.7 | UXT12 | | |
| 1.5 16V | 4 | D15Z8 | 84/113 | 01/97→02/01 | Z158 | | 1.1 | | ZS532 | |
| 1.5 16V LPG | 4 | D15Z8 | 84/113 | 01/97→02/01 | Z116 | | 0.8 | UXT5 | | |
| 1.5 i | 4 | D15Z6 | 84/113 | 11/95→02/01 | Z158 | | 1.1 | | ZS275 | |
| 1.5 i LPG | 4 | D15Z6 | 84/113 | 11/95→02/01 | Z116 | | 0.8 | UXT5 | | |
| 1.5 i Vtec-E | 4 | D 15 B, D 15 Z 3 | 66/89 | 09/94→01/97 | | | | | | ZM045 |
| 1.5 i Vtec-E | 4 | D15Z3 | 66/89 | 09/94→01/97 | Z158 | | 1.1 | | ZS275 | |
| 1.5 i Vtec-E LPG | 4 | D15Z3 | 66/89 | 09/94→01/97 | Z116 | | 0.8 | UXT5 | | |
| 1.6 | 4 | D16Y2 | 93/125 | 10/95→09/00 | | | | | ZS275 | |
| 1.6 16V | 4 | D16B2 | 85/114 | 01/97→02/01 | Z158 | | 1.1 | | ZS275 | |
| 1.6 16V LPG | 4 | D16B2 | 85/114 | 01/97→02/01 | Z116 | | 0.8 | UXT5 | | |
| 1.6 i | 4 | D16Y7 | 77/103 | 03/96→03/00 | Z16 | | 1.1 | UXT11 | ZS275 | |
| | | | | | →12/98 | | | →12/98 | | |
| | | | | | Z158 | | 1.1 | | | |
| | | | | | 01/99→ | | | | | |
| 1.6 i | 4 | D16Y3 | 83/111 | 09/94→01/97 | Z16 | | 1.1 | UXT11 | ZS532 | ZM045 |
| | | | | | | | | | 01/96→ | |
| 1.6 i | 4 | D16Y5 | 84/113 | 11/95→02/01 | Z98 | | 0.8 | UXT1 / UXT3 | ZS532 | |
| 1.6 i LPG | 4 | D16Y7 | 77/103 | 03/96→03/00 | Z340 | | 0.7 | UXT12 | | |
| | | | | | →12/98 | | | →12/98 | | |
| | | | | | Z116 | | 0.8 | UXT5 | | |
| | | | | | 01/99→ | | | 01/99→ | | |
| 1.6 i LPG | 4 | D16Y3 | 83/111 | 09/94→01/97 | Z340 | | 0.7 | UXT12 | | |
| 1.6 i LPG | 4 | D16Y5 | 84/113 | 11/95→02/01 | Z116 | | 0.8 | UXT5 | | |
| 1.6 i Vtec | 4 | D16Y6, D16Y8 | 92/123 | 11/95→02/01 | Z16 | | 1.1 | UXT11 | ZS275 | |
| 1.6 i Vtec | 4 | D16Y8 | 92/123 | 03/96→03/00 | Z16 | | 1.1 | UXT11 | | |
| | | | | | →12/98 | | | →12/98 | | |
| | | | | | Z158 | | 1.1 | | | |
| | | | | | 01/99→ | | | | | |
| 1.6 i Vtec | 4 | D16Y2 | 93/125 | 09/94→01/97 | Z16 | | 1.1 | UXT11 | ZS275 | ZM045 |
| 1.6 i Vtec | 4 | B16A2 | 118/158 | 04/99→12/00 | | | | | ZS275 | |
| 1.6 i Vtec LPG | 4 | D16Y6, D16Y8 | 92/123 | 11/95→02/01 | Z340 | | 0.7 | UXT12 | | |
| 1.6 i Vtec LPG | 4 | D16Y8 | 92/123 | 03/96→03/00 | Z340 | | 0.7 | UXT12 | | |
| | | | | | →12/98 | | | →12/98 | | |
| | | | | | Z116 | | 0.8 | UXT5 | | |
| | | | | | 01/99→ | | | 01/99→ | | |
| 1.6 i Vtec LPG | 4 | D16Y2 | 93/125 | 09/94→01/97 | Z340 | | 0.7 | UXT12 | | |
| 1.6 VTi | 4 | B16A2 | 118/158 | 11/95→02/01 | Z16 | | 1.1 | UXT11 | ZS275 | |
| 1.6 VTi LPG | 4 | B16A2 | 118/158 | 11/95→02/01 | Z340 | | 0.7 | UXT12 | | |
| 1.8 16V | 4 | B18C4 | 124/166 | 01/97→02/01 | Z16 | | 1.1 | UXT11 | ZS275 | |
| 1.8 16V LPG | 4 | B18C4 | 124/166 | 01/97→02/01 | Z340 | | 0.7 | UXT12 | | |
| 2.0 i D | 4 | 20T2N | 74/99 | 04/98→02/01 | GN073 | | 11V | | | |
| 2.0 i D | 4 | 20T2N | 77/103 | 04/98→02/01 | GN073 | | 11V | | | |
| 2.0 i TD | 4 | 20T2R | 63/84 | 01/97→02/01 | GN073 | | 11V | | | |
| 2.0 TDiC | 4 | 20T2N | 74/99 | 11/98→10/00 | GN073 | | 11V | | | |
| 2.0 TDiC | 4 | 20T2N | 77/103 | 11/98→10/00 | GN073 | | 11V | | | |

CIVIC VII

| | | | | | | | | | | |
|---------|---|-------|-------|-------------|------|--|-----|--|----------------|--|
| 1.2 | 4 | L12A1 | 58/78 | 04/01→10/04 | | | | | ZSE175 (15X18) | |
| | | | | | | | | | ZSE176 (10X20) | |
| 1.3 IMA | 4 | LDA1 | 61/82 | 01/04→09/05 | | | | | ZSE175 (15X18) | |
| | | | | | | | | | ZSE176 (10X20) | |
| 1.4 | 4 | D14Z5 | 66/89 | 12/00→09/05 | Z158 | | 1.1 | | ZSE170 | |

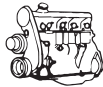

kW/BHP

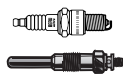

... HONDA



... CIVIC VII

| | | | | | | | | |
|-----------------|---|--------------|---------|-------------|-------|-----|------|--------------------------|
| 1.4 LPG | 4 | D14Z5 | 66/89 | 12/00→09/05 | Z116 | 0.8 | UXT5 | |
| 1.4 i | 4 | D14Z6 | 55/74 | 02/01→09/05 | Z158 | 1.1 | | ZSE170 |
| 1.4 i LPG | 4 | D14Z6 | 55/74 | 02/01→09/05 | Z116 | 0.8 | UXT5 | |
| 1.4 iS | 4 | D14Z5, D14Z6 | 66/89 | 02/01→09/05 | Z158 | 1.1 | | ZSE170 |
| 1.4 iS LPG | 4 | D14Z5, D14Z6 | 66/89 | 02/01→09/05 | Z116 | 0.8 | UXT5 | |
| 1.6 | 4 | D16V1 | 81/109 | 02/01→09/05 | Z158 | 1.1 | | ZSE170 |
| 1.6 LPG | 4 | D16V1 | 81/109 | 02/01→09/05 | Z116 | 0.8 | UXT5 | |
| 1.6 i | 4 | D16V1 | 81/109 | 02/01→12/05 | Z158 | 1.1 | | ZSE166 |
| 1.6 i | 4 | D16V1 | 81/109 | 02/01→09/05 | | | | ZSE170 |
| 1.6 i LPG | 4 | D16V1 | 81/109 | 02/01→12/05 | Z116 | 0.8 | UXT5 | |
| 1.7 | 4 | D17A6 | 85/114 | 02/01→09/05 | | | | ZSE170 |
| 1.7 | 4 | D17A6 | 92/123 | 01/00→08/05 | | | | ZSE166 [1] ZSE170 [1] |
| 1.7 CTDi | 4 | 4E2 | 74/99 | 01/02→09/05 | GN104 | 11V | | |
| 1.7 i | 4 | D17A8 | 88/118 | 05/01→12/05 | Z158 | 1.1 | | ZSE166 |
| 1.7 i LPG | 4 | D17A8 | 88/118 | 05/01→12/05 | Z116 | 0.8 | UXT5 | |
| 1.7 i VTEC | 4 | D17A5 | 92/123 | 05/01→12/05 | | | | ZSE166 |
| 1.7 i VTEC | 4 | D17A9 | 92/123 | 05/01→12/05 | Z158 | 1.1 | | ZSE166 |
| 1.7 i VTEC LPG | 4 | D17A9 | 92/123 | 05/01→12/05 | Z116 | 0.8 | UXT5 | |
| 1.8 | 4 | R18A1 | 103/138 | 02/01→09/05 | Z275 | 1.1 | | |
| 2.0 | 4 | K20A3 | 118/158 | 10/03→09/05 | Z299 | 1.0 | | ZSE169 |
| 2.0 LPG | 4 | K20A3 | 118/158 | 10/03→09/05 | Z116 | 0.8 | UXT5 | |
| 2.0 i Sport | 4 | K20A3 | 118/158 | 09/01→09/05 | Z299 | 1.0 | | ZSE169 |
| 2.0 i Sport LPG | 4 | K20A3 | 118/158 | 09/01→09/05 | Z116 | 0.8 | UXT5 | |
| 2.0 Type-R | 4 | K20A2 | 147/197 | 09/01→09/05 | | | | ZSE169 |

CIVIC VIII

| | | | | | | | | |
|------------|---|--------------|---------|-------------|----------------------|-----|----------------|------------------------------------|
| 1.3 Hybrid | 4 | LDA2 | 70/94 | 01/06→ | | | | ZSE175 [15][18] ZSE176 [10][20] |
| 1.4 | 4 | L13A7 | 61/82 | 01/06→ | Z312 [172] →10/08 | 1.0 | UXT9 →10/08 | ZSE175 [15][18] ZSE176 [10][20] |
| 1.4 | 4 | L13Z1 | 73/98 | 10/08→ | Z354 | 1.1 | | ZSE175 [15][18] ZSE176 [10][20] |
| 1.8 | 4 | R18A1, R18A2 | 103/138 | 09/05→ | Z354 | 1.1 | | |
| 1.8 | 4 | R18A2 | 103/138 | 01/06→ | Z275 | 1.1 | | |
| 2.0 | 4 | K20A3, K20Z2 | 114/153 | 02/06→02/12 | Z299 | 1.0 | | ZSE169 |
| 2.0 LPG | 4 | K20A3, K20Z2 | 114/153 | 02/06→02/12 | Z116 | 0.8 | UXT5 | |
| 2.0 Type R | 4 | K20Z4 | 148/198 | 09/06→ | | | | ZSE169 |
| 2.2 CTDi | 4 | N22A2 | 103/138 | 01/06→ | GN073 | 11V | | |

CIVIC IX

| | | | | | | | | |
|------------|---|-------|-------|--------|------|-----|--|--|
| 1.4 i-VTEC | 4 | L13Z4 | 73/98 | 02/12→ | Z354 | 1.1 | | |
|------------|---|-------|-------|--------|------|-----|--|--|

CONCERTO

| | | | | | | | | |
|---------------|---|--------------|--------|-------------|------|-----|-------|--------------------------|
| 1.4 | 4 | D14A1, D14A8 | 66/89 | 08/89→10/91 | Z16 | 1.1 | UXT11 | |
| 1.5 i 16V | 4 | D15B2 | 66/89 | 08/89→03/95 | Z99 | 1.0 | UXT5 | ZM023 →08/92 |
| 1.5 i 16V | 4 | D15B2 | 66/89 | 08/89→05/95 | | | | ZS278 |
| 1.6 16V | 4 | D16Z2 | 78/105 | 08/89→03/95 | | | | ZS276 [1] |
| 1.6 i 16V | 4 | D16Z2 | 82/110 | 08/89→03/95 | Z16 | 1.1 | UXT11 | ZS276 →08/92 ZM023 |
| 1.6 i 16V | 4 | D16A8 | 90/121 | 08/89→03/95 | Z16 | 1.1 | UXT11 | ZS276 →08/92 ZM023 |
| 1.6 i 16V LPG | 4 | D16Z2 | 82/110 | 08/89→03/95 | Z340 | 0.7 | UXT12 | |
| 1.6 i 16V LPG | 4 | D16A8 | 90/121 | 08/89→03/95 | Z340 | 0.7 | UXT12 | |

CR-V I

| | | | | | | | | |
|-----------------|---|-------|---------|-------------|------|-----|------|-------|
| 2.0 4WD | 4 | B20Z1 | 98/131 | 04/99→02/02 | | | | ZS275 |
| 2.0 16V 4WD | 4 | B20B | 94/126 | 10/95→01/99 | Z158 | 1.1 | | ZS275 |
| 2.0 16V 4WD | 4 | B20Z1 | 108/145 | 01/99→02/02 | Z158 | 1.1 | | ZS275 |
| 2.0 16V 4WD LPG | 4 | B20B | 94/126 | 10/95→01/99 | Z116 | 0.8 | UXT5 | |
| 2.0 16V 4WD LPG | 4 | B20Z1 | 108/145 | 01/99→02/02 | Z116 | 0.8 | UXT5 | |

HONDA



kW/BHP

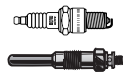

... HONDA



CR-V II

| | | | | | | | | |
|--------------|---|-------|---------|-------------|-------|-----|------|--------|
| 2.0 4WD | 4 | K20A4 | 110/148 | 07/02→09/06 | Z299 | 1.0 | | ZSE169 |
| 2.0 4WD LPG | 4 | K20A4 | 110/148 | 07/02→09/06 | Z116 | 0.8 | UXT5 | |
| 2.2 CTDi 4WD | 4 | N22A2 | 103/138 | 02/05→09/06 | GN073 | 11V | | |

CR-V III

| | | | | | | | | |
|----------------|---|--------------|---------|--------|-------|-----|--|--------|
| 2.0 i 4WD | 4 | R20A2 | 110/148 | 01/07→ | Z275 | 1.1 | | ZSE169 |
| 2.2 i-CTDi 4WD | 4 | N22A2 | 103/138 | 01/07→ | GN073 | 11V | | |
| 2.4 i-VTEC 4WD | 4 | K24Z1, K24Z4 | 122/164 | 09/09→ | Z354 | 1.1 | | |

CRX I

| | | | | | | | | |
|-----------|---|-----|--------|-------------|-----|-----|-------------|-----------------|
| 1.5 i | 4 | EW3 | 74/99 | 10/83→11/86 | Z21 | 1.1 | UXT2 / UXT6 | ZM016 08/84→ |
| 1.6 i 16V | 4 | ZC1 | 92/123 | 03/86→10/87 | Z16 | 1.1 | UXT11 | ZM016 |

CRX II

| | | | | | | | | |
|----------------|---|--------------|---------|-------------|-----|-----|-------|--------------------------|
| 1.6 i 16V | 4 | D16Z5 | 91/122 | 10/87→02/92 | Z16 | 1.1 | UXT11 | ZS276 ZM023 →08/89 |
| 1.6 i 16V | 4 | D16A8, D16A9 | 96/129 | 10/87→12/89 | Z16 | 1.1 | UXT11 | ZS276 ZM023 |
| 1.6 i 16V Vtec | 4 | B16A1 | 110/148 | 10/89→02/92 | Z16 | 1.1 | UXT11 | ZS276 |

CRX III

| | | | | | | | | |
|---------------|---|-------|---------|-------------|------|-----|-------|-------|
| 1.6 ESi | 4 | D16Y8 | 92/123 | 03/92→12/98 | | | | ZS275 |
| 1.6 ESi | 4 | D16Z6 | 92/123 | 03/92→12/98 | Z16 | 1.1 | UXT11 | ZS275 |
| 1.6 ESi LPG | 4 | D16Z6 | 92/123 | 03/92→12/98 | Z340 | 0.7 | UXT12 | |
| 1.6 i VTi | 4 | B16A2 | 118/158 | 03/92→12/98 | Z16 | 1.1 | UXT11 | ZS275 |
| 1.6 i VTi LPG | 4 | B16A2 | 118/158 | 03/92→12/98 | Z340 | 0.7 | UXT12 | |

DOMANI

| | | | | | | | | |
|-----|---|-------|--------|-------------|--|--|--|-------|
| 1.6 | 4 | D16Z2 | 81/109 | 11/88→12/97 | | | | ZS278 |
|-----|---|-------|--------|-------------|--|--|--|-------|

FR-V

| | | | | | | | | |
|------------|---|-------|---------|-------------|-------|-----|------|--------|
| 1.7 | 4 | D17A2 | 92/123 | 08/04→ | Z158 | 1.1 | | ZSE166 |
| 1.7 LPG | 4 | D17A2 | 92/123 | 08/04→ | Z116 | 0.8 | UXT5 | |
| 1.8 | 4 | R18A1 | 103/138 | 01/07→ | Z275 | 1.1 | | |
| 2.0 | 4 | K20A9 | 110/148 | 02/05→ | Z299 | 1.0 | | ZSE169 |
| | | | | | | | | →09/06 |
| 2.0 | 4 | K20A9 | 114/153 | 08/04→09/06 | Z299 | 1.0 | | |
| 2.0 LPG | 4 | K20A9 | 110/148 | 02/05→ | Z116 | 0.8 | UXT5 | |
| | | | | | | | | →09/06 |
| 2.0 LPG | 4 | K20A9 | 114/153 | 08/04→09/06 | Z116 | 0.8 | UXT5 | |
| 2.2 i CTDi | 4 | N22A1 | 103/138 | 07/05→ | GN073 | 11V | | |

HR-V

| | | | | | | | | |
|-----------------|---|-------|--------|--------|------|-----|------|-----------------|
| 1.6 16V | 4 | D16W1 | 77/103 | 03/99→ | Z158 | 1.1 | | ZS275 |
| 1.6 16V 4WD | 4 | D16W5 | 91/122 | 10/99→ | Z158 | 1.1 | | ZS275 →12/05 |
| 1.6 16V LPG | 4 | D16W1 | 77/103 | 03/99→ | Z116 | 0.8 | UXT5 | |
| 1.6 16V 4WD LPG | 4 | D16W5 | 91/122 | 10/99→ | Z116 | 0.8 | UXT5 | |

INTEGRA

| | | | | | | | | |
|------------|---|-------|---------|-------------|------|-----|-------|--------|
| 1.8 Type-R | 4 | B18C6 | 140/188 | 11/97→10/01 | Z284 | 1.1 | UXT14 | ZS275 |
| 2.0 | 4 | K20A3 | 118/158 | 02/02→ | Z299 | 1.0 | | ZSE169 |
| 2.0 LPG | 4 | K20A3 | 118/158 | 02/02→ | Z116 | 0.8 | UXT5 | |

JAZZ

| | | | | | | | | |
|-----|---|-------|-------|--------|-----|-----|-------|--|
| 1.3 | 4 | L13A1 | 63/84 | 05/03→ | Z16 | 1.1 | UXT11 | ZSE175 ₍₁₅₎₁₁₈ ZSE176 ₍₁₀₎₁₂₀ |
|-----|---|-------|-------|--------|-----|-----|-------|--|

JAZZ I

| | | | | | | | | |
|--------|---|-----|-------|-------------|-----|------|-------------|---------|
| 1.2 45 | 4 | ER2 | 33/44 | 02/84→10/86 | Z9 | 1.15 | UXT2 / UXT6 | |
| 1.2 55 | 4 | ER4 | 40/54 | 09/84→10/86 | Z21 | 1.1 | UXT2 / UXT6 | |
| | | | | | | | | →08/85 |
| | | | | | Z9 | 1.15 | UXT2 / UXT6 | |
| | | | | | | | | →09/85→ |
| 1.2 56 | 4 | ER1 | 41/55 | 10/83→10/86 | Z9 | 1.15 | UXT2 / UXT6 | |

HONDA

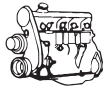

kW/BHP

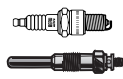

... HONDA



JAZZ II

| | | | | | | | | |
|----------|---|-------|-------|-------------|------|-----|-------|----------------------------------|
| 1.2 | 4 | L12A1 | 57/76 | 03/02→07/08 | Z16 | 1.1 | UXT11 | ZSE175 (15X18) ZSE176 (10X20) |
| 1.2 LPG | 4 | L12A1 | 57/76 | 03/02→07/08 | Z340 | 0.7 | UXT12 | |
| 1.3 iDSi | 4 | L13A1 | 63/84 | 03/02→09/07 | Z16 | 1.1 | UXT11 | |
| 1.4 | 4 | L13A1 | 61/82 | 03/02→07/08 | Z16 | 1.1 | UXT11 | ZSE175 (15X18) ZSE176 (10X20) |
| 1.4 LPG | 4 | L13A1 | 61/82 | 03/02→07/08 | Z340 | 0.7 | UXT12 | |

JAZZ III

| | | | | | | | | |
|-------|---|-------|-------|--------|------|-----|--|----------------------------------|
| 1.2 | 4 | L12B1 | 66/89 | 07/08→ | | | | ZSE175 (15X18) ZSE176 (10X20) |
| 1.4 | 4 | L13Z1 | 74/99 | 11/08→ | Z354 | 1.1 | | |
| 1.4 i | 4 | L13Z1 | 73/98 | 07/08→ | Z354 | 1.1 | | ZSE175 (15X18) ZSE176 (10X20) |

LEGEND I

| | | | | | | | | |
|-----------|---|-------|---------|-------------|-----|-----|-------|--|
| 2.5 i | 6 | C25A1 | 110/148 | 01/86→12/87 | Z16 | 1.1 | UXT11 | |
| 2.5 i | 6 | C25A2 | 127/170 | 02/87→06/88 | Z16 | 1.1 | UXT11 | |
| 2.7 i 24V | 6 | C27A1 | 124/166 | 10/87→12/90 | Z16 | 1.1 | UXT11 | |

LEGEND II

| | | | | | | | | |
|---------------|---|-------|---------|-------------|-----------|-----|-------|--|
| 3.2 i 24V | 6 | C32A2 | 151/202 | 01/91→02/96 | Z284 | 1.1 | UXT14 | |
| 3.2 i 24V LPG | 6 | C32A2 | 151/202 | 01/91→02/96 | Z30 [168] | 0.8 | UXT5 | |

LEGEND III

| | | | | | | | | |
|-----------|---|-------|---------|--------|------|-----|-------|--|
| 3.5 i 24V | 6 | C35A2 | 151/202 | 02/96→ | Z284 | 1.1 | UXT14 | |
|-----------|---|-------|---------|--------|------|-----|-------|--|

LEGEND IV

| | | | | | | | | |
|------------|---|-------|---------|--------|------|-----|--|--------|
| 3.5 V6 4WD | 6 | C35A8 | 217/291 | 05/06→ | Z354 | 1.1 | | ZSE166 |
|------------|---|-------|---------|--------|------|-----|--|--------|

LOGO

| | | | | | | | | |
|---------|---|-------|-------|-------------|------|-----|------|-------|
| 1.3 | 4 | D13B7 | 48/64 | 03/99→03/02 | Z158 | 1.1 | | ZS275 |
| 1.3 LPG | 4 | D13B7 | 48/64 | 03/99→03/02 | Z116 | 0.8 | UXT5 | |

NSX

| | | | | | | | | |
|----------------------------|---|-------|---------|-------------|-----------|-----|-------|--|
| 3.0 24V Vtec | 6 | C30A3 | 201/270 | 06/90→09/05 | Z284 | 1.1 | UXT14 | |
| 3.0 24V Vtec LPG | 6 | C30A3 | 201/270 | 06/90→09/05 | Z30 [168] | 0.8 | UXT5 | |
| 3.0 24V Vtec Automatic | 6 | C30A4 | 188/252 | 03/95→09/05 | Z284 | 1.1 | UXT14 | |
| 3.0 24V Vtec Automatic LPG | 6 | C30A4 | 188/252 | 03/95→09/05 | Z30 [168] | 0.8 | UXT5 | |
| 3.0 24V Vtec Automatic | 6 | C30A4 | 188/252 | 06/90→09/05 | Z284 | 1.1 | UXT14 | |
| 3.0 24V Vtec Automatic LPG | 6 | C30A4 | 188/252 | 06/90→09/05 | Z30 [168] | 0.8 | UXT5 | |
| 3.2 24V Vtec | 6 | C32B2 | 206/276 | 01/97→09/05 | Z284 | 1.1 | UXT14 | |
| 3.2 24V Vtec LPG | 6 | C32B2 | 206/276 | 01/97→09/05 | Z30 [168] | 0.8 | UXT5 | |

PRELUDE I

| | | | | | | | | |
|-----|---|----------|-------|-------------|----|-----|-------------|-------|
| 1.6 | 4 | EL, EL14 | 59/79 | 11/78→10/82 | Z8 | 0.8 | UXT2 / UXT6 | ZM054 |
|-----|---|----------|-------|-------------|----|-----|-------------|-------|

PRELUDE II

| | | | | | | | | |
|--------|---|----------|--------|-------------|-----|-----|-------------|--------------------------|
| 1.8 EX | 4 | ET3, ET4 | 74/99 | 11/85→04/87 | Z21 | 1.1 | UXT2 / UXT6 | ZS417 ZM016 |
| 1.8 EX | 4 | ET2, ET3 | 77/103 | 11/83→04/87 | Z21 | 1.1 | UXT2 / UXT6 | ZS417 ZM054 →12/85 |

PRELUDE III

| | | | | | | | | |
|--------------|---|-------|---------|-------------|-----|-----|-------|---|
| 2.0 | 4 | B20A4 | 84/113 | 08/87→01/92 | Z16 | 1.1 | UXT11 | ZS275 ZM055 |
| 2.0 EX | 4 | B20A3 | 80/107 | 04/87→01/92 | Z16 | 1.1 | UXT11 | ZS275 ZM056 |
| 2.0 i EX 16V | 4 | B20A1 | 101/135 | 04/86→12/87 | Z16 | 1.1 | UXT11 | ZS275 ZM016 →08/87 ZM055 04/87→ |
| 2.0 i EX 16V | 4 | B20A5 | 101/135 | 04/87→01/92 | Z16 | 1.1 | UXT11 | ZS275 ZM055 |
| 2.0 i EX 16V | 4 | B20A9 | 103/138 | 04/90→01/92 | Z16 | 1.1 | UXT11 | ZS275 ZM055 |
| 2.0 i EX 16V | 4 | B20A7 | 110/148 | 10/87→12/90 | Z16 | 1.1 | UXT11 | ZS275 |

PRELUDE IV

| | | | | | | | | |
|----------------|---|-------|---------|-------------|------|-----|------|-------|
| 2.0 i 16V | 4 | F20A4 | 98/131 | 02/92→09/96 | Z158 | 1.1 | | ZS275 |
| 2.0 i 16V LPG | 4 | F20A4 | 98/131 | 02/92→09/96 | Z116 | 0.8 | UXT5 | |
| 2.2 i 16V Vtec | 4 | H22A2 | 136/182 | 02/93→09/96 | Z158 | 1.1 | | ZS275 |

HONDA

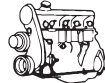

kW/BHP

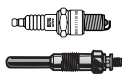
**... HONDA****... PRELUDE IV**

| | | | | | | | | |
|--------------------|---|-------|---------|-------------|------|-----|------|-------|
| 2.2 i 16V Vtec LPG | 4 | H22A2 | 136/182 | 02/93→09/96 | Z116 | 0.8 | UXT5 | |
| 2.3 i 16V | 4 | H23A2 | 118/158 | 02/92→09/96 | Z158 | 1.1 | | ZS275 |
| 2.3 i 16V LPG | 4 | H23A2 | 118/158 | 02/92→09/96 | Z116 | 0.8 | UXT5 | |

PRELUDE V

| | | | | | | | | |
|-------------|---|--------------|---------|-------------|-----------------------|-----|-------|-------|
| 2.0 16V | 4 | F20A4 | 98/131 | 10/96→10/00 | Z158 | 1.1 | | ZS275 |
| 2.0 16V LPG | 4 | F20A4 | 98/131 | 10/96→10/00 | Z116 | 0.8 | UXT5 | |
| 2.2 16V | 4 | H22A2, H22A5 | 136/182 | 10/96→10/00 | Z228 | 1.0 | UXT11 | ZS275 |
| 2.2 16V | 4 | H22A5 | 147/197 | 10/96→10/00 | Z228 | 1.0 | UXT11 | ZS275 |
| 2.2 16V LPG | 4 | H22A2, H22A5 | 136/182 | 10/96→10/00 | Z221 ^[168] | 1.0 | UXT14 | |
| 2.2 16V LPG | 4 | H22A5 | 147/197 | 10/96→10/00 | Z221 ^[168] | 1.0 | UXT14 | |

QUINTET

| | | | | | | | | |
|--------|---|----|-------|-------------|----|-----|-------------|-------|
| 1.6 EX | 4 | EL | 59/79 | 02/80→12/84 | Z8 | 0.8 | UXT2 / UXT6 | ZM054 |
|--------|---|----|-------|-------------|----|-----|-------------|-------|

S2000

| | | | | | | | | |
|----------|---|-----------|---------|--------|------|-----|--|--------|
| 2.0 | 4 | F20C VTEC | 177/237 | 06/99→ | Z323 | 1.1 | | ZSE169 |
| 2.2 Vtec | 4 | F22C1 | 176/236 | 10/03→ | | | | ZSE169 |

SHUTTLE

| | | | | | | | | |
|-------------|---|-------|---------|-------------|------|-----|------|-------|
| 2.2 16V | 4 | F22B8 | 110/148 | 10/94→02/98 | Z158 | 1.1 | | ZS275 |
| 2.2 16V LPG | 4 | F22B8 | 110/148 | 10/94→02/98 | Z116 | 0.8 | UXT5 | |
| 2.3 16V | 4 | F23A7 | 110/148 | 10/97→06/04 | Z158 | 1.1 | | ZS275 |
| 2.3 16V LPG | 4 | F23A7 | 110/148 | 10/97→06/04 | Z116 | 0.8 | UXT5 | |

STEPWAGON

| | | | | | | | | |
|---------|---|-------|---------|-------------|------|-----|------|--|
| 2.0 | 4 | K20A9 | 118/158 | 10/00→09/05 | Z299 | 1.0 | | |
| 2.0 LPG | 4 | K20A9 | 118/158 | 10/00→09/05 | Z116 | 0.8 | UXT5 | |

STREAM

| | | | | | | | | |
|-------------|---|-------|---------|--------|----------------|-----|----------------|--------|
| 1.7 16V | 4 | D17A2 | 92/123 | 05/01→ | Z158 | 1.1 | | ZSE166 |
| 1.7 16V LPG | 4 | D17A2 | 92/123 | 05/01→ | Z116 | 0.8 | UXT5 | |
| 2.0 16V | 4 | K20A1 | 115/154 | 05/01→ | Z299 →09/05 | 1.0 | | ZSE169 |
| 2.0 16V LPG | 4 | K20A1 | 115/154 | 05/01→ | Z116 →09/05 | 0.8 | UXT5 →09/05 | |

HYUNDAI**ACCENT**

| | | | | | | | | |
|---------------|---|--------|--------|-------------|-----------------------|-----|-------|-----------------|
| 1.3 | 4 | G4EH | 44/59 | 10/94→01/00 | Z73 | 1.1 | UXT11 | ZS264 |
| 1.3 | 4 | G4EA | 55/74 | 01/00→11/05 | Z73 | 1.1 | UXT11 | ZS479 |
| 1.3 | 4 | G4EH | 55/74 | 10/94→01/00 | Z73 | 1.1 | UXT11 | ZS264 |
| 1.3 | 4 | G4EA | 63/84 | 01/00→11/05 | Z73 | 1.1 | UXT11 | ZS479 |
| 1.3 LPG | 4 | G4EH | 44/59 | 10/94→01/00 | Z206 ^[168] | 0.7 | UXT10 | |
| 1.3 LPG | 4 | G4EH | 55/74 | 10/94→01/00 | Z206 ^[168] | 0.7 | UXT10 | |
| 1.3 i 12V | 4 | G4EH | 62/83 | 10/94→01/00 | Z73 | 1.1 | UXT11 | ZS264 →07/99 |
| 1.3 i 12V LPG | 4 | G4EH | 62/83 | 10/94→01/00 | Z206 ^[168] | 0.7 | UXT10 | |
| 1.4 GL | 4 | G4EE | 71/95 | 11/05→11/10 | Z16 | 1.1 | UXT11 | ZS481 |
| 1.4 GL LPG | 4 | G4EE | 71/95 | 11/05→11/10 | Z340 | 0.7 | UXT12 | |
| 1.5 | 4 | G4EB | 66/89 | 01/00→11/05 | Z73 | 1.1 | UXT11 | ZS479 |
| 1.5 | 4 | G4FK | 75/101 | 09/99→10/02 | Z73 | 1.1 | UXT11 | |
| 1.5 LPG | 4 | G4EB | 66/89 | 01/00→11/05 | Z206 ^[168] | 0.7 | UXT10 | |
| 1.5 CRDi | 3 | D3EA | 60/80 | 01/02→11/05 | GN035 | 11V | | |
| 1.5 CRDi GLS | 4 | D4FA | 81/109 | 11/05→11/10 | GN062 | 11V | | |
| 1.5 i 12V | 4 | G4EK | 65/87 | 10/94→01/00 | Z73 | 1.1 | UXT11 | ZS264 |
| 1.5 i 12V LPG | 4 | G4EK | 65/87 | 10/94→01/00 | Z206 ^[168] | 0.7 | UXT10 | |
| 1.5 i 16V | 4 | G4ER | 73/98 | 10/95→01/00 | Z73 | 1.1 | UXT11 | |
| 1.5 i 16V LPG | 4 | G4ER | 73/98 | 10/95→01/00 | Z206 | 0.7 | UXT10 | |
| 1.6 | 4 | G4ED-G | 77/103 | 12/02→11/05 | Z73 | 1.1 | UXT11 | ZS483 |
| 1.6 LPG | 4 | G4ED-G | 77/103 | 12/02→11/05 | Z206 ^[168] | 0.7 | UXT10 | |
| 1.6 GLS | 4 | G4ED | 82/110 | 11/05→11/10 | Z73 | 1.1 | UXT11 | ZS481 10/09→ |

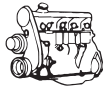

kw/BHP

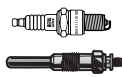

... HYUNDAI



ACCENT I

| | | | | | | | | |
|---------------|---|------|-------|-------------|------------|-----|-------|-------|
| 1.3 | 4 | G4EH | 44/59 | 10/94→01/00 | Z73 | 1.1 | UXT11 | ZS264 |
| 1.3 | 4 | G4EH | 55/74 | 10/94→01/00 | Z73 | 1.1 | UXT11 | ZS264 |
| 1.3 LPG | 4 | G4EH | 44/59 | 10/94→01/00 | Z206 [168] | 0.7 | UXT10 | |
| 1.3 LPG | 4 | G4EH | 55/74 | 10/94→01/00 | Z206 [168] | 0.7 | UXT10 | |
| 1.3 i 12V | 4 | G4EH | 62/83 | 10/94→01/00 | Z73 | 1.1 | UXT11 | ZS264 |
| 1.3 i 12V LPG | 4 | G4EH | 62/83 | 10/94→01/00 | Z206 [168] | 0.7 | UXT10 | |
| 1.5 i 12V | 4 | G4EK | 65/87 | 10/94→01/00 | Z73 | 1.1 | UXT11 | ZS264 |
| 1.5 i 12V LPG | 4 | G4EK | 65/87 | 10/94→01/00 | Z206 [168] | 0.7 | UXT10 | |
| 1.5 i 16V | 4 | G4ER | 73/98 | 12/95→01/00 | Z73 | 1.1 | UXT11 | |
| 1.5 i 16V LPG | 4 | G4ER | 73/98 | 12/95→01/00 | Z206 | 0.7 | UXT10 | |

ACCENT II

| | | | | | | | | |
|----------|---|--------|--------|-------------|------------|-----|-------|-------|
| 1.3 | 4 | G4EA | 55/74 | 01/00→11/05 | Z73 | 1.1 | UXT11 | ZS479 |
| 1.3 | 4 | G4EA | 61/82 | 01/00→11/05 | Z73 | 1.1 | UXT11 | ZS479 |
| 1.3 | 4 | G4EH | 62/83 | 08/02→11/05 | Z73 | 1.1 | UXT11 | ZS479 |
| 1.3 | 4 | G4EA | 63/84 | 01/00→11/05 | Z73 | 1.1 | UXT11 | ZS479 |
| 1.3 LPG | 4 | G4EA | 55/74 | 01/00→11/05 | Z206 [168] | 0.7 | UXT10 | |
| 1.3 LPG | 4 | G4EA | 61/82 | 01/00→11/05 | Z206 [168] | 0.7 | UXT10 | |
| 1.3 LPG | 4 | G4EH | 62/83 | 08/02→11/05 | Z206 [168] | 0.7 | UXT10 | |
| 1.3 LPG | 4 | G4EA | 63/84 | 01/00→11/05 | Z206 [168] | 0.7 | UXT10 | |
| 1.5 | 4 | G4EB | 66/89 | 01/00→11/05 | Z73 | 1.1 | UXT11 | ZS479 |
| 1.5 | 4 | G4EC-G | 75/101 | 09/00→11/05 | Z73 | 1.1 | UXT11 | ZS479 |
| 1.5 LPG | 4 | G4EB | 66/89 | 01/00→11/05 | Z206 [168] | 0.7 | UXT10 | |
| 1.5 LPG | 4 | G4EC-G | 75/101 | 09/00→11/05 | Z206 [168] | 0.7 | UXT10 | |
| 1.5 CRDi | 3 | D3EA | 60/80 | 04/02→11/05 | GN035 | 11V | | |
| 1.6 | 4 | G4ED-G | 77/103 | 12/02→11/05 | Z73 | 1.1 | UXT11 | ZS483 |
| 1.6 LPG | 4 | G4ED-G | 77/103 | 12/02→11/05 | Z206 [168] | 0.7 | UXT10 | |

ACCENT III

| | | | | | | | | |
|--------------|---|------|--------|-------------|-------|-----|-------|-------------|
| 1.4 GL | 4 | G4EE | 71/95 | 11/05→11/10 | Z16 | 1.1 | UXT11 | ZS481 |
| 1.4 GL LPG | 4 | G4EE | 71/95 | 11/05→11/10 | Z340 | 0.7 | UXT12 | |
| 1.5 CRDi GLS | 4 | D4FA | 81/109 | 11/05→11/10 | GN062 | 11V | | |
| 1.6 GLS | 4 | G4ED | 82/110 | 11/05→11/10 | Z16 | 1.1 | UXT11 | ZS481 |
| | | | | | | | | 09/06→03/10 |
| 1.6 GLS LPG | 4 | G4ED | 82/110 | 11/05→11/10 | Z340 | 0.7 | UXT12 | |

ACCENT IV

| | | | | | | | | |
|-----|---|------|--------|--------|--|--|--|-----------|
| 1.4 | 4 | G4FA | 79/106 | 11/10→ | | | | ZS475 [1] |
| 1.6 | 4 | G4FC | 90/121 | 11/10→ | | | | ZS475 [1] |
| 1.6 | 4 | G4FC | 91/122 | 11/10→ | | | | ZS475 [1] |

ATOS

| | | | | | | | | |
|-----------|---|--------|-------|-------------|------------|-----|-------|------------|
| 1.0 i | 4 | G4HC | 40/54 | 02/98→03/02 | Z73 | 1.1 | UXT11 | ZSE011 |
| | | | | | | | | →08/00 |
| | | | | | | | | ZS266 [33] |
| | | | | | | | | 08/00→ |
| 1.0 i | 4 | G4HC-E | 43/58 | 03/01→ | Z73 | 1.1 | UXT11 | ZS266 [34] |
| 1.0 i LPG | 4 | G4HC | 40/54 | 02/98→03/02 | Z206 | 0.7 | UXT10 | |
| 1.0 i LPG | 4 | G4HC-E | 43/58 | 03/01→ | Z206 [168] | 0.7 | UXT10 | |
| 1.1 | 4 | G4HD | 43/58 | 08/03→05/05 | Z73 | 1.1 | UXT11 | ZS266 [1] |
| 1.1 | 4 | G4HG | 46/62 | 03/04→ | Z73 | 1.1 | UXT11 | ZSE011 |
| | | | | | | | | →05/05 |
| 1.1 LPG | 4 | G4HG | 46/62 | 03/04→ | Z206 [168] | 0.7 | UXT10 | |

ATOS PRIME

| | | | | | | | | |
|-----------|---|--------|-------|--------|------------|-----|-------|------------|
| 1.0 i | 4 | G4HC | 40/54 | 08/99→ | Z73 | 1.1 | UXT11 | ZSE011 |
| | | | | | | | | →08/00 |
| | | | | | | | | ZS266 [33] |
| | | | | | | | | 08/00→ |
| 1.0 i | 4 | G4HC-E | 43/58 | 03/01→ | Z73 | 1.1 | UXT11 | ZS266 [34] |
| 1.0 i LPG | 4 | G4HC | 40/54 | 08/99→ | Z206 [168] | 0.7 | UXT10 | |
| 1.0 i LPG | 4 | G4HC-E | 43/58 | 03/01→ | Z206 [168] | 0.7 | UXT10 | |
| 1.1 | 4 | G4HD | 43/58 | 06/03→ | Z73 | 1.1 | UXT11 | ZS266 |

HYUNDAI

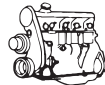

kW/BHP

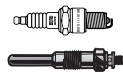

... HYUNDAI



... ATOS PRIME

| | | | | | | | | |
|---------|---|------|-------|--------|----------------------|-----|-----------------|--|
| 1.1 | 4 | G4HG | 46/62 | 09/05→ | Z73 →03/08 | 1.1 | UXT11 →03/08 | |
| 1.1 LPG | 4 | G4HD | 43/58 | 06/03→ | Z206 [168] | 0.7 | UXT10 | |
| 1.1 LPG | 4 | G4HG | 46/62 | 09/05→ | Z206 [168] →03/08 | 0.7 | UXT10 →03/08 | |

COUPE

| | | | | | | | | |
|------------------|---|--------|---------|-------------|--------------------|------------|----------------------|------------------------------------|
| 1.6 16V | 4 | G4ED-G | 77/103 | 03/02→08/09 | Z16 | 1.1 | UXT11 | ZS483 |
| 1.6 16V | 4 | G4ED-G | 79/106 | 03/02→08/09 | Z16 | 1.1 | UXT11 | ZS483 |
| 1.6 16V | 4 | G4GR | 85/114 | 03/98→04/02 | Z73 | 1.1 | UXT11 | ZS267 →05/00 ZS483 09/01→ |
| 1.6 16V LPG | 4 | G4ED-G | 77/103 | 03/02→08/09 | Z340 | 0.7 | UXT12 | |
| 1.6 16V LPG | 4 | G4ED-G | 79/106 | 03/02→08/09 | Z340 | 0.7 | UXT12 | |
| 1.6 16V LPG | 4 | G4GR | 85/114 | 03/98→04/02 | Z206 | 0.7 | UXT10 | |
| 1.6 i 16V | 4 | 4G61 | 84/113 | 12/96→04/02 | Z73 | 1.1 | UXT11 | ZS267 →12/00 |
| 1.6 i 16V LPG | 4 | 4G61 | 84/113 | 12/96→04/02 | Z206 | 0.7 | UXT10 | |
| 2.0 | 4 | G4GC-G | 100/134 | 08/01→08/09 | Z73 10/01→ | 1.1 | UXT11 10/01→ | ZS482 08/02→12/06 |
| 2.0 | 4 | G4DF | 101/135 | 08/99→01/02 | Z73 | 1.1 | UXT11 | ZS267 →08/01 |
| 2.0 | 4 | G4GC-G | 102/137 | 03/02→08/09 | Z73 | 1.1 | UXT11 | ZS482 08/02→12/06 |
| 2.0 LPG | 4 | G4GC-G | 102/137 | 03/02→08/09 | Z206 [168] | 0.7 | UXT10 | |
| 2.0 16V | 4 | G4DF | 99/133 | 03/01→04/02 | Z16 | 1.1 | UXT11 | ZS267 →08/01 |
| 2.0 16V | 4 | G4GF | 102/137 | 08/96→04/02 | Z15 [6] Z73 [4] | 0.8 1.1 | UXT1 / UXT3 UXT11 | ZS267 →12/00 |
| 2.0 16V LPG | 4 | G4DF | 99/133 | 03/01→04/02 | Z340 | 0.7 | UXT12 | |
| 2.0 16V LPG | 4 | G4GF | 102/137 | 08/96→04/02 | Z206 [168] | 0.7 | UXT10 | |
| 2.0 F2 Evolution | 4 | | 115/154 | 01/99→05/99 | Z73 | 1.1 | UXT11 | ZS267 |
| 2.0 GLS | 4 | G4GC-G | 105/141 | 02/03→08/09 | Z16 | 1.1 | UXT11 | ZS482 |
| 2.0 GLS LPG | 4 | G4GC-G | 105/141 | 02/03→08/09 | Z340 | 0.7 | UXT12 | |
| 2.7 V6 | 6 | G6BA-G | 121/162 | 01/07→08/09 | Z240 | 1.0 | UXT9 | ZS485 |
| 2.7 V6 | 6 | G6BA-G | 123/165 | 03/02→08/09 | Z228 | 1.0 | UXT11 | ZS485 |
| 2.7 V6 LPG | 6 | G6BA-G | 123/165 | 03/02→08/09 | Z221 [168] | 1.0 | UXT14 | |

ELANTRA

| | | | | | | | | |
|----------|---|--------|---------|-------------|----------------|-----|----------------|-----------------|
| 1.6 | 4 | G4GR | 66/89 | 06/00→07/06 | Z73 | 1.1 | UXT11 | ZS483 |
| 1.6 | 4 | G4ED-G | 77/103 | 05/03→07/06 | Z73 | 1.1 | UXT11 | ZS483 |
| 1.6 | 4 | G4ED-G | 79/106 | 06/00→07/06 | Z73 | 1.1 | UXT11 | ZS483 |
| 1.6 | 4 | G4GA | 82/110 | 09/03→07/06 | Z312 04/04→ | 1.0 | UXT9 04/04→ | |
| 1.6 LPG | 4 | G4ED-G | 77/103 | 05/03→07/06 | Z206 [168] | 0.7 | UXT10 | |
| 1.6 LPG | 4 | G4ED-G | 79/106 | 06/00→07/06 | Z206 [168] | 0.7 | UXT10 | |
| 1.6 CRDi | 4 | D4FB | 94/126 | 02/11→ | GN062 | 11V | | |
| 1.6 CVT | 4 | G4FC | 90/121 | 06/06→06/11 | Z334 [17] | 0.9 | | ZS474 |
| 1.8 | 4 | | 79/106 | 06/00→07/03 | Z73 | 1.1 | UXT11 | |
| 1.8 | 4 | G4BB | 97/130 | 06/00→07/06 | Z73 | 1.1 | UXT11 | ZS482 09/02→ |
| 1.8 | 4 | G4GB | 98/131 | 11/02→07/06 | Z312 05/04→ | 1.0 | UXT9 05/04→ | |
| 1.8 LPG | 4 | G4BB | 97/130 | 06/00→07/06 | Z206 [168] | 0.7 | UXT10 | |
| 2.0 | 4 | G4GC-G | 102/137 | 06/00→07/06 | Z73 | 1.1 | UXT11 | ZS482 09/02→ |
| 2.0 | 4 | G4GC | 104/139 | 06/00→07/06 | Z73 | 1.1 | UXT11 | ZS482 09/02→ |
| 2.0 | 4 | G4GC | 105/141 | 10/03→07/06 | Z73 | 1.1 | UXT11 | ZS482 |
| 2.0 LPG | 4 | G4GC-G | 102/137 | 06/00→07/06 | Z206 [168] | 0.7 | UXT10 | |

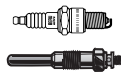

kW/BHP

**... HYUNDAI****... ELANTRA**

| | | | | | | | | |
|-------------|---|------|---------|-------------|-----------------------|-----|-------|------------------------|
| 2.0 LPG | 4 | G4GC | 104/139 | 06/00→07/06 | Z206 ^[168] | 0.7 | UXT10 | |
| 2.0 LPG | 4 | G4GC | 105/141 | 10/03→07/06 | Z206 | 0.7 | UXT10 | |
| 2.0 CRDi | 4 | D4EA | 83/111 | 04/01→07/06 | GN035 | 11V | | |
| 2.0 CVT | 4 | G4GC | 105/141 | 06/06→06/11 | Z73 | 1.1 | UXT11 | ZSE502 ^[16] |
| 2.0 CVT LPG | 4 | G4GC | 105/141 | 06/06→06/11 | Z206 ^[168] | 0.7 | UXT10 | |

EQUUS / CENTENNIAL

| | | | | | | | | |
|-----|---|------|---------|-------------|----------------------------|-----|----------------------------|---|
| 3.5 | 6 | G6CU | 155/208 | 10/99→03/09 | Z312 <i>08/00→03/05</i> | 1.0 | UXT9 <i>08/00→03/05</i> | ZSE086 <i>→08/02</i> ZSE087 <i>09/02→03/05</i> |
| 4.5 | 8 | 8A80 | 195/261 | 10/99→09/03 | Z312 <i>08/00→</i> | 1.0 | UXT9 <i>08/00→</i> | |

GALLOPER I

| | | | | | | | | |
|------------------------|---|-------|---------|-------------|---|-----|-------|--|
| 2.5 TD 4WD | 4 | 4D56T | 62/83 | 08/91→07/98 | GV921 <i>07/94→12/95</i> GN107 <i>01/96→</i> | 11V | | |
| 2.5 TD intercooler 4WD | 4 | 4D56T | 70/94 | 08/91→07/98 | GV921 <i>07/94→12/95</i> GN107 <i>01/96→</i> | 11V | | |
| 3.0 V6 4WD | 6 | 6G72 | 104/139 | 08/91→07/98 | Z73 | 1.1 | UXT11 | |

GALLOPER II

| | | | | | | | | |
|------------------------|---|------|---------|-------------|-------|-----|-------|-------|
| 2.5 TGi D 4WD | 4 | D4BH | 77/103 | 08/98→12/03 | GN955 | 11V | | |
| 2.5 TD 4WD | 4 | D4BA | 65/87 | 08/98→12/03 | GN107 | 11V | | |
| 2.5 TD intercooler 4WD | 4 | D4BH | 73/98 | 08/98→12/03 | GV921 | 11V | | |
| 2.6 TD 4WD | 4 | D4BB | 63/84 | 08/98→06/03 | GN107 | 11V | | |
| 3.0 V6 4WD | 6 | G6AT | 104/139 | 08/98→12/03 | Z343 | 1.1 | UXT11 | ZS511 |
| 3.0 V6 4WD LPG | 6 | G6AT | 104/139 | 08/98→12/03 | Z206 | 0.7 | UXT10 | |

GETZ

| | | | | | | | | |
|--------------|---|--------|--------|-------------|-----------------------|-----|-------|------------------------|
| 1.1 | 4 | G4HD | 46/62 | 09/02→09/05 | Z73 | 1.1 | UXT11 | ZS480 |
| 1.1 | 4 | G4HD | 49/66 | 09/05→06/09 | Z73 | 1.1 | UXT11 | |
| 1.1 LPG | 4 | G4HD | 46/62 | 09/02→09/05 | Z206 ^[168] | 0.7 | UXT10 | |
| 1.1 LPG | 4 | G4HD | 49/66 | 09/05→06/09 | Z206 ^[168] | 0.7 | UXT10 | |
| 1.3 | 4 | G4EA | 61/82 | 09/04→06/09 | | | | ZS479 |
| 1.3 | 4 | G4EA | 63/84 | 09/03→09/05 | Z73 | 1.1 | UXT11 | ZS479 |
| 1.3 LPG | 4 | G4EA | 63/84 | 09/03→09/05 | Z206 ^[168] | 0.7 | UXT10 | |
| 1.3 i | 4 | G4EA | 60/80 | 09/02→03/04 | Z73 | 1.1 | UXT11 | ZS479 |
| 1.3 i LPG | 4 | G4EA | 60/80 | 09/02→03/04 | Z206 ^[168] | 0.7 | UXT10 | |
| 1.4 i | 4 | G4EE | 71/95 | 08/05→06/09 | Z73 | 1.1 | UXT11 | ZS483 <i>11/06→</i> |
| 1.4 i LPG | 4 | G4EE | 71/95 | 08/05→06/09 | Z206 ^[168] | 0.7 | UXT10 | |
| 1.5 CRDi | 3 | D3EA | 60/80 | 03/03→09/05 | GN035 | 11V | | |
| 1.5 CRDi | 4 | D4FA | 65/87 | 08/05→06/09 | GN062 | 11V | | |
| 1.5 CRDi GLS | 4 | D4FA | 75/101 | 07/04→08/05 | GN062 | 11V | | |
| 1.5 CRDi GLS | 4 | D4FA | 81/109 | 08/05→06/09 | GN062 | 11V | | |
| 1.6 | 4 | G4ED-G | 77/103 | 09/02→09/05 | Z73 | 1.1 | UXT11 | ZS483 |
| 1.6 | 4 | G4ED-G | 78/105 | 08/05→06/09 | Z73 | 1.1 | UXT11 | ZS483 |
| 1.6 LPG | 4 | G4ED-G | 77/103 | 09/02→09/05 | Z206 ^[168] | 0.7 | UXT10 | |
| 1.6 LPG | 4 | G4ED-G | 78/105 | 08/05→06/09 | Z206 ^[168] | 0.7 | UXT10 | |

GRANDEUR

| | | | | | | | | |
|----------|---|------|---------|--------|-------|-----|------|--|
| 2.2 CRDi | 4 | D4EB | 110/148 | 06/06→ | GN035 | 11V | | |
| 2.2 CRDi | 4 | D4EB | 114/153 | 06/06→ | GN035 | 11V | | |
| 3.3 | 6 | G6DB | 173/232 | 04/05→ | Z240 | 1.0 | UXT9 | |

H-1 / STAREX

| | | | | | | | | |
|-----|---|------|---------|-------------|-----|------|-------------|------------------------|
| 2.4 | 4 | G4CS | 82/110 | 06/97→04/04 | Z9 | 1.15 | UXT2 / UXT6 | ZS261 |
| 2.4 | 4 | G4JS | 101/135 | 02/03→04/04 | Z21 | 1.1 | UXT2 / UXT6 | ZSE502 ^[16] |
| 2.4 | 4 | G4JS | 107/143 | 11/01→04/04 | Z21 | 1.1 | UXT2 / UXT6 | ZSE502 ^[16] |

HYUNDAI



kW/BHP



... HYUNDAI



... H-1 / STAREX

| | | | | | | | | |
|------------|---|------|---------|-------------|-----------|-----|-------------|--|
| 2.4 LPG | 4 | G4CS | 82/110 | 06/97→04/04 | Z20 [168] | 0.8 | UXT2 / UXT6 | |
| 2.5 CRDi | 4 | D4CB | 81/109 | 06/06→12/07 | GN057 | 11V | | |
| 2.5 CRDi | 4 | | 85/114 | 06/97→04/04 | GN057 | 11V | | |
| 2.5 CRDi | 4 | D4CB | 103/138 | 12/02→04/04 | GN057 | 11V | | |
| 2.5 CRDi | 4 | | 120/161 | 12/02→04/04 | GN057 | 11V | | |
| 2.5 D | 4 | D4BF | 57/76 | 10/97→04/04 | GN107 [1] | 11V | | |
| | | | | | GN955 [1] | 11V | | |
| 2.5 D | 4 | D4BF | 62/83 | 10/97→04/04 | GN107 [1] | 11V | | |
| | | | | | GN955 [1] | 11V | | |
| 2.5 TGi | 4 | D4BH | 73/98 | 10/97→12/07 | GN107 [1] | 11V | | |
| | | | | | GN955 [1] | 11V | | |
| 2.5 TGi | 4 | D4BH | 74/99 | 05/04→12/07 | GN107 [1] | 11V | | |
| | | | | | GN955 [1] | 11V | | |
| 2.5 TD | 4 | D4BF | 59/79 | 06/97→04/04 | GN107 [1] | 11V | | |
| | | | | | GN955 [1] | 11V | | |
| 2.5 TD 4WD | 4 | D4BH | 73/98 | 03/01→04/04 | GN107 [1] | 11V | | |
| | | | | | GN955 [1] | 11V | | |
| 2.5 TD 4WD | 4 | D4BH | 74/99 | 11/01→04/04 | GN107 [1] | 11V | | |
| | | | | | GN955 [1] | 11V | | |
| 2.6 TDiC | 4 | D4BB | 63/84 | 10/97→04/04 | GN057 | 11V | | |

H100

| | | | | | | | | |
|-------|---|------|-------|-------------|-------|-----|--|--|
| 2.5 D | 4 | D4BA | 57/76 | 05/96→10/01 | GN955 | 11V | | |
|-------|---|------|-------|-------------|-------|-----|--|--|

i10

| | | | | | | | | |
|----------|---|------|-------|--------|------------|-----|-------|-------|
| 1.1 | 4 | G4HG | 48/64 | 12/07→ | Z73 | 1.1 | UXT11 | |
| 1.1 | 4 | G4HG | 49/66 | 01/08→ | Z73 | 1.1 | UXT11 | |
| 1.1 | 4 | G4HG | 51/68 | 04/11→ | Z334 [17] | 0.9 | | ZS477 |
| 1.1 LPG | 4 | G4HG | 48/64 | 12/07→ | Z206 [168] | 0.7 | UXT10 | |
| 1.1 LPG | 4 | G4HG | 49/66 | 01/08→ | Z206 [168] | 0.7 | UXT10 | |
| 1.1 CRDi | 3 | D3FA | 55/74 | 01/08→ | GN062 | 11V | | |
| 1.2 | 4 | G4LA | 57/76 | 11/08→ | Z359 | 0.8 | | ZS536 |
| 1.2 | 4 | G4LA | 63/84 | 04/11→ | Z359 | 0.8 | | ZS536 |

i20

| | | | | | | | | |
|----------|---|------|--------|--------|-------|-----|--------|-----------|
| 1.1 CRDi | 3 | D3FA | 55/74 | 03/12→ | GN062 | 11V | | |
| 1.2 | 4 | G4LA | 57/76 | 09/08→ | Z359 | 0.8 | | ZS536 |
| 1.2 | 4 | G4LA | 63/84 | 03/12→ | Z359 | 0.8 | | ZS536 |
| 1.4 | 4 | G4FA | 74/99 | 09/08→ | | | | ZS475 [1] |
| 1.4 CRDi | 4 | D4FC | 55/74 | 08/09→ | GN062 | 11V | | |
| 1.4 CRDi | 4 | D4FC | 66/89 | 08/08→ | GN062 | 11V | | |
| 1.6 | 4 | G4FC | 93/125 | 09/08→ | Z73 | 1.1 | UXT11 | ZS475 [1] |
| | | | | →06/09 | | | →06/09 | |
| 1.6 CRDi | 4 | D4FB | 85/114 | 09/08→ | GN062 | 11V | | |
| 1.6 CRDi | 4 | D4FB | 94/126 | 01/09→ | GN062 | 11V | | |

i30

| | | | | | | | | |
|----------|---|------|--------|-------------|-------|-----|--------|-----------|
| 1.4 | 4 | G4FA | 73/98 | 11/11→ | | | | ZS475 [1] |
| 1.4 | 4 | G4FA | 77/103 | 10/07→11/11 | Z158 | 1.1 | | |
| | | | | →12/08 | | | | |
| 1.4 | 4 | G4FA | 77/103 | 10/07→06/12 | Z73 | 1.1 | UXT11 | ZS474 |
| | | | | →03/09 | | | →03/09 | |
| 1.4 | 4 | G4FA | 80/107 | 10/07→11/11 | Z158 | 1.1 | | ZS474 |
| | | | | →12/08 | | | | |
| 1.4 | 4 | G4FA | 80/107 | 11/09→06/12 | | | | ZS475 [1] |
| 1.4 CRDi | 4 | D4FC | 66/89 | 11/11→ | GN062 | 11V | | |
| 1.6 | 4 | G4FC | 85/114 | 10/07→06/12 | Z73 | 1.1 | UXT11 | ZS475 |
| | | | | →03/09 | | | →03/09 | |
| 1.6 | 4 | G4FC | 90/121 | 10/07→06/12 | Z73 | 1.1 | UXT11 | ZS475 |
| | | | | →03/09 | | | →03/09 | |
| 1.6 | 4 | G4FC | 93/125 | 02/08→06/12 | Z73 | 1.1 | UXT11 | ZS475 |
| | | | | →03/09 | | | →03/09 | |

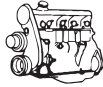

kW/BHP

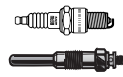

... HYUNDAI



... i30

| | | | | | | | | |
|----------|---|---------------|---------|-------------|------------|-----|-------|-------|
| 1.6 CRDi | 4 | D4FB | 66/89 | 10/07→06/12 | GN062 | 11V | | |
| 1.6 CRDi | 4 | D4FB | 81/109 | 06/12→ | GN062 | 11V | | |
| 1.6 CRDi | 4 | D4FB | 85/114 | 10/07→06/12 | GN062 | 11V | | |
| 1.6 CRDi | 4 | D4FB, D4FB-5P | 94/126 | 01/10→ | GN062 | 11V | | |
| 2.0 | 4 | G4GC, G4GC-G | 105/141 | 10/07→06/12 | Z73 | 1.1 | UXT11 | ZS482 |
| 2.0 LPG | 4 | G4GC, G4GC-G | 105/141 | 10/07→06/12 | Z206 [168] | 0.7 | UXT10 | |
| 2.0 CRDi | 4 | D4EA | 100/134 | 10/07→06/12 | GN035 | 11V | | |
| 2.0 CRDi | 4 | D4EA | 103/138 | 10/07→06/12 | GN035 | 11V | | |

ix20

| | | | | | | | | |
|----------|---|--------|--------|--------|-------|-----|--|-----------|
| 1.4 | 4 | G4FA | 66/89 | 11/10→ | | | | ZS475 [1] |
| 1.4 CRDi | 4 | D4FC-M | 57/76 | 06/11→ | GN062 | 11V | | |
| 1.4 CRDi | 4 | D4FC | 66/89 | 11/10→ | GN062 | 11V | | |
| 1.6 | 4 | G4FC | 92/123 | 11/10→ | | | | ZS475 [1] |
| 1.6 CRDi | 4 | D4FB | 85/114 | 06/11→ | GN062 | 11V | | |
| 1.6 CRDi | 4 | D4FB | 94/126 | 06/11→ | GN062 | 11V | | |

ix35

| | | | | | | | | |
|-----|---|------|---------|--------|------|-----|-------|--|
| 2.0 | 4 | G4KD | 120/161 | 01/10→ | Z183 | 0.9 | UXT13 | |
|-----|---|------|---------|--------|------|-----|-------|--|

ix55

| | | | | | | | | |
|-----------------|---|------|---------|--------|-------|------|--|--|
| 3.0 V6 CRDi 4WD | 6 | D6EA | 176/236 | 09/08→ | GE113 | 4.4V | | |
| 3.0 V6 CRDi 4WD | 6 | D6EB | 184/247 | 09/11→ | GE113 | 4.4V | | |

LANTRA I

| | | | | | | | | |
|------------------|---|------------|--------|-------------|-----------|-----|-------------|-------|
| 1.5 i.e. | 4 | G4DJ, G15B | 63/84 | 10/90→11/95 | Z21 | 1.1 | UXT2 / UXT6 | ZS263 |
| 1.5 i.e. LPG | 4 | G4DJ, G15B | 63/84 | 10/90→11/95 | Z27 [168] | 0.8 | UX56 | |
| 1.6 i.e. 16V | 4 | G4CR | 78/105 | 10/90→11/95 | Z20 [6] | 0.8 | UXT2 / UXT6 | ZS265 |
| | | | | | Z21 [8] | 1.1 | | |
| 1.6 i.e. 16V | 4 | G4CR | 84/113 | 10/90→11/95 | Z20 [6] | 0.8 | UXT2 / UXT6 | ZS265 |
| | | | | | Z21 [8] | 1.1 | | |
| 1.6 i.e. 16V LPG | 4 | G4CR | 78/105 | 10/90→11/95 | Z27 [168] | 0.8 | UX56 | |
| 1.6 i.e. 16V LPG | 4 | G4CR | 84/113 | 10/90→11/95 | Z27 [168] | 0.8 | UX56 | |
| 1.8 i.e. 16V | 4 | G4CN | 93/125 | 10/90→11/95 | Z20 [6] | 0.8 | UXT2 / UXT6 | ZS265 |
| | | | | | Z21 [8] | 1.1 | | |
| 1.8 i.e. 16V LPG | 4 | G4CN | 93/125 | 10/90→11/95 | Z27 [168] | 0.8 | UX56 | |

LANTRA II

| | | | | | | | | |
|-------------|---|------|---------|-------------|------------|-----|-------|-------|
| 1.5 12V | 4 | G4EK | 65/87 | 12/96→10/00 | Z16 | 1.1 | UXT11 | ZS264 |
| 1.5 12V LPG | 4 | G4EK | 65/87 | 12/96→10/00 | Z340 | 0.7 | UXT12 | |
| 1.6 16V | 4 | 4G61 | 84/113 | 11/95→10/00 | Z73 | 1.1 | UXT11 | ZS267 |
| 1.6 16V LPG | 4 | 4G61 | 84/113 | 11/95→10/00 | Z206 [168] | 0.7 | UXT10 | |
| 1.6 i | 4 | G4GR | 66/89 | 11/95→10/00 | Z73 | 1.1 | UXT11 | ZS267 |
| 1.6 i LPG | 4 | G4GR | 66/89 | 11/95→10/00 | Z206 [168] | 0.7 | UXT10 | |
| 1.8 16V | 4 | G4GM | 94/126 | 11/95→10/00 | Z73 | 1.1 | UXT11 | ZS267 |
| 1.8 16V LPG | 4 | G4GM | 94/126 | 11/95→10/00 | Z206 [168] | 0.7 | UXT10 | |
| 1.9 D | 4 | DJY | 50/67 | 03/98→10/00 | GN013 | 11V | | |
| 2.0 16V | 4 | G4GF | 102/137 | 08/96→10/00 | Z73 | 1.1 | UXT11 | ZS267 |
| 2.0 16V LPG | 4 | G4GF | 102/137 | 08/96→10/00 | Z206 [168] | 0.7 | UXT10 | |

MATRIX

| | | | | | | | | |
|--------------|---|--------|--------|-------------|------------|-----|-------|-------|
| 1.5 CRDi | 3 | D3EA | 60/80 | 10/01→08/10 | GN035 | 11V | | |
| 1.5 CRDi | 4 | D4FA | 75/101 | 12/04→08/10 | GN062 | 11V | | |
| 1.5 CRDi VGT | 4 | D4FA | 81/109 | 08/05→08/10 | GN062 | 11V | | |
| 1.6 | 4 | G4ED-L | 66/89 | 01/02→12/05 | Z73 | 1.1 | UXT11 | ZS483 |
| 1.6 | 4 | G4ED-G | 76/102 | 06/01→08/10 | Z73 | 1.1 | UXT11 | ZS267 |
| 1.6 LPG | 4 | G4ED-G | 76/102 | 06/01→08/10 | Z206 [168] | 0.7 | UXT10 | |
| 1.8 | 4 | G4GB-G | 90/121 | 06/01→08/10 | Z73 | 1.1 | UXT11 | ZS482 |
| 1.8 LPG | 4 | G4GB-G | 90/121 | 06/01→08/10 | Z206 [168] | 0.7 | UXT10 | |

PONY

| | | | | | | | | |
|-----|---|------|-------|-------------|----|------|-------------|-------|
| 1.2 | 4 | | 40/54 | 06/74→ | Z8 | 0.8 | UXT2 / UXT6 | |
| 1.3 | 4 | G4DG | 43/58 | 10/89→01/95 | Z9 | 1.15 | UXT2 / UXT6 | ZS263 |

HYUNDAI



kW/BHP

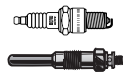

... HYUNDAI



... PONY

| | | | | | | | | | |
|-----------|---|------------|-------|-------------|-----------|------|-------------|-------|-------|
| 1.3 | 4 | G4DG | 49/66 | 10/89→01/95 | Z9 | 1.15 | UXT2 / UXT6 | ZS263 | |
| 1.3 | 4 | G13B | 50/67 | 10/85→09/89 | Z20 | 0.8 | UXT2 / UXT6 | ZS263 | |
| 1.3 LPG | 4 | G4DG | 43/58 | 10/89→01/95 | Z20 [168] | 0.8 | UXT2 / UXT6 | | |
| 1.3 LPG | 4 | G4DG | 49/66 | 10/89→01/95 | Z20 [168] | 0.8 | UXT2 / UXT6 | | |
| 1.4 | 4 | 4G33 | 50/67 | 08/77→ | Z8 | 0.8 | UXT2 / UXT6 | | |
| 1.5 | 4 | G4DJ, G15B | 53/71 | 10/85→09/89 | Z21 | 1.1 | UXT2 / UXT6 | | |
| 1.5 | 4 | G4DJ, G15B | 53/71 | 10/85→01/95 | | | | ZS263 | |
| 1.5 | 4 | G4DJ, G15B | 53/71 | 10/89→01/95 | Z9 | 1.15 | UXT2 / UXT6 | | ZM035 |
| 1.5 LPG | 4 | G4DJ, G15B | 53/71 | 10/89→01/95 | Z20 [168] | 0.8 | UXT2 / UXT6 | | |
| 1.5 i | 4 | G4DJ, G15B | 61/82 | 10/89→01/95 | Z21 | 1.1 | UXT2 / UXT6 | ZS263 | |
| 1.5 i | 4 | G4DJ, G15B | 62/83 | 10/89→01/95 | Z21 | 1.1 | UXT2 / UXT6 | ZS263 | |
| 1.5 i LPG | 4 | G4DJ, G15B | 61/82 | 10/89→01/95 | Z27 [168] | 0.8 | UX56 | | |
| 1.5 i LPG | 4 | G4DJ, G15B | 62/83 | 10/89→01/95 | Z27 [168] | 0.8 | UX56 | | |

PONY / EXCEL

| | | | | | | | | | |
|-----------|---|------------|-------|-------------|-----------|------|-------------|-------|-----------------|
| 1.3 | 4 | G4DG | 48/64 | 12/92→09/94 | | | | ZS263 | |
| 1.3 | 4 | G4DG | 49/66 | 01/90→01/95 | Z9 | 1.15 | UXT2 / UXT6 | ZS263 | |
| 1.3 LPG | 4 | G4DG | 49/66 | 01/90→01/95 | Z20 [168] | 0.8 | UXT2 / UXT6 | | |
| 1.5 | 4 | G4DJ, G15B | 53/71 | 01/90→01/95 | Z9 | 1.15 | UXT2 / UXT6 | ZS263 | ZM053 →12/91 |
| 1.5 LPG | 4 | G4DJ, G15B | 53/71 | 01/90→01/95 | Z20 [168] | 0.8 | UXT2 / UXT6 | | |
| 1.5 i | 4 | G4DJ, G15B | 61/82 | 01/90→01/95 | Z9 | 1.15 | UXT2 / UXT6 | ZS263 | |
| 1.5 i | 4 | G4DJ, G15B | 62/83 | 01/90→01/95 | Z9 | 1.15 | UXT2 / UXT6 | ZS263 | |
| 1.5 i LPG | 4 | G4DJ, G15B | 61/82 | 01/90→01/95 | Z20 [168] | 0.8 | UXT2 / UXT6 | | |
| 1.5 i LPG | 4 | G4DJ, G15B | 62/83 | 01/90→01/95 | Z20 [168] | 0.8 | UXT2 / UXT6 | | |

PORTER

| | | | | | | | | | |
|----------|---|------|---------|-------------|-----------|------|-------------|--|--|
| 2.4 | 4 | G4CS | 82/110 | 03/96→04/04 | Z9 | 1.15 | UXT2 / UXT6 | | |
| 2.4 LPG | 4 | G4CS | 82/110 | 03/96→04/04 | Z20 [168] | 0.8 | UXT2 / UXT6 | | |
| 2.5 CRDi | 4 | D4CB | 103/138 | 02/03→04/04 | GN057 | 11V | | | |
| 2.5 TD | 4 | D4BA | 57/76 | 07/94→04/04 | GN955 | 11V | | | |
| 2.6 TD | 4 | D4BB | 63/84 | 07/94→04/04 | GN107 | 11V | | | |

SANTA FÉ I

| | | | | | | | | | |
|----------------|---|--------|---------|-------------|-----------------|-----|-------|-------------|--|
| 2.0 | 4 | G4BP | 99/133 | 08/01→03/06 | Z343 | 1.1 | UXT11 | ZSE502 [16] | |
| 2.0 LPG | 4 | G4BP | 99/133 | 08/01→03/06 | Z206 | 0.7 | UXT10 | | |
| 2.0 CRDi | 4 | D4EA | 83/111 | 04/01→03/06 | GN035 | 11V | | | |
| 2.0 CRDi 4WD | 4 | D4EA | 92/123 | 08/03→03/06 | GN035 | 11V | | | |
| 2.0 CRDi 4WD | 4 | D4EA | 107/143 | 11/03→02/06 | GN035 →12/05 | 11V | | | |
| 2.2 CRDi | 4 | D4EB | 110/148 | 10/05→03/06 | GN035 | 11V | | | |
| 2.4 16V | 4 | G4JS-G | 100/134 | 02/01→03/06 | Z311 | 1.0 | | ZSE502 [16] | |
| 2.4 16V | 4 | G4JS-G | 107/143 | 02/01→03/06 | Z311 | 1.0 | | ZSE502 [16] | |
| 2.7 4WD | 6 | G6EA | 132/177 | 11/00→03/06 | | | | ZS485 | |
| 2.7 | 6 | G6EA | 139/186 | 10/05→03/06 | | | | ZS485 | |
| 2.7 4WD | 6 | G6EA | 139/186 | 10/05→03/06 | | | | ZS485 | |
| 2.7 V6 4WD | 6 | G6BA-G | 127/170 | 02/01→03/06 | Z228 | 1.0 | UXT11 | ZS485 | |
| 2.7 V6 4WD LPG | 6 | G6BA-G | 127/170 | 02/01→03/06 | Z221 [168] | 1.0 | UXT14 | | |
| 3.5 | 6 | G6CU | 147/197 | 09/03→02/06 | | | | ZSE087 | |

SANTA FÉ II

| | | | | | | | | | |
|--------------|---|------|---------|-------------|-------|-----|-------|--|--|
| 2.2 CRDi | 4 | D4EB | 102/137 | 03/06→ | GN035 | 11V | | | |
| 2.2 CRDi 4WD | 4 | D4EB | 110/148 | 10/05→03/06 | GN035 | 11V | | | |
| 2.2 CRDi | 4 | D4EB | 114/153 | 03/06→ | GN035 | 11V | | | |
| 2.2 CRDi 4WD | 4 | D4HB | 145/194 | 01/09→ | GN035 | 11V | | | |
| 2.2 CRDi GLS | 4 | D4EB | 110/148 | 03/06→ | GN035 | 11V | | | |
| 2.4 | 4 | G4KE | 128/172 | 11/10→ | Z183 | 0.9 | UXT13 | | |
| 2.7 | 6 | G6BA | 125/168 | 03/06→ | Z343 | 1.1 | UXT11 | | |
| 2.7 LPG | 6 | G6BA | 125/168 | 03/06→ | Z206 | 0.7 | UXT10 | | |

SANTAMO

| | | | | | | | | | |
|---------|---|------|---------|--------|-----|-----|-------------|------------------------------------|--|
| 2.0 16V | 4 | G4CP | 102/137 | 05/99→ | Z21 | 1.1 | UXT2 / UXT6 | ZS261 [1] [254] ZS521 [1] [140] | |
|---------|---|------|---------|--------|-----|-----|-------------|------------------------------------|--|



kW/BHP

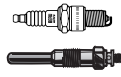

... HYUNDAI



S COUPE

| | | | | | | | | | |
|-----------------|---|------------|--------|-------------|---------------------|-----|-----------------------|-------|----------------------|
| 1.5 i | 4 | G4DJ | 62/83 | 02/90→05/96 | Z21 →06/92 | 1.1 | UXT2 / UXT6 →06/92 | ZS263 | ZM049 01/93→12/94 |
| 1.5 i | 4 | G15B | 62/83 | 02/90→05/96 | Z21 →06/92 | 1.1 | UXT2 / UXT6 →06/92 | ZS263 | |
| 1.5 i | 4 | G4EK | 65/87 | 04/92→05/96 | Z73 | 1.1 | UXT11 | | ZM049 |
| 1.5 i LPG | 4 | G4DJ, G15B | 62/83 | 02/90→05/96 | Z27 [168] →06/92 | 0.8 | UX56 →06/92 | | |
| 1.5 i LPG | 4 | G4EK | 65/87 | 04/92→05/96 | Z206 | 0.7 | UXT10 | | |
| 1.5 i Turbo | 4 | G4EK-TC | 85/114 | 04/91→05/96 | Z73 | 1.1 | UXT11 | ZS263 | ZM049 |
| 1.5 i Turbo LPG | 4 | G4EK-TC | 85/114 | 04/91→05/96 | Z206 | 0.7 | UXT10 | | |

SONATA II

| | | | | | | | | | |
|---------------|---|--------|---------|-------------|-----------|------|-------------|-----------------------------|-------|
| 1.8 i | 4 | 4G62 | 70/94 | 09/88→10/93 | Z9 | 1.15 | UXT2 / UXT6 | ZS261 | |
| 1.8 i LPG | 4 | 4G62 | 70/94 | 09/88→10/93 | Z20 [168] | 0.8 | UXT2 / UXT6 | | |
| 2.0 i | 4 | G4CP | 74/99 | 09/88→08/91 | Z9 | 1.15 | UXT2 / UXT6 | ZS261 | |
| 2.0 i | 4 | G4CP-U | 80/107 | 01/91→10/93 | Z9 | 1.15 | UXT2 / UXT6 | ZS265 | |
| 2.0 i LPG | 4 | G4CP | 74/99 | 09/88→08/91 | Z20 [168] | 0.8 | UXT2 / UXT6 | | |
| 2.0 i LPG | 4 | G4CP-U | 80/107 | 01/91→10/93 | Z20 [168] | 0.8 | UXT2 / UXT6 | | |
| 2.0 i 16V | 4 | G4CP-D | 96/129 | 01/91→10/93 | Z9 | 1.15 | UXT2 / UXT6 | ZS261 [1][254] ZS265 [1] | |
| 2.0 i 16V LPG | 4 | G4CP-D | 96/129 | 01/91→10/93 | Z20 [168] | 0.8 | UXT2 / UXT6 | | |
| 2.4 i | 4 | G4CS | 83/111 | 09/88→08/91 | Z9 | 1.15 | UXT2 / UXT6 | ZS261 | |
| 2.4 i LPG | 4 | G4CS | 83/111 | 09/88→08/91 | Z20 [168] | 0.8 | UXT2 / UXT6 | | |
| 3.0 i V6 | 6 | G6AT | 107/143 | 01/91→10/93 | Z82 [172] | 0.7 | UXT2 / UXT6 | ZS261 | ZM049 |

SONATA III

| | | | | | | | | | |
|---------------|---|---------|---------|-------------|-------------------------------|-----------------------|--|-----------|--|
| 1.8 GLS | 4 | G4DM | 63/84 | 07/96→05/98 | | | | ZS261 | |
| 1.8 i | 4 | G4CM | 72/97 | 05/93→06/98 | Z9 | 1.15 | UXT2 / UXT6 | ZS261 | |
| 1.8 i LPG | 4 | G4CM | 72/97 | 05/93→06/98 | Z20 [168] | 0.8 | UXT2 / UXT6 | | |
| 2.0 i | 4 | | 70/94 | 08/96→06/98 | Z21 | 1.1 | UXT2 / UXT6 | ZS261 | |
| 2.0 i | 4 | G4CP | 77/103 | 06/94→08/96 | Z1 [169] | 0.7 | UXT2 / UXT6 | ZS261 | |
| 2.0 i LPG | 4 | | 70/94 | 08/96→06/98 | Z27 [168] | 0.8 | UX56 | | |
| 2.0 i LPG | 4 | G4CP | 77/103 | 06/94→08/96 | Z11 [168] | 0.8 | UXT2 / UXT6 | | |
| 2.0 i 16V | 4 | G4CP-DM | 92/123 | 06/96→06/98 | Z11 | 0.8 | UXT2 / UXT6 | ZS261 | |
| 2.0 i 16V | 4 | G4CP-D | 102/137 | 05/93→06/98 | Z9 →04/96 Z11 05/96→ | 1.15 →04/96 0.8 | UXT2 / UXT6 →04/96 UXT2 / UXT6 05/96→ | ZS265 [1] | |
| 2.0 i 16V LPG | 4 | G4CP-D | 102/137 | 05/93→06/98 | Z20 [168] →04/96 | 0.8 | UXT2 / UXT6 →04/96 | | |
| 3.0 i V6 | 6 | G6AT | 107/143 | 05/93→06/98 | Z9 | 1.15 | UXT2 / UXT6 | ZS261 | |
| 3.0 i V6 LPG | 6 | G6AT | 107/143 | 05/93→06/98 | Z20 [168] | 0.8 | UXT2 / UXT6 | | |

SONATA IV

| | | | | | | | | | |
|------------------|---|---------|---------|-------------|------------|------|-------------|----------------------------|--|
| 2.0 16V | 4 | G4JP-EG | 96/129 | 10/01→11/04 | Z9 | 1.15 | UXT2 / UXT6 | ZSE502 [16] | |
| 2.0 16V | 4 | G4JP-G | 100/134 | 06/98→10/01 | Z20 | 0.8 | UXT2 / UXT6 | ZSE502 [16] | |
| 2.0 16V | 4 | | 106/142 | 10/01→11/04 | | | | ZSE502 [16] | |
| 2.0 16V LPG | 4 | G4JP-EG | 96/129 | 10/01→11/04 | Z20 [168] | 0.8 | UXT2 / UXT6 | | |
| 2.0 16V LPG | 4 | G4JP-G | 100/134 | 06/98→10/01 | Z27 [168] | 0.8 | UX56 | | |
| 2.0 CRDi Dynamic | 4 | D4EA | 103/138 | 10/01→11/04 | GN035 | 11V | | | |
| 2.2 CRDi | 4 | D4EB | 110/148 | 06/02→11/04 | GN035 | 11V | | | |
| 2.4 16V | 4 | G4BS | 105/141 | 03/98→10/01 | Z9 | 1.15 | UXT2 / UXT6 | ZSE502 [16] →03/01 | |
| 2.4 16V LPG | 4 | G4BS | 105/141 | 03/98→10/01 | Z20 [168] | 0.8 | UXT2 / UXT6 | | |
| 2.5 V6 24V | 6 | G6BV-G | 118/158 | 06/98→10/01 | Z228 | 1.0 | UXT11 | ZS269 | |
| 2.5 V6 24V LPG | 6 | G6BV-G | 118/158 | 06/98→10/01 | Z221 [168] | 1.0 | UXT14 | | |
| 2.7 V6 | 6 | G6BA-G | 127/170 | 10/01→11/04 | Z228 | 1.0 | UXT11 | ZS269 [138] ZS522 [139] | |
| 2.7 V6 | 6 | G6BA | 129/173 | 11/02→11/04 | Z312 | 1.0 | UXT9 | | |
| 2.7 V6 LPG | 6 | G6BA-G | 127/170 | 10/01→11/04 | Z221 [168] | 1.0 | UXT14 | | |

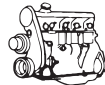

kW/BHP

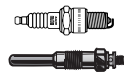

... HYUNDAI



SONATA V

| | | | | | | | | |
|--------------|---|------|---------|--------|-----------|------|-------------|--|
| 2.0 CRDi | 4 | D4EA | 100/134 | 02/06→ | GN035 | 11V | | |
| 2.0 CRDi | 4 | D4EA | 103/138 | 02/06→ | GN035 | 11V | | |
| 2.0 CRDi | 4 | D4EA | 110/148 | 03/09→ | GN035 | 11V | | |
| 2.0 VVTi GLS | 4 | G4KD | 121/162 | 01/08→ | Z183 | 0.9 | UXT13 | |
| 2.4 | 4 | G4KC | 119/160 | 01/05→ | Z9 | 1.15 | UXT2 / UXT6 | |
| 2.4 LPG | 4 | G4KC | 119/160 | 01/05→ | Z20 [168] | 0.8 | UXT2 / UXT6 | |
| 3.3 | 6 | G6DB | 171/229 | 01/05→ | Z240 | 1.0 | UXT9 | |
| 3.3 | 6 | G6DB | 173/232 | 06/05→ | Z240 | 1.0 | UXT9 | |
| 3.3 | 6 | G6DB | 184/247 | 01/08→ | Z240 | 1.0 | UXT9 | |

STELLAR

| | | | | | | | | |
|-----|---|------|-------|-------------|----|-----|-------------|------------|
| 1.4 | 4 | 4G33 | 50/67 | 10/83→08/86 | | | | ZS110 [15] |
| 1.6 | 4 | G32B | 56/75 | 10/83→12/91 | Z8 | 0.8 | UXT2 / UXT6 | ZS110 [15] |

TERRACAN

| | | | | | | | | |
|------------------|---|------|---------|-------------|------------|-----|-------|--|
| 2.5 D | 4 | D4BH | 59/79 | 06/01→10/03 | GN955 | 11V | | |
| 2.5 D | 4 | D4BH | 74/99 | 06/01→10/03 | GN955 | 11V | | |
| 2.5 TD 4WD | 4 | D4BH | 74/99 | 12/01→12/06 | GN955 | 11V | | |
| 2.9 CRDi | 4 | J3 | 110/148 | 11/01→12/06 | GN107 | 11V | | |
| 2.9 CRDi 4WD | 4 | J3 | 120/161 | 11/03→12/06 | GN107 | 11V | | |
| 3.5 i V6 4WD | 6 | G6CU | 143/192 | 12/01→12/06 | Z228 | 1.0 | UXT11 | |
| 3.5 i V6 4WD | 6 | G6CU | 147/197 | 12/01→12/06 | Z228 | 1.0 | UXT11 | |
| 3.5 i V6 4WD LPG | 6 | G6CU | 143/192 | 12/01→12/06 | Z221 [168] | 1.0 | UXT14 | |
| 3.5 i V6 4WD LPG | 6 | G6CU | 147/197 | 12/01→12/06 | Z221 [168] | 1.0 | UXT14 | |

TIBURON

| | | | | | | | | |
|-------------|---|------|---------|-------------|------------|-----|-------|-------------|
| 2.0 CVT | 4 | G4GC | 105/141 | 10/06→12/08 | Z73 | 1.1 | UXT11 | ZSE502 [16] |
| 2.0 CVT LPG | 4 | G4GC | 105/141 | 10/06→12/08 | Z206 [168] | 0.7 | UXT10 | |

TRAJET

| | | | | | | | | |
|------------|---|--------|---------|-------------|------------|-----|-------------|--|
| 2.0 | 4 | G4JP-G | 100/134 | 03/00→07/08 | Z21 | 1.1 | UXT2 / UXT6 | ZSE502 [16] →02/04 ZS482 02/04→ |
| 2.0 | 4 | G4GC-G | 103/138 | 01/04→07/08 | Z73 | 1.1 | UXT11 | ZSE502 [16] →02/04 ZS482 02/04→ |
| 2.0 | 4 | G4GC | 104/139 | 11/03→07/08 | Z73 | 1.1 | UXT11 | ZSE502 [16] |
| 2.0 LPG | 4 | G4JP-G | 100/134 | 03/00→07/08 | Z27 [168] | 0.8 | UX56 | |
| 2.0 LPG | 4 | G4GC-G | 103/138 | 01/04→07/08 | Z206 [168] | 0.7 | UXT10 | |
| 2.0 LPG | 4 | G4GC | 104/139 | 11/03→07/08 | Z206 [168] | 0.7 | UXT10 | |
| 2.0 CRDi | 4 | D4EA | 83/111 | 04/01→07/08 | GN035 | 11V | | |
| 2.0 CRDi | 4 | D4EA | 92/123 | 08/05→07/08 | GN035 | 11V | | |
| 2.7 V6 | 6 | G6BA-G | 127/170 | 09/00→07/08 | Z228 | 1.0 | UXT11 | ZS522 |
| 2.7 V6 LPG | 6 | G6BA-G | 127/170 | 09/00→07/08 | Z221 [168] | 1.0 | UXT14 | |

TUCSON

| | | | | | | | | |
|-------------|---|----------------|---------|-------------|------------|-----|-------|----------------|
| 2.0 | 4 | G4GC | 104/139 | 08/04→03/10 | Z73 | 1.1 | UXT11 | ZS482 |
| 2.0 4WD | 4 | G4GC | 104/139 | 08/04→03/10 | Z73 | 1.1 | UXT11 | ZSE502 [1][16] |
| 2.0 LPG | 4 | G4GC | 104/139 | 08/04→03/10 | Z206 [168] | 0.7 | UXT10 | |
| 2.0 CRDi | 4 | D4EA | 83/111 | 08/04→03/10 | GN035 | 11V | | |
| 2.0 CRDi | 4 | D4EA | 88/118 | 01/07→03/10 | GN035 | 11V | | |
| 2.0 CRDi | 4 | D4EA | 100/134 | 01/06→03/10 | GN035 | 11V | | |
| 2.0 CRDi | 4 | D4EA-F, D4EA-V | 103/138 | 01/06→03/10 | GN035 | 11V | | |
| 2.0 CRDi | 4 | D4EA | 110/148 | 01/09→03/10 | GN035 | 11V | | |
| 2.7 4WD | 6 | G6BA-G | 129/173 | 08/04→03/10 | Z73 | 1.1 | UXT11 | |
| 2.7 4WD LPG | 6 | G6BA-G | 129/173 | 08/04→03/10 | Z206 [168] | 0.7 | UXT10 | |

XG

| | | | | | | | | |
|-------------|---|--------|---------|-------------|------------|-----|-------|--------|
| 2.5 250 | 6 | G6AV | 120/161 | 12/98→12/05 | Z228 | 1.0 | UXT11 | |
| 2.5 250 LPG | 6 | G6AV | 120/161 | 12/98→12/05 | Z221 [168] | 1.0 | UXT14 | |
| 3.0 30 | 6 | G6CT-G | 138/185 | 12/98→12/05 | Z228 | 1.0 | UXT11 | ZSE086 |
| 3.0 30 LPG | 6 | G6CT-G | 138/185 | 12/98→12/05 | Z221 [168] | 1.0 | UXT14 | |

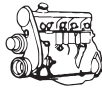

kW/BHP

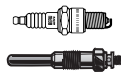
**... HYUNDAI****... XG**

| | | | | | | | | | | |
|-------------|---|------|---------|-------------|------------|--|-----|-------|--|--------------------------------------|
| 3.0 300 | 6 | | 145/194 | 09/99→09/03 | | | | | | ZSE086 →10/02 ZSE087 11/02→ |
| 3.5 350 | 6 | G6CU | 145/194 | 10/02→12/05 | Z228 | | 1.0 | UXT11 | | ZSE086 [1][65] ZSE087 [1][66] |
| 3.5 350 LPG | 6 | G6CU | 145/194 | 10/02→12/05 | Z221 [168] | | 1.0 | UXT14 | | |

HYUNDAI**GRACE**

| | | | | | | | | | | |
|------------|---|--------------|---------|-------------|------------------------|--|------|-------------|-------------|--|
| 2.5 TD | 4 | D4BF | 59/79 | 06/98→10/01 | GV921 | | | | 11V | |
| H-1 | | | | | | | | | | |
| 2.4 | 4 | G4CS | 82/110 | 03/00→04/04 | Z9 | | 1.15 | UXT2 / UXT6 | ZS261 | |
| 2.4 | 4 | G4JS | 107/143 | 11/01→04/04 | Z21 | | 1.1 | UXT2 / UXT6 | ZSE502 [16] | |
| 2.4 LPG | 4 | G4CS | 82/110 | 03/00→04/04 | Z20 [168] | | 0.8 | UXT2 / UXT6 | | |
| 2.5 CRDi | 4 | D4CB | 81/109 | 07/01→ | GN057 | | | | 11V | |
| 2.5 CRDi | 4 | D4CB | 85/114 | 08/11→ | GN057 | | | | 11V | |
| 2.5 CRDi | 4 | D4CB, D4CB-W | 100/134 | 07/08→ | GN057 | | | | 11V | |
| 2.5 CRDi | 4 | D4CB | 103/138 | 08/03→04/04 | GN057 | | | | 11V | |
| 2.5 CRDi | 4 | D4CB, D4CB-L | 120/161 | 02/08→ | GN057 | | | | 11V | |
| 2.5 CRDi | 4 | D4CB | 125/168 | 02/08→ | GN057 | | | | 11V | |
| 2.5 D | 4 | D4BH | 73/98 | 06/00→10/05 | GN107 [1] GN955 [1] | | | | 11V 11V | |
| 2.5 TD | 4 | D4BF | 59/79 | 03/00→09/00 | GN107 [1] GN955 [1] | | | | 11V 11V | |
| 2.5 TD | 4 | D4BH | 73/98 | 03/00→04/04 | GN107 [1] GN955 [1] | | | | 11V 11V | |
| 2.5 TD | 4 | D4BH | 74/99 | 10/01→04/04 | GN107 [1] GN955 [1] | | | | 11V 11V | |

H100

| | | | | | | | | | | |
|----------|---|------------|--------|-------------|-----------|--|------|-------------|-------|--|
| 2.4 | 4 | G4CS | 82/110 | 10/97→12/04 | Z9 | | 1.15 | UXT2 / UXT6 | | |
| 2.4 | 4 | G4CS | 84/113 | 05/96→03/00 | Z21 | | 1.1 | UXT2 / UXT6 | ZS261 | |
| 2.4 | 4 | G4CS | 90/121 | 07/93→03/00 | Z21 | | 1.1 | UXT2 / UXT6 | ZS261 | |
| 2.4 LPG | 4 | G4CS | 82/110 | 10/97→12/04 | Z20 [168] | | 0.8 | UXT2 / UXT6 | | |
| 2.4 LPG | 4 | G4CS | 84/113 | 05/96→03/00 | Z27 [168] | | 0.8 | UX56 | | |
| 2.4 LPG | 4 | G4CS | 90/121 | 07/93→03/00 | Z27 [168] | | 0.8 | UX56 | | |
| 2.5 D | 4 | D4BA, D4BX | 55/74 | 07/93→12/94 | GN955 | | | | 11V | |
| 2.5 D | 4 | D4BA | 57/76 | 07/93→03/00 | GN955 | | | | 11V | |
| 2.5 D | 4 | D4BF | 59/79 | 05/96→12/97 | GN955 | | | | 11V | |
| 2.5 TD | 4 | D4BF | 59/79 | 07/93→03/00 | GN955 | | | | 11V | |
| 2.5 TDiC | 4 | D4BF | 59/79 | 06/98→10/03 | GN955 | | | | 11V | |
| 2.6 D | 4 | | 57/76 | 10/99→12/04 | GN955 | | | | 11V | |

HIGHWAY VAN

| | | | | | | | | | | |
|----------------|---|------|---------|--------|------|--|-----|-------|--|--|
| 2.0 16V | 4 | | 100/134 | 03/00→ | Z343 | | 1.1 | UXT11 | | |
| 2.0 16V LPG | 4 | | 100/134 | 03/00→ | Z206 | | 0.7 | UXT10 | | |
| 2.7 V6 24V | 6 | G6BA | 125/168 | 03/00→ | Z343 | | 1.1 | UXT11 | | |
| 2.7 V6 24V LPG | 6 | G6BA | 125/168 | 03/00→ | Z206 | | 0.7 | UXT10 | | |

PORTER

| | | | | | | | | | | |
|----------|---|------|---------|-------------|-----------|--|------|-------------|-----|--|
| 2.4 | 4 | G4CS | 82/110 | 03/96→04/04 | Z9 | | 1.15 | UXT2 / UXT6 | | |
| 2.4 LPG | 4 | G4CS | 82/110 | 03/96→04/04 | Z20 [168] | | 0.8 | UXT2 / UXT6 | | |
| 2.5 CRDi | 4 | D4CB | 103/138 | 02/03→ | GN057 | | | | 11V | |
| 2.5 TD | 4 | D4BA | 57/76 | 07/94→04/04 | GN955 | | | | 11V | |
| 2.6 TD | 4 | D4BB | 63/84 | 07/94→04/04 | GN107 | | | | 11V | |

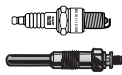

kW/BHP

**INFINITI****EX**

| | | | | | | | | | |
|------------|---|--------|---------|--------|--|--|--|--|--------|
| 3.5 35 4WD | 6 | VQ35HR | 221/296 | 10/08→ | | | | | ZSE158 |
|------------|---|--------|---------|--------|--|--|--|--|--------|

FX

| | | | | | | | | | |
|----------------|---|--------|---------|-------------|------------|-----|-------|--|--------|
| 3.5 35 | 6 | VQ35DE | 206/276 | 02/03→12/08 | | | | | ZSE132 |
| 3.5 35 4WD | 6 | VQ35DE | 206/276 | 01/03→12/08 | Z219 | 1.1 | UXT13 | | ZSE132 |
| 3.5 35 4WD LPG | 6 | VQ35DE | 206/276 | 01/03→12/08 | Z184 [168] | 0.9 | UXT13 | | |
| 4.5 45 | 8 | VK45DE | 232/311 | 02/03→12/08 | | | | | ZSE157 |
| 4.5 45 4WD | 8 | VK45DE | 232/311 | 01/03→12/08 | Z219 | 1.1 | UXT13 | | ZSE157 |
| 4.5 45 4WD LPG | 8 | VK45DE | 232/311 | 01/03→12/08 | Z184 [168] | 0.9 | UXT13 | | |
| 5.0 50 4WD | 8 | VK50VE | 287/385 | 10/08→ | | | | | ZSE088 |
| 5.0 50 4WD | 8 | VK50VE | 309/414 | 06/13→ | | | | | ZSE088 |

G

| | | | | | | | | | |
|--------|---|--------|---------|--------|--|--|--|--|--------|
| 2.5 25 | 6 | VQ25HR | 163/219 | 01/11→ | | | | | ZSE158 |
| 3.5 35 | 6 | VQ35DE | 191/256 | 10/02→ | | | | | ZSE132 |

G20

| | | | | | | | | | |
|-----|---|--------|--------|-------------|--|--|--|--|-------------|
| 2.0 | 4 | SR20DE | 85/114 | 01/90→12/97 | | | | | ZS269 ZM048 |
|-----|---|--------|--------|-------------|--|--|--|--|-------------|

i30

| | | | | | | | | |
|---------|---|--------|---------|--------|------------|-----|-------|---|
| 3.0 | 6 | VQ30DE | 142/190 | 01/97→ | Z228 | 1.0 | UXT11 | ZSE071 [119] →12/99 ZSE073 [21] →12/99 ZSE078 01/00→12/00 ZSE082 01/00→12/00 ZSE075 01/01→12/01 ZSE077 01/01→12/01 |
| 3.0 LPG | 6 | VQ30DE | 142/190 | 01/97→ | Z221 [168] | 1.0 | UXT14 | |

J30

| | | | | | | | | |
|---------|---|--------|---------|-------------|------------|-----|-------|--|
| 3.0 | 6 | VG30DE | 157/211 | 01/92→12/97 | Z228 | 1.0 | UXT11 | |
| 3.0 LPG | 6 | VG30DE | 157/211 | 01/92→12/97 | Z221 [168] | 1.0 | UXT14 | |

M

| | | | | | | | | | |
|---------|---|--------|---------|--------|--|--|--|--|--------|
| 3.5 35h | 6 | VQ35HR | 225/302 | 04/11→ | | | | | ZSE158 |
|---------|---|--------|---------|--------|--|--|--|--|--------|

M30

| | | | | | | | | | |
|-----|---|-------|---------|-------------|--|--|--|--|-------------|
| 3.0 | 6 | VG30E | 121/162 | 01/89→12/93 | | | | | ZS277 ZM048 |
|-----|---|-------|---------|-------------|--|--|--|--|-------------|

M35

| | | | | | | | | | |
|-------|---|--------|---------|--------|--|--|--|--|--------|
| 3.5 | 6 | VQ35DE | 206/276 | 01/05→ | | | | | ZSE132 |
| 3.5 h | 6 | VQ35HR | 268/359 | 01/10→ | | | | | ZSE158 |

M45

| | | | | | | | | | |
|-----|---|--------|---------|--------|--|--|--|--|------------------|
| 4.5 | 8 | VK45DE | 250/335 | 01/05→ | | | | | ZSE156 03/07→ |
|-----|---|--------|---------|--------|--|--|--|--|------------------|

Q45 I

| | | | | | | | | |
|---------|---|--------|---------|-------------|------------|-----|-------|--------|
| 4.1 | 8 | VH41DE | 205/275 | 01/93→ | Z228 | 1.0 | UXT11 | ZSE074 |
| 4.1 LPG | 8 | VH41DE | 205/275 | 01/93→ | Z221 [168] | 1.0 | UXT14 | |
| 4.5 | 8 | VH45DE | 205/275 | 01/89→12/93 | Z343 | 1.1 | UXT11 | ZSE157 |
| 4.5 LPG | 8 | VH45DE | 205/275 | 01/89→12/93 | Z206 | 0.7 | UXT10 | |

Q45 III

| | | | | | | | | | |
|-----|---|--------|---------|--------|--|--|--|--|--------|
| 4.5 | 8 | VK45DE | 250/335 | 02/01→ | | | | | ZSE157 |
|-----|---|--------|---------|--------|--|--|--|--|--------|

Q50

| | | | | | | | | | |
|---------------|---|--------|---------|--------|--|--|--|--|--------|
| 3.5 50 Hybrid | 6 | VQ35HR | 268/359 | 04/13→ | | | | | ZSE158 |
|---------------|---|--------|---------|--------|--|--|--|--|--------|

QX4

| | | | | | | | | |
|-------------|---|-------|---------|--------|------------|-----|-------|--------|
| 3.3 4WD | 6 | VG33E | 125/168 | 01/97→ | Z73 | 1.1 | UXT11 | ZSE076 |
| 3.3 4WD LPG | 6 | VG33E | 125/168 | 01/97→ | Z206 [168] | 0.7 | UXT10 | |

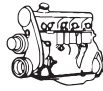

kW/BHP



... INFINITI



QX70

| | | | | | | | | | |
|------------|---|--------|---------|--------|--|--|--|--|--------|
| 5.0 50 4WD | 8 | VK50VE | 287/385 | 08/13→ | | | | | ZSE088 |
|------------|---|--------|---------|--------|--|--|--|--|--------|

ISUZU



ASCENDER

| | | | | | | | | | |
|---------|---|-----|---------|--------|--|--|--|--|--------|
| 4.2 4WD | 6 | LL8 | 217/291 | 03/03→ | | | | | ZSE133 |
|---------|---|-----|---------|--------|--|--|--|--|--------|

01/06→

ASKA

| | | | | | | | | | |
|-------|---|------|-------|-------------|----------------------|--|----|--|--|
| 2.0 D | 4 | 4FC1 | 50/67 | 04/83→06/89 | GV945 ^[1] | | 5V | | |
|-------|---|------|-------|-------------|----------------------|--|----|--|--|

GV947 ^[1]

11V

| | | | | | | | | | |
|--------|---|-------|-------|-------------|----------------------|--|----|--|--|
| 2.0 TD | 4 | 4FC1T | 62/83 | 10/87→06/89 | GV945 ^[1] | | 5V | | |
|--------|---|-------|-------|-------------|----------------------|--|----|--|--|

GV947 ^[1]

11V

CAMPO

| | | | | | | | | | |
|-------|---|------|-------|-------------|----------------------|--|----|--|--|
| 2.2 D | 4 | C223 | 39/52 | 01/83→12/90 | GV749 ^[1] | | 5V | | |
|-------|---|------|-------|-------------|----------------------|--|----|--|--|

GV946 ^[1]

11V

| | | | | | | | | | |
|-------|---|------|-------|-------------|-------|--|----|--|--|
| 2.2 D | 4 | C223 | 45/60 | 01/83→12/91 | GV749 | | 5V | | |
|-------|---|------|-------|-------------|-------|--|----|--|--|

D-MAX

| | | | | | | | | | |
|----------|---|---------|---------|--------|-------|--|-----|--|--|
| 2.5 DiTD | 4 | 4JK1-TC | 100/134 | 10/06→ | GN095 | | 11V | | |
|----------|---|---------|---------|--------|-------|--|-----|--|--|

| | | | | | | | | | |
|-------|---|---------|---------|--------|-------|--|-----|--|--|
| 3.0 D | 4 | 4JJ1-TC | 120/161 | 01/07→ | GN095 | | 11V | | |
|-------|---|---------|---------|--------|-------|--|-----|--|--|

GEMINI

| | | | | | | | | | |
|-----|---|------------|-------|-------------|---------------------|--|-----|-------------|--|
| 1.5 | 4 | 4XC1U Kat. | 52/70 | 02/88→12/90 | Z1 ^[169] | | 0.7 | UXT2 / UXT6 | |
|-----|---|------------|-------|-------------|---------------------|--|-----|-------------|--|

| | | | | | | | | | |
|-------|---|------|-------|-------------|----------------------|--|----|--|--|
| 1.5 D | 4 | 4EC1 | 37/50 | 09/80→09/84 | GV749 ^[1] | | 5V | | |
|-------|---|------|-------|-------------|----------------------|--|----|--|--|

| | | | | | | | | | |
|-------|---|------|-------|-------------|----------------------|--|----|--|--|
| 1.5 D | 4 | 4EC1 | 37/50 | 02/88→12/90 | GV749 ^[1] | | 5V | | |
|-------|---|------|-------|-------------|----------------------|--|----|--|--|

→11/88

GV946 ^[1]

11V

12/88→

| | | | | | | | | | |
|--------|---|-------|-------|-------------|-------|--|----|--|--|
| 1.5 TD | 4 | 4EC1T | 49/66 | 02/88→12/90 | GV945 | | 5V | | |
|--------|---|-------|-------|-------------|-------|--|----|--|--|

→11/88

GV947

11V

12/88→

| | | | | | | | | | |
|-------------|---|------|--------|-------------|-----|--|-----|-------|--|
| 1.6 GTI 16V | 4 | 4XE1 | 84/113 | 08/88→12/90 | Z16 | | 1.1 | UXT11 | |
|-------------|---|------|--------|-------------|-----|--|-----|-------|--|

| | | | | | | | | | |
|-----------------|---|------|--------|-------------|------|--|-----|-------|--|
| 1.6 GTI 16V LPG | 4 | 4XE1 | 84/113 | 08/88→12/90 | Z340 | | 0.7 | UXT12 | |
|-----------------|---|------|--------|-------------|------|--|-----|-------|--|

IMPULSE

| | | | | | | | | | |
|-----|---|--------|-------|-------------|--|--|--|--|-------|
| 1.6 | 4 | 4XE1-V | 71/95 | 01/90→12/93 | | | | | ZS355 |
|-----|---|--------|-------|-------------|--|--|--|--|-------|

| | | | | | | | | | |
|-----|---|----------|---------|-------------|--|--|--|--|-------|
| 1.6 | 4 | 4XE1-XUT | 120/161 | 01/90→12/93 | | | | | ZS355 |
|-----|---|----------|---------|-------------|--|--|--|--|-------|

KB

| | | | | | | | | | |
|---------------|---|---------|---------|--------|-------|--|-----|--|--|
| 3.0 D-TEQ 4WD | 4 | 4JJ1-TC | 120/161 | 08/10→ | GN061 | | 11V | | |
|---------------|---|---------|---------|--------|-------|--|-----|--|--|

PIAZZA

| | | | | | | | | | |
|-----------|---|--------|---------|-------------|-----|--|-----|-------------|--|
| 2.0 Turbo | 4 | 4ZC1-T | 104/139 | 06/85→12/90 | Z21 | | 1.1 | UXT2 / UXT6 | |
|-----------|---|--------|---------|-------------|-----|--|-----|-------------|--|

TROOPER

| | | | | | | | | | |
|-----------|---|------|-------|-------------|-------|--|----|--|--|
| 2.2 D 4WD | 4 | C223 | 39/52 | 05/84→12/89 | GV749 | | 5V | | |
|-----------|---|------|-------|-------------|-------|--|----|--|--|

| | | | | | | | | | |
|-------|---|-------|-------|-------------|-------|--|----|--|--|
| 2.2 D | 4 | C223T | 45/60 | 01/83→12/83 | GV749 | | 5V | | |
|-------|---|-------|-------|-------------|-------|--|----|--|--|

| | | | | | | | | | |
|------------|---|-------|-------|-------------|-------|--|----|--|--|
| 2.2 TD 4WD | 4 | C223T | 53/71 | 03/84→12/91 | GV749 | | 5V | | |
|------------|---|-------|-------|-------------|-------|--|----|--|--|

→07/87

GV946

11V

08/87→10/88

| | | | | | | | | | |
|---------|---|------|-------|-------------|----|--|------|-------------|--|
| 2.3 4WD | 4 | 4ZD1 | 66/89 | 11/85→12/91 | Z9 | | 1.15 | UXT2 / UXT6 | |
|---------|---|------|-------|-------------|----|--|------|-------------|--|

| | | | | | | | | | |
|-------------|---|------|-------|-------------|----------------------|--|-----|-------------|--|
| 2.3 4WD LPG | 4 | 4ZD1 | 66/89 | 11/85→12/91 | Z20 ^[168] | | 0.8 | UXT2 / UXT6 | |
|-------------|---|------|-------|-------------|----------------------|--|-----|-------------|--|

| | | | | | | | | | |
|-----------|---|------|--------|-------------|----|--|------|-------------|--|
| 2.6 i 4WD | 4 | 4ZE1 | 85/114 | 10/87→12/91 | Z9 | | 1.15 | UXT2 / UXT6 | |
|-----------|---|------|--------|-------------|----|--|------|-------------|--|

| | | | | | | | | | |
|---------------|---|------|--------|-------------|----------------------|--|-----|-------------|--|
| 2.6 i 4WD LPG | 4 | 4ZE1 | 85/114 | 10/87→12/91 | Z20 ^[168] | | 0.8 | UXT2 / UXT6 | |
|---------------|---|------|--------|-------------|----------------------|--|-----|-------------|--|

| | | | | | | | | | |
|------------|---|-------|-------|-------------|-------|--|-----|--|--|
| 2.8 TD 4WD | 4 | 4JB1T | 71/95 | 10/87→12/91 | GN061 | | 11V | | |
|------------|---|-------|-------|-------------|-------|--|-----|--|--|

| | | | | | | | | | |
|------------|---|---------|--------|-------------|-------|--|-----|--|--|
| 2.8 TD 4WD | 4 | 4JB1-TC | 78/105 | 10/88→12/91 | GN061 | | 11V | | |
|------------|---|---------|--------|-------------|-------|--|-----|--|--|

| | | | | | | | | | |
|-------------|---|-------------|---------|--------|-------|--|-----|--|--|
| 3.0 DTI 4WD | 4 | 4JX1, 4JX1T | 118/158 | 04/00→ | GN997 | | 11V | | |
|-------------|---|-------------|---------|--------|-------|--|-----|--|--|

| | | | | | | | | | |
|------------|---|--------|--------|-------------|-------|--|-----|--|--|
| 3.1 TD 4WD | 4 | 4JG2 T | 84/113 | 08/91→07/98 | GN103 | | 11V | | |
|------------|---|--------|--------|-------------|-------|--|-----|--|--|

| | | | | | | | | | |
|---------|---|------|---------|-------------|-----|--|-----|-------|-------|
| 3.2 4WD | 6 | 6VD1 | 130/174 | 08/91→07/98 | Z16 | | 1.1 | UXT11 | ZS355 |
|---------|---|------|---------|-------------|-----|--|-----|-------|-------|

| | | | | | | | | | |
|-------------|---|------|---------|-------------|------|--|-----|-------|--|
| 3.2 4WD LPG | 6 | 6VD1 | 130/174 | 08/91→07/98 | Z340 | | 0.7 | UXT12 | |
|-------------|---|------|---------|-------------|------|--|-----|-------|--|



kW/BHP

**... ISUZU****... TROOPER**

| | | | | | | | |
|--------------------|---|------|---------|--------|--------------|------------|---------------|
| 3.5 V6 24V 4WD | 6 | 6VE1 | 158/212 | 04/00→ | Z122 Z343 | 1.0 1.1 | UXT9 UXT11 |
| 3.5 V6 24V 4WD LPG | 6 | 6VE1 | 158/212 | 04/00→ | Z206 | 0.7 | UXT10 |

ISUZU**D-MAX**

| | | | | | | | |
|-----------|---|---------|---------|--------|-------|-----|--|
| 3.0 D 4WD | 4 | 4JJ1-TC | 120/161 | 01/07→ | GN095 | 11V | |
|-----------|---|---------|---------|--------|-------|-----|--|

MIDI

| | | | | | | | |
|--------|---|-------|-------|--------|------------------------|-----------|-------------|
| 2.0 | 4 | 4ZC1 | 61/82 | 06/88→ | Z11 | 0.8 | UXT2 / UXT6 |
| 2.0 TD | 4 | 4FC1T | 51/68 | 01/89→ | GV945 [1] GV947 [1] | 5V 11V | |
| 2.2 D | 4 | 4FD1 | 45/60 | 09/88→ | GV945 [1] GV947 [1] | 5V 11V | |
| 2.4 D | 4 | 4FG1T | 56/75 | 01/94→ | GV945 [1] GV947 [1] | 5V 11V | |
| 2.4 TD | 4 | 4FG1T | 56/75 | 01/94→ | GV945 [1] GV947 [1] | 5V 11V | |

N-Serie

| | | | | | | | |
|--|---|---------|---------|--|-------|-----|--|
| NKR 85EA, NLR 85AL, NLR 85L, NNR 85L, NPR 85G, NPR 85L | 4 | 4JJ1-TC | 110/148 | | GN095 | 11V | |
| NMR 250 | 4 | 4JJ1-TC | 96/129 | | GN095 | 11V | |
| NPR 85L, NPR 85P | 4 | 4JJ1-TC | 110/148 | | GN095 | 11V | |

IVECO**MASSIF**

| | | | | | | | |
|-------------|---|------------|---------|--------|-------|-----|--|
| 3.0 HPI 4WD | 4 | F1CE0481FA | 107/143 | 10/08→ | GN037 | 11V | |
| 3.0 HPT 4WD | 4 | F1CE0481HA | 130/174 | 10/08→ | GN037 | 11V | |

IVECO**DAILY I**

| | | | | | | | |
|-------------|---|-------------|-------|-------------|-------|-------|-----|
| 2.4 30-8 | 4 | 8140.61.200 | 53/71 | 01/78→12/89 | GN954 | GR034 | 11V |
| 2.4 35-8 | 4 | 8140.61.200 | 53/71 | 01/78→12/89 | GN954 | GR034 | 11V |
| 2.4 35-10 | 4 | 8140.21.200 | 68/91 | 01/85→12/89 | GN954 | | 11V |
| 2.4 40-8 | 4 | 8140.61.200 | 53/71 | 01/83→06/89 | GN954 | GR034 | 11V |
| 2.4 40-8 V | 4 | 8140.61.200 | 53/71 | 01/83→06/89 | GN954 | GR034 | 11V |
| 2.4 45-10 | 4 | 8140.21.200 | 68/91 | 01/85→12/89 | GN927 | | 11V |
| 2.4 45-10 V | 4 | 8140.21.200 | 68/91 | 01/85→12/89 | GN927 | | 11V |
| 2.4 49-10 | 4 | 8140.21.200 | 68/91 | 01/85→12/89 | GN954 | | 11V |
| 2.4 49-10 V | 4 | 8140.21.200 | 68/91 | 01/85→12/89 | GN954 | | 11V |
| 2.5 40-10 | 4 | 8140.27 S | 68/91 | 01/85→12/89 | GF974 | | 12V |
| 2.5 40-10 V | 4 | 8140.27 S | 68/91 | 01/85→12/89 | GF974 | | 12V |

DAILY II

| | | | | | | | |
|-------------|---|---|--------|-------------|-------|--|-----|
| 2.5 30-8 | 4 | 8140.07.2700, 8140.07.2712 | 55/74 | 01/89→08/98 | GF974 | | 12V |
| 2.5 30-8 | 4 | 8140.67E, 8140.67E.3710, 8140.67E.3711, 8140.67E.3713, 8140.67E.3721 | 60/80 | 01/89→08/98 | GN927 | | 11V |
| 2.5 35-8 | 4 | 8140.07.2700, 8140.07.2712 | 55/74 | 01/89→08/98 | GF974 | | 12V |
| 2.5 35-8 | 4 | 8140.67E, 8140.67E.3701, 8140.67E.3710, 8140.67E.3711, 8140.67E.3713, 8140.67E.3721 | 60/80 | 01/89→08/98 | GN927 | | 11V |
| 2.5 35-10 | 4 | 8140.97.2781 | 68/91 | 01/89→08/98 | GF974 | | 12V |
| 2.5 35-10 | 4 | 8140.47R.2790 | 76/102 | 01/89→08/98 | GF974 | | 12V |
| 2.5 35-10 | 4 | 8140.47R | 80/107 | 01/89→08/98 | GF974 | | 12V |
| 2.5 35-12 | 4 | 8140.47.2700 | 85/114 | 01/90→04/96 | GF984 | | 11V |
| 2.5 40-10 V | 4 | 8140.27.2720 | 76/102 | 01/90→04/96 | GF974 | | 12V |

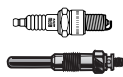

kW/BHP

**... IVECO****... DAILY II**

| | | | | | | |
|-----------------|---|-----------------------------|--------|-------------|-------|-----|
| 2.5 40-12 | 4 | 8140.47.2700 | 85/114 | 10/90→04/96 | GF984 | 11V |
| 2.5 40-12 V | 4 | 8140.47.2700 | 85/114 | 10/90→04/96 | GF984 | 11V |
| 2.5 45-10 | 4 | 8140.27.2720 | 76/102 | 01/89→04/96 | GF974 | 12V |
| 2.5 45-10 V | 4 | 8140.27.2720 | 76/102 | 01/89→04/96 | GF974 | 12V |
| 2.5 49-10 | 4 | 8140.27.2700, 8140.47R.2790 | 76/102 | 01/89→04/96 | GF974 | 12V |
| 2.5 49-10 V | 4 | 8140.27.2700, 8140.47R.2790 | 76/102 | 01/89→04/96 | GF974 | 12V |
| 2.5 49-10 K | 4 | 8140.27.2700, 8140.47R.2790 | 76/102 | 01/89→04/96 | GF974 | 12V |
| 2.5 49-12 | 4 | 8140.47.2711, 8140.47.2721 | 85/114 | 06/90→04/96 | GF984 | 11V |
| 2.5 49-12 V | 4 | 8140.47.2711, 8140.47.2721 | 85/114 | 06/90→04/96 | GF984 | 11V |
| 2.5 49-12 K | 4 | 8140.47.2711, 8140.47.2721 | 85/114 | 06/90→04/96 | GF984 | 11V |
| 2.5 59-12 | 4 | 8140.47.2700, 8140.47.2711 | 85/114 | 05/91→04/96 | GF984 | 11V |
| 2.5 59-12 V | 4 | 8140.47.2700, 8140.47.2711 | 85/114 | 05/91→04/96 | GF984 | 11V |
| 2.5 59-12 K | 4 | 8140.47.2700, 8140.47.2711 | 85/114 | 05/91→04/96 | GF984 | 11V |
| 2.5 A 40-10 | 4 | 8140.27.2720 | 76/102 | 01/91→12/96 | GF974 | 12V |
| 2.5 A 45-10 | 4 | 8140.27.2720 | 76/102 | 01/91→04/96 | GF974 | 12V |
| 2.5 A 45-12 | 4 | 8140.47.2711, 8140.47.2721 | 85/114 | 06/90→04/96 | GF984 | 11V |
| 2.8 4WD | 4 | 8140.43. | 90/121 | 02/95→05/99 | GF974 | 12V |
| 2.8 30-8 | 4 | 8140.63. | 62/83 | 09/98→05/99 | GN012 | 11V |
| 2.8 30-8 V | 4 | 8140.63. | 62/83 | 09/98→05/99 | GN012 | 11V |
| 2.8 30-10 | 4 | 8140.23. | 76/102 | 01/97→05/99 | GF984 | 11V |
| 2.8 30-10 C | 4 | 8140.23. | 76/102 | 01/97→05/99 | GF984 | 11V |
| 2.8 35-8 | 4 | 8140.63. | 62/83 | 09/98→05/99 | GN012 | 11V |
| 2.8 35-8 K | 4 | 8140.63. | 62/83 | 09/98→05/99 | GN012 | 11V |
| 2.8 35-10 | 4 | 8140.23. | 76/102 | 01/96→05/99 | GF984 | 11V |
| 2.8 35-10 K | 4 | 8140.23. | 76/102 | 01/97→05/99 | GF984 | 11V |
| 2.8 35-12 | 4 | 8140.43. | 90/121 | 02/95→05/99 | GF974 | 12V |
| 2.8 35-12 K | 4 | 8140.43. | 90/121 | 09/96→08/98 | GF974 | 12V |
| 2.8 40-10 4WD | 4 | 8140.23. | 76/102 | 01/97→05/99 | GF984 | 11V |
| 2.8 40-10 W 4WD | 4 | 8140.23. | 76/102 | 01/97→05/99 | GF984 | 11V |
| 2.8 49-10 | 4 | 8140.23. | 76/102 | 05/96→05/99 | GF984 | 11V |
| 2.8 49-10 K | 4 | 8140.23. | 76/102 | 05/96→05/99 | GF984 | 11V |
| 2.8 49-12 | 4 | 8140.43. | 90/121 | 05/96→05/99 | GF974 | 12V |
| 2.8 49-12 V | 4 | 8140.43. | 90/121 | 05/96→05/99 | GF974 | 12V |
| 2.8 49-12 K | 4 | 8140.43. | 90/121 | 05/96→05/99 | GF974 | 12V |
| 2.8 59-12 | 4 | 8140.43. | 90/121 | 05/96→05/99 | GF974 | 12V |
| 2.8 59-12 V | 4 | 8140.43. | 90/121 | 05/96→05/99 | GF974 | 12V |
| 2.8 59-12 K | 4 | 8140.43. | 90/121 | 05/96→05/99 | GF974 | 12V |
| 2.8 A 40-10 | 4 | 8140.23. | 76/102 | 09/96→05/99 | GF984 | 11V |
| 2.8 A 40-12 | 4 | 8140.43. | 90/121 | 05/96→05/99 | GF974 | 12V |
| 2.8 A 45-10 | 4 | 8140.23. | 76/102 | 05/96→05/99 | GF984 | 11V |
| 2.8 A 45-12 | 4 | 8140.43. | 90/121 | 05/96→05/99 | GF974 | 12V |

DAILY III

| | | | | | | |
|--------------------------|---|-----------|---------|-------------|-------|-----|
| 2.3 29 L 10 | 4 | F1AE0481A | 70/94 | 09/02→ | GN037 | 11V |
| 2.3 29 L 10 V | 4 | F1AE0481A | 70/94 | 09/02→ | GN037 | 11V |
| 2.3 29 L 12 | 4 | F1AE0481B | 85/114 | 09/02→ | GN037 | 11V |
| 2.3 29 L 12 V | 4 | F1AE0481B | 85/114 | 09/02→ | GN037 | 11V |
| 2.3 29 L 14 | 4 | F1AE0481M | 100/134 | 01/05→ | GN037 | 11V |
| 2.3 35 C 10 V, 35 S 10 V | 4 | F1AE0481A | 70/94 | 09/02→ | GN037 | 11V |
| 2.3 35 C 12, 35 S 12 | 4 | F1AE0481B | 85/114 | 09/02→ | GN037 | 11V |
| 2.3 35 C 12 V, 35 S 12 V | 4 | F1AE0481B | 85/114 | 09/02→ | GN037 | 11V |
| 2.3 35 C 14, 35 S 14 | 4 | F1AE0481M | 100/134 | 01/05→04/06 | GN037 | 11V |
| 2.3 35 S 10 | 4 | F1AE0481A | 70/94 | 09/02→ | GN037 | 11V |
| 2.3 40 C 14 | 4 | F1AE0481M | 100/134 | 01/05→04/06 | GN037 | 11V |
| 2.8 | 4 | 8140.23. | 76/102 | 11/97→07/07 | GF974 | 12V |
| 2.8 29 L 9 | 4 | 8140.63. | 62/83 | 05/99→ | GN012 | 11V |
| 2.8 29 L 9 V | 4 | 8140.63. | 62/83 | 05/99→ | GN012 | 11V |
| 2.8 29 L 11 | 4 | 8140.43B | 78/105 | 05/99→ | GF006 | 12V |
| 2.8 29 L 11 | 4 | 8140.43C | 78/105 | 05/99→ | GF984 | 11V |
| 2.8 29 L 11 V | 4 | 8140.43C | 78/105 | 05/99→ | GF984 | 11V |

IVECO

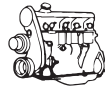

kW/BHP

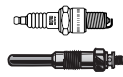
**... IVECO****... DAILY III**

| | | | | | | |
|--------------------------|---|-----------|---------|-------------|-------|-----|
| 2.8 29 L13 | 4 | 8140.43S | 92/123 | 05/01→ | GN012 | 11V |
| 2.8 35 C15 | 4 | 8140.43N | 107/143 | 11/01→ | GN012 | 11V |
| 2.8 35 S 9,35 C 9 | 4 | 8140.63. | 62/83 | 05/99→ | GN012 | 11V |
| 2.8 35 S 9 V,35 C 9 V | 4 | 8140.63. | 62/83 | 05/99→ | GN012 | 11V |
| 2.8 35 S 11,35 C 11 | 4 | 8140.43C | 78/105 | 05/99→ | GF984 | 11V |
| 2.8 35 S 11 V,35 C 11 V | 4 | 8140.43C | 78/105 | 05/99→ | GF984 | 11V |
| 2.8 35 S 13,35 C 13 | 4 | 8140.43S | 92/123 | 05/99→ | GN012 | 11V |
| 2.8 35 S 13 V,35 C 13 V | 4 | 8140.43S | 92/123 | 05/99→ | GN012 | 11V |
| 2.8 35 S 15 V, 35 C 15 V | 4 | 8140.43N | 107/143 | 11/02→ | GN012 | 11V |
| 2.8 40 C13 | 4 | 8140.43S | 92/123 | 05/99→04/06 | GN012 | 11V |
| 2.8 40 C15 | 4 | 8140.43N | 107/143 | 11/01→04/06 | GN012 | 11V |
| 2.8 50 C11 | 4 | 8140.43C | 78/105 | 05/99→ | GF984 | 11V |
| 2.8 50 C13 | 4 | 8140.43S | 92/123 | 05/99→ | GN012 | 11V |
| 2.8 50 C15 | 4 | 8140.43N | 107/143 | 01/01→ | GN012 | 11V |
| 2.8 65 C15 | 4 | 8140.43N | 107/143 | 11/01→ | GN012 | 11V |
| 3.0 35 C14 | 4 | F1CE0481A | 100/134 | 09/04→04/06 | GN037 | 11V |
| 3.0 35 C17, 35 S17 | 4 | F1CE0481B | 122/164 | 01/05→04/06 | GN037 | 11V |
| 3.0 40 C14 | 4 | F1CE0481A | 100/134 | 09/04→04/06 | GN037 | 11V |
| 3.0 40 C17, 40 S17 | 4 | F1CE0481B | 122/164 | 01/05→04/06 | GN037 | 11V |
| 3.0 45 C14 | 4 | F1CE0481A | 100/134 | 07/99→04/06 | GN037 | 11V |
| 3.0 50 C14 | 4 | F1CE0481A | 100/134 | 09/04→04/06 | GN037 | 11V |
| 3.0 50 C17 | 4 | F1CE0481B | 122/164 | 09/04→04/06 | GN037 | 11V |
| 3.0 65 C14 | 4 | F1CE0481A | 100/134 | 09/04→04/06 | GN037 | 11V |
| 3.0 65 C17 | 4 | F1CE0481B | 122/164 | 09/04→04/06 | GN037 | 11V |

DAILY IV

| | | | | | | |
|--|---|------------|---------|--------|-------|-----|
| 2.3 29L10 | 4 | F1AE0481FA | 70/94 | 05/06→ | GN037 | 11V |
| 2.3 29L10 V | 4 | F1AE0481FA | 70/94 | 05/06→ | GN037 | 11V |
| 2.3 29L12 | 4 | F1AE0481GA | 85/114 | 05/06→ | GN037 | 11V |
| 2.3 29L12 V, 29L12 V/P | 4 | F1AE0481GA | 85/114 | 05/06→ | GN037 | 11V |
| 2.3 29L14 | 4 | F1AE0481HA | 100/134 | 05/06→ | GN037 | 11V |
| 2.3 29L14 C, 29L14 C/P, 29L14 V, 29L14 V/P | 4 | F1AE0481HA | 100/134 | 05/06→ | GN037 | 11V |
| 2.3 35C10, 35S10 | 4 | F1AE0481FA | 70/94 | 05/06→ | GN037 | 11V |
| 2.3 35C10 K | 4 | F1AE0481FA | 70/94 | 05/06→ | GN037 | 11V |
| 2.3 35C11, 35S11, 35S11 D, 35S11 /P | 4 | F1AE0481FA | 78/105 | 07/07→ | GN037 | 11V |
| 2.3 35C11 V, 35S11 V | 4 | F1AE0481FA | 78/105 | 07/07→ | GN037 | 11V |
| 2.3 35C11 K, 35C11 DK, 35S11 K, 35S11 DK | 4 | F1AE0481FA | 78/105 | 07/07→ | GN037 | 11V |
| 2.3 35C12 | 4 | F1AE0481GA | 85/114 | 05/06→ | GN037 | 11V |
| 2.3 35C12, 35S12 | 4 | F1AE0481GA | 85/114 | 05/06→ | GN037 | 11V |
| 2.3 35C12 V, 35C12 V/P, 35S12 V, 35S12 V/P | 4 | F1AE0481GA | 85/114 | 05/06→ | GN037 | 11V |
| 2.3 35C13, 35C13 /P, 35S13 D, 35S13, 35S13 /P | 4 | F1AE0481GA | 93/125 | 07/07→ | GN037 | 11V |
| 2.3 35C13 V, 35C13 V/P, 35S13 V, 35S13 V/P | 4 | F1AE0481GA | 93/125 | 07/07→ | GN037 | 11V |
| 2.3 35C13 K, 35C13 DK, 35S13 K, 35S13 DK | 4 | F1AE0481GA | 93/125 | 07/07→ | GN037 | 11V |
| 2.3 35C14, 35S14, 35S14 /P | 4 | F1AE0481HA | 100/134 | 05/06→ | GN037 | 11V |
| 2.3 35S14, 35S14 /P | 4 | F1AE0481HA | 100/134 | 05/06→ | GN037 | 11V |
| 2.3 35S14 C, 35S14 C/P, 35S14 V, 35S14 V/P, 35C14 V, 35C14 V/P | 4 | F1AE0481HA | 100/134 | 05/06→ | GN037 | 11V |
| 2.3 35S14 K, 35S14 DK | 4 | F1AE0481HA | 100/134 | 07/07→ | GN037 | 11V |
| 2.3 40C10 | 4 | F1AE0481FA | 70/94 | 05/06→ | GN037 | 11V |
| 2.3 40C10 V | 4 | F1AE0481FA | 70/94 | 05/06→ | GN037 | 11V |
| 2.3 40C11, 40C11 D | 4 | F1AE0481FA | 78/105 | 07/07→ | GN037 | 11V |
| 2.3 40C11 V | 4 | F1AE0481FA | 78/105 | 07/07→ | GN037 | 11V |



kW/BHP

**... IVECO****... DAILY IV**

| | | | | | | |
|--|---|------------|---------|--------|--------------|-----|
| 2.3 40C12 | 4 | F1AE0481GA | 85/114 | 05/06→ | GN037 | 11V |
| 2.3 40C12 V, 40C14 V/P | 4 | F1AE0481GA | 85/114 | 05/06→ | GN037 | 11V |
| 2.3 40C13, 40C13 /P | 4 | F1AE0481GA | 93/125 | 07/07→ | GN037 | 11V |
| 2.3 40C13 V, 40C13 V/P | 4 | F1AE0481GA | 93/125 | 07/07→ | GN037 | 11V |
| 3.0 35C14, 35C14 /P, 35S14, 35S14 /P, 35S14 D, 35S14 D/P | 4 | F1CE3481LC | 103/138 | 07/07→ | GN037 | 11V |
| 3.0 35C14 V, 35C14 V/P, 35S14 V, 35S14 V/P | 4 | F1CE3481LC | 103/138 | 07/07→ | GN037 | 11V |
| 3.0 35C14 K, 35C14 DK, 35S14 K, 35S14 DK | 4 | F1CE3481LC | 103/138 | 07/07→ | GN037 | 11V |
| 3.0 35C15 | 4 | F1CE0481FA | 107/143 | 05/06→ | GN037 | 11V |
| 3.0 35C15 V, 35C15 V/P | 4 | F1CE0481FA | 107/143 | 05/06→ | GN037 | 11V |
| 3.0 35C17, 35C17 /P, 35S17, 35S17 /P, 35S17 D | 4 | F1CE0481HA | 125/168 | 07/07→ | GN037 | 11V |
| 3.0 35C17 V, 35C17 V/P, 35S17 V, 35S17 V/P | 4 | F1CE0481HA | 125/168 | 07/07→ | GN037 | 11V |
| 3.0 35C17 K, 35C17 DK, 35S17 K, 35S17 DK | 4 | F1CE0481HA | 125/168 | 07/07→ | GN037 | 11V |
| 3.0 35C18 | 4 | F1CE0481HA | 130/174 | 05/06→ | GN037 | 11V |
| 3.0 35C18, 35S18 | 4 | F1CE0481HA | 130/174 | 05/06→ | GN037 | 11V |
| 3.0 35C18 V, 35C18 V/P, 35S18 V, 35S18 V/P | 4 | F1CE0481HA | 130/174 | 05/06→ | GN037 | 11V |
| 3.0 35S15 | 4 | F1CE0481L | 110/148 | 06/06→ | GN037 | 11V |
| 3.0 35S17 W, 35S17 WD 4WD | 4 | F1CE0481HA | 125/168 | 07/07→ | GN037 | 11V |
| 3.0 40C14, 40C14 /P | 4 | F1CE3481LC | 103/138 | 07/07→ | GN037 | 11V |
| 3.0 40C14 V, 40C14 V/P | 4 | F1CE3481LC | 103/138 | 07/07→ | GN037 | 11V |
| 3.0 40C14 K, 40C14 DK | 4 | F1CE3481LC | 103/138 | 07/07→ | GN037 | 11V |
| 3.0 40C15 | 4 | F1CE0481FA | 107/143 | 05/06→ | GN037 | 11V |
| 3.0 40C15 V, 40C15 V/P | 4 | F1CE0481FA | 107/143 | 05/06→ | GN037 | 11V |
| 3.0 40C17, 40C17 /P | 4 | F1CE0481HA | 125/168 | 07/07→ | GN037 | 11V |
| 3.0 40C17 V, 40C17 V/P | 4 | F1CE0481HA | 125/168 | 07/07→ | GN037 | 11V |
| 3.0 40C17 K, 40C17 DK | 4 | F1CE0481HA | 125/168 | 07/07→ | GN037 | 11V |
| 3.0 40C18 | 4 | F1CE0481HA | 130/174 | 05/06→ | GN037 | 11V |
| 3.0 40C18 V, 40C18 V/P | 4 | F1CE0481HA | 130/174 | 05/06→ | GN037 | 11V |
| 3.0 45C14, 45C14 /P | 4 | F1CE3481LC | 103/138 | 07/07→ | GN037 | 11V |
| 3.0 45C15 | 4 | F1CE0481FA | 107/143 | 05/06→ | GN037 | 11V |
| 3.0 45C15 V | 4 | F1CE0481FA | 107/143 | 05/06→ | GN037 | 11V |
| 3.0 45C17, 45C17 /P | 4 | F1CE0481HA | 125/168 | 07/07→ | GN037 | 11V |
| 3.0 45C17 V, 45C17 V/P | 4 | F1CE0481HA | 125/168 | 07/07→ | GN037 | 11V |
| 3.0 45C18 | 4 | F1CE0481HA | 130/174 | 05/06→ | GN037 | 11V |
| 3.0 45C18, 45C18 /P, 45C18 D, 45C18 D/P | 4 | F1CE0481HA | 130/174 | 05/06→ | GN037 | 11V |
| 3.0 50C14, 50C14 /P | 4 | F1CE3481LC | 103/138 | 07/07→ | GN037 | 11V |
| 3.0 50C14 V, 50C14 V/P | 4 | F1CE3481LC | 103/138 | 07/07→ | GN037 | 11V |
| 3.0 50C14 K, 50C14 DK | 4 | F1CE3481LC | 103/138 | 07/07→ | GN037 | 11V |
| 3.0 50C15 | 4 | F1CE0481FA | 107/143 | 05/06→ | GN037 | 11V |
| 3.0 50C15 V, 50C15 V/P | 4 | F1CE0481FA | 107/143 | 05/06→ | GN037 | 11V |
| 3.0 50C17, 50C17 /P | 4 | F1CE0481HA | 125/168 | 07/07→ | GN037 | 11V |
| 3.0 50C17 V, 50C17 V/P | 4 | F1CE0481HA | 125/168 | 07/07→ | GN037 | 11V |
| 3.0 50C17 K, 50C17 DK | 4 | F1CE0481HA | 125/168 | 07/07→ | GN037 | 11V |
| 3.0 50C18 | 4 | F1CE0481HA | 130/174 | 05/06→ | GN037 | 11V |
| 3.0 50C18 V, 50C18 V/P | 4 | F1CE0481HA | 130/174 | 05/06→ | GN037 | 11V |
| 3.0 55S17 W, 55S17 WD 4WD | 4 | F1CE0481HA | 125/168 | 07/07→ | GN037 | 11V |
| 3.0 60C14, 60C14 /P | 4 | F1CE3481LC | 103/138 | 07/07→ | GN037 | 11V |
| 3.0 60C14 K, 60C14 DK | 4 | F1CE3481LC | 103/138 | 07/07→ | GN037 | 11V |
| 3.0 60C15 | 4 | F1CE0481FA | 107/143 | 05/06→ | GN037 | 11V |



kW/BHP

**... IVECO****... DAILY IV**

| | | | | | | |
|---|---|------------|---------|--------|-------|-----|
| 3.0 60C15, 60C15 /P, 60C15 D, 60C15 D/P | 4 | F1CE0481FA | 107/143 | 05/06→ | GN037 | 11V |
| 3.0 60C15 V | 4 | F1CE0481FA | 107/143 | 05/06→ | GN037 | 11V |
| 3.0 60C17, 60C17 /P | 4 | F1CE0481HA | 125/168 | 07/07→ | GN037 | 11V |
| 3.0 60C17 V, 60C17 V/P | 4 | F1CE0481HA | 125/168 | 07/07→ | GN037 | 11V |
| 3.0 60C17 K, 60C17 DK | 4 | F1CE0481HA | 125/168 | 07/07→ | GN037 | 11V |
| 3.0 60C18 | 4 | F1CE0481HC | 130/174 | 05/06→ | GN037 | 11V |
| 3.0 65C14, 65C14 /P | 4 | F1CE3481LC | 103/138 | 07/07→ | GN037 | 11V |
| 3.0 65C14 V, 65C14 V/P | 4 | F1CE3481LC | 103/138 | 07/07→ | GN037 | 11V |
| 3.0 65C14 K, 65C14 DK | 4 | F1CE3481LC | 103/138 | 07/07→ | GN037 | 11V |
| 3.0 65C15 | 4 | F1CE0481FA | 107/143 | 05/06→ | GN037 | 11V |
| 3.0 65C15, 65C15 /P, 65C15 D, 65C15 D/P | 4 | F1CE0481FA | 107/143 | 05/06→ | GN037 | 11V |
| 3.0 65C17, 65C17 /P | 4 | F1CE0481HA | 125/168 | 07/07→ | GN037 | 11V |
| 3.0 65C17 V, 65C17 V/P | 4 | F1CE0481HA | 125/168 | 07/07→ | GN037 | 11V |
| 3.0 65C17 K, 65C17 DK, 65C17KK | 4 | F1CE0481HA | 125/168 | 07/07→ | GN037 | 11V |
| 3.0 65C18 | 4 | F1CE0481HC | 130/174 | 05/06→ | GN037 | 11V |
| 3.0 70C14, 70C14 /P | 4 | F1CE3481LC | 103/138 | 07/07→ | GN037 | 11V |
| 3.0 70C14 V, 70C14 V/P | 4 | F1CE3481LC | 103/138 | 07/07→ | GN037 | 11V |
| 3.0 70C14 K, 70C14 DK, 70C14 KK | 4 | F1CE3481LC | 103/138 | 07/07→ | GN037 | 11V |
| 3.0 70C15 | 4 | F1CE0481FA | 107/143 | 07/08→ | GN037 | 11V |
| 3.0 70C17, 70C17 /P | 4 | F1CE0481HA | 125/168 | 07/07→ | GN037 | 11V |
| 3.0 70C17 V, 70C17 V/P | 4 | F1CE0481HA | 125/168 | 07/07→ | GN037 | 11V |
| 3.0 70C17 K, 70C17 DK, 70C17 KK | 4 | F1CE0481HA | 125/168 | 07/07→ | GN037 | 11V |

DAILY V

| | | | | | | |
|---|---|----------------------|---------|--------|-------|-----|
| 2.3 26L11, 26L11D, 35C11D, 35S11, 40C11 | 4 | F1AE3481A | 78/105 | 09/11→ | GN037 | 11V |
| 2.3 29L11 V, 35C11 V, 35S11 V, 40C11 V | 4 | F1AE3481A | 78/105 | 09/11→ | GN037 | 11V |
| 2.3 29L13, 29L13D, 35C13D, 40C13 | 4 | F1AE3481B | 93/125 | 09/11→ | GN037 | 11V |
| 2.3 29L13 V, 35C13 V, 35S13 V, 40C13 V, 40S13 V | 4 | F1AE3481B | 93/125 | 09/11→ | GN037 | 11V |
| 2.3 29L15 V, 35C15L V, 40C15L V, 50C15L V | 4 | F1AE3481C | 107/143 | 09/11→ | GN037 | 11V |
| 2.3 35C11K, 35S11DKP | 4 | F1AE3481A | 78/105 | 09/11→ | GN037 | 11V |
| 2.3 35C13K, 35C13DKP | 4 | F1AE3481B | 93/125 | 09/11→ | GN037 | 11V |
| 3.0 35C15, 35C15D, 35S15, 40C15, 45C15, 50C15, 60C15, 70C15 | 4 | F1CE3481J, F1CE3481L | 107/143 | 09/11→ | GN037 | 11V |
| 3.0 35C15 V, 40C15 V | 4 | F1CE3481J | 107/143 | 09/11→ | GN037 | 11V |
| 3.0 35C15K, 35S15DKP, 50C15K, 60C15K, 65C15DK, 70C15K | 4 | F1CE3481L | 107/143 | 09/11→ | GN037 | 11V |
| 3.0 35C17, 35C17D, 35S17, 40C17, 45C17, 50C17, 60C17, 70C17 | 4 | F1CE3481C, F1CE3481K | 125/168 | 09/11→ | GN037 | 11V |
| 3.0 35C17 V, 35S17 V, 40C17 V, 45C17 V, 50C17 V, 60C17 V, | 4 | F1CE3481C | 125/168 | 09/11→ | GN037 | 11V |
| 3.0 35C17K, 35S17DKP, 50C17K, 65C17DK 70C17K | 4 | F1CE3481C | 125/168 | 09/11→ | GN037 | 11V |
| 3.0 35C21, 35S21, 40C21, 45C21, 50C21, 60C21, 70C21 | 4 | F1CE3481D | 150/201 | 09/11→ | GN037 | 11V |

IVECO

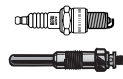

kW/BHP

**... IVECO****... DAILY V**

| | | | | | | | | |
|--|---|-----------|---------|--------|-------|-----|--|--|
| 3.0 35C21 V, 35S21 V, 40C21 V, 45C21 V, 50C21 V | 4 | FICE3481D | 150/201 | 09/11→ | GN037 | 11V | | |
| 3.0 35S21DKP | 4 | FICE3481D | 150/201 | 09/11→ | GN037 | 11V | | |

MASSIF

| | | | | | | | | |
|-------------|---|------------|---------|--------|-------|-----|--|--|
| 3.0 HPI 4WD | 4 | FICE0481FA | 107/143 | 10/08→ | GN037 | 11V | | |
| 3.0 HPT 4WD | 4 | FICE0481HA | 130/174 | 10/08→ | GN037 | 11V | | |

MK

| | | | | | | | | |
|-----------|---|---------------------|---------|--|-------|-----|--|--|
| 75-9 A | 4 | BF4L 913 T, F4L 913 | 64/86 | | GF974 | 12V | | |
| 75-9 H | 4 | F4L 913 | 64/86 | | GF974 | 12V | | |
| 80-9 A | 4 | F4L 913 | 64/86 | | GF974 | 12V | | |
| 80-9 AH | 4 | F4L 913 | 64/86 | | GF974 | 12V | | |
| 80-13 A | 6 | BF6L 913 T, F6L 913 | 96/129 | | GF974 | 12V | | |
| 80-13 AH | 6 | BF6L 913 T, F6L 913 | 96/129 | | GF974 | 12V | | |
| 80-13 AT | 6 | BF6L 913 T, F6L 913 | 96/129 | | GF974 | 12V | | |
| 80-13 AW | 6 | BF6L 913 T, F6L 913 | 96/129 | | GF974 | 12V | | |
| 80-16 A | 6 | BF6L 913 | 118/158 | | GF974 | 12V | | |
| 80-16 AW | 6 | BF6L 913 | 118/158 | | GF974 | 12V | | |
| 90-13 A | 6 | BF6L 913 T | 96/129 | | GF974 | 12V | | |
| 90-13 AH | 6 | BF6L 913 T | 96/129 | | GF974 | 12V | | |
| 110-13 A | 6 | BF6L 913 T, F6L 913 | 96/129 | | GF974 | 12V | | |
| 110-13 AH | 6 | BF6L 913 T, F6L 913 | 96/129 | | GF974 | 12V | | |
| 110-16 A | 6 | BF6L 913 | 118/158 | | GF974 | 12V | | |
| 110-16 AH | 6 | BF6L 913 | 118/158 | | GF974 | 12V | | |
| 110-16 AT | 6 | F6L 913 | 118/158 | | GF974 | 12V | | |
| 130-13 A | 6 | BF6L 913 T, F6L 913 | 96/129 | | GF974 | 12V | | |
| 130-13 AH | 6 | BF6L 913 T, F6L 913 | 96/129 | | GF974 | 12V | | |

JAGUAR**E-TYPE**

| | | | | | | | | |
|---------|----|--|---------|-------------|----------|-----|-------------|------------|
| 3.8 | 6 | | 195/261 | 04/61→07/64 | Z1 [167] | 0.7 | UXT2 / UXT6 | ZS106 [11] |
| 4.2 | 6 | | 127/170 | 03/71→04/75 | Z1 [167] | 0.7 | UXT2 / UXT6 | ZS110 [15] |
| 4.2 | 6 | | 195/261 | 05/64→09/68 | Z1 [167] | 0.7 | UXT2 / UXT6 | ZS106 [11] |
| 4.2 | 6 | | 198/266 | 07/68→05/71 | Z1 [167] | 0.7 | UXT2 / UXT6 | ZS106 [11] |
| 5.3 V12 | 12 | | 203/272 | 03/71→04/75 | Z1 [167] | 0.7 | UXT2 / UXT6 | |

E-TYPE 2+2

| | | | | | | | | |
|---------|----|--|---------|-------------|----------|-----|-------------|------------|
| 4.2 | 6 | | 127/170 | 05/68→04/75 | Z1 [167] | 0.7 | UXT2 / UXT6 | |
| 4.2 | 6 | | 127/170 | 05/68→05/71 | | | | ZS106 [11] |
| 4.2 | 6 | | 195/261 | 06/66→09/68 | Z1 [167] | 0.7 | UXT2 / UXT6 | ZS106 [11] |
| 5.3 V12 | 12 | | 203/272 | 03/71→04/75 | Z1 [167] | 0.7 | UXT2 / UXT6 | |

S-TYPE

| | | | | | | | | |
|--------------|---|-----------|---------|-------------|-------|-----|-------------|-------|
| 2.7 D | 6 | AJD | 152/204 | 06/04→10/07 | GN045 | 11V | | |
| 3.0 V6 | 6 | AJ-V6, FB | 175/235 | 01/99→10/07 | Z209 | 1.3 | UXT15 | ZS367 |
| 4.0 V8 | 8 | AJ-V8 | 203/272 | 01/99→04/02 | Z15 | 0.8 | UXT1 / UXT3 | ZS368 |
| 4.2 R 4,2 V8 | 8 | AJ8FT | 291/390 | 04/02→10/07 | Z312 | 1.0 | UXT9 | ZS368 |
| 4.2 V8 | 8 | | 219/294 | 04/02→10/07 | Z312 | 1.0 | UXT9 | ZS368 |

XF

| | | | | | | | | |
|-------|---|-------|---------|--------|-------|-----|--------|--|
| 2.2 D | 4 | 224DT | 120/161 | 04/11→ | GN063 | 11V | | |
| 2.2 D | 4 | 224DT | 140/188 | 05/11→ | GN063 | 11V | | |
| 2.2 D | 4 | 224DT | 147/197 | 03/12→ | GN063 | 11V | | |
| 2.7 D | 6 | AJD | 152/204 | 03/08→ | GN045 | 11V | | |
| | | | | →02/09 | | | | |
| 4.2 | 8 | SV82G | 219/294 | 03/08→ | Z312 | 1.0 | UXT9 | |
| | | | | →10/09 | | | →10/09 | |

XF SPORTBRAKE

| | | | | | | | | |
|-------|---|-------|---------|--------|-------|-----|--|--|
| 2.2 D | 4 | 224DT | 120/161 | 09/12→ | GN063 | 11V | | |
| 2.2 D | 4 | 224DT | 147/197 | 09/12→ | GN063 | 11V | | |



kW/BHP



... JAGUAR



XJ

| | | | | | | | | |
|---------------------|---|---------------------------|---------|-------------|-----------------------|------|-----------------------|---|
| 2.7 2,7 D | 6 | AJD | 152/204 | 10/05→03/09 | GN045 | 11V | | |
| 2.8 | 6 | | 132/177 | 10/68→10/73 | | | ZS106 ^[11] | |
| 2.8 6 | 6 | | 110/148 | 09/68→09/73 | Z47 | 0.8 | UX56 | ZS109 ^[15] |
| 2.9 6 | 6 | AJ 6 (2.9, KAT) | 108/145 | 10/86→08/90 | | | | ZS115 ^[11] |
| 2.9 6 | 6 | AJ 6 (2.9) | 117/157 | 10/86→08/90 | Z40 | 0.6 | | ZS115 ^[11] |
| 2.9 6 | 6 | AJ 6 (2.9) | 123/165 | 10/86→08/90 | | | | ZS115 ^[11] |
| 3.2 6 | 6 | 9JPGRB | 155/208 | 11/94→07/97 | Z193 | 0.9 | UXT1 / UXT3 | ZS126 |
| 3.2 6 LPG | 6 | 9JPGRB | 155/208 | 11/94→07/97 | Z340 | 0.7 | UXT12 | |
| 3.2 6 3.2 24V | 6 | 9BPMNA | 146/196 | 09/90→11/94 | Z193 | 0.9 | UXT1 / UXT3 | ZS126 →09/94 |
| 3.2 8 | 8 | | 174/233 | 07/97→05/03 | | | | ZS368 |
| 3.4 6 | 6 | XK 3.4 (82-86) | 119/160 | 05/75→10/86 | Z1 ^[170] | 0.7 | UXT2 / UXT6 | ZS110 ^[15] |
| 3.5 | 8 | | 190/255 | 05/03→03/09 | Z228 | 1.0 | UXT11 | |
| 3.5 LPG | 8 | | 190/255 | 05/03→03/09 | Z221 ^[168] | 1.0 | UXT14 | |
| 3.6 | 6 | | 136/182 | 01/88→05/92 | Z193 | 0.9 | UXT1 / UXT3 | ZS126 →08/89 |
| 3.6 | 6 | 9DPALA, 9DPANA | 146/196 | 01/88→05/91 | Z193 | 0.9 | UXT1 / UXT3 | ZS126 ch. 139052→ →ch. 226645 |
| 3.6 | 6 | AJ 6 (3.6, 156KW) | 156/209 | 08/87→12/89 | Z193 | 0.9 | UXT1 / UXT3 | ZS126 →08/89 |
| 3.6 | 6 | AJ 6 (3.6, 162KW) | 162/217 | 10/83→12/88 | Z193 | 0.9 | UXT1 / UXT3 | ZS126 10/86→ ch. 139052→ →ch. 226645 |
| 3.6 6 | 6 | | 136/182 | 10/86→08/89 | Z40 | 0.6 | | ZS126 |
| 3.6 6 | 6 | 9DPANA | 145/194 | 10/86→08/89 | | | | ZS126 |
| 3.6 6 | 6 | 9DPANA, AJ 6 (3.6, 156KW) | 156/209 | 10/86→08/89 | Z193 | 0.9 | UXT1 / UXT3 | ZS126 |
| 4.0 | 6 | 9EPCNA | 163/219 | 05/91→09/94 | Z193 | 0.9 | UXT1 / UXT3 | ZS126 ch. 179737→ →ch. 226645 |
| 4.0 | 6 | 9LPFRB | 171/229 | 07/94→03/96 | Z193 | 0.9 | UXT1 / UXT3 | ZS126 10/94→ ch. 179737→ →ch. 226645 |
| 4.0 LPG | 6 | 9LPFRB | 171/229 | 07/94→03/96 | Z340 | 0.7 | UXT12 | |
| 4.0 6 | 6 | 9EPCNA | 163/219 | 09/89→11/94 | Z193 | 0.9 | UXT1 / UXT3 | ZS126 →09/94 |
| 4.0 8 | 8 | BC | 209/280 | 07/97→05/03 | Z15 ^[167] | 0.8 | UXT1 / UXT3 | ZS368 →08/02 |
| 4.0 8 LPG | 8 | BC | 209/280 | 07/97→05/03 | Z340 →08/02 | 0.7 | UXT12 | →08/02 |
| 4.0 R | 8 | DC | 267/358 | 07/97→05/03 | | | | ZS368 |
| 4.0 R Super Charged | 6 | 9KPDRB | 235/315 | 11/94→07/97 | | | | ZS126 |
| 4.2 | 8 | AJ-V8 | 219/294 | 05/03→03/09 | Z228 | 1.0 | UXT11 | |
| 4.2 LPG | 8 | AJ-V8 | 219/294 | 05/03→03/09 | Z221 ^[168] | 1.0 | UXT14 | |
| 4.2 6 | 6 | XK 4.2 (-79) | 124/166 | 01/75→09/79 | Z9 →02/79 | 1.15 | UXT2 / UXT6 | ZS110 ^[15] →02/79 |
| 4.2 6 | 6 | 8L (85-87) | 127/170 | 01/75→12/79 | Z9 →02/79 | 1.15 | UXT2 / UXT6 | →02/79 |
| 4.2 6 | 6 | 8L (85-87) | 130/174 | 09/85→12/86 | | | | ZS110 ^[15] |
| 4.2 6 | 6 | 8L (85-87) | 133/178 | 09/85→12/86 | | | | ZS110 ^[15] |
| 4.2 6 | 6 | | 137/184 | 10/69→05/75 | Z9 | 1.15 | UXT2 / UXT6 | ZS110 ^[15] |
| 4.2 6 | 6 | XK 4.2 (82-87) | 151/202 | 09/79→12/87 | | | | ZS110 ^[15] |
| 4.2 R | 8 | AJ8FT | 291/390 | 05/03→03/09 | Z228 | 1.0 | UXT11 | |
| 4.2 R LPG | 8 | AJ8FT | 291/390 | 05/03→03/09 | Z221 ^[168] | 1.0 | UXT14 | |

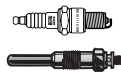

kW/BHP

**... JAGUAR****XJSC**

| | | | | | | | | | |
|---------|---|-------------------|---------|-------------|------|--|-----|-------------|---|
| 3.6 | 6 | | 136/182 | 08/87→05/91 | Z193 | | 0.9 | UXT1 / UXT3 | ZS126 01/88→ ch. 139052→ →ch. 226645 |
| 3.6 | 6 | AJ 6 (3.6, 156KW) | 156/209 | 08/87→05/91 | Z193 | | 0.9 | UXT1 / UXT3 | ZS126 01/88→ ch. 139052→ →ch. 226645 |
| 3.6 | 6 | AJ 6 (3.6, 162KW) | 162/217 | 10/86→12/88 | Z193 | | 0.9 | UXT1 / UXT3 | ZS126 ch. 139052→ →ch. 226645 |
| 4.0 | 6 | 9EPCNA | 163/219 | 05/91→09/94 | Z193 | | 0.9 | UXT1 / UXT3 | ZS126 ch. 179737→ →ch. 226645 |
| 4.0 | 6 | 9LPFRB | 171/229 | 07/94→03/96 | Z193 | | 0.9 | UXT1 / UXT3 | ZS126 10/94→ ch. 179737→ →ch. 226645 |
| 4.0 LPG | 6 | 9LPFRB | 171/229 | 07/94→03/96 | Z340 | | 0.7 | UXT12 | |

XK

| | | | | | | | | | |
|---------|---|-------|---------|--------|---------------------|--|-----|---------------------|--|
| 3.5 | 8 | | 190/255 | 07/07→ | Z312 →02/09 | | 1.0 | UXT9 →02/09 | |
| 3.6 | 8 | | 190/255 | 10/07→ | Z312 03/08→02/09 | | 1.0 | UXT9 03/08→02/09 | |
| 4.2 XK8 | 8 | | 219/294 | 03/06→ | Z312 →02/09 | | 1.0 | UXT9 →02/09 | |
| 4.2 XKR | 8 | AJ8FT | 291/390 | 03/06→ | Z312 →02/09 | | 1.0 | UXT9 →02/09 | |
| 4.2 XKR | 8 | | 306/410 | 03/06→ | Z312 →02/09 | | 1.0 | UXT9 →02/09 | |

XK 8

| | | | | | | | | | |
|---------------|---|-------|---------|-------------|------------|--|-----|-------|--|
| 4.2 | 8 | | 219/294 | 08/02→12/06 | Z228 | | 1.0 | UXT11 | |
| 4.2 LPG | 8 | | 219/294 | 08/02→12/06 | Z221 [168] | | 1.0 | UXT14 | |
| 4.2 R 4,2 | 8 | AJ8FT | 291/390 | 08/02→07/05 | Z228 | | 1.0 | UXT11 | |
| 4.2 R 4,2 LPG | 8 | AJ8FT | 291/390 | 08/02→07/05 | Z221 [168] | | 1.0 | UXT14 | |

X-TYPE

| | | | | | | | | | |
|------------|---|---------------------|---------|-------------|-------|--|-------|-------|--|
| 2.0 D | 4 | FMBA, FMBB, R4-X404 | 96/129 | 07/03→12/09 | GN939 | | 11.5V | | |
| 2.2 D | 4 | LJ46G | 107/143 | 01/07→12/09 | GN063 | | 11V | | |
| 2.2 D | 4 | LJ46G | 110/148 | 10/05→12/09 | GN063 | | 11V | | |
| 2.2 D | 4 | LJ46G | 114/153 | 10/05→12/09 | GN063 | | 11V | | |
| 2.5 V6 4WD | 6 | | 144/193 | 06/01→11/09 | Z209 | | 1.3 | UXT15 | |

JEEP**CHEROKEE**

| | | | | | | | | | |
|------------|---|-----|---------|-------------|-----------------|--|-----|--|------------------------------------|
| 2.1 TD | 4 | J8S | 59/79 | 06/89→03/92 | GV852 | | 11V | | |
| 2.1 TD 4WD | 4 | J8S | 64/86 | 10/84→09/01 | GV852 →08/94 | | 11V | | |
| 2.4 4WD | 4 | ED1 | 108/145 | 09/01→01/08 | | | | | ZS380 →12/03 ZS379 01/04→ |
| 2.4 Laredo | 4 | ED1 | 108/145 | 10/01→09/04 | | | | | ZS380 →12/03 ZS379 01/04→ |
| 2.5 | 4 | EPE | 89/119 | 10/90→09/96 | | | | | ZS394 |

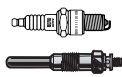

kW/BHP

**... JEEP**

| ... CHEROKEE | | | | | | | | |
|-----------------|---|-----------------|---------|-------------|--|--|------------|---|
| 2.5 4WD | 4 | EPE | 89/119 | 10/95→09/01 | | | | ZS394 →12/97 ZS396 01/98→ |
| 2.5 | 4 | EPE | 90/121 | 10/86→09/90 | | | | ZS394 |
| 2.5 CRD 4WD | 4 | R 425 DOHC | 105/141 | 09/01→01/08 | GN055 | | 11V | |
| 2.5 i 4WD | 4 | EPE | 87/117 | 10/84→09/01 | | | | ZS394 →12/97 ZS396 01/98→ |
| 2.5 i 4WD | 4 | EPE | 90/121 | 12/91→09/01 | | | | ZS394 |
| 2.5 SE | 4 | EPE | 87/117 | 10/96→09/99 | | | | ZS394 →12/97 ZS396 01/98→ |
| 2.5 TD 4WD | 4 | VM HR 425 CLIRX | 85/114 | 01/88→09/01 | GN909 →04/95 GN007 05/95→ | | 11V | |
| 2.5 Tdi 4WD | 4 | ENC | 85/114 | 10/96→09/01 | GN954 →12/96 GN046 01/97→ | | 11V 12V | |
| 2.8 CRD 4WD | 4 | ENR | 110/148 | 11/02→01/08 | GN055 | | 11V | |
| 2.8 CRD 4WD | 4 | ENR | 120/161 | 11/04→01/08 | GN055 | | 11V | |
| 3.7 4WD | 6 | EKG | 150/201 | 08/03→01/08 | Z158 | | 1.1 | |
| 3.7 4WD | 6 | EKG | 155/208 | 09/01→01/08 | Z158 | | 1.1 | |
| 3.7 4WD LPG | 6 | EKG | 150/201 | 08/03→01/08 | Z116 | | 0.8 | UXT5 |
| 3.7 4WD LPG | 6 | EKG | 155/208 | 09/01→01/08 | Z116 | | 0.8 | UXT5 |
| 3.7 V6 4WD | 6 | EKG | 151/202 | 01/08→ | Z158 | | 1.1 | |
| 3.7 V6 | 6 | EKG | 157/211 | 01/08→ | Z158 | | 1.1 | |
| 3.7 V6 4WD LPG | 6 | EKG | 151/202 | 01/08→ | Z116 | | 0.8 | UXT5 |
| 3.7 V6 LPG | 6 | EKG | 157/211 | 01/08→ | Z116 | | 0.8 | UXT5 |
| 4.0 i 4WD | 6 | | 127/170 | 07/98→09/01 | Z248 [170] →04/01 | | 0.8 | ZS452 09/00→08/01 |
| 4.0 i 4WD | 6 | ERH | 131/176 | 01/95→09/01 | Z248 [170] | | 0.8 | ZS394 →09/98 ZS396 10/98→09/00 |
| 4.0 i 4WD | 6 | MX | 135/181 | 12/91→09/01 | Z248 [170] | | 0.8 | ZS394 |
| 4.0 i 4WD | 6 | MX | 135/181 | 02/99→09/01 | | | | ZS396 |
| 4.0 i 4WD | 6 | ERH | 136/182 | 01/88→09/01 | Z15 →08/90 Z248 [170] 09/90→ | | 0.8 0.8 | UXT1 / UXT3 →08/90 ZS251 [1][213][254] ZS316 [1][206][254] |
| 4.0 i 4WD LPG | 6 | | 127/170 | 07/98→09/01 | Z225 [168] →04/01 | | 1.1 | |
| 4.0 i 4WD LPG | 6 | ERH | 131/176 | 01/95→09/01 | Z225 [168] | | 1.1 | |
| 4.0 i 4WD LPG | 6 | MX | 135/181 | 12/91→09/01 | Z225 [168] | | 1.1 | |
| 4.0 i 4WD LPG | 6 | ERH | 136/182 | 01/88→09/01 | Z340 →08/90 Z225 [168] 09/90→ | | 0.7 1.1 | UXT12 →08/90 |
| COMANCHE | | | | | | | | |
| 2.1 D | 4 | JBS-814 | 63/84 | 01/86→09/90 | GN954 | | 11V | |
| 2.5 | 4 | EPE | 90/121 | 10/86→09/90 | | | | ZS394 |
| 4.0 | 6 | ERH | 130/174 | 10/87→09/96 | | | | ZS393 01/91→12/92 |

JEEP

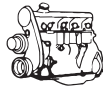

kW/BHP



... JEEP



COMMANDER

| | | | | | | | |
|----------------|---|-----|---------|-------------|-------|------|------|
| 3.0 CRD 4WD | 6 | EXL | 160/215 | 04/06→12/10 | GE105 | 4.4V | |
| 3.7 V6 4WD | 6 | EKG | 157/211 | 09/05→12/10 | Z158 | 1.1 | |
| 3.7 V6 4WD LPG | 6 | EKG | 157/211 | 09/05→12/10 | Z116 | 0.8 | UXT5 |

COMPASS

| | | | | | | | |
|---------|---|----------|---------|--------|-------|------|--|
| 2.0 CRD | 4 | ECD, ECE | 103/138 | 08/06→ | GE101 | 4.4V | |
|---------|---|----------|---------|--------|-------|------|--|

GRAND CHEROKEE I

| | | | | | | | |
|------------|---|----------|---------|-------------|------------|-----|-------|
| 2.5 TD 4WD | 4 | M51, M52 | 85/114 | 10/95→04/99 | GN007 | 11V | |
| 4.0 i 4WD | 6 | S01 | 130/174 | 10/95→04/99 | Z248 [170] | 0.8 | ZS394 |

→12/97
ZS396
01/98→12/98
ZS452
01/99→

| | | | | | | | |
|-----------|---|-----|---------|-------------|------------|-----|---------------------|
| 4.0 i 4WD | 6 | ERH | 132/177 | 09/91→04/99 | Z248 [170] | 0.8 | ZS394 [1][136][254] |
|-----------|---|-----|---------|-------------|------------|-----|---------------------|

ZS396 [1][137]
ZS452 [1][81]

| | | | | | | | |
|-----------|---|----|---------|-------------|------------|-----|-------|
| 4.0 i 4WD | 6 | MX | 135/181 | 09/91→04/99 | Z248 [170] | 0.8 | ZS394 |
|-----------|---|----|---------|-------------|------------|-----|-------|

→12/97
ZS396
01/98→

| | | | | | | | |
|---------------|---|-----|---------|-------------|------------|-----|--|
| 4.0 i 4WD LPG | 6 | S01 | 130/174 | 10/95→04/99 | Z225 [168] | 1.1 | |
|---------------|---|-----|---------|-------------|------------|-----|--|

| | | | | | | | |
|---------------|---|-----|---------|-------------|------------|-----|--|
| 4.0 i 4WD LPG | 6 | ERH | 132/177 | 09/91→04/99 | Z225 [168] | 1.1 | |
|---------------|---|-----|---------|-------------|------------|-----|--|

| | | | | | | | |
|---------------|---|----|---------|-------------|------------|-----|--|
| 4.0 i 4WD LPG | 6 | MX | 135/181 | 09/91→04/99 | Z225 [168] | 1.1 | |
|---------------|---|----|---------|-------------|------------|-----|--|

| | | | | | | | |
|------------|---|-----|---------|-------------|--|--|---------------------|
| 4.0 Laredo | 6 | ERH | 131/176 | 10/96→09/98 | | | ZS394 [1][136][254] |
|------------|---|-----|---------|-------------|--|--|---------------------|

ZS396 [1][137]
ZS452 [1][81]

| | | | | | | | |
|---------|---|-----|---------|-------------|-----|-----|-------------|
| 5.2 4WD | 8 | Y01 | 156/209 | 10/95→04/99 | Z73 | 1.1 | UXT11 ZS396 |
|---------|---|-----|---------|-------------|-----|-----|-------------|

| | | | | | | | |
|-----|---|-----|---------|-------------|--|--|-------|
| 5.2 | 8 | ELF | 164/220 | 10/96→09/98 | | | ZS394 |
|-----|---|-----|---------|-------------|--|--|-------|

→12/97
ZS396
01/98→

| | | | | | | | |
|-------------|---|-----|---------|-------------|------|-----|-------|
| 5.2 4WD LPG | 8 | Y01 | 156/209 | 10/95→04/99 | Z206 | 0.7 | UXT10 |
|-------------|---|-----|---------|-------------|------|-----|-------|

| | | | | | | | |
|-----------|---|-----|---------|-------------|-----|-----|-------------|
| 5.2 i 4WD | 8 | ELF | 155/208 | 01/92→04/99 | Z73 | 1.1 | UXT11 ZS394 |
|-----------|---|-----|---------|-------------|-----|-----|-------------|

09/92→

09/92→

| | | | | | | | |
|-----------|---|---|---------|-------------|------|-----|-------------------|
| 5.2 i 4WD | 8 | Y | 158/212 | 09/92→04/99 | Z255 | 0.9 | UXT1 / UXT3 ZS394 |
|-----------|---|---|---------|-------------|------|-----|-------------------|

→12/97
ZS396
01/98→

| | | | | | | | |
|---------------|---|-----|---------|-------------|------|-----|-------|
| 5.2 i 4WD LPG | 8 | ELF | 155/208 | 01/92→04/99 | Z206 | 0.7 | UXT10 |
|---------------|---|-----|---------|-------------|------|-----|-------|

09/92→

09/92→

| | | | | | | | |
|---------------|---|---|---------|-------------|------|-----|-------|
| 5.2 i 4WD LPG | 8 | Y | 158/212 | 09/92→04/99 | Z206 | 0.7 | UXT10 |
|---------------|---|---|---------|-------------|------|-----|-------|

| | | | | | | | |
|-----------------|---|-----|---------|-------------|--|--|-------|
| 5.2 Limited 4WD | 8 | ELF | 136/182 | 10/96→09/98 | | | ZS394 |
|-----------------|---|-----|---------|-------------|--|--|-------|

→12/97
ZS396
01/98→

| | | | | | | | |
|-----------|---|--|---------|-------------|--|--|-------|
| 5.9 i 4WD | 8 | | 177/237 | 08/97→04/99 | | | ZS396 |
|-----------|---|--|---------|-------------|--|--|-------|

GRAND CHEROKEE II

| | | | | | | | |
|-------------|---|-----|---------|-------------|-------|-------|--|
| 2.7 CRD 4WD | 5 | ENF | 120/161 | 10/01→09/05 | GN003 | 11.5V | |
|-------------|---|-----|---------|-------------|-------|-------|--|

| | | | | | | | |
|------------|---|-----|---------|-------------|-------|-----|--|
| 3.1 TD 4WD | 5 | EXA | 103/138 | 04/99→12/01 | GN007 | 11V | |
|------------|---|-----|---------|-------------|-------|-----|--|

| | | | | | | | |
|-----|---|-----|---------|-------------|--|--|-------|
| 4.0 | 6 | ERH | 140/188 | 10/98→09/04 | | | ZS452 |
|-----|---|-----|---------|-------------|--|--|-------|

| | | | | | | | |
|---------|---|-----|---------|-------------|------------|-----|-------|
| 4.0 4WD | 6 | ERH | 140/188 | 04/99→09/05 | Z248 [170] | 0.8 | ZS452 |
|---------|---|-----|---------|-------------|------------|-----|-------|

| | | | | | | | |
|-------------|---|-----|---------|-------------|------------|-----|--|
| 4.0 4WD LPG | 6 | ERH | 140/188 | 04/99→09/05 | Z225 [168] | 1.1 | |
|-------------|---|-----|---------|-------------|------------|-----|--|

| | | | | | | | |
|------------|---|-----|---------|-------------|------|-----|--|
| 4.7 V8 4WD | 8 | EVA | 162/217 | 04/99→08/00 | Z220 | 1.0 | |
|------------|---|-----|---------|-------------|------|-----|--|

GRAND CHEROKEE III

| | | | | | | | |
|-------------|---|-----|---------|-------------|-------|------|--|
| 3.0 CRD 4WD | 6 | EXL | 155/208 | 05/06→12/10 | GE105 | 4.4V | |
|-------------|---|-----|---------|-------------|-------|------|--|

| | | | | | | | |
|-------------|---|-----|---------|-------------|-------|------|--|
| 3.0 CRD 4WD | 6 | EXL | 160/215 | 06/05→12/10 | GE105 | 4.4V | |
|-------------|---|-----|---------|-------------|-------|------|--|

| | | | | | | | |
|------------|---|-----|---------|-------------|------|-----|--|
| 3.7 V6 4WD | 6 | EKG | 157/211 | 06/05→12/10 | Z158 | 1.1 | |
|------------|---|-----|---------|-------------|------|-----|--|

| | | | | | | | |
|----------------|---|-----|---------|-------------|------|-----|------|
| 3.7 V6 4WD LPG | 6 | EKG | 157/211 | 06/05→12/10 | Z116 | 0.8 | UXT5 |
|----------------|---|-----|---------|-------------|------|-----|------|

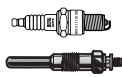

kW/BHP

**... JEEP****PATRIOT**

| | | | | | | | |
|---------|---|----------|---------|--------|-------|------|--|
| 2.0 CRD | 4 | ECD, ECE | 103/138 | 02/07→ | GE101 | 4.4V | |
|---------|---|----------|---------|--------|-------|------|--|

WRANGLER I

| | | | | | | | |
|-------------|---|--------|---------|-------------|------------|-----|-------|
| 2.5 4WD | 4 | | 76/102 | 01/88→12/91 | Z248 [170] | 0.8 | |
| 2.5 4WD | 4 | 4L <H> | 76/102 | 01/88→12/91 | | | ZS251 |
| 2.5 4WD | 4 | EPE | 89/119 | 12/91→08/96 | Z248 [170] | 0.8 | ZS394 |
| 2.5 4WD LPG | 4 | EPE | 89/119 | 12/91→08/96 | Z225 [168] | 1.1 | |
| 4.0 4WD | 6 | ERH | 131/176 | 12/91→08/96 | Z248 [170] | 0.8 | ZS394 |
| 4.0 4WD LPG | 6 | ERH | 131/176 | 12/91→08/96 | Z225 [168] | 1.1 | |

WRANGLER II

| | | | | | | | |
|-----------------|---|-----|---------|-------------|------------|-----|---|
| 2.4 4WD | 4 | ED1 | 105/141 | 11/02→04/07 | Z216 | 1.3 | ZS380 |
| 2.5 4WD | 4 | P00 | 87/117 | 08/96→04/07 | Z248 [170] | 0.8 | ZS396 |
| 2.5 4WD LPG | 4 | P00 | 87/117 | 08/96→04/07 | Z225 [168] | 1.1 | |
| 3.8 4WD | 6 | EGT | 153/205 | 02/06→12/08 | | | ZS455 |
| 4.0 4WD | 6 | | 124/166 | 06/98→04/07 | Z248 [170] | 0.8 | ZS396 →12/00 ZS452 01/01→12/06 |
| 4.0 4WD | 6 | S01 | 130/174 | 08/96→04/07 | Z248 [170] | 0.8 | ZS396 →12/00 ZS452 01/01→12/06 |
| 4.0 4WD LPG | 6 | | 124/166 | 06/98→04/07 | Z225 [168] | 1.1 | |
| 4.0 4WD LPG | 6 | S01 | 130/174 | 08/96→04/07 | Z225 [168] | 1.1 | |
| 4.0 Rubicon 4WD | 6 | | 128/172 | 08/03→04/07 | | | ZS452 →12/06 |

WRANGLER III

| | | | | | | | |
|---------|---|-----|---------|--------|--|--|-------|
| 3.8 4WD | 6 | EGT | 146/196 | 04/07→ | | | ZS455 |
|---------|---|-----|---------|--------|--|--|-------|

KIA**AVELLA**

| | | | | | | | |
|-----|---|----|-------|-------------|--|--|-------|
| 1.3 | 4 | B3 | 55/74 | 11/95→12/01 | | | ZS511 |
| 1.5 | 4 | | 55/74 | 02/97→12/01 | | | ZS511 |

CARENS I

| | | | | | | | |
|-----------|---|----|--------|-------------|------|-----|-------------------|
| 1.8 i | 4 | T8 | 81/109 | 11/00→07/02 | Z15 | 0.8 | UXT1 / UXT3 ZS433 |
| 1.8 i LPG | 4 | T8 | 81/109 | 11/00→07/02 | Z340 | 0.7 | UXT12 |

CARENS II

| | | | | | | | |
|-------------|---|------|---------|--------|------------|-----|-----------------------------------|
| 1.6 | 4 | GA6D | 77/103 | 07/02→ | Z16 | 1.1 | UXT11 ZS433 [1] [50] ZS486 [1] |
| 1.6 LPG | 4 | GA6D | 77/103 | 07/02→ | Z340 | 0.7 | UXT12 |
| 1.8 | 4 | | 93/125 | 07/02→ | Z15 | 0.8 | UXT1 / UXT3 ZS433 |
| 1.8 LPG | 4 | | 93/125 | 07/02→ | Z340 | 0.7 | UXT12 |
| 2.0 CRDi | 4 | D4EA | 83/111 | 07/02→ | GN035 | 11V | |
| 2.0 CRDi | 4 | D4EA | 103/138 | 11/05→ | GN035 | 11V | |
| 2.0 CVT | 4 | G4GC | 102/137 | 08/04→ | Z73 | 1.1 | UXT11 ZS482 |
| 2.0 CVT LPG | 4 | G4GC | 102/137 | 08/04→ | Z206 [168] | 0.7 | UXT10 |

CARENS III

| | | | | | | | |
|--------------|---|------|---------|--------|-------|-----|-------|
| 1.6 CRDi 110 | 4 | D4FB | 85/114 | 10/10→ | GN062 | 11V | |
| 1.6 CRDi 128 | 4 | D4FB | 94/126 | 10/10→ | GN062 | 11V | |
| 1.6 CVT | 4 | G4FC | 93/125 | 10/10→ | Z308 | 0.9 | ZS475 |
| 1.6 CVT | 4 | G4FC | 97/130 | 08/09→ | Z308 | 0.9 | ZS475 |
| 2.0 CRDi 115 | 4 | D4EA | 85/114 | 05/07→ | GN035 | 11V | |
| 2.0 CRDi 135 | 4 | D4EA | 100/134 | 08/09→ | GN035 | 11V | |
| 2.0 CRDi 140 | 4 | D4EA | 103/138 | 09/06→ | GN035 | 11V | |
| 2.0 CVT | 4 | G4KA | 106/142 | 09/06→ | Z73 | 1.1 | UXT11 |
| 2.0 CVT LPG | 4 | G4KA | 106/142 | 09/06→ | Z206 | 0.7 | UXT10 |

CARENS IV

| | | | | | | | |
|----------|---|--------|--------|--------|-------|-----|--|
| 1.7 CRDi | 4 | D4FD-L | 85/114 | 03/13→ | GN062 | 11V | |
|----------|---|--------|--------|--------|-------|-----|--|

KIA



kW/BHP



... KIA



... CARENS IV

| | | | | | | | |
|----------|---|--------|---------|--------|-------|-----|--|
| 1.7 CRDi | 4 | D4FD-L | 100/134 | 03/13→ | GN062 | 11V | |
|----------|---|--------|---------|--------|-------|-----|--|

CARNIVAL I

| | | | | | | | |
|------------|---|------|---------|-------------|-------|-----|-------|
| 2.5 V6 | 6 | KRV6 | 121/162 | 08/99→10/01 | Z158 | 1.1 | ZS487 |
| 2.5 V6 LPG | 6 | KRV6 | 121/162 | 08/99→10/01 | Z116 | 0.8 | UXT5 |
| 2.9 TD | 4 | J3 | 93/125 | 08/99→10/01 | GN035 | 11V | |

CARNIVAL II

| | | | | | | | |
|------------|---|------|---------|--------|-----------------------|-----|-------|
| 2.5 V6 | 6 | K5 | 110/148 | 10/01→ | Z158 | 1.1 | ZS487 |
| 2.5 V6 LPG | 6 | K5 | 110/148 | 10/01→ | Z116 | 0.8 | UXT5 |
| 2.9 CRDi | 4 | J3 | 106/142 | 10/01→ | GN035 | 11V | |
| 2.9 TD | 4 | J3 | 93/125 | 01/99→ | GN035 | 11V | |
| 3.5 | 6 | G6CU | 143/192 | 07/02→ | Z228 | 1.0 | UXT11 |
| 3.5 LPG | 6 | G6CU | 143/192 | 07/02→ | Z221 ^[168] | 1.0 | UXT14 |

CEE'D

| | | | | | | | |
|-----|---|------|--------|--------|----------------|-----|------------------------------------|
| 1.4 | 4 | G4FA | 77/103 | 12/06→ | | | ZS475 |
| 1.4 | 4 | G4FA | 80/107 | 12/06→ | Z158 →03/09 | 1.1 | ZS474 |
| 1.4 | 4 | G4FA | 80/107 | 09/07→ | | | ZS474 →01/09 ZS475 02/09→ |

| | | | | | | | |
|-------------|---|--------|--------|--------|----------------|-----|---|
| 1.4 CRDi | 4 | D4FC | 66/89 | 09/12→ | GN062 | 11V | |
| 1.4 CRDi 90 | 4 | D4FC | 66/89 | 05/12→ | GN062 | 11V | |
| 1.4 CVT | 4 | G4FA-L | 66/89 | 06/10→ | | | ZS475 |
| 1.6 | 4 | G4FC | 85/114 | 09/07→ | Z158 →03/09 | 1.1 | ZS474 →03/09 ZS475 04/09→12/12 |

| | | | | | | | |
|-----|---|------|--------|--------|----------------------------------|------------|-------|
| 1.6 | 4 | G4FC | 90/121 | 12/06→ | Z158 →03/09 Z308 03/12→ | 1.1 0.9 | ZS474 |
|-----|---|------|--------|--------|----------------------------------|------------|-------|

| | | | | | | | |
|-----|---|------|--------|--------|--|------------|------------------------------------|
| 1.6 | 4 | G4FC | 90/121 | 09/07→ | Z158 →03/09 Z334 ^[17] | 1.1 0.9 | ZS474 →03/09 ZS475 04/09→ |
|-----|---|------|--------|--------|--|------------|------------------------------------|

| | | | | | | | |
|-----|---|------|--------|--------|----------------|-----|------------------------------------|
| 1.6 | 4 | G4FC | 93/125 | 09/07→ | Z158 →03/09 | 1.1 | ZS474 →03/09 ZS475 04/09→ |
|-----|---|------|--------|--------|----------------|-----|------------------------------------|

| | | | | | | | |
|-----|---|------|--------|--------|--|------------|---|
| 1.6 | 4 | G4FC | 93/125 | 02/08→ | Z158 →03/09 Z334 ^[17] | 1.1 0.9 | ZS474 →03/09 ZS475 04/09→12/12 |
|-----|---|------|--------|--------|--|------------|---|

| | | | | | | | |
|--------------|---|--------|---------|--------|-----------------------|-----|----------------|
| 1.6 CRDi | 4 | D4FB | 81/109 | 03/13→ | GN062 | 11V | |
| 1.6 CRDi | 4 | D4FB | 94/126 | 09/12→ | GN062 | 11V | |
| 1.6 CRDi 90 | 4 | D4FB-L | 66/89 | 12/06→ | GN062 | 11V | |
| 1.6 CRDi 110 | 4 | D4FB | 81/109 | 05/12→ | GN062 | 11V | |
| 1.6 CRDi 115 | 4 | D4FB | 85/114 | 12/06→ | GN062 | 11V | |
| 1.6 CRDi 128 | 4 | D4FB | 94/126 | 10/10→ | GN062 | 11V | |
| 1.6 CVT | 4 | G4FC | 92/123 | 06/09→ | | | ZS475 |
| 2.0 | 4 | G4GC | 105/141 | 12/06→ | Z73 | 1.1 | UXT11 ZS482 |
| 2.0 LPG | 4 | G4GC | 105/141 | 12/06→ | Z206 ^[168] | 0.7 | UXT10 |
| 2.0 CRDi | 4 | D4EA | 100/134 | 06/07→ | GN035 | 11V | |
| 2.0 CRDi 140 | 4 | D4EA-F | 103/138 | 09/07→ | GN035 | 11V | |



kW/BHP



... KIA



CERATO

| | | | | | | | | |
|----------|---|------|---------|--------|----------------|-----|-------|---|
| 1.5 CRDi | 4 | D4FA | 75/101 | 07/05→ | GN035 | 11V | | |
| 1.6 | 4 | G4ED | 77/103 | 04/04→ | Z73 | 1.1 | UXT11 | ZS483 →10/06 ZS481 [71] ZS474 11/06→ |
| 1.6 | 4 | G4ED | 77/103 | 07/04→ | | | | ZS483 →10/06 ZS474 11/06→01/08 ZS481 [71] |
| 1.6 | 4 | G4FC | 90/121 | 05/06→ | Z158 →01/08 | 1.1 | | ZS474 |
| 1.6 LPG | 4 | G4ED | 77/103 | 04/04→ | Z206 [168] | 0.7 | UXT10 | |
| 1.6 CRDi | 4 | D4FB | 85/114 | 06/05→ | GN062 | 11V | | |
| 1.8 | 4 | G4GB | 93/125 | 08/05→ | Z312 | 1.0 | UXT9 | |
| 2.0 | 4 | G4GC | 105/141 | 04/04→ | Z73 | 1.1 | UXT11 | ZS482 [69][70] |
| 2.0 LPG | 4 | G4GC | 105/141 | 04/04→ | Z206 [168] | 0.7 | UXT10 | |
| 2.0 CRDi | 4 | D4EA | 83/111 | 04/04→ | GN035 | 11V | | |

CLARUS

| | | | | | | | | |
|---------------|---|----------|--------|--------|----------------|-----|-----------------|-------|
| 1.8 i 16V | 4 | T8 | 85/114 | 07/96→ | Z15 | 0.8 | UXT1 / UXT3 | ZS433 |
| 1.8 i 16V LPG | 4 | T8 | 85/114 | 07/96→ | Z340 | 0.7 | UXT12 | |
| 2.0 i 16V | 4 | FE (16V) | 98/131 | 07/96→ | Z73 →05/98 | 1.1 | UXT11 →05/98 | |
| 2.0 i 16V | 4 | FE (16V) | 98/131 | 05/98→ | Z73 | 1.1 | UXT11 | |
| 2.0 i 16V LPG | 4 | FE (16V) | 98/131 | 07/96→ | Z206 →05/98 | 0.7 | UXT10 →05/98 | |
| 2.0 i 16V LPG | 4 | FE (16V) | 98/131 | 05/98→ | Z206 | 0.7 | UXT10 | |

JOICE

| | | | | | | | | |
|---------|---|------|---------|--------|---------------------|-----|----------------|-----------------|
| 2.0 | 4 | G4CP | 88/118 | 09/01→ | Z21 | 1.1 | UXT2 / UXT6 | ZS521 →02/03 |
| 2.0 | 4 | G4CP | 102/137 | 02/00→ | Z21 →09/01 | 1.1 | UXT2 / UXT6 | ZS521 →09/01 |
| 2.0 LPG | 4 | G4CP | 88/118 | 09/01→ | Z27 [168] | 0.8 | UX56 | |
| 2.0 LPG | 4 | G4CP | 102/137 | 02/00→ | Z27 [168] →09/01 | 0.8 | UX56 →09/01 | |

MAGENTIS

| | | | | | | | | |
|------------|---|------|---------|-------------|------------|-----|-------------|-------------|
| 2.0 | 4 | G4JP | 100/134 | 05/01→ | Z21 | 1.1 | UXT2 / UXT6 | ZSE502 [16] |
| 2.0 | 4 | G4KA | 106/142 | 11/05→ | Z73 | 1.1 | UXT11 | |
| 2.0 | 4 | G4KD | 121/162 | 07/09→ | Z183 | 0.9 | UXT13 | |
| 2.0 LPG | 4 | G4JP | 100/134 | 05/01→ | Z27 [168] | 0.8 | UX56 | |
| 2.0 LPG | 4 | G4KA | 106/142 | 11/05→ | Z206 | 0.7 | UXT10 | |
| 2.0 CRDi | 4 | D4EA | 100/134 | 11/05→12/08 | GN035 | 11V | | |
| 2.0 CRDi | 4 | D4EA | 103/138 | 04/06→ | GN035 | 11V | | |
| 2.0 CRDi | 4 | D4EA | 110/148 | 04/06→ | GN035 | 11V | | |
| 2.5 V6 | 6 | G6BV | 124/166 | 05/01→ | Z228 | 1.0 | UXT11 | ZS269 |
| 2.5 V6 LPG | 6 | G6BV | 124/166 | 05/01→ | Z221 [168] | 1.0 | UXT14 | |

OPIRUS

| | | | | | | | | |
|---------|---|------|---------|--------|------------|-----|-------|--------|
| 3.5 | 6 | G6CU | 149/200 | 09/03→ | Z228 | 1.0 | UXT11 | ZSE087 |
| 3.5 LPG | 6 | G6CU | 149/200 | 09/03→ | Z221 [168] | 1.0 | UXT14 | |

OPTIMA

| | | | | | | | | |
|----------|---|--------|---------|--------|-------|-----|--|--|
| 1.7 CRDi | 4 | D4FD-L | 100/134 | 03/12→ | GN062 | 11V | | |
|----------|---|--------|---------|--------|-------|-----|--|--|

PICANTO

| | | | | | | | | |
|---------|---|------|-------|--------|---------------|-----|-----------------|-------|
| 1.0 | 3 | G3LA | 51/68 | 05/11→ | | | | ZS476 |
| 1.0 | 4 | G4HE | 45/60 | 04/04→ | Z16 | 1.1 | UXT11 | ZS477 |
| 1.0 | 4 | G4HE | 46/62 | 11/09→ | Z73 →01/11 | 1.1 | UXT11 →01/11 | ZS477 |
| 1.0 LPG | 4 | G4HE | 45/60 | 04/04→ | Z340 | 0.7 | UXT12 | |

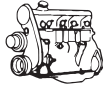

kW/BHP

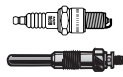

... KIA



... PICANTO

| | | | | | | | | |
|-------------|---|------|-------|--------|------------|-----|-------|--------------------------|
| 1.0 Bi-Fuel | 3 | B3LA | 60/80 | 05/11→ | | | | ZS476 |
| 1.1 | 4 | G4HG | 48/64 | 04/04→ | Z73 | 1.1 | UXT11 | ZS477 |
| 1.1 LPG | 4 | G4HG | 48/64 | 04/04→ | Z206 [168] | 0.7 | UXT10 | |
| 1.1 CRDi | 3 | D3FA | 55/74 | 11/05→ | GN062 | 11V | | |
| 1.2 | 4 | G4LA | 63/84 | 09/11→ | | | | ZS478 [68] ZS536 [67] |

PRIDE

| | | | | | | | | |
|----------------|---|------|--------|--------|------------------|------------|-----------------------|-------|
| 1.1 i | 4 | B1 | 38/51 | 01/91→ | Z11 →05/96 | 0.8 | UXT2 / UXT6 →05/96 | ZS511 |
| 1.3 | 4 | | 47/63 | 08/99→ | Z9 | 1.15 | UXT2 / UXT6 | ZS511 |
| 1.3 LPG | 4 | | 47/63 | 08/99→ | Z20 [168] | 0.8 | UXT2 / UXT6 | |
| 1.3 16V | 4 | B3 | 44/59 | 01/90→ | Z11 | 0.8 | UXT2 / UXT6 | ZS511 |
| 1.3 16V | 4 | B3 | 47/63 | 10/96→ | Z21 | 1.1 | UXT2 / UXT6 | ZS511 |
| 1.3 16V | 4 | B3 | 53/71 | 01/90→ | Z11 10/93→ | 0.8 | UXT2 / UXT6 10/93→ | ZS511 |
| 1.3 16V LPG | 4 | B3 | 47/63 | 10/96→ | Z27 [168] | 0.8 | UX56 | |
| 1.3 i | 4 | | 51/68 | 01/90→ | Z11 →05/96 | 0.8 | UXT2 / UXT6 →05/96 | ZS511 |
| 1.4 LX | 4 | G4EE | 71/95 | 03/05→ | Z334 [17] Z73 | 0.9 1.1 | UXT11 | |
| 1.4 LX LPG | 4 | G4EE | 71/95 | 03/05→ | Z206 [168] | 0.7 | UXT10 | |
| 1.6 CVT LX | 4 | G4ED | 82/110 | 03/05→ | Z334 [17] Z73 | 0.9 1.1 | UXT11 | |
| 1.6 CVT LX LPG | 4 | G4ED | 82/110 | 03/05→ | Z206 [168] | 0.7 | UXT10 | |

PRO CEE'D

| | | | | | | | | |
|--------------|---|--------|---------|--------|-----------------|-----|-------|------------------------------|
| 1.4 | 4 | G4FA | 77/103 | 02/08→ | | | | ZS475 [1] |
| 1.4 | 4 | G4FA | 80/107 | 02/08→ | Z158 →12/08 | 1.1 | | ZS474 |
| 1.4 CRDi | 4 | D4FC | 66/89 | 03/13→ | GN062 | 11V | | |
| 1.4 CVT | 4 | G4FA-L | 66/89 | 06/10→ | | | | ZS475 |
| 1.6 | 4 | G4FC | 90/121 | 02/08→ | Z158 →03/09 | 1.1 | | ZS474 →03/09 ZS475 [1] |
| 1.6 | 4 | G4FC | 93/125 | 02/08→ | Z158 →03/09 | 1.1 | | ZS474 →03/09 ZS475 [1] |
| 1.6 CRDi | 4 | D4FB | 81/109 | 03/13→ | GN062 | 11V | | |
| 1.6 CRDi | 4 | D4FB | 94/126 | 03/13→ | GN062 | 11V | | |
| 1.6 CRDi 90 | 4 | D4FB-L | 66/89 | 02/08→ | GN062 11/10→ | 11V | | |
| 1.6 CRDi 115 | 4 | D4FB | 85/114 | 02/08→ | GN062 | 11V | | |
| 1.6 CRDi 128 | 4 | D4FB | 94/126 | 10/10→ | GN062 | 11V | | |
| 1.6 CVT | 4 | G4FC | 92/123 | 10/10→ | | | | ZS475 [1] |
| 2.0 | 4 | G4GC | 105/141 | 02/08→ | Z73 | 1.1 | UXT11 | ZS482 |
| 2.0 LPG | 4 | G4GC | 105/141 | 02/08→ | Z206 [168] | 0.7 | UXT10 | |
| 2.0 CRDi 140 | 4 | D4EA-F | 103/138 | 02/08→ | GN035 | 11V | | |

RETONA

| | | | | | | | | |
|-----------------|---|----------|--------|--------|-------|-----|-------|-------|
| 2.0 16V 4WD | 4 | FE (16V) | 94/126 | 05/00→ | Z16 | 1.1 | UXT11 | ZS434 |
| 2.0 16V 4WD LPG | 4 | FE (16V) | 94/126 | 05/00→ | Z340 | 0.7 | UXT12 | |
| 2.0 TD 4WD | 4 | RF | 61/82 | 06/99→ | GN005 | 11V | | |

RIO

| | | | | | | | | |
|---------|---|-----|-------|-------------|-----------|------|-------------|-------|
| 1.3 | 4 | A3E | 55/74 | 08/00→02/05 | Z9 | 1.15 | UXT2 / UXT6 | |
| 1.3 | 4 | A3E | 60/80 | 08/00→02/05 | Z9 | 1.15 | UXT2 / UXT6 | |
| 1.3 LPG | 4 | A3E | 55/74 | 08/00→02/05 | Z20 [168] | 0.8 | UXT2 / UXT6 | |
| 1.3 LPG | 4 | A3E | 60/80 | 08/00→02/05 | Z20 [168] | 0.8 | UXT2 / UXT6 | |
| 1.5 16V | 4 | A5D | 71/95 | 09/02→02/05 | Z16 | 1.1 | UXT11 | ZS486 |
| 1.5 16V | 4 | A5D | 72/97 | 08/00→02/05 | Z16 | 1.1 | UXT11 | ZS486 |
| 1.5 16V | 4 | A5D | 72/97 | 09/00→02/05 | Z15 [168] | 0.8 | UXT1 / UXT3 | |



kW/BHP

**... KIA****... RIO**

| | | | | | | | | |
|-------------|---|-----|-------|-------------|------|-----|-------|--|
| 1.5 16V LPG | 4 | A5D | 71/95 | 09/02→02/05 | Z340 | 0.7 | UXT12 | |
| 1.5 16V LPG | 4 | A5D | 72/97 | 08/00→02/05 | Z340 | 0.7 | UXT12 | |

RIO II

| | | | | | | | | |
|-------------|---|------|--------|--------|-----------------|-----|-------|--|
| 1.4 16V | 4 | G4EE | 71/95 | 03/05→ | Z73 | 1.1 | UXT11 | ZS481 04/05→12/06 ZS483 04/05→12/06 |
| 1.4 16V LPG | 4 | G4EE | 71/95 | 03/05→ | Z206 [168] | 0.7 | UXT10 | |
| 1.5 CRDi | 4 | D4FA | 65/87 | 06/08→ | GN062 →03/09 | 11V | | |
| 1.5 CRDi | 4 | D4FA | 81/109 | 03/05→ | GN062 →03/09 | 11V | | |
| 1.6 16V | 4 | G4ED | 82/110 | 03/05→ | Z73 | 1.1 | UXT11 | ZS481 04/05→12/06 ZS483 04/05→12/06 |
| 1.6 16V LPG | 4 | G4ED | 82/110 | 03/05→ | Z206 [168] | 0.7 | UXT10 | |
| 1.6 CVT | 4 | G4ED | 82/110 | 03/05→ | Z73 | 1.1 | UXT11 | ZS481 04/05→12/06 ZS483 04/05→12/06 |
| 1.6 CVT LPG | 4 | G4ED | 82/110 | 03/05→ | Z206 [168] | 0.7 | UXT10 | |

RIO III

| | | | | | | | | |
|----------|---|------|--------|--------|-------|-----|--|-----------|
| 1.1 CRDi | 3 | D3FA | 55/74 | 09/11→ | GN062 | 11V | | |
| 1.4 CRDi | 4 | D4FC | 66/89 | 09/11→ | GN062 | 11V | | |
| 1.4 CVT | 4 | G4FA | 79/106 | 09/11→ | | | | ZS475 [1] |
| 1.4 CVT | 4 | G4FA | 80/107 | 09/11→ | | | | ZS475 [1] |

SEPHIA

| | | | | | | | | |
|---------------|---|--------------|--------|-------------|-----------|------|-------------|-------|
| 1.5 i | 4 | B5 | 59/79 | 02/96→10/97 | Z9 | 1.15 | UXT2 / UXT6 | ZS436 |
| 1.5 i LPG | 4 | B5 | 59/79 | 02/96→10/97 | Z20 [168] | 0.8 | UXT2 / UXT6 | |
| 1.6 i | 4 | B6 | 59/79 | 09/93→10/97 | Z9 | 1.15 | UXT2 / UXT6 | |
| 1.6 i LPG | 4 | B6 | 59/79 | 09/93→10/97 | Z20 [168] | 0.8 | UXT2 / UXT6 | |
| 1.8 i 16V | 4 | OK24N, OK26Y | 82/110 | 01/95→10/97 | Z15 | 0.8 | UXT1 / UXT3 | ZS433 |
| 1.8 i 16V LPG | 4 | OK24N, OK26Y | 82/110 | 01/95→10/97 | Z340 | 0.7 | UXT12 | |

SHUMA

| | | | | | | | | |
|---------------|---|-------|--------|-------------|------|-----|-------------|-------|
| 1.5 | 4 | OK280 | 59/79 | 03/96→12/98 | Z16 | 1.1 | UXT11 | ZS436 |
| 1.5 i 16V | 4 | | 65/87 | 10/97→10/01 | Z16 | 1.1 | UXT11 | ZS436 |
| 1.5 i 16V LPG | 4 | | 65/87 | 10/97→10/01 | Z340 | 0.7 | UXT12 | |
| 1.6 | 4 | GA6D | 75/101 | 01/01→12/01 | Z16 | 1.1 | UXT11 | ZS486 |
| 1.8 i 16V | 4 | T8 | 81/109 | 10/97→03/01 | Z15 | 0.8 | UXT1 / UXT3 | ZS433 |
| 1.8 i 16V LPG | 4 | T8 | 81/109 | 10/97→03/01 | Z340 | 0.7 | UXT12 | |

SHUMA II

| | | | | | | | | |
|---------|---|------|--------|-------------|------|-----|-------------|-------|
| 1.6 | 4 | GA6D | 75/101 | 05/01→08/04 | Z16 | 1.1 | UXT11 | ZS486 |
| 1.6 LPG | 4 | GA6D | 75/101 | 05/01→08/04 | Z340 | 0.7 | UXT12 | |
| 1.8 | 4 | T8 | 84/113 | 04/03→08/04 | Z15 | 0.8 | UXT1 / UXT3 | ZS433 |

SORENTO I

| | | | | | | | | |
|----------------|---|------|---------|--------|------------|-----|-------|----------------------------------|
| 2.4 4WD | 4 | G4JS | 102/137 | 08/02→ | Z311 | 1.0 | | ZSE502 [16] |
| 2.5 CRDi 4WD | 4 | D4CB | 103/138 | 08/02→ | GN057 | 11V | | |
| 2.5 CRDi 4WD | 4 | D4CB | 120/161 | 05/06→ | GN057 | 11V | | |
| 2.5 CRDi 4WD | 4 | D4CB | 125/168 | 12/06→ | GN057 | 11V | | |
| 3.5 V6 4WD | 6 | G6CU | 143/192 | 08/02→ | Z228 | 1.0 | UXT11 | ZSE086 [1][65] ZSE087 [1][66] |
| 3.5 V6 4WD LPG | 6 | G6CU | 143/192 | 08/02→ | Z221 [168] | 1.0 | UXT14 | |

SORENTO II

| | | | | | | | | |
|---------|---|------|---------|--------|------|-----|-------|--|
| 2.4 CVT | 4 | G4KE | 128/172 | 11/09→ | Z183 | 0.9 | UXT13 | |
|---------|---|------|---------|--------|------|-----|-------|--|

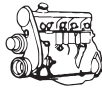

kW/BHP

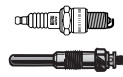
**... KIA****SOUL**

| | | | | | | | |
|--------------|---|------|--------|--------|-------|-----|-----------|
| 1.6 CRDi 115 | 4 | D4FB | 85/114 | 02/09→ | GN062 | 11V | |
| 1.6 CRDi 128 | 4 | D4FB | 94/126 | 02/09→ | GN062 | 11V | |
| 1.6 CVT | 4 | | 77/103 | 02/09→ | | | ZS475 [1] |
| 1.6 CVT | 4 | G4FC | 93/125 | 02/09→ | Z308 | 0.9 | ZS475 |

SOUL II

| | | | | | | | |
|--------------|---|------|--------|--------|-------|-----|--|
| 1.6 CRDi 128 | 4 | D4FB | 94/126 | 02/14→ | GN062 | 11V | |
|--------------|---|------|--------|--------|-------|-----|--|

SPORTAGE

| | | | | | | | | |
|-----------------|---|----------------|---------|-------------|--------------------------------|------------|----------------------|------------------------------------|
| 2.0 | 4 | FE (16V) | 87/117 | 10/00→08/03 | Z16 | 1.1 | UXT11 | ZS434 |
| 2.0 LPG | 4 | FE (16V) | 87/117 | 10/00→08/03 | Z340 | 0.7 | UXT12 | |
| 2.0 16V 4WD | 4 | G4GC | 104/139 | 09/04→ | Z73 | 1.1 | UXT11 | ZS482 →05/07 |
| 2.0 16V 4WD LPG | 4 | G4GC | 104/139 | 09/04→ | Z206 [168] | 0.7 | UXT10 | |
| 2.0 CRDi | 4 | D4EA | 83/111 | 09/04→ | GN035 | 11V | | |
| 2.0 CRDi | 4 | D4EA | 100/134 | 01/06→ | GN035 | 11V | | |
| 2.0 CRDi | 4 | D4EA-F, D4EA-V | 103/138 | 01/06→ | GN035 | 11V | | |
| 2.0 CRDi | 4 | D4EA | 110/148 | 09/08→ | GN035 | 11V | | |
| 2.0 CVT | 4 | G4KD | 120/161 | 07/10→ | Z183 | 0.9 | UXT13 | |
| 2.0 i 4WD | 4 | FE (8V) | 70/94 | 04/94→08/99 | Z15 →05/95 Z16 06/95→ | 0.8 1.1 | UXT1 / UXT3 UXT11 | ZS234 →05/95 |
| 2.0 i 4WD LPG | 4 | FE (8V) | 70/94 | 04/94→08/99 | Z340 | 0.7 | UXT12 | |
| 2.0 i 16V | 4 | FE (16V) | 94/126 | 10/99→08/03 | Z16 | 1.1 | UXT11 | ZS434 |
| 2.0 i 16V 4WD | 4 | FE (16V) | 94/126 | 04/94→08/03 | Z16 | 1.1 | UXT11 | ZS234 →11/98 ZS434 12/98→ |
| 2.0 i 16V | 4 | G4GC | 104/139 | 09/04→ | Z73 | 1.1 | UXT11 | ZS482 →07/07 |
| 2.0 i 16V LPG | 4 | FE (16V) | 94/126 | 04/94→08/03 | Z340 | 0.7 | UXT12 | |
| 2.0 i 16V LPG | 4 | G4GC | 104/139 | 09/04→ | Z206 [168] | 0.7 | UXT10 | |
| 2.0 TD 4WD | 4 | RF | 61/82 | 10/97→08/03 | GN005 →10/98 | 11V | | |
| 2.7 V6 4WD | 6 | G6BA | 129/173 | 09/04→ | Z73 | 1.1 | UXT11 | |
| 2.7 V6 4WD LPG | 6 | G6BA | 129/173 | 09/04→ | Z206 [168] | 0.7 | UXT10 | |

VENGA

| | | | | | | | |
|--------------|---|--------|--------|--------|-------|-----|-----------|
| 1.4 CRDi 75 | 4 | D4FC | 55/74 | 02/10→ | GN062 | 11V | |
| 1.4 CRDi 75 | 4 | D4FC | 57/76 | 02/10→ | GN062 | 11V | |
| 1.4 CRDi 90 | 4 | D4FC | 66/89 | 02/10→ | GN062 | 11V | |
| 1.4 CVT | 4 | G4FA-L | 66/89 | 02/10→ | | | ZS475 [1] |
| 1.6 CRDi 115 | 4 | D4FB | 85/114 | 02/10→ | GN062 | 11V | |
| 1.6 CRDi 128 | 4 | D4FB | 94/126 | 02/10→ | GN062 | 11V | |
| 1.6 CVT | 4 | G4FC | 92/123 | 02/10→ | | | ZS475 [1] |

KIA**BESTA**

| | | | | | | | |
|-------|---|----|-------|--------|-----------------|-----|--|
| 2.2 D | 4 | R2 | 48/64 | 02/96→ | GN005 →07/99 | 11V | |
|-------|---|----|-------|--------|-----------------|-----|--|

K2500

| | | | | | | | |
|-------|---|------|-------|--------|------------------------------------|------------|--|
| 2.5 D | 4 | D4BH | 69/93 | 01/03→ | GN107 →08/03 GN955 09/03→ | 11V 11V | |
|-------|---|------|-------|--------|------------------------------------|------------|--|

K2700

| | | | | | | | |
|-------|---|----|-------|--------|-------|-----|--|
| 2.7 D | 4 | J2 | 59/79 | 10/99→ | GN005 | 11V | |
|-------|---|----|-------|--------|-------|-----|--|

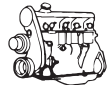

kW/BHP

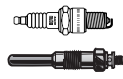
**... KIA****PREGIO**

| | | | | | | | | |
|----------|---|------|-------|-------------|-----------------|-----|--|--|
| 2.5 D | 4 | D4BH | 69/93 | 08/95→09/04 | GN107 →11/03 | 11V | | |
| 2.5 TG D | 4 | D4BH | 69/93 | 09/02→ | GV921 | 11V | | |
| 2.7 D | 4 | J2 | 60/80 | 10/97→ | GN005 | 11V | | |

LADA**110**

| | | | | | | | | | |
|-------------|---|-----------|---------|--------|---------------------------------------|------------|----------------------|-----------------|--|
| 1.5 | 4 | BA3 2111 | 54/72 | 01/95→ | Z20 | 0.8 | UXT2 / UXT6 | ZS120 | |
| 1.5 | 4 | VAZ-2111 | 56/75 | 10/00→ | Z20 | 0.8 | UXT2 / UXT6 | | |
| 1.5 | 4 | VAZ-2111 | 57/76 | 01/95→ | Z20 | 0.8 | UXT2 / UXT6 | ZS120 →12/00 | |
| 1.5 LPG | 4 | BA3 2111 | 54/72 | 01/95→ | Z27 [168] | 0.8 | UX56 | | |
| 1.5 LPG | 4 | VAZ-2111 | 56/75 | 10/00→ | Z27 [168] | 0.8 | UX56 | | |
| 1.5 LPG | 4 | VAZ-2111 | 57/76 | 01/95→ | Z27 [168] | 0.8 | UX56 | | |
| 1.5 16V | 4 | | 67/90 | 10/00→ | Z16 | 1.1 | UXT11 | | |
| 1.5 16V | 4 | VAZ-2112 | 70/94 | 01/95→ | Z20 →09/00 Z16 10/00→ | 0.8 1.1 | UXT2 / UXT6 UXT11 | ZS120 | |
| 1.5 16V LPG | 4 | | 67/90 | 10/00→ | Z340 | 0.7 | UXT12 | | |
| 1.5 16V LPG | 4 | VAZ-2112 | 70/94 | 01/95→ | Z27 [168] →09/00 Z340 10/00→ | 0.8 0.7 | UX56 UXT12 | | |
| 1.6 | 4 | VAZ-21114 | 60/80 | 01/00→ | Z20 | 0.8 | UXT2 / UXT6 | ZS395 01/05→ | |
| 1.6 | 4 | VAZ-21124 | 66/89 | 01/00→ | Z20 | 0.8 | UXT2 / UXT6 | | |
| 1.6 LPG | 4 | VAZ-21114 | 60/80 | 01/00→ | Z27 [168] | 0.8 | UX56 | | |
| 1.6 LPG | 4 | VAZ-21124 | 66/89 | 01/00→ | Z27 [168] | 0.8 | UX56 | | |
| 2.0 i | 4 | C 20 XE | 110/148 | 08/96→ | Z16 | 1.1 | UXT11 | | |
| 2.0 i LPG | 4 | C 20 XE | 110/148 | 08/96→ | Z340 | 0.7 | UXT12 | | |
| 111 | | | | | | | | | |
| 1.5 | 4 | VAZ-2111 | 56/75 | 10/00→ | Z20 | 0.8 | UXT2 / UXT6 | ZS120 | |
| 1.5 | 4 | VAZ-2111 | 57/76 | 01/96→ | Z20 | 0.8 | UXT2 / UXT6 | ZS120 | |
| 1.5 LPG | 4 | VAZ-2111 | 56/75 | 10/00→ | Z27 [168] | 0.8 | UX56 | | |
| 1.5 LPG | 4 | VAZ-2111 | 57/76 | 01/96→ | Z27 [168] | 0.8 | UX56 | | |
| 1.5 16V | 4 | VAZ-2112 | 67/90 | 10/00→ | Z16 | 1.1 | UXT11 | | |
| 1.5 16V | 4 | VAZ-2112 | 70/94 | 01/95→ | Z20 →09/00 Z16 10/00→ | 0.8 1.1 | UXT2 / UXT6 UXT11 | ZS120 | |
| 1.5 16V LPG | 4 | VAZ-2112 | 67/90 | 10/00→ | Z340 | 0.7 | UXT12 | | |
| 1.5 16V LPG | 4 | VAZ-2112 | 70/94 | 01/95→ | Z27 [168] →09/00 Z340 10/00→ | 0.8 0.7 | UX56 UXT12 | | |
| 1.6 | 4 | | 60/80 | 01/05→ | Z16 | 1.1 | UXT11 | ZS395 | |
| 1.6 | 4 | VAZ-21124 | 66/89 | 03/06→ | Z16 | 1.1 | UXT11 | ZS395 | |
| 1.6 LPG | 4 | | 60/80 | 01/05→ | Z340 | 0.7 | UXT12 | | |
| 1.6 LPG | 4 | VAZ-21124 | 66/89 | 03/06→ | Z340 | 0.7 | UXT12 | | |
| 112 | | | | | | | | | |
| 1.5 | 4 | | 54/72 | 01/95→ | Z20 | 0.8 | UXT2 / UXT6 | ZS120 | |
| 1.5 | 4 | VAZ-2111 | 56/75 | 10/00→ | Z20 | 0.8 | UXT2 / UXT6 | | |
| 1.5 | 4 | VAZ-2111 | 57/76 | 01/95→ | Z20 | 0.8 | UXT2 / UXT6 | ZS120 | |
| 1.5 LPG | 4 | | 54/72 | 01/95→ | Z27 [168] | 0.8 | UX56 | | |
| 1.5 LPG | 4 | VAZ-2111 | 56/75 | 10/00→ | Z27 [168] | 0.8 | UX56 | | |
| 1.5 LPG | 4 | VAZ-2111 | 57/76 | 01/95→ | Z27 [168] | 0.8 | UX56 | | |
| 1.5 16V | 4 | VAZ-2112 | 67/90 | 10/00→ | Z16 | 1.1 | UXT11 | | |

LADA



kW/BHP

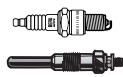

... LADA



... 112

| | | | | | | | | |
|---------------------|---|-----------|-------|-------------|---------------------------------------|------------|----------------------|-------------------------------------|
| 1.5 16V | 4 | VAZ-2112 | 70/94 | 01/95→ | Z20 →09/00 Z16 10/00→ | 0.8 1.1 | UXT2 / UXT6 UXT11 | ZS120 |
| 1.5 16V LPG | 4 | VAZ-2112 | 67/90 | 10/00→ | Z340 | 0.7 | UXT12 | |
| 1.5 16V LPG | 4 | VAZ-2112 | 70/94 | 01/95→ | Z27 [168] →09/00 Z340 10/00→ | 0.8 0.7 | UX56 UXT12 | |
| 1.6 | 4 | | 60/80 | 01/05→ | Z16 | 1.1 | UXT11 | |
| 1.6 | 4 | VAZ-21124 | 66/89 | 03/06→ | Z16 | 1.1 | UXT11 | |
| 1.6 LPG | 4 | | 60/80 | 01/05→ | Z340 | 0.7 | UXT12 | |
| 1.6 LPG | 4 | VAZ-21124 | 66/89 | 03/06→ | Z340 | 0.7 | UXT12 | |
| 1200-1500 | | | | | | | | |
| 1.2 1200 | 4 | BA3 2101 | 44/59 | 09/73→08/84 | Z11 [167] | 0.8 | UXT2 / UXT6 | ZS106 [1][11][254] ZS115 [1][11] |
| 1.4 1500 | 4 | BA3 2103 | 54/72 | 09/73→06/85 | Z11 [167] | 0.8 | UXT2 / UXT6 | ZS106 [1][11][254] ZS115 [1][11] |
| 1200-1600 | | | | | | | | |
| 1.2 1200 L/S | 4 | BA3 2101 | 44/59 | 01/70→06/86 | Z11 [167] | 0.8 | UXT2 / UXT6 | ZS106 [1][11][254] ZS115 [1][11] |
| 1.3 1300 | 4 | BA3 21011 | 48/64 | 05/78→01/87 | Z11 [167] | 0.8 | UXT2 / UXT6 | ZS106 [11] →08/84 |
| 1.3 1300 | 4 | BA3 2105 | 51/68 | 08/74→08/84 | Z11 [168] | 0.8 | UXT2 / UXT6 | ZS106 [1][11][254] ZS115 [1][11] |
| 1.4 1500 | 4 | BA3 2103 | 55/74 | 09/72→08/84 | Z11 [167] | 0.8 | UXT2 / UXT6 | ZS106 [1][11][254] ZS115 [1][11] |
| 1.4 1500 N/S | 4 | BA3 2103 | 55/74 | 11/75→10/86 | Z11 [167] | 0.8 | UXT2 / UXT6 | ZS106 [11] →08/84 |
| 1.6 1600 | 4 | | 56/75 | 01/84→01/90 | | | | ZS106 [11] |
| 1.6 1600 | 4 | BA3 2106 | 58/78 | 09/72→08/84 | Z11 [167] | 0.8 | UXT2 / UXT6 | ZS106 [11] |
| 1.6 1600 N/L | 4 | BA3 2106 | 57/76 | 03/79→10/86 | Z11 [167] | 0.8 | UXT2 / UXT6 | ZS106 [11] |
| GRANTA | | | | | | | | |
| 1.6 | 4 | | 60/80 | 10/11→ | Z16 | 1.1 | UXT11 | |
| 1.6 | 4 | | 64/86 | 10/11→ | Z16 | 1.1 | UXT11 | |
| 1.6 | 4 | VAZ-21126 | 72/97 | 10/11→ | Z16 | 1.1 | UXT11 | |
| KALINA | | | | | | | | |
| 1.4 16V | 4 | VAZ-11194 | 66/89 | 11/08→ | Z16 [171] | 1.1 | UXT11 | |
| 1.4 16V LPG | 4 | VAZ-11194 | 66/89 | 11/08→ | Z340 | 0.7 | UXT12 | |
| 1.6 | 4 | VAZ-21114 | 60/80 | 10/04→ | Z20 | 0.8 | UXT2 / UXT6 | ZS395 |
| 1.6 | 4 | VAZ-21124 | 60/80 | 10/04→ | Z16 [171] | 1.1 | UXT11 | ZS395 |
| 1.6 | 4 | | 62/83 | 01/10→ | Z16 | 1.1 | UXT11 | |
| 1.6 LPG | 4 | VAZ-21114 | 60/80 | 10/04→ | Z27 [168] | 0.8 | UX56 | |
| 1.6 LPG | 4 | VAZ-21124 | 60/80 | 10/04→ | Z340 | 0.7 | UXT12 | |
| 1.6 16V | 4 | | 66/89 | 10/04→ | Z16 | 1.1 | UXT11 | ZS395 |
| NIVA | | | | | | | | |
| 1.6 1600 4WD | 4 | BA3 2121 | 54/72 | 01/87→03/95 | Z20 | 0.8 | UXT2 / UXT6 | ZS106 [1][11][254] ZS115 [1][11] |
| 1.6 1600 4WD | 4 | BA3 2121 | 56/75 | 12/76→12/87 | Z11 [168] | 0.8 | UXT2 / UXT6 | ZS106 [1][11][254] ZS115 [1][11] |
| 1.6 1600 4WD LPG | 4 | BA3 2121 | 54/72 | 01/87→03/95 | Z27 [168] | 0.8 | UX56 | |
| 1.7 1700 i 4WD | 4 | BA3 21214 | 59/79 | 06/96→ | Z20 | 0.8 | UXT2 / UXT6 | ZS395 |
| 1.7 1700 i 4WD | 4 | | 60/80 | 10/00→ | Z20 | 0.8 | UXT2 / UXT6 | ZS395 |
| 1.7 1700 i 4WD | 4 | | 61/82 | 09/10→ | | | | ZS395 |
| 1.7 1700 i 4WD LPG | 4 | BA3 21214 | 59/79 | 06/96→ | Z27 [168] | 0.8 | UX56 | |
| 1.7 1700 i 4WD LPG | 4 | | 60/80 | 10/00→ | Z27 [168] | 0.8 | UX56 | |
| 1.9 1900 Diesel 4WD | 4 | XUD9A | 47/63 | 01/93→ | GN909 [2][222] GV636 | 11V 11V | | |

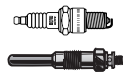

kW/BHP

**... LADA****... NIVA**

| | | | | | | | | | |
|---------------------|---|--------|-------|--------|--------------|--|-----|--|--|
| 1.9 1900 Diesel 4WD | 4 | XUD9SD | 55/74 | 01/99→ | GN013 | | 11V | | |
|---------------------|---|--------|-------|--------|--------------|--|-----|--|--|

NIVA II

| | | | | | | | | | |
|-------------|---|--|-------|--------|--|--|--|--|--------------|
| 1.7 4WD | 4 | | 59/79 | 09/02→ | | | | | ZS395 |
| 1.7 4WD | 4 | | 61/82 | 08/04→ | | | | | ZS395 |
| | | | | | | | | | 06/07→ |
| 1.7 LPG 4WD | 4 | | 57/76 | 09/02→ | | | | | ZS395 |

NOVA

| | | | | | | | | | |
|------------------------|---|-----------------|-------|-------------|---|--|--|---|---|
| 1.2 1200 Junior/L | 4 | BA3 2101 | 44/59 | 09/81→ | Z11 ^[168] →06/88 Z20 07/88→ | | 0.8 UXT2 / UXT6 →06/88 0.8 UXT2 / UXT6 07/88→ | ZS106 ^{[1][11][254]} ZS115 ^{[1][11]} | |
| 1.3 1300 | 4 | BA3 2105 | 48/64 | 09/85→12/90 | Z11 ^[168] →06/88 Z20 07/88→ | | 0.8 UXT2 / UXT6 →06/88 0.8 UXT2 / UXT6 07/88→ | ZS106 ^{[1][11][254]} ZS115 ^{[1][11]} | |
| 1.3 1300 Spezial/L | 4 | BA3 2105 | 48/64 | 05/81→ | Z11 ^[168] →06/88 Z20 07/88→ | | 0.8 UXT2 / UXT6 →06/88 0.8 UXT2 / UXT6 07/88→ | ZS106 ^{[1][11][254]} ZS115 ^{[1][11]} | |
| 1.4 1500 | 4 | BA3 2103 | 55/74 | 09/85→02/93 | Z11 ^[168] →06/88 Z20 07/88→ | | 0.8 UXT2 / UXT6 →06/88 0.8 UXT2 / UXT6 07/88→ | ZS106 ^{[1][11][254]} ZS115 ^{[1][11]} | |
| 1.4 1500 Special | 4 | BA3 2103 | 55/74 | 03/85→ | Z11 ^[168] →06/88 Z20 07/88→ | | 0.8 UXT2 / UXT6 →06/88 0.8 UXT2 / UXT6 07/88→ | ZS106 ^{[1][11][254]} ZS115 ^{[1][11]} | |
| 1.5 1500 | 4 | BA3 2103 (KAT) | 49/66 | 05/93→ | Z11 ^[168] | | 0.8 UXT2 / UXT6 | ZS106 ^{[1][11][254]} ZS115 ^{[1][11]} | |
| 1.5 1500 | 4 | BA3 2103 | 55/74 | 10/86→04/98 | Z11 ^[168] →06/88 Z20 07/88→ | | 0.8 UXT2 / UXT6 →06/88 0.8 UXT2 / UXT6 07/88→ | ZS106 ^{[1][11][254]} ZS115 ^{[1][11]} | |
| 1.5 1500 S | 4 | BA3 21083 | 52/70 | 06/89→ | Z11 ^[168] | | 0.8 UXT2 / UXT6 | ZS106 ^[11] | |
| 1.6 1600 | 4 | BA3 2106 | 56/75 | 01/88→10/01 | Z11 ^[168] →06/88 Z20 07/88→ | | 0.8 UXT2 / UXT6 →06/88 0.8 UXT2 / UXT6 07/88→ | ZS106 ^{[1][11][254]} ZS120 ^{[1][214][254]} | |
| 1.7 1700 | 4 | | 62/83 | 08/94→ | Z11 ^[168] | | 0.8 UXT2 / UXT6 | ZS234 | |
| 1.7 1700 i Classic | 4 | | 62/83 | 06/96→ | Z20 | | 0.8 UXT2 / UXT6 | ZS234 | |
| 1.7 1700 i Classic LPG | 4 | | 62/83 | 06/96→ | Z27 ^[168] | | 0.8 UX56 | | |
| OKA | | | | | | | | | |
| 0.8 | 2 | | 26/35 | 02/88→ | Z16 | | 1.1 UXT11 | | |
| PRIORA | | | | | | | | | |
| 1.6 | 4 | | 60/80 | 12/08→ | Z21 | | 1.1 UXT2 / UXT6 | ZS395 | |
| 1.6 | 4 | VAZ-21126 | 72/97 | 12/08→ | Z16 | | 1.1 UXT11 | | |
| 1.6 LPG | 4 | VAZ-21126 | 72/97 | 12/08→ | Z340 | | 0.7 UXT12 | | |
| SAMARA | | | | | | | | | |
| 1.1 1100 | 4 | BA3 21081 | 39/52 | 02/88→12/94 | Z20 | | 0.8 UXT2 / UXT6 | ZS120 | ZM010 ^[212] ZM039 |
| 1.1 1100 | 4 | BA3 21081 (KAT) | 43/58 | 02/96→ | Z11 ^[168] | | 0.8 UXT2 / UXT6 | ZS120 | ZM010 ^[212] ZM039 |
| 1.3 1300 | 4 | BA3 2108 (KAT) | 45/60 | 09/91→ | Z20 | | 0.8 UXT2 / UXT6 | ZS115 ^[11] | ZM010 ^[212] ZM039 |
| 1.3 1300 | 4 | BA3 2108 | 46/62 | 01/88→ | Z11 ^[168] →06/88 Z20 07/88→ | | 0.8 UXT2 / UXT6 →06/88 0.8 UXT2 / UXT6 07/88→ | ZS120 | ZM010 ^[212] ZM039 |

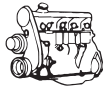

kw/BHP

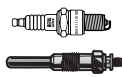

... LADA



... SAMARA

| | | | | | | | | | |
|--------------|---|-----------------|-------|-------------|--------------------------------------|-----|-------------|------------|----------------------|
| 1.3 1300 | 4 | BA3 2108 | 48/64 | 01/86→12/94 | Z11 [168] →06/88 Z20 07/88→ | 0.8 | UXT2 / UXT6 | ZS120 | ZM010 [212] ZM039 |
| 1.3 1300 | 4 | BA3 21115 | 50/67 | 02/96→ | Z20 | 0.8 | UXT2 / UXT6 | ZS115 [11] | |
| 1.3 1300 LPG | 4 | BA3 2108 (KAT) | 45/60 | 09/91→ | Z27 [168] | 0.8 | UX56 | | |
| 1.3 1300 LPG | 4 | BA3 2108 | 46/62 | 01/88→ | Z27 [168] 07/88→ | 0.8 | UX56 | | |
| 1.3 1300 LPG | 4 | BA3 21115 | 50/67 | 02/96→ | Z27 [168] | 0.8 | UX56 | | |
| 1.5 | 4 | VAZ-2111 | 57/76 | 04/96→ | Z20 | 0.8 | UXT2 / UXT6 | | |
| 1.5 LPG | 4 | VAZ-2111 | 57/76 | 04/96→ | Z27 [168] | 0.8 | UX56 | | |
| 1.5 1500 | 4 | BA3 21083 (KAT) | 50/67 | 09/91→ | Z20 | 0.8 | UXT2 / UXT6 | ZS115 [11] | ZM039 |
| 1.5 1500 | 4 | BA3 2111 | 52/70 | 02/95→ | Z20 | 0.8 | UXT2 / UXT6 | ZS120 | ZM039 |
| 1.5 1500 | 4 | BA3 21083 | 53/71 | 01/88→ | Z20 | 0.8 | UXT2 / UXT6 | ZS120 | ZM010 [212] ZM039 |
| 1.5 1500 LPG | 4 | BA3 21083 (KAT) | 50/67 | 09/91→ | Z27 [168] | 0.8 | UX56 | | |
| 1.5 1500 LPG | 4 | BA3 2111 | 52/70 | 02/95→ | Z27 [168] | 0.8 | UX56 | | |
| 1.5 1500 LPG | 4 | BA3 21083 | 53/71 | 01/88→ | Z27 [168] | 0.8 | UX56 | | |

SAMARA FORMA

| | | | | | | | | | |
|--------------|---|-----------------|-------|-------------|-----------|-----|-------------|----------------------|-------|
| 1.1 1100 | 4 | BA3 21081 (KAT) | 39/52 | 07/91→ | Z11 [168] | 0.8 | UXT2 / UXT6 | ZS115 [11] →12/00 | ZM039 |
| 1.3 1300 | 4 | BA3 2108 | 45/60 | 07/91→ | Z11 [168] | 0.8 | UXT2 / UXT6 | ZS115 [1][11] | ZM039 |
| 1.3 1300 | 4 | BA3 2108 | 46/62 | 05/90→ | Z11 [168] | 0.8 | UXT2 / UXT6 | ZS115 [1][11] | ZM039 |
| 1.3 1300 | 4 | BA3 2108 | 48/64 | 05/89→07/97 | Z20 | 0.8 | UXT2 / UXT6 | ZS115 [11] | ZM039 |
| 1.3 1300 | 4 | BA3 21115 | 50/67 | 02/96→ | Z11 [168] | 0.8 | UXT2 / UXT6 | ZS115 [1][11] | |
| 1.3 1300 LPG | 4 | BA3 2108 | 48/64 | 05/89→07/97 | Z27 [168] | 0.8 | UX56 | | |
| 1.5 | 4 | VAZ-2111 | 59/79 | 08/03→ | Z20 | 0.8 | UXT2 / UXT6 | | |
| 1.5 LPG | 4 | VAZ-2111 | 59/79 | 08/03→ | Z27 [168] | 0.8 | UX56 | | |
| 1.5 1500 | 4 | BA3 21083 (KAT) | 50/67 | 07/91→ | Z20 | 0.8 | UXT2 / UXT6 | | ZM039 |
| 1.5 1500 | 4 | BA3 2111 | 52/70 | 11/94→ | Z20 | 0.8 | UXT2 / UXT6 | ZS120 →12/00 | ZM039 |
| 1.5 1500 | 4 | BA3 21083 | 53/71 | 09/91→ | Z20 | 0.8 | UXT2 / UXT6 | ZS115 [11] | ZM039 |
| 1.5 1500 LPG | 4 | BA3 21083 (KAT) | 50/67 | 07/91→ | Z27 [168] | 0.8 | UX56 | | |
| 1.5 1500 LPG | 4 | BA3 2111 | 52/70 | 11/94→ | Z27 [168] | 0.8 | UX56 | | |
| 1.5 1500 LPG | 4 | BA3 21083 | 53/71 | 09/91→ | Z27 [168] | 0.8 | UX56 | | |

TOSCANA

| | | | | | | | | | |
|--------------|---|----------|-------|-------------|-----------|-----|-------------|-------------------------------------|--|
| 1.3 1300 | 4 | BA3 2105 | 48/64 | 12/85→05/12 | Z20 | 0.8 | UXT2 / UXT6 | ZS106 [11] | |
| 1.3 1300 LPG | 4 | BA3 2105 | 48/64 | 12/85→05/12 | Z27 [168] | 0.8 | UX56 | | |
| 1.4 1500 | 4 | BA3 2103 | 55/74 | 09/83→02/93 | Z20 | 0.8 | UXT2 / UXT6 | ZS106 [1][11][254] ZS115 [1][11] | |

LANCIA



A 112

| | | | | | | | | | |
|-------------|---|---|-------|-------------|-----------|-----|-------------|------------|-------|
| 0.9 Junior | 4 | A112 A.000, A112 A5.000, A112 B2.000 | 29/39 | 03/81→06/86 | Z20 | 0.8 | UXT2 / UXT6 | ZS106 [11] | |
| 1.0 Abarath | 4 | A112 A2.000 | 51/68 | 03/78→02/84 | Z27 [170] | 0.8 | UX56 | | ZM005 |
| 1.0 LX | 4 | A112 B1.000 | 35/47 | 03/84→12/86 | Z20 | 0.8 | UXT2 / UXT6 | ZS106 [11] | ZM005 |

BETA

| | | | | | | | | | |
|---------------|---|------------|--------|-------------|-----------|-----|-------------|------------|--|
| 1.3 1300 | 4 | | 61/82 | 04/76→07/82 | | | | ZS106 [11] | |
| 1.4 1300 | 4 | 828 D3.000 | 62/83 | 12/81→12/84 | Z22 | 0.7 | UX56 | | |
| 1.4 1400 | 4 | 828 A2.000 | 66/89 | 08/73→07/76 | Z27 | 0.8 | UX56 | | |
| 1.6 1600 | 4 | 828 B.000 | 74/99 | 08/73→12/84 | Z22 | 0.7 | UX56 | | |
| 1.8 1800 | 4 | 828 A1.000 | 81/109 | 08/73→07/76 | Z20 | 0.8 | UXT2 / UXT6 | | |
| 2.0 2000 | 4 | 828 B1.000 | 85/114 | 04/79→10/86 | Z22 [167] | 0.7 | UX56 | | |
| 2.0 2000 | 4 | 828 B1.000 | 85/114 | 01/81→12/84 | Z22 | 0.7 | UX56 | | |
| 2.0 2000 | 4 | 828 B1.000 | 88/118 | 04/76→07/78 | Z27 | 0.8 | UX56 | | |
| 2.0 2000 | 4 | 828 B1.000 | 88/118 | 04/76→12/84 | Z22 | 0.7 | UX56 | | |
| 2.0 2000 i.e. | 4 | | 90/121 | 12/81→12/84 | Z11 | 0.8 | UXT2 / UXT6 | | |

LADA

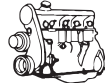

kW/BHP

**... LANCIA****... BETA**

| | | | | | | | | | |
|-------------|---|------------|--------|-------------|-----|-----|------|--|--|
| 2.0 2000 VX | 4 | 828 B7.000 | 99/133 | 07/83→12/84 | Z22 | 0.7 | UX56 | | |
|-------------|---|------------|--------|-------------|-----|-----|------|--|--|

BETA H.P.E.

| | | | | | | | | | |
|------------------|---|------------|--------|-------------|-----------|-----|-------------|--|--|
| 2.0 2000 | 4 | 828 B1.000 | 85/114 | 04/79→09/84 | Z22 | 0.7 | UX56 | | |
| 2.0 2000 | 4 | 828 B1.000 | 88/118 | 05/76→05/78 | Z22 | 0.7 | UX56 | | |
| 2.0 2000 i.e. | 4 | 828 B4.000 | 90/121 | 05/81→09/84 | Z11 [168] | 0.8 | UXT2 / UXT6 | | |
| 2.0 2000 Volumex | 4 | | 99/133 | 07/83→09/84 | Z22 | 0.7 | UX56 | | |

BETA MONTE CARLO

| | | | | | | | | | |
|-----|---|------------|--------|-------------|-----|-----|------|--|--|
| 2.0 | 4 | 134 A5.000 | 88/118 | 09/75→05/81 | Z47 | 0.8 | UX56 | | |
|-----|---|------------|--------|-------------|-----|-----|------|--|--|

DEDRA

| | | | | | | | | | |
|-------------|---|------------|--------|-------------|-----------|-----|-------------|-----------------|--|
| 1.6 | 4 | 159 B9.000 | 66/89 | 10/94→07/99 | Z252 | 0.9 | UXT5 | | |
| 1.6 LPG | 4 | 159 B9.000 | 66/89 | 10/94→07/99 | Z30 [168] | 0.8 | UXT5 | | |
| 1.6 16V | 4 | 182 A4.000 | 76/102 | 01/96→07/99 | Z98 | 0.8 | UXT1 / UXT3 | | |
| 1.6 16V LPG | 4 | 182 A4.000 | 76/102 | 01/96→07/99 | Z116 | 0.8 | UXT5 | | |
| 1.6 i.e. | 4 | 835 C1.000 | 55/74 | 04/93→07/99 | Z252 | 0.9 | UXT5 | ZS234 →10/94 | |

| | | | | | | | | | |
|----------------|---|------------|--------|-------------|----------------|-----|-------------|-------|--|
| 1.6 i.e. | 4 | 835 A1.046 | 57/76 | 08/89→03/93 | Z27 [170] | 0.8 | UX56 | | |
| 1.6 i.e. LPG | 4 | 835 C1.000 | 55/74 | 04/93→07/99 | Z30 [168] | 0.8 | UXT5 | | |
| 1.6 LE | 4 | 159 B9.000 | 66/89 | 07/94→07/99 | Z252 | 0.9 | UXT5 | ZS234 | |
| 1.6 LE LPG | 4 | 159 B9.000 | 66/89 | 07/94→07/99 | Z30 [168] | 0.8 | UXT5 | | |
| 1.8 16V LE | 4 | 182 A2.000 | 83/111 | 03/96→07/99 | Z98 | 0.8 | UXT1 / UXT3 | | |
| 1.8 16V LE LPG | 4 | 182 A2.000 | 83/111 | 03/96→07/99 | Z116 | 0.8 | UXT5 | | |
| 1.8 GT 16V | 4 | 183 A1.000 | 96/129 | 03/96→07/99 | Z98 | 0.8 | UXT1 / UXT3 | | |
| 1.8 GT 16V LPG | 4 | 183 A1.000 | 96/129 | 03/96→07/99 | Z116 | 0.8 | UXT5 | | |
| 1.8 i.e. | 4 | 835 C5.000 | 66/89 | 08/93→07/99 | Z30 | 0.8 | UXT5 | | |
| 1.8 i.e. | 4 | 836 A5.000 | 74/99 | 07/94→07/99 | Z27 [168][170] | 0.8 | UX56 | ZS283 | |
| 1.8 i.e. | 4 | 835 A2.046 | 77/103 | 09/89→07/99 | Z27 [170] | 0.8 | UX56 | ZS283 | |
| 1.8 i.e. | 4 | 835 A2.000 | 80/107 | 09/89→06/94 | | | | ZS283 | |
| 1.8 i.e. LPG | 4 | 836 A5.000 | 74/99 | 07/94→07/99 | Z47 [168] | 0.8 | UX56 | | |
| 1.8 i.e. LPG | 4 | 835 A2.046 | 77/103 | 09/89→07/99 | Z47 [168] | 0.8 | UX56 | | |

| | | | | | | | | | |
|---------|---|------------------------------------|-------|-------------|--|-----|--|--|--|
| 1.9 TDS | 4 | 160 D1.000, 835 A4.000, 835 A4.046 | 66/89 | 04/89→07/99 | GN909 [222] →09/94 GV663 →09/94 GN013 [222] 10/94→ GN908 10/94→ | 11V | | | |
|---------|---|------------------------------------|-------|-------------|--|-----|--|--|--|

| | | | | | | | | | |
|-------------|---|------------|---------|-------------|-----------|-----|------|-------------------------------------|--|
| 2.0 4WD | 4 | 836 A3.000 | 102/137 | 07/94→07/99 | Z27 [170] | 0.8 | UX56 | | |
| 2.0 4WD LPG | 4 | 836 A3.000 | 102/137 | 07/94→07/99 | Z47 [168] | 0.8 | UX56 | | |
| 2.0 16V | 4 | 836 A3.000 | 102/137 | 07/94→07/99 | Z27 [170] | 0.8 | UX56 | | |
| 2.0 16V LPG | 4 | 836 A3.000 | 102/137 | 07/94→07/99 | Z47 [168] | 0.8 | UX56 | | |
| 2.0 HF 4WD | 4 | 835 A7.046 | 124/166 | 11/90→07/94 | | | | ZS106 [1][11][254] ZS115 [1][11] | |

| | | | | | | | | | |
|--------------------|---|------------|---------|-------------|---------------------|-----|----------------|--|--|
| 2.0 i.e. | 4 | 835 A5.046 | 83/111 | 09/89→07/99 | Z27 | 0.8 | UX56 | | |
| 2.0 i.e. LPG | 4 | 835 A5.046 | 83/111 | 09/89→07/99 | Z47 [168] | 0.8 | UX56 | | |
| 2.0 i.e. Turbo 4WD | 4 | 835 A7.000 | 121/162 | 05/90→07/94 | Z27 [170] →07/92 | 0.8 | UX56 →07/92 | | |
| 2.0 Turbo | 4 | 835 A8.000 | 130/174 | 11/90→06/94 | Z27 [170] →07/92 | 0.8 | UX56 →07/92 | | |

DELTA I

| | | | | | | | | | |
|--------|---|------------------------|--------|-------------|-----------|-----|------|---|-------|
| 1.3 | 4 | 831 A2.000, 831 B.000 | 55/74 | 09/79→08/92 | Z27 [168] | 0.8 | UX56 | ZS248 →eng. 6651557 | ZM009 |
| 1.3 | 4 | 831 A2.000 | 58/78 | 09/83→08/92 | Z27 [168] | 0.8 | UX56 | | |
| 1.5 | 4 | 831 A1.000, 831 B1.000 | 63/84 | 09/79→12/92 | Z27 [168] | 0.8 | UX56 | ZS106 [1][11][254] ZS115 [1][11] →04/86 | ZM005 |
| 1.6 GT | 4 | 831 A4.000 | 77/103 | 11/82→04/86 | Z27 [168] | 0.8 | UX56 | ZS106 [1][11][254] ZS115 [1][11] | |

LANCIA

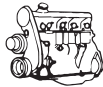

kW/BHP

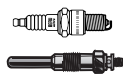

... LANCIA



... DELTA I

| | | | | | | | | |
|--------------------|---|------------------------|---------|-------------|-------------------------|------------|------|-------------------------------------|
| 1.6 GT i.e. | 4 | 149 C2.000 | 66/89 | 05/87→08/92 | Z27 [168] | 0.8 | UX56 | ZS106 [1][11][254] ZS115 [1][11] |
| 1.6 GT i.e. | 4 | 831 B7.000 | 80/107 | 08/86→08/88 | Z27 [168] | 0.8 | UX56 | |
| 1.6 HF Turbo | 4 | 831 A7.000 | 96/129 | 10/83→12/86 | | | | ZM061 05/86→ |
| 1.6 HF Turbo | 4 | 831 B7.046 | 97/130 | 04/87→03/89 | | | | ZS106 [1][11][254] ZS115 [1][11] |
| 1.6 HF Turbo | 4 | 831 B3.000 | 103/138 | 08/86→08/88 | | | | ZM061 |
| 1.9 Turbo DS | 4 | 831 D1.000 | 59/79 | 10/86→12/89 | GN909 [2][222] GV663 | 11V 11V | | |
| 2.0 16V HF 4WD | 4 | 831 D5.000 | 144/193 | 03/89→09/91 | | | | ZS283 |
| 2.0 16V HF Evo 4WD | 4 | 831 E5.000, 831 E5.046 | 155/208 | 06/93→01/94 | | | | ZS283 |
| 2.0 HF 4WD | 4 | 831 B5.000 | 122/164 | 11/86→08/88 | | | | ZM061 |

DELTA II

| | | | | | | | | |
|---------------------|---|---------------------------------------|---------|-------------|-------------------------|------------|-----------------------|-------|
| 1.4 i.e. | 4 | 160 A1.046 | 51/68 | 10/94→08/99 | Z27 [168] | 0.8 | UX56 | |
| 1.4 i.e. | 4 | 836 A4.000 | 51/68 | 10/94→08/99 | Z27 [168] | 0.8 | UX56 | ZS234 |
| 1.4 i.e. LPG | 4 | 160 A1.046, 836 A4.000 | 51/68 | 10/94→08/99 | Z47 [168] | 0.8 | UX56 | |
| 1.6 i.e. | 4 | 835 C1.000 | 55/74 | 06/93→08/99 | Z252 | 0.9 | UXT5 | ZS234 |
| 1.6 i.e. | 4 | 182 A6.000 | 66/89 | 03/96→08/99 | Z98 | 0.8 | UXT1 / UXT3 | ZS029 |
| 1.6 i.e. LPG | 4 | 835 C1.000 | 55/74 | 06/93→08/99 | Z30 [168] | 0.8 | UXT5 | |
| 1.6 i.e. LPG | 4 | 182 A6.000 | 66/89 | 03/96→08/99 | Z116 | 0.8 | UXT5 | |
| 1.6 i.e. 16V | 4 | 182 A4.000 | 76/102 | 01/96→08/99 | Z98 | 0.8 | UXT1 / UXT3 | ZS029 |
| 1.6 i.e. 16V LPG | 4 | 182 A4.000 | 76/102 | 01/96→08/99 | Z116 | 0.8 | UXT5 | |
| 1.8 i.e. | 4 | 835 C4.000, 836 A6.000, 836 C4.000 | 66/89 | 07/94→08/99 | Z27 [170] | 0.8 | UX56 | ZS283 |
| 1.8 i.e. | 4 | 835 C2.000 | 76/102 | 06/93→08/99 | Z27 [170] | 0.8 | UX56 | ZS283 |
| 1.8 i.e. LPG | 4 | 835 C4.000, 836 A6.000, 836 C4.000 | 66/89 | 07/94→08/99 | Z47 [168] | 0.8 | UX56 | |
| 1.8 i.e. LPG | 4 | 835 C2.000 | 76/102 | 06/93→08/99 | Z47 [168] | 0.8 | UX56 | |
| 1.8 i.e. 16V | 4 | 182 A2.000 | 83/111 | 03/96→08/99 | Z98 | 0.8 | UXT1 / UXT3 | |
| 1.8 i.e. 16V LPG | 4 | 182 A2.000 | 83/111 | 03/96→08/99 | Z116 | 0.8 | UXT5 | |
| 1.8 i.e. 16V GT | 4 | 183 A1.000 | 96/129 | 03/96→08/99 | Z98 | 0.8 | UXT1 / UXT3 | |
| 1.8 i.e. 16V GT LPG | 4 | 183 A1.000 | 96/129 | 03/96→08/99 | Z116 | 0.8 | UXT5 | |
| 1.9 TD | 4 | 160 D1.000, 835 A4.000 | 66/89 | 10/94→08/99 | GN013 [2][222] GN908 | 11V 11V | | |
| 2.0 16V | 4 | 836 A3.000 | 102/137 | 06/93→08/99 | Z27 [170] | 0.8 | UX56 | |
| 2.0 16V LPG | 4 | 836 A3.000 | 102/137 | 06/93→08/99 | Z47 [168] | 0.8 | UX56 | |
| 2.0 16V Turbo | 4 | 836 A2.000 | 137/184 | 06/93→08/99 | Z12 →09/96 | 0.8 | UXT2 / UXT6 →09/96 | ZS283 |
| 2.0 16V Turbo | 4 | 175 A4.000 | 142/190 | 07/96→08/99 | Z15 | 0.8 | UXT1 / UXT3 | ZS283 |
| 2.0 16V Turbo LPG | 4 | 175 A4.000 | 142/190 | 07/96→08/99 | Z340 | 0.7 | UXT12 | |

DELTA III

| | | | | | | | | |
|----------------|---|------------------------|---------|--------|-------|------|--|-------|
| 1.4 | 4 | 198 A4.000 | 88/118 | 09/08→ | Z338 | 0.8 | | ZS095 |
| 1.4 | 4 | 198 A1.000 | 110/148 | 09/08→ | Z338 | 0.8 | | ZS095 |
| 1.4 16V | 4 | 198 A7.000 | 103/138 | 07/10→ | Z338 | 0.8 | | |
| 1.4 Bifuel LPG | 4 | 198 A4.000 | 88/118 | 07/11→ | | | | ZS095 |
| 1.6 D Multijet | 4 | 944 A 3.000 | 77/103 | 04/11→ | GE114 | 4.4V | | |
| 1.6 D Multijet | 4 | 955 A4.000 | 85/114 | 08/08→ | GE114 | 4.4V | | |
| 1.6 D Multijet | 4 | 198 A2.000 | 88/118 | 09/08→ | GE114 | 4.4V | | |
| 1.9 D Multijet | 4 | 844 A1.000 | 140/188 | 01/09→ | GE114 | 4.4V | | |
| 2.0 D Multijet | 4 | 844 A2.000 | 120/161 | 09/08→ | GE114 | 4.4V | | |
| 2.0 D Multijet | 4 | 198 A5.000, 198 A8.000 | 121/162 | 09/08→ | GE114 | 4.4V | | |

FULVIA

| | | | | | | | | |
|-----|---|--|-------|-------------|-----|-----|------|--|
| 1.3 | 4 | | 65/87 | 09/68→07/75 | Z42 | 0.8 | UX56 | |
|-----|---|--|-------|-------------|-----|-----|------|--|

GAMMA

| | | | | | | | | |
|----------|---|-----------------------|---------|-------------|-----|-----|------|--|
| 2.5 2500 | 4 | 830 A.000, 830 A4.000 | 103/138 | 08/81→12/84 | Z42 | 0.8 | UX56 | |
|----------|---|-----------------------|---------|-------------|-----|-----|------|--|

LANCIA



kW/BHP

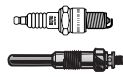

... LANCIA



KAPPA

| | | | | | | | | | |
|-------------------|---|------------------------|---------|-------------|-------|-----|-------------|-------------|-------|
| 2.0 16V Turbo | 4 | 838 A4.000 | 151/202 | 02/95→10/01 | Z245 | 0.9 | UXT5 | ZS234 | ZM026 |
| 2.0 16V Turbo LPG | 4 | 838 A4.000 | 151/202 | 02/95→10/01 | Z192 | 0.8 | | | |
| 2.0 20V | 5 | 838 A1.000 | 107/143 | 10/94→10/01 | Z245 | 0.9 | UXT5 | ZS310 | |
| 2.0 20V | 5 | 838 A6.000 | 114/153 | 07/96→10/01 | Z245 | 0.9 | UXT5 | ZS310 | |
| | | | | | | | | →05/98 | ZS311 |
| | | | | | | | | 06/98→12/00 | ZS310 |
| 2.0 20V | 5 | 838 A6.000 | 114/153 | 07/96→03/01 | | | | | ZS310 |
| 2.0 20V LPG | 5 | 838 A1.000 | 107/143 | 10/94→10/01 | Z192 | 0.8 | | | |
| 2.0 20V LPG | 5 | 838 A6.000 | 114/153 | 07/96→10/01 | Z192 | 0.8 | | | |
| 2.0 20V Turbo | 5 | 175 A3.000 | 162/217 | 06/98→10/01 | | | | | ZS310 |
| 2.4 20V | 5 | 838 A2.000, 838 A2.027 | 129/173 | 08/94→10/01 | Z98 | 0.8 | UXT1 / UXT3 | ZS310 | |
| 2.4 20V | 5 | 838 A2.000 | 129/173 | 07/96→10/01 | | | | | ZS310 |
| | | | | | | | | →05/98 | ZS311 |
| | | | | | | | | 06/98→12/00 | |
| 2.4 20V LPG | 5 | 838 A2.000, 838 A2.027 | 129/173 | 08/94→10/01 | Z116 | 0.8 | UXT5 | | |
| 2.4 JTD | 5 | 838 A8.000 | 100/134 | 06/98→10/01 | GN041 | 11V | | | |
| 2.4 T.DS | 5 | 838 A3.000, 838 A7.000 | 91/122 | 08/94→10/01 | GN970 | 11V | | | |
| 3.0 24V | 6 | 838 B.000 | 150/201 | 08/94→10/01 | Z188 | 0.7 | UXT10 | ZS428 | |
| 3.0 24V LPG | 6 | 838 B.000 | 150/201 | 08/94→10/01 | Z340 | 0.7 | UXT12 | | |

LYBRA

| | | | | | | | | | |
|-------------|---|------------------------------------|---------|-------------|-------|-----|-------------|-------|--|
| 1.6 16V | 4 | 182 A4.000 | 76/102 | 07/99→10/05 | Z98 | 0.8 | UXT1 / UXT3 | ZS029 | |
| 1.6 16V LPG | 4 | 182 A4.000 | 76/102 | 07/99→10/05 | Z116 | 0.8 | UXT5 | | |
| 1.8 16V | 4 | 839 A4.000, 839 A7.000, 839 A9.000 | 96/129 | 07/99→10/05 | Z98 | 0.8 | UXT1 / UXT3 | | |
| 1.8 16V LPG | 4 | 839 A4.000, 839 A7.000, 839 A9.000 | 96/129 | 07/99→10/05 | Z116 | 0.8 | UXT5 | | |
| 1.9 JTD | 4 | AR 32302 | 77/103 | 07/99→09/00 | GN041 | 11V | | | |
| 1.9 JTD | 4 | AR 37101 | 81/109 | 09/00→05/01 | GN041 | 11V | | | |
| 1.9 JTD | 4 | 937 A2.000 | 85/114 | 05/01→10/05 | GN041 | 11V | | | |
| 2.0 20V | 5 | 185 A8.000 | 110/148 | 09/00→10/05 | Z98 | 0.8 | UXT1 / UXT3 | ZS311 | |
| 2.0 20V | 5 | 182 B7.000 | 113/152 | 07/99→09/00 | Z98 | 0.8 | UXT1 / UXT3 | ZS311 | |
| 2.0 20V LPG | 5 | 185 A8.000 | 110/148 | 09/00→10/05 | Z116 | 0.8 | UXT5 | | |
| 2.0 20V LPG | 5 | 182 B7.000 | 113/152 | 07/99→09/00 | Z116 | 0.8 | UXT5 | | |
| 2.4 20V | 5 | 192 A2.000 | 125/168 | 10/01→10/05 | Z98 | 0.8 | UXT1 / UXT3 | ZS311 | |
| 2.4 JTD | 5 | 839 A5.000, AR 32501 | 99/133 | 07/99→02/01 | GN041 | 11V | | | |
| 2.4 JTD | 5 | 839 A6.000 | 103/138 | 09/00→10/05 | GN041 | 11V | | | |
| 2.4 JTD | 5 | 841 C.000 | 110/148 | 05/02→10/05 | GN041 | 11V | | | |

MUSA

| | | | | | | | | | |
|----------------|---|------------------------|--------|--------|--------------------------|-------------|--|-------|--|
| 1.3 D Multijet | 4 | 188 A9.000 | 51/68 | 10/04→ | GE112 [37] GN053 [36] | 4.4V 11V | | | |
| 1.3 D Multijet | 4 | 199 A3.000 | 66/89 | 09/06→ | GE112 [37] GN053 [36] | 4.4V 11V | | | |
| 1.3 D Multijet | 4 | 199 B1.000 | 70/94 | 03/09→ | GE112 | 4.4V | | | |
| 1.4 | 4 | 350 A1.000 | 57/76 | 09/05→ | Z293 | 1.05 | | ZS079 | |
| 1.4 | 4 | 192 B2.000 | 66/89 | 10/07→ | Z292 | 1.05 | | ZS322 | |
| 1.4 | 4 | 843 A 1.000 | 70/94 | 10/04→ | Z293 | 1.05 | | ZS322 | |
| 1.4 LPG | 4 | 192 B2.000 | 66/89 | 10/07→ | Z291 [168] | 0.9 | | | |
| 1.4 LPG | 4 | 350 A1.000 | 57/76 | 11/10→ | Z293 | 1.05 | | ZS079 | |
| 1.6 D Multijet | 4 | 350 A2.000, 350 A3.000 | 85/114 | 07/08→ | GE114 | 4.4V | | | |
| 1.6 D Multijet | 4 | 350 A2.000 | 88/118 | 07/08→ | GE114 | 4.4V | | | |
| 1.9 D Multijet | 4 | 188 B2.000 | 74/99 | 10/04→ | GN041 | 11V | | | |

PHEDRA

| | | | | | | | | | |
|----------------|---|-----------------|---------|-------------|----------------------------|------------|-------|--|--|
| 2.0 | 4 | RFN (EW10J4) | 100/134 | 09/02→11/10 | Z223 | 0.9 | UXT13 | | |
| 2.0 D Multijet | 4 | RHR (DW10BTD4) | 100/134 | 07/06→11/10 | GN054 | 11V | | | |
| 2.0 JTD | 4 | RHM (DW10ATED4) | 79/106 | 07/03→11/10 | GN027 [124] GN054 [125] | 11V 11V | | | |

LANCIA



kW/BHP

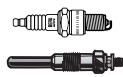

... LANCIA



... PHEDRA

| | | | | | | | | |
|----------------|---|-----------------|---------|-------------|--|------------|--|--------------|
| 2.0 JTD | 4 | RHW (DW10ATED4) | 80/107 | 09/02→11/10 | GN027 ^[124] GN054 ^[125] | 11V 11V | | |
| 2.0 JTD | 4 | RHK (DW10UTED4) | 88/118 | 06/06→11/10 | GN027 ^[124] GN054 ^[125] | 11V 11V | | |
| 2.2 D Multijet | 4 | 4HS, 4HT | 125/168 | 03/08→11/10 | GN063 | 11V | | |
| 2.2 JTD | 4 | 4HW(DW12ATED4) | 94/126 | 09/02→11/10 | GN027 ^[124] GN054 ^[125] | 11V 11V | | |
| 2.2 JTD | 4 | 4HP, 4HR | 120/161 | 04/06→11/10 | GN063 | 11V | | |
| 3.0 V6 | 6 | ES9 J4S | 150/201 | 09/02→11/10 | | | | ZS347 |

PRISMA

| | | | | | | | | |
|------------------|---|------------------------|--------|-------------|--|------------|-------------|--|
| 1.3 | 4 | 831 A2.000 | 58/78 | 01/83→02/92 | Z27 ^[168] | 0.8 | UX56 | ZS248 |
| 1.5 | 4 | 138 C2.048, 831 B1.048 | 55/74 | 09/85→02/92 | Z27 ^[168] | 0.8 | UX56 | |
| 1.5 | 4 | 831 B1.000 | 59/79 | 08/86→02/92 | Z27 ^[168] | 0.8 | UX56 | |
| 1.5 | 4 | 831 A1.000 | 63/84 | 01/83→04/86 | Z27 ^[168] | 0.8 | UX56 | ZS106 ^{[1][11][254]} ZS115 ^{[1][11]} ZM005 |
| 1.6 | 4 | 831 B6.000 | 73/98 | 08/86→02/92 | Z27 ^[168] | 0.8 | UX56 | |
| 1.6 | 4 | 831 A4.000 | 77/103 | 01/83→04/86 | Z27 ^[168] | 0.8 | UX56 | ZS106 ^{[1][11][254]} ZS115 ^{[1][11]} |
| 1.6 i.e. | 4 | 831 B7.000 | 80/107 | 05/86→12/89 | Z27 ^[168] | 0.8 | UX56 | ZM061 |
| 1.6 i.e. Super | 4 | 149 C2.000 | 66/89 | 05/87→12/89 | Z27 ^[168] | 0.8 | UX56 | ZS106 ^{[1][11][254]} ZS115 ^{[1][11]} ZM061 |
| 1.9 Diesel | 4 | 831 D.000 | 48/64 | 01/83→02/92 | GN909 ^{[2][222]} GV663 | 11V 11V | | |
| 1.9 Turbo Diesel | 4 | 831 D1.000 | 59/79 | 05/85→12/89 | GN909 ^{[2][222]} GV663 | 11V 11V | | |
| 2.0 i.e. 4WD | 4 | 831 B4.000 | 85/114 | 04/86→12/89 | Z27 ^[168] | 0.8 | UX56 | ZS106 ^{[1][11][254]} ZS115 ^{[1][11]} |

THEMA

| | | | | | | | | |
|-------------------------|---|------------|---------|-------------|--|------------|--------------------|--|
| 2.0 2000 16V | 4 | 834 F1.000 | 112/150 | 05/92→07/94 | Z27 ^[170] | 0.8 | UX56 | ZS234 |
| 2.0 2000 16V Turbo | 4 | 834 C1.000 | 133/178 | 12/88→06/90 | Z12 | 0.8 | UXT2 / UXT6 | ZS283 |
| 2.0 2000 16V Turbo | 4 | 834 F2.000 | 148/198 | 10/92→07/94 | | | | ZS234 ZM026 |
| 2.0 2000 i.e. | 4 | 834 B.048 | 83/111 | 03/86→09/88 | Z27 ^[170] | 0.8 | UX56 | ZS106 ^{[1][11][254]} ZS115 ^{[1][11]} |
| 2.0 2000 i.e. | 4 | 834 B.146 | 85/114 | 09/87→05/92 | Z27 ^[170] | 0.8 | UX56 | ZS106 ^{[1][11][254]} ZS115 ^{[1][11]} ZM061 |
| 2.0 2000 i.e. | 4 | 834 B.000 | 88/118 | 11/84→09/88 | Z27 ^[168] | 0.8 | UX56 | |
| 2.0 2000 i.e. 16V | 4 | 834 B2.246 | 104/139 | 02/89→05/92 | Z27 ^[170] | 0.8 | UX56 | ZS106 ^{[1][11][254]} ZS115 ^{[1][11]} ZM061 →05/90 |
| 2.0 2000 i.e. 16V | 4 | 834 B2.000 | 108/145 | 05/88→08/92 | | | | ZS283 |
| 2.0 2000 i.e. 16V Turbo | 4 | 834 C1.246 | 130/174 | 04/89→05/92 | Z12 | 0.8 | UXT2 / UXT6 | ZM061 |
| 2.0 2000 i.e. 16V Turbo | 4 | 834 C1.246 | 130/174 | 04/89→03/93 | Z11 ^[168] | 0.8 | UXT2 / UXT6 | ZS248 |
| 2.0 2000 i.e. 16V Turbo | 4 | 834 C1.000 | 133/178 | 12/88→06/90 | | | | ZS283 |
| 2.0 2000 i.e. Turbo | 4 | 834 C.146 | 110/148 | 07/86→05/90 | Z27 ^[170] | 0.8 | UX56 | ZS106 ^{[1][11][254]} ZS115 ^{[1][11]} ZM061 |
| 2.0 2000 i.e. Turbo | 4 | 834 C.000 | 122/164 | 11/84→12/87 | Z27 ^[170] | 0.8 | UX56 | ZS248 ZM061 07/86→ |
| 2.0 2000 Turbo | 4 | 834 C.146 | 110/148 | 01/89→03/92 | Z27 ^[170] | 0.8 | UX56 | |
| 2.0 2000 Turbo 16V | 4 | 834 F2.000 | 148/198 | 11/92→07/94 | Z12 | 0.8 | UXT2 / UXT6 | ZS234 |
| 2.4 2500 Turbo D | 4 | 8144.91 | 74/99 | 11/84→09/88 | GN013 ^[222] | 11V | | |
| 2.4 2500 Turbo DS | 4 | 8144.91 | 74/99 | 03/87→09/90 | GN013 ^[222] | 11V | | |
| 2.5 2500 Turbo DS | 4 | 8144.97S | 77/103 | 05/88→07/92 | GN909 | 11V | | |
| 2.5 2500 Turbo DS | 4 | 8144.97 | 85/114 | 06/88→05/92 | GN013 ^{[2][222]} GN908 | 11V 11V | | |
| 2.5 2500 Turbo DS | 4 | 8144.97 Y | 85/114 | 05/92→07/94 | GN908 ^[279] GN925 ^[281] | 11V 11V | | |
| 2.8 2850 V6 i.e. | 6 | 834 E.146 | 108/145 | 06/88→05/92 | | | | ZS119 ZM040 →09/91 |
| 3.0 3000 V6 | 6 | 834 F.000 | 126/169 | 08/92→07/94 | Z27 ^[168] | 0.8 | UX56 | ZS230 |

LANCIA

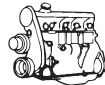

kW/BHP

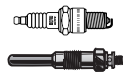
**... LANCIA****THESIS**

| | | | | | | | | |
|----------------|---|----------------------|---------|-------------|-------|-----|------|-------|
| 2.0 Turbo | 5 | 841 E.000 | 136/182 | 07/02→07/09 | | | | ZS311 |
| 2.4 | 5 | 841 D.000 | 125/168 | 07/02→07/09 | Z245 | 0.9 | UXT5 | ZS311 |
| 2.4 LPG | 5 | 841 D.000 | 125/168 | 07/02→07/09 | Z192 | 0.8 | | |
| 2.4 D Multijet | 5 | 841 P.000 | 136/182 | 04/06→07/09 | GN059 | 11V | | |
| 2.4 JTD | 5 | 841 C.000 | 110/148 | 07/02→07/09 | GN041 | 11V | | |
| 2.4 JTD | 5 | 841 M.000, 841 N.000 | 120/161 | 09/03→07/09 | GN059 | 11V | | |
| 2.4 JTD | 5 | 841 G.000 | 129/173 | 05/03→07/09 | GN059 | 11V | | |
| 3.0 V6 | 6 | 841 A.000 | 158/212 | 07/02→07/09 | | | | ZS428 |
| 3.2 V6 | 6 | 841 L.000 | 169/227 | 05/03→07/09 | | | | ZS428 |

TREVI

| | | | | | | | | |
|------------------|---|------------|--------|-------------|-----------|-----|-------------|--|
| 2.0 2000 i.e. | 4 | 828 B4.000 | 90/121 | 05/80→01/87 | Z11 [168] | 0.8 | UXT2 / UXT6 | |
| 2.0 2000 Volumex | 4 | 828 B7.000 | 99/133 | 08/83→05/85 | Z22 | 0.7 | UX56 | |

Y

| | | | | | | | | |
|-------------|---|------------------------|-------|-------------|------------|------|-------------|-------|
| 1.1 | 4 | 176 B2.000 | 40/54 | 11/95→09/03 | Z193 | 0.9 | UXT1 / UXT3 | ZS283 |
| 1.1 LPG | 4 | 176 B2.000 | 40/54 | 11/95→09/03 | Z340 | 0.7 | UXT12 | |
| 1.2 | 4 | 188 A4.000, 840 A3.000 | 44/59 | 03/96→09/03 | Z250 | 0.7 | UXT1 / UXT3 | ZS283 |
| 1.2 LPG | 4 | 188 A4.000, 840 A3.000 | 44/59 | 03/96→09/03 | Z340 | 0.7 | UXT12 | |
| 1.2 16V | 4 | 188 A5.000 | 59/79 | 10/00→09/03 | Z234 | 0.9 | | ZS234 |
| 1.2 16V | 4 | 176 B9.000 | 63/84 | 04/97→09/03 | Z234 | 0.9 | | ZS283 |
| 1.2 16V LPG | 4 | 188 A5.000 | 59/79 | 10/00→09/03 | Z292 [168] | 1.05 | | |
| 1.2 16V LPG | 4 | 176 B9.000 | 63/84 | 04/97→09/03 | Z292 [168] | 1.05 | | |
| 1.4 12V | 4 | 840 A4.000 | 55/74 | 03/96→09/03 | Z245 | 0.9 | UXT5 | ZS234 |
| 1.4 12V | 4 | 840 A2.000 | 59/79 | 10/96→09/03 | Z245 | 0.9 | UXT5 | ZS234 |
| 1.4 12V LPG | 4 | 840 A4.000 | 55/74 | 03/96→09/03 | Z192 | 0.8 | | |
| 1.4 12V LPG | 4 | 840 A2.000 | 59/79 | 10/96→09/03 | Z192 | 0.8 | | |

Y10

| | | | | | | | | | |
|-------------------|---|------------------------|-------|-------------|--------------------------------------|-----|---------------------------------|------------------------------------|--------------------------------|
| 1.0 Fire | 4 | 156 A2.100 | 32/43 | 06/85→06/91 | Z11 [168] →02/89 Z15 03/89→ | 0.8 | UXT2 / UXT6 →02/89 01/89→ | ZS244 01/89→ | ZM017 →12/89 ZM009 [193] |
| 1.0 Fire 4WD | 4 | 156 A2.100 | 32/43 | 12/86→02/89 | Z15 [168] | 0.8 | UXT1 / UXT3 | ZS244 | ZM009 [193] ZM017 [213] |
| 1.0 Fire | 4 | 156 A2.000 | 33/44 | 03/85→06/89 | Z15 [168] | 0.8 | UXT1 / UXT3 | ZS244 | ZM009 [193] ZM017 [213] |
| 1.0 Fire | 4 | 156 A2.246 | 33/44 | 10/87→02/92 | Z247 | 0.9 | UXT1 / UXT3 | ZS244 01/89→ | ZM017 →12/89 ZM009 [193] |
| 1.0 Fire 4WD | 4 | 156 A2.246 | 33/44 | 12/87→02/92 | Z247 | 0.9 | UXT1 / UXT3 | ZS244 | ZM017 →08/89 ZM009 [193] |
| 1.0 Fire | 4 | 156 A2.000 | 37/50 | 03/85→02/90 | | | | ZS244 | ZM017 →08/89 ZM009 [193] |
| 1.0 Fire | 4 | 156 A.000 | 41/55 | 03/85→07/89 | | | | | ZM009 [193] ZM017 [213] |
| 1.0 Turbo | 4 | 156 A1.000 | 62/83 | 03/85→02/89 | | | | | ZM009 [193] ZM017 [213] |
| 1.1 Avenue | 4 | 176 B2.000 | 40/54 | 01/95→12/95 | Z193 | 0.9 | UXT1 / UXT3 | ZS234 | ZM009 |
| 1.1 Avenue LPG | 4 | 176 B2.000 | 40/54 | 01/95→12/95 | Z340 | 0.7 | UXT12 | | |
| 1.1 i.e. | 4 | 156 C.000 | 42/56 | 08/89→06/92 | | | | ZS244 | |
| 1.1 i.e. Fire | 4 | 156 C.046 | 37/50 | 07/89→09/95 | Z193 | 0.9 | UXT1 / UXT3 | ZS244 →12/92 ZS234 01/92→ | ZM009 |
| 1.1 i.e. Fire 4WD | 4 | 156 C.046 | 37/50 | 09/92→12/95 | Z193 | 0.9 | UXT1 / UXT3 | ZS234 | ZM009 |
| 1.1 i.e. Fire LPG | 4 | 156 C.046 | 37/50 | 07/89→12/95 | Z340 | 0.7 | UXT12 | | |
| 1.3 i.e. Fire | 4 | 146 A 5.046, 156 B.000 | 53/71 | 02/89→12/95 | Z20 [170] →09/92 | 0.8 | UXT2 / UXT6 | ZS248 | ZM009 →09/92 |

LANCIA

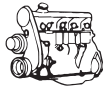

kW/BHP

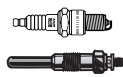

... LANCIA



... Y10

| | | | | | | | | | |
|-------------------|---|------------------------|-------|-------------|---------------------|-----|----------------|--|--|
| 1.3 i.e. Fire LPG | 4 | 146 A 5.046, 156 B.000 | 53/71 | 02/89→12/95 | Z27 [168] →09/92 | 0.8 | UX56 →09/92 | | |
|-------------------|---|------------------------|-------|-------------|---------------------|-----|----------------|--|--|

YPSILON

| | | | | | | | | | |
|-------------|---|------------|-------|--------|--|--|--|-------|--|
| 0.9 Twinair | 2 | 312 A2.000 | 63/84 | 05/11→ | | | | ZS090 | |
|-------------|---|------------|-------|--------|--|--|--|-------|--|

| | | | | | | | | | |
|-----|---|------------|-------|-------------|--|-----|------------------------------|-------|--|
| 1.2 | 4 | 188 A4.000 | 44/59 | 10/03→12/11 | Z255 →eng. 2533528 Z234 eng. 2533529→ | 0.9 | UXT1 / UXT3 →eng. 2533528 | ZS283 | |
|-----|---|------------|-------|-------------|--|-----|------------------------------|-------|--|

| | | | | | | | | | |
|-----|---|------------|-------|--------|------------------------|--------------|--|--------------------------|--|
| 1.2 | 4 | 169 A4.000 | 51/68 | 08/10→ | Z292 [36] Z293 [37] | 1.05 1.05 | | ZS079 [37] ZS283 [36] | |
|-----|---|------------|-------|--------|------------------------|--------------|--|--------------------------|--|

| | | | | | | | | | |
|-----|---|------------|-------|-------------|------|-----|--|-------|--|
| 1.2 | 4 | 188 A5.000 | 59/79 | 10/03→12/11 | Z234 | 0.9 | | ZS322 | |
|-----|---|------------|-------|-------------|------|-----|--|-------|--|

| | | | | | | | | | |
|---------|---|------------|-------|-------------|--|-------------|------------------------|--|--|
| 1.2 LPG | 4 | 188 A4.000 | 44/59 | 10/03→12/11 | Z206 →eng. 2533528 Z292 [168] eng. 2533529→ | 0.7 1.05 | UXT10 →eng. 2533528 | | |
|---------|---|------------|-------|-------------|--|-------------|------------------------|--|--|

| | | | | | | | | | |
|---------|---|------------|-------|-------------|------------|------|--|--|--|
| 1.2 LPG | 4 | 188 A5.000 | 59/79 | 10/03→12/11 | Z292 [168] | 1.05 | | | |
|---------|---|------------|-------|-------------|------------|------|--|--|--|

| | | | | | | | | | |
|------------|---|------------|-------|--------|------------------------|--------------|--|--------------------------|--|
| 1.2 Bifuel | 4 | 169 A4.000 | 49/66 | 05/11→ | Z292 [36] Z293 [37] | 1.05 1.05 | | ZS079 [37] ZS283 [36] | |
|------------|---|------------|-------|--------|------------------------|--------------|--|--------------------------|--|

| | | | | | | | | | |
|----------------|---|------------|-------|-------------|--------------------------|-------------|--|--|--|
| 1.3 D Multijet | 4 | 199 A2.000 | 55/74 | 09/06→12/11 | GE112 [37] GN053 [36] | 4.4V 11V | | | |
|----------------|---|------------|-------|-------------|--------------------------|-------------|--|--|--|

| | | | | | | | | | |
|----------------|---|------------|-------|-------------|-------|-----|--|--|--|
| 1.3 D Multijet | 4 | 199 A3.000 | 66/89 | 09/06→12/11 | GN053 | 11V | | | |
|----------------|---|------------|-------|-------------|-------|-----|--|--|--|

| | | | | | | | | | |
|----------------|---|------------|--------|-------------|-------|-----|--|--|--|
| 1.3 D Multijet | 4 | 199 A3.000 | 77/103 | 05/07→12/11 | GN053 | 11V | | | |
|----------------|---|------------|--------|-------------|-------|-----|--|--|--|

| | | | | | | | | | |
|---------|---|------------|-------|-------------|-------|-----|--|--|--|
| 1.3 JTD | 4 | 188 A9.000 | 51/68 | 10/03→12/11 | GN053 | 11V | | | |
|---------|---|------------|-------|-------------|-------|-----|--|--|--|

| | | | | | | | | | |
|--------------|---|------------|-------|--------|-------|------|--|--|--|
| 1.3 Multijet | 4 | 199 B1.000 | 70/94 | 05/11→ | GE112 | 4.4V | | | |
|--------------|---|------------|-------|--------|-------|------|--|--|--|

| | | | | | | | | | |
|-----|---|------------|-------|-------------|------|------|--|-------|--|
| 1.4 | 4 | 350 A1.000 | 57/76 | 02/06→12/11 | Z293 | 1.05 | | ZS079 | |
|-----|---|------------|-------|-------------|------|------|--|-------|--|

| | | | | | | | | | |
|---------|---|-------------|-------|-------------|------|-----|--|-------|--|
| 1.4 16V | 4 | 843 A 1.000 | 70/94 | 10/03→12/11 | Z234 | 0.9 | | ZS322 | |
|---------|---|-------------|-------|-------------|------|-----|--|-------|--|

| | | | | | | | | | |
|---------|---|------------|-------|-------------|------|------|--|-------|--|
| 1.4 LPG | 4 | 350 A1.000 | 57/76 | 11/10→12/11 | Z293 | 1.05 | | ZS079 | |
|---------|---|------------|-------|-------------|------|------|--|-------|--|

ZETA

| | | | | | | | | | |
|---------|---|---------------|--------|-------------|--|--|--|-------|--|
| 2.0 16V | 4 | RFV (XU10J4R) | 97/130 | 05/98→07/00 | | | | ZS349 | |
|---------|---|---------------|--------|-------------|--|--|--|-------|--|

| | | | | | | | | | |
|---------|---|-----|---------|-------------|------|-----|-------|--|--|
| 2.0 16V | 4 | RFN | 100/134 | 07/00→09/02 | Z183 | 0.9 | UXT13 | | |
|---------|---|-----|---------|-------------|------|-----|-------|--|--|

| | | | | | | | | | |
|-------------|---|-----|---------|-------------|------------|-----|-------|--|--|
| 2.0 16V LPG | 4 | RFN | 100/134 | 07/00→09/02 | Z184 [168] | 0.9 | UXT13 | | |
|-------------|---|-----|---------|-------------|------------|-----|-------|--|--|

| | | | | | | | | | |
|---------|---|------------------------------------|--------|-------------|-------|-----|--|--|--|
| 2.0 JTD | 4 | RHW (DW10ATED4), RHZ (DW10ATED) | 80/107 | 09/99→09/02 | GN027 | 11V | | | |
|---------|---|------------------------------------|--------|-------------|-------|-----|--|--|--|

| | | | | | | | | | |
|-----------|---|----------------|---------|-------------|------|-----|-------------|-------|-------|
| 2.0 Turbo | 4 | RGX (XU10J2TE) | 108/145 | 05/95→09/02 | Z193 | 0.9 | UXT1 / UXT3 | ZS341 | ZM026 |
|-----------|---|----------------|---------|-------------|------|-----|-------------|-------|-------|

| | | | | | | | | | |
|---------------|---|----------------|---------|-------------|------|-----|-------|--|--|
| 2.0 Turbo LPG | 4 | RGX (XU10J2TE) | 108/145 | 05/95→09/02 | Z340 | 0.7 | UXT12 | | |
|---------------|---|----------------|---------|-------------|------|-----|-------|--|--|

| | | | | | | | | | |
|--------|---|-------|--------|-------------|-------|-----|--|--|--|
| 2.1 TD | 4 | P 8 C | 80/107 | 05/96→09/99 | GN908 | 11V | | | |
|--------|---|-------|--------|-------------|-------|-----|--|--|--|

LAND ROVER



88/109

| | | | | | | | | | |
|---------|---|-----------|-------|-------------|--------------------|-----|-----------------------|------------|--|
| 2.3 4WD | 4 | 10 H, 11H | 51/68 | 09/63→12/86 | Z1 [169] →03/83 | 0.7 | UXT2 / UXT6 →03/83 | ZS109 [15] | |
|---------|---|-----------|-------|-------------|--------------------|-----|-----------------------|------------|--|

| | | | | | | | | | |
|-----------|---|------------|-------|-------------|--|------------|--|--|--|
| 2.3 D 4WD | 4 | 10 J, 23 J | 46/62 | 09/63→12/86 | GN909 [222] 01/83→ GV602 01/83→ | 11V 11V | | | |
|-----------|---|------------|-------|-------------|--|------------|--|--|--|

90/110

| | | | | | | | | | |
|-----------|---|------|-------|-------------|-------------------------|-----|--|--|--|
| 2.3 D 4WD | 4 | 10 J | 46/62 | 06/84→08/87 | GN954 eng. 10J01175→ | 11V | | | |
|-----------|---|------|-------|-------------|-------------------------|-----|--|--|--|

| | | | | | | | | | |
|---------|---|------|-------|-------------|-----|-----|-------------|------------|--|
| 2.5 4WD | 4 | 17 H | 62/83 | 09/85→07/90 | Z62 | 0.8 | UXT2 / UXT6 | ZS106 [11] | |
|---------|---|------|-------|-------------|-----|-----|-------------|------------|--|

| | | | | | | | | | |
|-----------|---|------|-------|-------------|-------|-----|--|--|--|
| 2.5 D 4WD | 4 | 12 J | 51/68 | 09/83→07/90 | GN954 | 11V | | | |
|-----------|---|------|-------|-------------|-------|-----|--|--|--|

| | | | | | | | | | |
|------------|---|------|-------|-------------|-------------------------|------------|--|--|--|
| 2.5 TD 4WD | 4 | 19 J | 63/84 | 09/86→07/90 | GN909 [2][222] GV602 | 11V 11V | | | |
|------------|---|------|-------|-------------|-------------------------|------------|--|--|--|

| | | | | | | | | | |
|------------|---|--|---------|-------------|-----|-----|-------------|--|--|
| 3.5 V8 4WD | 8 | | 100/134 | 09/83→07/90 | Z62 | 0.8 | UXT2 / UXT6 | ZS115 [1][11] ZS117 [1][254] ZS120 [1][214][254] | |
|------------|---|--|---------|-------------|-----|-----|-------------|--|--|

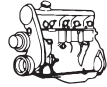

kW/BHP

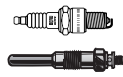

... LAND ROVER 

| DEFENDER | |
|----------------------|---|
| 2.4 Td4 4WD | 4 244DT 90/121 05/07→ GN939 11.5V |
| 2.5 90,110 TDI 4WD | 4 23 L 83/111 09/90→12/98 GV783 11.5V |
| 2.5 90 TDI 4WD | 4 23 L 83/111 09/90→ GV783 11.5V |
| 2.5 D 4WD | 4 12 J 51/68 09/90→09/01 GN954 11V |
| 2.5 Td5 4WD | 5 10 P, 14 P, 15 P 90/121 06/98→ GV783 11.5V |
| | |
| | |
| 3.5 4WD | 8 11 D 86/115 09/90→08/93 GN985 11V |
| | |
| | |
| 3.5 4WD | 8 22 D 100/134 09/90→12/98 ZS115 [1][11] ZS117 [1][254] ZS120 [1][214][254] |
| | |
| | |
| 3.9 V8 4WD | 8 37 L 136/182 11/98→ Z82 0.7 UXT2 / UXT6 |
| DISCOVERY I | |
| 2.0 16 V 4WD | 4 99/133 09/93→10/98 Z15 0.8 UXT1 / UXT3 |
| 2.5 D 4WD | 4 19 L, 22 L 90/121 07/94→10/98 GV783 11.5V |
| 2.5 TDI 4WD | 4 12 L, 17 L, 19 L, 21 L 83/111 10/89→10/98 GV783 11.5V |
| 3.5 4WD | 8 98/131 10/89→08/90 ZS115 [1][11] ZS117 [1][254] ZS120 [1][214][254] |
| | |
| | |
| 3.5 4WD | 8 22 D 113/152 10/89→06/94 Z20 0.8 UXT2 / UXT6 ZS115 [1][11] ZS117 [1][254] ZS120 [1][214][254] |
| | |
| | |
| 3.5 4WD | 8 22 D 122/164 10/89→06/94 ZS115 [1][11] ZS117 [1][254] ZS120 [1][214][254] |
| | |
| | |
| 3.9 V8 4WD | 8 35 D, 36 D 134/180 09/93→10/98 Z82 0.7 UXT2 / UXT6 ZS115 [1][11] ZS117 [1][254] ZS120 [1][214][254] |
| DISCOVERY II | |
| 2.5 Td5 4WD | 5 10 P 102/137 01/99→06/04 GN985 11V |
| 4.0 V8 4WD | 8 56 D 136/182 11/98→06/04 Z82 0.7 UXT2 / UXT6 ZS234 |
| DISCOVERY III | |
| 2.7 TD 4WD | 6 276DT 140/188 07/04→09/09 GN045 11V |
| DISCOVERY IV | |
| 2.7 TD 4WD | 6 276DT 140/188 09/09→ GN045 11V |
| FREELANDER | |
| 1.8 16V 4WD | 4 18 K4F 86/115 11/00→10/06 Z228 1.0 UXT11 ZS501 →ch. 5A000001 ZS469 ch. 1A000001→ |
| | |
| 1.8 16V 4WD LPG | 4 18 K4F 86/115 11/00→10/06 Z221 [168] 1.0 UXT14 |
| 1.8 i 16V 4WD | 4 18 K4F 88/118 02/98→10/06 Z228 1.0 UXT11 ZS469 ch. 1A000001→ ZS501 ch. 5A000001→ |
| | |
| | |
| 1.8 i 16V 4WD | 4 18 K4F 88/118 02/98→11/00 ZS469 [1][149] ZS501 [1] |
| | |
| | |
| 1.8 i 16V 4WD LPG | 4 18 K4F 88/118 02/98→10/06 Z221 [168] 1.0 UXT14 |
| 2.0 DI 4WD | 4 20 T2N 72/97 02/98→10/06 GN905 11V |
| 2.0 Td4 4WD | 4 204D3 80/107 03/01→10/06 GN024 11V |
| 2.0 Td4 4WD | 4 204D3, M 47 82/110 11/00→10/06 GN024 11V |
| 2.5 V6 4WD | 6 25 K4F 130/174 11/00→10/06 Z228 1.0 UXT11 ZS068 ch. 3A224999→ →ch. 4A999999 |
| | |
| | |
| 2.5 V6 4WD LPG | 6 25 K4F 130/174 11/00→10/06 Z221 [168] 1.0 UXT14 |

LAND ROVER

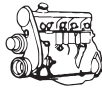

kW/BHP

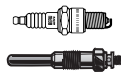
**... LAND ROVER****FREELANDER 2**

| | | | | | | | | | |
|-------------|---|-----------|---------|--------|---------------|--|-----|--|--|
| 2.2 eD4 | 4 | DW12BTED4 | 110/148 | 08/10→ | GN063 | | 11V | | |
| 2.2 SD4 4WD | 4 | 224DT | 140/188 | 08/10→ | GN063 | | 11V | | |
| | | | | | →ch. AH999999 | | | | |
| 2.2 TD4 4WD | 4 | DW12BTED4 | 110/148 | 10/06→ | GN063 | | 11V | | |
| 2.2 TD4 4WD | 4 | 224DT | 112/150 | 01/07→ | GN063 | | 11V | | |
| | | | | | →ch. AH999999 | | | | |
| 2.2 TD4 4WD | 4 | 224DT | 115/154 | 10/06→ | GN063 | | 11V | | |
| 2.2 TD4 4WD | 4 | 224DT | 118/158 | 10/06→ | GN063 | | 11V | | |
| | | | | | →ch. AH999999 | | | | |

RANGE ROVER I

| | | | | | | | | | | |
|-------------------|---|------------|---------|-------------|----------|-------|-------|-------------|--|-----------------|
| 2.4 TD 4WD | 4 | 11 A | 78/105 | 04/86→12/90 | GV657 | GR065 | 11V | | | |
| 2.4 TD 4WD | 4 | 11 A | 83/111 | 04/86→07/94 | GV657 | GR065 | 11V | | | |
| 2.4 TD 4WD | 4 | 11 A | 89/119 | 10/89→02/92 | GV657 | GR065 | 11V | | | |
| 2.5 TD 4WD | 4 | | 89/119 | 10/89→04/94 | GV783 | | 11.5V | | | |
| 2.5 TDi 4WD | 4 | 14 L | 83/111 | 09/91→04/94 | GV783 | | 11.5V | | | |
| 3.5 4WD | 8 | 31 D | 107/143 | 01/87→09/90 | Z11 | | 0.8 | UXT2 / UXT6 | ZS115 [1][11] ZS117 [1][254] ZS120 [1][214][254] | ZM047 |
| 3.5 Vogue 4WD | 8 | 11 D | 93/125 | 08/81→09/90 | Z11 | | 0.8 | UXT2 / UXT6 | ZS115 [1][11] ZS117 [1][254] ZS120 [1][214][254] | ZM047 01/87→ |
| 3.5 Vogue 4WD | 8 | 24 D, 25 D | 120/161 | 10/85→09/90 | Z11 | | 0.8 | UXT2 / UXT6 | ZS115 [1][11] ZS117 [1][254] ZS120 [1][214][254] | ZM047 01/87→ |
| 3.9 4WD | 8 | 37 D, 38 D | 127/170 | 11/88→07/94 | Z1 [169] | | 0.7 | UXT2 / UXT6 | ZS117 | ZM047 →12/90 |
| 3.9 Vogue SEI 4WD | 8 | 35 D, 36 D | 134/180 | 11/88→07/94 | Z1 [169] | | 0.7 | UXT2 / UXT6 | ZS117 | ZM047 →12/90 |
| 4.3 Vogue LSE 4WD | 8 | 40 D | 149/200 | 09/92→07/94 | Z82 | | 0.7 | UXT2 / UXT6 | ZS115 [1][11] ZS117 [1][254] ZS120 [1][214][254] | |

RANGE ROVER II

| | | | | | | | | | | |
|-------------|---|-------------|---------|-------------|-------------------------|--|------------|-------------|-------|--|
| 2.5 D 4WD | 4 | 19 L, 22 L | 83/111 | 08/94→03/02 | GN013 [2][222] GV719 | | 11V 11V | | | |
| 2.5 TD 4WD | 6 | 25 6T (BMW) | 100/134 | 07/94→03/02 | GN013 [2][222] GV719 | | 11V 11V | | | |
| 3.9 4WD | 8 | 42 D | 140/188 | 07/94→03/02 | Z82 | | 0.7 | UXT2 / UXT6 | ZS234 | |
| 4.0 4WD | 8 | 42 D | 136/182 | 06/98→03/02 | Z82 | | 0.7 | UXT2 / UXT6 | ZS234 | |
| 4.6 4WD | 8 | 60 D | 160/215 | 06/98→03/02 | Z20 | | 0.8 | UXT2 / UXT6 | ZS234 | |
| 4.6 4WD | 8 | 46 D | 165/221 | 07/94→03/02 | Z20 | | 0.8 | UXT2 / UXT6 | ZS234 | |
| 4.6 4WD LPG | 8 | 60 D | 160/215 | 06/98→03/02 | Z27 [168] | | 0.8 | UX56 | | |
| 4.6 4WD LPG | 8 | 46 D | 165/221 | 07/94→03/02 | Z27 [168] | | 0.8 | UX56 | | |

RANGE ROVER III

| | | | | | | | | | | |
|--------------|---|---------|---------|-------------|-------|--|-----|-------------|-------|--|
| 3.0 TD 6 4WD | 6 | 306D1 | 130/174 | 03/02→08/12 | GN024 | | 11V | | | |
| 3.6 TD 8 4WD | 8 | 368DT | 200/268 | 04/06→08/12 | GN045 | | 11V | | | |
| 4.4 4WD | 8 | M62 B44 | 210/282 | 03/02→08/12 | Z14 | | 0.9 | UXT1 / UXT3 | ZS302 | |
| 4.4 4WD LPG | 8 | M62 B44 | 210/282 | 03/02→08/12 | Z116 | | 0.8 | UXT5 | | |

RANGE ROVER EVOQUE

| | | | | | | | | | |
|-------------|---|-------|---------|--------|-------|--|-----|--|--|
| 2.2 eD4 | 4 | 224DT | 110/148 | 06/11→ | GN063 | | 11V | | |
| 2.2 SD4 4WD | 4 | 224DT | 140/188 | 06/11→ | GN063 | | 11V | | |
| 2.2 TD4 4WD | 4 | 224DT | 110/148 | 06/11→ | GN063 | | 11V | | |

RANGE ROVER SPORT

| | | | | | | | | | |
|--------------|---|-------|---------|--------|-------|--|-----|--|--|
| 2.7 TDVM 4WD | 6 | 276DT | 140/188 | 02/05→ | GN045 | | 11V | | |
| 3.6 TD 8 4WD | 8 | 368DT | 200/268 | 04/06→ | GN045 | | 11V | | |



kW/BHP

**LEXUS****ES**

| | | | | | | | | |
|----------|---|---------|---------|-------------|------|-----|-------|--------|
| 2.5 250 | 4 | 2AR-FE | 135/181 | 06/12→ | | | | ZSE172 |
| 2.5 300h | 4 | 2AR-FXE | 118/158 | 06/12→ | | | | ZSE172 |
| 3.0 | 6 | 1MZ-FE | 140/188 | 10/96→07/01 | Z221 | 1.0 | UXT14 | ZS430 |
| 3.0 | 6 | 1MZ-FE | 157/211 | 08/01→10/06 | Z221 | 1.0 | UXT14 | ZS430 |
| 3.0 | 6 | 1MZ-FE | 158/212 | 10/01→06/08 | Z221 | 1.0 | UXT14 | ZS430 |
| 3.0 300 | 6 | 3VZ-FE | 138/185 | 09/91→12/97 | Z343 | 1.1 | UXT11 | ZSE173 |

GS

| | | | | | | | | |
|----------------|---|---------|---------|-------------|----------------------|-----|-------|---|
| 2.5 250 | 6 | 4GR-FSE | 154/207 | 01/12→ | | | | ZSE172 |
| 2.5 300h | 4 | 2AR-FSE | 133/178 | 10/13→ | | | | ZSE172 |
| 3.0 | 6 | 3GR-FE | 170/228 | 04/05→11/11 | | | | ZSE172 |
| 3.0 300 | 6 | 2JZ-GE | 156/209 | 03/93→08/97 | Z312 | 1.0 | UXT9 | ZS445 ⁽¹⁾ ZSE173 ⁽¹⁾⁽⁵⁷⁾ |
| 3.0 300 | 6 | 2JZ-GE | 161/216 | 10/00→03/05 | Z343 | 1.1 | UXT11 | |
| 3.0 300 | 6 | 3GR-FSE | 183/245 | 04/05→11/11 | | | | ZSE172 |
| 3.0 300 LPG | 6 | 2JZ-GE | 161/216 | 10/00→03/05 | Z206 | 0.7 | UXT10 | |
| 3.0 300 T3 | 6 | 2JZ-GE | 163/219 | 08/97→10/00 | Z343 | 1.1 | UXT11 | |
| 3.0 300 T3 LPG | 6 | 2JZ-GE | 163/219 | 08/97→10/00 | Z206 | 0.7 | UXT10 | |
| 3.5 350 4WD | 6 | 2GR-FSE | 232/311 | 05/08→11/11 | | | | ZSE172 |
| 3.5 350 | 6 | 2GR-FSE | 234/314 | 01/12→ | | | | ZSE172 |
| 3.5 450h | 6 | 2GR-FXE | 215/288 | 01/12→ | | | | ZSE172 |
| 3.5 450h | 6 | 2GR-FSE | 218/292 | 02/06→11/11 | | | | ZSE172 |
| 3.5 450h | 6 | 2GR-FSE | 254/341 | 02/06→11/11 | | | | ZSE172 |
| 4.0 400 | 8 | 1UZ-FE | 216/290 | 12/97→11/00 | Z313 | 1.1 | UXT14 | |
| 4.0 400 LPG | 8 | 1UZ-FE | 216/290 | 12/97→11/00 | Z30 ^[168] | 0.8 | UXT5 | |
| 4.3 430 | 8 | 3UZ-FE | 208/279 | 11/00→03/05 | Z221 | 1.0 | UXT14 | ZSE172 |
| 4.3 430 | 8 | 3UZ-FE | 208/279 | 04/05→11/11 | Z280 | 1.0 | UXT9 | |
| 4.3 VVTi | 8 | 3UZ-FE | 221/296 | 04/05→11/11 | Z280 | 1.0 | UXT9 | |

GX

| | | | | | | | | |
|-------------|---|--------|---------|--------|--|--|--|--------|
| 4.6 460 4WD | 8 | 1UR-FE | 218/292 | 11/09→ | | | | ZSE172 |
|-------------|---|--------|---------|--------|--|--|--|--------|

IS

| | | | | | | | | |
|-------------|---|--------|---------|-------------|----------------------|-----|-------|--------|
| 2.0 200 | 6 | 1G-FE | 114/153 | 10/02→10/05 | Z221 | 1.0 | UXT14 | ZSE172 |
| 3.0 300 | 6 | 2JZ-GE | 157/211 | 10/01→10/05 | Z313 | 1.1 | UXT14 | |
| 3.0 300 LPG | 6 | 2JZ-GE | 157/211 | 10/01→10/05 | Z30 ^[168] | 0.8 | UXT5 | |

IS I

| | | | | | | | | |
|-------------|---|--------|---------|-------------|----------------------|-----|-------|--------|
| 2.0 200 | 6 | 1G-FE | 114/153 | 04/99→07/05 | Z221 | 1.0 | UXT14 | ZSE172 |
| 3.0 300 | 6 | 2JZ-GE | 157/211 | 09/01→07/05 | Z313 | 1.1 | UXT14 | |
| 3.0 300 LPG | 6 | 2JZ-GE | 157/211 | 09/01→07/05 | Z30 ^[168] | 0.8 | UXT5 | |

IS II

| | | | | | | | | |
|-------------|---|---------|---------|--------|-------|-----|--|--------|
| 2.2 200d | 4 | 2AD-FTV | 110/148 | 07/10→ | GN108 | 11V | | |
| 2.5 250 | 6 | 4GR-FSE | 153/205 | 10/05→ | | | | ZSE172 |
| 2.5 250 4WD | 6 | 4GR-FSE | 153/205 | 10/05→ | | | | ZSE172 |
| 5.0 IS F | 8 | 2UR-GSE | 311/417 | 11/07→ | | | | ZSE167 |

IS III

| | | | | | | | | |
|----------|---|---------|---------|--------|--|--|--|--------|
| 2.5 300h | 4 | 2AR-FSE | 133/178 | 04/13→ | | | | ZSE172 |
|----------|---|---------|---------|--------|--|--|--|--------|

IS C

| | | | | | | | | |
|---------|---|---------|---------|--------|--|--|--|--------|
| 2.5 250 | 6 | 4GR-FSE | 153/205 | 04/09→ | | | | ZSE172 |
|---------|---|---------|---------|--------|--|--|--|--------|

LS

| | | | | | | | | |
|-------------|---|---------|---------|-------------|------|-----|-------|--------|
| 4.0 400 | 8 | 1UZ-FE | 180/241 | 12/89→12/94 | Z130 | 1.0 | UXT14 | ZS445 |
| 4.0 400 | 8 | 1UZ-FE | 194/260 | 12/94→08/97 | Z151 | 0.8 | UXT10 | ZS445 |
| 4.0 400 | 8 | 1UZ-FE | 203/272 | 09/98→10/00 | | | | ZS445 |
| 4.0 400 | 8 | 1UZ-FE | 209/280 | 09/97→10/00 | | | | ZS445 |
| 4.0 400 LPG | 8 | 1UZ-FE | 194/260 | 12/94→08/97 | Z129 | 1.6 | | |
| 4.3 430 | 8 | 3UZ-FE | 207/278 | 10/00→08/06 | Z221 | 1.0 | UXT14 | ZSE172 |
| 4.6 460 | 8 | 1UR-FE | 255/342 | 05/08→ | | | | ZSE172 |
| 4.6 460 4WD | 8 | 1UR-FSE | 270/362 | 12/08→ | | | | ZSE172 |



kW/BHP

**... LEXUS****... LS**

| | | | | | | | | |
|--------------|---|---------|---------|--------|------|--|-----|--------|
| 4.6 460 4WD | 8 | 1UR-FSE | 272/365 | 09/12→ | | | | ZSE172 |
| 4.6 460 | 8 | 1UR-FSE | 280/375 | 04/06→ | Z235 | | 1.0 | ZSE172 |
| 4.6 460 | 8 | 1UR-FSE | 285/382 | 09/12→ | | | | ZSE172 |
| 5.0 600h 4WD | 8 | 2UR-FSE | 290/389 | 08/07→ | | | | ZSE172 |

LX

| | | | | | | | | |
|-------------|---|--------|---------|-------------|--|--|--|--------|
| 4.7 470 4WD | 8 | 2UZ-FE | 170/228 | 05/98→03/08 | | | | ZSE172 |
| 5.7 570 4WD | 8 | 3UR-FE | 270/362 | 11/07→ | | | | ZSE172 |

RX

| | | | | | | | | |
|-------------|---|--------|---------|-------------|------|--|-----|--------------|
| 2.7 270 | 4 | 1AR-FE | 138/185 | 12/08→ | | | | ZSE172 |
| 3.0 300 | 6 | 1MZ-FE | 148/198 | 07/00→03/03 | Z221 | | 1.0 | UXT14 ZSE173 |
| 3.0 300 4WD | 6 | 1MZ-FE | 148/198 | 10/00→05/03 | Z221 | | 1.0 | UXT14 ZSE173 |
| 3.0 300 4WD | 6 | 1MZ-FE | 150/201 | 05/03→12/08 | Z221 | | 1.0 | UXT14 ZSE173 |
| 3.3 400h | 6 | 3MZ-FE | 155/208 | 09/04→12/08 | Z284 | | 1.1 | UXT14 |

SC

| | | | | | | | | |
|---------|---|--------|---------|-------------|------|--|-----|------------------------|
| 4.3 430 | 8 | 3UZ-FE | 210/282 | 05/01→07/10 | Z221 | | 1.0 | UXT14 ZSE172 →07/03 |
| 4.3 430 | 8 | 3UZ-FE | 215/288 | 05/01→07/10 | Z280 | | 1.0 | UXT9 |
| 4.3 430 | 8 | 3UZ-FE | 244/327 | 05/01→07/10 | Z280 | | 1.0 | UXT9 |

LOTUS**ECLAT**

| | | | | | | | | |
|-----|---|-----|---------|-------------|-----|--|-----|--|
| 2.0 | 4 | 907 | 119/160 | 10/75→05/80 | Z27 | | 0.8 | UX56 ZS106 (1)(11)(254) ZS109 (1)(15) |
| 2.2 | 4 | 912 | 119/160 | 05/80→08/86 | | | | ZS106 (1)(11)(254) ZS109 (1)(15) |

ELAN

| | | | | | | | | |
|---------------------|---|--------|---------|-------------|---------------------|--|-----|----------------------|
| 1.6 i 16V | 4 | 4XE1 | 97/130 | 09/89→11/95 | Z24 →06/92 | | 0.8 | UXT5 ZS355 →06/92 |
| 1.6 i 16V LPG | 4 | 4XE1 | 97/130 | 09/89→11/95 | Z30 [168] →06/92 | | 0.8 | UXT5 ZS355 →06/92 |
| 1.6 i 16V Turbo | 4 | 4XE1-T | 115/154 | 09/91→11/95 | Z24 | | 0.8 | UXT5 ZS355 |
| 1.6 i 16V Turbo | 4 | 4XE1-T | 123/165 | 09/89→11/95 | Z24 →06/92 | | 0.8 | UXT5 ZS355 →06/92 |
| 1.6 i 16V Turbo LPG | 4 | 4XE1-T | 115/154 | 09/91→11/95 | Z30 [168] | | 0.8 | UXT5 |
| 1.6 i 16V Turbo LPG | 4 | 4XE1-T | 123/165 | 09/89→11/95 | Z30 [168] →06/92 | | 0.8 | UXT5 ZS355 →06/92 |

ELISE

| | | | | | | | | |
|-------------|---|--------|---------|-------------|------|--|-----|------------|
| 1.8 | 4 | 18 K4F | 90/121 | 11/00→08/05 | Z312 | | 1.0 | UXT9 |
| 1.8 16V | 4 | 18 K4F | 88/118 | 08/95→11/00 | Z149 | | 1.1 | UXT11 |
| 1.8 16V LPG | 4 | 18 K4F | 88/118 | 08/95→11/00 | Z129 | | 1.6 | |
| 1.8 111 S | 4 | 18 K4K | 107/143 | 03/99→11/00 | | | | ZS502 [16] |

ELITE

| | | | | | | | | |
|-----|---|-----|---------|-------------|-----------|--|-----|------|
| 2.0 | 4 | 907 | 119/160 | 05/74→05/80 | Z27 [167] | | 0.8 | UX56 |
| 2.2 | 4 | 912 | 119/160 | 05/80→12/82 | Z27 [167] | | 0.8 | UX56 |

ESPRIT S2

| | | | | | | | | |
|-----------|---|-----|---------|-------------|-----------|--|-----|--|
| 2.0 | 4 | 907 | 119/160 | 10/75→05/80 | Z27 [167] | | 0.8 | UX56 ZS106 (1)(11)(254) ZS109 (1)(15) |
| 2.2 Turbo | 4 | 910 | 157/211 | 02/80→08/88 | Z47 [167] | | 0.8 | UX56 ZS106 (1)(11)(254) ZS109 (1)(15) |

ESPRIT S3

| | | | | | | | | |
|-----|---|-----|---------|-------------|-----------|--|-----|--|
| 2.2 | 4 | 912 | 119/160 | 05/80→08/86 | Z27 [167] | | 0.8 | UX56 ZS106 (1)(11)(254) ZS109 (1)(15) |
|-----|---|-----|---------|-------------|-----------|--|-----|--|

ESPRIT S4

| | | | | | | | | |
|-----|---|--|---------|-------------|--|--|--|-------------------------------------|
| 2.2 | 4 | | 158/212 | 09/90→01/92 | | | | ZS106 (1)(11)(254) ZS109 (1)(15) |
|-----|---|--|---------|-------------|--|--|--|-------------------------------------|

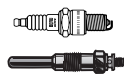

kW/BHP

**... LOTUS****... ESPRIT S4**

| | | | | | | | | | |
|----------------------|---|-------|---------|-------------|-----------|--|-----|-------------|--------------------|
| 2.2 | 4 | | 168/225 | 09/90→10/91 | | | | | ZS106 [1][11][254] |
| | | | | | | | | | ZS109 [1][15] |
| 2.2 | 4 | | 221/296 | 05/93→07/96 | | | | | ZS106 [1][11][254] |
| | | | | | | | | | ZS109 [1][15] |
| 2.2 | 4 | | 222/298 | 11/94→07/96 | | | | | ZS106 [1][11][254] |
| | | | | | | | | | ZS109 [1][15] |
| 2.2 16V Turbo SE | 4 | 910 S | 197/264 | 05/89→09/96 | Z47 [167] | | 0.8 | UX56 | ZS106 [1][11][254] |
| | | | | | | | | | ZS109 [1][15] |
| 3.5 V8 32V Turbo | 8 | 618 | 260/349 | 02/96→06/03 | Z98 | | 0.8 | UXT1 / UXT3 | |
| 3.5 V8 32V Turbo LPG | 8 | 618 | 260/349 | 02/96→06/03 | Z116 | | 0.8 | UXT5 | |

EUROPA

| | | | | | | | | | |
|-----|---|--|--------|-------------|--|--|--|--|------------|
| 1.5 | 4 | | 57/76 | 10/66→10/70 | | | | | ZS106 [11] |
| 1.6 | 4 | | 78/105 | 05/70→04/76 | | | | | ZS106 [11] |

EXCEL

| | | | | | | | | | |
|-----------|---|-------|---------|-------------|-----|--|-----|------|--|
| 2.2 | 4 | 912 | 119/160 | 10/83→08/86 | Z27 | | 0.8 | UX56 | |
| 2.2 SE/SA | 4 | 912 S | 135/181 | 10/84→08/91 | Z27 | | 0.8 | UX56 | |

MAZDA**2 (DE)**

| | | | | | | | | | |
|------------|---|--------------|--------|--------|--------|--|-----|-------|--|
| 1.3 | 4 | ZJ-VE | 55/74 | 10/07→ | Z307 | | 1.3 | UXT11 | |
| 1.3 | 4 | ZJ-VE | 63/84 | 10/07→ | Z307 | | 1.3 | UXT11 | |
| 1.3 LPG | 4 | ZJ-VE | 55/74 | 10/07→ | Z340 | | 0.7 | UXT12 | |
| 1.3 LPG | 4 | ZJ-VE | 63/84 | 10/07→ | Z340 | | 0.7 | UXT12 | |
| 1.4 MZR-CD | 4 | | 50/67 | 01/08→ | GN047 | | 11V | | |
| 1.5 | 4 | ZY-DE, ZY-VE | 76/102 | 10/07→ | Z307 | | 1.3 | UXT11 | |
| 1.5 LPG | 4 | ZY-DE, ZY-VE | 76/102 | 10/07→ | Z340 | | 0.7 | UXT12 | |
| 1.6 MZ-CD | 4 | | 66/89 | 10/08→ | GN047 | | 11V | | |
| 1.6 MZ-CD | 4 | | 70/94 | 06/11→ | GE121A | | 5V | | |

2 (DY)

| | | | | | | | | | |
|--------|---|------------|-------|--------|--------|--|-----|--------|--------|
| 1.2 | 4 | FUJA | 55/74 | 02/03→ | Z177 | | 1.3 | UXT7 | |
| | | | | | →06/07 | | | →06/07 | |
| 1.3 | 4 | FUJA | 55/74 | 04/03→ | Z177 | | 1.3 | UXT7 | ZS350 |
| | | | | | | | | | →02/05 |
| 1.4 | 4 | FXJA | 59/79 | 02/03→ | Z177 | | 1.3 | UXT7 | ZS422 |
| | | | | | →06/07 | | | →06/07 | →02/05 |
| | | | | | | | | | ZS387 |
| | | | | | | | | | 02/05→ |
| 1.4 | 4 | FXJA | 59/79 | 04/03→ | Z177 | | 1.3 | UXT7 | ZS350 |
| | | | | | | | | | →02/05 |
| 1.4 CD | 4 | F6JA, F6JB | 50/67 | 04/03→ | GN047 | | 11V | | |
| 1.6 | 4 | FYJA | 74/99 | 04/03→ | Z177 | | 1.3 | UXT7 | ZS350 |
| | | | | | | | | | →02/05 |

3 (BK)

| | | | | | | | | | |
|------------|---|--------------|---------|-------------|-------------|--|-----|-------|--------|
| 1.4 | 4 | FXJA | 59/79 | 02/04→06/09 | Z177 | | 1.3 | UXT7 | ZS350 |
| | | | | | | | | | →02/05 |
| | | | | | | | | | ZS387 |
| | | | | | | | | | 03/05→ |
| 1.4 | 4 | ZJ-VE | 62/83 | 10/03→06/09 | Z73 | | 1.1 | UXT11 | |
| 1.4 LPG | 4 | ZJ-VE | 62/83 | 10/03→06/09 | Z206 [168] | | 0.7 | UXT10 | |
| 1.6 | 4 | B6ZE | 77/103 | 10/03→06/09 | Z73 | | 1.1 | UXT11 | |
| 1.6 LPG | 4 | B6ZE | 77/103 | 10/03→06/09 | Z206 [168] | | 0.7 | UXT10 | |
| 1.6 MZ-CD | 4 | | 66/89 | 06/06→ | GN056 | | 11V | | |
| 2.0 | 4 | LF17 | 110/148 | 10/03→06/09 | Z298 | | 1.3 | UXT15 | |
| 2.0 LPG | 4 | LF17 | 110/148 | 10/03→06/09 | Z95 | | 0.7 | UXT4 | |
| 2.0 MZR-CD | 4 | RF7J | 105/141 | 12/06→06/09 | GN064 | | 11V | | |
| | | | | | 09/07→01/09 | | | | |
| 2.3 MPS | 4 | L3N9, L3-VDT | 191/256 | 12/06→06/09 | Z342 | | 1.3 | UXT7 | |

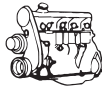

kW/BHP

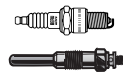
**... MAZDA****3 /Saloon (BK)**

| | | | | | | | |
|--------------|---|------|---------|--------|------------------------|-----|------------------------|
| 1.6 DI Turbo | 4 | Y601 | 80/107 | 06/04→ | GN047 →12/08 | 11V | |
| 2.0 | 4 | LF17 | 110/148 | 10/03→ | | | ZS422 →02/06 |

3 Saloon (BK)

| | | | | | | | |
|------------|---|------|---------|-------------|--|-----|---|
| 1.6 | 4 | Z6 | 77/103 | 02/04→ | Z73 | 1.1 | UXT11 |
| 1.6 LPG | 4 | Z6 | 77/103 | 02/04→ | Z206 [168] | 0.7 | UXT10 |
| 2.0 | 4 | LF17 | 104/139 | 04/04→06/06 | | | ZS408 |
| 2.0 | 4 | LF17 | 110/148 | 02/04→ | Z298 →05/09 Z310 06/09→ | 1.3 | UXT15 →05/09 UXT8 06/09→ |
| 2.0 LPG | 4 | LF17 | 110/148 | 02/04→ | Z95 →05/09 | 0.7 | UXT4 →05/09 |
| 2.0 MZR-CD | 4 | RF7J | 105/141 | 12/06→ | GN064 | 11V | |

3 (BL)

| | | | | | | | |
|------------|---|------|--------|--------|--------------|-----|--|
| 1.6 MZR CD | 4 | Y601 | 80/107 | 06/09→ | GN056 | 11V | |
|------------|---|------|--------|--------|--------------|-----|--|

3 /Saloon (BL)

| | | | | | | | |
|------------|---|----|--------|--------|---------------|-----|--------------|
| 1.6 MZR | 4 | Z6 | 77/103 | 06/09→ | Z73 | 1.1 | UXT11 |
| 1.6 MZR CD | 4 | | 85/114 | 11/10→ | GE121A | 5V | |

3 Saloon (BL)

| | | | | | | | |
|------------|---|--|--------|--------|--------------|-----|--|
| 1.6 MZR CD | 4 | | 80/107 | 06/09→ | GN056 | 11V | |
|------------|---|--|--------|--------|--------------|-----|--|

5 (CR19)

| | | | | | | | |
|---------|---|------|---------|--------|--------------|-----|--------------|
| 1.8 | 4 | L823 | 85/114 | 03/05→ | Z298 | 1.3 | UXT15 |
| 1.8 LPG | 4 | L823 | 85/114 | 03/05→ | Z95 | 0.7 | UXT4 |
| 2.0 CD | 4 | | 81/109 | 03/05→ | GN064 | 11V | |
| 2.0 CD | 4 | RF7J | 105/141 | 06/05→ | GN064 | 11V | |

5 (CW)

| | | | | | | | |
|--------|---|--|--------|--------|---------------|----|--|
| 1.6 CD | 4 | | 85/114 | 09/10→ | GE121A | 5V | |
|--------|---|--|--------|--------|---------------|----|--|

6 /Hatchback (GG)

| | | | | | | | |
|---------|---|------------|---------|-------------|--|-----|-----------------------|
| 1.8 | 4 | L813 | 88/118 | 08/02→08/07 | Z298 | 1.3 | UXT15 |
| 1.8 LPG | 4 | L813 | 88/118 | 08/02→08/07 | Z95 | 0.7 | UXT4 |
| 2.0 | 4 | LF17, LF18 | 104/139 | 06/02→08/07 | Z230 | 1.3 | |
| 2.0 | 4 | LFF7 | 108/145 | 03/05→08/07 | Z342 | 1.3 | UXT7 |
| 2.0 DI | 4 | RF5C | 89/119 | 08/02→08/07 | GN064 | 11V | |
| 2.0 DI | 4 | RF5C | 100/134 | 06/02→08/07 | GN064 | 11V | |
| 2.0 DI | 4 | RF7J | 105/141 | 06/05→08/07 | GN064 | 11V | |
| 2.3 | 4 | L3C1 | 122/164 | 06/02→08/07 | Z230 →02/05 Z342 03/05→ | 1.3 | UXT7 03/05→ |

6 /Estate/Hatchback (GH)

| | | | | | | | |
|-------------|---|------|---------|--------|--------------|-----|--------------|
| 1.8 MZR | 4 | L813 | 88/118 | 08/07→ | Z298 | 1.3 | UXT15 |
| 1.8 MZR LPG | 4 | L813 | 88/118 | 08/07→ | Z95 | 0.7 | UXT4 |
| 2.0 MZR-CD | 4 | RF7J | 103/138 | 08/07→ | GN064 | 11V | |

6 Station Wagon (GY)

| | | | | | | | |
|--------------|---|------------|---------|-------------|--------------|-----|--------------|
| 1.8 | 4 | L813 | 88/118 | 08/02→08/07 | Z298 | 1.3 | UXT15 |
| 1.8 LPG | 4 | L813 | 88/118 | 08/02→08/07 | Z95 | 0.7 | UXT4 |
| 2.0 | 4 | LF17, LF18 | 104/139 | 08/02→08/07 | Z230 | 1.3 | |
| 2.0 | 4 | LFF7 | 108/145 | 03/05→08/07 | Z342 | 1.3 | UXT7 |
| 2.0 CiTD 4WD | 4 | RF5C | 89/119 | 10/02→02/05 | GN064 | 11V | |
| 2.0 CiTD 4WD | 4 | RF5C | 100/134 | 10/02→02/05 | GN064 | 11V | |
| 2.0 DI | 4 | RF5C | 89/119 | 08/02→08/07 | GN064 | 11V | |
| 2.0 DI | 4 | RF5C | 100/134 | 08/02→08/07 | GN064 | 11V | |
| 2.0 DI | 4 | RF7J | 105/141 | 06/05→08/07 | GN064 | 11V | |

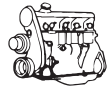

kW/BHP

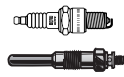

... MAZDA



... 6 Station Wagon (GY)

| | | | | | | | | | |
|---------|---|------|---------|-------------|----------------------------------|-----|----------------|-----------------|--|
| 2.3 4WD | 4 | L3CI | 119/160 | 11/02→08/07 | Z230 →02/05 Z342 03/05→ | 1.3 | | | |
| 2.3 | 4 | L3CI | 122/164 | 08/02→08/07 | Z230 →02/05 Z342 03/05→ | 1.3 | UXT7 03/05→ | ZS422 →02/05 | |

121 I (DA)

| | | | | | | | | | |
|-----|---|------|-------|-------------|----|------|-------------|--|-------|
| 1.1 | 4 | B1 | 42/56 | 10/87→10/90 | Z8 | 0.8 | UXT2 / UXT6 | | |
| 1.1 | 4 | B116 | 42/56 | 10/87→10/90 | Z9 | 1.15 | UXT2 / UXT6 | | |
| 1.3 | 4 | B3 | 40/54 | 04/89→10/90 | Z9 | 1.15 | UXT2 / UXT6 | | ZM025 |
| 1.3 | 4 | B3 | 44/59 | 10/87→11/90 | Z9 | 1.15 | UXT2 / UXT6 | | ZM025 |

121 II (DB)

| | | | | | | | | | |
|---------------|---|----------|-------|-------------|------|-----|-------------|--|-------|
| 1.1 | 4 | B1 | 40/54 | 11/90→10/93 | Z8 | 0.8 | UXT2 / UXT6 | | |
| 1.3 16V | 4 | B3 (16V) | 39/52 | 11/90→03/96 | Z16 | 1.1 | UXT11 | | ZM025 |
| 1.3 16V LPG | 4 | B3 (16V) | 39/52 | 11/90→03/96 | Z340 | 0.7 | UXT12 | | |
| 1.3 i 16V | 4 | B3 (16V) | 53/71 | 11/90→03/96 | Z16 | 1.1 | UXT11 | | ZM025 |
| 1.3 i 16V LPG | 4 | B3 (16V) | 53/71 | 11/90→03/96 | Z340 | 0.7 | UXT12 | | |

121 III (JASM, JBSM)

| | | | | | | | | | |
|---------|---|----------|-------|-------------|-------|-----|-------|--|--|
| 1.3 | 4 | JJK, JJM | 37/50 | 03/96→04/03 | Z67 | 1.1 | UXT4 | ZS350 | |
| 1.3 | 4 | J4R, J4T | 44/59 | 03/96→04/03 | Z67 | 1.1 | UXT4 | ZS350 | |
| 1.3 | 4 | DHF, DHG | 55/74 | 03/96→04/03 | Z177 | 1.3 | UXT7 | ZS239 ^[119] ZS350 ^[126] | |
| 1.3 LPG | 4 | JJK, JJM | 37/50 | 03/96→04/03 | Z26 | 0.7 | UXK56 | | |
| 1.3 LPG | 4 | J4R, J4T | 44/59 | 03/96→04/03 | Z26 | 0.7 | UXK56 | | |
| 1.8 D | 4 | RTJ, RTK | 44/59 | 03/96→04/03 | GN022 | 10V | | | |

323 C IV (BG)

| | | | | | | | | | |
|-------------------|---|------------|---------|-------------|-------|------|-------------|----------------------|-----------------|
| 1.3 | 4 | B3E | 49/66 | 09/89→07/94 | Z9 | 1.15 | UXT2 / UXT6 | ZS279 | |
| 1.3 16V | 4 | B3 (16V) | 54/72 | 09/89→07/94 | Z16 | 1.1 | UXT11 | ZS279 04/91→ | ZM050 04/91→ |
| 1.6 | 4 | B6E | 62/83 | 09/89→06/91 | Z9 | 1.15 | UXT2 / UXT6 | ZS279 | ZM025 |
| 1.6 16V | 4 | B6 | 65/87 | 03/91→10/94 | Z16 | 1.1 | UXT11 | ZS279 ^[1] | |
| 1.6 16V LPG | 4 | B6 | 65/87 | 03/91→10/94 | Z340 | 0.7 | UXT12 | | |
| 1.7 D | 4 | PN54 | 41/55 | 08/89→07/94 | GN005 | 11V | | | |
| 1.8 16V 4WD | 4 | BP | 76/102 | 11/91→12/93 | Z16 | 1.1 | UXT11 | ZS279 | ZM050 |
| 1.8 16V | 4 | BP22, BP31 | 103/138 | 09/89→03/93 | | | | ZS279 | |
| 1.8 16V GT | 4 | BP (DOHC) | 94/126 | 09/89→03/93 | Z16 | 1.1 | UXT11 | ZS279 | ZM050 01/90→ |
| 1.8 16V GT LPG | 4 | BP (DOHC) | 94/126 | 09/89→03/93 | Z340 | 0.7 | UXT12 | | |
| 1.8 16V Turbo 4WD | 4 | BP Turbo | 120/161 | 09/90→12/92 | Z16 | 1.1 | UXT11 | ZS279 | ZM050 |
| 1.8 16V Turbo 4WD | 4 | BP Turbo | 136/182 | 01/93→07/94 | Z16 | 1.1 | UXT11 | ZS279 | ZM050 |

323 C V (BA)

| | | | | | | | | | |
|-------------|---|----------|--------|-------------|------|-----|-------|--|--|
| 1.3 16V | 4 | B3 (16V) | 54/72 | 08/94→09/98 | Z16 | 1.1 | UXT11 | | |
| 1.3 16V LPG | 4 | B3 (16V) | 54/72 | 08/94→09/98 | Z340 | 0.7 | UXT12 | | |
| 1.5 16V | 4 | Z5-DE | 65/87 | 08/94→09/98 | Z16 | 1.1 | UXT11 | | |
| 1.5 16V LPG | 4 | Z5-DE | 65/87 | 08/94→09/98 | Z340 | 0.7 | UXT12 | | |
| 1.8 16V | 4 | BP-ZE | 84/113 | 08/94→09/98 | Z16 | 1.1 | UXT11 | | |
| 1.8 16V LPG | 4 | BP-ZE | 84/113 | 08/94→09/98 | Z340 | 0.7 | UXT12 | | |

323 F IV (BG)

| | | | | | | | | | |
|-------------|---|------|---------|-------------|------|------|-------------|----------------------|-------------|
| 1.6 | 4 | B6E | 62/83 | 09/89→06/91 | Z9 | 1.15 | UXT2 / UXT6 | ZS279 | ZM025 |
| 1.6 | 4 | | 66/89 | 04/91→04/94 | Z227 | 0.8 | UXT10 | ZS279 ^[1] | |
| 1.6 16V | 4 | B6 | 65/87 | 03/91→10/94 | Z16 | 1.1 | UXT11 | ZS279 | ZM050 |
| 1.6 16V LPG | 4 | B6 | 65/87 | 03/91→10/94 | Z340 | 0.7 | UXT12 | | |
| 1.8 4WD | 4 | BPC | 76/102 | 01/91→04/94 | Z16 | 1.1 | UXT11 | ZS279 | ZM050 |
| 1.8 16V | 4 | BP | 76/102 | 08/89→07/94 | Z16 | 1.1 | UXT11 | ZS279 | ZM050 |
| 1.8 16V | 4 | BP31 | 103/138 | 09/89→03/93 | | | | ZS279 | ch. 500001→ |

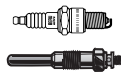

kW/BHP

**... MAZDA****... 323 F IV (BG)**

| | | | | | | | | | |
|----------------|---|-----------|--------|-------------|------|-----|-------|-------|-----------------|
| 1.8 16V LPG | 4 | BP | 76/102 | 08/89→07/94 | Z340 | 0.7 | UXT12 | | |
| 1.8 16V GT | 4 | BP (DOHC) | 94/126 | 08/89→07/94 | Z16 | 1.1 | UXT11 | ZS279 | ZM050 01/90→ |
| 1.8 16V GT LPG | 4 | BP (DOHC) | 94/126 | 08/89→07/94 | Z340 | 0.7 | UXT12 | | |

323 F V (BA)

| | | | | | | | | | |
|-------------|---|-------|---------|-------------|------|-----|-------|--|-------|
| 1.5 16V | 4 | Z5-DE | 65/87 | 07/94→09/98 | Z16 | 1.1 | UXT11 | | ZM024 |
| 1.5 16V LPG | 4 | Z5-DE | 65/87 | 07/94→09/98 | Z340 | 0.7 | UXT12 | | |
| 1.8 16V | 4 | BP-ZE | 84/113 | 08/94→09/98 | Z16 | 1.1 | UXT11 | | |
| 1.8 16V LPG | 4 | BP-ZE | 84/113 | 08/94→09/98 | Z340 | 0.7 | UXT12 | | |
| 2.0 24V | 6 | KF | 106/142 | 08/94→09/98 | Z16 | 1.1 | UXT11 | | |
| 2.0 24V LPG | 6 | KF | 106/142 | 08/94→09/98 | Z340 | 0.7 | UXT12 | | |

323 F VI (BJ)

| | | | | | | | | | |
|-------------|---|------------|--------|-------------|-------|-----|-------|--------|-------|
| 1.4 | 4 | B3 (16V) | 53/71 | 01/01→05/04 | Z73 | 1.1 | UXT11 | | |
| 1.4 LPG | 4 | B3 (16V) | 53/71 | 01/01→05/04 | Z206 | 0.7 | UXT10 | | |
| 1.4 16V | 4 | B3 ME | 54/72 | 09/98→01/01 | Z16 | 1.1 | UXT11 | | |
| 1.4 16V LPG | 4 | B3 ME | 54/72 | 09/98→01/01 | Z340 | 0.7 | UXT12 | | |
| 1.5 16V | 4 | ZL05, ZL06 | 65/87 | 09/98→01/01 | Z16 | 1.1 | UXT11 | | ZM024 |
| 1.5 16V LPG | 4 | ZL05, ZL06 | 65/87 | 09/98→01/01 | Z340 | 0.7 | UXT12 | | |
| 1.6 | 4 | ZM | 70/94 | 01/01→05/04 | Z158 | 1.1 | | | |
| 1.6 | 4 | ZM | 72/97 | 01/01→05/04 | Z158 | 1.1 | | | |
| 1.6 LPG | 4 | ZM | 70/94 | 01/01→05/04 | Z116 | 0.8 | UXT5 | | |
| 1.6 LPG | 4 | ZM | 72/97 | 01/01→05/04 | Z116 | 0.8 | UXT5 | | |
| 1.8 Astina | 4 | BP (DOHC) | 92/123 | 09/98→05/04 | | | | ZSE083 | |
| 1.9 16V | 4 | FP, FP55 | 84/113 | 09/98→01/01 | Z73 | 1.1 | UXT11 | ZSE083 | |
| 1.9 16V LPG | 4 | FP, FP55 | 84/113 | 09/98→01/01 | Z206 | 0.7 | UXT10 | | |
| 2.0 | 4 | FS7E, FS7G | 96/129 | 01/01→05/04 | Z16 | 1.1 | UXT11 | ZSE083 | |
| 2.0 LPG | 4 | FS7E, FS7G | 96/129 | 01/01→05/04 | Z340 | 0.7 | UXT12 | | |
| 2.0 D | 4 | RF1G | 52/70 | 09/98→05/04 | GN064 | | 11V | | |
| 2.0 TD | 4 | | 66/89 | 09/98→01/01 | GN064 | | 11V | | |
| 2.0 TD | 4 | RF4F | 74/99 | 01/01→05/04 | GN064 | | 11V | | |

323 I (FA)

| | | | | | | | | | |
|-----|---|-------|-------|-------------|-----|-----|-------------|--|--|
| 1.0 | 4 | P, PC | 33/44 | 06/77→05/80 | Z20 | 0.8 | UXT2 / UXT6 | | |
| 1.3 | 4 | T, TC | 44/59 | 01/77→05/80 | Z20 | 0.8 | UXT2 / UXT6 | | |
| 1.4 | 4 | U, UC | 51/68 | 05/78→05/80 | Z8 | 0.8 | UXT2 / UXT6 | | |

323 I Station Wagon (FA)

| | | | | | | | | | |
|-----|---|----|-------|-------------|-----|-----|-------------|--|--|
| 1.3 | 4 | TC | 44/59 | 05/78→05/86 | Z8 | 0.8 | UXT2 / UXT6 | | |
| 1.4 | 4 | UC | 51/68 | 05/78→08/82 | Z20 | 0.8 | UXT2 / UXT6 | | |
| 1.5 | 4 | D5 | 52/70 | 04/82→05/86 | Z8 | 0.8 | UXT2 / UXT6 | | |

323 II (BD)

| | | | | | | | | | |
|-----|---|----|-------|-------------|----|-----|-------------|--|-------|
| 1.5 | 4 | E5 | 59/79 | 11/80→07/85 | Z8 | 0.8 | UXT2 / UXT6 | | ZM022 |
|-----|---|----|-------|-------------|----|-----|-------------|--|-------|

323 II /Hatchback (BD)

| | | | | | | | | | |
|-----|---|----|-------|-------------|----|-----|-------------|--|-----------------|
| 1.3 | 4 | E3 | 44/59 | 11/80→10/85 | Z8 | 0.8 | UXT2 / UXT6 | | ZM022 09/82→ |
| 1.3 | 4 | E3 | 50/67 | 11/80→10/89 | Z8 | 0.8 | UXT2 / UXT6 | | ZM022 09/82→ |
| 1.5 | 4 | E5 | 65/87 | 03/82→09/86 | Z8 | 0.8 | UXT2 / UXT6 | | ZM022 09/82→ |

323 II Hatchback (BD)

| | | | | | | | | | |
|-----|---|----|-------|-------------|----|-----|-------------|--|-----------------|
| 1.1 | 4 | E1 | 40/54 | 11/80→10/85 | Z8 | 0.8 | UXT2 / UXT6 | | ZM022 09/82→ |
| 1.5 | 4 | E5 | 55/74 | 05/81→07/85 | Z8 | 0.8 | UXT2 / UXT6 | | ZM022 |
| 1.5 | 4 | E5 | 63/84 | 11/80→12/83 | Z8 | 0.8 | UXT2 / UXT6 | | ZM022 09/82→ |



kW/BHP

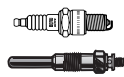

... MAZDA

**323 III (BF)**

| | | | | | | | | | |
|--------|---|-----------|-------|-------------|----|--|------|-------------|------------------------------------|
| 1.3 | 4 | E3 | 44/59 | 08/85→05/89 | Z9 | | 1.15 | UXT2 / UXT6 | ZM022 →07/87 ZM024 08/87→ |
| 1.6 GT | 4 | B6 (SOHC) | 63/84 | 11/86→10/89 | | | | | ZM022 →06/87 ZM024 07/87→ |

323 III /Hatchback (BF)

| | | | | | | | | | |
|--------------|---|-----------|---------|-------------|-------|--|------|-------------|--------------------------|
| 1.3 | 4 | E3 | 44/59 | 08/85→05/89 | | | | ZS274 | |
| 1.5 | 4 | B5 | 54/72 | 09/87→10/89 | Z8 | | 0.8 | UXT2 / UXT6 | |
| 1.5 | 4 | E5 | 55/74 | 08/85→05/89 | Z8 | | 0.8 | UXT2 / UXT6 | ZM022 →08/87 |
| 1.6 GT | 4 | B6 (SOHC) | 63/84 | 11/86→10/89 | Z9 | | 1.15 | UXT2 / UXT6 | ZS274 |
| 1.6 GT | 4 | B6 (SOHC) | 77/103 | 08/85→08/93 | Z8 | | 0.8 | UXT2 / UXT6 | ZS274 ZM022 →08/87 |
| 1.6 GT Turbo | 4 | B6T | 103/138 | 10/85→08/93 | | | | | ZS274 |
| 1.7 D | 4 | PN27 | 40/54 | 04/86→05/89 | GN005 | | 11V | | |
| 1.7 D | 4 | PN46 | 42/56 | 01/87→05/89 | GN005 | | 11V | | |

323 III Hatchback (BF)

| | | | | | | | | | |
|------------------|---|-----------|---------|-------------|--------------------|--|------|----------------------|-------|
| 1.1 | 4 | E1 | 40/54 | 09/85→10/89 | Z8 | | 0.8 | UXT2 / UXT6 | ZM022 |
| 1.3 | 4 | E3 | 44/59 | 09/85→12/87 | Z8 | | 0.8 | UXT2 / UXT6 | ZM022 |
| 1.3 | 4 | E3 | 50/67 | 09/85→03/87 | Z8 | | 0.8 | UXT2 / UXT6 | |
| 1.3 i | 4 | B3E | 49/66 | 09/85→08/89 | Z9 | | 1.15 | UXT2 / UXT6 | ZS274 |
| 1.3 i LPG | 4 | B3E | 49/66 | 09/85→08/89 | Z20 [168] | | 0.8 | UXT2 / UXT6 | |
| 1.4 | 4 | B3 | 44/59 | 09/87→10/89 | Z20 | | 0.8 | UXT2 / UXT6 | ZS274 |
| 1.6 GT | 4 | B6 (SOHC) | 63/84 | 09/87→10/89 | | | | | ZM024 |
| 1.6 GT Turbo | 4 | B6T | 103/138 | 10/85→08/93 | Z16 06/87→05/89 | | 1.1 | UXT11 06/87→05/89 | |
| 1.6 GT Turbo 4WD | 4 | B6T | 103/138 | 10/87→11/91 | Z16 →05/89 | | 1.1 | UXT11 →05/89 | ZS274 |
| 1.6 GT Turbo 4WD | 4 | | 110/148 | 08/87→10/89 | Z15 | | 0.8 | UXT1 / UXT3 | ZS274 |

323 III Station Wagon (BW)

| | | | | | | | | | |
|---------|---|----------------------|-------|-------------|-----------|--|------|-------------|------------------------------------|
| 1.3 | 4 | E3 | 44/59 | 07/86→04/90 | Z8 | | 0.8 | UXT2 / UXT6 | |
| 1.5 | 4 | B5, B50, B53 | 54/72 | 01/87→05/89 | Z8 | | 0.8 | UXT2 / UXT6 | ZM022 →08/87 ZM025 08/87→ |
| 1.5 | 4 | B50, B53, E5 | 55/74 | 05/86→05/89 | Z8 | | 0.8 | UXT2 / UXT6 | ZM022 →08/87 |
| 1.6 | 4 | B6 (SOHC) | 63/84 | 09/86→10/95 | Z9 | | 1.15 | UXT2 / UXT6 | ZM025 |
| 1.6 | 4 | B6E | 63/84 | 09/86→10/95 | Z9 | | 1.15 | UXT2 / UXT6 | ZS279 ZM025 |
| 1.6 | 4 | B65M | 63/84 | 09/86→10/95 | Z9 | | 1.15 | UXT2 / UXT6 | ZS274 ZM025 |
| 1.6 4WD | 4 | B6E | 63/84 | 05/90→03/93 | Z9 | | 1.15 | UXT2 / UXT6 | ZS279 |
| 1.6 4WD | 4 | B65M | 63/84 | 05/90→03/93 | Z9 | | 1.15 | UXT2 / UXT6 | ZS274 |
| 1.6 LPG | 4 | B6 (SOHC), B6E, B65M | 63/84 | 09/86→10/95 | Z20 [168] | | 0.8 | UXT2 / UXT6 | |
| 1.7 D | 4 | PN26 | 40/54 | 11/86→08/87 | GN005 | | 11V | | |
| 1.7 D | 4 | PN26, PN54 | 41/55 | 10/89→03/93 | GN005 | | 11V | | |
| 1.7 D | 4 | PN26, PN54 | 42/56 | 11/86→10/89 | GN005 | | 11V | | |

323 P V (BA)

| | | | | | | | | | |
|-------------|---|----------|-------|--------|-------|--|-----|-------|--|
| 1.3 16V | 4 | B3 (16V) | 54/72 | 10/96→ | Z16 | | 1.1 | UXT11 | |
| 1.3 16V LPG | 4 | B3 (16V) | 54/72 | 10/96→ | Z340 | | 0.7 | UXT12 | |
| 1.5 16V | 4 | Z5-DE | 65/87 | 10/96→ | Z73 | | 1.1 | UXT11 | |
| 1.5 16V LPG | 4 | Z5-DE | 65/87 | 10/96→ | Z206 | | 0.7 | UXT10 | |
| 2.0 D | 4 | RFIG | 52/70 | 10/96→ | GN005 | | 11V | | |

323 S IV (BG)

| | | | | | | | | | |
|-----|---|-----------|-------|-------------|----|--|------|-------------|-------|
| 1.3 | 4 | B3E, B383 | 49/66 | 09/89→06/91 | Z9 | | 1.15 | UXT2 / UXT6 | ZS274 |
|-----|---|-----------|-------|-------------|----|--|------|-------------|-------|



kW/BHP

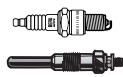

... MAZDA



... 323 S IV (BG)

| | | | | | | | | | |
|-------------------|---|------------------|---------|-------------|------------------------------------|------|-------------------------------------|----------------------|--------------------------------|
| 1.3 16V | 4 | B3 (16V) | 54/72 | 04/91→07/94 | Z16 <small>ch. 500001→</small> | 1.1 | UXT11 <small>ch. 500001→</small> | ZS279 | ZM025 |
| 1.3 16V LPG | 4 | B3 (16V) | 54/72 | 04/91→07/94 | Z340 <small>ch. 500001→</small> | 0.7 | UXT12 <small>ch. 500001→</small> | | |
| 1.6 | 4 | B6E | 62/83 | 09/89→06/91 | Z9 | 1.15 | UXT2 / UXT6 | ZS279 | ZM025 |
| 1.6 | 4 | | 66/89 | 04/91→10/94 | | | | ZS279 ⁽¹⁾ | |
| 1.6 16V | 4 | B6 | 65/87 | 08/89→10/94 | Z16 | 1.1 | UXT11 | ZS279 | ZM050 |
| 1.6 16V LPG | 4 | B6 | 65/87 | 08/89→10/94 | Z340 | 0.7 | UXT12 | | |
| 1.7 D | 4 | PN46, PN54, PN62 | 41/55 | 08/89→07/94 | GN005 | 11V | | | |
| 1.8 16V | 4 | BP52 | 76/102 | 08/89→07/94 | Z16 | 1.1 | UXT11 | ZS279 | ZM050 |
| 1.8 16V 4WD | 4 | BP52 | 76/102 | 09/91→07/94 | Z16 | 1.1 | UXT11 | ZS279 | |
| 1.8 16V LPG | 4 | BP52 | 76/102 | 08/89→07/94 | Z340 | 0.7 | UXT12 | | |
| 1.8 16V GT | 4 | BP (DOHC) | 94/126 | 06/89→07/94 | Z16 | 1.1 | UXT11 | ZS279 | ZM050 <small>01/90→</small> |
| 1.8 16V GT LPG | 4 | BP (DOHC) | 94/126 | 06/89→07/94 | Z340 | 0.7 | UXT12 | | |
| 1.8 16V Turbo 4WD | 4 | BP Turbo | 120/161 | 01/91→07/94 | Z16 | 1.1 | UXT11 | | ZM050 |

323 S V (BA)

| | | | | | | | | | |
|-------------|---|----------|--------|-------------|-------|-----|-------|--|-------|
| 1.3 16V | 4 | B3 (16V) | 54/72 | 08/94→09/98 | Z16 | 1.1 | UXT11 | | |
| 1.3 16V LPG | 4 | B3 (16V) | 54/72 | 08/94→09/98 | Z340 | 0.7 | UXT12 | | |
| 1.5 16V | 4 | Z5-DE | 65/87 | 08/94→09/98 | Z16 | 1.1 | UXT11 | | ZM024 |
| 1.5 16V LPG | 4 | Z5-DE | 65/87 | 08/94→09/98 | Z340 | 0.7 | UXT12 | | |
| 1.6 TD | 4 | 4EE1-T | 60/80 | 05/94→09/98 | GN005 | 11V | | | |
| 1.8 16V | 4 | BP-ZE | 84/113 | 08/94→09/98 | Z16 | 1.1 | UXT11 | | |
| 1.8 16V LPG | 4 | BP-ZE | 84/113 | 08/94→09/98 | Z340 | 0.7 | UXT12 | | |
| 2.0 D | 4 | RF1G | 52/70 | 10/96→09/98 | GN005 | 11V | | | |

323 S VI (BJ)

| | | | | | | | | | |
|-------------|---|------------|--------|-------------|-------------------------------|-----|-------------------------------|--------|-------|
| 1.4 | 4 | B3 (16V) | 53/71 | 01/01→05/04 | Z73 | 1.1 | UXT11 | | |
| 1.4 LPG | 4 | B3 (16V) | 53/71 | 01/01→05/04 | Z206 | 0.7 | UXT10 | | |
| 1.4 16V | 4 | B3 ME | 54/72 | 09/98→01/01 | Z16 | 1.1 | UXT11 | | |
| 1.4 16V LPG | 4 | B3 ME | 54/72 | 09/98→01/01 | Z340 | 0.7 | UXT12 | | |
| 1.5 16V | 4 | ZL05, ZL06 | 65/87 | 09/98→01/01 | Z73 | 1.1 | UXT11 | | ZM024 |
| 1.5 16V LPG | 4 | ZL05, ZL06 | 65/87 | 09/98→01/01 | Z206 | 0.7 | UXT10 | | |
| 1.6 | 4 | ZM | 70/94 | 01/01→05/04 | Z158 <small>→09/03</small> | 1.1 | | | |
| 1.6 | 4 | ZM | 72/97 | 01/01→05/04 | Z158 <small>→09/03</small> | 1.1 | | | |
| 1.6 LPG | 4 | ZM | 70/94 | 01/01→05/04 | Z116 <small>→09/03</small> | 0.8 | UXT5 <small>→09/03</small> | | |
| 1.6 LPG | 4 | ZM | 72/97 | 01/01→05/04 | Z116 <small>→09/03</small> | 0.8 | UXT5 <small>→09/03</small> | | |
| 1.8 Protege | 4 | BP (DOHC) | 92/123 | 05/98→05/04 | | | | ZSE083 | |
| 1.9 16V | 4 | FP, FP55 | 84/113 | 09/98→05/04 | Z16 | 1.1 | UXT11 | ZSE083 | |
| 1.9 16V LPG | 4 | FP, FP55 | 84/113 | 09/98→05/04 | Z340 | 0.7 | UXT12 | | |
| 2.0 | 4 | FS7E, FS7G | 96/129 | 01/01→05/04 | Z16 | 1.1 | UXT11 | ZSE083 | |
| 2.0 LPG | 4 | FS7E, FS7G | 96/129 | 01/01→05/04 | Z340 | 0.7 | UXT12 | | |
| 2.0 D | 4 | RF1G | 52/70 | 09/98→05/04 | GN064 | 11V | | | |
| 2.0 DiTD | 4 | RF4F | 74/99 | 10/00→10/02 | GN064 | 11V | | | |
| 2.0 TD | 4 | RF3F | 66/89 | 09/98→05/04 | GN064 | 11V | | | |

616

| | | | | | | | | | |
|-----|---|----|-------|-------------|-----|-----|-------------|--|--|
| 1.6 | 4 | NA | 55/74 | 06/73→02/78 | Z11 | 0.8 | UXT2 / UXT6 | | |
|-----|---|----|-------|-------------|-----|-----|-------------|--|--|

626 I (CB)

| | | | | | | | | | |
|-----|---|------------|-------|-------------|-----------------------------|-----|--------------------------------------|--|--|
| 1.6 | 4 | H6, N, NA | 55/74 | 05/79→05/82 | Z8 <small>09/80→</small> | 0.8 | UXT2 / UXT6 <small>09/80→</small> | | |
| 2.0 | 4 | HE3, M, MA | 66/89 | 05/79→05/82 | Z8 | 0.8 | UXT2 / UXT6 | | |

626 II (GC)

| | | | | | | | | | |
|-------|---|---------|-------|-------------|-----------------------------|-----|--------------------------------------|--|--|
| 2.0 | 4 | FE (8V) | 74/99 | 03/83→09/87 | Z8 <small>07/85→</small> | 0.8 | UXT2 / UXT6 <small>07/85→</small> | | |
| 2.0 D | 4 | RF46 | 47/63 | 11/82→07/85 | GV705 | 7V | | | |

MAZDA



kW/BHP

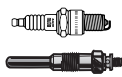

... MAZDA

**626 II /Hatchback (GC)**

| | | | | | | | | |
|-------|---|---------|--------|-------------|-------|-----|-------------|-------|
| 1.6 | 4 | F6 | 59/79 | 11/82→09/87 | Z8 | 0.8 | UXT2 / UXT6 | ZM022 |
| 2.0 | 4 | FE (8V) | 68/91 | 01/85→09/87 | Z20 | 0.8 | UXT2 / UXT6 | ZM022 |
| 2.0 | 4 | FE (8V) | 74/99 | 03/83→09/87 | | | | ZM022 |
| 2.0 | 4 | FE (8V) | 88/118 | 01/86→09/87 | Z20 | 0.8 | UXT2 / UXT6 | ZM022 |
| 2.0 D | 4 | RF46 | 46/62 | 01/83→06/87 | GN005 | 11V | | |

08/85→

626 II Coupe (GC)

| | | | | | | | | |
|-----|---|---------|--------|-------------|----|-----|-------------|-------|
| 2.0 | 4 | FE (8V) | 70/94 | 02/83→10/87 | Z8 | 0.8 | UXT2 / UXT6 | ZM022 |
| 2.0 | 4 | FE (8V) | 81/109 | 01/86→10/87 | | | | ZS274 |

626 II Hatchback (GC)

| | | | | | | | | |
|-----|---|---------|-------|-------------|----|-----|-------------|-------|
| 1.6 | 4 | | 55/74 | 03/83→09/87 | Z8 | 0.8 | UXT2 / UXT6 | ZM022 |
| 2.0 | 4 | FE (8V) | 74/99 | 03/83→09/87 | Z8 | 0.8 | UXT2 / UXT6 | |

626 III (GD)

| | | | | | | | | |
|---------|---|----------|---------|-------------|-----------|------|-------------|-------------|
| 2.0 | 4 | FE (12V) | 66/89 | 09/87→10/90 | Z9 | 1.15 | UXT2 / UXT6 | ZS274 ZM024 |
| 2.0 LPG | 4 | FE (12V) | 66/89 | 09/87→10/90 | Z20 [168] | 0.8 | UXT2 / UXT6 | |
| 2.0 16V | 4 | FE (16V) | 103/138 | 11/87→05/92 | Z16 | 1.1 | UXT11 | |

→07/91

→07/91

626 III /Coupe (GD)

| | | | | | | | | |
|-------------|---|----------|---------|-------------|------|-----|-------|--|
| 2.0 16V | 4 | FE (16V) | 109/146 | 06/87→09/89 | Z16 | 1.1 | UXT11 | |
| 2.0 16V LPG | 4 | FE (16V) | 109/146 | 06/87→09/89 | Z340 | 0.7 | UXT12 | |

626 III /Coupe/Hatchback (GD)

| | | | | | | | | |
|---------|---|----------|---------|-------------|------|-----|--|-------------|
| 1.8 | 4 | F8 (12V) | 65/87 | 09/87→05/92 | | | | ZM024 |
| 2.0 12V | 4 | FE (12V) | 79/106 | 09/87→05/92 | | | | ZS274 ZM024 |
| 2.0 16V | 4 | FE (16V) | 103/138 | 11/87→05/92 | | | | ZS274 ZM024 |
| 2.0 16V | 4 | FE (16V) | 109/146 | 06/87→09/89 | | | | ZS274 ZM024 |
| 2.2 12V | 4 | F2 | 85/114 | 11/87→04/92 | Z158 | 1.1 | | ZS274 |

626 III /Hatchback (GD)

| | | | | | | | | |
|-------------|---|----------|--------|-------------|----------|-----|-------------|-------|
| 1.8 | 4 | F8 (12V) | 65/87 | 11/87→05/92 | Z1 [169] | 0.7 | UXT2 / UXT6 | |
| | | | | | →08/89 | | →08/89 | |
| | | | | | Z16 | 1.1 | UXT11 | |
| | | | | | 09/89→ | | 09/89→ | |
| 2.0 12V | 4 | FE (12V) | 79/106 | 09/87→05/92 | Z15 | 0.8 | UXT1 / UXT3 | |
| | | | | | →08/89 | | →08/89 | |
| 2.0 D | 4 | RF-N | 44/59 | 07/87→07/91 | GN005 | 11V | | |
| 2.2 12V 4WD | 4 | F2 | 85/114 | 11/87→05/92 | Z158 | 1.1 | | ZS274 |

626 III Coupe (GD)

| | | | | | | | | |
|-------------|---|----------|---------|-------------|-------------|------|-------------|------------|
| 1.6 | 4 | | 60/80 | 06/87→05/92 | Z20 | 0.8 | UXT2 / UXT6 | ZS109 [15] |
| 1.8 | 4 | F8 (12V) | 65/87 | 09/87→08/91 | Z8 | 0.8 | UXT2 / UXT6 | |
| 2.0 | 4 | FE (8V) | 66/89 | 09/87→10/90 | Z9 | 1.15 | UXT2 / UXT6 | |
| 2.0 LPG | 4 | FE (8V) | 66/89 | 09/87→10/90 | Z20 [168] | 0.8 | UXT2 / UXT6 | |
| 2.0 12V | 4 | FE (12V) | 79/106 | 09/87→12/88 | Z15 | 0.8 | UXT1 / UXT3 | |
| 2.0 16V | 4 | FE (16V) | 103/138 | 12/87→10/90 | Z16 | 1.1 | UXT11 | |
| | | | | | ch. 500001→ | | ch. 500001→ | |
| 2.0 16V LPG | 4 | FE (16V) | 103/138 | 12/87→10/90 | Z340 | 0.7 | UXT12 | |
| | | | | | ch. 500001→ | | ch. 500001→ | |

626 III Coupe/Hatchback (GD) III

| | | | | | | | | |
|-----|---|---------|-------|-------------|--|--|--|-------|
| 2.0 | 4 | FE (8V) | 66/89 | 09/87→10/90 | | | | ZM024 |
|-----|---|---------|-------|-------------|--|--|--|-------|

626 III Hatchback (GD)

| | | | | | | | | |
|-------------|---|----------|---------|-------------|-------------|-----|-------------|--------|
| 1.8 | 4 | | 69/93 | 11/87→05/92 | | | | ZM024 |
| | | | | | | | | →08/89 |
| 2.0 | 4 | FE (8V) | 66/89 | 09/87→10/90 | Z20 | 0.8 | UXT2 / UXT6 | ZS274 |
| 2.0 4WD | 4 | | 110/148 | 08/89→07/91 | | | | ZS274 |
| 2.0 16V | 4 | FE (16V) | 103/138 | 11/87→10/90 | Z16 | 1.1 | UXT11 | |
| 2.0 16V | 4 | FE (16V) | 109/146 | 06/87→08/89 | Z16 | 1.1 | UXT11 | |
| | | | | | ch. 500001→ | | ch. 500001→ | |
| 2.0 16V LPG | 4 | FE (16V) | 109/146 | 06/87→08/89 | Z340 | 0.7 | UXT12 | |
| | | | | | ch. 500001→ | | ch. 500001→ | |



kW/BHP

**... MAZDA****626 III Station Wagon (GV)**

| | | | | | | | | | |
|---------------|---|----------|---------|-------------|-------------------------------------|------|-----------------------|-------|-------|
| 1.8 | 4 | F8 (12V) | 65/87 | 01/88→03/92 | Z8 →09/89 Z15 10/89→07/91 | 0.8 | UXT2 / UXT6 →09/89 | | ZM024 |
| 2.0 | 4 | FE (8V) | 66/89 | 10/88→09/97 | Z9 | 1.15 | UXT2 / UXT6 | | ZM024 |
| 2.0 LPG | 4 | FE (8V) | 66/89 | 10/88→09/97 | Z20 [168] | 0.8 | UXT2 / UXT6 | | |
| 2.0 12V | 4 | FE (12V) | 81/109 | 09/87→01/90 | Z1 [169] →08/89 Z15 09/89→ | 0.7 | UXT2 / UXT6 →08/89 | | ZM024 |
| 2.0 16V | 4 | FE (16V) | 103/138 | 01/88→03/92 | Z16 | 1.1 | UXT11 | ZS274 | ZM024 |
| 2.0 D | 4 | RF-N | 44/59 | 09/88→07/91 | GN005 | 11V | | | |
| 2.0 D | 4 | RF-G5 | 60/80 | 11/94→09/97 | GN005 | 11V | | | |
| 2.0 D Compreh | 4 | RF-CX | 55/74 | 05/93→11/96 | GN005 | 11V | | | |
| 2.0 i 16V | 4 | | 110/148 | 11/94→09/97 | Z16 | 1.1 | UXT11 | | |
| 2.0 i 16V LPG | 4 | | 110/148 | 11/94→09/97 | Z340 | 0.7 | UXT12 | | |
| 2.2 12V | 4 | F2, F2L1 | 85/114 | 03/89→11/96 | Z158 | 1.1 | | ZS274 | |
| 2.2 12V LPG | 4 | F2 | 85/114 | 03/89→11/96 | Z116 | 0.8 | UXT5 | | |

626 IV (GE)

| | | | | | | | | | |
|-------------------|---|--------|--------|-------------|----------------|-----|-----------------|--|-------|
| 1.8 i | 4 | | 66/89 | 08/94→04/97 | Z16 | 1.1 | UXT11 | | ZM024 |
| 1.8 i | 4 | FP | 77/103 | 01/92→04/97 | Z16 →06/94 | 1.1 | UXT11 →06/94 | | ZM024 |
| 1.8 i LPG | 4 | | 66/89 | 08/94→04/97 | Z340 | 0.7 | UXT12 | | |
| 1.8 i LPG | 4 | FP | 77/103 | 01/92→04/97 | Z340 →06/94 | 0.7 | UXT12 →06/94 | | |
| 2.0 D GLX Compreh | 4 | RF OHC | 55/74 | 10/92→04/97 | GN005 | 11V | | | |
| 2.0 i | 4 | FS | 85/114 | 01/92→04/97 | Z16 →06/94 | 1.1 | UXT11 →06/94 | | |
| 2.0 i LPG | 4 | FS | 85/114 | 01/92→04/97 | Z340 →06/94 | 0.7 | UXT12 →06/94 | | |

626 IV /Hatchback (GE)

| | | | | | | | | | |
|---------------|---|----|--------|-------------|----------------|-----|-----------------|--|--|
| 2.0 i 4WD | 4 | FS | 85/114 | 04/92→04/97 | Z16 →06/94 | 1.1 | UXT11 →06/94 | | |
| 2.0 i 4WD LPG | 4 | FS | 85/114 | 04/92→04/97 | Z340 →06/94 | 0.7 | UXT12 →06/94 | | |

626 IV Hatchback (GE)

| | | | | | | | | | |
|-------------------|---|--------|---------|-------------|-----------------|-----|-------|--|-------|
| 1.8 | 4 | | 66/89 | 08/94→04/97 | Z16 | 1.1 | UXT11 | | ZM024 |
| 1.8 | 4 | FP | 77/103 | 08/91→04/97 | Z16 | 1.1 | UXT11 | | ZM024 |
| 1.8 LPG | 4 | | 66/89 | 08/94→04/97 | Z340 | 0.7 | UXT12 | | |
| 1.8 LPG | 4 | FP | 77/103 | 08/91→04/97 | Z340 | 0.7 | UXT12 | | |
| 2.0 D GLX Compreh | 4 | RF OHC | 55/74 | 01/93→04/97 | GN005 →12/95 | 11V | | | |
| 2.0 i | 4 | FS | 85/114 | 08/91→04/97 | Z16 | 1.1 | UXT11 | | |
| 2.0 i LPG | 4 | FS | 85/114 | 08/91→04/97 | Z340 | 0.7 | UXT12 | | |
| 2.5 24V | 6 | KL | 120/161 | 08/94→04/97 | Z158 | 1.1 | | | |
| 2.5 24V | 6 | KL | 121/162 | 01/92→04/97 | Z158 | 1.1 | | | |
| 2.5 24V LPG | 6 | KL | 120/161 | 08/94→04/97 | Z116 | 0.8 | UXT5 | | |
| 2.5 24V LPG | 6 | KL | 121/162 | 01/92→04/97 | Z116 | 0.8 | UXT5 | | |

626 V (GF)

| | | | | | | | | | |
|---------|---|------|---------|-------------|------|-----|-------|----------------------------|--|
| 1.8 | 4 | FP9A | 74/99 | 12/99→10/02 | Z229 | 0.8 | | ZS239 [1][19] ZS281 [1] | |
| 1.8 LPG | 4 | FP9A | 74/99 | 12/99→10/02 | Z206 | 0.7 | UXT10 | | |
| 2.0 | 4 | FS | 85/114 | 05/97→10/02 | | | | ZS237 | |
| 2.0 | 4 | FS2C | 100/134 | 04/98→10/02 | Z229 | 0.8 | | ZS281 | |
| 2.0 LPG | 4 | FS2C | 100/134 | 04/98→10/02 | Z206 | 0.7 | UXT10 | | |



kW/BHP

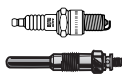

... MAZDA 

| 626 V /Hatchback (GF) | | | | | | | | | |
|---------------------------------|---|---------------|---------|-------------|-------|--|--|-----|-------------------------------------|
| 1.8 | 4 | FPY3 | 66/89 | 05/97→12/99 | Z229 | | | 0.8 | ZS237 [1] ZS238 [1] ZS281 [1] |
| 1.8 LPG | 4 | FPY3 | 66/89 | 05/97→12/99 | Z206 | | | 0.7 | UXT10 |
| 2.0 | 4 | FS | 85/114 | 05/97→10/02 | Z229 | | | 0.8 | |
| 2.0 LPG | 4 | FS | 85/114 | 05/97→10/02 | Z206 | | | 0.7 | UXT10 |
| 2.0 DI TD | 4 | RF3F | 66/89 | 04/98→10/02 | GN064 | | | 11V | |
| 2.0 TD | 4 | | 81/109 | 10/00→10/02 | GN064 | | | 11V | |
| 2.0 Turbo DI | 4 | | 74/99 | 04/98→10/02 | GN064 | | | 11V | |
| 626 V Hatchback (GF) | | | | | | | | | |
| 1.8 | 4 | FP | 74/99 | 12/99→10/02 | Z229 | | | 0.8 | ZS237 [1] ZS238 [1] ZS281 [1] |
| 1.8 LPG | 4 | FP | 74/99 | 12/99→10/02 | Z206 | | | 0.7 | UXT10 |
| 2.0 | 4 | FS | 85/114 | 05/97→10/02 | | | | | ZS281 |
| 2.0 H.P. | 4 | FS2C | 100/134 | 02/98→10/02 | Z229 | | | 0.8 | ZS354 |
| 2.0 H.P. LPG | 4 | FS2C | 100/134 | 02/98→10/02 | Z206 | | | 0.7 | UXT10 |
| 626 V Station Wagon (GW) | | | | | | | | | |
| 1.8 | 4 | FPY3 | 66/89 | 02/98→01/00 | Z229 | | | 0.8 | ZS237 [1] ZS238 [1] ZS281 [1] |
| 1.8 | 4 | FP9A | 74/99 | 01/00→10/02 | Z229 | | | 0.8 | ZS239 [1][119] ZS281 [1] |
| 1.8 LPG | 4 | FPY3 | 66/89 | 02/98→01/00 | Z206 | | | 0.7 | UXT10 |
| 1.8 LPG | 4 | FP9A | 74/99 | 01/00→10/02 | Z206 | | | 0.7 | UXT10 |
| 2.0 | 4 | FS | 85/114 | 02/98→10/02 | Z229 | | | 0.8 | ZS281 |
| 2.0 LPG | 4 | FS | 85/114 | 02/98→10/02 | Z206 | | | 0.7 | UXT10 |
| 2.0 DITD | 4 | RF3F | 66/89 | 09/99→10/02 | GN064 | | | 11V | |
| 2.0 H.P. | 4 | FS2C | 100/134 | 02/98→10/02 | Z229 | | | 0.8 | ZS239 [1][119] ZS281 [1] |
| 2.0 H.P. LPG | 4 | FS2C | 100/134 | 02/98→10/02 | Z206 | | | 0.7 | UXT10 |
| 2.0 TD | 4 | | 81/109 | 10/00→10/02 | GN064 | | | 11V | |
| 2.0 Turbo DI | 4 | RF4F | 74/99 | 04/98→10/02 | GN064 | | | 11V | |
| 818 Estate | | | | | | | | | |
| 1.3 | 4 | TC | 44/59 | 01/74→10/78 | Z11 | | | 0.8 | UXT2 / UXT6 |
| 1.6 | 4 | NA | 55/74 | 01/77→10/78 | Z11 | | | 0.8 | UXT2 / UXT6 |
| 929 I (LA) | | | | | | | | | |
| 2.0 | 4 | M, MA | 66/89 | 05/79→07/86 | Z8 | | | 0.8 | UXT2 / UXT6 |
| 929 II (HB) | | | | | | | | | |
| 2.0 | 4 | FE (8V) | 74/99 | 03/84→07/87 | Z8 | | | 0.8 | UXT2 / UXT6 |
| 2.0 i GLX | 4 | FE (8V) | 88/118 | 10/84→07/87 | Z8 | | | 0.8 | UXT2 / UXT6 |
| 929 II /Coupe (HB) | | | | | | | | | |
| 2.0 | 4 | HEE, MA | 66/89 | 05/82→03/84 | Z8 | | | 0.8 | UXT2 / UXT6 |
| 2.0 | 4 | FE (8V) | 74/99 | 03/84→07/87 | | | | | ZS274 |
| 929 II Coupe (HB) | | | | | | | | | |
| 2.0 | 4 | FE (8V) | 74/99 | 03/84→07/87 | Z8 | | | 0.8 | UXT2 / UXT6 |
| 2.0 i Turbo | 4 | FET | 88/118 | 10/84→07/87 | Z20 | | | 0.8 | UXT2 / UXT6 |
| 929 II Estate (HV) | | | | | | | | | |
| 2.0 | 4 | HEE, MA | 66/89 | 01/83→12/87 | Z8 | | | 0.8 | UXT2 / UXT6 ZS274 |
| 929 III (HC) | | | | | | | | | |
| 2.0 | 4 | FE (8V), FEFA | 85/114 | 06/87→12/88 | Z8 | | | 0.8 | UXT2 / UXT6 ZS274 ZM024 |
| 2.2 12V | 4 | F2, F2E, F2I | 85/114 | 01/88→04/89 | Z158 | | | 1.1 | ZS274 |
| 2.2 12V | 4 | F2-C | 94/126 | 04/89→06/91 | Z158 | | | 1.1 | ZS274 |
| 2.2 i | 4 | F2-EGI | 100/134 | 05/87→12/88 | Z72 | | | 0.8 | UXT1 / UXT3 ZS274 |
| 3.0 | 6 | JE3 | 125/168 | 01/88→12/89 | Z158 | | | 1.1 | ZS274 |

MAZDA

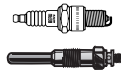

kW/BHP

**... MAZDA****... 929 III (HC)**

| | | | | | | | | | |
|-----|---|----|---------|-------------|---------------|-----|-------------|-------|-----------------|
| 3.0 | 6 | JE | 140/188 | 06/87→06/91 | Z72 →06/89 | 0.8 | UXT1 / UXT3 | ZS274 | ZM024 01/90→ |
|-----|---|----|---------|-------------|---------------|-----|-------------|-------|-----------------|

| | | | | | | | | | |
|-------|---|-----|---------|-------------|------|-----|--|-------|--|
| 3.0 i | 6 | JE3 | 123/165 | 01/90→06/91 | Z158 | 1.1 | | ZS274 | |
|-------|---|-----|---------|-------------|------|-----|--|-------|--|

1000

| | | | | | | | | | |
|-----|---|----|-------|-------------|-----|-----|-------------|--|--|
| 1.0 | 4 | PC | 33/44 | 01/75→01/77 | Z11 | 0.8 | UXT2 / UXT6 | | |
|-----|---|----|-------|-------------|-----|-----|-------------|--|--|

1300

| | | | | | | | | | |
|-----|---|----|-------|-------------|-----|-----|-------------|--|--|
| 1.3 | 4 | TC | 44/59 | 01/75→01/77 | Z11 | 0.8 | UXT2 / UXT6 | | |
|-----|---|----|-------|-------------|-----|-----|-------------|--|--|

B-SERIE (UF)

| | | | | | | | | | |
|-----|---|---------|-------|-------------|----|-----|-------------|-------|--|
| 2.0 | 4 | FE (8V) | 62/83 | 01/85→12/91 | Z8 | 0.8 | UXT2 / UXT6 | ZS274 | |
|-----|---|---------|-------|-------------|----|-----|-------------|-------|--|

| | | | | | | | | | |
|-----|---|---------|-------|-------------|----|-----|-------------|-------|--|
| 2.0 | 4 | FE (8V) | 65/87 | 01/85→03/96 | Z8 | 0.8 | UXT2 / UXT6 | ZS274 | |
|-----|---|---------|-------|-------------|----|-----|-------------|-------|--|

| | | | | | | | | | |
|-----------|---|--|-------|-------------|-------|-----|--|--|--|
| 2.5 D 4WD | 4 | | 57/76 | 09/98→06/99 | GN005 | 11V | | | |
|-----------|---|--|-------|-------------|-------|-----|--|--|--|

| | | | | | | | | | |
|-----------|---|--|-------|-------------|-------|-----|--|--|--|
| 2.5 D 4WD | 4 | | 63/84 | 02/96→06/99 | GN005 | 11V | | | |
|-----------|---|--|-------|-------------|-------|-----|--|--|--|

| | | | | | | | | | |
|-------------|---|-------|--------|-------------|------|-----|--|--|--|
| 2.6 12V 4WD | 4 | G6MPV | 90/121 | 01/90→06/99 | Z158 | 1.1 | | | |
|-------------|---|-------|--------|-------------|------|-----|--|--|--|

B-SERIE (UN)

| | | | | | | | | | |
|-------|---|--------|-------|--------|-------|-----|--|--|--|
| 2.5 D | 4 | MD25NA | 57/76 | 06/99→ | GN005 | 11V | | | |
|-------|---|--------|-------|--------|-------|-----|--|--|--|

| | | | | | | | | | |
|------------|---|--------|--------|-------------|-------|-----|--|--|--|
| 2.5 TD 4WD | 4 | MD25TI | 80/107 | 06/99→07/06 | GN005 | 11V | | | |
|------------|---|--------|--------|-------------|-------|-----|--|--|--|

| | | | | | | | | | |
|-------------|---|------|--------|--------|------|-----|--|--|--|
| 2.6 12V 4WD | 4 | JK26 | 90/121 | 06/99→ | Z158 | 1.1 | | | |
|-------------|---|------|--------|--------|------|-----|--|--|--|

| | | | | | | | | | |
|-----------------|---|------|--------|--------|------|-----|------|--|--|
| 2.6 12V 4WD LPG | 4 | JK26 | 90/121 | 06/99→ | Z116 | 0.8 | UXT5 | | |
|-----------------|---|------|--------|--------|------|-----|------|--|--|

DEMIO (DW)

| | | | | | | | | | |
|---------|---|-------|-------|--------|---------------|-----|-----------------|--|--|
| 1.3 16V | 4 | B3 ME | 46/62 | 08/98→ | Z16 →10/02 | 1.1 | UXT11 →10/02 | | |
|---------|---|-------|-------|--------|---------------|-----|-----------------|--|--|

| | | | | | | | | | |
|-------------|---|-------|-------|--------|------|-----|-------|--|--|
| 1.3 16V LPG | 4 | B3 ME | 46/62 | 08/98→ | Z340 | 0.7 | UXT12 | | |
|-------------|---|-------|-------|--------|------|-----|-------|--|--|

| | | | | | | | | | |
|-----------|---|----------|-------|-------------|-----|-----|-------|--|--|
| 1.3 i 16V | 4 | B3 (16V) | 53/71 | 08/98→04/00 | Z16 | 1.1 | UXT11 | | |
|-----------|---|----------|-------|-------------|-----|-----|-------|--|--|

| | | | | | | | | | |
|---------------|---|----------|-------|-------------|------|-----|-------|--|--|
| 1.3 i 16V LPG | 4 | B3 (16V) | 53/71 | 08/98→04/00 | Z340 | 0.7 | UXT12 | | |
|---------------|---|----------|-------|-------------|------|-----|-------|--|--|

| | | | | | | | | | |
|---------|---|------|-------|-------------|--------------------|-----|----------------------|--|--|
| 1.5 16V | 4 | B5 E | 55/74 | 04/00→07/03 | Z16 ch. 300001→ | 1.1 | UXT11 ch. 300001→ | | |
|---------|---|------|-------|-------------|--------------------|-----|----------------------|--|--|

| | | | | | | | | | |
|-------------|---|------|-------|-------------|---------------------|-----|----------------------|--|--|
| 1.5 16V LPG | 4 | B5 E | 55/74 | 04/00→07/03 | Z340 ch. 300001→ | 0.7 | UXT12 ch. 300001→ | | |
|-------------|---|------|-------|-------------|---------------------|-----|----------------------|--|--|

MPV I (LV)

| | | | | | | | | | |
|--------|---|------|--------|-------------|-------|-----|--|--|--|
| 2.5 TD | 4 | WL-T | 85/114 | 05/96→09/99 | GN005 | 11V | | | |
|--------|---|------|--------|-------------|-------|-----|--|--|--|

| | | | | | | | | | |
|----------|---|------|---------|-------------|-----|-----|-------|--|--|
| 3.0 i V6 | 6 | JE94 | 109/146 | 05/96→09/99 | Z16 | 1.1 | UXT11 | | |
|----------|---|------|---------|-------------|-----|-----|-------|--|--|

| | | | | | | | | | |
|----------|---|------|---------|-------------|------|-----|--|--|--|
| 3.0 i V6 | 6 | JE94 | 113/152 | 03/95→09/99 | Z158 | 1.1 | | | |
|----------|---|------|---------|-------------|------|-----|--|--|--|

| | | | | | | | | | |
|--------------|---|------|---------|-------------|------|-----|-------|--|--|
| 3.0 i V6 LPG | 6 | JE94 | 109/146 | 05/96→09/99 | Z340 | 0.7 | UXT12 | | |
|--------------|---|------|---------|-------------|------|-----|-------|--|--|

| | | | | | | | | | |
|--------------|---|------|---------|-------------|------|-----|------|--|--|
| 3.0 i V6 LPG | 6 | JE94 | 113/152 | 03/95→09/99 | Z116 | 0.8 | UXT5 | | |
|--------------|---|------|---------|-------------|------|-----|------|--|--|

MPV II (LW)

| | | | | | | | | | |
|-----|---|----|--------|-------------|--|--|--|-----------------------------|--|
| 2.0 | 4 | FS | 88/118 | 08/00→07/02 | | | | ZS239 (1)(119) ZS281 (1) | |
|-----|---|----|--------|-------------|--|--|--|-----------------------------|--|

| | | | | | | | | | |
|-----|---|-------|--------|-------------|------|-----|--|--|--|
| 2.0 | 4 | FS-DS | 90/121 | 09/99→08/00 | Z158 | 1.1 | | | |
|-----|---|-------|--------|-------------|------|-----|--|--|--|

| | | | | | | | | | |
|---------|---|-------|--------|-------------|------|-----|------|--|--|
| 2.0 LPG | 4 | FS-DS | 90/121 | 09/99→08/00 | Z116 | 0.8 | UXT5 | | |
|---------|---|-------|--------|-------------|------|-----|------|--|--|

| | | | | | | | | | |
|--------|---|------|---------|-------------|-------|-----|--|--|--|
| 2.0 DI | 4 | RF5C | 100/134 | 07/02→02/06 | GN064 | 11V | | | |
|--------|---|------|---------|-------------|-------|-----|--|--|--|

| | | | | | | | | | |
|-----|---|----|---------|-------------|------|-----|-------|--|--|
| 2.3 | 4 | L3 | 104/139 | 07/02→02/06 | Z298 | 1.3 | UXT15 | | |
|-----|---|----|---------|-------------|------|-----|-------|--|--|

| | | | | | | | | | |
|---------|---|----|---------|-------------|-----|-----|------|--|--|
| 2.3 LPG | 4 | L3 | 104/139 | 07/02→02/06 | Z95 | 0.7 | UXT4 | | |
|---------|---|----|---------|-------------|-----|-----|------|--|--|

MPV III (LY) III

| | | | | | | | | | |
|-----|---|-------|---------|--------|------|-----|-------|--|--|
| 2.3 | 4 | L3-VE | 120/161 | 02/06→ | Z298 | 1.3 | UXT15 | | |
|-----|---|-------|---------|--------|------|-----|-------|--|--|

| | | | | | | | | | |
|---------|---|-------|---------|--------|-----|-----|------|--|--|
| 2.3 LPG | 4 | L3-VE | 120/161 | 02/06→ | Z95 | 0.7 | UXT4 | | |
|---------|---|-------|---------|--------|-----|-----|------|--|--|

MX-3 (EC)

| | | | | | | | | | |
|-------|---|-----|-------|--------|-----|-----|-------|-------|--|
| 1.6 i | 4 | B69 | 65/87 | 07/91→ | Z73 | 1.1 | UXT11 | ZS279 | |
|-------|---|-----|-------|--------|-----|-----|-------|-------|--|

| | | | | | | | | | |
|-------|---|-----|--------|--------|-----|-----|-------|-------|--|
| 1.6 i | 4 | B6D | 79/106 | 01/94→ | Z16 | 1.1 | UXT11 | ZS279 | |
|-------|---|-----|--------|--------|-----|-----|-------|-------|--|

| | | | | | | | | | |
|-----------|---|-----|-------|--------|------|-----|-------|--|--|
| 1.6 i LPG | 4 | B69 | 65/87 | 07/91→ | Z206 | 0.7 | UXT10 | | |
|-----------|---|-----|-------|--------|------|-----|-------|--|--|

| | | | | | | | | | |
|-----------|---|-----|--------|--------|------|-----|-------|--|--|
| 1.6 i LPG | 4 | B6D | 79/106 | 01/94→ | Z340 | 0.7 | UXT12 | | |
|-----------|---|-----|--------|--------|------|-----|-------|--|--|

| | | | | | | | | | |
|----------|---|------|--------|--------|-----|-----|-------|--|--|
| 1.8 i V6 | 6 | K838 | 95/127 | 01/94→ | Z16 | 1.1 | UXT11 | | |
|----------|---|------|--------|--------|-----|-----|-------|--|--|

| | | | | | | | | | |
|----------|---|------|--------|-------------|-----|-----|-------|--|--|
| 1.8 i V6 | 6 | K819 | 98/131 | 01/92→01/94 | Z73 | 1.1 | UXT11 | | |
|----------|---|------|--------|-------------|-----|-----|-------|--|--|

| | | | | | | | | | |
|--------------|---|------|--------|--------|------|-----|-------|--|--|
| 1.8 i V6 LPG | 6 | K838 | 95/127 | 01/94→ | Z340 | 0.7 | UXT12 | | |
|--------------|---|------|--------|--------|------|-----|-------|--|--|

MX-5 I (NA)

| | | | | | | | | | |
|-----|---|--|-------|-------------|-----|-----|-------|--|--|
| 1.6 | 4 | | 66/89 | 01/95→04/98 | Z16 | 1.1 | UXT11 | | |
|-----|---|--|-------|-------------|-----|-----|-------|--|--|

| | | | | | | | | | |
|-----|---|------|--------|-------------|-----|-----|-------|--|--|
| 1.6 | 4 | B64F | 85/114 | 05/90→01/94 | Z16 | 1.1 | UXT11 | | |
|-----|---|------|--------|-------------|-----|-----|-------|--|--|



kW/BHP

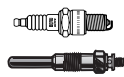

... MAZDA



... MX-5 I (NA)

| | | | | | | | | |
|---------|---|-----------------|--------|-------------|------|-----|-------|--|
| 1.6 LPG | 4 | | 66/89 | 01/95→04/98 | Z340 | 0.7 | UXT12 | |
| 1.6 LPG | 4 | B64F | 85/114 | 05/90→01/94 | Z340 | 0.7 | UXT12 | |
| 1.8 | 4 | BP (DOHC), BPF1 | 96/129 | 09/93→04/98 | Z16 | 1.1 | UXT11 | |
| 1.8 LPG | 4 | BP (DOHC), BPF1 | 96/129 | 02/94→04/98 | Z340 | 0.7 | UXT12 | |

MX-5 II (NB)

| | | | | | | | | |
|-------------|---|------------|---------|-------------|------|-----|-------|--------|
| 1.6 16V | 4 | B6D | 81/109 | 05/98→10/05 | Z73 | 1.1 | UXT11 | |
| 1.6 16V LPG | 4 | B6D | 81/109 | 05/98→10/05 | Z206 | 0.7 | UXT10 | |
| 1.8 | 4 | BPD | 103/138 | 01/98→07/02 | Z73 | 1.1 | UXT11 | ZSE084 |
| 1.8 | 4 | | 107/143 | 08/02→10/05 | | | | ZSE084 |
| 1.8 LPG | 4 | BPD | 103/138 | 01/98→07/02 | Z206 | 0.7 | UXT10 | |
| 1.8 16V | 4 | BPD | 102/137 | 11/00→10/05 | Z73 | 1.1 | UXT11 | ZSE084 |
| 1.8 16V | 4 | BP-ZE | 103/138 | 05/98→10/05 | Z73 | 1.1 | UXT11 | ZSE084 |
| 1.8 16V | 4 | BPD, BP-ZE | 107/143 | 11/00→10/05 | Z73 | 1.1 | UXT11 | ZSE084 |
| 1.8 16V LPG | 4 | BPD | 102/137 | 11/00→10/05 | Z206 | 0.7 | UXT10 | |
| 1.8 16V LPG | 4 | BP-ZE | 103/138 | 05/98→10/05 | Z206 | 0.7 | UXT10 | |
| 1.8 16V LPG | 4 | BPD, BP-ZE | 107/143 | 11/00→10/05 | Z206 | 0.7 | UXT10 | |
| 1.8 i Turbo | 4 | BP Turbo | 136/182 | 04/02→10/05 | | | | ZSE084 |

MX-5 III (NC)

| | | | | | | | | |
|---------|---|-------------|---------|--------|------|-----|-------|--|
| 1.8 | 4 | L8-DE | 93/125 | 03/05→ | Z298 | 1.3 | UXT15 | |
| 1.8 LPG | 4 | L8-DE, L828 | 93/125 | 03/05→ | Z95 | 0.7 | UXT4 | |
| 2.0 | 4 | LF-DE | 118/158 | 03/05→ | Z310 | 1.3 | UXT8 | |

MX-6 (GE)

| | | | | | | | | |
|---------------|---|----|---------|-------------|------|-----|-------|--|
| 2.0 | 4 | FS | 85/114 | 02/92→02/97 | Z16 | 1.1 | UXT11 | |
| 2.0 LPG | 4 | FS | 85/114 | 02/92→02/97 | Z340 | 0.7 | UXT12 | |
| 2.5 24V | 6 | KL | 121/162 | 02/92→02/97 | Z158 | 1.1 | | |
| 2.5 24V LPG | 6 | KL | 121/162 | 02/92→02/97 | Z116 | 0.8 | UXT5 | |
| 2.5 i 24V | 6 | KL | 120/161 | 08/94→02/97 | Z158 | 1.1 | | |
| 2.5 i 24V LPG | 6 | KL | 120/161 | 08/94→02/97 | Z116 | 0.8 | UXT5 | |

PREMACY (CP)

| | | | | | | | | | |
|---------------------|---|----------------|--------|-------------|--|------------|---|--------|--|
| 1.9 | 4 | FP | 74/99 | 07/99→03/05 | Z16 →ch. 151 177 Z158 ch. 151 178→ | 1.1 1.1 | UXT11 →ch. 151 177 | ZSE083 | |
| 1.9 | 4 | FP | 84/113 | 07/99→03/05 | Z16 →ch. 151 177 Z158 ch. 151 178→ | 1.1 1.1 | UXT11 →ch. 151 177 | ZSE083 | |
| 1.9 LPG | 4 | FP | 74/99 | 07/99→03/05 | Z340 →ch. 151 177 Z116 ch. 151 178→ | 0.7 0.8 | UXT12 →ch. 151 177 UXT5 ch. 151 178→ | | |
| 1.9 LPG | 4 | FP | 84/113 | 07/99→03/05 | Z340 →ch. 151 177 Z116 ch. 151 178→ | 0.7 0.8 | UXT12 →ch. 151 177 UXT5 ch. 151 178→ | | |
| 2.0 | 4 | FS7E, FS7G | 96/129 | 11/01→03/05 | Z16 →ch. 151 177 Z158 ch. 151 178→ | 1.1 1.1 | UXT11 →ch. 151 177 | ZSE083 | |
| 2.0 LPG | 4 | FS7E, FS7G | 96/129 | 11/01→03/05 | Z340 →ch. 151 177 Z116 ch. 151 178→ | 0.7 0.8 | UXT12 →ch. 151 177 UXT5 ch. 151 178→ | | |
| 2.0 TD | 4 | RF3F | 66/89 | 10/99→07/00 | GN064 | 11V | | | |
| 2.0 TD | 4 | RF4F | 74/99 | 07/00→03/05 | GN064 | 11V | | | |
| TRIBUTE (EP) | | | | | | | | | |
| 2.0 | 4 | FORD ZETEC 16V | 91/122 | 03/00→05/08 | Z177 | 1.3 | UXT7 | | |

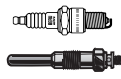

kW/BHP

**... MAZDA****... TRIBUTE (EP)**

| | | | | | | | | | |
|----------------|---|-------|---------|-------------|------|--|-----|-------|-----------------|
| 2.0 | 4 | YF | 91/122 | 03/00→05/08 | | | | | ZS350 →12/05 |
| 2.0 4WD | 4 | YF | 91/122 | 03/00→05/08 | | | | | ZS350 →12/03 |
| 2.3 4WD | 4 | L3-VE | 110/148 | 04/04→05/08 | Z298 | | 1.3 | UXT15 | ZS408 |
| 2.3 4WD LPG | 4 | L3-VE | 110/148 | 04/04→05/08 | Z95 | | 0.7 | UXT4 | |
| 3.0 V6 4WD | 6 | AJ | 149/200 | 04/04→05/08 | Z26 | | 0.7 | UXK56 | ZS410 |
| 3.0 V6 24V 4WD | 6 | AJ | 145/194 | 03/00→05/08 | Z26 | | 0.7 | UXK56 | ZS410 |

XEDOS 6 (CA)

| | | | | | | | | | |
|-------------|---|-----------|---------|-------------|------|--|-----|-------|--|
| 1.6 16V | 4 | B6 (DOHC) | 79/106 | 06/94→10/99 | Z73 | | 1.1 | UXT11 | |
| 1.6 16V | 4 | B69 | 83/111 | 08/92→05/94 | Z73 | | 1.1 | UXT11 | |
| 1.6 16V LPG | 4 | B6 (DOHC) | 79/106 | 06/94→10/99 | Z206 | | 0.7 | UXT10 | |
| 2.0 V6 | 6 | KF1 | 103/138 | 06/94→10/99 | Z16 | | 1.1 | UXT11 | |
| 2.0 V6 | 6 | KF1 | 106/142 | 01/92→05/94 | Z16 | | 1.1 | UXT11 | |
| 2.0 V6 LPG | 6 | KF1 | 103/138 | 06/94→10/99 | Z340 | | 0.7 | UXT12 | |
| 2.0 V6 LPG | 6 | KF1 | 106/142 | 01/92→05/94 | Z340 | | 0.7 | UXT12 | |

XEDOS 9 (TA)

| | | | | | | | | | |
|-------------|---|--------|---------|-------------|-----------------------|--|-----|-------|--|
| 2.0 24V | 6 | KF | 105/141 | 08/93→01/00 | Z16 | | 1.1 | UXT11 | |
| 2.0 24V LPG | 6 | KF | 105/141 | 08/93→01/00 | Z340 | | 0.7 | UXT12 | |
| 2.3 24V | 6 | KJ-ZEM | 155/208 | 02/95→01/00 | Z312 ^[172] | | 1.0 | UXT9 | |
| 2.5 24V | 6 | KL | 123/165 | 07/93→07/00 | Z158 | | 1.1 | | |
| 2.5 24V LPG | 6 | KL | 123/165 | 07/93→07/00 | Z116 | | 0.8 | UXT5 | |
| 2.5 V6 | 6 | KL | 120/161 | 07/00→09/02 | Z73 | | 1.1 | UXT11 | |
| 2.5 V6 LPG | 6 | KL | 120/161 | 07/00→09/02 | Z206 | | 0.7 | UXT10 | |

MAZDA**E-SERIE Box**

| | | | | | | | | | |
|-----------|---|----|-------|-------------|---------------------|--|-----|-------------|--|
| 1.6 E1600 | 4 | NA | 51/68 | 08/80→06/84 | Z1 ^[169] | | 0.7 | UXT2 / UXT6 | |
|-----------|---|----|-------|-------------|---------------------|--|-----|-------------|--|

E-SERIE Platform/Chassis (SD1)

| | | | | | | | | | |
|-----------|---|------|-------|-------------|-------|--|----|--|--|
| 2.2 E2200 | 4 | R281 | 47/63 | 11/88→03/97 | GV705 | | 7V | | |
|-----------|---|------|-------|-------------|-------|--|----|--|--|

E-SERIE Bus (SR1)

| | | | | | | | | | |
|---------------|---|------------|-------|-------------|-------|--|-----|-------------|--|
| 2.0 E2000 4WD | 4 | FEBN | 60/80 | 10/88→09/89 | Z8 | | 0.8 | UXT2 / UXT6 | |
| 2.0 E2000 | 4 | FE18, FEV4 | 63/84 | 11/84→02/88 | Z8 | | 0.8 | UXT2 / UXT6 | |
| 2.2 E2200 D | 4 | R207 | 46/62 | 01/84→02/88 | GV705 | | 7V | | |

E-SERIE Box (SR2)

| | | | | | | | | | |
|----------------|---|---------------------|-------|-------------|-----------------|--|-----|-------------|--|
| 2.0 E2000 | 4 | FE (8V), FE60, FE61 | 60/80 | 03/91→05/94 | Z8 | | 0.8 | UXT2 / UXT6 | |
| 2.0 E2000 | 4 | FE18, FE58 | 63/84 | 05/85→04/89 | Z8 | | 0.8 | UXT2 / UXT6 | |
| 2.0 E2000 | 4 | FE (8V) | 70/94 | 06/94→05/03 | Z16 | | 1.1 | UXT11 | |
| 2.0 E2000 LPG | 4 | FE (8V) | 70/94 | 06/94→05/03 | Z340 | | 0.7 | UXT12 | |
| 2.2 2200 D 4WD | 4 | R203, R207 | 47/63 | 03/91→05/03 | GV705 →04/97 | | 7V | | |
| 2.2 E2200 D | 4 | R203, R207 | 46/62 | 05/85→02/88 | GV705 | | 7V | | |
| 2.2 E2200 D | 4 | R203, R207 | 47/63 | 03/91→05/03 | GV705 →04/97 | | 7V | | |
| 2.2 E2200 D | 4 | R2 | 52/70 | 02/97→05/03 | GN005 | | 11V | | |

E-SERIE Bus

| | | | | | | | | | |
|-------------|---|--|-------|-------------|-------|--|----|--|--|
| 2.2 E2200 D | 4 | | 47/63 | 03/91→05/03 | GV705 | | 7V | | |
|-------------|---|--|-------|-------------|-------|--|----|--|--|

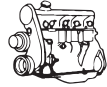

kW/BHP

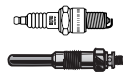
**MERCEDES-BENZ****/8 (W114)**

| | | | | | | | | |
|-------------|---|-----------|---------|-------------|------------|------------|---------------------|--|
| 2.3 230.6 | 6 | M 180.954 | 88/118 | 01/68→11/76 | Z20 Z42 | 0.8 0.8 | UXT2 / UXT6 UX56 | ZS109 [15] |
| 2.5 250 | 6 | M 114.920 | 85/114 | 01/68→08/72 | Z22 | 0.7 | UX56 | ZS115 [11] →07/69 ZS109 [15] 08/69→ ZS400 [11] 08/69→ |
| 2.5 250 | 6 | M 114.920 | 96/129 | 07/68→08/72 | Z22 | 0.7 | UX56 | ZS115 [11] →07/69 ZS400 [11] 08/69→ ZS109 [15] 09/69→ |
| 2.7 250 2.8 | 6 | M 130.923 | 96/129 | 06/72→11/76 | Z22 | 0.7 | UX56 | ZS109 [15] ZS400 [11][254] |
| 2.7 280 | 6 | M 110.921 | 118/158 | 06/72→11/76 | Z22 | 0.7 | UX56 | ZS109 [15] |
| 2.7 280 E | 6 | M 110.981 | 136/182 | 06/72→11/76 | Z22 | 0.7 | UX56 | ZS109 [15] |

/8 (W115)

| | | | | | | | | |
|---------------|---|----------------------|--------|-------------|-----------------|------|------|--|
| 2.0 200 | 4 | M 115.923, M 115.926 | 63/84 | 01/68→01/77 | Z22 | 0.7 | UX56 | ZS109 [15] |
| 2.0 200 | 4 | M 115.923, M 115.926 | 70/94 | 01/68→01/77 | Z22 | 0.7 | UX56 | ZS109 [15] |
| 2.0 200 D | 4 | OM 615.913 | 40/54 | 01/68→01/77 | GD382 | 0.9V | | |
| 2.2 220 | 4 | M 115.924 | 66/89 | 01/68→07/73 | Z22 | 0.7 | UX56 | ZS106 [11] →07/69 ZS109 [15] 08/69→ ZS400 [11] 08/69→ |
| 2.2 220 | 4 | M 115.920 | 77/103 | 01/68→07/73 | Z22 | 0.7 | UX56 | ZS106 [11] →07/69 ZS109 [15] 08/69→ |
| 2.2 220 D | 4 | OM 615.912 | 44/59 | 01/68→01/77 | GD382 | 0.9V | | |
| 2.3 230.4 | 4 | M 115.951 | 81/109 | 08/73→12/76 | Z22 | 0.7 | UX56 | ZS109 [15] |
| 2.4 240 D | 4 | OM 616.916 | 48/64 | 08/73→01/77 | GD382 →01/76 | 0.9V | | |
| 3.0 240 D 3.0 | 5 | OM 617.910 | 59/79 | 08/74→11/76 | GD382 | 0.9V | | |

/8 Coupe (W114)

| | | | | | | | | |
|---------------|---|-----------|---------|-------------|-----|-----|------|--|
| 2.5 250 C | 6 | M 114.920 | 96/129 | 04/69→06/72 | Z22 | 0.7 | UX56 | ZS115 [11] →07/69 ZS109 [15] 08/69→ ZS400 [11] 08/69→ |
| 2.5 250 CE | 6 | M 114.980 | 110/148 | 04/69→04/72 | Z42 | 0.8 | UX56 | ZS115 [11] →07/69 ZS109 [15] 08/69→ ZS400 [11] 08/69→ |
| 2.7 250 C 2.8 | 6 | M 130.923 | 96/129 | 06/72→11/76 | Z22 | 0.7 | UX56 | ZS109 [15] 11/74→ |
| 2.7 280 C | 6 | M 110.921 | 118/158 | 06/72→02/77 | Z22 | 0.7 | UX56 | ZS109 [15] |
| 2.7 280 CE | 6 | M 110.981 | 136/182 | 06/72→01/77 | Z22 | 0.7 | UX56 | ZS109 [15] |

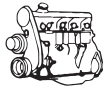

kW/BHP

**... MERCEDES-BENZ** **170 (W170)**

| | | | | | | | | | |
|---------|---|------------|-------|-------------|--|--|------|--|--|
| 1.7 D | 4 | OM 636.915 | 29/39 | 06/49→10/56 | GD318 →12/50 GD214 01/51→ | | 1.7V | | |
| | | | | | | | 0.9V | | |
| 1.7 V | 4 | M 136.920 | 33/44 | 06/46→05/50 | Z57 | | 0.6 | | |
| 1.8 S | 4 | M 136.922 | 38/51 | 05/49→10/56 | Z57 | | 0.6 | | |
| 1.8 S-D | 4 | OM 636.931 | 29/39 | 07/53→02/58 | GD214 | | 0.9V | | |

190 (W201)

| | | | | | | | | | | |
|--------------------|---|----------------------|---------|-------------|--|--|-------|--------------|---|--------------|
| 1.8 E | 4 | M 102.910 | 80/107 | 04/90→08/93 | Z18 | | 0.8 | UXT4 | ZS296 | |
| 2.0 | 4 | M 102.921 | 66/89 | 10/82→10/84 | Z18 | | 0.8 | UXT4 | ZS117 | ZM004 |
| 2.0 | 4 | M 102.924 | 75/101 | 01/86→05/90 | Z18 | | 0.8 | UXT4 | ZS117 (1) [6] [254] ZS296 (1) [4] [214] [254] | ZM004 |
| 2.0 | 4 | M 102.924 | 77/103 | 09/84→05/90 | Z18 | | 0.8 | UXT4 | ZS117 (1) [6] [254] ZS296 (1) [4] [214] [254] | ZM004 |
| 2.0 D | 4 | OM 601.911 | 53/71 | 08/83→08/89 | GN909 [222] →01/89 GV603 →01/89 GN858 02/89→ | GR070 →01/89 GR074 02/89→ | 11V | | | |
| | | | | | | | 11.5V | | | |
| | | | | | | | 11.5V | | | |
| 2.0 D | 4 | OM 601.911 | 55/74 | 08/89→08/93 | GN858 | GR074 | 11.5V | | | |
| 2.0 E | 4 | M 102.961, M 102.962 | 83/111 | 02/85→12/86 | Z18 | | 0.8 | UXT4 | ZS117 (1) [254] ZS296 (1) [2] [4] [254] | |
| 2.0 E | 4 | M 102.962 | 85/114 | 02/85→12/86 | Z18 | | 0.8 | UXT4 | ZS296 | |
| 2.0 E | 4 | M 102.962 | 87/117 | 01/85→08/93 | Z18 | | 0.8 | UXT4 | ZS117 (1) [254] ZS296 (1) [2] [4] [254] | ZM004 |
| 2.0 E | 4 | M 102.961 | 90/121 | 10/82→06/93 | Z18 | | 0.8 | UXT4 | ZS296 (1) | ZM004 |
| 2.0 E | 4 | M 102.962 | 90/121 | 10/82→06/93 | Z18 | | 0.8 | UXT4 | ZS117 (1) [254] ZS296 (1) [2] [4] [254] | ZM004 |
| 2.0 E | 4 | M 102.961 | 93/125 | 10/82→06/93 | Z18 | | 0.8 | UXT4 | ZS115 (1) [11] ZS117 (1) [254] ZS120 (1) [2] [4] [254] | |
| 2.3 E | 4 | M 102.985 | 97/130 | 09/86→08/91 | Z18 | | 0.8 | UXT4 | ZS296 | |
| 2.3 E | 4 | A0031593603 | 100/134 | 10/82→09/88 | Z7 | | 0.8 | UXT4 | | |
| 2.3 E | 4 | M 102.985 | 100/134 | 10/86→08/93 | Z18 | | 0.8 | UXT4 | ZS117 (1) [6] [254] ZS296 (1) [4] [214] [254] | |
| 2.3 E 2.3-16 | 4 | M 102.983 | 125/168 | 09/85→12/87 | Z56 | | 0.8 | UXK56 | ZS339 | |
| 2.3 E 2.3-16 | 4 | M 102.983 | 130/174 | 09/85→08/88 | Z56 | | 0.8 | UXK56 | ZS339 | |
| 2.3 E 2.3-16 | 4 | M 102.983 | 136/182 | 04/84→01/87 | Z46 | | 0.8 | UXK56 | ZS339 | |
| 2.5 D | 5 | OM 602.911 | 66/89 | 04/85→08/93 | GN909 [222] →01/89 GV603 →01/89 GN858 02/89→ | GR071 →01/89 GR075 02/89→ | 11V | | | |
| | | | | | | | 11.5V | | | |
| | | | | | | | 11.5V | | | |
| 2.5 D | 5 | OM 602.911 | 69/93 | 08/89→08/93 | GN858 | GR075 | 11.5V | | | |
| 2.5 E 2.5-16 | 4 | M 102.991 | 143/192 | 03/89→08/93 | Z18 | | 0.8 | UXT4 | ZS339 | |
| 2.5 E 2.5-16 | 4 | M 102.990 | 150/201 | 09/88→08/93 | Z18 | | 0.8 | UXT4 | ZS339 | |
| 2.5 E Evolution II | 4 | M 102.992 | 173/232 | 05/90→08/93 | Z18 | | 0.8 | UXT4 | ZS339 | |
| 2.5 Turbo-D | 5 | OM 602.961 | 90/121 | 02/88→08/93 | GN909 [222] →01/89 GV603 →01/89 GN858 02/89→ | GR049 | 11V | | | |
| | | | | | | | 11.5V | | | |
| | | | | | | | 11.5V | | | |

MERCEDES-BENZ

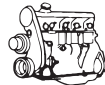

kW/BHP

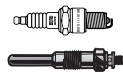
**... MERCEDES-BENZ****... 190 (W201)**

| | | | | | | | | |
|-------------|---|------------|---------|-------------|---|-------------------------------|------|---|
| 2.5 Turbo-D | 5 | OM 602.961 | 93/125 | 02/88→08/93 | GN909 [222] →01/89 GV603 →01/89 GN858 02/89→ | 11V 11.5V 11.5V | | |
| 2.6 E | 6 | M 103.942 | 118/158 | 09/86→08/93 | Z7 | 0.8 | UXT4 | ZS117 [1]X6[X254] ZS296 [1]X4[X214] [254] |
| 2.6 E | 6 | M 103.942 | 122/164 | 09/86→12/89 | Z7 | 0.8 | UXT4 | ZS117 [1]X6[X254] ZS296 [1]X4[X214] [254] |

A-CLASS (W168)

| | | | | | | | | |
|---------------|---|------------|---------|-------------|-------|--------|-------|--------|
| 1.4 A 140 | 4 | M 166.940 | 60/80 | 07/97→08/04 | Z121 | 1.0 | UXT9 | ZSE146 |
| 1.4 A 140 LPG | 4 | M 166.940 | 60/80 | 07/97→08/04 | Z206 | 0.7 | UXT10 | |
| 1.6 A 140 | 4 | M 166.960 | 60/80 | 01/01→08/04 | Z121 | 1.0 | UXT9 | ZSE146 |
| 1.6 A 140 LPG | 4 | M 166.960 | 60/80 | 01/01→08/04 | Z206 | 0.7 | UXT10 | |
| 1.6 A 160 | 4 | M 166.960 | 75/101 | 07/97→08/04 | Z121 | 1.0 | UXT9 | ZSE146 |
| 1.6 A 160 LPG | 4 | M 166.960 | 75/101 | 07/97→08/04 | Z206 | 0.7 | UXT10 | |
| 1.7 A 160 CDI | 4 | OM 668.941 | 44/59 | 07/98→02/01 | GN010 | GSE140 | 11V | |
| 1.7 A 160 CDI | 4 | OM 668.940 | 55/74 | 02/01→08/04 | GN010 | GSE140 | 11V | |
| 1.7 A 170 CDI | 4 | OM 668.940 | 66/89 | 07/98→02/01 | GN010 | GSE140 | 11V | |
| 1.7 A 170 CDI | 4 | OM 668.942 | 70/94 | 02/01→08/04 | GN010 | GSE140 | 11V | |
| 1.9 A 190 | 4 | M 166.990 | 92/123 | 03/99→08/04 | Z121 | 1.0 | UXT9 | ZSE146 |
| 1.9 A 190 LPG | 4 | M 166.990 | 92/123 | 03/99→08/04 | Z206 | 0.7 | UXT10 | |
| 2.1 A 210 | 4 | M 166.995 | 103/138 | 03/02→08/04 | Z121 | 1.0 | UXT9 | ZSE146 |
| 2.1 A 210 LPG | 4 | M 166.995 | 103/138 | 03/02→08/04 | Z206 | 0.7 | UXT10 | |

A-CLASS (W169)

| | | | | | | | | |
|-----------------|---|------------|---------|-------------|-------|------|-------|-------|
| 1.5 A 150 | 4 | M 266.920 | 70/94 | 09/04→06/12 | Z227 | 0.8 | UXT10 | ZS297 |
| 1.5 A 150 LPG | 4 | M 266.920 | 70/94 | 09/04→06/12 | Z206 | 0.7 | UXT10 | |
| 1.5 A 160 | 4 | M 266.920 | 70/94 | 04/09→06/12 | Z227 | 0.8 | UXT10 | ZS297 |
| 1.5 A 160 LPG | 4 | M 266.920 | 70/94 | 04/09→06/12 | Z206 | 0.7 | UXT10 | |
| 1.7 A 170 | 4 | M 266.940 | 85/114 | 09/04→06/12 | Z227 | 0.8 | UXT10 | ZS297 |
| 1.7 A 170 LPG | 4 | M 266.940 | 85/114 | 09/04→06/12 | Z206 | 0.7 | UXT10 | |
| 1.7 A 180 | 4 | M 266.940 | 85/114 | 04/09→06/12 | Z227 | 0.8 | UXT10 | ZS297 |
| 1.7 A 180 LPG | 4 | M 266.940 | 85/114 | 04/09→06/12 | Z206 | 0.7 | UXT10 | |
| 2.0 A 160 CDI | 4 | OM 640.942 | 60/80 | 09/04→06/12 | GE105 | 4.4V | | |
| 2.0 A 180 CDI | 4 | OM 640.940 | 80/107 | 09/04→06/12 | GE105 | 4.4V | | |
| 2.0 A 200 | 4 | M 266.960 | 100/134 | 09/04→06/12 | Z227 | 0.8 | UXT10 | ZS297 |
| 2.0 A 200 LPG | 4 | M 266.960 | 100/134 | 09/04→06/12 | Z206 | 0.7 | UXT10 | |
| 2.0 A 200 CDI | 4 | OM 640.941 | 100/134 | 09/04→06/12 | GE105 | 4.4V | | |
| 2.0 A 200 CDI | 4 | OM 640.941 | 103/138 | 09/04→06/12 | GE105 | 4.4V | | |
| 2.0 A 200 TURBO | 4 | M 266.980 | 142/190 | 09/05→06/12 | Z322 | 0.9 | | ZS297 |

A-CLASS (W176)

| | | | | | | | | |
|---------------|---|------------|--------|--------|------------|------|--|--|
| 1.5 A 160 CDI | 4 | OM 607.951 | 66/89 | 06/13→ | GE110 [37] | 4.4V | | |
| 1.5 A 180 CDI | 4 | OM 607.951 | 80/107 | 06/12→ | GE110 [37] | 4.4V | | |

B-CLASS (W245)

| | | | | | | | | |
|---------------|---|------------|--------|-------------|-------|------|-------|-------|
| 1.5 B 150 | 4 | M 266.920 | 70/94 | 03/05→11/11 | Z227 | 0.8 | UXT10 | ZS297 |
| 1.5 B 150 LPG | 4 | M 266.920 | 70/94 | 03/05→11/11 | Z206 | 0.7 | UXT10 | |
| 1.5 B 160 | 4 | M 266.920 | 70/94 | 04/09→11/11 | Z227 | 0.8 | UXT10 | ZS297 |
| 1.5 B 160 LPG | 4 | M 266.920 | 70/94 | 04/09→11/11 | Z206 | 0.7 | UXT10 | |
| 1.7 B 170 | 4 | M 266.940 | 85/114 | 03/05→11/11 | Z227 | 0.8 | UXT10 | ZS297 |
| 1.7 B 170 LPG | 4 | M 266.940 | 85/114 | 03/05→11/11 | Z206 | 0.7 | UXT10 | |
| 1.7 B 180 | 4 | M 266.940 | 85/114 | 04/09→11/11 | Z227 | 0.8 | UXT10 | ZS297 |
| 1.7 B 180 LPG | 4 | M 266.940 | 85/114 | 04/09→11/11 | Z206 | 0.7 | UXT10 | |
| 2.0 B 170 NGT | 4 | M 266.960 | 85/114 | 04/08→11/11 | Z227 | 0.8 | UXT10 | ZS297 |
| 2.0 B 180 CDI | 4 | OM 640.940 | 80/107 | 03/05→11/11 | GE105 | 4.4V | | |
| 2.0 B 180 NGT | 4 | M 266.960 | 85/114 | 04/08→11/11 | Z227 | 0.8 | UXT10 | ZS297 |

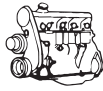

kw/BHP

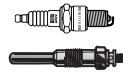

... MERCEDES-BENZ 

... B-CLASS (W245)

| | | | | | | | | | |
|-----------------|---|------------|---------|-------------|-------|--|------|-------|-------|
| 2.0 B 200 | 4 | M 266.960 | 100/134 | 03/05→11/11 | Z227 | | 0.8 | UXT10 | ZS297 |
| 2.0 B 200 LPG | 4 | M 266.960 | 100/134 | 03/05→11/11 | Z206 | | 0.7 | UXT10 | |
| 2.0 B 200 CDI | 4 | OM 640.941 | 100/134 | 03/05→11/11 | GE105 | | 4.4V | | |
| 2.0 B 200 CDI | 4 | OM 640.941 | 103/138 | 03/05→11/11 | GE105 | | 4.4V | | |
| 2.0 B 200 TURBO | 4 | M 266.980 | 142/190 | 03/05→11/11 | Z322 | | 0.9 | | ZS297 |

B-CLASS (W246)

| | | | | | | | | | |
|---------------|---|------------|--------|--------|-----------------------|--|------|--|--|
| 1.5 B 160 CDI | 4 | OM 607.951 | 66/89 | 05/13→ | GE110 ^[37] | | 4.4V | | |
| 1.5 B 180 CDI | 4 | OM 607.951 | 80/107 | 02/13→ | GE110 ^[37] | | 4.4V | | |

CABRIOLET (A124)

| | | | | | | | | | |
|---------------|---|-----------|---------|-------------|------|--|-----|-------------|-------|
| 3.0 300 CE-24 | 6 | M 104.980 | 162/217 | 04/92→06/93 | Z100 | | 0.8 | UXT1 / UXT3 | ZS298 |
|---------------|---|-----------|---------|-------------|------|--|-----|-------------|-------|

CABRIOLET (W111)

| | | | | | | | | | |
|----------------|---|-----------|---------|-------------|-----|--|-----|------|-----------------------|
| 3.5 280 SE 3.5 | 8 | M 116.980 | 147/197 | 01/69→12/71 | Z42 | | 0.8 | UX56 | ZS109 ^[15] |
|----------------|---|-----------|---------|-------------|-----|--|-----|------|-----------------------|

C-CLASS (W202)

| | | | | | | | | | |
|--------------------------|---|----------------------|---------|-------------|----------------------------------|--------|-------|-------------|-----------------|
| 1.8 C 180 | 4 | M 111.921 | 89/119 | 11/94→05/00 | Z100 →06/97 Z121 07/97→ | | 0.8 | UXT1 / UXT3 | ZS313 →08/95 |
| 1.8 C 180 | 4 | M 111.920 | 90/121 | 03/93→05/00 | Z100 | | 0.8 | UXT1 / UXT3 | ZS313 →08/95 |
| 1.8 C 180 | 4 | M 111.921 | 90/121 | 03/93→05/00 | Z121 | | 1.0 | UXT9 | ZS340 09/95→ |
| 1.8 C 180 LPG | 4 | M 111.921 | 89/119 | 11/94→05/00 | Z206 | | 0.7 | UXT10 | |
| 1.8 C 180 LPG | 4 | M 111.920, M 111.921 | 90/121 | 03/93→05/00 | Z206 | | 0.7 | UXT10 | |
| 2.0 C 200 | 4 | M 111.941 | 100/134 | 01/94→05/00 | Z100 →06/97 Z121 07/97→ | | 0.8 | UXT1 / UXT3 | ZS313 →08/95 |
| 2.0 C 200 | 4 | M 111.945 | 100/134 | 01/94→05/00 | Z100 →06/97 Z121 07/97→ | | 0.8 | UXT1 / UXT3 | ZS340 09/95→ |
| 2.0 C 200 LPG | 4 | M 111.941, M 111.945 | 100/134 | 01/94→05/00 | Z206 | | 0.7 | UXT10 | |
| 2.0 C 200 D | 4 | OM 601.913 | 55/74 | 03/93→05/00 | GN858 | GR074 | 11.5V | | |
| 2.0 C 200 D | 4 | OM 604.915 | 65/87 | 10/96→05/00 | GN948 ^[255] | GSE140 | 11.5V | | |
| 2.0 C 200 Kompressor | 4 | M 111.944 | 132/177 | 10/95→05/00 | Z120 | | 1.0 | UXT9 | ZS340 |
| 2.0 C 200 Kompressor | 4 | M 111.944 | 141/189 | 11/96→05/00 | Z120 | | 1.0 | UXT9 | ZS340 |
| 2.0 C 200 Kompressor LPG | 4 | M 111.944 | 132/177 | 10/95→05/00 | Z340 | | 0.7 | UXT12 | |
| 2.0 C 200 Kompressor LPG | 4 | M 111.944 | 141/189 | 11/96→05/00 | Z340 | | 0.7 | UXT12 | |
| 2.2 C 200 CDI | 4 | OM 611.960 | 75/101 | 03/98→05/00 | GN003 | GSE140 | 11.5V | | |
| 2.2 C 220 | 4 | M 111.961 | 110/148 | 03/93→05/00 | Z100 →06/97 Z121 07/97→ | | 0.8 | UXT1 / UXT3 | ZS313 →08/95 |
| 2.2 C 220 | 4 | M 111.961 | 110/148 | 03/93→05/00 | Z100 →06/97 Z121 07/97→ | | 1.0 | UXT9 | ZS340 09/95→ |
| 2.2 C 220 LPG | 4 | M 111.961 | 110/148 | 03/93→05/00 | Z206 | | 0.7 | UXT10 | |
| 2.2 C 220 CDI | 4 | OM 611.960 | 92/123 | 09/97→05/00 | GN003 | GSE140 | 11.5V | | |
| 2.2 C 220 D | 4 | OM 604.910 | 55/74 | 07/96→05/00 | GN860 ^{[1][129][257]} | GSE140 | 11.5V | | |
| 2.2 C 220 D | 4 | OM 604.910 | 55/74 | 07/96→05/00 | GN948 ^{[1][130][255]} | | 11.5V | | |
| 2.2 C 220 D | 4 | OM 604.910 | 70/94 | 08/93→05/00 | GN860 ^{[1][129][257]} | GSE140 | 11.5V | | |
| 2.2 C 220 D | 4 | OM 604.910 | 70/94 | 08/93→05/00 | GN948 ^{[1][130][255]} | | 11.5V | | |
| 2.3 C 230 | 4 | M 111.974 | 110/148 | 06/96→06/97 | Z100 | | 0.8 | UXT1 / UXT3 | ZS340 |
| 2.3 C 230 LPG | 4 | M 111.974 | 110/148 | 06/96→06/97 | Z206 | | 0.7 | UXT10 | |
| 2.3 C 230 Kompressor | 4 | M 111.975 | 142/190 | 10/95→05/00 | Z120 | | 1.0 | UXT9 | ZS340 |
| 2.3 C 230 Kompressor LPG | 4 | M 111.975 | 142/190 | 10/95→05/00 | Z340 | | 0.7 | UXT12 | |
| 2.4 C 240 | 6 | M 112.910 | 125/168 | 06/97→05/00 | Z122 | | 1.0 | UXT9 | ZS297 |
| 2.4 C 240 LPG | 6 | M 112.910 | 125/168 | 06/97→05/00 | Z206 | | 0.7 | UXT10 | |
| 2.5 C 250 D | 5 | OM 605.910 | 83/111 | 05/93→05/00 | GN860 ^{[1][129][257]} | GR080 | 11.5V | | |
| 2.5 C 250 D | 5 | OM 605.910 | 83/111 | 05/93→05/00 | GN948 ^{[1][130][255]} | | 11.5V | | |
| 2.5 C 250 Turbo-D | 5 | OM 605.960 | 110/148 | 10/95→05/00 | GN948 ^[255] | GSE141 | 11.5V | | |

MERCEDES-BENZ



kW/BHP

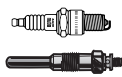

... MERCEDES-BENZ



... C-CLASS (W202)

| | | | | | | | | | | |
|------------------|---|---------------------|---------|-------------|----------------------------------|--|------------|---|-------|--|
| 2.8 C 280 | 6 | M 104.941 | 142/190 | 05/93→05/00 | Z100 →06/97 Z121 07/97→ | | 0.8 1.0 | UXT1 / UXT3 →06/97 UXT9 07/97→ | ZS340 | |
| 2.8 C 280 | 6 | M 112.920 | 145/194 | 06/97→05/00 | Z122 | | 1.0 | UXT9 | ZS297 | |
| 2.8 C 280 LPG | 6 | M 104.941 | 142/190 | 05/93→05/00 | Z206 | | 0.7 | UXT10 | | |
| 2.8 C 280 LPG | 6 | M 112.920 | 145/194 | 06/97→05/00 | Z206 | | 0.7 | UXT10 | | |
| 3.6 C 36 AMG | 6 | M 104.941 (AMG 3.6) | 206/276 | 05/94→05/00 | Z100 →06/97 Z121 07/97→ | | 0.8 1.0 | UXT1 / UXT3 →06/97 UXT9 07/97→ | ZS340 | |
| 3.6 C 36 AMG LPG | 6 | M 104.941 (AMG 3.6) | 206/276 | 05/94→05/00 | Z206 | | 0.7 | UXT10 | | |
| 4.3 C 43 AMG | 8 | M 113.944 | 225/302 | 08/97→05/00 | Z122 | | 1.0 | UXT9 | ZS297 | |
| 4.3 C 43 AMG LPG | 8 | M 113.944 | 225/302 | 08/97→05/00 | Z206 | | 0.7 | UXT10 | | |

C-CLASS (W203)

| | | | | | | | | | | |
|--------------------------|---|------------|---------|-------------|---|--------|------------|----------------------------------|--|------|
| 1.8 C 180 Kompressor | 4 | M 271.946 | 105/141 | 05/02→02/07 | Z226 →eng. 3085 3899 Z359 eng. 30853900→ | | 0.8 0.8 | | ZS053 →11/06 →eng. 3085 3899 ZS077 11/06→ eng. 3085 3900→ | |
| 1.8 C 200 CGI Kompressor | 4 | M 271.942 | 125/168 | 07/03→02/07 | Z226 →eng. 30853899 Z359 eng. 30853900→ | | 0.8 0.8 | | ZS053 →11/06 →eng. 3085 3899 ZS077 11/06→ eng. 3085 3900→ | |
| 1.8 C 200 Kompressor | 4 | M 271.940 | 120/161 | 05/02→02/07 | Z226 →eng. 30853899 Z359 eng. 30853900→ | | 0.8 0.8 | | ZS053 →11/06 →eng. 3085 3899 ZS077 11/06→ eng. 3085 3900→ | |
| 1.8 C 230 Kompressor | 4 | M 271.948 | 141/189 | 02/04→02/07 | Z226 →eng. 30853899 Z359 eng. 30853900→ | | 0.8 0.8 | | ZS053 →11/06 →eng. 3085 3899 ZS077 11/06→ eng. 3085 3900→ | |
| 2.0 C 180 | 4 | M 111.951 | 95/127 | 10/00→05/02 | Z282 | | 1.0 | UXT9 | ZS041 | GS17 |
| 2.0 C 180 LPG | 4 | M 111.951 | 95/127 | 10/00→05/02 | Z340 | | 0.7 | UXT12 | | |
| 2.0 C 200 Kompressor | 4 | M 111.955 | 120/161 | 05/00→06/02 | Z170 | | 1.0 | UXT9 | ZS041 | GS17 |
| 2.0 C 200 Kompressor LPG | 4 | M 111.955 | 120/161 | 05/00→06/02 | Z340 | | 0.7 | UXT12 | | |
| 2.2 C 200 CDI | 4 | OM 646.962 | 75/101 | 02/01→02/07 | GN003 | GSE140 | 11.5V | | | |
| 2.2 C 200 CDI | 4 | OM 611.962 | 85/114 | 09/00→02/07 | GN003 | GSE140 | 11.5V | | | |
| 2.2 C 200 CDI | 4 | OM 646.962 | 90/121 | 04/03→02/07 | GN003 | GSE140 | 11.5V | | | |
| 2.2 C 220 CDI | 4 | OM 611.962 | 100/134 | 05/00→02/07 | GN003 | GSE140 | 11.5V | | | |
| 2.2 C 220 CDI | 4 | OM 611.962 | 105/141 | 05/00→02/07 | GN003 | GSE140 | 11.5V | | | |
| 2.2 C 220 CDI | 4 | OM 646.963 | 110/148 | 02/03→02/07 | GN003 | GSE140 | 11.5V | | | |
| 2.5 C 230 | 6 | M 272.920 | 150/201 | 01/05→02/07 | Z359 | | 0.8 | | ZSE140 | |
| 2.6 C 240 | 6 | M 112.912 | 125/168 | 05/00→02/07 | Z122 →02/02 Z240 03/02→ | | 1.0 1.0 | UXT9 →02/02 UXT9 03/02→ | ZS297 | |
| 2.6 C 240 4WD | 6 | M 112.916 | 125/168 | 07/02→02/07 | Z240 | | 1.0 | UXT9 | ZS297 | |
| 2.6 C 240 LPG | 6 | M 112.912 | 125/168 | 05/00→02/07 | Z206 →02/02 | | 0.7 | UXT10 | | |
| 2.7 C 270 CDI | 5 | OM 612.962 | 125/168 | 12/00→02/07 | GN003 | GSE141 | 11.5V | | | |

MERCEDÉS-BENZ

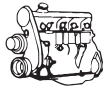

kw/BHP

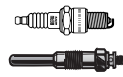

... MERCEDES-BENZ 

... C-CLASS (W203)

| | | | | | | | | | |
|-----------------------------|---|----------------------|---------|-------------|----------------------------------|--------|------------|----------------------------------|-----------------|
| 3.0 C 30 CDI AMG | 5 | OM 612.990 | 170/228 | 01/03→02/07 | GE104 [1] GE116 [1][262] | | 5V 5V | | |
| 3.0 C 280 | 6 | M 272.940, M 272.941 | 170/228 | 01/05→02/07 | Z359 | | 0.8 | | ZSE140 |
| 3.0 C 320 CDI | 6 | OM 642.910 | 165/221 | 01/05→02/07 | GE105 | GSE114 | 4.4V | | |
| 3.2 C 32 AMG Kompressor | 6 | M 112.961 | 260/349 | 02/01→02/07 | Z170 | | 1.0 | UXT9 | ZS297 09/02→ |
| 3.2 C 32 AMG Kompressor LPG | 6 | M 112.961 | 260/349 | 02/01→02/07 | Z340 | | 0.7 | UXT12 | |
| 3.2 C 320 | 6 | M 112.946 | 160/215 | 05/00→02/07 | Z122 →02/02 Z240 03/02→ | | 1.0 1.0 | UXT9 UXT9 →02/02 03/02→ | ZS297 |
| 3.2 C 320 4WD | 6 | M 112.953 | 160/215 | 07/02→02/07 | Z240 | | 1.0 | UXT9 | ZS297 |
| 3.2 C 320 LPG | 6 | M 112.946 | 160/215 | 05/00→02/07 | Z206 →02/02 | | 0.7 | UXT10 →02/02 | |
| 3.5 C 350 | 6 | M 272.960 | 200/268 | 01/05→02/07 | Z359 | | 0.8 | | ZSE140 |
| 3.5 C 350 4WD | 6 | M 272.960, M 272.970 | 200/268 | 01/05→02/07 | Z240 | | 1.0 | UXT9 | ZSE140 |
| 5.4 C 55 AMG | 8 | M 113.988 | 270/362 | 02/04→02/07 | Z170 | | 1.0 | UXT9 | ZS297 |
| 5.4 C 55 AMG LPG | 8 | M 113.988 | 270/362 | 02/04→02/07 | Z340 | | 0.7 | UXT12 | |

C-CLASS (W204)

| | | | | | | | | | | |
|----------------------|---|------------------------|---------|--------|-------|--------|------|--|---------------------------|------|
| 1.6 C 180 Kompressor | 4 | M 271.910 | 115/154 | 01/08→ | Z359 | | 0.8 | | ZS077 | GS21 |
| 1.8 C 180 CGI | 4 | M 271.820 | 115/154 | 01/07→ | Z359 | | 0.8 | | ZS077 | GS21 |
| 1.8 C 180 Kompressor | 4 | M 271.952 | 115/154 | 01/07→ | Z359 | | 0.8 | | ZS077 eng. 308 539 00→ | |
| 1.8 C 200 CGI | 4 | M 271.820 | 135/181 | 01/07→ | | | | | ZS077 | GS21 |
| 1.8 C 200 Kompressor | 4 | M 271.950 | 135/181 | 01/07→ | Z359 | | 0.8 | | ZS077 eng. 308 539 00→ | |
| 1.8 C 250 CGI | 4 | M 271.860 | 150/201 | 07/09→ | | | | | ZS077 | GS21 |
| 2.5 C 230 | 6 | M 272.911, M 272.921 | 150/201 | 01/07→ | Z359 | | 0.8 | | ZSE140 | |
| 3.0 C 280 | 6 | M 272.947, M 272.948 | 170/228 | 01/07→ | Z359 | | 0.8 | | ZSE140 | |
| 3.0 C 300 | 6 | M 272.947, M 272.948 | 170/228 | 07/07→ | Z359 | | 0.8 | | ZSE140 | |
| 3.0 C 300 CDI 4WD | 6 | OM 642.832 | 170/228 | 01/11→ | | GSE116 | | | | |
| 3.0 C 320 CDI | 6 | OM 642.960 | 165/221 | 01/07→ | GE105 | GSE114 | 4.4V | | | |
| 3.0 C 320 CDI 4WD | 6 | OM 642.961 | 165/221 | 07/07→ | GE105 | GSE114 | 4.4V | | | |
| 3.0 C 350 CDI | 6 | OM 642.960, OM 642.961 | 165/221 | 07/09→ | GE105 | GSE114 | 4.4V | | | |
| 3.0 C 350 CDI | 6 | OM 642.830, OM 642.832 | 170/228 | 10/09→ | | GSE116 | | | | |
| 3.0 C 350 CDI | 6 | OM 642.834 | 195/261 | 06/11→ | | GSE116 | | | | |
| 3.5 C 300 | 6 | M 276.957 | 185/248 | 02/11→ | | | | | ZSE093 | |
| 3.5 C 350 | 6 | M 272.961, M 272.971 | 200/268 | 01/07→ | | | | | ZSE140 | |
| 3.5 C 350 | 6 | M 276.957 | 225/302 | 01/11→ | | | | | ZSE093 | |
| 6.2 C 63 AMG | 8 | M 156.985 | 336/451 | 02/08→ | Z355 | | 1.0 | | | |
| 6.2 C 63 AMG | 8 | M 156.985 | 358/480 | 02/08→ | Z355 | | 1.0 | | | |

C-CLASS Coupe (C204)

| | | | | | | | | | | |
|--------------|---|-----------|---------|--------|------|--|-----|--|--------|--|
| 1.8 C 180 | 4 | M 271.820 | 115/154 | 06/11→ | | | | | ZS077 | |
| 1.8 C 250 | 4 | M 271.860 | 150/201 | 06/11→ | | | | | ZS077 | |
| 3.5 C 350 | 6 | M 276.957 | 225/302 | 06/11→ | | | | | ZSE093 | |
| 6.2 C 63 AMG | 8 | M 156.985 | 336/451 | 06/11→ | Z355 | | 1.0 | | | |
| 6.2 C 63 AMG | 8 | M 156.985 | 358/480 | 01/12→ | Z355 | | 1.0 | | | |
| 6.2 C 63 AMG | 8 | M 156.985 | 380/510 | 01/12→ | Z355 | | 1.0 | | | |

C-CLASS Coupe (CL203)

| | | | | | | | | | | |
|----------------------|---|-----------|--------|-------------|--|--|------------|--|--|--|
| 1.8 C 160 Kompressor | 4 | M 271.921 | 90/121 | 05/02→05/08 | Z226 →eng. 30853899 Z359 eng. 30853900→ | | 0.8 0.8 | | ZS053 →11/06 →eng. 3085 3899 ZS077 11/06→ eng. 3085 3900→ | |
|----------------------|---|-----------|--------|-------------|--|--|------------|--|--|--|

MERCEDES-BENZ



kW/BHP

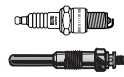

... MERCEDES-BENZ



... C-CLASS Coupe (CL203)

| | | | | | | | | | | |
|------------------------------|---|----------------------|---------|-------------|---|------------|---|--|-------------|--|
| 1.8 C 180 Kompressor | 4 | M 271.946 | 105/141 | 05/02→05/08 | Z226 →eng. 3085 3899 Z359 eng. 30853900→ | 0.8 | | ZS053 →11/06 →eng. 3085 3899 ZS077 11/06→ eng. 3085 3900→ | | |
| 1.8 C 200 CGI Kompressor | 4 | M 271.942 | 125/168 | 03/03→05/08 | Z226 →eng. 30853899 Z359 eng. 30853900→ | 0.8 | | ZS053 →11/06 →eng. 3085 3899 ZS077 11/06→ eng. 3085 3900→ | | |
| 1.8 C 200 Kompressor | 4 | M 271.940 | 120/161 | 05/02→05/08 | Z226 →eng. 30853899 Z359 eng. 30853900→ | 0.8 | | ZS053 →11/06 →eng. 3085 3899 ZS077 11/06→ eng. 3085 3900→ | | |
| 1.8 C 230 Kompressor | 4 | M 271.948 | 141/189 | 05/02→05/08 | Z226 →eng. 30853899 Z359 eng. 30853900→ | 0.8 | | ZS053 →11/06 →eng. 3085 3899 ZS077 11/06→ eng. 3085 3900→ | | |
| 2.0 C 180 | 4 | M 111.951 | 95/127 | 03/01→05/02 | Z282 | 1.0 | UXT9 | ZS041 | GS17 | |
| 2.0 C 180 LPG | 4 | M 111.951 | 95/127 | 03/01→05/02 | Z340 | 0.7 | UXT12 | | | |
| 2.0 C 200 Kompressor | 4 | M 111.955 | 120/161 | 03/01→05/02 | Z170 | 1.0 | UXT9 | ZS041 | GS17 | |
| 2.0 C 200 Kompressor LPG | 4 | M 111.955 | 120/161 | 03/01→05/02 | Z340 | 0.7 | UXT12 | | | |
| 2.2 C 200 CDI | 4 | OM 646.962 | 90/121 | 03/03→05/08 | GN003 | GSE140 | 11.5V | | | |
| 2.2 C 220 CDI | 4 | OM 611.962 | 100/134 | 03/01→05/08 | GN003 | GSE140 | 11.5V | | | |
| 2.2 C 220 CDI | 4 | OM 611.962 | 105/141 | 03/01→05/08 | GN003 | GSE140 | 11.5V | | | |
| 2.2 C 220 CDI | 4 | OM 646.963 | 110/148 | 02/04→05/08 | GN003 | GSE140 | 11.5V | | | |
| 2.3 C 230 Kompressor | 4 | M 111.981 | 145/194 | 03/01→05/02 | Z170 | 1.0 | UXT9 | ZS041 | GS17 | |
| 2.3 C 230 Kompressor LPG | 4 | M 111.981 | 145/194 | 03/01→05/02 | Z340 | 0.7 | UXT12 | | | |
| 2.5 C 230 | 6 | M 272.920 | 150/201 | 01/05→05/08 | Z359 | 0.8 | | ZSE140 | | |
| 3.0 C 30 CDI AMG | 5 | OM 612.990 | 170/228 | 09/02→05/08 | GE104 [1] GE116 [1][262] | 5V 5V | | | | |
| 3.2 C 32 AMG Kompressor | 6 | M 112.961 | 260/349 | 05/02→05/08 | Z170 | 1.0 | UXT9 | ZS297 | | |
| 3.2 C 32 AMG Kompressor LPG | 6 | M 112.961 | 260/349 | 05/02→05/08 | Z340 | 0.7 | UXT12 | | | |
| 3.2 C 320 | 6 | M 112.946 | 160/215 | 09/02→05/08 | Z122 | 1.0 | UXT9 | ZS297 | | |
| 3.2 C 320 LPG | 6 | M 112.946 | 160/215 | 09/02→05/08 | Z206 | 0.7 | UXT10 | | | |
| 3.5 C 350 | 6 | M 272.960 | 200/268 | 01/05→05/08 | Z359 | 0.8 | | ZSE140 | | |
| C-CLASS Estate (S202) | | | | | | | | | | |
| 1.8 C 180 T | 4 | M 111.920 | 90/121 | 06/96→09/00 | Z100 | 0.8 | UXT1 / UXT3 | ZS313 | | |
| 1.8 C 180 T | 4 | M 111.921 | 90/121 | 06/96→09/00 | Z121 | 1.0 | UXT9 | ZS340 | | |
| 1.8 C 180 T LPG | 4 | M 111.920, M 111.921 | 90/121 | 06/96→09/00 | Z206 | 0.7 | UXT10 | | | |
| 2.0 C 180 T | 4 | M 111.952 | 95/127 | 09/00→03/01 | Z282 | 1.0 | UXT9 | ZS041 | | |
| 2.0 C 180 T LPG | 4 | M 111.952 | 95/127 | 09/00→03/01 | Z340 | 0.7 | UXT12 | | | |
| 2.0 C 200 T | 4 | M 111.941 | 100/134 | 06/96→03/01 | Z100 →06/97 Z121 07/97→ | 0.8 1.0 | UXT1 / UXT3 UXT9 07/97→ | ZS313 | | |
| 2.0 C 200 T | 4 | M 111.945 | 100/134 | 06/96→03/01 | Z100 →06/97 Z121 07/97→ | 0.8 1.0 | UXT1 / UXT3 UXT9 07/97→ | ZS340 | | |
| 2.0 C 200 T LPG | 4 | M 111.941, M 111.945 | 100/134 | 06/96→03/01 | Z206 | 0.7 | UXT10 | | | |
| 2.0 C 200 T D | 4 | OM 604.915 | 65/87 | 10/96→03/01 | GN948 [255] | GSE140 | 11.5V | | | |
| 2.0 C 200 T Kompressor | 4 | M 111.956 | 120/161 | 09/00→03/01 | Z170 | 1.0 | UXT9 | ZS041 | | |

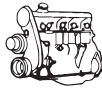

kW/BHP

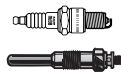

... MERCEDES-BENZ 

... C-CLASS Estate (S202)

| | | | | | | | | | |
|----------------------------|---|------------|---------|-------------|------------------------|--------|-------|-------------|-------|
| 2.0 C 200 T Kompressor | 4 | M 111.944 | 141/189 | 11/96→03/01 | Z120 | | 1.0 | UXT9 | ZS340 |
| 2.0 C 200 T Kompressor LPG | 4 | M 111.956 | 120/161 | 09/00→03/01 | Z340 | | 0.7 | UXT12 | |
| 2.0 C 200 T Kompressor LPG | 4 | M 111.944 | 141/189 | 11/96→03/01 | Z340 | | 0.7 | UXT12 | |
| 2.2 C 200 T CDI | 4 | OM 611.960 | 75/101 | 03/98→03/01 | GN003 | GSE140 | 11.5V | | |
| 2.2 C 220 T CDI | 4 | OM 611.960 | 92/123 | 09/97→03/01 | GN003 | GSE140 | 11.5V | | |
| 2.2 C 220 T D | 4 | OM 604.910 | 55/74 | 06/96→03/01 | GN948 ^[255] | GSE140 | 11.5V | | |
| 2.2 C 220 T D | 4 | OM 604.910 | 70/94 | 06/96→09/98 | GN948 ^[255] | GSE140 | 11.5V | | |
| 2.3 C 230 T | 4 | M 111.974 | 110/148 | 06/96→06/98 | Z100 | | 0.8 | UXT1 / UXT3 | ZS340 |
| 2.3 C 230 T LPG | 4 | M 111.974 | 110/148 | 06/96→06/98 | Z206 | | 0.7 | UXT10 | |
| 2.3 C 230 T Kompressor | 4 | M 111.975 | 142/190 | 06/97→09/00 | Z120 | | 1.0 | UXT9 | ZS340 |
| 2.3 C 230 T Kompressor LPG | 4 | M 111.975 | 142/190 | 06/97→09/00 | Z340 | | 0.7 | UXT12 | |
| 2.4 C 240 T | 6 | M 112.910 | 125/168 | 06/97→09/00 | Z122 | | 1.0 | UXT9 | ZS297 |
| 2.4 C 240 T LPG | 6 | M 112.910 | 125/168 | 06/97→09/00 | Z206 | | 0.7 | UXT10 | |
| 2.5 C 250 T Turbo-D | 5 | OM 605.960 | 110/148 | 06/96→03/01 | GN948 ^[255] | GSE141 | 11.5V | | |
| 2.6 C 240 T | 6 | M 112.915 | 125/168 | 09/00→03/01 | Z122 | | 1.0 | UXT9 | ZS297 |
| 2.6 C 240 T LPG | 6 | M 112.915 | 125/168 | 09/00→03/01 | Z206 | | 0.7 | UXT10 | |
| 2.8 C 280 T | 6 | M 112.920 | 145/194 | 06/97→03/01 | Z122 | | 1.0 | UXT9 | ZS297 |
| 2.8 C 280 T LPG | 6 | M 112.920 | 145/194 | 06/97→03/01 | Z206 | | 0.7 | UXT10 | |
| 4.3 C 43 AMG | 8 | M 113.944 | 225/302 | 08/97→03/01 | Z122 | | 1.0 | UXT9 | ZS297 |
| 4.3 C 43 AMG LPG | 8 | M 113.944 | 225/302 | 08/97→03/01 | Z206 | | 0.7 | UXT10 | |

C-CLASS T-Model (S203)

| | | | | | | | | | |
|--------------------------|---|------------------------|---------|-------------|--|--------|------------|-------|--|
| 1.8 C 180 Kompressor | 4 | M 271.946 | 105/141 | 05/02→08/07 | Z359 Z226 →eng. 3085 3899 | | 0.8 0.8 | | ZS053 →11/06 →eng. 3085 3899 ZS077 11/06→ eng. 3085 3900→ |
| 1.8 C 200 CGI Kompressor | 4 | M 271.942 | 125/168 | 07/03→08/07 | Z226 →eng. 30853899 Z359 eng. 30853900→ | | 0.8 0.8 | | ZS053 →11/06 →eng. 3085 3899 ZS077 11/06→ eng. 3085 3900→ |
| 1.8 C 200 Kompressor | 4 | M 271.940 | 120/161 | 05/02→08/07 | Z226 →eng. 30853899 Z359 eng. 30853900→ | | 0.8 0.8 | | ZS053 →11/06 →eng. 3085 3899 ZS077 11/06→ eng. 3085 3900→ |
| 1.8 C 230 Kompressor | 4 | M 271.948 | 141/189 | 02/04→08/07 | Z226 →eng. 30853899 Z359 eng. 30853900→ | | 0.8 0.8 | | ZS053 →11/06 →eng. 3085 3899 ZS077 11/06→ eng. 3085 3900→ |
| 2.0 C 180 | 4 | M 111.951 | 95/127 | 03/01→05/02 | Z282 | | 1.0 | UXT9 | ZS041 GS17 |
| 2.0 C 180 LPG | 4 | M 111.951 | 95/127 | 03/01→05/02 | Z340 | | 0.7 | UXT12 | |
| 2.0 C 200 Kompressor | 4 | M 111.955 | 120/161 | 03/01→05/02 | Z170 | | 1.0 | UXT9 | ZS041 GS17 |
| 2.0 C 200 Kompressor LPG | 4 | M 111.955 | 120/161 | 03/01→05/02 | Z340 | | 0.7 | UXT12 | |
| 2.2 C 200 CDI | 4 | OM 611.962, OM 646.962 | 75/101 | 03/01→08/07 | GN003 | GSE140 | 11.5V | | |
| 2.2 C 200 CDI | 4 | OM 611.962 | 85/114 | 03/01→08/07 | GN003 | GSE140 | 11.5V | | |
| 2.2 C 200 CDI | 4 | OM 646.962 | 90/121 | 04/03→08/07 | GN003 | GSE140 | 11.5V | | |
| 2.2 C 220 CDI | 4 | OM 646.963 | 100/134 | 08/06→08/07 | GN003 | GSE140 | 11.5V | | |
| 2.2 C 220 CDI | 4 | OM 611.962 | 105/141 | 03/01→08/07 | GN003 | GSE140 | 11.5V | | |
| 2.2 C 220 CDI | 4 | OM 646.963 | 110/148 | 02/04→08/07 | GN003 | GSE140 | 11.5V | | |
| 2.5 C 230 | 6 | M 272.920 | 150/201 | 01/05→08/07 | Z359 | | 0.8 | | ZSE140 |

MERCEDES-BENZ

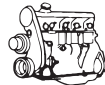

kW/BHP

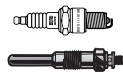
**... MERCEDES-BENZ****... C-CLASS T-Model (S203)**

| | | | | | | | | | |
|-----------------------------|---|----------------------|---------|-------------|----------------------------------|--------|----------|-----------------|-----------------|
| 2.6 C 240 | 6 | M 112.912 | 125/168 | 03/01→08/07 | Z122 →02/02 Z240 03/02→ | | 1.0 | UXT9 →02/02 | ZS297 |
| 2.6 C 240 4WD | 6 | M 112.916 | 125/168 | 07/02→08/07 | Z240 | | 1.0 | UXT9 03/02→ | ZS297 →01/04 |
| 2.6 C 240 LPG | 6 | M 112.912 | 125/168 | 03/01→08/07 | Z206 →02/02 | | 0.7 | UXT10 →02/02 | |
| 2.7 C 270 CDI | 5 | OM 612.962 | 125/168 | 03/01→08/07 | GN003 | GSE141 | 11.5V | | |
| 3.0 C 30 CDI AMG | 5 | OM 612.990 | 170/228 | 01/03→08/07 | GE104 [1] GE116 [1][262] | | 5V 5V | | |
| 3.0 C 280 | 6 | M 272.940, M 272.941 | 170/228 | 01/05→08/07 | Z359 | | 0.8 | | ZSE140 |
| 3.0 C 320 CDI | 6 | OM 642.910 | 165/221 | 06/05→08/07 | GE105 | GSE114 | 4.4V | | |
| 3.2 C 32 AMG Kompressor | 6 | M 112.961 | 260/349 | 03/01→08/07 | Z170 | | 1.0 | UXT9 | ZS297 →01/04 |
| 3.2 C 32 AMG Kompressor LPG | 6 | M 112.961 | 260/349 | 03/01→08/07 | Z340 | | 0.7 | UXT12 | |
| 3.2 C 320 | 6 | M 112.946 | 160/215 | 03/01→08/07 | Z122 →02/02 Z240 03/02→ | | 1.0 | UXT9 →02/02 | ZS297 |
| 3.2 C 320 4WD | 6 | M 112.953 | 160/215 | 07/02→08/07 | Z240 | | 1.0 | UXT9 | ZS297 |
| 3.2 C 320 LPG | 6 | M 112.946 | 160/215 | 03/01→08/07 | Z206 →02/02 | | 0.7 | UXT10 →02/02 | |
| 3.5 C 350 | 6 | M 272.960 | 200/268 | 01/05→08/07 | Z359 | | 0.8 | | ZSE140 |
| 3.5 C 350 4WD | 6 | M 272.970 | 200/268 | 01/05→08/07 | | | | | ZSE140 |
| 5.4 C 55 AMG | 8 | M 113.988 | 270/362 | 02/04→08/07 | Z170 | | 1.0 | UXT9 | ZS297 |
| 5.4 C 55 AMG LPG | 8 | M 113.988 | 270/362 | 02/04→08/07 | Z340 | | 0.7 | UXT12 | |

C-CLASS T-Model (S204)

| | | | | | | | | | | |
|----------------------|---|------------------------|---------|--------|-------|--------|------|--|---------------------------|------|
| 1.8 C 180 CGI | 4 | M 271.820 | 115/154 | 11/09→ | | | | | ZS077 | GS21 |
| 1.8 C 180 Kompressor | 4 | M 271.910 | 115/154 | 01/08→ | | | | | ZS077 | GS21 |
| 1.8 C 180 Kompressor | 4 | M 271.952 | 115/154 | 08/07→ | Z359 | | 0.8 | | ZS077 eng. 308 539 00→ | |
| 1.8 C 200 CGI | 4 | M 271.820, M 271.860 | 135/181 | 08/07→ | Z359 | | 0.8 | | ZS077 | |
| 1.8 C 200 Kompressor | 4 | M 271.950 | 135/181 | 08/07→ | Z359 | | 0.8 | | ZS077 eng. 308 539 00→ | |
| 1.8 C 250 CGI | 4 | M 271.860 | 150/201 | 07/09→ | | | | | ZS077 | GS21 |
| 2.5 C 230 | 6 | M 272.921 | 150/201 | 08/07→ | Z359 | | 0.8 | | ZSE140 | |
| 3.0 C 280 | 6 | M 272.947 | 170/228 | 08/07→ | Z359 | | 0.8 | | ZSE140 | |
| 3.0 C 320 CDI | 6 | OM 642.960 | 165/221 | 08/07→ | GE105 | GSE114 | 4.4V | | | |
| 3.0 C 320 CDI 4WD | 6 | OM 642.961 | 165/221 | 08/07→ | GE105 | GSE114 | 4.4V | | | |
| 3.0 C 350 CDI | 6 | OM 642.830 | 165/221 | 08/07→ | | GSE116 | | | | |
| 3.0 C 350 CDI | 6 | OM 642.830, OM 642.832 | 170/228 | 10/09→ | | GSE116 | | | | |
| 3.0 C 350 CDI | 6 | OM 642.834 | 195/261 | 06/11→ | | GSE116 | | | | |
| 3.5 C 350 | 6 | M 272.961 | 200/268 | 08/07→ | | | | | ZSE140 | |
| 3.5 C 350 CGI | 6 | M 276.957 | 225/302 | 06/11→ | | | | | ZSE093 | |
| 6.2 C 63 AMG | 8 | M 156.985 | 336/451 | 02/08→ | Z355 | | 1.0 | | | |
| 6.2 C 63 AMG | 8 | M 156.985 | 358/480 | 01/12→ | Z355 | | 1.0 | | | |

CITAN Combi (415)

| | | | | | | | | | | |
|-------------|---|------------|--------|--------|------------|--|------|--|--|--|
| 1.5 108 CDI | 4 | OM 607.951 | 55/74 | 11/12→ | GE110 [37] | | 4.4V | | | |
| 1.5 109 CDI | 4 | OM 607.951 | 66/89 | 11/12→ | GE110 [37] | | 4.4V | | | |
| 1.5 111 CDI | 4 | OM 607.951 | 81/109 | 06/13→ | GE110 [37] | | 4.4V | | | |

CLA Coupe (C117)

| | | | | | | | | | | |
|-----------------|---|------------|--------|--------|------------|--|------|--|--|--|
| 1.5 CLA 180 CDI | 4 | OM 607.951 | 80/107 | 10/13→ | GE110 [37] | | 4.4V | | | |
|-----------------|---|------------|--------|--------|------------|--|------|--|--|--|

CLC-CLASS (CL203)

| | | | | | | | | | | |
|------------------------|---|------------|---------|-------------|-------|--------|-------|--|-------|--|
| 1.6 CLC 160 | 4 | M 271.911 | 95/127 | 02/09→06/11 | | | | | ZS077 | |
| 1.8 CLC 180 Kompressor | 4 | M 271.946 | 105/141 | 05/08→06/11 | Z359 | | 0.8 | | ZS077 | |
| 1.8 CLC 200 Kompressor | 4 | M 271.957 | 135/181 | 05/08→06/11 | Z359 | | 0.8 | | ZS077 | |
| 2.1 CLC 200 CDI | 4 | OM 646.962 | 90/121 | 05/08→06/11 | GN003 | GSE140 | 11.5V | | | |



kW/BHP

**... MERCEDES-BENZ****... CLC-CLASS (CL203)**

| | | | | | | | | | |
|-----------------|---|------------|---------|-------------|--------------|---------------|-------|--|---------------|
| 2.1 CLC 220 CDI | 4 | OM 646.963 | 110/148 | 05/08→06/11 | GN003 | GSE140 | 11.5V | | |
| 2.5 CLC 230 | 6 | M 272.920 | 150/201 | 05/08→06/11 | Z359 | | 0.8 | | ZSE140 |
| 3.5 CLC 350 | 6 | M 272.960 | 200/268 | 05/08→06/11 | Z359 | | 0.8 | | ZSE140 |

CLK (C208)

| | | | | | | | | | |
|------------------------|---|----------------------|---------|-------------|-------------|--|-----|--------------|--------------|
| 2.0 200 | 4 | M 111.941 | 100/134 | 06/97→06/02 | | | | | ZS313 |
| 2.0 200 | 4 | M 111.945 | 100/134 | 06/97→06/02 | Z121 | | 1.0 | UXT9 | ZS340 |
| 2.0 200 LPG | 4 | M 111.945 | 100/134 | 06/97→06/02 | Z206 | | 0.7 | UXT10 | |
| 2.0 200 Kompressor | 4 | M 111.956 | 120/161 | 06/00→06/02 | Z170 | | 1.0 | UXT9 | ZS041 |
| 2.0 200 Kompressor | 4 | M 111.944 | 141/189 | 06/97→06/00 | Z120 | | 1.0 | UXT9 | ZS340 |
| 2.0 200 Kompressor LPG | 4 | M 111.956 | 120/161 | 06/00→06/02 | Z340 | | 0.7 | UXT12 | |
| 2.0 200 Kompressor LPG | 4 | M 111.944 | 141/189 | 06/97→06/00 | Z340 | | 0.7 | UXT12 | |
| 2.3 230 Kompressor | 4 | M 111.973, M 111.975 | 142/190 | 06/97→06/00 | Z120 | | 1.0 | UXT9 | ZS340 |
| 2.3 230 Kompressor | 4 | M 111.982 | 145/194 | 06/00→06/02 | Z170 | | 1.0 | UXT9 | ZS041 |
| 2.3 230 Kompressor LPG | 4 | M 111.973, M 111.975 | 142/190 | 06/97→06/00 | Z340 | | 0.7 | UXT12 | |
| 2.3 230 Kompressor LPG | 4 | M 111.982 | 145/194 | 06/00→06/02 | Z340 | | 0.7 | UXT12 | |
| 3.2 320 | 6 | M 112.940 | 160/215 | 06/97→06/02 | Z122 | | 1.0 | UXT9 | ZS297 |
| 3.2 320 LPG | 6 | M 112.940 | 160/215 | 06/97→06/02 | Z206 | | 0.7 | UXT10 | |
| 4.3 430 | 8 | M 113.943 | 205/275 | 07/98→06/02 | Z122 | | 1.0 | UXT9 | ZS297 |
| 4.3 430 LPG | 8 | M 113.943 | 205/275 | 07/98→06/02 | Z206 | | 0.7 | UXT10 | |
| 5.4 55 AMG | 8 | M 113.981, M 113.984 | 255/342 | 08/99→06/02 | Z240 | | 1.0 | UXT9 | ZS297 |

CLK (C209)

| | | | | | | | | | | |
|--------------------|---|-----------|---------|-------------|--|--|-----|--|--|-------------|
| 1.8 200 CGI | 4 | M 271.942 | 125/168 | 07/03→05/09 | Z226 →eng. 30853899 Z359 eng. 30853900→ | | 0.8 | | ZS053 | GS21 |
| | | | | | | | 0.8 | | →11/06 →eng. 30853899 ZS077 11/06→ eng. 30853900→ | |
| 1.8 200 Kompressor | 4 | M 271.940 | 120/161 | 09/02→05/09 | Z226 →eng. 30853899 Z359 eng. 30853900→ | | 0.8 | | ZS053 | |
| | | | | | | | 0.8 | | →11/06 →eng. 30853899 ZS077 11/06→ eng. 30853900→ | |
| 1.8 200 Kompressor | 4 | M 271.955 | 135/181 | 10/06→05/09 | Z226 →eng. 30853899 Z359 eng. 30853900→ | | 0.8 | | ZS053 | |
| | | | | | | | 0.8 | | →eng. 30853899 ZS077 eng. 30853900→ | |

| | | | | | | | | | |
|----------------|---|------------------------|---------|-------------|--------------|---------------|-------|--------------|---------------|
| 2.2 220 CDI | 4 | OM 646.966 | 100/134 | 01/05→05/09 | GN003 | GSE140 | 11.5V | | |
| 2.2 220 CDI | 4 | OM 646.966 | 110/148 | 01/05→05/09 | GN003 | GSE140 | 11.5V | | |
| 2.6 240 | 6 | M 112.912 | 120/161 | 06/02→05/09 | | | | | ZS297 |
| 2.6 240 | 6 | M 112.912 | 125/168 | 06/02→05/09 | Z240 | | 1.0 | UXT9 | ZS297 |
| 2.7 270 CDI | 5 | OM 612.967 | 120/161 | 02/03→06/05 | GN003 | GSE141 | 11.5V | | |
| 2.7 270 CDI | 5 | OM 612.962, OM 612.967 | 125/168 | 10/02→05/09 | GN003 | GSE141 | 11.5V | | |
| 3.0 280 | 6 | M 272.940 | 170/228 | 01/05→05/09 | Z359 | | 0.8 | | ZSE140 |
| 3.0 320 CDI | 6 | OM 642.910 | 165/221 | 01/05→05/09 | GE105 | GSE114 | 4.4V | | |
| 3.2 320 | 6 | M 112.955 | 160/215 | 06/02→05/09 | Z240 | | 1.0 | UXT9 | ZS297 |
| 3.5 350 | 6 | M 272.960 | 200/268 | 01/05→05/09 | Z359 | | 0.8 | | ZSE140 |
| 5.0 500 | 8 | M 113.968 | 225/302 | 06/02→05/09 | Z240 | | 1.0 | UXT9 | ZS297 |
| 5.4 55 AMG | 8 | M 113.987 | 270/362 | 09/02→05/09 | Z170 | | 1.0 | UXT9 | ZS297 |
| 5.4 55 AMG LPG | 8 | M 113.987 | 270/362 | 09/02→05/09 | Z340 | | 0.7 | UXT12 | |
| 5.4 DTM AMG | 8 | M 113.994 | 428/574 | 06/04→05/09 | | | | | ZS297 |
| 5.5 500 | 8 | M 273.965 | 285/382 | 06/06→05/09 | Z359 | | 0.8 | | ZSE140 |
| 6.2 63 AMG | 8 | M 156.982 | 354/475 | 04/06→05/09 | Z355 | | 1.0 | | |
| 6.2 63 AMG | 8 | M 156.982 | 373/500 | 05/07→05/09 | Z355 | | 1.0 | | |

CLK Convertible (A208)

| | | | | | | | | | |
|-------------|---|----------------------|---------|-------------|-------------|--|-----|--------------|--------------|
| 2.0 200 | 4 | M 111.941 | 100/134 | 03/98→03/02 | Z121 | | 1.0 | UXT9 | ZS313 |
| 2.0 200 | 4 | M 111.945 | 100/134 | 03/98→03/02 | Z121 | | 1.0 | UXT9 | ZS340 |
| 2.0 200 LPG | 4 | M 111.941, M 111.945 | 100/134 | 03/98→03/02 | Z206 | | 0.7 | UXT10 | |

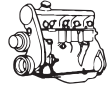

kW/BHP

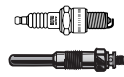
**... MERCEDES-BENZ****... CLK Convertible (A208)**

| | | | | | | | | | |
|------------------------|---|----------------------|---------|-------------|------|-----|-------|-------|------|
| 2.0 200 Kompressor | 4 | M 111.956 | 120/161 | 06/00→03/02 | Z170 | 1.0 | UXT9 | ZS041 | |
| 2.0 200 Kompressor | 4 | M 111.944 | 141/189 | 03/98→06/00 | Z120 | 1.0 | UXT9 | ZS340 | |
| 2.0 200 Kompressor LPG | 4 | M 111.956 | 120/161 | 06/00→03/02 | Z340 | 0.7 | UXT12 | | |
| 2.0 200 Kompressor LPG | 4 | M 111.944 | 141/189 | 03/98→06/00 | Z340 | 0.7 | UXT12 | | |
| 2.3 230 Kompressor | 4 | M 111.973, M 111.975 | 142/190 | 03/98→06/00 | Z120 | 1.0 | UXT9 | ZS340 | |
| 2.3 230 Kompressor | 4 | M 111.982 | 145/194 | 06/00→03/02 | Z170 | 1.0 | UXT9 | ZS041 | GS17 |
| 2.3 230 Kompressor LPG | 4 | M 111.973, M 111.975 | 142/190 | 03/98→06/00 | Z340 | 0.7 | UXT12 | | |
| 2.3 230 Kompressor LPG | 4 | M 111.982 | 145/194 | 06/00→03/02 | Z340 | 0.7 | UXT12 | | |
| 3.2 320 | 6 | M 112.940 | 160/215 | 03/98→03/02 | Z122 | 1.0 | UXT9 | ZS297 | |
| 3.2 320 LPG | 6 | M 112.940 | 160/215 | 03/98→03/02 | Z206 | 0.7 | UXT10 | | |
| 4.3 430 | 8 | M 113.943 | 205/275 | 09/98→03/02 | Z122 | 1.0 | UXT9 | ZS297 | |
| 4.3 430 LPG | 8 | M 113.943 | 205/275 | 09/98→03/02 | Z206 | 0.7 | UXT10 | | |
| 5.4 55 AMG | 8 | M 113.981, M 113.984 | 255/342 | 01/00→03/02 | Z240 | 1.0 | UXT9 | ZS297 | |

CLK Convertible (A209)

| | | | | | | | | | |
|------------------------|---|------------|---------|-------------|--|--------|-------|--|--|
| 1.8 CLK 200 CGI | 4 | M 271.942 | 125/168 | 07/03→03/10 | Z226 →eng. 30853899 Z359 eng. 30853900→ | 0.8 | | ZS053 →11/06 ZS077 11/06→ | |
| 1.8 CLK 200 Kompressor | 4 | M 271.940 | 120/161 | 02/03→03/10 | Z226 →eng. 30853899 Z359 eng. 30853900→ | 0.8 | | ZS053 →11/06 →eng. 30853899 ZS077 11/06→ eng. 30853900→ | |
| 1.8 CLK 200 Kompressor | 4 | M 271.955 | 135/181 | 10/06→03/10 | Z226 →eng. 30853899 | 0.8 | | ZS053 →eng. 30853899 ZS077 eng. 30853900→ | |
| 2.6 CLK 240 | 6 | M 112.912 | 125/168 | 02/03→03/10 | Z240 | 1.0 | UXT9 | ZS297 | |
| 3.0 CLK 280 | 6 | M 272.940 | 170/228 | 01/05→03/10 | Z359 | 0.8 | | ZSE140 | |
| 3.0 CLK 320 CDI | 6 | OM 642.910 | 165/221 | 03/05→03/10 | GE105 | GSE114 | 4.4V | | |
| 3.2 CLK 320 | 6 | M 112.955 | 160/215 | 02/03→03/10 | Z240 | 1.0 | UXT9 | ZS297 | |
| 3.5 CLK 350 | 6 | M 272.960 | 200/268 | 01/05→03/10 | Z359 | 0.8 | | ZSE140 | |
| 5.0 CLK 500 | 8 | M 113.968 | 225/302 | 02/03→03/10 | Z240 | 1.0 | UXT9 | ZS297 | |
| 5.4 CLK AMG DTM | 8 | M 113.994 | 428/574 | 06/04→03/10 | | | | ZS297 | |
| 5.5 CLK 55 AMG | 8 | M 113.987 | 270/362 | 02/03→03/10 | Z170 | 1.0 | UXT9 | ZS297 | |
| 5.5 CLK 55 AMG LPG | 8 | M 113.987 | 270/362 | 02/03→03/10 | Z340 | 0.7 | UXT12 | | |
| 5.5 CLK 500 | 8 | M 273.967 | 285/382 | 06/06→03/10 | Z359 | 0.8 | | ZSE140 | |
| 6.2 CLK 63 AMG | 8 | M 156.982 | 354/475 | 04/06→03/10 | Z355 | 1.0 | | | |

CLS (C218)

| | | | | | | | | | |
|---------------------|---|------------------------|---------|--------|--|--------|--|--------|--|
| 3.0 CLS 350 BlueTEC | 6 | OM 642.852, OM 642.858 | 185/248 | 11/12→ | | GSE116 | | | |
| 3.0 CLS 350 CDI | 6 | OM 642.853, OM 642.854 | 195/261 | 01/11→ | | GSE116 | | | |
| 3.5 CLS 350 | 6 | M 276.952 | 225/302 | 01/11→ | | | | ZSE093 | |
| 4.7 CLS 500 | 8 | M 278.922 | 300/402 | 02/11→ | | | | ZSE093 | |
| 5.5 CLS 63 AMG | 8 | M 157.981 | 386/518 | 02/11→ | | | | ZSE093 | |
| 5.5 CLS 63 AMG | 8 | M 157.981 | 410/550 | 01/11→ | | | | ZSE093 | |
| 5.5 CLS 63 AMG | 8 | M 157.981 | 430/577 | 02/13→ | | | | ZSE093 | |

CLS (C219)

| | | | | | | | | | |
|-----------------|---|------------|---------|-------------|-------|--|------|--------|--|
| 3.0 CLS 280 | 6 | M 272.943 | 170/228 | 07/08→12/10 | Z359 | | 0.8 | ZSE140 | |
| 3.0 CLS 300 | 6 | M 272.943 | 170/228 | 04/09→12/10 | Z359 | | 0.8 | ZSE140 | |
| 3.0 CLS 320 CDI | 6 | OM 642.920 | 155/208 | 01/05→12/10 | GE105 | GSE114 ^[135] GSE116 ^[134] | 4.4V | | |
| 3.0 CLS 320 CDI | 6 | OM 642.920 | 165/221 | 01/05→12/10 | GE105 | GSE114 ^[135] GSE116 ^[134] | 4.4V | | |
| 3.0 CLS 350 CDI | 6 | OM 642.920 | 165/221 | 04/09→12/10 | GE105 | GSE114 ^[135] GSE116 ^[134] | 4.4V | | |
| 3.0 CLS 350 CDI | 6 | | 200/268 | 04/09→12/10 | GE105 | | 4.4V | | |
| 3.5 CLS 350 | 6 | M 272.964 | 200/268 | 10/04→12/10 | | | | ZSE140 | |



kW/BHP

**... MERCEDES-BENZ****... CLS (C219)**

| | | | | | | | | | | |
|----------------|---|-----------|---------|-------------|------|--|-----|------|--------|--|
| 5.0 CLS 500 | 8 | M 113.967 | 225/302 | 10/04→12/10 | Z240 | | 1.0 | UXT9 | ZS297 | |
| 5.4 CLS 55 AMG | 8 | M 113.990 | 350/469 | 01/05→12/10 | Z226 | | 0.8 | | ZS297 | |
| 5.5 CLS 500 | 8 | M 273.960 | 285/382 | 04/06→12/10 | Z359 | | 0.8 | | ZSE140 | |
| 6.2 CLS 63 AMG | 8 | M 156.983 | 378/507 | 04/06→12/10 | Z355 | | 1.0 | | | |

CLS Shooting Brake (X218)

| | | | | | | | | | | |
|-----------------|---|------------------------|---------|--------|--|--------|--|--|--------|--|
| 3.0 CLS 350 CDI | 6 | OM 642.853, OM 642.854 | 195/261 | 10/12→ | | GSE116 | | | | |
| 3.5 CLS 350 | 6 | M 276.952 | 225/302 | 10/12→ | | | | | ZSE093 | |
| 4.7 CLS 500 | 8 | M 278.922 | 300/402 | 10/12→ | | | | | ZSE093 | |
| 5.5 CLS 63 AMG | 8 | M 157.981 | 386/518 | 10/12→ | | | | | ZSE093 | |
| 5.5 CLS 63 AMG | 8 | M 157.981 | 410/550 | 05/13→ | | | | | ZSE093 | |
| 5.5 CLS 63 AMG | 8 | M 157.981 | 430/577 | 02/13→ | | | | | ZSE093 | |

COUPE (C123)

| | | | | | | | | | | |
|-------------------|---|------------|---------|-------------|------------------------------------|-------|--------------|-------------|--|-------|
| 2.3 230 C | 4 | M 115.954 | 80/107 | 05/77→04/80 | Z62 | | 0.8 | UXT2 / UXT6 | ZS109 ⁽¹⁵⁾ | |
| 2.3 230 CE | 4 | M 102.980 | 100/134 | 04/80→12/85 | Z18 | | 0.8 | UXT4 | ZS117 | ZM004 |
| 2.7 280 C | 6 | M 110.923 | 115/154 | 03/77→03/80 | Z62 | | 0.8 | UXT2 / UXT6 | ZS109 ⁽¹⁾⁽¹⁵⁾ →10/77 ZS400 ⁽¹⁾⁽¹¹⁾ 11/77→ | |
| 2.7 280 CE | 6 | M 110.988 | 130/174 | 09/77→08/79 | Z62 | | 0.8 | UXT2 / UXT6 | ZS400 ⁽¹¹⁾ | ZM004 |
| 2.7 280 CE | 6 | M 110.988 | 136/182 | 03/77→11/85 | Z62 | | 0.8 | UXT2 / UXT6 | ZS117 | ZM004 |
| 2.9 300 C Turbo-D | 5 | OM 617.952 | 92/123 | 09/81→07/85 | GN909 ⁽²⁾⁽²²²⁾ GV603 | GR071 | 11V 11.5V | | | |

COUPE (C124)

| | | | | | | | | | | |
|---------------|---|-----------|---------|-------------|------|--|-----|-------------|--|-------|
| 2.2 220 CE | 4 | M 111.960 | 110/148 | 10/92→05/93 | Z100 | | 0.8 | UXT1 / UXT3 | ZS313 | |
| 2.3 230 CE | 4 | M 102.982 | 97/130 | 03/87→12/92 | Z18 | | 0.8 | UXT4 | ZS117 ⁽¹⁾⁽⁶⁾⁽²⁵⁴⁾ ZS339 ⁽¹⁾⁽⁵⁾⁽²¹⁴⁾ ⁽²⁵⁴⁾ | ZM004 |
| 2.3 230 CE | 4 | M 102.982 | 100/134 | 03/87→12/92 | Z18 | | 0.8 | UXT4 | ZS117 ⁽¹⁾⁽⁶⁾⁽²⁵⁴⁾ ZS339 ⁽¹⁾⁽⁵⁾⁽²¹⁴⁾ ⁽²⁵⁴⁾ | ZM004 |
| 3.0 300 CE | 6 | M 103.983 | 132/177 | 03/87→05/93 | Z7 | | 0.8 | UXT4 | ZS296 | |
| 3.0 300 CE | 6 | M 103.983 | 138/185 | 03/87→12/89 | Z7 | | 0.8 | UXT4 | ZS296 | |
| 3.0 300 CE-24 | 6 | M 104.980 | 162/217 | 09/89→12/92 | Z100 | | 0.8 | UXT1 / UXT3 | ZS298 | |
| 3.0 300 CE-24 | 6 | M 104.980 | 170/228 | 09/89→12/92 | Z100 | | 0.8 | UXT1 / UXT3 | ZS298 | |
| 3.2 320 CE | 6 | M 104.992 | 162/217 | 10/92→05/93 | Z5 | | 0.8 | UXT1 / UXT3 | ZS340 | |

COUPE (W111)

| | | | | | | | | | | |
|----------------|---|----------------------|---------|-------------|-----------------------------|--|-----|---------------------|-----------------------|--|
| 2.2 220 SEB | 6 | M 127.984 | 88/118 | 01/61→12/65 | Z42 | | 0.8 | UX56 | | |
| 2.5 250 SE | 6 | M 129.980, M 129.981 | 110/148 | 01/65→12/67 | Z42 | | 0.8 | UX56 | ZS106 ⁽¹¹⁾ | |
| 2.7 280 SE | 6 | M 130.980, M 130.984 | 118/158 | 01/67→12/71 | Z42 Z62 ^[200] | | 0.8 | UX56 UXT2 / UXT6 | ZS109 ⁽¹⁵⁾ | |
| 3.5 280 SE 3.5 | 8 | M 116.980 | 147/197 | 01/69→12/71 | Z42 | | 0.8 | UX56 | ZS109 ⁽¹⁵⁾ | |

E-CLASS (W124)

| | | | | | | | | | | |
|-------------------|---|------------------------|---------|-------------|------------------------|--|-------|-------------|-------|--|
| 2.0 E 200 | 4 | M 111.940 | 100/134 | 06/93→06/95 | Z100 | | 0.8 | UXT1 / UXT3 | ZS313 | |
| 2.0 E 200 LPG | 4 | M 111.940 | 100/134 | 06/93→06/95 | Z206 | | 0.7 | UXT10 | | |
| 2.0 E 200 D | 4 | OM 601.912 | 55/74 | 06/93→06/95 | GN858 | | 11.5V | | | |
| 2.2 E 220 | 4 | M 111.960 | 110/148 | 06/93→06/95 | Z100 | | 0.8 | UXT1 / UXT3 | ZS313 | |
| 2.2 E 220 LPG | 4 | M 111.960 | 110/148 | 06/93→06/95 | Z206 | | 0.7 | UXT10 | | |
| 2.5 E 250 D | 5 | OM 605.911 | 83/111 | 07/93→06/95 | GN860 ^[257] | | 11.5V | | | |
| 2.5 E 250 Turbo-D | 5 | OM 602.962 | 93/125 | 06/93→06/95 | GN858 | | 11.5V | | | |
| 2.8 E 280 | 6 | M 104.942 | 142/190 | 06/93→06/95 | Z100 | | 0.8 | UXT1 / UXT3 | ZS340 | |
| 2.8 E 280 | 6 | M 104.942 | 145/194 | 06/93→06/95 | Z100 | | 0.8 | UXT1 / UXT3 | ZS340 | |
| 2.8 E 280 LPG | 6 | M 104.942 | 145/194 | 06/93→06/95 | Z206 | | 0.7 | UXT10 | | |
| 3.0 E 300 4WD | 6 | M 103.985 | 132/177 | 06/93→06/95 | Z7 | | 0.8 | UXT4 | ZS296 | |
| 3.0 E 300 4WD LPG | 6 | M 103.985 | 132/177 | 06/93→06/95 | Z17 ^[168] | | 0.8 | UXT4 | | |
| 3.0 E 300 D | 6 | OM 606.910 | 100/134 | 07/93→06/95 | GN860 ^[257] | | 11.5V | | | |
| 3.0 E 300 Turbo-D | 6 | OM 603.960, OM 603.963 | 108/145 | 06/93→06/95 | GN858 | | 11.5V | | | |
| 3.2 E 320 | 6 | M 104.992 | 162/217 | 06/93→06/95 | Z100 | | 0.8 | UXT1 / UXT3 | ZS340 | |
| 3.2 E 320 LPG | 6 | M 104.992 | 162/217 | 06/93→06/95 | Z206 | | 0.7 | UXT10 | | |

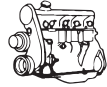

kW/BHP

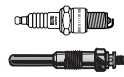
**... MERCEDES-BENZ****... E-CLASS (W124)**

| | | | | | | | | | |
|---------------|---|---------------------|---------|-------------|------|--|-----|-------------|---|
| 3.6 E 36 AMG | 6 | M 104.992 | 200/268 | 07/94→01/95 | Z100 | | 0.8 | UXT1 / UXT3 | |
| 3.6 E 36 AMG | 6 | M 104.992 (AMG 3.6) | 200/268 | 07/94→01/95 | | | | | ZS340 |
| 4.2 E 420 | 8 | M 119.975 | 205/275 | 06/93→06/95 | Z100 | | 0.8 | UXT1 / UXT3 | ZS298 [30][214][254] ZS299 [22][254] |
| 4.2 E 420 LPG | 8 | M 119.975 | 205/275 | 06/93→06/95 | Z206 | | 0.7 | UXT10 | |
| 5.0 E 500 | 8 | M 119.974 | 235/315 | 06/93→06/95 | Z100 | | 0.8 | UXT1 / UXT3 | ZS296 |
| 5.0 E 500 LPG | 8 | M 119.974 | 235/315 | 06/93→06/95 | Z206 | | 0.7 | UXT10 | |
| 6.0 E 60 AMG | 8 | M 119.974 AMG | 280/375 | 05/94→06/95 | | | | | ZS296 |

E-CLASS (W210)

| | | | | | | | | | |
|--------------------------|---|---------------------|---------|-------------|----------------------------------|--------|-------|-------------|-----------------|
| 2.0 E 200 | 4 | M 111.942 | 100/134 | 06/95→08/00 | Z100 →06/97 Z121 07/97→ | | 0.8 | UXT1 / UXT3 | ZS340 |
| 2.0 E 200 LPG | 4 | M 111.942 | 100/134 | 06/95→08/00 | Z206 | | 0.7 | UXT10 | |
| 2.0 E 200 D | 4 | OM 604.917 | 65/87 | 01/96→03/02 | GN948 [255] | GSE140 | 11.5V | | |
| 2.0 E 200 Kompressor | 4 | M 111.957 | 120/161 | 08/00→03/02 | Z170 | | 1.0 | UXT9 | ZS041 |
| 2.0 E 200 Kompressor | 4 | M 111.947 | 137/184 | 06/97→03/02 | Z120 | | 1.0 | UXT9 | ZS340 |
| 2.0 E 200 Kompressor LPG | 4 | M 111.957 | 120/161 | 08/00→03/02 | Z340 | | 0.7 | UXT12 | |
| 2.0 E 200 Kompressor LPG | 4 | M 111.947 | 137/184 | 06/97→03/02 | Z340 | | 0.7 | UXT12 | |
| 2.2 E 200 CDI | 4 | OM 611.961 | 75/101 | 06/98→03/02 | GN003 | GSE140 | 11.5V | | |
| 2.2 E 200 CDI | 4 | OM 611.961 | 85/114 | 07/99→03/02 | GN003 | GSE140 | 11.5V | | |
| 2.2 E 220 CDI | 4 | OM 611.961 | 92/123 | 06/98→07/99 | GN003 | GSE140 | 11.5V | | |
| 2.2 E 220 CDI | 4 | OM 611.961 | 100/134 | 07/99→03/02 | GN003 | GSE140 | 11.5V | | |
| 2.2 E 220 CDI | 4 | OM 611.961 | 105/141 | 07/99→03/02 | GN003 | GSE140 | 11.5V | | |
| 2.2 E 220 D | 4 | OM 604.912 | 55/74 | 05/96→03/02 | GN948 [255] | GSE140 | 11.5V | | |
| 2.2 E 220 D | 4 | OM 604.912 | 70/94 | 06/95→07/99 | GN948 [255] | GSE140 | 11.5V | | |
| 2.3 E 230 | 4 | M 111.970 | 110/148 | 06/95→06/97 | Z100 | | 0.8 | UXT1 / UXT3 | ZS340 |
| 2.3 E 230 LPG | 4 | M 111.970 | 110/148 | 06/95→06/97 | Z206 | | 0.7 | UXT10 | |
| 2.4 E 240 | 6 | M 112.911 | 125/168 | 06/97→08/00 | Z122 | | 1.0 | UXT9 | ZS297 →06/99 |
| 2.4 E 240 LPG | 6 | M 112.911 | 125/168 | 06/97→08/00 | Z206 | | 0.7 | UXT10 | |
| 2.5 E 250 D | 5 | OM 605.912 | 83/111 | 06/95→07/99 | GN948 [255] | GSE141 | 11.5V | | |
| 2.5 E 250 Turbo-D | 5 | OM 605.962 | 110/148 | 06/97→07/99 | GN948 [255] | GSE141 | 11.5V | | |
| 2.6 E 240 | 6 | M 112.914 | 125/168 | 08/00→03/02 | Z122 | | 1.0 | UXT9 | ZS297 |
| 2.6 E 240 LPG | 6 | M 112.914 | 125/168 | 08/00→03/02 | Z206 | | 0.7 | UXT10 | |
| 2.7 E 270 CDI | 5 | OM 612.961 | 120/161 | 07/99→03/02 | GN003 | GSE141 | 11.5V | | |
| 2.7 E 270 CDI | 5 | OM 612.961 | 125/168 | 07/99→03/02 | GN003 | GSE141 | 11.5V | | |
| 2.8 E 280 | 6 | M 104.945 | 142/190 | 01/96→06/97 | Z100 | | 0.8 | UXT1 / UXT3 | ZS340 |
| 2.8 E 280 | 6 | M 112.921 | 150/201 | 12/96→03/02 | Z122 | | 1.0 | UXT9 | ZS297 |
| 2.8 E 280 4WD | 6 | M 112.921 | 150/201 | 12/96→03/02 | Z122 | | 1.0 | UXT9 | ZS297 →06/99 |
| 2.8 E 280 LPG | 6 | M 104.945 | 142/190 | 01/96→06/97 | Z206 | | 0.7 | UXT10 | |
| 2.8 E 280 LPG | 6 | M 112.921 | 150/201 | 12/96→03/02 | Z206 | | 0.7 | UXT10 | |
| 2.9 E 290 Turbo-D | 5 | OM 602.982 | 95/127 | 03/96→07/99 | GN961 | GSE141 | 11V | | |
| 3.0 E 300 D | 6 | OM 606.912 | 100/134 | 06/95→06/97 | GN948 [255] | | 11.5V | | |
| 3.0 E 300 Turbo-D | 6 | OM 606.962 | 130/174 | 12/96→07/99 | GN948 [255] | GSE141 | 11.5V | | |
| 3.2 E 320 | 6 | M 104.995 | 162/217 | 06/95→06/97 | Z100 | | 0.8 | UXT1 / UXT3 | ZS340 |
| 3.2 E 320 | 6 | M 112.941 | 165/221 | 06/97→03/02 | Z122 | | 1.0 | UXT9 | ZS297 |
| 3.2 E 320 LPG | 6 | M 104.995 | 162/217 | 06/95→06/97 | Z206 | | 0.7 | UXT10 | |
| 3.2 E 320 LPG | 6 | M 112.941 | 165/221 | 06/97→03/02 | Z206 | | 0.7 | UXT10 | |
| 3.2 E 320 CDI | 6 | OM 613.961 | 145/194 | 07/99→03/02 | GN003 | GSE141 | 11.5V | | |
| 3.6 E 36 AMG | 6 | M 104.992 | 200/268 | 04/96→01/98 | Z100 | | 0.8 | UXT1 / UXT3 | |
| 4.2 E 420 | 8 | M 119.985 | 205/275 | 01/96→06/97 | Z100 | | 0.8 | UXT1 / UXT3 | |
| 4.2 E 420 LPG | 8 | M 119.985 | 205/275 | 01/96→06/97 | Z206 | | 0.7 | UXT10 | |
| 4.3 E 430 | 8 | M 113.940 | 205/275 | 06/97→03/02 | Z122 | | 1.0 | UXT9 | ZS297 |
| 4.3 E 430 LPG | 8 | M 113.940 | 205/275 | 06/97→03/02 | Z206 | | 0.7 | UXT10 | |
| 5.0 E 50 AMG | 8 | M 119.985 (AMG 5.0) | 255/342 | 02/96→08/97 | Z100 | | 0.8 | UXT1 / UXT3 | |
| 5.0 E 50 AMG LPG | 8 | M 119.985 (AMG 5.0) | 255/342 | 02/96→08/97 | Z206 | | 0.7 | UXT10 | |
| 5.4 E 55 AMG | 8 | M 113.980 | 260/349 | 08/97→03/02 | Z122 | | 1.0 | UXT9 | ZS297 |



kW/BHP

**... MERCEDES-BENZ****... E-CLASS (W210)**

| | | | | | | | | | |
|------------------|---|-----------|---------|-------------|------|--|-----|-------|--|
| 5.4 E 55 AMG LPG | 8 | M 113.980 | 260/349 | 08/97→03/02 | Z206 | | 0.7 | UXT10 | |
|------------------|---|-----------|---------|-------------|------|--|-----|-------|--|

E-CLASS (W211)

| | | | | | | | | | |
|----------------------|---|-----------|---------|-------------|--|--|-----|--|--|
| 1.8 E 200 Kompressor | 4 | M 271.941 | 120/161 | 11/02→12/08 | Z226 →eng. 30853899 Z359 eng. 30853900→ | | 0.8 | | ZS053 →11/06 →eng. 30853899 ZS077 11/06→ eng. 30853900→ |
| 1.8 E 200 Kompressor | 4 | M 271.956 | 135/181 | 04/06→12/08 | Z226 →11/06 →eng. 30853899 | | 0.8 | | ZS053 →11/06 →eng. 30853899 ZS077 11/06→ eng. 30853900→ |

| | | | | | | | | | |
|---------------|---|-----------|---------|-------------|--|--|-----|--|--|
| 1.8 E 200 NGT | 4 | M 271.941 | 120/161 | 03/04→12/08 | Z226 →eng. 30853899 Z359 eng. 30853900→ | | 0.8 | | ZS053 →eng. 30853899 ZS077 11/06→ eng. 30853900→ |
|---------------|---|-----------|---------|-------------|--|--|-----|--|--|

| | | | | | | | | | |
|---------------|---|------------|---------|-------------|-------|--------|-------|--|--|
| 2.1 E 200 CDI | 4 | OM 646.820 | 100/134 | 04/06→12/08 | | GSE140 | | | |
| 2.1 E 220 CDI | 4 | OM 646.961 | 100/134 | 03/02→12/08 | GN003 | GSE140 | 11.5V | | |
| 2.1 E 220 CDI | 4 | OM 646.961 | 110/148 | 03/02→12/08 | GN003 | GSE140 | 11.5V | | |
| 2.1 E 220 CDI | 4 | OM 646.821 | 120/161 | 03/03→12/08 | GN003 | GSE140 | 11.5V | | |
| 2.1 E 220 CDI | 4 | OM 646.821 | 125/168 | 04/06→12/08 | | GSE140 | | | |
| 2.2 E 200 CDI | 4 | OM 646.951 | 75/101 | 07/02→12/08 | GN003 | GSE140 | 11.5V | | |
| 2.2 E 200 CDI | 4 | OM 646.951 | 90/121 | 07/02→12/08 | GN003 | GSE140 | 11.5V | | |

| | | | | | | | | | |
|-----------|---|-----------|---------|-------------|------|--|-----|--|--------|
| 2.5 E 230 | 6 | M 272.922 | 150/201 | 09/07→12/08 | Z359 | | 0.8 | | ZSE140 |
|-----------|---|-----------|---------|-------------|------|--|-----|--|--------|

| | | | | | | | | | |
|-----------|---|----------------------|---------|-------------|------|--|-----|------|-------|
| 2.6 E 240 | 6 | M 112.913, M 112.917 | 130/174 | 03/02→12/08 | Z240 | | 1.0 | UXT9 | ZS297 |
|-----------|---|----------------------|---------|-------------|------|--|-----|------|-------|

| | | | | | | | | | |
|---------------|---|------------|---------|-------------|-------|--------|-------|--|--|
| 2.7 E 270 CDI | 5 | OM 647.961 | 120/161 | 03/02→12/08 | GN003 | GSE141 | 11.5V | | |
|---------------|---|------------|---------|-------------|-------|--------|-------|--|--|

| | | | | | | | | | |
|---------------|---|------------|---------|-------------|-------|--------|-------|--|--|
| 2.7 E 270 CDI | 5 | OM 647.961 | 130/174 | 03/02→12/08 | GN003 | GSE141 | 11.5V | | |
|---------------|---|------------|---------|-------------|-------|--------|-------|--|--|

| | | | | | | | | | |
|-----------|---|-----------|---------|-------------|------|--|-----|--|--------|
| 3.0 E 280 | 6 | M 272.943 | 170/228 | 03/05→12/08 | Z359 | | 0.8 | | ZSE140 |
|-----------|---|-----------|---------|-------------|------|--|-----|--|--------|

| | | | | | | | | | |
|---------------|---|------------|---------|-------------|-------|--|------|--|--|
| 3.0 E 280 CDI | 6 | OM 642.920 | 140/188 | 03/05→12/08 | GE105 | GSE114 ^[135] GSE116 ^[134] | 4.4V | | |
|---------------|---|------------|---------|-------------|-------|--|------|--|--|

| | | | | | | | | | |
|-------------------|---|------------|---------|-------------|-------|--|------|--|--|
| 3.0 E 280 CDI 4WD | 6 | OM 642.921 | 140/188 | 03/05→12/08 | GE105 | GSE114 ^[135] GSE116 ^[134] | 4.4V | | |
|-------------------|---|------------|---------|-------------|-------|--|------|--|--|

| | | | | | | | | | |
|-------------------|---|------------|---------|-------------|-------|--|------|--|--|
| 3.0 E 300 BlueTEC | 6 | OM 642.920 | 155/208 | 09/07→12/08 | GE105 | GSE114 ^[135] GSE116 ^[134] | 4.4V | | |
|-------------------|---|------------|---------|-------------|-------|--|------|--|--|

| | | | | | | | | | |
|---------------|---|------------------------|---------|-------------|-------|--|------|--|--|
| 3.0 E 320 CDI | 6 | OM 642.910, OM 642.920 | 165/221 | 03/05→12/08 | GE105 | GSE114 ^[135] GSE116 ^[134] | 4.4V | | |
|---------------|---|------------------------|---------|-------------|-------|--|------|--|--|

| | | | | | | | | | |
|---------------|---|------------|---------|-------------|--|--------|-------------|--|--|
| 3.2 E 280 CDI | 6 | OM 648.961 | 130/174 | 05/04→12/08 | GE116 ^[280] GN003 ^[279] | GSE141 | 5V 11.5V | | |
|---------------|---|------------|---------|-------------|--|--------|-------------|--|--|

| | | | | | | | | | |
|-----------|---|----------------------|---------|-------------|------|--|-----|------|-------|
| 3.2 E 320 | 6 | M 112.949, M 112.954 | 165/221 | 03/02→12/08 | Z240 | | 1.0 | UXT9 | ZS297 |
|-----------|---|----------------------|---------|-------------|------|--|-----|------|-------|

| | | | | | | | | | |
|---------------|---|------------|---------|-------------|--|--------|-------------|--|--|
| 3.2 E 320 CDI | 6 | OM 648.961 | 150/201 | 11/02→12/08 | GE116 ^[280] GN003 ^[279] | GSE141 | 5V 11.5V | | |
|---------------|---|------------|---------|-------------|--|--------|-------------|--|--|

| | | | | | | | | | |
|-----------|---|----------------------|---------|-------------|--|--|--|--|--------|
| 3.5 E 350 | 6 | M 272.964, M 272.972 | 200/268 | 03/05→12/08 | | | | | ZSE140 |
|-----------|---|----------------------|---------|-------------|--|--|--|--|--------|

| | | | | | | | | | |
|---------------|---|------------|---------|-------------|-------|--|-------|--|--|
| 4.0 E 400 CDI | 8 | OM 628.961 | 191/256 | 02/03→12/08 | GN003 | | 11.5V | | |
|---------------|---|------------|---------|-------------|-------|--|-------|--|--|

| | | | | | | | | | |
|---------------|---|------------|---------|-------------|-------|--|------|--|--|
| 4.0 E 420 CDI | 8 | OM 629.910 | 231/310 | 01/06→12/08 | GE105 | | 4.4V | | |
|---------------|---|------------|---------|-------------|-------|--|------|--|--|

| | | | | | | | | | |
|-----------|---|----------------------|---------|-------------|------|--|-----|------|-------|
| 5.0 E 500 | 8 | M 113.967, M 113.969 | 225/302 | 03/02→12/08 | Z240 | | 1.0 | UXT9 | ZS297 |
|-----------|---|----------------------|---------|-------------|------|--|-----|------|-------|

| | | | | | | | | | |
|-------------------------|---|-----------|---------|-------------|------|--|-----|--|-------|
| 5.5 E 55 AMG Kompressor | 8 | M 113.990 | 350/469 | 10/02→12/08 | Z226 | | 0.8 | | ZS297 |
|-------------------------|---|-----------|---------|-------------|------|--|-----|--|-------|

| | | | | | | | | | |
|-----------|---|----------------------|---------|-------------|------|--|-----|--|--------|
| 5.5 E 500 | 8 | M 273.960, M 273.962 | 285/382 | 04/06→12/08 | Z359 | | 0.8 | | ZSE140 |
|-----------|---|----------------------|---------|-------------|------|--|-----|--|--------|

| | | | | | | | | | |
|--------------|---|-----------|---------|-------------|------|--|-----|--|--|
| 6.2 E 63 AMG | 8 | M 156.983 | 378/507 | 03/06→12/08 | Z355 | | 1.0 | | |
|--------------|---|-----------|---------|-------------|------|--|-----|--|--|

E-CLASS (W212)

| | | | | | | | | | |
|---------------|---|----------------------|---------|--------|--|--|--|--|-------|
| 1.8 E 200 CGI | 4 | M 271.820, M 271.860 | 135/181 | 08/09→ | | | | | ZS077 |
|---------------|---|----------------------|---------|--------|--|--|--|--|-------|

| | | | | | | | | | |
|---------------|---|-----------|---------|--------|--|--|--|--|------------|
| 1.8 E 200 NGT | 4 | M 271.958 | 120/161 | 03/11→ | | | | | ZS077 GS21 |
|---------------|---|-----------|---------|--------|--|--|--|--|------------|

| | | | | | | | | | |
|---------------|---|-----------|---------|--------|--|--|--|--|-------|
| 1.8 E 250 CGI | 4 | M 271.860 | 150/201 | 01/09→ | | | | | ZS077 |
|---------------|---|-----------|---------|--------|--|--|--|--|-------|

| | | | | | | | | | |
|-----------|---|-----------|---------|--------|------|--|-----|--|--------------------------|
| 3.0 E 300 | 6 | M 272.952 | 170/228 | 01/09→ | Z359 | | 0.8 | | ZSE140 eng. 30417697→ |
|-----------|---|-----------|---------|--------|------|--|-----|--|--------------------------|

| | | | | | | | | | |
|---------------|---|------------|---------|--------|--|--------|--|--|--|
| 3.0 E 300 CDI | 6 | OM 642.850 | 150/201 | 03/11→ | | GSE116 | | | |
|---------------|---|------------|---------|--------|--|--------|--|--|--|

| | | | | | | | | | |
|-------------------------|---|------------------------|---------|--------|--|--------|--|--|--|
| 3.0 E 300 CDI / BlueTEC | 6 | OM 642.850, OM 642.852 | 170/228 | 03/11→ | | GSE116 | | | |
|-------------------------|---|------------------------|---------|--------|--|--------|--|--|--|

| | | | | | | | | | |
|-------------------|---|------------|---------|--------|--|--------|--|--|--|
| 3.0 E 350 BlueTEC | 6 | OM 642.850 | 155/208 | 01/09→ | | GSE116 | | | |
|-------------------|---|------------|---------|--------|--|--------|--|--|--|

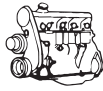

kw/BHP

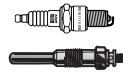

... MERCEDES-BENZ 

E-CLASS Coupe (C207)

| | | | | | | | | |
|-------------------|---|----------------------|---------|--------|------|--------|-----|--------|
| 1.8 E 200 CGI | 4 | M 271.820, M 271.860 | 135/181 | 01/10→ | | | | ZS077 |
| 1.8 E 250 CGI | 4 | M 271.860 | 150/201 | 01/09→ | | | | ZS077 |
| 3.0 E 350 BlueTEC | 6 | OM 642.838 | 185/248 | 03/13→ | | GSE116 | | |
| 3.0 E 350 CDI | 6 | OM 642.836 | 170/228 | 01/09→ | | GSE116 | | |
| 3.0 E 350 CDI | 6 | OM 642.838 | 195/261 | 04/11→ | | GSE116 | | |
| 3.5 E 300 | 6 | M 276.957 | 185/248 | 04/11→ | | | | ZSE093 |
| 3.5 E 350 | 6 | M 272.988 | 200/268 | 05/11→ | Z359 | | 0.8 | ZSE140 |
| 3.5 E 350 | 6 | M 276.957 | 225/302 | 04/11→ | | | | ZSE093 |
| 4.7 E 500 | 8 | M 278.922 | 300/402 | 09/11→ | | | | ZSE093 |
| 5.5 E 500 | 8 | M 273.966 | 285/382 | 01/09→ | Z359 | | 0.8 | ZSE140 |

E-CLASS Estate (S124)

| | | | | | | | | | |
|---------------------|---|------------------------|---------|-------------|------------------------|--|-------|-------------|-------|
| 2.0 E 200 T | 4 | M 111.940 | 100/134 | 06/93→06/96 | Z100 | | 0.8 | UXT1 / UXT3 | ZS313 |
| 2.0 E 200 T LPG | 4 | M 111.940 | 100/134 | 06/93→06/96 | Z206 | | 0.7 | UXT10 | |
| 2.2 E 220 T | 4 | M 111.960 | 110/148 | 06/93→06/96 | Z100 | | 0.8 | UXT1 / UXT3 | ZS313 |
| 2.2 E 220 T LPG | 4 | M 111.960 | 110/148 | 06/93→06/96 | Z206 | | 0.7 | UXT10 | |
| 2.5 E 250 TD | 5 | OM 605.911 | 83/111 | 06/93→06/96 | GN860 ^[257] | | 11.5V | | |
| 2.5 E 250 Turbo D | 5 | OM 602.962 | 93/125 | 06/93→06/96 | GN858 | | 11.5V | | |
| 2.8 E 280 T | 6 | M 104.942 | 142/190 | 06/93→06/96 | Z100 | | 0.8 | UXT1 / UXT3 | ZS340 |
| 2.8 E 280 T | 6 | M 104.942 | 145/194 | 06/93→06/96 | Z100 | | 0.8 | UXT1 / UXT3 | ZS340 |
| 2.8 E 280 T LPG | 6 | M 104.942 | 142/190 | 06/93→06/96 | Z206 | | 0.7 | UXT10 | |
| 2.8 E 280 T LPG | 6 | M 104.942 | 145/194 | 06/93→06/96 | Z206 | | 0.7 | UXT10 | |
| 3.0 300 TD T | 6 | | 100/134 | 06/92→05/93 | GN858 | | 11.5V | | |
| 3.0 E 300 T 4WD | 6 | M 103.985 | 132/177 | 06/93→06/96 | Z7 | | 0.8 | UXT4 | ZS296 |
| 3.0 E 300 T 4WD LPG | 6 | M 103.985 | 132/177 | 06/93→06/96 | Z17 ^[168] | | 0.8 | UXT4 | |
| 3.0 E 300 TD | 6 | OM 606.910 | 100/134 | 06/93→06/96 | GN860 ^[257] | | 11.5V | | |
| | | | | | →05/95 | | | | |
| | | | | | GN948 ^[255] | | 11.5V | | |
| | | | | | 06/95→ | | | | |
| 3.0 E 300 TE-24 AMG | 6 | M 104.980 | 162/217 | 06/93→06/96 | Z100 | | 0.8 | UXT1 / UXT3 | |
| 3.0 E 300 T Turbo-D | 6 | OM 603.960, OM 603.963 | 108/145 | 06/93→06/96 | GN858 | | 11.5V | | |
| 3.2 E 320 T | 6 | M 104.992 | 162/217 | 06/93→06/96 | Z100 | | 0.8 | UXT1 / UXT3 | ZS340 |
| 3.2 E 320 T LPG | 6 | M 104.992 | 162/217 | 06/93→06/96 | Z206 | | 0.7 | UXT10 | |
| 3.6 E 36 T AMG | 6 | M 104.992 (AMG 3.6) | 200/268 | 05/94→06/96 | Z100 | | 0.8 | UXT1 / UXT3 | ZS340 |
| 3.6 E 36 T AMG LPG | 6 | M 104.992 (AMG 3.6) | 200/268 | 05/94→06/96 | Z206 | | 0.7 | UXT10 | |

E-CLASS Estate (S210)

| | | | | | | | | | |
|----------------------------|---|------------|---------|-------------|------------------------|--------|-------|-------------|-------|
| 2.0 E 200 T | 4 | M 111.942 | 100/134 | 06/96→08/00 | Z100 | | 0.8 | UXT1 / UXT3 | ZS340 |
| | | | | | →06/97 | | | | |
| | | | | | Z121 | | 1.0 | UXT9 | |
| | | | | | 07/97→ | | | 07/97→ | |
| 2.0 E 200 T LPG | 4 | M 111.942 | 100/134 | 06/96→08/00 | Z206 | | 0.7 | UXT10 | |
| 2.0 E 200 T Kompressor | 4 | M 111.957 | 120/161 | 08/00→03/03 | Z170 | | 1.0 | UXT9 | ZS041 |
| 2.0 E 200 T Kompressor | 4 | M 111.947 | 137/184 | 06/97→03/03 | Z120 | | 1.0 | UXT9 | ZS340 |
| 2.0 E 200 T Kompressor LPG | 4 | M 111.957 | 120/161 | 08/00→03/03 | Z340 | | 0.7 | UXT12 | |
| 2.0 E 200 T Kompressor LPG | 4 | M 111.947 | 137/184 | 06/97→03/03 | Z340 | | 0.7 | UXT12 | |
| 2.1 E 220 T CDI | 4 | OM 611.961 | 100/134 | 05/99→03/03 | GN003 | GSE140 | 11.5V | | |
| | | | | | eng. 30 161511; | | | | |
| | | | | | 40 000001;50 055543→ | | | | |
| 2.2 E 220 T CDI | 4 | OM 611.961 | 92/123 | 06/98→07/99 | GN003 | GSE140 | 11.5V | | |
| 2.2 E 220 T CDI | 4 | OM 611.961 | 105/141 | 07/99→03/03 | GN003 | GSE140 | 11.5V | | |
| 2.3 E 230 T | 4 | M 111.970 | 110/148 | 06/96→06/97 | Z100 | | 0.8 | UXT1 / UXT3 | ZS340 |
| 2.3 E 230 T LPG | 4 | M 111.970 | 110/148 | 06/96→06/97 | Z206 | | 0.7 | UXT10 | |
| 2.4 E 240 T | 6 | M 112.911 | 125/168 | 06/97→03/03 | Z122 | | 1.0 | UXT9 | ZS297 |
| 2.4 E 240 T LPG | 6 | M 112.911 | 125/168 | 06/97→03/03 | Z206 | | 0.7 | UXT10 | |
| 2.5 E 250 T D | 5 | OM 605.912 | 83/111 | 06/96→07/99 | GN948 ^[255] | GSE141 | 11.5V | | |
| 2.5 E 250 T Turbo-D | 5 | OM 605.962 | 110/148 | 06/97→07/99 | GN948 ^[255] | GSE141 | 11.5V | | |
| 2.6 E 240 T | 6 | M 112.914 | 125/168 | 08/00→03/03 | Z122 | | 1.0 | UXT9 | ZS297 |
| 2.6 E 240 T LPG | 6 | M 112.914 | 125/168 | 08/00→03/03 | Z206 | | 0.7 | UXT10 | |
| 2.7 E 270 T CDI | 5 | OM 612.961 | 120/161 | 02/00→03/03 | GN003 | GSE141 | 11.5V | | |
| | | | | | eng. 30 006561→ | | | | |

MERCEDES-BENZ

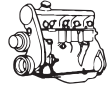

kW/BHP

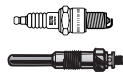
**... MERCEDES-BENZ****... E-CLASS Estate (S210)**

| | | | | | | | | | |
|---------------------|---|------------|---------|-------------|-------------|--------|-------|-------|-------|
| 2.7 E 270 T CDI | 5 | OM 612.961 | 125/168 | 07/99→03/03 | GN003 | GSE141 | 11.5V | | |
| 2.8 E 280 T | 6 | M 112.921 | 150/201 | 12/96→03/03 | Z122 | | 1.0 | UXT9 | ZS297 |
| 2.8 E 280 T LPG | 6 | M 112.921 | 150/201 | 12/96→03/03 | Z206 | | 0.7 | UXT10 | |
| 2.9 E 290 T Turbo-D | 5 | OM 602.982 | 95/127 | 06/96→07/99 | GN961 | GSE141 | 11V | | |
| 3.0 E 300 T Turbo-D | 6 | OM 606.962 | 130/174 | 12/96→07/99 | GN948 [255] | GSE141 | 11.5V | | |
| 3.2 E 320 T | 6 | M 112.941 | 165/221 | 12/96→03/03 | Z122 | | 1.0 | UXT9 | ZS297 |
| 3.2 E 320 T LPG | 6 | M 112.941 | 165/221 | 12/96→03/03 | Z206 | | 0.7 | UXT10 | |
| 3.2 E 320 T CDI | 6 | OM 613.961 | 145/194 | 07/99→03/03 | GN003 | GSE141 | 11.5V | | |
| 4.2 E 420 T | 8 | M 119.985 | 205/275 | 06/96→06/97 | Z122 | | 1.0 | UXT9 | |
| 4.2 E 420 T LPG | 8 | M 119.985 | 205/275 | 06/96→06/97 | Z206 | | 0.7 | UXT10 | |
| 4.3 E 430 T | 8 | M 113.940 | 205/275 | 06/97→03/03 | Z122 | | 1.0 | UXT9 | ZS297 |
| 4.3 E 430 T LPG | 8 | M 113.940 | 205/275 | 06/97→03/03 | Z206 | | 0.7 | UXT10 | |
| 5.4 E 55 T AMG | 8 | M 113.980 | 260/349 | 08/97→03/03 | Z122 | | 1.0 | UXT9 | ZS297 |
| 5.4 E 55 T AMG LPG | 8 | M 113.980 | 260/349 | 08/97→03/03 | Z206 | | 0.7 | UXT10 | |

E-CLASS T-Model (S211)

| | | | | | | | | | |
|---------------------------|---|----------------------|---------|-------------|---|------------------------------|----------------|------|--|
| 1.8 E 200 Kompressor | 4 | M 271.956 | 135/181 | 04/06→07/09 | Z226 →11/06 →eng. 30853899 | | 0.8 | | ZS053 →11/06 →eng. 3085 3899 ZS077 11/06→ eng. 3085 3900→ |
| 1.8 E 200 T Kompressor | 4 | M 271.941 | 120/161 | 03/03→07/09 | Z226 →eng. 30853899 Z359 eng. 3053900→ | | 0.8 0.8 | | ZS053 →11/06 →eng. 3085 3899 ZS077 11/06→ eng. 3085 3900→ |
| 2.1 E 220 CDI | 4 | OM 646.961 | 100/134 | 03/03→07/09 | GN003 | GSE140 | 11.5V | | |
| 2.1 E 220 T CDI | 4 | OM 646.961 | 110/148 | 03/03→07/09 | GN003 | GSE140 | 11.5V | | |
| 2.1 E 220 T CDI | 4 | OM 646.821 | 120/161 | 03/03→07/09 | GN003 | GSE140 | 11.5V | | |
| 2.1 E 220 T CDI | 4 | OM 646.821 | 125/168 | 04/06→07/09 | | GSE140 | | | |
| 2.5 E 230 T | 6 | M 272.922 | 150/201 | 05/07→07/09 | Z359 | | 0.8 | | ZSE140 |
| 2.6 E 240 T | 6 | M 112.913, M 112.917 | 130/174 | 03/03→07/09 | Z240 | | 1.0 | UXT9 | ZS297 |
| 2.7 E 270 T CDI | 5 | OM 647.961 | 120/161 | 03/03→07/09 | GN003 | GSE141 | 11.5V | | |
| 2.7 E 270 T CDI | 5 | OM 647.961 | 130/174 | 03/03→07/09 | GN003 | GSE141 | 11.5V | | |
| 3.0 E 280 T | 6 | M 272.943 | 170/228 | 03/05→07/09 | Z359 | | 0.8 | | ZSE140 |
| 3.0 E 280 T CDI | 6 | OM 642.920 | 140/188 | 03/05→07/09 | GE105 | GSE114 [135] GSE116 [134] | 4.4V | | |
| 3.0 E 280 T CDI 4WD | 6 | OM 642.921 | 140/188 | 03/05→07/09 | GE105 | GSE114 [135] GSE116 [134] | 4.4V | | |
| 3.0 E 320 T CDI | 6 | OM 642.920 | 165/221 | 03/05→07/09 | GE105 | GSE114 [135] GSE116 [134] | 4.4V | | |
| 3.2 E 280 T CDI | 6 | OM 648.961 | 130/174 | 05/04→07/09 | GE116 [280] GN003 [279] | GSE141 | 5V 11.5V | | |
| 3.2 E 320 T | 6 | M 112.949, M 112.954 | 165/221 | 03/03→07/09 | Z240 | | 1.0 | UXT9 | ZS297 |
| 3.2 E 320 T CDI | 6 | OM 648.961 | 150/201 | 03/03→07/09 | GE116 [280] GN003 [279] | GSE141 | 5V 11.5V | | |
| 3.5 E 350 T | 6 | M 272.964, M 272.972 | 200/268 | 03/05→07/09 | | | | | ZSE140 |
| 5.0 E 500 T | 8 | M 113.967, M 113.969 | 225/302 | 10/03→07/09 | Z240 | | 1.0 | UXT9 | ZS297 |
| 5.4 E 55 T AMG Kompressor | 8 | M 113.990 | 350/469 | 07/03→07/09 | Z226 | | 0.8 | | ZS297 |
| 5.5 E 500 T | 8 | M 273.960, M 273.962 | 285/382 | 04/06→07/09 | Z359 | | 0.8 | | ZSE140 |
| 6.2 E 63 AMG | 8 | M 156.983 | 378/507 | 03/06→07/09 | Z355 | | 1.0 | | |

E-CLASS T-Model (S212)

| | | | | | | | | | |
|-------------------------|---|------------------------|---------|--------|--|--------|--|--|-------|
| 1.8 E 200 CGI | 4 | M 271.820, M 271.860 | 135/181 | 11/09→ | | | | | ZS077 |
| 1.8 E 250 CGI | 4 | M 271.860 | 150/201 | 11/09→ | | | | | ZS077 |
| 3.0 E 300 CDI | 6 | OM 642.850 | 150/201 | 03/11→ | | GSE116 | | | |
| 3.0 E 300 CDI / BlueTEC | 6 | OM 642.850, OM 642.852 | 170/228 | 11/09→ | | GSE116 | | | |
| 3.0 E 350 BlueTEC | 6 | OM 642.850 | 155/208 | 11/09→ | | GSE116 | | | |
| 3.0 E 350 BlueTEC | 6 | OM 642.852, OM 642.858 | 185/248 | 11/12→ | | GSE116 | | | |

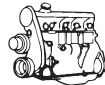

kW/BHP

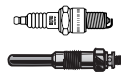
**... MERCEDES-BENZ****... G-CLASS (W461)**

| | | | | | | | | | |
|------------------------|---|----------------------|---------|--------|----------------------------------|--------|------------|-------|--|
| 2.3 230 GE 4WD LPG | 4 | M 102.979 | 90/121 | 02/93→ | Z17 [168] | | 0.8 | UXT4 | |
| 2.3 230 GE 4WD LPG | 4 | M 102.996, M 102.997 | 92/123 | 06/93→ | Z25 [168] | | 0.8 | UXK56 | |
| 2.5 250 GD 4WD | 5 | OM 602.939 | 68/91 | 02/90→ | GN858 | | 11.5V | | |
| 2.7 G 270 CDI 4WD | 5 | OM 612.966 | 115/154 | 01/03→ | GN003 | GSE141 | 11.5V | | |
| 2.9 290 GD/G 290 D 4WD | 5 | OM 602.942 | 70/94 | 04/92→ | GN858 | GR049 | 11.5V | | |
| 2.9 G 290 TD 4WD | 5 | OM 602.983 | 88/118 | 07/97→ | GN066 [1][128] GN961 [1][131] | GSE141 | 23V 11V | | |
| 3.0 G 280 CDI 4WD | 6 | OM 642.884 | 135/181 | 04/09→ | GE105 | GSE114 | 4.4V | | |
| 3.0 G 300 CDI 4WD | 6 | OM 642.884 | 135/181 | 04/10→ | GE105 | GSE114 | 4.4V | | |

G-CLASS (W463)

| | | | | | | | | | |
|----------------------|---|---------------------|---------|-------------|----------------------------------|--------|------------|---|--|
| 2.0 200 GE 4WD | 4 | M 102.965 | 85/114 | 01/90→07/93 | Z18 | | 0.8 | UXT4 | |
| 2.3 230 GE 4WD | 4 | M 102.989 | 93/125 | 06/90→06/93 | Z18 | | 0.8 | UXT4 | ZS339 |
| 2.5 250 GD 4WD | 5 | OM 602.931 | 69/93 | 06/90→ | GN858 | | 11.5V | | |
| 2.7 G 270 CDI 4WD | 5 | OM 612.965 | 115/154 | 10/01→ | GN003 | GSE141 | 11.5V | | |
| 3.0 300 GD 4WD | 6 | OM 603.931 | 83/111 | 09/89→ | GN858 | GR076 | 11.5V | | |
| 3.0 300 GE 4WD | 6 | M 103.987 | 125/168 | 06/90→ | Z7 | | 0.8 | UXT4 | ZS339 →10/94 |
| 3.0 300 GE 4WD | 6 | M 103.987 | 128/172 | 06/90→ | Z7 | | 0.8 | UXT4 | ZS298 [1] →08/93 ZS339 [1][39][214] [254] |
| 3.0 300 GE 4WD LPG | 6 | M 103.987 | 125/168 | 06/90→ | Z17 [168] | | 0.8 | UXT4 | |
| 3.0 300 GE 4WD LPG | 6 | M 103.987 | 128/172 | 06/90→ | Z17 [168] | | 0.8 | UXT4 | |
| 3.0 G 300 TD 4WD | 6 | OM 606.964 | 130/174 | 08/96→ | GN948 [255] | GSE141 | 11.5V | | |
| 3.0 G 320 CDI 4WD | 6 | OM 642.970 | 165/221 | 09/06→ | | GSE116 | | | |
| 3.0 G 350 CDI 4WD | 6 | OM 642.886 | 155/208 | 07/11→ | | GSE116 | | | |
| 3.2 G 320 4WD | 6 | M 104.996 | 155/208 | 09/94→12/97 | Z100 →06/97 Z121 07/97→ | | 0.8 1.0 | UXT1 / UXT3 →06/97 UXT9 07/97→ | ZS340 |
| 3.2 G 320 4WD | 6 | M 112.945 | 158/212 | 07/97→ | Z122 | | 1.0 | UXT9 | ZS297 |
| 3.2 G 320 4WD LPG | 6 | M 104.996 | 155/208 | 09/94→12/97 | Z206 | | 0.7 | UXT10 | |
| 3.2 G 320 4WD LPG | 6 | M 112.945 | 158/212 | 07/97→ | Z206 | | 0.7 | UXT10 | |
| 3.4 350 Turbo GD 4WD | 6 | OM 603.972 | 100/134 | 09/91→ | GN858 →06/93 | | 11.5V | | |
| 3.6 G 36 AMG 4WD | 6 | M 104.996 (AMG 3,6) | 200/268 | 01/95→ | Z100 →06/97 | | 0.8 | UXT1 / UXT3 →06/97 | ZS340 ZLE234 |
| 3.6 G 36 AMG 4WD LPG | 6 | M 104.996 (AMG 3,6) | 200/268 | 01/95→ | Z206 →06/97 | | 0.7 | UXT10 →06/97 | |
| 4.0 G 400 CDI | 8 | OM 628.962 | 184/247 | 12/00→ | GN003 | | 11.5V | | |
| 4.9 G 500 E | 8 | M 117.965 | 177/237 | 09/93→ | Z62 | | 0.8 | UXT2 / UXT6 | ZS298 |
| 5.0 G 500 4WD | 8 | M 113.962 | 218/292 | 04/98→ | Z122 →02/02 Z240 03/02→ | | 1.0 1.0 | UXT9 →02/02 UXT9 03/02→ | ZS297 |
| 5.0 G 500 4WD LPG | 8 | M 113.962 | 218/292 | 04/98→ | Z206 →02/02 | | 0.7 | UXT10 →02/02 | |
| 5.4 G 55 AMG 4WD | 8 | M 113.993 | 350/469 | 06/04→ | | | | | ZS297 |
| 5.4 G 55 AMG 4WD | 8 | M 113.993 | 368/493 | 08/06→ | Z226 | | 0.8 | | ZS297 |
| 5.5 G 55 AMG 4WD | 8 | M 113.982 | 260/349 | 04/99→ | Z122 | | 1.0 | UXT9 | ZS297 |
| 5.5 G 55 AMG 4WD | 8 | M 113.993 | 373/500 | 08/08→ | Z226 | | 0.8 | | ZS297 |
| 5.5 G 55 AMG 4WD LPG | 8 | M 113.982 | 260/349 | 04/99→ | Z206 | | 0.7 | UXT10 | |
| 5.5 G 63 AMG 4WD | 8 | M 157.980 | 400/536 | 05/12→ | | | | | ZSE093 |

G-CLASS Cabrio (W463)

| | | | | | | | | | |
|----------------|---|------------|---------|-------------|-------|-------|-------|------|-------|
| 2.0 200 GE 4WD | 4 | M 102.965 | 80/107 | 01/90→07/93 | Z18 | | 0.8 | UXT4 | |
| 2.0 200 GE 4WD | 4 | M 102.965 | 85/114 | 01/90→07/93 | Z18 | | 0.8 | UXT4 | |
| 2.3 230 GE 4WD | 4 | M 102.989 | 93/125 | 06/90→02/93 | Z18 | | 0.8 | UXT4 | ZS339 |
| 3.0 300 GD 4WD | 6 | OM 603.931 | 83/111 | 12/90→09/97 | GN858 | GR076 | 11.5V | | |
| 3.0 300 GE 4WD | 6 | M 103.987 | 125/168 | 09/89→09/97 | Z7 | | 0.8 | UXT4 | ZS339 |

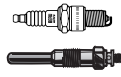

kW/BHP

**... MERCEDES-BENZ** **... G-CLASS Cabrio (W463)**

| | | | | | | | | | |
|-----------------------|---|------------|---------|-------------|----------------------------------|--------|-------|---|-----------------|
| 3.0 300 GE 4WD LPG | 6 | M 103.987 | 125/168 | 09/89→09/97 | Z17 [168] | | 0.8 | UXT4 | |
| 3.0 G 300 TD 4WD | 6 | OM 606.964 | 130/174 | 09/96→ | GN948 [255] | GSE141 | 11.5V | | |
| 3.0 G 320 CDI 4WD | 6 | OM 642.970 | 165/221 | 09/06→ | | GSE116 | | | |
| 3.0 G 350 CDI 4WD | 6 | OM 642.886 | 155/208 | 07/11→ | | GSE116 | | | |
| 3.2 320 GE 4WD | 6 | M 104.996 | 155/208 | 09/94→11/97 | Z100 →06/97 Z121 07/97→ | | 0.8 | UXT1 / UXT3 →06/97 UXT9 07/97→ | ZS340 |
| 3.2 320 GE 4WD LPG | 6 | M 104.996 | 155/208 | 09/94→11/97 | Z206 | | 0.7 | UXT10 | |
| 3.2 G 320 4WD | 6 | M 112.945 | 158/212 | 11/97→ | Z122 | | 1.0 | UXT9 | ZS297 |
| 3.2 G 320 4WD LPG | 6 | M 112.945 | 158/212 | 11/97→ | Z206 | | 0.7 | UXT10 | |
| 3.4 350 G Turbo-D 4WD | 6 | OM 603.972 | 100/134 | 09/91→09/97 | GN858 | | 11.5V | | |
| 4.0 G 400 CDI | 8 | OM 628.962 | 184/247 | 12/00→ | GN003 | | 11.5V | | |
| 5.0 G 500 4WD | 8 | M 113.962 | 218/292 | 04/98→ | Z122 →02/02 Z240 03/02→ | | 1.0 | UXT9 →02/02 UXT9 03/02→ | ZS297 →09/05 |
| 5.0 G 500 4WD LPG | 8 | M 113.962 | 218/292 | 04/98→ | Z206 →02/02 | | 0.7 | UXT10 →02/02 | |
| 5.5 G 500 4WD | 8 | M 273.963 | 285/382 | 12/09→ | Z359 | | 0.8 | | ZSE140 |

GLA-CLASS (X156)

| | | | | | | | | | |
|-----------------|---|------------|--------|--------|------------|--|------|--|--|
| 1.5 GLA 180 CDI | 4 | OM 607.951 | 80/107 | 07/14→ | GE110 [37] | | 4.4V | | |
|-----------------|---|------------|--------|--------|------------|--|------|--|--|

GL-CLASS (X164)

| | | | | | | | | | |
|-------------------------------------|---|------------|---------|-------------|-------|------------------------------|------|--|--------|
| 3.0 GL 320 CDI 4WD | 6 | OM 642.940 | 165/221 | 09/06→05/09 | GE105 | GSE114 [135] GSE116 [134] | 4.4V | | |
| 3.0 GL 320 CDI / 350 BlueTEC 4WD | 6 | OM 642.820 | 155/208 | 12/09→ | | GSE116 | | | |
| 3.0 GL 350 CDI 4WD | 6 | OM 642.940 | 165/221 | 05/09→ | GE105 | GSE114 [135] GSE116 [134] | 4.4V | | |
| 3.0 GL 350 CDI 4WD | 6 | OM 642.822 | 195/261 | 10/10→ | | GSE116 | | | |
| 4.0 GL 420 CDI 4WD | 8 | OM 629.912 | 225/302 | 09/06→05/09 | GE105 | | 4.4V | | |
| 4.0 GL 450 CDI 4WD | 8 | OM 629.912 | 225/302 | 05/09→ | GE105 | | 4.4V | | |
| 4.7 GL 450 4WD | 8 | M 273.923 | 250/335 | 09/06→ | Z359 | | 0.8 | | ZSE140 |
| 5.5 GL 500 4WD | 8 | M 273.963 | 285/382 | 09/06→ | Z359 | | 0.8 | | ZSE140 |

GL-CLASS (X166)

| | | | | | | | | | |
|------------------------|---|------------|---------|--------|--|--------|--|--|--------|
| 3.0 GL 350 BlueTec 4WD | 6 | OM 642.826 | 190/255 | 07/12→ | | GSE116 | | | |
| 3.0 GL 400 4WD | 6 | M 276.821 | 245/329 | 08/13→ | | | | | ZSE094 |
| 4.7 GL 500 4WD | 8 | M 278.928 | 320/429 | 07/12→ | | | | | ZSE093 |
| 5.5 GL 63 AMG 4WD | 8 | M 157.982 | 410/550 | 07/12→ | | | | | ZSE093 |

GLK-CLASS (X204)

| | | | | | | | | | |
|-----------------|---|------------|---------|-------------|-------|--------|------|--|------------------|
| 3.0 280 4WD | 6 | M 272.948 | 170/228 | 06/08→06/09 | Z359 | | 0.8 | | ZSE140 |
| 3.0 300 4WD | 6 | M 272.948 | 170/228 | 07/09→04/11 | Z359 | | 0.8 | | ZSE140 |
| 3.0 320 CDI 4WD | 6 | OM 642.961 | 165/221 | 06/08→ | GE105 | GSE114 | 4.4V | | |
| 3.0 350 CDI 4WD | 6 | OM 642.832 | 165/221 | 07/09→01/10 | | GSE116 | | | |
| 3.0 350 CDI 4WD | 6 | OM 642.832 | 170/228 | 02/10→05/10 | | GSE116 | | | |
| 3.0 350 CDI 4WD | 6 | OM 642.835 | 195/261 | 07/12→ | | GSE116 | | | |
| 3.5 350 | 6 | M 272.991 | 200/268 | 04/09→ | Z359 | | 0.8 | | ZSE140 |
| 3.5 350 4WD | 6 | M 272.971 | 200/268 | 06/08→04/11 | | | | | ZSE140 |
| 3.5 350 4WD | 6 | M 276.957 | 225/302 | 06/08→ | | | | | ZSE093 06/11→ |

GULLWING (W198)

| | | | | | | | | | |
|------------|---|-----------|---------|-------------|-----|--|-----|--|--|
| 3.0 300 SL | 6 | M 198.980 | 143/192 | 09/54→05/57 | Z38 | | 0.4 | | |
| 3.0 300 SL | 6 | M 198.980 | 158/212 | 09/54→05/57 | Z38 | | 0.4 | | |

HECKFLOSSE (W110)

| | | | | | | | | | |
|------------|---|------------|-------|-------------|-------|--|------|------|--|
| 1.9 190 C | 4 | M 121.924 | 59/79 | 04/61→08/65 | Z22 | | 0.7 | UX56 | |
| 2.0 190 DC | 4 | OM 621.912 | 40/54 | 06/61→08/65 | GD348 | | 0.9V | | |
| 2.0 200 | 4 | M 115.926 | 70/94 | 07/65→02/68 | Z22 | | 0.7 | UX56 | |
| 2.0 200 D | 4 | OM 621.918 | 40/54 | 07/65→02/68 | GD348 | | 0.9V | | |

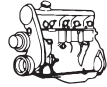

kW/BHP

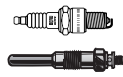

... MERCEDES-BENZ



... HECKFLOSSE (W110)

| | | | | | | | | | | |
|---------|---|----------------------|--------|-------------|-----|--|-----|-------------|--|--|
| 2.3 230 | 6 | M 180.945, M 180.949 | 77/103 | 07/65→02/68 | Z22 | | 0.7 | UX56 | | |
| 2.3 230 | 6 | M 180.950 | 88/118 | 06/66→12/67 | Z62 | | 0.8 | UXT2 / UXT6 | | |

HECKFLOSSE (W111, W112)

| | | | | | | | | | | |
|-------------|---|----------------------|--------|-------------|-----|--|-----|------|--|--|
| 2.2 220 B | 6 | M 180.940 | 70/94 | 08/59→08/65 | Z22 | | 0.7 | UX56 | | |
| 2.2 220 SB | 6 | M 180.941 | 81/109 | 08/59→08/65 | Z22 | | 0.7 | UX56 | | |
| 2.2 220 SEB | 6 | M 127.982 | 88/118 | 08/59→08/65 | Z42 | | 0.8 | UX56 | | |
| 2.3 230 S | 6 | M 180.947, M 180.950 | 88/118 | 07/65→01/68 | Z47 | | 0.8 | UX56 | | |

KOMBI Estate (S123)

| | | | | | | | | | | |
|-------------|---|------------|---------|-------------|----------------------------------|-------|-------|-------------|-----------------------|-----------------|
| 2.0 200 T | 4 | M 102.939 | 74/99 | 11/80→11/85 | Z18 | | 0.8 | UXT4 | ZS117 | ZM004 →07/84 |
| 2.0 200 T | 4 | M 102.920 | 80/107 | 11/80→11/85 | Z18 | | 0.8 | UXT4 | ZS117 | ZM004 →07/84 |
| 2.3 230 T | 4 | M 115.954 | 80/107 | 09/77→03/80 | Z62 | | 0.8 | UXT2 / UXT6 | ZS109 ^[15] | |
| 2.3 230 TE | 4 | M 102.980 | 100/134 | 04/80→11/85 | Z18 | | 0.8 | UXT4 | ZS117 | ZM004 |
| 2.4 240 T D | 4 | OM 616.912 | 48/64 | 09/77→02/79 | GD382 | GR069 | 0.9V | | | |
| 2.4 240 T D | 4 | OM 616.912 | 53/71 | 03/79→12/85 | GD382 | GR069 | 0.9V | | | |
| | | | | | →07/80 GN909 ^[222] | | 11V | | | |
| | | | | | 08/80→ GV603 | | 11.5V | | | |
| | | | | | 08/80→ | | | | | |

| | | | | | | | | | | |
|-----------|---|-----------|---------|-------------|--------|--|-----|------|-----------------------|-------|
| 2.5 250 T | 6 | M 123.921 | 95/127 | 05/78→10/79 | Z22 | | 0.7 | UX56 | ZS400 ^[11] | ZM004 |
| 2.5 250 T | 6 | M 123.921 | 103/138 | 05/78→08/82 | Z22 | | 0.7 | UX56 | ZS400 ^[11] | ZM004 |
| | | | | | →08/81 | | | | | |

| | | | | | | | | | | |
|------------|---|-----------|---------|-------------|-----|--|-----|-------------|-------|-------|
| 2.7 280 TE | 6 | M 110.988 | 136/182 | 09/77→11/85 | Z62 | | 0.8 | UXT2 / UXT6 | ZS117 | ZM004 |
|------------|---|-----------|---------|-------------|-----|--|-----|-------------|-------|-------|

| | | | | | | | | | | |
|-------------|---|------------|-------|-------------|----------------------------------|-------|-------|--|--|--|
| 2.9 300 T D | 5 | OM 617.912 | 59/79 | 09/77→10/85 | GD382 | GR071 | 0.9V | | | |
| | | | | | →07/80 GN909 ^[222] | | 11V | | | |
| | | | | | 08/80→ GV603 | | 11.5V | | | |
| | | | | | 08/80→ | | | | | |

| | | | | | | | | | | |
|-------------|---|------------|-------|-------------|----------------------------------|-------|-------|--|--|--|
| 2.9 300 T D | 5 | OM 617.912 | 65/87 | 03/79→11/85 | GD382 | GR071 | 0.9V | | | |
| | | | | | →07/80 GN909 ^[222] | | 11V | | | |
| | | | | | 08/80→ GV603 | | 11.5V | | | |
| | | | | | 08/80→ | | | | | |

| | | | | | | | | | | |
|-------------------|---|------------|--------|-------------|----------------------------|-------|-------|--|--|--|
| 2.9 300 T Turbo-D | 5 | OM 617.952 | 92/123 | 10/80→11/85 | GN909 ^{[21][222]} | GR071 | 11V | | | |
| | | | | | GV603 | | 11.5V | | | |

KOMBI Estate (S124)

| | | | | | | | | | | |
|-----------|---|-----------|--------|-------------|-----|--|-----|------|--|-------|
| 2.0 200 T | 4 | M 102.922 | 77/103 | 01/86→05/90 | Z18 | | 0.8 | UXT4 | ZS117 ^{[1][6][254]} ZS339 ^{[1][5][214]} | ZM004 |
| | | | | | | | | | ^[254] | |

| | | | | | | | | | | |
|-----------|---|-----------|--------|-------------|-----|--|-----|------|--|-------|
| 2.0 200 T | 4 | M 102.922 | 80/107 | 09/85→08/89 | Z18 | | 0.8 | UXT4 | ZS117 ^{[1][6][254]} ZS339 ^{[1][5][214]} | ZM004 |
| | | | | | | | | | ^[254] | |

| | | | | | | | | | | |
|-------------|---|------------|-------|-------------|------------------------|-------------------|-------|--|--|--|
| 2.0 200 T D | 4 | OM 601.912 | 53/71 | 09/85→08/91 | GN909 ^[222] | GR069 | 11V | | | |
| | | | | | →01/89 GV603 | →01/89 GR070 | 11.5V | | | |
| | | | | | →01/89 GN858 | →01/89 GR073-B | 11.5V | | | |
| | | | | | 02/89→ | 02/89→ | | | | |

| | | | | | | | | | | |
|-------------|---|------------|-------|-------------|----------------------------|-------------------|-------|--|--|--|
| 2.0 200 T D | 4 | OM 601.912 | 55/74 | 09/88→08/91 | GN909 ^{[21][222]} | GR069 | 11V | | | |
| | | | | | →01/89 GV603 | →01/89 GR070 | 11.5V | | | |
| | | | | | →01/89 GN858 | →01/89 GR073-B | 11.5V | | | |
| | | | | | 02/89→ | 02/89→ | | | | |

MERCEDÉS-BENZ



kW/BHP

**... MERCEDES-BENZ****... KOMBI Estate (S124)**

| | | | | | | | | | | |
|-----------------------|---|------------------------|---------|-------------|---|------------------------------------|-----------------------|-------------|---|-------|
| 2.0 200 TE | 4 | M 102.963 | 87/117 | 09/88→08/92 | Z18 | | 0.8 | UXT4 | ZS117 (1)(6)(254) ZS339 (1)(5)(214) [254] | ZM004 |
| 2.0 200 TE | 4 | M 102.962 | 90/121 | 09/88→12/89 | Z18 | | 0.8 | UXT4 | ZS117 (1)(6)(254) ZS339 (1)(5)(214) [254] | ZM004 |
| 2.0 200 TE | 4 | M 111.940 | 100/134 | 05/86→06/93 | Z100 | | 0.8 | UXT1 / UXT3 | ZS313 | |
| 2.2 220 TE | 4 | M 111.960 | 110/148 | 10/92→05/93 | Z100 | | 0.8 | UXT1 / UXT3 | ZS313 | |
| 2.3 230 TE | 4 | M 102.982 | 97/130 | 09/85→08/92 | Z18 | | 0.8 | UXT4 | ZS117 (1)(6)(254) ZS339 (1)(5)(214) [254] | ZM004 |
| 2.3 230 TE | 4 | M 102.982 | 100/134 | 09/85→08/92 | Z18 | | 0.8 | UXT4 | ZS117 (1)(6)(254) ZS339 (1)(5)(214) [254] | ZM004 |
| 2.5 250 T D | 5 | OM 602.912 | 66/89 | 09/85→06/93 | GN909 (222) →01/89 GV603 →01/89 GN858 02/89→ | GR071 →01/89 GR075 02/89→ | 11V 11.5V 11.5V | | | |
| 2.5 250 T D | 5 | OM 602.912 | 69/93 | 01/89→06/93 | GN858 02/89→ | GR075 02/89→ | 11.5V | | | |
| 2.5 250 TD Turbo | 5 | OM 602.962 | 93/125 | 03/88→07/93 | GV603 →01/89 GN858 02/89→ | | 11.5V 11.5V | | | |
| 2.6 260 TE FGST. | 6 | M 103.940 | 118/158 | 09/89→08/92 | Z7 | | 0.8 | UXT4 | ZS296 | |
| 2.6 260 TE FGST. | 6 | M 103.940 | 122/164 | 09/85→12/89 | Z7 | | 0.8 | UXT4 | ZS296 | |
| 2.8 280 TE | 6 | M 104.942 | 145/194 | 10/92→06/93 | Z5 | | 0.8 | UXT1 / UXT3 | ZS340 | |
| 3.0 300 T D | 6 | OM 603.912 | 80/107 | 09/86→06/93 | GN909 (222) →01/89 GV603 →01/89 GN858 02/89→ | GR076 02/89→ | 11V 11.5V 11.5V | | | |
| 3.0 300 T D | 6 | OM 603.912 | 81/109 | 01/89→06/93 | GN858 02/89→ | GR076 02/89→ | 11.5V | | | |
| 3.0 300 T D | 6 | OM 603.912 | 83/111 | 01/89→06/93 | GN858 02/89→ | GR076 02/89→ | 11.5V | | | |
| 3.0 300 TD T | 6 | OM 603.960 | 100/134 | 06/92→05/93 | GN858 | | 11.5V | | | |
| 3.0 300 TE | 6 | M 103.983, M 103.985 | 132/177 | 01/86→06/93 | Z7 | | 0.8 | UXT4 | ZS296 | |
| 3.0 300 TE | 6 | M 103.983 | 138/185 | 01/86→12/89 | Z7 | | 0.8 | UXT4 | ZS296 | |
| 3.0 300 TE-24 | 6 | M 104.980 | 162/217 | 09/89→08/92 | Z100 | | 0.8 | UXT1 / UXT3 | ZS298 | |
| 3.0 300 T Turbo-D | 6 | OM 603.960, OM 603.963 | 105/141 | 09/86→01/89 | GN909 (2)(222) GV603 | | 11V 11.5V | | | |
| 3.0 300 T Turbo-D 4WD | 6 | OM 603.963 | 105/141 | 09/86→01/89 | GV603 | | 11.5V | | | |
| 3.0 300 T Turbo-D | 6 | OM 603.960 | 108/145 | 01/89→06/93 | GN858 02/89→ | | 11.5V | | | |
| 3.2 320 TE | 6 | M 104.992 | 162/217 | 10/92→06/93 | Z5 | | 0.8 | UXT1 / UXT3 | ZS340 | |

M-CLASS (W163)

| | | | | | | | | | | |
|--------------------|---|------------|---------|-------------|-------|--------|-------|-------|-------|--|
| 2.3 ML 230 4WD | 4 | M 111.977 | 110/148 | 02/98→06/05 | Z121 | | 1.0 | UXT9 | ZS340 | |
| 2.3 ML 230 4WD LPG | 4 | M 111.977 | 110/148 | 02/98→06/05 | Z206 | | 0.7 | UXT10 | | |
| 2.7 ML 270 CDI 4WD | 5 | OM 612.963 | 120/161 | 12/99→06/05 | GN003 | GSE141 | 11.5V | | | |
| 3.2 ML 320 4WD | 6 | M 112.942 | 160/215 | 02/98→08/02 | Z122 | | 1.0 | UXT9 | ZS297 | |
| 3.2 ML 320 4WD LPG | 6 | M 112.942 | 160/215 | 02/98→08/02 | Z206 | | 0.7 | UXT10 | | |
| 3.7 ML 350 4WD | 6 | M 112.970 | 173/232 | 02/03→06/05 | Z240 | | 1.0 | UXT9 | ZS297 | |
| 3.7 ML 350 4WD | 6 | M 112.970 | 180/241 | 08/02→06/05 | Z240 | | 1.0 | UXT9 | ZS297 | |
| 4.0 ML 400 CDI 4WD | 8 | OM 628.963 | 184/247 | 09/01→06/05 | GN003 | | 11.5V | | | |
| 4.3 ML 430 4WD | 8 | M 113.942 | 200/268 | 02/98→06/05 | Z240 | | 1.0 | UXT9 | ZS297 | |

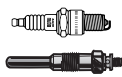

kW/BHP

**... MERCEDES-BENZ****... M-CLASS (W163)**

| | | | | | | | | | |
|-----------------------|---|----------------------|---------|-------------|----------------|--|-----|--------|-------|
| 5.0 ML 500 4WD | 8 | M 113.964, M 113.965 | 215/288 | 09/01→06/05 | Z240 | | 1.0 | UXT9 | ZS297 |
| 5.4 ML 55 AMG 4WD | 8 | M 113.981 | 255/342 | 02/00→06/05 | Z122 | | 1.0 | UXT9 | ZS297 |
| | | | | | →02/02 Z240 | | 1.0 | UXT9 | |
| | | | | | 03/02→ | | | | |
| 5.4 ML 55 AMG 4WD LPG | 8 | M 113.981 | 255/342 | 02/00→06/05 | Z206 | | 0.7 | UXT10 | |
| | | | | | →02/02 | | | →02/02 | |

M-CLASS (W164)

| | | | | | | | | | |
|--------------------|---|------------------------|---------|-------------|-------|--|------|------|--------|
| 3.0 ML 280 CDI 4WD | 6 | OM 642.940 | 140/188 | 07/05→07/09 | GE105 | GSE114 ^[135] GSE116 ^[134] | 4.4V | | |
| 3.0 ML 300 CDI 4WD | 6 | OM 642.940 | 140/188 | 07/09→ | GE105 | GSE114 ^[135] GSE116 ^[134] | 4.4V | | |
| 3.0 ML 300 CDI 4WD | 6 | OM 642.820, OM 642.832 | 150/201 | 02/10→ | | GSE116 | | | |
| 3.0 ML 320 CDI 4WD | 6 | OM 642.940 | 165/221 | 07/05→07/09 | GE105 | GSE114 ^[135] GSE116 ^[134] | 4.4V | | |
| 3.0 ML 350 CDI 4WD | 6 | OM 642.820 | 155/208 | 09/09→ | | GSE116 | | | |
| 3.0 ML 350 CDI 4WD | 6 | OM 642.940 | 165/221 | 07/09→ | GE105 | GSE114 ^[135] GSE116 ^[134] | 4.4V | | |
| 3.0 ML 350 CDI 4WD | 6 | OM 642.820 | 170/228 | 02/10→ | | GSE116 | | | |
| 3.5 ML 350 4WD | 6 | | 200/268 | 07/05→ | | | | | ZSE140 |
| 4.0 ML 420 CDI 4WD | 8 | OM 629.912 | 225/302 | 02/06→09/09 | GE105 | | 4.4V | | |
| 4.0 ML 450 CDI 4WD | 8 | OM 629.912 | 225/302 | 09/09→ | GE105 | | 4.4V | | |
| 5.0 ML 500 4WD | 8 | M 113.964 | 225/302 | 07/05→ | Z240 | | 1.0 | UXT9 | ZS297 |
| 5.5 ML 500 4WD | 8 | M 273.963 | 285/382 | 12/07→ | Z359 | | 0.8 | | ZSE140 |
| 6.2 ML 63 AMG 4WD | 8 | M 156.980 | 375/503 | 01/06→ | Z355 | | 1.0 | | |

M-CLASS (W166)

| | | | | | | | | | |
|------------------------|---|------------|---------|--------|--|--------|--|--|-----------------------------|
| 3.0 ML 350 BlueTEC 4WD | 6 | OM 642.826 | 190/255 | 06/11→ | | GSE116 | | | |
| 3.0 ML 400 4WD | 6 | M 276.821 | 245/329 | 08/13→ | | | | | ZSE094 |
| 3.5 ML 350 4WD | 6 | M 276.955 | 225/302 | 06/11→ | | | | | ZSE093 |
| | | | | | | | | | ZSE094 ^{[72][183]} |
| 4.7 ML 500 4WD | 8 | M 278.928 | 300/402 | 02/12→ | | | | | ZSE093 |
| 5.5 ML 63 AMG 4WD | 8 | M 157.980 | 386/518 | 11/11→ | | | | | ZSE093 |
| 5.5 ML 63 AMG 4WD | 8 | M 157.982 | 410/550 | 11/11→ | | | | | ZSE093 |

PAGODE (W113)

| | | | | | | | | | |
|------------|---|-----------|---------|-------------|-----|--|-----|------|-----------------------|
| 2.3 230 SL | 6 | M 127.981 | 110/148 | 01/63→01/67 | Z42 | | 0.8 | UX56 | |
| 2.5 250 SL | 6 | M 129.982 | 110/148 | 01/66→01/68 | Z42 | | 0.8 | UX56 | ZS106 ^[11] |
| 2.7 280 SL | 6 | M 130.983 | 125/168 | 01/68→03/71 | Z42 | | 0.8 | UX56 | |

PONTON (W120)

| | | | | | | | | | |
|-----------|---|------------|-------|-------------|-------|--|------|--|--|
| 1.8 180 D | 4 | OM 636.930 | 32/43 | 01/53→07/59 | GD348 | | 0.9V | | |
| 1.9 180 | 4 | M 136.925 | 48/64 | 07/53→12/62 | Z57 | | 0.6 | | |

PONTON (W121)

| | | | | | | | | | |
|------------|---|------------|-------|-------------|-------|--|------|-------------|--|
| 1.9 190 b | 4 | M 121.920 | 59/79 | 06/59→12/61 | Z11 | | 0.8 | UXT2 / UXT6 | |
| 1.9 190 Db | 4 | OM 621.910 | 37/50 | 01/59→12/61 | GD382 | | 0.9V | | |

PONTON (W128)

| | | | | | | | | | |
|------------|---|-----------|--------|-------------|-----|--|-----|------|--|
| 2.2 220 SE | 6 | M 127.980 | 88/118 | 01/58→08/59 | Z22 | | 0.7 | UX56 | |
|------------|---|-----------|--------|-------------|-----|--|-----|------|--|

PONTON (W180)

| | | | | | | | | | |
|-----------|---|-----------|--------|-------------|-----|--|-----|--|--|
| 2.2 220 | 6 | M 180.921 | 63/84 | 01/54→12/56 | Z10 | | 0.8 | | |
| 2.2 220 S | 6 | M 180.924 | 78/105 | 01/56→12/59 | Z10 | | 0.8 | | |

PULLMANN (W100)

| | | | | | | | | | |
|---------|---|-----------|---------|-------------|-----|--|-----|-------------|---|
| 6.3 600 | 8 | M 100.980 | 184/247 | 09/64→01/79 | Z62 | | 0.8 | UXT2 / UXT6 | ZS110 ^{[1][15]} →10/65 ZS115 ^{[1][11]} 11/65→07/69 ZS109 ^{[1][15]} 08/69→ |
|---------|---|-----------|---------|-------------|-----|--|-----|-------------|---|

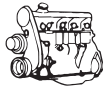

kW/BHP

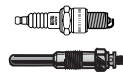

... MERCEDES-BENZ 

... PULLMANN (W100)

| | | | | | | | | | | |
|---------|---|-----------|---------|-------------|-----|--|-----|-------------|---|--|
| 6.3 600 | 8 | M 100.982 | 184/247 | 09/64→01/79 | Z70 | | 0.8 | UXT2 / UXT6 | ZS110 ^{[1][15]} →10/65 ZS115 ^{[1][11]} 11/65→07/69 ZS109 ^{[1][15]} 08/69→ | |
|---------|---|-----------|---------|-------------|-----|--|-----|-------------|---|--|

R-CLASS (W251, V251)

| | | | | | | | | | | |
|-------------------|---|------------------------|---------|--------|----------------------------------|--|------|--|--------|----------------|
| 3.0 R 280 | 6 | M 272.945 | 170/228 | 01/07→ | Z359 | | 0.8 | | ZSE140 | |
| 3.0 R 280 4WD | 6 | M 272.945 | 170/228 | 05/07→ | Z359 | | 0.8 | | ZSE140 | eng. 30417697→ |
| 3.0 R 280 CDI | 6 | OM 642.870, OM 642.872 | 140/188 | 05/06→ | | GSE116 | | | | |
| 3.0 R 280 CDI | 6 | OM 642.950 | 140/188 | 05/06→ | GE105 →08/13 | GSE114 ^[135] GSE116 ^[134] | 4.4V | | | |
| 3.0 R 280 CDI 4WD | 6 | OM 642.950 | 140/188 | 05/06→ | GE105 →08/13 | GSE114 ^[135] GSE116 ^[134] | 4.4V | | | |
| 3.0 R 300 | 6 | M 272.945 | 170/228 | 07/09→ | Z359 | | 0.8 | | ZSE140 | |
| 3.0 R 300 CDI | 6 | OM 642.870, OM 642.872 | 140/188 | 07/09→ | | GSE116 | | | | |
| 3.0 R 300 CDI | 6 | OM 642.950 | 140/188 | 07/09→ | GE105 ^[279] →08/13 | GSE114 ^[135] GSE116 ^[134] | 4.4V | | | |
| 3.0 R 300 CDI 4WD | 6 | OM 642.950 | 140/188 | 07/09→ | GE105 →08/13 | GSE114 ^[135] GSE116 ^[134] | 4.4V | | | |
| 3.0 R 320 CDI 4WD | 6 | OM 642.870 | 155/208 | 01/06→ | | GSE116 | | | | |
| 3.0 R 320 CDI 4WD | 6 | OM 642.950 | 155/208 | 01/06→ | GE105 ^[279] | GSE114 ^[135] GSE116 ^[134] | 4.4V | | | |
| 3.0 R 320 CDI 4WD | 6 | OM 642.950 | 165/221 | 01/06→ | GE105 →08/13 | GSE114 ^[135] GSE116 ^[134] | 4.4V | | | |
| 3.0 R 350 CDI 4WD | 6 | OM 642.870 | 155/208 | 01/06→ | | GSE116 | | | | |
| 3.0 R 350 CDI 4WD | 6 | OM 642.950 | 155/208 | 01/06→ | GE105 | GSE114 ^[135] GSE116 ^[134] | 4.4V | | | |
| 3.0 R 350 CDI 4WD | 6 | OM 642.950 | 165/221 | 07/09→ | GE105 →08/13 | GSE114 ^[135] GSE116 ^[134] | 4.4V | | | |
| 3.0 R 350 CDI 4WD | 6 | OM 642.872 | 195/261 | 08/10→ | | GSE116 | | | | |
| 3.5 R 350 | 6 | M 272.967 | 200/268 | 01/06→ | | | | | ZSE140 | |
| 3.5 R 350 CGI 4WD | 6 | M 276.958 | 225/302 | 01/06→ | | | | | ZSE093 | 06/11→ |

| | | | | | | | | | | |
|------------------|---|-----------|---------|--------|------|--|-----|------|--------|--|
| 5.0 R 500 4WD | 8 | M 113.971 | 225/302 | 01/06→ | Z240 | | 1.0 | UXT9 | ZS297 | |
| 5.5 R 500 4WD | 8 | M 273.963 | 285/382 | 01/07→ | Z359 | | 0.8 | | ZSE140 | |
| 6.2 R 63 AMG 4WD | 8 | M 156.980 | 375/503 | 02/06→ | Z355 | | 1.0 | | | |

Saloon (W123)

| | | | | | | | | | | |
|-----------|---|----------------------|---------|-------------|--|-------|--------------------------|-------------|---------------------------------|-------|
| 2.0 200 | 4 | M 115.938, M 115.939 | 62/83 | 02/76→08/80 | Z62 | | 0.8 | UXT2 / UXT6 | ZS109 ^[15] 09/77→ | |
| 2.0 200 | 4 | M 115.938, M 115.939 | 69/93 | 02/76→08/80 | Z62 | | 0.8 | UXT2 / UXT6 | ZS109 ^[15] | |
| 2.0 200 | 4 | M 102.939 | 74/99 | 06/80→11/85 | Z18 | | 0.8 | UXT4 | ZS117 | ZM004 |
| 2.0 200 | 4 | M 102.920 | 80/107 | 06/80→11/85 | Z18 | | 0.8 | UXT4 | ZS117 | ZM004 |
| 2.0 200 D | 4 | OM 615.940 | 40/54 | 07/76→02/79 | GD382 | GR069 | 0.9V | | | |
| 2.0 200 D | 4 | OM 615.940 | 44/59 | 03/79→11/85 | GD382 →07/80 GN909 ^[222] 08/80→ GV603 08/80→ | GR069 | 0.9V 11V 11.5V | | | |
| 2.2 220 D | 4 | OM 615.941 | 44/59 | 01/76→02/79 | GD382 | | 0.9V | | | |
| 2.2 220 D | 4 | OM 615.941 | 49/66 | 01/77→03/79 | GD382 | | 0.9V | | | |
| 2.3 230 | 4 | M 115.954 | 80/107 | 02/76→03/81 | Z70 | | 0.8 | UXT2 / UXT6 | ZS109 ^[15] 09/77→ | |
| 2.3 230 E | 4 | M 102.980 | 100/134 | 04/80→12/85 | Z18 | | 0.8 | UXT4 | ZS117 | ZM004 |
| 2.4 240 D | 4 | OM 616.912 | 48/64 | 02/76→02/79 | GD382 | GR069 | 0.9V | | | |

MERCEDES-BENZ

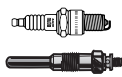

kW/BHP

**... MERCEDES-BENZ****... Saloon (W123)**

| | | | | | | | | | | |
|-----------------|---|----------------------|---------|-------------|--|--------------|------------------------------|--------------------|--|------------------------|
| 2.4 240 D | 4 | OM 616.912 | 53/71 | 03/79→11/85 | GD382 →07/80 GN909 [222] 08/80→ GV603 08/80→ | | 0.9V 11V 11.5V | | | |
| 2.5 250 | 6 | M 123.921 | 95/127 | 02/76→10/79 | Z22 | | 0.7 | UX56 | ZS400 [11] 11/77→ | |
| 2.5 250 | 6 | M 123.921 | 103/138 | 10/79→07/85 | Z22 | | 0.7 | UX56 | ZS400 [1][11] →08/82 ZS117 [1] 09/82→ | ZM004 09/82→ |
| 2.7 280 | 6 | M 110.923 | 115/154 | 02/76→08/81 | Z62 | | 0.8 | UXT2 / UXT6 | ZS109 [15] | |
| 2.7 280 E | 6 | M 110.988 | 130/174 | 08/76→08/81 | Z62 | | 0.8 | UXT2 / UXT6 | ZS400 [1][11] →03/80 ZS117 [1] 04/80→ | |
| 2.7 280 E | 6 | M 110.984, M 110.988 | 136/182 | 02/76→11/85 | Z62 | | 0.8 | UXT2 / UXT6 | ZS400 [1][11][254] ZS117 [1] 04/80→ | ZM004 09/81→ |
| 2.9 300 D | 5 | OM 617.912 | 59/79 | 02/76→07/80 | GD382 | GR071 | 0.9V | | | |
| 2.9 300 D | 5 | OM 617.912 | 65/87 | 03/79→11/85 | GD382 →07/80 GN909 [222] 08/80→ GV603 08/80→ | GR071 | 0.9V 11V 11.5V | | | |
| 2.9 300 Turbo-D | 5 | OM 617.952 | 92/123 | 08/81→07/85 | GN909 [2][222] GV603 | GR071 | 11V 11.5V | | | |

Saloon (W124)

| | | | | | | | | | | |
|-----------|---|------------|---------|-------------|--|--|-------------------------------|--------------------|---|--------------|
| 2.0 200 | 4 | M 102.922 | 75/101 | 01/86→05/90 | Z18 | | 0.8 | UXT4 | ZS117 [1][6][254] ZS339 [1][5][214] [254] | ZM004 |
| 2.0 200 | 4 | M 102.922 | 77/103 | 01/86→05/90 | Z18 | | 0.8 | UXT4 | ZS117 [1][6][254] ZS339 [1][5][214] [254] | ZM004 |
| 2.0 200 | 4 | M 102.922 | 80/107 | 12/85→05/90 | Z18 | | 0.8 | UXT4 | ZS117 [1][6][254] ZS339 [1][5][214] [254] | ZM004 |
| 2.0 200 D | 4 | OM 601.912 | 53/71 | 12/84→08/89 | GN909 [222] →01/89 GV603 →01/89 GN858 02/89→ | GR069 →01/89 GR070 →01/89 GR073-B 02/89→ | 11V 11.5V 11.5V | | | |
| 2.0 200 D | 4 | OM 601.912 | 55/74 | 08/89→06/93 | GN858 | GR073-B | 11.5V | | | |
| 2.0 200 E | 4 | M 102.963 | 87/117 | 09/88→08/92 | Z18 | | 0.8 | UXT4 | ZS117 [1][6][254] ZS339 [1][5][214] [254] | ZM004 |
| 2.0 200 E | 4 | M 102.963 | 90/121 | 09/88→12/89 | Z18 | | 0.8 | UXT4 | ZS117 [1][6][254] ZS339 [1][5][214] [254] | ZM004 |
| 2.0 200 E | 4 | M 111.940 | 100/134 | 10/92→06/93 | Z100 | | 0.8 | UXT1 / UXT3 | ZS313 | |
| 2.2 220 E | 4 | M 111.960 | 110/148 | 10/92→06/93 | Z100 | | 0.8 | UXT1 / UXT3 | ZS313 | |
| 2.3 230 E | 4 | M 102.982 | 97/130 | 12/84→06/93 | Z18 | | 0.8 | UXT4 | ZS117 [1][6][254] ZS339 [1][5][214] [254] | ZM004 |

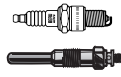

kW/BHP

**... MERCEDES-BENZ****... Saloon (W124)**

| | | | | | | | | | | |
|-----------------|---|------------------------|---------|-------------|---|--|-----------------------|--------------------|--|--------------|
| 2.3 230 E | 4 | M 102.982 | 100/134 | 01/85→06/93 | Z18 | | 0.8 | UXT4 | ZS117 ^{[1][6][254]} ZS339 ^{[1][5][214]} ^[254] | ZM004 |
| 2.5 250 D | 5 | OM 602.912 | 66/89 | 04/85→06/93 | GN909 ^[222] →01/89 GV603 →01/89 GN858 02/89→ | GR071 →01/89 GR075 02/89→ | 11V 11.5V 11.5V | | | |
| 2.5 250 D | 5 | OM 602.912 | 69/93 | 01/89→06/93 | GN909 ^[222] →01/89 GV603 →01/89 GN858 02/89→ | GR071 →01/89 GR075 02/89→ | 11V 11.5V 11.5V | | | |
| 2.5 250 Turbo-D | 5 | OM 602.962 | 93/125 | 09/88→06/93 | GN909 ^[222] →01/89 GV603 →01/89 GN858 02/89→ | | 11V 11.5V 11.5V | | | |
| 2.6 260 E | 6 | M 103.940 | 118/158 | 09/85→08/92 | Z7 | | 0.8 | UXT4 | ZS339 →ch. → A 511 983 ZS296 ch. A 511 984 → | |
| 2.6 260 E 4WD | 6 | M 103.943 | 118/158 | 09/86→08/92 | Z7 | | 0.8 | UXT4 | ZS296 | |
| 2.6 260 E | 6 | M 103.940 | 122/164 | 09/85→12/89 | Z7 | | 0.8 | UXT4 | ZS296 →ch. → A 511 983 ZS339 ch. A 511 984 → | |
| 2.6 260 E 4WD | 6 | M 103.940 | 122/164 | 12/86→12/89 | Z7 | | 0.8 | UXT4 | ZS296 | |
| 2.8 280 E | 6 | M 104.942 | 145/194 | 10/92→06/93 | Z5 | | 0.8 | UXT1 / UXT3 | ZS340 | |
| 3.0 300 D | 6 | OM 603.912, OM 603.913 | 80/107 | 12/84→08/92 | GN909 ^[222] →01/89 GV603 →01/89 GN858 02/89→ | GR076 02/89→ | 11V 11.5V 11.5V | | | |
| 3.0 300 D | 6 | OM 603.912 | 81/109 | 06/90→06/93 | GN858 | GR076 | 11.5V | | | |
| 3.0 300 D | 6 | OM 603.912, OM 603.913 | 83/111 | 08/89→06/93 | GN858 | GR076 | 11.5V | | | |
| 3.0 300 E | 6 | M 103.983, M 103.985 | 132/177 | 08/85→06/93 | Z7 | | 0.8 | UXT4 | ZS296 | |
| 3.0 300 E | 6 | M 103.980 | 138/185 | 01/85→12/85 | Z18 | | 0.8 | UXT4 | ZS296 | |
| 3.0 300 E | 6 | M 103.983 | 138/185 | 06/85→08/92 | Z7 | | 0.8 | UXT4 | ZS296 | |
| 3.0 300 E-24 | 6 | M 104.980 | 162/217 | 09/88→08/92 | Z100 | | 0.8 | UXT1 / UXT3 | ZS298 | |
| 3.0 300 Turbo-D | 6 | OM 603.960, OM 603.963 | 105/141 | 09/86→09/88 | GN909 ^{[2][222]} GV603 | | 11V 11.5V | | | |
| 3.0 300 Turbo-D | 6 | OM 603.960, OM 603.963 | 108/145 | 01/88→06/93 | GN909 ^[222] →01/89 GV603 →01/89 GN858 02/89→ | | 11V 11.5V 11.5V | | | |
| 3.2 320 E | 6 | M 104.992 | 162/217 | 10/92→06/93 | Z100 | | 0.8 | UXT1 / UXT3 | ZS340 | |
| 4.2 400 E | 8 | M 119.975 | 205/275 | 10/92→06/93 | Z5 | | 0.8 | UXT1 / UXT3 | ZS298 ^{[30][214][254]} ZS299 ^{[22][254]} | |

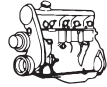

kW/BHP

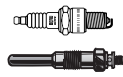

... MERCEDES-BENZ



... Saloon (W124)

| | | | | | | | | | |
|---------------|---|-----------|---------|-------------|----|--|-----|-------------|--|
| 5.0 500 E | 8 | M 119.974 | 240/322 | 01/91→06/93 | Z5 | | 0.8 | UXT1 / UXT3 | ZS339 →ch. B 568955 ZS296 →ch. B 968955 ZS298 [214] ch. B 568956→ ZS299 ch. B 568956→ |
| 6.0 500 E AMG | 8 | | 275/369 | 01/92→06/93 | | | | | ZS339 →ch. B 568955 ZS296 →ch. B 968955 ZS298 ch. B 568956→ ZS299 ch. B 568956→ |

S-CLASS (W108, W109)

| | | | | | | | | | |
|--------------------|---|-----------|---------|-------------|------|--|-----|-------------|----------------------|
| 2.5 250 S | 6 | M 108.920 | 96/129 | 01/66→12/69 | Z104 | | 0.6 | | ZS106 [11] 05/67→ |
| 2.5 250 SE | 6 | M 129.980 | 110/148 | 01/66→12/67 | | | | | ZS106 [11] |
| 2.7 280 S | 6 | M 130.920 | 103/138 | 10/67→07/72 | Z42 | | 0.8 | UX56 | ZS109 [15] |
| 2.7 280 SE,SEL | 6 | M 130.980 | 118/158 | 01/68→08/72 | Z42 | | 0.8 | UX56 | ZS109 [15] |
| 2.7 300 SEL | 6 | M 130.981 | 118/158 | 01/68→08/72 | Z42 | | 0.8 | UX56 | ZS109 [15] |
| 3.5 280 SE,SEL 3.5 | 8 | M 116.980 | 147/197 | 03/71→08/72 | Z42 | | 0.8 | UX56 | ZS109 [15] |
| 3.5 300 SEL 3.5 | 8 | M 116.981 | 147/197 | 01/70→07/72 | Z22 | | 0.7 | UX56 | ZS109 [15] |
| 6.3 300 SEL 6.3 | 8 | M 100.981 | 184/247 | 03/68→08/72 | Z62 | | 0.8 | UXT2 / UXT6 | ZS109 [15] |

S-CLASS (W116)

| | | | | | | | | | |
|-----------------|---|----------------------|---------|-------------|-----|--|-----|-------------|--|
| 2.7 280 S | 6 | M 110.922 | 115/154 | 08/72→07/80 | Z62 | | 0.8 | UXT2 / UXT6 | ZS109 [15] |
| 2.7 280 S | 6 | M 110.922 | 118/158 | 08/72→07/80 | Z62 | | 0.8 | UXT2 / UXT6 | ZS109 [15] |
| 2.7 280 SE,SEL | 6 | M 110.985 | 130/174 | 08/72→07/80 | Z62 | | 0.8 | UXT2 / UXT6 | ZS109 [1][15] ZS400 [1][11] 08/76→ |
| 2.7 280 SE,SEL | 6 | M 110.983, M 110.985 | 136/182 | 08/72→07/80 | Z62 | | 0.8 | UXT2 / UXT6 | ZS109 [15] |
| 3.5 350 SE,SEL | 8 | M 116.985 | 143/192 | 03/76→03/80 | Z62 | | 0.8 | UXT2 / UXT6 | ZS400 [11] |
| 3.5 350 SE,SEL | 8 | M 116.983 | 147/197 | 08/72→02/76 | Z22 | | 0.7 | UX56 | ZS400 [11] |
| 3.5 350 SE,SEL | 8 | M 116.985 | 151/202 | 03/76→03/80 | Z62 | | 0.8 | UXT2 / UXT6 | ZS400 [11] |
| 4.5 450 SE | 8 | M 117.983 | 143/192 | 08/72→12/76 | Z22 | | 0.7 | UX56 | |
| 4.5 450 SE | 8 | M 117.986 | 143/192 | 08/72→12/76 | Z62 | | 0.8 | UXT2 / UXT6 | |
| 4.5 450 SE,SEL | 8 | M 117.985, M 117.986 | 160/215 | 12/75→04/80 | Z62 | | 0.8 | UXT2 / UXT6 | ZS400 [11] |
| 4.5 450 SE,SEL | 8 | M 117.983, M 117.986 | 165/221 | 01/73→04/80 | Z62 | | 0.8 | UXT2 / UXT6 | ZS400 [11] |
| 6.8 450 SEL 6.9 | 8 | M 100.985 | 210/282 | 07/75→03/80 | Z62 | | 0.8 | UXT2 / UXT6 | ZS400 [11] |

S-CLASS (W126)

| | | | | | | | | | |
|----------------|---|----------------------|---------|-------------|--------------|--|-----|-------------|---|
| 2.5 260 SE | 6 | M 103.941 | 118/158 | 09/85→06/91 | Z7 03/87→ | | 0.8 | UXT4 | ZS296 [3][214][254] ZS339 [214][254] |
| 2.5 260 SE | 6 | M 103.941 | 122/164 | 09/85→06/91 | Z7 03/87→ | | 0.8 | UXT4 | ZS296 [3][214][254] ZS339 [214][254] |
| 2.7 280 S | 6 | M 110.924, M 110.926 | 115/154 | 12/79→07/85 | Z62 | | 0.8 | UXT2 / UXT6 | ZS400 [1][11] ZM004 →ch. → 010991 ZS117 [1] ch. 010992 → |
| 2.7 280 SE,SEL | 6 | M 110.987, M 110.989 | 136/182 | 10/79→07/85 | Z62 | | 0.8 | UXT2 / UXT6 | ZS400 [1][11] ZM004 →ch. → 042769 ZS117 [1] ch. 042770 → |
| 3.0 300 SE,SEL | 6 | M 103.981 | 132/177 | 01/86→06/91 | Z18 | | 0.8 | UXT4 | ZS296 [3][214][254] ZS339 [214][254] |
| 3.0 300 SE,SEL | 6 | M 103.981 | 138/185 | 09/85→12/89 | Z18 | | 0.8 | UXT4 | ZS296 [1][214][254] ZS339 [1][214][254] |

MERCEDES-BENZ

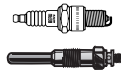

kW/BHP

**... MERCEDES-BENZ** **... S-CLASS (W126)**

| | | | | | | | | | | |
|----------------|---|----------------------|---------|-------------|-----|--|-----|-------------|--|-----------------|
| 3.8 | 8 | M 116.960 | 160/215 | 08/80→08/84 | Z62 | | 0.8 | UXT2 / UXT6 | | |
| 3.8 380 SE,SEL | 8 | M 116.963 | 150/201 | 12/79→08/85 | Z62 | | 0.8 | UXT2 / UXT6 | ZS118 | ZM004 09/81→ |
| 3.8 380 SE,SEL | 8 | M 116.961 | 160/215 | 09/80→08/86 | Z62 | | 0.8 | UXT2 / UXT6 | | |
| 4.1 420 SE,SEL | 8 | M 116.965 | 150/201 | 10/85→06/91 | Z62 | | 0.8 | UXT2 / UXT6 | ZS298 | |
| 4.1 420 SE,SEL | 8 | M 116.965 | 160/215 | 10/85→12/87 | Z62 | | 0.8 | UXT2 / UXT6 | ZS298 | |
| 4.1 420 SE,SEL | 8 | M 116.965 | 165/221 | 10/85→06/91 | Z62 | | 0.8 | UXT2 / UXT6 | ZS298 | |
| 4.1 420 SE,SEL | 8 | M 116.965 | 170/228 | 10/85→12/87 | Z62 | | 0.8 | UXT2 / UXT6 | ZS298 | |
| 4.9 500 SE,SEL | 8 | M 117.965 | 164/220 | 09/85→06/91 | Z62 | | 0.8 | UXT2 / UXT6 | ZS298 | |
| 4.9 500 SE,SEL | 8 | M 117.961, M 117.963 | 170/228 | 12/79→08/85 | Z62 | | 0.8 | UXT2 / UXT6 | ZS400 ⁽¹¹⁾ →ch. 013680 ZS118 ch. 013681→ | ZM004 09/81→ |
| 4.9 500 SE,SEL | 8 | M 117.961, M 117.963 | 177/237 | 12/79→08/85 | Z62 | | 0.8 | UXT2 / UXT6 | ZS400 ⁽¹¹⁾ →ch. → 013680 ZS118 ch. 013681→ | ZM004 09/81→ |
| 4.9 500 SE,SEL | 8 | M 117.964, M 117.965 | 180/241 | 09/85→06/91 | Z62 | | 0.8 | UXT2 / UXT6 | ZS298 | |
| 4.9 500 SE,SEL | 8 | M 117.965 | 185/248 | 09/87→06/91 | Z62 | | 0.8 | UXT2 / UXT6 | ZS298 | |
| 4.9 500 SE,SEL | 8 | M 117.965 | 195/261 | 09/87→06/91 | Z62 | | 0.8 | UXT2 / UXT6 | ZS298 | |
| 5.0 500 SE,SEL | 8 | M 117.965 | 185/248 | 06/89→06/91 | Z62 | | 0.8 | UXT2 / UXT6 | ZS298 | |
| 5.5 560 SE,SEL | 8 | M 117.968 | 178/239 | 10/85→06/91 | Z62 | | 0.8 | UXT2 / UXT6 | ZS298 | |
| 5.5 560 SE,SEL | 8 | M 117.968 | 200/268 | 10/85→12/87 | Z62 | | 0.8 | UXT2 / UXT6 | ZS298 | |
| 5.5 560 SE,SEL | 8 | M 117.968 | 205/275 | 08/87→06/91 | Z62 | | 0.8 | UXT2 / UXT6 | ZS298 | |
| 5.5 560 SE,SEL | 8 | M 117.968 | 220/295 | 10/85→06/91 | Z62 | | 0.8 | UXT2 / UXT6 | ZS298 →08/87 | |

S-CLASS (W140)

| | | | | | | | | | | |
|-------------------------|----|----------------------|---------|-------------|----------------------------------|--------|------------|-------------------------------|--|--|
| 2.8 300 SE | 6 | M 104.944 | 145/194 | 01/93→10/98 | Z100 | | 0.8 | UXT1 / UXT3 | ZS340 | |
| 2.8 300 SE LPG | 6 | M 104.944 | 145/194 | 01/93→10/98 | Z206 | | 0.7 | UXT10 | | |
| 2.8 S 280 | 6 | M 104.944 | 142/190 | 02/93→10/98 | Z100 | | 0.8 | UXT1 / UXT3 | ZS340 | |
| 2.8 S 280 LPG | 6 | M 104.944 | 142/190 | 02/93→10/98 | Z206 | | 0.7 | UXT10 | | |
| 3.0 S 300 Turbo-D | 6 | OM 606.961 | 130/174 | 05/96→10/98 | GN948 ⁽²⁵⁵⁾ | GSE141 | 11.5V | | | |
| 3.2 300 SE,SEL/S320 | 6 | M 104.990 | 170/228 | 03/91→10/98 | Z100 | | 0.8 | UXT1 / UXT3 | | |
| 3.2 300 SE,SEL/S320 | 6 | M 104.994 | 170/228 | 03/91→10/98 | Z100 | | 0.8 | UXT1 / UXT3 | ZS340 | |
| 3.2 300 SE,SEL/S320 LPG | 6 | M 104.990, M 104.994 | 170/228 | 03/91→10/98 | Z206 | | 0.7 | UXT10 | | |
| 3.4 S 350 Turbo-D | 6 | OM 603.971 | 110/148 | 01/93→10/98 | GN858 | | 11.5V | | | |
| 4.2 400 SE,SEL/S420 | 8 | M 119.971 | 210/282 | 02/91→10/98 | Z100 →08/95 Z122 09/95→ | | 0.8 1.0 | UXT1 / UXT3 UXT9 09/95→ | ZS296 ^{(19)T214I[254]} ZS339 ^{(21)T214I[254]} | |
| 4.2 400 SE,SEL/S420 LPG | 8 | M 119.971 | 210/282 | 02/91→10/98 | Z206 | | 0.7 | UXT10 | | |
| 4.2 S 420 | 8 | M 119.971 | 205/275 | 01/93→10/98 | Z100 | | 0.8 | UXT1 / UXT3 | ZS296 ^{(19)T214I[254]} ZS339 ^{(21)T214I[254]} | |
| 4.2 S 420 LPG | 8 | M 119.971 | 205/275 | 01/93→10/98 | Z206 | | 0.7 | UXT10 | | |
| 5.0 500 SE,SEL | 8 | M 119.970 | 240/322 | 02/91→10/98 | Z100 →08/95 Z122 09/95→ | | 0.8 1.0 | UXT1 / UXT3 UXT9 09/95→ | ZS296 ^{(19)T214I[254]} ZS339 ^{(21)T214I[254]} | |
| 5.0 500 SE,SEL LPG | 8 | M 119.970 | 240/322 | 02/91→10/98 | Z206 | | 0.7 | UXT10 | | |
| 5.0 S 500 | 8 | M 119.970, M 119.980 | 235/315 | 01/93→10/98 | Z100 →08/95 Z122 09/95→ | | 0.8 1.0 | UXT1 / UXT3 UXT9 09/95→ | ZS296 ^{(19)T214I[254]} ZS339 ^{(21)T214I[254]} | |
| 5.0 S 500 LPG | 8 | M 119.970, M 119.980 | 235/315 | 01/93→10/98 | Z206 | | 0.7 | UXT10 | | |
| 6.0 600 SE,SEL | 12 | M 120.980, M 120.982 | 300/402 | 04/91→12/92 | Z100 | | 0.8 | UXT1 / UXT3 | ZS298 ^{(21)T214I[254]} ZS299 ^{(19)T214I[254]} | |

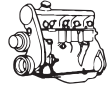

kW/BHP

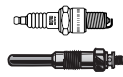
**... MERCEDES-BENZ****... S-CLASS (W140)**

| | | | | | | | | | |
|---------------|----|----------------------|---------|-------------|--|--|------------|---|--|
| 6.0 S 600 | 12 | M 120.980, M 120.982 | 290/389 | 01/93→10/98 | Z100 →08/95 Z122 09/95→ | | 0.8 1.0 | UXT1 / UXT3 →08/95 UXT9 09/95→ | ZS298 [21][24][254] ZS299 [19][254] |
| 6.0 S 600 LPG | 12 | M 120.980, M 120.982 | 290/389 | 01/93→10/98 | Z206 | | 0.7 | UXT10 | |

S-CLASS (W220)

| | | | | | | | | | |
|-------------------------|----|----------------------|---------|-------------|--|---------------|------------|--|--------------|
| 2.8 S 280 | 6 | M 112.922 | 150/201 | 10/98→08/05 | Z122 →02/02 Z240 03/02→ | | 1.0 1.0 | UXT9 →02/02 UXT9 03/02→ | ZS297 |
| 2.8 S 280 LPG | 6 | M 112.922 | 150/201 | 10/98→08/05 | Z206 →02/02 | | 0.7 | UXT10 →02/02 | |
| 3.2 S 320 | 6 | M 112.944 | 165/221 | 10/98→08/05 | Z122 →02/02 Z240 03/02→ | | 1.0 1.0 | UXT9 →02/02 UXT9 03/02→ | ZS297 |
| 3.2 S 320 LPG | 6 | M 112.944 | 165/221 | 10/98→08/05 | Z206 →02/02 | | 0.7 | UXT10 →02/02 | |
| 3.2 S 320 CDI | 6 | OM 613.960 | 145/194 | 08/99→09/02 | GN003 | GSE141 | 11.5V | | |
| 3.2 S 320 CDI | 6 | OM 648.960 | 150/201 | 09/02→08/05 | GN003 | GSE141 | 11.5V | | |
| 3.7 S 350 | 6 | M 112.972, M 112.975 | 180/241 | 09/02→08/05 | Z240 | | 1.0 | UXT9 | ZS297 |
| 4.0 S 400 CDI | 8 | OM 628.960 | 184/247 | 06/00→08/05 | GN003 | | 11.5V | | |
| 4.0 S 400 CDI | 8 | OM 628.960 | 191/256 | 06/03→08/05 | GN003 | | 11.5V | | |
| 4.3 S 430 | 8 | M 113.941 | 205/275 | 10/98→08/05 | Z122 →02/02 Z240 03/02→ | | 1.0 1.0 | UXT9 →02/02 UXT9 03/02→ | ZS297 |
| 4.3 S 430 4WD | 8 | M 113.948 | 205/275 | 09/02→08/05 | Z240 | | 1.0 | UXT9 | ZS297 |
| 4.3 S 430 LPG | 8 | M 113.941 | 205/275 | 10/98→08/05 | Z206 →02/02 | | 0.7 | UXT10 →02/02 | |
| 5.0 S 500 | 8 | M 113.960, M 113.966 | 225/302 | 10/98→08/05 | Z122 →02/02 Z240 03/02→ | | 1.0 1.0 | UXT9 →02/02 UXT9 03/02→ | ZS297 |
| 5.0 S 500 4WD | 8 | M 113.966 | 225/302 | 09/02→08/05 | Z240 | | 1.0 | UXT9 | ZS297 |
| 5.0 S 500 LPG | 8 | M 113.960, M 113.966 | 225/302 | 10/98→08/05 | Z206 →02/02 | | 0.7 | UXT10 →02/02 | |
| 5.5 S 55 AMG | 8 | M 113.986 | 265/355 | 04/99→08/05 | Z122 →02/02 Z240 03/02→ | | 1.0 1.0 | UXT9 →02/02 UXT9 03/02→ | ZS297 |
| 5.5 S 55 AMG LPG | 8 | M 113.986 | 265/355 | 04/99→08/05 | Z206 →02/02 | | 0.7 | UXT10 →02/02 | |
| 5.5 S 55 AMG Kompressor | 8 | M 113.991 | 368/493 | 06/02→08/05 | Z226 | | 0.8 | | ZS297 |
| 5.5 S 600 | 12 | M 275.950 | 368/493 | 09/02→08/05 | Z312 | | 1.0 | UXT9 | |
| 5.8 S 600 | 12 | M 137.970 | 270/362 | 01/00→08/05 | Z171 | | 1.0 | UXT9 | |
| 5.8 S 600 LPG | 12 | M 137.970 | 270/362 | 01/00→08/05 | Z340 | | 0.7 | UXT12 | |
| 6.0 S 65 AMG | 12 | M 275.980 | 450/603 | 03/04→08/05 | Z312 | | 1.0 | UXT9 | |

S-CLASS (W221)

| | | | | | | | | | |
|---------------------------|---|------------------------|---------|--------|--------------|---------------|------|--|---------------|
| 3.0 S 280 | 6 | M 272.946 | 170/228 | 08/06→ | | | | | ZSE140 |
| 3.0 S 300 | 6 | M 272.946 | 170/228 | 08/06→ | | | | | ZSE140 |
| 3.0 S 320 CDI | 6 | OM 642.930, OM 642.932 | 155/208 | 10/05→ | GE105 | GSE114 | 4.4V | | |
| 3.0 S 320 CDI | 6 | OM 642.930, OM 642.932 | 173/232 | 12/05→ | GE105 | GSE114 | 4.4V | | |
| 3.0 S 350 BlueTec | 6 | OM 642.862, OM 642.868 | 190/255 | 04/11→ | | GSE116 | | | |
| 3.0 S 350 CDI | 6 | OM 642.930 | 173/232 | 06/09→ | GE105 | GSE114 | 4.4V | | |
| 3.5 S 350 | 6 | M 272.965, M 272.975 | 200/268 | 10/05→ | | | | | ZSE140 |
| 3.5 S 350 CGI | 6 | M 276.950 | 225/302 | 04/11→ | | | | | ZSE093 |
| 3.5 S 400 Hybrid | 6 | M 272.974 | 205/275 | 01/09→ | | | | | ZSE140 |
| 4.0 S 420 CDI / S 450 CDI | 8 | OM 629.911 | 235/315 | 10/06→ | GE105 | | 4.4V | | |



kW/BHP

**... MERCEDES-BENZ** **... S-CLASS (W221)**

| | | | | | | | |
|---------------|----|----------------------|---------|-------------|------|-----|-------------|
| 4.7 S 450 | 8 | M 273.922, M 273.924 | 250/335 | 12/05→ | Z359 | 0.8 | ZSE140 |
| 4.7 S 500 CGI | 8 | M 278.932 | 320/429 | 03/11→ | | | ZSE093 |
| 5.5 S 63 AMG | 8 | M 157.980 | 400/536 | 03/11→ | | | ZSE093 |
| 5.5 S 63 AMG | 8 | M 157.980 | 420/563 | 02/12→ | | | ZSE093 |
| 5.5 S 500 | 8 | M 273.961, M 273.968 | 285/382 | 10/05→ | Z359 | 0.8 | ZSE140 |
| 5.5 S 600 | 12 | M 275.953 | 380/510 | 12/05→ | Z312 | 1.0 | UXT9 |
| 6.0 S 65 AMG | 12 | M 275.982 | 450/603 | 12/05→ | Z312 | 1.0 | UXT9 |
| | | | | 07/06→08/10 | | | 07/06→08/10 |
| 6.0 S 65 AMG | 12 | M 275.982 | 463/621 | 04/11→ | Z312 | 1.0 | UXT9 |
| 6.2 S 63 AMG | 8 | M 156.984 | 386/518 | 10/06→ | Z355 | 1.0 | |

S-CLASS (W222)

| | | | | | | | |
|-----------------------|---|------------------------|---------|--------|--|--------|--------|
| 3.0 S 350 BlueTEC 4WD | 6 | OM 642.867 | 185/248 | 02/14→ | | GSE116 | |
| 3.0 S 350 BlueTEC | 6 | OM 642.861, OM 642.867 | 190/255 | 05/13→ | | GSE116 | |
| 3.5 S 400 Hybrid | 6 | M 276.960 | 225/302 | 05/13→ | | | ZSE093 |
| 4.7 S 500 | 8 | M 278.929 | 335/449 | 05/13→ | | | ZSE093 |
| 5.5 S 63 AMG | 8 | M 157.985 | 430/577 | 05/13→ | | | ZSE093 |

S-CLASS Coupe (C126)

| | | | | | | | |
|-------------|---|-----------|---------|-------------|-----|-----|-------------------------|
| 3.8 380 SEC | 8 | M 116.963 | 150/201 | 10/81→07/85 | Z62 | 0.8 | UXT2 / UXT6 ZS118 ZM004 |
| 4.1 420 SEC | 8 | M 116.965 | 150/201 | 10/85→06/91 | Z62 | 0.8 | UXT2 / UXT6 ZS298 |
| 4.1 420 SEC | 8 | M 116.965 | 160/215 | 10/85→12/87 | Z62 | 0.8 | UXT2 / UXT6 ZS298 |
| 4.1 420 SEC | 8 | M 116.965 | 165/221 | 10/85→06/91 | Z62 | 0.8 | UXT2 / UXT6 ZS298 |
| 4.9 500 SEC | 8 | M 117.965 | 164/220 | 10/85→06/91 | Z62 | 0.8 | UXT2 / UXT6 ZS298 |
| 4.9 500 SEC | 8 | M 117.963 | 170/228 | 10/81→08/85 | Z62 | 0.8 | UXT2 / UXT6 ZS118 ZM004 |
| 4.9 500 SEC | 8 | M 117.965 | 180/241 | 09/85→06/91 | Z62 | 0.8 | UXT2 / UXT6 ZS298 |
| 4.9 500 SEC | 8 | M 117.965 | 185/248 | 08/87→06/91 | Z62 | 0.8 | UXT2 / UXT6 ZS298 |
| 4.9 500 SEC | 8 | M 117.965 | 185/248 | 06/89→06/91 | Z62 | 0.8 | UXT2 / UXT6 ZS298 |
| 5.0 500 SEC | 8 | M 117.965 | 195/261 | 09/85→06/91 | Z62 | 0.8 | UXT2 / UXT6 ZS298 |
| 5.5 560 SEC | 8 | M 117.968 | 178/239 | 10/85→06/91 | Z62 | 0.8 | UXT2 / UXT6 ZS298 |
| 5.5 560 SEC | 8 | M 117.968 | 200/268 | 10/85→12/87 | Z62 | 0.8 | UXT2 / UXT6 ZS298 |
| 5.5 560 SEC | 8 | M 117.968 | 205/275 | 10/85→06/91 | Z62 | 0.8 | UXT2 / UXT6 ZS298 |
| 5.5 560 SEC | 8 | M 117.968 | 220/295 | 10/85→12/89 | Z62 | 0.8 | UXT2 / UXT6 ZS298 |

→08/87

S-CLASS Coupe (C140)

| | | | | | | | |
|--------------------|----|----------------------|---------|-------------|----------------------------------|------------|--|
| 4.2 SEC/CL 420 | 8 | M 119.971, M 119.981 | 205/275 | 10/94→02/99 | Z100 →08/95 Z122 09/95→ | 0.8 1.0 | UXT1 / UXT3 ZS299 →08/95 UXT9 09/95→ |
| 4.2 SEC/CL 420 LPG | 8 | M 119.971, M 119.981 | 205/275 | 10/94→02/99 | Z206 | 0.7 | UXT10 |
| 5.0 SEC/CL 500 | 8 | M 119.970 | 235/315 | 10/92→02/99 | Z100 →08/95 Z122 09/95→ | 0.8 1.0 | UXT1 / UXT3 ZS299 →08/95 UXT9 →ch. A 290166 09/95→ |
| 5.0 SEC/CL 500 LPG | 8 | M 119.970 | 235/315 | 10/92→02/99 | Z206 | 0.7 | UXT10 |
| 6.0 SEC/CL 600 | 12 | M 120.980, M 120.982 | 290/389 | 09/92→02/99 | Z100 →08/95 Z122 09/95→ | 0.8 1.0 | UXT1 / UXT3 ZS298 ^[21] →08/95 UXT9 →ch. A 290166 ZS299 ^[19] →09/95 →ch. A 290166 |
| 6.0 SEC/CL 600 LPG | 12 | M 120.980, M 120.982 | 290/389 | 09/92→02/99 | Z206 | 0.7 | UXT10 |

S-CLASS Coupe (C215)

| | | | | | | | |
|----------------|---|-----------|---------|-------------|----------------------------------|------------|----------------------------------|
| 5.0 CL 500 | 8 | M 113.960 | 225/302 | 03/99→03/06 | Z122 →02/02 Z240 03/02→ | 1.0 1.0 | UXT9 →02/02 UXT9 03/02→ |
| 5.0 CL 500 LPG | 8 | M 113.960 | 225/302 | 03/99→03/06 | Z206 →02/02 | 0.7 | UXT10 →02/02 |



kW/BHP

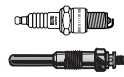

... MERCEDES-BENZ



... S-CLASS Coupe (C215)

| | | | | | | | | |
|--------------------------|----|-----------|---------|-------------|----------------------------------|--|-------|--|
| 5.4 CL 55 AMG | 8 | M 113.986 | 265/355 | 10/99→03/06 | Z122 →02/02 Z240 03/02→ | 1.0 UXT9 →02/02 1.0 UXT9 03/02→ | ZS297 | |
| 5.4 CL 55 AMG LPG | 8 | M 113.986 | 265/355 | 10/99→03/06 | Z206 →02/02 | 0.7 UXT10 →02/02 | | |
| 5.5 CL 55 AMG Kompressor | 8 | M 113.991 | 368/493 | 06/02→03/06 | Z226 | 0.8 | ZS297 | |
| 5.5 CL 600 | 12 | M 275.950 | 368/493 | 09/02→03/06 | Z312 | 1.0 | UXT9 | |
| 5.8 CL 600 | 12 | M 137.970 | 270/362 | 03/99→03/06 | Z171 | 1.0 | UXT9 | |
| 5.8 CL 600 LPG | 12 | M 137.970 | 270/362 | 03/99→03/06 | Z340 | 0.7 | UXT12 | |
| 6.0 CL 65 AMG | 12 | M 275.980 | 450/603 | 09/03→03/06 | Z312 | 1.0 | UXT9 | |

S-CLASS Coupe (C216)

| | | | | | | | | |
|---------------|----|----------------------|---------|--------|---------------------|-----|---------------------|--|
| 4.7 CL 500 | 8 | M 278.920 | 320/429 | 02/11→ | | | ZSE093 | |
| 5.5 CL 63 AMG | 8 | M 157.980 | 400/536 | 02/11→ | | | ZSE093 | |
| 5.5 CL 63 AMG | 8 | M 157.980 | 420/563 | 01/10→ | | | ZSE093 09/11→ | |
| 5.5 CL 500 | 8 | M 273.961, M 273.968 | 285/382 | 06/06→ | Z359 | 0.8 | ZSE140 | |
| 5.5 CL 600 | 12 | M 275.953 | 380/510 | 05/06→ | Z312 | 1.0 | UXT9 | |
| 6.0 CL 65 AMG | 12 | M 275.982 | 450/603 | 10/06→ | Z312 09/07→07/10 | 1.0 | UXT9 09/07→07/10 | |
| 6.2 CL 63 AMG | 8 | M 156.984 | 386/518 | 10/06→ | Z355 | 1.0 | | |

SL (R107)

| | | | | | | | | | |
|------------|---|------------------------------------|---------|-------------|-----------------------------|------------|-------------|--|-----------------|
| 2.7 280 SL | 6 | M 110.982, M 110.986, M 110.990 | 130/174 | 06/76→09/81 | Z62 | 0.8 | UXT2 / UXT6 | ZS400 ^[11] | ZM004 |
| 2.7 280 SL | 6 | M 110.982, M 110.986, M 110.990 | 136/182 | 08/74→07/85 | Z62 | 0.8 | UXT2 / UXT6 | ZS400 ^[11] | ZM004 |
| 2.9 300 SL | 6 | M 103.982 | 132/177 | 09/85→08/89 | Z7 | 0.8 | UXT4 | ZS106 ^{[11][15]} ZS109 ^{[11][15]} | |
| 2.9 300 SL | 6 | M 103.982 | 138/185 | 09/85→08/89 | Z7 | 0.8 | UXT4 | ZS106 ^{[11][15]} ZS109 ^{[11][15]} | |
| 3.5 350 SL | 8 | M 116.982, M 116.984 | 143/192 | 05/71→02/80 | Z62 | 0.8 | UXT2 / UXT6 | ZS400 ^[11] | |
| 3.8 380 SL | 8 | M 116.962 | 150/201 | 09/80→08/85 | Z62 | 0.8 | UXT2 / UXT6 | | ZM004 |
| 3.8 380 SL | 8 | M 116.960 | 160/215 | 09/80→08/81 | Z62 | 0.8 | UXT2 / UXT6 | ZS400 ^[11] | ZM004 |
| 4.1 420 SL | 8 | M 116.964 | 150/201 | 01/86→08/89 | Z62 | 0.8 | UXT2 / UXT6 | ZS299 | |
| 4.1 420 SL | 8 | M 116.964 | 160/215 | 01/86→08/89 | Z62 | 0.8 | UXT2 / UXT6 | ZS299 | |
| 4.5 450 SL | 8 | M 117.982, M 117.985 | 160/215 | 09/75→10/80 | Z62 Z70 ^[200] | 0.8 0.8 | UXT2 / UXT6 | ZS400 ^[11] | |
| 4.5 450 SL | 8 | M 117.982, M 117.985 | 165/221 | 10/72→10/80 | Z62 Z70 ^[200] | 0.8 0.8 | UXT2 / UXT6 | ZS400 ^[11] | |
| 4.9 500 SL | 8 | M 117.964 | 164/220 | 01/86→08/89 | Z62 | 0.8 | UXT2 / UXT6 | ZS299 | |
| 4.9 500 SL | 8 | M 117.960 | 170/228 | 05/80→12/85 | Z62 | 0.8 | UXT2 / UXT6 | ZS400 ^[11] →08/81 ZS118 09/81→ | ZM004 09/81→ |
| 4.9 500 SL | 8 | M 117.960 | 177/237 | 05/80→12/81 | Z62 | 0.8 | UXT2 / UXT6 | ZS400 ^[11] →08/81 ZS118 09/81→ | ZM004 09/81→ |
| 4.9 500 SL | 8 | M 117.960, M 117.964 | 180/241 | 01/86→08/89 | Z62 | 0.8 | UXT2 / UXT6 | ZS299 | ZM004 |

SL (R129)

| | | | | | | | | |
|-------------|---|----------------------|---------|-------------|----------------------------------|---|-------|-------|
| 2.8 280 | 6 | M 104.943 | 142/190 | 08/93→10/01 | Z100 →06/97 Z121 07/97→ | 0.8 UXT1 / UXT3 →06/97 1.0 UXT9 07/97→ | ZS340 | |
| 2.8 280 | 6 | M 112.923, M 112.925 | 150/201 | 05/98→10/01 | Z122 | 1.0 | UXT9 | ZS297 |
| 2.8 280 LPG | 6 | M 104.943 | 142/190 | 08/93→10/01 | Z206 | 0.7 | UXT10 | |
| 2.8 280 LPG | 6 | M 112.923, M 112.925 | 150/201 | 05/98→10/01 | Z206 | 0.7 | UXT10 | |
| 3.0 300 SL | 6 | M 103.984 | 140/188 | 03/89→08/93 | Z7 | 0.8 | UXT4 | |

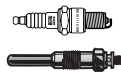

kW/BHP

**... MERCEDES-BENZ** **... SL (R129)**

| | | | | | | | | | |
|-----------------------|----|----------------------|---------|-------------|----------------------------------|------------|-------------------------------|--|--|
| 3.0 300 SL-24 | 6 | M 104.981 | 170/228 | 03/89→07/93 | Z100 | 0.8 | UXT1 / UXT3 | ZS299 | |
| 3.2 320 | 6 | M 112.943 | 165/221 | 05/98→10/01 | Z122 | 1.0 | UXT9 | ZS297 | |
| 3.2 320 | 6 | M 104.991 | 170/228 | 09/93→10/01 | Z100 →06/97 Z121 07/97→ | 0.8 1.0 | UXT1 / UXT3 UXT9 07/97→ | ZS340 | |
| 3.2 320 LPG | 6 | M 112.943 | 165/221 | 05/98→10/01 | Z206 | 0.7 | UXT10 | | |
| 3.2 320 LPG | 6 | M 104.991 | 170/228 | 09/93→10/01 | Z206 | 0.7 | UXT10 | | |
| 5.0 500 | 8 | M 113.961 | 225/302 | 05/98→10/01 | Z122 | 1.0 | UXT9 | ZS297 | |
| 5.0 500 | 8 | M 119.972, M 119.982 | 235/315 | 09/92→10/01 | Z100 →08/95 Z122 09/95→ | 0.8 1.0 | UXT1 / UXT3 UXT9 09/95→ | ZS298 ⁽¹⁹⁾ →09/95 ZS299 ⁽²¹⁾ →09/95 | |
| 5.0 500 LPG | 8 | M 113.961 | 225/302 | 05/98→10/01 | Z206 | 0.7 | UXT10 | | |
| 5.0 500 LPG | 8 | M 119.972, M 119.982 | 235/315 | 09/92→10/01 | Z206 | 0.7 | UXT10 | | |
| 5.0 500 SL | 8 | M 119.960, M 119.972 | 240/322 | 09/89→08/92 | Z100 | 0.8 | UXT1 / UXT3 | ZS296 ⁽¹⁹⁾ Z214 ⁽²⁵⁴⁾ ZS339 ⁽²¹⁾ Z214 ⁽²⁵⁴⁾ | |
| 5.5 55 AMG | 8 | M 113.985 | 260/349 | 03/00→10/01 | Z240 | 1.0 | UXT9 | | |
| 6.0 60 AMG | 8 | M 122.981 | 280/375 | 05/97→10/01 | Z100 | 0.8 | UXT1 / UXT3 | | |
| 6.0 60 AMG LPG | 8 | M 122.981 | 280/375 | 05/97→10/01 | Z206 | 0.7 | UXT10 | | |
| 6.0 600 | 12 | M 120.981, M 120.983 | 290/389 | 07/92→10/01 | Z100 →08/95 Z122 09/95→ | 0.8 1.0 | UXT1 / UXT3 UXT9 09/95→ | ZS298 ⁽¹⁹⁾ →09/95 ZS299 ⁽²¹⁾ →09/95 | |
| 6.0 600 LPG | 12 | M 120.981, M 120.983 | 290/389 | 07/92→10/01 | Z206 | 0.7 | UXT10 | | |
| 6.0 600 SL | 12 | M 120.980 | 300/402 | 02/92→08/94 | Z100 | 0.8 | UXT1 / UXT3 | | |
| 6.0 600 SL LPG | 12 | M 120.980 | 300/402 | 02/92→08/94 | Z206 | 0.7 | UXT10 | | |
| SL (R198) | | | | | | | | | |
| 3.0 300 SL | 6 | M 198.980 | 158/212 | 05/57→02/63 | Z38 | 0.4 | | | |
| SL (R230) | | | | | | | | | |
| 3.0 280 | 6 | M 272.949 | 170/228 | 03/08→01/12 | Z359 | 0.8 | | ZSE140 | |
| 3.0 300 | 6 | M 272.949 | 170/228 | 04/09→01/12 | Z359 | 0.8 | | ZSE140 | |
| 3.5 350 | 6 | M 272.966 | 200/268 | 03/06→01/12 | Z359 →12/07 | 0.8 | | ZSE140 | |
| 3.5 350 | 6 | M 272.968 | 232/311 | 04/08→01/12 | | | | ZSE140 | |
| 3.7 350 | 6 | M 112.973 | 180/241 | 03/03→01/12 | Z240 | 1.0 | UXT9 | ZS297 | |
| 5.0 500 | 8 | M 113.963 | 225/302 | 10/01→01/12 | Z240 | 1.0 | UXT9 | ZS297 | |
| 5.4 55 AMG | 8 | M 113.992 | 350/469 | 10/01→06/02 | Z226 | 0.8 | | ZS297 | |
| 5.4 55 AMG | 8 | M 113.995 | 380/510 | 03/06→01/12 | Z226 | 0.8 | | ZS297 | |
| 5.5 55 AMG Kompressor | 8 | M 113.992 | 368/493 | 06/02→01/12 | Z226 | 0.8 | | ZS297 | |
| 5.5 500 | 8 | M 273.965 | 285/382 | 03/06→01/12 | Z359 | 0.8 | | ZSE140 | |
| 5.5 600 | 12 | M 275.951 | 368/493 | 04/03→01/12 | Z312 →12/05 | 1.0 | UXT9 →12/05 | | |
| 5.5 600 | 12 | M 275.954 | 380/510 | 03/06→01/12 | Z312 | 1.0 | UXT9 | | |
| 6.0 65 AMG | 12 | M 275.981 | 450/603 | 03/04→01/12 | Z312 | 1.0 | UXT9 | | |
| 6.2 63 AMG | 8 | M 156.981 | 386/518 | 03/08→01/12 | Z355 | 1.0 | | | |
| SL (R231) | | | | | | | | | |
| 3.5 350 | 6 | M 276.954 | 225/302 | 02/12→ | | | | ZSE093 | |
| 4.7 500 | 8 | M 278.927 | 320/429 | 01/12→ | | | | ZSE093 | |
| 5.5 63 AMG | 8 | M 157.983 | 395/530 | 01/12→ | | | | ZSE093 | |
| 5.5 63 AMG | 8 | M 157.983 | 415/557 | 01/12→ | | | | ZSE093 02/12→ | |
| SL (W121) | | | | | | | | | |
| 1.9 190 SL | 4 | | 77/103 | 01/55→12/63 | Z22 | 0.7 | UX56 | ZS106 ⁽¹¹⁾ | |



kW/BHP

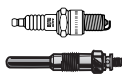

... MERCEDES-BENZ 

| ... MERCEDES-BENZ  | | | | | | | | | |
|---|---|---------------------------------|---------|-------------|--|------------|---------------------|--|-----------------|
| SL Coupe (C107) | | | | | | | | | |
| 2.7 280 SLC | 6 | M 110.982, M 110.986, M 110.990 | 130/174 | 06/76→09/81 | Z62 | 0.8 | UXT2 / UXT6 | ZS400 ^[11] | ZM004 09/81→ |
| 2.7 280 SLC | 6 | M 110.982, M 110.986, M 110.990 | 136/182 | 08/74→09/81 | Z62 | 0.8 | UXT2 / UXT6 | ZS400 ^[11] | ZM004 |
| 3.5 350 SLC | 8 | M 116.982, M 116.984 | 143/192 | 03/76→02/80 | Z62 | 0.8 | UXT2 / UXT6 | ZS400 ^[11] | |
| 3.5 350 SLC | 8 | M 116.982, M 116.984 | 147/197 | 01/72→02/76 | Z62 | 0.8 | UXT2 / UXT6 | ZS400 ^[11] | |
| 3.8 380 SLC | 8 | M 116.960 | 160/215 | 07/80→08/81 | Z62 | 0.8 | UXT2 / UXT6 | ZS400 ^[11] | |
| 4.5 450 SLC | 8 | M 117.982, M 117.985 | 160/215 | 09/75→08/79 | Z70 | 0.8 | UXT2 / UXT6 | ZS400 ^[11] | |
| 4.5 450 SLC | 8 | M 117.982, M 117.985 | 165/221 | 01/73→11/75 | Z22 | 0.7 | UX56 | ZS400 ^[11] | |
| 4.9 450 SLC 5.0 | 8 | M 117.960 | 177/237 | 06/78→02/80 | Z62 | 0.8 | UXT2 / UXT6 | ZS400 ^[11] | |
| SLK (R170) | | | | | | | | | |
| 2.0 200 | 4 | M 111.946 | 100/134 | 09/96→03/00 | Z100 →06/97 Z121 07/97→ | 0.8 1.0 | UXT1 / UXT3 UXT9 | ZS340 | |
| 2.0 200 LPG | 4 | M 111.946 | 100/134 | 09/96→03/00 | Z206 | 0.7 | UXT10 | | |
| 2.0 200 Kompressor | 4 | M 111.958 | 120/161 | 03/00→04/04 | Z170 | 1.0 | UXT9 | ZS041 | GS17 |
| 2.0 200 Kompressor | 4 | M 111.943 | 141/189 | 10/96→03/00 | Z120 | 1.0 | UXT9 | ZS340 | |
| 2.0 200 Kompressor LPG | 4 | M 111.958 | 120/161 | 03/00→04/04 | Z340 | 0.7 | UXT12 | | |
| 2.0 200 Kompressor LPG | 4 | M 111.943 | 141/189 | 10/96→03/00 | Z340 | 0.7 | UXT12 | | |
| 2.3 230 Kompressor | 4 | M 111.973 | 142/190 | 09/96→03/00 | Z120 | 1.0 | UXT9 | ZS340 | |
| 2.3 230 Kompressor | 4 | M 111.983 | 145/194 | 03/00→04/04 | Z170 | 1.0 | UXT9 | ZS041 | GS17 |
| 2.3 230 Kompressor LPG | 4 | M 111.973 | 142/190 | 09/96→03/00 | Z340 | 0.7 | UXT12 | | |
| 2.3 230 Kompressor LPG | 4 | M 111.983 | 145/194 | 03/00→04/04 | Z340 | 0.7 | UXT12 | | |
| 3.2 32 AMG Kompressor | 6 | M 112.960 | 260/349 | 03/01→04/04 | Z170 | 1.0 | UXT9 | ZS297 | |
| 3.2 32 AMG Kompressor LPG | 6 | M 112.960 | 260/349 | 03/01→04/04 | Z340 | 0.7 | UXT12 | | |
| 3.2 320 | 6 | M 112.947 | 160/215 | 03/00→04/04 | Z122 →02/02 Z240 03/02→ | 1.0 1.0 | UXT9 UXT9 | ZS297 | |
| 3.2 320 LPG | 6 | M 112.947 | 160/215 | 03/00→04/04 | Z206 →02/02 | 0.7 | UXT10 | | |
| SLK (R171) | | | | | | | | | |
| 1.8 200 Kompressor | 4 | M 271.944 | 120/161 | 03/04→02/11 | Z226 →eng. 30 853 899 Z359 eng. 30853900→ | 0.8 0.8 | | ZS053 →11/06 →eng. 3085 3899 ZS077 11/06→ eng. 3085 3900→ | |
| 1.8 200 Kompressor | 4 | M 271.954 | 135/181 | 01/08→02/11 | Z359 | 0.8 | | ZS077 eng. 308 539 00→ | |
| 3.0 280 | 6 | M 272.942 | 170/228 | 01/05→02/11 | Z359 | 0.8 | | ZSE140 | |
| 3.0 300 | 6 | M 272.942 | 170/228 | 04/09→02/11 | Z359 | 0.8 | | ZSE140 | |
| 3.5 350 | 6 | M 272.963 | 200/268 | 06/04→02/11 | | | | ZSE140 | |
| 3.5 350 | 6 | M 272.969 | 224/300 | 01/08→02/11 | Z359 | 0.8 | | ZSE140 | |
| 5.5 55 AMG | 8 | M 113.989 | 265/355 | 06/04→02/11 | Z170 | 1.0 | UXT9 | ZS297 | |
| 5.5 55 AMG | 8 | M 113.989 | 294/394 | 06/06→02/11 | | | | ZS297 | |
| 5.5 55 AMG LPG | 8 | M 113.989 | 265/355 | 06/04→02/11 | Z340 | 0.7 | UXT12 | | |
| SLK (R172) | | | | | | | | | |
| 1.8 200 | 4 | M 271.861 | 135/181 | 02/11→ | | | | ZS077 | GS21 |
| 1.8 250 | 4 | M 271.860, M 271.861 | 150/201 | 02/11→ | | | | ZS077 | |
| 3.5 350 | 6 | M 276.956 | 225/302 | 02/11→ | | | | ZSE093 | |
| 5.5 55 AMG | 8 | M 152.980 | 310/416 | 01/12→ | | | | ZSE093 | |
| SLR (R199) | | | | | | | | | |
| 5.4 | 8 | M 155.980 | 460/617 | 04/04→ | Z226 | 0.8 | | ZS297 | |
| 5.4 722 Edition | 8 | M 155.980 | 478/641 | 10/06→ | Z226 | 0.8 | | ZS297 | |

MERCEDÉS-BENZ

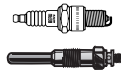

kW/BHP

**... MERCEDES-BENZ****SLR ROADSTER (R199)**

| | | | | | | | | |
|-----|---|-----------|---------|--------|------|--|-----|-------|
| 5.4 | 8 | M 155.980 | 460/617 | 04/07→ | Z226 | | 0.8 | ZS297 |
| 5.4 | 8 | M 155.980 | 478/641 | 10/06→ | Z226 | | 0.8 | ZS297 |

VANEO (414)

| | | | | | | | | |
|---------|---|------------|--------|-------------|-------|--------|-----|-------------|
| 1.4 | 4 | M 166.940 | 60/80 | 06/02→07/05 | Z121 | | 1.0 | UXT9 |
| 1.4 LPG | 4 | M 166.940 | 60/80 | 06/02→07/05 | Z206 | | 0.7 | UXT10 |
| 1.6 | 4 | M 166.961 | 60/80 | 02/02→07/05 | Z121 | | 1.0 | UXT9 ZSE146 |
| 1.6 | 4 | M 166.961 | 75/101 | 02/02→07/05 | Z121 | | 1.0 | UXT9 ZSE146 |
| 1.6 LPG | 4 | M 166.961 | 60/80 | 02/02→07/05 | Z206 | | 0.7 | UXT10 |
| 1.6 LPG | 4 | M 166.961 | 75/101 | 02/02→07/05 | Z206 | | 0.7 | UXT10 |
| 1.7 CDI | 4 | OM 668.914 | 55/74 | 02/02→07/05 | GN010 | GSE140 | 11V | |
| 1.7 CDI | 4 | OM 668.914 | 67/90 | 02/02→07/05 | GN010 | GSE140 | 11V | |
| 1.9 | 4 | M 166.991 | 92/123 | 02/02→07/05 | Z121 | | 1.0 | UXT9 ZSE146 |
| 1.9 LPG | 4 | M 166.991 | 92/123 | 02/02→07/05 | Z206 | | 0.7 | UXT10 |

V-CLASS (638/2)

| | | | | | | | | |
|---------------|---|----------------------|---------|-------------|-------|--------|-------|------------|
| 2.0 V 200 | 4 | M 111.948, M 111.950 | 95/127 | 02/97→07/03 | Z121 | | 1.0 | UXT9 ZS340 |
| 2.0 V 200 LPG | 4 | M 111.948, M 111.950 | 95/127 | 02/97→07/03 | Z206 | | 0.7 | UXT10 |
| 2.2 V 200 CDI | 4 | OM 611.980 | 75/101 | 03/99→07/03 | GN003 | GSE140 | 11.5V | |
| 2.2 V 220 CDI | 4 | OM 611.980 | 90/121 | 03/99→07/03 | GN003 | GSE140 | 11.5V | |
| 2.3 V 230 | 4 | M 111.978 | 105/141 | 10/96→07/03 | Z121 | | 1.0 | UXT9 ZS340 |
| 2.3 V 230 LPG | 4 | M 111.978 | 105/141 | 10/96→07/03 | Z206 | | 0.7 | UXT10 |
| 2.3 V 230 TD | 4 | OM 601.970 | 72/97 | 09/96→07/03 | GN858 | GR049 | 11.5V | |
| 2.8 V 280 | 6 | M 104.900 | 128/172 | 08/97→07/03 | Z173 | | 1.6 | ZSE004 |
| 2.8 V 280 LPG | 6 | M 104.900 | 128/172 | 08/97→07/03 | Z172 | | 1.6 | |

VIANO (W639)

| | | | | | | | | |
|---------|---|------------|---------|--------|-------|--------|-------|------------|
| 2.0 CDI | 4 | OM 646.982 | 80/107 | 09/03→ | GN003 | GSE140 | 11.5V | |
| 2.0 CDI | 4 | OM 646.982 | 85/114 | 08/05→ | GN003 | GSE140 | 11.5V | |
| 2.2 CDI | 4 | OM 646.982 | 110/148 | 09/03→ | GN003 | GSE140 | 11.5V | |
| 3.0 CDI | 6 | OM 642.990 | 150/201 | 03/06→ | GE105 | GSE114 | 4.4V | |
| 3.0 CDI | 6 | OM 642.990 | 165/221 | 07/10→ | GE105 | GSE114 | 4.4V | |
| 3.2 | 6 | M 112.951 | 160/215 | 09/03→ | Z240 | | 1.0 | UXT9 ZS297 |
| 3.2 3.0 | 6 | M 112.951 | 140/188 | 09/03→ | Z240 | | 1.0 | UXT9 ZS297 |
| 3.5 | 6 | M 272.978 | 190/255 | 09/07→ | | | | ZSE140 |
| 3.7 | 6 | M 112.976 | 170/228 | 06/04→ | Z240 | | 1.0 | UXT9 ZS297 |

MERCEDES-BENZ**100 Box (631)**

| | | | | | | | | |
|-------|---|------------|-------|-------------|--|-------|--|--|
| 2.4 D | 4 | OM 616.963 | 53/71 | 02/88→05/92 | | GR070 | | |
|-------|---|------------|-------|-------------|--|-------|--|--|

→01/89

100 Box/Bus (631)

| | | | | | | | | |
|-------|---|------------|-------|-------------|------------------------|--|-------|--|
| 2.0 D | 4 | OM 615.970 | 44/59 | 04/88→08/93 | GN858 | | 11.5V | |
| 2.0 D | 4 | OM 615.970 | 45/60 | 09/93→04/96 | GN858 | | 11.5V | |
| 2.4 D | 4 | OM 616.963 | 53/71 | 02/88→05/92 | GN909 ⁽²²²⁾ | | 11V | |
| | | | | | →01/89 | | | |
| | | | | | GV603 | | 11.5V | |
| | | | | | →01/89 | | | |
| | | | | | GN858 | | 11.5V | |
| | | | | | 02/89→ | | | |

100 Box/Bus/Platform/Chassis (631)

| | | | | | | | | |
|-------|---|------------|-------|-------------|-------|--|-------|--|
| 2.4 D | 4 | OM 616.963 | 55/74 | 12/90→02/96 | GN858 | | 11.5V | |
|-------|---|------------|-------|-------------|-------|--|-------|--|

100 Bus (631)

| | | | | | | | | |
|-------|---|------------|-------|-------------|-------|-------|-------|--|
| 2.0 D | 4 | OM 615.963 | 44/59 | 04/88→08/93 | GN858 | | 11.5V | |
| 2.4 D | 4 | OM 616 | 41/55 | 12/90→12/94 | GN858 | | 11.5V | |
| 2.4 D | 4 | OM 616.963 | 53/71 | 02/88→05/92 | | GR070 | | |

→08/89

| | | | | | | | | |
|-------|---|--------|-------|-------------|-------|--|-------|--|
| 2.4 D | 4 | OM 616 | 55/74 | 12/90→02/96 | GN858 | | 11.5V | |
|-------|---|--------|-------|-------------|-------|--|-------|--|

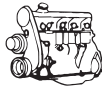

kW/BHP

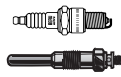
**... MERCEDES-BENZ****... SPRINTER 3,5-t Box/Bus/Platform/Chassis (906)**

| | | | | | | | | |
|-----------------------|---|------------------------|---------|--------|-------|--|-------|--------|
| 2.1 311 CDI | 4 | OM 646.985 | 80/107 | 06/06→ | GN003 | GSE140 | 11.5V | |
| 2.1 315 CDI | 4 | OM 646.989, OM 646.990 | 110/148 | 06/06→ | GN003 | GSE140 | 11.5V | |
| 3.0 318 CDI | 6 | OM 642.896 | 135/181 | 06/06→ | GE105 | GSE114 ^[135] GSE116 ^[134] | 4.4V | |
| 3.0 318 CDI | 6 | OM 642.992, OM 642.993 | 135/181 | 06/06→ | GE105 | GSE114 | 4.4V | |
| 3.0 319 CDI / BlueTEC | 6 | OM 642.896, OM 642.898 | 140/188 | 03/09→ | GE105 | GSE114 ^[135] GSE116 ^[134] | 4.4V | |
| 3.0 319 CDI / BlueTEC | 6 | OM 642.992 | 140/188 | 03/09→ | GE105 | GSE114 | 4.4V | |
| 3.5 324 | 6 | M 272.979 | 190/255 | 06/06→ | | | | ZSE140 |

SPRINTER 3,5-t Box/Platform/Chassis (906)

| | | | | | | | | |
|-------------|---|------------|--------|--------|-------|--------|-------|--|
| 2.1 309 CDI | 4 | OM 646.984 | 65/87 | 06/06→ | GN003 | GSE140 | 11.5V | |
| 2.1 313 CDI | 4 | OM 646.986 | 95/127 | 06/06→ | GN003 | GSE140 | 11.5V | |

SPRINTER 3,5-t Platform/Chassis (906)

| | | | | | | | | |
|---------|---|-----------|---------|--------|--|--|--|------|
| 1.8 316 | 4 | M 271.951 | 115/154 | 09/08→ | | | | GS21 |
|---------|---|-----------|---------|--------|--|--|--|------|

SPRINTER 3-t Box (903)

| | | | | | | | | |
|-------------------|---|------------|---------|-------------|-----------------------------|--|-------|-------------------|
| 2.3 314 | 4 | M 111.979 | 105/141 | 02/95→05/06 | Z101 | | 0.8 | UXT1 / UXT3 ZS340 |
| 2.3 314 LPG | 4 | M 111.979 | 105/141 | 02/95→05/06 | Z158 ^[168] | | 1.1 | |
| 2.9 310 D | 5 | OM 602.980 | 75/101 | 02/95→04/00 | GN961 | | 11V | |
| 2.9 312 D 2.9 4WD | 5 | OM 602.980 | 90/121 | 05/97→08/02 | GN909 ^{[222][251]} | | 11V | |
| | | | | | [253] →eng. 136/9849 | | 11.5V | |
| | | | | | GV603 ^{[251][253]} | | | |
| | | | | | →eng. 136/9849 | | 11V | |
| | | | | | GN961 ^{[251][253]} | | | |
| | | | | | →03/00 | | | |
| | | | | | eng. 137/9850→ | | | |

SPRINTER 3-t Box/Bus (903)

| | | | | | | | | |
|-------------------|---|------------|--------|-------------|--|--------|--|--|
| 2.9 312 D 2.9 4WD | 5 | OM 602.980 | 90/121 | 05/97→08/02 | | GSE141 | | |
|-------------------|---|------------|--------|-------------|--|--------|--|--|

SPRINTER 3-t Box/Bus/Platform/Chassis (903)

| | | | | | | | | |
|-------------|---|------------|---------|-------------|-----------------------------|--------|-------|-------------------|
| 2.1 308 CDI | 4 | OM 611.987 | 60/80 | 04/00→05/06 | GN003 | GSE140 | 11.5V | |
| 2.1 311 CDI | 4 | OM 611.981 | 80/107 | 04/00→05/06 | GN003 | GSE140 | 11.5V | |
| 2.1 313 CDI | 4 | OM 611.981 | 95/127 | 04/00→05/06 | GN003 | GSE140 | 11.5V | |
| 2.3 308 D | 4 | OM 601.943 | 58/78 | 02/95→04/00 | GN858 | GSE141 | 11.5V | |
| 2.3 308 D | 4 | OM 601.943 | 60/80 | 02/95→04/00 | GN858 | GSE141 | 11.5V | |
| 2.3 314 | 4 | M 111.984 | 105/141 | 02/95→05/06 | Z101 | | 0.8 | UXT1 / UXT3 ZS340 |
| 2.3 314 4WD | 4 | M 111.984 | 105/141 | 08/02→05/06 | Z121 | | 1.0 | UXT9 ZS340 |
| 2.3 314 LPG | 4 | M 111.984 | 105/141 | 02/95→05/06 | Z158 ^[168] | | 1.1 | |
| 2.7 316 CDI | 5 | OM 612.981 | 115/154 | 04/00→05/06 | GN003 | GSE141 | 11.5V | |
| 2.9 312 D | 5 | OM 602.980 | 90/121 | 02/95→04/00 | GN909 ^{[251][253]} | GSE141 | 11V | |
| | | | | | →eng. 136/9849 | | | |
| | | | | | GN961 ^{[251][253]} | | 11V | |
| | | | | | eng. 137/9850→ | | | |

SPRINTER 3-t Box/Platform/Chassis (903)

| | | | | | | | | |
|-------------|---|------------|--------|-------------|--|--------|--|-------|
| 2.3 314 NGT | 4 | | 92/123 | 04/00→05/06 | | | | ZS340 |
| 2.9 310 D | 5 | OM 602.980 | 75/101 | 02/95→04/00 | | GSE141 | | |

SPRINTER 3-t Bus (903)

| | | | | | | | | |
|-------------------|---|------------|--------|-------------|-----------------------------|--------|-----|------------|
| 2.3 314 NGT | 4 | M 111.984 | 92/123 | 04/00→05/06 | Z121 | | 1.0 | UXT9 ZS340 |
| 2.9 310 D 4WD | 5 | OM 602.980 | 75/101 | 05/97→08/02 | GN961 | GSE141 | 11V | |
| | | | | | →03/00 | | | |
| 2.9 312 D 2.9 4WD | 5 | OM 602.980 | 90/121 | 05/97→08/02 | GN909 ^{[251][253]} | | 11V | |
| | | | | | →eng. 000 136/009 849 | | | |
| | | | | | GN961 ^{[251][253]} | | 11V | |
| | | | | | eng. 000 137/009 850→ | | | |

MERCEDES-BENZ

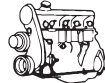

kW/BHP

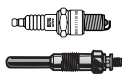
**... MERCEDES-BENZ****... SPRINTER 3-t Bus (903)**

| | | | | | | | | |
|---------|---|------------|--------|-------------|--|-----|--|--|
| 2.9 TDi | 5 | OM 602.980 | 75/101 | 01/97→12/99 | GN954 →eng. 000136;009849 GN961 eng. 000137;009850→ | 11V | | |
| | | | | | | 11V | | |

SPRINTER 3-t Platform/Chassis (903)

| | | | | | | | | |
|-----------|---|------------|--------|-------------|--|-----|--|--|
| 2.9 310 D | 5 | OM 602.980 | 75/101 | 01/97→04/00 | GN961 | 11V | | |
| 2.9 312 D | 5 | OM 602.980 | 85/114 | 12/98→09/01 | GN954 GSE141 →eng. 000136;009849 GN961 eng. 000137;009850→ | 11V | | |
| | | | | | | 11V | | |

SPRINTER 3-t Box (906)

| | | | | | | | | |
|-----------------------|---|------------------------|---------|--------|--------------|---------------|-------|--|
| 2.1 213 CDI | 4 | OM 651.955 | 95/127 | 06/06→ | GN003 | GSE140 | 11.5V | |
| 3.0 219 CDI / BlueTEC | 6 | OM 642.896, OM 642.992 | 140/188 | 03/09→ | GE105 | | 4.4V | |

SPRINTER 3-t Box/Bus/Platform/Chassis (906)

| | | | | | | | | |
|-------------|---|------------------------|---------|--------|--------------|---------------|-------|---------------|
| 2.1 211 CDI | 4 | OM 646.985 | 80/107 | 06/06→ | GN003 | GSE140 | 11.5V | |
| 2.1 215 CDI | 4 | OM 646.989, OM 646.990 | 110/148 | 06/06→ | GN003 | GSE140 | 11.5V | |
| 3.5 224 | 6 | M 272.979 | 190/255 | 06/06→ | | | | ZSE140 |

SPRINTER 3-t Box/Platform/Chassis (906)

| | | | | | | | | |
|-----------------------|---|------------|---------|--------|--------------|--|-------|--|
| 2.1 209 CDI | 4 | OM 646.984 | 65/87 | 06/06→ | GN003 | GSE140 | 11.5V | |
| 2.1 213 CDI | 4 | OM 646.986 | 95/127 | 06/06→ | GN003 | GSE140 | 11.5V | |
| 3.0 218 CDI | 6 | OM 642.896 | 135/181 | 06/06→ | GE105 | GSE114 ^[135] GSE116 ^[134] | 4.4V | |
| 3.0 218 CDI | 6 | OM 642.992 | 135/181 | 06/06→ | GE105 | GSE114 | 4.4V | |
| 3.0 219 CDI / BlueTEC | 6 | OM 642.896 | 140/188 | 03/09→ | | GSE114 ^[135] GSE116 ^[134] | | |
| 3.0 219 CDI / BlueTEC | 6 | OM 642.992 | 140/188 | 03/09→ | | GSE114 | | |

SPRINTER 3-t Bus (906)

| | | | | | | | | |
|-------------|---|------------|---------|--------|--------------|---------------|-------|--|
| 2.1 215 CDI | 4 | OM 646.986 | 110/148 | 06/06→ | GN003 | GSE140 | 11.5V | |
|-------------|---|------------|---------|--------|--------------|---------------|-------|--|

SPRINTER 3-t Platform/Chassis (906)

| | | | | | | | | |
|-----------------------|---|------------------------|---------|--------|------------------------|---------------|------|--------------|
| 1.8 216 | 4 | M 271.951 | 115/154 | 09/08→ | Z359 | | 0.8 | ZS077 |
| 3.0 218 CDI | 6 | OM 642.993 | 135/181 | 06/06→ | GE105 | GSE114 | 4.4V | |
| 3.0 219 CDI / BlueTEC | 6 | OM 642.896, OM 642.992 | 140/188 | 03/09→ | GE105 →08/13 | | 4.4V | |

SPRINTER 4,6-t Box (906)

| | | | | | | | | |
|-------------|---|------------|---------|--------|--------------|--|-------|--|
| 2.1 415 CDI | 4 | OM 646.989 | 110/148 | 06/09→ | GN003 | | 11.5V | |
|-------------|---|------------|---------|--------|--------------|--|-------|--|

SPRINTER 4,6-t Box/Platform/Chassis (906) 4,6-t

| | | | | | | | | |
|-------------|---|------------|---------|--------|--------------|--|-------|---------------|
| 2.1 411 CDI | 4 | OM 646.985 | 80/107 | 06/09→ | GN003 | GSE140 | 11.5V | |
| 2.1 413 CDI | 4 | OM 646.986 | 95/127 | 06/06→ | GN003 | GSE140 | 11.5V | |
| 2.1 415 CDI | 4 | OM 646.989 | 110/148 | 06/06→ | | GSE140 | | |
| 2.1 415 CDI | 4 | OM 646.990 | 110/148 | 06/06→ | GN003 | GSE140 | 11.5V | |
| 3.0 418 CDI | 6 | OM 642.896 | 135/181 | 06/06→ | GE105 | GSE114 ^[135] GSE116 ^[134] | 4.4V | |
| 3.0 418 CDI | 6 | OM 642.992 | 135/181 | 06/06→ | GE105 | GSE114 | 4.4V | |
| 3.0 419 CDI | 6 | OM 642.992 | 140/188 | 03/09→ | GE105 | GSE114 | 4.4V | |
| 3.5 424 | 6 | M 272.979 | 190/255 | 06/06→ | | | | ZSE140 |

SPRINTER 4,6-t Platform/Chassis (906)

| | | | | | | | | |
|-------------|---|------------------------|---------|--------|--------------|--|------|--|
| 3.0 418 CDI | 6 | OM 642.993 | 135/181 | 06/06→ | GE105 | GSE114 | 4.4V | |
| 3.0 419 CDI | 6 | OM 642.896, OM 642.898 | 140/188 | 03/09→ | GE105 | GSE114 ^[135] GSE116 ^[134] | 4.4V | |

SPRINTER 4-t Box (904)

| | | | | | | | | |
|-----------|---|------------|--------|-------------|--|-----|--|--|
| 2.9 412 D | 5 | OM 602.980 | 85/114 | 02/96→05/06 | GN909 ^{[251][253]} →03/00 →eng. 000136;009849 GN961 ^{[251][253]} →03/00 eng. 000137;009850→ | 11V | | |
| | | | | | | 11V | | |

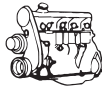

kW/BHP

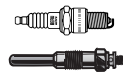
**... MERCEDES-BENZ****... SPRINTER 4-t Box (904)**

| | | | | | | | | | |
|-----------|---|------------|--------|-------------|---|--|-----|--|--|
| 2.9 412 D | 5 | OM 602.980 | 90/121 | 02/96→05/06 | GN909 <small>(251) [253]</small> →03/00 →eng. 000136; 009849 GN961 <small>(251) [253]</small> →03/00 eng. 137; 9850→ | | 11V | | |
| | | | | | | | 11V | | |

SPRINTER 4-t Box/Bus/Platform/Chassis (904)

| | | | | | | | | | |
|-------------|---|------------|---------|-------------|--|---------------|------------|---|--|
| 2.1 408 CDI | 4 | OM 611.987 | 60/80 | 04/00→05/06 | GN003 | GSE140 | 11.5V | | |
| 2.1 411 CDI | 4 | OM 611.981 | 80/107 | 04/00→05/06 | GN003 | GSE140 | 11.5V | | |
| 2.1 413 CDI | 4 | OM 611.981 | 95/127 | 04/00→05/06 | GN003 | GSE140 | 11.5V | | |
| 2.3 414 | 4 | M 111.979 | 105/141 | 02/96→05/06 | Z100 →06/97 Z121 07/97→ | | 0.8 1.0 | UXT1 / UXT3 ZS340 UXT9 07/97→ | |
| 2.3 414 LPG | 4 | M 111.979 | 105/141 | 02/96→05/06 | Z206 | | 0.7 | UXT10 | |
| 2.7 416 CDI | 5 | OM 612.981 | 115/154 | 04/00→05/06 | GN003 | GSE141 | 11.5V | | |

SPRINTER 4-t Box/Platform/Chassis (904)

| | | | | | | | | | |
|-----------------|---|------------|---------|-------------|---|---------------|-------|-------------------|--|
| 2.1 411 CDI 4WD | 4 | OM 611.981 | 80/107 | 04/00→05/06 | GN003 | GSE140 | 11.5V | | |
| 2.1 413 CDI 4WD | 4 | OM 611.981 | 95/127 | 04/00→05/06 | GN003 | GSE140 | 11.5V | | |
| 2.3 408 D | 4 | OM 601.943 | 58/78 | 02/96→05/06 | GN858 | | 11.5V | | |
| 2.3 414 4WD | 4 | M 111.979 | 105/141 | 05/97→05/06 | Z121 | | 1.0 | UXT9 ZS340 | |
| 2.3 414 4WD LPG | 4 | M 111.979 | 105/141 | 05/97→05/06 | Z206 | | 0.7 | UXT10 | |
| 2.7 416 CDI 4WD | 5 | OM 612.981 | 115/154 | 04/00→05/06 | GN003 | GSE141 | 11.5V | | |
| 2.9 410 D | 5 | OM 602.980 | 75/101 | 02/96→05/06 | GN909 <small>(251) [253]</small> →03/00 →eng. 000136; 009849 GN961 <small>(251) [253]</small> →03/00 eng. 000137; 0009850→ | GSE141 | 11V | | |
| 2.9 410 D 4WD | 5 | OM 602.980 | 75/101 | 05/97→05/06 | GN909 <small>(251) [253]</small> →03/00 →eng. 000136; 009849 GN961 <small>(251) [253]</small> →03/00 eng. 000137; 0009850→ | GSE141 | 11V | | |
| 2.9 412 D | 5 | OM 602.980 | 85/114 | 02/96→05/06 | | GSE141 | | | |
| 2.9 412 D 4WD | 5 | OM 602.980 | 85/114 | 05/97→05/06 | GN909 <small>(251) [253]</small> →03/00 →eng. 000136; 009849 GN961 <small>(251) [253]</small> →03/00 eng. 000137; 0009850→ | GSE141 | 11V | | |
| 2.9 412 D | 5 | OM 602.980 | 90/121 | 02/96→05/06 | | GSE141 | | | |

SPRINTER 4-t Platform/Chassis (904)

| | | | | | | | | | |
|-----------|---|------------|--------|-------------|---|--|-----|--|--|
| 2.9 412 D | 5 | OM 602.980 | 85/114 | 02/96→05/06 | GN909 <small>(251) [253]</small> →03/00 →eng. 000136; 009849 GN961 <small>(251) [253]</small> →03/00 eng. 000137; 0009850→ | | 11V | | |
| | | | | | | | 11V | | |
| 2.9 412 D | 5 | OM 602.980 | 90/121 | 02/96→05/06 | GN909 <small>(251) [253]</small> →03/00 →eng. 000136; 009849 GN961 <small>(251) [253]</small> →03/00 eng. 000137; 0009850→ | | 11V | | |
| | | | | | | | 11V | | |

SPRINTER 5-t Platform/Chassis (905)

| | | | | | | | | | |
|-------------|---|------------|---------|-------------|--------------|---------------|-------|--|--|
| 2.7 616 CDI | 5 | OM 612.981 | 115/154 | 04/01→05/06 | GN003 | GSE141 | 11.5V | | |
|-------------|---|------------|---------|-------------|--------------|---------------|-------|--|--|

MERCEDES-BENZ

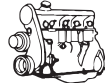

kW/BHP

**... MERCEDES-BENZ****SPRINTER 5-t Box (906)**

| | | | | | | | | | |
|-------------|---|------------|---------|--------|-------|--------|-------|--|--|
| 2.1 515 CDI | 4 | OM 646.986 | 110/148 | 06/06→ | GN003 | GSE140 | 11.5V | | |
|-------------|---|------------|---------|--------|-------|--------|-------|--|--|

SPRINTER 5-t Box/Platform/Chassis (906) 5-t

| | | | | | | | | | |
|-----------------------|---|------------------------|---------|--------|-------|------------------------------|-------|--|--------|
| 2.1 509 CDI | 4 | OM 646.984 | 65/87 | 06/06→ | GN003 | GSE140 | 11.5V | | |
| 2.1 511 CDI | 4 | OM 646.985 | 80/107 | 06/06→ | GN003 | GSE140 | 11.5V | | |
| 2.1 513 CDI | 4 | OM 646.986 | 95/127 | 06/06→ | GN003 | GSE140 | 11.5V | | |
| 2.1 515 CDI | 4 | OM 646.989, OM 646.990 | 110/148 | 06/06→ | GN003 | GSE140 | 11.5V | | |
| 3.0 518 CDI | 6 | OM 642.896 | 135/181 | 06/06→ | GE105 | GSE114 [135] GSE116 [134] | 4.4V | | |
| 3.0 518 CDI | 6 | OM 642.992, OM 642.993 | 135/181 | 06/06→ | GE105 | GSE114 | 4.4V | | |
| 3.0 519 CDI / BlueTEC | 6 | OM 642.896, OM 642.898 | 140/188 | 03/09→ | GE105 | GSE114 [135] GSE116 [134] | 4.4V | | |
| 3.0 519 CDI / BlueTEC | 6 | OM 642.992 | 140/188 | 03/09→ | GE105 | GSE114 | 4.4V | | |
| 3.5 524 | 6 | M 272.979 | 190/255 | 06/06→ | | | | | ZSE140 |

SPRINTER 5-t Platform/Chassis (906)

| | | | | | | | | | |
|-------------|---|-----------|---------|--------|----------------------------------|--|-----|--|------|
| 1.8 516 | 4 | M 271.951 | 115/154 | 09/08→ | Z226 →10/10 →eng. 30853899 | | 0.8 | ZS053 →10/10 →eng. 30853899 ZS077 11/10→ eng. 30853900→ | GS21 |
| 1.8 516 NGT | 4 | M 271.951 | 115/154 | 09/08→ | | | | ZS077 | |

SPRINTER Dumptruck (905)

| | | | | | | | | | |
|-------------|---|------------|---------|--------|-------|--------|-------|--|--|
| 2.7 616 CDI | 5 | OM 612.981 | 115/154 | 04/01→ | GN003 | GSE141 | 11.5V | | |
|-------------|---|------------|---------|--------|-------|--------|-------|--|--|

T1 Box (601)

| | | | | | | | | | |
|-------------|---|----------------------|--------|-------------|---|-----------------|----------------------|------|-----------------------|
| 2.3 210 | 4 | M 102.946 | 70/94 | 07/82→02/96 | Z7 | | 0.8 | UXT4 | ZS117 ZM004 |
| 2.3 210 | 4 | M 102.945 | 77/103 | 05/89→02/96 | | | | | ZS117 [254] →06/95 |
| 2.3 210 LPG | 4 | M 102.942, M 102.946 | 70/94 | 07/82→02/96 | Z17 [168] | | 0.8 | UXT4 | |
| 2.4 207 D | 4 | OM 616.937 | 53/71 | 06/82→01/90 | | GR069 →01/89 | | | |
| 2.4 207 D | 4 | OM 616.939 | 53/71 | 06/82→01/90 | GD382 →08/82 GN909 [222] 09/82→ GV603 09/82→ | GR069 →01/89 | 0.9V 11V 11.5V | | |

T1 Box/Bus (601)

| | | | | | | | | | |
|-------------|---|------------|--------|-------------|-----------|------------------------------------|-------|------|-----------------|
| 2.3 208 D | 4 | OM 601.940 | 60/80 | 10/88→02/96 | | GR069 →01/89 GR049 02/89→ | | | |
| 2.3 210 | 4 | M 102.945 | 77/103 | 05/89→02/96 | Z7 | | 0.8 | UXT4 | ZM004 →06/95 |
| 2.3 210 LPG | 4 | M 102.945 | 77/103 | 05/89→02/96 | Z17 [168] | | 0.8 | UXT4 | |
| 2.8 210 D | 5 | OM 602.940 | 70/94 | 10/88→02/96 | GN858 | GR049 | 11.5V | | |

T1 Box/Bus/Platform/Chassis (601)

| | | | | | | | | | |
|-----------|---|------------|-------|-------------|-------|------------------------------------|-------|------|----------------|
| 2.3 208 D | 4 | OM 601.940 | 58/78 | 10/88→02/96 | GN858 | GR069 →01/89 GR049 02/89→ | 11.5V | | |
| 2.3 208 D | 4 | OM 601.940 | 60/80 | 10/88→02/96 | GN858 | | 11.5V | | |
| 2.3 210 | 4 | M 102.942 | 70/94 | 04/77→02/96 | Z7 | | 0.8 | UXT4 | ZS117 ZM004 |
| 2.8 210 D | 5 | OM 602.940 | 72/97 | 10/88→02/96 | GN858 | GR049 | 11.5V | | |
| 2.9 209 D | 5 | OM 617.913 | 65/87 | 12/82→01/90 | | GR071 →01/89 | | | |

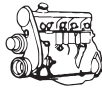

kW/BHP

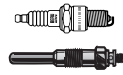
**... MERCEDES-BENZ****T1 Box/Platform/Chassis (601)**

| | | | | | | | | | |
|-----------|---|------------|-------|-------------|--|--|-------|--|--|
| 2.4 207 D | 4 | OM 616.937 | 53/71 | 12/77→01/90 | GD382 →08/82 GN909 [222] 09/82→ GV603 09/82→ | | 0.9V | | |
| | | | | | | | 11V | | |
| | | | | | | | 11.5V | | |
| 2.9 209 D | 5 | OM 617.913 | 65/87 | 12/82→01/90 | GN909 [2][222] GV603 | | 11V | | |
| | | | | | | | 11.5V | | |

T1 Bus (601)

| | | | | | | | | | |
|-----------|---|----------------------|--------|-------------|--|------------------------|-------|--------------------|------------------------|
| 2.3 208 | 4 | M 115.955, M 115.972 | 63/84 | 05/77→12/82 | Z11 | | 0.8 | UXT2 / UXT6 | ZS109 [15] |
| 2.3 210 | 4 | M 102.945 | 77/103 | 05/89→02/96 | | | | | ZS117 →06/95 |
| 2.4 207 D | 4 | OM 616.934 | 48/64 | 05/77→12/82 | GD382 →08/82 GN909 [222] 09/82→ GV603 09/82→ | | 0.9V | | |
| | | | | | | | 11V | | |
| | | | | | | | 11.5V | | |
| 2.4 207 D | 4 | | 53/71 | 07/82→01/90 | GN909 [222] →09/88 GV603 →09/88 | GR069 →01/89 | 11V | | |
| | | | | | | | 11.5V | | |
| 2.9 209 D | 5 | OM 617.913 | 65/87 | 12/82→01/90 | GN909 [222] →09/88 GV603 →09/88 | | 11V | | |
| | | | | | | | 11.5V | | |

T1 Bus/Platform/Chassis (601)

| | | | | | | | | | |
|-----------|---|------------|-------|-------------|--|--|-------|--|--|
| 2.4 207 D | 4 | OM 616.917 | 48/64 | 04/77→12/82 | GD382 →08/82 GN909 [222] 09/82→ GV603 09/82→ | | 0.9V | | |
| | | | | | | | 11V | | |
| | | | | | | | 11.5V | | |

T1 Platform/Chassis (601)

| | | | | | | | | | |
|-----------|---|------------|-------|-------------|--------------|--|-------|--------------------|----------------------|
| 2.3 208 D | 4 | OM 601.940 | 60/80 | 06/89→02/96 | | GR069 [32][132] GR073-B [32][133] | | | |
| 2.3 210 | 4 | M 115.955 | 63/84 | 04/77→10/89 | Z11 | | 0.8 | UXT2 / UXT6 | ZS109 [1][15] |
| 2.4 207 D | 4 | OM 616.937 | 53/71 | 12/77→10/89 | | GR069 09/82→ | | | |
| 2.9 210 D | 5 | OM 602.940 | 70/94 | 11/88→02/96 | GN858 | GR049 | 11.5V | | |

T1 Box/Bus (602)

| | | | | | | | | | |
|-----------|---|------------|-------|-------------|--|--------------|--|--|--|
| 2.9 310 D | 5 | OM 602.940 | 70/94 | 06/89→02/96 | | GR049 | | | |
| 2.9 310 D | 5 | OM 602.940 | 72/97 | 06/89→02/96 | | GR049 | | | |

T1 Box/Bus/Platform/Chassis (602)

| | | | | | | | | | |
|-----------|---|------------|-------|-------------|--------------|--------------|-------|--|--|
| 2.3 308 D | 4 | OM 601.940 | 58/78 | 11/88→02/96 | GN858 | GR049 | 11.5V | | |
| 2.3 308 D | 4 | OM 601.940 | 60/80 | 06/89→02/96 | GN858 | | 11.5V | | |
| 2.9 310 D | 5 | OM 602.940 | 70/94 | 06/89→02/96 | GN858 | | 11.5V | | |
| 2.9 310 D | 5 | OM 602.940 | 72/97 | 06/89→02/96 | GN858 | | 11.5V | | |

T1 Box/Platform/Chassis (602)

| | | | | | | | | | |
|-----------|---|------------------------|-------|-------------|---------------------------------------|------------------------|-------|--|--|
| 2.4 307 D | 4 | OM 616.937, OM 616.939 | 53/71 | 06/82→01/90 | GN909 [2][222] GV603 | GR069 →01/89 | 11V | | |
| | | | | | | | 11.5V | | |
| 3.0 309 D | 5 | OM 617.913 | 65/87 | 10/82→01/90 | GN909 [2][222] GV603 | GR071 →01/89 | 11V | | |
| | | | | | | | 11.5V | | |

T1 Bus/Platform/Chassis (602)

| | | | | | | | | | |
|-----------|---|------------|-------|-------------|--|--------------|--|--|--|
| 2.3 308 D | 4 | OM 601.940 | 60/80 | 06/89→02/96 | | GR049 | | | |
|-----------|---|------------|-------|-------------|--|--------------|--|--|--|

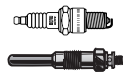

kW/BHP

**... MERCEDES-BENZ****T1 Platform/Chassis (602)**

| | | | | | | | | | |
|-----------|---|------------|-------|-------------|-----------------------|-------|------|--|--|
| 2.3 310 | 4 | M 102.942 | 70/94 | 01/82→12/94 | Z7 | 0.8 | UXT4 | | |
| 2.4 307 D | 4 | OM 616.917 | 48/64 | 01/77→12/90 | GD382 | 0.9V | | | |
| 2.4 307 D | 4 | OM 616.937 | 48/64 | 04/77→01/83 | GD382 | 0.9V | | | |
| | | | | | →08/82 GN909 [222] | 11V | | | |
| | | | | | 09/82→ GV603 | 11.5V | | | |
| | | | | | 09/82→ | | | | |

T1/TN Box Body / Estate/Platform/Chassis

| | | | | | | | | | |
|-----------|---|------------------------|--------|-------------|-------|-------|------|-------|-------|
| 2.3 408 D | 4 | OM 601.940 | 58/78 | 11/88→06/95 | GN858 | 11.5V | | | |
| 2.3 408 D | 4 | OM 601.940 | 60/80 | 11/88→06/95 | GN858 | 11.5V | | | |
| 2.3 410 | 4 | M 102.942 | 70/94 | 08/82→06/95 | Z7 | 0.8 | UXT4 | ZS117 | ZM004 |
| 2.3 410 | 4 | M 102.945 | 77/103 | 08/82→06/95 | Z7 | 0.8 | UXT4 | ZS117 | ZM004 |
| 2.4 407 D | 4 | OM 616.913, OM 616.939 | 53/71 | 07/81→01/89 | GV603 | 11.5V | | | |
| 2.8 410 D | 5 | OM 602.940 | 70/94 | 11/88→06/95 | GN858 | 11.5V | | | |
| 2.8 410 D | 5 | OM 602.940 | 72/97 | 11/88→06/95 | GN858 | 11.5V | | | |
| 2.9 409 D | 5 | OM 617.913 | 65/87 | 04/82→01/89 | GV603 | 11.5V | | | |

T2/L Box Body / Estate

| | | | | | | | | | |
|-------------|---|-----------|-------|-------------|-----|-----|-------------|--|-------|
| 2.0 L 408 G | 4 | M 115.11 | 55/74 | 01/68→12/72 | Z11 | 0.8 | UXT2 / UXT6 | | |
| 2.0 L 408 G | 4 | M 115.1 | 63/84 | 01/68→12/72 | Z11 | 0.8 | UXT2 / UXT6 | | |
| 2.3 L 410 | 4 | M 102.943 | 70/94 | 08/82→12/88 | | | | | ZM040 |

T2/L Box Body / Estate/Platform/Chassis

| | | | | | | | | | |
|--------------|---|------------|-------|-------------|-----------------|-------|-------------|------------|--|
| 2.2 L 405 D | 4 | OM 615 | 44/59 | 01/72→12/80 | GD382 | 0.9V | | | |
| 2.2 L 406 DG | 4 | OM 615.910 | 44/59 | 01/68→12/74 | GD382 | 0.9V | | | |
| 2.2 L 408 G | 4 | M 115.921 | 55/74 | 08/72→12/74 | Z42 | 0.8 | UX56 | | |
| 2.2 L 408 G | 4 | M 115.928 | 55/74 | 08/72→12/74 | Z11 | 0.8 | UXT2 / UXT6 | ZS106 [11] | |
| 2.2 L 408 G | 4 | M 115.921 | 63/84 | 08/72→12/74 | Z42 | 0.8 | UX56 | ZS106 [11] | |
| 2.2 L 408 G | 4 | M 115.928 | 63/84 | 08/72→12/74 | Z11 | 0.8 | UXT2 / UXT6 | | |
| 2.3 L 409 | 4 | M 115.952 | 66/89 | 01/75→08/82 | Z11 | 0.8 | UXT2 / UXT6 | | |
| 2.3 L 410 | 4 | M 102.943 | 70/94 | 08/82→12/88 | Z7 | 0.8 | UXT4 | ZS117 | |
| 2.4 L 407 D | 4 | OM 616.910 | 48/64 | 01/75→12/88 | GD382 | 0.9V | | | |
| | | | | | →08/82 GV603 | 11.5V | | | |
| | | | | | 09/82→ | | | | |
| 2.4 L 407 D | 4 | OM 616.910 | 53/71 | 01/75→12/88 | GD382 | 0.9V | | | |
| | | | | | →08/82 GV603 | 11.5V | | | |
| | | | | | 09/82→ | | | | |

T2/L Dumptruck

| | | | | | | | | | |
|----------------------|---|-----------|-------|-------------|-----|-----|-------------|--|--|
| 2.2 LK 408 G | 4 | M 115.921 | 63/84 | 01/68→12/74 | Z42 | 0.8 | UX56 | | |
| 2.3 LK 408 G, LK 409 | 4 | M 115.952 | 66/89 | 01/75→08/82 | Z11 | 0.8 | UXT2 / UXT6 | | |
| 2.3 LK 408 G, LK 409 | 4 | M 102.943 | 70/94 | 08/82→09/83 | Z7 | 0.8 | UXT4 | | |

T2/L Municipal Vehicle

| | | | | | | | | | |
|--------------|---|------------------------------------|-------|-------------|-----|-----|-------------|------------|--|
| 2.2 LF 408 G | 4 | M 115.927 | 55/74 | 08/72→12/74 | Z42 | 0.8 | UX56 | | |
| 2.2 LF 408 G | 4 | M 115.929 | 55/74 | 08/72→12/74 | Z11 | 0.8 | UXT2 / UXT6 | ZS106 [11] | |
| 2.2 LF 408 G | 4 | M 115.927 | 63/84 | 08/72→12/74 | Z42 | 0.8 | UX56 | ZS106 [11] | |
| 2.2 LF 408 G | 4 | M 115.929 | 63/84 | 08/72→12/74 | Z11 | 0.8 | UXT2 / UXT6 | | |
| 2.3 LF 409 G | 4 | M 115.952, M 115.970, M 115.971 | 66/89 | 01/75→08/82 | Z11 | 0.8 | UXT2 / UXT6 | | |

T2/L Platform/Chassis

| | | | | | | | | | |
|-----------|---|-----------|-------|-------------|--|--|--|--|-------|
| 2.3 L 410 | 4 | M 102.943 | 70/94 | 08/82→12/88 | | | | | ZM004 |
|-----------|---|-----------|-------|-------------|--|--|--|--|-------|

T2/LN1 Box Body / Estate/Dumptruck

| | | | | | | | | | |
|-----------|---|------------|-------|-------------|-------|-------|--|--|--|
| 2.3 508 D | 4 | OM 601.941 | 58/78 | 03/89→12/94 | GN858 | 11.5V | | | |
|-----------|---|------------|-------|-------------|-------|-------|--|--|--|

T2/LN1 Box Body / Estate/Platform/Chassis

| | | | | | | | | | |
|-----------|---|------------|--------|-------------|-------|-------|------|-------|-------|
| 2.3 510 | 4 | M 102.946 | 70/94 | 04/86→12/94 | Z7 | 0.8 | UXT4 | ZS117 | ZM004 |
| 2.3 510 | 4 | M 102.946 | 77/103 | 04/86→12/94 | Z7 | 0.8 | UXT4 | ZS117 | ZM004 |
| 2.4 507 D | 4 | OM 616.914 | 53/71 | 04/86→04/89 | GV603 | 11.5V | | | |

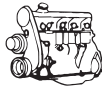

kW/BHP

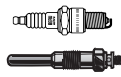
**... MERCEDES-BENZ****... T2/LN1 Box Body / Estate/Platform/Chassis**

| | | | | | | | | |
|----------------|---|------------------------|---------|-------------|-------|--|--|-------|
| 4.0 814 D | 4 | OM 364.981, OM 364.986 | 100/134 | 11/87→12/94 | GH011 | | | 11.5V |
| 4.0 814 DA 4WD | 4 | OM 364.987 | 100/134 | 11/87→12/94 | GH011 | | | 11.5V |

T2/LN1 Bus

| | | | | | | | | |
|-------------|---|------------------------|---------|-------------|-------|--|--|-------|
| 4.0 0 614 D | 4 | OM 364.980, OM 364.981 | 100/134 | 07/87→12/92 | GH011 | | | 11.5V |
|-------------|---|------------------------|---------|-------------|-------|--|--|-------|

T2/LN1 Dumptruck

| | | | | | | | | |
|------------|---|------------|-------|-------------|-------|--|--|-------|
| 2.4 507 DK | 4 | OM 616.914 | 53/71 | 04/86→04/89 | GV603 | | | 11.5V |
|------------|---|------------|-------|-------------|-------|--|--|-------|

UNIMOG

| | | | | | | | | |
|-------------|---|------------|--------|--|-------|--|--|-------|
| U 130,U 140 | 4 | OM 364.982 | 98/131 | | GH011 | | | 11.5V |
| U 140T | 4 | OM 364.982 | 98/131 | | GH011 | | | 11.5V |

VARIO Box Body / Estate/Dumptruck/Platform/Chassis

| | | | | | | | | |
|-----------|---|------------------------|--------|--------|-------|--|--|-----|
| 2.9 612 D | 5 | OM 602.984, OM 602.985 | 90/121 | 09/96→ | GN961 | | | 11V |
| 2.9 812 D | 5 | OM 602.984, OM 602.985 | 90/121 | 09/96→ | GN961 | | | 11V |

VARIO Box Body / Estate/Platform/Chassis

| | | | | | | | | |
|-----------|---|------------|--------|--------|-------|--|--|-----|
| 2.9 512 D | 5 | OM 602.984 | 90/121 | 09/96→ | GN961 | | | 11V |
|-----------|---|------------|--------|--------|-------|--|--|-----|

VARIO Bus

| | | | | | | | | |
|-----------|---|------------------------|--------|--------|-------|--|--|-----|
| 2.9 0 812 | 5 | OM 602.984, OM 602.985 | 90/121 | 09/96→ | GN961 | | | 11V |
|-----------|---|------------------------|--------|--------|-------|--|--|-----|

VITO Box (638)

| | | | | | | | | |
|-----------|---|------------|-------|-------------|-------|-------|--|-------|
| 2.3 110 D | 4 | OM 601.970 | 72/97 | 03/97→07/03 | GN858 | GR049 | | 11.5V |
|-----------|---|------------|-------|-------------|-------|-------|--|-------|

VITO Box/Bus (638)

| | | | | | | | | | |
|-------------|---|----------------------|---------|-------------|-------|--------|-----|-------|-------|
| 2.0 113 | 4 | M 111.948, M 111.950 | 95/127 | 02/96→07/03 | Z121 | | 1.0 | UXT9 | ZS340 |
| 2.0 113 LPG | 4 | M 111.948, M 111.950 | 95/127 | 02/96→07/03 | Z206 | | 0.7 | UXT10 | |
| 2.2 108 CDI | 4 | OM 611A (60 KW CDI) | 60/80 | 03/99→07/03 | GN003 | GSE140 | | 11.5V | |
| 2.2 110 CDI | 4 | OM 611LA (75 KW CDI) | 75/101 | 03/99→07/03 | GN003 | GSE140 | | 11.5V | |
| 2.2 112 CDI | 4 | OM 611.980 | 90/121 | 03/99→07/03 | GN003 | GSE140 | | 11.5V | |
| 2.3 108 D | 4 | OM 601.942 | 58/78 | 02/96→07/03 | GN858 | GR049 | | 11.5V | |
| 2.3 114 | 4 | M 111.978 | 105/141 | 12/96→07/03 | Z121 | | 1.0 | UXT9 | ZS340 |
| 2.3 114 LPG | 4 | M 111.978 | 105/141 | 12/96→07/03 | Z206 | | 0.7 | UXT10 | |

VITO Bus (638)

| | | | | | | | | | |
|------------|---|------------|-------|-------------|-------|-------|--|-------|--|
| 2.3 110 TD | 4 | OM 601.970 | 72/97 | 02/96→07/03 | GN858 | GR049 | | 11.5V | |
|------------|---|------------|-------|-------------|-------|-------|--|-------|--|

VITO Bus (W639)

| | | | | | | | | | |
|-------------|---|------------------------|---------|--------|-------|--------|-----|-------|--------|
| 2.2 109 CDI | 4 | OM 646.983 | 65/87 | 09/03→ | GN003 | GSE140 | | 11.5V | |
| 2.2 109 CDI | 4 | OM 646.980, OM 646.981 | 70/94 | 09/06→ | GN003 | GSE140 | | 11.5V | |
| 2.2 111 CDI | 4 | OM 646.982 | 80/107 | 09/03→ | GN003 | GSE140 | | 11.5V | |
| 2.2 111 CDI | 4 | OM 646.980 | 85/114 | 09/07→ | GN003 | GSE140 | | 11.5V | |
| 2.2 115 CDI | 4 | OM 646.982 | 110/148 | 09/03→ | GN003 | GSE140 | | 11.5V | |
| 3.0 119 | 6 | M 112.951 | 140/188 | 09/03→ | Z240 | | 1.0 | UXT9 | ZS297 |
| 3.0 120 CDI | 6 | OM 642.990 | 150/201 | 07/06→ | GE105 | GSE114 | | 4.4V | |
| 3.0 122 CDI | 6 | OM 642.890 | 165/221 | 09/10→ | | GSE116 | | | |
| 3.2 122 | 6 | M 112.951 | 160/215 | 09/03→ | Z240 | | 1.0 | UXT9 | ZS297 |
| 3.5 126 | 6 | M 272.978 | 190/255 | 09/07→ | | | | | ZSE140 |
| 3.7 123 | 6 | M 112.976 | 170/228 | 06/04→ | Z240 | | 1.0 | UXT9 | ZS297 |

VITO / MIXTO Box (W639)

| | | | | | | | | | |
|-------------|---|------------|---------|--------|-------|--------|-----|-------|--------|
| 2.2 109 CDI | 4 | OM 646.983 | 65/87 | 09/03→ | GN003 | GSE140 | | 11.5V | |
| 2.2 109 CDi | 4 | OM 646.981 | 70/94 | 08/06→ | GN003 | GSE140 | | 11.5V | |
| 2.2 111 CDI | 4 | OM 646.982 | 80/107 | 09/03→ | GN003 | GSE140 | | 11.5V | |
| 2.2 111 CDI | 4 | OM 646.982 | 85/114 | 09/07→ | GN003 | GSE140 | | 11.5V | |
| 2.2 115 CDI | 4 | OM 646.982 | 110/148 | 09/03→ | GN003 | GSE140 | | 11.5V | |
| 3.0 120 CDI | 6 | OM 642.990 | 150/201 | 07/06→ | GE105 | GSE114 | | 4.4V | |
| 3.0 122 CDI | 6 | OM 642.890 | 165/221 | 09/10→ | | GSE116 | | | |
| 3.2 119 | 6 | M 112.951 | 140/188 | 09/03→ | Z240 | | 1.0 | UXT9 | ZS297 |
| 3.2 122 | 6 | M 112.951 | 160/215 | 09/03→ | Z240 | | 1.0 | UXT9 | ZS297 |
| 3.5 126 | 6 | M 272.978 | 190/255 | 09/07→ | | | | | ZSE140 |

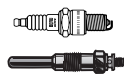

kW/BHP

**MG****MAESTRO**

| | | | | | | | | | |
|-----------|---|------|---------|-------------|--|--|--|--|--|
| 1.6 1600 | 4 | 16 H | 76/102 | 03/83→09/84 | | | | | ZS115 [1][11] ZS117 [1][254] ZS120 [1][214][254] |
| 2.0 EFI | 4 | | 86/115 | 10/84→09/90 | | | | | ZS115 [1][11] ZS117 [1][254] ZS120 [1][214][254] |
| 2.0 Turbo | 4 | | 112/150 | 10/88→09/90 | | | | | ZS115 [1][11] ZS117 [1][254] ZS120 [1][214][254] |

MAGNETTE

| | | | | | | | | | |
|-----|---|--|-------|-------------|--|--|--|--|------------|
| 1.6 | 4 | | 51/68 | 03/61→09/68 | | | | | ZS106 [11] |
|-----|---|--|-------|-------------|--|--|--|--|------------|

METRO

| | | | | | | | | | |
|-----------|---|--|-------|-------------|--|--|--|--|--|
| 1.3 1300 | 4 | | 54/72 | 05/82→09/90 | | | | | ZS109 [15] 10/84→ ch. XF400202→ →ch. XF944244 |
| 1.3 Turbo | 4 | | 69/93 | 10/82→09/90 | | | | | ZS115 [1][11] ZS117 [1][254] ZS120 [1][214][254] |

MGB

| | | | | | | | | | |
|-----|---|--|-------|-------------|-----|--|-----|-------------|----------------------|
| 1.8 | 4 | | 68/91 | 01/66→12/80 | Z11 | | 0.8 | UXT2 / UXT6 | ZS106 [11] →12/74 |
| 1.8 | 4 | | 70/94 | 01/66→12/80 | Z11 | | 0.8 | UXT2 / UXT6 | ZS106 [11] →12/74 |
| 1.8 | 4 | | 71/95 | 06/75→01/80 | | | | | ZS109 [15] →08/79 |

MGB GT

| | | | | | | | | | |
|-----|---|--|-------|-------------|-----|--|-----|-------------|----------------------|
| 1.8 | 4 | | 68/91 | 01/66→11/80 | Z11 | | 0.8 | UXT2 / UXT6 | ZS106 [11] →12/74 |
| 1.8 | 4 | | 70/94 | 01/66→11/80 | Z11 | | 0.8 | UXT2 / UXT6 | ZS106 [11] →12/74 |
| 1.8 | 4 | | 71/95 | 06/75→01/80 | | | | | ZS109 [15] →07/79 |

MGC

| | | | | | | | | | |
|-----|---|--|---------|-------------|--|--|--|--|------------|
| 3.0 | 6 | | 108/145 | 01/67→09/69 | | | | | ZS106 [11] |
|-----|---|--|---------|-------------|--|--|--|--|------------|

MGC GT

| | | | | | | | | | |
|-----|---|--|---------|-------------|--|--|--|--|------------|
| 3.0 | 6 | | 108/145 | 01/67→09/69 | | | | | ZS106 [11] |
|-----|---|--|---------|-------------|--|--|--|--|------------|

MGF

| | | | | | | | | | |
|-------------------|---|--------|---------|-------------|------------|--|-----|-------|----------------------------|
| 1.6 | 4 | 16 K4F | 82/110 | 02/00→03/02 | Z228 | | 1.0 | UXT11 | ZS501 |
| 1.6 LPG | 4 | 16 K4F | 82/110 | 02/00→03/02 | Z221 [168] | | 1.0 | UXT14 | |
| 1.8 1,8 i VVC | 4 | 18 K4K | 118/158 | 10/01→03/02 | Z228 | | 1.0 | UXT11 | ZS502 [16] |
| 1.8 1,8 i VVC LPG | 4 | 18 K4K | 118/158 | 10/01→03/02 | Z221 [168] | | 1.0 | UXT14 | |
| 1.8 i 16V | 4 | 18 K4F | 88/118 | 03/95→03/02 | Z228 | | 1.0 | UXT11 | ZS469 [149] ZS501 [252] |
| 1.8 i 16V LPG | 4 | 18 K4F | 88/118 | 03/95→03/02 | Z221 [168] | | 1.0 | UXT14 | |
| 1.8 i VVC | 4 | 18 K4K | 107/143 | 03/95→03/02 | Z228 | | 1.0 | UXT11 | ZS502 [16] |
| 1.8 i VVC LPG | 4 | 18 K4K | 107/143 | 03/95→03/02 | Z221 [168] | | 1.0 | UXT14 | |

MGR V8

| | | | | | | | | | |
|-----|---|--|---------|-------------|-----|--|-----|-------------|--|
| 3.9 | 8 | | 140/188 | 09/92→12/95 | Z20 | | 0.8 | UXT2 / UXT6 | ZS115 [1][11] ZS117 [1][254] ZS120 [1][214][254] |
|-----|---|--|---------|-------------|-----|--|-----|-------------|--|

| | | | | | | | | | |
|---------|---|--|---------|-------------|-----------|--|-----|------|--|
| 3.9 LPG | 8 | | 140/188 | 09/92→12/95 | Z27 [168] | | 0.8 | UX56 | |
|---------|---|--|---------|-------------|-----------|--|-----|------|--|

MG TF

| | | | | | | | | | |
|-------------|---|--------|--------|--------|------------|--|-----|-------|-------|
| 1.6 115 | 4 | 16 K4F | 85/114 | 03/02→ | Z228 | | 1.0 | UXT11 | ZS469 |
| 1.6 115 LPG | 4 | 16 K4F | 85/114 | 03/02→ | Z221 [168] | | 1.0 | UXT14 | |
| 1.8 120 | 4 | 18 K4F | 88/118 | 03/02→ | Z228 | | 1.0 | UXT11 | ZS501 |



kW/BHP



... MG



... MG TF

| | | | | | | | | |
|-------------|---|--------|---------|--------|------------|-----|-------|----------------------|
| 1.8 120 LPG | 4 | 18 K4F | 88/118 | 03/02→ | Z221 [168] | 1.0 | UXT14 | |
| 1.8 135 | 4 | 18 K4F | 100/134 | 03/02→ | Z228 | 1.0 | UXT11 | ZS469 →ch. 522572 |
| 1.8 135 LPG | 4 | 18 K4F | 100/134 | 03/02→ | Z221 [168] | 1.0 | UXT14 | |
| 1.8 160 | 4 | 18 K4K | 118/158 | 03/02→ | Z228 | 1.0 | UXT11 | ZS502 [16] |
| 1.8 160 LPG | 4 | 18 K4K | 118/158 | 03/02→ | Z221 [168] | 1.0 | UXT14 | |

MG ZR

| | | | | | | | | |
|-------------|---|--------|---------|-------------|------------|-----|-------|--|
| 1.4 105 | 4 | 14 K4F | 76/102 | 06/01→04/05 | Z228 | 1.0 | UXT11 | ZS469 →ch. 471564 ZS501 ch. 471656→ |
| 1.4 105 LPG | 4 | 14 K4F | 76/102 | 06/01→04/05 | Z221 [168] | 1.0 | UXT14 | |
| 1.8 120 | 4 | 18 K4F | 86/115 | 06/01→04/05 | Z228 | 1.0 | UXT11 | ZS501 |
| 1.8 120 LPG | 4 | 18 K4F | 86/115 | 06/01→04/05 | Z221 [168] | 1.0 | UXT14 | |
| 1.8 160 | 4 | 18 K4K | 118/158 | 06/01→04/05 | Z228 | 1.0 | UXT11 | ZS502 [16] |
| 1.8 160 LPG | 4 | 18 K4K | 118/158 | 06/01→04/05 | Z221 [168] | 1.0 | UXT14 | |
| 2.0 TD | 4 | 20 T2N | 74/99 | 06/01→04/05 | GN999 | 11V | | |
| 2.0 TD | 4 | 20 T2N | 83/111 | 12/02→04/05 | GN999 | 11V | | |

MG ZS

| | | | | | | | | |
|-------------|---|--------|---------|-------------|----------------|-----|-------|--|
| 1.6 | 4 | 16 K4F | 79/106 | 07/03→04/05 | Z228 | 1.0 | UXT11 | ZS501 |
| 1.6 | 4 | 16 K4F | 82/110 | 11/01→10/05 | Z312 03/05→ | 1.0 | UXT9 | |
| 1.6 LPG | 4 | 16 K4F | 79/106 | 07/03→04/05 | Z221 [168] | 1.0 | UXT14 | |
| 1.8 120 | 4 | 18 K4F | 86/115 | 07/01→10/05 | Z228 | 1.0 | UXT11 | |
| 1.8 120 | 4 | 18 K4F | 86/115 | 07/01→04/05 | | | | ZS501 |
| 1.8 120 LPG | 4 | 18 K4F | 86/115 | 07/01→10/05 | Z221 [168] | 1.0 | UXT14 | |
| 2.0 TD | 4 | 20 T2N | 74/99 | 01/04→10/05 | GN999 | 11V | | |
| 2.0 TD | 4 | 20 T2N | 83/111 | 01/04→10/05 | GN999 | 11V | | |
| 2.5 180 | 6 | 25 K4F | 130/174 | 07/01→10/05 | Z228 | 1.0 | UXT11 | ZS068 [1][201][256] [256] ZS302 [1][177] |

| | | | | | | | | |
|-------------|---|--------|---------|-------------|------------|-----|-------|--|
| 2.5 180 LPG | 6 | 25 K4F | 130/174 | 07/01→10/05 | Z221 [168] | 1.0 | UXT14 | |
|-------------|---|--------|---------|-------------|------------|-----|-------|--|

MG ZT

| | | | | | | | | |
|---------------|---|--------|---------|-------------|------------|-----|-------|--|
| 1.8 16V | 4 | 18 K4F | 88/118 | 01/03→07/05 | Z228 | 1.0 | UXT11 | ZS501 |
| 1.8 16V LPG | 4 | 18 K4F | 88/118 | 01/03→07/05 | Z221 [168] | 1.0 | UXT14 | |
| 1.8 T 16V | 4 | 18 K4G | 118/158 | 01/03→07/05 | Z228 | 1.0 | UXT11 | ZS501 |
| 1.8 T 16V LPG | 4 | 18 K4G | 118/158 | 01/03→07/05 | Z221 [168] | 1.0 | UXT14 | |
| 2.0 CDTi | 4 | 204D2 | 85/114 | 06/02→09/03 | GN024 | 11V | | |
| 2.0 CDTi | 4 | 204D2 | 96/129 | 11/02→07/05 | GN024 | 11V | | |
| 2.5 160 | 6 | 25 K4F | 118/158 | 06/01→07/05 | Z228 | 1.0 | UXT11 | ZS068 [1][201][256] ZS088 [1][201][256] |

| | | | | | | | | |
|-------------|---|--------|---------|-------------|------------|-----|-------|--|
| 2.5 160 LPG | 6 | 25 K4F | 118/158 | 06/01→07/05 | Z221 [168] | 1.0 | UXT14 | |
| 2.5 180 | 6 | 25 K4F | 130/174 | 01/03→07/05 | Z228 | 1.0 | UXT11 | ZS068 [1][201][256] ZS088 [1][201][256] |

| | | | | | | | | |
|-------------|---|--------|---------|-------------|------------|-----|-------|--|
| 2.5 180 LPG | 6 | 25 K4F | 130/174 | 01/03→07/05 | Z221 [168] | 1.0 | UXT14 | |
| 2.5 190 | 6 | 25 K4F | 140/188 | 06/01→07/05 | Z228 | 1.0 | UXT11 | ZS068 [1][201][256] ZS088 [1][201][256] |

| | | | | | | | | |
|-------------|---|--------|---------|-------------|------------|-----|-------|--|
| 2.5 190 LPG | 6 | 25 K4F | 140/188 | 06/01→07/05 | Z221 [168] | 1.0 | UXT14 | |
|-------------|---|--------|---------|-------------|------------|-----|-------|--|

MG ZT- T

| | | | | | | | | |
|---------------|---|--------|---------|-------------|------------|-----|-------|--|
| 1.8 16V | 4 | 18 K4F | 88/118 | 01/03→07/05 | Z228 | 1.0 | UXT11 | ZS501 |
| 1.8 16V LPG | 4 | 18 K4F | 88/118 | 01/03→07/05 | Z221 [168] | 1.0 | UXT14 | |
| 1.8 T 16V | 4 | 18 K4G | 118/158 | 01/03→07/05 | Z228 | 1.0 | UXT11 | ZS501 |
| 1.8 T 16V LPG | 4 | 18 K4G | 118/158 | 01/03→07/05 | Z221 [168] | 1.0 | UXT14 | |
| 2.0 CDTi | 4 | 204D2 | 85/114 | 06/02→09/03 | GN024 | 11V | | |
| 2.0 CDTi | 4 | 204D2 | 96/129 | 11/02→07/05 | GN024 | 11V | | |
| 2.5 160 | 6 | 25 K4F | 118/158 | 10/01→07/05 | Z228 | 1.0 | UXT11 | ZS068 [1][201][256] ZS088 [1][201][256] |

| | | | | | | | | |
|-------------|---|--------|---------|-------------|------------|-----|-------|--|
| 2.5 160 LPG | 6 | 25 K4F | 118/158 | 10/01→07/05 | Z221 [168] | 1.0 | UXT14 | |
|-------------|---|--------|---------|-------------|------------|-----|-------|--|



kW/BHP

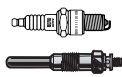

... MG



... MG ZT- T

| | | | | | | | | |
|-------------|---|--------|---------|-------------|------------|-----|-------|--|
| 2.5 180 | 6 | 25 K4F | 130/174 | 01/03→07/05 | Z228 | 1.0 | UXT11 | ZS068 [1][201][256] ZS088 [1][201][256] |
| 2.5 180 LPG | 6 | 25 K4F | 130/174 | 01/03→07/05 | Z221 [168] | 1.0 | UXT14 | |
| 2.5 190 | 6 | 25 K4F | 140/188 | 10/01→07/05 | Z228 | 1.0 | UXT11 | ZS068 [1][201][256] ZS088 [1][201][256] |
| 2.5 190 LPG | 6 | 25 K4F | 140/188 | 10/01→07/05 | Z221 [168] | 1.0 | UXT14 | |

MIDGET

| | | | | | | | | |
|-----|---|--|-------|-------------|-----|-----|-------------|------------|
| 1.1 | 4 | | 41/55 | 01/64→12/66 | | | | ZS106 [11] |
| 1.3 | 4 | | 48/64 | 01/67→09/74 | Z11 | 0.8 | UXT2 / UXT6 | ZS106 [11] |
| 1.5 | 4 | | 49/66 | 09/74→12/79 | Z1 | 0.7 | UXT2 / UXT6 | ZS109 [15] |

MONTEGO

| | | | | | | | | |
|-----------|---|-------|---------|-------------|--|--|--|--|
| 2.0 Efi | 4 | | 86/115 | 04/84→09/90 | | | | ZS115 [1][11] ZS117 [1][254] ZS120 [1][214][254] |
| 2.0 Turbo | 4 | 20 HT | 110/148 | 10/84→09/90 | | | | ZS115 [1][11] ZS117 [1][254] ZS120 [1][214][254] |

MG



EXPRESS

| | | | | | | | | |
|--------|---|--------|--------|-------------|-------|-----|--|-----------------------------|
| 1.4 | 4 | 14 K4F | 76/102 | 03/03→05/05 | | | | ZS469 [1][205] ZS501 [1] |
| 1.8 | 4 | 18 K4F | 86/115 | 03/03→05/05 | | | | ZS501 |
| 2.0 TD | 4 | 20 T2N | 74/99 | 03/03→05/05 | GN999 | 11V | | |

MINI



MINI

| | | | | | | | | |
|----------------|---|---------------|---------|-------------|----------------------------------|------|-------|------------------|
| 1.2 One | 3 | B38 A12 A | 55/74 | 06/14→ | | | | ZS538 |
| 1.2 One | 3 | B38 A12 A | 75/101 | 03/14→ | | | | ZS538 |
| 1.4 | 4 | | 55/74 | 04/03→09/06 | | | | ZS382 |
| 1.4 One | 4 | N12 B14 A | 55/74 | 03/09→ | Z233 →09/09 Z336 10/09→ | 1.0 | | ZSE143 →02/10 |
| 1.4 One | 4 | N12 B14 A | 70/94 | 03/07→ | Z233 →09/09 Z336 10/09→ | 1.0 | | ZSE143 →02/10 |
| 1.4 One D | 4 | 1ND | 55/74 | 06/03→09/06 | GN042 | 11V | | |
| 1.4 One D | 4 | 1ND-TV | 65/87 | 06/03→09/06 | GN042 | 11V | | |
| 1.5 Cooper | 3 | B38 A15 A | 100/134 | 12/13→ | | | | ZS538 |
| 1.6 Cooper | 4 | N16 B16 A | 85/114 | 03/10→ | | | | ZSE143 |
| 1.6 Cooper | 4 | W10 B16 A | 85/114 | 06/01→09/06 | Z237 | 1.6 | | ZS382 |
| 1.6 Cooper | 4 | W10 B16 A | 85/114 | 07/04→11/07 | Z237 | 1.6 | | ZS382 |
| 1.6 Cooper | 4 | N12 B16 A | 88/118 | 10/06→ | Z233 →09/09 Z336 10/09→ | 1.0 | | ZSE143 →08/10 |
| 1.6 Cooper | 4 | N12 B16 A | 88/118 | 03/09→ | | | | ZSE143 →06/10 |
| 1.6 Cooper | 4 | N16 B16 A | 90/121 | 03/10→ | Z336 | 1.0 | | ZSE143 |
| 1.6 Cooper LPG | 4 | W10 B16 A | 85/114 | 07/04→11/07 | Z340 | 0.7 | UXT12 | |
| 1.6 Cooper D | 4 | 9HZ (DV6TED4) | 80/107 | 03/07→ | GN056 | 11V | | |
| 1.6 Cooper D | 4 | N47 C16 A | 82/110 | 06/10→ | GE118 | 4.4V | | |
| 1.6 Cooper S | 4 | N18 B16 A | 120/161 | 03/10→ | Z332 | 0.7 | | |
| 1.6 Cooper S | 4 | W11 B16 A | 120/161 | 03/02→09/06 | Z237 | 1.6 | | ZS382 |
| 1.6 Cooper S | 4 | W11 B16 A | 125/168 | 07/04→11/07 | Z237 | 1.6 | | ZS382 |

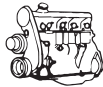

kw/BHP

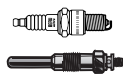

... MINI



... MINI

| | | | | | | | |
|------------------------|---|----------------------|---------|-------------|----------------------------------|----------------|----------------------|
| 1.6 Cooper S | 4 | N14 B16 A | 128/172 | 10/06→ | Z322 →07/10 Z332 08/10→ | 0.9 0.7 | ZSE143 |
| 1.6 Cooper S | 4 | N14 B16 A | 128/172 | 03/09→ | Z332 ^[268] | 0.7 | |
| 1.6 Cooper S | 4 | N18 B16 A | 135/181 | 03/10→ | Z332 ^[268] | 0.7 | ZSE143 |
| 1.6 Cooper S | 4 | N18 B16 A | 135/181 | 02/12→ | Z332 | 0.7 | |
| 1.6 Cooper S | 4 | N18 B16 A | 147/197 | 03/10→ | Z332 | 0.7 | |
| 1.6 Cooper S LPG | 4 | W11 B16 A | 120/161 | 03/02→09/06 | Z340 | 0.7 | UXT12 |
| 1.6 Cooper S LPG | 4 | W11 B16 A | 125/168 | 07/04→11/07 | Z340 | 0.7 | UXT12 |
| 1.6 John Cooper Works | 4 | N14 B16 C | 155/208 | 03/08→ | | | ZSE143 |
| 1.6 John Cooper Works | 4 | W11 B16 A | 155/208 | 07/04→11/07 | | | ZS382 |
| 1.6 One | 4 | N16 B16 A | 55/74 | 03/10→ | Z336 | 1.0 | ZSE143 |
| 1.6 One | 4 | W10 B16 A | 66/89 | 06/01→11/07 | Z237 | 1.6 | ZS382 |
| 1.6 One | 4 | N16 B16 A | 72/97 | 03/10→ | Z336 | 1.0 | ZSE143 |
| 1.6 One LPG | 4 | W10 B16 A | 66/89 | 06/01→11/07 | Z340 | 0.7 | UXT12 |
| 1.6 One D | 4 | 9HZ (DV6TED4) | 66/89 | 06/09→07/10 | GN056 | 11V | |
| 1.6 One D | 4 | N47 C16 A | 66/89 | 07/10→ | GE118 | 4.4V | |
| 1.6 S Works | 4 | W11 B16 A | 147/197 | 11/03→06/05 | | | ZS382 |
| 1.6 Works | 4 | W11 B16 A | 155/208 | 11/03→09/06 | | | ZS382 |
| 2.0 Cooper D | 4 | N47 C20 A | 82/110 | 02/11→ | GE118 ^[267] | 4.4V | |
| 2.0 Cooper S | 4 | B48 A20 A | 141/189 | 12/13→ | | | ZS538 |
| 2.0 Cooper SD | 4 | N47 C20 A | 100/134 | 02/11→ | GE118 | 4.4V | |
| 2.0 Cooper SD | 4 | N47 C20 A | 105/141 | 02/11→ | GE118 ^[267] | 4.4V | |
| 2.0 Cooper SD | 4 | N47 C20 A | 105/141 | 09/11→ | GE118 | 4.4V | |
| MINI CLUBMAN | | | | | | | |
| 1.4 One | 4 | N12 B14 A | 70/94 | 03/09→02/10 | Z336 | 1.0 | ZSE143 |
| 1.6 Cooper | 4 | N16 B16 A | 85/114 | 03/10→ | | | ZSE143 |
| 1.6 Cooper | 4 | N12 B16 A, N16 B16 A | 88/118 | 10/07→ | Z233 →09/09 Z336 10/09→ | 1.0 1.0 | ZSE143 →07/10 |
| 1.6 Cooper | 4 | N16 B16 A | 90/121 | 03/10→ | Z336 | 1.0 | ZSE143 |
| 1.6 Cooper D | 4 | 9HZ (DV6TED4) | 80/107 | 10/07→ | GN056 | 11V | |
| 1.6 Cooper D | 4 | N47 C16 A | 82/110 | 03/10→ | GE118 | 4.4V | |
| 1.6 Cooper S | 4 | N14 B16 A | 120/161 | 10/07→ | Z332 ^[268] | 0.7 | ZSE143 |
| 1.6 Cooper S | 4 | N14 B16 A | 128/172 | 10/07→ | Z332 ^[268] | 0.7 | ZSE143 |
| 1.6 Cooper S | 4 | N18 B16 A | 135/181 | 03/10→ | Z332 ^[268] | 0.7 | |
| 1.6 Cooper S | 4 | N18 B16 A | 147/197 | 03/10→ | Z332 | 0.7 | |
| 1.6 John Cooper Works | 4 | N14 B16 C | 155/208 | 03/08→ | | | ZSE143 |
| 1.6 One | 4 | N16 B16 A | 72/97 | 03/10→ | Z336 | 1.0 | ZSE143 |
| 1.6 One D | 4 | N47 C16 A | 66/89 | 03/10→ | GE118 | 4.4V | |
| 2.0 Cooper D | 4 | N47 C20 A | 82/110 | 02/11→ | GE118 | 4.4V | |
| 2.0 Cooper SD | 4 | N47 C20 A | 100/134 | 02/11→ | GE118 | 4.4V | |
| 2.0 Cooper SD | 4 | N47 C20 A | 105/141 | 02/11→ | GE118 | 4.4V | |
| MINI COUNTRYMAN | | | | | | | |
| 1.6 Cooper | 4 | N16 B16 A | 85/114 | 06/10→ | | | ZSE143 |
| 1.6 Cooper | 4 | N16 B16 A | 90/121 | 06/10→ | Z336 | 1.0 | ZSE143 09/10→ |
| 1.6 Cooper D | 4 | N47 C16 A | 82/110 | 06/10→ | GE118 | 4.4V | |
| 1.6 Cooper S | 4 | N18 B16 A | 135/181 | 06/10→ | Z332 ^[268] | 0.7 | ZSE143 |
| 1.6 Cooper S | 4 | N18 B16 A | 147/197 | 02/12→ | Z332 | 0.7 | |
| 1.6 One | 4 | N16 B16 A | 72/97 | 06/10→ | Z336 | 1.0 | ZSE143 |
| 1.6 One D | 4 | N47 C16 A | 66/89 | 06/10→ | GE118 | 4.4V | |
| 2.0 Cooper D | 4 | N47 C20 A | 82/110 | 02/11→ | GE118 | 4.4V | |
| 2.0 Cooper SD 4WD | 4 | N47 C20 A | 100/134 | 02/11→ | GE118 | 4.4V | |
| 2.0 Cooper SD | 4 | N47 C20 A | 105/141 | 02/11→ | GE118 | 4.4V | |

MINI



kW/BHP



... MINI



MINI PACEMAN

| | | | | | | | | |
|---------------|---|-----------|---------|--------|-------|------|--|--|
| 1.6 Cooper D | 4 | N47 C16 A | 82/110 | 09/12→ | GE118 | 4.4V | | |
| 2.0 Cooper SD | 4 | N47 C20 A | 105/141 | 10/12→ | GE118 | 4.4V | | |

MINI



MINI CLUBVAN

| | | | | | | | | |
|--------------|---|-----------|--------|--------|-------|------|--|--|
| 1.6 Cooper D | 4 | N47 C16 A | 82/110 | 12/12→ | GE118 | 4.4V | | |
|--------------|---|-----------|--------|--------|-------|------|--|--|

MITSUBISHI



CARISMA

| | | | | | | | | |
|-----------------|---|------------|---------|-------------|-------|-----|-------|--|
| 1.6 | 4 | 4G92 | 66/89 | 07/95→06/06 | Z16 | 1.1 | UXT11 | |
| 1.6 | 4 | 4G92 | 70/94 | 12/98→06/06 | Z16 | 1.1 | UXT11 | |
| 1.6 | 4 | 4G92 | 73/98 | 05/97→06/06 | Z16 | 1.1 | UXT11 | |
| 1.6 | 4 | 4G92 | 76/102 | 09/00→06/06 | Z16 | 1.1 | UXT11 | |
| 1.6 LPG | 4 | 4G92 | 66/89 | 07/95→06/06 | Z340 | 0.7 | UXT12 | |
| 1.6 LPG | 4 | 4G92 | 70/94 | 12/98→06/06 | Z340 | 0.7 | UXT12 | |
| 1.6 LPG | 4 | 4G92 | 73/98 | 05/97→06/06 | Z340 | 0.7 | UXT12 | |
| 1.6 LPG | 4 | 4G92 | 76/102 | 09/00→06/06 | Z340 | 0.7 | UXT12 | |
| 1.8 | 4 | 4G93 | 85/114 | 07/95→06/06 | Z16 | 1.1 | UXT11 | |
| 1.8 LPG | 4 | 4G93 | 85/114 | 07/95→06/06 | Z340 | 0.7 | UXT12 | |
| 1.8 16V | 4 | 4G93 | 103/138 | 07/95→06/06 | Z16 | 1.1 | UXT11 | |
| 1.8 16V LPG | 4 | 4G93 | 103/138 | 07/95→06/06 | Z340 | 0.7 | UXT12 | |
| 1.8 16V GDI | 4 | 4G93 (GDI) | 92/123 | 09/97→06/06 | Z279 | 0.6 | | |
| 1.8 16V GDI LPG | 4 | 4G93 (GDI) | 92/123 | 09/97→06/06 | Z116 | 0.8 | UXT5 | |
| 1.8 GDI | 4 | 4G93 (GDI) | 90/121 | 10/00→06/06 | Z279 | 0.6 | | |
| 1.8 GDI LPG | 4 | 4G93 (GDI) | 90/121 | 10/00→06/06 | Z116 | 0.8 | UXT5 | |
| 1.9 DI-D | 4 | F9Q1 | 75/101 | 09/00→06/06 | GN018 | 11V | | |
| 1.9 DI-D | 4 | F9Q2 | 85/114 | 09/00→06/06 | GN018 | 11V | | |
| 1.9 TD | 4 | F8QT | 66/89 | 10/96→09/00 | GN959 | 11V | | |

CELESTE

| | | | | | | | | |
|---------|---|------|--------|-------------|-----|-----|-------------|------------|
| 1.6 ST | 4 | 4G32 | 54/72 | 01/77→06/81 | Z11 | 0.8 | UXT2 / UXT6 | ZS106 [11] |
| 2.0 GSR | 4 | 4G52 | 66/89 | 10/75→06/81 | Z11 | 0.8 | UXT2 / UXT6 | ZS110 [15] |
| 2.0 GSR | 4 | 4G52 | 71/95 | 01/77→06/81 | Z11 | 0.8 | UXT2 / UXT6 | ZS110 [15] |
| 2.0 GSR | 4 | 4G52 | 77/103 | 01/79→06/81 | Z11 | 0.8 | UXT2 / UXT6 | ZS110 [15] |

COLT I

| | | | | | | | | |
|------------|---|--------|--------|-------------|-----|-----|-------------|------------|
| 1.2 GL | 4 | 4G11 | 40/54 | 12/78→01/84 | Z8 | 0.8 | UXT2 / UXT6 | ZS106 [11] |
| 1.4 GLX,GT | 4 | 4G12 | 51/68 | 05/79→01/84 | Z8 | 0.8 | UXT2 / UXT6 | ZS106 [11] |
| 1.4 Turbo | 4 | 4G12 T | 77/103 | 09/81→01/84 | Z20 | 0.8 | UXT2 / UXT6 | ZS106 [11] |

COLT II

| | | | | | | | | |
|---------------|---|----------|--------|-------------|-----------|------|-------------|-------------------------------|
| 1.2 EL,GL | 4 | 4G16 | 40/54 | 02/84→09/86 | Z20 | 0.8 | UXT2 / UXT6 | ZS106 [11] |
| 1.2 EL,GL | 4 | 4G16 | 44/59 | 09/86→04/88 | Z20 | 0.8 | UXT2 / UXT6 | ZS106 [11] |
| 1.5 GLX | 4 | G15B | 51/68 | 09/85→04/88 | Z9 | 1.15 | UXT2 / UXT6 | ZS106 [11] |
| 1.5 GLX | 4 | 4G15 | 55/74 | 09/84→04/88 | Z9 | 1.15 | UXT2 / UXT6 | ZS106 [11] |
| 1.5 GLX LPG | 4 | G15B | 51/68 | 09/85→04/88 | Z20 [168] | 0.8 | UXT2 / UXT6 | |
| 1.5 GLX LPG | 4 | 4G15 | 55/74 | 09/84→04/88 | Z20 [168] | 0.8 | UXT2 / UXT6 | |
| 1.6 Turbo ECi | 4 | G32BT | 77/103 | 07/86→04/88 | Z47 [172] | 0.8 | UX56 | |
| 1.6 Turbo ECi | 4 | 4G32 T/C | 92/123 | 02/84→04/88 | Z11 | 0.8 | UXT2 / UXT6 | ZS106 [11][254] ZS115 [11] |
| 1.8 GL Diesel | 4 | 4D65 | 43/58 | 02/84→09/86 | GV673 | 12V | | |
| 1.8 GL Diesel | 4 | 4D65 | 44/59 | 09/86→04/88 | GV673 | 12V | | |

COLT III

| | | | | | | | | |
|---------|---|------------|-------|-------------|-------------------------------|-------------|--------------------------------------|-----------------|
| 1.3 | 4 | 4G13 (8V) | 51/68 | 04/88→05/92 | Z20 | 0.8 | UXT2 / UXT6 | ZM049 01/89→ |
| 1.3 12V | 4 | 4G13 (12V) | 55/74 | 04/88→05/92 | Z20 →08/90 Z9 09/90→ | 0.8 1.15 | UXT2 / UXT6 →08/90 UXT2 / UXT6 | ZS263 ZM049 |

MITSUBISHI



kW/BHP

**... MITSUBISHI****... COLT III**

| | | | | | | | | | |
|----------------|---|------------|---------|-------------|--------------------------------|------------|--|-------------------------------------|-----------------|
| 1.3 GL | 4 | 4G13 (8V) | 44/59 | 04/88→12/90 | Z20 | 0.8 | UXT2 / UXT6 | ZS263 | ZM049 01/89→ |
| 1.5 | 4 | 4G15 (12V) | 66/89 | 07/90→05/92 | Z9 | 1.15 | UXT2 / UXT6 | ZS106 [1][11][254] ZS115 [1][11] | ZM049 |
| 1.5 LPG | 4 | 4G15 (12V) | 66/89 | 07/90→05/92 | Z20 [168] | 0.8 | UXT2 / UXT6 | | |
| 1.5 GLXi | 4 | 4G15 | 62/83 | 04/88→05/92 | Z20 →08/90 Z21 09/90→ | 0.8 1.1 | UXT2 / UXT6 →08/90 UXT2 / UXT6 09/90→ | ZS263 | ZM049 01/89→ |
| 1.6 GTi 16V | 4 | 4G61 | 91/122 | 04/88→05/90 | Z20 | 0.8 | UXT2 / UXT6 | ZS265 | ZM049 01/89→ |
| 1.8 Diesel GLX | 4 | 4D65 | 44/59 | 04/88→05/92 | GV673 | 12V | | | |
| 1.8 GTi 16V | 4 | 4G67 | 100/134 | 06/90→05/92 | Z27 | 0.8 | UX56 | | ZM049 |

COLT IV

| | | | | | | | | | |
|------------------|---|------------|---------|-------------|-----------|------|-------------|-------|-------|
| 1.3 GLi 12V | 4 | 4G13 (12V) | 55/74 | 04/92→04/96 | Z9 | 1.15 | UXT2 / UXT6 | ZS263 | ZM049 |
| 1.3 GLi 12V LPG | 4 | 4G13 (12V) | 55/74 | 04/92→04/96 | Z20 [168] | 0.8 | UXT2 / UXT6 | | |
| 1.6 | 4 | 4G92 | 66/89 | 02/94→04/96 | Z16 | 1.1 | UXT11 | | ZM049 |
| 1.6 LPG | 4 | 4G92 | 66/89 | 02/94→04/96 | Z340 | 0.7 | UXT12 | | |
| 1.6 GLXi 16V | 4 | 4G92 | 83/111 | 04/92→04/96 | Z16 | 1.1 | UXT11 | | ZM049 |
| 1.6 GLXi 16V LPG | 4 | 4G92 | 83/111 | 04/92→04/96 | Z340 | 0.7 | UXT12 | | |
| 1.8 GTi 16V | 4 | 4G93 | 103/138 | 04/92→04/96 | Z16 | 1.1 | UXT11 | | ZM049 |
| 1.8 GTi 16V LPG | 4 | 4G93 | 103/138 | 04/92→04/96 | Z340 | 0.7 | UXT12 | | |

COLT V

| | | | | | | | | | |
|----------------------|---|------------|--------|-------------|-----------|------|-------------|-------|-------|
| 1.3 1300 | 4 | 4G13 (16V) | 60/80 | 09/00→09/03 | Z16 | 1.1 | UXT11 | | |
| 1.3 1300 LPG | 4 | 4G13 (16V) | 60/80 | 09/00→09/03 | Z340 | 0.7 | UXT12 | | |
| 1.3 1300 GL, GLX | 4 | 4G13 (12V) | 55/74 | 05/96→09/00 | Z9 | 1.15 | UXT2 / UXT6 | ZS264 | ZM049 |
| 1.3 1300 GL, GLX LPG | 4 | 4G13 (12V) | 55/74 | 05/96→09/00 | Z20 [168] | 0.8 | UXT2 / UXT6 | | |
| 1.5 | 4 | 4G15 (16V) | 81/109 | 09/95→09/03 | Z9 | 1.15 | UXT2 / UXT6 | | |
| 1.5 LPG | 4 | 4G15 (16V) | 81/109 | 09/95→09/03 | Z20 [168] | 0.8 | UXT2 / UXT6 | | |
| 1.5 1500 | 4 | 4G15 (16V) | 69/93 | 11/95→09/03 | Z9 | 1.15 | UXT2 / UXT6 | | |
| 1.5 1500 LPG | 4 | 4G15 (16V) | 69/93 | 11/95→09/03 | Z20 [168] | 0.8 | UXT2 / UXT6 | | |
| 1.6 1600 | 4 | 4G92 | 76/102 | 09/00→09/03 | Z16 | 1.1 | UXT11 | | |
| 1.6 1600 LPG | 4 | 4G92 | 76/102 | 09/00→09/03 | Z340 | 0.7 | UXT12 | | |
| 1.6 1600 GLX | 4 | 4G92 | 66/89 | 05/96→09/00 | Z16 | 1.1 | UXT11 | | ZM049 |
| 1.6 1600 GLX LPG | 4 | 4G92 | 66/89 | 05/96→09/00 | Z340 | 0.7 | UXT12 | | |

COLT VI

| | | | | | | | | | |
|----------|---|------------|--------|-------------|-------|-------|--|--|--|
| 1.1 | 3 | 3A91 | 55/74 | 10/04→06/12 | Z273 | 1.1 | | | |
| 1.3 | 4 | 4A90 | 70/94 | 06/04→06/12 | Z273 | 1.1 | | | |
| 1.5 | 4 | 4A91 | 80/107 | 06/04→06/12 | Z235 | 1.0 | | | |
| 1.5 DI-D | 3 | OM 639 | 50/67 | 08/04→06/12 | GN058 | 11.5V | | | |
| 1.5 DI-D | 3 | OM 639.939 | 70/94 | 08/04→06/12 | GN058 | 11.5V | | | |

COLT LANCER

| | | | | | | | | | |
|-----|---|---------|-------|-------------|-----------|------------|-------------|--|--|
| 1.2 | 4 | 4G36 | 40/54 | 01/78→09/79 | Z58 [166] | 0.8 | | ZS106 [1][11][254] ZS115 [1][11] | |
| 1.4 | 4 | 4G33 | 50/67 | 01/78→09/79 | Z20 Z8 | 0.8 0.8 | UXT2 / UXT6 | ZS106 [1][11][254] ZS110 [1][15] ZS115 [1][11] | |
| 1.6 | 4 | 4G32 GS | 60/80 | 01/78→09/79 | Z11 | 0.8 | UXT2 / UXT6 | ZS106 [1][11][254] ZS115 [1][11] | |

CORDIA

| | | | | | | | | | |
|-----------|---|--------|--------|-------------|-----|-----|-------------|-------------------------------------|-----------------|
| 1.6 GSL | 4 | 4G32 | 55/74 | 10/82→12/86 | Z8 | 0.8 | UXT2 / UXT6 | ZS106 [1][11][254] ZS115 [1][11] | ZM053 01/83→ |
| 1.6 Turbo | 4 | 4G32 T | 84/113 | 10/82→05/85 | Z20 | 0.8 | UXT2 / UXT6 | ZS106 [1][11][254] ZS115 [1][11] | ZM053 01/83→ |
| 1.6 Turbo | 4 | 4G32 T | 85/114 | 07/83→05/85 | Z20 | 0.8 | UXT2 / UXT6 | ZS106 [1][11][254] ZS115 [1][11] | ZM053 |

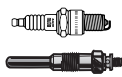

kW/BHP

**... MITSUBISHI****... CORDIA**

| | | | | | | | | |
|---------------|---|--------|---------|-------------|-----|-----|-------------|-------------------------------------|
| 1.8 GSL | 4 | 4G37 | 66/89 | 10/86→12/86 | Z11 | 0.8 | UXT2 / UXT6 | ZS106 [1][11][254] ZS115 [1][11] |
| 1.8 Turbo Eci | 4 | 4G62 T | 100/134 | 10/84→12/86 | | | | ZS106 [1][11][254] ZS115 [1][11] |

ECLIPSE I

| | | | | | | | | |
|---------------|---|-----------------|---------|-------------|-----------|-----|------|--|
| 2.0 i 16V | 4 | 4G63 (DOHC 16V) | 110/148 | 04/91→11/95 | Z27 | 0.8 | UX56 | |
| 2.0 i 16V LPG | 4 | 4G63 (DOHC 16V) | 110/148 | 04/91→11/95 | Z47 [168] | 0.8 | UX56 | |

ECLIPSE II

| | | | | | | | | |
|---------------------|---|-----------------|---------|-------------|-----------|-----|-------------|--|
| 2.0 2000 GS 16V | 4 | 4G63 (DOHC 16V) | 107/143 | 12/95→04/99 | Z21 | 1.1 | UXT2 / UXT6 | |
| 2.0 2000 GS 16V LPG | 4 | 4G63 (DOHC 16V) | 107/143 | 12/95→04/99 | Z27 [168] | 0.8 | UX56 | |
| 2.0 2000 GT 16V | 4 | | 157/211 | 12/95→04/99 | Z8 | 0.8 | UXT2 / UXT6 | |
| 2.0 2000 GT 16V LPG | 4 | | 157/211 | 12/95→04/99 | Z20 [168] | 0.8 | UXT2 / UXT6 | |
| 2.4 2400 GS 16V | 4 | 4G64 (SOHC 16V) | 105/141 | 09/98→04/99 | Z73 | 1.1 | UXT11 | |
| 2.4 2400 GS 16V LPG | 4 | 4G64 (SOHC 16V) | 105/141 | 09/98→04/99 | Z206 | 0.7 | UXT10 | |

GALANT I

| | | | | | | | | |
|---------|---|------|-------|-------------|-----|-----|-------------|--|
| 1.6 | 4 | 4G32 | 55/74 | 01/77→08/80 | Z11 | 0.8 | UXT2 / UXT6 | ZS106 [1][11][254] ZS110 [1][15] ZS115 [1][11] |
| 1.6 GL | 4 | 4G32 | 55/74 | 01/79→08/80 | Z20 | 0.8 | UXT2 / UXT6 | ZS106 [1][11][254] ZS110 [1][15] ZS115 [1][11] |
| 2.0 | 4 | 4G52 | 72/97 | 01/79→08/80 | Z27 | 0.8 | UX56 | ZS106 [1][11][254] ZS110 [1][15] ZS115 [1][11] |
| 2.0 GLX | 4 | 4G52 | 63/84 | 01/77→08/80 | Z11 | 0.8 | UXT2 / UXT6 | ZS106 [1][11][254] ZS110 [1][15] ZS115 [1][11] |
| 2.0 GLX | 4 | 4G52 | 72/97 | 01/79→08/80 | Z20 | 0.8 | UXT2 / UXT6 | ZS106 [1][11][254] ZS110 [1][15] ZS115 [1][11] |

GALANT II

| | | | | | | | | |
|---------------|---|----------------|---------|-------------|-----------|-----|-------------|--|
| 1.6 GLX | 4 | 4G32 | 55/74 | 09/80→05/84 | Z20 | 0.8 | UXT2 / UXT6 | ZS106 [1][11][254] ZS110 [1][15] ZS115 [1][11] |
| 2.0 GLS | 4 | 4G63 (SOHC 8V) | 75/101 | 09/80→05/84 | Z20 | 0.8 | UXT2 / UXT6 | ZS106 [1][11][254] ZS115 [1][11] |
| 2.0 GLX | 4 | 4G63 (SOHC 8V) | 75/101 | 09/80→06/83 | Z20 | 0.8 | UXT2 / UXT6 | ZM022 |
| 2.0 Turbo Eci | 4 | 4G63 T (ECI) | 125/168 | 05/82→05/84 | Z58 [166] | 0.8 | | ZS106 [1][11][254] ZS115 [1][11] |

2.3 Turbo-D

| | | | | | | | | |
|-------------|---|--------|-------|-------------|-------|-----|--|--|
| 2.3 Turbo-D | 4 | 4D55 T | 62/83 | 09/80→05/84 | GV673 | 12V | | |
|-------------|---|--------|-------|-------------|-------|-----|--|--|

GALANT III

| | | | | | | | | |
|---------------|---|------------------|---------|-------------|-----------|------|-------------|--|
| 1.6 GLX | 4 | 4G32 | 55/74 | 06/84→04/90 | Z20 | 0.8 | UXT2 / UXT6 | ZS106 [1][11][254] ZS110 [1][15] ZS115 [1][11] |
| 2.0 GLS | 4 | G63B | 66/89 | 06/86→04/90 | Z9 | 1.15 | UXT2 / UXT6 | ZS106 [1][11][254] ZS110 [1][15] ZS115 [1][11] |
| 2.0 GLS | 4 | 4G63 (SOHC 8V) | 75/101 | 06/84→04/90 | Z47 | 0.8 | UX56 | ZS106 [1][11][254] ZS115 [1][11] |
| 2.0 GLS LPG | 4 | G63B | 66/89 | 06/86→04/90 | Z20 [168] | 0.8 | UXT2 / UXT6 | |
| 2.0 Turbo Eci | 4 | 4G63 T (SOHC 8V) | 110/148 | 06/84→04/90 | | | | ZS263 ZM022 |
| 2.4 GLS | 4 | G64B | 82/110 | 07/85→04/90 | Z9 | 1.15 | UXT2 / UXT6 | ZS106 [1][11][254] ZS115 [1][11] |
| 2.4 GLS LPG | 4 | G64B | 82/110 | 07/85→04/90 | Z20 [168] | 0.8 | UXT2 / UXT6 | |

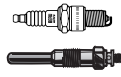

kW/BHP

**... MITSUBISHI****GALANT IV**

| | | | | | | | | | | |
|-----------------|---|-----------------|---------|-------------|-----------|--|------|-------------|--|-----------------|
| 1.6 | 4 | 4G32 | 55/74 | 01/88→10/92 | | | | | ZS106 [1][11][254] ZS109 [1][15] | |
| 1.8 | 4 | 4G37 | 63/84 | 11/87→08/90 | Z20 | | 0.8 | UXT2 / UXT6 | ZS106 [1][11][254] ZS115 [1][11] | ZM049 01/89→ |
| 1.8 | 4 | 4G37 | 66/89 | 11/87→10/92 | Z9 | | 1.15 | UXT2 / UXT6 | ZS106 [1][11][254] ZS115 [1][11] | ZM049 01/89→ |
| 1.8 LPG | 4 | 4G37 | 66/89 | 11/87→10/92 | Z20 [168] | | 0.8 | UXT2 / UXT6 | | |
| 2.0 | 4 | 4G63 (SOHC 8V) | 77/103 | 05/89→12/92 | | | | | ZS265 →05/90 ZS261 [254] →05/91 | |
| 2.0 | 4 | 4G63 (SOHC 8V) | 80/107 | 11/87→10/92 | Z9 | | 1.15 | UXT2 / UXT6 | ZS261 | ZM049 01/89→ |
| 2.0 | 4 | 4G63 (SOHC 8V) | 80/107 | 04/89→10/92 | | | | | | ZM049 |
| 2.0 LPG | 4 | 4G63 (SOHC 8V) | 80/107 | 11/87→10/92 | Z20 [168] | | 0.8 | UXT2 / UXT6 | | |
| 2.0 GTi 16V | 4 | 4G63 (DOHC 16V) | 106/142 | 11/87→10/92 | Z9 | | 1.15 | UXT2 / UXT6 | ZS265 →05/90 | ZM049 01/89→ |
| 2.0 GTi 16V | 4 | 4G63 (DOHC 16V) | 106/142 | 11/88→10/92 | | | | | ZS261 [142][254] ZS263 [144][254] | |
| 2.0 GTi 16V | 4 | E33A GTi | 106/142 | 11/88→10/92 | | | | | ZS265 →05/90 | |
| 2.0 GTi 16V 4WD | 4 | 4G63 (DOHC 16V) | 106/142 | 06/88→10/92 | Z9 | | 1.15 | UXT2 / UXT6 | ZS265 11/88→05/90 ZS261 [142][254] ZS263 [144][254] | ZM049 01/89→ |
| 2.0 GTi 16V 4WD | 4 | 4G63 (DOHC 16V) | 106/142 | 07/89→12/92 | Z20 | | 0.8 | UXT2 / UXT6 | | ZM049 |
| 2.0 GTi 16V 4WD | 4 | E39A GTi | 106/142 | 07/89→12/92 | | | | | ZS261 →11/89 ZS265 11/89→05/90 | |
| 2.0 GTi 16V | 4 | 4G63 (DOHC 16V) | 107/143 | 11/88→10/92 | Z20 | | 0.8 | UXT2 / UXT6 | ZS265 →05/90 | ZM049 01/89→ |
| 2.0 GTi 16V 4WD | 4 | 4G63 (DOHC 16V) | 110/148 | 09/91→10/92 | Z20 | | 0.8 | UXT2 / UXT6 | ZS263 | ZM049 |
| 2.0 GTi 16V LPG | 4 | 4G63 (DOHC 16V) | 106/142 | 11/87→10/92 | Z20 [168] | | 0.8 | UXT2 / UXT6 | | |

GALANT V

| | | | | | | | | | | |
|---------------|---|-----------------|---------|-------------|-----------------|--|-----|-------|---|-------|
| 1.8 | 4 | 4G93 | 85/114 | 02/94→08/96 | Z16 | | 1.1 | UXT11 | | ZM049 |
| 1.8 LPG | 4 | 4G93 | 85/114 | 02/94→08/96 | Z340 | | 0.7 | UXT12 | | |
| 1.8 GLSi | 4 | 4G93 (GDI) | 93/125 | 11/92→08/96 | Z16 | | 1.1 | UXT11 | | ZM049 |
| 1.8 GLSi LPG | 4 | 4G93 (GDI) | 93/125 | 11/92→08/96 | Z340 | | 0.7 | UXT12 | | |
| 2.0 GLSi | 4 | 4G63 (SOHC 16V) | 101/135 | 11/92→08/96 | Z16 | | 1.1 | UXT11 | ZS106 [1][11][254] ZS109 [1][15] ZS261 [1][254] ZS263 [1][254] | ZM049 |
| 2.0 GLSi LPG | 4 | 4G63 (SOHC 16V) | 101/135 | 11/92→08/96 | Z340 | | 0.7 | UXT12 | | |
| 2.0 GLSTD | 4 | 4D68 T | 66/89 | 11/92→08/96 | GN107 12/93→ | | 11V | | | |
| 2.0 V6-24 | 6 | 6A12 | 110/148 | 11/92→08/96 | | | | | | ZM049 |
| 2.5 V6-24 4WD | 6 | 6G73 | 125/168 | 11/92→08/96 | Z130 [172] | | 1.0 | UXT14 | | ZM049 |

GALANT VI

| | | | | | | | | | | |
|---------|---|---------------------|---------|-------------|-----------------|--|-----|-----------------|--|-------|
| 2.0 | 4 | 4G63 (SOHC 16V) | 98/131 | 09/00→10/03 | Z16 →09/02 | | 1.1 | UXT11 →09/02 | | |
| 2.0 | 4 | 4G63 (SOHC 16V) | 98/131 | 09/00→10/04 | Z16 | | 1.1 | UXT11 | | |
| 2.0 | 4 | 4G63 (SOHC 16V) | 100/134 | 09/96→09/00 | Z16 | | 1.1 | UXT11 | | ZM049 |
| 2.0 LPG | 4 | 4G63 (SOHC 16V) | 98/131 | 09/00→10/03 | Z340 →09/02 | | 0.7 | UXT12 →09/02 | | |
| 2.0 LPG | 4 | 4G63 (SOHC 16V) | 98/131 | 09/00→10/04 | Z340 | | 0.7 | UXT12 | | |
| 2.0 LPG | 4 | 4G63 (SOHC 16V) | 100/134 | 09/96→09/00 | Z340 | | 0.7 | UXT12 | | |
| 2.0 TDI | 4 | 4D68 (SOHC), 4D68 T | 66/89 | 09/96→10/04 | GN107 →02/00 | | 11V | | | |



kW/BHP



... MITSUBISHI



... GALANT VI

| | | | | | | | | |
|----------------|---|------------|---------|-------------|-----------|-----|-------|-------|
| 2.4 GDI | 4 | 4G64 (GDI) | 106/142 | 09/00→10/04 | Z278 | 0.6 | | |
| 2.4 GDI | 4 | 4G64 (GDI) | 110/148 | 02/99→10/03 | Z278 | 0.6 | | ZM049 |
| 2.5 V6 24V | 6 | 6A13 | 118/158 | 09/00→10/04 | Z284 | 1.1 | UXT14 | |
| 2.5 V6 24V | 6 | 6A13 | 120/161 | 09/96→09/00 | Z284 | 1.1 | UXT14 | ZM049 |
| 2.5 V6 24V LPG | 6 | 6A13 | 118/158 | 09/00→10/04 | Z30 [168] | 0.8 | UXT5 | |
| 2.5 V6 24V LPG | 6 | 6A13 | 120/161 | 09/96→09/00 | Z30 [168] | 0.8 | UXT5 | |
| 2.8 TD | 4 | 4M40-T | 92/123 | 10/96→07/01 | GN067 | 11V | | |

GALLOPER

| | | | | | | | | |
|------------------------|---|------|---------|-------------|-----------------|------|-------------|--------|
| 2.5 TD 4WD | 4 | D4BF | 65/87 | 09/98→12/03 | GN107 | 11V | | |
| 2.5 TD intercooler 4WD | 4 | D4BH | 73/98 | 09/98→12/03 | GN107 →12/01 | 11V | | |
| 3.0 V6 4WD | 6 | G6AT | 104/139 | 09/98→12/03 | Z9 | 1.15 | UXT2 / UXT6 | ZSE010 |
| 3.0 V6 4WD LPG | 6 | G6AT | 104/139 | 09/98→12/03 | Z20 [168] | 0.8 | UXT2 / UXT6 | |

GRANDIS

| | | | | | | | | |
|----------|---|-----|---------|--------|-------|------|--|--|
| 2.0 DI-D | 4 | BSY | 100/134 | 09/05→ | GE101 | 4.4V | | |
| 2.0 DI-D | 4 | BWC | 103/138 | 02/07→ | GE101 | 4.4V | | |

L 200

| | | | | | | | | |
|-------------|---|-----------------|---------|-------------|---|------------|-------------|------------------------------------|
| 1.6 | 4 | 4G32 | 60/80 | 03/80→08/84 | | | | ZS106 [1][1][254] ZS109 [1][15] |
| 2.0 | 4 | 4G63 (SOHC 8V) | 69/93 | 01/87→12/90 | Z20 | 0.8 | UXT2 / UXT6 | |
| 2.0 | 4 | 4G63 (SOHC 16V) | 90/121 | 06/96→12/07 | Z20 | 0.8 | UXT2 / UXT6 | |
| 2.0 LPG | 4 | 4G63 (SOHC 8V) | 69/93 | 01/87→12/90 | Z27 [168] | 0.8 | UX56 | |
| 2.0 LPG | 4 | 4G63 (SOHC 16V) | 90/121 | 06/96→12/07 | Z27 [168] | 0.8 | UX56 | |
| 2.3 D 4WD | 4 | 4D55 | 62/83 | 01/83→10/86 | GV673 | 12V | | |
| 2.4 4WD | 4 | 4G64 (SOHC 16V) | 97/130 | 06/96→12/07 | Z21 | 1.1 | UXT2 / UXT6 | |
| 2.4 4WD LPG | 4 | 4G64 (SOHC 16V) | 97/130 | 06/96→12/07 | Z27 [168] | 0.8 | UX56 | |
| 2.5 D | 4 | 4D56 (8V) | 51/68 | 11/86→10/96 | GV673 →10/93 GN107 11/93→05/96 | 12V 11V | | |
| 2.5 D 4WD | 4 | 4D56 (8V) | 51/68 | 12/87→05/93 | GV673 | 12V | | |
| 2.5 D | 4 | 4D56 (8V) | 55/74 | 06/96→12/07 | GN107 | 11V | | |
| 2.5 TD 4WD | 4 | 4D56 T | 64/86 | 11/92→08/96 | GV673 →10/93 GN107 11/93→ | 12V 11V | | |
| 2.5 TD | 4 | 4D56 T | 66/89 | 08/01→11/05 | GN107 | 11V | | |
| 2.5 TD 4WD | 4 | 4D56 TD | 73/98 | 06/96→12/07 | GN107 | 11V | | |
| 2.5 TD 4WD | 4 | 4D56 T | 85/114 | 09/01→12/07 | GN107 | 11V | | |
| 2.5 TD 4WD | 4 | 4D56 T | 98/131 | 08/01→12/07 | GN107 | 11V | | |
| 2.6 4WD | 4 | G54B | 76/102 | 11/89→05/95 | Z21 | 1.1 | UXT2 / UXT6 | |
| 2.6 4WD LPG | 4 | G54B | 76/102 | 11/89→05/95 | Z27 [168] | 0.8 | UX56 | |
| 3.0 4WD | 6 | 6G72 (SOHC 12V) | 107/143 | 11/86→05/92 | | | | ZS282 |
| 3.0 | 6 | 6G72 (SOHC 12V) | 109/146 | 06/92→08/96 | | | | ZS282 |

LANCER

| | | | | | | | | |
|---------|---|------------|--------|--------|------|-----|-------|--|
| 1.3 | 4 | 4G13 (16V) | 60/80 | 09/03→ | Z16 | 1.1 | UXT11 | |
| 1.3 LPG | 4 | 4G13 (16V) | 60/80 | 09/03→ | Z340 | 0.7 | UXT12 | |
| 1.5 | 4 | 4A91 | 80/107 | 06/08→ | Z184 | 0.9 | UXT13 | |
| 1.6 | 4 | 4G18 | 72/97 | 09/03→ | Z16 | 1.1 | UXT11 | |
| 1.6 LPG | 4 | 4G18 | 72/97 | 09/03→ | Z340 | 0.7 | UXT12 | |

LANCER I

| | | | | | | | | |
|---------------|---|------------------|---------|-------------|-----|-----|-------------|-------|
| 1.2 | 4 | 4G11 | 40/54 | 01/80→12/81 | Z20 | 0.8 | UXT2 / UXT6 | |
| 1.4 GLX | 4 | 4G12 | 50/67 | 09/79→02/83 | Z8 | 0.8 | UXT2 / UXT6 | |
| 1.6 | 4 | 4G32 GS | 60/80 | 09/79→02/83 | Z20 | 0.8 | UXT2 / UXT6 | |
| 1.6 | 4 | 4G32 GS | 62/83 | 01/81→02/83 | Z20 | 0.8 | UXT2 / UXT6 | |
| 2.0 Turbo Eci | 4 | 4G63 T (SOHC 8V) | 125/168 | 03/81→02/83 | | | | ZM022 |

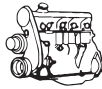

kw/BHP

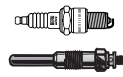

... MITSUBISHI



LANCER III

| | | | | | | | | | | |
|-------------|---|------------|-------|-------------|-------------------------------|--|------------|--|-------------------------------------|-----------------|
| 1.2 | 4 | 4G16 | 44/59 | 08/86→04/88 | Z20 | | 0.8 | UXT2 / UXT6 | ZS106 (1)(11)(254) ZS109 (1)(15) | |
| 1.2 GL | 4 | 4G16 | 40/54 | 01/84→10/86 | Z1 →08/84 Z20 09/84→ | | 0.7 0.8 | UXT2 / UXT6 →08/84 UXT2 / UXT6 09/84→ | ZS106 (1)(11)(254) ZS109 (1)(15) | |
| 1.5 | 4 | G15B | 51/68 | 09/85→08/89 | Z21 | | 1.1 | UXT2 / UXT6 | | ZM049 01/89→ |
| 1.5 | 4 | 4G15 | 55/74 | 09/85→12/87 | Z20 | | 0.8 | UXT2 / UXT6 | ZS263 | |
| 1.5 | 4 | 4G15 | 61/82 | 09/88→12/90 | Z9 | | 1.15 | UXT2 / UXT6 | ZS263 | ZM049 01/89→ |
| 1.5 LPG | 4 | 4G15 | 61/82 | 09/88→12/90 | Z20 [168] | | 0.8 | UXT2 / UXT6 | | |
| 1.5 12V | 4 | 4G15 (12V) | 66/89 | 09/90→12/91 | Z9 | | 1.15 | UXT2 / UXT6 | ZS263 | ZM051 |
| 1.5 12V LPG | 4 | 4G15 (12V) | 66/89 | 09/90→12/91 | Z20 [168] | | 0.8 | UXT2 / UXT6 | | |
| 1.5 GLX | 4 | G15B | 51/68 | 06/85→04/88 | Z21 | | 1.1 | UXT2 / UXT6 | | |
| 1.5 GLX | 4 | 4G15 | 55/74 | 11/83→04/88 | Z20 | | 0.8 | UXT2 / UXT6 | ZS263 | |
| 1.8 4WD | 4 | G37B | 61/82 | 01/87→08/89 | Z9 | | 1.15 | UXT2 / UXT6 | | ZM049 01/89→ |
| 1.8 4WD | 4 | 4G37 | 63/84 | 03/89→12/90 | Z9 | | 1.15 | UXT2 / UXT6 | | ZM049 |
| 1.8 4WD | 4 | 4G37 | 66/89 | 01/87→12/87 | Z20 | | 0.8 | UXT2 / UXT6 | | |
| 1.8 4WD | 4 | 4G37 | 69/93 | 08/90→06/92 | Z9 | | 1.15 | UXT2 / UXT6 | | ZM049 |
| 1.8 4WD LPG | 4 | G37B | 61/82 | 01/87→08/89 | Z20 [168] | | 0.8 | UXT2 / UXT6 | | |
| 1.8 4WD LPG | 4 | 4G37 | 63/84 | 03/89→12/90 | Z20 [168] | | 0.8 | UXT2 / UXT6 | | |
| 1.8 4WD LPG | 4 | 4G37 | 69/93 | 08/90→06/92 | Z20 [168] | | 0.8 | UXT2 / UXT6 | | |
| 1.8 Diesel | 4 | 4D65 | 44/59 | 09/86→04/88 | GV673 | | 12V | | | |

LANCER IV

| | | | | | | | | | | |
|-------------|---|-----------------|---------|-------------|-------------------------------|--|-------------|--|-----------------------|-----------------|
| 1.3 | 4 | 4G13 (8V) | 44/59 | 04/88→05/92 | Z20 | | 0.8 | UXT2 / UXT6 | | ZM051 01/90→ |
| 1.3 | 4 | 4G13 (8V), G13B | 51/68 | 08/88→05/92 | Z20 | | 0.8 | UXT2 / UXT6 | | ZM051 01/90→ |
| 1.3 12V | 4 | 4G13 (12V) | 55/74 | 07/90→06/92 | Z20 | | 0.8 | UXT2 / UXT6 | | ZM051 |
| 1.3 12V | 4 | 4G13 (12V) | 55/74 | 06/92→05/94 | Z21 | | 1.1 | UXT2 / UXT6 | | ZM049 |
| 1.5 | 4 | 4G15 | 62/83 | 04/88→05/92 | Z20 →08/90 Z9 09/90→ | | 0.8 1.15 | UXT2 / UXT6 →08/90 UXT2 / UXT6 09/90→ | ZS263 | ZM051 01/90→ |
| 1.5 | 4 | 4G15 | 62/83 | 06/88→05/92 | Z9 | | 1.15 | UXT2 / UXT6 | | |
| 1.5 LPG | 4 | 4G15 | 62/83 | 06/88→05/92 | Z20 [168] | | 0.8 | UXT2 / UXT6 | | |
| 1.5 12V | 4 | 4G15 (12V) | 66/89 | 05/89→05/92 | Z20 →08/90 Z9 09/90→ | | 0.8 1.15 | UXT2 / UXT6 →08/90 UXT2 / UXT6 09/90→ | ZS263 [254] →05/90 | ZM051 01/90→ |
| 1.6 16V | 4 | 4G92 | 83/111 | 06/92→05/94 | Z16 ch. 500001→ | | 1.1 | UXT11 ch. 500001→ | | ZM049 |
| 1.6 16V LPG | 4 | 4G92 | 83/111 | 06/92→05/94 | Z340 ch. 500001→ | | 0.7 | UXT12 ch. 500001→ | | |
| 1.6 GTi | 4 | 4G61 | 91/122 | 05/88→05/90 | | | | | ZS265 →04/89 | |
| 1.8 4WD | 4 | 4G37 | 71/95 | 09/89→06/92 | Z9 | | 1.15 | UXT2 / UXT6 | ZS263 | ZM051 01/90→ |
| 1.8 4WD LPG | 4 | 4G37 | 71/95 | 09/89→06/92 | Z20 [168] | | 0.8 | UXT2 / UXT6 | | |
| 1.8 GTi 16V | 4 | 4G67 | 100/134 | 11/89→05/92 | Z20 | | 0.8 | UXT2 / UXT6 | | ZM051 01/90→ |
| 1.8 GTi 16V | 4 | 4G93 | 103/138 | 06/92→12/93 | Z16 | | 1.1 | UXT11 | | ZM049 |

LANCER V

| | | | | | | | | | | |
|---------|---|------------|-------|-------------|-----------|--|------|-------------|--|-------|
| 1.3 | 4 | 4G13 (12V) | 55/74 | 06/92→12/96 | Z9 | | 1.15 | UXT2 / UXT6 | | ZM049 |
| 1.3 LPG | 4 | 4G13 (12V) | 55/74 | 06/92→12/96 | Z20 [168] | | 0.8 | UXT2 / UXT6 | | |
| 1.6 | 4 | 4G92 | 66/89 | 02/94→12/96 | Z73 | | 1.1 | UXT11 | | ZM049 |
| 1.6 LPG | 4 | 4G92 | 66/89 | 02/94→12/96 | Z206 | | 0.7 | UXT10 | | |

MITSUBISHI

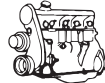

kW/BHP

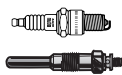
**... MITSUBISHI****... LANCER V**

| | | | | | | | | | |
|-------------|---|--------|---------|-------------|-------|-----|-------|--|-------|
| 1.6 16V | 4 | 4G92 | 83/111 | 06/92→10/03 | Z16 | 1.1 | UXT11 | | ZM049 |
| 1.6 16V LPG | 4 | 4G92 | 83/111 | 06/92→10/03 | Z340 | 0.7 | UXT12 | | |
| 1.8 16V | 4 | 4G93 | 103/138 | 06/92→12/93 | Z16 | 1.1 | UXT11 | | |
| 2.0 D | 4 | 4D68 | 50/67 | 12/92→10/03 | GN107 | 11V | | | |
| | | | | 12/93→05/96 | | | | | |
| 2.0 D | 4 | 4D68 T | 65/87 | 03/95→10/03 | GN107 | 11V | | | |
| | | | | →05/96 | | | | | |
| 2.0 Diesel | 4 | 4D68 | 50/67 | 06/92→12/96 | GN107 | 11V | | | |
| | | | | 12/93→04/96 | | | | | |

LANCER VI

| | | | | | | | | | |
|-----------------|---|------------|---------|-------------|-----------|------|-------------|---------------------|-------|
| 1.3 12V | 4 | 4G13 (12V) | 55/74 | 12/95→08/03 | Z9 | 1.15 | UXT2 / UXT6 | | ZM049 |
| 1.3 12V LPG | 4 | 4G13 (12V) | 55/74 | 12/95→08/03 | Z20 [168] | 0.8 | UXT2 / UXT6 | | |
| 1.5 16V | 4 | 4G15 (16V) | 69/93 | 12/95→08/03 | Z9 | 1.15 | UXT2 / UXT6 | ZS106 [1][11][141] | ZM049 |
| | | | | →09/00 | | | →09/00 | [254] | |
| | | | | | | | | ZS263 [1][143][254] | |
| 1.5 16V LPG | 4 | 4G15 (16V) | 69/93 | 12/95→08/03 | Z20 [168] | 0.8 | UXT2 / UXT6 | | |
| | | | | →09/00 | | | →09/00 | | |
| 1.6 16V | 4 | 4G92 | 66/89 | 12/95→08/03 | Z73 | 1.1 | UXT11 | | ZM049 |
| 1.6 16V LPG | 4 | 4G92 | 66/89 | 12/95→08/03 | Z206 | 0.7 | UXT10 | | |
| 2.0 16V EVO 4WD | 4 | 4G63 Turbo | 206/276 | 08/98→08/01 | | | | | ZM049 |
| 2.0 D | 4 | 4D68 | 50/67 | 09/95→08/03 | GN107 | 11V | | | |

LANCER F II

| | | | | | | | | | |
|-----------|---|--------|--------|-------------|-----|-----|-------------|--------------------|--|
| 1.2 GLX | 4 | 4G11 | 40/54 | 03/83→01/84 | Z20 | 0.8 | UXT2 / UXT6 | ZS106 [1][11][254] | |
| | | | | | | | | ZS109 [1][15] | |
| 1.4 GLX | 4 | 4G12 | 51/68 | 03/83→01/84 | Z8 | 0.8 | UXT2 / UXT6 | ZS106 [1][11][254] | |
| | | | | | | | | ZS109 [1][15] | |
| 1.4 Turbo | 4 | 4G12 T | 77/103 | 03/83→01/84 | Z8 | 0.8 | UXT2 / UXT6 | ZS106 [1][11][254] | |
| | | | | | | | | ZS109 [1][15] | |

OUTLANDER II

| | | | | | | | | | |
|--------------|---|----------|---------|-------------|-------|------|--|--|--|
| 2.0 DI-D 4WD | 4 | BSY | 103/138 | 02/07→11/12 | GE101 | 4.4V | | | |
| 2.2 DI-D 4WD | 4 | 4HK, 4HN | 115/154 | 08/07→11/12 | GN063 | 11V | | | |

PAJERO I

| | | | | | | | | | |
|------------|---|-----------------|---------|-------------|-------------|------|-------------|-------|-------|
| 2.3 D 4WD | 4 | 4D55 | 62/83 | 10/84→09/86 | GV673 [275] | 12V | | | |
| | | | | →04/86 | | | | | |
| 2.3 TD 4WD | 4 | 4D55 T | 62/83 | 12/82→04/86 | GV921 [269] | 11V | | | |
| | | | | →10/83 | | | | | |
| | | | | | GV673 [275] | 12V | | | |
| | | | | →07/85 | | | | | |
| 2.5 TD 4WD | 4 | 4D56 T | 62/83 | 05/86→10/89 | GV673 | 12V | | | |
| 2.5 TD 4WD | 4 | 4D56 T | 62/83 | 10/86→05/91 | GV673 [275] | 12V | | | |
| 2.5 TD 4WD | 4 | 4D56 T | 64/86 | 01/90→12/91 | GV673 | 12V | | | |
| | | | | →11/90 | | | | | |
| 2.5 TD 4WD | 4 | 4D56 T | 70/94 | 11/89→11/90 | GV673 | 12V | | | |
| 2.6 4WD | 4 | 4G54 | 76/102 | 01/83→11/90 | Z20 | 0.8 | UXT2 / UXT6 | ZS282 | |
| | | | | →08/84 | | | →08/84 | | |
| | | | | | Z8 | 0.8 | UXT2 / UXT6 | | |
| | | | | 09/84→ | | | 09/84→ | | |
| 3.0 i 4WD | 6 | 6G72 (SOHC 12V) | 105/141 | 05/88→05/91 | | | | ZS282 | |
| 3.0 V6 4WD | 6 | 6G72 (SOHC 12V) | 104/139 | 11/88→11/90 | Z9 | 1.15 | UXT2 / UXT6 | ZS282 | ZM049 |

PAJERO II

| | | | | | | | | | |
|-------------|---|------------|--------|-------------|-----------|------|-------------|-------|--|
| 2.4 4WD | 4 | 4G64 (12V) | 82/110 | 04/91→04/00 | Z9 | 1.15 | UXT2 / UXT6 | ZS263 | |
| 2.4 4WD LPG | 4 | 4G64 (12V) | 82/110 | 04/91→04/00 | Z20 [168] | 0.8 | UXT2 / UXT6 | | |
| 2.5 TD 4WD | 4 | 4D56 TD | 73/98 | 12/90→04/00 | GV673 | 12V | | | |
| | | | | →10/93 | | | | | |
| | | | | | GN107 | 11V | | | |
| | | | | 11/93→01/98 | | | | | |
| 2.5 TDiC | 4 | 4D56 T | 73/98 | 03/91→08/99 | GN107 | 11V | | | |
| | | | | 11/93→ | | | | | |



kW/BHP

**... MITSUBISHI****... PAJERO II**

| | | | | | | | | |
|--------------------|---|-----------------|---------|-------------|------------------------|------|--------------------|--------------|
| 2.8 TD 4WD | 4 | 4M40-T | 92/123 | 06/94→10/99 | GN067 06/97→ | 11V | | |
| 3.0 V6 4WD | 6 | 6G72 (SOHC 12V) | 110/148 | 12/90→12/95 | Z9 | 1.15 | UXT2 / UXT6 | ZS282 |
| 3.0 V6 4WD LPG | 6 | 6G72 (SOHC 12V) | 110/148 | 12/90→12/95 | Z20 [168] | 0.8 | UXT2 / UXT6 | ZM049 |
| 3.0 V6 24V 4WD | 6 | 6G72 (SOHC 24V) | 133/178 | 06/94→04/00 | Z9 | 1.15 | UXT2 / UXT6 | |
| 3.0 V6 24V 4WD LPG | 6 | 6G72 (SOHC 24V) | 133/178 | 06/94→04/00 | Z20 [168] | 0.8 | UXT2 / UXT6 | |

PAJERO III

| | | | | | | | | |
|--------------|---|--------|---------|-------------|--------------|-----|--|--|
| 2.5 TDi 4WD | 4 | 4D56 T | 73/98 | 04/00→12/06 | GN107 | 11V | | |
| 2.5 TDi 4WD | 4 | 4D56 T | 85/114 | 09/01→12/06 | GN107 | 11V | | |
| 3.2 D 4WD | 4 | 4M41 | 121/162 | 04/00→12/06 | GN070 | 11V | | |
| 3.2 Di-D 4WD | 4 | 4M41 | 118/158 | 04/00→12/06 | GN070 | 11V | | |
| 3.2 Di-D 4WD | 4 | 4M41 | 121/162 | 04/00→12/06 | GN070 | 11V | | |

PAJERO IV

| | | | | | | | | |
|--------------|---|------|---------|--------|--------------|-----|--|--|
| 3.2 DI-D 4WD | 4 | 4M41 | 118/158 | 02/07→ | GN070 | 11V | | |
| 3.2 DI-D 4WD | 4 | 4M41 | 125/168 | 02/07→ | GN070 | 11V | | |
| 3.2 TD 4WD | 4 | 4M41 | 147/197 | 01/09→ | GN070 | 11V | | |

PAJERO CLASSIC

| | | | | | | | | |
|------------|---|--------|--------|--------|--------------|-----|--|--|
| 2.5 TD 4WD | 4 | 4D56 T | 85/114 | 07/02→ | GN107 | 11V | | |
|------------|---|--------|--------|--------|--------------|-----|--|--|

PAJERO PININ

| | | | | | | | | |
|-----------------|---|------------|--------|-------------|-------------|-----|-------------|--|
| 1.8 4WD | 4 | 4G93 | 84/113 | 11/01→06/07 | Z279 | 0.6 | | |
| 1.8 4WD LPG | 4 | 4G93 | 84/113 | 11/01→06/07 | Z116 | 0.8 | UXT5 | |
| 1.8 GDI 4WD | 4 | 4G93 (GDI) | 88/118 | 10/99→06/07 | Z279 | 0.6 | | |
| 1.8 GDI 4WD LPG | 4 | 4G93 (GDI) | 88/118 | 10/99→06/07 | Z116 | 0.8 | UXT5 | |
| 2.0 GDI 4WD | 4 | 4G94 (GDI) | 95/127 | 10/00→06/07 | Z278 | 0.6 | | |

PAJERO SPORT

| | | | | | | | | |
|----------------|---|--------|---------|-------------|------------------------|-----|--------------|--|
| 2.5 TD 4WD | 4 | 4D56 T | 73/98 | 11/98→ | GN107 | 11V | | |
| 2.5 TD 4WD | 4 | 4D56 T | 83/111 | 11/97→10/98 | GN107 08/98→ | 11V | | |
| 2.5 TD 4WD | 4 | 4D56 T | 85/114 | 07/02→ | GN107 | 11V | | |
| 2.5 TD 4WD | 4 | 4D56 T | 98/131 | 08/03→ | GN107 | 11V | | |
| 2.8 TDi 4WD | 4 | 4M40-T | 92/123 | 11/98→10/03 | GN067 | 11V | | |
| 3.0 V6 4WD | 6 | 6G72 | 125/168 | 06/00→ | Z228 | 1.0 | UXT11 | |
| 3.0 V6 4WD | 6 | 6G72 | 130/174 | 11/98→ | Z228 | 1.0 | UXT11 | |
| 3.0 V6 4WD LPG | 6 | 6G72 | 125/168 | 06/00→ | Z221 [168] | 1.0 | UXT14 | |
| 3.0 V6 4WD LPG | 6 | 6G72 | 130/174 | 11/98→ | Z221 [168] | 1.0 | UXT14 | |

SANTAMO

| | | | | | | | | |
|---------|---|-----------------|---------|-------------|----------------------|-----|--------------------|------------------------|
| 2.0 16V | 4 | 4G63 (DOHC 16V) | 102/137 | 05/99→12/04 | Z21 →12/02 | 1.1 | UXT2 / UXT6 | ZS521 →12/02 |
|---------|---|-----------------|---------|-------------|----------------------|-----|--------------------|------------------------|

SAPORO I

| | | | | | | | | |
|------------|---|------|--------|-------------|------------|-----|--------------------|---|
| 1.6 SL, GL | 4 | 4G32 | 55/74 | 04/78→07/80 | Z11 | 0.8 | UXT2 / UXT6 | ZS106 [1][11][254] ZS110 [1][15] ZS115 [1][11] |
| 2.0 | 4 | 4G52 | 66/89 | 04/78→07/80 | Z11 | 0.8 | UXT2 / UXT6 | ZS106 [1][11][254] ZS110 [1][15] ZS115 [1][11] |
| 2.0 | 4 | 4G52 | 72/97 | 04/78→07/80 | Z11 | 0.8 | UXT2 / UXT6 | ZS110 [15] |
| 2.0 | 4 | 4G52 | 79/106 | 01/79→07/80 | Z11 | 0.8 | UXT2 / UXT6 | ZS110 [15] |

SAPORO II

| | | | | | | | | |
|---------------|---|----------------|---------|-------------|------------|-----|--------------------|---|
| 1.6 GLX | 4 | 4G32 | 55/74 | 08/80→09/84 | Z8 | 0.8 | UXT2 / UXT6 | |
| 2.0 GSL | 4 | 4G63 (SOHC 8V) | 75/101 | 08/80→08/83 | Z27 | 0.8 | UX56 | ZM022 |
| 2.0 GSR | 4 | 4G63 (SOHC 8V) | 82/110 | 08/80→09/84 | Z27 | 0.8 | UX56 | ZS106 [1][11][254] ZS115 [1][11] |
| 2.0 Turbo ECi | 4 | 4G63 T (ECi) | 125/168 | 08/82→08/83 | | | | ZS106 [1][11][254] ZS115 [1][11] |

SAPORO III

| | | | | | | | | |
|-----|---|-----------|--------|-------------|------------|-----|-------------|--------------|
| 2.4 | 4 | 4G64 (8V) | 91/122 | 06/87→08/90 | Z28 | 1.1 | UX56 | ZS261 |
|-----|---|-----------|--------|-------------|------------|-----|-------------|--------------|

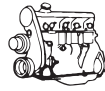

kW/BHP

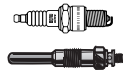
**... MITSUBISHI****SIGMA**

| | | | | | | | | | |
|------------|---|-----------------|---------|-------------|------------------------|------|-------------|-------|-------|
| 3.0 | 6 | 6G72 (SOHC 12V) | 125/168 | 06/92→10/96 | | | | | ZS511 |
| 3.0 | 6 | 6G72 SOHC | 125/168 | 06/92→10/96 | Z21 | 1.1 | UXT2 / UXT6 | | |
| 3.0 LPG | 6 | 6G72 SOHC | 125/168 | 06/92→10/96 | Z27 [168] | 0.8 | UX56 | | |
| 3.0 V6 | 6 | 6G72 (SOHC 12V) | 130/174 | 12/90→07/96 | Z9 | 1.15 | UXT2 / UXT6 | ZS511 | |
| 3.0 V6 LPG | 6 | 6G72 (SOHC 12V) | 130/174 | 12/90→07/96 | Z20 [168] Z27 [168] | 0.8 | UXT2 / UXT6 | | |

SPACE RUNNER

| | | | | | | | | | |
|-------------|---|-----------------|---------|-------------|-----------------|-----|-------|--|--|
| 1.8 | 4 | 4G93 | 85/114 | 06/96→08/99 | Z16 | 1.1 | UXT11 | | |
| 1.8 | 4 | 4G93 | 90/121 | 10/91→08/99 | Z16 | 1.1 | UXT11 | | |
| 1.8 LPG | 4 | 4G93 | 85/114 | 06/96→08/99 | Z340 | 0.7 | UXT12 | | |
| 1.8 LPG | 4 | 4G93 | 90/121 | 10/91→08/99 | Z340 | 0.7 | UXT12 | | |
| 2.0 | 4 | 4G63 (DOHC 16V) | 100/134 | 08/99→08/02 | Z16 | 1.1 | UXT11 | | |
| 2.0 LPG | 4 | 4G63 (DOHC 16V) | 100/134 | 08/99→08/02 | Z340 | 0.7 | UXT12 | | |
| 2.0 16V | 4 | 4G63 (DOHC 16V) | 98/131 | 06/97→08/99 | Z16 | 1.1 | UXT11 | | |
| 2.0 16V LPG | 4 | 4G63 (DOHC 16V) | 98/131 | 06/97→08/99 | Z340 | 0.7 | UXT12 | | |
| 2.0 TD | 4 | 4D68 T | 60/80 | 10/92→08/99 | GN107 06/93→ | 11V | | | |
| 2.4 GDI | 4 | 4G64 (GDI) | 110/148 | 08/99→08/02 | Z278 | 0.6 | | | |

SPACE STAR

| | | | | | | | | | |
|-------------|---|------------|--------|-------------|-------|-----|-------|--|--|
| 1.3 16V | 4 | 4G13 (16V) | 60/80 | 09/00→12/04 | Z73 | 1.1 | UXT11 | | |
| 1.3 16V | 4 | 4G13 (16V) | 61/82 | 12/98→12/04 | Z73 | 1.1 | UXT11 | | |
| 1.3 16V | 4 | 4G13 (16V) | 63/84 | 06/98→12/04 | Z73 | 1.1 | UXT11 | | |
| 1.3 16V LPG | 4 | 4G13 (16V) | 60/80 | 09/00→12/04 | Z206 | 0.7 | UXT10 | | |
| 1.3 16V LPG | 4 | 4G13 (16V) | 61/82 | 12/98→12/04 | Z206 | 0.7 | UXT10 | | |
| 1.3 16V LPG | 4 | 4G13 (16V) | 63/84 | 06/98→12/04 | Z206 | 0.7 | UXT10 | | |
| 1.6 16V | 4 | 4G18 | 72/97 | 01/01→12/04 | Z16 | 1.1 | UXT11 | | |
| 1.6 16V LPG | 4 | 4G18 | 72/97 | 01/01→12/04 | Z340 | 0.7 | UXT12 | | |
| 1.8 GDI | 4 | 4G93 (GDI) | 87/117 | 06/98→12/04 | Z279 | 0.6 | | | |
| 1.8 GDI | 4 | 4G93 (GDI) | 90/121 | 06/98→12/04 | Z279 | 0.6 | | | |
| 1.8 GDI LPG | 4 | 4G93 (GDI) | 87/117 | 06/98→12/04 | Z116 | 0.8 | UXT5 | | |
| 1.8 GDI LPG | 4 | 4G93 (GDI) | 90/121 | 06/98→12/04 | Z116 | 0.8 | UXT5 | | |
| 1.8 MPI | 4 | 4G93 | 82/110 | 10/02→12/04 | Z279 | 0.6 | | | |
| 1.8 MPI LPG | 4 | 4G93 | 82/110 | 10/02→12/04 | Z116 | 0.8 | UXT5 | | |
| 1.9 DI-D | 4 | F9Q1 | 75/101 | 02/01→12/04 | GN018 | 11V | | | |
| 1.9 DI-D | 4 | F9Q2 | 85/114 | 10/02→12/04 | GN018 | 11V | | | |

SPACE WAGON

| | | | | | | | | | |
|-------------|---|-----------------|---------|-------------|--------------------------------|-----|-----------------|-----------------------------------|--|
| 1.8 4WD | 4 | 4G37 | 66/89 | 10/87→08/88 | Z20 | 0.8 | UXT2 / UXT6 | | |
| 1.8 | 4 | 4G93 | 90/121 | 10/91→10/98 | Z16 | 1.1 | UXT11 | | |
| 1.8 LPG | 4 | 4G93 | 90/121 | 10/91→10/98 | Z340 | 0.7 | UXT12 | | |
| 1.8 GLX | 4 | 4G37 | 66/89 | 01/84→12/88 | Z20 | 0.8 | UXT2 / UXT6 | | |
| 2.0 | 4 | 4G63 (SOHC 8V) | 70/94 | 09/87→01/92 | | | | ZS261 06/88→04/91 | |
| 2.0 4WD | 4 | 4G63 (SOHC 8V) | 75/101 | 03/85→04/91 | Z21 →05/88 Z28 06/88→ | 1.1 | UXT2 / UXT6 | ZS261 →05/88 UX56 06/88→ | |
| 2.0 | 4 | 4G63 (DOHC 16V) | 98/131 | 10/92→10/98 | Z16 | 1.1 | UXT11 | ZS261 [1][254] ZS263 [1][254] | |
| 2.0 LPG | 4 | 4G63 (DOHC 16V) | 98/131 | 10/92→10/98 | Z340 | 0.7 | UXT12 | | |
| 2.0 GLX | 4 | G63B | 62/83 | 06/86→05/88 | Z21 | 1.1 | UXT2 / UXT6 | | |
| 2.0 GLX LPG | 4 | G63B | 62/83 | 06/86→05/88 | Z27 [168] | 0.8 | UX56 | | |
| 2.0 GLXi | 4 | 4G63 (SOHC 8V) | 74/99 | 06/88→04/91 | Z28 | 1.1 | UX56 | ZS261 | |
| 2.0 TD | 4 | 4D68 T | 60/80 | 10/92→10/98 | GN107 06/93→ | 11V | | | |
| 2.4 GDI | 4 | 4G64 (GDI) | 108/145 | 09/00→12/04 | Z278 | 0.6 | | | |
| 2.4 GDI | 4 | 4G64 (GDI) | 110/148 | 10/98→12/04 | Z278 | 0.6 | | | |
| 2.4 i | 4 | 4G64 (SOHC 16V) | 102/137 | 10/92→10/98 | Z16 →12/94 | 1.1 | UXT11 →12/94 | | |



kW/BHP

**... MITSUBISHI****... SPACE WAGON**

| | | | | | | | | | |
|-----------|---|-----------------|---------|-------------|----------------|-----|-----------------|--|--|
| 2.4 i LPG | 4 | 4G64 (SOHC 16V) | 102/137 | 10/92→10/98 | Z340 →12/94 | 0.7 | UXT12 →12/94 | | |
|-----------|---|-----------------|---------|-------------|----------------|-----|-----------------|--|--|

STARION

| | | | | | | | | | |
|-------------------|---|--------------|---------|-------------|-----------|------|-------------|-------|-------|
| 2.0 Turbo EGi | 4 | 4G63 T (ECI) | 125/168 | 06/82→12/85 | | | | ZS263 | ZM022 |
| 2.0 Turbo EGi | 4 | 4G63 T/C | 132/177 | 05/85→08/87 | | | | ZS263 | |
| 2.6 Turbo EGi | 4 | G54B T/C | 114/153 | 09/87→06/90 | Z9 | 1.15 | UXT2 / UXT6 | | |
| 2.6 Turbo EGi LPG | 4 | G54B T/C | 114/153 | 09/87→06/90 | Z20 [168] | 0.8 | UXT2 / UXT6 | | |

TREDIA

| | | | | | | | | | |
|-----------|---|--------|--------|-------------|-----|-----|-------------|-------------------------------------|--|
| 1.4 GLX | 4 | 4G12 | 51/68 | 10/82→08/85 | Z8 | 0.8 | UXT2 / UXT6 | ZS106 [1][11][254] ZS109 [1][15] | |
| 1.6 GLS | 4 | 4G32 | 55/74 | 09/82→10/87 | Z8 | 0.8 | UXT2 / UXT6 | ZS106 [1][11][254] ZS109 [1][15] | |
| 1.6 Turbo | 4 | 4G32 T | 84/113 | 09/82→05/85 | Z20 | 0.8 | UXT2 / UXT6 | | |
| 1.6 Turbo | 4 | 4G32 T | 85/114 | 09/82→07/84 | Z20 | 0.8 | UXT2 / UXT6 | | |
| 1.8 GLS | 4 | 4G37 | 66/89 | 08/84→07/86 | Z20 | 0.8 | UXT2 / UXT6 | | |

MITSUBISHI**CANTER**

| | | | | | | | | | |
|-----------|---|----------|--------|-------------|-------|-----|--|--|--|
| 3.0 TDi | 4 | 4M42-0AT | 92/123 | 08/01→07/05 | GN070 | 11V | | | |
| Canter 35 | 4 | 4M40-A | 69/93 | | GN067 | 11V | | | |
| Canter 35 | 4 | 4M40-2AT | 85/114 | | GN067 | 11V | | | |
| Canter 35 | 4 | 4M42-0AT | 92/123 | | GN070 | 11V | | | |
| Canter 55 | 4 | 4M42-0AT | 92/123 | | GN070 | 11V | | | |

L 200

| | | | | | | | | | |
|-----------|---|-----------|-------|-------------|--|-----|--|--|--|
| 2.5 D | 4 | 4D56 (8V) | 55/74 | 10/86→10/96 | GV673 [261] →10/93 GN107 11/93→ | 12V | | | |
| 2.5 D 4WD | 4 | 4D56 (8V) | 55/74 | 12/86→10/96 | GV673 [275] →10/93 GN107 11/93→ | 12V | | | |

| | | | | | | | | | |
|-----------|---|-----------------|---------|-------------|--|--|--|-------|--|
| 3.0 i 4WD | 6 | 6G72 (SOHC 12V) | 109/146 | 09/90→10/96 | | | | ZS282 | |
|-----------|---|-----------------|---------|-------------|--|--|--|-------|--|

L 300

| | | | | | | | | | |
|-------------|---|-----------------|--------|-------------|--------------------------------|------------|--|-------------------------------------|--|
| 1.6 | 4 | 4G32 | 48/64 | 05/80→10/86 | Z8 →05/86 Z21 06/86→ | 0.8 1.1 | UXT2 / UXT6 →05/86 UXT2 / UXT6 06/86→ | ZS106 [1][11][254] ZS109 [1][15] | |
| 1.6 | 4 | 4G32 | 51/68 | 04/83→ | Z8 | 0.8 | UXT2 / UXT6 | | |
| 1.6 | 4 | 4G32 | 51/68 | 04/83→05/94 | | | | ZS106 [1][11][254] ZS109 [1][15] | |
| 1.6 | 4 | 4G32 | 51/68 | 11/86→ | | | | ZS106 [1][11] | |
| 1.6 LPG | 4 | 4G32 | 51/68 | 11/86→ | Z20 [168] | 0.8 | UXT2 / UXT6 | | |
| 1.8 4WD | 4 | 4G62 | 60/80 | 08/84→02/87 | Z20 | 0.8 | UXT2 / UXT6 | | |
| 2.0 4WD | 4 | 4G63 (SOHC 8V) | 63/84 | 08/88→05/94 | | | | ZS106 [11] | |
| 2.0 | 4 | G63B | 64/86 | 11/86→ | Z9 | 1.15 | UXT2 / UXT6 | ZS106 [11] | |
| 2.0 4WD | 4 | 4G63 (SOHC 8V) | 65/87 | 11/86→ | Z20 | 0.8 | UXT2 / UXT6 | ZS106 [11] | |
| 2.0 | 4 | 4G63 (SOHC 8V) | 66/89 | 11/86→ | Z21 →11/88 Z20 12/88→ | 1.1 0.8 | UXT2 / UXT6 →11/88 UXT2 / UXT6 12/88→ | ZS106 [11] | |
| 2.0 4WD | 4 | 4G63 (SOHC 8V) | 66/89 | 11/86→ | Z20 | 0.8 | UXT2 / UXT6 | ZS106 [11] | |
| 2.0 | 4 | 4G63 (DOHC 16V) | 85/114 | 07/94→04/00 | Z16 | 1.1 | UXT11 | ZS106 [11] | |
| 2.0 LPG | 4 | G63B | 64/86 | 11/86→ | Z20 [168] Z27 [168] | 0.8 0.8 | UXT2 / UXT6 UX56 | | |
| 2.0 4WD LPG | 4 | 4G63 (SOHC 8V) | 65/87 | 12/86→ | Z27 [168] | 0.8 | UX56 | | |
| 2.0 LPG | 4 | 4G63 (SOHC 8V) | 66/89 | 11/86→ | Z27 [168] | 0.8 | UX56 | | |

MITSUBISHI



kW/BHP

**... MITSUBISHI****... L 300**

| | | | | | | | | | |
|-------------|---|-----------------|--------|-------------|---|-------------------|-------------|-------|--|
| 2.0 LPG | 4 | 4G63 (DOHC 16V) | 85/114 | 07/94→04/00 | Z340 | 0.7 | UXT12 | | |
| 2.0 i | 4 | 4G63 (DOHC 16V) | 83/111 | 07/96→ | Z73 | 1.1 | UXT11 | | |
| 2.0 i LPG | 4 | 4G63 (DOHC 16V) | 83/111 | 07/96→ | Z206 | 0.7 | UXT10 | | |
| 2.3 D | 4 | 4D55 | 50/67 | 04/83→10/86 | GV673 | 12V | | | |
| 2.4 4WD | 4 | G64B | 80/107 | 11/86→12/90 | Z9 | 1.15 | UXT2 / UXT6 | | |
| 2.4 | 4 | 4G64 (8V) | 82/110 | 11/90→ | Z21 | 1.1 | UXT2 / UXT6 | ZS263 | |
| 2.4 4WD | 4 | 4G64 (8V) | 82/110 | 11/90→ | Z9 | 1.15 | UXT2 / UXT6 | | |
| 2.4 4WD LPG | 4 | G64B | 80/107 | 11/86→12/90 | Z20 [168] | 0.8 | UXT2 / UXT6 | | |
| 2.4 LPG | 4 | 4G64 (8V) | 82/110 | 11/90→ | Z27 [168] | 0.8 | UX56 | | |
| 2.4 4WD LPG | 4 | 4G64 (8V) | 82/110 | 11/90→ | Z20 [168] | 0.8 | UXT2 / UXT6 | | |
| 2.5 D | 4 | 4D56 (8V) | 51/68 | 11/86→ | GV673 [275] →05/93 GN107 06/93→ | 12V 11V | | | |
| 2.5 D | 4 | 4D56 (8V) | 55/74 | 09/91→09/03 | GV673 [275] →05/93 GN107 06/93→06/94 GN017 06/93→08/97 | 12V 11V 11V | | | |
| 2.5 TD | 4 | 4D56 T | 64/86 | 02/87→05/03 | GV673 [275] →05/93 GN017 06/93→ | 12V 11V | | | |
| 2.5 TD | 4 | 4D56 T | 64/86 | 02/87→ | GV673 [275] →05/93 GN107 06/93→ | 12V 11V | | | |
| 2.5 TD | 4 | 4D56 T | 64/86 | 11/94→04/00 | GN107 | 11V | | | |

L 400

| | | | | | | | | | |
|-------------|---|--------|-------|-------------|-------|-----|--|--|--|
| 2.5 2500 TD | 4 | 4D56 T | 64/86 | 09/96→06/05 | GN107 | 11V | | | |
|-------------|---|--------|-------|-------------|-------|-----|--|--|--|

L 400 / SPACE GEAR

| | | | | | | | | | |
|---------------|---|-----------------|--------|-------------|-------|-----|-------|--|--|
| 2.0 16V | 4 | 4G63 (DOHC 16V) | 85/114 | 05/95→05/00 | Z73 | 1.1 | UXT11 | | |
| 2.0 16V LPG | 4 | 4G63 (DOHC 16V) | 85/114 | 05/95→05/00 | Z206 | 0.7 | UXT10 | | |
| 2.4 i 4WD | 4 | 4G64 (SOHC 16V) | 97/130 | 05/95→05/00 | Z73 | 1.1 | UXT11 | | |
| 2.4 i 4WD LPG | 4 | 4G64 (SOHC 16V) | 97/130 | 05/95→05/00 | Z206 | 0.7 | UXT10 | | |
| 2.5 2500 TD | 4 | 4D56 T | 64/86 | 05/95→06/05 | GN107 | 11V | | | |
| 2.5 TD | 4 | 4D56 TD | 73/98 | 05/95→05/00 | GN107 | 11V | | | |

OUTLANDER II Van

| | | | | | | | | | |
|--------------|---|-----|---------|-------------|-------|------|--|--|--|
| 2.0 DI-D 4WD | 4 | BSY | 103/138 | 12/06→11/12 | GE101 | 4.4V | | | |
|--------------|---|-----|---------|-------------|-------|------|--|--|--|

PAJERO SPORT VAN

| | | | | | | | | | |
|------------|---|--------|--------|-------------|-------|-----|--|--|--|
| 2.5 TD 4WD | 4 | 4D56 T | 85/114 | 12/99→01/08 | GN107 | 11V | | | |
|------------|---|--------|--------|-------------|-------|-----|--|--|--|

NISSAN**100 NX**

| | | | | | | | | | |
|---------|---|--------|---------|-------------|----------------|-----|-------------|-------|-------|
| 1.6 | 4 | GA16DS | 66/89 | 03/90→10/94 | Z247 →10/92 | 0.9 | UXT1 / UXT3 | ZS277 | ZM048 |
| 1.6 SR | 4 | GA16DE | 75/101 | 09/93→10/94 | Z16 | 1.1 | UXT11 | ZS277 | |
| 2.0 GTI | 4 | SR20DE | 105/141 | 03/91→10/94 | Z155 | 0.8 | UXT10 | ZS277 | ZM048 |

180 SX

| | | | | | | | | | |
|---------------|---|---------|---------|-------------|-----------|-----|-------|--|--|
| 2.0 Turbo | 4 | SR20DET | 147/197 | 04/91→03/94 | Z314 | 0.9 | UXT14 | | |
| 2.0 Turbo LPG | 4 | SR20DET | 147/197 | 04/91→03/94 | Z30 [168] | 0.8 | UXT5 | | |

200 SX

| | | | | | | | | | |
|---------------------|---|---------|---------|-------------|-----------|-----|-------|--|--|
| 1.8 Turbo | 4 | CA18DET | 124/166 | 07/88→11/93 | Z313 | 1.1 | UXT14 | | |
| 1.8 Turbo LPG | 4 | CA18DET | 124/166 | 07/88→11/93 | Z30 [168] | 0.8 | UXT5 | | |
| 2.0 i 16V Turbo | 4 | SR20DET | 147/197 | 10/93→12/99 | Z314 | 0.9 | UXT14 | | |
| 2.0 i 16V Turbo LPG | 4 | SR20DET | 147/197 | 10/93→12/99 | Z30 [168] | 0.8 | UXT5 | | |



kW/BHP

**... NISSAN****... 200 SX**

| | | | | | | | | |
|---------------|---|---------|---------|-------------|-----------|-----|-------|--|
| 2.0 Turbo | 4 | SR20DET | 162/217 | 04/94→09/99 | Z314 | 0.9 | UXT14 | |
| 2.0 Turbo LPG | 4 | SR20DET | 162/217 | 04/94→09/99 | Z30 [168] | 0.8 | UXT5 | |

280 ZX,ZXT

| | | | | | | | | |
|---------|---|-------|---------|-------------|-----------|------|-------------|--|
| 2.8 | 6 | L28E | 103/138 | 10/78→06/83 | Z21 | 1.1 | UXT2 / UXT6 | |
| 2.8 | 6 | L28E | 108/145 | 02/80→09/82 | Z21 | 1.1 | UXT2 / UXT6 | |
| 2.8 | 6 | L28E | 110/148 | 01/82→02/84 | Z21 | 1.1 | UXT2 / UXT6 | |
| 2.8 | 6 | L28ET | 147/197 | 01/83→02/84 | Z9 | 1.15 | UXT2 / UXT6 | |
| 2.8 LPG | 6 | L28ET | 147/197 | 01/83→02/84 | Z20 [168] | 0.8 | UXT2 / UXT6 | |

300 ZX

| | | | | | | | | |
|--------------------|---|----------|---------|-------------|------------|-----|--------|--|
| 3.0 | 6 | VG30E | 125/168 | 01/84→12/87 | Z16 | 1.1 | UXT11 | |
| 3.0 Turbo | 6 | VG30ET | 149/200 | 05/87→10/90 | Z73 | 1.1 | UXT11 | |
| 3.0 Turbo | 6 | VG30T | 168/225 | 04/84→10/90 | Z16 | 1.1 | UXT11 | |
| | | | | | →06/89 | | →06/89 | |
| 3.0 Twin Turbo | 6 | VG30DETT | 197/264 | 05/90→09/95 | Z228 | 1.0 | UXT11 | |
| 3.0 Twin Turbo | 6 | VG30DETT | 208/279 | 05/90→09/95 | Z228 | 1.0 | UXT11 | |
| 3.0 Twin Turbo LPG | 6 | VG30DETT | 197/264 | 05/90→09/95 | Z221 [168] | 1.0 | UXT14 | |
| 3.0 Twin Turbo LPG | 6 | VG30DETT | 208/279 | 05/90→09/95 | Z221 [168] | 1.0 | UXT14 | |

350 Z

| | | | | | | | | |
|---------|---|--------|---------|--------|------------|-----|-------|---|
| 3.5 | 6 | VQ35DE | 206/276 | 10/03→ | Z219 | 1.1 | UXT13 | ZSE132 →01/07 ZSE158 01/07→12/09 |
| 3.5 | 6 | VQ35DE | 221/296 | 09/02→ | Z219 | 1.1 | UXT13 | ZSE132 →01/07 ZSE158 01/07→12/09 |
| 3.5 | 6 | VQ35HR | 230/308 | 09/05→ | | | | ZSE158 01/07→12/09 |
| 3.5 LPG | 6 | VQ35DE | 206/276 | 10/03→ | Z184 [168] | 0.9 | UXT13 | |
| 3.5 LPG | 6 | VQ35DE | 221/296 | 09/02→ | Z184 [168] | 0.9 | UXT13 | |

AD Van

| | | | | | | | | |
|-------|---|------|-------|-------------|-------|-----|--|--|
| 1.7 D | 4 | CD17 | 40/54 | 10/84→ | GN101 | 11V | | |
| 2.0 D | 4 | CD20 | 55/74 | 10/94→04/99 | GN102 | 11V | | |

AD Wagon

| | | | | | | | | |
|-------|---|------|-------|-------------|-------|-----|--|--|
| 1.7 D | 4 | CD17 | 40/54 | 10/90→08/04 | GN101 | 11V | | |
|-------|---|------|-------|-------------|-------|-----|--|--|

ALMERA I

| | | | | | | | | |
|-----------------|---|--------|---------|-------------|-----------|-----|-------------|-------|
| 1.4 | 4 | GA14DE | 64/86 | 09/95→07/00 | Z15 [168] | 0.8 | UXT1 / UXT3 | ZS277 |
| 1.4 LPG | 4 | GA14DE | 64/86 | 09/95→07/00 | Z340 | 0.7 | UXT12 | |
| 1.4 GX,LX | 4 | GA14DE | 55/74 | 09/95→07/00 | Z15 [168] | 0.8 | UXT1 / UXT3 | ZS277 |
| 1.4 GX,LX LPG | 4 | GA14DE | 55/74 | 09/95→07/00 | Z340 | 0.7 | UXT12 | |
| 1.4 S,GX,LX | 4 | GA14DE | 55/74 | 09/95→03/00 | Z15 [168] | 0.8 | UXT1 / UXT3 | ZS277 |
| 1.4 S,GX,LX LPG | 4 | GA14DE | 55/74 | 09/95→03/00 | Z340 | 0.7 | UXT12 | |
| 1.6 | 4 | GA16DE | 73/98 | 09/95→07/00 | Z247 | 0.9 | UXT1 / UXT3 | ZS277 |
| 1.6 | 4 | GA16DE | 75/101 | 07/95→03/00 | | | | ZS277 |
| 1.6 LPG | 4 | GA16DE | 73/98 | 09/95→07/00 | Z340 | 0.7 | UXT12 | |
| 1.6 SLX | 4 | GA16DE | 66/89 | 09/95→07/00 | Z247 | 0.9 | UXT1 / UXT3 | ZS277 |
| 1.6 SLX LPG | 4 | GA16DE | 66/89 | 09/95→07/00 | Z340 | 0.7 | UXT12 | |
| 1.6 SR,SLX | 4 | GA16DE | 66/89 | 09/95→03/00 | Z247 | 0.9 | UXT1 / UXT3 | ZS277 |
| 1.6 SR,SLX LPG | 4 | GA16DE | 66/89 | 09/95→03/00 | Z340 | 0.7 | UXT12 | |
| 2.0 D | 4 | CD20 | 55/74 | 11/95→07/00 | GN102 | 11V | | |
| | | | | | →04/96 | | | |
| 2.0 GTi | 4 | SR20DE | 105/141 | 07/96→03/00 | Z157 | 1.1 | UXT11 | |

ALMERA II

| | | | | | | | | |
|-----|---|--------|-------|--------|-----|-----|-------|---|
| 1.5 | 4 | QG15DE | 66/89 | 03/00→ | Z73 | 1.1 | UXT11 | ZSE081 [215] 10/00→08/02 ZSE021 [10][215] →12/04 |
|-----|---|--------|-------|--------|-----|-----|-------|---|

NISSAN

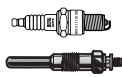

kW/BHP

**... NISSAN****... ALMERA II**

| | | | | | | | | | |
|---------|---|----------|---------|--------|--|--|-----|-----------------|--|
| 1.5 | 4 | QG15DE | 66/89 | 07/00→ | | | | | ZSE081 [215] →08/02 ZSE021 [10] →12/04 |
| 1.5 | 4 | QG15DE | 72/97 | 10/02→ | Z303 | | 1.1 | UXT13 | ZSE021 [10] →12/04 ZSE081 [207][215] |
| 1.5 LPG | 4 | QG15DE | 66/89 | 03/00→ | Z206 | | 0.7 | UXT10 | |
| 1.5 LPG | 4 | QG15DE | 72/97 | 10/02→ | Z226 [168] | | 0.8 | | |
| 1.5 dCi | 4 | K9K 722 | 60/80 | 01/03→ | GN018 | | 11V | | |
| 1.8 | 4 | QG18DE | 84/113 | 01/00→ | Z73 →09/02 Z303 10/02→ | | 1.1 | UXT11 →09/02 | ZSE021 [10][215] →12/04 |
| | | | | | | | 1.1 | UXT13 10/02→ | ZSE081 [215] 10/00→ |
| 1.8 | 4 | QG18DE | 84/113 | 07/00→ | | | | | ZSE081 [215] 03/01→08/02 ZSE021 [10] →12/04 |
| 1.8 | 4 | QG18DE | 85/114 | 10/02→ | Z303 | | 1.1 | UXT13 | ZSE021 [10] →12/04 ZSE081 [207][215] |
| 1.8 LPG | 4 | QG18DE | 84/113 | 01/00→ | Z206 [168] →09/02 Z226 [168] 10/02→ | | 0.7 | UXT10 →09/02 | |
| | | | | | | | 0.8 | | |
| 1.8 LPG | 4 | QG18DE | 85/114 | 10/02→ | Z226 [168] | | 0.8 | | |
| 2.2 dCi | 4 | YD22DDT | 82/110 | 09/03→ | GN109 | | 11V | | |
| 2.2 dCi | 4 | YD22DDTi | 100/134 | 09/03→ | GN109 | | 11V | | |
| 2.2 Di | 4 | YD22DDT | 81/109 | 03/00→ | GN109 | | 11V | | |

ALMERA TINO

| | | | | | | | | | |
|---------|---|----------|---------|--------|--|--|-----|-----------------|-----------------------|
| 1.8 | 4 | QG18DE | 84/113 | 08/00→ | Z73 →12/02 Z303 01/03→ | | 1.1 | UXT11 →12/02 | ZSE021 [10] →11/00 |
| | | | | | | | 1.1 | UXT13 01/03→ | ZSE081 11/00→ |
| 1.8 | 4 | QG18DE | 85/114 | 12/02→ | Z303 | | 1.1 | UXT13 | ZSE081 |
| 1.8 LPG | 4 | QG18DE | 84/113 | 08/00→ | Z206 [168] →12/02 Z226 [168] 01/03→ | | 0.7 | UXT10 →12/02 | |
| | | | | | | | 0.8 | | |
| 1.8 LPG | 4 | QG18DE | 85/114 | 12/02→ | Z226 [168] | | 0.8 | | |
| 2.0 | 4 | SR20DE | 100/134 | 08/00→ | Z221 | | 1.0 | UXT14 | |
| 2.0 LPG | 4 | SR20DE | 100/134 | 08/00→ | Z30 [168] | | 0.8 | UXT5 | |
| 2.2 dCi | 4 | YD22DDT | 82/110 | 09/03→ | GN109 | | 11V | | |
| 2.2 dCi | 4 | YD22DDTi | 100/134 | 09/03→ | GN109 | | 11V | | |
| 2.2 Di | 4 | YD22DDTi | 84/113 | 08/00→ | GN109 | | 11V | | |

ALTIMA

| | | | | | | | | | |
|-----|---|--------|---------|--------|--|--|--|--|------------------|
| 3.5 | 6 | VQ35DE | 201/270 | 10/06→ | | | | | ZSE158 →12/09 |
|-----|---|--------|---------|--------|--|--|--|--|------------------|

ARMADA

| | | | | | | | | | |
|-----|---|--------|---------|-------------|--|--|--|--|---------------------------|
| 5.6 | 8 | VK56DE | 227/304 | 08/03→12/06 | | | | | ZSE134 [1] ZSE156 [64] |
|-----|---|--------|---------|-------------|--|--|--|--|---------------------------|

AVENIR

| | | | | | | | | | |
|--------|---|-------|-------|-------------|-------|--|-----|--|--|
| 2.0 TD | 4 | CD20T | 66/89 | 11/92→09/99 | GN102 | | 11V | | |
|--------|---|-------|-------|-------------|-------|--|-----|--|--|

BLUEBIRD

| | | | | | | | | | |
|-----|---|-------|-------|-------------|------|--|-----|-------------|--|
| 1.6 | 4 | CA16S | 61/82 | 03/86→06/90 | Z247 | | 0.9 | UXT1 / UXT3 | |
| 1.8 | 4 | L18S | 65/87 | 01/80→05/84 | Z8 | | 0.8 | UXT2 / UXT6 | ZS106 [1][11][254] ZS109 [1][15] ZS115 [1][11] |

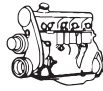

kW/BHP



... NISSAN



... BLUEBIRD

| | | | | | | | | |
|------------------------|---|--------|---------|-------------|----------------------|------------|-------------|--|
| 1.8 | 4 | CA18S | 66/89 | 11/83→06/88 | Z20 | 0.8 | UXT2 / UXT6 | |
| 1.8 | 4 | L18T | 66/89 | 01/80→05/84 | Z20 | 0.8 | UXT2 / UXT6 | ZS106 [1][11][254] ZS109 [1][15] ZS115 [1][11] |
| 1.8 i 16V | 4 | CA18D | 95/127 | 02/89→12/90 | Z284 Z313 | 1.1 1.1 | UXT14 | |
| 1.8 i 16V LPG | 4 | CA18D | 95/127 | 02/89→12/90 | Z30 [168] | 0.8 | UXT5 | |
| 1.9 i | 4 | Z20E | 80/107 | 01/82→05/84 | Z9 | 1.15 | UXT2 / UXT6 | |
| 2.0 | 4 | CA20S | 75/101 | 12/85→09/90 | Z247 | 0.9 | UXT1 / UXT3 | |
| 2.0 | 4 | CA20S | 75/101 | 12/85→12/87 | | | | ZS277 |
| 2.0 | 4 | CA20S | 75/101 | 04/86→09/90 | | | | ZS106 [1][11][254] ZS115 [1][11] |
| 2.0 D | 4 | LD20 | 43/58 | 04/84→01/88 | GV888 →10/85 | 6.5V | | |
| 2.0 D | 4 | LD20 | 44/59 | 01/80→05/84 | GN959 | 11V | | |
| 2.0 D | 4 | LD20 | 49/66 | 03/86→12/90 | GN101 | 11V | | |
| 2.0 i | 4 | CA20E | 77/103 | 04/84→12/90 | Z16 (IN) Z73 (EX) | 1.1 1.1 | UXT11 | ZS106 [1][11][254] ZS115 [1][11] |
| 2.0 i | 4 | CA20E | 77/103 | 12/85→12/90 | | | | ZS277 |
| 2.0 i | 4 | Z20E | 80/107 | 01/82→12/83 | Z9 | 1.15 | UXT2 / UXT6 | |
| 2.0 i | 4 | CA20E | 85/114 | 09/88→09/90 | Z16 | 1.1 | UXT11 | ZS277 |
| 2.0 LX | 4 | CA20S | 66/89 | 12/85→02/90 | | | | ZS277 |
| BLUEBIRD SYLPHY | | | | | | | | |
| 1.5 | 4 | HR15DE | 80/107 | 09/05→08/12 | | | | ZSE088 |
| 2.0 | 4 | MR20DE | 98/131 | 09/05→08/12 | Z325 | 1.1 | | |
| CEFIRO | | | | | | | | |
| 2.0 | 6 | VQ20DE | 103/138 | 10/94→12/99 | Z227 | 0.8 | UXT10 | ZSE071 [19][62] ZSE073 [21][61] |
| CEFIRO I | | | | | | | | |
| 2.0 | 6 | VQ20DE | 103/138 | 01/00→ | Z227 | 0.8 | UXT10 | ZSE078 →08/00 ZSE082 →08/00 ZSE075 08/00→ ZSE077 08/00→ |
| 3.0 | 6 | VQ30DE | 147/197 | 01/00→ | | | | ZSE078 [1] →08/00 ZSE082 [1] →08/00 ZSE075 [1] 08/00→ ZSE077 [1] 08/00→ |
| CHERRY II | | | | | | | | |
| 1.0 | 4 | A10S | 32/43 | 08/78→07/81 | Z8 | 0.8 | UXT2 / UXT6 | ZS109 [15] |
| 1.2 | 4 | A12 | 38/51 | 08/78→07/81 | Z8 | 0.8 | UXT2 / UXT6 | ZS106 [1][11][254] ZS109 [1][15] ZS115 [1][11] |
| 1.2 | 4 | A12 | 38/51 | 10/78→07/81 | | | | ZS106 [1][11][254] ZS115 [1][11] |
| 1.3 | 4 | E13 | 44/59 | 08/81→12/83 | Z8 | 0.8 | UXT2 / UXT6 | ZS106 [1][11][254] ZS115 [1][11] |
| 1.4 | 4 | A14S | 59/79 | 08/80→07/81 | Z8 | 0.8 | UXT2 / UXT6 | |
| 1.4 i.e. | 4 | A14S | 59/79 | 08/80→07/81 | Z8 | 0.8 | UXT2 / UXT6 | |
| 1.5 | 4 | E15 | 51/68 | 08/81→12/82 | Z8 | 0.8 | UXT2 / UXT6 | |



kW/BHP

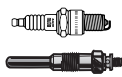

... NISSAN



CHERRY III

| | | | | | | | | |
|--------------|---|-------|--------|-------------|---------------|------|-------------|-------------------------------------|
| 1.0 | 4 | E10 | 37/50 | 05/82→05/86 | Z8 | 0.8 | UXT2 / UXT6 | |
| 1.3 | 4 | E13 | 44/59 | 05/82→10/86 | Z8 | 0.8 | UXT2 / UXT6 | ZS106 [1][11][254] ZS115 [1][11] |
| 1.5 | 4 | E15S | 55/74 | 11/83→10/86 | Z8 | 0.8 | UXT2 / UXT6 | ZS106 [1][11][254] ZS115 [1][11] |
| 1.5 ET Turbo | 4 | E15ET | 77/103 | 01/83→12/85 | Z11 07/83→ | 0.8 | UXT2 / UXT6 | |
| 1.7 D | 4 | CD17 | 40/54 | 10/82→12/86 | GV685 | 6.5V | | |

CIMA

| | | | | | | | | |
|-----|---|--------|---------|-------------|--|--|--|--------|
| 4.1 | 8 | VH41DE | 198/266 | 09/91→02/01 | | | | ZSE074 |
|-----|---|--------|---------|-------------|--|--|--|--------|

CUBE

| | | | | | | | | |
|---------|---|--------|--------|-------------|------------|------|-------|--------|
| 1.4 | 4 | CR14DE | 72/97 | 01/03→09/05 | Z302 | 1.1 | UXT13 | |
| 1.5 dCi | 4 | | 78/105 | 03/10→ | GE110 [37] | 4.4V | | |
| 1.5 dCi | 4 | | 81/109 | 03/10→ | GE110 [37] | 4.4V | | |
| 1.6 16V | 4 | HR16DE | 81/109 | 03/10→ | Z325 | 1.1 | | ZSE056 |

DATSUN 100 A

| | | | | | | | | |
|----------|---|-----|-------|-------------|-----|-----|-------------|--|
| 1.0 | 4 | A10 | 33/44 | 12/74→06/78 | Z11 | 0.8 | UXT2 / UXT6 | |
| 1.0 F-II | 4 | A10 | 33/44 | 12/75→08/80 | Z11 | 0.8 | UXT2 / UXT6 | |

DATSUN 120

| | | | | | | | | |
|------------|---|-----|-------|-------------|-----|-----|-------------|--|
| 1.2 A F-II | 4 | A12 | 38/51 | 12/75→07/80 | Z8 | 0.8 | UXT2 / UXT6 | |
| 1.2 Y | 4 | A12 | 38/51 | 04/62→07/80 | Z11 | 0.8 | UXT2 / UXT6 | |

DATSUN 120 Y

| | | | | | | | | |
|------------|---|-----|-------|-------------|----|-----|-------------|--|
| 1.2 A F-II | 4 | A12 | 38/51 | 12/75→08/80 | Z8 | 0.8 | UXT2 / UXT6 | |
|------------|---|-----|-------|-------------|----|-----|-------------|--|

ELGRAND

| | | | | | | | | |
|-----------|---|---------|---------|-------------|-------|-----|--|--|
| 3.0 D | 4 | ZD30 | 113/152 | 04/03→12/10 | GN072 | 11V | | |
| 3.2 D 4WD | 4 | QD32ETI | 110/148 | 10/95→08/01 | GN101 | 11V | | |

JUKE

| | | | | | | | | |
|---------|---|--------|--------|--------|------------|------|--|--------|
| 1.5 dCi | 4 | | 81/109 | 06/10→ | GE110 [37] | 4.4V | | |
| 1.6 | 4 | HR16DE | 86/115 | 06/10→ | Z325 | 1.1 | | ZSE088 |

KUBISTAR

| | | | | | | | | |
|------------|---|------------------|-------|--------|-------|-----|--|----------------------|
| 1.2 | 4 | D7F 764 | 44/59 | 08/03→ | | | | ZS052 ZS354 [154] |
| 1.2 16V | 4 | D4F 712 | 55/74 | 04/06→ | Z243 | 0.9 | | ZS354 |
| 1.5 dCi | 4 | K9K 710, K9K 714 | 42/56 | 08/03→ | GN018 | 11V | | |
| 1.5 dCi | 4 | K9K 710, K9K 714 | 45/60 | 08/05→ | GN018 | 11V | | |
| 1.5 dCi | 4 | K9K 704 | 48/64 | 08/03→ | GN018 | 11V | | |
| 1.5 dCi | 4 | K9K 722 | 60/80 | 08/03→ | GN018 | 11V | | |
| 1.5 dCi 70 | 4 | K9K 700, K9K 716 | 50/67 | 04/06→ | GN018 | 11V | | |
| 1.5 dCi 85 | 4 | K9K 276 | 62/83 | 04/06→ | GN018 | 11V | | |
| 1.6 16V | 4 | K4M 752 | 70/94 | 08/03→ | | | | ZS052 |

LATIO

| | | | | | | | | |
|-----|---|--------|--------|--------|------|-----|--|--------|
| 1.5 | 4 | HR15DE | 80/107 | 11/04→ | | | | ZSE088 |
| 1.6 | 4 | HR16DE | 81/109 | 03/07→ | Z325 | 1.1 | | |

LAUREL

| | | | | | | | | |
|-------|---|------------|--------|-------------|------------------------------------|-------------|-------------|------------|
| 2.0 | 6 | L20A | 71/95 | 03/77→05/83 | Z8 [170] | 0.8 | UXT2 / UXT6 | |
| 2.0 | 6 | L20A | 71/95 | 03/77→01/84 | | | | ZS109 [15] |
| 2.0 | 6 | L20A | 71/95 | 01/81→01/84 | Z8 | 0.8 | UXT2 / UXT6 | |
| 2.4 | 6 | L24 | 83/111 | 12/77→05/83 | Z8 [170] | 0.8 | UXT2 / UXT6 | |
| 2.4 | 6 | L24 | 83/111 | 12/77→01/84 | | | | ZS109 [15] |
| 2.4 | 6 | L24 | 83/111 | 01/81→01/84 | Z20 | 0.8 | UXT2 / UXT6 | |
| 2.4 | 6 | L24 | 88/118 | 09/83→12/85 | Z62 | 0.8 | UXT2 / UXT6 | ZS109 [15] |
| 2.4 | 6 | L24E, L24S | 94/126 | 01/85→12/87 | Z8 | 0.8 | UXT2 / UXT6 | |
| 2.8 D | 6 | LD28 | 62/83 | 01/81→10/85 | GV689 →10/81 GV888 11/81→ | 11V 6.5V | | |



kW/BHP

**... NISSAN****... LAUREL**

| | | | | | | | | |
|-------|---|------|-------|-------------|------------------------|------|--|--|
| 2.8 D | 6 | LD28 | 62/83 | 01/85→12/87 | GV888 | 6.5V | | |
| 2.8 D | 6 | RD28 | 66/89 | 01/85→12/89 | GV888 →02/87 | 6.5V | | |

LIVINA /GRAND LIVINA

| | | | | | | | | |
|-----|---|--------|--------|--------|-------------|-----|--|--|
| 1.6 | 4 | HR16DE | 80/107 | 02/07→ | Z325 | 1.1 | | |
|-----|---|--------|--------|--------|-------------|-----|--|--|

LUCINO

| | | | | | | | | |
|---------|---|---------|---------|-------------|------------------|-----|--------------|--|
| 2.0 | 4 | SR20DET | 162/217 | 10/91→10/95 | Z314 | 0.9 | UXT14 | |
| 2.0 LPG | 4 | SR20DET | 162/217 | 10/91→10/95 | Z30 [168] | 0.8 | UXT5 | |
| 2.0 D | 4 | CD20 | 55/74 | 11/97→01/00 | GN102 | 11V | | |

MAXIMA

| | | | | | | | | |
|------------|---|--------|---------|--------|------------------|-----|--------------|--|
| 2.0 QX | 6 | VQ20DE | 103/138 | 02/95→ | Z284 | 1.1 | UXT14 | ZSE071 [19][62] ZSE073 [21][61] |
| 2.0 QX LPG | 6 | VQ20DE | 103/138 | 10/97→ | Z30 [168] | 0.8 | UXT5 | |
| 2.5 V6 24V | 6 | VQ25DE | 140/188 | 10/97→ | Z284 | 1.1 | UXT14 | |
| 3.0 QX | 6 | VQ30DE | 142/190 | 01/95→ | Z284 | 1.1 | UXT14 | ZSE071 [19][62] ZSE073 [21][61] |
| 3.0 QX LPG | 6 | VQ30DE | 142/190 | 10/97→ | Z30 [168] | 0.8 | UXT5 | |

MAXIMA II

| | | | | | | | | |
|-----------|---|-------|---------|-------------|-------------|-----|--------------|---------------------------|
| 3.0 i | 6 | VG30E | 125/168 | 10/88→06/94 | Z16 | 1.1 | UXT11 | ZS277 ZM048 |
| 3.0 i LPG | 6 | VG30E | 125/168 | 10/88→06/94 | Z340 | 0.7 | UXT12 | |

MAXIMA QX

| | | | | | | | | |
|------------|---|--------|---------|-------------|------------------|-----|--------------|--|
| 2.0 LPG | 6 | VQ20DE | 103/138 | 02/95→08/00 | Z30 [168] | 0.8 | UXT5 | |
| 2.0 V6 24V | 6 | VQ20DE | 103/138 | 03/00→11/03 | Z284 | 1.1 | UXT14 | ZSE078 [19] →08/00 ZSE082 [21] →08/00 ZSE075 [19] 08/00→ ZSE077 [21] 08/00→ |

| | | | | | | | | |
|----------------|---|--------|---------|-------------|------------------|-----|--------------|--|
| 2.0 V6 24V LPG | 6 | VQ20DE | 103/138 | 03/00→11/03 | Z30 [168] | 0.8 | UXT5 | |
| 2.5 V6 24V | 6 | VQ25DE | 140/188 | 02/95→08/00 | Z284 | 1.1 | UXT14 | |
| 2.5 V6 24V | 6 | VQ25DE | 154/207 | 03/00→11/03 | Z284 | 1.1 | UXT14 | |
| 3.0 LPG | 6 | VQ30DE | 142/190 | 01/95→08/00 | Z30 [168] | 0.8 | UXT5 | |
| 3.0 V6 24V | 6 | VQ30DE | 147/197 | 03/00→11/03 | Z284 | 1.1 | UXT14 | ZSE078 [19] →08/00 ZSE082 [21] →08/00 ZSE075 [19] 08/00→ ZSE077 [21] 08/00→ |

| | | | | | | | | |
|----------------|---|--------|---------|-------------|------------------|-----|-------------|---------------|
| 3.0 V6 24V LPG | 6 | VQ30DE | 147/197 | 03/00→11/03 | Z30 [168] | 0.8 | UXT5 | |
| 3.5 | 6 | VQ35DE | 170/228 | 10/03→11/03 | | | | ZSE079 |
| 3.5 | 6 | VQ35DE | 188/252 | 08/01→02/03 | | | | ZSE079 |
| 3.5 | 6 | VQ35DE | 190/255 | 03/03→11/03 | | | | ZSE079 |

| | | | | | | | | |
|----------------|---|--------|---------|-------------|------------------|-----|-------------|---------------|
| 3.0 V6 24V LPG | 6 | VQ30DE | 147/197 | 03/00→11/03 | Z30 [168] | 0.8 | UXT5 | |
| 3.5 | 6 | VQ35DE | 170/228 | 10/03→11/03 | | | | ZSE079 |
| 3.5 | 6 | VQ35DE | 188/252 | 08/01→02/03 | | | | ZSE079 |
| 3.5 | 6 | VQ35DE | 190/255 | 03/03→11/03 | | | | ZSE079 |

MICRA I

| | | | | | | | | |
|-----|---|-------|-------|-------------|--|------|--------------------|-----------------------------|
| 1.0 | 4 | MA10S | 37/50 | 12/82→12/89 | Z8 Z9 [4] | 0.8 | UXT2 / UXT6 | ZS109 [15] |
| 1.0 | 4 | MA10S | 40/54 | 12/82→05/89 | Z8 | 1.15 | UXT2 / UXT6 | →11/88 |
| 1.0 | 4 | MA10S | 40/54 | 12/82→05/89 | Z8 | 0.8 | UXT2 / UXT6 | ZS109 [15] →11/88 |
| 1.0 | 4 | | 43/58 | 12/82→05/91 | Z8 | 0.8 | UXT2 / UXT6 | ZS109 [15] |
| 1.2 | 4 | MA12S | 40/54 | 07/86→07/92 | Z9 | 1.15 | UXT2 / UXT6 | ZS277 |
| 1.2 | 4 | MA12S | 44/59 | 07/86→07/92 | Z9 →11/88 Z8 12/88→ | 1.15 | UXT2 / UXT6 | ZS277 →11/88 |
| | | | | | | 0.8 | UXT2 / UXT6 | 01/87→ |

NISSAN



kW/BHP



... NISSAN



MICRA II

| | | | | | | | | |
|---------------|---|--------|-------|-------------|-------------------------|------------|-------|-----------------|
| 1.0 | 4 | MA10S | 40/54 | 01/92→04/93 | | | | ZS109 [1][15] |
| 1.0 i 16V | 4 | CG10DE | 40/54 | 08/92→09/00 | Z73 | 1.1 | UXT11 | ZS337 07/00→ |
| 1.0 i 16V | 4 | CG10DE | 44/59 | 09/00→02/03 | Z73 | 1.1 | UXT11 | ZS337 →10/02 |
| 1.0 i 16V LPG | 4 | CG10DE | 40/54 | 08/92→09/00 | Z206 | 0.7 | UXT10 | |
| 1.0 i 16V LPG | 4 | CG10DE | 44/59 | 09/00→02/03 | Z206 | 0.7 | UXT10 | |
| 1.3 i 16V | 4 | CG13DE | 55/74 | 08/92→09/00 | Z73 | 1.1 | UXT11 | ZS337 |
| 1.3 i 16V LPG | 4 | CG13DE | 55/74 | 08/92→09/00 | Z206 | 0.7 | UXT10 | |
| 1.4 i 16V | 4 | CGA3DE | 60/80 | 09/00→02/03 | Z73 | 1.1 | UXT11 | ZS337 →10/02 |
| 1.4 i 16V LPG | 4 | CGA3DE | 60/80 | 09/00→02/03 | Z206 | 0.7 | UXT10 | |
| 1.5 D | 4 | TD15 | 42/56 | 02/98→02/03 | GN016 [2][222] GN912 | 11V 11V | | |

MICRA III

| | | | | | | | | |
|-------------|---|----------------|--------|-------------|------------|-----|-------|--------|
| 1.0 16V | 4 | CG10DE | 48/64 | 01/03→06/10 | Z302 | 1.1 | UXT13 | |
| 1.2 16V | 4 | CG12DE, CR12DE | 48/64 | 01/03→06/10 | Z302 | 1.1 | UXT13 | |
| 1.2 16V | 4 | CG12DE, CR12DE | 59/79 | 01/03→06/10 | Z302 | 1.1 | UXT13 | |
| 1.2 16V LPG | 4 | CG12DE, CR12DE | 48/64 | 01/03→06/10 | Z184 [168] | 0.9 | UXT13 | |
| 1.2 16V LPG | 4 | CG12DE, CR12DE | 59/79 | 01/03→06/10 | Z184 [168] | 0.9 | UXT13 | |
| 1.4 16V | 4 | CR14DE | 65/87 | 01/03→06/10 | Z302 | 1.1 | UXT13 | |
| 1.4 16V LPG | 4 | CR14DE | 65/87 | 01/03→06/10 | Z184 [168] | 0.9 | UXT13 | |
| 1.5 dCi | 4 | K9K 704 | 48/64 | 01/03→06/10 | GN018 | 11V | | |
| 1.5 dCi | 4 | K9K 708 | 50/67 | 06/05→06/10 | GN018 | 11V | | |
| 1.5 dCi | 4 | K9K 722 | 60/80 | 09/03→06/10 | GN018 | 11V | | |
| 1.5 dCi | 4 | K9K 276 | 63/84 | 06/05→06/10 | GN018 | 11V | | |
| 1.6 160 SR | 4 | HR16DE | 81/109 | 05/05→06/10 | Z325 | 1.1 | | ZSE056 |

MICRA IV

| | | | | | | | | |
|---------|---|---------|-------|--------|--|--|--|--------|
| 1.2 | 3 | HR12DE | 56/75 | 05/10→ | | | | ZSE088 |
| 1.2 | 3 | HR12DE | 59/79 | 05/10→ | | | | ZSE088 |
| 1.2 DIG | 3 | HR12DDR | 72/97 | 04/11→ | | | | ZSE088 |

MICRA C+C

| | | | | | | | | |
|------------|---|--------|--------|--------|------|-----|-------|--------|
| 1.4 16V | 4 | CR14DE | 65/87 | 08/05→ | Z302 | 1.1 | UXT13 | |
| 1.6 160 SR | 4 | HR16DE | 81/109 | 08/05→ | Z325 | 1.1 | | ZSE056 |

MURANO

| | | | | | | | | |
|-------------|---|--------|---------|--------|------------|-----|-------|--------|
| 3.5 4WD | 6 | VQ35DE | 172/231 | 08/03→ | Z219 | 1.1 | UXT13 | ZSE079 |
| 3.5 4WD | 6 | VQ35DE | 188/252 | 10/08→ | | | | ZSE158 |
| 3.5 | 6 | VQ35DE | 195/261 | 11/07→ | | | | ZSE158 |
| 3.5 4WD LPG | 6 | VQ35DE | 172/231 | 08/03→ | Z184 [168] | 0.9 | UXT13 | |

NAVARA

| | | | | | | | | |
|-------------|---|----------|---------|--------|-----------------|-----|--|--|
| 2.5 dCi | 4 | YD25DDTi | 106/142 | 07/05→ | GN109 →01/10 | 11V | | |
| 2.5 dCi 4WD | 4 | YD25DDTi | 126/169 | 10/06→ | GN109 →01/10 | 11V | | |
| 2.5 dCi | 4 | YD25DDTi | 128/172 | 07/05→ | GN109 →01/10 | 11V | | |
| 2.5 dCi 4WD | 4 | YD25DDTi | 140/188 | 12/09→ | GN109 →01/10 | 11V | | |

NOTE

| | | | | | | | | |
|---------|---|---------|-------|--------|---|-------------|-------|--|
| 1.4 | 4 | CR14DE | 65/87 | 03/06→ | Z302 | 1.1 | UXT13 | |
| 1.5 dCi | 4 | K9K 700 | 50/67 | 03/06→ | GN018 →10/10 GE110 [37] 11/10→ | 11V 4.4V | | |
| 1.5 dCi | 4 | K9K 276 | 63/84 | 03/06→ | GN018 →10/10 GE110 [37] 11/10→ | 11V 4.4V | | |

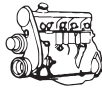

kW/BHP

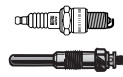

... NISSAN



... NOTE

| | | | | | | | | | |
|---------------------|---|------------------|---------|-------------|--|-------|-------------|--------------------------------------|--|
| 1.5 dCi | 4 | K9K 276, K9K 608 | 66/89 | 09/10→ | GE110 [37] | 4.4V | | | |
| 1.5 dCi | 4 | K9K 292 | 76/102 | 07/08→ | GN018 →10/10 GE110 [37] 11/10→ | 11V | | | |
| 1.6 | 4 | HR16DE | 81/109 | 03/06→ | Z325 | 1.1 | | ZSE056 | |
| NP300 | | | | | | | | | |
| 2.5 dCi | 4 | YD25DDTi | 98/131 | 04/08→ | GN109 | 11V | | | |
| PATHFINDER | | | | | | | | | |
| 2.5 dCi 4WD | 4 | YD25DDTi | 126/169 | 10/06→ | GN109 | 11V | | | |
| 2.5 dCi | 4 | YD25DDTi | 128/172 | 01/05→ | GN109 →01/10 | 11V | | | |
| 3.3 V6 4WD | 6 | VG33E | 110/148 | 03/98→10/00 | Z73 | 1.1 | UXT11 | ZSE076 | |
| 3.3 V6 4WD | 6 | VG33E | 125/168 | 09/97→12/04 | Z73 | 1.1 | UXT11 | ZSE076 | |
| 3.3 V6 4WD LPG | 6 | VG33E | 110/148 | 03/98→10/00 | Z206 | 0.7 | UXT10 | | |
| 3.3 V6 4WD LPG | 6 | VG33E | 125/168 | 09/97→12/04 | Z206 | 0.7 | UXT10 | | |
| 3.5 V6 4WD | 6 | VQ35 | 162/217 | 11/00→12/04 | Z219 | 1.1 | UXT13 | ZSE076 →12/02 ZSE079 01/03→ | |
| 3.5 V6 4WD LPG | 6 | VQ35 | 162/217 | 11/00→12/04 | Z184 [168] | 0.9 | UXT13 | | |
| 4.0 4WD | 6 | VQ40DE | 198/266 | 09/05→ | Z183 | 0.9 | UXT13 | ZSE134 [1] | |
| PATROL | | | | | | | | | |
| 2.8 4WD | 6 | L28 | 88/118 | 07/80→06/90 | Z20 | 0.8 | UXT2 / UXT6 | | |
| 2.8 4WD | 6 | L28 | 88/118 | 07/80→08/88 | | | | ZS109 [15] | |
| 2.8 4WD | 6 | L28 | 88/118 | 05/86→06/90 | | | | ZS110 [15] | |
| 2.8 4WD | 6 | L28 | 89/119 | 07/80→08/88 | Z20 | 0.8 | UXT2 / UXT6 | ZS109 [15] | |
| 3.2 D 4WD | 6 | SD33 | 70/94 | 11/79→08/88 | GV887 →06/82 GV890 07/82→06/85 GN044 07/85→ | 23V | | | |
| 3.2 D 4WD | 6 | SD33T | 81/109 | 08/88→06/90 | GN044 | 24V | | | |
| 3.2 TD 4WD | 6 | SD33T | 81/109 | 07/83→08/88 | GV890 →06/85 GN044 07/85→ | 23V | | | |
| 3.2 TD 4WD | 6 | SD33T | 81/109 | 07/83→08/88 | GV890 →06/85 GN044 07/85→ | 24V | | | |
| PATROL GR I | | | | | | | | | |
| 4.2 4WD | 6 | TB42E | 121/162 | 11/88→02/98 | Z8 | 0.8 | UXT2 / UXT6 | ZS376 | |
| 4.2 4WD LPG | 6 | TB42E | 121/162 | 11/88→02/98 | Z20 [168] | 0.8 | UXT2 / UXT6 | | |
| 4.2 D 4WD | 6 | TD42 | 85/114 | 11/88→06/97 | GV921 | 11V | | | |
| PATROL GR II | | | | | | | | | |
| 2.8 TD 4WD | 6 | RD28Ti | 95/127 | 06/97→05/00 | GN075 | 11V | | | |
| 2.8 TDiC 4WD | 6 | RD28Ti | 96/129 | 10/97→02/00 | GN075 | 11V | | | |
| 3.0 D 4WD | 4 | ZD30DDTi | 116/156 | 05/00→09/04 | GN072 | 11V | | | |
| 3.0 D 4WD | 4 | ZD30DDTi | 118/158 | 10/04→ | GN072 →12/06 | 11V | | | |
| 3.0 DTi 4WD | 4 | ZD30DDTi | 116/156 | 05/00→ | GN072 →12/06 | 11V | | | |
| 3.0 DTi 4WD | 4 | ZD30DDTi | 118/158 | 05/00→ | GN072 →12/06 | 11V | | | |
| 4.2 D 4WD | 6 | TD42T | 114/153 | 05/99→09/04 | GN854 | 11V | | | |
| PICK UP | | | | | | | | | |
| 1.8 | 4 | L18 | 59/79 | 01/83→03/86 | Z8 | 0.8 | UXT2 / UXT6 | ZS109 [1][15] | |
| 2.2 4WD | 4 | Z22 | 71/95 | 04/83→03/86 | Z22 | 0.7 | UX56 | ZS109 [1][15] | |
| 2.2 D | 4 | SD22 | 47/63 | 01/82→01/84 | GV892 | 10.5V | | | |



kW/BHP

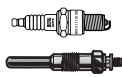

... NISSAN



... PICK UP

| | | | | | | | | | |
|--------------------|---|----------|---------|-------------|------------------------------------|------------------|--|------------------|-------|
| 2.3 D | 4 | SD23 | 51/68 | 04/83→03/86 | GV892 →09/85 GV920 09/85→ | 10.5V 11V | | | |
| 2.3 D | 4 | SD23 | 51/68 | 09/85→08/88 | GV920 | 11V | | | |
| 2.4 i 4WD | 4 | Z24i | 74/99 | 03/86→04/92 | Z20 | 0.8 | UXT2 / UXT6 | | |
| 2.4 i | 4 | KA24E | 88/118 | 02/98→ | Z225 | 1.1 | | | |
| 2.4 i 4WD | 4 | KA24DE | 98/131 | 03/02→ | Z225 | 1.1 | | | |
| 2.4 i 12V | 4 | KA24E | 91/122 | 04/92→02/98 | Z225 | 1.1 | | | |
| 2.4 i 12V 4WD | 4 | KA24E | 93/125 | 04/92→02/98 | Z225 | 1.1 | | | |
| 2.5 D 4WD | 4 | SD25 | 53/71 | 04/83→03/86 | GV889 →08/85 GV920 09/85→ | 11V 11V | | | |
| 2.5 D 4WD | 4 | SD25 | 53/71 | 09/85→08/88 | GV920 | 11V | | | |
| 2.5 D | 4 | TD25 | 55/74 | 09/87→02/98 | GV921 | 11V | | | |
| 2.5 D 4WD | 4 | SD25 | 55/74 | 03/86→08/91 | GV920 →08/87 | 11V | | | |
| 2.5 D | 4 | TD25 | 59/79 | 08/87→02/98 | GV921 | 11V | | | |
| 2.5 D | 4 | TD25 | 61/82 | 03/96→02/98 | GV921 | 11V | | | |
| 2.5 D | 4 | TD25 | 61/82 | 02/98→ | GN994 | 11V | | | |
| 2.5 D 4WD | 4 | | 96/129 | 01/08→ | GN109 | 11V | | | |
| 2.5 Di | 4 | YD25DDTi | 98/131 | 03/02→ | GN109 | 11V | | | |
| 2.5 TD 4WD | 4 | TD25Ti | 76/102 | 05/98→ | GN994 | 11V | | | |
| 2.7 D 4WD | 4 | TD27 | 58/78 | 09/87→08/91 | GV921 | 11V | | | |
| 2.7 D | 4 | TD27 | 66/89 | 02/98→ | GV921 | 11V | | | |
| 2.7 D 4WD | 4 | TD27 | 73/98 | 08/87→02/98 | GV921 | 11V | | | |
| 3.0 i V6 4WD | 6 | VG30E | 109/146 | 09/90→02/98 | Z155 | 0.8 | UXT10 | | |
| 3.0 TD 4WD | 4 | ZD30 | 110/148 | 11/01→ | GN072 | 11V | | | |
| 3.2 D 4WD | 4 | QD32 | 76/102 | 12/98→ | GN101 GV921 | 11V 11V | | | |
| 3.2 TD | 4 | QD32 | 76/102 | 01/97→10/01 | GN101 GV921 | 11V 11V | | | |
| PIXO | | | | | | | | | |
| 1.0 | 3 | K10 B | 50/67 | 06/09→ | Z333 | 1.1 | | | |
| 1.0 LPG | 3 | K10 B | 50/67 | 06/09→ | Z291 [168] | 0.9 | | | |
| PRAIRIE | | | | | | | | | |
| 1.5 S | 4 | E15S | 55/74 | 01/84→12/87 | Z1 [170] | 0.7 | UXT2 / UXT6 | | |
| 1.8 SGL | 4 | CA18S | 65/87 | 07/83→12/85 | Z20 | 0.8 | UXT2 / UXT6 | | |
| 1.8 SGL | 4 | CA18S | 66/89 | 05/85→10/87 | Z20 | 0.8 | UXT2 / UXT6 | | |
| 2.0 4WD | 4 | CA20S | 68/91 | 06/86→09/88 | Z20 | 0.8 | UXT2 / UXT6 | | |
| PRAIRIE PRO | | | | | | | | | |
| 2.0 i | 4 | CA20E | 72/97 | 10/88→12/92 | Z16 (IN) Z73 (EX) | 1.1 1.1 | UXT11 | ZS277 | |
| 2.4 i | 4 | KA24E | 98/131 | 04/92→07/94 | Z225 | 1.1 | | ZS277 | ZM048 |
| PRIMERA | | | | | | | | | |
| 1.6 | 4 | GA16DS | 66/89 | 06/90→01/96 | Z193 →05/93 Z153 06/93→ | 0.9 0.8 | UXT1 / UXT3 →05/93 UXT10 06/93→ | ZS277 | ZM049 |
| 1.6 | 4 | GA16DS | 71/95 | 06/90→01/96 | Z193 | 0.9 | UXT1 / UXT3 | ZS277 | |
| 1.6 | 4 | GA16DE | 75/101 | 06/93→01/96 | Z193 | 0.9 | UXT1 / UXT3 | ZS277 | |
| 1.6 | 4 | QG16DE | 78/105 | 03/02→ | Z183 →10/10 | 0.9 | UXT13 →10/10 | ZSE081 →06/10 | |
| 1.6 | 4 | QG16DE | 80/107 | 01/02→ | | | | ZSE081 →06/10 | |



kW/BHP



... NISSAN



... PRIMERA

| | | | | | | | | |
|-------------|---|--------|---------|-------------|--|--|---|----------------------|
| 1.6 LPG | 4 | GA16DS | 66/89 | 06/90→01/96 | Z340 →05/93 Z151 [168] 06/93→ | 0.7 UXT12 →05/93 0.8 UXT10 06/93→ | | |
| 1.6 LPG | 4 | GA16DE | 75/101 | 06/93→01/96 | Z340 | 0.7 UXT12 | | |
| 1.6 LPG | 4 | QG16DE | 78/105 | 03/02→ | Z184 [168] →06/10 | 0.9 UXT13 →06/10 | | |
| 1.6 16V | 4 | GA16DE | 66/89 | 09/96→12/01 | Z193 →05/99 | 0.9 UXT1 / UXT3 →05/99 | | |
| 1.6 16V | 4 | GA16DE | 66/89 | 09/96→07/02 | Z193 | 0.9 UXT1 / UXT3 | ZS277 | |
| 1.6 16V | 4 | GA16DE | 66/89 | 04/98→12/01 | Z247 | 0.9 UXT1 / UXT3 | | |
| 1.6 16V | 4 | GA16DE | 73/98 | 09/96→10/00 | Z193 | 0.9 UXT1 / UXT3 | | |
| 1.6 16V | 4 | GA16DE | 73/98 | 09/96→07/02 | Z247 | 0.9 UXT1 / UXT3 | ZS277 | |
| 1.6 16V | 4 | QG16DE | 78/105 | 06/96→07/02 | Z73 | 1.1 UXT11 | | |
| 1.6 16V | 4 | QG16DE | 78/105 | 06/96→12/01 | | | ZSE081 09/00→ | |
| 1.6 16V | 4 | QG16DE | 78/105 | 09/00→07/02 | | | ZSE081 →12/01 | |
| 1.6 16V LPG | 4 | GA16DE | 66/89 | 09/96→12/01 | Z340 →05/99 | 0.7 UXT12 →05/99 | | |
| 1.6 16V LPG | 4 | GA16DE | 66/89 | 09/96→07/02 | Z340 | 0.7 UXT12 | | |
| 1.6 16V LPG | 4 | GA16DE | 73/98 | 09/96→07/02 | Z340 | 0.7 UXT12 | | |
| 1.6 16V LPG | 4 | QG16DE | 78/105 | 06/96→07/02 | Z206 | 0.7 UXT10 | | |
| 1.6 i | 4 | GA16DS | 66/89 | 07/90→03/98 | Z193 →05/93 Z153 06/93→ | 0.9 UXT1 / UXT3 →05/93 0.8 UXT10 06/93→ | ZS277 →05/93 | |
| 1.6 i | 4 | GA16DE | 75/101 | 03/94→03/98 | Z247 | 0.9 UXT1 / UXT3 | ZS277 | |
| 1.6 i LPG | 4 | GA16DS | 66/89 | 07/90→03/98 | Z340 [168] →05/93 Z151 [168] 06/93→ | 0.7 UXT12 →05/93 0.8 UXT10 06/93→ | | |
| 1.6 i LPG | 4 | GA16DE | 75/101 | 03/94→03/98 | Z340 | 0.7 UXT12 | | |
| 1.6 Visia | 4 | QG16DE | 80/107 | 01/02→ | | | ZSE081 →06/10 | |
| 1.8 | 4 | QG18DE | 85/114 | 03/02→ | Z303 | 1.1 UXT13 | ZSE081 | |
| 1.8 LPG | 4 | QG18DE | 85/114 | 03/02→ | Z226 [168] | 0.8 | | |
| 1.8 16V | 4 | QG18DE | 84/113 | 08/99→12/01 | Z16 Z73 | 1.1 UXT11 1.1 | | |
| 1.8 16V | 4 | QG18DE | 84/113 | 08/99→07/02 | Z16 | 1.1 UXT11 | ZSE021 [10] →09/00 ZSE081 09/00→ | |
| 1.8 16V LPG | 4 | QG18DE | 84/113 | 08/99→12/01 | Z206 [168] Z340 | 0.7 UXT10 0.7 UXT12 | | |
| 1.8 16V LPG | 4 | QG18DE | 84/113 | 08/99→07/02 | Z340 | 0.7 UXT12 | | |
| 1.9 dCi | 4 | | 85/114 | 08/02→ | GN018 | 11V | | |
| 1.9 dCi | 4 | | 88/118 | 04/03→ | GN018 | 11V | | |
| 2.0 | 4 | QR20DE | 103/138 | 03/02→ | Z303 | 1.1 UXT13 | ZSE080 | |
| 2.0 | 4 | SR20DE | 105/141 | 06/90→04/93 | | | ZS277 | |
| 2.0 | 4 | SR20DE | 110/148 | 06/90→01/98 | | | ZS277 | |
| 2.0 LPG | 4 | QR20DE | 103/138 | 03/02→ | Z226 [168] | 0.8 | | |
| 2.0 16V | 4 | SR20De | 85/114 | 06/96→07/02 | Z155 | 0.8 UXT10 | | ZM048 |
| 2.0 16V | 4 | SR20DI | 85/114 | 06/90→01/96 | Z153 | 0.8 UXT10 | ZS277 [254] 05/93→06/94 | ZM048 05/93→06/94 |
| 2.0 16V 4WD | 4 | SR20DI | 85/114 | 04/91→06/96 | Z153 | 0.8 UXT10 | ZS277 | ZM048 05/93→06/94 |
| 2.0 16V | 4 | SR20DE | 96/129 | 09/96→07/02 | Z155 | 0.8 UXT10 | ZS277 | ZM048 |
| 2.0 16V | 4 | SR20DE | 103/138 | 08/99→07/02 | Z221 | 1.0 UXT14 | ZS277 | ZM048 |

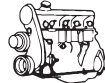

kW/BHP

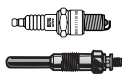

... NISSAN



... PRIMERA

| | | | | | | | | | |
|-------------|---|---------|---------|-------------|------------|-----|-------|--------|-------|
| 2.0 16V | 4 | SR20DE | 110/148 | 09/96→07/02 | Z155 | 0.8 | UXT10 | ZS277 | ZM048 |
| 2.0 16V LPG | 4 | SR20DI | 85/114 | 06/90→06/96 | Z151 [168] | 0.8 | UXT10 | | |
| 2.0 16V LPG | 4 | SR20DE | 103/138 | 08/99→07/02 | Z30 [168] | 0.8 | UXT5 | | |
| 2.0 D | 4 | CD20 | 55/74 | 07/90→01/96 | GN102 | 11V | | | |
| 2.0 GT 4WD | 4 | SR20DE | 105/141 | 03/91→04/93 | | | | ZS277 | |
| 2.0 GT | 4 | SR20DE | 110/148 | 06/90→01/96 | Z155 | 0.8 | UXT10 | ZS277 | ZM048 |
| 2.0 i | 4 | SR20DI | 85/114 | 07/90→03/98 | Z153 | 0.8 | UXT10 | ZS277 | ZM048 |
| | | | | | | | | →07/94 | |
| 2.0 i | 4 | SR20DE | 92/123 | 01/95→06/96 | Z155 | 0.8 | UXT10 | ZS277 | ZM048 |
| 2.0 i LPG | 4 | SR20DI | 85/114 | 07/90→03/98 | Z151 [168] | 0.8 | UXT10 | | |
| 2.0 TD | 4 | CD20T | 66/89 | 09/96→07/02 | GN102 | 11V | | | |
| 2.2 dCi | 4 | YD22DDT | 102/137 | 04/03→ | GN109 | 11V | | | |
| 2.2 Di | 4 | YD22DDT | 93/125 | 03/02→ | GN109 | 11V | | | |

QASHQAI

| | | | | | | | | | |
|---------|---|---------|--------|--------|------------|------|--|--|--|
| 1.5 dCi | 4 | K9K 636 | 81/109 | 02/14→ | GE110 [37] | 4.4V | | | |
|---------|---|---------|--------|--------|------------|------|--|--|--|

QASHQAI / QASHQAI +2

| | | | | | | | | | |
|---------|---|------------------|---------|--------|------------|------|--|-----------------|--|
| 1.5 dCi | 4 | K9K 410 | 76/102 | 07/08→ | GN018 | 11V | | | |
| 1.5 dCi | 4 | K9K 732, K9K 764 | 78/105 | 02/07→ | GN018 | 11V | | | |
| 1.5 dCi | 4 | K9K | 81/109 | 11/10→ | GE110 [37] | 4.4V | | | |
| 1.6 | 4 | HR16DE | 84/113 | 02/07→ | Z325 | 1.1 | | ZSE056 | |
| 1.6 | 4 | HR16DE | 86/115 | 11/10→ | Z325 | 1.1 | | ZSE056 [35][63] | |
| | | | | | | | | ZSE088 [37][60] | |
| 2.0 | 4 | MR20DE | 104/139 | 02/07→ | Z325 | 1.1 | | ZSE088 | |

SERENA

| | | | | | | | | | |
|-------------|---|--------|---------|-------------|--------|-----|-------------|--------|-------|
| 1.6 | 4 | GA16DE | 75/101 | 10/94→08/00 | | | | ZS376 | |
| 1.6 16V | 4 | GA16DE | 71/95 | 02/93→09/01 | Z193 | 0.9 | UXT1 / UXT3 | ZS277 | ZM048 |
| | | | | | | | | →09/94 | |
| | | | | | | | | ZS376 | |
| | | | | | | | | 10/94→ | |
| 1.6 16V LPG | 4 | GA16DE | 71/95 | 02/93→09/01 | Z340 | 0.7 | UXT12 | | |
| 2.0 | 4 | MR20DE | 108/145 | 04/05→ | Z325 | 1.1 | | | |
| 2.0 16V | 4 | SR20DE | 93/125 | 11/92→09/01 | Z157 | 1.1 | UXT11 | ZS277 | ZM048 |
| 2.0 D | 4 | LD20 | 49/66 | 11/92→09/01 | GN101 | 11V | | | |
| | | | | | →09/94 | | | | |
| 2.0 SGX | 4 | SR20DE | 107/143 | 09/00→ | | | | ZS277 | |
| 2.3 D | 4 | LD23 | 55/74 | 01/95→09/01 | GN853 | 11V | | | |
| | | | | | →02/98 | | | | |
| | | | | | GN039 | 11V | | | |
| | | | | | 03/98→ | | | | |

SILVIA

| | | | | | | | | | |
|------------|---|-------|---------|-------------|-----------|------|-------------|--|--|
| 2.0 GP | 4 | FJ20E | 107/143 | 04/84→09/88 | Z9 | 1.15 | UXT2 / UXT6 | | |
| 2.0 GP LPG | 4 | FJ20E | 107/143 | 04/84→09/88 | Z20 [168] | 0.8 | UXT2 / UXT6 | | |

STAGEA

| | | | | | | | | | |
|---------------|---|---------|---------|-------------|------------|-----|--------|--|--|
| 2.5 | 6 | RB25DE | 140/188 | 09/96→10/01 | Z312 [172] | 1.0 | UXT9 | | |
| 2.5 Turbo 4WD | 6 | RB25DET | 173/232 | 09/96→10/01 | Z312 [172] | 1.0 | UXT9 | | |
| | | | | | →08/98 | | →08/98 | | |

STANZA

| | | | | | | | | | |
|---------|---|-------------|-------|-------------|-----|-----|-------------|---------------|--------|
| 1.6 | 4 | CA16S | 60/80 | 08/81→12/85 | Z20 | 0.8 | UXT2 / UXT6 | ZS109 [1][15] | ZM048 |
| | | | | | | | | | 01/85→ |
| 1.8 | 4 | CA18, CA18S | 65/87 | 08/81→12/85 | Z20 | 0.8 | UXT2 / UXT6 | ZS109 [1][15] | ZM048 |
| | | | | | | | | | 01/85→ |
| 1.8 | 4 | CA18S | 66/89 | 08/81→12/85 | Z20 | 0.8 | UXT2 / UXT6 | ZS109 [1][15] | ZM048 |
| | | | | | | | | | 01/85→ |
| 1.8 SGL | 4 | CA18S | 66/89 | 03/83→12/85 | Z20 | 0.8 | UXT2 / UXT6 | ZS109 [1][15] | ZM048 |
| | | | | | | | | | 01/85→ |



kW/BHP



... NISSAN



SUNNY

| | | | | | | | | |
|-----|---|-----|-------|-------------|----|-----|-------------|-----------------------|
| 1.4 | 4 | A14 | 48/64 | 01/70→02/82 | Z8 | 0.8 | UXT2 / UXT6 | ZS109 ^[15] |
| 1.4 | 4 | A14 | 49/66 | 06/79→02/82 | Z8 | 0.8 | UXT2 / UXT6 | ZS109 ^[15] |
| 1.5 | 4 | A15 | 51/68 | 06/79→02/82 | Z8 | 0.8 | UXT2 / UXT6 | ZS109 ^[15] |

SUNNY I

| | | | | | | | | |
|-------|---|------|-------|-------------|-------|------|-------------|-----------------------|
| 1.3 | 4 | E13 | 44/59 | 03/82→09/87 | Z8 | 0.8 | UXT2 / UXT6 | |
| 1.3 | 4 | E13 | 44/59 | 08/82→08/90 | Z8 | 0.8 | UXT2 / UXT6 | |
| | | | | →02/84 | | | →02/84 | |
| 1.5 | 4 | E15S | 55/74 | 03/82→10/86 | Z8 | 0.8 | UXT2 / UXT6 | ZS109 ^[15] |
| 1.7 D | 4 | CD17 | 40/54 | 03/82→10/86 | GV685 | 6.5V | | |
| | | | | →12/84 | | | | |

SUNNY II

| | | | | | | | | |
|-----------------|---|-------|--------|-------------|-----------------------|------|-------------|-----------------------|
| 1.3 | 4 | E13S | 44/59 | 06/86→10/91 | Z8 | 0.8 | UXT2 / UXT6 | |
| 1.4 LX | 4 | GA14S | 55/74 | 10/88→08/91 | Z247 | 0.9 | UXT1 / UXT3 | ZS109 ^[15] |
| 1.5 | 4 | E15S | 52/70 | 06/86→10/88 | Z1 ^[169] | 0.7 | UXT2 / UXT6 | |
| | | | | | Z8 | 0.8 | | |
| | | | | | Z9 | 1.15 | | |
| 1.6 | 4 | E16S | 62/83 | 06/86→10/88 | Z8 | 0.8 | UXT2 / UXT6 | |
| | | | | | Z9 | 1.15 | | |
| 1.6 GTI 16V | 4 | CA16D | 81/109 | 02/87→05/89 | Z313 | 1.1 | UXT14 | |
| 1.6 GTI 16V LPG | 4 | CA16D | 81/109 | 02/87→05/89 | Z30 ^[168] | 0.8 | UXT5 | |
| 1.6 i | 4 | E16i | 54/72 | 06/86→10/90 | Z9 | 1.15 | UXT2 / UXT6 | ZS511 |
| 1.6 i | 4 | E16i | 54/72 | 06/86→05/89 | | | | ZS277 |
| 1.6 i 4WD | 4 | E16i | 54/72 | 06/86→10/90 | Z9 | 1.15 | UXT2 / UXT6 | ZS511 |
| 1.6 i 12V | 4 | GA16i | 66/89 | 06/86→10/90 | Z16 | 1.1 | UXT11 | |
| | | | | 10/88→ | | | 10/88→ | |
| 1.6 i 12V | 4 | GA16i | 66/89 | 06/86→06/91 | | | | ZS277 |
| 1.6 i 12V | 4 | GA16i | 66/89 | 10/88→06/91 | Z16 | 1.1 | UXT11 | |
| 1.7 D | 4 | CD17 | 40/54 | 01/86→06/91 | GN101 | 11V | | |
| 1.8 GTI 16V | 4 | CA18D | 92/123 | 01/89→06/91 | Z228 | 1.0 | UXT11 | |
| | | | | →08/90 | | | →08/90 | |
| | | | | | Z313 | 1.1 | UXT14 | |
| 1.8 GTI 16V LPG | 4 | CA18D | 92/123 | 01/89→06/91 | Z221 ^[168] | 1.0 | UXT14 | |
| | | | | | Z30 ^[168] | 0.8 | UXT5 | |

SUNNY III

| | | | | | | | | |
|-----------------|---|----------------|--------|-------------|----------------------|-----|-------------|-----------------------------|
| 1.4 | 4 | GA14DS | 60/80 | 10/90→06/95 | | | | ZS277 |
| 1.4 i | 4 | GA14DE, GA14DS | 55/74 | 10/90→05/95 | Z15 ^[168] | 0.8 | UXT1 / UXT3 | ZS277 |
| | | | | | | | | →10/92 |
| | | | | | | | | ZS277 ^[254] |
| 1.4 i LPG | 4 | GA14DE, GA14DS | 55/74 | 10/90→05/95 | Z340 | 0.7 | UXT12 | |
| 1.4 i 16V | 4 | GA14DE | 64/86 | 10/90→05/95 | Z255 | 0.9 | UXT1 / UXT3 | |
| | | | | 12/92→ | | | 12/92→ | |
| | | | | | Z72 | 0.8 | UXT1 / UXT3 | |
| | | | | 12/92→ | | | 12/92→ | |
| 1.4 i 16V | 4 | GA14DE | 64/86 | 10/90→06/95 | Z255 | 0.9 | UXT1 / UXT3 | ZS277 |
| | | | | | Z334 ^[17] | 0.9 | | |
| | | | | | Z72 | 0.8 | | |
| 1.6 | 4 | GA16DE | 82/110 | 08/90→10/94 | Z15 | 0.8 | UXT1 / UXT3 | ZS277 |
| | | | | 10/92→ | | | 10/92→ | |
| | | | | | Z16 | 1.1 | UXT11 | |
| | | | | 10/92→ | | | 10/92→ | |
| | | | | | Z24 | 0.8 | UXT5 | |
| | | | | 10/92→ | | | 10/92→ | |
| 1.6 16V 4WD | 4 | GA16DS | 66/89 | 11/90→05/95 | Z24 | 0.8 | UXT5 | ZS277 |
| 1.6 16V 4WD LPG | 4 | GA16DS | 66/89 | 11/90→05/95 | Z30 ^[168] | 0.8 | UXT5 | |
| 1.6 i | 4 | GA16DE | 66/89 | 10/90→05/95 | Z15 ^[168] | 0.8 | UXT1 / UXT3 | ZS277 ^{[192][254]} |
| | | | | 10/92→ | | 0.8 | 10/92→ | →10/92 |
| 1.6 i | 4 | GA16DE, GA16DS | 66/89 | 06/91→03/00 | Z24 | 0.8 | UXT5 | ZS277 |
| | | | | | | | | →10/92 |

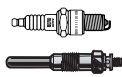

kW/BHP

**... NISSAN****... SUNNY III**

| | | | | | | | | | |
|-------------------|---|----------------|---------|-------------|---|-------------------|-----------------------------|---|------------------------|
| 1.6 i | 4 | GA16DEL | 66/89 | 10/90→05/95 | | | | | ZS277 →10/92 |
| 1.6 i | 4 | GA16DS | 66/89 | 10/90→05/95 | Z15 [168] Z24 | 0.8 | UXT1 / UXT3 | ZS277 [192][254] | →10/92 |
| 1.6 i LPG | 4 | GA16DE | 66/89 | 10/90→05/95 | Z340 10/92→ | 0.7 | UXT12 | | |
| 1.6 i LPG | 4 | GA16DE, GA16DS | 66/89 | 06/91→03/00 | Z30 [168] | 0.8 | UXT5 | | |
| 1.6 i LPG | 4 | GA16DS | 66/89 | 10/90→05/95 | Z30 [168] Z340 | 0.8 0.7 | UXT5 UXT12 | | |
| 1.6 i 16V 4WD | 4 | GA16DS | 66/89 | 10/90→05/95 | Z15 [168] | 0.8 | UXT1 / UXT3 | ZS277 | |
| 1.6 i 16V | 4 | GA16DE | 75/101 | 10/92→05/95 | Z15 [168] Z255 Z72 | 0.8 0.9 0.8 | UXT1 / UXT3 | ZS277 | |
| 1.6 i 16V 4WD | 4 | GA16DE | 75/101 | 10/92→05/95 | Z255 Z72 | 0.9 0.8 | UXT1 / UXT3 | | |
| 1.6 i 16V 4WD | 4 | GA16DE | 75/101 | 10/92→03/00 | Z15 [168] | 0.8 | UXT1 / UXT3 | ZS277 | |
| 1.6 i 16V 4WD LPG | 4 | GA16DS | 66/89 | 10/90→05/95 | Z340 | 0.7 | UXT12 | | |
| 1.6 i 16V LPG | 4 | GA16DE | 75/101 | 10/92→03/00 | Z340 | 0.7 | UXT12 | | |
| 1.6 SR 4WD | 4 | GA16DEL | 66/89 | 01/92→06/95 | | | | ZS277 | |
| 2.0 | 4 | SR20DE | 104/139 | 08/90→12/96 | | | | ZS277 | |
| 2.0 D | 4 | CD20 | 55/74 | 10/90→03/00 | GN102 | 11V | | | |
| 2.0 GTI 16V | 4 | SR20DE | 105/141 | 10/90→05/95 | Z155 | 0.8 | UXT10 | ZS277 | |
| 2.0 GTI-R 4WD | 4 | SR20DET | 162/217 | 10/90→05/95 | Z314 | 0.9 | UXT14 | ZS277 | |
| 2.0 GTI-R 4WD LPG | 4 | SR20DET | 162/217 | 10/90→05/95 | Z30 [168] | 0.8 | UXT5 | | |
| 2.0 i 16V | 4 | SR20DE | 105/141 | 10/90→05/95 | Z155 | 0.8 | UXT10 | ZS277 | |
| TEANA I | | | | | | | | | |
| 2.0 | 4 | QR20DE | 103/138 | 10/03→06/08 | Z183 | 0.9 | UXT13 | ZSE080 | |
| 2.3 | 6 | VQ23DE | 127/170 | 10/03→06/08 | | | | ZSE079 03/07→ | |
| 3.5 | 6 | VQ35DE | 170/228 | 10/03→06/08 | Z219 | 1.1 | UXT13 | ZS079 | |
| TEANA II | | | | | | | | | |
| 2.5 | 6 | VQ25DE | 134/180 | 07/08→ | Z235 | 1.0 | | ZSE158 | |
| 3.5 | 6 | VQ35DE | 183/245 | 07/08→ | | | | ZSE158 | |
| TERRANO I | | | | | | | | | |
| 2.4 i 4WD | 4 | Z24i | 76/102 | 10/87→02/93 | Z8 | 0.8 | UXT2 / UXT6 | | |
| 2.7 TD 4WD | 4 | TD27T | 73/98 | 02/89→02/96 | GN854 | 11V | | | |
| 3.0 i 4WD | 6 | VG30E | 109/146 | 01/90→12/95 | Z155 | 0.8 | UXT10 | ZS277 | ZM048 |
| TERRANO II | | | | | | | | | |
| 2.4 4WD | 4 | KA24E | 85/114 | 05/96→01/02 | Z225 | 1.1 | | ZS277 | |
| 2.4 4WD | 4 | KA24E | 87/117 | 05/96→ | Z225 | 1.1 | | ZS277 | |
| 2.4 i 12V 4WD | 4 | KA24E | 91/122 | 02/93→06/96 | Z225 | 1.1 | | ZS277 | ZM048 |
| 2.7 TD 4WD | 4 | TD27T | 74/99 | 02/93→01/02 | GN994 | 11V | | | |
| 2.7 TDi 4WD | 4 | TD27TI | 92/123 | 05/96→ | GN994 | 11V | | | |
| 3.0 Di 4WD | 4 | ZD30 | 113/152 | 05/02→ | GN072 | 11V | | | |
| TIIDA | | | | | | | | | |
| 1.5 | 4 | HR15DE | 80/107 | 05/04→02/07 | | | | ZSE088 | |
| 1.5 dCi | 4 | K9K 772 | 76/102 | 01/07→ | GN018 | 11V | | | |
| 1.5 dCi | 4 | K9K 728 | 78/105 | 09/07→ | GN018 | 11V | | | |
| 1.6 | 4 | HR16DE | 81/109 | 09/07→ | Z325 | 1.1 | | ZSE056 | |
| 1.8 | 4 | MR18DE | 93/125 | 05/04→ | | | | ZSE056 | |
| 1.8 | 4 | MR18DE | 93/125 | 09/07→ | Z325 | 1.1 | | | |
| TITAN | | | | | | | | | |
| 5.6 | 8 | VK56DE | 227/304 | 10/03→ | | | | ZSE134 [1] ZSE156 [64] | |
| 5.6 Flex-Fuel 4WD | 8 | VK56DE | 224/300 | 01/04→12/07 | | | | ZSE134 [1] | |

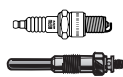

kW/BHP

**... NISSAN****X-TRAIL**

| | | | | | | | | |
|-------------|---|----------|---------|--------|-----------------------|------------|-------|----------------------------------|
| 2.0 | 4 | MR20DE | 103/138 | 06/08→ | Z325 | 1.1 | | ZSE056 |
| 2.0 | 4 | QR20DE | 103/138 | 07/01→ | Z184 Z303 | 0.9 1.1 | UXT13 | ZSE080 |
| 2.0 4WD | 4 | QR20DE | 103/138 | 07/01→ | Z303 | 1.1 | UXT13 | ZSE080 |
| 2.0 | 4 | MR20DE | 104/139 | 03/07→ | Z325 | 1.1 | | ZSE056 |
| 2.0 | 4 | QR20DE | 110/148 | 09/01→ | Z184 Z303 | 0.9 1.1 | UXT13 | ZSE080 →01/07 |
| 2.0 4WD | 4 | QR20DE | 110/148 | 09/01→ | | | | ZSE080 →01/07 |
| 2.0 4WD | 4 | QR20DE | 206/276 | 06/01→ | | | | ZSE080 →01/07 |
| 2.0 4WD LPG | 4 | QR20DE | 103/138 | 07/01→ | Z226 ^[168] | 0.8 | | |
| 2.2 dCi | 4 | YD22DDTi | 84/113 | 06/01→ | GN109 | 11V | | |
| 2.2 dCi | 4 | YD22DDTi | 100/134 | 12/03→ | GN109 | 11V | | |
| 2.2 Di 4WD | 4 | YD22ETi | 84/113 | 07/01→ | GN109 | 11V | | |
| 2.5 4WD | 4 | QR25DE | 121/162 | 09/02→ | Z303 | 1.1 | UXT13 | ZSE080 |
| 2.5 4WD | 4 | QR25DE | 124/166 | 06/07→ | Z325 | 1.1 | | ZSE056 |
| 2.5 4WD | 4 | QR25DE | 132/177 | 11/02→ | Z184 Z303 | 0.9 1.1 | UXT13 | ZSE080 →01/07 eng. QR25DE→ |
| 2.5 4WD LPG | 4 | QR25DE | 121/162 | 09/02→ | Z226 ^[168] | 0.8 | | |

NISSAN**CABSTAR**

| | | | | | | | | |
|---------|---|----------------------------|---------|-------------|-------|-----|--|--|
| 2.5 D | 4 | TD25 | 55/74 | 01/92→12/00 | GV921 | 11V | | |
| 2.5 dCi | 4 | YD25DDTi | 96/129 | 10/06→09/11 | GN109 | 11V | | |
| 45.15 | 4 | ZD30, ZD30DDTi, ZD30H HD-5 | 110/148 | | GN072 | 11V | | |

CABSTAR E

| | | | | | | | | |
|-------|---|------|-------|--|-------|-----|--|--|
| 75.28 | 4 | LD23 | 55/74 | | GN039 | 11V | | |
|-------|---|------|-------|--|-------|-----|--|--|

CARAVAN

| | | | | | | | | |
|--------|---|--------|--------|--------|-------|-----|--|--|
| 3.0 Di | 4 | ZD30DD | 77/103 | 10/00→ | GN072 | 11V | | |
|--------|---|--------|--------|--------|-------|-----|--|--|

INTERSTAR

| | | | | | | | | |
|-------------|---|------------------|---------|--------|-------|-----|--|--|
| 1.9 dCi 80 | 4 | F9Q 772 | 60/80 | 07/02→ | GN018 | 11V | | |
| 2.2 dCi 90 | 4 | G9T 722 | 66/89 | 07/02→ | GN026 | 11V | | |
| 2.5 dCi 100 | 4 | G9U 720 | 73/98 | 11/03→ | GN026 | 11V | | |
| 2.5 dCi 100 | 4 | G9U 650, G9U 720 | 74/99 | 04/06→ | GN026 | 11V | | |
| 2.5 dCi 120 | 4 | G9U 720 | 84/113 | 07/02→ | GN026 | 11V | | |
| 2.5 dCi 120 | 4 | G9U 650 | 88/118 | 08/06→ | GN026 | 11V | | |
| 2.5 dCi 150 | 4 | G9U 632 | 107/143 | 08/06→ | GN026 | 11V | | |
| 3.0 dCi 140 | 4 | ZD30 | 100/134 | 11/03→ | GN072 | 11V | | |

KUBISTAR

| | | | | | | | | |
|-------------|---|------------------|-------|--------|-------|-----|-------------|--|
| 1.2 | 4 | D7F 764 | 44/59 | 08/03→ | | | | ZS052 |
| 1.2 16V | 4 | D4F 712 | 55/74 | 04/06→ | Z243 | 0.9 | | ZS325 ^[157] ZS375 ^[156] |
| 1.5 dCi | 4 | K9K 710, K9K 714 | 45/60 | 08/05→ | GN018 | 11V | | |
| 1.5 dCi | 4 | K9K 704 | 48/64 | 08/03→ | GN018 | 11V | | |
| 1.5 dCi | 4 | K9K 722 | 60/80 | 08/03→ | GN018 | 11V | | |
| 1.6 16V | 4 | K4M 752 | 70/94 | 08/03→ | Z193 | 0.9 | UXT1 / UXT3 | ZS052 |
| 1.6 16V LPG | 4 | K4M 752 | 70/94 | 08/03→ | Z340 | 0.7 | UXT12 | |

NAVARA

| | | | | | | | | |
|-------------|---|----------|---------|--------|-----------------|-----|--|--|
| 2.5 dCi 4WD | 4 | YD25DDTi | 106/142 | 08/08→ | GN109 →01/10 | 11V | | |
| 2.5 dCi 4WD | 4 | YD25DDTi | 126/169 | 08/08→ | GN109 →01/10 | 11V | | |



kW/BHP

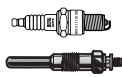

... NISSAN



NV200

| | | | | | | | | |
|---------|---|--------|--------|--------|-----------------|-----|--|--------|
| 1.5 dci | 4 | | 63/84 | 02/10→ | GN018 →09/10 | 11V | | |
| 1.5 dci | 4 | | 66/89 | 04/11→ | GN018 | 11V | | |
| 1.5 dci | 4 | | 81/109 | 04/11→ | GN018 | 11V | | |
| 1.6 16V | 4 | HR16DE | 81/109 | 02/10→ | Z325 | 1.1 | | ZSE056 |

NV200 EVALIA

| | | | | | | | | |
|---------|---|--------|--------|--------|-------|-----|--|--------|
| 1.5 dci | 4 | | 63/84 | 07/10→ | GN018 | 11V | | |
| 1.5 dci | 4 | | 66/89 | 04/11→ | GN018 | 11V | | |
| 1.5 dci | 4 | | 81/109 | 04/11→ | GN018 | 11V | | |
| 1.6 16V | 4 | HR16DE | 81/109 | 07/10→ | Z325 | 1.1 | | ZSE056 |

PATROL

| | | | | | | | | |
|------------|---|-------|--------|-------------|------------------------------------|------------|--|--|
| 3.3 D 4WD | 6 | SD33 | 70/94 | 06/80→12/87 | GV920 →07/85 GN044 08/85→ | 11V 24V | | |
| 3.3 TD 4WD | 6 | SD33T | 81/109 | 01/84→12/87 | GV890 →06/85 GN044 07/85→ | 23V 24V | | |

PATROL II

| | | | | | | | | |
|-----------|---|----------|---------|--------|-------|-----|--|--|
| 3.0 D 4WD | 4 | ZD30DDTi | 118/158 | 09/07→ | GN072 | 11V | | |
|-----------|---|----------|---------|--------|-------|-----|--|--|

PRIMASTAR

| | | | | | | | | |
|-------------|---|------------------|---------|-------------|-------|-----|-------|-------|
| 1.9 dCi | 4 | F9Q 760 | 74/99 | 07/02→08/06 | GN018 | 11V | | |
| 1.9 dCi 80 | 4 | F9Q 762 | 60/80 | 03/01→ | GN018 | 11V | | |
| 1.9 dCi 100 | 4 | F9Q 760 | 74/99 | 03/01→ | GN018 | 11V | | |
| 2.0 | 4 | F4R 720, F4R 722 | 88/118 | 03/01→ | Z206 | 0.7 | UXT10 | ZS052 |
| 2.0 LPG | 4 | F4R 720, F4R 722 | 88/118 | 03/01→ | Z340 | 0.7 | UXT12 | |
| 2.5 dCi 140 | 4 | G9U 730 | 99/133 | 07/03→ | GN026 | 11V | | |
| 2.5 dCi 150 | 4 | G9U 632 | 107/143 | 09/06→ | GN026 | 11V | | |

SUNNY

| | | | | | | | | |
|---------------|---|--------|-------|-------------|----------------------|-----|------|-------|
| 1.6 i 16V | 4 | GA16DE | 66/89 | 10/92→03/00 | Z24 | 0.8 | UXT5 | ZS277 |
| 1.6 i 16V LPG | 4 | GA16DE | 66/89 | 10/92→03/00 | Z30 ^[168] | 0.8 | UXT5 | |
| 1.7 D | 4 | CD17 | 40/54 | 11/90→03/00 | GN101 05/92→04/98 | 11V | | |

TERRANO Van

| | | | | | | | | |
|-------------|---|--------|---------|--------|-------|-----|--|--|
| 2.7 TDi 4WD | 4 | TD27Ti | 92/123 | 06/98→ | GN101 | 11V | | |
| 3.0 Di 4WD | 4 | ZD30 | 113/152 | 04/03→ | GN072 | 11V | | |

TRADE

| | | | | | | | | |
|-------|---|------|-------|-------------|-------|-----|--|--|
| 2.0 D | 4 | LD20 | 44/59 | 11/86→03/93 | GN857 | 11V | | |
|-------|---|------|-------|-------------|-------|-----|--|--|

URVAN

| | | | | | | | | |
|---------|---|--------|--------|-------------|----------------------|-------|-------------|-----------------------|
| 2.0 | 4 | H20 | 55/74 | 07/81→11/82 | Z20 | 0.8 | UXT2 / UXT6 | ZS109 ^[15] |
| 2.0 | 4 | Z20 | 64/86 | 12/82→05/97 | Z20 | 0.8 | UXT2 / UXT6 | |
| 2.0 LPG | 4 | Z20 | 64/86 | 05/87→05/97 | Z27 ^[168] | 0.8 | UX56 | |
| 2.2 D | 4 | SD22 | 47/63 | 07/81→11/82 | GV887 | 23V | | |
| 2.3 D | 4 | SD23 | 50/67 | 11/82→05/87 | GV892 | 10.5V | | |
| 2.3 D | 4 | SD23 | 51/68 | 04/85→11/88 | GV892 | 10.5V | | |
| 2.3 D | 4 | TD23 | 51/68 | 01/88→05/97 | GV921 | 11V | | |
| 2.4 i | 4 | Z24i | 74/99 | 05/89→09/93 | Z8 | 0.8 | UXT2 / UXT6 | |
| 2.5 D | 4 | TD25 | 59/79 | 12/88→05/97 | GV921 | 11V | | |
| 2.7 D | 4 | TD27 | 62/83 | 03/87→09/93 | GV921 | 11V | | |
| 3.0 D | 4 | ZD30DD | 77/103 | 10/00→01/12 | GN072 | 11V | | |
| 3.0 Di | 4 | ZD30DD | 77/103 | 10/00→ | GN072 | 11V | | |

VANETTE

| | | | | | | | | |
|-----|---|------|-------|-------------|----|-----|-------------|---------------------------------|
| 1.5 | 4 | A15S | 49/66 | 07/81→06/87 | | | | ZS109 ^[15] |
| 1.5 | 4 | A15 | 51/68 | 01/83→12/87 | Z8 | 0.8 | UXT2 / UXT6 | ZS109 ^[15] |
| 1.5 | 4 | A15 | 51/68 | 10/86→12/95 | | | | ZS109 ^[15] →06/94 |

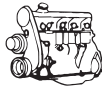

kW/BHP

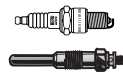
**... NISSAN****... VANETTE**

| | | | | | | | | | |
|----------------------|---|--------------|--------|-------------|------------------------------------|----------------|-------------|---------------------------------|--|
| 1.5 | 4 | A15S | 51/68 | 10/86→12/95 | Z8 | 0.8 | UXT2 / UXT6 | ZS109 ^[15] →06/94 | |
| 1.5 | 4 | A15S | 60/80 | 03/83→11/86 | | | | ZS109 ^{[1][15]} | |
| 2.0 D | 4 | LD20 | 47/63 | 10/86→12/95 | GN101 | 11V | | | |
| 2.0 D | 4 | LD20, LD20II | 49/66 | 10/86→12/95 | GN101 | 11V | | | |
| 2.4 i | 4 | Z24i | 74/99 | 10/86→12/95 | Z8 | 0.8 | UXT2 / UXT6 | | |
| 2.4 i | 4 | Z24i | 77/103 | 10/86→12/95 | Z8 | 0.8 | UXT2 / UXT6 | | |
| 2.4 i LPG | 4 | Z24i | 74/99 | 10/86→12/95 | Z20 ^[168] | 0.8 | UXT2 / UXT6 | | |
| 2.4 i LPG | 4 | Z24i | 77/103 | 10/86→12/95 | Z20 ^[168] | 0.8 | UXT2 / UXT6 | | |
| VANETTE CARGO | | | | | | | | | |
| 1.6 i | 4 | GA16DE | 71/95 | 01/95→ | Z247 | 0.9 | UXT1 / UXT3 | | |
| 1.6 i | 4 | GA16DE | 72/97 | 01/96→ | Z247 | 0.9 | UXT1 / UXT3 | ZS277 | |
| 1.6 i LPG | 4 | GA16DE | 71/95 | 01/95→ | Z340 | 0.7 | UXT12 | | |
| 1.6 i LPG | 4 | GA16DE | 72/97 | 01/96→ | Z340 | 0.7 | UXT12 | | |
| 2.3 D | 4 | LD23 | 55/74 | 01/95→ | GN853 →02/98 GN039 03/98→ | 11V 11V | | | |

OPEL**ADMIRAL A**

| | | | | | | | | |
|--------|---|-------|---------|-------------|----------------------|-----|--|-----------------------|
| 2.6 S | 6 | 26 S | 74/99 | 04/64→09/65 | Z19 ^[168] | 0.8 | | ZS105 ^[11] |
| 2.8 HL | 6 | 28 HL | 103/138 | 10/67→03/69 | Z19 ^[168] | 0.8 | | |
| 2.8 S | 6 | 28 S | 92/123 | 10/65→03/69 | Z19 ^[168] | 0.8 | | |
| 4.6 | 8 | 46 S | 140/188 | 04/65→03/69 | Z267 | 0.6 | | |

ADMIRAL B

| | | | | | | | | |
|-------|---|------|---------|-------------|----------------------|-----|--|--|
| 2.8 | 6 | 28 H | 103/138 | 03/75→07/76 | Z19 ^[168] | 0.8 | | |
| 2.8 | 6 | 28 H | 107/143 | 03/69→02/75 | Z19 ^[168] | 0.8 | | |
| 2.8 E | 6 | 28 E | 118/158 | 03/75→01/78 | Z19 ^[168] | 0.8 | | |
| 2.8 E | 6 | 28 E | 121/162 | 03/69→02/75 | Z19 ^[168] | 0.8 | | |
| 2.8 S | 6 | 28 S | 95/127 | 03/75→01/78 | Z19 ^[168] | 0.8 | | |
| 2.8 S | 6 | 28 S | 97/130 | 03/69→07/75 | Z48 | 0.8 | | |

AGILA (A)

| | | | | | | | | |
|----------------------|---|----------|-------|-------------|------------------------------|------------|---|--------|
| 1.0 | 3 | Z 10 XEP | 44/59 | 08/03→12/07 | Z203 | 0.9 | | ZS359 |
| 1.0 LPG | 3 | Z 10 XEP | 44/59 | 08/03→12/07 | Z206 ^[168] | 0.7 | UXT10 | |
| 1.0 12V | 3 | Z 10 XE | 43/58 | 09/00→12/07 | Z190 ^[282] Z74 | 1.2 1.0 | | ZS358 |
| 1.0 12V LPG | 3 | Z 10 XE | 43/58 | 09/00→12/07 | Z206 | 0.7 | UXT10 | |
| 1.2 16V | 4 | Z 12 XE | 55/74 | 09/00→12/07 | Z190 ^[282] Z74 | 1.2 1.0 | | ZSE147 |
| 1.2 16V LPG | 4 | Z 12 XE | 55/74 | 09/00→12/07 | Z206 | 0.7 | UXT10 | |
| 1.2 16V Twinport | 4 | Z 12 XEP | 59/79 | 07/04→12/07 | Z203 | 0.9 | | ZS338 |
| 1.2 16V Twinport LPG | 4 | Z 12 XEP | 59/79 | 07/04→12/07 | Z206 ^[168] | 0.7 | UXT10 | |
| 1.3 CDTI | 4 | Z 13 DT | 51/68 | 08/03→12/07 | GN053 | 11V | GSE142 ^[11] →ch. 46999999 | |

AGILA (B)

| | | | | | | | | |
|----------|---|----------------|-------|--------|-------------------------------|------------|------------------------|--|
| 1.0 | 3 | K10B | 48/64 | 04/08→ | Z333 | 1.1 | | |
| 1.0 | 3 | K10B | 50/67 | 07/11→ | Z333 | 1.1 | | |
| 1.0 LPG | 3 | K10B | 48/64 | 04/08→ | Z291 ^[168] | 0.9 | | |
| 1.0 LPG | 3 | K10B | 50/67 | 07/11→ | Z291 ^[168] | 0.9 | | |
| 1.0 LPG | 3 | K10B | 48/64 | 01/10→ | Z291 ^[168] Z333 | 0.9 1.1 | | |
| 1.2 | 4 | K12B | 63/84 | 04/08→ | Z333 | 1.1 | | |
| 1.2 | 4 | K12B | 69/93 | 11/10→ | Z333 | 1.1 | | |
| 1.2 LPG | 4 | K12B | 63/84 | 04/08→ | Z291 ^[168] Z333 | 0.9 1.1 | | |
| 1.3 CDTI | 4 | D13A, Z 13 DTJ | 55/74 | 04/08→ | GN053 | 11V | GSE142 ^[11] | |



kW/BHP

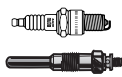

... OPEL



ANTARA

| | | | | | | | | |
|-------------|---|------------------|---------|--------|------------------------------|------|-------------|--------|
| 2.0 CDTI | 4 | Z 20 DM, Z 20 S | 93/125 | 03/07→ | GE125 | 4.4V | | |
| 2.0 CDTI | 4 | Z 20 DMH, Z 20 S | 110/148 | 05/06→ | GE125 | 4.4V | | |
| 2.4 | 4 | Z 24 XE | 103/138 | 01/07→ | Z74 | 1.0 | UXT1 / UXT3 | ZS447A |
| 2.4 4WD | 4 | Z 24 XED | 104/139 | 05/06→ | Z190 ^[282] Z74 | 1.2 | | ZS447A |
| 2.4 LPG | 4 | Z 24 XE | 103/138 | 09/08→ | Z206 | 1.0 | UXT1 / UXT3 | |
| 2.4 4WD LPG | 4 | Z 24 XED | 104/139 | 05/06→ | Z206 | 0.7 | UXT10 | |
| 2.4 LPG | 4 | Z 24 XE | 103/138 | 10/08→ | Z74 | 1.0 | UXT1 / UXT3 | ZS447A |
| 3.2 V6 4WD | 6 | 10 HM, Z 32 SEE | 167/224 | 03/07→ | Z356 | 1.1 | UXT8 | |

ASCONA A

| | | | | | | | | |
|--------|---|------|-------|-------------|--|-----|-------------|--|
| 1.2 S | 4 | 12 S | 44/59 | 04/72→08/75 | Z19 ^[168] | 0.8 | | |
| 1.6 N | 4 | 16 N | 44/59 | 03/75→08/75 | Z19 ^[168] | 0.8 | | |
| 1.6 N | 4 | 16 N | 50/67 | 10/70→02/75 | Z19 ^[168] | 0.8 | | |
| 1.6 S | 4 | 16 S | 55/74 | 03/75→08/75 | Z19 ^[168] | 0.8 | | |
| 1.6 S | 4 | 16 S | 59/79 | 10/70→02/75 | Z20 ^[168] Z22 ^[168] | 0.8 | UXT2 / UXT6 | |
| 1.9 SR | 4 | 19 S | 65/87 | 03/75→08/75 | Z19 ^[168] | 0.8 | UX56 | |
| 1.9 SR | 4 | 19 S | 66/89 | 10/70→02/75 | Z19 ^[168] | 0.8 | | |

ASCONA B

| | | | | | | | | |
|-------------|---|------|---------|-------------|---|-----|-------------|-------|
| 1.2 | 4 | 12 N | 40/54 | 08/76→02/79 | Z19 ^[168] | 0.8 | | |
| 1.2 S | 4 | 12 S | 44/59 | 09/75→02/79 | Z19 ^[168] | 0.8 | | |
| 1.3 N | 4 | 13 N | 44/59 | 03/79→08/81 | Z20 | 0.8 | UXT2 / UXT6 | ZS252 |
| 1.3 S | 4 | 13 S | 55/74 | 08/79→08/81 | Z20 | 0.8 | UXT2 / UXT6 | ZS252 |
| 1.6 N | 4 | 16 N | 44/59 | 09/75→08/81 | Z19 ^[168] | 0.8 | | |
| 1.6 S | 4 | 16 S | 55/74 | 09/75→08/81 | Z19 ^[168] | 0.8 | | |
| 1.9 N | 4 | 19 N | 55/74 | 08/76→08/81 | Z19 ^[168] | 0.8 | | |
| 1.9 S | 4 | 19 S | 66/89 | 09/75→08/81 | Z19 ^[168] | 0.8 | | |
| 2.0 D | 4 | 20 D | 43/58 | 08/78→08/81 | GV137 →10/79 →eng. 90309 GN909 ^[222] 11/79→ eng. 90310→ GV602 11/79→ eng. 90310→ | 11V | | |
| | | | | | | 11V | | |
| | | | | | | 11V | | |
| 2.0 E | 4 | 20 E | 81/109 | 08/79→08/81 | Z19 ^[168] | 0.8 | | |
| 2.0 N | 4 | 20 N | 66/89 | 08/77→08/81 | Z19 ^[168] | 0.8 | | |
| 2.0 S | 4 | 20 S | 74/99 | 08/77→08/81 | Z19 ^[168] | 0.8 | | |
| 2.4 2.4 400 | 4 | 24 E | 106/142 | 07/80→08/81 | Z25 | 0.8 | UXK56 | |

ASCONA C

| | | | | | | | | | |
|-------|---|------------------|-------|-------------|-------------------------------------|-----|-------------|-------|--|
| 1.3 N | 4 | 13 N | 44/59 | 09/81→08/86 | Z20 | 0.8 | UXT2 / UXT6 | ZS252 | ZM006 |
| 1.3 S | 4 | 13 S | 55/74 | 09/81→08/88 | Z20 | 0.8 | UXT2 / UXT6 | ZS252 | ZM006 |
| 1.6 | 4 | 16 N | 55/74 | 09/81→08/88 | Z20 | 0.8 | UXT2 / UXT6 | ZS252 | ZM002 ^[175] ZM015 09/83→ |
| 1.6 | 4 | 16 SV | 60/80 | 09/86→08/88 | Z20 | 0.8 | UXT2 / UXT6 | | ZM002 ^[175] ZM015 ^[175] |
| 1.6 D | 4 | 16 D, 16 DA | 40/54 | 03/82→08/88 | GN013 ^{[21][222]} GN954 | 11V | | | |
| 1.6 i | 4 | C 16 LZ | 55/74 | 09/86→08/88 | Z21 | 1.1 | UXT2 / UXT6 | ZS252 | ZM016 |
| 1.6 i | 4 | C 16 NZ | 55/74 | 09/86→08/88 | Z119 | 0.8 | UXT2 / UXT6 | ZS252 | ZM016 |
| 1.6 i | 4 | E 16 LZ, E 16 NZ | 55/74 | 09/87→08/88 | Z8 | 0.8 | UXT2 / UXT6 | ZS252 | ZM016 |
| 1.6 S | 4 | 16 SH | 66/89 | 09/81→08/86 | Z20 | 0.8 | UXT2 / UXT6 | | ZM002 ^[175] ZM015 09/83→ |
| 1.8 | 4 | E 18 NV | 62/83 | 09/87→08/88 | Z20 | 0.8 | UXT2 / UXT6 | | |
| 1.8 E | 4 | C 18 NE, S 18 NV | 74/99 | 01/85→08/86 | Z20 | 0.8 | UXT2 / UXT6 | | ZM032 |

OPEL

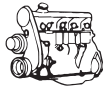

kW/BHP

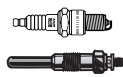

... OPEL



... ASCONA C

| | | | | | | | | |
|----------|---|----------------|--------|-------------|-----|-----|-------------|--|
| 1.8 i | 4 | 18 E | 85/114 | 09/82→08/86 | Z20 | 0.8 | UXT2 / UXT6 | ZM002 ^[175] ZM015 ^[175] |
| 2.0 i | 4 | C 20 NEF | 74/99 | 08/87→08/88 | Z20 | 0.8 | UXT2 / UXT6 | |
| 2.0 i | 4 | 20 NE, C 20 NE | 85/114 | 09/86→08/88 | Z8 | 0.8 | UXT2 / UXT6 | |
| 2.0 i GT | 4 | 20 SEH | 95/127 | 03/87→08/88 | Z20 | 0.8 | UXT2 / UXT6 | |

ASTRA F

| | | | | | | | | |
|---------------|---|------------------|-------|-------------|--|--------------------------|---|--|
| 1.4 | 4 | 14 NV | 55/74 | 09/91→09/93 | Z119 Z20 ^[242] Z74 | 0.8 0.8 1.0 | UXT2 / UXT6 UXT2 / UXT6 UXT1 / UXT3 | ZSE026 ZM001 |
| 1.4 | 4 | 14 SE | 60/80 | 09/92→09/98 | Z190 ^[282] Z74 | 1.2 1.0 | UXT2 / UXT6 UXT1 / UXT3 | ZS253 |
| 1.4 LPG | 4 | 14 SE | 60/80 | 09/92→09/98 | Z206 | 0.7 | UXT10 | |
| 1.4 i | 4 | C 14 NZ | 44/59 | 09/91→09/98 | Z119 ^[284] Z190 ^{[282] [283]} Z74 ^[283] | 0.8 1.2 1.0 | UXT2/UXT6 ^[284] ZS253 ^{[1] [254]} UXT1 / UXT3 ZSE026 ^{[1] [151]} | ZM018 |
| 1.4 i | 4 | X 14 NZ | 44/59 | 09/91→09/98 | Z119 ^[284] Z190 ^{[282] [283]} Z74 ^[283] | 0.8 1.2 1.0 | UXT2/UXT6 ^[284] ZS253 ^[1] UXT1 / UXT3 | ZM018 |
| 1.4 i LPG | 4 | C 14 NZ, X 14 NZ | 44/59 | 09/91→09/98 | Z20 ^[168] Z206 | 0.8 0.7 | UXT2 / UXT6 UXT10 | |
| 1.4 i 16V | 4 | X 14 XE | 66/89 | 01/96→03/01 | Z190 ^[282] Z74 | 1.2 1.0 | UXT2 / UXT6 UXT1 / UXT3 | ZSE026 |
| 1.4 i 16V LPG | 4 | X 14 XE | 66/89 | 01/96→03/01 | Z206 | 0.7 | UXT10 | |
| 1.4 Si | 4 | C 14 SE | 60/80 | 03/92→01/98 | Z119 ^[284] →07/95 Z190 ^{[282] [283]} 08/95→ Z74 ^[283] 08/95→ | 0.8 1.2 1.0 | UXT2/UXT6 ^[284] →07/95 UXT1 / UXT3 | |
| 1.4 Si | 4 | C 14 SE | 60/80 | 03/92→03/01 | Z119 ^[284] Z190 ^{[282] [283]} Z74 ^[283] | 0.8 1.2 1.0 | UXT2/UXT6 ^[284] →eng. 028D0921; 02T14052;02V57974 UXT1 / UXT3 eng. 028D0922; 02T14053;02V57975→ ZSE026 eng. 02T14053→ | ZM018 |
| 1.4 Si | 4 | C 14 SE | 60/80 | 03/92→09/98 | | | | ZM018 →eng. 02T14052 |
| 1.4 Si LPG | 4 | C 14 SE | 60/80 | 03/92→01/98 | Z20 ^[168] →07/95 Z206 | 0.8 0.7 | UXT2 / UXT6 →07/95 UXT10 | |
| 1.4 Si LPG | 4 | C 14 SE | 60/80 | 03/92→03/01 | Z20 ^[168] Z206 | 0.8 0.7 | UXT2 / UXT6 UXT10 | |
| 1.6 | 4 | 16 LZ2 | 55/74 | 09/95→09/98 | Z190 ^[282] Z74 | 1.2 1.0 | UXT2 / UXT6 UXT1 / UXT3 | ZS253 ^[1] →02/98 ZS252 ^{[1] [254]} |
| 1.6 | 4 | 16 LZ2 | 55/74 | 09/95→01/98 | | | | ZS253 ^{[1] [254]} |
| 1.6 | 4 | 16 NZR | 55/74 | 09/95→01/98 | Z119 ^[284] Z190 ^{[282] [283]} Z74 ^[283] Z8 | 0.8 1.2 1.0 0.8 | UXT2/UXT6 ^[284] ZS253 ^[254] ZSE026 ^{[1] [151]} UXT1 / UXT3 ^[283] UXT2 / UXT6 ^[284] | |
| 1.6 | 4 | 16 NZR | 55/74 | 09/95→09/98 | Z190 ^[282] Z74 | 1.2 1.0 | UXT2 / UXT6 UXT1 / UXT3 | ZS252 ^[1] |
| 1.6 LPG | 4 | 16 LZ2, 16 NZR | 55/74 | 09/95→09/98 | Z206 | 0.7 | UXT10 | |

OPEL

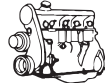

kW/BHP



... OPEL



... ASTRA F

| | | | | | | | | | | |
|---------------|---|-------------------------------------|-------|-------------|--|-------|-----------------------------|--|--|-------|
| 1.6 i | 4 | X 16 SZ | 52/70 | 03/93→08/96 | Z119 ^[284] →12/94 Z190 ^{[282] [283]} 01/95→ Z74 ^[283] 01/95→ | | 0.8 →12/94 1.2 1.0 | UXT2/UXT6 ^[284] →12/94 UXT1/UXT3 ^[283] 01/95→ | ZSE026 | |
| 1.6 i | 4 | X 16 SZ | 52/70 | 05/93→07/96 | Z119 ^[284] Z190 ^{[282] [283]} Z74 ^[283] | | 0.8 1.2 1.0 | UXT2/UXT6 ^[284] UXT1/UXT3 ^[283] | | |
| 1.6 i | 4 | C 16 NZ | 55/74 | 09/91→09/98 | Z119 ^[284] Z190 ^{[282] [283]} Z74 ^[283] | | 0.8 1.2 1.0 | UXT2/UXT6 ^[284] UXT1/UXT3 ^[283] | | ZM016 |
| 1.6 i | 4 | C 16 NZ | 55/74 | 09/91→01/98 | | | | | ZS252 ^[1] →12/93 ZS252 ^{[1] [254]} | |
| 1.6 i | 4 | C 16 NZ | 55/74 | 03/92→09/98 | | | | | ZS252 ^[1] | |
| 1.6 i | 4 | X 16 SZR | 55/74 | 09/91→09/98 | Z119 ^[284] Z190 ^{[282] [283]} Z74 ^[283] | | 0.8 1.2 1.0 | UXT2/UXT6 ^[284] UXT1/UXT3 ^[283] | ZSE026 ^[1] | |
| 1.6 i | 4 | X 16 SZR | 55/74 | 03/92→09/98 | | | | | | ZM016 |
| 1.6 i | 4 | X 16 SZR | 55/74 | 01/96→03/01 | Z190 ^{[282] [283]} Z74 ^[283] | | 1.2 1.0 | UXT1/UXT3 ^[283] | ZSE026 | |
| 1.6 i LPG | 4 | X 16 SZ | 52/70 | 03/93→08/96 | Z20 ^[168] →12/94 Z206 01/95→ | | 0.8 0.7 | UXT2 / UXT6 →12/94 UXT10 01/95→ | | |
| 1.6 i LPG | 4 | X 16 SZ | 52/70 | 05/93→07/96 | Z20 ^[168] Z206 | | 0.8 0.7 | UXT2 / UXT6 UXT10 | | |
| 1.6 i LPG | 4 | C 16 NZ, X 16 SZR | 55/74 | 09/91→09/98 | Z20 ^[168] Z206 | | 0.8 0.7 | UXT2 / UXT6 UXT10 | | |
| 1.6 i LPG | 4 | X 16 SZR | 55/74 | 01/96→03/01 | Z206 | | 0.7 | UXT10 | | |
| 1.6 i 16V | 4 | X 16 XEL | 74/99 | 08/94→09/98 | Z190 ^[282] Z74 | | 1.2 1.0 | UXT1 / UXT3 | ZSE026 | |
| 1.6 i 16V LPG | 4 | X 16 XEL | 74/99 | 08/94→09/98 | Z206 | | 0.7 | UXT10 | | |
| 1.6 Si | 4 | C 16 SE | 74/99 | 03/92→12/94 | Z119 ^[284] Z190 ^{[282] [283]} Z74 ^[283] | | 0.8 1.2 1.0 | UXT2/UXT6 ^[284] UXT1/UXT3 ^[283] | ZSE026 | |
| 1.7 D | 4 | 17 D | 42/56 | 12/91→09/92 | GN013 ^{[2] [222]} GN954 | GR064 | 11V 11V | | | |
| 1.7 D | 4 | 17 DR | 44/59 | 07/92→09/98 | GN013 ^{[2] [222]} GN954 | | 11V 11V | | | |
| 1.7 TD | 4 | X 17 DTL | 50/67 | 11/94→09/98 | GN013 ^{[2] [222]} GN954 | | 11V 11V | | | |
| 1.7 TDS | 4 | 17 DT (TC4EE1), X 17 DT (TC4EE1) | 60/80 | 12/91→09/98 | GV947 →eng. 956632 GN103 eng. 956633→ | | 11V 11V | | | |
| 1.8 i | 4 | C 18 NZ | 66/89 | 09/91→09/98 | Z119 ^[284] Z190 ^{[282] [283]} Z74 ^[283] | | 0.8 1.2 1.0 | UXT2/UXT6 ^[284] UXT1/UXT3 ^[283] | | ZM018 |
| 1.8 i | 4 | C 18 NZ | 66/89 | 09/91→01/98 | | | | | ZS253 ^[254] →eng. 14349311 eng. 14349312→ | |
| 1.8 i | 4 | C 18 NZ | 66/89 | 03/92→09/98 | | | | | ZS253 →eng. 14349311 eng. 14349312→ | |
| 1.8 i LPG | 4 | C 18 NZ | 66/89 | 09/91→09/98 | Z20 ^[168] Z206 | | 0.8 0.7 | UXT2 / UXT6 UXT10 | | |



kW/BHP



... OPEL





... ASTRA F

| | | | | | | | | | |
|-----------------|---|-------------------|---------|-------------|---|--------------------------|--|--------------------------|-------|
| 1.8 i 16V | 4 | C 18 XEL | 85/114 | 07/94→03/01 | Z190 ^[282] Z74 | 1.2 1.0 | UXT1 / UXT3 | ZS344 | |
| 1.8 i 16V | 4 | C 18 XEL, X 18 XE | 85/114 | 09/94→01/98 | | | | ZS344 →02/96 | |
| 1.8 i 16V | 4 | X 18 XE | 85/114 | 07/94→03/01 | Z190 ^[282] Z74 | 1.2 1.0 | UXT1 / UXT3 | | |
| 1.8 i 16V | 4 | X 18 XE | 85/114 | 11/94→03/01 | | | | ZS344 | |
| 1.8 i 16V | 4 | C 18 XE | 92/123 | 06/93→01/98 | Z190 ^[282] Z74 | 1.2 1.0 | UXT1 / UXT3 | ZS344 →02/96 | |
| 1.8 i 16V | 4 | C 18 XE | 92/123 | 06/93→10/94 | | | | ZS344 | |
| 1.8 i 16V LPG | 4 | C 18 XEL, X 18 XE | 85/114 | 07/94→03/01 | Z206 | 0.7 | UXT10 | | |
| 1.8 i 16V LPG | 4 | C 18 XE | 92/123 | 06/93→01/98 | Z206 | 0.7 | UXT10 | | |
| 2.0 GSI 16V | 4 | C 20 XE | 110/148 | 09/91→01/98 | Z98 →08/92 Z250 09/92→ | 0.8 0.7 | UXT1 / UXT3 UXT1 / UXT3 | ZS300 eng. 14137013 → | ZM034 |
| 2.0 GSI 16V LPG | 4 | C 20 XE | 110/148 | 09/91→01/98 | Z116 →08/92 Z340 09/92→ | 0.8 0.7 | UXT5 UXT12 | | |
| 2.0 i | 4 | C 20 NE | 85/114 | 09/91→01/98 | Z119 ^[284] Z190 ^{[282][283]} Z74 ^[283] Z8 | 0.8 1.2 1.0 0.8 | UXT2/UXT6 ^[284] UXT1/UXT3 ^[283] UXT2/UXT6 ^[284] | | |
| 2.0 i | 4 | C 20 NE | 85/114 | 09/91→09/98 | | | | ZS127 | |
| 2.0 i | 4 | C 20 NE | 85/114 | 03/92→09/98 | Z119 ^[284] Z190 ^{[282][283]} Z74 ^[283] | 0.8 1.2 1.0 | UXT2/UXT6 ^[284] UXT1/UXT3 ^[283] | | |
| 2.0 i LPG | 4 | C 20 NE | 85/114 | 09/91→09/98 | Z20 ^[168] Z206 | 0.8 0.7 | UXT2 / UXT6 UXT10 | | |
| 2.0 i 16V | 4 | X 20 XEV | 100/134 | 02/95→09/98 | Z190 ^[282] Z74 | 1.2 1.0 | UXT1 / UXT3 | ZS344 | ZM026 |
| 2.0 i 16V | 4 | C 20 XE | 110/148 | 03/93→01/98 | Z190 ^[282] Z74 | 1.2 1.0 | UXT1 / UXT3 | ZS300 eng. 14137013 → | ZM034 |
| 2.0 i 16V LPG | 4 | X 20 XEV | 100/134 | 02/95→09/98 | Z206 | 0.7 | UXT10 | | |
| 2.0 i 16V LPG | 4 | C 20 XE | 110/148 | 03/93→01/98 | Z206 | 0.7 | UXT10 | | |
| ASTRA G | | | | | | | | | |
| 1.2 16V | 4 | X 12 XE | 48/64 | 02/98→09/00 | Z190 ^[282] Z74 | 1.2 1.0 | UXT1 / UXT3 | ZSE147 | |
| 1.2 16V | 4 | Z 12 XE | 55/74 | 09/00→01/05 | Z190 | 1.2 | | ZSE147 →09/03 | |
| 1.2 16V LPG | 4 | X 12 XE | 48/64 | 02/98→09/00 | Z206 | 0.7 | UXT10 | | |
| 1.2 16V LPG | 4 | Z 12 XE | 55/74 | 09/00→01/05 | Z206 | 0.7 | UXT10 | | |
| 1.4 | 4 | Z 14 XEP | 66/89 | 09/07→12/09 | Z203 | 0.9 | | ZS338 | |
| 1.4 LPG | 4 | Z 14 XEP | 66/89 | 09/07→12/09 | Z158 ^[168] Z206 ^[168] | 1.1 0.7 | UXT10 | | |
| 1.4 16V | 4 | X 14 XE, Z 14 XE | 66/89 | 02/98→01/05 | Z190 ^[282] Z74 | 1.2 1.0 | UXT1 / UXT3 | ZS259 | |
| 1.4 16V LPG | 4 | X 14 XE, Z 14 XE | 66/89 | 02/98→01/05 | Z206 | 0.7 | UXT10 | | |
| 1.6 | 4 | X 16 SZR | 55/74 | 02/98→09/00 | Z190 ^[282] Z74 | 1.2 1.0 | UXT1 / UXT3 | ZSE026 | |
| 1.6 | 4 | Z 16 SE | 62/83 | 09/00→07/04 | Z190 Z74 | 1.2 1.0 | UXT1 / UXT3 | | |
| 1.6 | 4 | Z 16 SE | 62/83 | 09/00→01/05 | Z190 Z74 | 1.2 1.0 | UXT1 / UXT3 | | |
| 1.6 | 4 | Z 16 XEP | 76/102 | 12/02→12/09 | Z173 →08/03 Z203 09/03→ | 1.6 0.9 | | ZS427 | |

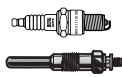

kw/BHP



... OPEL 

| ... ASTRA G | | | | | | | | |
|-------------|---|-----------------------------|--------|-------------|--|--------------------|-----|--------------------------------|
| 1.6 LPG | 4 | X 16 SZR | 55/74 | 02/98→09/00 | Z206 | | 0.7 | UXT10 |
| 1.6 LPG | 4 | Z 16 SE | 62/83 | 09/00→01/05 | Z206 | | 0.7 | UXT10 |
| 1.6 LPG | 4 | Z 16 XEP | 76/102 | 12/02→12/09 | Z172 →08/03 Z206 [168] 09/03→ | | 1.6 | |
| 1.6 16V | 4 | C 16 SEL, Z 16 XE | 74/99 | 02/98→01/05 | Z190 [282] →ch. 42000000;45000000; 46000000;48000000; 48000000;46000000; 4H000000 Z74 →ch. 42000000;45000000; 46000000;48000000; 48000000;46000000; 4H000000 Z203 ch. 42000001;45000001; 46000001;48000001; 48000001;46000001; 4H000001→ | | 1.2 | |
| 1.6 16V | 4 | X 16 XEL | 74/99 | 02/98→01/05 | Z190 [282] →eng. 420 00000 →ch. 42000000; 45000000;46000000; 48000000;48000000; 46000000;4H000000 Z74 →eng. 420 00000 →ch. 42000000; 45000000;46000000; 48000000;48000000; 46000000;4H000000 Z203 eng. 420 00001→ ch. 42000001;45000001; 46000001;48000001; 48000001;46000001; 4H000001→ | | 1.2 | ZS259 |
| 1.6 16V | 4 | Z 16 XE | 74/99 | 02/98→10/05 | Z190 [282] →eng. 420 00000 Z74 →eng. 420 00000 Z203 eng. 420 00001→ | | 1.2 | |
| 1.6 16V | 4 | Z 16 XE | 74/99 | 03/00→10/05 | | | | ZS259 →eng. 41000000 |
| 1.6 16V | 4 | Z 16 XEP | 76/102 | 03/00→05/05 | Z173 →08/03 Z203 [282] 09/03→ | | 1.6 | ZS427 |
| 1.6 16V LPG | 4 | C 16 SEL, X 16 XEL, Z 16 XE | 74/99 | 02/98→10/05 | Z206 | | 0.7 | UXT10 |
| 1.6 16V LPG | 4 | Z 16 XEP | 76/102 | 03/00→05/05 | Z172 →08/03 Z206 [168] 09/03→ | | 1.6 | |
| 1.6 CNG | 4 | Z 16 YNG | 71/95 | 03/03→07/04 | Z206 | | 0.7 | UXT10 ZS259 |
| 1.7 CDTI | 4 | Z 17 DTL | 59/79 | 04/03→12/09 | GN104 | GSE143 [10] | 11V | |
| 1.7 DTI 16V | 4 | Y 17 DT | 55/74 | 02/00→01/05 | GN104 | GSE143 [10] | 11V | |

OPEL

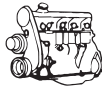

kW/BHP

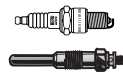

... OPEL



... ASTRA G

| | | | | | | | | | |
|-------------------|---|--------------------|---------|-------------|--|------------------------|-------------------|-----------------------|------------------|
| 1.7 TD | 4 | X 17 DTL | 50/67 | 02/98→08/00 | GN013 ^{[2][222]} GN954 | GSE143 ^[10] | 11V 11V | | |
| 1.8 16V | 4 | X 18 XE1 | 85/114 | 02/98→09/00 | Z190 Z74 | | 1.2 1.0 | UXT1 / UXT3 | |
| 1.8 16V | 4 | X 18 XE1 | 85/114 | 02/98→10/00 | | | | | ZS342 |
| 1.8 16V | 4 | X 18 XE1 | 85/114 | 03/00→10/00 | Z190 ^[282] | | 1.2 | | |
| 1.8 16V | 4 | Z 18 XE | 92/123 | 06/00→10/05 | Z190 Z74 | | 1.2 1.0 | UXT1 / UXT3 | ZS342 |
| 1.8 16V | 4 | Z 18 XE | 92/123 | 09/00→05/05 | Z190 Z74 | | 1.2 1.0 | UXT1 / UXT3 | |
| 1.8 16V LPG | 4 | X 18 XE1 | 85/114 | 02/98→10/00 | Z206 | | 0.7 | UXT10 | |
| 1.8 16V LPG | 4 | Z 18 XE | 92/123 | 06/00→10/05 | Z206 | | 0.7 | UXT10 | |
| 2.0 16V | 4 | C 20 SEL, X 20 XEV | 100/134 | 02/98→01/05 | Z190 ^[282] Z74 | | 1.2 1.0 | UXT1 / UXT3 | ZS344 |
| 2.0 16V LPG | 4 | C 20 SEL, X 20 XEV | 100/134 | 02/98→01/05 | Z206 | | 0.7 | UXT10 | |
| 2.0 16V OPC | 4 | X 20 XER | 118/158 | 11/99→09/02 | Z74 | | 1.0 | UXT1 / UXT3 | ZS344 |
| 2.0 16V OPC LPG | 4 | X 20 XER | 118/158 | 11/99→09/02 | Z206 | | 0.7 | UXT10 | |
| 2.0 16V Turbo | 4 | Z 20 LET | 140/188 | 09/00→08/01 | Z190 ^[282] Z74 | | 1.2 1.0 | UXT1 / UXT3 | ZSE151 |
| 2.0 16V Turbo | 4 | Z 20 LET | 141/189 | 08/01→05/05 | Z190 ^[282] Z74 | | 1.2 1.0 | UXT1 / UXT3 | ZSE151 |
| 2.0 16V Turbo | 4 | Z 20 LET | 147/197 | 11/02→10/05 | Z190 ^[282] →01/04 Z74 →01/04 Z287 02/04→ | | 1.2 1.0 0.8 | UXT1 / UXT3 →01/04 | ZSE151 |
| 2.0 16V Turbo LPG | 4 | Z 20 LET | 140/188 | 09/00→08/01 | Z206 | | 0.7 | UXT10 | |
| 2.0 16V Turbo LPG | 4 | Z 20 LET | 141/189 | 08/01→05/05 | Z206 | | 0.7 | UXT10 | |
| 2.0 16V Turbo LPG | 4 | Z 20 LET | 147/197 | 11/02→10/05 | Z206 →01/04 Z158 ^[168] 02/04→ | | 0.7 1.1 | UXT10 →01/04 | |
| 2.0 DI | 4 | X 20 DTL, Y 20 DTL | 60/80 | 02/98→01/05 | GN992 | GSE143 ^[10] | 11V | | |
| 2.0 DTI 16V | 4 | Y 20 DTH | 74/99 | 08/99→01/05 | GN992 →08/02 GN033 09/02→ | GSE142 ^[11] | 11V 11V | | |
| 2.0 OPC | 4 | Z 20 LET | 141/189 | 03/02→10/05 | Z74 | | 1.0 | UXT1 / UXT3 | ZSE151 |
| 2.0 OPC | 4 | Z 20 LET | 141/189 | 09/02→01/05 | Z190 ^[282] →01/04 Z74 →01/04 | | 1.2 1.0 | UXT1 / UXT3 →01/04 | ZSE151 →01/04 |
| 2.0 OPC | 4 | Z 20 LET | 147/197 | 11/02→07/04 | Z74 | | 1.0 | UXT1 / UXT3 | ZSE151 |
| 2.0 OPC | 4 | Z 20 LET | 147/197 | 11/02→01/05 | Z190 ^[282] →01/04 Z74 →01/04 Z287 02/04→ | | 1.2 1.0 0.8 | UXT1 / UXT3 →01/04 | ZSE151 →01/04 |
| 2.0 OPC LPG | 4 | Z 20 LET | 141/189 | 03/02→10/05 | Z206 | | 0.7 | UXT10 | |
| 2.0 OPC LPG | 4 | Z 20 LET | 141/189 | 09/02→01/05 | Z206 →01/04 | | 0.7 | UXT10 →01/04 | |
| 2.0 OPC LPG | 4 | Z 20 LET | 147/197 | 11/02→07/04 | Z206 | | 0.7 | UXT10 | |
| 2.0 OPC LPG | 4 | Z 20 LET | 147/197 | 11/02→01/05 | Z206 →01/04 Z158 ^[168] 02/04→ | | 0.7 1.1 | UXT10 →01/04 | |
| 2.2 16V | 4 | Z 22 SE | 108/145 | 06/00→10/05 | Z222 | | 1.1 | | |

OPEL

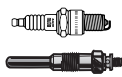

kW/BHP

**... OPEL****... ASTRA G**

| | | | | | | | | |
|---------|---|----------|--------|-------------|-------|-------------|-----|--|
| 2.2 DTI | 4 | Y 22 DTR | 86/115 | 09/02→01/05 | GN033 | GSE142 [11] | 11V | |
| 2.2 DTI | 4 | Y 22 DTR | 92/123 | 09/02→10/05 | GN033 | GSE142 [11] | 11V | |

ASTRA H

| | | | | | | | | |
|---------------|---|--------------------|---------|--------|---|-----------------|-----|--------|
| 1.2 | 4 | Z 12 XEP | 59/79 | 08/05→ | Z203 | | 0.9 | ZS338 |
| 1.2 LPG | 4 | Z 12 XEP | 59/79 | 08/05→ | Z206 [168] | | 0.7 | UXT10 |
| 1.3 CDTI | 4 | Z 13 DTH | 66/89 | 04/05→ | GN053 | GSE142 [11] | 11V | |
| 1.4 | 4 | Z 14 XEP | 66/89 | 03/04→ | Z203 | | 0.9 | ZS338 |
| 1.4 LPG | 4 | Z 14 XEP | 66/89 | 03/04→ | Z206 [168] | | 0.7 | UXT10 |
| 1.4 LPG | 4 | Z 14 XEP | 66/89 | 08/09→ | Z203 | | 0.9 | ZS338 |
| | | | | | Z206 | | 0.7 | UXT10 |
| 1.6 | 4 | Z 16 XE1, Z 16 XEP | 77/103 | 03/04→ | Z203 | | 0.9 | ZS427 |
| 1.6 | 4 | Z 16 XE1, Z 16 XEP | 77/103 | 03/05→ | | | | ZS427 |
| | | | | | | | | 12/05→ |
| 1.6 | 4 | A 16 XER, Z 16 XER | 85/114 | 12/06→ | Z203 | | 0.9 | ZS427 |
| 1.6 LPG | 4 | Z 16 XE1, Z 16 XEP | 77/103 | 03/04→ | Z206 [168] | | 0.7 | UXT10 |
| 1.6 LPG | 4 | A 16 XER, Z 16 XER | 85/114 | 12/06→ | Z206 [168] | | 0.7 | UXT10 |
| 1.6 LPG | 4 | Z 16 XER | 85/114 | 08/09→ | Z203 | | 0.9 | ZS427 |
| | | | | | Z206 [168] | | 0.7 | UXT10 |
| 1.6 Turbo | 4 | Z 16 LET | 132/177 | 02/07→ | Z346 | | 0.8 | ZS427 |
| 1.6 Turbo LPG | 4 | Z 16 LET | 132/177 | 02/07→ | Z116 | | 0.8 | UXT5 |
| 1.7 CDTI | 4 | Z 17 DTL | 59/79 | 03/04→ | GN104 | GSE143 [10] | 11V | |
| 1.7 CDTI | 4 | Z 17 DTH | 74/99 | 03/04→ | GN104 | GSE143 [10] | 11V | |
| 1.7 CDTI | 4 | A 17 DTJ, Z 17 DTJ | 81/109 | 02/07→ | GN104 | GSE143 [10] | 11V | |
| 1.7 CDTI | 4 | A 17 DTR, Z 17 DTR | 92/123 | 02/07→ | GN104 | GSE143 [10] | 11V | |
| 1.8 | 4 | Z 18 XE | 92/123 | 03/04→ | Z203 | | 0.9 | ZS342 |
| 1.8 | 4 | A 18 XER, Z 18 XER | 103/138 | 08/05→ | Z203 | | 0.9 | ZS427 |
| 1.8 LPG | 4 | Z 18 XE | 92/123 | 03/04→ | Z206 [168] | | 0.7 | UXT10 |
| 1.8 LPG | 4 | A 18 XER, Z 18 XER | 103/138 | 08/05→ | Z206 [168] | | 0.7 | UXT10 |
| 1.9 CDTI | 4 | Z 19 DTL | 74/99 | 09/05→ | GN041 | GSE142 [11][32] | 11V | |
| | | | | | →ch. 72045139; 75030986;78007391;7G GN097 | GSE143 [10][32] | 11V | |
| | | | | | ch. 72045140;75030987; 78007392;7G; 88000001→ | | | |
| 1.9 CDTI | 4 | Z 19 DTL | 74/99 | 01/06→ | GN041 | | 11V | |
| | | | | | →ch. 78007391;7G GN097 | | 11V | |
| | | | | | ch. 78007392;7G; 88000001→ | | | |
| 1.9 CDTI | 4 | Z 19 DT | 88/118 | 06/04→ | GN041 | GSE142 [11][32] | 11V | |
| | | | | | →ch. 72045139; 75030986;78007391;7G GN097 | GSE143 [10][32] | 11V | |
| | | | | | ch. 72045140;75030987; 78007392;7G; 88000001→ | | | |
| 1.9 CDTI | 4 | Z 19 DTH | 110/148 | 09/04→ | GN059 | GSE142 [11][32] | 11V | |
| | | | | | | GSE143 [10][32] | | |
| 1.9 CDTI 16V | 4 | Z 19 DTJ | 88/118 | 04/04→ | GN059 | GSE142 [11] | 11V | |
| 2.0 Turbo | 4 | Z 20 LEL | 125/168 | 03/04→ | Z287 | | 0.8 | ZSE151 |
| 2.0 Turbo | 4 | Z 20 LER | 147/197 | 09/04→ | Z287 | | 0.8 | ZSE151 |
| 2.0 Turbo | 4 | Z 20 LEH | 177/237 | 03/05→ | Z284 | | 1.1 | UXT14 |
| 2.0 Turbo LPG | 4 | Z 20 LEL | 125/168 | 03/04→ | Z158 [168] | | 1.1 | |
| 2.0 Turbo LPG | 4 | Z 20 LER | 147/197 | 09/04→ | Z158 [168] | | 1.1 | |
| 2.0 Turbo LPG | 4 | Z 20 LEH | 177/237 | 03/05→ | Z130 [168] | | 1.0 | UXT14 |

OPEL



kW/BHP



... OPEL



ASTRA J

| | | | | | | | | | |
|------------------|---|----------|---------|--------|--|---------------|------|--------------|--|
| 1.3 CDTI | 4 | A 13 DTE | 70/94 | 12/09→ | GE112 [26] →ch. B3999999; B8999999;BG999999 ch. C0000001;C1000001; C3000001;C8000001; CG000001→ PSG003 [24] →ch. B3999999; B8999999;BG999999 | | 4.4V | | |
| 1.3 CDTI | 4 | A 13 DTE | 70/94 | 10/10→ | GE112 →ch. B3999999; B8999999;BG999999 ch. C0000001;C1000001; C3000001;C8000001; CG000001→ PSG003 →ch. B3999999; B8999999;BG999999 | | 4.4V | | |
| 1.4 | 4 | A 14 XEL | 64/86 | 12/09→ | Z203 | | 0.9 | | |
| 1.4 LPG | 4 | A 14 XEL | 64/86 | 12/09→ | Z206 [168] | | 0.7 | UXT10 | |
| 1.6 CDTi | 4 | B 16 DTL | 81/109 | 02/14→ | GE126 | | 4.4V | | |
| 1.6 CDTi | 4 | B 16 DTH | 100/134 | 01/14→ | GE126 | | 4.4V | | |
| 1.6 Turbo | 4 | A 16 LET | 132/177 | 12/09→ | Z346 | | 0.8 | | |
| 1.6 Turbo LPG | 4 | A 16 LET | 132/177 | 12/09→ | Z116 | | 0.8 | UXT5 | |
| 1.7 CDTI | 4 | A 17 DTL | 74/99 | 10/10→ | GN104 | GSE145 | 11V | | |
| 1.7 CDTI | 4 | A 17 DTC | 81/109 | 12/09→ | GE117 | | 4.4V | | |
| 1.7 CDTI | 4 | A 17 DTE | 81/109 | 12/09→ | PSG004 | | 4.4V | | |
| 1.7 CDTI | 4 | A 17 DTJ | 81/109 | 12/09→ | GN104 | GSE145 | 11V | | |
| 1.7 CDTI | 4 | A 17 DTR | 92/123 | 12/09→ | GN104 | GSE145 | 11V | | |
| 1.7 CDTI | 4 | A 17 DTF | 96/129 | 12/09→ | PSG004 | | 4.4V | | |
| 1.7 CDTI | 4 | A 17 DTS | 96/129 | 12/09→ | GE117 | | 4.4V | | |
| 2.0 BiTurbo CDTI | 4 | A 20 DTR | 143/192 | 12/12→ | GE114 →ch. B3999999; B8999999;BG999999 PSG001 →ch. B3999999; B8999999;BG999999 ch. C0000001;C1000001; C3000001;C8000001; CG000001→ PSG006 ch. 17B08416→ | | 4.4V | | |
| 2.0 CDTI | 4 | A 20 DTH | 118/158 | 12/09→ | GE114 →ch. B3999999; B8999999;BG999999 PSG001 →ch. B3999999; B8999999;BG999999 ch. C0000001;C1000001; C3000001;C8000001; CG000001→ PSG006 ch. 17B08416→ | | 4.4V | | |

OPEL



kW/BHP

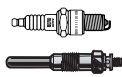

... OPEL



... ASTRA J

| | | | | | | | | |
|----------|---|----------|---------|--------|--|------|--|--|
| 2.0 CDTI | 4 | A 20 DTH | 121/162 | 06/11→ | GE114 →ch. B3999999; B8999999;B6999999 PSG001 →ch. B3999999; B8999999;B6999999 ch. C0000001;C1000001; C3000001;C8000001; CG000001→ PSG006 ch. 17B08416→ | 4.4V | | |
| | | | | | | 4.4V | | |
| | | | | | | 4.4V | | |

ASTRA F CLASSIC

| | | | | | | | | |
|---------------|---|----------|-------|-------------|---|-----|------------------------|---------------|
| 1.4 i | 4 | X 14 NZ | 44/59 | 01/98→01/05 | Z190 [282] Z74 | 1.2 | | ZS253 |
| 1.4 i LPG | 4 | X 14 NZ | 44/59 | 01/98→01/05 | Z206 | 1.0 | UXT1 / UXT3 | |
| 1.6 i | 4 | X 16 SZR | 55/74 | 01/98→01/05 | Z119 [284] Z190 [282],[283] Z74 [283] Z8 | 0.7 | UXT10 | |
| | | | | | | 0.8 | UXT2/UXT6 [284] | ZSE026 |
| | | | | | | 1.2 | | |
| | | | | | | 1.0 | UXT1/UXT3 [283] | |
| | | | | | | 0.8 | UXT2/UXT6 [284] | |
| 1.6 i LPG | 4 | X 16 SZR | 55/74 | 01/98→01/05 | Z206 | 0.7 | UXT10 | |
| 1.6 i 16V | 4 | X 16 XEL | 74/99 | 01/98→01/05 | Z190 [282] Z74 | 1.2 | | ZSE026 |
| | | | | | | 1.0 | UXT1 / UXT3 | |
| 1.6 i 16V LPG | 4 | X 16 XEL | 74/99 | 01/98→01/05 | Z206 | 0.7 | UXT10 | |

ASTRA GTC J

| | | | | | | | | |
|----------|---|----------|---------|--------|--|--------|-------------|--------------|
| 1.6 | 4 | A 16 LET | 132/177 | 10/11→ | Z346 | 0.8 | | |
| 1.6 LPG | 4 | A 16 LET | 132/177 | 10/11→ | Z116 | 0.8 | UXT5 | |
| 1.7 CDTI | 4 | A 17 DTC | 81/109 | 10/11→ | GE117 | 4.4V | | |
| 1.7 CDTI | 4 | A 17 DTE | 81/109 | 10/11→ | PSG004 | 4.4V | | |
| 1.7 CDTI | 4 | A 17 DTJ | 81/109 | 10/11→ | GN104 | GSE145 | 11V | |
| 1.7 CDTI | 4 | A 17 DTF | 96/129 | 10/11→ | PSG004 | 4.4V | | |
| 1.7 CDTI | 4 | A 17 DTS | 96/129 | 10/11→ | GE117 | 4.4V | | |
| 1.8 | 4 | A 18 XER | 103/138 | 10/11→ | Z203 →ch. 92999999; 95999999;98999999; 98999999;96999999 | 0.9 | | ZS427 |

| | | | | | | | | |
|------------------|---|----------|---------|--------|--|------|--|--|
| 2.0 BiTurbo CDTI | 4 | A 20 DTR | 143/192 | 10/12→ | GE114 →ch. B3999999; B8999999;B6999999 PSG001 →ch. B3999999; B8999999;B6999999 ch. C0000001;C1000001; C3000001;C8000001; CG000001→ PSG006 ch. 17B08416→ | 4.4V | | |
| | | | | | | 4.4V | | |
| | | | | | | 4.4V | | |
| 2.0 CDTI | 4 | A 20 DTH | 121/162 | 10/11→ | GE114 →ch. B3999999; B8999999;B6999999 PSG001 →ch. B3999999; B8999999;B6999999 ch. C0000001;C1000001; C3000001;C8000001; CG000001→ PSG006 ch. 17B08416→ | 4.4V | | |
| | | | | | | 4.4V | | |
| | | | | | | 4.4V | | |

OPEL



kW/BHP



... OPEL



CALIBRA A

| | | | | | | | | |
|---------------------|---|------------------|---------|-------------|---|---|--|--------------------------|
| 2.0 i | 4 | C 20 NE | 85/114 | 06/90→07/97 | Z119 ^[284] Z190 ^{[282][283]} Z74 ^[283] | 0.8 UXT2/UXT6 ^[284] 1.2 1.0 UXT1/UXT3 ^[283] | ZS125 ^[1] →eng. 14180385 ZS127 ^[1] eng. 14180386→ | |
| 2.0 i 4WD | 4 | C 20 NE | 85/114 | 06/90→07/97 | Z119 ^[284] Z190 ^{[282][283]} Z74 ^[283] | 0.8 UXT2/UXT6 ^[284] 1.2 1.0 UXT1/UXT3 ^[283] | ZS125 ^[1] →eng. 14180385 ZS127 ^[1] eng. 14180386→ | ZM034 eng. 14028515→ |
| 2.0 i LPG | 4 | C 20 NE | 85/114 | 06/90→07/97 | Z20 ^[168] Z206 | 0.8 UXT2 / UXT6 0.7 UXT10 | | |
| 2.0 i 16V | 4 | X 20 XEV | 100/134 | 02/94→07/97 | Z250 | 0.7 UXT1 / UXT3 | ZS344 | ZM034 eng. 14028515→ |
| 2.0 i 16V | 4 | C 20 XE | 110/148 | 06/90→02/94 | Z250 →08/92 Z190 ^[282] 09/92→ Z74 09/92→ | 0.7 UXT1 / UXT3 →08/92 1.2 1.0 UXT1 / UXT3 09/92→ | ZS300 ch. P1000001 → eng. 14028515 → | ZM034 eng. 140218515→ |
| 2.0 i 16V 4WD | 4 | C 20 XE | 110/148 | 06/90→02/94 | Z250 →08/92 Z190 ^[282] 09/92→ Z74 09/92→ | 0.7 UXT1 / UXT3 →08/92 1.2 1.0 UXT1 / UXT3 09/92→ | ZS300 ch. P1000001 → eng. 14028515 → | ZM034 eng. 14028515→ |
| 2.0 i 16V LPG | 4 | X 20 XEV | 100/134 | 02/94→07/97 | Z340 | 0.7 UXT12 | | |
| 2.0 i Turbo 4WD | 4 | C 20 LET | 150/201 | 03/92→07/97 | Z158 | 1.1 | | ZM034 |
| 2.0 i Turbo 4WD LPG | 4 | C 20 LET | 150/201 | 03/92→07/97 | Z116 | 0.8 UXT5 | | |
| 2.5 i V6 | 6 | C 25 XE, X 25 XE | 125/168 | 04/93→07/97 | Z190 ^[282] Z74 | 1.2 1.0 UXT1 / UXT3 | ZS301 | |
| 2.5 i V6 LPG | 6 | C 25 XE, X 25 XE | 125/168 | 04/93→07/97 | Z206 | 0.7 UXT10 | | |

CAMPO

| | | | | | | | | |
|---------|---|-------------|--------|-------------|----------------------|-----------------|--|--|
| 2.2 D | 4 | C223 | 39/52 | 08/91→09/96 | GV946 | 11V | | |
| 2.2 D | 4 | 4FD1, C223 | 45/60 | 08/87→08/92 | GV946 | 11V | | |
| 2.3 | 4 | 4 ZD1 | 69/93 | 08/91→08/94 | Z20 | 0.8 UXT2 / UXT6 | | |
| 2.3 | 4 | 4 ZD1, 23 P | 72/97 | 08/94→09/96 | Z20 | 0.8 UXT2 / UXT6 | | |
| 2.3 LPG | 4 | 4 ZD1, 23 P | 72/97 | 08/94→09/96 | Z27 ^[168] | 0.8 UX56 | | |
| 2.5 D | 4 | 4 JA1 | 56/75 | 08/91→06/94 | GN061 | 11V | | |
| 2.5 DTI | 4 | 4 JA1 | 74/99 | 12/01→ | GN061 | 11V | | |
| 2.5 TD | 4 | 4 JA1T | 56/75 | 07/94→ | GN061 | 11V | | |
| 3.1 TD | 4 | 4 JG2T | 80/107 | 12/92→ | GV947 03/95→12/96 | 11V | | |

CASCADA

| | | | | | | | | |
|----------|---|----------|---------|--------|--------|------|--|--|
| 2.0 CDTI | 4 | A 20 DTH | 121/162 | 03/13→ | PSG006 | 4.4V | | |
| 2.0 CDTI | 4 | A 20 DTR | 143/192 | 03/13→ | PSG006 | 4.4V | | |

COMBO

| | | | | | | | | |
|--------------|---|------------------|--------|--------|---------------------------------|----------------------------------|-------|--|
| 1.3 CDTI 16V | 4 | Y 13 DT, Z 13 DT | 51/68 | 10/04→ | GN053 | 11V | | |
| 1.3 CDTI 16V | 4 | Z 13 DTJ | 55/74 | 10/05→ | GN053 | 11V | | |
| 1.4 | 4 | Z 14 XEP | 66/89 | 10/04→ | Z203 | 0.9 | ZS338 | |
| 1.4 LPG | 4 | Z 14 XEP | 66/89 | 10/04→ | Z206 ^[168] | 0.7 UXT10 | | |
| 1.6 | 4 | Z 16 SE | 64/86 | 10/01→ | Z190 →08/04 Z74 →08/04 | 1.2 1.0 UXT1 / UXT3 →08/04 | | |
| 1.6 LPG | 4 | Z 16 SE | 64/86 | 10/01→ | Z206 →08/04 | 0.7 UXT10 →08/04 | | |
| 1.6 CDTI | 4 | A 16 FDL | 66/89 | 02/12→ | GE114 | 4.4V | | |
| 1.6 CDTI | 4 | A 16 FDH | 74/99 | 02/12→ | GE114 | 4.4V | | |
| 1.6 CDTI | 4 | A 16 FDH | 77/103 | 02/12→ | GE114 | 4.4V | | |



kW/BHP

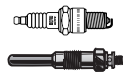

... OPEL



... COMBO

| | | | | | | | | | |
|--------------|---|----------|--------|--------|-------|------|-------|-------|--|
| 1.6 CNG | 4 | Z 16 YNG | 69/93 | 06/06→ | Z206 | 0.7 | UXT10 | ZS259 | |
| 1.6 CNG | 4 | Z 16 YNG | 71/95 | 04/05→ | Z206 | 0.7 | UXT10 | ZS259 | |
| 1.7 CDTI 16V | 4 | Z 17 DTH | 74/99 | 12/04→ | GN104 | 11V | | | |
| 1.7 DI 16V | 4 | Y 17 DTL | 48/64 | 10/01→ | GN104 | 11V | | | |
| 1.7 DTI 16V | 4 | Y 17 DT | 55/74 | 10/01→ | GN104 | 11V | | | |
| 2.0 CDTI | 4 | A 20 FD | 99/133 | 02/12→ | GE114 | 4.4V | | | |

COMMODORE A

| | | | | | | | | | |
|----------|---|-------|---------|-------------|-----------|-----|--|--|--|
| 2.5 | 6 | 25 S | 85/114 | 08/67→08/69 | Z19 [168] | 0.8 | | | |
| 2.5 | 6 | 25 SV | 88/118 | 08/69→01/72 | Z19 [168] | 0.8 | | | |
| | | | | | Z48 [168] | 0.8 | | | |
| 2.5 GS | 6 | 25 H | 96/129 | 08/67→01/72 | Z19 [168] | 0.8 | | | |
| 2.5 GS/E | 6 | 25 E | 110/148 | 08/69→01/72 | Z19 [168] | 0.8 | | | |
| 2.8 GS | 6 | 28 HL | 107/143 | 05/70→01/72 | Z19 | 0.8 | | | |

COMMODORE B

| | | | | | | | | | |
|----------|---|-------------|---------|-------------|-----------|-----|--|--|-------|
| 2.5 | 6 | 25 S | 85/114 | 01/72→07/78 | Z19 [168] | 0.8 | | | ZM002 |
| 2.5 GS | 6 | 25 H | 96/129 | 01/72→08/75 | Z19 [168] | 0.8 | | | ZM002 |
| 2.8 GS | 6 | 28 HC | 103/138 | 03/75→07/78 | Z19 [168] | 0.8 | | | ZM002 |
| 2.8 GS | 6 | 28 HC | 104/139 | 01/72→07/78 | Z19 [168] | 0.8 | | | ZM002 |
| 2.8 GS/E | 6 | 28 HC | 114/153 | 03/75→07/78 | Z19 [168] | 0.8 | | | ZM002 |
| 2.8 GS/E | 6 | 28 E, 28 EC | 118/158 | 07/72→02/75 | Z19 [168] | 0.8 | | | |

COMMODORE C

| | | | | | | | | | |
|-------|---|------|--------|-------------|-----------|-----|--|--|--|
| 2.5 E | 6 | 25 E | 96/129 | 12/80→12/82 | Z19 [168] | 0.8 | | | |
| 2.5 S | 6 | 25 S | 85/114 | 08/78→12/82 | Z19 [168] | 0.8 | | | |

CORSA A

| | | | | | | | | | |
|--------|---|----------------|-------|-------------|------------------|-----|-----------------|-------------------|-------------|
| 1.0 | 4 | 10 S | 33/44 | 09/82→03/93 | Z19 [168] | 0.8 | | | |
| 1.2 | 4 | 12 NC | 33/44 | 09/82→08/90 | Z19 [168] | 0.8 | | ZS253 [175] [192] | ZM001 [175] |
| | | | | | | | | [254] | ZM006 [209] |
| 1.2 | 4 | E 12 GV | 33/44 | 09/82→08/90 | Z19 [168] | 0.8 | | ZS253 [175] [192] | ZM006 |
| | | | | | | | | [254] | |
| 1.2 | 4 | 12 S | 44/59 | 09/82→08/90 | Z20 | 0.8 | UXT2 / UXT6 | ZS252 | |
| 1.2 i | 4 | C 12 NZ | 33/44 | 09/89→03/93 | Z119 | 0.8 | UXT2 / UXT6 | ZS253 [175] [192] | |
| | | | | | Z8 | 0.8 | | [254] | |
| 1.2 N | 4 | 12 NC, E 12 GV | 33/44 | 01/85→10/87 | Z19 [168] | 0.8 | | | |
| 1.2 N | 4 | 12 NV | 38/51 | 01/90→03/93 | Z20 | 0.8 | UXT2 / UXT6 | ZS252 | |
| 1.2 S | 4 | 12 ST | 40/54 | 09/82→03/93 | Z20 | 0.8 | UXT2 / UXT6 | ZS252 | ZM006 |
| | | | | | | | | | 01/85→ |
| 1.2 S | 4 | 12 S | 43/58 | 09/82→10/87 | Z20 | 0.8 | UXT2 / UXT6 | ZS252 | ZM006 |
| | | | | | | | | | 01/85→ |
| 1.3 | 4 | 13 NB | 44/59 | 09/85→10/89 | Z20 | 0.8 | UXT2 / UXT6 | ZS252 | |
| 1.3 | 4 | 13 NB | 44/59 | 09/85→10/87 | | | | | ZM016 |
| 1.3 | 4 | C 13 N | 44/59 | 09/85→10/87 | Z20 | 0.8 | UXT2 / UXT6 | ZS252 | ZM016 |
| 1.3 GL | 4 | 13 S | 55/74 | 09/82→03/93 | | | | ZS252 | |
| 1.3 i | 4 | C 13 N | 44/59 | 09/86→09/90 | Z20 | 0.8 | UXT2 / UXT6 | ZS252 | ZM016 |
| 1.3 S | 4 | 13 SB | 51/68 | 09/82→10/89 | Z20 | 0.8 | UXT2 / UXT6 | ZS252 | ZM006 |
| | | | | | | | | | →07/85 |
| | | | | | | | | | ZM007 |
| | | | | | | | | | 08/85→ |
| 1.4 i | 4 | C 14 NZ | 40/54 | 01/85→03/93 | | | | | ZM015 [175] |
| | | | | | | | | | ZM018 [192] |
| 1.4 i | 4 | C 14 NZ | 44/59 | 10/89→03/93 | Z119 [284] | 0.8 | UXT2/UXT6 [284] | ZS253 | ZM041 |
| | | | | | →12/89 | | →12/89 | | |
| | | | | | Z74 [283] | 1.0 | UXT1/UXT3 [283] | | |
| | | | | | 01/90→ | | 01/90→ | | |
| 1.4 i | 4 | C 14 NZ | 44/59 | 01/90→03/93 | Z20 [284] | 0.8 | UXT2/UXT6 [284] | ZS253 | |
| 1.4 S | 4 | 14 NV | 53/71 | 09/89→03/93 | Z119 [284] | 0.8 | UXT2/UXT6 [284] | | |
| 1.4 S | 4 | 14 NV | 53/71 | 01/90→03/93 | Z119 [284] | 0.8 | UXT2/UXT6 [284] | ZS253 | |
| | | | | | Z190 [282] [283] | 1.2 | | | |
| | | | | | Z74 [283] | 1.0 | UXT1/UXT3 [283] | | |

OPEL

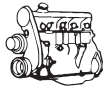

kW/BHP



... OPEL



... CORSA A

| | | | | | | | | | |
|----------------|---|-------------------------|-------|-------------|---|-------------------|--|--|--|
| 1.4 Si | 4 | C 14 SE | 60/80 | 09/91→03/93 | Z119 ^[284] Z190 ^{[282][283]} Z74 ^[283] | 0.8 1.2 1.0 | UXT2/UXT6 ^[284] UXT1/UXT3 ^[283] | ZS253 ^{[1][254]} ZSE026 ^[1] eng. 02T14053→ | ZM041 |
| 1.5 D | 4 | 15 D (4EC1) | 37/50 | 09/87→03/93 | GV749 →eng. 804794 GV946 eng. 804795→ | 5V 11V | | | |
| 1.5 TD | 4 | 15 DT (T4EC1) | 49/66 | 10/87→03/93 | GV945 →eng. 804794 GV947 eng. 804795→ | 5V 11V | | | |
| 1.6 GSI | 4 | C 16 NZ | 55/74 | 08/88→09/92 | Z119 ^[284] →12/89 Z74 ^[283] 01/90→ | 0.8 1.0 | UXT2/UXT6 ^[284] →12/89 UXT1/UXT3 ^[283] 01/90→ | ZS252 | |
| 1.6 GSI | 4 | C 16 SEI | 72/97 | 09/89→03/93 | Z190 ^{[282][283]} Z20 ^[284] Z74 ^[283] | 1.2 0.8 1.0 | UXT2/UXT6 ^[284] UXT1/UXT3 ^[283] | ZS253 | ZM016 |
| 1.6 GSI | 4 | C 16 SE | 74/99 | 02/92→03/93 | Z20 ^[284] Z74 ^[283] | 0.8 1.0 | UXT2/UXT6 ^[284] UXT1/UXT3 ^[283] | ZS253 ^{[1][254]} ZSE026 ^[1] ch. L4000001→ | ZM016 |
| 1.6 GSI | 4 | E 16 SE | 74/99 | 05/88→03/92 | Z190 ^{[282][283]} Z20 ^[284] Z74 ^[283] | 1.2 0.8 1.0 | UXT2/UXT6 ^[284] UXT1/UXT3 ^[283] | ZS253 ^{[1][254]} ZSE026 ^[1] ch. L4000001→ | ZM016 04/89→ |
| CORSA B | | | | | | | | | |
| 1.0 i 12V | 3 | X 10 XE | 40/54 | 11/96→09/00 | Z190 ^[282] Z74 | 1.2 1.0 | UXT1 / UXT3 | ZS358 | |
| 1.0 i 12V LPG | 3 | X 10 XE | 40/54 | 11/96→09/00 | Z206 | 0.7 | UXT10 | | |
| 1.2 i | 4 | 12 NZ | 33/44 | 03/93→09/00 | Z119 ^[284] Z190 ^{[282][283]} Z74 ^[283] | 0.8 1.2 1.0 | UXT2/UXT6 ^[284] UXT1/UXT3 ^[283] | ZS253 | ZM041 |
| 1.2 i | 4 | C 12 NZ | 33/44 | 03/93→09/00 | Z119 ^[284] Z190 ^{[282][283]} Z74 ^[283] | 0.8 1.2 1.0 | UXT2/UXT6 ^[284] UXT1/UXT3 ^[283] | ZS253 ^[1] | ZM018 |
| 1.2 i | 4 | X 12 SZ | 33/44 | 03/93→09/00 | Z119 ^[284] Z190 ^{[282][283]} Z74 ^[283] | 0.8 1.2 1.0 | UXT2/UXT6 ^[284] UXT1/UXT3 ^[283] | ZSE026 ^[1] | ZM018 |
| 1.2 i LPG | 4 | 12 NZ, C 12 NZ, X 12 SZ | 33/44 | 03/93→09/00 | Z20 ^[168] Z206 | 0.8 0.7 | UXT2 / UXT6 UXT10 | | |
| 1.2 i 16V | 4 | X 12 XE | 48/64 | 03/98→09/00 | Z190 ^[282] Z74 | 1.2 1.0 | UXT1 / UXT3 | ZSE147 | |
| 1.2 i 16V LPG | 4 | X 12 XE | 48/64 | 03/98→09/00 | Z206 | 0.7 | UXT10 | | |
| 1.4 i | 4 | C 14 NZ, X 14 SZ | 40/54 | 03/93→09/00 | Z74 | 1.0 | UXT1 / UXT3 | | |
| 1.4 i | 4 | C 14 NZ | 44/59 | 03/93→09/00 | Z119 ^[284] Z190 ^{[282][283]} Z74 ^[283] | 0.8 1.2 1.0 | UXT2/UXT6 ^[284] UXT1/UXT3 ^[283] | ZS253 ^[1] | ZM018 ^[192] ZM041 ^[192] |
| 1.4 i | 4 | X 14 SZ | 44/59 | 03/93→09/00 | Z119 ^[284] Z190 ^{[282][283]} Z74 ^[283] | 0.8 1.2 1.0 | UXT2/UXT6 ^[284] UXT1/UXT3 ^[283] | ZSE026 ^[1] | |
| 1.4 i LPG | 4 | C 14 NZ, X 14 SZ | 44/59 | 03/93→09/00 | Z20 ^[168] Z206 | 0.8 0.7 | UXT2 / UXT6 UXT10 | | |
| 1.4 i 16V | 4 | C 14 SEL | 63/84 | 08/97→09/00 | Z190 ^[282] Z74 | 1.2 1.0 | UXT1 / UXT3 | | |
| 1.4 i 16V | 4 | X 14 XE | 66/89 | 09/94→09/00 | Z190 ^[282] Z74 | 1.2 1.0 | UXT1 / UXT3 | | |
| 1.4 i 16V | 4 | X 14 XE | 66/89 | 09/94→ | | | | ZSE026 | |
| 1.4 i 16V | 4 | X 14 XE | 66/89 | 01/99→ | Z74 | 1.0 | UXT1 / UXT3 | | |
| 1.4 i 16V | 4 | X 14 XE | 67/90 | 09/94→09/00 | Z190 ^[282] Z74 | 1.2 1.0 | UXT2 / UXT6 UXT1 / UXT3 | ZSE026 | |

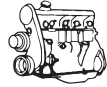

kW/BHP

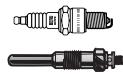

... OPEL



... CORSA B

| | | | | | | | | | |
|-----------------|---|--------------------------------|--------|-------------|---|--|-------------------|---|--------|
| 1.4 i 16V LPG | 4 | C 14 SEL | 63/84 | 08/97→09/00 | Z206 | | 0.7 | UXT10 | |
| 1.4 i 16V LPG | 4 | X 14 XE | 66/89 | 09/94→ | Z206 | | 0.7 | UXT10 | |
| 1.4 i 16V LPG | 4 | X 14 XE | 67/90 | 09/94→09/00 | Z206 | | 0.7 | UXT10 | |
| 1.4 Si | 4 | C 14 SE | 60/80 | 03/93→09/00 | Z119 ^[284] Z190 ^{[282][283]} Z74 ^[283] | | 0.8 1.2 1.0 | UXT2/UXT6 ^[284] ZS253 ^{[1][254]} ZSE026 ^{[1][151]} | |
| 1.4 Si LPG | 4 | C 14 SE | 60/80 | 03/93→09/00 | Z20 ^[168] Z206 | | 0.8 0.7 | UXT2 / UXT6 UXT10 | |
| 1.5 D | 4 | 15 D (4EC1) | 37/50 | 03/93→09/00 | GN103 | | 11V | | |
| 1.5 TD | 4 | 15 DT (T4EC1), X 15 DT (T4EC1) | 49/66 | 03/93→09/00 | GN103 | | 11V | | |
| 1.6 GSI 16V | 4 | C 16 XE | 80/107 | 03/93→09/00 | Z190 ^[282] Z74 | | 1.2 1.0 | | ZSE026 |
| 1.6 GSI 16V LPG | 4 | C 16 XE | 80/107 | 03/93→09/00 | Z206 | | 0.7 | UXT1 / UXT3 UXT10 | |
| 1.6 i 16V | 4 | C 16 SEL | 74/99 | 08/97→09/00 | Z190 ^[282] Z74 | | 1.2 1.0 | | ZSE026 |
| 1.6 i 16V | 4 | X 16 XE | 78/105 | 09/94→09/00 | Z190 ^[282] Z74 | | 1.2 1.0 | | ZSE026 |
| 1.6 i 16V LPG | 4 | C 16 SEL | 74/99 | 08/97→09/00 | Z206 | | 0.7 | UXT1 / UXT3 UXT10 | |
| 1.6 i 16V LPG | 4 | X 16 XE | 78/105 | 09/94→09/00 | Z206 | | 0.7 | UXT10 | |
| 1.7 D | 4 | 17 D (4EE1), X 17 D (4EE1) | 44/59 | 02/96→ | GN103 | | 11V | | |

CORSA C

| | | | | | | | | | |
|------------------|---|----------|--------|-------------|------------------------------|------------------------|------------|-------|---|
| 1.0 | 3 | Z 10 XE | 43/58 | 09/00→12/09 | Z190 ^[282] Z74 | | 1.2 1.0 | | ZS358 UXT1 / UXT3 |
| 1.0 | 3 | Z 10 XEP | 44/59 | 06/03→12/09 | Z203 | | 0.9 | | ZS359 |
| 1.0 LPG | 3 | Z 10 XE | 43/58 | 09/00→12/09 | Z206 | | 0.7 | UXT10 | |
| 1.0 LPG | 3 | Z 10 XEP | 44/59 | 06/03→12/09 | Z206 ^[168] | | 0.7 | UXT10 | |
| 1.2 | 4 | Z 12 XE | 55/74 | 09/00→12/09 | Z190 ^[282] Z74 | | 1.2 1.0 | | ZSE147 →06/04 →ch. 33999999; 34999999;36999999 ZS338 ch. 43000001;44000001; 46000001→ |
| 1.2 LPG | 4 | Z 12 XE | 55/74 | 09/00→12/09 | Z206 | | 0.7 | UXT10 | |
| 1.2 Twinport | 4 | Z 12 XEP | 59/79 | 07/04→12/09 | Z203 | | 0.9 | | ZS338 |
| 1.2 Twinport LPG | 4 | Z 12 XEP | 59/79 | 07/04→12/09 | Z206 ^[168] | | 0.7 | UXT10 | |
| 1.3 CDTI | 4 | Z 13 DT | 51/68 | 06/03→12/09 | GN053 | GSE142 ^[11] | 11V | | |
| 1.4 | 4 | Z 14 XE | 66/89 | 09/00→12/09 | Z190 ^[282] Z74 | | 1.2 1.0 | | ZS259 UXT1 / UXT3 |
| 1.4 LPG | 4 | Z 14 XE | 66/89 | 09/00→12/09 | Z206 | | 0.7 | UXT10 | |
| 1.4 Twinport | 4 | Z 14 XEP | 66/89 | 06/03→12/09 | Z203 | | 0.9 | | ZS338 |
| 1.4 Twinport LPG | 4 | Z 14 XEP | 66/89 | 06/03→12/09 | Z206 ^[168] | | 0.7 | UXT10 | |
| 1.7 CDTI | 4 | Z 17 DTH | 74/99 | 06/03→12/09 | GN104 →09/06 | GSE143 ^[10] | 11V | | |
| 1.7 DI | 4 | Y 17 DTL | 48/64 | 09/00→12/09 | GN104 | GSE143 ^[10] | 11V | | |
| 1.7 DTI | 4 | Y 17 DT | 55/74 | 09/00→12/09 | GN104 | GSE143 ^[10] | 11V | | |
| 1.8 | 4 | Z 18 XE | 92/123 | 09/00→12/09 | Z190 ^[282] Z74 | | 1.2 1.0 | | ZS342 UXT1 / UXT3 |
| 1.8 LPG | 4 | Z 18 XE | 92/123 | 09/00→12/09 | Z206 | | 0.7 | UXT10 | |

CORSA D

| | | | | | | | | | |
|---------|---|----------|-------|--------|-----------------------|--|-----|-------|-------|
| 1.0 | 3 | Z 10 XEP | 44/59 | 07/06→ | Z203 | | 0.9 | | ZS359 |
| 1.0 | 3 | A 10 XEP | 48/64 | 01/10→ | | | | | ZS359 |
| 1.0 LPG | 3 | Z 10 XEP | 44/59 | 07/06→ | Z206 ^[168] | | 0.7 | UXT10 | |
| 1.2 | 4 | A 12 XEL | 51/68 | 06/10→ | Z203 | | 0.9 | | |
| 1.2 | 4 | Z 12 XEP | 59/79 | 07/06→ | Z203 | | 0.9 | | ZS338 |
| 1.2 | 4 | A 12 XER | 63/84 | 06/10→ | Z203 | | 0.9 | | |
| 1.2 LPG | 4 | A 12 XEL | 51/68 | 06/10→ | Z206 ^[168] | | 0.7 | UXT10 | |
| 1.2 LPG | 4 | Z 12 XEP | 59/79 | 07/06→ | Z206 ^[168] | | 0.7 | UXT10 | |
| 1.2 LPG | 4 | A 12 XER | 63/84 | 06/10→ | Z206 ^[168] | | 0.7 | UXT10 | |

OPEL

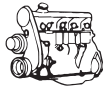

kW/BHP

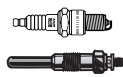

... OPEL



... CORSA D

| | | | | | | | | | |
|---------------|---|------------------------------|---------|--------|-----------------|--------|--------------|-------|-------|
| 1.2 LPG | 4 | Z 12 XEP | 59/79 | 09/09→ | | | | | ZS338 |
| 1.3 CDTI | 4 | A 13 DTC | 55/74 | 07/06→ | GE112 PSG003 | | 4.4V 4.4V | | |
| 1.3 CDTI | 4 | Z 13 DTJ | 55/74 | 07/06→ | GN053 | GSE144 | 11V | | |
| 1.3 CDTI | 4 | Z 13 DTH | 66/89 | 07/06→ | GN053 | GSE144 | 11V | | |
| 1.3 CDTI | 4 | A 13 DTE, A 13 DTR, Z 13 DTE | 70/94 | 06/10→ | GE112 | | 4.4V | | |
| 1.4 | 4 | A 14 XEL | 64/86 | 09/09→ | Z203 | | 0.9 | | |
| 1.4 | 4 | Z 14 XEP | 66/89 | 07/06→ | Z203 | | 0.9 | | ZS338 |
| 1.4 | 4 | A 14 XER | 74/99 | 06/10→ | | | | | ZS338 |
| 1.4 LPG | 4 | A 14 XEL | 64/86 | 09/09→ | Z206 [168] | | 0.7 | UXT10 | |
| 1.4 LPG | 4 | Z 14 XEP | 66/89 | 07/06→ | Z158 [168] | | 1.1 | | ZS338 |
| 1.6 Turbo | 4 | A 16 LEL, Z 16 LEL | 110/148 | 02/07→ | Z346 | | 0.8 | | ZS427 |
| 1.6 Turbo | 4 | A 16 LER, Z 16 LER | 141/189 | 02/07→ | Z346 | | 0.8 | | ZS427 |
| 1.6 Turbo | 4 | B 16 LER | 141/189 | 02/07→ | Z346 | | 0.8 | | |
| 1.6 Turbo | 4 | A 16 LER, Z 16 LER | 155/208 | 06/11→ | | | | | ZS427 |
| 1.6 Turbo | 4 | A 16 LES, B 16 LES | 155/208 | 06/11→ | Z346 | | 0.8 | | |
| 1.6 Turbo LPG | 4 | A 16 LEL, Z 16 LEL | 110/148 | 02/07→ | Z116 | | 0.8 | UXT5 | |
| 1.6 Turbo LPG | 4 | A 16 LER, B 16 LER, Z 16 LER | 141/189 | 02/07→ | Z116 | | 0.8 | UXT5 | |
| 1.6 Turbo LPG | 4 | A 16 LES, B 16 LES | 155/208 | 06/11→ | Z116 | | 0.8 | UXT5 | |
| 1.7 CDTI | 4 | Z 17 DTR | 92/123 | 07/06→ | GN104 | GSE145 | 11V | | |
| 1.7 CDTI | 4 | A 17 DTS | 96/129 | 06/10→ | GE117 | | 4.4V | | |

DIPLOMAT A

| | | | | | | | | | |
|-----|---|------|---------|-------------|------------|--|-----|--|--|
| 4.6 | 8 | 46 S | 140/188 | 10/64→03/69 | Z267 | | 0.6 | | |
| 5.4 | 8 | 54 S | 169/227 | 03/65→03/69 | Z112 [169] | | 0.5 | | |

DIPLOMAT B

| | | | | | | | | | |
|-------|---|------|---------|-------------|------------|--|-----|--|--|
| 2.8 E | 6 | 28 E | 121/162 | 03/69→02/75 | Z19 [168] | | 0.8 | | |
| 5.4 | 8 | 54 S | 169/227 | 03/69→01/78 | Z112 [169] | | 0.5 | | |

FRONTERA A

| | | | | | | | | | |
|---------------|--------|----------------|---------|-------------|-----------------|--|--------|-----------------|-----------------------------|
| 2.0 i 4WD | 4 | C 20 NE | 85/114 | 03/92→10/98 | Z119 [284] | | 0.8 | UXT2/UXT6 [284] | ZS127 [11] |
| | | | | | →08/95 | | →08/95 | | |
| | | | | | Z190 [282][283] | | 1.2 | | |
| | | | | | →08/95 | | 0.7 | UXT10 | |
| | | | | | Z206 [283] | | →08/95 | 1.0 | |
| →08/95 | →08/95 | | | | | | | | |
| 2.0 i 4WD | 4 | X 20 SE | 85/114 | 03/92→10/98 | Z190 [282][283] | | 1.2 | ZS300 [11] | |
| | | | | | Z74 [283] | | 1.0 | | UXT1/UXT3 [283] |
| 2.0 i 4WD LPG | 4 | C 20 NE | 85/114 | 03/92→10/98 | Z20 [168] | | 0.8 | UXT2 / UXT6 | |
| | | | | | →08/95 | | →08/95 | | |
| 2.0 i 4WD LPG | 4 | X 20 SE | 85/114 | 03/92→10/98 | Z206 | | 0.7 | UXT10 | |
| 2.2 i 4WD | 4 | X 22 XE | 100/134 | 03/95→10/98 | Z190 [282] | | 1.2 | ZS300 | |
| | | | | | Z74 | | 1.0 | | UXT1 / UXT3 ch. SV 720103 → |
| | | | | | Z206 | | 0.7 | | UXT10 |
| 2.3 TD 4WD | 4 | 23 DTR | 74/99 | 03/92→10/98 | GN013 [222] | | 11V | | |
| | | | | | →02/95 | | 11V | | |
| 2.4 i 4WD | 4 | C 24 NE | 92/123 | 03/92→10/98 | Z19 [168] | | 0.8 | ZS127 | |
| | | | | | →08/95 | | | | |
| 2.5 TDS 4WD | 4 | 25TDS (VM41B) | 85/114 | 09/96→10/98 | GN007 | | 11V | | |
| 2.8 TD 4WD | 4 | 28 TDI (4JB1T) | 83/111 | 03/95→10/98 | GN061 | | 11V | | |

FRONTERA B

| | | | | | | | | |
|-------------|---|--------------------|--------|-------------|---------------|--|-----|--|
| 2.2 DTI 4WD | 4 | X 22 DTH, Y 22 DTH | 85/114 | 10/98→09/02 | GN992 | | 11V | |
| | | | | | →08/00 | | | |
| | | | | | →ch. YV699999 | | | |
| | | | | | GN033 | | 11V | |
| | | | | | 09/00→ | | | |

OPEL



kW/BHP

**... OPEL****... FRONTERA B**

| | | | | | | | |
|---------------|---|------------------|---------|--------|-------------------|------------|-------------|
| 2.2 DTI 4WD | 4 | Y 22 DTH | 88/118 | 09/02→ | GN033 | 11V | |
| 2.2 i 4WD | 4 | X 22 SE | 100/134 | 10/98→ | Z190 [282] Z74 | 1.2 1.0 | UXT1 / UXT3 |
| 2.2 i 4WD | 4 | Y 22 SE | 100/134 | 10/98→ | Z343 | 1.1 | UXT11 |
| 2.2 i 4WD LPG | 4 | X 22 SE, Y 22 SE | 100/134 | 10/98→ | Z206 | 0.7 | UXT10 |
| 3.2 i 4WD | 6 | 6 VDI, Y 32 NE | 151/202 | 10/98→ | Z343 | 1.1 | UXT11 |
| 3.2 i 4WD LPG | 6 | 6 VDI, Y 32 NE | 151/202 | 10/98→ | Z206 | 0.7 | UXT10 |

GT

| | | | | | | | |
|-----|---|-------|-------|-------------|-----------|-----|--|
| 1.1 | 4 | 11 SR | 44/59 | 09/68→12/70 | Z19 [168] | 0.8 | |
| 1.9 | 4 | 19 S | 66/89 | 09/68→08/73 | Z19 [168] | 0.8 | |

INSIGNIA

| | | | | | | | |
|------------------|---|--------------------|---------|--------|---|----------------------|------------------------|
| 1.6 | 4 | A 16 XER | 85/114 | 07/08→ | Z203 | 0.9 | |
| 1.6 LPG | 4 | A 16 XER | 85/114 | 07/08→ | Z206 [168] | 0.7 | UXT10 |
| 1.6 Turbo | 4 | A 16 LET | 132/177 | 07/08→ | Z346 | 0.8 | ZS427 →ch. B1999999 |
| 1.6 Turbo LPG | 4 | A 16 LET | 132/177 | 07/08→ | Z116 | 0.8 | UXT5 |
| 1.8 | 4 | A 18 XER | 103/138 | 07/08→ | Z203 | 0.9 | |
| 1.8 LPG | 4 | A 18 XER | 103/138 | 07/08→ | Z206 [168] | 0.7 | UXT10 |
| 2.0 Biturbo CDTI | 4 | A 20 DTR | 140/188 | 07/08→ | PSG001 | 4.4V | |
| 2.0 Biturbo CDTI | 4 | A 20 DTR | 143/192 | 01/12→ | PSG001 | 4.4V | |
| 2.0 CDTI | 4 | A 20 DTC, A 20 DTL | 81/109 | 07/08→ | GE114 PSG001 →ch. C1999999 PSG006 ch. D1000001→ | 4.4V 4.4V 4.4V | |
| 2.0 CDTI | 4 | A 20 DTE | 88/118 | 03/12→ | PSG001 | 4.4V | |
| 2.0 CDTI | 4 | A 20 DT, A 20 DTJ | 96/129 | 07/08→ | GE114 PSG001 →ch. C1999999 PSG006 ch. D1000001→ | 4.4V 4.4V 4.4V | |
| 2.0 CDTI | 4 | A 20 DTE | 103/138 | 07/13→ | PSG001 | 4.4V | |
| 2.0 CDTI | 4 | A 20 DTH | 118/158 | 07/08→ | GE114 PSG001 →ch. C1999999 PSG006 ch. D1000001→ | 4.4V 4.4V 4.4V | |
| 2.0 CDTI | 4 | A 20 DTH | 120/161 | 07/13→ | GE114 PSG001 →ch. C1999999 PSG006 ch. D1000001→ | 4.4V 4.4V 4.4V | |

KADETT A

| | | | | | | | |
|-------|---|------|-------|-------------|-----------|-----|--|
| 1.0 | 4 | 10 N | 29/39 | 09/62→08/65 | Z57 [168] | 0.6 | |
| 1.0 N | 4 | 10 N | 29/39 | 03/63→08/65 | Z57 [168] | 0.6 | |
| 1.0 S | 4 | 10 S | 35/47 | 09/62→08/65 | Z57 [168] | 0.6 | |

KADETT B

| | | | | | | | |
|--------|---|-------|-------|-------------|-----------|-----|--|
| 1.1 | 4 | 11 N | 33/44 | 09/65→07/71 | Z19 [168] | 0.8 | |
| 1.1 | 4 | 11 N | 37/50 | 08/71→08/73 | Z19 [168] | 0.8 | |
| 1.1 | 4 | 11 S | 40/54 | 09/65→07/71 | Z19 [168] | 0.8 | |
| 1.1 | 4 | 11 SR | 44/59 | 11/66→07/71 | Z19 [168] | 0.8 | |
| 1.1 S | 4 | 11 S | 40/54 | 09/65→07/71 | Z19 [168] | 0.8 | |
| 1.1 SR | 4 | 11 SR | 44/59 | 11/66→07/71 | Z19 [168] | 0.8 | |
| 1.2 | 4 | 12 S | 44/59 | 08/71→08/73 | Z19 [168] | 0.8 | |
| 1.2 S | 4 | 12 S | 44/59 | 08/71→08/73 | Z19 [168] | 0.8 | |
| 1.7 | 4 | 17 L | 55/74 | 08/67→08/71 | Z19 [168] | 0.8 | |
| 1.9 | 4 | 19 S | 66/89 | 08/67→08/73 | Z19 [168] | 0.8 | |



kW/BHP



... OPEL



KADETT C

| | | | | | | | | | |
|--------------|---|-------|--------|-------------|-----------|--|-----|--|--|
| 1.0 | 4 | 10 N | 29/39 | 01/74→07/79 | Z19 [168] | | 0.8 | | |
| 1.2 | 4 | 12 N | 38/51 | 08/73→04/77 | Z19 [168] | | 0.8 | | |
| 1.2 | 4 | 12 N | 40/54 | 08/73→07/79 | Z19 [168] | | 0.8 | | |
| 1.2 S | 4 | 12 S | 44/59 | 08/73→07/79 | Z19 [168] | | 0.8 | | |
| 1.6 S | 4 | 16 S | 55/74 | 05/77→07/79 | Z19 [168] | | 0.8 | | |
| 1.9 GT/E | 4 | 19 E | 77/103 | 09/75→07/77 | Z19 [168] | | 0.8 | | |
| 2.0 E Rallye | 4 | 20 E | 81/109 | 08/77→07/79 | Z19 [168] | | 0.8 | | |
| 2.0 GT/E | 4 | 20 EH | 85/114 | 08/77→07/79 | Z19 [168] | | 0.8 | | |

KADETT D

| | | | | | | | | | |
|----------|---|--------|--------|-------------|-------------------------|-------|------------|-------------------|--------------------------------|
| 1.2 | 4 | 12 N | 39/52 | 08/79→07/82 | Z19 [168] | | 0.8 | | |
| 1.2 | 4 | 12 ST | 40/54 | 08/82→08/84 | Z20 | | 0.8 | UXT2 / UXT6 | |
| 1.2 S | 4 | 12 S | 44/59 | 08/79→08/84 | Z19 [168] | | 0.8 | | ZM006 08/82→ |
| 1.3 N | 4 | 13 N | 44/59 | 08/79→08/84 | Z20 | | 0.8 | UXT2 / UXT6 ZS252 | ZM006 |
| 1.3 N | 4 | C 13 N | 44/59 | 08/79→08/84 | Z20 | | 0.8 | UXT2 / UXT6 ZS252 | |
| 1.3 S | 4 | 13 S | 55/74 | 08/79→08/84 | Z20 | | 0.8 | UXT2 / UXT6 ZS252 | ZM006 |
| 1.6 D | 4 | 16 D | 40/54 | 03/82→08/84 | GN013 [2][222] GN954 | GR064 | 11V 11V | | |
| 1.6 S | 4 | 16 SH | 66/89 | 09/81→08/84 | Z20 | | 0.8 | UXT2 / UXT6 | ZM002 [175] ZM015 09/83→ |
| 1.8 GT/E | 4 | 18 E | 85/114 | 02/83→08/84 | Z20 | | 0.8 | UXT2 / UXT6 | ZM002 [175] ZM015 09/83→ |

KADETT E

| | | | | | | | | | |
|-----------|---|------------------|-------|-------------|---|-------|--------------------------|--|--------------------------------|
| 1.2 | 4 | 12 SC | 40/54 | 09/84→07/86 | Z19 [168] | | 0.8 | | |
| 1.3 | 4 | 13 S | 50/67 | 01/85→12/87 | | | | | ZS252 |
| 1.3 i | 4 | C 13 N | 44/59 | 09/85→08/91 | Z20 | | 0.8 | UXT2 / UXT6 ZS252 | ZM016 →08/89 |
| 1.3 N | 4 | 13 N, 13 NB | 44/59 | 09/84→08/91 | Z20 | | 0.8 | UXT2 / UXT6 ZS252 | |
| 1.3 S | 4 | 13 S | 55/74 | 09/84→02/93 | Z20 | | 0.8 | UXT2 / UXT6 ZS252 | ZM006 |
| 1.4 i | 4 | C 14 NZ | 44/59 | 01/90→08/91 | Z119 [284] Z190 [282][283] Z74 [283] | | 0.8 1.2 1.0 | UXT2/UXT6 [284] [254] UXT1/UXT3 [283] | ZM018 [192] ZM041 09/90→ |
| 1.4 S | 4 | 14 NV | 55/74 | 01/90→08/91 | Z119 [284] Z190 [282][283] Z20 [284] Z74 [283] | | 0.8 1.2 0.8 1.0 | UXT2/UXT6 [284] ZS253 UXT2/UXT6 [284] UXT1/UXT3 [283] | ZM015 [175] ZM018 [192] |
| 1.4 S | 4 | 14 NV | 55/74 | 08/90→02/93 | Z119 [284] Z190 [282][283] Z74 [283] | | 0.8 1.2 1.0 | UXT2/UXT6 [284] UXT1/UXT3 [283] | |
| 1.4 S | 4 | C 14 SE | 60/80 | 09/89→08/91 | Z119 [284] Z190 [282][283] Z74 [283] | | 0.8 1.2 1.0 | UXT2/UXT6 [284] UXT1/UXT3 [283] | |
| 1.4 S LPG | 4 | C 14 SE | 60/80 | 09/89→08/91 | Z20 [168] Z206 | | 0.8 0.7 | UXT2 / UXT6 UXT10 | |
| 1.5 TD | 4 | 15 DT (T4EC1) | 53/71 | 07/88→08/91 | GV945 →eng. 817252 GV947 eng. 817253→ | | 5V 11V | | |
| 1.6 | 4 | 16 SV | 60/80 | 09/86→08/91 | Z20 | | 0.8 | UXT2 / UXT6 ZS252 [1][254] ZS253 [1][254] | |
| 1.6 D | 4 | 16 D, 16 DA | 40/54 | 09/84→01/89 | GN013 [2][222] GN954 | GR064 | 11V 11V | | |
| 1.6 i | 4 | C 16 LZ | 55/74 | 09/86→02/93 | Z21 | | 1.1 | UXT2 / UXT6 ZS252 | |
| 1.6 i | 4 | C 16 LZ, E 16 NZ | 55/74 | 09/86→02/93 | | | | | ZM018 [192] ZM016 09/87→ |



kW/BHP

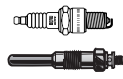

... OPEL



... KADETT E

| | | | | | | | | | | |
|---------|---|----------------|--------|-------------|---|-------|--------------------------|--|---|--|
| 1.6 i | 4 | C 16 LZ | 55/74 | 10/87→02/93 | | | | | | ZM016 ^[209] ZM018 ^[192] |
| 1.6 i | 4 | C 16 NZ | 55/74 | 09/86→08/91 | Z21 | | 1.1 | UXT2 / UXT6 | | ZM018 ^[192] ZM016 09/87→ |
| 1.6 i | 4 | C 16 NZ | 55/74 | 09/86→02/93 | | | | | ZS252 | |
| 1.6 i | 4 | C 16 NZ | 55/74 | 10/87→02/93 | Z8 | | 0.8 | UXT2 / UXT6 | | ZM016 ^[209] ZM018 ^[192] |
| 1.6 i | 4 | E 16 NZ | 55/74 | 09/86→08/91 | Z119 ^[284] Z190 ^{[282][283]} Z21 Z74 ^[283] | | 0.8 1.2 1.1 1.0 | UXT2/UXT6 ^[284] UXT2/UXT6 ^[284] UXT1/UXT3 ^[283] | ZS252 | |
| 1.6 i | 4 | E 16 NZ | 55/74 | 10/86→02/93 | Z21 | | 1.1 | UXT2 / UXT6 | ZS252 ^[1] 09/87→08/91 | |
| 1.6 i | 4 | 16 SV | 60/80 | 07/89→02/93 | Z20 | | 0.8 | UXT2 / UXT6 | ZS252 ^{[1][205][254]} ZS253 ^{[1][254]} | |
| 1.6 S | 4 | 16 SV | 60/80 | 09/86→08/91 | Z20 | | 0.8 | UXT2 / UXT6 | ZS252 ^{[1][254]} ZS253 ^{[1][254]} ZS253 01/90→ | ZM007 →08/87 |
| 1.6 S | 4 | 16 SH | 66/89 | 09/84→08/86 | Z20 | | 0.8 | UXT2 / UXT6 | | ZM002 ^[175] ZM015 ^[175] |
| 1.7 D | 4 | 17 D | 42/56 | 02/89→08/91 | GN013 ^{[2][222]} GN954 | GR064 | 11V 11V | | | |
| 1.8 | 4 | 18 E | 84/113 | 09/87→08/90 | Z20 | | 0.8 | UXT2 / UXT6 | ZS127 ^{[1][214][254]} ZS253 ^{[1][254]} | |
| 1.8 E | 4 | C 18 NE | 74/99 | 10/85→08/86 | Z20 | | 0.8 | UXT2 / UXT6 | | |
| 1.8 GSI | 4 | 18 E | 85/114 | 09/84→08/86 | Z20 | | 0.8 | UXT2 / UXT6 | | ZM002 |
| 1.8 i | 4 | 18 SV, C 18 NZ | 66/89 | 09/90→08/91 | Z119 ^[284] Z190 ^{[282][283]} Z74 ^[283] | | 0.8 1.2 1.0 | UXT2/UXT6 ^[284] UXT1/UXT3 ^[283] | | |
| 1.8 i | 4 | C 18 NT | 66/89 | 06/85→08/91 | Z20 ^[284] →09/85 Z119 ^[284] 10/85→ Z190 ^{[282][283]} 10/85→ Z74 ^[283] 10/85→ | | 0.8 0.8 1.2 1.0 | UXT2/UXT6 ^[284] UXT2/UXT6 ^[284] UXT1/UXT3 ^[283] | | ZM001 ^[175] →09/85 ZM018 ^[192] 01/89→ |
| 1.8 i | 4 | C 18 NT | 66/89 | 09/90→08/91 | Z119 ^[284] Z190 ^{[282][283]} Z74 ^[283] | | 0.8 1.2 1.0 | UXT2/UXT6 ^[284] UXT1/UXT3 ^[283] | | ZM015 |
| 1.8 i | 4 | C 18 NZ | 66/89 | 06/85→08/91 | Z20 ^[284] →09/85 Z119 ^[284] 10/85→ Z190 ^{[282][283]} 10/85→ Z74 ^[283] 10/85→ | | 0.8 0.8 1.2 1.0 | UXT2/UXT6 ^[284] UXT2/UXT6 ^[284] UXT1/UXT3 ^[283] | ZS253 ^[1] →09/85 | ZM018 01/89→ |
| 1.8 i | 4 | S 18 NV | 66/89 | 06/85→08/91 | Z190 ^{[282][283]} Z20 ^[284] Z74 ^[283] | | 1.2 0.8 1.0 | UXT2/UXT6 ^[284] UXT1/UXT3 ^[283] | ZS125 ^[1] →08/88 ZS127 ^{[1][214][254]} | |
| 1.8 i | 4 | C 18 NE | 74/99 | 10/85→08/86 | Z20 | | 0.8 | UXT2 / UXT6 | | |
| 1.8 i | 4 | 18 E, 18 SE | 85/114 | 09/84→08/86 | Z20 | | 0.8 | UXT2 / UXT6 | | |
| 1.8 S | 4 | E 18 NV | 62/83 | 09/87→08/91 | Z20 | | 0.8 | UXT2 / UXT6 | ZS125 ^[1] →08/88 ZS127 ^[1] 09/88→ | ZM034 →12/90 ZM034 01/89→ |

OPEL



kW/BHP



... OPEL



... KADETT E

| | | | | | | | | | |
|-------------|---|-----------------------|---------|-------------|---|-------------------|--|--|-----------------|
| 1.8 S | 4 | S 18 NV | 62/83 | 09/87→08/91 | Z20 | 0.8 | UXT2 / UXT6 | ZS125 ^[1] →08/88 ZS127 ^[1] 09/88→ | ZM034 →12/90 |
| 2.0 GSI | 4 | 20 NE, C 20 NE | 85/114 | 09/86→08/91 | Z119 ^[284] Z190 ^{[282][283]} Z74 ^[283] | 0.8 1.2 1.0 | UXT2/UXT6 ^[284] UXT1/UXT3 ^[283] | ZS125 ^[1] →08/88 ZS127 ^[1] 09/88→ | |
| 2.0 GSI | 4 | 20 SEH | 95/127 | 09/86→08/91 | Z20 | 0.8 | UXT2 / UXT6 | ZS125 ^[1] →08/88 ZS127 ^[1] 09/88→ | |
| 2.0 GSI 16V | 4 | 20 XEJ | 110/148 | 03/88→08/91 | Z250 | 0.7 | UXT1 / UXT3 | ZS125 ^{[1][214][254]} ZS127 ^{[1][214][254]} | ZM034 |
| 2.0 GSI 16V | 4 | C 20 XE | 110/148 | 03/88→08/91 | Z250 | 0.7 | UXT1 / UXT3 | ZS125 | |
| 2.0 GSI 16V | 4 | 20 XE | 115/154 | 12/87→08/91 | Z250 | 0.7 | UXT1 / UXT3 | ZS125 | ZM034 03/88→ |
| 2.0 i | 4 | 20 NE, 20 SE, C 20 NE | 85/114 | 10/86→02/93 | Z119 ^[284] Z190 ^{[282][283]} Z74 ^[283] | 0.8 1.2 1.0 | UXT2/UXT6 ^[284] UXT1/UXT3 ^[283] | ZS125 ^[1] →08/88 ZS127 ^[1] 09/88→ | |

KAPITÄN

| | | | | | | | | | |
|-------|---|--|-------|-------------|-----|-----|--|--|--|
| 2.6 P | 6 | | 66/89 | 05/58→12/63 | Z57 | 0.6 | | | |
|-------|---|--|-------|-------------|-----|-----|--|--|--|

MANTA A

| | | | | | | | | | |
|----------|---|------|--------|-------------|---|------------|---------------------------------------|--|--|
| 1.2 | 4 | 12 S | 44/59 | 04/72→08/75 | Z19 ^[168] | 0.8 | | | |
| 1.6 | 4 | 16 N | 44/59 | 02/75→08/75 | Z19 ^[168] | 0.8 | | | |
| 1.6 | 4 | 16 N | 50/67 | 09/70→08/75 | Z19 ^[168] | 0.8 | | | |
| 1.6 | 4 | 16 S | 55/74 | 02/75→08/75 | Z19 ^[168] | 0.8 | | | |
| 1.6 S | 4 | 16 S | 59/79 | 09/70→08/75 | Z20 ^[168] →12/74 →eng. 300000 Z19 ^[168] 01/75→ eng. 300 001→ | 0.8 0.8 | UXT2 / UXT6 →12/74 →eng. 300000 | | |
| 1.9 GT/E | 4 | 19 E | 77/103 | 02/74→08/75 | Z19 ^[168] | 0.8 | | | |
| 1.9 S | 4 | 19 S | 65/87 | 09/70→08/75 | Z19 ^[168] | 0.8 | | | |
| 1.9 S | 4 | 19 S | 66/89 | 09/70→08/75 | Z19 ^[168] | 0.8 | | | |

MANTA B

| | | | | | | | | | |
|-------------|---|------|---------|-------------|----------------------|-----|-------------|-------|---|
| 1.2 N | 4 | 12 N | 40/54 | 08/76→07/83 | Z19 ^[168] | 0.8 | | | |
| 1.2 S | 4 | 12 S | 44/59 | 09/75→02/79 | Z19 ^[168] | 0.8 | | | |
| 1.3 N | 4 | 13 N | 44/59 | 03/79→12/80 | Z20 | 0.8 | UXT2 / UXT6 | | |
| 1.3 S | 4 | 13 S | 55/74 | 08/79→08/86 | Z20 | 0.8 | UXT2 / UXT6 | ZS252 | ZM006 01/82→ |
| 1.3 S | 4 | 13 S | 55/74 | 08/81→08/86 | | | | | ZM002 ^[175] ZM006 01/82→ |
| 1.6 N | 4 | 16 N | 44/59 | 09/75→12/80 | Z19 ^[168] | 0.8 | | | |
| 1.6 S | 4 | 16 S | 55/74 | 09/75→12/81 | Z19 ^[168] | 0.8 | | | ZM002 |
| 1.8 S | 4 | 18 S | 66/89 | 07/82→08/87 | Z20 | 0.8 | UXT2 / UXT6 | | ZM002 |
| 1.9 E | 4 | 19 E | 77/103 | 09/75→08/77 | Z19 ^[168] | 0.8 | | | |
| 1.9 N | 4 | 19 N | 55/74 | 08/76→12/81 | Z19 ^[168] | 0.8 | | | |
| 1.9 S | 4 | 19 S | 66/89 | 09/75→12/80 | Z19 ^[168] | 0.8 | | | |
| 2.0 | 4 | 20 N | 66/89 | 08/77→12/80 | Z19 ^[168] | 0.8 | | | |
| 2.0 E | 4 | 20 E | 81/109 | 08/77→08/88 | Z19 ^[168] | 0.8 | | | ZM002 |
| 2.0 S | 4 | 20 S | 74/99 | 08/77→08/84 | Z19 ^[168] | 0.8 | | | ZM002 |
| 2.4 2.4 400 | 4 | 24 E | 106/142 | 07/80→08/84 | Z25 | 0.8 | UXK56 | | |

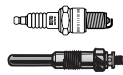

kW/BHP

**... OPEL****MERIVA**

| | | | | | | | | | |
|----------------------|---|-------------------|---------|-------------|-------------------------------|------------------------|------------|-------|-------|
| 1.3 CDTI | 4 | Y 13 DT, Z 13 DT | 51/68 | 04/05→05/10 | GN053 | GSE142 ^[11] | 11V | | |
| 1.3 CDTI | 4 | Z 13 DTJ | 55/74 | 09/03→05/10 | GN053 | GSE142 ^[11] | 11V | | |
| 1.4 16V Twinport | 4 | Z 14 XEP | 66/89 | 07/04→05/10 | Z203 | | 0.9 | | ZS338 |
| 1.4 16V Twinport LPG | 4 | Z 14 XEP | 66/89 | 07/04→05/10 | Z206 ^[168] Z203 | | 0.7 0.9 | UXT10 | ZS338 |
| 1.6 | 4 | Z 16 SE | 64/86 | 05/03→05/10 | Z190 | | 1.2 | | |
| 1.6 | 4 | Z 16 XEP | 77/103 | 01/06→05/10 | Z203 | | 0.9 | | ZS427 |
| 1.6 LPG | 4 | Z 16 SE | 64/86 | 05/03→05/10 | Z206 | | 0.7 | UXT10 | |
| 1.6 LPG | 4 | Z 16 XEP | 77/103 | 01/06→05/10 | Z206 ^[168] | | 0.7 | UXT10 | |
| 1.6 16V | 4 | Z 16 XE | 74/99 | 05/03→01/06 | Z203 | | 0.9 | | ZS259 |
| 1.6 16V LPG | 4 | Z 16 XE | 74/99 | 05/03→01/06 | Z206 ^[168] | | 0.7 | UXT10 | |
| 1.6 Turbo | 4 | Z 16 LET | 132/177 | 09/05→05/10 | Z346 | | 0.8 | | ZS427 |
| 1.6 Turbo LPG | 4 | Z 16 LET | 132/177 | 09/05→05/10 | Z116 | | 0.8 | UXT5 | |
| 1.7 CDTI | 4 | Z 17 DT, Z 17 DTH | 74/99 | 09/03→05/10 | GN104 | GSE143 ^[10] | 11V | | |
| 1.7 CDTI | 4 | A 17 DTR | 92/123 | 09/06→05/10 | GN104 | | 11V | | |
| 1.7 CDTI | 4 | Z 17 DTR | 92/123 | 09/06→05/10 | GN104 | GSE143 ^[10] | 11V | | |
| 1.7 DTI | 4 | Y 17 DT | 55/74 | 09/03→05/10 | GN104 | GSE143 ^[10] | 11V | | |
| 1.8 | 4 | Z 18 XE | 92/123 | 05/03→05/10 | Z190 | | 1.2 | | ZS342 |
| 1.8 LPG | 4 | Z 18 XE | 92/123 | 05/03→05/10 | Z206 | | 0.7 | UXT10 | |

MERIVA B

| | | | | | | | | | |
|----------|---|----------|---------|--------|-----------------|--------|--------------|--|--|
| 1.3 CDTI | 4 | A 13 DTC | 55/74 | 06/10→ | GE112 PSG003 | | 4.4V 4.4V | | |
| 1.3 CDTI | 4 | A 13 DTE | 70/94 | 06/10→ | GE112 PSG003 | | 4.4V 4.4V | | |
| 1.6 CDTI | 4 | B 16 DTC | 70/94 | 01/14→ | GE126 | | 4.4V | | |
| 1.6 CDTI | 4 | B 16 DTL | 81/109 | 03/14→ | GE126 | | 4.4V | | |
| 1.6 CDTi | 4 | B 16 DTH | 100/134 | 08/13→ | GE126 | | 4.4V | | |
| 1.7 CDTI | 4 | A 17 DT | 74/99 | 06/10→ | GN104 | GSE145 | 11V | | |
| 1.7 CDTI | 4 | A 17 DTC | 81/109 | 06/10→ | GE117 | | 4.4V | | |
| 1.7 CDTI | 4 | A 17 DTI | 81/109 | 06/10→ | GN104 | GSE145 | 11V | | |
| 1.7 CDTI | 4 | A 17 DTS | 96/129 | 06/10→ | GE117 | | 4.4V | | |

MOKKA

| | | | | | | | | | |
|----------|---|----------|--------|--------|--------|--|------|--|--|
| 1.7 CDTI | 4 | A 17 DTS | 96/129 | 06/12→ | PSG004 | | 4.4V | | |
|----------|---|----------|--------|--------|--------|--|------|--|--|

MONTEREY A

| | | | | | | | | | |
|-------------|---|---------|---------|-------------|-----------------|--|-----|-------|-------|
| 3.1 TD 4WD | 4 | 4 JG2TC | 84/113 | 09/91→07/98 | GV947 →12/97 | | 11V | | |
| 3.2 4WD | 6 | 6 VD1 | 130/174 | 06/92→07/98 | Z343 | | 1.1 | UXT11 | ZS355 |
| 3.2 4WD LPG | 6 | 6 VD1 | 130/174 | 06/92→07/98 | Z206 | | 0.7 | UXT10 | |

MONTEREY B

| | | | | | | | | | |
|--------------------|---|-------|---------|-------------|-------|--|-----|-------|--|
| 3.0 DTI 4WD | 4 | 4 JX1 | 117/157 | 07/98→08/99 | GN997 | | 11V | | |
| 3.5 V6 24V 4WD | 6 | 6 VE1 | 158/212 | 07/98→08/99 | Z343 | | 1.1 | UXT11 | |
| 3.5 V6 24V 4WD LPG | 6 | 6 VE1 | 158/212 | 07/98→08/99 | Z206 | | 0.7 | UXT10 | |

MONZA A

| | | | | | | | | | |
|---------|---|---------|---------|-------------|----------------------|--|-----|--|--|
| 2.0 E | 4 | H 20 E | 85/114 | 03/83→10/84 | Z19 ^[168] | | 0.8 | | ZM015 |
| 2.2 E | 4 | 22 E | 85/114 | 11/84→08/86 | Z19 ^[168] | | 0.8 | | ZM002 ^[175] ZM015 |
| 2.5 E | 6 | H 25 E | 100/134 | 05/81→08/86 | Z19 ^[168] | | 0.8 | | 09/84→ ZM002 ^[175] ZM015 |
| 2.5 E | 6 | 25 E | 103/138 | 06/84→08/86 | Z19 ^[168] | | 0.8 | | 09/84→ |
| 2.8 | 6 | 28 H | 103/138 | 02/78→04/81 | Z19 ^[168] | | 0.8 | | |
| 3.0 | 6 | 30 H | 110/148 | 04/78→07/82 | Z19 ^[168] | | 0.8 | | ZM002 08/81→ |
| 3.0 GSE | 6 | C 30 LE | 115/154 | 09/85→08/86 | Z19 ^[168] | | 0.8 | | ZM002 ^[175] ZM015 ^[175] |

OPEL

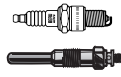

kW/BHP

**... OPEL****... MONZA A**

| | | | | | | | | | | |
|---------|---|------|---------|-------------|-----------|--|-----|--|--|------------------------------------|
| 3.0 GSE | 6 | 30 E | 132/177 | 02/78→08/86 | Z19 [168] | | 0.8 | | | ZM002 08/81→ ZM015 09/83→ |
|---------|---|------|---------|-------------|-----------|--|-----|--|--|------------------------------------|

OLYMPIA A

| | | | | | | | | | | |
|-----|---|-------|-------|-------------|-----------|--|-----|--|--|--|
| 1.0 | 4 | 11 SR | 44/59 | 08/67→08/71 | Z48 [168] | | 0.8 | | | |
| 1.7 | 4 | 17 S | 55/74 | 08/67→08/71 | Z48 [168] | | 0.8 | | | |
| 1.9 | 4 | 19 S | 66/89 | 08/67→08/71 | Z48 [168] | | 0.8 | | | |

OLYMPIA REKORD

| | | | | | | | | | | |
|-----|---|------|-------|-------------|-----------|--|-----|--|--|--|
| 1.5 | 4 | 15LN | 29/39 | 03/53→12/55 | Z57 [170] | | 0.6 | | | |
| 1.5 | 4 | | 33/44 | 01/56→12/60 | Z57 [170] | | 0.6 | | | |
| 1.5 | 4 | | 37/50 | 07/57→12/63 | Z57 [170] | | 0.6 | | | |

OMEGA A

| | | | | | | | | | | |
|----------------|---|----------|---------|-------------|-------------------------|-------|------------|-------------|--|--|
| 1.8 | 4 | E 18 NVR | 65/87 | 09/87→03/94 | Z20 | | 0.8 | UXT2 / UXT6 | ZS125 [1][214][254] ZS127 [1] eng. 14258180→ | ZM034 |
| 1.8 | 4 | 18 SEH | 85/114 | 09/86→03/94 | Z20 | | 0.8 | UXT2 / UXT6 | ZS253 | ZM032 [1] ZM034 [1][216] |
| 1.8 N | 4 | 18 NV | 60/80 | 09/86→08/87 | Z20 | | 0.8 | UXT2 / UXT6 | ZS125 [1][214][254] ZS127 [1] eng. 14258180→ | ZM032 |
| 1.8 S | 4 | 18 SV | 66/89 | 09/86→03/94 | Z20 | | 0.8 | UXT2 / UXT6 | ZS253 [254] ch. 14258180→ | ZM032 [1] →ch. K1000098 ZM034 [1] →ch. 14258179 ZM041 ch. L1019855→ |
| 2.0 | 4 | C 20 NEJ | 73/98 | 09/90→03/94 | Z119 | | 0.8 | UXT2 / UXT6 | ZS125 [1] →eng. 14180385 ZS127 [1] eng. 14180386→ | |
| 2.0 | 4 | C 20 NEF | 74/99 | 09/90→03/94 | Z119 | | 0.8 | UXT2 / UXT6 | ZS125 [1][214][254] →eng. 14180385 ZS127 [1] eng. 14180386→ | ZM034 |
| 2.0 | 4 | 20 SE | 90/121 | 09/86→03/94 | Z20 | | 0.8 | UXT2 / UXT6 | ZS125 [1][214][254] ZS127 [1] eng. 14180386→ | |
| 2.0 i | 4 | C 20 NEJ | 73/98 | 09/90→03/94 | Z119 | | 0.8 | UXT2 / UXT6 | ZS125 [1] →eng. 14180385 ZS127 [1] eng. 14180386→ | |
| 2.0 i | 4 | C 20 NE | 85/114 | 09/86→03/94 | Z119 | | 0.8 | UXT2 / UXT6 | ZS125 [1] →eng. 14180385 ZS127 [1] eng. 14180386→ | |
| 2.3 D | 4 | 23 YD | 54/72 | 09/86→03/94 | GN013 [2][222] GN954 | GR064 | 11V 11V | | | |
| 2.3 TD | 4 | 23 YDT | 66/89 | 09/86→08/88 | GN013 [2][222] GN954 | | 11V 11V | | | |
| 2.3 TD Interc. | 4 | 23 DTR | 74/99 | 08/88→03/94 | GN013 [2][222] GN954 | GR064 | 11V 11V | | | |
| 2.4 i | 4 | C 24 NE | 92/123 | 09/88→03/94 | Z19 [168] | | 0.8 | | ZS127 [1] →ch. K1999999 ZS125 [1] ch. L1000001→ | |
| 2.6 i | 6 | C 26 NE | 110/148 | 09/90→03/94 | Z19 [168] | | 0.8 | | ZS127 | |

OPEL

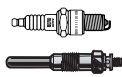

kW/BHP

**... OPEL****... OMEGA A**

| | | | | | | | | |
|--------------------------|---|----------|---------|-------------|-----------|-----|---|-------|
| 3.0 | 6 | C 30 LE | 115/154 | 03/87→03/94 | Z19 [168] | 0.8 | ZS125 [1] ch. K1000099→ →ch. K1999999 ZS127 [1] ch. L1000001→ | |
| 3.0 | 6 | 30 NE | 130/174 | 03/87→09/90 | Z19 [168] | 0.8 | ZS125 [1][214][254] ZS127 [1][214][254] | |
| 3.0 | 6 | C 30 NE | 130/174 | 03/87→03/94 | Z19 [168] | 0.8 | ZS125 [1] ch. K1000099→ →ch. K1999999 ZS127 [1] ch. L1000001→ | |
| 3.0 (3000) | 6 | C 30 LE | 115/154 | 03/87→12/87 | Z19 [168] | 0.8 | ZS125 [1] ch. K1000099→ →ch. K1999999 ZS127 [1] ch. L1000001→ | |
| 3.0 (3000) | 6 | 30 NE | 130/174 | 03/87→09/90 | Z19 [168] | 0.8 | ZS125 [1][214][254] ZS127 [1][214][254] →08/89 | ZM001 |
| 3.0 (3000) | 6 | C 30 NE | 130/174 | 03/88→03/94 | Z19 [168] | 0.8 | ZS125 [1] ch. K1000099→ →ch. K1999999 ZS127 [1] ch. L1000001→ | |
| 3.0 3.0 24V Evolution500 | 6 | C 30 XEI | 169/227 | 03/91→07/92 | Z98 | 0.8 | UXT1 / UXT3 ZS127 | |
| 3.0 24V | 6 | C 30 SEJ | 147/197 | 09/89→03/94 | Z98 | 0.8 | UXT1 / UXT3 ZS127 | |
| 3.0 24V (3000) | 6 | C 30 SEJ | 147/197 | 09/89→03/94 | Z98 | 0.8 | UXT1 / UXT3 ZS127 | |
| 3.0 24V (3000) | 6 | C 30 SE | 150/201 | 09/89→03/94 | Z98 | 0.8 | UXT1 / UXT3 ZS127 | |
| 3.0 24V Omega 3000 | 6 | C 30 SE | 150/201 | 09/88→04/94 | Z98 | 0.8 | UXT1 / UXT3 ZS127 | |
| 3.6 24V Lotus | 6 | C 36 GET | 277/371 | 08/90→09/92 | Z15 | 0.8 | UXT1 / UXT3 ZS355 | |

OMEGA B

| | | | | | | | | |
|-------------|---|-------------------------|---------|-------------|-------------------------|------------|--|--|
| 2.0 | 4 | 20 SE, X 20 SE | 85/114 | 03/94→12/00 | Z190 [282] Z74 | 1.2 1.0 | ZS300 UXT1 / UXT3 | |
| 2.0 LPG | 4 | 20 SE, X 20 SE | 85/114 | 03/94→12/00 | Z206 | 0.7 | UXT10 | |
| 2.0 16V | 4 | X 20 XEV | 100/134 | 03/94→09/99 | Z190 [282] Z74 | 1.2 1.0 | ZS344 UXT1 / UXT3 | |
| 2.0 16V LPG | 4 | X 20 XEV | 100/134 | 03/94→09/99 | Z206 | 0.7 | UXT10 | |
| 2.0 DTI 16V | 4 | X 20 DTH | 74/99 | 09/97→09/00 | GN992 | 11V | | |
| 2.2 16V | 4 | Y 22 XE, Z 22 XE | 106/142 | 09/99→07/03 | Z190 [282] Z74 | 1.2 1.0 | ZSE150 UXT1 / UXT3 | |
| 2.2 16V LPG | 4 | Y 22 XE, Z 22 XE | 106/142 | 09/99→07/03 | Z206 | 0.7 | UXT10 | |
| 2.2 DTI 16V | 4 | Y 22 DTH | 81/109 | 09/00→07/03 | GN033 | 11V | | |
| 2.2 DTI 16V | 4 | Y 22 DTR | 86/115 | 01/01→ | GN033 | 11V | | |
| 2.2 DTI 16V | 4 | Y 22 DTH | 88/118 | 09/00→07/03 | GN033 | 11V | | |
| 2.5 D | 6 | X 25 TD | 96/129 | 05/94→05/99 | GN013 [2][222] GV719 | 11V 11V | | |
| 2.5 DTI | 6 | Y 25 DT | 110/148 | 09/01→07/03 | GN024 | 11V | | |
| 2.5 TD | 6 | 25 DT, X 25 DT, X 25 TD | 96/129 | 04/94→07/03 | GN013 [2][222] GV719 | 11V 11V | | |
| 2.5 V6 | 6 | X 25 XE | 125/168 | 03/94→09/00 | Z190 [282] Z74 | 1.2 1.0 | ZS301 UXT1 / UXT3 ZS306 ZS451 | |
| 2.5 V6 LPG | 6 | X 25 XE | 125/168 | 03/94→09/00 | Z206 | 0.7 | UXT10 | |
| 2.6 V6 | 6 | Y 26 SE | 132/177 | 09/00→07/03 | Z173 | 1.6 | ZSE152 [23] ZSE153 [27] | |
| 2.6 V6 LPG | 6 | Y 26 SE | 132/177 | 09/00→07/03 | Z172 | 1.6 | | |
| 3.0 V6 | 6 | X 30 XE | 155/208 | 04/94→02/01 | Z190 [282] Z74 | 1.2 1.0 | ZS301 UXT1 / UXT3 ZS306 ZS451 | |

OPEL



kW/BHP

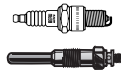

... OPEL



... OMEGA B

| | | | | | | | | |
|------------|---|---------|---------|-------------|------|-----|-------|----------------------------|
| 3.0 V6 LPG | 6 | X 30 XE | 155/208 | 04/94→02/01 | Z206 | 0.7 | UXT10 | |
| 3.2 V6 | 6 | Y 32 SE | 160/215 | 02/01→07/03 | Z173 | 1.6 | | ZSE152 [23] ZSE153 [27] |
| 3.2 V6 LPG | 6 | Y 32 SE | 160/215 | 02/01→07/03 | Z172 | 1.6 | | |

REKORD A

| | | | | | | | | |
|----------|---|--|-------|-------------|-----------|-----|--|--|
| 1.5 1500 | 4 | | 40/54 | 02/63→12/65 | Z57 [170] | 0.6 | | |
| 1.7 1700 | 4 | | 44/59 | 02/63→12/65 | Z57 [170] | 0.6 | | |
| 1.7 1700 | 4 | | 49/66 | 01/63→12/65 | Z57 [170] | 0.6 | | |
| 2.6 2600 | 6 | | 74/99 | 05/64→12/65 | Z57 [170] | 0.6 | | |

REKORD B

| | | | | | | | | |
|-----|---|------------|-------|-------------|-----|-----|--|------------|
| 1.5 | 4 | | 44/59 | 08/65→08/66 | Z48 | 0.8 | | ZS106 [11] |
| 1.7 | 4 | 17 N, 17 S | 55/74 | 08/65→12/66 | Z48 | 0.8 | | ZS106 [11] |
| 1.9 | 4 | 19 S | 66/89 | 08/65→02/67 | Z48 | 0.8 | | ZS106 [11] |

REKORD C

| | | | | | | | | |
|------------|---|--------|--------|-------------|-----------|-----|--|-------------------------------------|
| 1.5 | 4 | 15 ... | 43/58 | 08/66→12/71 | Z19 [168] | 0.8 | | |
| 1.5 | 4 | 15 ... | 44/59 | 02/68→12/71 | Z19 [168] | 0.8 | | |
| 1.7 | 4 | 17 N | 44/59 | 08/66→12/71 | Z19 [168] | 0.8 | | ZS106 [1][11][254] ZS109 [1][15] |
| 1.7 | 4 | 17 N | 49/66 | 02/68→12/71 | Z19 [168] | 0.8 | | |
| 1.7 S | 4 | 17 S | 55/74 | 08/66→12/71 | Z19 [168] | 0.8 | | |
| 1.9 | 4 | 19 S | 66/89 | 08/66→12/71 | Z19 [168] | 0.8 | | |
| 1.9 Sprint | 4 | 19 SH | 78/105 | 08/67→12/71 | Z19 [168] | 0.8 | | |
| 2.2 | 6 | | 70/94 | 08/66→09/69 | Z19 | 0.8 | | |

REKORD D

| | | | | | | | | |
|-------|---|-------|-------|-------------|-----------|-----|-------------|--|
| 1.7 | 4 | 17 N | 44/59 | 03/75→08/77 | Z19 [168] | 0.8 | | |
| 1.7 | 4 | 17 N | 49/66 | 01/72→02/75 | Z19 [168] | 0.8 | | |
| 1.7 S | 4 | 17 S | 61/82 | 01/72→02/75 | Z20 | 0.8 | UXT2 / UXT6 | |
| 1.9 | 4 | 19 N | 55/74 | 03/75→08/77 | Z19 [168] | 0.8 | | |
| 1.9 | 4 | 19 SH | 66/89 | 03/75→08/77 | Z19 [168] | 0.8 | | |
| 1.9 S | 4 | 19 SH | 71/95 | 01/72→02/75 | Z19 [168] | 0.8 | | |
| 2.0 | 4 | 20 S | 74/99 | 09/75→08/77 | Z19 [168] | 0.8 | | |
| 2.0 D | 4 | 20 D | 40/54 | 08/74→08/77 | GV106 | 8V | | |
| 2.0 S | 4 | 20 S | 74/99 | 09/75→08/77 | Z19 [168] | 0.8 | | |
| 2.1 D | 4 | 21 D | 44/59 | 09/72→08/77 | GV137 | 11V | | |

REKORD E

| | | | | | | | | |
|--------|---|---------|--------|-------------|--------------------------------|------------|-----------------|--------------------------------|
| 1.7 | 4 | 17 N | 44/59 | 09/77→10/82 | Z19 [168] | 0.8 | | ZM002 |
| 1.8 | 4 | 18 N | 55/74 | 11/82→08/86 | Z20 | 0.8 | UXT2 / UXT6 | ZM002 |
| 1.8 E | 4 | C 18 NV | 74/99 | 05/85→08/86 | Z20 | 0.8 | UXT2 / UXT6 | ZM015 |
| 1.8 S | 4 | 18 S | 66/89 | 11/82→08/86 | Z20 | 0.8 | UXT2 / UXT6 | ZM002 [175] ZM015 03/84→ |
| 1.9 | 4 | 19 N | 55/74 | 09/77→10/82 | Z19 [168] | 0.8 | | ZM002 |
| 2.0 | 4 | 20 N | 66/89 | 09/77→10/82 | Z19 [168] | 0.8 | | ZM002 |
| 2.0 D | 4 | 20 D | 43/58 | 09/77→10/82 | GV137 →eng. 90309 | 11V | | |
| 2.0 E | 4 | 20 E | 81/109 | 09/77→10/84 | Z19 [168] | 0.8 | | ZM002 |
| 2.0 S | 4 | 20 S | 74/99 | 08/77→08/86 | Z19 [168] | 0.8 | | ZM002 |
| 2.1 D | 4 | 21 D | 44/59 | 09/77→07/78 | GV137 | 11V | | |
| 2.2 D | 4 | 23 D | 48/64 | 08/78→08/83 | GV137 →10/82 →eng. 40018 | 11V | GR064 →01/82 | |
| 2.2 D | 4 | 23 D | 52/70 | 11/82→08/86 | GN909 [2][222] GV602 | 11V 11V | | |
| 2.2 E | 4 | 22 E | 85/114 | 11/84→08/86 | Z19 [168] | 0.8 | | ZM015 |
| 2.2 TD | 4 | 23 TD | 63/84 | 06/84→08/86 | GN013 [2][222] GN954 | 11V 11V | GR064 | |

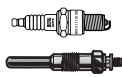

kW/BHP

**... OPEL****... REKORD E**

| | | | | | | | | |
|-------|---|------|-------|-------------|--|----------------|--|--|
| 2.3 D | 4 | 23 D | 52/70 | 11/82→08/86 | GN909 [222] eng. 40019→ GV602 eng. 40019→ | 11V 11V | | |
|-------|---|------|-------|-------------|--|----------------|--|--|

REKORD P1

| | | | | | | | | |
|----------|---|----|-------|-------------|------------------|-----|--|--|
| 1.2 1200 | 4 | 12 | 29/39 | 07/59→07/60 | Z57 [170] | 0.6 | | |
| 1.5 1500 | 4 | 15 | 37/50 | 07/57→09/61 | Z57 [170] | 0.6 | | |
| 1.7 1700 | 4 | 17 | 40/54 | 07/57→07/60 | Z57 [170] | 0.6 | | |

REKORD P2

| | | | | | | | | |
|-----|---|----|-------|-------------|------------------|-----|---|--|
| 1.5 | 4 | | 37/50 | 08/60→01/63 | Z57 [170] | 0.6 | | |
| 1.7 | 4 | | 44/59 | 08/60→01/63 | Z57 [170] | 0.6 | | |
| 1.7 | 4 | 17 | 44/59 | 08/60→01/63 | Z57 [170] | 0.6 | ZS105 [1][11] ZS106 [1][11][254] | |
| 1.7 | 4 | | 48/64 | 08/61→01/63 | Z57 [170] | 0.6 | ZS105 [1][11] ZS106 [1][11][254] | |

SENATOR A

| | | | | | | | | |
|--------|---|---------|---------|-------------|---|---------------------------|--|--------------|
| 2.0 E | 4 | H 20 E | 85/114 | 03/83→10/84 | Z19 [168] | 0.8 | | ZM002 |
| 2.2 E | 4 | 22 E | 85/114 | 11/84→08/87 | Z19 [168] | 0.8 | | ZM015 |
| 2.2 TD | 4 | 23 TD | 63/84 | 11/84→08/87 | GV137 →eng. 40018 GN013 [222] eng. 40019→ GN954 eng. 40019→ | 11V 11V 11V | | |
| 2.5 | 6 | 25 S | 85/114 | 05/78→12/80 | Z19 [168] | 0.8 | | |
| 2.5 E | 6 | H 25 E | 100/134 | 01/83→08/84 | Z19 [168] | 0.8 | | ZM002 |
| 2.5 E | 6 | 25 E | 103/138 | 09/84→08/87 | Z19 [168] | 0.8 | | |
| 2.8 | 6 | 28 H | 103/138 | 02/78→04/81 | Z19 [168] | 0.8 | | |
| 3.0 | 6 | 30 H | 110/148 | 04/78→07/82 | Z19 [168] | 0.8 | | ZM002 |
| 3.0 | 6 | C 30 LE | 115/154 | 09/85→08/87 | Z19 [168] | 0.8 | | |
| 3.0 E | 6 | 30 E | 132/177 | 02/78→12/86 | Z19 [168] | 0.8 | | ZM002 |

SENATOR B

| | | | | | | | | |
|---------|---|---------|---------|-------------|------------------|-----|---|--------------|
| 2.5 i | 6 | 25 NE | 103/138 | 09/90→09/93 | Z19 | 0.8 | ZS127 | ZM015 |
| 2.6 i | 6 | C 26 NE | 110/148 | 09/90→09/93 | Z19 [168] | 0.8 | ZS127 | ZM015 |
| 3.0 | 6 | C 30 LE | 115/154 | 09/87→09/93 | Z19 [168] | 0.8 | ZS125 [1] ch. K1000099→ →ch. K1999999 ZS127 [1] ch. L1000001→ | ZM015 |
| 3.0 | 6 | 30 NE | 130/174 | 01/88→09/90 | Z19 [168] | 0.8 | ZS125 eng. K1000099→ →eng. K1999999 | ZM015 |
| 3.0 24V | 6 | C 30 SE | 150/201 | 09/89→09/93 | Z98 | 0.8 | UXT1 / UXT3 ZS127 | ZM015 |
| 3.0 i | 6 | C 30 NE | 130/174 | 01/88→09/93 | Z19 [168] | 0.8 | ZS125 [1] ch. K1000099→ →ch. K1999999 ZS127 [1] ch. L1000001→ | ZM015 |

SIGNUM

| | | | | | | | | |
|----------|---|----------|---------|--------|--|----------------|--|--|
| 1.8 | 4 | Z 18 XE | 90/121 | 05/03→ | Z190 | 1.2 | ZS342 | |
| 1.8 | 4 | Z 18 XER | 103/138 | 09/05→ | Z203 | 0.9 | ZS427 | |
| 1.8 LPG | 4 | Z 18 XE | 90/121 | 05/03→ | Z206 | 0.7 | UXT10 | |
| 1.8 LPG | 4 | Z 18 XER | 103/138 | 09/05→ | Z206 [168] | 0.7 | UXT10 | |
| 1.9 CDTI | 4 | Z 19 DT | 74/99 | 08/05→ | GN041 →ch. 48999999;71021891 GN097 ch. 71021892;78→ | 11V 11V | GSE143 [10] →ch. 61010105 GSE142 [11] ch. 61010106→ | |



kW/BHP



... OPEL



... SIGNUM

| | | | | | | | | | | |
|------------------|---|----------|---------|-------------|--|--|------------|------------------------------------|---|--|
| 1.9 CDTI | 4 | Z 19 DT | 88/118 | 04/04→ | GN041 →ch. 48999999;71021891 GN097 ch. 71021892;78→ | GSE143 ^[10] →ch. 61010105 GSE142 ^[11] ch. 61010106→ | 11V | | | |
| 1.9 CDTI | 4 | Z 19 DTH | 110/148 | 04/04→ | GN059 | GSE143 ^[10] →ch. 61010105 GSE142 ^[11] ch. 61010106→ | 11V | | | |
| 2.0 DTI | 4 | Y 20 DTH | 74/99 | 05/03→ | GN033 | GSE143 ^[10] | 11V | | | |
| 2.0 Turbo | 4 | Z 20 NET | 129/173 | 05/03→ | Z284 | | 1.1 | UXT14 | | |
| 2.0 Turbo LPG | 4 | Z 20 NET | 129/173 | 05/03→ | Z130 ^[168] | | 1.0 | UXT14 | | |
| 2.2 direct | 4 | Z 22 YH | 114/153 | 05/03→ | Z190 | | 1.2 | | ZSE149 →09/08 | |
| 2.2 direct LPG | 4 | Z 22 YH | 114/153 | 05/03→ | Z206 | | 0.7 | UXT10 | | |
| 2.2 DTI | 4 | Y 22 DTR | 92/123 | 05/03→ | GN033 | GSE143 ^[10] | 11V | | | |
| 2.2 DTI 16V | 4 | Y 22 DTR | 86/115 | 05/03→06/08 | GN033 | GSE143 ^[10] | 11V | | | |
| 2.8 V6 Turbo | 6 | Z 28 NEL | 169/227 | 09/05→ | Z235 | | 1.0 | | ZSE174 | |
| 2.8 V6 Turbo | 6 | Z 28 NET | 184/247 | 01/06→ | Z235 →10/08 | | 1.0 | | ZSE174 | |
| 3.0 V6 CDTI | 6 | Y 30 DT | 130/174 | 05/03→ | GN106 | | 11V | | | |
| 3.0 V6 CDTI | 6 | Z 30 DT | 135/181 | 09/05→ | GN106 | | 11V | | | |
| 3.2 V6 | 6 | Z 32 SE | 155/208 | 05/03→ | Z173 | | 1.6 | | ZS115 ^{[1][11][27]} ZSE152 ^{[1][23]} | |
| 3.2 V6 LPG | 6 | Z 32 SE | 155/208 | 05/03→ | Z172 | | 1.6 | | | |
| SINTRA | | | | | | | | | | |
| 2.2 DTI | 4 | X 22 DTH | 85/114 | 07/97→04/99 | GN992 | GSE143 ^[10] | 11V | | | |
| 2.2 i 16V | 4 | X 22 XE | 104/139 | 11/96→04/99 | Z190 ^[282] Z74 | | 1.2 1.0 | | ZS450 | |
| 2.2 i 16V LPG | 4 | X 22 XE | 104/139 | 11/96→04/99 | Z206 | | 0.7 | UXT1 / UXT3 UXT10 | | |
| 3.0 i 24V | 6 | X 30 XE | 148/198 | 11/96→04/99 | Z190 ^[282] Z74 | | 1.2 1.0 | | | |
| 3.0 i 24V LPG | 6 | X 30 XE | 148/198 | 11/96→04/99 | Z206 | | 0.7 | UXT1 / UXT3 UXT10 | | |
| SPEEDSTER | | | | | | | | | | |
| 2.0 Turbo | 4 | Z 20 LET | 147/197 | 04/03→ | Z190 Z74 | | 1.2 1.0 | | ZSE151 →09/06 | |
| 2.0 Turbo LPG | 4 | Z 20 LET | 147/197 | 04/03→ | Z206 | | 0.7 | UXT10 | | |
| 2.2 | 4 | Z 22 SE | 108/145 | 09/00→ | Z222 →09/06 | | 1.1 | | | |
| TIGRA | | | | | | | | | | |
| 1.3 CDTI | 4 | Z 13 DT | 51/68 | 06/04→ | GN053 | GSE142 ^[11] | 11V | | | |
| 1.4 | 4 | Z 14 XEP | 66/89 | 06/04→ | Z203 | | 0.9 | | ZS338 | |
| 1.4 LPG | 4 | Z 14 XEP | 66/89 | 06/04→ | Z206 ^[168] | | 0.7 | UXT10 | | |
| 1.4 16V | 4 | X 14 XE | 63/84 | 08/97→12/00 | Z190 ^[282] Z74 | | 1.2 1.0 | | ZSE026 | |
| 1.4 16V | 4 | X 14 XE | 66/89 | 07/94→12/00 | Z190 ^[282] Z74 | | 1.2 1.0 | | ZSE026 | |
| 1.4 16V LPG | 4 | X 14 XE | 63/84 | 08/97→12/00 | Z206 | | 0.7 | UXT10 | | |
| 1.4 16V LPG | 4 | X 14 XE | 66/89 | 07/94→12/00 | Z206 | | 0.7 | UXT10 | | |
| 1.6 16V | 4 | C 16 SEL | 74/99 | 08/97→08/98 | Z190 ^[282] Z74 | | 1.2 1.0 | | ZSE026 | |
| 1.6 16V | 4 | X 16 XE | 78/105 | 07/94→08/98 | Z190 ^[282] Z74 | | 1.2 1.0 | | ZSE026 | |
| 1.6 16V LPG | 4 | C 16 SEL | 74/99 | 08/97→08/98 | Z206 | | 0.7 | UXT10 | | |
| 1.6 16V LPG | 4 | X 16 XE | 78/105 | 07/94→08/98 | Z206 | | 0.7 | UXT10 | | |
| 1.8 | 4 | Z 18 XE | 92/123 | 06/04→ | Z74 →12/09 | | 1.0 | UXT1 / UXT3 | ZS342 →12/09 | |



kW/BHP



... OPEL



VECTRA A

| | | | | | | | | | | |
|-----------|---|-------------------------------------|-------|-------------|---|-------|-------------------|--|--|-----------------|
| 1.4 S | 4 | 14 NV | 55/74 | 04/88→06/92 | Z119 | | 0.8 | UXT2 / UXT6 | | |
| 1.6 | 4 | 16 SV | 60/80 | 09/88→05/93 | Z20 | | 0.8 | UXT2 / UXT6 | ZS252 →12/90 ZS253 01/90→ | ZM018 →07/92 |
| 1.6 i | 4 | X 16 SZ | 52/70 | 09/93→11/95 | Z119 ^[284] Z190 ^{[282][283]} Z74 ^[283] | | 0.8 1.2 1.0 | UXT2/UXT6 ^[284] UXT1/UXT3 ^[283] | ZSE026 | |
| 1.6 i | 4 | 16 LZ2, C 16 LZ2 | 55/74 | 09/93→11/95 | Z190 ^[282] Z74 | | 1.2 1.0 | UXT2 / UXT6 UXT1 / UXT3 | ZS253 | |
| 1.6 i | 4 | C 16 NZ, C 16 NZ2, E 16 NZ | 55/74 | 09/88→11/95 | Z119 ^[284] Z190 ^{[282][283]} Z74 ^[283] | | 0.8 1.2 1.0 | UXT2/UXT6 ^[284] UXT1/UXT3 ^[283] | ZS252 | ZM016 |
| 1.6 i LPG | 4 | X 16 SZ | 52/70 | 09/93→11/95 | Z20 ^[168] Z206 | | 0.8 0.7 | UXT2 / UXT6 UXT10 | | |
| 1.6 i LPG | 4 | 16 LZ2, C 16 LZ2 | 55/74 | 09/93→11/95 | Z206 | | 0.7 | UXT10 | | |
| 1.6 i LPG | 4 | C 16 NZ, C 16 NZ2 | 55/74 | 09/88→11/95 | Z20 ^[168] Z206 | | 0.8 0.7 | UXT2 / UXT6 UXT10 | | |
| 1.6 S | 4 | 16 SV | 60/80 | 09/88→05/93 | Z20 | | 0.8 | UXT2 / UXT6 | ZS252 →12/90 ZS253 01/90→ | ZM018 →07/92 |
| 1.7 D | 4 | 17 D | 42/56 | 09/88→09/92 | GN013 ^{[2][222]} GN954 | GR064 | 11V 11V | | | |
| 1.7 D | 4 | 17 DR | 44/59 | 07/92→11/95 | GN013 ^{[2][222]} GN954 | | 11V 11V | | | |
| 1.7 TD | 4 | 17 DT (TC4EE1), X 17 DT (TC4EE1) | 60/80 | 03/90→11/95 | GV749 →eng. 731416 GV946 →eng. 731416 GN103 eng. 731417→ | | 5V 11V 11V | | | |
| 1.8 i | 4 | 18 SV | 66/89 | 09/88→10/90 | Z20 | | 0.8 | UXT2 / UXT6 | ZS253 →eng. 14258179 eng. 14258180→ →eng. 14275381 eng. 14275382→ →eng. Ch. R1/R5/R7 eng. Ch. S1/S5/S7→ | |
| 1.8 i | 4 | C 18 NZ | 66/89 | 03/90→11/95 | Z119 ^[284] Z190 ^{[282][283]} Z74 ^[283] | | 0.8 1.2 1.0 | UXT2/UXT6 ^[284] UXT1/UXT3 ^[283] | ZS253 →eng. 14258179 eng. 14258180→ →eng. 14275381 eng. 14275382→ →eng. Ch. R1/R5/R7 eng. Ch. S1/S5/S7→ | |
| 1.8 i LPG | 4 | C 18 NZ | 66/89 | 03/90→11/95 | Z20 ^[168] Z206 | | 0.8 0.7 | UXT2 / UXT6 UXT10 | | |
| 1.8 S | 4 | E 18 NVR | 65/87 | 09/88→07/89 | Z20 | | 0.8 | UXT2 / UXT6 | ZS125 ^{[1][214][254]} ZS253 ^[1] →eng. 14258179 eng. 14258180→ →eng. 14275381 eng. 14275382→ →eng. Ch. R1/R5/R7 eng. Ch. S1/S5/S7→ | |

OPEL



kW/BHP

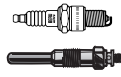

... OPEL



... VECTRA A

| | | | | | | | | | | |
|---------------------|---|----------------|---------|-------------|---|--|-------------------|--|---|---|
| 1.8 S 4WD | 4 | E 18 NVR | 65/87 | 01/89→07/89 | Z20 | | 0.8 | UXT2 / UXT6 | ZS125 ^[1] [[214][254] ZS253 ^[1] →eng. 14258179 eng. 14258180→ →eng. 14275381 eng. 14275382→ →eng. Ch.R1/RS/R7 eng. Ch. S1/S5/S7→ | |
| 1.8 S | 4 | 18 SV | 66/89 | 09/89→10/90 | Z20 | | 0.8 | UXT2 / UXT6 | ZS253 →eng. 14258179 eng. 14258180→ →eng. 14275381 eng. 14275382→ →eng. Ch.R1/RS/R7 eng. Ch. S1/S5/S7→ | |
| 2.0 | 4 | C 20 NEF | 74/99 | 04/88→09/89 | Z20 | | 0.8 | UXT2 / UXT6 | ZS125 ^[1] →eng. 14180385 ZS127 ^[1] eng. 14180386→ | |
| 2.0 2000 16V 4WD | 4 | 20 XEJ | 110/148 | 01/89→10/90 | Z190 ^[282] Z74 | | 1.2 1.0 | UXT1 / UXT3 | ZS127 | ZM034 09/89→ |
| 2.0 2000/GT 16V | 4 | 20 XEJ | 110/148 | 01/89→06/94 | Z190 ^[282] Z74 | | 1.2 1.0 | UXT1 / UXT3 | ZS127 | ZM034 09/89→08/92 |
| 2.0 2000/GT 16V | 4 | C 20 XE | 110/148 | 02/90→11/95 | Z190 ^[282] Z74 | | 1.2 1.0 | UXT1 / UXT3 | ZS300 ch. P1000001 → | ZM034 |
| 2.0 2000/GT 16V 4WD | 4 | C 20 XE | 110/148 | 02/90→11/95 | Z190 ^[282] Z74 | | 1.2 1.0 | UXT1 / UXT3 | ZS300 →08/92 ch. P1000001→ | ZM034 |
| 2.0 2000/GT 16V LPG | 4 | C 20 XE | 110/148 | 02/90→11/95 | Z206 | | 0.7 | UXT10 | | |
| 2.0 i | 4 | 20 NE, C 20 NE | 85/114 | 09/88→11/95 | Z119 ^[284] Z190 ^[282] [[283] Z74 ^[283] | | 0.8 1.2 1.0 | UXT2/UXT6 ^[284] UXT1/UXT3 ^[283] | ZS125 ^[1] →eng. 14180385 ZS127 ^[1] eng. 14180386→ | |
| 2.0 i | 4 | 20 SEH | 95/127 | 09/88→09/92 | Z20 | | 0.8 | UXT2 / UXT6 | ZS125 ^[1] →eng. 14180385 ZS127 ^[1] eng. 14180386→ | |
| 2.0 i LPG | 4 | C 20 NE | 85/114 | 09/88→11/95 | Z20 ^[168] Z206 | | 0.8 0.7 | UXT2 / UXT6 UXT10 | | |
| 2.0 i 16V | 4 | X 20 XEV | 100/134 | 06/94→11/95 | Z190 ^[282] Z74 | | 1.2 1.0 | UXT1 / UXT3 | ZS344 | ZM026 |
| 2.0 i 16V 4WD | 4 | X 20 XEV | 100/134 | 06/94→11/95 | Z190 ^[282] Z74 | | 1.2 1.0 | UXT1 / UXT3 | ZS344 | |
| 2.0 i 16V | 4 | 20 XEJ | 110/148 | 02/89→10/90 | Z190 ^[282] Z74 | | 1.2 1.0 | UXT1 / UXT3 | ZS127 | ZM034 08/89→ |
| 2.0 i 16V | 4 | C 20 XE | 110/148 | 02/90→11/95 | Z190 ^[282] Z74 | | 1.2 1.0 | UXT1 / UXT3 | ZS300 ch. P1000001 → | ZM034 eng. 14028515→ →eng. 14180386 |
| 2.0 i 16V LPG | 4 | X 20 XEV | 100/134 | 06/94→11/95 | Z206 | | 0.7 | UXT10 | | |
| 2.0 i 16V LPG | 4 | C 20 XE | 110/148 | 02/90→11/95 | Z206 | | 0.7 | UXT10 | | |
| 2.0 i GT | 4 | 20 SEH | 95/127 | 09/88→11/95 | Z20 | | 0.8 | UXT2 / UXT6 | ZS125 ^[1] →eng. 14180385 ZS127 ^[1] eng. 14180386→ | |
| 2.0 i GT LPG | 4 | 20 SEH | 95/127 | 09/88→11/95 | Z27 ^[168] | | 0.8 | UX56 | | |
| 2.0 i Turbo 4WD | 4 | C 20 LET | 150/201 | 06/94→11/95 | Z158 | | 1.1 | | ZS127 | ZM034 |
| 2.0 i Turbo 4WD LPG | 4 | C 20 LET | 150/201 | 06/94→11/95 | Z116 | | 0.8 | UXT5 | | |
| 2.5 V6 | 6 | C 25 XE | 125/168 | 02/93→11/95 | Z190 ^[282] Z74 | | 1.2 1.0 | UXT1 / UXT3 | ZS301 →08/94 | |
| 2.5 V6 LPG | 6 | C 25 XE | 125/168 | 02/93→11/95 | Z206 | | 0.7 | UXT10 | | |



kW/BHP

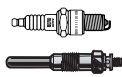

... OPEL



VECTRA B

| | | | | | | | | | |
|-----------------|---|-----------------------------|---------|-------------|---|------------|--|--|--|
| 1.6 i | 4 | 16 LZ2 | 55/74 | 10/95→07/03 | Z190 ^[282] Z74 | 1.2 1.0 | UXT1 / UXT3 | | |
| 1.6 i | 4 | X 16 SZR | 55/74 | 10/95→07/03 | Z190 ^[282] Z74 | 1.2 1.0 | UXT1 / UXT3 | ZSE026 | |
| 1.6 i LPG | 4 | 16 LZ2, X 16 SZR | 55/74 | 10/95→07/03 | Z206 | 0.7 | UXT10 | | |
| 1.6 i 16V | 4 | X 16 XEL, Y 16 XE, Z 16 XE | 74/99 | 10/95→07/02 | Z190 ^[282] Z74 | 1.2 1.0 | UXT1 / UXT3 | ZS259 ^[152] ch. W 1285447/ W 71544259→ | |
| 1.6 i 16V LPG | 4 | X 16 XEL, Y 16 XE, Z 16 XE | 74/99 | 10/95→07/02 | Z206 | 0.7 | UXT10 | | |
| 1.7 TD | 4 | X 17 DT (TC4EE1) | 60/80 | 10/95→12/98 | GN103 | 11V | | | |
| 1.8 i 16V | 4 | X 18 XE | 85/114 | 10/95→09/00 | Z190 ^[282] Z74 | 1.2 1.0 | UXT1 / UXT3 | ZS344 | |
| 1.8 i 16V | 4 | X 18 XE1, Z 18 XEL | 85/114 | 10/95→09/00 | Z190 ^[282] Z74 | 1.2 1.0 | UXT1 / UXT3 | ZS342 | |
| 1.8 i 16V | 4 | X 18 XE1, Z 18 XEL | 85/114 | 11/96→09/00 | | | | ZM026 | |
| 1.8 i 16V | 4 | Z 18 XE | 92/123 | 09/00→07/03 | Z190 ^[282] Z74 | 1.2 1.0 | UXT1 / UXT3 | ZS342 | |
| 1.8 i 16V LPG | 4 | X 18 XE, X 18 XE1, Z 18 XEL | 85/114 | 10/95→09/00 | Z206 | 0.7 | UXT10 | | |
| 1.8 i 16V LPG | 4 | Z 18 XE | 92/123 | 09/00→07/03 | Z206 | 0.7 | UXT10 | | |
| 2.0 DI 16V | 4 | X 20 DTL | 60/80 | 11/96→04/02 | GN944 →07/99 GN992 08/99→ | 11V 11V | | | |
| 2.0 DTI 16V | 4 | X 20 DTH | 74/99 | 06/97→07/03 | GN992 | 11V | | | |
| 2.0 DTI 16V | 4 | Y 20 DTH | 74/99 | 06/97→07/03 | GN033 | 11V | | | |
| 2.0 i | 4 | 20 NEJ | 82/110 | 10/95→04/02 | Z119 ^[284] Z74 ^[283] | 0.8 1.0 | UXT2/UXT6 ^[284] UXT1/UXT3 ^[283] | ZS300 | |
| 2.0 i 16V | 4 | C 20 SEL, X 20 XEV | 100/134 | 10/95→09/00 | Z190 ^[282] Z74 | 1.2 1.0 | UXT1 / UXT3 | ZS344 ZM026 | |
| 2.0 i 16V LPG | 4 | C 20 SEL, X 20 XEV | 100/134 | 10/95→09/00 | Z206 | 0.7 | UXT10 | | |
| 2.2 DTI 16V | 4 | Y 22 DTR | 88/118 | 09/00→04/02 | GN033 | 11V | | | |
| 2.2 DTI 16V | 4 | Y 22 DTR | 92/123 | 09/00→07/03 | GN033 | 11V | | | |
| 2.2 i 16V | 4 | Z 22 SE | 108/145 | 09/00→07/03 | Z222 | 1.1 | | | |
| 2.5 | 6 | X 25 XE | 144/193 | 10/99→06/00 | Z74 | 1.0 | UXT1 / UXT3 | ZS451 | |
| 2.5 i 500 | 6 | X 25 XE | 143/192 | 05/98→09/00 | Z190 ^[282] Z74 | 1.2 1.0 | UXT1 / UXT3 | ZS451 | |
| 2.5 i V6 | 6 | X 25 XE | 125/168 | 10/95→09/00 | Z190 ^[282] Z74 | 1.2 1.0 | UXT1 / UXT3 | ZS451 | |
| 2.5 i V6 LPG | 6 | X 25 XE | 125/168 | 10/95→09/00 | Z206 | 0.7 | UXT10 | | |
| 2.6 i V6 | 6 | Y 26 SE | 125/168 | 09/00→07/03 | Z173 | 1.6 | | ZSE152 ^[23] →09/02 ZSE153 ^[27] →09/02 | |
| 2.6 i V6 | 6 | Y 26 SE | 125/168 | 09/00→04/02 | | | | ZSE152 ^[23] ZSE153 ^[27] | |
| 2.6 i V6 LPG | 6 | Y 26 SE | 125/168 | 09/00→07/03 | Z172 | 1.6 | | | |
| VECTRA C | | | | | | | | | |
| 1.6 | 4 | Z 16 XE | 74/99 | 08/05→ | Z203 | 0.9 | | ZS259 | |
| 1.6 | 4 | Z 16 XEP | 77/103 | 01/06→ | Z203 | 0.9 | | ZS427 | |
| 1.6 LPG | 4 | Z 16 XE | 74/99 | 08/05→ | Z206 ^[168] | 0.7 | UXT10 | | |
| 1.6 LPG | 4 | Z 16 XEP | 77/103 | 01/06→ | Z206 ^[168] | 0.7 | UXT10 | | |
| 1.6 16V | 4 | Z 16 XE | 74/99 | 06/04→ | Z203 | 0.9 | | ZS259 | |
| 1.6 16V LPG | 4 | Z 16 XE | 74/99 | 06/04→ | Z206 ^[168] | 0.7 | UXT10 | | |
| 1.8 | 4 | Z 18 XEL | 81/109 | 04/02→ | Z173 →08/03 Z203 09/03→ | 1.6 0.9 | | ZS342 | |
| 1.8 | 4 | Z 18 XE | 90/121 | 10/03→ | Z203 | 0.9 | | ZS342 | |
| 1.8 | 4 | Z 18 XER | 103/138 | 01/06→ | Z203 | 0.9 | | ZS427 | |



kW/BHP



... OPEL



... VECTRA C

| | | | | | | | | | |
|-------------------|---|-------------------|---------|-------------|--|--|-----|-----------------------|-------------------------------------|
| 1.8 LPG | 4 | Z 18 XEL | 81/109 | 04/02→ | Z172 →08/03 Z206 [168] 09/03→ | | 1.6 | | |
| 1.8 LPG | 4 | Z 18 XE | 90/121 | 10/03→ | Z206 [168] | | 0.7 | UXT10 09/03→ | |
| 1.8 LPG | 4 | Z 18 XER | 103/138 | 01/06→ | Z206 [168] | | 0.7 | UXT10 | |
| 1.8 16V | 4 | Z 18 XEL | 81/109 | 08/02→12/06 | Z74 →08/05 | | 1.0 | UXT1 / UXT3 →08/05 | |
| 1.8 16V | 4 | Z 18 XE | 90/121 | 04/02→ | Z173 →08/03 Z203 09/03→ | | 1.6 | | ZS342 |
| 1.8 16V LPG | 4 | Z 18 XE | 90/121 | 04/02→ | Z172 →08/03 Z206 [168] 09/03→ | | 1.6 | 0.7 | UXT10 09/03→ |
| 1.9 CDTI | 4 | Z 19 DT, Z 19 DTL | 74/99 | 10/05→ | GN041 →ch. 48999999;71021891 GN097 ch. 71021892;78→ | GSE143 [10] →ch. 48999999;61010105 GSE142 [11] ch. 61010106;68→ | 11V | | |
| 1.9 CDTI | 4 | Z 19 DT | 88/118 | 04/04→ | GN041 →ch. 48999999;71021891 GN097 ch. 71021892;78→ | GSE143 [10] →ch. 48999999;61010105 GSE142 [11] ch. 61010106;68→ | 11V | | |
| 1.9 CDTI | 4 | Z 19 DTH | 110/148 | 04/04→ | GN059 →03/07 | GSE143 [10] →ch. 48999999;61010105 GSE142 [11] ch. 61010106;68→ | 11V | | |
| 2.0 16V Turbo | 4 | Z 20 NET | 129/173 | 03/03→ | Z284 | | 1.1 | UXT14 | |
| 2.0 16V Turbo LPG | 4 | Z 20 NET | 129/173 | 03/03→ | Z130 [168] | | 1.0 | UXT14 | |
| 2.0 DTI | 4 | Y 20 DTH | 74/99 | 10/03→ | GN033 | GSE143 [10] | 11V | | |
| 2.0 DTI 16V | 4 | Y 20 DTH | 74/99 | 04/02→ | GN033 | GSE143 [10] | 11V | | |
| 2.0 Turbo | 4 | Z 20 NET | 129/173 | 10/03→ | Z284 | | 1.1 | UXT14 | |
| 2.0 Turbo LPG | 4 | Z 20 NET | 129/173 | 10/03→ | Z130 [168] | | 1.0 | UXT14 | |
| 2.2 16V | 4 | Z 22 SE | 108/145 | 04/02→ | Z222 →09/05 | | 1.1 | | |
| 2.2 direct | 4 | Z 22 YH | 114/153 | 10/03→ | Z190 | | 1.2 | | ZSE149 →10/08 |
| 2.2 direct LPG | 4 | Z 22 YH | 114/153 | 10/03→ | Z206 | | 0.7 | UXT10 | |
| 2.2 DTI | 4 | Y 22 DTR | 86/115 | 10/03→06/08 | GN033 | GSE143 [10] | 11V | | |
| 2.2 DTI | 4 | Y 22 DTR | 92/123 | 10/03→ | GN033 | GSE143 [10] | 11V | | |
| 2.2 DTI 16V | 4 | Y 22 DTR | 86/115 | 04/02→06/08 | GN033 | GSE143 [10] | 11V | | |
| 2.2 DTI 16V | 4 | Y 22 DTR | 92/123 | 04/02→ | GN033 | GSE143 [10] | 11V | | |
| 2.8 V6 Turbo | 6 | Z 28 NEL | 169/227 | 08/05→ | Z235 | | 1.0 | | ZSE174 |
| 2.8 V6 Turbo | 6 | Z 28 NET | 184/247 | 08/06→ | Z235 →10/08 | | 1.0 | | ZSE174 |
| 2.8 V6 Turbo | 6 | Z 28 NET | 188/252 | 08/05→ | Z235 →10/08 | | 1.0 | | ZSE174 |
| 2.8 V6 Turbo | 6 | Z 28 NET | 206/276 | 08/06→ | Z235 →10/08 | | 1.0 | | ZSE174 |
| 2.8 V6 Turbo OPC | 6 | Z 28 NET | 206/276 | 09/06→09/08 | | | | | ZSE174 |
| 3.0 CDTI | 6 | Y 30 DT | 130/174 | 06/03→ | GN106 | | 11V | | |
| 3.0 CDTi | 6 | Z 30 DT | 135/181 | 08/05→ | GN106 | | 11V | | |
| 3.0 V6 CDTI | 6 | Y 30 DT | 130/174 | 10/03→ | GN106 | | 11V | | |
| 3.0 V6 CDTI | 6 | Z 30 DT | 135/181 | 08/05→ | GN106 | | 11V | | |
| 3.2 V6 | 6 | Z 32 SE | 155/208 | 08/02→ | Z173 | | 1.6 | | ZS115 [1][11][27] ZSE152 [1][23] |
| 3.2 V6 | 6 | Z 32 SE | 155/208 | 10/03→ | | | | | ZS115 [1][11][27] ZSE152 [1][23] |
| 3.2 V6 LPG | 6 | Z 32 SE | 155/208 | 08/02→ | Z172 | | 1.6 | | |

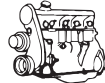

kW/BHP

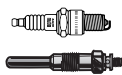

... OPEL



ZAFIRA A

| | | | | | | | | | | |
|-----------------|---|--------------------|---------|-------------|---|--|-----|--------------------------------|--------|--|
| 1.6 16V | 4 | X 16 XEL | 74/99 | 04/99→06/05 | Z190 ^[282] →eng. 420 00000 Z74 →eng. 420 00000 Z203 eng. 420 00001→ | | 1.2 | | ZS259 | |
| | | | | | | | 1.0 | UXT1 / UXT3 →eng. 420 00000 | | |
| | | | | | | | 0.9 | | | |
| 1.6 16V | 4 | Z 16 XE | 74/99 | 04/99→06/05 | Z190 ^[282] →eng. 420 00000 Z74 →eng. 420 00000 Z203 eng. 420 00001→ | | 1.2 | | | |
| | | | | | | | 1.0 | UXT1 / UXT3 →eng. 420 00000 | | |
| | | | | | | | 0.9 | | | |
| 1.6 16V LPG | 4 | X 16 XEL, Z 16 XE | 74/99 | 04/99→06/05 | Z206 | | 0.7 | UXT10 | | |
| 1.6 CNG | 4 | Z 16 YNG | 71/95 | 09/01→06/05 | Z206 | | 0.7 | UXT10 | ZS259 | |
| 1.8 16V | 4 | X 18 XE1 | 85/114 | 04/99→09/00 | Z190 ^[282] Z74 | | 1.2 | | ZS342 | |
| | | | | | | | 1.0 | UXT1 / UXT3 | | |
| 1.8 16V | 4 | Z 18 XE | 92/123 | 09/00→06/05 | Z190 ^[282] Z74 | | 1.2 | | ZS342 | |
| | | | | | | | 1.0 | UXT1 / UXT3 | | |
| 1.8 16V LPG | 4 | X 18 XE1 | 85/114 | 04/99→09/00 | Z206 | | 0.7 | UXT10 | | |
| 1.8 16V LPG | 4 | Z 18 XE | 92/123 | 09/00→06/05 | Z206 | | 0.7 | UXT10 | | |
| 2.0 DI 16V | 4 | X 20 DTL | 60/80 | 10/99→06/05 | GN992 | GSE143 ^[10] | 11V | | | |
| 2.0 DTI | 4 | X 20 DTL | 63/84 | 11/03→06/05 | GN992 | GSE143 ^[10] | 11V | | | |
| 2.0 DTI 16V | 4 | Y 20 DTH | 74/99 | 09/00→06/05 | GN992 →08/02 GN033 09/02→ | GSE142 ^[11] | 11V | | | |
| | | | | | | | 11V | | | |
| 2.0 OPC | 4 | Z 20 LET | 141/189 | 09/01→06/05 | Z74 | | 1.0 | UXT1 / UXT3 | ZSE151 | |
| 2.0 OPC | 4 | Z 20 LER, Z 20 LET | 147/197 | 11/02→06/05 | Z74 →01/04 Z287 02/04→ | | 1.0 | UXT1 / UXT3 →01/04 | ZSE151 | |
| | | | | | | | 0.8 | | | |
| 2.0 OPC LPG | 4 | Z 20 LET | 141/189 | 09/01→06/05 | Z206 | | 0.7 | UXT10 | | |
| 2.0 OPC LPG | 4 | Z 20 LER, Z 20 LET | 147/197 | 11/02→06/05 | Z206 →01/04 Z158 ^[168] 02/04→ | | 0.7 | UXT10 →01/04 | | |
| | | | | | | | 1.1 | | | |
| 2.2 16V | 4 | Z 22 SE | 108/145 | 09/00→06/05 | Z222 | | 1.1 | | | |
| 2.2 DTI 16V | 4 | Y 22 DTR | 86/115 | 01/02→06/05 | GN033 | GSE142 ^[11] | 11V | | | |
| 2.2 DTI 16V | 4 | Y 22 DTR | 92/123 | 01/02→06/05 | GN033 | GSE142 ^[11] | 11V | | | |
| ZAFIRA B | | | | | | | | | | |
| 1.6 | 4 | Z 16 XE1, Z 16 XEP | 77/103 | 07/05→ | Z203 | | 0.9 | | ZS427 | |
| 1.6 | 4 | Z 16 XER | 85/114 | 01/08→ | Z203 | | 0.9 | | ZS427 | |
| 1.6 LPG | 4 | Z 16 XE1, Z 16 XEP | 77/103 | 07/05→ | Z206 ^[168] | | 0.7 | UXT10 | | |
| 1.6 LPG | 4 | Z 16 XER | 85/114 | 01/08→ | Z206 | | 0.7 | UXT10 | | |
| 1.6 CNG | 4 | Z 16 YNG | 69/93 | 01/06→ | Z206 | | 0.7 | UXT10 | ZS259 | |
| 1.6 CNG Turbo | 4 | A 16 XNT, Z 16 XNT | 110/148 | 02/09→ | | | | | ZS427 | |
| 1.7 CDTI | 4 | A 17 DTJ, Z 17 DTJ | 81/109 | 01/08→ | GN104 | GSE143 ^[10] | 11V | | | |
| 1.7 CDTI | 4 | A 17 DTR | 92/123 | 01/08→ | GN104 | GSE143 ^[10] | 11V | | | |
| 1.8 | 4 | A 18 XER, Z 18 XER | 103/138 | 07/05→ | Z203 | | 0.9 | | ZS427 | |
| 1.8 LPG | 4 | A 18 XER, Z 18 XER | 103/138 | 07/05→ | Z206 ^[168] | | 0.7 | UXT10 | | |
| 1.9 CDTI | 4 | Z 19 DTL | 74/99 | 07/05→ | GN041 →ch. 62999999;66999999 GN097 ch. 72000001;76000001→ | GSE142 ^{[11] 32} GSE143 ^{[10] 32} | 11V | | | |
| | | | | | | | 11V | | | |
| 1.9 CDTI | 4 | Z 19 DT | 88/118 | 07/05→ | GN041 →ch. 62999999;66999999 GN097 ch. 72000001;76000001→ | GSE142 ^{[11] 32} GSE143 ^{[10] 32} | 11V | | | |
| | | | | | | | 11V | | | |



kW/BHP

**... OPEL****... ZAFIRA B**

| | | | | | | | | | |
|----------|---|----------|---------|--------|-----------------------|--|-----|-------|--------|
| 1.9 CDTi | 4 | Z 19 DTH | 110/148 | 07/05→ | GN059 | GSE142 ^{[11][32]} GSE143 ^{[10][32]} | 11V | | |
| 2.0 | 4 | Z 20 LER | 147/197 | 07/05→ | Z287 | | 0.8 | | ZSE151 |
| 2.0 | 4 | Z 20 LEH | 177/237 | 01/06→ | Z284 | | 1.1 | UXT14 | ZSE151 |
| 2.0 LPG | 4 | Z 20 LER | 147/197 | 07/05→ | Z158 ^[168] | | 1.1 | | |
| 2.0 LPG | 4 | Z 20 LEH | 177/237 | 01/06→ | Z130 ^[168] | | 1.0 | UXT14 | |
| 2.2 | 4 | Z 22 YH | 110/148 | 07/05→ | Z190 | | 1.2 | | ZSE149 |
| 2.2 LPG | 4 | Z 22 YH | 110/148 | 07/05→ | Z206 | | 0.7 | UXT10 | |

ZAFIRA TOURER C

| | | | | | | | | | |
|------------------|---|--------------------|---------|--------|--|--|----------------------|--|-------|
| 1.6 CDTi | 4 | B 16 DTH | 100/134 | 02/13→ | GE126 PSG005 | | 4.4V 4.4V | | |
| 1.6 CNG | 4 | A 16 XNT, B 16 XNT | 110/148 | 10/11→ | | | | | ZS427 |
| 1.8 | 4 | A 18 XER | 103/138 | 10/11→ | Z203 →ch. AG999999;D2999999 | | 0.9 | | ZS427 |
| 2.0 BiTurbo CDTi | 4 | A 20 DTR | 143/192 | 01/13→ | PSG006 | | 4.4V | | |
| 2.0 CDTi | 4 | A 20 DTL | 81/109 | 10/11→ | GE114 ^[253] PSG001 →ch. D2 PSG006 ch. D2;F1000001→ | | 4.4V 4.4V 4.4V | | |
| 2.0 CDTi | 4 | A 20 DT | 96/129 | 10/11→ | GE114 ^[253] PSG001 →ch. D2 PSG006 ^[253] ch. D2;F1000001→ | | 4.4V 4.4V 4.4V | | |
| 2.0 CDTi | 4 | Y 20 DTJ | 96/129 | 10/11→ | PSG001 →ch. D2 PSG006 ch. D2;F1000001→ | | 4.4V 4.4V | | |
| 2.0 CDTi | 4 | Z 20 DTJ | 96/129 | 10/11→ | PSG001 →ch. D2 | | 4.4V | | |
| 2.0 CDTi | 4 | Z 20 DTY | 96/129 | 10/11→ | PSG006 ch. D2;F1000001→ | | 4.4V | | |
| 2.0 CDTi | 4 | A 20 DTH | 118/158 | 10/11→ | PSG006 | | 4.4V | | |
| 2.0 CDTi | 4 | A 20 DTH | 121/162 | 10/11→ | PSG006 | | 4.4V | | |

OPEL**ARENA**

| | | | | | | | | | |
|-------|---|---|-------|-------------|-------|--|-----|--|--|
| 1.9 D | 4 | 19 DJ, 19 DL, F8Q 600, F8Q 606 | 44/59 | 01/97→12/01 | GN963 | | 11V | | |
| 2.5 D | 4 | 25 DG, 25 DM, S8U 758, S8U 780, S8U 782 | 55/74 | 01/97→12/01 | GN927 | | 11V | | |

ASTRA F

| | | | | | | | | | |
|-----------|---|---------|-------|-------------|---|--|-------------------|---|--------|
| 1.4 i | 4 | C 14 NZ | 44/59 | 10/91→01/99 | Z119 ^[284] Z190 ^{[282][283]} Z74 ^[283] | | 0.8 1.2 1.0 | UXT2/UXT6 ^[284] ZS253 ^{[1][254]} ZSE026 ^{[1][151]} | ZM018 |
| 1.4 i LPG | 4 | C 14 NZ | 44/59 | 10/91→01/99 | Z20 ^[168] Z206 | | 0.8 0.7 | UXT2 / UXT6 UXT10 | |
| 1.6 i | 4 | X 16 SZ | 52/70 | 02/93→07/96 | Z119 ^[284] →12/94 Z190 ^{[282][283]} 01/95→ Z74 ^[283] 01/95→ | | 0.8 1.2 1.0 | UXT2/UXT6 ^[284] →12/94 UXT1/UXT3 ^[283] 01/95→ | ZSE026 |
| 1.6 i | 4 | C 16 NZ | 55/74 | 10/91→04/93 | Z119 ^[284] Z190 ^{[282][283]} Z74 ^[283] | | 0.8 1.2 1.0 | UXT2/UXT6 ^[284] ZS252 ^[1] UXT1/UXT3 ^[283] | ZM016 |

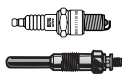

kW/BHP

**... OPEL****... ASTRA F**

| | | | | | | | | |
|-----------|---|------------------|-------|-------------|---------------------------------------|-------|--|--|
| 1.6 i LPG | 4 | X 16 SZ | 52/70 | 02/93→07/96 | Z20 [168] →12/94 Z206 01/95→ | | 0.8 UXT2 / UXT6 →12/94 0.7 UXT10 01/95→ | |
| 1.7 D | 4 | 17 D | 42/56 | 12/91→09/92 | GN013 [23][222] GN954 | GR064 | 11V 11V | |
| 1.7 D | 4 | 17 DR | 44/59 | 07/92→01/99 | GN013 [23][222] GN954 | | 11V 11V | |
| 1.7 TD | 4 | X 17 DTL | 50/67 | 08/94→01/99 | GN013 [23][222] GN954 | | 11V 11V | |
| 1.7 TD | 4 | X 17 DT (TC4EE1) | 60/80 | 03/95→02/98 | GV947 | | 11V | |

ASTRA G

| | | | | | | | | |
|-------------|---|----------|-------|-------------|--------------------------|-------------|-------------------------------|--|
| 1.6 | 4 | X 16 SZR | 55/74 | 01/99→09/00 | Z190 [282] Z74 | | 1.2 ZSE026 1.0 UXT1 / UXT3 | |
| 1.6 | 4 | Z 16 SE | 62/83 | 09/00→04/05 | Z190 [282] | | 1.2 | |
| 1.6 LPG | 4 | X 16 SZR | 55/74 | 01/99→09/00 | Z206 | | 0.7 UXT10 | |
| 1.6 LPG | 4 | Z 16 SE | 62/83 | 09/00→04/05 | Z206 | | 0.7 UXT10 | |
| 1.7 DTI 16V | 4 | Y 17 DT | 55/74 | 02/00→04/05 | GN104 | | 11V | |
| 1.7 TD | 4 | X 17 DTL | 50/67 | 01/99→04/05 | GN013 [23][222] GN954 | GSE143 [10] | 11V 11V | |
| 2.0 DI | 4 | X 20 DTL | 60/80 | 01/99→04/05 | GN992 | GSE143 [10] | 11V | |

ASTRA H

| | | | | | | | | |
|--------------|---|--------------------|---------|--------|---|------------------------------------|------------|--|
| 1.3 CDTI | 4 | Z 13 DTH | 66/89 | 08/05→ | GN053 | GSE142 [11] | 11V | |
| 1.7 CDTI | 4 | Z 17 DTH | 74/99 | 03/04→ | GN104 | GSE143 [10] | 11V | |
| 1.7 CDTI | 4 | A 17 DTJ, Z 17 DTJ | 81/109 | 02/07→ | GN104 | GSE143 [10] | 11V | |
| 1.7 CDTI | 4 | A 17 DTR, Z 17 DTR | 92/123 | 02/07→ | GN104 | GSE143 [10] | 11V | |
| 1.9 CDTI | 4 | Z 19 DT | 88/118 | 09/05→ | GN041 →ch. 72045139; 75030986;78007391;76 GN097 ch. 72045140;75030987; 78007392;76; 88000001→ | GSE142 [11][32] GSE143 [10][32] | 11V 11V | |
| 1.9 CDTI | 4 | Z 19 DTH | 110/148 | 09/04→ | GN059 | GSE142 [11][32] GSE143 [10][32] | 11V | |
| 1.9 CDTI 16V | 4 | Z 19 DTJ | 88/118 | 08/04→ | GN059 | GSE142 [11] | 11V | |

COMBO

| | | | | | | | | |
|--------------|---|------------------|-------|-------------|--|--|--|--|
| 1.2 | 4 | C 12 NZ | 33/44 | 07/94→10/01 | Z119 [284] Z190 [282][283] Z74 [283] | | 0.8 UXT2/UCT6 [284] ZSE026 1.2 1.0 UXT1/UCT3 [283] | |
| 1.2 | 4 | X 12 SZ | 33/44 | 07/94→10/01 | Z119 [284] Z190 [282][283] Z74 [283] | | 0.8 UXT2/UCT6 [284] 1.2 1.0 UXT1/UCT3 [283] | |
| 1.2 LPG | 4 | C 12 NZ, X 12 SZ | 33/44 | 07/94→10/01 | Z20 [168] Z206 | | 0.8 UXT2 / UXT6 0.7 UXT10 | |
| 1.3 CDTI 16V | 4 | Z 13 DT | 51/68 | 08/05→ | GN053 | | 11V | |
| 1.3 CDTI 16V | 4 | Z 13 DTJ | 55/74 | 10/05→ | GN053 | | 11V | |
| 1.4 | 4 | C 14 NZ | 44/59 | 07/94→10/01 | Z119 [284] Z190 [282][283] Z74 [283] | | 0.8 UXT2/UCT6 [284] ZS253 [1] 1.2 →08/00 1.0 UXT1/UCT3 [283] | |
| 1.4 | 4 | X 14 SZ | 44/59 | 07/94→10/01 | Z119 [284] Z190 [282][283] Z74 [283] | | 0.8 UXT2/UCT6 [284] ZSE026 [1] 1.2 1.0 UXT1/UCT3 [283] | |
| 1.4 | 4 | C 14 SE | 60/80 | 07/94→10/01 | Z119 [284] Z190 [282][283] Z74 [283] | | 0.8 UXT2/UCT6 [284] ZSE026 1.2 1.0 UXT1/UCT3 [283] | |
| 1.4 LPG | 4 | C 14 NZ, X 14 SZ | 44/59 | 07/94→10/01 | Z20 [168] Z206 | | 0.8 UXT2 / UXT6 0.7 UXT10 | |

OPEL



kW/BHP



... OPEL



... COMBO

| | | | | | | | | | |
|--------------|---|----------------------------|--------|-------------|-----------------------------|--|------------|----------------------|-----------------------|
| 1.4 LPG | 4 | C 14 SE | 60/80 | 07/94→10/01 | Z20 [168] Z206 | | 0.8 0.7 | UXT2 / UXT6 UXT10 | |
| 1.4 16V | 4 | X 14 XE | 66/89 | 08/99→10/01 | Z190 [282] Z74 | | 1.2 1.0 | | ZSE026 UXT1 / UXT3 |
| 1.4 16V | 4 | Z 14 XEP | 66/89 | 08/05→ | Z203 | | 0.9 | | ZS338 |
| 1.4 16V LPG | 4 | X 14 XE | 66/89 | 08/99→10/01 | Z206 | | 0.7 | UXT10 | |
| 1.4 16V LPG | 4 | Z 14 XEP | 66/89 | 08/05→ | Z206 [168] | | 0.7 | UXT10 | |
| 1.6 | 4 | Z 16 SE | 64/86 | 10/01→ | Z190 [282] →08/04 Z74 | | 1.2 1.0 | | |
| 1.6 LPG | 4 | Z 16 SE | 64/86 | 10/01→ | Z206 →08/04 | | 0.7 | UXT10 →08/04 | |
| 1.6 CDTI | 4 | A 16 FDL | 66/89 | 02/12→ | GE114 | | 4.4V | | |
| 1.6 CDTI | 4 | A 16 FDH | 74/99 | 02/12→ | GE114 | | 4.4V | | |
| 1.6 CDTI | 4 | A 16 FDH | 77/103 | 02/12→ | GE114 | | 4.4V | | |
| 1.6 CNG 16V | 4 | Z 16 YNG | 69/93 | 06/06→ | Z206 | | 0.7 | UXT10 | ZS259 |
| 1.6 CNG 16V | 4 | Z 16 YNG | 71/95 | 04/05→ | Z206 | | 0.7 | UXT10 | ZS259 |
| 1.7 CDTI 16V | 4 | Z 17 DTH | 74/99 | 12/04→ | GN104 | | 11V | | |
| 1.7 D | 4 | 17 D (4EE1), X 17 D (4EE1) | 44/59 | 07/94→10/01 | GN103 | | 11V | | |
| 1.7 DI 16V | 4 | Y 17 DTL | 48/64 | 10/01→ | GN104 | | 11V | | |
| 1.7 DTI 16V | 4 | Y 17 DT | 55/74 | 10/01→ | GN104 | | 11V | | |
| 2.0 CDTI | 4 | A 20 FD | 99/133 | 02/12→ | GE114 | | 4.4V | | |

CORSA A

| | | | | | | | | | |
|-------|---|----------------|-------|-------------|--|--|-----------|-------------|-----------------|
| 1.0 | 4 | 10 S | 33/44 | 02/86→04/89 | Z19 [168] | | 0.8 | | |
| 1.2 | 4 | 12 NC, E 12 GV | 33/44 | 02/86→04/89 | Z19 [168] | | 0.8 | | ZM006 |
| 1.2 | 4 | 12 ST | 40/54 | 02/86→04/89 | Z20 | | 0.8 | UXT2 / UXT6 | ZS252 [1] ZM006 |
| 1.2 | 4 | 12 S | 44/59 | 02/86→07/90 | Z20 | | 0.8 | UXT2 / UXT6 | ZS252 |
| 1.3 | 4 | 13 NB | 44/59 | 02/86→04/89 | Z20 | | 0.8 | UXT2 / UXT6 | ZS252 |
| 1.3 | 4 | 13 SB | 51/68 | 02/86→04/89 | Z20 | | 0.8 | UXT2 / UXT6 | ZS252 |
| 1.5 D | 4 | 15 D (4EC1) | 37/50 | 06/87→04/89 | GV749 →eng. 804794 GV946 eng. 804795→ | | 5V 11V | | |

CORSA B

| | | | | | | | | | |
|-----------|---|----------------------------|-------|-------------|------------------------------|--|------------|-------|---------------------------|
| 1.4 i | 4 | X 14 SZ | 44/59 | 08/99→09/00 | Z190 [282][283] Z74 [283] | | 1.2 1.0 | | ZSE026 UXT1/UXT3 [283] |
| 1.4 i LPG | 4 | X 14 SZ | 44/59 | 08/99→09/00 | Z206 | | 0.7 | UXT10 | |
| 1.7 D | 4 | 17 D (4EE1), X 17 D (4EE1) | 44/59 | 08/99→09/00 | GN103 | | 11V | | |

CORSA C

| | | | | | | | | | |
|--------------|---|----------|-------|--------|-------------------|-------------|------------|-------|---|
| 1.2 | 4 | Z 12 XEP | 59/79 | 07/05→ | Z203 | | 0.9 | | ZS338 |
| 1.2 LPG | 4 | Z 12 XEP | 59/79 | 07/05→ | Z206 [168] | | 0.7 | UXT10 | |
| 1.2 16V | 4 | Z 12 XE | 55/74 | 09/00→ | Z190 [282] Z74 | | 1.2 1.0 | | ZSE147 →06/04 →ch. 33999999; 34999999;36999999 ZS338 →06/04 ch. 43000001;44000001; 46000001→ |
| 1.2 16V LPG | 4 | Z 12 XE | 55/74 | 09/00→ | Z206 | | 0.7 | UXT10 | |
| 1.3 CDTI 16V | 4 | Z 13 DT | 51/68 | 08/05→ | GN053 | GSE142 [11] | 11V | | |
| 1.4 | 4 | Z 14 XEP | 66/89 | 08/03→ | Z203 | | 0.9 | | ZS338 |
| 1.4 LPG | 4 | Z 14 XEP | 66/89 | 08/03→ | Z206 [168] | | 0.7 | UXT10 | |
| 1.7 CDTi | 4 | Z 17 DTH | 74/99 | 08/03→ | GN104 →09/06 | GSE143 [10] | 11V | | |
| 1.7 DI 16V | 4 | Y 17 DTL | 48/64 | 09/00→ | GN104 | GSE143 [10] | 11V | | |
| 1.7 DTI 16V | 4 | Y 17 DT | 55/74 | 09/00→ | GN104 | GSE143 [10] | 11V | | |



kW/BHP



... OPEL



CORSA D

| | | | | | | | | |
|----------|---|--------------------|-------|--------|-----------------|--------------|-------|--|
| 1.0 | 3 | A 10 XEP | 44/59 | 07/06→ | Z203 | 0.9 | ZS359 | |
| 1.0 | 3 | A 10 XEP | 48/64 | 01/10→ | Z203 | 0.9 | ZS359 | |
| 1.2 | 4 | A 12 XEL | 51/68 | 06/10→ | Z203 | 0.9 | | |
| 1.2 | 4 | Z 12 XEP | 59/79 | 07/09→ | Z203 | 0.9 | ZS338 | |
| 1.2 | 4 | A 12 XER | 63/84 | 06/10→ | Z203 | 0.9 | | |
| 1.2 LPG | 4 | A 12 XEL | 51/68 | 06/10→ | Z206 [168] | 0.7 | UXT10 | |
| 1.2 LPG | 4 | Z 12 XEP | 59/79 | 07/09→ | Z206 [168] | 0.7 | UXT10 | |
| 1.2 LPG | 4 | A 12 XER | 63/84 | 06/10→ | Z206 [168] | 0.7 | UXT10 | |
| 1.3 CDTI | 4 | A 13 DTC | 55/74 | 07/06→ | GE112 PSG003 | 4.4V 4.4V | | |
| 1.3 CDTI | 4 | Z 13 DTJ | 55/74 | 07/06→ | GN053 | GSE144 | 11V | |
| 1.3 CDTI | 4 | Z 13 DTH | 66/89 | 07/06→ | GN053 | GSE144 | 11V | |
| 1.3 CDTI | 4 | A 13 DTR, Z 13 DTE | 70/94 | 06/10→ | GE112 | 4.4V | | |

KADETT E

| | | | | | | | | |
|-------|---|-------------|-------|-------------|--|-------------------|------------------------------------|-------------------------------------|
| 1.2 | 4 | 12 SC | 40/54 | 09/84→07/86 | Z19 [168] | 0.8 | | |
| 1.3 N | 4 | 13 N, 13 NB | 44/59 | 09/84→12/89 | Z20 | 0.8 | UXT2 / UXT6 | ZS252 |
| 1.3 S | 4 | 13 S | 55/74 | 01/86→12/89 | Z20 | 0.8 | UXT2 / UXT6 | ZS252 |
| 1.4 i | 4 | C 14 NZ | 44/59 | 01/90→07/94 | Z119 [284] Z190 [282][283] Z74 [283] | 0.8 1.2 1.0 | UXT2/UXT6 [284] UXT1/UXT3 [283] | ZM006 ZM018 |
| 1.4 i | 4 | C 14 NZ | 44/59 | 01/90→08/91 | | | | ZS253 |
| 1.4 S | 4 | 14 NV | 55/74 | 07/89→08/91 | Z119 [284] Z190 [282][283] Z74 [283] | 0.8 1.2 1.0 | UXT2/UXT6 [284] UXT1/UXT3 [283] | ZS253 ZM015 [175] ZM018 [192] |
| 1.6 | 4 | 16 SV | 60/80 | 09/86→12/91 | Z20 | 0.8 | UXT2 / UXT6 | ZS252 [1][254] ZS253 [1][254] |
| 1.6 D | 4 | 16 D, 16 DA | 40/54 | 08/84→08/88 | GN909 [2][222] GV636 | 11V 11V | | |
| 1.6 D | 4 | 16 DA | 40/54 | 01/86→12/89 | GN013 [2][222] GN954 | 11V 11V | | |
| 1.6 i | 4 | C 16 NZ | 55/74 | 08/89→09/93 | Z8 | 0.8 | UXT2/UXT6 [284] | ZS252 |
| 1.6 i | 4 | C 16 NZ | 55/74 | 08/89→07/94 | | | | ZM016 [209] ZM018 [192] |
| 1.6 i | 4 | C 16 NZ | 55/74 | 08/91→07/94 | Z119 [284] Z190 [282][283] Z74 [283] | 0.8 1.2 1.0 | UXT2/UXT6 [284] UXT1/UXT3 [283] | ZS252 [1][254] ZS253 [1][254] |
| 1.7 D | 4 | 17 D | 42/56 | 08/88→07/94 | GN013 [2][222] GN954 | 11V 11V | | |
| 1.7 D | 4 | 17 DR | 44/59 | 07/92→07/94 | GN013 [2][222] GN954 | 11V 11V | | |
| 1.8 i | 4 | C 18 NT | 66/89 | 08/84→09/92 | Z119 [284] Z190 [282][283] Z74 [283] | 0.8 1.2 1.0 | UXT2/UXT6 [284] UXT1/UXT3 [283] | ZM001 06/85→09/85 |

MOVANO

| | | | | | | | | |
|----------|---|---------------------------------------|---------|-------------|-------|-----|--|--|
| 1.9 DTI | 4 | F9Q 770 | 59/79 | 09/00→10/01 | GN018 | 11V | | |
| 1.9 DTI | 4 | F9Q 772 | 60/80 | 10/01→ | GN018 | 11V | | |
| 2.2 DTI | 4 | G9T 720, G9T 722, G9T 750 | 66/89 | 09/00→ | GN026 | 11V | | |
| 2.5 CDTI | 4 | | 73/98 | 10/03→12/06 | GN026 | 11V | | |
| 2.5 CDTI | 4 | G9U 650 | 74/99 | 10/03→ | GN026 | 11V | | |
| 2.5 CDTI | 4 | G9U 632, G9U 650 | 88/118 | 10/03→ | GN026 | 11V | | |
| 2.5 CDTI | 4 | G9U 632, G9U 650 | 107/143 | 10/03→ | GN026 | 11V | | |
| 2.5 D | 4 | S8U 770, S8U 772 | 59/79 | 07/98→09/00 | GN927 | 11V | | |
| 2.5 DTi | 4 | G9U 754 | 73/98 | 10/03→ | GN026 | 11V | | |
| 2.5 DTI | 4 | G9U 720, G9U 724, G9U 750, G9U 754 | 84/113 | 10/01→ | GN026 | 11V | | |
| 2.8 DTI | 4 | S9W 700, S9W 702 | 84/113 | 07/98→10/01 | GF984 | 11V | | |

OPEL

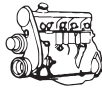

kW/BHP

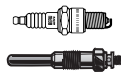

... OPEL



VIVARO

| | | | | | | | | | |
|----------------|---|------------------|---------|--------|------------------------|--|-----|------------------------|------------|
| 1.9 DI | 4 | F9Q 762, F9Q 774 | 60/80 | 08/01→ | GN018 | | 11V | | |
| 1.9 DTI | 4 | F9Q 760 | 74/99 | 08/01→ | GN018 | | 11V | | |
| 2.0 16V | 4 | F4R 720 | 88/118 | 08/01→ | Z337 | | 0.9 | UXT9 | ZS052 GS29 |
| | | | | | →ch. 61699999;61999999 | | | →ch. 61699999;61999999 | |
| 2.0 16V LPG | 4 | F4R 720 | 88/118 | 08/01→ | Z340 | | 0.7 | UXT12 | |
| | | | | | →ch. 61699999;61999999 | | | →ch. 61699999;61999999 | |
| 2.0 ECOTEC | 4 | F4R 820 | 86/115 | 08/06→ | Z337 | | 0.9 | UXT9 | ZS052 GS29 |
| | | | | | ch. 71600001;71000001→ | | | ch. 71600001;71000001→ | |
| 2.0 ECOTEC LPG | 4 | F4R 820 | 86/115 | 08/06→ | Z340 | | 0.7 | UXT12 | |
| | | | | | ch. 71600001;71000001→ | | | ch. 71600001;71000001→ | |
| 2.5 CDTI | 4 | G9U 630 | 84/113 | 08/06→ | GN026 | | 11V | | |
| 2.5 CDTI | 4 | G9MB6, G9U 630 | 107/143 | 08/06→ | GN026 | | 11V | | |
| 2.5 DTI | 4 | G9U 730 | 99/133 | 05/03→ | GN026 | | 11V | | |

ZAFIRA B

| | | | | | | | | | |
|---------------|---|--------------------|---------|--------|-----------------------|------------------------|-----|-------|-------|
| 1.6 CNG Turbo | 4 | A 16 XNT, Z 16 XNT | 110/148 | 02/09→ | | | | | ZS427 |
| 1.7 CDTI | 4 | A 17 DTJ, Z 17 DTJ | 81/109 | 01/08→ | GN104 | GSE143 ^[10] | 11V | | |
| 1.7 CDTI | 4 | A 17 DTR | 92/123 | 01/08→ | GN104 | GSE143 ^[10] | 11V | | |
| 1.8 | 4 | A 18 XER, Z 18 XER | 103/138 | 07/05→ | Z203 | | 0.9 | | ZS427 |
| 1.8 LPG | 4 | A 18 XER, Z 18 XER | 103/138 | 07/05→ | Z206 ^[168] | | 0.7 | UXT10 | |

PEUGEOT



104

| | | | | | | | | | |
|-----|---|----------------------|-------|-------------|-----|--|-----|-------|-----------------------------|
| 0.9 | 4 | 108 (XV3), 108 (XV5) | 33/44 | 09/73→10/83 | Z17 | | 0.8 | UXT4 | ZS110 ^[15] |
| 0.9 | 4 | 108 (XV3) | 34/46 | 10/72→10/79 | Z17 | | 0.8 | UXT4 | ZS110 ^[15] |
| 1.0 | 4 | 108C (XV8) | 32/43 | 09/83→06/88 | Z17 | | 0.8 | UXT4 | ZS110 ^[15] |
| 1.1 | 4 | 109F (XW7) | 37/50 | 08/79→06/88 | Z17 | | 0.8 | UXT4 | ZS110 ^[15] ZM001 |
| 1.1 | 4 | 109 (XW3) | 42/56 | 07/76→06/83 | Z17 | | 0.8 | UXT4 | ZS110 ^[15] |
| 1.1 | 4 | XW3S | 48/64 | 09/73→09/79 | Z31 | | 0.8 | UXK56 | |
| 1.1 | 4 | 121 (XW3S) | 49/66 | 08/75→06/80 | Z31 | | 0.8 | UXK56 | ZS110 ^[15] |
| 1.2 | 4 | 129 (XZ5) | 42/56 | 08/79→06/83 | Z17 | | 0.8 | UXT4 | ZS110 ^[15] ZM001 |
| | | | | | | | | | 05/80→ |
| 1.4 | 4 | 150 (XY6B) | 53/71 | 08/79→06/84 | Z17 | | 0.8 | UXT4 | ZS110 ^[15] ZM001 |
| | | | | | | | | | 05/80→ |

106 I

| | | | | | | | | | | |
|---------|---|-------------------------|-------|-------------|---------------------------------|--|-----|-------------|---|-------------------------------|
| 1.0 | 4 | CDY (TU9M), TU9 | 33/44 | 09/91→04/96 | Z193 | | 0.9 | UXT1 / UXT3 | ZS249 ^{[175][181]} ZS231 ^{[193][254]} ZS231 ^{07/92→} | ZM003 |
| 1.0 | 4 | CDZ (TU9M) | 37/50 | 09/91→04/96 | Z193 | | 0.9 | UXT1 / UXT3 | | |
| 1.0 LPG | 4 | CDY (TU9M), TU9 | 33/44 | 09/91→04/96 | Z340 | | 0.7 | UXT12 | | |
| 1.0 LPG | 4 | CDZ (TU9M) | 37/50 | 09/91→04/96 | Z340 | | 0.7 | UXT12 | | |
| 1.1 | 4 | HDZ (TU1M) | 44/59 | 09/91→04/96 | Z193 | | 0.9 | UXT1 / UXT3 | ZS249 ^{→12/92} ZS231 ^{01/93→} | ZM003 |
| 1.1 LPG | 4 | HDZ (TU1M) | 44/59 | 09/91→04/96 | Z340 | | 0.7 | UXT12 | | |
| 1.3 | 4 | TU2J2 | 72/97 | 10/93→04/96 | Z193 | | 0.9 | UXT1 / UXT3 | ZS231 | ZM003 |
| 1.3 LPG | 4 | TU2J2 | 72/97 | 10/93→04/96 | Z340 | | 0.7 | UXT12 | | |
| 1.4 | 4 | K5A (TU3) | 51/68 | 08/91→03/96 | | | | | ZS249 | |
| 1.4 | 4 | KDX (TU3MC), KDY (TU3M) | 55/74 | 09/91→04/96 | Z193 | | 0.9 | UXT1 / UXT3 | ZS249 ^{→02/94} ZS231 ^{03/94→} | ZM003 ZM026 ^{→02/94} |
| 1.4 | 4 | KFZ (TU3J2/Z) | 69/93 | 09/91→04/96 | Z193 | | 0.9 | UXT1 / UXT3 | ZS231 | |
| 1.4 LPG | 4 | KDX (TU3MC), KDY (TU3M) | 55/74 | 09/91→04/96 | Z340 | | 0.7 | UXT12 | | |
| 1.4 LPG | 4 | KFZ (TU3J2/Z) | 69/93 | 09/91→04/96 | Z340 | | 0.7 | UXT12 | | |
| 1.4 D | 4 | K9Y (TUD3Y) | 37/50 | 09/92→04/96 | GN927 ^{[2][222]} GV661 | | 11V | | | |
| | | | | | | | 11V | | | |



kW/BHP



... PEUGEOT



... 106 I

| | | | | | | | | | |
|---------|---|-------------|--------|-------------|-------------------------|-------|------------|-------------|--------------------|
| 1.5 D | 4 | VJY (TUD5) | 40/54 | 06/94→04/96 | GN016 [2][222] GN912 | GR054 | 11V 11V | | |
| 1.5 D | 4 | VJY (TUD5) | 43/58 | 06/94→04/96 | GN016 [2][222] GN912 | GR054 | 11V 11V | | |
| 1.6 | 4 | NFZ (TU5JP) | 65/87 | 06/93→04/96 | Z193 | | 0.9 | UXT1 / UXT3 | ZS231 →ch. 3200 |
| 1.6 | 4 | NFY (TU5J2) | 76/102 | 01/94→04/96 | Z193 | | 0.9 | UXT1 / UXT3 | ZS231 |
| 1.6 LPG | 4 | NFZ (TU5JP) | 65/87 | 06/93→04/96 | Z340 | | 0.7 | UXT12 | |
| 1.6 LPG | 4 | NFY (TU5J2) | 76/102 | 01/94→04/96 | Z340 | | 0.7 | UXT12 | |

106 II

| | | | | | | | | | |
|-------------|---|--------------------------|--------|--------|-------------------------|-------|------------|-------------|--|
| 1.0 i | 4 | CDY (TU9M) | 33/44 | 05/96→ | Z193 | | 0.9 | UXT1 / UXT3 | ZS232 |
| 1.0 i | 4 | CDZ (TU9M) | 37/50 | 01/97→ | Z193 | | 0.9 | UXT1 / UXT3 | ZS232 ZM003 |
| 1.0 i LPG | 4 | CDY (TU9M) | 33/44 | 05/96→ | Z340 | | 0.7 | UXT12 | |
| 1.0 i LPG | 4 | CDZ (TU9M) | 37/50 | 01/97→ | Z340 | | 0.7 | UXT12 | |
| 1.1 i | 4 | HDY (TU1M) | 40/54 | 01/97→ | Z193 | | 0.9 | UXT1 / UXT3 | ZS232 |
| 1.1 i | 4 | HDZ (TU1M) | 44/59 | 05/96→ | Z193 | | 0.9 | UXT1 / UXT3 | ZS232 |
| 1.1 i | 4 | HFX (TU1JP) | 44/59 | 05/96→ | Z193 | | 0.9 | UXT1 / UXT3 | ZSE047 [13] |
| 1.1 i LPG | 4 | HDY (TU1M) | 40/54 | 01/97→ | Z340 | | 0.7 | UXT12 | |
| 1.1 i LPG | 4 | HDZ (TU1M), HFX (TU1JP) | 44/59 | 05/96→ | Z340 | | 0.7 | UXT12 | |
| 1.4 i | 4 | KFW (TU3JP), KFX (TU3JP) | 55/74 | 05/96→ | Z193 | | 0.9 | UXT1 / UXT3 | ZS381 03/98→05/05 ZS232 [153][202][218] ZSE047 [13] |
| 1.4 i LPG | 4 | KFW (TU3JP), KFX (TU3JP) | 55/74 | 05/96→ | Z340 | | 0.7 | UXT12 | |
| 1.5 D | 4 | VJY (TUD5) | 40/54 | 05/96→ | GN016 [2][222] GN912 | GR054 | 11V 11V | | |
| 1.5 D | 4 | VJX (TUD5) | 42/56 | 04/98→ | GN016 [2][222] GN912 | | 11V 11V | | |
| 1.6 i | 4 | NFZ (TU5JP) | 65/87 | 05/96→ | Z193 | | 0.9 | UXT1 / UXT3 | ZS232 →ch. 3200 |
| 1.6 i | 4 | NFW (TU5J2), NFY (TU5J2) | 74/99 | 05/96→ | Z193 | | 0.9 | UXT1 / UXT3 | ZS231 |
| 1.6 i LPG | 4 | NFZ (TU5JP) | 65/87 | 05/96→ | Z340 | | 0.7 | UXT12 | |
| 1.6 i LPG | 4 | NFW (TU5J2), NFY (TU5J2) | 74/99 | 05/96→ | Z340 | | 0.7 | UXT12 | |
| 1.6 S16 | 4 | NFX (TU5J4) | 87/117 | 05/96→ | Z193 | | 0.9 | UXT1 / UXT3 | ZSE046 [89] ZS241 [38] ch. 51450→ |
| 1.6 S16 LPG | 4 | NFX (TU5J4) | 87/117 | 05/96→ | Z340 | | 0.7 | UXT12 | |

107

| | | | | | | | | | |
|---------|---|-------------|-------|--------|-------|--|-----|--|--------|
| 1.0 | 3 | 1KR (384 F) | 50/67 | 06/05→ | Z273 | | 1.1 | | ZSE164 |
| 1.4 HDi | 4 | 8HT (DV4TD) | 40/54 | 06/05→ | GN056 | | 11V | | |

204

| | | | | | | | | | |
|----------------|---|-----|-------|-------------|-----|--|-----|------|------------|
| 1.1 | 4 | XK | 39/52 | 10/65→07/69 | Z42 | | 0.8 | UX56 | ZS106 [11] |
| 1.1 | 4 | XK4 | 40/54 | 05/69→10/70 | Z42 | | 0.8 | UX56 | |
| 1.1 | 4 | XK4 | 40/54 | 07/69→07/77 | Z42 | | 0.8 | UX56 | ZS106 [11] |
| | | | | | Z17 | | 0.8 | UXT4 | |
| | | | | | Z17 | | 0.8 | UXT4 | |
| 1.1 | 4 | XK5 | 43/58 | 09/75→07/77 | Z17 | | 0.8 | UXT4 | ZS106 [11] |
| 1.1 Grand Luxe | 4 | XK4 | 40/54 | 05/69→10/77 | Z42 | | 0.8 | UX56 | |
| | | | | | Z17 | | 0.8 | UXT4 | |
| | | | | | Z17 | | 0.8 | UXT4 | |

205 I

| | | | | | | | | | |
|-----|---|------------|-------|-------------|-----|--|-----|------|--|
| 1.0 | 4 | 108C (XV8) | 33/44 | 02/83→10/87 | Z17 | | 0.8 | UXT4 | ZS115 [1][11] ZS117 [1][254] ZS120 [1][214][254] |
|-----|---|------------|-------|-------------|-----|--|-----|------|--|



kW/BHP



... PEUGEOT



... 205 I

| | | | | | | | | | | |
|------------|---|--------------------------|--------|-------------|-------------------------|-------|------------|-------------|---|-----------------|
| 1.1 | 4 | 109N (XW7) | 36/48 | 02/83→10/87 | Z17 | | 0.8 | UXT4 | ZS115 (1)(111) ZS117 (1)(254) ZS120 (1)(214)(254) | ZM003 |
| 1.1 | 4 | 109F (XW7) | 37/50 | 02/83→10/87 | Z17 | | 0.8 | UXT4 | ZS115 (1)(111) ZS117 (1)(254) ZS120 (1)(214)(254) | ZM001 |
| 1.1 CJ | 4 | HDZ (TU1M) | 44/59 | 10/89→12/94 | Z247 | | 0.9 | UXT1 / UXT3 | ZS247 (175)(181) [254] | ZM003 |
| 1.4 | 4 | 150D (XY7), 150G (XY7) | 44/59 | 02/83→10/87 | Z17 | | 0.8 | UXT4 | ZS115 (1)(111) ZS117 (1)(254) ZS120 (1)(214)(254) | ZM001 |
| 1.4 | 4 | 150 (XY6B) | 53/71 | 02/83→10/87 | | | | | ZS115 (1)(111) ZS117 (1)(254) ZS120 (1)(214)(254) | |
| 1.4 | 4 | 150H (XY8) | 58/78 | 10/85→10/87 | Z25 | | 0.8 | UXK56 | ZS115 (1)(111) ZS117 (1)(254) ZS120 (1)(214)(254) | ZM001 |
| 1.4 | 4 | 150B (XY8) | 59/79 | 02/83→10/87 | Z25 | | 0.8 | UXK56 | ZS115 (1)(111) ZS117 (1)(254) ZS120 (1)(214)(254) | ZM001 |
| 1.4 CJ | 4 | 150D (XY7), 150G (XY7) | 44/59 | 03/88→05/89 | Z17 | | 0.8 | UXT4 | ZS115 (1)(111) ZS117 (1)(254) ZS120 (1)(214)(254) | ZM003 |
| 1.4 CJ | 4 | KAY (TU3CP) | 44/59 | 01/89→09/93 | Z247 | | 0.9 | UXT1 / UXT3 | ZS247 →12/92 | ZM003 →12/92 |
| 1.4 CJ | 4 | KTD (TU3A) | 49/66 | 03/89→12/94 | Z247 | | 0.9 | UXT1 / UXT3 | ZS247 | ZM003 |
| 1.4 CJ | 4 | KDY (TU3M), KDZ (TU3M) | 55/74 | 05/91→12/94 | Z247 | | 0.9 | UXT1 / UXT3 | ZS247 (6)(18)(175) [181](254) | ZM003 |
| 1.4 CT | 4 | 150B (XY8), 150H (XY8) | 58/78 | 04/86→12/88 | Z25 | | 0.8 | UXK56 | ZS115 (1)(111) ZS117 (1)(254) ZS120 (1)(214)(254) | ZM003 |
| 1.6 | 4 | B1E (XU51C) | 53/71 | 03/87→10/87 | Z17 | | 0.8 | UXT4 | ZS115 (1)(111) ZS117 (1)(254) ZS120 (1)(214)(254) | ZM003 |
| 1.6 | 4 | B1A (XU51C) | 55/74 | 08/86→10/87 | Z17 | | 0.8 | UXT4 | ZS115 (1)(111) ZS117 (1)(254) ZS120 (1)(214)(254) | ZM003 |
| 1.6 | 4 | BAZ (XU5CP) | 55/74 | 08/86→10/87 | | | | | ZS115 (1)(111) ZS117 (1)(254) ZS120 (1)(214)(254) | |
| 1.6 CJ | 4 | BDY (XU5M3Z) | 65/87 | 08/92→12/94 | Z247 | | 0.9 | UXT1 / UXT3 | ZS232 | ZM003 |
| 1.6 CTI | 4 | 180A (XU5J), 180Z (XU5J) | 76/102 | 04/86→10/90 | Z25 | | 0.8 | UXK56 | ZS115 (1)(111) ZS117 (1)(254) ZS120 (1)(214)(254) | ZM003 |
| 1.6 GTI | 4 | 180A (XU5J) | 76/102 | 12/84→10/87 | Z25 | | 0.8 | UXK56 | ZS115 (1)(111) ZS117 (1)(254) ZS120 (1)(214)(254) | ZM003 |
| 1.7 Diesel | 4 | 161A (XUD7) | 44/59 | 08/83→10/87 | GN909 (2)(222) GV636 | GR065 | 11V 11V | | | |
| 1.9 CTi | 4 | DFZ (XU9J1) | 74/99 | 08/87→07/90 | | | | | ZS247 (1) | |
| 1.9 CTI | 4 | DFZ (XU9J1) | 75/101 | 10/87→12/94 | Z247 | | 0.9 | UXT1 / UXT3 | ZS247 (1) 04/91→ | ZM003 |
| 1.9 GTI | 4 | DFZ (XU9J1) | 75/101 | 03/87→10/87 | Z17 | | 0.8 | UXT4 | ZS247 (1) | |
| 1.9 GTI | 4 | D6B (XU9JA) | 94/126 | 10/86→10/87 | Z193 | | 0.9 | UXT1 / UXT3 | ZS115 (1)(111) ZS117 (1)(254) ZS120 (1)(214)(254) | ZM003 |

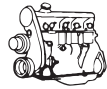

kW/BHP

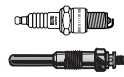

... PEUGEOT



205 II

| | | | | | | | | | | |
|--------------|---|---|--------|-------------|---------------------------------|-------|-----|-----------------------|--|-----------------|
| 1.0 | 4 | TU9 | 33/44 | 10/87→09/98 | Z255 →06/95 Z74 07/95→ | | 0.9 | UXT1 / UXT3 →06/95 | ZS231 01/91→12/94 | ZM003 |
| | | | | | | | 1.0 | UXT1 / UXT3 07/95→ | ZS247 [175][181] [193][254] | |
| 1.0 LPG | 4 | TU9 | 33/44 | 10/87→09/98 | Z206 | | 0.7 | UXT10 | | |
| 1.1 | 4 | 109N (XW7) | 36/48 | 10/87→10/90 | Z17 | | 0.8 | UXT4 | ZS115 [1][11] ZS117 [1][254] ZS120 [1][214][254] | ZM003 |
| 1.1 | 4 | H1B (TU1) | 40/54 | 10/87→10/90 | Z193 | | 0.9 | UXT1 / UXT3 | ZS247 [175][181] [193][254] | ZM003 |
| 1.1 | 4 | HDZ (TU1M) | 44/59 | 07/89→09/98 | Z193 | | 0.9 | UXT1 / UXT3 | ZS231 01/91→12/94 ZS247 [175][181] [254] | ZM003 |
| 1.1 LPG | 4 | HDZ (TU1M) | 44/59 | 07/89→09/98 | Z340 | | 0.7 | UXT12 | | |
| 1.3 Rallye | 4 | TU24 | 74/99 | 10/87→10/90 | | | | | ZS247 | |
| 1.4 | 4 | 150D (XY7), 150G (XY7) | 44/59 | 10/87→05/89 | Z17 | | 0.8 | UXT4 | ZS115 [1][11] ZS117 [1][254] ZS120 [1][214][254] | ZM001 |
| 1.4 | 4 | KAY (TU3CP) | 44/59 | 08/87→09/93 | Z247 →10/90 | | 0.9 | UXT1 / UXT3 →10/90 | ZS247 | ZM003 |
| 1.4 | 4 | K1D (TU3A) | 49/66 | 10/87→10/90 | Z247 | | 0.9 | UXT1 / UXT3 | ZS247 | ZM003 |
| 1.4 | 4 | 150 (XY6B) | 53/71 | 01/87→07/88 | | | | | ZS115 [1][11] ZS117 [1][254] ZS120 [1][214][254] | |
| 1.4 | 4 | KDX (TU3MC) | 55/74 | 08/90→07/98 | Z193 | | 0.9 | UXT1 / UXT3 | ZS231 [1] →01/96 ZS232 [1] 02/96→ | ZM003 |
| 1.4 | 4 | KDY (TU3M), KDZ (TU3M), | 55/74 | 07/88→09/98 | Z193 | | 0.9 | UXT1 / UXT3 | ZS247 [6][8][254] ZS231 01/91→ | ZM003 |
| 1.4 | 4 | TU32 | 55/74 | 08/90→07/98 | | | | | ZS232 [1] 02/96→ | |
| 1.4 | 4 | 150B (XY8), 150H (XY8) | 58/78 | 07/88→05/89 | Z25 | | 0.8 | UXK56 | ZS247 | ZM001 |
| 1.4 | 4 | K2B (TU3S) | 62/83 | 06/87→12/89 | Z24 | | 0.8 | UXT5 | ZS247 | ZM003 |
| 1.4 LPG | 4 | KDX (TU3MC), KDY (TU3M), KDZ (TU3M), KFX (TU3JP) | 55/74 | 07/88→09/98 | Z340 | | 0.7 | UXT12 | | |
| 1.6 | 4 | B1E (XU51C) | 53/71 | 10/87→09/98 | Z247 | | 0.9 | UXT1 / UXT3 | ZS232 01/91→12/94 | |
| 1.6 | 4 | B1A (XU51C), BAZ (XU5CP) | 55/74 | 10/87→09/98 | Z247 | | 0.9 | UXT1 / UXT3 | ZS115 [1][11] ZS117 [1][254] ZS120 [1][214][254] | |
| 1.6 LPG | 4 | B1E (XU51C) | 53/71 | 10/87→09/98 | Z340 | | 0.7 | UXT12 | | |
| 1.6 LPG | 4 | B1A (XU51C), BAZ (XU5CP) | 55/74 | 10/87→09/98 | Z340 | | 0.7 | UXT12 | | |
| 1.6 Aut. | 4 | | 58/78 | 10/87→09/98 | | | | | ZS115 [1][11] ZS117 [1][254] ZS120 [1][214][254] | |
| 1.6 Aut. | 4 | BDY (XU5M2Z), BDY (XU5M3Z) | 65/87 | 05/90→09/98 | Z193 | | 0.9 | UXT1 / UXT3 | ZS232 →12/94 | ZM003 |
| 1.6 Aut. LPG | 4 | BDY (XU5M2Z), BDY (XU5M3Z) | 65/87 | 05/90→09/98 | Z340 | | 0.7 | UXT12 | | |
| 1.6 GTI | 4 | 180A (XU5J), 180Z (XU5J) | 76/102 | 10/87→12/89 | Z24 | | 0.8 | UXT5 | | ZM003 10/88→ |
| 1.7 Diesel | 4 | 161A (XUD7) | 44/59 | 07/87→09/98 | GN909 [2][222] GV636 | GR065 | 11V | | | |
| 1.8 TD | 4 | A8B (XUD7TE) | 57/76 | 01/90→09/98 | GN909 [2][222] GV636 | GR065 | 11V | | | |
| 1.8 XDT | 4 | XUD7T | 58/78 | 08/90→05/97 | GN013 | | 11V | | | |



kW/BHP

**... PEUGEOT****... 205 II**

| | | | | | | | | | |
|----------------|---|---------------------------------|---------|-------------|--|-------|------------|-------------|--|
| 1.9 Diesel | 4 | DJZ (XUD9Y) | 47/63 | 10/87→09/98 | GN909 ^{[2][222]} GV636 | GR065 | 11V 11V | | |
| 1.9 GTI | 4 | D2A (XU92C) | 75/101 | 10/87→05/89 | Z247 | | 0.9 | UXT1 / UXT3 | ZS115 ^{[1][11]} ZS117 ^{[1][254]} ZS120 ^{[1][214][254]} ZM003 |
| 1.9 GTI | 4 | DFZ (XU9J1) | 75/101 | 10/87→07/94 | Z247 | | 0.9 | UXT1 / UXT3 | ZS247 ^[1] 04/91→ ZM001 |
| 1.9 GTI | 4 | DKZ (XU9JAZ) | 88/118 | 10/87→10/94 | Z193 | | 0.9 | UXT1 / UXT3 | ZS247 ZM003 |
| 1.9 GTI | 4 | D6B (XU9JA) | 94/126 | 10/87→09/98 | Z15 ^[168] | | 0.8 | UXT1 / UXT3 | ZS247 ^[1] 01/90→ ZM003 |
| 1.9 GTI LPG | 4 | D6B (XU9JA) | 94/126 | 10/87→09/98 | Z340 | | 0.7 | UXT12 | |
| 206 | | | | | | | | | |
| 1.1 | 4 | | 40/54 | 08/98→07/00 | | | | | ZS381 |
| 1.1 | 4 | HFX (TU1JP) | 44/59 | 07/02→ | Z193 | | 0.9 | UXT1 / UXT3 | ZSE047 ^[13] |
| 1.1 LPG | 4 | HFX (TU1JP) | 44/59 | 07/02→ | Z340 | | 0.7 | UXT12 | |
| 1.1 i | 4 | HFX (TU1JP), HFZ (TU1JP) | 44/59 | 09/98→ | Z193 | | 0.9 | UXT1 / UXT3 | ZS381 ^[88] ZSE047 ^[13] |
| 1.1 i LPG | 4 | HFX (TU1JP), HFZ (TU1JP) | 44/59 | 09/98→ | Z340 | | 0.7 | UXT12 | |
| 1.4 | 4 | KFV (TU3A), KFW (TU3JP) | 55/74 | 07/02→ | Z193 | | 0.9 | UXT1 / UXT3 | ZSE047 ^[13] |
| 1.4 | 4 | KFV (TU3A), KFW (TU3JP) | 55/74 | 03/07→ | | | | | ZSE048 ^[10] |
| 1.4 LPG | 4 | KFV (TU3A), KFW (TU3JP) | 55/74 | 07/02→ | Z340 | | 0.7 | UXT12 | |
| 1.4 16V | 4 | KFU | 65/87 | 10/03→ | Z243 | | 0.9 | | |
| 1.4 16V | 4 | KFU (ET3J4) | 65/87 | 10/03→ | Z243 | | 0.9 | | ZS472 |
| 1.4 HDi | 4 | 8HX (DV4TD) | 50/67 | 07/02→ | GN047 ^[248] GN056 ^[165] | | 11V 11V | | |
| 1.4 HDi | 4 | 8HX (DV4TD) | 51/68 | 09/02→02/07 | GN047 →ch. 10443 GN056 ch. 10444→ | | 11V 11V | | |
| 1.4 HDi eco 70 | 4 | 8HX (DV4TD), 8HZ (DV4TD) | 50/67 | 09/01→ | GN047 ^[248] GN056 ^[165] | | 11V 11V | | |
| 1.4 i | 4 | KFW (TU3JP) | 55/74 | 09/98→ | Z193 | | 0.9 | UXT1 / UXT3 | ZSE047 ^[13] 06/00→ |
| 1.4 i | 4 | KFX (TU3JP) | 55/74 | 09/98→ | Z193 | | 0.9 | UXT1 / UXT3 | ZS381 →05/00 |
| 1.4 i LPG | 4 | KFW (TU3JP), KFX (TU3JP) | 55/74 | 09/98→ | Z340 | | 0.7 | UXT12 | |
| 1.4 LPG | 4 | KFV (TU3JP) | 55/74 | 05/06→09/07 | | | | | ZSE047 ^[13] |
| 1.6 16V | 4 | NFU (TU5JP4) | 80/107 | 09/00→ | Z184 | | 0.9 | UXT13 | ZSE045 |
| 1.6 16V LPG | 4 | NFU (TU5JP4) | 80/107 | 09/00→ | Z226 ^[168] | | 0.8 | | |
| 1.6 HDi 110 | 4 | 9HY (DV6TED4), 9HZ (DV6TED4) | 80/107 | 05/04→ | GN047 ^[249] GN056 ^[158] | | 11V 11V | | |
| 1.6 i | 4 | NEZ (TU5JP) | 65/87 | 09/98→12/00 | Z193 | | 0.9 | UXT1 / UXT3 | ZS381 eng. 3200→ ZS231 →ch. 3200 |
| 1.6 i LPG | 4 | NEZ (TU5JP) | 65/87 | 09/98→12/00 | Z340 | | 0.7 | UXT12 | |
| 1.9 D | 4 | WJZ (DW8) | 51/68 | 09/98→11/01 | GN016 | GR054 | 11V | | |
| 2.0 16V | 4 | RFN (EW10J4) | 100/134 | 07/02→ | Z183 | | 0.9 | UXT13 | ZS348 |
| 2.0 16V LPG | 4 | RFN (EW10J4) | 100/134 | 07/02→ | Z184 ^[168] | | 0.9 | UXT13 | |
| 2.0 HDi | 4 | RHY (DW10TD) | 66/89 | 07/02→ | GN027 | | 11V | | |
| 2.0 HDi 90 | 4 | RHY (DW10TD) | 66/89 | 12/99→ | GN027 | | 11V | | |
| 2.0 RC | 4 | RFK (EW10J4S) | 130/174 | 07/03→ | Z184 | | 0.9 | UXT13 | ZS351 |
| 2.0 RC LPG | 4 | RFK (EW10J4S) | 130/174 | 07/03→ | Z226 ^[168] | | 0.8 | | |
| 2.0 ST6 | 4 | RFR (DEW10J4) | 99/133 | 04/99→10/00 | Z183 | | 0.9 | UXT13 | ZS348 |
| 2.0 ST6 | 4 | RFN (EW10J4) | 100/134 | 06/99→ | Z183 | | 0.9 | UXT13 | ZS348 |
| 2.0 ST6 LPG | 4 | RFR (DEW10J4) | 99/133 | 04/99→10/00 | Z184 ^[168] | | 0.9 | UXT13 | |
| 2.0 ST6 LPG | 4 | RFN (EW10J4) | 100/134 | 06/99→ | Z184 ^[168] | | 0.9 | UXT13 | |

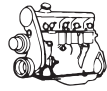

kW/BHP

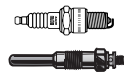
**... PEUGEOT****206+**

| | | | | | | | | |
|----------------|---|---------------------------------|-------|--------|--|------------|-------------|------------------------|
| 1.1 | 4 | HFX (TU1A), HFX (TU1JP), TU1AES | 44/59 | 01/09→ | Z193 | 0.9 | UXT1 / UXT3 | ZSE048 ^[10] |
| 1.4 HDi eco 70 | 4 | 8HX (DV4TD), 8HZ (DV4TD) | 50/67 | 01/09→ | GN047 ^[248] GN056 ^[165] | 11V 11V | | |
| 1.4 i | 4 | KFT (TU3A) | 54/72 | 09/10→ | Z193 | 0.9 | UXT1 / UXT3 | ZSE048 ^[10] |
| 1.4 i | 4 | KFV (TU3A), KFW (TU3A) | 55/74 | 01/09→ | Z193 | 0.9 | UXT1 / UXT3 | ZSE048 ^[10] |
| 1.4 i LPG | 4 | KFT (TU3A) | 54/72 | 09/10→ | Z340 | 0.7 | UXT12 | |
| 1.4 i LPG | 4 | KFV (TU3A), KFW (TU3A) | 55/74 | 01/09→ | Z340 | 0.7 | UXT12 | |

207

| | | | | | | | | |
|---------------|---|-------------------------------|---------|--------|-----------------------|------------|-------------|------------------------|
| 1.4 | 4 | KFV (TU3A) | 53/71 | 02/06→ | Z193 | 0.9 | UXT1 / UXT3 | ZSE048 ^[10] |
| 1.4 | 4 | KFV (TU3A) | 54/72 | 12/07→ | Z15 Z193 | 0.8 0.9 | UXT1 / UXT3 | ZSE048 ^[10] |
| 1.4 | 4 | KFV (TU3A), KFW (TU3A) | 55/74 | 08/08→ | Z193 | 0.9 | UXT1 / UXT3 | ZSE048 ^[10] |
| 1.4 LPG | 4 | KFV (TU3A) | 53/71 | 02/06→ | Z340 | 0.7 | UXT12 | |
| 1.4 LPG | 4 | KFV (TU3A) | 54/72 | 12/07→ | Z340 | 0.7 | UXT12 | |
| 1.4 LPG | 4 | KFV (TU3A), KFW (TU3A) | 55/74 | 08/08→ | Z340 | 0.7 | UXT12 | |
| 1.4 16V | 4 | KFU (ET3J4) | 65/87 | 02/06→ | Z243 | 0.9 | | ZS472 |
| 1.4 16V | 4 | 8FS (EP3), EP3, EP3C | 70/94 | 06/07→ | Z320 | 1.0 | | ZSE143 |
| 1.4 16V | 4 | | 72/97 | 10/09→ | | | | ZSE143 |
| 1.4 16V LPG | 4 | 8FS (EP3), EP3, EP3C | 70/94 | 06/07→ | Z320 ^[168] | 1.0 | | |
| 1.4 Flex | 4 | KFW (TU3A) | 60/80 | 11/08→ | | | | ZSE048 ^[10] |
| 1.4 HDi | 4 | 8HR (DV4C), 8HZ (DV4TD) | 50/67 | 02/06→ | GN056 | 11V | | |
| 1.6 16V | 4 | NFU (TU5JP4) | 80/107 | 02/06→ | Z184 | 0.9 | UXT13 | ZSE045 |
| 1.6 16V LPG | 4 | NFU (TU5JP4) | 80/107 | 02/06→ | Z226 ^[168] | 0.8 | | |
| 1.6 16V RC | 4 | 5FY (EP6DTS) | 128/172 | 02/07→ | Z332 | 0.7 | | ZSE143 |
| 1.6 16V Turbo | 4 | 5FX (EP6DT) | 110/148 | 02/06→ | Z332 | 0.7 | | ZSE143 |
| 1.6 16V Turbo | 4 | 5FR (EP6DT) | 115/154 | 10/09→ | Z332 | 0.7 | | ZSE143 |
| 1.6 16V VTi | 4 | 5FS (EP6C), EP6 | 88/118 | 02/07→ | Z332 | 0.7 | | ZSE143 |
| | | | | | | | | 03/07→ |
| 1.6 Bioflex | 4 | N6A (TU5JP4) | 83/111 | 01/08→ | | | | ZSE045 |
| 1.6 HDi | 4 | 9HV (DV6TED4), 9HX (DV6ATED4) | 66/89 | 02/06→ | GN056 | 11V | | |
| 1.6 HDi | 4 | 9HP (DV6DTED) | 68/91 | 11/09→ | GE121A | 5V | | |
| 1.6 HDi | 4 | 9HY (DV6TED4), 9HZ (DV6TED4) | 80/107 | 02/06→ | GN056 | 11V | | |
| 1.6 HDi 110 | 4 | 9HR (DV6C) | 82/110 | 08/09→ | GE121A | 5V | | |
| 207 CC | | | | | | | | |
| 1.6 16V | 4 | 5FS (EP6C), EP6 | 88/118 | 02/07→ | Z320 | 1.0 | | ZSE143 |
| | | | | | | | | 03/07→ |
| 1.6 16V LPG | 4 | 5FS (EP6C), EP6 | 88/118 | 02/07→ | Z233 ^[168] | 1.0 | | |
| 1.6 16V Turbo | 4 | 5FX (EP6DT) | 110/148 | 02/07→ | Z332 | 0.7 | | ZSE143 |
| 1.6 16V Turbo | 4 | 5FR (EP6DT) | 115/154 | 10/09→ | Z332 | 0.7 | | ZSE143 |
| 1.6 HDi | 4 | 9HZ (DV6TED4) | 80/107 | 02/07→ | GN056 | 11V | | |
| 1.6 HDi | 4 | 9HR (DV6C) | 82/110 | 08/09→ | GE121A | 5V | | |
| 207 SW | | | | | | | | |
| 1.4 | 4 | KFV (TU3A) | 54/72 | 06/07→ | Z193 | 0.9 | UXT1 / UXT3 | ZSE048 ^[10] |
| 1.4 LPG | 4 | KFV (TU3A) | 54/72 | 06/07→ | Z340 | 0.7 | UXT12 | |
| 1.4 16V | 4 | 8FS (EP3), EP3, EP3C | 70/94 | 06/07→ | Z320 | 1.0 | | ZSE143 |
| 1.4 16V LPG | 4 | 8FS (EP3), EP3, EP3C | 70/94 | 06/07→ | Z320 ^[168] | 1.0 | | |
| 1.6 16V | 4 | 5FS (EP6C), EP6 | 88/118 | 06/07→ | Z320 | 1.0 | | ZSE143 |
| 1.6 16V LPG | 4 | 5FS (EP6C), EP6 | 88/118 | 06/07→ | Z233 ^[168] | 1.0 | | |
| 1.6 16V RC | 4 | 5FY (EP6DTS) | 128/172 | 02/07→ | Z332 | 0.7 | | ZSE143 |
| 1.6 HDi | 4 | 9HX (DV6ATED4) | 66/89 | 06/07→ | GN056 | 11V | | |
| 1.6 HDi | 4 | 9HP (DV6DTED) | 68/91 | 11/09→ | GE121A | 5V | | |
| 1.6 HDi | 4 | 9HZ (DV6TED4) | 80/107 | 06/07→ | GN056 | 11V | | |
| 1.6 HDi | 4 | 9HR (DV6C) | 82/110 | 08/09→ | GE121A | 5V | | |



kW/BHP



... PEUGEOT



208

| | | | | | | | | | |
|---------|---|------------------------|--------|--------|--------|--|----|--|--------|
| 1.4 | 4 | 8FS (EP3), EP3C | 70/94 | 03/12→ | | | | | ZSE143 |
| 1.4 HDi | 4 | 8HP (DV4C), 8HR (DV4C) | 50/67 | 03/12→ | GE121A | | 5V | | |
| 1.6 | 4 | 5FS (EP6C) | 88/118 | 03/12→ | | | | | ZSE143 |
| 1.6 HDi | 4 | 9HK (DV6ETEDM) | 55/74 | 01/13→ | GE121A | | 5V | | |
| 1.6 HDi | 4 | 9HP (DV6DTED) | 68/91 | 03/12→ | GE121A | | 5V | | |
| 1.6 HDi | 4 | | 84/113 | 03/12→ | GE121A | | 5V | | |

301

| | | | | | | | | | |
|------------|---|---------------|-------|--------|--------|--|----|--|--|
| 1.6 HDi 90 | 4 | 9HF (DV6DTED) | 68/91 | 11/12→ | GE121A | | 5V | | |
|------------|---|---------------|-------|--------|--------|--|----|--|--|

304

| | | | | | | | | | |
|--------|---|------|-------|-------------|---------------|--------|-----|--------|----------------------|
| 1.1 | 4 | XK5 | 43/58 | 10/76→10/80 | Z17 | | 0.8 | UXT4 | |
| 1.3 | 4 | XL3 | 48/64 | 03/70→09/73 | Z42 | | 0.8 | UX56 | |
| 1.3 | 4 | XL5 | 48/64 | 09/70→10/80 | Z42 | | 0.8 | UX56 | |
| | | | | | →09/75 Z17 | | 0.8 | UXT4 | |
| | | | | | 10/75→ | | | 10/75→ | |
| 1.3 | 4 | XL3S | 55/74 | 03/72→07/76 | Z42 | | 0.8 | UX56 | |
| 1.3 | 4 | XL3S | 55/74 | 09/72→07/76 | | | | | ZS106 ^[1] |
| 1.3 | 4 | XL5S | 55/74 | 08/72→09/75 | Z27 | | 0.8 | UX56 | |
| 1.3 GL | 4 | XL5 | 48/64 | 09/72→10/79 | Z42 | | 0.8 | UX56 | |
| | | | | | →09/75 Z17 | | 0.8 | UXT4 | |
| | | | | | 10/75→ | | | 10/75→ | |
| 1.3 GT | 4 | XL3 | 48/64 | 10/69→09/75 | Z42 | | 0.8 | UX56 | |
| 1.4 D | 4 | XL4D | 33/44 | 10/76→10/79 | | GR059 | | | |
| | | | | | | 02/79→ | | | |

305 I

| | | | | | | | | | | |
|-----|---|------------|-------|-------------|-----|--|-----|------|--------------------------------|-------|
| 1.3 | 4 | 118 (XL5) | 44/59 | 11/77→09/82 | Z17 | | 0.8 | UXT4 | ZS110 ^[15] | ZM001 |
| 1.5 | 4 | 142 (XR5) | 54/72 | 11/79→09/82 | Z17 | | 0.8 | UXT4 | ZS110 ^[15] | ZM001 |
| 1.5 | 4 | 117 (XR5S) | 65/87 | 05/80→09/82 | Z17 | | 0.8 | UXT4 | ZS106 ^{[1][11][254]} | ZM001 |
| | | | | | | | | | ZS115 ^{[1][11]} | |
| | | | | | | | | | ZS117 ^{[1][254]} | |
| | | | | | | | | | ZS120 ^{[1][214][254]} | |

| | | | | | | | | | | |
|------------|---|-----------|-------|-------------|---------------------------|-----------------------|-----|--|--|--|
| 1.5 Diesel | 4 | 149 (XID) | 36/48 | 11/77→09/82 | GN909 ^{[2][222]} | GR059 ^[32] | 11V | | | |
| | | | | | GV636 | 01/79→06/81 | 11V | | | |
| | | | | | | GR065 ^[32] | | | | |
| | | | | | | 07/81→ | | | | |

| | | | | | | | | | | |
|------------|---|-----------|-------|-------------|--|-----------------------|--|--|--|--|
| 1.5 Diesel | 4 | 149 (XID) | 36/48 | 08/80→09/82 | | GR059 ^[32] | | | | |
| | | | | | | →06/81 | | | | |
| | | | | | | GR065 ^[32] | | | | |
| | | | | | | 07/81→ | | | | |

305 II

| | | | | | | | | | | |
|-----|---|-------------|-------|-------------|----------------|--|-----|-------------|--------------------------------|-------|
| 1.3 | 4 | 118 (XL5) | 44/59 | 10/82→08/86 | Z17 | | 0.8 | UXT4 | ZS110 ^[15] | ZM001 |
| 1.5 | 4 | 142 (XR5A) | 50/67 | 09/85→07/90 | Z17 | | 0.8 | UXT4 | ZS110 ^[15] | ZM001 |
| 1.5 | 4 | 142 (XR5A) | 50/67 | 09/85→10/86 | | | | | ZS115 ^{[1][11]} | |
| | | | | | | | | | ZS117 ^{[1][254]} | |
| | | | | | | | | | ZS120 ^{[1][214][254]} | |
| 1.5 | 4 | 142 (XR5) | 54/72 | 10/82→08/86 | Z17 | | 0.8 | UXT4 | ZS110 ^[15] | ZM001 |
| 1.6 | 4 | BAZ (XU5CP) | 54/72 | 11/86→12/88 | Z17 | | 0.8 | UXT4 | ZS115 ^{[1][11]} | ZM001 |
| | | | | | →07/87 Z247 | | 0.9 | UXT1 / UXT3 | ZS117 ^{[1][254]} | |
| | | | | | 08/87→ | | | | ZS120 ^{[1][214][254]} | |
| 1.6 | 4 | BIA (XU51C) | 55/74 | 10/82→12/88 | Z17 | | 0.8 | UXT4 | ZS115 ^{[1][11]} | ZM001 |
| | | | | | →07/87 Z247 | | 0.9 | UXT1 / UXT3 | ZS117 ^{[1][254]} | |
| | | | | | 08/87→ | | | | ZS120 ^{[1][214][254]} | |
| 1.6 | 4 | 171 (XU5S) | 66/89 | 07/84→12/87 | Z25 | | 0.8 | UXK56 | ZS115 ^{[1][11]} | ZM001 |
| | | | | | | | | | ZS117 ^{[1][254]} | |
| | | | | | | | | | ZS120 ^{[1][214][254]} | |

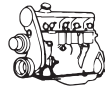

kW/BHP

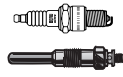

... PEUGEOT



... 305 II

| | | | | | | | | | | |
|------------|---|---------------------------------------|--------|-------------|---------------------------------|-------|------------|---|---|-------|
| 1.6 | 4 | 171 (XU5S) | 69/93 | 10/82→06/88 | Z25 | | 0.8 | UXK56 | ZS115 [1][11] ZS117 [1][254] ZS120 [1][214][254] | |
| 1.6 | 4 | 171 (XU5S) | 71/95 | 10/82→06/84 | Z25 | | 0.8 | UXK56 | ZS115 [1][11] ZS117 [1][254] ZS120 [1][214][254] | ZM001 |
| 1.8 D | 4 | 161A (XUD7) | 44/59 | 11/82→12/88 | GN909 | | 11V | | | |
| 1.9 | 4 | DFZ (XU9J1) | 72/97 | 11/86→12/88 | Z17 →06/87 Z193 07/87→ | | 0.8 0.9 | UXT4 →06/87 UXT1 / UXT3 07/87→ | ZS115 [1][11] ZS117 [1][254] ZS120 [1][214][254] | |
| 1.9 | 4 | 159 (XU9S) | 75/101 | 10/82→10/87 | Z25 | | 0.8 | UXK56 | ZS115 [1][11] ZS117 [1][254] ZS120 [1][214][254] | ZM001 |
| 1.9 D | 4 | 162 (XUD9), D9A (XUD9) | 47/63 | 10/82→07/88 | GN909 [2][222] GV636 | GR065 | 11V 11V | | | |
| 1.9 D | 4 | 162 (XUD9) | 48/64 | 10/82→07/88 | GN909 [2][222] GV636 | GR065 | 11V 11V | | | |
| 1.9 Diesel | 4 | 162 (XUD9), D9A (XUD9) | 47/63 | 10/82→12/88 | GN909 [2][222] GV636 | GR065 | 11V 11V | | | |
| 1.9 Diesel | 4 | 162 (XUD9) | 48/64 | 10/82→12/88 | GN909 [2][222] GV636 | GR065 | 11V 11V | | | |
| 306 | | | | | | | | | | |
| 1.1 | 4 | HDZ (TU1M) | 44/59 | 05/93→05/01 | Z193 | | 0.9 | UXT1 / UXT3 | ZS231 [1] ZS232 [1][153][202] | |
| 1.1 LPG | 4 | HDZ (TU1M) | 44/59 | 05/93→05/01 | Z340 | | 0.7 | UXT12 | | |
| 1.4 | 4 | KDX (TU3MC) | 55/74 | 05/93→05/01 | Z193 | | 0.9 | UXT1 / UXT3 | ZS231 | |
| 1.4 | 4 | KFW (TU3JP), KFX (TU3JP) | 55/74 | 05/93→04/02 | Z193 | | 0.9 | UXT1 / UXT3 | ZS232 [153][202][244] ZS381 [88][161] | |
| 1.4 LPG | 4 | KDX (TU3MC), KFW (TU3JP), KFX (TU3JP) | 55/74 | 05/93→04/02 | Z340 | | 0.7 | UXT12 | | |
| 1.4 SL | 4 | KDX (TU3MC) | 55/74 | 06/94→05/01 | Z193 | | 0.9 | UXT1 / UXT3 | ZS231 | |
| 1.4 SL | 4 | KFW (TU3JP), KFX (TU3JP) | 55/74 | 06/94→05/01 | Z193 | | 0.9 | UXT1 / UXT3 | ZS232 [153][202][244] ZS381 [88][161] | |
| 1.4 SL LPG | 4 | KDX (TU3MC), KFW (TU3JP), KFX (TU3JP) | 55/74 | 06/94→05/01 | Z340 | | 0.7 | UXT12 | | |
| 1.6 | 4 | NFZ (TU5JP) | 65/87 | 05/93→10/00 | Z60 →06/95 Z193 | | 1.2 0.9 | | ZS232 [1][153][202] [241] ZS231 [1] →ch. 3200 ZS381 07/98→ | |
| 1.6 | 4 | NFZ (TU5JP) | 65/87 | 04/96→10/00 | Z193 | | 0.9 | UXT1 / UXT3 | ZS231 →ch. 3200 ZS381 07/98→ | |
| 1.6 | 4 | NFZ (TU5JP) | 65/87 | 03/97→10/00 | | | | | ZS232 [153][202][244] ZS381 [88][161] | |
| 1.6 | 4 | | 66/89 | 07/00→05/01 | Z15 | | 0.8 | UXT1 / UXT3 | ZS232 →ch. 07874 ZS381 [88] ch. 07875→ | |
| 1.6 | 4 | NFT | 72/97 | 10/00→04/02 | Z123 | | 1.0 | UXT9 | ZSE047 [13] | |
| 1.6 LPG | 4 | NFZ (TU5JP) | 65/87 | 05/93→10/00 | Z340 | | 0.7 | UXT12 | | |
| 1.6 LPG | 4 | NFT | 72/97 | 10/00→04/02 | Z129 | | 1.6 | | | |
| 1.6 SR | 4 | NFZ (TU5JP) | 65/87 | 06/94→10/00 | Z60 →06/95 Z193 07/95→ | | 1.2 0.9 | | ZS231 →ch. 3200 UXT1 / UXT3 ZS381 07/95→ | |



kW/BHP



... PEUGEOT



... 306

| | | | | | | | | | | |
|-------------|---|-----------------------|--------|-------------|--|-----------------|-----|-----------------|--|-------|
| 1.6 SR LPG | 4 | NFZ (TU5JP) | 65/87 | 06/94→10/00 | Z340 07/95→ | | 0.7 | UXT12 07/95→ | | |
| 1.8 | 4 | LFZ (XU7JP) | 74/99 | 05/93→04/02 | Z193 | | 0.9 | UXT1 / UXT3 | ZS232 | |
| 1.8 | 4 | LFZ (XU7JP) | 74/99 | 05/97→04/99 | Z15 | | 0.8 | UXT1 / UXT3 | | |
| 1.8 LPG | 4 | LFZ (XU7JP) | 74/99 | 05/93→04/02 | Z340 | | 0.7 | UXT12 | | |
| 1.8 16V | 4 | LFY (XU7JP4) | 81/109 | 03/97→04/02 | Z193 | | 0.9 | UXT1 / UXT3 | ZS256 ^{(84)[243]} ZS349 ^{(85)[160]} | ZM026 |
| 1.8 16V LPG | 4 | LFY (XU7JP4) | 81/109 | 03/97→04/02 | Z340 | | 0.7 | UXT12 | | |
| 1.8 D | 4 | A9A (XUD7) | 43/58 | 05/93→05/01 | GN013 | | 11V | | | |
| 1.8 ST | 4 | LFZ (XU7JP) | 74/99 | 06/94→05/01 | Z193 | | 0.9 | UXT1 / UXT3 | ZS232 | |
| 1.8 ST LPG | 4 | LFZ (XU7JP) | 74/99 | 06/94→05/01 | Z340 | | 0.7 | UXT12 | | |
| 1.9 D | 4 | DJZ (XUD9Y) | 47/63 | 05/93→05/01 | GN909 ^[222] →08/98 GV636 →08/98 GN013 09/98→ | GR054 →08/98 | 11V | | | |
| 1.9 D | 4 | DJY (XUD9A) | 50/67 | 06/94→04/02 | GN909 ^[222] →08/98 GV636 →08/98 GN013 09/98→ | GR054 →08/98 | 11V | | | |
| 1.9 D | 4 | DJY (XUD9A), XUD9 | 51/68 | 04/93→05/99 | GN013 | | 11V | | | |
| 1.9 D | 4 | WJY (DW8B), WJZ (DW8) | 51/68 | 09/98→04/02 | GN016 | | 11V | | | |
| 1.9 D | 4 | DHV (XUD9BSD) | 55/74 | 03/98→04/02 | GN013 | | 11V | | | |
| 1.9 D | 4 | XUD9TE | 69/93 | 04/93→04/97 | GN013 | | 11V | | | |
| 1.9 DT | 4 | DHY (XUD9TE) | 66/89 | 05/93→05/01 | GN909 →08/98 GN013 09/98→ | | 11V | | | |
| 1.9 SLD | 4 | DJZ (XUD9Y) | 47/63 | 06/94→05/01 | GN909 ^[222] →08/98 GV636 →08/98 GN013 09/98→ | GR054 →08/98 | 11V | | | |
| 1.9 SLD | 4 | DJY (XUD9A) | 50/67 | 06/94→05/01 | GN909 ^[222] →08/98 GV636 →08/98 GN013 09/98→ | GR054 →08/98 | 11V | | | |
| 1.9 SRDT | 4 | DHY (XUD9TE) | 66/89 | 06/94→05/01 | GN909 →08/98 GN013 09/98→ | | 11V | | | |
| 1.9 STD | 4 | XUD9 | 51/68 | 02/94→10/95 | GN013 | | 11V | | | |
| 1.9 TD | 4 | DHY (XUD9TE) | 66/89 | 02/97→04/02 | GN909 →08/98 GN013 09/98→ | | 11V | | | |
| 2.0 | 4 | RFX (XU10J2) | 89/119 | 03/94→04/02 | Z193 | | 0.9 | UXT1 / UXT3 | ZS232 | |
| 2.0 | 4 | RFV (XU10J4R) | 97/130 | 03/97→04/02 | Z193 | | 0.9 | UXT1 / UXT3 | ZS349 ⁽⁸⁵⁾ ZS232 09/97→ | |
| 2.0 | 4 | RFV (XU10J4R) | 97/130 | 03/97→05/01 | | | | | ZS232 ^{(153)[202]} ZS349 09/97→ | |



kW/BHP



... PEUGEOT



... 306

| | | | | | | | | |
|-------------|---|----------------|---------|-------------|-------|-----|-------------|-------------------------------------|
| 2.0 LPG | 4 | RFX (XU10J2) | 89/119 | 03/94→04/02 | Z340 | 0.7 | UXT12 | |
| 2.0 LPG | 4 | RFV (XU10J4R) | 97/130 | 03/97→04/02 | Z340 | 0.7 | UXT12 | |
| 2.0 16V | 4 | RFV (XU10J4R) | 97/130 | 03/97→04/02 | Z193 | 0.9 | UXT1 / UXT3 | ZS232 [153][202] ZS349 09/97→ |
| 2.0 16V | 4 | RFV (XU10J4R) | 97/130 | 03/97→05/01 | | | | ZS232 [153][202] ZS349 [85] |
| 2.0 16V LPG | 4 | RFV (XU10J4R) | 97/130 | 03/97→04/02 | Z340 | 0.7 | UXT12 | |
| 2.0 HDI 90 | 4 | RHY (DW10TD) | 66/89 | 06/99→04/02 | GN027 | 11V | | |
| 2.0 S16 | 4 | RFT (XU10J4) | 110/148 | 06/94→05/01 | Z193 | 0.9 | UXT1 / UXT3 | ZS323 |
| 2.0 S16 | 4 | XU10J4TEZ | 110/148 | 06/94→05/01 | | | | ZS323 |
| 2.0 S16 | 4 | RFY (XU10J4Z) | 112/150 | 05/93→05/01 | Z193 | 0.9 | UXT1 / UXT3 | ZS232 |
| 2.0 S16 | 4 | RFS (XU10J4RS) | 120/161 | 03/96→05/01 | Z193 | 0.9 | UXT1 / UXT3 | ZS346 |
| 2.0 S16 LPG | 4 | RFT (XU10J4) | 110/148 | 06/94→05/01 | Z340 | 0.7 | UXT12 | |
| 2.0 S16 LPG | 4 | RFY (XU10J4Z) | 112/150 | 05/93→05/01 | Z340 | 0.7 | UXT12 | |
| 2.0 S16 LPG | 4 | RFS (XU10J4RS) | 120/161 | 03/96→05/01 | Z340 | 0.7 | UXT12 | |
| 2.0 ST | 4 | RFX (XU10J2) | 89/119 | 07/94→05/01 | Z193 | 0.9 | UXT1 / UXT3 | ZS232 |
| 2.0 ST LPG | 4 | RFX (XU10J2) | 89/119 | 07/94→05/01 | Z340 | 0.7 | UXT12 | |
| 2.0 XSi | 4 | RFX (XU10J2) | 89/119 | 05/93→05/01 | Z193 | 0.9 | UXT1 / UXT3 | ZS232 |
| 2.0 XSi LPG | 4 | RFX (XU10J2) | 89/119 | 05/93→05/01 | Z340 | 0.7 | UXT12 | |

307

| | | | | | | | | |
|-------------|---|-----------------------------------|---------|-------------|----------------------------|------------|-----------------|-----------------------|
| 1.4 | 4 | KFW (TU3JP) | 55/74 | 08/00→ | Z193 | 0.9 | UXT1 / UXT3 | ZSE047 [13] 09/01→ |
| 1.4 | 4 | KFW (TU3JP) | 55/74 | 04/02→09/03 | | | | ZSE047 [13] |
| 1.4 LPG | 4 | KFW (TU3JP) | 55/74 | 08/00→ | Z340 | 0.7 | UXT12 | |
| 1.4 16V | 4 | KFU (ET3J4) | 65/87 | 11/03→ | Z243 | 0.9 | | ZS472 |
| 1.4 HDi | 4 | 8HX (DV4TD), 8HZ (DV4TD) | 50/67 | 10/01→ | GN047 [246] GN056 [163] | 11V 11V | | |
| 1.4 HDi 70 | 4 | 8HZ (DV4TD) | 50/67 | 03/02→01/05 | GN047 | 11V | | |
| 1.6 16V | 4 | NFU (TU5JP4) | 80/107 | 08/00→ | Z184 →05/05 | 0.9 | UXT13 →05/05 | ZSE045 |
| 1.6 16V | 4 | NFU (TU5JP4) | 80/107 | 02/05→ | Z184 | 0.9 | UXT13 | |
| 1.6 16V LPG | 4 | NFU (TU5JP4) | 80/107 | 08/00→ | Z226 [168] →05/05 | 0.8 | | |
| 1.6 16V LPG | 4 | NFU (TU5JP4) | 80/107 | 02/05→ | Z226 [168] | 0.8 | | |
| 1.6 BioFlex | 4 | NFU (TU5JP4) | 80/107 | 09/07→ | | | | ZSE045 |
| 1.6 HDi | 4 | 9HV (DV6ATED4) | 66/89 | 04/05→ | GN047 [249] GN056 [158] | 11V 11V | | |
| 1.6 HDi 90 | 4 | 9HV (DV6ATED4), 9HX (DV6ATED4) | 66/89 | 12/06→ | GN047 [249] GN056 [158] | 11V 11V | | |
| 1.6 HDi 110 | 4 | 9HY (DV6TED4), 9HZ (DV6TED4) | 80/107 | 02/04→ | GN047 [249] GN056 [158] | 11V 11V | | |
| 2.0 | 4 | RFN (EW10J4) | 100/134 | 03/02→ | Z223 | 0.9 | UXT13 | ZS348 |
| 2.0 16V | 4 | RFN (EW10J4) | 100/134 | 08/00→ | Z223 | 0.9 | UXT13 | ZS348 03/01→ |
| 2.0 16V | 4 | RFN (EW10J4) | 100/134 | 03/02→ | | | | ZS348 |
| 2.0 16V | 4 | RFJ (EW10A) | 103/138 | 03/05→ | Z223 | 0.9 | UXT13 | ZS352 |
| 2.0 16V | 4 | RFK (EW10J4S) | 130/174 | 10/03→ | Z184 | 0.9 | UXT13 | ZS351 |
| 2.0 16V | 4 | RFK (EW10J4S) | 130/174 | 06/05→ | Z223 | 0.9 | UXT13 | |
| 2.0 16V LPG | 4 | RFK (EW10J4S) | 130/174 | 10/03→ | Z226 [168] | 0.8 | | |
| 2.0 HDi 90 | 4 | RHY (DW10TD) | 66/89 | 08/00→ | GN027 | 11V | | |
| 2.0 HDi 110 | 4 | RHS (DW10ATED) | 79/106 | 08/00→ | GN027 | 11V | | |
| 2.0 HDi 135 | 4 | RHR (DW10BTED4) | 100/134 | 10/03→ | GN054 | 11V | | |

308

| | | | | | | | | |
|---------|---|-----------|-------|--------|------|-----|--|------------------|
| 1.4 16V | 4 | 8FS (EP3) | 70/94 | 09/07→ | | | | ZSE143 →03/10 |
| 1.4 16V | 4 | EP3 | 70/94 | 09/07→ | Z320 | 1.0 | | ZSE143 →03/10 |

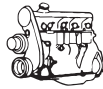

kW/BHP

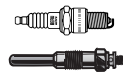
**... PEUGEOT****... 308**

| | | | | | | | | |
|-------------|---|-----------------|----------------|--------|------------------------------|--|-----|-------------------------|
| 1.4 16V | 4 | | 72/97 | 12/09→ | Z320 | | 1.0 | ZSE143 04/10→ |
| 1.4 16V LPG | 4 | EP3 | 70/94 | 09/07→ | Z320 ^[168] | | 1.0 | |
| 1.4 16V LPG | 4 | | 72/97 | 12/09→ | Z320 ^[168] | | 1.0 | |
| 1.6 16V | 4 | EP6 | 88/118 | 09/07→ | Z320 | | 1.0 | ZSE143 |
| 1.6 16V | 4 | 5FT (EP6DT) | 103/138 | 09/07→ | Z332 | | 0.7 | ZSE143 |
| 1.6 16V | 4 | 5FX (EP6DT) | 110/148 | 09/07→ | Z332 | | 0.7 | ZSE143 |
| 1.6 16V | 4 | EP6CDT | 115/154 | 10/09→ | Z332 | | 0.7 | ZSE143 |
| 1.6 16V | 4 | 5FY (EP6DTS) | 128/172 | 03/08→ | Z332 | | 0.7 | ZSE143 |
| 1.6 16V LPG | 4 | EP6 | 88/118 | 09/07→ | Z233 ^[168] | | 1.0 | |
| 1.6 GTi | 4 | EP6CDTX | 147/197 | 07/10→ | | | | ZSE143 |
| 1.6 HDi | 4 | | 66/89 | 09/07→ | GN056 | | 11V | |
| 1.6 HDi | 4 | 9HP (DV6DTED) | 68/91 | 11/09→ | GE121A | | 5V | |
| 1.6 HDi | 4 | 9HZ (DV6TED4) | 80/107 | 09/07→ | GN056 | | 11V | |
| 1.6 HDi | 4 | 9HR (DV6C) | 82/110 | 12/09→ | GE121A | | 5V | |
| 1.6 HDi | 4 | | 84/113 | 03/13→ | GE121A | | 5V | |
| 2.0 HDi | 4 | RHR (DW10BTED4) | 100/134 | 09/07→ | GN054 | | 11V | |
| 2.0 HDi | 4 | RHR (DW10BTED4) | 103/138 | 07/10→ | GN054 | | 11V | |
| 2.0 HDi | 4 | RHE (DW10CTED4) | 110/148 | 10/11→ | GE121A | | 5V | |
| 2.0 HDi | 4 | RHH (DW10CTED4) | 120/161 | 04/12→ | GE121A | | 5V | |

308 II

| | | | | | | | | |
|-------------|---|--|----------------|--------|---------------|--|----|--|
| 1.6 HDi | 4 | | 68/91 | 09/13→ | GE121A | | 5V | |
| 1.6 HDi | 4 | | 85/114 | 09/13→ | GE121A | | 5V | |
| 1.6 HDi 100 | 4 | | 73/98 | 04/14→ | GE121A | | 5V | |
| 1.6 HDi 120 | 4 | | 88/118 | 11/13→ | GE121A | | 5V | |
| 2.0 HDi 150 | 4 | | 110/148 | 11/13→ | GE121A | | 5V | |

308 CC

| | | | | | | | | |
|-------------|---|-----------------|----------------|--------|------------------------------|--|-----|---------------|
| 1.6 16V | 4 | EP6 | 88/118 | 06/09→ | Z320 | | 1.0 | ZSE143 |
| 1.6 16V | 4 | 5FT (EP6DT) | 103/138 | 06/09→ | Z332 | | 0.7 | ZSE143 |
| 1.6 16V | 4 | 5FX (EP6DT) | 110/148 | 06/09→ | Z332 | | 0.7 | ZSE143 |
| 1.6 16V | 4 | EP6CDT | 115/154 | 06/09→ | Z332 | | 0.7 | ZSE143 |
| 1.6 16V LPG | 4 | EP6 | 88/118 | 06/09→ | Z233 ^[168] | | 1.0 | |
| 1.6 HDi | 4 | 9HR (DV6C) | 82/110 | 06/09→ | GE121A | | 5V | |
| 1.6 HDi | 4 | | 84/113 | 03/13→ | GE121A | | 5V | |
| 2.0 HDi | 4 | RHR (DW10BTED4) | 100/134 | 04/09→ | GN054 | | 11V | |
| 2.0 HDi | 4 | RHF (DW10BTED4) | 103/138 | 04/09→ | GN054 | | 11V | |
| 2.0 HDi | 4 | RHH (DW10CTED4) | 120/161 | 06/09→ | GE121A | | 5V | |

308 SW

| | | | | | | | | |
|-------------|---|-----------------------------------|----------------|--------|------------------------------|--|-----|------------------------------|
| 1.4 16V | 4 | 8FS (EP3) | 70/94 | 09/07→ | Z320 | | 1.0 | ZSE143 05/08→03/10 |
| 1.4 16V | 4 | | 72/97 | 12/09→ | Z320 | | 1.0 | ZSE143 |
| 1.4 16V LPG | 4 | 8FS (EP3) | 70/94 | 09/07→ | Z320 ^[168] | | 1.0 | |
| 1.4 16V LPG | 4 | | 72/97 | 12/09→ | Z320 ^[168] | | 1.0 | |
| 1.6 16V | 4 | EP6 | 88/118 | 09/07→ | Z320 | | 1.0 | ZSE143 05/08→ |
| 1.6 16V | 4 | 5FT (EP6DT) | 103/138 | 09/07→ | Z332 | | 0.7 | ZSE143 |
| 1.6 16V | 4 | 5FX (EP6DT) | 110/148 | 09/07→ | Z332 | | 0.7 | ZSE143 |
| 1.6 16V | 4 | EP6CDT | 115/154 | 10/09→ | Z332 | | 0.7 | ZSE143 |
| 1.6 16V | 4 | 5FY (EP6DTS) | 128/172 | 03/08→ | Z332 | | 0.7 | ZSE143 |
| 1.6 16V LPG | 4 | EP6 | 88/118 | 09/07→ | Z233 ^[168] | | 1.0 | |
| 1.6 Bioflex | 4 | NFU (TU5JP4) | 82/110 | 03/09→ | | | | ZSE045 |
| 1.6 HDi | 4 | 9HV (DV6ATED4), 9HX (DV6ATED4) | 66/89 | 09/07→ | GN056 | | 11V | |
| 1.6 HDi | 4 | 9HP (DV6DTED) | 68/91 | 11/09→ | GE121A | | 5V | |
| 1.6 HDi | 4 | 9HZ (DV6TED4) | 80/107 | 09/07→ | GN056 | | 11V | |
| 1.6 HDi | 4 | 9HR (DV6C) | 82/110 | 12/09→ | GE121A | | 5V | |
| 1.6 HDi | 4 | | 84/113 | 03/13→ | GE121A | | 5V | |
| 2.0 Bioflex | 4 | RFJ (EW10A) | 103/138 | 01/08→ | Z223 | | 0.9 | UXT13 |



kW/BHP

**... PEUGEOT****... 308 SW**

| | | | | | | | | |
|---------|---|-----------------|---------|--------|--------|-----|--|--|
| 2.0 HDi | 4 | RHR (DW10BTD4) | 100/134 | 09/07→ | GN054 | 11V | | |
| 2.0 HDi | 4 | RHR (DW10BTD4) | 103/138 | 09/07→ | GN054 | 11V | | |
| 2.0 HDi | 4 | RHE (DW10CTED4) | 110/148 | 04/11→ | GE121A | 5V | | |
| 2.0 HDi | 4 | RHH (DW10CTED4) | 120/161 | 06/09→ | GE121A | 5V | | |

308 SW II

| | | | | | | | | |
|-------------|---|--|---------|--------|--------|----|--|--|
| 1.6 HDi 92 | 4 | | 68/91 | 03/14→ | GE121A | 5V | | |
| 1.6 HDi 100 | 4 | | 73/98 | 04/14→ | GE121A | 5V | | |
| 1.6 HDi 115 | 4 | | 85/114 | 03/14→ | GE121A | 5V | | |
| 1.6 HDi 120 | 4 | | 88/118 | 03/14→ | GE121A | 5V | | |
| 2.0 HDi 150 | 4 | | 110/148 | 03/14→ | GE121A | 5V | | |

309 I

| | | | | | | | | | |
|---------|---|-------------------------|--------|-------------|--|------------|--|--|-------|
| 1.1 | 4 | E1 | 40/54 | 10/85→07/89 | Z247 | 0.9 | UXT1 / UXT3 | ZS257 | ZM001 |
| 1.3 | 4 | G1A | 47/63 | 10/85→07/89 | Z247 | 0.9 | UXT1 / UXT3 | ZS115 [1][11] →01/88 ZS257 [1] 01/88→ | ZM001 |
| 1.4 | 4 | K1D (TU3A) | 49/66 | 03/89→07/89 | Z247 | 0.9 | UXT1 / UXT3 | ZS247 | ZM003 |
| 1.4 | 4 | KDY (TU3M), KDZ (TU3M) | 55/74 | 03/89→07/89 | Z255 | 0.9 | UXT1 / UXT3 | ZS247 | |
| 1.4 | 4 | K2B (TU3S) | 62/83 | 03/89→07/89 | Z24 | 0.8 | UXT5 | ZS247 | ZM003 |
| 1.4 LPG | 4 | KDY (TU3M), KDZ (TU3M) | 55/74 | 03/89→07/89 | Z206 | 0.7 | UXT10 | | |
| 1.5 | 4 | Y2/K | 63/84 | 06/87→12/89 | | | | ZS115 [1][11] →12/87 ZS117 [1] →12/87 ZS120 [1] →12/87 ZS257 [1] 01/88→ | |
| 1.6 | 4 | B1E (XU51C) | 53/71 | 08/87→07/89 | Z247 | 0.9 | UXT1 / UXT3 | ZS115 [1][11] ZS117 [1][254] ZS120 [1][214][254] | ZM001 |
| 1.6 | 4 | B1A (XU51C) | 55/74 | 10/85→07/89 | Z17 [167] →07/87 Z13 [170] 08/87→ | 0.8 0.8 | UXT4 →07/87 UXT1 / UXT3 08/87→ | ZS115 [1][11] ZS117 [1][254] ZS120 [1][214][254] | ZM003 |
| 1.6 | 4 | BAZ (XU5CP) | 55/74 | 09/86→12/89 | | | | ZS115 [1][11] ZS117 [1][254] ZS120 [1][214][254] | |
| 1.6 | 4 | | 59/79 | 10/85→07/89 | | | | ZS115 [1][11] ZS117 [1][254] ZS120 [1][214][254] | |
| 1.6 | 4 | | 69/93 | 01/86→07/89 | | | | ZS257 | |
| 1.6 | 4 | 180Z (XU5J), B6B (XU5J) | 76/102 | 11/85→09/88 | Z25 →07/87 Z24 08/87→ | 0.8 0.8 | UXK56 →07/87 UXT5 08/87→ | ZS247 04/86→ | ZM001 |
| 1.9 | 4 | DFZ (XU9J1) | 72/97 | 03/86→07/89 | Z17 →07/87 Z247 08/87→ | 0.8 0.9 | UXT4 →07/87 UXT1 / UXT3 08/87→ | ZS115 [1][11] ZS117 [1][254] ZS120 [1][214][254] | ZM001 |
| 1.9 | 4 | D2B (XU9S) | 75/101 | 10/85→07/89 | Z25 →07/87 Z247 08/87→ | 0.8 0.9 | UXK56 →07/87 UXT1 / UXT3 08/87→ | ZS115 [1][11] ZS117 [1][254] ZS120 [1][214][254] | |
| 1.9 | 4 | DDZ (XU9M) | 80/107 | 07/88→07/89 | Z247 | 0.9 | UXT1 / UXT3 | | |
| 1.9 D | 4 | 162 (XUD9), D9A (XUD9) | 47/63 | 06/86→07/89 | GN909 [2][222] GV636 | 11V 11V | | | GR065 |



kW/BHP

**... PEUGEOT****... 309 I**

| | | | | | | | | | | |
|---------|---|--------------|--------|-------------|------|--|-----|-------------|--|-------|
| 1.9 GTI | 4 | DKZ (XU9JAZ) | 88/118 | 07/88→07/89 | Z247 | | 0.9 | UXT1 / UXT3 | ZS115 [1][11] ZS117 [1][254] ZS120 [1][214][254] | |
| 1.9 GTI | 4 | D6B (XU9JA) | 94/126 | 10/86→07/89 | Z193 | | 0.9 | UXT1 / UXT3 | | ZM001 |

309 II

| | | | | | | | | | | |
|--------------|---|---|---------|-------------|-------------------------|-------|------------|-------------|--|-----------------|
| 1.1 | 4 | HDZ (TU1M) | 44/59 | 08/90→12/93 | Z193 | | 0.9 | UXT1 / UXT3 | ZS247 [175][181] [254] ZS257 [193][254] | ZM003 10/90→ |
| 1.4 | 4 | K1D (TU3A) | 49/66 | 07/90→12/93 | Z193 | | 0.9 | UXT1 / UXT3 | ZS247 | |
| 1.4 | 4 | KDY (TU3M), KDZ (TU3M) | 55/74 | 07/89→12/93 | Z193 | | 0.9 | UXT1 / UXT3 | ZS247 | ZM003 06/90→ |
| 1.6 | 4 | BDY, BDZ | 65/87 | 07/89→12/93 | Z193 | | 0.9 | UXT1 / UXT3 | | |
| 1.6 | 4 | BDY (XU5M2Z), BDY (XU5M3Z), BDZ (XU5M) | 65/87 | 07/89→12/93 | | | | | ZS232 | |
| 1.6 | 4 | B2A (XU52C/K) | 68/91 | 07/89→12/93 | Z247 | | 0.9 | UXT1 / UXT3 | ZS257 | ZM003 |
| 1.6 | 4 | B2A (XU52C/K) | 69/93 | 07/89→12/93 | Z247 | | 0.9 | UXT1 / UXT3 | ZS257 | ZM003 |
| 1.8 Diesel | 4 | 161A (XUD7) | 44/59 | 07/89→12/93 | GN909 [2][222] GV636 | GR065 | 11V 11V | | | |
| 1.8 TD | 4 | A8B (XUD7TE) | 57/76 | 08/89→12/93 | GN909 [2][222] GV636 | GR065 | 11V 11V | | | |
| 1.9 | 4 | DFZ (XU9J1) | 72/97 | 08/89→12/93 | Z247 | | 0.9 | UXT1 / UXT3 | ZS115 [1][11] →ch. 10561562 ZS117 [1] →ch. 10561562 ZS120 [1] →ch. 10561562 | ZM001 |
| 1.9 | 4 | DDZ (XU9M) | 80/107 | 10/90→12/93 | Z247 | | 0.9 | UXT1 / UXT3 | | |
| 1.9 Diesel | 4 | 162 (XUD9), D9A (XUD9), DJZ (XUD9Y) | 47/63 | 07/89→12/93 | GN909 [2][222] GV636 | GR065 | 11V 11V | | | |
| 1.9 GTI | 4 | DKZ (XU9JAZ) | 88/118 | 07/89→12/93 | Z193 | | 0.9 | UXT1 / UXT3 | ZS247 01/91→ | ZM001 |
| 1.9 GTI 16V | 4 | DFW (XU9J4Z) | 108/145 | 10/90→12/93 | Z60 | | 1.2 | | ZS257 | ZM001 |
| 1.9 GTI 16V | 4 | D6C (XU9J4) | 116/156 | 08/89→07/90 | Z60 | | 1.2 | | ZS257 | ZM001 |
| 404 | | | | | | | | | | |
| 1.6 | 4 | XC6 | 48/64 | 04/63→12/71 | Z11 [168] | | 0.8 | UXT2 / UXT6 | | |
| 1.6 | 4 | XC6 | 54/72 | 11/67→12/71 | Z11 [168] | | 0.8 | UXT2 / UXT6 | | |
| 1.6 | 4 | XC6 | 59/79 | 04/63→12/68 | Z11 [168] | | 0.8 | UXT2 / UXT6 | | |
| 1.6 GT | 4 | XC6 | 50/67 | 07/71→12/71 | Z11 [168] | | 0.8 | UXT2 / UXT6 | | |
| 405 I | | | | | | | | | | |
| 1.4 | 4 | K5A (TU3) | 47/63 | 01/87→07/92 | Z193 | | 0.9 | UXT1 / UXT3 | ZS247 | |
| 1.6 | 4 | B1E (XU51C) | 53/71 | 07/87→12/92 | Z247 Z335 [17] | | 0.9 0.9 | UXT1 / UXT3 | ZS257 | |
| 1.6 | 4 | B1E (XU51C) | 53/71 | 10/88→08/92 | | | | | | ZM003 |
| 1.6 | 4 | B1E (XU51C) | 55/74 | 07/87→06/88 | Z247 Z335 [17] | | 0.9 0.9 | UXT1 / UXT3 | ZS257 | ZM003 |
| 1.6 | 4 | BAZ | 55/74 | 07/87→06/88 | Z63 [170] | | 0.8 | UXT1 / UXT3 | | |
| 1.6 | 4 | BAZ (XU5CP) | 55/74 | 07/87→06/88 | Z335 [17] | | 0.9 | | | |
| 1.6 | 4 | BAZ (XU5CP) | 55/74 | 07/87→08/92 | | | | | ZS257 | ZM003 |
| 1.6 | 4 | BAZ (XU5CP) | 55/74 | 10/88→08/92 | Z247 Z335 [17] | | 0.9 0.9 | UXT1 / UXT3 | | |
| 1.6 | 4 | BDY, BDZ | 65/87 | 10/88→08/92 | Z193 | | 0.9 | UXT1 / UXT3 | | |
| 1.6 | 4 | BDY (XU5M2Z), BDZ (XU5M) | 65/87 | 07/87→12/92 | Z193 | | 0.9 | UXT1 / UXT3 | ZS257 →ch. -77119980 | ZM003 |
| 1.6 | 4 | BDY (XU5M2Z), BDY (XU5M3Z), BDZ (XU5M) | 65/87 | 10/88→08/92 | | | | | ZS257 →09/90 ZS232 10/90→ | |



kW/BHP



... PEUGEOT



... 405 I

| | | | | | | | | | | |
|------------------|---|-----------------------------|---------|-------------|------------------------------------|-----------------|------------|-------------|---|-------|
| 1.6 | 4 | BDZ (XU5M) | 66/89 | 10/88→08/92 | Z247 Z335 ^[17] | | 0.9 0.9 | UXT1 / UXT3 | ZS257 | |
| 1.6 | 4 | BDZ (XU5M) | 66/89 | 10/88→12/92 | | | | | | ZM003 |
| 1.6 | 4 | BDZ (XU5M) | 66/89 | 10/89→12/92 | Z193 | | 0.9 | UXT1 / UXT3 | ZS257 →ch. 70119980 | |
| 1.6 | 4 | B2A (XU52C/K) | 68/91 | 05/88→07/92 | | | | | ZS257 | |
| 1.6 | 4 | B2A (XU52C/K) | 69/93 | 01/87→12/92 | Z193 | | 0.9 | UXT1 / UXT3 | ZS257 | |
| 1.8 GLD | 4 | | 44/59 | 04/90→07/92 | GN013 | | 11V | | | |
| 1.8 TD | 4 | A8A (XUD7TE), AJZ (XUD7TEY) | 66/89 | 10/88→08/92 | GN909 ^{[2][222]} GV636 | GR065 | 11V 11V | | | |
| 1.8 Turbo Diesel | 4 | A8A (XUD7TE), AJZ (XUD7TEY) | 66/89 | 03/88→12/92 | GN909 ^{[2][222]} GV636 | GR065 | 11V 11V | | | |
| 1.9 | 4 | D2C (XU92C) | 70/94 | 07/87→12/92 | Z193 | | 0.9 | UXT1 / UXT3 | ZS257 | ZM003 |
| 1.9 | 4 | D2C (XU92C) | 70/94 | 10/88→08/92 | Z247 Z335 ^[17] | | 0.9 0.9 | UXT1 / UXT3 | | |
| 1.9 | 4 | DFZ (XU9J1) | 72/97 | 05/88→07/92 | Z247 Z335 ^[17] | | 0.9 0.9 | UXT1 / UXT3 | ZS257 | ZM003 |
| 1.9 | 4 | DFZ (XU9J1) | 77/103 | 09/88→08/92 | Z247 Z335 ^[17] | | 0.9 0.9 | UXT1 / UXT3 | ZS115 ^{[1][11]} ZS117 ^{[1][254]} ZS120 ^{[1][214][254]} | ZM003 |
| 1.9 | 4 | DDZ (XU9M) | 80/107 | 07/88→12/92 | Z15 | | 0.8 | UXT1 / UXT3 | ZS257 | ZM003 |
| 1.9 | 4 | DDZ (XU9M) | 80/107 | 10/88→08/92 | Z247 Z335 ^[17] | | 0.9 0.9 | UXT1 / UXT3 | | |
| 1.9 4WD | 4 | DDZ (XU9M) | 80/107 | 07/88→12/92 | Z193 | | 0.9 | UXT1 / UXT3 | | ZM003 |
| 1.9 | 4 | DKZ (XU9JAZ) | 88/118 | 07/88→12/92 | Z193 | | 0.9 | UXT1 / UXT3 | ZS257 | ZM003 |
| 1.9 | 4 | DKZ (XU9JAZ) | 88/118 | 10/88→08/92 | Z247 Z335 ^[17] | | 0.9 0.9 | UXT1 / UXT3 | | |
| 1.9 | 4 | D6A (XU9J2) | 90/121 | 01/89→12/92 | Z15 | | 0.8 | UXT1 / UXT3 | ZS232 | |
| 1.9 | 4 | D6A (XU9J2) | 93/125 | 07/87→12/93 | Z193 | | 0.9 | UXT1 / UXT3 | ZS232 | |
| 1.9 4WD | 4 | D6C (XU9J4) | 116/156 | 06/87→07/92 | | | | | ZS257 | |
| 1.9 D | 4 | DJZ (XUD9Y) | 47/63 | 10/88→08/92 | GN909 ^{[2][222]} GV636 | | 11V 11V | | | |
| 1.9 D | 4 | D9B (XUD9A), DJY (XUD9A) | 51/68 | 10/88→08/92 | GN909 ^{[2][222]} GV636 | GR065 →01/92 | 11V 11V | | | |
| 1.9 Diesel | 4 | DJZ (XUD9Y) | 47/63 | 07/88→09/92 | GN909 ^{[2][222]} GV636 | | 11V 11V | | | |
| 1.9 Diesel | 4 | D9B (XUD9A) | 51/68 | 03/88→12/92 | GN909 ^{[2][222]} GV636 | GR065 →01/92 | 11V 11V | | | |
| 1.9 Injection | 4 | DFZ (XU9J1) | 77/103 | 07/87→12/92 | Z193 | | 0.9 | UXT1 / UXT3 | ZS115 ^{[1][11]} ZS117 ^{[1][254]} ZS120 ^{[1][214][254]} | ZM003 |
| 1.9 Sport MI-16 | 4 | DFW (XU9J4Z) | 108/145 | 04/88→12/92 | Z60 | | 1.2 | | ZS257 | ZM003 |
| 1.9 Sport MI-16 | 4 | D6C (XU9J4) | 116/156 | 07/87→11/91 | Z60 | | 1.2 | | ZS257 | ZM003 |

405 II

| | | | | | | | | | | |
|---------|---|---|-------|-------------|------------------------------------|-----------------|------------|-------------|-------|-------|
| 1.4 | 4 | KDX (TU3MC) | 55/74 | 08/92→10/96 | Z193 | | 0.9 | UXT1 / UXT3 | ZS231 | ZM003 |
| 1.4 | 4 | | 58/78 | 07/93→06/94 | | | | | ZS247 | |
| 1.4 LPG | 4 | KDX (TU3MC) | 55/74 | 08/92→10/96 | Z340 | | 0.7 | UXT12 | | |
| 1.6 | 4 | BDY (XU5M2Z), BDY (XU5M3Z), BDZ (XU5M), BFZ (XU5JP) | 65/87 | 08/92→10/96 | Z193 | | 0.9 | UXT1 / UXT3 | ZS232 | ZM003 |
| 1.6 LPG | 4 | BDY (XU5M2Z), BDY (XU5M3Z), BDZ (XU5M), BFZ (XU5JP) | 65/87 | 08/92→10/96 | Z340 | | 0.7 | UXT12 | | |
| 1.8 | 4 | LFZ (XU7JP) | 74/99 | 08/92→10/96 | Z193 | | 0.9 | UXT1 / UXT3 | ZS232 | ZM003 |
| 1.8 LPG | 4 | LFZ (XU7JP) | 74/99 | 08/92→10/96 | Z340 | | 0.7 | UXT12 | | |
| 1.9 D | 4 | DJZ (XUD9Y) | 47/63 | 08/92→10/96 | GN909 | GR054 07/94→ | 11V | | | |
| 1.9 D | 4 | DJY (XUD9A) | 50/67 | 06/94→10/96 | GN909 ^{[2][222]} GV636 | GR065 | 11V 11V | | | |
| 1.9 D | 4 | XUD9 | 51/68 | 08/92→12/95 | GN013 | | 11V | | | |
| 1.9 TD | 4 | DHY (XUD9TE) | 66/89 | 08/92→10/96 | GN909 | | 11V | | | |

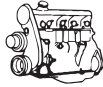

kw/BHP

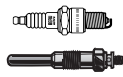

... PEUGEOT



... 405 II

| | | | | | | | | |
|---------------|---|------------------|---------|-------------|-------|-----|-------------|-------------|
| 1.9 TD | 4 | XUD9TE | 69/93 | 08/92→05/97 | GN013 | 11V | | |
| 2.0 | 4 | RFX (XU10J2) | 89/119 | 08/92→10/96 | Z193 | 0.9 | UXT1 / UXT3 | ZS232 ZM003 |
| 2.0 4WD | 4 | RGZ (XU10J4TE/Z) | 144/193 | 08/92→12/95 | Z60 | 1.2 | | ZS232 ZM026 |
| 2.0 4WD | 4 | XU10J4TEZ | 144/193 | 08/92→12/95 | | | | ZS323 |
| 2.0 LPG | 4 | RFX (XU10J2) | 89/119 | 08/92→10/96 | Z340 | 0.7 | UXT12 | |
| 2.0 16V | 4 | RFT (XU10J4) | 110/148 | 06/94→10/95 | Z193 | 0.9 | UXT1 / UXT3 | ZS323 |
| 2.0 16V LPG | 4 | RFT (XU10J4) | 110/148 | 06/94→10/95 | Z340 | 0.7 | UXT12 | |
| 2.0 MI-16 | 4 | RFY (XU10J4Z) | 112/150 | 08/92→10/95 | Z193 | 0.9 | UXT1 / UXT3 | ZS232 ZM026 |
| 2.0 MI-16 LPG | 4 | RFY (XU10J4Z) | 112/150 | 08/92→10/95 | Z340 | 0.7 | UXT12 | |
| 2.0 T 16 4WD | 4 | RGZ (XU10J4TE/Z) | 144/193 | 08/92→10/95 | Z60 | 1.2 | | ZS232 ZM026 |
| 2.0 T 16 4WD | 4 | XU10J4TEZ | 144/193 | 08/92→10/95 | | | | ZS323 |

406

| | | | | | | | | |
|---------------|---|-----------------------------------|---------|-------------|-----------------------|-----|-------------|---|
| 1.6 | 4 | BFZ (XU5JP) | 65/87 | 11/95→05/04 | Z193 | 0.9 | UXT1 / UXT3 | ZS232 |
| 1.6 LPG | 4 | BFZ (XU5JP) | 65/87 | 11/95→05/04 | Z340 | 0.7 | UXT12 | |
| 1.8 | 4 | LFX (XU7JB) | 66/89 | 05/97→10/04 | Z193 | 0.9 | UXT1 / UXT3 | ZS232 |
| 1.8 LPG | 4 | LFX (XU7JB) | 66/89 | 05/97→10/04 | Z340 | 0.7 | UXT12 | |
| 1.8 16V | 4 | LFY (XU7JP4) | 81/109 | 11/95→10/00 | Z193 | 0.9 | UXT1 / UXT3 | ZS256 ^{[84][243]} ZS349 ^{[85][160]} |
| 1.8 16V | 4 | 6FZ (EW7J4) | 85/114 | 10/00→10/04 | Z183 | 0.9 | UXT13 | ZS348 |
| 1.8 16V LPG | 4 | LFY (XU7JP4) | 81/109 | 11/95→10/00 | Z340 | 0.7 | UXT12 | |
| 1.8 16V LPG | 4 | 6FZ (EW7J4) | 85/114 | 10/00→10/04 | Z184 ^[168] | 0.9 | UXT13 | |
| 1.9 D | 4 | DHW (XUD9SD) | 55/74 | 10/96→10/04 | GN013 | | GR034 | 11V |
| 1.9 TD | 4 | DHX (XUD9TE) | 66/89 | 01/96→10/04 | GN909 | | | 11V |
| | | | | →08/98 | GN013 | | | 11V |
| | | | | 09/98→ | | | | |
| 1.9 TD | 4 | DHY (XUD9TE) | 68/91 | 01/96→05/04 | GN909 | | | 11V |
| | | | | →08/98 | GN013 | | | 11V |
| | | | | 09/98→ | | | | |
| 2.0 16V | 4 | RFV (XU10J4R) | 97/130 | 11/95→05/04 | Z247 | 0.9 | UXT1 / UXT3 | |
| 2.0 16V | 4 | RFV (XU10J4R) | 97/130 | 11/95→10/04 | | | | ZS256 →09/97 ZS232 ^{[153][202]} ZS349 09/97→ |
| 2.0 16V | 4 | RFV (XU10J4R) | 97/130 | 10/96→12/04 | Z74 | 1.0 | UXT1 / UXT3 | |
| 2.0 16V | 4 | RFV (XU10J4R) | 97/130 | 03/97→12/04 | | | | ZS256 →09/97 ZS232 ^{[153][202]} ZS349 ^[85] |
| 2.0 16V | 4 | RFR (DEW10J4) | 99/133 | 01/99→10/00 | Z183 | 0.9 | UXT13 | ZS348 04/99→ |
| 2.0 16V | 4 | RFR (DEW10J4) | 99/133 | 01/99→08/00 | | | | ZS348 |
| 2.0 16V | 4 | RFN (EW10J4) | 100/134 | 08/00→12/04 | Z183 | 0.9 | UXT13 | |
| 2.0 16V | 4 | RFN (EW10J4) | 100/134 | 08/00→10/04 | | | | ZS348 |
| 2.0 16V | 4 | RFN (EW10J4) | 100/134 | 10/00→12/04 | | | | ZS348 ZSE165 ^[105] |
| 2.0 16V LPG | 4 | RFV (XU10J4R) | 97/130 | 11/95→05/04 | Z340 | 0.7 | UXT12 | |
| 2.0 16V LPG | 4 | RFV (XU10J4R) | 97/130 | 10/96→12/04 | Z206 | 0.7 | UXT10 | |
| 2.0 16V LPG | 4 | RFR (DEW10J4) | 99/133 | 01/99→10/00 | Z184 ^[168] | 0.9 | UXT13 | |
| 2.0 16V LPG | 4 | RFN (EW10J4) | 100/134 | 08/00→12/04 | Z184 ^[168] | 0.9 | UXT13 | |
| 2.0 16V HPi | 4 | RLZ (EW10D) | 103/138 | 05/01→10/04 | Z242 | 1.0 | | |
| 2.0 HDi 90 | 4 | RHY (DW10TD) | 66/89 | 02/99→10/04 | GN027 | | | 11V |
| 2.0 HDi 110 | 4 | RHS (DW10ATED), RHZ (DW10ATED) | 79/106 | 08/01→10/04 | GN027 | | | 11V |
| 2.0 HDi 110 | 4 | RHZ (DW10ATED) | 80/107 | 06/98→04/04 | GN027 | | | 11V |
| 2.0 Turbo | 4 | RGX (XU10J2TE) | 108/145 | 04/96→10/04 | Z193 | 0.9 | UXT1 / UXT3 | ZS232 |
| 2.0 Turbo LPG | 4 | RGX (XU10J2TE) | 108/145 | 04/96→10/04 | Z340 | 0.7 | UXT12 | |

PEUGEOT

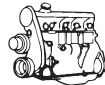

kW/BHP

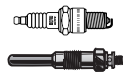

... PEUGEOT



... 406

| | | | | | | | | |
|----------------|---|--------------------|---------|-------------|------------------------------------|----------------|-------|-----------------|
| 2.1 TD 12V | 4 | P8C (XUD11BTE) | 80/107 | 01/96→10/04 | GN909 →08/98 GN013 09/98→ | 11V 11V | | |
| 2.2 | 4 | 3FZ (EW12J4) | 116/156 | 07/00→12/04 | Z183 | 0.9 | UXT13 | ZS351 |
| 2.2 LPG | 4 | 3FZ (EW12J4) | 116/156 | 07/00→12/04 | Z184 [168] | 0.9 | UXT13 | |
| 2.2 HDi | 4 | 4HX (DW12TED4/FAP) | 98/131 | 03/00→12/04 | GN027 [245] GN054 [162] | 11V 11V | | |
| 3.0 24V | 6 | ES9J4/L3 | 140/188 | 10/96→10/04 | | | | ZS343 →12/99 |
| 3.0 24V | 6 | XFZ (ES9J4) | 140/188 | 10/96→10/04 | Z123 | 1.0 | UXT9 | |
| 3.0 24V LPG | 6 | XFZ (ES9J4) | 140/188 | 10/96→10/04 | Z340 | 0.7 | UXT12 | |
| 3.0 V6 | 6 | XFZ (ES9J4S) | 152/204 | 03/00→12/04 | Z235 | 1.0 | | ZS347 |
| 3.0 V6 24V | 6 | ES9J4/L3 | 140/188 | 03/97→12/04 | | | | ZS343 →12/99 |
| 3.0 V6 24V | 6 | XFZ (ES9J4) | 140/188 | 03/97→12/04 | Z123 | 1.0 | UXT9 | |
| 3.0 V6 24V LPG | 6 | XFZ (ES9J4) | 140/188 | 03/97→12/04 | Z340 | 0.7 | UXT12 | |

407

| | | | | | | | | |
|-------------|---|-----------------------------------|---------|--------|----------------------------|------------|-------|--------------------------|
| 1.6 HDi 110 | 4 | 9HZ (DV6TED4) | 80/107 | 05/04→ | GN047 [249] GN056 [158] | 11V 11V | | |
| 1.8 | 4 | 6FZ (EW7J4) | 85/114 | 05/04→ | Z223 | 0.9 | UXT13 | ZS348 ZS351 [90] |
| 1.8 16V | 4 | 6FY (EW7A) | 92/123 | 09/05→ | | | | ZS352 |
| 2.0 | 4 | RFN (EW10J4) | 100/134 | 05/04→ | Z223 | 0.9 | UXT13 | ZS348 |
| 2.0 16V | 4 | RFJ (EW10A) | 103/138 | 09/05→ | Z223 | 0.9 | UXT13 | ZS352 01/06→ |
| 2.0 Bioflex | 4 | RFJ (EW10A) | 103/138 | 09/07→ | Z223 | 0.9 | UXT13 | |
| 2.0 HDi | 4 | RHR (DW10BTE4) | 100/134 | 10/05→ | GN054 | 11V | | |
| 2.0 HDi | 4 | RHF (DW10BTE4), RHR (DW10BTE4) | 103/138 | 08/08→ | GN054 | 11V | | |
| 2.0 HDi | 4 | RHE (DW10CTED4) | 110/148 | 02/10→ | GE121A | 5V | | |
| 2.0 HDi | 4 | RHH (DW10CTED4) | 120/161 | 06/09→ | GE121A | 5V | | |
| 2.0 HDi 135 | 4 | RHR (DW10BTE4) | 100/134 | 05/04→ | GN054 | 11V | | |
| 2.2 | 4 | 3FZ (EW12J4) | 116/156 | 05/04→ | Z223 | 0.9 | UXT13 | ZS351 |
| 2.2 16V | 4 | 3FY (EW12J4) | 120/161 | 09/05→ | Z183 | 0.9 | UXT13 | ZS351 [90] ZS353 [91] |
| 2.2 HDi | 4 | 4HP (DW12BTE4) | 120/161 | 06/08→ | GN063 | 11V | | |
| 2.2 HDi 170 | 4 | 4HT (DW12BTE4) | 125/168 | 05/06→ | GN063 | 11V | | |
| 2.7 HDi | 6 | UHZ (DT17) | 150/201 | 10/05→ | GN045 | 11V | | |
| 3.0 | 6 | XFV (ES9A) | 155/208 | 05/04→ | Z211 | 1.4 | | ZS347 |
| 3.0 V6 | 6 | XFV (ES9A) | 155/208 | 10/05→ | Z211 | 1.4 | | ZS347 |

504

| | | | | | | | | |
|---------------|---|-----------|-------|-------------|---|-------------------------|-------------|--|
| 1.6 | 4 | XC7P | 46/62 | 01/80→06/87 | | | | ZS115 [1][11] ZS117 [1][254] ZS120 [1][214][254] |
| 1.8 | 4 | XM7 | 54/72 | 04/71→07/86 | Z11 [168] | 0.8 | UXT2 / UXT6 | |
| 1.8 | 4 | XM7 | 58/78 | 01/71→06/83 | Z11 [168] | 0.8 | UXT2 / UXT6 | ZS115 [11] |
| 1.8 | 4 | XM | 60/80 | 07/68→02/71 | Z11 [168] | 0.8 | UXT2 / UXT6 | |
| 1.8 Injection | 4 | KF5, KF6 | 71/95 | 07/68→02/71 | Z42 | 0.8 | UX56 | |
| 1.9 D | 4 | XD4x88 | 40/54 | 03/73→07/86 | GV107 →05/78 GN909 [222] 06/78→ GV602 06/78→ | 10.5V 11V 11V | | |
| 1.9 D | 4 | XD4x88 | 40/54 | 01/80→12/89 | GN909 [2][222] GV602 | 11V 11V | | |
| 2.0 | 4 | XN1 | 68/91 | 04/71→07/86 | Z11 [168] | 0.8 | UXT2 / UXT6 | ZM001 |
| 2.0 | 4 | 106 (XN1) | 71/95 | 03/71→06/86 | Z11 [168] | 0.8 | UXT2 / UXT6 | ZS106 [11] ZM001 |



kW/BHP

**... PEUGEOT****... 504**

| | | | | | | | | | |
|--------|---|-----------|--------|-------------|---|---|---|--|--|
| 2.0 TI | 4 | 107 (XN2) | 78/105 | 01/71→06/83 | Z42 →08/75 Z11 [168] 09/75→ | | 0.8 UX56 →08/75 0.8 UXT2 / UXT6 09/75→ | | |
| 2.1 D | 4 | XD90 | 43/58 | 09/79→08/82 | GN954 | | 11V | | |
| 2.1 D | 4 | XD4x90 | 48/64 | 02/71→07/86 | GV108 →05/78 GV602 06/78→04/81 GN909 [222] 06/78→ GV636 05/81→ | GR059 06/78→04/81 GR065 05/81→ | 9.5V 11V 11V 11V | | |
| 2.1 D | 4 | | 49/66 | 09/79→08/82 | GN954 | | 11V | | |
| 2.3 D | 4 | 134 (XD2) | 51/68 | 07/75→07/86 | GV108 →05/78 GV602 06/78→04/81 GN909 [222] 06/78→ GV636 05/81→ | GR059 06/78→04/81 GR065 05/81→ | 9.5V 11V 11V 11V | | |
| 2.3 D | 4 | 134 (XD2) | 51/68 | 01/80→12/89 | GV602 →04/81 GN909 [2][222] GV636 05/81→ | GR059 →04/81 GR065 05/81→ | 11V 11V 11V | | |

505

| | | | | | | | | | |
|------------|---|-------------|--------|-------------|------------------|--|------------------------|---|--------------|
| 1.8 | 4 | 105 (XM7) | 55/74 | 06/81→10/85 | Z11 [168] | | 0.8 UXT2 / UXT6 | ZS110 [15] | ZM001 |
| 1.8 | 4 | 105 (XM7) | 60/80 | 01/82→10/85 | Z11 [168] | | 0.8 UXT2 / UXT6 | ZS110 [15] | ZM001 |
| 1.8 | 4 | 105C (XM7A) | 62/83 | 09/85→10/86 | Z11 [168] | | 0.8 UXT2 / UXT6 | | |
| 1.8 | 4 | XM7A | 62/83 | 09/85→10/86 | | | | | ZM001 |
| 2.0 | 4 | 106 (XN1) | 69/93 | 08/83→12/85 | Z11 [168] | | 0.8 UXT2 / UXT6 | ZS110 [15] | ZM001 |
| 2.0 | 4 | XN1 | 69/93 | 09/83→09/85 | | | | ZS115 [1][11] ZS117 [1][254] ZS120 [1][214][254] | |
| 2.0 | 4 | 106 (XN1) | 71/95 | 11/80→12/85 | Z11 [168] | | 0.8 UXT2 / UXT6 | ZS110 [15] | ZM001 |
| 2.0 | 4 | 106E (XN1A) | 72/97 | 09/85→09/95 | Z11 [168] | | 0.8 UXT2 / UXT6 | ZS110 [15] | ZM001 |
| 2.0 | 4 | 106E (XN1A) | 72/97 | 09/85→11/87 | | | | ZS115 [1][11] ZS117 [1][254] ZS120 [1][214][254] | |
| 2.0 | 4 | XN1 | 79/106 | 09/80→11/82 | | | | ZS115 [1][11] ZS117 [1][254] ZS120 [1][214][254] | |
| 2.0 TI,STI | 4 | 829 (ZEJ) | 81/109 | 08/79→10/86 | Z25 | | 0.8 UXK56 | ZS115 [1][11] ZS117 [1][254] ZS120 [1][214][254] | ZM001 |
| 2.2 | 4 | 851X (ZDJL) | 84/113 | 01/86→12/93 | Z25 | | 0.8 UXK56 | ZS115 [1][11] ZS117 [1][254] ZS120 [1][214][254] | |
| 2.2 | 4 | 851X (ZDJL) | 84/113 | 03/86→12/93 | | | | | ZM001 |
| 2.2 | 4 | 851 (ZDJ) | 85/114 | 05/81→10/84 | Z25 | | 0.8 UXK56 | ZS115 [1][11] ZS117 [1][254] ZS120 [1][214][254] | ZM001 |
| 2.2 GTI | 4 | 851B (ZDJL) | 90/121 | 08/83→12/93 | Z25 | | 0.8 UXK56 | ZS115 [1][11] ZS117 [1][254] ZS120 [1][214][254] | ZM001 |

PEUGEOT



kW/BHP



... PEUGEOT



... 505

| | | | | | | | | | | |
|---------------------|---|-----------------|---------|-------------|--|------------------------------------|-------------------|---------------------|--|-------|
| 2.2 GTI | 4 | | 96/129 | 08/83→12/93 | | | | | ZS115 [1][11] ZS117 [1][254] ZS120 [1][214][254] | |
| 2.2 Turbo | 4 | | 132/177 | 07/85→09/88 | | | | | ZS115 [1][11] ZS117 [1][254] ZS120 [1][214][254] | |
| 2.2 Turbo Injection | 4 | 176X (N9TE) | 110/148 | 01/86→12/87 | | | | | ZS115 [1][11] ZS117 [1][254] ZS120 [1][214][254] | |
| 2.2 Turbo Injection | 4 | 176B (N9TE) | 114/153 | 03/84→10/88 | Z12 [195] Z22 | | 0.8 0.7 | UXT2 / UXT6 UX56 | ZS115 [1][11] ZS117 [1][254] ZS120 [1][214][254] | ZM001 |
| 2.2 Turbo Injection | 4 | 176W (N9TEA) | 128/172 | 06/87→12/88 | | | | | ZS115 [1][11] ZS117 [1][254] ZS120 [1][214][254] | ZM001 |
| 2.3 D | 4 | XD2 | 51/68 | 06/82→09/84 | GN954 | | 11V | | | |
| 2.3 Diesel | 4 | 147 (XD2S) | 59/79 | 04/82→06/86 | GN909 [2][222] GV636 | GR065 | 11V 11V | | | |
| 2.3 Turbo Diesel | 4 | 147 (XD2S) | 59/79 | 09/80→06/86 | GV602 →08/81 GN909 [2][222] GV636 09/81→ | GR059 →08/81 GR065 09/81→ | 11V 11V 11V | | | |
| 2.5 D | 4 | XD3T | 70/94 | 10/85→08/91 | GN954 | | 11V | | | |
| 2.5 Diesel | 4 | 155 (XD3) | 51/68 | 10/81→12/93 | GN909 [2][222] GV636 | GR065 | 11V 11V | | | |
| 2.5 Diesel | 4 | 155 (XD3) | 55/74 | 06/81→12/93 | GN909 [2][222] GV636 | GR065 | 11V 11V | | | |
| 2.5 Turbo Diesel | 4 | 152A (XD3T) | 66/89 | 10/83→12/93 | GN909 [2][222] GV636 | GR065 | 11V 11V | | | |
| 2.5 Turbo Diesel | 4 | XD3T | 70/94 | 10/83→12/90 | GN909 [2][222] GV636 | GR065 | 11V 11V | | | |
| 2.5 Turbo Diesel | 4 | 152B (XD3TE) | 77/103 | 10/86→12/93 | GN909 [2][222] GV636 | | 11V 11V | | | |
| 2.8 GTI V6 | 6 | 154X (ZN3J) | 105/141 | 06/86→12/93 | | | | | ZS119 | ZM015 |
| 508 | | | | | | | | | | |
| 1.6 HDi | 4 | 9HR (DV6C) | 82/110 | 11/10→ | GE121A | | 5V | | | |
| 1.6 HDi | 4 | 9HD (DV6CTED) | 84/113 | 02/12→ | GE121A | | 5V | | | |
| 1.6 THP | 4 | EP6CDT | 115/154 | 11/10→ | | | | | ZSE143 | |
| 1.6 VTi | 4 | | 85/114 | 11/10→ | | | | | ZSE143 | |
| 1.6 VTi | 4 | 5FS (EP6C) | 88/118 | 11/10→ | Z332 | | 0.7 | | ZSE143 | |
| 2.0 HDi | 4 | RHR (DW10BTED4) | 100/134 | 11/10→ | GN054 | | 11V | | | |
| 2.0 HDi | 4 | RHF (DW10BTED4) | 103/138 | 11/10→ | GN054 | | 11V | | | |
| 2.0 HDi | 4 | RHH (DW10CTED4) | 120/161 | 11/10→ | GE121A | | 5V | | | |
| 2.0 HDi 150 | 4 | | 110/148 | 04/14→ | GE121A | | 5V | | | |
| 2.0 HDi 180 | 4 | | 133/178 | 04/14→ | GE121A | | 5V | | | |
| 2.0 HDi Hybrid4 4WD | 4 | RHC (DW10CTED4) | 120/161 | 11/10→ | GE121A | | 5V | | | |
| 2.0 HDi Hybrid4 4WD | 4 | | 147/197 | 11/10→ | GE121A | | 5V | | | |
| 508 SW | | | | | | | | | | |
| 1.6 HDi | 4 | 9HR (DV6C) | 82/110 | 11/10→ | GE121A | | 5V | | | |
| 1.6 HDi | 4 | 9HD (DV6CTED) | 84/113 | 02/12→ | GE121A | | 5V | | | |
| 1.6 THP | 4 | EP6CDT | 115/154 | 11/10→ | | | | | ZSE143 | |
| 1.6 VTi | 4 | 5FS (EP6C) | 88/118 | 11/10→ | Z332 | | 0.7 | | ZSE143 | |
| 2.0 HDi | 4 | RHR (DW10BTED4) | 100/134 | 11/10→ | GN054 | | 11V | | | |
| 2.0 HDi | 4 | RHF (DW10BTED4) | 103/138 | 11/10→ | GN054 | | 11V | | | |
| 2.0 HDi | 4 | RHH (DW10CTED4) | 120/161 | 11/10→ | GE121A | | 5V | | | |
| 2.0 HDi 150 | 4 | | 110/148 | 04/14→ | GE121A | | 5V | | | |
| 2.0 HDi 180 | 4 | | 133/178 | 04/14→ | GE121A | | 5V | | | |
| 2.0 HDi Hybrid4 4WD | 4 | RHC (DW10CTED4) | 120/161 | 11/10→ | GE121A | | 5V | | | |

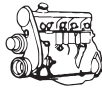

kW/BHP

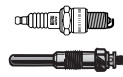
**... PEUGEOT****... 508 SW**

| | | | | | | | | | |
|-------------------------|---|-----------------|---------|--------|--------|--|----|--|--|
| 2.0 HDi RXH Hybrid4 4WD | 4 | RHC (DW10CTED4) | 147/197 | 12/11→ | GE121A | | 5V | | |
|-------------------------|---|-----------------|---------|--------|--------|--|----|--|--|

604

| | | | | | | | | | |
|--------|---|------------|-------|-------------|----------------|--------|-----|--|--|
| 2.3 TD | 4 | 147 (XD2S) | 59/79 | 09/79→05/83 | GV602 | GR059 | 11V | | |
| | | | | | →08/81 | →09/81 | | | |
| | | | | | GN909 [2][222] | GR065 | 11V | | |
| | | | | | GV636 | 10/81→ | 11V | | |
| | | | | | 09/81→ | | | | |

| | | | | | | | | | |
|--------|---|-------------|-------|-------------|----------------|-------|-----|--|--|
| 2.5 TD | 4 | 152A (XD3T) | 66/89 | 08/83→12/86 | GN909 [2][222] | GR065 | 11V | | |
| | | | | | GV636 | | 11V | | |

| | | | | | | | | | |
|--------|---|----------|---------|-------------|-----|--|-----|------|--|
| 2.7 SL | 6 | 112 (ZM) | 100/134 | 08/77→05/83 | Z17 | | 0.8 | UXT4 | |
|--------|---|----------|---------|-------------|-----|--|-----|------|--|

| | | | | | | | | | |
|------------|---|-----------|---------|-------------|-----|--|-----|------|--|
| 2.7 TI,STI | 6 | 140 (ZMJ) | 106/142 | 08/77→05/83 | Z17 | | 0.8 | UXT4 | |
|------------|---|-----------|---------|-------------|-----|--|-----|------|--|

| | | | | | | | | | |
|---------|---|-------------|---------|-------------|-----|--|-----|------|--|
| 2.8 GTI | 6 | 154A (ZMJK) | 110/148 | 09/83→07/87 | Z17 | | 0.8 | UXT4 | |
|---------|---|-------------|---------|-------------|-----|--|-----|------|--|

605

| | | | | | | | | | | |
|-----|---|--|--------|-------------|------|--|-----|-------------|-------|-------|
| 2.0 | 4 | | 79/106 | 02/90→09/99 | Z193 | | 0.9 | UXT1 / UXT3 | ZS258 | ZM003 |
|-----|---|--|--------|-------------|------|--|-----|-------------|-------|-------|

| | | | | | | | | | | |
|-----|---|--------------|--------|-------------|-----|--|-----|------|--|--|
| 2.0 | 4 | R5A (XU102C) | 84/113 | 06/89→09/99 | Z24 | | 0.8 | UXT5 | | |
|-----|---|--------------|--------|-------------|-----|--|-----|------|--|--|

| | | | | | | | | | | |
|-----|---|---------------|--------|-------------|------|--|-----|-------------|-------------|--------|
| 2.0 | 4 | RFZ (XU10J2Z) | 89/119 | 06/89→09/99 | Z193 | | 0.9 | UXT1 / UXT3 | ZS249 | ZM001 |
| | | | | | | | | | →09/90 | →09/90 |
| | | | | | | | | | ZS232 | ZM026 |
| | | | | | | | | 10/90→ | 10/90→06/93 | |

| | | | | | | | | | | |
|---------|---|--|--------|-------------|------|--|-----|-------|--|--|
| 2.0 LPG | 4 | | 79/106 | 02/90→09/99 | Z340 | | 0.7 | UXT12 | | |
|---------|---|--|--------|-------------|------|--|-----|-------|--|--|

| | | | | | | | | | | |
|---------|---|--------------|--------|-------------|-----------|--|-----|------|--|--|
| 2.0 LPG | 4 | R5A (XU102C) | 84/113 | 06/89→09/99 | Z30 [168] | | 0.8 | UXT5 | | |
|---------|---|--------------|--------|-------------|-----------|--|-----|------|--|--|

| | | | | | | | | | | |
|---------|---|---------------|--------|-------------|------|--|-----|-------|--|--|
| 2.0 LPG | 4 | RFZ (XU10J2Z) | 89/119 | 06/89→09/99 | Z340 | | 0.7 | UXT12 | | |
|---------|---|---------------|--------|-------------|------|--|-----|-------|--|--|

| | | | | | | | | | | |
|---------|---|---------------|--------|-------------|------|--|-----|-------------|-----------------|--|
| 2.0 16V | 4 | RFV (XU10J4R) | 97/130 | 07/94→09/99 | Z193 | | 0.9 | UXT1 / UXT3 | ZS256 [84][243] | |
| | | | | | | | | | ZS349 | |
| | | | | | | | | | 09/97→ | |

| | | | | | | | | | | |
|-------------|---|---------------|--------|-------------|------|--|-----|-------|--|--|
| 2.0 16V LPG | 4 | RFV (XU10J4R) | 97/130 | 07/94→09/99 | Z340 | | 0.7 | UXT12 | | |
|-------------|---|---------------|--------|-------------|------|--|-----|-------|--|--|

| | | | | | | | | | | |
|-----------|---|----------------|---------|-------------|------|--|-----|-------------|-------|-------|
| 2.0 Turbo | 4 | RGY (XU10J2TE) | 104/139 | 07/92→09/99 | Z193 | | 0.9 | UXT1 / UXT3 | ZS232 | ZM026 |
|-----------|---|----------------|---------|-------------|------|--|-----|-------------|-------|-------|

| | | | | | | | | | | |
|-----------|---|----------------|---------|-------------|------|--|-----|-------------|-------|-------|
| 2.0 Turbo | 4 | RGX (XU10J2TE) | 108/145 | 07/91→09/99 | Z193 | | 0.9 | UXT1 / UXT3 | ZS232 | ZM026 |
|-----------|---|----------------|---------|-------------|------|--|-----|-------------|-------|-------|

| | | | | | | | | | | |
|---------------|---|----------------|---------|-------------|------|--|-----|-------|--|--|
| 2.0 Turbo LPG | 4 | RGY (XU10J2TE) | 104/139 | 07/92→09/99 | Z340 | | 0.7 | UXT12 | | |
|---------------|---|----------------|---------|-------------|------|--|-----|-------|--|--|

| | | | | | | | | | | |
|---------------|---|----------------|---------|-------------|------|--|-----|-------|--|--|
| 2.0 Turbo LPG | 4 | RGX (XU10J2TE) | 108/145 | 07/91→09/99 | Z340 | | 0.7 | UXT12 | | |
|---------------|---|----------------|---------|-------------|------|--|-----|-------|--|--|

| | | | | | | | | | |
|-------|---|--------------|-------|-------------|----------------|-------|-----|--|--|
| 2.1 D | 4 | P9A (XUD11A) | 60/80 | 06/89→07/95 | GN909 [2][222] | GR065 | 11V | | |
| | | | | | GV636 | | 11V | | |

| | | | | | | | | | |
|------------|---|----------------|--------|-------------|--------|--------|-----|--|--|
| 2.1 TD 12V | 4 | P8C (XUD11BTE) | 80/107 | 08/94→09/99 | GN909 | GR065 | 11V | | |
| | | | | | →08/98 | →08/98 | | | |
| | | | | | GN013 | | 11V | | |
| | | | | | 09/98→ | | | | |

| | | | | | | | | | |
|------------------|---|----------------|--------|-------------|-------|-------|-----|--|--|
| 2.1 Turbo Diesel | 4 | PHZ (XUD11ATE) | 80/107 | 06/89→09/99 | GN909 | GR065 | 11V | | |
|------------------|---|----------------|--------|-------------|-------|-------|-----|--|--|

| | | | | | | | | | |
|------------------|---|--------------|--------|-------------|-------|--|-----|--|--|
| 2.5 Turbo Diesel | 4 | THY (DKSATE) | 95/127 | 07/94→09/99 | GN909 | | 11V | | |
|------------------|---|--------------|--------|-------------|-------|--|-----|--|--|

| | | | | | | | | | | |
|-----|---|-----------|---------|-------------|-----|--|-----|--|--|-------|
| 3.0 | 6 | UFZ (ZPJ) | 123/165 | 10/89→09/99 | Z60 | | 1.2 | | | ZM015 |
|-----|---|-----------|---------|-------------|-----|--|-----|--|--|-------|

| | | | | | | | | | | |
|-----------|---|--------------|---------|-------------|-----|--|-----|--|--|-------|
| 3.0 SV 24 | 6 | UKZ (ZPJ4/Z) | 147/197 | 08/89→09/99 | Z60 | | 1.2 | | | ZM015 |
|-----------|---|--------------|---------|-------------|-----|--|-----|--|--|-------|

| | | | | | | | | | | |
|--------|---|----------|---------|-------------|--|--|--|--|-------|--|
| 3.0 V6 | 6 | ES9J4/L3 | 140/188 | 04/97→09/99 | | | | | ZS343 | |
|--------|---|----------|---------|-------------|--|--|--|--|-------|--|

| | | | | | | | | | | |
|--------|---|-------------|---------|-------------|------|--|-----|-------------|--|-------|
| 3.0 V6 | 6 | XFZ (ES9J4) | 140/188 | 04/97→09/99 | Z193 | | 0.9 | UXT1 / UXT3 | | ZM015 |
|--------|---|-------------|---------|-------------|------|--|-----|-------------|--|-------|

| | | | | | | | | | | |
|------------|---|-------------|---------|-------------|------|--|-----|-------|--|--|
| 3.0 V6 LPG | 6 | XFZ (ES9J4) | 140/188 | 04/97→09/99 | Z340 | | 0.7 | UXT12 | | |
|------------|---|-------------|---------|-------------|------|--|-----|-------|--|--|

| | | | | | | | | | | |
|--|--|--|--|--|--|--|--|--|--|--|
| | | | | | | | | | | |
|--|--|--|--|--|--|--|--|--|--|--|

| | | | | | | | | | | |
|--|--|--|--|--|--|--|--|--|--|--|
| | | | | | | | | | | |
|--|--|--|--|--|--|--|--|--|--|--|

| | | | | | | | | | | |
|--|--|--|--|--|--|--|--|--|--|--|
| | | | | | | | | | | |
|--|--|--|--|--|--|--|--|--|--|--|

| | | | | | | | | | | |
|--|--|--|--|--|--|--|--|--|--|--|
| | | | | | | | | | | |
|--|--|--|--|--|--|--|--|--|--|--|

| | | | | | | | | | | |
|-----|---|--------------|---------|--------|------|--|-----|-------|-------|--|
| 2.0 | 4 | RFN (EW10J4) | 100/134 | 02/00→ | Z223 | | 0.9 | UXT13 | ZS348 | |
|-----|---|--------------|---------|--------|------|--|-----|-------|-------|--|

| | | | | | | | | | | |
|--|--|--|--|--|--|--|--|--|--------|--|
| | | | | | | | | | 05/00→ | |
|--|--|--|--|--|--|--|--|--|--------|--|

| | | | | | | | | | | |
|---------|---|----------------|--------|-------------|-------|--|-----|--|--|--|
| 2.0 HDi | 4 | RHS (DW10ATED) | 79/106 | 03/01→07/04 | GN027 | | 11V | | | |
|---------|---|----------------|--------|-------------|-------|--|-----|--|--|--|

| | | | | | | | | | | |
|---------|---|----------------|--------|--------|-------|--|-----|--|--|--|
| 2.0 HDI | 4 | RHZ (DW10ATED) | 80/107 | 05/00→ | GN027 | | 11V | | | |
|---------|---|----------------|--------|--------|-------|--|-----|--|--|--|

| | | | | | | | | | | |
|---------|---|-----------------|---------|--------|-------|--|-----|--|--|--|
| 2.0 HDI | 4 | RHR (DW10BTED4) | 100/134 | 09/05→ | GN054 | | 11V | | | |
|---------|---|-----------------|---------|--------|-------|--|-----|--|--|--|

| | | | | | | | | | | |
|---------|---|--------------|---------|--------|------|--|-----|--------|--------|--|
| 2.2 16V | 4 | 3FZ (EW12J4) | 116/156 | 02/00→ | Z223 | | 0.9 | UXT13 | ZS351 | |
| | | | | | | | | | 05/00→ | |
| | | | | | | | | | ZS353 | |
| | | | | | | | | 10/04→ | | |

| | | | | | | | | | | |
|---------|---|--------------|---------|--------|------|--|-----|-------|------------|------------|
| 2.2 16V | 4 | 3FY (EW12J4) | 120/161 | 09/05→ | Z223 | | 0.9 | UXT13 | ZS351 [90] | ZS353 [91] |
|---------|---|--------------|---------|--------|------|--|-----|-------|------------|------------|

| | | | | | | | | | | |
|--|--|--|--|--|--|--|--|--|--|--|
| | | | | | | | | | | |
|--|--|--|--|--|--|--|--|--|--|--|

| | | | | | | | | | | |
|---------|---|--------------------|--------|--------|-------------|--|-----|--|--|--|
| 2.2 HDI | 4 | 4HX (DW12TED4/FAP) | 98/131 | 02/00→ | GN027 [245] | | 11V | | | |
| | | | | | GN054 [162] | | 11V | | | |

| | | | | | | | | | | |
|---------|---|-----------------|---------|--------|-------|--|-----|--|--|--|
| 2.2 HDi | 4 | 4HT (DW12BTED4) | 125/168 | 05/06→ | GN063 | | 11V | | | |
|---------|---|-----------------|---------|--------|-------|--|-----|--|--|--|

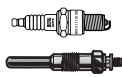

kW/BHP

**... PEUGEOT****... 607**

| | | | | | | | | |
|-------------|---|--------------|---------|--------|-------|-----|-------|--------|
| 2.7 HDi 24V | 6 | DT17TED4 | 150/201 | 12/04→ | GN045 | 11V | | |
| 3.0 V6 24V | 6 | XFV (ES9J4S) | 152/204 | 02/00→ | Z211 | 1.4 | ZS347 | |
| 3.0 V6 24V | 6 | XFV (ES9A) | 155/208 | 03/04→ | Z211 | 1.4 | ZS347 | 10/04→ |

806

| | | | | | | | | |
|---------------|---|-----------------|---------|-------------|-----------------|-----|-------------|--------|
| 1.8 | 4 | LFW (XU7JP) | 73/98 | 07/95→08/02 | Z193 | 0.9 | UXT1 / UXT3 | ZS232 |
| 1.8 LPG | 4 | LFW (XU7JP) | 73/98 | 07/95→08/02 | Z340 | 0.7 | UXT12 | |
| 1.9 TD | 4 | DHX (XUD9TE) | 66/89 | 07/95→08/02 | GN909 | 11V | | |
| | | | | | →08/98 GN013 | 11V | | |
| | | | | | 09/98→ | | | |
| 1.9 TD | 4 | DHY (XUD9TE) | 68/91 | 05/97→08/02 | GN909 | 11V | | |
| | | | | | →08/98 GN013 | 11V | | |
| | | | | | 09/98→ | | | |
| 2.0 | 4 | RFU (XU10J2) | 89/119 | 06/94→08/02 | Z193 | 0.9 | UXT1 / UXT3 | ZS232 |
| 2.0 LPG | 4 | RFU (XU10J2) | 89/119 | 06/94→08/02 | Z340 | 0.7 | UXT12 | |
| 2.0 16V | 4 | RFV (XU10J4R) | 97/130 | 05/98→09/00 | Z193 | 0.9 | UXT1 / UXT3 | ZS349 |
| | | | | | | | | ZM026 |
| | | | | | | | | 10/98→ |
| 2.0 16V | 4 | RFN (EW10J4) | 100/134 | 09/00→08/02 | Z183 | 0.9 | UXT13 | ZS348 |
| | | | | | | | | →05/02 |
| 2.0 16V LPG | 4 | RFV (XU10J4R) | 97/130 | 05/98→09/00 | Z340 | 0.7 | UXT12 | |
| 2.0 16V LPG | 4 | RFN (EW10J4) | 100/134 | 09/00→08/02 | Z184 [168] | 0.9 | UXT13 | |
| 2.0 HDi | 4 | RHZ (DW10ATED) | 80/107 | 08/99→08/02 | GN027 | 11V | | |
| 2.0 HDi 16V | 4 | RHW (DW10ATED4) | 80/107 | 08/99→08/02 | GN027 | 11V | | |
| 2.0 Turbo | 4 | RGX (XU10J2TE) | 108/145 | 06/94→08/02 | Z193 | 0.9 | UXT1 / UXT3 | ZS232 |
| | | | | | | | | ZM026 |
| 2.0 Turbo LPG | 4 | RGX (XU10J2TE) | 108/145 | 06/94→08/02 | Z340 | 0.7 | UXT12 | |
| 2.1 td 12V | 4 | P8C (XUD11BTE) | 80/107 | 06/96→08/99 | GN013 | 11V | | |

807

| | | | | | | | | |
|---------|---|---|---------|-------------|----------------------------|------------|-------|--------|
| 2.0 | 4 | RFN (EW10J4) | 100/134 | 06/02→ | Z223 | 0.9 | UXT13 | ZS348 |
| 2.0 16V | 4 | RFJ (EW10A) | 103/138 | 09/05→ | Z223 | 0.9 | UXT13 | ZS352 |
| | | | | | | | | 02/06→ |
| 2.0 HDi | 4 | RHM (DW10ATED4), RHT (DW10ATED4), RHW (DW10ATED4) | 79/106 | 06/02→ | GN027 [245] GN054 [162] | 11V 11V | | |
| 2.0 HDi | 4 | RHW (DW10ATED4) | 80/107 | 04/04→05/06 | GN027 [245] GN054 [162] | 11V 11V | | |
| 2.0 HDi | 4 | RHK (DW10ATED4) | 88/118 | 02/06→ | GN054 | 11V | | |
| 2.0 HDi | 4 | RHR (DW10ATED4) | 100/134 | 06/06→ | GN054 | 11V | | |
| 2.0 HDi | 4 | RHH (DW10ATED4) | 120/161 | 06/09→ | GE121A | 5V | | |
| 2.2 | 4 | 3FZ (EW12J4) | 116/156 | 06/02→ | Z223 | 0.9 | UXT13 | ZS351 |
| 2.2 HDi | 4 | 4HX (DW12TED4/FAP) | 94/126 | 06/02→ | GN027 [245] GN054 [162] | 11V 11V | | |
| 2.2 HDi | 4 | 4HT (DW12BTED4) | 120/161 | 06/06→ | GN063 | 11V | | |
| 2.2 HDi | 4 | 4HT (DW12BTED4) | 125/168 | 06/06→ | GN063 | 11V | | |
| 3.0 V6 | 6 | XFV (ES9J4S) | 150/201 | 06/02→ | Z211 | 1.4 | | ZS347 |

1007

| | | | | | | | | |
|-------------|---|--------------------------|--------|--------|------------|-----|-------------|----------------------------|
| 1.4 | 4 | KFV (TU3JP) | 54/72 | 04/05→ | Z193 | 0.9 | UXT1 / UXT3 | ZSE047 [13] ZSE048 [10] |
| | | | | | | | | 09/05→ |
| 1.4 LPG | 4 | KFV (TU3JP) | 54/72 | 04/05→ | Z340 | 0.7 | UXT12 | |
| 1.4 16V | 4 | KFU (ET3J4) | 65/87 | 10/05→ | Z243 | 0.9 | | ZS472 |
| 1.4 HDi | 4 | 8HX (DV4TD), 8HZ (DV4TD) | 50/67 | 04/05→ | GN056 | 11V | | |
| 1.6 16V | 4 | NFU (TU5JP4) | 80/107 | 04/05→ | Z184 | 0.9 | UXT13 | ZSE045 |
| 1.6 16V LPG | 4 | NFU (TU5JP4) | 80/107 | 04/05→ | Z226 [168] | 0.8 | | |
| 1.6 HDi | 4 | 9HZ (DV6TED4) | 80/107 | 06/07→ | GN056 | 11V | | |

2008

| | | | | | | | | |
|---------|---|------------|-------|--------|--------|----|--|--|
| 1.4 HDi | 4 | 8HR (DV4C) | 50/67 | 06/13→ | GE121A | 5V | | |
|---------|---|------------|-------|--------|--------|----|--|--|

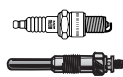

kW/BHP

**... PEUGEOT****... 2008**

| | | | | | | | | |
|---------|---|---------------|--------|--------|--------|----|--|--|
| 1.6 HDi | 4 | 9HP (DV6DTE) | 68/91 | 03/13→ | GE121A | 5V | | |
| 1.6 HDi | 4 | 9HD (DV6CTED) | 84/113 | 03/13→ | GE121A | 5V | | |

3008

| | | | | | | | | |
|---------------------|---|-----------------|---------|--------|--------|-----|--|--------|
| 1.6 HDi | 4 | 9HZ (DV6TED4) | 80/107 | 06/09→ | GN056 | 11V | | |
| 1.6 HDi | 4 | 9HR (DV6C) | 82/110 | 08/10→ | GE121A | 5V | | |
| 1.6 HDi | 4 | 9HD (DV6CTED) | 84/113 | 03/13→ | GE121A | 5V | | |
| 1.6 THP | 4 | 5FX (EP6DT) | 110/148 | 06/09→ | Z332 | 0.7 | | ZSE143 |
| 1.6 THP | 4 | 5FV (EP6DT) | 115/154 | 06/09→ | Z332 | 0.7 | | ZSE143 |
| 1.6 VTi | 4 | 5FS (EP6C), EP6 | 88/118 | 06/09→ | | | | ZSE143 |
| 2.0 HDi | 4 | | 100/134 | 09/11→ | GE121A | 5V | | |
| 2.0 HDi | 4 | RHE (DW10CTED4) | 110/148 | 06/09→ | GE121A | 5V | | |
| 2.0 HDi | 4 | RHH (DW10CTED4) | 120/161 | 06/09→ | GE121A | 5V | | |
| 2.0 HDi Hybrid4 4WD | 4 | RHH (DW10CTED4) | 120/161 | 02/11→ | GE121A | 5V | | |
| 2.0 HDi Hybrid4 4WD | 4 | | 147/197 | 11/11→ | GE121A | 5V | | |

4007

| | | | | | | | | |
|-------------|---|-------------------------------------|---------|--------|-------|-----|--|--|
| 2.2 HDi 4WD | 4 | 4HK (DW12MTED4), 4HN (DW12MTED4) | 115/154 | 02/07→ | GN063 | 11V | | |
|-------------|---|-------------------------------------|---------|--------|-------|-----|--|--|

4008

| | | | | | | | | |
|-------------|---|--|--------|--------|--------|----|--|--|
| 1.6 HDi 4WD | 4 | | 84/113 | 05/12→ | GE121A | 5V | | |
|-------------|---|--|--------|--------|--------|----|--|--|

5008

| | | | | | | | | |
|---------|---|-----------------|---------|--------|--------|-----|--|--------|
| 1.6 16V | 4 | 5FS (EP6C), EP6 | 88/118 | 09/09→ | | | | ZSE143 |
| 1.6 16V | 4 | EP6CDT | 115/154 | 09/09→ | Z332 | 0.7 | | ZSE143 |
| 1.6 HDi | 4 | 9HZ (DV6TED4) | 80/107 | 09/09→ | GN056 | 11V | | |
| 1.6 HDi | 4 | 9HR (DV6C) | 82/110 | 08/10→ | GE121A | 5V | | |
| 1.6 HDi | 4 | 9HD (DV6CTED) | 84/113 | 03/13→ | GE121A | 5V | | |
| 2.0 HDi | 4 | | 100/134 | 02/12→ | GE121A | 5V | | |
| 2.0 HDi | 4 | RHE (DW10CTED4) | 110/148 | 06/09→ | GE121A | 5V | | |
| 2.0 HDi | 4 | RHH (DW10CTED4) | 120/161 | 09/09→ | GE121A | 5V | | |

BIPPER Tepee

| | | | | | | | | |
|------------|---|--------------|-------|--------|-------|------|-------------|------------------------|
| 1.3 HDi 75 | 4 | 199 A9.000 | 55/74 | 10/10→ | GE112 | 4.4V | | |
| 1.4 | 4 | KFV (TU3A) | 54/72 | 04/08→ | Z193 | 0.9 | UXT1 / UXT3 | ZSE048 ^[10] |
| 1.4 LPG | 4 | KFV (TU3A) | 54/72 | 04/08→ | Z340 | 0.7 | UXT12 | |
| 1.4 HDi | 4 | 8HS (DV4TED) | 50/67 | 04/08→ | GN056 | 11V | | |

EXPERT

| | | | | | | | | |
|-------------|---|-----------------------------------|---------|-------------|--|-------|-------------|-------|
| 1.6 | 4 | 222A2 (1580 SPI) | 58/78 | 02/96→ | Z252 | 0.9 | UXT5 | ZS234 |
| 1.6 LPG | 4 | 222A2 (1580 SPI) | 58/78 | 02/96→ | Z30 ^[168] | 0.8 | UXT5 | |
| 1.8 | 4 | LFZ (XU7JP) | 74/99 | 10/96→09/00 | Z193 | 0.9 | UXT1 / UXT3 | ZS232 |
| 1.8 LPG | 4 | LFZ (XU7JP) | 74/99 | 10/96→09/00 | Z340 | 0.7 | UXT12 | |
| 1.9 D | 4 | D9B (XUD9AU) | 51/68 | 02/96→ | GN909 | 11V | | |
| | | | | | →08/98 GN013 | 11V | | |
| | | | | | 09/98→ | | | |
| 1.9 D | 4 | WJY (DW8B), WJZ (DW8) | 51/68 | 12/03→ | GN016 | GR054 | 11V | |
| 1.9 TD | 4 | DHX (XUD9TE) | 66/89 | 02/96→ | GN909 | 11V | | |
| | | | | | →08/98 GN013 | 11V | | |
| | | | | | 09/98→ | | | |
| 1.9 TD | 4 | D8B (XUD9TE) | 68/91 | 02/96→ | GN909 | 11V | | |
| | | | | | →08/98 GN013 | 11V | | |
| | | | | | 09/98→ | | | |
| 2.0 | 4 | RFN (EW10J4) | 100/134 | 07/00→ | Z183 | 0.9 | UXT13 | ZS348 |
| 2.0 LPG | 4 | RFN (EW10J4) | 100/134 | 07/00→ | Z184 ^[168] | 0.9 | UXT13 | |
| 2.0 HDi | 4 | RHX (DW10BTED) | 69/93 | 10/00→11/03 | GN027 | 11V | | |
| 2.0 HDi | 4 | RHZ (DW10ATED), RHZ (DW10BTED) | 80/107 | 07/00→ | GN027 ^[245] GN054 ^[162] | 11V | | |
| 2.0 HDi 16V | 4 | RHW (DW10ATED4) | 80/107 | 07/00→ | GN027 ^[245] GN054 ^[162] | 11V | | |



kW/BHP

**... PEUGEOT****EXPERT Tepee**

| | | | | | | | | |
|----------------|---|---------------------------|---------|--------|--------|-----|-------|-------|
| 1.6 HDi 90 8V | 4 | 9HH (DV6DUM), 9HM (DV6UC) | 66/89 | 01/07→ | GE121A | 5V | | |
| 1.6 HDi 90 16V | 4 | 9HU (DV6UTED4) | 66/89 | 01/07→ | GN056 | 11V | | |
| 2.0 16V | 4 | RFH (EW10A), RFJ (EW10A) | 103/138 | 01/07→ | Z223 | 0.9 | UXT13 | ZS352 |
| 2.0 HDi 100 | 4 | | 72/97 | 03/11→ | GE121A | 5V | | |
| 2.0 HDi 120 | 4 | RHK (DW1OUTED4) | 88/118 | 01/07→ | GN054 | 11V | | |
| 2.0 HDi 130 | 4 | AHZ (DW10CD) | 94/126 | 03/11→ | GE121A | 5V | | |
| 2.0 HDi 140 | 4 | RHR (DW10BTED4) | 100/134 | 01/07→ | GN054 | 11V | | |
| 2.0 HDi 165 | 4 | RHH (DW10CTED4) | 120/161 | 09/09→ | GE121A | 5V | | |

PARTNER

| | | | | | | | | |
|-------------|---|--------------------------|--------|-------------|------------------------------------|------------|-----------------|---|
| 1.1 | 4 | HDZ (TU1M), HFX (TU1JP) | 44/59 | 06/96→ | Z193 | 0.9 | UXT1 / UXT3 | ZS232 |
| 1.1 LPG | 4 | HDZ (TU1M), HFX (TU1JP) | 44/59 | 06/96→ | Z340 | 0.7 | UXT12 | |
| 1.4 | 4 | KFW (TU3JP) | 54/72 | 11/02→10/06 | | | | ZSE047 [13] |
| 1.4 | 4 | KFW (TU3JP) | 55/74 | 06/96→ | Z193 | 0.9 | UXT1 / UXT3 | ZS232 [153][202] ZSE047 [13] 09/00→ ZSE048 [10] 09/05→ |
| 1.4 | 4 | KFX (TU3JP) | 55/74 | 06/96→ | Z193 | 0.9 | UXT1 / UXT3 | ZS381 →08/02 ZS232 [153][202] ZSE047 [13] 09/00→ ZSE048 [10] 09/05→ |
| 1.4 | 4 | TU32 | 55/74 | 06/96→ | | | | ZS232 [153][202] ZSE047 [13] 09/00→ ZSE048 [10] 09/05→ |
| 1.4 LPG | 4 | KFW (TU3JP), KFX (TU3JP) | 55/74 | 06/96→ | Z340 | 0.7 | UXT12 | |
| 1.6 16V | 4 | NFU (TU5JP4) | 80/107 | 07/01→ | Z184 →08/02 | 0.9 | UXT13 →08/02 | ZSE045 |
| 1.6 16V LPG | 4 | NFU (TU5JP4) | 80/107 | 07/01→ | Z226 [168] →08/02 | 0.8 | | |
| 1.6 HDi 75 | 4 | 9HW (DV6BTED4) | 55/74 | 02/06→ | GN056 | 11V | | |
| 1.6 HDi 90 | 4 | 9HX (DV6ATED4) | 66/89 | 02/06→ | GN047 [249] GN056 [158] | 11V 11V | | |
| 1.8 | 4 | LFX (XU7JB) | 66/89 | 05/97→ | Z193 | 0.9 | UXT1 / UXT3 | ZS232 |
| 1.8 LPG | 4 | LFX (XU7JB) | 66/89 | 05/97→ | Z340 | 0.7 | UXT12 | |
| 1.9 D | 4 | DJY (XUD9A) | 50/67 | 06/96→ | GN909 →08/98 GN013 09/98→ | 11V 11V | GR054 →08/98 | |
| 1.9 D | 4 | WJY (DW8B), WJZ (DW8) | 51/68 | 12/98→ | GN016 | 11V | | |
| 1.9 D | 4 | XUD9 | 51/68 | 05/96→12/98 | GN909 | 11V | | |
| 2.0 HDi | 4 | RHY (DW10TD) | 66/89 | 02/00→ | GN027 | 11V | | |

PARTNER Tepee

| | | | | | | | | |
|------------|---|-----------------------------------|--------|--------|----------------------------|------------|--|--------|
| 1.6 | 4 | NFR (TU5JP4B) | 66/89 | 04/08→ | | | | ZSE045 |
| 1.6 | 4 | NFU (TU5JP4) | 80/107 | 04/08→ | | | | ZSE045 |
| 1.6 HDi | 4 | 9HT (DV6BTED4), 9HW (DV6BTED4) | 55/74 | 04/08→ | GN047 [249] GN056 [158] | 11V 11V | | |
| 1.6 HDi | 4 | 9HV (DV6TED4), 9HX (DV6ATED4) | 66/89 | 04/08→ | GN056 | 11V | | |
| 1.6 HDi | 4 | 9HZ (DV6TED4) | 80/107 | 04/08→ | GN047 | 11V | | |
| 1.6 HDi | 4 | 9HL (DV6C) | 82/110 | 08/10→ | GE121A | 5V | | |
| 1.6 HDi | 4 | 9HL (DV6C) | 84/113 | 03/13→ | GE121A | 5V | | |
| 1.6 HDi 90 | 4 | 9HP (DV6DTE) | 68/91 | 04/10→ | GE121A | 5V | | |

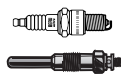

kW/BHP

**... PEUGEOT****RCZ**

| | | | | | | | |
|---------|---|-----------------|---------|--------|--------|-----|--------|
| 1.6 16V | 4 | EP6CDT | 115/154 | 03/10→ | Z332 | 0.7 | ZSE143 |
| 1.6 16V | 4 | EP6CDTX | 147/197 | 06/10→ | | | ZSE143 |
| 2.0 HDi | 4 | RHH (DW10CTED4) | 120/161 | 03/10→ | GE121A | 5V | |

PEUGEOT**106 Van**

| | | | | | | | |
|-------|---|-----------------|-------|-------------|-------|-----|-------------|
| 1.0 | 4 | CDY (TU9M), TU9 | 33/44 | 09/91→03/01 | Z193 | 0.9 | UXT1 / UXT3 |
| 1.5 D | 4 | VJY (TUD5) | 40/54 | 05/96→03/01 | GN016 | 11V | |
| 1.5 D | 4 | VJX (TUD5) | 42/56 | 10/00→03/01 | GN016 | 11V | |

205

| | | | | | | | |
|------------|---|-------------|-------|-------------|-------------------------|------------|--|
| 1.1 | 4 | | 36/48 | 02/83→07/87 | | | ZS115 (1)(11) ZS117 (1)(254) ZS120 (1)(214)(254) |
| 1.1 | 4 | H1B (TU1) | 40/54 | 08/87→07/90 | | | ZS247 (1) |
| 1.4 | 4 | | 44/59 | 02/83→07/87 | | | ZS115 (1)(11) ZS117 (1)(254) ZS120 (1)(214)(254) |
| 1.7 Diesel | 4 | 161A (XUD7) | 44/59 | 03/94→ | GN909 (2)(222) GV636 | 11V 11V | |
| 1.8 D | 4 | A9A (XUD7) | 44/59 | 02/83→07/90 | GN013 | 11V | |

206 Van

| | | | | | | | |
|---------|---|--------------------------|-------|-------------|----------------------------|------------|--|
| 1.4 HDi | 4 | 8HX (DV4TD), 8HZ (DV4TD) | 50/67 | 09/01→03/09 | GN047 (248) GN056 (165) | 11V 11V | |
| 1.9 D | 4 | WJZ (DW8) | 51/68 | 04/99→05/07 | GN016 | 11V | |

207

| | | | | | | | |
|---------|---|----------------|-------|--------|-------|-----|--|
| 1.4 HDi | 4 | 8HZ (DV4TD) | 50/67 | 04/07→ | GN056 | 11V | |
| 1.6 HDi | 4 | 9HX (DV6ATED4) | 66/89 | 04/07→ | GN056 | 11V | |

306 Van

| | | | | | | | |
|---------|---|--------|-------|-------------|-------|-----|--|
| 1.9 D | 4 | XUD9TE | 69/93 | 02/94→04/99 | GN013 | 11V | |
| 1.9 STD | 4 | XUD9 | 51/68 | 02/94→10/95 | GN013 | 11V | |

BIPPER

| | | | | | | | |
|------------|---|--------------|-------|--------|-------|------|-------------------------|
| 1.3 HDi 75 | 4 | 199 A9.000 | 55/74 | 10/10→ | GE112 | 4.4V | |
| 1.4 | 4 | KFV (TU3A) | 54/72 | 02/08→ | Z193 | 0.9 | UXT1 / UXT3 ZSE048 (10) |
| 1.4 LPG | 4 | KFV (TU3A) | 54/72 | 02/08→ | Z340 | 0.7 | UXT12 |
| 1.4 HDi | 4 | 8HS (DV4TED) | 50/67 | 02/08→ | GN056 | 11V | |

BOXER

| | | | | | | | |
|------------|---|--------------------------------|--------|-------------|------------------------------------|------------|-----------------------------|
| 1.9 D | 4 | DJY (XUD9A) | 50/67 | 07/99→04/02 | GN013 | 11V | |
| 1.9 D | 4 | D9B (XUD9AU) | 51/68 | 03/94→04/02 | GN909 →08/98 GN013 09/98→ | 11V 11V | |
| 1.9 DT 4WD | 4 | XUD9TE | 66/89 | 03/96→09/98 | GN013 | GR034 | 11V |
| 1.9 TD | 4 | DHY (XUD9TE), XUD9TE | 66/89 | 08/94→04/02 | GN013 | GR034 | 11V |
| 1.9 TD | 4 | D8C (XUD9UTF) | 68/91 | 03/94→04/02 | GN909 →08/98 GN013 09/98→ | 11V 11V | |
| 2.0 | 4 | RFL (XU10J2U) | 81/109 | 12/01→04/02 | | | ZS232 02/02→ |
| 2.0 | 4 | RFL (XU10J2U) | 81/109 | 04/02→ | Z193 | 0.9 | UXT1 / UXT3 ZS232 →05/06 |
| 2.0 LPG | 4 | RFL (XU10J2U) | 81/109 | 04/02→ | Z340 | 0.7 | UXT12 |
| 2.0 HDi | 4 | RHV (DW10TD), RHV (DW10UTD) | 62/83 | 08/01→ | GN027 | 11V | |
| 2.0 i | 4 | RFW (XU10J2) | 80/107 | 03/94→04/02 | Z193 | 0.9 | UXT1 / UXT3 ZS232 |
| 2.0 i LPG | 4 | RFW (XU10J2) | 80/107 | 03/94→04/02 | Z340 | 0.7 | UXT12 |

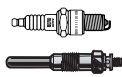

kW/BHP

**... PEUGEOT****... BOXER**

| | | | | | | | | |
|-------------|---|--------------------|---------|-------------|------------------------------------|------------|-----|--|
| 2.2 HDi | 4 | 4HY (DW12UTED) | 74/99 | 04/02→ | GN027 →04/03 GN054 05/03→ | 11V 11V | | |
| 2.2 HDi 100 | 4 | 4HV (P22DTE) | 74/99 | 04/06→ | GN939 | 11.5V | | |
| 2.2 HDi 110 | 4 | | 81/109 | 03/11→ | GE122 | 4.4V | | |
| 2.2 HDi 120 | 4 | 4HU (P22DTE) | 88/118 | 04/06→ | GN939 | 11.5V | | |
| 2.2 HDi 130 | 4 | | 96/129 | 03/11→ | GE122 | 4.4V | | |
| 2.2 HDi 150 | 4 | | 110/148 | 03/11→ | GE122 | 4.4V | | |
| 2.5 D | 4 | T9A (DJ5) | 63/84 | 03/94→04/02 | GN909 | GR054 | 11V | |
| 2.5 TD | 4 | T8A (DJ5T) | 76/102 | 03/94→04/02 | GN909 | GR054 | 11V | |
| 2.5 TDI | 4 | THX (DJ5TED) | 79/106 | 01/97→04/02 | GN964 | | 11V | |
| 2.8 D | 4 | 8140.63 (F28D) | 64/86 | 01/99→02/02 | GN012 | | 11V | |
| 2.8 HDi | 4 | 8140.43S (F28DTCR) | 93/125 | 10/00→09/09 | GN012 | | 11V | |
| 2.8 HDi | 4 | 8140.43S (F28DTCR) | 94/126 | 10/00→ | GN012 | | 11V | |
| 2.8 HDi | 4 | 8140.43N | 107/143 | 04/04→ | GN012 | | 11V | |
| 3.0 HDi | 4 | | 115/154 | 07/06→ | GN037 | | 11V | |
| 3.0 HDi 145 | 4 | | 107/143 | 04/10→ | GN037 | | 11V | |
| 3.0 HDi 160 | 4 | F1CE0481D (F30DT) | 116/156 | 04/06→ | GN037 | | 11V | |
| 3.0 HDi 175 | 4 | | 130/174 | 03/11→ | GN037 | | 11V | |

EXPERT

| | | | | | | | | |
|----------------|---|---|---------|-------------|------------------------------------|------------|---------------------|----------------|
| 1.6 | 4 | 222A2 (1580 SPI) | 58/78 | 02/96→ | Z15 Z252 | 0.8 0.9 | UXT1 / UXT3 UXT5 | ZS234 ZS324 |
| 1.6 LPG | 4 | 222A2 (1580 SPI) | 58/78 | 02/96→ | Z30 [168] | 0.8 | UXT5 | |
| 1.6 HDi 90 | 4 | 9HU (DV6UTED4) | 66/89 | 01/07→ | GN056 | | 11V | |
| 1.6 HDi 90 8V | 4 | 9HH (DV6DUM), 9HM (DV6UC) | 66/89 | 01/07→ | GE121A | | 5V | |
| 1.6 HDi 90 16V | 4 | 9HU (DV6UTED4) | 66/89 | 01/07→ | GN056 | | 11V | |
| 1.8 | 4 | LFZ (XU7JP) | 74/99 | 10/96→09/00 | Z193 | 0.9 | UXT1 / UXT3 | ZS232 |
| 1.8 LPG | 4 | LFZ (XU7JP) | 74/99 | 10/96→09/00 | Z340 | 0.7 | UXT12 | |
| 1.9 D | 4 | D9B (XUD9AU) | 51/68 | 02/96→ | GN909 →08/98 GN013 09/98→ | 11V 11V | | |
| 1.9 D | 4 | WJY (DW8B), WJZ (DW8) | 51/68 | 06/98→11/03 | GN016 | GR054 | 11V | |
| 1.9 D 70 | 4 | WJY (DW8B), WJZ (DW8) | 51/68 | 12/98→ | GN016 | GR054 | 11V | |
| 1.9 TD | 4 | DHX (XUD9TE) | 66/89 | 02/96→ | GN909 →08/98 GN013 09/98→ | 11V 11V | | |
| 1.9 TD | 4 | D8B (XUD9TE) | 68/91 | 02/96→ | GN909 →08/98 GN013 09/98→ | 11V 11V | | |
| 2.0 | 4 | RFN (EW10J4) | 100/134 | 09/02→ | Z183 | 0.9 | UXT13 | ZS348 |
| 2.0 LPG | 4 | RFN (EW10J4) | 100/134 | 09/02→ | Z184 [168] | 0.9 | UXT13 | |
| 2.0 16V | 4 | RFH (EW10A), RFJ (EW10A) | 103/138 | 01/07→ | Z223 | 0.9 | UXT13 | ZS352 |
| 2.0 HDi | 4 | RHX (DW10BTEd) | 69/93 | 07/00→ | GN027 | | 11V | |
| 2.0 HDi | 4 | RHW (DW10ATED4), RHZ (DW10ATED), RHZ (DW10BTEd) | 80/107 | 07/00→ | GN027 [245] GN054 [162] | 11V 11V | | |
| 2.0 HDi 100 | 4 | | 72/97 | 03/11→ | GE121A | | 5V | |
| 2.0 HDi 120 | 4 | RHK (DW10UTED4) | 88/118 | 01/07→ | GN054 | | 11V | |
| 2.0 HDi 130 | 4 | | 94/126 | 03/11→ | GE121A | | 5V | |
| 2.0 HDi 140 | 4 | RHR (DW10BTEd4) | 100/134 | 01/07→ | GN054 | | 11V | |
| 2.0 HDi 165 | 4 | RHH (DW10CTED4) | 120/161 | 09/09→ | GE121A | | 5V | |

J5

| | | | | | | | | | |
|-----|---|-------------|-------|-------------|-----------|-----|-------------|--|-------|
| 1.8 | 4 | 169B (XM7T) | 51/68 | 01/83→11/88 | Z11 [168] | 0.8 | UXT2 / UXT6 | ZS115 [1][11] ZS117 [1][254] ZS120 [1][214][254] | ZM001 |
|-----|---|-------------|-------|-------------|-----------|-----|-------------|--|-------|

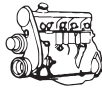

kW/BHP

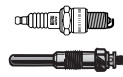

... PEUGEOT



... J5

| | | | | | | | | | | |
|--------|---|---------------------------|-------|-------------|--|--|-----------------------|--------------------|--|--------------|
| 1.9 D | 4 | D9B (XUD9A), XUD9 | 51/68 | 09/87→08/90 | GN013 | | 11V | | | |
| 1.9 D | 4 | D9B (XUD9A) | 51/68 | 10/90→03/94 | GN909 ^{[2][222]} →01/94 GV636 →01/94 | GR065 →01/94 | 11V 11V | | | |
| 2.0 | 4 | 170B (XN1T) | 55/74 | 09/81→09/90 | Z11 ^[168] | | 0.8 | UXT2 / UXT6 | ZS110 ^[15] | ZM001 |
| 2.0 | 4 | 170B (XN1T) | 55/74 | 01/86→11/88 | | | | | ZS115 ^{[1][11]} ZS117 ^{[1][254]} ZS120 ^{[1][214][254]} | |
| 2.0 | 4 | 170 (XN1T) | 58/78 | 01/83→09/90 | Z11 ^[168] | | 0.8 | UXT2 / UXT6 | ZS115 ^{[1][11]} ZS117 ^{[1][254]} ZS120 ^{[1][214][254]} | ZM001 |
| 2.0 | 4 | XN1P | 58/78 | 09/81→08/90 | | | | | ZS115 ^{[1][11]} ZS117 ^{[1][254]} ZS120 ^{[1][214][254]} | |
| 2.0 | 4 | 170D (XN1TACP), XN1TA | 62/83 | 09/90→02/94 | | | | | ZS115 ^{[1][11]} ZS117 ^{[1][254]} ZS120 ^{[1][214][254]} | |
| 2.0 | 4 | 170D (XN1TACP) | 62/83 | 10/90→02/94 | Z11 ^[168] | | 0.8 | UXT2 / UXT6 | | ZM001 |
| 2.5 D | 4 | CRD93, CRD93 (U25/661) | 54/72 | 09/81→09/90 | GN909 ^{[2][222]} GV602 | GR059 | 11V 11V | | | |
| 2.5 D | 4 | CRD93, CRD93 (U25/661) | 54/72 | 09/90→03/94 | GV602 →06/91 GN909 ^{[2][222]} GV636 07/91→ | GR059 ^[32] →06/91 GR065 ^[32] 07/91→ | 11V 11V 11V | | | |
| 2.5 DT | 4 | CRD93L, CRD93LS (U25/673) | 70/94 | 09/81→01/94 | GN013 | | 11V | | | |
| 2.5 TD | 4 | CRD93LS (U25/673) | 70/94 | 10/90→03/94 | GV602 →06/91 GN909 ^{[2][222]} GV636 07/91→ | GR059 ^[32] →06/91 GR065 ^[32] 07/91→ | 11V 11V 11V | | | |

J7

| | | | | | | | | | | |
|-------|---|--------|-------|-------------|--|--|-----------------|--------------------|------------------------------|--|
| 1.6 | 4 | XC7P | 44/59 | 08/68→03/80 | Z11 ^[168] | | 0.8 | UXT2 / UXT6 | | |
| 1.6 | 4 | XC7P | 44/59 | 07/70→03/80 | Z11 ^[167] Z11 ^[168] | | 0.8 0.8 | UXT2 / UXT6 | ZS106 ^[11] | |
| 1.6 | 4 | XC5P | 50/67 | 08/68→03/80 | Z11 ^[168] | | 0.8 | UXT2 / UXT6 | | |
| 1.8 | 4 | XM7P | 48/64 | 07/70→03/80 | Z11 ^[168] | | 0.8 | UXT2 / UXT6 | | |
| 1.9 D | 4 | XDP88 | 40/54 | 08/68→07/78 | GV107 | | 10.5V | | | |
| 2.1 D | 4 | XDP90 | 42/56 | 08/68→07/77 | GV107 | | 10.5V | | | |
| 2.3 D | 4 | XD2P94 | 49/66 | 07/77→03/80 | GV108 →10/79 GN909 11/79→ | | 9.5V 11V | | | |

J9

| | | | | | | | | | | |
|-------|---|---------|-------|-------------|--|--|------------|--------------------|--|--------------|
| 1.6 | 4 | XC7P | 44/59 | 03/80→06/87 | Z11 ^[168] | | 0.8 | UXT2 / UXT6 | ZS115 ^{[1][11]} ZS117 ^{[1][254]} ZS120 ^{[1][214][254]} | ZM001 |
| 2.0 | 4 | XN1P | 57/76 | 03/80→06/87 | Z11 ^[168] | | 0.8 | UXT2 / UXT6 | ZS115 ^{[1][11]} ZS117 ^{[1][254]} ZS120 ^{[1][214][254]} | ZM001 |
| 2.1 D | 4 | XDPX90 | 41/55 | 03/80→06/87 | GN909 ^{[2][222]} GV636 | GR059 ^[32] →10/81 GR065 ^[32] 11/81→ | 11V 11V | | | |
| 2.3 D | 4 | XD2PX94 | 49/66 | 03/80→07/82 | GN909 ^{[2][222]} GV636 | GR059 ^[32] →10/81 GR065 ^[32] 11/81→ | 11V 11V | | | |

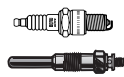

kW/BHP

**... PEUGEOT****... J9**

| | | | | | | | | | |
|-------|---|------|-------|-------------|-------------------------------------|-------|------------|--|--|
| 2.5 D | 4 | XD3P | 53/71 | 07/82→06/87 | GN909 ^{[21][222]} GV636 | GR065 | 11V 11V | | |
|-------|---|------|-------|-------------|-------------------------------------|-------|------------|--|--|

PARTNER

| | | | | | | | | | |
|------------|---|------------------------------------|--------|-------------|--|-----------------|------------|-------------|---|
| 1.1 | 4 | HDZ (TU1M) | 44/59 | 06/96→ | Z193 | | 0.9 | UXT1 / UXT3 | ZS232 ^{[153][202]} ZSE047 ^[13] |
| 1.1 LPG | 4 | HDZ (TU1M) | 44/59 | 06/96→ | Z340 | | 0.7 | UXT12 | |
| 1.4 | 4 | KFV (TU3A) | 54/72 | 11/02→10/06 | | | | | ZSE048 ^[10] |
| 1.4 | 4 | KFX (TU3JP) | 55/74 | 06/96→ | Z193 | | 0.9 | UXT1 / UXT3 | ZS381 →08/02 ZS232 ^{[153][202]} |
| 1.4 | 4 | TU32 | 55/74 | 06/96→ | | | | | ZS381 →08/02 ZS232 ^{[153][202]} |
| 1.4 LPG | 4 | KFX (TU3JP) | 55/74 | 06/96→ | Z340 | | 0.7 | UXT12 | |
| 1.4 BiFuel | 4 | KFW (TU3JP) | 55/74 | 04/03→ | Z206 | | 0.7 | UXT10 | ZSE047 ^[13] |
| 1.6 | 4 | NFR (TU5JP4B) | 66/89 | 04/08→ | | | | | ZSE045 |
| 1.6 | 4 | | 72/97 | 11/10→ | | | | | ZSE143 |
| 1.6 | 4 | NFU (TU5JP4) | 80/107 | 04/08→ | | | | | ZSE045 |
| 1.6 | 4 | | 88/118 | 04/10→ | | | | | ZSE143 |
| 1.6 HDi | 4 | 9HT (DV6BTED4), 9HW (DV6BTED4) | 55/74 | 04/08→ | GN047 ^[249] GN056 ^[158] | | 11V 11V | | |
| 1.6 HDi | 4 | 9HS (DV6TED4BU), 9HX (DV6ATED4) | 66/89 | 04/08→ | GN047 ^[249] GN056 ^[158] | | 11V 11V | | |
| 1.6 HDi | 4 | 9HZ (DV6TED4) | 80/107 | 04/08→ | GN056 | | 11V | | |
| 1.6 HDi | 4 | | 82/110 | 08/10→ | GE121A | | 5V | | |
| 1.6 HDi | 4 | 9HL (DV6C) | 84/113 | 03/13→ | GE121A | | 5V | | |
| 1.6 HDi 75 | 4 | 9HW (DV6BTED4) | 55/74 | 02/06→ | GN056 | | 11V | | |
| 1.6 HDi 90 | 4 | 9HX (DV6ATED4) | 66/89 | 02/06→ | GN047 ^[249] GN056 ^[158] | | 11V 11V | | |
| 1.6 HDi 90 | 4 | 9HP (DV6DTED) | 68/91 | 04/10→ | GE121A | | 5V | | |
| 1.8 D | 4 | A9A (XUD7) | 43/58 | 06/96→ | GN909 →08/98 GN013 09/98→ | | 11V 11V | | |
| 1.8 D | 4 | A9A (XUD7) | 44/59 | 11/96→02/98 | GN013 | | 11V | | |
| 1.9 D | 4 | DJY (XUD9A) | 50/67 | 05/96→12/98 | GN013 | | 11V | | |
| 1.9 D | 4 | DJY (XUD9A) | 51/68 | 06/96→ | GN909 →08/98 GN013 09/98→ | GR054 →08/98 | 11V 11V | | |
| 1.9 D | 4 | WJY (DW8B), WJZ (DW8) | 51/68 | 06/96→ | GN016 | | 11V | | |
| 2.0 HDi | 4 | RHY (DW10TD) | 66/89 | 04/00→ | GN027 | | 11V | | |

PORSCHE**356 Cabriolet/Speedster**

| | | | | | | | | | |
|--------------|---|--------|-------|-------------|-----|--|-----|--|-----------------------|
| 1.1 1100 | 4 | | 29/39 | 01/50→12/55 | Z40 | | 0.6 | | |
| 1.3 1300 | 4 | | 32/43 | 01/50→12/55 | Z40 | | 0.6 | | |
| 1.5 1500 | 4 | | 44/59 | 01/50→12/55 | Z40 | | 0.6 | | |
| 1.6 A 1600 | 4 | | 44/59 | 01/55→12/59 | Z40 | | 0.6 | | |
| 1.6 A 1600 S | 4 | 616.15 | 55/74 | 01/55→12/59 | Z40 | | 0.6 | | ZS105 ^[11] |
| 1.6 B 1600 | 4 | | 44/59 | 01/59→12/63 | | | | | ZS106 ^[11] |

356 Cabriolet/Speedster/Coupe

| | | | | | | | | | |
|---------------------|---|--------|-------|-------------|--|--|------------|--|--|
| 1.3 1300 S | 4 | | 44/59 | 01/50→12/55 | Z39 | | 0.4 | | |
| 1.5 1500 S | 4 | | 51/68 | 01/50→12/55 | Z39 | | 0.4 | | |
| 1.6 B 1600 | 4 | | 44/59 | 01/59→12/63 | Z41 ^[168] | | 0.8 | | |
| 1.6 B 1600 Super 75 | 4 | 616.15 | 55/74 | 01/59→12/63 | Z40 ^[127] Z41 ^[168] | | 0.6 0.8 | | ZS105 ^{[1][11][271]} ZS106 ^{[1][11][254]} |

[270]



kW/BHP

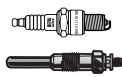

... PORSCHE



... 356 Cabriolet/Speedster/Coupe

| | | | | | | | | |
|-------------------------|---|--|---------|-------------|--------------------------|------------|----------------|-------------------------------------|
| 1.6 B 1600 Super 90 | 4 | | 66/89 | 01/59→12/63 | Z41 [168] | 0.8 | | ZS105 [1][11] ZS106 [1][11][254] |
| 1.6 C 1600 | 4 | 616.15 | 55/74 | 01/63→12/65 | Z41 [168] | 0.8 | | |
| 1.6 C 1600 SC | 4 | | 70/94 | 01/63→12/65 | Z41 [168] | 0.8 | | |
| 356 Coupe | | | | | | | | |
| 1.1 1100 | 4 | | 29/39 | 01/50→12/55 | Z40 [168] | 0.6 | | ZS105 [11] |
| 1.3 1300 | 4 | | 32/43 | 01/50→12/55 | Z40 [168] | 0.6 | | ZS105 [11] |
| 1.3 1300 S | 4 | | 44/59 | 01/50→12/55 | | | | ZS105 [11] |
| 1.5 1500 | 4 | | 40/54 | 01/50→12/55 | Z40 [168] | 0.6 | | ZS105 [11] |
| 1.5 1500 | 4 | | 44/59 | 01/50→12/55 | Z40 [168] | 0.6 | | ZS105 [11] |
| 1.5 1500 S | 4 | | 51/68 | 01/54→12/55 | | | | ZS105 [11] |
| 1.5 A 1500 GS Carrera | 4 | 547/1 | 73/98 | 01/55→12/61 | Z38 | 0.4 | | ZS105 [11] |
| 1.5 A 1500 GS Carrera | 4 | | 77/103 | 01/55→12/61 | Z38 | 0.4 | | ZS105 [11] |
| 1.5 A 1500 GS Carrera | 4 | 547/1 | 81/109 | 01/55→12/61 | Z38 | 0.4 | | ZS105 [11] |
| 1.6 A 1600 | 4 | | 44/59 | 01/55→12/59 | Z41 [168] | 0.8 | | ZS105 [11] |
| 1.6 A 1600 GS Carrera | 4 | | 85/114 | 01/55→12/61 | Z38 | 0.4 | | ZS105 [11] |
| 1.6 A 1600 Super | 4 | 616.15 | 55/74 | 01/55→12/59 | Z40 [127] Z41 [168] | 0.6 0.8 | | ZS105 [11] |
| 1.6 B 1600 | 4 | | 44/59 | 01/59→12/63 | | | | ZS105 [1][11] ZS106 [1][11][254] |
| 1.6 C 1600 SC | 4 | | 70/94 | 01/63→12/65 | | | | ZS105 [11] |
| 2.0 B 2000 GS Carrera 2 | 4 | 587/1 | 96/129 | 01/61→12/64 | Z38 | 0.4 | | ZS105 [11] |
| 2.0 C 2000 GS Carrera 2 | 4 | 587/1 | 96/129 | 01/61→12/64 | Z38 | 0.4 | | ZS105 [11] |
| 2.0 C 2000 GS Carrera 2 | 4 | | 103/138 | 10/61→03/68 | Z38 | 0.4 | | ZS105 [11] |
| 911 | | | | | | | | |
| 2.0 L | 6 | 901.06, 901.07, 901.14, 901.17 | 96/129 | 01/63→08/67 | | | | ZS115 [11] |
| 2.0 T | 6 | 901.03, 901.13 | 81/109 | 08/68→02/72 | Z42 →08/69 | 0.8 | UX56 →08/69 | ZS109 [15] |
| 2.2 T | 6 | 911.03, 911.07, 911.08 | 92/123 | 01/70→12/72 | Z42 | 0.8 | UX56 | |
| 2.3 S | 6 | 911.53, 911.63 | 140/188 | 08/71→01/76 | Z38 [168] | 0.4 | | |
| 2.3 T | 6 | 911.51, 911.61, 911.91, 911.96 | 103/138 | 08/71→12/73 | Z42 | 0.8 | UX56 | |
| 2.7 S Carrera | 6 | 911.42, 911.47, 911.93, 911.98 | 129/173 | 08/73→01/76 | Z42 | 0.8 | UX56 | |
| 2.7 SC Carrera RS | 6 | 911.83 | 154/207 | 08/72→01/79 | Z38 [168] 09/73→08/75 | 0.4 | | |
| 3.0 SC Carrera | 6 | | 154/207 | 03/74→10/83 | Z38 [168] 07/80→ | 0.4 | | |
| 3.0 Turbo | 6 | 930.50, 930.52 | 191/256 | 01/75→12/77 | Z38 | 0.4 | | |
| 3.2 SC Carrera | 6 | 930.21 | 152/204 | 02/84→06/87 | Z20 | 0.8 | UXT2 / UXT6 | |
| 911 /Convertible | | | | | | | | |
| 3.0 SC | 6 | 930.10 | 150/201 | 08/80→07/83 | Z38 [168] | 0.4 | | |
| 911 /Targa | | | | | | | | |
| 2.0 L | 6 | 901.01, 901.05 | 96/129 | 01/63→11/68 | | | | ZS115 [11] |
| 2.2 T | 6 | 911.06 | 92/123 | 01/70→12/72 | Z42 | 0.8 | UX56 | |
| 2.3 E | 6 | 911.52, 911.62 | 121/162 | 08/71→12/73 | Z38 [168] | 0.4 | | |
| 2.3 T | 6 | 911.57, 911.67 | 96/129 | 01/72→12/73 | Z42 | 0.8 | UX56 | |
| 2.7 | 6 | 911.41, 911.46, 911.92, 911.97 | 110/148 | 09/73→08/75 | Z42 | 0.8 | UX56 | |
| 2.7 | 6 | 911.43, 911.48, 911.81, 911.82, 911.84, 911.85, 911.86, 911.89, 911.90, 911.94, 911.99 | 121/162 | 09/75→06/77 | Z42 | 0.8 | UX56 | |
| 3.0 SC Carrera | 6 | 930.03, 930.13 | 132/177 | 07/77→06/80 | Z38 [168] | 0.4 | | |
| 3.0 SC Carrera | 6 | 930.02, 930.12 | 147/197 | 09/75→06/77 | Z38 [168] | 0.4 | | |
| 911 Convertible | | | | | | | | |
| 3.1 SC Carrera | 6 | 930.21 | 152/204 | 10/84→08/89 | Z20 | 0.8 | UXT2 / UXT6 | |

PORSCHE

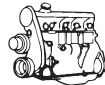

kW/BHP

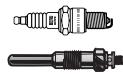

... PORSCHE



911 Targa

| | | | | | | | | | |
|-------------------|---|-----------------------------------|---------|-------------|---------------------|--|-----|------------|--|
| 2.0 E | 6 | 901.09, 901.11 | 103/138 | 09/68→02/72 | | | | ZS109 [15] | |
| 2.0 S | 6 | 901.02, 901.08 | 118/158 | 07/66→11/68 | | | | ZS115 [11] | |
| 2.0 S | 6 | 901.10 | 125/168 | 07/66→02/72 | | | | ZS109 [15] | |
| 2.0 T | 6 | 901.03, 901.13 | 81/109 | 06/67→02/72 | Z42 | | 0.8 | UX56 | ZS115 [1][11] →08/68 ZS109 [1][15] 09/68→ |
| 2.7 S | 6 | 911.42, 911.47, 911.93, 911.98 | 129/173 | 08/73→01/76 | Z42 | | 0.8 | UX56 | |
| 2.7 SC Carrera RS | 6 | 911.83 | 154/207 | 08/72→01/79 | Z38 [168] →08/75 | | 0.4 | | |

911 (964)

| | | | | | | | | | |
|----------------|---|------------------|---------|-------------|-----------|--|-----|------|-------|
| 3.6 Carrera | 6 | M 64.01, M 64.02 | 184/247 | 12/88→09/93 | | | | | ZM015 |
| 3.6 Carrera RS | 6 | M 64.03 | 191/256 | 06/91→09/93 | Z45 [169] | | 0.7 | UXT5 | |
| 3.6 Turbo | 6 | M 64.50 | 265/355 | 01/93→09/93 | Z116 | | 0.8 | UXT5 | |

911 /Convertible (964)

| | | | | | | | | | |
|-------------|---|------------------|---------|-------------|-----------|--|-----|------|--|
| 3.6 Carrera | 6 | M 64.01, M 64.02 | 184/247 | 12/88→05/94 | Z45 [169] | | 0.7 | UXT5 | |
|-------------|---|------------------|---------|-------------|-----------|--|-----|------|--|

911 (993)

| | | | | | | | | | |
|-------------------|---|---------------------------------------|---------|-------------|-----------|--|-----|------|-------------|
| 3.6 Carrera | 6 | M 64.21, M 64.22, M 64.23, M 64.24 | 210/282 | 08/95→09/97 | Z116 | | 0.8 | UXT5 | |
| 3.6 Turbo 4WD | 6 | M 64.60 | 300/402 | 03/95→09/97 | Z116 | | 0.8 | UXT5 | |
| 3.6 Turbo 4WD LPG | 6 | M 64.60 | 300/402 | 03/95→09/97 | Z192 | | 0.8 | | |
| 3.6 Turbo GT2 | 6 | M 64.60R | 316/424 | 03/95→09/97 | Z116 | | 0.8 | UXT5 | |
| 3.6 Turbo GT2 LPG | 6 | M 64.60R | 316/424 | 03/95→09/97 | Z192 | | 0.8 | | |
| 3.8 Carrera 4WD | 6 | M 64.05S, M 64.06S | 210/282 | 06/95→09/97 | | | | | ZS357 |
| 3.8 Carrera RS | 6 | M 64.20 | 221/296 | 06/95→09/97 | Z45 [169] | | 0.7 | UXT5 | ZS357 ZM026 |

911 /Convertible (993)

| | | | | | | | | | |
|-----------------|---|---------------------------------------|---------|-------------|-----------|--|-----|------|-------------|
| 3.6 Carrera | 6 | M 64.05, M 64.06, M 64.07, M 64.08 | 200/268 | 10/93→08/95 | Z45 [169] | | 0.7 | UXT5 | ZS357 ZM026 |
| 3.6 Carrera 4WD | 6 | M 64.21, M 64.23 | 210/282 | 08/95→09/97 | Z45 [169] | | 0.7 | UXT5 | ZS357 ZM026 |
| 3.8 Carrera | 6 | M 64.05S, M 64.06S | 210/282 | 06/95→09/97 | | | | | ZS357 |
| 3.8 Carrera 4WD | 6 | M 64.21S | 221/296 | 08/95→09/97 | Z45 [169] | | 0.7 | UXT5 | ZS357 ZM026 |

911 /Convertible/Targa (993)

| | | | | | | | | | |
|-------------|---|---------------------------------------|---------|-------------|--|--|--|--|-------------|
| 3.6 Carrera | 6 | M 64.21, M 64.22, M 64.23, M 64.24 | 210/282 | 08/95→09/97 | | | | | ZS357 ZM026 |
|-------------|---|---------------------------------------|---------|-------------|--|--|--|--|-------------|

911 Convertible (993)

| | | | | | | | | | |
|-----------------|---|--------------------|---------|-------------|-----------|--|-----|------|-----------------|
| 3.8 Carrera | 6 | M 64.05S, M 64.06S | 210/282 | 06/95→09/97 | Z45 [169] | | 0.7 | UXT5 | ZM026 |
| 3.8 Carrera 4WD | 6 | M 64.05S, M 64.06S | 210/282 | 06/95→09/97 | Z45 [169] | | 0.7 | UXT5 | ZS357 →08/95 |

911 Convertible/Targa (993)

| | | | | | | | | | |
|-------------|---|---------------------------------------|---------|-------------|-----------|--|-----|------|-------------|
| 3.6 Carrera | 6 | M 64.21, M 64.22, M 64.23, M 64.24 | 210/282 | 08/95→09/97 | Z45 [169] | | 0.7 | UXT5 | |
| 3.8 Carrera | 6 | M 64.21S | 221/296 | 08/95→09/97 | Z45 [169] | | 0.7 | UXT5 | ZS357 ZM026 |

911 (996)

| | | | | | | | | | |
|-------------------|---|---------|---------|-------------|------|--|-----|------|-------------------------------|
| 3.4 Carrera 4WD | 6 | M 96.01 | 221/296 | 09/97→09/01 | Z129 | | 1.6 | | ZS031 ZLE278 |
| 3.4 Carrera 4WD | 6 | M 96.04 | 221/296 | 09/97→09/01 | | | | | ZS031 ZLE278 |
| 3.6 Carrera 4 4WD | 6 | M 96.03 | 235/315 | 10/01→08/05 | | | | | ZS031 ZLE278 |
| 3.6 GT2 | 6 | M 96.70 | 340/456 | 04/01→08/05 | Z116 | | 0.8 | UXT5 | ZS036 ZLE255 |
| 3.6 GT2 | 6 | M 96.70 | 355/476 | 10/03→08/05 | Z116 | | 0.8 | UXT5 | ZS036 ZLE255 |
| 3.6 GT3 | 6 | M 96.76 | 265/355 | 03/99→08/05 | Z116 | | 0.8 | UXT5 | ZS036 ZLE255 →08/03 →08/03 |
| 3.6 GT3 | 6 | M 96.79 | 280/375 | 03/03→08/05 | Z116 | | 0.8 | UXT5 | ZS036 ZLE255 |
| 3.6 GT3 LPG | 6 | M 96.76 | 265/355 | 03/99→08/05 | Z192 | | 0.8 | | |
| 3.6 GT3 LPG | 6 | M 96.79 | 280/375 | 03/03→08/05 | Z192 | | 0.8 | | |

911 /Convertible (996)

| | | | | | | | | | |
|-----------------|---|------------------|---------|-------------|------|--|-----|--|--------------|
| 3.4 Carrera | 6 | M 96.01, M 96.04 | 221/296 | 09/97→09/01 | Z129 | | 1.6 | | ZS031 ZLE278 |
| 3.4 Carrera 4WD | 6 | M 96.04 | 221/296 | 09/97→09/01 | Z129 | | 1.6 | | |

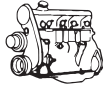

kW/BHP

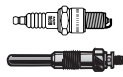

... PORSCHE



... 911 /Convertible (996)

| | | | | | | | | | |
|----------------------|---|---------|---------|-------------|------|--|-----|------|---------------|
| 3.4 Carrera | 6 | | 235/315 | 05/01→08/05 | Z129 | | 1.6 | | |
| 3.6 3.6 Turbo 4WD | 6 | M 96.70 | 309/414 | 06/00→08/05 | Z116 | | 0.8 | UXT5 | ZS036 ZLE255 |
| 3.6 3.6 Turbo 4S 4WD | 6 | M 96.70 | 331/444 | 02/03→08/05 | Z116 | | 0.8 | UXT5 | ZS036 ZLE255 |
| 3.6 Carrera | 6 | M 96.03 | 235/315 | 10/01→08/05 | | | | | ZS036 ZLE255 |
| 3.6 Carrera 4S 4WD | 6 | M 96.03 | 254/341 | 06/02→08/05 | | | | | ZS036 ZLE255 |
| | | | | | | | | | →07/04 →07/04 |
| 3.6 Carrera S | 6 | M 96.03 | 254/341 | 06/02→08/05 | | | | | ZS036 ZLE255 |
| | | | | | | | | | →07/04 →07/04 |
| 3.6 S | 6 | M 96.70 | 331/444 | 08/04→08/05 | Z116 | | 0.8 | UXT5 | ZS036 ZLE255 |

911 Convertible (996)

| | | | | | | | | | |
|-------------------|---|---------|---------|-------------|------|--|-----|--|--------------|
| 3.4 Carrera 4WD | 6 | M 96.02 | 221/296 | 02/98→09/01 | Z129 | | 1.6 | | ZS036 ZLE255 |
| 3.4 Carrera 4WD | 6 | M 96.04 | 221/296 | 02/98→09/01 | | | | | ZS036 ZLE255 |
| 3.6 Carrera 4 4WD | 6 | M 96.03 | 235/315 | 10/01→08/05 | | | | | ZS036 ZLE255 |

911 Targa (996)

| | | | | | | | | | |
|-----|---|---------|---------|-------------|--|--|--|--|--------------|
| 3.6 | 6 | M 96.03 | 235/315 | 12/01→08/05 | | | | | ZS036 ZLE255 |
|-----|---|---------|---------|-------------|--|--|--|--|--------------|

911 (997)

| | | | | | | | | | |
|--------------------|---|---------|---------|-------------|------|--|-----|--|-------|
| 3.6 Carrera | 6 | M 96.05 | 239/320 | 07/04→12/08 | | | | | ZS031 |
| 3.6 GT2 RS | 6 | M 97.70 | 456/611 | 05/10→12/12 | Z185 | | 0.8 | | ZS031 |
| 3.6 GT 3 | 6 | M 97.76 | 305/409 | 03/06→12/09 | | | | | ZS031 |
| 3.8 Carrera 4S 4WD | 6 | M 97.01 | 261/350 | 07/04→12/08 | | | | | ZS031 |
| 3.8 Carrera S | 6 | M 97.01 | 261/350 | 07/04→12/08 | | | | | ZS031 |

911 /Convertible (997)

| | | | | | | | | | |
|-----------------------|---|---------|---------|-------------|------|--|-----|--|-------------|
| 3.6 Carrera | 6 | MA1.02 | 254/341 | 06/08→12/11 | | | | | ZSE052 GS28 |
| 3.6 Turbo 4WD | 6 | M 97.70 | 353/473 | 03/06→12/09 | Z185 | | 0.8 | | ZS031 |
| 3.8 Carrera 4 GTS 4WD | 6 | MA1.01 | 300/402 | 06/09→12/12 | | | | | ZSE052 GS28 |
| 3.8 Carrera GTS | 6 | MA1.01 | 300/402 | 06/09→12/11 | | | | | ZSE052 GS28 |
| 3.8 Carrera S | 6 | MA1.01 | 283/380 | 06/08→12/11 | | | | | ZSE052 GS28 |

911 /Convertible/Targa (997)

| | | | | | | | | | |
|--------------------|---|--------|---------|-------------|--|--|--|--|-------------|
| 3.6 Carrera 4WD | 6 | MA1.02 | 254/341 | 06/08→12/12 | | | | | ZSE052 GS28 |
| 3.8 Carrera 4S 4WD | 6 | MA1.01 | 283/380 | 06/08→12/12 | | | | | ZSE052 GS28 |

911 Convertible (997)

| | | | | | | | | | |
|---------------|---|---------|---------|-------------|--|--|--|--|--------------|
| 3.8 Carrera S | 6 | M 97.01 | 261/350 | 04/05→12/08 | | | | | ZS036 ZLE255 |
|---------------|---|---------|---------|-------------|--|--|--|--|--------------|

912 /Targa

| | | | | | | | | | |
|-----|---|------------------------|-------|-------------|-----|--|-----|--|-----------------------|
| 1.6 | 4 | 616.36, 616.39, 616.40 | 66/89 | 01/65→02/70 | Z41 | | 0.8 | | ZS106 ⁽¹¹⁾ |
|-----|---|------------------------|-------|-------------|-----|--|-----|--|-----------------------|

914

| | | | | | | | | | |
|--------|---|----------------|--------|-------------|----------------------|--|-----|------|-----------------------|
| 1.7 | 4 | W | 59/79 | 01/69→12/73 | Z58 ^[167] | | 0.8 | | ZS106 ⁽¹¹⁾ |
| 1.8 | 4 | AN | 63/84 | 08/73→02/76 | Z58 ^[167] | | 0.8 | | ZS106 ⁽¹¹⁾ |
| 2.0 | 4 | GB | 74/99 | 01/72→12/75 | Z58 ^[167] | | 0.8 | | ZS106 ⁽¹¹⁾ |
| 2.0 /6 | 6 | 901.36, 901.37 | 81/109 | 11/69→12/73 | Z42 | | 0.8 | UX56 | |

924

| | | | | | | | | | |
|-----------|---|------------------|---------|-------------|-----|--|-----|-------------|-----------------------|
| 2.0 | 4 | XJ | 92/123 | 11/75→08/89 | Z42 | | 0.8 | UX56 | ZS115 ⁽¹¹⁾ |
| 2.0 Turbo | 4 | M 31.01 | 125/168 | 11/78→06/80 | Z42 | | 0.8 | UX56 | |
| 2.5 S | 4 | M 44.07, M 44.08 | 110/148 | 09/85→07/87 | Z20 | | 0.8 | UXT2 / UXT6 | |
| 2.5 S | 4 | M 44.09, M 44.10 | 118/158 | 08/87→07/88 | Z20 | | 0.8 | UXT2 / UXT6 | |
| 2.5 S | 4 | M 44.01, M 44.03 | 120/161 | 10/81→12/84 | Z20 | | 0.8 | UXT2 / UXT6 | |

928

| | | | | | | | | | |
|--------|---|------------------------------------|---------|-------------|-----|--|-----|-------------|-----------------------------|
| 4.5 | 8 | M 28.01, M 28.02, M 28.09, M 28.10 | 177/237 | 09/77→08/82 | Z1 | | 0.7 | UXT2 / UXT6 | ZS400 ⁽¹¹⁾ |
| 4.7 S | 8 | M 28.11, M 28.12 | 221/296 | 09/79→07/83 | Z20 | | 0.8 | UXT2 / UXT6 | ZS400 ⁽¹¹⁾ ZM015 |
| | | | | | | | | | 09/82→ |
| 4.7 S | 8 | M 28.21, M 28.22 | 228/306 | 08/83→07/86 | Z20 | | 0.8 | UXT2 / UXT6 | ZM015 |
| 5.0 GT | 8 | M 28.47 | 243/326 | 01/89→07/91 | Z20 | | 0.8 | UXT2 / UXT6 | ZS122 ZM015 |
| 5.0 S | 8 | M 28.45, M 28.46 | 212/284 | 09/85→12/86 | Z20 | | 0.8 | UXT2 / UXT6 | ZM015 |
| 5.0 S4 | 8 | M 28.41, M 28.42 | 235/315 | 08/86→07/91 | Z20 | | 0.8 | UXT2 / UXT6 | ZS122 ZM015 |

08/89→

PORSCHE



kW/BHP

**... PORSCHE****... 928**

| | | | | | | | | | |
|-------------|---|------------------|---------|-------------|-----------|-----|-------------|-------|-------|
| 5.0 S,S4 | 8 | M 28.41, M 28.42 | 235/315 | 08/86→07/91 | Z20 | 0.8 | UXT2 / UXT6 | ZS122 | ZM015 |
| 5.4 GTS | 8 | M 28.49, M 28.50 | 257/345 | 08/91→11/95 | Z20 | 0.8 | UXT2 / UXT6 | ZS122 | ZM015 |
| 5.4 GTS LPG | 8 | M 28.49, M 28.50 | 257/345 | 08/91→11/95 | Z27 [168] | 0.8 | UX56 | | |

944

| | | | | | | | | | |
|-----------|---|------------------------------------|---------|-------------|-----|-----|-------------|--|-------|
| 2.5 | 4 | M 44.02, M 44.04, M 44.07, M 44.08 | 110/148 | 01/85→07/87 | Z20 | 0.8 | UXT2 / UXT6 | | |
| 2.5 | 4 | M 44.05, M 44.09, M 44.10 | 118/158 | 08/87→12/90 | Z20 | 0.8 | UXT2 / UXT6 | | |
| 2.5 | 4 | M 44.01, M 44.03, M 44.05, M 44.06 | 120/161 | 06/81→07/87 | Z20 | 0.8 | UXT2 / UXT6 | | |
| 2.5 S | 4 | M 44.40 | 140/188 | 08/86→07/88 | Z20 | 0.8 | UXT2 / UXT6 | | ZM015 |
| 2.5 Turbo | 4 | M 44.50, M 44.51 | 162/217 | 08/85→07/88 | Z20 | 0.8 | UXT2 / UXT6 | | |
| 2.7 | 4 | M 44.11, M 44.12 | 121/162 | 11/88→08/89 | Z20 | 0.8 | UXT2 / UXT6 | | ZM015 |

944 /Convertible

| | | | | | | | | | |
|-----------|---|---------|---------|-------------|-----------|-----|-------------|--|-------|
| 2.5 Turbo | 4 | M 44.52 | 184/247 | 09/87→07/91 | Z20 | 0.8 | UXT2 / UXT6 | | |
| 3.0 S2 | 4 | M 44.41 | 155/208 | 12/88→07/91 | Z47 [168] | 0.8 | UX56 | | ZM015 |

959

| | | | | | | | | | |
|---------|---|--------|---------|-------------|--|--|--|-------|--|
| 2.8 4WD | 6 | 959.50 | 330/443 | 01/86→04/91 | | | | ZS298 | |
|---------|---|--------|---------|-------------|--|--|--|-------|--|

968

| | | | | | | | | | |
|-----------------|---|--|---------|-------------|------|-----|-------------|--|--|
| 3.0 Turbo S | 4 | | 224/300 | 03/93→11/95 | Z250 | 0.7 | UXT1 / UXT3 | | |
| 3.0 Turbo S LPG | 4 | | 224/300 | 03/93→11/95 | Z340 | 0.7 | UXT12 | | |

BOXSTER (986)

| | | | | | | | | | |
|-----------|---|---------|---------|-------------|------|-----|-------------|--------|--------|
| 2.5 | 6 | M 96.20 | 150/201 | 09/96→08/99 | Z98 | 0.8 | UXT1 / UXT3 | ZS031 | ZLE278 |
| 2.5 LPG | 6 | M 96.20 | 150/201 | 09/96→08/99 | Z116 | 0.8 | UXT5 | | |
| 2.7 | 6 | M 96.22 | 162/217 | 08/99→07/02 | Z129 | 1.6 | | ZS036 | ZLE255 |
| 2.7 | 6 | M 96.23 | 168/225 | 07/02→12/04 | Z129 | 1.6 | | ZS036 | ZLE255 |
| | | | | | | | | →10/04 | →10/04 |
| 3.2 S | 6 | M 96.21 | 185/248 | 08/99→07/02 | Z129 | 1.6 | | ZS036 | ZLE255 |
| 3.2 S | 6 | M 96.24 | 196/263 | 01/04→12/04 | Z129 | 1.6 | | ZS036 | ZLE255 |
| | | | | | | | | →10/04 | →10/04 |
| 3.2 S 3,2 | 6 | M 96.24 | 191/256 | 07/02→12/04 | Z129 | 1.6 | | ZS036 | ZLE255 |
| | | | | | | | | →10/04 | →10/04 |

BOXSTER (987)

| | | | | | | | | | |
|------------|---|---------|---------|-------------|------|-----|--|--------|------|
| 2.7 | 6 | M 96.25 | 176/236 | 11/04→12/06 | | | | ZS031 | |
| 2.7 | 6 | M 97.20 | 180/241 | 07/06→12/09 | | | | ZS031 | |
| 2.9 | 6 | MA1.20 | 188/252 | 06/09→12/11 | | | | ZSE052 | GS28 |
| 3.2 S | 6 | M 96.26 | 206/276 | 11/04→12/06 | Z129 | 1.6 | | ZS031 | |
| 3.4 S | 6 | M 97.21 | 217/291 | 07/06→12/09 | | | | ZS031 | |
| 3.4 S | 6 | M 97.22 | 223/299 | 08/08→12/09 | | | | ZSE052 | |
| 3.4 S | 6 | MA1.21 | 228/306 | 06/09→12/11 | | | | ZSE052 | GS28 |
| 3.4 Spyder | 6 | MA1.21 | 235/315 | 06/10→12/11 | | | | ZSE052 | |

CARRERA GT

| | | | | | | | | | |
|-----|----|---------|---------|-------------|--|--|--|--------|------|
| 5.7 | 10 | M 80.01 | 450/603 | 07/03→12/06 | | | | ZSE054 | GS28 |
|-----|----|---------|---------|-------------|--|--|--|--------|------|

CAYENNE

| | | | | | | | | | |
|--------------------|---|--------------------------------|---------|--------|-------|------|--|--------|--|
| 3.0 Diesel 4WD | 6 | MCR.CB | 155/208 | 06/10→ | GE115 | 4.4V | | | |
| 3.0 Diesel 4WD | 6 | M 05.9E, MCN.RB | 176/236 | 06/10→ | GE115 | 4.4V | | | |
| 3.0 Diesel 4WD | 6 | MCR.CA | 180/241 | 06/11→ | GE115 | 4.4V | | | |
| 3.0 S E-Hybrid 4WD | 6 | M 06.EC, MCG.E, MCG.EA, MCG.FA | 245/329 | 06/10→ | | | | ZSE032 | |
| 4.2 S Diesel 4WD | 8 | MCU.DB | 281/377 | 10/12→ | GE115 | 4.4V | | | |

CAYENNE (955)

| | | | | | | | | | |
|---------------|---|---------|---------|-------------|-------|------|--|--------|------|
| 3.0 TDI 4WD | 6 | M 05.9D | 176/236 | 02/09→09/10 | GE115 | 4.4V | | | |
| 3.2 4WD | 6 | M02.2Y | 184/247 | 10/03→09/07 | Z306 | 0.9 | | ZSE044 | |
| 3.6 4WD | 6 | M 55.01 | 213/286 | 02/07→09/10 | | | | ZSE044 | |
| | | | | | | | | →04/10 | |
| 4.5 S 4WD | 8 | M 48.00 | 250/335 | 09/02→09/07 | Z129 | 1.6 | | ZSE012 | GS28 |
| 4.5 Turbo 4WD | 8 | M 48.50 | 331/444 | 09/02→09/07 | Z185 | 0.8 | | ZSE012 | GS28 |

PORSCHE



kW/BHP

**... PORSCHE****... CAYENNE (955)**

| | | | | | | | | | |
|-----------------|---|---------|---------|-------------|------|--|-----|-------------|------|
| 4.8 S 4WD | 8 | M 48.01 | 283/380 | 02/07→09/10 | | | | ZSE042 [16] | GS28 |
| 4.8 Turbo S 4WD | 8 | M 48.51 | 368/493 | 02/07→09/10 | Z277 | | 0.8 | ZSE042 [16] | GS28 |

CAYMAN (987)

| | | | | | | | | | |
|-----------------|---|---------|---------|-------------|--|--|--|--------|------|
| 2.7 | 6 | M 97.20 | 180/241 | 07/06→12/09 | | | | ZS031 | |
| 2.9 | 6 | MA1.20 | 195/261 | 02/09→ | | | | ZSE052 | GS28 |
| 3.4 S | 6 | M 97.21 | 217/291 | 11/05→12/09 | | | | ZS036 | |
| 3.4 S | 6 | MA1.21 | 235/315 | 02/09→ | | | | ZSE052 | GS28 |
| 3.4 S 3,4 Sport | 6 | M 97.22 | 223/299 | 08/08→12/12 | | | | ZS036 | |

MACAN

| | | | | | | | | | |
|------------------|---|----------------|---------|--------|-------|--|------|--------|--|
| 2.0 4WD | 4 | MCN.CC, MCY.NA | 174/233 | 07/14→ | | | | ZSE068 | |
| 3.0 S Diesel 4WD | 6 | MCT.BB | 155/208 | 02/14→ | GE115 | | 4.4V | | |
| 3.0 S Diesel 4WD | 6 | MCT.BC | 184/247 | 02/14→ | GE115 | | 4.4V | | |
| 3.0 S Diesel 4WD | 6 | MCT.BA | 190/255 | 02/14→ | GE115 | | 4.4V | | |

PANAMERA

| | | | | | | | | | |
|----------------|---|------------------|---------|--------|-------|--|------|-------------|--|
| 3.0 D | 6 | MCR.CB | 155/208 | 08/11→ | GE115 | | 4.4V | | |
| 3.0 D | 6 | MCR.CC | 184/247 | 08/11→ | GE115 | | 4.4V | | |
| 3.0 D | 6 | | 221/296 | 01/14→ | GE115 | | 4.4V | | |
| 3.0 S E-Hybrid | 6 | MCG.EA, MCG.FA | 245/329 | 03/11→ | | | | ZSE032 | |
| 3.6 | 6 | M 46.20, M 46.40 | 220/295 | 05/10→ | | | | ZSE042 [16] | |
| 4.8 4S 4WD | 8 | M 48.40 | 294/394 | 09/09→ | | | | ZSE042 [16] | |
| 4.8 S | 8 | M 48.20 | 294/394 | 09/09→ | | | | ZSE042 [16] | |
| 4.8 Turbo 4WD | 8 | M 48.70 | 368/493 | 09/09→ | | | | ZSE042 [16] | |

RENAULT

| | | | | | | | | | |
|---------------|---|---------------------------|-------|-------------|-----------|--|-----|---------------|--------------------|
| 4 | | | | | | | | | |
| 0.7 | 4 | 680.702 | 15/20 | 04/62→04/71 | | | | ZS105 [11] | |
| 0.8 | 4 | 800, 800 705 | 19/25 | 10/62→09/83 | Z10 [167] | | 0.8 | ZS105 [1][11] | ZS106 [1][11][254] |
| 0.8 | 4 | 839 706 | 20/27 | 01/81→09/82 | | | | ZS106 [11] | |
| 0.8 | 4 | 800 705, B1B 707 | 21/28 | 10/83→10/88 | Z10 [167] | | 0.8 | ZS105 [1][11] | ZS106 [1][11][254] |
| 0.8 | 4 | 800 01 | 25/34 | 09/71→12/88 | Z10 [167] | | 0.8 | ZS106 [11] | |
| 1.0 | 4 | C1C 708 | 25/34 | 06/87→06/93 | Z10 | | 0.8 | | |
| 1.1 | 4 | 688 712, C1E 714, C1E 719 | 25/34 | 06/78→06/90 | Z10 [167] | | 0.8 | ZS106 [11] | |
| | | | | →09/84 | Z57 | | 0.6 | | |
| | | | | 10/84→ | | | | | |
| 1.1 | 4 | C1E 714 | 32/43 | 06/86→06/90 | | | | ZS110 [15] | |
| 1.1 | 4 | 688 712 | 33/44 | 02/78→03/84 | | | | ZS106 [11] | 10/82→ |
| 5 | | | | | | | | | |
| 0.8 | 4 | 800 710 | 26/35 | 10/72→08/84 | Z10 | | 0.8 | ZS106 [11] | |
| 0.8 | 4 | 800 710 | 27/36 | 01/82→12/84 | Z10 | | 0.8 | ZS106 [11] | |
| 1.0 | 4 | 689 710 | 32/43 | 01/72→12/85 | Z10 | | 0.8 | | |
| 1.1 | 4 | 688 713, C1E 726 | 33/44 | 09/80→12/85 | Z10 | | 0.8 | ZS106 [11] | |
| 1.3 | 4 | 810 726 | 31/42 | 09/76→09/79 | Z10 | | 0.8 | ZS106 [11] | |
| 1.3 | 4 | 810 719 | 33/44 | 06/79→09/84 | Z1 [169] | | 0.7 | UXT2 / UXT6 | ZS106 [11] |
| 1.3 | 4 | 810 725 | 47/63 | 09/75→09/84 | Z10 | | 0.8 | ZS110 [15] | |
| 1.3 Automatik | 4 | 810 729 | 40/54 | 06/79→09/84 | Z10 | | 0.8 | ZS106 [11] | |
| 1.4 | 4 | 847 725, C2J 713 | 46/62 | 01/82→12/85 | Z11 | | 0.8 | UXT2 / UXT6 | |
| 1.4 Alpine A5 | 4 | 840 725 | 68/91 | 09/77→09/81 | Z25 | | 0.8 | UXK56 | ZS110 [15] |
| 1.4 Automatik | 4 | 847 712 | 43/58 | 06/82→09/84 | Z1 [169] | | 0.7 | UXT2 / UXT6 | |
| 6 | | | | | | | | | |
| 0.8 | 4 | 800.02 | 25/34 | 10/69→04/80 | Z10 | | 0.8 | | |
| 1.1 | 4 | 688.10 | 33/44 | 08/70→04/87 | Z10 | | 0.8 | | |
| 1.1 | 4 | 688.10 | 35/47 | 07/71→04/80 | Z10 | | 0.8 | | |



kW/BHP

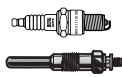

... RENAULT



| | | | | | | | | | |
|---------------|---|------------------------------------|--------|-------------|---------------------|-----------------|--|-----|--|
| 8 | | | | | | | | | |
| 1.0 | 4 | | 29/39 | 11/62→10/72 | Z19 | | | 0.8 | |
| 1.1 | 4 | 688.01 | 33/44 | 11/62→10/72 | Z57 | | | 0.6 | |
| 9 | | | | | | | | | |
| 1.1 | 4 | C1E 715, C1E 720 | 35/47 | 09/81→05/87 | Z1 ^[169] | | | 0.7 | UXT2 / UXT6 ZS106 ^[11] |
| 1.2 | 4 | C1G 700, C1G 710 | 40/54 | 09/85→12/88 | Z1 ^[169] | | | 0.7 | UXT2 / UXT6 ZS106 ^[11] |
| 1.4 | 4 | C1J 715, C1J 792, C1J 796, C2J 730 | 44/59 | 12/81→12/88 | Z82 | | | 0.7 | UXT2 / UXT6 ZS251 ^{[1]213254} ZS316 ^{[1]206254} |
| 1.4 | 4 | C2J 720, C2J 766, C2J 767, C2J 768 | 49/66 | 09/85→12/88 | Z1 ^[169] | | | 0.7 | UXT2 / UXT6 ZS251 ^{[213]254} ZS316 ^{[206]254} |
| 1.4 | 4 | C2J 717, C2J 755 | 53/71 | 09/81→12/85 | Z1 ^[169] | | | 0.7 | UXT2 / UXT6 |
| 1.4 Automatik | 4 | C2J 718, C2J 757 | 50/67 | 09/81→12/85 | Z1 ^[169] | | | 0.7 | UXT2 / UXT6 |
| 1.4 Turbo | 4 | C1J 760, C1J 764 | 77/103 | 04/84→12/86 | | | | | ZS115 ^[11] |
| 1.4 Turbo | 4 | C1J 760, C1J 764 | 85/114 | 12/86→12/89 | | | | | ZS251 ^{[1]213254} ZS316 ^{[1]206254} |
| 1.6 D | 4 | F8M 700, F8M 720, F8M 730 | 40/54 | 10/82→12/88 | GV852 | GR066 →09/83 | | 11V | |
| 1.7 | 4 | F3N 718 | 54/72 | 10/86→12/88 | Z22 | | | 0.7 | UX56 ZS251 ^{[213]254} ZS316 ^{[206]254} |
| 1.7 | 4 | F2N 730 | 55/74 | 10/86→12/88 | Z22 | | | 0.7 | UX56 ZS251 ^{[213]254} ZS316 ^{[206]254} |
| 1.7 | 4 | F2N 700, F2N 704 | 59/79 | 09/84→12/89 | Z22 | | | 0.7 | UX56 |
| 1.7 | 4 | F2N 708, F2N 710, F2N 798 | 65/87 | 10/86→12/88 | Z22 | | | 0.7 | UX56 ZS251 ^{[213]254} ZS316 ^{[206]254} |
| 1.7 | 4 | F3N 708 | 69/93 | 06/87→12/88 | Z22 | | | 0.7 | UX56 ZS251 ^{[213]254} ZS316 ^{[206]254} |
| 10 | | | | | | | | | |
| 1.1 | 4 | 688.01 | 33/44 | 05/66→10/72 | Z57 | | | 0.6 | |
| 1.3 | 4 | 810.03 | 35/47 | 07/69→10/72 | Z57 | | | 0.6 | |
| 11 | | | | | | | | | |
| 1.1 | 4 | C1E 715, C1E 720 | 35/47 | 03/83→06/86 | Z1 ^[169] | | | 0.7 | UXT2 / UXT6 ZS106 ^[11] |
| 1.2 | 4 | C1G 700, C1G 710 | 40/54 | 10/84→12/88 | Z1 ^[169] | | | 0.7 | UXT2 / UXT6 |
| 1.4 | 4 | C1J 715, C2J 730 | 44/59 | 03/83→12/88 | Z1 ^[169] | | | 0.7 | UXT2 / UXT6 ZS251 ^{[213]254} ZS316 ^{[194]206} ^[254] |
| 1.4 | 4 | C2J 720, C2J 766, C2J 767, C2J 768 | 49/66 | 03/83→12/88 | Z1 ^[169] | | | 0.7 | UXT2 / UXT6 ZS251 ^{[213]254} ZS316 ^{[194]206} ^[254] |
| 1.4 | 4 | C2J 718, C2J 757 | 50/67 | 03/83→12/85 | Z1 ^[169] | | | 0.7 | UXT2 / UXT6 |
| 1.4 | 4 | C2J 717, C2J 755 | 53/71 | 05/83→12/85 | Z1 ^[169] | | | 0.7 | UXT2 / UXT6 |
| 1.4 Turbo | 4 | C1J 760, C1J 764 | 77/103 | 04/84→12/86 | | | | | ZM005 |
| 1.4 Turbo | 4 | C1J 770, C1J 782 | 85/114 | 10/86→12/88 | | | | | ZM005 |
| 1.6 D | 4 | F8M 700, F8M 720, F8M 730 | 40/54 | 08/83→12/88 | GV852 | | | 11V | |
| 1.7 | 4 | F2N 730 | 54/72 | 10/86→12/88 | Z22 | | | 0.7 | UX56 |
| 1.7 | 4 | F3N 718 | 55/74 | 10/84→12/88 | Z20 | | | 0.8 | UXT2 / UXT6 ZS251 ^{[1]213254} ZS316 ^{[1]206254} |
| 1.7 | 4 | F2N 700, F2N 704 | 59/79 | 10/83→12/87 | Z22 | | | 0.7 | UX56 ZS251 ^{[213]254} ZS316 ^{[206]254} |
| 1.7 | 4 | F2N 732, F2N 742 | 64/86 | 06/87→12/88 | Z22 | | | 0.7 | UX56 |
| 1.7 | 4 | F2N 708, F2N 710, F2N 798 | 65/87 | 10/86→12/88 | Z22 | | | 0.7 | UX56 |
| 1.7 | 4 | F3N 708 | 69/93 | 06/87→12/88 | Z20 | | | 0.8 | UXT2 / UXT6 |
| 12 | | | | | | | | | |
| 1.3 | 4 | 810.02 | 37/50 | 07/75→04/80 | Z10 | | | 0.8 | ZS106 ^[11] |
| 1.3 | 4 | 810.02/97 | 40/54 | 10/69→08/80 | Z10 | | | 0.8 | ZS106 ^[11] |
| 1.3 | 4 | 810.05, 810.06 | 44/59 | 08/73→08/80 | Z10 | | | 0.8 | ZS106 ^[11] |
| 1.3 TS | 4 | 810.05 | 44/59 | 08/72→08/80 | Z10 | | | 0.8 | ZS106 ^{[1]11} |
| 1.3 TS | 4 | 810.06 | 44/59 | 08/72→08/80 | Z10 | | | 0.8 | ZS110 ^{[1]15} →08/79 |
| 1.4 | 4 | C1J 791 | 49/66 | 08/76→08/80 | Z118 | | | 0.9 | |



kW/BHP



... RENAULT



... 12

| | | | | | | | | | |
|-------------|---|---------------------|--------|-------------|------------------------------------|-------|------------|-----------------------|--|
| 1.6 | 4 | 821.10, 821.11 | 50/67 | 08/70→08/76 | | | | ZS106 ^[11] | |
| 14 | | | | | | | | | |
| 1.2 | 4 | 129 | 42/56 | 05/76→01/80 | Z25 | | 0.8 | UXK56 | ZS106 ^[11] |
| 1.2 | 4 | 129 | 43/58 | 01/80→12/83 | Z31 ^[167] | | 0.8 | UXK56 | ZS106 ^[11] |
| 1.4 | 4 | X5J | 44/59 | 12/81→12/83 | Z25 | | 0.8 | UXK56 | |
| 1.4 | 4 | 150 | 52/70 | 09/79→06/83 | Z95 ^[169] | | 0.7 | UXT4 | ZS106 ^[11] |
| 15 | | | | | | | | | |
| 1.3 | 4 | 810.05 | 44/59 | 03/72→10/80 | Z10 | | 0.8 | | |
| 1.6 | 4 | 807.10 | 66/89 | 03/72→10/80 | Z22 | | 0.7 | UX56 | |
| 16 | | | | | | | | | |
| 1.5 | 4 | | 40/54 | 09/65→10/75 | Z11 | | 0.8 | UXT2 / UXT6 | |
| 1.6 TA | 4 | | 52/70 | 01/69→08/80 | Z22 | | 0.7 | UX56 | |
| 1.6 TL | 4 | 821 | 40/54 | 07/75→08/80 | Z11 | | 0.8 | UXT2 / UXT6 | |
| 1.6 TL | 4 | 821, 821.03, 821.04 | 48/64 | 01/71→08/80 | Z11 | | 0.8 | UXT2 / UXT6 | ZS110 ^[15] |
| 1.6 TS | 4 | 807, 807.04, 807.05 | 61/82 | 09/68→08/80 | Z11 | | 0.8 | UXT2 / UXT6 | |
| 1.6 TX | 4 | 843, 843.01 | 68/91 | 06/74→08/80 | Z22 | | 0.7 | UX56 | |
| 17 | | | | | | | | | |
| 1.6 | 4 | 807.10 | 66/89 | 03/72→10/80 | Z22 | | 0.7 | UX56 | |
| 1.6 | 4 | 843.05 | 68/91 | 06/74→08/79 | Z22 | | 0.7 | UX56 | |
| 18 | | | | | | | | | |
| 1.4 | 4 | 847 720, 847 722 | 47/63 | 04/78→07/86 | Z1 ^[169] | | 0.7 | UXT2 / UXT6 | ZS106 ^[11] |
| 1.6 | 4 | 841 717, A2M 723 | 54/72 | 01/82→07/86 | Z11 | | 0.8 | UXT2 / UXT6 | ZS106 ^[11] |
| 1.6 | 4 | 841 725, 841 726 | 58/78 | 04/78→09/82 | Z11 | | 0.8 | UXT2 / UXT6 | ZS106 ^[11] |
| 1.6 TS | 4 | A6M 725, A6M 726 | 71/95 | 05/82→07/86 | Z22 | | 0.7 | UX56 | ZS251 ^[1] |
| 1.6 Turbo | 4 | 807 727 | 80/107 | 10/80→09/82 | Z38 | | 0.4 | | |
| 1.6 Turbo | 4 | ASL 717, ASL 718 | 92/123 | 10/82→07/86 | Z38 | | 0.4 | | ZM005 01/83→ |
| 2.0 4WD | 4 | J6R 714, J6R 716 | 76/102 | 05/83→12/86 | Z26 | | 0.7 | UXK56 | |
| 2.0 | 4 | J6R 716 | 77/103 | 10/81→07/86 | Z25 | | 0.8 | UXK56 | ZS106 ^[11] |
| 2.0 | 4 | J6R 716 | 77/103 | 05/82→07/86 | | | | | ZS251 ^[1] |
| 2.1 Diesel | 4 | 852 710, J85 711 | 49/66 | 11/80→07/86 | GN909 ^{[2][222]} GV642 | GR066 | 11V 11V | | |
| 2.1 Diesel | 4 | J85 711 | 53/71 | 05/79→07/86 | GN909 | | 11V | | |
| 2.1 TD | 4 | J85 712 | 65/87 | 11/81→07/86 | GN909 ^{[2][222]} GV642 | | 11V 11V | | |
| 2.2 i | 4 | J7T 718 | 76/102 | 06/84→07/86 | | | | | ZS251 ^{[213][254]} ZS316 ^{[206][254]} |
| 19 I | | | | | | | | | |
| 1.2 | 4 | C1G 730 | 40/54 | 01/88→12/92 | Z1 ^[169] | | 0.7 | UXT2 / UXT6 | ZS251 ^{[1][213][254]} ZS316 ^{[1][206][254]} |
| 1.4 | 4 | C2J 772, C3J 710 | 43/58 | 07/88→04/92 | Z82 ^[169] | | 0.7 | UXT2 / UXT6 | ZS251 ^{[213][254]} ZS316 ^{[194][206][254]} |
| 1.4 | 4 | C2J 772 | 43/58 | 01/89→12/89 | Z1 ^[169] | | 0.7 | UXT2 / UXT6 | ZS251 ^[1] |
| 1.4 | 4 | C3J 710 | 43/58 | 01/89→04/92 | | | | | ZS251 ^{[213][254]} ZS316 ^{[206][254]} |
| 1.4 | 4 | E7J 700 | 55/74 | 09/90→04/92 | | | | | ZS251 ^{[1][213][254]} ZS316 ^{[1][206][254]} |
| 1.4 | 4 | E6J 700, E6J 701 | 57/76 | 07/88→08/90 | | | | | ZS251 ^{[1][213][254]} ZS316 ^{[1][206][254]} |
| 1.4 | 4 | E6J 700, E6J 701 | 59/79 | 01/88→12/92 | Z63 | | 0.8 | UXT1 / UXT3 | ZS251 |
| 1.7 | 4 | F3N 740, F3N 741 | 54/72 | 09/88→04/92 | Z20 | | 0.8 | UXT2 / UXT6 | ZS251 ^{[213][254]} ZS316 ^{[194][206][254]} |
| 1.7 | 4 | F3N 740, F3N 741 | 54/72 | 10/89→04/92 | | | | | ZS251 ^[1] |
| 1.7 | 4 | F3N 742, F3N 743 | 66/89 | 07/88→04/92 | Z20 | | 0.8 | UXT2 / UXT6 | ZS251 ^{[213][254]} ZS316 ^{[206][254]} |
| 1.7 | 4 | F2N 720, F2N 721 | 68/91 | 09/88→12/92 | Z27 | | 0.8 | UX56 | ZS251 |

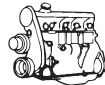

kW/BHP

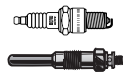

... RENAULT



... 19 I

| | | | | | | | | | |
|---------|---|------------------|---------|-------------|---|-----------------|-----|-------------|--|
| 1.7 | 4 | F3N 742, F3N 743 | 70/94 | 07/91→04/92 | Z27 | | 0.8 | UX56 | ZS251 [1][213][254] ZS316 [1][206][254] |
| 1.7 | 4 | F3N 746 | 79/106 | 08/88→12/92 | Z20 | | 0.8 | UXT2 / UXT6 | ZS251 [1] |
| 1.8 16V | 4 | F7P 704 | 99/133 | 06/89→04/92 | Z24 | | 0.8 | UXT5 | ZS251 [213][254] ZS316 [206][254] |
| 1.8 16V | 4 | F7P 704 | 101/135 | 07/91→04/92 | Z24 | | 0.8 | UXT5 | |
| 1.9 D | 4 | F8Q 706, F8Q 742 | 47/63 | 09/88→04/92 | GN909 [222] →02/91 GV642 →02/91 GV852 03/91→ | GR067 03/91→ | 11V | | |
| 1.9 DT | 4 | F8Q 610 | 68/91 | 09/90→04/92 | GN909 [235] GV844 [236] | | 11V | | |
| 1.9 TD | 4 | F8Q 740 | 68/91 | 09/90→04/92 | GN959 [2][222] GV844 | | 11V | | |

19 II

| | | | | | | | | | |
|---------|---|---|-------|-------------|-----------------|--|------------|-------------|---|
| 1.2 | 4 | C1G 730 | 40/54 | 04/92→12/95 | Z1 [169] | | 0.7 | UXT2 / UXT6 | ZS251 [1][213][254] ZS316 [1][206][254] |
| 1.2 | 4 | E7F 730 | 44/59 | 05/92→09/94 | | | | | ZS251 [1][213][254] ZS316 [1][206][254] |
| 1.2 LPG | 4 | C1G 730 | 40/54 | 04/92→12/95 | Z11 [168] | | 0.8 | UXT2 / UXT6 | |
| 1.4 | 4 | C3J 710 | 43/58 | 04/92→12/95 | Z82 [169] | | 0.7 | UXT2 / UXT6 | ZS251 [213][254] ZS316 [206][254] |
| 1.4 | 4 | E6J/701, E7J | 43/58 | 04/92→12/95 | | | | | ZS251 [213][254] ZS316 [206][254] |
| 1.4 | 4 | E7J 742 | 55/74 | 01/92→12/95 | Z247 | | 0.9 | UXT1 / UXT3 | ZS251 |
| 1.4 | 4 | E7J 742 | 55/74 | 11/93→12/95 | | | | | ZS251 [213][254] ZS316 [194][206] [254] |
| 1.4 | 4 | E6J 700, E7J 706 | 59/79 | 01/92→12/95 | Z63 | | 0.8 | UXT1 / UXT3 | ZS251 |
| 1.4 | 4 | E7J 706 | 59/79 | 10/94→11/95 | | | | | ZS251 [1][213][254] ZS316 [1][206][254] |
| 1.4 LPG | 4 | E7J 742 | 55/74 | 01/92→12/95 | Z340 | | 0.7 | UXT12 | |
| 1.4 LPG | 4 | E6J 700, E7J 706 | 59/79 | 01/92→12/95 | Z340 | | 0.7 | UXT12 | |
| 1.7 | 4 | F3N 740, F3N 741 | 54/72 | 04/92→12/95 | Z20 | | 0.8 | UXT2 / UXT6 | ZS251 |
| 1.7 | 4 | F3N 740, F3N 741 | 55/74 | 05/92→11/95 | | | | | ZS251 |
| 1.7 | 4 | F3N 742, F3N 743 | 66/89 | 04/92→12/95 | Z20 | | 0.8 | UXT2 / UXT6 | |
| 1.7 | 4 | F3N 742, F3N 743 | 66/89 | 04/92→09/93 | | | | | ZS251 [1] |
| 1.7 | 4 | F3N 742 | 66/89 | 04/92→12/95 | | | | | ZS251 [213][254] ZS316 [194][206] [254] |
| 1.7 | 4 | F3N 743 | 66/89 | 04/92→12/95 | | | | | ZS251 [213][254] ZS316 [194][206] [254] |
| 1.7 | 4 | F2N 720, F2N 721 | 68/91 | 01/93→08/95 | Z27 | | 0.8 | UX56 | ZS251 |
| 1.7 LPG | 4 | F3N 740, F3N 741 | 54/72 | 04/92→12/95 | Z27 [168] | | 0.8 | UX56 | |
| 1.7 LPG | 4 | F3N 742, F3N 743 | 66/89 | 04/92→12/95 | Z27 [168] | | 0.8 | UX56 | |
| 1.8 | 4 | F3P 704 | 65/87 | 04/92→12/95 | Z1 [169] | | 0.7 | UXT2 / UXT6 | |
| 1.8 | 4 | F3P 704, F3P 705, F3P 706, F3P 707, F3P 708, F3P 760 | 65/87 | 04/92→06/96 | Z20 | | 0.8 | UXT2 / UXT6 | ZS251 [213][254] ZS316 [206][254] |
| 1.8 | 4 | F3P 705 | 65/87 | 04/92→12/95 | Z11 | | 0.8 | UXT2 / UXT6 | |
| 1.8 | 4 | F3P 706, F3P 708, F3P 760 | 65/87 | 04/92→12/95 | Z1 [169] Z20 | | 0.7 0.8 | UXT2 / UXT6 | |
| 1.8 | 4 | F3P 707 | 65/87 | 04/92→12/95 | Z11 Z20 | | 0.8 0.8 | UXT2 / UXT6 | |
| 1.8 | 4 | F3P 706, F3P 760 | 66/89 | 04/92→06/96 | Z20 | | 0.8 | UXT2 / UXT6 | |
| 1.8 | 4 | F3P 706, F3P 760 | 66/89 | 04/92→12/95 | | | | | ZS251 [1][213][254] ZS316 [1][206][254] |



kW/BHP

**... RENAULT****... 19 II**

| | | | | | | | | | | |
|-------------|---|---|--------|-------------|--|--------------------------|------------|---------------------|-------------------|--|
| 1.8 | 4 | F3P 706, F3P 760 | 66/89 | 09/93→06/96 | | | | | | ZS251 [213][254] ZS316 [206][254] |
| 1.8 | 4 | F3P 682, F3P 765 | 79/106 | 05/94→06/96 | Z20 | | 0.8 | UXT2 / UXT6 | | |
| 1.8 | 4 | F3P 682, F3P 765 | 79/106 | 05/94→12/95 | | | | | | ZS250 |
| 1.8 | 4 | F3P 682, F3P 765 | 79/106 | 07/94→06/96 | | | | | | ZS251 [1] |
| 1.8 | 4 | F3P 764 | 79/106 | 07/94→06/96 | Z20 | | 0.8 | UXT2 / UXT6 | | ZS251 [1] |
| 1.8 | 4 | F3P 700 | 81/109 | 04/92→05/94 | Z20 | | 0.8 | UXT2 / UXT6 | | ZS251 [1][213][254] ZS316 [1][206][254] |
| 1.8 LPG | 4 | F3P 704 | 65/87 | 04/92→12/95 | Z11 [168] | | 0.8 | UXT2 / UXT6 | | |
| 1.8 LPG | 4 | F3P 704, F3P 705, F3P 706, F3P 707, F3P 708, F3P 760 | 65/87 | 04/92→06/96 | Z27 [168] | | 0.8 | UX56 | | |
| 1.8 LPG | 4 | F3P 706, F3P 708, F3P 760 | 65/87 | 04/92→12/95 | Z11 [168] Z27 [168] | | 0.8 0.8 | UXT2 / UXT6 UX56 | | |
| 1.8 LPG | 4 | F3P 706, F3P 760 | 66/89 | 04/92→06/96 | Z27 [168] | | 0.8 | UX56 | | |
| 1.8 LPG | 4 | F3P 682, F3P 764, F3P 765 | 79/106 | 05/94→06/96 | Z27 [168] | | 0.8 | UX56 | | |
| 1.8 16V | 4 | F7P 704 | 99/133 | 04/92→06/96 | Z24 | | 0.8 | UXT5 | | ZS251 [1] |
| 1.8 16V LPG | 4 | F7P 704 | 99/133 | 04/92→06/96 | Z30 [168] | | 0.8 | UXT5 | | |
| 1.9 D | 4 | F8Q 742 | 47/63 | 04/92→12/95 | GV852 | GR067 | | | 11V | |
| 1.9 D | 4 | F8Q 744 | 68/91 | 05/92→11/95 | GN959 [2][222] GV844 | | | | 11V 11V | |
| 1.9 dT | 4 | F8Q 744 | 66/89 | 04/92→12/95 | GN959 [2][222] GV844 | | | | 11V 11V | |
| 20 | | | | | | | | | | |
| 1.6 | 4 | 843 | 66/89 | 10/75→05/77 | Z22 | | 0.7 | UX56 | | |
| 1.6 | 4 | 843 720, 843 721 | 71/95 | 05/77→12/83 | Z22 | | 0.7 | UX56 | | |
| 2.0 | 4 | 829 702, 829 703 | 76/102 | 10/80→12/83 | Z25 | | 0.8 | UXK56 | | |
| 2.0 | 4 | 829.01, 829 700, 829 701 | 80/107 | 10/77→10/80 | Z25 | | 0.8 | UXK56 | | ZS106 [11] |
| 2.1 Diesel | 4 | 852 | 47/63 | 10/80→12/83 | GV602 →04/81 GN909 [2][222] GV642 05/81→ | GR059 →04/81 GR065 | | | 11V 11V 11V | |
| 2.1 TD | 4 | J8S 702 | 63/84 | 01/82→12/83 | GN909 [2][222] GV642 | GR065 | | | 11V 11V | |
| 2.2 | 4 | 851 700 | 85/114 | 10/80→12/83 | Z25 | | 0.8 | UXK56 | | |
| 21 | | | | | | | | | | |
| 1.4 | 4 | C2J 770 | 51/68 | 06/88→10/93 | Z1 [169] | | 0.7 | UXT2 / UXT6 | | ZS251 [1][213][254] ZS316 [1][206][254] |
| 1.4 (B48D) | 4 | C2J 770 | 51/68 | 09/89→05/93 | | | | | | ZS251 [1][213][254] ZS316 [1][206][254] |
| 1.7 | 4 | F2N 750 | 54/72 | 06/86→02/94 | Z22 | | 0.7 | UX56 | | ZS251 [213][254] ZS316 [206][254] |
| 1.7 | 4 | F3N 726 | 54/72 | 07/86→02/94 | Z20 | | 0.8 | UXT2 / UXT6 | | ZS251 [213][254] ZS316 [206][254] |
| 1.7 | 4 | F3N 726 | 54/72 | 05/88→06/93 | | | | | | ZS251 [1] |
| 1.7 | 4 | F3N 726 | 54/72 | 09/89→10/92 | | | | | | ZS251 |
| 1.7 | 4 | F2N 712 | 55/74 | 03/86→03/93 | Z22 | | 0.7 | UX56 | | |
| 1.7 | 4 | F2N 712 | 55/74 | 03/86→12/87 | | | | | | ZS251 [213] →ch. H000006; H00058840 ZS316 [206] →ch. H000006; H00058840 |
| 1.7 | 4 | F2N 712 | 55/74 | 06/86→03/93 | | | | | | ZS251 [213] →ch. H00000685; H00058840 ZS316 [206] →ch. H00000685; H00058840 |



kW/BHP

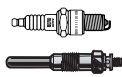

... RENAULT 

| ... 21 | | | | | | | | | | |
|-------------|---|---|---------|-------------|----------------------------------|-------|--|-------------------|-------------|--|
| 1.7 | 4 | F2N 752 | 64/86 | 06/87→04/89 | Z22 | | | 0.7 | UX56 | ZS251 [213] →ch. H0000685; H0058840 ZS316 [206] →ch. H0000685; H0058840 |
| 1.7 | 4 | F2N 710 | 65/87 | 03/86→03/93 | Z22 | | | 0.7 | UX56 | ZS251 [1][213][254] ZS316 [1][206][254] |
| 1.7 | 4 | F2N 710 | 65/87 | 10/86→12/88 | | | | | | ZS251 [213] →ch. H0000685; H0058840 ch. H0058841, H0000686→ ZS316 [206] →ch. H0000685; H0058840 ch. H0058841, H0000686→ |
| 1.7 | 4 | F3N 722, F3N 723 | 66/89 | 09/89→06/94 | Z22 | | | 0.7 | UX56 | ZS251 |
| 1.7 | 4 | F3N 722, F3N 723 | 66/89 | 09/89→02/94 | | | | | | ZS251 [1][213][254] ZS316 [1][206][254] |
| 1.7 | 4 | F3N 722, F3N 723 | 66/89 | 10/89→12/93 | Z20 | | | 0.8 | UXT2 / UXT6 | |
| 1.7 | 4 | F3N 722, F3N 723 | 69/93 | 03/86→02/94 | Z22 | | | 0.7 | UX56 | ZS251 [213][254] ZS316 [206][254] |
| 1.7 | 4 | F3N 722, F3N 723 | 69/93 | 06/86→12/89 | Z20 | | | 0.8 | UXT2 / UXT6 | |
| 1.9 D | 4 | F8Q 710 | 47/63 | 03/86→08/94 | GN909 | GR067 | | 11V | | |
| 2.0 | 4 | J6R 758, J6R 759, J6R 792, J6R 793 | 75/101 | 03/86→10/93 | | | | | | ZS251 [1][213][254] ZS316 [1][206][254] |
| 2.0 | 4 | J7R 750, J7R 751 | 85/114 | 03/86→12/88 | Z46 | | | 0.8 | UXK56 | ZS251 [1][213][254] ZS316 [1][206][254] |
| 2.0 | 4 | J7R 746, J7R 747 | 88/118 | 03/86→12/93 | | | | | | ZS251 [1][213][254] ZS316 [1][206][254] |
| 2.0 | 4 | J7R 746, J7R 747 | 88/118 | 09/89→12/93 | | | | | | ZS251 [213][254] ZS316 [194][206] [254] |
| 2.0 | 4 | J7R 740 | 99/133 | 12/89→06/94 | Z52 | | | 0.8 | UXT5 | ZS251 [213][254] ZS316 [206][254] |
| 2.0 Turbo | 4 | J7R 756 | 119/160 | 02/90→10/92 | Z46 | | | 0.8 | UXK56 | ZS251 [213] →ch. F00349091 ZS316 [206] →ch. F00349091 |
| 2.1 D | 4 | J8S 704 | 48/64 | 03/86→05/92 | GN909 [2][222] GV642 | GR066 | | 11V 11V | | |
| 2.1 D | 4 | J8S 704, J8S 784 | 50/67 | 07/89→05/93 | GN954 | | | 11V | | |
| 2.1 D | 4 | J8S 784 | 51/68 | 02/92→09/95 | GN013 [2][222] GN954 GV642 | | | 11V 11V 11V | | |
| 2.1 D | 4 | J8S 600, J8S 740 | 53/71 | 05/89→06/94 | GN909 [2][222] GV642 | GR066 | | 11V 11V | | |
| 2.1 TD | 4 | J8S 704 | 50/67 | 04/86→06/89 | GN954 | | | 11V | | |
| 2.1 Turbo-D | 4 | J8S 714, J8S 786, J8S 788 | 65/87 | 03/86→06/94 | GN909 [2][222] GV642 | GR066 | | 11V 11V | | |
| 2.2 | 4 | J7T 754, J7T 755 | 79/106 | 06/86→06/94 | Z25 | | | 0.8 | UXK56 | ZS251 [213][254] ZS316 [206][254] |
| 25 | | | | | | | | | | |
| 2.0 | 4 | J6R 706, J6R 707, J6R 760, J6R 762, J6R 763 | 74/99 | 04/84→12/92 | Z25 | | | 0.8 | UXK56 | ZS251 [213][254] ZS316 [206][254] |
| 2.0 12V | 4 | J7R 726 | 99/133 | 06/89→12/92 | Z60 | | | 1.2 | | ZS251 [213][254] ZS316 [206][254] |

RENAULT



kW/BHP

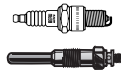

... RENAULT



... 25

| | | | | | | | | | |
|------------------|---|---------------------------------------|---------|-------------|-------------------------|-------|------------|-------|--|
| 2.1 Diesel | 4 | J8S 706 | 46/62 | 04/84→05/89 | GN909 [2][222] GV642 | GR065 | 11V 11V | | |
| 2.1 Diesel | 4 | J8S 736 | 51/68 | 06/89→12/92 | GN909 [2][222] GV642 | GR065 | 11V 11V | | |
| 2.1 Turbo-D | 4 | J8S 708, J8S 738 | 63/84 | 04/84→12/92 | GN909 [2][222] GV642 | GR065 | 11V 11V | | |
| 2.2 | 4 | | 76/102 | 11/85→03/89 | Z95 [169] | | 0.7 | UXT4 | |
| 2.2 | 4 | J7T 708, J7T 732, J7T 733 | 79/106 | 09/86→12/92 | Z31 | | 0.8 | UXK56 | ZS251 [1] |
| 2.2 | 4 | J7T 706, J7T 707, J7T 714, J7T 715 | 89/119 | 04/84→12/89 | Z31 | | 0.8 | UXK56 | ZS251 [1] |
| 2.2 | 4 | J7T 730, J7T 731 | 91/122 | 04/84→12/89 | Z31 | | 0.8 | UXK56 | ZS251 [1] |
| 2.4 V6 Turbo | 6 | Z7U 702 | 133/178 | 10/84→05/90 | | | | | ZS251 [1][213][254] ZS316 [1][206][254] |
| 2.5 V6 Turbo | 6 | Z7U 700 | 151/202 | 01/90→12/92 | | | | | ZS251 [1] |
| 2.7 V6 Injection | 6 | Z7V 708, Z7V 709, Z7V 711 | 104/139 | 04/84→08/89 | Z26 [170] | | 0.7 | UXK56 | |
| 2.8 V6 | 6 | Z7W 700 | 115/154 | 06/87→02/90 | Z25 | | 0.8 | UXK56 | ZS251 [1] |
| 2.8 V6 Injection | 6 | Z7W 702 | 100/134 | 06/86→02/88 | Z25 | | 0.8 | UXK56 | |
| 2.8 V6 Injection | 6 | Z7W 706, Z7W 707, Z7W 709 | 110/148 | 06/87→12/92 | Z25 | | 0.8 | UXK56 | ZS251 [1] |

30

| | | | | | | | | | |
|-------------|---|---------|---------|-------------|-------------------------|-------|------------|-------|------------|
| 2.1 Turbo-D | 4 | J8S 702 | 63/84 | 02/82→03/86 | GN909 [2][222] GV642 | GR065 | 11V 11V | | |
| 2.6 | 6 | 112 | 92/123 | 08/76→08/78 | Z25 | | 0.8 | UXK56 | |
| 2.6 | 6 | 112 | 96/129 | 02/75→07/76 | Z25 | | 0.8 | UXK56 | |
| 2.6 TS | 6 | 144 | 94/126 | 07/78→01/84 | Z25 | | 0.8 | UXK56 | |
| 2.6 TX | 6 | 140 | 105/141 | 10/78→12/83 | Z25 | | 0.8 | UXK56 | ZS110 [15] |

AVANTIME

| | | | | | | | | | |
|-------------------|---|------------------|---------|-------------|-------|--|-----|-------|------------|
| 2.0 16V Turbo | 4 | F4R 760, F4R 761 | 120/161 | 11/01→05/03 | Z337 | | 0.9 | UXT9 | ZS052 GS29 |
| 2.0 16V Turbo LPG | 4 | F4R 760, F4R 761 | 120/161 | 11/01→05/03 | Z340 | | 0.7 | UXT12 | |
| 2.2 dCi | 4 | G9T 712 | 110/148 | 05/02→05/03 | GN026 | | 11V | | |
| 3.0 V6 | 6 | L7X 720, L7X 721 | 152/204 | 09/01→05/03 | | | | | ZS347 |

CAPTUR

| | | | | | | | | | |
|-------------|---|--|--------|--------|------------|--|------|--|--------|
| 0.9 TCe 90 | 3 | | 66/89 | 06/13→ | | | | | ZSE131 |
| 1.2 TCe 120 | 4 | | 88/118 | 06/13→ | | | | | ZSE131 |
| 1.5 dCi 90 | 4 | | 66/89 | 06/13→ | GE110 [37] | | 4.4V | | |

CLIO I

| | | | | | | | | | |
|---------|---|---------------------------------------|-------|-------------|--|--|--------------------------|-------------|--------------------------------------|
| 1.1 | 4 | C1E 700 | 34/46 | 01/91→09/98 | Z76 | | 0.8 | UXT2 / UXT6 | ZS106 [11] |
| 1.1 | 4 | C1E 700 | 36/48 | 04/92→08/92 | | | | | ZS106 [11] |
| 1.2 | 4 | C3G 720 | 40/54 | 01/96→12/96 | Z76 | | 0.8 | UXT2 / UXT6 | ZS250 04/98→ |
| 1.2 | 4 | D7F 730 | 40/54 | 01/96→09/98 | Z247 | | 0.9 | UXT1 / UXT3 | ZS345 |
| 1.2 | 4 | E7F 706 | 40/54 | 01/91→06/96 | Z100 | | 0.8 | UXT1 / UXT3 | ZS251 [213][254] ZS316 [206][254] |
| 1.2 | 4 | D7F 730 | 43/58 | 01/96→09/98 | Z247 | | 0.9 | UXT1 / UXT3 | ZS345 |
| 1.2 | 4 | E7F 700, E7F 708, E7F 750 | 43/58 | 05/90→09/98 | Z5 | | 0.8 | UXT1 / UXT3 | ZS251 [213][254] ZS316 [206][254] |
| 1.2 | 4 | ESF 710 | 44/59 | 05/90→03/96 | Z72 | | 0.8 | UXT1 / UXT3 | ZS251 |
| 1.2 LPG | 4 | D7F 730 | 40/54 | 01/96→09/98 | Z340 | | 0.7 | UXT12 | |
| 1.2 LPG | 4 | E7F 706 | 40/54 | 01/91→06/96 | Z206 | | 0.7 | UXT10 | |
| 1.2 LPG | 4 | D7F 730 | 43/58 | 01/96→09/98 | Z340 | | 0.7 | UXT12 | |
| 1.2 LPG | 4 | E7F 700, E7F 708, E7F 750 | 43/58 | 05/90→09/98 | Z206 | | 0.7 | UXT10 | |
| 1.4 | 4 | E7J 756, E7J 757 | 55/74 | 01/91→09/98 | Z247 | | 0.9 | UXT1 / UXT3 | ZS251 [213][254] ZS316 [206][254] |
| 1.4 | 4 | E7J 601, E7J 718, E7J 719, E7J 754 | 58/78 | 01/91→09/98 | Z247 | | 0.9 | UXT1 / UXT3 | ZS251 [213][254] ZS316 [206][254] |
| 1.4 | 4 | E7J 710, E7J 711 | 59/79 | 01/91→09/98 | Z100 [98][196] Z15 [96][203] Z247 Z63 [97][184] | | 0.8 0.8 0.9 0.8 | UXT1 / UXT3 | ZS251 [213][254] ZS316 [206][254] |

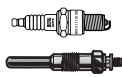

kW/BHP

**... RENAULT****... CLIO I**

| | | | | | | | | | |
|--------------|---|------------------------------------|---------|-------------|--|-------|-----|-----------------------|---|
| 1.4 LPG | 4 | E7J 756, E7J 757 | 55/74 | 01/91→09/98 | Z340 | | 0.7 | UXT12 | |
| 1.4 LPG | 4 | E7J 601, E7J 718, E7J 719, E7J 754 | 58/78 | 01/91→09/98 | Z340 | | 0.7 | UXT12 | |
| 1.7 | 4 | F2N 770 | 68/91 | 01/91→12/93 | Z42 | | 0.8 | UX56 | ZS251 [1] |
| 1.8 | 4 | F3P 710, F3P 714 | 65/87 | 01/91→09/98 | Z20 →08/96 Z119 [170] 09/96→ | | 0.8 | UXT2 / UXT6 →08/96 | ZS251 [213][254] ZS316 [206][254] |
| 1.8 | 4 | F3P 754 | 66/89 | 08/94→09/98 | Z20 →08/96 Z119 [170] 09/96→ | | 0.8 | UXT2 / UXT6 →08/96 | ZS251 [213][254] ZS316 [206][254] |
| 1.8 | 4 | F3P 755 | 66/89 | 08/90→04/96 | Z20 | | 0.8 | UXT2 / UXT6 | |
| 1.8 | 4 | F3P 755 | 66/89 | 08/90→09/98 | | | | | ZS251 [213][254] ZS316 [206][254] |
| 1.8 | 4 | F3P 755 | 66/89 | 08/94→09/98 | Z20 →08/96 Z119 [170] 09/96→ | | 0.8 | UXT2 / UXT6 →08/96 | |
| 1.8 | 4 | F3P 710 | 70/94 | 01/91→09/98 | Z20 →08/96 Z119 [170] 09/96→ | | 0.8 | UXT2 / UXT6 →08/96 | ZS251 [1] |
| 1.8 LPG | 4 | F3P 710, F3P 714 | 65/87 | 01/91→09/98 | Z27 →08/96 Z20 [168] 09/96→ | | 0.8 | UX56 →08/96 | |
| 1.8 LPG | 4 | F3P 754, F3P 755 | 66/89 | 08/94→09/98 | Z27 [168] →08/96 Z20 [168] 09/96→ | | 0.8 | UX56 →08/96 | |
| 1.8 LPG | 4 | F3P 755 | 66/89 | 08/90→04/96 | Z27 [168] | | 0.8 | UX56 | |
| 1.8 LPG | 4 | F3P 710 | 70/94 | 01/91→09/98 | Z20 [168] 09/96→ | | 0.8 | UXT2 / UXT6 09/96→ | |
| 1.8 16V | 4 | F7P 722 | 99/133 | 01/91→03/96 | Z24 | | 0.8 | UXT5 | ZS251 [213][254] ZS316 [194][206] [254] |
| 1.8 Rsi | 4 | F3P 758 | 79/106 | 08/95→09/98 | Z20 →08/96 Z119 [170] 09/96→ | | 0.8 | UXT2 / UXT6 →08/96 | ZS251 [213][254] ZS316 [206][254] |
| 1.8 Rsi | 4 | F3P 712 | 80/107 | 01/93→08/95 | Z20 | | 0.8 | UXT2 / UXT6 | ZS251 [213][254] ZS316 [206][254] |
| 1.8 Rsi LPG | 4 | F3P 758 | 79/106 | 08/95→09/98 | Z27 [168] →08/96 Z20 [168] 09/96→ | | 0.8 | UX56 →08/96 | |
| 1.8 Rsi LPG | 4 | F3P 712 | 80/107 | 01/93→08/95 | Z27 [168] | | 0.8 | UX56 | |
| 1.9 D | 4 | F8Q 678 | 40/54 | 01/97→09/98 | GV852 | | 11V | | |
| 1.9 D | 4 | F8Q 730, F8Q 732 | 47/63 | 01/91→09/98 | GV852 | GR067 | 11V | | |
| 1.9 D | 4 | F8Q 676, F8Q 696 | 48/64 | 05/96→02/98 | GN991 | | 11V | | |
| 2.0 Williams | 4 | F7R 700 | 108/145 | 01/94→09/98 | Z60 | | 1.2 | | ZS251 [213][254] ZS316 [206][254] |

CLIO II

| | | | | | | | | | |
|-----|---|---|-------|-------------|------|--|-----|------|------------------------------------|
| 1.0 | 4 | D7D 760 | 40/54 | 02/00→05/01 | | | | | ZS354 |
| 1.2 | 4 | D7F 720, D7F 726, D7F 746, D7F 764, D7F 766 | 43/58 | 09/98→ | Z224 | | 0.9 | UXT9 | ZS345 →10/98 ZS354 11/98→ |



kW/BHP

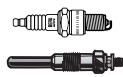

... RENAULT



... CLIO II

| | | | | | | | | | |
|-----------------------|---|---|---------|-------------|------------------------------------|----------------|-------------|---|------|
| 1.2 | 4 | D7F 722 | 44/59 | 03/99→05/01 | Z224 | 0.9 | UXT9 | ZS354 | |
| 1.2 | 4 | | 55/74 | 06/01→10/03 | Z243 | 0.9 | | ZS454 ⁽¹⁾ | |
| 1.2 LPG | 4 | D7F 720, D7F 726, D7F 746, D7F 764, D7F 766 | 43/58 | 09/98→ | Z340 | 0.7 | UXT12 | | |
| 1.2 LPG | 4 | D7F 722 | 44/59 | 03/99→05/01 | Z340 | 0.7 | UXT12 | | |
| 1.2 16V | 4 | D4F 706, D4F 712 | 54/72 | 06/06→ | Z243 | 0.9 | | | |
| 1.2 16V | 4 | D4F 706, D4F 722, D4F 728 | 55/74 | 06/01→ | | | | ZS325 ⁽¹⁾⁽¹⁵⁷⁾ ZS375 ⁽¹⁾⁽¹⁵⁶⁾ ZS454 ⁽¹⁾⁽¹⁰¹⁾ | |
| 1.2 16V | 4 | D4F 712, D4F 714 | 55/74 | 06/01→ | Z243 | 0.9 | | ZS325 ⁽¹⁾⁽¹⁵⁷⁾ ZS375 ⁽¹⁾⁽¹⁵⁶⁾ ZS454 ⁽¹⁾⁽¹⁰¹⁾ | |
| 1.2 LPG | 4 | D7F 764, D7F 766 | 43/58 | 09/98→06/09 | | | | ZS354 | |
| 1.4 | 4 | E7J.6.34, E7J.6.35 | 55/74 | 09/98→05/05 | | | | ZS354 | |
| 1.4 | 4 | E7J 780 | 55/74 | 09/98→05/05 | Z247 | 0.9 | UXT1 / UXT3 | ZS242 ⁽²⁴⁾ ZS243 ⁽²⁶⁾ | |
| 1.4 LPG | 4 | E7J 780 | 55/74 | 09/98→05/05 | Z340 | 0.7 | UXT12 | | |
| 1.4 16V | 4 | K4J 712, K4J 713 | 70/94 | 10/99→09/04 | Z193 | 0.9 | UXT1 / UXT3 | ZS052 | GS29 |
| 1.4 16V | 4 | K4J 710, K4J 711 | 72/97 | 08/00→ | | | | ZS052 | GS29 |
| 1.4 16V | 4 | K4J 712, K4J 713 | 72/97 | 08/00→ | Z193 | 0.9 | UXT1 / UXT3 | ZS052 | GS29 |
| 1.4 16V LPG | 4 | K4J 712, K4J 713 | 70/94 | 10/99→09/04 | Z340 | 0.7 | UXT12 | | |
| 1.4 16V LPG | 4 | K4J 712, K4J 713 | 72/97 | 08/00→ | Z340 | 0.7 | UXT12 | | |
| 1.5 dCi | 4 | K9K 704 | 42/56 | 06/01→12/06 | GN018 | 11V | | | |
| 1.5 dCi | 4 | K9K 740 | 47/63 | 06/05→ | GN018 | 11V | | | |
| 1.5 dCi | 4 | K9K 700, K9K 704 | 48/64 | 06/01→ | GN018 | 11V | | | |
| 1.5 dCi | 4 | K9K 700, K9K 714 | 50/67 | 08/04→ | GN018 | 11V | | | |
| 1.5 dCi | 4 | K9K 702 | 59/79 | 06/01→10/03 | GN018 | 11V | | | |
| 1.5 dCi | 4 | K9K 702 | 60/80 | 06/01→ | GN018 | 11V | | | |
| 1.5 dCi | 4 | K9K 718 | 62/83 | 02/07→ | GN018 | 11V | | | |
| 1.5 dCi | 4 | K9K 712 | 74/99 | 01/04→ | GN018 | 11V | | | |
| 1.6 | 4 | K7M 744, K7M 745 | 66/89 | 09/98→05/05 | Z74 | 1.0 | UXT1 / UXT3 | ZS052 →03/01 ZS354 09/99→12/02 ZS242 ⁽²⁴⁾ ZS243 ⁽²⁶⁾ | |
| 1.6 LPG | 4 | K7M 744, K7M 745 | 66/89 | 09/98→05/05 | Z206 | 0.7 | UXT10 | | |
| 1.6 16V | 4 | K4M 708, K4M 748 | 79/106 | 09/98→ | Z193 | 0.9 | UXT1 / UXT3 | ZS052 | GS29 |
| 1.6 16V | 4 | K4M 740, K4M 742, K4M 743, K4M 744, K4M 745 | 79/106 | 09/98→ | | | | ZS052 | GS29 |
| 1.6 16V LPG | 4 | K4M 708, K4M 748 | 79/106 | 09/98→ | Z340 | 0.7 | UXT12 | | |
| 1.6 Hi-Flex | 4 | K4M 748 | 86/115 | 01/05→02/10 | | | | ZS052 | |
| 1.9 D | 4 | F8Q 630 | 47/63 | 09/98→05/05 | GN963 →02/99 GN019 03/99→ | 11V 11V | | | |
| 1.9 D | 4 | F8Q 632 | 48/64 | 02/00→05/01 | GN963 | 11V | | | |
| 1.9 dTi | 4 | F9Q 780 | 59/79 | 12/99→05/05 | GN018 | 11V | | | |
| 2.0 2.0 16V Sport | 4 | F4R 730 | 124/166 | 02/00→ | Z193 | 0.9 | UXT1 / UXT3 | ZS354 ⁽¹⁾⁽¹⁵⁴⁾ ZS345 ⁽¹⁾ 04/01→ | GS29 |
| 2.0 2.0 16V Sport LPG | 4 | F4R 730 | 124/166 | 02/00→ | Z340 | 0.7 | UXT12 | | |
| 2.0 16V Sport | 4 | F4R 738 | 132/177 | 01/04→ | Z284 | 1.1 | UXT14 | ZS345 →05/05 | |
| 2.0 16V Sport LPG | 4 | F4R 738 | 132/177 | 01/04→ | Z130 ^[168] | 1.0 | UXT14 | | |
| 3.0 V6 Sport | 6 | L7X 760 | 166/223 | 11/00→12/02 | | | | ZS347 | |
| 3.0 V6 Sport | 6 | L7X 762 | 187/251 | 12/02→ | | | | ZS347 | |

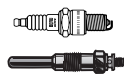

kW/BHP

**... RENAULT****CLIO III**

| | | | | | | | | |
|-----------------|---|------------------|---------|-------------|----------------------|--|-----|--|
| 1.2 | 4 | D4F 764 | 57/76 | 10/05→ | | | | ZS325 [157] ZS375 [156] |
| 1.2 16V | 4 | D4F 740 | 48/64 | 06/05→ | Z243 | | 0.9 | ZS375 →05/08 ZS325 06/08→ |
| 1.2 16V | 4 | D4F 740 | 55/74 | 06/05→ | Z243 | | 0.9 | ZS375 →05/08 ZS325 06/08→ |
| 1.2 16V | 4 | D4F 764 | 58/78 | 06/05→ | Z243 | | 0.9 | ZS375 →05/08 ZS325 06/08→ |
| 1.2 16V | 4 | D4F 784 | 74/99 | 05/07→ | Z274 | | 0.7 | ZS375 →05/08 ZS354 [1][154] ZS325 06/08→ |
| 1.2 16V | 4 | D4F 786 | 76/102 | 09/10→ | Z243 eng. 140701→ | | 0.9 | ZS325 [157] ZS375 [156] |
| 1.2 16V Hi-Flex | 4 | D4F 740, D4F 742 | 55/74 | 07/08→ | | | | ZS325 [157] ZS375 [156] |
| 1.4 16V | 4 | K4J 780 | 72/97 | 06/05→ | Z193 | | 0.9 | UXT1 / UXT3 ZS052 |
| 1.4 16V LPG | 4 | K4J 780 | 72/97 | 06/05→ | Z340 | | 0.7 | UXT12 |
| 1.5 dCi | 4 | K9K 752 | 47/63 | 06/05→ | GN018 | | 11V | |
| 1.5 dCi | 4 | K9K 752 | 48/64 | 05/05→ | GN018 | | 11V | |
| 1.5 dCi | 4 | K9K 714, K9K 768 | 50/67 | 06/05→ | GN018 | | 11V | |
| 1.5 dCi | 4 | K9K 770 | 55/74 | 08/10→ | GN018 | | 11V | |
| 1.5 dCi | 4 | K9K 750 | 60/80 | 11/07→ | GN018 | | 11V | |
| 1.5 dCi | 4 | K9K 766 | 63/84 | 06/05→ | GN018 | | 11V | |
| 1.5 dCi | 4 | K9K 770 | 65/87 | 08/10→ | GN018 | | 11V | |
| 1.5 dCi | 4 | K9K 772 | 76/102 | 06/05→ | GN018 | | 11V | |
| 1.5 dCi | 4 | K9K 764 | 78/105 | 06/05→ | GN018 | | 11V | |
| 1.6 16V | 4 | K4M 804 | 65/87 | 06/05→ | Z193 | | 0.9 | UXT1 / UXT3 ZS052 |
| 1.6 16V | 4 | K4M 800, K4M 801 | 82/110 | 06/05→ | Z193 | | 0.9 | UXT1 / UXT3 ZS052 |
| 1.6 16V LPG | 4 | K4M 804 | 65/87 | 06/05→ | Z340 | | 0.7 | UXT12 |
| 1.6 16V LPG | 4 | K4M 800, K4M 801 | 82/110 | 06/05→ | Z340 | | 0.7 | UXT12 |
| 1.6 16V GT | 4 | K4M 862 | 94/126 | 06/09→ | Z193 | | 0.9 | UXT1 / UXT3 ZS052 |
| 1.6 Hi-Flex | 4 | K4M 748 | 86/115 | 05/05→02/10 | | | | ZS052 |
| 2.0 16V | 4 | M4R 700, M4R 701 | 102/137 | 09/06→ | Z325 | | 1.1 | ZSE056 |
| 2.0 16V Sport | 4 | F4R 830 | 145/194 | 02/06→ | | | | ZS052 |
| 2.0 16V Sport | 4 | F4R 830 | 148/198 | 09/08→ | Z206 | | 0.7 | UXT10 ZS052 |

CLIO IV

| | | | | | | | | |
|------------|---|---------|-------|--------|--|--|------------|---------------------------------|
| 1.2 16V | 4 | D4F 740 | 54/72 | 11/12→ | Z274 [9][103][189] Z243 →eng. 140701 | | 0.7 0.9 | ZS325 [157][266] ZS375 [156] |
| 1.5 dCi 75 | 4 | K9K 612 | 55/74 | 11/12→ | GE110 [16][37] | | 4.4V | |
| 1.5 dCi 90 | 4 | K9K 608 | 66/89 | 11/12→ | GE110 [16][37] | | 4.4V | |

CLIO Grandtour

| | | | | | | | | |
|---------|---|---------|-------|--------|------|--|-----|------------------------------------|
| 1.2 16V | 4 | D4F 740 | 55/74 | 02/08→ | Z243 | | 0.9 | ZS375 →05/08 ZS325 06/08→ |
| 1.2 16V | 4 | D4F 764 | 58/78 | 02/08→ | Z243 | | 0.9 | ZS375 →05/08 ZS325 06/08→ |

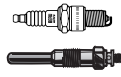

kW/BHP

**... RENAULT****... CLIO Grandtour**

| | | | | | | | | | |
|--------------------------|---|---------------------------------------|---------|-------------|------------------------------|-------|-------------|-------------|--|
| 1.2 16V | 4 | D4F 784 | 74/99 | 02/08→ | Z274 | | 0.7 | | ZS375 →05/08 ZS354 (1)(154) ZS325 06/08→ |
| 1.2 16V | 4 | D4F 786 | 76/102 | 09/10→ | Z243 eng. 140701→ | | 0.9 | | ZS354 |
| 1.2 16V Hi-Flex | 4 | D4F 740 | 55/74 | 07/08→ | | | | | ZS325 (157) ZS375 (156) |
| 1.4 16V | 4 | K4J 780 | 72/97 | 02/10→ | Z193 | | 0.9 | UXT1 / UXT3 | ZS052 |
| 1.4 16V LPG | 4 | K4J 780 | 72/97 | 02/10→ | Z340 | | 0.7 | UXT12 | |
| 1.5 dCi | 4 | K9K 752 | 48/64 | 02/10→ | GN018 | | 11V | | |
| 1.5 dCi | 4 | K9K 714, K9K 768 | 50/67 | 02/08→ | GN018 | | 11V | | |
| 1.5 dCi | 4 | K9K 770 | 55/74 | 08/10→ | GN018 | | 11V | | |
| 1.5 dCi | 4 | K9K 766 | 63/84 | 02/08→ | GN018 | | 11V | | |
| 1.5 dCi | 4 | K9K 770, K9K 772 | 65/87 | 08/10→ | GN018 | | 11V | | |
| 1.5 dCi | 4 | K9K 772 | 76/102 | 02/08→ | GN018 | | 11V | | |
| 1.5 dCi | 4 | K9K 764 | 78/105 | 02/08→ | GN018 | | 11V | | |
| 1.6 16V | 4 | K4M 800, K4M 801 | 82/110 | 02/08→ | Z193 | | 0.9 | UXT1 / UXT3 | ZS052 |
| 1.6 16V | 4 | K4M 862 | 94/126 | 11/08→ | | | | | ZS052 |
| 1.6 16V LPG | 4 | K4M 800, K4M 801 | 82/110 | 02/08→ | Z340 | | 0.7 | UXT12 | |
| CLIO Grandtour IV | | | | | | | | | |
| 1.2 16V | 4 | D4F 740 | 54/72 | 01/13→ | | | | | ZS325 (157)(266) ZS375 (156) |
| 1.5 dCi 75 | 4 | K9K 612 | 55/74 | 01/13→ | GE110 (16)(37) | | 4.4V | | |
| 1.5 dCi 90 | 4 | K9K 608 | 66/89 | 01/13→ | GE110 (16)(37) | | 4.4V | | |
| DUSTER | | | | | | | | | |
| 1.5 dCi | 4 | K9K 884 | 66/89 | 06/09→ | GE110 (16)(37) GN018 (14) | | 4.4V 11V | | |
| 1.6 16V | 4 | K4M 616 | 75/101 | 02/12→ | Z193 | | 0.9 | UXT1 / UXT3 | ZS052 |
| 2.0 | 4 | | 98/131 | 02/12→ | Z193 | | 0.9 | UXT1 / UXT3 | ZS052 |
| ESPACE I | | | | | | | | | |
| 2.0 | 4 | J6R 734 | 74/99 | 01/88→12/90 | Z25 | | 0.8 | UXK56 | ZS251 (213)(254) ZS316 (206)(254) |
| 2.0 | 4 | J6R 234, J6R 236 | 80/107 | 07/84→12/90 | Z25 | | 0.8 | UXK56 | ZS251 (213)(254) ZS316 (206)(254) |
| 2.0 i | 4 | J7R 760 | 87/117 | 03/88→12/92 | Z31 | | 0.8 | UXK56 | ZS251 (213)(254) ZS316 (206)(254) |
| 2.1 TD | 4 | J8S 240, J8S 774 | 65/87 | 10/84→12/90 | GN909 (2)(222) GV642 | GR066 | 11V 11V | | |
| 2.2 | 4 | J7T 770 | 79/106 | 07/86→12/90 | Z25 | | 0.8 | UXK56 | ZS251 (213)(254) ZS316 (206)(254) |
| ESPACE II | | | | | | | | | |
| 2.0 | 4 | J7R 768 | 76/102 | 01/91→10/96 | Z25 | | 0.8 | UXK56 | ZS251 (213)(254) ZS316 (206)(254) |
| 2.0 LPG | 4 | J7R 768 | 76/102 | 01/91→10/96 | Z31 (168) | | 0.8 | UXK56 | |
| 2.1 RTDT 4WD | 4 | J8S 772 | 65/87 | 01/91→05/92 | GN954 | | 11V | | |
| 2.1 TD | 4 | J8S 610, J8S 772, J8S 776, J8S 778 | 65/87 | 01/91→10/96 | GN909 (2)(222) GV642 | GR066 | 11V 11V | | |
| 2.1 TD | 4 | J8S 612 | 66/89 | 11/94→10/96 | GN909 (2)(222) GV642 | GR066 | 11V 11V | | |
| 2.2 | 4 | J7T 772, J7T 773, J7T 776 | 79/106 | 01/91→12/96 | Z25 | | 0.8 | UXK56 | ZS251 (213)(254) ZS316 (206)(254) |
| 2.2 LPG | 4 | J7T 772, J7T 773, J7T 776 | 79/106 | 01/91→12/96 | Z31 (168) | | 0.8 | UXK56 | |
| 2.8 V6 | 6 | Z7W 712, Z7W 713, Z7W 717 | 110/148 | 01/91→10/96 | Z25 | | 0.8 | UXK56 | ZS251 (213)(254) ZS316 (206)(254) |
| 2.8 V6 LPG | 6 | Z7W 712, Z7W 713, Z7W 717 | 110/148 | 01/91→10/96 | Z31 (168) | | 0.8 | UXK56 | |



kW/BHP

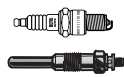

... RENAULT



ESPACE III

| | | | | | | | | |
|----------------|---|---|---------|-------------|------------|-----|-------------|---|
| 1.9 dTi | 4 | F9Q 722 | 72/97 | 02/99→10/02 | GN018 | 11V | | |
| 2.0 | 4 | F3R 728, F3R 729, F3R 742, F3R 768, F3R 769 | 84/113 | 11/96→10/00 | Z119 [170] | 0.8 | UXT2 / UXT6 | ZS052 ZS317 [10][272] ZS315 04/97→ |
| 2.0 | 4 | F4R 700, F4R 701 | 102/137 | 09/01→10/02 | Z193 | 0.9 | UXT1 / UXT3 | ZS052 |
| 2.0 LPG | 4 | F3R 728, F3R 729, F3R 742, F3R 768, F3R 769 | 84/113 | 11/96→10/00 | Z20 [168] | 0.8 | UXT2 / UXT6 | |
| 2.0 LPG | 4 | F4R 700, F4R 701 | 102/137 | 09/01→10/02 | Z340 | 0.7 | UXT12 | |
| 2.0 16V | 4 | F4R 700, F4R 701 | 103/138 | 10/98→10/02 | Z193 | 0.9 | UXT1 / UXT3 | ZS052 GS29 |
| 2.0 16V LPG | 4 | F4R 700, F4R 701 | 103/138 | 10/98→10/02 | Z340 | 0.7 | UXT12 | |
| 2.2 12V TD | 4 | G8T 714, G8T 716, G8T 760 | 83/111 | 11/96→10/00 | GN999 | 11V | | |
| 2.2 D | 4 | G8T 716 | 84/113 | 11/97→01/00 | GN999 | 11V | | |
| 2.2 dCi | 4 | G9T 710 | 85/114 | 07/00→10/02 | GN026 | 11V | | |
| 2.2 dCi | 4 | G9T 642, G9T 710 | 95/127 | 10/00→10/02 | GN026 | 11V | | |
| 3.0 | 6 | Z7X 775 | 123/165 | 11/96→10/98 | Z16 | 1.1 | UXT11 | ZS317 [10][272] ZS318 [13][273] ZS319 [12][274] |
| 3.0 LPG | 6 | Z7X 775 | 123/165 | 11/96→10/98 | Z340 | 0.7 | UXT12 | |
| 3.0 V6 24V | 6 | L7X 727 | 140/188 | 10/98→10/02 | Z313 | 1.1 | UXT14 | ZS343 |
| 3.0 V6 24V LPG | 6 | L7X 727 | 140/188 | 10/98→10/02 | Z30 [168] | 0.8 | UXT5 | |

ESPACE IV

| | | | | | | | | |
|---------------|---|------------------------------------|---------|-------------|--|-------------------|------------------------------|--------|
| 1.9 dCi | 4 | F9Q 820 | 85/114 | 04/03→02/05 | GN018 | 11V | | |
| 1.9 dCi | 4 | F9Q 680, F9Q 820, F9Q 826 | 88/118 | 11/02→ | GN018 | 11V | | |
| 2.0 | 4 | F4R 792 | 100/134 | 11/02→ | Z193 [179] Z206 [198] Z337 [197] | 0.9 0.7 0.9 | UXT1 / UXT3 UXT10 UXT9 | ZS052 |
| 2.0 | 4 | F4R 796, F4R 797, F4R 896, F4R 897 | 125/168 | 04/05→ | Z337 | 0.9 | UXT9 | ZS052 |
| 2.0 LPG | 4 | F4R 796, F4R 797, F4R 896, F4R 897 | 125/168 | 04/05→ | Z340 | 0.7 | UXT12 | |
| 2.0 Turbo | 4 | F4R 794, F4R 795, F4R 796, F4R 797 | 120/161 | 11/02→ | Z337 | 0.9 | UXT9 | ZS052 |
| 2.0 Turbo LPG | 4 | F4R 794, F4R 795, F4R 796, F4R 797 | 120/161 | 11/02→ | Z340 | 0.7 | UXT12 | |
| 2.2 dCi | 4 | G9T 645 | 102/137 | 02/06→ | GN026 | 11V | | |
| 2.2 dCi | 4 | G9T 742, G9T 743 | 110/148 | 11/02→ | GN026 | 11V | | |
| 3.0 dCi | 6 | | 120/161 | 09/05→ | GN106 | 11V | | |
| 3.0 dCi | 6 | P9X 701 | 130/174 | 11/02→ | GN106 | 11V | | |
| 3.0 dCi | 6 | P9X 715 | 133/178 | 01/06→ | GN106 | 11V | | |
| 3.5 V6 | 6 | V4Y 711, V4Y 715 | 177/237 | 11/02→ | Z183 | 0.9 | UXT13 | ZSE079 |
| 3.5 V6 LPG | 6 | V4Y 711, V4Y 715 | 177/237 | 11/02→ | Z184 [168] | 0.9 | UXT13 | |

EXPRESS

| | | | | | | | | |
|-------|---|------------------|-------|-------------|--------------------------------------|------------|--|--|
| 1.9 D | 4 | F8Q 640 | 40/54 | 07/95→10/97 | GN909 [224][253] GN991 [223][253] | 11V 11V | | |
| 1.9 D | 4 | F8Q 724, F8Q 776 | 47/63 | 07/95→10/99 | GN909 [225][253] GN991 [223][253] | 11V 11V | | |

FLUENCE

| | | | | | | | | |
|---------|---|------------------|---------|--------|----------------|------|-------------|--------------|
| 1.5 dCi | 4 | K9K 830 | 63/84 | 02/10→ | GE110 [37] | 4.4V | | |
| 1.5 dCi | 4 | K9K 834 | 66/89 | 02/10→ | GE110 [16][37] | 4.4V | | |
| 1.5 dCi | 4 | K9K 826 | 70/94 | 07/14→ | GE110 [37] | 4.4V | | |
| 1.5 dCi | 4 | K9K 832 | 78/105 | 02/10→ | GE110 [37] | 4.4V | | |
| 1.5 dCi | 4 | K9K 836, K9K 837 | 81/109 | 02/10→ | GE110 [37] | 4.4V | | |
| 1.6 16V | 4 | K4M 838, K4M 839 | 81/109 | 02/10→ | Z193 | 0.9 | UXT1 / UXT3 | ZS052 |
| 1.6 16V | 4 | K4M 838 | 82/110 | 02/10→ | Z193 | 0.9 | UXT1 / UXT3 | ZS052 |
| 2.0 16V | 4 | M4R 714, M4R 751 | 103/138 | 02/10→ | | | | ZSE161 [259] |

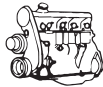

kW/BHP

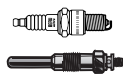

... RENAULT



FUEGO

| | | | | | | | | | |
|------------|---|--|--------|-------------|---|-----------------|-----|-------------|-------|
| 1.4 TL/GTL | 4 | 847 720 | 47/63 | 02/80→10/85 | Z1 ^[169] | | 0.7 | UXT2 / UXT6 | |
| 1.6 | 4 | A2M 723 | 52/70 | 04/83→10/85 | Z11 ^[167] | | 0.8 | UXT2 / UXT6 | |
| 1.6 TS/GTS | 4 | 843 723, 843 724, A6M 725, A6M 726 | 71/95 | 10/80→10/85 | Z22 | | 0.7 | UX56 | |
| 1.6 Turbo | 4 | A5L 750 | 97/130 | 08/83→10/85 | Z38 | | 0.4 | | ZM005 |
| 2.0 TX/GTX | 4 | 829 710, J6R 710, J6R 712, J6R 713, J6R 715, J6R 726 | 81/109 | 10/80→10/85 | Z25 | | 0.8 | UXK56 | |
| 2.1 TD | 4 | J8S 712 | 65/87 | 08/82→10/85 | GN909 ^[222] →07/84 GV642 →07/84 | GR065 →07/84 | 11V | | |
| | | | | | | | 11V | | |

GRAND SCÉNIC II

| | | | | | | | | | |
|---------|---|-----------------------------|---------|-------------|-------|--|-----|-------------|-------|
| 1.5 dCi | 4 | K9K 722 | 60/80 | 04/04→ | GN018 | | 11V | | |
| 1.5 dCi | 4 | K9K 728 | 74/99 | 04/04→ | GN018 | | 11V | | |
| 1.5 dCi | 4 | K9K 734 | 76/102 | 06/06→11/08 | GN855 | | 12V | | |
| 1.5 dCi | 4 | K9K P 732 | 78/105 | 05/05→ | GN018 | | 11V | | |
| 1.6 | 4 | K4M 788 | 77/103 | 06/06→ | Z247 | | 0.9 | UXT1 / UXT3 | ZS052 |
| 1.6 | 4 | K4M 761, K4M 782 | 83/111 | 04/04→ | Z193 | | 0.9 | UXT1 / UXT3 | ZS052 |
| 1.6 LPG | 4 | K4M 761, K4M 782 | 83/111 | 04/04→ | Z340 | | 0.7 | UXT12 | |
| 1.9 dCi | 4 | F9Q E 804 | 81/109 | 05/05→ | GN018 | | 11V | | |
| 1.9 dCi | 4 | | 85/114 | 05/05→01/09 | GN018 | | 11V | | |
| 1.9 dCi | 4 | F9Q 812 | 88/118 | 04/04→ | GN018 | | 11V | | |
| 1.9 dCi | 4 | F9Q 816, F9Q 818, F9Q J 803 | 96/129 | 05/05→ | GN018 | | 11V | | |
| 2.0 | 4 | F4R 770, F4R 771 | 99/133 | 04/04→ | Z193 | | 0.9 | UXT1 / UXT3 | ZS052 |
| 2.0 | 4 | F4R 776 | 120/161 | 04/04→ | Z337 | | 0.9 | UXT9 | ZS052 |
| 2.0 LPG | 4 | F4R 770, F4R 771 | 99/133 | 04/04→ | Z340 | | 0.7 | UXT12 | |
| 2.0 LPG | 4 | F4R 776 | 120/161 | 04/04→ | Z340 | | 0.7 | UXT12 | |

GRAND SCÉNIC III

| | | | | | | | | | |
|----------------|---|---------------------------|---------|--------|---------------------------|--|------|-------------|-------------------------|
| 1.2 TCe | 4 | H5F 400 | 85/114 | 04/12→ | | | | | ZSE131 |
| 1.4 16V | 4 | H4J 700 | 96/129 | 02/09→ | Z274 | | 0.7 | | ZSE066 |
| 1.5 dCi | 4 | K9K 830 | 63/84 | 04/09→ | GE110 ^[37] | | 4.4V | | |
| 1.5 dCi | 4 | K9K 846 | 70/94 | 11/10→ | GE110 ^{[16][37]} | | 4.4V | | |
| 1.5 dCi | 4 | K9K 832 | 78/105 | 02/09→ | GE110 ^[37] | | 4.4V | | |
| 1.5 dCi | 4 | K9K 636, K9K 836, K9K 837 | 81/109 | 04/09→ | GE110 ^[37] | | 4.4V | | |
| 1.6 16V | 4 | K4M 866 | 81/109 | 02/09→ | | | | | ZS052 06/09→ |
| 1.6 16V | 4 | K4M 858 | 81/109 | 02/09→ | Z193 | | 0.9 | UXT1 / UXT3 | |
| 1.6 16V Bifuel | 4 | K4M 866 | 81/109 | 02/09→ | | | | | ZS052 |
| 1.9 dCi | 4 | F9Q 870, F9Q 872 | 96/129 | 02/09→ | GE111 ^[37] | | 4.4V | | |
| 2.0 16V | 4 | M4R 711 | 103/138 | 02/09→ | | | | | ZSE161 ^[259] |

KANGOO

| | | | | | | | | | |
|---------|---|--|-------|--------|------|--|-----|-------------|--|
| 1.2 | 4 | D7F 710, D7F 720, D7F 722, D7F 726, D7F 744, D7F 746 | 43/58 | 08/97→ | Z224 | | 0.9 | UXT9 | ZS345 →10/98 ZS354 11/98→ |
| 1.2 LPG | 4 | D7F 710, D7F 720, D7F 722, D7F 726, D7F 744, D7F 746 | 43/58 | 08/97→ | Z340 | | 0.7 | UXT12 | |
| 1.2 16V | 4 | D4F 712, D4F 714, D4F 716 | 55/74 | 06/01→ | Z243 | | 0.9 | | ZS454 ^{[1][101]} ZS345 ^{[1][155]} 03/03→ ZS325 ^{[1][157]} 07/04→ ZS375 ^{[1][156]} 07/04→ |
| 1.4 | 4 | E7J 634, E7J 635 | 55/74 | 08/97→ | Z247 | | 0.9 | UXT1 / UXT3 | ZS354 09/98→12/07 |
| 1.4 | 4 | E7J 780 | 55/74 | 08/97→ | Z247 | | 0.9 | UXT1 / UXT3 | ZS242 ^[24] ZS243 ^[26] |



kW/BHP



... RENAULT



... KANGOO

| | | | | | | | | | |
|-------------|---|---------------------------|-------|-------------|--------|-----|-------------|-------|-------------|
| 1.4 | 4 | K7J 700, K7J 701 | 55/74 | 08/97→ | Z14 | 0.9 | UXT1 / UXT3 | ZS354 | |
| | | | | | | | | | 09/98→12/07 |
| 1.4 LPG | 4 | E7J 634, E7J 635, E7J 780 | 55/74 | 08/97→ | Z340 | 0.7 | UXT12 | | |
| 1.4 LPG | 4 | K7J 700, K7J 701 | 55/74 | 08/97→ | Z116 | 0.8 | UXT5 | | |
| 1.5 dCi | 4 | K9K 704 | 42/56 | 07/03→ | GN018 | | | | 11V |
| 1.5 dCi | 4 | | 45/60 | 04/05→06/10 | GN018 | | | | 11V |
| 1.5 dCi | 4 | K9K 700, K9K 704 | 48/64 | 12/01→ | GN018 | | | | 11V |
| 1.5 dCi | 4 | K9K 714 | 50/67 | 06/05→ | GN018 | | | | 11V |
| 1.5 dCi | 4 | K9K 702, K9K 710 | 60/80 | 07/02→ | GN018 | | | | 11V |
| 1.5 dCi | 4 | K9K 718 | 62/83 | 06/05→ | GN018 | | | | 11V |
| 1.6 | 4 | K7M 746 | 66/89 | 09/99→06/01 | | | | ZS354 | |
| 1.6 16V | 4 | K4M 750, K4M 752, K4M 753 | 70/94 | 06/01→ | Z193 | 0.9 | UXT1 / UXT3 | ZS052 | GS29 |
| 1.6 16V 4WD | 4 | K4M 750, K4M 752, K4M 753 | 70/94 | 10/01→ | Z193 | 0.9 | UXT1 / UXT3 | ZS052 | |
| 1.6 16V LPG | 4 | K4M 750, K4M 752, K4M 753 | 70/94 | 06/01→ | Z340 | 0.7 | UXT12 | | |
| 1.9 D 55 | 4 | F8Q 662 | 40/54 | 08/97→ | GN963 | | | | 11V |
| | | | | | →02/99 | | | | |
| | | | | | GN019 | | | | 11V |
| | | | | | 03/99→ | | | | |
| 1.9 D 65 | 4 | F8Q 630 | 47/63 | 08/97→ | GN963 | | | | 11V |
| 1.9 D 65 | 4 | F8Q 632 | 47/63 | 08/97→ | GN019 | | | | 11V |
| 1.9 dCi 4WD | 4 | F9Q 782, F9Q 790 | 59/79 | 10/01→ | GN018 | | | | 11V |
| 1.9 dCi 4WD | 4 | F9Q 790 | 62/83 | 10/03→ | GN018 | | | | 11V |
| 1.9 dTi | 4 | F9Q 780 | 59/79 | 02/00→ | GN018 | | | | 11V |
| 1.9 RXED | 4 | F8Q 632 | 48/64 | 09/99→06/01 | GN963 | | | | 11V |

KANGOO BE BOP

| | | | | | | | | | |
|------------|---|---------|--------|--------|----------------|------|-------------|-------|--|
| 1.5 dCi | 4 | K9K 808 | 66/89 | 06/09→ | GE110 [16][37] | 4.4V | | | |
| | | | | | GN018 [14] | 11V | | | |
| 1.5 dCi | 4 | K9K 806 | 76/102 | 02/09→ | GE110 [16][37] | 4.4V | | | |
| | | | | | GN018 [14] | 11V | | | |
| 1.5 dCi | 4 | K9K 804 | 80/107 | 06/09→ | GE110 [16][37] | 4.4V | | | |
| | | | | | GN018 [14] | 11V | | | |
| 1.5 dCi 75 | 4 | K9K 802 | 55/74 | 09/10→ | GE110 [16][37] | 4.4V | | | |
| | | | | | GN018 [14] | 11V | | | |
| 1.6 | 4 | K4M 830 | 78/105 | 02/09→ | Z193 | 0.9 | UXT1 / UXT3 | ZS052 | |

KANGOO / GRAND KANGOO

| | | | | | | | | | |
|-----------------|---|------------------|--------|--------|----------------|------|-------------|-------|--------|
| 1.5 dCi | 4 | K9K 800 | 50/67 | 02/08→ | GE110 [16][37] | 4.4V | | | |
| | | | | | GN018 [14] | 11V | | | |
| 1.5 dCi | 4 | K9K 608, K9K 802 | 55/74 | 11/12→ | GE110 [16][37] | 4.4V | | | |
| | | | | | GN018 [14] | 11V | | | |
| 1.5 dCi | 4 | K9K 802 | 63/84 | 02/08→ | GE110 [16][37] | 4.4V | | | |
| | | | | | GN018 [14] | 11V | | | |
| 1.5 dCi | 4 | K9K 808 | 66/89 | 11/12→ | GE110 [16][37] | 4.4V | | | |
| | | | | | GN018 [14] | 11V | | | |
| 1.5 dCi | 4 | K9K 804, K9K 806 | 76/102 | 02/08→ | GE110 [16][37] | 4.4V | | | |
| | | | | | GN018 [14] | 11V | | | |
| 1.5 dCi | 4 | | 78/105 | 02/08→ | GE110 [16][37] | 4.4V | | | |
| | | | | | GN018 [14] | 11V | | | |
| 1.5 dCi 110 | 4 | K9K 804 | 80/107 | 09/10→ | GE110 [16][37] | 4.4V | | | |
| | | | | | GN018 [14] | 11V | | | |
| 1.6 | 4 | K7M 750 | 64/86 | 02/08→ | Z257 | 0.9 | UXT1 / UXT3 | ZS354 | |
| 1.6 16V | 4 | K4M 830 | 78/105 | 02/08→ | Z193 | 0.9 | UXT1 / UXT3 | ZS052 | |
| 1.6 16V | 4 | K4M 831 | 78/105 | 02/08→ | Z193 | 0.9 | UXT1 / UXT3 | | |
| 1.6 16V Hi-Flex | 4 | K4M 834 | 78/105 | 02/08→ | | | | ZS052 | |
| | | | | | | | | | 01/09→ |

KOLEOS

| | | | | | | | | | |
|-----|---|---------------------------|---------|--------|--|--|--|--------|--|
| 2.5 | 4 | 2TR 700, 2TR 702, 2TR 703 | 126/169 | 09/08→ | | | | ZSE088 | |
|-----|---|---------------------------|---------|--------|--|--|--|--------|--|



kW/BHP



... RENAULT



LAGUNA

| | | | | | | | | |
|-------------------|---|-------------------|---------|--------|----------------|------|-------|--------|
| 1.5 dCi | 4 | K9K 846 | 81/109 | 03/12→ | GE110 [16][37] | 4.4V | | |
| 2.0 16V Turbo | 4 | F4R 811, F4Rt 811 | 125/168 | 09/08→ | Z337 | 0.9 | UXT9 | ZS052 |
| 2.0 16V Turbo LPG | 4 | F4R 811, F4Rt 811 | 125/168 | 09/08→ | Z340 | 0.7 | UXT12 | |
| 2.0 GT | 4 | F4R 800 | 150/201 | 09/08→ | | | | ZS052 |
| 3.5 V6 | 6 | V4Y 713 | 175/235 | 09/08→ | | | | ZSE158 |

LAGUNA I

| | | | | | | | | |
|-------------|---|------------------------------------|--------|-------------|----------------|------------|-------------|---|
| 1.6 16V | 4 | K4M 720 | 79/106 | 11/97→03/01 | Z193 05/98→ | 0.9 | UXT1 / UXT3 | ZS052 |
| 1.6 16V LPG | 4 | K4M 720 | 79/106 | 11/97→03/01 | Z340 05/98→ | 0.7 | UXT12 | |
| 1.8 | 4 | F3P 670 | 66/89 | 08/95→03/01 | Z119 [170] | 0.8 | UXT2 / UXT6 | ZS315 ZS317 [10][272] |
| 1.8 | 4 | F3P 670 | 66/89 | 09/95→03/01 | | | | ZS317 [1][10][272] →04/97 ZS251 [1][213][254] ZS316 [1][206][254] ZS315 [1] 04/97→ |
| 1.8 | 4 | F3P 678 | 66/89 | 08/95→03/01 | Z119 [170] | 0.8 | UXT2 / UXT6 | ZS251 [213][254] ZS316 [206][254] |
| 1.8 | 4 | F3P 678 | 66/89 | 09/95→03/01 | | | | ZS315 [1] 04/97→ |
| 1.8 | 4 | F3P 720, F3P 724 | 66/89 | 11/93→03/01 | Z119 [170] | 0.8 | UXT2 / UXT6 | ZS251 |
| 1.8 | 4 | 724 | 69/93 | 08/95→03/01 | Z119 [170] | 0.8 | UXT2 / UXT6 | |
| 1.8 | 4 | F3P 674 | 69/93 | 06/95→02/01 | Z62 | 0.8 | UXT2 / UXT6 | ZS317 [10][272] →03/97 ZS315 04/97→ |
| 1.8 | 4 | F3P 720 | 69/93 | 08/95→03/01 | Z119 [170] | 0.8 | UXT2 / UXT6 | ZS317 [10][272] →eng. 970402 ZS315 eng. 970403→ |
| 1.8 | 4 | F3P 720 | 69/93 | 09/95→03/01 | | | | ZS251 [1][213][254] ZS316 [1][206][254] |
| 1.8 | 4 | F3P 724 | 69/93 | 08/95→03/01 | | | | ZS317 [10][272] →eng. 970402 ZS315 eng. 970403→ |
| 1.8 | 4 | F3P 724 | 69/93 | 09/95→03/01 | Z119 [170] | 0.8 | UXT2 / UXT6 | ZS251 [1][213][254] ZS316 [1][206][254] |
| 1.8 | 4 | F3P 676 | 70/94 | 06/95→06/98 | | | | ZS315 [1] →eng. 970402 ZS317 [1][10][272] eng. 970402→ |
| 1.8 LPG | 4 | F3P 670, F3P 678, F3P 720, F3P 724 | 66/89 | 11/93→03/01 | Z20 [168] | 0.8 | UXT2 / UXT6 | |
| 1.8 LPG | 4 | F3P 720, F3P 724 | 69/93 | 08/95→03/01 | Z20 [168] | 0.8 | UXT2 / UXT6 | |
| 1.8 16V | 4 | F4P 760 | 88/118 | 04/98→03/01 | Z15 Z193 | 0.8 0.9 | UXT1 / UXT3 | ZS052 GS29 |
| 1.8 16V LPG | 4 | F4P 760 | 88/118 | 04/98→03/01 | Z340 | 0.7 | UXT12 | |
| 1.9 dCi | 4 | F9Q 718 | 79/106 | 09/99→03/01 | GN018 | 11V | | |
| 1.9 dTi | 4 | F9Q 710 | 72/97 | 10/97→03/01 | GN018 | 11V | | |
| 1.9 dTi | 4 | F9Q 716 | 72/97 | 10/97→03/01 | GN999 | 11V | | |
| 2.0 | 4 | | 70/94 | 11/93→03/01 | Z193 | 0.9 | UXT1 / UXT3 | ZS315 [1] →eng. 970402 ZS317 [1][10][272] eng. 970402→ |

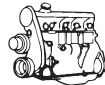

kW/BHP

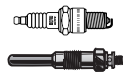

... RENAULT



... LAGUNA I

| | | | | | | | | |
|-------------|---|---------------------------------------|---------|-------------|------------|-----|-------------|---|
| 2.0 | 4 | F3R 611 | 80/107 | 03/99→03/01 | Z193 | 0.9 | UXT1 / UXT3 | ZS315 [1] →eng. 970402 ZS317 [1][10][272] eng. 970402→ |
| 2.0 | 4 | F3R 722, F3R 723 | 83/111 | 11/93→03/01 | Z119 [170] | 0.8 | UXT2 / UXT6 | ZS251 [213][254] ZS316 [206][254] |
| 2.0 | 4 | F3R 722, F3R 723 | 83/111 | 09/95→03/01 | | | | ZS317 [10][272] ZS251 [213] 01/96→ ZS316 [206] 01/96→ |
| 2.0 | 4 | F3R 768 | 84/113 | 06/95→02/01 | Z119 [170] | 0.8 | UXT2 / UXT6 | ZS317 [10][272] →04/97 ZS315 04/97→ |
| 2.0 | 4 | F3R 768 | 84/113 | 10/98→01/01 | | | | ZS315 |
| 2.0 | 4 | F4R 780 | 102/137 | 09/99→02/01 | | | | ZS052 [1] |
| 2.0 | 4 | N7Q 700, N7Q 704 | 103/138 | 06/95→02/01 | | | | ZS254 [1][10][24] ZS255 [1][26] |
| 2.0 LPG | 4 | | 70/94 | 11/93→03/01 | Z340 | 0.7 | UXT12 | |
| 2.0 LPG | 4 | F3R 611 | 80/107 | 03/99→03/01 | Z340 | 0.7 | UXT12 | |
| 2.0 LPG | 4 | F3R 722, F3R 723 | 83/111 | 11/93→03/01 | Z20 [168] | 0.8 | UXT2 / UXT6 | |
| 2.0 LPG | 4 | F3R 768 | 84/113 | 06/95→02/01 | Z20 [168] | 0.8 | UXT2 / UXT6 | |
| 2.0 16V | 4 | N7Q 700, N7Q 704 | 102/137 | 06/95→03/01 | Z204 | 1.2 | | ZS254 [24] ZS255 [26] |
| 2.0 16V | 4 | N7Q 700, N7Q 704 | 102/137 | 09/95→03/01 | | | | ZS254 [1][24] ZS255 [1][26] |
| 2.0 16V | 4 | F4R 780 | 103/138 | 09/99→03/01 | Z193 | 0.9 | UXT1 / UXT3 | ZS052 |
| 2.0 16V LPG | 4 | N7Q 700, N7Q 704 | 102/137 | 06/95→03/01 | Z60 | 1.2 | | |
| 2.0 16V LPG | 4 | F4R 780 | 103/138 | 09/99→03/01 | Z340 | 0.7 | UXT12 | |
| 2.2 D | 4 | G8T 706, G8T 752, G8T 790, G8T 794 | 61/82 | 11/93→03/01 | GN999 | 11V | | |
| 2.2 dT | 4 | G8T 760 | 83/111 | 03/96→03/01 | GN999 | 11V | | |
| 3.0 | 6 | Z7X 760, Z7X 765 | 123/165 | 11/93→03/01 | Z60 | 1.2 | | ZS317 [10][272] ZS318 [13][273] ZS319 [12][274] |
| 3.0 24V | 6 | L7X 700, L7X 701 | 140/188 | 03/97→03/01 | Z123 | 1.0 | UXT9 | ZS343 |
| 3.0 24V LPG | 6 | L7X 700, L7X 701 | 140/188 | 03/97→03/01 | Z129 | 1.6 | | |

LAGUNA II

| | | | | | | | | |
|-------------|---|--|--------|-------------|-------|-----|-------------|------------|
| 1.6 16V | 4 | K4M 710 | 79/106 | 03/01→ | Z193 | 0.9 | UXT1 / UXT3 | ZS052 |
| 1.6 16V | 4 | K4M 714 | 79/106 | 03/01→ | | | | ZS052 |
| 1.6 16V | 4 | K4M 716 | 82/110 | 02/05→ | Z193 | 0.9 | UXT1 / UXT3 | ZS052 |
| 1.6 16V LPG | 4 | K4M 710 | 79/106 | 03/01→ | Z340 | 0.7 | UXT12 | |
| 1.6 16V LPG | 4 | K4M 716 | 82/110 | 02/05→ | Z340 | 0.7 | UXT12 | |
| 1.8 16V | 4 | F4P 770, F4P 771, F4P 773, F4P 774, F4P 775 | 85/114 | 03/01→ | Z193 | 0.9 | UXT1 / UXT3 | ZS052 |
| 1.8 16V | 4 | F4P 770, F4P 774 | 86/115 | 03/01→ | Z193 | 0.9 | UXT1 / UXT3 | ZS052 |
| 1.8 16V | 4 | F4P 770, F4P 773 | 88/118 | 03/01→ | Z193 | 0.9 | UXT1 / UXT3 | ZS052 GS29 |
| 1.8 16V | 4 | F4P 770, F4P 772, F4P 774 | 89/119 | 03/01→ | Z193 | 0.9 | UXT1 / UXT3 | ZS052 |
| 1.8 16V LPG | 4 | F4P 770, F4P 771, F4P 773, F4P 774, F4P 775 | 85/114 | 03/01→ | Z340 | 0.7 | UXT12 | |
| 1.8 16V LPG | 4 | F4P 770, F4P 774 | 86/115 | 03/01→ | Z340 | 0.7 | UXT12 | |
| 1.8 16V LPG | 4 | F4P 770, F4P 773 | 88/118 | 03/01→ | Z340 | 0.7 | UXT12 | |
| 1.8 16V LPG | 4 | F4P 770, F4P 772, F4P 774 | 89/119 | 03/01→ | Z340 | 0.7 | UXT12 | |
| 1.9 dCi | 4 | | 66/89 | 08/03→09/07 | GN018 | 11V | | |
| 1.9 dCi | 4 | F9Q 664 | 68/91 | 03/04→ | GN018 | 11V | | |
| 1.9 dCi | 4 | F9Q 754 | 74/99 | 10/01→ | GN018 | 11V | | |
| 1.9 dCi | 4 | F9Q 752 | 77/103 | 06/01→ | GN018 | 11V | | |
| 1.9 dCi | 4 | F9Q 718, F9Q 754 | 79/106 | 03/01→ | GN018 | 11V | | |



kW/BHP

**... RENAULT****... LAGUNA II**

| | | | | | | | | |
|-------------------|---|------------------------------------|---------|-------------|-----------------------|-----|-------------|---|
| 1.9 dCi | 4 | F9Q 674, F9Q 758 | 81/109 | 01/05→ | GN018 | 11V | | |
| 1.9 dCi | 4 | F9Q 758, F9Q 759 | 85/114 | 08/05→ | GN018 | 11V | | |
| 1.9 dCi | 4 | F9Q 650, F9Q 670, F9Q 674, F9Q 750 | 88/118 | 03/01→ | GN018 | 11V | | |
| 1.9 dCi | 4 | | 92/123 | 09/05→ | GN018 | 11V | | |
| 1.9 dCi | 4 | F9Q 758, F9Q 759 | 96/129 | 05/05→ | GN018 | 11V | | |
| 2.0 16V | 4 | F4R 712, F4R 713, F4R 714, F4R 715 | 99/133 | 08/02→ | Z193 | 0.9 | UXT1 / UXT3 | ZS052 |
| 2.0 16V | 4 | F4R 784, F4R 786, F4R 787 | 125/168 | 01/05→ | Z337 | 0.9 | UXT9 | ZS052 |
| 2.0 16V | 4 | F4R.784, F4R.786 | 150/201 | 01/05→ | | | | ZS052 |
| 2.0 16V | 4 | F4R 886, F4R 887 | 150/201 | 01/05→ | Z337 | 0.9 | UXT9 | ZS052 →09/07 |
| 2.0 16V LPG | 4 | F4R 712, F4R 713, F4R 714, F4R 715 | 99/133 | 08/02→ | Z340 | 0.7 | UXT12 | |
| 2.0 16V LPG | 4 | F4R 784, F4R 786, F4R 787 | 125/168 | 01/05→ | Z340 | 0.7 | UXT12 | |
| 2.0 16V LPG | 4 | F4R 886, F4R 887 | 150/201 | 01/05→ | Z340 | 0.7 | UXT12 | |
| 2.0 16V IDE | 4 | F5R 700 | 103/138 | 04/01→ | | | | ZS345 ^[155] →09/07 |
| 2.0 16V IDE | 4 | F5R 701 | 103/138 | 04/01→ | | | | ZS052 →02/05 ZS345 ^[155] →09/07 |
| 2.0 16V Turbo | 4 | F4R 764, F4R 765, F4R 786, F4R 787 | 120/161 | 01/03→ | Z337 | 0.9 | UXT9 | ZS052 |
| 2.0 16V Turbo LPG | 4 | F4R 764, F4R 765, F4R 786, F4R 787 | 120/161 | 01/03→ | Z340 | 0.7 | UXT12 | |
| 2.2 dCi | 4 | G9T 600 | 85/114 | 04/04→10/05 | GN026 | 11V | | |
| 2.2 dCi | 4 | G9T 600, G9T 605, G9T 706, G9T 707 | 102/137 | 05/05→ | GN026 | 11V | | |
| 2.2 dCi | 4 | G9T 700, G9T 702 | 110/148 | 10/01→ | GN026 | 11V | | |
| 3.0 V6 24V | 6 | L7X 731 | 152/204 | 03/01→ | Z211 ^[176] | 1.4 | | ZS347 |

LAGUNA III

| | | | | | | | | |
|-------------------|---|------------------|---------|--------|-------|-----|-------------|-------------------------|
| 1.5 dCi | 4 | K9K 780 | 81/109 | 10/07→ | GN018 | 11V | | |
| 1.6 16V | 4 | K4M 824 | 81/109 | 10/07→ | Z193 | 0.9 | UXT1 / UXT3 | ZS052 |
| 1.6 16V LPG | 4 | K4M 824 | 81/109 | 10/07→ | Z340 | 0.7 | UXT12 | |
| 2.0 16V | 4 | M4R 704 | 103/138 | 10/07→ | Z325 | 1.1 | | ZSE161 ^[259] |
| 2.0 16V Hi-Flex | 4 | M4R 704, M4R 726 | 103/138 | 10/07→ | Z325 | 1.1 | | ZSE161 ^[259] |
| 2.0 16V Turbo | 4 | F4R 811 | 125/168 | 10/07→ | Z337 | 0.9 | UXT9 | ZS052 |
| 2.0 16V Turbo LPG | 4 | F4R 811 | 125/168 | 10/07→ | Z340 | 0.7 | UXT12 | |
| 2.0 GT | 4 | F4R 800 | 150/201 | 03/08→ | | | | ZS052 |
| 3.5 V6 | 6 | V4Y 713 | 175/235 | 04/08→ | | | | ZSE158 |

LATITUDE

| | | | | | | | | |
|--------------|---|---------|---------|--------|---------------------------|------|--|-------------------------|
| 1.5 dCi | 4 | K9K 782 | 81/109 | 07/10→ | GE110 ^{[16][37]} | 4.4V | | |
| 2.0 16V | 4 | M4R 746 | 103/138 | 02/11→ | | | | ZSE161 ^[259] |
| 2.0 16V eco2 | 4 | M4R 746 | 103/138 | 02/11→ | | | | ZSE161 ^[259] |
| 2.5 V6 | 6 | 2ZV 604 | 130/174 | 05/11→ | | | | ZSE158 |

LOGAN

| | | | | | | | | |
|---------|---|------------------|--------|--------|--------------------------------|-------------|-------------|-------|
| 1.4 | 4 | K7J 710 | 55/74 | 09/04→ | Z193 | 0.9 | UXT1 / UXT3 | ZS354 |
| 1.4 LPG | 4 | K7J 710 | 55/74 | 09/04→ | Z340 | 0.7 | UXT12 | |
| 1.5 dCi | 4 | K9K 790, K9K 794 | 48/64 | 06/11→ | GE110 ^[37] GN018 | 4.4V 11V | | |
| 1.5 dCi | 4 | K9K 792 | 50/67 | 04/07→ | GN018 | 11V | | |
| 1.5 dCi | 4 | K9K 796 | 63/84 | 02/08→ | GN018 | 11V | | |
| 1.5 dCi | 4 | | 66/89 | 06/11→ | GE110 ^[37] | 4.4V | | |
| 1.6 | 4 | K7M 710 | 64/86 | 09/04→ | Z98 | 0.8 | UXT1 / UXT3 | ZS354 |
| 1.6 | 4 | K4M 690, K4M 697 | 77/103 | 04/07→ | Z193 | 0.9 | UXT1 / UXT3 | ZS052 |
| 1.6 LPG | 4 | K7M 710 | 64/86 | 09/04→ | Z116 | 0.8 | UXT5 | |
| 1.6 LPG | 4 | K4M 690, K4M 697 | 77/103 | 04/07→ | Z340 | 0.7 | UXT12 | |



kW/BHP

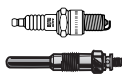

... RENAULT 

| ... RENAULT | | | | | | | | | |
|--------------------|---|------------------------------------|--------|-------------|--|-----|-------------|---|------|
| MEGANE | | | | | | | | | |
| 1.4 i | 4 | E7J 764 | 55/74 | 01/97→09/99 | Z193 | 0.9 | UXT1 / UXT3 | ZS251 [213][254] ZS316 [194][206] [254] | |
| 1.4 i LPG | 4 | E7J 764 | 55/74 | 01/97→09/99 | Z340 | 0.7 | UXT12 | | |
| 1.6 16V | 4 | K4M 700, K4M 701, K4M 704, K4M 708 | 79/106 | 04/98→10/99 | Z193 | 0.9 | UXT1 / UXT3 | ZS052 | GS29 |
| 1.6 16V LPG | 4 | K4M 700, K4M 701, K4M 704, K4M 708 | 79/106 | 04/98→10/99 | Z340 | 0.7 | UXT12 | | |
| 1.6 e | 4 | K7M 702, K7M 703 | 66/89 | 10/96→10/99 | Z247 →eng. 981015 Z193 eng. 981016→ | 0.9 | UXT1 / UXT3 | ZS245 [24] →03/97 | |
| | | | | | | 0.9 | UXT1 / UXT3 | ZS246 [26] →03/97 ZS242 [24] 04/97→ ZS243 [26] 04/97→ ZS354 09/97→ | |
| 1.6 e LPG | 4 | K7M 702, K7M 703 | 66/89 | 10/96→10/99 | Z340 | 0.7 | UXT12 | | |
| 1.6 i | 4 | K7M 720 | 55/74 | 01/97→09/99 | Z193 | 0.9 | UXT1 / UXT3 | ZS245 [24] →03/97 ZS246 [26] →03/97 ZS242 [24] 04/97→ ZS243 [26] 04/97→ ZS354 09/97→ | |
| 1.6 i LPG | 4 | K7M 720 | 55/74 | 01/97→09/99 | Z340 | 0.7 | UXT12 | | |
| 1.9 D | 4 | F8Q 790 | 47/63 | 03/97→09/99 | GN963 | 11V | | | |
| 1.9 dT | 4 | F8Q 784, F8Q 786 | 66/89 | 01/97→09/99 | GN959 | 11V | | | |
| 1.9 dTi | 4 | F9Q 730, F9Q 734 | 72/97 | 04/97→09/99 | GN999 | 11V | | | |
| 2.0 i | 4 | F3R 796 | 80/107 | 01/99→09/99 | Z119 [170] | 0.8 | UXT2 / UXT6 | ZS315 | |
| 2.0 i | 4 | F3R 750 | 84/113 | 01/97→08/03 | Z119 [170] | 0.8 | UXT2 / UXT6 | | |
| 2.0 i | 4 | F3R 750 | 84/113 | 01/97→09/99 | | | | ZS317 [10][272] →eng. 970402 ZS315 eng. 970402→ | |
| 2.0 i | 4 | F3R 751 | 84/113 | 01/97→09/99 | Z119 [170] | 0.8 | UXT2 / UXT6 | ZS317 [10][272] →eng. 970402 ZS315 eng. 970402→ | |
| 2.0 i LPG | 4 | F3R 796 | 80/107 | 01/99→09/99 | Z20 [168] | 0.8 | UXT2 / UXT6 | | |
| 2.0 i LPG | 4 | F3R 750, F3R 751 | 84/113 | 01/97→09/99 | Z20 [168] | 0.8 | UXT2 / UXT6 | | |
| 2.0 RXE 4WD | 4 | F3R 750 | 84/113 | 05/97→10/99 | | | | ZS315 | |
| MEGANE I | | | | | | | | | |
| 1.4 | 4 | E7J 626 | 55/74 | 09/96→08/03 | Z193 | 0.9 | UXT1 / UXT3 | ZS052 ZS354 [154] | |
| 1.4 | 4 | E7J 764 | 55/74 | 09/96→08/03 | Z63 [170] | 0.8 | UXT1 / UXT3 | ZS251 | |
| 1.4 LPG | 4 | E7J 626, E7J 764 | 55/74 | 09/96→08/03 | Z340 | 0.7 | UXT12 | | |
| 1.4 16V | 4 | K4J 714, K4J 750 | 70/94 | 03/99→08/03 | Z193 | 0.9 | UXT1 / UXT3 | ZS052 | GS29 |
| 1.4 16V LPG | 4 | K4J 714, K4J 750 | 70/94 | 03/99→08/03 | Z340 | 0.7 | UXT12 | | |
| 1.4 e | 4 | E7J 626 | 55/74 | 01/96→08/03 | Z193 | 0.9 | UXT1 / UXT3 | ZS251 →02/99 ZS052 ZS354 02/99→ | |

RENAULT

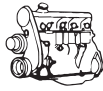

kW/BHP

**... RENAULT****... MEGANE I**

| | | | | | | | | | |
|-------------|---|---------------------------------------|--------|-------------|------|--|-----|-------------|---|
| 1.4 e | 4 | E7J 626 | 55/74 | 03/99→08/03 | | | | | ZS052 ZS354 ^[154] |
| 1.4 e | 4 | E7J 764 | 55/74 | 01/96→08/03 | Z193 | | 0.9 | UXT1 / UXT3 | ZS251 →02/99 ZS354 02/99→ |
| 1.4 e LPG | 4 | E7J 626, E7J 764 | 55/74 | 01/96→08/03 | Z340 | | 0.7 | UXT12 | |
| 1.4 Eco | 4 | E7J 624 | 52/70 | 01/96→03/99 | Z193 | | 0.9 | UXT1 / UXT3 | ZS251 ^{[213][254]} ZS316 ^{[206][254]} |
| 1.4 Eco LPG | 4 | E7J 624 | 52/70 | 01/96→03/99 | Z340 | | 0.7 | UXT12 | |
| 1.6 16V | 4 | K4M 700, K4M 701, K4M 704, K4M 708 | 79/106 | 03/99→08/03 | Z193 | | 0.9 | UXT1 / UXT3 | ZS052 |
| 1.6 16V LPG | 4 | K4M 700, K4M 701, K4M 704, K4M 708 | 79/106 | 03/99→08/03 | Z340 | | 0.7 | UXT12 | |
| 1.6 e | 4 | K7M 702, K7M 703 | 66/89 | 01/96→08/03 | Z193 | | 0.9 | UXT1 / UXT3 | |
| 1.6 e | 4 | K7M 702, K7M 703 | 66/89 | 01/96→03/99 | | | | | ZS245 ^[24] →03/97 ZS246 ^[26] →03/97 ZS242 ^[24] 04/97→07/98 ZS243 ^[26] 04/97→07/98 ZS354 08/98→ |
| 1.6 e | 4 | K7M 702, K7M 703 | 66/89 | 03/96→03/99 | | | | | ZS354 ^[59] ZS245 ^[24] →eng. 970310 ZS246 ^[26] →eng. 970310 ZS242 ^[24] eng. 970310→ →eng. 980708 ZS243 ^[26] eng. 970310→ →eng. 980708 |
| 1.6 e | 4 | K7M 702, K7M 703, K7M 790 | 66/89 | 09/96→03/99 | | | | | ZS245 ^[24] →03/97 ZS246 ^[26] →03/97 ZS242 ^[24] 04/97→ ZS243 ^[26] 04/97→ |
| 1.6 e | 4 | K7M 702, K7M 703 | 66/89 | 03/99→08/03 | | | | | ZS354 |
| 1.6 e | 4 | K7M 790 | 66/89 | 01/96→03/99 | Z193 | | 0.9 | UXT1 / UXT3 | ZS245 ^[24] →03/97 ZS246 ^[26] →03/97 ZS242 ^[24] 04/97→07/98 ZS243 ^[26] 04/97→07/98 ZS354 08/98→ |
| 1.6 e LPG | 4 | K7M 702, K7M 703, K7M 790 | 66/89 | 01/96→08/03 | Z340 | | 0.7 | UXT12 | |



kW/BHP

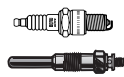

... RENAULT



... MEGANE I

| | | | | | | | | | |
|-------------|---|---------------------------------------|---------|-------------|--|------------|----------------------------|--|--------|
| 1.6 i | 4 | K7M 720 | 55/74 | 01/96→03/99 | Z193 | 0.9 | UXT1 / UXT3 | ZS245 ^[24] →03/97 ZS246 ^[26] →03/97 ZS242 ^[24] 04/97→ ZS243 ^[26] 04/97→ | |
| 1.6 i LPG | 4 | K7M 720 | 55/74 | 01/96→03/99 | Z340 | 0.7 | UXT12 | | |
| 1.8 16V | 4 | F4P 720, F4P 722 | 85/114 | 01/01→08/03 | Z193 | 0.9 | UXT1 / UXT3 | ZS052 | GS29 |
| 1.8 16V LPG | 4 | F4P 720, F4P 722 | 85/114 | 01/01→08/03 | Z340 | 0.7 | UXT12 | | |
| 1.9 D | 4 | 624, F8Q 620 | 47/63 | 09/96→08/03 | GN991 | 11V | | | |
| 1.9 D | 4 | -790, F8Q-622 | 47/63 | 04/99→08/03 | GN019 | 11V | | | |
| 1.9 D | 4 | F8Q 784 | 69/93 | 04/96→02/01 | GN959 | 11V | | | |
| 1.9 dCi | 4 | F9Q 732, F9Q 733 | 75/101 | 02/01→08/03 | GN018 ^{[94][100]} ^[234] GN999 ^{[94][236]} | 11V | | | |
| 1.9 dCi | 4 | F9Q 738 | 75/101 | 02/01→08/03 | GN018 ^{[100][234]} GN999 ^{[94][236]} | 11V | | | |
| 1.9 DCi | 4 | F9Q 732, F9Q 733, F9Q 738 | 77/103 | 03/99→08/03 | GN018 ^{[100][234]} GN999 ^{[94][236]} | 11V | | | |
| 1.9 D Eco | 4 | F8Q 620, F8Q 624 | 47/63 | 01/96→08/03 | GN991 | 11V | | | |
| 1.9 dT | 4 | F8Q 784, F8Q 786 | 66/89 | 01/96→08/03 | GN959 | 11V | | | |
| 1.9 dTi | 4 | F9Q 744 | 59/79 | 02/01→08/03 | GN018 | 11V | | | |
| 1.9 DTi | 4 | | 60/80 | 02/00→09/00 | GN018 ^{[100][234]} GN999 ^{[94][236]} | 11V | | | |
| 1.9 dTi | 4 | F9Q 730, F9Q 731, F9Q 734, F9Q 736 | 72/97 | 03/97→02/01 | GN018 ^{[100][234]} GN999 ^{[94][236]} | 11V | | | |
| 1.9 TDI | 4 | F8Q 784 | 69/93 | 09/96→08/03 | GN959 | 11V | | | |
| 2.0 | 4 | F3R 750 | 84/113 | 04/97→08/03 | | | | ZS315 | |
| 2.0 LPG | 4 | F3R 750 | 84/113 | 04/97→08/03 | Z20 ^[168] | 0.8 | UXT2 / UXT6 | | |
| 2.0 16V | 4 | F4R 746, F4R 770 | 102/137 | 01/02→08/03 | Z193 | 0.9 | UXT1 / UXT3 | ZS052 | |
| 2.0 16V | 4 | F7R 710, F7R 714 | 108/145 | 03/96→08/03 | Z60 | 1.2 | | | |
| 2.0 16V | 4 | F7R 710, F7R 714 | 108/145 | 03/96→11/99 | | | | ZS345 02/99→ | |
| 2.0 16V | 4 | F7R 710, F7R 714 | 108/145 | 07/96→08/03 | | | | ZS052 | |
| 2.0 16V LPG | 4 | F4R 746, F4R 770 | 102/137 | 01/02→08/03 | Z340 | 0.7 | UXT12 | | |
| 2.0 16V IDE | 4 | F5R 740 | 103/138 | 11/99→08/03 | | | | ZS345 ^[155] 06/00→ | |
| 2.0 i | 4 | F3R 750, F3R 751 | 80/107 | 03/99→08/03 | Z193 | 0.9 | UXT1 / UXT3 | ZS315 ^{[11][95]} →eng. 970402 ZS317 ^{[11][10][99]} ^{[240][272]} ch. 970402→ | |
| 2.0 i | 4 | F3R 752, F3R 797, F3R 798 | 80/107 | 03/99→08/03 | Z193 | 0.9 | UXT1 / UXT3 | ZS315 ^[95] ZS317 ^{[10][99][240]} ^[272] | |
| 2.0 i | 4 | F3R 791, F3R 796 | 80/107 | 03/99→08/03 | Z119 ^[170] Z193 | 0.8 0.9 | UXT2 / UXT6 UXT1 / UXT3 | ZS315 ^[95] ZS317 ^{[10][99][240]} ^[272] ZS345 ^[155] | |
| 2.0 i | 4 | F3R 750, F3R 751 | 84/113 | 01/96→08/03 | Z119 ^[170] | 0.8 | UXT2 / UXT6 | ZS317 ^{[10][272]} →03/97 ZS315 04/97→ | |
| 2.0 i | 4 | F3R 750, F3R 751 | 84/113 | 09/96→08/03 | Z119 ^[170] →04/97 | 0.8 | UXT2 / UXT6 | | →04/97 |



kW/BHP

**... RENAULT****... MEGANE I**

| | | | | | | | | |
|-----------|---|---|--------|-------------|----------------------|------------|-----------------------|---|
| 2.0 i | 4 | F3R 752, F3R 791, F3R 796, F3R 797, F3R 798 | 84/113 | 09/96→08/03 | Z119 [170] →04/97 | 0.8 | UXT2 / UXT6 →04/97 | ZS317 [110][272] →03/97 ZS315 04/97→ |
| 2.0 i LPG | 4 | F3R 750, F3R 751, F3R 752, F3R 797, F3R 798 | 80/107 | 03/99→08/03 | Z340 | 0.7 | UXT12 | |
| 2.0 i LPG | 4 | F3R 791, F3R 796 | 80/107 | 03/99→08/03 | Z20 [168] Z340 | 0.8 0.7 | UXT2 / UXT6 UXT12 | |
| 2.0 i LPG | 4 | F3R 750, F3R 751 | 84/113 | 01/96→08/03 | Z20 [168] | 0.8 | UXT2 / UXT6 | |
| 2.0 i LPG | 4 | F3R 750, F3R 751, F3R 752, F3R 791, F3R 796, F3R 797, F3R 798 | 84/113 | 09/96→08/03 | Z20 [168] →04/97 | 0.8 | UXT2 / UXT6 →04/97 | |

MEGANE II

| | | | | | | | | |
|-----------------------|---|--|---------|-------------|-------|-----|-------------|-------|
| 1.4 | 4 | K4J 732 | 60/80 | 09/03→ | Z193 | 0.9 | UXT1 / UXT3 | ZS052 |
| 1.4 | 4 | K4J 730, K4J 740 | 72/97 | 08/03→ | Z193 | 0.9 | UXT1 / UXT3 | ZS052 |
| 1.4 LPG | 4 | K4J 732 | 60/80 | 09/03→ | Z340 | 0.7 | UXT12 | |
| 1.4 LPG | 4 | K4J 730, K4J 740 | 72/97 | 08/03→ | Z340 | 0.7 | UXT12 | |
| 1.4 16V | 4 | K4J 732 | 60/80 | 10/03→ | Z193 | 0.9 | UXT1 / UXT3 | ZS052 |
| 1.4 16V | 4 | K4J 730, K4J 740 | 72/97 | 11/02→ | Z193 | 0.9 | UXT1 / UXT3 | ZS052 |
| 1.4 16V LPG | 4 | K4J 732 | 60/80 | 10/03→ | Z340 | 0.7 | UXT12 | |
| 1.4 16V LPG | 4 | K4J 730, K4J 740 | 72/97 | 11/02→ | Z340 | 0.7 | UXT12 | |
| 1.5 dCi | 4 | K9K 722 | 60/80 | 11/02→ | GN018 | 11V | | |
| 1.5 dCi | 4 | K9K 724 | 63/84 | 05/05→ | GN018 | 11V | | |
| 1.5 dCi | 4 | K9K 728, K9K 729 | 74/99 | 10/03→ | GN018 | 11V | | |
| 1.5 dCi | 4 | K9K 728, K9K 734 | 76/102 | 01/07→ | GN018 | 11V | | |
| 1.5 dCi | 4 | K9K 732, K9K 734 | 78/105 | 05/05→ | GN018 | 11V | | |
| 1.6 | 4 | K4M 768 | 75/101 | 09/03→ | | | | ZS052 |
| 1.6 | 4 | K4M 764 | 77/103 | 05/05→ | | | | ZS052 |
| 1.6 | 4 | K4M 762 | 77/103 | 05/05→ | Z193 | 0.9 | UXT1 / UXT3 | |
| 1.6 | 4 | K4M 788 | 77/103 | 06/05→ | Z247 | 0.9 | UXT1 / UXT3 | ZS052 |
| 1.6 | 4 | K4M 760, K4M 761 | 83/111 | 08/03→ | Z193 | 0.9 | UXT1 / UXT3 | ZS052 |
| 1.6 LPG | 4 | K4M 760, K4M 761 | 83/111 | 08/03→ | Z340 | 0.7 | UXT12 | |
| 1.6 16V | 4 | | 77/103 | 05/05→07/09 | Z193 | 0.9 | UXT1 / UXT3 | ZS052 |
| 1.6 16V | 4 | K4M 760, K4M 761, K4M 812, K4M 813, K4M C 813, K4M D 812 | 82/110 | 01/06→ | Z193 | 0.9 | UXT1 / UXT3 | ZS052 |
| 1.6 16V | 4 | K4M 760 | 83/111 | 11/02→ | Z193 | 0.9 | UXT1 / UXT3 | ZS052 |
| 1.6 16V LPG | 4 | K4M 760, K4M 761, K4M 812, K4M 813, K4M C 813, K4M D 812 | 82/110 | 01/06→ | Z340 | 0.7 | UXT12 | |
| 1.6 16V LPG | 4 | K4M 760 | 83/111 | 11/02→ | Z340 | 0.7 | UXT12 | |
| 1.6 16V Hi-Flex | 4 | K4M 762, K4M 856 | 77/103 | 02/08→ | | | | ZS052 |
| 1.6 Flex-Fuel | 4 | K4M 788 | 77/103 | 01/07→ | Z247 | 0.9 | UXT1 / UXT3 | ZS052 |
| 1.9 dCi | 4 | F9Q 808 | 66/89 | 11/02→12/05 | GN018 | 11V | | |
| 1.9 dCi | 4 | F9Q 808 | 68/91 | 03/04→ | GN018 | 11V | | |
| 1.9 dCi | 4 | F9Q 803, F9Q 804, F9Q 816, F9Q 818 | 81/109 | 05/05→ | GN018 | 11V | | |
| 1.9 dCi | 4 | F9Q 804, F9Q 816, F9Q 818 | 85/114 | 11/02→ | GN018 | 11V | | |
| 1.9 dCi | 4 | F9Q 800 | 88/118 | 11/02→ | GN018 | 11V | | |
| 1.9 dCi | 4 | F9Q 803, F9Q 804, F9Q 816, F9Q 818 | 96/129 | 05/05→ | GN018 | 11V | | |
| 2.0 | 4 | F4R 770, F4R 771 | 99/133 | 08/03→ | Z193 | 0.9 | UXT1 / UXT3 | ZS052 |
| 2.0 | 4 | F4R 774 | 169/227 | 08/06→ | Z206 | 0.7 | UXT10 | ZS052 |
| 2.0 LPG | 4 | F4R 770, F4R 771 | 99/133 | 08/03→ | Z340 | 0.7 | UXT12 | |
| 2.0 LPG | 4 | F4R 774 | 169/227 | 08/06→ | Z340 | 0.7 | UXT12 | |
| 2.0 16V | 4 | F4R 770 | 99/133 | 11/02→ | Z193 | 0.9 | UXT1 / UXT3 | ZS052 |
| 2.0 16V LPG | 4 | F4R 770 | 99/133 | 11/02→ | Z340 | 0.7 | UXT12 | |
| 2.0 16V Turbo | 4 | F4R 776 | 120/161 | 05/04→ | Z337 | 0.9 | UXT9 | ZS052 |
| 2.0 16V Turbo LPG | 4 | F4R 776 | 120/161 | 05/04→ | Z340 | 0.7 | UXT12 | |
| 2.0 Renault Sport | 4 | F4R 774, F4Rt 774 | 165/221 | 05/04→ | Z206 | 0.7 | UXT10 | ZS052 |
| 2.0 Renault Sport LPG | 4 | F4R 774, F4Rt 774 | 165/221 | 05/04→ | Z340 | 0.7 | UXT12 | |



kW/BHP



... RENAULT



MEGANE III

| | | | | | | | | |
|----------------|---|---|---------|--------|-------------------|------|-------------|--------------|
| 1.2 TCe | 4 | H5F 400 | 85/114 | 03/12→ | | | | ZSE131 |
| 1.4 TCe | 4 | H4J 700 | 96/129 | 04/09→ | Z274 | 0.7 | | ZSE066 |
| 1.5 dCi | 4 | | 63/84 | 03/09→ | GE110 [16][37] | 4.4V | | |
| 1.5 dCi | 4 | K9K 830 | 63/84 | 12/09→ | GE110 [37] | 4.4V | | |
| 1.5 dCi | 4 | K9K F 830 | 63/84 | 11/08→ | GE110 [1][16][37] | 4.4V | | |
| 1.5 dCi | 4 | K9K 834, K9K H 834 | 66/89 | 11/08→ | GE110 [37] | 4.4V | | |
| 1.5 dCi | 4 | | 70/94 | 11/13→ | GE110 [16][37] | 4.4V | | |
| 1.5 dCi | 4 | K9K 836, K9K 846, K9K G 832 | 78/105 | 02/09→ | GE110 [37] | 4.4V | | |
| 1.5 dCi | 4 | K9K 636, K9K 836, K9K 837, K9K 846, K9K J 836 | 81/109 | 02/09→ | GE110 [37] | 4.4V | | |
| 1.6 16V | 4 | K4M 848, K4M P 848 | 74/99 | 11/08→ | Z193 | 0.9 | UXT1 / UXT3 | ZS052 |
| 1.6 16V | 4 | K4M 858 | 81/109 | 11/08→ | Z193 | 0.9 | UXT1 / UXT3 | ZS052 |
| 1.6 16V | 4 | K4M 760 | 82/110 | 11/08→ | Z193 | 0.9 | UXT1 / UXT3 | ZS052 |
| 1.6 16V LPG | 4 | K4M 848, K4M P 848 | 74/99 | 11/08→ | Z340 | 0.7 | UXT12 | |
| 1.6 16V LPG | 4 | K4M 858 | 81/109 | 11/08→ | Z340 | 0.7 | UXT12 | |
| 1.6 16V Bifuel | 4 | K4M 866 | 81/109 | 11/08→ | | | | ZS052 |
| 1.9 dCi | 4 | F9Q 870, F9Q 872 | 96/129 | 11/08→ | GE111 [37] | 4.4V | | |
| 2.0 | 4 | M4R 710 | 105/141 | 01/11→ | | | | ZSE161 [259] |
| 2.0 CVT | 4 | M4R 711, M4R 713 | 103/138 | 02/09→ | Z325 | 1.1 | | ZSE161 [259] |
| 2.0 CVT | 4 | M4R F 713 | 103/138 | 05/09→ | | | | ZSE161 [259] |
| 2.0 R.S. | 4 | F4R 874 | 195/261 | 11/08→ | | | | ZS052 |
| 2.0 TCe | 4 | F4R 870, F4R 872 | 132/177 | 11/08→ | Z337 | 0.9 | UXT9 | ZS052 |
| 2.0 TCe | 4 | F4R 874 | 184/247 | 05/09→ | | | | ZS052 |
| 2.0 TCe LPG | 4 | F4R 870, F4R 872 | 132/177 | 11/08→ | Z340 | 0.7 | UXT12 | |
| 2.0 TCe 220 | 4 | | 162/217 | 11/13→ | | | | ZS052 |

MEGANE CC

| | | | | | | | | |
|-------------|---|------------------|---------|--------|----------------|------|-------|--------------|
| 1.4 TCe | 4 | H4J 700 | 96/129 | 06/10→ | Z274 | 0.7 | | ZSE066 |
| 1.5 dCi | 4 | K9K 837 | 81/109 | 06/10→ | GE110 [37] | 4.4V | | |
| 1.6 16V | 4 | K4M 858 | 81/109 | 06/10→ | | | | ZS052 |
| 1.9 dCi | 4 | F9Q 870 | 96/129 | 06/10→ | GE111 [16][37] | 4.4V | | |
| 2.0 CVT | 4 | M4R 711, M4R 713 | 103/138 | 06/10→ | | | | ZSE161 [259] |
| 2.0 TCe | 4 | F4R 870 | 132/177 | 06/10→ | Z337 | 0.9 | UXT9 | |
| 2.0 TCe | 4 | F4R 872 | 132/177 | 06/10→ | Z337 | 0.9 | UXT9 | ZS052 |
| 2.0 TCe LPG | 4 | F4R 870, F4R 872 | 132/177 | 06/10→ | Z340 | 0.7 | UXT12 | |
| 2.0 Turbo | 4 | F4R 874 | 195/261 | 10/11→ | | | | ZS052 |

MODUS / GRAND MODUS

| | | | | | | | | |
|-----------------|---|------------------|--------|--------|-----------------------|------------|-------------|---|
| 1.2 | 4 | D4F 740 | 48/64 | 05/05→ | Z243 | 0.9 | | ZS325 [157] ZS375 [156] |
| 1.2 | 4 | D4F 740 | 55/74 | 12/04→ | Z243 | 0.9 | | ZS325 [157] ZS375 [156] |
| 1.2 | 4 | D4F 764 | 58/78 | 12/04→ | Z243 Z274 [9][189] | 0.9 0.7 | | ZS325 [1][157] ZS354 [1][154] ZS375 [156] |
| 1.2 | 4 | D4F 786 | 76/102 | 04/11→ | Z243 | 0.9 | | ZS354 |
| 1.2 16V | 4 | D4F 784 | 74/99 | 05/07→ | Z274 | 0.7 | | ZS354 |
| 1.2 16V Hi-Flex | 4 | D4F 740 | 55/74 | 10/08→ | | | | ZS325 [1][157] ZS375 [1][156] |
| 1.4 | 4 | K4J 770, K4J 780 | 72/97 | 12/04→ | Z193 | 0.9 | UXT1 / UXT3 | ZS052 |
| 1.4 LPG | 4 | K4J 770, K4J 780 | 72/97 | 12/04→ | Z340 | 0.7 | UXT12 | |
| 1.5 dCi | 4 | K9K 752 | 48/64 | 12/04→ | GN018 | 11V | | |
| 1.5 dCi | 4 | K9K 762, K9K 768 | 50/67 | 12/04→ | GN018 | 11V | | |
| 1.5 dCi | 4 | K9K 750 | 60/80 | 09/04→ | GN018 | 11V | | |
| 1.5 dCi | 4 | K9K 760, K9K 766 | 63/84 | 12/04→ | GN018 | 11V | | |
| 1.5 dCi | 4 | K9K 772 | 76/102 | 05/07→ | GN018 | 11V | | |
| 1.5 dCi | 4 | K9K 764 | 78/105 | 05/05→ | GN018 | 11V | | |
| 1.5 dCi 75 | 4 | K9K 770 | 55/74 | 10/10→ | GN018 | 11V | | |
| 1.5 dCi 90 | 4 | K9K 750 | 65/87 | 10/10→ | GN018 | 11V | | |
| 1.6 | 4 | K4M 794 | 65/87 | 12/04→ | Z193 | 0.9 | UXT1 / UXT3 | ZS052 |

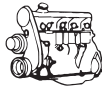

kW/BHP

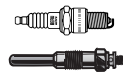
**... RENAULT****... MODUS / GRAND MODUS**

| | | | | | | | | |
|---------|---|------------------------------------|--------|--------|------|-----|-------------|---------------------------------|
| 1.6 | 4 | K4M 790, K4M 791, K4M 800, K4M 801 | 82/110 | 12/04→ | Z193 | 0.9 | UXT1 / UXT3 | ZS052 ZS354 ^[154] |
| 1.6 LPG | 4 | K4M 794 | 65/87 | 12/04→ | Z340 | 0.7 | UXT12 | |
| 1.6 LPG | 4 | K4M 790, K4M 791, K4M 800, K4M 801 | 82/110 | 12/04→ | Z340 | 0.7 | UXT12 | |

SAFRANE I

| | | | | | | | | |
|-----------------|---|------------------------------------|---------|-------------|------------------------------------|------------|-------|---|
| 2.0 | 4 | J7R 732, J7R 733 | 77/103 | 11/92→07/96 | Z25 Z56 | 0.8 0.8 | UXK56 | ZS251 ^{[213][254]} ZS316 ^{[1][206][254]} |
| 2.0 LPG | 4 | J7R 732, J7R 733 | 77/103 | 11/92→07/96 | Z31 | 0.8 | UXK56 | |
| 2.0 12V | 4 | J7R 734, J7R 735 | 97/130 | 04/92→07/96 | Z53 | 1.0 | UXT5 | ZS251 ^{[1][213][254]} ZS316 ^{[1][206][254]} |
| 2.1 dT | 4 | J8S 760 | 65/87 | 11/93→07/96 | GN909 ^{[2][222]} GV642 | 11V 11V | | |
| 2.2 | 4 | J7T 762 | 79/106 | 04/92→07/96 | Z17 | 0.8 | UXT4 | ZS251 ^{[1][213][254]} ZS316 ^{[1][206][254]} |
| 2.2 | 4 | J7T 760, J7T 761 | 101/135 | 04/92→07/96 | Z52 | 0.8 | UXT5 | ZS251 |
| 2.2 LPG | 4 | J7T 762 | 79/106 | 04/92→07/96 | Z25 ^[168] | 0.8 | UXK56 | |
| 2.2 LPG | 4 | J7T 760, J7T 761 | 101/135 | 04/92→07/96 | Z29 ^[168] | 0.8 | UXT5 | |
| 2.5 dT | 4 | S8U 762, S8U 763 | 83/111 | 12/92→07/96 | GN013 ^{[2][222]} GN917 | 11V 11V | | |
| 3.0 Biturbo 4WD | 6 | Z7X 726 | 193/259 | 02/93→07/96 | Z30 | 0.8 | UXT5 | ZS251 ^[1] |
| 3.0 V6 | 6 | Z7X 721, Z7X 722, Z7X 723, Z7X 753 | 123/165 | 12/92→07/96 | Z60 | 1.2 | | ZS251 ^{[1][213][254]} ZS316 ^{[1][206][254]} ZM052 |
| 3.0 V6 4WD | 6 | Z7X 721 | 123/165 | 12/92→07/96 | | | | ZS251 ^[1] |
| 3.0 V6 4WD | 6 | Z7X 722, Z7X 723 | 123/165 | 12/92→07/96 | | | | ZS251 ^[1] ZM052 |

SAFRANE II

| | | | | | | | | |
|-------------|---|------------------|---------|-------------|-------|-----|-------------|--|
| 2.0 16V | 4 | N7Q 710, N7Q 711 | 100/134 | 07/96→12/00 | Z247 | 0.9 | UXT1 / UXT3 | ZS254 ^[24] ZS255 ^[26] |
| 2.2 dT | 4 | G8T 740 | 83/111 | 07/96→12/00 | GN999 | 11V | | |
| 2.5 20V | 5 | N7U 700, N7U 701 | 121/162 | 07/96→12/00 | Z247 | 0.9 | UXT1 / UXT3 | ZSE037 ZM036 |
| 2.9 24V | 6 | L7X 713 | 140/188 | 03/99→12/00 | Z123 | 1.0 | UXT9 | ZS343 |
| 2.9 24V LPG | 6 | L7X 713 | 140/188 | 03/99→12/00 | Z129 | 1.6 | | |
| 3.0 V6 | 6 | Z7X 755 | 123/165 | 07/96→12/00 | Z60 | 1.2 | | ZS251 ^{[1][213][254]} ZS316 ^{[1][206][254]} |

SANDERO/STEPWAY

| | | | | | | | | |
|---------|---|---------|--------|--------|---|--|---|-------|
| 1.4 | 4 | K7J 710 | 55/74 | 02/09→ | Z98 | 0.8 | UXT1 / UXT3 | ZS354 |
| 1.4 LPG | 4 | K7J 710 | 55/74 | 02/09→ | Z116 | 0.8 | UXT5 | |
| 1.6 | 4 | K7M 718 | 62/83 | 11/10→ | Z257 ^[185] →eng. 050425 Z14 →eng. 050425;140325 Z193 eng. 050425→ | 0.9 →eng. 050425 0.9 →eng. 050425;140325 0.9 eng. 050425→ | UXT1 / UXT3 UXT1 / UXT3 UXT1 / UXT3 | ZS354 |
| 1.6 | 4 | K7M 710 | 64/86 | 02/09→ | | | | ZS338 |
| 1.6 | 4 | K7M 710 | 75/101 | 12/07→ | Z14 →eng. 050425;140325 Z193 eng. 050426→ | 0.9 →eng. 050425;140325 0.9 eng. 050426→ | UXT1 / UXT3 UXT1 / UXT3 | ZS354 |
| 1.6 | 4 | | 76/102 | 12/07→ | Z14 →eng. 050425;140325 Z193 eng. 050426→ | 0.9 →eng. 050425;140325 0.9 eng. 050426→ | UXT1 / UXT3 UXT1 / UXT3 | ZS052 |
| 1.6 LPG | 4 | K7M 718 | 62/83 | 11/10→ | Z116 | 0.8 | UXT5 | |
| 1.6 LPG | 4 | K7M 710 | 75/101 | 12/07→ | Z116 | 0.8 | UXT5 | |
| 1.6 LPG | 4 | | 76/102 | 12/07→ | Z116 | 0.8 | UXT5 | |

SCÉNIC I

| | | | | | | | | |
|-------------|---|------------------|-------|-------------|------|-----|-------------|-------|
| 1.4 16V | 4 | K4J 714, K4J 750 | 70/94 | 09/99→08/03 | Z193 | 0.9 | UXT1 / UXT3 | ZS052 |
| 1.4 16V LPG | 4 | K4J 714, K4J 750 | 70/94 | 09/99→08/03 | Z340 | 0.7 | UXT12 | |



kW/BHP

**... RENAULT****... SCÉNIC I**

| | | | | | | | | |
|----------------|---|------------------------------------|---------|-------------|-------------------------------------|------------|-------------|-------|
| 1.6 | 4 | K4M 708, K4M 709 | 75/101 | 03/01→08/03 | Z193 | 0.9 | UXT1 / UXT3 | ZS052 |
| 1.6 | 4 | K4M 700, K4M 706 | 79/106 | 09/99→09/03 | Z193 | 0.9 | UXT1 / UXT3 | ZS052 |
| 1.6 BiFuel LPG | 4 | K4M 704 | 79/106 | 09/99→04/01 | Z193 [168] | 0.9 | UXT1 / UXT3 | ZS052 |
| 1.8 4WD | 4 | F4P 722 | 85/114 | 07/00→04/01 | | | | ZS052 |
| 1.8 16V | 4 | F4P 720, F4P 722 | 85/114 | 01/01→08/03 | Z193 | 0.9 | UXT1 / UXT3 | ZS052 |
| 1.8 16V LPG | 4 | F4P 720, F4P 722 | 85/114 | 01/01→08/03 | Z340 | 0.7 | UXT12 | |
| 1.9 D | 4 | F8Q 790 | 47/63 | 09/99→03/01 | GN019 | 11V | | |
| 1.9 dCi 4WD | 4 | F9Q 732, F9Q 748, F9Q 796 | 74/99 | 12/02→08/03 | GN018 | 11V | | |
| 1.9 dCi | 4 | F9Q 732, F9Q 733, F9Q 740 | 75/101 | 09/99→08/03 | GN018 | 11V | | |
| 1.9 dTi | 4 | F9Q 744 | 59/79 | 02/01→08/03 | GN018 | 11V | | |
| 1.9 dTi | 4 | F9Q 731, F9Q 734, F9Q 736 | 72/97 | 09/99→08/03 | GN018 [100][221] GN999 [94][174] | 11V 11V | | |
| | | | | | [236] | | | |
| 2.0 16V | 4 | F4R 740, F4R 741, F4R 744, F4R 746 | 102/137 | 06/00→08/03 | Z193 | 0.9 | UXT1 / UXT3 | ZS052 |
| 2.0 16V | 4 | F4R 746 | 102/137 | 07/00→08/03 | | | | ZS052 |
| 2.0 16V | 4 | F4R 740, F4R 741, F4R 744, F4R 747 | 103/138 | 09/99→08/03 | Z193 | 0.9 | UXT1 / UXT3 | ZS052 |
| 2.0 16V LPG | 4 | F4R 740, F4R 741, F4R 744, F4R 746 | 102/137 | 06/00→08/03 | Z340 | 0.7 | UXT12 | |

SCÉNIC II

| | | | | | | | | |
|-------------------|---|--------------------------------------|---------|--------|-------|-----|-------------|-------|
| 1.4 | 4 | K4J 730, K4J 740, K4J 770 | 72/97 | 06/03→ | Z193 | 0.9 | UXT1 / UXT3 | ZS052 |
| 1.4 LPG | 4 | K4J 730, K4J 740, K4J 770 | 72/97 | 06/03→ | Z340 | 0.7 | UXT12 | |
| 1.5 dCi | 4 | K9K 722 | 60/80 | 06/03→ | GN018 | 11V | | |
| 1.5 dCi | 4 | K9K 724 | 63/84 | 05/05→ | GN018 | 11V | | |
| 1.5 dCi | 4 | K9K 728, K9K 729 | 74/99 | 11/03→ | GN018 | 11V | | |
| 1.5 dCi | 4 | K9K 734 | 76/102 | 01/07→ | GN018 | 11V | | |
| 1.5 dCi | 4 | K9K 732 | 78/105 | 05/05→ | GN018 | 11V | | |
| 1.6 | 4 | K4M 788 | 77/103 | 06/06→ | Z247 | 0.9 | UXT1 / UXT3 | ZS052 |
| 1.6 | 4 | K4M 761, K4M 782 | 83/111 | 06/03→ | Z193 | 0.9 | UXT1 / UXT3 | ZS052 |
| 1.6 LPG | 4 | K4M 761, K4M 782 | 83/111 | 06/03→ | Z340 | 0.7 | UXT12 | |
| 1.6 16V | 4 | K4M 812, K4M 9 766, K4M C 813 | 82/110 | 01/07→ | Z193 | 0.9 | UXT1 / UXT3 | ZS052 |
| 1.9 D | 4 | F9Q 812, F9Q J 803 | 85/114 | 06/06→ | GN018 | 11V | | |
| 1.9 dCi | 4 | F9Q 804 | 81/109 | 05/05→ | GN018 | 11V | | |
| 1.9 dCi | 4 | F9Q 812 | 88/118 | 06/03→ | GN018 | 11V | | |
| 1.9 dCi | 4 | F9Q 804 | 92/123 | 06/03→ | GN018 | 11V | | |
| 1.9 dCi | 4 | F9Q 804, F9Q 816, F9Q 818, F9Q J 803 | 96/129 | 05/05→ | GN018 | 11V | | |
| 2.0 | 4 | F4R 770, F4R 771 | 99/133 | 06/03→ | Z193 | 0.9 | UXT1 / UXT3 | ZS052 |
| 2.0 LPG | 4 | F4R 770, F4R 771 | 99/133 | 06/03→ | Z340 | 0.7 | UXT12 | |
| 2.0 16V Turbo | 4 | F4R 776 | 120/161 | 05/04→ | Z337 | 0.9 | UXT9 | ZS052 |
| 2.0 16V Turbo LPG | 4 | F4R 776 | 120/161 | 05/04→ | Z340 | 0.7 | UXT12 | |

SCÉNIC III

| | | | | | | | | |
|---------|---|---------------------------|--------|--------|----------------|------|-------------|--------|
| 1.2 TCe | 4 | H5F 400 | 85/114 | 04/12→ | | | | ZSE131 |
| 1.4 16V | 4 | H4J 700 | 96/129 | 02/09→ | Z274 | 0.7 | | ZSE066 |
| 1.5 dCi | 4 | K9K 830 | 63/84 | 04/09→ | GE110 [37] | 4.4V | | |
| 1.5 dCi | 4 | K9K 846 | 70/94 | 11/10→ | GE110 [16][37] | 4.4V | | |
| 1.5 dCi | 4 | K9K 832 | 78/105 | 02/09→ | GE110 [37] | 4.4V | | |
| 1.5 dCi | 4 | K9K 636, K9K 836, K9K 837 | 81/109 | 04/09→ | GE110 [37] | 4.4V | | |
| 1.6 16V | 4 | K4M 858 | 81/109 | 02/09→ | Z193 | 0.9 | UXT1 / UXT3 | ZS052 |
| 1.6 E85 | 4 | K4M 866 | 81/109 | 02/09→ | | | | ZS052 |
| 1.9 dCi | 4 | F9Q 870, F9Q 872 | 96/129 | 02/09→ | GE111 [37] | 4.4V | | |

SUPER 5

| | | | | | | | | |
|-----|---|---------|-------|-------------|----------|-----|-------------|------------|
| 1.0 | 4 | C1C 700 | 30/40 | 10/84→10/88 | Z1 [169] | 0.7 | UXT2 / UXT6 | ZS106 [11] |
|-----|---|---------|-------|-------------|----------|-----|-------------|------------|



kW/BHP

**... RENAULT****... SUPER 5**

| | | | | | | | |
|-----------|---|---|--------|-------------|-------------------------------------|--|---|
| 1.1 | 4 | C1E 750, C1E 752, C1E 756, C1E 760 | 33/44 | 01/86→03/95 | Z1 [169] →09/90 Z82 10/90→ | 0.7 UXT2 / UXT6 →09/90 0.7 UXT2 / UXT6 10/90→ | ZS106 [11] |
| 1.1 | 4 | C1E 750, C1E 752, C1E 754 | 34/46 | 10/84→10/88 | Z1 [169] | 0.7 UXT2 / UXT6 | ZS106 [11] |
| 1.1 LPG | 4 | C1E 750, C1E 752, C1E 756, C1E 760 | 33/44 | 01/86→03/95 | Z11 [168] →09/90 | 0.8 UXT2 / UXT6 →09/90 | |
| 1.2 | 4 | C1G 702, C1G 720, C1G 722 | 40/54 | 01/87→08/90 | Z1 [169] | 0.7 UXT2 / UXT6 | ZS251 [1] |
| 1.4 | 4 | C1J 768, C1J 780 | 43/58 | 10/84→06/88 | Z1 [169] | 0.7 UXT2 / UXT6 | ZS251 [213][254] ZS316 [206][254] |
| 1.4 | 4 | C3J 700, C3J 702, C3J 760 | 43/58 | 10/85→12/96 | Z1 [169] | 0.7 UXT2 / UXT6 | ZS251 |
| 1.4 | 4 | C2J 784 | 44/59 | 06/87→08/90 | Z1 [169] | 0.7 UXT2 / UXT6 | ZS251 |
| 1.4 | 4 | C2J 782 | 49/66 | 06/87→07/89 | Z1 [169] | 0.7 UXT2 / UXT6 | ZS251 [1] |
| 1.4 | 4 | C2J 700, C2J 780, C2J 781, C2J 788, C2J 789, C2J 798 | 52/70 | 10/84→07/89 | Z1 [169] | 0.7 UXT2 / UXT6 | ZS251 |
| 1.4 LPG | 4 | C3J 700, C3J 702, C3J 760 | 43/58 | 10/85→12/96 | Z11 [168] | 0.8 UXT2 / UXT6 | |
| 1.4 Turbo | 4 | C1J 788 | 85/114 | 08/85→06/89 | | | ZS251 [1][213][254] ZS316 [1][206][254] ZS251 [1] |
| 1.4 Turbo | 4 | C1J 782, C1J 784, C1J 788 | 88/118 | 04/85→08/90 | | | |
| 1.6 D | 4 | F8M 720, F8M 730 | 40/54 | 04/85→12/96 | GN909 | 11V | |
| 1.7 | 4 | F3N 716, F3N 717 | 54/72 | 10/86→03/95 | Z20 | 0.8 UXT2 / UXT6 | ZS251 |
| 1.7 | 4 | F2N 740, F2N 742 | 64/86 | 06/87→03/95 | Z22 | 0.7 UX56 | ZS251 [1][213][254] ZS316 [1][206][254] |
| 1.7 LPG | 4 | F3N 716, F3N 717 | 54/72 | 10/86→03/95 | Z27 [168] | 0.8 UX56 | |
| 1.7 i | 4 | F3N 702, F3N 722 | 69/93 | 10/86→08/91 | Z20 | 0.8 UXT2 / UXT6 | ZS251 [1][213][254] ZS316 [1][206][254] |

THALIA I

| | | | | | | | |
|-------------|---|------------------|---------|-------------|-------------------------|------------------------|--|
| 1.2 | 4 | D7F 744, D7F 746 | 43/58 | 02/98→10/03 | | | ZS345 |
| 1.2 16V | 4 | D4F 712 | 55/74 | 04/02→ | Z243 | 0.9 | ZS325 [1][157] ZS375 [1][156] ZS454 [1][101] |
| 1.4 | 4 | K7J 700 | 55/74 | 08/00→ | Z14 [204] Z257 [185] | 0.9 UXT1 / UXT3 0.9 | ZS354 |
| 1.4 LPG | 4 | K7J 700 | 55/74 | 08/00→ | Z116 | 0.8 UXT5 | |
| 1.4 16V | 4 | K4J 712 | 72/97 | 08/00→ | Z193 | 0.9 UXT1 / UXT3 | ZS052 |
| 1.4 16V LPG | 4 | K4J 712 | 72/97 | 08/00→ | Z340 | 0.7 UXT12 | |
| 1.5 dCi | 4 | K9K 740 | 47/63 | 06/05→ | GN018 | 11V | |
| 1.5 dCi | 4 | K9K 700 | 48/64 | 04/02→ | GN018 | 11V | |
| 1.5 dCi | 4 | K9K 700, K9K 714 | 50/67 | 02/03→ | GN018 | 11V | |
| 1.5 dCi | 4 | K9K 702 | 60/80 | 06/01→ | GN018 | 11V | |
| 1.6 | 4 | K7M 746 | 66/89 | 03/98→ | | | ZS354 |
| 1.6 16V | 4 | K4M 740 | 79/106 | 04/02→ | | | ZS052 |
| 1.9 D | 4 | F8Q 630 | 48/64 | 02/98→05/01 | GN963 | 11V | |
| 2.0 | 4 | F4R 738 | 124/166 | 09/01→ | Z284 | 1.1 UXT14 | ZS345 →05/05 |
| 2.0 LPG | 4 | F4R 738 | 124/166 | 09/01→ | Z130 [168] | 1.0 UXT14 | |

THALIA II

| | | | | | | | |
|---------|---|---------|-------|--------|-------|-----|----------------------------|
| 1.2 16V | 4 | D4F 728 | 55/74 | 09/08→ | Z243 | 0.9 | ZS325 [157] ZS375 [156] |
| 1.5 dCi | 4 | K9K 740 | 47/63 | 09/08→ | GN018 | 11V | |
| 1.5 dCi | 4 | K9K 700 | 48/64 | 01/09→ | GN018 | 11V | |
| 1.5 dCi | 4 | K9K 718 | 62/83 | 09/08→ | GN018 | 11V | |

THALIA III

| | | | | | | | |
|---------|---|--|-------|--------|----------------|------|--|
| 1.5 dCi | 4 | | 66/89 | 07/14→ | GE110 [16][37] | 4.4V | |
|---------|---|--|-------|--------|----------------|------|--|

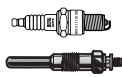

kW/BHP

**... RENAULT****TWINGO I**

| | | | | | | | | | |
|---------|---|--|-------|-------------|-----------|-----|-------------|--|--|
| 1.2 | 4 | C3G 700, C3G 702 | 40/54 | 03/93→10/96 | Z82 [169] | 0.7 | UXT2 / UXT6 | ZS250 | |
| 1.2 | 4 | D7F 700, D7F 701 | 40/54 | 05/96→ | Z257 | 0.9 | UXT1 / UXT3 | ZS345 →10/98 ZS354 11/98→ | |
| 1.2 | 4 | D7F 700, D7F 701, D7F 702, D7F 703, D7F 704 | 43/58 | 05/96→ | Z257 | 0.9 | UXT1 / UXT3 | ZS345 →10/98 ZS354 11/98→ | |
| 1.2 | 4 | D7F 702, D7F 703, D7F 704 | 44/59 | 09/98→08/00 | | | | ZS345 →eng. 981021 ZS354 [1] eng. 981021→ →eng. 111215 | |
| 1.2 LPG | 4 | D7F 700, D7F 701 | 40/54 | 05/96→ | Z116 | 0.8 | UXT5 | | |
| 1.2 LPG | 4 | D7F 700, D7F 701, D7F 702, D7F 703, D7F 704 | 43/58 | 05/96→ | Z116 | 0.8 | UXT5 | | |
| 1.2 16V | 4 | D4F 708 | 44/59 | 08/04→ | Z243 | 0.9 | | ZS325 [157] ZS354 [1][154] ZS375 [156] | |
| 1.2 16V | 4 | D4F 702 | 55/74 | 01/01→ | Z243 | 0.9 | | ZS454 [1][101] ZS354 [1] 09/04→ | |

TWINGO II

| | | | | | | | | | |
|-------------|---|------------------|--------|--------|--|-------------|---------------|----------------------------|--|
| 1.2 | 4 | D7F 800 | 43/58 | 03/07→ | Z193 | 0.9 | UXT1 / UXT3 | ZS354 | |
| 1.2 LPG | 4 | D7F 800 | 43/58 | 03/07→ | Z340 | 0.7 | UXT12 | | |
| 1.2 16V | 4 | D4F 764, D4F 772 | 55/74 | 03/07→ | | | | ZS325 [157] ZS375 [156] | |
| 1.2 16V | 4 | D4F 772 | 56/75 | 03/07→ | Z243 | 0.9 | | ZS325 [157] ZS375 [156] | |
| 1.2 TCe 100 | 4 | D4F 780, D4F 782 | 75/101 | 02/11→ | | | | ZS354 | |
| 1.2 Turbo | 4 | D4F 780, D4F 782 | 74/99 | 03/07→ | Z274 | 0.7 | | ZS354 | |
| 1.5 dCi | 4 | K9K 740 | 47/63 | 03/07→ | GN018 | 11V | | | |
| 1.5 dCi | 4 | K9K 718 | 62/83 | 04/08→ | GN018 | 11V | | | |
| 1.5 dCi 75 | 4 | K9K 820 | 55/74 | 10/10→ | GE110 [16][37] [104][238] GN018 [14][102] [237] | 4.4V 11V | | | |
| 1.5 dCi 90 | 4 | K9K 820 | 63/84 | 10/10→ | GE110 [16][37] [104][238] GN018 [14][102] [237] | 4.4V 11V | | | |
| 1.6 RS | 4 | K4M 854 | 98/131 | 05/08→ | Z206 [198] Z337 [197] | 0.7 0.9 | UXT10 UXT9 | ZS052 | |

VEL SATIS

| | | | | | | | | | |
|--------------------|---|--|---------|--------|-------|-----|-------|--------|------|
| 2.0 16V Turbo | 4 | F4R 762, F4R 763 | 120/161 | 06/02→ | Z337 | 0.9 | UXT9 | ZS052 | GS29 |
| 2.0 16 V Turbo | 4 | F4R 766, F4R 767 | 125/168 | 04/04→ | Z337 | 0.9 | UXT9 | ZS052 | |
| 2.0 16V Turbo LPG | 4 | F4R 762, F4R 763 | 120/161 | 06/02→ | Z340 | 0.7 | UXT12 | | |
| 2.0 16 V Turbo LPG | 4 | F4R 766, F4R 767 | 125/168 | 04/04→ | Z340 | 0.7 | UXT12 | | |
| 2.0 Turbo | 4 | F4R 867 | 108/145 | 04/05→ | | | | ZS052 | |
| 2.2 dCi | 4 | | 83/111 | 12/04→ | GN026 | 11V | | | |
| 2.2 dCi | 4 | G9T 600 | 85/114 | 04/04→ | GN026 | 11V | | | |
| 2.2 dCi | 4 | G9T 600, G9T 606, G9T 607, G9T 700, G9T 702 | 102/137 | 09/04→ | GN026 | 11V | | | |
| 2.2 dCi | 4 | G9T 702, G9T 703 | 110/148 | 06/02→ | GN026 | 11V | | | |
| 3.0 dCi | 6 | P9X701, P9X715 | 130/174 | 06/02→ | GN106 | 11V | | | |
| 3.0 dCi | 6 | P9X 715 | 133/178 | 06/06→ | GN106 | 11V | | | |
| 3.5 | 6 | V4Y 715 | 170/228 | 10/04→ | | | | ZSE079 | |
| 3.5 V6 | 6 | V4Y 701, V4Y 711 | 177/237 | 06/02→ | Z183 | 0.9 | UXT13 | ZSE079 | |



kW/BHP

**... RENAULT****... VEL SATIS**

| | | | | | | | | |
|-------------|---|------------------|---------|--------|------------|-----|-------|-------|
| 3.5 V6 LPG | 6 | V4Y 701, V4Y 711 | 177/237 | 06/02→ | Z184 [168] | 0.9 | UXT13 | |
| WIND | | | | | | | | |
| 1.2 | 4 | D4F 782 | 74/99 | 07/10→ | Z274 | 0.7 | | ZS354 |
| 1.2 TCe 100 | 4 | D4F 780 | 75/101 | 02/11→ | | | | ZS354 |
| 1.6 | 4 | K4M 854 | 98/131 | 07/10→ | | | | ZS052 |

RENAULT

| | | | | | | | | |
|--------------|---|---|-------|-------------|---|-------------------|-------------|---|
| 4 | | | | | | | | |
| 0.8 | 4 | 839 706 | 19/25 | 09/71→08/82 | | | | ZS106 [11] |
| 0.8 | 4 | 800 705, B1B 707 | 21/28 | 04/83→07/89 | Z10 [167] | 0.8 | | |
| 0.8 | 4 | 800 01 | 25/34 | 09/66→12/88 | Z10 | 0.8 | | |
| 1.0 | 4 | C1C 708 | 25/34 | 06/87→12/93 | Z10 | 0.8 | | |
| 1.1 | 4 | 688 711, 688 712, C1E 714, C1E 718, C1E 719 | 25/34 | 10/76→07/89 | Z10 [167] →09/83 Z57 10/83→ | 0.8 | | ZS106 [11] |
| 1.1 | 4 | C1E 718, C1E 719 | 26/35 | 07/82→05/89 | Z10 [167] →09/83 Z57 10/83→ | 0.8 | | |
| 5 | | | | | | | | |
| 0.8 | 4 | 800 710 | 26/35 | 10/72→08/84 | Z10 | 0.8 | | |
| 1.0 | 4 | 689 710 | 32/43 | 01/72→12/85 | Z10 | 0.8 | | |
| 1.1 | 4 | 688 713, C1E 726 | 33/44 | 09/80→12/85 | Z118 | 0.9 | | |
| 1.3 | 4 | 810 726 | 32/43 | 03/76→08/82 | Z10 | 0.8 | | |
| 11 | | | | | | | | |
| 1.1 | 4 | C1E 715, C1E 720 | 35/47 | 03/83→06/86 | Z1 [169] | 0.7 | UXT2 / UXT6 | ZS106 [11] |
| 1.2 | 4 | C1G 700, C1G 710 | 40/54 | 10/84→12/88 | Z1 [169] | 0.7 | UXT2 / UXT6 | ZS106 [11] |
| 1.4 | 4 | C1J 715, C2J 730 | 44/59 | 03/83→09/86 | Z1 [169] | 0.7 | UXT2 / UXT6 | |
| 1.4 | 4 | C2J 768 | 50/67 | 03/83→12/86 | Z1 [169] | 0.7 | UXT2 / UXT6 | |
| 1.6 D | 4 | F8M 700, F8M 720, F8M 730 | 40/54 | 08/83→12/88 | GV852 | 11V | | |
| 12 | | | | | | | | |
| 1.3 | 4 | 810.02 | 37/50 | 07/75→04/80 | Z68 | 0.6 | | |
| 18 | | | | | | | | |
| 1.4 | 4 | 847 720, 847 722 | 47/63 | 05/79→07/86 | | | | ZS106 [1][11][181] [254] ZS251 [1][213][254] ZS316 [1][206][254] |
| 2.1 Diesel | 4 | 852 710, J8S 711 | 49/66 | 11/81→07/86 | GN909 [2][222] GV642 | 11V 11V | | |
| 19 I | | | | | | | | |
| 1.2 | 4 | C1G 730 | 40/54 | 01/88→12/92 | Z1 [169] | 0.7 | UXT2 / UXT6 | ZS251 [1][213][254] ZS316 [1][206][254] |
| 1.4 | 4 | E6J 700 | 59/79 | 01/88→12/92 | Z63 | 0.8 | UXT1 / UXT3 | |
| 1.9 D | 4 | F8Q 706, F8Q 742 | 48/64 | 01/88→12/92 | GN909 [222] →02/91 GV642 →02/91 GV852 03/91→ | 11V 11V 11V | | |
| 19 II | | | | | | | | |
| 1.2 | 4 | C1G 730 | 40/54 | 03/92→12/95 | Z1 [169] | 0.7 | UXT2 / UXT6 | ZS251 [1][213][254] ZS316 [1][206][254] |
| 1.2 LPG | 4 | C1G 730 | 40/54 | 03/92→12/95 | Z11 [168] | 0.8 | UXT2 / UXT6 | |
| 1.4 | 4 | E6J 700 | 59/79 | 03/92→12/95 | Z63 | 0.8 | UXT1 / UXT3 | |
| 1.4 LPG | 4 | E6J 700 | 59/79 | 03/92→12/95 | Z340 | 0.7 | UXT12 | |
| 1.9 D | 4 | F8Q 706, F8Q 742 | 48/64 | 03/92→12/95 | GV852 | 11V | | |



kW/BHP

**... RENAULT****... 19 II**

| | | | | | | | | |
|--------|---|---------|-------|-------------|-------------------------|--|------------|--|
| 1.9 dT | 4 | F8Q 740 | 68/91 | 03/92→12/95 | GN959 [2][222] GV844 | | 11V 11V | |
|--------|---|---------|-------|-------------|-------------------------|--|------------|--|

21

| | | | | | | | | |
|-----|---|---------|-------|-------------|--|--|--|--|
| 1.7 | 4 | F2N 710 | 65/87 | 06/86→04/95 | | | | ZS251 [1][213][254] ZS316 [1][206][254] |
|-----|---|---------|-------|-------------|--|--|--|--|

| | | | | | | | | |
|-------|---|---------|-------|-------------|-------------------------|-------|------------|--|
| 1.9 D | 4 | F8Q 710 | 47/63 | 06/86→08/94 | GN909 | GR067 | 11V | |
| 2.1 D | 4 | J8S 704 | 49/66 | 06/86→08/94 | GN909 [2][222] GV642 | | 11V 11V | |

CLIO I

| | | | | | | | | |
|---------|---|------------------|-------|-------------|-------|-------|-----|--|
| 1.1 | 4 | C1E 700 | 34/46 | 01/91→09/98 | Z76 | | 0.8 | UXT2 / UXT6 ZS106 [11] |
| 1.2 | 4 | E7F 706 | 40/54 | 01/91→09/98 | Z100 | | 0.8 | UXT1 / UXT3 ZS251 [1][213][254] ZS316 [1][206][254] |
| 1.2 | 4 | E7F 750 | 44/59 | 01/91→09/98 | Z100 | | 0.8 | UXT1 / UXT3 ZS251 [1][213][254] ZS316 [1][206][254] |
| 1.2 LPG | 4 | E7F 706 | 40/54 | 01/91→09/98 | Z206 | | 0.7 | UXT10 |
| 1.2 LPG | 4 | E7F 750 | 44/59 | 01/91→09/98 | Z206 | | 0.7 | UXT10 |
| 1.9 D | 4 | F8Q 730, F8Q 732 | 48/64 | 01/91→09/98 | GV852 | GR066 | 11V | |
| 1.9 RND | 4 | F8Q 678 | 40/54 | 04/96→02/98 | GN909 | | 11V | |

CLIO II

| | | | | | | | | |
|---------|---|---------------------------|-------|-------------|-------|--|-----|--|
| 1.1 | 4 | D7F 720, D7F 726, D7F 746 | 43/58 | 09/98→ | Z247 | | 0.9 | UXT1 / UXT3 ZS345 →eng. 981021 ZS354 [1] eng. 981021→ →eng. 111215 |
| 1.1 LPG | 4 | D7F 720, D7F 726, D7F 746 | 43/58 | 09/98→ | Z340 | | 0.7 | UXT12 |
| 1.2 | 4 | D7F 722, D7F 726, D7F 746 | 44/59 | 03/99→10/03 | | | | ZS354 |
| 1.5 dCi | 4 | K9K 700, K9K 704 | 48/64 | 06/01→ | GN018 | | 11V | |
| 1.5 dCi | 4 | K9K 714 | 50/67 | 04/04→ | GN018 | | 11V | |
| 1.5 dCi | 4 | K9K 702 | 59/79 | 06/01→10/04 | GN018 | | 11V | |
| 1.5 dCi | 4 | K9K 702, K9K 710 | 60/80 | 11/03→ | GN018 | | 11V | |
| 1.9 D | 4 | F8Q 630 | 47/63 | 09/98→ | GN963 | | 11V | |
| 1.9 D | 4 | F8Q 632 | 48/64 | 02/00→05/01 | GN963 | | 11V | |
| 1.9 DTi | 4 | F9Q 780 | 59/79 | 02/00→05/01 | GN018 | | 11V | |

KANGOO

| | | | | | | | | |
|------------|---|---|-------|-------------|---------------------------------------|--|-------------------|--|
| 1.2 | 4 | D7F 710, D7F 720, D7F 722, D7F 726, D7F 744, D7F 746 | 43/58 | 08/97→ | Z224 | | 0.9 | UXT9 ZS345 →10/98 ZS354 11/98→ |
| 1.2 | 4 | D7F 764, D7F 766 | 44/59 | 07/98→07/01 | Z14 [204] Z224 [190] Z257 [185] | | 0.9 0.9 0.9 | UXT1 / UXT3 ZS345 UXT9 eng. 981022→ UXT1 / UXT3 |
| 1.2 LPG | 4 | D7F 710, D7F 720, D7F 722, D7F 726, D7F 744, D7F 746 | 43/58 | 08/97→ | Z340 | | 0.7 | UXT12 |
| 1.2 16V | 4 | D4F 712, D4F 714, D4F 730 | 55/74 | 10/01→ | Z243 | | 0.9 | ZS454 [1][101] ZS345 [1][155] 03/03→ ZS325 [1][157] 06/08→ ZS375 [1][156] 06/08→ |
| 1.2 BiFuel | 4 | D7F 710, D7F 744 | 43/58 | 07/98→07/01 | Z257 05/00→ | | 0.9 | UXT1 / UXT3 ZS354 05/00→ eng. 981021→ |
| 1.4 | 4 | E7J 634, E7J 635 | 55/74 | 08/97→ | Z247 | | 0.9 | UXT1 / UXT3 ZS354 09/98→12/07 |
| 1.4 | 4 | E7J 780 | 55/74 | 08/97→ | Z247 | | 0.9 | UXT1 / UXT3 ZS354 09/98→12/07 ZS242 [24] ZS243 [26] |

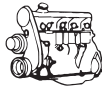

kW/BHP

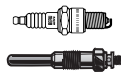
**... RENAULT****... KANGOO**

| | | | | | | | | |
|------------------|---|---------------------------|--------|-------------|------------------------------------|-------------|-------------|-------------|
| 1.4 | 4 | K7J 701 | 55/74 | 08/97→ | Z14 | 0.9 | UXT1 / UXT3 | ZS354 |
| | | | | | | | | 09/98→12/07 |
| 1.4 LPG | 4 | E7J 634, E7J 635, E7J 780 | 55/74 | 08/97→ | Z340 | 0.7 | UXT12 | |
| 1.4 LPG | 4 | K7J 701 | 55/74 | 08/97→ | Z116 | 0.8 | UXT5 | |
| 1.5 dCi | 4 | K9K 704 | 42/56 | 12/02→ | GN018 | | | 11V |
| 1.5 dCi | 4 | K9K 716 | 45/60 | 10/05→ | GN018 | | | 11V |
| 1.5 dCi | 4 | K9K 700, K9K 702, K9K 704 | 48/64 | 12/01→ | GN018 | | | 11V |
| 1.5 dCi | 4 | K9K 714 | 50/67 | 06/05→ | GN018 | | | 11V |
| 1.5 dCi | 4 | K9K 800 | 50/67 | 02/08→ | GE110 [16][37] GN018 [14] | 4.4V 11V | | |
| 1.5 dCi | 4 | K9K 702, K9K 710 | 60/80 | 04/03→ | GN018 | | | 11V |
| 1.5 dCi | 4 | K9K 718 | 62/83 | 06/05→ | GN018 | | | 11V |
| 1.5 dCi | 4 | K9K 806 | 76/102 | 02/08→ | GE110 [16][37] GN018 [14] | 4.4V 11V | | |
| 1.5 dCi 75 | 4 | K9K 808 | 55/74 | 09/10→ | GE110 [16][37] GN018 [14] | 4.4V 11V | | |
| 1.5 dCi 85 | 4 | K9K 800, K9K 802 | 63/84 | 02/08→ | GE110 [16][37] GN018 [14] | 4.4V 11V | | |
| 1.5 dCi 90 | 4 | K9K 808 | 66/89 | 06/09→ | GE110 [16][37] GN018 [14] | 4.4V 11V | | |
| 1.5 dCi 110 | 4 | K9K 804 | 80/107 | 09/10→ | GE110 [16][37] GN018 [14] | 4.4V 11V | | |
| 1.6 | 4 | K7M 750 | 64/86 | 02/08→ | Z14 [204] Z257 [185] | 0.9 0.9 | UXT1 / UXT3 | ZS354 |
| 1.6 16V | 4 | K4M 750, K4M 752, K4M 753 | 70/94 | 10/01→ | Z193 | 0.9 | UXT1 / UXT3 | ZS052 |
| 1.6 16V | 4 | K4M 830 | 78/105 | 02/08→ | Z193 | 0.9 | UXT1 / UXT3 | ZS052 |
| 1.6 16V LPG | 4 | K4M 750, K4M 752, K4M 753 | 70/94 | 10/01→ | Z340 | 0.7 | UXT12 | |
| 1.6 16V bivalent | 4 | K4M 850 | 60/80 | 06/05→ | | | | ZS052 |
| 1.6 16V LPG | 4 | K4M 834 | 72/97 | 02/08→ | | | | ZS052 |
| 1.9 D | 4 | F8Q 632 | 48/64 | 09/99→06/03 | GN019 | | | 11V |
| 1.9 D 55 | 4 | F8Q 662 | 40/54 | 08/97→ | GN963 →02/99 GN019 03/99→ | 11V 11V | | |
| 1.9 D 65 | 4 | F8Q 630 | 47/63 | 08/97→ | GN963 | | | 11V |
| 1.9 D 65 | 4 | F8Q 632 | 47/63 | 08/97→ | GN019 | | | 11V |
| 1.9 dCi 4WD | 4 | F9Q 782, F9Q 790 | 59/79 | 10/01→ | GN018 | | | 11V |
| 1.9 dCi | 4 | F9Q 782, F9Q 790 | 62/83 | 07/03→ | GN018 | | | 11V |
| 1.9 dTi | 4 | F9Q 780 | 59/79 | 02/00→ | GN018 | | | 11V |

LOGAN EXPRESS

| | | | | | | | | |
|---------|---|--|-------|--------|------------------------------|-------------|--|--|
| 1.5 dCi | 4 | | 50/67 | 04/07→ | GE110 [16][37] GN018 [14] | 4.4V 11V | | |
|---------|---|--|-------|--------|------------------------------|-------------|--|--|

| | | | | | | | | |
|-----|---|--|-------|--------|--|--|--|-------|
| 1.6 | 4 | | 64/86 | 04/07→ | | | | ZS354 |
|-----|---|--|-------|--------|--|--|--|-------|

MASTER I

| | | | | | | | | |
|-----------------|---|---------------------------|-------|-------------|--|------------|------|--|
| 2.0 | 4 | 829 730, J5R 716, J5R 728 | 60/80 | 06/85→12/95 | | | | ZS106 [11] |
| 2.0 28-35 2.0 | 4 | J5R 718, J5R 728 | 58/78 | 10/86→07/98 | | | | ZS251 [1][213][254] ZS316 [1][206][254] |
| 2.0 28-35 2.0 | 4 | 829 730 | 59/79 | 10/82→09/86 | Z22 | 0.7 | UX56 | ZS106 [11] |
| 2.0 28-35 2.0 | 4 | 829 731 | 59/79 | 08/80→10/86 | Z22 | 0.7 | UX56 | |
| 2.0 28-35 2.0 | 4 | 829 731 | 59/79 | 08/80→09/86 | | | | ZS106 [11] |
| 2.0 28-35 2.1 D | 4 | J8S 330 | 44/59 | 08/80→07/98 | GN909 [222] 01/86→ GV642 01/86→ | 11V 11V | | |
| 2.1 D | 4 | J8S 330 | 44/59 | 11/89→04/95 | GN954 | | | 11V |
| 2.1 D | 4 | J8S 330 | 46/62 | 11/89→07/93 | GN954 | | | 11V |
| 2.2 30 2,2 | 4 | J7T 782 | 67/90 | 08/80→07/98 | Z18 | 0.8 | UXT4 | ZS251 [1][213][254] ZS316 [1][206][254] |

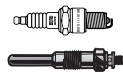

kW/BHP

**... RENAULT****... MASTER I**

| | | | | | | | | | |
|------------------|---|-------------------------------------|-------|-------------|-------------------------|-------|-----|-------|--|
| 2.2 30 2,2 | 4 | J7T 788 | 67/90 | 08/80→07/98 | Z207 | | 1.2 | UXT4 | ZS251 [1][213][254] ZS316 [1][206][254] |
| 2.2 30 2,2 LPG | 4 | J7T 782 | 67/90 | 08/80→07/98 | Z25 [168] | | 0.8 | UXK56 | |
| 2.2 30 2,2 LPG | 4 | J7T 788 | 67/90 | 08/80→07/98 | Z17 [168] | | 0.8 | UXT4 | |
| 2.4 28-35 2.4 D | 4 | 8140.61.2300, S8U 731 | 52/70 | 08/80→08/89 | GN909 [2][222] GV642 | GR066 | 11V | | |
| 2.4 D | 4 | S8U 731 | 50/67 | 07/80→06/83 | GN954 | | 11V | | |
| 2.4 D | 4 | S8U 730 | 52/70 | 07/83→02/98 | GN954 | | 11V | | |
| 2.4 D | 4 | S8U 730, S8U 731 | 53/71 | 09/86→12/92 | GN954 | | 11V | | |
| 2.5 28-35 2,5 D | 4 | 8140.67.2510, S8U 742 | 55/74 | 08/89→07/98 | GN909 [2][222] GV642 | GR066 | 11V | | |
| 2.5 28-35 2,5 TD | 4 | 8140.27.2580, S9U 702 | 72/97 | 08/89→07/98 | GN909 | | 11V | | |
| 2.5 28-35 2,5 D | 4 | 8140.61.2300, S8U 731 | 52/70 | 09/80→07/98 | GN909 [2][222] GV642 | GR066 | 11V | | |
| 2.5 28-35 2,5 D | 4 | 8140.67.2510, S8U 742 | 55/74 | 08/89→07/98 | GN909 [2][222] GV642 | | 11V | | |
| 2.5 35 2,5 TD | 4 | 8140.27.2500, 8140.27.2510, S9U 714 | 69/93 | 08/89→07/98 | GN927 | | 11V | | |
| 2.5 D | 4 | S8U 742 | 55/74 | 07/80→10/89 | GN927 | | 11V | | |
| 2.5 DT | 4 | S9U 702 | 69/93 | 11/89→10/93 | GN954 | | 11V | | |

MASTER II

| | | | | | | | | | |
|-------------|---|---------------------------|---------|-------------|-----------------|--|-----|--|--|
| 1.9 dCi 80 | 4 | F9Q 772, F9Q 774 | 60/80 | 11/01→ | GN018 | | 11V | | |
| 1.9 dTi | 4 | F9Q 770 | 59/79 | 09/00→ | GN018 | | 11V | | |
| 2.2 dCi 90 | 4 | G9T 720, G9T 722, G9T 750 | 66/89 | 09/00→ | GN026 | | 11V | | |
| 2.5 D | 4 | S8U 770 | 59/79 | 07/98→01/01 | GN927 | | 11V | | |
| 2.5 dCi | 4 | G9U 754 | 74/99 | 08/06→ | GN026 | | 11V | | |
| 2.5 dCi | 4 | G9U 750 | 84/113 | 01/04→ | GN026 →10/06 | | 11V | | |
| 2.5 dCi | 4 | G9U 650 | 88/118 | 08/06→ | GN026 | | 11V | | |
| 2.5 dCi | 4 | G9U 632 | 107/143 | 08/06→ | GN026 | | 11V | | |
| 2.5 dCi 100 | 4 | G9U 754 | 73/98 | 10/03→ | GN026 | | 11V | | |
| 2.5 dCi 120 | 4 | G9U 720, G9U 724, G9U 754 | 84/113 | 10/01→ | GN026 | | 11V | | |
| 2.8 dTi | 4 | S9W 702 | 84/113 | 07/98→10/01 | GN012 | | 11V | | |
| 3.0 dCi 140 | 4 | ZD3 200, ZD3 202 | 100/134 | 10/03→ | GN072 | | 11V | | |

MASTER III

| | | | | | | | | | |
|-------------|---|---|---------|--------|------------|--|------|--|--|
| 2.3 dCi | 4 | M9T 670, M9T 672, M9T 676, M9T 690, M9T 692, M9T 870, M9T 890 | 74/99 | 02/10→ | GE124 [16] | | 4.6V | | |
| 2.3 dCi | 4 | M9T 670, M9T 672, M9T 676, M9T 686, M9T 690, M9T 692, M9T 696, M9T 698, M9T 870, M9T 890, M9T 896 | 92/123 | 02/10→ | GE124 [16] | | 4.6V | | |
| 2.3 dCi | 4 | M9T 678, M9T 680, M9T 694, M9T 696, M9T 698, M9T 896 | 107/143 | 02/10→ | GE124 [16] | | 4.6V | | |
| 2.3 dCi 100 | 4 | M9T 670, M9T 672, M9T 676, M9T 870 | 74/99 | 02/11→ | GE124 [16] | | 4.6V | | |
| 2.3 dCi 125 | 4 | M9T 670, M9T 672, M9T 676, M9T 870 | 92/123 | 02/11→ | GE124 [16] | | 4.6V | | |
| 2.3 dCi 150 | 4 | M9T 880 | 110/148 | 10/12→ | GE124 [16] | | 4.6V | | |

RAPID

| | | | | | | | | | |
|-----|---|--|-------|-------------|----------|--|------------|-------------|------------|
| 1.0 | 4 | C1C 706 | 27/36 | 02/86→05/92 | Z1 Z8 | | 0.7 0.8 | UXT2 / UXT6 | ZS106 [11] |
| 1.1 | 4 | C1E 750, C1E 752, C1E 754, C1E 760, C1E 762, C1E 792 | 33/44 | 07/85→04/95 | Z1 [169] | | 0.7 | UXT2 / UXT6 | ZS106 [11] |
| 1.1 | 4 | C1E 756 | 33/44 | 06/87→09/91 | Z1 [169] | | 0.7 | UXT2 / UXT6 | |
| 1.1 | 4 | C1E 750 | 34/46 | 09/85→08/91 | | | | | ZS106 [11] |
| 1.1 | 4 | C1E 762 | 35/47 | 09/93→04/95 | | | | | ZS106 [11] |



kW/BHP

**... RENAULT****... RAPID**

| | | | | | | | | | |
|---------|---|--|-------|-------------|-----------|--|-----|-------------|--|
| 1.1 LPG | 4 | C1E 750, C1E 752, C1E 754, C1E 760, C1E 762, C1E 792 | 33/44 | 07/85→04/95 | Z11 [168] | | 0.8 | UXT2 / UXT6 | |
| 1.2 | 4 | C3G 710, C3G 712 | 40/54 | 09/91→03/98 | Z82 | | 0.7 | UXT2 / UXT6 | ZS250 |
| 1.4 | 4 | C1J 768, C1J 780, C3J 700, C3J 702, C3J 760, C3J 762 | 43/58 | 07/85→03/98 | Z1 [169] | | 0.7 | UXT2 / UXT6 | ZS251 [1] |
| 1.4 | 4 | C2J 784 | 44/59 | 03/86→08/91 | Z1 [169] | | 0.7 | UXT2 / UXT6 | ZS251 [1] |
| 1.4 | 4 | E7J 720, E7J 724, E7J 726, E7J 773 | 55/74 | 09/91→03/98 | Z247 | | 0.9 | UXT1 / UXT3 | ZS251 |
| 1.4 | 4 | E7J 728 | 58/78 | 01/94→03/98 | Z247 | | 0.9 | UXT1 / UXT3 | ZS251 [1] |
| 1.4 | 4 | E7J 773 | 59/79 | 05/95→08/97 | | | | | ZS251 [1][213][254] ZS316 [1][206][254] |
| 1.4 LPG | 4 | C3J 700, C3J 702, C3J 760, C3J 762 | 43/58 | 08/88→03/98 | Z11 [168] | | 0.8 | UXT2 / UXT6 | |
| 1.6 D | 4 | F8M 720, F8M 730, F8M 736, F8M 760 | 40/54 | 03/86→08/98 | GN909 | | 11V | | |
| 1.9 D | 4 | F8Q 640, F8Q 682 | 40/54 | 09/94→03/98 | GN991 | | 11V | | |
| 1.9 D | 4 | F8Q 646, F8Q 722, F8Q 724, F8Q 774, F8Q 776 | 47/63 | 09/91→03/98 | GV852 | | 11V | | |

SUPER 5

| | | | | | | | | | |
|---------|---|---------------------------|-------|-------------|-----------|--|-----|-------------|--|
| 1.0 | 4 | C1C 700 | 30/40 | 10/84→10/88 | Z1 [169] | | 0.7 | UXT2 / UXT6 | |
| 1.1 | 4 | C1E 750, C1E 752, C1E 754 | 34/46 | 10/84→12/96 | Z1 [169] | | 0.7 | UXT2 / UXT6 | |
| 1.1 LPG | 4 | C1E 750, C1E 752, C1E 754 | 34/46 | 10/84→12/96 | Z11 [168] | | 0.8 | UXT2 / UXT6 | |
| 1.2 | 4 | C1G 702 | 44/59 | 01/87→12/96 | Z1 [169] | | 0.7 | UXT2 / UXT6 | |
| 1.2 LPG | 4 | C1G 702 | 44/59 | 01/87→12/96 | Z11 [168] | | 0.8 | UXT2 / UXT6 | |
| 1.6 D | 4 | F8M 720 | 40/54 | 10/84→12/96 | GN909 | | 11V | | |

TRAFIC

| | | | | | | | | | |
|-------|---|---------------------------|-------|-------------|-------------------------|-------|------------|-------------|---|
| 1.4 | 4 | 847 700, C1J 700 | 35/47 | 03/80→04/89 | Z11 | | 0.8 | UXT2 / UXT6 | ZS106 [1][11][181] [254] ZS251 [1][213][254] ZS316 [1][206][254] |
| 1.4 | 4 | 847 701 | 35/47 | 03/80→04/89 | Z11 | | 0.8 | UXT2 / UXT6 | ZS106 [11] |
| 1.4 | 4 | C1J 700 | 35/47 | 05/89→06/91 | | | | | ZS106 [1][11][181] [254] ZS251 [1][213][254] ZS316 [1][206][254] |
| 1.6 | 4 | 841 705, A1M 705, A1M 707 | 48/64 | 03/80→08/86 | | | | | ZS106 [11] |
| 1.6 | 4 | 841 705 | 48/64 | 01/84→06/86 | Z1 [169] | | 0.7 | UXT2 / UXT6 | |
| 1.6 | 4 | A1M 707, A1M 708 | 48/64 | 01/83→06/86 | Z11 | | 0.8 | UXT2 / UXT6 | ZS106 [11] |
| 1.6 | 4 | A1M 707, A1M 708 | 48/64 | 01/84→06/86 | Z11 [167] | | 0.8 | UXT2 / UXT6 | |
| 1.7 | 4 | FIN 720, FIN 724 | 50/67 | 06/86→08/94 | Z22 | | 0.7 | UX56 | ZS251 [213][254] ZS316 [206][254] |
| 1.7 | 4 | FIN 722 | 50/67 | 06/86→08/94 | | | | | ZS251 [213][254] ZS316 [206][254] |
| 1.7 | 4 | FIN 724 | 51/68 | 03/89→08/94 | Z8 | | 0.8 | UXT2 / UXT6 | ZS251 |
| 1.9 D | 4 | F8Q 606 | 44/59 | 06/97→03/01 | GN963 | | 11V | | |
| 2.0 | 4 | J5R 716, J5R 722, J5R 726 | 59/79 | 06/86→08/90 | Z22 | | 0.7 | UX56 | ZS251 [213][254] ZS316 [206][254] |
| 2.0 | 4 | J5R 726 | 59/79 | 03/80→08/90 | | | | | ZS251 [213][254] ZS316 [206][254] |
| 2.0 | 4 | J5R 726 | 59/79 | 06/86→08/90 | Z22 | | 0.7 | UX56 | |
| 2.0 | 4 | J5R 726 | 59/79 | 05/89→10/97 | | | | | ZS251 [1][213][254] ZS316 [1][206][254] |
| 2.0 | 4 | 829 720, 829 721 | 63/84 | 03/80→12/86 | Z22 | | 0.7 | UX56 | |
| 2.1 D | 4 | 852 720, 852 750 | 43/58 | 03/80→06/94 | GN909 [2][222] GV642 | GR066 | 11V 11V | | |
| 2.1 D | 4 | 852 750 | 43/58 | 07/80→02/89 | GV642 | | 11V | | |
| 2.1 D | 4 | J8S 750 | 44/59 | 05/85→02/89 | GN954 | | 11V | | |
| 2.1 D | 4 | J8S 620, J8S 758 | 47/63 | 06/94→04/98 | GN909 [2][222] GN954 | GR066 | 11V 11V | | |

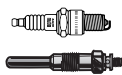

kW/BHP

**... RENAULT****... TRAFIC**

| | | | | | | | | | |
|---------|---|---|-------|-------------|-------------------------|-------|-----|------|--|
| 2.2 | 4 | J7T 780 | 70/94 | 05/89→06/94 | Z17 | | 0.8 | UXT4 | ZS251 [213][254] ZS316 [206][254] |
| 2.2 | 4 | J7T 600 | 74/99 | 06/94→10/97 | Z207 | | 1.2 | UXT4 | |
| 2.2 | 4 | J7T 600 | 74/99 | 06/94→04/98 | | | | | ZS251 [1][213][254] ZS316 [1][206][254] |
| 2.2 LPG | 4 | J7T 600 | 74/99 | 06/94→10/97 | Z17 [168] | | 0.8 | UXT4 | |
| 2.5 D | 4 | 8140.61.240, S8U 720, S8U 722 | 51/68 | 03/80→03/01 | GN909 [2][222] GV642 | | 11V | | |
| 2.5 D | 4 | 8140.67.2500, 8140.67.2550, 8140.67.2580, S8U 750, S8U 752 | 55/74 | 05/89→03/01 | GN909 [2][222] GV642 | GR066 | 11V | | |
| 2.5 D | 4 | S8U 758, S8U 780 | 55/74 | 05/89→03/01 | GN927 | GR066 | 11V | | |
| 2.5 D | 4 | S8U 750 | 56/75 | 03/89→08/94 | GN954 | | 11V | | |
| 2.5 D | 4 | S8U 758 | 58/78 | 09/94→01/99 | GN927 | | 11V | | |

TRAFIC II

| | | | | | | | | | |
|-------------|---|------------------|---------|-------------|-------|--|-----|-------|-------|
| 1.9 dCi | 4 | F9Q 762 | 59/79 | 04/01→07/03 | GN018 | | 11V | | |
| 1.9 dCi | 4 | F9Q 760 | 75/101 | 03/01→ | GN018 | | 11V | | |
| 1.9 dCi 80 | 4 | F9Q 760, F9Q 762 | 60/80 | 03/01→ | GN018 | | 11V | | |
| 1.9 dCi 100 | 4 | F9Q 760 | 74/99 | 03/01→ | GN018 | | 11V | | |
| 2.0 | 4 | F4R 720, F4R 722 | 88/118 | 03/01→ | Z337 | | 0.9 | UXT9 | ZS052 |
| 2.0 LPG | 4 | F4R 720, F4R 722 | 88/118 | 03/01→ | Z340 | | 0.7 | UXT12 | |
| 2.0 16V | 4 | F4R 820 | 86/115 | 08/06→ | Z337 | | 0.9 | UXT9 | ZS052 |
| 2.0 16V LPG | 4 | F4R 820 | 86/115 | 08/06→ | Z340 | | 0.7 | UXT12 | |
| 2.5 dCi | 4 | G9U 630 | 84/113 | 08/07→ | GN026 | | 11V | | |
| 2.5 dCi 115 | 4 | G9U 630 | 84/113 | 02/08→ | GN026 | | 11V | | |
| 2.5 dCi 135 | 4 | G9U 730 | 99/133 | 03/01→ | GN026 | | 11V | | |
| 2.5 dCi 145 | 4 | G9U 630 | 107/143 | 08/06→ | GN026 | | 11V | | |
| 2.5 DTi | 4 | G9U 730 | 99/133 | 03/03→07/03 | GN026 | | 11V | | |

TWINGO I

| | | | | | | | | | |
|---------|---|---------------------------|-------|-------------|--------------------------------------|--|-----|---------------------------------------|--|
| 1.2 | 4 | C3G 700, C3G 702 | 40/54 | 03/93→05/96 | Z76 | | 0.8 | UXT2 / UXT6 | |
| 1.2 | 4 | - 701 | 43/58 | 05/96→ | Z63 [170] →06/97 | | 0.8 | UXT1 / UXT3 →06/97 | |
| 1.2 | 4 | D7F 700 | 43/58 | 05/96→ | Z63 [170] →06/97 Z74 07/97→ | | 0.8 | UXT1 / UXT3 →06/97 →eng. 981021 | ZS345 |
| 1.2 | 4 | D7F 701, D7F 702 | 43/58 | 05/96→ | Z74 07/97→ | | 1.0 | UXT1 / UXT3 07/97→ | ZS354 [1] eng. 981021→ →eng. 111215 |
| 1.2 | 4 | D7F 703, D7F 704, D7F 706 | 43/58 | 05/96→ | | | | | ZS345 →eng. 981021 ZS354 [1] eng. 981021→ →eng. 111215 |
| 1.2 | 4 | D7F 700, D7F 701 | 43/58 | 05/96→ | Z340 →06/97 Z206 07/97→ | | 0.7 | UXT12 →06/97 | |
| 1.2 | 4 | D7F 702 | 43/58 | 05/96→ | Z206 07/97→ | | 0.7 | UXT10 07/97→ | |
| 1.2 LPG | 4 | D7F 700, D7F 701 | 43/58 | 05/96→ | Z340 →06/97 Z206 07/97→ | | 0.7 | UXT12 →06/97 | |
| 1.2 LPG | 4 | D7F 702 | 43/58 | 05/96→ | Z206 07/97→ | | 0.7 | UXT10 07/97→ | |

RENAULT

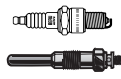

kW/BHP

**ROVER****25**

| | | | | | | | | | |
|-------------|---|--------|---------|-------------|-----------------------------------|-----|-------------|---------------------------|---|
| 1.1 | 4 | | 44/59 | 11/99→05/05 | | | | | ZS501 |
| 1.1 | 4 | 11 K4F | 55/74 | 09/99→06/01 | | | | | ZS501 |
| 1.1 16V | 4 | 11 K4F | 55/74 | 01/04→05/05 | Z15 | 0.8 | UXT1 / UXT3 | | ZS501 |
| 1.1 16V LPG | 4 | 11 K4F | 55/74 | 01/04→05/05 | Z340 | 0.7 | UXT12 | | |
| 1.4 16V | 4 | 14 K4M | 62/83 | 10/99→05/05 | Z15 →ch. YD 471 564 | 0.8 | UXT1 / UXT3 | ch. 471564→ | ZS469 |
| 1.4 16V | 4 | 14 K4F | 76/102 | 10/99→05/05 | Z15 02/00→ →ch. YD 471 564 | 0.8 | UXT1 / UXT3 | 02/00→ →ch. 471564 | ZS469 ZS501 ch. 471565→ |
| 1.4 16V LPG | 4 | 14 K4M | 62/83 | 10/99→05/05 | Z340 →ch. YD 471 564 | 0.7 | UXT12 | →ch. YD 471 564 | |
| 1.4 16V LPG | 4 | 14 K4F | 76/102 | 10/99→05/05 | Z340 02/00→ →ch. YD 471 564 | 0.7 | UXT12 | 02/00→ →ch. YD 471 564 | |
| 1.6 16V | 4 | 16 K4F | 80/107 | 10/99→05/05 | Z15 →ch. YD 471 564 | 0.8 | UXT1 / UXT3 | →ch. 471564 | ZS469 ZS501 ch. 471565→ |
| 1.6 16V LPG | 4 | 16 K4F | 80/107 | 10/99→05/05 | Z340 →ch. YD 471 564 | 0.7 | UXT12 | →ch. YD 471 564 | |
| 1.8 16V | 4 | 18 K4F | 85/114 | 10/99→05/05 | Z228 | 1.0 | UXT11 | | ZS502 ⁽¹⁶⁾ ZS469 →ch. 471564 |
| 1.8 16V | 4 | 18 K4K | 107/143 | 02/00→05/05 | Z228 | 1.0 | UXT11 | | ZS502 ⁽¹⁶⁾ |
| 1.8 16V LPG | 4 | 18 K4F | 85/114 | 10/99→05/05 | Z221 ⁽¹⁶⁸⁾ | 1.0 | UXT14 | | |
| 1.8 16V LPG | 4 | 18 K4K | 107/143 | 02/00→05/05 | Z221 ⁽¹⁶⁸⁾ | 1.0 | UXT14 | | |
| 2.0 iDT | 4 | 20 T2N | 74/99 | 10/99→05/05 | GN905 | 11V | | | |
| 2.0 iDT | 4 | 20 T2N | 83/111 | 01/02→12/04 | GN999 | 11V | | | |

45

| | | | | | | | | | |
|---------|---|--------|--------|-------------|--|------------|-------|--|-----------------------|
| 1.4 | 4 | 14 K4F | 76/102 | 02/00→05/05 | Z228 | 1.0 | UXT11 | | |
| 1.4 LPG | 4 | 14 K4F | 76/102 | 02/00→05/05 | Z221 ⁽¹⁶⁸⁾ | 1.0 | UXT14 | | |
| 1.6 | 4 | 16 K4F | 80/107 | 02/00→05/05 | Z228 | 1.0 | UXT11 | | |
| 1.6 LPG | 4 | 16 K4F | 80/107 | 02/00→05/05 | Z221 ⁽¹⁶⁸⁾ | 1.0 | UXT14 | | |
| 1.8 | 4 | 18 K4F | 86/115 | 02/00→05/05 | Z228 | 1.0 | UXT11 | | ZS502 ⁽¹⁶⁾ |
| 1.8 LPG | 4 | 18 K4F | 86/115 | 02/00→05/05 | Z221 ⁽¹⁶⁸⁾ | 1.0 | UXT14 | | |
| 2.0 iDT | 4 | 20 T2N | 74/99 | 02/00→05/05 | GN905 | 11V | | | |
| 2.0 iDT | 4 | 20 T2N | 83/111 | 01/04→05/05 | GN046 →eng. 2072N11N16272 GN999 eng. 2072N11N16273→ | 12V 11V | | | |

| | | | | | | | | |
|------------|---|--------|---------|-------------|-----------------------|-----|-------|------------------------------------|
| 2.0 V6 | 6 | 20 K4F | 110/148 | 02/00→05/05 | Z228 | 1.0 | UXT11 | ZS435 →03/03 ZS437 →03/03 |
| 2.0 V6 LPG | 6 | 20 K4F | 110/148 | 02/00→05/05 | Z221 ⁽¹⁶⁸⁾ | 1.0 | UXT14 | |

75

| | | | | | | | | | |
|---------------|---|--------|---------|-------------|-----------------------|-----|-------|--|-------|
| 1.8 | 4 | K 1.8 | 88/118 | 02/99→05/05 | Z228 | 1.0 | UXT11 | | |
| 1.8 | 4 | K 1.8 | 88/118 | 08/01→05/05 | | | | | ZS501 |
| 1.8 LPG | 4 | K 1.8 | 88/118 | 02/99→05/05 | Z221 ⁽¹⁶⁸⁾ | 1.0 | UXT14 | | |
| 1.8 Turbo | 4 | 18 K4G | 110/148 | 05/03→05/05 | Z228 | 1.0 | UXT11 | | ZS501 |
| 1.8 Turbo LPG | 4 | 18 K4G | 110/148 | 05/03→05/05 | Z221 ⁽¹⁶⁸⁾ | 1.0 | UXT14 | | |
| 2.0 CDT | 4 | M 47 R | 85/114 | 02/99→05/05 | GN024 | 11V | | | |
| 2.0 CDTi | 4 | 204D2 | 96/129 | 02/03→05/05 | GN024 | 11V | | | |
| 2.0 V6 | 6 | 20 K4F | 110/148 | 02/99→05/05 | Z228 | 1.0 | UXT11 | ZS068 ^{(1) [201] [256]} ZS088 ^{(1) [201] [256]} | |
| 2.0 V6 LPG | 6 | 20 K4F | 110/148 | 02/99→05/05 | Z221 ⁽¹⁶⁸⁾ | 1.0 | UXT14 | | |
| 2.5 V6 | 6 | KV 6 | 129/173 | 02/99→10/01 | Z228 | 1.0 | UXT11 | ZS068 ^{(1) [201] [256]} ZS088 ^{(1) [201] [256]} | |

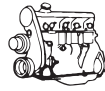

kW/BHP

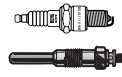

... ROVER



... 75

| | | | | | | | | |
|------------|---|--------------|---------|-------------|------------|-----|-------|--|
| 2.5 V6 | 6 | 25 K4F, KV 6 | 130/174 | 08/01→05/05 | Z228 | 1.0 | UXT11 | ZS068 [1][201][256] ZS088 [1][201][256] |
| 2.5 V6 LPG | 6 | KV 6 | 129/173 | 02/99→10/01 | Z221 [168] | 1.0 | UXT14 | |
| 2.5 V6 LPG | 6 | 25 K4F, KV 6 | 130/174 | 08/01→05/05 | Z221 [168] | 1.0 | UXT14 | |

100

| | | | | | | | | |
|-------------|---|----------------|--------|-------------|------|-----|-------------|-------|
| 1.1 111 | 4 | 11 K2D | 44/59 | 04/94→10/97 | Z15 | 0.8 | UXT1 / UXT3 | ZS469 |
| 1.1 111 LPG | 4 | 11 K2D | 44/59 | 04/94→10/97 | Z340 | 0.7 | UXT12 | |
| 1.4 114 | 4 | 14 K2A, 14 K2D | 55/74 | 04/94→10/97 | Z15 | 0.8 | UXT1 / UXT3 | ZS469 |
| 1.4 114 | 4 | 14 K4F | 75/101 | 03/97→10/98 | Z15 | 0.8 | UXT1 / UXT3 | ZS469 |
| 1.4 114 LPG | 4 | 14 K2A, 14 K2D | 55/74 | 04/94→10/97 | Z340 | 0.7 | UXT12 | |
| 1.4 114 LPG | 4 | 14 K4F | 75/101 | 03/97→10/98 | Z340 | 0.7 | UXT12 | |

100 / METRO

| | | | | | | | | |
|------------------------|---|----------------|--------|-------------|-------------------------|------------|-------------|-------|
| 1.1 111 C/L/S | 4 | 11 K2A, 11 K2D | 44/59 | 03/90→12/98 | Z15 | 0.8 | UXT1 / UXT3 | ZS469 |
| 1.1 111 C/L/S LPG | 4 | 11 K2A, 11 K2D | 44/59 | 03/90→12/98 | Z340 | 0.7 | UXT12 | |
| 1.4 114 D | 4 | TUD 3 | 38/51 | 10/92→12/94 | GN927 [2][222] GV661 | 11V 11V | | |
| 1.4 114 GSi | 4 | 14 K4F | 76/102 | 10/94→10/95 | Z15 | 0.8 | UXT1 / UXT3 | ZS469 |
| 1.4 114 GSi LPG | 4 | 14 K4F | 76/102 | 10/94→10/95 | Z340 | 0.7 | UXT12 | |
| 1.4 114 GTI 16V | 4 | 14 K4C, 14 K4D | 69/93 | 03/90→08/91 | Z15 | 0.8 | UXT1 / UXT3 | ZS469 |
| 1.4 114 GTI 16V | 4 | 14 K4F | 76/102 | 08/91→12/98 | Z15 | 0.8 | UXT1 / UXT3 | ZS469 |
| 1.4 114 GTI 16V LPG | 4 | 14 K4F | 76/102 | 08/91→12/98 | Z340 | 0.7 | UXT12 | |
| 1.4 114 GTI/GT 16V | 4 | 14 K4C, 14 K4D | 66/89 | 03/90→12/98 | Z15 | 0.8 | UXT1 / UXT3 | ZS469 |
| 1.4 114 GTI/GT 16V LPG | 4 | 14 K4C, 14 K4D | 66/89 | 03/90→12/98 | Z340 | 0.7 | UXT12 | |
| 1.4 114 S/L/GTA | 4 | 14 K2A, 14 K2D | 55/74 | 03/90→12/98 | Z15 | 0.8 | UXT1 / UXT3 | ZS449 |
| 1.4 114 S/L/GTA LPG | 4 | 14 K2A, 14 K2D | 55/74 | 03/90→12/98 | Z340 | 0.7 | UXT12 | |
| 1.5 115 D | 4 | TUD 5 | 42/56 | 12/94→12/98 | GN016 [2][222] GN912 | 11V 11V | | |

200

| | | | | | | | | |
|--------------------|---|----------------|---------|-------------|------|-----|-------------|---|
| 1.1 211 | 4 | 11 K2D | 44/59 | 01/98→03/00 | | | | ZS469 |
| 1.3 213 S | 4 | EV 2 | 54/72 | 09/85→09/89 | Z21 | 1.1 | UXT2 / UXT6 | |
| 1.4 214 | 4 | 14 K2A, 14 K2D | 55/74 | 09/93→10/95 | Z15 | 0.8 | UXT1 / UXT3 | ZS115 [1][11] |
| 1.4 214 LPG | 4 | 14 K2A, 14 K2D | 55/74 | 09/93→10/95 | Z340 | 0.7 | UXT12 | |
| 1.4 214 GSi/Si | 4 | 14 K4C | 70/94 | 01/90→10/95 | Z247 | 0.9 | UXT1 / UXT3 | ZS469 |
| 1.4 214 GSi/Si | 4 | 14 K4F | 76/102 | 12/92→10/95 | Z15 | 0.8 | UXT1 / UXT3 | ZS469 [149][205] ZS501 |
| 1.4 214 GSi/Si LPG | 4 | 14 K4F | 76/102 | 12/92→10/95 | Z340 | 0.7 | UXT12 | |
| 1.4 214 i | 4 | 14 K2F | 55/74 | 11/95→03/00 | Z15 | 0.8 | UXT1 / UXT3 | ZS469 |
| 1.4 214 i LPG | 4 | 14 K2F | 55/74 | 11/95→03/00 | Z340 | 0.7 | UXT12 | |
| 1.4 214 Si | 4 | 14 K4F | 76/102 | 11/95→03/00 | Z247 | 0.9 | UXT1 / UXT3 | ZS115 [1][11] ZS469 [1][149][205] ZS501 [1] |
| 1.4 214 Si/Gsi | 4 | 14 K4C, 14 K4D | 66/89 | 10/89→10/95 | Z15 | 0.8 | UXT1 / UXT3 | ZS469 |
| 1.4 214 Si/Gsi LPG | 4 | 14 K4C, 14 K4D | 66/89 | 10/89→10/95 | Z340 | 0.7 | UXT12 | |
| 1.6 216 | 4 | 16 H | 61/82 | 03/85→09/89 | Z15 | 0.8 | UXT1 / UXT3 | ZS115 [1][11] |
| 1.6 216 | 4 | 16 K4F | 82/110 | 01/96→12/97 | | | | ZS469 |
| 1.6 216 | 4 | D 16 A8 | 90/121 | 10/92→06/99 | Z16 | 1.1 | UXT11 | ZS276 |
| 1.6 216 LPG | 4 | D 16 A8 | 90/121 | 10/92→06/99 | Z340 | 0.7 | UXT12 | |
| 1.6 216 GSi | 4 | D 16 Z2 | 82/110 | 10/89→10/95 | Z16 | 1.1 | UXT11 | ZS276 [254] ZS469 [149][205] |
| 1.6 216 GSi LPG | 4 | D 16 Z2 | 82/110 | 10/89→10/95 | Z340 | 0.7 | UXT12 | |
| 1.6 216 GTi | 4 | D 16 A8 | 90/121 | 09/90→10/95 | Z16 | 1.1 | UXT11 | ZS276 |
| 1.6 216 GTi | 4 | D 16 A9 | 96/129 | 09/90→10/95 | | | | ZS276 [1] |
| 1.6 216 GTi LPG | 4 | D 16 A8 | 90/121 | 09/90→10/95 | Z340 | 0.7 | UXT12 | |
| 1.6 216 Si | 4 | 16 K4F | 82/110 | 11/95→03/00 | Z16 | 1.1 | UXT11 | ZS469 →ch. 471564 |
| 1.6 216 Si LPG | 4 | 16 K4F | 82/110 | 11/95→03/00 | Z340 | 0.7 | UXT12 | |
| 1.6 216 Vitesse | 4 | 16 H | 75/101 | 03/85→09/89 | Z15 | 0.8 | UXT1 / UXT3 | ZS115 [1][11] |
| 1.8 218 K Vi | 4 | 18 K4K | 107/143 | 11/95→03/00 | Z188 | 0.7 | UXT10 | ZS502 [16] |

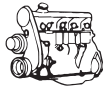

kW/BHP

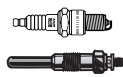

... ROVER



... 200

| | | | | | | | | |
|-------------------|---|---------|---------|-------------|--|------------|-------------|--------------------------|
| 1.8 218 K Vi LPG | 4 | 18 K4K | 107/143 | 11/95→03/00 | Z340 | 0.7 | UXT12 | |
| 1.8 218 TD | 4 | XUD 7TE | 65/87 | 09/91→10/95 | GN909 ⁽¹⁾ GV636 ⁽¹⁾ | 11V 11V | | |
| 1.9 218 D | 4 | | 52/70 | 09/91→10/95 | GN909 ⁽²⁾⁽²²²⁾ GV636 | 11V 11V | | |
| 2.0 220 D/SD | 4 | 20 T2R | 63/84 | 11/95→03/00 | GN905 | 11V | | |
| 2.0 220 GSi | 4 | 20 T4H | 100/134 | 05/94→06/99 | Z247 | 0.9 | UXT1 / UXT3 | ZS115 ⁽¹⁾⁽¹¹⁾ |
| 2.0 220 GTi | 4 | 20 T4H | 100/134 | 01/93→10/95 | Z247 | 0.9 | UXT1 / UXT3 | |
| 2.0 220 GTi | 4 | 20 M4F | 103/138 | 09/91→10/95 | Z16 | 1.1 | UXT11 | ZS115 ⁽¹⁾⁽¹¹⁾ |
| 2.0 220 GTi LPG | 4 | 20 M4F | 103/138 | 09/91→10/95 | Z340 | 0.7 | UXT12 | |
| 2.0 220 SDi | 4 | 20 T2N | 77/103 | 11/95→03/00 | GN905 | 11V | | |
| 2.0 220 Turbo | 4 | 20 T4G | 147/197 | 10/92→06/99 | Z15 | 0.8 | UXT1 / UXT3 | |
| 2.0 220 Turbo | 4 | 20 T4G | 147/197 | 01/93→10/95 | Z24 | 0.8 | UXT5 | |
| 2.0 220 Turbo LPG | 4 | 20 T4G | 147/197 | 10/92→06/99 | Z340 | 0.7 | UXT12 | |
| 2.0 220 Turbo LPG | 4 | 20 T4G | 147/197 | 01/93→10/95 | Z30 ^[168] | 0.8 | UXT5 | |

400

| | | | | | | | | |
|------------------------------|---|----------------|---------|-------------|------------------------------------|------------|-------------|--|
| 1.4 414 | 4 | 14 K2F | 55/74 | 03/96→12/97 | | | | ZS469 |
| 1.4 414 | 4 | 14 K2F | 55/74 | 03/96→12/99 | | | | ZS469 |
| 1.4 414 | 4 | 14 K4C | 70/94 | 01/93→04/95 | | | | ZS469 |
| 1.4 414 GSi/Si | 4 | 14 K4C, 14 K4D | 66/89 | 04/90→04/95 | Z247 | 0.9 | UXT1 / UXT3 | ZS115 ⁽¹⁾⁽¹¹⁾ |
| 1.4 414 GSi/Si | 4 | 14 K4F | 76/102 | 01/93→04/95 | Z15 | 0.8 | UXT1 / UXT3 | ZS469 |
| 1.4 414 GSi/Si LPG | 4 | 14 K4F | 76/102 | 01/93→04/95 | Z340 | 0.7 | UXT12 | |
| 1.4 414 Si | 4 | 14 K4F | 76/102 | 05/95→03/00 | Z247 | 0.9 | UXT1 / UXT3 | ZS469 |
| 1.6 416 GSi | 4 | D 16 Z2 | 82/110 | 04/90→04/95 | Z16 | 1.1 | UXT11 | ZS276 ⁽²⁵⁴⁾ ZS469 ⁽⁵¹⁾⁽²⁰⁵⁾ |
| 1.6 416 GSi LPG | 4 | D 16 Z2 | 82/110 | 04/90→04/95 | Z340 | 0.7 | UXT12 | |
| 1.6 416 GSi/GSE | 4 | D 16 A7 | 85/114 | 04/90→04/95 | | | | ZS276 ⁽¹⁾ |
| 1.6 416 GTi | 4 | D 16 A8 | 90/121 | 04/90→04/95 | Z16 | 1.1 | UXT11 | ZS276 |
| 1.6 416 GTi LPG | 4 | D 16 A8 | 90/121 | 04/90→04/95 | Z340 | 0.7 | UXT12 | |
| 1.6 416 Si | 4 | 16 K4F | 82/110 | 05/95→03/00 | Z15 Z247 | 0.8 0.9 | UXT1 / UXT3 | ZS469 ⁽²⁰⁵⁾ →ch. 74464 ch. 74464→ ZS532 ⁽¹⁸⁸⁾ ch. 74465→ |
| 1.6 416 Si | 4 | D 16 Y2 | 83/111 | 05/95→03/00 | Z16 | 1.1 | UXT11 | ZS532 ch. 74465→ |
| 1.6 416 Si | 4 | D 16 Y2 | 83/111 | 06/95→03/00 | Z15 | 0.8 | UXT1 / UXT3 | |
| 1.6 416 Si LPG | 4 | 16 K4F | 82/110 | 05/95→03/00 | Z340 | 0.7 | UXT12 | |
| 1.6 416 Si LPG | 4 | D 16 Y2 | 83/111 | 05/95→03/00 | Z340 | 0.7 | UXT12 | |
| 1.6 i | 4 | D 16 Z2 | 82/110 | 05/94→11/98 | Z16 | 1.1 | UXT11 | ZS469 ⁽¹⁴⁹⁾⁽²⁰⁵⁾ ZS532 ⁽¹⁸⁸⁾ |
| 1.6 i | 4 | D 16 A8 | 90/121 | 05/94→11/98 | Z16 | 1.1 | UXT11 | ZS469 ⁽¹⁴⁹⁾⁽²⁰⁵⁾ ZS532 ⁽¹⁸⁸⁾ |
| 1.6 i LPG | 4 | D 16 Z2 | 82/110 | 05/94→11/98 | Z340 | 0.7 | UXT12 | |
| 1.6 i LPG | 4 | D 16 A8 | 90/121 | 05/94→11/98 | Z340 | 0.7 | UXT12 | |
| 1.8 418 D | 4 | | 49/66 | 09/91→04/95 | GN909 ⁽²⁾⁽²²²⁾ GV636 | 11V 11V | | |
| 1.8 418 TD | 4 | XUD 7TE | 65/87 | 09/91→04/95 | GN909 ⁽²⁾⁽²²²⁾ GV636 | 11V 11V | | |
| 1.8 i | 4 | 18 K4K | 107/143 | 06/96→11/98 | Z228 | 1.0 | UXT11 | ZS502 ⁽¹⁶⁾ |
| 1.8 i LPG | 4 | 18 K4K | 107/143 | 06/96→11/98 | Z221 ^[168] | 1.0 | UXT14 | |
| 1.8 TD | 4 | XUD 7TE | 65/87 | 09/93→11/98 | GN909 ⁽²⁾⁽²²²⁾ GV636 | 11V 11V | | |
| 2.0 420 D | 4 | 20 T2R | 63/84 | 11/95→03/00 | GN905 | 11V | | |
| 2.0 420 Di | 4 | 20 T2N | 77/103 | 05/95→03/00 | GN905 | 11V | | |
| 2.0 420 GSi/SLI/GTi/Vite | 4 | 20 T4H | 100/134 | 01/93→04/95 | Z15 | 0.8 | UXT1 / UXT3 | |
| 2.0 420 GSi/SLI/GTi/Vite LPG | 4 | 20 T4H | 100/134 | 01/93→04/95 | Z340 | 0.7 | UXT12 | |
| 2.0 420 GTi/GSi/Vitesse | 4 | 20 M4F | 103/138 | 02/92→04/95 | Z247 | 0.9 | UXT1 / UXT3 | |
| 2.0 420 Si Lux | 4 | 20 T4H | 100/134 | 12/95→03/00 | Z15 | 0.8 | UXT1 / UXT3 | ZS231 |

ROVER



kW/BHP

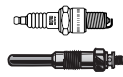

... ROVER 

| ... ROVER | | | | | | | | | |
|-----------------------|---|------------|---------|-------------|-----------|-----|-------------|---------------------|-----------------------|
| ... 400 | | | | | | | | | |
| 2.0 420 Si Lux LPG | 4 | 20 T4H | 100/134 | 12/95→03/00 | Z340 | 0.7 | UXT12 | | |
| 2.0 420 Turbo | 4 | 20 T4G | 147/197 | 01/93→04/95 | Z24 | 0.8 | UXT5 | | |
| 2.0 420 Turbo LPG | 4 | 20 T4G | 147/197 | 01/93→04/95 | Z30 [168] | 0.8 | UXT5 | | |
| 2.0 i | 4 | 20 T4H | 100/134 | 05/94→11/98 | Z15 | 0.8 | UXT1 / UXT3 | | |
| 2.0 i LPG | 4 | 20 T4H | 100/134 | 05/94→11/98 | Z340 | 0.7 | UXT12 | | |
| 600 | | | | | | | | | |
| 1.9 618 i/Si | 4 | F 18 A3 | 85/114 | 03/96→02/99 | Z158 | 1.1 | | ZS532 | ch. 246797→ |
| 1.9 618 i/Si LPG | 4 | F 18 A3 | 85/114 | 03/96→02/99 | Z116 | 0.8 | UXT5 | | |
| 2.0 620 i | 4 | F 20 Z2 | 85/114 | 08/93→06/96 | Z158 | 1.1 | | ZS275 | →ch. 246796 |
| | | | | | | | | ZS532 | ch. 246797→ |
| 2.0 620 i LPG | 4 | F 20 Z2 | 85/114 | 08/93→06/96 | Z116 | 0.8 | UXT5 | | |
| 2.0 620 Sdi | 4 | 20 T2N | 77/103 | 12/94→02/99 | GN905 | 11V | | | |
| 2.0 620 Si | 4 | F 20 Z1 | 96/129 | 08/93→02/99 | Z158 | 1.1 | | ZS275 | →ch. 246796 |
| | | | | | | | | ZS532 | ch. 246797→ |
| 2.0 620 Si LPG | 4 | F 20 Z1 | 96/129 | 08/93→02/99 | Z116 | 0.8 | UXT5 | | |
| 2.0 620 Ti Vitesse | 4 | 20 T4G | 147/197 | 07/94→02/99 | Z247 | 0.9 | UXT1 / UXT3 | ZS275 | |
| 2.3 623 Si | 4 | H 23 A3 | 116/156 | 08/93→02/99 | Z158 | 1.1 | | ZS275 | |
| 2.3 623 Si LPG | 4 | H 23 A3 | 116/156 | 08/93→02/99 | Z116 | 0.8 | UXT5 | | |
| 800 | | | | | | | | | |
| 2.0 | 4 | 20 T4H | 100/134 | 08/87→09/88 | | | | ZS115 [1][11] | |
| | | | | | | | | ZS117 [1][254] | |
| | | | | | | | | ZS120 [1][214][254] | |
| 2.0 820 | 4 | | 74/99 | 10/88→10/91 | Z22 | 0.7 | UX56 | | |
| 2.0 820 16 V I/SI | 4 | 20 HD | 103/138 | 10/86→10/88 | Z15 | 0.8 | UXT1 / UXT3 | ZS115 [1][11] | |
| | | | | | | | | ZS117 [1][254] | |
| | | | | | | | | ZS120 [1][214][254] | |
| 2.0 820 16V Turbo | 4 | T 16 | 132/177 | 01/92→02/99 | Z15 | 0.8 | UXT1 / UXT3 | ZS231 [1] | 01/96→ ch. 230967→ |
| 2.0 820 16V Turbo LPG | 4 | T 16 | 132/177 | 01/92→02/99 | Z340 | 0.7 | UXT12 | | |
| 2.0 820e | 4 | 20 HS | 88/118 | 10/86→10/91 | Z15 | 0.8 | UXT1 / UXT3 | ZS115 [1][11] | |
| | | | | | | | | ZS117 [1][254] | |
| | | | | | | | | ZS120 [1][214][254] | |
| 2.0 820 I/SI | 4 | 20 T4H | 100/134 | 01/92→02/99 | Z15 | 0.8 | UXT1 / UXT3 | ZS231 | |
| 2.0 820 I/SI | 4 | 20 T4H | 100/134 | 01/93→02/99 | | | | ZS231 [1] | 01/96→ ch. 230967→ |
| 2.0 820 i/Si | 4 | 20 HD | 103/138 | 10/88→12/91 | Z15 | 0.8 | UXT1 / UXT3 | ZS115 [1][11] | |
| | | | | | | | | ZS117 [1][254] | |
| | | | | | | | | ZS120 [1][214][254] | |
| 2.0 820 I/SI LPG | 4 | 20 T4H | 100/134 | 01/92→02/99 | Z340 | 0.7 | UXT12 | | |
| 2.0 820 SE/SI | 4 | 20 HS | 88/118 | 10/86→12/91 | | | | ZS115 [1][11] | |
| | | | | | | | | ZS117 [1][254] | |
| | | | | | | | | ZS120 [1][214][254] | |
| 2.0 820 SI | 4 | 20 HD M 16 | 98/131 | 10/88→12/91 | Z15 | 0.8 | UXT1 / UXT3 | ZS115 [1][11] | |
| | | | | | | | | ZS117 [1][254] | |
| | | | | | | | | ZS120 [1][214][254] | |
| 2.0 820 Sport | 4 | 20 T4G | 145/194 | 04/94→03/96 | Z15 | 0.8 | UXT1 / UXT3 | ZS231 | 01/96→ ch. 230967→ |
| 2.0 820 Sport LPG | 4 | 20 T4G | 145/194 | 04/94→03/96 | Z340 | 0.7 | UXT12 | | |
| 2.5 | 6 | 25 K4F | 129/173 | 02/96→10/98 | Z15 | 0.8 | UXT1 / UXT3 | | |
| 2.5 LPG | 6 | 25 K4F | 129/173 | 02/96→10/98 | Z340 | 0.7 | UXT12 | | |

ROVER

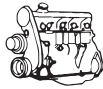

kW/BHP

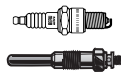

... ROVER



... 800

| | | | | | | | | |
|-------------------------|---|------------------------|---------|-------------|--|-----|--------------------|--|
| 2.5 825 D/SD | 4 | 425 SL1RR, 492 4 SHIRG | 87/117 | 01/90→02/99 | GN909 →04/95 GN007 05/95→ | 11V | | |
| 2.5 825 SD | 4 | 425 SL1RR, 492 4 SHIRG | 87/117 | 09/93→02/99 | GN909 →04/95 GN007 05/95→ | 11V | | |
| 2.5 825 Si | 6 | 25 K4F | 129/173 | 04/96→02/99 | Z15 | 0.8 | UXT1 / UXT3 | |
| 2.5 825 Si LPG | 6 | 25 K4F | 129/173 | 04/96→02/99 | Z340 | 0.7 | UXT12 | |
| 2.5 825 Si Lux | 6 | 25 K4F | 129/173 | 04/96→02/99 | Z15 | 0.8 | UXT1 / UXT3 | |
| 2.5 825 Si Lux LPG | 6 | 25 K4F | 129/173 | 04/96→02/99 | Z340 | 0.7 | UXT12 | |
| 2.5 825 Si/Sterling | 6 | C 25 A1 | 110/148 | 10/86→12/91 | Z16 | 1.1 | UXT11 | |
| 2.5 825 Si/Sterling | 6 | C 25 A2 | 123/165 | 10/86→10/88 | Z16 | 1.1 | UXT11 | |
| 2.5 825 Si/Sterling | 6 | C 25 A2 | 127/170 | 01/87→12/91 | Z16 | 1.1 | UXT11 | |
| 2.5 Si | 6 | 25 K4F | 129/173 | 02/96→10/98 | Z15 | 0.8 | UXT1 / UXT3 | |
| 2.5 Si LPG | 6 | 25 K4F | 129/173 | 02/96→10/98 | Z340 | 0.7 | UXT12 | |
| 2.7 827 24V | 6 | C 27 A1 | 124/166 | 08/92→02/99 | Z16 | 1.1 | UXT11 | |
| 2.7 827 24V LPG | 6 | C 27 A1 | 124/166 | 08/92→02/99 | Z340 | 0.7 | UXT12 | |
| 2.7 827 24V I/SI | 6 | C 27 A1 | 124/166 | 01/92→02/99 | Z16 | 1.1 | UXT11 | |
| 2.7 827 24V I/SI LPG | 6 | C 27 A1 | 124/166 | 01/92→02/99 | Z340 | 0.7 | UXT12 | |
| 2.7 827 Si/Sterling | 6 | C 27 A1 | 124/166 | 02/88→02/99 | Z16 | 1.1 | UXT11 | |
| 2.7 827 Si/Sterling | 6 | C 27 A2 | 130/174 | 02/88→12/91 | Z16 | 1.1 | UXT11 | |
| 2.7 827 Si/Sterling LPG | 6 | C 27 A1 | 124/166 | 02/88→02/99 | Z340 | 0.7 | UXT12 | |
| 2.7 827 Vitesse | 6 | C 27 A1 | 124/166 | 10/88→12/91 | Z16 | 1.1 | UXT11 | |
| 2.7 827 Vitesse/SLI | 6 | C 27 A2 | 130/174 | 10/88→12/91 | Z16 | 1.1 | UXT11 | |

2000-3500

| | | | | | | | | | |
|------------------|---|------------|---------|-------------|-----------------|-----|--------------------|--|------------------------|
| 2.0 2000 | 4 | | 74/99 | 10/82→10/86 | Z6 [167] | 0.8 | UXT4 | ZS106 (1)(11)(254) ZS109 (1)(15) ZS115 (1)(11) ZS117 (1)(254) ZS120 (1)(214)(254) | |
| 2.2 2200 | 4 | | 83/111 | 09/63→05/76 | Z11 | 0.8 | UXT2 / UXT6 | | |
| 2.3 2300 | 6 | | 88/118 | 09/77→10/86 | Z6 [167] | 0.8 | UXT4 | ZS106 (1)(11)(254) ZS109 (1)(15) ZS115 (1)(11) ZS117 (1)(254) ZS120 (1)(214)(254) | ZM047 01/84→ |
| 2.4 2400 TD | 4 | HR 492 HT | 67/90 | 05/82→10/86 | GV657 | 11V | | | |
| 2.6 2600 | 6 | 12 C, 13 C | 99/133 | 09/77→10/82 | Z6 [167] | 0.8 | UXT4 | ZS109 (15) | |
| 2.6 2600 S | 6 | 12 C, 13 C | 93/125 | 10/82→10/86 | Z6 [167] | 0.8 | UXT4 | ZS106 (1)(11)(254) ZS109 (1)(15) | ZM047 01/84→ |
| 3.5 3500 | 8 | | 104/139 | 04/68→05/76 | Z10 | 0.8 | | ZS109 (15) | |
| 3.5 3500 | 8 | | 110/148 | 04/68→05/76 | Z10 | 0.8 | | ZS109 (15) | |
| 3.5 3500 | 8 | 38 A, 39 A | 115/154 | 06/76→10/86 | Z11 | 0.8 | UXT2 / UXT6 | ZS115 (1)(11) | |
| 3.5 3500 Vitesse | 8 | 30 A, 31 A | 142/190 | 10/82→10/86 | Z20 | 0.8 | UXT2 / UXT6 | ZS115 (1)(11) | ZM047 01/85→ |

CABRIOLET

| | | | | | | | | | |
|----------------------|---|----------------|--------|-------------|-------------|-----|--------------------|--------------|--|
| 1.4 214 | 4 | 14 K4C | 70/94 | 04/90→09/92 | | | | ZS469 | |
| 1.4 214 1.4 | 4 | 14 K4C, 14 K4D | 66/89 | 01/92→11/99 | Z247 | 0.9 | UXT1 / UXT3 | ZS469 | |
| 1.4 214 1.4i 16V | 4 | 14 K4F | 76/102 | 01/93→11/99 | Z247 | 0.9 | UXT1 / UXT3 | ZS469 | |
| 1.6 216 1.6i | 4 | D 16 A8 | 90/121 | 01/92→11/99 | Z16 | 1.1 | UXT11 | ZS276 | |
| 1.6 216 1.6i LPG | 4 | D 16 A8 | 90/121 | 01/92→11/99 | Z340 | 0.7 | UXT12 | | |
| 1.6 216 1.6i 16V | 4 | 16 K4F | 82/110 | 01/96→11/99 | Z16 | 1.1 | UXT11 | ZS469 | |
| 1.6 216 1.6i 16V LPG | 4 | 16 K4F | 82/110 | 01/96→11/99 | Z340 | 0.7 | UXT12 | | |

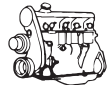

kW/BHP

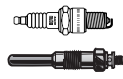
**... ROVER****CITYROVER**

| | | | | | | | | | |
|--------------|---|--------|-------|-------------|--|--|--|--|---|
| 1.4 Elegance | 4 | 475 Si | 62/83 | 01/04→06/05 | | | | | ZS232 [1][153][202] ZS341 [1][87][180] |
|--------------|---|--------|-------|-------------|--|--|--|--|---|

COUPE

| | | | | | | | | | |
|--------------|---|--------|---------|-------------|------------|--|-----|-------------|------------|
| 1.6 16 V | 4 | 16 K4F | 82/110 | 03/96→11/99 | Z15 [168] | | 0.8 | UXT1 / UXT3 | ZS469 |
| 1.6 16 V LPG | 4 | 16 K4F | 82/110 | 03/96→11/99 | Z340 | | 0.7 | UXT12 | |
| 1.8 16 V | 4 | 18 K4K | 107/143 | 03/96→11/99 | Z228 | | 1.0 | UXT11 | ZS502 [16] |
| 1.8 16 V LPG | 4 | 18 K4K | 107/143 | 03/96→11/99 | Z221 [168] | | 1.0 | UXT14 | |

MAESTRO

| | | | | | | | | | |
|--------|---|-------|-------|-------------|-------------------------|--|-----|--|--|
| 1.3 | 4 | 12 HE | 49/66 | 09/90→01/95 | | | | | ZS115 [1][11] ZS117 [1][254] ZS120 [1][214][254] |
| 1.3 | 4 | 12 HE | 51/68 | 09/90→01/95 | | | | | ZS115 [1][11] ZS117 [1][254] ZS120 [1][214][254] |
| 1.6 | 4 | | 63/84 | 09/90→01/95 | | | | | ZS115 [1][11] ZS117 [1][254] ZS120 [1][214][254] |
| 2.0 D | 4 | | 44/59 | 09/90→10/92 | GN909 [2][222] GV636 | | 11V | | |
| 2.0 TD | 4 | BB | 60/80 | 09/90→01/95 | GN909 [2][222] GV636 | | 11V | | |

MINI

| | | | | | | | | | |
|--------------|---|----------------|-------|-------------|-----------|--|-----|-------------|--|
| 1.0 1000 | 4 | 99 HD 81 | 30/40 | 01/92→06/93 | Z11 [167] | | 0.8 | UXT2 / UXT6 | ZS106 [11] |
| 1.3 1300 | 4 | 12 A2B | 37/50 | 10/92→11/00 | Z20 | | 0.8 | UXT2 / UXT6 | |
| 1.3 1300 | 4 | 12 A2L | 37/50 | 04/92→10/96 | | | | | ZS231 ch. BD 134455→ |
| 1.3 1300 | 4 | 12 A2D | 39/52 | 01/92→04/95 | Z20 | | 0.8 | UXT2 / UXT6 | ZS115 [1][11] ZS117 [1][254] ZS120 [1][214][254] |
| 1.3 1300 | 4 | 12 A2A | 45/60 | 01/91→12/91 | Z20 | | 0.8 | UXT2 / UXT6 | ZS115 [1][11] ZS117 [1][254] ZS120 [1][214][254] |
| 1.3 1300 | 4 | 12 A2E, 12 A2L | 46/62 | 01/92→11/00 | Z20 | | 0.8 | UXT2 / UXT6 | ZS231 ch. BD 134455→ |
| 1.3 1300 | 4 | 12 A2E | 46/62 | 09/92→04/95 | | | | | ZS115 [1][11] ZS117 [1][254] ZS120 [1][214][254] |
| 1.3 1300 LPG | 4 | 12 A2B | 37/50 | 10/92→11/00 | Z27 [168] | | 0.8 | UX56 | |
| 1.3 1300 LPG | 4 | 12 A2D | 39/52 | 01/92→04/95 | Z27 [168] | | 0.8 | UX56 | |
| 1.3 1300 LPG | 4 | 12 A2E, 12 A2L | 46/62 | 01/92→11/00 | Z27 [168] | | 0.8 | UX56 | |

MONTEGO

| | | | | | | | | | |
|-------------|---|-------|--------|-------------|-------------------------|--|-----|-------------|--|
| 1.3 | 4 | 12 HL | 50/67 | 10/84→10/88 | | | | | ZS115 [1][11] ZS117 [1][254] ZS120 [1][214][254] |
| 1.6 | 4 | 16 HL | 61/82 | 10/90→09/92 | | | | | ZS115 [1][11] ZS117 [1][254] ZS120 [1][214][254] |
| 2.0 D Turbo | 4 | BB | 60/80 | 10/88→10/95 | GN909 [2][222] GV636 | | 11V | | |
| 2.0 GTI/LXI | 4 | 20 H | 75/101 | 12/90→12/93 | Z11 [171] | | 0.8 | UXT2 / UXT6 | ZS115 [1][11] ZS117 [1][254] ZS120 [1][214][254] |
| 2.0 i | 4 | 20 H | 75/101 | 12/90→10/94 | Z21 [171] | | 1.1 | UXT2 / UXT6 | ZS115 [1][11] ZS117 [1][254] ZS120 [1][214][254] |
| 2.0 Turbo-D | 4 | BB | 60/80 | 01/93→12/93 | GN909 [2][222] GV636 | | 11V | | |

ROVER



kW/BHP

**... ROVER****STREETWISE**

| | | | | | | | | |
|--------|---|--------|--------|-------------|-------|--|-----|-------|
| 1.4 | 4 | 14 K4M | 62/83 | 08/03→05/05 | | | | ZS501 |
| 1.4 | 4 | 14 K4F | 76/102 | 08/03→05/05 | | | | ZS501 |
| 1.6 | 4 | 16 K4F | 80/107 | 01/04→05/05 | | | | ZS501 |
| 1.8 | 4 | 18 K4F | 86/115 | 08/03→05/05 | | | | ZS501 |
| 2.0 TD | 4 | 20 T2N | 74/99 | 08/03→05/05 | GN905 | | 11V | |

SAAB**9-3**

| | | | | | | | | |
|-----------------------|---|--------------------|---------|-------------|---|--|------|-----------------|
| 1.8 i | 4 | Z 18 XE | 90/121 | 01/04→ | | | | ZS342 |
| 1.8 t | 4 | B207E | 110/148 | 03/05→ | Z313 | | 1.1 | UXT14 |
| 1.8 t LPG | 4 | B207E | 110/148 | 03/05→ | Z30 [168] | | 0.8 | UXT5 |
| 1.9 TiD | 4 | Z 19 DT | 88/118 | 09/04→ | GN041 →ch. 71019398;76004481 GN097 ch. 71100001;7610001→ | | 11V | |
| 1.9 TiD | 4 | Z 19 DT | 88/118 | 03/05→ | GN041 →ch. 71019398;76004481 GN097 ch. 71100001;7610001→ | | 11V | |
| 1.9 TiD | 4 | Z 19 DTH | 110/148 | 09/04→ | GN059 | | 11V | |
| 1.9 TTiD | 4 | A 19 DTR | 96/129 | 12/07→ | GE114 | | 4.4V | |
| 1.9 TTiD | 4 | A 19 DTR | 118/158 | 12/07→ | GE114 | | 4.4V | |
| 1.9 TTiD | 4 | A 19 DTR, Z 19 DTR | 132/177 | 12/07→ | GE114 | | 4.4V | |
| 2.0 1,8t | 4 | B207E | 110/148 | 09/02→ | Z221 | | 1.0 | UXT14 |
| 2.0 1,8t LPG | 4 | B207E | 110/148 | 09/02→ | Z30 [168] | | 0.8 | UXT5 |
| 2.0 1,8t BioPower | 4 | B207L | 129/173 | 01/07→ | Z313 | | 1.1 | UXT14 |
| 2.0 1,8t BioPower LPG | 4 | B207L | 129/173 | 01/07→ | Z30 [168] | | 0.8 | UXT5 |
| 2.0 i | 4 | B204I | 96/129 | 02/98→08/03 | Z16 [171] →08/00 | | 1.1 | UXT11 →08/00 |
| 2.0 i LPG | 4 | B204I | 96/129 | 02/98→08/03 | Z340 →08/00 | | 0.7 | UXT12 →08/00 |
| 2.0 SE Turbo | 4 | B204R | 147/197 | 02/98→08/03 | Z253 | | 1.0 | UXT5 →08/00 |
| 2.0 t | 4 | B207E | 110/148 | 03/05→ | Z221 | | 1.0 | UXT14 |
| 2.0 t | 4 | B207L | 129/173 | 09/02→ | Z221 | | 1.0 | UXT14 |
| 2.0 t | 4 | B207R | 154/207 | 09/02→ | Z221 02/03→ | | 1.0 | UXT14 02/03→ |
| 2.0 t | 4 | B207R | 154/207 | 08/03→ | Z221 | | 1.0 | UXT14 |
| 2.0 t LPG | 4 | B207E | 110/148 | 03/05→ | Z30 [168] | | 0.8 | UXT5 |
| 2.0 t LPG | 4 | B207L | 129/173 | 09/02→ | Z30 [168] | | 0.8 | UXT5 |
| 2.0 t LPG | 4 | B207R | 154/207 | 09/02→ | Z30 [168] 02/03→ | | 0.8 | UXT5 02/03→ |
| 2.0 t LPG | 4 | B207R | 154/207 | 08/03→ | Z30 [168] | | 0.8 | UXT5 |
| 2.0 Turbo | 4 | B205E | 110/148 | 01/01→08/03 | Z221 | | 1.0 | UXT14 →08/00 |
| 2.0 Turbo | 4 | B204E | 113/152 | 10/98→08/03 | Z253 | | 1.0 | UXT5 →08/00 |
| 2.0 Turbo | 4 | B204L, B205L | 136/182 | 02/98→09/02 | Z253 | | 1.0 | UXT5 |
| 2.0 Turbo | 4 | B204L, B205L | 136/182 | 02/98→08/03 | Z221 | | 1.0 | UXT14 →08/00 |
| 2.0 Turbo | 4 | B205R | 151/202 | 10/99→08/03 | Z221 | | 1.0 | UXT14 →08/00 |
| 2.0 Turbo 4WD | 4 | B207R | 154/207 | 01/08→ | Z313 →08/09 | | 1.1 | UXT14 →08/09 |
| 2.0 Turbo LPG | 4 | B205E | 110/148 | 01/01→08/03 | Z30 [168] | | 0.8 | UXT5 |
| 2.0 Turbo LPG | 4 | B204L, B205L | 136/182 | 02/98→08/03 | Z30 [168] | | 0.8 | UXT5 |
| 2.0 Turbo LPG | 4 | B205R | 151/202 | 10/99→08/03 | Z30 [168] | | 0.8 | UXT5 |
| 2.0 Turbo 4WD LPG | 4 | B207R | 154/207 | 01/08→ | Z30 [168] →08/09 | | 0.8 | UXT5 →08/09 |
| 2.2 TiD | 4 | D223L, X 22 DTH | 85/114 | 02/98→11/00 | GN992 | | 11V | |

ROVER



kW/BHP

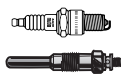

... SAAB



... 9-3

| | | | | | | | | |
|---------------|---|--------------|---------|-------------|---------------------|-----|-----------------|-----------------|
| 2.2 TiD | 4 | D223L | 92/123 | 11/00→ | GN033 | 11V | | |
| 2.3 i | 4 | B234I | 110/148 | 02/98→09/02 | Z151 [171] | 0.8 | UXT10 | |
| 2.3 i | 4 | B234I | 110/148 | 02/98→08/03 | Z221 →08/00 | 1.0 | UXT14 →08/00 | ZS127 →08/00 |
| 2.3 i LPG | 4 | B234I | 110/148 | 02/98→08/03 | Z30 [168] →08/00 | 0.8 | UXT5 →08/00 | |
| 2.3 Turbo | 4 | B235R | 165/221 | 10/98→08/03 | Z221 →09/01 | 1.0 | UXT14 →09/01 | |
| 2.3 Turbo | 4 | B235R | 165/221 | 10/98→09/02 | | | | ZS127 →08/00 |
| 2.3 Turbo LPG | 4 | B235R | 165/221 | 10/98→08/03 | Z30 [168] →09/01 | 0.8 | UXT5 →09/01 | |
| 2.8 Turbo V6 | 6 | LP9 | 169/227 | 03/05→ | | | | ZSE174 |
| 2.8 Turbo V6 | 6 | LP9 | 184/247 | 03/05→ | | | | ZSE174 |
| 2.8 Turbo V6 | 6 | B284L | 188/252 | 12/07→ | Z235 | 1.0 | | ZSE174 |
| 2.8 Turbo V6 | 6 | B284L, B284R | 203/272 | 04/08→ | | | | ZSE174 |
| 2.8 Turbo V6 | 6 | B284R | 206/276 | 05/08→ | | | | ZSE174 |

9-3X

| | | | | | | | | |
|---------|---|--------------------|---------|--------|-------|------|--|--|
| 1.9 TiD | 4 | A 19 DTR, Z 19 DTR | 132/177 | 02/09→ | GE114 | 4.4V | | |
|---------|---|--------------------|---------|--------|-------|------|--|--|

9-5

| | | | | | | | | |
|------------------|---|----------|---------|-------------|--------------------------|-----|----------------------|-------|
| 1.9 TiD | 4 | Z 19 DTH | 110/148 | 01/06→ | GN059 | 11V | | |
| 1.9 TiD | 4 | Z 19 DTR | 129/173 | 01/07→ | GN059 | 11V | | |
| 2.0 t | 4 | B205E | 110/148 | 09/97→ | Z221 →09/00 | 1.0 | UXT14 →09/00 | |
| 2.0 t | 4 | B205L | 136/182 | 07/00→07/01 | Z221 | 1.0 | UXT14 | |
| 2.0 t | 4 | B204R | 141/189 | 10/98→ | Z221 09/99→08/00 | 1.0 | UXT14 09/99→08/00 | |
| 2.0 t LPG | 4 | B205E | 110/148 | 09/97→ | Z30 [168] →09/00 | 0.8 | UXT5 →09/00 | |
| 2.0 t LPG | 4 | B205L | 136/182 | 07/00→07/01 | Z30 [168] | 0.8 | UXT5 | |
| 2.0 t LPG | 4 | B204R | 141/189 | 10/98→ | Z30 [168] 09/99→08/00 | 0.8 | UXT5 09/99→08/00 | |
| 2.0 Turbo SE | 4 | B205E | 141/189 | 10/98→07/00 | Z221 | 1.0 | UXT14 | ZS127 |
| 2.0 Turbo SE LPG | 4 | B205E | 141/189 | 10/98→07/00 | Z30 [168] | 0.8 | UXT5 | |
| 2.2 TiD | 4 | D223L | 88/118 | 03/02→ | GN992 | 11V | | |
| 2.3 t | 4 | B235E | 125/168 | 09/97→ | Z221 →08/00 | 1.0 | UXT14 →08/00 | |
| 2.3 t | 4 | B235E | 136/182 | 01/01→ | Z221 | 1.0 | UXT14 | |
| 2.3 t LPG | 4 | B235E | 125/168 | 09/97→ | Z30 [168] →08/00 | 0.8 | UXT5 →08/00 | |
| 2.3 t LPG | 4 | B235E | 125/168 | 10/98→ | Z30 [168] 09/99→08/00 | 0.8 | UXT5 09/99→08/00 | |
| 2.3 t LPG | 4 | B235E | 136/182 | 01/01→ | Z30 [168] | 0.8 | UXT5 | |
| 2.3 Turbo | 4 | B235L | 162/217 | 07/03→ | Z99 | 1.0 | UXT5 | |
| 2.3 Turbo | 4 | B235R | 169/227 | 10/99→09/01 | Z221 | 1.0 | UXT14 | |
| 2.3 Turbo | 4 | B235R | 184/247 | 09/01→ | Z221 | 1.0 | UXT14 | |
| 2.3 Turbo LPG | 4 | B235L | 162/217 | 07/03→ | Z30 [168] | 0.8 | UXT5 | |
| 2.3 Turbo LPG | 4 | B235R | 169/227 | 10/99→09/01 | Z30 [168] | 0.8 | UXT5 | |
| 2.3 Turbo LPG | 4 | B235R | 184/247 | 09/01→ | Z30 [168] | 0.8 | UXT5 | |
| 3.0 TiD | 6 | D308L | 130/174 | 07/01→ | GN106 | 11V | | |
| 3.0 V6t | 6 | B308E | 147/197 | 01/98→ | Z221 →08/01 | 1.0 | UXT14 →08/01 | |
| 3.0 V6t LPG | 6 | B308E | 147/197 | 01/98→ | Z30 [168] →08/01 | 0.8 | UXT5 →08/01 | |

9-7X

| | | | | | | | | |
|---------|---|-----|---------|--------|--|--|--|--------|
| 4.2 4WD | 6 | LL8 | 213/286 | 12/05→ | | | | ZSE133 |
|---------|---|-----|---------|--------|--|--|--|--------|

90

| | | | | | | | | | |
|-----|---|--------|-------|-------------|-----|-----|-------------|-------|-------|
| 2.0 | 4 | B 20 I | 74/99 | 08/84→08/87 | Z11 | 0.8 | UXT2 / UXT6 | ZS121 | ZM002 |
|-----|---|--------|-------|-------------|-----|-----|-------------|-------|-------|

SAAB



kW/BHP



... SAAB



95

| | | | | | | | | | |
|--------|---|---------|-------|-------------|-----------------------------------|-----|----------------------------|------------|--|
| 1.5 V4 | 4 | Ford V4 | 46/62 | 01/76→08/77 | Z11 | 0.8 | UXT2 / UXT6 | ZS106 [11] | |
| 1.5 V4 | 4 | Ford V4 | 48/64 | 10/65→12/75 | Z41 | 0.8 | | ZS106 [11] | |
| | | | | | 08/66→08/70 →eng. 59835 Z20 | 0.8 | UXT2 / UXT6 | | |
| | | | | | 08/66→08/70 eng. 59836→ | | 08/66→08/70 eng. 59836→ | | |
| 1.5 V4 | 4 | Ford V4 | 50/67 | 09/77→12/78 | Z11 | 0.8 | UXT2 / UXT6 | ZS106 [11] | |

96

| | | | | | | | | | |
|--------|---|---------|-------|-------------|--------------------|-----|-------------|------------|--|
| 1.5 V4 | 4 | Ford V4 | 46/62 | 11/75→07/77 | Z11 | 0.8 | UXT2 / UXT6 | ZS106 [11] | |
| 1.5 V4 | 4 | Ford V4 | 48/64 | 10/65→10/75 | Z41 | 0.8 | | | |
| | | | | | →eng. 59835 Z20 | 0.8 | UXT2 / UXT6 | | |
| | | | | | eng. 59836→ | | eng. 59836→ | | |

| | | | | | | | | | |
|--------|---|---------|-------|-------------|-----|-----|-------------|------------|--|
| 1.5 V4 | 4 | Ford V4 | 50/67 | 08/77→08/80 | Z11 | 0.8 | UXT2 / UXT6 | ZS106 [11] | |
|--------|---|---------|-------|-------------|-----|-----|-------------|------------|--|

99

| | | | | | | | | | |
|---------|---|----------------|--------|-------------|-----|-----|-------------|---------------|-------|
| 1.7 | 4 | | 59/79 | 08/68→05/71 | | | | ZS115 [11] | |
| 1.9 | 4 | | 65/87 | 10/70→05/74 | | | | ZS115 [11] | |
| 1.9 i | 4 | | 71/95 | 10/71→09/72 | | | | ZS115 [11] | |
| 2.0 | 4 | B 20 P | 70/94 | 10/72→08/74 | Z11 | 0.8 | UXT2 / UXT6 | ZS106 [11] | |
| 2.0 | 4 | B20T | 79/106 | 03/76→05/78 | Z11 | 0.8 | UXT2 / UXT6 | ZS106 [11] | |
| 2.0 | 4 | | 81/109 | 02/79→01/84 | | | | ZS106 [11] | |
| 2.0 EMS | 4 | B20I | 81/109 | 04/72→08/74 | Z22 | 0.7 | UX56 | ZS115 [11] | |
| 2.0 EMS | 4 | B 20 I | 87/117 | 09/74→12/78 | Z11 | 0.8 | UXT2 / UXT6 | ZS106 [11] | |
| 2.0 GL | 4 | B 20 C, B 20 I | 74/99 | 09/74→12/84 | Z11 | 0.8 | UXT2 / UXT6 | ZS106 [1][11] | ZM002 |

→08/83
ZS121 [1]
09/83→

| | | | | | | | | | |
|-----------|---|-------|---------|-------------|-----|-----|------|------------|--|
| 2.0 i | 4 | BI 20 | 87/117 | 01/81→12/84 | | | | ZS106 [11] | |
| 2.0 Turbo | 4 | | 107/143 | 10/77→06/80 | Z42 | 0.8 | UX56 | | |

900 I

| | | | | | | | | | |
|-----|---|------|--------|-------------|--|--|--|--|--|
| 2.0 | 4 | | 73/98 | 04/84→10/91 | | | | ZS115 [1][11] ZS117 [1][254] ZS120 [1][214][254] | |
| 2.0 | 4 | B20I | 81/109 | 10/85→09/89 | | | | ZS115 [1][11] ZS117 [1][254] ZS120 [1][214][254] | |

| | | | | | | | | | |
|---------|---|-------|--------|-------------|--------|-----|--------|--|--|
| 2.0 -16 | 4 | B202I | 93/125 | 01/89→08/92 | Z73 | 1.1 | UXT11 | | |
| | | | | | 08/91→ | | 08/91→ | | |

| | | | | | | | | | |
|---------|---|-------|--------|-------------|--|--|--|--|------------------------------------|
| 2.0 -16 | 4 | B202I | 93/125 | 01/89→12/93 | | | | | ZM015 →02/90 ZM029 03/90→ |
|---------|---|-------|--------|-------------|--|--|--|--|------------------------------------|

| | | | | | | | | | |
|---------|---|-------|--------|-------------|--------|-----|--------|--|--|
| 2.0 -16 | 4 | B202I | 93/125 | 01/89→06/94 | Z73 | 1.1 | UXT11 | | |
| | | | | | →08/91 | | →08/91 | | |

| | | | | | | | | | |
|---------|---|-------|--------|-------------|--|--|--|--|-------|
| 2.0 -16 | 4 | B202I | 93/125 | 01/90→06/94 | | | | | ZM029 |
|---------|---|-------|--------|-------------|--|--|--|--|-------|

| | | | | | | | | | |
|-------|---|--------------|-------|-------------|-----------|-----|-------------|---------------------|----------------------|
| 2.0 c | 4 | B 20, B201XC | 74/99 | 09/79→12/88 | Z11 [168] | 0.8 | UXT2 / UXT6 | ZS106 [1][11] | ZM002 |
| | | | | | | | | →08/83 ZS121 [1] | 09/81→08/88 ZM012 |
| | | | | | | | | 09/83→ | 09/88→ |

| | | | | | | | | | |
|-------|---|--------------|-------|-------------|--|--|--|--|------------------------------------|
| 2.0 c | 4 | B 20, B201XC | 74/99 | 07/82→12/88 | | | | | ZM002 →08/88 ZM012 09/88→ |
|-------|---|--------------|-------|-------------|--|--|--|--|------------------------------------|

| | | | | | | | | | |
|-------|---|-------------|--------|-------------|-----------|-----|-------------|---------------------|-------|
| 2.0 c | 4 | B20T, BT 20 | 79/106 | 09/78→08/84 | Z11 [168] | 0.8 | UXT2 / UXT6 | ZS106 [1][11] | ZM002 |
| | | | | | | | | →08/83 ZS121 [1] | |
| | | | | | | | | 09/83→ | |

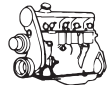

kW/BHP

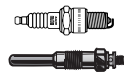

... SAAB



... 900 I

| | | | | | | | | | | |
|----------------|---|---------------|---------|-------------|---------------------|--|-----|-----------------------|--|---|
| 2.0 c | 4 | B20T, BT 20 | 79/106 | 11/80→08/84 | | | | | | ZM002 09/81→ |
| 2.0 EMS | 4 | BI 20 | 87/117 | 09/78→08/79 | Z20 | | 0.8 | UXT2 / UXT6 | | |
| 2.0 EMS | 4 | BI 20 | 87/117 | 09/78→12/80 | | | | | ZS115 [1][11] ZS117 [1][254] ZS120 [1][214][254] | |
| 2.0 EMS | 4 | BI 20 | 87/117 | 01/79→12/80 | Z11 [168] | | 0.8 | UXT2 / UXT6 | | |
| 2.0 i | 4 | B201 | 81/109 | 09/85→08/90 | Z11 [168] | | 0.8 | UXT2 / UXT6 | ZS121 | ZM002 →08/88 ZM012 09/88→ |
| 2.0 i | 4 | B201XI, BI 20 | 85/114 | 11/80→12/88 | Z11 09/83→ | | 0.8 | UXT2 / UXT6 09/83→ | | ZM002 →08/88 ZM012 09/88→ |
| 2.0 i | 4 | B201XI, BI 20 | 85/114 | 11/80→08/90 | Z11 [168] 09/83→ | | 0.8 | UXT2 / UXT6 09/83→ | ZS121 09/83→ | ZM002 09/81→08/88 ZM012 09/88→ |
| 2.0 S Turbo-16 | 4 | B202S | 104/139 | 07/91→12/93 | Z24 | | 0.8 | UXT5 | | |
| 2.0 S Turbo-16 | 4 | B202S | 104/139 | 09/91→06/94 | Z24 →08/93 | | 0.8 | UXT5 →08/93 | | |
| 2.0 S Turbo-16 | 4 | B202S | 107/143 | 01/92→12/93 | | | | | | ZM012 |
| 2.0 Turbo | 4 | B201XL | 103/138 | 10/86→12/91 | Z22 →09/90 | | 0.7 | UX56 →09/90 | ZS115 [1][11] ZS117 [1][254] ZS120 [1][214][254] | ZM002 →08/88 ZM012 09/88→ |
| 2.0 Turbo | 4 | B201S | 107/143 | 09/78→07/85 | Z22 →08/84 | | 0.7 | UX56 →08/84 | ZS121 09/81→ | ZM002 09/81→ |
| 2.0 Turbo | 4 | B201S | 107/143 | 10/80→07/85 | | | | | ZS121 | |
| 2.0 Turbo | 4 | BSI 20 | 107/143 | 09/78→07/85 | Z22 →08/84 | | 0.7 | UX56 →08/84 | | ZM002 09/81→ |
| 2.0 Turbo | 4 | B201XL | 110/148 | 01/86→12/88 | Z22 | | 0.7 | UX56 | ZS115 [1][11] ZS117 [1][254] ZS120 [1][214][254] | ZM002 →08/88 ZM012 09/88→ |
| 2.0 Turbo-16 | 4 | B202XL | 118/158 | 11/85→12/93 | Z24 | | 0.8 | UXT5 | | |
| 2.0 Turbo-16 | 4 | B202XL | 118/158 | 11/85→06/94 | Z24 →08/93 | | 0.8 | UXT5 →08/93 | ZS121 | ZM002 →08/88 ZM012 09/88→ |
| 2.0 Turbo-16 | 4 | B202L | 132/177 | 01/93→06/94 | Z24 →08/93 | | 0.8 | UXT5 →08/93 | ZS121 | ZM012 |
| 2.0 Turbo-16 S | 4 | B202XL | 125/168 | 01/89→12/93 | Z24 | | 0.8 | UXT5 | ZS121 | ZM012 |
| 2.0 Turbo-16 S | 4 | B202XL | 129/173 | 01/84→12/93 | Z24 | | 0.8 | UXT5 | | |
| 2.0 Turbo-16 S | 4 | B202XL | 129/173 | 01/84→06/94 | | | | | ZS121 | ZM002 →08/88 ZM012 09/88→ |
| 2.0 Turbo-16 S | 4 | B202XL | 129/173 | 11/86→06/94 | Z24 →08/93 | | 0.8 | UXT5 →08/93 | | |
| 2.0 Turbo-16 S | 4 | B202XL | 129/173 | 01/89→12/93 | | | | | | ZM012 |
| 2.1 -16 | 4 | B212I | 100/134 | 08/90→06/94 | Z73 →08/91 | | 1.1 | UXT11 →08/91 | ZS121 | ZM001 [1][175] ZM015 [1][175] |
| 2.1 -16 | 4 | B212I | 100/134 | 09/90→07/93 | Z73 08/91→ | | 1.1 | UXT11 08/91→ | | ZM015 |
| 900 II | | | | | | | | | | |
| 2.0 -16 Turbo | 4 | B204L | 136/182 | 07/93→02/98 | Z253 | | 1.0 | UXT5 | ZS127 | |
| 2.0 i | 4 | B204I | 96/129 | 12/93→02/98 | Z16 [171] | | 1.1 | UXT11 | ZS127 | |



kW/BHP

**... SAAB****... 900 II**

| | | | | | | | | | |
|----------------|---|-------|---------|-------------|------------|--|-----|-------------|-----------------|
| 2.0 i | 4 | B206I | 98/131 | 07/93→07/94 | | | | | ZS127 |
| 2.0 i | 4 | B206I | 98/131 | 12/93→07/94 | Z151 [171] | | 0.8 | UXT10 | |
| 2.0 i LPG | 4 | B204I | 96/129 | 12/93→02/98 | Z340 | | 0.7 | UXT12 | |
| 2.3 -16 | 4 | B234I | 110/148 | 07/93→02/98 | Z15 [168] | | 0.8 | UXT1 / UXT3 | ZS127 |
| 2.3 -16 LPG | 4 | B234I | 110/148 | 07/93→02/98 | Z340 | | 0.7 | UXT12 | |
| 2.5 -24 V6 | 6 | B258I | 125/168 | 07/93→02/98 | Z237 | | 1.6 | | ZS301 →08/95 |
| 2.5 -24 V6 LPG | 6 | B258I | 125/168 | 07/93→02/98 | Z340 | | 0.7 | UXT12 | |

9000

| | | | | | | | | | |
|-----------------------|---|---------------------|---------|-------------|----------------|--|-----|-----------------|--|
| 2.0 | 4 | | 99/133 | 10/88→08/90 | | | | | ZS115 [1][11] ZS117 [1][254] ZS120 [1][214][254] |
| 2.0 -16 | 4 | B202XI | 92/123 | 12/85→12/88 | Z73 08/86→ | | 1.1 | UXT11 08/86→ | ZS121 ZM015 →08/86 |
| 2.0 -16 | 4 | B202I | 94/126 | 01/89→01/93 | Z73 09/89→ | | 1.1 | UXT11 09/89→ | ZS121 09/89→ |
| 2.0 -16 | 4 | B202XI | 94/126 | 12/85→08/88 | Z73 | | 1.1 | UXT11 | ZS121 ZM015 |
| 2.0 -16 CD | 4 | B204I | 96/129 | 09/93→12/98 | Z16 | | 1.1 | UXT11 | |
| 2.0 -16 CD | 4 | B204E, B204S | 110/148 | 09/93→12/98 | Z253 | | 1.0 | UXT5 | |
| 2.0 -16 CD LPG | 4 | B204I | 96/129 | 09/93→12/98 | Z340 | | 0.7 | UXT12 | |
| 2.0 -16 CS | 4 | B202I | 94/126 | 01/89→12/98 | Z73 →09/89 | | 1.1 | UXT11 →09/89 | ZS115 [1][11] ZS117 [1][254] ZS120 [1][214][254] |
| 2.0 -16 CS | 4 | B204I | 96/129 | 09/93→12/98 | Z16 | | 1.1 | UXT11 | |
| 2.0 -16 CS LPG | 4 | B202I | 94/126 | 01/89→12/98 | Z206 →09/89 | | 0.7 | UXT10 →09/89 | |
| 2.0 -16 CS LPG | 4 | B204I | 96/129 | 09/93→12/98 | Z340 | | 0.7 | UXT12 | |
| 2.0 -16 ND Turbo | 4 | B202S, B204E, B204S | 110/148 | 09/93→12/98 | Z253 | | 1.0 | UXT5 | |
| 2.0 -16 Turbo | 4 | B202XL | 118/158 | 09/84→08/93 | Z253 | | 1.0 | UXT5 | ZS121 |
| 2.0 -16 Turbo | 4 | B202XL | 118/158 | 05/88→08/93 | | | | | ZM002 |
| 2.0 -16 Turbo | 4 | B202XL | 120/161 | 05/88→08/93 | Z253 | | 1.0 | UXT5 | ZS121 |
| 2.0 -16 Turbo | 4 | B202 | 127/170 | 06/89→12/92 | Z253 | | 1.0 | UXT5 | ZS121 |
| 2.0 -16 Turbo | 4 | B202XL | 129/173 | 09/84→12/91 | Z253 | | 1.0 | UXT5 | ZS121 |
| 2.0 -16 Turbo | 4 | B202XL | 129/173 | 04/85→12/91 | | | | | ZM002 |
| 2.0 -16 Turbo CD | 4 | B202S, B204E | 108/145 | 09/92→12/98 | Z16 | | 1.1 | UXT11 | |
| 2.0 -16 Turbo CD | 4 | B202XL | 120/161 | 09/88→08/93 | Z253 | | 1.0 | UXT5 | ZS121 |
| 2.0 -16 Turbo CD | 4 | B202L | 136/182 | 09/89→12/98 | Z253 | | 1.0 | UXT5 | ZS121 →08/92 |
| 2.0 -16 Turbo CD LPG | 4 | B202S, B204E | 108/145 | 09/92→12/98 | Z340 | | 0.7 | UXT12 | |
| 2.0 -16 Turbo CS | 4 | B202L | 136/182 | 09/88→12/98 | Z253 | | 1.0 | UXT5 | ZS121 →08/92 |
| 2.3 | 4 | B234I | 110/148 | 10/89→12/93 | | | | | ZS115 [1][11] ZS117 [1][254] ZS120 [1][214][254] |
| 2.3 -16 Aero CS | 4 | B234R | 162/217 | 02/93→12/98 | Z253 | | 1.0 | UXT5 | ZS121 →08/93 |
| 2.3 -16 Aero CS | 4 | B234R | 165/221 | 02/93→12/98 | Z253 | | 1.0 | UXT5 | ZS121 →08/93 |
| 2.3 -16 CD | 4 | B234I | 107/143 | 08/89→12/98 | Z16 →08/93 | | 1.1 | UXT11 →08/93 | ZS121 →08/93 |
| 2.3 -16 CD LPG | 4 | B234I | 107/143 | 08/89→12/98 | Z340 →08/93 | | 0.7 | UXT12 →08/93 | |
| 2.3 -16 CDE | 4 | B234I | 108/145 | 09/93→12/98 | Z16 | | 1.1 | UXT11 | |
| 2.3 -16 CDE LPG | 4 | B234I | 108/145 | 09/93→12/98 | Z340 | | 0.7 | UXT12 | |
| 2.3 -16 CDE Eco-Power | 4 | B234E | 125/168 | 09/93→12/98 | Z253 | | 1.0 | UXT5 | |
| 2.3 -16 CD Turbo | 4 | B234L | 147/197 | 07/90→12/98 | Z253 | | 1.0 | UXT5 | |
| 2.3 -16 CS | 4 | B234I | 107/143 | 09/89→12/98 | Z16 →08/93 | | 1.1 | UXT11 →08/93 | ZS121 →08/93 |

SAAB

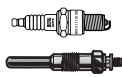

kW/BHP

**... SAAB****... 9000**

| | | | | | | | | | |
|-----------------------|---|-------|---------|-------------|----------------|-----|-----------------|-----------------|--|
| 2.3 -16 CS LPG | 4 | B234I | 107/143 | 09/89→12/98 | Z340 →08/93 | 0.7 | UXT12 →08/93 | | |
| 2.3 -16 CSE | 4 | B234I | 108/145 | 09/93→12/98 | Z16 | 1.1 | UXT11 | | |
| 2.3 -16 CSE LPG | 4 | B234I | 108/145 | 09/93→12/98 | Z340 | 0.7 | UXT12 | | |
| 2.3 -16 CSE Eco Power | 4 | B234E | 125/168 | 09/93→12/98 | Z253 | 1.0 | UXT5 | | |
| 2.3 -16 Turbo | 4 | B234L | 143/192 | 09/90→12/98 | Z253 | 1.0 | UXT5 | ZS121 →08/93 | |
| 2.3 -16 Turbo CSE | 4 | B234L | 147/197 | 09/93→12/98 | Z253 | 1.0 | UXT5 | | |
| 3.0 -24 V6 CD/CDE | 6 | B308I | 155/208 | 07/94→12/98 | Z74 | 1.0 | UXT1 / UXT3 | | |
| 3.0 -24 V6 CD/CDE LPG | 6 | B308I | 155/208 | 07/94→12/98 | Z206 | 0.7 | UXT10 | | |
| 3.0 -24 V6 CS/CSE | 6 | B308I | 155/208 | 07/94→12/98 | Z74 | 1.0 | UXT1 / UXT3 | | |
| 3.0 -24 V6 CS/CSE LPG | 6 | B308I | 155/208 | 07/94→12/98 | Z206 | 0.7 | UXT10 | | |

SEAT**124**

| | | | | | | | | | |
|-------------------|---|-----------|-------|-------------|---|-----|---|------------|--|
| 1.2 D1200 | 4 | 124 A.000 | 44/59 | 01/68→12/76 | Z11 | 0.8 | UXT2 / UXT6 | | |
| 1.2 LS1200 | 4 | 124 A.000 | 48/64 | 01/70→12/76 | Z11 | 0.8 | UXT2 / UXT6 | | |
| 1.2 LS1200 | 4 | FA12 | 48/64 | 01/68→10/80 | Z20 →03/74 Z8 04/74→08/75 Z27 09/75→ | 0.8 | UXT2 / UXT6 →03/74 0.8 UXT2 / UXT6 04/74→08/75 0.8 UX56 09/75→ | ZS106 [11] | |
| 1.4 1430 | 4 | | 55/74 | 01/70→12/76 | Z11 | 0.8 | UXT2 / UXT6 | ZS106 [11] | |
| 1.6 1430 Especial | 4 | | 70/94 | 01/70→12/76 | Z22 | 0.7 | UX56 | | |

127

| | | | | | | | | | |
|-----|---|-------------|-------|-------------|-----|-----|-------------|------------|--|
| 0.9 | 4 | A112 A5.000 | 33/44 | 04/72→12/82 | Z11 | 0.8 | UXT2 / UXT6 | ZS106 [11] | |
| 1.0 | 4 | | 38/51 | 04/72→12/82 | Z11 | 0.8 | UXT2 / UXT6 | | |

128

| | | | | | | | | | |
|-----|---|--|-------|-------------|-----|-----|-------------|------------|--|
| 1.2 | 4 | | 49/66 | 01/76→12/80 | Z11 | 0.8 | UXT2 / UXT6 | ZS106 [11] | |
| 1.4 | 4 | | 57/76 | 01/76→12/80 | Z22 | 0.7 | UX56 | ZS106 [11] | |

131

| | | | | | | | | | |
|------------|---|-------------|--------|-------------|-------|-------|-------------|--|--|
| 1.6 | 4 | 132 BB 0A 0 | 71/95 | 03/82→01/85 | Z27 | 0.8 | UX56 | | |
| 2.0 | 4 | 131 C4.000 | 85/114 | 06/78→12/85 | Z11 | 0.8 | UXT2 / UXT6 | | |
| 2.4 Diesel | 4 | 8144.61 | 53/71 | 06/78→12/86 | GV642 | GR065 | 11V | | |

132

| | | | | | | | | | |
|-------|---|------------|--------|-------------|-------------------------|-----|------|------------|--|
| 1.6 | 4 | | 72/97 | 05/73→12/80 | Z22 | 0.7 | UX56 | | |
| 1.8 | 4 | | 77/103 | 05/73→12/80 | Z22 | 0.7 | UX56 | ZS106 [11] | |
| 1.9 | 4 | | 80/107 | 05/79→12/82 | Z22 | 0.7 | UX56 | | |
| 2.0 D | 4 | | 40/54 | 05/73→12/80 | GN909 [2][222] GV642 | 11V | | | |
| 2.2 D | 4 | OM 615.912 | 44/59 | 05/79→12/82 | GN909 [2][222] GV642 | 11V | | | |

133

| | | | | | | | | | |
|-----|---|----|-------|-------------|-----|-----|-------------|------------|--|
| 0.8 | 4 | DG | 25/34 | 05/74→11/79 | Z11 | 0.8 | UXT2 / UXT6 | ZS106 [11] | |
|-----|---|----|-------|-------------|-----|-----|-------------|------------|--|

600 D

| | | | | | | | | | |
|-----|---|--|-------|-------------|-----|-----|--|------------|--|
| 0.8 | 4 | | 17/23 | 09/63→04/70 | Z57 | 0.6 | | ZS106 [11] | |
|-----|---|--|-------|-------------|-----|-----|--|------------|--|

850

| | | | | | | | | | |
|-----|---|--|-------|-------------|-----|-----|-------------|------------|--|
| 0.9 | 4 | | 25/34 | 02/72→07/75 | Z11 | 0.8 | UXT2 / UXT6 | ZS106 [11] | |
| 0.9 | 4 | | 27/36 | 01/66→12/74 | Z11 | 0.8 | UXT2 / UXT6 | | |
| 0.9 | 4 | | 35/47 | 01/66→12/74 | Z11 | 0.8 | UXT2 / UXT6 | | |

ALHAMBRA

| | | | | | | | | | |
|---------------|---|------------------|---------|-------------|------|-----|-------|--------|-------|
| 1.4 TSI | 4 | CAVA, CNWB, CTHA | 110/148 | 06/10→ | | | | ZSE030 | |
| 1.8 T 20V | 4 | AJH | 110/148 | 10/97→03/10 | Z188 | 0.7 | UXT10 | ZS016 | ZM062 |
| 1.8 T 20V | 4 | AWC | 110/148 | 10/97→03/10 | Z188 | 0.7 | UXT10 | ZSE009 | ZM062 |
| 1.8 T 20V LPG | 4 | AJH, AWC | 110/148 | 10/97→03/10 | Z340 | 0.7 | UXT12 | | |

SEAT



kW/BHP



... SEAT



... ALHAMBRA

| | | | | | | | | | | |
|-----------|---|--------------|---------|-------------|----------------------------|-------|------|-------------|----------------------------|-------|
| 1.8 TFSI | 4 | CDA | 118/158 | 11/12→ | Z347 | | 0.7 | UXT12 | ZSE033 | |
| 1.9 TDI | 4 | IZ, AHU, ANU | 66/89 | 04/96→03/10 | GN855 | GR081 | 12V | | | |
| 1.9 TDI | 4 | AFN | 81/109 | 08/96→06/00 | GN855 | GR081 | 12V | | | |
| 1.9 TDI | 4 | AVG | 81/109 | 08/96→06/00 | | GR081 | | | | |
| 1.9 TDI | 4 | AUY, BVK | 85/114 | 06/00→03/10 | GN855 | GR081 | 12V | | | |
| | | | | | →ch. 7M-2-514 000 GN046 | | 12V | | | |
| | | | | | ch. 7M-2-514 001→ | | | | | |
| 1.9 TDI | 4 | ASZ | 96/129 | 11/02→11/08 | GN046 | GR081 | 12V | | | |
| 1.9 TDI | 4 | BTB | 110/148 | 05/05→05/07 | GN046 | GR081 | 12V | | | |
| 2.0 i | 4 | ADY | 85/114 | 04/96→03/10 | Z90 | | 1.0 | UXT1 / UXT3 | ZSE001 | ZM013 |
| 2.0 i | 4 | ATM | 85/114 | 04/96→03/10 | Z90 | | 1.0 | UXT1 / UXT3 | ZSE003 | ZM013 |
| 2.0 i LPG | 4 | ADY, ATM | 85/114 | 04/96→03/10 | Z340 [168] | | 0.7 | UXT12 | | |
| 2.0 TDI | 4 | CFFE | 85/114 | 05/11→ | GE115 | | 4.4V | | | |
| 2.0 TDI | 4 | CFFA | 100/134 | 06/10→05/11 | GE115 | | 4.4V | | | |
| 2.0 TDI | 4 | BRT | 103/138 | 11/05→03/10 | CGP002 | | 7V | | | |
| 2.0 TDI | 4 | CFFB | 103/138 | 06/10→ | GE115 | | 4.4V | | | |
| 2.0 TDI | 4 | CFGB | 125/168 | 06/10→ | GE115 | | 4.4V | | | |
| 2.0 TDI | 4 | CFGC | 130/174 | 11/12→ | GE115 | | 4.4V | | | |
| 2.0 TSI | 4 | CCZA | 147/197 | 11/10→ | Z347 | | 0.7 | UXT12 | ZSE033 [47] ZSE142 [48] | |
| 2.8 V6 | 6 | AUE, AYL | 150/201 | 06/00→03/10 | Z176 | | 1.1 | | ZSE063 | |

ALTEA

| | | | | | | | | | | |
|-------------|---|---------------------------|---------|-------------|-------------------------------------|--------|------------|----------------------|----------------------------|--|
| 1.2 TSI | 4 | CBZB | 77/103 | 04/10→ | | | | | ZSE003 | |
| 1.4 16V | 4 | BXW | 63/84 | 05/06→ | Z272 | | 1.0 | | ZSE030 | |
| 1.4 16V | 4 | CGGB | 63/84 | 05/06→ | Z272 | | 1.0 | | | |
| 1.4 TSI | 4 | CAXC | 92/123 | 11/07→ | Z349 | | 0.9 | | ZSE030 | |
| 1.6 | 4 | BGU, BSE, BSF, CCSA, CMXA | 75/101 | 03/04→ | Z90 | | 1.0 | UXT1 / UXT3 | ZSE003 | |
| 1.6 LPG | 4 | BGU, BSE, BSF, CCSA, CMXA | 75/101 | 03/04→ | Z340 | | 0.7 | UXT12 | | |
| 1.6 LPG | 4 | CHGA | 75/101 | 09/09→ | Z340 Z90 | | 0.7 1.0 | UXT12 UXT1 / UXT3 | ZSE003 | |
| 1.6 TDI | 4 | CAYB | 66/89 | 11/10→ | GE115 | | 4.4V | | | |
| 1.6 TDI | 4 | CAYC | 77/103 | 10/09→ | GE115 | | 4.4V | | | |
| 1.8 TFSI | 4 | BYT, BZB, CDA | 118/158 | 01/07→ | Z347 | | 0.7 | UXT12 | ZSE033 [47] ZSE142 [48] | |
| 1.9 TDI | 4 | BXF | 66/89 | 08/09→ | GE100 | | 5V | | | |
| 1.9 TDI | 4 | BJB, BKC, BXE | 77/103 | 04/04→ | GE100 [1] | GSE100 | 5V | | | |
| 1.9 TDI | 4 | BLS | 77/103 | 04/04→ | CGP002 [1][148] GE100 [1][147] | | 7V 5V | | | |
| 2.0 FSI | 4 | BLR, BLY, BVY, BVZ | 110/148 | 05/04→03/09 | Z236 | | 1.0 | | ZSE033 [47] ZSE142 [48] | |
| 2.0 TDI | 4 | AZV | 100/134 | 03/04→05/09 | GE101 | GSE100 | 4.4V | | | |
| 2.0 TDI | 4 | BMM | 103/138 | 11/05→ | CGP002 →05/10 GE100 05/10→ | | 7V 5V | | | |
| 2.0 TDI | 4 | BMN | 125/168 | 03/06→ | CGP003 | | 7V | | | |
| 2.0 TDI | 4 | CEGA | 125/168 | 03/06→ | GE115 | | 4.4V | | | |
| 2.0 TDI 16V | 4 | BKD | 103/138 | 03/04→ | GE101 | GSE100 | 4.4V | | | |
| 2.0 TDI 16V | 4 | CFHC | 103/138 | 03/04→ | GE115 | →09/04 | 4.4V | | | |
| 2.0 TFSI | 4 | BWA | 147/197 | 04/06→05/09 | Z347 | | 0.7 | UXT12 | ZSE033 [47] ZSE142 [48] | |

ALTEA XL

| | | | | | | | | | | |
|---------|---|----------------------|--------|--------|------|--|-----|-------------|--------|--|
| 1.2 TSI | 4 | CBZB | 77/103 | 04/10→ | | | | | ZSE003 | |
| 1.4 16V | 4 | BXW | 63/84 | 10/06→ | Z272 | | 1.0 | | ZSE030 | |
| 1.4 16V | 4 | CGGB | 63/84 | 10/06→ | Z272 | | 1.0 | | | |
| 1.4 TSI | 4 | CAXC | 92/123 | 11/07→ | Z349 | | 0.9 | | ZSE030 | |
| 1.6 | 4 | BSE, BSF, CCSA, CMXA | 75/101 | 10/06→ | Z90 | | 1.0 | UXT1 / UXT3 | ZSE003 | |

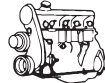

kW/BHP

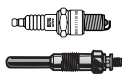

... SEAT



... ALTEA XL

| | | | | | | | | | |
|---------------|---|----------------------|---------|-------------|-------------------------------------|--------|------------|----------------------|----------------------------|
| 1.6 LPG | 4 | BSE, BSF, CCSA, CMXA | 75/101 | 10/06→ | Z340 | | 0.7 | UXT12 | |
| 1.6 LPG | 4 | CHGA | 75/101 | 09/09→ | Z340 Z90 | | 0.7 1.0 | UXT12 UXT1 / UXT3 | ZSE003 |
| 1.6 Multifuel | 4 | CCSA | 75/101 | 10/06→ | | | | | ZSE003 |
| 1.6 TDI | 4 | CAYB | 66/89 | 11/10→ | GE115 | | 4.4V | | |
| 1.6 TDI | 4 | CAYC | 77/103 | 10/09→ | GE115 | | 4.4V | | |
| 1.8 TFSI | 4 | BYT | 118/158 | 01/07→ | Z347 | | 0.7 | UXT12 | ZSE033 |
| 1.8 TFSI | 4 | BZB, CDA | 118/158 | 01/07→ | | | | | ZSE033 |
| 1.9 TDI | 4 | BXF | 66/89 | 08/09→ | GE100 | | 5V | | |
| 1.9 TDI | 4 | BKC, BXE | 77/103 | 10/06→ | GE100 [1] | GSE100 | 5V | | |
| 1.9 TDI | 4 | BLS | 77/103 | 10/06→ | CGP002 [1][145] GE100 [1][147] | | 7V 5V | | |
| 2.0 FSI | 4 | BVY, BVZ | 110/148 | 10/06→03/09 | Z236 | | 1.0 | | ZSE033 [47] ZSE142 [48] |
| 2.0 TDI | 4 | AZV | 100/134 | 11/06→03/09 | GE101 | | 4.4V | | |
| 2.0 TDI | 4 | BMM | 103/138 | 10/06→ | CGP002 →05/10 GE100 05/10→ | | 7V 5V | | |
| 2.0 TDI | 4 | BMN | 125/168 | 06/07→ | CGP003 | | 7V | | |
| 2.0 TDI | 4 | CEGA, CFJA | 125/168 | 06/07→ | GE115 | | 4.4V | | |
| 2.0 TDI 16V | 4 | BKD | 103/138 | 10/06→ | GE101 | | 4.4V | | |
| 2.0 TDI 16V | 4 | CFHC | 103/138 | 10/06→ | GE115 | | 4.4V | | |
| 2.0 TFSI 4WD | 4 | BWA | 147/197 | 06/07→05/09 | Z347 | | 0.7 | UXT12 | ZSE033 [47] ZSE142 [48] |
| 2.0 TFSI 4WD | 4 | CCZB | 155/208 | 05/09→ | | | | | ZSE033 [47] ZSE142 [48] |

AROSA

| | | | | | | | | | |
|-------------|---|---------------|-------|-------------|------------------------------------|----------------------------|------------|-------------|--|
| 1.0 | 4 | AER, ALL | 37/50 | 05/97→06/04 | Z91 | | 0.8 | UXT2 / UXT6 | ZSE001 [1][175] [254] ZSE040 [1] |
| 1.0 | 4 | AHT | 37/50 | 10/98→01/01 | Z188 | | 0.7 | UXT10 | ZSE040 |
| 1.0 | 4 | ALD, ANV, AUC | 37/50 | 05/97→06/04 | Z176 | | 1.1 | | ZSE003 [1][208] ZSE040 [1] |
| 1.0 LPG | 4 | AER, ALL | 37/50 | 05/97→06/04 | Z27 [168] | | 0.8 | UX56 | |
| 1.0 LPG | 4 | AHT | 37/50 | 10/98→01/01 | Z340 | | 0.7 | UXT12 | |
| 1.4 | 4 | AEX, AKV, APQ | 44/59 | 05/97→06/04 | Z91 | | 0.8 | UXT2 / UXT6 | ZSE001 |
| 1.4 | 4 | AKK, ANW, AUD | 44/59 | 05/97→06/04 | Z176 | | 1.1 | | ZSE003 |
| 1.4 LPG | 4 | AEX, AKV, APQ | 44/59 | 05/97→06/04 | Z27 [168] | | 0.8 | UX56 | |
| 1.4 1.4 TDI | 3 | AMF | 55/74 | 01/00→06/04 | GN855 →10/01 GN046 11/01→ | GR081 →ch. 6H-3-007 207 | 12V 12V | | |
| 1.4 16V | 4 | AFK, AUB | 74/99 | 01/00→06/04 | Z90 | | 1.0 | UXT1 / UXT3 | ZSE003 |
| 1.4 16V | 4 | ANM | 74/99 | 01/00→06/04 | | | | | ZSE003 |
| 1.4 16V | 4 | AQQ | 74/99 | 01/00→06/04 | Z90 | | 1.0 | UXT1 / UXT3 | |
| 1.4 16V LPG | 4 | AFK, AQQ, AUB | 74/99 | 01/00→06/04 | Z340 | | 0.7 | UXT12 | |
| 1.7 SDI | 4 | AKU | 44/59 | 08/97→06/04 | GN855 →10/01 GN046 11/01→ | GR081 →ch. 6H-3-007 207 | 12V 12V | | |

CORDOBA

| | | | | | | | | | |
|-----------|---|---------------|-------|-------------|-----------|--|-----|-------------|--------|
| 1.0 | 4 | ALD, ANV, AUC | 37/50 | 06/99→10/02 | Z176 | | 1.1 | | ZSE003 |
| 1.0 i | 4 | AER | 37/50 | 09/96→06/99 | Z91 | | 0.8 | UXT2 / UXT6 | ZSE001 |
| 1.0 i LPG | 4 | AER | 37/50 | 09/96→06/99 | Z27 [168] | | 0.8 | UX56 | |
| 1.2 | 3 | AZQ, BME | 47/63 | 10/02→06/06 | Z200 | | 0.9 | | ZSE030 |
| 1.2 12V | 3 | BXV | 51/68 | 05/06→11/09 | Z200 | | 0.9 | | ZSE030 |
| 1.3 | 4 | ZG, AAV | 40/54 | 02/93→08/94 | | | | | ZSE001 |
| 1.4 | 4 | ANX | 40/54 | 12/97→04/99 | Z91 | | 0.8 | UXT2 / UXT6 | ZSE001 |



kW/BHP

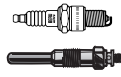

... SEAT



... CORDOBA

| | | | | | | | | | |
|-----------------|---|--------------------|---------|-------------|--------------------------|-------|-----|-------------|--|
| 1.4 | 4 | AKK, ANW | 44/59 | 06/99→12/02 | Z176 | | 1.1 | ZSE003 | |
| 1.4 | 4 | AUD | 44/59 | 06/99→12/02 | Z176 | | 1.1 | | |
| 1.4 16V | 4 | APE, AUA | 55/74 | 06/99→12/02 | Z90 | | 1.0 | UXT1 / UXT3 | ZSE003 |
| 1.4 16V | 4 | BBY | 55/74 | 09/02→12/07 | Z176 [251] Z90 [253] | | 1.1 | | ZSE030 |
| 1.4 16V | 4 | BKY | 55/74 | 09/02→12/07 | Z176 [251] Z272 [253] | | 1.1 | | ZSE030 |
| 1.4 16V | 4 | BXW | 63/84 | 05/06→11/09 | Z272 | | 1.0 | | ZSE030 |
| 1.4 16V | 4 | AQQ, AUB | 74/99 | 02/00→11/09 | Z90 | | 1.0 | UXT1 / UXT3 | |
| 1.4 16V | 4 | AUB | 74/99 | 02/00→10/02 | | | | | ZSE003 |
| 1.4 16V | 4 | AUB | 74/99 | 10/02→11/09 | | | | | ZSE030 |
| 1.4 16V | 4 | BBZ | 74/99 | 10/02→11/09 | Z90 | | 1.0 | UXT1 / UXT3 | ZSE030 |
| 1.4 16V LPG | 4 | APE, AUA | 55/74 | 06/99→12/02 | Z340 | | 0.7 | UXT12 | |
| 1.4 16V LPG | 4 | BBY | 55/74 | 09/02→12/07 | Z340 | | 0.7 | UXT12 | |
| 1.4 16V LPG | 4 | AQQ, AUB | 74/99 | 02/00→10/02 | Z340 [168] | | 0.7 | UXT12 | |
| 1.4 16V LPG | 4 | AUB, BBZ | 74/99 | 10/02→11/09 | Z340 | | 0.7 | UXT12 | |
| 1.4 i | 4 | ABD | 44/59 | 06/94→06/99 | Z2 | | 1.0 | UXT2 / UXT6 | ZSE001 |
| 1.4 i | 4 | AEX, AKV, APQ | 44/59 | 06/94→06/99 | Z91 | | 0.8 | UXT2 / UXT6 | ZSE001 |
| 1.4 i LPG | 4 | ABD | 44/59 | 06/94→06/99 | Z11 [168] | | 0.8 | UXT2 / UXT6 | |
| 1.4 i LPG | 4 | AEX, AKV, APQ | 44/59 | 06/94→06/99 | Z27 [168] | | 0.8 | UX56 | |
| 1.4 i 16V | 4 | AFH | 74/99 | 09/96→06/99 | Z90 | | 1.0 | UXT1 / UXT3 | ZSE001 |
| 1.4 i 16V LPG | 4 | AFH | 74/99 | 09/96→06/99 | Z340 | | 0.7 | UXT12 | |
| 1.4 TDI | 3 | BNM | 51/68 | 05/05→11/09 | GN046 | GR081 | 12V | | |
| 1.4 TDI | 3 | AMF | 55/74 | 10/02→12/05 | GN046 | GR081 | 12V | | |
| 1.4 TDI | 3 | BMS | 59/79 | 06/05→11/09 | CGP002 | | 7V | | |
| 1.4 TDI | 3 | BNV | 59/79 | 06/05→11/09 | GN046 | GR081 | 12V | | |
| 1.6 | 4 | ALM | 55/74 | 06/99→12/02 | Z91 | | 0.8 | UXT2 / UXT6 | ZSE001 |
| 1.6 | 4 | AEH | 74/99 | 06/99→12/02 | Z90 | | 1.0 | UXT1 / UXT3 | ZSE003 |
| 1.6 | 4 | AEH | 74/99 | 06/99→10/02 | | | | | →10/02 ZSE003 |
| 1.6 | 4 | AKL | 74/99 | 06/99→12/02 | Z90 | | 1.0 | UXT1 / UXT3 | ZSE003 |
| 1.6 | 4 | APF, AUR | 74/99 | 06/99→12/02 | Z90 | | 1.0 | UXT1 / UXT3 | ZSE003 |
| 1.6 | 4 | BAH | 74/99 | 04/03→11/09 | Z344 | | 1.0 | | ZSE003 |
| 1.6 LPG | 4 | ALM | 55/74 | 06/99→12/02 | Z27 [168] | | 0.8 | UX56 | |
| 1.6 LPG | 4 | AEH, AKL, APF, AUR | 74/99 | 06/99→12/02 | Z340 | | 0.7 | UXT12 | |
| 1.6 16V | 4 | BTS | 77/103 | 11/06→11/09 | Z272 | | 1.0 | | ZSE030 |
| 1.6 i | 4 | 1F | 55/74 | 05/94→06/99 | Z2 | | 1.0 | UXT2 / UXT6 | ZSE001 |
| 1.6 i | 4 | 1F | 55/74 | 05/97→06/99 | Z92 | | 0.8 | UXT2 / UXT6 | |
| 1.6 i | 4 | ABU | 55/74 | 02/93→06/99 | Z91 | | 0.8 | UXT2 / UXT6 | ZSE001 |
| 1.6 i | 4 | AEE, ALM | 55/74 | 02/93→06/99 | Z91 | | 0.8 | UXT2 / UXT6 | ZSE001 |
| 1.6 i | 4 | AFT, AKL | 74/99 | 07/96→10/99 | Z90 | | 1.0 | UXT1 / UXT3 | ZSE001 |
| 1.6 i LPG | 4 | 1F | 55/74 | 05/94→06/99 | Z20 [168] | | 0.8 | UXT2 / UXT6 | |
| 1.6 i LPG | 4 | ABU, AEE, ALM | 55/74 | 02/93→06/99 | Z27 [168] | | 0.8 | UX56 | |
| 1.6 i LPG | 4 | AFT, AKL | 74/99 | 07/96→10/99 | Z340 | | 0.7 | UXT12 | |
| 1.8 i | 4 | ABS | 66/89 | 02/93→06/99 | Z91 | | 0.8 | UXT2 / UXT6 | ZSE001 |
| 1.8 i | 4 | ACC, ADZ | 66/89 | 02/93→06/99 | Z91 | | 0.8 | UXT2 / UXT6 | ZM013 |
| 1.8 i LPG | 4 | ABS, ACC, ADZ | 66/89 | 02/93→06/99 | Z27 [168] | | 0.8 | UX56 | |
| 1.8 i 16V | 4 | ADL | 95/127 | 10/93→08/96 | Z89 | | 0.8 | UXT5 | ZSE002 →ch. 6K-ZR132108; 6K-ZR671 ZSE001 ch. 6K-ZR132109, 6K-ZR672→ |
| 1.8 i 16V LPG | 4 | ADL | 95/127 | 10/93→08/96 | Z30 [168] | | 0.8 | UXT5 | |
| 1.8 T 20V Cupra | 4 | AQX | 115/154 | 07/00→10/02 | Z90 | | 1.0 | UXT1 / UXT3 | ZSE009 |
| 1.8 T 20V Cupra | 4 | AYP | 115/154 | 07/00→10/02 | Z90 | | 1.0 | UXT1 / UXT3 | ZSE043 |



kW/BHP

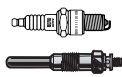

... SEAT



... CORDOBA

| | | | | | | | | |
|---------------------|---|-------------------|---------|-------------|----------------------|-------|-------------|--------|
| 1.8 T 20V Cupra LPG | 4 | AQX, AYP | 115/154 | 07/00→10/02 | Z340 | 0.7 | UXT12 | |
| 1.9 D | 4 | 1Y | 47/63 | 01/96→08/96 | GN857 | 11V | | |
| 1.9 D | 4 | 1Y | 50/67 | 02/93→08/96 | GN857 | 11V | | |
| 1.9 SDI | 4 | AEY | 47/63 | 08/96→06/99 | GN855 | GR081 | 12V | |
| 1.9 SDI | 4 | ASY | 47/63 | 09/02→11/09 | GN046 | GR081 | 12V | |
| 1.9 SDI | 4 | AGP, AQM | 50/67 | 06/99→12/02 | GN855 | GR081 | 12V | |
| 1.9 TD | 4 | AAZ | 55/74 | 02/93→08/96 | GN857 | | 11V | |
| 1.9 TDI | 4 | 1Z, AGR, AHU, ALH | 66/89 | 08/96→12/02 | GN855 | GR081 | 12V | |
| 1.9 TDI | 4 | ATD, AXR | 74/99 | 09/02→11/09 | GN046 | GR081 | 12V | |
| 1.9 TDI | 4 | BMT | 74/99 | 09/02→11/09 | CGP002 | | 7V | |
| 1.9 TDI | 4 | AFN, ASK, ASV | 81/109 | 03/97→12/02 | GN855 | GR081 | 12V | |
| 1.9 TDI | 4 | ASZ, BLT | 96/129 | 10/02→11/09 | GN046 | GR081 | 12V | |
| 2.0 | 4 | AZL, BBX | 85/114 | 09/02→11/09 | Z90 | 1.0 | UXT1 / UXT3 | ZSE003 |
| 2.0 LPG | 4 | AZL, BBX | 85/114 | 09/02→11/09 | Z340 | 0.7 | UXT12 | |
| 2.0 i | 4 | 2E | 85/114 | 02/93→06/99 | Z91 | 0.8 | UXT2 / UXT6 | ZSE001 |
| 2.0 i | 4 | AGG | 85/114 | 02/93→06/99 | Z91 | 0.8 | UXT2 / UXT6 | |
| 2.0 i LPG | 4 | 2E, AGG | 85/114 | 02/93→06/99 | Z27 ^[168] | 0.8 | UX56 | |
| 2.0 i 16V | 4 | ABF | 110/148 | 08/96→06/99 | Z317 | 0.85 | UXT12 | ZSE001 |

EXEO

| | | | | | | | | |
|----------|---|------------|---------|-------------|-------|------|-------------|--|
| 1.6 | 4 | ALZ | 75/101 | 03/09→09/10 | Z90 | 1.0 | UXT1 / UXT3 | ZSE003 |
| 1.6 LPG | 4 | ALZ | 75/101 | 06/09→09/10 | Z340 | 0.7 | UXT12 | |
| 1.8 T | 4 | CFMA | 110/148 | 12/08→05/10 | Z188 | 0.7 | UXT10 | ZSE043 |
| 1.8 TSI | 4 | CDHA | 88/118 | 09/10→ | | | | ZSE033 |
| 1.8 TSI | 4 | CDHB | 118/158 | 05/10→ | Z347 | 0.7 | UXT12 | ZSE033 ⁽⁴⁷⁾ ZSE142 ⁽⁴⁸⁾ |
| 2.0 TDI | 4 | CAGC, CICC | 88/118 | 12/08→ | GE115 | 4.4V | | |
| 2.0 TDI | 4 | CAGA, CICA | 105/141 | 12/08→ | GE115 | 4.4V | | |
| 2.0 TDI | 4 | CAHA, CGLB | 125/168 | 02/09→ | GE115 | 4.4V | | |
| 2.0 TFSI | 4 | BWE | 147/197 | 03/09→ | Z347 | 0.7 | UXT12 | ZSE033 ⁽⁴⁷⁾ ZSE142 ⁽⁴⁸⁾ |
| 2.0 TFSI | 4 | CDND | 155/208 | 05/10→ | Z347 | 0.7 | UXT12 | ZSE033 ⁽⁴⁷⁾ ZSE142 ⁽⁴⁸⁾ |

FURA

| | | | | | | | | |
|-----|---|---------------------|-------|-------------|--------|-----|-------------|--|
| 0.9 | 4 | 09 NCA, 100 GL 7000 | 29/39 | 03/84→12/86 | Z20 | 0.8 | UXT2 / UXT6 | |
| 0.9 | 4 | HB 90 | 31/42 | 01/82→06/86 | Z20 | 0.8 | UXT2 / UXT6 | |
| | | | | | →12/84 | | →12/84 | |
| 1.4 | 4 | 127 B.7000 | 55/74 | 01/82→06/86 | Z20 | 0.8 | UXT2 / UXT6 | |
| | | | | | →12/84 | | →12/84 | |

IBIZA I

| | | | | | | | | | |
|-------|---|-------------------|--------|-------------|-----|-----|-------------|-----------------------|--------|
| 0.9 | 4 | 09 NCA, 146 A 000 | 29/39 | 08/90→05/93 | Z20 | 0.8 | UXT2 / UXT6 | ZS106 ^[11] | |
| 0.9 | 4 | 146 A 000 | 32/43 | 08/86→05/93 | Z20 | 0.8 | UXT2 / UXT6 | | ZM002 |
| 1.2 | 4 | 021 A 1000 | 44/59 | 11/84→12/93 | Z29 | 0.8 | UXT5 | ZS120 | ZM002 |
| 1.2 | 4 | 021 A 1000 | 47/63 | 11/84→12/93 | Z30 | 0.8 | UXT5 | ZS120 ^[11] | |
| 1.2 i | 4 | 021 C.1000 | 52/70 | 01/89→05/93 | Z29 | 0.8 | UXT5 | ZS120 | ZM015 |
| | | | | | | | →03/91 | | →03/91 |
| 1.5 | 4 | 021 A 2000 | 63/84 | 11/84→05/93 | Z29 | 0.8 | UXT5 | ZS120 ^[11] | ZM002 |
| 1.5 i | 4 | 021 D.2000 | 65/87 | 10/86→05/93 | Z29 | 0.8 | UXT5 | ZS120 | ZM015 |
| | | | | | | | 11/89→03/91 | | →03/91 |
| 1.5 i | 4 | 021 C.2000 | 66/89 | 10/86→05/93 | Z29 | 0.8 | UXT5 | ZS120 | ZM015 |
| | | | | | | | →03/91 | | →03/91 |
| 1.5 i | 4 | 021 B.2000 | 74/99 | 10/86→05/93 | Z29 | 0.8 | UXT5 | ZS120 | ZM015 |
| | | | | | | | →03/91 | | →03/91 |
| 1.7 | 4 | 021 A.3000 | 72/97 | 01/91→05/93 | Z29 | 0.8 | UXT5 | ZS120 | ZM015 |
| | | | | | | | →03/91 | | →03/91 |
| 1.7 | 4 | 021 B.3000 | 76/102 | 01/91→05/93 | Z29 | 0.8 | UXT5 | ZS120 | ZM015 |
| | | | | | | | →03/91 | | →03/91 |

SEAT



kW/BHP

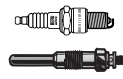

... SEAT



... IBIZA I

| | | | | | | | | | |
|-------|---|------------|-------|-------------|--|-----------------|------------|--|--|
| 1.7 D | 4 | 022 A.5000 | 40/54 | 06/84→05/93 | GV602 →08/87 GN909 [2][222] GV663 09/87→ | GR065 →08/87 | 11V | | |
| 1.7 D | 4 | 022 A.5000 | 42/56 | 08/90→05/93 | GN909 [2][222] GV663 | | 11V 11V | | |

IBIZA II

| | | | | | | | | | | |
|---------------|---|---------------|---------|-------------|------------------------|-------|------------|-----------------------|--------|-------|
| 1.0 | 4 | AAU | 33/44 | 03/93→09/96 | Z2 | | 1.0 | UXT2 / UXT6 | ZSE001 | ZM013 |
| 1.0 LPG | 4 | AAU | 33/44 | 03/93→09/96 | Z11 [168] | | 0.8 | UXT2 / UXT6 | | |
| 1.0 i | 4 | AER | 37/50 | 09/96→08/99 | Z91 | | 0.8 | UXT2 / UXT6 | ZSE001 | |
| 1.0 i LPG | 4 | AER | 37/50 | 09/96→08/99 | Z27 [168] | | 0.8 | UX56 | | |
| 1.3 i | 4 | 2G | 40/54 | 03/93→08/99 | Z12 | | 0.8 | UXT2 / UXT6 | ZSE002 | ZM013 |
| 1.3 i | 4 | AAV | 40/54 | 03/93→08/99 | Z2 | | 1.0 | UXT2 / UXT6 | ZSE001 | ZM013 |
| 1.3 i LPG | 4 | AAV | 40/54 | 03/93→08/99 | Z11 [168] →07/94 | | 0.8 | UXT2 / UXT6 →07/94 | | |
| 1.4 | 4 | ANX | 40/54 | 12/97→04/99 | Z91 | | 0.8 | UXT2 / UXT6 | ZSE001 | |
| 1.4 i | 4 | ABD | 44/59 | 09/93→08/99 | Z2 | | 1.0 | UXT2 / UXT6 | ZSE001 | ZM013 |
| 1.4 i | 4 | AEX, AKV, APQ | 44/59 | 09/93→08/99 | Z91 | | 0.8 | UXT2 / UXT6 | ZSE001 | ZM013 |
| 1.4 i LPG | 4 | ABD | 44/59 | 09/93→08/99 | Z11 [168] | | 0.8 | UXT2 / UXT6 | | |
| 1.4 i LPG | 4 | AEX, AKV, APQ | 44/59 | 09/93→08/99 | Z27 [168] | | 0.8 | UX56 | | |
| 1.4 i 16V | 4 | AFH | 74/99 | 06/97→08/99 | Z90 | | 1.0 | UXT1 / UXT3 | ZSE001 | |
| 1.4 i 16V LPG | 4 | AFH | 74/99 | 06/97→08/99 | Z340 | | 0.7 | UXT12 | | |
| 1.6 i | 4 | 1F | 55/74 | 09/94→06/99 | Z92 | | 0.8 | UXT2 / UXT6 | ZSE001 | |
| 1.6 i | 4 | ABU, AEE, ALM | 55/74 | 03/93→02/02 | Z91 | | 0.8 | UXT2 / UXT6 | ZSE001 | |
| 1.6 i | 4 | AFT | 74/99 | 04/96→08/99 | Z90 | | 1.0 | UXT1 / UXT3 | ZSE001 | |
| 1.6 i LPG | 4 | 1F | 55/74 | 09/94→06/99 | Z20 [168] | | 0.8 | UXT2 / UXT6 | | |
| 1.6 i LPG | 4 | ABU, AEE, ALM | 55/74 | 03/93→08/99 | Z27 [168] Z47 [168] | | 0.8 0.8 | UX56 | | |
| 1.6 i LPG | 4 | AFT | 74/99 | 04/96→08/99 | Z340 | | 0.7 | UXT12 | | |
| 1.8 i | 4 | ABS | 66/89 | 03/93→08/99 | Z91 | | 0.8 | UXT2 / UXT6 | ZSE002 | ZM013 |
| 1.8 i | 4 | ACC | 66/89 | 03/93→08/99 | | | | | ZSE002 | |
| 1.8 i | 4 | ADZ | 66/89 | 03/93→08/99 | Z91 | | 0.8 | UXT2 / UXT6 | ZSE002 | |
| 1.8 i LPG | 4 | ABS, ADZ | 66/89 | 03/93→08/99 | Z27 [168] | | 0.8 | UX56 | | |
| 1.8 i 16V | 4 | ADL | 95/127 | 11/93→08/96 | Z89 | | 0.8 | UXT5 | ZSE001 | |
| 1.8 i 16V LPG | 4 | ADL | 95/127 | 11/93→08/96 | Z30 [168] | | 0.8 | UXT5 | | |
| 1.9 D | 4 | 1Y | 47/63 | 04/93→08/96 | GN857 | | 11V | | | |
| 1.9 D | 4 | 1Y | 50/67 | 10/94→08/96 | GN857 | | 11V | | | |
| 1.9 SDI | 4 | AEY | 47/63 | 08/96→08/99 | GN855 | GR081 | 12V | | | |
| 1.9 TD | 4 | AAZ | 55/74 | 03/93→08/96 | GN857 | | 11V | | | |
| 1.9 TDI | 4 | 1Z, AHU | 66/89 | 08/96→08/99 | GN855 | GR081 | 12V | | | |
| 1.9 TDI | 4 | AFN | 81/109 | 02/97→08/99 | GN855 | GR081 | 12V | | | |
| 2.0 i | 4 | 2E | 85/114 | 03/93→08/99 | Z91 | | 0.8 | UXT2 / UXT6 | ZSE002 | ZM013 |
| 2.0 i | 4 | AGG | 85/114 | 03/93→08/99 | Z91 | | 0.8 | UXT2 / UXT6 | ZSE002 | |
| 2.0 i LPG | 4 | 2E, AGG | 85/114 | 03/93→08/99 | Z27 [168] | | 0.8 | UX56 | | |
| 2.0 i 16V | 4 | ABF | 110/148 | 08/96→08/99 | Z317 | | 0.85 | UXT12 | ZSE001 | |

IBIZA III

| | | | | | | | | | | |
|-------------|---|--------------------|-------|-------------|------------|--|-----|-------------|--------|--|
| 1.0 | 4 | ALD, ANV, AUC | 37/50 | 08/99→02/02 | Z176 | | 1.1 | | ZSE003 | |
| 1.0 16V | 4 | AST, AVZ | 51/68 | 10/99→02/02 | | | | | ZSE001 | |
| 1.4 | 4 | AKK, ANW, AUD | 44/59 | 08/99→02/02 | Z176 | | 1.1 | | ZSE003 | |
| 1.4 16V | 4 | APE, AUA | 55/74 | 05/00→02/02 | Z90 | | 1.0 | UXT1 / UXT3 | ZSE003 | |
| 1.4 16V | 4 | AQQ | 74/99 | 08/99→02/02 | Z90 | | 1.0 | UXT1 / UXT3 | | |
| 1.4 16V | 4 | AUB | 74/99 | 08/99→02/02 | Z90 | | 1.0 | UXT1 / UXT3 | ZSE003 | |
| 1.4 16V LPG | 4 | APE, AUA | 55/74 | 05/00→02/02 | Z340 | | 0.7 | UXT12 | | |
| 1.4 16V LPG | 4 | AQQ, AUB | 74/99 | 08/99→02/02 | Z340 [168] | | 0.7 | UXT12 | | |
| 1.6 | 4 | AEH, AKL, APF, AUR | 74/99 | 08/99→02/02 | Z90 | | 1.0 | UXT1 / UXT3 | ZSE003 | |
| 1.6 LPG | 4 | ALM | 55/74 | 08/99→02/02 | Z27 [168] | | 0.8 | UX56 | | |
| 1.6 LPG | 4 | AEH, AKL, APF, AUR | 74/99 | 08/99→02/02 | Z340 | | 0.7 | UXT12 | | |



kW/BHP

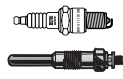

... SEAT



... IBIZA III

| | | | | | | | | | |
|---------------------|---|----------|---------|-------------|-------|-------|-----|-------------|--------|
| 1.8 T 20V Cupra | 4 | AQX | 115/154 | 07/00→02/02 | Z90 | | 1.0 | UXT1 / UXT3 | ZSE009 |
| 1.8 T 20V Cupra | 4 | AYP | 115/154 | 07/00→02/02 | Z90 | | 1.0 | UXT1 / UXT3 | ZSE043 |
| 1.8 T 20V Cupra LPG | 4 | AQX, AYP | 115/154 | 07/00→02/02 | Z340 | | 0.7 | UXT12 | |
| 1.9 SDI | 4 | AGP, AQM | 50/67 | 08/99→02/02 | GN855 | GR081 | 12V | | |
| 1.9 TDI | 4 | AGR, ALH | 66/89 | 08/99→02/02 | GN855 | GR081 | 12V | | |
| 1.9 TDI | 4 | ASK | 81/109 | 08/99→02/02 | | GR081 | | | |
| 1.9 TDI | 4 | ASV | 81/109 | 08/99→02/02 | GN855 | GR081 | 12V | | |

IBIZA IV

| | | | | | | | | | |
|-------------------|---|----------|---------|-------------|-----------------------|-------|-----|-------------|--------|
| 1.2 | 3 | BBM | 44/59 | 06/07→05/08 | Z200 | | 0.9 | | ZSE059 |
| 1.2 | 3 | AZQ, BME | 47/63 | 02/02→06/06 | Z200 | | 0.9 | | ZSE030 |
| 1.2 12V | 3 | BXV | 51/68 | 05/06→11/09 | Z200 | | 0.9 | | ZSE030 |
| 1.4 16V | 4 | BBY | 55/74 | 02/02→12/07 | Z176 ^[251] | | 1.1 | | ZSE030 |
| | | | | | Z90 ^[253] | | 1.0 | UXT1 / UXT3 | |
| 1.4 16V | 4 | BKY | 55/74 | 02/02→12/07 | Z176 ^[251] | | 1.1 | | ZSE030 |
| | | | | | Z272 ^[253] | | 1.0 | | |
| 1.4 16V | 4 | BXW | 63/84 | 05/06→11/09 | Z272 | | 1.0 | | ZSE030 |
| 1.4 16V | 4 | AUB | 74/99 | 02/02→11/09 | Z90 | | 1.0 | UXT1 / UXT3 | ZSE003 |
| 1.4 16V | 4 | BBZ | 74/99 | 02/02→11/09 | Z90 | | 1.0 | UXT1 / UXT3 | ZSE030 |
| 1.4 16V LPG | 4 | BBY | 55/74 | 02/02→12/07 | Z340 | | 0.7 | UXT12 | |
| 1.4 16V LPG | 4 | AUB, BBZ | 74/99 | 02/02→11/09 | Z340 | | 0.7 | UXT12 | |
| 1.4 TDI | 3 | BNM | 51/68 | 05/05→11/09 | GN046 | GR081 | 12V | | |
| 1.4 TDI | 3 | AMF | 55/74 | 05/02→12/05 | GN046 | GR081 | 12V | | |
| 1.4 TDI | 3 | BMS | 59/79 | 06/05→11/09 | CGP002 | | 7V | | |
| 1.4 TDI | 3 | BNV | 59/79 | 06/05→11/09 | GN046 | GR081 | 12V | | |
| 1.6 | 4 | BAH | 74/99 | 02/03→11/09 | Z344 | | 1.0 | | ZSE003 |
| 1.6 16V | 4 | BTS | 77/103 | 11/06→11/09 | Z272 | | 1.0 | | ZSE030 |
| 1.8 T Cupra R | 4 | BBU, BLZ | 132/177 | 01/04→02/08 | Z188 | | 0.7 | UXT10 | ZSE043 |
| 1.8 T Cupra R LPG | 4 | BBU, BLZ | 132/177 | 01/04→02/08 | Z340 | | 0.7 | UXT12 | |
| 1.8 T FR | 4 | BJX | 110/148 | 12/03→05/08 | Z188 | | 0.7 | UXT10 | ZSE043 |
| 1.8 T FR | 4 | BKV | 110/148 | 12/03→05/08 | Z188 | | 0.7 | UXT10 | |
| 1.8 T FR LPG | 4 | BJX, BKV | 110/148 | 12/03→05/08 | Z340 | | 0.7 | UXT12 | |
| 1.9 SDI | 4 | ASY | 47/63 | 02/02→12/05 | GN046 | GR081 | 12V | | |
| 1.9 TDI | 4 | ATD, AXR | 74/99 | 02/02→11/09 | GN046 | GR081 | 12V | | |
| 1.9 TDI | 4 | BMT | 74/99 | 02/02→11/09 | CGP002 | | 7V | | |
| | | | | 05/05→ | | | | | |
| 1.9 TDI | 4 | ASZ, BLT | 96/129 | 02/02→11/09 | GN046 | GR081 | 12V | | |
| 1.9 TDI Cupra R | 4 | BPX, BUK | 118/158 | 03/04→02/08 | GN046 | GR081 | 12V | | |
| 2.0 | 4 | AZL, BBX | 85/114 | 04/02→11/09 | Z90 | | 1.0 | UXT1 / UXT3 | ZSE003 |
| 2.0 LPG | 4 | AZL, BBX | 85/114 | 04/02→11/09 | Z340 | | 0.7 | UXT12 | |

IBIZA V

| | | | | | | | | | |
|---------------|---|------------------|---------|-------------|---------------------|--|------|--|--------|
| 1.2 | 3 | CGPB | 44/59 | 07/09→ | Z272 | | 1.0 | | ZSE030 |
| 1.2 | 3 | BZG, CGPA | 51/68 | 03/08→ | Z272 | | 1.0 | | ZSE030 |
| 1.2 | 3 | CJLB | 51/68 | 03/08→ | | | | | ZSE030 |
| 1.2 | 3 | CJLB | 51/68 | 05/10→ | Z272 | | 1.0 | | |
| 1.2 TDI | 3 | CFWA | 55/74 | 04/10→ | GE115 | | 4.4V | | |
| 1.2 TSI | 4 | CBZA | 63/84 | 08/12→ | | | | | ZSE003 |
| 1.2 TSI | 4 | CBZB | 77/103 | 09/10→ | | | | | ZSE003 |
| 1.4 | 4 | BXW, CGGB | 63/84 | 03/08→ | Z272 | | 1.0 | | ZSE030 |
| 1.4 TDI | 3 | BMS | 59/79 | 07/08→06/10 | CGP002 | | 7V | | |
| 1.4 TSI | 4 | CAVF | 110/148 | 06/09→ | Z349 ^[1] | | 0.9 | | ZSE030 |
| | | | | | →02/11 | | | | |
| 1.4 TSI | 4 | CNUB, CTHE, CTJB | 110/148 | 06/09→ | | | | | ZSE030 |
| 1.4 TSI Cupra | 4 | CAVE | 132/177 | 06/09→ | Z349 ^[1] | | 0.9 | | ZSE030 |
| | | | | | →02/11 | | | | |
| 1.4 TSI Cupra | 4 | CTHE, CTJC | 132/177 | 06/09→ | | | | | ZSE030 |
| 1.6 | 4 | BTS | 77/103 | 05/08→ | Z272 | | 1.0 | | ZSE030 |
| 1.6 LPG | 4 | CNKA | 60/80 | 05/11→ | Z272 | | 1.0 | | ZSE030 |
| 1.6 TDI | 4 | CAYA | 55/74 | 05/10→06/10 | GE115 | | 4.4V | | |
| 1.6 TDI | 4 | CAYB | 66/89 | 05/09→ | GE115 | | 4.4V | | |



kW/BHP



... SEAT



... IBIZA V

| | | | | | | | | |
|---------|---|------------|---------|-------------|--------|------|-------------|--------|
| 1.6 TDI | 4 | CAYC, CLNA | 77/103 | 05/09→ | GE115 | 4.4V | | |
| 1.9 TDI | 4 | BXJ | 66/89 | 07/08→06/10 | CGP002 | 7V | | |
| 1.9 TDI | 4 | BLS | 77/103 | 03/08→06/10 | CGP002 | 7V | | |
| 2.0 | 4 | CEKA | 85/114 | 10/08→ | Z90 | 1.0 | UXT1 / UXT3 | ZSE003 |
| 2.0 TDI | 4 | CFHD | 105/141 | 01/10→ | GE115 | 4.4V | | |

LEON

| | | | | | | | | |
|-------------------|---|---------------------------|---------|-------------|-----------------|--------------|-------------|---|
| 1.2 TSI | 4 | CJZB | 63/84 | 12/12→ | | | | ZSE126 ^[1] →09/13 ZSE067 ^{[1],[42]} |
| 1.2 TSI | 4 | CJZB | 63/84 | 11/13→ | | | | ZSE067 ^[1] |
| 1.2 TSI | 4 | CBZB | 77/103 | 02/10→ | | | | ZSE003 |
| 1.2 TSI | 4 | CJZA | 77/103 | 01/13→ | | | | ZSE126 ^[1] →09/13 ZSE067 ^{[1],[42]} |
| 1.4 16V | 4 | AHW, APE, AXP | 55/74 | 11/99→06/06 | Z90 | 1.0 | UXT1 / UXT3 | ZSE003 |
| 1.4 16V | 4 | BCA | 55/74 | 11/99→06/06 | Z200 | 0.9 | | ZSE030 |
| 1.4 16V | 4 | BXW, CGGB | 63/84 | 06/06→ | Z272 | 1.0 | | ZSE030 |
| 1.4 16V LPG | 4 | AHW, APE, AXP | 55/74 | 11/99→06/06 | Z340 | 0.7 | UXT12 | |
| 1.4 TSI | 4 | CMBA, CXSA | 90/121 | 11/12→ | | | | ZSE126 ^[1] →09/13 ZSE067 ^{[1],[42]} |
| 1.4 TSI | 4 | CMBA, CXSA | 90/121 | 10/13→ | | | | ZSE067 ^[1] |
| 1.4 TSI | 4 | CAXC | 92/123 | 11/07→ | Z349 | 0.9 | | ZSE030 |
| 1.4 TSI | 4 | CHPA, CPTA | 103/138 | 09/12→ | | | | ZSE126 ^[1] →09/13 ZSE067 ^{[1],[42]} |
| 1.4 TSI | 4 | CHPA, CPTA | 103/138 | 10/13→ | | | | ZSE067 ^[1] |
| 1.6 | 4 | AEH, AKL | 74/99 | 11/99→06/06 | Z90 | 1.0 | UXT1 / UXT3 | ZSE003 |
| 1.6 | 4 | BFQ, BSE, BSF, CCSA, CMXA | 75/101 | 07/05→ | Z90 | 1.0 | UXT1 / UXT3 | ZSE003 |
| 1.6 LPG | 4 | AEH, AKL | 74/99 | 11/99→06/06 | Z340 | 0.7 | UXT12 | |
| 1.6 LPG | 4 | BFQ, BSE, BSF, CCSA, CMXA | 75/101 | 07/05→ | Z340 | 0.7 | UXT12 | |
| 1.6 16 V | 4 | AUS | 77/103 | 09/00→06/06 | Z90 | 1.0 | UXT1 / UXT3 | ZSE003 |
| 1.6 16 V | 4 | AZD, BCB | 77/103 | 09/00→06/06 | Z176 | 1.1 | | ZSE030 |
| 1.6 16 V LPG | 4 | AUS | 77/103 | 09/00→06/06 | Z340 | 0.7 | UXT12 | |
| 1.6 LPG | 4 | CHGA | 75/101 | 12/09→ | | | | ZSE003 |
| 1.6 MultiFuel | 4 | CMXA | 75/101 | 11/10→ | Z90 | 1.0 | UXT1 / UXT3 | ZSE003 |
| 1.6 TDI | 4 | CAYB | 66/89 | 11/10→ | GE115 | 4.4V | | |
| 1.6 TDI | 4 | CLHB | 66/89 | 11/12→ | GE115 PSG002 | 4.4V 4.4V | | |
| 1.6 TDI | 4 | CAYC | 77/103 | 02/10→ | GE115 | 4.4V | | |
| 1.6 TDI | 4 | CLHA | 77/103 | 11/12→ | GE115 PSG002 | 4.4V 4.4V | | |
| 1.6 TDI | 4 | CRKB | 81/109 | 09/13→ | GE115 PSG002 | 4.4V 4.4V | | |
| 1.8 20V | 4 | AGN, APG | 92/123 | 11/99→06/06 | Z90 | 1.0 | UXT1 / UXT3 | ZSE003 |
| 1.8 20V LPG | 4 | AGN, APG | 92/123 | 11/99→06/06 | Z340 | 0.7 | UXT12 | |
| 1.8 20V T | 4 | APP | 132/177 | 11/99→06/06 | Z188 | 0.7 | UXT10 | ZSE009 ZM062 |
| 1.8 20V T | 4 | AUQ | 132/177 | 11/99→06/06 | Z188 | 0.7 | UXT10 | ZSE043 |
| 1.8 20V T 4WD | 4 | AJQ | 132/177 | 11/99→06/06 | Z188 | 0.7 | UXT10 | ZS016 ZLE276 |
| 1.8 20V T 4WD | 4 | ARY | 132/177 | 11/99→06/06 | Z188 | 0.7 | UXT10 | |
| 1.8 20V T LPG | 4 | AJQ, APP, ARY, AUQ | 132/177 | 11/99→06/06 | Z340 | 0.7 | UXT12 | |
| 1.8 T Cupra R | 4 | AMK | 154/207 | 02/02→06/06 | Z90 | 1.0 | UXT1 / UXT3 | ZSE043 |
| 1.8 T Cupra R | 4 | BAM | 165/221 | 07/03→06/06 | Z188 | 0.7 | UXT10 | ZSE043 |
| 1.8 T Cupra R LPG | 4 | AMK | 154/207 | 02/02→06/06 | Z340 | 0.7 | UXT12 | |
| 1.8 T Cupra R LPG | 4 | BAM | 165/221 | 07/03→06/06 | Z340 | 0.7 | UXT12 | |
| 1.8 TSI | 4 | BZB, CDA | 118/158 | 06/07→ | Z347 | 0.7 | UXT12 | ZSE033 ^[47] ZSE142 ^[48] |
| 1.8 TSI | 4 | CJSA | 132/177 | 02/13→ | Z348 | 0.8 | | ZSE068 |
| 1.9 SDI | 4 | AQM | 50/67 | 11/99→06/06 | GN855 | GR081 | 12V | |



kW/BHP

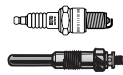

... SEAT



... LEON

| | | | | | | | | | |
|---------------|---|------------------------|---------|-------------|-------------------|-------------------|--------------|-------|--|
| 1.9 TDI | 4 | AGR, ALH | 66/89 | 11/99→06/06 | GN855 | GR081 | 12V | | |
| 1.9 TDI | 4 | BXF | 66/89 | 06/07→ | GE100 | | 5V | | |
| 1.9 TDI | 4 | AXR | 74/99 | 10/05→06/06 | GE100 | GR081 | 5V | | |
| 1.9 TDI | 4 | BKC, BXE | 77/103 | 07/05→ | GE100 | GSE100 | 5V | | |
| 1.9 TDI | 4 | BLS | 77/103 | 07/05→ | CGP002 | GSE100 | 7V | | |
| 1.9 TDI | 4 | AHF, ASV | 81/109 | 11/99→ | GN855 | GR081 | 12V | | |
| 1.9 TDI | 4 | ASZ | 96/129 | 05/03→06/06 | GN046 | GR081 | 12V | | |
| 1.9 TDI | 4 | ARL | 110/148 | 02/01→06/06 | GN855 | GR081 | 12V | | |
| | | | | | →ch. 1M-2-062 000 | →ch. 1M-3-148 000 | | | |
| | | | | | GN046 | | 12V | | |
| | | | | | ch. 1M-2-062 001→ | | | | |
| 2.0 Cupra R | 4 | CDLA | 195/261 | 09/09→ | Z347 | | 0.7 | UXT12 | ZSE033 |
| 2.0 FSI | 4 | BLR, BLY, BVY, BVZ | 110/148 | 07/05→05/10 | Z236 | | 1.0 | | ZSE033 ⁽⁴⁷⁾ ZSE142 ⁽⁴⁸⁾ |
| 2.0 TDI | 4 | CRVA | 81/109 | 02/13→ | GE115 PSG002 | | 4.4V 4.4V | | |
| 2.0 TDI | 4 | AZV | 100/134 | 07/05→05/10 | GE101 | GSE100 | 4.4V | | |
| 2.0 TDI | 4 | BMM | 103/138 | 10/05→ | GE100 | | 5V | | |
| 2.0 TDI | 4 | CRVC | 105/141 | 05/13→ | GE115 PSG002 | | 4.4V 4.4V | | |
| 2.0 TDI | 4 | CKFC, CRBC, CRLB, CRMB | 110/148 | 10/12→ | GE115 PSG002 | | 4.4V 4.4V | | |
| 2.0 TDI | 4 | BMN | 125/168 | 05/06→ | CGP003 | | 7V | | |
| 2.0 TDI | 4 | CEGA, CFJA | 125/168 | 05/06→ | GE115 | | 4.4V | | |
| 2.0 TDI | 4 | CUNA, CUPA | 135/181 | 09/12→ | GE115 PSG002 | | 4.4V 4.4V | | |
| 2.0 TDI 16V | 4 | BKD | 103/138 | 07/05→ | GE101 | GSE100 | 4.4V | | |
| 2.0 TDI 16V | 4 | CFHC, CLCB | 103/138 | 07/05→ | GE115 | | 4.4V | | |
| 2.0 TFSI | 4 | BWAT | 136/182 | 09/05→05/06 | Z347 | | 0.7 | UXT12 | ZSE033 ⁽⁴⁷⁾ ZSE142 ⁽⁴⁸⁾ |
| 2.0 TFSI | 4 | BWA | 147/197 | 05/05→03/09 | Z347 | | 0.7 | UXT12 | ZSE033 ⁽⁴⁷⁾ ZSE142 ⁽⁴⁸⁾ |
| 2.0 TFSI | 4 | CCZB | 155/208 | 06/09→ | Z347 | | 0.7 | UXT12 | ZSE033 ⁽⁴⁷⁾ ZSE142 ⁽⁴⁸⁾ |
| 2.0 TFSI | 4 | BWJ | 177/237 | 11/06→ | Z347 | | 0.7 | UXT12 | ZSE033 ⁽⁴⁷⁾ ZSE142 ⁽⁴⁸⁾ |
| 2.0 TFSI | 4 | CDLD | 177/237 | 11/06→ | | | | | ZSE033 ⁽⁴⁷⁾ ZSE142 ⁽⁴⁸⁾ |
| 2.8 | 6 | BDE | 150/201 | 05/02→06/04 | Z176 | | 1.1 | | ZSE041 ⁽¹⁷³⁾ ZSE044 ⁽¹⁹⁹⁾ |
| 2.8 Cupra 4WD | 6 | AUE | 150/201 | 02/01→06/06 | Z176 | | 1.1 | | ZSE013 |

MALAGA

| | | | | | | | | | | |
|-------|---|------------------------------------|-------|-------------|---------------------------|--------|-----|--------|----------------------|--------|
| 1.2 | 4 | 021 A 1000 | 44/59 | 05/85→12/93 | Z29 | | 0.8 | UXT5 | ZS120 ^[1] | ZM002 |
| 1.2 | 4 | 021 A 1000 | 47/63 | 11/84→12/93 | | | | | ZS120 ^[1] | |
| 1.2 i | 4 | 021 C.1000 | 52/70 | 12/89→12/93 | Z29 | | 0.8 | UXT5 | ZS120 | ZM015 |
| | | | | | | | | | →03/91 | →03/91 |
| 1.5 | 4 | 021 A 2000 | 63/84 | 05/85→12/93 | Z29 | | 0.8 | UXT5 | ZS120 ^[1] | ZM002 |
| 1.5 i | 4 | 021 A 2000, 021 C.2000, 021 D.2000 | 66/89 | 10/86→12/93 | Z29 | | 0.8 | UXT5 | ZS120 | ZM015 |
| | | | | | | | | | →03/91 | →03/91 |
| 1.5 i | 4 | 021 B.2000 | 74/99 | 01/87→12/93 | Z29 | | 0.8 | UXT5 | ZS120 | ZM015 |
| | | | | | 11/89→ | | | 11/89→ | →03/91 | →03/91 |
| 1.7 D | 4 | 022 A.5000 | 40/54 | 05/85→12/93 | GV602 | GR065 | 11V | | | |
| | | | | | →08/87 | →08/87 | | | | |
| | | | | | GN909 ^{[2][222]} | | 11V | | | |
| | | | | | GV663 | | 11V | | | |
| | | | | | 09/87→ | | | | | |
| 1.7 D | 4 | 022 A.5000 | 42/56 | 05/90→12/93 | GN909 ^{[2][222]} | | 11V | | | |
| | | | | | GV663 | | 11V | | | |



kW/BHP



... SEAT



MARBELLA

| | | | | | | | | | |
|-----|---|---------------------|-------|-------------|-----------|--|-----|-------------|--------------------------------|
| 0.8 | 4 | 08 NCA | 25/34 | 08/86→12/93 | Z20 [168] | | 0.8 | UXT2 / UXT6 | ZS106 [1][2][10][193] [254] |
| 0.9 | 4 | 09 NCA, 100 GL 7000 | 29/39 | 01/87→12/93 | Z20 | | 0.8 | UXT2 / UXT6 | ZS106 [1][2][10][193] [254] |
| 0.9 | 4 | 09 NCB, 100 GL 7000 | 29/39 | 01/90→11/96 | Z82 | | 0.7 | UXT2 / UXT6 | ZS106 [1][193][254] →12/90 |
| 0.9 | 4 | 08 NCB | 30/40 | 11/96→10/98 | Z82 | | 0.7 | UXT2 / UXT6 | ZS327 |
| 0.9 | 4 | 08 NCB | 32/43 | 07/97→10/98 | Z82 | | 0.7 | UXT2 / UXT6 | ZS315 [1] |

Mii

| | | | | | | | | | |
|-------------|---|------|-------|--------|--|--|--|--|--|
| 1.0 | 3 | CHYA | 44/59 | 10/11→ | | | | | ZSE126 [1] →01/12 ZSE067 [1][42] |
| 1.0 | 3 | CHYB | 55/74 | 10/11→ | | | | | ZSE126 [1] →01/12 ZSE067 [1][42] |
| 1.0 EcoFuel | 3 | CPGA | 50/67 | 11/12→ | | | | | ZSE067 [1][42] ZSE126 [1][43] |

PANDA

| | | | | | | | | | |
|-----|---|-------------|-------|-------------|-----|--|-----|-------------|--|
| 0.9 | 4 | 100 GL 3000 | 31/42 | 10/80→12/86 | Z11 | | 0.8 | UXT2 / UXT6 | |
|-----|---|-------------|-------|-------------|-----|--|-----|-------------|--|

RITMO

| | | | | | | | | | |
|-------|---|------------|-------|-------------|-------|--|-----|-------------|--|
| 1.4 | 4 | | 57/76 | 07/78→09/83 | Z11 | | 0.8 | UXT2 / UXT6 | |
| 1.7 D | 4 | 022 A.5000 | 41/55 | 10/79→09/83 | GV602 | | 11V | | |

RONDA

| | | | | | | | | | |
|------------|---|------------------------|-------|-----------------------|-------------------------|-------|------------|-----------------------|------------------------------|
| 1.2 | 4 | 021 A 1000 | 44/59 | 10/84→12/86 | Z29 | | 0.8 | UXT5 | ZS120 [1] |
| 1.2 | 4 | 021 A 1000, 124 B6.000 | 47/63 | 08/83→05/85 →12/83 | Z11 | | 0.8 | UXT2 / UXT6 →12/83 | ZS120 [1] ZM002 05/84→ |
| 1.4 | 4 | 124 B7.000 | 54/72 | 06/82→11/88 | Z11 | | 0.8 | UXT2 / UXT6 | |
| 1.5 | 4 | 021 A 2000 | 63/84 | 09/84→12/86 | Z29 | | 0.8 | UXT5 | ZM002 |
| 1.6 | 4 | 022 A 000, 138 AR6.000 | 68/91 | 08/83→09/85 | Z22 | | 0.7 | UX56 | ZS120 [1] |
| 1.7 Diesel | 4 | 022 A.5000 | 40/54 | 06/82→12/86 | GN909 [2][222] GV602 | GR065 | 11V 11V | | |
| 1.7 Diesel | 4 | 022 A.5000 | 41/55 | 06/82→12/86 | GN909 [2][222] GV602 | GR065 | 11V 11V | | |

TERRA

| | | | | | | | | | |
|---------|---|--------|-------|-------------|-----------|--|-----|-------------|--|
| 0.9 | 4 | 09 NCA | 29/39 | 02/87→12/96 | Z20 | | 0.8 | UXT2 / UXT6 | ZS106 [1][11][254] ZS315 [1] ZS327 [1] |
| 0.9 | 4 | 09 NCB | 29/39 | 02/92→12/94 | Z20 | | 0.8 | UXT2 / UXT6 | ZS327 |
| 0.9 LPG | 4 | 09 NCA | 29/39 | 02/87→12/96 | Z27 [168] | | 0.8 | UX56 | |
| 1.3 D | 4 | MN | 33/44 | 03/90→12/94 | GN857 | | 11V | | |
| 1.4 D | 4 | 1 W | 35/47 | 10/90→12/95 | GN857 | | 11V | | |

TOLEDO I

| | | | | | | | | | |
|-----------|---|---------|-------|-------------|-------------------------------|--|------------|----------------------------|--------------------------------------|
| 1.6 i | 4 | 1F | 52/70 | 05/91→12/93 | Z2 →09/91 Z92 10/91→ | | 1.0 0.8 | UXT2 / UXT6 UXT2 / UXT6 | ZSE001 ZM012 |
| 1.6 i | 4 | 1F | 54/72 | 05/91→03/99 | Z92 | | 0.8 | UXT2 / UXT6 | ZSE001 ZM012 ch. 1L-ZR001001-→ |
| 1.6 i | 4 | ABN, EZ | 54/72 | 05/91→03/99 | Z2 | | 1.0 | UXT2 / UXT6 | ZSE001 ZM012 ch. 1L-ZR001001-→ |
| 1.6 i | 4 | 1F | 55/74 | 01/93→03/99 | Z2 →07/94 Z92 08/94→ | | 1.0 0.8 | UXT2 / UXT6 UXT2 / UXT6 | ZSE001 ZM012 |
| 1.6 i | 4 | AFT | 74/99 | 11/96→03/99 | Z90 | | 1.0 | UXT1 / UXT3 | ZSE001 |
| 1.6 i LPG | 4 | 1F | 54/72 | 05/91→03/99 | Z20 [168] | | 0.8 | UXT2 / UXT6 | |
| 1.6 i LPG | 4 | ABN, EZ | 54/72 | 05/91→03/99 | Z11 [168] | | 0.8 | UXT2 / UXT6 | |
| 1.6 i LPG | 4 | 1F | 55/74 | 01/93→03/99 | Z11 [168] | | 0.8 | UXT2 / UXT6 | |

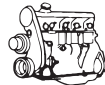

kW/BHP

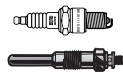

... SEAT



... TOLEDO I

| | | | | | | | | | | |
|-------------|---|----------|---------|-------------|-----------|-------|------|-------------|--------------------|-------------------|
| 1.6 i LPG | 4 | AFT | 74/99 | 11/96→03/99 | Z340 | | 0.7 | UXT12 | | |
| 1.8 16V | 4 | PL | 92/123 | 05/91→03/99 | Z89 | | 0.8 | UXT5 | ZS124 | ZM012 |
| | | | | | | | | | →03/94 | |
| 1.8 16V | 4 | KR | 98/131 | 05/91→03/99 | Z52 | | 0.8 | UXT5 | ZS124 | |
| | | | | | | | | | →11/92 | |
| 1.8 16V LPG | 4 | PL | 92/123 | 05/91→03/99 | Z30 [168] | | 0.8 | UXT5 | | |
| 1.8 16V LPG | 4 | KR | 98/131 | 05/91→03/99 | Z29 [168] | | 0.8 | UXT5 | | |
| 1.8 i | 4 | RP | 65/87 | 05/91→12/96 | Z12 | | 0.8 | UXT2 / UXT6 | ZS124 | ZM012 |
| | | | | | →11/93 | | | →11/93 | →11/93 | |
| | | | | | Z91 | | 0.8 | UXT2 / UXT6 | | |
| | | | | | 12/93→ | | | 12/93→ | | |
| 1.8 i | 4 | ABS, ADZ | 66/89 | 11/93→12/96 | Z91 | | 0.8 | UXT2 / UXT6 | ZSE001 | ZM013 |
| | | | | | | | | | ch. 1L-ZR001001→ | ch. 1L-ZR001001→ |
| 1.8 i | 4 | ACC | 66/89 | 11/93→12/96 | | | | | ZSE001 | ZM013 |
| | | | | | | | | | ch. 1L-ZR001001→ | ch. 1L-ZR001001→ |
| 1.8 i LPG | 4 | RP | 65/87 | 05/91→12/96 | Z27 [168] | | 0.8 | UX56 | | |
| | | | | | 12/93→ | | | 12/93→ | | |
| 1.8 i LPG | 4 | ABS, ADZ | 66/89 | 11/93→12/96 | Z27 [168] | | 0.8 | UX56 | | |
| 1.9 D | 4 | 1Y | 47/63 | 12/95→03/99 | GN857 | | 11V | | | |
| 1.9 D | 4 | 1Y | 50/67 | 05/91→03/99 | GN857 | | 11V | | | |
| 1.9 TD | 4 | AAZ | 55/74 | 05/91→03/99 | GN857 | | 11V | | | |
| 1.9 TDI | 4 | 1Z, AHU | 66/89 | 08/95→03/99 | GN855 | GR081 | 12V | | | |
| 1.9 TDI | 4 | AFN | 81/109 | 11/96→03/99 | GN855 | GR081 | 12V | | | |
| 2.0 i | 4 | 2E, AGG | 85/114 | 05/91→03/99 | Z91 | | 0.8 | UXT2 / UXT6 | ZSE002 | |
| | | | | | | | | | →ch. -1L-ZR001000 | |
| | | | | | | | | | ZSE001 | |
| | | | | | | | | | 01/93→ | |
| | | | | | | | | | ch. 1L-ZR001001→ | |
| 2.0 i LPG | 4 | 2E, AGG | 85/114 | 05/91→03/99 | Z27 [168] | | 0.8 | UX56 | | |
| 2.0 i 16V | 4 | ABF | 110/148 | 11/93→03/99 | Z317 | | 0.85 | UXT12 | ZSE002 | ZM013 |
| | | | | | | | | | →ch. -1L-ZR001000 | →ch. -1L-ZR001000 |
| | | | | | | | | | ZSE001 | |
| | | | | | | | | | ch. 1L-ZR0010001 → | |

TOLEDO II

| | | | | | | | | | | |
|--------------|---|----------|---------|-------------|-------------------|-------------------|-----|-------------|--------|--|
| 1.4 16V | 4 | AHW | 55/74 | 07/99→05/06 | Z90 | | 1.0 | UXT1 / UXT3 | ZSE003 | |
| 1.4 16V | 4 | AXP | 55/74 | 07/99→05/06 | Z90 | | 1.0 | UXT1 / UXT3 | | |
| 1.4 16V LPG | 4 | AHW, AXP | 55/74 | 07/99→05/06 | Z340 | | 0.7 | UXT12 | | |
| 1.6 | 4 | AEH, AKL | 74/99 | 04/99→09/00 | Z90 | | 1.0 | UXT1 / UXT3 | ZSE003 | |
| 1.6 | 4 | BFQ | 75/101 | 08/05→05/06 | | | | | ZSE003 | |
| 1.6 LPG | 4 | AEH, AKL | 74/99 | 04/99→09/00 | Z340 | | 0.7 | UXT12 | | |
| 1.6 16V | 4 | AUS | 77/103 | 09/00→05/06 | Z90 | | 1.0 | UXT1 / UXT3 | ZSE003 | |
| 1.6 16V | 4 | AZD, BCB | 77/103 | 09/00→05/06 | Z176 | | 1.1 | | ZSE030 | |
| 1.6 16V LPG | 4 | AUS | 77/103 | 09/00→05/06 | Z340 | | 0.7 | UXT12 | | |
| 1.8 20V | 4 | AGN, APG | 92/123 | 04/99→05/06 | Z90 | | 1.0 | UXT1 / UXT3 | ZSE003 | |
| 1.8 20V LPG | 4 | AGN, APG | 92/123 | 04/99→05/06 | Z340 | | 0.7 | UXT12 | | |
| 1.8 20VT | 4 | APP | 132/177 | 05/01→05/06 | | | | | ZSE009 | |
| 1.8 20VT | 4 | AUQ | 132/177 | 05/01→05/06 | Z188 | | 0.7 | UXT10 | ZSE043 | |
| | | | | | →05/02 | | | →05/02 | | |
| 1.8 20VT LPG | 4 | AUQ | 132/177 | 05/01→05/06 | Z340 | | 0.7 | UXT12 | | |
| | | | | | →05/02 | | | →05/02 | | |
| 1.9 SDI | 4 | AQM | 50/67 | 11/99→06/04 | GN855 | GR081 | 12V | | | |
| 1.9 TDI | 4 | AGR, ALH | 66/89 | 04/99→05/06 | GN855 | GR081 | 12V | | | |
| 1.9 TDI | 4 | AHF, ASV | 81/109 | 04/99→05/06 | GN855 | GR081 | 12V | | | |
| 1.9 TDI | 4 | ASZ | 96/129 | 05/03→05/06 | GN046 | GR081 | 12V | | | |
| 1.9 TDI | 4 | ARL | 110/148 | 10/00→05/06 | GN855 | GR081 | 12V | | | |
| | | | | | →ch. 1M-2-062 000 | →ch. 1M-3-148 000 | | | | |
| | | | | | GN046 | | 12V | | | |
| | | | | | ch. 1M-2-062 001→ | | | | | |

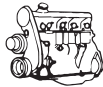

kw/BHP

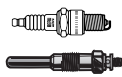

... SEAT



... TOLEDO II

| | | | | | | | | |
|------------|---|-----|---------|-------------|------|--|-----|-----------------|
| 2.3 V5 | 5 | AGZ | 110/148 | 04/99→05/01 | Z173 | | 1.6 | ZS037 →11/00 |
| 2.3 V5 LPG | 5 | AGZ | 110/148 | 04/99→05/01 | Z172 | | 1.6 | |
| 2.3 V5 20V | 5 | AQN | 125/168 | 05/01→05/06 | Z176 | | 1.1 | ZSE063 |

TOLEDO III

| | | | | | | | | |
|-------------|---|---------------|---------|-------------|-----------------------|--------|------|--|
| 1.4 16V | 4 | BXW | 63/84 | 05/06→05/09 | | | | ZSE030 |
| 1.6 | 4 | BGU, BSE, BSF | 75/101 | 10/04→05/09 | Z90 | | 1.0 | UXT1 / UXT3 ZSE003 |
| 1.6 | 4 | CCSA | 75/101 | 10/04→05/09 | | | | ZSE003 |
| 1.6 LPG | 4 | BGU, BSE, BSF | 75/101 | 10/04→05/09 | Z340 | | 0.7 | UXT12 |
| 1.8 TFSI | 4 | BYT, BZB, CDA | 118/158 | 01/07→05/09 | Z347 | | 0.7 | UXT12 ZSE033 |
| 1.9 TDI | 4 | BJB, BKC, BXE | 77/103 | 10/04→05/09 | GE100 | GSE100 | 5V | |
| 1.9 TDI | 4 | BLS | 77/103 | 10/04→05/09 | CGP002 | GSE100 | 7V | |
| 2.0 FSI | 4 | BLR, BVY | 110/148 | 10/04→05/09 | Z236 | | 1.0 | ZSE033 ^[47] ZSE142 ^[48] |
| 2.0 FSI | 4 | BLY, BVZ | 110/148 | 10/04→05/09 | Z228 | | 1.0 | UXT11 ZSE033 ^[47] ZSE142 ^[48] |
| 2.0 FSI LPG | 4 | BLY, BVZ | 110/148 | 10/04→05/09 | Z221 ^[168] | | 1.0 | UXT14 |
| 2.0 TDI | 4 | AZV | 100/134 | 09/04→05/09 | GE101 | | 4.4V | |
| 2.0 TDI | 4 | BMM | 103/138 | 11/05→05/09 | CGP002 | | 7V | |
| 2.0 TDI | 4 | BMN | 125/168 | 01/06→05/09 | CGP003 | | 7V | |
| 2.0 TDI | 4 | CEGA | 125/168 | 01/06→05/09 | GE115 | | 4.4V | |
| 2.0 TDI 16V | 4 | BKD | 103/138 | 04/04→05/09 | GE101 | GSE100 | 4.4V | |
| 2.0 TFSI | 4 | BWA | 147/197 | 11/05→05/09 | Z347 | | 0.7 | UXT12 ZSE033 ^[47] ZSE142 ^[48] |

TOLEDO IV

| | | | | | | | | |
|---------|---|------------|--------|--------|-------|--|------|--------|
| 1.2 | 3 | CGPC | 55/74 | 07/12→ | Z272 | | 1.0 | ZSE030 |
| 1.2 TSI | 4 | CBZA | 63/84 | 07/12→ | | | | ZSE003 |
| 1.2 TSI | 4 | CBZB | 77/103 | 07/12→ | | | | ZSE003 |
| 1.4 TSI | 4 | CAXA | 90/121 | 07/12→ | Z349 | | 0.9 | ZSE030 |
| 1.6 | 4 | CFNA | 77/103 | 07/13→ | Z272 | | 1.0 | ZSE030 |
| 1.6 TDI | 4 | CAYB | 66/89 | 06/13→ | GE115 | | 4.4V | |
| 1.6 TDI | 4 | CAYC, CLNA | 77/103 | 07/12→ | GE115 | | 4.4V | |

SEAT



INCA

| | | | | | | | | |
|-------------|---|---------------|-------|-------------|----------------------|----------------------------|-----|--------------------|
| 1.4 16V | 4 | AUA | 55/74 | 04/00→06/03 | Z90 | | 1.0 | UXT1 / UXT3 ZSE003 |
| 1.4 16V LPG | 4 | AUA | 55/74 | 04/00→06/03 | Z340 | | 0.7 | UXT12 |
| 1.4 i | 4 | AEX, AKV, APQ | 44/59 | 11/95→06/03 | Z91 | | 0.8 | UXT2 / UXT6 ZSE001 |
| 1.4 i | 4 | AUD | 44/59 | 11/95→06/03 | Z176 | | 1.1 | ZSE003 |
| 1.4 i LPG | 4 | AEX, AKV, APQ | 44/59 | 11/95→06/03 | Z27 ^[168] | | 0.8 | UX56 |
| 1.6 i | 4 | 1F | 55/74 | 11/95→05/98 | Z93 | | 1.0 | UXT2 / UXT6 ZSE001 |
| 1.6 i | 4 | AEE | 55/74 | 06/97→09/00 | Z91 | | 0.8 | UXT2 / UXT6 ZSE001 |
| 1.6 i | 4 | ALM | 55/74 | 06/97→09/00 | | | | ZSE001 |
| 1.6 i LPG | 4 | 1F | 55/74 | 11/95→05/98 | Z20 ^[168] | | 0.8 | UXT2 / UXT6 |
| 1.7 D | 4 | AHB | 42/56 | 09/96→06/03 | GN857 | GR081 →ch. 9K-3-001 600 | 11V | |
| 1.9 D | 4 | 1Y | 47/63 | 11/95→06/03 | GN857 | | 11V | |
| 1.9 SDI | 4 | AEY, AYQ | 47/63 | 11/95→06/03 | GN855 | GR081 →ch. 9K-3-001 600 | 12V | |
| 1.9 TDI | 4 | ALH | 66/89 | 09/96→06/03 | GN855 | | 12V | |

MARBELLA

| | | | | | | | | |
|-----|---|--------|-------|-------------|----------------------|--|-----|-----------------------------------|
| 0.8 | 4 | 08 NCA | 25/34 | 01/87→12/93 | Z20 ^[168] | | 0.8 | UXT2 / UXT6 ZS106 ^[11] |
| 0.9 | 4 | 09 NCA | 29/39 | 01/87→12/93 | Z20 ^[168] | | 0.8 | UXT2 / UXT6 ZS106 ^[11] |
| 0.9 | 4 | 09 NCB | 29/39 | 01/87→12/93 | Z82 | | 0.7 | UXT2 / UXT6 ZS106 ^[11] |

SEAT



kW/BHP

**... SEAT****TERRA**

| | | | | | | | | |
|---------|---|----------------|-------|-------------|-----------|-----|-------------|--|
| 0.9 | 4 | 09 NCA, 09 NCB | 29/39 | 01/87→12/95 | Z20 | 0.8 | UXT2 / UXT6 | ZS106 [1][11][254] ZS315 [1] ZS327 [1] |
| 0.9 LPG | 4 | 09 NCA, 09 NCB | 29/39 | 01/87→12/95 | Z27 [168] | 0.8 | UX56 | |
| 1.3 D | 4 | MN | 33/44 | 03/90→02/92 | GN857 | 11V | | |
| 1.4 D | 4 | 1 W | 35/47 | 10/90→02/92 | GN857 | 11V | | |

SKODA**100**

| | | | | | | | | |
|-----|---|-----|-------|-------------|-----|-----|--|------------|
| 1.0 | 4 | OHV | 29/39 | 01/70→12/77 | Z57 | 0.6 | | ZS106 [11] |
| 1.0 | 4 | OHV | 31/42 | 01/70→12/77 | Z57 | 0.6 | | ZS106 [11] |

105,120

| | | | | | | | | |
|----------------|---|----------|-------|-------------|-----------|-----|--|---|
| 1.0 105 S,L | 4 | 10, 742 | 32/43 | 02/88→12/90 | Z10 [167] | 0.8 | | ZS106 [11] |
| 1.0 105 S,L | 4 | 10, 742 | 34/46 | 08/76→12/90 | Z10 [167] | 0.8 | | ZS106 [11] |
| 1.0 105 S,L,GL | 4 | 10, 742 | 33/44 | 08/76→08/83 | Z10 [167] | 0.8 | | ZS106 [11] |
| 1.0 105 S,L,LS | 4 | 10, 742 | 33/44 | 10/83→12/90 | Z10 [167] | 0.8 | | ZS106 [11] |
| 1.2 120 GLS | 4 | 742.12 X | 43/58 | 02/83→12/90 | Z48 | 0.8 | | ZS109 [1][15] |
| 1.2 120 L | 4 | 12, 742 | 35/47 | 08/87→12/90 | Z10 [167] | 0.8 | | ZS109 [15] |
| 1.2 120 L | 4 | | 38/51 | 08/76→12/90 | Z10 [167] | 0.8 | | ZS106 [1][11] →08/79 ZS109 [1][15] 09/79→ |
| 1.2 120 L | 4 | 12, 742 | 38/51 | 10/83→12/90 | Z10 [167] | 0.8 | | ZS106 [11] →12/88 |
| 1.2 120 LS | 4 | 742.12 X | 43/58 | 08/76→12/90 | Z48 | 0.8 | | ZS106 [1][11] →08/83 ZS109 [1][15] 09/83→12/88 |

110

| | | | | | | | | |
|--------|---|-----|-------|-------------|---------------|-----|--|------------|
| 1.1 L | 4 | | 33/44 | 12/69→03/82 | Z57 →12/79 | 0.6 | | ZS106 [11] |
| 1.1 L | 4 | | 35/47 | 12/69→03/82 | Z57 | 0.6 | | ZS106 [11] |
| 1.1 LS | 4 | OHV | 38/51 | 07/70→03/82 | | 0.6 | | ZS106 [11] |
| 1.1 R | 4 | OHV | 38/51 | 07/70→03/82 | Z57 →12/81 | 0.6 | | ZS106 [11] |

130

| | | | | | | | | |
|----------|---|---------|-------|-------------|---------------|-----|--|--|
| 1.3 G,GL | 4 | | 46/62 | 05/88→10/91 | Z48 [167] | 0.8 | | |
| 1.3 GL | 4 | 135/8 | 43/58 | 05/88→10/91 | Z48 [167] | 0.8 | | |
| 1.3 L,GL | 4 | 13, 742 | 45/60 | 02/85→10/91 | Z48 →12/90 | 0.8 | | |

CITIGO

| | | | | | | | | |
|-----|---|------|-------|--------|--|--|--|----------------------------------|
| 1.0 | 3 | CHYA | 44/59 | 10/11→ | | | | ZSE067 [1][42] ZSE126 [1][43] |
| 1.0 | 3 | CHYB | 55/74 | 10/11→ | | | | ZSE067 [1][42] ZSE126 [1][43] |

FABIA

| | | | | | | | | |
|---------|---|-----------|-------|-------------|--|------------|-------|--------|
| 1.0 | 4 | AQV, ARV | 37/50 | 12/99→08/02 | Z188 | 0.7 | UXT10 | ZSE040 |
| 1.0 LPG | 4 | AQV, ARV | 37/50 | 12/99→08/02 | Z340 | 0.7 | UXT12 | |
| 1.2 | 3 | AWY, BMD | 40/54 | 07/01→03/08 | Z200 | 0.9 | | ZSE059 |
| 1.2 | 3 | BBM, CHFA | 44/59 | 12/06→ | Z200 →ch. 51-88501 225 Z272 ch. 51-88501 226→ | 0.9 1.0 | | ZSE059 |
| 1.2 | 3 | AZQ | 47/63 | 01/03→03/08 | Z200 | 0.9 | | ZSE030 |
| 1.2 | 3 | BME | 47/63 | 01/03→03/08 | Z272 | 1.0 | | ZSE030 |



kW/BHP

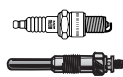

... SKODA



... FABIA

| | | | | | | | |
|-------------|---|---------------|---------|-------------|--|--------------|---|
| 1.2 | 3 | BZG, CEVA | 51/68 | 01/07→ | Z200 →ch. 5J-8B501 225 Z272 ch. 5J-8B501 226→ | 0.9 | ZSE030 |
| 1.2 | 3 | CGPA, CHTA | 51/68 | 01/07→ | Z200 →ch. 5J-83074 394 Z272 ch. 5J-83074 395→ | 0.9 | ZSE030 |
| 1.2 12V | 3 | CGPB | 44/59 | 11/11→ | Z272 | 1.0 | ZSE030 |
| 1.2 TDI | 3 | CFWA | 55/74 | 05/10→ | GE115 | 4.4V | |
| 1.2 TSI | 4 | CBZA | 63/84 | 03/10→ | | | ZSE003 |
| 1.2 TSI | 4 | CBZB | 77/103 | 03/10→ | | | ZSE003 |
| 1.4 | 4 | AZE, AZF | 44/59 | 04/00→03/03 | Z238 | 0.8 | ZSE040 |
| 1.4 | 4 | AME, AQW, ATZ | 50/67 | 08/99→05/03 | Z238 | 0.8 | ZSE040 |
| 1.4 | 4 | BXW | 63/84 | 01/07→ | Z272 | 1.0 | ZSE030 ch. 5J-7-000 001→ |
| 1.4 | 4 | BXW, CGGB | 63/84 | 10/07→ | | | ZSE030 |
| 1.4 | 4 | CGGB | 63/84 | 01/07→ | Z272 | 1.0 | |
| 1.4 LPG | 4 | AZE, AZF | 44/59 | 04/00→03/03 | Z206 | 0.7 | UXT10 |
| 1.4 LPG | 4 | AME, AQW, ATZ | 50/67 | 08/99→05/03 | Z206 | 0.7 | UXT10 |
| 1.4 16V | 4 | AUA, BBY | 55/74 | 10/99→03/08 | Z176 [251] Z90 [253] | 1.1 1.0 | ZSE003 [1][208] ZSE030 [1] ZSE040 [1] |
| 1.4 16V | 4 | BKY | 55/74 | 10/99→03/08 | Z200 | 0.9 | ZSE003 [1][208] ZSE030 [1] ZSE040 [1] |
| 1.4 16V | 4 | BUD | 59/79 | 04/06→12/07 | Z272 | 1.0 | ZSE030 |
| 1.4 16V | 4 | AUB, BBZ | 74/99 | 12/99→03/08 | Z90 | 1.0 | UXT1 / UXT3 ZSE003 [1][208] ZSE030 [1] ZSE040 [1] |
| 1.4 16V LPG | 4 | AUA, BBY | 55/74 | 10/99→03/08 | Z340 | 0.7 | UXT12 |
| 1.4 16V LPG | 4 | AUB, BBZ | 74/99 | 12/99→03/08 | Z340 | 0.7 | UXT12 |
| 1.4 TDI | 3 | BNM | 51/68 | 10/05→ | GN046 | 12V | |
| 1.4 TDI | 3 | BNM | 51/68 | 10/05→03/08 | | | GR081 →ch. 6Y-64648 255 |
| 1.4 TDI | 3 | AMF | 55/74 | 04/03→03/08 | GN046 | 12V | GR081 →ch. 6Y-64648 255 |
| 1.4 TDI | 3 | BMS | 59/79 | 01/07→ | CGP002 | 7V | |
| 1.4 TDI | 3 | BNV | 59/79 | 10/05→ | GN046 | 12V | |
| 1.4 TDI | 3 | BNV | 59/79 | 10/05→03/08 | | | GR081 →ch. 6Y-64648 255 |
| 1.4 TDI | 3 | CUSB | 66/89 | 08/14→ | GE115 PSG002 | 4.4V 4.4V | |
| 1.4 TDI | 3 | CUTA | 77/103 | 08/14→ | GE115 PSG002 | 4.4V 4.4V | |
| 1.4 TSI RS | 4 | CAVE | 132/177 | 05/10→ | | | ZSE030 |
| 1.6 | 4 | BTS | 77/103 | 04/07→ | Z272 | 1.0 | ZSE030 ch. 5J-7-000 001→ |
| 1.6 | 4 | BTS, CFNA | 77/103 | 10/07→ | | | ZSE030 →ch. 5J-83147 326 →ch. 5J-8A500 601 →ch. 5J-8B502 695 |
| 1.6 | 4 | CFNA | 77/103 | 04/07→ | Z272 | 1.0 | |
| 1.6 TDI | 4 | CAYA | 55/74 | 04/10→ | GE115 | 4.4V | |
| 1.6 TDI | 4 | CAYB | 66/89 | 03/10→ | GE115 | 4.4V | |
| 1.6 TDI | 4 | CAYC | 77/103 | 03/10→ | GE115 | 4.4V | |
| 1.9 SDI | 4 | ASY | 47/63 | 11/99→03/08 | GN855 | 12V | GR081 →ch. 6Y-64648 255 |

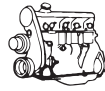

kW/BHP

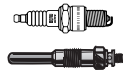

... SKODA



... FABIA

| | | | | | | | | | |
|------------|---|----------|--------|-------------|--------|----------------------------|-----|-------------|--------|
| 1.9 TDI | 4 | ATD, AXR | 74/99 | 01/00→03/08 | GN046 | GR081 →ch. 6Y-64648 Z55 | 12V | | |
| 1.9 TDI | 4 | BLS | 77/103 | 04/07→ | CGP002 | | 7V | | |
| 1.9 TDI | 4 | BSW | 77/103 | 04/07→ | GN046 | | 12V | | |
| 1.9 TDI RS | 4 | ASZ, BLT | 96/129 | 06/03→03/08 | GN046 | GR081 →ch. 6Y-64648 Z55 | 12V | | |
| 2.0 | 4 | AQY | 85/114 | 12/99→03/08 | Z90 | | 1.0 | UXT1 / UXT3 | |
| 2.0 | 4 | AZL | 85/114 | 12/99→03/08 | Z90 | | 1.0 | UXT1 / UXT3 | ZSE003 |
| 2.0 LPG | 4 | AQY, AZL | 85/114 | 12/99→03/08 | Z340 | | 0.7 | UXT12 | |

FAVORIT

| | | | | | | | | | | |
|------------------|---|----------------|-------|-------------|------------|--|-----|-------------|------------------|-----------------|
| 1.3 | 4 | 135B | 40/54 | 12/92→06/97 | Z254 | | 0.7 | UXT1 / UXT3 | ZSE001 | ZM060 →12/95 |
| 1.3 | 4 | 781.135E | 40/54 | 09/91→06/95 | Z254 | | 0.7 | UXT1 / UXT3 | ZSE001 | ZM060 |
| 1.3 | 4 | 781.135 | 42/56 | 12/92→06/97 | Z254 | | 0.7 | UXT1 / UXT3 | ZSE001 | ZM060 →12/95 |
| 1.3 | 4 | 781.135 | 44/59 | 12/91→06/95 | Z100 [168] | | 0.8 | UXT1 / UXT3 | ZSE001 01/93→ | ZM060 |
| 1.3 | 4 | OHC | 45/60 | 08/91→06/95 | Z100 [168] | | 0.8 | UXT1 / UXT3 | ZSE001 | ZM060 |
| 1.3 | 4 | 136B | 50/67 | 12/92→06/97 | Z15 | | 0.8 | UXT1 / UXT3 | ZSE001 | ZM060 →12/95 |
| 1.3 | 4 | 136B | 50/67 | 01/94→06/95 | Z15 [168] | | 0.8 | UXT1 / UXT3 | | ZM060 |
| 1.3 LPG | 4 | 135B, 781.135E | 40/54 | 09/91→06/97 | Z206 | | 0.7 | UXT10 | | |
| 1.3 LPG | 4 | 781.135 | 42/56 | 12/92→06/97 | Z206 | | 0.7 | UXT10 | | |
| 1.3 LPG | 4 | 781.135 | 44/59 | 12/91→06/95 | Z206 | | 0.7 | UXT10 | | |
| 1.3 LPG | 4 | OHC | 45/60 | 08/91→06/95 | Z206 | | 0.7 | UXT10 | | |
| 1.3 LPG | 4 | 136B | 50/67 | 12/92→06/97 | Z340 | | 0.7 | UXT12 | | |
| 1.3 135 | 4 | 781.135 | 42/56 | 12/91→09/94 | Z100 [168] | | 0.8 | UXT1 / UXT3 | ZSE001 07/93→ | ZM060 |
| 1.3 135 | 4 | 781.135 | 43/58 | 12/91→09/94 | Z100 [168] | | 0.8 | UXT1 / UXT3 | ZSE001 →12/93 | ZM060 |
| 1.3 135 | 4 | 781.135 | 44/59 | 10/90→09/94 | Z100 [168] | | 0.8 | UXT1 / UXT3 | ZSE001 →12/93 | ZM060 |
| 1.3 135 X,LX,GLX | 4 | 781.135E | 40/54 | 01/90→09/94 | Z254 | | 0.7 | UXT1 / UXT3 | ZSE001 07/93→ | ZM060 |
| 1.3 135L | 4 | 781.135 | 43/58 | 05/89→09/94 | Z63 [168] | | 0.8 | UXT1 / UXT3 | ZSE001 07/93→ | ZM060 |
| 1.3 136 | 4 | 136 L | 45/60 | 10/90→09/94 | Z100 [168] | | 0.8 | UXT1 / UXT3 | ZSE001 | ZM060 |

FELICIA I

| | | | | | | | | | | |
|------------|---|-----------------|-------|-------------|------|--|-----|-------------|--------|-------|
| 1.3 | 4 | 135B | 40/54 | 10/94→03/98 | Z15 | | 0.8 | UXT1 / UXT3 | | |
| 1.3 | 4 | 135B, AMG | 40/54 | 10/94→04/02 | | | | | ZSE001 | ZM060 |
| 1.3 | 4 | 135B, AMG | 40/54 | 06/97→04/02 | Z238 | | 0.8 | | | |
| 1.3 | 4 | 135M | 40/54 | 06/97→04/02 | Z238 | | 0.8 | | ZSE001 | ZM060 |
| 1.3 | 4 | AMG | 40/54 | 10/94→03/98 | Z90 | | 1.0 | UXT1 / UXT3 | | |
| 1.3 | 4 | 135 L | 43/58 | 10/94→03/98 | Z15 | | 0.8 | UXT1 / UXT3 | ZSE001 | ZM060 |
| 1.3 | 4 | AMJ | 43/58 | 10/94→03/98 | Z90 | | 1.0 | UXT1 / UXT3 | ZSE001 | ZM060 |
| 1.3 | 4 | 136B | 50/67 | 10/94→03/98 | Z15 | | 0.8 | UXT1 / UXT3 | | |
| 1.3 | 4 | 136B, AMH | 50/67 | 10/94→04/02 | | | | | ZSE001 | ZM060 |
| 1.3 | 4 | 136B, AMH | 50/67 | 06/97→04/02 | Z238 | | 0.8 | | | |
| 1.3 | 4 | 136M | 50/67 | 06/97→04/02 | Z238 | | 0.8 | | ZSE001 | ZM060 |
| 1.3 | 4 | AMH | 50/67 | 10/94→03/98 | Z121 | | 1.0 | UXT9 | | |
| 1.3 LPG | 4 | 135B, AMG | 40/54 | 10/94→03/98 | Z340 | | 0.7 | UXT12 | | |
| 1.3 LPG | 4 | 135B, 135M, AMG | 40/54 | 06/97→04/02 | Z206 | | 0.7 | UXT10 | | |
| 1.3 LPG | 4 | 135 L, AMJ | 43/58 | 10/94→03/98 | Z340 | | 0.7 | UXT12 | | |
| 1.3 LPG | 4 | 136B | 50/67 | 10/94→03/98 | Z340 | | 0.7 | UXT12 | | |
| 1.3 LPG | 4 | 136B, 136M, AMH | 50/67 | 10/94→04/02 | Z206 | | 0.7 | UXT10 | | |
| 1.3 LX | 4 | 135B | 40/54 | 08/95→03/98 | Z15 | | 0.8 | UXT1 / UXT3 | ZSE001 | ZM060 |
| 1.3 LX | 4 | AMG | 40/54 | 08/95→03/98 | Z90 | | 1.0 | UXT1 / UXT3 | ZSE001 | ZM060 |
| 1.3 LX LPG | 4 | 135B, AMG | 40/54 | 08/95→03/98 | Z340 | | 0.7 | UXT12 | | |

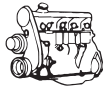

kW/BHP

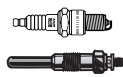

... SKODA



... FELICIA I

| | | | | | | | | | |
|-------------|---|------------|-------|-------------|----------------|-----|-----------------------|--------|-------|
| 1.3 LXI | 4 | 136B | 50/67 | 08/95→03/98 | Z15 →07/96 | 0.8 | UXT1 / UXT3 →07/96 | ZSE001 | ZM060 |
| 1.3 LXI | 4 | AMH | 50/67 | 08/95→03/98 | Z121 | 1.0 | UXT9 | ZSE001 | ZM060 |
| 1.3 LXI LPG | 4 | 136B | 50/67 | 08/95→03/98 | Z340 →07/96 | 0.7 | UXT12 →07/96 | | |
| 1.3 LXI LPG | 4 | AMH | 50/67 | 08/95→03/98 | Z206 | 0.7 | UXT10 | | |
| 1.6 | 4 | AEE | 55/74 | 06/97→04/02 | Z91 | 0.8 | UXT2 / UXT6 | ZSE001 | |
| 1.6 LPG | 4 | AEE | 55/74 | 06/97→04/02 | Z27 [168] | 0.8 | UX56 | | |
| 1.6 GLX | 4 | AEE | 55/74 | 08/95→03/98 | Z91 | 0.8 | UXT2 / UXT6 | ZSE001 | |
| 1.6 GLX LPG | 4 | AEE | 55/74 | 08/95→03/98 | Z27 [168] | 0.8 | UX56 | | |
| 1.6 LX | 4 | AEE, EA111 | 55/74 | 08/95→03/98 | Z91 | 0.8 | UXT2 / UXT6 | ZSE001 | |
| 1.6 LX LPG | 4 | AEE, EA111 | 55/74 | 08/95→03/98 | Z27 [168] | 0.8 | UX56 | | |
| 1.9 D | 4 | AEF | 47/63 | 10/95→04/02 | GN857 | 11V | | | |

FELICIA II

| | | | | | | | | | |
|---------|---|-----|-------|-------------|-----------|-----|-------------|-----------------------------|-------|
| 1.3 | 4 | AMG | 40/54 | 01/98→06/01 | Z238 | 0.8 | | ZSE001 [175][254] ZSE039 | ZM060 |
| 1.3 | 4 | AMJ | 43/58 | 01/98→06/01 | Z90 | 1.0 | UXT1 / UXT3 | ZSE001 [175][254] ZSE039 | ZM060 |
| 1.3 | 4 | AMH | 50/67 | 01/98→06/01 | Z238 | 0.8 | | ZSE001 [175][254] ZSE039 | ZM060 |
| 1.3 LPG | 4 | AMG | 40/54 | 01/98→06/01 | Z206 | 0.7 | UXT10 | | |
| 1.3 LPG | 4 | AMJ | 43/58 | 01/98→06/01 | Z340 | 0.7 | UXT12 | | |
| 1.3 LPG | 4 | AMH | 50/67 | 01/98→06/01 | Z206 | 0.7 | UXT10 | | |
| 1.6 | 4 | AEE | 55/74 | 01/98→06/01 | Z91 | 0.8 | UXT2 / UXT6 | ZSE001 [175][254] ZSE039 | |
| 1.6 LPG | 4 | AEE | 55/74 | 01/98→06/01 | Z27 [168] | 0.8 | UX56 | | |
| 1.9 D | 4 | AEF | 47/63 | 01/98→06/01 | GN857 | 11V | | | |

OCTAVIA

| | | | | | | | | | |
|---------|---|-------------------------------------|---------|-------------|--|------------|-------------|---|--|
| 1.2 TSI | 4 | CJZB | 63/84 | 11/12→ | | | | ZSE067 [1][42] ZSE126 [1][43] | |
| 1.2 TSI | 4 | CBZB | 77/103 | 02/10→ | Z347 | 0.7 | UXT12 | ZSE003 | |
| 1.2 TSI | 4 | CJZA | 77/103 | 11/12→ | | | | ZSE067 [1][42] ZSE126 [1][43] | |
| 1.4 | 4 | AMD | 44/59 | 04/99→03/01 | Z238 | 0.8 | | ZSE040 | |
| 1.4 | 4 | BCA | 55/74 | 05/04→05/06 | Z200 Z90 | 0.9 1.0 | | ZSE030 [1] ZSE040 [1] | |
| 1.4 | 4 | BUD, CGGA | 59/79 | 06/04→ | Z200 →ch. 1Z-4-000 000 Z272 ch. 1Z-4-000 001→ | 0.9 1.0 | | ZSE030 [1] →12/11 | |
| 1.4 LPG | 4 | AMD | 44/59 | 04/99→03/01 | Z206 | 0.7 | UXT10 | | |
| 1.4 16V | 4 | AXP | 55/74 | 08/00→12/10 | Z176 [1][52] Z90 [1][253] →30.04.2002 | 1.1 1.0 | | ZSE003 [1] →28.02.2002 →30.04.2002 | |
| 1.4 16V | 4 | BCA | 55/74 | 08/00→12/10 | Z90 [1] 01.05.2002→ | 1.0 | UXT1 / UXT3 | ZSE003 [1] →28.02.2002 ZSE030 [1][41] | |
| 1.4 TSI | 4 | CAXA | 90/121 | 11/08→ | Z349 | 0.9 | | ZSE030 | |
| 1.4 TSI | 4 | CHPA | 103/138 | 11/12→ | | | | ZSE067 [1][42] ZSE126 [1][43] | |
| 1.6 | 4 | AEE | 55/74 | 09/96→09/04 | Z91 | 0.8 | UXT2 / UXT6 | ZSE001 | |
| 1.6 | 4 | AEH, AKL | 74/99 | 02/97→12/07 | Z90 | 1.0 | UXT1 / UXT3 | ZSE003 | |
| 1.6 | 4 | AVU, BFQ, BGU, BSE, BSF, CCSA, CMXA | 75/101 | 09/00→ | Z90 | 1.0 | UXT1 / UXT3 | ZSE003 | |
| 1.6 LPG | 4 | AEE | 55/74 | 09/96→09/04 | Z27 [168] | 0.8 | UX56 | | |
| 1.6 LPG | 4 | AEH, AKL | 74/99 | 02/97→12/07 | Z340 | 0.7 | UXT12 | | |
| 1.6 LPG | 4 | AVU, BFQ, BGU, BSE, BSF, CCSA, CMXA | 75/101 | 09/00→ | Z340 | 0.7 | UXT12 | | |
| 1.6 FSI | 4 | BLF | 85/114 | 02/04→10/08 | Z300 | 1.35 | | ZSE030 | |

SKODA



kW/BHP

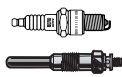

... SKODA



... OCTAVIA

| | | | | | | | | | | |
|-------------------|---|--------------------|---------|-------------|-------------------------------------|----------------------|--------------|----------------------|--|-----------------|
| 1.6 LPG | 4 | CHGA | 75/101 | 08/09→ | Z340 Z90 | | 0.7 1.0 | UXT12 UXT1 / UXT3 | ZSE003 | |
| 1.6 MultiFuel | 4 | CCSA | 75/101 | 01/08→ | Z90 | | 1.0 | UXT1 / UXT3 | ZSE003 | |
| 1.6 MultiFuel LPG | 4 | CCSA | 75/101 | 01/08→ | Z340 | | 0.7 | UXT12 | | |
| 1.6 TDI | 4 | CLHB | 66/89 | 11/12→ | GE115 PSG002 | | 4.4V 4.4V | | | |
| 1.6 TDI | 4 | CAYC | 77/103 | 06/09→ | GE115 | | 4.4V | | | |
| 1.6 TDI | 4 | CLHA | 77/103 | 11/12→ | GE115 PSG002 | | 4.4V 4.4V | | | |
| 1.6 TDI | 4 | CRKB | 81/109 | 05/13→ | GE115 PSG002 | | 4.4V 4.4V | | | |
| 1.8 | 4 | AGN | 92/123 | 09/96→07/00 | Z90 | | 1.0 | UXT1 / UXT3 | ZSE003 | |
| 1.8 LPG | 4 | AGN | 92/123 | 09/96→07/00 | Z340 | | 0.7 | UXT12 | | |
| 1.8 20V | 4 | AGN | 92/123 | 07/98→07/00 | Z90 | | 1.0 | UXT1 / UXT3 | ZSE003 | |
| 1.8 20V LPG | 4 | AGN | 92/123 | 07/98→07/00 | Z340 | | 0.7 | UXT12 | | |
| 1.8 RS 1.8 T | 4 | AUQ | 132/177 | 05/01→01/06 | Z188 | | 0.7 | UXT10 | ZSE043 | |
| 1.8 RS 1.8 T LPG | 4 | AUQ | 132/177 | 05/01→01/06 | Z340 | | 0.7 | UXT12 | | |
| 1.8 T | 4 | AGU | 110/148 | 08/97→12/10 | Z90 | | 1.0 | UXT1 / UXT3 | ZS016 | ZLE276 ZM062 |
| 1.8 T | 4 | ARX, AUM | 110/148 | 08/97→12/10 | Z188 | | 0.7 | UXT10 | ZSE043 | |
| 1.8 T | 4 | ARZ | 110/148 | 08/97→12/10 | Z188 | | 0.7 | UXT10 | ZSE009 | ZLE276 |
| | | | | | | | | | →2000 | |
| 1.8 T LPG | 4 | AGU, ARX, ARZ, AUM | 110/148 | 08/97→12/10 | Z340 | | 0.7 | UXT12 | | |
| 1.8 TSI | 4 | CDAB | 112/150 | 03/09→ | Z347 | | 0.7 | UXT12 | ZSE142 | |
| 1.8 TSI 4WD | 4 | CDAB | 112/150 | 03/09→ | Z347 | | 0.7 | UXT12 | ZSE033 ⁽⁴⁷⁾ ZSE142 ⁽⁴⁸⁾ | |
| 1.8 TSI | 4 | BZB, CDAA | 118/158 | 06/07→ | Z347 | | 0.7 | UXT12 | ZSE033 ⁽⁴⁷⁾ ZSE142 ⁽⁴⁸⁾ | |
| 1.8 TSI | 4 | CJSA, CJSB | 132/177 | 11/12→ | Z348 | | 0.8 | | ZSE068 | |
| 1.8 TSI 4WD | 4 | CJSB | 132/177 | 11/12→ | Z348 | | 0.8 | | | |
| 1.9 SDI | 4 | AGP, AQM | 50/67 | 06/97→12/03 | GN855 | GR081 | 12V | | | |
| 1.9 TDI | 4 | AGR, ALH | 66/89 | 09/96→03/10 | GN855 | GR081 | 12V | | | |
| 1.9 TDI | 4 | ATD, AXR | 74/99 | 08/00→12/10 | GN046 | GR081 | 12V | | | |
| | | | | | 01.12.2001→ GN855 →30.11.2001 | | 12V | | | |
| 1.9 TDI | 4 | AXR | 74/99 | 10/05→12/10 | GN046 | | 12V | | | |
| 1.9 TDI | 4 | BJB, BKC, BLS, BXE | 77/103 | 06/04→12/10 | GE100 | GSE100 ch. 70251→ | 5V | | | |
| 1.9 TDI | 4 | AHF, ASV | 81/109 | 08/97→01/06 | GN855 | GR081 | 12V | | | |
| 1.9 TDI | 4 | ASZ | 96/129 | 09/02→09/04 | GN046 | GR081 | 12V | | | |
| 2.0 | 4 | AEG, APK, AQY, AZH | 85/114 | 04/99→05/07 | Z90 | | 1.0 | UXT1 / UXT3 | ZSE003 | |
| 2.0 | 4 | AZJ | 85/114 | 04/99→05/07 | Z176 | | 1.1 | | ZSE029 | |
| 2.0 4WD | 4 | ATF | 88/118 | 01/00→12/10 | Z176 | | 1.1 | | ZSE003 | |
| 2.0 LPG | 4 | AEG, APK, AQY, AZH | 85/114 | 04/99→05/07 | Z340 | | 0.7 | UXT12 | | |
| 2.0 FSI | 4 | BLR, BLX, BVX, BVY | 110/148 | 11/04→ | Z236 | | 1.0 | | ZSE033 ⁽⁴⁷⁾ ZSE142 ⁽⁴⁸⁾ | |
| 2.0 FSI | 4 | BLY, BVZ | 110/148 | 11/04→ | Z228 | | 1.0 | UXT11 | ZSE033 ⁽⁴⁷⁾ ZSE142 ⁽⁴⁸⁾ | |
| 2.0 RS | 4 | BWA, CCZA | 147/197 | 10/05→ | Z347 | | 0.7 | UXT12 | ZSE033 ⁽⁴⁷⁾ ZSE142 ⁽⁴⁸⁾ | |
| 2.0 TDI | 4 | CFHF, CLCA | 81/109 | 03/10→ | GE115 | | 4.4V | | | |
| 2.0 TDI | 4 | AZV | 100/134 | 02/04→05/10 | GE101 | | 4.4V | | | |
| 2.0 TDI | 4 | BMM | 103/138 | 11/05→ | CGP002 | GSE100 | 7V | | | |
| | | | | | →12/05 GE100 | | 5V | | | |
| | | | | | 01/06→ | | | | | |
| 2.0 TDI 4WD | 4 | BMM | 103/138 | 07/06→ | GE100 | GSE100 | 5V | | | |

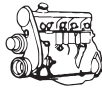

kW/BHP

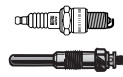
**... SKODA****... OCTAVIA**

| | | | | | | | | | |
|-------------|---|------------|---------|-------------|-----------------|--------|--------------|--|--------|
| 2.0 TDI | 4 | CKFB, CRVC | 105/141 | 11/12→ | GE115 PSG002 | | 4.4V 4.4V | | |
| 2.0 TDI | 4 | CKFC | 110/148 | 11/12→ | GE115 PSG002 | | 4.4V 4.4V | | |
| 2.0 TDI 4WD | 4 | CUNA, CUPA | 135/181 | 09/14→ | GE115 PSG002 | | 4.4V 4.4V | | |
| 2.0 TDI 16V | 4 | AZV | 100/134 | 02/04→05/10 | GE101 | | 4.4V | | |
| 2.0 TDI 16V | 4 | BKD | 103/138 | 02/04→ | GE101 | GSE100 | 4.4V | | |
| 2.0 TDI 16V | 4 | CFHC, CLCB | 103/138 | 02/04→ | GE115 | | 4.4V | | |
| 2.0 TDI RS | 4 | BMN | 125/168 | 04/06→ | CGP003 | | 7V | | |
| 2.0 TDI RS | 4 | CEGA | 125/168 | 04/06→ | GE115 | | 4.4V | | |
| 2.0 TDI RS | 4 | CUNA, CUPA | 135/181 | 05/13→ | GE115 PSG002 | | 4.4V 4.4V | | |
| 2.0 TSI RS | 4 | CHHB | 162/217 | 11/12→ | Z348 | | 0.8 | | ZSE068 |

OCTAVIA

| | | | | | | | | | |
|-----------|---|--|-------|-------------|-----|--|-----|--|--|
| 1.1 | 4 | | 29/39 | 04/59→02/62 | Z57 | | 0.6 | | |
| 1.1 | 4 | | 31/42 | 02/62→10/71 | Z57 | | 0.6 | | |
| 1.2 Super | 4 | | 32/43 | 02/61→10/71 | Z57 | | 0.6 | | |
| 1.2 Super | 4 | | 33/44 | 04/59→02/61 | Z57 | | 0.6 | | |

RAPID

| | | | | | | | | | |
|---------|---|------------|--------|-------------|----------------------|--|------|--|--------------------------|
| 1.2 | 3 | CGPC | 55/74 | 07/12→ | Z272 | | 1.0 | | ZSE030 |
| 1.2 | 4 | | 43/58 | 02/83→12/90 | | | | | ZS109 ^[15] |
| 1.2 TSI | 4 | CBZA | 63/84 | 07/12→ | | | | | ZSE003 |
| 1.2 TSI | 4 | CBZB | 77/103 | 07/12→ | | | | | ZSE003 |
| 1.3 | 4 | 13, 742 | 45/60 | 03/85→08/88 | Z48 | | 0.8 | | ZS106 ^[11] |
| 1.3 S | 4 | 135/8 | 43/58 | 09/84→12/90 | Z48 ^[167] | | 0.8 | | ZS109 ^{[1][15]} |
| 1.4 TSI | 4 | CAXA | 90/121 | 07/12→ | Z349 | | 0.9 | | ZSE030 |
| 1.6 | 4 | CFNA | 77/103 | 07/12→ | Z272 | | 1.0 | | ZSE030 |
| 1.6 TDI | 4 | CAYB | 66/89 | 08/13→ | GE115 | | 4.4V | | |
| 1.6 TDI | 4 | CAYC, CLNA | 77/103 | 07/12→ | GE115 | | 4.4V | | |

ROOMSTER

| | | | | | | | | | |
|---------|---|-----------|--------|-------------|--------|--|------|--|------------------|
| 1.2 | 3 | BME | 47/63 | 05/06→01/07 | Z272 | | 1.0 | | ZSE030 |
| 1.2 | 3 | BZG | 51/68 | 01/07→ | Z200 | | 0.9 | | ZSE030 |
| 1.2 | 3 | CGPA | 51/68 | 01/07→ | Z272 | | 1.0 | | ZSE030 |
| 1.2 TDI | 3 | CFWA | 55/74 | 03/10→ | GE115 | | 4.4V | | |
| 1.2 TSI | 4 | CBZA | 63/84 | 03/10→ | | | | | ZSE003 |
| 1.2 TSI | 4 | CBZB | 77/103 | 03/10→ | | | | | ZSE003 |
| 1.4 | 4 | BXW, CGGB | 63/84 | 09/06→ | Z272 | | 1.0 | | ZSE030 →12/11 |
| 1.4 TDI | 3 | BNM | 51/68 | 07/06→03/10 | GN046 | | 12V | | |
| 1.4 TDI | 3 | BMS | 59/79 | 09/06→03/10 | CGP002 | | 7V | | |
| 1.4 TDI | 3 | BNV | 59/79 | 09/06→03/10 | GN046 | | 12V | | |
| 1.6 | 4 | BTS, CFNA | 77/103 | 09/06→ | Z272 | | 1.0 | | ZSE030 →12/11 |
| 1.6 TDI | 4 | CAYB | 66/89 | 03/10→ | GE115 | | 4.4V | | |
| 1.6 TDI | 4 | CAYC | 77/103 | 03/10→ | GE115 | | 4.4V | | |
| 1.9 TDI | 4 | AXR | 74/99 | 03/06→05/06 | GN046 | | 12V | | |
| 1.9 TDI | 4 | BLS | 77/103 | 09/06→03/10 | CGP002 | | 7V | | |
| 1.9 TDI | 4 | BSW | 77/103 | 09/06→03/10 | GN046 | | 12V | | |

SUPERB

| | | | | | | | | | |
|-----------|---|------|---------|-------------|----------------|--|---------------|-------|--|
| 1.4 TSI | 4 | CAXC | 92/123 | 07/08→ | Z349 | | 0.9 | | ZSE030 |
| 1.6 TDI | 4 | CAYC | 77/103 | 09/10→ | GE115 | | 4.4V | | |
| 1.8 T | 4 | AWT | 110/148 | 12/01→03/08 | Z188 | | 0.7 | UXT10 | ZSE043 |
| 1.8 T LPG | 4 | AWT | 110/148 | 12/01→03/08 | Z340 | | 0.7 | UXT12 | |
| 1.8 TSI | 4 | CDAB | 112/150 | 03/09→ | Z347 →04/10 | | 0.7 →04/10 | UXT12 | ZSE033 ^[47] ZSE142 ^[48] |



kW/BHP

**... SKODA****... SUPERB**

| | | | | | | | | | |
|-------------|---|------------|---------|-------------|--------|--------|------|-------------|--|
| 1.8 TSI | 4 | BZB, CDAA | 118/158 | 03/08→ | Z347 | | 0.7 | UXT12 | ZSE142 ⁽⁴⁸⁾ ZSE033 08/12→ |
| 1.9 TDI | 4 | AVB | 74/99 | 08/02→10/05 | GN046 | | 12V | | |
| 1.9 TDI | 4 | BLS, BXE | 77/103 | 03/08→ | GE100 | GSE100 | 5V | | |
| 1.9 TDI | 4 | BSV | 77/103 | 10/05→05/07 | CGP002 | | 7V | | |
| 1.9 TDI | 4 | BPZ | 85/114 | 01/07→03/08 | CGP002 | | 7V | | |
| 1.9 TDI | 4 | AVF, AWX | 96/129 | 12/01→03/08 | GN046 | | 12V | | |
| 2.0 | 4 | AZM | 85/114 | 12/01→03/08 | Z90 | | 1.0 | UXT1 / UXT3 | ZSE003 |
| 2.0 LPG | 4 | AZM | 85/114 | 12/01→03/08 | Z340 | | 0.7 | UXT12 | |
| 2.0 TDI | 4 | BMP, BSS | 103/138 | 10/05→ | CGP002 | | 7V | | |
| 2.0 TDI | 4 | CBBB, CFGB | 125/168 | 07/08→ | GE115 | | 4.4V | | |
| 2.0 TDI 16V | 4 | BKD | 103/138 | 01/09→ | GE101 | GSE100 | 4.4V | | |
| 2.0 TDI 16V | 4 | CFFB, CLJA | 103/138 | 01/09→ | GE115 | | 4.4V | | |
| 2.0 TSI | 4 | CCZA | 147/197 | 05/10→ | Z347 | | 0.7 | UXT12 | ZSE142 |
| 2.5 TDI | 6 | AYM | 114/153 | 12/01→08/03 | GN008 | | 12V | | |
| 2.5 TDI | 6 | BDG | 120/161 | 06/03→03/08 | GN008 | | 12V | | |
| 2.8 V6 | 6 | BBG | 140/188 | 06/02→03/08 | Z145 | | 1.6 | | |
| 2.8 V6 | 6 | AMX | 142/190 | 12/01→03/08 | Z145 | | 1.6 | | ZSE154 |
| 3.6 V6 4WD | 6 | CDVA | 191/256 | 11/08→ | | | | | ZSE041 |

YETI

| | | | | | | | | | |
|-------------|---|------------------|---------|--------|-------|--|------|-------|--|
| 1.2 TSI | 4 | CBZB | 77/103 | 09/09→ | | | | | ZSE003 |
| 1.4 TSI | 4 | CAXA | 90/121 | 06/10→ | Z349 | | 0.9 | | ZSE030 |
| 1.6 TDI | 4 | CAYC | 77/103 | 11/10→ | GE115 | | 4.4V | | |
| 1.8 TSI 4WD | 4 | CDAB | 112/150 | 11/09→ | Z347 | | 0.7 | UXT12 | ZSE033 ⁽⁴⁷⁾ ZSE142 ⁽⁴⁸⁾ |
| 1.8 TSI 4WD | 4 | CDAA | 118/158 | 05/09→ | Z347 | | 0.7 | UXT12 | ZSE033 ⁽⁴⁷⁾ ZSE142 ⁽⁴⁸⁾ |
| 2.0 TDI | 4 | CFHA, CFHF, CLCA | 81/109 | 11/09→ | GE115 | | 4.4V | | |
| 2.0 TDI | 4 | CBDB, CFHC, CLCB | 103/138 | 05/09→ | GE115 | | 4.4V | | |
| 2.0 TDI 4WD | 4 | CEGA, CFJA | 125/168 | 11/09→ | GE115 | | 4.4V | | |

SKODA**FABIA**

| | | | | | | | | | |
|---------|---|---------------|-------|-------------|-------|----------------------------|-----|-------|--------|
| 1.2 | 3 | AWY, BMD | 40/54 | 07/01→12/07 | Z200 | | 0.9 | | ZSE059 |
| 1.2 | 3 | AZQ | 47/63 | 01/03→12/07 | Z200 | | 0.9 | | ZSE030 |
| 1.2 | 3 | BME | 47/63 | 01/03→12/07 | Z272 | | 1.0 | | ZSE030 |
| 1.4 | 4 | AME, AQW, ATZ | 50/67 | 07/01→05/03 | Z238 | | 0.8 | | ZSE040 |
| 1.4 LPG | 4 | AME, AQW, ATZ | 50/67 | 07/01→05/03 | Z206 | | 0.7 | UXT10 | |
| 1.4 TDI | 3 | BNM | 51/68 | 10/05→12/07 | GN046 | GR081 →ch. 6Y-64648 255 | 12V | | |
| 1.9 SDI | 4 | ASY | 47/63 | 07/01→12/07 | GN046 | GR081 →ch. 6Y-64648 255 | 12V | | |

ROOMSTER Praktik

| | | | | | | | | | |
|---------|---|-----------|-------|-------------|--------|--|------|--|---|
| 1.2 | 3 | BZG | 51/68 | 03/07→ | Z200 | | 0.9 | | ZSE030 →ch. 5J-83147 326 →ch. 5J-8A500 601 →ch. 5J-8B502 695 |
| 1.2 | 3 | CGPA | 51/68 | 03/07→ | Z272 | | 1.0 | | ZSE030 →ch. 5J-83147 326 →ch. 5J-8A500 601 →ch. 5J-8B502 695 |
| 1.2 TDI | 3 | CFWA | 55/74 | 03/10→ | GE115 | | 4.4V | | |
| 1.2 TSI | 4 | CBZA | 63/84 | 03/10→ | | | | | ZSE003 |
| 1.4 | 4 | BXW, CGGB | 63/84 | 03/07→ | Z272 | | 1.0 | | ZSE030 →12/11 |
| 1.4 TDI | 3 | BNM | 51/68 | 03/07→03/10 | GN046 | | 12V | | |
| 1.4 TDI | 3 | BMS | 59/79 | 03/07→03/10 | CGP002 | | 7V | | |

SKODA

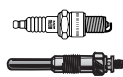

kW/BHP

**... SKODA****... ROOMSTER Praktik**

| | | | | | | | | |
|---------|---|------|-------|-------------|-------|------|--|--|
| 1.4 TDI | 3 | BNV | 59/79 | 03/07→03/10 | GN046 | 12V | | |
| 1.6 TDI | 4 | CAYB | 66/89 | 03/10→ | GE115 | 4.4V | | |

SMART**CABRIO**

| | | | | | | | | |
|---------|---|---------------------------|-------|-------------|-------|-----|------|-----------------|
| 0.6 | 3 | M 160.920, M 160 E6AL B03 | 40/54 | 03/00→01/04 | Z194 | 0.6 | UXT5 | ZS304 |
| 0.6 | 3 | M 160.920, M 160 E6AL B05 | 45/60 | 01/01→01/04 | Z194 | 0.6 | UXT5 | ZS304 →12/02 |
| 0.6 | 3 | M 160.920 | 52/70 | 06/02→01/04 | Z194 | 0.6 | UXT5 | ZS304 |
| 0.6 LPG | 3 | M 160.920, M 160 E6AL B03 | 40/54 | 03/00→01/04 | Z198 | 0.9 | | |
| 0.6 LPG | 3 | M 160.920, M 160 E6AL B05 | 45/60 | 01/01→01/04 | Z198 | 0.9 | | |
| 0.6 LPG | 3 | M 160.920 | 52/70 | 06/02→01/04 | Z198 | 0.9 | | |
| 0.7 | 3 | M 160.910 | 45/60 | 01/03→01/04 | Z286 | 0.6 | | ZS304 |
| 0.7 | 3 | M 160.910 | 55/74 | 01/03→01/04 | Z286 | 0.6 | | ZS304 |
| 0.8 CDI | 3 | OM 660.940, OM 660 DE 8LA | 30/40 | 03/01→01/04 | GN015 | 11V | | |

CITY-COUPE

| | | | | | | | | |
|---------|---|---------------------------|-------|-------------|-------|-----|------|-----------------|
| 0.6 | 3 | M 160.920, M 160 E6AL B04 | 33/44 | 07/98→01/04 | Z194 | 0.6 | UXT5 | ZS304 |
| 0.6 | 3 | M 160.920, M 160 E6AL B03 | 40/54 | 07/98→01/04 | Z194 | 0.6 | UXT5 | ZS304 |
| 0.6 | 3 | M 160.920, M 160 E6AL B05 | 45/60 | 01/01→01/04 | Z194 | 0.6 | UXT5 | ZS304 →12/02 |
| 0.6 | 3 | M 160.920 | 52/70 | 06/02→01/04 | Z194 | 0.6 | UXT5 | ZS304 |
| 0.6 LPG | 3 | M 160.920, M 160 E6AL B04 | 33/44 | 07/98→01/04 | Z198 | 0.9 | | |
| 0.6 LPG | 3 | M 160.920, M 160 E6AL B03 | 40/54 | 07/98→01/04 | Z198 | 0.9 | | |
| 0.6 LPG | 3 | M 160.920, M 160 E6AL B05 | 45/60 | 01/01→01/04 | Z198 | 0.9 | | |
| 0.6 LPG | 3 | M 160.920 | 52/70 | 06/02→01/04 | Z198 | 0.9 | | |
| 0.7 | 3 | M 160.910 | 37/50 | 01/03→01/04 | Z286 | 0.6 | | ZS304 |
| 0.7 | 3 | M 160.910 | 45/60 | 01/03→01/04 | Z286 | 0.6 | | ZS304 |
| 0.7 | 3 | M 160.910 | 55/74 | 01/03→01/04 | Z286 | 0.6 | | ZS304 |
| 0.8 CDI | 3 | OM 660.940, OM 660 DE 8LA | 30/40 | 11/99→01/04 | GN015 | 11V | | |

CROSSBLADE

| | | | | | | | | |
|---------|---|-----------|-------|-------------|------|-----|------|-------|
| 0.6 | 3 | M 160.920 | 52/70 | 06/02→12/03 | Z194 | 0.6 | UXT5 | ZS304 |
| 0.6 LPG | 3 | M 160.920 | 52/70 | 06/02→12/03 | Z198 | 0.9 | | |

FORFOUR

| | | | | | | | | |
|---------|---|------------|--------|-------------|-------|-------|--|--|
| 1.1 | 3 | M 134.911 | 47/63 | 02/05→06/06 | Z235 | 1.0 | | |
| 1.1 | 3 | M 134.910 | 55/74 | 01/04→06/06 | Z235 | 1.0 | | |
| 1.3 | 4 | M 135.930 | 70/94 | 01/04→06/06 | Z235 | 1.0 | | |
| 1.5 | 4 | M 135.950 | 80/107 | 01/04→06/06 | Z235 | 1.0 | | |
| 1.5 | 4 | M 135.950 | 90/121 | 01/04→06/06 | Z235 | 1.0 | | |
| 1.5 CDI | 3 | OM 639.939 | 50/67 | 09/04→06/06 | GN058 | 11.5V | | |
| 1.5 CDI | 3 | OM 639.939 | 70/94 | 09/04→06/06 | GN058 | 11.5V | | |

FORTWO

| | | | | | | | | |
|------------------|---|---------------------------|--------|-------------|-------|-----|--|-------|
| 0.7 | 3 | M 160.910 | 37/50 | 01/04→01/07 | Z286 | 0.6 | | ZS304 |
| 0.7 | 3 | M 160.910 | 45/60 | 01/04→01/07 | Z286 | 0.6 | | ZS304 |
| 0.7 | 3 | M 160.910 | 55/74 | 01/04→01/07 | Z286 | 0.6 | | ZS304 |
| 0.8 CDI | 3 | OM 660.940, OM 660 DE 8LA | 30/40 | 01/04→01/07 | GN015 | 11V | | |
| 0.8 CDi | 3 | OM 660.950 | 33/44 | 01/07→ | GN015 | 11V | | |
| 1.0 | 3 | M 132.910 | 45/60 | 01/07→ | Z308 | 0.9 | | |
| 1.0 | 3 | M 132.910 | 52/70 | 01/07→ | Z308 | 0.9 | | |
| 1.0 Brabus | 3 | M 132.930 | 72/97 | 01/08→ | Z308 | 0.9 | | |
| 1.0 Turbo | 3 | M 132.930 | 62/83 | 01/07→ | Z308 | 0.9 | | |
| 1.0 Turbo Brabus | 3 | M 132.930 | 75/101 | 07/10→ | Z308 | 0.9 | | |

ROADSTER

| | | | | | | | | |
|------------|---|-----------|-------|-------------|------|-----|--|-------|
| 0.7 | 3 | | 45/60 | 06/03→11/05 | | | | ZS304 |
| 0.7 | 3 | M 160.921 | 45/60 | 04/03→11/05 | Z286 | 0.6 | | ZS304 |
| 0.7 | 3 | M 160.922 | 60/80 | 04/03→11/05 | Z286 | 0.6 | | ZS304 |
| 0.7 Brabus | 3 | M 160.923 | 74/99 | 12/03→11/05 | | | | ZS304 |

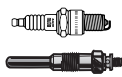

kW/BHP

**SSANGYONG****ACTYON I**

| | | | | | | | | |
|-----------------|---|-------|---------|--------|-------|-----|--|-------|
| 2.0 200 Xdi 4WD | 4 | D20DT | 100/134 | 07/07→ | GN060 | 11V | | |
| 2.0 200 Xdi 4WD | 4 | D20DT | 104/139 | 10/06→ | GN060 | 11V | | |
| 2.0 Xdi | 4 | D20DT | 100/134 | 07/07→ | GN060 | 11V | | |
| 2.0 Xdi | 4 | D20DT | 104/139 | 11/05→ | GN060 | 11V | | |
| 2.3 | 4 | G23D | 110/148 | 11/06→ | | | | ZS340 |

ACTYON SPORTS I

| | | | | | | | | |
|---------|---|--------|---------|--------|-------|------|--|--|
| 2.0 Xdi | 4 | D20DT | 104/139 | 04/07→ | GN060 | 11V | | |
| 2.0 Xdi | 4 | D20DTR | 114/153 | 09/11→ | GE120 | 4.4V | | |

ACTYON SPORTS II

| | | | | | | | | |
|---------|---|--------|---------|--------|-------|------|--|--|
| 2.0 Xdi | 4 | D20DTR | 114/153 | 10/12→ | GE120 | 4.4V | | |
|---------|---|--------|---------|--------|-------|------|--|--|

KORANDO

| | | | | | | | | |
|-------------|---|------------|---------|-------------|-------|-------|-------------|-----------------|
| 2.0 4WD | 4 | | 94/126 | 05/97→ | | | | ZS340 →10/01 |
| 2.0 | 4 | | 110/148 | 02/12→ | | | | ZS537 08/12→ |
| 2.0 e-XDi | 4 | D20DTF | 129/173 | 11/10→ | GE120 | 4.4V | | |
| 2.2 D 4WD | 4 | DC23 | 50/67 | 12/88→12/96 | GV946 | 11V | | |
| 2.3 4WD | 4 | M 111.970 | 103/138 | 05/97→ | Z100 | 0.8 | UXT1 / UXT3 | ZS340 →10/01 |
| 2.3 4WD | 4 | | 105/141 | 01/99→ | | | | ZS340 →10/01 |
| 2.3 4WD LPG | 4 | M 111.970 | 103/138 | 05/97→ | Z206 | 0.7 | UXT10 | |
| 2.3 D 4WD | 4 | OM 601.940 | 58/78 | 12/96→ | GN858 | 11.5V | | |
| 2.9 D 4WD | 5 | MB-OM 662 | 72/97 | 12/96→ | GN858 | 11.5V | | |
| 2.9 D 4WD | 5 | MB-OM 662 | 73/98 | 06/97→10/00 | GN858 | 11.5V | | |
| 2.9 TD 4WD | 5 | | 88/118 | 04/98→ | GN858 | 11.5V | | |
| 3.2 4WD | 6 | M 104.995 | 154/207 | 12/96→ | Z100 | 0.8 | UXT1 / UXT3 | ZS340 →12/05 |
| 3.2 4WD | 6 | M 104.995 | 156/209 | 01/99→ | | | | ZS340 |
| 3.2 4WD LPG | 6 | M 104.995 | 154/207 | 12/96→ | Z206 | 0.7 | UXT10 | |

KYRON

| | | | | | | | | |
|------------------|---|-------|---------|--------|-------|-----|-------------|-------|
| 2.0 Xdi | 4 | D20DT | 100/134 | 01/10→ | GN060 | 11V | | |
| 2.0 Xdi | 4 | D20DT | 104/139 | 05/05→ | GN060 | 11V | | |
| 2.7 Xdi 4WD | 5 | D27DT | 120/161 | 03/06→ | GN060 | 11V | | |
| 2.7 Xdi 4WD | 5 | D27DT | 121/162 | 05/05→ | GN060 | 11V | | |
| 3.2 M320 4WD | 6 | G32D | 162/217 | 03/08→ | Z100 | 0.8 | UXT1 / UXT3 | ZS340 |
| 3.2 M320 4WD LPG | 6 | G32D | 162/217 | 03/08→ | Z206 | 0.7 | UXT10 | |

MUSSO

| | | | | | | | | |
|-------------|---|-----------------------|---------|-------------|-------|-------|-------------|-------|
| 2.0 4WD | 4 | E20 | 93/125 | 10/96→ | Z100 | 0.8 | UXT1 / UXT3 | ZS340 |
| 2.0 4WD LPG | 4 | E20 | 93/125 | 10/96→ | Z206 | 0.7 | UXT10 | |
| 2.3 4WD | 4 | M 111.970 | 103/138 | 10/96→ | Z100 | 0.8 | UXT1 / UXT3 | ZS340 |
| 2.3 4WD | 4 | | 110/148 | 04/03→ | | | | ZS340 |
| 2.3 4WD LPG | 4 | M 111.970 | 103/138 | 10/96→ | Z206 | 0.7 | UXT10 | |
| 2.3 D 4WD | 4 | OM 661.940 | 58/78 | 03/93→04/97 | GN858 | 11.5V | | |
| 2.3 D 4WD | 4 | MB-OM 661, OM 601.940 | 59/79 | 10/95→ | GN858 | GR049 | | |
| 2.9 D 4WD | 5 | MB-OM 662 | 73/98 | 03/96→ | GN858 | 11.5V | | |
| 2.9 TD 4WD | 5 | | 88/118 | 04/98→ | GN858 | 11.5V | | |
| 3.2 4WD | 6 | M 104.992 | 162/217 | 06/96→ | Z100 | 0.8 | UXT1 / UXT3 | ZS340 |
| 3.2 4WD LPG | 6 | M 104.992 | 162/217 | 06/96→ | Z206 | 0.7 | UXT10 | |

REXTON

| | | | | | | | | |
|-------------------|---|--------|---------|-------------|-------|-------|-------------|-------|
| 2.3 RX230 4WD | 4 | G23D | 110/148 | 05/02→ | Z100 | 0.8 | UXT1 / UXT3 | ZS340 |
| 2.3 RX230 4WD LPG | 4 | G23D | 110/148 | 05/02→ | Z206 | 0.7 | UXT10 | |
| 2.7 D 4WD | 5 | D27DTP | 137/184 | 05/06→ | GN060 | 11V | | |
| 2.7 Xdi 4WD | 5 | D27DT | 118/158 | 03/11→ | GN060 | 11V | | |
| 2.7 Xdi 4WD | 5 | D27DT | 120/161 | 08/04→ | GN060 | 11V | | |
| 2.7 Xdi | 5 | D27DT | 121/162 | 03/05→08/06 | GN060 | 11V | | |
| 2.7 Xdi Turbo 4WD | 5 | D27DTP | 132/177 | 03/11→ | GN060 | 11V | | |
| 2.9 TD 4WD | 5 | | 88/118 | 04/02→ | GN858 | 11.5V | | |

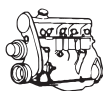

kW/BHP

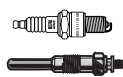

... SSANGYONG



... REXTON

| | | | | | | | |
|-------------|---|------|---------|--------|------|-----|-------------------|
| 3.2 4WD | 6 | G32D | 162/217 | 04/02→ | Z100 | 0.8 | UXT1 / UXT3 ZS340 |
| 3.2 4WD LPG | 6 | G32D | 162/217 | 04/02→ | Z206 | 0.7 | UXT10 |

REXTON W

| | | | | | | | |
|---------|---|--------|---------|--------|-------|------|--|
| 2.0 Xdi | 4 | D20DTR | 114/153 | 07/12→ | GE120 | 4.4V | |
|---------|---|--------|---------|--------|-------|------|--|

RODIUS

| | | | | | | | |
|---------|---|-------|---------|--------|-------|-----|-------------------|
| 2.7 Xdi | 5 | D27DT | 120/161 | 05/05→ | GN060 | 11V | |
| 2.7 Xdi | 5 | D27DT | 121/162 | 05/05→ | GN060 | 11V | |
| 3.2 | 6 | G32D | 162/217 | 05/05→ | Z100 | 0.8 | UXT1 / UXT3 ZS340 |
| 3.2 LPG | 6 | G32D | 162/217 | 05/05→ | Z206 | 0.7 | UXT10 |

SSANGYONG



ISTANA

| | | | | | | | |
|--------|---|------------|--------|-------------|------------------|-------|--|
| 2.9 D | 5 | OM 602.940 | 70/94 | 10/92→05/95 | GN858 | 11.5V | |
| 2.9 D | 5 | OM 602.980 | 90/121 | 06/95→ | GN909 (251)[253] | 11V | |
| | | | | | →03/00 | | |
| | | | | | →eng. 000136 | | |
| | | | | | →eng. 009849 | | |
| | | | | | GN961 (251)[253] | 11V | |
| | | | | | →03/00 | | |
| | | | | | eng. 137→ | | |
| | | | | | eng. 9850→ | | |
| 2.9 TD | 5 | OM 602.940 | 70/94 | 10/92→05/95 | GN858 | 11.5V | |

SUBARU



FORESTER

| | | | | | | | |
|---------------------|---|-------|---------|-------------|------------|-----|-------|
| 2.0 4WD | 4 | EJ20 | 90/121 | 08/97→09/02 | Z73 | 1.1 | UXT11 |
| 2.0 4WD | 4 | EJ20 | 92/123 | 06/98→09/02 | Z16 | 1.1 | UXT11 |
| 2.0 4WD | 4 | EJ20 | 92/123 | 09/02→ | Z73 | 1.1 | UXT11 |
| 2.0 4WD LPG | 4 | EJ20 | 90/121 | 08/97→09/02 | Z206 | 0.7 | UXT10 |
| 2.0 4WD LPG | 4 | EJ20 | 92/123 | 06/98→09/02 | Z340 | 0.7 | UXT12 |
| 2.0 4WD LPG | 4 | EJ20 | 92/123 | 09/02→ | Z206 | 0.7 | UXT10 |
| 2.0 X 4WD | 4 | EJ204 | 116/156 | 09/05→ | Z188 | 0.7 | UXT10 |
| 2.0 S Turbo 4WD | 4 | EJ20 | 125/168 | 06/98→04/01 | Z221 [169] | 1.0 | UXT14 |
| 2.0 S Turbo 4WD | 4 | EJ20 | 130/174 | 09/02→ | Z221 [169] | 1.0 | UXT14 |
| 2.0 S Turbo 4WD | 4 | EJ205 | 130/174 | 04/01→09/02 | Z188 | 0.7 | UXT10 |
| 2.0 S Turbo 4WD LPG | 4 | EJ20 | 125/168 | 06/98→04/01 | Z30 [168] | 0.8 | UXT5 |
| 2.0 S Turbo 4WD LPG | 4 | EJ20 | 130/174 | 09/02→ | Z30 [168] | 0.8 | UXT5 |
| 2.0 S Turbo 4WD LPG | 4 | EJ205 | 130/174 | 04/01→09/02 | Z340 | 0.7 | UXT12 |

IMPREZA

| | | | | | | | |
|---------------|---|--------------|--------|-------------|--------|-----|-------------|
| 1.6 | 4 | EJ16E, EJ161 | 66/89 | 12/96→12/00 | Z16 | 1.1 | UXT11 |
| 1.6 4WD | 4 | EJ16 | 70/94 | 12/00→ | Z16 | 1.1 | UXT11 |
| 1.6 LPG | 4 | EJ16E, EJ161 | 66/89 | 12/96→12/00 | Z340 | 0.7 | UXT12 |
| 1.6 4WD LPG | 4 | EJ16 | 70/94 | 12/00→ | Z340 | 0.7 | UXT12 |
| 1.6 i | 4 | EJ16 | 66/89 | 08/92→12/00 | Z16 | 1.1 | UXT11 |
| 1.6 i 4WD | 4 | EJ16 | 66/89 | 08/92→12/00 | Z16 | 1.1 | UXT11 |
| | | | | | →07/96 | | →07/96 |
| 1.6 i | 4 | EJ161 | 70/94 | 06/98→12/00 | Z16 | 1.1 | UXT11 |
| 1.6 i LPG | 4 | EJ16 | 66/89 | 08/92→12/00 | Z340 | 0.7 | UXT12 |
| 1.6 i 4WD LPG | 4 | EJ16 | 66/89 | 08/92→12/00 | Z340 | 0.7 | UXT12 |
| | | | | | →07/96 | | →07/96 |
| 1.6 i LPG | 4 | EJ161 | 70/94 | 06/98→12/00 | Z340 | 0.7 | UXT12 |
| 1.8 i | 4 | EJ18E | 76/102 | 11/95→06/96 | Z11 | 0.8 | UXT2 / UXT6 |
| 1.8 i 4WD | 4 | EJ18 | 76/102 | 08/92→12/00 | Z16 | 1.1 | UXT11 |
| | | | | | →06/96 | | →06/96 |
| 1.8 i LPG | 4 | EJ18E | 76/102 | 11/95→06/96 | Z340 | 0.7 | UXT12 |
| 1.8 i 4WD LPG | 4 | EJ18 | 76/102 | 08/92→12/00 | Z340 | 0.7 | UXT12 |
| | | | | | →06/96 | | →06/96 |

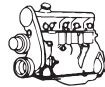

kW/BHP

**... SUBARU****... IMPREZA**

| | | | | | | | |
|-----------------------|---|--------------|---------|-------------|----------------|-----|-----------------|
| 2.0 4WD | 4 | EJ20 | 85/114 | 12/95→12/00 | Z16 →07/96 | 1.1 | UXT11 →07/96 |
| 2.0 4WD | 4 | EJ20 | 92/123 | 12/00→ | Z16 | 1.1 | UXT11 |
| 2.0 4WD LPG | 4 | EJ20 | 85/114 | 12/95→12/00 | Z340 →07/96 | 0.7 | UXT12 →07/96 |
| 2.0 4WD LPG | 4 | EJ20 | 92/123 | 12/00→ | Z340 | 0.7 | UXT12 |
| 2.0 i 4WD | 4 | EJ20 | 85/114 | 10/95→12/00 | Z16 →07/96 | 1.1 | UXT11 →07/96 |
| 2.0 i 4WD | 4 | EJ20 | 85/114 | 12/95→12/00 | Z16 | 1.1 | UXT11 |
| 2.0 i | 4 | EJ20, EJ201 | 92/123 | 06/98→ | Z16 | 1.1 | UXT11 |
| 2.0 i 4WD LPG | 4 | EJ20 | 85/114 | 10/95→12/00 | Z340 →07/96 | 0.7 | UXT12 →07/96 |
| 2.0 i 4WD LPG | 4 | EJ20 | 85/114 | 12/95→12/00 | Z340 | 0.7 | UXT12 |
| 2.0 i LPG | 4 | EJ20, EJ201 | 92/123 | 06/98→ | Z340 | 0.7 | UXT12 |
| 2.0 i 16V 4WD | 4 | EJ20 | 92/123 | 06/98→12/00 | Z16 | 1.1 | UXT11 |
| 2.0 i 16V 4WD LPG | 4 | EJ20 | 92/123 | 06/98→12/00 | Z340 | 0.7 | UXT12 |
| 2.0 i Turbo 4WD | 4 | EJ20 (Turbo) | 155/208 | 03/94→12/00 | Z221 [169] | 1.0 | UXT14 |
| 2.0 i Turbo 4WD LPG | 4 | EJ20 (Turbo) | 155/208 | 03/94→12/00 | Z30 [168] | 0.8 | UXT5 |
| 2.0 Turbo 4WD | 4 | EJ205 | 160/215 | 12/00→ | Z284 | 1.1 | UXT14 |
| 2.0 Turbo 4WD LPG | 4 | EJ205 | 160/215 | 12/00→ | Z30 [168] | 0.8 | UXT5 |
| 2.0 Turbo GT 4WD | 4 | EJ20 (Turbo) | 155/208 | 03/94→12/00 | Z221 [169] | 1.0 | UXT14 |
| 2.0 Turbo GT 4WD | 4 | EJ205 | 160/215 | 06/98→12/00 | Z188 | 0.7 | UXT10 |
| 2.0 Turbo GT 4WD LPG | 4 | EJ20 (Turbo) | 155/208 | 03/94→12/00 | Z30 [168] | 0.8 | UXT5 |
| 2.0 Turbo GT 4WD LPG | 4 | EJ205 | 160/215 | 06/98→12/00 | Z340 | 0.7 | UXT12 |
| 2.0 WRX STi 4WD | 4 | EJ207 | 195/261 | 11/01→ | Z284 | 1.1 | UXT14 |
| 2.0 WRX Turbo 4WD | 4 | EJ205 | 160/215 | 12/00→ | Z188 | 0.7 | UXT10 |
| 2.0 WRX Turbo 4WD | 4 | EJ205 | 165/221 | 12/02→ | Z188 | 0.7 | UXT10 |
| 2.0 WRX Turbo 4WD LPG | 4 | EJ205 | 160/215 | 12/00→ | Z340 | 0.7 | UXT12 |
| 2.0 WRX Turbo 4WD LPG | 4 | EJ205 | 165/221 | 12/02→ | Z340 | 0.7 | UXT12 |

JUSTY I

| | | | | | | | |
|------------------|---|------|-------|-------------|------------------------|------|---------------------|
| 1.0 1000 | 3 | EF10 | 37/50 | 05/87→10/95 | Z9 | 1.15 | UXT2 / UXT6 |
| 1.0 1000 | 3 | EF10 | 40/54 | 11/84→12/90 | Z9 | 1.15 | UXT2 / UXT6 |
| 1.0 1000 LPG | 3 | EF10 | 37/50 | 05/87→10/95 | Z20 [168] Z27 [168] | 0.8 | UXT2 / UXT6 UX56 |
| 1.0 1000 4WD LPG | 3 | EF10 | 37/50 | 05/87→11/94 | Z20 [168] | 0.8 | UXT2 / UXT6 |
| 1.0 1000 LPG | 3 | EF10 | 40/54 | 11/84→12/90 | Z20 [168] | 0.8 | UXT2 / UXT6 |
| 1.2 1200 | 3 | EF12 | 49/66 | 05/87→10/95 | Z9 | 1.15 | UXT2 / UXT6 |
| 1.2 1200 4WD | 3 | EF12 | 50/67 | 10/86→12/90 | Z9 | 1.15 | UXT2 / UXT6 |
| 1.2 1200 4WD | 3 | EF12 | 55/74 | 10/90→12/94 | Z9 | 1.15 | UXT2 / UXT6 |
| 1.2 1200 LPG | 3 | EF12 | 49/66 | 05/87→10/95 | Z20 [168] Z27 [168] | 0.8 | UXT2 / UXT6 UX56 |
| 1.2 1200 4WD LPG | 3 | EF12 | 49/66 | 05/87→05/91 | Z20 [168] | 0.8 | UXT2 / UXT6 |
| 1.2 1200 4WD LPG | 3 | EF12 | 50/67 | 10/86→12/90 | Z20 [168] | 0.8 | UXT2 / UXT6 |
| 1.2 1200 4WD LPG | 3 | EF12 | 55/74 | 10/90→12/94 | Z20 [168] | 0.8 | UXT2 / UXT6 |

JUSTY II

| | | | | | | | |
|----------------|---|-------|-------|-------------|---------------------|-----|-----------------------|
| 1.3 4WD | 4 | G13BB | 63/84 | 04/01→11/03 | Z16 | 1.1 | UXT11 |
| 1.3 4WD LPG | 4 | G13BB | 63/84 | 04/01→11/03 | Z340 | 0.7 | UXT12 |
| 1.3 GX 4WD | 4 | EF13 | 50/67 | 10/95→11/03 | Z20 →09/96 | 0.8 | UXT2 / UXT6 →09/96 |
| 1.3 GX 4WD LPG | 4 | EF13 | 50/67 | 10/95→11/03 | Z27 [168] →09/96 | 0.8 | UX56 →09/96 |

JUSTY IV

| | | | | | | | |
|-----|---|--------|-------|--------|------|-----|--------|
| 1.0 | 3 | 1KR-FE | 51/68 | 01/07→ | Z235 | 1.0 | ZSE164 |
|-----|---|--------|-------|--------|------|-----|--------|

LEGACY I

| | | | | | | | |
|------------------|---|-----------|--------|-------------|------|-----|-------|
| 1.8 1800 | 4 | EJ18 SPI | 76/102 | 01/89→07/94 | Z16 | 1.1 | UXT11 |
| 1.8 1800 LPG | 4 | EJ18 SPI | 76/102 | 01/89→07/94 | Z340 | 0.7 | UXT12 |
| 2.0 2000 | 4 | EJ20 EMPI | 85/114 | 08/91→07/94 | Z16 | 1.1 | UXT11 |
| 2.0 2000 4WD LPG | 4 | EJ20 EMPI | 85/114 | 08/91→07/94 | Z340 | 0.7 | UXT12 |

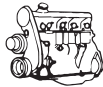

kw/BHP

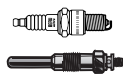

... SUBARU



... LEGACY I

| | | | | | | | | |
|--------------------------|---|-----------|---------|-------------|------|-----|-------|--|
| 2.0 2000 Turbo 4WD | 4 | EJ20-GN | 147/197 | 05/92→07/94 | Z149 | 1.1 | UXT11 | |
| 2.0 2000 Turbo Super 4WD | 4 | EJ20-GN | 147/197 | 05/92→07/94 | Z149 | 1.1 | UXT11 | |
| 2.2 2200 4WD | 4 | EJ22 EMPI | 100/134 | 01/89→07/94 | Z16 | 1.1 | UXT11 | |
| 2.2 2200 4WD LPG | 4 | EJ22 EMPI | 100/134 | 01/89→07/94 | Z340 | 0.7 | UXT12 | |
| 2.2 2200 Super 4WD | 4 | EJ22 EMPI | 100/134 | 01/89→07/94 | Z16 | 1.1 | UXT11 | |
| 2.2 2200 Super 4WD LPG | 4 | EJ22 EMPI | 100/134 | 01/89→07/94 | Z340 | 0.7 | UXT12 | |

LEGACY II

| | | | | | | | | |
|---------------|---|------------------------|---------|-------------|------|-----|-------|--|
| 2.0 i | 4 | EJ20, EJ20E, EJ20 EMPI | 85/114 | 09/94→03/99 | Z16 | 1.1 | UXT11 | |
| 2.0 i LPG | 4 | EJ20, EJ20E, EJ20 EMPI | 85/114 | 09/94→03/99 | Z340 | 0.7 | UXT12 | |
| 2.2 i 4WD | 4 | EJ22 EMPI | 94/126 | 02/94→03/99 | Z16 | 1.1 | UXT11 | |
| 2.2 i 4WD | 4 | EJ22 EMPI | 96/129 | 06/96→03/99 | Z16 | 1.1 | UXT11 | |
| 2.2 i 4WD LPG | 4 | EJ22 EMPI | 94/126 | 02/94→03/99 | Z340 | 0.7 | UXT12 | |
| 2.2 i 4WD LPG | 4 | EJ22 EMPI | 96/129 | 06/96→03/99 | Z340 | 0.7 | UXT12 | |
| 2.5 i 4WD | 4 | EJ25D | 110/148 | 06/96→03/99 | Z343 | 1.1 | UXT11 | |
| 2.5 i 4WD LPG | 4 | EJ25D | 110/148 | 06/96→03/99 | Z206 | 0.7 | UXT10 | |

LEGACY III

| | | | | | | | | |
|-------------|---|------|---------|-------------|------|-----|-------|--|
| 2.0 4WD | 4 | EJ20 | 92/123 | 12/98→08/03 | Z16 | 1.1 | UXT11 | |
| 2.0 4WD LPG | 4 | EJ20 | 92/123 | 12/98→08/03 | Z340 | 0.7 | UXT12 | |
| 2.5 4WD | 4 | EJ25 | 115/154 | 10/98→08/03 | Z16 | 1.1 | UXT11 | |
| 2.5 4WD LPG | 4 | EJ25 | 115/154 | 10/98→08/03 | Z340 | 0.7 | UXT12 | |

LEGACY IV

| | | | | | | | | |
|-------------|---|------|---------|--------|--------|-----|--------|--|
| 2.0 4WD | 4 | EJ20 | 101/135 | 09/03→ | Z16 | 1.1 | UXT11 | |
| 2.0 4WD LPG | 4 | EJ20 | 101/135 | 09/03→ | Z340 | 0.7 | UXT12 | |
| 2.5 4WD | 4 | EJ25 | 121/162 | 09/03→ | Z312 | 1.0 | UXT9 | |
| | | | | | →06/06 | | →06/06 | |
| 2.5 i 4WD | 4 | EJ25 | 127/170 | 09/07→ | Z312 | 1.0 | UXT9 | |
| | | | | | →05/09 | | →05/09 | |

LEONE I

| | | | | | | | | |
|----------------------|---|------|-------|-------------|-----|-----|-------------|--|
| 1.8 1800 4WD | 4 | EA81 | 59/79 | 09/80→10/84 | Z20 | 0.8 | UXT2 / UXT6 | |
| 1.8 1800 4WD | 4 | EA81 | 60/80 | 09/80→10/84 | Z20 | 0.8 | UXT2 / UXT6 | |
| 1.8 1800 Super 4WD | 4 | EA81 | 60/80 | 09/80→10/84 | Z20 | 0.8 | UXT2 / UXT6 | |
| 1.8 1800 Turismo 4WD | 4 | EA81 | 60/80 | 09/80→10/84 | Z20 | 0.8 | UXT2 / UXT6 | |

LEONE II

| | | | | | | | | |
|--------------------------|---|------|---------|-------------|-----|-----|-------------|-----------------|
| 1.8 1800 4WD | 4 | EA82 | 66/89 | 11/84→12/90 | Z20 | 0.8 | UXT2 / UXT6 | |
| 1.8 1800 4WD | 4 | EA82 | 70/94 | 07/86→09/91 | Z20 | 0.8 | UXT2 / UXT6 | ZM046 →12/90 |
| 1.8 1800 4WD | 4 | EA82 | 72/97 | 12/86→07/91 | Z20 | 0.8 | UXT2 / UXT6 | |
| 1.8 1800 Super 4WD | 4 | EA82 | 70/94 | 07/86→02/92 | Z20 | 0.8 | UXT2 / UXT6 | ZM046 →12/90 |
| 1.8 1800 Super 4WD | 4 | EA82 | 96/129 | 03/89→12/90 | Z21 | 1.1 | UXT2 / UXT6 | |
| 1.8 1800 Super Turbo 4WD | 4 | EA82 | 100/134 | 11/84→12/90 | Z21 | 1.1 | UXT2 / UXT6 | |
| 1.8 1800 Turbo 4WD | 4 | EA82 | 96/129 | 03/89→12/90 | Z21 | 1.1 | UXT2 / UXT6 | |
| 1.8 1800 Turbo 4WD | 4 | EA82 | 100/134 | 11/84→12/90 | Z21 | 1.1 | UXT2 / UXT6 | |

OUTBACK

| | | | | | | | | |
|-------------|---|-------|---------|-------------|------|-----|-------|--|
| 2.5 4WD | 4 | EJ25 | 115/154 | 10/00→08/03 | Z16 | 1.1 | UXT11 | |
| 2.5 4WD | 4 | EJ251 | 127/170 | 09/08→09/09 | Z312 | 1.0 | UXT9 | |
| 2.5 4WD LPG | 4 | EJ25 | 115/154 | 10/00→08/03 | Z340 | 0.7 | UXT12 | |

SVX

| | | | | | | | | |
|-------------------|---|-----------|---------|-------------|-----------|-----|-------|--|
| 3.3 i 24V 4WD | 6 | EG33 DOHC | 162/217 | 09/94→12/97 | Z284 | 1.1 | UXT14 | |
| 3.3 i 24V 4WD | 6 | EG33 DOHC | 169/227 | 09/92→09/94 | Z284 | 1.1 | UXT14 | |
| 3.3 i 24V 4WD LPG | 6 | EG33 DOHC | 162/217 | 09/94→12/97 | Z30 [168] | 0.8 | UXT5 | |

TREZIA

| | | | | | | | | |
|-----|---|--------|-------|--------|--|--|--|--------|
| 1.3 | 4 | 1NR-FE | 73/98 | 03/11→ | | | | ZSE172 |
|-----|---|--------|-------|--------|--|--|--|--------|

VIVIO

| | | | | | | | | |
|-----------------|---|-------|-------|-------------|------|-----|-------|--|
| 0.7 660 4WD | 4 | EN07E | 32/43 | 03/92→10/95 | Z16 | 1.1 | UXT11 | |
| 0.7 660 4WD LPG | 4 | EN07E | 32/43 | 03/92→10/95 | Z340 | 0.7 | UXT12 | |

SUBARU

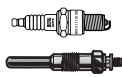

kW/BHP

**... SUBARU****XT**

| | | | | | | | |
|---------------|---|------|---------|-------------|-----|-----|-------------|
| 1.8 Turbo 4WD | 4 | EA82 | 88/118 | 01/88→12/90 | Z27 | 0.8 | UX56 |
| 1.8 Turbo 4WD | 4 | EA82 | 96/129 | 01/87→12/90 | Z21 | 1.1 | UXT2 / UXT6 |
| 1.8 Turbo 4WD | 4 | EA82 | 100/134 | 11/84→12/90 | Z21 | 1.1 | UXT2 / UXT6 |

SUBARU**LIBERO**

| | | | | | | | |
|---------------|---|------|-------|-------------|-----------|------|-------------|
| 1.0 4WD | 3 | EF10 | 37/50 | 01/83→12/87 | Z9 | 1.15 | UXT2 / UXT6 |
| 1.0 4WD LPG | 3 | EF10 | 37/50 | 01/83→12/87 | Z20 [168] | 0.8 | UXT2 / UXT6 |
| 1.2 4WD | 3 | EF12 | 38/51 | 08/86→02/00 | Z9 | 1.15 | UXT2 / UXT6 |
| 1.2 4WD LPG | 3 | EF12 | 38/51 | 08/86→02/00 | Z20 [168] | 0.8 | UXT2 / UXT6 |
| 1.2 i 4WD | 3 | EF12 | 40/54 | 08/91→02/00 | Z9 | 1.15 | UXT2 / UXT6 |
| 1.2 i 4WD LPG | 3 | EF12 | 40/54 | 08/91→02/00 | Z20 [168] | 0.8 | UXT2 / UXT6 |

SUZUKI**ALTO I (SS80)**

| | | | | | | | |
|-----|---|-----|-------|-------------|----|-----|---------------------------|
| 0.8 | 3 | F8B | 29/39 | 06/82→12/85 | Z8 | 0.8 | UXT2 / UXT6 ZS110 [1][15] |
|-----|---|-----|-------|-------------|----|-----|---------------------------|

ALTO II (EC)

| | | | | | | | |
|-----|---|-----|-------|-------------|----|-----|------------------------|
| 0.8 | 3 | F8B | 29/39 | 01/86→11/93 | Z8 | 0.8 | UXT2 / UXT6 ZS106 [11] |
|-----|---|-----|-------|-------------|----|-----|------------------------|

ALTO III (EF)

| | | | | | | | |
|---------|---|-------|-------|-------------|-----------|-----|-------------|
| 1.0 | 4 | G10BB | 39/52 | 09/94→06/02 | Z8 | 0.8 | UXT2 / UXT6 |
| 1.0 | 4 | G10BB | 43/58 | 01/00→06/02 | Z8 | 0.8 | UXT2 / UXT6 |
| 1.0 LPG | 4 | G10BB | 39/52 | 09/94→06/02 | Z20 [168] | 0.8 | UXT2 / UXT6 |
| 1.0 LPG | 4 | G10BB | 43/58 | 01/00→06/02 | Z20 [168] | 0.8 | UXT2 / UXT6 |

ALTO IV (FF)

| | | | | | | | |
|-----|---|-------------|-------|-------------|------|-----|--|
| 1.1 | 4 | F10D, F10DN | 46/62 | 06/02→12/08 | Z234 | 0.9 | |
|-----|---|-------------|-------|-------------|------|-----|--|

ALTO V (GF)

| | | | | | | | |
|---------|---|------|-------|--------|------------|-----|--|
| 1.0 | 3 | K10B | 50/67 | 01/09→ | Z333 | 1.1 | |
| 1.0 LPG | 3 | K10B | 50/67 | 01/09→ | Z291 [168] | 0.9 | |

BALENO (EG)

| | | | | | | | |
|---------------|---|-------|--------|-------------|-------|-----|--------------|
| 1.3 | 4 | G13BA | 52/70 | 09/96→05/02 | Z15 | 0.8 | UXT1 / UXT3 |
| 1.3 LPG | 4 | G13BA | 52/70 | 09/96→05/02 | Z340 | 0.7 | UXT12 |
| 1.3 i 16V | 4 | G13BB | 63/84 | 07/95→05/02 | Z15 | 0.8 | UXT1 / UXT3 |
| 1.3 i 16V LPG | 4 | G13BB | 63/84 | 07/95→05/02 | Z340 | 0.7 | UXT12 |
| 1.6 i 16V | 4 | G16B | 72/97 | 07/95→05/02 | Z15 | 0.8 | UXT1 / UXT3 |
| 1.6 i 16V LPG | 4 | G16B | 72/97 | 07/95→05/02 | Z340 | 0.7 | UXT12 |
| 1.8 GTX | 4 | J18A | 89/119 | 03/96→05/02 | Z16 | 1.1 | UXT11 ZSE072 |
| 1.8 GTX LPG | 4 | J18A | 89/119 | 03/96→05/02 | Z340 | 0.7 | UXT12 |
| 1.9 TD | 4 | | 55/74 | 04/98→05/02 | GN909 | 11V | |

BALENO Estate (EG)

| | | | | | | | |
|---------------|---|-------|--------|-------------|------|-----|--------------|
| 1.3 16V | 4 | G13BB | 63/84 | 03/97→05/02 | Z15 | 0.8 | UXT1 / UXT3 |
| 1.3 16V LPG | 4 | G13BB | 63/84 | 03/97→05/02 | Z340 | 0.7 | UXT12 |
| 1.8 i 16V | 4 | J18A | 89/119 | 08/96→05/02 | Z16 | 1.1 | UXT11 ZSE072 |
| 1.8 i 16V LPG | 4 | J18A | 89/119 | 08/96→05/02 | Z340 | 0.7 | UXT12 |

BALENO Estate/Hatchback (EG)

| | | | | | | | |
|---------------|---|------|-------|-------------|-------|-----|-------------|
| 1.6 i 16V | 4 | G16B | 72/97 | 07/95→05/02 | Z15 | 0.8 | UXT1 / UXT3 |
| 1.6 i 16V LPG | 4 | G16B | 72/97 | 07/95→05/02 | Z340 | 0.7 | UXT12 |
| 1.9 TD | 4 | | 55/74 | 04/98→05/02 | GN909 | 11V | |

BALENO Hatchback (EG)

| | | | | | | | |
|---------------|---|-------|--------|-------------|------|-----|--------------|
| 1.3 | 4 | G13BA | 52/70 | 09/96→05/02 | Z15 | 0.8 | UXT1 / UXT3 |
| 1.3 LPG | 4 | G13BA | 52/70 | 09/96→05/02 | Z340 | 0.7 | UXT12 |
| 1.3 i 16V | 4 | G13BB | 63/84 | 07/95→05/02 | Z15 | 0.8 | UXT1 / UXT3 |
| 1.3 i 16V LPG | 4 | G13BB | 63/84 | 07/95→05/02 | Z340 | 0.7 | UXT12 |
| 1.8 GTX | 4 | J18A | 89/119 | 03/96→05/02 | Z16 | 1.1 | UXT11 ZSE072 |
| 1.8 GTX LPG | 4 | J18A | 89/119 | 03/96→05/02 | Z340 | 0.7 | UXT12 |

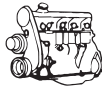

kW/BHP

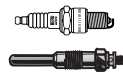

... SUZUKI



GRAND VITARA I (FT, GT)

| | | | | | | | | |
|---------------------|---|--------|---------|-------------|-------|-----|-------|--------|
| 1.6 4WD | 4 | G16B | 69/93 | 03/98→07/03 | Z16 | 1.1 | UXT11 | ZSE136 |
| 1.6 4WD | 4 | G16B | 73/98 | 02/00→09/02 | | | | ZSE136 |
| 1.6 4WD LPG | 4 | G16B | 69/93 | 03/98→07/03 | Z340 | 0.7 | UXT12 | |
| 2.0 4WD | 4 | J20A | 94/126 | 03/98→07/03 | Z16 | 1.1 | UXT11 | ZSE072 |
| 2.0 4WD | 4 | J20A | 103/138 | 04/98→08/05 | | | | ZSE072 |
| 2.0 4WD LPG | 4 | J20A | 94/126 | 03/98→07/03 | Z340 | 0.7 | UXT12 | |
| 2.0 HDI 110 4WD | 4 | RHZ | 80/107 | 07/01→09/05 | GN054 | 11V | | |
| 2.0 HDI 110 16V 4WD | 4 | RHW | 80/107 | 07/01→09/05 | GN054 | 11V | | |
| 2.0 TD 4WD | 4 | RF | 64/86 | 03/98→07/03 | GN005 | 11V | | |
| 2.5 V6 24V 4WD | 6 | H 25 A | 106/142 | 04/98→07/03 | Z16 | 1.1 | UXT11 | ZSE072 |
| 2.5 V6 24V 4WD | 6 | H 25 A | 116/156 | 04/01→07/03 | | | | ZSE072 |
| 2.5 V6 24V 4WD LPG | 6 | H 25 A | 106/142 | 04/98→07/03 | Z340 | 0.7 | UXT12 | |
| 2.7 4WD | 6 | H 27 A | 127/170 | 09/01→07/03 | | | | ZSE072 |
| 2.7 4WD | 6 | H 27 A | 135/181 | 04/03→07/03 | | | | ZSE072 |

GRAND VITARA II (JT)

| | | | | | | | | |
|--------------|---|------|---------|--------|------------------------------|-------------|-------|--------|
| 1.6 4WD | 4 | M16A | 78/105 | 04/05→ | Z221 | 1.0 | UXT14 | ZSE069 |
| 1.6 4WD LPG | 4 | M16A | 78/105 | 04/05→ | Z30 [168] | 0.8 | UXT5 | |
| 1.9 DDiS 4WD | 4 | F9QB | 95/127 | 10/05→ | GE111 [37][55] GN018 [56] | 4.4V 11V | | |
| 2.0 4WD | 4 | J20A | 103/138 | 10/05→ | | | | ZSE072 |
| 3.2 4WD | 6 | N32A | 171/229 | 01/09→ | Z342 | 1.3 | UXT7 | |

IGNIS (FH)

| | | | | | | | | |
|---------|---|------|-------|-------------|------|-----|-------|--------|
| 1.3 | 4 | M13A | 61/82 | 10/00→09/03 | Z16 | 1.1 | UXT11 | |
| 1.3 4WD | 4 | M13A | 61/82 | 10/00→09/03 | Z16 | 1.1 | UXT11 | ZSE069 |
| 1.3 LPG | 4 | M13A | 61/82 | 10/00→09/03 | Z340 | 0.7 | UXT12 | |

IGNIS II

| | | | | | | | | |
|---------------|---|-------|--------|--------|-----------|-----|-------|--------|
| 1.3 | 4 | M13A | 69/93 | 09/03→ | Z284 | 1.1 | UXT14 | |
| 1.3 4WD | 4 | M13A | 69/93 | 09/03→ | Z221 | 1.0 | UXT14 | ZSE069 |
| 1.3 LPG | 4 | M13A | 69/93 | 09/03→ | Z30 [168] | 0.8 | UXT5 | |
| 1.3 DDiS | 4 | Z13DT | 51/68 | 09/03→ | GN053 | 11V | | |
| 1.5 | 4 | M15A | 73/98 | 09/03→ | Z284 | 1.1 | UXT14 | ZSE069 |
| 1.5 LPG | 4 | M15A | 73/98 | 09/03→ | Z30 [168] | 0.8 | UXT5 | |
| 1.5 Sport | 4 | M15A | 80/107 | 12/03→ | Z284 | 1.1 | UXT14 | ZSE069 |
| 1.5 Sport LPG | 4 | M15A | 80/107 | 12/03→ | Z30 [168] | 0.8 | UXT5 | |

JIMNY (FJ)

| | | | | | | | | |
|-----------------|---|---------|-------|-------------|-----------|-----|-------------|--------|
| 1.3 4WD | 4 | G13BB | 63/84 | 09/98→08/00 | | | | ZSE136 |
| 1.3 16V | 4 | G13BB | 59/79 | 09/98→ | Z15 | 0.8 | UXT1 / UXT3 | ZSE136 |
| 1.3 16V | 4 | M13A | 60/80 | 02/01→ | Z15 | 0.8 | UXT1 / UXT3 | ZSE136 |
| 1.3 16V 4WD | 4 | M13A | 63/84 | 08/05→ | Z221 | 1.0 | UXT14 | ZSE136 |
| 1.3 16V LPG | 4 | G13BB | 59/79 | 09/98→ | Z340 | 0.7 | UXT12 | |
| 1.3 16V LPG | 4 | M13A | 60/80 | 02/01→ | Z340 | 0.7 | UXT12 | |
| 1.3 16V 4WD LPG | 4 | M13A | 63/84 | 08/05→ | Z30 [168] | 0.8 | UXT5 | |
| 1.5 DDiS 4WD | 4 | K9K 700 | 48/64 | 12/03→ | GN018 | 11V | | |
| 1.5 DDiS 4WD | 4 | K9K 266 | 63/84 | 08/05→ | GN018 | 11V | | |

LIANA (ER)

| | | | | | | | | |
|-------------|---|------|--------|-------------|-----------|-----|-------|--------|
| 1.3 | 4 | M13A | 66/89 | 03/02→ | Z284 | 1.1 | UXT14 | ZSE069 |
| 1.3 LPG | 4 | M13A | 66/89 | 03/02→ | Z30 [168] | 0.8 | UXT5 | |
| 1.4 DDiS | 4 | 8HY | 66/89 | 04/04→ | GN047 | 11V | | |
| 1.6 | 4 | M16A | 76/102 | 03/02→ | Z284 | 1.1 | UXT14 | ZSE069 |
| 1.6 4WD | 4 | M16A | 76/102 | 03/02→ | Z284 | 1.1 | UXT14 | ZSE069 |
| 1.6 4WD | 4 | M16A | 78/105 | 04/02→ | Z284 | 1.1 | UXT14 | ZSE069 |
| 1.6 4WD | 4 | M16A | 79/106 | 01/05→12/07 | | | | ZSE069 |
| 1.6 LPG | 4 | M16A | 76/102 | 03/02→ | Z30 [168] | 0.8 | UXT5 | |
| 1.6 4WD LPG | 4 | M16A | 78/105 | 04/02→ | Z30 [168] | 0.8 | UXT5 | |
| 1.6 i | 4 | M16A | 78/105 | 04/02→ | Z284 | 1.1 | UXT14 | ZSE069 |
| 1.6 i LPG | 4 | M16A | 78/105 | 04/02→ | Z30 [168] | 0.8 | UXT5 | |



kW/BHP

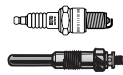

... SUZUKI



LIANA Estate (ER)

| | | | | | | | | | |
|-------------|---|------|--------|-------------|-----------|-----|-------|--------|--|
| 1.3 | 4 | M13A | 66/89 | 07/01→12/07 | Z284 | 1.1 | UXT14 | | |
| 1.3 LPG | 4 | M13A | 66/89 | 07/01→12/07 | Z30 [168] | 0.8 | UXT5 | | |
| 1.4 DDiS | 4 | 8HY | 66/89 | 04/04→12/07 | GN047 | 11V | | | |
| 1.6 | 4 | M16A | 76/102 | 07/01→12/07 | Z284 | 1.1 | UXT14 | ZSE069 | |
| 1.6 4WD | 4 | M16A | 76/102 | 07/01→12/07 | Z284 | 1.1 | UXT14 | | |
| 1.6 4WD | 4 | M16A | 78/105 | 04/02→12/07 | Z284 | 1.1 | UXT14 | ZSE069 | |
| 1.6 | 4 | M16A | 79/106 | 01/05→12/07 | | | | ZSE069 | |
| 1.6 4WD | 4 | M16A | 79/106 | 01/05→12/07 | Z284 | 1.1 | UXT14 | ZSE069 | |
| 1.6 LPG | 4 | M16A | 76/102 | 07/01→12/07 | Z30 [168] | 0.8 | UXT5 | | |
| 1.6 4WD LPG | 4 | M16A | 78/105 | 04/02→12/07 | Z30 [168] | 0.8 | UXT5 | | |
| 1.6 4WD LPG | 4 | M16A | 79/106 | 01/05→12/07 | Z30 [168] | 0.8 | UXT5 | | |
| 1.6 i | 4 | M16A | 78/105 | 04/02→12/07 | Z284 | 1.1 | UXT14 | ZSE069 | |
| 1.6 i LPG | 4 | M16A | 78/105 | 04/02→12/07 | Z30 [168] | 0.8 | UXT5 | | |

LJ 80

| | | | | | | | | | |
|---------|---|-----|-------|-------------|----|-----|-------------|--|--|
| 0.8 4WD | 4 | F8A | 29/39 | 01/80→01/84 | Z8 | 0.8 | UXT2 / UXT6 | | |
|---------|---|-----|-------|-------------|----|-----|-------------|--|--|

SAMURAI (SJ)

| | | | | | | | | | |
|-------------|---|-------|-------|-------------|-----------|-----|-------------|--|--|
| 1.0 4WD | 4 | F10A | 33/44 | 11/88→12/04 | Z8 | 0.8 | UXT2 / UXT6 | | |
| 1.0 4WD LPG | 4 | F10A | 33/44 | 11/88→12/04 | Z20 [168] | 0.8 | UXT2 / UXT6 | | |
| 1.3 4WD | 4 | G13A | 44/59 | 11/88→12/04 | Z8 | 0.8 | UXT2 / UXT6 | | |
| 1.3 4WD | 4 | G13A | 47/63 | 11/88→12/04 | Z8 | 0.8 | UXT2 / UXT6 | | |
| 1.3 4WD | 4 | G13BA | 51/68 | 11/88→12/04 | Z8 | 0.8 | UXT2 / UXT6 | | |
| 1.3 4WD LPG | 4 | G13A | 44/59 | 11/88→12/04 | Z20 [168] | 0.8 | UXT2 / UXT6 | | |
| 1.3 4WD LPG | 4 | G13A | 47/63 | 11/88→12/04 | Z20 [168] | 0.8 | UXT2 / UXT6 | | |
| 1.3 4WD LPG | 4 | G13BA | 51/68 | 11/88→12/04 | Z20 [168] | 0.8 | UXT2 / UXT6 | | |
| 1.9 TD 4WD | 4 | XUD9 | 46/62 | 11/98→12/04 | GN013 | 11V | | | |

SJ 410

| | | | | | | | | | |
|---------|---|------|-------|-------------|----|-----|-------------|------------|--|
| 1.0 4WD | 4 | F10A | 33/44 | 09/81→12/88 | Z8 | 0.8 | UXT2 / UXT6 | ZS110 [15] | |
|---------|---|------|-------|-------------|----|-----|-------------|------------|--|

SJ 410 Cabrio

| | | | | | | | | | |
|---------|---|------|-------|-------------|----|-----|-------------|-------------------------|--|
| 1.0 4WD | 4 | F10A | 33/44 | 09/81→12/88 | Z8 | 0.8 | UXT2 / UXT6 | ZS110 [1][15] →12/86 | |
|---------|---|------|-------|-------------|----|-----|-------------|-------------------------|--|

SJ 413

| | | | | | | | | | |
|---------|---|------|-------|-------------|----|-----|-------------|--|--|
| 1.3 4WD | 4 | G13A | 44/59 | 08/86→08/90 | Z8 | 0.8 | UXT2 / UXT6 | | |
| 1.3 4WD | 4 | G13A | 47/63 | 09/84→12/88 | Z8 | 0.8 | UXT2 / UXT6 | | |

SPLASH

| | | | | | | | | | |
|-------------|---|----------------|-------|--------|------------|-----|--|--|--|
| 1.0 | 3 | K10B | 48/64 | 01/08→ | Z333 | 1.1 | | | |
| 1.0 | 3 | K10B | 50/67 | 06/11→ | Z333 | 1.1 | | | |
| 1.0 LPG | 3 | K10B | 48/64 | 01/08→ | Z291 [168] | 0.9 | | | |
| 1.0 LPG | 3 | K10B | 50/67 | 06/11→ | Z291 [168] | 0.9 | | | |
| 1.2 | 4 | K12B | 63/84 | 01/08→ | Z333 | 1.1 | | | |
| 1.2 LPG | 4 | K12B | 63/84 | 01/08→ | Z291 [168] | 0.9 | | | |
| 1.2 VVT | 4 | K12B | 66/89 | 06/11→ | Z333 | 1.1 | | | |
| 1.2 VVT | 4 | K12B | 69/93 | 09/10→ | Z333 | 1.1 | | | |
| 1.2 VVT LPG | 4 | K12B | 66/89 | 06/11→ | Z291 [168] | 0.9 | | | |
| 1.2 VVT LPG | 4 | K12B | 69/93 | 09/10→ | Z291 [168] | 0.9 | | | |
| 1.3 CDTI | 4 | D13A, Z 13 DTJ | 55/74 | 01/08→ | GN053 | 11V | | | |

SWIFT Convertible (SF413)

| | | | | | | | | | |
|-----------|---|-------|-------|-------------|-----------|-----|-------------|--|--|
| 1.3 i | 4 | G13BA | 50/67 | 09/91→10/96 | Z20 | 0.8 | UXT2 / UXT6 | | |
| 1.3 i LPG | 4 | G13BA | 50/67 | 09/91→10/96 | Z27 [168] | 0.8 | UX56 | | |

SWIFT I (AA)

| | | | | | | | | | |
|-------------|---|-----------|-------|-------------|-----|-----|-------------|-------|-------|
| 1.0 | 3 | G10, G10A | 37/50 | 10/83→03/89 | Z11 | 0.8 | UXT2 / UXT6 | | |
| 1.0 Turbo | 3 | G10T | 52/70 | 02/85→12/89 | Z20 | 0.8 | UXT2 / UXT6 | | |
| 1.3 | 4 | G13A | 47/63 | 08/86→03/89 | Z20 | 0.8 | UXT2 / UXT6 | | |
| 1.3 | 4 | G13A | 50/67 | 10/84→03/89 | Z20 | 0.8 | UXT2 / UXT6 | | |
| 1.3 | 4 | G13A | 54/72 | 10/84→03/89 | Z20 | 0.8 | UXT2 / UXT6 | | |
| 1.3 Gti/Gxi | 4 | G13B | 74/99 | 08/85→03/89 | Z20 | 0.8 | UXT2 / UXT6 | ZS274 | ZM024 |



kW/BHP

**... SUZUKI****SWIFT II Saloon (AH, AJ)**

| | | | | | | | | | |
|-----------|---|------|-------|-------------|-----------|-----|-------------|--|--|
| 1.3 | 4 | G13A | 50/67 | 03/89→05/01 | Z20 | 0.8 | UXT2 / UXT6 | | |
| 1.3 | 4 | G13A | 52/70 | 03/89→12/91 | Z20 | 0.8 | UXT2 / UXT6 | | |
| 1.3 LPG | 4 | G13A | 50/67 | 03/89→05/01 | Z27 [168] | 0.8 | UX56 | | |
| 1.6 | 4 | G16B | 70/94 | 11/89→12/91 | Z15 | 0.8 | UXT1 / UXT3 | | |
| 1.6 i | 4 | G16B | 68/91 | 01/90→05/01 | Z15 | 0.8 | UXT1 / UXT3 | | |
| 1.6 i LPG | 4 | G16B | 68/91 | 01/90→05/01 | Z340 | 0.7 | UXT12 | | |

SWIFT II Hatchback (EA, MA)

| | | | | | | | | | |
|-------------|---|------|-------|-------------|-----------|-----|-------------|-------|-------|
| 1.0 | 3 | G10A | 37/50 | 03/89→05/01 | Z20 | 0.8 | UXT2 / UXT6 | | |
| 1.0 LPG | 3 | G10A | 37/50 | 03/89→05/01 | Z27 [168] | 0.8 | UX56 | | |
| 1.0 i | 3 | G10A | 39/52 | 01/95→12/05 | Z20 | 0.8 | UXT2 / UXT6 | | |
| 1.0 i | 3 | G10A | 40/54 | 03/89→12/91 | Z20 | 0.8 | UXT2 / UXT6 | | |
| 1.0 i LPG | 3 | G10A | 39/52 | 01/95→12/05 | Z27 [168] | 0.8 | UX56 | | |
| 1.3 | 4 | G13A | 50/67 | 03/89→05/01 | Z20 | 0.8 | UXT2 / UXT6 | | |
| 1.3 | 4 | G13A | 52/70 | 03/89→12/91 | Z20 | 0.8 | UXT2 / UXT6 | | |
| 1.3 LPG | 4 | G13A | 50/67 | 03/89→05/01 | Z27 [168] | 0.8 | UX56 | | |
| 1.3 GTi | 4 | G13B | 74/99 | 03/89→05/01 | Z20 | 0.8 | UXT2 / UXT6 | ZS274 | ZM024 |
| 1.3 GTi LPG | 4 | G13B | 74/99 | 03/89→05/01 | Z27 [168] | 0.8 | UX56 | | |

SWIFT III (MZ, EZ)

| | | | | | | | | | |
|-------------|---|--------|--------|--------|-----------|-----|-------|--------|--|
| 1.3 4WD | 4 | M13A | 66/89 | 01/06→ | Z221 | 1.0 | UXT14 | ZSE069 | |
| 1.3 | 4 | M13A | 68/91 | 02/05→ | Z284 | 1.1 | UXT14 | ZSE069 | |
| 1.3 4WD | 4 | M13A | 68/91 | 02/05→ | Z284 | 1.1 | UXT14 | | |
| 1.3 4WD LPG | 4 | M13A | 66/89 | 01/06→ | Z30 [168] | 0.8 | UXT5 | | |
| 1.3 LPG | 4 | M13A | 68/91 | 02/05→ | Z30 [168] | 0.8 | UXT5 | | |
| 1.3 DDiS | 4 | Z13DT | 51/68 | 08/05→ | GN053 | 11V | | | |
| 1.3 DDiS | 4 | Z13DTJ | 55/74 | 08/05→ | GN053 | 11V | | | |
| 1.5 4WD | 4 | M15A | 74/99 | 02/05→ | Z221 | 1.0 | UXT14 | | |
| 1.5 | 4 | M15A | 75/101 | 02/05→ | Z284 | 1.1 | UXT14 | ZSE069 | |
| 1.5 4WD LPG | 4 | M15A | 74/99 | 02/05→ | Z30 [168] | 0.8 | UXT5 | | |
| 1.5 LPG | 4 | M15A | 75/101 | 02/05→ | Z30 [168] | 0.8 | UXT5 | | |
| 1.6 | 4 | M16A | 92/123 | 05/06→ | Z284 | 1.1 | UXT14 | ZSE069 | |
| 1.6 LPG | 4 | M16A | 92/123 | 05/06→ | Z30 [168] | 0.8 | UXT5 | | |

SWIFT IV (FZ, NZ)

| | | | | | | | | | |
|----------|---|------|-------|--------|------------|-----|--|--|--|
| 1.2 | 4 | K12B | 66/89 | 10/10→ | Z333 | 1.1 | | | |
| 1.2 | 4 | K12B | 69/93 | 10/10→ | Z333 | 1.1 | | | |
| 1.2 LPG | 4 | K12B | 66/89 | 10/10→ | Z291 [168] | 0.9 | | | |
| 1.2 LPG | 4 | K12B | 69/93 | 10/10→ | Z291 [168] | 0.9 | | | |
| 1.3 DDiS | 4 | D13A | 55/74 | 10/10→ | GN053 | 11V | | | |

SX4 (GY)

| | | | | | | | | | |
|-------------|---|-------|--------|--------|-----------|------|-------------|--------|--|
| 1.5 | 4 | M15A | 73/98 | 06/06→ | Z284 | 1.1 | UXT14 | ZSE069 | |
| 1.5 LPG | 4 | M15A | 73/98 | 06/06→ | Z30 [168] | 0.8 | UXT5 | | |
| 1.5 VVT | 4 | M15A | 82/110 | 07/10→ | | | | ZSE069 | |
| 1.6 VVT | 4 | M16A | 79/106 | 06/06→ | Z193 | 0.9 | UXT1 / UXT3 | ZSE069 | |
| 1.6 VVT 4WD | 4 | M16A | 82/110 | 07/09→ | | | | ZSE069 | |
| 1.6 VVT | 4 | M16A | 88/118 | 07/09→ | | | | ZSE069 | |
| 1.9 DDiS | 4 | D19AA | 88/118 | 06/06→ | GN097 | 11V | | | |
| 2.0 DDiS | 4 | D20AA | 99/133 | 07/09→ | GE114 | 4.4V | | | |

SX4 Saloon (GY)

| | | | | | | | | | |
|-----|---|------|--------|--------|--|--|--|--------|--|
| 1.6 | 4 | M16A | 79/106 | 10/07→ | | | | ZSE069 | |
| 1.6 | 4 | M16A | 88/118 | 10/07→ | | | | ZSE069 | |

SX4 S-Cross

| | | | | | | | | | |
|----------|---|--|--------|--------|-------|------|--|--|--|
| 1.6 DDiS | 4 | | 88/118 | 08/13→ | GE114 | 4.4V | | | |
|----------|---|--|--------|--------|-------|------|--|--|--|

VITARA (ET, TA)

| | | | | | | | | | |
|---------------|---|-----------|-------|-------------|-----------|-----|-------------|--|--|
| 1.6 4WD | 4 | G16A (8V) | 59/79 | 07/88→03/98 | Z20 | 0.8 | UXT2 / UXT6 | | |
| 1.6 4WD | 4 | G16A (8V) | 60/80 | 07/88→12/91 | Z20 | 0.8 | UXT2 / UXT6 | | |
| 1.6 4WD LPG | 4 | G16A (8V) | 59/79 | 07/88→03/98 | Z27 [168] | 0.8 | UX56 | | |
| 1.6 i 16V 4WD | 4 | G16B | 71/95 | 07/90→03/98 | Z15 | 0.8 | UXT1 / UXT3 | | |
| 1.9 D 4WD | 4 | XUD9A | 50/67 | 01/95→03/98 | GN013 | 11V | | | |

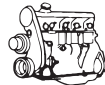

kW/BHP

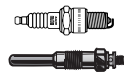
**... SUZUKI****... VITARA (ET, TA)**

| | | | | | | | | |
|------------------------|---|--------|---------|-------------|-------|-----|-------------|--------|
| 1.9 D 4WD | 4 | XUD9SD | 55/74 | 08/96→03/98 | GN909 | 11V | | |
| 2.0 16V 4WD | 4 | J20A | 97/130 | 12/96→03/98 | Z15 | 0.8 | UXT1 / UXT3 | ZSE072 |
| 2.0 16V 4WD LPG | 4 | J20A | 97/130 | 12/96→03/98 | Z340 | 0.7 | UXT12 | |
| 2.0 TD 4WD | 4 | RF | 52/70 | 12/94→03/98 | GN005 | 11V | | |
| 2.0 TD Intercooler 4WD | 4 | RF | 64/86 | 12/95→03/98 | GN005 | 11V | | |
| 2.0 V6 24V 4WD | 6 | H 20 A | 100/134 | 12/94→03/98 | Z15 | 0.8 | UXT1 / UXT3 | ZSE072 |
| 2.0 V6 24V 4WD LPG | 6 | H 20 A | 100/134 | 12/94→03/98 | Z340 | 0.7 | UXT12 | |
| 2.5 V6 24V 4WD | 6 | H 25 A | 118/158 | 12/95→03/98 | Z15 | 0.8 | UXT1 / UXT3 | ZSE072 |
| 2.5 V6 24V 4WD LPG | 6 | H 25 A | 118/158 | 12/95→03/98 | Z340 | 0.7 | UXT12 | |

VITARA Cabrio (ET, TA)

| | | | | | | | | |
|-------------------|---|-----------|--------|-------------|----------------------|-----|-------------|--------|
| 1.6 4WD | 4 | G16A (8V) | 59/79 | 07/88→01/95 | Z20 | 0.8 | UXT2 / UXT6 | |
| 1.6 4WD LPG | 4 | G16A (8V) | 59/79 | 07/88→01/95 | Z27 ^[168] | 0.8 | UX56 | |
| 1.6 i 16V 4WD | 4 | G16B | 71/95 | 07/90→03/99 | Z15 | 0.8 | UXT1 / UXT3 | |
| 1.6 i 16V 4WD LPG | 4 | G16B | 71/95 | 07/90→03/99 | Z340 | 0.7 | UXT12 | |
| 1.9 D 4WD | 4 | XUD9A | 50/67 | 01/95→03/98 | GN013 | 11V | | |
| 1.9 D 4WD | 4 | XUD9SD | 55/74 | 08/96→03/99 | GN909 | 11V | | |
| 2.0 16V 4WD | 4 | J20A | 97/130 | 12/96→03/99 | Z15 | 0.8 | UXT1 / UXT3 | ZSE072 |
| 2.0 16V 4WD LPG | 4 | J20A | 97/130 | 12/96→03/99 | Z340 | 0.7 | UXT12 | |

WAGON R

| | | | | | | | | |
|-----|---|----------|-------|-------------|--|--|--|-------|
| 1.2 | 4 | Z 12 XEP | 59/79 | 06/04→08/05 | | | | ZS338 |
|-----|---|----------|-------|-------------|--|--|--|-------|

WAGON R+ (EM)

| | | | | | | | | |
|---------|---|------|-------|-------------|-----------------------|------|--|--|
| 1.0 | 4 | K10A | 48/64 | 02/98→05/00 | Z234 | 0.9 | | |
| 1.0 LPG | 4 | K10A | 48/64 | 02/98→05/00 | Z292 ^[168] | 1.05 | | |
| 1.2 | 4 | K12A | 51/68 | 02/98→05/00 | Z234 | 0.9 | | |
| 1.2 LPG | 4 | K12A | 51/68 | 02/98→05/00 | Z292 ^[168] | 1.05 | | |

WAGON R+ (MM)

| | | | | | | | | |
|----------|---|-------|-------|--------|----------------------|-----|-------|--------|
| 1.3 | 4 | G13BB | 56/75 | 05/00→ | Z16 | 1.1 | UXT11 | |
| 1.3 | 4 | M13A | 65/87 | 08/01→ | Z221 | 1.0 | UXT14 | |
| 1.3 | 4 | M13A | 69/93 | 09/03→ | Z284 | 1.1 | UXT14 | ZSE069 |
| 1.3 4WD | 4 | M13A | 69/93 | 09/03→ | Z284 | 1.1 | UXT14 | |
| 1.3 LPG | 4 | G13BB | 56/75 | 05/00→ | Z340 | 0.7 | UXT12 | |
| 1.3 LPG | 4 | M13A | 65/87 | 08/01→ | Z30 ^[168] | 0.8 | UXT5 | |
| 1.3 LPG | 4 | M13A | 69/93 | 09/03→ | Z30 ^[168] | 0.8 | UXT5 | |
| 1.3 DDiS | 4 | Z13DT | 51/68 | 09/03→ | GN053 | 11V | | |

X-90 (EL)

| | | | | | | | | |
|---------------|---|------|-------|-------------|----------------------|-----|-------------|--|
| 1.6 i 16V | 4 | G16B | 71/95 | 09/95→12/97 | Z15 ^[168] | 0.8 | UXT1 / UXT3 | |
| 1.6 i 16V LPG | 4 | G16B | 71/95 | 09/95→12/97 | Z340 | 0.7 | UXT12 | |

SUZUKI**CARRY Box (FD)**

| | | | | | | | | |
|---------|---|-------|-------|--------|------|-----|-------------|--|
| 1.3 | 4 | G13BB | 58/78 | 03/99→ | Z15 | 0.8 | UXT1 / UXT3 | |
| 1.3 LPG | 4 | G13BB | 58/78 | 03/99→ | Z340 | 0.7 | UXT12 | |

CARRY Box (ST90V)

| | | | | | | | | |
|-----|---|-----|-------|-------------|----|-----|-------------|---|
| 0.8 | 4 | F8A | 27/36 | 11/80→10/85 | Z8 | 0.8 | UXT2 / UXT6 | ZS106 ^{[1][11][254]} ZS109 ^{[1][15]} |
|-----|---|-----|-------|-------------|----|-----|-------------|---|

SUPER CARRY Bus (ED)

| | | | | | | | | |
|---------|---|------|-------|-------------|----------------------|-----|-------------|-----------------------|
| 1.0 | 4 | F10A | 30/40 | 09/94→03/99 | Z8 | 0.8 | UXT2 / UXT6 | ZS109 ^[15] |
| 1.0 | 4 | F10A | 31/42 | 10/92→03/99 | Z8 | 0.8 | UXT2 / UXT6 | ZS106 ^[11] |
| 1.0 | 4 | F10A | 33/44 | 10/85→03/99 | Z8 | 0.8 | UXT2 / UXT6 | ZS106 ^[11] |
| 1.0 LPG | 4 | F10A | 30/40 | 09/94→03/99 | Z20 ^[168] | 0.8 | UXT2 / UXT6 | |
| 1.0 LPG | 4 | F10A | 31/42 | 10/92→03/99 | Z20 ^[168] | 0.8 | UXT2 / UXT6 | |
| 1.0 LPG | 4 | F10A | 33/44 | 10/85→03/99 | Z20 ^[168] | 0.8 | UXT2 / UXT6 | |

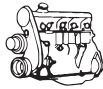

kW/BHP

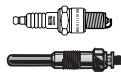

TALBOT



160

| | | | | | | | | | |
|-----|---|-----|-------|-------------|-----|--|-----|------|--|
| 1.6 | 4 | | 59/79 | 01/73→03/79 | Z42 | | 0.8 | UX56 | |
| 1.6 | 4 | 7R2 | 66/89 | 07/76→03/79 | Z42 | | 0.8 | UX56 | |

180

| | | | | | | | | | |
|-------|---|-----|--------|-------------|-------------------------|--|------------|------|--|
| 1.8 | 4 | 7S2 | 74/99 | 01/82→12/82 | Z22 | | 0.7 | UX56 | |
| 1.9 D | 4 | | 44/59 | 01/82→12/82 | GN909 (2)[222] GV636 | | 11V 11V | | |
| 2.0 | 4 | 7T2 | 81/109 | 02/73→09/77 | Z22 | | 0.7 | UX56 | |

1307-1510

| | | | | | | | | | |
|---------------------|---|-----------|-------|-------------|-----|--|-----|-------------|--|
| 1.3 Simca 1307 1.3 | 4 | 6G1D | 40/54 | 01/78→08/81 | Z22 | | 0.7 | UX56 | |
| 1.3 Simca 1307 1.3 | 4 | | 44/59 | 09/75→01/80 | Z22 | | 0.7 | UX56 | |
| 1.3 Simca 1307 1.3 | 4 | | 50/67 | 07/75→01/80 | Z22 | | 0.7 | UX56 | |
| 1.3 Simca 1307 1.3S | 4 | | 60/80 | 07/75→12/78 | Z22 | | 0.7 | UX56 | |
| 1.4 Simca 1308 1.4 | 4 | 6Y2, 6Y2D | 55/74 | 11/78→08/80 | Z22 | | 0.7 | UX56 | |
| 1.4 Simca 1308 1.4 | 4 | 6Y2 | 63/84 | 11/78→08/81 | Z22 | | 0.7 | UX56 | |
| 1.4 Simca 1510 1.4 | 4 | 6G1 | 51/68 | 01/80→04/84 | Z11 | | 0.8 | UXT2 / UXT6 | |
| 1.4 Simca 1510 1.4 | 4 | 6Y2D | 55/74 | 01/80→04/81 | Z11 | | 0.8 | UXT2 / UXT6 | |
| 1.4 Simca 1510 1.4 | 4 | 6Y2 | 63/84 | 01/80→04/81 | Z11 | | 0.8 | UXT2 / UXT6 | |
| 1.6 1510 1.6 | 4 | 6J2A | 66/89 | 07/81→06/82 | Z11 | | 0.8 | UXT2 / UXT6 | |
| 1.6 Simca 1510 1.6 | 4 | 6J1 | 54/72 | 11/80→12/83 | Z11 | | 0.8 | UXT2 / UXT6 | |
| 1.6 Simca 1510 1.6 | 4 | 6J2 | 65/87 | 10/78→01/80 | Z11 | | 0.8 | UXT2 / UXT6 | |

AVENGER

| | | | | | | | | | |
|-----|---|--|-------|-------------|-----|--|-----|-------------|--|
| 1.3 | 4 | | 44/59 | 02/70→07/81 | Z20 | | 0.8 | UXT2 / UXT6 | |
| 1.6 | 4 | | 51/68 | 02/70→07/81 | Z11 | | 0.8 | UXT2 / UXT6 | |
| 1.6 | 4 | | 59/79 | 02/70→07/81 | Z11 | | 0.8 | UXT2 / UXT6 | |

HORIZON

| | | | | | | | | | |
|------------|---|-----------|-------|-------------|-------------------------|-------|------------|-------------|--|
| 1.1 | 4 | E1B | 40/54 | 01/79→09/84 | Z11 | | 0.8 | UXT2 / UXT6 | |
| 1.3 | 4 | 2G1-BTC | 40/54 | 09/81→06/86 | Z11 | | 0.8 | UXT2 / UXT6 | |
| 1.3 | 4 | 2G1-BTC | 43/58 | 09/78→09/84 | Z11 | | 0.8 | UXT2 / UXT6 | |
| 1.3 | 4 | | 47/63 | 02/78→01/80 | Z11 | | 0.8 | UXT2 / UXT6 | |
| 1.3 | 4 | 2G1 | 50/67 | 02/78→01/80 | Z11 | | 0.8 | UXT2 / UXT6 | |
| 1.4 | 4 | 2Y1B | 48/64 | 02/82→09/84 | Z11 | | 0.8 | UXT2 / UXT6 | |
| 1.4 | 4 | 2Y1 | 51/68 | 07/79→06/86 | Z11 | | 0.8 | UXT2 / UXT6 | |
| 1.4 | 4 | 2Y2, Y2 | 61/82 | 07/79→06/86 | Z11 | | 0.8 | UXT2 / UXT6 | |
| 1.6 | 4 | 6J2A, J2A | 66/89 | 07/82→06/86 | Z11 | | 0.8 | UXT2 / UXT6 | |
| 1.9 Diesel | 4 | XUD9 | 47/63 | 07/84→06/86 | GN909 (2)[222] GV636 | GR065 | 11V 11V | | |
| 1.9 Diesel | 4 | XUD9 | 48/64 | 07/82→06/86 | GN909 (2)[222] GV636 | GR065 | 11V 11V | | |

MATRA BAGHEERA

| | | | | | | | | | |
|-----|---|-----|-------|-------------|-----|--|-----|------|---------------|
| 1.3 | 4 | 3G4 | 62/83 | 01/74→03/78 | Z42 | | 0.8 | UX56 | ZS115 (1)[11] |
| 1.4 | 4 | Y2 | 62/83 | 11/79→09/80 | Z42 | | 0.8 | UX56 | ZS115 (1)[11] |
| 1.4 | 4 | 6Y4 | 66/89 | 12/75→09/80 | Z42 | | 0.8 | UX56 | |
| 1.4 | 4 | 6Y4 | 66/89 | 11/79→09/80 | | | | | ZS115 (1)[11] |

MURENA

| | | | | | | | | | |
|-------|---|-------|---------|-------------|-----|--|-----|-------------|--|
| 1.6 | 4 | X5J2A | 66/89 | 08/81→01/85 | Z11 | | 0.8 | UXT2 / UXT6 | |
| 2.1 | 4 | 5N2 | 85/114 | 09/80→07/84 | Z11 | | 0.8 | UXT2 / UXT6 | |
| 2.1 S | 4 | X5N2 | 103/138 | 04/83→01/85 | Z11 | | 0.8 | UXT2 / UXT6 | |

RANCHO

| | | | | | | | | | |
|-----|---|------|-------|-------------|-----|--|-----|-------------|---------------|
| 1.4 | 4 | X3Y2 | 59/79 | 01/77→07/84 | Z11 | | 0.8 | UXT2 / UXT6 | ZS115 (1)[11] |
|-----|---|------|-------|-------------|-----|--|-----|-------------|---------------|

SAMBA

| | | | | | | | | | |
|------------|---|----------------------|-------|-------------|-----|--|-----|-------|--|
| 0.9 | 4 | 5C1 (XV5), 5C1 (XV8) | 31/42 | 01/81→12/85 | Z17 | | 0.8 | UXT4 | ZS115 (1)[11] ZS117 (1)[254] ZS120 (1)[214][254] |
| 1.1 | 4 | XW7 | 37/50 | 01/81→06/86 | Z17 | | 0.8 | UXT4 | ZS115 (1)[11] ZS117 (1)[254] ZS120 (1)[214][254] |
| 1.2 Rallye | 4 | 129 D | 65/87 | 01/83→10/86 | Z25 | | 0.8 | UXK56 | ZM001 |

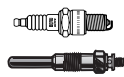

kW/BHP

**... TALBOT****... SAMBA**

| | | | | | | | | | | |
|------------|---|----------|-------|-------------|-----|--|-----|------|--|-------|
| 1.4 | 4 | 150 D | 44/59 | 06/83→10/86 | Z17 | | 0.8 | UXT4 | ZS115 [1][11] ZS117 [1][254] ZS120 [1][214][254] | |
| 1.4 | 4 | XY7, XY8 | 53/71 | 01/81→06/86 | Z17 | | 0.8 | UXT4 | ZS115 [1][11] ZS117 [1][254] ZS120 [1][214][254] | ZM001 |
| 1.4 | 4 | XY8 | 58/78 | 01/81→06/86 | Z17 | | 0.8 | UXT4 | ZS115 [1][11] ZS117 [1][254] ZS120 [1][214][254] | |
| 1.4 Rallye | 4 | XY8 | 58/78 | 01/83→10/86 | Z17 | | 0.8 | UXT4 | ZS115 [1][11] ZS117 [1][254] ZS120 [1][214][254] | |

SIMCA 1000

| | | | | | | | | | | |
|------------------|---|-----|-------|-------------|-----|--|-----|-------------|------------|--|
| 0.9 | 4 | 1D1 | 29/39 | 10/61→09/75 | Z42 | | 0.8 | UX56 | | |
| 0.9 1005 LS, GLS | 4 | 1D1 | 29/39 | 10/76→07/78 | Z42 | | 0.8 | UX56 | | |
| 0.9 GL, GLS | 4 | | 32/43 | 10/61→05/72 | Z42 | | 0.8 | UX56 | | |
| 0.9 LS, GL | 4 | | 32/43 | 10/70→09/75 | Z42 | | 0.8 | UX56 | | |
| 1.1 1006 SR, GLS | 4 | | 40/54 | 10/76→07/78 | Z22 | | 0.7 | UX56 | | |
| 1.1 Rallye | 4 | | 39/52 | 10/70→09/72 | Z42 | | 0.8 | UX56 | | |
| 1.1 Spezial | 4 | | 39/52 | 10/68→09/75 | Z42 | | 0.8 | UX56 | | |
| 1.3 Rallye 1 | 4 | 1G1 | 44/59 | 10/72→09/77 | Z11 | | 0.8 | UXT2 / UXT6 | | |
| 1.3 Rallye 2 | 4 | 1G4 | 60/80 | 09/72→09/76 | Z42 | | 0.8 | UX56 | | |
| 1.3 Rallye 2 | 4 | 1G4 | 63/84 | 10/76→09/77 | Z42 | | 0.8 | UX56 | ZS106 [11] | |
| 1.3 Spezial | 4 | 1G1 | 44/59 | 08/74→09/77 | Z42 | | 0.8 | UX56 | | |

SIMCA 1100

| | | | | | | | | | | |
|---------------------|---|--------|-------|-------------|-----|--|-----|-------------|--|--|
| 0.9 LE | 4 | | 35/47 | 10/76→01/80 | Z11 | | 0.8 | UXT2 / UXT6 | | |
| 0.9 LS | 4 | | 35/47 | 10/70→05/72 | Z11 | | 0.8 | UXT2 / UXT6 | | |
| 1.1 | 4 | E1/BTC | 37/50 | 10/76→01/80 | Z11 | | 0.8 | UXT2 / UXT6 | | |
| 1.1 | 4 | 3E1 | 41/55 | 10/68→05/72 | Z11 | | 0.8 | UXT2 / UXT6 | | |
| 1.1 | 4 | | 44/59 | 10/70→05/72 | Z42 | | 0.8 | UX56 | | |
| 1.1 | 4 | 3E1A | 44/59 | 10/76→09/79 | Z11 | | 0.8 | UXT2 / UXT6 | | |
| 1.1 LE, LX, GLS, ES | 4 | 3E1 | 37/50 | 10/76→01/80 | Z11 | | 0.8 | UXT2 / UXT6 | | |
| 1.1 LE, LX, GLS, ES | 4 | 3E1A | 43/58 | 10/76→01/80 | Z11 | | 0.8 | UXT2 / UXT6 | | |
| 1.1 LS, GLS | 4 | E1/BTC | 40/54 | 11/73→09/77 | Z11 | | 0.8 | UXT2 / UXT6 | | |
| 1.1 LS, GLS | 4 | | 41/55 | 10/68→05/72 | Z11 | | 0.8 | UXT2 / UXT6 | | |
| 1.1 LS, GLS | 4 | | 44/59 | 10/68→05/76 | Z42 | | 0.8 | UX56 | | |
| 1.2 Spezial | 4 | | 55/74 | 10/71→09/77 | Z11 | | 0.8 | UXT2 / UXT6 | | |
| 1.3 Spezial | 4 | | 55/74 | 07/74→11/76 | Z42 | | 0.8 | UX56 | | |
| 1.3 Spezial TI | 4 | 3G4 | 60/80 | 10/72→09/77 | Z22 | | 0.7 | UX56 | | |

SIMCA 1200 S

| | | | | | | | | | | |
|-----|---|------|-------|-------------|-----|--|-----|-------------|--|--|
| 1.2 | 4 | 354 | 59/79 | 10/68→03/72 | Z11 | | 0.8 | UXT2 / UXT6 | | |
| 1.2 | 4 | 353S | 63/84 | 10/70→03/72 | Z11 | | 0.8 | UXT2 / UXT6 | | |

SIMCA 1300

| | | | | | | | | | | |
|-----|---|--|-------|-------------|-----|--|-----|--|--|--|
| 1.3 | 4 | | 38/51 | 08/63→02/68 | Z40 | | 0.6 | | | |
|-----|---|--|-------|-------------|-----|--|-----|--|--|--|

SIMCA 1301

| | | | | | | | | | | |
|-----------------|---|--|-------|-------------|-----|--|-----|--|--|--|
| 1.3 | 4 | | 40/54 | 08/66→07/72 | Z40 | | 0.6 | | | |
| 1.3 LS | 4 | | 44/59 | 08/66→07/72 | Z40 | | 0.6 | | | |
| 1.3 LS, GL, GLS | 4 | | 40/54 | 08/66→07/72 | Z40 | | 0.6 | | | |
| 1.3 Spezial | 4 | | 40/54 | 05/74→11/76 | Z40 | | 0.6 | | | |
| 1.3 Spezial | 4 | | 49/66 | 10/73→11/76 | Z40 | | 0.6 | | | |
| 1.3 Spezial | 4 | | 51/68 | 10/70→07/72 | Z40 | | 0.6 | | | |

SIMCA 1500

| | | | | | | | | | | |
|-----|---|--|-------|-------------|-----|--|-----|------|--|--|
| 1.5 | 4 | | 49/66 | 10/63→02/68 | Z42 | | 0.8 | UX56 | | |
|-----|---|--|-------|-------------|-----|--|-----|------|--|--|

SIMCA 1501

| | | | | | | | | | | |
|------------|---|--|-------|-------------|-----|--|-----|------|--|--|
| 1.5 | 4 | | 51/68 | 10/66→03/72 | Z42 | | 0.8 | UX56 | | |
| 1.5 | 4 | | 52/70 | 10/66→03/72 | Z42 | | 0.8 | UX56 | | |
| 1.5 Autom. | 4 | | 53/71 | 10/66→03/72 | Z42 | | 0.8 | UX56 | | |

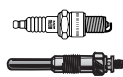

kW/BHP

**... TALBOT****... SIMCA 1501**

| | | | | | | | | |
|-------------|---|--|-------|-------------|-----|--|-----|------|
| 1.5 Spezial | 4 | | 52/70 | 10/73→11/76 | Z42 | | 0.8 | UX56 |
| 1.5 Spezial | 4 | | 60/80 | 10/70→05/72 | Z42 | | 0.8 | UX56 |

SIMCA 1609/1610

| | | | | | | | | |
|----------------|---|-----|--------|-------------|------------------------------------|--|------------|------|
| 1.6 1609 | 4 | 7R2 | 66/89 | 09/76→03/78 | Z42 | | 0.8 | UX56 |
| 1.8 1610 | 4 | 7S2 | 74/99 | 09/76→12/80 | Z22 | | 0.7 | UX56 |
| 1.9 1610 2.0 D | 4 | | 44/59 | 09/76→12/80 | GN909 ^{[2][222]} GV636 | | 11V 11V | |
| 2.0 1610 | 4 | 7T2 | 81/109 | 09/76→12/80 | Z22 | | 0.7 | UX56 |

SIMCA SIM'4

| | | | | | | | | |
|-----|---|--|-------|-------------|-----|--|-----|------|
| 0.8 | 4 | | 24/32 | 10/68→12/72 | Z18 | | 0.8 | UXT4 |
|-----|---|--|-------|-------------|-----|--|-----|------|

SIMCA SUNBEAM

| | | | | | | | | |
|------------|---|----|---------|-------------|----------------------|--|-----|-------------|
| 0.9 | 4 | CB | 31/42 | 07/77→04/81 | Z20 | | 0.8 | UXT2 / UXT6 |
| 1.3 | 4 | JB | 40/54 | 07/77→04/81 | Z20 | | 0.8 | UXT2 / UXT6 |
| 1.3 | 4 | | 44/59 | 07/77→04/81 | Z20 | | 0.8 | UXT2 / UXT6 |
| 1.6 | 4 | | 51/68 | 07/77→04/81 | Z20 | | 0.8 | UXT2 / UXT6 |
| 1.6 | 4 | TB | 59/79 | 10/78→04/81 | Z20 | | 0.8 | UXT2 / UXT6 |
| 1.6 Ti | 4 | TB | 74/99 | 10/78→03/83 | Z27 | | 0.8 | UX56 |
| 1.6 Ti LPG | 4 | TB | 74/99 | 10/78→03/83 | Z47 ^[168] | | 0.8 | UX56 |
| 2.1 Lotus | 4 | | 110/148 | 10/79→04/81 | Z42 | | 0.8 | UX56 |
| 2.1 Lotus | 4 | | 114/153 | 10/79→03/82 | Z42 | | 0.8 | UX56 |

SOLARA

| | | | | | | | | |
|-----|---|-------------|-------|-------------|-----|--|-----|-------------|
| 1.3 | 4 | 6G1D/VP | 40/54 | 02/80→07/86 | Z11 | | 0.8 | UXT2 / UXT6 |
| 1.6 | 4 | J1B | 51/68 | 07/82→04/84 | Z11 | | 0.8 | UXT2 / UXT6 |
| 1.6 | 4 | 6J1 | 54/72 | 09/81→10/84 | Z11 | | 0.8 | UXT2 / UXT6 |
| 1.6 | 4 | 6J2, J1, J2 | 65/87 | 02/80→06/81 | Z11 | | 0.8 | UXT2 / UXT6 |
| 1.6 | 4 | J1B | 66/89 | 09/81→07/86 | Z11 | | 0.8 | UXT2 / UXT6 |

TAGORA

| | | | | | | | | |
|------------------|---|------|---------|-------------|------------------------------------|-------|------------|-------------|
| 2.1 | 4 | 5N2 | 85/114 | 06/80→12/83 | Z11 | | 0.8 | UXT2 / UXT6 |
| 2.3 Turbo Diesel | 4 | XD2S | 59/79 | 08/81→12/87 | GN909 ^{[2][222]} GV636 | GR065 | 11V 11V | |
| 2.6 | 6 | 9L6 | 122/164 | 08/81→10/83 | Z25 | | 0.8 | UXK56 |

TALBOT**EXPRESS 1000 -1500**

| | | | | | | | | |
|--------|---|---------|-------|-------------|-------|--|-----|--|
| 1.9 D | 4 | XUD9A | 51/68 | 07/87→10/90 | GN909 | | 11V | |
| 2.5 D | 4 | CRD93 | 54/72 | 07/82→10/94 | GN954 | | 11V | |
| 2.5 TD | 4 | CRD93LS | 70/94 | 06/87→10/94 | GN954 | | 11V | |

EXPRESS 1000 -1800

| | | | | | | | | |
|--------|---|---------|-------|-------------|-------|--|-----|--|
| 1.9 D | 4 | XUD9A | 51/68 | 07/87→10/90 | GN909 | | 11V | |
| 2.5 D | 4 | CRD93 | 54/72 | 07/82→10/94 | GN954 | | 11V | |
| 2.5 TD | 4 | CRD93LS | 70/94 | 06/87→10/94 | GN954 | | 11V | |

TOYOTA**4 RUNNER**

| | | | | | | | | |
|-----------------|---|--------|---------|-------------|-----------------------|--|-----|-----------------|
| 2.4 TD 4WD | 4 | 2L-T | 66/89 | 08/89→11/95 | GV968 | | 11V | |
| 2.7 i 4WD | 4 | 3RZ-FE | 112/150 | 11/95→03/96 | Z150 | | 1.3 | UXT11 |
| 2.7 i 4WD LPG | 4 | 3RZ-FE | 112/150 | 11/95→03/96 | Z129 | | 1.6 | |
| 3.0 Turbo-D 4WD | 4 | 1KZ-T | 92/123 | 10/93→11/02 | GN110 | | 11V | |
| 3.0 V6 4WD | 6 | 3VZ-E | 105/141 | 07/90→11/95 | Z249 | | 1.0 | ZS445 09/91→ |
| 3.0 V6 4WD LPG | 6 | 3VZ-E | 105/141 | 07/90→11/95 | Z151 ^[168] | | 0.8 | UXT10 |
| 3.4 i 4WD | 6 | 5VZ-FE | 136/182 | 11/95→03/96 | Z208 | | 1.0 | ZS473 |
| 3.4 i 4WD LPG | 6 | 5VZ-FE | 136/182 | 11/95→03/96 | Z158 ^[168] | | 1.1 | |

1000

| | | | | | | | | |
|-----|---|----|-------|-------------|-----|--|-----|-------------|
| 1.0 | 4 | 2K | 33/44 | 04/69→08/88 | Z20 | | 0.8 | UXT2 / UXT6 |
|-----|---|----|-------|-------------|-----|--|-----|-------------|



kW/BHP

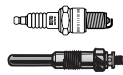

... TOYOTA



| | | | | | | | | |
|-----------------------------|---|------------------|---------|-------------|------------------------|--|------------|------------------------------------|
| ALLION II | | | | | | | | |
| 1.5 | 4 | 1NZ-FE | 81/109 | 07/07→ | Z154 | | 0.9 | UXT9 ZSE167 |
| ALPHARD I | | | | | | | | |
| 3.0 | 6 | 1MZ-FE | 162/217 | 04/03→04/08 | | | | ZS430 |
| ARISTO | | | | | | | | |
| 3.0 | 6 | 2JZ-GE | 169/227 | 10/90→07/97 | Z312 [172] 10/91→ | | 1.0 | UXT9 10/91→ |
| 3.0 | 6 | 2JZ-GTE | 205/275 | 10/90→09/96 | Z284 | | 1.1 | UXT14 |
| 3.0 LPG | 6 | 2JZ-GTE | 205/275 | 10/90→09/96 | Z30 [168] | | 0.8 | UXT5 |
| AURIS | | | | | | | | |
| 1.3 Dual-VVTi | 4 | 1NR-FE | 73/98 | 01/10→ | | | | ZSE172 |
| 1.4 D-4D | 4 | 1ND-TV | 66/89 | 03/07→ | GN042 | | 11V | |
| 1.4 VVTi | 4 | 4ZZ-FE | 71/95 | 03/07→ | Z249 | | 1.0 | ZSE164 |
| 2.0 D-4D | 4 | 1AD-FTV | 93/125 | 03/07→ | GN108 | | 11V | |
| 2.2 D | 4 | 2AD-FHV | 130/174 | 03/07→ | GN108 | | 11V | |
| AURIS TOURING SPORTS | | | | | | | | |
| 1.4 D-4D | 4 | 1ND-TV | 66/89 | 07/13→ | GN042 | | 11V | |
| AVALON | | | | | | | | |
| 3.0 | 6 | 1MZ-FE | 137/184 | 08/01→04/05 | | | | ZS430 |
| 3.0 | 6 | 1MZ-FE | 140/188 | 03/95→05/05 | | | | ZS430 |
| AVENSIS | | | | | | | | |
| 1.6 | 4 | 4A-FE | 74/99 | 09/97→10/00 | Z150 | | 1.3 | UXT11 ZS356 |
| 1.6 | 4 | 4A-FE | 81/109 | 09/97→10/00 | Z150 | | 1.3 | UXT11 ZS356 |
| 1.6 LPG | 4 | 4A-FE | 74/99 | 09/97→10/00 | Z129 | | 1.6 | |
| 1.6 LPG | 4 | 4A-FE | 81/109 | 09/97→10/00 | Z129 | | 1.6 | |
| 1.6 VVT-i | 4 | 3ZZ-FE | 81/109 | 10/00→02/03 | Z150 | | 1.3 | UXT11 |
| 1.6 VVT-i | 4 | 3ZZ-FE | 81/109 | 10/00→11/08 | | | | ZSE164 |
| 1.6 VVT-i | 4 | 3ZZ-FE | 81/109 | 04/03→11/08 | Z157 Z249 | | 1.1 1.0 | UXT11 |
| 1.6 VVT-i LPG | 4 | 3ZZ-FE | 81/109 | 10/00→02/03 | Z129 | | 1.6 | |
| 1.8 | 4 | 7A-FE | 81/109 | 09/97→10/00 | Z284 | | 1.1 | UXT14 |
| 1.8 | 4 | 1ZZ-FE | 95/127 | 04/03→11/08 | Z249 | | 1.0 | ZSE164 |
| 1.8 LPG | 4 | 7A-FE | 81/109 | 09/97→10/00 | Z30 [168] | | 0.8 | UXT5 |
| 1.8 LPG | 4 | 1ZZ-FE | 95/127 | 04/03→11/08 | Z151 [168] | | 0.8 | UXT10 |
| 1.8 VVT-i | 4 | 1ZZ-FE | 95/127 | 10/00→02/03 | Z150 Z249 | | 1.3 1.0 | UXT11 ZSE164 |
| 1.8 VVT-i LPG | 4 | 1ZZ-FE | 95/127 | 10/00→02/03 | Z129 Z151 [168] | | 1.6 0.8 | UXT10 |
| 1.9 D | 4 | 2C-T | 61/82 | 10/97→05/98 | GN043 | | 11V | |
| 1.9 D | 4 | 1CD-FTV | 85/114 | 09/02→02/03 | GN065 | | 11V | |
| 2.0 | 4 | 3S-FE | 94/126 | 09/97→10/00 | Z157 | | 1.1 | UXT11 |
| 2.0 | 4 | 1AZ-FSE | 108/145 | 04/03→11/08 | Z280 Z312 | | 1.0 1.0 | UXT9 ZSE167 [1] ZSE171 [1][113] |
| 2.0 D | 4 | 2C-T | 61/82 | 10/97→05/98 | GN043 | | 11V | |
| 2.0 D | 4 | 1CD-FTV | 85/114 | 09/02→02/03 | GN065 | | 11V | |
| 2.0 D-4D | 4 | 1CD-FTV | 81/109 | 10/99→02/03 | GN065 | | 11V | |
| 2.0 D-4D | 4 | 1CD-FTV | 85/114 | 04/03→11/08 | GN065 | | 11V | |
| 2.0 D-4D | 4 | 1AD-FTV | 93/125 | 03/06→11/08 | GN108 | | 11V | |
| 2.0 TD | 4 | 2C-TE | 66/89 | 09/97→02/03 | GN043 →07/00 | | 11V | |
| 2.0 VVTi | 4 | 1AZ-FE | 114/153 | 04/03→11/08 | Z221 | | 1.0 | UXT14 |
| 2.0 VVT-i | 4 | 1AZ-FSE | 110/148 | 10/00→02/03 | Z312 →01/03 Z280 | | 1.0 1.0 | UXT9 ZSE167 [114] ZSE171 [113] |
| 2.2 D-4D | 4 | 2AD-FHV, 2AD-FTV | 110/148 | 10/05→ | GN108 | | 11V | |
| 2.2 D-4D | 4 | 2AD-FHV | 130/174 | 02/09→ | GN108 | | 11V | |
| 2.2 D-CAT | 4 | 2AD-FHV | 130/174 | 07/05→11/08 | GN108 | | 11V | |
| 2.4 | 4 | 2AZ-FSE | 120/161 | 10/03→11/08 | Z312 [172] | | 1.0 | UXT9 ZSE167 |
| 2.4 | 4 | 2AZ-FSE | 125/168 | 09/03→11/08 | Z312 [172] | | 1.0 | UXT9 ZSE167 |



kW/BHP

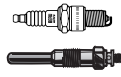

... TOYOTA



AVENSIS VERSO

| | | | | | | | | |
|---------------|---|---------|---------|-------------|-----------|-----|-------|-------------------------------|
| 2.0 D-4D | 4 | 1CD-FTV | 85/114 | 08/01→08/05 | GN065 | 11V | | |
| 2.0 VVT-i | 4 | 1AZ-FE | 110/148 | 08/01→11/09 | Z221 | 1.0 | UXT14 | ZSE167 [1] ZSE171 [1][117] |
| 2.0 VVT-i LPG | 4 | 1AZ-FE | 110/148 | 08/01→11/09 | Z30 [168] | 0.8 | UXT5 | |

AYGO

| | | | | | | | | |
|---------|---|--------|-------|-------------|-------|-----|--|-------------------------------|
| 1.0 | 3 | 1KR-FE | 50/67 | 07/05→ | Z273 | 1.1 | | ZSE164 [1][116] ZSE165 [1] |
| 1.4 HDi | 4 | 2WTZV | 40/54 | 07/05→08/10 | GN047 | 11V | | |

CALDINA

| | | | | | | | | |
|--------|---|----|-------|-------------|-------|-----|--|--|
| 2.0 TD | 4 | 2C | 56/75 | 06/94→09/97 | GN043 | 11V | | |
|--------|---|----|-------|-------------|-------|-----|--|--|

CAMRY

| | | | | | | | | |
|---------------|---|--------------|---------|-------------|------------------------------------|-----------|--|-----------------------------------|
| 1.8 | 4 | 1S | 66/89 | 11/86→08/88 | | | | ZS356 |
| 1.8 | 4 | 1S-L | 66/89 | 02/83→10/86 | Z8 →08/85 Z9 09/85→ | 0.8 | UXT2 / UXT6 →08/85 1.15 UXT2 / UXT6 09/85→ | ZM059 |
| 1.8 i | 4 | 1S-L | 66/89 | 10/86→08/88 | Z8 | 0.8 | UXT2 / UXT6 | ZS356 ZM059 |
| 1.8 Turbo-D | 4 | 1C-TL | 54/72 | 11/83→01/88 | GV886 | 7V | | |
| 2.0 | 4 | 2S-E, 2S-ELC | 73/98 | 04/86→01/88 | Z9 | 1.15 | UXT2 / UXT6 | ZS356 |
| 2.0 | 4 | 3S-FE | 94/126 | 11/86→05/91 | Z73 10/87→ | 1.1 | UXT11 10/87→ | ZS356 |
| 2.0 4WD | 4 | 3S-FE | 94/126 | 08/88→05/91 | | | | ZS356 |
| 2.0 GLI | 4 | 2S-EL | 79/106 | 03/83→10/86 | Z9 | 1.15 | UXT2 / UXT6 | ZS356 |
| 2.0 GLi 4WD | 4 | 3S-FE | 88/118 | 10/87→07/88 | | | | ZS356 |
| 2.0 GLi 4WD | 4 | 3S-FE | 94/126 | 08/88→05/91 | | | | ZS356 |
| 2.0 GLi 16V | 4 | 3S-FE | 89/119 | 11/86→05/91 | Z73 10/87→ | 1.1 | UXT11 10/87→ | ZS356 |
| 2.0 TD | 4 | 2C-TL | 62/83 | 09/85→10/86 | GV886 | 7V | | |
| 2.0 Turbo-D | 4 | 2C-T | 62/83 | 11/86→05/91 | GV886 →07/88 GN043 08/88→ | 7V 11V | | |
| 2.0 Turbo-D | 4 | 2C-T | 63/84 | 11/88→05/91 | GN043 | 11V | | |
| 2.0 VVTi | 4 | 1AZ-FE | 110/148 | 08/01→11/06 | Z221 | 1.0 | UXT14 | |
| 2.0 VVT-i | 4 | 1AZ-FE | 108/145 | 01/06→09/11 | Z221 | 1.0 | UXT14 | ZSE167 |
| 2.2 | 4 | 5S-FE | 93/125 | 11/00→11/01 | Z16 | 1.1 | UXT11 | |
| 2.2 | 4 | 5S-FE | 96/129 | 08/96→11/01 | Z157 | 1.1 | UXT11 | |
| 2.2 | 4 | 5S-FE | 100/134 | 06/91→08/96 | Z157 | 1.1 | UXT11 | |
| 2.4 VVTi | 4 | 2AZ-FE | 116/156 | 01/06→09/11 | | | | ZSE167 |
| 2.4 VVTi | 4 | 2AZ-FE | 123/165 | 01/06→09/11 | | | | ZSE167 |
| 2.4 VVT-i | 4 | 2AZ-FE | 112/150 | 11/01→11/06 | Z221 | 1.0 | UXT14 | ZSE167 [1] ZSE171 [1][117] |
| 2.4 VVT-i LPG | 4 | 2AZ-FE | 112/150 | 11/01→11/06 | Z30 [168] | 0.8 | UXT5 | |
| 2.5 | 4 | 2AR-FE | 133/178 | 09/11→ | | | | ZSE172 |
| 2.5 | 6 | 2VZ-FE | 118/158 | 01/90→05/91 | Z149 | 1.1 | UXT11 | |
| 2.5 V6 GXI | 6 | 2VZ-FE | 118/158 | 02/88→05/91 | Z149 | 1.1 | UXT11 | |
| 2.5 VVTi | 4 | 2AR-FE | 129/173 | 01/10→09/11 | | | | ZSE172 |
| 3.0 | 6 | 1MZ-FE | 135/181 | 09/93→07/96 | | | | ZS430 |
| 3.0 | 6 | 3VZ-FE | 138/185 | 06/91→08/96 | Z284 | 1.1 | UXT14 | ZSE173 |
| 3.0 | 6 | 1MZ-FE | 140/188 | 08/96→07/01 | | | | ZS430 |
| 3.0 | 6 | 1MZ-FE | 141/189 | 09/02→06/06 | | | | ZS430 |
| 3.0 LPG | 6 | 3VZ-FE | 138/185 | 06/91→08/96 | Z30 [168] | 0.8 | UXT5 | |
| 3.0 24V | 6 | 1MZ-FE | 140/188 | 08/96→11/01 | Z16 | 1.1 | UXT11 | ZS430 [1][109] ZSE173 [1][110] |
| 3.0 24V LPG | 6 | 1MZ-FE | 140/188 | 08/96→11/01 | Z340 | 0.7 | UXT12 | |
| 3.0 V6 | 6 | 1MZ-FE | 135/181 | 08/96→11/01 | | | | ZS430 [1][109] ZSE173 [1][110] |

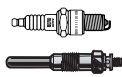

kW/BHP

**... TOYOTA****... CAMRY**

| | | | | | | | | |
|------------|---|--------|---------|-------------|-----------|-----|-------|-----------------------------------|
| 3.0 V6 | 6 | 1MZ-FE | 137/184 | 11/01→11/06 | Z284 | 1.1 | UXT14 | ZS430 (1)(109) ZSE173 (1)(108) |
| 3.0 V6 LPG | 6 | 1MZ-FE | 137/184 | 11/01→11/06 | Z30 (168) | 0.8 | UXT5 | |

CAMRY SOLARA

| | | | | | | | | |
|-----|---|--------|---------|-------------|--|--|--|-------|
| 3.0 | 6 | 1MZ-FE | 137/184 | 07/03→11/08 | | | | ZS430 |
|-----|---|--------|---------|-------------|--|--|--|-------|

CARIBE

| | | | | | | | | |
|-----|---|-------|-------|-------------|------|-----|-------|--|
| 1.3 | 4 | 4E-FE | 55/74 | 09/94→08/96 | Z156 | 0.7 | UXT10 | |
|-----|---|-------|-------|-------------|------|-----|-------|--|

CARINA

| | | | | | | | | |
|-------|---|-----|-------|-------------|-------|-----|-------------|--|
| 1.6 | 4 | 2T | 54/72 | 03/81→01/82 | Z8 | 0.8 | UXT2 / UXT6 | |
| 1.6 | 4 | 2T | 55/74 | 02/76→09/83 | Z8 | 0.8 | UXT2 / UXT6 | |
| 1.6 | 4 | 2T | 58/78 | 05/73→03/78 | Z20 | 0.8 | UXT2 / UXT6 | |
| 1.6 | 4 | 2TB | 63/84 | 10/75→03/78 | Z8 | 0.8 | UXT2 / UXT6 | |
| 1.8 | 4 | 3T | 63/84 | 01/82→09/83 | Z8 | 0.8 | UXT2 / UXT6 | |
| 1.8 D | 4 | 1C | 48/64 | 04/82→09/83 | GV886 | 7V | | |

CARINA E

| | | | | | | | | |
|-----------------|---|-------|---------|-------------|-----------|-----|--------|-----------------|
| 1.6 | 4 | 4A-FE | 73/98 | 12/93→09/97 | Z151 | 0.8 | UXT10 | ZS356 (1) |
| 1.6 | 4 | 4A-FE | 78/105 | 10/95→09/97 | Z150 | 1.3 | UXT11 | |
| 1.6 | 4 | 4A-FE | 79/106 | 01/93→09/97 | Z150 | 1.3 | UXT11 | ZS356 |
| 1.6 | 4 | 4A-FE | 85/114 | 04/92→09/97 | Z154 | 0.9 | UXT9 | ZS356 |
| | | | | →01/96 | | | →01/96 | |
| 1.6 | 4 | 4A-FE | 85/114 | 12/93→09/97 | Z150 | 1.3 | UXT11 | ZS356 →01/96 |
| 1.6 LPG | 4 | 4A-FE | 73/98 | 12/93→09/97 | Z129 | 1.6 | | |
| 1.6 LPG | 4 | 4A-FE | 78/105 | 10/95→09/97 | Z129 | 1.6 | | |
| 1.6 LPG | 4 | 4A-FE | 79/106 | 01/93→09/97 | Z129 | 1.6 | | |
| 1.6 LPG | 4 | 4A-FE | 85/114 | 12/93→09/97 | Z129 | 1.6 | | |
| 1.6 16V | 4 | 4A-FE | 78/105 | 10/95→09/97 | Z150 | 1.3 | UXT11 | |
| 1.6 16V | 4 | 4A-FE | 85/114 | 12/94→09/97 | Z150 | 1.3 | UXT11 | ZS356 →01/96 |
| 1.6 16V LPG | 4 | 4A-FE | 78/105 | 10/95→09/97 | Z129 | 1.6 | | |
| 1.6 16V LPG | 4 | 4A-FE | 85/114 | 12/94→09/97 | Z129 | 1.6 | | |
| 1.6 GLI | 4 | 4A-FE | 79/106 | 04/92→09/97 | Z150 | 1.3 | UXT11 | ZS356 |
| 1.6 GLI LPG | 4 | 4A-FE | 79/106 | 04/92→09/97 | Z129 | 1.6 | | |
| 1.6 i | 4 | 4A-FE | 73/98 | 02/95→09/97 | Z151 | 0.8 | UXT10 | ZS356 (1) |
| 1.6 i LPG | 4 | 4A-FE | 73/98 | 02/95→09/97 | Z129 | 1.6 | | |
| 1.8 | 4 | 7A-FE | 79/106 | 01/95→09/97 | Z284 | 1.1 | UXT14 | |
| 1.8 LPG | 4 | 7A-FE | 79/106 | 01/95→09/97 | Z30 (168) | 0.8 | UXT5 | |
| 1.8 i | 4 | 7A-FE | 79/106 | 02/95→09/97 | Z284 | 1.1 | UXT14 | |
| 1.8 i LPG | 4 | 7A-FE | 79/106 | 02/95→09/97 | Z30 (168) | 0.8 | UXT5 | |
| 1.8 i 16V | 4 | 7A-FE | 79/106 | 01/95→09/97 | Z284 | 1.1 | UXT14 | |
| 1.8 i 16V LPG | 4 | 7A-FE | 79/106 | 01/95→09/97 | Z30 (168) | 0.8 | UXT5 | |
| 2.0 | 4 | 3S-FE | 98/131 | 01/93→09/97 | Z157 | 1.1 | UXT11 | |
| 2.0 D | 4 | 2C | 54/72 | 04/92→01/96 | GN043 | 11V | | |
| 2.0 GLI | 4 | 3S-FE | 98/131 | 04/92→09/97 | Z157 | 1.1 | UXT11 | |
| 2.0 GTi | 4 | 3S-GE | 116/156 | 04/92→02/94 | Z151 | 0.8 | UXT10 | |
| 2.0 GTi 16V | 4 | 3S-GE | 129/173 | 03/94→09/97 | Z151 | 0.8 | UXT10 | |
| 2.0 GTi 16V LPG | 4 | 3S-GE | 129/173 | 03/94→09/97 | Z129 | 1.6 | | |
| 2.0 i | 4 | 3S-FE | 93/125 | 12/92→09/97 | Z157 | 1.1 | UXT11 | |
| 2.0 TD | 4 | 2C-T | 61/82 | 01/96→09/97 | GN043 | 11V | | |

CARINA II

| | | | | | | | | |
|-----|---|-------|-------|-------------|----------|-------------|-------------|-----------------|
| 1.6 | 4 | 4A-LC | 55/74 | 10/83→11/87 | Z9 | 1.15 | UXT2 / UXT6 | ZM058 →04/87 |
| 1.6 | 4 | 4A-L | 62/83 | 10/83→11/87 | Z8 Z9 | 0.8 1.15 | UXT2 / UXT6 | ZM058 |
| 1.6 | 4 | 4A-L | 63/84 | 10/86→11/87 | Z9 | 1.15 | UXT2 / UXT6 | ZM058 →04/87 |
| 1.6 | 4 | 4A-F | 66/89 | 12/87→08/90 | Z248 | 0.8 | | ZS356 |



kW/BHP

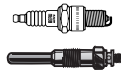

... TOYOTA



... CARINA II

| | | | | | | | | | |
|---------|---|----------|--------|-------------|----------------------------------|------------|------------------------------------|---------------------------------------|-------|
| 1.6 | 4 | 4A-FE | 72/97 | 12/87→03/92 | Z150 09/89→ | 1.3 | UXT11 09/89→ | ZS356 | ZM057 |
| 1.6 | 4 | 4A-FE | 75/101 | 12/87→03/92 | Z156 →08/89 Z150 09/89→ | 0.7 1.3 | UXT10 →08/89 UXT11 09/89→ | ZS356 ^{[107][254]} 11/89→ | ZM057 |
| 1.8 GLI | 4 | 1S-EL | 74/99 | 10/83→11/87 | Z8 | 0.8 | UXT2 / UXT6 | ZS356 | |
| 1.8 GLI | 4 | 1S-L | 74/99 | 10/83→11/87 | Z8 | 0.8 | UXT2 / UXT6 | | |
| 2.0 | 4 | 3S-FE | 89/119 | 12/87→04/92 | Z157 | 1.1 | UXT11 | ZS356 | |
| 2.0 D | 4 | 2C-L | 50/67 | 02/84→05/88 | GV886 →11/87 | 7V | | | |
| 2.0 D | 4 | 2C-L | 51/68 | 12/85→11/87 | GV886 | 7V | | | |
| 2.0 D | 4 | 2C, 2C-L | 54/72 | 12/87→06/92 | GN043 | 11V | | | |
| 2.0 GLI | 4 | 3S-FE | 89/119 | 12/87→03/92 | Z157 →11/89 | 1.1 | UXT11 →11/89 | ZS356 | |

CELICA

| | | | | | | | | | |
|---------------------|---|-----------|---------|-------------|-------------------------------|------------|--|---|-----------------|
| 1.6 | 4 | 4A-L | 63/84 | 04/86→08/89 | Z8 | 0.8 | UXT2 / UXT6 | ZS356 | |
| 1.6 | 4 | 4A-GE | 91/122 | 12/83→12/85 | Z157 | 1.1 | UXT11 | | |
| 1.6 GT | 4 | 2T-G | 79/106 | 12/74→03/78 | Z20 | 0.8 | UXT2 / UXT6 | | |
| 1.6 GT | 4 | 2T-G | 80/107 | 04/78→07/81 | Z20 | 0.8 | UXT2 / UXT6 | | |
| 1.6 GT | 4 | 2T-G | 81/109 | 04/80→07/81 | Z20 | 0.8 | UXT2 / UXT6 | | |
| 1.6 GT | 4 | 4A-GELC | 85/114 | 08/87→08/89 | Z228 | 1.0 | UXT11 | | |
| 1.6 GT LPG | 4 | 4A-GELC | 85/114 | 08/87→08/89 | Z221 ^[168] | 1.0 | UXT14 | | |
| 1.6 GT 16V | 4 | 4A-GEL | 91/122 | 09/85→08/89 | Z157 | 1.1 | UXT11 | | ZM057 01/86→ |
| 1.6 GT 16V | 4 | 4A-GEL | 91/122 | 04/86→08/89 | | | | | ZM057 |
| 1.6 LT | 4 | 2T | 55/74 | 02/76→03/78 | Z20 | 0.8 | UXT2 / UXT6 | | |
| 1.6 LT | 4 | 2TB | 55/74 | 02/79→07/81 | Z8 | 0.8 | UXT2 / UXT6 | | |
| 1.6 LT | 4 | 2TJ | 58/78 | 05/73→03/78 | Z1 ^[169] | 0.7 | UXT2 / UXT6 | | |
| 1.6 ST | 4 | 2TB, 4A-L | 63/84 | 05/73→07/81 | Z1 ^[169] | 0.7 | UXT2 / UXT6 | | |
| 1.6 ST | 4 | 2T | 66/89 | 02/79→07/81 | Z8 | 0.8 | UXT2 / UXT6 | | |
| 1.6 STI | 4 | 4A-FE | 77/103 | 10/89→11/93 | Z72 →10/93 | 0.8 | UXT1 / UXT3 →10/93 | ZS356 | |
| 1.8 16V TS | 4 | 2ZZ-GE | 141/189 | 08/99→09/05 | Z284 | 1.1 | UXT14 | ZSE168 | |
| 1.8 16V TS LPG | 4 | 2ZZ-GE | 141/189 | 08/99→09/05 | Z30 ^[168] | 0.8 | UXT5 | | |
| 1.8 16V VT-i | 4 | 1ZZ-FE | 105/141 | 08/99→07/05 | Z249 | 1.0 | | ZSE164 ^[116] ZSE168 ^[111] | |
| 1.8 16V VT-i LPG | 4 | 1ZZ-FE | 105/141 | 08/99→07/05 | Z151 ^[168] | 0.8 | UXT10 | | |
| 1.8 i 16V | 4 | 7A-FE | 85/114 | 11/93→11/99 | Z156 | 0.7 | UXT10 | ZS356 | |
| 2.0 | 4 | 18R | 63/84 | 10/75→07/77 | Z20 | 0.8 | UXT2 / UXT6 | | |
| 2.0 | 4 | 2TR-U | 77/103 | 01/82→12/85 | Z20 →08/83 | 0.8 | UXT2 / UXT6 →08/83 | ZS106 ^{[1][11][254]} ZS109 ^{[1][15]} | |
| 2.0 | 4 | 18R-G | 88/118 | 01/82→12/85 | Z20 →08/84 Z8 09/84→ | 0.8 0.8 | UXT2 / UXT6 →08/84 UXT2 / UXT6 09/84→ | ZS106 ^{[1][11][254]} ZS109 ^{[1][15]} | |
| 2.0 | 4 | 3S-GEL | 110/148 | 01/87→08/89 | Z157 | 1.1 | UXT11 | | |
| 2.0 GT | 4 | 18R-G | 90/121 | 08/77→07/81 | | | | ZS106 ^{[1][11][254]} ZS109 ^{[1][15]} | |
| 2.0 GT | 4 | 3S-GELC | 103/138 | 08/85→08/89 | Z228 | 1.0 | UXT11 | | |
| 2.0 GT | 4 | 3S-GEL | 110/148 | 08/85→08/89 | Z157 | 1.1 | UXT11 | | |
| 2.0 GT LPG | 4 | 3S-GELC | 103/138 | 08/85→08/89 | Z221 ^[168] | 1.0 | UXT14 | | |
| 2.0 GTi | 4 | 3S-GE | 115/154 | 10/89→11/93 | Z151 | 0.8 | UXT10 | | |
| 2.0 i 16V | 4 | 3S-GE | 125/168 | 11/93→11/99 | Z151 | 0.8 | UXT10 | | |
| 2.0 i 16V | 4 | 3S-GE | 129/173 | 11/93→11/99 | Z151 | 0.8 | UXT10 | | |
| 2.0 i 16V LPG | 4 | 3S-GE | 125/168 | 11/93→11/99 | Z129 | 1.6 | | | |
| 2.0 i 16V LPG | 4 | 3S-GE | 129/173 | 11/93→11/99 | Z129 | 1.6 | | | |
| 2.0 i Turbo 4WD | 4 | 3S-GTE | 178/239 | 02/94→11/99 | Z151 | 0.8 | UXT10 | | |
| 2.0 i Turbo 4WD LPG | 4 | 3S-GTE | 178/239 | 02/94→11/99 | Z129 | 1.6 | | | |



kW/BHP

**... TOYOTA****... CELICA**

| | | | | | | | | | |
|-------------------|---|--------|---------|-------------|-------------------------------|--------------------------------|----------------------------|--------------------|---------------|
| 2.0 Turbo 4WD | 4 | 3S-GTE | 136/182 | 03/88→08/89 | Z228 | 1.0 | UXT11 | | |
| 2.0 Turbo 4WD | 4 | 3S-GTE | 150/201 | 10/89→11/93 | Z151 | 0.8 | UXT10 | | |
| 2.0 Turbo 4WD | 4 | 3S-GTE | 153/205 | 10/89→11/93 | Z151 | 0.8 | UXT10 | | |
| 2.0 Turbo 4WD LPG | 4 | 3S-GTE | 136/182 | 03/88→08/89 | Z221 [168] | 1.0 | UXT14 | | |
| 2.0 XT | 4 | 18R | 65/87 | 01/80→07/81 | Z8 | 0.8 | UXT2 / UXT6 | | |
| 2.0 XT | 4 | 18R | 66/89 | 02/79→07/81 | Z8 | 0.8 | UXT2 / UXT6 | ZS106 [1][11][254] | |
| | | | | | | | | ZS109 [1][15] | |
| 2.0 XT | 4 | 21R-C | 77/103 | 02/82→08/85 | Z20 →08/84 Z8 09/84→ | 0.8 →08/84 0.8 09/84→ | UXT2 / UXT6 UXT2 / UXT6 | ZS106 [1][11][254] | ZS109 [1][15] |

CELICA SUPRA

| | | | | | | | | | |
|-------|---|-------|---------|-------------|-----|-----|-------------|--|--|
| 2.8 i | 6 | 5M-GE | 125/168 | 08/81→12/85 | Z20 | 0.8 | UXT2 / UXT6 | | |
|-------|---|-------|---------|-------------|-----|-----|-------------|--|--|

CHASER

| | | | | | | | | | |
|-------|---|----|-------|-------------|-------|-----|--|--|--|
| 2.4 D | 4 | 2L | 63/84 | 10/92→08/96 | GV968 | 11V | | | |
|-------|---|----|-------|-------------|-------|-----|--|--|--|

COROLLA

| | | | | | | | | | |
|-------------|---|----------------------|-------|-------------|------------------------------------|---------------------------------|----------------------------|--------------------|-------------|
| 1.2 | 4 | 3K, 3K-B, 3K-C, 3K-H | 40/54 | 08/74→12/80 | Z8 | 0.8 | UXT2 / UXT6 | | |
| 1.2 | 4 | 3K-B, 3K-C, 3K-H | 43/58 | 10/72→06/77 | Z8 | 0.8 | UXT2 / UXT6 | | |
| 1.3 | 4 | 4K | 44/59 | 09/79→01/82 | Z1 [169] →08/80 Z9 09/80→ | 0.7 →08/80 1.15 09/80→ | UXT2 / UXT6 UXT2 / UXT6 | | |
| 1.3 | 4 | 4K | 44/59 | 09/79→06/83 | Z9 | 1.15 | UXT2 / UXT6 | | |
| 1.3 | 4 | 4K-C | 44/59 | 12/79→01/82 | Z8 | 0.8 | UXT2 / UXT6 | | |
| 1.3 | 4 | 4K | 48/64 | 02/82→08/87 | Z8 | 0.8 | UXT2 / UXT6 | ZS106 [1][11][254] | ZM058 |
| | | | | | | | | ZS109 [1][15] | ZM059 |
| | | | | | | | | | 01/87→ |
| 1.3 | 4 | 2A-L | 51/68 | 06/83→10/84 | Z8 | 0.8 | UXT2 / UXT6 | | ZM058 |
| 1.3 | 4 | 2E | 55/74 | 08/87→10/01 | Z9 | 1.15 | UXT2 / UXT6 | ZS356 | |
| 1.3 | 4 | 2E | 55/74 | 08/87→06/92 | | | | | ZM057 |
| | | | | | | | | | →08/89 |
| | | | | | | | | | ZM058 [1] |
| | | | | | | | | | 09/89→ |
| 1.3 | 4 | 2E-L, 2E-LC | 55/74 | 10/84→08/87 | Z21 | 1.1 | UXT2 / UXT6 | ZS356 | |
| 1.3 | 4 | 2E-L, 2E-LC | 55/74 | 01/85→08/87 | | | | ZS106 [1][11][254] | ZM057 |
| | | | | | | | | ZS109 [1][15] | 08/85→ |
| 1.3 | 4 | 2E | 60/80 | 05/87→04/92 | Z8 Z9 | 0.8 1.15 | UXT2 / UXT6 | ZS356 | |
| 1.3 | 4 | 2E | 60/80 | 07/87→04/92 | Z9 | 1.15 | UXT2 / UXT6 | | |
| 1.3 | 4 | 1NR-FE | 74/99 | 01/07→ | | | | ZSE172 | |
| 1.3 12V | 4 | 2E | 53/71 | 07/92→04/97 | Z9 | 1.15 | UXT2 / UXT6 | ZS356 | |
| 1.3 12V LPG | 4 | 2E | 53/71 | 07/92→04/97 | Z20 [168] | 0.8 | UXT2 / UXT6 | | |
| 1.3 i | 4 | 2E, 2E-E | 55/74 | 08/87→04/92 | Z9 →02/90 Z8 03/90→ | 1.15 →02/90 0.8 03/90→ | UXT2 / UXT6 UXT2 / UXT6 | | |
| 1.3 i | 4 | 2E, 2E-E | 55/74 | 08/87→12/92 | Z9 | 1.15 | UXT2 / UXT6 | ZS356 | ZM057 |
| | | | | | | | | | →08/89 |
| | | | | | | | | | ZM059 [1] |
| | | | | | | | | | 09/89→12/90 |
| | | | | | | | | | ZM058 [1] |
| | | | | | | | | | 09/89→ |
| 1.3 XLI | 4 | 4E-FE | 55/74 | 09/95→04/97 | Z156 | 0.7 | UXT10 | ZS356 | |
| 1.3 XLI | 4 | 4E-FE | 65/87 | 07/92→04/97 | Z156 | 0.7 | UXT10 | ZS356 | |
| 1.3 XLI 16V | 4 | 4E-FE | 65/87 | 07/92→09/95 | Z156 | 0.7 | UXT10 | ZS356 | |
| 1.4 | 4 | 4E-FE | 63/84 | 04/97→02/00 | Z156 Z208 | 0.7 1.0 | UXT10 | ZS356 | |

TOYOTA



kW/BHP



... TOYOTA



... COROLLA

| | | | | | | | | | |
|---------------|---|---------|--------|-------------|------------|------|-------------|-------------------------------------|------------------------------|
| 1.4 | 4 | 4ZZ-FE | 71/95 | 02/00→01/02 | Z154 | 0.9 | UXT9 | ZS449 →09/01 | |
| 1.4 LPG | 4 | 4E-FE | 63/84 | 04/97→02/00 | Z158 [168] | 1.1 | | | |
| 1.4 LPG | 4 | 4ZZ-FE | 71/95 | 02/00→01/02 | Z151 [168] | 0.8 | UXT10 | | |
| 1.4 16V | 4 | 4ZZ-FE | 71/95 | 02/00→11/01 | Z154 | 0.9 | UXT9 | ZS449 →09/01 | |
| 1.4 16V | 4 | 4ZZ-FE | 71/95 | 02/00→10/01 | | | | ZS449 | |
| 1.4 16V LPG | 4 | 4ZZ-FE | 71/95 | 02/00→11/01 | Z151 [168] | 0.8 | UXT10 | | |
| 1.4 D | 4 | 1ND-TV | 66/89 | 07/04→02/07 | GN042 | 11V | | | |
| 1.4 D-4D | 4 | 1ND-TV | 66/89 | 03/04→ | GN042 | 11V | | | |
| 1.4 D4-D | 4 | 1ND-TV | 66/89 | 07/04→02/07 | GN042 | 11V | | | |
| 1.4 VVT-i | 4 | 4ZZ-FE | 71/95 | 01/02→07/07 | Z154 | 0.9 | UXT9 | ZSE164 | |
| 1.4 VVT-i | 4 | 4ZZ-FE | 71/95 | 01/02→02/07 | | | | ZSE164 [1] ZSE169 [1][116] | |
| 1.4 VVT-i | 4 | 4ZZ-FE | 71/95 | 01/07→ | Z16 | 1.1 | UXT11 | ZSE164 | |
| 1.4 VVT-i LPG | 4 | 4ZZ-FE | 71/95 | 01/02→07/07 | Z151 [168] | 0.8 | UXT10 | | |
| 1.6 | 4 | 4A-LC | 53/71 | 08/85→08/87 | Z9 | 1.15 | UXT2 / UXT6 | ZS356 | ZM058 ZM059 [8] |
| 1.6 | 4 | 2T | 54/72 | 09/76→01/80 | Z20 | 0.8 | UXT2 / UXT6 | | |
| 1.6 | 4 | 2T | 54/72 | 09/79→05/83 | Z8 | 0.8 | UXT2 / UXT6 | | |
| 1.6 | 4 | 4A-LC | 54/72 | 08/85→08/87 | Z9 | 1.15 | UXT2 / UXT6 | | ZM058 ZM059 01/87→ |
| 1.6 | 4 | 4A-LC | 54/72 | 08/85→05/88 | | | | ZS356 | |
| 1.6 | 4 | 4A-LC | 54/72 | 12/85→05/88 | Z8 | 0.8 | UXT2 / UXT6 | | ZM058 →12/87 ZM059 [8] |
| 1.6 | 4 | 2T | 55/74 | 09/79→09/83 | Z8 | 0.8 | UXT2 / UXT6 | | |
| 1.6 | 4 | 2T | 55/74 | 09/79→05/83 | | | | ZS106 [1][11][254] ZS109 [1][15] | |
| 1.6 | 4 | 2TB | 62/83 | 09/76→01/80 | Z20 | 0.8 | UXT2 / UXT6 | | |
| 1.6 | 4 | 4A-L | 62/83 | 06/83→08/87 | Z8 | 0.8 | UXT2 / UXT6 | ZS356 | ZM058 ZM059 01/84→ |
| 1.6 | 4 | 2TB | 63/84 | 09/79→05/83 | Z8 | 0.8 | UXT2 / UXT6 | | |
| 1.6 | 4 | 4A-L | 63/84 | 07/85→05/88 | Z8 | 0.8 | UXT2 / UXT6 | ZS356 | ZM058 →12/87 ZM059 [8] |
| 1.6 | 4 | 4A-F | 66/89 | 08/87→05/92 | Z248 | 0.8 | | ZS356 | ZM059 |
| 1.6 | 4 | 4A-F | 66/89 | 08/87→04/92 | | | | ZS356 [107][254] 02/89→03/90 | ZM059 →12/90 |
| 1.6 | 4 | 4A-F | 70/94 | 08/87→04/92 | Z248 | 0.8 | | ZS356 | ZM059 →12/90 |
| 1.6 | 4 | 4A-FE | 77/103 | 08/89→04/92 | Z254 | 0.7 | UXT1 / UXT3 | ZS356 | ZM059 →12/90 |
| 1.6 | 4 | 3ZZ-FE | 81/109 | 02/00→03/09 | Z157 | 1.1 | UXT11 | | |
| 1.6 | 4 | 3ZZ-FE | 81/109 | 02/00→01/02 | | | | ZSE164 [116] →10/01 | |
| 1.6 | 4 | 3ZZ-FE | 81/109 | 04/04→03/09 | | | | ZSE164 | |
| 1.6 | 4 | 4A-FE | 81/109 | 04/97→02/00 | Z155 | 0.8 | UXT10 | ZS356 | |
| 1.6 | 4 | 4A-FE | 85/114 | 05/92→07/95 | Z155 | 0.8 | UXT10 | ZS356 | |
| 1.6 | 4 | 4A-GELC | 85/114 | 05/85→04/87 | Z312 [172] | 1.0 | UXT9 | | |
| 1.6 16V | 4 | 3ZZ-FE | 81/109 | 02/00→11/01 | Z157 | 1.1 | UXT11 | ZSE164 | |
| 1.6 16V | 4 | 4A-GEC | 85/114 | 12/85→04/87 | Z312 [172] | 1.0 | UXT9 | | ZM058 ZM059 [8] |
| 1.6 Aut. | 4 | 4A-FE | 79/106 | 04/97→02/00 | Z155 | 0.8 | UXT10 | ZS356 | |
| 1.6 GLI | 4 | 4A-FE | 84/113 | 07/92→04/97 | Z156 | 0.7 | UXT10 | ZS356 | |
| 1.6 GT | 4 | 2T-G | 81/109 | 05/80→09/83 | Z20 | 0.8 | UXT2 / UXT6 | | |

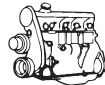

kW/BHP

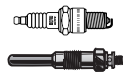

... TOYOTA



... COROLLA

| | | | | | | | | | | |
|-------------------|---|---------|---------|-------------|-----------------|--|-----|-----------------------|------------------------------|--------------------------|
| 1.6 GT 16V | 4 | 4A-GE | 91/122 | 08/83→07/87 | Z157 | | 1.1 | UXT11 | | ZM058 ZM059 01/84→ |
| 1.6 GTi | 4 | 4A-GE | 85/114 | 08/87→04/92 | Z151 09/89→ | | 0.8 | UXT10 09/89→ | | ZM059 →12/90 |
| 1.6 GTI | 4 | 4A-GE | 92/123 | 07/87→06/93 | Z151 08/89→ | | 0.8 | UXT10 08/89→ | | ZM059 →12/90 |
| 1.6 i | 4 | 4A-FE | 77/103 | 08/89→04/92 | Z254 | | 0.7 | UXT1 / UXT3 | | |
| 1.6 i | 4 | 4A-FE | 77/103 | 08/89→06/93 | | | | | ZS356 | ZM059 →12/90 |
| 1.6 i | 4 | 4A-FE | 77/103 | 11/89→06/93 | Z254 →04/92 | | 0.7 | UXT1 / UXT3 →04/92 | | |
| 1.6 i 4WD | 4 | 4A-FE | 77/103 | 10/87→08/90 | Z155 | | 0.8 | UXT10 | | |
| 1.6 Si | 4 | 4A-FE | 84/113 | 07/92→04/97 | Z156 | | 0.7 | UXT10 | ZS356 | |
| 1.6 VVT-i | 4 | 3ZZ-FE | 81/109 | 01/02→12/06 | Z157 | | 1.1 | UXT11 | | |
| 1.6 VVT-i | 4 | 3ZZ-FE | 81/109 | 01/02→07/07 | Z154 | | 0.9 | UXT9 | ZSE164 | |
| 1.6 VVT-i LPG | 4 | 3ZZ-FE | 81/109 | 01/02→07/07 | Z151 [168] | | 0.8 | UXT10 | | |
| 1.6 XLI | 4 | 4A-FE | 77/103 | 08/88→06/92 | Z254 | | 0.7 | UXT1 / UXT3 | ZS356 | ZM059 →12/90 |
| 1.8 4WD | 4 | 7A-FE | 81/109 | 04/97→10/01 | Z155 | | 0.8 | UXT10 | ZS356 | |
| 1.8 | 4 | 1ZZ-FE | 92/123 | 05/02→05/04 | | | | | ZSE164 | |
| 1.8 | 4 | 1ZZ-FE | 95/127 | 04/04→03/09 | Z249 | | 1.0 | | ZSE164 [116] ZSE168 [111] | |
| 1.8 | 4 | 1ZZ-FE | 96/129 | 03/01→07/05 | Z249 | | 1.0 | | ZSE164 | |
| 1.8 | 4 | 1ZZ-FE | 100/134 | 11/01→07/07 | Z249 | | 1.0 | | ZSE164 | |
| 1.8 4WD | 4 | 1ZZ-FE | 100/134 | 12/01→02/07 | | | | | ZSE164 | |
| 1.8 LPG | 4 | 1ZZ-FE | 95/127 | 04/04→03/09 | Z151 [168] | | 0.8 | UXT10 | | |
| 1.8 LPG | 4 | 1ZZ-FE | 96/129 | 03/01→07/05 | Z151 [168] | | 0.8 | UXT10 | | |
| 1.8 LPG | 4 | 1ZZ-FE | 100/134 | 11/01→07/07 | Z151 [168] | | 0.8 | UXT10 | | |
| 1.8 16V 4WD | 4 | 7A-FE | 81/109 | 09/95→04/97 | Z156 | | 0.7 | UXT10 | ZS356 | |
| 1.8 D | 4 | 1C | 43/58 | 01/83→05/88 | GV886 | | 7V | | | |
| 1.8 D | 4 | 1C | 44/59 | 05/83→08/87 | GV886 | | 7V | | | |
| 1.8 D | 4 | 1C | 47/63 | 07/87→06/93 | GN043 | | 11V | | | |
| 1.8 D | 4 | 1C-L | 47/63 | 06/83→06/89 | GV886 →04/87 | | 7V | | | |
| 1.8 D | 4 | 1C | 48/64 | 01/83→09/83 | GV886 | | 7V | | | |
| 1.8 D | 4 | 1C | 49/66 | 08/89→06/93 | GN043 | | 11V | | | |
| 1.8 GT | 4 | 7A-FE | 86/115 | 11/92→05/95 | | | | | ZS356 | |
| 1.8 VVTi | 4 | 1ZZ-FE | 100/134 | 06/04→02/07 | Z249 | | 1.0 | | ZSE164 | |
| 1.8 VVTi LPG | 4 | 1ZZ-FE | 100/134 | 06/04→02/07 | Z151 [168] | | 0.8 | UXT10 | | |
| 1.8 VVT-i | 4 | 1ZZ-FE | 99/133 | 01/02→05/04 | Z249 | | 1.0 | | ZSE164 [116] ZSE168 [111] | |
| 1.8 VVT-i LPG | 4 | 1ZZ-FE | 99/133 | 01/02→05/04 | Z151 [168] | | 0.8 | UXT10 | | |
| 1.8 VVTL-i TS | 4 | 2ZZ-GE | 141/189 | 01/02→02/07 | Z221 | | 1.0 | UXT14 | ZSE168 | |
| 1.8 VVTL-i TS | 4 | 2ZZ-GE | 160/215 | 10/05→12/06 | Z313 | | 1.1 | UXT14 | ZSE168 | |
| 1.8 VVTL-i TS | 4 | 2ZZ-GE | 165/221 | 02/05→02/07 | Z221 | | 1.0 | UXT14 | ZSE168 | |
| 1.8 VVTL-i TS LPG | 4 | 2ZZ-GE | 141/189 | 01/02→02/07 | Z30 [168] | | 0.8 | UXT5 | | |
| 1.8 VVTL-i TS LPG | 4 | 2ZZ-GE | 160/215 | 10/05→12/06 | Z30 [168] | | 0.8 | UXT5 | | |
| 1.8 VVTL-i TS LPG | 4 | 2ZZ-GE | 165/221 | 02/05→02/07 | Z30 [168] | | 0.8 | UXT5 | | |
| 1.9 D | 4 | 1WZ | 51/68 | 02/00→01/02 | GN016 | | 11V | | | |
| 2.0 D | 4 | 2C | 53/71 | 07/92→04/97 | GN043 | | 11V | | | |
| 2.0 D | 4 | 2C-E | 53/71 | 04/97→02/00 | GN043 →09/99 | | 11V | | | |
| 2.0 D-4D | 4 | 1CD-FTV | 66/89 | 09/00→07/07 | GN065 | | 11V | | | |
| 2.0 D-4D | 4 | 1CD-FTV | 81/109 | 08/00→12/06 | GN065 | | 11V | | | |
| 2.0 D-4D | 4 | 1CD-FTV | 85/114 | 04/97→03/09 | GN065 | | 11V | | | |
| 2.2 D-4D | 4 | 2AD-FTV | 100/134 | 10/05→03/09 | GN108 →09/08 | | 11V | | | |
| 2.2 D-4D | 4 | 2AD-FHV | 130/174 | 10/05→ | GN108 | | 11V | | | |
| 2.2 TD | 4 | 3C-TE | 66/89 | 04/98→10/01 | GN110 | | 11V | | | |

TOYOTA

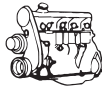

kW/BHP

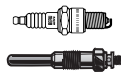
**... TOYOTA****COROLLA FX**

| | | | | | | | | | |
|------------|---|---------|--------|-------------|-----------------------|-----|-------------|---|-------------------------------|
| 1.3 | 4 | 2E-L | 55/74 | 08/85→08/87 | Z21 | 1.1 | UXT2 / UXT6 | ZS106 ^{[1][11][25-4]} ZS109 ^{[1][15]} ZS356 | ZM058 |
| 1.6 | 4 | 4A-LC | 54/72 | 01/87→09/87 | | | | | ZM058 |
| 1.6 | 4 | 4A-GELC | 85/114 | 05/85→04/87 | Z312 ^[172] | 1.0 | UXT9 | | |
| 1.6 GT 16V | 4 | 4A-GEL | 89/119 | 08/85→08/87 | Z157 | 1.1 | UXT11 | | ZM058 ZM059 ^[8] |
| 1.8 D | 4 | 1C | 43/58 | 01/85→05/88 | GV886 | 7V | | | |
| 1.8 D | 4 | 1C-L | 47/63 | 08/85→08/87 | GV886 →04/87 | 7V | | | |

CORONA

| | | | | | | | | | |
|-------------|---|-------|--------|-------------|----------------------|-----|-------------|-------|--|
| 1.5 | 4 | 5A-F | 85/114 | 11/87→08/89 | | | | ZS356 | |
| 1.6 | 4 | 4A-FE | 73/98 | 02/92→09/97 | Z334 ^[17] | 0.9 | | | |
| 1.8 | 4 | 3T | 63/84 | 06/79→07/81 | Z20 | 0.8 | UXT2 / UXT6 | | |
| 2.0 | 4 | 18R | 65/87 | 09/75→05/79 | Z20 | 0.8 | UXT2 / UXT6 | | |
| 2.0 D | 4 | 2C | 54/72 | 12/87→01/92 | GN043 | 11V | | | |
| 2.0 Mark II | 4 | 18R | 65/87 | 12/75→10/77 | Z20 | 0.8 | UXT2 / UXT6 | | |

CRESSIDA

| | | | | | | | | | |
|---------|---|------------|--------|-------------|------------------------------------|------------|----------------------------|--|--|
| 2.0 | 4 | 18R | 66/89 | 07/77→07/81 | Z8 →08/80 Z20 09/80→ | 0.8 0.8 | UXT2 / UXT6 UXT2 / UXT6 | | |
| 2.0 | 4 | 21R, 21R-C | 77/103 | 02/81→03/85 | Z20 | 0.8 | UXT2 / UXT6 | | |
| 2.0 GLI | 6 | 1G-E | 80/107 | 11/82→12/84 | Z20 | 0.8 | UXT2 / UXT6 | | |
| 2.2 D | 4 | L | 49/66 | 09/80→03/85 | GV688 →07/82 GV894 08/82→ | 11V 7V | | | |
| 2.4 TD | 4 | 2L-T | 63/84 | 01/85→10/88 | GV001 | 6V | | | |
| 2.4 TD | 4 | 2L-T | 66/89 | 05/85→09/88 | GV001 | 6V | | | |

CRESTA

| | | | | | | | | | |
|--------|---|-------|-------|-------------|-------|-----|--|--|--|
| 2.2 TD | 4 | 3C-TE | 66/89 | 10/96→09/01 | GN110 | 11V | | | |
| 2.4 D | 4 | 2L | 63/84 | 09/88→10/96 | GV968 | 11V | | | |

CROWN

| | | | | | | | | | |
|--------------------|---|----------|---------|-------------|-----------------------|-----|-------------|--|--|
| 2.2 D | 4 | L | 53/71 | 04/80→07/83 | GV688 | 11V | | | |
| 2.4 D | 4 | 2L-TE | 67/90 | 08/94→07/02 | GV968 | 11V | | | |
| 2.8 | 6 | 5M, 5M-E | 107/143 | 09/80→09/83 | Z20 | 0.8 | UXT2 / UXT6 | | |
| 2.8 i Super Saloon | 6 | 5M-GE | 125/168 | 02/84→03/85 | Z20 | 0.8 | UXT2 / UXT6 | | |
| 2.8 Si | 6 | 5M, 5M-E | 107/143 | 04/80→07/83 | Z20 | 0.8 | UXT2 / UXT6 | | |
| 3.0 | 6 | 2JZ-FSE | 147/197 | 09/99→08/03 | Z312 ^[172] | 1.0 | UXT9 | | |
| 4.3 Royal Saloon | 8 | 3UZ-FE | 206/276 | 09/03→02/08 | Z284 | 1.1 | UXT14 | | |

ECHO

| | | | | | | | | | |
|---------|---|--------|-------|-------------|-------|-----|--|--|--|
| 1.4 D4d | 4 | 1ND-TV | 55/74 | 01/00→03/03 | GN042 | 11V | | | |
|---------|---|--------|-------|-------------|-------|-----|--|--|--|

FJ CRUISER

| | | | | | | | | | |
|--------------|---|--------|---------|--------|--|--|--|--------|--|
| 4.0 i V6 4WD | 6 | 1GR-FE | 203/272 | 01/11→ | | | | ZSE172 | |
|--------------|---|--------|---------|--------|--|--|--|--------|--|

FORTUNER

| | | | | | | | | | |
|--------------|---|---------|---------|--------|-------|-----|--|--|--|
| 2.5 D-4D 4WD | 4 | 2KD-FTV | 75/101 | 01/09→ | GN065 | 11V | | | |
| 2.5 D-4D 4WD | 4 | 2KD-FTV | 106/142 | 01/09→ | GN065 | 11V | | | |
| 3.0 D | 4 | 1KD-FTV | 120/161 | 06/04→ | GN065 | 11V | | | |
| 3.0 D 4WD | 4 | 1KD-FTV | 125/168 | 08/09→ | GN068 | 11V | | | |

GAIA

| | | | | | | | | | |
|--------|---|-------|-------|-------------|-------|-----|--|--|--|
| 2.2 TD | 4 | 3C-TE | 69/93 | 10/98→10/03 | GN110 | 11V | | | |
|--------|---|-------|-------|-------------|-------|-----|--|--|--|

GRANVIA

| | | | | | | | | | |
|---------|---|--------|---------|--------|-------|-----|-------|--|--|
| 2.7 | 4 | 3RZ-FE | 112/150 | 08/95→ | Z150 | 1.3 | UXT11 | | |
| 2.7 LPG | 4 | 3RZ-FE | 112/150 | 08/95→ | Z129 | 1.6 | | | |
| 3.0 TDi | 4 | 1KZ-TE | 96/129 | 08/95→ | GN110 | 11V | | | |



kW/BHP

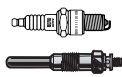

... TOYOTA

**HARRIER**

| | | | | | | | | | | |
|--------------|---|--------|---------|-------------|--|--|--|--|--|-------|
| 3.0 4WD | 6 | 1MZ-FE | 164/220 | 03/98→01/03 | | | | | | ZS430 |
| 3.0 VVTi 4WD | 6 | 1MZ-FE | 150/201 | 10/03→12/08 | | | | | | ZS430 |

HIACE

| | | | | | | | | | | |
|-------|---|---|-------|-------------|-------|--|--|----|--|--|
| 2.2 D | 4 | L | 49/66 | 01/79→07/85 | GV894 | | | 7V | | |
|-------|---|---|-------|-------------|-------|--|--|----|--|--|

HILUX

| | | | | | | | | | | |
|--------------|---|-------------|---------|-------------|-------|--|--|-----|-------|--|
| 2.4 TD 4WD | 4 | 2L-T, 2L-TE | 66/89 | 08/89→07/01 | GV968 | | | 11V | | |
| 2.7 | 4 | 3RZ-FE | 107/143 | 08/01→07/04 | Z150 | | | 1.3 | UXT11 | |
| 2.7 LPG | 4 | 3RZ-FE | 107/143 | 08/01→07/04 | Z129 | | | 1.6 | | |
| 3.0 D | 4 | 5L | 67/90 | 08/02→07/04 | GN043 | | | 11V | | |
| 3.0 TDiC 4WD | 4 | 1KZ-T | 92/123 | 08/93→07/97 | GN110 | | | 11V | | |

HILUX I

| | | | | | | | | | | |
|-------|---|---|-------|-------------|-----------------|--|--|-----|--|--|
| 2.2 D | 4 | L | 47/63 | 05/79→03/83 | GV968 | | | 11V | | |
| | | | | | →08/81 GV894 | | | 7V | | |
| | | | | | 09/81→ | | | | | |

HILUX II

| | | | | | | | | | | |
|---------------|---|------------------------------|---------|-------------|-----------|--|--|-----|-------------|-------|
| 1.8 | 4 | 2Y | 61/82 | 08/88→07/94 | Z8 | | | 0.8 | UXT2 / UXT6 | ZS356 |
| 2.0 | 4 | 3Y | 65/87 | 01/84→12/86 | Z8 | | | 0.8 | UXT2 / UXT6 | |
| 2.2 4WD | 4 | 4Y | 69/93 | 01/87→12/89 | Z8 | | | 0.8 | UXT2 / UXT6 | |
| 2.2 D | 4 | L | 49/66 | 08/83→08/84 | GV894 | | | 7V | | |
| 2.4 D | 4 | 2L, LN51R | 55/74 | 01/84→01/02 | GV968 | | | 11V | | |
| 2.4 D 4WD | 4 | LN51, LN56, LN60, LN61, LN65 | 55/74 | 01/84→08/88 | GV894 | | | 7V | | |
| 2.4 D | 4 | 2L | 56/75 | 10/88→08/91 | GV968 | | | 11V | | |
| 2.4 D | 4 | 2L | 58/78 | 01/94→07/05 | GV968 | | | 11V | | |
| | | | | | →08/97 | | | | | |
| 2.4 D | 4 | 2L | 59/79 | 01/92→07/05 | GV968 | | | 11V | | |
| | | | | | →08/97 | | | | | |
| 2.4 D | 4 | 2L | 61/82 | 08/88→07/05 | GV968 | | | 11V | | |
| | | | | | →08/97 | | | | | |
| 2.4 D 4WD | 4 | | 73/98 | 08/91→07/97 | GV968 | | | 11V | | |
| 2.4 i 4WD | 4 | 22R, 22RE | 84/113 | 06/89→07/05 | Z8 | | | 0.8 | UXT2 / UXT6 | |
| 2.4 i 4WD | 4 | 2RZ-FE | 103/138 | 08/97→07/05 | Z155 | | | 0.8 | UXT10 | |
| 2.4 i 4WD LPG | 4 | 22R, 22RE | 84/113 | 06/89→07/05 | Z20 [168] | | | 0.8 | UXT2 / UXT6 | |
| 2.4 TD 4WD | 4 | 2L-T | 66/89 | 08/98→01/02 | GV968 | | | 11V | | |
| 2.5 D-4D | 4 | 2KD-FTV | 65/87 | 11/01→07/05 | GN065 | | | 11V | | |
| 2.5 D-4D 4WD | 4 | 2KD-FTV | 75/101 | 11/01→07/05 | GN065 | | | 11V | | |
| 2.7 | 4 | 3RZ-FE | 107/143 | 08/01→07/04 | Z150 | | | 1.3 | UXT11 | |
| 2.7 4WD | 4 | 3RZ-FE | 108/145 | 11/97→04/05 | Z150 | | | 1.3 | UXT11 | |
| 2.7 | 4 | 3RZ-FE | 110/148 | 08/94→07/00 | Z150 | | | 1.3 | UXT11 | |
| 2.7 LPG | 4 | 3RZ-FE | 107/143 | 08/01→07/04 | Z129 | | | 1.6 | | |
| 2.7 4WD LPG | 4 | 3RZ-FE | 108/145 | 11/97→04/05 | Z129 | | | 1.6 | | |
| 2.7 LPG | 4 | 3RZ-FE | 110/148 | 08/94→07/00 | Z129 | | | 1.6 | | |
| 2.8 D | 4 | 3L | 60/80 | 10/88→12/97 | GV968 | | | 11V | | |
| 2.8 D 4WD | 4 | 3L | 61/82 | 08/94→07/01 | GV968 | | | 11V | | |
| 3.0 D 4WD | 4 | 5L | 65/87 | 11/97→04/05 | GV968 | | | 11V | | |
| 3.0 D | 4 | 5L | 67/90 | 01/02→07/05 | GN043 | | | 11V | | |
| 3.0 D 4WD | 4 | 1KZ-T | 87/117 | 11/01→04/05 | GN110 | | | 11V | | |

HILUX III

| | | | | | | | | | | |
|--------------|---|---------|---------|-------------|-------|--|--|-----|--|--|
| 2.5 D 4WD | 4 | 2KD-FTV | 75/101 | 08/05→ | GN065 | | | 11V | | |
| 2.5 D-4D | 4 | 2KD-FTV | 75/101 | 06/06→ | GN065 | | | 11V | | |
| 2.5 D-4D | 4 | 2KD-FTV | 88/118 | 12/07→ | GN065 | | | 11V | | |
| 2.5 D-4D | 4 | 2KD-FTV | 106/142 | 12/07→ | GN065 | | | 11V | | |
| 3.0 | 4 | 1KD-FTV | 120/161 | 08/05→09/06 | GN068 | | | 11V | | |
| 3.0 4WD | 4 | 1KD-FTV | 120/161 | 08/05→ | GN065 | | | 11V | | |
| 3.0 D | 4 | 1KD-FTV | 126/169 | 10/06→ | GN068 | | | 11V | | |
| 3.0 D-4D 4WD | 4 | 1KD-FTV | 126/169 | 12/07→ | GN068 | | | 11V | | |

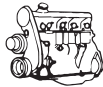

kW/BHP

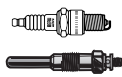

... TOYOTA



MARK II

| | | | | | | | | |
|--------|---|-------|-------|-------------|-------|-----|--|--|
| 2.4 D | 4 | 2L | 54/72 | 04/88→09/96 | GV968 | 11V | | |
| 2.4 TD | 4 | 2L-TE | 69/93 | 04/88→09/96 | GV968 | 11V | | |
| 2.4 TD | 4 | 2L-TE | 71/95 | 11/84→03/88 | GV001 | 6V | | |

MARK X I

| | | | | | | | | |
|----------|---|---------|---------|-------------|--|--|--|--------|
| 2.5 VVTi | 6 | 4GR-FSE | 158/212 | 03/04→09/09 | | | | ZSE172 |
| 3.0 VVTi | 6 | 3GR-FSE | 183/245 | 05/04→09/09 | | | | ZSE172 |

IQ

| | | | | | | | | |
|----------|---|--------|-------|--------|-------|-----|-------|--------|
| 1.0 | 3 | 1KR-FE | 50/67 | 01/09→ | Z184 | 0.9 | UXT13 | ZSE165 |
| 1.3 | 4 | 1NR-FE | 72/97 | 01/09→ | | | | ZSE172 |
| 1.4 D-4D | 4 | 1ND-TV | 66/89 | 01/09→ | GN042 | 11V | | |

KIJANG INNOVA

| | | | | | | | | |
|----------|---|---------|--------|--------|-------|-----|--|--|
| 2.5 D-4D | 4 | 2KD-FTV | 75/101 | 08/04→ | GN065 | 11V | | |
|----------|---|---------|--------|--------|-------|-----|--|--|

KLUGER

| | | | | | | | | |
|---------|---|--------|---------|-------------|--|--|--|-------|
| 3.0 4WD | 6 | 1MZ-FE | 150/201 | 10/03→05/07 | | | | ZS430 |
| 3.0 4WD | 6 | 1MZ-FE | 164/220 | 06/00→05/07 | | | | ZS430 |

LAND CRUISER

| | | | | | | | | |
|-----------------|---|---------|---------|-------------|-----------|-----|-------------|------------|
| 2.4 4WD | 4 | 22R | 77/103 | 11/84→05/93 | Z8 | 0.8 | UXT2 / UXT6 | |
| 2.4 4WD | 4 | 22R | 81/109 | 11/84→05/93 | Z8 | 0.8 | UXT2 / UXT6 | |
| 2.4 4WD | 4 | 22RE | 84/113 | 12/88→12/96 | Z8 | 0.8 | UXT2 / UXT6 | |
| 2.4 4WD LPG | 4 | 22RE | 84/113 | 12/88→12/96 | Z20 [168] | 0.8 | UXT2 / UXT6 | |
| 2.4 D 4WD | 4 | 2L | 53/71 | 11/84→10/85 | GV894 | 7V | | |
| 2.4 TD 4WD | 4 | 2L-T | 63/84 | 10/85→05/90 | GV001 | 6V | | |
| | | | | →12/89 | GV968 | 11V | | |
| | | | | 01/90→ | | | | |
| 2.4 TD 4WD | 4 | 2L-T | 66/89 | 01/90→05/96 | GV968 | 11V | | |
| 2.7 4WD | 4 | 3RZ-FE | 112/150 | 09/02→08/04 | Z150 | 1.3 | UXT11 | |
| 2.7 4WD LPG | 4 | 3RZ-FE | 112/150 | 09/02→08/04 | Z129 | 1.6 | | |
| 2.7 TD 4WD | 4 | 3L | 61/82 | 01/90→08/01 | GV968 | 11V | | |
| 3.0 D 4WD | 4 | B | 59/79 | 02/74→10/84 | GV895 | 14V | | |
| 3.0 D-4D 4WD | 4 | 1KZ-TE | 92/123 | 09/02→02/10 | GN065 | 11V | | |
| 3.0 D-4D 4WD | 4 | 1KD-FTV | 120/161 | 01/03→02/10 | GN068 | 11V | | |
| 3.0 D-4D 4WD | 4 | 1KD-FTV | 122/164 | 08/04→02/10 | GN068 | 11V | | |
| 3.0 D-4D 4WD | 4 | 1KD-FTV | 127/170 | 09/02→ | GN068 | 11V | | |
| 3.0 TD 4WD | 4 | 1KZ-T | 92/123 | 05/93→05/96 | GN110 | 11V | | |
| 3.4 D 4WD | 4 | 3B | 66/89 | 08/80→10/84 | GV895 | 14V | | |
| 3.4 D 4WD | 4 | 3B | 70/94 | 11/84→12/96 | GN043 | 11V | | |
| | | | | 09/88→ | | | | |
| 3.9 4WD | 6 | F | 96/129 | 03/69→01/75 | | | | ZS106 [11] |
| 4.0 4WD | 6 | 3F-E | 115/154 | 08/87→12/89 | Z82 | 0.7 | UXT2 / UXT6 | |
| 4.0 4WD | 6 | 1GR-FE | 183/245 | 01/03→ | Z184 | 0.9 | UXT13 | ZSE167 |
| 4.0 Turbo-D 4WD | 6 | 12HT | 100/134 | 10/85→12/89 | GV895 | 14V | | |
| | | | | 08/87→ | | | | |
| 4.2 4WD | 6 | 2F | 88/118 | 10/81→01/88 | Z82 | 0.7 | UXT2 / UXT6 | |
| 4.5 D-4D 4WD | 8 | 1VD-FTV | 195/261 | 01/08→ | GN108 | 11V | | |
| 4.5 D4-D 4WD | 8 | 1VD-FTV | 173/232 | 08/07→ | GN108 | 11V | | |
| 4.5 D4-D 4WD | 8 | 1VD-FTV | 200/268 | 01/12→ | GN108 | 11V | | |
| 4.5 D V8 4WD | 8 | 1VD-FTV | 210/282 | 01/08→ | GN108 | 11V | | |
| 4.6 V8 4WD | 8 | 1UR-FE | 227/304 | 09/10→ | | | | ZSE172 |
| 4.6 V8 4WD | 8 | 1UR-FE | 234/314 | 01/12→ | | | | ZSE172 |
| 4.7 V8 4WD | 8 | 2UZ-FE | 212/284 | 01/08→ | Z313 | 1.1 | UXT14 | |
| 4.7 V8 4WD LPG | 8 | 2UZ-FE | 212/284 | 01/08→ | Z30 [168] | 0.8 | UXT5 | |

LAND CRUISER 80

| | | | | | | | | |
|-------------|---|--------|---------|-------------|-------|------|-------------|--|
| 4.0 4WD | 6 | 3F-E | 115/154 | 01/90→08/92 | Z9 | 1.15 | UXT2 / UXT6 | |
| 4.2 D 4WD | 6 | 1H-Z | 99/133 | 01/90→12/97 | GN043 | 11V | | |
| 4.2 TD 4WD | 6 | 1HD-T | 118/158 | 10/92→12/97 | GN043 | 11V | | |
| 4.2 TD 4WD | 6 | 1HD-T | 123/165 | 01/90→12/97 | GN043 | 11V | | |
| 4.5 24V 4WD | 6 | 1FZ-FE | 151/202 | 08/92→12/97 | Z249 | 1.0 | | |

TOYOTA



kW/BHP

**... TOYOTA****... LAND CRUISER 80**

| | | | | | | | | |
|-----------------|---|--------|---------|-------------|------------|-----|-------|--|
| 4.5 24V 4WD LPG | 6 | 1FZ-FE | 151/202 | 08/92→12/97 | Z151 [168] | 0.8 | UXT10 | |
|-----------------|---|--------|---------|-------------|------------|-----|-------|--|

LAND CRUISER 90

| | | | | | | | | |
|-------------------|---|---------|---------|-------------|------------|-----|-------|-------|
| 2.7 4WD | 4 | 3RZ-FE | 110/148 | 04/95→07/02 | Z150 | 1.3 | UXT11 | |
| 2.7 4WD LPG | 4 | 3RZ-FE | 110/148 | 04/95→07/02 | Z129 | 1.6 | | |
| 3.0 D-4D 4WD | 4 | 1KD-FTV | 120/161 | 10/00→ | GN068 | 11V | | |
| 3.0 TD 4WD | 4 | 1KZ-TE | 92/123 | 04/96→ | GN110 | 11V | | |
| 3.0 TD 4WD | 4 | 1KZ-TE | 103/138 | 04/95→07/00 | GN110 | 11V | | |
| 3.4 i 24V 4WD | 6 | 5VZ-FE | 131/176 | 04/96→ | Z208 | 1.0 | | ZS473 |
| 3.4 i 24V 4WD LPG | 6 | 5VZ-FE | 131/176 | 04/96→ | Z158 [168] | 1.1 | | |

LAND CRUISER 100

| | | | | | | | | |
|-------------|---|--------|---------|--------|-----------|-----|-------|--------|
| 4.7 4WD | 8 | 2UZ-FE | 173/232 | 01/98→ | Z221 | 1.0 | UXT14 | ZSE172 |
| 4.7 4WD | 8 | 2UZ-FE | 175/235 | 02/02→ | Z221 | 1.0 | UXT14 | ZSE172 |
| 4.7 4WD LPG | 8 | 2UZ-FE | 173/232 | 01/98→ | Z30 [168] | 0.8 | UXT5 | |
| 4.7 4WD LPG | 8 | 2UZ-FE | 175/235 | 02/02→ | Z30 [168] | 0.8 | UXT5 | |

LAND CRUISER 150

| | | | | | | | | |
|-----------------------|---|---------|---------|--------|-------|-----|--|-------------------------------|
| 3.0 D-4D 4WD | 4 | 1KD-FTV | 127/170 | 03/10→ | GN068 | 11V | | |
| 3.0 D-4D 4WD | 4 | 1KD-FTV | 140/188 | 01/10→ | GN068 | 11V | | |
| 4.0 V6 Dual VVT-i 4WD | 6 | 1GR-FE | 205/275 | 01/10→ | | | | ZSE172 |
| 4.0 V6 VVT-i 4WD | 6 | 1GR-FE | 207/278 | 01/10→ | Z235 | 1.0 | | ZSE167 [1] ZSE172 [1][115] |

MR 2 I

| | | | | | | | | |
|-------------|---|---------|--------|-------------|------------|-----|-------|--|
| 1.6 16V | 4 | 4A-GELC | 85/114 | 11/84→06/90 | Z228 | 1.0 | UXT11 | |
| 1.6 16V | 4 | 4A-GEL | 91/122 | 11/84→06/90 | Z157 | 1.1 | UXT11 | |
| 1.6 16V LPG | 4 | 4A-GELC | 85/114 | 11/84→06/90 | Z221 [168] | 1.0 | UXT14 | |

MR 2 II

| | | | | | | | | |
|-------------|---|-------|---------|-------------|----------------------------------|------------|----------------|---------------------------|
| 2.0 16V | 4 | 3S-GE | 115/154 | 12/89→05/00 | Z155 | 0.8 | UXT10 | ZS445 →12/91 |
| 2.0 16V | 4 | 3S-GE | 125/168 | 12/89→05/00 | Z151 →05/96 Z155 06/96→ | 0.8 0.8 | UXT10 UXT10 | ZS445 →12/91 →12/91 |
| 2.0 16V | 4 | 3S-GE | 129/173 | 12/89→05/00 | Z151 →05/96 Z155 06/96→ | 0.8 0.8 | UXT10 UXT10 | ZS445 →12/91 →12/91 |
| 2.0 16V LPG | 4 | 3S-GE | 125/168 | 12/89→05/00 | Z129 →05/96 | 1.6 | | |
| 2.0 16V LPG | 4 | 3S-GE | 129/173 | 12/89→05/00 | Z129 →05/96 | 1.6 | | |

MR 2 III

| | | | | | | | | |
|------------------|---|--------|---------|-------------|------------|-----|-------|--------|
| 1.8 16V VT-i | 4 | 1ZZ-FE | 103/138 | 10/99→06/07 | Z249 | 1.0 | | ZSE164 |
| 1.8 16V VT-i LPG | 4 | 1ZZ-FE | 103/138 | 10/99→06/07 | Z151 [168] | 0.8 | UXT10 | |

NADIA

| | | | | | | | | |
|------------|---|-------|-------|-------------|-------|-----|--|--|
| 2.2 TD 4WD | 4 | 3C-TE | 66/89 | 04/98→08/03 | GN110 | 11V | | |
|------------|---|-------|-------|-------------|-------|-----|--|--|

PASEO

| | | | | | | | | |
|---------|---|-------|-------|-------------|--|--|--|-------|
| 1.5 | 4 | 5E-FE | 66/89 | 10/96→03/99 | | | | ZS356 |
| 1.5 16V | 4 | 5E-FE | 66/89 | 08/95→07/99 | | | | ZS356 |

PICNIC

| | | | | | | | | |
|---------|---|-------|--------|-------------|-------|-----|-------|--|
| 2.0 | 4 | 3S-FE | 90/121 | 01/01→12/01 | Z157 | 1.1 | UXT11 | |
| 2.0 16V | 4 | 3S-FE | 94/126 | 05/96→12/01 | Z157 | 1.1 | UXT11 | |
| 2.2 D | 4 | 3C-TE | 66/89 | 08/97→12/01 | GN110 | 11V | | |

PREVIA

| | | | | | | | | |
|----------|---|---------|---------|-------------|-------|-----|-------|-------------------------------|
| 2.0 D-4D | 4 | 1CD-FTV | 85/114 | 03/01→01/06 | GN065 | 11V | | |
| 2.4 | 4 | 2TZ-FE | 97/130 | 05/90→08/00 | Z228 | 1.0 | UXT11 | |
| 2.4 | 4 | 2AZ-FE | 115/154 | 08/00→01/06 | Z221 | 1.0 | UXT14 | ZSE167 [1] ZSE171 [1][117] |

TOYOTA



kW/BHP

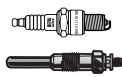

... TOYOTA



... PREVIA

| | | | | | | | | |
|----------|---|--------|---------|-------------|------------|-----|-------|-------|
| 2.4 LPG | 4 | 2TZ-FE | 97/130 | 05/90→08/00 | Z221 [168] | 1.0 | UXT14 | |
| 2.4 LPG | 4 | 2AZ-FE | 115/154 | 08/00→01/06 | Z30 [168] | 0.8 | UXT5 | |
| 3.0 VVTi | 6 | 1MZ-FE | 162/217 | 08/00→12/05 | | | | ZS430 |

PRIUS

| | | | | | | | | |
|------------|---|---------|-------|-------------|------|-----|------|--------|
| 1.5 | 4 | 1NZ-FXE | 53/71 | 05/00→01/04 | Z240 | 1.0 | UXT9 | ZSE165 |
| 1.5 | 4 | 1NZ-FXE | 57/76 | 08/03→03/09 | Z240 | 1.0 | UXT9 | ZSE165 |
| 1.8 Hybrid | 4 | 2ZR-FXE | 73/98 | 04/09→ | | | | ZSE165 |

PRIUS C

| | | | | | | | | |
|------------|---|---------|-------|--------|--|--|--|--------|
| 1.5 Hybrid | 4 | 1NZ-FXE | 54/72 | 02/12→ | | | | ZSE165 |
|------------|---|---------|-------|--------|--|--|--|--------|

PROBOX/SUCCEED

| | | | | | | | | |
|-----------------|---|---------|-------|--------|-------|-----|------|--|
| 1.4 D-4D | 4 | 1ND-TV | 55/74 | 07/02→ | GN042 | 11V | | |
| 1.5 VVTi Hybrid | 4 | 1NZ-FXE | 68/91 | 07/02→ | Z240 | 1.0 | UXT9 | |

RAV 4 I

| | | | | | | | | |
|-------------|---|-------|--------|-------------|------|-----|-------|-------|
| 2.0 4WD | 4 | 3S-FE | 95/127 | 06/94→06/00 | Z157 | 1.1 | UXT11 | ZS356 |
| 2.0 16V 4WD | 4 | 3S-FE | 94/126 | 12/97→06/00 | Z157 | 1.1 | UXT11 | |

RAV 4 II

| | | | | | | | | |
|--------------|---|---------|---------|-------------|------------|-----|-------|-------------------------------|
| 1.8 VVTi | 4 | 1ZZ-FE | 92/123 | 08/00→11/05 | Z249 | 1.0 | | ZSE164 |
| 1.8 VVTi LPG | 4 | 1ZZ-FE | 92/123 | 08/00→11/05 | Z151 [168] | 0.8 | UXT10 | |
| 2.0 D-4D 4WD | 4 | 1CD-FTV | 85/114 | 09/01→11/05 | GN065 | 11V | | |
| 2.0 VVTi 4WD | 4 | 1AZ-FE | 110/148 | 06/00→11/05 | Z280 | 1.0 | UXT9 | ZSE167 [1] ZSE171 [1][117] |
| 2.4 VVTi 4WD | 4 | 2AZ-FE | 112/150 | 08/03→11/05 | | | | ZSE167 |

RAV 4 III

| | | | | | | | | |
|-------------------|---|---------|---------|--------|-----------|-----|-------|-------------------------------|
| 2.0 VVT-i 4WD | 4 | 1AZ-FE | 112/150 | 03/06→ | Z221 | 1.0 | UXT14 | ZSE167 [1] ZSE171 [1][117] |
| 2.0 VVT-i 4WD LPG | 4 | 1AZ-FE | 112/150 | 03/06→ | Z30 [168] | 0.8 | UXT5 | |
| 2.2 D-4D 4WD | 4 | 2AD-FTV | 100/134 | 03/06→ | GN108 | 11V | | |
| 2.2 D-4D | 4 | 2AD-FHV | 110/148 | 12/08→ | GN108 | 11V | | |
| 2.2 D-CAT 4WD | 4 | 2AD-FHV | 130/174 | 03/06→ | GN108 | 11V | | |
| 2.4 VVTi | 4 | 2AZ-FE | 125/168 | 11/05→ | Z221 | 1.0 | UXT14 | ZSE167 [1] ZSE171 [1][117] |
| 2.4 VVTi 4WD | 4 | 2AZ-FE | 125/168 | 11/05→ | | | | ZSE171 |
| 2.4 VVTi LPG | 4 | 2AZ-FE | 125/168 | 11/05→ | Z30 [168] | 0.8 | UXT5 | |

RAV 4 IV

| | | | | | | | | |
|--------------|---|------------------|---------|--------|-------|-----|--|--|
| 2.2 D4-D 4WD | 4 | 2AD-FHV, 2AD-FTV | 110/148 | 12/12→ | GN108 | 11V | | |
|--------------|---|------------------|---------|--------|-------|-----|--|--|

SIENNA

| | | | | | | | | |
|-----|---|--------|---------|-------------|--|--|--|-------|
| 3.0 | 6 | 1MZ-FE | 143/192 | 05/97→04/03 | | | | ZS430 |
| 3.0 | 6 | 1MZ-FE | 154/207 | 05/97→04/03 | | | | ZS430 |

SPRINTER

| | | | | | | | | |
|--------|---|-------|-------|-------------|-------|-----|--|--|
| 2.0 D | 4 | 2C | 54/72 | 04/95→11/00 | GN043 | 11V | | |
| 2.2 TD | 4 | 3C-TE | 66/89 | 04/95→11/02 | GN110 | 11V | | |

STARLET

| | | | | | | | | |
|---------|---|-------|-------|-------------|-------------------------------|-----------------------|----------------------------|--------------------------|
| 1.0 | 4 | 2K | 33/44 | 02/78→09/84 | Z8 | 0.8 | UXT2 / UXT6 | |
| 1.0 | 4 | 1E | 40/54 | 12/89→12/92 | Z20 | 0.8 | UXT2 / UXT6 | ZS356 |
| 1.0 | 4 | 1E-L | 40/54 | 10/84→12/89 | Z20 | 0.8 | UXT2 / UXT6 | ZS106 [11] |
| 1.2 | 4 | 3K-H | 41/55 | 02/78→09/82 | Z8 | 0.8 | UXT2 / UXT6 | |
| 1.2 S | 4 | 3K-H | 39/52 | 10/78→08/82 | Z8 | 0.8 | UXT2 / UXT6 | |
| 1.3 | 4 | 2E-LC | 55/74 | 10/84→12/89 | Z21 →08/87 Z9 09/87→ | 1.1 →08/87 1.15 | UXT2 / UXT6 UXT2 / UXT6 | ZS356 ZM057 01/85→ |
| 1.3 | 4 | 4E-FE | 55/74 | 04/96→03/99 | Z156 | 0.7 | UXT10 | ZS356 ZM057 |
| 1.3 12V | 4 | 2E | 55/74 | 12/89→12/92 | Z8 | 0.8 | UXT2 / UXT6 | ZS356 ZM057 06/91→ |
| 1.3 12V | 4 | 2E-E | 55/74 | 12/89→12/92 | Z8 | 0.8 | UXT2 / UXT6 | ZM057 06/91→ |

TOYOTA



kW/BHP



... TOYOTA



... STARLET

| | | | | | | | | | |
|-------------|---|------|-------|-------------|-----------|------|-------------|-------|-------|
| 1.3 12V | 4 | 2E-E | 55/74 | 12/89→03/96 | Z9 | 1.15 | UXT2 / UXT6 | ZS356 | ZM057 |
| 1.3 12V LPG | 4 | 2E-E | 55/74 | 12/89→03/96 | Z20 [168] | 0.8 | UXT2 / UXT6 | | |
| 1.3 S | 4 | 4K | 48/64 | 08/82→09/84 | Z8 | 0.8 | UXT2 / UXT6 | | |
| 1.5 D | 4 | 1N | 40/54 | 12/86→12/89 | GV894 | 7V | | | |
| 1.5 D | 4 | 1N | 40/54 | 12/89→03/96 | GV968 | 11V | | | |

STARLET 1000

| | | | | | | | | | |
|-----|---|----|-------|-------------|----|-----|-------------|------------|--|
| 1.0 | 4 | 2K | 33/44 | 11/74→08/78 | Z8 | 0.8 | UXT2 / UXT6 | ZS106 [11] | |
|-----|---|----|-------|-------------|----|-----|-------------|------------|--|

SUPRA

| | | | | | | | | | |
|--------------------|---|---------|---------|-------------|-----------|-----|-------|--|--|
| 3.0 24V | 6 | 7M-GE | 150/201 | 01/86→08/88 | Z155 | 0.8 | UXT10 | | |
| 3.0 i Bi-Turbo | 6 | 2JZ-GTE | 243/326 | 05/93→08/02 | Z284 | 1.1 | UXT14 | | |
| 3.0 i Bi-Turbo LPG | 6 | 2JZ-GTE | 243/326 | 05/93→08/02 | Z30 [168] | 0.8 | UXT5 | | |
| 3.0 Turbo | 6 | 7M-GTE | 173/232 | 09/87→04/93 | Z151 | 0.8 | UXT10 | | |
| 3.0 Turbo | 6 | 7M-GTE | 175/235 | 08/88→05/93 | Z151 | 0.8 | UXT10 | | |

TERCEL

| | | | | | | | | | |
|---------|---|------|-------|-------------|----|-----|-------------|---------------|-------|
| 1.3 | 4 | 2A | 48/64 | 03/79→01/88 | Z8 | 0.8 | UXT2 / UXT6 | ZS110 [1][15] | |
| 1.5 4WD | 4 | 3A-C | 50/67 | 05/86→01/88 | Z8 | 0.8 | UXT2 / UXT6 | ZS110 [15] | ZM058 |
| 1.5 4WD | 4 | 3A | 52/70 | 08/82→10/86 | | | | ZS110 [1][15] | |
| 1.5 4WD | 4 | 3A | 52/70 | 10/82→01/88 | Z8 | 0.8 | UXT2 / UXT6 | | |

URBAN CRUISER

| | | | | | | | | | |
|----------|---|--------|-------|--------|-------|-----|--|--------|--|
| 1.3 | 4 | 1NR-FE | 73/98 | 04/10→ | | | | ZSE172 | |
| 1.3 | 4 | 1NR-FE | 74/99 | 04/09→ | | | | ZSE172 | |
| 1.4 D-4D | 4 | 1ND-TV | 66/89 | 04/09→ | GN042 | 11V | | | |

VENZA

| | | | | | | | | | |
|-----|---|--------|---------|--------|--|--|--|--------|--|
| 2.7 | 4 | 1AR-FE | 136/182 | 11/08→ | | | | ZSE172 | |
|-----|---|--------|---------|--------|--|--|--|--------|--|

VERSO

| | | | | | | | | | |
|-----------|---|---------|---------|--------|-------|-----|--|--|--|
| 2.2 D-4D | 4 | 2AD-FHV | 110/148 | 04/09→ | GN108 | 11V | | | |
| 2.2 D-CAT | 4 | 2AD-FHV | 130/174 | 04/09→ | GN108 | 11V | | | |

VERSO S

| | | | | | | | | | |
|----------|---|--------|-------|--------|-------|-----|--|--------|--|
| 1.3 | 4 | 1NR-FE | 70/94 | 11/10→ | | | | ZSE172 | |
| 1.3 | 4 | 1NR-FE | 73/98 | 11/10→ | | | | ZSE172 | |
| 1.4 D4-D | 4 | 1ND-TV | 66/89 | 11/10→ | GN042 | 11V | | | |

VIOS/YARIS

| | | | | | | | | | |
|-----|---|----------------|-------|--------|------|-----|-------|--------|--|
| 1.0 | 3 | 1KR-FE | 52/70 | 08/07→ | Z184 | 0.9 | UXT13 | ZSE164 | |
| 1.3 | 4 | 2NZ-FE, 2SZ-FE | 64/86 | 08/07→ | Z249 | 1.0 | | ZSE165 | |

VISTA

| | | | | | | | | | |
|-------------|---|--------|---------|-------------|-------|-----|-------|-------|--|
| 2.0 D4 N200 | 4 | 1AZ-FE | 112/150 | 06/98→08/03 | Z221 | 1.0 | UXT14 | | |
| 2.0 TD | 4 | 2C-T | 62/83 | 11/88→06/91 | GN043 | 11V | | | |
| 3.0 | 6 | 1MZ-FE | 140/188 | 06/98→08/02 | | | | ZS430 | |

WINDOM

| | | | | | | | | | |
|-------------|---|--------|---------|-------------|--|--|--|-------|--|
| 3.0 | 6 | 1MZ-FE | 155/208 | 10/96→07/01 | | | | ZS430 | |
| 3.0 VVT-i G | 6 | 1MZ-FE | 158/212 | 08/01→07/04 | | | | ZS430 | |

WISH

| | | | | | | | | | |
|------------|---|---------|---------|-------------|------|-----|-------|--------|--|
| 1.8 Hi 4WD | 4 | 1ZZ-FE | 92/123 | 04/03→03/09 | | | | ZSE164 | |
| 1.8 Hi | 4 | 1ZZ-FE | 97/130 | 04/03→03/09 | | | | ZSE164 | |
| 2.0 Zi | 4 | 1AZ-FSE | 114/153 | 04/03→03/09 | Z284 | 1.1 | UXT14 | | |

YARIS

| | | | | | | | | | |
|-----------|---|-----------------|-------|-------------|------------|-----|-------|----------------|------------|
| 1.0 | 3 | 1KR-FE | 51/68 | 09/11→ | | | | ZSE164 [1][16] | ZSE165 [1] |
| 1.0 16V | 4 | 1SZ-FE | 48/64 | 03/03→09/05 | Z157 | 1.1 | UXT11 | ZSE165 | |
| 1.0 16V | 4 | 1SZ-FE | 50/67 | 04/99→09/05 | Z157 | 1.1 | UXT11 | ZSE165 | |
| 1.0 VVT-i | 3 | 1KR-FE | 51/68 | 08/05→ | Z273 | 1.1 | | ZSE164 [1][16] | ZSE165 [1] |
| 1.3 | 4 | 2SZ-FE | 64/86 | 04/02→09/05 | Z156 [170] | 0.7 | UXT10 | ZSE165 | |
| 1.3 | 4 | 1NR-FE | 70/94 | 09/11→ | | | | ZSE172 | |
| 1.3 | 4 | 1NR-FE, 1NR-FKE | 73/98 | 09/11→ | | | | ZSE172 | |
| 1.3 16V | 4 | 2NZ-FE | 63/84 | 11/99→09/05 | Z249 | 1.0 | | ZSE165 | |

TOYOTA

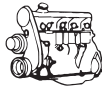

kW/BHP

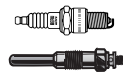
**... TOYOTA****... YARIS**

| | | | | | | | | |
|--------------|---|---------|---------|-------------|-----------------------|-----|-----------------|--|
| 1.3 16V LPG | 4 | 2NZ-FE | 63/84 | 11/99→09/05 | Z151 ^[168] | 0.8 | UXT10 | |
| 1.3 VVT-i | 4 | 2NZ-FE | 63/84 | 11/05→ | | | | ZSE165 |
| 1.3 VVT-i | 4 | 2SZ-FE | 64/86 | 08/05→ | Z155 →10/08 | 0.8 | UXT10 →10/08 | ZSE165 |
| 1.3 VVT-i | 4 | 1NR-FE | 73/98 | 07/10→ | | | | ZSE172 |
| 1.3 VVT-i | 4 | 1NR-FE | 74/99 | 03/09→ | | | | ZSE165 ^[112] ZSE172 ^[115] |
| 1.4 D-4D | 4 | 1ND-TV | 55/74 | 12/01→09/05 | GN042 | 11V | | |
| 1.4 D-4D | 4 | 1ND-TV | 66/89 | 05/05→ | GN042 | 11V | | |
| 1.4 D-4D | 4 | 1ND-TV | 66/89 | 09/11→ | GN096 | 11V | | |
| 1.5 Hybrid | 4 | 1NZ-FXE | 55/74 | 03/12→ | | | | ZSE165 |
| 1.5 TS | 4 | 1NZ-FE | 77/103 | 01/03→09/05 | Z156 | 0.7 | UXT10 | ZSE165 |
| 1.5 VVT-i TS | 4 | 1NZ-FE | 78/105 | 04/01→09/05 | Z156 | 0.7 | UXT10 | ZSE165 |
| 1.5 VVT-i TS | 4 | 1NZ-FE | 110/148 | 03/03→07/05 | Z155 | 0.8 | UXT10 | ZSE165 |

YARIS VERSO

| | | | | | | | | |
|----------|---|--------|--------|-------------|-----------------------|-----|-------|--------|
| 1.3 | 4 | 2NZ-FE | 62/83 | 08/99→09/05 | Z249 | 1.0 | | ZSE165 |
| 1.3 | 4 | 2NZ-FE | 63/84 | 08/99→09/05 | Z249 | 1.0 | | ZSE165 |
| 1.3 LPG | 4 | 2NZ-FE | 62/83 | 08/99→09/05 | Z151 ^[168] | 0.8 | UXT10 | |
| 1.3 LPG | 4 | 2NZ-FE | 63/84 | 08/99→09/05 | Z151 ^[168] | 0.8 | UXT10 | |
| 1.4 D-4D | 4 | 1ND-TV | 55/74 | 12/01→09/05 | GN042 | 11V | | |
| 1.5 | 4 | 1NZ-FE | 77/103 | 05/03→09/05 | Z156 | 0.7 | UXT10 | ZSE165 |
| 1.5 | 4 | 1NZ-FE | 78/105 | 03/00→09/05 | Z156 | 0.7 | UXT10 | ZSE165 |

TOYOTA**1000**

| | | | | | | | | |
|-----|---|----|-------|-------------|-----|-----|-------------|--|
| 1.0 | 4 | 2K | 33/44 | 04/69→08/88 | Z20 | 0.8 | UXT2 / UXT6 | |
|-----|---|----|-------|-------------|-----|-----|-------------|--|

AURIS VAN

| | | | | | | | | |
|----------|---|--------|-------|--------|-------|-----|--|--|
| 1.4 D-4D | 4 | 1ND-TV | 66/89 | 03/13→ | GN042 | 11V | | |
|----------|---|--------|-------|--------|-------|-----|--|--|

COASTER

| | | | | | | | | |
|---------|---|--------|---------|-------------|------|-----|-------|--|
| 2.7 | 4 | 3RZ-FE | 112/150 | 08/99→10/03 | Z150 | 1.3 | UXT11 | |
| 2.7 LPG | 4 | 3RZ-FE | 112/150 | 08/99→10/03 | Z129 | 1.6 | | |

DELIBOY

| | | | | | | | | |
|-------|---|-------|-------|-------------|-------|-----|--|--|
| 2.0 D | 4 | 2C | 54/72 | 10/89→10/95 | GN043 | 11V | | |
| 2.2 D | 4 | 3C-TE | 66/89 | 10/94→10/95 | GN110 | 11V | | |

DYNA

| | | | | | | | | |
|---------|---|---------|---------|-------------|------------------------------------|-----------|--|--|
| 2.4 D | 4 | 2L | 61/82 | 08/87→07/01 | GV894 →08/88 GV968 09/88→ | 7V 11V | | |
| 2.5 D4d | 4 | 2KD-FTV | 65/87 | 08/01→ | GN065 | 11V | | |
| 2.5 D4d | 4 | 2KD-FTV | 75/101 | 08/01→ | GN065 | 11V | | |
| 3.0 D4d | 4 | 1KD-FTV | 80/107 | 09/06→ | GN068 | 11V | | |
| 3.0 D4d | 4 | 1KD-FTV | 100/134 | 10/09→ | GN068 | 11V | | |
| 3.0 D4d | 4 | 1KD-FTV | 106/142 | 09/06→ | GN068 | 11V | | |

DYNA 100

| | | | | | | | | |
|-----|---|----|-------|-------------|--|--|--|-------|
| 1.8 | 4 | 2Y | 58/78 | 08/85→04/95 | | | | ZS356 |
|-----|---|----|-------|-------------|--|--|--|-------|

DYNA 150

| | | | | | | | | |
|-------|---|----|-------|-------------|-------|-----|--|--|
| 2.4 D | 4 | 2L | 54/72 | 08/85→08/87 | GV894 | 7V | | |
| 2.4 D | 4 | 2L | 54/72 | 05/95→07/01 | GV968 | 11V | | |
| 2.8 D | 4 | 3L | 58/78 | 09/88→06/95 | GV968 | 11V | | |
| 2.8 D | 4 | 3L | 61/82 | 05/95→08/98 | GV968 | 11V | | |
| 3.0 D | 4 | 5L | 65/87 | 09/98→07/01 | GV968 | 11V | | |

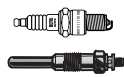

kW/BHP

**... TOYOTA****HIACE I**

| | | | | | | | | |
|-------|---|-----|-------|-------------|---|-----|------------------------------|--|
| 1.6 | 4 | 12R | 49/66 | 01/79→11/82 | Z8 →08/79 Z20 09/79→ | 0.8 | UXT2 / UXT6 →08/79 | |
| 2.2 D | 4 | L | 46/62 | 01/79→03/83 | GV688 | 11V | | |
| 2.2 D | 4 | L | 49/66 | 01/80→12/80 | GV968 | 11V | | |

HIACE II

| | | | | | | | | |
|-----------|---|----|-------|-------------|--|------|------------------------------|--|
| 1.8 | 4 | 2Y | 58/78 | 03/83→11/89 | Z9 | 1.15 | UXT2 / UXT6 | |
| 2.0 | 4 | 3Y | 65/87 | 01/84→11/89 | Z9 | 1.15 | UXT2 / UXT6 | |
| 2.0 | 4 | 3Y | 65/87 | 01/85→08/89 | Z9 →08/87 Z8 09/87→ | 1.15 | UXT2 / UXT6 →08/87 | |
| 2.2 D | 4 | L | 49/66 | 03/83→11/89 | GV894 →07/85 | 7V | | |
| 2.4 D 4WD | 4 | 2L | 54/72 | 01/87→01/88 | GV894 | 7V | | |
| 2.4 D | 4 | 2L | 55/74 | 04/84→11/89 | GV968 | 11V | | |

HIACE III

| | | | | | | | | |
|--------------|---|---------|--------|-------------|------------------|------|--------------------|--------------|
| 2.0 | 4 | 1RZ | 74/99 | 08/89→04/98 | Z8 | 0.8 | UXT2 / UXT6 | ZS356 |
| 2.0 LPG | 4 | 1RZ | 74/99 | 08/89→04/98 | Z20 [168] | 0.8 | UXT2 / UXT6 | |
| 2.4 | 4 | 2RZ-E | 88/118 | 08/89→08/95 | Z9 | 1.15 | UXT2 / UXT6 | ZS356 |
| 2.4 LPG | 4 | 2RZ-E | 88/118 | 08/89→08/95 | Z20 [168] | 0.8 | UXT2 / UXT6 | |
| 2.4 D | 4 | 2L | 53/71 | 01/92→08/95 | GV968 | 11V | | |
| 2.4 D | 4 | 2L | 55/74 | 08/89→08/95 | GV968 | 11V | | |
| 2.4 D | 4 | 2L | 57/76 | 08/89→08/95 | GV968 | 11V | | |
| 2.5 D-4D 4WD | 4 | 2KD-FTV | 65/87 | 08/01→08/04 | GN065 | 11V | | |
| 2.5 D-4D 4WD | 4 | 2KD-FTV | 75/101 | 08/01→08/04 | GN065 | 11V | | |
| 2.8 D | 4 | 3L | 61/82 | 08/89→08/00 | GV968 | 11V | | |
| 3.0 D | 4 | 5L | 65/87 | 08/98→08/04 | GV968 | 11V | | |

HIACE IV

| | | | | | | | | |
|----------|---|---------|---------|-------------|------------------------|------|--------------------|--------------|
| 2.4 | 4 | 2RZ-E | 85/114 | 08/95→02/05 | Z9 | 1.15 | UXT2 / UXT6 | ZS356 |
| 2.4 D | 4 | 2L | 55/74 | 09/95→08/06 | GV968 | 11V | | |
| 2.4 D | 4 | 2L | 58/78 | 08/95→08/06 | GV968 →08/97 | 11V | | |
| 2.4 D | 4 | 2L | 61/82 | 08/95→08/06 | GV968 →08/97 | 11V | | |
| 2.4 TD | 4 | 2L-T | 66/89 | 08/95→08/06 | GV968 | 11V | | |
| 2.5 D-4D | 4 | 2KD-FTV | 65/87 | 11/01→08/06 | GN065 | 11V | | |
| 2.5 D-4D | 4 | 2KD-FTV | 70/94 | 08/06→ | GN065 | 11V | | |
| 2.5 D-4D | 4 | 2KD-FTV | 75/101 | 11/01→ | GN065 | 11V | | |
| 2.5 D-4D | 4 | 2KD-FTV | 86/115 | 08/06→ | GN065 | 11V | | |
| 2.7 | 4 | 3RZ-FE | 105/141 | 04/98→08/06 | Z150 | 1.3 | UXT11 | |
| 2.7 | 4 | 3RZ-FE | 106/142 | 04/98→ | Z150 | 1.3 | UXT11 | |
| 2.7 LPG | 4 | 3RZ-FE | 105/141 | 04/98→08/06 | Z129 | 1.6 | | |
| 2.7 LPG | 4 | 3RZ-FE | 106/142 | 04/98→ | Z129 | 1.6 | | |
| 3.0 D | 4 | 1KD-FTV | 100/134 | 01/05→ | GN068 | 11V | | |
| 3.0 D | 4 | 1KD-FTV | 106/142 | 11/08→ | GN068 | 11V | | |

HIACE / COMMUTER IV

| | | | | | | | | |
|--------------|---|---------|---------|--------|--------------|-----|--|--|
| 2.5 D-4D | 4 | 2KD-FTV | 75/101 | 09/06→ | GN065 | 11V | | |
| 2.5 D-4D 4WD | 4 | 2KD-FTV | 94/126 | 01/05→ | GN065 | 11V | | |
| 3.0 D | 4 | 1KD-FTV | 100/134 | 01/05→ | GN068 | 11V | | |
| 3.0 D | 4 | 1KD-FTV | 106/142 | 11/08→ | GN068 | 11V | | |

HILUX II

| | | | | | | | | |
|-----------|---|------------------------------|-------|-------------|--------------|-----|--|--|
| 2.4 D 4WD | 4 | LN51, LN56, LN60, LN61, LN65 | 55/74 | 01/84→08/88 | GV894 | 7V | | |
| 2.4 D 4WD | 4 | LN51R | 55/74 | 01/84→08/88 | GV968 | 11V | | |

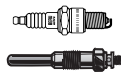

kW/BHP

**... TOYOTA****KIJANG**

| | | | | | | | | |
|-------|---|----|-------|-------------|-------|-----|--|--|
| 2.4 D | 4 | 2L | 57/76 | 08/89→08/95 | GV968 | 11V | | |
| 2.7 D | 4 | 3L | 61/82 | 09/93→08/00 | GV968 | 11V | | |
| 3.0 D | 4 | 5L | 65/87 | 07/99→07/01 | GV968 | 11V | | |

LITEACE

| | | | | | | | | |
|-------|---|----------|-------|-------------|-------|-----|-------------|---|
| 1.3 | 4 | 4K, 4K-C | 42/56 | 10/79→10/86 | Z20 | 0.8 | UXT2 / UXT6 | ZS106 ^{[1][11][254]} ZS109 ^{[1][15]} |
| 1.3 | 4 | 4K | 43/58 | 10/79→09/85 | Z8 | 0.8 | UXT2 / UXT6 | ZS106 ^{[1][11][254]} ZS109 ^{[1][15]} |
| 1.5 | 4 | 5K | 51/68 | 10/85→09/91 | Z8 | 0.8 | UXT2 / UXT6 | |
| 1.5 | 4 | 5K | 52/70 | 07/89→01/92 | Z8 | 0.8 | UXT2 / UXT6 | |
| 1.5 | 4 | 5K | 52/70 | 01/92→01/95 | | | | ZS445 |
| 1.8 D | 4 | 1C | 41/55 | 10/82→09/85 | GV886 | 7V | | |
| 1.8 D | 4 | 1C | 46/62 | 10/85→08/88 | GV886 | 7V | | |
| 1.8 D | 4 | 1C | 47/63 | 10/85→07/88 | GV886 | 7V | | |
| 2.0 D | 4 | 2C | 51/68 | 01/92→05/94 | GV967 | 11V | | |
| 2.0 D | 4 | 2C | 53/71 | 08/88→01/92 | GN043 | 11V | | |
| 2.0 D | 4 | 2C | 53/71 | 01/92→05/94 | GV967 | 11V | | |
| 2.2 D | 4 | 3C-TE | 66/89 | 02/95→08/97 | GN110 | 11V | | |

MASTER ACE SURF

| | | | | | | | | |
|--------|---|------|-------|-------------|---|-----------|--|--|
| 2.0 D | 4 | 2C | 49/66 | 02/85→10/93 | GV886 09/85→02/87 GN043 03/87→ | 7V 11V | | |
| 2.0 TD | 4 | 2C-T | 62/83 | 02/85→10/93 | GV886 →07/88 GN043 08/88→ | 7V 11V | | |

MODELL F

| | | | | | | | | |
|-------------|---|----------|-------|-------------|---|-----------|-------------|-------|
| 1.8 De Luxe | 4 | 2Y, 2Y-C | 58/78 | 11/82→08/84 | Z9 | 1.15 | UXT2 / UXT6 | ZS356 |
| 2.0 | 4 | 3Y | 66/89 | 08/88→01/90 | Z8 | 0.8 | UXT2 / UXT6 | ZS356 |
| 2.0 D | 4 | 2C | 49/66 | 04/85→08/88 | GV886 09/85→02/87 GN043 03/87→ | 7V 11V | | |
| 2.0 Super | 4 | 3Y, 3Y-C | 65/87 | 08/84→08/88 | Z8 | 0.8 | UXT2 / UXT6 | ZS356 |
| 2.2 | 4 | 4Y-EC | 72/97 | 08/87→01/90 | | | | ZS356 |

REGIUSACE

| | | | | | | | | |
|----------|---|---------|--------|--------|-------|-----|--|--|
| 2.5 D-4D | 4 | 2KD-FTV | 80/107 | 08/04→ | GN065 | 11V | | |
|----------|---|---------|--------|--------|-------|-----|--|--|

TARAGO

| | | | | | | | | |
|---------|---|--------|---------|-------------|------|-----|-------|--|
| 2.7 | 4 | 3RZ-FE | 106/142 | 08/98→08/04 | Z150 | 1.3 | UXT11 | |
| 2.7 LPG | 4 | 3RZ-FE | 106/142 | 08/98→08/04 | Z129 | 1.6 | | |

TOWN ACE

| | | | | | | | | |
|-------|---|----|-------|-------------|-----------------|-----|--|--|
| 2.0 D | 4 | 2C | 51/68 | 01/92→04/95 | GV967 | 11V | | |
| 2.4 D | 4 | 2L | 57/76 | 04/85→12/91 | GV968 09/88→ | 11V | | |

VAUXHALL**AGILA Mk I (A)**

| | | | | | | | | |
|-------------|---|----------|-------|-------------|--|-------------------|-------------|---|
| 1.0 12V | 3 | Z 10 XE | 43/58 | 09/00→08/05 | Z190 ^[282] Z74 | 1.2 1.0 | UXT1 / UXT3 | ZS358 |
| 1.0 12V | 3 | Z 10 XEP | 44/59 | 02/00→11/06 | Z203 | 0.9 | | ZS359 |
| 1.0 12V LPG | 3 | Z 10 XE | 43/58 | 09/00→08/05 | Z206 | 0.7 | UXT10 | |
| 1.0 12V LPG | 3 | Z 10 XEP | 44/59 | 02/00→11/06 | Z206 ^[168] | 0.7 | UXT10 | |
| 1.2 16V | 4 | Z 12 XE | 55/74 | 09/00→03/08 | Z190 ^[282] Z203 ^[120] Z74 ^[118] | 1.2 0.9 1.0 | UXT1 / UXT3 | ZS338 ^[121] ZSE147 ^[106] |
| 1.2 16V LPG | 4 | Z 12 XE | 55/74 | 09/00→03/08 | Z206 | 0.7 | UXT10 | |



kW/BHP

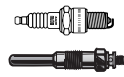

... VAUXHALL



... AGILA Mk I (A)

| | | | | | | | | | |
|----------------------|---|----------|-------|-------------|------------|--|-----|-------|-------|
| 1.2 16V Twinport | 4 | Z 12 XEP | 59/79 | 07/04→11/06 | Z203 | | 0.9 | | ZS338 |
| 1.2 16V Twinport LPG | 4 | Z 12 XEP | 59/79 | 07/04→11/06 | Z206 [168] | | 0.7 | UXT10 | |

AGILA Mk II (B)

| | | | | | | | | | |
|-----------|---|----------------|-------|--------|-------|-------------|-----|--|--|
| 1.2 i 16V | 4 | K12B | 63/84 | 01/08→ | Z333 | | 1.1 | | |
| 1.3 CDTI | 4 | D13A, Z 13 DTJ | 55/74 | 01/08→ | GN053 | GSE142 [11] | 11V | | |

ANTARA

| | | | | | | | | | |
|--------------|---|-----------------|---------|--------|-------|--|------|------|--|
| 2.0 CDTi 4WD | 4 | Z 20 DM | 93/125 | 08/06→ | GE125 | | 4.4V | | |
| 2.0 CDTi | 4 | Z 20 DMH | 110/148 | 08/06→ | GE125 | | 4.4V | | |
| 3.2 V6 4WD | 6 | 10 HM, Z 32 SED | 167/224 | 11/06→ | Z356 | | 1.1 | UXT8 | |

ASTRA

| | | | | | | | | | |
|---------|---|-------|--------|-------------|-------------------------|-----------------|------------|-------------|-----------------|
| 1.2 | 4 | 12 S | 40/54 | 10/79→08/82 | | | | | ZS252 [1] |
| 1.2 S | 4 | 12 S | 44/59 | 02/82→08/84 | Z19 [168] | | 0.8 | | ZS252 [1] |
| 1.3 S | 4 | 13 S | 55/74 | 09/79→08/84 | Z20 | | 0.8 | UXT2 / UXT6 | ZS252 |
| 1.6 D | 4 | 16 D | 40/54 | 02/82→08/86 | GN909 [2][222] GV636 | GR064 09/84→ | 11V 11V | | |
| 1.6 S | 4 | 16 S | 66/89 | 09/81→08/86 | Z20 | | 0.8 | UXT2 / UXT6 | ZS253 [1] ZM002 |
| 1.6 S | 4 | 16 SH | 66/89 | 09/81→08/86 | Z20 | | 0.8 | UXT2 / UXT6 | ZS253 [1] ZM002 |
| 1.8 GTE | 4 | 18 E | 85/114 | 03/83→08/86 | Z20 | | 0.8 | UXT2 / UXT6 | ZM002 |

ASTRA Mk II

| | | | | | | | | | |
|---------|---|------------------|--------|-------------|--|-----------------|-------------------|--|--|
| 1.2 | 4 | 12 S | 40/54 | 09/84→08/91 | | | | | ZS252 [1] |
| 1.2 | 4 | 12 S | 44/59 | 09/84→12/88 | Z19 [168] | | 0.8 | | |
| 1.2 | 4 | 12 S | 44/59 | 09/84→08/91 | Z19 [168] →12/88 Z20 [168] 01/89→ | | 0.8 | UXT2 / UXT6 01/89→ | ZS252 [1] |
| 1.3 | 4 | 13 S | 44/59 | 09/84→08/91 | | | | | ZS252 |
| 1.3 | 4 | 13 S | 51/68 | 09/84→08/91 | Z20 | | 0.8 | UXT2 / UXT6 | ZS252 |
| 1.3 | 4 | 13 S | 55/74 | 09/84→08/91 | Z20 | | 0.8 | UXT2 / UXT6 | ZS252 |
| 1.3 i | 4 | C 13 N | 44/59 | 09/85→08/91 | | | | | ZS252 |
| 1.4 i | 4 | C 14 NZ | 44/59 | 01/90→12/91 | Z119 [284] Z190 [282][283] Z74 [283] | | 0.8 1.2 1.0 | UXT2/UXT6 [284] UXT1/UXT3 [283] | |
| 1.4 S | 4 | 14 NV | 55/74 | 01/89→08/91 | Z20 | | 0.8 | UXT2 / UXT6 | |
| 1.5 DT | 4 | 15 DT (T4EC1) | 49/66 | 01/88→08/91 | GV947 | | 11V | | |
| 1.5 DT | 4 | 15 DT | 53/71 | 01/87→08/89 | GV947 | | 11V | | |
| 1.6 | 4 | 16 SV | 60/80 | 09/84→08/91 | Z20 | | 0.8 | UXT2 / UXT6 | ZS252 [1][254] ZM018 ZS253 [1][254] 01/88→ |
| 1.6 | 4 | 16 SH | 66/89 | 09/85→08/91 | Z20 | | 0.8 | UXT2 / UXT6 | ZS252 [1][254] ZM007 ZS253 [1][254] 01/86→12/87 |
| 1.6 D | 4 | 16 DA | 40/54 | 09/84→08/91 | GN909 [2][222] GV636 | GR064 →01/89 | 11V 11V | | |
| 1.6 i | 4 | C 16 LZ, C 16 NZ | 55/74 | 10/87→02/93 | Z21 | | 1.1 | UXT2 / UXT6 | ZM016 [209] ZM018 [192] |
| 1.6 i | 4 | E 16 NZ | 55/74 | 01/91→08/93 | Z21 | | 1.1 | UXT2 / UXT6 | ZS252 [1][254] ZM016 [209] ZS253 [1][254] ZM018 [192] |
| 1.6 i | 4 | 16 SV | 60/80 | 01/87→12/91 | Z20 | | 0.8 | UXT2 / UXT6 | ZS253 ZM007 01/90→ →08/87 |
| 1.6 S | 4 | 16 SV | 60/80 | 01/89→12/91 | Z20 | | 0.8 | UXT2 / UXT6 | ZS252 [1][254] ZS253 [1][254] |
| 1.6 S | 4 | 16 S, 16 SH | 66/89 | 09/84→08/86 | Z20 | | 0.8 | UXT2 / UXT6 | ZS253 [1] |
| 1.7 D | 4 | 17 D, 17 DR | 42/56 | 01/89→12/91 | GN909 [2][222] GV636 | GR064 | 11V 11V | | |
| 1.8 | 4 | 18 SE | 82/110 | 01/86→12/90 | Z119 [284] Z190 [282][283] Z74 [283] | | 0.8 1.2 1.0 | UXT2/UXT6 [284] ZS127 [1][214][254] ZS253 [1][254] | |
| 1.8 GTE | 4 | 18 E | 82/110 | 09/84→08/91 | Z20 [284] | | 0.8 | UXT2/UXT6 [284] | ZS127 [1][214][254] ZM002 ZS253 [1][254] |



kW/BHP

**... VAUXHALL****... ASTRA Mk II**

| | | | | | | | | | |
|-------------|---|----------------|---------|-------------|---|-------------------|--|---|-------|
| 1.8 GTE | 4 | 18 SE | 82/110 | 09/84→08/91 | Z119 ^[284] Z190 ^{[282][283]} Z74 ^[283] | 0.8 1.2 1.0 | UXT2/UXT6 ^[284] UXT1/UXT3 ^[283] | ZS127 ^{[1][214][254]} ZS253 ^{[1][254]} | ZM002 |
| 1.8 i | 4 | 18 E | 83/111 | 01/90→08/91 | Z20 | 0.8 | UXT2 / UXT6 | | |
| 1.8 i | 4 | 18 E | 85/114 | 09/85→08/91 | Z20 ^[284] | 0.8 | UXT2/UXT6 ^[284] | ZS127 ^{[1][214][254]} ZS253 ^{[1][254]} | |
| 1.8 i | 4 | 18 SE | 85/114 | 09/85→08/91 | Z119 ^[284] Z190 ^{[282][283]} Z74 ^[283] | 0.8 1.2 1.0 | UXT2/UXT6 ^[284] UXT1/UXT3 ^[283] | ZS127 ^{[1][214][254]} ZS253 ^{[1][254]} | |
| 2.0 | 4 | 20 NE | 85/114 | 09/86→08/91 | | | | ZS127 ^[1] eng. 14180386→ ZS125 ^[1] ch. J2791968;J5273428; JE215466→ →eng. 14180385 | |
| 2.0 GTE | 4 | 20 SEH | 95/127 | 09/86→08/91 | Z20 | 0.8 | UXT2 / UXT6 | ZS125 ^[1] →eng. 14180385 ZS127 ^[1] eng. 14180386→ | |
| 2.0 GTE 16V | 4 | 20 XE | 115/154 | 05/88→08/91 | Z250 | 0.7 | UXT1 / UXT3 | | |
| 2.0 i | 4 | 20 NE, C 20 NE | 85/114 | 01/87→08/93 | Z119 ^[284] Z190 ^{[282][283]} Z74 ^[283] | 0.8 1.2 1.0 | UXT2/UXT6 ^[284] UXT1/UXT3 ^[283] | ZS125 ^[1] →eng. 14180385 ZS127 ^[1] eng. 14180386→ | |

ASTRA Mk III (F)

| | | | | | | | | | |
|---------------|---|-------------------|-------|-------------|---|-------------------|--|--------|--|
| 1.4 i | 4 | C 14 NZ | 44/59 | 09/91→09/98 | Z119 ^[284] Z190 ^{[282][283]} Z74 ^[283] | 0.8 1.2 1.0 | UXT2/UXT6 ^[284] UXT1/UXT3 ^[283] | | |
| 1.4 i | 4 | C 14 NZ | 44/59 | 09/91→02/98 | | | | ZS253 | |
| 1.4 i | 4 | C 14 SE | 60/80 | 03/91→03/01 | Z119 ^[284] Z190 ^{[282][283]} Z74 ^[283] | 0.8 1.2 1.0 | UXT2/UXT6 ^[284] UXT1/UXT3 ^[283] | ZS253 | |
| 1.4 i LPG | 4 | C 14 NZ | 44/59 | 09/91→09/98 | Z20 ^[168] Z206 | 0.8 0.7 | UXT2 / UXT6 UXT10 | | |
| 1.4 i LPG | 4 | C 14 SE | 60/80 | 03/91→03/01 | Z20 ^[168] Z206 | 0.8 0.7 | UXT2 / UXT6 UXT10 | | |
| 1.4 i 16V | 4 | X 14 XE | 66/89 | 01/96→03/01 | Z190 ^[282] Z74 | 1.2 1.0 | UXT1 / UXT3 | ZSE026 | |
| 1.4 i 16V LPG | 4 | X 14 XE | 66/89 | 01/96→03/01 | Z206 | 0.7 | UXT10 | | |
| 1.4 S | 4 | 14 NV | 55/74 | 09/91→02/98 | Z119 ^[284] Z190 ^{[282][283]} Z74 ^[283] | 0.8 1.2 1.0 | UXT2/UXT6 ^[284] UXT1/UXT3 ^[283] | ZSE026 | |
| 1.4 S LPG | 4 | 14 NV | 55/74 | 09/91→02/98 | Z20 ^[168] Z206 | 0.8 0.7 | UXT2 / UXT6 UXT10 | | |
| 1.6 i | 4 | X 16 SZ | 52/70 | 03/93→02/98 | Z119 ^[284] Z190 ^{[282][283]} Z74 ^[283] | 0.8 1.2 1.0 | UXT2/UXT6 ^[284] UXT1/UXT3 ^[283] | ZSE026 | |
| 1.6 i | 4 | C 16 NZ, X 16 SZR | 55/74 | 09/91→03/01 | Z119 ^[284] Z190 ^{[282][283]} Z74 ^[283] | 0.8 1.2 1.0 | UXT2/UXT6 ^[284] UXT1/UXT3 ^[283] | | |
| 1.6 i | 4 | C 16 NZ | 55/74 | 09/91→09/98 | | | | ZS252 | |
| 1.6 i | 4 | C 16 NZ, X 16 SZR | 55/74 | 03/92→09/98 | Z119 ^[284] →08/96 Z190 ^{[282][283]} Z74 ^[283] | 0.8 1.2 1.0 | UXT2/UXT6 ^[284] UXT1/UXT3 ^[283] | | |
| 1.6 i | 4 | E 16 NZ | 55/74 | 09/91→02/98 | Z119 ^[284] Z190 ^{[282][283]} Z74 ^[283] | 0.8 1.2 1.0 | UXT2/UXT6 ^[284] UXT1/UXT3 ^[283] | ZS252 | |
| 1.6 i | 4 | X 16 SZR | 55/74 | 03/92→03/01 | | | | ZSE026 | |



kW/BHP



... VAUXHALL



... ASTRA Mk III (F)

| | | | | | | | | | |
|---------------|---|----------------------------|---------|-------------|---|-------|-----------------------|--|-------------------------------|
| 1.6 i | 4 | C 16 SE | 74/99 | 03/92→02/98 | Z119 ^[284] Z190 ^{[282][283]} Z74 ^[283] | | 0.8 1.2 1.0 | UXT2/UXT6 ^[284] UXT1/UXT3 ^[283] | ZSE026 |
| 1.6 i | 4 | C 16 SE | 74/99 | 05/92→12/94 | Z190 ^{[282][283]} Z74 ^[283] | | 1.2 1.0 | UXT1/UXT3 ^[283] | |
| 1.6 i LPG | 4 | X 16 SZ | 52/70 | 03/93→02/98 | Z20 ^[168] Z206 | | 0.8 0.7 | UXT2 / UXT6 UXT10 | |
| 1.6 i LPG | 4 | C 16 NZ, E 16 NZ, X 16 SZR | 55/74 | 09/91→03/01 | Z20 ^[168] Z206 | | 0.8 0.7 | UXT2 / UXT6 UXT10 | |
| 1.6 i LPG | 4 | C 16 NZ, X 16 SZR | 55/74 | 03/92→09/98 | Z20 ^[168] →08/96 Z206 | | 0.8 0.7 | UXT2 / UXT6 →08/96 UXT10 | |
| 1.6 i LPG | 4 | C 16 SE | 74/99 | 03/92→02/98 | Z20 ^[168] Z206 | | 0.8 0.7 | UXT2 / UXT6 UXT10 | |
| 1.6 i 16V | 4 | X 16 XEL | 74/99 | 01/94→09/98 | Z190 ^[282] Z74 | | 1.2 1.0 | | ZSE026 UXT1 / UXT3 |
| 1.6 i 16V LPG | 4 | X 16 XEL | 74/99 | 01/94→09/98 | Z206 | | 0.7 | UXT10 | |
| 1.6 Si | 4 | C 16 SE | 74/99 | 03/91→12/94 | Z190 ^[282] Z74 | | 1.2 1.0 | | ZSE026 UXT1 / UXT3 |
| 1.7 D | 4 | 17 D | 42/56 | 12/91→02/98 | GN909 ^{[2][222]} GV636 | GR064 | 11V 11V | | |
| 1.7 D | 4 | 17 DR | 44/59 | 03/91→09/98 | GN013 ^{[2][222]} GN954 | GR064 | 11V 11V | | |
| 1.7 TD | 4 | X 17 DTL | 50/67 | 01/94→09/98 | GN013 ^{[2][222]} GN954 | | 11V 11V | | |
| 1.7 TD | 4 | 17 DT (TC4EE1) | 60/80 | 12/91→09/98 | GV947 →eng. 956632 GN103 eng. 956633→ | | 11V 11V | | |
| 1.8 16V | 4 | C 18 XEL, X 18 XE | 85/114 | 11/94→03/01 | Z190 ^[282] Z74 | | 1.2 1.0 | | ZS344 UXT1 / UXT3 |
| 1.8 16V LPG | 4 | C 18 XEL, X 18 XE | 85/114 | 11/94→03/01 | Z206 | | 0.7 | UXT10 | |
| 1.8 i | 4 | C 18 NZ | 66/89 | 09/91→09/98 | Z119 ^[284] Z190 ^{[282][283]} Z74 ^[283] | | 0.8 1.2 1.0 | UXT2/UXT6 ^[284] UXT1/UXT3 ^[283] | ZS253 ^[1] ZM018 |
| 1.8 i LPG | 4 | C 18 NZ | 66/89 | 09/91→09/98 | Z20 ^[168] Z206 | | 0.8 0.7 | UXT2 / UXT6 UXT10 | |
| 1.8 i 16V | 4 | C 18 XEL, X 18 XE | 85/114 | 01/94→02/98 | Z190 ^[282] Z74 | | 1.2 1.0 | | ZS344 UXT1 / UXT3 |
| 1.8 i 16V | 4 | C 18 XE | 92/123 | 06/93→02/98 | Z190 ^[282] Z74 | | 1.2 1.0 | | ZS344 UXT1 / UXT3 |
| 1.8 i 16V LPG | 4 | C 18 XEL, X 18 XE | 85/114 | 01/94→02/98 | Z206 | | 0.7 | UXT10 | |
| 1.8 i 16V LPG | 4 | C 18 XE | 92/123 | 09/94→02/98 | Z206 | | 0.7 | UXT10 | |
| 2.0 i | 4 | C 20 NE | 85/114 | 09/91→09/98 | Z119 ^[284] Z190 ^{[282][283]} Z74 ^[283] | | 0.8 1.2 1.0 | UXT2/UXT6 ^[284] UXT1/UXT3 ^[283] | ZS127 |
| 2.0 i LPG | 4 | C 20 NE | 85/114 | 09/91→09/98 | Z20 ^[168] Z206 | | 0.8 0.7 | UXT2 / UXT6 UXT10 | |
| 2.0 i 16V | 4 | X 20 XEV | 100/134 | 01/94→09/98 | Z190 ^[282] Z74 | | 1.2 1.0 | | ZS344 UXT1 / UXT3 |
| 2.0 i 16V | 4 | C 20 XE | 110/148 | 09/91→02/98 | Z250 →08/92 Z190 ^[282] Z74 09/92→ | | 0.7 1.2 1.0 | UXT1 / UXT3 →08/92 UXT1 / UXT3 09/92→ | ZS300 eng. 14137013 → |
| 2.0 i 16V LPG | 4 | X 20 XEV | 100/134 | 01/94→09/98 | Z206 | | 0.7 | UXT10 | |



kW/BHP

**... VAUXHALL****... ASTRA Mk III (F)**

| | | | | | | | | | |
|---------------|---|---------|---------|-------------|--|--|-----|------------------------|--|
| 2.0 i 16V LPG | 4 | C 20 XE | 110/148 | 09/91→02/98 | Z340 →08/92 Z206 09/92→ | | 0.7 | UXT12 →08/92 | |
| | | | | | | | 0.7 | UXT10 09/92→ | |

ASTRA Mk IV (G)

| | | | | | | | | | |
|----------------------|---|-----------------------------|---------|-------------|--|--------------------|-------------------|--|-------------------------|
| 1.2 16V | 4 | X 12 XE | 48/64 | 02/98→09/00 | Z190 [282] Z74 | | 1.2 1.0 | UXT1 / UXT3 | ZSE147 →08/00 |
| 1.2 16V | 4 | X 12 XE | 48/64 | 09/98→09/00 | | | | | ZSE147 →08/00 |
| 1.2 16V | 4 | Z 12 XE | 55/74 | 09/00→05/05 | Z190 [282] Z74 | | 1.2 1.0 | UXT1 / UXT3 | ZSE147 |
| 1.2 16V LPG | 4 | X 12 XE | 48/64 | 02/98→09/00 | Z206 | | 0.7 | UXT10 | |
| 1.2 16V LPG | 4 | Z 12 XE | 55/74 | 09/00→05/05 | Z206 | | 0.7 | UXT10 | |
| 1.4 | 4 | C 14 NZ | 44/59 | 05/98→05/05 | Z119 Z190 [282] Z74 | | 0.8 1.2 1.0 | UXT2 / UXT6 UXT1 / UXT3 | |
| 1.4 LPG | 4 | C 14 NZ | 44/59 | 05/98→05/05 | Z20 [168] Z206 | | 0.8 0.7 | UXT2 / UXT6 UXT10 | |
| 1.4 16V | 4 | X 14 XE, Z 14 XE | 66/89 | 02/98→05/05 | Z190 [282] Z74 | | 1.2 1.0 | UXT1 / UXT3 | ZS259 |
| 1.4 16V LPG | 4 | X 14 XE, Z 14 XE | 66/89 | 02/98→05/05 | Z206 | | 0.7 | UXT10 | |
| 1.6 | 4 | X 16 SZR | 55/74 | 02/98→04/04 | Z190 [282] Z74 | | 1.2 1.0 | UXT1 / UXT3 | ZSE026 |
| 1.6 | 4 | Z 16 SE | 62/83 | 03/98→05/05 | Z190 [282] Z74 | | 1.2 1.0 | UXT1 / UXT3 | |
| 1.6 LPG | 4 | X 16 SZR | 55/74 | 02/98→04/04 | Z206 | | 0.7 | UXT10 | |
| 1.6 LPG | 4 | Z 16 SE | 62/83 | 03/98→05/05 | Z206 | | 0.7 | UXT10 | |
| 1.6 16V | 4 | C 16 SEL, Z 16 XE, Z 16 XEP | 74/99 | 02/98→10/05 | | | | | ZS259 |
| 1.6 16V | 4 | X 16 XEL | 74/99 | 02/98→05/05 | Z190 [282] Z74 | | 1.2 1.0 | UXT1 / UXT3 | ZS259 |
| 1.6 16V | 4 | Z 16 XE | 74/99 | 02/98→05/05 | Z203 | | 0.9 | | |
| 1.6 16V | 4 | Z 16 XE | 74/99 | 03/98→10/05 | Z190 [282] Z74 | | 1.2 1.0 | UXT1 / UXT3 | |
| 1.6 16V LPG | 4 | X 16 XEL, Z 16 XE | 74/99 | 02/98→10/05 | Z206 | | 0.7 | UXT10 | |
| 1.6 Dualfuel LPG | 4 | Z 16 XE | 63/84 | 03/98→05/05 | Z206 | | 0.7 | UXT10 | ZS259 |
| 1.7 CDTI 16V | 4 | Z 17 DTL | 59/79 | 04/03→05/05 | GN104 | GSE143 [10] | 11V | | |
| 1.7 DTI 16V | 4 | Y 17 DT | 55/74 | 02/00→05/05 | GN104 | GSE143 [10] | 11V | | |
| 1.7 TD | 4 | X 17 DTL | 50/67 | 02/98→08/00 | GN013 [2][222] GN954 | | 11V 11V | | |
| 1.8 16V | 4 | X 18 XE1, Z 18 XEL | 85/114 | 02/98→08/05 | Z190 [282] Z74 | | 1.2 1.0 | UXT1 / UXT3 | ZS342 |
| 1.8 16V | 4 | Z 18 XE | 92/123 | 02/98→10/05 | Z190 [282] Z74 | | 1.2 1.0 | UXT1 / UXT3 | ZS342 |
| 1.8 16V LPG | 4 | X 18 XE1, Z 18 XEL | 85/114 | 02/98→08/05 | Z206 | | 0.7 | UXT10 | |
| 1.8 16V LPG | 4 | Z 18 XE | 92/123 | 02/98→10/05 | Z206 | | 0.7 | UXT10 | |
| 1.8 16V Dualfuel | 4 | Z 18 XE | 87/117 | 09/02→05/05 | Z203 | | 0.9 | | ZS342 |
| 1.8 16V Dualfuel LPG | 4 | Z 18 XE | 87/117 | 02/98→05/05 | Z203 Z206 [168] | | 0.9 0.7 | UXT10 | |
| 1.8 16V Dualfuel LPG | 4 | Z 18 XE | 87/117 | 02/98→08/05 | | | | | ZS342 |
| 2.0 | 4 | X 20 XER | 118/158 | 10/99→08/00 | | | | | ZS344 |
| 2.0 16V | 4 | X 20 XEV | 100/134 | 02/98→05/05 | Z190 [282] Z74 | | 1.2 1.0 | UXT1 / UXT3 | ZS344 →02/04 |
| 2.0 16V | 4 | X 20 XEV | 100/134 | 09/98→05/05 | | | | | ZS344 |
| 2.0 16V LPG | 4 | X 20 XEV | 100/134 | 02/98→05/05 | Z206 | | 0.7 | UXT10 | |
| 2.0 16V Turbo | 4 | Z 20 LET | 140/188 | 09/00→08/05 | Z190 [282] Z74 | | 1.2 1.0 | UXT1 / UXT3 | |
| 2.0 16V Turbo LPG | 4 | Z 20 LET | 140/188 | 09/00→08/05 | Z206 | | 0.7 | UXT10 | |
| 2.0 DI | 4 | X 20 DTL, Y 20 DTL | 60/80 | 02/98→05/05 | GN992 | | 11V | | |

VAUXHALL



kW/BHP



... VAUXHALL



... ASTRA Mk IV (G)

| | | | | | | | | | |
|-------------------|---|----------|---------|-------------|--|--------------------|-----|-----|--------------------|
| 2.0 DTI 16V | 4 | Y 20 DTH | 74/99 | 02/98→05/05 | GN992 →ch. 229999999; 259999999;269999999; 289999999;289999999,2G; 2H9999999 GN033 ch. 32000001;35000001; 36000001;38000001; 38000001;3H000001; 4G000001→ | GSE142 [11] | 11V | | |
| 2.0 SRI Turbo | 4 | Z 20 LET | 141/189 | 07/02→05/05 | Z190 [282] Z74 | | 11V | 1.2 | |
| 2.0 SRI Turbo LPG | 4 | Z 20 LET | 141/189 | 07/02→05/05 | Z206 | | | 1.0 | UXT1 / UXT3 |
| 2.0 Turbo | 4 | Z 20 LET | 141/189 | 03/02→10/05 | Z190 [282] Z74 | | | 0.7 | UXT10 |
| 2.0 Turbo LPG | 4 | Z 20 LET | 141/189 | 03/02→10/05 | Z206 | | | 1.2 | |
| 2.2 16V | 4 | Z 22 SE | 108/145 | 03/00→08/05 | Z222 09/00→ | | | 1.0 | UXT1 / UXT3 |
| 2.2 16V | 4 | Z 22 SE | 108/145 | 03/01→05/05 | Z222 | | | 0.7 | UXT10 |
| 2.2 16V | 4 | Z 22 SE | 108/145 | 03/01→10/05 | Z222 →08/05 | | | 1.1 | |
| 2.2 DTI | 4 | Y 22 DTR | 92/123 | 09/02→05/05 | GN033 | GSE142 [11] | 11V | | |

ASTRA Mk V (H)

| | | | | | | | | | |
|---------------|---|--------------------|---------|-------------|---|--------------------|-----|-----|------------------------|
| 1.3 CDTI | 4 | Z 13 DTH | 66/89 | 01/04→11/10 | GN053 | GSE142 [11] | 11V | | |
| 1.4 | 4 | Z 14 XEP | 66/89 | 01/04→05/09 | Z203 | | | 0.9 | ZS338 |
| 1.4 LPG | 4 | Z 14 XEP | 66/89 | 01/04→05/09 | Z206 [168] | | | 0.7 | UXT10 |
| 1.4 i 16V | 4 | Z 14 XEP | 66/89 | 03/05→11/10 | Z203 | | | 0.9 | ZS338 |
| 1.4 i 16V LPG | 4 | Z 14 XEP | 66/89 | 03/05→11/10 | Z206 [168] | | | 0.7 | UXT10 |
| 1.6 | 4 | Z 16 XEP | 77/103 | 01/04→11/10 | Z203 | | | 0.9 | ZS427 12/05→ |
| 1.6 | 4 | A 16 XER, Z 16 XER | 85/114 | 01/04→05/09 | Z203 | | | 0.9 | ZS427 12/05→ |
| 1.6 | 4 | Z 16 LET | 132/177 | 08/04→11/10 | Z346 | | | 0.8 | |
| 1.6 | 4 | Z 16 LET | 132/177 | 08/04→03/09 | | | | | ZS427 12/05→ |
| 1.6 | 4 | Z 16 LET | 132/177 | 10/06→11/10 | | | | | ZS427 |
| 1.6 LPG | 4 | Z 16 XEP | 77/103 | 01/04→05/09 | Z206 [168] | | | 0.7 | UXT10 |
| 1.6 LPG | 4 | A 16 XER, Z 16 XER | 85/114 | 01/04→05/09 | Z206 [168] | | | 0.7 | UXT10 |
| 1.6 LPG | 4 | Z 16 LET | 132/177 | 08/04→11/10 | Z116 | | | 0.8 | UXT5 |
| 1.6 i 16V | 4 | Z 16 XER | 85/114 | 12/06→11/10 | Z203 | | | 0.9 | ZS427 |
| 1.6 i 16V LPG | 4 | Z 16 XER | 85/114 | 12/06→11/10 | Z206 [168] | | | 0.7 | UXT10 |
| 1.7 CDTI | 4 | Z 17 DTL | 59/79 | 01/04→05/09 | GN104 | GSE143 [10] | 11V | | |
| 1.7 CDTI | 4 | Z 17 DTH | 74/99 | 01/04→11/10 | GN104 →03/07 | GSE143 [10] | 11V | | |
| 1.7 CDTi | 4 | A 17 DTJ, Z 17 DTJ | 81/109 | 01/04→11/10 | GN104 | GSE143 [10] | 11V | | |
| 1.7 CDTI | 4 | A 17 DTR, Z 17 DTR | 92/123 | 02/07→ | GN104 | GSE143 [10] | 11V | | |
| 1.7 TD | 4 | | 79/106 | 01/04→05/09 | GN104 | | 11V | | |
| 1.8 | 4 | Z 18 XE | 92/123 | 01/04→05/09 | Z203 →ch. 989999999; D59999999;D89999999; DG9999999 | | | 0.9 | |
| 1.8 | 4 | Z 18 XE | 92/123 | 01/04→11/10 | | | | | ZS342 |
| 1.8 | 4 | Z 18 XE | 92/123 | 10/04→03/09 | Z203 | | | 0.9 | |
| 1.8 | 4 | Z 18 XE | 92/123 | 02/05→11/10 | Z203 →ch. 989999999; D29999999;D59999999; D89999999;DG9999999 | | | 0.9 | |

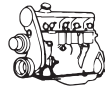

kW/BHP

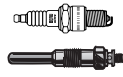
**... VAUXHALL****... ASTRA Mk VI (J)**

| | | | | | | | | | |
|----------------------------|---|--------------------|---------|--------|--|--------|------|------|--|
| 1.6 Turbo LPG | 4 | A 16 LET | 132/177 | 12/09→ | Z116 | | 0.8 | UXT5 | |
| 1.7 CDTi | 4 | A 17 DTL, Z 17 DTH | 74/99 | 12/09→ | GN104 | GSE145 | 11V | | |
| 1.7 CDTi | 4 | A 17 DTC | 81/109 | 12/09→ | GE117 | | 4.4V | | |
| 1.7 CDTi | 4 | A 17 DTE | 81/109 | 12/09→ | PSG004 | | 4.4V | | |
| 1.7 CDTi | 4 | A 17 DTJ | 81/109 | 12/09→ | GN104 | GSE145 | 11V | | |
| 1.7 CDTi | 4 | A 17 DTR | 92/123 | 12/09→ | GN104 | GSE145 | 11V | | |
| 1.7 CDTi | 4 | A 17 DTF | 96/129 | 06/11→ | PSG004 | | 4.4V | | |
| 1.7 CDTi | 4 | A 17 DTS | 96/129 | 06/11→ | GE117 | | 4.4V | | |
| 2.0 BiTurbo CDTi | 4 | A 20 DTR | 143/192 | 12/12→ | GE114 | | 4.4V | | |
| | | | | | →ch. B3999999; B8999999;BG999999 | | | | |
| | | | | | PSG001 | | 4.4V | | |
| | | | | | →ch. B3999999; B8999999;BG999999 | | | | |
| | | | | | ch. C0000001;C1000001; C3000001;C8000001; | | | | |
| | | | | | CG000001→ | | | | |
| | | | | | PSG006 | | 4.4V | | |
| | | | | | ch. 17B08416→ | | | | |
| 2.0 CDTi | 4 | A 20 DTH | 118/158 | 12/09→ | GE114 | | 4.4V | | |
| | | | | | →ch. B3999999; B8999999;BG999999 | | | | |
| | | | | | PSG001 | | 4.4V | | |
| | | | | | →ch. B3999999; B8999999;BG999999 | | | | |
| | | | | | ch. C0000001;C1000001; C3000001;C8000001; | | | | |
| | | | | | CG000001→ | | | | |
| | | | | | PSG006 | | 4.4V | | |
| | | | | | ch. 17B08416→ | | | | |
| 2.0 CDTi | 4 | A 20 DTH | 121/162 | 08/11→ | GE114 | | 4.4V | | |
| | | | | | →ch. B3999999; B8999999;BG999999 | | | | |
| | | | | | PSG001 | | 4.4V | | |
| | | | | | →ch. B3999999; B8999999;BG999999 | | | | |
| | | | | | ch. C0000001;C1000001; C3000001;C8000001; | | | | |
| | | | | | CG000001→ | | | | |
| | | | | | PSG006 | | 4.4V | | |
| | | | | | ch. 17B08416→ | | | | |
| ASTRA GTC Mk VI (J) | | | | | | | | | |
| 1.6 | 4 | A 16 LET | 132/177 | 10/11→ | Z346 | | 0.8 | | |
| 1.6 LPG | 4 | A 16 LET | 132/177 | 10/11→ | Z116 | | 0.8 | UXT5 | |
| 1.7 CDTi | 4 | A 17 DTC | 81/109 | 10/11→ | GE117 | | 4.4V | | |
| 1.7 CDTi | 4 | A 17 DTE | 81/109 | 10/11→ | PSG004 | | 4.4V | | |
| 1.7 CDTi | 4 | A 17 DTJ | 81/109 | 10/11→ | GN104 | GSE145 | 11V | | |
| 1.7 CDTi | 4 | A 17 DTF | 96/129 | 10/11→ | PSG004 | | 4.4V | | |
| 1.7 CDTi | 4 | A 17 DTS | 96/129 | 10/11→ | GE117 | | 4.4V | | |



kW/BHP



... VAUXHALL



... ASTRA GTC Mk VI (J)

| | | | | | | | | |
|------------------|---|----------|---------|--------|---|------|--|--|
| 2.0 BiTurbo CDTi | 4 | A 20 DTR | 143/192 | 12/12→ | GE114 →ch. B3999999; B8999999;BG999999 PSG001 →ch. B3999999; B8999999;BG999999 PSG006 ch. 17B08416→ PSG001 ch. C0000001;C1000001; C3000001;C8000001; CG000001→ | 4.4V | | |
| 2.0 CDTi | 4 | A 20 DTH | 121/162 | 10/11→ | GE114 →ch. B3999999; B8999999;BG999999 PSG001 →ch. B3999999; B8999999;BG999999 PSG006 ch. 17B08416→ PSG001 ch. C0000001;C1000001; C3000001;C8000001; CG000001→ | 4.4V | | |

ASTRA TwinTop Mk V (H)

| | | | | | | | | |
|----------|---|----------|---------|-------------|-------------------|--|--------------|--------------|
| 1.6 | 4 | Z 16 XEP | 77/103 | 09/05→11/10 | Z203 | 0.9 | | ZS427 |
| 1.6 | 4 | Z 16 LET | 132/177 | 10/06→11/10 | Z346 | 0.8 | | |
| 1.6 LPG | 4 | Z 16 XEP | 77/103 | 09/05→11/10 | Z206 [168] | 0.7 | UXT10 | |
| 1.6 LPG | 4 | Z 16 LET | 132/177 | 10/06→11/10 | Z116 | 0.8 | UXT5 | |
| 1.8 | 4 | Z 18 XER | 103/138 | 05/08→11/10 | Z203 | 0.9 | | ZS427 |
| 1.8 LPG | 4 | Z 18 XER | 103/138 | 05/08→11/10 | Z206 [168] | 0.7 | UXT10 | |
| 1.9 CDTi | 4 | Z 19 DTH | 110/148 | 01/06→11/10 | GN059 | GSE142 [11][32] GSE143 [10][32] | 11V | |
| 2.0 | 4 | Z 20 LEL | 125/168 | 02/06→11/10 | Z287 | 0.8 | | |
| 2.0 LPG | 4 | Z 20 LEL | 125/168 | 02/06→11/10 | Z158 [168] | 1.1 | | |

BRAVA

| | | | | | | | | |
|-----------|---|---------|--------|-------------|---------------------------------------|--------------|--------------------|--|
| 2.2 D | 4 | C223 | 39/52 | 12/88→09/96 | GV946 | 11V | | |
| 2.2 D | 4 | 4FD1 | 45/60 | 07/90→09/92 | GV946 | 11V | | |
| 2.3 | 4 | 4 ZD1 | 69/93 | 06/90→08/94 | Z20 | 0.8 | UXT2 / UXT6 | |
| 2.3 | 4 | 23 P | 72/97 | 08/94→09/96 | Z20 | 0.8 | UXT2 / UXT6 | |
| 2.3 LPG | 4 | 23 P | 72/97 | 08/94→09/96 | Z27 [168] | 0.8 | UX56 | |
| 2.5 D | 4 | 4 JA1 | 56/75 | 08/91→06/94 | GN909 [2][222] GV636 | GR064 | 11V | |
| 2.5 D 4WD | 4 | 4 JA1T | 56/75 | 06/90→06/94 | GN061 | 11V | | |
| 2.5 DTI | 4 | 4 JA1 | 74/99 | 08/01→12/02 | GN061 | 11V | | |
| 2.5 TD | 4 | 4 JA1T | 56/75 | 07/94→12/02 | GN061 | 11V | | |
| 3.1 D | 4 | 4 JG2 T | 80/107 | 07/91→07/01 | GV947 | 11V | | |

CALIBRA

| | | | | | | | | |
|-----------|---|---------|--------|-------------|--|-------------------|--|--|
| 2.0 i | 4 | C 20 NE | 85/114 | 06/90→07/97 | Z119 [284] Z190 [282][283] Z74 [283] | 0.8 1.2 1.0 | UXT2/UXT6 [284] UXT1/UXT3 [283] | ZS125 [1] →eng. 14180385 ZS127 [1] eng. 14180386→ |
| 2.0 i 4WD | 4 | C 20 NE | 85/114 | 06/90→07/97 | Z119 [284] Z190 [2][282][283] Z74 [283] | 0.8 1.2 1.0 | UXT2/UXT6 [284] UXT1/UXT3 [283] | ZS125 [1] →eng. 14180385 ZS127 [1] eng. 14180386→ |
| 2.0 i LPG | 4 | C 20 NE | 85/114 | 06/90→07/97 | Z20 [168] Z206 | 0.8 0.7 | UXT2 / UXT6 UXT10 | |



kW/BHP

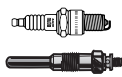

... VAUXHALL



... CALIBRA

| | | | | | | | | | | |
|---------------------|---|------------------|---------|-------------|-------------------|--|------------|-------------|-------|-------|
| 2.0 i 16V | 4 | X 20 XEV | 100/134 | 06/90→07/97 | Z190 [282] Z74 | | 1.2 1.0 | UXT1 / UXT3 | ZS344 | |
| 2.0 i 16V | 4 | C 20 XE | 110/148 | 06/90→02/94 | Z250 | | 0.7 | UXT1 / UXT3 | ZS300 | ZM026 |
| 2.0 i 16V LPG | 4 | X 20 XEV | 100/134 | 06/90→07/97 | Z206 | | 0.7 | UXT10 | | |
| 2.0 i Turbo 4WD | 4 | C 20 LET | 150/201 | 03/92→07/97 | Z158 | | 1.1 | | | |
| 2.0 i Turbo 4WD LPG | 4 | C 20 LET | 150/201 | 03/92→07/97 | Z116 | | 0.8 | UXT5 | | |
| 2.5 i V6 | 6 | C 25 XE, X 25 XE | 125/168 | 04/93→07/97 | Z190 [282] Z74 | | 1.2 1.0 | UXT1 / UXT3 | ZS301 | |
| 2.5 i V6 LPG | 6 | C 25 XE, X 25 XE | 125/168 | 04/93→07/97 | Z206 | | 0.7 | UXT10 | | |

CARLTON Mk II

| | | | | | | | | | | |
|-------|---|----------|--------|-------------|-------------------------|-------|------------|-------------|--|--|
| 1.8 S | 4 | 18 S | 65/87 | 12/82→08/86 | Z20 | | 0.8 | UXT2 / UXT6 | ZS125 [1][214][254] ZS127 [1][214][254] | |
| 1.8 S | 4 | 18 S | 66/89 | 11/82→08/86 | Z20 | | 0.8 | UXT2 / UXT6 | ZS125 [1][214][254] ZS127 [1][214][254] | |
| 2.0 i | 4 | 20 E | 81/109 | 01/83→12/84 | Z19 [168] | | 0.8 | | | |
| 2.0 S | 4 | C 20 NEJ | 74/99 | 10/78→08/86 | Z19 | | 0.8 | | | |
| 2.0 S | 4 | C 20 NEJ | 74/99 | 01/82→08/86 | Z19 [168] | | 0.8 | | | |
| 2.2 i | 4 | 22 E | 85/114 | 11/84→08/86 | Z19 [168] | | 0.8 | | | |
| 2.3 D | 4 | 23 D | 52/70 | 05/83→08/86 | GN909 [2][222] GV636 | GR064 | 11V 11V | | | |

CARLTON Mk III

| | | | | | | | | | | |
|----------------|---|----------|--------|-------------|---|-------|--------------------------|--|--|-------|
| 1.8 | 4 | E 18 NVR | 65/87 | 09/87→03/94 | Z20 | | 0.8 | UXT2 / UXT6 | | |
| 1.8 i | 4 | 18 SEH | 85/114 | 09/86→03/94 | Z119 [284] Z190 [282][283] Z74 [283] Z253 [209] →ch. L1019854 eng. 14258180→ | | 0.8 1.2 1.0 1.0 | UXT2/UXT6 [284] →ch. L1019854 eng. 14258180→ UXT1/UXT3 [283] UXT5 →ch. L1019854 eng. 14258180→ | ZS253 [1] →ch. L1019854 eng. 14258180→ | ZM032 |
| 1.8 N | 4 | 18 NV | 60/80 | 09/86→08/87 | Z20 | | 0.8 | UXT2 / UXT6 | ZS125 [1][214][254] ZS127 [1] eng. 14258180→ | |
| 1.8 S | 4 | 18 SV | 66/89 | 09/86→03/94 | Z20 | | 0.8 | UXT2 / UXT6 | ZS253 [1] eng. 14258180→ | |
| 2.0 | 4 | C 20 NEJ | 73/98 | 09/90→03/94 | Z119 [284] Z190 [282][283] Z74 [283] | | 0.8 1.2 1.0 | UXT2/UXT6 [284] →eng. 14180385 UXT1/UXT3 [283] eng. 14258180→ | ZS125 [1] →eng. 14180385 ZS127 [1] | |
| 2.0 | 4 | C 20 NEF | 74/99 | 09/90→03/94 | Z119 [284] Z190 [282][283] Z74 [283] | | 0.8 1.2 1.0 | UXT2/UXT6 [284] →eng. 14180385 UXT1/UXT3 [283] eng. 14258180→ | ZS125 [1] →eng. 14180385 ZS127 [1] | |
| 2.0 | 4 | C 20 NE | 85/114 | 09/86→03/94 | Z119 [284] Z190 [282][283] Z74 [283] | | 0.8 1.2 1.0 | UXT2/UXT6 [284] →eng. 14180385 UXT1/UXT3 [283] eng. 14180386→ | ZS125 [1] →eng. 14180385 ZS127 [1] | |
| 2.0 i | 4 | C 20 NEJ | 73/98 | 09/90→03/94 | Z119 [284] Z190 [282][283] Z74 [283] | | 0.8 1.2 1.0 | UXT2/UXT6 [284] →eng. 14180385 UXT1/UXT3 [283] eng. 14258180→ | ZS125 [1] →eng. 14180385 ZS127 [1] | |
| 2.0 i | 4 | 20 SE | 90/121 | 09/86→03/94 | Z20 | | 0.8 | UXT2 / UXT6 | ZS125 [1][214][254] ZS127 [1] eng. 14258180→ | |
| 2.2 TD | 4 | 23 YDT | 66/89 | 09/86→08/88 | GN013 [2][222] GN954 | | 11V 11V | | | |
| 2.3 D | 4 | 23 YD | 54/72 | 09/86→03/94 | GN013 [2][222] GN954 | GR064 | 11V 11V | | | |
| 2.3 TD Interc. | 4 | 23 DTR | 74/99 | 08/88→03/94 | GN909 [2][222] GV636 | GR064 | 11V 11V | | | |

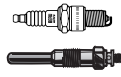

kW/BHP

**... VAUXHALL****... CARLTON Mk III**

| | | | | | | | | |
|---------------|---|----------|---------|-------------|-----------|--|-----|---|
| 2.4 i | 4 | C 24 NE | 92/123 | 09/88→03/94 | Z19 [168] | | 0.8 | ZS127 [1] →ch. K1999999 ZS125 [1] ch. L1000001→ |
| 2.6 i | 6 | C 26 NE | 110/148 | 09/90→03/94 | Z19 [168] | | 0.8 | ZS127 |
| 2.9 3000 | 6 | C 30 LE | 115/154 | 03/87→12/87 | Z19 [168] | | 0.8 | ZS125 [1] ch. K1000099→ →ch. K1999999 ZS127 [1] ch. L1000001→ |
| 3.0 | 6 | C 30 NE | 130/174 | 03/87→03/94 | Z19 [168] | | 0.8 | ZS125 [1] ch. K1000099→ →ch. K1999999 ZS127 [1] ch. L1000001→ |
| 3.0 24V | 6 | C 30 SEJ | 147/197 | 09/89→03/94 | Z98 | | 0.8 | UXT1 / UXT3 ZS127 |
| 3.0 3000 | 6 | 30 NE | 130/174 | 03/87→09/90 | Z19 [168] | | 0.8 | ZS125 [1][214][254] ZS127 [1][214][254] |
| 3.0 3000 | 6 | C 30 NE | 130/174 | 03/88→03/94 | Z19 [168] | | 0.8 | ZS125 [1] ch. K1000099→ →ch. K1999999 ZS127 [1] ch. L1000001→ |
| 3.0 3000 24V | 6 | C 30 SEJ | 147/197 | 09/89→03/94 | Z98 | | 0.8 | UXT1 / UXT3 ZS127 |
| 3.0 3000 24V | 6 | C 30 SE | 150/201 | 09/89→03/94 | Z98 | | 0.8 | UXT1 / UXT3 ZS127 |
| 3.6 24V Lotus | 6 | C 36 GET | 277/371 | 08/90→09/92 | Z63 [168] | | 0.8 | UXT1 / UXT3 ZS355 |

CASCADA

| | | | | | | | | |
|----------|---|----------|---------|--------|--------|--|------|--|
| 2.0 CDTI | 4 | A 20 DTH | 121/162 | 02/13→ | PSG006 | | 4.4V | |
| 2.0 CDTI | 4 | A 20 DTR | 143/192 | 02/13→ | PSG006 | | 4.4V | |

CAVALIER

| | | | | | | | | |
|----------|---|------------|-------|-------------|-----------|--|-----|-------------|
| 1.3 1300 | 4 | 13 N | 44/59 | 08/77→08/81 | Z11 | | 0.8 | UXT2 / UXT6 |
| 1.6 N | 4 | 16 N (CIH) | 44/59 | 03/75→08/81 | Z19 [168] | | 0.8 | |
| 1.6 S | 4 | 16 S CIH | 55/74 | 08/75→08/81 | Z19 | | 0.8 | |
| 1.9 1900 | 4 | 19 S | 66/89 | 10/75→03/78 | Z19 [168] | | 0.8 | |
| 1.9 S | 4 | 19 S | 66/89 | 10/75→03/78 | Z19 [168] | | 0.8 | |
| 2.0 S | 4 | 20 S | 74/99 | 01/78→08/81 | Z19 [168] | | 0.8 | |

CAVALIER Mk II

| | | | | | | | | |
|-----------|---|-------------|-------|-------------|--|-------|-----|---|
| 1.3 | 4 | 13 NB | 44/59 | 09/81→08/88 | | | | ZS252 eng. 879422→ |
| 1.3 N | 4 | 13 N | 44/59 | 09/81→08/88 | Z20 | | 0.8 | UXT2 / UXT6 ZS252 [1] |
| 1.3 S | 4 | 13 S | 55/74 | 09/81→08/88 | Z20 | | 0.8 | UXT2 / UXT6 ZS252 [1] eng. 885919→ |
| 1.6 | 4 | 16 SH | 66/89 | 10/83→08/88 | Z20 | | 0.8 | UXT2 / UXT6 ZM007 01/86→12/87 |
| 1.6 1600D | 4 | 16 D, 16 DA | 40/54 | 03/82→08/88 | GN909 [2][222] GV636 | GR064 | 11V | |
| 1.6 D | 4 | 16 D, 16 DA | 40/54 | 03/82→08/88 | GN909 [2][222] GV636 | GR064 | 11V | |
| 1.6 i | 4 | C 16 LZ | 55/74 | 08/86→08/88 | Z21 | | 1.1 | UXT2 / UXT6 |
| 1.6 i | 4 | C 16 NZ | 55/74 | 08/86→08/88 | Z119 [284] Z190 [282][283] Z74 [283] | | 0.8 | UXT2/UXT6 [284] 1.2 1.0 UXT1/UXT3 [283] |
| 1.6 i | 4 | E 16 NZ | 55/74 | 08/86→08/88 | Z119 [284] Z190 [282][283] Z74 [283] | | 0.8 | UXT2/UXT6 [284] ZS252 1.2 1.0 UXT1/UXT3 [283] |
| 1.6 N | 4 | 16 N | 55/74 | 09/81→08/88 | Z20 | | 0.8 | UXT2 / UXT6 |
| 1.6 S | 4 | 16 SH | 66/89 | 09/81→08/88 | Z20 | | 0.8 | UXT2 / UXT6 ZM002 |
| 1.8 | 4 | E 18 NV | 62/83 | 08/86→08/88 | Z20 | | 0.8 | UXT2 / UXT6 |



kW/BHP

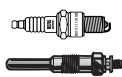

... VAUXHALL



... CAVALIER Mk II

| | | | | | | | | |
|-------------|---|-------------|--------|-------------|---|--------------------------|--|--|
| 1.8 1800i | 4 | 18 SE | 82/110 | 03/85→10/88 | Z119 ^[284] Z190 ^{[282][283]} Z74 ^[283] | 0.8 1.2 1.0 | UXT2/UXT6 ^[284] UXT1/UXT3 ^[283] | ZM032 01/86→ |
| 1.8 i | 4 | C 18 NE | 74/99 | 01/85→08/86 | Z20 | 0.8 | UXT2 / UXT6 | |
| 1.8 i | 4 | 18 E, 18 SE | 82/110 | 09/81→08/86 | Z20 ^[284] | 0.8 | UXT2/UXT6 ^[284] | |
| 1.8 i | 4 | 18 SE | 82/110 | 09/81→08/88 | Z119 ^[284] Z190 ^{[282][283]} Z74 ^[283] | 0.8 1.2 1.0 | UXT2/UXT6 ^[284] UXT1/UXT3 ^[283] | |
| 1.8 i | 4 | 18 E | 85/114 | 09/81→08/88 | Z20 | 0.8 | UXT2/UXT6 ^[284] | |
| 2.0 2000i | 4 | 20 SE | 90/121 | 09/86→08/88 | Z119 ^[284] Z190 ^{[282][283]} Z20 ^[284] Z74 ^[283] | 0.8 1.2 0.8 1.0 | UXT2/UXT6 ^[284] ZS127 ^[1] eng. 14180386→ UXT2/UXT6 ^[284] ZS125 ^[1] ch. 1000099→ UXT1/UXT3 ^[283] →eng. 14180385 | |
| 2.0 i | 4 | 20 NE | 85/114 | 09/86→08/88 | Z119 | 0.8 | UXT2/UXT6 ^[284] | ZS125 ^{[1][214][254]} ZS127 ^{[1][214][254]} |
| 2.0 i | 4 | C 20 NE | 85/114 | 09/86→08/88 | Z119 ^[284] Z190 ^{[282][283]} Z74 ^[283] | 0.8 1.2 1.0 | UXT2/UXT6 ^[284] ZS125 ^{[1][214][254]} ZS127 ^{[1][214][254]} UXT1/UXT3 ^[283] | |
| 2.0 SRi 130 | 4 | 20 SEH | 95/127 | 03/87→08/88 | Z20 | 0.8 | UXT2 / UXT6 | ZS125 ^{[1][214][254]} eng. 14180386→ ZS125 ^[1] ch. 1000099→ →eng. 14180385 |

CAVALIER Mk III

| | | | | | | | | |
|-----------|---|----------------|-------|-------------|---|-------------------|--|--|
| 1.4 S | 4 | 14 NV | 55/74 | 09/88→11/95 | Z119 ^[284] Z190 ^{[282][283]} Z74 ^[283] | 0.8 1.2 1.0 | UXT2/UXT6 ^[284] UXT1/UXT3 ^[283] | |
| 1.4 S LPG | 4 | 14 NV | 55/74 | 09/88→11/95 | Z20 ^[168] Z206 | 0.8 0.7 | UXT2 / UXT6 UXT10 | |
| 1.6 | 4 | 16 SV | 60/80 | 09/88→05/93 | Z20 | 0.8 | UXT2 / UXT6 | ZS252 ^{[1][254]} →ch. K1999999; K5999999;K1999999 ZS253 ^{[1][254]} ch. L1000001;L5000001; LV100001→ |
| 1.6 i | 4 | X 16 SZ | 52/70 | 09/93→11/95 | Z190 ^[282] Z74 | 1.2 1.0 | UXT1 / UXT3 | ZSE026 |
| 1.6 i | 4 | E 16 NZ | 55/74 | 09/88→11/95 | Z119 ^[284] Z190 ^{[282][283]} Z74 ^[283] | 0.8 1.2 1.0 | UXT2/UXT6 ^[284] UXT1/UXT3 ^[283] | ZS252 |
| 1.6 i LPG | 4 | X 16 SZ | 52/70 | 09/93→11/95 | Z206 | 0.7 | UXT10 | |
| 1.6 i LPG | 4 | E 16 NZ | 55/74 | 09/88→11/95 | Z20 ^[168] Z206 | 0.8 0.7 | UXT2 / UXT6 UXT10 | |
| 1.7 D | 4 | 17 D | 42/56 | 09/88→09/92 | GN909 ^{[2][222]} GV636 | 11V 11V | GR064 →01/92 | |
| 1.7 D | 4 | 17 DR | 44/59 | 07/92→11/95 | GN013 ^{[2][222]} GN954 | 11V 11V | | |
| 1.7 TD | 4 | 17 DT (TC4EE1) | 60/80 | 09/88→11/95 | GV946 →eng. 731416 GN103 eng. 731417→ | 11V 11V | | |
| 1.8 | 4 | 18 SV | 66/89 | 09/88→08/95 | Z20 ^[284] | 0.8 | UXT2/UXT6 ^[284] | |
| 1.8 | 4 | C 18 NZ | 66/89 | 09/88→10/90 | Z119 ^[284] Z190 ^{[282][283]} Z74 ^[283] | 0.8 1.2 1.0 | UXT2/UXT6 ^[284] UXT1/UXT3 ^[283] | |
| 1.8 | 4 | C 18 NZ | 66/89 | 09/88→08/95 | Z119 ^[284] | 0.8 | UXT2/UXT6 ^[284] | |
| 1.8 i | 4 | C 18 NZ | 66/89 | 03/90→11/95 | Z119 ^[284] Z190 ^{[282][283]} Z74 ^[283] | 0.8 1.2 1.0 | UXT2/UXT6 ^[284] UXT1/UXT3 ^[283] | |

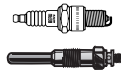

kW/BHP

**... VAUXHALL****... CAVALIER Mk III**

| | | | | | | | | | |
|---------------------|---|----------------|---------|-------------|---|-------------------|--|--|-------|
| 1.8 i LPG | 4 | C 18 NZ | 66/89 | 03/90→11/95 | Z20 [168] Z206 | 0.8 0.7 | UXT2 / UXT6 UXT10 | | |
| 2.0 i | 4 | 20 NE | 85/114 | 09/88→10/90 | Z119 [284] | 0.8 | UXT2/UXT6 [284] | | |
| 2.0 i | 4 | 20 NE | 85/114 | 09/88→10/92 | Z119 [284] Z190 [282][283] Z74 [283] | 0.8 1.2 1.0 | UXT2/UXT6 [284] →eng. 14180385 UXT1/UXT3 [283] | ZS125 [1] ZS127 [1] | |
| 2.0 i | 4 | 20 NE, C 20 NE | 85/114 | 09/90→11/95 | Z119 [284] Z190 [282][283] Z74 [283] | 0.8 1.2 1.0 | UXT2/UXT6 [284] →eng. 14180385 UXT1/UXT3 [283] | ZS125 [1] ZS127 [1] | |
| 2.0 i 4WD | 4 | 20 SEH | 95/127 | 09/88→09/92 | Z20 | 0.8 | UXT2 / UXT6 | ZS125 [1] →eng. 14180385 ZS127 [1] eng. 14180386→ | |
| 2.0 i LPG | 4 | C 20 NE | 85/114 | 09/90→11/95 | Z20 [168] Z206 | 0.8 0.7 | UXT2 / UXT6 UXT10 | | |
| 2.0 i 16V | 4 | X 20 XEV | 100/134 | 09/93→11/95 | Z190 [282] Z74 | 1.2 1.0 | | ZS344 | |
| 2.0 i 16V | 4 | C 20 XE | 110/148 | 09/88→11/95 | Z250 →08/92 Z190 [282] 09/92→ Z74 09/92→ | 0.7 1.2 1.0 | UXT1 / UXT3 →08/92 UXT1 / UXT3 | ZS300 | ZM034 |
| 2.0 i 16V LPG | 4 | X 20 XEV | 100/134 | 09/93→11/95 | Z206 | 0.7 | UXT10 | | |
| 2.0 i 16V LPG | 4 | C 20 XE | 110/148 | 09/88→11/95 | Z206 09/92→ | 0.7 | UXT10 09/92→ | | |
| 2.0 i Turbo 4WD | 4 | C 20 LET | 150/201 | 06/92→11/94 | Z158 | 1.1 | | ZS127 | |
| 2.0 i Turbo 4WD LPG | 4 | C 20 LET | 150/201 | 06/92→11/94 | Z116 | 0.8 | UXT5 | | |
| 2.0 SRi | 4 | 20 SEH | 95/127 | 09/88→09/92 | Z20 | 0.8 | UXT2 / UXT6 | ZS125 [1] →eng. 14180385 ZS127 [1] eng. 14180386→ | |
| 2.0 SRi 16V | 4 | X 20 XEV | 100/134 | 09/93→11/95 | Z190 [282] Z74 | 1.2 1.0 | | ZS344 | |
| 2.0 SRi 16V LPG | 4 | X 20 XEV | 100/134 | 09/93→11/95 | Z206 | 0.7 | UXT10 | | |
| 2.5 V6 | 6 | C 25 XE | 125/168 | 08/88→06/94 | Z98 →08/93 Z190 [282] 09/93→ Z74 09/93→ | 0.8 1.2 1.0 | UXT1 / UXT3 →08/93 UXT1 / UXT3 | ZS301 | |
| 2.5 V6 LPG | 6 | C 25 XE | 125/168 | 08/88→06/94 | Z116 →08/93 Z206 09/93→ | 0.8 0.7 | UXT5 →08/93 UXT10 09/93→ | | |

CAVALIER CC

| | | | | | | | | | |
|----------|---|----------|-------|-------------|-----------|-----|--|--|--|
| 1.6 1600 | 4 | 16 S CIH | 55/74 | 09/75→08/81 | Z19 | 0.8 | | | |
| 2.0 2000 | 4 | 20 S | 74/99 | 08/77→08/81 | Z19 [168] | 0.8 | | | |

CHEVETTE

| | | | | | | | | | |
|----------|---|------|-------|-------------|---------------|-----|----------------|-------------------------------------|--|
| 1.2 | 4 | 13 N | 39/52 | 09/76→12/85 | Z28 10/80→ | 1.1 | UX56 10/80→ | ZS106 [1][11][254] ZS109 [1][15] | |
| 1.3 1300 | 4 | 13 N | 39/52 | 03/75→12/85 | Z28 10/80→ | 1.1 | UX56 10/80→ | ZS106 [1][11][254] ZS109 [1][15] | |
| 1.3 1300 | 4 | 13 S | 42/56 | 03/75→12/85 | Z28 10/80→ | 1.1 | UX56 10/80→ | ZS106 [1][11][254] ZS109 [1][15] | |



kW/BHP

**... VAUXHALL****COMBO TOUR Mk II (C)**

| | | | | | | | | | |
|--------------|---|------------------|-------|-------------|-------|--|-----|-------|-------|
| 1.3 CDTI 16V | 4 | Y 13 DT, Z 13 DT | 51/68 | 09/04→09/06 | GN053 | | 11V | | |
| 1.3 CDTI 16V | 4 | Z 13 DTJ | 55/74 | 07/06→02/12 | GN053 | | 11V | | |
| 1.6 CNG | 4 | Z 16 YNG | 69/93 | 06/06→09/10 | Z206 | | 0.7 | UXT10 | ZS259 |
| 1.6 CNG 16V | 4 | Z 16 YNG | 71/95 | 04/05→02/12 | Z206 | | 0.7 | UXT10 | ZS259 |
| 1.7 CDTI 16V | 4 | Z 17 DTH | 74/99 | 12/04→09/10 | GN104 | | 11V | | |
| 1.7 DI 16V | 4 | Y 17 DTL | 48/64 | 09/01→06/04 | GN104 | | 11V | | |
| 1.7 DTI 16V | 4 | Y 17 DT | 55/74 | 10/01→02/12 | GN104 | | 11V | | |

CORSA Mk I (B)

| | | | | | | | | | |
|-----------------|---|--------------------------------|--------|-------------|--|--|-------------------|------------------------------------|--------|
| 1.0 i 12V | 3 | X 10 XE | 40/54 | 11/96→09/00 | Z190 [282] Z74 | | 1.2 1.0 | UXT1 / UXT3 | ZS358 |
| 1.0 i 12V LPG | 3 | X 10 XE | 40/54 | 11/96→09/00 | Z206 | | 0.7 | UXT10 | |
| 1.2 i | 4 | C 12 NZ, X 12 SZ | 33/44 | 03/93→09/00 | Z119 [284] Z190 [282][283] Z74 [283] | | 0.8 1.2 1.0 | UXT2/UXT6 [284] UXT1/UXT3 [283] | ZS253 |
| 1.2 i LPG | 4 | C 12 NZ, X 12 SZ | 33/44 | 03/93→09/00 | Z20 [168] Z206 | | 0.8 0.7 | UXT2 / UXT6 UXT10 | |
| 1.2 i 16V | 4 | X 12 XE | 48/64 | 03/98→09/00 | Z190 [282] Z74 | | 1.2 1.0 | UXT1 / UXT3 | ZSE147 |
| 1.2 i 16V LPG | 4 | X 12 XE | 48/64 | 03/98→09/00 | Z206 | | 0.7 | UXT10 | |
| 1.4 i | 4 | C 14 NZ, X 14 SZ | 44/59 | 03/93→09/00 | Z119 [284] Z190 [282][283] Z74 [283] | | 0.8 1.2 1.0 | UXT2/UXT6 [284] UXT1/UXT3 [283] | ZS253 |
| 1.4 i LPG | 4 | C 14 NZ, X 14 SZ | 44/59 | 03/93→09/00 | Z20 [168] Z206 | | 0.8 0.7 | UXT2 / UXT6 UXT10 | |
| 1.4 i 16V | 4 | X 14 XE | 66/89 | 09/94→09/00 | Z190 [282] Z74 | | 1.2 1.0 | UXT1 / UXT3 | ZSE026 |
| 1.4 i 16V LPG | 4 | X 14 XE | 66/89 | 09/94→09/00 | Z206 | | 0.7 | UXT10 | |
| 1.4 i S | 4 | C 14 SE | 60/80 | 03/93→09/00 | Z119 [284] Z190 [282][283] Z74 [283] | | 0.8 1.2 1.0 | UXT2/UXT6 [284] UXT1/UXT3 [283] | ZSE026 |
| 1.4 i S LPG | 4 | C 14 SE | 60/80 | 03/93→09/00 | Z20 [168] Z206 | | 0.8 0.7 | UXT2 / UXT6 UXT10 | |
| 1.5 D | 4 | 15 D | 37/50 | 03/93→09/00 | GN103 | | 11V | | |
| 1.5 TD | 4 | 15 DT (T4EC1), X 15 DT (T4EC1) | 49/66 | 03/93→10/96 | GN103 | | 11V | | |
| 1.6 GSI 16V | 4 | C 16 XE | 80/107 | 03/93→09/00 | Z190 [282] Z74 | | 1.2 1.0 | UXT1 / UXT3 | ZSE026 |
| 1.6 GSI 16V LPG | 4 | C 16 XE | 80/107 | 03/93→09/00 | Z206 | | 0.7 | UXT10 | |
| 1.6 i 16V | 4 | X 16 XE | 78/105 | 09/94→09/00 | Z190 [282] Z74 | | 1.2 1.0 | UXT1 / UXT3 | ZSE026 |
| 1.6 i 16V LPG | 4 | X 16 XE | 78/105 | 09/94→09/00 | Z206 | | 0.7 | UXT10 | |
| 1.7 D | 4 | 17 D (4EE1), X 17 D (4EE1) | 44/59 | 02/96→09/00 | GN103 | | 11V | | |

CORSA Mk II (C)

| | | | | | | | | | |
|----------------------|---|----------|-------|-------------|---------------------------|-------------|-------------------|----------------------|------------------|
| 1.0 12V | 3 | Z 10 XE | 43/58 | 09/00→10/03 | Z190 [282] Z74 | | 1.2 1.0 | UXT1 / UXT3 | ZS358 |
| 1.0 12V | 3 | Z 10 XEP | 44/59 | 11/03→10/06 | Z203 | | 0.9 | | ZS359 |
| 1.0 12V LPG | 3 | Z 10 XE | 43/58 | 09/00→10/03 | Z206 | | 0.7 | UXT10 | |
| 1.0 12V LPG | 3 | Z 10 XEP | 44/59 | 11/03→10/06 | Z206 [168] | | 0.7 | UXT10 | |
| 1.2 16V | 4 | Z 12 XE | 55/74 | 09/00→10/06 | Z190 [282] Z74 | | 1.2 1.0 | UXT1 / UXT3 | ZSE147 →08/04 |
| 1.2 16V LPG | 4 | Z 12 XE | 55/74 | 09/00→10/06 | Z206 | | 0.7 | UXT10 | |
| 1.2 16V Dualfuel LPG | 4 | Z 12 XE | 55/74 | 08/01→10/06 | Z190 [282] Z206 Z74 | | 1.2 0.7 1.0 | UXT10 UXT1 / UXT3 | ZSE147 →08/04 |
| 1.2 Twinport | 4 | Z 12 XEP | 59/79 | 07/04→10/06 | Z203 | | 0.9 | | ZS338 |
| 1.2 Twinport LPG | 4 | Z 12 XEP | 59/79 | 07/04→10/06 | Z206 [168] | | 0.7 | UXT10 | |
| 1.3 CDTI 16V | 4 | Z 13 DT | 52/70 | 08/00→09/06 | GN053 | GSE142 [11] | 11V | | |
| 1.3 CDTI 16V | 4 | Z 13 DTJ | 55/74 | 09/05→09/06 | GN053 | GSE142 [11] | 11V | | |
| 1.4 16V | 4 | Z 14 XE | 66/89 | 09/00→10/06 | Z190 [282] Z74 | | 1.2 1.0 | UXT1 / UXT3 | ZS259 |



kW/BHP

**... VAUXHALL****... CORSA Mk II (C)**

| | | | | | | | | | |
|-----------------|---|----------|--------|-------------|-----------------------|------------------------|-----|-------------|-------|
| 1.4 16V LPG | 4 | Z 14 XE | 66/89 | 09/00→10/06 | Z206 | | 0.7 | UXT10 | |
| 1.4 Twinport | 4 | Z 14 XEP | 66/89 | 06/03→10/06 | Z203 | | 0.9 | | ZS338 |
| 1.7 CDTI 16V | 4 | Z 17 DTH | 74/99 | 08/00→09/06 | GN104 | GSE143 ^[10] | 11V | | |
| | | | | | →09/05 | | | | |
| 1.7 DI 16V | 4 | Y 17 DTL | 48/64 | 08/00→09/06 | GN104 | GSE143 ^[10] | 11V | | |
| 1.7 DTI 16V | 4 | Y 17 DT | 55/74 | 08/00→09/06 | GN104 | GSE143 ^[10] | 11V | | |
| 1.8 1.8 16V | 4 | Z 18 XE | 92/123 | 08/00→09/06 | Z190 ^[282] | | 1.2 | | ZS342 |
| | | | | | Z74 | | 1.0 | UXT1 / UXT3 | |
| 1.8 1.8 16V LPG | 4 | Z 18 XE | 92/123 | 08/00→09/06 | Z206 | | 0.7 | UXT10 | |

CORSA Mk III (D)

| | | | | | | | | | |
|---------------|---|------------------------------|---------|-------------|-----------------------|--------|------|-------|-------|
| 1.0 | 3 | Z 10 XEP | 44/59 | 11/06→ | Z203 | | 0.9 | | ZS359 |
| 1.0 LPG | 3 | Z 10 XEP | 44/59 | 11/06→ | Z206 ^[168] | | 0.7 | UXT10 | |
| 1.2 | 4 | Z 12 XEP | 59/79 | 11/06→ | Z203 | | 0.9 | | ZS338 |
| 1.2 LPG | 4 | Z 12 XEP | 59/79 | 11/06→ | Z206 ^[168] | | 0.7 | UXT10 | |
| 1.2 i 16V | 4 | A 12 XER | 63/84 | 11/06→ | Z203 | | 0.9 | | |
| 1.2 i 16V LPG | 4 | A 12 XER | 63/84 | 11/06→ | Z206 ^[168] | | 0.7 | UXT10 | |
| 1.3 CDTI | 4 | A 13 DTC | 55/74 | 11/06→ | GE112 | | 4.4V | | |
| | | | | | PSG003 | | 4.4V | | |
| 1.3 CDTI | 4 | Z 13 DTJ | 55/74 | 11/06→ | GN053 | GSE144 | 11V | | |
| 1.3 CDTI | 4 | Z 13 DTH | 66/89 | 11/06→ | GN053 | GSE144 | 11V | | |
| 1.3 CDTI | 4 | A 13 DTE, A 13 DTR, Z 13 DTE | 70/94 | 11/06→ | GE112 | | 4.4V | | |
| 1.4 | 4 | Z 14 XEP | 66/89 | 07/06→ | Z203 | | 0.9 | | ZS338 |
| 1.4 | 4 | A 14 XER | 74/99 | 07/10→ | Z203 | | 0.9 | | |
| 1.4 LPG | 4 | Z 14 XEP | 66/89 | 07/06→ | Z206 ^[168] | | 0.7 | UXT10 | |
| 1.6 SRi | 4 | A 16 LEL, Z 16 LEL | 110/148 | 05/07→ | Z346 | | 0.8 | | ZS427 |
| 1.6 SRi LPG | 4 | A 16 LEL, Z 16 LEL | 110/148 | 05/07→ | Z116 | | 0.8 | UXT5 | |
| 1.6 VXR | 4 | A 16 LER, Z 16 LER | 141/189 | 02/07→ | Z346 | | 0.8 | | ZS427 |
| 1.6 VXR | 4 | A 16 LES | 150/201 | 06/11→03/12 | Z346 | | 0.8 | | |
| 1.6 VXR LPG | 4 | A 16 LER, Z 16 LER | 141/189 | 02/07→ | Z116 | | 0.8 | UXT5 | |
| 1.6 VXR LPG | 4 | A 16 LES | 150/201 | 06/11→03/12 | Z116 | | 0.8 | UXT5 | |
| 1.7 CDTI | 4 | Z 17 DTR | 92/123 | 11/06→ | GN104 | | 11V | | |
| 1.7 CDTI | 4 | A 17 DTS | 96/129 | 11/06→ | GE117 | | 4.4V | | |

CRESTA

| | | | | | | | | | |
|-----|---|--|--------|-------------|-----|--|-----|--|--|
| 2.7 | 6 | | 84/113 | 01/64→10/72 | Z58 | | 0.8 | | |
| 3.3 | 6 | | 91/122 | 01/64→10/72 | Z58 | | 0.8 | | |

FIRENZA

| | | | | | | | | | |
|----------|---|--|--------|-------------|-----|--|-----|-------------|--|
| 1.3 1300 | 4 | | 40/54 | 01/71→10/73 | Z11 | | 0.8 | UXT2 / UXT6 | |
| 1.8 1800 | 4 | | 57/76 | 01/72→10/73 | Z49 | | 0.8 | | |
| 2.3 2300 | 4 | | 81/109 | 01/72→10/74 | Z49 | | 0.8 | | |
| 2.3 2300 | 4 | | 97/130 | 10/74→10/75 | Z49 | | 0.8 | | |

FRONTERA Mk I (A)

| | | | | | | | | | |
|---------------|---|------------------|---------|-------------|----------------------------|--------|-----|----------------------------|----------------------|
| 2.0 4WD | 4 | C 20 NE | 85/114 | 04/95→08/98 | | | | | ZS127 ^[1] |
| | | | | | | | | | →eng. SV720102 |
| 2.0 4WD | 4 | X 20 SE | 85/114 | 04/95→08/98 | | | | | ZS300 ^[1] |
| | | | | | | | | | eng. SV720103→ |
| 2.0 i 4WD | 4 | C 20 NE | 85/114 | 03/92→10/98 | Z119 ^[284] | | 0.8 | UXT2/UXT6 ^[284] | |
| | | | | | Z190 ^{[282][283]} | | 1.2 | | |
| | | | | | Z74 ^[283] | | 1.0 | UXT1/UXT3 ^[283] | |
| 2.0 i 4WD | 4 | X 20 SE | 85/114 | 03/92→10/98 | Z119 ^[284] | | 0.8 | UXT2/UXT6 ^[284] | ZS300 |
| | | | | | Z190 ^{[282][283]} | | 1.2 | | ch. SV 720103 → |
| | | | | | Z74 ^[283] | | 1.0 | UXT1/UXT3 ^[283] | |
| 2.0 i 4WD LPG | 4 | C 20 NE, X 20 SE | 85/114 | 03/92→10/98 | Z20 ^[168] | | 0.8 | UXT2 / UXT6 | |
| | | | | | Z206 | | 0.7 | UXT10 | |
| 2.2 i 4WD | 4 | X 22 XE | 100/134 | 03/95→10/98 | Z190 ^[282] | | 1.2 | | ZS300 |
| | | | | | Z74 | | 1.0 | UXT1 / UXT3 | ch. SV 720103 → |
| 2.2 i 4WD LPG | 4 | X 22 XE | 100/134 | 03/95→10/98 | Z206 | | 0.7 | UXT10 | |
| 2.3 TD 4WD | 4 | 23 DTR | 74/99 | 09/91→06/98 | GN909 ^{[2][222]} | GR064 | 11V | | |
| | | | | | GV636 | →01/95 | 11V | | |



kW/BHP

**... VAUXHALL****... FRONTERA Mk I (A)**

| | | | | | | | | |
|-------------|---|----------------|--------|-------------|-----------|--|-----|------------------------|
| 2.4 i 4WD | 4 | C 24 NE | 92/123 | 03/92→10/98 | Z19 [168] | | 0.8 | ZS127 ch. S1720102→ |
| 2.5 TDS 4WD | 4 | 25TDS (VM41B) | 85/114 | 11/91→10/98 | GN007 | | 11V | |
| 2.8 TD 4WD | 4 | 28 TDI (4JB1T) | 83/111 | 03/95→10/98 | GN061 | | 11V | |

FRONTERA Mk II (B)

| | | | | | | | | |
|---------------|---|--------------------|---------|-------------|------------------------------------|--|------------|-------------|
| 2.2 DTI 4WD | 4 | X 22 DTH, Y 22 DTH | 85/114 | 10/98→09/04 | GN992 →08/00 GN033 09/00→ | | 11V | |
| 2.2 i 4WD | 4 | X 22 SE | 100/134 | 10/98→10/04 | Z190 [282] Z74 | | 1.2 1.0 | UXT1 / UXT3 |
| 2.2 i 4WD | 4 | Y 22 SE | 100/134 | 10/98→10/04 | Z343 | | 1.1 | UXT11 |
| 2.2 i 4WD LPG | 4 | X 22 SE, Y 22 SE | 100/134 | 10/98→10/04 | Z206 | | 0.7 | UXT10 |
| 3.2 i 4WD | 6 | 6 VDI, Y 32 NE | 151/202 | 10/98→10/04 | Z343 | | 1.1 | UXT11 |
| 3.2 i 4WD LPG | 6 | 6 VDI, Y 32 NE | 151/202 | 10/98→10/04 | Z206 | | 0.7 | UXT10 |

INSIGNIA

| | | | | | | | | |
|------------------|---|----------|---------|-------------|-----------------|--|--------------|-------|
| 1.6 | 4 | A 16 XER | 85/114 | 07/08→ | Z203 | | 0.9 | |
| 1.6 LPG | 4 | A 16 XER | 85/114 | 07/08→ | Z206 [168] | | 0.7 | UXT10 |
| 1.6 Turbo | 4 | A 16 LET | 132/177 | 01/09→ | Z346 | | 0.8 | |
| 1.6 Turbo LPG | 4 | A 16 LET | 132/177 | 01/09→ | Z116 | | 0.8 | UXT5 |
| 1.8 | 4 | A 18 XER | 103/138 | 07/08→09/13 | Z203 | | 0.9 | |
| 1.8 LPG | 4 | A 18 XER | 103/138 | 07/08→09/13 | Z206 [168] | | 0.7 | UXT10 |
| 2.0 Biturbo CDTI | 4 | A 20 DTR | 143/192 | 03/12→ | PSG001 | | 4.4V | |
| 2.0 CDTI | 4 | A 20 DTC | 81/109 | 07/08→ | GE114 PSG001 | | 4.4V 4.4V | |
| 2.0 CDTI | 4 | A 20 DTJ | 96/129 | 07/08→ | GE114 PSG001 | | 4.4V 4.4V | |
| 2.0 CDTI | 4 | A 20 DTH | 118/158 | 07/08→ | GE114 PSG001 | | 4.4V 4.4V | |
| 2.0 CDTI | 4 | A 20 DTH | 120/161 | 07/13→ | GE114 | | 4.4V | |
| 2.0 CDTI | 4 | A 20 DTR | 140/188 | 10/08→ | PSG001 | | 4.4V | |

MAGNUM

| | | | | | | | | |
|----------|---|--|--------|-------------|-----|--|-----|--|
| 1.8 | 4 | | 65/87 | 01/73→01/81 | Z49 | | 0.8 | |
| 1.8 1800 | 4 | | 57/76 | 01/73→10/77 | Z49 | | 0.8 | |
| 2.3 | 4 | | 81/109 | 01/73→01/81 | Z49 | | 0.8 | |
| 2.3 2300 | 4 | | 81/109 | 01/73→10/75 | Z49 | | 0.8 | |

MERIVA Mk I (A)

| | | | | | | | | |
|------------------------|---|----------|---------|-------------|------------|-------------|-----|-------------------|
| 1.3 CDTI | 4 | Z 13 DTJ | 55/74 | 01/03→10/09 | GN053 | GSE142 [11] | 11V | |
| 1.4 16V Twinport | 4 | Z 14 XEP | 66/89 | 01/03→10/09 | Z203 | | 0.9 | ZS338 |
| 1.4 16V Twinport LPG | 4 | Z 14 XEP | 66/89 | 01/03→10/09 | Z206 [168] | | 0.7 | UXT10 |
| 1.6 i 16V | 4 | Z 16 XE | 74/99 | 01/03→09/05 | Z74 | | 1.0 | UXT1 / UXT3 ZS259 |
| 1.6 i 16V LPG | 4 | Z 16 XE | 74/99 | 01/03→09/05 | Z206 | | 0.7 | UXT10 |
| 1.6 i 16V Twinport | 4 | Z 16 XEP | 77/103 | 05/03→06/10 | Z203 | | 0.9 | ZS427 12/05→ |
| 1.6 i 16V Twinport LPG | 4 | Z 16 XEP | 77/103 | 05/03→06/10 | Z206 [168] | | 0.7 | UXT10 |
| 1.6 Turbo | 4 | Z 16 LET | 132/177 | 05/06→06/10 | | | | ZS427 |
| 1.7 CDTI 16V | 4 | Z 17 DTH | 74/99 | 09/03→08/05 | GN104 | GSE143 [10] | 11V | |
| 1.7 DTI 16V | 4 | Y 17 DT | 55/74 | 06/03→06/10 | GN104 | GSE143 [10] | 11V | |
| 1.8 i 16V | 4 | Z 18 XE | 92/123 | 05/03→08/05 | Z203 | | 0.9 | ZS342 |
| 1.8 i 16V LPG | 4 | Z 18 XE | 92/123 | 05/03→08/05 | Z206 [168] | | 0.7 | UXT10 |

MERIVA Mk II (B)

| | | | | | | | | |
|----------|---|----------|---------|--------|-----------------|--------|--------------|--|
| 1.3 CDTI | 4 | A 13 DTC | 55/74 | 06/10→ | GE112 PSG003 | | 4.4V 4.4V | |
| 1.3 CDTi | 4 | A 13 DTE | 70/94 | 06/10→ | GE112 | | 4.4V | |
| 1.6 CDTi | 4 | B 16 DTH | 100/134 | 11/13→ | GE126 | | 4.4V | |
| 1.7 CDTI | 4 | A 17 DT | 74/99 | 06/10→ | GN104 | GSE145 | 11V | |
| 1.7 CDTi | 4 | A 17 DTC | 81/109 | 06/10→ | GE117 | | 4.4V | |
| 1.7 CDTi | 4 | A 17 DTS | 96/129 | 06/10→ | GE117 | | 4.4V | |

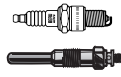

kW/BHP

**... VAUXHALL****MOKKA**

| | | | | | | | | |
|----------|---|----------|--------|--------|--------|------|--|--|
| 1.7 CDTI | 4 | A 17 DTS | 96/129 | 06/12→ | PSG004 | 4.4V | | |
|----------|---|----------|--------|--------|--------|------|--|--|

MONTEREY

| | | | | | | | | |
|-------------|---|---------|---------|-------------|-----------|-----|-------|-------|
| 3.1 TD 4WD | 4 | 4 JG2TC | 84/113 | 09/91→07/98 | GV947 | 11V | | |
| 3.2 4WD | 6 | 6 VDI | 130/174 | 06/92→07/98 | Z16 [171] | 1.1 | UXT11 | ZS355 |
| 3.2 4WD LPG | 6 | 6 VDI | 130/174 | 06/92→07/98 | Z340 | 0.7 | UXT12 | |

MONTEREY Mk II

| | | | | | | | | |
|--------------------|---|-------|---------|-------------|-------|-----|-------|--|
| 3.0 DTI 4WD | 4 | 4 JX1 | 117/157 | 07/98→08/99 | GN997 | 11V | | |
| 3.5 V6 24V 4WD | 6 | 6 VE1 | 158/212 | 07/98→08/99 | Z343 | 1.1 | UXT11 | |
| 3.5 V6 24V 4WD LPG | 6 | 6 VE1 | 158/212 | 07/98→08/99 | Z206 | 0.7 | UXT10 | |

NOVA

| | | | | | | | | | |
|------------------|---|------------------|---------|-------------|--|-------------------|------------------------------------|------------------|--|
| 1.0 | 4 | 10 S | 33/44 | 09/82→03/93 | Z19 [168] | 0.8 | | | |
| 1.2 i | 4 | 12 NC | 33/44 | 01/85→10/89 | Z20 | 0.8 | UXT2 / UXT6 | ZS252 [1] | |
| 1.2 i | 4 | C 12 NZ, E 12 GV | 33/44 | 01/85→03/93 | Z20 | 0.8 | UXT2 / UXT6 | | |
| 1.2 N | 4 | 12 NC | 33/44 | 01/85→10/87 | Z19 [168] | 0.8 | | ZS252 | |
| 1.2 N | 4 | E 12 GV | 33/44 | 01/85→10/87 | Z19 [168] | 0.8 | | | |
| 1.2 N | 4 | 12 NV | 38/51 | 01/90→03/93 | Z20 | 0.8 | UXT2 / UXT6 | ZS252 [1] | |
| 1.2 S | 4 | 12 ST | 40/54 | 09/82→02/90 | Z19 [168] | 0.8 | | ZS252 [1] | |
| 1.2 S | 4 | 12 S, 12 ST | 43/58 | 01/88→02/90 | | | | ZS252 | |
| 1.3 i | 4 | 13 NB, C 13 N | 44/59 | 09/85→03/93 | Z20 | 0.8 | UXT2 / UXT6 | ZS252 | |
| 1.3 S | 4 | 13 SB | 51/68 | 09/82→10/89 | Z20 | 0.8 | UXT2 / UXT6 | ZS252 | |
| 1.4 i | 4 | C 14 NZ | 44/59 | 01/90→03/93 | Z119 [284] Z190 [282][283] Z74 [283] | 0.8 1.2 1.0 | UXT2/UXT6 [284] UXT1/UXT3 [283] | | |
| 1.4 i S | 4 | C 14 SE | 60/80 | 09/91→03/93 | Z119 [284] Z190 [282][283] Z74 [283] | 0.8 1.2 1.0 | UXT2/UXT6 [284] UXT1/UXT3 [283] | ZS253 | |
| 1.4 S | 4 | 14 NV | 55/74 | 01/90→03/93 | Z119 [284] Z190 [282][283] Z74 [283] | 0.8 1.2 1.0 | UXT2/UXT6 [284] UXT1/UXT3 [283] | | |
| 1.5 D | 4 | 15 D | 37/50 | 09/87→03/93 | GV749 →eng. 804794 GV946 eng. 804795→ | 5V 11V | | | |
| 1.5 TD | 4 | 15 DT (T4EC1) | 49/66 | 01/90→03/93 | GV945 →eng. 804794 GV947 eng. 804795→ | 5V 11V | | | |
| 1.6 GSI | 4 | C 16 SEI | 72/97 | 09/89→03/93 | Z119 [284] Z190 [282][283] Z74 [283] | 0.8 1.2 1.0 | UXT2/UXT6 [284] UXT1/UXT3 [283] | | |
| 1.6 GSI | 4 | C 16 SE | 74/99 | 02/92→03/93 | Z119 [284] Z190 [282][283] Z74 [283] | 0.8 1.2 1.0 | UXT2/UXT6 [284] UXT1/UXT3 [283] | ZSE026 [1] | |
| 1.6 GSI | 4 | E 16 SE | 74/99 | 05/88→03/92 | Z20 | 0.8 | UXT2 / UXT6 | | |
| OMEGA (B) | | | | | | | | | |
| 2.0 | 4 | 20 SE, X 20 SE | 85/114 | 03/94→09/99 | Z190 [282] Z74 | 1.2 1.0 | UXT1 / UXT3 | ZS300 | |
| 2.0 LPG | 4 | 20 SE, X 20 SE | 85/114 | 03/94→09/99 | Z206 | 0.7 | UXT10 | | |
| 2.0 16V | 4 | X 20 XEV | 100/134 | 03/94→02/01 | Z190 [282] Z74 | 1.2 1.0 | UXT1 / UXT3 | ZS344 | |
| 2.0 16V LPG | 4 | X 20 XEV | 100/134 | 03/94→02/01 | Z206 | 0.7 | UXT10 | | |
| 2.0 DTI 16V | 4 | X 20 DTH | 74/99 | 01/98→09/00 | GN992 | 11V | | | |
| 2.2 16V | 4 | Y 22 XE, Z 22 XE | 106/142 | 01/94→06/03 | Z190 [282] Z74 | 1.2 1.0 | UXT1 / UXT3 | ZSE150 09/99→ | |
| 2.2 16V LPG | 4 | Y 22 XE, Z 22 XE | 106/142 | 01/94→06/03 | Z206 | 0.7 | UXT10 | | |
| 2.2 DTI 16V | 4 | Y 22 DTH | 88/118 | 08/00→07/03 | GN033 | 11V | | | |
| 2.5 DTI 24V | 6 | Y 25 DT | 110/148 | 09/01→07/03 | GN024 | 11V | | | |

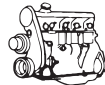

kW/BHP

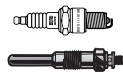
**... VAUXHALL****... OMEGA (B)**

| | | | | | | | | |
|------------|---|----------------|---------|-------------|---------------------------------------|------------|--------------------|--|
| 2.5 TD | 6 | 25 DT, X 25 DT | 96/129 | 04/94→07/01 | GN013 [2][222] GV719 | 11V 11V | | |
| 2.5 V6 | 6 | X 25 XE | 125/168 | 03/94→09/00 | Z190 [282] Z74 | 1.2 1.0 | UXT1 / UXT3 | ZS301 [1] ZS306 [1] |
| 2.5 V6 LPG | 6 | X 25 XE | 125/168 | 03/94→09/00 | Z206 | 0.7 | UXT10 | |
| 2.6 V6 | 6 | Y 26 SE | 132/177 | 08/00→07/03 | Z173 | 1.6 | | ZSE152 [23] ZSE153 [27] |
| 2.6 V6 LPG | 6 | Y 26 SE | 132/177 | 08/00→07/03 | Z172 | 1.6 | | |
| 3.0 V6 | 6 | X 30 XE | 155/208 | 04/94→07/00 | Z190 [282] Z74 | 1.2 1.0 | UXT1 / UXT3 | ZS301 [1] ZS306 [1] |
| 3.0 V6 LPG | 6 | X 30 XE | 155/208 | 04/94→07/00 | Z206 | 0.7 | UXT10 | |
| 3.2 V6 | 6 | Y 32 SE | 160/215 | 02/01→07/03 | Z173 | 1.6 | | ZSE152 [23] ZSE153 [27] |
| 3.2 V6 LPG | 6 | Y 32 SE | 160/215 | 02/01→07/03 | Z172 | 1.6 | | |

ROYALE

| | | | | | | | | |
|--------|---|---------|---------|-------------|---------------------------------------|------------|--------------|--|
| 2.0 E | 4 | H 20 E | 85/114 | 03/83→10/84 | Z19 [168] | 0.8 | | |
| 2.2 E | 4 | 22 E | 85/114 | 11/84→08/87 | Z19 [168] | 0.8 | | |
| 2.2 TD | 4 | 23 TD | 63/84 | 11/84→08/87 | GN013 [2][222] GN954 | 11V 11V | GR064 | |
| 2.5 | 6 | 25 S | 85/114 | 05/78→12/80 | Z19 [168] | 0.8 | | |
| 2.5 E | 6 | H 25 E | 100/134 | 01/83→08/84 | Z19 [168] | 0.8 | | |
| 2.5 E | 6 | 25 E | 103/138 | 09/84→08/87 | Z19 [168] | 0.8 | | |
| 2.8 | 6 | 28 H | 103/138 | 02/78→10/82 | Z19 [168] | 0.8 | | |
| 2.9 | 6 | 30 H | 110/148 | 04/78→07/82 | Z19 [168] | 0.8 | | |
| 2.9 | 6 | C 30 LE | 115/154 | 09/85→08/87 | Z19 [168] | 0.8 | | |
| 2.9 | 6 | 30 E | 132/177 | 02/78→08/86 | Z19 [168] | 0.8 | | |
| 2.9 E | 6 | 30 E | 132/177 | 02/78→12/86 | Z19 [168] | 0.8 | | |
| 3.0 | 6 | 30 E | 132/177 | 10/79→10/82 | Z19 [168] | 0.8 | | |

SENATOR

| | | | | | | | | |
|-------|---|------|---------|-------------|------------------|-----|--|--|
| 2.5 i | 6 | 25 E | 103/138 | 09/84→08/87 | Z19 [168] | 0.8 | | |
| 3.0 i | 6 | 30 E | 132/177 | 09/84→12/86 | Z19 [168] | 0.8 | | |

SENATOR Mk II (B)

| | | | | | | | | |
|---------|---|---------|---------|-------------|------------------|-----|--------------------|---|
| 2.5 i | 6 | 25 E | 103/138 | 09/87→10/90 | Z19 [168] | 0.8 | | ZS125 [1][214][254] ZS127 [1][214][254] |
| 2.6 i | 6 | C 26 NE | 110/148 | 09/90→09/93 | Z19 [168] | 0.8 | | ZS127 |
| 3.0 | 6 | C 30 LE | 115/154 | 09/87→09/93 | Z19 [168] | 0.8 | | ZS125 [1] ch. K1000099→ →ch. K1999999 ZS127 [1] ch. L1000001→ |
| 3.0 | 6 | 30 NE | 130/174 | 01/88→09/90 | Z19 [168] | 0.8 | | ZS125 [1][214][254] ZS127 [1][214][254] |
| 3.0 24V | 6 | C 30 SE | 150/201 | 09/89→09/93 | Z98 | 0.8 | UXT1 / UXT3 | ZS127 ch. L 1000001→ |
| 3.0 i | 6 | C 30 NE | 130/174 | 01/88→09/93 | Z19 [168] | 0.8 | | ZS125 [1] ch. K1000099→ →ch. K1999999 ZS127 [1] ch. L1000001→ |

SIGNUM

| | | | | | | | | |
|---------|---|----------|---------|-------------|-------------------|-----|--------------|------------------------|
| 1.8 | 4 | Z 18 XE | 90/121 | 06/03→07/05 | Z190 | 1.2 | | ZS342 |
| 1.8 | 4 | Z 18 XER | 103/138 | 08/05→05/08 | Z203 | 0.9 | | ZS427 12/05→ |
| 1.8 LPG | 4 | Z 18 XE | 90/121 | 06/03→07/05 | Z206 | 0.7 | UXT10 | |
| 1.8 LPG | 4 | Z 18 XER | 103/138 | 08/05→05/08 | Z206 [168] | 0.7 | UXT10 | |

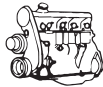

kw/BHP

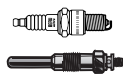

... VAUXHALL



... SIGNUM

| | | | | | | | | | |
|-----------------|---|----------|---------|-------------|--|--|-----|------------------------|---------------|
| 1.9 CDTI | 4 | Z 19 DT | 88/118 | 04/04→03/08 | GN041 →ch. 71021891 GN097 ch. 71021892→ | GSE143 ^[10] →ch. 61010105 GSE142 ^[11] ch. 61010106→ | 11V | | |
| 1.9 CDTI 16V | 4 | Z 19 DTH | 110/148 | 04/04→03/08 | GN059 | GSE143 ^[10] →ch. 61010105 GSE142 ^[11] ch. 61010106→ | 11V | | |
| 1.9 Turbo | 4 | Z 19 DTL | 74/99 | 01/05→05/08 | GN041 →ch. 71021891 GN097 ch. 71021892→ | GSE142 ^[11] ch. 61010106→ | 11V | | |
| 2.0 DTI | 4 | Y 20 DTH | 74/99 | 05/03→05/08 | GN033 →09/05 | GSE143 ^[10] | 11V | | |
| 2.0 i Turbo | 4 | Z 20 NET | 129/173 | 01/02→10/08 | Z284 | | 1.1 | UXT14 | |
| 2.0 i Turbo LPG | 4 | Z 20 NET | 129/173 | 01/02→10/08 | Z130 ^[168] | | 1.0 | UXT14 | |
| 2.2 DTI | 4 | Y 22 DTR | 92/123 | 05/03→05/08 | GN033 | GSE143 ^[10] | 11V | | |
| 2.2 i | 4 | Z 22 YH | 114/153 | 05/03→05/08 | | | | | ZSE149 |
| 2.8 V6 Turbo | 6 | Z 28 NEL | 169/227 | 04/02→05/08 | | | | | ZSE174 |
| 2.8 V6 Turbo | 6 | Z 28 NET | 184/247 | 05/07→10/08 | | | | | ZSE174 |
| 3.0 CDTi | 6 | Y 30 DT | 130/174 | 05/03→05/08 | GN106 | | 11V | | |
| 3.0 V6 CDTI | 6 | Z 30 DT | 135/181 | 04/02→05/08 | GN106 | | 11V | | |
| 3.2 V6 | 6 | Z 32 SE | 155/208 | 05/03→05/08 | Z190 →09/05 | | 1.2 | | ZSE152 |
| 3.2 V6 LPG | 6 | Z 32 SE | 155/208 | 05/03→05/08 | Z206 →09/05 | | 0.7 | UXT10 →09/05 | |

SINTRA

| | | | | | | | | | |
|----------------|---|----------|---------|-------------|--|-------------------------------|-----|--------------------|--------------|
| 2.2 DTI | 4 | X 22 DTH | 85/114 | 07/97→04/99 | GN992 | GSE143 ^[10] | 11V | | |
| 2.2 i 16 V | 4 | X 22 XE | 104/139 | 11/96→04/99 | Z190 ^[282] Z74 | | 1.2 | | ZS450 |
| 2.2 i 16 V LPG | 4 | X 22 XE | 104/139 | 11/96→04/99 | Z206 | | 1.0 | UXT1 / UXT3 | |
| | | | | | | | 0.7 | UXT10 | |

TIGRA

| | | | | | | | | | |
|----------|---|----------|--------|-------------|------------------------------|-------------------------------|-----|--------------|--------------|
| 1.3 CDTI | 4 | Z 13 DT | 51/68 | 06/04→08/09 | GN053 | GSE142 ^[11] | 11V | | |
| 1.4 | 4 | Z 14 XEP | 66/89 | 06/04→08/09 | Z203 | | 0.9 | | ZS338 |
| 1.4 LPG | 4 | Z 14 XEP | 66/89 | 06/04→08/09 | Z206 ^[168] | | 0.7 | UXT10 | |
| 1.8 | 4 | Z 18 XE | 92/123 | 06/04→08/09 | Z203 | | 0.9 | | ZS342 |
| 1.8 LPG | 4 | Z 18 XE | 92/123 | 06/04→08/09 | Z206 ^[168] | | 0.7 | UXT10 | |

TIGRA Mk I

| | | | | | | | | | |
|-------------|---|---------|--------|-------------|---|--|-----|--------------------|---------------|
| 1.4 16V | 4 | X 14 XE | 66/89 | 07/94→12/00 | Z190 ^[282] Z204 →ch. 19K87117 Z74 ch. 19K87118→ | | 1.2 | | ZSE026 |
| | | | | | | | 1.2 | | |
| 1.4 16V LPG | 4 | X 14 XE | 66/89 | 07/94→12/00 | Z206 | | 0.7 | UXT10 | |
| 1.6 16V | 4 | X 16 XE | 78/105 | 07/94→12/00 | Z190 ^[282] Z74 | | 1.2 | | ZSE026 |
| | | | | | | | 1.0 | UXT1 / UXT3 | |
| 1.6 16V LPG | 4 | X 16 XE | 78/105 | 07/94→12/00 | Z206 | | 0.7 | UXT10 | |

VECTRA (B)

| | | | | | | | | | |
|---------------|---|----------------------------|--------|-------------|--|--|-----|--------------------|---|
| 1.6 i | 4 | X 16 SZR | 55/74 | 08/95→10/01 | Z74 | | 1.0 | UXT1 / UXT3 | ZS253 ^[254] ZSE026 ^[151] |
| 1.6 i LPG | 4 | X 16 SZR | 55/74 | 08/95→10/01 | Z206 | | 0.7 | UXT10 | |
| 1.6 i 16V | 4 | X 16 XEL, Y 16 XE, Z 16 XE | 74/99 | 08/95→10/01 | Z190 ^[282] Z74 | | 1.2 | | ZS259 |
| | | | | | | | 1.0 | UXT1 / UXT3 | |
| 1.6 i 16V LPG | 4 | X 16 XEL, Y 16 XE, Z 16 XE | 74/99 | 08/95→10/01 | Z206 | | 0.7 | UXT10 | |
| 1.7 TD | 4 | X 17 DT (TC4EE1) | 60/80 | 10/95→11/96 | GN103 | | 11V | | |
| 1.8 i 16V | 4 | X 18 XE, X 18 XE1 | 85/114 | 10/95→09/00 | Z74 | | 1.0 | UXT1 / UXT3 | ZS342 ^[150] ZS344 |

VAUXHALL



kW/BHP



... VAUXHALL



... VECTRA (B)

| | | | | | | | | | |
|-------------------------|---|-------------------|---------|-------------|---|------------|-----------------|--|--|
| 1.8 i 16V | 4 | Z 18 XE | 92/123 | 09/00→03/02 | Z190 ^[282] Z74 | 1.2 1.0 | UXT1 / UXT3 | | |
| 1.8 i 16V | 4 | Z 18 XE | 92/123 | 09/00→07/03 | | | | ZS342 | |
| 1.8 i 16V LPG | 4 | X 18 XE, X 18 XE1 | 85/114 | 10/95→09/00 | Z206 | 0.7 | UXT10 | | |
| 1.8 i 16V LPG | 4 | Z 18 XE | 92/123 | 09/00→03/02 | Z206 | 0.7 | UXT10 | | |
| 2.0 DI 16V | 4 | X 20 DTL | 60/80 | 08/95→10/01 | GN944 →07/99 GN992 08/99→ | 11V 11V | | | |
| 2.0 DTI 16V | 4 | Y 20 DTH | 74/99 | 08/95→10/01 | GN033 | 11V | | | |
| 2.0 i 16V | 4 | X 20 XEV | 100/134 | 10/95→01/01 | Z74 | 1.0 | UXT1 / UXT3 | ZS344 | |
| 2.0 i 16V LPG | 4 | X 20 XEV | 100/134 | 10/95→01/01 | Z206 | 0.7 | UXT10 | | |
| 2.2 DTI 16V | 4 | Y 22 DTR | 92/123 | 08/95→10/01 | GN033 | 11V | | | |
| 2.2 i 16V | 4 | Z 22 SE | 108/145 | 08/95→07/03 | Z222 →08/01 | 1.1 | | | |
| 2.5 i GSi | 6 | X 25 XE | 143/192 | 03/98→07/00 | | | | ZS451 | |
| 2.5 i V6 | 6 | X 25 XE | 125/168 | 09/95→08/00 | Z74 | 1.0 | UXT1 / UXT3 | ZS451 | |
| 2.5 i V6 LPG | 6 | X 25 XE | 125/168 | 09/95→08/00 | Z206 | 0.7 | UXT10 | | |
| 2.6 i V6 | 6 | Y 26 SE | 125/168 | 09/00→07/03 | Z173 | 1.6 | | ZSE152 ^[23] ZSE153 ^[27] | |
| 2.6 i V6 LPG | 6 | Y 26 SE | 125/168 | 09/00→07/03 | Z172 | 1.6 | | | |
| VECTRA Mk II (C) | | | | | | | | | |
| 1.8 | 4 | Z 18 XER | 103/138 | 01/06→07/08 | Z203 | 0.9 | | ZS427 | |
| 1.8 LPG | 4 | Z 18 XER | 103/138 | 01/06→07/08 | Z206 ^[168] | 0.7 | UXT10 | | |
| 1.8 16V | 4 | Z 18 XE | 90/121 | 04/02→07/08 | Z190 →08/05 | 1.2 | | ZS342 | |
| 1.8 16V | 4 | Z 18 XE | 90/121 | 08/02→07/08 | Z203 →08/05 | 0.9 | | | |
| 1.8 16V | 4 | Z 18 XE | 90/121 | 10/03→08/05 | Z203 | 0.9 | | | |
| 1.8 16V LPG | 4 | Z 18 XE | 90/121 | 04/02→07/08 | Z206 →08/05 | 0.7 | UXT10 →08/05 | | |
| 1.8 16V LPG | 4 | Z 18 XE | 90/121 | 08/02→07/08 | Z206 ^[168] →08/05 | 0.7 | UXT10 →08/05 | | |
| 1.8 16V LPG | 4 | Z 18 XE | 90/121 | 10/03→08/05 | Z206 ^[168] | 0.7 | UXT10 | | |
| 1.8 16V Dualfuel | 4 | Z 18 XE | 90/121 | 08/02→07/08 | Z203 →08/05 | 0.9 | | ZS342 | |
| 1.8 16V Dualfuel LPG | 4 | Z 18 XE | 90/121 | 04/02→07/08 | Z190 ^[282] →08/05 Z206 →08/05 | 1.2 0.7 | | ZS342 UXT10 →08/05 | |
| 1.8 16V Dualfuel LPG | 4 | Z 18 XE | 90/121 | 08/02→07/08 | Z206 ^[168] →08/05 | 0.7 | UXT10 →08/05 | | |
| 1.9 CDTI | 4 | Z 19 DT | 88/118 | 04/02→09/08 | GN041 →ch. 71021891 GN097 ch. 71021892→ | 11V 11V | | | |
| | | | | | | | | GSE143 ^[10] →ch. 48999999;61010105 GSE142 ^[11] ch. 61010106;68→ | |
| 1.9 CDTI 16V | 4 | Z 19 DTH | 110/148 | 04/04→08/08 | GN059 | 11V | | | |
| | | | | | | | | GSE143 ^[10] →ch. 48999999;61010105 GSE142 ^[11] ch. 61010106;68→ | |
| 2.0 16V Turbo | 4 | Z 20 NET | 129/173 | 01/00→10/08 | Z284 | 1.1 | UXT14 | | |
| 2.0 16V Turbo LPG | 4 | Z 20 NET | 129/173 | 01/00→10/08 | Z130 ^[168] | 1.0 | UXT14 | | |
| 2.0 DTI 16V | 4 | Y 20 DTH | 74/99 | 04/02→10/08 | GN033 | 11V | | | |
| 2.2 16V | 4 | Z 22 SE | 108/145 | 01/02→10/08 | Z222 →09/05 | 1.1 | | | |
| 2.2 direct | 4 | Z 22 YH | 114/153 | 01/02→10/08 | | | | ZSE149 | |
| 2.2 DTI 16V | 4 | Y 22 DTR | 92/123 | 04/02→10/08 | GN033 | 11V | | | |
| | | | | | | | | GSE143 ^[10] | |
| 2.8 V6 Turbo | 6 | Z 28 NEL | 169/227 | 08/05→07/08 | Z235 | 1.0 | | ZSE174 | |
| 2.8 V6 Turbo | 6 | Z 28 NET | 184/247 | 08/06→07/08 | Z235 | 1.0 | | ZSE174 | |

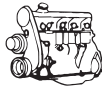

kW/BHP

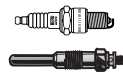
**... VAUXHALL****... VECTRA Mk II (C)**

| | | | | | | | |
|--------------|---|----------|---------|-------------|----------------|-----|-----------------|
| 2.8 V6 Turbo | 6 | Z 28 NET | 188/252 | 08/05→07/08 | Z235 | 1.0 | ZSE174 |
| 2.8 V6 Turbo | 6 | Z 28 NET | 206/276 | 08/06→ | | | ZSE174 |
| 2.8 V6 Turbo | 6 | Z 28 NET | 206/276 | 10/06→07/08 | Z235 | 1.0 | |
| 3.0 CDTi | 6 | Z 30 DT | 135/181 | 08/05→07/08 | GN106 | 11V | |
| 3.0 V6 CDTI | 6 | Y 30 DT | 130/174 | 06/03→08/05 | GN106 | 11V | |
| 3.2 V6 | 6 | Z 32 SE | 155/208 | 08/02→07/08 | Z190 →09/05 | 1.2 | ZSE152 |
| 3.2 V6 | 6 | Z 32 SE | 155/208 | 10/03→08/05 | Z190 | 1.2 | |
| 3.2 V6 LPG | 6 | Z 32 SE | 155/208 | 08/02→07/08 | Z206 →09/05 | 0.7 | UXT10 →09/05 |
| 3.2 V6 LPG | 6 | Z 32 SE | 155/208 | 10/03→08/05 | Z206 | 0.7 | UXT10 |

VENTORA

| | | | | | | | |
|----------|---|--|--------|-------------|-----|-----|-------------|
| 3.3 3300 | 6 | | 91/122 | 03/69→10/76 | Z20 | 0.8 | UXT2 / UXT6 |
|----------|---|--|--------|-------------|-----|-----|-------------|

VICTOR

| | | | | | | | |
|----------|---|--|-------|-------------|-----|-----|--|
| 1.6 1600 | 4 | | 53/71 | 03/69→09/72 | Z49 | 0.8 | |
| 1.8 1800 | 4 | | 57/76 | 10/72→10/76 | Z49 | 0.8 | |
| 2.0 2000 | 4 | | 65/87 | 01/67→09/72 | Z49 | 0.8 | |

VIVA

| | | | | | | | |
|------------|---|--|-------|-------------|-----|-----|-------------|
| 1.3 1256 | 4 | | 43/58 | 10/71→10/75 | Z20 | 0.8 | UXT2 / UXT6 |
| 1.3 1256 E | 4 | | 43/58 | 10/71→10/75 | Z20 | 0.8 | UXT2 / UXT6 |
| 1.6 1600 | 4 | | 51/68 | 10/70→10/72 | Z49 | 0.8 | |
| 1.6 1600 | 4 | | 53/71 | 01/68→09/70 | Z49 | 0.8 | |
| 1.8 1800 | 4 | | 57/76 | 01/73→10/79 | Z49 | 0.8 | |

VX220

| | | | | | | | |
|-------|---|---------|---------|-------------|------|-----|--|
| 2.2 i | 4 | Z 22 SE | 108/145 | 09/00→07/05 | Z222 | 1.1 | |
|-------|---|---------|---------|-------------|------|-----|--|

ZAFIRA Mk I (A)

| | | | | | | | |
|------------------|---|-------------------|---------|-------------|---|-------------------|-----------------------|
| 1.6 16V | 4 | X 16 XEL, Z 16 XE | 74/99 | 04/99→08/05 | Z190 Z203 eng. 41000001→ | 1.2 0.9 | ZS259 |
| 1.6 16V LPG | 4 | X 16 XEL, Z 16 XE | 74/99 | 04/99→08/05 | Z206 [168] | 0.7 | UXT10 |
| 1.6 CNG | 4 | Z 16 YNG | 71/95 | 09/01→06/05 | Z206 | 0.7 | UXT10 ZS259 |
| 1.6 Dualfuel LPG | 4 | X 16 XEL, Z 16 XE | 74/99 | 11/98→08/05 | | | ZS259 |
| 1.8 16V | 4 | X 18 XE1 | 85/114 | 05/99→08/00 | Z74 | 1.0 | UXT1 / UXT3 ZS342 |
| 1.8 16V | 4 | Z 18 XE | 92/123 | 09/00→08/05 | Z190 [282] Z74 | 1.2 1.0 | ZS342 UXT1 / UXT3 |
| 1.8 16V LPG | 4 | X 18 XE1 | 85/114 | 05/99→08/00 | Z206 | 0.7 | UXT10 |
| 1.8 16V LPG | 4 | Z 18 XE | 92/123 | 09/00→08/05 | Z206 | 0.7 | UXT10 |
| 2.0 | 4 | Z 20 LET | 147/197 | 06/02→06/05 | Z190 [282] →01/04 Z74 →01/04 Z287 02/04→ | 1.2 1.0 0.8 | UXT1 / UXT3 →01/04 |
| 2.0 LPG | 4 | Z 20 LET | 147/197 | 06/02→06/05 | Z206 →01/04 Z158 [168] 02/04→ | 0.7 1.1 | UXT10 →01/04 |
| 2.0 DI 16V | 4 | X 20 DTL | 60/80 | 10/99→08/05 | GN992 | 11V | |
| 2.0 DTI 16V | 4 | Y 20 DTH | 74/99 | 04/99→08/05 | GN992 | GSE142 [11] | 11V |
| 2.2 16V | 4 | Z 22 SE | 108/145 | 11/98→08/04 | Z222 | 1.1 | |
| 2.2 D | 4 | Y 22 DTR | 92/123 | 06/01→06/05 | GN033 | GSE142 [11] | 11V |

ZAFIRA Mk II (B)

| | | | | | | | |
|---------|---|--------------------|--------|--------|--------------------------------|-----|-----------------|
| 1.6 | 4 | Z 16 XE1, Z 16 XEP | 77/103 | 07/05→ | Z203 | 0.9 | ZS427 12/05→ |
| 1.6 | 4 | A 16 XER, Z 16 XER | 85/114 | 12/07→ | Z203 →ch. 92999999;96999999 | 0.9 | ZS427 |
| 1.6 LPG | 4 | Z 16 XE1, Z 16 XEP | 77/103 | 07/05→ | Z206 [168] | 0.7 | UXT10 |
| 1.6 LPG | 4 | A 16 XER, Z 16 XER | 85/114 | 12/07→ | Z206 [168] | 0.7 | UXT10 |

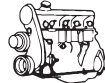

kW/BHP

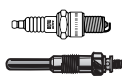
**... VAUXHALL****ZAFIRA Mk II (B)**

| | | | | | | | | | |
|----------|---|--------------------|---------|--------|--|------------------------------------|------------|-------|-----------------|
| 1.6 CNG | 4 | Z 16 YNG | 69/93 | 07/05→ | Z206 | | 0.7 | UXT10 | ZS259 |
| 1.7 CDTi | 4 | A 17 DTJ, Z 17 DTJ | 81/109 | 04/09→ | GN104 | GSE143 [10] | 11V | | |
| 1.7 CDTi | 4 | A 17 DTR | 92/123 | 01/08→ | GN104 | GSE143 [10] | 11V | | |
| 1.8 | 4 | A 18 XER, Z 18 XER | 103/138 | 04/05→ | Z203 | | 0.9 | | ZS427 12/05→ |
| 1.8 LPG | 4 | A 18 XER, Z 18 XER | 103/138 | 04/05→ | Z206 [168] | | 0.7 | UXT10 | |
| 1.9 CDTi | 4 | Z 19 DTL | 74/99 | 07/05→ | GN041 →ch. 62999999;66999999 GN097 ch. 72000001;76000001→ | GSE142 [11][32] GSE143 [10][32] | 11V 11V | | |
| 1.9 CDTi | 4 | Z 19 DT | 88/118 | 07/05→ | GN041 →ch. 62999999;66999999 GN097 ch. 72000001;76000001→ | GSE142 [11][32] GSE143 [10][32] | 11V 11V | | |
| 1.9 CDTi | 4 | Z 19 DTH | 110/148 | 07/05→ | GN059 | GSE142 [11][32] GSE143 [10][32] | 11V | | |
| 2.0 | 4 | Z 20 LER | 147/197 | 07/05→ | Z287 | | 0.8 | | |
| 2.0 | 4 | Z 20 LEH | 176/236 | 01/06→ | Z284 | | 1.1 | UXT14 | |
| 2.0 LPG | 4 | Z 20 LER | 147/197 | 07/05→ | Z158 [168] | | 1.1 | | |
| 2.0 LPG | 4 | Z 20 LEH | 176/236 | 01/06→ | Z130 [168] | | 1.0 | UXT14 | |
| 2.2 | 4 | Z 22 YH | 110/148 | 07/05→ | | | | | ZSE149 |

ZAFIRA Mk III

| | | | | | | | | | |
|------------------|---|--------------------|---------|--------|--|--|----------------------|-------|-------|
| 1.6 CDTi | 4 | B 16 DTH | 100/134 | 03/13→ | GE126 PSG005 | | 4.4V 4.4V | | |
| 1.6 CNG | 4 | A 16 XNT | 110/148 | 10/11→ | | | | | ZS427 |
| 1.8 | 4 | A 18 XER | 103/138 | 10/11→ | Z203 | | 0.9 | | |
| 1.8 LPG | 4 | A 18 XER | 103/138 | 10/11→ | Z206 [168] | | 0.7 | UXT10 | |
| 2.0 BiTurbo CDTi | 4 | A 20 DTR | 143/192 | 01/13→ | PSG006 | | 4.4V | | |
| 2.0 CDTi | 4 | A 20 DTL | 81/109 | 10/11→ | GE114 [253] PSG001 →ch. D2 PSG006 ch. D2;F1000001→ | | 4.4V 4.4V 4.4V | | |
| 2.0 CDTi | 4 | A 20 DT | 96/129 | 10/11→ | GE114 [253] PSG001 →ch. D2 PSG006 [253] ch. D2;F1000001→ | | 4.4V 4.4V 4.4V | | |
| 2.0 CDTi | 4 | Y 20 DTJ, Z 20 DTJ | 96/129 | 10/11→ | PSG001 →ch. D2 PSG006 ch. D2;F1000001→ | | 4.4V 4.4V | | |
| 2.0 CDTi | 4 | A 20 DTH | 118/158 | 10/11→ | PSG006 | | 4.4V | | |
| 2.0 CDTi | 4 | A 20 DTH | 121/162 | 10/11→ | PSG006 | | 4.4V | | |

VAUXHALL**ARENA**

| | | | | | | | | | |
|-------|---|---------------------------|-------|-------------|-------------------------|--|------------|--|--|
| 1.9 D | 4 | F8Q 600, F8Q 606 | 44/59 | 03/98→08/01 | GN963 | | 11V | | |
| 2.5 D | 4 | S8U 758, S8U 780, S8U 782 | 55/74 | 03/98→08/01 | GN909 [2][222] GV642 | | 11V 11V | | |

ASTRAMAX

| | | | | | | | | | |
|-------|---|-------------|-------|-------------|--|--|-------------------|------------------------------------|-------|
| 1.3 N | 4 | 13 N, 13 NB | 44/59 | 08/85→12/89 | Z20 | | 0.8 | UXT2 / UXT6 | |
| 1.3 S | 4 | 13 S | 55/74 | 08/85→12/89 | Z20 | | 0.8 | UXT2 / UXT6 | ZS252 |
| 1.4 i | 4 | C 14 NZ | 44/59 | 08/91→07/94 | Z20 | | 0.8 | UXT2 / UXT6 | ZS253 |
| 1.4 S | 4 | 14 NV | 55/74 | 07/89→08/91 | Z119 [284] Z190 [282][283] Z74 [283] | | 0.8 1.2 1.0 | UXT2/UXT6 [284] UXT1/UXT3 [283] | ZS253 |
| 1.6 D | 4 | 16 DA | 40/54 | 05/86→06/90 | GN013 [2][222] GN954 | | 11V 11V | | |

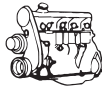

kW/BHP

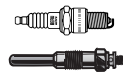
**... VAUXHALL****... ASTRAMAX**

| | | | | | | | | |
|-------|---|------|-------|-------------|--|--------------|------------|--|
| 1.7 D | 4 | 17 D | 42/56 | 01/89→07/94 | GN013 ^{[2][222]} GN954 | GR064 | 11V 11V | |
|-------|---|------|-------|-------------|--|--------------|------------|--|

ASTRAVAN Mk III (F)

| | | | | | | | | |
|-------|---|---------|-------|-------------|--|--|---|--|
| 1.4 i | 4 | C 14 NZ | 44/59 | 01/91→10/94 | Z119 ^[284] Z190 ^{[282][283]} Z74 ^[283] | | 0.8 UXT2/UXT6 ^[284] 1.2 1.0 UXT1/UXT3 ^[283] | |
|-------|---|---------|-------|-------------|--|--|---|--|

| | | | | | | | | |
|-------|---|---------|-------|-------------|--|--|---|--|
| 1.6 i | 4 | X 16 SZ | 52/70 | 02/94→10/96 | Z190 ^[282] Z74 | | 1.2 ZSE026 1.0 UXT1 / UXT3 | |
|-------|---|---------|-------|-------------|--|--|---|--|

| | | | | | | | | |
|-------|---|---------|-------|-------------|--|--|--|--|
| 1.6 i | 4 | C 16 NZ | 55/74 | 01/91→08/98 | Z119 ^[284] Z190 ^{[282][283]} Z74 ^[283] | | 0.8 UXT2/UXT6 ^[284] ZS252 1.2 1.0 UXT1/UXT3 ^[283] | |
|-------|---|---------|-------|-------------|--|--|--|--|

| | | | | | | | | |
|-----------|---|---------|-------|-------------|-------------|--|------------------|--|
| 1.6 i LPG | 4 | X 16 SZ | 52/70 | 02/94→10/96 | Z206 | | 0.7 UXT10 | |
|-----------|---|---------|-------|-------------|-------------|--|------------------|--|

| | | | | | | | | |
|-----------|---|---------|-------|-------------|--|--|--|--|
| 1.6 i LPG | 4 | C 16 NZ | 55/74 | 01/91→08/98 | Z20 ^[168] Z206 | | 0.8 UXT2 / UXT6 0.7 UXT10 | |
|-----------|---|---------|-------|-------------|--|--|--|--|

| | | | | | | | | |
|-------|---|-------|-------|-------------|--|--|------------|--|
| 1.7 D | 4 | 17 DR | 44/59 | 01/91→08/94 | GN013 ^{[2][222]} GN954 | | 11V 11V | |
|-------|---|-------|-------|-------------|--|--|------------|--|

| | | | | | | | | |
|--------|---|----------|-------|-------------|--|--|------------|--|
| 1.7 TD | 4 | X 17 DTL | 50/67 | 01/94→08/98 | GN013 ^{[2][222]} GN954 | | 11V 11V | |
|--------|---|----------|-------|-------------|--|--|------------|--|

ASTRAVAN Mk IV (G)

| | | | | | | | | |
|-------|---|----------|-------|-------------|--|--|---|--|
| 1.6 i | 4 | X 16 SZR | 55/74 | 08/98→09/00 | Z190 ^[282] Z74 | | 1.2 ZSE026 1.0 UXT1 / UXT3 | |
|-------|---|----------|-------|-------------|--|--|---|--|

| | | | | | | | | |
|-------|---|---------|-------|-------------|--|--|-------------------------------|--|
| 1.6 i | 4 | Z 16 SE | 62/83 | 09/00→08/06 | Z190 ^[282] Z74 | | 1.2 1.0 UXT1 / UXT3 | |
|-------|---|---------|-------|-------------|--|--|-------------------------------|--|

| | | | | | | | | |
|-----------|---|----------|-------|-------------|-------------|--|------------------|--|
| 1.6 i LPG | 4 | X 16 SZR | 55/74 | 08/98→09/00 | Z206 | | 0.7 UXT10 | |
|-----------|---|----------|-------|-------------|-------------|--|------------------|--|

| | | | | | | | | |
|-----------|---|---------|-------|-------------|-------------|--|------------------|--|
| 1.6 i LPG | 4 | Z 16 SE | 62/83 | 09/00→08/06 | Z206 | | 0.7 UXT10 | |
|-----------|---|---------|-------|-------------|-------------|--|------------------|--|

| | | | | | | | | |
|----------|---|----------|-------|-------------|--------------|-------------------------------|-----|--|
| 1.7 CDTi | 4 | Z 17 DTL | 59/79 | 04/04→08/06 | GN104 | GSE143 ^[10] | 11V | |
|----------|---|----------|-------|-------------|--------------|-------------------------------|-----|--|

| | | | | | | | | |
|-------------|---|---------|-------|-------------|--------------|-------------------------------|-----|--|
| 1.7 DTi 16V | 4 | Y 17 DT | 55/74 | 04/01→08/06 | GN104 | GSE143 ^[10] | 11V | |
|-------------|---|---------|-------|-------------|--------------|-------------------------------|-----|--|

| | | | | | | | | |
|--------|---|----------|-------|-------------|--|--|------------|--|
| 1.7 TD | 4 | X 17 DTL | 50/67 | 08/98→08/06 | GN013 ^{[2][222]} GN954 | | 11V 11V | |
|--------|---|----------|-------|-------------|--|--|------------|--|

| | | | | | | | | |
|--------|---|----------|-------|-------------|--------------|--|-----|--|
| 2.0 DI | 4 | X 20 DTL | 60/80 | 08/98→08/06 | GN992 | | 11V | |
|--------|---|----------|-------|-------------|--------------|--|-----|--|

| | | | | | | | | |
|---------|---|----------|-------|-----------------------|--------------|-------------------------------|-----|--|
| 2.0 DTi | 4 | Y 20 DTH | 74/99 | 04/04→08/06 →08/05 | GN992 | GSE142 ^[11] | 11V | |
|---------|---|----------|-------|-----------------------|--------------|-------------------------------|-----|--|

ASTRAVAN Mk V (H)

| | | | | | | | | |
|----------|---|----------|-------|--------|--------------|-------------------------------|-----|--|
| 1.3 CDTi | 4 | Z 13 DTH | 66/89 | 08/05→ | GN053 | GSE142 ^[11] | 11V | |
|----------|---|----------|-------|--------|--------------|-------------------------------|-----|--|

| | | | | | | | | |
|-------|---|----------|-------|--------|-------------|--|------------------|--|
| 1.4 i | 4 | Z 14 XEP | 66/89 | 03/05→ | Z203 | | 0.9 ZS338 | |
|-------|---|----------|-------|--------|-------------|--|------------------|--|

| | | | | | | | | |
|-----------|---|----------|-------|--------|------------------------------|--|------------------|--|
| 1.4 i LPG | 4 | Z 14 XEP | 66/89 | 03/05→ | Z206 ^[168] | | 0.7 UXT10 | |
|-----------|---|----------|-------|--------|------------------------------|--|------------------|--|

| | | | | | | | | |
|-----|---|--------------------|--------|--------|--|--|--|--------------|
| 1.6 | 4 | Z 16 XE1, Z 16 XEP | 76/102 | 03/05→ | | | | ZS427 |
|-----|---|--------------------|--------|--------|--|--|--|--------------|

| | | | | | | | | |
|----------|---|----------|-------|-------------|--------------|-------------------------------|-----|--|
| 1.7 CDTi | 4 | Z 17 DTL | 59/79 | 03/05→07/06 | GN104 | GSE143 ^[10] | 11V | |
|----------|---|----------|-------|-------------|--------------|-------------------------------|-----|--|

| | | | | | | | | |
|----------|---|----------|-------|-----------------------|--------------|-------------------------------|-----|--|
| 1.7 CDTi | 4 | Z 17 DTH | 74/99 | 03/05→11/11 →03/07 | GN104 | GSE143 ^[10] | 11V | |
|----------|---|----------|-------|-----------------------|--------------|-------------------------------|-----|--|

| | | | | | | | | |
|----------|---|--------------------|--------|--------|--------------|-------------------------------|-----|--|
| 1.7 CDTi | 4 | A 17 DTJ, Z 17 DTJ | 81/109 | 11/11→ | GN104 | GSE143 ^[10] | 11V | |
|----------|---|--------------------|--------|--------|--------------|-------------------------------|-----|--|

| | | | | | | | | |
|----------|---|--------------------|--------|--------|--------------|-------------------------------|-----|--|
| 1.7 CDTi | 4 | A 17 DTR, Z 17 DTR | 92/123 | 11/11→ | GN104 | GSE143 ^[10] | 11V | |
|----------|---|--------------------|--------|--------|--------------|-------------------------------|-----|--|

| | | | | | | | | |
|----------|---|---------|--------|-------------|---|--|-----|--|
| 1.9 CDTi | 4 | Z 19 DT | 88/118 | 03/05→11/11 | GN041 →ch. 72045139 →ch. 75030986 →ch. 78007391 | GSE142 ^{[11][32]} GSE143 ^{[10][32]} | 11V | |
|----------|---|---------|--------|-------------|---|--|-----|--|

| | | | | | | | | |
|--|--|--|--|--|--|--|-----|--|
| | | | | | GN097 ch. 72045140→ ch. 75030987→ ch. 78007392→ ch. 88000001→ | | 11V | |
|--|--|--|--|--|--|--|-----|--|

| | | | | | | | | |
|----------|---|----------|---------|-------------|--------------|--|-----|--|
| 1.9 CDTi | 4 | Z 19 DTH | 110/148 | 03/05→11/11 | GN059 | GSE142 ^{[11][32]} GSE143 ^{[10][32]} | 11V | |
|----------|---|----------|---------|-------------|--------------|--|-----|--|

| | | | | | | | | |
|--|--|--|--|--|--|--|--|--|
| | | | | | | | | |
|--|--|--|--|--|--|--|--|--|

| | | | | | | | | |
|--|--|--|--|--|--|--|--|--|
| | | | | | | | | |
|--|--|--|--|--|--|--|--|--|

| | | | | | | | | |
|--|--|--|--|--|--|--|--|--|
| | | | | | | | | |
|--|--|--|--|--|--|--|--|--|

COMBO Mk I (B)

| | | | | | | | | |
|-----|---|------------------|-------|-------------|--|--|---|--|
| 1.2 | 4 | C 12 NZ, X 12 SZ | 33/44 | 07/94→10/01 | Z119 ^[284] Z190 ^{[282][283]} Z74 ^[283] | | 0.8 UXT2/UXT6 ^[284] 1.2 1.0 UXT1/UXT3 ^[283] | |
|-----|---|------------------|-------|-------------|--|--|---|--|

VAUXHALL

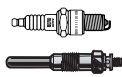

kW/BHP

**... VAUXHALL****... COMBO Mk I (B)**

| | | | | | | | | |
|---------|---|----------------------------|-------|-------------|--|-------------------|------------------------------------|--|
| 1.2 LPG | 4 | C 12 NZ, X 12 SZ | 33/44 | 07/94→10/01 | Z20 [168] Z206 | 0.8 0.7 | UXT2 / UXT6 UXT10 | |
| 1.4 | 4 | C 14 NZ | 44/59 | 07/94→10/01 | Z119 [284] Z190 [282][283] Z74 [283] | 0.8 1.2 1.0 | UXT2/UXT6 [284] UXT1/UXT3 [283] | |
| 1.4 | 4 | C 14 SE | 60/80 | 07/94→10/01 | Z119 [284] Z190 [282][283] Z74 [283] | 0.8 1.2 1.0 | UXT2/UXT6 [284] UXT1/UXT3 [283] | |
| 1.4 LPG | 4 | C 14 NZ | 44/59 | 07/94→10/01 | Z20 [168] Z206 | 0.8 0.7 | UXT2 / UXT6 UXT10 | |
| 1.4 LPG | 4 | C 14 SE | 60/80 | 07/94→10/01 | Z20 [168] Z206 | 0.8 0.7 | UXT2 / UXT6 UXT10 | |
| 1.7 D | 4 | 17 D (4EE1), X 17 D (4EE1) | 44/59 | 07/94→10/01 | GN103 04/96→ | 11V | | |

COMBO Mk II (C)

| | | | | | | | | |
|---------------|---|----------|-------|-------------|-------------------|------------|-------|----------------------|
| 1.3 CDTi 16V | 4 | Z 13 DT | 51/68 | 09/04→02/12 | GN053 | 11V | | |
| 1.3 CDTi 16V | 4 | Z 13 DTJ | 55/74 | 10/05→11/11 | GN053 | 11V | | |
| 1.4 16V | 4 | Z 14 XE | 66/89 | 10/01→05/07 | Z190 [282] Z74 | 1.2 1.0 | | ZS259 UXT1 / UXT3 |
| 1.4 i 16V | 4 | Z 14 XEP | 66/89 | 01/04→11/11 | Z203 | 0.9 | | ZS338 |
| 1.4 i 16V LPG | 4 | Z 14 XEP | 66/89 | 01/04→11/11 | Z206 [168] | 0.7 | UXT10 | |
| 1.6 | 4 | Z 16 SE | 62/83 | 08/01→10/04 | Z190 Z74 | 1.2 1.0 | | UXT1 / UXT3 |
| 1.6 | 4 | Z 16 SE | 64/86 | 10/01→11/11 | Z190 | 1.2 | | |
| 1.6 LPG | 4 | Z 16 SE | 62/83 | 08/01→10/04 | Z206 | 0.7 | UXT10 | |
| 1.6 LPG | 4 | Z 16 SE | 64/86 | 10/01→11/11 | Z206 | 0.7 | UXT10 | |
| 1.6 CNG 16V | 4 | Z 16 YNG | 69/93 | 06/06→02/12 | Z206 | 0.7 | UXT10 | ZS259 |
| 1.6 CNG 16V | 4 | Z 16 YNG | 71/95 | 04/05→02/12 | Z206 | 0.7 | UXT10 | ZS259 |
| 1.7 CDTi 16V | 4 | Z 17 DTH | 74/99 | 12/04→11/11 | GN104 | 11V | | |
| 1.7 DI 16V | 4 | Y 17 DTL | 48/64 | 09/01→11/11 | GN104 | 11V | | |
| 1.7 DTi 16V | 4 | Y 17 DT | 55/74 | 10/01→11/11 | GN104 | 11V | | |

COMBO Mk III (D)

| | | | | | | | | |
|----------|---|----------|--------|--------|-------|------|--|--|
| 1.6 CDTi | 4 | A 16 FDL | 66/89 | 11/11→ | GE114 | 4.4V | | |
| 1.6 CDTi | 4 | A 16 FDH | 74/99 | 11/11→ | GE114 | 4.4V | | |
| 1.6 CDTi | 4 | A 16 FDH | 77/103 | 11/11→ | GE114 | 4.4V | | |
| 2.0 CDTi | 4 | A 20 FD | 99/133 | 11/11→ | GE114 | 4.4V | | |

CORSAVAN Mk I (B)

| | | | | | | | | |
|-----------|---|----------------------------|-------|-------------|--|-------------------|------------------------------------|--|
| 1.4 i | 4 | C 14 NZ | 44/59 | 01/94→09/00 | Z119 [284] Z190 [282][283] Z74 [283] | 0.8 1.2 1.0 | UXT2/UXT6 [284] UXT1/UXT3 [283] | |
| 1.4 i LPG | 4 | C 14 NZ | 44/59 | 01/94→09/00 | Z20 [168] Z206 | 0.8 0.7 | UXT2 / UXT6 UXT10 | |
| 1.5 D | 4 | 15 D | 37/50 | 08/94→12/95 | GV947 | 11V | | |
| 1.7 D | 4 | 17 D (4EE1), X 17 D (4EE1) | 44/59 | 01/94→09/00 | GN103 04/96→ | 11V | | |

CORSAVAN Mk II (C)

| | | | | | | | | |
|----------------------|---|----------|-------|-------------|-------------------|-------------|-------|------------------------------|
| 1.2 16V | 4 | Z 12 XE | 55/74 | 09/00→06/06 | Z190 [282] Z74 | 1.2 1.0 | | ZSE147 UXT1 / UXT3 →08/04 |
| 1.2 16V LPG | 4 | Z 12 XE | 55/74 | 09/00→06/06 | Z206 | 0.7 | UXT10 | |
| 1.2 16V Dualfuel LPG | 4 | Z 12 XE | 55/74 | 08/01→06/06 | | | | ZSE147 →08/04 |
| 1.3 CDTi 16V | 4 | Z 13 DT | 52/70 | 04/04→06/06 | GN053 | GSE142 [11] | 11V | |
| 1.7 DI 16V | 4 | Y 17 DTL | 48/64 | 09/00→06/06 | GN104 | GSE143 [10] | 11V | |
| 1.7 DTi 16V | 4 | Y 17 DT | 55/74 | 09/00→06/06 | GN104 | GSE143 [10] | 11V | |

CORSAVAN Mk III (D)

| | | | | | | | | |
|---------|---|----------|-------|--------|------------|-----|-------|-------|
| 1.2 | 4 | A 12 XEL | 51/68 | 01/10→ | Z203 | 0.9 | | |
| 1.2 | 4 | Z 12 XEP | 59/79 | 07/09→ | Z203 | 0.9 | | ZS338 |
| 1.2 LPG | 4 | A 12 XEL | 51/68 | 01/10→ | Z206 [168] | 0.7 | UXT10 | |

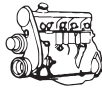

kW/BHP

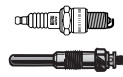
**... VAUXHALL****... CORSAVAN Mk III (D)**

| | | | | | | | | |
|----------|---|------------------------------|-------|--------|------------|--------|------|-------|
| 1.2 LPG | 4 | Z 12 XEP | 59/79 | 07/09→ | Z206 [168] | | 0.7 | UXT10 |
| 1.3 CDTI | 4 | Z 13 DTJ | 55/74 | 07/06→ | GN053 | GSE144 | 11V | |
| 1.3 CDTI | 4 | Z 13 DTH | 66/89 | 07/06→ | GN053 | GSE144 | 11V | |
| 1.3 CDTI | 4 | A 13 DTE, A 13 DTR, Z 13 DTE | 70/94 | 07/06→ | GE112 | | 4.4V | |

MIDI II

| | | | | | | | | |
|--------|---|-------------|-------|-------------|-----------|--|-----|--|
| 2.0 TD | 4 | 4FC1T | 51/68 | 06/88→07/90 | GV945 | | 5V | |
| 2.2 D | 4 | 4FD1, 22DIE | 45/60 | 06/88→12/94 | GV945 | | 5V | |
| 2.4 TD | 4 | 4FG1T | 56/75 | 09/94→08/97 | GV945 [1] | | 5V | |
| | | | | | GV947 [1] | | 11V | |

MOVANO Mk I (A)

| | | | | | | | | |
|----------|---|------------------------------------|---------|-------------|-------|--|-----|--|
| 1.9 DTI | 4 | F9Q 770 | 59/79 | 09/00→10/01 | GN018 | | 11V | |
| 1.9 DTI | 4 | F9Q 774 | 60/80 | 10/01→05/10 | GN018 | | 11V | |
| 2.2 DTI | 4 | G9T 720, G9T 722, G9T 750 | 66/89 | 09/00→05/10 | GN026 | | 11V | |
| 2.5 CDTI | 4 | G9U 650, G9U 754 | 74/99 | 10/01→05/10 | GN026 | | 11V | |
| 2.5 CDTI | 4 | G9U 632, G9U 650 | 88/118 | 02/03→05/10 | GN026 | | 11V | |
| 2.5 CDTI | 4 | G9U 632 | 107/143 | 08/06→05/10 | GN026 | | 11V | |
| 2.5 D | 4 | S8U 770 | 59/79 | 10/98→09/00 | GN927 | | 11V | |
| 2.5 DTI | 4 | G9U 720, G9U 724, G9U 750, G9U 754 | 84/113 | 10/01→05/10 | GN026 | | 11V | |
| 2.8 DTI | 4 | S9W 702 | 84/113 | 10/98→10/01 | GF984 | | 11V | |
| 2.8 TDI | 4 | S9W 702 | 84/113 | 10/98→10/01 | GF984 | | 11V | |

NOVAVAN

| | | | | | | | | |
|-------|---|-------|-------|-------------|-------|--|-----|-----------------------|
| 1.2 | 4 | 12 NV | 38/51 | 01/90→10/94 | Z20 | | 0.8 | UXT2 / UXT6 ZS252 [1] |
| 1.5 D | 4 | 15 D | 37/50 | 01/91→10/94 | GV946 | | 11V | |

eng. 804795→

VIVARO

| | | | | | | | | |
|-------------|---|------------------|---------|-------------|------------------------|--|-----|------------------------|
| 1.9 DI | 4 | F9Q 762 | 59/79 | 08/01→07/14 | GN018 | | 11V | |
| 1.9 DTI | 4 | F9Q 760 | 74/99 | 08/01→12/06 | GN018 | | 11V | |
| 2.0 16V | 4 | F4R 720 | 88/118 | 08/01→12/06 | Z337 | | 0.9 | UXT9 |
| | | | | | →ch. 61699999;61999999 | | | →ch. 61699999;61999999 |
| 2.0 16V | 4 | F4R 720 | 88/118 | 08/01→07/14 | | | | ZS052 |
| 2.0 16V | 4 | F4R 720 | 88/118 | 04/03→07/14 | Z206 | | 0.7 | UXT10 |
| 2.0 16V LPG | 4 | F4R 720 | 88/118 | 08/01→12/06 | Z340 | | 0.7 | UXT12 |
| | | | | | →ch. 61699999;61999999 | | | →ch. 61699999;61999999 |
| 2.0 16V LPG | 4 | F4R 720 | 88/118 | 04/03→07/14 | Z340 | | 0.7 | UXT12 |
| 2.0 ECOTEC | 4 | F4R 820 | 86/115 | 08/06→07/14 | | | | ZS052 |
| 2.5 CDTI | 4 | G9U 630, G9U 730 | 99/133 | 04/03→07/06 | GN026 | | 11V | |
| 2.5 CDTI | 4 | G9U 630, G9U 730 | 107/143 | 01/06→07/14 | GN026 | | 11V | |
| 2.5 DTI | 4 | G9U 630, G9U 730 | 99/133 | 07/03→07/14 | GN026 | | 11V | |

VOLVO**66**

| | | | | | | | | |
|--------|---|-------|-------|-------------|-----|--|-----|--|
| 1.1 DL | 4 | B 11 | 33/44 | 08/75→11/79 | Z10 | | 0.8 | |
| 1.3 GL | 4 | B 130 | 42/56 | 08/75→11/79 | Z10 | | 0.8 | |

140

| | | | | | | | | |
|-------|---|--------|--------|-------------|-----|--|-----|------------|
| 1.8 | 4 | B 18 A | 55/74 | 08/66→07/68 | Z57 | | 0.6 | ZS106 [11] |
| 1.8 S | 4 | B 18 A | 55/74 | 08/66→07/68 | Z57 | | 0.6 | ZS106 [11] |
| 1.8 S | 4 | B 18 B | 74/99 | 08/66→01/72 | Z40 | | 0.6 | |
| 1.8 S | 4 | B 18 B | 74/99 | 07/67→01/72 | | | | ZS106 [11] |
| 2.0 | 4 | B 20 A | 60/80 | 08/68→07/74 | Z10 | | 0.8 | |
| 2.0 | 4 | B 20 D | 70/94 | 08/71→07/72 | Z48 | | 0.8 | |
| 2.0 | 4 | B 20 E | 91/122 | 09/70→04/75 | Z41 | | 0.8 | |
| 2.0 S | 4 | B 20 A | 60/80 | 08/68→07/74 | Z10 | | 0.8 | |
| 2.0 S | 4 | B 20 B | 73/98 | 08/72→07/73 | Z48 | | 0.8 | |
| 2.0 S | 4 | B 20 B | 74/99 | 11/68→07/74 | Z48 | | 0.8 | |
| 2.0 S | 4 | B 20 F | 85/114 | 09/72→08/75 | Z48 | | 0.8 | |
| 2.0 S | 4 | B 20 E | 91/122 | 08/72→07/73 | Z41 | | 0.8 | |



kW/BHP

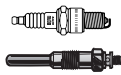

... VOLVO



164

| | | | | | | | | |
|-------|---|--------|---------|-------------|-----|-----|------------|--|
| 2.9 | 6 | B 30 E | 118/158 | 08/72→07/74 | Z41 | 0.8 | ZS115 [11] | |
| 2.9 E | 6 | B 30 A | 96/129 | 08/68→07/73 | Z48 | 0.8 | ZS115 [11] | |

240

| | | | | | | | | |
|-----|---|--------|-------|-------------|-----------|-----|-------------|----------------------|
| 2.0 | 4 | B 20 A | 60/80 | 08/74→07/76 | Z10 | 0.8 | | |
| 2.0 | 4 | B 19 A | 66/89 | 08/76→07/79 | Z11 [168] | 0.8 | UXT2 / UXT6 | ZS106 [11] →07/78 |

| | | | | | | | | |
|-----|---|---------|--------|-------------|-----------|-----|-------------|---|
| 2.0 | 4 | B 19 A | 71/95 | 09/78→12/84 | Z11 [168] | 0.8 | UXT2 / UXT6 | |
| 2.0 | 4 | B 200 K | 76/102 | 08/84→07/85 | Z20 | 0.8 | UXT2 / UXT6 | ZS115 [11][11] ZS117 [11][254] ZS120 [11][214][254] |

| | | | | | | | | |
|-----|---|---------|--------|-------------|-----|-----|------|---|
| 2.0 | 4 | B 200 E | 86/115 | 08/83→07/93 | Z27 | 0.8 | UX56 | ZS115 [11][11] ZS117 [11][254] ZS120 [11][214][254] |
|-----|---|---------|--------|-------------|-----|-----|------|---|

| | | | | | | | | |
|-------|---|---------|--------|-------------|-------|-----|------|--|
| 2.0 | 4 | B 200 E | 89/119 | 09/84→12/93 | Z27 | 0.8 | UX56 | |
| 2.0 D | 5 | D 20 | 50/67 | 09/78→10/80 | GN857 | 11V | | |

| | | | | | | | | |
|-----|---|--------|-------|-------------|-----------|-----|-------------|---------------------------|
| 2.1 | 4 | B 21 A | 71/95 | 08/74→07/75 | Z11 [168] | 0.8 | UXT2 / UXT6 | ZS106 [11] |
| 2.1 | 4 | B 21 A | 74/99 | 08/75→07/80 | Z11 [168] | 0.8 | UXT2 / UXT6 | ZS106 [11][254] →12/78 |

| | | | | | | | | |
|-----|---|--------|--------|-------------|-----------|-----|-------------|------------|
| 2.1 | 4 | B 21 A | 79/106 | 08/80→07/84 | Z11 [168] | 0.8 | UXT2 / UXT6 | ZS106 [11] |
| 2.1 | 4 | B 21 F | 80/107 | 08/80→07/84 | Z11 [168] | 0.8 | UXT2 / UXT6 | |

| | | | | | | | | |
|-----------|---|---------|---------|-------------|-----|-----|------|------------|
| 2.1 | 4 | B 21 E | 90/121 | 08/74→07/80 | Z22 | 0.7 | UX56 | ZS106 [11] |
| 2.1 Turbo | 4 | B 21 ET | 114/153 | 08/80→07/85 | Z22 | 0.7 | UX56 | |

| | | | | | | | | |
|-----|---|---------|--------|-------------|-----------|-----|-------------|-------|
| 2.3 | 4 | B 230 A | 81/109 | 08/84→07/86 | Z11 [168] | 0.8 | UXT2 / UXT6 | ZM039 |
| 2.3 | 4 | B 23 A | 82/110 | 08/80→07/84 | Z11 [168] | 0.8 | UXT2 / UXT6 | |

| | | | | | | | | |
|-----|---|---------|--------|-------------|------------------|------------|-------------|---|
| 2.3 | 4 | B 230 F | 83/111 | 08/86→07/87 | Z11 [168] Z20 | 0.8 0.8 | UXT2 / UXT6 | ZS115 [11][11] ZS117 [11][254] ZS120 [11][214][254] |
|-----|---|---------|--------|-------------|------------------|------------|-------------|---|

| | | | | | | | | |
|-----|---|---------|--------|-------------|-----|-----|-------------|---|
| 2.3 | 4 | B 230 K | 85/114 | 08/86→12/88 | Z20 | 0.8 | UXT2 / UXT6 | ZS120 |
| 2.3 | 4 | B 230 E | 96/129 | 08/83→07/85 | Z22 | 0.7 | UX56 | ZS115 [11][11] ZS117 [11][254] ZS120 [11][214][254] |

| | | | | | | | | |
|-----|---|---------|--------|-------------|--|--|--|-------|
| 2.3 | 4 | B 230 E | 96/129 | 08/84→07/85 | | | | ZM002 |
|-----|---|---------|--------|-------------|--|--|--|-------|

| | | | | | | | | |
|-----|---|--------|--------|-------------|--------------------------------------|------------|----------------------------------|---|
| 2.3 | 4 | B 23 E | 98/131 | 08/84→12/89 | Z22 →07/87 Z27 [168] 08/87→ | 0.7 0.8 | UX56 →07/87 UX56 08/87→ | ZS115 [11][11] ZS117 [11][254] ZS120 [11][214][254] |
|-----|---|--------|--------|-------------|--------------------------------------|------------|----------------------------------|---|

| | | | | | | | | |
|-----|---|--------|---------|-------------|-----|-----|------|--|
| 2.3 | 4 | B 23 E | 100/134 | 08/80→12/84 | Z22 | 0.7 | UX56 | |
| 2.3 | 4 | B 23 E | 103/138 | 08/78→07/80 | Z22 | 0.7 | UX56 | |

| | | | | | | | | |
|-------|---|---------|--------|-------------|-----------|-----|-------------|---|
| 2.3 i | 4 | B 230 F | 85/114 | 08/86→07/93 | Z20 [168] | 0.8 | UXT2 / UXT6 | ZS120 ch. 809000→ →12/90 ZM015 ch. 809000→ ZM039 →07/90 |
| 2.3 i | 4 | B 230 K | 85/114 | 08/86→07/93 | | | | |

| | | | | | | | | |
|------------|---|------|-------|-------------|-------|-----|--|--|
| 2.4 Diesel | 6 | D 24 | 58/78 | 08/87→08/93 | GN857 | 11V | | |
| 2.4 Diesel | 6 | D 24 | 60/80 | 08/78→08/93 | GN857 | 11V | | |

| | | | | | | | | |
|----------|---|--------|---------|-------------|-----------|-----|-------|--|
| 2.7 GLT6 | 6 | B 27 E | 104/139 | 08/79→07/80 | Z26 [167] | 0.7 | UXK56 | |
|----------|---|--------|---------|-------------|-----------|-----|-------|--|

260

| | | | | | | | | |
|-----|---|--------|---------|-------------|-----------|-----|-------|--|
| 2.7 | 6 | B 27 A | 92/123 | 08/75→07/82 | Z26 [167] | 0.7 | UXK56 | |
| 2.7 | 6 | B 27 E | 103/138 | 08/74→07/82 | Z26 [167] | 0.7 | UXK56 | |

| | | | | | | | | |
|-----|---|----------------|---------|-------------|-----------|-----|-------|--|
| 2.7 | 6 | B 27 E, B 27 F | 109/146 | 08/78→07/82 | Z26 [167] | 0.7 | UXK56 | |
| 2.8 | 6 | B 28 A | 95/127 | 08/80→07/82 | Z26 [167] | 0.7 | UXK56 | |
| 2.8 | 6 | B 28 E, B 28 F | 114/153 | 08/80→07/82 | Z26 [167] | 0.7 | UXK56 | |

340-360

| | | | | | | | | |
|-----|---|----------|-------|-------------|-----|-----|-------------|--|
| 1.4 | 4 | B 14.3 E | 46/62 | 08/82→08/85 | Z20 | 0.8 | UXT2 / UXT6 | ZS115 [11][11] ZS251 [11][213][254] ZS316 [11][206][254] |
|-----|---|----------|-------|-------------|-----|-----|-------------|--|

| | | | | | | | | |
|-----|---|----------|-------|-------------|--|--|--|-------|
| 1.4 | 4 | B 14.3 E | 46/62 | 01/83→12/86 | | | | ZS251 |
|-----|---|----------|-------|-------------|--|--|--|-------|

VOLVO



kW/BHP



... VOLVO



... 340-360

| | | | | | | | | | |
|------------------|---|----------------------------|--------|-------------|--|------------|----------------------------|--|-------|
| 1.4 | 4 | B 14.3 E | 47/63 | 08/79→07/83 | Z11 [168] | 0.8 | UXT2 / UXT6 | ZS115 [11] | |
| 1.4 | 4 | B 14.4 S | 50/67 | 08/86→12/88 | Z20 | 0.8 | UXT2 / UXT6 | ZS115 [1][11][181] ZS251 [1][213][254] ZS316 [1][206][254] | |
| 1.4 | 4 | B 14.4 S | 51/68 | 08/75→07/83 | Z11 [168] | 0.8 | UXT2 / UXT6 | ZS115 [11] | |
| 1.4 | 4 | B 14.4 S | 51/68 | 08/87→07/88 | | | | ZS251 [1][213][254] ZS316 [1][206][254] | |
| 1.4 | 4 | B 14.4 S | 52/70 | 08/83→07/86 | Z11 [168] →07/84 Z20 08/84→ | 0.8 0.8 | UXT2 / UXT6 UXT2 / UXT6 | ZS115 [1][11] | |
| 1.4 | 4 | B 14.4 S | 53/71 | 08/83→07/86 | Z11 [168] →07/84 Z20 08/84→ | 0.8 0.8 | UXT2 / UXT6 UXT2 / UXT6 | ZS251 [1][213][254] ZS316 [1][206][254] | |
| 1.6 Diesel | 4 | D 16 | 40/54 | 08/84→07/91 | GV852 | 11V | | | |
| 1.7 | 4 | B 17 2 K | 59/79 | 08/85→07/91 | Z20 →08/86 →ch. 240999 Z82 09/86→ ch. 241000→ | 0.8 0.7 | UXT2 / UXT6 UXT2 / UXT6 | ZS251 [1][213][254] ZS316 [1][206][254] | |
| 2.0 | 4 | B 19 A | 65/87 | 08/80→07/84 | Z11 [168] | 0.8 | UXT2 / UXT6 | | |
| 2.0 | 4 | B 19 A | 66/89 | 08/82→07/84 | Z11 [168] | 0.8 | UXT2 / UXT6 | | |
| 2.0 | 4 | B 19 A | 68/91 | 08/83→07/84 | Z11 [168] | 0.8 | UXT2 / UXT6 | | |
| 2.0 | 4 | B 19 A, B 200 K | 70/94 | 08/80→07/83 | Z11 [168] | 0.8 | UXT2 / UXT6 | | |
| 2.0 | 4 | B 200 K | 75/101 | 08/84→07/90 | Z20 | 0.8 | UXT2 / UXT6 | ZS251 | |
| 2.0 | 4 | B 200 K | 77/103 | 08/84→07/87 | Z20 | 0.8 | UXT2 / UXT6 | ZS251 | ZM039 |
| 2.0 | 4 | B 200 F | 80/107 | 08/88→07/89 | Z27 [168] | 0.8 | UX56 | ZS251 [1][213][254] ZS316 [1][206][254] | |
| 2.0 | 4 | B 200 EA, B 200 F | 81/109 | 08/87→07/88 | Z27 [168] | 0.8 | UX56 | ZS251 [1][213][254] ZS316 [1][206][254] | |
| 2.0 | 4 | B 200 E, B 200 EA, B 200 F | 82/110 | 08/86→07/88 | Z27 [168] | 0.8 | UX56 | ZS251 [1][213][254] ZS316 [1][206][254] | |
| 2.0 | 4 | B 19 E | 83/111 | 08/82→07/84 | Z27 [168] | 0.8 | UX56 | | |
| 2.0 | 4 | B 19 E | 85/114 | 08/82→07/84 | Z27 [168] | 0.8 | UX56 | | |
| 2.0 | 4 | B 200 E | 85/114 | 08/84→07/86 | Z27 [168] | 0.8 | UX56 | ZS251 | |
| 2.0 | 4 | B 200 E | 87/117 | 08/84→07/86 | Z27 [168] | 0.8 | UX56 | ZS251 | |
| 440 K | | | | | | | | | |
| 1.6 | 4 | B 16 F | 61/82 | 09/88→12/96 | | | | ZS251 [1][213][254] ZS316 [1][206][254] | |
| 1.7 | 4 | B 18 KP | 64/86 | 09/88→12/96 | Z20 | 0.8 | UXT2 / UXT6 | ZS251 | |
| 1.7 | 4 | B 18 F | 70/94 | 08/88→07/89 | Z82 | 0.7 | UXT2 / UXT6 | ZS251 | |
| 1.7 | 4 | B 18 FP | 75/101 | 08/89→12/96 | Z20 | 0.8 | UXT2 / UXT6 | ZS251 | |
| 1.7 | 4 | B 18 EP | 78/105 | 09/88→12/96 | | | | ZS251 | |
| 1.7 LPG | 4 | B 18 KP | 64/86 | 09/88→12/96 | Z27 [168] | 0.8 | UX56 | | |
| 1.7 LPG | 4 | B 18 FP | 75/101 | 08/89→12/96 | Z27 [168] | 0.8 | UX56 | | |
| 1.7 Turbo | 4 | B 18 FT | 88/118 | 08/88→07/96 | Z20 | 0.8 | UXT2 / UXT6 | | ZM033 |
| 1.7 Turbo | 4 | B 18 FT | 90/121 | 01/91→12/96 | Z20 | 0.8 | UXT2 / UXT6 | | ZM033 |
| 1.7 Turbo LPG | 4 | B 18 FT | 88/118 | 08/88→07/96 | Z27 [168] | 0.8 | UX56 | | |
| 1.7 Turbo LPG | 4 | B 18 FT | 90/121 | 01/91→12/96 | Z27 [168] | 0.8 | UX56 | | |
| 1.8 | 4 | B 18 U | 66/89 | 08/91→07/96 | | | | ZS251 | |
| 1.8 | 4 | B 18 U | 66/89 | 09/95→12/96 | | | | ZS251 [1][213][254] ZS316 [1][206][254] | |
| 1.9 Turbo-Diesel | 4 | D 19 T | 66/89 | 07/94→12/96 | GN959 [2][222] GV844 | 11V 11V | | | |
| 2.0 | 4 | B 20 F | 80/107 | 08/93→07/96 | Z20 | 0.8 | UXT2 / UXT6 | ZS251 | |
| 2.0 | 4 | B 20 F | 81/109 | 08/92→07/95 | Z20 | 0.8 | UXT2 / UXT6 | ZS251 [1] | |
| 2.0 LPG | 4 | B 20 F | 80/107 | 08/93→07/96 | Z27 [168] | 0.8 | UX56 | | |
| 2.0 LPG | 4 | B 20 F | 81/109 | 08/92→07/95 | Z27 [168] | 0.8 | UX56 | | |



kW/BHP

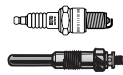

... VOLVO



460 L

| | | | | | | | | | | |
|------------------|---|---------|--------|-------------|-------------------------|--|------------|-------------|--|-----------------|
| 1.6 | 4 | B 16 F | 61/82 | 07/92→07/96 | | | | | ZS251 | |
| 1.7 | 4 | B 18 KP | 64/86 | 09/88→07/96 | | | | | ZS251 [1][213][254] ZS316 [1][206][254] | |
| 1.7 | 4 | B 18 KP | 66/89 | 09/90→07/96 | | | | | ZS251 [1][213][254] ZS316 [1][206][254] | |
| 1.7 | 4 | B 18 EP | 75/101 | 08/89→07/92 | | | | | ZS251 [1][213][254] ZS316 [1][206][254] | |
| 1.7 | 4 | B 18 E | 80/107 | 08/89→07/92 | | | | | ZS251 [1][213][254] ZS316 [1][206][254] | |
| 1.7 Turbo | 4 | B 18 FT | 88/118 | 08/89→07/96 | Z20 | | 0.8 | UXT2 / UXT6 | | ZM033 →12/93 |
| 1.7 Turbo | 4 | B 18 FT | 90/121 | 01/91→07/96 | Z20 | | 0.8 | UXT2 / UXT6 | | ZM033 |
| 1.7 Turbo LPG | 4 | B 18 FT | 88/118 | 08/89→07/96 | Z27 [168] | | 0.8 | UX56 | | |
| 1.7 Turbo LPG | 4 | B 18 FT | 90/121 | 01/91→07/96 | Z27 [168] | | 0.8 | UX56 | | |
| 1.8 | 4 | B 18 U | 66/89 | 08/91→07/96 | | | | | ZS251 | |
| 1.9 Turbo-Diesel | 4 | D 19 T | 66/89 | 07/94→07/96 | GN959 [2][222] GV844 | | 11V 11V | | | |
| 2.0 | 4 | B 20 F | 80/107 | 08/93→07/96 | Z20 | | 0.8 | UXT2 / UXT6 | ZS251 | |
| 2.0 | 4 | B 20 F | 81/109 | 08/92→07/95 | Z20 | | 0.8 | UXT2 / UXT6 | ZS251 [1][213][254] ZS316 [1][206][254] | |
| 2.0 LPG | 4 | B 20 F | 80/107 | 08/93→07/96 | Z27 [168] | | 0.8 | UX56 | | |
| 2.0 LPG | 4 | B 20 F | 81/109 | 08/92→07/95 | Z27 [168] | | 0.8 | UX56 | | |

480 E

| | | | | | | | | | | |
|---------------|---|---------|--------|-------------|-----------|--|-----|-------------|--|----------------------|
| 1.7 | 4 | B 18 F | 70/94 | 08/87→07/89 | Z82 | | 0.7 | UXT2 / UXT6 | ZS251 | |
| 1.7 | 4 | B 18 EP | 75/101 | 08/89→07/96 | | | | | ZS251 | |
| 1.7 | 4 | B 18 E | 78/105 | 04/86→07/89 | Z27 [168] | | 0.8 | UX56 | ZS251 | |
| 1.7 | 4 | B 18 E | 80/107 | 08/86→07/88 | Z27 [168] | | 0.8 | UX56 | ZS251 | |
| 1.7 Turbo | 4 | B 18 FT | 88/118 | 08/87→07/96 | Z20 | | 0.8 | UXT2 / UXT6 | | ZM033 01/88→12/93 |
| 1.7 Turbo | 4 | B 18 FT | 90/121 | 01/91→07/96 | Z20 | | 0.8 | UXT2 / UXT6 | | ZM033 →12/93 |
| 1.7 Turbo LPG | 4 | B 18 FT | 88/118 | 08/87→07/96 | Z27 [168] | | 0.8 | UX56 | | |
| 1.7 Turbo LPG | 4 | B 18 FT | 90/121 | 01/91→07/96 | Z27 [168] | | 0.8 | UX56 | | |
| 2.0 | 4 | B 20 F | 81/109 | 08/92→09/95 | Z20 | | 0.8 | UXT2 / UXT6 | ZS251 [1][213][254] ZS316 [1][206][254] | |
| 2.0 LPG | 4 | B 20 F | 81/109 | 08/92→09/95 | Z27 [168] | | 0.8 | UX56 | | |

740

| | | | | | | | | | | |
|-----------|---|-----------------|---------|-------------|--|--|-----|---|--|-------|
| 2.0 | 4 | B 200 F | 82/110 | 08/89→07/91 | Z20 | | 0.8 | UXT2 / UXT6 | | |
| 2.0 | 4 | B 200 F | 82/110 | 08/89→08/92 | | | | | ZS119 | |
| 2.0 | 4 | B 200 E | 86/115 | 01/87→08/88 | Z27 | | 0.8 | UX56 | ZS119 | ZM040 |
| 2.0 | 4 | B 200 E | 89/119 | 08/85→07/92 | Z27 | | 0.8 | UX56 | ZS119 | |
| 2.0 | 4 | B 200 G | 89/119 | 08/85→07/92 | Z20 | | 0.8 | UXT2 / UXT6 | ZS119 | |
| 2.0 Turbo | 4 | B 200 FT | 114/153 | 09/90→08/91 | | | | | ZS119 | |
| 2.0 Turbo | 4 | B 200 ET | 121/162 | 05/85→08/87 | | | | | ZS122 | |
| 2.3 | 4 | B 230 A | 82/110 | 08/84→07/86 | | | | | ZS115 [1][11] ZS117 [1][254] ZS120 [1][214][254] | |
| 2.3 | 4 | B 230 F | 83/111 | 08/85→12/89 | Z11 [168] →08/86 Z27 [168] 09/86→ | | 0.8 | UXT2 / UXT6 →08/86 0.8 UX56 09/86→ | ZS119 | ZM040 |
| 2.3 | 4 | B 230 F | 83/111 | 09/85→12/89 | Z20 | | 0.8 | UXT2 / UXT6 | | ZM039 |
| 2.3 | 4 | B 23 A, B 230 F | 84/113 | 08/84→07/90 | Z11 [168] →07/87 Z27 [168] 08/87→ | | 0.8 | UXT2 / UXT6 →07/87 0.8 UX56 08/87→ | ZS119 | ZM039 |

VOLVO

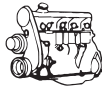

kW/BHP

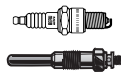
**... VOLVO****... 740**

| | | | | | | | | |
|------------------|---|--------------------|---------|-------------|--|--|--|-----------------|
| 2.3 | 4 | B 230 K | 84/113 | 09/85→07/90 | Z11 [168] →08/86 Z27 [168] 09/86→ | 0.8 UXT2 / UXT6 →08/86 0.8 UX56 09/86→ | ZS119 | ZM039 |
| 2.3 | 4 | B 230 F | 85/114 | 08/87→07/92 | Z20 | 0.8 UXT2 / UXT6 | ZS119 | ZM039 |
| 2.3 | 4 | B 230 K | 86/115 | 08/86→07/88 | Z11 [168] | 0.8 UXT2 / UXT6 | ZS119 | ZM039 |
| 2.3 | 4 | B 230 F | 87/117 | 01/88→10/90 | Z20 | 0.8 UXT2 / UXT6 | ZS119 | ZM039 |
| 2.3 | 4 | B 23 E | 95/127 | 08/83→07/84 | Z22 | 0.7 UX56 | ZS120 | ZM002 |
| 2.3 | 4 | B 230 E | 96/129 | 08/84→07/88 | Z27 [168] | 0.8 UX56 | ZS119 | ZM040 01/87→ |
| 2.3 | 4 | B 230 FB | 100/134 | 08/88→07/90 | | | ZS115 [1][11] ZS117 [1][254] ZS120 [1][214][254] | |
| 2.3 | 4 | B 230 FB | 100/134 | 08/89→07/90 | | | ZS119 | |
| 2.3 | 4 | B 234 F | 111/149 | 08/88→08/92 | Z27 [168] | 0.8 UX56 | ZS119 →07/90 | ZM040 →12/90 |
| 2.3 | 4 | B 234 F | 111/149 | 07/89→08/92 | | | ZS119 | |
| 2.3 | 4 | B 234 F | 114/153 | 08/88→07/91 | Z27 [168] | 0.8 UX56 | ZS119 | ZM040 →12/90 |
| 2.3 | 4 | B 234 F | 114/153 | 08/88→07/90 | | | | ZM040 |
| 2.3 | 4 | B 234 F | 117/157 | 08/87→07/89 | Z27 [168] | 0.8 UX56 | ZS119 | ZM040 |
| 2.3 GL | 4 | B 230 E | 89/119 | 08/84→08/87 | Z27 [168] | 0.8 UX56 | ZS119 | |
| 2.3 Turbo | 4 | B 230 FT | 115/154 | 08/86→07/89 | Z20 | 0.8 UXT2 / UXT6 | ZS119 | ZM040 |
| 2.3 Turbo | 4 | B 230 FT, B 230 GT | 121/162 | 08/89→07/90 | Z27 [168] | 0.8 UX56 | ZS119 | ZM040 |
| 2.3 Turbo | 4 | B 230 FT | 125/168 | 09/89→08/91 | | | ZS119 | |
| 2.3 Turbo | 4 | B 230 ET | 134/180 | 08/85→07/88 | Z11 →08/86 Z20 09/86→ | 0.8 UXT2 / UXT6 →08/86 0.8 UXT2 / UXT6 09/86→ | | |
| 2.3 Turbo | 4 | B 230 ET | 134/180 | 08/85→12/88 | Z20 | 0.8 UXT2 / UXT6 | | |
| 2.3 Turbo | 4 | B 230 FT | 140/188 | 08/89→07/90 | Z27 [168] | 0.8 UX56 | ZS119 | ZM040 |
| 2.4 Diesel | 6 | D 24 | 60/80 | 08/84→07/92 | GN857 | 11V | | |
| 2.4 TD | 6 | D 24 T | 80/107 | 08/85→12/90 | GN857 | 11V | | |
| 2.4 TD | 6 | D 24 T | 83/111 | 08/84→07/90 | GN857 | 11V | | |
| 2.4 TD | 6 | D 24 TIC | 90/121 | 08/86→10/88 | GN857 | 11V | | |
| 2.4 TD Interc. | 6 | D 24 TIC | 90/121 | 08/86→07/88 | GN857 | 11V | | |
| 2.4 Turbo-Diesel | 6 | D 24 T | 80/107 | 09/85→07/92 | GN857 | 11V | | |

760

| | | | | | | | | |
|------------------|---|-----------------|---------|-------------|-----------|-----------------|-------|-----------------|
| 2.3 | 4 | B 230 FT | 121/162 | 01/88→07/92 | | | ZS119 | |
| 2.3 Turbo | 4 | B 23 ET | 127/170 | 08/82→07/84 | Z22 | 0.7 UX56 | | |
| 2.3 Turbo | 4 | B 230 ET | 134/180 | 08/84→10/88 | Z11 [168] | 0.8 UXT2 / UXT6 | | |
| 2.3 Turbo | 4 | B 230 ET | 134/180 | 08/84→08/90 | Z20 | 0.8 UXT2 / UXT6 | | |
| 2.4 D | 6 | D 24 | 60/80 | 01/82→07/92 | GN857 | 11V | | |
| 2.4 TD Interc. | 6 | D 24 TIC | 85/114 | 08/87→07/92 | GN857 | 11V | | |
| 2.4 Turbo Diesel | 6 | D 24 T | 80/107 | 04/87→07/92 | GN857 | 11V | | |
| 2.4 Turbo Diesel | 6 | D 24 T | 82/110 | 08/82→07/87 | GN857 | 11V | | |
| 2.8 | 6 | B 280 F | 105/141 | 05/86→08/91 | Z26 [167] | 0.7 UXK56 | ZS119 | ZM040 |
| 2.8 | 6 | B 280 E, F | 108/145 | 08/86→07/90 | | | | ZM040 |
| 2.8 | 6 | B 280 F | 108/145 | 08/86→07/90 | Z26 [167] | 0.7 UXK56 | ZS119 | |
| 2.8 | 6 | B 28 E, B 280 E | 115/154 | 08/81→07/88 | Z26 [167] | 0.7 UXK56 | | ZM040 08/86→ |
| 2.8 | 6 | B 28 E, B 280 E | 115/154 | 08/86→08/90 | Z26 [167] | 0.7 UXK56 | ZS119 | ZM040 |
| 2.8 | 6 | B 280 E | 125/168 | 08/84→08/90 | | | ZS119 | |

780

| | | | | | | | | |
|-------|---|------------|---------|-------------|-----------|-----------|-------|-------|
| 2.4 D | 6 | D 24 TIC | 90/121 | 04/86→07/90 | GN857 | 11V | | |
| 2.9 | 6 | B 280 E, F | 108/145 | 08/87→07/90 | | | | ZM040 |
| 2.9 | 6 | B 280 F | 108/145 | 08/87→07/90 | Z26 [167] | 0.7 UXK56 | ZS119 | |
| 2.9 | 6 | B 280 E | 115/154 | 08/86→07/87 | | | ZS119 | ZM040 |
| 2.9 | 6 | F | 115/154 | 08/86→07/87 | | | | ZM040 |



kW/BHP



... VOLVO



850

| | | | | | | | | | | |
|---------------|---|---------------------|---------|-------------|-----------|--|-----|-------|---------------------|--------|
| 2.0 | 5 | B 5202 S | 93/125 | 08/94→12/96 | Z204 | | 1.2 | | ZSE037 | ZM036 |
| | | | | | | | | | 08/95→ | 08/95→ |
| 2.0 | 5 | B 5204 F | 105/141 | 06/91→12/96 | Z24 | | 0.8 | UXT5 | ZS251 [1][213][254] | ZM036 |
| | | | | | | | | | ZSE037 [1] | 08/95→ |
| | | | | | | | | | 08/95→ | |
| 2.0 | 5 | B 5204 F | 105/141 | 02/93→12/96 | | | | | ZSE037 | ZM036 |
| | | | | | | | | | 08/95→ | 08/95→ |
| 2.0 LPG | 5 | B 5202 S | 93/125 | 08/94→12/96 | Z60 | | 1.2 | | | |
| 2.0 LPG | 5 | B 5204 F | 105/141 | 06/91→12/96 | Z30 [168] | | 0.8 | UXT5 | | |
| 2.0 Turbo | 5 | B 5204 T2 | 132/177 | 09/93→10/97 | | | | | ZSE037 | ZM036 |
| | | | | | | | | | 01/96→ | →12/95 |
| 2.0 Turbo | 5 | B 5204 FT, B 5204 T | 155/208 | 02/93→12/96 | Z206 | | 0.7 | UXT10 | ZSE037 | ZM036 |
| | | | | | | | | | 08/95→ | 08/95→ |
| 2.0 Turbo LPG | 5 | B 5204 FT, B 5204 T | 155/208 | 02/93→12/96 | Z340 | | 0.7 | UXT12 | | |
| 2.3 T5 | 5 | B 5234 FT | 166/223 | 02/93→12/96 | Z206 | | 0.7 | UXT10 | ZSE037 | ZM036 |
| | | | | | | | | | 08/95→ | 08/95→ |
| 2.3 T5 LPG | 5 | B 5234 FT | 166/223 | 02/93→12/96 | Z340 | | 0.7 | UXT12 | | |
| 2.3 T5-R | 5 | B 5234 T4 | 184/247 | 08/95→12/96 | Z206 | | 0.7 | UXT10 | ZSE037 | ZM036 |
| 2.3 T5-R LPG | 5 | B 5234 T4 | 184/247 | 08/95→12/96 | Z340 | | 0.7 | UXT12 | | |
| 2.5 | 5 | B 5252 | 103/138 | 06/91→07/94 | Z204 | | 1.2 | | ZSE037 | ZM036 |
| 2.5 | 5 | B 5252 FS | 106/142 | 08/94→12/96 | Z204 | | 1.2 | | ZSE037 | ZM036 |
| | | | | | | | | | 08/95→ | 08/95→ |
| 2.5 | 5 | B 5254 S | 125/168 | 08/91→12/96 | Z204 | | 1.2 | | ZSE037 | ZM036 |
| | | | | | | | | | 08/95→ | 08/95→ |
| 2.5 4WD | 5 | B 5254 T | 142/190 | 04/96→12/96 | Z206 | | 0.7 | UXT10 | ZSE037 | ZM036 |
| | | | | | | | | | 09/96→ | 09/96→ |
| 2.5 LPG | 5 | B 5252 FS | 106/142 | 08/94→12/96 | Z60 | | 1.2 | | | |
| 2.5 LPG | 5 | B 5254 S | 125/168 | 08/91→12/96 | Z60 | | 1.2 | | | |
| 2.5 4WD LPG | 5 | B 5254 T | 142/190 | 04/96→12/96 | Z340 | | 0.7 | UXT12 | | |
| 2.5 TDI | 5 | D 5252 T | 103/138 | 08/95→12/96 | GN855 | | 12V | | | |

940

| | | | | | | | | | | |
|--------------------|---|-------------------|---------|-------------|-----------|--|-----|-------------|-------|-------|
| 2.0 | 4 | B 200 F | 82/110 | 01/92→07/94 | Z20 | | 0.8 | UXT2 / UXT6 | ZS119 | ZM040 |
| 2.0 | 4 | B 200 E | 89/119 | 09/90→09/93 | Z27 | | 0.8 | UX56 | | |
| 2.0 | 4 | B 200 G | 89/119 | 09/90→09/93 | Z20 | | 0.8 | UXT2 / UXT6 | | |
| 2.0 Turbo | 4 | B 200 FT | 114/153 | 08/90→12/94 | | | | | ZS446 | |
| 2.3 | 4 | B 230 FD | 85/114 | 08/92→07/94 | Z20 | | 0.8 | UXT2 / UXT6 | ZS119 | ZM040 |
| 2.3 | 4 | B 230 FB, B 230 G | 96/129 | 08/90→12/94 | Z20 | | 0.8 | UXT2 / UXT6 | ZS119 | ZM040 |
| 2.3 | 4 | B 234 F, B 234 G | 114/153 | 08/90→07/91 | Z27 [168] | | 0.8 | UX56 | ZS119 | ZM040 |
| 2.3 Turbo | 4 | B 230 FT | 121/162 | 08/90→07/94 | Z20 | | 0.8 | UXT2 / UXT6 | ZS119 | ZM040 |
| 2.3 Turbo | 4 | B 230 FT+ | 140/188 | 08/91→07/93 | Z20 | | 0.8 | UXT2 / UXT6 | | |
| 2.4 D | 6 | D 24 | 60/80 | 08/90→07/95 | GN857 | | 11V | | | |
| 2.4 TD Intercooler | 6 | D 24 TIC | 90/121 | 08/90→12/94 | GN857 | | 11V | | | |
| 2.4 Turbo Diesel | 6 | D 24 T | 80/107 | 08/90→12/94 | GN857 | | 11V | | | |

940 II

| | | | | | | | | | | |
|----------------|---|----------|---------|-------------|-----------|--|-----|-------------|-------|-------|
| 2.0 | 4 | B 200 G | 89/119 | 11/94→12/95 | Z20 | | 0.8 | UXT2 / UXT6 | | |
| 2.3 | 4 | B 230 FD | 85/114 | 08/94→07/95 | Z20 | | 0.8 | UXT2 / UXT6 | ZS119 | ZM040 |
| 2.3 | 4 | B 230 FB | 96/129 | 08/94→10/98 | Z20 | | 0.8 | UXT2 / UXT6 | ZS119 | ZM040 |
| 2.3 LPG | 4 | B 230 FD | 85/114 | 08/94→07/95 | Z27 [168] | | 0.8 | UX56 | | |
| 2.3 LPG | 4 | B 230 FB | 96/129 | 08/94→10/98 | Z27 [168] | | 0.8 | UX56 | | |
| 2.3 ti | 4 | B 230 FK | 99/133 | 01/95→10/98 | Z20 | | 0.8 | UXT2 / UXT6 | ZS119 | ZM040 |
| 2.3 ti LPG | 4 | B 230 FK | 99/133 | 01/95→10/98 | Z27 [168] | | 0.8 | UX56 | | |
| 2.3 Turbo | 4 | B 230 FT | 121/162 | 08/94→10/98 | Z20 | | 0.8 | UXT2 / UXT6 | ZS119 | ZM040 |
| 2.3 Turbo | 4 | B 230 FT | 126/169 | 08/95→10/98 | Z20 | | 0.8 | UXT2 / UXT6 | | |
| 2.3 Turbo LPG | 4 | B 230 FT | 121/162 | 08/94→10/98 | Z27 [168] | | 0.8 | UX56 | | |
| 2.3 Turbo LPG | 4 | B 230 FT | 126/169 | 08/95→10/98 | Z27 [168] | | 0.8 | UX56 | | |
| 2.4 TD Interc. | 6 | D 24 TIC | 90/121 | 08/94→10/98 | GN857 | | 11V | | | |

VOLVO



kW/BHP

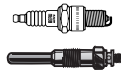

... VOLVO



960

| | | | | | | | | |
|----------------|---|------------------------------|---------|-------------|-------|-----|-------------|-------|
| 2.0 | 4 | B 200 F | 82/110 | 09/90→09/93 | | | | ZS446 |
| 2.3 Turbo | 4 | B 230 FT | 121/162 | 09/90→08/93 | Z20 | 0.8 | UXT2 / UXT6 | ZS119 |
| 2.4 Tdi | 6 | D 24 TIC | 90/121 | 09/90→08/93 | GN857 | 11V | | |
| 2.4 TD Interc. | 6 | D 24 TIC | 85/114 | 09/91→07/94 | GN857 | 11V | | |
| 2.9 | 6 | B 6304 F, B 6304 G, B 6304 S | 150/201 | 08/90→07/94 | Z15 | 0.8 | UXT1 / UXT3 | |

960 II

| | | | | | | | | |
|---------|---|----------|---------|-------------|------|-----|-------------|-------|
| 2.5 | 6 | B 6254 S | 125/168 | 07/94→12/96 | Z251 | 0.8 | UXT1 / UXT3 | ZS446 |
| 2.5 | 6 | B 6254 S | 125/168 | 08/94→12/96 | Z250 | 0.7 | UXT1 / UXT3 | |
| 2.5 LPG | 6 | B 6254 S | 125/168 | 07/94→12/96 | Z340 | 0.7 | UXT12 | |
| 2.9 | 6 | B 6304 S | 150/201 | 07/94→12/96 | Z204 | 1.2 | | ZS446 |
| 2.9 | 6 | B 6304 S | 150/201 | 09/94→12/96 | Z15 | 0.8 | UXT1 / UXT3 | |
| 2.9 LPG | 6 | B 6304 S | 150/201 | 07/94→12/96 | Z340 | 0.7 | UXT12 | |

C30

| | | | | | | | | |
|--------------|---|-----------------------|---------|-------------|-----------------------|------------|-------|--------|
| 1.6 | 4 | B 4164 S3 | 74/99 | 10/06→12/12 | Z177 | 1.3 | UXT7 | ZS387 |
| 1.6 D | 4 | D 4164 T | 80/107 | 10/06→12/12 | GN047 | 11V | | |
| | | | | | →eng. 16125 GN056 | 11V | | |
| | | | | | eng. 16126→ | | | |
| 1.6 D2 | 4 | D 4162 T | 84/113 | 10/10→12/12 | GE121A | 5V | | |
| 1.8 | 4 | B 4184 S11 | 92/123 | 10/06→12/12 | Z209 | 1.3 | UXT15 | ZS408 |
| 1.8 FlexFuel | 4 | B 4184 S8 | 92/123 | 01/07→12/12 | | | | ZS408 |
| 2.0 | 4 | B 4204 S3 | 107/143 | 10/06→12/12 | Z209 Z230 | 1.3 1.3 | UXT15 | ZS408 |
| 2.0 D | 4 | D 4204 T | 100/134 | 10/06→12/12 | GN054 | 11V | | |
| 2.0 FlexFuel | 4 | B 4204 S4 | 107/143 | 01/10→12/12 | Z230 | 1.3 | | ZS408 |
| 2.4 D5 | 5 | D 5244 T9 | 120/161 | 10/06→12/12 | GE123 | 4.4V | | |
| | | | | | →ch. 62745 | | | |
| 2.4 D5 | 5 | D 5244 T13, D 5244 T8 | 132/177 | 10/06→12/12 | GE123 | 4.4V | | |
| | | | | | →ch. 62745 | | | |
| 2.4 i | 5 | B 5244 S4 | 125/168 | 10/06→12/12 | Z294 | 1.7 | | ZSE055 |
| 2.5 T5 | 5 | B 5254 T3 | 162/217 | 10/06→12/12 | Z326 | 0.7 | | ZSE055 |
| | | | | | →07/07 | | | →07/07 |
| 2.5 T5 | 5 | B 5254 T7 | 169/227 | 03/07→12/12 | Z326 | 0.7 | | ZSE055 |
| | | | | | 08/07→ | | | |
| 2.5 T5 LPG | 5 | B 5254 T3 | 162/217 | 10/06→12/12 | Z226 ^[168] | 0.8 | | |
| | | | | | →07/07 | | | |
| 2.5 T5 LPG | 5 | B 5254 T7 | 169/227 | 03/07→12/12 | Z226 ^[168] | 0.8 | | |
| | | | | | 08/07→ | | | |

C70 I

| | | | | | | | | |
|------------|---|-----------|---------|-------------|------|-----|-------|--------|
| 2.0 | 5 | B 5204 T2 | 132/177 | 03/97→10/05 | Z206 | 0.7 | UXT10 | ZSE037 |
| | | | | | | | | →07/98 |
| 2.0 | 5 | B 5204 T2 | 132/177 | 03/97→09/02 | | | | ZM036 |
| | | | | | | | | →08/98 |
| 2.0 LPG | 5 | B 5204 T2 | 132/177 | 03/97→10/05 | Z340 | 0.7 | UXT12 | |
| 2.0 T | 5 | B 5204 T4 | 120/161 | 03/00→10/05 | Z206 | 0.7 | UXT10 | ZSE019 |
| 2.0 T | 5 | B 5204 T3 | 166/223 | 03/97→10/05 | Z206 | 0.7 | UXT10 | |
| 2.0 T | 5 | B 5204 T3 | 166/223 | 03/97→09/02 | | | | ZSE037 |
| | | | | | | | | →07/98 |
| | | | | | | | | ZSE019 |
| | | | | | | | | 08/98→ |
| 2.0 T | 5 | B 5204 T3 | 166/223 | 03/98→10/05 | | | | ZSE019 |
| | | | | | | | | 08/98→ |
| 2.0 T LPG | 5 | B 5204 T4 | 120/161 | 03/00→10/05 | Z340 | 0.7 | UXT12 | |
| 2.0 T LPG | 5 | B 5204 T3 | 166/223 | 03/97→10/05 | Z340 | 0.7 | UXT12 | |
| 2.3 T5 | 5 | B 5234 T3 | 176/236 | 03/98→10/05 | Z206 | 0.7 | UXT10 | ZSE019 |
| | | | | | | | | 09/98→ |
| 2.3 T5 | 5 | B 5234 T9 | 180/241 | 07/02→10/05 | Z206 | 0.7 | UXT10 | ZSE019 |
| 2.3 T5 LPG | 5 | B 5234 T3 | 176/236 | 03/98→10/05 | Z340 | 0.7 | UXT12 | |

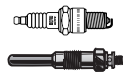

kW/BHP

**... VOLVO****... C70 I**

| | | | | | | | | | |
|-------------|---|--------------------|---------|-------------|-----------|-----|-------------|--------------------------------------|----------------------|
| 2.3 T5 LPG | 5 | B 5234 T9 | 180/241 | 07/02→10/05 | Z340 | 0.7 | UXT12 | | |
| 2.3 T-5 | 5 | B 5234 T3 | 176/236 | 03/97→09/02 | Z206 | 0.7 | UXT10 | ZSE037 →07/98 ZSE019 08/98→ | ZM036 →08/98 |
| 2.3 T-5 LPG | 5 | B 5234 T3 | 176/236 | 03/97→09/02 | Z340 | 0.7 | UXT12 | | |
| 2.4 T | 5 | B 5244 T7 | 147/197 | 07/02→10/05 | Z206 | 0.7 | UXT10 | ZSE019 | |
| 2.4 T LPG | 5 | B 5244 T7 | 147/197 | 07/02→10/05 | Z340 | 0.7 | UXT12 | | |
| 2.5 | 5 | B 5254 S | 121/162 | 03/99→09/02 | Z15 [168] | 0.8 | UXT1 / UXT3 | ZSE019 | |
| 2.5 | 5 | B 5244 S | 125/168 | 05/99→09/02 | Z204 | 1.2 | | ZSE019 | |
| 2.5 | 5 | B 5254 S | 125/168 | 06/98→10/05 | Z204 | 1.2 | | ZS446 [54] ZSE019 03/99→ | ZM036 →03/99 |
| 2.5 | 5 | B 5254 S | 125/168 | 05/99→09/02 | | | | ZSE019 | |
| 2.5 LPG | 5 | B 5254 S | 121/162 | 03/99→09/02 | Z340 | 0.7 | UXT12 | | |
| 2.5 LPG | 5 | B 5244 S, B 5254 S | 125/168 | 06/98→10/05 | Z60 | 1.2 | | | |
| 2.5 T | 5 | B 5244 T, B 5254 T | 142/190 | 03/97→10/05 | Z206 | 0.7 | UXT10 | | |
| 2.5 T | 5 | B 5244 T, B 5254 T | 142/190 | 03/97→09/02 | | | | ZSE037 →07/98 ZSE019 08/98→ | ZM036 01/98→07/98 |
| 2.5 T | 5 | B 5244 T, B 5254 T | 142/190 | 03/98→10/05 | | | | ZSE019 08/98→ | |
| 2.5 T LPG | 5 | B 5244 T, B 5254 T | 142/190 | 03/97→10/05 | Z340 | 0.7 | UXT12 | | |

C70 II

| | | | | | | | | | |
|------------|---|-----------------------|---------|--------|----------------------|------|--|------------------|--|
| 2.0 D | 4 | D 4204 T | 100/134 | 01/08→ | GN054 | 11V | | | |
| 2.4 | 5 | B 5244 S5 | 103/138 | 03/06→ | Z294 | 1.7 | | ZSE055 | |
| 2.4 D | 5 | D 5244 T9 | 120/161 | 03/07→ | GE123 →ch. 49640 | 4.4V | | | |
| 2.4 D5 | 5 | D 5244 T13, D 5244 T8 | 132/177 | 03/06→ | GE123 →ch. 49640 | 4.4V | | | |
| 2.4 i | 5 | B 5244 S4 | 125/168 | 03/06→ | Z294 | 1.7 | | ZSE055 | |
| 2.5 T5 | 5 | B 5254 T3 | 162/217 | 03/06→ | Z326 →07/07 | 0.7 | | ZSE055 →07/07 | |
| 2.5 T5 | 5 | B 5254 T7 | 169/227 | 03/07→ | Z326 08/07→ | 0.7 | | ZSE055 | |
| 2.5 T5 LPG | 5 | B 5254 T3 | 162/217 | 03/06→ | Z226 [168] →07/07 | 0.8 | | | |
| 2.5 T5 LPG | 5 | B 5254 T7 | 169/227 | 03/07→ | Z226 [168] 08/07→ | 0.8 | | | |

DUETT

| | | | | | | | | | |
|-----|---|--------|-------|-------------|-----|-----|--|--|--|
| 1.8 | 4 | B 18 A | 50/67 | 08/61→07/67 | Z57 | 0.6 | | | |
|-----|---|--------|-------|-------------|-----|-----|--|--|--|

P 121

| | | | | | | | | | |
|-----|---|--------|-------|-------------|------|-----|--|------------|--|
| 1.6 | 4 | B 16 A | 44/59 | 05/59→09/66 | Z266 | 0.6 | | | |
| 1.8 | 4 | B 18 A | 50/67 | 05/59→09/66 | Z57 | 0.6 | | | |
| 1.8 | 4 | B 18 | 55/74 | 02/67→05/71 | Z57 | 0.6 | | ZS106 [11] | |
| 2.0 | 4 | B 20 A | 60/80 | 11/68→05/71 | Z10 | 0.8 | | | |

P 122 S AMAZON

| | | | | | | | | | |
|-----|---|--------|--------|-------------|-----------|-----|--|------------|--|
| 1.6 | 4 | B 16 | 61/82 | 05/59→09/66 | Z266 | 0.6 | | | |
| 1.8 | 4 | B 18 | 59/79 | 05/59→07/67 | Z10 | 0.8 | | | |
| 1.8 | 4 | B 18 | 63/84 | 09/66→05/71 | Z10 | 0.8 | | ZS106 [11] | |
| 1.8 | 4 | B 18 D | 66/89 | 02/67→05/71 | Z57 | 0.6 | | | |
| 1.8 | 4 | B 18 | 76/102 | 09/66→05/71 | Z40 | 0.6 | | | |
| 2.0 | 4 | B 20 B | 74/99 | 11/68→05/71 | Z48 [168] | 0.8 | | | |

P 544

| | | | | | | | | | |
|-----|---|--------|-------|-------------|-----------|-----|--|--|--|
| 1.6 | 4 | B 16 A | 44/59 | 08/61→07/66 | Z266 | 0.6 | | | |
| 1.6 | 4 | B 16 B | 61/82 | 08/61→07/67 | Z266 | 0.6 | | | |
| 1.8 | 4 | B 18 A | 50/67 | 08/61→07/67 | Z57 [168] | 0.6 | | | |
| 1.8 | 4 | B 18 D | 59/79 | 08/61→07/67 | Z57 [168] | 0.6 | | | |

VOLVO

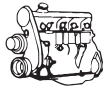

kW/BHP

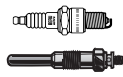

... VOLVO



P 1800

| | | | | | | | | |
|--------|---|--------|--------|-------------|-----|--|-----|--|
| 1.8 | 4 | | 66/89 | 04/62→05/70 | Z41 | | 0.8 | |
| 1.8 | 4 | | 76/102 | 04/62→05/70 | Z41 | | 0.8 | |
| 1.8 S | 4 | | 71/95 | 04/62→05/70 | Z41 | | 0.8 | |
| 2.0 ES | 4 | B 20 E | 91/122 | 04/72→11/73 | Z41 | | 0.8 | |

P 2200

| | | | | | | | | |
|-----|---|--|-------|-------------|-----|--|-----|--|
| 1.8 | 4 | | 50/67 | 09/64→08/67 | Z10 | | 0.8 | |
| 1.8 | 4 | | 59/79 | 09/64→08/67 | Z10 | | 0.8 | |
| 1.8 | 4 | | 63/84 | 09/64→08/67 | Z10 | | 0.8 | |

S40 I

| | | | | | | | | |
|------------|---|-----------------------------------|---------|-------------|-------|--|-----|---|
| 1.6 | 4 | B 4164 S | 77/103 | 09/95→08/99 | Z204 | | 1.2 | ZS254 ^[24] ZS255 ^[26] ZS429 |
| 1.6 | 4 | B 4164 S2 | 80/107 | 03/99→12/03 | Z204 | | 1.2 | |
| 1.6 LPG | 4 | B 4164 S | 77/103 | 09/95→08/99 | Z60 | | 1.2 | |
| 1.6 LPG | 4 | B 4164 S2 | 80/107 | 03/99→12/03 | Z60 | | 1.2 | |
| 1.8 | 4 | B 4184 S, B 4184 S3 | 85/114 | 07/95→08/99 | Z204 | | 1.2 | ZS254 ^[24] ZS255 ^[26] |
| 1.8 | 4 | B 4184 S2 | 85/114 | 06/01→08/03 | Z204 | | 1.2 | ZS429 |
| 1.8 | 4 | B 4184 S2, B 4184 S9 | 90/121 | 03/99→12/03 | Z204 | | 1.2 | ZS245 ^[24] ZS246 ^[26] |
| 1.8 LPG | 4 | B 4184 S, B 4184 S2, B 4184 S3 | 85/114 | 07/95→08/03 | Z60 | | 1.2 | |
| 1.8 LPG | 4 | B 4184 S2, B 4184 S9 | 90/121 | 03/99→12/03 | Z60 | | 1.2 | |
| 1.8 i | 4 | B 4184 SJ | 90/121 | 06/01→12/03 | Z279 | | 0.6 | ZS254 ^{[24][92]} ZS255 ^{[26][93]} ZS446 ^[54] |
| 1.8 i | 4 | B 4184 SM | 92/123 | 03/98→12/03 | Z279 | | 0.6 | |
| 1.8 i LPG | 4 | B 4184 SJ | 90/121 | 06/01→12/03 | Z116 | | 0.8 | UXT5 |
| 1.8 i LPG | 4 | B 4184 SM | 92/123 | 03/98→12/03 | Z116 | | 0.8 | UXT5 |
| 1.9 DI | 4 | D 4192 T2 | 70/94 | 03/99→07/00 | GN999 | | 11V | |
| 1.9 DI | 4 | D 4192 T4 | 75/101 | 07/00→12/03 | GN018 | | 11V | |
| 1.9 DI | 4 | D 4192 T3 | 85/114 | 07/00→12/03 | GN018 | | 11V | |
| 1.9 T4 | 4 | B 4194 T, B 4194 T2 | 147/197 | 05/97→07/00 | Z206 | | 0.7 | UXT10 ZS429 |
| 1.9 T4 LPG | 4 | B 4194 T, B 4194 T2 | 147/197 | 05/97→07/00 | Z340 | | 0.7 | UXT12 |
| 1.9 TD | 4 | D 4192 T | 66/89 | 07/95→08/99 | GN959 | | 11V | |
| 2.0 | 4 | B 4204 S | 100/134 | 07/95→12/03 | Z204 | | 1.2 | |
| 2.0 | 4 | B 4204 S2 | 100/134 | 07/95→12/03 | Z204 | | 1.2 | ZS429 04/99→ |
| 2.0 | 4 | B 4204 S | 103/138 | 07/95→08/99 | Z204 | | 1.2 | ZS254 ^[24] ZS255 ^[26] |
| 2.0 LPG | 4 | B 4204 S, B 4204 S2 | 100/134 | 07/95→12/03 | Z60 | | 1.2 | |
| 2.0 LPG | 4 | B 4204 S | 103/138 | 07/95→08/99 | Z60 | | 1.2 | |
| 2.0 T | 4 | B 4204 T | 118/158 | 10/97→12/03 | Z206 | | 0.7 | UXT10 ZS429 |
| 2.0 T | 4 | B 4204 T3 | 120/161 | 06/01→12/03 | Z206 | | 0.7 | UXT10 ZS429 |
| 2.0 T | 4 | B 4204 T2, B 4204 T3 | 121/162 | 07/00→06/01 | Z206 | | 0.7 | UXT10 ZS429 ^[1] ZS446 ^{[1][54]} |
| 2.0 T LPG | 4 | B 4204 T | 118/158 | 10/97→12/03 | Z340 | | 0.7 | UXT12 |
| 2.0 T LPG | 4 | B 4204 T3 | 120/161 | 06/01→12/03 | Z340 | | 0.7 | UXT12 |
| 2.0 T LPG | 4 | B 4204 T2, B 4204 T3 | 121/162 | 07/00→06/01 | Z340 | | 0.7 | UXT12 |
| 2.0 T4 | 4 | B 4204 T5 | 147/197 | 07/00→12/03 | Z206 | | 0.7 | UXT10 ZS429 |
| 2.0 T4 LPG | 4 | B 4204 T5 | 147/197 | 07/00→12/03 | Z340 | | 0.7 | UXT12 |

S40 II

| | | | | | | | | |
|--------|---|-----------|--------|--------|--|--|-----|------------------------------|
| 1.6 | 4 | B 4164 S3 | 74/99 | 01/05→ | Z177 | | 1.3 | UXT7 ZS387 ch. 106167→ |
| 1.6 D | 4 | D 4164 T | 81/109 | 01/05→ | GN047 →eng. 16125 GN056 eng. 16126→ | | 11V | |
| 1.6 D2 | 4 | D 4162 T | 84/113 | 10/10→ | GE121A | | 5V | |

VOLVO

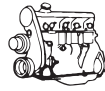

kW/BHP

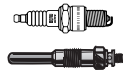
**... VOLVO****... S40 II**

| | | | | | | | | |
|--------------|---|-----------------------|---------|--------|-----------------------|------|-------|-----------------------------|
| 1.8 | 4 | B 4184 S11 | 92/123 | 04/04→ | Z209 | 1.3 | UXT15 | ZS408 |
| 1.8 FlexFuel | 4 | B 4184 S8 | 92/123 | 01/06→ | | | | ZS408 |
| 2.0 | 4 | B 4204 S3 | 107/143 | 10/06→ | Z230 | 1.3 | | ZS408 |
| 2.0 D | 4 | D 4204 T | 100/134 | 01/04→ | GN054 | 11V | | |
| 2.0 D4 | 4 | D 4204 T2 | 96/129 | 07/05→ | GN054 | 11V | | |
| 2.0 F | 4 | B 4204 S4 | 107/143 | 10/06→ | Z230 | 1.3 | | ZS408 |
| 2.4 | 5 | B 5244 S5 | 103/138 | 01/04→ | Z294 | 1.7 | | ZSE055 |
| 2.4 | 5 | B 5244 S4 | 125/168 | 01/04→ | Z294 | 1.7 | | ZS446 [1][S4] ZSE055 [1] |
| 2.4 4WD | 5 | B 5244 S4 | 125/168 | 08/06→ | | | | ZSE055 |
| 2.4 D5 | 5 | D 5244 T13, D 5244 T8 | 132/177 | 03/06→ | GE123 → ch. 380303 | 4.4V | | |
| 2.5 T5 | 5 | B 5254 T3 | 162/217 | 01/04→ | Z326 →07/07 | 0.7 | | ZSE055 →07/07 |
| 2.5 T5 | 5 | B 5254 T7 | 169/227 | 03/07→ | Z326 08/07→ | 0.7 | | ZSE055 |
| 2.5 T5 LPG | 5 | B 5254 T3 | 162/217 | 01/04→ | Z226 [168] →07/07 | 0.8 | | |
| 2.5 T5 LPG | 5 | B 5254 T7 | 169/227 | 03/07→ | Z226 [168] 08/07→ | 0.8 | | |

S60 I

| | | | | | | | | |
|------------------|---|-----------|---------|-------------|---|------------|-----------------|--------------------------------------|
| 2.0 T | 5 | B 5204 T5 | 132/177 | 07/00→04/10 | Z206 →07/04 Z326 08/04→07/09 | 0.7 0.7 | UXT10 →07/04 | ZSE019 →07/04 ZSE055 08/04→ |
| 2.0 T LPG | 5 | B 5204 T5 | 132/177 | 07/00→04/10 | Z340 →07/04 Z226 [168] 08/04→07/09 | 0.7 0.8 | UXT12 →07/04 | |
| 2.3 T5 | 5 | B 5234 T3 | 184/247 | 11/00→04/10 | Z206 | 0.7 | UXT10 | ZSE019 |
| 2.3 T5 | 5 | B 5234 T7 | 195/261 | 07/00→09/02 | | | | ZSE019 |
| 2.3 T5 LPG | 5 | B 5234 T3 | 184/247 | 11/00→04/10 | Z340 | 0.7 | UXT12 | |
| 2.4 | 5 | B 5244 S2 | 103/138 | 11/00→04/10 | Z204 | 1.2 | | ZSE019 |
| 2.4 | 5 | B 5244 S | 125/168 | 11/00→04/10 | Z204 | 1.2 | | ZSE019 |
| 2.4 4WD | 5 | B 5244 T5 | 191/256 | 02/04→04/10 | | | | ZSE055 |
| 2.4 LPG | 5 | B 5244 S2 | 103/138 | 11/00→04/10 | Z60 | 1.2 | | |
| 2.4 LPG | 5 | B 5244 S | 125/168 | 11/00→04/10 | Z60 | 1.2 | | |
| 2.4 Bifuel (CNG) | 5 | B 5244 SG | 103/138 | 06/02→04/10 | Z204 | 1.2 | | ZSE019 |
| 2.4 D | 5 | D 5244 T7 | 93/125 | 09/05→04/10 | GE123 | 4.4V | | |
| 2.4 D | 5 | D 5244 T2 | 96/129 | 12/01→04/10 | GN045 | 11V | | |
| 2.4 D | 5 | D 5244 T5 | 120/161 | 09/05→01/09 | GE123 | 4.4V | | |
| 2.4 D5 | 5 | D 5244 T | 120/161 | 07/01→04/10 | GN045 | 11V | | |
| 2.4 D5 | 5 | D 5244 T4 | 136/182 | 09/05→04/10 | GE123 | 4.4V | | |
| 2.4 T | 5 | B 5244 T3 | 147/197 | 11/00→04/10 | Z206 →10/01 Z326 11/01→ | 0.7 0.7 | UXT10 →07/01 | ZSE019 →07/03 ZSE055 08/03→ |
| 2.4 T 4WD | 5 | B 5244 T3 | 147/197 | 11/01→04/10 | Z326 | 0.7 | | ZSE019 →07/03 ZSE055 08/03→ |
| 2.4 T LPG | 5 | B 5244 T3 | 147/197 | 11/00→04/10 | Z340 →10/01 | 0.7 | UXT12 →10/01 | |
| 2.4 T5 | 5 | B 5244 T5 | 191/256 | 04/04→04/10 | Z326 →07/09 | 0.7 | | ZSE055 |
| 2.5 R 2,5 T 4WD | 5 | B 5254 T4 | 221/296 | 03/03→04/10 | Z326 →07/07 | 0.7 | | ZSE055 →07/07 |
| 2.5 T | 5 | B 5254 T2 | 154/207 | 02/04→04/10 | Z206 | 0.7 | UXT10 | ZSE019 |
| 2.5 T LPG | 5 | B 5254 T2 | 154/207 | 02/04→04/10 | Z340 | 0.7 | UXT12 | |

VOLVO

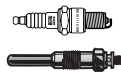

kW/BHP

**... VOLVO****S60 II**

| | | | | | | | | |
|----------------|---|----------|--------|--------|--------|----|--|--|
| 1.6 DRIVe / D2 | 4 | D 4162 T | 84/113 | 01/11→ | GE121A | 5V | | |
|----------------|---|----------|--------|--------|--------|----|--|--|

S70

| | | | | | | | | | |
|---------------|---|----------------------|---------|-------------|------|-----|------------------|------------------|-----------------|
| 2.0 | 5 | B 5202 FS, B 5202 S | 93/125 | 01/97→11/00 | Z204 | 1.2 | ZSE037 | ZM036 | |
| 2.0 | 5 | B 5204 F | 105/141 | 01/97→11/00 | Z204 | 1.2 | ZSE037 →07/98 | ZM036 →07/98 | |
| 2.0 | 5 | B 5204 T4 | 120/161 | 01/97→11/00 | Z204 | 1.2 | ZSE019 | | |
| 2.0 | 5 | B 5204 T2 | 132/177 | 01/97→11/00 | Z204 | 1.2 | ZSE037 →07/98 | ZM036 →07/98 | |
| 2.0 LPG | 5 | B 5202 FS, B 5202 S | 93/125 | 01/97→11/00 | Z60 | 1.2 | | | |
| 2.0 LPG | 5 | B 5204 F | 105/141 | 01/97→11/00 | Z60 | 1.2 | | | |
| 2.0 LPG | 5 | B 5204 T4 | 120/161 | 01/97→11/00 | Z60 | 1.2 | | | |
| 2.0 LPG | 5 | B 5204 T2 | 132/177 | 01/97→11/00 | Z60 | 1.2 | | | |
| 2.0 Turbo | 5 | B 5204 T | 155/208 | 01/97→11/00 | Z206 | 0.7 | UXT10 →07/98 | ZSE037 →07/98 | ZM036 →07/98 |
| 2.0 Turbo | 5 | B 5204 T3 | 166/223 | 01/97→11/00 | Z206 | 0.7 | UXT10 | ZSE019 | ZM036 →08/98 |
| 2.0 Turbo LPG | 5 | B 5204 T | 155/208 | 01/97→11/00 | Z340 | 0.7 | UXT12 | | |
| 2.0 Turbo LPG | 5 | B 5204 T3 | 166/223 | 01/97→11/00 | Z340 | 0.7 | UXT12 | | |
| 2.3 | 5 | B 5234 T3 | 177/237 | 11/96→11/00 | | | ZSE019 | | |
| 2.3 | 5 | B 5234 T7 | 195/261 | 04/99→09/00 | | | ZSE019 | | |
| 2.3 T5 4WD | 5 | B 5234 T3 | 177/237 | 11/96→09/98 | | | ZSE019 | | |
| 2.3 T-5 | 5 | B 5234 T3 | 176/236 | 01/97→11/00 | Z206 | 0.7 | UXT10 →07/98 | ZSE037 →07/98 | ZM036 →07/98 |
| | | | | | | | ZSE019 08/98→ | | |
| 2.3 T-5 LPG | 5 | B 5234 T3 | 176/236 | 01/97→11/00 | Z340 | 0.7 | UXT12 | | |
| 2.3 Turbo | 5 | B 5234 FT+ | 184/247 | 01/97→11/00 | Z206 | 0.7 | UXT10 →07/98 | ZSE037 →07/98 | ZM036 →07/98 |
| 2.3 Turbo LPG | 5 | B 5234 FT+ | 184/247 | 01/97→11/00 | Z340 | 0.7 | UXT12 | | |
| 2.4 | 5 | B 5244 S2, B 5244 SG | 103/138 | 08/99→11/00 | Z204 | 1.2 | ZSE019 | | |
| 2.4 4WD | 5 | B 5244 S2 | 103/138 | 04/99→09/00 | | | ZSE019 | | |
| 2.4 4WD | 5 | B 5252 FS | 106/142 | 11/96→05/99 | | | ZSE037 | | |
| 2.4 4WD | 5 | B 5254 S | 121/162 | 10/98→05/99 | | | ZSE019 | | |
| 2.4 | 5 | B 5244 S | 125/168 | 01/97→11/00 | | | ZSE037 →07/98 | ZM036 →07/98 | |
| | | | | | | | ZSE019 08/98→ | | |
| 2.4 | 5 | B 5254 S | 125/168 | 01/97→11/00 | Z204 | 1.2 | ZSE037 →07/98 | ZM036 →07/98 | |
| | | | | | | | ZSE019 08/98→ | | |
| 2.4 4WD | 5 | B 5244 S | 125/168 | 04/99→09/00 | | | ZSE019 | | |
| 2.4 LPG | 5 | B 5244 S2, B 5244 SG | 103/138 | 08/99→11/00 | Z60 | 1.2 | | | |
| 2.4 LPG | 5 | B 5254 S | 125/168 | 01/97→11/00 | Z60 | 1.2 | | | |
| 2.4 Blu-Fuel | 5 | B 5244 S2, B 5244 SG | 103/138 | 07/97→09/00 | | | ZSE019 | | |
| 2.4 T5 4WD | 5 | B 5254 T | 142/190 | 11/96→04/99 | | | ZSE019 08/98→ | | |
| 2.4 Turbo | 5 | B 5244 T, B 5254 T | 142/190 | 01/97→11/00 | Z206 | 0.7 | UXT10 →07/98 | ZSE037 →07/98 | ZM036 →07/98 |
| | | | | | | | ZSE019 08/98→ | | |
| 2.4 Turbo LPG | 5 | B 5244 T, B 5254 T | 142/190 | 01/97→11/00 | Z340 | 0.7 | UXT12 | | |
| 2.5 | 5 | B 5252 FS | 106/142 | 01/97→11/00 | Z204 | 1.2 | ZSE037 | ZM036 | |
| 2.5 | 5 | B 5254 S | 121/162 | 06/98→11/00 | Z204 | 1.2 | ZSE037 →07/98 | ZM036 →07/98 | |
| | | | | | | | ZSE019 08/98→ | | |
| 2.5 LPG | 5 | B 5252 FS | 106/142 | 01/97→11/00 | Z60 | 1.2 | | | |
| 2.5 LPG | 5 | B 5254 S | 121/162 | 06/98→11/00 | Z60 | 1.2 | | | |

VOLVO

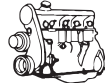

kW/BHP

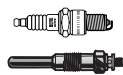

... VOLVO



... S70

| | | | | | | | | |
|------------|---|-----------|---------|-------------|-------|-----|--------|-------|
| 2.5 Bifuel | 5 | B 5244 SG | 103/138 | 07/99→11/00 | Z204 | 1.2 | ZSE019 | |
| 2.5 Bifuel | 5 | GB 5252 S | 106/142 | 10/98→11/00 | Z204 | 1.2 | ZSE037 | ZM036 |
| 2.5 TDI | 5 | D 5252 T | 103/138 | 01/97→11/00 | GN855 | 12V | | |

S80 I

| | | | | | | | | |
|---------|---|-----------|---------|-------------|----------------------------------|-----|-----------------|--------------------------------------|
| 2.0 | 5 | B 5204 T4 | 120/161 | 06/98→07/06 | Z206 | 0.7 | UXT10 | ZSE019 |
| 2.0 LPG | 5 | B 5204 T4 | 120/161 | 06/98→07/06 | Z340 | 0.7 | UXT12 | |
| 2.0 T | 5 | B 5204 T5 | 132/177 | 12/99→07/06 | Z206 →07/04 Z326 08/04→ | 0.7 | UXT10 →07/04 | ZSE019 →07/04 ZSE055 08/04→ |

| | | | | | | | | |
|-----------|---|-----------|---------|-------------|--|------------|-----------------|--------|
| 2.0 T | 5 | B 5204 T3 | 166/223 | 06/98→07/06 | Z206 | 0.7 | UXT10 | ZSE019 |
| 2.0 T LPG | 5 | B 5204 T5 | 132/177 | 12/99→07/06 | Z340 →07/04 Z226 [168] 08/04→ | 0.7 0.8 | UXT12 →07/04 | |

| | | | | | | | | |
|------------------|---|------------|---------|-------------|----------------------------------|------------|-----------------|--------|
| 2.0 T LPG | 5 | B 5204 T3 | 166/223 | 06/98→07/06 | Z340 | 0.7 | UXT12 | |
| 2.4 | 5 | B 5244 S2 | 103/138 | 01/99→07/06 | Z204 | 1.2 | | ZSE019 |
| 2.4 | 5 | B 5244 S | 125/168 | 01/99→07/06 | Z204 | 1.2 | | ZSE019 |
| 2.4 LPG | 5 | B 5244 S2 | 103/138 | 01/99→07/06 | Z60 | 1.2 | | |
| 2.4 LPG | 5 | B 5244 S | 125/168 | 01/99→07/06 | Z60 | 1.2 | | |
| 2.4 Bifuel (CNG) | 5 | B 5244 SG2 | 103/138 | 09/01→07/06 | Z204 | 1.2 | | ZSE019 |
| 2.4 D | 5 | D 5244 T2 | 96/129 | 10/01→07/06 | GN045 | 11V | | |
| 2.4 D5 | 5 | D 5244 T | 120/161 | 08/01→07/06 | GN045 | 11V | | |
| 2.4 T | 5 | B 5244 T3 | 147/197 | 06/00→07/06 | Z206 →10/01 Z326 11/01→ | 0.7 0.7 | UXT10 →10/01 | ZSE019 |

| | | | | | | | | |
|-----------|---|-----------|---------|-------------|----------------|-----|-----------------|--|
| 2.4 T LPG | 5 | B 5244 T3 | 147/197 | 06/00→07/06 | Z340 →10/01 | 0.7 | UXT12 →10/01 | |
|-----------|---|-----------|---------|-------------|----------------|-----|-----------------|--|

| | | | | | | | | |
|------------|---|-----------|---------|-------------|----------------------------------|------------|-----------------|--------|
| 2.4 T5 4WD | 5 | B 5244 T3 | 147/197 | 04/00→09/03 | Z206 →10/01 Z326 11/01→ | 0.7 0.7 | UXT10 →10/01 | ZSE019 |
|------------|---|-----------|---------|-------------|----------------------------------|------------|-----------------|--------|

| | | | | | | | | |
|----------------|---|-----------|---------|-------------|----------------|-----|-----------------|--|
| 2.4 T5 4WD LPG | 5 | B 5244 T3 | 147/197 | 04/00→09/03 | Z340 →10/01 | 0.7 | UXT12 →10/01 | |
|----------------|---|-----------|---------|-------------|----------------|-----|-----------------|--|

| | | | | | | | | |
|-----------|---|-----------|---------|-------------|------|-----|-------|--------|
| 2.5 T | 5 | B 5254 T2 | 154/207 | 03/03→07/06 | Z206 | 0.7 | UXT10 | ZSE019 |
| 2.5 T LPG | 5 | B 5254 T2 | 154/207 | 03/03→07/06 | Z340 | 0.7 | UXT12 | |

| | | | | | | | | |
|---------|---|----------|---------|-------------|-------|-----|-------|--------|
| 2.5 TDI | 5 | D 5252 T | 103/138 | 01/99→07/06 | GN855 | 12V | | |
| 2.8 T6 | 6 | B 6284 T | 200/268 | 05/98→07/06 | Z206 | 0.7 | UXT10 | ZSE019 |

| | | | | | | | | |
|------------|---|----------|---------|-------------|------|-----|-------|--------|
| 2.8 T6 LPG | 6 | B 6284 T | 200/268 | 05/98→07/06 | Z340 | 0.7 | UXT12 | |
| 2.9 | 6 | B 6294 S | 147/197 | 03/99→07/06 | | | | ZSE019 |

| | | | | | | | | |
|---------|---|-----------|---------|-------------|------|-----|--|--------|
| 2.9 | 6 | B 6304 S3 | 150/201 | 05/98→07/06 | Z204 | 1.2 | | ZSE019 |
| 2.9 LPG | 6 | B 6304 S3 | 150/201 | 05/98→07/06 | Z60 | 1.2 | | |

| | | | | | | | | |
|--------|---|-----------|---------|-------------|------|-----|-------|--------|
| 3.0 | 6 | B 6294 S2 | 144/193 | 06/01→07/06 | Z204 | 1.2 | | ZSE019 |
| 3.0 T6 | 6 | B 6294 T | 200/268 | 06/01→07/06 | Z206 | 0.7 | UXT10 | ZSE019 |

| | | | | | | | | |
|------------|---|----------|---------|-------------|------|-----|-------|--|
| 3.0 T6 LPG | 6 | B 6294 T | 200/268 | 06/01→07/06 | Z340 | 0.7 | UXT12 | |
|------------|---|----------|---------|-------------|------|-----|-------|--|

S80 II

| | | | | | | | | |
|-------------|---|----------|--------|--------|--------|-----|--|--|
| 1.6 D DRIVe | 4 | D 4164 T | 80/107 | 01/10→ | GN056 | 11V | | |
| 1.6 DRIVe | 4 | D 4162 T | 84/113 | 06/11→ | GE121A | 5V | | |

| | | | | | | | | |
|--------|---|-----------|---------|--------|-------|------|--|-------|
| 2.0 | 4 | B 4204 S3 | 107/143 | 01/08→ | | | | ZS408 |
| 2.0 D3 | 5 | D 5204 T7 | 100/134 | 05/12→ | GE123 | 4.4V | | |

| | | | | | | | | |
|--------------|---|----------------------|---------|--------|-------|------|--|-------|
| 2.0 D3 / D4 | 5 | D 5204 T2, D 5204 T3 | 120/161 | 01/10→ | GE123 | 4.4V | | |
| 2.0 FlexFuel | 4 | B 4204 S4 | 107/143 | 01/08→ | Z230 | 1.3 | | ZS408 |

| | | | | | | | | |
|---------|---|-----------|---------|--------|-------|------|--|--|
| 2.0 TDi | 4 | D 4204 T | 100/134 | 02/08→ | GN054 | 11V | | |
| 2.4 D | 5 | D 5244 T5 | 120/161 | 03/06→ | GE123 | 4.4V | | |

| | | | | | | | | |
|--------|---|------------------------|---------|--------|-------|------|--|--|
| 2.4 D | 5 | D 5244 T14 | 129/173 | 01/10→ | GE123 | 4.4V | | |
| 2.4 D5 | 5 | D 5244 T4 | 136/182 | 03/06→ | GE123 | 4.4V | | |
| 2.4 D5 | 5 | D 5244 T11, D 5244 T15 | 158/212 | 06/11→ | GE123 | 4.4V | | |



kW/BHP

**... VOLVO****... S80 II**

| | | | | | | | |
|----------------|---|------------|---------|--------|----------------------|-----|----------------|
| 2.5 T | 5 | B 5254 T6 | 147/197 | 03/06→ | Z326 →07/09 | 0.7 | ZSE055 |
| 2.5 T | 5 | B 5254 T10 | 170/228 | 01/10→ | | | ZSE055 |
| 2.5 T LPG | 5 | B 5254 T6 | 147/197 | 03/06→ | Z226 [168] →07/09 | 0.8 | |
| 2.5 T FlexFuel | 5 | B 5254 T8 | 147/197 | 05/08→ | | | ZSE055 |
| 2.5 T FlexFuel | 5 | B 5254 T11 | 170/228 | 01/10→ | | | ZSE055 |
| 3.2 | 6 | B 6324 S | 175/235 | 03/06→ | Z326 08/06→ | 0.7 | |
| 3.2 LPG | 6 | B 6324 S | 175/235 | 03/06→ | Z226 [168] 08/06→ | 0.8 | |
| 4.4 V8 4WD | 8 | B 8444 S | 232/311 | 03/06→ | Z312 →12/10 | 1.0 | UXT9 →12/10 |

S90

| | | | | | | | |
|---------|---|-----------|---------|-------------|------|-----|-------------------|
| 2.5 | 6 | B 6254 FS | 125/168 | 11/96→10/98 | | | ZS446 |
| 2.9 | 6 | B 6304 S2 | 132/177 | 01/97→05/98 | Z251 | 0.8 | UXT1 / UXT3 ZS446 |
| 2.9 | 6 | B 6304 G | 150/201 | 01/97→05/98 | Z251 | 0.8 | UXT1 / UXT3 ZS446 |
| 2.9 LPG | 6 | B 6304 S2 | 132/177 | 01/97→05/98 | Z340 | 0.7 | UXT12 |
| 2.9 LPG | 6 | B 6304 G | 150/201 | 01/97→05/98 | Z340 | 0.7 | UXT12 |

V40

| | | | | | | | |
|------------|---|----------------------|---------|-------------|--------|-----|--------------------------|
| 1.6 | 4 | B 4164 S | 77/103 | 12/95→08/99 | Z204 | 1.2 | ZS254 [24] ZS255 [26] |
| 1.6 | 4 | B 4164 S2 | 80/107 | 03/99→06/04 | Z204 | 1.2 | ZS245 [24] ZS246 [26] |
| 1.6 LPG | 4 | B 4164 S | 77/103 | 12/95→08/99 | Z60 | 1.2 | |
| 1.6 LPG | 4 | B 4164 S2 | 80/107 | 03/99→06/04 | Z60 | 1.2 | |
| 1.6 D2 | 4 | D 4162 T | 84/113 | 03/12→ | GE121A | 5V | |
| 1.8 | 4 | B 4184 S, B 4184 S3 | 85/114 | 07/95→08/99 | Z204 | 1.2 | ZS254 [24] ZS255 [26] |
| 1.8 | 4 | B 4184 S2, B 4184 S9 | 90/121 | 03/99→06/04 | Z204 | 1.2 | ZS254 [24] ZS255 [26] |
| 1.8 LPG | 4 | B 4184 S, B 4184 S3 | 85/114 | 07/95→08/99 | Z60 | 1.2 | |
| 1.8 LPG | 4 | B 4184 S2, B 4184 S9 | 90/121 | 03/99→06/04 | Z60 | 1.2 | |
| 1.8 i | 4 | B 4184 SJ | 90/121 | 06/01→06/04 | Z279 | 0.6 | ZS429 |
| 1.8 i | 4 | B 4184 SM | 92/123 | 03/98→06/04 | Z279 | 0.6 | ZS245 [24] ZS246 [26] |
| 1.8 i LPG | 4 | B 4184 SJ | 90/121 | 06/01→06/04 | Z116 | 0.8 | UXT5 |
| 1.8 i LPG | 4 | B 4184 SM | 92/123 | 03/98→06/04 | Z116 | 0.8 | UXT5 |
| 1.9 DI | 4 | D 4192 T2 | 70/94 | 03/99→07/00 | GN999 | 11V | |
| 1.9 DI | 4 | D 4192 T4 | 75/101 | 07/00→06/04 | GN018 | 11V | |
| 1.9 DI | 4 | D 4192 T3 | 85/114 | 07/00→06/04 | GN018 | 11V | |
| 1.9 T4 | 4 | B 4194 T | 147/197 | 05/97→07/00 | Z206 | 0.7 | UXT10 ZS429 |
| 1.9 T4 LPG | 4 | B 4194 T | 147/197 | 05/97→07/00 | Z340 | 0.7 | UXT12 |
| 1.9 TD | 4 | D 4192 T | 66/89 | 07/95→08/99 | GN959 | 11V | |
| 2.0 | 4 | B 4204 S, B 4204 S2 | 100/134 | 07/95→06/04 | Z204 | 1.2 | ZS245 [24] ZS246 [26] |
| 2.0 | 4 | B 4204 S | 103/138 | 07/95→08/99 | Z204 | 1.2 | ZS254 [24] ZS255 [26] |
| 2.0 LPG | 4 | B 4204 S, B 4204 S2 | 100/134 | 07/95→06/04 | Z60 | 1.2 | |
| 2.0 LPG | 4 | B 4204 S | 103/138 | 07/95→08/99 | Z60 | 1.2 | |
| 2.0 T | 4 | B 4204 T | 118/158 | 10/97→07/00 | Z206 | 0.7 | UXT10 ZS429 |
| 2.0 T | 4 | B 4204 T3 | 120/161 | 06/01→06/04 | Z206 | 0.7 | UXT10 ZS429 |
| 2.0 T | 4 | B 4204 T2 | 121/162 | 07/99→06/04 | Z206 | 0.7 | UXT10 ZS429 |
| 2.0 T LPG | 4 | B 4204 T | 118/158 | 10/97→07/00 | Z340 | 0.7 | UXT12 |
| 2.0 T LPG | 4 | B 4204 T3 | 120/161 | 06/01→06/04 | Z340 | 0.7 | UXT12 |
| 2.0 T LPG | 4 | B 4204 T2 | 121/162 | 07/99→06/04 | Z340 | 0.7 | UXT12 |
| 2.0 T4 | 4 | B 4204 T5 | 147/197 | 07/00→06/04 | Z206 | 0.7 | UXT10 ZS429 |
| 2.0 T4 LPG | 4 | B 4204 T5 | 147/197 | 07/00→06/04 | Z340 | 0.7 | UXT12 |

VOLVO



kW/BHP

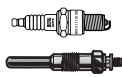

... VOLVO



V50

| | | | | | | | | |
|--------------|---|-----------------------|---------|--------|--|------------|-------|----------------------|
| 1.6 | 4 | B 4164 S3 | 74/99 | 01/05→ | Z177 | 1.3 | UXT7 | ZS387 ch. 105440→ |
| 1.6 D | 4 | D 4164 T | 81/109 | 01/05→ | GN047 →eng. 16125 GN056 eng. 16126→ | 11V 11V | | |
| 1.6 D2 | 4 | D 4162 T | 84/113 | 01/10→ | GE121A | 5V | | |
| 1.8 | 4 | B 4184 S11 | 92/123 | 04/04→ | Z209 | 1.3 | UXT15 | ZS408 |
| 1.8 FlexFuel | 4 | B 4184 S8 | 92/123 | 01/05→ | | | | ZS408 |
| 2.0 | 4 | B 4204 S3 | 107/143 | 10/06→ | Z209 | 1.3 | UXT15 | ZS408 |
| 2.0 D | 4 | D 4204 T | 100/134 | 04/04→ | GN054 | 11V | | |
| 2.0 D3 | 5 | D 5204 T5 | 110/148 | 10/10→ | GE123 →ch. 396178 | 4.4V | | |
| 2.0 D4 | 5 | D 5204 T | 130/174 | 10/10→ | GE123 →ch. 396178 | 4.4V | | |
| 2.0 FlexFuel | 4 | B 4204 S4 | 107/143 | 01/10→ | Z230 | 1.3 | | ZS408 |
| 2.4 | 5 | B 5244 S5 | 103/138 | 04/04→ | Z294 | 1.7 | | ZSE055 |
| 2.4 | 5 | B 5244 S4 | 125/168 | 04/04→ | Z294 | 1.7 | | ZSE055 |
| 2.4 4WD | 5 | B 5244 S4 | 125/168 | 08/06→ | | | | ZSE055 |
| 2.4 D5 | 5 | D 5244 T13, D 5244 T8 | 132/177 | 03/06→ | GE123 →ch. 396178 | 4.4V | | |
| 2.4 Tdi | 5 | D 5244 T9 | 120/161 | 05/07→ | GE123 →ch. 396178 | 4.4V | | |
| 2.5 T5 | 5 | B 5254 T3 | 162/217 | 04/04→ | Z326 →07/07 | 0.7 | | ZSE055 →07/07 |
| 2.5 T5 | 5 | B 5254 T7 | 169/227 | 03/07→ | Z326 08/07→ | 0.7 | | ZSE055 |
| 2.5 T5 LPG | 5 | B 5254 T3 | 162/217 | 04/04→ | Z226 [168] →07/07 | 0.8 | | |
| 2.5 T5 LPG | 5 | B 5254 T7 | 169/227 | 03/07→ | Z226 [168] 08/07→ | 0.8 | | |

V60

| | | | | | | | | |
|-----------|---|----------|--------|--------|--------|----|--|--|
| 1.6 DRIVe | 4 | D 4162 T | 84/113 | 06/11→ | GE121A | 5V | | |
|-----------|---|----------|--------|--------|--------|----|--|--|

V70 I

| | | | | | | | | |
|---------------|---|-----------|---------|-------------|------|-----|-------|--|
| 2.0 | 5 | B 5202 S | 93/125 | 01/97→03/00 | Z204 | 1.2 | | ZSE037 ZM036 |
| 2.0 | 5 | B 5204 F | 105/141 | 01/97→03/00 | Z204 | 1.2 | | ZSE037 →07/98 ZSE019 08/98→ ZSE019 08/98→ |
| 2.0 | 5 | B 5204 T4 | 120/161 | 01/97→03/00 | Z204 | 1.2 | | ZSE019 |
| 2.0 | 5 | B 5204 T2 | 132/177 | 01/97→03/00 | Z206 | 0.7 | UXT10 | ZSE037 →07/98 ZSE019 08/98→ |
| 2.0 LPG | 5 | B 5202 S | 93/125 | 01/97→03/00 | Z60 | 1.2 | | |
| 2.0 LPG | 5 | B 5204 F | 105/141 | 01/97→03/00 | Z60 | 1.2 | | |
| 2.0 LPG | 5 | B 5204 T4 | 120/161 | 01/97→03/00 | Z60 | 1.2 | | |
| 2.0 LPG | 5 | B 5204 T2 | 132/177 | 01/97→03/00 | Z340 | 0.7 | UXT12 | |
| 2.0 Turbo | 5 | B 5204 T | 155/208 | 01/97→03/00 | Z206 | 0.7 | UXT10 | ZSE037 →07/98 ZSE019 08/98→ |
| 2.0 Turbo | 5 | B 5204 T3 | 166/223 | 01/97→03/00 | Z206 | 0.7 | UXT10 | ZSE037 →07/98 ZSE019 08/98→ |
| 2.0 Turbo 4WD | 5 | B 5204 T3 | 166/223 | 01/97→03/00 | Z206 | 0.7 | UXT10 | ZSE037 →07/98 ZSE019 08/98→ |
| 2.0 Turbo LPG | 5 | B 5204 T | 155/208 | 01/97→03/00 | Z340 | 0.7 | UXT12 | |

VOLVO



kW/BHP

**... VOLVO****... V70 I**

| | | | | | | | | | |
|-------------------|---|-----------------------|---------|-------------|-------|-----|-------|--------------------------------------|-----------------|
| 2.0 Turbo LPG | 5 | B 5204 T3 | 166/223 | 01/97→03/00 | Z340 | 0.7 | UXT12 | | |
| 2.3 | 5 | B 5234 T3 | 177/237 | 11/96→11/00 | | | | ZSE019 | |
| 2.3 T 4WD | 5 | B 5234 FT+, B 5234 T4 | 184/247 | 04/97→03/00 | Z206 | 0.7 | UXT10 | ZSE037 →07/98 | ZM036 →07/98 |
| 2.3 T 4WD LPG | 5 | B 5234 FT+, B 5234 T4 | 184/247 | 04/97→03/00 | Z340 | 0.7 | UXT12 | | |
| 2.3 T-5 | 5 | B 5234 T3 | 176/236 | 01/97→03/00 | Z206 | 0.7 | UXT10 | ZSE037 →07/98 ZSE019 08/98→ | ZM036 →07/98 |
| 2.3 T-5 4WD | 5 | B 5234 T3 | 176/236 | 01/97→03/00 | Z206 | 0.7 | UXT10 | ZSE037 →07/98 ZSE019 08/98→ | ZM036 →07/98 |
| 2.3 T-5 LPG | 5 | B 5234 T3 | 176/236 | 01/97→03/00 | Z340 | 0.7 | UXT12 | | |
| 2.3 Turbo | 5 | B 5234 FT+ | 184/247 | 01/97→03/00 | Z206 | 0.7 | UXT10 | ZSE037 | ZM036 |
| 2.3 Turbo LPG | 5 | B 5234 FT+ | 184/247 | 01/97→03/00 | Z340 | 0.7 | UXT12 | | |
| 2.4 | 5 | B 5244 S2, B 5244 SG2 | 103/138 | 08/99→05/00 | Z204 | 1.2 | | ZSE019 | |
| 2.4 4WD | 5 | B 5254 S | 121/162 | 10/98→05/99 | | | | ZSE019 | |
| 2.4 | 5 | B 5244 S, B 5254 S | 125/168 | 01/97→05/00 | Z204 | 1.2 | | ZSE037 →07/98 ZSE019 08/98→ | ZM036 →07/98 |
| 2.4 LPG | 5 | B 5244 S2, B 5244 SG2 | 103/138 | 08/99→05/00 | Z60 | 1.2 | | | |
| 2.4 LPG | 5 | B 5244 S, B 5254 S | 125/168 | 01/97→05/00 | Z60 | 1.2 | | | |
| 2.4 Bifuel | 5 | B 5244 SG | 103/138 | 08/99→03/00 | Z204 | 1.2 | | ZSE019 | |
| 2.4 Turbo | 5 | B 5244 T, B 5254 T | 142/190 | 01/97→03/00 | Z206 | 0.7 | UXT10 | ZSE037 →07/98 ZSE019 08/98→ | ZM036 |
| 2.4 Turbo LPG | 5 | B 5244 T, B 5254 T | 142/190 | 01/97→03/00 | Z340 | 0.7 | UXT12 | | |
| 2.5 | 5 | B 5252 FS | 106/142 | 01/97→03/00 | Z204 | 1.2 | | ZSE037 | ZM036 |
| 2.5 | 5 | B 5254 S | 121/162 | 06/98→03/00 | Z204 | 1.2 | | ZSE037 →07/98 ZSE019 08/98→ | ZM036 |
| 2.5 4WD | 5 | B 5244 T2 | 195/261 | 03/99→03/00 | | | | ZSE019 | |
| 2.5 LPG | 5 | B 5252 FS | 106/142 | 01/97→03/00 | Z60 | 1.2 | | | |
| 2.5 LPG | 5 | B 5254 S | 121/162 | 06/98→03/00 | Z60 | 1.2 | | | |
| 2.5 Bifuel | 5 | GB 5252 S | 106/142 | 10/98→08/99 | Z204 | 1.2 | | ZSE037 | ZM036 |
| 2.5 TDI | 5 | D 5252 T | 103/138 | 01/97→05/00 | GN855 | 12V | | | |
| 2.5 Turbo 4WD | 5 | B 5244 T, B 5254 T | 142/190 | 01/97→05/00 | Z206 | 0.7 | UXT10 | ZSE037 →07/98 ZSE019 08/98→ | ZM036 |
| 2.5 Turbo 4WD LPG | 5 | B 5244 T, B 5254 T | 142/190 | 01/97→05/00 | Z340 | 0.7 | UXT12 | | |

V70 II

| | | | | | | | | | |
|------------|---|----------------------|---------|-------------|--|----------------|---------------------|--|--|
| 2.0 T | 5 | B 5204 T5 | 132/177 | 07/01→08/07 | Z206 →07/04 Z326 08/04→ | 0.7 0.7 | UXT10 →07/04 | ZSE019 →07/04 ZSE055 08/04→ | |
| 2.0 T LPG | 5 | B 5204 T5 | 132/177 | 07/01→08/07 | Z340 →07/04 Z226 [168] 08/04→ | 0.7 0.8 | UXT12 →07/04 | | |
| 2.3 | 5 | B 5234 T7 | 195/261 | 10/00→09/04 | | | | ZSE019 | |
| 2.3 T5 | 5 | B 5234 T3, B 5234 T4 | 184/247 | 03/00→08/07 | Z206 | 0.7 | UXT10 | ZSE019 | |
| 2.3 T5 LPG | 5 | B 5234 T3, B 5234 T4 | 184/247 | 03/00→08/07 | Z340 | 0.7 | UXT12 | | |
| 2.4 | 5 | B 5244 S2 | 103/138 | 03/00→08/07 | Z204 | 1.2 | | ZSE019 | |
| 2.4 | 5 | B 5244 S | 125/168 | 03/00→08/07 | Z204 | 1.2 | | ZSE019 | |

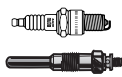

kW/BHP

**... VOLVO****... V70 II**

| | | | | | | | | |
|---------------------|---|--------------------------------|---------|-------------|----------------------------------|------------|-----------------|------------------|
| 2.4 LPG | 5 | B 5244 S2 | 103/138 | 03/00→08/07 | Z60 | 1.2 | | |
| 2.4 LPG | 5 | B 5244 S | 125/168 | 03/00→08/07 | Z60 | 1.2 | | |
| 2.4 Bifuel (CNG) | 5 | B 5244 SG2 | 103/138 | 09/01→08/07 | Z204 | 1.2 | | ZSE019 |
| 2.4 D | 5 | D 5244 T7 | 93/125 | 05/05→08/07 | GE123 | 4.4V | | |
| 2.4 D | 5 | D 5244 T2 | 96/129 | 12/01→08/07 | GN045 | 11V | | |
| 2.4 D5 | 5 | D 5244 T, D 5244 T2, D 5244 T5 | 120/161 | 08/01→08/07 | GN045 | 11V | | |
| 2.4 D5 | 5 | D 5244 T5 | 120/161 | 08/01→08/07 | GE123 | 4.4V | | |
| 2.4 D5 | 5 | D 5244 T4 | 136/182 | 12/05→08/07 | GE123 | 4.4V | | |
| 2.4 T | 5 | B 5244 T3 | 147/197 | 03/00→08/07 | Z206 →10/01 Z326 11/01→ | 0.7 0.7 | UXT10 →10/01 | ZSE019 |
| 2.4 T LPG | 5 | B 5244 T3 | 147/197 | 03/00→08/07 | Z340 →10/01 | 0.7 | UXT12 →10/01 | |
| 2.4 T5 | 5 | B 5244 T5 | 191/256 | 04/04→08/07 | Z326 →07/07 | 0.7 | | ZSE055 →07/07 |
| 2.4 T5 LPG | 5 | B 5244 T5 | 191/256 | 04/04→08/07 | Z226 [168] →07/07 | 0.8 | | |
| 2.5 R 2,5 T 4WD | 5 | B 5254 T4 | 221/296 | 03/03→08/07 | Z326 →07/07 | 0.7 | | ZSE055 →07/07 |
| 2.5 R 2,5 T 4WD LPG | 5 | B 5254 T4 | 221/296 | 03/03→08/07 | Z226 [168] →07/07 | 0.8 | | |
| 2.5 R Sport | 5 | B 5254 T4 | 221/296 | 12/02→08/07 | Z326 →07/07 | 0.7 | | |
| 2.5 R Sport LPG | 5 | B 5254 T4 | 221/296 | 12/02→08/07 | Z226 [168] →07/07 | 0.8 | | |
| 2.5 T | 5 | B 5254 T2 | 154/207 | 09/02→08/07 | Z206 | 0.7 | UXT10 | ZSE019 |
| 2.5 T LPG | 5 | B 5254 T2 | 154/207 | 09/02→08/07 | Z340 | 0.7 | UXT12 | |
| 2.5 TDI | 5 | D 5252 T | 103/138 | 03/00→08/07 | GN855 | 12V | | |

V70 III

| | | | | | | | | |
|-----------------|---|------------|---------|--------|--------|------|--|--------|
| 1.6 D | 4 | D 4164 T | 80/107 | 01/10→ | GN056 | 11V | | |
| 1.6 DRIVe / D2 | 4 | D 4162 T | 84/113 | 06/11→ | GE121A | 5V | | |
| 2.0 | 4 | B 4204 S3 | 107/143 | 10/07→ | Z230 | 1.3 | | ZS408 |
| 2.0 D | 4 | D 4204 T | 100/134 | 10/07→ | GN054 | 11V | | |
| 2.0 FlexiFuel | 4 | B 4204 S4 | 107/143 | 01/08→ | Z230 | 1.3 | | ZS408 |
| 2.4 D | 5 | D 5244 T5 | 120/161 | 08/07→ | GE123 | 4.4V | | |
| 2.4 D5 | 5 | D 5244 T4 | 136/182 | 08/07→ | GE123 | 4.4V | | |
| 2.5 T | 5 | B 5254 T6 | 147/197 | 08/07→ | | | | ZSE055 |
| 2.5 T | 5 | B 5254 T10 | 170/228 | 01/10→ | | | | ZSE055 |
| 2.5 T FlexiFuel | 5 | B 5254 T8 | 147/197 | 05/08→ | | | | ZSE055 |
| 2.5 T FlexiFuel | 5 | B 5254 T11 | 170/228 | 10/09→ | | | | ZSE055 |

V90

| | | | | | | | | |
|---------|---|-----------|---------|-------------|------|-----|-------------|-------|
| 2.5 | 6 | B 6254 FS | 125/168 | 11/96→10/98 | | | | ZS446 |
| 2.9 | 6 | B 6304 S2 | 132/177 | 01/97→12/98 | Z251 | 0.8 | UXT1 / UXT3 | ZS446 |
| 2.9 | 6 | B 6304 G | 150/201 | 01/97→12/98 | Z251 | 0.8 | UXT1 / UXT3 | ZS446 |
| 2.9 LPG | 6 | B 6304 S2 | 132/177 | 01/97→12/98 | Z340 | 0.7 | UXT12 | |
| 2.9 LPG | 6 | B 6304 G | 150/201 | 01/97→12/98 | Z340 | 0.7 | UXT12 | |

XC60

| | | | | | | | | |
|---------------------|---|-----------|---------|--------|---------------------------|------|--|---|
| 2.4 D5 4WD | 5 | D 5244 T4 | 136/182 | 05/08→ | GE123 | 4.4V | | |
| 2.4 D / D3 / D4 4WD | 5 | D 5244 T5 | 120/161 | 05/08→ | GE123 | 4.4V | | |
| 3.0 T6 4WD | 6 | B 6304 T2 | 210/282 | 05/08→ | Z326 03/09→07/10 | 0.7 | | |
| 3.0 T6 4WD LPG | 6 | B 6304 T2 | 210/282 | 05/08→ | Z226 [168] 03/09→07/10 | 0.8 | | |
| 3.2 4WD | 6 | B 6324 S5 | 179/240 | 03/10→ | | | | ZS115 [1X11] ZS117 [1X254] ZS120 [1X214][254] |



kW/BHP

**... VOLVO****XC70 II**

| | | | | | | | | |
|----------------|---|-----------|---------|--------|------------|------|--|--|
| 2.4 D5 4WD | 5 | D 5244 T4 | 136/182 | 08/07→ | GE123 | 4.4V | | |
| 2.4 D / D4 4WD | 5 | D 5244 T5 | 120/161 | 08/07→ | GE123 | 4.4V | | |
| 3.0 T6 4WD | 6 | B 6304 T2 | 210/282 | 01/08→ | Z326 | 0.7 | | |
| | | | | | 08/08→ | | | |
| 3.0 T6 4WD LPG | 6 | B 6304 T2 | 210/282 | 01/08→ | Z226 [168] | 0.8 | | |
| | | | | | 08/08→ | | | |

XC70 CROSS COUNTRY

| | | | | | | | | |
|---------------|---|-----------|---------|-------------|--------|------|--------|--------|
| 2.4 D5 4WD | 5 | D 5244 T | 120/161 | 09/02→08/07 | GN045 | 11V | | |
| 2.4 D5 4WD | 5 | D 5244 T4 | 136/182 | 12/05→08/07 | GE123 | 4.4V | | |
| 2.4 T 4WD | 5 | B 5254 T | 142/190 | 11/97→09/02 | Z206 | 0.7 | UXT10 | ZSE037 |
| 2.4 T 4WD | 5 | B 5244 T3 | 147/197 | 03/00→09/02 | Z206 | 0.7 | UXT10 | ZSE019 |
| | | | | | →10/01 | | →10/01 | |
| | | | | | Z326 | 0.7 | | |
| | | | | | 11/01→ | | | |
| 2.4 T 4WD LPG | 5 | B 5254 T | 142/190 | 11/97→09/02 | Z340 | 0.7 | UXT12 | |
| 2.4 T 4WD LPG | 5 | B 5244 T3 | 147/197 | 03/00→09/02 | Z340 | 0.7 | UXT12 | |
| | | | | | →10/01 | | →10/01 | |
| 2.5 T 4WD | 5 | B 5254 T2 | 154/207 | 09/02→08/07 | Z206 | 0.7 | UXT10 | ZSE019 |
| 2.5 T 4WD LPG | 5 | B 5254 T2 | 154/207 | 09/02→08/07 | Z340 | 0.7 | UXT12 | |

XC90 I

| | | | | | | | | |
|----------------|---|------------|---------|--------|------------|------|--------|--------|
| 2.4 D3 / D5 | 5 | D 5244 T5 | 120/161 | 04/09→ | GE123 | 4.4V | | |
| 2.4 D5 4WD | 5 | D 5244 T | 120/161 | 10/02→ | GN045 | 11V | | |
| 2.4 D5 4WD | 5 | D 5244 T5 | 120/161 | 10/02→ | GE123 | 4.4V | | |
| 2.4 D5 4WD | 5 | D 5244 T4 | 136/182 | 05/06→ | GE123 | 4.4V | | |
| 2.4 D5 4WD | 5 | D 5244 T18 | 147/197 | 01/11→ | GE123 | 4.4V | | |
| 2.5 T 4WD | 5 | B 5254 T2 | 154/207 | 10/02→ | Z206 | 0.7 | UXT10 | ZSE019 |
| 2.5 T 4WD LPG | 5 | B 5254 T2 | 154/207 | 10/02→ | Z340 | 0.7 | UXT12 | |
| 2.9 T6 4WD | 6 | B 6294 T | 200/268 | 10/02→ | Z206 | 0.7 | UXT10 | ZSE019 |
| 2.9 T6 4WD LPG | 6 | B 6294 T | 200/268 | 10/02→ | Z340 | 0.7 | UXT12 | |
| 3.2 4WD | 6 | B 6324 S | 175/235 | 05/06→ | Z326 | 0.7 | | |
| 3.2 4WD LPG | 6 | B 6324 S | 175/235 | 05/06→ | Z226 [168] | 0.8 | | |
| 4.4 V8 4WD | 8 | B 8444 S | 232/311 | 01/05→ | Z312 | 1.0 | UXT9 | |
| | | | | | →12/10 | | →12/10 | |

VW**181**

| | | | | | | | | |
|-----|---|--------|-------|-------------|-----|-----|--|------------|
| 1.5 | 4 | H | 32/43 | 09/69→07/70 | Z57 | 0.6 | | ZS106 [11] |
| 1.6 | 4 | AG | 32/43 | 08/70→07/73 | Z57 | 0.6 | | ZS106 [11] |
| 1.6 | 4 | AL, AM | 35/47 | 03/73→02/79 | Z57 | 0.6 | | ZS106 [11] |

411,412

| | | | | | | | | |
|-----|---|------|-------|-------------|-----------|-----|--|------------|
| 1.7 | 4 | V, Z | 50/67 | 07/68→08/73 | Z58 [167] | 0.8 | | ZS106 [11] |
| 1.7 | 4 | W | 59/79 | 09/69→08/73 | Z58 [167] | 0.8 | | ZS106 [11] |
| 1.8 | 4 | AT | 55/74 | 07/73→03/75 | Z58 [167] | 0.8 | | ZS106 [11] |
| 1.8 | 4 | AN | 63/84 | 07/73→03/75 | Z58 [167] | 0.8 | | ZS106 [11] |

412

| | | | | | | | | |
|-----------|---|----|-------|-------------|-----------|-----|--|------------|
| 1.7 | 4 | W | 59/79 | 01/72→12/73 | Z58 [168] | 0.8 | | ZS106 [11] |
| 1.8 E, LE | 4 | AT | 55/74 | 07/73→03/75 | Z58 [167] | 0.8 | | ZS106 [11] |
| 1.8 E, LE | 4 | AN | 63/84 | 07/73→03/75 | Z58 [167] | 0.8 | | ZS106 [11] |

1500,1600

| | | | | | | | | |
|--------|---|------|-------|-------------|-----|-----|--|------------|
| 1.5 | 4 | K | 33/44 | 04/61→07/73 | Z68 | 0.6 | | ZS106 [11] |
| 1.5 L | 4 | K | 33/44 | 07/68→07/73 | Z68 | 0.6 | | ZS106 [11] |
| 1.5 S | 4 | | 40/54 | 08/63→07/65 | Z57 | 0.6 | | ZS106 [11] |
| 1.6 | 4 | T, U | 40/54 | 08/65→07/73 | Z68 | 0.6 | | ZS106 [11] |
| 1.6 L | 4 | P | 37/50 | 07/64→07/73 | Z57 | 0.6 | | ZS106 [11] |
| 1.6 L | 4 | T, U | 40/54 | 08/65→07/73 | Z68 | 0.6 | | ZS106 [11] |
| 1.6 TL | 4 | T, U | 40/54 | 08/65→07/73 | Z68 | 0.6 | | ZS106 [11] |



kW/BHP

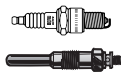

... VW



AMAROK

| | | | | | | | | |
|-----------|---|------------|---------|--------|-------|------|-------|--|
| 2.0 BiTDI | 4 | CDCA | 120/161 | 09/10→ | GE115 | 4.4V | | |
| 2.0 BiTDI | 4 | CNEA, CSHA | 132/177 | 11/11→ | GE115 | 4.4V | | |
| 2.0 TDI | 4 | CDBA, CNFA | 90/121 | 09/10→ | GE115 | 4.4V | | |
| 2.0 TDI | 4 | CNFB | 103/138 | 06/12→ | GE115 | 4.4V | | |
| 2.0 TSI | 4 | CFPA | 118/158 | 12/10→ | Z347 | 0.7 | UXT12 | ZSE033 ⁽⁴⁷⁾ ZSE142 ⁽⁴⁸⁾ |

BEETLE

| | | | | | | | | |
|---------|---|------------------------|---------|--------|--------|------|-------|------------------|
| 1.2 TSI | 4 | CBZB | 77/103 | 07/11→ | | | | ZSE003 |
| 1.4 TSI | 4 | CAVD, CNWA, CTHD, CTKA | 118/158 | 04/11→ | | | | ZSE030 |
| 1.6 TDI | 4 | CAYC | 77/103 | 10/11→ | GE115 | 4.4V | | |
| 2.0 TDI | 4 | CFFB | 103/138 | 04/11→ | GE115 | 4.4V | | |
| 2.0 TDI | 4 | CJAA | 103/138 | 04/11→ | PSG002 | 4.4V | | |
| 2.0 TDI | 4 | CUUB | 110/148 | 09/14→ | PSG002 | 4.4V | | |
| 2.0 TSI | 4 | CBFA, CCTA, CCZA | 147/197 | 04/11→ | Z347 | 0.7 | UXT12 | ZSE142 |
| 2.0 TSI | 4 | CPLA, CPPA | 155/208 | 12/12→ | | | | ZSE068 →11/13 |
| 2.5 | 5 | CBTA, CBUA, CCCA | 125/168 | 04/11→ | Z272 | 1.0 | | ZSE033 |

BORA

| | | | | | | | | |
|-------------|---|--------------------|---------|-------------|-----------------------------|-------|-------------|-------------|
| 1.4 16V | 4 | AHW, AKQ, APE, AXP | 55/74 | 03/00→05/05 | Z90 | 1.0 | UXT1 / UXT3 | ZSE003 |
| 1.4 16V | 4 | AHW, AXP | 55/74 | 09/01→05/05 | | | | ZSE030 |
| 1.4 16V | 4 | BCA | 55/74 | 03/00→05/05 | Z176 | 1.1 | | ZSE030 |
| 1.4 16V LPG | 4 | AHW, AKQ, APE, AXP | 55/74 | 03/00→05/05 | Z340 | 0.7 | UXT12 | |
| 1.6 | 4 | AEH, AKL, APF | 74/99 | 10/98→05/05 | Z90 | 1.0 | UXT1 / UXT3 | ZSE003 |
| 1.6 | 4 | AVU, BFQ | 75/101 | 08/00→05/05 | Z90 | 1.0 | UXT1 / UXT3 | ZSE003 |
| 1.6 | 4 | BJH | 75/101 | 08/00→05/05 | | | | ZSE003 |
| 1.6 LPG | 4 | AEH, AKL, APF | 74/99 | 10/98→05/05 | Z340 | 0.7 | UXT12 | |
| 1.6 LPG | 4 | AVU, BFQ | 75/101 | 08/00→05/05 | Z340 | 0.7 | UXT12 | |
| 1.6 16V | 4 | ATN, AUS | 77/103 | 02/00→05/05 | Z90 | 1.0 | UXT1 / UXT3 | ZSE003 |
| 1.6 16V | 4 | AZD, BCB | 77/103 | 02/00→05/05 | Z176 | 1.1 | | ZSE030 |
| 1.6 16V LPG | 4 | ATN, AUS | 77/103 | 02/00→05/05 | Z340 | 0.7 | UXT12 | |
| 1.6 FSI | 4 | BAD | 81/109 | 01/02→05/05 | Z300 | 1.35 | | ZSE030 |
| 1.8 | 4 | AGN | 92/123 | 10/98→05/05 | Z90 | 1.0 | UXT1 / UXT3 | ZSE003 |
| 1.8 LPG | 4 | AGN | 92/123 | 10/98→05/05 | Z340 | 0.7 | UXT12 | |
| 1.8 T | 4 | AGU | 110/148 | 05/00→05/05 | Z188 | 0.7 | UXT10 | ZS016 ZM062 |
| 1.8 T | 4 | ARX | 110/148 | 05/00→05/05 | Z188 | 0.7 | UXT10 | |
| 1.8 T | 4 | AUM | 110/148 | 05/00→05/05 | Z188 | 0.7 | UXT10 | ZSE043 |
| 1.8 T | 4 | AUQ | 132/177 | 03/02→05/05 | Z188 | 0.7 | UXT10 | ZSE043 |
| 1.8 T LPG | 4 | AGU, ARX, AUM | 110/148 | 05/00→05/05 | Z340 | 0.7 | UXT12 | |
| 1.8 T LPG | 4 | AUQ | 132/177 | 03/02→05/05 | Z340 | 0.7 | UXT12 | |
| 1.9 SDI | 4 | AGP, AQM | 50/67 | 10/98→05/05 | GN855 | GR081 | 12V | |
| 1.9 TDI | 4 | AGR, ALH | 66/89 | 10/98→05/05 | GN855 | GR081 | 12V | |
| 1.9 TDI | 4 | ATD, AXR | 74/99 | 09/00→05/05 | GN855 | GR081 | 12V | |
| | | | | | →ch. 11-2-600 000 GN046 | | 12V | |
| | | | | | ch. 11-2-600 001→ | | | |
| 1.9 TDI | 4 | AHF, ASV | 81/109 | 10/98→06/01 | GN855 | GR081 | 12V | |
| 1.9 TDI | 4 | AJM, AUY | 85/114 | 12/98→01/02 | GN855 | GR081 | 12V | |
| | | | | | →ch. 11-2-600 000 | | | |
| 1.9 TDI | 4 | ASZ | 96/129 | 11/00→05/05 | GN855 | GR081 | 12V | |
| | | | | | →ch. F11-2-600 000 GN046 | | 12V | |
| | | | | | ch. F11-2-600 001→ | | | |
| 1.9 TDI | 4 | ARL | 110/148 | 05/00→05/05 | GN855 | GR081 | 12V | |
| | | | | | →ch. 11-2-600 000 GN046 | | 12V | |
| | | | | | ch. 11-2-600 001→ | | | |
| 2.0 | 4 | APK, AQY, AZH | 85/114 | 10/98→05/05 | Z90 | 1.0 | UXT1 / UXT3 | ZSE003 |
| 2.0 | 4 | AZG, AZJ | 85/114 | 10/98→05/05 | Z176 | 1.1 | | ZSE029 |
| 2.0 LPG | 4 | APK, AQY, AZH | 85/114 | 10/98→05/05 | Z340 | 0.7 | UXT12 | |

VW



kW/BHP

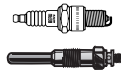

... VW



... BORA

| | | | | | | | | | |
|------------|---|----------|---------|-------------|------|--|-----|-------------|--|
| 2.3 V5 | 5 | AGZ | 110/148 | 10/98→10/00 | Z173 | | 1.6 | ZS037 | |
| 2.3 V5 | 5 | AQN | 125/168 | 10/00→05/05 | Z176 | | 1.1 | ZSE063 | |
| 2.3 V5 LPG | 5 | AGZ | 110/148 | 10/98→10/00 | Z172 | | 1.6 | | |
| 2.8 V6 4WD | 6 | AQP, AUE | 150/201 | 03/99→05/05 | Z176 | | 1.1 | ZSE013 | |
| | | | | | | | | →04/01 | |
| 2.8 V6 4WD | 6 | AQP, AUE | 150/201 | 05/99→05/05 | | | | ZSE013 | |
| 2.8 V6 4WD | 6 | BDE | 150/201 | 03/99→05/05 | Z176 | | 1.1 | ZSE063 | |
| | | | | | | | | 05/01→05/03 | |
| 2.8 VR6 | 6 | AUE | 150/201 | 03/00→05/00 | Z176 | | 1.1 | ZSE013 | |

CADDY I

| | | | | | | | | | |
|-------|---|--------|-------|-------------|-------------------|--------|-----|-------------------|-----------------------|
| 1.5 | 4 | JB | 51/68 | 08/82→07/83 | Z1 | | 0.7 | UXT2 / UXT6 | ZS115 ^[11] |
| 1.6 | 4 | EM | 55/74 | 10/82→10/83 | Z70 | | 0.8 | UXT2 / UXT6 | ZS115 ^[11] |
| | | | | | →ch. 14-K-020 000 | | | →ch. 14-K-020 000 | |
| 1.6 | 4 | EW | 55/74 | 01/83→07/92 | Z1 | | 0.7 | UXT2 / UXT6 | ZS115 ^[11] |
| 1.6 D | 4 | JK, ME | 40/54 | 08/82→07/92 | GN857 | GR001 | 11V | | |
| | | | | | | →07/90 | | | |
| | | | | | | GR031 | | | |
| | | | | | | 08/90→ | | | |
| 1.8 | 4 | JH | 70/94 | 08/85→07/92 | Z91 | | 0.8 | UXT2 / UXT6 | ZS124 |
| | | | | | | | | | ZM002 |
| | | | | | | | | | →09/86 |
| | | | | | | | | | ZM012 |
| | | | | | | | | | 10/86→ |

CADDY II

| | | | | | | | | | |
|-------------|---|---------------|-------|-------------|----------------------|-------|-----|-------------|--------|
| 1.4 | 4 | AEX, AKV, APQ | 44/59 | 11/95→01/04 | Z91 | | 0.8 | UXT2 / UXT6 | ZSE001 |
| 1.4 | 4 | AUD | 44/59 | 11/95→01/04 | Z176 | | 1.1 | | ZSE003 |
| 1.4 LPG | 4 | AEX, AKV, APQ | 44/59 | 11/95→01/04 | Z27 ^[168] | | 0.8 | UX56 | |
| 1.4 16V | 4 | AUA | 55/74 | 08/00→01/04 | Z90 | | 1.0 | UXT1 / UXT3 | ZSE003 |
| 1.4 16V LPG | 4 | AUA | 55/74 | 08/00→01/04 | Z340 | | 0.7 | UXT12 | |
| 1.6 | 4 | 1F | 55/74 | 11/95→05/97 | Z92 | | 0.8 | UXT2 / UXT6 | ZSE001 |
| 1.6 | 4 | AEE | 55/74 | 06/96→12/00 | Z91 | | 0.8 | UXT2 / UXT6 | ZSE001 |
| 1.6 LPG | 4 | 1F | 55/74 | 11/95→05/97 | Z20 ^[168] | | 0.8 | UXT2 / UXT6 | |
| 1.6 LPG | 4 | AEE | 55/74 | 06/96→12/00 | Z27 ^[168] | | 0.8 | UX56 | |
| 1.7 SDI | 4 | AHB | 42/56 | 07/96→09/00 | GN855 | GR081 | 12V | | |
| 1.9 D | 4 | 1Y, AEF | 47/63 | 11/95→01/04 | GN857 | | 11V | | |
| 1.9 SDI | 4 | AEY, AYQ | 47/63 | 11/95→01/04 | GN855 | GR081 | 12V | | |
| 1.9 TDI | 4 | AHU, ALE, ALH | 66/89 | 10/96→01/04 | GN855 | GR081 | 12V | | |

CADDY III

| | | | | | | | | | |
|----------------|---|---------------|---------|-------------|-------|-------------------|------|--------------------|--------|
| 1.2 TSI | 4 | CBZA | 63/84 | 09/10→ | | | | | ZSE003 |
| 1.2 TSI | 4 | CBZB | 77/103 | 09/10→ | | | | | ZSE003 |
| 1.4 | 4 | BCA | 55/74 | 03/04→05/06 | Z90 | | 1.0 | UXT1 / UXT3 | ZSE030 |
| 1.4 LPG | 4 | BCA | 55/74 | 03/04→05/06 | Z340 | | 0.7 | UXT12 | |
| 1.4 16V | 4 | BUD | 59/79 | 05/06→08/10 | Z272 | | 1.0 | | ZSE030 |
| | | | | | | | | →ch. F1K-8-281 299 | |
| 1.6 | 4 | BGU, BSE, BSF | 75/101 | 04/04→ | Z90 | | 1.0 | UXT1 / UXT3 | ZSE003 |
| 1.6 LPG | 4 | BGU, BSE, BSF | 75/101 | 04/04→ | Z340 | | 0.7 | UXT12 | |
| 1.6 BiFuel LPG | 4 | CHGA | 75/101 | 05/11→ | Z340 | | 0.7 | UXT12 | ZSE003 |
| | | | | | Z90 | | 1.0 | UXT1 / UXT3 | |
| 1.6 TDI | 4 | CAYE | 55/74 | 08/10→ | GE115 | | 4.4V | | |
| 1.6 TDI | 4 | CAYD | 75/101 | 08/10→ | GE115 | | 4.4V | | |
| 1.9 TDI | 4 | BSU | 55/74 | 09/05→08/10 | GE100 | GSE100 | 5V | | |
| 1.9 TDI | 4 | BJB | 77/103 | 04/04→08/10 | GE100 | GSE100 | 5V | | |
| | | | | | | →ch. 2K-5-150 000 | | | |
| 1.9 TDI | 4 | BLS | 77/103 | 04/04→08/10 | GE100 | | 5V | | |
| 2.0 EcoFuel | 4 | BSX | 80/107 | 04/06→ | Z193 | | 0.9 | UXT1 / UXT3 | ZSE029 |
| 2.0 SDI | 4 | BDJ, BST | 51/68 | 03/04→08/10 | GN046 | GR081 | 12V | | |
| 2.0 TDI | 4 | CFHF, CLCA | 81/109 | 08/10→ | GE115 | | 4.4V | | |
| 2.0 TDI | 4 | BMM | 103/138 | 09/07→08/10 | GE100 | GSE100 | 5V | | |
| 2.0 TDI | 4 | CFJA | 125/168 | 05/12→ | GE115 | | 4.4V | | |
| 2.0 TDI 16V | 4 | CFHC, CLCB | 103/138 | 11/10→ | GE115 | | 4.4V | | |



kW/BHP

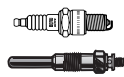

... VW



CC

| | | | | | | | | | |
|-------------|---|------------|---------|--------|-------|--|------|--------|--------|
| 1.4 TSI | 4 | CTHD | 118/158 | 11/11→ | | | | ZSE030 | |
| 1.8 TSI | 4 | CDAB | 112/150 | 11/11→ | Z347 | | 0.7 | UXT12 | ZSE142 |
| 1.8 TSI | 4 | CDAA | 118/158 | 11/11→ | Z347 | | 0.7 | UXT12 | ZSE142 |
| 2.0 TDI | 4 | CFFA | 100/134 | 11/11→ | GE115 | | 4.4V | | |
| 2.0 TDI | 4 | CFFB | 103/138 | 11/11→ | GE115 | | 4.4V | | |
| 2.0 TDI | 4 | CFGB, CLLA | 125/168 | 11/11→ | GE115 | | 4.4V | | |
| 2.0 TDI | 4 | CFGC | 130/174 | 12/12→ | GE115 | | 4.4V | | |
| 2.0 TSI | 4 | CBFA, CCTA | 147/197 | 11/11→ | Z347 | | 0.7 | UXT12 | ZSE142 |
| 2.0 TSI | 4 | CCZB | 155/208 | 11/11→ | Z347 | | 0.7 | UXT12 | ZSE142 |
| 3.6 FSI 4WD | 6 | BWS | 220/295 | 11/11→ | | | | | ZSE041 |

CORRADO

| | | | | | | | | | | |
|---------------|---|---------|---------|-------------|----------------------|--|-----|-------------|--------|-------|
| 1.8 16V | 4 | KR | 100/134 | 04/89→07/92 | Z52 | | 0.8 | UXT5 | ZS123 | ZM012 |
| 1.8 G60 | 4 | PG | 118/158 | 09/88→09/93 | Z104 | | 0.6 | | ZS124 | ZM012 |
| 2.0 i | 4 | 2E, ADY | 85/114 | 04/93→12/95 | Z91 | | 0.8 | UXT2 / UXT6 | ZSE001 | |
| 2.0 i LPG | 4 | 2E, ADY | 85/114 | 04/93→12/95 | Z27 ^[168] | | 0.8 | UX56 | | |
| 2.0 i 16V | 4 | 9A | 100/134 | 08/91→12/95 | Z89 | | 0.8 | UXT5 | ZSE001 | ZM013 |
| 2.0 i 16V LPG | 4 | 9A | 100/134 | 08/91→12/95 | Z30 ^[168] | | 0.8 | UXT5 | | |
| 2.9 VR6 | 6 | ABV | 140/188 | 08/91→12/95 | Z173 | | 1.6 | | ZSE004 | |
| | | | | | | | | | 04/93→ | |
| 2.9 VR6 LPG | 6 | ABV | 140/188 | 08/91→12/95 | Z172 | | 1.6 | | | |

DERBY

| | | | | | | | | | | |
|-----|---|----|-------|-------------|----------------------|--|-----|-------------|----------------------------|--|
| 0.9 | 4 | HA | 29/39 | 02/77→09/81 | Z11 | | 0.8 | UXT2 / UXT6 | ZS106 ^[11] | |
| 1.0 | 4 | GL | 29/39 | 10/81→12/84 | Z11 | | 0.8 | UXT2 / UXT6 | ZS115 ^[11] | |
| | | | | | | | | | →04/84 | |
| 1.1 | 4 | HB | 37/50 | 02/77→07/83 | Z11 | | 0.8 | UXT2 / UXT6 | | |
| 1.1 | 4 | HB | 37/50 | 02/77→09/81 | | | | | ZS106 ^{[11][254]} | |
| | | | | | | | | | ZS115 ^[11] | |
| | | | | | | | | | 01/81→ | |
| 1.1 | 4 | HB | 37/50 | 10/81→07/83 | | | | | ZS106 ^{[11][254]} | |
| | | | | | | | | | ZS115 ^{[11][186]} | |
| 1.3 | 4 | HW | 37/50 | 08/83→12/84 | Z11 | | 0.8 | UXT2 / UXT6 | | |
| 1.3 | 4 | HK | 40/54 | 08/83→12/84 | Z11 | | 0.8 | UXT2 / UXT6 | ZS115 ^[11] | |
| | | | | | | | | | →05/84 | |
| 1.3 | 4 | HJ | 43/58 | 02/77→09/81 | Z11 ^[175] | | 0.8 | UXT2 / UXT6 | ZS115 ^[11] | |
| | | | | | Z61 ^[174] | | 0.7 | | | |
| 1.3 | 4 | HH | 44/59 | 02/77→07/83 | Z11 | | 0.8 | UXT2 / UXT6 | ZS115 ^[11] | |
| 1.3 | 4 | GK | 55/74 | 09/82→12/84 | Z42 | | 0.8 | UX56 | ZS124 | |

EOS

| | | | | | | | | | | |
|-------------|---|----------------------------------|---------|-------------|-----------------------|--------|------|-------|------------------------|--|
| 1.4 TSI | 4 | CAXA | 90/121 | 11/07→ | Z349 | | 0.9 | | ZSE030 | |
| 1.4 TSI | 4 | CAVD, CTHD | 118/158 | 05/08→ | | | | | ZSE030 | |
| 1.6 FSI | 4 | BLF | 85/114 | 06/06→05/08 | Z300 | | 1.35 | | ZSE030 | |
| 2.0 FSI | 4 | BVY | 110/148 | 03/06→05/08 | Z236 | | 1.0 | | ZSE033 ⁽⁴⁷⁾ | |
| | | | | | | | | | ZSE142 ⁽⁴⁸⁾ | |
| 2.0 FSI | 4 | BVZ | 110/148 | 03/06→05/08 | Z228 | | 1.0 | UXT11 | ZSE033 ⁽⁴⁷⁾ | |
| | | | | | | | | | ZSE142 ⁽⁴⁸⁾ | |
| 2.0 FSI LPG | 4 | BVZ | 110/148 | 03/06→05/08 | Z221 ^[168] | | 1.0 | UXT14 | | |
| 2.0 TDI | 4 | CFFA | 100/134 | 11/10→ | GE115 | | 4.4V | | | |
| 2.0 TDI | 4 | BMM | 103/138 | 06/06→05/08 | GE100 | GSE100 | 5V | | | |
| 2.0 TDI 16V | 4 | CBAB, CFFB | 103/138 | 05/08→ | GE115 | | 4.4V | | | |
| 2.0 TFSI | 4 | BPY, BWA, CAWB, CBFA, CCTA, CCZA | 147/197 | 03/06→ | Z347 | | 0.7 | UXT12 | ZSE033 ⁽⁴⁷⁾ | |
| | | | | | | | | | ZSE142 ⁽⁴⁸⁾ | |
| 2.0 TFSI | 4 | CULC | 162/217 | 11/13→ | | | | | ZSE068 | |
| 2.0 TSI | 4 | CCZB | 155/208 | 11/09→ | Z347 | | 0.7 | UXT12 | ZSE033 ⁽⁴⁷⁾ | |
| | | | | | | | | | ZSE142 ⁽⁴⁸⁾ | |
| 3.2 V6 | 6 | BUB | 184/247 | 06/06→05/09 | Z306 | | 0.9 | | ZSE044 | |
| 3.6 V6 | 6 | CDVA | 191/256 | 05/09→11/10 | | | | | ZSE041 | |

VW



kW/BHP



... VW



| | | | | | | | | | |
|----------------|---|----------------|--------|-------------|---|-------|--|------------|---|
| FOX | | | | | | | | | |
| 1.2 | 3 | BMD | 40/54 | 04/05→ | Z200 →11/07 | | | 0.9 | ZSE059 ch. 5Z-60009 326; 5Z-64081 327→ |
| | | | | | Z272 12/07→ | | | 1.0 | →ch. 5Z-80016 409; 5Z-94149 953 |
| 1.2 | 3 | CHFB | 40/54 | 04/05→ | Z272 | | | 1.0 | ZSE059 ch. 5Z-60009 326; 5Z-64081 327→ |
| | | | | | | | | | →ch. 5Z-80016 409; 5Z-94149 953 |
| 1.2 | 3 | CHFA | 44/59 | 09/10→ | Z272 | | | 1.0 | ZSE059 |
| 1.4 | 4 | BKR | 55/74 | 04/05→ | Z176 Z344 | | | 1.1 1.0 | ZSE003 |
| 1.4 TDI | 3 | BNM | 51/68 | 04/05→ | GN046 | GR081 | | 12V | |
| 1.6 | 4 | BAH, BLH, CFZA | 74/99 | 10/03→ | Z344 | | | 1.0 | ZSE003 |
| 1.6 | 4 | BPA, CCRA | 74/99 | 10/03→ | | | | | ZSE003 |
| 1.6 Total Flex | 4 | BPA, CCRA | 74/99 | 10/03→ | | | | | ZSE003 |
| GOL | | | | | | | | | |
| 1.0 | 4 | BTY | 53/71 | 10/05→05/08 | | | | | ZSE003 |
| 1.6 | 4 | UNF | 68/91 | 08/02→05/08 | Z344 ch. 5W-9P050 700; 5W-9T061 965→ | | | 1.0 | ZS314 →ch. 5W-9P050 699; 5W-9T061 964 |
| 1.6 | 4 | UPD | 73/98 | 06/02→05/08 | | | | | ZS314 |
| 1.6 Hybrid | 4 | UNF | 68/91 | 09/05→05/08 | Z344 ch. 5W-9P050 700; 5W-9T061 965→ | | | 1.0 | ZS314 →ch. 5W-9P050 699; 5W-9T061 964 |
| 1.9 D | 4 | | 51/68 | 04/98→05/02 | GN855 | | | 12V | |
| 2.0 | 4 | | 85/114 | 10/96→05/02 | | | | | ZS314 |
| GOLF I | | | | | | | | | |
| 1.1 | 4 | FA, GG | 37/50 | 04/74→07/83 | Z11 | | | 0.8 | UXT2 / UXT6 ZS115 ⁽¹¹⁾ |
| 1.1 | 4 | FJ | 38/51 | 08/76→07/80 | Z11 | | | 0.8 | UXT2 / UXT6 ZS115 ⁽¹¹⁾ |
| 1.3 | 4 | HK | 40/54 | 08/83→07/86 | Z11 | | | 0.8 | UXT2 / UXT6 ZS115 ⁽¹¹⁾ ZM002 |
| 1.3 | 4 | GS | 43/58 | 08/82→12/83 | Z11 | | | 0.8 | UXT2 / UXT6 ZS115 ⁽¹¹⁾ |
| 1.3 | 4 | GF | 44/59 | 08/79→07/83 | Z11 | | | 0.8 | UXT2 / UXT6 ZS115 ⁽¹¹⁾ |
| 1.5 | 4 | FH | 51/68 | 04/74→12/75 | Z11 | | | 0.8 | UXT2 / UXT6 ZS115 ⁽¹¹⁾ |
| 1.5 | 4 | JB | 51/68 | 08/77→11/83 | Z1 | | | 0.7 | UXT2 / UXT6 ZS115 ⁽¹¹⁾ |
| 1.5 D | 4 | CK | 37/50 | 08/76→07/80 | GN857 | GR001 | | 11V | |
| 1.6 | 4 | FT | 51/68 | 08/75→07/77 | Z11 | | | 0.8 | UXT2 / UXT6 ZS115 ⁽¹¹⁾ |
| 1.6 | 4 | RE | 53/71 | 04/86→02/90 | Z93 | | | 1.0 | UXT2 / UXT6 ZS124 |
| 1.6 | 4 | EM | 55/74 | 08/75→02/84 | Z70 | | | 0.8 | UXT2 / UXT6 ZS115 ⁽¹¹⁾ |
| 1.6 | 4 | EM | 55/74 | 08/79→07/83 | Z11 ch. F 159 2800 001; F 16 A 0000 001; F1793000 001→ | | | 0.8 | UXT2 / UXT6 ch. F 159 2800 001; F 16 A 0000 001; F1793000 001→ |
| | | | | | Z61 ch. F 159 2800 001; F 16 A 0000 001; F1793000 001→ | | | 0.7 | UXT2 / UXT6 ch. F 159 2800 001; F 16 A 0000 001; F1793000 001→ |
| 1.6 | 4 | EW, HN | 55/74 | 01/83→04/92 | Z2 | | | 1.0 | UXT2 / UXT6 |
| 1.6 | 4 | EW, HN | 55/74 | 01/83→02/84 | | | | | ZS115 ⁽¹¹⁾ |
| 1.6 | 4 | EW, HN | 55/74 | 08/83→04/92 | | | | | ZS124 |
| 1.6 | 4 | FN, FP | 55/74 | 08/75→02/84 | Z11 | | | 0.8 | UXT2 / UXT6 ZS115 ⁽¹¹⁾ |
| 1.6 | 4 | EG | 81/109 | 08/79→07/82 | Z44 | | | 0.8 | UX56 ZS115 ⁽¹¹⁾ |
| 1.6 D | 4 | CR, JK | 40/54 | 08/80→07/83 | GN857 | GR001 | | 11V | |
| 1.6 GTI | 4 | EG | 81/109 | 08/76→07/82 | Z44 | | | 0.8 | UX56 ZS115 ⁽¹¹⁾ |
| 1.6 TD | 4 | CY | 51/68 | 03/82→07/83 | GN857 | GR001 | | 11V | |
| 1.6 TD | 4 | | 55/74 | 08/83→07/85 | GN857 | | | 11V | |

VW

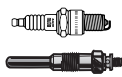

kW/BHP

**... VW****... GOLF I**

| | | | | | | | | | |
|---------|---|--------|--------|-------------|--------------------------------|--------------------------------|-------------------------------|---|--|
| 1.8 | 4 | EX | 66/89 | 08/83→09/92 | Z22 →08/84 Z12 09/84→ | 0.7 →08/84 0.8 09/84→ | UX56 →08/84 UXT2 / UXT6 | ZS124 | |
| 1.8 | 4 | JH | 70/94 | 08/83→04/93 | Z91 | 0.8 | UXT2 / UXT6 | ZS124 [1] 08/84→07/88 ZS123 [1] 08/88→ | |
| 1.8 | 4 | 2H | 72/97 | 08/89→03/93 | Z12 | 0.8 | UXT2 / UXT6 | ZS124 | |
| 1.8 | 4 | DX, EV | 82/110 | 08/82→12/92 | Z12 | 0.8 | UXT2 / UXT6 | ZS115 [1][11] →07/84 ZS124 [1] 08/84→ | |
| 1.8 | 4 | PB | 82/110 | 08/82→12/89 | Z61 | 0.7 | UXT2 / UXT6 | ZS115 [1][11] →07/84 ZS124 [1] 08/84→ | |
| 1.8 LPG | 4 | JH | 70/94 | 08/83→04/93 | Z27 [168] | 0.8 | UX56 | | |
| 1.8 GTI | 4 | DX | 82/110 | 08/82→12/83 | Z12 | 0.8 | UXT2 / UXT6 | ZS115 [11] | |
| 1.8 GTI | 4 | JJ | 82/110 | 08/82→12/83 | | | | ZS115 [11] | |

GOLF II

| | | | | | | | | | |
|-----|---|--------|-------|-------------|--|--|--|--|------------------------------------|
| 1.0 | 4 | GN | 33/44 | 11/83→08/85 | Z11 | 0.8 | UXT2 / UXT6 | ZS115 [11] →07/84 | ZM002 |
| 1.0 | 4 | HZ | 37/50 | 08/85→10/91 | Z61 | 0.7 | UXT2 / UXT6 | ZS124 [1] →07/87 ZS123 [1] 08/87→ | ZM002 →09/86 ZM012 10/86→ |
| 1.3 | 4 | NU | 37/50 | 08/85→12/87 | Z61 | 0.7 | UXT2 / UXT6 | ZS123 | ZM002 →09/86 ZM012 10/86→ |
| 1.3 | 4 | 2G, NZ | 40/54 | 06/86→12/92 | Z61 | 0.7 | UXT2 / UXT6 | ZS123 [1] →07/89 ZS124 [1] 08/89→ | ZM002 →09/86 ZM012 10/86→ |
| 1.3 | 4 | HK | 40/54 | 08/83→06/87 | Z11 | 0.8 | UXT2 / UXT6 | ZS115 [1][11] | ZM002 →09/86 ZM012 10/86→ |
| 1.3 | 4 | MH | 40/54 | 08/83→12/92 | Z61 | 0.7 | UXT2 / UXT6 | | ZM002 →09/86 ZM012 10/86→ |
| 1.3 | 4 | MH | 40/54 | 08/83→06/87 | | | | ZS123 [1] | |
| 1.3 | 4 | MH | 40/54 | 06/86→12/92 | | | | ZS123 [1] →07/89 | |
| 1.3 | 4 | GT | 43/58 | 08/83→10/86 | Z11 →04/86 Z61 →04/86 Z12 05/86→ Z91 05/86→ | 0.8 →04/86 0.7 →04/86 0.8 05/86→ 0.8 05/86→ | UXT2 / UXT6 →04/86 UXT2 / UXT6 →04/86 UXT2 / UXT6 05/86→ UXT2 / UXT6 05/86→ | ZS115 [11] | ZM002 |
| 1.6 | 4 | PN | 51/68 | 10/86→12/92 | Z93 | 1.0 | UXT2 / UXT6 | ZS124 [1] →07/88 ZS123 [1] 08/88→ | ZM012 |

VW



kW/BHP



... VW



... GOLF II

| | | | | | | | | | | |
|---------|---|---------|--------|-------------|--------------------------|-------|-----|---------------------------|--|------------------------------------|
| 1.6 | 4 | RF | 53/71 | 02/86→10/91 | Z93 | | 1.0 | UXT2 / UXT6 | ZS124 [1] →07/88 ZS123 [1] 08/88→ | ZM002 →09/86 ZM012 10/86→ |
| 1.6 | 4 | ABN, EZ | 55/74 | 08/83→07/92 | | | | | ZS115 [1][11] →07/84 ZS124 [1] 01/85→07/88 ZS123 [1] 08/88→ | ZM002 →09/86 ZM012 10/86→ |
| 1.6 | 4 | HM | 55/74 | 08/83→07/92 | Z2 | | 1.0 | UXT2 / UXT6 | ZS115 [1][11] →07/84 ZS124 [1] 01/85→07/88 ZS123 [1] 08/88→ | ZM002 →09/86 ZM012 10/86→ |
| 1.6 D | 4 | | 37/50 | 08/83→10/91 | GN857 | | 11V | | | |
| 1.6 D | 4 | JP, ME | 40/54 | 08/83→10/91 | GN857 | GR031 | 11V | | | |
| 1.6 TD | 4 | TV | 44/59 | 08/89→10/91 | GN857 | GR031 | 11V | | | |
| 1.6 TD | 4 | JR, MF | 51/68 | 08/83→10/91 | GN857 | GR031 | 11V | | | |
| 1.6 TD | 4 | | 55/74 | 08/83→07/85 | GN857 | | 11V | | | |
| 1.6 TD | 4 | RA, SB | 59/79 | 04/89→10/91 | GN857 | GR031 | 11V | | | |
| 1.8 | 4 | RH | 62/83 | 08/86→01/90 | Z61 | | 0.7 | UXT2 / UXT6 | ZS123 [1][214][254] ZS124 [1][214][254] | ZM002 →09/86 ZM012 10/86→ |
| 1.8 4WD | 4 | RH | 62/83 | 08/87→07/88 | Z22 →ch. 16-J-990 000 | | 0.7 | UX56 →ch. 16-J-990 000 | ZS124 →ch. 16-J-990 000 | |
| 1.8 | 4 | GU, HV | 66/89 | 08/84→10/91 | Z12 | | 0.8 | UXT2 / UXT6 | ZS124 | ZM002 →09/86 ZM012 10/86→ |
| 1.8 | 4 | GX | 66/89 | 08/84→10/91 | Z91 | | 0.8 | UXT2 / UXT6 | ZS124 | ZM002 →09/86 ZM012 10/86→ |
| 1.8 4WD | 4 | GU | 66/89 | 02/86→07/91 | Z12 | | 0.8 | UXT2 / UXT6 | ZS123 [1] 08/88→ | ZM002 →09/86 ZM012 10/86→ |
| 1.8 4WD | 4 | GX | 66/89 | 02/86→07/91 | Z91 | | 0.8 | UXT2 / UXT6 | ZS124 [1] →07/88 | ZM002 →09/86 ZM012 10/86→ |
| 1.8 4WD | 4 | 1P | 72/97 | 08/88→07/91 | Z61 | | 0.7 | UXT2 / UXT6 | ZS123 [1] →07/89 ZS124 [1] 08/89→ | ZM012 |
| 1.8 GTI | 4 | HT, RV | 77/103 | 01/85→07/85 | Z12 | | 0.8 | UXT2 / UXT6 | ZS124 | |
| 1.8 GTI | 4 | PF | 79/106 | 01/87→10/91 | Z61 | | 0.7 | UXT2 / UXT6 | ZS123 | ZM012 |
| 1.8 GTI | 4 | RD | 79/106 | 08/85→10/87 | Z91 | | 0.8 | UXT2 / UXT6 | ZS124 | ZM002 →09/86 ZM012 10/86→ |
| 1.8 GTI | 4 | DX | 82/110 | 08/83→10/91 | Z12 | | 0.8 | UXT2 / UXT6 | | ZM002 →09/86 ZM012 10/86→ |

VW

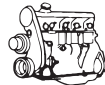

kW/BHP

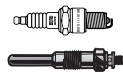

... VW



... GOLF II

| | | | | | | | | | |
|-------------|---|--------|---------|-------------|------|-----|-------------|--|------------------------------------|
| 1.8 GTI | 4 | EV, GZ | 82/110 | 08/83→10/91 | Z12 | 0.8 | UXT2 / UXT6 | ZS124 | ZM002 →09/86 ZM012 10/86→ |
| 1.8 GTI | 4 | PB | 82/110 | 08/83→10/91 | Z61 | 0.7 | UXT2 / UXT6 | ZS124 | ZM002 →09/86 ZM012 10/86→ |
| 1.8 GTI 16V | 4 | PL | 95/127 | 02/86→10/91 | Z89 | 0.8 | UXT5 | ZS120 [1] →07/87 ZS123 [1] 08/87→ | ZM002 →09/86 ZM012 10/86→ |
| 1.8 GTI 16V | 4 | KR | 102/137 | 02/86→06/90 | Z52 | 0.8 | UXT5 | ZS123 | ZM002 →09/86 ZM012 10/86→ |
| 1.8 GTI G60 | 4 | 1H, PG | 118/158 | 08/88→12/91 | Z104 | 0.6 | | ZS124 | ZM012 |
| 1.8 i | 4 | GX, RP | 66/89 | 08/87→10/91 | Z91 | 0.8 | UXT2 / UXT6 | ZS124 | ZM012 |

GOLF III

| | | | | | | | | | |
|---------|---|---------------|-------|-------------|--|------------|--|----------------------------|-------|
| 1.3 | 4 | 2G | 40/54 | 08/91→07/92 | | | | ZSE001 | |
| 1.4 | 4 | ABD | 40/54 | 11/91→08/97 | Z2 | 1.0 | UXT2 / UXT6 | | |
| 1.4 | 4 | ABD | 40/54 | 11/91→04/99 | | | | ZSE001 | ZM013 |
| 1.4 | 4 | ABD | 40/54 | 07/93→04/99 | Z2 →06/95 Z91 07/95→ | 1.0 0.8 | UXT2 / UXT6 →06/95 UXT2 / UXT6 07/95→ | | |
| 1.4 | 4 | AEX | 40/54 | 11/91→08/97 | Z91 | 0.8 | UXT2 / UXT6 | ZSE001 | ZM013 |
| 1.4 | 4 | ABD | 44/59 | 10/91→04/99 | Z2 | 1.0 | UXT2 / UXT6 | ZSE001 | ZM013 |
| 1.4 | 4 | AEX, APQ | 44/59 | 10/91→04/99 | Z91 | 0.8 | UXT2 / UXT6 | ZSE001 | |
| 1.4 LPG | 4 | ABD | 40/54 | 11/91→08/97 | Z11 [168] | 0.8 | UXT2 / UXT6 | | |
| 1.4 LPG | 4 | ABD | 40/54 | 07/93→04/99 | Z11 [168] →06/95 Z27 [168] 07/95→ | 0.8 0.8 | UXT2 / UXT6 →06/95 UX56 07/95→ | | |
| 1.4 LPG | 4 | AEX | 40/54 | 11/91→08/97 | Z27 [168] | 0.8 | UX56 | | |
| 1.4 LPG | 4 | ABD | 44/59 | 10/91→04/99 | Z11 [168] | 0.8 | UXT2 / UXT6 | | |
| 1.4 LPG | 4 | AEX, APQ | 44/59 | 10/91→04/99 | Z27 [168] | 0.8 | UX56 | | |
| 1.6 | 4 | ABU | 55/74 | 09/92→08/97 | Z91 | 0.8 | UXT2 / UXT6 | ZSE001 | ZM014 |
| 1.6 | 4 | AEA, AEE | 55/74 | 09/92→08/97 | Z91 | 0.8 | UXT2 / UXT6 | ZSE001 | |
| 1.6 | 4 | AEK | 74/99 | 07/94→04/99 | Z246 | 0.9 | | ZSE001 [175][181] [254] | |
| 1.6 | 4 | AEK | 74/99 | 10/94→05/98 | | | | ZSE001 | |
| 1.6 | 4 | AFT | 74/99 | 07/94→04/99 | Z90 | 1.0 | UXT1 / UXT3 | ZSE001 [175][181] [254] | |
| 1.6 | 4 | AFT | 74/99 | 10/94→05/98 | | | | ZSE001 | |
| 1.6 | 4 | AKS | 74/99 | 07/94→04/99 | Z246 | 0.9 | | | |
| 1.6 | 4 | AKS | 74/99 | 10/94→05/98 | | | | ZSE001 04/97→ | |
| 1.6 LPG | 4 | ABU, AEA, AEE | 55/74 | 09/92→08/97 | Z27 [168] | 0.8 | UX56 | | |
| 1.6 LPG | 4 | AEK, AKS | 74/99 | 07/94→04/99 | Z206 | 0.7 | UXT10 | | |
| 1.6 LPG | 4 | AFT | 74/99 | 07/94→04/99 | Z340 | 0.7 | UXT12 | | |
| 1.8 | 4 | AAM, ANN | 55/74 | 11/91→04/99 | Z92 | 0.8 | UXT2 / UXT6 | ZSE001 | ZM013 |
| 1.8 | 4 | ABS | 66/89 | 11/91→04/99 | Z91 | 0.8 | UXT2 / UXT6 | ZSE001 | ZM013 |
| 1.8 | 4 | ACC | 66/89 | 11/91→08/97 | Z91 | 0.8 | UXT2 / UXT6 | | ZM013 |
| 1.8 | 4 | ADZ, ANP | 66/89 | 11/91→04/99 | Z91 | 0.8 | UXT2 / UXT6 | ZSE001 | |
| 1.8 | 4 | ADZ | 66/89 | 11/91→08/97 | | | | | ZM013 |
| 1.8 4WD | 4 | ADZ | 66/89 | 01/93→04/99 | Z91 | 0.8 | UXT2 / UXT6 | | |
| 1.8 4WD | 4 | ADZ | 66/89 | 10/94→04/99 | | | | ZSE001 | |
| 1.8 LPG | 4 | AAM, ANN | 55/74 | 11/91→04/99 | Z20 [168] | 0.8 | UXT2 / UXT6 | | |

VW



kW/BHP

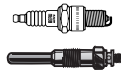

... VW



... GOLF III

| | | | | | | | | | | |
|-----------------|---|-------------------------|---------|-------------|------------|-------|------|-------------|---|-----------------|
| 1.8 LPG | 4 | ABS, ACC, ADZ, ANP | 66/89 | 11/91→04/99 | Z27 [168] | | 0.8 | UX56 | | |
| 1.9 D | 4 | 1Y | 48/64 | 11/91→04/99 | GN857 | | 11V | | | |
| 1.9 SDI | 4 | AEY | 47/63 | 07/95→04/99 | GN855 | GR081 | 12V | | | |
| 1.9 TD | 4 | AAZ | 55/74 | 07/93→04/99 | GN857 | | 11V | | | |
| 1.9 TD, GTD | 4 | AAZ | 55/74 | 11/91→08/97 | GN857 | | 11V | | | |
| 1.9 TDI | 4 | 1Z, AHU, ALE | 66/89 | 09/93→04/99 | GN855 | GR081 | 12V | | | |
| 1.9 TDI 4WD | 4 | 1Z, AHU, ALE | 66/89 | 07/95→04/99 | GN855 | | 12V | | | |
| 1.9 TDI | 4 | AFN | 81/109 | 04/96→04/99 | GN855 | GR081 | 12V | | | |
| 2.0 | 4 | AEP | 79/106 | 08/95→04/96 | Z91 | | 0.8 | UXT2 / UXT6 | | |
| 2.0 | 4 | 2E, ADY, AGG, AKR | 85/114 | 11/91→04/99 | Z91 | | 0.8 | UXT2 / UXT6 | ZSE001 | ZM013 |
| 2.0 | 4 | ABA | 85/114 | 11/91→08/97 | | | | | ZSE001 | ZM013 |
| 2.0 4WD | 4 | AGG | 85/114 | 08/95→04/99 | Z91 | | 0.8 | UXT2 / UXT6 | ZSE001 | |
| 2.0 LPG | 4 | AEP | 79/106 | 08/95→04/96 | Z27 [168] | | 0.8 | UX56 | | |
| 2.0 LPG | 4 | 2E, ADY, AGG, AKR | 85/114 | 11/91→04/99 | Z27 [168] | | 0.8 | UX56 | | |
| 2.0 GL | 4 | AEP | 79/106 | 08/95→09/97 | Z91 | | 0.8 | UXT2 / UXT6 | ZSE001 | |
| 2.0 GTI 16V | 4 | ABF | 110/148 | 08/92→08/97 | Z317 | | 0.85 | UXT12 | ZSE001 | |
| 2.8 VR6 | 6 | AAA | 120/161 | 08/95→09/97 | Z173 | | 1.6 | | ZSE004 | |
| 2.8 VR6 | 6 | AAA | 128/172 | 01/92→08/97 | Z173 | | 1.6 | | ZSE001 | |
| | | | | | | | | | → ch. 1H-PB060 000; 1H-PW480 000 ZSE004 ch. 1H-PB060 001; 1H-PW480 001→ | |
| 2.8 VR6 LPG | 6 | AAA | 120/161 | 08/95→09/97 | Z172 | | 1.6 | | | |
| 2.8 VR6 LPG | 6 | AAA | 128/172 | 01/92→08/97 | Z172 | | 1.6 | | | |
| 2.9 VR6 4WD | 6 | ABV | 140/188 | 10/94→04/99 | Z173 | | 1.6 | | ZSE004 | |
| | | | | | | | | | →12/97 | |
| 2.9 VR6 4WD | 6 | ABV | 140/188 | 10/94→08/97 | | | | | ZSE004 | |
| 2.9 VR6 4WD LPG | 6 | ABV | 140/188 | 10/94→04/99 | Z172 | | 1.6 | | | |
| GOLF IV | | | | | | | | | | |
| 1.4 16V | 4 | AHW, AKQ, APE, AXP | 55/74 | 08/97→06/06 | Z90 | | 1.0 | UXT1 / UXT3 | ZSE003 | |
| 1.4 16V | 4 | BCA | 55/74 | 08/97→06/06 | Z90 | | 1.0 | UXT1 / UXT3 | ZSE030 | |
| 1.4 16V LPG | 4 | AHW, AKQ, APE, AXP, BCA | 55/74 | 08/97→06/06 | Z340 | | 0.7 | UXT12 | | |
| 1.6 | 4 | AEH, AKL, APF | 74/99 | 08/97→05/04 | Z90 | | 1.0 | UXT1 / UXT3 | ZSE003 | |
| 1.6 | 4 | AFT | 74/99 | 06/98→06/02 | Z90 | | 1.0 | UXT1 / UXT3 | ZSE001 | ZM013 |
| 1.6 | 4 | AKS | 74/99 | 06/98→06/02 | Z246 | | 0.9 | | ZSE001 | ZM013 |
| 1.6 | 4 | BAH | 74/99 | 02/01→06/01 | Z344 | | 1.0 | | ZSE003 | |
| 1.6 | 4 | AVU, BFQ | 75/101 | 08/00→06/06 | Z90 | | 1.0 | UXT1 / UXT3 | ZSE003 | |
| 1.6 LPG | 4 | AEH, AKL, APF | 74/99 | 08/97→05/04 | Z340 [168] | | 0.7 | UXT12 | | |
| 1.6 LPG | 4 | AEH, AFT, AKL, APF | 74/99 | 06/98→06/02 | Z340 | | 0.7 | UXT12 | | |
| 1.6 LPG | 4 | AKS | 74/99 | 06/98→06/02 | Z206 | | 0.7 | UXT10 | | |
| 1.6 LPG | 4 | AVU, BFQ | 75/101 | 08/00→06/06 | Z340 | | 0.7 | UXT12 | | |
| 1.6 16V | 4 | ATN, AUS | 77/103 | 02/00→06/06 | Z90 | | 1.0 | UXT1 / UXT3 | ZSE003 | |
| 1.6 16V | 4 | AZD, BCB | 77/103 | 02/00→06/06 | Z176 | | 1.1 | | ZSE030 | |
| 1.6 16V LPG | 4 | ATN, AUS | 77/103 | 02/00→06/06 | Z340 | | 0.7 | UXT12 | | |
| 1.6 FSI | 4 | BAD | 81/109 | 01/02→06/06 | Z300 | | 1.35 | | ZSE030 | |
| 1.8 | 4 | AAM, ANN | 55/74 | 06/98→06/02 | Z92 | | 0.8 | UXT2 / UXT6 | ZSE001 | |
| 1.8 | 4 | ACC | 66/89 | 10/97→09/99 | Z91 | | 0.8 | UXT2 / UXT6 | | |
| 1.8 | 4 | ADZ, ANP | 66/89 | 06/98→06/02 | Z91 | | 0.8 | UXT2 / UXT6 | ZSE001 | |
| 1.8 | 4 | AGN | 92/123 | 08/97→06/06 | Z90 | | 1.0 | UXT1 / UXT3 | ZSE003 | |
| 1.8 LPG | 4 | AAM, ANN | 55/74 | 06/98→06/02 | Z20 [168] | | 0.8 | UXT2 / UXT6 | | |
| 1.8 LPG | 4 | ACC, ADZ, ANP | 66/89 | 10/97→06/02 | Z27 [168] | | 0.8 | UX56 | | |
| 1.8 LPG | 4 | AGN | 92/123 | 08/97→06/06 | Z340 | | 0.7 | UXT12 | | |
| 1.8 T | 4 | AGU | 110/148 | 08/97→06/06 | Z188 | | 0.7 | UXT10 | ZS016 | |
| 1.8 T | 4 | AGU | 110/148 | 08/97→06/05 | | | | | | ZLE276 |
| 1.8 T | 4 | AGU | 110/148 | 05/00→06/06 | | | | | | ZLE276 ZM062 |
| 1.8 T | 4 | ARZ | 110/148 | 08/97→06/06 | Z188 | | 0.7 | UXT10 | ZSE009 | |

VW



kW/BHP

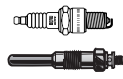

... VW



... GOLF IV

| | | | | | | | | | | |
|---------------|---|------------------------------|---------|-------------|--------------------|-------|------|-------------|--------|--------------------|
| 1.8 T | 4 | AUM | 110/148 | 08/97→06/06 | Z188 | | 0.7 | UXT10 | ZSE043 | |
| 1.8 T | 4 | AWD | 110/148 | 08/97→06/06 | Z188 | | 0.7 | UXT10 | ZSE009 | 05/01→ |
| | | | | | | | | | ZSE043 | →ch. 1J-Y-900 000 |
| | | | | | | | | | ZSE043 | ch. 1J-1-000 001→ |
| 1.8 T LPG | 4 | AGU, ARZ, AUM, AWD | 110/148 | 08/97→06/06 | Z340 | | 0.7 | UXT12 | | |
| 1.8 T GTI | 4 | AUQ | 132/177 | 08/01→06/05 | Z188 | | 0.7 | UXT10 | ZSE043 | |
| 1.8 T GTI LPG | 4 | AUQ | 132/177 | 08/01→06/05 | Z340 | | 0.7 | UXT12 | | |
| 1.9 SDI | 4 | AGP, AQM | 50/67 | 08/97→06/06 | GN855 | GR081 | 12V | | | |
| 1.9 TD | 4 | AAZ | 55/74 | 10/97→09/99 | GN857 | | 11V | | | |
| 1.9 TDI | 4 | AGR, AHU, ALE, ALH | 66/89 | 10/97→05/06 | GN855 | GR081 | 12V | | | |
| 1.9 TDI | 4 | ATD, AXR | 74/99 | 09/00→06/06 | GN855 | GR081 | 12V | | | |
| | | | | | →ch. 1J-2-545 141 | | | | | |
| | | | | | GN046 | | 12V | | | |
| | | | | | ch. 1J-2-545 142→ | | | | | |
| 1.9 TDI | 4 | AFN, AHF, ASV, AVG | 81/109 | 08/97→05/04 | GN855 | GR081 | 12V | | | |
| 1.9 TDI | 4 | AJM, AUY | 85/114 | 12/98→06/01 | GN855 | GR081 | 12V | | | |
| 1.9 TDI | 4 | ASZ | 96/129 | 11/00→06/06 | GN855 | GR081 | 12V | | | |
| | | | | | →ch. F1J-2-600 000 | | | | | |
| | | | | | GN046 | | 12V | | | |
| | | | | | ch. F1J-2-600 001→ | | | | | |
| 1.9 TDI | 4 | ARL | 110/148 | 02/00→06/05 | GN855 | GR081 | 12V | | | |
| | | | | | →ch. 1J-2-545 141 | | | | | |
| | | | | | GN046 | | 12V | | | |
| | | | | | ch. 1J-2-545 142→ | | | | | |
| 2.0 | 4 | AGG, AKR | 85/114 | 06/98→06/02 | Z91 | | 0.8 | UXT2 / UXT6 | ZSE001 | |
| 2.0 | 4 | APK, AQY | 85/114 | 07/98→06/06 | Z90 | | 1.0 | UXT1 / UXT3 | ZSE003 | |
| 2.0 | 4 | ATU, AWF, AWG | 85/114 | 06/98→06/02 | Z188 | | 0.7 | UXT10 | | |
| 2.0 | 4 | AZG, AZJ | 85/114 | 07/98→06/06 | Z176 | | 1.1 | | ZSE029 | |
| 2.0 4WD | 4 | AZH | 85/114 | 10/00→06/06 | Z90 | | 1.0 | UXT1 / UXT3 | ZSE003 | →06/01 |
| 2.0 LPG | 4 | AGG, AKR | 85/114 | 06/98→06/02 | Z27 [168] | | 0.8 | UX56 | | |
| 2.0 LPG | 4 | APK, AQY, ATU, AWF, AWG, AZH | 85/114 | 06/98→06/06 | Z340 | | 0.7 | UXT12 | | |
| 2.0 Bi-Fuel | 4 | BEH | 85/114 | 02/02→06/06 | Z176 [168] | | 1.1 | | ZSE029 | |
| 2.3 V5 | 5 | AGZ | 110/148 | 08/97→06/06 | Z173 | | 1.6 | | ZS037 | |
| 2.3 V5 | 5 | AQN | 125/168 | 10/00→06/06 | Z176 | | 1.1 | | ZSE063 | |
| 2.3 V5 LPG | 5 | AGZ | 110/148 | 08/97→06/06 | Z172 | | 1.6 | | | |
| 2.8 V6 4WD | 6 | AQP, AUE | 150/201 | 03/99→06/06 | Z176 | | 1.1 | | ZSE013 | |
| 2.8 V6 4WD | 6 | BDE | 150/201 | 03/99→06/06 | Z176 | | 1.1 | | | |
| 2.8 V6 4WD | 6 | BDE | 150/201 | 03/99→06/05 | | | | | ZSE063 | 05/01→ |
| 2.8 V6 4WD | 6 | BDE | 150/201 | 05/99→06/06 | | | | | ZSE063 | 05/01→06/05 |
| 3.2 R32 4WD | 6 | BFH, BML | 177/237 | 09/02→06/05 | Z306 | | 0.9 | | ZSE044 | |
| GOLF V | | | | | | | | | | |
| 1.4 | 4 | BUD | 59/79 | 06/07→07/09 | Z272 | | 1.0 | | ZSE030 | →ch. F1K-8-281 299 |
| 1.4 16V | 4 | BCA | 55/74 | 10/03→05/06 | Z90 | | 1.0 | UXT1 / UXT3 | ZSE030 | |
| 1.4 16V | 4 | BUD | 59/79 | 05/06→11/08 | Z272 | | 1.0 | | ZSE030 | |
| 1.4 16V LPG | 4 | BCA | 55/74 | 10/03→05/06 | Z340 | | 0.7 | UXT12 | | |
| 1.4 FSI | 4 | BKG, BLN | 66/89 | 10/03→07/06 | Z300 | | 1.35 | | ZSE030 | |
| 1.4 TSI | 4 | CAXA | 90/121 | 05/07→11/08 | | | | | ZSE030 | |
| 1.4 TSI | 4 | CAXA | 90/121 | 06/07→07/09 | | | | | ZSE030 | →ch. F1K-8-281 299 |
| 1.4 TSI | 4 | BMV | 103/138 | 05/06→11/08 | | | | | ZSE030 | |
| 1.4 TSI | 4 | BMV | 103/138 | 06/07→07/09 | | | | | ZSE030 | →ch. F1K-8-281 299 |

VW



kW/BHP



... VW



... GOLF V

| | | | | | | | | | |
|-------------------|---|---------------------------------|---------|-------------|---------------------|-------------|------|-------------|------------------------|
| 1.4 TSI | 4 | CAVD | 118/158 | 07/08→07/09 | | | | | ZSE030 |
| | | | | | | | | | ch. 1K-9-400 001 → |
| 1.4 TSI | 4 | BLG | 125/168 | 11/05→11/08 | Z349 | | 0.9 | | |
| 1.4 TSI | 4 | BLG | 125/168 | 11/05→07/09 | | | | | ZSE030 |
| | | | | | | | | | →ch. FIK-8-281 299 |
| 1.6 | 4 | BGU | 75/101 | 01/04→11/08 | Z90 | | 1.0 | UXT1 / UXT3 | |
| 1.6 | 4 | BGU | 75/101 | 01/04→07/09 | | | | | ZSE003 |
| 1.6 | 4 | BSE, BSF, CCSA | 75/101 | 01/04→07/09 | Z90 | | 1.0 | UXT1 / UXT3 | ZSE003 |
| 1.6 LPG | 4 | BGU, BSE, BSF, CCSA | 75/101 | 01/04→07/09 | Z340 | | 0.7 | UXT12 | |
| 1.6 FSI | 4 | BAG, BLF, BLP | 85/114 | 10/03→07/08 | Z300 | | 1.35 | | ZSE030 |
| 1.6 MultiFuel | 4 | CCSA | 75/101 | 10/07→07/09 | Z90 | | 1.0 | UXT1 / UXT3 | ZSE003 |
| 1.6 MultiFuel LPG | 4 | CCSA | 75/101 | 10/07→07/09 | Z340 | | 0.7 | UXT12 | |
| 1.9 TDI | 4 | BRU, BXF, BXJ | 66/89 | 05/04→11/08 | GE100 | GSE100 | 5V | | |
| | | | | | | →09/04 | | | |
| | | | | | | ch. 70251 → | | | |
| 1.9 TDI | 4 | BKC, BXE | 77/103 | 10/03→11/08 | GE100 | GSE100 | 5V | | |
| | | | | | | →03/06 | | | |
| 1.9 TDI | 4 | BLS, BXE | 77/103 | 10/03→07/09 | GE100 | | 5V | | |
| 1.9 TDI | 4 | BLS, BXE | 77/103 | 10/03→11/08 | | GSE100 | | | |
| | | | | | | →03/06 | | | |
| 2.0 | 4 | BHY, CBPA | 85/114 | 08/06→11/08 | Z90 | | 1.0 | UXT1 / UXT3 | ZSE003 |
| 2.0 | 4 | BWA, CAWB, CCTA | 147/197 | 06/07→07/09 | Z347 | | 0.7 | UXT12 | ZSE033 ^[47] |
| | | | | | | | | | ZSE142 ^[48] |
| 2.0 FSI | 4 | AXW, BLR, BLX, BVX, BVY | 110/148 | 01/04→11/08 | Z236 | | 1.0 | | ZSE033 |
| 2.0 FSI | 4 | BLY, BVZ | 110/148 | 01/04→11/08 | Z193 | | 0.9 | UXT1 / UXT3 | ZSE033 |
| 2.0 GTI | 4 | AXX, BPY, BWA, CAWB, CBFA, CCTA | 147/197 | 10/04→02/09 | Z347 | | 0.7 | UXT12 | ZSE033 |
| | | | | | | | | | →ch. 1K-9W124 420 |
| 2.0 GTI | 4 | BYD | 169/227 | 09/06→12/08 | Z347 | | 0.7 | UXT12 | ZSE033 |
| 2.0 SDI | 4 | BDK | 55/74 | 01/04→11/08 | GE100 | GSE100 | 5V | | |
| | | | | | | →09/04 | | | |
| 2.0 TDI | 4 | AZV | 100/134 | 10/03→07/09 | GE101 | GSE100 | 4.4V | | |
| 2.0 TDI | 4 | BMM | 103/138 | 08/04→07/09 | GE100 | GSE100 | 5V | | |
| 2.0 TDI | 4 | BMN | 125/168 | 11/05→11/08 | CGP003 | | 7V | | |
| | | | | | ch. 1K-6-000 001 → | | | | |
| 2.0 TDI 16V | 4 | BKD | 103/138 | 10/03→07/09 | GE101 | GSE100 | 4.4V | | |
| 2.0 TDI 16V | 4 | CBDB | 103/138 | 06/07→07/09 | GE115 | | 4.4V | | |
| 3.2 | 6 | BUB | 184/247 | 09/05→11/08 | Z306 | | 0.9 | | ZSE044 |
| 3.2 R32 4WD | 6 | BUB | 184/247 | 11/05→11/08 | Z306 | | 0.9 | | ZSE044 |
| 3.2 R32 4WD | 6 | CBRA | 184/247 | 11/05→11/08 | Z306 | | 0.9 | | |
| GOLF VI | | | | | | | | | |
| 1.2 TSI | 4 | CBZA | 63/84 | 05/10→07/13 | | | | | ZSE003 |
| 1.2 TSI | 4 | CBZB | 77/103 | 05/09→11/13 | | | | | ZSE003 |
| 1.4 | 4 | BUD | 59/79 | 07/09→07/13 | Z200 | | 0.9 | | ZSE030 |
| | | | | | | | | | ch. 1K-8-281 300 → |
| 1.4 | 4 | CGGA | 59/79 | 10/08→11/12 | Z272 | | 1.0 | | ZSE030 |
| 1.4 | 4 | CGGA | 59/79 | 07/09→07/13 | Z272 | | 1.0 | | ZSE030 |
| | | | | | ch. 1K-9-400 001 → | | | | ch. 1K-8-281 300 → |
| 1.4 TSI | 4 | CAXA | 90/121 | 10/08→ | Z349 | | 0.9 | | ZSE030 |
| 1.4 TSI | 4 | CAVD, CNWA, CTHD, CTKA | 118/158 | 10/08→ | | | | | ZSE030 |
| 1.4 TSI | 4 | CAVD, CNWA, CTHD, CTKA | 118/158 | 07/09→07/13 | Z349 ^[1] | | 0.9 | | |
| | | | | | →02/11 | | | | |
| 1.6 | 4 | BSE, BSF, CCSA, CMXA | 75/101 | 10/08→07/13 | Z90 | | 1.0 | UXT1 / UXT3 | ZSE003 |
| 1.6 LPG | 4 | BSE, BSF, CCSA, CMXA | 75/101 | 10/08→07/13 | Z340 | | 0.7 | UXT12 | |
| 1.6 BiFuel LPG | 4 | CHGA | 75/101 | 03/09→11/12 | Z340 | | 0.7 | UXT12 | ZSE003 |
| | | | | | Z90 | | 1.0 | UXT1 / UXT3 | |
| 1.6 MultiFuel | 4 | CCSA, CMXA | 75/101 | 10/08→07/13 | Z90 | | 1.0 | UXT1 / UXT3 | ZSE003 |
| 1.6 MultiFuel LPG | 4 | CCSA, CMXA | 75/101 | 10/08→07/13 | Z340 | | 0.7 | UXT12 | |
| 1.6 TDI | 4 | CAYB | 66/89 | 02/09→07/13 | GE115 | | 4.4V | | |
| 1.6 TDI | 4 | CAYC | 77/103 | 02/09→ | GE115 | | 4.4V | | |

VW

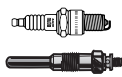

kW/BHP

**... VW**

| ... GOLF VI | | | | | | | | | |
|--------------------|---|------------------------|---------|-------------|-----------------|--|--------------|-------|--|
| 1.8 TSI | 4 | CDA | 118/158 | 06/09→01/11 | Z347 | | 0.7 | UXT12 | ZSE033 →07/09 ZSE142 07/09→ |
| 2.0 GTi | 4 | CBFA, CCTA | 147/197 | 06/09→11/13 | Z347 | | 0.7 | UXT12 | ZSE142 07/09→ |
| 2.0 GTi | 4 | CCZA | 147/197 | 06/09→11/13 | | | | | ZSE142 07/09→ |
| 2.0 GTi | 4 | CCZB | 155/208 | 04/09→ | Z347 | | 0.7 | UXT12 | |
| 2.0 GTi | 4 | CCZB | 155/208 | 04/09→11/12 | | | | | ZSE033 →07/09 ZSE142 07/09→ |
| 2.0 GTI | 4 | CCZB | 155/208 | 11/11→ | | | | | ZSE033 |
| 2.0 GTi | 4 | CDLG | 173/232 | 05/11→11/12 | Z347 | | 0.7 | UXT12 | ZSE033 |
| 2.0 R 4WD | 4 | CDLC, CRZA | 188/252 | 11/09→11/13 | Z347 | | 0.7 | UXT12 | ZSE033 |
| 2.0 R | 4 | CDLA | 195/261 | 11/09→ | Z347 | | 0.7 | UXT12 | ZSE033 |
| 2.0 R 4WD | 4 | CDLF | 199/267 | 11/09→11/12 | Z347 | | 0.7 | UXT12 | ZSE033 |
| 2.0 TDI | 4 | CBDC, CLCA | 81/109 | 10/08→07/13 | GE115 | | 4.4V | | |
| 2.0 TDI | 4 | CBAA, CBDA, CFFA, CFHB | 100/134 | 10/08→07/13 | GE115 | | 4.4V | | |
| 2.0 TDI | 4 | CBAB, CFFB, CFHC | 103/138 | 10/08→ | GE115 | | 4.4V | | |
| 2.0 TDI | 4 | CJAA | 103/138 | 10/08→05/13 | PSG002 | | 4.4V | | |
| 2.0 TDI | 4 | CBBB, CFGB | 125/168 | 04/09→11/12 | GE115 | | 4.4V | | |
| 2.0 TDI 16V | 4 | CBDB, CFHC, CLCB | 103/138 | 07/09→07/13 | GE115 | | 4.4V | | |
| 2.0 TDI 16V | 4 | CJAA | 103/138 | 07/09→07/13 | PSG002 | | 4.4V | | |
| 2.0 TSI | 4 | CCZA | 147/197 | 07/09→07/13 | Z347 | | 0.7 | UXT12 | |
| 2.0 TSI | 4 | CULC | 162/217 | 11/13→ | Z347 | | 0.7 | UXT12 | ZSE068 ZSE142 ⁽⁴⁸⁾ |
| GOLF VII | | | | | | | | | |
| 1.2 TSI | 4 | CJZB, CYVA | 63/84 | 08/12→ | | | | | ZSE067 ^{(42) [174]} ZSE126 ^{(43) [182]} |
| 1.2 TSI | 4 | CJZA | 77/103 | 11/12→ | | | | | ZSE067 ^{(42) [174]} ZSE126 ^{(43) [182]} |
| 1.4 TGI CNG | 4 | CPWA | 81/109 | 09/13→ | | | | | ZSE067 ^{(42) [174]} ZSE126 ^{(43) [182]} |
| 1.4 TSI | 4 | CMBA, CPVA, CUKA, CXSA | 90/121 | 11/12→ | | | | | ZSE067 ^{(42) [174]} ZSE126 ^{(43) [182]} |
| 1.4 TSI | 4 | CHPA, CPTA | 103/138 | 11/12→ | | | | | ZSE067 ^{(42) [174]} ZSE126 ^{(43) [182]} |
| 1.4 TSI MultiFuel | 4 | CPVA | 90/121 | 04/13→ | | | | | ZSE067 ^{(42) [174]} ZSE126 ^{(43) [182]} |
| 1.6 TDI | 4 | CLHB | 66/89 | 04/13→ | GE115 PSG002 | | 4.4V 4.4V | | |
| 1.6 TDI | 4 | CRKA | 66/89 | 04/13→ | GE115 | | 4.4V | | |
| 1.6 TDI | 4 | CLHA | 77/103 | 08/12→ | GE115 PSG002 | | 4.4V 4.4V | | |
| 1.6 TDI | 4 | CRKB | 81/109 | 01/13→ | GE115 PSG002 | | 4.4V 4.4V | | |
| 1.6 TDI | 4 | CXXB | 81/109 | 01/13→ | GE115 | | 4.4V | | |
| 2.0 GTD | 4 | CUNA | 135/181 | 04/13→ | GE115 PSG002 | | 4.4V 4.4V | | |
| 2.0 GTI | 4 | CHHB | 162/217 | 04/13→ | Z348 | | 0.8 | | ZSE068 |
| 2.0 GTI | 4 | CHHA | 169/227 | 04/13→ | Z348 | | 0.8 | | ZSE068 |
| 2.0 TDI | 4 | CRVA | 81/109 | 11/12→ | GE115 PSG002 | | 4.4V 4.4V | | |
| 2.0 TDI | 4 | CRVC | 105/141 | 08/12→ | GE115 PSG002 | | 4.4V 4.4V | | |
| 2.0 TDI | 4 | CRBC, CRLB | 110/148 | 11/12→ | GE115 PSG002 | | 4.4V 4.4V | | |

VW

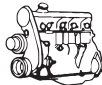

kW/BHP

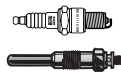

... VW



GOLF PLUS

| | | | | | | | | |
|-----------------------|---|----------------------|---------|-------------|-----------------------|-------------------|-------------|--------------------|
| 1.2 TSI | 4 | CBZA | 63/84 | 05/10→ | | | | ZSE003 |
| 1.2 TSI | 4 | CBZB | 77/103 | 11/09→ | | | | ZSE003 |
| 1.4 16V | 4 | BCA | 55/74 | 01/05→ | Z90 | 1.0 | UXT1 / UXT3 | ZSE030 |
| 1.4 16V | 4 | BUD | 59/79 | 05/06→ | Z200 | 0.9 | | |
| 1.4 16V | 4 | CGGA | 59/79 | 05/06→ | Z272 | 1.0 | | ZSE030 |
| | | | | | ch. 1K-9-400 001→ | | | ch. 1K-9-400 001→ |
| 1.4 16V LPG | 4 | BCA | 55/74 | 01/05→ | Z340 | 0.7 | UXT12 | |
| 1.4 FSI | 4 | BLN | 66/89 | 07/05→ | Z300 | 1.35 | | ZSE030 |
| 1.4 TSI | 4 | CAXA | 90/121 | 06/07→ | Z349 | 0.9 | | ZSE030 |
| | | | | | 06/08→ | | | →ch. F1K-8-281 299 |
| | | | | | ch. WVVZZ1KZ9W900001→ | | | |
| 1.4 TSI | 4 | BMY | 103/138 | 05/06→06/08 | | | | ZSE030 |
| | | | | | | | | →ch. F1K-8-281 299 |
| 1.4 TSI | 4 | CAVD, CNWA | 118/158 | 06/08→ | | | | ZSE030 |
| 1.4 TSI | 4 | BLG | 125/168 | 05/06→06/08 | | | | ZSE030 |
| | | | | | | | | →ch. F1K-8-281 299 |
| 1.6 | 4 | BSE, BSF, CCSA, CMXA | 75/101 | 05/05→ | Z90 | 1.0 | UXT1 / UXT3 | ZSE003 |
| 1.6 LPG | 4 | BSE, BSF, CCSA, CMXA | 75/101 | 05/05→ | Z340 | 0.7 | UXT12 | |
| 1.6 BiFuel LPG | 4 | CHGA | 75/101 | 05/09→ | Z340 | 0.7 | UXT12 | ZSE003 |
| | | | | | Z90 | 1.0 | UXT1 / UXT3 | |
| 1.6 FSI | 4 | BLF | 85/114 | 01/05→05/08 | Z300 | 1.35 | | ZSE030 |
| 1.6 MultiFuel | 4 | CCSA, CMXA | 75/101 | 11/07→ | Z90 | 1.0 | UXT1 / UXT3 | ZSE003 |
| 1.6 MultiFuel LPG | 4 | CCSA | 75/101 | 11/07→ | Z340 | 0.7 | UXT12 | |
| 1.6 TDI | 4 | CAYB | 66/89 | 02/09→ | GE115 | 4.4V | | |
| 1.6 TDI | 4 | CAYC | 77/103 | 03/09→ | GE115 | 4.4V | | |
| 1.9 TDI | 4 | BRU, BXF, BXJ | 66/89 | 05/05→12/08 | GE100 | GR081 | 5V | |
| 1.9 TDI | 4 | BKC, BLS, BXE | 77/103 | 01/05→01/09 | GE100 | GR081 (31)X75) | 5V | |
| | | | | | | GSE100 | | |
| | | | | | | →ch. 5M-5-530 000 | | |
| 2.0 FSI | 4 | BLR, BVY | 110/148 | 05/05→06/08 | Z236 | 1.0 | | ZSE033 (47) |
| | | | | | | | | ZSE142 (48) |
| 2.0 FSI | 4 | BLY, BVZ | 110/148 | 05/05→06/08 | Z228 | 1.0 | UXT11 | ZSE033 (47) |
| | | | | | | | | ZSE142 (48) |
| 2.0 FSI LPG | 4 | BLY, BVZ | 110/148 | 05/05→06/08 | Z221 (168) | 1.0 | UXT14 | |
| 2.0 TDI | 4 | CBDC, CLCA | 81/109 | 01/09→ | GE115 | 4.4V | | |
| 2.0 TDI | 4 | BEE | 96/129 | 05/05→05/07 | GE101 | GR081 | 4.4V | |
| 2.0 TDI | 4 | AZV | 100/134 | 05/05→ | GE101 | GR081 (31)X75) | 4.4V | |
| | | | | | | GSE100 | | |
| | | | | | | →ch. 5M-5-530 000 | | |
| 2.0 TDI | 4 | CBDA, CFHB | 100/134 | 05/05→ | GE115 | GR081 | 4.4V | |
| 2.0 TDI | 4 | BMM | 103/138 | 12/05→05/09 | GE100 | GR081 | 5V | |
| 2.0 TDI 16V | 4 | BKD | 103/138 | 01/05→ | GE101 | GR081 (31)X75) | 4.4V | |
| | | | | | | GSE100 | | |
| | | | | | | →ch. 5M-5-530 000 | | |
| 2.0 TDI 16V | 4 | CBDB, CFHC | 103/138 | 01/05→ | GE115 | GR081 | 4.4V | |
| GOLF SPORTSVAN | | | | | | | | |
| 1.6 TDI | 4 | CRKA | 66/89 | 02/14→ | GE115 | 4.4V | | |
| | | | | | PSG002 | 4.4V | | |
| 1.6 TDI | 4 | CRKB | 81/109 | 02/14→ | GE115 | 4.4V | | |
| | | | | | PSG002 | 4.4V | | |
| 2.0 TDI | 4 | CRVA | 81/109 | 05/14→ | GE115 | 4.4V | | |
| | | | | | PSG002 | 4.4V | | |
| 2.0 TDI | 4 | CRLB | 110/148 | 02/14→ | GE115 | 4.4V | | |
| | | | | | PSG002 | 4.4V | | |
| ILTIS | | | | | | | | |
| 1.6 TD 4WD | 4 | 1C | 51/68 | 08/87→12/88 | GN857 | 11V | | |
| 1.7 4WD | 4 | WL, YX | 55/74 | 03/79→12/88 | Z11 | 0.8 | UXT2 / UXT6 | ZS115 (11) |
| | | | | | Z111 | 0.5 | | →12/80 |

VW



kW/BHP

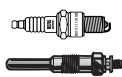

... VW



JETTA I

| | | | | | | | | | | |
|---------|---|--------|--------|-------------|-------|-------|-----|-------------|----------------------|--|
| 1.1 | 4 | FA, GG | 37/50 | 08/78→02/84 | Z11 | | 0.8 | UXT2 / UXT6 | ZS115 [11] →07/82 | |
| 1.3 | 4 | GS | 43/58 | 08/82→02/84 | Z11 | | 0.8 | UXT2 / UXT6 | | |
| 1.3 | 4 | GF | 44/59 | 08/79→02/84 | Z11 | | 0.8 | UXT2 / UXT6 | ZS115 [11] | |
| 1.5 | 4 | JB | 51/68 | 08/78→02/84 | Z1 | | 0.7 | UXT2 / UXT6 | ZS115 [11] | |
| 1.5 D | 4 | CK | 37/50 | 08/78→07/80 | GN857 | GR001 | 11V | | | |
| 1.6 | 4 | EM | 55/74 | 08/81→07/83 | Z70 | | 0.8 | UXT2 / UXT6 | | |
| 1.6 | 4 | EW | 55/74 | 08/82→07/83 | Z2 | | 1.0 | UXT2 / UXT6 | | |
| 1.6 | 4 | FR | 63/84 | 08/78→02/84 | Z61 | | 0.7 | UXT2 / UXT6 | ZS115 [11] | |
| 1.6 D | 4 | CR, JK | 40/54 | 08/80→02/84 | GN857 | GR031 | 11V | | | |
| 1.6 GLI | 4 | EG | 81/109 | 08/78→07/82 | Z44 | | 0.8 | UX56 | ZS115 [11] →07/80 | |
| 1.6 TD | 4 | CY | 51/68 | 03/82→02/84 | GN857 | GR031 | 11V | | | |
| 1.8 | 4 | DX | 82/110 | 08/82→02/84 | Z12 | | 0.8 | UXT2 / UXT6 | | |

JETTA II

| | | | | | | | | | | |
|--------|---|---------|-------|-------------|-----------|-------|-----|-------------|--|------------------------------------|
| 1.3 | 4 | 2G, NZ | 40/54 | 06/87→12/91 | Z61 | | 0.7 | UXT2 / UXT6 | ZS123 [1] →04/89 ZS124 [1] 05/89→ | ZM002 [175] ZM012 [175] |
| 1.3 | 4 | HK | 40/54 | 01/84→06/87 | Z11 | | 0.8 | UXT2 / UXT6 | ZS115 [1][11] →06/84 | ZM002 →09/86 ZM012 10/86→ |
| 1.3 | 4 | MH | 40/54 | 01/84→06/87 | Z61 [169] | | 0.7 | UXT2 / UXT6 | ZS124 [1] 08/85→ | ZM002 →09/86 ZM012 10/86→ |
| 1.3 | 4 | MH | 40/54 | 06/87→12/91 | Z61 | | 0.7 | UXT2 / UXT6 | ZS123 [1] →04/89 | ZM002 [175] ZM012 [175] |
| 1.3 | 4 | GT | 43/58 | 01/84→10/86 | Z11 | | 0.8 | UXT2 / UXT6 | ZS115 [11] | |
| 1.6 | 4 | PN | 51/68 | 10/86→10/91 | Z93 | | 1.0 | UXT2 / UXT6 | ZS124 | ZM002 [175] ZM012 [175] |
| 1.6 | 4 | RF | 53/71 | 03/86→10/91 | Z93 | | 1.0 | UXT2 / UXT6 | ZS124 | ZM002 →09/86 ZM012 10/86→ |
| 1.6 | 4 | ABN, EZ | 55/74 | 01/84→07/92 | Z1 [169] | | 0.7 | UXT2 / UXT6 | ZS124 | ZM002 →09/86 ZM012 10/86→ |
| 1.6 | 4 | HM | 55/74 | 01/84→07/92 | Z2 | | 1.0 | UXT2 / UXT6 | ZS124 | ZM002 →09/86 ZM012 10/86→ |
| 1.6 D | 4 | JP, ME | 40/54 | 01/84→10/91 | GN857 | GR031 | 11V | | | |
| 1.6 TD | 4 | 1V | 44/59 | 01/90→10/91 | GN857 | GR031 | 11V | | | |
| 1.6 TD | 4 | JR, MF | 51/68 | 01/84→10/91 | GN857 | GR031 | 11V | | | |
| 1.6 TD | 4 | RA, SB | 59/79 | 04/89→10/91 | GN857 | GR031 | 11V | | | |
| 1.8 | 4 | RH | 62/83 | 08/86→01/90 | Z61 | | 0.7 | UXT2 / UXT6 | ZS123 [1][214][254] ZS124 [1][214][254] | ZM002 →09/86 ZM012 10/86→ |
| 1.8 | 4 | GU | 66/89 | 08/84→10/91 | Z12 | | 0.8 | UXT2 / UXT6 | ZS123 [1] | ZM002 →09/86 ZM012 10/86→ |

VW



kW/BHP

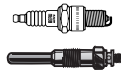

... VW



... JETTA II

| | | | | | | | | | | |
|---------|---|--------|---------|-------------|-----|--|-----|-------------|--|------------------------------------|
| 1.8 | 4 | GX | 66/89 | 08/84→10/91 | Z91 | | 0.8 | UXT2 / UXT6 | ZS124 ^[1] →07/89 ZS123 ^{[1][214][254]} | ZM002 →09/86 ZM012 10/86→ |
| 1.8 | 4 | GX | 66/89 | 08/87→10/91 | | | | | ZS124 | ZM012 |
| 1.8 | 4 | HV | 66/89 | 08/84→10/91 | Z12 | | 0.8 | UXT2 / UXT6 | ZS123 ^{[1][214][254]} ZS124 ^[1] ch. 19.E.855001→ | ZM002 →09/86 ZM012 10/86→ |
| 1.8 | 4 | GU, RP | 66/89 | 08/87→10/91 | Z91 | | 0.8 | UXT2 / UXT6 | ZS124 | ZM012 |
| 1.8 4WD | 4 | 1P | 72/97 | 08/88→07/91 | Z61 | | 0.7 | UXT2 / UXT6 | ZS124 | ZM012 |
| 1.8 | 4 | PF | 79/106 | 01/87→10/91 | Z61 | | 0.7 | UXT2 / UXT6 | ZS124 | ZM012 |
| 1.8 | 4 | RD | 79/106 | 08/85→10/87 | Z91 | | 0.8 | UXT2 / UXT6 | ZS124 | ZM002 →09/86 ZM012 10/86→ |
| 1.8 | 4 | EV, GZ | 82/110 | 01/84→10/91 | Z12 | | 0.8 | UXT2 / UXT6 | ZS124 | ZM002 →09/86 ZM012 10/86→ |
| 1.8 | 4 | PB | 82/110 | 01/84→10/91 | Z61 | | 0.7 | UXT2 / UXT6 | ZS124 | ZM002 →09/86 ZM012 10/86→ |
| 1.8 16V | 4 | PL | 95/127 | 08/86→10/91 | Z89 | | 0.8 | UXT5 | ZS120 ^[1] →07/87 ZS123 ^[1] 08/87→ ZS124 ^[1] 08/87→ | ZM002 →09/86 ZM012 10/86→ |
| 1.8 16V | 4 | KR | 102/137 | 06/87→12/89 | Z52 | | 0.8 | UXT5 | ZS124 | ZM012 |

JETTA III

| | | | | | | | | | | |
|-------------------|---|--------------------|---------|-------------|----------------------------------|--------|------------|-------------|------------------------------|--|
| 1.4 TSI | 4 | CAXA | 90/121 | 05/07→10/10 | | | | | ZSE030 | |
| 1.4 TSI | 4 | BMY | 103/138 | 07/06→10/10 | | | | | ZSE030 →ch. FIK-8-281 299 | |
| 1.4 TSI | 4 | CAVD | 118/158 | 07/08→10/10 | | | | | ZSE030 | |
| 1.4 TSI | 4 | BLG | 125/168 | 07/06→10/10 | | | | | ZSE030 →ch. FIK-8-281 299 | |
| 1.6 | 4 | BSE, BSF, CCSA | 75/101 | 10/05→10/10 | Z90 | | 1.0 | UXT1 / UXT3 | ZSE003 | |
| 1.6 LPG | 4 | BSE, BSF, CCSA | 75/101 | 10/05→10/10 | Z340 | | 0.7 | UXT12 | | |
| 1.6 FSI | 4 | BLF | 85/114 | 09/05→10/10 | Z300 | | 1.35 | | ZSE030 ch. 1K-7-000 000→ | |
| 1.6 MultiFuel | 4 | CCSA | 75/101 | 01/08→10/10 | Z90 | | 1.0 | UXT1 / UXT3 | ZSE003 | |
| 1.6 MultiFuel LPG | 4 | CCSA | 75/101 | 01/08→10/10 | Z340 | | 0.7 | UXT12 | | |
| 1.6 TDI | 4 | CAYB | 66/89 | 12/09→10/10 | GE115 | | 4.4V | | | |
| 1.6 TDI | 4 | CAYC | 77/103 | 06/09→10/10 | GE115 | | 4.4V | | | |
| 1.9 TDI | 4 | BKC, BXE | 77/103 | 08/05→10/10 | GE100 | | 5V | | | |
| 1.9 TDI | 4 | BLS | 77/103 | 08/05→10/10 | CGP002 ^[146] GE100 | | 7V 5V | | | |
| 2.0 FSI | 4 | BLR, BLY, BVY, BVZ | 110/148 | 08/05→10/10 | Z193 Z236 | | 0.9 1.0 | UXT1 / UXT3 | ZSE033 | |
| 2.0 FSI | 4 | BLX | 110/148 | 08/05→10/10 | | | | | ZSE033 | |
| 2.0 FSI LPG | 4 | BLY, BVZ | 110/148 | 08/05→10/10 | Z221 ^[168] | | 1.0 | UXT14 | | |
| 2.0 TDI | 4 | AZV | 100/134 | 09/05→10/10 | GE101 | GSE100 | 4.4V | | | |
| 2.0 TDI | 4 | CBDA | 100/134 | 09/05→10/10 | GE115 | GSE100 | 4.4V | | | |
| 2.0 TDI | 4 | BMM | 103/138 | 10/05→10/10 | GE100 | GSE100 | 5V | | | |
| 2.0 TDI | 4 | BMN | 125/168 | 10/06→10/10 | CGP003 | | 7V | | | |
| 2.0 TDI | 4 | CEGA | 125/168 | 10/06→10/10 | GE115 | | 4.4V | | | |
| 2.0 TDI 16V | 4 | BKD | 103/138 | 08/05→10/10 | GE101 | | 4.4V | | | |



kW/BHP



... VW



... JETTA III

| | | | | | | | | |
|-------------|---|---------------------|---------|-------------|--------|------|-------|--|
| 2.0 TDI 16V | 4 | CBDB | 103/138 | 08/05→10/10 | GE115 | 4.4V | | |
| 2.0 TDI 16V | 4 | CJAA | 103/138 | 08/05→10/10 | PSG002 | 4.4V | | |
| 2.0 TFSI | 4 | CAWA | 125/168 | 03/08→10/10 | Z347 | 0.7 | UXT12 | ZSE033 |
| 2.0 TFSI | 4 | AXX, BPY, BWA, CAWB | 147/197 | 10/05→10/10 | Z347 | 0.7 | UXT12 | ZSE033 |
| 2.0 TFSI | 4 | CBFA, CCTA, CCZA | 147/197 | 10/05→10/10 | Z347 | 0.7 | UXT12 | ZSE033 ⁽⁴⁷⁾ ZSE142 ⁽⁴⁸⁾ |
| 2.5 FSI | 5 | BGP, BTK | 110/148 | 01/06→10/10 | Z176 | 1.1 | | ZSE142 |
| 2.5 FSI | 5 | CBTA | 125/168 | 07/08→10/10 | Z176 | 1.1 | | ZSE033 ⁽⁴⁷⁾ ZSE142 ⁽⁴⁸⁾ |
| 2.5 FSI | 5 | CBUA | 125/168 | 07/08→10/10 | | | | ZSE033 ⁽⁴⁷⁾ ZSE142 ⁽⁴⁸⁾ |
| 2.5 FSI | 5 | CCCA | 125/168 | 07/08→10/10 | Z272 | 1.0 | | ZSE033 ⁽⁴⁷⁾ ZSE142 ⁽⁴⁸⁾ |

JETTA IV

| | | | | | | | | |
|----------------|---|------------------|---------|--------|--|--------------|-------|--|
| 1.2 TSI | 4 | CBZB | 77/103 | 02/11→ | | | | ZSE003 |
| 1.4 TSI | 4 | CAXA | 90/121 | 05/11→ | Z349 | 0.9 | | ZSE030 |
| | | | | | ch. 3VWZZZ16ZBM000001; WVWZZZ16ZF000001; XW8ZZZ16ZFN9000001→ | | | |
| 1.4 TSI | 4 | CMSB | 90/121 | 05/11→ | Z349 | 0.9 | | ZSE030 |
| | | | | | ch. 3VWZZZ16ZBM000001; WVWZZZ16ZF000001; XW8ZZZ16ZFN9000001→ | | | |
| 1.4 TSI | 4 | CAVD | 118/158 | 04/11→ | | | | ZSE030 |
| 1.4 TSI Hybrid | 4 | CNLA | 110/148 | 04/11→ | | | | ZSE067 ⁽¹¹⁾⁽⁴²⁾ ZSE126 ⁽¹¹⁾⁽⁴³⁾ |
| 1.6 | 4 | CFNA, CLRA | 77/103 | 12/11→ | Z200 Z272 | 0.9 1.0 | | ZSE030 |
| 1.6 TDI | 4 | CAYC | 77/103 | 02/11→ | GE115 | 4.4V | | |
| 2.0 | 4 | CBPA | 85/114 | 06/10→ | Z272 | 1.0 | | |
| | | | | | ch. 16-B-000 001→ | | | |
| 2.0 TDI | 4 | CFFB, CFHC, CLCB | 81/109 | 10/10→ | GE115 | 4.4V | | |
| 2.0 TDI | 4 | CJAA | 81/109 | 10/10→ | PSG002 | 4.4V | | |
| 2.0 TDI | 4 | CFFB, CFHC, CLCB | 103/138 | 02/11→ | GE115 PSG002 | 4.4V 4.4V | | |
| 2.0 TDI | 4 | CJAA | 103/138 | 02/11→ | PSG002 | 4.4V | | |
| 2.0 TDI | 4 | CJAA | 110/148 | 08/14→ | PSG002 | 4.4V | | |
| 2.0 TDI | 4 | CUUB | 110/148 | 08/14→ | GE115 | 4.4V | | |
| 2.0 TSI | 4 | CBFA, CCTA, CCZA | 147/197 | 12/10→ | Z347 | 0.7 | UXT12 | ZSE033 ⁽⁴⁷⁾ ZSE142 ⁽⁴⁸⁾ |
| 2.0 TSI | 4 | CPLA, CPPA | 155/208 | 12/12→ | | | | ZSE068 →24.11.2013 |
| 2.5 FSI | 5 | CBTA | 125/168 | 04/10→ | Z176 | 1.1 | | |
| 2.5 FSI | 5 | CCCA | 125/168 | 04/10→ | Z272 | 1.0 | | |

K 70

| | | | | | | | | |
|-----|---|----|-------|-------------|-----|-----|------|--|
| 1.6 | 4 | DB | 55/74 | 08/70→07/71 | Z22 | 0.7 | UX56 | |
| 1.6 | 4 | DA | 66/89 | 08/70→10/74 | Z22 | 0.7 | UX56 | |
| 1.8 | 4 | DC | 74/99 | 08/73→10/74 | Z22 | 0.7 | UX56 | |

KAEFER

| | | | | | | | | |
|----------|---|-----|-------|-------------|---------------|-----|--|-------------------------------------|
| 1.1 | 4 | M5 | 18/24 | 12/47→12/53 | Z68 | 0.6 | | ZS105 ⁽¹¹⁾ |
| 1.2 | 4 | M5I | 22/30 | 01/54→07/65 | Z57 | 0.6 | | ZS105 ⁽¹¹⁾ |
| 1.2 1200 | 4 | D | 25/34 | 01/60→12/85 | Z57 | 0.6 | | ZS105 ⁽¹¹⁾⁽¹¹⁾ |
| | | | | | →12/77 Z68 | 0.6 | | →07/75 ZS106 ⁽¹¹⁾⁽¹¹⁾ |
| | | | | | | | | 08/69→ |
| 1.2 1302 | 4 | D | 25/34 | 08/69→08/72 | Z57 | 0.6 | | ZS106 ⁽¹¹⁾ |
| 1.2 1303 | 4 | D | 25/34 | 07/72→12/79 | Z57 | 0.6 | | |
| 1.2 1303 | 4 | D | 25/34 | 07/72→02/76 | | | | ZS106 ⁽¹¹⁾ |

VW



kW/BHP



... VW



... KAEFER

| | | | | | | | | | |
|---------------------|---|-------------------------|--------|-------------|---|-------|------|--|--|
| 1.2 1303 | 4 | D | 25/34 | 04/75→12/79 | | | | ZS106 ^[11] →07/75 | |
| 1.3 1300 | 4 | E | 27/36 | 08/65→07/70 | Z68 | | 0.6 | ZS106 ^[11] | |
| 1.3 1300 | 4 | F | 29/39 | 01/65→07/70 | Z68 | | 0.6 | ZS106 ^[11] | |
| 1.3 1300 | 4 | AB | 32/43 | 01/70→01/73 | Z68 | | 0.6 | ZS106 ^[11] | |
| 1.3 1302 | 4 | AC | 29/39 | 08/70→07/74 | Z57 | | 0.6 | | |
| 1.3 1302 | 4 | AC | 29/39 | 08/70→07/75 | Z68 | | 0.6 | | |
| 1.3 1302 | 4 | AB | 32/43 | 08/70→08/72 | Z68 ^[169] | | 0.6 | ZS106 ^[11] | |
| 1.3 1303 | 4 | AB, AR | 32/43 | 07/70→03/81 | Z68 | | 0.6 | | |
| 1.3 Karmann | 4 | F | 29/39 | 07/64→07/70 | Z57 | | 0.6 | ZS106 ^[11] 08/69→ | |
| 1.5 1500 | 4 | H | 32/43 | 01/66→12/70 | Z57 | | 0.6 | ZS106 ^[11] | |
| 1.5 1500 | 4 | H | 32/43 | 08/66→11/73 | Z68 | | 0.6 | ZS106 ^[11] 08/69→07/70 | |
| 1.6 1302 | 4 | AF | 34/46 | 08/70→07/74 | Z57 ^[168] | | 0.6 | | |
| 1.6 1302 | 4 | AE, AH, AK | 35/47 | 07/71→07/74 | Z68 | | 0.6 | | |
| 1.6 1302 | 4 | AD | 37/50 | 01/70→08/72 | Z57 | | 0.6 | ZS106 ^[11] | |
| 1.6 1302, 1303 | 4 | AD | 37/50 | 07/70→06/79 | Z57 | | 0.6 | ZS106 ^[11] | |
| 1.6 1303 | 4 | AD | 35/47 | 08/72→12/79 | Z57 | | 0.6 | | |
| 1.6 1303 | 4 | AE, AH, AK | 35/47 | 08/70→07/74 | Z68 | | 0.6 | | |
| 1.6 1303 LS,S | 4 | AD, AJ, AS | 37/50 | 08/72→12/79 | Z57 | | 0.6 | | |
| 1.6 1500 | 4 | B | 35/47 | 07/69→07/70 | Z68 | | 0.6 | ZS106 ^[11] | |
| 1.6 1500 | 4 | AD | 37/50 | 07/70→01/73 | Z68 | | 0.6 | ZS106 ^[11] | |
| 1.6 1600 | 4 | AF | 34/46 | 05/73→09/92 | Z57 | | 0.6 | ZS106 ^[11] | |
| 1.6 1600 i | 4 | ACD | 34/46 | 10/92→07/03 | Z76 | | 0.8 | UXT2 / UXT6 ZSE001 | |
| KARMANN GHIA | | | | | | | | | |
| 1.2 1200 | 4 | D | 25/34 | 09/57→12/64 | Z57 | | 0.6 | | |
| 1.3 1300 | 4 | AB | 32/43 | 07/70→07/74 | Z68 | | 0.6 | | |
| 1.3 1500 | 4 | F | 29/39 | 07/64→07/74 | Z57 | | 0.6 | | |
| 1.5 1500 | 4 | H | 32/43 | 01/66→12/69 | Z57 | | 0.6 | | |
| 1.5 1500 | 4 | H | 33/44 | 01/66→12/69 | Z57 | | 0.6 | | |
| 1.5 1500 | 4 | | 40/54 | 08/61→05/70 | Z68 | | 0.6 | | |
| 1.6 1600 | 4 | AD, AL | 35/47 | 07/71→07/74 | Z68 | | 0.6 | | |
| 1.6 1600 | 4 | AD | 37/50 | 01/70→12/73 | Z57 | | 0.6 | | |
| LUPO | | | | | | | | | |
| 1.0 | 4 | AER, ALL | 37/50 | 09/98→07/05 | Z91 | | 0.8 | UXT2 / UXT6 ZSE001 ^{[1][175][254]} ZSE040 ^[1] | |
| 1.0 | 4 | AHT | 37/50 | 10/98→05/00 | Z188 | | 0.7 | UXT10 ZSE040 | |
| 1.0 | 4 | ALD, ANV, AUC | 37/50 | 09/98→07/05 | Z176 | | 1.1 | ZSE003 ^{[1][208]} ZSE040 ^[1] | |
| 1.0 LPG | 4 | AER, ALL | 37/50 | 09/98→07/05 | Z27 ^[168] | | 0.8 | UX56 | |
| 1.0 LPG | 4 | AHT | 37/50 | 10/98→05/00 | Z340 | | 0.7 | UXT12 | |
| 1.2 TDI 3L | 3 | ANY | 45/60 | 07/99→07/05 | GN855 | | 12V | | |
| 1.2 TDI 3L | 3 | AYZ | 45/60 | 07/99→07/05 | GN855 | | 12V | | |
| | | | | | →ch. 6X-2-005 000 GN046 ch. 6X-2-005 001→ | | 12V | | |
| 1.4 | 4 | AUD | 44/59 | 10/00→07/05 | Z176 | | 1.1 | ZSE003 | |
| 1.4 16V | 4 | AHW, AKQ, APE, AUA | 55/74 | 09/98→07/05 | Z90 | | 1.0 | UXT1 / UXT3 ZSE003 | |
| 1.4 16V | 4 | BBY | 55/74 | 09/98→07/05 | Z90 | | 1.0 | UXT1 / UXT3 ZSE030 | |
| 1.4 16V | 4 | AFK, AQQ, AUB | 74/99 | 08/99→07/05 | Z90 | | 1.0 | UXT1 / UXT3 ZSE003 | |
| 1.4 16V | 4 | ANM | 74/99 | 08/99→07/05 | | | | ZSE003 | |
| 1.4 16V LPG | 4 | AHW, AKQ, APE, AUA, BBY | 55/74 | 09/98→07/05 | Z340 | | 0.7 | UXT12 | |
| 1.4 16V LPG | 4 | AFK, AQQ, AUB | 74/99 | 08/99→07/05 | Z340 | | 0.7 | UXT12 | |
| 1.4 FSI | 4 | ARR | 77/103 | 02/01→07/05 | Z300 | | 1.35 | | |
| 1.4 TDI | 3 | AMF | 55/74 | 01/99→07/05 | GN855 | GR081 | 12V | | |
| | | | | | →10/01 GN046 11/01→ | | 12V | | |

VW

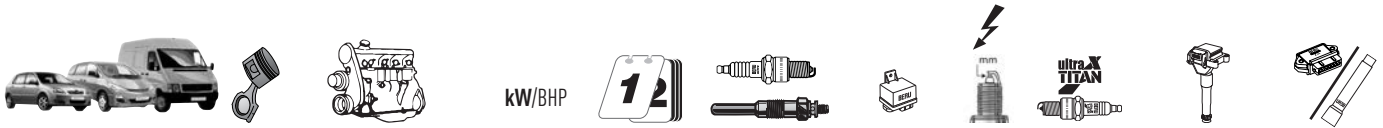

| ... VW | | | | | | | | | |
|-------------------|---|--------------------------|---------|-------------|-----------------|-------|------------|-------------|------------------------------------|
| ... LUPO | | | | | | | | | |
| 1.6 GTI | 4 | AVY | 92/123 | 09/00→07/05 | Z90 | | 1.0 | UXT1 / UXT3 | ZSE003 |
| 1.6 GTI LPG | 4 | AVY | 92/123 | 09/00→07/05 | Z340 | | 0.7 | UXT12 | |
| 1.7 SDI | 4 | AKU | 44/59 | 09/98→07/05 | GN855 | GR081 | 12V | | |
| | | | | | →09/01 GN046 | | 12V | | |
| | | | | | 10/01→ | | | | |
| MULTIVAN V | | | | | | | | | |
| 1.9 TDI | 4 | BRR | 62/83 | 01/06→11/09 | GE100 | | 5V | | |
| 1.9 TDI | 4 | AXC | 63/84 | 04/03→11/09 | GN046 | | 12V | | |
| 1.9 TDI | 4 | BRS | 75/101 | 06/06→11/09 | GE100 | | 5V | | |
| 1.9 TDI | 4 | AXB | 77/103 | 04/03→11/09 | GN046 | | 12V | | |
| 2.0 | 4 | AXA | 85/114 | 11/03→ | Z90 | | 1.0 | UXT1 / UXT3 | ZSE003 |
| 2.0 LPG | 4 | AXA | 85/114 | 11/03→ | Z340 | | 0.7 | UXT12 | |
| 2.0 BiTDI | 4 | CFCA | 132/177 | 09/09→ | GE115 | | 4.4V | | |
| 2.0 TDI | 4 | CAAA | 62/83 | 09/09→ | GE115 | | 4.4V | | |
| 2.0 TDI | 4 | CAAB | 75/101 | 09/09→ | GE115 | | 4.4V | | |
| 2.0 TDI | 4 | CAAD | 84/113 | 05/11→ | GE115 | | 4.4V | | |
| 2.0 TDI | 4 | CAAE, CCHB | 100/134 | 05/10→ | GE115 | | 4.4V | | |
| 2.0 TDI | 4 | CAAC, CCHA | 103/138 | 09/09→ | GE115 | | 4.4V | | |
| 2.0 TSI | 4 | CJKB | 110/148 | 07/12→ | Z347 | | 0.7 | UXT12 | ZSE033 |
| 2.0 TSI | 4 | CJKA | 150/201 | 05/11→ | Z347 | | 0.7 | UXT12 | ZSE033 |
| 2.5 TDI | 5 | AXD | 96/129 | 04/03→11/09 | GN046 | | 12V | | |
| 2.5 TDI | 5 | BLJ | 120/161 | 11/03→11/09 | GN046 | | 12V | | |
| 2.5 TDI | 5 | AXE | 128/172 | 04/03→11/09 | GN046 | | 12V | | |
| 3.2 V6 | 6 | BDL | 170/228 | 02/04→06/04 | Z306 | | 0.9 | | ZSE044 |
| 3.2 V6 | 6 | BKK, CFLA | 173/232 | 02/04→11/09 | Z306 | | 0.9 | | ZSE041 [1][173] ZSE044 [1][199] |
| 3.2 V6 | 6 | CFLA | 173/232 | 02/04→11/09 | | | | | ZSE041 [1][173] ZSE044 [1][199] |
| NEW BEETLE | | | | | | | | | |
| 1.4 | 4 | BCA | 55/74 | 11/01→09/10 | Z176 | | 1.1 | | ZSE030 |
| 1.6 | 4 | AWH | 74/99 | 10/99→09/00 | Z90 | | 1.0 | UXT1 / UXT3 | ZSE003 |
| 1.6 | 4 | AYD | 75/101 | 06/00→09/10 | Z176 | | 1.1 | | ZSE003 |
| 1.6 | 4 | BFS | 75/101 | 06/00→09/10 | Z90 | | 1.0 | UXT1 / UXT3 | ZSE003 |
| 1.6 LPG | 4 | AWH | 74/99 | 10/99→09/00 | Z340 | | 0.7 | UXT12 | |
| 1.6 LPG | 4 | BFS | 75/101 | 06/00→09/10 | Z340 | | 0.7 | UXT12 | |
| 1.8 T | 4 | AGU | 110/148 | 10/99→09/10 | | | | | ZM062 |
| 1.8 T | 4 | APH | 110/148 | 10/99→09/10 | Z188 | | 0.7 | UXT10 | ZSE009 |
| 1.8 T | 4 | AVC, AWU, AWW | 110/148 | 10/99→09/10 | Z188 | | 0.7 | UXT10 | ZSE043 |
| 1.8 T | 4 | BKF | 110/148 | 10/99→09/10 | Z188 | | 0.7 | UXT10 | |
| 1.8 T | 4 | BKF | 110/148 | 01/03→09/10 | | | | | ZSE043 |
| 1.8 T | 4 | AWP, BNU | 132/177 | 11/01→06/05 | Z188 | | 0.7 | UXT10 | ZSE043 |
| 1.8 T LPG | 4 | AWU, AWW, BKF | 110/148 | 01/03→09/10 | Z340 | | 0.7 | UXT12 | |
| 1.9 TDI | 4 | ALH | 66/89 | 01/98→06/04 | GN855 | GR081 | 12V | | |
| 1.9 TDI | 4 | ATD | 74/99 | 02/01→09/10 | GN046 | GR081 | 12V | | |
| 1.9 TDI | 4 | AXR | 74/99 | 06/03→09/10 | GN046 | GR081 | 12V | | |
| 1.9 TDI | 4 | BEW | 74/99 | 02/01→09/10 | CGP002 | | 7V | | |
| 1.9 TDI | 4 | BSW | 77/103 | 07/05→09/10 | GE100 | GR081 | 5V | | |
| 2.0 | 4 | AEG, APK, AQY, BER, CBPA | 85/114 | 01/98→09/10 | Z90 | | 1.0 | UXT1 / UXT3 | ZSE003 |
| 2.0 | 4 | AVH, AZG, AZJ, BEJ, BEV | 85/114 | 01/98→09/10 | Z176 | | 1.1 | | ZSE029 |
| 2.0 | 4 | AZJ, BEV | 85/114 | 09/02→10/10 | Z176 Z200 | | 1.1 0.9 | | ZSE029 |
| | | | | | 2006→ | | | | |
| 2.0 | 4 | BDC, BGD | 85/114 | 09/02→10/10 | Z176 | | 1.1 | | ZSE029 |
| 2.0 | 4 | BHP | 85/114 | 01/98→09/10 | Z176 | | 1.1 | | ZSE003 [40][208] ZSE029 [45] |
| 2.0 LPG | 4 | AEG, APK, AQY, BER, CBPA | 85/114 | 01/98→09/10 | Z340 | | 0.7 | UXT12 | |
| 2.3 V5 | 5 | AQN | 125/168 | 10/00→09/10 | Z176 | | 1.1 | | ZSE063 |



kW/BHP

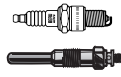

... VW



... NEW BEETLE

| | | | | | | | | | | |
|-------------------|---|----------|---------|-------------|---|--------------|-----|------------------------------|--|--|
| 2.5 | 5 | BPR, BPS | 110/148 | 07/05→09/10 | Z176 →ch. 1C-8-517 069 Z272 ch. 1C-8-517 070→ | | 1.1 | | ZSE142 | |
| 3.2 RSI 3.2 4WD | 6 | AXJ | 165/221 | 04/00→05/01 | Z176 | | 1.1 | | ZSE013 | |
| PARATI | | | | | | | | | | |
| 1.8 | 4 | UDH | 73/98 | 08/02→ | Z91 | | 0.8 | UXT2 / UXT6 | ZS314 | |
| 1.8 Hybrid | 4 | BNY | 73/98 | 01/05→05/08 | | | | | ZS314 →ch. 9BWZZZSKZ6-120000 | |
| 1.9 SDI | 4 | BGG | 47/63 | 08/02→ | GN857 | | 11V | | | |
| PASSAT | | | | | | | | | | |
| 1.3 | 4 | FY, ZA | 40/54 | 05/73→07/83 | Z11 | | 0.8 | UXT2 / UXT6 | | |
| 1.3 | 4 | FY | 40/54 | 05/73→07/80 | | | | | ZS115 ⁽¹¹⁾ | |
| 1.3 | 4 | FY | 40/54 | 08/80→07/83 | | | | | | ZM002 |
| 1.3 | 4 | EP | 44/59 | 08/80→07/86 | Z11 →04/84 Z20 Z2 05/85→ Z93 05/85→ | | 0.8 | UXT2 / UXT6 | ZS124 ⁽²¹⁴⁾⁽²⁵⁴⁾ 05/84→ | |
| 1.3 | 4 | EU | 44/59 | 08/80→07/86 | Z11 →04/84 | | 0.8 | UXT2 / UXT6 →04/84 | ZS124 ⁽²¹⁴⁾⁽²⁵⁴⁾ 05/84→ | |
| 1.3 | 4 | FZ | 44/59 | 01/78→07/80 | | | | | ZS115 ⁽¹¹⁾ | |
| 1.3 | 4 | FZ | 44/59 | 08/80→07/86 | Z11 ^[168] | | 0.8 | UXT2 / UXT6 | | ZM002 |
| 1.3 | 4 | ZF | 44/59 | 05/73→01/78 | Z11 | | 0.8 | UXT2 / UXT6 | ZS115 ⁽¹¹⁾ | |
| 1.4 TSI | 4 | CAXA | 90/121 | 05/07→ | Z349 | | 0.9 | | ZSE030 | |
| 1.4 TSI | 4 | CTHD | 118/158 | 11/12→ | Z349 | | 0.9 | | ZSE030 | |
| 1.4 TSI EcoFuel | 4 | CDGA | 110/148 | 01/09→11/10 | | | | | ZSE030 | |
| 1.4 TSI EcoFuel | 4 | CDGA | 110/148 | 08/10→ | | | | | ZSE030 ZSE040 | |
| 1.4 TSI MultiFuel | 4 | CKMA | 118/158 | 11/10→ | | | | | ZSE030 | |
| 1.5 | 4 | YJ | 55/74 | 07/73→12/75 | Z11 | | 0.8 | UXT2 / UXT6 | ZS115 ⁽¹¹⁾ | |
| 1.5 | 4 | ZB | 55/74 | 07/73→12/75 | Z22 | | 0.7 | UX56 | ZS115 ⁽¹¹⁾ | |
| 1.5 | 4 | ZC | 63/84 | 05/73→12/75 | Z42 | | 0.8 | UX56 | ZS115 ⁽¹¹⁾ | |
| 1.5 D | 4 | CK | 37/50 | 02/77→07/80 | GN857 | GR001 | 11V | | | |
| 1.6 | 4 | PP | 51/68 | 08/87→03/88 | Z92 ^[171] | | 0.8 | UXT2 / UXT6 | ZS124 | ZM002 ⁽¹⁷⁵⁾ ZM012 ⁽¹⁷⁵⁾ |
| 1.6 | 4 | 1F | 53/71 | 02/88→09/91 | Z92 | | 0.8 | UXT2 / UXT6 | ZS124 | ZM012 →02/91 ZM014 02/91→ |
| 1.6 | 4 | EZ | 53/71 | 02/88→09/91 | | | | | ZS124 | ZM012 →02/91 ZM014 02/91→ |
| 1.6 | 4 | FS | 53/71 | 08/75→07/80 | Z11 | | 0.8 | UXT2 / UXT6 | | |
| 1.6 | 4 | FS | 53/71 | 02/76→08/79 | | | | | ZS115 ⁽¹¹⁾ | |
| 1.6 | 4 | RL | 53/71 | 01/85→03/88 | Z2 | | 1.0 | UXT2 / UXT6 | ZS124 | ZM002 →07/87 ZM012 08/87→ |
| 1.6 | 4 | ABN, EZ | 55/74 | 02/88→12/88 | Z2 | | 1.0 | UXT2 / UXT6 | ZS123 ⁽¹⁾⁽²¹⁴⁾⁽²⁵⁴⁾ ZS124 ⁽¹⁾⁽²¹⁴⁾⁽²⁵⁴⁾ | ZM012 04/88→ |
| 1.6 | 4 | DT | 55/74 | 08/80→03/88 | Z2 | | 1.0 | UXT2 / UXT6 | ZS124 08/84→ | |

VW



kW/BHP



... VW



... PASSAT

| | | | | | | | | | | |
|---------|---|-------------------------|--------|-------------|-----------------|-------|--------------|--|--|------------------------------------|
| 1.6 | 4 | DT, YN | 55/74 | 08/80→03/88 | | | | ZS124 | ZM002 →07/87 ZM012 08/87→ | |
| 1.6 | 4 | EZ | 55/74 | 04/88→12/88 | | | | ZS124 [1][214][254] ZS123 [1] →ch. 31...K...400000 | ZM012 | |
| 1.6 | 4 | WV | 55/74 | 08/80→03/88 | Z11 | | 0.8 | UXT2 / UXT6 | ZS124 | ZM002 →07/87 ZM012 08/87→ |
| 1.6 | 4 | WY, WZ | 55/74 | 09/79→07/80 | Z11 | | 0.8 | UXT2 / UXT6 | ZS115 [11] | |
| 1.6 | 4 | YN | 55/74 | 02/76→03/88 | Z11 | | 0.8 | UXT2 / UXT6 | | |
| 1.6 | 4 | YN | 55/74 | 02/76→07/80 | | | | | ZS115 [11] | |
| 1.6 | 4 | YG, YH | 61/82 | 09/75→07/80 | Z11 | | 0.8 | UXT2 / UXT6 | ZS115 [11] | |
| 1.6 | 4 | YP | 63/84 | 08/75→02/83 | Z11 | | 0.8 | UXT2 / UXT6 | | |
| 1.6 | 4 | YP | 63/84 | 08/75→07/80 | | | | | ZS115 [11] | |
| 1.6 | 4 | YP | 63/84 | 01/81→02/83 | | | | | | ZM002 |
| 1.6 | 4 | ADP | 74/99 | 10/96→11/00 | Z90 | | 1.0 | UXT1 / UXT3 | ZSE006 | |
| 1.6 | 4 | AEK | 74/99 | 07/94→08/96 | Z246 | | 0.9 | | | |
| 1.6 | 4 | AEK, AFT | 74/99 | 07/94→12/95 | | | | | ZSE001 10/94→ | |
| 1.6 | 4 | AEK, AFT | 74/99 | 10/94→08/96 | | | | | ZSE001 | |
| 1.6 | 4 | AFT, AHL, ANA, ARM | 74/99 | 07/94→11/00 | Z90 | | 1.0 | UXT1 / UXT3 | | |
| 1.6 | 4 | AHL, ANA, ARM | 74/99 | 10/96→11/00 | | | | | ZSE003 | |
| 1.6 | 4 | ALZ, BSE, BSF | 75/101 | 11/00→11/10 | Z90 | | 1.0 | UXT1 / UXT3 | ZSE003 | |
| 1.6 LPG | 4 | ADP, AFT, AHL, ANA, ARM | 74/99 | 07/94→11/00 | Z340 | | 0.7 | UXT12 | | |
| 1.6 LPG | 4 | AEK | 74/99 | 07/94→08/96 | Z206 | | 0.7 | UXT10 | | |
| 1.6 LPG | 4 | ALZ, BSE, BSF | 75/101 | 11/00→11/10 | Z340 | | 0.7 | UXT12 | | |
| 1.6 D | 4 | CR, JK | 40/54 | 02/79→03/88 | GN857 | GR001 | 11V | | | |
| 1.6 FSI | 4 | BLF | 85/114 | 03/05→06/08 | Z300 | | 1.35 | | ZSE030 | |
| 1.6 i | 4 | YS | 81/109 | 06/78→07/80 | Z42 | | 0.8 | UX56 | ZS115 [11] 05/79→ | |
| 1.6 TD | 4 | CY | 51/68 | 04/82→03/88 | GN857 | GR001 | 11V | | | |
| 1.6 TD | 4 | RA, SB | 59/79 | 05/86→09/93 | GN857 | GR001 | 11V | | | |
| 1.6 TDI | 4 | CAYC | 77/103 | 08/09→ | GE115 | | 4.4V | | | |
| 1.6 TDI | 4 | DCXA | 88/118 | 08/14→ | GE115 PSG002 | | 4.4V 4.4V | | | |
| 1.8 | 4 | AAM | 55/74 | 08/90→05/97 | Z92 | | 0.8 | UXT2 / UXT6 | ZSE001 | ZM014 02/91→ |
| 1.8 | 4 | RM | 64/86 | 05/86→03/88 | Z22 | | 0.7 | UX56 | ZS124 [1] →07/87 ZS123 [1] 08/87→ | ZM002 →07/87 ZM012 08/87→ |
| 1.8 | 4 | ABS | 66/89 | 02/88→05/97 | Z91 | | 0.8 | UXT2 / UXT6 | ZSE001 [1] 08/91→ | ZM012 →07/90 |
| 1.8 | 4 | ADZ | 66/89 | 02/88→05/97 | Z91 | | 0.8 | UXT2 / UXT6 | ZSE001 [1] 10/94→ | ZM012 →07/90 |
| 1.8 | 4 | DS, JN | 66/89 | 01/83→03/88 | Z12 | | 0.8 | UXT2 / UXT6 | ZS124 08/84→ | ZM002 →07/87 ZM012 08/87→ |
| 1.8 | 4 | DS, JN | 66/89 | 01/85→03/88 | | | | | ZS124 | |
| 1.8 | 4 | JV | 66/89 | 01/83→03/88 | Z51 | | 0.8 | UX56 | ZS124 08/84→ | ZM002 →07/87 ZM012 08/87→ |
| 1.8 | 4 | RP | 66/89 | 02/88→05/97 | Z91 | | 0.8 | UXT2 / UXT6 | ZS124 [1] | ZM012 →07/90 |

VW



kW/BHP

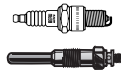

... VW



... PASSAT

| | | | | | | | | | | |
|-----------------|---|---------------|---------|-------------|----------------------|-------|-----|-------------|--|------------------------------------|
| 1.8 4WD | 4 | DS, JN | 66/89 | 01/86→03/88 | Z12 | | 0.8 | UXT2 / UXT6 | ZS124 | ZM002 →07/87 ZM012 08/87→ |
| 1.8 | 4 | PF | 79/106 | 04/88→07/93 | Z61 | | 0.7 | UXT2 / UXT6 | ZS124 →07/90 | ZM012 →07/90 |
| 1.8 | 4 | PF | 79/106 | 04/88→07/90 | | | | | ZS124 | ZM012 |
| 1.8 | 4 | DZ | 82/110 | 12/83→03/88 | Z12 | | 0.8 | UXT2 / UXT6 | ZS124 05/84→ | ZM002 →07/87 ZM012 08/87→ |
| 1.8 | 4 | PB | 82/110 | 04/88→07/92 | Z61 | | 0.7 | UXT2 / UXT6 | ZS124 ^[1] →07/89 ZS123 ^[1] 08/89→ | ZM012 |
| 1.8 | 4 | AFY | 85/114 | 01/97→11/00 | Z90 | | 1.0 | UXT1 / UXT3 | ZSE162 | |
| 1.8 | 4 | ADR, ARG | 92/123 | 10/96→11/00 | Z90 | | 1.0 | UXT1 / UXT3 | ZSE001 ^{[175][254]} ZSE162 ^[44] | ZLE276 |
| 1.8 | 4 | ADR, APT, ARG | 92/123 | 06/97→03/05 | | | | | ZSE162 | |
| 1.8 | 4 | APT | 92/123 | 10/96→03/05 | Z90 | | 1.0 | UXT1 / UXT3 | | |
| 1.8 | 4 | APT | 92/123 | 10/96→11/00 | | | | | ZSE001 ^{[175][254]} ZSE162 ^[44] | ZLE276 |
| 1.8 4WD | 4 | ADR, APT, ARG | 92/123 | 10/96→11/00 | Z90 | | 1.0 | UXT1 / UXT3 | ZSE162 | ZLE276 |
| 1.8 | 4 | KR | 102/137 | 08/91→09/93 | Z52 | | 0.8 | UXT5 | | |
| 1.8 4WD | 4 | AWM | 125/168 | 03/01→05/05 | Z188 | | 0.7 | UXT10 | ZSE043 | |
| 1.8 LPG | 4 | AAM | 55/74 | 08/90→05/97 | Z20 ^[168] | | 0.8 | UXT2 / UXT6 | | |
| 1.8 LPG | 4 | ABS, ADZ, RP | 66/89 | 02/88→05/97 | Z27 ^[168] | | 0.8 | UX56 | | |
| 1.8 LPG | 4 | AFY | 85/114 | 01/97→11/00 | Z340 | | 0.7 | UXT12 | | |
| 1.8 LPG | 4 | ADR, APT, ARG | 92/123 | 10/96→03/05 | Z340 | | 0.7 | UXT12 | | |
| 1.8 16V | 4 | KR | 100/134 | 04/88→12/89 | Z52 | | 0.8 | UXT5 | ZS123 ^{[1][214][254]} →07/89 ZS124 ^[1] 08/89→ | ZM012 |
| 1.8 G60 4WD | 4 | PG | 118/158 | 08/88→05/97 | Z104 | | 0.6 | | ZS124 | |
| 1.8 G60 4WD LPG | 4 | PG | 118/158 | 08/88→05/97 | Z42 | | 0.8 | UX56 | | |
| 1.8 GL | 4 | KR | 102/137 | 08/91→09/93 | Z52 | | 0.8 | UXT5 | | |
| 1.8 T | 4 | AEB, ANB, APU | 110/148 | 10/96→11/00 | Z188 | | 0.7 | UXT10 | ZS016 | ZLE276 ZM062 05/97→ |
| 1.8 T | 4 | AEB, ANB, APU | 110/148 | 06/97→11/00 | | | | | | ZLE276 ZM062 |
| 1.8 T 4WD | 4 | AEB | 110/148 | 11/96→08/00 | Z188 | | 0.7 | UXT10 | ZS016 | |
| 1.8 T | 4 | AWM | 125/168 | 02/01→08/05 | Z188 | | 0.7 | UXT10 | ZSE043 | |
| 1.8 T LPG | 4 | AEB, ANB, APU | 110/148 | 10/96→11/00 | Z340 | | 0.7 | UXT12 | | |
| 1.8 T 20V | 4 | AWL | 110/148 | 11/00→05/05 | | | | | ZSE043 | |
| 1.8 T 20V | 4 | AWT | 110/148 | 11/00→05/05 | Z188 | | 0.7 | UXT10 | ZSE043 | |
| 1.8 T 20V LPG | 4 | AWT | 110/148 | 11/00→05/05 | Z340 | | 0.7 | UXT12 | | |
| 1.8 TSI | 4 | CDAB | 112/150 | 11/09→ | Z347 | | 0.7 | UXT12 | ZSE142 | |
| 1.8 TSI | 4 | CGYA | 112/150 | 11/09→11/10 | Z347 | | 0.7 | UXT12 | ZSE033 | |
| 1.8 TSI | 4 | BZB | 118/158 | 05/07→10/11 | Z347 | | 0.7 | UXT12 | ZSE033 | |
| 1.8 TSI | 4 | CDA A | 118/158 | 05/07→ | Z347 | | 0.7 | UXT12 | | |
| 1.8 TSI | 4 | CDA A | 118/158 | 05/07→10/11 | | | | | ZSE142 | |
| 1.8 TSI | 4 | CDA A | 118/158 | 08/10→ | | | | | ZSE033 ^[47] ZSE142 ^[48] | |
| 1.9 | 5 | WN | 85/114 | 01/81→07/83 | Z44 | | 0.8 | UX56 | | ZM002 |
| 1.9 D | 4 | TY | 50/67 | 05/89→10/93 | GN857 | GR001 | 11V | | | |
| 1.9 TD | 4 | AAZ | 55/74 | 03/91→05/97 | GN857 | | 11V | | | |
| 1.9 TDI | 4 | IZ, AHH, AHU | 66/89 | 10/93→11/00 | GN855 | GR081 | 12V | | | |

VW



kW/BHP

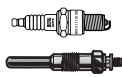

... VW



... PASSAT

| | | | | | | | | | |
|-------------|---|---------------------------------|---------|-------------|--|--------------|--------------------|--|--|
| 1.9 TDI | 4 | AVB | 74/99 | 02/00→05/05 | GN855 →ch. 38-2-350 000 GN046 ch. 38-2-350 001→ | 12V | | | |
| 1.9 TDI | 4 | BKC, BXE | 77/103 | 03/05→11/08 | GE100 | 5V | | | |
| 1.9 TDI | 4 | BLS | 77/103 | 03/05→11/08 | CGP002 05/07→05/08 GE100 [147] | 7V | | | |
| 1.9 TDI | 4 | AFN, AVG | 81/109 | 03/96→11/00 | GN855 | GR081 | 12V | | |
| 1.9 TDI | 4 | AJM, ATJ | 85/114 | 08/98→11/00 | GN855 | | 12V | | |
| 1.9 TDI | 4 | AVF, AWX | 96/129 | 11/00→05/05 | GN855 →10/01 GN046 11/01→ | | 12V | | |
| 2.0 | 4 | AEP | 79/106 | 03/95→08/96 | Z91 | 0.8 | UXT2 / UXT6 | ZSE001 | |
| 2.0 | 4 | 2E, ADY, AGG | 85/114 | 02/90→05/97 | Z91 | 0.8 | UXT2 / UXT6 | ZSE001 | ZM002 |
| 2.0 | 4 | 2E, ABA, ADY, AGG | 85/114 | 02/90→08/96 | | | | ZSE001 ch. 31-M-000 001; 31-M-066 001→ | ZM013 |
| 2.0 | 4 | AZM | 85/114 | 11/00→05/05 | Z90 | 1.0 | UXT1 / UXT3 | ZSE003 | |
| 2.0 4WD | 4 | 2E, ADY, AGG | 85/114 | 10/90→05/97 | Z91 | 0.8 | UXT2 / UXT6 | ZSE001 (1175)(254) ZSE002 (1175)(254) | |
| 2.0 | 4 | ALT | 96/129 | 11/01→05/05 | Z121 | 1.0 | UXT9 | ZSE043 | |
| 2.0 | 5 | HP | 85/114 | 08/83→03/88 | Z12 | 0.8 | UXT2 / UXT6 | ZS124 08/84→ | ZM002 →07/87 ZM012 08/87→ |
| 2.0 | 5 | HP, JS | 85/114 | 08/84→07/85 | | | | ZS124 | |
| 2.0 | 5 | JS | 85/114 | 08/83→03/88 | Z12 | 0.8 | UXT2 / UXT6 | ZS124 [214][254] 08/84→ | ZM002 →07/87 ZM012 08/87→ |
| 2.0 4WD | 5 | JS | 85/114 | 05/84→03/88 | Z12 | 0.8 | UXT2 / UXT6 | ZS124 | ZM002 →07/87 ZM012 08/87→ |
| 2.0 LPG | 4 | AEP | 79/106 | 03/95→08/96 | Z27 [168] | 0.8 | UX56 | | |
| 2.0 LPG | 4 | 2E, ADY, AGG | 85/114 | 02/90→05/97 | Z27 [168] | 0.8 | UX56 | | |
| 2.0 LPG | 4 | AZM | 85/114 | 11/00→05/05 | Z340 | 0.7 | UXT12 | | |
| 2.0 LPG | 4 | ALT | 96/129 | 11/01→05/05 | Z206 | 0.7 | UXT10 | | |
| 2.0 16V | 4 | 9A | 100/134 | 08/88→09/93 | Z89 | 0.8 | UXT5 | | |
| 2.0 16V | 4 | ABF | 110/148 | 01/94→05/97 | Z317 | 0.85 | UXT12 | ZSE001 | ZM002 |
| 2.0 BlueTDI | 4 | CBAC | 105/141 | 01/09→11/10 | GE115 | 4.4V | | | |
| 2.0 FSI | 4 | BLR, BLX, BVX, BVY | 110/148 | 03/05→11/10 | Z236 | 1.0 | | ZSE033 | |
| 2.0 FSI | 4 | BLY, BVZ | 110/148 | 03/05→11/10 | Z193 | 0.9 | UXT1 / UXT3 | ZSE033 | |
| 2.0 FSI | 4 | CCTB | 125/168 | 08/07→11/10 | Z347 | 0.7 | UXT12 | ZSE033 →09/08 ZSE142 09/08→ | |
| 2.0 FSI | 4 | AXX, BPY, BWA, CAWB, CCTA, CCZA | 147/197 | 07/05→11/10 | Z347 | 0.7 | UXT12 | | |
| 2.0 FSI | 4 | AXX, BPY, BWA, CAWB, CCTA, CCZA | 147/197 | 07/05→07/10 | | | | ZSE033 [47] ZSE142 [48][175] | |
| 2.0 FSI | 4 | AXX, BPY, BWA, CAWB, CCTA, CCZA | 147/197 | 08/05→11/10 | | | | ZSE033 [47][182] ZSE142 [48][175] | |
| 2.0 FSI LPG | 4 | BLY, BVZ | 110/148 | 03/05→11/10 | Z221 [168] | 1.0 | UXT14 | | |
| 2.0 TDI | 4 | CBDC | 81/109 | 11/08→11/10 | GE115 | 4.4V | | | |
| 2.0 TDI | 4 | BWV | 88/118 | 11/05→05/07 | CGP003 | 7V | | | |
| 2.0 TDI | 4 | BVE | 90/121 | 08/05→07/06 | CGP003 | 7V | | | |

VW

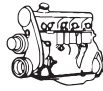

kW/BHP



... VW



... PASSAT

| | | | | | | | | | | |
|-----------------|---|------------------|---------|-------------|---------------------------------|--------|------------|--|--|------------------------------------|
| 2.0 TDI | 4 | BGW | 100/134 | 12/03→05/05 | GE119 | | 5V | | | |
| 2.0 TDI | 4 | BMA | 100/134 | 03/05→11/10 | CGP003 | GSE100 | 7V | | | |
| | | | | | →05/07 GE101 | | 4.4V | | | |
| | | | | | 06/07→ | | | | | |
| 2.0 TDI | 4 | CBAA, CFFA | 100/134 | 03/05→ | GE115 | | 4.4V | | | |
| 2.0 TDI | 4 | BMP | 103/138 | 03/05→05/09 | CGP002 | | 7V | | | |
| 2.0 TDI | 4 | CFFB | 103/138 | 08/10→ | GE115 | | 4.4V | | | |
| 2.0 TDI | 4 | CRLB | 110/148 | 11/14→ | GE115 | | 4.4V | | | |
| | | | | | PSG002 | | 4.4V | | | |
| 2.0 TDI | 4 | BUZ | 120/161 | 08/05→05/09 | CGP003 | | 7V | | | |
| 2.0 TDI | 4 | BMR | 125/168 | 08/05→11/10 | CGP003 | | 7V | | | |
| 2.0 TDI | 4 | CBBB, CFGB, CLLA | 125/168 | 08/05→ | GE115 | | 4.4V | | | |
| 2.0 TDI | 4 | CFGC | 130/174 | 12/12→ | GE115 | | 4.4V | | | |
| 2.0 TDI | 4 | DDAA | 140/188 | 11/14→ | GE115 | | 4.4V | | | |
| | | | | | PSG002 | | 4.4V | | | |
| 2.0 TDI 4WD | 4 | CUAA | 176/236 | 11/14→ | GE115 | | 4.4V | | | |
| | | | | | PSG002 | | 4.4V | | | |
| 2.0 TDI 16V | 4 | BKP | 103/138 | 03/05→11/10 | CGP003 | GSE100 | 7V | | | |
| | | | | | →05/07 GE101 | | 4.4V | | | |
| | | | | | 06/07→05/09 | | | | | |
| 2.0 TDI 16V | 4 | CBAB | 103/138 | 03/05→11/10 | GE115 | | 4.4V | | | |
| 2.0 TDI 16V 4WD | 4 | BKP | 103/138 | 03/05→08/10 | CGP003 | | 7V | | | |
| | | | | | →05/07 GE101 | | 4.4V | | | |
| | | | | | 06/07→05/09 | | | | | |
| 2.0 TDI 16V 4WD | 4 | BKP | 103/138 | 03/05→11/10 | | GSE100 | | | | |
| 2.0 TDI 16V 4WD | 4 | BKP | 103/138 | 08/05→11/10 | CGP003 | | 7V | | | |
| | | | | | →05/07 GE101 | | 4.4V | | | |
| | | | | | 06/07→05/09 | | | | | |
| 2.0 TSI | 4 | CCZB | 155/208 | 11/10→ | Z347 | | 0.7 | UXT12 | ZSE033 ^[47] ZSE142 ^[48] | |
| 2.1 | 5 | WE | 85/114 | 01/81→07/83 | Z11 | | 0.8 | UXT2 / UXT6 | | |
| 2.2 | 5 | KX | 85/114 | 01/85→03/88 | Z12 | | 0.8 | UXT2 / UXT6 | ZS124 | ZM002 →07/87 ZM012 08/87→ |
| 2.2 4WD | 5 | JT | 88/118 | 08/85→03/88 | Z12 | | 0.8 | UXT2 / UXT6 | ZS124 | ZM002 →07/87 ZM012 08/87→ |
| 2.2 | 5 | KV | 100/134 | 01/85→03/88 | Z51 | | 0.8 | UX56 | ZS124 | ZM002 →07/87 ZM012 08/87→ |
| 2.2 4WD | 5 | HY | 100/134 | 08/84→07/88 | Z91 Z22 →ch. 33-F-550 000 | | 0.8 0.7 | UXT2 / UXT6 UX56 →ch. 33-F-550 000 | ZS124 | |
| 2.3 V5 | 5 | AZX | 125/168 | 11/00→05/05 | Z176 | | 1.1 | | ZSE065 | |
| 2.3 VR5 | 5 | AGZ | 110/148 | 10/96→11/00 | Z173 | | 1.6 | | ZS037 | |
| 2.3 VR5 | 5 | AZX | 125/168 | 11/00→05/05 | Z176 | | 1.1 | | ZSE065 | |
| 2.3 VR5 LPG | 5 | AGZ | 110/148 | 10/96→11/00 | Z172 | | 1.6 | | | |
| 2.5 TDI | 6 | AFB, AKN | 110/148 | 07/98→05/05 | GN008 | | 12V | | | |
| 2.5 TDI | 6 | BDG | 120/161 | 05/03→05/05 | GN008 | | 12V | | | |
| 2.5 TDI 4WD | 6 | BAU, BDH | 132/177 | 01/03→05/05 | GN008 | | 12V | | | |
| 2.8 4WD | 6 | AGE | 132/177 | 05/97→09/99 | Z145 | | 1.6 | | | |
| 2.8 4WD | 6 | AMX, ATQ | 142/190 | 11/00→05/05 | Z145 | | 1.6 | | ZSE154 | |

VW



kW/BHP

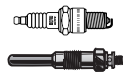

... VW



... PASSAT

| | | | | | | | | |
|---------|---|---------------|---------|-------------|------|-----|--|--|
| 2.8 V6 | 6 | AGE | 132/177 | 05/97→09/99 | Z145 | 1.6 | | |
| 2.8 V6 | 6 | ATX | 140/188 | 09/99→11/00 | Z145 | 1.6 | | |
| 2.8 V6 | 6 | ACK, ALG, APR | 142/190 | 08/96→11/00 | Z145 | 1.6 | | ZSE154 |
| 2.8 V6 | 6 | AQD, AQP | 142/190 | 08/96→11/00 | Z145 | 1.6 | | |
| 2.8 V6 | 6 | AQD | 142/190 | 10/96→11/00 | | | | ZSE154 |
| 2.8 VR6 | 6 | AAA | 128/172 | 06/91→05/97 | Z173 | 1.6 | | ZSE001 →ch. 31-P-136 398 ZSE004 ch. 31-P-136 399→ |

| | | | | | | | | |
|-----------------|---|----------|---------|-------------|------|-----|--|--------|
| 2.8 VR6 LPG | 6 | AAA | 128/172 | 06/91→05/97 | Z172 | 1.6 | | |
| 2.9 VR6 4WD | 6 | ABV | 135/181 | 01/94→05/97 | Z173 | 1.6 | | ZSE004 |
| 2.9 VR6 4WD LPG | 6 | ABV | 135/181 | 01/94→05/97 | Z172 | 1.6 | | |
| 3.2 FSI 4WD | 6 | AXZ | 184/247 | 11/05→11/10 | | | | ZSE041 |
| 3.6 FSI 4WD | 6 | BWS | 220/295 | 01/11→ | | | | ZSE041 |
| 3.6 R36 4WD | 6 | BWS | 220/295 | 04/07→11/10 | | | | ZSE041 |
| 4.0 W8 4WD | 8 | BDN, BDP | 202/271 | 09/01→09/04 | Z213 | 1.7 | | ZSE031 |

PASSAT ALLTRACK

| | | | | | | | | |
|-------------|---|------|---------|--------|-----------|------|-----------|--------|
| 1.8 TSI | 4 | CDAB | 112/150 | 01/12→ | Z347 | 0.7 | UXT12 | ZSE142 |
| 1.8 TSI | 4 | CDA | 118/158 | 01/12→ | Z347 | 0.7 | UXT12 | ZSE142 |
| | | | | | →eng. CDA | | →eng. CDA | |
| 2.0 TDI | 4 | CFFB | 103/138 | 01/12→ | GE115 | 4.4V | | |
| 2.0 TDI 4WD | 4 | CFGB | 125/168 | 01/12→ | GE115 | 4.4V | | |
| 2.0 TDI 4WD | 4 | CFGC | 130/174 | 01/13→ | GE115 | 4.4V | | |
| 2.0 TSI 4WD | 4 | CCZB | 155/208 | 01/12→ | Z347 | 0.7 | UXT12 | ZSE142 |

PASSAT CC

| | | | | | | | | |
|-------------------|---|------------------------|---------|-------------|-------|------|-------|--|
| 1.4 TSI MultiFuel | 4 | CKMA | 118/158 | 01/11→01/12 | | | | ZSE030 |
| 1.8 TSI | 4 | CDAB, CGYA | 112/150 | 11/08→05/10 | Z347 | 0.7 | UXT12 | ZSE142 |
| 1.8 TSI | 4 | BZB, CDA | 118/158 | 06/08→11/10 | Z347 | 0.7 | UXT12 | ZSE033 ⁽⁴⁷⁾ ZSE142 ⁽⁴⁸⁾ |
| 2.0 BlueTDI | 4 | CBAC | 105/141 | 05/09→11/10 | GE115 | 4.4V | | |
| 2.0 TDI | 4 | CBAA, CFFA | 100/134 | 06/08→05/11 | GE115 | 4.4V | | |
| 2.0 TDI | 4 | CBAB, CFFB | 103/138 | 06/08→01/12 | GE115 | 4.4V | | |
| 2.0 TDI | 4 | CBBA | 120/161 | 05/08→05/11 | GE115 | 4.4V | | |
| 2.0 TDI | 4 | CBBB, CFGB, CLLA | 125/168 | 06/08→01/12 | GE115 | 4.4V | | |
| 2.0 TSI | 4 | CAWB, CBFA, CCTA, CCZA | 147/197 | 06/08→01/12 | Z347 | 0.7 | UXT12 | ZSE033 ⁽⁴⁷⁾ ZSE142 ⁽⁴⁸⁾ |
| 2.0 TSI | 4 | CCZB | 155/208 | 11/10→01/12 | Z347 | 0.7 | UXT12 | ZSE033 ⁽⁴⁷⁾ ZSE142 ⁽⁴⁸⁾ |
| 3.6 FSI 4WD | 6 | BWS | 220/295 | 06/08→05/10 | | | | ZSE041 |

PHAETON

| | | | | | | | | |
|-----------------|----|------------|---------|--------|-------|------|--|------------------------------|
| 3.0 V6 TDI 4WD | 6 | BMK | 165/221 | 09/04→ | GE115 | 4.4V | | |
| 3.0 V6 TDI 4WD | 6 | CARA | 171/229 | 06/07→ | GE115 | 4.4V | | |
| 3.0 V6 TDI 4WD | 6 | CEXA | 176/236 | 11/08→ | GE115 | 4.4V | | |
| 3.0 V6 TDI 4WD | 6 | CEXB | 180/241 | 11/13→ | GE115 | 4.4V | | |
| 3.2 V6 | 6 | AYT, BKL | 177/237 | 04/02→ | Z306 | 0.9 | | ZSE044 |
| 3.2 V6 4WD | 6 | BRK | 177/237 | 02/04→ | | | | ZSE044 |
| 3.6 V6 4WD | 6 | CHNA, CMVA | 206/276 | 11/08→ | | | | ZSE041 |
| 4.2 V8 4WD | 8 | BGH, BGJ | 246/330 | 05/03→ | Z239 | 1.6 | | ZSE062 |
| 5.0 V10 TDI 4WD | 10 | AJS | 230/308 | 11/02→ | GN046 | 12V | | |
| 6.0 W12 4WD | 12 | BAN | 309/414 | 04/02→ | Z176 | 1.1 | | ZSE031 ch. F3D-4-030-001→ |
| 6.0 W12 4WD | 12 | BRN, BTI | 331/444 | 05/05→ | | | | ZSE031 |

POINTER

| | | | | | | | | |
|--------|---|--|-------|-------------|-------|-----|--|--|
| 1.9 TD | 4 | | 55/74 | 08/95→09/97 | GN857 | 11V | | |
|--------|---|--|-------|-------------|-------|-----|--|--|

POLO

| | | | | | | | | |
|-----|---|----|-------|-------------|-----|-----|-------------|--|
| 0.8 | 4 | HE | 25/34 | 09/75→09/81 | Z11 | 0.8 | UXT2 / UXT6 | |
| 0.9 | 4 | HA | 29/39 | 09/75→12/81 | Z11 | 0.8 | UXT2 / UXT6 | |

VW

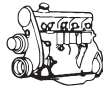

kW/BHP



... VW



... POLO

| | | | | | | | | | |
|------------|---|----------|-------|-------------|----------------------|--|-----|--|--|
| 0.9 | 4 | HA | 29/39 | 09/75→09/81 | | | | ZS106 ^[11] →07/81 | |
| 1.0 | 4 | GL | 29/39 | 10/81→10/86 | Z11 | | 0.8 | UXT2 / UXT6 | ZS115 ^[11] →04/84 ZM002 08/85→09/86 ZM012 09/86→ |
| 1.0 | 4 | GL | 29/39 | 05/82→10/86 | | | | ZS115 ^[11] →06/84 | ZM002 08/85→ ZM012 09/86→ |
| 1.0 | 4 | GL | 29/39 | 01/85→10/86 | | | | ZS115 ^[11] | |
| 1.0 | 4 | AAK | 33/44 | 01/85→09/94 | Z61 | | 0.7 | UXT2 / UXT6 | ZM002 08/85→09/86 ZM012 09/86→ |
| 1.0 | 4 | AAK | 33/44 | 08/89→09/94 | Z12 | | 0.8 | UXT2 / UXT6 | ZSE001 ^{[1][175][254]} ZSE002 ^{[1][175][254]} ZS124 ^{[1][214][254]} ch. 80-L-000-001→ →09/90 ZM012 |
| 1.0 | 4 | AAU | 33/44 | 01/85→09/94 | Z61 | | 0.7 | UXT2 / UXT6 | ZSE001 ^[1] 10/90→ ZM002 08/85→09/86 ZM012 09/86→ |
| 1.0 | 4 | AAU | 33/44 | 08/89→09/94 | Z2 | | 1.0 | UXT2 / UXT6 | ZSE001 ^{[1][175][254]} ZSE002 ^{[1][175][254]} →09/90 ZM012 |
| 1.0 | 4 | ACM | 33/44 | 08/89→09/94 | Z12 | | 0.8 | UXT2 / UXT6 | ZSE001 ^{[1][175][254]} ZSE002 ^{[1][175][254]} →09/90 ZM012 |
| 1.0 | 4 | HZ | 33/44 | 01/85→09/94 | Z61 | | 0.7 | UXT2 / UXT6 | ZS123 ^[1] 08/87→07/89 ZS124 ^[1] 08/89→09/90 ZSE002 ^[1] 10/90→ ZM002 08/85→09/86 ZM012 09/86→ |
| 1.0 | 4 | HZ | 33/44 | 08/85→01/92 | | | | ZS123 ^[1] 08/87→07/89 ZS124 ^[1] 08/89→09/90 ZSE001 ^[1] 10/90→ ZSE002 ^[1] 10/90→ ZM002 →09/86 ZM012 09/86→09/90 ZM014 10/90→ | |
| 1.0 | 4 | ALD, AUC | 37/50 | 10/99→09/01 | Z176 | | 1.1 | | ZSE003 |
| 1.0 45 | 4 | AEV | 33/44 | 10/94→09/96 | Z91 | | 0.8 | UXT2 / UXT6 | ZSE001 |
| 1.0 45 LPG | 4 | AEV | 33/44 | 10/94→09/96 | Z27 ^[168] | | 0.8 | UX56 | |
| 1.0 50 | 4 | AER, ALL | 37/50 | 09/96→10/99 | Z91 | | 0.8 | UXT2 / UXT6 | ZSE001 |
| 1.0 50 LPG | 4 | AER, ALL | 37/50 | 09/96→10/99 | Z27 ^[168] | | 0.8 | UX56 | |
| 1.1 | 4 | HB | 37/50 | 03/75→09/89 | Z11 | | 0.8 | UXT2 / UXT6 | |
| 1.1 | 4 | HB | 37/50 | 03/75→09/81 | | | | | ZS115 ^[11] 07/77→ |
| 1.1 | 4 | HB | 37/50 | 10/81→09/89 | | | | | ZS115 ^[11] ZM002 |
| 1.1 | 4 | HC | 44/59 | 03/75→09/81 | Z22 | | 0.7 | UX56 | |
| 1.2 | 3 | AWY | 40/54 | 01/02→05/07 | Z200 | | 0.9 | | ZSE059 →ch. 9H-5-260 000 |
| 1.2 | 3 | BMD | 40/54 | 01/02→05/07 | Z200 | | 0.9 | | ZSE059 05/04→ |

VW

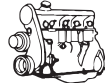

kW/BHP



... VW 

... POLO

| | | | | | | | | | |
|---------|---|----------|--------|-------------|---|------------|----------------------------|---|--|
| 1.2 | 3 | BBM | 44/59 | 05/07→11/09 | Z200 →11/07 Z272 11/07→ | 0.9 | | ZSE059 | |
| 1.2 | 3 | CGPB | 44/59 | 06/09→ | Z272 | 1.0 | | ZSE030 ch. 6R-A-000 001→ | |
| 1.2 | 3 | CGPA | 51/68 | 06/09→ | Z272 | 1.0 | | ZSE030 ch. 6R-A-000 001→ | |
| 1.2 12V | 3 | AZQ, BME | 47/63 | 10/01→07/07 | Z200 | 0.9 | | ZSE030 | |
| 1.2 12V | 3 | BZG | 51/68 | 05/07→11/09 | Z200 →11/07 Z272 11/07→ | 0.9 | | ZSE030 | |
| 1.2 TDI | 3 | CFWA | 55/74 | 10/09→ | GE115 | 4.4V | | | |
| 1.2 TSI | 4 | CBZC | 66/89 | 05/11→05/14 | | | | ZSE003 | |
| 1.2 TSI | 4 | CBZB | 77/103 | 11/09→ | | | | ZSE003 | |
| 1.3 | 4 | HW | 37/50 | 08/83→07/85 | Z11 | 0.8 | UXT2 / UXT6 | | |
| 1.3 | 4 | 2G | 40/54 | 07/87→09/94 | Z61 | 0.7 | UXT2 / UXT6 | ZS123 [1] →07/89 ZS124 [1] 08/89→09/90 ZSE001 [1] 10/90→ ZSE002 [1] 10/90→ | ZM012 →09/90 ZM014 10/90→ |
| 1.3 | 4 | AAV | 40/54 | 07/87→09/94 | Z2 | 1.0 | UXT2 / UXT6 | ZSE001 [1] 10/90→ | ZM012 →09/90 |
| 1.3 | 4 | HK | 40/54 | 08/83→07/88 | Z11 | 0.8 | UXT2 / UXT6 | ZS115 [1][11] | ZM002 08/85→09/86 ZM012 09/86→ |
| 1.3 | 4 | MH | 40/54 | 08/83→09/94 | Z61 | 0.7 | UXT2 / UXT6 | | |
| 1.3 | 4 | MH | 40/54 | 08/83→07/88 | | | | ZS123 [1] | ZM002 08/85→09/86 ZM012 09/86→ |
| 1.3 | 4 | MH | 40/54 | 07/87→09/94 | | | | ZS123 [1] →07/89 | ZM012 [175] →09/90 |
| 1.3 | 4 | MH | 40/54 | 07/87→08/94 | | | | | ZM012 →09/90 |
| 1.3 | 4 | NZ | 40/54 | 07/87→09/94 | Z61 | 0.7 | UXT2 / UXT6 | ZS123 [1] →07/89 ZS124 [1] 08/89→09/90 ZSE001 [1] 10/90→ ZSE002 [1] 10/90→ | ZM012 [175] →09/90 ZM014 10/90→ |
| 1.3 | 4 | NZ | 40/54 | 07/87→08/94 | | | | | ZM012 →09/90 ZM014 10/90→ |
| 1.3 | 4 | GT | 43/58 | 08/82→07/88 | Z11 →ch. 80-H-220 000; 80-H-220 000 Z61 →ch. 80-K-220 000 ch. 80-H-220 000; 80-J-000 001→ | 0.8 0.7 | UXT2 / UXT6 UXT2 / UXT6 | ZS115 [11] →ch. 80-H-220 000; 80-H-220 000 →ch. 80-K-220 000 ch. 80-H-220 000; 80-J-000 001→ | |

VW



kW/BHP

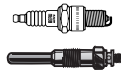

... VW



... POLO

| | | | | | | | | | | |
|-----------------|---|--------------------|--------|-------------|--|-------|------|-------------|---|---|
| 1.3 | 4 | HJ | 43/58 | 08/82→07/88 | Z11 →ch. 80-H-220 000 Z61 ch. 80-H-220 000→ | | 0.8 | UXT2 / UXT6 | ZS115 ^[11] | |
| 1.3 | 4 | HH | 44/59 | 12/76→07/83 | Z11 | | 0.7 | UXT2 / UXT6 | | |
| 1.3 | 4 | HH | 44/59 | 12/76→09/81 | | | 0.8 | UXT2 / UXT6 | ZS115 ^[11] 08/77→ | |
| 1.3 | 4 | HH | 44/59 | 10/81→07/83 | | | | | ZS115 ^[11] | |
| 1.3 | 4 | 3F | 55/74 | 10/89→09/94 | Z51 | | 0.8 | UX56 | ZS124 ^{[1][214][254]} ZSE001 ^[1] 10/90→ | ZM012 →09/90 |
| 1.3 | 4 | 3F | 55/74 | 10/89→03/91 | | | | | ZS124 ^{[1][214][254]} ZSE001 ^{[1][175][254]} | |
| 1.3 | 4 | GK | 55/74 | 09/82→09/89 | Z42 | | 0.8 | UX56 | ZS123 | ZM002 08/85→09/86 ZM012 09/86→ |
| 1.3 | 4 | 3F | 57/76 | 03/91→09/94 | Z51 | | 0.8 | UX56 | ZSE001 | |
| 1.3 55 | 4 | ADX | 40/54 | 10/94→07/95 | Z91 | | 0.8 | UXT2 / UXT6 | ZSE001 | |
| 1.3 55 LPG | 4 | ADX | 40/54 | 10/94→07/95 | Z27 ^[168] | | 0.8 | UX56 | | |
| 1.3 D | 4 | MN | 33/44 | 08/86→08/90 | GN857 | | 11V | | | |
| 1.3 G40 | 4 | PY | 83/111 | 08/90→09/94 | | | | | ZSE001 | |
| 1.3 G40 | 4 | PY | 85/114 | 01/87→08/90 | Z44 | | 0.8 | UX56 | ZS124 | ZM002 |
| 1.4 | 4 | AKP, ANX | 40/54 | 12/98→09/01 | Z176 | | 1.1 | | ZSE003 | |
| 1.4 | 4 | AEX, AKV, APQ | 44/59 | 05/97→09/01 | Z91 | | 0.8 | UXT2 / UXT6 | ZSE001 | |
| 1.4 | 4 | AKK | 44/59 | 05/97→09/01 | Z176 | | 1.1 | | ZSE003 | |
| 1.4 | 4 | ANW | 44/59 | 05/97→09/01 | Z176 | | 1.1 | | ZSE001 | |
| 1.4 | 4 | ANX | 44/59 | 05/97→09/01 | | | | | ZSE001 | |
| 1.4 | 4 | AUD | 44/59 | 05/97→09/01 | Z176 | | 1.1 | | | |
| 1.4 | 4 | AUD | 44/59 | 10/99→09/01 | | | | | ZSE003 | |
| 1.4 | 4 | BBY | 55/74 | 07/03→ | Z176 ^[251] Z90 ^[253] | | 1.1 | | ZSE030 | |
| 1.4 | 4 | BKY | 55/74 | 07/03→ | Z200 | | 1.0 | UXT1 / UXT3 | | |
| 1.4 | 4 | AGY | 62/83 | 05/96→07/02 | Z22 | | 0.9 | | ZSE030 | |
| 1.4 | 4 | | 63/84 | 06/05→11/09 | Z300 | | 0.7 | UX56 | | |
| 1.4 | 4 | CDDA, CGGB, CLPA | 63/84 | 06/09→ | Z272 | | 1.35 | | ZSE030 | |
| 1.4 | 4 | BBZ | 74/99 | 11/03→ | Z90 | | 1.0 | | ZSE030 | |
| 1.4 | 4 | BBZ | 74/99 | 11/03→ | Z90 | | 1.0 | UXT1 / UXT3 | ZSE030 | |
| 1.4 LPG | 4 | AEX, AKV, APQ | 44/59 | 05/97→09/01 | Z27 ^[168] | | 0.8 | UX56 | | |
| 1.4 LPG | 4 | BBY | 55/74 | 07/03→ | Z340 | | 0.7 | UXT12 | | |
| 1.4 LPG | 4 | BBZ | 74/99 | 11/03→ | Z340 | | 0.7 | UXT12 | | |
| 1.4 1.4 16V | 4 | AHW, APE, AUA | 55/74 | 10/99→09/01 | Z90 | | 1.0 | UXT1 / UXT3 | ZSE003 | |
| 1.4 1.4 16V LPG | 4 | AHW, APE, AUA | 55/74 | 10/99→09/01 | Z340 | | 0.7 | UXT12 | | |
| 1.4 1.4 TDI | 3 | AMF | 55/74 | 10/99→09/01 | GN855 | GR081 | 12V | | | |
| 1.4 16V | 4 | AUA | 55/74 | 10/01→05/08 | Z90 | | 1.0 | UXT1 / UXT3 | ZSE003 | |
| 1.4 16V | 4 | BBY | 55/74 | 10/01→05/08 | Z176 ^[251] Z90 ^[253] | | 1.1 | | ZSE030 | |
| 1.4 16V | 4 | BKY | 55/74 | 10/01→05/08 | Z200 | | 1.0 | UXT1 / UXT3 | | |
| 1.4 16V | 4 | BUD | 59/79 | 05/06→11/09 | Z272 | | 0.9 | | ZSE030 | |
| 1.4 16V | 4 | AFK | 74/99 | 10/99→09/01 | Z90 | | 1.0 | | ZSE003 | |
| 1.4 16V | 4 | AQQ, AUB | 74/99 | 10/99→05/08 | Z90 | | 1.0 | UXT1 / UXT3 | | |
| 1.4 16V | 4 | AUB | 74/99 | 10/99→09/01 | | | | | ZSE003 | |
| 1.4 16V | 4 | AUB | 74/99 | 10/01→05/08 | | | | | ZSE030 | |
| 1.4 16V | 4 | BBZ | 74/99 | 10/01→05/08 | Z90 | | 1.0 | UXT1 / UXT3 | ZSE030 | |
| 1.4 16V LPG | 4 | AUA, BBY | 55/74 | 10/01→05/08 | Z340 | | 0.7 | UXT12 | | |
| 1.4 16V LPG | 4 | AFK, AQQ, AUB, BBZ | 74/99 | 10/99→05/08 | Z340 | | 0.7 | UXT12 | | |
| 1.4 54 | 4 | ANX | 40/54 | 01/98→08/99 | Z91 | | 0.8 | UXT2 / UXT6 | ZSE001 | |
| 1.4 54 LPG | 4 | ANX | 40/54 | 01/98→08/99 | Z27 ^[168] | | 0.8 | UX56 | | |
| 1.4 55 | 4 | AEX | 40/54 | 08/95→10/99 | Z91 | | 0.8 | UXT2 / UXT6 | ZSE001 | |
| 1.4 55 LPG | 4 | AEX | 40/54 | 08/95→10/99 | Z27 ^[168] | | 0.8 | UX56 | | |

VW



kW/BHP

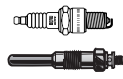

... VW



... POLO

| | | | | | | | | | |
|-------------------------|---|-------------------------|---------|-------------|----------------------|-------|--------------|-------------|--|
| 1.4 60 | 4 | AEX, AKV, APQ | 44/59 | 07/95→09/01 | Z91 | | 0.8 | UXT2 / UXT6 | ZSE001 |
| 1.4 60 | 4 | AKK, ANW, AUD | 44/59 | 12/95→09/01 | Z176 | | 1.1 | | ZSE003 |
| 1.4 60 | 4 | ANX | 44/59 | 12/95→09/01 | | | | | ZSE001 |
| 1.4 60 LPG | 4 | AEX, AKV, APQ | 44/59 | 07/95→09/01 | Z27 ^[168] | | 0.8 | UX56 | |
| 1.4 75 1.4 16V | 4 | APE, AUA | 55/74 | 10/99→09/01 | Z90 | | 1.0 | UXT1 / UXT3 | ZSE003 |
| 1.4 75 1.4 16V LPG | 4 | APE, AUA | 55/74 | 10/99→09/01 | Z340 | | 0.7 | UXT12 | |
| 1.4 100 1.4 16V | 4 | AFH | 74/99 | 04/96→10/99 | Z90 | | 1.0 | UXT1 / UXT3 | ZSE001 |
| 1.4 100 1.4 16V LPG | 4 | AFH | 74/99 | 04/96→10/99 | Z340 | | 0.7 | UXT12 | |
| 1.4 BiFuel LPG | 4 | CMAA | 60/80 | 03/10→01/11 | Z200 | | 0.9 | | ZSE030 |
| 1.4 D | 4 | 1W | 35/47 | 08/90→09/94 | GN857 | | 11V | | |
| 1.4 FSI | 4 | AXU | 63/84 | 02/02→07/06 | Z300 | | 1.35 | | ZSE030 |
| 1.4 GTI | 4 | CAVE, CTHE | 132/177 | 05/10→ | | | | | ZSE030 |
| 1.4 TDI | 3 | BNM | 51/68 | 04/05→11/09 | GN046 | GR081 | 12V | | |
| 1.4 TDI | 3 | BWB | 51/68 | 04/05→11/09 | CGP002 | | 7V | | |
| 1.4 TDI | 3 | AMF, BAY | 55/74 | 10/01→ | GN046 | GR081 | 12V | | |
| 1.4 TDI | 3 | CUSA | 55/74 | 03/14→ | GE115 PSG002 | | 4.4V 4.4V | | |
| 1.4 TDI | 3 | BMS | 59/79 | 04/05→11/09 | CGP002 | | 7V | | |
| 1.4 TDI | 3 | BNV | 59/79 | 04/05→11/09 | GN046 | GR081 | 12V | | |
| 1.4 TDi | 3 | ATL | 66/89 | 01/00→10/00 | GN855 | GR081 | 12V | | |
| 1.4 TDI | 3 | CUSB | 66/89 | 02/14→ | GE115 PSG002 | | 4.4V 4.4V | | |
| 1.4 TDI | 3 | CYZA | 77/103 | 05/14→ | GE115 | | 4.4V | | |
| 1.4 TSI | 4 | CPTA | 103/138 | 10/12→ | | | | | ZSE067 ^{[1][42]} ZSE126 ^{[1][43]} |
| 1.6 | 4 | AEE, ALM | 55/74 | 05/97→09/01 | Z91 | | 0.8 | UXT2 / UXT6 | ZSE001 |
| 1.6 | 4 | CFNB | 63/84 | 11/10→ | Z272 | | 1.0 | | ZSE030 |
| 1.6 | 4 | AEH, AKL, APF, AUR | 74/99 | 05/97→09/01 | Z90 | | 1.0 | UXT1 / UXT3 | ZSE003 |
| 1.6 | 4 | AFT | 74/99 | 05/97→09/01 | Z90 | | 1.0 | UXT1 / UXT3 | ZSE001 |
| 1.6 | 4 | BAH | 74/99 | 08/02→ | Z344 | | 1.0 | | ZSE003 |
| 1.6 | 4 | CFNA, CLSA | 77/103 | 05/10→ | Z272 | | 1.0 | | ZSE030 |
| 1.6 LPG | 4 | AEE, ALM | 55/74 | 05/97→09/01 | Z27 ^[168] | | 0.8 | UX56 | |
| 1.6 LPG | 4 | AEH, AFT, AKL, APF, AUR | 74/99 | 05/97→09/01 | Z340 | | 0.7 | UXT12 | |
| 1.6 1.6 16V GTI | 4 | ARC, AVY | 92/123 | 10/99→09/01 | Z90 | | 1.0 | UXT1 / UXT3 | ZSE003 |
| 1.6 1.6 16V GTI LPG | 4 | ARC, AVY | 92/123 | 10/99→09/01 | Z340 | | 0.7 | UXT12 | |
| 1.6 16V | 4 | BTS | 77/103 | 05/06→11/09 | Z272 | | 1.0 | | ZSE030 |
| 1.6 75 | 4 | 1F | 55/74 | 11/95→09/97 | Z92 | | 0.8 | UXT2 / UXT6 | ZSE001 |
| 1.6 75 | 4 | AEA, AEE | 55/74 | 10/94→09/01 | Z91 | | 0.8 | UXT2 / UXT6 | ZSE001 |
| 1.6 75 | 4 | AHS | 55/74 | 10/94→10/99 | Z94 | | 0.8 | UXT2 / UXT6 | ZSE001 |
| 1.6 75 | 4 | ALM | 55/74 | 11/95→09/01 | Z91 | | 0.8 | UXT2 / UXT6 | |
| 1.6 75 LPG | 4 | 1F, AHS | 55/74 | 10/94→10/99 | Z20 ^[168] | | 0.8 | UXT2 / UXT6 | |
| 1.6 75 LPG | 4 | AEA, AEE, ALM | 55/74 | 10/94→09/01 | Z27 ^[168] | | 0.8 | UX56 | |
| 1.6 100 | 4 | AEH, AFT, AKL, APF, AUR | 74/99 | 12/95→09/01 | Z90 | | 1.0 | UXT1 / UXT3 | ZSE001 |
| 1.6 100 LPG | 4 | AEH, AFT, AKL, APF, AUR | 74/99 | 12/95→09/01 | Z340 | | 0.7 | UXT12 | |
| 1.6 120 1.6 16V GTI | 4 | AJV | 88/118 | 09/98→10/99 | Z90 | | 1.0 | UXT1 / UXT3 | ZSE003 |
| 1.6 120 1.6 16V GTI LPG | 4 | AJV | 88/118 | 09/98→10/99 | Z340 | | 0.7 | UXT12 | |
| 1.6 BiFuel LPG | 4 | CNKA | 60/80 | 01/11→ | Z272 | | 1.0 | | ZSE030 |
| 1.6 Flex | 4 | CCRA | 74/99 | 06/08→04/09 | | | | | ZSE003 |
| 1.6 TDI | 4 | CAYA | 55/74 | 06/09→ | GE115 | | 4.4V | | |
| 1.6 TDI | 4 | CAYB | 66/89 | 06/09→ | GE115 | | 4.4V | | |
| 1.6 TDI | 4 | CAYC, CLNA | 77/103 | 06/09→ | GE115 | | 4.4V | | |
| 1.7 57 1.7 SDI | 4 | AKW | 42/56 | 07/97→09/01 | GN855 | GR081 | 12V | | |
| 1.7 60 1.7 SDI | 4 | AKU | 44/59 | 08/97→10/99 | GN855 | GR081 | 12V | | |
| 1.7 SDI | 4 | AHG, AKW | 42/56 | 04/97→09/01 | GN855 | GR081 | 12V | | |
| 1.7 SDI | 4 | AKU | 44/59 | 10/99→09/01 | GN855 | GR081 | 12V | | |
| 1.8 | 4 | ADZ | 66/89 | 05/97→09/01 | Z91 | | 0.8 | UXT2 / UXT6 | ZSE001 |
| 1.8 LPG | 4 | ADZ | 66/89 | 05/97→09/01 | Z27 ^[168] | | 0.8 | UX56 | |
| 1.8 90 | 4 | ABS | 66/89 | 01/97→09/01 | | | | | ZSE001 |

VW



kW/BHP

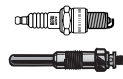

... VW



... POLO

| | | | | | | | | | | |
|---------------------|---|--------------------|---------|-------------|--------|-------|-----|-------------|--------|--|
| 1.8 90 | 4 | ADD, ADZ | 66/89 | 01/97→09/01 | Z91 | | 0.8 | UXT2 / UXT6 | ZSE001 | |
| 1.8 GTI | 4 | BJX | 110/148 | 09/05→11/09 | Z188 | | 0.7 | UXT10 | ZSE043 | |
| 1.8 GTI LPG | 4 | BJX | 110/148 | 09/05→11/09 | Z340 | | 0.7 | UXT12 | | |
| 1.8 GTi Cup Edition | 4 | BBU | 132/177 | 05/06→11/09 | Z188 | | 0.7 | UXT10 | ZSE043 | |
| 1.9 64 1.9 D | 4 | 1Y | 47/63 | 01/96→10/96 | GN857 | | | | 11V | |
| 1.9 64 1.9 D | 4 | AEF | 47/63 | 10/94→10/99 | GN857 | | | | 11V | |
| 1.9 68 1.9 SDI | 4 | AEY, AGD | 47/63 | 12/95→10/99 | GN855 | GR081 | 12V | | | |
| 1.9 68 1.9 SDI | 4 | AGP, AQM | 50/67 | 08/99→01/02 | GN855 | GR081 | 12V | | | |
| 1.9 90 1.9 TDI | 4 | AGR, AHU, ALE, ALH | 66/89 | 09/96→09/01 | GN855 | GR081 | 12V | | | |
| 1.9 110 1.9 TDI | 4 | AFN, ASV | 81/109 | 06/98→01/02 | GN855 | GR081 | 12V | | | |
| 1.9 D | 4 | AEF | 47/63 | 10/99→09/01 | GN857 | | | | 11V | |
| 1.9 SDI | 4 | AEY, AGD, ASX, ASY | 47/63 | 06/97→ | GN855 | GR081 | 12V | | | |
| 1.9 SDI | 4 | AEY | 48/64 | 06/96→09/01 | GN857 | GR081 | 11V | | | |
| 1.9 SDI | 4 | AGP, AQM | 50/67 | 08/99→09/01 | GN855 | GR081 | 12V | | | |
| 1.9 TDI | 4 | AGR, AHU, ALE, ALH | 66/89 | 05/97→09/01 | GN855 | GR081 | 12V | | | |
| 1.9 TDI | 4 | AHU | 67/90 | 01/97→08/99 | GN855 | GR081 | 12V | | | |
| 1.9 TDI | 4 | ATD, AXR | 74/99 | 10/01→ | GN046 | GR081 | 12V | | | |
| 1.9 TDI | 4 | BMT | 74/99 | 10/01→11/09 | CGP002 | | 7V | | | |
| 1.9 TDI | 4 | AFN, ASV | 81/109 | 06/98→09/01 | GN855 | GR081 | 12V | | | |
| 1.9 TDI | 4 | ASZ | 96/129 | 11/03→11/09 | GN046 | GR081 | 12V | | | |
| 1.9 TDI | 4 | BLT | 96/129 | 11/03→11/09 | GN046 | | 12V | | | |
| 2.0 R WRC | 4 | CDLJ | 162/217 | 08/13→ | Z347 | | 0.7 | UXT12 | ZSE033 | |

QUANTUM

| | | | | | | | | | | |
|--------|---|--|-------|-------------|-------|--|-----|--|--|--|
| 1.9 TD | 4 | | 55/74 | 10/93→06/97 | GN857 | | 11V | | | |
|--------|---|--|-------|-------------|-------|--|-----|--|--|--|

ROUTAN

| | | | | | | | | | | |
|-----|---|------|---------|-------------|--|--|--|--|-------|--|
| 3.8 | 6 | CGUA | 147/197 | 09/08→12/10 | | | | | ZS455 | |
| 4.0 | 6 | CGVA | 187/251 | 09/08→12/10 | | | | | ZS453 | |

SANTANA

| | | | | | | | | | | |
|--------|---|--------|--------|-------------|-------|-------|-----|-------------|-----------------------|-------|
| 1.3 | 4 | FZ | 44/59 | 08/81→07/83 | Z11 | | 0.8 | UXT2 / UXT6 | ZS115 ⁽¹¹⁾ | ZM002 |
| 1.6 | 4 | DT | 55/74 | 08/81→12/84 | Z2 | | 1.0 | UXT2 / UXT6 | | |
| 1.6 | 4 | WV | 55/74 | 08/81→12/84 | Z11 | | 0.8 | UXT2 / UXT6 | ZS115 ⁽¹¹⁾ | ZM002 |
| 1.6 | 4 | YP | 63/84 | 08/81→12/82 | Z11 | | 0.8 | UXT2 / UXT6 | ZS115 ⁽¹¹⁾ | ZM002 |
| 1.6 D | 4 | CR, JK | 40/54 | 08/81→12/84 | GN857 | GR001 | 11V | | | |
| 1.6 TD | 4 | CY | 51/68 | 12/81→12/84 | GN857 | GR001 | 11V | | | |
| 1.8 | 4 | | 63/84 | 01/95→ | Z11 | | 0.8 | UXT2 / UXT6 | | |
| 1.8 | 4 | DS | 66/89 | 01/83→12/84 | Z12 | | 0.8 | UXT2 / UXT6 | ZS124 | ZM002 |
| 1.9 | 5 | WN | 85/114 | 08/81→07/83 | Z44 | | 0.8 | UX56 | ZS106 ⁽¹¹⁾ | |
| 2.0 | 5 | HP, JS | 85/114 | 08/83→12/84 | Z12 | | 0.8 | UXT2 / UXT6 | ZS124 | ZM002 |
| 2.1 | 5 | WE | 85/114 | 08/82→12/83 | Z11 | | 0.8 | UXT2 / UXT6 | | |

SCIROCCO

| | | | | | | | | | | |
|---------|---|------------------------|---------|-------------|----------------------|--|-----|-------------|-----------------------|-------|
| 1.1 | 4 | FA | 37/50 | 04/74→07/79 | Z11 | | 0.8 | UXT2 / UXT6 | ZS115 ⁽¹¹⁾ | |
| 1.3 | 4 | HK | 40/54 | 08/83→07/84 | | | | | ZS115 ⁽¹¹⁾ | |
| 1.3 | 4 | GF | 44/59 | 08/79→12/83 | Z11 | | 0.8 | UXT2 / UXT6 | | ZM002 |
| 1.3 | 4 | GF | 44/59 | 08/79→07/80 | | | | | ZS115 ⁽¹¹⁾ | |
| 1.3 | 4 | GF | 44/59 | 08/80→12/83 | | | | | ZS115 ⁽¹¹⁾ | |
| 1.4 TSI | 4 | CAXA, CMSB | 90/121 | 08/08→ | Z349 | | 0.9 | | ZSE030 | |
| 1.4 TSI | 4 | CAVD, CNWA, CTHD, CTKA | 118/158 | 05/08→ | | | | | ZSE030 | |
| 1.5 | 4 | FH | 51/68 | 02/74→12/75 | Z11 | | 0.8 | UXT2 / UXT6 | ZS115 ⁽¹¹⁾ | |
| 1.5 | 4 | JB | 51/68 | 08/77→12/83 | Z1 | | 0.7 | UXT2 / UXT6 | ZS115 ⁽¹¹⁾ | ZM002 |
| 1.5 | 4 | YJ | 55/74 | 02/74→08/75 | Z11 | | 0.8 | UXT2 / UXT6 | ZS115 ⁽¹¹⁾ | |
| 1.5 | 4 | ZB | 55/74 | 02/74→08/75 | Z22 ^[169] | | 0.7 | UX56 | ZS115 ⁽¹¹⁾ | |
| 1.5 | 4 | FD | 63/84 | 02/74→12/77 | Z42 | | 0.8 | UX56 | ZS115 ⁽¹¹⁾ | |
| 1.6 | 4 | EWA | 51/68 | 08/83→07/84 | Z11 | | 0.8 | UXT2 / UXT6 | | |
| 1.6 | 4 | FT | 51/68 | 08/75→07/77 | Z11 | | 0.8 | UXT2 / UXT6 | ZS115 ⁽¹¹⁾ | |
| 1.6 | 4 | RE | 53/71 | 04/86→07/90 | Z93 | | 1.0 | UXT2 / UXT6 | ZS124 | ZM002 |

VW

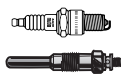

kW/BHP

**... VW****... SCIROCCO**

| | | | | | | | | | |
|---------------|---|------------------|---------|-------------|---|--------------|---|--|--|
| 1.6 | 4 | EM | 55/74 | 08/82→07/83 | Z11 Z61 | 0.8 0.7 | UXT2 / UXT6 | | |
| 1.6 | 4 | EW | 55/74 | 01/83→12/89 | Z2 | 1.0 | UXT2 / UXT6 | ZS124 08/84→ | ZM012 08/83→ |
| 1.6 | 4 | FN | 55/74 | 08/75→07/79 | | | | ZS115 ^[11] | |
| 1.6 | 4 | FP | 55/74 | 08/75→07/79 | Z11 | 0.8 | UXT2 / UXT6 | ZS115 ^[11] | |
| 1.6 | 4 | FR | 63/84 | 08/75→04/84 | Z11 | 0.8 | UXT2 / UXT6 | | ZM002 |
| 1.6 | 4 | FR | 63/84 | 08/75→07/80 | | | | ZS115 ^[11] | |
| 1.6 | 4 | FR | 63/84 | 08/80→04/84 | | | | ZS115 ^[11] →12/83 | |
| 1.6 | 4 | EG | 81/109 | 06/76→07/82 | Z44 | 0.8 | UX56 | ZS115 ^[11] | ZM002 |
| 1.8 | 4 | EX | 66/89 | 08/83→07/92 | Z22 ^[169] →08/84 Z12 09/84→ | 0.7 0.8 | UX56 →08/84 UXT2 / UXT6 09/84→ | ZS124 08/84→ | ZM002 ^[175] ZM012 ^[175] |
| 1.8 | 4 | JH | 70/94 | 11/85→07/92 | Z91 | 0.8 | UXT2 / UXT6 | ZS124 | ZM002 →09/86 ZM012 10/86→ |
| 1.8 | 4 | DX, EV | 82/110 | 08/82→12/89 | Z12 | 0.8 | UXT2 / UXT6 | ZS124 08/84→ | ZM002 →09/86 ZM012 10/86→ |
| 1.8 | 4 | JJ | 82/110 | 08/82→12/89 | | | | ZS124 08/84→ | ZM002 →09/86 ZM012 10/86→ |
| 1.8 | 4 | PB | 82/110 | 08/82→12/89 | Z61 | 0.7 | UXT2 / UXT6 | ZS124 08/84→ | ZM002 →09/86 ZM012 10/86→ |
| 1.8 LPG | 4 | JH | 70/94 | 11/85→07/92 | Z27 ^[168] | 0.8 | UX56 | | |
| 1.8 16V | 4 | PL | 95/127 | 03/86→07/92 | Z89 | 0.8 | UXT5 | ZS124 | ZM002 →09/86 ZM012 10/86→ |
| 1.8 16V | 4 | KR | 102/137 | 10/85→07/89 | Z52 | 0.8 | UXT5 | ZS124 | ZM002 →09/86 ZM012 10/86→ |
| 2.0 R | 4 | CDLC | 188/252 | 11/09→ | Z347 | 0.7 | UXT12 | ZSE033 ^[47] ZSE142 ^[48] | |
| 2.0 R | 4 | CDLA | 195/261 | 11/09→ | Z347 | 0.7 | UXT12 | ZSE033 ^[47] ZSE142 ^[48] | |
| 2.0 TDI | 4 | CFHB | 100/134 | 11/10→ | GE115 | 4.4V | | | |
| 2.0 TDI | 4 | CBDB, CFHC | 103/138 | 08/08→ | GE115 | 4.4V | | | |
| 2.0 TDI | 4 | CUUB | 110/148 | 11/13→ | GE115 PSG002 | 4.4V 4.4V | | | |
| 2.0 TDI | 4 | CBBB, CFGB | 125/168 | 05/09→ | GE115 | 4.4V | | | |
| 2.0 TDI | 4 | CFGC | 130/174 | 01/13→ | GE115 | 4.4V | | | |
| 2.0 TDI | 4 | | 135/181 | 05/14→ | GE115 PSG002 | 4.4V 4.4V | | | |
| 2.0 TSI | 4 | CAWB | 147/197 | 05/08→11/09 | Z347 | 0.7 | UXT12 | ZSE033 ^[47] ZSE142 ^[48] | |
| 2.0 TSI | 4 | CCZB | 155/208 | 11/09→05/11 | Z347 | 0.7 | UXT12 | ZSE033 ^[47] ZSE142 ^[48] | |
| SHARAN | | | | | | | | | |
| 1.4 TSI | 4 | CAVA, CNWB, CTHA | 110/148 | 05/10→ | | | | ZSE030 | |
| 1.8 T 20V | 4 | AJH | 110/148 | 09/97→03/10 | Z188 | 0.7 | UXT10 | ZS016 | ZLE276 |

VW



kW/BHP

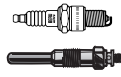

... VW



... SHARAN

| | | | | | | | | | | |
|---------------|---|------------------|---------|-------------|-------------------|-------|------|-------------|-------------|-------|
| 1.8 T 20V | 4 | AWC | 110/148 | 09/97→03/10 | Z188 | | 0.7 | UXT10 | ZSE009 | |
| | | | | | | | | | 04/00→ | |
| 1.8 T 20V LPG | 4 | AJH, AWC | 110/148 | 09/97→03/10 | Z340 | | 0.7 | UXT12 | | |
| 1.9 TDI | 4 | 1Z, AHU | 66/89 | 09/95→03/10 | GN855 | GR081 | 12V | | | |
| | | | | | →02/00 | | | | | |
| 1.9 TDI | 4 | ANU | 66/89 | 09/95→03/10 | GN855 | GR081 | 12V | | | |
| | | | | | →02/00 | | | | | |
| | | | | | GN046 | | 12V | | | |
| | | | | | 03/00→ | | | | | |
| 1.9 TDI | 4 | AFN, AVG | 81/109 | 09/96→04/00 | GN855 | GR081 | 12V | | | |
| 1.9 TDI | 4 | AUY | 85/114 | 04/00→03/10 | GN855 | GR081 | 12V | | | |
| | | | | | →ch. 7M-2-030 004 | | | | | |
| | | | | | GN046 | | 12V | | | |
| | | | | | ch. 7M-2-030 005→ | | | | | |
| 1.9 TDI | 4 | BVK | 85/114 | 04/00→03/10 | | GR081 | | | | |
| 1.9 TDI | 4 | ASZ | 96/129 | 11/02→03/10 | GN046 | GR081 | 12V | | | |
| 1.9 TDI | 4 | BTB | 110/148 | 06/05→03/10 | GN046 | GR081 | 12V | | | |
| 2.0 | 4 | ADY | 85/114 | 09/95→03/10 | Z90 | | 1.0 | UXT1 / UXT3 | ZSE001 | ZM013 |
| 2.0 | 4 | ATM | 85/114 | 09/95→03/10 | Z90 | | 1.0 | UXT1 / UXT3 | | |
| 2.0 LPG | 4 | ADY, ATM | 85/114 | 09/95→03/10 | Z340 [168] | | 0.7 | UXT12 | | |
| 2.0 16V | 4 | | 110/148 | 09/95→02/00 | Z317 | | 0.85 | UXT12 | ZSE001 | |
| 2.0 LPG | 4 | ATM | 85/114 | 04/06→03/10 | Z90 | | 1.0 | UXT1 / UXT3 | ZSE003 | |
| 2.0 TDI | 4 | CFFE | 85/114 | 05/11→ | GE115 | | 4.4V | | | |
| 2.0 TDI | 4 | BVH | 100/134 | 11/05→03/10 | CGP002 | | 7V | | | |
| 2.0 TDI | 4 | CFFA | 100/134 | 05/10→ | GE115 | | 4.4V | | | |
| 2.0 TDI | 4 | BRT | 103/138 | 11/05→03/10 | CGP002 | | 7V | | | |
| 2.0 TDI | 4 | CFFB | 103/138 | 05/10→ | GE115 | | 4.4V | | | |
| 2.0 TDI | 4 | CFGB | 125/168 | 08/10→ | GE115 | | 4.4V | | | |
| 2.0 TDI | 4 | CFGC | 130/174 | 01/13→ | GE115 | | 4.4V | | | |
| 2.0 TSI | 4 | CCZA | 147/197 | 12/10→ | Z347 | | 0.7 | UXT12 | ZSE033 [47] | |
| | | | | | | | | | ZSE142 [48] | |
| 2.8 V6 24V | 6 | AYL | 150/201 | 04/00→03/10 | Z176 | | 1.1 | | ZSE063 | |
| 2.8 VR6 | 6 | AAA, AMY | 128/172 | 09/95→04/00 | Z173 | | 1.6 | | ZSE004 | |
| 2.8 VR6 LPG | 6 | AAA, AMY | 128/172 | 09/95→04/00 | Z172 | | 1.6 | | | |
| TARO | | | | | | | | | | |
| 1.8 | 4 | 2Y | 61/82 | 04/89→09/94 | Z8 | | 0.8 | UXT2 / UXT6 | | |
| 2.2 | 4 | 4Y | 69/93 | 06/89→07/94 | Z8 | | 0.8 | UXT2 / UXT6 | | |
| 2.4 D | 4 | 2L | 58/78 | 07/94→03/97 | GV968 | | 11V | | | |
| 2.4 D | 4 | 2L | 59/79 | 09/91→07/94 | GV968 | | 11V | | | |
| 2.4 D | 4 | 2L | 61/82 | 04/89→03/97 | GV968 | | 11V | | | |
| 2.4 i 4WD | 4 | 22R | 84/113 | 06/89→03/97 | Z82 [169] | | 0.7 | UXT2 / UXT6 | ZS445 | |
| TIGUAN | | | | | | | | | | |
| 1.4 TSI | 4 | CAXA | 90/121 | 08/10→ | Z349 | | 0.9 | | ZSE030 | |
| 1.4 TSI | 4 | BWK, CAVA, CTHA | 110/148 | 09/07→ | | | | | ZSE030 | |
| 1.4 TSI | 4 | CAVD, CTHD | 118/158 | 05/11→ | | | | | ZSE030 | |
| 2.0 TDI | 4 | CFFD | 81/109 | 05/10→ | GE115 | | 4.4V | | | |
| 2.0 TDI 4WD | 4 | CBAA, CFFA | 100/134 | 11/07→ | GE115 | | 4.4V | | | |
| 2.0 TDI | 4 | CBAB, CFFB, CLJA | 103/138 | 09/07→ | GE115 | | 4.4V | | | |
| 2.0 TDI 4WD | 4 | CBBA | 120/161 | 02/08→08/09 | GE115 | | 4.4V | | | |
| 2.0 TDI 4WD | 4 | CBBB, CFGB | 125/168 | 09/07→ | GE115 | | 4.4V | | | |
| 2.0 TDI 4WD | 4 | CFGC | 130/174 | 11/12→ | GE115 | | 4.4V | | | |
| 2.0 TFSI 4WD | 4 | CAWA, CCZC | 125/168 | 09/07→ | Z347 | | 0.7 | UXT12 | ZSE033 [47] | |
| | | | | | | | | | ZSE142 [48] | |
| 2.0 TFSI 4WD | 4 | CAWB, CCTA, CCZA | 147/197 | 09/07→ | Z347 | | 0.7 | UXT12 | ZSE033 [47] | |
| | | | | | | | | | ZSE142 [48] | |
| 2.0 TSI 4WD | 4 | CCZD | 132/177 | 05/11→ | Z347 | | 0.7 | UXT12 | ZSE033 | |
| 2.0 TSI 4WD | 4 | CCZB | 155/208 | 05/11→ | Z347 | | 0.7 | UXT12 | ZSE033 | |

VW

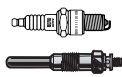

kW/BHP

**... VW**

| TOUAREG | | | | | | | |
|-----------------------|----|--------------------|---------|-------------|-----------------|------------------|--|
| 2.5 R5 TDI 4WD | 5 | BLK | 120/161 | 08/03→05/10 | GN046 →11/06 | GR081 | 12V |
| 2.5 R5 TDI 4WD | 5 | BPD | 120/161 | 08/03→05/10 | CGP002 | | 7V |
| 2.5 R5 TDI 4WD | 5 | BAC | 128/172 | 01/03→05/10 | GN046 | GR081 | 12V |
| 2.5 R5 TDI 4WD | 5 | BPE | 128/172 | 01/03→05/10 | CGP002 | | 7V |
| 3.0 TDI 4WD | 6 | BUN, CASB | 155/208 | 04/06→05/10 | GE115 | | 4.4V |
| 3.0 V6 TDI 4WD | 6 | CASD, CJMA | 150/201 | 01/10→ | GE115 | | 4.4V |
| 3.0 V6 TDI 4WD | 6 | BKS | 165/221 | 11/04→05/10 | GE115 | | 4.4V |
| 3.0 V6 TDI 4WD | 6 | CATA | 165/221 | 11/04→ | GE115 PSG002 | | 4.4V 4.4V |
| 3.0 V6 TDI 4WD | 6 | CASA, CASC | 176/236 | 11/07→ | GE115 | | 4.4V |
| 3.0 V6 TDI 4WD | 6 | CNRB | 176/236 | 01/10→ | GE115 PSG002 | | 4.4V 4.4V |
| 3.0 V6 TDI 4WD | 6 | CJGD, CRCA | 180/241 | 05/11→ | GE115 | | 4.4V |
| 3.0 V6 TDI 4WD | 6 | CVVA | 193/259 | 09/14→ | GE115 | | 4.4V |
| 3.0 V6 TSI 4WD | 6 | CJTA | 213/286 | 08/10→ | | | ZSE032 |
| 3.0 V6 TSI Hybrid 4WD | 6 | CGEA, CGFA | 245/329 | 04/10→ | | | ZSE032 |
| 3.2 V6 4WD | 6 | AZZ, BAA, BKJ | 162/217 | 10/02→11/06 | Z306 | | 0.9 ZSE044 →06/05 |
| 3.2 V6 4WD | 6 | BMV, BMX | 162/217 | 10/02→11/06 | Z306 | | 0.9 ZSE044 |
| 3.2 V6 4WD | 6 | BRJ | 162/217 | 10/02→11/06 | | | ZSE044 →06/05 ZSE041 06/05→ |
| 3.2 V6 4WD | 6 | BMV | 177/237 | 11/04→11/06 | Z306 | | 0.9 ZSE044 |
| 3.6 V6 FSI 4WD | 6 | BHK, BHL, CGRA | 206/276 | 10/05→ | | | ZSE041 |
| 4.2 V8 4WD | 8 | AXQ, BHX | 228/306 | 12/02→11/06 | Z239 | | 1.6 ZSE062 |
| 4.2 V8 FSI 4WD | 8 | BAR | 257/345 | 06/06→05/10 | Z295 | | 0.8 ZSE032 (16X46) ZSE033 (11X10X49) |
| 4.2 V8 FSI 4WD | 8 | CGNA | 265/355 | 01/11→ | | | ZSE032 |
| 4.2 V8 TDI 4WD | 8 | CKDA | 250/335 | 01/10→ | GE115 | | 4.4V |
| 5.0 R50 TDI 4WD | 10 | CBWA | 257/345 | 08/07→05/10 | CGP002 | | 7V |
| 5.0 V10 TDI 4WD | 10 | AYH | 230/308 | 10/02→05/10 | GN046 | | 12V |
| 5.0 V10 TDI 4WD | 10 | BLE | 230/308 | 10/02→05/10 | CGP002 | | 7V |
| 6.0 W12 4WD | 12 | BJN, CFRA | 331/444 | 08/04→05/10 | Z176 | | 1.1 ZSE031 |
| TOURAN | | | | | | | |
| 1.2 TSI | 4 | CBZB | 77/103 | 05/10→ | | | ZSE003 |
| 1.4 FSI | 4 | BLG, CAVB | 125/168 | 11/06→05/10 | | | ZSE030 |
| 1.4 TSI | 4 | BMV, CAVC | 103/138 | 02/06→05/10 | | | ZSE030 →ch. FIK-8-281 299 |
| 1.4 TSI | 4 | CAVC, CTHC | 103/138 | 05/10→ | | | ZSE030 |
| 1.4 TSI | 4 | CAVB, CTHB | 125/168 | 05/10→ | | | ZSE030 |
| 1.4 TSI EcoFuel | 4 | CDGA | 110/148 | 05/09→ | | | ZSE030 |
| 1.6 | 4 | BGU, BSE, BSF | 75/101 | 07/03→05/10 | Z90 | | 1.0 UXT1 / UXT3 ZSE003 |
| 1.6 FSI | 4 | BAG, BLF, BLP | 85/114 | 02/03→01/07 | Z300 | | 1.35 ZSE030 |
| 1.6 TDI | 4 | CAYB | 66/89 | 05/10→ | GE115 | | 4.4V |
| 1.6 TDI | 4 | CAYC | 77/103 | 05/10→ | GE115 | | 4.4V |
| 1.9 TDI | 4 | BRU, BXF, BXJ | 66/89 | 11/04→05/10 | GE100 | GSE100 | 5V |
| 1.9 TDI | 4 | AVQ | 74/99 | 02/03→05/04 | GE100 | GSE100 | 5V |
| 1.9 TDI | 4 | BKC, BLS, BXE | 77/103 | 08/03→05/10 | GE100 | GSE100 →05/05 | 5V |
| 2.0 EcoFuel | 4 | BSX | 80/107 | 02/06→05/09 | Z193 | | 0.9 UXT1 / UXT3 ZSE029 |
| 2.0 FSI | 4 | AXW, BLR, BLX, BZY | 110/148 | 10/03→11/05 | Z236 | | 1.0 ZSE033 |
| 2.0 FSI | 4 | BLY, BVZ | 110/148 | 10/03→11/05 | Z193 | | 0.9 UXT1 / UXT3 ZSE033 |
| 2.0 TDI | 4 | CFHF, CLCA | 81/109 | 11/10→ | GE115 | | 4.4V |
| 2.0 TDI | 4 | AZV | 100/134 | 02/03→05/10 | GE101 | GSE100 →09/04 | 4.4V |
| 2.0 TDI | 4 | BMM | 103/138 | 12/05→05/10 | GE100 | GSE100 | 5V |
| 2.0 TDI | 4 | CFHC | 103/138 | 05/10→ | GE115 | | 4.4V |

VW



kW/BHP



... VW



... TOURAN

| | | | | | | | | | |
|-------------|---|------|---------|-------------|--------|------------------|------|--|--|
| 2.0 TDI | 4 | BMN | 125/168 | 12/05→05/10 | CGP003 | | 7V | | |
| 2.0 TDI | 4 | CFJA | 125/168 | 12/05→01/13 | GE115 | | 4.4V | | |
| 2.0 TDI | 4 | CFJB | 130/174 | 01/13→ | GE115 | | 4.4V | | |
| 2.0 TDI 16V | 4 | BKD | 103/138 | 08/03→05/10 | GE101 | GSE100 →09/04 | 4.4V | | |

UP

| | | | | | | | | | |
|-------------|---|------|-------|--------|--|--|--|--|----------------------------------|
| 1.0 | 3 | CHYA | 44/59 | 08/11→ | | | | | ZSE067 [1][42] ZSE126 [1][43] |
| 1.0 | 3 | CHYB | 55/74 | 08/11→ | | | | | ZSE067 [1][42] ZSE126 [1][43] |
| 1.0 EcoFuel | 3 | CPGA | 50/67 | 11/12→ | | | | | ZSE067 [1][42] ZSE126 [1][43] |

VENTO

| | | | | | | | | | |
|-------------|---|-------------------|---------|-------------|--|-------|--|--|-------|
| 1.4 | 4 | ABD, AEX | 40/54 | 11/91→09/98 | Z2 →06/95 Z91 07/95→ | | 1.0 UXT2 / UXT6 →06/95 0.8 UXT2 / UXT6 07/95→ | ZSE001 | ZM013 |
| 1.4 | 4 | ABD | 44/59 | 11/91→09/98 | Z2 | | 1.0 UXT2 / UXT6 | ZSE001 | ZM013 |
| 1.4 | 4 | AEX | 44/59 | 11/91→09/98 | Z91 | | 0.8 UXT2 / UXT6 | ZSE001 | ZM013 |
| 1.4 LPG | 4 | ABD, AEX | 40/54 | 11/91→09/98 | Z11 [168] →06/95 Z27 [168] 07/95→ | | 0.8 UXT2 / UXT6 →06/95 0.8 UX56 07/95→ | | |
| 1.4 LPG | 4 | ABD | 44/59 | 11/91→09/98 | Z11 [168] | | 0.8 UXT2 / UXT6 | | |
| 1.4 LPG | 4 | AEX | 44/59 | 11/91→09/98 | Z27 [168] | | 0.8 UX56 | | |
| 1.6 | 4 | ABU, AEA, AEE | 55/74 | 09/92→09/98 | Z91 | | 0.8 UXT2 / UXT6 | ZSE002 | |
| 1.6 | 4 | AEK | 74/99 | 10/94→09/98 | Z246 | | 0.9 | ZSE001 →12/95 | |
| 1.6 | 4 | AFT | 74/99 | 10/94→09/98 | Z90 | | 1.0 UXT1 / UXT3 | ZSE001 →12/95 | |
| 1.6 LPG | 4 | ABU, AEA, AEE | 55/74 | 09/92→09/98 | Z27 [168] | | 0.8 UX56 | | |
| 1.6 LPG | 4 | AEK | 74/99 | 10/94→09/98 | Z206 | | 0.7 UXT10 | | |
| 1.6 LPG | 4 | AFT | 74/99 | 10/94→09/98 | Z340 | | 0.7 UXT12 | | |
| 1.8 | 4 | AAM | 55/74 | 11/91→09/98 | Z92 | | 0.8 UXT2 / UXT6 | ZSE001 | ZM013 |
| 1.8 | 4 | ABS, ADZ | 66/89 | 11/91→09/98 | Z91 | | 0.8 UXT2 / UXT6 | ZSE001 | ZM013 |
| 1.8 LPG | 4 | AAM | 55/74 | 11/91→09/98 | Z20 [168] | | 0.8 UXT2 / UXT6 | | |
| 1.8 LPG | 4 | ABS, ADZ | 66/89 | 11/91→09/98 | Z27 [168] | | 0.8 UX56 | | |
| 1.9 D | 4 | 1Y | 48/64 | 11/91→09/98 | GN857 | | 11V | | |
| 1.9 SDI | 4 | AEY | 47/63 | 04/97→09/98 | GN855 | GR081 | 12V | | |
| 1.9 TD | 4 | AAZ | 55/74 | 11/91→09/98 | GN857 | | 11V | | |
| 1.9 TDI | 4 | 1Z, AHU | 66/89 | 09/93→09/98 | GN855 | GR081 | 12V | | |
| 1.9 TDI | 4 | ALE | 66/89 | 09/93→09/98 | GN855 | | 12V | | |
| 1.9 TDI | 4 | AFN | 81/109 | 04/96→09/98 | GN855 | GR081 | 12V | | |
| 2.0 | 4 | 2E, ADY, AGG, AKR | 85/114 | 11/91→09/98 | Z91 | | 0.8 UXT2 / UXT6 | ZSE001 [1] | |
| 2.0 LPG | 4 | 2E, ADY, AGG, AKR | 85/114 | 11/91→09/98 | Z27 [168] | | 0.8 UX56 | | |
| 2.0 GL | 4 | AAC | 62/83 | 11/91→07/98 | Z78 →07/95 Z92 08/95→ | | 0.8 UXT2 / UXT6 →07/95 0.8 UXT2 / UXT6 08/95→ | | |
| 2.0 GL | 4 | AEP | 79/106 | 05/96→12/97 | Z91 | | 0.8 UXT2 / UXT6 | | |
| 2.0 GL LPG | 4 | AAC | 62/83 | 11/91→07/98 | Z20 [168] 08/95→ | | 0.8 UXT2 / UXT6 08/95→ | | |
| 2.0 GL LPG | 4 | AEP | 79/106 | 05/96→12/97 | Z27 [168] | | 0.8 UX56 | | |
| 2.8 VR6 | 6 | AAA | 120/161 | 08/95→04/96 | | | | ZSE004 | |
| 2.8 VR6 | 6 | AAA | 128/172 | 01/92→09/98 | Z173 | | 1.6 | ZSE001 →ch. 1H-PM480 000 ZSE004 ch. 1H-PM480 001→ | |
| 2.8 VR6 LPG | 6 | AAA | 128/172 | 01/92→09/98 | Z172 | | 1.6 | | |

VW

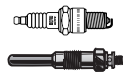

kW/BHP

**... VW**

| VOYAGE | | | | | | | | | |
|------------------|---|------|-------|-------------|--------|--|------|------|--------|
| 1.4 | 4 | AGY | 62/83 | 05/96→07/02 | Z22 | | 0.7 | UX56 | |
| 1.6 Flex | 4 | CFZA | 74/99 | 07/08→ | Z344 | | 1.0 | | ZSE003 |
| 1.9 TDi | 4 | 1Z | 66/89 | 09/99→09/01 | GN855 | | 12V | | |
| XLI | | | | | | | | | |
| 0.8 TDI E-Hybrid | 2 | CSCA | 35/47 | 02/14→ | PSG002 | | 4.4V | | |

VW

| CADDY II | | | | | | | | | |
|----------------------|---|---------------|---------|-------------|----------------------|-------------------|------|-------------|--------------------|
| 1.4 | 4 | AUA | 55/74 | 08/00→01/04 | Z90 | | 1.0 | UXT1 / UXT3 | ZSE003 |
| 1.4 LPG | 4 | AUA | 55/74 | 08/00→01/04 | Z340 | | 0.7 | UXT12 | |
| 1.4 60 | 4 | AEX, APQ | 44/59 | 11/95→01/04 | Z91 | | 0.8 | UXT2 / UXT6 | ZSE001 |
| 1.4 60 | 4 | AUD | 44/59 | 11/95→01/04 | Z176 | | 1.1 | | ZSE003 |
| 1.4 60 LPG | 4 | AEX, APQ | 44/59 | 11/95→01/04 | Z27 ^[168] | | 0.8 | UX56 | |
| 1.6 75 | 4 | 1F | 55/74 | 11/95→05/97 | Z92 | | 0.8 | UXT2 / UXT6 | ZSE001 |
| 1.6 75 | 4 | AEE | 55/74 | 11/95→09/00 | Z91 | | 0.8 | UXT2 / UXT6 | ZSE001 |
| 1.6 75 LPG | 4 | 1F | 55/74 | 11/95→05/97 | Z20 ^[168] | | 0.8 | UXT2 / UXT6 | |
| 1.6 75 LPG | 4 | AEE | 55/74 | 11/95→09/00 | Z27 ^[168] | | 0.8 | UX56 | |
| 1.7 SDI | 4 | AHB | 42/56 | 07/96→09/00 | GN855 | GR081 | 12V | | |
| 1.9 D | 4 | 1Y | 47/63 | 11/95→01/04 | GN857 | | 11V | | |
| 1.9 SDI | 4 | AEY, AYQ | 47/63 | 11/95→01/04 | GN855 | GR081 | 12V | | |
| 1.9 TDI | 4 | 1Z, AHU, ALH | 66/89 | 09/96→01/04 | GN855 | GR081 | 12V | | |
| CADDY III | | | | | | | | | |
| 1.2 TSI | 4 | CBZA | 63/84 | 09/10→ | | | | | ZSE003 |
| 1.2 TSI | 4 | CBZB | 77/103 | 09/10→ | | | | | ZSE003 |
| 1.4 | 4 | BCA | 55/74 | 03/04→05/06 | Z90 | | 1.0 | UXT1 / UXT3 | ZSE030 |
| 1.4 LPG | 4 | BCA | 55/74 | 03/04→05/06 | Z340 | | 0.7 | UXT12 | |
| 1.4 16V | 4 | BUD | 59/79 | 05/06→08/10 | Z272 | | 1.0 | | ZSE030 |
| | | | | | | | | | →ch. FIK-8-281 299 |
| 1.6 | 4 | BGU, BSE, BSF | 75/101 | 04/04→ | Z90 | | 1.0 | UXT1 / UXT3 | ZSE003 |
| 1.6 LPG | 4 | BGU, BSE, BSF | 75/101 | 04/04→ | Z340 | | 0.7 | UXT12 | |
| 1.6 BiFuel LPG | 4 | CHGA | 75/101 | 05/11→ | Z340 | | 0.7 | UXT12 | ZSE003 |
| | | | | | Z90 | | 1.0 | UXT1 / UXT3 | |
| 1.6 TDI | 4 | CAYE | 55/74 | 08/10→ | GE115 | | 4.4V | | |
| 1.6 TDI | 4 | CAYD | 75/101 | 08/10→ | GE115 | | 4.4V | | |
| 1.9 TDI | 4 | BSU | 55/74 | 09/05→08/10 | GE100 | GSE100 | 5V | | |
| 1.9 TDI | 4 | BJB | 77/103 | 04/04→08/10 | GE100 | GSE100 | 5V | | |
| | | | | | | →ch. 2K-5-150-000 | | | |
| 1.9 TDI | 4 | BLS | 77/103 | 04/04→08/10 | GE100 | | 5V | | |
| 2.0 EcoFuel | 4 | BSX | 80/107 | 04/06→ | Z193 | | 0.9 | UXT1 / UXT3 | ZSE029 |
| 2.0 SDI | 4 | BDJ, BST | 51/68 | 03/04→08/10 | GN046 | GR081 | 12V | | |
| 2.0 TDI | 4 | CFHE | 62/83 | 11/10→ | GE115 | | 4.4V | | |
| 2.0 TDI | 4 | CFHF, CLCA | 81/109 | 08/10→ | GE115 | | 4.4V | | |
| 2.0 TDI | 4 | BMM | 103/138 | 09/07→08/10 | GE100 | GSE100 | 5V | | |
| 2.0 TDI | 4 | CFJA | 125/168 | 05/12→ | GE115 | | 4.4V | | |
| 2.0 TDI 16V | 4 | CFHC, CLCB | 103/138 | 11/10→ | GE115 | | 4.4V | | |
| CRAFTER 30-35 | | | | | | | | | |
| 2.0 TDI | 4 | CKTB | 80/107 | 05/11→ | GE115 | | 4.4V | | |
| 2.0 TDI | 4 | CSLB | 84/113 | 11/13→ | GE115 | | 4.4V | | |
| 2.0 TDI | 4 | CKTC | 100/134 | 05/11→ | GE115 | | 4.4V | | |
| 2.0 TDI | 4 | CKUC | 105/141 | 10/11→ | GE115 | | 4.4V | | |
| 2.0 TDI | 4 | CKUB | 120/161 | 07/11→ | GE115 | | 4.4V | | |
| 2.5 TDI | 5 | BJJ, CEBA | 65/87 | 04/06→07/11 | CGP002 | | 7V | | |
| 2.5 TDI | 5 | BJK, CEBB | 80/107 | 04/06→ | CGP002 | | 7V | | |
| 2.5 TDI | 5 | BJL, CECA | 100/134 | 04/06→ | CGP002 | | 7V | | |
| 2.5 TDI | 5 | BJM, CECB | 120/161 | 04/06→07/11 | CGP002 | | 7V | | |

VW

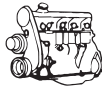

kW/BHP

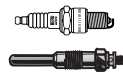

... VW



CRAFTER 30-50

| | | | | | | | | |
|---------|---|-----------|---------|-------------|--------|------|--|--|
| 2.0 TDI | 4 | CKTB | 80/107 | 05/11→ | GE115 | 4.4V | | |
| 2.0 TDI | 4 | CSLB | 84/113 | 11/13→ | GE115 | 4.4V | | |
| 2.0 TDI | 4 | CKTC | 100/134 | 05/11→ | GE115 | 4.4V | | |
| 2.0 TDI | 4 | CKUC | 105/141 | 10/11→ | GE115 | 4.4V | | |
| 2.0 TDI | 4 | CKUB | 120/161 | 07/11→ | GE115 | 4.4V | | |
| 2.5 TDI | 5 | BJJ, CEBA | 65/87 | 04/06→07/11 | CGP002 | 7V | | |
| 2.5 TDI | 5 | BJK, CEBB | 80/107 | 04/06→ | CGP002 | 7V | | |
| 2.5 TDI | 5 | BJL, CECA | 100/134 | 04/06→ | CGP002 | 7V | | |
| 2.5 TDI | 5 | BJM, CECB | 120/161 | 04/06→07/11 | CGP002 | 7V | | |

LT 28-35 I

| | | | | | | | | | |
|------------|---|---------|--------|-------------|---|-------------------|---|---------------------------------|-------|
| 2.0 | 4 | CH | 55/74 | 04/75→09/83 | Z22 ^[169] | 0.7 | UX56 | ZS115 ^[11] →12/82 | |
| 2.4 | 6 | DL | 66/89 | 12/82→07/92 | Z61 | 0.7 | UXT2 / UXT6 | ZS115 ^[11] →06/84 | ZM002 |
| 2.4 4WD | 6 | DL | 66/89 | 08/91→07/92 | Z11 →ch. 28-H-025 000 Z61 ch. 28-J-000 001→ | 0.8 0.7 | UXT2 / UXT6 UXT2 / UXT6 | ZS115 ^[11] | |
| 2.4 4WD | 6 | 1E | 70/94 | 08/92→07/94 | Z8 | 0.8 | UXT2 / UXT6 | ZS124 | |
| 2.4 D | 6 | 1S, ACT | 51/68 | 08/89→06/96 | GN857 | | | | |
| 2.4 D | 6 | CP, DW | 55/74 | 12/78→07/92 | GN857 | | GR001 | | |
| 2.4 D 4WD | 6 | DW | 55/74 | 08/91→07/92 | GN857 | | | | |
| 2.4 i | 6 | 1E | 69/93 | 08/89→06/96 | Z61 →12/90 Z2 01/91→07/95 Z92 08/95→ | 0.7 1.0 0.8 | UXT2 / UXT6 UXT2 / UXT6 UXT2 / UXT6 | ZS124 | |
| 2.4 i | 6 | 1E | 69/93 | 03/94→06/96 | Z2 →07/95 Z92 08/95→ | 1.0 0.8 | UXT2 / UXT6 UXT2 / UXT6 | | |
| 2.4 i LPG | 6 | 1E | 69/93 | 08/89→06/96 | Z11 ^[168] 01/91→07/95 Z20 ^[168] 08/95→ | 0.8 0.8 | UXT2 / UXT6 UXT2 / UXT6 | | |
| 2.4 i LPG | 6 | 1E | 69/93 | 03/94→06/96 | Z11 ^[168] →07/95 Z20 ^[168] 08/95→ | 0.8 0.8 | UXT2 / UXT6 UXT2 / UXT6 | | |
| 2.4 TD | 6 | 1G | 68/91 | 08/88→08/92 | GN857 | | GR001 | | |
| 2.4 TD 4WD | 6 | 1G | 68/91 | 08/91→07/92 | GN857 | | | | |
| 2.4 TD | 6 | ACL | 70/94 | 06/92→06/96 | GN857 | | | | |
| 2.4 TD | 6 | DV | 75/101 | 12/82→09/93 | GN857 | | GR001 | | |
| 2.4 TD 4WD | 6 | DV | 75/101 | 08/91→07/92 | GN857 | | | | |
| 2.7 D | 4 | CG | 48/64 | 11/75→01/80 | GN857 | | | | |

LT 28-35 II

| | | | | | | | | | |
|---------|---|----------|---------|-------------|-----------------------|-------|-------------|-------|--|
| 2.3 | 4 | AGL | 105/141 | 05/96→07/06 | Z101 | 0.8 | UXT1 / UXT3 | ZS340 | |
| 2.3 LPG | 4 | AGL | 105/141 | 05/96→07/06 | Z158 ^[168] | 1.1 | | | |
| 2.5 SDI | 5 | AGX | 55/74 | 07/96→07/06 | GN855 | 12V | | | |
| 2.5 TDI | 5 | BBE | 61/82 | 05/01→07/06 | GN855 | 12V | | | |
| 2.5 TDI | 5 | APA | 66/89 | 05/99→07/06 | GN855 | 12V | | | |
| 2.5 TDI | 5 | BBF | 70/94 | 05/01→07/06 | GN855 | 12V | | | |
| 2.5 TDI | 5 | AHD | 75/101 | 05/96→08/99 | GN855 | 12V | | | |
| 2.5 TDI | 5 | ANJ, AVR | 80/107 | 05/99→07/06 | GN855 | 12V | | | |
| 2.8 TDI | 4 | AGK | 92/123 | 02/97→12/98 | GN989 | 11.5V | | | |
| 2.8 TDI | 4 | ATA | 96/129 | 01/99→01/02 | GN989 | 11.5V | | | |
| 2.8 TDI | 4 | BCQ | 116/156 | 05/01→06/06 | GN050 | 11.5V | | | |

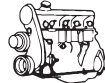

kW/BHP

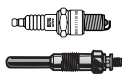

... VW



LT 28-46 II

| | | | | | | | | |
|---------|---|----------|---------|-------------|------------|-------|-------------|-------|
| 2.3 | 4 | AGL | 105/141 | 05/96→07/06 | Z101 | 0.8 | UXT1 / UXT3 | ZS340 |
| 2.3 LPG | 4 | AGL | 105/141 | 05/96→07/06 | Z158 [168] | 1.1 | | |
| 2.5 SDI | 5 | AGX | 55/74 | 09/96→07/06 | GN855 | 12V | | |
| 2.5 TDI | 5 | BBE | 61/82 | 05/01→07/06 | GN855 | 12V | | |
| 2.5 TDI | 5 | APA | 66/89 | 05/99→07/06 | GN855 | 12V | | |
| 2.5 TDI | 5 | BBF | 70/94 | 05/01→07/06 | GN855 | 12V | | |
| 2.5 TDI | 5 | AHD | 75/101 | 05/96→08/99 | GN855 | 12V | | |
| 2.5 TDI | 5 | ANJ, AVR | 80/107 | 05/99→07/06 | GN855 | 12V | | |
| 2.8 TDI | 4 | AGK | 92/123 | 06/97→12/98 | GN989 | 11.5V | | |
| 2.8 TDI | 4 | ATA | 96/129 | 01/99→07/06 | GN989 | 11.5V | | |
| 2.8 TDI | 4 | AUH, BCQ | 116/156 | 04/02→07/06 | GN050 | 11.5V | | |

LT 40-55 I

| | | | | | | | | |
|------------|---|---------|--------|-------------|-----------|-------|-------------|------------|
| 2.0 | 4 | CH | 55/74 | 04/75→09/83 | Z22 | 0.7 | UX56 | |
| 2.4 | 6 | DL | 66/89 | 12/82→07/92 | Z61 | 0.7 | UXT2 / UXT6 | ZS115 [11] |
| 2.4 | 6 | DL | 66/89 | 12/82→07/89 | Z20 [168] | 0.8 | UXT2 / UXT6 | |
| 2.4 4WD | 6 | DL | 66/89 | 12/82→07/92 | Z61 | 0.7 | UXT2 / UXT6 | ZS115 [11] |
| 2.4 | 6 | 1E | 70/94 | 08/88→07/89 | Z20 [168] | 0.8 | UXT2 / UXT6 | ZS124 |
| 2.4 D | 6 | 1S, ACT | 51/68 | 07/90→06/96 | GN857 | 11V | | |
| 2.4 D | 6 | CP, DW | 55/74 | 12/78→07/92 | GN857 | GR001 | 11V | |
| 2.4 i | 6 | 1E | 69/93 | 01/93→06/96 | Z2 | 1.0 | UXT2 / UXT6 | ZS124 |
| | | | | →07/95 | Z92 | 0.8 | UXT2 / UXT6 | |
| | | | | 08/95→ | | | 08/95→ | |
| 2.4 i LPG | 6 | 1E | 69/93 | 01/93→06/96 | Z11 [168] | 0.8 | UXT2 / UXT6 | |
| | | | | →07/95 | Z20 [168] | 0.8 | UXT2 / UXT6 | |
| | | | | 08/95→ | | | 08/95→ | |
| 2.4 TD | 6 | 1G | 68/91 | 08/88→08/92 | GN857 | GR001 | 11V | |
| 2.4 TD 4WD | 6 | 1G | 68/91 | 08/91→07/92 | GN857 | | 11V | |
| 2.4 TD | 6 | ACL | 70/94 | 06/92→06/96 | GN857 | | 11V | |
| 2.4 TD | 6 | DV | 75/101 | 08/78→09/93 | GN857 | GR001 | 11V | |

POLO

| | | | | | | | | |
|---------|---|----------|-------|-------------|-----------|-------|-------------|--------|
| 1.0 | 4 | AAU, AEV | 33/44 | 08/92→12/99 | Z2 | 1.0 | UXT2 / UXT6 | ZSE001 |
| 1.0 LPG | 4 | AAU, AEV | 33/44 | 08/92→12/99 | Z11 [168] | 0.8 | UXT2 / UXT6 | |
| 1.3 | 4 | AAV | 40/54 | 08/92→07/94 | Z2 | 1.0 | UXT2 / UXT6 | ZSE002 |
| 1.3 LPG | 4 | AAV | 40/54 | 08/92→07/94 | Z11 [168] | 0.8 | UXT2 / UXT6 | |
| 1.4 | 4 | AEX, APQ | 44/59 | 05/98→12/99 | Z91 | 0.8 | UXT2 / UXT6 | ZSE001 |
| 1.4 LPG | 4 | AEX, APQ | 44/59 | 05/98→12/99 | Z27 [168] | 0.8 | UX56 | |
| 1.4 D | 4 | 1W | 35/47 | 08/92→07/94 | GN857 | 11V | | |
| 1.7 SDI | 4 | AKU | 44/59 | 08/97→12/99 | GN855 | GR081 | 12V | |
| 1.9 D | 4 | AEF | 47/63 | 10/94→12/99 | GN857 | | 11V | |
| 1.9 SDI | 4 | AGD | 47/63 | 07/96→12/99 | GN855 | GR081 | 12V | |

TRANSPORTER I

| | | | | | | | | |
|-----|---|----|-------|-------------|-----|-----|--|------------|
| 1.1 | 4 | M5 | 18/24 | 01/50→12/62 | Z57 | 0.6 | | |
| 1.2 | 4 | | 25/34 | 01/50→07/67 | Z57 | 0.6 | | |
| 1.5 | 4 | H | 32/43 | 02/62→10/70 | Z57 | 0.6 | | |
| 1.6 | 4 | | 35/47 | 08/64→12/68 | Z68 | 0.6 | | ZS106 [11] |
| 1.6 | 4 | B | 35/47 | 08/64→12/68 | Z57 | 0.6 | | ZS106 [11] |
| 1.6 | 4 | B | 35/47 | 06/66→07/67 | | | | ZS124 |

TRANSPORTER II

| | | | | | | | | |
|-----|---|--------|-------|-------------|-----------|-----|--|-------------|
| 1.6 | 4 | AF | 34/46 | 08/67→07/70 | Z57 | 0.6 | | |
| 1.6 | 4 | AD, AS | 37/50 | 08/68→07/79 | Z57 [169] | 0.6 | | |
| 1.6 | 4 | AD, AS | 37/50 | 08/70→04/79 | Z57 | 0.6 | | ZS106 [11] |
| | | | | | | | | 05/73→02/79 |
| 1.6 | 4 | AE | 37/50 | 08/70→04/79 | Z57 | 0.6 | | ZS106 [11] |
| | | | | | | | | 05/73→02/79 |
| 1.6 | 4 | AH | 37/50 | 08/70→04/79 | Z57 | 0.6 | | ZS106 [11] |
| | | | | | | | | 05/73→ |

VW



kW/BHP



... VW



... TRANSPORTER II

| | | | | | | | | | |
|-----|---|--------|-------|-------------|-----------|--|-----|------------|--------|
| 1.7 | 4 | CA, CB | 49/66 | 08/71→12/73 | Z58 [167] | | 0.8 | ZS106 [11] | |
| 1.8 | 4 | AP | 50/67 | 11/73→07/75 | Z58 [167] | | 0.8 | ZS106 [11] | |
| 2.0 | 4 | CJ | 51/68 | 08/75→07/79 | Z58 [167] | | 0.8 | ZS106 [11] | |
| | | | | | | | | | →03/79 |
| 2.0 | 4 | CJ | 51/68 | 08/75→04/79 | | | | ZS106 [11] | |
| 2.0 | 4 | GD, GE | 51/68 | 08/75→07/79 | Z58 [167] | | 0.8 | ZS106 [11] | |
| | | | | | | | | | →03/79 |

TRANSPORTER III

| | | | | | | | | | | |
|--------|---|----|--------|-------------|--|-------|-----|----------------|---|-------|
| 1.6 | 4 | CT | 37/50 | 05/79→12/82 | Z57 →04/80 →eng. CT 065010/ Kurzgewind Z58 [167] 05/80→ eng. CT 065011/ Langgewind→ | | 0.6 | | | ZM002 |
| 1.6 D | 4 | CS | 37/50 | 01/81→07/87 | GN857 | GR001 | 11V | | | |
| 1.6 TD | 4 | | 51/68 | 08/85→07/87 | GN857 | | 11V | | | |
| 1.6 TD | 4 | JX | 51/68 | 08/84→07/92 | GN857 | GR001 | 11V | | | |
| 1.7 D | 4 | KY | 42/56 | 08/85→07/92 | GN857 | GR001 | 11V | | | |
| 1.9 | 4 | DF | 44/59 | 08/82→07/92 | Z61 | | 0.7 | UXT2 / UXT6 | ZS124 [1] 09/84→07/87 ZS123 [1] 08/87→ | ZM002 |
| 1.9 | 4 | DG | 57/76 | 08/82→07/92 | Z62 | | 0.8 | UXT2 / UXT6 | ZS123 [1] 08/87→07/89 ZS124 [1][214][254] | ZM012 |
| 1.9 | 4 | DH | 61/82 | 01/83→07/85 | Z58 [167] | | 0.8 | | ZS124 09/84→ | ZM002 |
| 1.9 | 4 | DH | 61/82 | 10/84→02/89 | Z58 | | 0.8 | | ZS124 | |
| 1.9 | 4 | GW | 66/89 | 08/83→02/89 | Z58 [167] | | 0.8 | | ZS124 | ZM002 |
| 1.9 | 4 | GW | 66/89 | 08/83→07/85 | | | | | ZS124 09/84→ | |
| 2.0 | 4 | CU | 51/68 | 05/79→04/86 | Z58 [167] | | 0.8 | | ZS106 [11] →07/80 | ZM002 |
| 2.0 | 4 | CV | 51/68 | 05/79→12/82 | Z58 [167] | | 0.8 | | | ZM002 |
| 2.1 | 4 | SR | 64/86 | 10/86→07/92 | Z58 [167] | | 0.8 | | ZS124 | |
| 2.1 | 4 | MV | 70/94 | 08/85→07/92 | Z58 [167] | | 0.8 | | ZS124 | ZM012 |
| 2.1 | 4 | DJ | 82/110 | 08/84→07/92 | Z42 →ch. K Z12 ch. L→ | | 0.8 | UX56 →ch. K | ZS123 [1] 08/87→07/89 | ZM012 |
| | | | | | | | 0.8 | UXT2 / UXT6 | ZS124 [1][214][254] | |
| | | | | | | | | | ch. L→ | |
| 2.1 i | 4 | SS | 68/91 | 07/89→07/92 | Z58 [167] | | 0.8 | | ZS124 | |

TRANSPORTER IV

| | | | | | | | | | | |
|--------|---|-----|-------|-------------|--------------------------------|-------|-----|-------------|---|---|
| 1.8 | 4 | PD | 49/66 | 12/90→07/92 | Z12 | | 0.8 | UXT2 / UXT6 | ZSE001 [175][254] ZSE002 [175][254] ch. 70-N-180001 → →ch. 70-N-180000 | ZM013 [175] ZM014 ch. 70-N-180001 → →ch. 70-N-180000 |
| 1.9 D | 4 | 1X | 44/59 | 09/90→12/95 | GN857 | GR031 | 11V | | | |
| 1.9 D | 4 | 1X | 45/60 | 07/90→12/95 | GN857 | GR031 | 11V | | | |
| 1.9 TD | 4 | ABL | 50/67 | 10/92→04/03 | GN857 | | 11V | | | |
| 2.0 | 4 | AAC | 62/83 | 07/90→04/03 | Z78 →07/95 Z92 08/95→ | | 0.8 | UXT2 / UXT6 | ZSE001 →07/95 | ZM013 →12/93 →ch. 70-S-045000 |
| | | | | | | | 0.8 | UXT2 / UXT6 | 08/95→ | |
| 2.0 | 4 | AAC | 62/83 | 09/90→04/03 | | | | | | ZM013 →12/93 →ch. 70-S-045000 |



kW/BHP



... VW



... TRANSPORTER IV

| | | | | | | | | | | |
|--------------|---|--------------------|---------|-------------|---------------------|-------|-----|-----------------------|--------|-------|
| 2.0 LPG | 4 | AAC | 62/83 | 07/90→04/03 | Z20 [168] 08/95→ | | 0.8 | UXT2 / UXT6 08/95→ | | |
| 2.4 D | 5 | AJA | 55/74 | 08/97→04/03 | GN857 | GR031 | 11V | | | |
| 2.4 D | 5 | AAB | 57/76 | 07/90→09/98 | GN857 | GR031 | 11V | | | |
| 2.5 | 5 | AAF | 81/109 | 11/90→04/03 | Z2 | | 1.0 | UXT2 / UXT6 | ZSE001 | ZM013 |
| 2.5 | 5 | ACU, AEN, AEU | 81/109 | 11/90→04/03 | Z92 | | 0.8 | UXT2 / UXT6 | ZSE001 | ZM013 |
| 2.5 | 5 | AET | 85/114 | 07/96→04/03 | Z92 | | 0.8 | UXT2 / UXT6 | ZSE001 | ZM013 |
| 2.5 | 5 | APL, AVT | 85/114 | 07/96→04/03 | Z126 | | 0.8 | | ZSE001 | ZM013 |
| 2.5 LPG | 5 | AAF | 81/109 | 11/90→04/03 | Z11 [168] | | 0.8 | UXT2 / UXT6 | | |
| 2.5 LPG | 5 | ACU, AEN, AEU | 81/109 | 11/90→04/03 | Z20 [168] | | 0.8 | UXT2 / UXT6 | | |
| 2.5 LPG | 5 | AET | 85/114 | 07/96→04/03 | Z20 [168] | | 0.8 | UXT2 / UXT6 | | |
| 2.5 LPG | 5 | APL, AVT | 85/114 | 07/96→04/03 | Z206 | | 0.7 | UXT10 | | |
| 2.5 TDI | 5 | AJT, AYY | 65/87 | 05/98→04/03 | GN855 | GR081 | 12V | | | |
| 2.5 TDI | 5 | ACV, AUF, AXL, AYC | 75/101 | 09/95→04/03 | GN855 | GR081 | 12V | | | |
| 2.5 TDI | 5 | AHY, AXG | 111/149 | 05/98→04/03 | GN855 | GR081 | 12V | | | |
| 2.8 | 6 | AES | 103/138 | 05/96→05/00 | Z173 | | 1.6 | | | |
| 2.8 LPG | 6 | AES | 103/138 | 05/96→05/00 | Z172 | | 1.6 | | | |
| 2.8 VR 6 | 6 | AES | 103/138 | 11/95→05/00 | Z173 | | 1.6 | | | |
| 2.8 VR 6 | 6 | AES | 103/138 | 11/95→04/00 | | | | | ZSE004 | |
| 2.8 VR6 | 6 | AMV | 150/201 | 04/00→04/03 | Z176 | | 1.1 | | ZSE004 | |
| 2.8 VR 6 LPG | 6 | AES | 103/138 | 11/95→04/00 | Z172 | | 1.6 | | | |

TRANSPORTER V

| | | | | | | | | | | |
|-----------|---|------------|---------|-------------|--------|--|------|-------------|--------|--|
| 1.9 TDI | 4 | BRR | 62/83 | 01/06→11/09 | GE100 | | 5V | | | |
| 1.9 TDI | 4 | AXC | 63/84 | 04/03→11/09 | GN046 | GR081 →ch. 7H-6-080 000; 7H-6X022 500; 7J-6-022 500 | 12V | | | |
| 1.9 TDI | 4 | BRS | 75/101 | 06/06→11/09 | GE100 | | 5V | | | |
| 1.9 TDI | 4 | AXB | 77/103 | 04/03→11/09 | GN046 | GR081 →ch. 7H-6-080 000; 7H-6X022 500; 7J-6-022 500 | 12V | | | |
| 2.0 | 4 | AXA | 85/114 | 11/03→ | Z90 | | 1.0 | UXT1 / UXT3 | ZSE003 | |
| 2.0 BitDI | 4 | CFCA | 132/177 | 09/09→ | GE115 | | 4.4V | | | |
| 2.0 TDI | 4 | CAAA | 62/83 | 09/09→ | GE115 | | 4.4V | | | |
| 2.0 TDI | 4 | CAAB | 75/101 | 09/09→ | GE115 | | 4.4V | | | |
| 2.0 TDI | 4 | CAAD | 84/113 | 05/11→ | GE115 | | 4.4V | | | |
| 2.0 TDI | 4 | CAAE, CCHB | 100/134 | 05/10→ | GE115 | | 4.4V | | | |
| 2.0 TDI | 4 | CAAC, CCHA | 103/138 | 09/09→ | GE115 | | 4.4V | | | |
| 2.0 TSI | 4 | CJKB | 110/148 | 07/12→ | Z347 | | 0.7 | UXT12 | ZSE033 | |
| 2.0 TSI | 4 | CJKA | 150/201 | 05/11→ | Z347 | | 0.7 | UXT12 | ZSE033 | |
| 2.5 TDI | 5 | AXD | 96/129 | 04/03→11/09 | GN046 | GR081 →ch. 7H-6-080 000; 7H-6X022 500; 7J-6-022 500 | 12V | | | |
| 2.5 TDI | 5 | BNZ | 96/129 | 04/03→11/09 | CGP002 | | 7V | | | |
| 2.5 TDi | 5 | BLJ | 120/161 | 11/03→11/09 | GN046 | GR081 →ch. 7H-6-080 000; 7H-6X022 500; 7J-6-022 500 | 12V | | | |
| 2.5 TDI | 5 | AXE | 128/172 | 04/03→11/09 | GN046 | GR081 →ch. 7H-6-080 000; 7H-6X022 500; 7J-6-022 500 | 12V | | | |
| 2.5 TDI | 5 | BPC | 128/172 | 04/03→11/09 | CGP002 | | 7V | | | |
| 3.2 4WD | 6 | BKK | 173/232 | 11/03→11/09 | Z306 | | 0.9 | | ZSE044 | |
| 3.2 4WD | 6 | CFLA | 173/232 | 11/03→11/09 | | | | | ZSE044 | |
| 3.2 V6 | 6 | BDL | 170/228 | 04/03→11/09 | Z306 | | 0.9 | | ZSE044 | |
| 3.2 V6 | 6 | BKK | 173/232 | 08/03→11/09 | Z306 | | 0.9 | | ZSE044 | |

VW

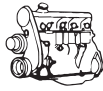

kW/BHP

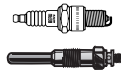
**... VW****... TRANSPORTER V**

| | | | | | | | | |
|------------|---|------|---------|-------------|--|--|--|--------|
| 3.2 V6 4WD | 6 | CFLA | 173/232 | 11/03→11/09 | | | | ZSE044 |
|------------|---|------|---------|-------------|--|--|--|--------|

WARTBURG**353**

| | | | | | | | | |
|-----|---|-----------------|-------|-------------|---------------|--|-----|-------------------------|
| 1.0 | 3 | 18,353 | 37/50 | 04/69→02/75 | Z57 07/71→ | | 0.6 | |
| 1.0 | 3 | 18,353 | 37/50 | 04/69→01/89 | | | | ZS106 ⁽¹¹⁾ |
| 1.0 | 3 | 18,353 | 37/50 | 02/75→01/89 | Z57 01/78→ | | 0.6 | |
| 1.3 | 4 | 2/7, 4V07, 5GRF | 43/58 | 09/88→05/91 | Z11 | | 0.8 | UXT2 / UXT6 ZS124 ZM012 |

ZAZ**TAVRIA**

| | | | | | | | | |
|-----|---|----------|-------|-------------|--------------------------------|--|-----|-----------------------|
| 1.1 | 4 | MEMZ-245 | 37/50 | 01/89→ | Z11 ^[167] 06/90→ | | 0.8 | UXT2 / UXT6 06/90→ |
| 1.3 | 4 | MEMZ-310 | 44/59 | 01/89→ | Z11 ^[167] 06/90→ | | 0.8 | UXT2 / UXT6 06/90→ |
| 1.3 | 4 | | 52/70 | 10/01→12/07 | Z20 | | 0.8 | UXT2 / UXT6 |

VW



CGP001

BMW 3 (E90), 3 (F30, F35, F80), 3 GRAN TURISMO (F34), 3 Touring (E91), 4 Convertible (F33, F83), 4 Coupe (F32, F82), 5 (F10, F18), 5 GRAN TURISMO (F07), 5 Touring (F11), 6 Convertible (F12), 6 Coupe (F13), 6 Gran Coupe (F06), 7 (F01, F02, F03, F04), X3 (F25), X5 (E70), X6 (E71, E72)

CGP002

AUDI A3, A4
SEAT ALHAMBRA, ALTEA, ALTEA XL, CORDOBA, IBIZA IV, IBIZA V, LEON, TOLEDO III
SKODA FABIA, OCTAVIA, ROOMSTER, ROOMSTER Praktik, SUPERB
VW CRAFTER 30-35, CRAFTER 30-50, JETTA III, NEW BEETLE, PASSAT, POLO, SHARAN, TOUAREG, TRANSPORTER V

CGP003

AUDI A3, A4, A6
SEAT ALTEA, ALTEA XL, LEON, TOLEDO III
SKODA OCTAVIA
VW GOLF V, JETTA III, PASSAT, TOURAN

GD214

MERCEDES-BENZ 170 (W170)

GD318

MERCEDES-BENZ 170 (W170)

GD348

MERCEDES-BENZ HECKFLOSSE (W110), PONTON (W120)

GD382

MERCEDES-BENZ /8 (W115), G-CLASS (W460), HENSCHEL 2-t, KOMBI Estate (S123), PONTON (W121), Saloon (W123), T1 Box (601), T1 Box/Platform/Chassis (601), T1 Bus (601), T1 Bus/Platform/Chassis (601), T1 Platform/Chassis (602), T2/L Box Body / Estate/Platform/Chassis

GE100

AUDI A2, A3, A4
SEAT ALTEA, ALTEA XL, LEON, TOLEDO III
SKODA OCTAVIA, SUPERB
VW CADDY III, EOS, GOLF V, GOLF PLUS, JETTA III, MULTIVAN V, NEW BEETLE, PASSAT, TOURAN, TRANSPORTER V

GE101

AUDI A3, A4, A6
CHRYSLER SEBRING
JEEP COMPASS, PATRIOT
MITSUBISHI GRANDIS, OUTLANDER II, OUTLANDER II Van

...GE101

SEAT ALTEA, ALTEA XL, LEON, TOLEDO III
SKODA OCTAVIA, SUPERB
VW GOLF V, GOLF PLUS, JETTA III, PASSAT, TOURAN

GE102

BMW 1 (E87), 3 (E46), 3 (E90), 3 Compact (E46), 3 Convertible (E93), 3 Convertible/Coupe (E46), 3 Coupe (E92), 3 /Touring (E46), 3 Touring (E91), 5 (E60), 5 Touring (E61), 6 (E63), 6 Convertible (E64), 7 (E65, E66, E67), X3 (E83), X5 (E53), X5 (E70), X6 (E71, E72)

GE103

BMW 7 (E65, E66, E67)

GE104

MERCEDES-BENZ C-CLASS (W203), C-CLASS Coupe (CL203), C-CLASS T-Model (S203)

GE105

CHRYSLER 300 C
JEEP COMMANDER, GRAND CHEROKEE III
MERCEDES-BENZ A-CLASS (W169), B-CLASS (W245), C-CLASS (W203), C-CLASS (W204), C-CLASS T-Model (S203), C-CLASS T-Model (S204), CLK (C209), CLK Convertible (A209), CLS (C219), E-CLASS (W211), E-CLASS T-Model (S211), G-CLASS (W461), GL-CLASS (X164), GLK-CLASS (X204), M-CLASS (W164), R-CLASS (W251, V251), S-CLASS (W221), SPRINTER 3,5-t Box/Bus/Platform/Chassis (906), SPRINTER 3-t Box (906), SPRINTER 3-t Box/Platform/Chassis (906), SPRINTER 3-t Platform/Chassis (906), SPRINTER 4,6-t Box/Platform/Chassis (906) 4,6-t, SPRINTER 4,6-t Platform/Chassis (906), SPRINTER 5-t Box/Platform/Chassis (906) 5-t, VIANO (W639), VITO Bus (W639), VITO / MIXTO Box (W639)

GE109

CHEVROLET SILVERADO 2500 HD

GE110

DACIA DOKKER, DOKKER Express, DUSTER, LODGY, LOGAN, LOGAN II, LOGAN MCV, LOGAN MCV II, SANDERO, SANDERO II

MERCEDES-BENZ A-CLASS (W176), B-CLASS (W246), CITAN Box (415), CITAN Box/Mixto (415), CITAN Combi (415), CLA Coupe (C117), GLA-CLASS (X156)

...GE110

NISSAN CUBE, JUKE, NOTE, QASHQAI, QASHQAI / QASHQAI +2
RENAULT CAPTUR, CLIO Grandtour IV, CLIO IV, DUSTER, FLUENCE, GRAND SCÉNIC III, KANGOO, KANGOO BE BOP, KANGOO / GRAND KANGOO, LAGUNA, LATITUDE, LOGAN, LOGAN EXPRESS, MEGANE CC, MEGANE III, SCÉNIC III, THALIA III, TWINGO II

GE111

RENAULT GRAND SCÉNIC III, MEGANE CC, MEGANE III, SCÉNIC III
SUZUKI GRAND VITARA II (JT)

GE112

ALFA ROMEO MITO
CHEVROLET AVEO
CHRYSLER YPSILON
CITROËN NEMO
FIAT 500, 500 C, 500L, DOBLO, FIORINO, IDEA, PANDA, PUNTO, PUNTO EVO, PUNTO / GRANDE PUNTO, QUBO
FORD KA
LANCIA MUSA, YPSILON
OPEL ASTRA J, CORSA D, MERIVA B
PEUGEOT BIPPER, BIPPER Tepee
VAUXHALL ASTRA Mk VI (J), CORSA Mk III (D), CORSAVAN Mk III (D), MERIVA Mk II (B)

GE113

HYUNDAI ix55

GE114

ALFA ROMEO 159, BRERA, GIULIETTA, MITO, SPIDER
CHRYSLER DELTA
FIAT 500L, BRAVO II, BRAVO Van, DOBLO, DUCATO, FREEMONT, IDEA, LINEA, PUNTO EVO, PUNTO / GRANDE PUNTO, SEDICI
LANCIA DELTA III, MUSA
OPEL ASTRA GTC J, ASTRA J, COMBO, INSIGNIA, ZAFIRA TOURER C
SAAB 9-3, 9-3X
SUZUKI SX4 (GY), SX4 S-Cross
VAUXHALL ASTRA GTC Mk VI (J), ASTRA Mk VI (J), COMBO Mk III (D), INSIGNIA, ZAFIRA Mk III

GE115

AUDI A1, A3, A4, A4 Allroad, A5, A6, A6 Allroad, A7, A8, Q3, Q5, Q7, TT
PORSCHE CAYENNE, CAYENNE (955), MACAN, PANAMERA
SEAT ALHAMBRA, ALTEA, ALTEA XL, EXEO, IBIZA V, LEON, TOLEDO III, TOLEDO IV

...GE115

SKODA FABIA, OCTAVIA, RAPID, ROOMSTER, ROOMSTER Praktik, SUPERB, YETI
VW AMAROK, BEETLE, CADDY III, CC, CRAFTER 30-35, CRAFTER 30-50, EOS, GOLF V, GOLF VI, GOLF VII, GOLF PLUS, GOLF SPORTSVAN, JETTA III, JETTA IV, MULTIVAN V, PASSAT, PASSAT ALLTRACK, PASSAT CC, PHAETON, POLO, SCIROCCO, SHARAN, TIGUAN, TOUAREG, TOURAN, TRANSPORTER V

GE116

MERCEDES-BENZ C-CLASS (W203), C-CLASS Coupe (CL203), C-CLASS T-Model (S203), E-CLASS (W211), E-CLASS T-Model (S211)

GE117

OPEL ASTRA GTC J, ASTRA J, CORSA D, MERIVA B
VAUXHALL ASTRA GTC Mk VI (J), ASTRA Mk VI (J), CORSA Mk III (D), MERIVA Mk II (B)

GE118

MINI MINI, MINI CLUBMAN, MINI CLUBVAN, MINI COUNTRYMAN, MINI PACEMAN

GE119

VW PASSAT

GE120

SSANGYONG ACTYON SPORTS I, ACTYON SPORTS II, KORANDO, REXTON W

GE121A

CITROËN BERLINGO, C3 II, C3 Picasso, C4 AIRCROSS, C4 CACTUS, C4 Grand Picasso I, C4 Grand Picasso II, C4 II, C4 Picasso I, C4 Picasso II, C5 III, C8, C-ELYSEE, DS3, DS4, DS5, JUMPY
FORD B-MAX, C-MAX, C-MAX II, ECOSPORT, FIESTA, FIESTA VI, FOCUS III, GALAXY, GRAND C-MAX, KUGA I, KUGA II, MONDEO IV, S-MAX, TOURNEO CONNECT, TOURNEO COURIER, TRANSIT CONNECT, TRANSIT COURIER
MAZDA 2 (DE), 3 /Saloon (BL), 5 (CW)
PEUGEOT 207, 207 CC, 207 SW, 208, 301, 308, 308 CC, 308 II, 308 SW, 308 SW II, 407, 508, 508 SW, 807, 2008, 3008, 4008, 5008, EXPERT, EXPERT Tepee, PARTNER, PARTNER Tepee, RCZ
VOLVO C30, S40 II, S60 II, S80 II, V40, V50, V60, V70 III



GE122

FORD RANGER, TOURNEO CUSTOM,
TRANSIT, TRANSIT CUSTOM
PEUGEOT BOXER

GE123

VOLVO C30, C70 II, S40 II, S60 I, S80 II,
V50, V70 II, V70 III, XC60,
XC70 CROSS COUNTRY, XC70 II, XC90 I

GE124

RENAULT MASTER III

GE125

CHEVROLET CAPTIVA, CRUZE, EPICA,
LACETTI, NUBIRA
DAEWOO TOSCA
OPEL ANTARA
VAUXHALL ANTARA

GE126

OPEL ASTRA J, MERIVA B,
ZAFIRA TOURER C
VAUXHALL ASTRA Mk VI (J),
MERIVA Mk II (B), ZAFIRA Mk III

GF006

IVECO DAILY III

GF683

ALFA ROMEO AR 6, AR 8

GF859

FORD TRANSIT

GF974

IVECO DAILY I, DAILY II, DAILY III, MK

GF982-B

FORD TRANSIT, TRANSIT TOURNEO

GF983

FORD TRANSIT, TRANSIT TOURNEO

GF984

FIAT DUCATO
IVECO DAILY II, DAILY III
OPEL MOVANO
VAUXHALL MOVANO Mk I (A)

GH011

MERCEDES-BENZ
T2/LN1 Box Body / Estate/Platform/
Chassis, T2/LN1 Bus, UNIMOG

GH760

FORD TRANSIT

GN003

CHRYSLER PT CRUISER
JEEP GRAND CHEROKEE II
MERCEDES-BENZ C-CLASS (W202),
C-CLASS (W203), C-CLASS Coupe (CL203),
C-CLASS Estate (S202),
C-CLASS T-Model (S203),
CLC-CLASS (CL203), CLK (C209),
E-CLASS (W210), E-CLASS (W211),
E-CLASS Estate (S210),
E-CLASS T-Model (S211), G-CLASS (W461),
G-CLASS (W463), G-CLASS Cabrio (W463),
M-CLASS (W163), S-CLASS (W220),
SPRINTER 2-t Box/Bus/Platform/
Chassis (901, 902),
SPRINTER 3,5-t Box (906),
SPRINTER 3,5-t Box/Bus/Platform/
Chassis (906),
SPRINTER 3,5-t Box/Platform/
Chassis (906), SPRINTER 3-t Box (906),
SPRINTER 3-t Box/Bus/Platform/
Chassis (903),
SPRINTER 3-t Box/Bus/Platform/
Chassis (906), SPRINTER 3-t Box/Platform/
Chassis (906), SPRINTER 3-t Bus (906),
SPRINTER 4,6-t Box (906),
SPRINTER 4,6-t Box/Platform/
Chassis (906) 4,6-t,
SPRINTER 4-t Box/Bus/Platform/
Chassis (904), SPRINTER 4-t Box/Platform/
Chassis (904), SPRINTER 5-t Box (906),
SPRINTER 5-t Box/Platform/
Chassis (906) 5-t, SPRINTER 5-t Platform/
Chassis (905), SPRINTER Dumpertruck (905),
V-CLASS (638/2), VIANO (W639),
VITO Box/Bus (638), VITO Bus (W639),
VITO / MIXTO Box (W639)

GN005

FORD RANGER
KIA BESTA, K2700, PREGIO, RETONA,
SPORTAGE
MAZDA 323 C IV (BG),
323 III /Hatchback (BF),
323 III Station Wagon (BW), 323 P V (BA),
323 S IV (BG), 323 S V (BA),
626 II /Hatchback (GC),
626 III /Hatchback (GD),
626 III Station Wagon (GV), 626 IV (GE),
626 IV Hatchback (GE), B-SERIE (UF),
B-SERIE (UN), E-SERIE Box (SR2),
MPV I (LV)
SUZUKI GRAND VITARA I (FT, GT),
VITARA (ET, TA)

GN007

ALFA ROMEO 155, 164
CHRYSLER VOYAGER II, VOYAGER III
FORD SCORPIO II
JEEP CHEROKEE, GRAND CHEROKEE I,
GRAND CHEROKEE II
OPEL FRONTERA A
ROVER 800

...GN007

VAUXHALL FRONTERA Mk I (A)

GN008

AUDI A4, A6, A8, ALLROAD
SKODA SUPERB
VW PASSAT

GN010

MERCEDES-BENZ A-CLASS (W168),
Vaneo (414)

GN012

CITROËN JUMPER
FIAT DUCATO
IVECO DAILY II, DAILY III
PEUGEOT BOXER
RENAULT MASTER II

GN013

ALFA ROMEO 145, 146, 155, 164, AR 6
BEDFORD BLITZ
BMW 3 (E36), 3 /Compact/Touring (E36),
3 /Touring (E30), 3 /Touring (E36),
5 (E34), 5 (E39), 5 /Touring (E34),
5 Touring (E34), 5 Touring (E39), 7 (E38)
CHRYSLER VOYAGER II, VOYAGER III
CITROËN BERLINGO, C25, EVASION,
JUMPER, JUMPY, XANTIA, XM, XSARA, ZX
FIAT CROMA, DUCATO, FIORINO,
FIORINO Pick up, PALIO, PUNTO, SCUDO,
STRADA, TEMPRA, TIPO, ULYSSE
HYUNDAI LANTRA II
LADA NIVA
LANCIA DEDRA, DELTA II, THEMA
LAND ROVER RANGE ROVER II
OPEL ASCONA C, ASTRA F, ASTRA G,
FRONTERA A, KADETT D, KADETT E,
OMEGA A, OMEGA B, REKORD E,
SENATOR A, VECTRA A
PEUGEOT 205, 205 II, 306, 306 Van,
405 I, 405 II, 406, 605, 806, BOXER,
EXPERT, J5, PARTNER
RENAULT 21, SAFRANE I
SUZUKI SAMURAI (SJ), VITARA (ET, TA),
VITARA Cabrio (ET, TA)
VAUXHALL ASTRA Mk III (F),
ASTRA Mk IV (G), ASTRAMAX,
ASTRAVAN Mk III (F), ASTRAVAN Mk IV (G),
CARLTON Mk III, CAVALIER Mk III,
OMEGA (B), ROYALE

GN015

SMART CABRIO, CITY-COUPE, FORTWO

GN016

CITROËN AX, BERLINGO, C15, JUMPY,
SAXO, XSARA
FIAT SCUDO
NISSAN MICRA II
PEUGEOT 106 I, 106 II, 106 Van, 206,
206 Van, 306, EXPERT, PARTNER

...GN016

ROVER 100 / METRO
TOYOTA COROLLA

GN017

ALFA ROMEO 145, 146, 156, 166
FIAT BRAVA, BRAVO I, MAREA, MULTIPLA
MITSUBISHI L 300

GN018

DACIA DUSTER, LOGAN, LOGAN MCV,
SANDERO
MITSUBISHI CARISMA, SPACE STAR
NISSAN ALMERA II, INTERSTAR, KUBISTAR,
MICRA III, NOTE, NV200, NV200 EVALIA,
PRIMASTAR, PRIMERA,
QASHQAI / QASHQAI +2, TIIDA
OPEL MOVANO, VIVARO
RENAULT CLIO Grandtour, CLIO II,
CLIO III, DUSTER, ESPACE III, ESPACE IV,
GRAND SCÉNIC II, KANGOO,
KANGOO BE BOP,
KANGOO / GRAND KANGOO, LAGUNA I,
LAGUNA II, LAGUNA III, LOGAN,
LOGAN EXPRESS, MASTER II, MEGANE I,
MEGANE II, MODUS / GRAND MODUS,
SCÉNIC I, SCÉNIC II, THALIA I, THALIA II,
TRAFIC II, TWINGO II
SUZUKI GRAND VITARA II (JT), JIMNY (FJ)
VAUXHALL MOVANO Mk I (A), VIVARO
VOLVO S40 I, V40

GN019

DACIA SOLENZA
RENAULT CLIO II, KANGOO, MEGANE I,
SCÉNIC I

GN022

FORD ESCORT '95, ESCORT VI, ESCORT VII,
FIESTA, FIESTA IV, MONDEO II
MAZDA 121 III (JASM, JBSM)

GN024

BMW 3 (E46), 3 /Touring (E46),
5 /Touring (E39), 7 (E38), X5 (E53)
LAND ROVER FREELANDER,
RANGE ROVER III
MG MG ZT, MG ZT- T
OPEL OMEGA B
ROVER 75
VAUXHALL OMEGA (B)

GN025

ALPINA D10
BMW 7 (E38)

GN026

NISSAN INTERSTAR, PRIMASTAR
OPEL MOVANO, VIVARO
RENAULT AVANTIME, ESPACE III,
ESPACE IV, LAGUNA II, MASTER II, TRAFIC II,
VEL SATIS



| | | | |
|---|--|---|--|
| ...GN026 VAUXHALL MOVANO Mk I (A), VIVARO | ...GN042 TOYOTA AURIS, AURIS TOURING SPORTS, AURIS VAN, COROLLA, ECHO, IQ, PROBOX/SUCCEED, URBAN CRUISER, VERSO S, YARIS, YARIS VERSO | GN053 ALFA ROMEO MITO FIAT 500, 500 C, DOBLO, FIORINO, IDEA, LINEA, PANDA, PUNTO, PUNTO EVO, PUNTO / GRANDE PUNTO, QUBO, SIENA, STRADA FORD KA LANCIA MUSA, YPSILON OPEL AGILA (A), AGILA (B), ASTRA H, COMBO, CORSA C, CORSA D, MERIVA, TIGRA SUZUKI IGNIS II, SPLASH, SWIFT III (MZ, EZ), SWIFT IV (FZ, NZ), WAGON R+ (MM) VAUXHALL AGILA Mk II (B), ASTRA Mk V (H), ASTRVAN Mk V (H), COMBO Mk II (C), COMBO TOUR Mk II (C), CORSA Mk II (C), CORSA Mk III (D), CORSAVAN Mk II (C), CORSAVAN Mk III (D), MERIVA Mk I (A), TIGRA | GN059 ALFA ROMEO 147, 156, 159, 166, BRERA, GT, SPIDER FIAT BRAVO II, CROMA, STILO LANCIA THESIS OPEL ASTRA H, SIGNUM, VECTRA C, ZAFIRA B SAAB 9-3, 9-5 VAUXHALL ASTRA Mk V (H), ASTRA TwinTop Mk V (H), ASTRVAN Mk V (H), SIGNUM, VECTRA Mk II (C), ZAFIRA Mk II (B) |
| GN027 CITROËN BERLINGO, C4 Grand Picasso I, C5 I, C5 II, C8, EVASION, JUMPER, JUMPY, XANTIA, XSARA, XSARA PICASSO FIAT DUCATO, SCUDO, ULYSSE LANCIA PHEDRA, ZETA PEUGEOT 206, 306, 307, 406, 607, 806, 807, BOXER, EXPERT, PARTNER | GN043 TOYOTA AVENSIS, CALDINA, CAMRY, CARINA E, CARINA II, COROLLA, CORONA, DELIBOY, HILUX, HILUX II, LAND CRUISER, LAND CRUISER 80, LITEACE, MASTER ACE SURF, MODELL F, SPRINTER, VISTA | GN044 NISSAN PATROL | GN060 SSANGYONG ACTYON I, ACTYON SPORTS I, KYRON, REXTON, RODIUS |
| GN030 FIAT DOBLO, PALIO, PUNTO, SIENA, STRADA | GN045 CITROËN C5 III, C6 JAGUAR S-TYPE, XF, XJ LAND ROVER DISCOVERY III, DISCOVERY IV, RANGE ROVER III, RANGE ROVER SPORT PEUGEOT 407, 607 VOLVO S60 I, S80 I, V70 II, XC70 CROSS COUNTRY, XC90 I | GN054 CITROËN C4, C4 I, C4 Picasso I, C5 I, C5 II, C5 III, C8, JUMPER, JUMPY FIAT SCUDO, ULYSSE FORD C-MAX, FOCUS C-MAX, FOCUS II, GALAXY, KUGA I, MONDEO IV, S-MAX LANCIA PHEDRA PEUGEOT 307, 308, 308 CC, 308 SW, 406, 407, 508, 508 SW, 607, 807, BOXER, EXPERT, EXPERT Tepee SUZUKI GRAND VITARA I (FT, GT) VOLVO C30, C70 II, S40 II, S80 II, V50, V70 III | GN061 ISUZU KB, TROOPER OPEL CAMPO, FRONTERA A VAUXHALL BRAVA, FRONTERA Mk I (A) |
| GN033 CHEVROLET ASTRA OPEL ASTRA G, FRONTERA B, OMEGA B, SIGNUM, VECTRA B, VECTRA C, ZAFIRA A SAAB 9-3 VAUXHALL ASTRA Mk IV (G), FRONTERA Mk II (B), OMEGA (B), SIGNUM, VECTRA (B), VECTRA Mk II (C), ZAFIRA Mk I (A) | GN046 AUDI A2, A3, A4, A6 FORD GALAXY JEEP CHEROKEE ROVER 45 SEAT ALHAMBRA, AROSA, CORDOBA, IBIZA IV, LEON, TOLEDO II SKODA FABIA, OCTAVIA, ROOMSTER, ROOMSTER Praktik, SUPERB VW BORA, CADDY III, FOX, GOLF IV, LUPO, MULTIVAN V, NEW BEETLE, PASSAT, PHAETON, POLO, SHARAN, TOUAREG, TRANSPORTER V | GN055 CHRYSLER VOYAGER IV JEEP CHEROKEE | GN062 HYUNDAI ACCENT, ACCENT III, ELANTRA, GETZ, i10, i20, i30, ix20, MATRIX KIA CARENS III, CARENS IV, CEE'D, CERATO, OPTIMA, PICANTO, PRO CEE'D, RIO II, RIO III, SOUL, SOUL II, VENG A |
| GN035 HYUNDAI ACCENT, ACCENT II, ELANTRA, GETZ, GRANDEUR, i30, MATRIX, SANTA FÉ I, SANTA FÉ II, SONATA IV, SONATA V, TRAJET, TUCSON KIA CARENS II, CARENS III, CARNIVAL I, CARNIVAL II, CEE'D, CERATO, MAGENTIS, PRO CEE'D, SPORTAGE | GN047 CITROËN BERLINGO, C2, C2 ENTERPRISE, C3, C3 I, C4, C4 I, C5 II, XSARA, XSARA PICASSO FORD FIESTA, FIESTA V, FOCUS C-MAX, FOCUS II, FUSION MAZDA 2 (DE), 2 (DY), 3 /Saloon (BK) PEUGEOT 206, 206+, 206 Van, 307, 407, PARTNER, PARTNER Tepee SUZUKI LIANA (ER), LIANA Estate (ER) TOYOTA AYGO VOLVO C30, S40 II, V50 | GN056 CITROËN BERLINGO, C1, C2, C3, C3 I, C3 II, C3 Picasso, C4, C4 Grand Picasso I, C4 I, C4 Picasso I, C5 II, C5 III, JUMPY, NEMO, XSARA PICASSO FIAT SCUDO FORD C-MAX, FIESTA, FIESTA V, FIESTA VI, FOCUS C-MAX, FOCUS II, FUSION MAZDA 3 (BK), 3 (BL), 3 Saloon (BL) MINI MINI, MINI CLUBMAN PEUGEOT 107, 206, 206+, 206 Van, 207, 207 CC, 207 SW, 307, 308, 308 SW, 407, 1007, 3008, 5008, BIPPER, BIPPER Tepee, EXPERT, EXPERT Tepee, PARTNER, PARTNER Tepee VOLVO C30, S40 II, S80 II, V50, V70 III | GN063 CITROËN C5 II, C5 III, C6, C8, C-CROSSER, C-CROSSER ENTERPRISE FIAT ULYSSE FORD GALAXY, MONDEO IV, S-MAX JAGUAR XF, XF SPORTBRAKE, X-TYPE LANCIA PHEDRA LAND ROVER FREELANDER 2, RANGE ROVER EVOQUE MITSUBISHI OUTLANDER II PEUGEOT 407, 607, 807, 4007 |
| GN037 CITROËN JUMPER FIAT DUCATO IVECO DAILY III, DAILY IV, DAILY V, MASSIF PEUGEOT BOXER | GN050 VW LT 28-35 II, LT 28-46 II | GN057 HYUNDAI H-1, H-1 / STAREX, PORTER KIA SORENTO I | GN064 MAZDA 3 (BK), 3 Saloon (BK), 5 (CR19), 6 /Estate/Hatchback (GH), 6 /Hatchback (GG), 6 Station Wagon (GY), 323 F VI (BJ), 323 S VI (BJ), 626 V /Hatchback (GF), 626 V Station Wagon (GW), MPV II (LW), PREMACY (CP) |
| GN039 NISSAN CABSTAR E, SERENA, VANETTE CARGO | GN051 MINI MINI | GN058 MITSUBISHI COLT VI SMART FORFOUR | GN065 TOYOTA AVENSIS, AVENSIS VERSO, COROLLA, DYNA, FORTUNER, HIACE / COMMUTER IV, HIACE III, HIACE IV, HILUX II, HILUX III, KIJANG INNOVA, LAND CRUISER, PREVIA, RAV 4 II, REGIUSACE |
| GN042 MINI MINI | | | GN066 MERCEDES-BENZ G-CLASS (W461) |



GN067

mitsubishi CANTER, GALANT VI, PAJERO II, PAJERO SPORT

GN068

toyota DYNA, FORTUNER, HIACE / COMMUTER IV, HIACE IV, HILUX III, LAND CRUISER, LAND CRUISER 90, LAND CRUISER 150

GN069

ALFA ROMEO 147, 159, BRERA, GT

GN070

mitsubishi CANTER, PAJERO III, PAJERO IV

GN072

NISSAN CABSTAR, CARAVAN, ELGRAND, INTERSTAR, PATROL GR II, PATROL II, PICK UP, TERRANO II, TERRANO Van, URVAN
RENAULT MASTER II

GN073

HONDA ACCORD VII, CIVIC VI, CIVIC VIII, CR-V II, CR-V III, FR-V

GN075

NISSAN PATROL GR II

GN095

ISUZU D-MAX, N-Serie

GN096

TOYOTA YARIS

GN097

ALFA ROMEO 147, 159
FIAT BRAVO II, CROMA, DOBLO, MULTIPLA, PUNTO, PUNTO / GRANDE PUNTO, STILO
OPEL ASTRA H, SIGNUM, VECTRA C, ZAFIRA B
SAAB 9-3
SUZUKI SX4 (GY)
VAUXHALL ASTRA Mk V (H), ASTRVAN Mk V (H), SIGNUM, VECTRA Mk II (C), ZAFIRA Mk II (B)

GN101

NISSAN AD Van, AD Wagon, BLUEBIRD, ELGRAND, PICK UP, SERENA, SUNNY, SUNNY II, TERRANO Van, VANETTE

GN102

NISSAN AD Van, ALMERA I, AVENIR, LUCINO, PRIMERA, SUNNY III

GN103

ISUZU TROOPER
OPEL ASTRA F, COMBO, CORSA B, VECTRA A, VECTRA B

...GN103

VAUXHALL ASTRA Mk III (F), CAVALIER Mk III, COMBO Mk I (B), CORSA Mk I (B), CORSAVAN Mk I (B), VECTRA (B)

GN104

HONDA CIVIC VII
OPEL ASTRA G, ASTRA GTC J, ASTRA H, ASTRA J, COMBO, CORSA C, CORSA D, MERIVA, MERIVA B, ZAFIRA B
VAUXHALL ASTRA GTC Mk VI (J), ASTRA Mk IV (G), ASTRA Mk V (H), ASTRA Mk VI (J), ASTRVAN Mk IV (G), ASTRVAN Mk V (H), COMBO Mk II (C), COMBO TOUR Mk II (C), CORSA Mk II (C), CORSA Mk III (D), CORSAVAN Mk II (C), MERIVA Mk I (A), MERIVA Mk II (B), ZAFIRA Mk II (B)

GN106

OPEL SIGNUM, VECTRA C
RENAULT ESPACE IV, VEL SATIS
SAAB 9-5
VAUXHALL SIGNUM, VECTRA Mk II (C)

GN107

HYUNDAI GALLOPER I, GALLOPER II, H-1, H-1 / STAREX, PORTER, TERRACAN
KIA K2500, PREGIO
mitsubishi GALANT V, GALANT VI, GALLOPER, L 200, L 300, L 400, L 400 / SPACE GEAR, LANCER V, LANCER VI, PAJERO CLASSIC, PAJERO II, PAJERO III, PAJERO SPORT, PAJERO SPORT VAN, SPACE RUNNER, SPACE WAGON

GN108

LEXUS IS II
toyota AURIS, AVENSIS, COROLLA, LAND CRUISER, RAV 4 III, RAV 4 IV, VERSO

GN109

NISSAN ALMERA II, ALMERA TINO, CABSTAR, NAVARA, NP300, PATHFINDER, PICK UP, PRIMERA, X-TRAIL

GN110

toyota 4 RUNNER, COROLLA, CRESTA, DELIBOY, GAIA, GRANVIA, HILUX, HILUX II, LAND CRUISER, LAND CRUISER 90, LITEACE, NADIA, PICNIC, SPRINTER

GN853

NISSAN SERENA, VANETTE CARGO

GN854

FORD MAVERICK
NISSAN PATROL GR II, TERRANO I

GN855

AUDI 80, 100, A3, A4, A6, CABRIOLET
FORD GALAXY
RENAULT GRAND SCÉNIC II
SEAT ALHAMBRA, AROSA, CORDOBA, IBIZA II, IBIZA III, INCA, LEON, TOLEDO I, TOLEDO II
SKODA FABIA, OCTAVIA
VOLVO 850, S70, S80 I, V70 I, V70 II
VW BORA, CADDY II, GOL, GOLF III, GOLF IV, LT 28-35 II, LT 28-46 II, LUPO, NEW BEETLE, PASSAT, POLO, SHARAN, TRANSPORTER IV, VENTO, VOYAGE

GN857

AUDI 80, 90, 100
NISSAN TRADE
SEAT CORDOBA, IBIZA II, INCA, TERRA, TOLEDO I
SKODA FELICIA I, FELICIA II
VOLVO 240, 740, 760, 780, 940, 940 II, 960
VW CADDY I, CADDY II, GOLF I, GOLF II, GOLF III, GOLF IV, ILTIS, JETTA I, JETTA II, LT 28-35 I, LT 40-55 I, PARATI, PASSAT, POINTER, POLO, QUANTUM, SANTANA, TRANSPORTER III, TRANSPORTER IV, VENTO

GN858

DAEWOO KORANDO, MUSSO, REXTON
MERCEDES-BENZ 100 Box/Bus (631), 100 Box/Bus/Platform/Chassis (631), 100 Bus (631), 190 (W201), C-CLASS (W202), E-CLASS (W124), E-CLASS Estate (S124), G-CLASS (W460), G-CLASS (W461), G-CLASS (W463), G-CLASS Cabrio (W463), KOMBI Estate (S124), Saloon (W124), S-CLASS (W140), SPRINTER 2-t Box/Bus/Platform/Chassis (901, 902), SPRINTER 2-t Box/Platform/Chassis (901, 902), SPRINTER 3-t Box/Bus/Platform/Chassis (903), SPRINTER 4-t Box/Platform/Chassis (904), T1 Box/Bus (601), T1 Box/Bus/Platform/Chassis (601), T1 Box/Bus/Platform/Chassis (602), T1 Platform/Chassis (601), T1/TN Box Body / Estate/Platform/Chassis, T2/LN1 Box Body / Estate/Dumptruck, V-CLASS (638/2), VITO Box (638), VITO Box/Bus (638), VITO Bus (638)
SSANGYONG ISTANA, KORANDO, MUSSO, REXTON

GN860

MERCEDES-BENZ C-CLASS (W202), E-CLASS (W124), E-CLASS Estate (S124)

GN905

HONDA ACCORD VI
LAND ROVER FREELANDER
ROVER 25, 45, 200, 400, 600, STREETWISE

GN908

ALFA ROMEO 145, 146, 155, 164, AR 6
FIAT DUCATO, FIORINO, FIORINO Pick up, PALIO, PUNTO, SIENA, TEMPRA, TIPO, ULYSSE
LANCIA DEDRA, DELTA II, THEMA, ZETA

GN909

ALFA ROMEO AR 6, AR 8
ARO 240-244
BEDFORD ASTRAMAX, ASTRA VAN
BMW 3 (E30), 5 (E28)
CITROËN BERLINGO, BX, C15, C25, C35, CX I, CX II, EVASION, JUMPER, JUMPY, VISA, XANTIA, XM, ZX
FIAT 127, 131, 132, 147, 242-SERIE, ARGENTA, BRAVA, BRAVO I, CAMPAGNOLA, CROMA, DUCATO, DUNA, ELBA, FIORINO, FIORINO Pick up, PANDA, REGATA, RITMO I, RITMO II, SCUDDO, TALENTO, TIPO, UNO
FORD GRANADA, SCORPIO I, SIERRA
FSO POLONEZ II, POLONEZ III
JEEP CHEROKEE
LADA NIVA
LANCIA DEDRA, DELTA I, PRISMA, THEMA
LAND ROVER 88/109, 90/110
MERCEDES-BENZ 100 Box/Bus (631), 100 Platform/Chassis (631), 190 (W201), COUPE (C123), G-CLASS (W460), KOMBI Estate (S123), KOMBI Estate (S124), Saloon (W123), Saloon (W124), SPRINTER 2-t Box/Bus/Platform/Chassis (901, 902), SPRINTER 3-t Box (903), SPRINTER 3-t Box/Bus/Platform/Chassis (903), SPRINTER 3-t Bus (903), SPRINTER 4-t Box (904), SPRINTER 4-t Box/Platform/Chassis (904), SPRINTER 4-t Platform/Chassis (904), T1 Box (601), T1 Box/Platform/Chassis (601), T1 Box/Platform/Chassis (602), T1 Bus (601), T1 Bus/Platform/Chassis (601), T1 Platform/Chassis (602)
OPEL ASCONA B, KADETT E, REKORD E
PEUGEOT 205, 205 I, 205 II, 305 I, 305 II, 306, 309 I, 309 II, 405 I, 405 II, 406, 504, 505, 604, 605, 806, BOXER, EXPERT, J5, J7, J9, PARTNER
RENAULT 18, 19 I, 20, 21, 25, 30, CLIO I, ESPACE I, ESPACE II, EXPRESS, FUEGO, MASTER I, RAPID, SAFRANE I, SUPER 5, TRAFIC
ROVER 200, 400, 800, MAESTRO, MONTEGO
SEAT 132, IBIZA I, MALAGA, RONDA
SSANGYONG ISTANA



| | | | |
|--|---|---|---|
| ...GN909 SUZUKI BALENO (EG), BALENO Estate/Hatchback (EG), VITARA (ET, TA), VITARA Cabrio (ET, TA) TALBOT 180, EXPRESS 1000 -1500, EXPRESS 1000 -1800, HORIZON, SIMCA 1609/1610, TAGORA VAUXHALL ARENA, ASTRA, ASTRA Mk II, ASTRA Mk III (F), BRAVA, CARLTON Mk II, CARLTON Mk III, CAVALIER Mk II, CAVALIER Mk III, FRONTERA Mk I (A) | GN954 BEDFORD BLITZ CHRYSLER VOYAGER II, VOYAGER III CITROËN BX, C15 FIAT PENNY, STRADA IVECO DAILY I JEEP CHEROKEE, COMANCHE LAND ROVER 90/110, DEFENDER MERCEDES-BENZ SPRINTER 3-t Bus (903), SPRINTER 3-t Platform/Chassis (903) OPEL ASCONA C, ASTRA F, ASTRA G, FRONTERA A, KADETT D, KADETT E, OMEGA A, REKORD E, SENATOR A, VECTRA A PEUGEOT 504, 505 RENAULT 21, ESPACE II, MASTER I, TRAFIC TALBOT EXPRESS 1000 -1500, EXPRESS 1000 -1800 VAUXHALL ASTRA Mk III (F), ASTRA Mk IV (G), ASTRAMAX, ASTRAVAN Mk III (F), ASTRAVAN Mk IV (G), CARLTON Mk III, CAVALIER Mk III, ROYALE | GN970 FIAT BRAVA, BRAVO I, MAREA LANCIA KAPPA GN985 LAND ROVER DEFENDER, DISCOVERY II GN989 VW LT 28-35 II, LT 28-46 II GN991 RENAULT CLIO I, EXPRESS, MEGANE I, RAPID GN992 OPEL ASTRA G, FRONTERA B, OMEGA B, SINTRA, VECTRA B, ZAFIRA A SAAB 9-3, 9-5 VAUXHALL ASTRA Mk IV (G), ASTRAVAN Mk IV (G), FRONTERA Mk II (B), OMEGA (B), SINTRA, VECTRA (B), ZAFIRA Mk I (A) GN993 FORD C-MAX, FIESTA, FIESTA IV, FOCUS, FOCUS C-MAX, FOCUS II, GALAXY, MONDEO IV, S-MAX, TOURNEO CONNECT, TRANSIT CONNECT, TRANSIT TOURNEO GN994 FORD MAVERICK NISSAN PICK UP, TERRANO II GN997 ISUZU TROOPER OPEL MONTEREY B VAUXHALL MONTEREY Mk II GN999 HONDA ACCORD V MG EXPRESS, MG ZR, MG ZS RENAULT ESPACE III, LAGUNA I, MEGANE, MEGANE I, SAFRANE II, SCÉNIC I ROVER 25, 45 VOLVO S40 I, V40 | GV130 CITROËN C35, CX I FIAT 242-SERIE GV137 OPEL ASCONA B, REKORD D, REKORD E, SENATOR A GV602 ALFA ROMEO AR 6, AR 8 CITROËN C25, C35, CX I, CX II FIAT 147, CAMPAGNOLA, FIORINO, RITMO I FORD GRANADA LAND ROVER 88/109, 90/110 OPEL ASCONA B, REKORD E PEUGEOT 504, 505, 604, J5 RENAULT 20 SEAT IBIZA I, MALAGA, RITMO, RONDA GV603 MERCEDES-BENZ 100 Box/Bus (631), 100 Platform/Chassis (631), 190 (W201), COUPE (C123), G-CLASS (W460), KOMBI Estate (S123), KOMBI Estate (S124), Saloon (W123), Saloon (W124), SPRINTER 3-t Box (903), T1 Box (601), T1 Box/Platform/Chassis (601), T1 Box/Platform/Chassis (602), T1 Bus (601), T1 Bus/Platform/ Chassis (601), T1 Platform/Chassis (602), T1/TN Box Body / Estate/Platform/ Chassis, T2/L Box Body / Estate/Platform/ Chassis, T2/LN1 Box Body / Estate/Platform/ Chassis, T2/LN1 Dumptruck |
| GN912 CITROËN AX, SAXO NISSAN MICRA II PEUGEOT 106 I, 106 II ROVER 100 / METRO | GN955 HYUNDAI GALLOPER II, H-1, H-1 / STAREX, H100, PORTER, TERRACAN KIA K2500 | GN994 NISSAN PICK UP, TERRANO II | GV604 BEDFORD BLITZ FORD TRANSIT |
| GN917 FIAT DUCATO RENAULT SAFRANE I | GN959 ARO 10 MITSUBISHI CARISMA NISSAN BLUEBIRD RENAULT 19 I, 19 II, MEGANE, MEGANE I VOLVO 440 K, 460 L, S40 I, V40 | GN997 ISUZU TROOPER OPEL MONTEREY B VAUXHALL MONTEREY Mk II | GV631 FORD ESCORT '81, ESCORT '86, ESCORT III, ESCORT IV, FIESTA, FIESTA II, ORION I, ORION II |
| GN925 FIAT CROMA LANCIA THEMA | GN961 MERCEDES-BENZ E-CLASS (W210), E-CLASS Estate (S210), G-CLASS (W461), SPRINTER 2-t Box/Bus/Platform/ Chassis (901, 902), SPRINTER 3-t Box (903), SPRINTER 3-t Box/Bus/Platform/ Chassis (903), SPRINTER 3-t Bus (903), SPRINTER 3-t Platform/Chassis (903), SPRINTER 4-t Box (904), SPRINTER 4-t Box/Platform/Chassis (904), SPRINTER 4-t Platform/Chassis (904), VARIO Box Body / Estate/Dumptruck/ Platform/Chassis, VARIO Box Body / Estate/Platform/Chassis, VARIO Bus SSANGYONG ISTANA | GN999 HONDA ACCORD V MG EXPRESS, MG ZR, MG ZS RENAULT ESPACE III, LAGUNA I, MEGANE, MEGANE I, SAFRANE II, SCÉNIC I ROVER 25, 45 VOLVO S40 I, V40 | GV636 ARO 240-244 BEDFORD ASTRAMAX, ASTRA VAN BMW 3 (E30), 5 (E28) CITROËN BX, C15, C25, C35, VISA, XANTIA, XM, ZX FIAT ELBA FSO POLONEZ III LADA NIVA OPEL KADETT E PEUGEOT 205, 205 I, 205 II, 305 I, 305 II, 306, 309 I, 309 II, 405 I, 405 II, 504, 505, 604, 605, J5, J9 ROVER 200, 400, MAESTRO, MONTEGO TALBOT 180, HORIZON, SIMCA 1609/1610, TAGORA |
| GN927 BEDFORD BLITZ CITROËN AX FIAT DUCATO FORD ESCORT '81, ESCORT '86, ESCORT '91, ESCORT '95, ESCORT CLASSIC, ESCORT III, ESCORT IV, ESCORT V, ESCORT VI, ESCORT VII, FIESTA, FIESTA II, FIESTA III, MONDEO I, ORION I, ORION II, ORION III, P 100 II, SIERRA, TRANSIT IVECO DAILY I, DAILY II OPEL ARENA, MOVANO PEUGEOT 106 I RENAULT MASTER I, MASTER II, TRAFIC ROVER 100 / METRO VAUXHALL MOVANO Mk I (A) | GN963 OPEL ARENA RENAULT CLIO II, KANGOO, MEGANE, THALIA I, TRAFIC VAUXHALL ARENA | GV001 TOYOTA CRESSIDA, MARK II, LAND CRUISER | |
| GN939 CITROËN JUMPER FIAT DUCATO FORD GALAXY, MONDEO III, TRANSIT, TRANSIT TOURNEO JAGUAR X-TYPE LAND ROVER DEFENDER PEUGEOT BOXER | GN964 CITROËN JUMPER PEUGEOT BOXER | GV106 OPEL REKORD D GV107 FORD GRANADA PEUGEOT 504, J7 GV108 PEUGEOT 504, J7 | |
| GN944 OPEL VECTRA B VAUXHALL VECTRA (B) | | | |
| GN948 MERCEDES-BENZ C-CLASS (W202), C-CLASS Estate (S202), E-CLASS (W210), E-CLASS Estate (S124), E-CLASS Estate (S210), G-CLASS (W463), G-CLASS Cabrio (W463), S-CLASS (W140) | | | |



...GV636

VAUXHALL ASTRA, ASTRA Mk II, ASTRA Mk III (F), BRAVA, CARLTON Mk II, CARLTON Mk III, CAVALIER Mk II, CAVALIER Mk III, FRONTERA Mk I (A)

GV642

ALFA ROMEO AR 8
FIAT 131, 132, 242-SERIE, ARGENTA, CROMA
FSO POLONEZ II
RENAULT 18, 19 I, 20, 21, 25, 30, ESPACE I, ESPACE II, FUEGO, MASTER I, SAFRANE I, TRAFIC
SEAT 131, 132
VAUXHALL ARENA

GV657

ALFA ROMEO 6, 33, 75, 90, 164, ALFETTA, GIULIA, GIULIETTA
LAND ROVER RANGE ROVER I
ROVER 2000-3500

GV661

CITROËN AX, ZX
PEUGEOT 106 I
ROVER 100 / METRO

GV663

FIAT 127, BRAVA, BRAVO I, CROMA, DUCATO, DUNA, ELBA, FIORINO, FIORINO Pick up, REGATA, RITMO II, TALENTO, TIPO, UNO
LANCIA DEDRA, DELTA I, PRISMA
SEAT IBIZA I, MALAGA

GV666

FORD ESCORT '86, ESCORT '91, ESCORT '95, ESCORT CLASSIC, ESCORT IV, ESCORT V, ESCORT VI, ESCORT VII, FIESTA, FIESTA III, MONDEO I, ORION II, ORION III, P 100 II, SIERRA

GV673

MITSUBISHI COLT II, COLT III, GALANT II, L 200, L 300, LANCER III, PAJERO I, PAJERO II

GV685

NISSAN CHERRY III, SUNNY I

GV688

TOYOTA CRESSIDA, CROWN, HIACE I

GV689

NISSAN LAUREL

GV705

FORD ECONOVAN
MAZDA 626 II (GC), E-SERIE Box (SR2), E-SERIE Bus, E-SERIE Bus (SR1), E-SERIE Platform/Chassis (SD1)

GV719

BMW 3 (E36), 3 /Compact/Touring (E36), 3 /Touring (E30), 3 /Touring (E36), 5 (E34), 5 (E39), 5 /Touring (E34), 5 Touring (E34), 5 Touring (E39), 7 (E38)
LAND ROVER RANGE ROVER II
OPEL OMEGA B
VAUXHALL OMEGA (B)

GV730

FIAT CROMA

GV736

MERCEDES-BENZ G-CLASS (W460)

GV749

ISUZU CAMPO, GEMINI, TROOPER
OPEL CORSA A, VECTRA A
VAUXHALL NOVA

GV783

LAND ROVER DEFENDER, DISCOVERY I, RANGE ROVER I

GV844

RENAULT 19 I, 19 II
VOLVO 440 K, 460 L

GV852

JEEP CHEROKEE
RENAULT 9, 11, 19 I, 19 II, CLIO I, RAPID
VOLVO 340-360

GV886

DAIHATSU CHARADE II, ROCKY Hard Top, ROCKY Soft Top, RUGGER, TAFT, WILDCAT/ROCKY
TOYOTA CAMRY, CARINA, CARINA II, COROLLA, COROLLA FX, LITEACE, MASTER ACE SURF, MODELL F

GV887

NISSAN PATROL, URVAN

GV888

NISSAN BLUEBIRD, LAUREL

GV889

NISSAN PICK UP

GV890

NISSAN PATROL

GV892

NISSAN PICK UP, URVAN

GV894

TOYOTA CRESSIDA, DYNA, DYNA 150, HIACE, HIACE II, HILUX I, HILUX II, LAND CRUISER, STARLET

GV895

TOYOTA LAND CRUISER

GV920

NISSAN PATROL, PICK UP

GV921

HYUNDAI GALLOPER I, GALLOPER II, GRACE
KIA PREGIO
MITSUBISHI PAJERO I
NISSAN CABSTAR, PATROL GR I, PICK UP, URVAN

GV945

ISUZU ASKA, GEMINI, MIDI
OPEL CORSA A, KADETT E
VAUXHALL MIDI II, NOVA

GV946

ISUZU CAMPO, GEMINI, TROOPER
OPEL CAMPO, CORSA A, VECTRA A
SSANGYONG KORANDO
VAUXHALL BRAVA, CAVALIER Mk III, NOVA, NOVAVAN

GV947

BEDFORD MIDI
ISUZU ASKA, GEMINI, MIDI
OPEL ASTRA F, CAMPO, CORSA A, KADETT E, MONTEREY A
VAUXHALL ASTRA Mk II, ASTRA Mk III (F), BRAVA, CORSAVAN Mk I (B), MIDI II, MONTEREY, NOVA

GV967

DAIHATSU CHARADE III
TOYOTA LITEACE, TOWN ACE

GV968

TOYOTA 4 RUNNER, CHASER, CRESTA, CROWN, DYNA, DYNA 150, HIACE I, HIACE II, HIACE III, HIACE IV, HILUX, HILUX I, HILUX II, MARK II, KIJANG, LAND CRUISER, STARLET, TOWN ACE
VW TARO

PSG001

OPEL ASTRA GTC J, ASTRA J, INSIGNIA, ZAFIRA TOURER C
VAUXHALL ASTRA GTC Mk VI (J), ASTRA Mk VI (J), INSIGNIA, ZAFIRA Mk III

PSG002

AUDI A1, A3, A4, A4 Allroad, A5, A6, A6 Allroad, A7, A8, Q3, Q5, Q7, TT
SEAT LEON
SKODA FABIA, OCTAVIA
VW BEETLE, GOLF VI, GOLF VII, GOLF SPORTSVAN, JETTA III, JETTA IV, PASSAT, POLO, SCIROCCO, TOUAREG, XLI

PSG003

OPEL ASTRA J, CORSA D, MERIVA B
VAUXHALL ASTRA Mk VI (J), CORSA Mk III (D), MERIVA Mk II (B)

PSG004

OPEL ASTRA GTC J, ASTRA J, MOKKA
VAUXHALL ASTRA GTC Mk VI (J), ASTRA Mk VI (J), MOKKA

PSG005

OPEL ZAFIRA TOURER C
VAUXHALL ZAFIRA Mk III

PSG006

OPEL ASTRA GTC J, ASTRA J, CASCADA, INSIGNIA, ZAFIRA TOURER C
VAUXHALL ASTRA GTC Mk VI (J), ASTRA Mk VI (J), CASCADA, ZAFIRA Mk III

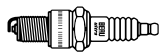

Z1
ALFA ROMEO 6
BMW 02 (E10), 3 (E21), 3 (E30), 5 (E12), 5 (E28), 6 (E24), 7 (E23)
HYUNDAI SONATA III
ISUZU GEMINI
JAGUAR E-TYPE, E-TYPE 2+2, XJ
LAND ROVER 88/109, RANGE ROVER I
MAZDA 626 III /Hatchback (GD), 626 III Station Wagon (GV), E-SERIE Box
MG MIDGET
MITSUBISHI LANCER III
NISSAN PRAIRIE, SUNNY II
PORSCHE 928
RENAULT 5, 9, 11, 18, 19 I, 19 II, 21, FUEGO, RAPID, SUPER 5, TRAFIC
TOYOTA CELICA, COROLLA
VW CADDY I, GOLF I, JETTA I, JETTA II, SCIROCCO

Z2
AUDI 80, 100, COUPE
SEAT CORDOBA, IBIZA II, TOLEDO I
VW GOLF I, GOLF II, GOLF III, JETTA I, JETTA II, LT 28-35 I, LT 40-55 I, PASSAT, POLO, SANTANA, SCIROCCO, TRANSPORTER IV, VENTO

Z3
BMW 3 (E30), 3 /Convertible (E30), 3 /Convertible/Touring (E30), 3 /Touring (E30), 5 (E28), 5 (E34), 6 (E24), 7 (E23), 7 (E32), Z1

Z4
BMW 3 (E30), 3 /Convertible (E30), 3 Touring (E30), 7 (E32), 8 (E31)

Z5
MERCEDES-BENZ COUPE (C124), KOMBI Estate (S124), Saloon (W124)
RENAULT CLIO I

Z6
ROVER 2000-3500

Z7
MERCEDES-BENZ 190 (W201), COUPE (C124), E-CLASS (W124), E-CLASS Estate (S124), G-CLASS (W461), G-CLASS (W463), G-CLASS Cabrio (W463), KOMBI Estate (S124), Saloon (W124), S-CLASS (W126), SL (R107), SL (R129), T1 Box (601), T1 Box/Bus (601), T1 Box/Bus/Platform/Chassis (601), T1 Platform/Chassis (602), T1/TN Box Body / Estate/Platform/Chassis, T2/L Box Body / Estate/Platform/Chassis, T2/L Dumptruck, T2/LN1 Box Body / Estate/Platform/Chassis

Z8
CHRYSLER VOYAGER II
DACIA NOVA
DAEWOO ESPERO, LANOS, NEXIA, NUBIRA, REZZO
DAIHATSU CHARADE I, CHARADE II, CHARMANT, HIJET, ROCKY Hard Top, ROCKY Soft Top, SPARCAR
FIAT 128, UNO
FORD ECONOVAN
HONDA ACCORD I, CIVIC I, CIVIC II, PRELUDE I, QUINTET
HYUNDAI PONY, STELLAR
MAZDA 121 I (DA), 121 II (DB), 323 I (FA), 323 I Station Wagon (FA), 323 II (BD), 323 II /Hatchback (BD), 323 II Hatchback (BD), 323 III /Hatchback (BF), 323 III Hatchback (BF), 323 III Station Wagon (BW), 626 I (CB), 626 II (GC), 626 II Coupe (GC), 626 II /Hatchback (GC), 626 II Hatchback (GC), 626 III Coupe (GD), 626 III Station Wagon (GV), 929 I (LA), 929 II (HB), 929 II /Coupe (HB), 929 II Coupe (HB), 929 II Estate (HV), 929 III (HC), B-SERIE (UF), E-SERIE Box (SR2), E-SERIE Bus (SR1)
MITSUBISHI COLT I, COLT LANCER, CORDIA, ECLIPSE II, L 300, LANCER F II, LANCER I, PAJERO I, SAPPORO II, TREDIA
NISSAN BLUEBIRD, CHERRY II, CHERRY III, DATSUN 120, DATSUN 120 Y, LAUREL, MICRA I, PATROL GR I, PICK UP, SUNNY, SUNNY I, SUNNY II, TERRANO I, URVAN, VANETTE
OPEL ASCONA C, ASTRA F, ASTRA F CLASSIC, CORSA A, KADETT E
RENAULT RAPID, TRAFIC
SEAT 124
SUZUKI ALTO I (SS80), ALTO II (EC), ALTO III (EF), CARRY Box (ST90V), LJ 80, SAMURAI (SJ), SJ 410, SJ 410 Cabrio, SJ 413, SUPER CARRY Bus (ED)
TOYOTA CAMRY, CARINA, CARINA II, CELICA, COROLLA, CRESSIDA, HIACE I, HIACE II, HIACE III, HILUX II, LAND CRUISER, LITEACE, MODELL F, STARLET, STARLET 1000, TERCEL
VW LT 28-35 I, TARO

Z9
CHEVROLET AVEO, KALOS, MATIZ, SPARK
CHRYSLER SARATOGA
DAEWOO KALOS, MATIZ, TICO
DAIHATSU CHARADE III, CHARADE IV, HIJET, SKYWING
HONDA ACCORD III, JAZZ I
HYUNDAI H-1, H-1 / STAREX, H100, PONY, PONY / EXCEL, PORTER, SONATA II, SONATA III, SONATA IV, SONATA V
ISUZU TROOPER
JAGUAR XJ

...Z9
KIA PRIDE, RIO, SEPHIA
MAZDA 121 I (DA), 323 C IV (BG), 323 F IV (BG), 323 III (BF), 323 III /Hatchback (BF), 323 III Hatchback (BF), 323 III Station Wagon (BW), 323 S IV (BG), 626 III (GD), 626 III Coupe (GD), 626 III Station Wagon (GV)
MITSUBISHI COLT II, COLT III, COLT IV, COLT V, GALANT III, GALANT IV, GALLOPER, L 300, LANCER III, LANCER IV, LANCER V, LANCER VI, PAJERO I, PAJERO II, SIGMA, STARION
NISSAN 280 ZX, ZXT, BLUEBIRD, MICRA I, SILVIA, SUNNY II
SUBARU JUSTY I, LIBERO
TOYOTA CAMRY, CARINA II, COROLLA, HIACE II, HIACE III, HIACE IV, LAND CRUISER 80, MODELL F, STARLET

Z10
ARO 10
CITROËN ID
DACIA 1300, 1310
FIAT 126, 500
MERCEDES-BENZ PONTON (W180)
MG MGB GT
RENAULT 4, 5, 6, 12, 15
ROVER 2000-3500
SKODA 105, 120
VOLVO 66, 140, 240, P 121, P 122 S AMAZON, P 2200

Z11
ALFA ROMEO 6, 33, 75, 90, 1750-2000, ALFASUD, ALFETTA, ALFETTA GT, GIULIA, GIULIETTA, GT, GTV, SPIDER
ALPINA B9, B10, B11, C1, C2
ASTON MARTIN LAGONDA I
AUDI 50, 60, 75, 80, 100, COUPE
AUSTIN 1000-Series MK II, ALLEGRO, MAESTRO, MAXI, METRO, MINI, PRINCESS
BMW 02 (E10), 02 Convertible (E10), 02 Touring (E6), 3 (E21), 5 (E12), 1500-2000 (115, 116, 118, 121), 1600 GT Coupe, 2000-3.2 Coupe (E9), 2500-3.3 (E3)
CITROËN C25, GS, SM
FIAT 130, 131, 132, ARGENTA, DUCATO
FORD CAPRI, CORTINA, ESCORT I, GRANADA, TAUNUS 12M, TAUNUS 15M, TAUNUS 17M, TAUNUS 20M, TAUNUS 20M XL, TRANSIT
FSO 125P, 126P, POLONEZ I, POLONEZ II
HONDA CIVIC I
HYUNDAI SONATA III
ISUZU MIDI
KIA PRIDE
LADA 1200-1500, 1200-1600, NIVA, NOVA, SAMARA, SAMARA FORMA
LANCIA BETA, BETA H.P.E., THEMA, TREVI, Y10

...Z11
LAND ROVER RANGE ROVER I
MAZDA 616, 818 Estate, 1000, 1300
MERCEDES-BENZ PONTON (W121), T1 Bus (601), T1 Platform/Chassis (601), T2/L Box Body / Estate, T2/L Box Body / Estate/Platform/Chassis, T2/L Dumptruck, T2/L Municipal Vehicle
MG MGB, MGB GT, MIDGET
MITSUBISHI CELESTE, COLT II, COLT LANCER, CORDIA, GALANT I, SAPPORO I
NISSAN CHERRY III, DATSUN 100 A, DATSUN 120
PEUGEOT 404, 504, 505, J5, J7, J9
RENAULT 5, 16, 18, 19 II, FUEGO, RAPID, SUPER 5, TRAFIC
ROVER 2000-3500, MINI, MONTEGO
SAAB 90, 95, 96, 99, 900 I
SEAT 124, 127, 128, 131, 133, 850, CORDOBA, IBIZA II, PANDA, RITMO, RONDA, TOLEDO I
SUBARU IMPREZA
SUZUKI SWIFT I (AA)
TALBOT 1307-1510, AVENGER, HORIZON, MURENA, RANCHO, SIMCA 1000, SIMCA 1100, SIMCA 1200 S, SOLARA, TAGORA
VAUXHALL CAVALIER, FIRENZA
VOLVO 240, 340-360, 740, 760
VW DERBY, GOLF I, GOLF II, GOLF III, ILTIS, JETTA I, JETTA II, LT 28-35 I, LT 40-55 I, PASSAT, POLO, SANTANA, SCIROCCO, TRANSPORTER IV, VENTO
WARTBURG 353
ZAZ TAVRIA

Z12
ALFA ROMEO 33
AUDI 80, 90, 100, 200, COUPE
LANCIA DELTA II, THEMA
PEUGEOT 505
SEAT IBIZA II, TOLEDO I
VW GOLF I, GOLF II, JETTA I, JETTA II, PASSAT, POLO, SANTANA, SCIROCCO, TRANSPORTER III, TRANSPORTER IV

Z13
CITROËN BX, C15, XM, ZX
PEUGEOT 309 I

**Z14**

ALPINA B3, B8, B10, B12
BMW 3 (E30), 3 (E36), 3 Compact (E36), 3 /Compact/Coupe/Touring (E36), 3 Convertible (E30), 3 /Convertible/Coupe (E36), 3 Convertible/Coupe (E36), 3 /Convertible/Coupe/Touring (E36), 3 Convertible/Coupe/Touring (E36), 3 /Convertible/Touring (E36), 3 /Coupe (E36), 3 Coupe (E36), 5 (E34), 5 (E39), 5 /Touring (E34), 5 Touring (E34), 5 /Touring (E39), 5 Touring (E39), 7 (E32), 7 (E38), 8 (E31), Z3 (E36)
DACIA 1310, LODGY, LOGAN, LOGAN MCV, SANDERO
LAND ROVER RANGE ROVER III
RENAULT KANGOO, SANDERO/STEPWAY, THALIA I

Z15

ASTON MARTIN VIRAGE
AUTOBIANCHI Y10
CHRYSLER CIRRUS, NEON, NEON II, STRATUS, VOYAGER III
CITROËN BERLINGO, XSARA PICASSO
DACIA DUSTER, LOGAN, LOGAN MCV, SANDERO
FIAT 900 T/E Pulmino, FIORINO Pick up, PALIO, PANDA, TIPO, UNO
FORD SCORPIO I, SIERRA, TRANSIT
HYUNDAI COUPE
JAGUAR S-TYPE, XJ
JEEP CHEROKEE
KIA CARENS I, CARENS II, CLARUS, RIO, SEPHIA, SHUMA, SHUMA II, SPORTAGE
LANCIA DELTA II, Y10
LAND ROVER DISCOVERY I
MAZDA 323 III Hatchback (BF), 626 III Coupe (GD), 626 III /Hatchback (GD), 626 III Station Wagon (GV)
NISSAN ALMERA I, SUNNY III
OPEL OMEGA A
PEUGEOT 205 II, 207, 306, 405 I, EXPERT
RENAULT CLIO I, LAGUNA I
ROVER 25, 100, 100 /METRO, 200, 400, 800, COUPE
SAAB 900 II
SKODA FAVORIT, FELICIA I
SUZUKI BALENO (EG), BALENO Estate (EG), BALENO Estate/Hatchback (EG), BALENO Hatchback (EG), CARRY Box (FD), JIMNY (FJ), SWIFT II Saloon (AH, AJ), VITARA (ET, TA), VITARA Cabrio (ET, TA), X-90 (EL)
VOLVO 960, 960 II, C70 I

Z16

ACURA LEGEND II
CHEVROLET AVEO, CRUZE, KALOS, LACETTI, NUBIRA, REZZO
DAEWOO ESPERO, KALOS, LACETTI, LANOS, NEXIA, NUBIRA
DAIHATSU APPLAUSE I, APPLAUSE II, CHARADE III, CHARADE IV, FEROZA Hard Top, FEROZA Soft Top, GRAN MOVE, HIJET, MOVE, SIRION
FORD ESCORT '86, ESCORT '95, ESCORT IV, ESCORT V, ESCORT VI, ESCORT VII, FIESTA II, FIESTA III, ORION II, ORION III, SCORPIO II, SIERRA
FSO LANOS
HONDA ACCORD III, CITY, CIVIC II, CIVIC IV, CIVIC V, CIVIC VI, CONCERTO, CRX I, CRX II, CRX III, JAZZ, JAZZ II, LEGEND I, PRELUDE III
HYUNDAI ACCENT, ACCENT III, COUPE, LANTRA II
ISUZU GEMINI, TROOPER
KIA CARENS II, PICANTO, RETONA, RIO, SHUMA, SHUMA II, SPORTAGE
LADA 110, 111, 112, GRANTA, KALINA, OKA, PRIORA
MAZDA 121 II (DB), 323 C IV (BG), 323 C V (BA), 323 F IV (BG), 323 F V (BA), 323 F VI (BJ), 323 III Hatchback (BF), 323 P V (BA), 323 S IV (BG), 323 S V (BA), 323 S VI (BJ), 626 III (GD), 626 III /Coupe (GD), 626 III Coupe (GD), 626 III /Hatchback (GD), 626 III Hatchback (GD), 626 III Station Wagon (GV), 626 IV (GE), 626 IV /Hatchback (GE), 626 IV Hatchback (GE), DEMIO (DW), E-SERIE Box (SR2), MPV I (LV), MX-3 (EC), MX-5 I (NA), MX-6 (GE), PREMACY (CP), XEDOS 6 (CA), XEDOS 9 (TA)
MITSUBISHI CARISMA, COLT IV, COLT V, GALANT V, GALANT VI, L 300, LANCER, LANCER IV, LANCER V, SPACE RUNNER, SPACE STAR, SPACE WAGON
NISSAN 100 NX, 300 ZX, BLUEBIRD, MAXIMA II, PRAIRIE PRO, PRIMERA, SUNNY II, SUNNY III
RENAULT ESPACE III
ROVER 200, 400, 800, CABRIOLET
SAAB 9-3, 900 II, 9000
SUBARU FORESTER, IMPREZA, JUSTY II, LEGACY I, LEGACY II, LEGACY III, LEGACY IV, OUTBACK, VIVIO
SUZUKI BALENO (EG), BALENO Estate (EG), BALENO Hatchback (EG), GRAND VITARA I (FT, GT), IGNIS (FH), WAGON R+ (MM)
TOYOTA CAMRY, COROLLA
VAUXHALL MONTEREY

Z17

CITROËN BX, CX I, CX II, LNA, VISA
FORD SIERRA
MERCEDES-BENZ E-CLASS (W124), E-CLASS Estate (S124), G-CLASS (W461), G-CLASS (W463), G-CLASS Cabrio (W463), T1 Box (601), T1 Box/Bus (601)
PEUGEOT 104, 204, 205 I, 205 II, 304, 305 I, 305 II, 309 I, 604
RENAULT MASTER I, SAFRANE I, TRAFIC
TALBOT SAMBA

Z18

MERCEDES-BENZ 190 (W201), COUPE (C123), COUPE (C124), G-CLASS (W460), G-CLASS (W461), G-CLASS (W463), G-CLASS Cabrio (W463), KOMBI Estate (S123), KOMBI Estate (S124), Saloon (W123), Saloon (W124), S-CLASS (W126)
RENAULT MASTER I
TALBOT SIMCA SIM'4

Z19

ARO 240-244
BEDFORD BLITZ
CITROËN DS
DACIA 1210, 1307, 1309, 1310, 1410
OPEL ADMIRAL A, ADMIRAL B, ASCONA A, ASCONA B, COMMODORE A, COMMODORE B, COMMODORE C, CORSA A, DIPLOMAT B, FRONTERA A, GT, KADETT B, KADETT C, KADETT D, KADETT E, MANTA A, MANTA B, MONZA A, OMEGA A, REKORD C, REKORD D, REKORD E, SENATOR A, SENATOR B
RENAULT 8
VAUXHALL ASTRA, ASTRA Mk II, CARLTON Mk II, CARLTON Mk III, CAVALIER, CAVALIER CC, FRONTERA Mk I (A), NOVA, ROYALE, SENATOR, SENATOR Mk II (B)

Z20

ALFA ROMEO 164, 2300
ALPINA B3, B6, C1, C2
ASTON MARTIN DB6, DBS, LAGONDA I, V8
AUDI 80, 100, A6, COUPE, QUATTRO
AUSTIN ALLEGRO, METRO, MINI
AUTOBIANCHI A 111, A 112, Y10
BEDFORD RASCAL
CHEVROLET AVEO, KALOS, LANOS, MATIZ, NIVA
CHRYSLER SARATOGA, VOYAGER II
CITROËN C25
DAEWOO CIELO, ESPERO, KALOS, LANOS, MATIZ, NEXIA, NUBIRA, REZZO, TICO
DAIHATSU CHARADE II, CHARADE III, CHARADE IV, CUORE I, CUORE II, CUORE III, CUORE IV, CUORE V, HIJET, SKYWING, SPARCAR

...Z20

FIAT 124, 126, 127, 128, 131, 132, 238-SERIE, 900 T/E Pulmino, CAMPAGNOLA, CINQUECENTO, DUCATO, DUNA, FIORINO, FIORINO Pick up, PANDA, REGATA, RITMO I, RITMO II, SEICENTO, TALENTO, TEMPRA, TIPO, UNO
FORD CAPRI II, CAPRI III, CONSUL, ESCORT I, ESCORT II, GRANADA, SCORPIO I, SIERRA
FSO 132P, LANOS
HYUNDAI H-1, H-1 / STAREX, H100, LANTRA I, PONY, PONY / EXCEL, PORTER, SONATA II, SONATA III, SONATA IV, SONATA V
ISUZU TROOPER
KIA PRIDE, RIO, SEPHIA
LADA 110, 111, 112, KALINA, NIVA, NOVA, SAMARA, SAMARA FORMA, TOSCANA
LANCIA A 112, BETA, Y10
LAND ROVER DISCOVERY I, RANGE ROVER II
MAZDA 323 I (FA), 323 I Station Wagon (FA), 323 III Hatchback (BF), 323 III Station Wagon (BW), 626 II /Hatchback (GC), 626 III (GD), 626 III Coupe (GD), 626 III Hatchback (GD), 626 III Station Wagon (GV), 929 II Coupe (HB)
MERCEDES-BENZ /8 (W114)
MG MGR V8
MITSUBISHI COLT I, COLT II, COLT III, COLT IV, COLT V, COLT LANCER, CORDIA, ECLIPSE II, GALANT I, GALANT II, GALANT III, GALANT IV, GALLOPER, L 200, L 300, LANCER F II, LANCER I, LANCER III, LANCER IV, LANCER V, LANCER VI, PAJERO I, PAJERO II, SIGMA, SPACE WAGON, STARION, TREDIA
NISSAN 280 ZX,ZXT, BLUEBIRD, LAUREL, PATROL, PATROL GR I, PICK UP, PRAIRIE, SILVIA, STANZA, URVAN, VANETTE
OPEL ASCONA A, ASCONA B, ASCONA C, ASTRA F, CALIBRA A, CAMPO, COMBO, CORSA A, CORSA B, FRONTERA A, KADETT D, KADETT E, MANTA A, MANTA B, OMEGA A, REKORD D, REKORD E, VECTRA A
PORSCHE 911, 911 Convertible, 924, 928, 944, 944 /Convertible
RENAULT 11, 19 I, 19 II, 21, CLIO I, ESPACE III, LAGUNA I, MEGANE, MEGANE I, SUPER 5
ROVER 2000-3500, MINI
SAAB 95, 96, 900 I

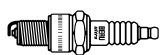
**...Z20**

SEAT 124, CORDOBA, FURA, IBIZA I, IBIZA II, INCA, MARBELLA, TERRA, TOLEDO I
SUBARU JUSTY I, JUSTY II, LEONE I, LEONE II, LIBERO
SUZUKI ALTO III (EF), SAMURAI (SJ), SUPER CARRY Bus (ED), SWIFT Convertible (SF413), SWIFT I (AA), SWIFT II Hatchback (EA, MA), SWIFT II Saloon (AH, AJ), VITARA (ET, TA), VITARA Cabrio (ET, TA)
TALBOT AVENGER, SIMCA SUNBEAM
TOYOTA 1000, CARINA, CELICA, CELICA SUPRA, COROLLA, CORONA, CRESSIDA, CROWN, HIACE I, HIACE III, HILUX II, LAND CRUISER, LITEACE, STARLET
VAUXHALL ASTRA, ASTRA Mk II, ASTRA Mk III (F), ASTRA Mk IV (G), ASTRAMAX, ASTRAVAN Mk III (F), BRAVA, CALIBRA, CARLTON Mk II, CARLTON Mk III, CAVALIER Mk II, CAVALIER Mk III, COMBO Mk I (B), CORSA Mk I (B), CORSAVAN Mk I (B), FRONTERA Mk I (A), NOVA, NOVAVAN, VENTORA, VIVA
VOLVO 240, 340-360, 440 K, 460 L, 480 E, 740, 760, 940, 940 II, 960
VW CADDY II, GOLF III, GOLF IV, LT 28-35 I, LT 40-55 I, PASSAT, POLO, TRANSPORTER IV, VENTO
ZAZ TAVRIA

Z21

ASTON MARTIN ZAGATO
AUSTIN MONTEGO
CHEVROLET SPARK
DAEWOO TICO
DAIHATSU MOVE
HONDA ACCORD II, ACCORD III, CIVIC I, CIVIC III, CRX I, JAZZ I, PRELUDE II
HYUNDAI H-1, H-1 / STAREX, H100, LANTRA I, PONY, SANTAMO, S COUPE, SONATA III, TRAJET
ISUZU PIAZZA
KIA JOICE, MAGENTIS, PRIDE
LADA PRIORA
MITSUBISHI COLT III, ECLIPSE II, L 200, L 300, LANCER III, LANCER IV, SANTAMO, SIGMA, SPACE WAGON
NISSAN 280 ZX, ZXT
OPEL ASCONA C, KADETT E
ROVER 200, MONTEGO
SUBARU LEONE II, XT
TOYOTA COROLLA, COROLLA FX, STARLET
VAUXHALL ASTRA Mk II, CAVALIER Mk II

Z22

ALFA ROMEO 33, 75, ALFASUD, GIULIA, GT
AUDI 50, 80, 100, COUPE
AUSTIN MAESTRO, MONTEGO

...Z22

BMW 02 (E10), 02 Convertible (E10), 02 Touring (E6), 5 (E12), 1500-2000 (115, 116, 118, 121), 2000-3.2 Coupe (E9)
CITROËN AMI, GS
FIAT 124, 125, 126, 131, 132, 850
FORD CAPRI, CORSAIR, CORTINA, ESCORT I, TAUNUS 12M, TAUNUS 15M, TAUNUS 17M, TAUNUS 26M XL
FSO POLONEZ I
LANCIA BETA, BETA H.P.E., TREVI
MERCEDES-BENZ /8 (W114), /8 (W115), /8 Coupe (W114), G-CLASS (W460), HECKFLOSSE (W110), HECKFLOSSE (W111, W112), KOMBI Estate (S123), PONTON (W128), Saloon (W123), S-CLASS (W108, W109), S-CLASS (W116), SL (W121), SL Coupe (C107)
NISSAN PICK UP
OPEL ASCONA A
PEUGEOT 505
RENAULT 9, 11, 15, 16, 17, 18, 20, 21, FUEGO, MASTER I, SUPER 5, TRAFIC
ROVER 800
SAAB 99, 900 I
SEAT 124, 128, 132, RONDA
TALBOT 180, 1307-1510, SIMCA 1000, SIMCA 1100, SIMCA 1609/1610
VOLVO 240, 740, 760
VW GOLF I, GOLF II, K 70, LT 28-35 I, LT 40-55 I, PASSAT, POLO, SCIROCCO, VOYAGE

Z24

ASTON MARTIN DB7
AUDI COUPE
CITROËN AX, BX, JUMPY, SAXO, XANTIA, ZX
FIAT PUNTO, SCUDO, UNO
FORD ESCORT '81, ESCORT III, ESCORT IV, ESCORT VI, ESCORT VII, FIESTA II, FIESTA III, ORION I, ORION II, ORION III, SCORPIO I, SIERRA, TRANSIT
LOTUS ELAN
NISSAN SUNNY, SUNNY III
PEUGEOT 205 II, 309 I, 605
RENAULT 19 I, 19 II, CLIO I
ROVER 200, 400
SAAB 900 I
VOLVO 850

Z25

AUSTIN AMBASSADOR
CITROËN AXEL, BX, C15, CX II, GS, LNA, VISA
MERCEDES-BENZ G-CLASS (W461)
OPEL ASCONA B, MANTA B
PEUGEOT 205 I, 205 II, 305 II, 309 I, 505

...Z25

RENAULT 5, 14, 18, 20, 21, 25, 30, ESPACE I, ESPACE II, FUEGO, MASTER I, SAFRANE I
TALBOT SAMBA, TAGORA

Z26

CITROËN BX, VISA
FORD ESCORT VI, ESCORT VII, FIESTA, FIESTA III, FIESTA IV, KA
MAZDA 121 III (JASM, JBSM), TRIBUTE (EP)
RENAULT 18, 25
VOLVO 240, 260, 760, 780

Z27

ALFA ROMEO 164, SPIDER
ASTON MARTIN LAGONDA I, ZAGATO
AUDI 80, A6, CABRIOLET, COUPE
AUSTIN MAESTRO, METRO, MONTEGO
AUTOBIANCHI A 112, Y10
CHEVROLET KALOS
DAEWOO KALOS, NEXIA
DAIHATSU CUORE IV, CUORE V, HIJET, MOVE
FIAT 124, 126, 127, 132, 850, CINQUECENTO, COUPE, CROMA, FIORINO, FIORINO Pick up, X 1/9, PANDA, REGATA, RITMO, RITMO I, RITMO II, SEICENTO, TEMpra, TIPO, UNO
FORD CAPRI II, CAPRI III, CONSUL, ESCORT II, ESCORT IV, GRANADA, TAUNUS, TAUNUS '80
FSO 132P
HYUNDAI H100, LANTRA I, PONY, S COUPE, SONATA III, SONATA IV, TRAJET
KIA JOICE, MAGENTIS, PRIDE
LADA 110, 111, 112, KALINA, NIVA, NOVA, SAMARA, SAMARA FORMA, TOSCANA
LANCIA A 112, BETA, DEDRA, DELTA I, DELTA II, PRISMA, THEMA, Y10
LAND ROVER RANGE ROVER II
LOTUS ECLAT, ELITE, ESPRIT S2, ESPRIT S3, EXCEL
MG MGR V8
MITSUBISHI COLT III, ECLIPSE I, ECLIPSE II, GALANT I, L 200, L 300, SAPPORO II, SIGMA, SPACE WAGON
NISSAN URVAN
OPEL CAMPO, VECTRA A
PEUGEOT 304
PORSCHE 928
RENAULT 19 I, 19 II, CLIO I, SUPER 5
ROVER MINI
SEAT 124, 131, AROSA, CORDOBA, IBIZA II, IBIZA III, INCA, TERRA, TOLEDO I
SKODA FELICIA I, FELICIA II, OCTAVIA
SUBARU JUSTY I, JUSTY II, XT
SUZUKI SWIFT Convertible (SF413), SWIFT II Hatchback (EA, MA), SWIFT II Saloon (AH, AJ), VITARA (ET, TA), VITARA Cabrio (ET, TA)
TALBOT SIMCA SUNBEAM

...Z27

VAUXHALL BRAVA
VOLVO 240, 340-360, 440 K, 460 L, 480 E, 740, 940, 940 II
VW CADDY II, CORRADO, GOLF I, GOLF III, GOLF IV, LUPO, PASSAT, POLO, SCIROCCO, VENTO

Z28

MITSUBISHI SAPPORO III, SPACE WAGON
VAUXHALL CHEVETTE

Z29

ALFA ROMEO 75, 155, 164
CITROËN AX
RENAULT SAFRANE I
SEAT IBIZA I, MALAGA, RONDA, TOLEDO I

Z30

ASTON MARTIN DB7
AUDI 80, A6, CABRIOLET, COUPE
CHEVROLET EPICA
CITROËN JUMPY, XANTIA, ZX
FIAT FIORINO, PUNTO, SCUDO, TEMpra, TIPO, ULYSSE
FORD ESCORT III, ESCORT IV, ESCORT V, ESCORT VI, ESCORT VII, FIESTA I, FIESTA II, FIESTA III, GALAXY, ORION I, ORION II, SCORPIO II, SIERRA, TRANSIT
HONDA LEGEND II, NSX
LANCIA DEDRA, DELTA II
LEXUS GS, IS, IS I
LOTUS ELAN
MITSUBISHI GALANT VI
NISSAN 180 SX, 200 SX, ALMERA TINO, BLUEBIRD, LUCINO, MAXIMA, MAXIMA QX, PRIMERA, SUNNY, SUNNY II, SUNNY III
PEUGEOT 605, EXPERT
RENAULT 19 II, ESPACE III, SAFRANE I
ROVER 200, 400
SAAB 9-3, 9-5
SEAT CORDOBA, IBIZA I, IBIZA II, TOLEDO I
SUBARU FORESTER, IMPREZA, SVX
SUZUKI GRAND VITARA II (JT), IGNIS II, JIMNY (FJ), LIANA (ER), LIANA Estate (ER), SWIFT III (MZ, EZ), SX4 (GY), WAGON R+ (MM)
TOYOTA ARISTO, AVENSIS, AVENSIS VERSO, CAMRY, CARINA E, CELICA, COROLLA, LAND CRUISER, LAND CRUISER 100, PREVIA, RAV 4 III, SUPRA
VOLVO 850
VW CORRADO

Z31

AUSTIN AMBASSADOR
CITROËN BX, C15
PEUGEOT 104
RENAULT 14, 25, ESPACE I, ESPACE II, SAFRANE I

**Z32**

FORD CAPRI, CAPRI II, CONSUL, GRANADA, SCORPIO I, SIERRA, TAUNUS, TAUNUS '80, TRANSIT

Z33

FORD CAPRI, CAPRI II, CAPRI III, ESCORT II, GRANADA, SCORPIO I, SIERRA, TAUNUS, TAUNUS '80, TRANSIT

Z38

ALFA ROMEO ALFASUD, GIULIETTA
BMW 600 (111), 700 (107), 700 Coupe
MERCEDES-BENZ GULLWING (W198), SL (R198)
PORSCHE 356 Coupe, 911, 911 /Convertible, 911 /Targa, 911 Targa
RENAULT 18, FUEGO

Z39

BMW ISETTA (100, 101, 102, 103)
PORSCHE 356 Cabriolet/Speedster/Coupe

Z40

BMW 503 Convertible
CITROËN 2 CV, ACADIANE, AMI, DYANE, LNA, MEHARI
FIAT 600, 1000er-Serie
FORD TAUNUS 12M, TAUNUS 17M
JAGUAR XJ
PORSCHE 356 Cabriolet/Speedster, 356 Cabriolet/Speedster/Coupe, 356 Coupe
TALBOT SIMCA 1300, SIMCA 1301
VOLVO 140, P 122 S AMAZON

Z41

CITROËN CX I, CX II, DS
FORD TAUNUS 15M, TAUNUS 20M
FSO 126P
PORSCHE
356 Cabriolet/Speedster/Coupe,
356 Coupe, 912 /Targa
SAAB 95, 96
VOLVO 140, 164, P 1800

Z42

ALFA ROMEO 33, 75, 90, 145, 146, 155, 164, 1750-2000, ALFASUD, ARNA, GIULIA, GIULIETTA, GT, GTA, GTV, MONTREAL, RZ, SPIDER
AUDI 80, 100, COUPE, SUPER 90
FIAT 124, 125, 850
FORD CAPRI
FSO 127P
LANCIA FULVIA, GAMMA

...Z42

MERCEDES-BENZ /8 (W114), /8 Coupe (W114), CABRIOLET (W111), COUPE (W111), HECKFLOSSE (W111, W112), PAGODE (W113), S-CLASS (W108, W109), T2/L Box Body / Estate/Platform/Chassis, T2/L Dumptruck, T2/L Municipal Vehicle
PEUGEOT 204, 304, 504
PORSCHE 911, 911 /Targa, 911 Targa, 914, 924
RENAULT CLIO I
SAAB 99
TALBOT 160, MATRA BAGHEERA, SIMCA 1000, SIMCA 1100, SIMCA 1500, SIMCA 1501, SIMCA 1609/1610, SIMCA SUNBEAM
VW DERBY, PASSAT, POLO, SCIROCCO, TRANSPORTER III

Z44

AUDI 80, 200
VW GOLF I, JETTA I, PASSAT, POLO, SANTANA, SCIROCCO

Z45

PORSCHE 911 (964), 911 (993), 911 /Convertible (964), 911 /Convertible (993), 911 Convertible (993), 911 Convertible/Targa (993)

Z46

MERCEDES-BENZ 190 (W201)
RENAULT 21

Z47

ALFA ROMEO 33, 164, 166, 1750-2000, 1900, ARNA, SPIDER
AUDI QUATTRO
FIAT 131, COUPE, CROMA, FIORINO Pick up, RITMO II, TEMPRA, TIPO
FORD CAPRI II, CAPRI III, ESCORT I
JAGUAR XJ
LANCIA BETA MONTE CARLO, DEDRA, DELTA II
LOTUS ESPRIT S2, ESPRIT S4
MERCEDES-BENZ
HECKFLOSSE (W111, W112)
MITSUBISHI COLT II, ECLIPSE I, GALANT III
PORSCHE 944 /Convertible
SEAT IBIZA II
TALBOT SIMCA SUNBEAM

Z48

CITROËN DS, ID
FORD TAUNUS 12M, TRANSIT, TRANSIT '55-
OPEL ADMIRAL B, COMMODORE A, OLYMPIA A, REKORD B
SKODA 105, 120, 130, RAPID
VOLVO 140, 164, P 122 S AMAZON

Z49

BEDFORD BLITZ
CHEVROLET MALIBU
VAUXHALL FIRENZA, MAGNUM, VICTOR, VIVA

Z51

ALFA ROMEO 33, 145, 146, 155
AUDI 80, 90, 100, 200, COUPE, QUATTRO
BMW 02 Convertible (E10)
VW PASSAT, POLO

Z52

AUDI 90, COUPE
FIAT UNO
RENAULT 21, SAFRANE I
SEAT TOLEDO I
VW CORRADO, GOLF II, JETTA II, PASSAT, SCIROCCO

Z53

RENAULT SAFRANE I

Z56

MERCEDES-BENZ 190 (W201)
RENAULT SAFRANE I

Z57

ARO 240-244
CITROËN 2 CV, DS, ID
FIAT 500, JAGST
FORD TAUNUS 12M, TAUNUS 15M, TAUNUS 17M, TAUNUS '51
MERCEDES-BENZ 170 (W170), PONTON (W120)
OPEL KADETT A, KAPITÄN, OLYMPIA REKORD, REKORD A, REKORD P1, REKORD P2
RENAULT 4, 8, 10
SEAT 600 D
SKODA 100, 110, OKTAVIA
VOLVO 140, DUETT, P 121, P 122 S AMAZON, P 544
VW 181, 1500, 1600, KAEFER, KARMANN GHIA, TRANSPORTER I, TRANSPORTER II, TRANSPORTER III
WARTBURG 353

Z58

MITSUBISHI COLT LANCER, GALANT II
PORSCHE 914
VAUXHALL CRESTA
VW 411, 412, 412, TRANSPORTER II, TRANSPORTER III

Z59

HONDA ACCORD I

Z60

CITROËN AX, BX, XM
PEUGEOT 306, 309 II, 405 I, 405 II, 605
RENAULT 25, CLIO I, LAGUNA I, MEGANE I, SAFRANE I, SAFRANE II
VOLVO 850, C70 I, S40 I, S60 I, S70, S80 I, V40, V70 I, V70 II

Z61

AUDI 80
VW DERBY, GOLF I, GOLF II, JETTA I, JETTA II, LT 28-35 I, LT 40-55 I, PASSAT, POLO, SCIROCCO, TRANSPORTER III

Z62

FIAT 1500, 1500-2300
LAND ROVER 90/110
MERCEDES-BENZ COUPE (C123), COUPE (W111), G-CLASS (W460), G-CLASS (W463), HECKFLOSSE (W110), HENSCHEL 2-t, KOMBI Estate (S123), PULLMANN (W100), Saloon (W123), S-CLASS (W108, W109), S-CLASS (W116), S-CLASS (W126), S-CLASS Coupe (C126), SL (R107), SL Coupe (C107)
NISSAN LAUREL
RENAULT LAGUNA I
VW TRANSPORTER III

Z63

AUSTIN MAESTRO, MONTEGO
CITROËN C15
PEUGEOT 405 I
RENAULT 19 I, 19 II, CLIO I, MEGANE I, TWINGO I
SKODA FAVORIT
VAUXHALL CARLTON Mk III

Z67

FORD ESCORT '86, ESCORT '91, ESCORT IV, ESCORT V, ESCORT VI, ESCORT VII, FIESTA, FIESTA II, FIESTA III, FIESTA IV, KA, KA Van, ORION II, ORION III, SCORPIO I
MAZDA 121 III (JASM, JBSM)

Z68

ARO 240-244
RENAULT 12
VW 1500, 1600, KAEFER, KARMANN GHIA, TRANSPORTER I

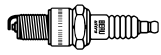

Z70

MERCEDES-BENZ PULLMANN (W100), Saloon (W123), SL (R107), SL Coupe (C107)
VW CADDY I, GOLF I, JETTA I

Z72

CHRYSLER NEON
MAZDA 929 III (HC)
NISSAN SUNNY III
RENAULT CLIO I
TOYOTA CELICA

Z73

CHEVROLET BERETTA
CHRYSLER STRATUS, VOYAGER III
DAEWOO REZZO
DAIHATSU CUORE VI
HYUNDAI ACCENT, ACCENT I, ACCENT II, ATOS, ATOS PRIME, COUPE, ELANTRA, GALLOPER I, GETZ, i10, i20, i30, LANTRA II, MATRIX, S COUPE, TIBURON, TRAJET, TUCSON
INFINITI QX4
JEEP GRAND CHEROKEE I
KIA CARENS II, CARENS III, CEE'D, CERATO, CLARUS, MAGENTIS, PICANTO, PRIDE, PRO CEE'D, RIO II, SPORTAGE
MAZDA 3 (BK), 3 Saloon (BK), 3 /Saloon (BL), 323 F VI (BJ), 323 P V (BA), 323 S VI (BJ), MX-3 (EC), MX-5 II (NB), XEDOS 6 (CA), XEDOS 9 (TA)
MITSUBISHI ECLIPSE II, L 300, L 400 / SPACE GEAR, LANCER V, LANCER VI, SPACE STAR
NISSAN 300 ZX, ALMERA II, ALMERA TINO

Z73

NISSAN BLUEBIRD

Z73

NISSAN MICRA II, PATHFINDER

Z73

NISSAN PRAIRIE PRO

Z73

NISSAN PRIMERA
SAAB 900 I, 9000
SUBARU FORESTER
TOYOTA CAMRY

Z74

CHEVROLET ASTRA, CAPTIVA, EVANDA, REZZO, VECTRA
DAEWOO LEGANZA, NUBIRA, REZZO, WINSTORM
FIAT PALIO, SIENA

...Z74

OPEL AGILA (A), ANTARA, ASTRA F, ASTRA F CLASSIC, ASTRA G, CALIBRA A, COMBO, CORSA A, CORSA B, CORSA C, FRONTERA A, FRONTERA B, KADETT E, OMEGA B, SINTRA, SPEEDSTER, TIGRA, VECTRA A, VECTRA B, VECTRA C, ZAFIRA A
PEUGEOT 205 II, 406
RENAULT CLIO II, TWINGO I
SAAB 9000
VAUXHALL AGILA Mk I (A), ASTRA Mk II, ASTRA Mk III (F), ASTRA Mk IV (G), ASTRAMAX, ASTRAVAN Mk III (F), ASTRAVAN Mk IV (G), CALIBRA, CARLTON Mk III, CAVALIER Mk II, CAVALIER Mk III, COMBO Mk I (B), COMBO Mk II (C), CORSA Mk I (B), CORSA Mk II (C), CORSAVAN Mk I (B), CORSAVAN Mk II (C), FRONTERA Mk I (A), FRONTERA Mk II (B), MERIVA Mk I (A), NOVA, OMEGA (B), SINTRA, TIGRA Mk I, VECTRA (B), ZAFIRA Mk I (A)

Z75

AUDI 80, 90, CABRIOLET, COUPE

Z76

RENAULT CLIO I, TWINGO I
VW KAEFER

Z78

VW TRANSPORTER IV, VENTO

Z79

AUDI A6, A8

Z82

CHRYSLER DAYTONA, LE BARON, VOYAGER II
DAEWOO ESPERO
DAIHATSU CHARMANT
HYUNDAI SONATA II
LAND ROVER DEFENDER, DISCOVERY I, DISCOVERY II, RANGE ROVER I, RANGE ROVER II
RENAULT 9, 19 I, 19 II, RAPID, SUPER 5, TWINGO I
SEAT MARBELLA
TOYOTA LAND CRUISER
VOLVO 340-360, 440 K, 480 E
VW TARO

Z89

AUDI 80, 90, 100, A6, CABRIOLET, COUPE
SEAT CORDOBA, IBIZA II, TOLEDO I
VW CORRADO, GOLF II, JETTA II, PASSAT, SCIROCCO

Z90

AUDI 80, 100, A2, A3, A4, A6, A8, CABRIOLET, COUPE, TT
SEAT ALHAMBRA, ALTEA, ALTEA XL, AROSA, CORDOBA, EXEO, IBIZA II, IBIZA III, IBIZA IV, IBIZA V, INCA, LEON, TOLEDO I, TOLEDO II, TOLEDO III
SKODA FABIA, FELICIA I, FELICIA II, OCTAVIA, SUPERB
VW BORA, CADDY II, CADDY III, GOLF III, GOLF IV, GOLF V, GOLF VI, GOLF PLUS, JETTA III, LUPO, MULTIVAN V, NEW BEETLE, PASSAT, POLO, SHARAN, TOURAN, TRANSPORTER V, VENTO

Z91

AUDI 80, 90, 100, A6, CABRIOLET, COUPE
SEAT AROSA, CORDOBA, IBIZA II, INCA, TOLEDO I
SKODA FELICIA I, FELICIA II, OCTAVIA
VW CADDY I, CADDY II, CORRADO, GOLF I, GOLF II, GOLF III, GOLF IV, JETTA II, LUPO, PARATI, PASSAT, POLO, SCIROCCO, VENTO

Z92

AUDI 80, COUPE
SEAT CORDOBA, IBIZA II, TOLEDO I
VW CADDY II, GOLF III, GOLF IV, LT 28-35 I, LT 40-55 I, PASSAT, POLO, TRANSPORTER IV, VENTO

Z93

AUDI 80, 100
SEAT INCA
VW GOLF I, GOLF II, JETTA II, PASSAT, SCIROCCO

Z94

AUDI 80, 100, A6, CABRIOLET, COUPE
VW POLO

Z95

CITROËN BX, LNA
FORD COUGAR, ESCORT '81, ESCORT '86, ESCORT III, ESCORT IV, FIESTA, FIESTA I, FIESTA II, MONDEO I, MONDEO II, ORION II
MAZDA 3 (BK), 3 Saloon (BK), 5 (CR19), 6 /Estate/Hatchback (GH), 6 /Hatchback (GG), 6 Station Wagon (GY), MPV II (LW), MPV III (LY) III, MX-5 III (NC), TRIBUTE (EP)
RENAULT 14, 25

Z97

CHEVROLET TRAILBLAZER
FORD ESCORT CLASSIC, ESCORT V, ESCORT VI, ESCORT VII, FOCUS, MONDEO I, MONDEO II, ORION III, TOURNEO CONNECT, TRANSIT CONNECT

Z98

CITROËN XSARA
DACIA LOGAN, LOGAN MCV, SANDERO, SOLENZA
DAIHATSU TERIOS
FIAT BARCHETTA, BRAVA, BRAVO I, COUPE, DOBLO, MAREA, PALIO, STILO
HONDA CIVIC VI
LANCIA DEDRA, DELTA II, KAPPA, LYBRA
LOTUS ESPRIT S4
OPEL ASTRA F, OMEGA A, SENATOR B
PORSCHE BOXSTER (986)
RENAULT LOGAN, SANDERO/STEPWAY
VAUXHALL CARLTON Mk III, CAVALIER Mk III, SENATOR Mk II (B)

Z99

DAIHATSU CHARADE III
FORD ESCORT '86, ESCORT IV, ESCORT V, ESCORT VI, ESCORT VII, FIESTA II, FIESTA III, ORION II, ORION III
HONDA CIVIC II, CIVIC IV, CONCERTO
SAAB 9-5

Z100

DAEWOO KORANDO, MUSSO, REXTON
FIAT 1000er-Serie
MERCEDES-BENZ CABRIOLET (A124), C-CLASS (W202), C-CLASS Estate (S202), COUPE (C124), E-CLASS (W124), E-CLASS (W210), E-CLASS Convertible (A124), E-CLASS Coupe (C124), E-CLASS Estate (S124), E-CLASS Estate (S210), G-CLASS (W463), G-CLASS Cabrio (W463), KOMBI Estate (S124), Saloon (W124), S-CLASS (W140), S-CLASS Coupe (C140), SL (R129), SLK (R170), SPRINTER 4-t Box/Bus/Platform/Chassis (904)
RENAULT CLIO I
SKODA FAVORIT
SSANGYONG KORANDO, KYRON, MUSSO, REXTON, RODIUS

Z101

MERCEDES-BENZ SPRINTER 2-t Box (901, 902), SPRINTER 2-t Box/Bus/Platform/Chassis (901, 902), SPRINTER 3-t Box (903), SPRINTER 3-t Box/Bus/Platform/Chassis (903)
VW LT 28-35 II, LT 28-46 II

Z104

ALPINA B7, B10
MERCEDES-BENZ S-CLASS (W108, W109)
VW CORRADO, GOLF II, PASSAT

**Z108****CITROËN GS****Z111****VW ILTIS****Z112****OPEL DIPLOMAT A, DIPLOMAT B****Z116**

BMW 3 (E46), 3 (E90), 3 Compact (E36), 3 Compact (E46), 3 /Compact/Coupe/Touring (E36), 3 Convertible (E46), 3 Convertible (E93), 3 /Convertible/Coupe (E36), 3 Convertible/Coupe (E46), 3 /Convertible/Coupe/Touring (E36), 3 /Convertible/Touring (E36), 3 /Coupe (E36), 3 Coupe (E92), 3 /Touring (E46), 3 Touring (E91), 5 (E34), 5 (E39), 5 (E60), 5 /Touring (E34), 5 Touring (E34), 5 /Touring (E39), 5 Touring (E39), 5 Touring (E61), 6 (E63), 6 Convertible (E64), 7 (E38), 7 (E65, E66, E67), 8 (E31), X1 (E84), X3 (E83), X5 (E53), X5 (E70), Z3 (E36), Z4 (E85)

CITROËN XSARA

DACIA LODGY, LOGAN, LOGAN MCV

DAIHATSU TERIOS

FIAT BARCHETTA, BRAVA, BRAVO I, COUPE, MAREA, PALIO, STILO

HONDA ACCORD IV, ACCORD V, ACCORD VI, ACCORD VII, CIVIC V, CIVIC VI, CIVIC VII, CIVIC VIII, CR-V I, CR-V II, FR-V, HR-V, INTEGRA, LOGO, PRELUDE IV, PRELUDE V, SHUTTLE, STEPWAGON, STREAM

JEEP CHEROKEE, COMMANDER, GRAND CHEROKEE III

KIA CARNIVAL I, CARNIVAL II

LANCIA DEDRA, DELTA II, KAPPA, LYBRA

LAND ROVER RANGE ROVER III

LOTUS ESPRIT S4

MAZDA 323 F VI (BJ), 323 S VI (BJ), 626 III Station Wagon (GV), 626 IV Hatchback (GE), B-SERIE (UN), MPV I (LV), MPV II (LW), MX-6 (GE), PREMACY (CP), XEDOS 9 (TA)

MITSUBISHI CARISMA, PAJERO PININ, SPACE STAR

OPEL ASTRA F, ASTRA GTC J, ASTRA H, ASTRA J, CALIBRA A, CORSA D, INSIGNIA, MERIVA, VECTRA A

PORSCHE 911 (964), 911 (993), 911 (996), 911 /Convertible (996), BOXSTER (986)

RENAULT KANGOO, LOGAN, SANDERO/STEPWAY, THALIA I, TWINGO I

ROVER 600

...Z116

VAUXHALL ASTRA GTC Mk VI (JJ), ASTRA Mk V (H), ASTRA Mk VI (J), ASTRA TwinTop Mk V (H), CALIBRA, CAVALIER Mk III, CORSA Mk III (D), INSIGNIA

VOLVO S40 I, V40

Z117

CHEVROLET LUMINA APV

FORD SCORPIO I, SIERRA

Z118

DACIA 1310

RENAULT 5, 12

Z119

BMW 5 (E28)

OPEL ASCONA C, ASTRA F, ASTRA F CLASSIC, CALIBRA A, COMBO, CORSA A, CORSA B, FRONTERA A, KADETT E, OMEGA A, VECTRA A, VECTRA B

RENAULT CLIO I, ESPACE III, LAGUNA I, MEGANE, MEGANE I

VAUXHALL ASTRA Mk II, ASTRA Mk III (F), ASTRA Mk IV (G), ASTRAMAX, ASTRAVAN Mk III (F), CALIBRA, CARLTON Mk III, CAVALIER Mk II, CAVALIER Mk III, COMBO Mk I (B), CORSA Mk I (B), CORSAVAN Mk I (B), FRONTERA Mk I (A), NOVA

Z120

MERCEDES-BENZ C-CLASS (W202), C-CLASS Estate (S202), CLK (C208), CLK Convertible (A208), E-CLASS (W210), E-CLASS Estate (S210), SLK (R170)

Z121

AUDI A4, A6

MERCEDES-BENZ A-CLASS (W168), C-CLASS (W202), C-CLASS Estate (S202), CLK (C208), CLK Convertible (A208), E-CLASS (W210), E-CLASS Estate (S210), G-CLASS (W463), G-CLASS Cabrio (W463), M-CLASS (W163), SL (R129), SLK (R170), SPRINTER 2-t Box/Bus (901, 902), SPRINTER 2-t Platform/Chassis (901, 902), SPRINTER 3-t Box/Bus/Platform/Chassis (903), SPRINTER 3-t Bus (903), SPRINTER 4-t Box/Bus/Platform/Chassis (904), SPRINTER 4-t Box/Platform/Chassis (904), Vaneo (414), V-CLASS (638/2), VITO Box/Bus (638)

SKODA FELICIA I

VW PASSAT

Z122

ISUZU TROOPER

MERCEDES-BENZ C-CLASS (W202), C-CLASS (W203), C-CLASS Coupe (CL203), C-CLASS Estate (S202), C-CLASS T-Model (S203), CLK (C208), CLK Convertible (A208), E-CLASS (W210), E-CLASS Estate (S210), G-CLASS (W463), G-CLASS Cabrio (W463), M-CLASS (W163), S-CLASS (W140), S-CLASS (W220), S-CLASS Coupe (C140), S-CLASS Coupe (C215), SL (R129), SLK (R170)

Z123

CITROËN AX, BERLINGO, C15, SAXO, XANTIA, XSARA, ZX

PEUGEOT 306, 406

RENAULT LAGUNA I, SAFRANE II

Z126

VW TRANSPORTER IV

Z127

AUDI 100, A6, A8, V8

Z129

AUDI A6, A8

CITROËN AX, BERLINGO, C15, SAXO, XANTIA, XSARA, ZX

LEXUS LS

LOTUS ELISE

PEUGEOT 306

PORSCHE 911 (996), 911 /Convertible (996), 911 Convertible (996), BOXSTER (986), BOXSTER (987), CAYENNE (955)

RENAULT LAGUNA I, SAFRANE II

TOYOTA 4 RUNNER, AVENSIS, CARINA E, CELICA, COASTER, GRANVIA, HIACE IV, HILUX, HILUX II, LAND CRUISER, LAND CRUISER 90, MR 2 II, TARAGO

Z130

ALFA ROMEO 33

FORD GALAXY, SCORPIO I, SCORPIO II, SIERRA, TRANSIT, TRANSIT TOURNEO

LEXUS LS

MITSUBISHI GALANT V

OPEL ASTRA H, SIGNUM, VECTRA C, ZAFIRA B

RENAULT CLIO II, THALIA I

VAUXHALL ASTRA Mk V (H), SIGNUM, VECTRA Mk II (C), ZAFIRA Mk II (B)

Z144

AUDI A6, A8

Z145

AUDI A4, A6, A8

SKODA SUPERB

VW PASSAT

Z148

FORD COUGAR, MONDEO I, MONDEO III, TRANSIT

Z149

LOTUS ELISE

SUBARU LEGACY I

TOYOTA CAMRY

Z150

TOYOTA 4 RUNNER, AVENSIS, CARINA E, CARINA II, COASTER, GRANVIA, HIACE IV, HILUX, HILUX II, LAND CRUISER, LAND CRUISER 90, TARAGO

Z151

LEXUS LS

NISSAN PRIMERA

SAAB 9-3, 900 II

TOYOTA 4 RUNNER, AVENSIS, CARINA E, CELICA, COROLLA, LAND CRUISER 80, MR 2 II, MR 2 III, RAV 4 II, SUPRA, YARIS, YARIS VERSO

Z152

CHRYSLER NEW YORKER, VIPER

Z153

NISSAN PRIMERA

Z154

TOYOTA ALLION II, CARINA E, COROLLA

Z155

NISSAN 100 NX, PICK UP, PRIMERA, SUNNY III, TERRANO I

TOYOTA COROLLA, HILUX II, MR 2 II, SUPRA, YARIS

Z156

TOYOTA CARIBE, CARINA II, CELICA, COROLLA, STARLET, YARIS, YARIS VERSO

Z157

DAIHATSU COPEN, SIRION, TERIOS

NISSAN ALMERA I, SERENA

TOYOTA AVENSIS, CAMRY, CARINA E, CARINA II, CELICA, COROLLA, COROLLA FX, MR 2 I, PICNIC, RAV 4 I, YARIS

Z158

BMW 8 (E31)

CHEVROLET CRUZE, ORLANDO

HONDA ACCORD IV, ACCORD V, ACCORD VI, CIVIC V, CIVIC VI, CIVIC VII, CR-V I, FR-V, HR-V, LOGO, PRELUDE IV, PRELUDE V, SHUTTLE, STREAM

HYUNDAI i30

JEEP CHEROKEE, COMMANDER, GRAND CHEROKEE III



...Z158

KIA CARNIVAL I, CARNIVAL II, CEE'D, CERATO, PRO CEE'D
MAZDA 323 F VI (BJ), 323 S VI (BJ), 626 III /Coupe/Hatchback (GD), 626 III /Hatchback (GD), 626 III Station Wagon (GV), 626 IV Hatchback (GE), 929 III (HC), B-SERIE (UF), B-SERIE (UN), MPV I (LV), MPV II (LW), MX-6 (GE), PREMACY (CP), XEDOS 9 (TA)

MERCEDES-BENZ

SPRINTER 2-t Box (901, 902), SPRINTER 2-t Box/Bus/Platform/Chassis (901, 902), SPRINTER 3-t Box (903), SPRINTER 3-t Box/Bus/Platform/Chassis (903)
OPEL ASTRA G, ASTRA H, CALIBRA A, CORSA D, VECTRA A, ZAFIRA A, ZAFIRA B
ROVER 600

TOYOTA 4 RUNNER, COROLLA, LAND CRUISER 90

VAUXHALL ASTRA Mk V (H), ASTRA TwinTop Mk V (H), CALIBRA, CAVALIER Mk III, ZAFIRA Mk I (A), ZAFIRA Mk II (B)

VW LT 28-35 II, LT 28-46 II

Z159

FORD GALAXY, SCORPIO II, TRANSIT

Z170

CHRYSLER CROSSFIRE
MERCEDES-BENZ C-CLASS (W203), C-CLASS Coupe (CL203), C-CLASS Estate (S202), C-CLASS T-Model (S203), CLK (C208), CLK (C209), CLK Convertible (A208), CLK Convertible (A209), E-CLASS (W210), E-CLASS Estate (S210), SLK (R170), SLK (R171)

Z171

MERCEDES-BENZ S-CLASS (W220), S-CLASS Coupe (C215)

Z172

AUDI A8
FORD GALAXY
MERCEDES-BENZ V-CLASS (638/2)
OPEL ASTRA G, OMEGA B, SIGNUM, VECTRA B, VECTRA C
SEAT TOLEDO II
VAUXHALL OMEGA (B), VECTRA (B)
VW BORA, CORRADO, GOLF III, GOLF IV, PASSAT, SHARAN, TRANSPORTER IV, VENTO

Z173

FORD GALAXY
MERCEDES-BENZ V-CLASS (638/2)
OPEL ASTRA G, OMEGA B, SIGNUM, VECTRA B, VECTRA C
SEAT TOLEDO II
VAUXHALL OMEGA (B), VECTRA (B)
VW BORA, CORRADO, GOLF III, GOLF IV, PASSAT, SHARAN, TRANSPORTER IV, VENTO

Z176

AUDI A8
FORD GALAXY
SEAT ALHAMBRA, AROSA, CORDOBA, IBIZA III, IBIZA IV, INCA, LEON, TOLEDO II
SKODA FABIA, OCTAVIA
VW BORA, CADDY II, FOX, GOLF IV, JETTA III, JETTA IV, LUPO, NEW BEETLE, PASSAT, PHAETON, POLO, SHARAN, TOUAREG, TRANSPORTER IV

Z177

FORD C-MAX, C-MAX II, COUGAR, FIESTA, FIESTA III, FIESTA IV, FIESTA V, FIESTA VI, FOCUS, FOCUS C-MAX, FOCUS II, FOCUS III, FUSION, GRAND C-MAX, KA, KA Van, MAVERICK, MONDEO IV, PUMA, STREET KA
MAZDA 2 (DY), 3 (BK), 121 III (JASM, JBSM), TRIBUTE (EP)
VOLVO C30, S40 II, V50

Z183

CITROËN C4, C4 I, C5 I, C8, EVASION, JUMPY, XSARA, XSARA PICASSO
FIAT SCUDO, ULYSSE
HYUNDAI ix35, SANTA FÉ II, SONATA V
KIA MAGENTIS, SORENTO II, SPORTAGE
LANCIA ZETA
NISSAN PATHFINDER, PRIMERA, TEANA I
PEUGEOT 206, 406, 407, 806, EXPERT
RENAULT ESPACE IV, VEL SATIS

Z184

CITROËN BERLINGO, C2, C3, C3 I, C4, C4 I, C5 I, C8, EVASION, JUMPY, XSARA, XSARA PICASSO
FIAT SCUDO, ULYSSE
INFiniti FX
LANCIA ZETA
MITSUBISHI LANCER
NISSAN 350 Z, MICRA III, MURANO, PATHFINDER, PRIMERA, X-TRAIL
PEUGEOT 206, 207, 307, 406, 806, 1007, EXPERT, PARTNER
RENAULT ESPACE IV, VEL SATIS
TOYOTA IQ, LAND CRUISER, VIOS/YARIS

Z185

PORSCHE 911 (997), 911 /Convertible (997), CAYENNE (955)

Z188

ALFA ROMEO 33, 145, 146, 147, 156, 164, 166, GT, GTV, SPIDER
AUDI A3, A4, A6, ALLROAD, TT
LANCIA KAPPA
ROVER 200
SEAT ALHAMBRA, AROSA, EXEO, IBIZA IV, LEON, TOLEDO II
SKODA FABIA, OCTAVIA, SUPERB
SUBARU FORESTER, IMPREZA
VW BORA, GOLF IV, LUPO, NEW BEETLE, PASSAT, POLO, SHARAN

Z190

CHEVROLET CAPTIVA
DAEWOO WINSTORM
OPEL AGILA (A), ANTARA, ASTRA F, ASTRA F CLASSIC, ASTRA G, CALIBRA A, COMBO, CORSA A, CORSA B, CORSA C, FRONTERA A, FRONTERA B, KADETT E, MERIVA, OMEGA B, SIGNUM, SINTRA, SPEEDSTER, TIGRA, VECTRA A, VECTRA B, VECTRA C, ZAFIRA A, ZAFIRA B
VAUXHALL AGILA Mk I (A), ASTRA Mk II, ASTRA Mk III (F), ASTRA Mk IV (G), ASTRAMAX, ASTRAVAN Mk III (F), ASTRAVAN Mk IV (G), CALIBRA, CARLTON Mk III, CAVALIER Mk II, CAVALIER Mk III, COMBO Mk I (B), COMBO Mk II (C), CORSA Mk I (B), CORSA Mk II (C), CORSAVAN Mk I (B), CORSAVAN Mk II (C), FRONTERA Mk I (A), FRONTERA Mk II (B), NOVA, OMEGA (B), SIGNUM, SINTRA, TIGRA Mk I, VECTRA (B), VECTRA Mk II (C), ZAFIRA Mk I (A)

Z192

LANCIA KAPPA, THESIS, Y
PORSCHE 911 (993), 911 (996)

Z193

ALFA ROMEO 156, GT
CITROËN AX, BERLINGO, BX, C2, C3, C3 I, C3 II, EVASION, JUMPER, NEMO, SAXO, XANTIA, XM, XSARA, ZX
DACIA 1310, DUSTER, LOGAN, SANDERO
DAEWOO LEGANZA, NUBIRA
FIAT CINQUECENTO, DUCATO, FIORINO, PANDA, PUNTO, QUBO, SEDICI, SEICENTO, TEMPRA, ULYSSE, UNO
JAGUAR XJ, XJSC
LANCIA Y, Y10, ZETA
NISSAN KUBISTAR, PRIMERA, SERENA
PEUGEOT 106 I, 106 II, 106 Van, 205 I, 205 II, 206, 206+, 207, 207 SW, 305 II, 306, 307, 309 I, 309 II, 405 I, 405 II, 406, 605, 806, 1007, BIPPER, BIPPER Tepee, BOXER, EXPERT, PARTNER

...Z193

RENAULT CLIO Grandtour, CLIO II, CLIO III, DUSTER, ESPACE III, ESPACE IV, FLUENCE, GRAND SCÉNIC II, GRAND SCÉNIC III, KANGOO, KANGOO BE BOP, KANGOO / GRAND KANGOO, LAGUNA I, LAGUNA II, LAGUNA III, LOGAN, MEGANE, MEGANE I, MEGANE II, MEGANE III, MODUS / GRAND MODUS, SANDERO/STEPWAY, SCÉNIC I, SCÉNIC II, SCÉNIC III, THALIA I, TWINGO II
SUZUKI SX4 (GY)
VW CADDY III, GOLF V, JETTA III, PASSAT, TOURAN

Z194

SMART CABRIO, CITY-COUPÉ, CROSSBLADE

Z198

SMART CABRIO, CITY-COUPÉ, CROSSBLADE

Z200

SEAT CORDOBA, IBIZA IV, LEON
SKODA FABIA, OCTAVIA, ROOMSTER, ROOMSTER Praktik
VW FOX, GOLF VI, GOLF PLUS, JETTA IV, NEW BEETLE, POLO

Z203

ALFA ROMEO 159
CHEVROLET AVEO, VIVA
FIAT CROMA, STILO
OPEL AGILA (A), ASTRA G, ASTRA GTC J, ASTRA H, ASTRA J, COMBO, CORSA C, CORSA D, INSIGNIA, MERIVA, SIGNUM, TIGRA, VECTRA C, ZAFIRA A, ZAFIRA B, ZAFIRA TOURER C
VAUXHALL AGILA Mk I (A), ASTRA Mk IV (G), ASTRA Mk V (H), ASTRA Mk VI (J), ASTRA TwinTop Mk V (H), ASTRAVAN Mk V (H), COMBO Mk II (C), CORSA Mk II (C), CORSA Mk III (D), CORSAVAN Mk III (D), INSIGNIA, MERIVA Mk I (A), SIGNUM, TIGRA, VECTRA Mk II (C), ZAFIRA Mk I (A), ZAFIRA Mk II (B), ZAFIRA Mk III

Z204

RENAULT LAGUNA I
VAUXHALL TIGRA Mk I
VOLVO 850, 960 II, C70 I, S40 I, S60 I, S70, S80 I, V40, V70 I, V70 II

Z206

ACURA SLX
ALFA ROMEO 159, SPIDER
AUDI A4, A6
CHEVROLET BERETTA, CAPTIVA
CHRYSLER NEON, STRATUS, VOYAGER III
CITROËN BERLINGO

**...Z206**

DAEWOO KORANDO, LEGANZA, MUSSO, NUBIRA, REXTON, REZZO, WINSTORM
DAIHATSU CUORE VI
FIAT BARCHETTA, BRAVA, BRAVO I, CROMA, DOBLO, MAREA, MULTIPLA, PALIO, PANDA, PUNTO, SEICENTO, SIENA, STILO
HYUNDAI ACCENT, ACCENT I, ACCENT II, ATOS, ATOS PRIME, COUPE, ELANTRA, GALLOPER II, GETZ, HIGHWAY VAN, i10, i30, LANTRA II, MATRIX, SANTA FÉ I, SANTA FÉ II, S COUPE, TIBURON, TRAJET, TUCSON
INFINITI Q45 I, QX4
ISUZU TROOPER
JEEP GRAND CHEROKEE I
KIA CARENS II, CARENS III, CEE'D, CERATO, CLARUS, MAGENTIS, PICANTO, PRIDE, PRO CEE'D, RIO II, SPORTAGE
LANCIA YPSILON
LEXUS GS
MAZDA 3 (BK), 3 Saloon (BK), 323 F VI (BJ), 323 P V (BA), 323 S VI (BJ), 626 V (GF), 626 V /Hatchback (GF), 626 V Hatchback (GF), 626 V Station Wagon (GW), MX-3 (EC), MX-5 II (NB), XEDOS 6 (CA), XEDOS 9 (TA)
MERCEDES-BENZ A-CLASS (W168), A-CLASS (W169), B-CLASS (W245), C-CLASS (W202), C-CLASS (W203), C-CLASS Coupe (CL203), C-CLASS Estate (S202), C-CLASS T-Model (S203), CLK (C208), CLK Convertible (A208), E-CLASS (W124), E-CLASS (W210), E-CLASS Convertible (A124), E-CLASS Coupe (C124), E-CLASS Estate (S124), E-CLASS Estate (S210), G-CLASS (W463), G-CLASS Cabrio (W463), M-CLASS (W163), S-CLASS (W140), S-CLASS (W220), S-CLASS Coupe (C140), S-CLASS Coupe (C215), SL (R129), SLK (R170), SPRINTER 4-t Box/Bus/Platform/Chassis (904), SPRINTER 4-t Box/Platform/Chassis (904), Vaneo (414), V-CLASS (638/2), VITO Box/Bus (638)
MITSUBISHI ECLIPSE II, L 300, L 400 /SPACE GEAR, LANCER V, LANCER VI, SPACE STAR
NISSAN ALMERA II, ALMERA TINO, MICRA II, PATHFINDER, PRIMASTAR, PRIMERA
OPEL AGILA (A), ANTARA, ASTRA F, ASTRA F CLASSIC, ASTRA G, ASTRA H, ASTRA J, CALIBRA A, COMBO, CORSA B, CORSA C, CORSA D, FRONTERA A, FRONTERA B, INSIGNIA, KADETT E, MERIVA, MONTEREY A, MONTEREY B, OMEGA B, SIGNUM, SINTRA, SPEEDSTER, TIGRA, VECTRA A, VECTRA B, VECTRA C, ZAFIRA A, ZAFIRA B

...Z206

PEUGEOT 205 II, 309 I, 406, PARTNER
RENAULT CLIO I, CLIO II, CLIO III, ESPACE IV, MEGANE II, TWINGO I, TWINGO II
SAAB 9000
SKODA FABIA, FAVORIT, FELICIA I, FELICIA II, OCTAVIA
SSANGYONG KORANDO, KYRON, MUSSO, REXTON, RODIUS
SUBARU FORESTER, LEGACY II
VAUXHALL AGILA Mk I (A), ASTRA Mk III (F), ASTRA Mk IV (G), ASTRA Mk V (H), ASTRA Mk VI (J), ASTRA TwinTop Mk V (H), ASTRAVAN Mk III (F), ASTRAVAN Mk IV (G), ASTRAVAN Mk V (H), CALIBRA, CAVALIER Mk III, COMBO Mk I (B), COMBO Mk II (C), COMBO TOUR Mk II (C), CORSA Mk I (B), CORSA Mk II (C), CORSA Mk III (D), CORSAVAN Mk I (B), CORSAVAN Mk II (C), CORSAVAN Mk III (D), FRONTERA Mk I (A), FRONTERA Mk II (B), INSIGNIA, MERIVA Mk I (A), MONTEREY Mk II, OMEGA (B), SIGNUM, SINTRA, TIGRA, TIGRA Mk I, VECTRA (B), VECTRA Mk II (C), VIVARO, ZAFIRA Mk I (A), ZAFIRA Mk II (B), ZAFIRA Mk III
VOLVO 850, C70 I, S40 I, S60 I, S70, S80 I, V40, V70 I, V70 II, XC70 CROSS COUNTRY, XC90 I
VW GOLF III, GOLF IV, PASSAT, TRANSPORTER IV, VENTO

Z207

RENAULT MASTER I, TRAFIC

Z208

TOYOTA 4 RUNNER, COROLLA, LAND CRUISER 90

Z209

FORD C-MAX, FIESTA V, FOCUS C-MAX, FOCUS II, MAVERICK, MONDEO II, MONDEO III
JAGUAR S-TYPE, X-TYPE
VOLVO C30, S40 II, V50

Z210

ALFA ROMEO 145, 146, 147, 155, 156, 166, GT, GTV, SPIDER

Z211

CITROËN C5 I, C5 II, C6, C8
PEUGEOT 407, 607, 807
RENAULT LAGUNA II

Z213

VW PASSAT

Z216

CHRYSLER 300 C, PT CRUISER, SEBRING, VOYAGER IV
JEEP WRANGLER II

Z219

FIAT ULYSSE
INFINITI FX
NISSAN 350 Z, MURANO, PATHFINDER, TEANA I

Z220

JEEP GRAND CHEROKEE II

Z221

ACURA LEGEND III
AUDI A3
BENTLEY ARNAGE
CHRYSLER STRATUS
HONDA PRELUDE V
HYUNDAI COUPE, SANTA FÉ I, SONATA IV, TERRACAN, TRAJET, XG
INFINITI i30, J30, Q45 I
JAGUAR XJ, XK 8
KIA CARNIVAL II, MAGENTIS, OPIRUS, SORENTO I
LAND ROVER FREELANDER
LEXUS ES, GS, IS, IS I, LS, RX, SC
MG MGF, MG TF, MG ZR, MG ZS, MG ZT, MG ZT-T
MITSUBISHI PAJERO SPORT
NISSAN 300 ZX, ALMERA TINO, PRIMERA, SUNNY II
ROVER 25, 45, 75, 400, COUPE
SAAB 9-3, 9-5
SEAT TOLEDO III
SUBARU FORESTER, IMPREZA
SUZUKI GRAND VITARA II (JT), IGNIS II, JIMNY (FJ), SWIFT III (MZ, EZ), WAGON R+ (MM)
TOYOTA AVENSIS, AVENSIS VERSO, CAMRY, CELICA, COROLLA, LAND CRUISER 100, MR 2 I, PREVIA, RAV 4 III, VISTA
VW EOS, GOLF PLUS, JETTA III, PASSAT

Z222

FIAT CROMA
OPEL ASTRA G, SPEEDSTER, VECTRA B, VECTRA C, ZAFIRA A
VAUXHALL ASTRA Mk IV (G), VECTRA (B), VECTRA Mk II (C), VX220, ZAFIRA Mk I (A)

Z223

CITROËN C4, C4 Grand Picasso I, C4 I, C4 Picasso I, C5 I, C5 II, C5 III, C8, JUMPY, XSARA PICASSO
LANCIA PHEDRA
PEUGEOT 307, 308 SW, 407, 607, 807, EXPERT, EXPERT Tepee

Z224

RENAULT CLIO II, KANGOO

Z225

CHRYSLER VIPER
FORD MAVERICK
JEEP CHEROKEE, GRAND CHEROKEE I, GRAND CHEROKEE II, WRANGLER I, WRANGLER II
NISSAN PICK UP, PRAIRIE PRO, TERRANO II

Z226

CITROËN BERLINGO, C2, C3, C3 I, C4, C4 I, XSARA, XSARA PICASSO
FORD FOCUS II, MONDEO IV, S-MAX
MERCEDES-BENZ C-CLASS (W203), C-CLASS Coupe (CL203), C-CLASS T-Model (S203), CLK (C209), CLK Convertible (A209), CLS (C219), E-CLASS (W211), E-CLASS T-Model (S211), G-CLASS (W463), S-CLASS (W220), S-CLASS Coupe (C215), SL (R230), SLK (R171), SLR (R199), SLR ROADSTER (R199), SPRINTER 3,5-t Box/Bus/Platform/Chassis (906), SPRINTER 5-t Platform/Chassis (906)
NISSAN ALMERA II, ALMERA TINO, PRIMERA, X-TRAIL
PEUGEOT 206, 207, 307, 1007, PARTNER
VOLVO C30, C70 II, S40 II, S60 I, S80 I, S80 II, V50, V70 II, XC60, XC70 II, XC90 I

Z227

FIAT UNO
MAZDA 323 F IV (BG)
MERCEDES-BENZ A-CLASS (W169), B-CLASS (W245)
NISSAN CEFIRO, CEFIRO I

Z228

ACURA LEGEND III
AUDI A3
BENTLEY ARNAGE
CHRYSLER STRATUS
HONDA PRELUDE V
HYUNDAI COUPE, SANTA FÉ I, SONATA IV, TERRACAN, TRAJET, XG
INFINITI i30, J30, Q45 I
JAGUAR XJ, XK 8
KIA CARNIVAL II, MAGENTIS, OPIRUS, SORENTO I
LAND ROVER FREELANDER
MG MGF, MG TF, MG ZR, MG ZS, MG ZT, MG ZT-T
MITSUBISHI PAJERO SPORT
NISSAN 300 ZX, SUNNY II
ROVER 25, 45, 75, 400, COUPE
SEAT TOLEDO III
SKODA OCTAVIA
TOYOTA CELICA, MR 2 I, PREVIA
VW EOS, GOLF PLUS

**Z229**

MAZDA 626 V (GF),
626 V /Hatchback (GF),
626 V Hatchback (GF),
626 V Station Wagon (GW)

Z230

FORD C-MAX, GALAXY, MONDEO IV, S-MAX
MAZDA 6 /Hatchback (GG),
6 Station Wagon (GY)
VOLVO C30, S40 II, S80 II, V50, V70 III

Z233

MINI MINI, MINI CLUBMAN
PEUGEOT 207 CC, 207 SW, 308, 308 CC,
308 SW

Z234

ALFA ROMEO MITO
CHEVROLET AVEO
DAIHATSU MATERIA, SIRION, TERIOS
FIAT BRAVA, BRAVO I, DOBLO, FIORINO,
MAREA, PANDA, PUNTO, PUNTO EVO,
PUNTO / GRANDE PUNTO, QUBO,
SEICENTO, SIENA
LANCIA Y, YPSILON
SUZUKI ALTO IV (FF), WAGON R+ (EM)

Z235

BMW 1 (E81), 1 (E87),
1 Convertible (E88), 1 Coupe (E82),
3 (E90), 3 Convertible (E93),
3 Coupe (E92), 3 Touring (E91), 5 (E60),
5 Touring (E61), 6 (E63),
6 Convertible (E64), 7 (E65, E66, E67),
7 (F01, F02, F03, F04), X1 (E84),
X3 (E83), X3 (F25), X5 (E70), Z4 (E85),
Z4 (E89), Z4 Coupe (E86)
DAIHATSU CUORE VIII
LEXUS LS
MITSUBISHI COLT VI
NISSAN TEANA II
OPEL SIGNUM, VECTRA C
PEUGEOT 406
SAAB 9-3
SMART FORFOUR
SUBARU JUSTY IV
TOYOTA LAND CRUISER 150
VAUXHALL VECTRA Mk II (C)

Z236

AUDI A3, A4
SEAT ALTEA, ALTEA XL, LEON, TOLEDO III
SKODA OCTAVIA
VW EOS, GOLF V, GOLF PLUS, JETTA III,
PASSAT, TOURAN

Z237

ALFA ROMEO 145, 146, 147, 155, 156,
166, GT, GTV, SPIDER
ALPINA B3, B10, B12, ROADSTER,
ROADSTER S
AUDI A6, A8
BMW 3 (E36), 3 (E46), 3 Compact (E36),
3 Compact (E46), 3 Convertible (E46),
3 Convertible/Coupe (E46), 3 Coupe (E46),
3 /Touring (E46), 3 Touring (E46), 5 (E39),
5 (E60), 5 /Touring (E39), 5 Touring (E39),
5 Touring (E61), 6 (E63),
6 Convertible (E64), 7 (E38),
7 (E65, E66, E67), 8 (E31), X3 (E83),
X5 (E53), Z3 (E36), Z3 Coupe (E36),
Z4 (E85), Z8 (E52)
MINI MINI
SAAB 900 II

Z238

SKODA FABIA, FELICIA I, FELICIA II,
OCTAVIA

Z239

AUDI A4, A6, A8, ALLROAD
BMW 1 (E81), 1 (E87), 3 (E90),
3 Coupe (E46), 3 Touring (E46)
VW PHAETON, TOUAREG

Z240

ALFA ROMEO 159, BRERA, SPIDER
HYUNDAI COUPE, GRANDEUR, SONATA V
MERCEDES-BENZ C-CLASS (W203),
C-CLASS T-Model (S203), CLK (C208),
CLK (C209), CLK Convertible (A208),
CLK Convertible (A209), CLS (C219),
E-CLASS (W211), E-CLASS T-Model (S211),
G-CLASS (W463), G-CLASS Cabrio (W463),
M-CLASS (W163), M-CLASS (W164),
R-CLASS (W251, V251), S-CLASS (W220),
S-CLASS Coupe (C215), SL (R129),
SL (R230), SLK (R170), VIANO (W639),
VITO Bus (W639), VITO /
MIXTO Box (W639)
TOYOTA PRIUS, PROBOX/SUCCEED

Z242

CITROËN C5 I
PEUGEOT 406

Z243

CITROËN C2, C3 I, C4, C4 I
DACIA LOGAN, SANDERO
NISSAN KUBISTAR
PEUGEOT 206, 207, 307, 1007
RENAULT CLIO Grandtour, CLIO II,
CLIO III, CLIO IV, KANGOO, MODUS /
GRAND MODUS, THALIA I, THALIA II,
TWINGO I, TWINGO II

Z245

LANCIA KAPPA, THESIS, Y

Z246

VW GOLF III, GOLF IV, PASSAT, VENTO

Z247

AUTOBIANCHI Y10
CHEVROLET LUMINA APV
CITROËN BX, C15, EVASION, JUMPER,
SAXO, XANTIA, XM, XSARA,
XSARA PICASSO, ZX
FIAT DUCATO, PALIO, SIENA, UNO
LANCIA Y10
NISSAN 100 NX, ALMERA I, BLUEBIRD,
PRIMERA, SUNNY II, VANETTE CARGO
PEUGEOT 205 I, 205 II, 305 II, 309 I,
309 II, 405 I, 406
RENAULT 19 II, CLIO I, CLIO II,
GRAND SCÉNIC II, KANGOO, MEGANE,
MEGANE II, RAPID, SAFRANE II, SCÉNIC II
ROVER 200, 400, 600, CABRIOLET

Z248

CHRYSLER VIPER
JEEP CHEROKEE, GRAND CHEROKEE I,
GRAND CHEROKEE II, WRANGLER I,
WRANGLER II
TOYOTA CARINA II, COROLLA

Z249

TOYOTA 4 RUNNER, AURIS, AVENSIS,
CELICA, COROLLA, LAND CRUISER 80,
MR 2 III, RAV 4 II, VIOS/YARIS, YARIS,
YARIS VERSO

Z250

ASTON MARTIN VIRAGE
LANCIA Y
OPEL ASTRA F, CALIBRA A, KADETT E
PORSCHE 968
VAUXHALL ASTRA Mk II,
ASTRA Mk III (F), CALIBRA, CAVALIER Mk III
VOLVO 960 II

Z251

VOLVO 960 II, S90, V90

Z252

CITROËN JUMPY
FIAT FIORINO, PUNTO, TEMPRA, TIPO,
ULYSSE
LANCIA DEDRA, DELTA II
PEUGEOT EXPERT

Z253

FORD ESCORT '86, ESCORT IV
SAAB 9-3, 900 II, 9000
VAUXHALL CARLTON Mk III

Z254

SKODA FAVORIT
TOYOTA COROLLA

Z255

FIAT BARCHETTA, BRAVA, BRAVO I, DOBLO,
MAREA, MULTIPLA, PALIO, PANDA, PUNTO,
SEICENTO, SIENA, STILO
JEEP GRAND CHEROKEE I
LANCIA YPSILON
NISSAN SUNNY III
PEUGEOT 205 II, 309 I

Z257

DACIA 1310, LOGAN, LOGAN MCV,
SANDERO
DAIHATSU TERIOS
RENAULT KANGOO, KANGOO /
GRAND KANGOO, SANDERO/STEPWAY,
THALIA I, TWINGO I

Z266

VOLVO P 121, P 122 S AMAZON, P 544

Z267

OPEL ADMIRAL A, DIPLOMAT A

Z272

SEAT ALTEA, ALTEA XL, CORDOBA, IBIZA IV,
IBIZA V, LEON, TOLEDO IV
SKODA FABIA, OCTAVIA, RAPID,
ROOMSTER, ROOMSTER Praktik
VW BEETLE, CADDY III, FOX, GOLF V,
GOLF VI, GOLF PLUS, JETTA III, JETTA IV,
NEW BEETLE, POLO

Z273

CITROËN C1
DAIHATSU SIRION
MITSUBISHI COLT VI
PEUGEOT 107
TOYOTA AYGO, YARIS

Z274

RENAULT CLIO Grandtour, CLIO III,
CLIO IV, GRAND SCÉNIC III, MEGANE CC,
MEGANE III, MODUS / GRAND MODUS,
SCÉNIC III, TWINGO II, WIND

**Z275**

HONDA CIVIC VII, CIVIC VIII, CR-V III, FR-V

Z277

PORSCHE CAYENNE (955)

Z278

MINI COOPER S, COOPER R, COOPER SE, COOPER SE R55, COOPER SE R56, COOPER SE R57, COOPER SE R58, COOPER SE R59, COOPER SE R60, COOPER SE R61, COOPER SE R62, COOPER SE R63, COOPER SE R64, COOPER SE R65, COOPER SE R66, COOPER SE R67, COOPER SE R68, COOPER SE R69, COOPER SE R70, COOPER SE R71, COOPER SE R72, COOPER SE R73, COOPER SE R74, COOPER SE R75, COOPER SE R76, COOPER SE R77, COOPER SE R78, COOPER SE R79, COOPER SE R80, COOPER SE R81, COOPER SE R82, COOPER SE R83, COOPER SE R84, COOPER SE R85, COOPER SE R86, COOPER SE R87, COOPER SE R88, COOPER SE R89, COOPER SE R90, COOPER SE R91, COOPER SE R92, COOPER SE R93, COOPER SE R94, COOPER SE R95, COOPER SE R96, COOPER SE R97, COOPER SE R98, COOPER SE R99, COOPER SE R00

Z279

MINI COOPER S, COOPER R, COOPER SE, COOPER SE R55, COOPER SE R56, COOPER SE R57, COOPER SE R58, COOPER SE R59, COOPER SE R60, COOPER SE R61, COOPER SE R62, COOPER SE R63, COOPER SE R64, COOPER SE R65, COOPER SE R66, COOPER SE R67, COOPER SE R68, COOPER SE R69, COOPER SE R70, COOPER SE R71, COOPER SE R72, COOPER SE R73, COOPER SE R74, COOPER SE R75, COOPER SE R76, COOPER SE R77, COOPER SE R78, COOPER SE R79, COOPER SE R80, COOPER SE R81, COOPER SE R82, COOPER SE R83, COOPER SE R84, COOPER SE R85, COOPER SE R86, COOPER SE R87, COOPER SE R88, COOPER SE R89, COOPER SE R90, COOPER SE R91, COOPER SE R92, COOPER SE R93, COOPER SE R94, COOPER SE R95, COOPER SE R96, COOPER SE R97, COOPER SE R98, COOPER SE R99, COOPER SE R00

Z280

LEXUS GS, SC
TOYOTA AVENSIS, RAV 4 II

Z282

MERCEDES-BENZ C-CLASS (W203),
C-CLASS Coupe (CL203),
C-CLASS Estate (S202),
C-CLASS T-Model (S203)

Z284

FORD SCORPIO I, SCORPIO II, SIERRA
HONDA INTEGRA, LEGEND II, LEGEND III, NSX
LEXUS RX
MINI COOPER S, COOPER R, COOPER SE, COOPER SE R55, COOPER SE R56, COOPER SE R57, COOPER SE R58, COOPER SE R59, COOPER SE R60, COOPER SE R61, COOPER SE R62, COOPER SE R63, COOPER SE R64, COOPER SE R65, COOPER SE R66, COOPER SE R67, COOPER SE R68, COOPER SE R69, COOPER SE R70, COOPER SE R71, COOPER SE R72, COOPER SE R73, COOPER SE R74, COOPER SE R75, COOPER SE R76, COOPER SE R77, COOPER SE R78, COOPER SE R79, COOPER SE R80, COOPER SE R81, COOPER SE R82, COOPER SE R83, COOPER SE R84, COOPER SE R85, COOPER SE R86, COOPER SE R87, COOPER SE R88, COOPER SE R89, COOPER SE R90, COOPER SE R91, COOPER SE R92, COOPER SE R93, COOPER SE R94, COOPER SE R95, COOPER SE R96, COOPER SE R97, COOPER SE R98, COOPER SE R99, COOPER SE R00

Z285

CHRYSLER VOYAGER II, VOYAGER III

Z286

SMART CABRIO, CITY-COUPÉ, FORTWO, ROADSTER

Z287

OPEL ASTRA G, ASTRA H, ZAFIRA A, ZAFIRA B
VAUXHALL ASTRA Mk V (H), ASTRA TwinTop Mk V (H), ZAFIRA Mk I (A), ZAFIRA Mk II (B)

Z291

CHEVROLET AVEO, SPARK
FIAT 500, BRAVA, BRAVO I, BRAVO II, DOBLO, IDEA, MAREA, PALIO, PANDA, PUNTO, SIENA, STILO, STRADA
FORD KA
LANCIA MUSA
NISSAN PIXO
PEUGEOT AGILA (B)
SUZUKI ALTO V (GF), SPLASH, SWIFT IV (FZ, NZ)

Z292

DAIHATSU MATERIA, SIRION, TERIOS
FIAT 500, 500 C, 500L, BRAVA, BRAVO I, BRAVO II, DOBLO, IDEA, MAREA, PALIO, PANDA, PUNTO, PUNTO / GRANDE PUNTO, SIENA, STILO, STRADA
LANCIA MUSA, Y, YPSILON
SUZUKI WAGON R+ (EM)

Z293

ALFA ROMEO MITO
FIAT 500, 500 C, DOBLO, IDEA, LINEA, PANDA, PUNTO, PUNTO EVO, PUNTO / GRANDE PUNTO, SIENA
FORD KA
LANCIA MUSA, YPSILON

Z294

VOLVO C30, C70 II, S40 II, V50

Z295

AUDI A4, A5, A6, A6 Allroad, A8, Q7, R8
VW TOUAREG

Z296

FORD MONDEO III

Z297

HONDA ACCORD VIII

Z298

MAZDA 3 (BK), 3 Saloon (BK), 5 (CR19), 6 /Estate/Hatchback (GH), 6 /Hatchback (GG), 6 Station Wagon (GY), MPV II (LW), MPV III (LY) III, MX-5 III (NC), TRIBUTE (EP)

Z299

HONDA ACCORD VII, CIVIC VII, CIVIC VIII, CR-V II, FR-V, INTEGRA, STEPWAGON, STREAM

Z300

AUDI A2, A3
SKODA OCTAVIA
VW BORA, EOS, GOLF IV, GOLF V, GOLF PLUS, JETTA III, LUPO, PASSAT, POLO, TOURAN

Z301

BMW 1 (E81), 1 (E87), 1 (E88), 1 (E89), 1 (E90), 1 (E91), 1 (E92), 1 (E93), 1 (E94), 1 (E95), 1 (E96), 1 (E97), 1 (E98), 1 (E99), 1 (R50), 1 (R52), 1 (R53), 1 (R54), 1 (R55), 1 (R56), 1 (R57), 1 (R58), 1 (R59), 1 (R60), 1 (R61), 1 (R62), 1 (R63), 1 (R64), 1 (R65), 1 (R66), 1 (R67), 1 (R68), 1 (R69), 1 (R70), 1 (R71), 1 (R72), 1 (R73), 1 (R74), 1 (R75), 1 (R76), 1 (R77), 1 (R78), 1 (R79), 1 (R80), 1 (R81), 1 (R82), 1 (R83), 1 (R84), 1 (R85), 1 (R86), 1 (R87), 1 (R88), 1 (R89), 1 (R90), 1 (R91), 1 (R92), 1 (R93), 1 (R94), 1 (R95), 1 (R96), 1 (R97), 1 (R98), 1 (R99), 1 (R00)

Z302

NISSAN CUBE, MICRA C+C, MICRA III, NOTE

Z303

NISSAN ALMERA II, ALMERA TINO, PRIMERA, X-TRAIL

Z304

ALFA ROMEO 147

Z304

CHEVROLET EPICA, LACETTI, NUBIRA

Z305

CHEVROLET ALERO

Z306

AUDI A3, TT
PORSCHE CAYENNE (955)
VW EOS, GOLF IV, GOLF V, MULTIVAN V, PHAETON, TOUAREG, TRANSPORTER V

Z307

MAZDA 2 (DE)

Z308

KIA CARENS III, CEE'D, SOUL
SMART FORTWO

Z309

FORD MONDEO III

Z310

MAZDA 3 Saloon (BK), MX-5 III (NC)

Z311

HYUNDAI SANTA FÉ I
KIA SORENTO I

Z312

CHRYSLER CIRRUS, SEBRING
HONDA CIVIC VIII
HYUNDAI ELANTRA, EQUUS / CENTENNIAL, SONATA IV
JAGUAR S-TYPE, XF, XK
KIA CERATO
LEXUS GS
LOTUS ELISE

...Z312

MAZDA XEDOS 9 (TA)
MERCEDES-BENZ S-CLASS (W220), S-CLASS (W221), S-CLASS Coupe (C215), S-CLASS Coupe (C216), SL (R230)
MG MG ZS
NISSAN STAGEA
SUBARU LEGACY IV, OUTBACK
TOYOTA ARISTO, AVENSIS, COROLLA, COROLLA FX, CROWN
VOLVO S80 II, XC90 I

Z313

CHEVROLET EPICA
FORD SIERRA
LEXUS GS, IS, IS I
NISSAN 200 SX, BLUEBIRD, SUNNY II
RENAULT ESPACE III
SAAB 9-3
TOYOTA COROLLA, LAND CRUISER

Z314

NISSAN 180 SX, 200 SX, LUCINO, SUNNY III

Z315

FORD FOCUS

Z317

AUDI 100, A4, A6
SEAT CORDOBA, IBIZA II, TOLEDO I
VW GOLF III, PASSAT, SHARAN

Z320

CITROËN C3 II, C3 Picasso, DS3
PEUGEOT 207, 207 CC, 207 SW, 308, 308 CC, 308 SW

Z321

AUDI A4, A5, A6, Q5

Z322

MERCEDES-BENZ A-CLASS (W169), B-CLASS (W245)
MINI MINI

Z323

HONDA S2000

Z324

DAIHATSU CERIA, CHARADE, COO, CUORE VI, CUORE VII, MATERIA, SIRION, TREVIS, YRV

Z325

NISSAN BLUEBIRD SYLPHY, CUBE, JUKE, LATIO, LIVINA /GRAND LIVINA, MICRA C+C, MICRA III, NOTE, NV200, NV200 EVALIA, QASHQAI / QASHQAI +2, SERENA, TIIDA, X-TRAIL
RENAULT CLIO III, LAGUNA III, MEGANE III

**Z326**

FORD FOCUS II, MONDEO IV, S-MAX
VOLVO C30, C70 II, S40 II, S60 I, S80 I,
S80 II, V50, V70 II, XC60,
XC70 CROSS COUNTRY, XC70 II, XC90 I

Z332

BMW 1 (F20), 1 (F21), 3 (F30, F35, F80),
3 Touring (F31)
CITROËN BERLINGO, C3 II, C3 Picasso, C4,
C4 Grand Picasso I, C4 I, C4 II, C4 Picasso I,
C5 III, DS3, DS4, DS5
MINI MINI, MINI CLUBMAN,
MINI COUNTRYMAN
PEUGEOT 207, 207 CC, 207 SW, 308,
308 CC, 308 SW, 508, 508 SW, 3008,
5008, RCZ

Z333

NISSAN PIXO
OPEL AGILA (B)
SUZUKI ALTO V (GF), SPLASH,
SWIFT IV (FZ, NZ)
VAUXHALL AGILA Mk II (B)

Z334

HYUNDAI ELANTRA, i10
KIA CEE'D, PRIDE
NISSAN SUNNY III
TOYOTA CORONA

Z335

PEUGEOT 405 I

Z336

MINI MINI, MINI CLUBMAN,
MINI COUNTRYMAN

Z337

OPEL VIVARO
RENAULT AVANTIME, ESPACE IV,
GRAND SCÉNIC II, LAGUNA, LAGUNA II,
LAGUNA III, MEGANE CC, MEGANE II,
MEGANE III, SCÉNIC II, TRAFIC II,
TWINGO II, VEL SATIS
VAUXHALL VIVARO

Z338

ALFA ROMEO GIULIETTA, MITO
FIAT 500, 500 C, BRAVO II, DOBLO, LINEA,
PUNTO, PUNTO EVO, PUNTO /
GRANDE PUNTO
LANCIA DELTA III

Z339

AUDI A3, TT

Z340

ACURA LEGEND II
ALFA ROMEO 145, 146, 156, 164, 166,
GT, GTV, SPIDER

...Z340

ALPINA B3, B10, B12, ROADSTER,
ROADSTER S
ASTON MARTIN VIRAGE
AUDI 80, A2, A3, A4, A6, A8, ALLROAD,
CABRIOLET, COUPE, TT
AUTOBIANCHI Y10
BMW 3 (E46), 3 Compact (E46),
3 Convertible (E46),
3 Convertible/Coupe (E46), 3 Coupe (E46),
3 /Touring (E46), 3 Touring (E46), 5 (E39),
5 (E60), 5 /Touring (E39), 5 Touring (E39),
5 Touring (E61), 6 (E63),
6 Convertible (E64), 7 (E38),
7 (E65, E66, E67), 8 (E31), X3 (E83),
X5 (E53), Z3 (E36), Z3 Coupe (E36),
Z4 (E85)
CHEVROLET AVEO, KALOS, LACETTI,
LUMINA APV, NUBIRA, REZZO
CHRYSLER CIRRUS, CROSSFIRE, NEON,
NEON II, STRATUS, VOYAGER III
CITROËN AX, BERLINGO, C2, C3, C3 I,
C3 II, C15, EVASION, JUMPER, NEMO,
SAXO, XANTIA, XM, XSARA,
XSARA PICASSO, ZX
DACIA DUSTER, LOGAN, LOGAN MCV,
SANDERO
DAEWOO ESPERO, KALOS, LACETTI,
LANOS, LEGANZA, NEXIA, NUBIRA
DAIHATSU APPLAUSE I, APPLAUSE II,
CHARADE III, CHARADE IV,
FEROZA Hard Top, FEROZA Soft Top,
GRAN MOVE, HIJET, MOVE, SIRION
FIAT CINQUECENTO, DUCATO, FIORINO,
FIORINO Pick up, PALIO, PANDA, PUNTO,
QUBO, SEICENTO, SIENA, TEMPRA, ULYSSE
FORD ESCORT '95, ESCORT VI, ESCORT VII,
FIESTA III, SCORPIO II
HONDA CIVIC II, CIVIC IV, CIVIC V, CIVIC VI,
CONCERTO, CRX III, JAZZ II
HYUNDAI ACCENT, ACCENT III, COUPE,
LANTRA II
ISUZU GEMINI, TROOPER
JAGUAR XJ, XJSC
JEEP CHEROKEE
KIA CARENS I, CARENS II, CLARUS,
PICANTO, RETONA, RIO, SEPHIA, SHUMA,
SHUMA II, SPORTAGE
LADA 110, 111, 112, KALINA, PRIORA
LANCIA DELTA II, KAPPA, Y, Y10, ZETA
MAZDA 2 (DE), 121 II (DB),
323 C IV (BG), 323 C V (BA), 323 F IV (BG),
323 F V (BA), 323 F VI (BJ), 323 P V (BA),
323 S IV (BG), 323 S V (BA), 323 S VI (BJ),
626 III /Coupe (GD), 626 III Coupe (GD),
626 III Hatchback (GD),
626 III Station Wagon (GV), 626 IV (GE),
626 IV /Hatchback (GE),
626 IV Hatchback (GE), DEMIO (DW),
E-SERIE Box (SR2), MPV I (LV), MX-3 (EC),
MX-5 I (NA), MX-6 (GE), PREMACY (CP),
XEDOS 6 (CA), XEDOS 9 (TA)

...Z340

MERCEDES-BENZ C-CLASS (W202),
C-CLASS (W203), C-CLASS Coupe (CL203),
C-CLASS Estate (S202),
C-CLASS T-Model (S203), CLK (C208),
CLK (C209), CLK Convertible (A208),
CLK Convertible (A209), E-CLASS (W210),
E-CLASS Estate (S210), S-CLASS (W220),
S-CLASS Coupe (C215), SLK (R170),
SLK (R171)
MINI MINI
MITSUBISHI CARISMA, COLT IV, COLT V,
GALANT V, GALANT VI, L 300, LANCER,
LANCER IV, LANCER V, SPACE RUNNER,
SPACE STAR, SPACE WAGON
NISSAN ALMERA I, KUBISTAR, MAXIMA II,
PRIMASTAR, PRIMERA, SERENA, SUNNY III,
VANETTE CARGO
OPEL ASTRA F, CALIBRA A, VIVARO
PEUGEOT 106 I, 106 II, 205 II, 206,
206+, 207, 207 SW, 306, 307, 405 II,
406, 605, 806, 1007, BIPPER,
BIPPER Tepee, BOXER, EXPERT, PARTNER
PORSCHE 968
RENAULT 19 II, AVANTIME,
CLIO Grandtour, CLIO I, CLIO II, CLIO III,
ESPACE III, ESPACE IV, GRAND SCÉNIC II,
KANGOO, LAGUNA, LAGUNA I, LAGUNA II,
LAGUNA III, LOGAN, MEGANE, MEGANE CC,
MEGANE I, MEGANE II, MEGANE III, MODUS
/ GRAND MODUS, SCÉNIC I, SCÉNIC II,
THALIA I, TRAFIC II, TWINGO I, TWINGO II,
VEL SATIS
ROVER 25, 100, 100 / METRO, 200, 400,
800, CABRIOLET, COUPE
SAAB 9-3, 900 II, 9000
SEAT ALHAMBRA, ALTEA, ALTEA XL, AROSA,
CORDOBA, EXEO, IBIZA II, IBIZA III,
IBIZA IV, INCA, LEON, TOLEDO I, TOLEDO II,
TOLEDO III
SKODA FABIA, FAVORIT, FELICIA I,
FELICIA II, OCTAVIA, SUPERB
SUBARU FORESTER, IMPREZA, JUSTY II,
LEGACY I, LEGACY II, LEGACY III, LEGACY IV,
OUTBACK, VIVIO
SUZUKI BALENO (EG),
BALENO Estate (EG),
BALENO Hatchback (EG), CARRY Box (FD),
GRAND VITARA I (FT, GT), IGNIS (FH),
JIMNY (FJ), SWIFT II Saloon (AH, AJ),
VITARA (ET, TA), VITARA Cabrio (ET, TA),
WAGON R+ (MM), X-90 (EL)
TOYOTA CAMRY
VAUXHALL ASTRA Mk III (F), MONTEREY,
VIVARO
VOLVO 850, 960 II, C70 I, S40 I, S60 I,
S70, S80 I, S90, V40, V70 I, V70 II, V90,
XC70 CROSS COUNTRY, XC90 I
VW BORA, CADDY II, CADDY III, GOLF III,
GOLF IV, GOLF V, GOLF VI, GOLF PLUS,
JETTA III, LUPO, MULTIVAN V, NEW BEETLE,
PASSAT, POLO, SHARAN, VENTO

Z341

ALFA ROMEO 147

Z342

FORD GALAXY, MONDEO IV, S-MAX
MAZDA 3 (BK), 6 /Hatchback (GG),
6 Station Wagon (GY)
SUZUKI GRAND VITARA II (JT)

Z343

ACURA SLX
HYUNDAI GALLOPER II, HIGHWAY VAN,
SANTA FÉ I, SANTA FÉ II
INFINITI Q45 I
ISUZU TROOPER
LEXUS ES, GS
OPEL FRONTERA B, MONTEREY A,
MONTEREY B
SUBARU LEGACY II
VAUXHALL FRONTERA Mk II (B),
MONTEREY Mk II

Z344

SEAT CORDOBA, IBIZA IV
VW FOX, GOL, GOLF IV, POLO, VOYAGE

Z345

AUDI A6, A7, A8

Z346

OPEL ASTRA GTC J, ASTRA H, ASTRA J,
CORSA D, INSIGNIA, MERIVA
VAUXHALL ASTRA GTC Mk VI (J),
ASTRA Mk V (H), ASTRA Mk VI (J),
ASTRA TwinTop Mk V (H), CORSA Mk III (D),
INSIGNIA

Z347

AUDI A1, A3, A4, A4 Allroad, A5, A6,
A6 Allroad, A7, Q3, Q5, R8, TT
SEAT ALHAMBRA, ALTEA, ALTEA XL, EXEO,
LEON, TOLEDO III
SKODA OCTAVIA, SUPERB, YETI
VW AMAROK, BEETLE, CC, EOS, GOLF V,
GOLF VI, JETTA III, JETTA IV, MULTIVAN V,
PASSAT, PASSAT ALLTRACK, PASSAT CC,
POLO, SCIROCCO, SHARAN, TIGUAN,
TRANSPORTER V

Z348

AUDI A3, A4, A4 Allroad, A5, Q5
SEAT LEON
SKODA OCTAVIA
VW GOLF VII

Z349

AUDI A1, A3
SEAT ALTEA, ALTEA XL, IBIZA V, LEON,
TOLEDO IV
SKODA OCTAVIA, RAPID, SUPERB, YETI
VW EOS, GOLF V, GOLF VI, GOLF PLUS,
JETTA IV, PASSAT, SCIROCCO, TIGUAN

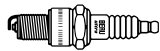
**Z354**

HONDA ACCORD VII, ACCORD VIII, CITY, CIVIC VIII, CIVIC IX, CR-V III, JAZZ III, LEGEND IV

Z355

MERCEDES-BENZ C-CLASS (W204), C-CLASS Coupe (C204), C-CLASS T-Model (S204), CLK (C209), CLK Convertible (A209), CLS (C219), E-CLASS (W211), E-CLASS (W212), E-CLASS T-Model (S211), E-CLASS T-Model (S212), M-CLASS (W164), R-CLASS (W251, V251), S-CLASS (W221), S-CLASS Coupe (C216), SL (R230)

Z356

**ALFA ROMEO 159, BRERA, SPIDER
CHEVROLET CAPTIVA
OPEL ANTARA
VAUXHALL ANTARA**

Z357

**CHRYSLER YPSILON
FIAT 500, 500 C, 500L, PANDA, PUNTO**

Z358

CHEVROLET AVEO

Z359

**HYUNDAI i10, i20
MERCEDES-BENZ C-CLASS (W203), C-CLASS (W204), C-CLASS Coupe (CL203), C-CLASS T-Model (S203), C-CLASS T-Model (S204), CLC-CLASS (CL203), CLK (C209), CLK Convertible (A209), CLS (C219), E-CLASS (W211), E-CLASS (W212), E-CLASS Convertible (A207), E-CLASS Coupe (C207), E-CLASS T-Model (S211), E-CLASS T-Model (S212), G-CLASS Cabrio (W463), GL-CLASS (X164), GLK-CLASS (X204), M-CLASS (W164), R-CLASS (W251, V251), S-CLASS (W221), S-CLASS Coupe (C216), SL (R230), SLK (R171), SPRINTER 3-t Platform/Chassis (906)**

Z360

DAIHATSU EXTOL, SIRION, TERIOS, YRV



UX56

ALFA ROMEO 33, 75, 90, 145, 146, 155, 164, 166, 1750-2000, 1900, ALFASUD, ARNA, GIULIA, GIULIETTA, GT, GTA, GTV, MONTREAL, RZ, SPIDER
ASTON MARTIN LAGONDA I, ZAGATO
AUDI 50, 80, 90, 100, 200, A6, CABRIOLET, COUPE, QUATTRO, SUPER 90
AUSTIN MAESTRO, METRO, MONTEGO
AUTOBIANCHI A 112, Y10
BMW 02 (E10), 02 Convertible (E10), 02 Touring (E6), 5 (E12), 1500-2000 (115, 116, 118, 121), 2000-3.2 Coupe (E9)
CHEVROLET KALOS
CITROËN AMI, GS
DAEWOO KALOS, NEXIA
DAIHATSU CUORE IV, CUORE V, HIJET, MOVE
FIAT 124, 125, 126, 127, 131, 132, 850, CINQUECENTO, COUPE, CROMA, FIORINO, FIORINO Pick up, X 1/9, PANDA, REGATA, RITMO, RITMO I, RITMO II, SEICENTO, TEMPRA, TIPO, UNO
FORD CAPRI, CAPRI II, CAPRI III, CONSUL, CORSAIR, CORTINA, ESCORT I, ESCORT II, ESCORT IV, GRANADA, TAUNUS, TAUNUS 12M, TAUNUS 15M, TAUNUS 17M, TAUNUS 26M XL, TAUNUS '80
FSO 127P, 132P, POLONEZ I
HYUNDAI H100, LANTRA I, PONY, S COUPE, SONATA III, SONATA IV, TRAJET
JAGUAR XJ
KIA JOICE, MAGENTIS, PRIDE
LADA 110, 111, 112, KALINA, NIVA, NOVA, SAMARA, SAMARA FORMA, TOSCANA
LANCIA A 112, BETA, BETA H.P.E., BETA MONTE CARLO, DEDRA, DELTA I, DELTA II, FULVIA, GAMMA, PRISMA, THEME, TREVI, Y10
LAND ROVER RANGE ROVER II
LOTUS ECLAT, ELITE, ESPRIT S2, ESPRIT S3, ESPRIT S4, EXCEL
MERCEDES-BENZ /8 (W114), /8 (W115), /8 Coupe (W114), CABRIOLET (W111), COUPE (W111), G-CLASS (W460), HECKFLOSSE (W110), HECKFLOSSE (W111, W112), KOMBI Estate (S123), PAGODE (W113), PONTON (W128), Saloon (W123), S-CLASS (W108, W109), S-CLASS (W116), SL (W121), SL Coupe (C107), T2/L Box Body / Estate/Platform/Chassis, T2/L Dumptruck, T2/L Municipal Vehicle
MG MGR V8
MITSUBISHI COLT II, COLT III, ECLIPSE I, ECLIPSE II, GALANT I, GALANT III, L 200, L 300, SAPPORO II, SAPPORO III, SIGMA, SPACE WAGON
NISSAN PICK UP, URVAN
OPEL ASCONA A, CAMPO, VECTRA A
PEUGEOT 204, 304, 504, 505

...UX56

PORSCHE 911, 911 /Targa, 911 Targa, 914, 924, 928, 944 /Convertible
RENAULT 9, 11, 15, 16, 17, 18, 19 I, 19 II, 20, 21, CLIO I, FUEGO, MASTER I, SUPER 5, TRAFIC
ROVER 800, MINI
SAAB 99, 900 I
SEAT 124, 128, 131, 132, AROSA, CORDOBA, IBIZA II, IBIZA III, INCA, RONDA, TERRA, TOLEDO I
SKODA FELICIA I, FELICIA II, OCTAVIA
SUBARU JUSTY I, JUSTY II, XT
SUZUKI SWIFT Convertible (SF413), SWIFT II Hatchback (EA, MA), SWIFT II Saloon (AH, AJ), VITARA (ET, TA), VITARA Cabrio (ET, TA)
TALBOT 160, 180, 1307-1510, MATRA BAGHEERA, SIMCA 1000, SIMCA 1100, SIMCA 1500, SIMCA 1501, SIMCA 1609/1610, SIMCA SUNBEAM
VAUXHALL BRAVA, CHEVETTE
VOLVO 240, 340-360, 440 K, 460 L, 480 E, 740, 760, 940, 940 II
VW CADDY II, CORRADO, DERBY, GOLF I, GOLF II, GOLF III, GOLF IV, JETTA I, K 70, LT 28-35 I, LT 40-55 I, LUPO, PASSAT, POLO, SANTANA, SCIROCCO, TRANSPORTER III, VENTO, VOYAGE

UXK56

AUSTIN AMBASSADOR
CITROËN AXEL, BX, C15, CX II, GS, LNA, VISA
FORD ESCORT VI, ESCORT VII, FIESTA, FIESTA III, FIESTA IV, KA
MAZDA 121 III (JASM, JBSM), TRIBUTE (EP)
MERCEDES-BENZ 190 (W201), G-CLASS (W461)
OPEL ASCONA B, MANTA B
PEUGEOT 104, 205 I, 205 II, 305 II, 309 I, 505
RENAULT 5, 14, 18, 20, 21, 25, 30, ESPACE I, ESPACE II, FUEGO, MASTER I, SAFRANE I
TALBOT SAMBA, TAGORA
VOLVO 240, 260, 760, 780

UXT1 / UXT3

ALFA ROMEO 156, GT
ALPINA B3, B8, B10, B12
ASTON MARTIN VIRAGE
AUDI 80, 100, A2, A3, A4, A6, A8, CABRIOLET, COUPE, TT
AUSTIN MAESTRO, MONTEGO
AUTOBIANCHI Y10

...UXT1 / UXT3

BMW 3 (E30), 3 (E36), 3 Compact (E36), 3 /Compact/Coupe/Touring (E36), 3 /Convertible (E30), 3 Convertible (E30), 3 /Convertible/Coupe (E36), 3 Convertible/Coupe (E36), 3 /Convertible/Coupe/Touring (E36), 3 /Convertible/Coupe/Touring (E36), 3 /Convertible/Touring (E36), 3 /Coupe (E36), 3 Coupe (E36), 3 Touring (E30), 5 (E34), 5 (E39), 5 /Touring (E34), 5 Touring (E34), 5 /Touring (E39), 5 Touring (E39), 7 (E32), 7 (E38), 8 (E31), Z3 (E36)
CHEVROLET ASTRA, CAPTIVA, EVANDA, LUMINA APV, REZZO, VECTRA
CHRYSLER CIRRRUS, NEON, NEON II, STRATUS, VOYAGER III
CITROËN AX, BERLINGO, BX, C2, C3, C3 I, C3 II, C15, EVASION, JUMPER, NEMO, SAXO, XANTIA, XM, XSARA, XSARA PICASSO, ZX
DACIA 1310, DUSTER, LODGY, LOGAN, LOGAN MCV, SANDERO, SOLENZA
DAEWOO KORANDO, LEGANZA, MUSSO, NUBIRA, REXTON, REZZO, WINSTORM
DAIHATSU TERIOS
FIAT 900 T/E Pulmino, 1000er-Serie, BARCHETTA, BRAVA, BRAVO I, CINQUECENTO, COUPE, DOBLO, DUCATO, FIORINO, FIORINO Pick up, MAREA, MULTIPLA, PALIO, PANDA, PUNTO, QUBO, SEDICI, SEICENTO, SIENA, STILO, TEMPRA, TIPO, ULYSSE, UNO
FORD SCORPIO I, SIERRA, TRANSIT
HONDA CIVIC VI
HYUNDAI COUPE
JAGUAR S-TYPE, XJ, XJSC
JEEP CHEROKEE, GRAND CHEROKEE I
KIA CARENS I, CARENS II, CLARUS, RIO, SEPHIA, SHUMA, SHUMA II, SPORTAGE
LANCIA DEDRA, DELTA II, KAPPA, LYBRA, Y, Y10, YPSILON, ZETA
LAND ROVER DISCOVERY I, RANGE ROVER III
LOTUS ESPRIT S4
MAZDA 323 III Hatchback (BF), 626 III Coupe (GD), 626 III /Hatchback (GD), 626 III Station Wagon (GV), 929 III (HC)

...UXT1 / UXT3

MERCEDES-BENZ CABRIOLET (A124), C-CLASS (W202), C-CLASS Estate (S202), COUPE (C124), E-CLASS (W124), E-CLASS (W210), E-CLASS Convertible (A124), E-CLASS Coupe (C124), E-CLASS Estate (S124), E-CLASS Estate (S210), G-CLASS (W463), G-CLASS Cabrio (W463), KOMBI Estate (S124), Saloon (W124), S-CLASS (W140), S-CLASS Coupe (C140), SL (R129), SLK (R170), SPRINTER 2-t Box (901, 902), SPRINTER 2-t Box/Bus/Platform/Chassis (901, 902), SPRINTER 3-t Box (903), SPRINTER 3-t Box/Bus/Platform/Chassis (903), SPRINTER 4-t Box/Bus/Platform/Chassis (904)
NISSAN 100 NX, ALMERA I, BLUEBIRD, KUBISTAR, PRIMERA, SERENA, SUNNY II, SUNNY III, VANETTE CARGO
OPEL AGILA (A), ANTARA, ASTRA F, ASTRA F CLASSIC, ASTRA G, CALIBRA A, COMBO, CORSA A, CORSA B, CORSA C, FRONTERA A, FRONTERA B, KADETT E, OMEGA A, OMEGA B, SENATOR B, SINTRA, SPEEDSTER, TIGRA, VECTRA A, VECTRA B, VECTRA C, ZAFIRA A
PEUGEOT 106 I, 106 II, 106 Van, 205 I, 205 II, 206, 206+, 207, 207 SW, 305 II, 306, 307, 309 I, 309 II, 405 I, 405 II, 406, 605, 806, 1007, BIPPER, BIPPER Tepee, BOXER, EXPERT, PARTNER
PORSCHE 968, BOXSTER (986)
RENAULT 19 I, 19 II, CLIO Grandtour, CLIO I, CLIO II, CLIO III, DUSTER, ESPACE III, ESPACE IV, FLUENCE, GRAND SCÉNIC II, GRAND SCÉNIC III, KANGOO, KANGOO BE BOP, KANGOO / GRAND KANGOO, LAGUNA I, LAGUNA II, LAGUNA III, LOGAN, MEGANE, MEGANE I, MEGANE II, MEGANE III, MODUS / GRAND MODUS, RAPID, SAFRANE II, SANDERO/STEPWAY, SCÉNIC I, SCÉNIC II, SCÉNIC III, THALIA I, TWINGO I, TWINGO II
ROVER 25, 100, 100 / METRO, 200, 400, 600, 800, CABRIOLET, COUPE
SAAB 900 II, 9000
SEAT ALHAMBRA, ALTEA, ALTEA XL, AROSA, CORDOBA, EXEO, IBIZA II, IBIZA III, IBIZA IV, IBIZA V, INCA, LEON, TOLEDO I, TOLEDO II, TOLEDO III
SKODA FABIA, FAVORIT, FELICIA I, FELICIA II, OCTAVIA, SUPERB
SSANGYONG KORANDO, KYRON, MUSSO, REXTON, RODIUS

**...UXT1 / UXT3**

SUZUKI BALENO (EG), BALENO Estate (EG), BALENO Estate/Hatchback (EG), BALENO Hatchback (EG), CARRY Box (FD), JIMNY (FJ), SWIFT II Saloon (AH, AJ), SX4 (GY), VITARA (ET, TA), VITARA Cabrio (ET, TA), X-90 (EL)
TOYOTA CELICA, COROLLA
VAUXHALL AGILA Mk I (A), ASTRA Mk II, ASTRA Mk III (F), ASTRA Mk IV (G), ASTRAMAX, ASTRAVAN Mk III (F), ASTRAVAN Mk IV (G), CALIBRA, CARLTON Mk III, CAVALIER Mk II, CAVALIER Mk III, COMBO Mk I (B), COMBO Mk II (C), CORSA Mk I (B), CORSA Mk II (C), CORSAVAN Mk I (B), CORSAVAN Mk II (C), FRONTERA Mk I (A), FRONTERA Mk II (B), MERIVA Mk I (A), NOVA, OMEGA (B), SENATOR Mk II (B), SINTRA, TIGRA Mk I, VECTRA (B), ZAFIRA Mk I (A)
VOLVO 960, 960 II, C70 I, S90, V90
VW BORA, CADDY II, CADDY III, GOLF III, GOLF IV, GOLF V, GOLF VI, GOLF PLUS, JETTA III, LT 28-35 II, LT 28-46 II, LUPO, MULTIVAN V, NEW BEETLE, PASSAT, POLO, SHARAN, TOURAN, TRANSPORTER V, VENTO

UXT2 / UXT6

ALFA ROMEO 6, 33, 75, 90, 164, 1750-2000, 2300, ALFASUD, ALFETTA, ALFETTA GT, GIULIA, GIULIETTA, GT, GTV, SPIDER
ALPINA B3, B6, B9, B10, B11, C1, C2
ASTON MARTIN DB6, DBS, LAGONDA I, V8, ZAGATO
AUDI 50, 60, 75, 80, 90, 100, 200, A6, CABRIOLET, COUPE, QUATTRO
AUSTIN 1000-Series MK II, ALLEGRO, MAESTRO, MAXI, METRO, MINI, MONTEGO, PRINCESS
AUTOBIANCHI A 111, A 112, Y10
BEDFORD RASCAL
BMW 02 (E10), 02 Convertible (E10), 02 Touring (E6), 3 (E21), 3 (E30), 3 /Convertible (E30), 3 /Convertible/Touring (E30), 3 /Touring (E30), 5 (E12), 5 (E28), 5 (E34), 6 (E24), 7 (E23), 7 (E32), 1500-2000 (115, 116, 118, 121), 1600 GT Coupe, 2000-3.2 Coupe (E9), 2500-3.3 (E3), Z1
CHEVROLET AVEO, KALOS, LANOS, MATIZ, NIVA, SPARK
CHRYSLER DAYTONA, LE BARON, SARATOGA, VOYAGER II
CITROËN C25, GS, SM
DACIA NOVA
DAEWOO CIELO, ESPERO, KALOS, LANOS, MATIZ, NEXIA, NUBIRA, REZZO, TICO

...UXT2 / UXT6

DAIHATSU CHARADE I, CHARADE II, CHARADE III, CHARADE IV, CHARMANT, CUORE I, CUORE II, CUORE III, CUORE IV, CUORE V, HIJET, MOVE, ROCKY Hard Top, ROCKY Soft Top, SKYWING, SPARCAR
FIAT 124, 126, 127, 128, 130, 131, 132, 238-SERIE, 900 T/E Pulmino, 1500, 1500-2300, ARGENTA, CAMPAGNOLA, CINQUECENTO, DUCATO, DUNA, FIORINO, FIORINO Pick up, PANDA, REGATA, RITMO I, RITMO II, SEICENTO, TALENTO, TEMPRA, TIPO, UNO
FORD CAPRI, CAPRI II, CAPRI III, CONSUL, CORTINA, ECONOVAN, ESCORT I, ESCORT II, GRANADA, SCORPIO I, SIERRA, TAUNUS 12M, TAUNUS 15M, TAUNUS 17M, TAUNUS 20M, TAUNUS 20M XL, TRANSIT
FSO 125P, 126P, 132P, LANOS, POLONEZ I, POLONEZ II
HONDA ACCORD I, ACCORD II, ACCORD III, CIVIC I, CIVIC II, CIVIC III, CRX I, JAZZ I, PRELUDE I, PRELUDE II, QUINTET
HYUNDAI H-1, H-1 / STAREX, H100, LANTRA I, PONY, PONY / EXCEL, PORTER, SANTAMO, S COUPE, SONATA II, SONATA III, SONATA IV, SONATA V, STELLAR, TRAJET
ISUZU GEMINI, MIDI, PIAZZA, TROOPER
JAGUAR E-TYPE, E-TYPE 2+2, XJ
KIA JOICE, MAGENTIS, PRIDE, RIO, SEPHIA
LADA 110, 111, 112, 1200-1500, 1200-1600, KALINA, NIVA, NOVA, PRIORA, SAMARA, SAMARA FORMA, TOSCANA
LANCIA A 112, BETA, BETA H.P.E., DELTA II, THEME, TREVI, Y10
LAND ROVER 88/109, 90/110, DEFENDER, DISCOVERY I, DISCOVERY II, RANGE ROVER I, RANGE ROVER II
MAZDA 121 I (DA), 121 II (DB), 323 C IV (BG), 323 F IV (BG), 323 I (FA), 323 I Station Wagon (FA), 323 II (BD), 323 II /Hatchback (BD), 323 II Hatchback (BD), 323 III (BF), 323 III /Hatchback (BF), 323 III Hatchback (BF), 323 III Station Wagon (BW), 323 S IV (BG), 616, 626 I (CB), 626 II (GC), 626 II Coupe (GC), 626 II /Hatchback (GC), 626 II Hatchback (GC), 626 III (GD), 626 III Coupe (GD), 626 III /Hatchback (GD), 626 III Hatchback (GD), 626 III Station Wagon (GV), 818 Estate, 929 I (LA), 929 II (HB), 929 II /Coupe (HB), 929 II Coupe (HB), 929 II Estate (HV), 929 III (HC), 1000, 1300, B-SERIE (UF), E-SERIE Box, E-SERIE Box (SR2), E-SERIE Bus (SR1)

...UXT2 / UXT6

MERCEDES-BENZ /8 (W114), COUPE (C123), COUPE (W111), G-CLASS (W460), G-CLASS (W463), HECKFLOSSE (W110), HENSCHEL 2-t, KOMBI Estate (S123), PONTON (W121), PULLMANN (W100), Saloon (W123), S-CLASS (W108, W109), S-CLASS (W116), S-CLASS (W126), S-CLASS Coupe (C126), SL (R107), SL Coupe (C107), T1 Bus (601), T1 Platform/Chassis (601), T2/L Box Body / Estate, T2/L Box Body / Estate/Platform/Chassis, T2/L Dumptruck, T2/L Municipal Vehicle
MG MGB, MGB GT, MGR V8, MIDGET
MITSUBISHI CELESTE, COLT I, COLT II, COLT III, COLT IV, COLT V, COLT LANCER, CORDIA, ECLIPSE II, GALANT I, GALANT II, GALANT III, GALANT IV, GALLOPER, L 200, L 300, LANCER F II, LANCER I, LANCER III, LANCER IV, LANCER V, LANCER VI, PAJERO I, PAJERO II, SANTAMO, SAPPORO I, SAPPORO II, SIGMA, SPACE WAGON, STARION, TREDIA
NISSAN 280 ZX,ZXT, BLUEBIRD, CHERRY II, CHERRY III, DATSUN 100 A, DATSUN 120, DATSUN 120 Y, LAUREL, MICRA I, PATROL, PATROL GR I, PICK UP, PRAIRIE, SILVIA, STANZA, SUNNY, SUNNY I, SUNNY II, TERRANO I, URVAN, VANETTE
OPEL ASCONA A, ASCONA B, ASCONA C, ASTRA F, ASTRA F CLASSIC, CALIBRA A, CAMPO, COMBO, CORSA A, CORSA B, FRONTERA A, KADETT D, KADETT E, MANTA A, MANTA B, OMEGA A, REKORD D, REKORD E, VECTRA A, VECTRA B
PEUGEOT 404, 504, 505, J5, J7, J9
PORSCHE 911, 911 Convertible, 924, 928, 944, 944 /Convertible
RENAULT 5, 9, 11, 16, 18, 19 I, 19 II, 21, CLIO I, ESPACE III, FUEGO, LAGUNA I, MEGANE, MEGANE I, RAPID, SUPER 5, TRAFIC, TWINGO I
ROVER 200, 2000-3500, MINI, MONTEGO
SAAB 90, 95, 96, 99, 900 I
SEAT 124, 127, 128, 131, 133, 850, AROSA, CORDOBA, FURA, IBIZA I, IBIZA II, INCA, MARBELLA, PANDA, RITMO, RONDA, TERRA, TOLEDO I
SKODA FELICIA I, FELICIA II, OCTAVIA
SUBARU IMPREZA, JUSTY I, JUSTY II, LEONE I, LEONE II, LIBERO, XT
SUZUKI ALTO I (SS80), ALTO II (EC), ALTO III (EF), CARRY Box (ST90V), LJ 80, SAMURAI (SJ), SJ 410, SJ 410 Cabrio, SJ 413, SUPER CARRY Bus (ED), SWIFT Convertible (SF413), SWIFT I (AA), SWIFT II Hatchback (EA, MA), SWIFT II Saloon (AH, AJ), VITARA (ET, TA), VITARA Cabrio (ET, TA)

...UXT2 / UXT6

TALBOT 1307-1510, AVENGER, HORIZON, MURENA, RANCHO, SIMCA 1000, SIMCA 1100, SIMCA 1200 S, SIMCA SUNBEAM, SOLARA, TAGORA
TOYOTA 1000, CAMRY, CARINA, CARINA II, CELICA, CELICA SUPRA, COROLLA, COROLLA FX, CORONA, CRESSIDA, CROWN, HIACE I, HIACE II, HIACE III, HIACE IV, HILUX II, LAND CRUISER, LAND CRUISER 80, LITEACE, MODELL F, STARLET, STARLET 1000, TERCEL
VAUXHALL ASTRA, ASTRA Mk II, ASTRA Mk III (F), ASTRA Mk IV (G), ASTRAMAX, ASTRAVAN Mk III (F), BRAVA, CALIBRA, CARLTON Mk II, CARLTON Mk III, CAVALIER, CAVALIER Mk II, CAVALIER Mk III, COMBO Mk I (B), CORSA Mk I (B), CORSAVAN Mk I (B), FIRENZA, FRONTERA Mk I (A), NOVA, NOVAVAN, VENTORA, VIVA
VOLVO 240, 340-360, 440 K, 460 L, 480 E, 740, 760, 940, 940 II, 960
VW CADDY I, CADDY II, CORRADO, DERBY, GOLF I, GOLF II, GOLF III, GOLF IV, ILTIS, JETTA I, JETTA II, KAEFER, LT 28-35 I, LT 40-55 I, LUPO, PARATI, PASSAT, POLO, SANTANA, SCIROCCO, TARO, TRANSPORTER III, TRANSPORTER IV, VENTO
WARTBURG 353
ZAZ TAVRIA

UXT4

AUDI 100, A6, A8, V8
CHEVROLET LUMINA APV
CITROËN BX, CX I, CX II, LNA, VISA
FORD COUGAR, ESCORT '81, ESCORT '86, ESCORT '91, ESCORT III, ESCORT IV, ESCORT V, ESCORT VI, ESCORT VII, FIESTA, FIESTA I, FIESTA II, FIESTA III, FIESTA IV, KA, KA Van, MONDEO I, MONDEO II, ORION II, ORION III, SCORPIO I, SIERRA
MAZDA 3 (BK), 3 Saloon (BK), 5 (CR19), 6 /Estate/Hatchback (GH), 6 /Hatchback (GG), 6 Station Wagon (GY), 121 III (JASM, JBSM), MPV II (LW), MPV III (LY) III, MX-5 III (NC), TRIBUTE (EP)
MERCEDES-BENZ 190 (W201), COUPE (C123), COUPE (C124), E-CLASS (W124), E-CLASS Estate (S124), G-CLASS (W460), G-CLASS (W461), G-CLASS (W463), G-CLASS Cabrio (W463), KOMBI Estate (S123), KOMBI Estate (S124), Saloon (W123), Saloon (W124), S-CLASS (W126), SL (R107), SL (R129), T1 Box (601), T1 Box/Bus (601), T1 Box/Bus/Platform/Chassis (601), T1 Platform/Chassis (602), T1/TN Box Body / Estate/Platform/Chassis, T2/L Box Body / Estate/Platform/Chassis, T2/L Dumptruck, T2/LN1 Box Body / Estate/Platform/Chassis



...UXT4

PEUGEOT 104, 204, 205 I, 205 II, 304, 305 I, 305 II, 309 I, 604
RENAULT 14, 25, MASTER I, SAFRANE I, TRAFIC
ROVER 2000-3500
TALBOT SAMBA, SIMCA SIM'4

UXT5

ALFA ROMEO 75, 155, 164
ASTON MARTIN DB7
AUDI 80, 90, 100, A6, CABRIOLET, COUPE
BMW 3 (E46), 3 (E90), 3 Compact (E36), 3 Compact (E46), 3 /Compact/Coupe/Touring (E36), 3 Convertible (E46), 3 Convertible (E93), 3 /Convertible/Coupe (E36), 3 Convertible/Coupe (E46), 3 /Convertible/Coupe/Touring (E36), 3 /Convertible/Touring (E36), 3 /Coupe (E36), 3 Coupe (E92), 3 /Touring (E46), 3 Touring (E91), 5 (E34), 5 (E39), 5 (E60), 5 /Touring (E34), 5 Touring (E34), 5 /Touring (E39), 5 Touring (E39), 5 Touring (E61), 6 (E63), 6 Convertible (E64), 7 (E38), 7 (E65, E66, E67), 8 (E31), X1 (E84), X3 (E83), X5 (E53), X5 (E70), Z3 (E36), Z4 (E85)
CHEVROLET EPICA
CITROËN AX, BX, JUMPY, SAXO, XANTIA, XSARA, ZX
DACIA LODGY, LOGAN, LOGAN MCV
DAIHATSU CHARADE III, TERIOS
FIAT BARCHETTA, BRAVA, BRAVO I, COUPE, FIORINO, MAREA, PALIO, PUNTO, SCUDO, STILO, TEMPRA, TIPO, ULYSSE, UNO
FORD ESCORT '81, ESCORT '86, ESCORT III, ESCORT IV, ESCORT V, ESCORT VI, ESCORT VII, FIESTA I, FIESTA II, FIESTA III, GALAXY, ORION I, ORION II, ORION III, SCORPIO I, SCORPIO II, SIERRA, TRANSIT
HONDA ACCORD IV, ACCORD V, ACCORD VI, ACCORD VII, CIVIC II, CIVIC IV, CIVIC V, CIVIC VI, CIVIC VII, CIVIC VIII, CONCERTO, CR-V I, CR-V II, FR-V, HR-V, INTEGRA, LEGEND II, LOGO, NSX, PRELUDE IV, PRELUDE V, SHUTTLE, STEPWAGON, STREAM
JEEP CHEROKEE, COMMANDER, GRAND CHEROKEE III
KIA CARNIVAL I, CARNIVAL II
LANCIA DEDRA, DELTA II, KAPPA, LYBRA, THESIS, Y
LAND ROVER RANGE ROVER III
LEXUS GS, IS, IS I
LOTUS ELAN, ESPRIT S4
MAZDA 323 F VI (BJ), 323 S VI (BJ), 626 III Station Wagon (GV), 626 IV Hatchback (GE), B-SERIE (UN), MPV I (LV), MPV II (LW), MX-6 (GE), PREMACY (CP), XEDOS 9 (TA)

...UXT5

MITSUBISHI CARISMA, GALANT VI, PAJERO PININ, SPACE STAR
NISSAN 180 SX, 200 SX, ALMERA TINO, BLUEBIRD, LUCINO, MAXIMA, MAXIMA QX, PRIMERA, SUNNY, SUNNY II, SUNNY III
OPEL ASTRA F, ASTRA GTC J, ASTRA H, ASTRA J, CALIBRA A, CORSA D, INSIGNIA, MERIVA, VECTRA A
PEUGEOT 205 II, 309 I, 605, EXPERT
PORSCHE 911 (964), 911 (993), 911 (996), 911 /Convertible (964), 911 /Convertible (993), 911 Convertible (993), 911 /Convertible (996), 911 Convertible/Targa (993), BOXSTER (986)
RENAULT 19 I, 19 II, 21, CLIO I, ESPACE III, KANGOO, LOGAN, SAFRANE I, SANDERO/STEPWAY, THALIA I, TWINGO I
ROVER 200, 400, 600
SAAB 9-3, 9-5, 900 I, 900 II, 9000
SEAT CORDOBA, IBIZA I, IBIZA II, MALAGA, RONDA, TOLEDO I
SMART CABRIO, CITY-COUPÉ, CROSSBLADE
SUBARU FORESTER, IMPREZA, SVX
SUZUKI GRAND VITARA II (JT), IGNIS II, JIMNY (FJ), LIANA (ER), LIANA Estate (ER), SWIFT III (MZ, EZ), SX4 (GY), WAGON R+ (MM)
TOYOTA ARISTO, AVENSIS, AVENSIS VERSO, CAMRY, CARINA E, CELICA, COROLLA, LAND CRUISER, LAND CRUISER 100, PREVIA, RAV 4 III, SUPRA
VAUXHALL ASTRA GTC Mk VI (J), ASTRA Mk V (H), ASTRA Mk VI (JJ), ASTRA TwinTop Mk V (H), CALIBRA, CARLTON Mk III, CAVALIER Mk III, CORSA Mk III (D), INSIGNIA
VOLVO 850, S40 I, V40
VW CORRADO, GOLF II, JETTA II, PASSAT, SCIROCCO

UXT7

FORD C-MAX, C-MAX II, COUGAR, FIESTA, FIESTA III, FIESTA IV, FIESTA V, FIESTA VI, FOCUS, FOCUS C-MAX, FOCUS II, FOCUS III, FUSION, GALAXY, GRAND C-MAX, KA, KA Van, MAVERICK, MONDEO IV, PUMA, S-MAX, STREET KA
MAZDA 2 (DY), 3 (BK), 6 /Hatchback (GG), 6 Station Wagon (GY), 121 III (JASM, JBSM), TRIBUTE (EP)
SUZUKI GRAND VITARA II (JT)
VOLVO C30, S40 II, V50

UXT8

ALFA ROMEO 159, BRERA, SPIDER
CHEVROLET CAPTIVA, TRAILBLAZER
FORD ESCORT CLASSIC, ESCORT V, ESCORT VI, ESCORT VII, FOCUS, MONDEO I, MONDEO II, ORION III, TOURNEO CONNECT, TRANSIT CONNECT
MAZDA 3 Saloon (BK), MX-5 III (NC)
OPEL ANTERA
VAUXHALL ANTERA

UXT9

ALFA ROMEO 159, BRERA, SPIDER
AUDI A4, A5, A6, Q5
CHRYSLER CIRRUS, CROSSFIRE, SEBRING
CITROËN AX, BERLINGO, C15, SAXO, XANTIA, XSARA, ZX
HONDA CIVIC VIII
HYUNDAI COUPE, ELANTRA, EQUUS / CENTENNIAL, GRANDEUR, SONATA IV, SONATA V
ISUZU TROOPER
JAGUAR S-TYPE, XF, XK
KIA CERATO
LEXUS GS, SC
LOTUS ELISE
MAZDA XEDOS 9 (TA)
MERCEDES-BENZ A-CLASS (W168), C-CLASS (W202), C-CLASS (W203), C-CLASS Coupe (CL203), C-CLASS Estate (S202), C-CLASS T-Model (S203), CLK (C208), CLK (C209), CLK Convertible (A208), CLK Convertible (A209), CLS (C219), E-CLASS (W210), E-CLASS (W211), E-CLASS Estate (S210), E-CLASS T-Model (S211), G-CLASS (W463), G-CLASS Cabrio (W463), M-CLASS (W163), M-CLASS (W164), R-CLASS (W251, V251), S-CLASS (W140), S-CLASS (W220), S-CLASS (W221), S-CLASS Coupe (C140), S-CLASS Coupe (C215), S-CLASS Coupe (C216), SL (R129), SL (R230), SLK (R170), SLK (R171), SPRINTER 2-t Box/Bus (901, 902), SPRINTER 2-t Platform/Chassis (901, 902), SPRINTER 3-t Box/Bus/Platform/Chassis (903), SPRINTER 3-t Bus (903), SPRINTER 4-t Box/Bus/Platform/Chassis (904), SPRINTER 4-t Box/Platform/Chassis (904), Vaneo (414), V-CLASS (638/2), VIANO (W639), VITO Box/Bus (638), VITO Bus (W639), VITO / MIXTO Box (W639)
MG MG ZS
NISSAN STAGEA
OPEL VIVARO
PEUGEOT 306, 406

...UXT9

RENAULT AVANTIME, CLIO II, ESPACE IV, GRAND SCÉNIC II, KANGOO, LAGUNA, LAGUNA I, LAGUNA II, LAGUNA III, MEGANE CC, MEGANE II, MEGANE III, SAFRANE II, SCÉNIC II, TRAFIC II, TWINGO II, VEL SATIS
SKODA FELICIA I
SUBARU LEGACY IV, OUTBACK
TOYOTA ALLION II, ARISTO, AVENSIS, CARINA E, COROLLA, COROLLA FX, CROWN, PRIUS, PROBOX/SUCCEED, RAV 4 II
VAUXHALL VIVARO
VOLVO S80 II, XC90 I
VW PASSAT

UXT10

ACURA SLX
ALFA ROMEO 33, 145, 146, 147, 156, 159, 164, 166, GT, GTV, SPIDER
AUDI A3, A4, A6, ALLROAD, TT
CHEVROLET BERETTA, CAPTIVA
CHRYSLER NEON, STRATUS, VOYAGER III
CITROËN BERLINGO
DAEWOO KORANDO, LEGANZA, MUSSO, NUBIRA, REXTON, REZZO, WINSTORM
DAIHATSU CUORE VI
FIAT BARCHETTA, BRAVA, BRAVO I, CROMA, DOBLO, MAREA, MULTIPLA, PALIO, PANDA, PUNTO, SEICENTO, SIENA, STILO, UNO
HYUNDAI ACCENT, ACCENT I, ACCENT II, ATOS, ATOS PRIME, COUPE, ELANTRA, GALLOPER II, GETZ, HIGHWAY VAN, i10, i30, LANTRA II, MATRIX, SANTA FÉ I, SANTA FÉ II, S COUPE, TIBURON, TRAJET, TUCSON
INFINITI Q45 I, QX4
ISUZU TROOPER
JEEP GRAND CHEROKEE I
KIA CARENS II, CARENS III, CEE'D, CERATO, CLARUS, MAGENTIS, PICANTO, PRIDE, PRO CEE'D, RIO II, SPORTAGE
LANCIA KAPPA, YPSILON
LEXUS GS, LS
MAZDA 3 (BK), 3 Saloon (BK), 323 F IV (BG), 323 F VI (BJ), 323 P V (BA), 323 S VI (BJ), 626 V (GF), 626 V /Hatchback (GF), 626 V Hatchback (GF), 626 V Station Wagon (GW), MX-3 (EC), MX-5 II (NB), XEDOS 6 (CA), XEDOS 9 (TA)



...UXT10

MERCEDES-BENZ A-CLASS (W168), A-CLASS (W169), B-CLASS (W245), C-CLASS (W202), C-CLASS (W203), C-CLASS Coupe (CL203), C-CLASS Estate (S202), C-CLASS T-Model (S203), CLK (C208), CLK Convertible (A208), E-CLASS (W124), E-CLASS (W210), E-CLASS Convertible (A124), E-CLASS Coupe (C124), E-CLASS Estate (S124), E-CLASS Estate (S210), G-CLASS (W463), G-CLASS Cabrio (W463), M-CLASS (W163), S-CLASS (W140), S-CLASS (W220), S-CLASS Coupe (C140), S-CLASS Coupe (C215), SL (R129), SLK (R170), SPRINTER 4-t Box/Bus/Platform/Chassis (904), SPRINTER 4-t Box/Platform/Chassis (904), Vaneo (414), V-CLASS (638/2), VITO Box/Bus (638)
MITSUBISHI ECLIPSE II, L 300, L 400 / SPACE GEAR, LANCER V, LANCER VI, SPACE STAR
NISSAN 100 NX, ALMERA II, ALMERA TINO, CEFIRO, CEFIRO I, MICRA II, PATHFINDER, PICK UP, PRIMASTAR, PRIMERA, SUNNY III, TERRANO I
OPEL AGILA (A), ANTARA, ASTRA F, ASTRA F CLASSIC, ASTRA G, ASTRA H, ASTRA J, CALIBRA A, COMBO, CORSA B, CORSA C, CORSA D, FRONTERA A, FRONTERA B, INSIGNIA, KADETT E, MERIVA, MONTEREY A, MONTEREY B, OMEGA B, SIGNUM, SINTRA, SPEEDSTER, TIGRA, VECTRA A, VECTRA B, VECTRA C, ZAFIRA A, ZAFIRA B
PEUGEOT 205 II, 309 I, 406, PARTNER
RENAULT CLIO I, CLIO II, CLIO III, ESPACE I, MEGANE II, TWINGO I, TWINGO II
ROVER 200
SAAB 9-3, 900 II, 9000
SEAT ALHAMBRA, AROSA, EXEO, IBIZA IV, LEON, TOLEDO II
SKODA FABIA, FAVORIT, FELICIA I, FELICIA II, OCTAVIA, SUPERB
SSANGYONG KORANDO, KYRON, MUSSO, REXTON, RODIUS
SUBARU FORESTER, IMPREZA, LEGACY II
TOYOTA 4 RUNNER, AVENSIS, CARIBE, CARINA E, CARINA II, CELICA, COROLLA, HILUX II, LAND CRUISER 80, MR 2 II, MR 2 III, RAV 4 II, STARLET, SUPRA, YARIS, YARIS VERSO

...UXT10

VAUXHALL AGILA Mk I (A), ASTRA Mk III (F), ASTRA Mk IV (G), ASTRA Mk V (H), ASTRA Mk VI (J), ASTRA TwinTop Mk V (H), ASTRAMAN Mk III (F), ASTRAMAN Mk IV (G), ASTRAMAN Mk V (H), CALIBRA, CAVALIER Mk III, COMBO Mk I (B), COMBO Mk II (C), COMBO TOUR Mk II (C), CORSA Mk I (B), CORSA Mk II (C), CORSA Mk III (D), CORSAVAN Mk I (B), CORSAVAN Mk II (C), CORSAVAN Mk III (D), FRONTERA Mk I (A), FRONTERA Mk II (B), INSIGNIA, MERIVA Mk I (A), MONTEREY Mk II, OMEGA (B), SIGNUM, SINTRA, TIGRA, TIGRA Mk I, VECTRA (B), VECTRA Mk II (C), VIVARO, ZAFIRA Mk I (A), ZAFIRA Mk II (B), ZAFIRA Mk III
VOLVO 850, C70 I, S40 I, S60 I, S70, S80 I, V40, V70 I, V70 II, XC70 CROSS COUNTRY, XC90 I
VW BORA, GOLF III, GOLF IV, LUPO, NEW BEETLE, PASSAT, POLO, SHARAN, TRANSPORTER IV, VENTO

UXT11

ACURA LEGEND II, LEGEND III, SLX
AUDI A3
BENTLEY ARNAGE
CHEVROLET AVEO, BERETTA, CRUZE, KALOS, LACETTI, NUBIRA, REZZO
CHRYSLER STRATUS, VOYAGER III
DAEWOO ESPERO, KALOS, LACETTI, LANOS, NEXIA, NUBIRA, REZZO
DAIHATSU APPLAUSE I, APPLAUSE II, CHARADE III, CHARADE IV, COPEN, CUORE VI, FERROZA Hard Top, FERROZA Soft Top, GRAN MOVE, HIJET, MOVE, SIRION, TERIOS
FORD ESCORT '86, ESCORT '95, ESCORT IV, ESCORT V, ESCORT VI, ESCORT VII, FIESTA II, FIESTA III, ORION II, ORION III, SCORPIO II, SIERRA
FSO LANOS
HONDA ACCORD III, ACCORD VIII, CITY, CIVIC II, CIVIC IV, CIVIC V, CIVIC VI, CONCERTO, CRX I, CRX II, CRX III, JAZZ, JAZZ II, LEGEND I, PRELUDE III, PRELUDE V
HYUNDAI ACCENT, ACCENT I, ACCENT II, ACCENT III, ATOS, ATOS PRIME, COUPE, ELANTRA, GALLOPER I, GALLOPER II, GETZ, HIGHWAY VAN, i10, i20, i30, LANTRA II, MATRIX, SANTA FÉ I, SANTA FÉ II, S COUPE, SONATA IV, TERRACAN, TIBURON, TRAJET, TUCSON, XG
INFINITI i30, J30, Q45 I, QX4
ISUZU GEMINI, TROOPER
JAGUAR XJ, XK 8
JEEP GRAND CHEROKEE I

...UXT11

KIA CARENS II, CARENS III, CARNIVAL II, CEE'D, CERATO, CLARUS, MAGENTIS, OPIRUS, PICANTO, PRIDE, PRO CEE'D, RETONA, RIO, RIO II, SHUMA, SHUMA II, SORENTO I, SPORTAGE
LADA 110, 111, 112, GRANTA, KALINA, OKA, PRIORA
LAND ROVER FREELANDER
LEXUS ES, GS
LOTUS ELISE
MAZDA 2 (DE), 3 (BK), 3 Saloon (BK), 3 /Saloon (BL), 121 II (DB), 323 C IV (BG), 323 C V (BA), 323 F IV (BG), 323 F V (BA), 323 F VI (BJ), 323 III Hatchback (BF), 323 P V (BA), 323 S IV (BG), 323 S V (BA), 323 S VI (BJ), 626 III (GD), 626 III /Coupe (GD), 626 III Coupe (GD), 626 III /Hatchback (GD), 626 III Hatchback (GD), 626 III Station Wagon (GV), 626 IV (GE), 626 IV /Hatchback (GE), 626 IV Hatchback (GE), DEMIO (DW), E-SERIE Box (SR2), MPV I (LV), MX-3 (EC), MX-5 I (NA), MX-5 II (NB), MX-6 (GE), PREMACY (CP), XEDOS 6 (CA), XEDOS 9 (TA)
MG MGF, MG TF, MG ZR, MG ZS, MG ZT, MG ZT-T
MITSUBISHI CARISMA, COLT IV, COLT V, ECLIPSE II, GALANT V, GALANT VI, L 300, L 400 / SPACE GEAR, LANCER, LANCER IV, LANCER V, LANCER VI, PAJERO SPORT, SPACE RUNNER, SPACE STAR, SPACE WAGON
NISSAN 100 NX, 300 ZX, ALMERA I, ALMERA II, ALMERA TINO, BLUEBIRD, MAXIMA II, MICRA II, PATHFINDER, PRAIRIE PRO, PRIMERA, SERENA, SUNNY II, SUNNY III
OPEL FRONTERA B, MONTEREY A, MONTEREY B
RENAULT ESPACE III
ROVER 25, 45, 75, 200, 400, 800, CABRIOLET, COUPE
SAAB 9-3, 900 I, 900 II, 9000
SEAT TOLEDO III
SKODA OCTAVIA
SUBARU FORESTER, IMPREZA, JUSTY II, LEGACY I, LEGACY II, LEGACY III, LEGACY IV, OUTBACK, VIVIO
SUZUKI BALENO (EG), BALENO Estate (EG), BALENO Hatchback (EG), GRAND VITARA I (FT, GT), IGNIS (FH), WAGON R+ (MM)
TOYOTA 4 RUNNER, AVENSIS, CAMRY, CARINA E, CARINA II, CELICA, COASTER, COROLLA, COROLLA FX, GRANVIA, HIACE IV, HILUX, HILUX II, LAND CRUISER, LAND CRUISER 90, MR 2 I, PICNIC, PREVIA, RAV 4 I, TARAGO, YARIS
VAUXHALL FRONTERA Mk II (B), MONTEREY, MONTEREY Mk II
VW EOS, GOLF PLUS

UXT12

ACURA LEGEND II
ALFA ROMEO 145, 146, 156, 164, 166, GT, GTV, SPIDER
ALPINA B3, B10, B12, ROADSTER, ROADSTER S
ASTON MARTIN VIRAGE
AUDI 80, 100, A1, A2, A3, A4, A4 Allroad, A5, A6, A6 Allroad, A7, A8, ALLROAD, CABRIOLET, COUPE, Q3, Q5, R8, TT
AUTOBIANCHI Y10
BMW 3 (E46), 3 Compact (E46), 3 Convertible (E46), 3 Convertible/Coupe (E46), 3 Coupe (E46), 3 /Touring (E46), 3 Touring (E46), 5 (E39), 5 (E60), 5 /Touring (E39), 5 Touring (E39), 5 Touring (E61), 6 (E63), 6 Convertible (E64), 7 (E38), 7 (E65, E66, E67), 8 (E31), X3 (E83), X5 (E53), Z3 (E36), Z3 Coupe (E36), Z4 (E85)
CHEVROLET AVEO, KALOS, LACETTI, LUMINA APV, NUBIRA, REZZO
CHRYSLER CIRRUS, CROSSFIRE, NEON, NEON II, STRATUS, VOYAGER III
CITROËN AX, BERLINGO, C2, C3, C3 I, C3 II, C15, EVASION, JUMPER, NEMO, SAXO, XANTIA, XM, XSARA, XSARA PICASSO, ZX
DACIA DUSTER, LOGAN, LOGAN MCV, SANDERO
DAEWOO ESPERO, KALOS, LACETTI, LANOS, LEGANZA, NEXIA, NUBIRA
DAIHATSU APPLAUSE I, APPLAUSE II, CHARADE III, CHARADE IV, FERROZA Hard Top, FERROZA Soft Top, GRAN MOVE, HIJET, MOVE, SIRION
FIAT CINQUECENTO, DUCATO, FIORINO, FIORINO Pick up, PALIO, PANDA, PUNTO, QUBO, SEICENTO, SIENA, TEMPRA, ULYSSE
FORD ESCORT '95, ESCORT VI, ESCORT VII, FIESTA III, SCORPIO II
HONDA CIVIC II, CIVIC IV, CIVIC V, CIVIC VI, CONCERTO, CRX III, JAZZ II
HYUNDAI ACCENT, ACCENT III, COUPE, LANTRA II
ISUZU GEMINI, TROOPER
JAGUAR XJ, XJS
JEEP CHEROKEE
KIA CARENS I, CARENS II, CLARUS, PICANTO, RETONA, RIO, SEPHIA, SHUMA, SHUMA II, SPORTAGE
LADA 110, 111, 112, KALINA, PRIORA
LANCIA DELTA II, KAPPA, Y, Y10, ZETA



...UXT12

MAZDA 2 (DE), 121 II (DB), 323 C IV (BG), 323 C V (BA), 323 F IV (BG), 323 F V (BA), 323 F VI (BJ), 323 P V (BA), 323 S IV (BG), 323 S V (BA), 323 S VI (BJ), 626 III /Coupe (GD), 626 III Coupe (GD), 626 III Hatchback (GD), 626 III Station Wagon (GV), 626 IV (GE), 626 IV /Hatchback (GE), 626 IV Hatchback (GE), DEMIO (DW), E-SERIE Box (SR2), MPV I (LV), MX-3 (EC), MX-5 I (NA), MX-6 (GE), PREMACY (CP), XEDOS 6 (CA), XEDOS 9 (TA)

MERCEDES-BENZ C-CLASS (W202), C-CLASS (W203), C-CLASS Coupe (CL203), C-CLASS Estate (S202), C-CLASS T-Model (S203), CLK (C208), CLK (C209), CLK Convertible (A208), CLK Convertible (A209), E-CLASS (W210), E-CLASS Estate (S210), S-CLASS (W220), S-CLASS Coupe (C215), SLK (R170), SLK (R171)

MINI MINI

MITSUBISHI CARISMA, COLT IV, COLT V, GALANT V, GALANT VI, L 300, LANCER, LANCER IV, LANCER V, SPACE RUNNER, SPACE STAR, SPACE WAGON

NISSAN ALMERA I, KUBISTAR, MAXIMA II, PRIMASTAR, PRIMERA, SERENA, SUNNY III, VANETTE CARGO

OPEL ASTRA F, CALIBRA A, VIVARO

PEUGEOT 106 I, 106 II, 205 II, 206, 206+, 207, 207 SW, 306, 307, 405 II, 406, 605, 806, 1007, BIPPER, BIPPER Tepee, BOXER, EXPERT, PARTNER

PORSCHE 968

RENAULT 19 II, AVANTIME, CLIO Grandtour, CLIO I, CLIO II, CLIO III, ESPACE III, ESPACE IV, GRAND SCÉNIC II, KANGOO, LAGUNA, LAGUNA I, LAGUNA II, LAGUNA III, LOGAN, MEGANE, MEGANE CC, MEGANE I, MEGANE II, MEGANE III, MODUS / GRAND MODUS, SCÉNIC I, SCÉNIC II, THALIA I, TRAFIC II, TWINGO I, TWINGO II, VEL SATIS

ROVER 25, 100, 100 / METRO, 200, 400, 800, CABRIOLET, COUPE

SAAB 9-3, 900 II, 9000

SEAT ALHAMBRA, ALTEA, ALTEA XL, AROSA, CORDOBA, EXEO, IBIZA II, IBIZA III, IBIZA IV, INCA, LEON, TOLEDO I, TOLEDO II, TOLEDO III

SKODA FABIA, FAVORIT, FELICIA I, FELICIA II, OCTAVIA, SUPERB, YETI

SUBARU FORESTER, IMPREZA, JUSTY II, LEGACY I, LEGACY II, LEGACY III, LEGACY IV, OUTBACK, VIVIO

...UXT12

SUZUKI BALENO (EG), BALENO Estate (EG), BALENO Estate/Hatchback (EG), BALENO Hatchback (EG), CARRY Box (FD), GRAND VITARA I (FT, GT), IGNIS (FH), JIMNY (FJ), SWIFT II Saloon (AH, AJ), VITARA (ET, TA), VITARA Cabrio (ET, TA), WAGON R+ (MM), X-90 (EL)

TOYOTA CAMRY

VAUXHALL ASTRA Mk III (F), MONTEREY, VIVARO

VOLVO 850, 960 II, C70 I, S40 I, S60 I, S70, S80 I, S90, V40, V70 I, V70 II, V90, XC70 CROSS COUNTRY, XC90 I

VW AMAROK, BEETLE, BORA, CADDY II, CADDY III, CC, EOS, GOLF III, GOLF IV, GOLF V, GOLF VI, GOLF PLUS, JETTA III, JETTA IV, LUPO, MULTIVAN V, NEW BEETLE, PASSAT, PASSAT ALLTRACK, PASSAT CC, POLO, SCIROCCO, SHARAN, TIGUAN, TRANSPORTER V, VENTO

UXT13

CITROËN BERLINGO, C2, C3, C3 I, C4, C4 Grand Picasso I, C4 I, C4 Picasso I, C5 I, C5 II, C5 III, C8, EVASION, JUMPY, XSARA, XSARA PICASSO

FIAT SCUDDO, ULYSSE

HYUNDAI ix35, SANTA FÉ II, SONATA V

INFINITI FX

KIA MAGENTIS, SORENTO II, SPORTAGE

LANCIA PHEDRA, ZETA

MITSUBISHI LANCER

NISSAN 350 Z, ALMERA II, ALMERA TINO, CUBE, MICRA C+C, MICRA III, MURANO, NOTE, PATHFINDER, PRIMERA, TEANA I, X-TRAIL

PEUGEOT 206, 207, 307, 308 SW, 406, 407, 607, 806, 807, 1007, EXPERT, EXPERT Tepee, PARTNER

RENAULT ESPACE IV, VEL SATIS

TOYOTA IQ, LAND CRUISER, VIOS/YARIS

UXT14

ACURA LEGEND III

ALFA ROMEO 33

AUDI A3

BENTLEY ARNAGE

CHEVROLET EPICA

CHRYSLER STRATUS

FORD GALAXY, SCORPIO I, SCORPIO II, SIERRA, TRANSIT, TRANSIT TOURNEO

HONDA INTEGRA, LEGEND II, LEGEND III, NSX, PRELUDE V

HYUNDAI COUPE, SANTA FÉ I, SONATA IV, TERRACAN, TRAJET, XG

INFINITI i30, J30, Q45 I

JAGUAR XJ, XK 8

KIA CARNIVAL II, MAGENTIS, OPIRUS, SORENTO I

LAND ROVER FREELANDER

LEXUS ES, GS, IS, IS I, LS, RX, SC

...UXT14

MG MGF, MG TF, MG ZR, MG ZS, MG ZT, MG ZT- T

MITSUBISHI GALANT V, GALANT VI, PAJERO SPORT

NISSAN 180 SX, 200 SX, 300 ZX, ALMERA TINO, BLUEBIRD, LUCINO, MAXIMA, MAXIMA QX, PRIMERA, SUNNY II, SUNNY III

OPEL ASTRA H, SIGNUM, VECTRA C, ZAFIRA B

RENAULT CLIO II, ESPACE III, THALIA I

ROVER 25, 45, 75, 400, COUPE

SAAB 9-3, 9-5

SEAT TOLEDO III

SUBARU FORESTER, IMPREZA, SVX

SUZUKI GRAND VITARA II (JT), IGNIS II, JIMNY (FJ), LIANA (ER), LIANA Estate (ER), SWIFT III (MZ, EZ), SX4 (GY), WAGON R+ (MM)

TOYOTA ARISTO, AVENSIS, AVENSIS VERSO, CAMRY, CARINA E, CELICA, COROLLA, CROWN, LAND CRUISER, LAND CRUISER 100, MR 2 I, PREVIA, RAV 4 III, SUPRA, VISTA, WISH

VAUXHALL ASTRA Mk V (H), SIGNUM,

VECTRA Mk II (C), ZAFIRA Mk II (B)

VW EOS, GOLF PLUS, JETTA III, PASSAT

UXT15

FORD C-MAX, COUGAR, FIESTA V, FOCUS C-MAX, FOCUS II, MAVERICK, MONDEO I, MONDEO II, MONDEO III, TRANSIT

JAGUAR S-TYPE, X-TYPE

MAZDA 3 (BK), 3 Saloon (BK), 5 (CR19), 6 /Estate/Hatchback (GH),

6 /Hatchback (GG), 6 Station Wagon (GY), MPV II (LW), MPV III (LY) III, MX-5 III (NC), TRIBUTE (EP)

VOLVO C30, S40 II, V50

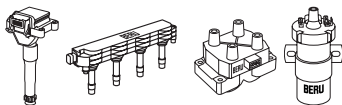

| | | | |
|---|---|--|--|
| <p>ZS014 BMW 3 (E36), 3 /Convertible (E36), 3 Convertible (E36), 3 Convertible/Coupe (E36), 3 /Coupe (E36), 3 Coupe (E36), 5 (E34), 5 /Touring (E34), 5 Touring (E34), 7 (E32), 7 (E38), 8 (E31)</p> | <p>ZS052 DACIA DUSTER, LOGAN, LOGAN MCV, SANDERO NISSAN KUBISTAR, PRIMASTAR OPEL VIVARO RENAULT AVANTIME, CLIO Grandtour, CLIO II, CLIO III, DUSTER, ESPACE III, ESPACE IV, FLUENCE, GRAND SCÉNIC II, GRAND SCÉNIC III, KANGOO, KANGOO BE BOP, KANGOO / GRAND KANGOO, LAGUNA, LAGUNA I, LAGUNA II, LAGUNA III, LOGAN, MEGANE, MEGANE CC, MEGANE I, MEGANE II, MEGANE III, MODUS / GRAND MODUS, SANDERO/STEPWAY, SCÉNIC I, SCÉNIC II, SCÉNIC III, THALIA I, TRAFIC II, TWINGO II, VEL SATIS, WIND VAUXHALL VIVARO</p> | <p>ZS088 MG MG ZT, MG ZT-T ROVER 75</p> | <p>...ZS106</p> |
| <p>ZS016 AUDI A3, A4, A6, A8, ALLROAD, TT SEAT ALHAMBRA, LEON SKODA OCTAVIA VW BORA, GOLF IV, PASSAT, SHARAN</p> | <p>ZS053</p> | <p>ZS090 FIAT 500, 500 C, 500L, PANDA, PUNTO LANCIA YPSILON</p> | <p>MITSUBISHI CELESTE, COLT I, COLT II, COLT III, COLT LANCER, CORDIA, GALANT I, GALANT II, GALANT III, GALANT IV, GALANT V, L 200, L 300, LANCER F II, LANCER III, LANCER VI, SAPPORO I, SAPPORO II, TREDIA NISSAN BLUEBIRD, CHERRY II, CHERRY III OPEL REKORD B, REKORD C, REKORD P2 PEUGEOT 204, 304, 305 I, 504, J7 PORSCHE 356 Cabriolet/Speedster, 356 Cabriolet/Speedster/Coupe, 356 Coupe, 912 /Targa, 914 RENAULT 4, 5, 9, 11, 12, 14, 18, 20, CLIO I, MASTER I, RAPID, SUPER 5, TRAFIC ROVER 2000-3500, MINI SAAB 95, 96, 99, 900 I SEAT 124, 127, 128, 132, 133, 600 D, 850, IBIZA I, MARBELLA, TERRA SKODA 100, 105, 120, 110, RAPID SUZUKI ALTO II (EC), CARRY Box (ST90V), SUPER CARRY Bus (ED) TALBOT SIMCA 1000 TOYOTA CELICA, COROLLA, COROLLA FX, LAND CRUISER, LITEACE, STARLET, STARLET 1000 VAUXHALL CHEVETTE VOLVO 140, 240, P 121, P 122 S AMAZON VW 181, 411, 412, 412, 1500, 1600, DERBY, KAEFER, POLO, SANTANA, TRANSPORTER I, TRANSPORTER II, TRANSPORTER III WARTBURG 353</p> |
| <p>ZS017 AUDI A8</p> | <p>ZS068 LAND ROVER FREELANDER MG MG ZS, MG ZT, MG ZT-T ROVER 75</p> | <p>ZS095 ALFA ROMEO GIULIETTA, MITO FIAT 500, BRAVO II, DOBLO, LINEA, PUNTO / GRANDE PUNTO LANCIA DELTA III</p> | <p>ZS106 ALFA ROMEO 1750-2000, ALFASUD, ALFETTA, ALFETTA GT, ARNA, GIULIA, GIULIETTA, GT, SPIDER ASTON MARTIN DBS AUDI 50, 80 AUSTIN 1000-Series MK II, ALLEGRO, MINI, PRINCESS, PRINCESS 2 AUTOBIANCHI A 111, A 112 BMW 02 (E10), 02 /Convertible (E10), 02 Touring (E6), 3 (E21), 5 (E12), 1500-2000 (115, 116, 118, 121) CITROËN CX I, CX II, DS, VISA DACIA 1210, 1300, 1310 FIAT 124, 125, 126, 127, 128, 131, 132, 500, 900 T/E Panorama, 900 T/E Pulmino, ARGENTA, FIORINO, X 1/9, JAGST, PANDA, REGATA, RITMO, RITMO I, RITMO II, UNO FORD CAPRI, CORSAIR, CORTINA, TAUNUS 12M, TAUNUS 17M, ZEPHYR III, ZEPHYR IV FSO 125P, 126P, POLONEZ I, POLONEZ II HONDA ACCORD II JAGUAR E-TYPE, E-TYPE 2+2, XJ LADA 1200-1500, 1200-1600, NIVA, NOVA, TOSCANA LANCIA A 112, BETA, DEDRA, DELTA I, PRISMA, THEMA LAND ROVER 90/110 LOTUS ECLAT, ESPRIT S2, ESPRIT S3, ESPRIT S4, EUROPA MERCEDES-BENZ /8 (W115), COUPE (W111), HENSCHEL 2-t, PAGODE (W113), S-CLASS (W108, W109), SL (R107), SL (W121), T2/L Box Body / Estate/Platform/Chassis, T2/L Municipal Vehicle MG MAGNETTE, MGB, MGB GT, MGC, MGC GT, MIDGET</p> |
| <p>ZS029 FIAT BRAVA, BRAVO I, DOBLO, MAREA, MULTIPLA, PALIO, SIENA LANCIA DELTA II, LYBRA</p> | <p>ZS077 MERCEDES-BENZ C-CLASS (W203), C-CLASS (W204), C-CLASS Coupe (C204), C-CLASS Coupe (CL203), C-CLASS T-Model (S203), C-CLASS T-Model (S204), CLC-CLASS (CL203), CLK (C209), CLK Convertible (A209), E-CLASS (W211), E-CLASS (W212), E-CLASS Convertible (A207), E-CLASS Coupe (C207), E-CLASS T-Model (S211), E-CLASS T-Model (S212), SLK (R171), SLK (R172), SPRINTER 3,5-t Box/Bus/Platform/Chassis (906), SPRINTER 3-t Platform/Chassis (906), SPRINTER 5-t Platform/Chassis (906)</p> | <p>ZS105 BMW 600 (111) OPEL ADMIRAL A, REKORD P2 PORSCHE 356 Cabriolet/Speedster, 356 Cabriolet/Speedster/Coupe, 356 Coupe RENAULT 4 VW KAEFER</p> | <p>ZS109 ASTON MARTIN DBS AUDI 100 AUSTIN MAXI, METRO, MINI, MONTEGO BEDFORD CHEVANNE, RASCAL BMW 02 (E10) DAIHATSU CHARADE I, CHARADE II, CHARADE III, CHARADE IV, CUORE I, CUORE II, CUORE III, ROCKY Hard Top, ROCKY Soft Top FORD CAPRI II, CAPRI III, ESCORT '81, ESCORT I, ESCORT II, ESCORT III, FIESTA, FIESTA I, P 100 I JAGUAR XJ LAND ROVER 88/109 LOTUS ECLAT, ESPRIT S2, ESPRIT S3, ESPRIT S4 MAZDA 626 III Coupe (GD) MERCEDES-BENZ /8 (W114), /8 (W115), /8 Coupe (W114), CABRIOLET (W111), COUPE (C123), COUPE (W111), G-CLASS (W460), KOMBI Estate (S123), PULLMANN (W100), Saloon (W123), S-CLASS (W108, W109), S-CLASS (W116), SL (R107), T1 Bus (601), T1 Platform/Chassis (601) MG METRO, MGB, MGB GT, MIDGET</p> |
| <p>ZS031 PORSCHE 911 (996), 911 (997), 911 /Convertible (996), 911 /Convertible (997), BOXSTER (986), BOXSTER (987), CAYMAN (987)</p> | <p>ZS079 ALFA ROMEO MITO FIAT 500, 500 C, DOBLO, FIORINO, IDEA, LINEA, PANDA, PUNTO, PUNTO EVO, PUNTO / GRANDE PUNTO, QUBO FORD KA LANCIA MUSA, YPSILON NISSAN TEANA I</p> | <p>ZS106 ALFA ROMEO 1750-2000, ALFASUD, ALFETTA, ALFETTA GT, ARNA, GIULIA, GIULIETTA, GT, SPIDER ASTON MARTIN DBS AUDI 50, 80 AUSTIN 1000-Series MK II, ALLEGRO, MINI, PRINCESS, PRINCESS 2 AUTOBIANCHI A 111, A 112 BMW 02 (E10), 02 /Convertible (E10), 02 Touring (E6), 3 (E21), 5 (E12), 1500-2000 (115, 116, 118, 121) CITROËN CX I, CX II, DS, VISA DACIA 1210, 1300, 1310 FIAT 124, 125, 126, 127, 128, 131, 132, 500, 900 T/E Panorama, 900 T/E Pulmino, ARGENTA, FIORINO, X 1/9, JAGST, PANDA, REGATA, RITMO, RITMO I, RITMO II, UNO FORD CAPRI, CORSAIR, CORTINA, TAUNUS 12M, TAUNUS 17M, ZEPHYR III, ZEPHYR IV FSO 125P, 126P, POLONEZ I, POLONEZ II HONDA ACCORD II JAGUAR E-TYPE, E-TYPE 2+2, XJ LADA 1200-1500, 1200-1600, NIVA, NOVA, TOSCANA LANCIA A 112, BETA, DEDRA, DELTA I, PRISMA, THEMA LAND ROVER 90/110 LOTUS ECLAT, ESPRIT S2, ESPRIT S3, ESPRIT S4, EUROPA MERCEDES-BENZ /8 (W115), COUPE (W111), HENSCHEL 2-t, PAGODE (W113), S-CLASS (W108, W109), SL (R107), SL (W121), T2/L Box Body / Estate/Platform/Chassis, T2/L Municipal Vehicle MG MAGNETTE, MGB, MGB GT, MGC, MGC GT, MIDGET</p> | <p>ZS106 ALFA ROMEO 1750-2000, ALFASUD, ALFETTA, ALFETTA GT, ARNA, GIULIA, GIULIETTA, GT, SPIDER ASTON MARTIN DBS AUDI 50, 80 AUSTIN 1000-Series MK II, ALLEGRO, MINI, PRINCESS, PRINCESS 2 AUTOBIANCHI A 111, A 112 BMW 02 (E10), 02 /Convertible (E10), 02 Touring (E6), 3 (E21), 5 (E12), 1500-2000 (115, 116, 118, 121) CITROËN CX I, CX II, DS, VISA DACIA 1210, 1300, 1310 FIAT 124, 125, 126, 127, 128, 131, 132, 500, 900 T/E Panorama, 900 T/E Pulmino, ARGENTA, FIORINO, X 1/9, JAGST, PANDA, REGATA, RITMO, RITMO I, RITMO II, UNO FORD CAPRI, CORSAIR, CORTINA, TAUNUS 12M, TAUNUS 17M, ZEPHYR III, ZEPHYR IV FSO 125P, 126P, POLONEZ I, POLONEZ II HONDA ACCORD II JAGUAR E-TYPE, E-TYPE 2+2, XJ LADA 1200-1500, 1200-1600, NIVA, NOVA, TOSCANA LANCIA A 112, BETA, DEDRA, DELTA I, PRISMA, THEMA LAND ROVER 90/110 LOTUS ECLAT, ESPRIT S2, ESPRIT S3, ESPRIT S4, EUROPA MERCEDES-BENZ /8 (W115), COUPE (W111), HENSCHEL 2-t, PAGODE (W113), S-CLASS (W108, W109), SL (R107), SL (W121), T2/L Box Body / Estate/Platform/Chassis, T2/L Municipal Vehicle MG MAGNETTE, MGB, MGB GT, MGC, MGC GT, MIDGET</p> |
| <p>ZS036 PORSCHE 911 (996), 911 /Convertible (996), 911 Convertible (996), 911 Convertible (997), 911 Targa (996), BOXSTER (986), CAYMAN (987)</p> | <p>ZS037 SEAT TOLEDO II VW BORA, GOLF IV, PASSAT</p> | <p>ZS106 ALFA ROMEO 1750-2000, ALFASUD, ALFETTA, ALFETTA GT, ARNA, GIULIA, GIULIETTA, GT, SPIDER ASTON MARTIN DBS AUDI 50, 80 AUSTIN 1000-Series MK II, ALLEGRO, MINI, PRINCESS, PRINCESS 2 AUTOBIANCHI A 111, A 112 BMW 02 (E10), 02 /Convertible (E10), 02 Touring (E6), 3 (E21), 5 (E12), 1500-2000 (115, 116, 118, 121) CITROËN CX I, CX II, DS, VISA DACIA 1210, 1300, 1310 FIAT 124, 125, 126, 127, 128, 131, 132, 500, 900 T/E Panorama, 900 T/E Pulmino, ARGENTA, FIORINO, X 1/9, JAGST, PANDA, REGATA, RITMO, RITMO I, RITMO II, UNO FORD CAPRI, CORSAIR, CORTINA, TAUNUS 12M, TAUNUS 17M, ZEPHYR III, ZEPHYR IV FSO 125P, 126P, POLONEZ I, POLONEZ II HONDA ACCORD II JAGUAR E-TYPE, E-TYPE 2+2, XJ LADA 1200-1500, 1200-1600, NIVA, NOVA, TOSCANA LANCIA A 112, BETA, DEDRA, DELTA I, PRISMA, THEMA LAND ROVER 90/110 LOTUS ECLAT, ESPRIT S2, ESPRIT S3, ESPRIT S4, EUROPA MERCEDES-BENZ /8 (W115), COUPE (W111), HENSCHEL 2-t, PAGODE (W113), S-CLASS (W108, W109), SL (R107), SL (W121), T2/L Box Body / Estate/Platform/Chassis, T2/L Municipal Vehicle MG MAGNETTE, MGB, MGB GT, MGC, MGC GT, MIDGET</p> | <p>ZS106 ALFA ROMEO 1750-2000, ALFASUD, ALFETTA, ALFETTA GT, ARNA, GIULIA, GIULIETTA, GT, SPIDER ASTON MARTIN DBS AUDI 50, 80 AUSTIN 1000-Series MK II, ALLEGRO, MINI, PRINCESS, PRINCESS 2 AUTOBIANCHI A 111, A 112 BMW 02 (E10), 02 /Convertible (E10), 02 Touring (E6), 3 (E21), 5 (E12), 1500-2000 (115, 116, 118, 121) CITROËN CX I, CX II, DS, VISA DACIA 1210, 1300, 1310 FIAT 124, 125, 126, 127, 128, 131, 132, 500, 900 T/E Panorama, 900 T/E Pulmino, ARGENTA, FIORINO, X 1/9, JAGST, PANDA, REGATA, RITMO, RITMO I, RITMO II, UNO FORD CAPRI, CORSAIR, CORTINA, TAUNUS 12M, TAUNUS 17M, ZEPHYR III, ZEPHYR IV FSO 125P, 126P, POLONEZ I, POLONEZ II HONDA ACCORD II JAGUAR E-TYPE, E-TYPE 2+2, XJ LADA 1200-1500, 1200-1600, NIVA, NOVA, TOSCANA LANCIA A 112, BETA, DEDRA, DELTA I, PRISMA, THEMA LAND ROVER 90/110 LOTUS ECLAT, ESPRIT S2, ESPRIT S3, ESPRIT S4, EUROPA MERCEDES-BENZ /8 (W115), COUPE (W111), HENSCHEL 2-t, PAGODE (W113), S-CLASS (W108, W109), SL (R107), SL (W121), T2/L Box Body / Estate/Platform/Chassis, T2/L Municipal Vehicle MG MAGNETTE, MGB, MGB GT, MGC, MGC GT, MIDGET</p> |
| <p>ZS041 MERCEDES-BENZ C-CLASS (W203), C-CLASS Coupe (CL203), C-CLASS Estate (S202), C-CLASS T-Model (S203), CLK (C208), CLK Convertible (A208), E-CLASS (W210), E-CLASS Estate (S210), SLK (R170)</p> | <p>ZS043 AUDI 80, 100, A6, COUPE</p> | <p>ZS106 ALFA ROMEO 1750-2000, ALFASUD, ALFETTA, ALFETTA GT, ARNA, GIULIA, GIULIETTA, GT, SPIDER ASTON MARTIN DBS AUDI 50, 80 AUSTIN 1000-Series MK II, ALLEGRO, MINI, PRINCESS, PRINCESS 2 AUTOBIANCHI A 111, A 112 BMW 02 (E10), 02 /Convertible (E10), 02 Touring (E6), 3 (E21), 5 (E12), 1500-2000 (115, 116, 118, 121) CITROËN CX I, CX II, DS, VISA DACIA 1210, 1300, 1310 FIAT 124, 125, 126, 127, 128, 131, 132, 500, 900 T/E Panorama, 900 T/E Pulmino, ARGENTA, FIORINO, X 1/9, JAGST, PANDA, REGATA, RITMO, RITMO I, RITMO II, UNO FORD CAPRI, CORSAIR, CORTINA, TAUNUS 12M, TAUNUS 17M, ZEPHYR III, ZEPHYR IV FSO 125P, 126P, POLONEZ I, POLONEZ II HONDA ACCORD II JAGUAR E-TYPE, E-TYPE 2+2, XJ LADA 1200-1500, 1200-1600, NIVA, NOVA, TOSCANA LANCIA A 112, BETA, DEDRA, DELTA I, PRISMA, THEMA LAND ROVER 90/110 LOTUS ECLAT, ESPRIT S2, ESPRIT S3, ESPRIT S4, EUROPA MERCEDES-BENZ /8 (W115), COUPE (W111), HENSCHEL 2-t, PAGODE (W113), S-CLASS (W108, W109), SL (R107), SL (W121), T2/L Box Body / Estate/Platform/Chassis, T2/L Municipal Vehicle MG MAGNETTE, MGB, MGB GT, MGC, MGC GT, MIDGET</p> | <p>ZS106 ALFA ROMEO 1750-2000, ALFASUD, ALFETTA, ALFETTA GT, ARNA, GIULIA, GIULIETTA, GT, SPIDER ASTON MARTIN DBS AUDI 50, 80 AUSTIN 1000-Series MK II, ALLEGRO, MINI, PRINCESS, PRINCESS 2 AUTOBIANCHI A 111, A 112 BMW 02 (E10), 02 /Convertible (E10), 02 Touring (E6), 3 (E21), 5 (E12), 1500-2000 (115, 116, 118, 121) CITROËN CX I, CX II, DS, VISA DACIA 1210, 1300, 1310 FIAT 124, 125, 126, 127, 128, 131, 132, 500, 900 T/E Panorama, 900 T/E Pulmino, ARGENTA, FIORINO, X 1/9, JAGST, PANDA, REGATA, RITMO, RITMO I, RITMO II, UNO FORD CAPRI, CORSAIR, CORTINA, TAUNUS 12M, TAUNUS 17M, ZEPHYR III, ZEPHYR IV FSO 125P, 126P, POLONEZ I, POLONEZ II HONDA ACCORD II JAGUAR E-TYPE, E-TYPE 2+2, XJ LADA 1200-1500, 1200-1600, NIVA, NOVA, TOSCANA LANCIA A 112, BETA, DEDRA, DELTA I, PRISMA, THEMA LAND ROVER 90/110 LOTUS ECLAT, ESPRIT S2, ESPRIT S3, ESPRIT S4, EUROPA MERCEDES-BENZ /8 (W115), COUPE (W111), HENSCHEL 2-t, PAGODE (W113), S-CLASS (W108, W109), SL (R107), SL (W121), T2/L Box Body / Estate/Platform/Chassis, T2/L Municipal Vehicle MG MAGNETTE, MGB, MGB GT, MGC, MGC GT, MIDGET</p> |

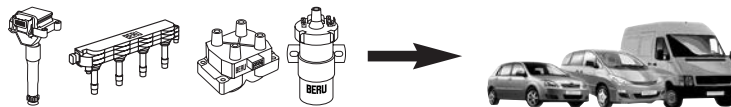

...ZS109

MITSUBISHI GALANT IV, GALANT V, L 200, L 300, LANCER F II, LANCER III, TREDIA
NISSAN BLUEBIRD, CHERRY II, LAUREL, MICRA I, MICRA II, PATROL, PICK UP, STANZA, SUNNY, SUNNY I, SUNNY II, URVAN, VANETTE
OPEL REKORD C
PORSCHE 911, 911 Targa
ROVER 2000-3500
SKODA 105, 120, RAPID
SUZUKI CARRY Box (ST90V), SUPER CARRY Bus (ED)
TOYOTA CELICA, COROLLA, COROLLA FX, LITEACE
VAUXHALL CHEVETTE

ZS110

CITROËN AMI, C35, CX I, DS, GS
DAIHATSU CHARMANT
FIAT X 1/9
HONDA ACCORD II, CIVIC I
HYUNDAI STELLAR
JAGUAR E-TYPE, XJ
MERCEDES-BENZ PULLMANN (W100)
MITSUBISHI CELESTE, COLT LANCER, GALANT I, GALANT II, GALANT III, SAPPORO I
NISSAN PATROL
PEUGEOT 104, 305 I, 305 II, 505, J5
RENAULT 4, 5, 12, 16, 30
SUZUKI ALTO I (SS80), SJ 410, SJ 410 Cabrio
TOYOTA TERCEL

ZS115

ALFA ROMEO 33, 75, 90, ALFETTA, ALFETTA GT, GTV
AUDI 50, 60, 75, 80, 100, SUPER 90
AUSTIN METRO, MINI
BMW 3 (E21), 5 (E12), 6 (E24), 7 (E23), 2000-3.2 Coupe (E9), 2500-3.3 (E3)
CITROËN AXEL, BX, C25, CX I, CX II, DS, GS, LNA, VISA
FIAT CROMA, DUCATO, TALENTO
FORD CAPRI, CAPRI II, CAPRI III, CORSAIR, CORTINA, ESCORT II, TAUNUS, TAUNUS 12M, ZEPHYR IV, ZODIAC, ZODIAC
JAGUAR XJ
LADA 1200-1500, 1200-1600, NIVA, NOVA, SAMARA, SAMARA FORMA, TOSCANA
LANCIA DEDRA, DELTA I, PRISMA, THEMA
LAND ROVER 90/110, DEFENDER, DISCOVERY I, RANGE ROVER I
MERCEDES-BENZ /8 (W114), /8 Coupe (W114), 190 (W201), G-CLASS (W460), G-CLASS (W461), PULLMANN (W100)
MG MAESTRO, METRO, MGR V8, MONTEGO
MITSUBISHI COLT II, COLT III, COLT LANCER, CORDIA, GALANT I, GALANT II, GALANT III, GALANT IV, SAPPORO I, SAPPORO II

...ZS115

NISSAN BLUEBIRD, CHERRY II, CHERRY III
OPEL SIGNUM, VECTRA C
PEUGEOT 205, 205 I, 205 II, 305 I, 305 II, 309 I, 309 II, 405 I, 504, 505, J5, J9
PORSCHE 911, 911 /Targa, 911 Targa, 924
RENAULT 9
ROVER 200, 400, 800, 2000-3500, MAESTRO, MINI, MONTEGO
SAAB 99, 900 I, 9000
TALBOT MATRA BAGHEERA, RANCHO, SAMBA
VOLVO 164, 240, 340-360, 740, XC60
VW CADDY I, DERBY, GOLF I, GOLF II, ILTIS, JETTA I, JETTA II, LT 28-35 I, LT 40-55 I, PASSAT, POLO, SANTANA, SCIROCCO

ZS117

ASTON MARTIN LAGONDA I, V8
LAND ROVER 90/110, DEFENDER, DISCOVERY I, RANGE ROVER I
MERCEDES-BENZ 190 (W201), COUPE (C123), COUPE (C124), G-CLASS (W460), G-CLASS (W461), KOMBI Estate (S123), KOMBI Estate (S124), Saloon (W123), Saloon (W124), S-CLASS (W126), T1 Box (601), T1 Box/Bus/Platform/Chassis (601), T1 Bus (601), T1/TN Box Body / Estate/Platform/Chassis, T2/L Box Body / Estate/Platform/Chassis, T2/LN1 Box Body / Estate/Platform/Chassis
MG MAESTRO, METRO, MGR V8, MONTEGO
PEUGEOT 205, 205 I, 205 II, 305 I, 305 II, 309 I, 309 II, 405 I, 504, 505, J5, J9
ROVER 800, 2000-3500, MAESTRO, MINI, MONTEGO
SAAB 900 I, 9000
TALBOT SAMBA
VOLVO 240, 740, XC60

ZS118

MERCEDES-BENZ S-CLASS (W126), S-CLASS Coupe (C126), SL (R107)

ZS119

LANCIA THEMA
PEUGEOT 505
VOLVO 740, 760, 780, 940, 940 II, 960

ZS120

AUDI QUATTRO
LADA 110, 111, 112, NOVA, SAMARA, SAMARA FORMA
LAND ROVER 90/110, DEFENDER, DISCOVERY I, RANGE ROVER I

...ZS120

MERCEDES-BENZ 190 (W201), G-CLASS (W460), G-CLASS (W461)
MG MAESTRO, METRO, MGR V8, MONTEGO
PEUGEOT 205, 205 I, 205 II, 305 I, 305 II, 309 I, 309 II, 405 I, 504, 505, J5, J9
ROVER 800, 2000-3500, MAESTRO, MINI, MONTEGO
SAAB 900 I, 9000
SEAT IBIZA I, MALAGA, RONDA
TALBOT SAMBA
VOLVO 240, 740, XC60
VW GOLF II, JETTA II

ZS121

BMW 3 (E30)
SAAB 90, 99, 900 I, 9000

ZS122

ALFA ROMEO 164, GTV, SPIDER
BMW 3 (E30), 3 (E36), 3 /Convertible (E30), 3 Convertible (E30), 3 /Convertible/Touring (E30), 3 Convertible/Touring (E30), 3 Touring (E30), 5 (E28), 5 (E34), 5 Touring (E34), 6 (E24), 7 (E23), 7 (E32), Z1
PORSCHE 928
VOLVO 740

ZS123

VW CORRADO, GOLF I, GOLF II, JETTA II, PASSAT, POLO, TRANSPORTER III

ZS124

AUDI 80, 90, 100, COUPE
SEAT TOLEDO I
VW CADDY I, CORRADO, DERBY, GOLF I, GOLF II, JETTA II, LT 28-35 I, LT 40-55 I, PASSAT, POLO, SANTANA, SCIROCCO, TRANSPORTER I, TRANSPORTER III
WARTBURG 353

ZS125

OPEL CALIBRA A, KADETT E, OMEGA A, SENATOR B, VECTRA A
VAUXHALL ASTRA Mk II, CALIBRA, CARLTON Mk II, CARLTON Mk III, CAVALIER Mk II, CAVALIER Mk III, SENATOR Mk II (B)

ZS126

FORD ESCORT '81, ESCORT '86, ESCORT III, ESCORT IV, ESCORT V, ESCORT VI, FIESTA, FIESTA II, FIESTA III, GRANADA, ORION I, ORION II, ORION III, P 100 II, SCORPIO I, SCORPIO II, SIERRA, TAUNUS '80, TRANSIT
JAGUAR XJ, XJSC

ZS127

OPEL ASTRA F, CALIBRA A, FRONTERA A, KADETT E, OMEGA A, SENATOR B, VECTRA A
SAAB 9-3, 9-5, 900 II
VAUXHALL ASTRA Mk II, ASTRA Mk III (F), CALIBRA, CARLTON Mk II, CARLTON Mk III, CAVALIER Mk II, CAVALIER Mk III, FRONTERA Mk I (A), SENATOR Mk II (B)

ZS230

ALFA ROMEO 155, 164, 166, SPIDER
FIAT CROMA
LANCIA THEMA

ZS231

CITROËN AX, ZX
PEUGEOT 106 I, 106 II, 205 II, 206, 306, 405 II
ROVER 400, 800, MINI

ZS232

CITROËN BX, XSARA
FIAT DUCATO
PEUGEOT 106 II, 205 I, 205 II, 306, 309 II, 405 I, 405 II, 406, 605, 806, BOXER, EXPERT, PARTNER
ROVER CITYROVER

ZS234

ALFA ROMEO 145, 146, 155, 164
CITROËN JUMPY
DACIA 1309, NOVA
FIAT BRAVA, BRAVO I, CROMA, FIORINO, FIORINO Pick up, MAREA, PALIO, PUNTO, SCUDO, SIENA, TEMpra, TIPO
FSO POLONEZ III
KIA SPORTAGE
LADA NOVA
LANCIA DEDRA, DELTA II, KAPPA, THEMA, Y, Y10
LAND ROVER DISCOVERY II, RANGE ROVER II
PEUGEOT EXPERT

ZS237

FORD FIESTA II, FIESTA III, KA, ORION III
MAZDA 626 V (GF), 626 V /Hatchback (GF), 626 V Hatchback (GF), 626 V Station Wagon (GW)

ZS238

FORD ESCORT '91, ESCORT IV, ESCORT V, ESCORT VI, ESCORT VII, FIESTA, FIESTA III, FIESTA IV, ORION II, ORION III
MAZDA 626 V /Hatchback (GF), 626 V Hatchback (GF), 626 V Station Wagon (GW)

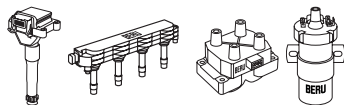

ZS239

FORD ESCORT VI, FIESTA III, MONDEO I, ORION III
MAZDA 121 III (JASM, JBSM), 626 V (GF), 626 V Station Wagon (GW), MPV II (LW)

ZS241

CITROËN SAXO
PEUGEOT 106 II

ZS242

RENAULT CLIO II, KANGOO, MEGANE, MEGANE I

ZS243

RENAULT CLIO II, KANGOO, MEGANE, MEGANE I

ZS244

FIAT TEMPRA, TIPO, UNO
LANCIA Y10

ZS245

RENAULT MEGANE, MEGANE I
VOLVO S40 I, V40

ZS246

RENAULT MEGANE, MEGANE I
VOLVO S40 I, V40

ZS247

CITROËN AX, BX, C15
PEUGEOT 205, 205 I, 205 II, 309 I, 309 II, 405 I, 405 II

ZS248

FIAT CROMA, DUNA, FIORINO, FIORINO Pick up, PANDA, REGATA, RITMO, RITMO I, RITMO II, TIPO, UNO
LANCIA DELTA I, PRISMA, THEME, Y10

ZS249

CITROËN AX, XM, ZX
PEUGEOT 106 I, 605

ZS250

RENAULT 19 II, CLIO I, RAPID, TWINGO I

ZS251

JEEP CHEROKEE, WRANGLER I
RENAULT 9, 11, 18, 19 I, 19 II, 21, 25, CLIO I, ESPACE I, ESPACE II, LAGUNA I, MASTER I, MEGANE, MEGANE I, RAPID, SAFRANE I, SAFRANE II, SUPER 5, TRAFIC
VOLVO 340-360, 440 K, 460 L, 480 E, 850

ZS252

OPEL ASCONA B, ASCONA C, ASTRA F, CORSA A, KADETT D, KADETT E, MANTA B, VECTRA A
VAUXHALL ASTRA, ASTRA Mk II, ASTRA Mk III (F), ASTRAMAX, ASTRAVAN Mk III (F), CAVALIER Mk II, CAVALIER Mk III, NOVA, NOVAVAN

ZS253

OPEL ASTRA F, ASTRA F CLASSIC, COMBO, CORSA A, CORSA B, KADETT E, OMEGA A, VECTRA A
VAUXHALL ASTRA, ASTRA Mk II, ASTRA Mk III (F), ASTRAMAX, CARLTON Mk III, CAVALIER Mk III, CORSA Mk I (B), NOVA, VECTRA (B)

ZS254

RENAULT LAGUNA I, SAFRANE II
VOLVO S40 I, V40

ZS255

RENAULT LAGUNA I, SAFRANE II
VOLVO S40 I, V40

ZS256

CITROËN XANTIA, XM, ZX
PEUGEOT 306, 406, 605

ZS257

CITROËN BX, C15
PEUGEOT 309 I, 309 II, 405 I

ZS258

CITROËN XM
PEUGEOT 605

ZS259

OPEL ASTRA G, COMBO, CORSA C, MERIVA, VECTRA B, VECTRA C, ZAFIRA A, ZAFIRA B
VAUXHALL ASTRA Mk IV (G), COMBO Mk II (C), COMBO TOUR Mk II (C), CORSA Mk II (C), MERIVA Mk I (A), VECTRA (B), ZAFIRA Mk I (A), ZAFIRA Mk II (B)

ZS261

HYUNDAI H-1, H-1 / STAREX, H100, SANTAMO, SONATA II, SONATA III
MITSUBISHI GALANT IV, GALANT V, SAPPORO III, SPACE WAGON

ZS263

HYUNDAI LANTRA I, PONY, PONY / EXCEL, S COUPE
MITSUBISHI COLT III, COLT IV, GALANT III, GALANT IV, GALANT V, L 300, LANCER III, LANCER IV, LANCER VI, PAJERO II, SPACE WAGON, STARION

ZS264

HYUNDAI ACCENT, ACCENT I, LANTRA II
MITSUBISHI COLT V

ZS265

HYUNDAI LANTRA I, SONATA II, SONATA III
MITSUBISHI COLT III, GALANT IV, LANCER IV

ZS266

HYUNDAI ATOS, ATOS PRIME

ZS267

HYUNDAI COUPE, LANTRA II, MATRIX

ZS269

HYUNDAI SONATA IV
INFINITI G20
KIA MAGENTIS

ZS274

MAZDA 323 III /Hatchback (BF), 323 III Hatchback (BF), 323 III Station Wagon (BW), 323 S IV (BG), 626 II Coupe (GC), 626 III (GD), 626 III /Coupe/Hatchback (GD), 626 III /Hatchback (GD), 626 III Hatchback (GD), 626 III Station Wagon (GV), 929 II /Coupe (HB), 929 II Estate (HV), 929 III (HC), B-SERIE (UF)
SUZUKI SWIFT I (AA), SWIFT II Hatchback (EA, MA)

ZS275

HONDA ACCORD IV, ACCORD V, ACCORD VI, CIVIC V, CIVIC VI, CR-V I, CRX III, HR-V, INTEGRA, LOGO, PRELUDE III, PRELUDE IV, PRELUDE V, SHUTTLE
ROVER 600

ZS276

ACURA INTEGRA
HONDA CIVIC II, CIVIC III, CIVIC IV, CONCERTO, CRX II
ROVER 200, 400, CABRIOLET

ZS277

FORD MAVERICK
INFINITI M30
NISSAN 100 NX, ALMERA I, BLUEBIRD, MAXIMA II, MICRA I, PRAIRIE PRO, PRIMERA, SERENA, SUNNY, SUNNY II, SUNNY III, TERRANO I, TERRANO II, VANETTE CARGO

ZS278

ACURA INTEGRA
HONDA CIVIC IV, CONCERTO, DOMANI

ZS279

MAZDA 323 C IV (BG), 323 F IV (BG), 323 III Station Wagon (BW), 323 S IV (BG), MX-3 (EC)

ZS280

AUDI 200

ZS281

FORD ESCORT '86, ESCORT '91, ESCORT '95, ESCORT CLASSIC, ESCORT IV, ESCORT V, ESCORT VI, ESCORT VII, FIESTA, FIESTA III, FIESTA IV, KA, MONDEO I, MONDEO II, ORION II, ORION III, PUMA, SIERRA, TRANSIT CONNECT
MAZDA 626 V (GF), 626 V /Hatchback (GF), 626 V Hatchback (GF), 626 V Station Wagon (GW), MPV II (LW)

ZS282

MITSUBISHI L 200, PAJERO I, PAJERO II

ZS283

ALFA ROMEO 33, 145, 146, 155
FIAT CINQUECENTO, COUPE, DOBLO, PALIO, PANDA, PUNTO, PUNTO / GRANDE PUNTO, SEICENTO, SIENA, STRADA, TEMPRA, TIPO
LANCIA DEDRA, DELTA I, DELTA II, THEME, Y, YPSILON

ZS296

MERCEDES-BENZ 190 (W201), COUPE (C124), E-CLASS (W124), E-CLASS Estate (S124), KOMBI Estate (S124), Saloon (W124), S-CLASS (W126), S-CLASS (W140), SL (R129)

ZS297

CHRYSLER CROSSFIRE
MERCEDES-BENZ A-CLASS (W169), B-CLASS (W245), C-CLASS (W202), C-CLASS (W203), C-CLASS Coupe (CL203), C-CLASS Estate (S202), C-CLASS T-Model (S203), CITARO (O 530), CLK (C208), CLK (C209), CLK Convertible (A208), CLK Convertible (A209), CLS (C219), E-CLASS (W210), E-CLASS (W211), E-CLASS Estate (S210), E-CLASS T-Model (S211), G-CLASS (W463), G-CLASS Cabrio (W463), M-CLASS (W163), M-CLASS (W164), R-CLASS (W251, V251), S-CLASS (W220), S-CLASS Coupe (C215), SL (R129), SL (R230), SLK (R170), SLK (R171), SLR (R199), SLR ROADSTER (R199), VIANO (W639), VITO Bus (W639), VITO / MIXTO Box (W639)

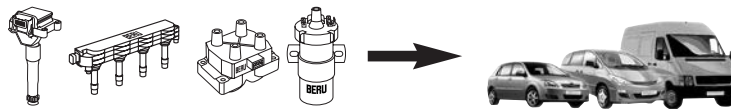

| | | | |
|---|--|--|---|
| <p>ZS298 MERCEDES-BENZ CABRIOLET (A124), COUPE (C124), E-CLASS (W124), G-CLASS (W463), KOMBI Estate (S124), Saloon (W124), S-CLASS (W126), S-CLASS (W140), S-CLASS Coupe (C126), S-CLASS Coupe (C140), SL (R129) PORSCHE 959</p> | <p>ZS308 FORD ESCORT V, ESCORT VI, ESCORT VII, SCORPIO II, TRANSIT</p> | <p>ZS322 ALFA ROMEO MITO FIAT 500, 500 C, 500L, BRAVO II, DOBLO, DUCATO, IDEA, PANDA, PUNTO, PUNTO / GRANDE PUNTO, STILO LANCIA MUSA, YPSILON</p> | <p>ZS340 DAEWOO KORANDO, MUSSO, REXTON MERCEDES-BENZ C-CLASS (W202), C-CLASS Estate (S202), CLK (C208), CLK Convertible (A208), COUPE (C124), E-CLASS (W124), E-CLASS (W210), E-CLASS Convertible (A124), E-CLASS Coupe (C124), E-CLASS Estate (S124), E-CLASS Estate (S210), G-CLASS (W463), G-CLASS Cabrio (W463), KOMBI Estate (S124), M-CLASS (W163), Saloon (W124), S-CLASS (W140), SL (R129), SLK (R170), SPRINTER 2-t Box (901, 902), SPRINTER 2-t Box/Bus (901, 902), SPRINTER 2-t Box/Bus/Platform/Chassis (901, 902), SPRINTER 2-t Platform/Chassis (901, 902), SPRINTER 3-t Box (903), SPRINTER 3-t Box/Bus/Platform/Chassis (903), SPRINTER 3-t Bus (903), SPRINTER 4-t Box/Bus/Platform/Chassis (904), SPRINTER 4-t Box/Platform/Chassis (904), V-CLASS (638/2), VITO Box/Bus (638) SSANGYONG ACTYON I, KORANDO, KYRON, MUSSO, REXTON, RODIUS VW LT 28-35 II, LT 28-46 II</p> |
| <p>ZS299 MERCEDES-BENZ E-CLASS (W124), Saloon (W124), S-CLASS (W140), S-CLASS Coupe (C140), SL (R107), SL (R129)</p> | <p>ZS309 ALFA ROMEO 145, 146, 156, 166, GTV, SPIDER</p> | <p>ZS323 CITROËN XANTIA, ZX PEUGEOT 306, 405 II</p> | |
| <p>ZS300 OPEL ASTRA F, CALIBRA A, FRONTERA A, OMEGA B, VECTRA A, VECTRA B VAUXHALL ASTRA Mk III (F), CALIBRA, CAVALIER Mk III, FRONTERA Mk I (A), OMEGA (B)</p> | <p>ZS310 FIAT BRAVO I, COUPE, MAREA LANCIA KAPPA</p> | <p>ZS324 ALPINA B7 BMW 1 (E81), 1 (E87), 3 (E46), 3 (E90), 3 Compact (E46), 3 Convertible (E46), 3 Convertible (E93), 3 Convertible/Coupe (E46), 3 Coupe (E46), 3 Coupe (E92), 3 /Touring (E46), 3 Touring (E46), 3 Touring (E91), 5 (E60), 5 /Touring (E39), 5 Touring (E61), 6 (E63), 6 Convertible (E64), 7 (E65, E66, E67), X3 (E83), X5 (E53), X5 (E70), Z3 (E36), Z3 Coupe (E36), Z4 (E85), Z4 Coupe (E86) PEUGEOT EXPERT</p> | |
| <p>ZS301 OPEL CALIBRA A, OMEGA B, VECTRA A SAAB 900 II VAUXHALL CALIBRA, CAVALIER Mk III, OMEGA (B)</p> | <p>ZS311 FIAT BRAVA, BRAVO I, COUPE, MAREA LANCIA KAPPA, LYBRA, THESIS</p> | <p>ZS325 DACIA LOGAN II, SANDERO, SANDERO II NISSAN KUBISTAR RENAULT CLIO Grandtour, CLIO Grandtour IV, CLIO II, CLIO III, CLIO IV, KANGOO, MODUS / GRAND MODUS, THALIA I, THALIA II, TWINGO I, TWINGO II</p> | |
| <p>ZS302 ALPINA ROADSTER BMW 3 (E46), 3 Compact (E36), 3 Compact (E46), 3 /Convertible (E36), 3 /Convertible/Coupe (E36), 3 Convertible/Coupe (E46), 3 /Convertible/Coupe/Touring (E36), 3 Coupe (E36), 3 Coupe (E46), 3 Touring (E36), 3 /Touring (E46), 3 Touring (E46), 5 (E39), 5 /Touring (E39), 7 (E38), 8 (E31), X5 (E53), Z3 (E36), Z3 Coupe (E36), Z8 (E52) LAND ROVER RANGE ROVER III MG MG ZS</p> | <p>ZS313 MERCEDES-BENZ C-CLASS (W202), C-CLASS Estate (S202), CLK (C208), CLK Convertible (A208), COUPE (C124), E-CLASS (W124), E-CLASS Convertible (A124), E-CLASS Coupe (C124), E-CLASS Estate (S124), KOMBI Estate (S124), Saloon (W124)</p> | <p>ZS327 SEAT MARBELLA, TERRA</p> | |
| <p>ZS304 SMART CABRIO, CITY-COUPE, CROSSBLADE, FORTWO, ROADSTER</p> | <p>ZS314 VW GOL, PARATI</p> | <p>ZS337 SEAT MARBELLA, TERRA</p> | |
| <p>ZS306 OPEL OMEGA B VAUXHALL OMEGA (B)</p> | <p>ZS315 RENAULT ESPACE III, LAGUNA I, MEGANE, MEGANE I SEAT MARBELLA, TERRA</p> | <p>ZS338 NISSAN MICRA II</p> | |
| <p>ZS307 BMW 3 (E36), 3 (E46), 3 Compact (E36), 3 /Compact/Coupe/Touring (E36), 3 /Convertible/Touring (E36), 3 /Coupe (E36), 3 Coupe (E46), 3 /Touring (E46), 3 Touring (E46), 5 /Touring (E34), 5 Touring (E34), Z3 (E36)</p> | <p>ZS316 JEEP CHEROKEE RENAULT 9, 11, 18, 19 I, 19 II, 21, 25, CLIO I, ESPACE I, ESPACE II, LAGUNA I, MASTER I, MEGANE, MEGANE I, RAPID, SAFRANE I, SAFRANE II, SUPER 5, TRAFIC VOLVO 340-360, 440 K, 460 L, 480 E</p> | <p>ZS339 MERCEDES-BENZ 190 (W201), COUPE (C124), G-CLASS (W463), G-CLASS Cabrio (W463), KOMBI Estate (S124), Saloon (W124), S-CLASS (W126), S-CLASS (W140), SL (R129)</p> | |
| | <p>ZS317 RENAULT ESPACE III, LAGUNA I, MEGANE, MEGANE I</p> | <p>ZS343 CITROËN XANTIA, XM PEUGEOT 406, 605 RENAULT ESPACE III, LAGUNA I, SAFRANE II</p> | |
| | <p>ZS318 RENAULT ESPACE III, LAGUNA I</p> | <p>ZS344 OPEL ASTRA F, ASTRA G, CALIBRA A, OMEGA B, VECTRA A, VECTRA B VAUXHALL ASTRA Mk III (F), ASTRA Mk IV (G), CALIBRA, CAVALIER Mk III, OMEGA (B), VECTRA (B)</p> | |



| | | | |
|--|--|--|---|
| ZS345 RENAULT CLIO I, CLIO II, KANGOO, LAGUNA II, MEGANE I, THALIA I, TWINGO I | ZS354 DACIA 1310, 1410, DOKKER, DOKKER Express, LODGY, LOGAN, LOGAN MCV, SANDERO MAZDA 626 V Hatchback (GF) NISSAN KUBISTAR RENAULT CLIO Grandtour, CLIO II, CLIO III, KANGOO, KANGOO / GRAND KANGOO, LOGAN, LOGAN EXPRESS, MEGANE, MEGANE I, MODUS / GRAND MODUS, SANDERO/STEPWAY, THALIA I, TWINGO I, TWINGO II, WIND | ZS368 JAGUAR S-TYPE, XJ | ZS394 CHRYSLER DAYTONA, VOYAGER II JEEP CHEROKEE, COMANCHE, GRAND CHEROKEE I, WRANGLER I |
| ZS346 CITROËN XSARA, ZX PEUGEOT 306 | ZS355 CHEVROLET BERETTA, CAMARO, CAVALIER, CORSICA, CORVETTE, IMPALA, LUMINA, LUMINA APV, MALIBU, S10 ISUZU IMPULSE, TROOPER LOTUS ELAN OPEL MONTEREY A, OMEGA A VAUXHALL CARLTON Mk III, MONTEREY | ZS369 FORD GT | ZS395 CHEVROLET NIVA LADA 110, 111, KALINA, NIVA, NIVA II, PRIORA |
| ZS347 CITROËN C5 I, C5 II, C5 III, C6, C8 FIAT ULYSSE LANCIA PHEDRA PEUGEOT 406, 407, 607, 807 RENAULT AVANTIME, CLIO II, LAGUNA II | ZS356 TOYOTA AVENSIS, CAMRY, CARINA E, CARINA II, CELICA, COROLLA, COROLLA FX, CORONA, DYNA 100, HIACE III, HIACE IV, HILUX II, MODELL F, PASEO, RAV 4 I, STARLET | ZS371 FORD COUGAR, MONDEO I, MONDEO II, SCORPIO I, SCORPIO II | ZS396 JEEP CHEROKEE, GRAND CHEROKEE I, WRANGLER II |
| ZS348 CITROËN C4, C4 I, C5 I, C5 II, C8, EVASION, JUMPY, XSARA, XSARA PICASSO FIAT SCUDO, ULYSSE PEUGEOT 206, 307, 406, 407, 607, 806, 807, EXPERT | ZS357 PORSCHÉ 911 (993), 911 /Convertible (993), 911 Convertible (993), 911 /Convertible/Targa (993), 911 Convertible/Targa (993) | ZS372 FORD COUGAR, MONDEO III | ZS397 BMW 3 (E21), 5 (E12), 6 (E24), 7 (E23), 2500-3.3 (E3) MERCEDES-BENZ /8 (W114), /8 (W115), /8 Coupe (W114), COUPE (C123), KOMBI Estate (S123), Saloon (W123), S-CLASS (W116), S-CLASS (W126), SL (R107), SL Coupe (C107) PORSCHÉ 928 |
| ZS349 CITROËN EVASION, XANTIA, XM, XSARA, ZX FIAT ULYSSE LANCIA ZETA PEUGEOT 306, 406, 605, 806 | ZS358 OPEL AGILA (A), CORSA B, CORSA C VAUXHALL AGILA Mk I (A), CORSA Mk I (B), CORSA Mk II (C) | ZS375 DACIA LOGAN II, SANDERO, SANDERO II NISSAN KUBISTAR RENAULT CLIO Grandtour, CLIO Grandtour IV, CLIO II, CLIO III, CLIO IV, KANGOO, MODUS / GRAND MODUS, THALIA I, THALIA II, TWINGO I, TWINGO II | ZS400 CHRYSLER VOYAGER I, VOYAGER II, VOYAGER III |
| ZS350 FORD COUGAR, ESCORT VII, FIESTA, FIESTA IV, FIESTA V, FOCUS, FUSION, KA, MAVERICK, MONDEO II, PUMA, STREET KA, TOURNEO CONNECT MAZDA 2 (DY), 3 (BK), 121 III (JASM, JBSM), TRIBUTE (EP) | ZS359 OPEL AGILA (A), CORSA C, CORSA D VAUXHALL AGILA Mk I (A), CORSA Mk II (C), CORSA Mk III (D) | ZS376 NISSAN PATROL GR I, SERENA | ZS405 CHRYSLER CONCORDE, NEW YORKER |
| ZS351 CITROËN C4, C4 I, C8 PEUGEOT 206, 307, 406, 407, 607, 807 | ZS360 FORD ESCORT VI, ESCORT VII | ZS377 CHRYSLER CIRRUS, NEON, NEON II, PT CRUISER, SEBRING, STRATUS JEEP CHEROKEE | ZS406 FORD C-MAX, FOCUS C-MAX, FOCUS II, GALAXY, MAVERICK, MONDEO IV, S-MAX, TRANSIT MAZDA 3 Saloon (BK), TRIBUTE (EP) VOLVO C30, S40 II, S80 II, V50, V70 III |
| ZS352 CITROËN C4, C4 Grand Picasso I, C4 I, C4 Picasso I, C5 II, C5 III, C8, JUMPY PEUGEOT 307, 407, 807, EXPERT, EXPERT Tepee | ZS361 ALFA ROMEO 147, 156, 166, GT, GTV, SPIDER | ZS380 CHRYSLER NEON II, PT CRUISER, SEBRING, STRATUS, VOYAGER III, VOYAGER IV JEEP CHEROKEE, WRANGLER II | ZS407 FORD MAVERICK MAZDA TRIBUTE (EP) |
| ZS353 PEUGEOT 407, 607 | ZS365 FORD TRANSIT CONNECT | ZS381 CITROËN BERLINGO, SAXO, XSARA, XSARA PICASSO PEUGEOT 106 II, 206, 306, PARTNER | ZS410 HONDA PRELUDE II |
| | ZS366 ALFA ROMEO 147, 156, 166, GT, GTV, SPIDER | ZS382 MINI MINI | ZS411 HONDA ACCORD IV |
| | ZS368 FORD ESCORT VI, ESCORT VII | ZS387 FORD B-MAX, C-MAX, C-MAX II, FIESTA, FIESTA V, FIESTA VI, FOCUS C-MAX, FOCUS II, FOCUS III, FUSION, GRAND C-MAX, KA, MONDEO IV MAZDA 2 (DY), 3 (BK) VOLVO C30, S40 II, V50 | ZS412 FORD FIESTA IV, FIESTA V, FOCUS II, GALAXY, MONDEO III MAZDA 2 (DY), 3 /Saloon (BK), 6 /Hatchback (GG), 6 Station Wagon (GY) |
| | ZS369 FORD TRANSIT CONNECT | ZS389 ASTON MARTIN DB9 | ZS426 ASTON MARTIN DB9 |
| | ZS371 JAGUAR S-TYPE | ZS392 CHRYSLER NEON II, PT CRUISER | |
| | | ZS393 JEEP COMANCHE | |

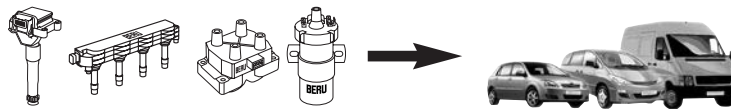

| | | | |
|---|---|--|--|
| ZS427 ALFA ROMEO 159 FIAT CROMA, STILO OPEL ASTRA G, ASTRA GTC J, ASTRA H, CORSA D, INSIGNIA, MERIVA, SIGNUM, VECTRA C, ZAFIRA B, ZAFIRA TOURER C VAUXHALL ASTRA Mk V (H), ASTRA TwinTop Mk V (H), ASTRAVAN Mk V (H), CORSA Mk III (D), MERIVA Mk I (A), SIGNUM, VECTRA Mk II (C), ZAFIRA Mk II (B), ZAFIRA Mk III | ZS447A CHEVROLET AVEO, CAPTIVA, CRUZE, EPICA, EVANDA, KALOS, LACETTI, LANOS, MATIZ, NUBIRA, OPTRA, REZZO, SPARK, VIVANT DAEWOO EVANDA, KALOS, LACETTI, LANOS, LEGANZA, MAGNUS, MATIZ, NUBIRA, REZZO OPEL ANTARA | ZS475 HYUNDAI ACCENT IV, i20, i30, ix20 KIA CARENS III, CEE'D, PRO CEE'D, RIO III, SOUL, VENG | ZS511 HYUNDAI GALLOPER II KIA AVELLA, PRIDE MITSUBISHI SIGMA NISSAN SUNNY II |
| ZS428 ALFA ROMEO 147, 156, 164, 166, GT, GTV, SPIDER LANCIA KAPPA, THESIS | ZS449 ROVER 100 / METRO TOYOTA COROLLA | ZS476 KIA PICANTO | ZS521 HYUNDAI SANTAMO KIA JOICE MITSUBISHI SANTAMO |
| ZS429 VOLVO S40 I, V40 | ZS450 OPEL SINTRA VAUXHALL SINTRA | ZS477 HYUNDAI i10 KIA PICANTO | ZS522 HYUNDAI SONATA IV, TRAJET |
| ZS430 LEXUS ES TOYOTA ALPHARD I, AVALON, CAMRY, CAMRY SOLARA, HARRIER, KLUGER, PREVIA, SIENNA, VISTA, WINDOM | ZS451 OPEL OMEGA B, VECTRA B VAUXHALL VECTRA (B) | ZS478 KIA PICANTO | ZS532 HONDA ACCORD V, ACCORD VI, CIVIC V, CIVIC VI ROVER 400, 600 |
| ZS431 CHRYSLER 300 C, 300 M, CONCORDE, SEBRING | ZS452 JEEP CHEROKEE, GRAND CHEROKEE I, GRAND CHEROKEE II, WRANGLER II | ZS479 HYUNDAI ACCENT, ACCENT II, GETZ | ZS536 HYUNDAI i10, i20 KIA PICANTO |
| ZS432 CHRYSLER 300 C, 300 M, CONCORDE, PACIFICA | ZS453 CHRYSLER 300 C, PACIFICA, SEBRING FIAT FREEMONT VW ROUTAN | ZS480 HYUNDAI GETZ | ZS537 SSANGYONG KORANDO |
| ZS433 KIA CARENS I, CARENS II, CLARUS, SEPHIA, SHUMA, SHUMA II | ZS454 RENAULT CLIO II, KANGOO, THALIA I, TWINGO I | ZS481 HYUNDAI ACCENT, ACCENT III KIA CERATO, RIO II | ZS538 BMW 2 Active Tourer (F45) MINI MINI |
| ZS434 KIA RETONA, SPORTAGE | ZS455 CHRYSLER GRAND VOYAGER V, TOWN & COUNTRY, VOYAGER III, VOYAGER IV JEEP WRANGLER II, WRANGLER III VW ROUTAN | ZS482 HYUNDAI COUPE, ELANTRA, i30, MATRIX, TRAJET, TUCSON KIA CARENS II, CEE'D, CERATO, PRO CEE'D, SPORTAGE | ZSE001 AUDI 80, 100, CABRIOLET, COUPE SEAT ALHAMBRA, AROSA, CORDOBA, IBIZA II, IBIZA III, INCA, TOLEDO I SKODA FAVORIT, FELICIA I, FELICIA II, OCTAVIA VW CADDY II, CORRADO, GOLF III, GOLF IV, KAEFER, LUPO, PASSAT, POLO, SHARAN, TRANSPORTER IV, VENTO |
| ZS435 ROVER 45 | ZS469 LAND ROVER FREELANDER MG EXPRESS, MGF, MG TF, MG ZR ROVER 25, 100, 100 / METRO, 200, 400, CABRIOLET, COUPE | ZS483 HYUNDAI ACCENT, ACCENT II, COUPE, ELANTRA, GETZ, MATRIX KIA CERATO, RIO II | ZSE002 SEAT CORDOBA, IBIZA II, TOLEDO I VW PASSAT, POLO, TRANSPORTER IV, VENTO |
| ZS436 KIA SEPHIA, SHUMA | ZS470 CHRYSLER VOYAGER III, VOYAGER IV | ZS485 HYUNDAI COUPE, SANTA FÉ I | ZSE003 AUDI A1, A2, A3, A4 SEAT ALHAMBRA, ALTEA, ALTEA XL, AROSA, CORDOBA, EXEO, IBIZA III, IBIZA IV, IBIZA V, INCA, LEÓN, TOLEDO II, TOLEDO III, TOLEDO IV SKODA FABIA, OCTAVIA, RAPID, ROOMSTER, ROOMSTER Praktik, SUPERB, YETI VW BEETLE, BORA, CADDY II, CADDY III, FOX, GOL, GOLF IV, GOLF V, GOLF VI, GOLF PLUS, JETTA III, JETTA IV, LUPO, MULTIVAN V, NEW BEETLE, PASSAT, POLO, SHARAN, TOURAN, TRANSPORTER V, VOYAGE |
| ZS437 ROVER 45 | ZS472 CITROËN C2, C3 I, C4, C4 I PEUGEOT 206, 207, 307, 1007 | ZS486 KIA CARENS II, RIO, SHUMA, SHUMA II | |
| ZS445 LEXUS GS, LS TOYOTA 4 RUNNER, LITEACE, MR 2 II VW TARO | ZS473 TOYOTA 4 RUNNER, LAND CRUISER 90 | ZS487 KIA CARNIVAL I, CARNIVAL II | |
| ZS446 VOLVO 940, 960, 960 II, C70 I, S40 I, S40 II, S90, V90 | ZS474 HYUNDAI ELANTRA, i30 KIA CEE'D, CERATO, PRO CEE'D | ZS501 LAND ROVER FREELANDER MG EXPRESS, MGF, MG TF, MG ZR, MG ZS, MG ZT, MG ZT-T ROVER 25, 75, 200, STREETWISE | |
| | | ZS502 LOTUS ELISE MG MGF, MG TF, MG ZR ROVER 25, 45, 200, 400, COUPE | |
| | | ZS508 CHEVROLET CRUZE, LACETTI, NUBIRA, OPTRA DAEWOO LACETTI, NUBIRA | |

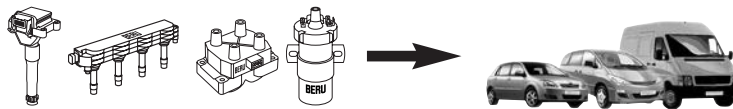
ZSE004

FORD GALAXY
MERCEDES-BENZ V-CLASS (638/2)
 VW CORRADO, GOLF III, PASSAT, SHARAN,
 TRANSPORTER IV, VENTO

ZSE005

AUDI 80, 90, 100, 200, CABRIOLET,
 COUPE

ZSE006

AUDI A4
 VW PASSAT

ZSE007

AUDI 80, 100, A6, CABRIOLET, COUPE

ZSE008

AUDI A4, A8

ZSE009

AUDI A3, A6, A8, TT
 SEAT ALHAMBRA, CORDOBA, IBIZA III,
 LEON, TOLEDO II
 SKODA OCTAVIA
 VW GOLF IV, NEW BEETLE, SHARAN

ZSE010

MINI COOPER
 MITSUBISHI GALLOPER

ZSE011

HYUNDAI ATOS, ATOS PRIME

ZSE012

PORSCHE CAYENNE (955)

ZSE013

SEAT LEON
 VW BORA, GOLF IV, NEW BEETLE

ZSE019

VOLVO C70 I, S60 I, S70, S80 I, V70 I,
 V70 II, XC70 CROSS COUNTRY, XC90 I

ZSE021

NISSAN ALMERA II, ALMERA TINO,
 PRIMERA

ZSE026

OPEL ASTRA F, ASTRA F CLASSIC, ASTRA G,
 COMBO, CORSA A, CORSA B, TIGRA,
 VECTRA A, VECTRA B
 VAUXHALL ASTRA Mk III (F),
 ASTRA Mk IV (G), ASTRAMAN Mk III (F),
 ASTRAMAN Mk IV (G), CAVALIER Mk III,
 CORSA Mk I (B), NOVA, TIGRA Mk I,
 VECTRA (B)

ZSE029

SKODA OCTAVIA
 VW BORA, CADDY III, GOLF IV,
 NEW BEETLE, TOURAN

ZSE030

AUDI A1, A2, A3
 SEAT ALHAMBRA, ALTEA, ALTEA XL,
 CORDOBA, IBIZA IV, IBIZA V, LEON,
 TOLEDO II, TOLEDO III, TOLEDO IV
 SKODA FABIA, OCTAVIA, RAPID,
 ROOMSTER, ROOMSTER Praktik, SUPERB,
 YETI
 VW BEETLE, BORA, CADDY III, CC, EOS,
 GOLF IV, GOLF V, GOLF VI, GOLF PLUS,
 JETTA III, JETTA IV, LUPO, NEW BEETLE,
 PASSAT, PASSAT CC, POLO, SCIROCCO,
 SHARAN, TIGUAN, TOURAN

ZSE031

AUDI A8
 BENTLEY CONTINENTAL,
 CONTINENTAL FLYING SPUR
 VW PASSAT, PHAETON, TOUAREG

ZSE032

AUDI A4, A5, A6, A6 Allroad, A7, A8, Q5,
 Q7, R8
 PORSCHE CAYENNE, PANAMERA
 VW TOUAREG

ZSE033

AUDI A1, A3, A4, A4 Allroad, A5, A6, A8,
 Q3, Q5, R8, TT
 SEAT ALHAMBRA, ALTEA, ALTEA XL, EXEO,
 LEON, TOLEDO III
 SKODA OCTAVIA, SUPERB, YETI
 VW AMAROK, BEETLE, EOS, GOLF V,
 GOLF VI, GOLF PLUS, JETTA III, JETTA IV,
 MULTIVAN V, PASSAT, PASSAT CC, POLO,
 SCIROCCO, SHARAN, TIGUAN, TOUAREG,
 TOURAN, TRANSPORTER V

ZSE036

AUDI 100, 200, A6, QUATTRO, V8

ZSE037

RENAULT SAFRANE II
 VOLVO 850, C70 I, S70, V70 I,
 XC70 CROSS COUNTRY

ZSE039

SKODA FELICIA II

ZSE040

SEAT AROSA
 SKODA FABIA, OCTAVIA
 VW LUPO, PASSAT

ZSE041

AUDI Q7
 SEAT LEON
 SKODA SUPERB
 VW CC, EOS, MULTIVAN V, PASSAT,
 PASSAT CC, PHAETON, TOUAREG

ZSE042

PORSCHE CAYENNE (955), PANAMERA

ZSE043

AUDI A3, A4, A6, TT
 SEAT CORDOBA, EXEO, IBIZA III, IBIZA IV,
 LEON, TOLEDO II
 SKODA OCTAVIA, SUPERB
 VW BORA, GOLF IV, NEW BEETLE, PASSAT,
 POLO

ZSE044

AUDI A3, TT
 PORSCHE CAYENNE (955)
 SEAT LEON
 VW EOS, GOLF IV, GOLF V, MULTIVAN V,
 PHAETON, TOUAREG, TRANSPORTER V

ZSE045

CITROËN BERLINGO, C2, C3, C3 I, C4,
 C4 I, XSARA, XSARA PICASSO
 PEUGEOT 206, 207, 307, 308 SW, 1007,
 PARTNER, PARTNER Tepee

ZSE046

CITROËN SAXO
 PEUGEOT 106 II

ZSE047

CITROËN BERLINGO, C2, C3, C3 I, SAXO,
 XSARA, XSARA PICASSO
 PEUGEOT 106 II, 206, 306, 307, 1007,
 PARTNER

ZSE048

CITROËN BERLINGO, C2, C3 I, C3 II, NEMO
 FIAT FIORINO, QUBO
 PEUGEOT 206, 206+, 207, 207 SW,
 1007, BIPPER, BIPPER Tepee, PARTNER

ZSE051

AUDI A4, A6, A8

ZSE052

PORSCHE 911 /Convertible (997),
 911 /Convertible/Targa (997),
 BOXSTER (987), CAYMAN (987)

ZSE054

PORSCHE CARRERA GT

ZSE055

FORD FOCUS II, KUGA I, MONDEO IV,
 S-MAX
 VOLVO C30, C70 II, S40 II, S60 I, S80 I,
 S80 II, V50, V70 II, V70 III

ZSE056

NISSAN CUBE, MICRA C+C, MICRA III,
 NOTE, NV200, NV200 EVALIA,
 QASHQAI / QASHQAI +2, TIIDA, X-TRAIL
 RENAULT CLIO III

ZSE059

SEAT IBIZA IV
 SKODA FABIA
 VW FOX, POLO

ZSE061

AUDI A4, A6, A8

ZSE062

AUDI ALLROAD
 VW PHAETON, TOUAREG

ZSE063

SEAT ALHAMBRA, TOLEDO II
 VW BORA, GOLF IV, NEW BEETLE, SHARAN

ZSE065

VW PASSAT

ZSE066

RENAULT GRAND SCÉNIC III, MEGANE CC,
 MEGANE III, SCÉNIC III

ZSE067

AUDI A1, A3
 SEAT LEON, Mii
 SKODA CITIGO, OCTAVIA
 VW GOLF VII, JETTA IV, POLO, UP

ZSE068

AUDI A3, A4, A4 Allroad, A5
 PORSCHE MACAN
 SEAT LEON
 SKODA OCTAVIA
 VW BEETLE, EOS, GOLF VI, GOLF VII,
 JETTA IV

ZSE069

SUZUKI GRAND VITARA II (JT),
 IGNIS (FH), IGNIS II, LIANA (ER),
 LIANA Estate (ER), SWIFT III (MZ, EZ),
 SX4 (GY), SX4 Saloon (GY),
 WAGON R+ (MM)

ZSE071

INFINITI i30
 NISSAN CEFIRO, MAXIMA

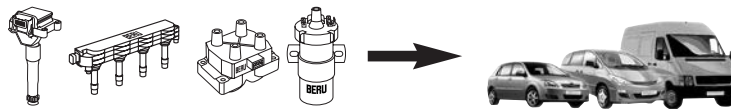

| | | | |
|---|--|---|---|
| ZSE072 SUZUKI BALENO (EG), BALENO Estate (EG), BALENO Hatchback (EG), GRAND VITARA I (FT, GT), GRAND VITARA II (JT), VITARA (ET, TA), VITARA Cabrio (ET, TA) | ZSE087 HYUNDAI EQUUS / CENTENNIAL, SANTA FÉ I, XG KIA OPIRUS, SORENTO I | ZSE137 AUDI A4, A5 | ...ZSE143 CITROËN BERLINGO, C3 II, C3 Picasso, C4, C4 Grand Picasso I, C4 I, C4 II, C4 Picasso I, C5 III, DS3, DS4 MINI MINI, MINI CLUBMAN, MINI COUNTRYMAN PEUGEOT 207, 207 CC, 207 SW, 208, 308, 308 CC, 308 SW, 508, 508 SW, 3008, 5008, PARTNER, RCZ |
| ZSE073 INFINITI i30 NISSAN CEFIRO, MAXIMA | ZSE088 INFINITI FX, QX70 NISSAN BLUEBIRD SYLPHY, JUKE, LATIO, MICRA IV, QASHQAI / QASHQAI +2, TIIDA RENAULT KOLEOS | ZSE138 AUDI A8 | ZSE144 BMW 1 (E81), 1 (E87), 1 Convertible (E88), 1 Coupe (E82), 3 (E90), 3 Convertible (E93), 3 Coupe (E92), 3 Touring (E91), 5 (E60), 5 (F10, F18), 5 Touring (E61), 5 Touring (F11), 6 (E63), 6 Convertible (E64) |
| ZSE074 INFINITI Q45 I NISSAN CIMA | ZSE089 FORD GALAXY | ZSE140 MERCEDES-BENZ C-CLASS (W203), C-CLASS (W204), C-CLASS Coupe (CL203), C-CLASS T-Model (S203), C-CLASS T-Model (S204), CLC-CLASS (CL203), CLK (C209), CLK Convertible (A209), CLS (C219), E-CLASS (W211), E-CLASS (W212), E-CLASS Convertible (A207), E-CLASS Coupe (C207), E-CLASS T-Model (S211), E-CLASS T-Model (S212), G-CLASS Cabrio (W463), GL-CLASS (X164), GLK-CLASS (X204), M-CLASS (W164), R-CLASS (W251, V251), S-CLASS (W221), S-CLASS Coupe (C216), SL (R230), SLK (R171), SPRINTER 3,5-t Box/Bus/Platform/ Chassis (906), SPRINTER 3-t Box/Bus/Platform/ Chassis (906), SPRINTER 4,6-t Box/Platform/ Chassis (906) 4,6-t, SPRINTER 5-t Box/Platform/ Chassis (906) 5-t, VIANO (W639), VITO Bus (W639), VITO / MIXTO Box (W639) | ZSE145 BMW 1 (E87), 3 (E90), 3 Touring (E91), 5 (E60), 5 Touring (E61), 6 (E63), 6 Convertible (E64), 7 (E65, E66, E67), Z4 (E85), Z4 Coupe (E86) |
| ZSE075 INFINITI i30 NISSAN CEFIRO I, MAXIMA QX | ZSE093 MERCEDES-BENZ C-CLASS (W204), C-CLASS Coupe (C204), C-CLASS T-Model (S204), CLS (C218), CLS Shooting Brake (X218), E-CLASS (W212), E-CLASS Convertible (A207), E-CLASS Coupe (C207), E-CLASS T-Model (S212), G-CLASS (W463), GL-CLASS (X166), GLK-CLASS (X204), M-CLASS (W166), R-CLASS (W251, V251), S-CLASS (W221), S-CLASS (W222), S-CLASS Coupe (C216), SL (R231), SLK (R172) | ZSE142 AUDI A3, A4, A4 Allroad, A5, A6, Q3, Q5, TT SEAT ALHAMBRA, ALTEA, ALTEA XL, EXEO, LEON, TOLEDO III SKODA OCTAVIA, SUPERB, YETI VW AMAROK, BEETLE, CC, EOS, GOLF V, GOLF VI, GOLF PLUS, JETTA III, JETTA IV, NEW BEETLE, PASSAT, PASSAT ALLTRACK, PASSAT CC, SCIROCCO, SHARAN, TIGUAN | ZSE146 MERCEDES-BENZ A-CLASS (W168), Vaneo (414) |
| ZSE076 INFINITI QX4 NISSAN PATHFINDER | ZSE094 MERCEDES-BENZ GL-CLASS (X166), M-CLASS (W166) | ZSE147 OPEL AGILA (A), ASTRA G, CORSA B, CORSA C VAUXHALL AGILA Mk I (A), ASTRA Mk IV (G), CORSA Mk I (B), CORSA Mk II (C), CORSAVAN Mk II (C) | ZSE147 OPEL AGILA (A), ASTRA G, CORSA B, CORSA C VAUXHALL AGILA Mk I (A), ASTRA Mk IV (G), CORSA Mk I (B), CORSA Mk II (C), CORSAVAN Mk II (C) |
| ZSE077 INFINITI i30 NISSAN CEFIRO I, MAXIMA QX | ZSE099 AUDI A3 SEAT LEON, Mii SKODA CITIGO, OCTAVIA VW GOLF VII, JETTA IV, POLO, UP | ZSE148 ALFA ROMEO 156, 159, GT, GTV, SPIDER | ZSE148 ALFA ROMEO 156, 159, GT, GTV, SPIDER |
| ZSE078 INFINITI i30 NISSAN CEFIRO I, MAXIMA QX | ZSE101 DACIA LODGY RENAULT CAPTUR, GRAND SCÉNIC III, MEGANE III, SCÉNIC III | ZSE149 ALFA ROMEO 159, BRERA, SPIDER OPEL SIGNUM, VECTRA C, ZAFIRA B VAUXHALL SIGNUM, VECTRA Mk II (C), ZAFIRA Mk II (B) | ZSE149 ALFA ROMEO 159, BRERA, SPIDER OPEL SIGNUM, VECTRA C, ZAFIRA B VAUXHALL SIGNUM, VECTRA Mk II (C), ZAFIRA Mk II (B) |
| ZSE079 NISSAN MAXIMA QX, MURANO, PATHFINDER, TEANA I RENAULT ESPACE IV, VEL SATIS | ZSE102 INFINITI FX, G, M35 NISSAN 350 Z | ZSE150 OPEL OMEGA B VAUXHALL OMEGA (B) | ZSE150 OPEL OMEGA B VAUXHALL OMEGA (B) |
| ZSE080 NISSAN PRIMERA, TEANA I, X-TRAIL | ZSE103 CHEVROLET TRAILBLAZER ISUZU ASCENDER SAAB 9-7X | ZSE151 OPEL ASTRA G, ASTRA H, SPEEDSTER, ZAFIRA A, ZAFIRA B | ZSE151 OPEL ASTRA G, ASTRA H, SPEEDSTER, ZAFIRA A, ZAFIRA B |
| ZSE081 NISSAN ALMERA II, ALMERA TINO, PRIMERA | ZSE104 NISSAN ARMADA, PATHFINDER, TITAN | ZSE152 OPEL OMEGA B, SIGNUM, VECTRA B, VECTRA C VAUXHALL OMEGA (B), SIGNUM, VECTRA (B), VECTRA Mk II (C) | ZSE152 OPEL OMEGA B, SIGNUM, VECTRA B, VECTRA C VAUXHALL OMEGA (B), SIGNUM, VECTRA (B), VECTRA Mk II (C) |
| ZSE082 INFINITI i30 NISSAN CEFIRO I, MAXIMA QX | ZSE105 SUZUKI GRAND VITARA I (FT, GT), JIMNY (FJ) | | |
| ZSE083 MAZDA 323 F VI (BJ), 323 S VI (BJ), PREMACY (CP) | | | |
| ZSE084 MAZDA MX-5 II (NB) | | | |
| ZSE086 HYUNDAI EQUUS / CENTENNIAL, XG KIA SORENTO I | | | |

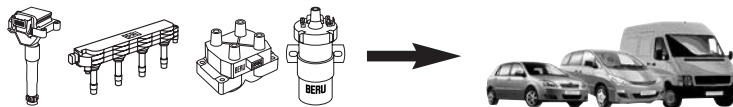

ZSE153

**OPEL OMEGA B, VECTRA B
VAUXHALL OMEGA (B), VECTRA (B)**

ZSE154

**AUDI A4, A6, A8
SKODA SUPERB
VW PASSAT**

ZSE156

**INFINITI M45
NISSAN ARMADA, TITAN**

ZSE157

INFINITI FX, Q45 I, Q45 III

ZSE158

**INFINITI EX, G, M, M35, Q50
NISSAN 350 Z, ALTIMA, MURANO,
TEANA II
RENAULT LAGUNA, LAGUNA III, LATITUDE**

ZSE159

**CHEVROLET AVALANCHE, CAMARO,
CORVETTE, EXPRESS, SILVERADO 1500,
TRAILBLAZER**

ZSE161

**RENAULT FLUENCE, GRAND SCÉNIC III,
LAGUNA III, LATITUDE, MEGANE CC,
MEGANE III**

ZSE162

**AUDI A4, A6, CABRIOLET
VW PASSAT**

ZSE164

**CITROËN C1
DAIHATSU CUORE VIII, SIRION
PEUGEOT 107
SUBARU JUSTY IV
TOYOTA AURIS, AVENSIS, AYGO, CELICA,
COROLLA, MR 2 III, RAV 4 II, VIOS/YARIS,
WISH, YARIS**

ZSE165

**PEUGEOT 406
TOYOTA AYGO, IQ, PRIUS, PRIUS C,
VIOS/YARIS, YARIS, YARIS VERSO**

ZSE166

**HONDA ACCORD VI, ACCORD VII, CIVIC VII,
FR-V, LEGEND IV, STREAM**

ZSE167

**FORD MONDEO III
LEXUS IS II
TOYOTA ALLION II, AVENSIS,
AVENSIS VERSO, CAMRY, LAND CRUISER,
LAND CRUISER 150, PREVIA, RAV 4 II,
RAV 4 III**

ZSE168

TOYOTA CELICA, COROLLA

ZSE169

**HONDA ACCORD VII, CIVIC VII, CIVIC VIII,
CR-V II, CR-V III, FR-V, INTEGRA, S2000,
STREAM
TOYOTA COROLLA**

ZSE170

HONDA CIVIC VII

ZSE171

**TOYOTA AVENSIS, AVENSIS VERSO, CAMRY,
PREVIA, RAV 4 II, RAV 4 III**

ZSE172

**DAIHATSU CHARADE
LEXUS ES, GS, GX, IS, IS C, IS I, IS II, IS III,
LS, LX, RX, SC
SUBARU TREZIA
TOYOTA AURIS, CAMRY, COROLLA,
FJ CRUISER, MARK X I, IQ, LAND CRUISER,
LAND CRUISER 100, LAND CRUISER 150,
URBAN CRUISER, VENZA, VERSO S, YARIS**

ZSE173

**LEXUS ES, GS, RX
TOYOTA CAMRY**

ZSE174

**ALFA ROMEO 159, BRERA, SPIDER
OPEL SIGNUM, VECTRA C
SAAB 9-3
VAUXHALL SIGNUM, VECTRA Mk II (C)**

ZSE175

**HONDA CITY, CIVIC VII, CIVIC VIII, JAZZ,
JAZZ II, JAZZ III**

ZSE176

**HONDA CITY, CIVIC VII, CIVIC VIII, JAZZ,
JAZZ II, JAZZ III**

ZSE502

**HYUNDAI ELANTRA, H-1, H-1 / STAREX,
SANTA FÉ I, SONATA IV, TIBURON, TRAJET,
TUCSON
KIA MAGENTIS, SORENTO I**

**GR001**

AUDI 80, 90
VW CADDY I, GOLF I, JETTA I, LT 28-35 I,
 LT 40-55 I, PASSAT, SANTANA,
 TRANSPORTER III

GR031

VW CADDY I, GOLF II, JETTA I, JETTA II,
 TRANSPORTER IV

GR034

CITROËN XANTIA, XM, XSARA, ZX
IVECO DAILY I
PEUGEOT 406, BOXER

GR049

MERCEDES-BENZ 190 (W201),
 G-CLASS (W461), T1 Box/Bus (601),
 T1 Box/Bus (602), T1 Box/Bus/Platform/
 Chassis (601), T1 Box/Bus/Platform/
 Chassis (602), T1 Bus/Platform/
 Chassis (601), T1 Platform/Chassis (601),
 V-CLASS (638/2), VITO Box (638),
 VITO Box/Bus (638), VITO Bus (638)
SSANGYONG MUSSO

GR054

CITROËN AX, BERLINGO, JUMPER, SAXO,
 XANTIA, XSARA
PEUGEOT 106 I, 106 II, 206, 306, 405 II,
 BOXER, EXPERT, PARTNER

GR059

CITROËN C25, CX I, CX II
PEUGEOT 304, 305 I, 504, 505, 604, J5,
 J9
RENAULT 20

GR064

BEDFORD ASTRAMAX, ASTRA VAN
FORD SCORPIO I
OPEL ASCONA C, ASTRA F, KADETT D,
 KADETT E, OMEGA A, REKORD E,
 SENATOR A, VECTRA A
VAUXHALL ASTRA, ASTRA Mk II,
 ASTRA Mk III (F), ASTRAMAX, BRAVA,
 CARLTON Mk II, CARLTON Mk III,
 CAVALIER Mk II, CAVALIER Mk III,
 FRONTERA Mk I (A), ROYALE

GR065

CITROËN AX, BX, C15, C25, VISA
FIAT 131, DUCATO
LAND ROVER RANGE ROVER I
PEUGEOT 205 I, 205 II, 305 I, 305 II,
 309 I, 309 II, 405 I, 405 II, 504, 505, 604,
 605, J5, J9
RENAULT 20, 25, 30, FUEGO
SEAT 131, IBIZA I, MALAGA, RONDA
TALBOT HORIZON, TAGORA

GR066

ALFA ROMEO 6, 90, ALFETTA, GIULIETTA
RENAULT 9, 18, 21, CLIO I, ESPACE I,
 ESPACE II, MASTER I, TRAFIC

GR067

RENAULT 19 I, 19 II, 21, CLIO I

GR069

MERCEDES-BENZ G-CLASS (W460),
 KOMBI Estate (S123), KOMBI Estate (S124),
 Saloon (W123), Saloon (W124),
 T1 Box (601), T1 Box/Bus (601),
 T1 Box/Bus/Platform/Chassis (601),
 T1 Box/Platform/Chassis (602),
 T1 Bus (601), T1 Platform/Chassis (601)

GR070

MERCEDES-BENZ 100 Box (631),
 100 Bus (631), 190 (W201),
 KOMBI Estate (S124), Saloon (W124)

GR071

MERCEDES-BENZ 190 (W201),
 COUPE (C123), G-CLASS (W460),
 KOMBI Estate (S123), KOMBI Estate (S124),
 Saloon (W123), Saloon (W124),
 T1 Box/Bus/Platform/Chassis (601),
 T1 Box/Platform/Chassis (602)

GR073-B

MERCEDES-BENZ KOMBI Estate (S124),
 Saloon (W124), T1 Platform/Chassis (601)

GR074

MERCEDES-BENZ 190 (W201),
 C-CLASS (W202)

GR075

MERCEDES-BENZ 190 (W201),
 KOMBI Estate (S124), Saloon (W124)

GR076

MERCEDES-BENZ G-CLASS (W463),
 G-CLASS Cabrio (W463),
 KOMBI Estate (S124), Saloon (W124)

GR080

MERCEDES-BENZ C-CLASS (W202)

GR081

AUDI A3
SEAT ALHAMBRA, AROSA, CORDOBA,
 IBIZA II, IBIZA III, IBIZA IV, INCA, LEON,
 TOLEDO I, TOLEDO II
SKODA FABIA, OCTAVIA
VW BORA, CADDY II, CADDY III, FOX,
 GOLF III, GOLF IV, GOLF PLUS, LUPO,
 NEW BEETLE, PASSAT, POLO, SHARAN,
 TOUAREG, TRANSPORTER IV,
 TRANSPORTER V, VENTO

GSE100

AUDI A2, A3, A4, A6
SEAT ALTEA, ALTEA XL, LEON, TOLEDO III
SKODA OCTAVIA, SUPERB
VW CADDY III, EOS, GOLF V, GOLF PLUS,
 JETTA III, PASSAT, TOURAN

GSE101

BMW 1 (E87), 3 (E46), 3 (E90),
 3 Compact (E46), 3 Convertible (E46),
 3 Coupe (E46), 3 /Touring (E46),
 3 Touring (E46), 3 Touring (E91), 5 (E60),
 5 Touring (E61), X3 (E83)

GSE102

BMW 3 (E90), 3 Convertible (E46),
 3 Coupe (E46), 3 Coupe (E92),
 3 /Touring (E46), 3 Touring (E91), 5 (E60),
 5 Touring (E61), 6 Convertible (E64),
 7 (E65, E66, E67), X3 (E83), X5 (E53),
 X5 (E70), X6 (E71, E72)

GSE103

BMW 7 (E65, E66, E67)

GSE114

MERCEDES-BENZ C-CLASS (W203),
 C-CLASS (W204), C-CLASS T-Model (S203),
 C-CLASS T-Model (S204), CLK (C209),
 CLK Convertible (A209), CLS (C219),
 E-CLASS (W211), E-CLASS T-Model (S211),
 G-CLASS (W461), GL-CLASS (X164),
 GLK-CLASS (X204), M-CLASS (W164),
 R-CLASS (W251, V251), S-CLASS (W221),
 SPRINTER 3,5-t Box/Bus/Platform/
 Chassis (906), SPRINTER 3-t Box/Platform/
 Chassis (906), SPRINTER 3-t Platform/
 Chassis (906),
 SPRINTER 4,6-t Box/Platform/
 Chassis (906) 4,6-t,
 SPRINTER 4,6-t Platform/Chassis (906),
 SPRINTER 5-t Box/Platform/
 Chassis (906) 5-t, VIANO (W639),
 VITO Bus (W639),
 VITO / MIXTO Box (W639)

GSE116

MERCEDES-BENZ C-CLASS (W204),
 C-CLASS T-Model (S204), CLS (C218),
 CLS (C219), CLS Shooting Brake (X218),
 E-CLASS (W211), E-CLASS (W212),
 E-CLASS Convertible (A207),
 E-CLASS Coupe (C207),
 E-CLASS T-Model (S211),
 E-CLASS T-Model (S212), G-CLASS (W463),
 G-CLASS Cabrio (W463), GL-CLASS (X164),
 GL-CLASS (X166), GLK-CLASS (X204),
 M-CLASS (W164), M-CLASS (W166),
 R-CLASS (W251, V251), S-CLASS (W221),
 S-CLASS (W222),
 SPRINTER 3,5-t Box/Bus/Platform/
 Chassis (906), SPRINTER 3-t Box/Platform/
 Chassis (906),
 SPRINTER 4,6-t Box/Platform/
 Chassis (906) 4,6-t,
 SPRINTER 4,6-t Platform/Chassis (906),
 SPRINTER 5-t Box/Platform/
 Chassis (906) 5-t, VITO Bus (W639),
 VITO / MIXTO Box (W639)

GSE140

MERCEDES-BENZ A-CLASS (W168),
 C-CLASS (W202), C-CLASS (W203),
 C-CLASS Coupe (C203),
 C-CLASS Estate (S202),
 C-CLASS T-Model (S203),
 CLC-CLASS (CL203), CLK (C209),
 E-CLASS (W210), E-CLASS (W211),
 E-CLASS Estate (S210),
 E-CLASS T-Model (S211),
 SPRINTER 2-t Box/Bus/Platform/
 Chassis (901, 902),
 SPRINTER 3,5-t Box (906),
 SPRINTER 3,5-t Box/Bus/Platform/
 Chassis (906),
 SPRINTER 3,5-t Box/Platform/
 Chassis (906), SPRINTER 3-t Box (906),
 SPRINTER 3-t Box/Bus/Platform/
 Chassis (903),
 SPRINTER 3-t Box/Bus/Platform/
 Chassis (906), SPRINTER 3-t Box/Platform/
 Chassis (906), SPRINTER 3-t Bus (906),
 SPRINTER 4,6-t Box/Platform/
 Chassis (906) 4,6-t,
 SPRINTER 4-t Box/Bus/Platform/
 Chassis (904), SPRINTER 4-t Box/Platform/
 Chassis (904), SPRINTER 5-t Box (906),
 SPRINTER 5-t Box/Platform/
 Chassis (906) 5-t, Vaneo (414),
 V-CLASS (638/2), VIANO (W639),
 VITO Box/Bus (638), VITO Bus (W639),
 VITO / MIXTO Box (W639)



GSE141

MERCEDES-BENZ C-CLASS (W202), C-CLASS (W203), C-CLASS Estate (S202), C-CLASS T-Model (S203), CLK (C209), E-CLASS (W210), E-CLASS (W211), E-CLASS Estate (S210), E-CLASS T-Model (S211), G-CLASS (W461), G-CLASS (W463), G-CLASS Cabrio (W463), M-CLASS (W163), S-CLASS (W140), S-CLASS (W220), SPRINTER 2-t Box/Bus/Platform/Chassis (901, 902), SPRINTER 2-t Box/Platform/Chassis (901, 902), SPRINTER 3-t Box/Bus (903), SPRINTER 3-t Box/Bus/Platform/Chassis (903), SPRINTER 3-t Box/Platform/Chassis (903), SPRINTER 3-t Bus (903), SPRINTER 3-t Platform/Chassis (903), SPRINTER 4-t Box/Bus/Platform/Chassis (904), SPRINTER 4-t Box/Platform/Chassis (904), SPRINTER 5-t Platform/Chassis (905), SPRINTER Dumptruck (905)

GSE142

OPEL AGILA (A), AGILA (B), ASTRA G, ASTRA H, CORSA C, MERIVA, SIGNUM, TIGRA, VECTRA C, ZAFIRA A, ZAFIRA B
VAUXHALL AGILA Mk II (B), ASTRA Mk IV (G), ASTRA Mk V (H), ASTRA TwinTop Mk V (H), ASTRAMAN Mk IV (G), ASTRAMAN Mk V (H), CORSA Mk II (C), CORSAVAN Mk II (C), MERIVA Mk I (A), SIGNUM, TIGRA, VECTRA Mk II (C), ZAFIRA Mk I (A), ZAFIRA Mk II (B)

GSE143

OPEL ASTRA G, ASTRA H, CORSA C, MERIVA, SIGNUM, SINTRA, VECTRA C, ZAFIRA A, ZAFIRA B
VAUXHALL ASTRA Mk IV (G), ASTRA Mk V (H), ASTRA TwinTop Mk V (H), ASTRAMAN Mk IV (G), ASTRAMAN Mk V (H), CORSA Mk II (C), CORSAVAN Mk II (C), MERIVA Mk I (A), SIGNUM, SINTRA, VECTRA Mk II (C), ZAFIRA Mk II (B)

GSE144

OPEL CORSA D
VAUXHALL CORSA Mk III (D), CORSAVAN Mk III (D)

GSE145

OPEL ASTRA GTC J, ASTRA J, CORSA D, MERIVA B
VAUXHALL ASTRA GTC Mk VI (J), ASTRA Mk VI (J), MERIVA Mk II (B)



| | | | |
|---|---|--|---|
| GS17 MERCEDES-BENZ C-CLASS (W203), C-CLASS Coupe (CL203), C-CLASS T-Model (S203), CLK (C208), CLK Convertible (A208), SLK (R170) | ZLE288 ALFA ROMEO 145, 146, 156, 166, GTV, SPIDER | ZM005 ALFA ROMEO ARNA, GIULIETTA AUTOBIANCHI A 112 CITROËN CX I FIAT 131, 132, ARGENTA, CROMA, REGATA FSO 125P, POLONEZ I LANCIA A 112, DELTA I, PRISMA RENAULT 11, 18, FUEGO | ZM016 HONDA ACCORD II, ACCORD III, CRX I, PRELUDE II, PRELUDE III OPEL ASCONA C, ASTRA F, CORSA A, KADETT E, VECTRA A VAUXHALL ASTRA Mk II |
| GS21 MERCEDES-BENZ C-CLASS (W204), C-CLASS T-Model (S204), CLK (C209), E-CLASS (W212), SLK (R172), SPRINTER 3,5-t Platform/Chassis (906), SPRINTER 5-t Platform/Chassis (906) | ZM001 ALFA ROMEO 33, 75, 90, ALFETTA, ARNA, GIULIETTA AUDI 80 BMW 3 (E21), 3 (E30), 5 (E12), 5 (E28), 6 (E24), 7 (E23) CITROËN AX, BX, C15, C25, CX I, CX II, GS, LNA, VISA, XM, ZX FIAT DUCATO, PANDA OPEL ASTRA F, CORSA A, KADETT E, OMEGA A PEUGEOT 104, 205 I, 205 II, 305 I, 305 II, 309 I, 309 II, 504, 505, 605, J5, J9 SAAB 900 I TALBOT SAMBA | ZM006 OPEL ASCONA C, CORSA A, KADETT D, KADETT E, MANTA B VAUXHALL CAVALIER Mk II | ZM017 FIAT PANDA, TIPO, UNO LANCIA Y10 |
| GS28 PORSCHE 911 /Convertible (997), 911 /Convertible/Targa (997), BOXSTER (987), CARRERA GT, CAYENNE (955), CAYMAN (987) | ZM002 AUDI 80, 90, 100, 200, COUPE, QUATTRO OPEL ASCONA C, COMMODORE B, KADETT D, KADETT E, MANTA B, MONZA A, REKORD E, SENATOR A SAAB 90, 99, 900 I, 9000 SEAT IBIZA I, MALAGA, RONDA VAUXHALL ASTRA, ASTRA Mk II, CAVALIER Mk II VOLVO 240, 740 VW CADDY I, GOLF I, GOLF II, JETTA II, LT 28-35 I, PASSAT, POLO, SANTANA, SCIROCCO, TRANSPORTER III | ZM007 OPEL CORSA A, KADETT E VAUXHALL ASTRA Mk II, CAVALIER Mk II | ZM018 OPEL ASTRA F, CORSA A, CORSA B, KADETT E, VECTRA A VAUXHALL ASTRA Mk II, ASTRA Mk III (F) |
| GS29 OPEL VIVARO RENAULT AVANTIME, CLIO II, ESPACE III, KANGOO, LAGUNA I, LAGUNA II, MEGANE, MEGANE I, VEL SATIS | ZM003 ALFA ROMEO 33 CITROËN AX, BERLINGO, BX, C15, ZX FORD ESCORT '81, ESCORT '86, ESCORT '91, ESCORT III, ESCORT IV, ESCORT V, ESCORT VI, ESCORT VII, FIESTA II, ORION I, ORION II PEUGEOT 106 I, 106 II, 205 I, 205 II, 309 I, 309 II, 405 I, 405 II, 605 | ZM008 FORD ESCORT '81, ESCORT III, ORION I | ZM019 FORD SCORPIO I, SCORPIO II, SIERRA |
| ZLE232 BMW 3 (E36), 3 Convertible (E36), 3 /Convertible/Coupe (E36), 3 /Coupe (E36), 3 Coupe (E36), 5 (E34), 5 (E39), 5 Touring (E34), 5 Touring (E39), 7 (E32) | ZM004 MERCEDES-BENZ 190 (W201), COUPE (C123), COUPE (C124), E-CLASS (W124), G-CLASS (W460), KOMBI Estate (S123), KOMBI Estate (S124), Saloon (W123), Saloon (W124), S-CLASS (W126), S-CLASS Coupe (C126), SL (R107), SL Coupe (C107), T1 Box (601), T1 Box/Bus (601), T1 Box/Bus/Platform/Chassis (601), T1/TN Box Body / Estate/Platform/Chassis, T2/LN1 Box Body / Estate/Platform/Chassis, T2/L Platform/Chassis | ZM009 FIAT DUNA, FIORINO, PANDA, TEMPRA, TIPO, UNO LANCIA DELTA I, Y10 | ZM020 FORD ESCORT III, ESCORT IV, FIESTA II, FIESTA III, ORION I, ORION II |
| ZLE233 AUDI 80, 100, A6, COUPE | ZM010 LADA SAMARA | ZM012 AUDI 80, 90, 100, 200, COUPE SAAB 900 I SEAT TOLEDO I VW CADDY I, CORRADO, GOLF II, JETTA II, PASSAT, POLO, SCIROCCO, TRANSPORTER III WARTBURG 353 | ZM022 MAZDA 323 II (BD), 323 II /Hatchback (BD), 323 II Hatchback (BD), 323 III (BF), 323 III /Hatchback (BF), 323 III Hatchback (BF), 323 III Station Wagon (BW), 626 II Coupe (GC), 626 II /Hatchback (GC), 626 II Hatchback (GC) MITSUBISHI GALANT II, GALANT III, LANCER I, SAPPORO II, STARION |
| ZLE234 MERCEDES-BENZ G-CLASS (W463), SPRINTER 2-t Platform/Chassis (901, 902) | ZM013 SEAT ALHAMBRA, CORDOBA, IBIZA II, TOLEDO I VW CORRADO, GOLF III, GOLF IV, PASSAT, SHARAN, TRANSPORTER IV, VENTO | ZM015 CITROËN XM FORD ESCORT IV, ORION I, ORION II OPEL ASCONA C, CORSA A, KADETT D, KADETT E, MONZA A, REKORD E, SENATOR A, SENATOR B PEUGEOT 505, 605 PORSCHE 911 (964), 928, 944, 944 /Convertible SAAB 900 I, 9000 SEAT IBIZA I, MALAGA VOLVO 240 | ZM023 HONDA ACCORD IV, ACCORD V, CIVIC II, CIVIC IV, CONCERTO, CRX II ROVER 200 |
| ZLE255 PORSCHE 911 (996), 911 /Convertible (996), 911 Convertible (996), 911 Convertible (997), 911 Targa (996), BOXSTER (986) | ZM014 VW GOLF III, PASSAT, POLO, TRANSPORTER IV | ZM016 AUDI 80, 90, 100, A6, COUPE | ZM024 MAZDA 323 F V (BA), 323 F VI (BJ), 323 III (BF), 323 III Hatchback (BF), 323 S V (BA), 323 S VI (BJ), 626 III (GD), 626 III /Coupe/Hatchback (GD), 626 III Coupe/Hatchback (GD) III, 626 III Hatchback (GD), 626 III Station Wagon (GV), 626 IV (GE), 626 IV Hatchback (GE), 929 III (HC) SUZUKI SWIFT I (AA), SWIFT II Hatchback (EA, MA) |
| ZLE276 AUDI A3, A4, A6, A8, ALLROAD, TT SEAT LEON SKODA OCTAVIA VW GOLF IV, PASSAT, SHARAN | ZM017 AUDI A8 | ZM018 AUDI A3, A4, A6, A8, ALLROAD, TT SEAT LEON SKODA OCTAVIA VW GOLF IV, PASSAT, SHARAN | ZM025 MAZDA 121 I (DA), 121 II (DB), 323 C IV (BG), 323 F IV (BG), 323 III Station Wagon (BW), 323 S IV (BG) |
| ZLE277 AUDI A8 | ZM019 AUDI A8 | ZM019 AUDI A8 | |
| ZLE278 PORSCHE 911 (996), 911 /Convertible (996), BOXSTER (986) | ZM020 AUDI A8 | ZM020 AUDI A8 | |



| |
|---|
| ZM026 |
| ALFA ROMEO 33 CITROËN AX, BERLINGO, BX, EVASION, XANTIA, XM, ZX FIAT PUNTO, ULYSSE LANCIA KAPPA, THEMA, ZETA OPEL ASTRA F, VECTRA A, VECTRA B PEUGEOT 106 I, 306, 405 II, 605, 806 PORSCHE 911 (993), 911 /Convertible (993), 911 Convertible (993), 911 /Convertible/Targa (993), 911 Convertible/Targa (993) VAUXHALL CALIBRA |
| ZM027 |
| AUDI 80, 100, A4, A6, COUPE |
| ZM029 |
| SAAB 900 I |
| ZM031 |
| AUDI 80, 100, COUPE |
| ZM032 |
| OPEL ASCONA C, OMEGA A VAUXHALL CARLTON Mk III, CAVALIER Mk II |
| ZM033 |
| VOLVO 440 K, 460 L, 480 E |
| ZM034 |
| OPEL ASTRA F, CALIBRA A, KADETT E, OMEGA A, VECTRA A VAUXHALL CAVALIER Mk III |
| ZM035 |
| ALFA ROMEO 164, GTV HYUNDAI PONY |
| ZM036 |
| RENAULT SAFRANE II VOLVO 850, C70 I, S70, V70 I |
| ZM037 |
| ALFA ROMEO 75 |
| ZM038 |
| BMW 3 (E21), 3 (E30), 3 /Convertible/Touring (E30), 3 Convertible/Touring (E30), 3 /Touring (E30), 5 (E28) |
| ZM039 |
| LADA SAMARA, SAMARA FORMA VOLVO 240, 340-360, 740 |

| |
|--|
| ZM040 |
| LANCIA THEMA MERCEDES-BENZ T2/L Box Body / Estate VOLVO 240, 740, 760, 780, 940, 940 II |
| ZM041 |
| OPEL CORSA A, CORSA B, KADETT E, OMEGA A |
| ZM043 |
| FIAT REGATA |
| ZM045 |
| HONDA ACCORD VI, CIVIC V, CIVIC VI |
| ZM046 |
| SUBARU LEONE II |
| ZM047 |
| ASTON MARTIN DB7, VIRAGE, VIRAGE Limited Edition FORD FIESTA, FIESTA III LAND ROVER RANGE ROVER I ROVER 2000-3500 |
| ZM048 |
| INFINITI G20, M30 NISSAN 100 NX, MAXIMA II, PRAIRIE PRO, PRIMERA, SERENA, STANZA, SUNNY III, TERRANO I, TERRANO II |
| ZM049 |
| HYUNDAI S COUPE, SONATA II MITSUBISHI COLT III, COLT IV, COLT V, GALANT IV, GALANT V, GALANT VI, LANCER III, LANCER IV, LANCER V, LANCER VI, PAJERO I, PAJERO II NISSAN PRIMERA |
| ZM050 |
| MAZDA 323 C IV (BG), 323 F IV (BG), 323 S IV (BG) |
| ZM051 |
| MITSUBISHI LANCER III, LANCER IV |
| ZM052 |
| RENAULT SAFRANE I |
| ZM053 |
| DAIHATSU APPLAUSE I HYUNDAI PONY / EXCEL MITSUBISHI CORDIA |
| ZM054 |
| HONDA ACCORD I, ACCORD II, CIVIC I, PRELUDE I, PRELUDE II, QUINTET |

| |
|---|
| ZM055 |
| HONDA PRELUDE III |
| ZM056 |
| HONDA ACCORD II, ACCORD III, CIVIC III, PRELUDE III |
| ZM057 |
| TOYOTA CARINA II, CELICA, COROLLA, STARLET |
| ZM058 |
| TOYOTA CARINA II, COROLLA, COROLLA FX, TERCEL |
| ZM059 |
| TOYOTA CAMRY, COROLLA, COROLLA FX |
| ZM060 |
| SKODA FAVORIT, FELICIA I, FELICIA II |
| ZM061 |
| FIAT ARGENTA, CROMA, TIPO, UNO LANCIA DELTA I, PRISMA, THEMA |
| ZM062 |
| AUDI A3, A4, A6, A8 SEAT ALHAMBRA, LEON SKODA OCTAVIA VW BORA, GOLF IV, NEW BEETLE, PASSAT |
| ZM063 |
| AUDI 80, 100, A4, A6, CABRIOLET, COUPE |

Glow plugs are specifically matched to the various engines and glowing concepts. For this reason, the following is especially important when changing glow plugs: **Each heating system may only be fitted with the glow plugs which exactly match the engine!**



CGP

BERU Ceramic Glow Plug (CGP) – Fast, heat-resistant, long lasting

The high requirements in terms of refinement, low emissions and performance made on modern diesel engines usually results in poorer starting characteristics. A problem that is exacerbated by low compression diesel engines. Beside glow plugs with an efficient cold-start function, modern engine designers are also looking for solutions that make heat energy available when the engine would otherwise generate higher emissions due to excessive cooling.



PSG

BERU Pressure Sensor Glow Plug (PSG) for diesel engines

The future exhaust gas limit values for diesel vehicles demand a drastic reduction in particles and nitrogen oxide. This demands optimisation of the combustion among other things. BERU Systems has developed the intelligent pressure sensor glow plug for this purpose. The PSG measures the pressure in the combustion chamber with an integrated sensor and reports this to the engine control electronics. This innovative concept will play a key role in the further reduction of the diesel emissions and has already won numerous innovation awards.



GE

Heating plug electronically controlled, pre-heating – start heating – after-heating

Type: Sheathed type plug with two-filament technology, electronically controlled

Use: Engines of the latest generation with electronic heating time control

Mode of function: The BERU diesel Instant Start System ISS consists of optimum performance, electronically controlled heating plugs and a control unit with microcontroller. The heating requirement of the engine is adapted by a stored parameter profile. It takes into account load, speed, temperature and fuel flow. ISS enables a spontaneous “combustion engine” key start up to minus 15°. At minus 24° the pre-heating time is only 2 seconds. Emission of pollutants is minimised.

Operating voltage: up to 5 Volts



GN

Heating plug, pre-heating – start heating – after-heating

Type: Sheathed type glow plug in two-filament technique

Use: Vehicles with heating system capable of post-heating

Mode of function: 3-phase glowing for modern glow systems (pre-heating – start heating – post-heating), new materials for glow tube, heating and control coil, most modern production technique

Operating voltage: up to 13.5 Volts

Only GN glow plugs are designed for this increased operational voltage! If, for example, a “GV” glow plug is used on a glow system designed for “GN” glow plugs, it can be destroyed within a very short space of time!



GV

Glow plug (only pre-heating)

Type: Sheathed type glow plug in two-filament/single filament technique

Use: Vehicles of older generations

Mode of function: 2-phase heating (merely pre-heating and start heating); after the engine has started, the glow plug is switched off

Operating voltage: 11 Volts

As this glow plug is only designed for a low operating voltage, it only ought to be fitted when prescribed by the manufacturer of the vehicle!



GF

Glow plug for flame-start engines

Type: Flame glow plug

Use: Large-volume direct injection diesel engines

Mode of function: When the glow temperature is reached, additional fuel enters the evaporation zone of the flame glow plug via a valve – a flame is generated, which permanently warms the intake air



GD

Glow plug with wire filament

Type: Wire-filament glow plug

Use: Mainly in older diesel vehicles and in tractors, traction engines, construction machines and stationary motors

Mode of function: The wire loop on the glow plug acts as a heating element



























GH

Glow plug for additional heaters

























Type: Sheathed type or filament glow plug

Use: Additional heating devices (petrol or diesel)



























| | | | | | |
|---|---|---|---|---|---|
| CGP001  | CGP002  | CGP003  | GD214  | GD318  | GD348  |
| GD382  | GE100  | GE101  | GE102  | GE103  | GE104  |
| GE105  | GE109  | GE110  | GE111  | GE112  | GE113  |
| GE114  | GE115  | GE116  | GE117  | GE118  | GE119  |



























| | | | | | |
|---|---|---|--|---|--|
| GE120  | GE121A  | GE122  | GE123  | GE124  | GE125  |
| GE126  | GF006  | GF683  | GF859  | GF974  | GF982-B  |
| GF983  | GF984  | GH011  | GH760  | GN003  | GN005  |
| GN007  | GN008  | GN010  | GN012  | GN013  | GN015  |



























| | | | | | |
|---|---|---|---|---|---|
| GN016  | GN017  | GN018  | GN019  | GN022  | GN024  |
| GN025  | GN026  | GN027  | GN030  | GN033  | GN035  |
| GN037  | GN039  | GN041  | GN042  | GN043  | GN044  |
| GN045  | GN046  | GN047  | GN050  | GN053  | GN054  |



























| | | | | | |
|---|---|---|---|---|---|
| GN055  | GN056  | GN057  | GN058  | GN059  | GN060  |
| GN061  | GN062  | GN063  | GN064  | GN065  | GN066  |
| GN067  | GN068  | GN069  | GN070  | GN072  | GN073  |
| GN075  | GN095  | GN096  | GN097  | GN101  | GN102  |



























| | | | | | |
|---|---|---|---|---|---|
| GN103  | GN104  | GN106  | GN107  | GN108  | GN109  |
| GN110  | GN853  | GN854  | GN855  | GN857  | GN858  |
| GN860  | GN905  | GN908  | GN909  | GN912  | GN917  |
| GN925  | GN927  | GN939  | GN944  | GN948  | GN954  |



















| | | | | | |
|---|---|---|---|---|---|
| GN955  | GN959  | GN961  | GN963  | GN964  | GN970  |
| GN985  | GN989  | GN991  | GN992  | GN993  | GN994  |
| GN997  | GN999  | GV001  | GV004  | GV106  | GV107  |
| GV108  | GV112  | GV130  | GV137  | GV602  | GV603  |









| | | | | | |
|---|---|---|---|---|---|
| GV604  | GV631  | GV636  | GV642  | GV657  | GV661  |
| GV663  | GV666  | GV673  | GV685  | GV688  | GV689  |
| GV705  | GV719  | GV730  | GV736  | GV749  | GV783  |
| GV844  | GV852  | GV886  | GV887  | GV888  | GV889  |



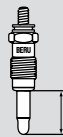
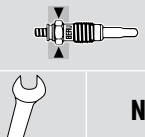
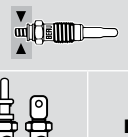



| | | | | | |
|--|--|--|--|--|---|
| GV890  | GV892  | GV894  | GV895  | GV920  | GV921  |
| GV945  | GV946  | GV947  | GV967  | GV968  | PSG001  |
| PSG002  | PSG003  | PSG004  | PSG005  | PSG006  | |
| | | | | | |



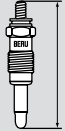
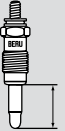
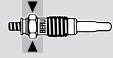



| |  |  |  |  | |  | |  | V | A | |
|---------|---|---|---|---|----------|--|--------------------|---|------|------|-----|
| | | | |  | Nm |  | Nm max. | | | | |
| CGP001 | | 134 | 29 | M 10x1,0 | 10 mm | 15 | 4 mm | - | 63 | 5,4 | 45 |
| CGP002 | | 97 | 30 | M 10x1,0 | 10 mm | 15 | 4 mm | - | 63 | 7 | 5 |
| CGP003 | | 117 | 30 | M 8x1,0 | 8 mm | 10 | 4 mm | - | 93 | 7 | 5 |
| GD214 | | 90 | 27,3 | M 18x1,5 | 21 mm | 38 | M5 | 3 | 60 | 0,9 | 40 |
| GD318 | | 90 | 27,3 | M 18x1,5 | 21 mm | 38 | M5 | 3 | 60 | 1,7 | 40 |
| GD348 | | 88 | 28 | M 18x1,5 | 21 mm | 38 | M5 | 3 | 60 | 0,9 | 42 |
| GD382 | | 88 | 28 | M 18x1,5 | 21 mm | 38 | M5 | 3 | 60 | 0,9 | 63 |
| GE100 | | 97 | 30 | M 10x1,0 | 10 mm | 15 | 4 mm | - | 63 | 5 | 25 |
| GE101 | | 117 | 30 | M 8x1,0 | 8 mm | 10 | 4 mm | - | 93 | 4,4 | 25 |
| GE102 | | 106,5 | 33 | M 10x1,0 | 10 mm | 15 | 4 mm | - | 63 | 5 | 25 |
| GE103 | | 133,5 | 29 | M 10x1,0 | 10 mm | 15 | 4 mm | - | 63 | 5 | 25 |
| GE104 | | 133 | 31 | M 10x1,0 | 10 mm | 15 | 4 mm | - | 63 | 5 | 25 |
| GE105 | | 148,5 | 27 | M 8x1,0 | 8 mm | 10 | 4 mm | - | 93 | 4,4 | 25 |
| GE109 | | 136,5 | 28 | M 10x1,25 | 12 mm | 15 | M4 | 2 | 119 | 4,7 | 10 |
| GE110 | | 96,5 | 24,5 | M 10x1,0 | 10 mm | 15 | 4 mm | - | 63 | 4,4 | 25 |
| GE111 | | 90,5 | 24,5 | M 10x1,0 | 10 mm | 15 | 4 mm | - | 63 | 4,4 | 25 |
| GE112 | | 119,5 | 28 | M 9x1,0 | 9 mm | 12 | 4 mm | - | 93 | 4,4 | 25 |
| GE113 | | 132 | 28 | M 8x1,0 | 8 mm | 10 | 4 mm | - | 93 | 4,4 | 9 |
| GE114 | | 156,5 | 35 | M 9x1,0 | 9 mm | 12 | 4 mm | - | 93 | 4,4 | 25 |
| GE115 | | 130 | 28 | M 10x1,0 | 10 mm | 15 | 4 mm | - | 63 | 4,4 | 25 |
| GE116 | | 130 | 28 | M 10x1,0 | 10 mm | 15 | 4 mm | - | 63 | 5 | 10 |
| GE117 | | 137,1 | 24 | M 10x1,25 | 10 mm | 18 | 4 mm | - | 121 | 4,4 | 8.5 |
| GE118 | | 134 | 29 | M 10x1,0 | 10 mm | 20 | 4 mm | - | 63 | 4,4 | 8.5 |
| GE119 | | 94 | 26 | M 10x1,0 | 10 mm | 15 | 4 mm | - | 63 | 5 | 9 |
| GE120 | | 156 | 26 | M 10x1,25 | 10 mm | 15 | 4 mm | - | 119 | 4,4 | 8.5 |
| GE121A | | 112 | 28 | M 8x1,0 | 8 mm | 10 | 4 mm | - | 123 | 5 | 30 |
| GE122 | | 148,5 | 35,5 | M 10x1,0 | 10 mm | 15 | M4 | 2 | 93 | 4,4 | 10 |
| GE123 | | 134 | 28 | M 8x1,0 | 8 mm | 10 | 4 mm | - | 93 | 4,4 | 7.9 |
| GE124 | | 162,7 | 26 | M 10x1,0 | 10 mm | 15 | 4 mm | - | 93 | 4,6 | 10 |
| GE125 | | 92,7 | 29,5 | M 8x1,0 | 8 mm | 10 | 4 mm | - | 93 | 4,4 | 7.9 |
| GE126 | | 146 | 31,4 | M 10x1,0 | 10 mm | 15 | 4 mm | - | 93 | 4,4 | 8.1 |
| GF006 | | 96 | 46 | M 20x1,5 | 21/24 mm | 20 | M5 | 3 | Plan | 12 | 26 |
| GF683 | | 92 | 41 | M 20x1,5 | 21/24 mm | 20 | M5 | 3 | Plan | 9,5 | 21 |
| GF859 | | 64,5 | 33 | M 22x1,5 | 26 mm | 20 | flat tongue 9,5 mm | - | Plan | 8 | 16 |
| GF974 | | 96 | 46 | M 20x1,5 | 21/24 mm | 20 | M5 | 3 | Plan | 12 | 29 |
| GF982-B | | 64,5 | 33 | M 22x1,5 | 26 mm | 20 | flat tongue 9,5 mm | - | Plan | 8 | 22 |
| GF983 | | 64,5 | 33 | M 22x1,5 | 26 mm | 20 | flat tongue 9,5 mm | - | Plan | 8 | 22 |
| GF984 | | 92 | 41 | M 20x1,5 | 21/24 mm | 20 | M5 | 3 | Plan | 11 | 29 |
| GH011 | | 87 | 64,5 | M 14x1,25 | 19 mm | 40 | M5 | 3 | Plan | 11,5 | 21 |
| GH760 | | 89 | 65 | M 22x1,5 | 26 mm | 20 | M5 | 3 | Plan | 11 | 50 |
| GN003 | | 130 | 28 | M 10x1,0 | 10 mm | 15 | 4 mm | - | 63 | 11,5 | 13 |
| GN005 | | 87,5 | 22 | M 10x1,25 | 12 mm | 15 | M4 | 2 | 120 | 11 | 13 |
| GN007 | | 97 | 30 | M 10x1,0 | 10 mm | 15 | 4 mm | - | 63 | 11 | 16 |



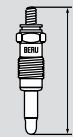
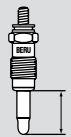
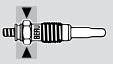
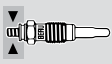



|  |  |  | |  | |  | |  | V | A |
|---|---|---|-----------|---|----|--|---------|---|------|------|
| | | | |  | Nm |  | Nm max. | | | |
| GN008 | 126 | 35 | M 10x1,0 | 10 mm | 15 | 4 mm | - | 63 | 12 | 18 |
| GN010 | 128 | 30,5 | M 10x1,0 | 10 mm | 15 | M4 | 2 | 63 | 11 | 14 |
| GN012 | 75 | 25 | M 10x1,0 | 10 mm | 15 | M4 | 2 | 63 | 11 | 15,5 |
| GN013 | 71 | 25 | M 12x1,25 | 12 mm | 22 | M5 | 3 | 63 | 11 | 14 |
| GN015 | 121 | 40 | M 10x1,0 | 10 mm | 15 | 4 mm | - | 63 | 11 | 14 |
| GN016 | 89 | 30 | M 10x1,0 | 10 mm | 15 | M4 | 2 | 63 | 11 | 8 |
| GN017 | 95 | 25 | M 10x1,0 | 10 mm | 15 | M4 | 2 | 63 | 11 | 16 |
| GN018 | 89 | 25 | M 10x1,0 | 10 mm | 15 | 4 mm | - | 63 | 11 | 10.5 |
| GN019 | 99 | 25 | M 10x1,0 | 10 mm | 15 | 4 mm | - | 63 | 11 | 11 |
| GN022 | 62 | 18 | M 12x1,25 | 12 mm | 22 | M5 | 3 | 63 | 10 | 18 |
| GN024 | 106,5 | 33 | M 10x1,0 | 10 mm | 15 | 4 mm | - | 63 | 11 | 15 |
| GN025 | 133,5 | 29 | M 10x1,0 | 10 mm | 15 | 4 mm | - | 63 | 11 | 14 |
| GN026 | 151 | 25 | M 10x1,0 | 10 mm | 15 | 4 mm | - | 63 | 11 | 17 |
| GN027 | 107 | 28 | M 10x1,0 | 10 mm | 15 | M4 | 1 | 63 | 11 | 18,5 |
| GN030 | 76 | 21 | M 12x1,25 | 12 mm | 22 | 4 mm | - | 63 | 11 | 18 |
| GN033 | 135 | 31 | M 10x1,0 | 10 mm | 15 | 4 mm | - | 63 | 11 | 15,5 |
| GN035 | 111,5 | 29,6 | M 10x1,0 | 10 mm | 15 | M4 | 2 | 63 | 11 | 16 |
| GN037 | 152 | 40 | M 8x1,0 | 8 mm | 10 | 4 mm | - | 93 | 11 | 11 |
| GN039 | 81,9 | 19 | M 10x1,25 | 12 mm | 15 | M4 | 2 | 123 | 11 | 18 |
| GN041 | 102,5 | 25 | M 10x1,0 | 10 mm | 15 | 4 mm | - | 63 | 11 | 17,5 |
| GN042 | 160 | 36 | M 10x1,25 | 10 mm | 15 | M4 | 2 | 93 | 11 | 17,5 |
| GN043 | 96 | 27 | M 10x1,25 | 12 mm | 15 | M4 | 2 | 93 | 11 | 9,5 |
| GN044 | 68 | 17 | M 10x1,25 | 12 mm | 15 | M4 | 2 | 120 | 24 | 5,5 |
| GN045 | 126,5 | 25 | M 8x1,0 | 8 mm | 10 | 4 mm | - | 93 | 11 | 9 |
| GN046 | 97 | 30 | M 10x1,0 | 10 mm | 15 | 4 mm | - | 63 | 12 | 16 |
| GN047 | 118,5 | 28 | M 8x1,0 | 8 mm | 10 | M4 | 1 | 123 | 11 | 11 |
| GN050 | 130 | 26,5 | M 10x1,0 | 10 mm | 15 | 4 mm | - | 90 | 11,5 | 16 |
| GN053 | 119,4 | 28 | M 8x1,0 | 8 mm | 10 | 4 mm | - | 93 | 11 | 13 |
| GN054 | 118,4 | 27,75 | M 10x1,0 | 10 mm | 15 | M4 | 1 | 63 | 11 | 18,5 |
| GN055 | 129,5 | 25,8 | M 10x1,0 | 10 mm | 15 | 4 mm | - | 63 | 11 | 14 |
| GN056 | 124,5 | 28 | M 8x1,0 | 8 mm | 10 | 4 mm | - | 123 | 11 | 10 |
| GN057 | 153,5 | 31 | M 10x1,25 | 12 mm | 15 | M4 | 2 | 120 | 11 | 14,5 |
| GN058 | 148,5 | 27 | M 8x1,0 | 8 mm | 10 | 4 mm | - | 93 | 11,5 | 13 |
| GN059 | 151,5 | 30 | M 9x1,0 | 9 mm | 12 | 4 mm | - | 93 | 11 | 13 |
| GN060 | 151 | 24,5 | M 10x1,0 | 10 mm | 15 | 4 mm | - | 63 | 11 | 11 |
| GN061 | 140 | 24 | M 12x1,25 | 12 mm | 15 | M4 | 2 | 119 | 11 | 7 |
| GN062 | 134,5 | 30 | M 10x1,25 | 12 mm | 15 | M4 | 2 | 120 | 11 | 13 |
| GN063 | 97 | 28 | M 8x1,0 | 8 mm | 10 | 4 mm | - | 123 | 11 | 11,5 |
| GN064 | 119,5 | 31 | M 10x1,25 | 12 mm | 15 | M4 | 2 | 119 | 11 | 14,5 |
| GN065 | 171 | 36,7 | M 10x1,25 | 12 mm | 15 | M4 | 2 | 119 | 11 | 14,5 |
| GN066 | 86 | 28 | M 12x1,25 | 12 mm | 22 | 4 mm | - | 63 | 23 | 8 |
| GN067 | 81 | 20 | M 10x1,25 | 12 mm | 15 | M4 | 2 | 123 | 11 | 10 |
| GN068 | 170 | 36,6 | M 10x1,25 | 12 mm | 15 | M4 | 2 | 93 | 11 | 16 |



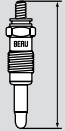
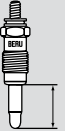
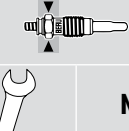
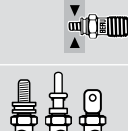





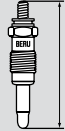
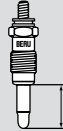
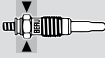

| |  |  |  |  | |  | |  | V | A | |
|--------------|---|---|---|---|-------|--|---------|---|-----|------|------|
| | | | |  | Nm |  | Nm max. | | | | |
| GN069 | | 156,5 | 35 | M 9x1,0 | 9 mm | 12 | 4 mm | - | 93 | 11 | 20 |
| GN070 | | 170 | 35 | M 10x1,25 | 12 mm | 18 | M4 | 2 | 93 | 11 | 10 |
| GN072 | | 213 | 23 | M 10x1,25 | 12 mm | 18 | M4 | 2 | 123 | 11 | 10 |
| GN073 | | 161 | 31 | M 10x1,25 | 12 mm | 18 | 4 mm | - | 119 | 11 | 10 |
| GN075 | | 87 | 21,5 | M 10x1,25 | 12 mm | 18 | M4 | 2 | 120 | 11 | 10 |
| GN095 | | 151,5 | 36 | M 10x1,25 | 12 mm | 15 | M4 | 2 | 119 | 11 | 11 |
| GN096 | | 160 | 28 | M 10x1,25 | 10 mm | 15 | M4 | 2 | 93 | 11 | 10 |
| GN097 | | 108 | 30 | M 10x1,0 | 10 mm | 12 | 4 mm | - | 63 | 11 | 31 |
| GN101 | | 82,5 | 19 | M 10x1,25 | 12 mm | 15 | M4 | 2 | 123 | 11 | 16 |
| GN102 | | 94,5 | 18,5 | M 10x1,25 | 10 mm | 15 | M4 | 2 | 123 | 11 | 17 |
| GN103 | | 85 | 19 | M 10x1,25 | 12 mm | 15 | M4 | 2 | 119 | 11 | 11,5 |
| GN104 | | 143 | 24 | M 10x1,25 | 12 mm | 15 | 4 mm | - | 119 | 11 | 15 |
| GN106 | | 132 | 24 | M 10x1,25 | 12 mm | 15 | M4 | 2 | 119 | 11 | 14,5 |
| GN107 | | 84,5 | 18 | M 10x1,25 | 12 mm | 15 | M4 | 2 | 123 | 11 | 17 |
| GN108 | | 160 | 28,3 | M 10x1,25 | 10 mm | 15 | M4 | 2 | 93 | 11 | 8,5 |
| GN109 | | 179 | 20,8 | M 10x1,0 | 12 mm | 15 | M4 | 2 | 119 | 11 | 11,7 |
| GN110 | | 101 | 25,4 | M 10x1,25 | 12 mm | 15 | M4 | 2 | 93 | 11 | 10 |
| GN853 | | 82 | 19 | M 10x1,25 | 12 mm | 15 | M4 | 2 | 123 | 11 | 12,5 |
| GN854 | | 84 | 20 | M 10x1,25 | 12 mm | 15 | M4 | 2 | 119 | 11 | 12,7 |
| GN855 | | 92 | 25 | M 10x1,0 | 10 mm | 15 | 4 mm | - | 63 | 12 | 16 |
| GN857 | | 58 | 21 | M 12x1,25 | 12 mm | 22 | M5 | 3 | 63 | 11 | 14 |
| GN858 | | 69 | 23 | M 12x1,25 | 12 mm | 22 | M5 | 3 | 63 | 11,5 | 15,5 |
| GN860 | | 119,5 | 28 | M 12x1,25 | 12 mm | 22 | 5 mm | - | 63 | 11,5 | 12 |
| GN905 | | 83 | 25 | M 10x1,0 | 10 mm | 18 | M4 | 2 | 63 | 11 | 14,5 |
| GN908 | | 71 | 25 | M 12x1,25 | 12 mm | 22 | M5 | 3 | 63 | 11 | 17 |
| GN909 | | 71 | 25 | M 12x1,25 | 12 mm | 22 | M5 | 3 | 63 | 11 | 14 |
| GN912 | | 89 | 30 | M 10x1,0 | 10 mm | 15 | M4 | 2 | 63 | 11 | 16 |
| GN917 | | 71 | 25 | M 12x1,25 | 12 mm | 22 | M5 | 3 | 63 | 11 | 18 |
| GN925 | | 67 | 16 | M 12x1,25 | 12 mm | 22 | M4 | 2 | 63 | 11 | 12 |
| GN927 | | 67 | 21 | M 12x1,25 | 12 mm | 22 | M4 | 2 | 63 | 11 | 14 |
| GN939 | | 147 | 35 | M 10x1,0 | 10 mm | 15 | M4 | 2 | 93 | 11,5 | 15,5 |
| GN944 | | 129 | 29 | M 10x1,0 | 10 mm | 15 | M4 | 2 | 63 | 11 | 15 |
| GN948 | | 115 | 28 | M 12x1,25 | 12 mm | 22 | 4 mm | - | 63 | 11,5 | 15 |
| GN954 | | 71 | 25 | M 12x1,25 | 12 mm | 22 | M5 | 3 | 63 | 11 | 14 |
| GN955 | | 95 | 22 | M 10x1,25 | 12 mm | 15 | M4 | 2 | 119 | 11 | 20 |
| GN959 | | 61 | 21 | M 12x1,25 | 12 mm | 22 | M5 | 3 | 63 | 11 | 16 |
| GN961 | | 86 | 28 | M 12x1,25 | 12 mm | 22 | 4 mm | - | 63 | 11,5 | 13 |
| GN963 | | 93 | 25 | M 10x1,0 | 10 mm | 15 | M4 | 2 | 63 | 11 | 15,5 |
| GN964 | | 120 | 34 | M 10x1,0 | 10 mm | 15 | M4 | 2 | 93 | 11 | 16,5 |
| GN970 | | 71 | 25 | M 12x1,25 | 12 mm | 22 | M4 | 2 | 63 | 11 | 14 |
| GN985 | | 106,5 | 25 | M 10x1,0 | 10 mm | 15 | 4 mm | - | 63 | 11 | 15,5 |
| GN989 | | 149 | 26,5 | M 10x1,0 | 8 mm | 15 | 4 mm | - | 90 | 11,5 | 17 |
| GN991 | | 68 | 26 | M 12x1,25 | 12 mm | 22 | M4 | 2 | 63 | 11 | 16 |



|  |  |  | |  | |  | |  | V | A |
|---|---|---|-----------|---|----|--|---------|---|------|------|
| | | | |  | Nm |  | Nm max. | | | |
| GN992 | 133 | 29 | M 10x1,0 | 10 mm | 15 | 4 mm | - | 63 | 11 | 15,5 |
| GN993 | 96 | 24,5 | M 10x1,0 | 10 mm | 15 | M4 | 2 | 93 | 10 | 16,5 |
| GN994 | 82 | 16 | M 10x1,25 | 12 mm | 15 | M4 | 2 | 119 | 11 | 18 |
| GN997 | 144,5 | 24 | M 10x1,25 | 12 mm | 15 | M4 | 2 | 123 | 11 | 18 |
| GN999 | 83 | 25 | M 10x1,0 | 10 mm | 15 | M4 | 2 | 63 | 11 | 17 |
| GV001 | 96 | 32 | M 10x1,25 | 12 mm | 15 | M4 | 2 | 93 | 6 | 11,5 |
| GV004 | 76 | 28,5 | M 10x1,0 | 7/8" | 15 | flat tongue 6,3 mm | - | 93 | 10,5 | 11 |
| GV106 | 77 | 28 | M 14x1,25 | 17 mm | 25 | M5 | 3 | 60 | 8 | 10 |
| GV107 | 93 | 38 | M 18x1,5 | 21 mm | 40 | M5 | 3 | 60 | 10,5 | 10 |
| GV108 | 93 | 38 | M 18x1,5 | 21 mm | 40 | M5 | 3 | 60 | 9,5 | 10 |
| GV112 | 90 | 28 | M 10x1,0 | 17 mm | 15 | 8/32" UNC | 3 | 93 | 12 | 6 |
| GV130 | 80 | 24 | M 14x1,25 | 17 mm | 25 | M5 | 3 | 60 | 9,5 | 10 |
| GV137 | 77 | 28 | M 14x1,25 | 17 mm | 25 | M5 | 3 | 63 | 11 | 8,5 |
| GV602 | 71 | 25 | M 12x1,25 | 12 mm | 22 | M5 | 3 | 63 | 11 | 10 |
| GV603 | 71 | 25 | M 12x1,25 | 12 mm | 22 | M5 | 3 | 63 | 11,5 | 14 |
| GV604 | 67 | 21 | M 12x1,25 | 12 mm | 22 | M5 | 3 | 63 | 11 | 8,5 |
| GV631 | 67 | 21 | M 12x1,25 | 12 mm | 22 | M5 | 3 | 63 | 11,5 | 14 |
| GV636 | 71 | 25 | M 12x1,25 | 12 mm | 22 | M5 | 3 | 63 | 11 | 13 |
| GV642 | 71 | 25 | M 12x1,25 | 12 mm | 22 | M5 | 3 | 63 | 11 | 15,5 |
| GV657 | 76 | 30 | M 12x1,25 | 12 mm | 22 | M5 | 3 | 63 | 11 | 13 |
| GV661 | 66 | 21 | M 12x1,25 | 12 mm | 22 | M4 | 2 | 63 | 11 | 13 |
| GV663 | 71 | 25 | M 12x1,25 | 12 mm | 22 | M5 | 3 | 63 | 11 | 13 |
| GV666 | 69 | 21 | M 12x1,25 | 12 mm | 22 | M4 | 2 | 63 | 11,5 | 16 |
| GV673 | 91 | 22 | M 10x1,25 | 12 mm | 15 | M4 | 2 | 119 | 12 | 9 |
| GV685 | 88 | 25 | M 10x1,0 | 12 mm | 15 | M4 | 2 | 119 | 6,5 | 14 |
| GV688 | 92 | 31,5 | M 10x1,25 | 12 mm | 15 | M4 | 2 | 93 | 11 | 9 |
| GV689 | 62 | 21 | M 12x1,25 | 12 mm | 22 | M5 | 3 | 63 | 11 | 14 |
| GV705 | 84 | 22,5 | M 10x1,25 | 12 mm | 15 | M4 | 2 | 119 | 7 | 14 |
| GV719 | 71 | 25 | M 12x1,25 | 12 mm | 22 | M5 | 3 | 63 | 11 | 17 |
| GV730 | 79 | 25 | M 10x1,0 | 10 mm | 15 | M4 | 2 | 63 | 11 | 13 |
| GV736 | 69 | 23 | M 12x1,25 | 12 mm | 22 | M5 | 3 | 63 | 18 | 5 |
| GV749 | 90 | 24 | M 10x1,25 | 12 mm | 15 | M4 | 2 | 119 | 5 | 14 |
| GV783 | 125 | 26 | M 10x1,0 | 10 mm | 15 | M4 | 2 | 90 | 11,5 | 16 |
| GV844 | 61 | 21 | M 12x1,25 | 12 mm | 22 | M5 | 3 | 63 | 11 | 13,5 |
| GV852 | 67 | 25 | M 12x1,25 | 12 mm | 22 | M5 | 3 | 63 | 11 | 13,5 |
| GV886 | 100,5 | 28 | M 10x1,25 | 12 mm | 15 | M4 | 2 | 93 | 7 | 11,2 |
| GV887 | 76 | 20 | M 10x1,25 | 12 mm | 15 | M4 | 2 | 119 | 23 | 6,5 |
| GV888 | 61 | 21 | M 12x1,25 | 12 mm | 22 | M5 | 3 | 63 | 6,5 | 11 |
| GV889 | 70 | 20 | M 10x1,25 | 12 mm | 15 | M4 | 2 | 119 | 11 | 11 |
| GV890 | 69,5 | 20 | M 10x1,25 | 12 mm | 15 | M4 | 2 | 119 | 23 | 6,7 |
| GV892 | 70 | 19 | M 10x1,25 | 12 mm | 15 | M4 | 2 | 120 | 10,5 | 16,5 |
| GV894 | 96 | 32 | M 10x1,25 | 12 mm | 15 | M4 | 2 | 93 | 7 | 10 |
| GV895 | 100,5 | 28 | M 10x1,25 | 12 mm | 15 | M4 | 2 | 93 | 14 | 8,5 |

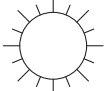

|  |  |  | |  | |  | |  | V | A |
|---|---|---|-----------|---|-----------|--|----------------|---|----------|----------|
| | | | |  | Nm |  | Nm max. | | | |
| GV920 | 68 | 18 | M 10x1,25 | 12 mm | 15 | M4 | 2 | 119 | 11 | 9.5 |
| GV921 | 88 | 23 | M 10x1,25 | 12 mm | 15 | M4 | 2 | 119 | 11 | 9,5 |
| GV945 | 85 | 19 | M 10x1,25 | 12 mm | 15 | M4 | 2 | 119 | 5 | 8 |
| GV946 | 90 | 24 | M 10x1,25 | 12 mm | 15 | M4 | 2 | 119 | 11 | 10 |
| GV947 | 85 | 19 | M 10x1,25 | 12 mm | 15 | M4 | 2 | 119 | 11 | 6 |
| GV967 | 100,5 | 28 | M 10x1,25 | 12 mm | 15 | M4 | 2 | 93 | 11 | 9,5 |
| GV968 | 95,5 | 32 | M 10x1,25 | 12 mm | 15 | M4 | 2 | 90 | 11 | 9,5 |
| PSG001 | 179,9 | 35 | M 9x1,0 | 12 mm | 11 | - | - | 93 | 4,4 | 8.5 |
| PSG002 | 148,5 | 28 | M 10x1,0 | 12 mm | 12 | - | - | 63 | 4,4 | 8.5 |
| PSG003 | 132,2 | 28 | M 9x1,0 | 12 mm | 11 | - | - | 93 | 4,4 | 8.5 |
| PSG004 | 168 | 24 | M 10x1,25 | 12 mm | 13 | - | - | 121 | 4,4 | 25 |
| PSG005 | 158,35 | 31,4 | M 10x1,0 | 12 mm | 12 | - | - | 93 | 4,4 | 8.5 |
| PSG006 | 179,95 | 35 | M 9x1,0 | 12 mm | 11 | - | - | 93 | 4,4 | 8.5 |

| | | | | | | |
|-----------|-----------|---------------|--|---|---|-------------------|
| Thread | | Configuration | | Thermal rating | | |
| 14 | | F | | 7 | | |
| 10 | M 10x1,0 | B | Screened, waterproof, burn-off resistor, ignition cable 7 mm | new <i>neu</i> |  | old <i>alt</i> |
| 12 | M 12x1,25 | C | same as B, however, ignition cable 5 mm | 13 | | 25 |
| 14 | M 14x1,25 | F | Flat seat  16 mm | 12 | | 50 |
| 18 | M 18x1,5 | G | Surface-gap plug | 11 | | 75 |
| | | GH | Surface gap plug with auxiliary spark path | 10 | | 100 |
| | | K | Conical seat | 9 | | 125 |
| | | R | Interference-suppression resistor 5 kΩ/10 kΩ | 8 | | 150 |
| | | S | Spark plug for small engines Flat seat | 7 | | 175 |
| | | T | same as S, however, with taper sealing seat | 6 | | 200 |
| | | V | Flat seat  14 mm | 5 | | 225 |
| | | Z | Spark plug for two-stroke engine | 4 | | 250 |
| | | ZR | Double hexagon Bi-hex  14 mm | 3 | | 275 |
| | | | | 2 | | 300 |
| | | | | 09 | | 325 |
| | | | | 08 | | 350 |
| | | | | 07 | | 375 |
| | | | | 06 | | 400 |
| | | | |  | | |
| | | | | Special indication | | |
| | | | | X | | |
| | | | | 01 | | |
| | | | | 02 | | |
| | | | | 03 | | |
| | | | | 04 | | |
| | | | | 05 | | |

Spark position and thread length
D

| | |
|----------|--|
| A | |
| B | |
| C | |
| D | |
| E | |
| F | |
| H | |
| K | |
| L | |
| M | |
| N | |
| S | |
| T | |
| W | |

Type of electrode
T

| | |
|----------|-----------------------------------|
| A | Triangular ground electrode |
| T | with multi-polar ground electrode |
| D | 2 ground electrodes |
| Q | 4 ground electrodes |
| K | Annular electrode |

Electrode material
U

| | |
|----------|-----------------|
| U | BERU ultra NiCu |
| S | Silver |
| P | Platinum |
| I | Iridium |
| E | Nickel-AL |

Other characteristics
O

| | | | |
|----------------------|---|----------------------|--|
| O | Deviation from the basic design (e.g. thicker middle electrode) | | |
| R | with consumption resistance | | |
| | S = 0,7 mm | T = 0,8 mm | |
| U = 1,0 mm | V = 1,3 mm | W = 0,9 mm | |
| X = 1,1 mm | Y = 1,5 mm | Z = 2,0 mm | |

| | |
|----------|--------------------------------|
| 1 | Differing from heat range |
| 2 | Two component ground electrode |
| 3 | Special |
| 4 | Extended insulator |
| 5 | Advanced insulator base |
| 6 | Retracted insulator base |
| 7 | Horn electrode |

BERU Ultra X Titan

The Spark Plug Innovation with state-of-the-art Electrode Geometry



BERU Ultra X Titan.

High-tech-petrol engines need high-tech spark plugs: The new BERU Ultra X Titan sets standards in performance, durability and fuel utilisation.

From Ultra X came Ultra X Titan – and with it the most streamlined range of spark plug products in the industry

That now consists of 15 types in total: 6 of the already established Ultra X spark plugs – supplemented by 9 new spark plugs which jointly form the Ultra X Titan line.

The common denominator: the highly erosion-resistant titanium alloy

In the case of the 9 new Ultra X Titan types the ground electrode is single-pole and is worked in an innovative Poly-V shape.

In the case of the 6 established Ultra X spark plugs the X shape of the electrode was retained and their erosion resistance reinforced by a titanium alloy. The Ultra X Titan range of products are available under the abbreviated designation UXT 1 to UXT 15 in new optimized packaging.

Good to know: The 6 previous Ultra X types without titanium electrodes (abbreviated designation: UX) are compatible with the new Ultra X Titan range.

BERU Ultra X and Ultra X Platinum

The spark plugs for x-tremely high demands



BERU Ultra X.
The spark plug innovation that unites current initial equipper technologies.

The BERU Ultra X range: 6 Ultra X + 2 Ultra X Platinum = 8 strong types

X-tremely powerful. X-tremely dependable. X-tremely reliable. The high-performance spark plugs of the Ultra X range meet the requirements for the change intervals specified by automobile manufacturers and provide a consistent performance for their whole life – the most important condition for reliable ignition.

Technical features

- Reliable ignition: Combined air/surface gap technique. Ignition reliability by several spark paths.
- Powerful: Optimal combustion due to protruding spark position
- Cold start reliability: Self-cleaning function by surface gap spark technology.
- Reliable: Quickly reaches the ideal operating temperature by a special insulator mount and intricate earth electrodes.
- Environmentally friendly: Pollutant emissions minimised and catalytic converter protected due to effective combustion
- The distinguishing feature of every BERU Ultra X spark plug: The x-shaped earth electrode arrangement.



BERU Ultra X Platinum.
The spark plug which easily meets the high requirements of the latest vehicle generations. For no-compromise, performance-orientated drivers.



The ground electrodes arranged in the form of an X on the BERU Ultra X.

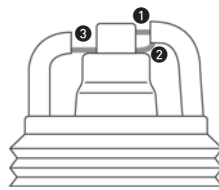

Schematic diagram of spark paths. 1 Air sparks 2 Auxiliary surface gap sparks 3 Air.

The multifunctional principle for optimum ignition reliability: Different functional principles are available for the spark process – air spark technique, surface gap spark technique and the combined air/surface gap spark technique. The sketch shows the spark process with the Ultra X as an example and explains three of the 6 possible paths available to the spark here.

And the BERU Ultra X Platinum additionally offers

- Platinum central electrode Extreme burn-off resistance, reliable cold start, optimum combustion and utilisation of fuel. Consistently reliable ignition at high running performance.
- Even more spark paths Constant air/surface gap spark technology: 8 spark paths, even greater ignition reliability.
- Horn electrodes New electrode geometry for good mixture accessibility and open flame propagation.
- Duplex insulator Smooth insulator body, combined with 2.5x leak current barrier on the insulator head for protection against sparkovers.

Our tip: Timely Spark Plug Replacement Pays for Itself! Spark plugs are subject to wear and must be regularly replaced. Otherwise there is a risk of incomplete combustion, increased fuel output and increased pollutant emissions as well as misfiring. Misfiring can result in unburned fuel reaching the catalytic converter. This can cause irreparable damage to the catalytic converter!

BERU Ultra

The Choice of Automotive Manufacturers



Under the name BERU Ultra, we offer a wide range of quality spark plugs for a large number of different engines and applications, these spark plugs are also often used in OEM. This guarantees a high quality level and innovative technology.

Technical features







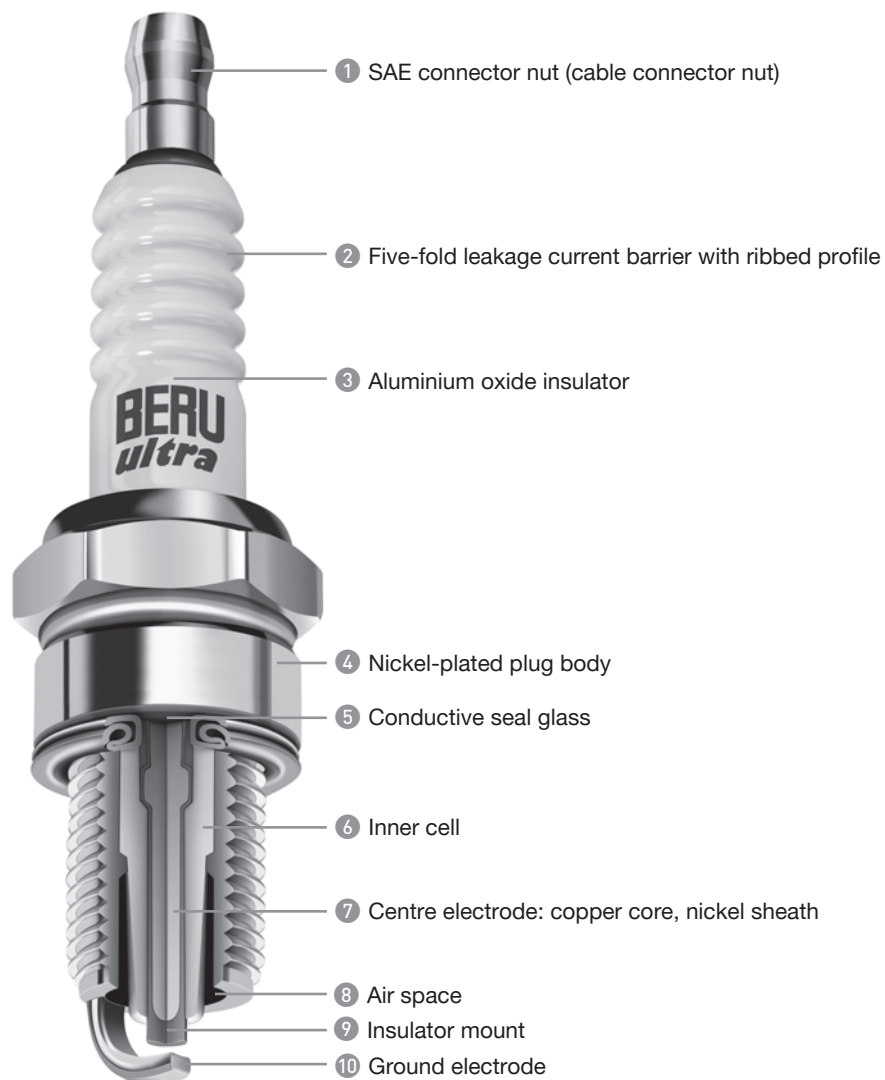

















- Optimal, environmentally friendly combustion: saves fuel and protects the catalytic converter
- Reliable ignition under all operating conditions
- Long life, high dependability
- Proven materials: Two-component earth and centre electrode with nickel-jacketed copper core adapted exactly to the application purpose
- Versions same as OEM

BERU Ultra - environmentally friendly and dependable.









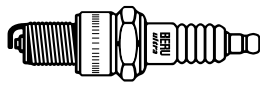















Our tip: Timely Spark Plug Replacement Pays for Itself! Spark plugs are subject to wear and must be regularly replaced. Otherwise there is a risk of incomplete combustion, higher fuel output and increased pollutant emissions as well as misfiring. Misfiring can result in unburned fuel reaching the catalytic converter. This can cause irreparable damage to the catalytic converter!





| | | | | | |
|---|---|---|---|---|--|
| UX56  | UXK56  | UXT1  | UXT2  | UXT3  | UXT4  |
| UXT5  | UXT6  | UXT7  | UXT8  | UXT9  | UXT10  |
| UXT11  | UXT12  | UXT13  | UXT14  | UXT15  | Z1  |
| Z2  | Z3  | Z4  | Z5  | Z6  | Z7  |



| | | | | | |
|---|---|---|---|---|---|
| Z8 | Z9 | Z10 | Z11 | Z12 | Z13 |
|  |  |  |  |  |  |
| Z14 | Z15 | Z16 | Z17 | Z18 | Z19 |
|  |  |  |  |  |  |
| Z20 | Z21 | Z22 | Z24 | Z25 | Z26 |
|  |  |  |  |  |  |
| Z27 | Z28 | Z29 | Z30 | Z31 | Z32 |
|  |  |  |  |  |  |

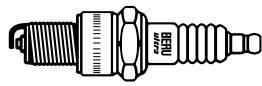



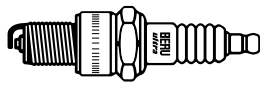





















| | | | | | |
|-----|-----|-----|-----|-----|-----|
| Z33 | Z38 | Z39 | Z40 | Z41 | Z42 |
| | | | | | |
| Z44 | Z45 | Z46 | Z47 | Z48 | Z49 |
| | | | | | |
| Z51 | Z52 | Z53 | Z56 | Z57 | Z58 |
| | | | | | |
| Z59 | Z60 | Z61 | Z62 | Z63 | Z67 |
| | | | | | |









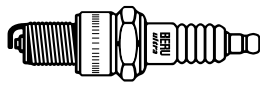

















| | | | | | |
|-----|-----|------|------|------|------|
| Z68 | Z70 | Z72 | Z73 | Z74 | Z75 |
| | | | | | |
| Z76 | Z78 | Z79 | Z82 | Z89 | Z90 |
| | | | | | |
| Z91 | Z92 | Z93 | Z94 | Z95 | Z97 |
| | | | | | |
| Z98 | Z99 | Z100 | Z101 | Z104 | Z108 |
| | | | | | |









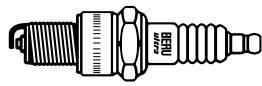











| | | | | | |
|---|---|---|---|---|---|
| Z111  | Z112  | Z116  | Z117  | Z118  | Z119  |
| Z120  | Z121  | Z122  | Z123  | Z127  | Z129  |
| Z130  | Z144  | Z145  | Z148  | Z149  | Z150  |
| Z151  | Z152  | Z153  | Z154  | Z155  | Z156  |









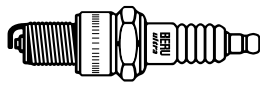

















| | | | | | |
|---|---|---|---|---|---|
| Z157  | Z158  | Z159  | Z170  | Z171  | Z172  |
| Z173  | Z176  | Z177  | Z183  | Z184  | Z185  |
| Z188  | Z190  | Z192  | Z193  | Z194  | Z198  |
| Z200  | Z203  | Z204  | Z206  | Z207  | Z208  |



| | | | | | |
|---|---|---|---|---|---|
| Z209  | Z210  | Z211  | Z213  | Z216  | Z219  |
| Z220  | Z221  | Z222  | Z223  | Z224  | Z225  |
| Z226  | Z227  | Z228  | Z229  | Z230  | Z233  |
| Z234  | Z235  | Z236  | Z237  | Z238  | Z239  |





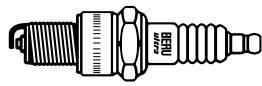



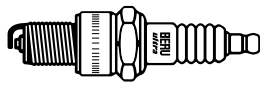

















| | | | | | |
|---|---|---|--|---|---|
| Z240  | Z242  | Z243  | Z245  | Z246  | Z247  |
| Z248  | Z249  | Z250  | Z252  | Z253  | Z254  |
| Z255  | Z257  | Z266  | Z267  | Z272  | Z273  |
| Z274  | Z275  | Z277  | Z278  | Z279  | Z280  |



| | | | | | |
|------|------|------|------|------|------|
| Z282 | Z284 | Z285 | Z286 | Z287 | Z291 |
| | | | | | |
| Z292 | Z293 | Z294 | Z295 | Z296 | Z297 |
| | | | | | |
| Z298 | Z299 | Z300 | Z301 | Z302 | Z303 |
| | | | | | |
| Z304 | Z305 | Z306 | Z307 | Z308 | Z309 |
| | | | | | |



| | | | | | |
|---|---|---|---|---|---|
| Z310 | Z311 | Z312 | Z313 | Z314 | Z315 |
|  |  |  |  |  |  |
| Z317 | Z320 | Z321 | Z322 | Z323 | Z324 |
|  |  |  |  |  |  |
| Z325 | Z326 | Z332 | Z333 | Z334 | Z335 |
|  |  |  |  |  |  |
| Z336 | Z337 | Z338 | Z339 | Z341 | Z342 |
|  |  |  |  |  |  |



Z343



Z344



Z345



Z346



Z347



Z348



Z349



Z354



Z355



Z356



Z357



Z358







Z359



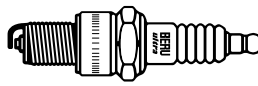

Z360

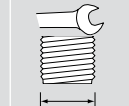
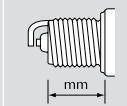
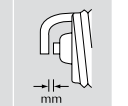

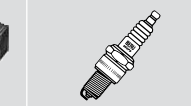
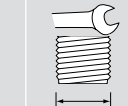
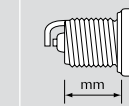
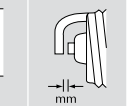





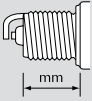
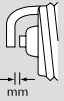

|  |  |  |  |  |  |  |  |  |  |
|---|---|---|---|---|---|--|---|---|---|
| UX56 | UX56 | 21 | M 14x1,25 | | Z29 | 14F-5DU | 16 | M 14x1,25 | 0,8 |
| UXK56 | UXK56 | 16 | M 14x1,25 | | Z30 | 14FR-5DU | 16 | M 14x1,25 | 0,8 |
| UXT1 | UXT1 | 16 | M 14x1,25 | | Z31 | 14K-5DU | 16 | M 14x1,25 | 0,8 |
| UXT2 | UXT2 | 21 | M 14x1,25 | | Z32 | 18K-7BU | 21 | M 18x1,5 | 0,7 |
| UXT3 | UXT3 | 16 | M 14x1,25 | | Z33 | 18K-6BU | 21 | M 18x1,5 | 0,7 |
| UXT4 | UXT4 | 16 | M 14x1,25 | | Z38 | 14Z-3CU | 21 | M 14x1,25 | 0,4 |
| UXT5 | UXT5 | 16 | M 14x1,25 | | Z39 | 14Z-4AU | 21 | M 14x1,25 | 0,4 |
| UXT6 | UXT6 | 21 | M 14x1,25 | | Z40 | 14-5AU | 21 | M 14x1,25 | 0,6 |
| UXT7 | UXT7 | 16 | M 14x1,25 | 1,3 | Z41 | 14-5BU | 21 | M 14x1,25 | 0,8 |
| UXT8 | UXT8 | 16 | M 14x1,25 | 1,0 | Z42 | 14-5DU | 21 | M 14x1,25 | 0,8 |
| UXT9 | UXT9 | 16 | M 14x1,25 | 1,0 | Z44 | 14-5DTU | 21 | M 14x1,25 | 0,8 |
| UXT10 | UXT10 | 16 | M 14x1,25 | 0,8 | Z45 | 14FR-5DTU | 16 | M 14x1,25 | 0,7 |
| UXT11 | UXT11 | 16 | M 14x1,25 | 1,1 | Z46 | 14K-5DUO | 16 | M 14x1,25 | 0,8 |
| UXT12 | UXT12 | 16 | M 14x1,25 | 0,8 | Z47 | 14R-5DU | 21 | M 14x1,25 | 0,8 |
| UXT13 | UXT13 | 16 | M 14x1,25 | 1,0 | Z48 | 14-6BU | 21 | M 14x1,25 | 0,8 |
| UXT14 | UXT14 | 16 | M 14x1,25 | 1,0 | Z49 | 14KR-6BU | 16 | M 14x1,25 | 0,8 |
| UXT15 | UXT15 | 16 | M 14x1,25 | 1,3 | Z51 | 14-6DTU | 21 | M 14x1,25 | 0,8 |
| Z1 | 14-8DU | 21 | M 14x1,25 | 0,7 | Z52 | 14F-6DTU | 16 | M 14x1,25 | 0,8 |
| Z2 | 14-8DTU | 21 | M 14x1,25 | 1,0 | Z53 | 14F-6DTU | 16 | M 14x1,25 | 1,0 |
| Z3 | 14-8LUR | 21 | M 14x1,25 | 0,7 | Z56 | 14K-6DUO | 16 | M 14x1,25 | 0,8 |
| Z4 | 14F-8LUR | 16 | M 14x1,25 | 0,7 | Z57 | 14-7AU | 21 | M 14x1,25 | 0,6 |
| Z5 | 14F-8DUO | 16 | M 14x1,25 | 0,8 | Z58 | 14-7CU | 21 | M 14x1,25 | 0,8 |
| Z6 | 14K-8DU | 16 | M 14x1,25 | 0,8 | Z59 | 14R-7CU | 21 | M 14x1,25 | 0,8 |
| Z7 | 14K-8DUO | 16 | M 14x1,25 | 0,8 | Z60 | 14FGR-7CTU | 16 | M 14x1,25 | 1,2 |
| Z8 | 14R-8DU | 21 | M 14x1,25 | 0,8 | Z61 | 14-7DUO | 21 | M 14x1,25 | 0,7 |
| Z9 | 14R-8DUX | 21 | M 14x1,25 | 1,15 | Z62 | 14-7DUO | 21 | M 14x1,25 | 0,8 |
| Z10 | 14-7BU | 21 | M 14x1,25 | 0,8 | Z63 | 14F-7DU | 16 | M 14x1,25 | 0,8 |
| Z11 | 14-7DU | 21 | M 14x1,25 | 0,8 | Z67 | 14KR-7DUX | 16 | M 14x1,25 | 1,1 |
| Z12 | 14-7DTU | 21 | M 14x1,25 | 0,8 | Z68 | 14-8AU | 21 | M 14x1,25 | 0,6 |
| Z13 | 14F-7DUOR | 16 | M 14x1,25 | 0,8 | Z70 | 14-8DUO | 21 | M 14x1,25 | 0,8 |
| Z14 | 14F-7LDUR4 | 16 | M 14x1,25 | 0,9 | Z72 | 14FR-8DU | 16 | M 14x1,25 | 0,8 |
| Z15 | 14FR-7DU | 16 | M 14x1,25 | 0,8 | Z73 | 14FR-8DUX | 16 | M 14x1,25 | 1,1 |
| Z16 | 14FR-7DUX | 16 | M 14x1,25 | 1,1 | Z74 | 14FLR-8LDUX | 16 | M 14x1,25 | 1,0 |
| Z17 | 14K-7DU | 16 | M 14x1,25 | 0,8 | Z75 | 14G-8DTU | 21 | M 14x1,25 | 1,2 |
| Z18 | 14K-7DUO | 16 | M 14x1,25 | 0,8 | Z76 | 14-9DU | 21 | M 14x1,25 | 0,8 |
| Z19 | 14R-7BU | 21 | M 14x1,25 | 0,8 | Z78 | 14-9DTU | 21 | M 14x1,25 | 0,8 |
| Z20 | 14R-7DU | 21 | M 14x1,25 | 0,8 | Z79 | 14F-9DUO | 16 | M 14x1,25 | 0,8 |
| Z21 | 14R-7DUX | 21 | M 14x1,25 | 1,1 | Z82 | 14R-9DU | 21 | M 14x1,25 | 0,7 |
| Z22 | 14-6DU | 21 | M 14x1,25 | 0,7 | Z89 | 14FGH-6DTUR | 16 | M 14x1,25 | 0,8 |
| Z24 | 14FR-6DU | 16 | M 14x1,25 | 0,8 | Z90 | 14FGH-7DTURX | 16 | M 14x1,25 | 1,0 |
| Z25 | 14K-6DU | 16 | M 14x1,25 | 0,8 | Z91 | 14GH-7DTUR | 21 | M 14x1,25 | 0,8 |
| Z26 | 14KR-6DU | 16 | M 14x1,25 | 0,7 | Z92 | 14GH-8DTUR | 21 | M 14x1,25 | 0,8 |
| Z27 | 14R-6DU | 21 | M 14x1,25 | 0,8 | Z93 | 14GH-8DTURX | 21 | M 14x1,25 | 1,0 |
| Z28 | 14R-6DUX | 21 | M 14x1,25 | 1,1 | Z94 | 14GR-8DTU | 21 | M 14x1,25 | 0,8 |

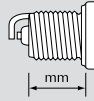
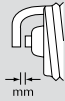

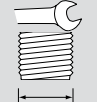

|  |  |  |  |  |
|--|---|---|---|---|
| Z95 | 14KR-7DU | 16 | M 14x1,25 | 0,7 |
| Z97 | 14KR-6MPX | 16 | M 14x1,25 | 1,0 |
| Z98 | 14FR-7LDU | 16 | M 14x1,25 | 0,8 |
| Z99 | 14FR-6DUX | 16 | M 14x1,25 | 1,0 |
| Z100 | 14F-8DU4 | 16 | M 14x1,25 | 0,8 |
| Z101 | 14F-8LDUSR | 16 | M 14x1,25 | 0,8 |
| Z104 | 14-6DPO | 21 | M 14x1,25 | 0,6 |
| Z108 | G3/18 | 21 | M 18x1,5 | 0,7 |
| Z111 | 14C-7 D | 21 | M 14x1,25 | 0,5 |
| Z112 | 14-8E | 21 | M 14x1,25 | 0,5 |
| Z116 | 14FR-6LDU | 16 | M 14x1,25 | 0,8 |
| Z117 | 14KR-9DUX | 16 | M 14x1,25 | 1,0 |
| Z118 | 14-8 BU | 21 | M 14x1,25 | 0,9 |
| Z119 | 14R-8DU4 | 21 | M 14x1,25 | 0,8 |
| Z120 | 14FGH-7DTURXO | 16 | M 14x1,25 | 1,0 |
| Z121 | 14FGH-8DTURXO | 16 | M 14x1,25 | 1,0 |
| Z122 | 14FGH-8DPURX2 | 16 | M 14x1,25 | 1,0 |
| Z123 | 14FR-7KDU | 16 | M 14x1,25 | 1,0 |
| Z127 | 14KGR-7KQU | 16 | M 14x1,25 | 1,6 |
| Z129 | 14FGR-6KQU | 16 | M 14x1,25 | 1,6 |
| Z130 | 14FR-5DPUX | 16 | M 14x1,25 | 1,0 |
| Z144 | 14KGR-6KQU | 16 | M 14x1,25 | 1,6 |
| Z145 | 14FGR-6DDU | 16 | M 14x1,25 | 1,6 |
| Z148 | 14KR-8DPUOV | 16 | M 14x1,25 | 1,3 |
| Z149 | 14FR-7KPUX | 16 | M 14x1,25 | 1,1 |
| Z150 | 14FR-7KPUV | 16 | M 14x1,25 | 1,3 |
| Z151 | 14FR-7KPU | 16 | M 14x1,25 | 0,8 |
| Z152 | 14FR-8HU | 16 | M 14x1,25 | 0,7 |
| Z153 | 14FR-8KU | 16 | M 14x1,25 | 0,8 |
| Z154 | 14FR-8KUO | 16 | M 14x1,25 | 0,9 |
| Z155 | 14FR-7KU | 16 | M 14x1,25 | 0,8 |
| Z156 | 14FR-7KUO | 16 | M 14x1,25 | 0,7 |
| Z157 | 14FR-7KUOX | 16 | M 14x1,25 | 1,1 |
| Z158 | 14FR-7LUX | 16 | M 14x1,25 | 1,1 |
| Z159 | 14FR-6DPUX | 16 | M 14x1,25 | 1,1 |
| Z170 | 14F-7DPUR2 | 16 | M 14x1,25 | 1,0 |
| Z171 | 14F-7DPURX2 | 16 | M 14x1,25 | 1,0 |
| Z172 | 14FGR-7KQU | 16 | M 14x1,25 | 1,6 |
| Z173 | 14FGR-8KQU | 16 | M 14x1,25 | 1,6 |
| Z176 | 14F-7HPURX2 | 16 | M 14x1,25 | 1,1 |
| Z177 | 14KR-8MUV | 16 | M 14x1,25 | 1,3 |
| Z183 | 14FR-8MU2 | 16 | M 14x1,25 | 0,9 |
| Z184 | 14FR-7MU2 | 16 | M 14x1,25 | 0,9 |
| Z185 | 14F-6DPUR02 | 16 | M 14x1,25 | 0,8 |

|  |  |  |  |  |
|---|--|---|---|---|
| Z188 | 14F-7DPUR02 | 16 | M 14x1,25 | 0,7 |
| Z190 | 14FGR-8DQU7 | 16 | M 14x1,25 | 1,2 |
| Z192 | 14FR-5LDU | 16 | M 14x1,25 | 0,8 |
| Z193 | 14FR-7DU2 | 16 | M 14x1,25 | 0,9 |
| Z194 | 14FR-6LDU3 | 16 | M 14x1,25 | 0,6 |
| Z198 | 14FR-5LDU3 | 16 | M 14x1,25 | 0,9 |
| Z200 | 14F-7HUR2 | 16 | M 14x1,25 | 0,9 |
| Z203 | 14FR-8LU2 | 16 | M 14x1,25 | 0,9 |
| Z204 | 14FGR-8CTU | 16 | M 14x1,25 | 1,2 |
| Z206 | 14FR-7DPPUS2 | 16 | M 14x1,25 | 0,7 |
| Z207 | 14KG-8DTU | 16 | M 14x1,25 | 1,2 |
| Z208 | 14FR-8LDU3 | 16 | M 14x1,25 | 1,0 |
| Z209 | 14KR-6DPUV02 | 16 | M 14x1,25 | 1,3 |
| Z210 | 10FR-6CPU03 | 16 | M 10x1,0 | 0,6 |
| Z211 | 14FGR-8MQPU | 16 | M 14x1,25 | 1,4 |
| Z213 | 14FGR-7KDU6 | 16 | M 14x1,25 | 1,7 |
| Z216 | 14KR-10SUV2 | 16 | M 14x1,25 | 1,3 |
| Z219 | 14FR-8MPUX02 | 16 | M 14x1,25 | 1,1 |
| Z220 | 14FR-9KUX2 | 16 | M 14x1,25 | 1,0 |
| Z221 | 14FR-6DPUX02 | 16 | M 14x1,25 | 1,0 |
| Z222 | 14KR-8STUX | 16 | M 14x1,25 | 1,1 |
| Z223 | 14FR-8NQU23 | 16 | M 14x1,25 | 0,9 |
| Z224 | 14FR-7DPU3 | 16 | M 14x1,25 | 0,9 |
| Z225 | 14FR-7HUX | 16 | M 14x1,25 | 1,1 |
| Z226 | 14FR-6MPU2 | 16 | M 14x1,25 | 0,8 |
| Z227 | 14F-8DUR | 16 | M 14x1,25 | 0,8 |
| Z228 | 14FR-7DPUX02 | 16 | M 14x1,25 | 1,0 |
| Z229 | 14FR-8LPUO | 16 | M 14x1,25 | 0,8 |
| Z230 | 14KR-6KPUV02 | 16 | M 14x1,25 | 1,3 |
| Z233 | 12ZR-6SPO3 | 14 | M 12x1,25 | 1,0 |
| Z234 | 12FR-7DU | 16 | M 12x1,25 | 0,9 |
| Z235 | 14FR-7SPUX03 | 16 | M 14x1,25 | 1,0 |
| Z236 | 14F-6HTPRX02 | 16 | M 14x1,25 | 1,0 |
| Z237 | 14FR-7DQUP7 | 16 | M 14x1,25 | 1,6 |
| Z238 | 14FR-8DPU2 | 16 | M 14x1,25 | 0,8 |
| Z239 | 14FGR-7KQE | 16 | M 14x1,25 | 1,6 |
| Z240 | 14F-8DPURX02 | 16 | M 14x1,25 | 1,0 |
| Z242 | 12ZR-8TP | 14 | M 12x1,25 | 1,0 |
| Z243 | 12VR-8SE | 14 | M 12x1,25 | 0,9 |
| Z245 | 14FR-6LDUW | 16 | M 14x1,25 | 0,9 |
| Z246 | 14FGH-8DTURW | 16 | M 14x1,25 | 0,9 |
| Z247 | 14FR-7DUW | 16 | M 14x1,25 | 0,9 |
| Z248 | 14FR-8HUT | 16 | M 14x1,25 | 0,8 |
| Z249 | 14FR-8KUOU | 16 | M 14x1,25 | 1,0 |

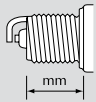
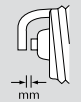

| |  |  |  |  |  |
|-------------|---|---|---|---|---|
| Z250 | | 14FR-7DU2S | 16 | M 14x1,25 | 0,7 |
| Z252 | | 14FR-6DUW | 16 | M 14x1,25 | 0,9 |
| Z253 | | 14FR-5DUU | 16 | M 14x1,25 | 1,0 |
| Z254 | | 14FR-8DUS | 16 | M 14x1,25 | 0,7 |
| Z255 | | 14FR-8DUW | 16 | M 14x1,25 | 0,9 |
| Z257 | | 14FR-7LDUW | 16 | M 14x1,25 | 0,9 |
| Z266 | | 14S-7E | 19 | M 14x1,25 | 0,6 |
| Z267 | | 14S-7EU0 | 21 | M 14x1,25 | 0,6 |
| Z272 | | 14F-7HURU02 | 16 | M 14x1,25 | 1,0 |
| Z273 | | 14FR-7NUX2 | 16 | M 14x1,25 | 1,1 |
| Z274 | | 12VR-6MPPUS | 14 | M 12x1,25 | 0,7 |
| Z275 | | 14FR-6LPUOX | 16 | M 14x1,25 | 1,1 |
| Z277 | | 14F-5MPUR03 | 16 | M 14x1,25 | 0,8 |
| Z278 | | 14FR-8LPU02 | 16 | M 14x1,25 | 0,6 |
| Z279 | | 14FR-7LPU02 | 16 | M 14x1,25 | 0,6 |
| Z280 | | 14FR-7KPUX02 | 16 | M 14x1,25 | 1,0 |
| Z282 | | 14FGH-7DPURX2 | 16 | M 14x1,25 | 1,0 |
| Z284 | | 14FR-6DPOX | 16 | M 14x1,25 | 1,1 |
| Z285 | | 14R-9KPUV2 | 21 | M 14x1,25 | 1,3 |
| Z286 | | 12FR-5SDU | 16 | M 12x1,25 | 0,6 |
| Z287 | | 14FR-8LU2T | 16 | M 14x1,25 | 0,8 |
| Z291 | | 12FR-5DU | 16 | M 12x1,25 | 0,9 |
| Z292 | | 12FR-6DU | 16 | M 12x1,25 | 1,05 |
| Z293 | | 12FR-6LUX | 16 | M 12x1,25 | 1,05 |
| Z294 | | 14FGR-5NTE | 16 | M 14x1,25 | 1,7 |
| Z295 | | 14F-6DTPR02 | 16 | M 14x1,25 | 0,8 |
| Z296 | | 14KR-7DPUV | 16 | M 14x1,25 | 1,3 |
| Z297 | | 14FR-7LPUXO | 16 | M 14x1,25 | 1,1 |
| Z298 | | 14KR-8DPUV | 16 | M 14x1,25 | 1,3 |
| Z299 | | 14FR-7LUXO | 16 | M 14x1,25 | 1,0 |
| Z300 | | 14FGR-6HQU | 16 | M 14x1,25 | 1,35 |
| Z301 | | 14FR-7LPUX02 | 16 | M 14x1,25 | 1,1 |
| Z302 | | 14FR-8MPUX2 | 16 | M 14x1,25 | 1,1 |
| Z303 | | 14FR-7MUX2 | 16 | M 14x1,25 | 1,1 |
| Z304 | | 14FGHR-7DTUT | 16 | M 14x1,25 | 0,8 |
| Z305 | | 14KR-6MUU | 16 | M 14x1,25 | 1,0 |
| Z306 | | 12F-HPURW | 16 | M 12x1,25 | 0,9 |
| Z307 | | 14FR-7DPUUV02 | 16 | M 14x1,25 | 1,3 |
| Z308 | | 12FR-6MUV | 16 | M 12x1,25 | 0,9 |
| Z309 | | 14KR-8LQPU07 | 16 | M 14x1,25 | 1,6 |
| Z310 | | 14KR-8MPUV2 | 16 | M 14x1,25 | 1,3 |
| Z311 | | 14R-8DPUU | 21 | M 14x1,25 | 1,0 |
| Z312 | | 14FR-7KPPU | 16 | M 14x1,25 | 1,0 |
| Z313 | | 14FR-6DPUX2 | 16 | M 14x1,25 | 1,1 |

| |  |  |  |  |  |
|-------------|---|---|---|---|---|
| Z314 | | 14FR-6DPUW2 | 16 | M 14x1,25 | 0,9 |
| Z315 | | 14KR-6MPV | 16 | M 14x1,25 | 1,3 |
| Z317 | | 14F-5DPUR2T | 16 | M 14x1,25 | 0,85 |
| Z320 | | 12ZR-8STP | 14/bi-hex | M 12x1,25 | 1,0 |
| Z321 | | 14F-7KPPRU2 | 16 | M 14x1,25 | 1,0 |
| Z322 | | 14F-6KPURW2 | 16 | M 14x1,25 | 0,9 |
| Z323 | | 14FR-5DPPUX | 16 | M 14x1,25 | 1,1 |
| Z324 | | 14FGHR-7LDUW | 16 | M 14x1,25 | 0,9 |
| Z325 | | 12VR-7SPUX | 14 | M 12x1,25 | 1,1 |
| Z326 | | 14FR-7MPUS | 16 | M 14x1,25 | 0,7 |
| Z332 | | 12ZR-6SP2-1 | 14/bi-hex | M 12x1,25 | 0,7 |
| Z333 | | 12FR-6DPUX | 16 | M 12x1,25 | 1,1 |
| Z334 | | 14FR-8DEW | 16 | M 14x1,25 | 0,9 |
| Z335 | | 14FR-6DUW2 | 16 | M 14x1,25 | 0,9 |
| Z336 | | 12ZR-6SP2 | 14/bi-hex | M 12x1,25 | 1,0 |
| Z337 | | 14FR-7DPPUW2 | 16 | M 14x1,25 | 0,9 |
| Z338 | | 12FR-4DPUT | 16 | M 12x1,25 | 0,8 |
| Z339 | | 14F-4NBPR | 16 | M 14x1,25 | 0,7 |
| Z341 | | 10FR-7KDUS | 16 | M 10x1,0 | 0,7 |
| Z342 | | 14KR-7MPUV2 | 16 | M 14x1,25 | 1,3 |
| Z343 | | 14FR-8DPPUX | 16 | M 14x1,25 | 1,1 |
| Z344 | | 14F-7HTUR | 16 | M 14x1,25 | 1,0 |
| Z345 | | 14F-4NBPR2LS | 16 | M 14x1,25 | 0,7 |
| Z346 | | 14FR-7LPUTO2 | 16 | M 14x1,25 | 0,8 |
| Z347 | | 14F-5DPURS2 | 16 | M 14x1,25 | 0,7 |
| Z348 | | 14F-5MPUR2L | 16 | M 14x1,25 | 0,8 |
| Z349 | | 14F-6LPURW03 | 16 | M 14x1,25 | 0,9 |
| Z354 | | 14FR-5LPUOX | 16 | M 14x1,25 | 1,1 |
| Z355 | | 12VR-5SPPU | 14 | M 12x1,25 | 1,0 |
| Z356 | | 14KR-7MPUX2 | 16 | M 14x1,25 | 1,1 |
| Z357 | | 12FR-4MPPUS | 16 | M 12x1,25 | 0,7 |
| Z358 | | 12FR-6DUT | 16 | M 12x1,25 | 0,8 |
| Z359 | | 12F-5NPUR2T | 16 | M 12x1,25 | 0,8 |
| Z360 | | 14FGHR-7DTUU | 16 | M 14x1,25 | 1,0 |

Full range, full sales potential

BERU supplies over 400 ignition coil types – for more than 7750 different vehicle models. This ensures reliability in the maintenance and repair business.

To reduce fuel consumption and emissions and increase efficiency, engine technology is being ever more optimised – and therefore ignition systems as well. BERU is the spark plug specialist. In width of product range terms this means: BERU not only supplies spark plugs, it also provides the entire ignition train – from ignition coils and ignition leads to plugs and distributor caps and ignition modules. Everything from a single source. The BERU ignition coil range is permanently further developed and supplemented in this way: BERU supplies practically all relevant volume applications of European vehicle manufacturers – and offers the maintenance and repair market the appropriate type in uncompromising OEM quality. Here is a brief overview of the various ignition coil types in the BERU range.

1. Distributor ignition coil

In the case of ignition coils with an ignition distributor the generated high voltage goes from the ignition coil into the ignition distributor. The ignition distributor distributes this high voltage to the corresponding spark plugs.

2. Block ignition coils

A block ignition coil combines several ignition coils and controls several spark plugs via ignition leads. There are block ignition coils with and without integrated end stage and which utilize single or dual spark technology.

3. Canister-type ignition coils

Canister-type ignition coils are mainly used in older vehicle models. Here, too, the installation of original BERU branded ignition coils is recommended: because they are much safer because of the dry and leak-proof insulation between the coil winding and the housing. The canister-type ignition coils manufactured by suppliers of cheap products are often filled with oil – which can leak in the event of a fault or accident and result in a vehicle fire.

4. Plug shaft/connector ignition coils

Plug shaft or connector ignition coils (utilizing single and dual spark technology) are inserted directly into the spark plug. As a result, the ignition energy can be transmitted directly to the spark plug with practically no power losses. Other advantages are: The existing spark plug shaft, depending on its design, can be used as mounting space for the ignition coil. Plug shaft or connector ignition coils are used in vehicles which feature fully electronic ignition.

5. Ignition coil rails

Several individual ignition coils are brought together in an ignition coil rail. They are then plugged directly onto the spark plugs. For the early detection of false firing, knocking and misfiring, the coils can also be fitted with an integral ionic current measurement that monitors the optimum mixture combustion. BERU ignition coils are installed for example by VW, Opel, Peugeot, Citroën and Škoda.



BERU distributor ignition coil – with integrated end-stage for rotating high-voltage distribution in vehicle models VW / Audi.



BERU block ignition coils for conventional vehicle models BMW, Fiat, Renault and VW.

Various designs of plug shaft/connector ignition coils for new vehicle models
BMW, Fiat, Mercedes-Benz, Porsche, Renault or VW.

4



Reliable and leak-proof:
the BERU canister type ignition coils for Oldtimer.

3



BERU ignition coil rails for conventional vehicles from VW, Opel,
Peugeot, Citroën and Škoda.

5

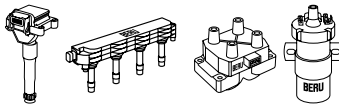

| | | |
|---|---|---|
| <p>ZS014</p>  <p> ZLE232 (2 kΩ)</p> | <p>ZS031</p>  <p> ZLE278 (2 kΩ)</p> | <p>ZS043</p>  <p> ZLE233 (5 kΩ)</p> |
| <p>ZS016</p>  <p> ZLE276 (2 kΩ)</p> | <p>ZS036</p>  <p> ZLE255 (2 kΩ)</p> | <p>ZS052 nur paarweise tauschen²⁶²</p>  <p> GS29</p> |
| <p>ZS017</p>  <p> ZLE277 (2 kΩ)</p> | <p>ZS037</p>  <p> GS21</p> | <p>ZS053</p>  <p> GS21</p> |
| <p>ZS029</p>  <p> GS17</p> | <p>ZS041</p>  <p> GS17</p> | <p>ZS068</p>  |

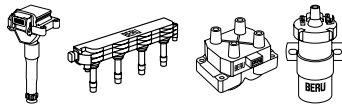



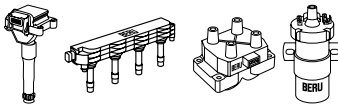



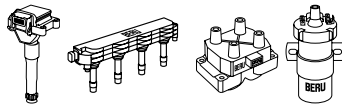

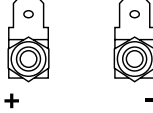



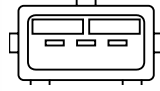

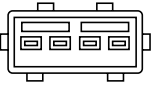

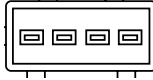

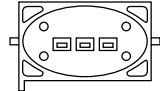

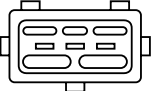





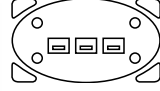

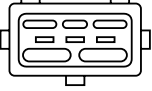
| | | |
|--|--|---|
| <p>ZS077</p>    <p>GS21</p> | <p>ZS095</p>   | <p>ZS109</p> <p>Ø55mm ↓ 150 mm</p>   <p>12 Volt, max. 33 kV Startspannungsanhebung möglich¹²⁹ Resistor-Hochleistungs-Zündspule, orange¹³⁵ Nach DIN 72531, mit internationaler Befestigungsschelle¹⁶² Fahrzeuge mit 4, 5, 6, 8-Zyl.-Motor, 1,8 Ω Widerstand WZ 18-2/0 110 520 001 vorschalten oder Widerstandsleitung 1,8 Ω verwenden (Serie oder nachrüsten)¹⁷⁶</p> |
| <p>ZS079</p>    | <p>ZS096</p>   <p>Anschlußtechnik Kontaktfeder</p> | <p>ZS110</p> <p>Ø55mm ↓ 150 mm</p>   <p>12 Volt, max. 33 kV mit Startspannungsanhebung¹²⁸ Resistor-Hochleistungs-Zündspule, orange¹³⁵ Nach DIN 72531, mit internationaler Befestigungsschelle¹⁶² Fahrzeuge mit 4, 5, 6, 8-Zyl.-Motor, 1,8 Ω Vorschaltwiderstand WZ 18-2/0 110 520 001 (beigepackt) zur Nachrüstung, dadurch Kaltstart-verbesserung¹⁷⁷</p> |
| <p>ZS088</p>    | <p>ZS105 ersetzt²⁶³ ZS101</p> <p>Ø55mm ↓ 150 mm</p>   <p>6 Volt, max. 26 kV ohne Startspannungsanhebung¹²⁷ Hochleistungs-Zündspule, blau¹³³ Nach DIN 72531, mit internationaler Befestigungsschelle¹⁶² Fahrzeuge mit 2, 3, 4, 5, 6, 8-Zyl.-Motor, Zündanlage ohne Vorwiderstand¹⁷⁴</p> | <p>ZS115</p> <p>Ø55mm ↓ 150 mm</p>   <p>12 Volt, max. 33,5 kV Startspannungsanhebung möglich¹²⁹ Hochleistungs-Zündspule, schwarz¹³⁸ Nach DIN 72531, mit internationaler Befestigungsschelle¹⁶² Fahrzeuge mit 4, 6-Zyl.-Motor, 0,9 Ω Widerstand WZ 09-2/0 110 510 008 vorschalten oder Widerstandsleitung 0,9 Ω verwenden (Serie oder nachrüsten)¹⁸¹</p> |
| <p>ZS090</p>    <p>GS21</p> | <p>ZS106 ersetzt²⁶³ ZS102</p> <p>Ø55mm ↓ 150 mm</p>   <p>12 Volt, max. 31 kV ohne Startspannungsanhebung¹²⁷ Hochleistungs-Zündspule, blau¹³⁴ Nach DIN 72531, mit internationaler Befestigungsschelle¹⁶² Fahrzeuge mit 2, 3, 4, 5, 6, 8-Zyl.-Motor, Zündanlage ohne Vorwiderstand¹⁷⁴</p> | <p>ZS117</p> <p>Ø60mm ↓ 150 mm</p> <p>M5 (1) (15) M6</p>   <p>12 Volt, max. 30 kV ohne Startspannungsanhebung¹²⁷ Zündspule für Transistor-Zündanlage⁵⁵ (Etikett gelb⁵³) Nach DIN 72531, mit internationaler Befestigungsschelle¹⁶²</p> |

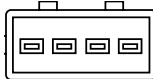

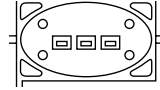

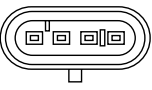



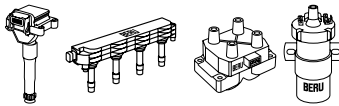

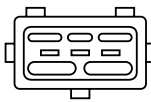

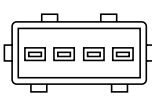

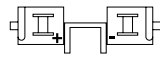

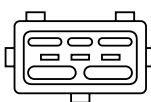

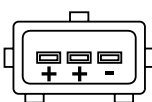

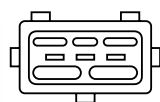

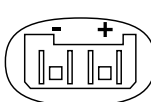

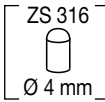

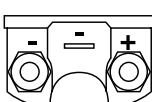

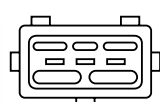
| | | |
|--|---|---|
| <p>ZS118</p> <p>Ø60mm ↓ 150 mm</p> <p>M5 (1)  (15) M6</p> <p>12 Volt, max. 30 kV ohne Startspannungsanhebung¹²⁷ Zündspule für Transistor-Zündanlage⁵⁵ (Etikett grün⁵⁴) Nach DIN 72531, mit internationaler Befestigungsschelle¹⁶²</p>  | <p>ZS122</p> <p>Ø60mm ↓ 149 mm</p> <p>M5 (1)  (15) M6</p> <p>12 Volt ohne Startspannungsanhebung¹²⁷ Zündspule für Transistor-Zündanlage⁵⁵ (Etikett gelb⁵³) ohne Befestigungsschelle¹⁸⁰</p>  | <p>ZS126</p> <p>Ø55mm ↓ 141 mm</p> <p>M5 (1)  (15) M6</p> <p>12 Volt ohne Startspannungsanhebung¹²⁷ Zündspule für Transistor-Zündanlage⁵⁵ (Etikett rot⁵⁸) Nach DIN 72531, mit internationaler Befestigungsschelle¹⁶²</p>  |
| <p>ZS119</p> <p>Ø60mm ↓ 156 mm</p> <p>M5 (1)  (15) M5</p> <p>12 Volt ohne Startspannungsanhebung¹²⁷ Zündspule (schwarz)¹³³ ohne Befestigungsschelle¹⁸⁰</p>  | <p>ZS123</p> <p>Ø55mm ↓ 146 mm</p> <p> </p> <p>12 Volt ohne Startspannungsanhebung¹²⁷ Zündspule für Transistor-Zündanlage⁵⁵ (Etikett grau)⁵⁷ Nach DIN 72531, mit internationaler Befestigungsschelle¹⁶²</p>  | <p>ZS127</p> <p>Ø55mm ↓ 148,5 mm</p> <p>M5 (1)  (15) M6</p> <p>12 Volt ohne Startspannungsanhebung¹²⁷ Zündspule für Transistor-Zündanlage⁵⁵ (Etikett gelb⁵³) Nach DIN 72531, mit internationaler Befestigungsschelle¹⁶²</p>  |
| <p>ZS120</p> <p>Ø55mm ↓ 151 mm</p> <p>M5 (1)  (15) M5</p> <p>12 Volt ohne Startspannungsanhebung¹²⁷ Zündspule (schwarz)¹³³ für elektron. Zündanlage²⁰¹ Nach DIN 72531, mit internationaler Befestigungsschelle¹⁶²</p>  | <p>ZS124</p> <p>Ø55mm ↓ 146 mm</p> <p> </p> <p>12 Volt ohne Startspannungsanhebung¹²⁷ Zündspule für Transistor-Zündanlage⁵⁵ (Etikett grün⁵⁴) Nach DIN 72531, mit internationaler Befestigungsschelle¹⁶²</p>  | <p>ZS210</p> <p>Ø40mm ↓ 115 mm</p> <p> </p> <p>3 Volt, max. 20 kV silber¹³⁶ ohne Befestigungsschelle¹⁸⁰ für 2-Zyl.-Motor u. 6-Volt-Batterie (2 Zündspulen primärseitig hintereinander geschaltet)¹⁸² </p>  |
| <p>ZS121</p> <p>Ø55mm ↓ 146 mm</p> <p>M5 (1)  (15) M6</p> <p>12 Volt ohne Startspannungsanhebung¹²⁷ Zündspule (schwarz)¹³³ ohne Befestigungsschelle¹⁸⁰</p>  | <p>ZS125</p> <p>Ø55mm ↓ 146 mm</p> <p>M5 (1)  (15) M6</p> <p>12 Volt ohne Startspannungsanhebung¹²⁷ Zündspule für Transistor-Zündanlage⁵⁵ (Etikett gelb⁵³) Nach DIN 72531, mit internationaler Befestigungsschelle¹⁶²</p>  | <p>ZS215</p> <p>Ø40mm ↓ 115 mm</p> <p> </p> <p>6 Volt, max. 18 kV silber¹³⁶ ohne Befestigungsschelle¹⁸⁰ für 1, 2-Zylinder-Motoren¹²⁵ </p>  |

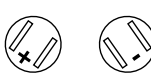

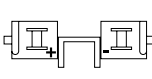

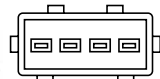



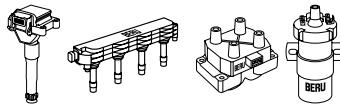

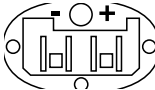

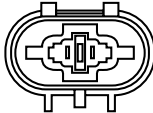

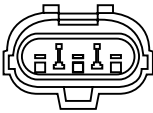

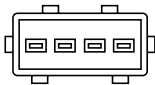

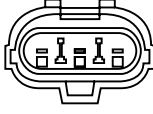



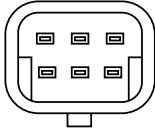

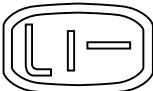
| | | |
|--|--|---|
| <p>ZS220</p> <p>Ø40mm ↓ 115 mm</p>    <p>12 Volt, max. 20 kV silber¹³⁶ ohne Befestigungsschelle¹⁸⁰ für 1, 2-Zylinder-Motoren¹²⁵, </p> | <p>ZS234 ersetzt²⁶³ ZS233</p>    <p>2 x Zndspulen ZS234 erforderlich für 8 Zylinder-Motoren und Alfa Romeo Twin Spark (4 Zylinder)¹²²</p> | <p>ZS241</p>    |
| <p>ZS230</p>    | <p>ZS237</p>    | <p>ZS242</p>    <p>ZS242 → Zylinder¹³⁰ 1 + 4 Steckergehäuse schwarz¹²⁰</p> |
| <p>ZS231</p>    | <p>ZS238</p>    | <p>ZS243</p>    <p>ZS243 → Zylinder¹³⁰ 3 + 2 Steckergehäuse weiss¹²¹</p> |
| <p>ZS232</p>    | <p>ZS239</p>    | <p>ZS244</p>    |

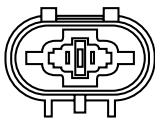

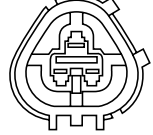

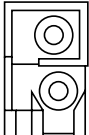



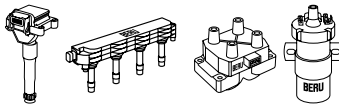

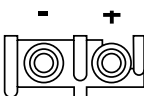

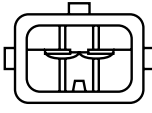



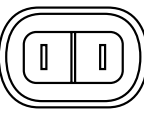

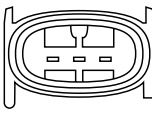

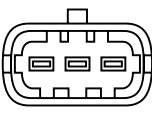

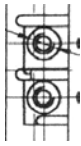

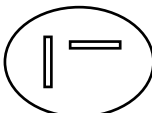

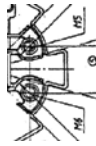
| | | |
|--|---|---|
| <p>ZS245</p>    <p>ZS245 → Zylinder¹³⁰ 1 + 4 Steckergehäuse schwarz¹²⁰</p> | <p>ZS249</p>    | <p>ZS253</p>    |
| <p>ZS246</p>    <p>ZS246 → Zylinder¹³⁰ 3 + 2 Steckergehäuse weiss¹²¹</p> | <p>ZS250</p>    | <p>ZS254</p>    <p>(ZS254 + ZS255) ZS254 → Zylinder¹³⁰ 1 + 4 Steckergehäuse schwarz¹²⁰</p> |
| <p>ZS247</p>    <p>(1)  (15) M4  ZS 316 Ø 4 mm</p> | <p>ZS251</p>    | <p>ZS255</p>    <p>(ZS254 + ZS255) ZS255 → Zylinder¹³⁰ 3 + 2 Steckergehäuse weiss¹²¹</p> |
| <p>ZS248</p>    | <p>ZS252</p>    | <p>ZS256</p>    |

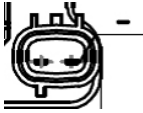

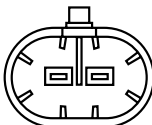

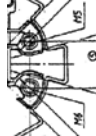



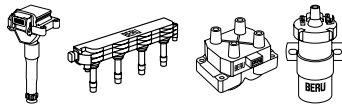

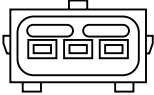

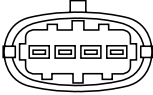

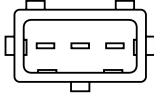

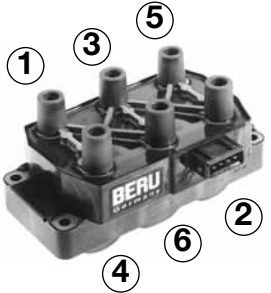
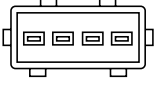

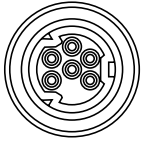

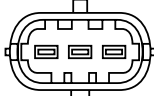

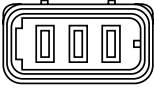

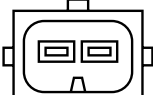



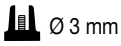

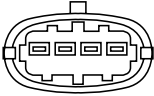

| | | |
|---|--|---|
| <p>ZS257</p>    | <p>ZS263</p>    | <p>ZS267</p>    |
| <p>ZS258</p>    | <p>ZS264</p>    | <p>ZS269</p>   |
| <p>ZS259</p>    | <p>ZS265</p>   | <p>ZS274</p>    |
| <p>ZS261</p>    | <p>ZS266</p>    | <p>ZS275</p>    |

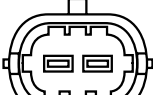

| | | |
|---|---|---|
| <p>ZS276</p>    | <p>ZS280</p>    | <p>ZS296</p>  <p>Transistor-Zündanlage¹⁴</p>  |
| <p>ZS277</p>    | <p>ZS281</p>   <p>FORD</p>  | <p>ZS297</p>    |
| <p>ZS278</p>    | <p>ZS282</p>    | <p>ZS298</p>    |
| <p>ZS279</p>    | <p>ZS283</p>    <p>2 x ZS283</p> | <p>ZS299</p>    |

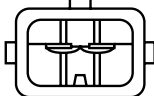

| | | |
|---|--|---|
| <p>ZS300</p>    | <p>ZS306</p>    | <p>ZS310</p>    |
| <p>ZS301</p>    | <p>ZS307</p>    | <p>ZS311</p>    |
| <p>ZS302</p>    | <p>ZS308</p>    <p>2 x ZS308 </p> | <p>ZS313</p>   <p>∅ 3 mm</p> <p> VS106</p> |
| <p>ZS304</p>    <p>3 x ZS304 </p> | <p>ZS309</p>    <p> ZLE288 (2 kΩ)</p> <p>4 x ZS309 </p> | <p>ZS314</p>    |

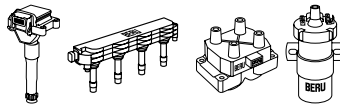



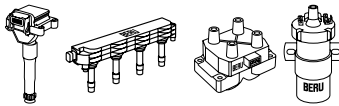



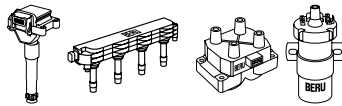

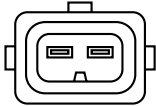

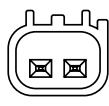

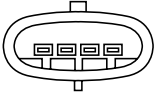

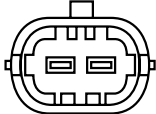



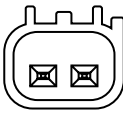

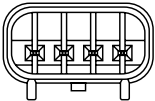

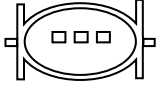

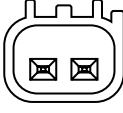

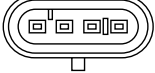
| | | |
|---|---|---|
| <p>ZS327</p>  <p>2 x ZS327 </p> | <p>ZS340 ersetzt²⁶³ ZS295</p>  <p>ZLE234 (2 kΩ) VS107</p> <p>Ø 4 mm</p> | <p>ZS344</p>  |
| <p>ZS337</p>  | <p>ZS341</p>  | <p>ZS345</p>  |
| <p>ZS338</p>  | <p>ZS342</p>  | <p>ZS346</p>  |
| <p>ZS339</p> <p>M5 (1) (15) M6</p>  <p>12 Volt Zündspule für Transistor-Zündanlage⁵⁵</p> | <p>ZS343</p>  | <p>ZS347</p>  |

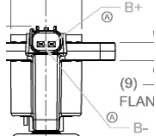

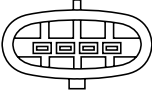
| | | |
|--|--|--|
| <p>ZS348</p> | <p>ZS352</p> | <p>ZS356</p> <p>Klemme: +/-</p> |
| <p>ZS349</p> | <p>ZS353</p> | <p>ZS357</p> |
| <p>ZS350 ersetzt²⁶³ ZSE035</p> <p>- CC1 + Battery - CC2</p> <p>FORD</p> | <p>ZS354</p> | <p>ZS358</p> |
| <p>ZS351</p> | <p>ZS355</p> <p>3 x ZS355 </p> | <p>ZS359</p> |





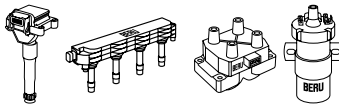



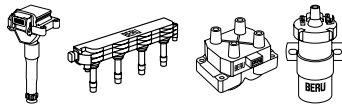

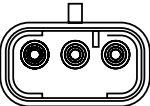

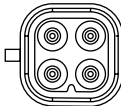

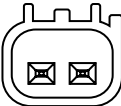





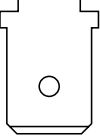

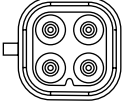

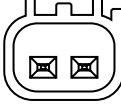

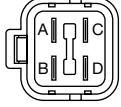
| | | |
|---|--|---|
| <p>ZS360</p>    | <p>ZS367</p>    | <p>ZS371</p>    |
| <p>ZS361</p>    <p>4 x ZS361 </p> <p> ZLE276 (2 kΩ)</p> | <p>ZS368</p>    | <p>ZS372</p>    |
| <p>ZS365</p>    | <p>ZS369</p>    | <p>ZS375</p>    |
| <p>ZS366</p>    | <p>ZS370</p>    | <p>ZS376</p>    |

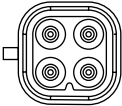

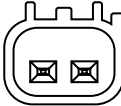
| | | |
|---|---|---|
| <p>ZS379 ersetzt²⁶³ ZSE027</p>    | <p>ZS387</p>    | <p>ZS393</p>    |
| <p>ZS380 ersetzt²⁶³ ZSE028</p>    | <p>ZS388</p>    | <p>ZS394</p>    |
| <p>ZS381</p>     | <p>ZS389</p>    | <p>ZS395</p>   |
| <p>ZS382</p>   | <p>ZS392</p>    | <p>ZS396</p>    |



| | | |
|--|--|---|
| <p>ZS398</p>    | <p>ZS406</p>    | <p>ZS410</p>    |
| <p>ZS400</p> <p>Ø55mm ↑ 150 mm</p>   <p>12 Volt, max. 35 kV ohne Startspannungsanhebung¹²⁷ Zündspule für Transistorzündung, blau¹³⁷ Transistor-Zündanlage¹⁴ Nach DIN 72531, mit internationaler Befestigungsschelle¹⁶²</p> | <p>ZS407</p>   | <p>ZS416</p>    |
| <p>ZS404</p>   | <p>ZS408</p>    | <p>ZS417</p>    |
| <p>ZS405</p>    | <p>ZS409</p>    | <p>ZS418</p>   |

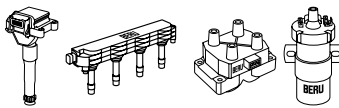

| | | |
|---|---|---|
| <p>ZS419</p>   | <p>ZS427</p>    | <p>ZS431</p>   <p>Anschlußtechnik SAE</p> |
| <p>ZS421</p>   | <p>ZS428</p>    | <p>ZS432</p>   <p>Anschlußtechnik SAE</p> |
| <p>ZS422</p>   | <p>ZS429</p>   | <p>ZS433</p>    |
| <p>ZS426</p>   | <p>ZS430</p>    | <p>ZS434</p>    |

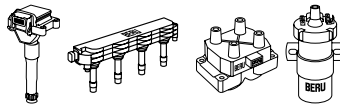



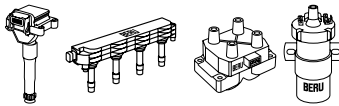

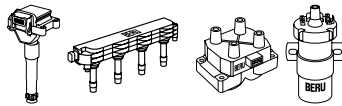

| | | |
|---|--|--|
| <p>ZS435</p>    | <p>ZS445</p>  | <p>ZS450</p>   <p>Anschlußausführung Sägezahn</p> |
| <p>ZS436</p>    | <p>ZS446</p>  | <p>ZS451</p>   <p>Anschlußausführung Sägezahn</p> |
| <p>ZS437</p>    | <p>ZS447A</p>  | <p>ZS452</p>  |
| <p>ZS438</p>    | <p>ZS449</p>    | <p>ZS453</p>   |



| | | |
|---|--|---|
| <p>ZS454</p>   | <p>ZS470</p>  | <p>ZS476</p>  |
| <p>ZS455</p>  | <p>ZS473</p>   | <p>ZS477</p>  |
| <p>ZS456</p>  | <p>ZS474</p>  | <p>ZS478</p>  |
| <p>ZS469</p>  | <p>ZS475</p>  | <p>ZS479</p>  |

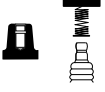

| | | |
|---|--|--|
| <p>ZS480</p>  | <p>ZS485</p>  | <p>ZS502</p>    <p>Steckerfarbe: rot¹¹⁷</p> |
| <p>ZS481</p>  | <p>ZS486</p>  | <p>ZS508</p>    |
| <p>ZS482</p>  | <p>ZS487</p>  | <p>ZS511</p>    |
| <p>ZS483</p>  | <p>ZS501 ersetzt²⁶³ ZS509</p>    <p>Steckerfarbe: schwarz¹²⁰</p> | <p>ZS513</p>  <p>Zündspule Anschlußausführung DIN Steckergehäuse schwarz¹²⁰ zum Zyl. 1 + 4 Steckergehäuse grau¹¹⁸ zum Zyl. 2 + 3</p> |

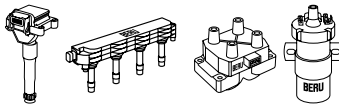

ZS515



Steckergehäuse grau¹¹⁸
zum Zyl. 1 + 4
Steckergehäuse schwarz¹²⁰
zum Zyl. 2 + 3

ZS522



Zündspule Anschlußausführung DIN

ZS536

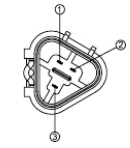

Zündspule Anschlußausführung DIN

ZS516



Zündspule Anschlußausführung DIN
Steckergehäuse schwarz¹²⁰
zum Zyl. 1 + 4
Steckergehäuse grau¹¹⁸
zum Zyl. 2 + 3

ZS526

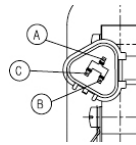

ZS537

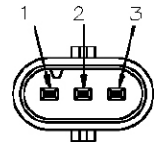

ZS518



Zündspule Anschlußausführung DIN

ZS532



ZS538

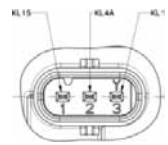

ZS521

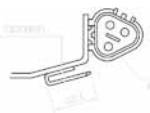

Zündspule Anschlußausführung DIN

ZS535

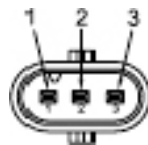





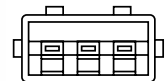

Anschlußtechnik Kontaktfeder

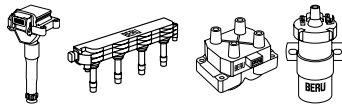
ZSE001

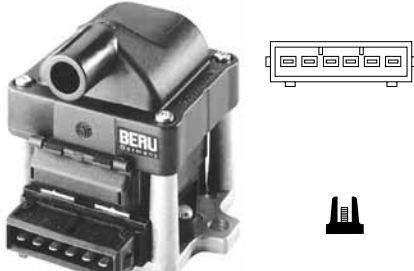
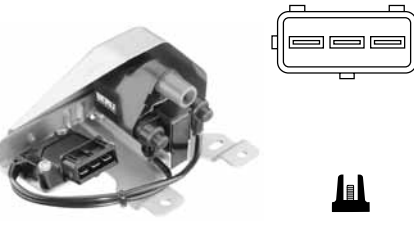
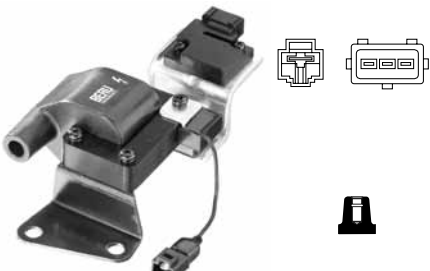
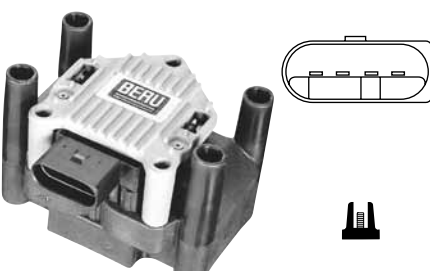

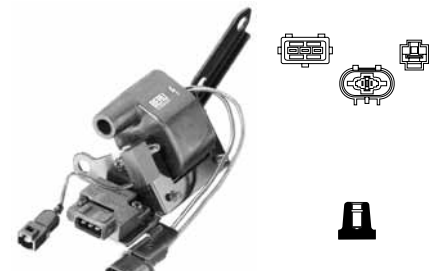
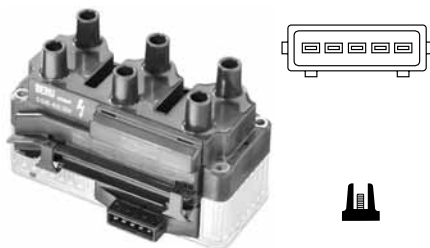
ZM013
mit Endstufe¹²³

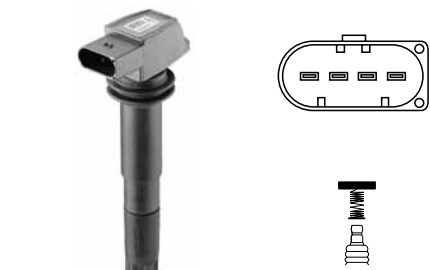

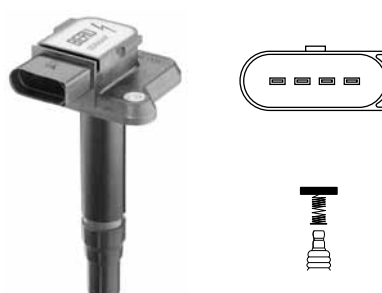
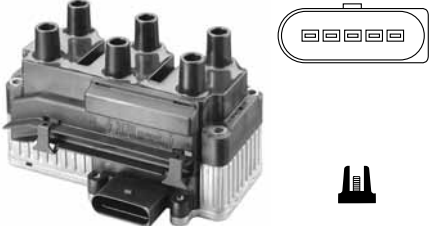

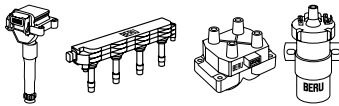



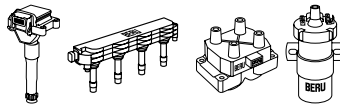



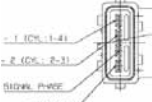



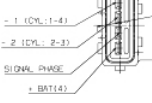
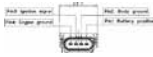

| | | |
|--|--|--|
| <p>ZSE002</p>  <p>mit Endstufe¹²³</p> | <p>ZSE006</p>  <p>ZM030 mit Endstufe¹²³</p> | <p>ZSE010</p>  <p>mit Endstufe¹²³</p> |
| <p>ZSE003</p>  <p>mit Endstufe¹²³</p> | <p>ZSE007</p>  <p>Kabellänge [mm] 75/85 mit Endstufe¹²³</p> | <p>ZSE011</p>  <p>mit Endstufe¹²³</p> |
| <p>ZSE004</p>  <p>(6-Zylinder³⁰) mit Endstufe¹²³</p> | <p>ZSE008</p>  <p>Kabellänge [mm] 75/145 mit Endstufe¹²³</p> | <p>ZSE012</p>  <p>mit Endstufe¹²³</p> |
| <p>ZSE005</p>  | <p>ZSE009</p>  <p>mit Endstufe¹²³</p> | <p>ZSE013</p>  <p>mit Endstufe¹²³</p> |

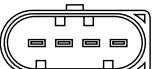

| | | |
|--|---|--|
| <p>ZSE019</p>  <p>mit Endstufe¹²³</p> | <p>ZSE030</p>  <p> ZSA042 mit Endstufe¹²³</p> | <p>ZSE036</p>  |
| <p>ZSE021</p>  | <p>ZSE031</p>  <p> ZSA042 mit Endstufe¹²³</p> | <p>ZSE037</p>  <p> ZM036 mit Endstufe¹²³</p> |
| <p>ZSE026</p>  <p>Zündspule Endstufe¹²³ Anschlußausführung Sägezahn</p> | <p>ZSE032</p>  <p> ZSA044 mit Endstufe¹²³ Zündspulenkopf⁶⁴ rot¹¹⁷</p> | <p>ZSE039</p>  |
| <p>ZSE029</p>  <p>mit Endstufe¹²³</p> | <p>ZSE033</p>  <p> ZS044 mit Endstufe¹²³</p> | <p>ZSE040</p>  |

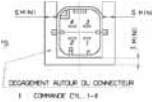

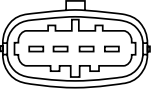
| | | |
|--|---|--|
| <p>ZSE041</p>    | <p>ZSE045</p>    | <p>ZSE051</p>    <p>mit Endstufe¹²³ Zündspulenkopf⁶⁴ rot⁴²</p> |
| <p>ZSE042 ersetzt²⁶³ ZSE053</p>   <p>Pin 1 = Karosserie-Masse Pin 2 = Motormasse Pin 3 = KL 15 Pin 4 = Zündsignal</p>  <p>Zündspulenkopf⁶⁴ rot⁴²</p> | <p>ZSE046</p>    | <p>ZSE052</p>    <p>mit Endstufe¹²³ Zündspulenkopf⁶⁴ grau¹¹⁸</p> |
| <p>ZSE043 ersetzt²⁶³ ZSE034</p>    <p> ZSA044 mit Endstufe¹²³</p> | <p>ZSE047</p>    | <p>ZSE054</p>    <p>mit Endstufe¹²³</p> |
| <p>ZSE044</p>    <p> ZSA043 mit Endstufe¹²³</p> | <p>ZSE048</p>    | <p>ZSE055</p>    <p>mit Endstufe¹²³ Steckergehäuse grau¹¹⁸</p> |

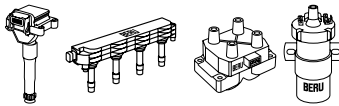

| | | |
|---|--|--|
| <p>ZSE056</p>    <p>mit Endstufe¹²³</p> | <p>ZSE063</p>    <p>mit Endstufe¹²³</p> | <p>ZSE068</p>   <p>mit Endstufe¹²³</p> |
| <p>ZSE 059</p>    <p>mit Endstufe¹²³</p> | <p>ZSE065</p>    <p>mit Endstufe¹²³</p> | <p>ZSE069</p>   <p>mit Endstufe¹²³</p> |
| <p>ZSE061</p>    <p>mit Endstufe¹²³ Zündspulenkopf⁶⁴ rot⁴²</p> | <p>ZSE066</p>    <p>mit Endstufe¹²³</p> | <p>ZSE071</p>   <p>Anschlußtechnik SAE Endstufe¹²³ Einbauseite Anbau links²⁸⁰</p> |
| <p>ZSE062</p>    <p>mit Endstufe¹²³</p> | <p>ZSE067</p>    <p>mit Endstufe¹²³</p> | <p>ZSE072</p>   <p>Anschlußtechnik SAE Endstufe¹²³</p> |

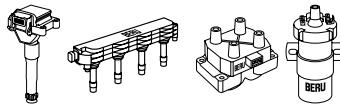



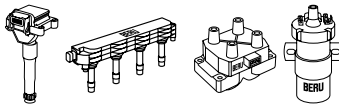



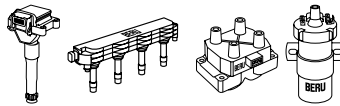

| | | |
|---|--|--|
| <p>ZSE073</p>   <p>Anschlußtechnik SAE Endstufe¹²³ Einbauseite Anbau rechts²⁸¹</p> | <p>ZSE077</p>   <p>Anschlußtechnik SAE Endstufe¹²³</p> | <p>ZSE081</p>   <p>mit Endstufe¹²³</p> |
| <p>ZSE074</p>   <p>Anschlußtechnik SAE Endstufe¹²³</p> | <p>ZSE078</p>   <p>Anschlußtechnik SAE Endstufe¹²³</p> | <p>ZSE082</p>   <p>Anschlußtechnik SAE Endstufe¹²³</p> |
| <p>ZSE075</p>   <p>Anschlußtechnik SAE Endstufe¹²³</p> | <p>ZSE079</p>   <p>mit Endstufe¹²³</p> | <p>ZSE083</p>   <p>Anschlußtechnik SAE Endstufe¹²³</p> |
| <p>ZSE076</p>   <p>Anschlußtechnik SAE Endstufe¹²³</p> | <p>ZSE080</p>   <p>mit Endstufe¹²³</p> | <p>ZSE084</p>   <p>Anschlußtechnik SAE Endstufe¹²³</p> |

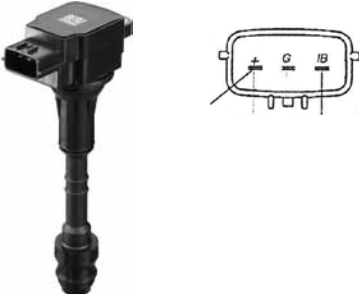

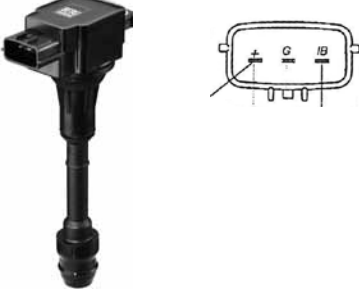
| | | |
|--|---|--|
| <p>ZSE086</p>   <p>mit Endstufe¹²³</p> | <p>ZSE093</p>   | <p>ZSE128</p>   <p>Zündspule Anschlussausführung Sägezahn Endstufe¹²³</p> |
| <p>ZSE087</p>   <p>mit Endstufe¹²³</p> | <p>ZSE094</p>   | <p>ZSE129</p>   <p>Zündspule Anschlussausführung Sägezahn Endstufe¹²³</p> |
| <p>ZSE088</p>   <p>mit Endstufe¹²³</p> | <p>ZSE126</p>  <p>mit Endstufe¹²³</p> | <p>ZSE131</p>   <p>mit Endstufe¹²³</p> |
| <p>ZSE089</p>  | <p>ZSE127</p>   <p>Zündspule Anschlussausführung Sägezahn Endstufe¹²³</p> | <p>ZSE132</p>   <p>mit Endstufe¹²³</p> |

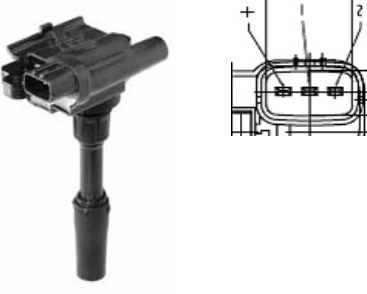

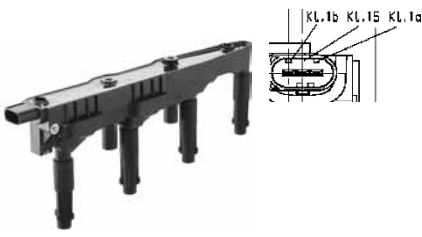
| | | |
|---|---|--|
| <p>ZSE133</p>  <p>mit Endstufe¹²³</p> | <p>ZSE137</p>  <p>mit Endstufe¹²³</p> | <p>ZSE143</p>  <p>mit Endstufe¹²³</p> |
| <p>ZSE134</p>  <p>mit Endstufe¹²³</p> | <p>ZSE138</p>  <p>Zündspule Anschlussausführung Sägezahn Endstufe¹²³</p> | <p>ZSE144</p>  <p>mit Endstufe¹²³</p> |
| <p>ZSE135</p>  <p>mit Endstufe¹²³</p> | <p>ZSE140</p>  <p>mit Endstufe¹²³</p> | <p>ZSE145</p>  <p>mit Endstufe¹²³</p> |
| <p>ZSE136</p>  <p>Zündspule Anschlussausführung Sägezahn Endstufe¹²³</p> | <p>ZSE142</p>  <p>mit Endstufe¹²³</p> | <p>ZSE146</p>  <p>mit Endstufe¹²³</p> |

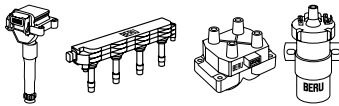

| | | |
|--|---|--|
| <p>ZSE147</p>  <p>mit Endstufe¹²³</p> | <p>ZSE151</p>  <p>mit Endstufe¹²³</p> | <p>ZSE155</p>  |
| <p>ZSE148</p>  <p>mit Endstufe¹²³</p> | <p>ZSE152</p>  <p>mit Endstufe¹²³ Nur in Verbindung mit ZSE153</p> | <p>ZSE156</p>  |
| <p>ZSE149</p>  <p>mit Endstufe¹²³</p> | <p>ZSE153</p>  <p>mit Endstufe¹²³ Nur in Verbindung mit ZSE152</p> | <p>ZSE157</p>  |
| <p>ZSE150</p>  <p>mit Endstufe¹²³</p> | <p>ZSE154</p>  | <p>ZSE158</p>  |

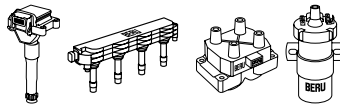

| | | |
|--|--|--|
| <p>ZSE159</p>   | <p>ZSE164</p>  | <p>ZSE168</p>  |
| <p>ZSE160</p>   | <p>ZSE165</p>  | <p>ZSE169</p>  |
| <p>ZSE161</p>   | <p>ZSE166</p>  | <p>ZSE170</p>  |
| <p>ZSE162</p>   | <p>ZSE167</p>  | <p>ZSE171</p>  |

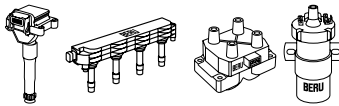

| | | |
|--|--|--|
| <p>ZSE172</p>  | <p>ZSE176</p>   | |
| <p>ZSE173</p>  | <p>ZSE177</p>   | |
| <p>ZSE174</p>   | <p>ZSE502 ersetzt²⁶³ ZS262</p>    <p>mit Endstufe¹²³</p> | |
| <p>ZSE175</p>   | <p>ZSH002</p>  <p>Hitzeschutzschild für Zündspule¹⁹ ZS350</p> | |



GR001

| | |
|----------|-------|
| | 4 - 5 |
| Volt | 12 |
| Sec. | 5.4 |
| Sec. | 0 |

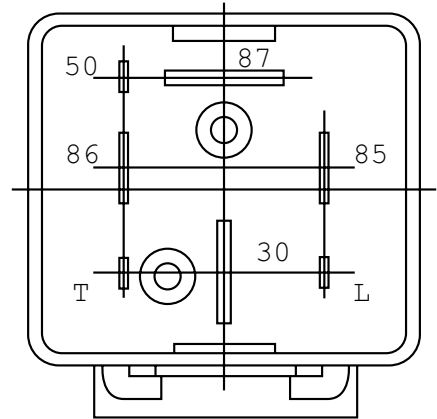

GR031

| | |
|----------|-------|
| | 4 - 6 |
| Volt | 12 |
| Sec. | 5.7 |
| Sec. | 180 |

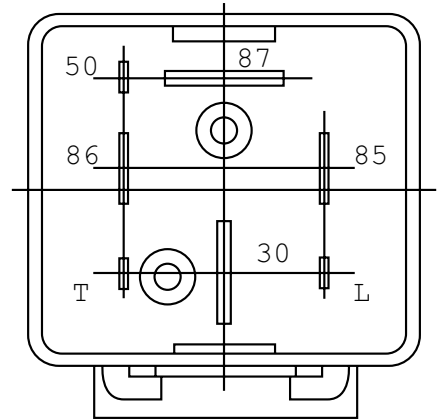

GR034

| | |
|----------|-----|
| | 4 |
| Volt | 12 |
| Sec. | 4.6 |
| Sec. | 180 |

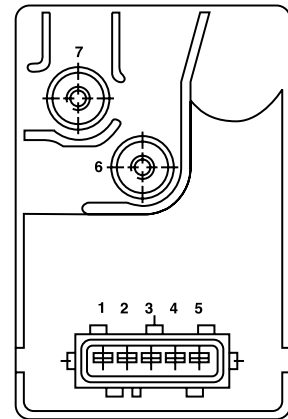

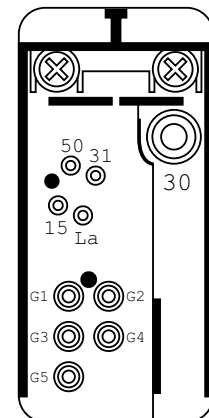

GR049

| | |
|----------|-------|
| | 4 - 5 |
| Volt | 12 |
| Sec. | 3.8 |
| Sec. | 180 |





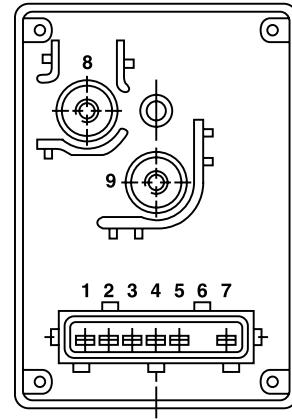

GR054

| | |
|--|-----|
|  | 4 |
| Volt | 12 |
|  Sec. | 3.3 |
|  Sec. | 13 |



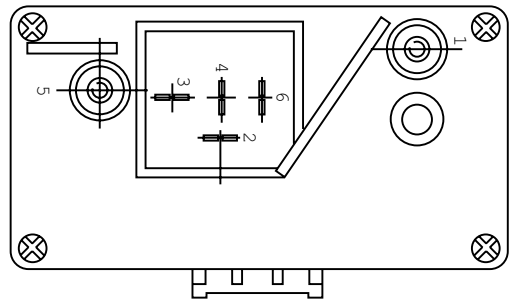

GR059

| | |
|--|------|
|  | 4 |
| Volt | 12 |
|  Sec. | 12.6 |
|  Sec. | 0 |



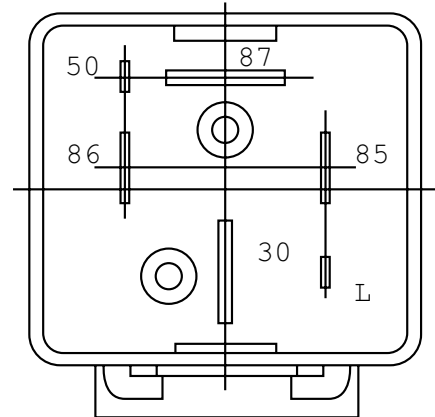

GR064

| | |
|--|----|
|  | 4 |
| Volt | 12 |
|  Sec. | 5 |
|  Sec. | 0 |



GR065

| | |
|--|-----|
|  | 4 |
| Volt | 12 |
|  Sec. | 6.8 |
|  Sec. | 0 |

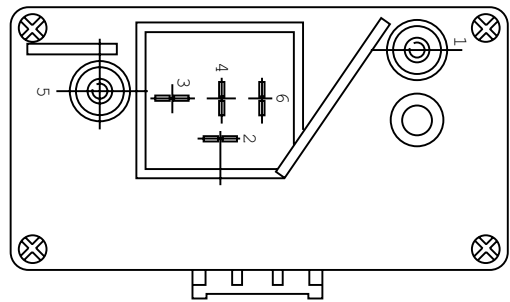



GR066

| | |
|------|-----|
| | 4 |
| Volt | 12 |
| | 8.1 |
| | 0 |

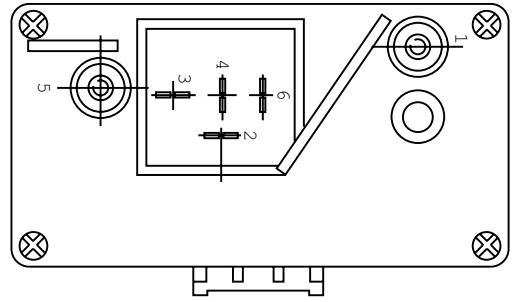

GR067

| | |
|------|-----|
| | 4 |
| Volt | 12 |
| | 8.5 |
| | 180 |

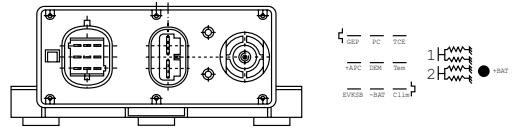

GR069

| | |
|------|-----|
| | 4 |
| Volt | 12 |
| | 5.3 |
| | 0 |

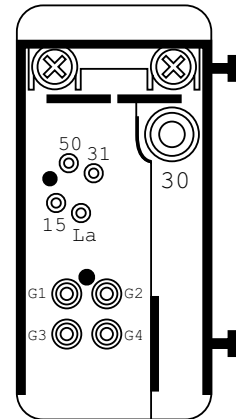

GR070

| | |
|------|----|
| | 4 |
| Volt | 12 |
| | 5 |
| | 0 |

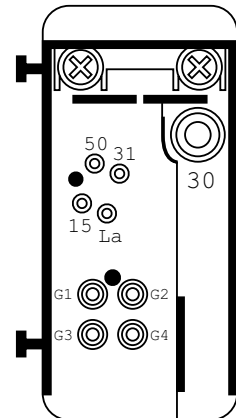



GR071

| | |
|----------|----|
| | 5 |
| Volt | 12 |
| Sec. | 5 |
| Sec. | 0 |

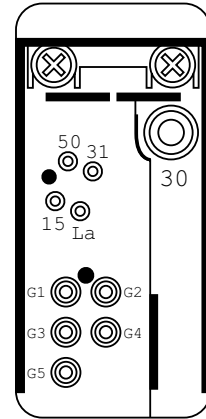

GR073-B

| | |
|----------|------|
| | 4 |
| Volt | 12 |
| Sec. | 12.9 |
| Sec. | 18.1 |

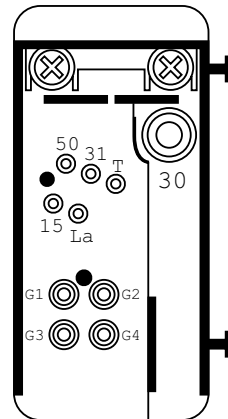

GR074

| | |
|----------|------|
| | 4 |
| Volt | 12 |
| Sec. | 12.9 |
| Sec. | 18.1 |

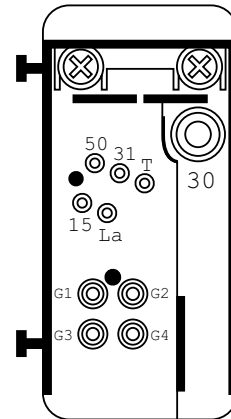

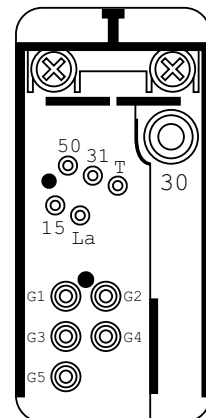

GR075

| | |
|----------|----|
| | 5 |
| Volt | 12 |
| Sec. | 13 |
| Sec. | 18 |





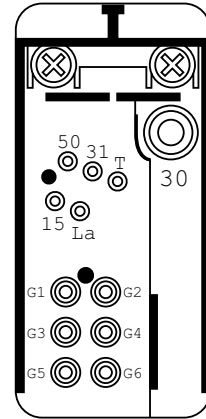

GR076

| | |
|--|------|
|  | 6 |
| Volt | 12 |
|  Sec. | 11.5 |
|  Sec. | 16.5 |





GR080

| | |
|---|----|
|  | 5 |
| Volt | 12 |
|  Sec. | 13 |
|  Sec. | 18 |





GR081

| | |
|--|-------|
|  | 3 - 5 |
| Volt | 12 |
|  Sec. | |
|  Sec. | |





GSE100

| | |
|--|----|
|  | 4 |
| Volt | 12 |
|  Sec. | |
|  Sec. | |







GSE101

| | |
|---|----|
|  | 4 |
| Volt | 12 |
|  | |
| Sec. | |
|  | |
| Sec. | |





GSE102

| | |
|---|----|
|  | 6 |
| Volt | 12 |
|  | |
| Sec. | |
|  | |
| Sec. | |





GSE103

| | |
|---|----|
|  | 8 |
| Volt | 12 |
|  | |
| Sec. | |
|  | |
| Sec. | |



GSE114

| | |
|---|----|
|  | |
| Volt | 12 |
|  | |
| Sec. | |
|  | |
| Sec. | |





GSE116

| | |
|------|------|
| | |
| Volt | 12 |
| | Sec. |
| | Sec. |



GSE140

| | |
|------|------|
| | 4 |
| Volt | 12 |
| | Sec. |
| | Sec. |



GSE141

| | |
|------|-------|
| | 5 - 6 |
| Volt | 12 |
| | Sec. |
| | Sec. |





GSE142

| | |
|------|------|
| | 4 |
| Volt | 12 |
| | Sec. |
| | Sec. |







GSE143

| | |
|---|----|
|  | 4 |
| Volt | 12 |
|  Sec. | |
|  Sec. | |





GSE144

| | |
|---|----|
|  | 4 |
| Volt | 12 |
|  Sec. | |
|  Sec. | |



GSE145





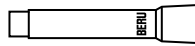



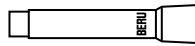







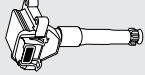
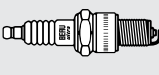



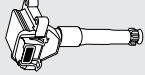
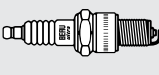



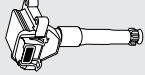
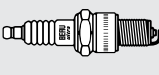







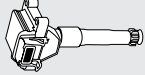
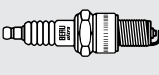



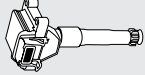
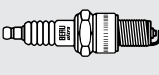

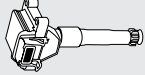
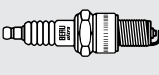

| | |
|---|----|
|  | 4 |
| Volt | 12 |
|  Sec. | |
|  Sec. | |











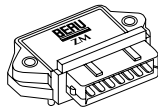

| | | | | | | | | | | | | | | | | | | | |
|--|---|-------------|---|---|---|---|---|--|---|--|---|----------------|-------------|------------|---|---|---|--|---|
| <p>ZLE232</p>  <table border="1" data-bbox="156 376 794 533"> <tr> <td></td> <td>EP/ VMQ</td> <td>↔ 117 mm</td> <td>Ω 2.000</td> <td></td> </tr> <tr> <td></td> <td colspan="2">↔</td> <td></td> </tr> </table> <p> ZS014</p> |  | EP/ VMQ | ↔ 117 mm | Ω 2.000 |  |  | ↔ | |  | <p>ZLE276</p>  <table border="1" data-bbox="833 376 1471 533"> <tr> <td></td> <td>EP/ VMQ</td> <td>↔ 112 mm</td> <td>Ω 2.000</td> <td></td> </tr> <tr> <td></td> <td colspan="2">↔</td> <td></td> </tr> </table> <p> ZS016</p> |  | EP/ VMQ | ↔ 112 mm | Ω 2.000 |  |  | ↔ | |  |
|  | EP/ VMQ | ↔ 117 mm | Ω 2.000 |  | | | | | | | | | | | | | | | |
|  | ↔ | |  | | | | | | | | | | | | | | | | |
|  | EP/ VMQ | ↔ 112 mm | Ω 2.000 |  | | | | | | | | | | | | | | | |
|  | ↔ | |  | | | | | | | | | | | | | | | | |
| <p>ZLE233</p>  <table border="1" data-bbox="156 846 794 1003"> <tr> <td></td> <td>EP/ VMQ</td> <td>↔ 122 mm</td> <td>Ω 5.000</td> <td></td> </tr> <tr> <td></td> <td colspan="2">↔</td> <td></td> </tr> </table> <p> ZS043</p> |  | EP/ VMQ | ↔ 122 mm | Ω 5.000 |  |  | ↔ | |  | <p>ZLE277</p>  <table border="1" data-bbox="833 846 1471 1003"> <tr> <td></td> <td>EP/ VMQ</td> <td>↔ 133 mm</td> <td>Ω 2.000</td> <td></td> </tr> <tr> <td></td> <td colspan="2">↔</td> <td></td> </tr> </table> <p> ZS017</p> |  | EP/ VMQ | ↔ 133 mm | Ω 2.000 |  |  | ↔ | |  |
|  | EP/ VMQ | ↔ 122 mm | Ω 5.000 |  | | | | | | | | | | | | | | | |
|  | ↔ | |  | | | | | | | | | | | | | | | | |
|  | EP/ VMQ | ↔ 133 mm | Ω 2.000 |  | | | | | | | | | | | | | | | |
|  | ↔ | |  | | | | | | | | | | | | | | | | |
| <p>ZLE234</p>  <table border="1" data-bbox="156 1326 794 1482"> <tr> <td></td> <td>EP/ VMQ</td> <td>↔ 113 mm</td> <td>Ω 2.000</td> <td></td> </tr> <tr> <td></td> <td colspan="2">↔</td> <td></td> </tr> </table> <p> ZS340</p> |  | EP/ VMQ | ↔ 113 mm | Ω 2.000 |  |  | ↔ | |  | <p>ZLE278</p>  <table border="1" data-bbox="833 1326 1471 1482"> <tr> <td></td> <td>EP/ VMQ</td> <td>↔ 117 mm</td> <td>Ω 2.000</td> <td></td> </tr> <tr> <td></td> <td colspan="2">↔</td> <td></td> </tr> </table> <p> ZS031</p> |  | EP/ VMQ | ↔ 117 mm | Ω 2.000 |  |  | ↔ | |  |
|  | EP/ VMQ | ↔ 113 mm | Ω 2.000 |  | | | | | | | | | | | | | | | |
|  | ↔ | |  | | | | | | | | | | | | | | | | |
|  | EP/ VMQ | ↔ 117 mm | Ω 2.000 |  | | | | | | | | | | | | | | | |
|  | ↔ | |  | | | | | | | | | | | | | | | | |
| <p>ZLE255</p>  <table border="1" data-bbox="156 1796 794 1953"> <tr> <td></td> <td>EP/ VMQ</td> <td>↔ 117 mm</td> <td>Ω 2.000</td> <td></td> </tr> <tr> <td></td> <td colspan="2">↔</td> <td></td> </tr> </table> <p> ZS036</p> |  | EP/ VMQ | ↔ 117 mm | Ω 2.000 |  |  | ↔ | |  | <p>ZLE288</p>  <table border="1" data-bbox="833 1796 1471 1953"> <tr> <td></td> <td>UP/ Silikon</td> <td>↔ 102 mm</td> <td>Ω 2.000</td> <td></td> </tr> <tr> <td></td> <td colspan="2">↔</td> <td></td> </tr> </table> <p> ZS309 / ZS361</p> |  | UP/ Silikon | ↔ 102 mm | Ω 2.000 |  |  | ↔ | |  |
|  | EP/ VMQ | ↔ 117 mm | Ω 2.000 |  | | | | | | | | | | | | | | | |
|  | ↔ | |  | | | | | | | | | | | | | | | | |
|  | UP/ Silikon | ↔ 102 mm | Ω 2.000 |  | | | | | | | | | | | | | | | |
|  | ↔ | |  | | | | | | | | | | | | | | | | |



| | | | | | | | | | | | | | | | |
|---|-----|-------|---|--|--|---|-----|---|--------|---|--|--|---|--|--|
| <p>GS17</p>  <table border="1" data-bbox="296 371 778 539"><tr><td>VMQ</td><td>↔</td><td>95 mm</td><td></td></tr></table> <p> ZS041</p> | VMQ | ↔ | 95 mm |  | <p>GS39</p>  <table border="1" data-bbox="804 371 1458 539"><tr><td></td><td>VMQ</td><td>↔</td><td>90 mm</td><td></td></tr><tr><td></td><td></td><td>↔</td><td></td><td></td></tr></table> <p> ZS259</p> |  | VMQ | ↔ | 90 mm |  |  | | ↔ | |  |
| VMQ | ↔ | 95 mm |  | | | | | | | | | | | | |
|  | VMQ | ↔ | 90 mm |  | | | | | | | | | | | |
|  | | ↔ | |  | | | | | | | | | | | |
| <p>GS21</p>  <table border="1" data-bbox="296 846 778 1014"><tr><td>VMQ</td><td>↔</td><td>55 mm</td><td></td></tr></table> <p> ZS053</p> | VMQ | ↔ | 55 mm |  | <p>GS51</p>  <table border="1" data-bbox="804 846 1458 1014"><tr><td></td><td>VMQ</td><td>↔</td><td>135 mm</td><td></td></tr><tr><td></td><td></td><td>↔</td><td></td><td></td></tr></table> <p> ZS090</p> |  | VMQ | ↔ | 135 mm |  |  | | ↔ | |  |
| VMQ | ↔ | 55 mm |  | | | | | | | | | | | | |
|  | VMQ | ↔ | 135 mm |  | | | | | | | | | | | |
|  | | ↔ | |  | | | | | | | | | | | |
| <p>GS28</p>  <table border="1" data-bbox="296 1321 778 1489"><tr><td>VMQ</td><td>↔</td><td>55 mm</td><td></td></tr></table> <p> ZSE012 / ZSE042 / ZSE052 / ZSE054</p> | VMQ | ↔ | 55 mm |  | | | | | | | | | | | |
| VMQ | ↔ | 55 mm |  | | | | | | | | | | | | |
| <p>GS29</p>  <table border="1" data-bbox="296 1796 778 1964"><tr><td>VMQ</td><td>↔</td><td>53 mm</td><td></td></tr></table> <p> ZS052</p> | VMQ | ↔ | 53 mm |  | | | | | | | | | | | |
| VMQ | ↔ | 53 mm |  | | | | | | | | | | | | |



| | | | |
|--|---|--|---|
| <p>ZM001</p> <p>Bosch Bosch 0 227 100 102 Ducellier 521008 Magneti Marelli 64833020 Peugeot 5945.48 Volvo 1 298 429</p> <p>Alfa Romeo, BMW, Fiat, Lancia, Mercedes Benz, Peugeot, Porsche, Renault, Seat, Saab, Talbot, Volvo, Zastava</p> |  <p>induktiv²⁰⁷ 6 Anschlüsse¹⁷⁰</p> | <p>ZM005</p> <p>Delco Delco Remy D 1906 Fiat/Lancia 4419 628 Lucas DAB 125 Magneti Marelli BKL 1A Renault 7701 021 955</p> <p>Alfa Romeo, Austin Rover, Fiat, GM, Jaguar, Lancia, Leyland, Peugeot, Renault, Seat</p> |  <p>induktiv²⁰⁷ 2+2 Anschlüsse¹⁷⁰</p> |
| <p>ZM002</p> <p>Bosch Bosch 0 227 100 103, 0 227 100 118, 0 227 100 137, 0 227 100 139 Opel 12 08 033 Volvo 1 317 809 VW 211 905 351A, B, D, E</p> <p>Alfa Romeo, Audi, Bedford, Lada, Nissan, Opel, Peugeot, Porsche, Saab, Mercedes Benz, Seat, Vauxhall, VW, Volvo, Yugo</p> |  <p>Hall²⁰⁸ 7 Anschlüsse¹⁷⁰</p> | <p>ZM006</p> <p>Delco Delco Remy D 1959 AMC 8134117 GM / Vauxhall 1978 778 Lucas DAB 700 Opel 12 11 560</p> <p>Bedford, Opel, Vauxhall</p> |  <p>induktiv²⁰⁷ 2+2 Anschlüsse¹⁷⁰</p> |
| <p>ZM003</p> <p>Bosch Bosch 0 227 100 140, 1 137 010 025 Citroën 9453130480 Lucas DAB 401 Peugeot 5945.45</p> <p>Citroën, Ford, Olcit (RO), Peugeot, Reliant</p> |  <p>induktiv²⁰⁷ 2+3 Anschlüsse¹⁷⁰</p> | <p>ZM007</p> <p>Delco Delco Remy D 1951, 7033103 GM 1985 703 Opel 12 11 561</p> <p>Bedford, Opel, Vauxhall</p> |  <p>induktiv²⁰⁷ 3+3 Anschlüsse¹⁷⁰</p> |
| <p>ZM004</p> <p>Bosch Bosch 0 227 100 114, 0 227 100 115 Mercedes Benz 002 545 18 32, 002 545 58 32, 002 545 90 32</p> <p>Mercedes-Benz</p> |  <p>induktiv²⁰⁷ 2+4 Anschlüsse¹⁷⁰</p> | <p>ZM008</p> <p>Lucas Delco Remy 16 010 888 Bosch 1 227 022 003 Ford 81SF-12K059-AB, 60 86 506 Lucas DAB 101</p> <p>Ford, Morgan, Reliant</p> |  <p>induktiv²⁰⁷ 4 Anschlüsse¹⁷⁰</p> |

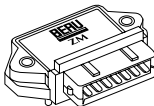

ZM009

Marelli
Marelli BKL 4A, 648 330 40
Fiat 9940095
Lucas DAB 800



induktiv²⁰⁷
5 Anschlüsse¹⁷⁰

Autobianchi, Fiat

ZM014

Bosch
Bosch 1 227 030 049
Marelli 940 038 507
VW 867 905 351



Hall²⁰⁸
6 Anschlüsse¹⁷⁰

VW

ZM010

Lada
Lada 2108-03734-910-70,
2108-33734-910-10,
2108-37349-108-0,
2108-37349-108-9
Lucas DAB 953



Hall²⁰⁸
7 Anschlüsse¹⁷⁰

Lada

ZM015

Bosch
Bosch 0 227 100 124,
1 227 010 003,
1 227 010 005,
1 227 010 006
Citroën 96 048 807 080
Ford 86AB-12K064-AA
Opel 12 08 038, 12 08 243
Saab 402 3149



Endstufe¹²³
6 Anschlüsse¹⁷⁰

Citroën, Ford, Opel, Peugeot, Porsche,
Saab, Seat

ZM012

Bosch
Bosch 0 227 100 142,
0 227 100 143,
0 227 100 147
Lucas DAB 402
VW 191 905 351, -A, -B, -C



Hall²⁰⁸
7 Anschlüsse¹⁷⁰

Audi, VW, Wartburg

ZM016

Delco
Delco Remy D 1957, D 1961,
1977 958, 1979 107,
1979 571
AMC 898 350 1087
GM 1615 8829, 1641 0049
Isuzu 80 1979 5710
Opel 12 11 582, 12 11 591



induktiv²⁰⁷
4+3 Anschlüsse¹⁷⁰

Opel, Vauxhall

ZM013

Bosch
Bosch 1 227 030 030
Lucas DAB 954
VW 867 905 352
Seat 867 905 352



Endstufe¹²³
2+3 Anschlüsse¹⁷⁰

Audi, Seat, VW

ZM017







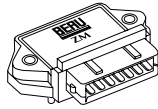

Valeo
Valeo CD 605, 73 502 602
Ducellier 252 8001 A, 245 509
Fiat 9942040
Marelli 940 038 518
Lucas DAB 202



induktiv²⁰⁷
2 Anschlüsse¹⁷⁰

Fiat, Lancia



| | |
|---|---|
| <p>ZM018</p> <p>Lucas Lucas DAB 126, 549 87 086 GM 90243618, 90360315 Opel 12 37 334, 12 37 464</p>  <p>Endstufe¹²³ 4 Anschlüsse¹⁷⁰</p> <p>Opel, Vauxhall</p> | <p>ZM023</p> <p>Nippon Denso Honda 30120-PM5-A01, 06302-PT2-A00, 06302-PT2-000 Lucas DAJ 904 NEC NEC-8132 Oki MINE-301/-302/-303, MC-8132</p>  <p>induktiv²⁰⁷ 4 Anschlüsse¹⁷⁰</p> <p>Acura (USA), Honda</p> |
| <p>ZM019</p> <p>Ford Ford E5RF-12A297-BA, E43Z-12A297-A, 1629456 Lucas DAB 750 Marelli 940 038 542 Motorcraft EDY 7, DY 425</p>  <p>Hall²⁰⁸ 6+3 Anschlüsse¹⁷⁰</p> <p>Ford</p> | <p>ZM024</p> <p>Mitsubishi Mitsubishi J 117, J007X00871 Ford E 92Z-12A297-A Mazda F 829 18V20 Motorcraft DYE 524, DYE 539, DYE 589</p>  <p>induktiv²⁰⁷ 4 Anschlüsse¹⁷⁰</p> <p>Ford, Mazda, Nissan</p> |
| <p>ZM020</p> <p>Lucas Lucas DAB 118, DAB 127, DAB 129, DAB 135, 84403 Ford 6153380, 84SF-12KO57-AA, 84SF-12KO59-AA Marelli 940 038 544 Rover RTC 5089</p>  <p>induktiv²⁰⁷ 2+3 Anschlüsse¹⁷⁰</p> <p>Ford, Morgan, Reliant, Rover</p> | <p>ZM025</p> <p>Mitsubishi Mitsubishi J 120, J 170, J 170-9910A Mazda B541-18-V20</p>  <p>induktiv²⁰⁷ 5 Anschlüsse¹⁷⁰</p> <p>Ford, Mazda</p> |
| <p>ZM022</p> <p>Mitsubishi Mitsubishi MD 607 364, DYE 923, J 106 Chrysler MD 607478 Lucas DAJ 204 Mazda 8574-24-910,</p>  <p>induktiv²⁰⁷ 4 Anschlüsse¹⁷⁰</p> <p>Chrysler, Mazda, Mitsubishi</p> | <p>ZM026</p> <p>Bosch Bosch 0 227 100 200 BMW 1214 1461 441 GM 90 44 650 Opel 12 08 074</p>  <p>Endstufe¹²³ 7 Anschlüsse¹⁷⁰</p> <p>BMW , Citroën, Fiat, Lancia, Opel, Peugeot, Porsche</p> |

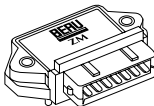

ZM027

Hitachi
Hitachi DIS4-05
VW / Audi 4A0 905 351



Endstufe¹²³
4+3 Anschlüsse¹⁷⁰

Audi

ZM034

Bosch
Bosch 1 227 022 028
GM 90241775, 90296502,
90297486, 90320586,
90350987, 90279786,
90297786
Opel 12 08 040, 12 08 045,
12 08 057, 12 37 306

Bosch 0 221 600 053,
0 221 600 057,
0 221 600 060

Opel



Endstufe¹²³
2+4 Anschlüsse¹⁷⁰

ZM029

Bosch
Lucas DAB 421
Saab 7538796

Bosch 0 221 600 055



Endstufe¹²³
2+4 Anschlüsse¹⁷⁰

Saab

ZM036

Bosch
Bosch 1 227 022 034
Renault 7401275174
Volvo 1275174, 1367777,
3507934

Bosch 0 221 601 005,
0 221 601 012,
0 221 601 452

Renault, Volvo



Endstufe¹²³
2+4 Anschlüsse¹⁷⁰

ZM031

Bosch
Hitachi CM1T204B,
CM1T204D,
CM1T204E
VW / Audi 440 905 105,
443 905 105 B



Endstufe¹²³
2+3 Anschlüsse¹⁷⁰

Audi

ZM038

Bosch
BMW 12 14 1 287 757,
12 14 1 705 607,
12 14 1 705 608,
12 14 1 706 439
Siemens 6116, 5WK6
Telefunken 337179

BMW



induktiv²⁰⁷
2+5 Anschlüsse¹⁷⁰

ZM032

Bosch
Bosch 1 227 022 024
GM 90273966
Opel 12 08 247



Endstufe¹²³
2+4 Anschlüsse¹⁷⁰

Opel, Vauxhall

ZM039







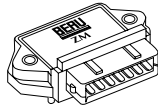

Bosch
Bosch 0 227 100 120
Lada/ 363734,
Shiguli 2108373491010
Volvo/DAF 285230, 3501922

Lada, Volvo



Hall²⁰⁸
7 Anschlüsse¹⁷⁰



| | |
|--|--|
| <p>ZM040</p> <p>Bosch Bosch 0 227 100 145 Fiat/Lancia 7612955, 9612955 Volvo 3501921, 3501921-5</p>  <p>Endstufe¹²³ 6 Anschlüsse¹⁷⁰</p> <p>Lancia, Volvo</p> | <p>ZM046</p> <p>Hitachi GM 94243344 Hitachi E1261, E1288 Honda 30120-PA0-661, 30120-PH4-005, 32120-PA0-661 8942433440 Isuzu 8942433440 Lucas DAJ 106 Nissan 22020-15M00, 22020-15M20, 22020-P4005 Subaru 49146-7401</p>  <p>induktiv²⁰⁷ 2 Anschlüsse¹⁷⁰</p> <p>Subaru</p> |
| <p>ZM041</p> <p>Lucas Lucas DAB 126, DAB 134, 80334 A, 8490 D GM 90360314, 90360315, 90243618, 90243630 Opel 12 37 334, 12 37 464, 62 37 777 Siemens 5 WKG 6208, 5 WKG 222</p>  <p>Endstufe¹²³ 4 Anschlüsse¹⁷⁰</p> <p>Opel, Vauxhall</p> | <p>ZM047</p> <p>Lucas Lucas 54 896, 80 428, 84 193, 84 453, 84 453B, 84 504B, 84 567, 84 567B, 84 896, DAB 119, DAB 120, DAB 121, DAB 127, DAB 135 Rover BAU5100, BAU5538, RTC5089</p>  <p>induktiv²⁰⁷ 2 Anschlüsse¹⁷⁰</p> <p>Aston Martin, Ford, Rover, TVR</p> |
| <p>ZM043</p> <p>Delco Delco 1798617, 1976908, 1977907, 1987744, D1948, D1952, D1956, D1963A Ford E2FS12A297B, ESFZ12Z297 GM 1976908, 1977907, 1978617, 1987744 Opel 16 05 130</p>  <p>induktiv²⁰⁷ 2+5 Anschlüsse¹⁷⁰</p> <p>Cadillac (USA), Fiat, Chevrolet (USA), GMC (USA), Oldmobile (USA), Pontiac (USA)</p> | <p>ZM048</p> <p>Lucas 84987, 84988, DAB 132, DAB 133 Ford F3XY12D 072A Nissan 22020-0B000, 22020-53J120, 22020-55Y00, 22020-53J10, 22020-53J20, 22020-56E11, 22020-56E16, 22020-56E17, 22020-70J00, 22020-71J00, PRW1A, PRW2, PRW2A, PRW3</p>  <p>Endstufe¹²³ 3 Anschlüsse¹⁷⁰</p> <p>Nissan</p> |
| <p>ZM045</p> <p>Hitachi Hitachi E12302, E12303 Honda 30130-P06-006</p>  <p>induktiv²⁰⁷ 4 Anschlüsse¹⁷⁰</p> <p>Honda</p> | <p>ZM049</p> <p>Mitsubishi Bosch 9 222 067 034 Chrysler MD112479, MD164475 Hyundai 27360-32800, 96056317, 96067829 Mitsubishi 112955, 132243, 2371771, J007X00971, J007X01271, J009T02071, J121, MD112479, MD129550, MD1312243, MD164475, MD611384, MD618268</p>  <p>induktiv²⁰⁷ 3 Anschlüsse¹⁷⁰</p> <p>Hyundai, Mitsubishi</p> |

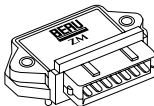

ZM050

Mitsubishi
 Ford F0BZ12A297A
 Mazda BP01-18-251
 Mitsubishi J701



induktiv²⁰⁷
 3 Anschlüsse¹⁷⁰

Mazda

ZM054

Nippon Denso
 Austin-Rover BNP 3661, CKP 7061
 Honda 30550-689-003,
 30550-692-004,
 30550-692-014,
 30550-692-2014



induktiv²⁰⁷
 5 Anschlüsse¹⁷⁰

Honda, Triumph

ZM051

Mitsubishi
 Mitsubishi MD618293, J153



induktiv²⁰⁷
 4 Anschlüsse¹⁷⁰

Mitsubishi

ZM055

Nippon Denso
 Honda 30550-PH3 004



induktiv²⁰⁷
 5 Anschlüsse¹⁷⁰

Honda

ZM052

Mitsubishi
 Mitsubishi 5201A, J007X03471,
 J304
 Nissan 22020-D0210



induktiv²⁰⁷
 6 Anschlüsse¹⁷⁰

Nissan (USA), Renault

ZM056

Nippon Denso
 Honda 30120-PA6-921,
 30120-PB1-006,
 30120-PH7-006,
 30120-PJ7-003



induktiv²⁰⁷
 4 Anschlüsse¹⁷⁰

Honda

ZM053

Mitsubishi
 Chrysler MD607814,
 MD611384
 Hyundai 27120-21020,
 27120-21050
 Mazda AM15-18-V20,
 E730-12-491 0
 Mitsubishi EJN902, J152,
 MD607814,
 MD611384



induktiv²⁰⁷
 2 Anschlüsse¹⁷⁰

Daihatsu, Hyundai, Mitsubishi

ZM057





Nippon Denso
 GM 9404544
 Isuzu 8944045440
 Mitsubishi CY-GS 065 A
 Nippon Denso 131300-0033,
 131300-0072,
 131300-033,
 131300-0330
 Toyota 89620-10090,
 89620-10120,
 89620-12340,
 89620-16070,
 CY-GS 065 A

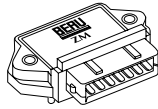

induktiv²⁰⁷
 2+2 Anschlüsse¹⁷⁰

Toyota



| | |
|---|--|
| <p>ZM058</p> <p>Nippon Denso GM 94840126 Nippon Denso 131000-0511, 131000-0920, 131000-511, 131000- 920, 131300-0511, 131300-0920 Toyota 16080-12320, 78512- 12310, 89612-12310, 89612-12320, 89612- 16080, 89620-12290, 89620-12310, 89620- 12320, 89620-16080, 89620-26080</p> <p>Toyota</p> | <p>ZM062</p> <p>Bosch Bosch 0 227 100 211 Ford 98 VW12A223AA VW/Audi 4D0905351</p>  <p>Endstufe¹²³ 5+4 Anschlüsse¹⁷⁰</p> <p>Audi, Seat, Skoda, VW</p> |
| <p>ZM059</p> <p>Nippon Denso Hitachi L130-5046 Honda 30120-PA-921 Nippon Denso 131000-0011, 131300-0011, 131300-0120, 131300-0121 Toyota 89620-14210, 89620-32020, L1305046</p> <p>Toyota</p> | <p>ZM063</p> <p>Bosch Bosch 0 227 100 209, 0 227 100 210 VW/Audi 4A0905351A</p>  <p>Endstufe¹²³ 4+3 Anschlüsse¹⁷⁰</p> <p>Audi</p> |
| <p>ZM060</p> <p>Lada Magneton-Pal TYP 443 213 221 020 Skoda 115915080 VW/Audi 115 915 080</p>  <p>induktiv²⁰⁷ 4 Anschlüsse¹⁷⁰</p> <p>Skoda</p> | |
| <p>ZM061</p> <p>Marelli Lucas DAB 801 Magnet Marelli 64833031, 64833036, 940038535, 64833031010, 64833036010, 581701010000, 581701020000, BKL3B, BKL 3BD</p>  <p>Endstufe¹²³ 6 (7) Anschlüsse¹⁷⁰</p> <p>Ferrari, Fiat, Lancia</p> | |

Short Code → Technical Code

| Short Code | Technical Code | Short Code | Technical Code | Short Code | Technical Code | Short Code | Technical Code |
|------------|----------------|------------|----------------|------------|----------------|------------|----------------|
| Z1 | 14-8DU | Z76 | 14-9DU | Z198 | 14FR-5LDU3 | Z288 | 12ZR-7SP03 |
| Z2 | 14-8DTU | Z78 | 14-9DTU | Z200 | 14F-7HUR2 | Z291 | 12FR-5DU |
| Z3 | 14-8LUR | Z79 | 14F-9DU0 | Z203 | 14FR-8LU2 | Z292 | 12FR-6DU |
| Z4 | 14F-8LUR | Z82 | 14R-9DU | Z204 | 14FGR-8CTU | Z293 | 12FR-6LUX |
| Z5 | 14F-8DU0 | Z89 | 14FGH-6DTUR | Z206 | 14FR-7DPPUS2 | Z294 | 14FGR-5NTE |
| Z6 | 14K-8DU | Z90 | 14FGH-7DTURX | Z207 | 14KG-8DTU | Z295 | 14F-6DTPRO2 |
| Z7 | 14K-8DU0 | Z91 | 14GH-7DTUR | Z208 | 14FR-8LDU3 | Z296 | 14KR-7DPUV |
| Z8 | 14R-8DU | Z92 | 14GH-8DTUR | Z209 | 14KR-6DPUV02 | Z297 | 14FR-7LPUX0 |
| Z9 | 14R-8DUX | Z93 | 14GH-8DTURX | Z210 | 10FR-6CPU03 | Z298 | 14KR-8DPUV |
| Z10 | 14-7BU | Z94 | 14GR-8DTU | Z211 | 14FGR-8MQPU | Z299 | 14FR-7LUX0 |
| Z11 | 14-7DU | Z95 | 14KR-7DU | Z213 | 14FGR-7KDU6 | Z300 | 14FGR-6HQU |
| Z12 | 14-7DTU | Z97 | 14KR-8MPX | Z216 | 14KR-10SUV2 | Z301 | 14FR-7LPUX02 |
| Z13 | 14F-7DUOR | Z98 | 14FR-7LDU | Z219 | 14FR-8MPUX02 | Z302 | 14FR-8MPUX2 |
| Z14 | 14F-7LDUR4 | Z99 | 14FR-6DUX | Z220 | 14FR-9KUX2 | Z303 | 14FR-7MUX2 |
| Z15 | 14FR-7DU | Z100 | 14F-8DU4 | Z221 | 14FR-6DPUX02 | Z304 | 14FGR-7DTUT |
| Z16 | 14FR-7DUX | Z101 | 14F-8LDUSR | Z222 | 14KR-8STUX | Z305 | 14KR-6MUU |
| Z17 | 14K-7DU | Z104 | 14-6DPO | Z223 | 14FR-8NQU23 | Z306 | 12F-6HPURW |
| Z18 | 14K-7DU0 | Z105 | 14F-6DSR | Z224 | 14FR-7DPU3 | Z307 | 14FR-7DPUV02 |
| Z19 | 14R-7BU | Z108 | G3/18 | Z225 | 14FR-7HUX | Z308 | 12FR-6MUW |
| Z20 | 14R-7DU | Z111 | 14C-7D | Z226 | 14FR-6MPU2 | Z309 | 14KR-8LQPU07 |
| Z21 | 14R-7DUX | Z112 | 14-8E | Z227 | 14F-8DUR | Z310 | 14KR-8MPUV2 |
| Z22 | 14-6DU | Z116 | 14FR-6LDU | Z228 | 14FR-7DPUX02 | Z311 | 14R-8DPUU |
| Z24 | 14FR-6DU | Z117 | 14KR-9DUX | Z229 | 14FR-8LPU0 | Z312 | 14FR-7KPPU |
| Z25 | 14K-6DU | Z118 | 14-8BU | Z230 | 14KR-6KPUV02 | Z313 | 14FR-6DPUX2 |
| Z26 | 14KR-6DU | Z119 | 14R-8DU4 | Z233 | 12ZR-6SP03 | Z314 | 14FR-6DPUW2 |
| Z27 | 14R-6DU | Z120 | 14FGH-7DTURX0 | Z234 | 12FR-7DU | Z315 | 14KR-6MPV |
| Z28 | 14R-6DUX | Z121 | 14FGH-8DTURX0 | Z235 | 14FR-7SPUX03 | Z317 | 14F-5DPUR2T |
| Z29 | 14F-5DU | Z122 | 14FGH-8DPURX2 | Z236 | 14F-6HTPRX02 | Z318 | 12ZR-6SPP2 |
| Z30 | 14FR-5DU | Z123 | 14FR-7KDU | Z237 | 14FR-7DQUP7 | Z320 | 12ZR-8STP |
| Z31 | 14K-5DU | Z126 | 14FGH-8DTUR | Z238 | 14FR-8DPU2 | Z321 | 14F-7KPPRU2 |
| Z32 | 18K-7BU | Z127 | 14KGR-7KQU | Z239 | 14FGR-7KQE | Z322 | 14F-6KPURW2 |
| Z33 | 18K-6BU | Z129 | 14FGR-6KQU | Z240 | 14F-8DPURX02 | Z323 | 14FR-5DPPUX |
| Z38 | 14Z-3CU | Z130 | 14FR-5DPUX | Z242 | 12ZR-8TP | Z324 | 14FGR-7LDUW |
| Z39 | 14Z-4AU | Z144 | 14KGR-6KQU | Z243 | 12VR-8SE | Z325 | 12VR-7SPUX |
| Z40 | 14-5AU | Z145 | 14FGR-6DDU | Z245 | 14FR-6LDUW | Z326 | 14FR-7MPUS |
| Z41 | 14-5BU | Z148 | 14KR-8DPUOV | Z246 | 14FGH-8DTURW | Z332 | 12ZR-6SPP2-1 |
| Z42 | 14-5DU | Z149 | 14FR-7KPUX | Z247 | 14FR-7DUW | Z333 | 12FR-6DPUX |
| Z44 | 14-5DTU | Z150 | 14FR-7KPUV | Z248 | 14FR-8HUT | Z334 | 14FR-8DEW |
| Z45 | 14FR-5DTU | Z151 | 14FR-7KPU | Z249 | 14FR-8KUOU | Z335 | 14FR-6DUW2 |
| Z46 | 14K-5DU0 | Z152 | 14FR-8HU | Z250 | 14FR-7DU2S | Z336 | 12ZR-6SP2 |
| Z47 | 14R-5DU | Z153 | 14FR-8KU | Z251 | 14FR-7DU2T | Z337 | 14FR-7DPPUW2 |
| Z48 | 14-6BU | Z154 | 14FR-8KU0 | Z252 | 14FR-6DUW | Z338 | 12FR-4DPUT |
| Z49 | 14KR-6BU | Z155 | 14FR-7KU | Z253 | 14FR-5DUU | Z339 | 14F-4NBPR |
| Z51 | 14-6DTU | Z156 | 14FR-7KU0 | Z254 | 14FR-8DUS | Z340 | 14FR-6DPU02S |
| Z52 | 14F-6DTU | Z157 | 14FR-7KUOX | Z255 | 14FR-8DUW | Z341 | 10FR-7KDUS |
| Z53 | 14F-6DTU | Z158 | 14FR-7LUX | Z257 | 14FR-7LDUW | Z342 | 14KR-7MPUV2 |
| Z56 | 14K-6DU0 | Z159 | 14FR-6DPUX | Z266 | 14S-7E | Z343 | 14FR-8DPPUX |
| Z57 | 14-7AU | Z170 | 14F-7DPURU2 | Z267 | 14S-7EU0 | Z344 | 14F-7HTUR |
| Z58 | 14-7CU | Z171 | 14F-7DPURX2 | Z272 | 14F-7HURU02 | Z345 | 14F-4NBPR2LS |
| Z59 | 14R-7CU | Z172 | 14FGR-7KQU | Z273 | 14FR-7NUX2 | Z346 | 14FR-7LPUT02 |
| Z60 | 14FGR-7CTU | Z173 | 14FGR-8KQU | Z274 | 12VR-6MPPUS | Z347 | 14F-5DPURS2 |
| Z61 | 14-7DU0 | Z176 | 14F-7HPURX2 | Z275 | 14FR-6LPUOX | Z348 | 14F-5MPUR2L |
| Z62 | 14-7DU0 | Z177 | 14KR-8MUV | Z277 | 14F-5MPURO3 | Z349 | 14F-6LPURW03 |
| Z63 | 14F-7DU | Z183 | 14FR-8MU2 | Z278 | 14FR-8LPU02 | Z354 | 14FR-5LPUOX |
| Z67 | 14KR-7DUX | Z184 | 14FR-7MU2 | Z279 | 14FR-7LPU02 | Z355 | 12VR-5SPPU |
| Z68 | 14-8AU | Z185 | 14F-6DPURO21 | Z280 | 14FR-7KPUX02 | Z356 | 14KR-7MPUX2 |
| Z70 | 14-8DU0 | Z188 | 14F-7DPURO2 | Z282 | 14FGH-7DPURX2 | Z357 | 12FR-4MPPUS |
| Z72 | 14FR-8DU | Z190 | 14FGR-8DQU7 | Z284 | 14FR-6DPOX | Z358 | 12FR-6DUT |
| Z73 | 14FR-8DUX | Z192 | 14FR-5LDU | Z285 | 14R-9KPUV2 | Z359 | 12F-5NPUR2T |
| Z74 | 14FR-8LDUOX4 | Z193 | 14FR-7DU2 | Z286 | 12FR-5SDU | Z360 | 14FGR-7DTUU |
| Z75 | 14G-8DTU | Z194 | 14FR-6LDU3 | Z287 | 14FR-8LU2T | | |

Technical Code → Short Code

| Technical Code | Short Code | Technical Code | Short Code | Technical Code | Short Code |
|----------------|------------|----------------|------------|----------------|------------|
| UX56 | | 14-9DTU | Z78 | 14FR-5DU | Z30 |
| UXK56 | | 14-9DU | Z76 | 14FR-5DUU | Z253 |
| UXT1 | | 14C-7D | Z111 | 14FR-5LDU | Z192 |
| UXT2 | | 14F-4NBPR | Z339 | 14FR-5LDU3 | Z198 |
| UXT3 | | 14F-4NBPR2LS | Z345 | 14FR-5LPUOX | Z354 |
| UXT4 | | 14F-5DPUR2T | Z317 | 14FR-6DPOX | Z284 |
| UXT5 | | 14F-5DPURS2 | Z347 | 14FR-6DPU02S | Z340 |
| UXT7 | | 14F-5DU | Z29 | 14FR-6DPUW2 | Z314 |
| UXT8 | | 14F-5MPURO3 | Z277 | 14FR-6DPUX | Z159 |
| UXT9 | | 14F-5MPUR2L | Z348 | 14FR-6DPUX02 | Z221 |
| UXT10 | | 14F-6DPUR021 | Z185 | 14FR-6DPUX2 | Z313 |
| UXT11 | | 14F-6DTPR02 | Z295 | 14FR-6DU | Z24 |
| UXT12 | | 14F-6DTU | Z52 | 14FR-6DUW | Z252 |
| UXT13 | | 14F-6DTU | Z53 | 14FR-6DUW2 | Z335 |
| UXT14 | | 14F-6HTPRX02 | Z236 | 14FR-6DUX | Z99 |
| UXT15 | | 14F-6KPURW2 | Z322 | 14FR-6LDU | Z116 |
| 10FR-6CPU03 | Z210 | 14F-6LPURW03 | Z349 | 14FR-6LDU3 | Z194 |
| 10FR-7KDUS | Z341 | 14F-7DPUR02 | Z188 | 14FR-6LDUW | Z245 |
| 12F-5NPUR2T | Z359 | 14F-7DPURU2 | Z170 | 14FR-6LPUOX | Z275 |
| 12F-6HPURW | Z306 | 14F-7DPURX2 | Z171 | 14FR-6MPU2 | Z226 |
| 12FR-4DPUT | Z338 | 14F-7DU | Z63 | 14FR-7DPPUS2 | Z206 |
| 12FR-4MPPUS | Z357 | 14F-7DU0R | Z13 | 14FR-7DPPUW2 | Z337 |
| 12FR-5DU | Z291 | 14F-7HPURX2 | Z176 | 14FR-7DPU3 | Z224 |
| 12FR-5SDU | Z286 | 14F-7HTUR | Z344 | 14FR-7DPUV02 | Z307 |
| 12FR-6DPUX | Z333 | 14F-7HUR2 | Z200 | 14FR-7DPUX02 | Z228 |
| 12FR-6DU | Z292 | 14F-7HURU02 | Z272 | 14FR-7DQUP7 | Z237 |
| 12FR-6DUT | Z358 | 14F-7KPPRU2 | Z321 | 14FR-7DU | Z15 |
| 12FR-6LUX | Z293 | 14F-7LDUR4 | Z14 | 14FR-7DU2 | Z193 |
| 12FR-6MUW | Z308 | 14F-8DPURX02 | Z240 | 14FR-7DU2S | Z250 |
| 12FR-7DU | Z234 | 14F-8DU0 | Z5 | 14FR-7DU2T | Z251 |
| 12VR-5SPPU | Z355 | 14F-8DU4 | Z100 | 14FR-7DUW | Z247 |
| 12VR-6MPPUS | Z274 | 14F-8DUR | Z227 | 14FR-7DUX | Z16 |
| 12VR-7SPUX | Z325 | 14F-8LDUSR | Z101 | 14FR-7HUX | Z225 |
| 12VR-8SE | Z243 | 14F-8LUR | Z4 | 14FR-7KDU | Z123 |
| 12ZR-6SP03 | Z233 | 14F-9DU0 | Z79 | 14FR-7KPPU | Z312 |
| 12ZR-6SP2 | Z336 | 14FGH-6DTUR | Z89 | 14FR-7KPU | Z151 |
| 12ZR-6SPP2-1 | Z332 | 14FGH-7DPURX2 | Z282 | 14FR-7KPUV | Z150 |
| 12ZR-8STP | Z320 | 14FGH-7DTURX | Z90 | 14FR-7KPUX | Z149 |
| 12ZR-8TP | Z242 | 14FGH-7DTURX0 | Z120 | 14FR-7KPUX02 | Z280 |
| 14-5AU | Z40 | 14FGH-8DPURX2 | Z122 | 14FR-7KU | Z155 |
| 14-5BU | Z41 | 14FGH-8DTUR | Z126 | 14FR-7KU0 | Z156 |
| 14-5DTU | Z44 | 14FGH-8DTURW | Z246 | 14FR-7KUOX | Z157 |
| 14-5DU | Z42 | 14FGH-8DTURX0 | Z121 | 14FR-7LDU | Z98 |
| 14-6BU | Z48 | 14FGHR-7DTUT | Z304 | 14FR-7LDUW | Z257 |
| 14-6DPO | Z104 | 14FGHR-7DTUU | Z360 | 14FR-7LPU02 | Z279 |
| 14-6DTU | Z51 | 14FGHR-7LDUW | Z324 | 14FR-7LPUT02 | Z346 |
| 14-6DU | Z22 | 14FGR-5NTE | Z294 | 14FR-7LPUX0 | Z297 |
| 14-7AU | Z57 | 14FGR-6DDU | Z145 | 14FR-7LPUX02 | Z301 |
| 14-7BU | Z10 | 14FGR-6HQU | Z300 | 14FR-7LUX | Z158 |
| 14-7CU | Z58 | 14FGR-6KQU | Z129 | 14FR-7LUX0 | Z299 |
| 14-7DTU | Z12 | 14FGR-7CTU | Z60 | 14FR-7MPUS | Z326 |
| 14-7DU | Z11 | 14FGR-7KDU6 | Z213 | 14FR-7MU2 | Z184 |
| 14-7DU0 | Z61 | 14FGR-7KQE | Z239 | 14FR-7MUX2 | Z303 |
| 14-7DU0 | Z62 | 14FGR-7KQU | Z172 | 14FR-7NUX2 | Z273 |
| 14-8AU | Z68 | 14FGR-8CTU | Z204 | 14FR-7SPUX03 | Z235 |
| 14-8BU | Z118 | 14FGR-8DQU7 | Z190 | 14FR-8DEW | Z334 |
| 14-8DTU | Z2 | 14FGR-8KQU | Z173 | 14FR-8DPPUX | Z343 |
| 14-8DU | Z1 | 14FGR-8MQPU | Z211 | 14FR-8DPU2 | Z238 |
| 14-8DU0 | Z70 | 14FR-5DPPUX | Z323 | 14FR-8DU | Z72 |
| 14-8E | Z112 | 14FR-5DPUX | Z130 | 14FR-8DUS | Z254 |
| 14-8LUR | Z3 | 14FR-5DTU | Z45 | 14FR-8DUW | Z255 |

Technical Code → Short Code

| Technical Code | Short Code | Technical Code | Short Code | Technical Code | Short Code |
|----------------|------------|----------------|------------|----------------|------------|
| 14FR-8DUX | Z73 | 14R-8DU | Z8 | | |
| 14FR-8HU | Z152 | 14R-8DU4 | Z119 | | |
| 14FR-8HUT | Z248 | 14R-8DUX | Z9 | | |
| 14FR-8KU | Z153 | 14R-9DU | Z82 | | |
| 14FR-8KUO | Z154 | 14R-9KPUV2 | Z285 | | |
| 14FR-8KUOU | Z249 | 14S-7E | Z266 | | |
| 14FR-8LDU3 | Z208 | 14S-7EU0 | Z267 | | |
| 14FR-8LDUOX4 | Z74 | 14Z-3CU | Z38 | | |
| 14FR-8LPU0 | Z229 | 14Z-4AU | Z39 | | |
| 14FR-8LPU02 | Z278 | 18K-6BU | Z33 | | |
| 14FR-8LU2 | Z203 | 18K-7BU | Z32 | | |
| 14FR-8LU2T | Z287 | G3/18 | Z108 | | |
| 14FR-8MPUX02 | Z219 | | | | |
| 14FR-8MPUX2 | Z302 | | | | |
| 14FR-8MU2 | Z183 | | | | |
| 14FR-8NQU23 | Z223 | | | | |
| 14FR-9KUX2 | Z220 | | | | |
| 14G-8DTU | Z75 | | | | |
| 14GH-7DTUR | Z91 | | | | |
| 14GH-8DTUR | Z92 | | | | |
| 14GH-8DTURX | Z93 | | | | |
| 14GR-8DTU | Z94 | | | | |
| 14K-5DU | Z31 | | | | |
| 14K-5DU0 | Z46 | | | | |
| 14K-6DU | Z25 | | | | |
| 14K-6DU0 | Z56 | | | | |
| 14K-7DU | Z17 | | | | |
| 14K-7DU0 | Z18 | | | | |
| 14K-8DU | Z6 | | | | |
| 14K-8DU0 | Z7 | | | | |
| 14KG-8DTU | Z207 | | | | |
| 14KGR-6KQU | Z144 | | | | |
| 14KGR-7KQU | Z127 | | | | |
| 14KR-10SUV2 | Z216 | | | | |
| 14KR-6BU | Z49 | | | | |
| 14KR-6DPUV02 | Z209 | | | | |
| 14KR-6DU | Z26 | | | | |
| 14KR-6KPUV02 | Z230 | | | | |
| 14KR-6MPV | Z315 | | | | |
| 14KR-6MUU | Z305 | | | | |
| 14KR-7DPUV | Z296 | | | | |
| 14KR-7DU | Z95 | | | | |
| 14KR-7DUX | Z67 | | | | |
| 14KR-7MPUV2 | Z342 | | | | |
| 14KR-7MPUX2 | Z356 | | | | |
| 14KR-8DPU0V | Z148 | | | | |
| 14KR-8DPUV | Z298 | | | | |
| 14KR-8LQPU07 | Z309 | | | | |
| 14KR-8MPUV2 | Z310 | | | | |
| 14KR-8MPX | Z97 | | | | |
| 14KR-8MUV | Z177 | | | | |
| 14KR-8STUX | Z222 | | | | |
| 14KR-9DUX | Z117 | | | | |
| 14R-5DU | Z47 | | | | |
| 14R-6DU | Z27 | | | | |
| 14R-6DUX | Z28 | | | | |
| 14R-7BU | Z19 | | | | |
| 14R-7CU | Z59 | | | | |
| 14R-7DU | Z20 | | | | |
| 14R-7DUX | Z21 | | | | |
| 14R-8DPUU | Z311 | | | | |

Long Code → Short Code

| Long Code | Short Code | Long Code | Short Code | Long Code | Short Code |
|--|------------|------------------|------------|------------------|------------|
| CONNECTOR, COIL | | GLOW PLUG | | GLOW PLUG | |
| 0300122111 | ZLE234 | 0100221106 | GV602 | 0100226284 | GN989 |
| 0300122114 | ZLE255 | 0100221107 | GV603 | 0100226299 | GN991 |
| 0300122115 | ZLE232 | 0100221108 | GV604 | 0100226300 | GN992 |
| 0300122116 | ZLE233 | 0100221132 | GV631 | 0100226302 | GN994 |
| 0300122117 | ZLE276 | 0100221133 | GV636 | 0100226312 | GN997 |
| 0300122118 | ZLE277 | 0100221135 | GV642 | 0100226336 | GN005 |
| 0300122119 | ZLE278 | 0100221141 | GV657 | 0100226338 | GN008 |
| 0300122122 | ZLE288 | 0100221144 | GV661 | 0100226343 | GN007 |
| CONNECTOR, SPARK PLUG AND COILS | | 0100221145 | GV663 | 0100226344 | GN027 |
| 0300122111 | ZLE234 | 0100221146 | GV666 | 0100226351 | GN026 |
| 0300122114 | ZLE255 | 0100221147 | GV673 | 0100226352 | GN039 |
| 0300122115 | ZLE232 | 0100221149 | GV685 | 0100226354 | GN012 |
| 0300122116 | ZLE233 | 0100221151 | GV688 | 0100226362 | GN024 |
| 0300122117 | ZLE276 | 0100221152 | GV689 | 0100226365 | GN010 |
| 0300122118 | ZLE277 | 0100221154 | GV705 | 0100226366 | GN013 |
| 0300122119 | ZLE278 | 0100221163 | GV719 | 0100226370 | GN025 |
| 0300122122 | ZLE288 | 0100221167 | GV727 | 0100226371 | GN016 |
| CONTROL UNIT, GLOW PLUG SYSTEM | | 0100221170 | GV730 | 0100226372 | GN017 |
| 0201010001 | GR001 | 0100221186 | GV749 | 0100226373 | GN018 |
| 0201010031 | GR031 | 0100221209 | GV106 | 0100226375 | GN019 |
| 0201010034 | GR034 | 0100221210 | GV130 | 0100226379 | GN003 |
| 0201010049 | GR049 | 0100222101 | GV894 | 0100226381 | GN022 |
| 0201010054 | GR054 | 0100222105 | GV001 | 0100226384 | GN993 |
| 0201010059 | GR059 | 0100222106 | GN057 | 0100226385 | GN939 |
| 0201010064 | GR064 | 0100222301 | GV107 | 0100226391 | GN030 |
| 0201010065 | GR065 | 0100222302 | GV108 | 0100226392 | GN015 |
| 0201010066 | GR066 | 0100226129 | GV783 | 0100226417 | GN033 |
| 0201010067 | GR067 | 0100226163 | GV852 | 0100226422 | GN035 |
| 0201010069 | GR069 | 0100226164 | GV844 | 0100226432 | GN925 |
| 0201010070 | GR070 | 0100226170 | GN853 | 0100226435 | GN050 |
| 0201010071 | GR071 | 0100226171 | GN854 | 0100226436 | GN041 |
| 0201010073 | GR073-B | 0100226173 | GN857 | 0100226475 | GN043 |
| 0201010074 | GR074 | 0100226180 | GV886 | 0100226480 | GN042 |
| 0201010075 | GR075 | 0100226182 | GV897 | 0100226482 | GN046 |
| 0201010076 | GR076 | 0100226184 | GN905 | 0100226492 | GN054 |
| 0201010080 | GR080 | 0100226185 | GN908 | 0100226494 | GN055 |
| 0201010081 | GR081 | 0100226186 | GN909 | 0100226495 | GN103 |
| 0522120701 | GSE101 | 0100226188 | GN912 | 0100226497 | GN104 |
| 0522120702 | GSE100 | 0100226189 | GN917 | 0100226511 | GN107 |
| 0522120720 | GSE140 | 0100226194 | GV921 | 0100226513 | GN102 |
| 0522120721 | GSE142 | 0100226198 | GN927 | 0100226514 | GN101 |
| 0522120722 | GSE143 | 0100226206 | GN944 | 0100226517 | GN060 |
| 0522120723 | GSE144 | 0100226207 | GV946 | 0100226520 | GN061 |
| 0522120724 | GSE145 | 0100226208 | GV947 | 0100226522 | GN062 |
| 0522140701 | GSE102 | 0100226209 | GV945 | 0100226525 | GN106 |
| 0522140709 | GSE114 | 0100226227 | GN855 | 0100226526 | GN064 |
| 0522140710 | GSE116 | 0100226229 | GN954 | 0100226527 | GN065 |
| 0522140711 | GSE141 | 0100226233 | GN955 | 0100226538 | GN108 |
| 0522150701 | GSE103 | 0100226234 | GN858 | 0100226568 | GN110 |
| GLOW PLUG | | 0100226235 | GN948 | 0100226569 | GN067 |
| 0100101302 | GD214 | 0100226237 | GN959 | 0100226570 | GN068 |
| 0100101304 | GD318 | 0100226238 | GN999 | 0100226577 | GN095 |
| 0100101305 | GD348 | 0100226242 | GV967 | 0100226638 | GN096 |
| 0100101308 | GD382 | 0100226243 | GV968 | 0100226639 | GN097 |
| 0100220113 | GV888 | 0100226245 | GN963 | 0100230101 | GV887 |
| 0100220114 | GV889 | 0100226246 | GN964 | 0100230102 | GV890 |
| 0100220115 | GV892 | 0100226249 | GN970 | 0100230107 | GN044 |
| 0100220118 | GV920 | 0100226250 | GN961 | 0100231107 | GV895 |
| 0100220206 | GV137 | 0100226255 | GN985 | 0100231120 | GV736 |
| 0100221101 | GV112 | 0100226258 | GN860 | 0100231133 | GN066 |

Long Code → Short Code

| Long Code | Short Code | Long Code | Short Code | Long Code | Short Code |
|----------------------|------------|----------------------|------------|----------------------|------------|
| GLOW PLUG | | IGNITION COIL | | IGNITION COIL | |
| 0100266002 | GE102 | 0040100017 | ZS017 | 0040100263 | ZS263 |
| 0100266003 | GE103 | 0040100029 | ZS029 | 0040100264 | ZS264 |
| 0100266008 | GE100 | 0040100031 | ZS031 | 0040100265 | ZS265 |
| 0100266009 | GE101 | 0040100036 | ZS036 | 0040100266 | ZS266 |
| 0100266010 | GE104 | 0040100037 | ZS037 | 0040100267 | ZS267 |
| 0100266011 | GE105 | 0040100041 | ZS041 | 0040100269 | ZS269 |
| 0100266019 | GE113 | 0040100043 | ZS043 | 0040100274 | ZS274 |
| 0100266031 | GE112 | 0040100052 | ZS052 | 0040100275 | ZS275 |
| 0100266032 | GE110 | 0040100053 | ZS053 | 0040100276 | ZS276 |
| 0100266033 | GE111 | 0040100068 | ZS068 | 0040100277 | ZS277 |
| 0100266034 | GE114 | 0040100077 | ZS077 | 0040100278 | ZS278 |
| 0100266037 | GE118 | 0040100079 | ZS079 | 0040100279 | ZS279 |
| 0100266040 | GE115 | 0040100088 | ZS088 | 0040100280 | ZS280 |
| 0100266042 | GE116 | 0040100090 | ZS090 | 0040100281 | ZS281 |
| 0100266050 | GE117 | 0040100095 | ZS095 | 0040100282 | ZS282 |
| 0100266059 | GE109 | 0040100105 | ZS105 | 0040100283 | ZS283 |
| 0100266065 | GE119 | 0040100106 | ZS106 | 0040100296 | ZS296 |
| 0100266066 | GE120 | 0040100109 | ZS109 | 0040100297 | ZS297 |
| 0100266068 | GE121A | 0040100110 | ZS110 | 0040100298 | ZS298 |
| 0100266071 | GE122 | 0040100115 | ZS115 | 0040100299 | ZS299 |
| 0100266072 | GE123 | 0040100117 | ZS117 | 0040100300 | ZS300 |
| 0100266075 | GE124 | 0040100118 | ZS118 | 0040100301 | ZS301 |
| 0100266076 | GE125 | 0040100119 | ZS119 | 0040100302 | ZS302 |
| 0100266077 | GE126 | 0040100120 | ZS120 | 0040100304 | ZS304 |
| 0100271106 | GV004 | 0040100121 | ZS121 | 0040100306 | ZS306 |
| 0100276003 | GN037 | 0040100122 | ZS122 | 0040100307 | ZS307 |
| 0100276004 | GN047 | 0040100123 | ZS123 | 0040100308 | ZS308 |
| 0100276005 | GN045 | 0040100124 | ZS124 | 0040100309 | ZS309 |
| 0100276008 | GN053 | 0040100125 | ZS125 | 0040100310 | ZS310 |
| 0100276012 | GN056 | 0040100126 | ZS126 | 0040100311 | ZS311 |
| 0100276014 | GN058 | 0040100127 | ZS127 | 0040100314 | ZS314 |
| 0100276015 | GN059 | 0040100215 | ZS215 | 0040100315 | ZS315 |
| 0100276024 | GN063 | 0040100220 | ZS220 | 0040100316 | ZS316 |
| 0100276031 | GN069 | 0040100230 | ZS230 | 0040100317 | ZS317 |
| 0100800031 | GN109 | 0040100231 | ZS231 | 0040100318 | ZS318 |
| 0100800033 | GN070 | 0040100232 | ZS232 | 0040100319 | ZS319 |
| 0100800035 | GN072 | 0040100234 | ZS234 | 0040100320 | ZS320 |
| 0100800036 | GN073 | 0040100237 | ZS237 | 0040100321 | ZS321 |
| 0100800038 | GN075 | 0040100238 | ZS238 | 0040100322 | ZS322 |
| 0101072405 | GF859 | 0040100239 | ZS239 | 0040100323 | ZS323 |
| 0101072408 | GF982-B | 0040100241 | ZS241 | 0040100324 | ZS324 |
| 0101072409 | GF983 | 0040100242 | ZS242 | 0040100325 | ZS325 |
| 0101223449 | GF984 | 0040100243 | ZS243 | 0040100327 | ZS327 |
| 0101223454 | GF683 | 0040100244 | ZS244 | 0040100337 | ZS337 |
| 0101223459 | GF974 | 0040100245 | ZS245 | 0040100338 | ZS338 |
| 0101223461 | GF006 | 0040100246 | ZS246 | 0040100339 | ZS339 |
| 0102024405 | GH760 | 0040100247 | ZS247 | 0040100340 | ZS340 |
| 0102224205 | GH011 | 0040100248 | ZS248 | 0040100341 | ZS341 |
| 0103010104 | PSG004 | 0040100249 | ZS249 | 0040100342 | ZS342 |
| 0103010107 | PSG005 | 0040100250 | ZS250 | 0040100343 | ZS343 |
| 0103010903 | PSG001 | 0040100251 | ZS251 | 0040100344 | ZS344 |
| 0103010907 | PSG006 | 0040100252 | ZS252 | 0040100345 | ZS345 |
| 0103110904 | PSG003 | 0040100253 | ZS253 | 0040100346 | ZS346 |
| 0103111104 | PSG002 | 0040100254 | ZS254 | 0040100347 | ZS347 |
| 0106671105 | CGP001 | 0040100255 | ZS255 | 0040100348 | ZS348 |
| 0106671108 | CGP002 | 0040100256 | ZS256 | 0040100349 | ZS349 |
| 0106671802 | CGP003 | 0040100257 | ZS257 | 0040100350 | ZS350 |
| IGNITION COIL | | 0040100258 | ZS258 | 0040100351 | ZS351 |
| 0040100014 | ZS014 | 0040100259 | ZS259 | 0040100352 | ZS352 |
| 0040100016 | ZS016 | 0040100261 | ZS261 | 0040100353 | ZS353 |

Long Code → Short Code

| Long Code | Short Code | Long Code | Short Code | Long Code | Short Code |
|----------------------|------------|----------------------|------------|----------------------|------------|
| IGNITION COIL | | IGNITION COIL | | IGNITION COIL | |
| 0040100354 | ZS354 | 0040100469 | ZS469 | 0040102065 | ZSE065 |
| 0040100355 | ZS355 | 0040100470 | ZS470 | 0040102066 | ZSE066 |
| 0040100356 | ZS356 | 0040100472 | ZS472 | 0040102067 | ZSE067 |
| 0040100357 | ZS357 | 0040100473 | ZS473 | 0040102068 | ZSE068 |
| 0040100358 | ZS358 | 0040100474 | ZS474 | 0040102069 | ZSE069 |
| 0040100359 | ZS359 | 0040100475 | ZS475 | 0040102071 | ZSE071 |
| 0040100360 | ZS360 | 0040100476 | ZS476 | 0040102072 | ZSE072 |
| 0040100361 | ZS361 | 0040100477 | ZS477 | 0040102073 | ZSE073 |
| 0040100365 | ZS365 | 0040100478 | ZS478 | 0040102074 | ZSE074 |
| 0040100366 | ZS366 | 0040100479 | ZS479 | 0040102075 | ZSE075 |
| 0040100367 | ZS367 | 0040100480 | ZS480 | 0040102076 | ZSE076 |
| 0040100368 | ZS368 | 0040100481 | ZS481 | 0040102077 | ZSE077 |
| 0040100369 | ZS369 | 0040100482 | ZS482 | 0040102078 | ZSE078 |
| 0040100370 | ZS370 | 0040100483 | ZS483 | 0040102079 | ZSE079 |
| 0040100371 | ZS371 | 0040100485 | ZS485 | 0040102080 | ZSE080 |
| 0040100372 | ZS372 | 0040100486 | ZS486 | 0040102081 | ZSE081 |
| 0040100376 | ZS376 | 0040100487 | ZS487 | 0040102082 | ZSE082 |
| 0040100379 | ZS379 | 0040100501 | ZS501 | 0040102083 | ZSE083 |
| 0040100380 | ZS380 | 0040100502 | ZS502 | 0040102084 | ZSE084 |
| 0040100381 | ZS381 | 0040100508 | ZS508 | 0040102086 | ZSE086 |
| 0040100382 | ZS382 | 0040100511 | ZS511 | 0040102087 | ZSE087 |
| 0040100387 | ZS387 | 0040100518 | ZS518 | 0040102088 | ZSE088 |
| 0040100389 | ZS389 | 0040100521 | ZS521 | 0040102089 | ZSE089 |
| 0040100392 | ZS392 | 0040100522 | ZS522 | 0040102093 | ZSE093 |
| 0040100393 | ZS393 | 0040100532 | ZS532 | 0040102094 | ZSE094 |
| 0040100394 | ZS394 | 0040100535 | ZS535 | 0040102126 | ZSE126 |
| 0040100395 | ZS395 | 0040100536 | ZS536 | 0040102127 | ZSE127 |
| 0040100396 | ZS396 | 0040100537 | ZS537 | 0040102128 | ZSE128 |
| 0040100400 | ZS400 | 0040100538 | ZS538 | 0040102131 | ZSE131 |
| 0040100405 | ZS405 | 0040102012 | ZSE012 | 0040102132 | ZSE132 |
| 0040100406 | ZS406 | 0040102013 | ZSE013 | 0040102133 | ZSE133 |
| 0040100408 | ZS408 | 0040102019 | ZSE019 | 0040102134 | ZSE134 |
| 0040100410 | ZS410 | 0040102021 | ZSE021 | 0040102136 | ZSE136 |
| 0040100417 | ZS417 | 0040102026 | ZSE026 | 0040102137 | ZSE137 |
| 0040100419 | ZS419 | 0040102029 | ZSE029 | 0040102138 | ZSE138 |
| 0040100422 | ZS422 | 0040102030 | ZSE030 | 0040102140 | ZSE140 |
| 0040100426 | ZS426 | 0040102031 | ZSE031 | 0040102142 | ZSE142 |
| 0040100427 | ZS427 | 0040102032 | ZSE032 | 0040102143 | ZSE143 |
| 0040100428 | ZS428 | 0040102033 | ZSE033 | 0040102144 | ZSE144 |
| 0040100429 | ZS429 | 0040102036 | ZSE036 | 0040102145 | ZSE145 |
| 0040100430 | ZS430 | 0040102037 | ZSE037 | 0040102146 | ZSE146 |
| 0040100431 | ZS431 | 0040102039 | ZSE039 | 0040102147 | ZSE147 |
| 0040100432 | ZS432 | 0040102040 | ZSE040 | 0040102148 | ZSE148 |
| 0040100433 | ZS433 | 0040102041 | ZSE041 | 0040102149 | ZSE149 |
| 0040100434 | ZS434 | 0040102042 | ZSE042 | 0040102150 | ZSE150 |
| 0040100435 | ZS435 | 0040102043 | ZSE043 | 0040102151 | ZSE151 |
| 0040100436 | ZS436 | 0040102044 | ZSE044 | 0040102152 | ZSE152 |
| 0040100437 | ZS437 | 0040102045 | ZSE045 | 0040102153 | ZSE153 |
| 0040100438 | ZS438 | 0040102046 | ZSE046 | 0040102154 | ZSE154 |
| 0040100445 | ZS445 | 0040102047 | ZSE047 | 0040102156 | ZSE156 |
| 0040100446 | ZS446 | 0040102048 | ZSE048 | 0040102157 | ZSE157 |
| 0040100447 | ZS447A | 0040102051 | ZSE051 | 0040102158 | ZSE158 |
| 0040100449 | ZS449 | 0040102052 | ZSE052 | 0040102159 | ZSE159 |
| 0040100450 | ZS450 | 0040102054 | ZSE054 | 0040102161 | ZSE161 |
| 0040100451 | ZS451 | 0040102055 | ZSE055 | 0040102162 | ZSE162 |
| 0040100452 | ZS452 | 0040102056 | ZSE056 | 0040102164 | ZSE164 |
| 0040100453 | ZS453 | 0040102059 | ZSE059 | 0040102165 | ZSE165 |
| 0040100454 | ZS454 | 0040102061 | ZSE061 | 0040102166 | ZSE166 |
| 0040100455 | ZS455 | 0040102062 | ZSE062 | 0040102167 | ZSE167 |
| 0040100456 | ZS456 | 0040102063 | ZSE063 | 0040102168 | ZSE168 |

Long Code → Short Code

| Long Code | Short Code | Long Code | Short Code | Long Code | Short Code |
|----------------------|------------|-------------------|------------|-------------------|------------|
| IGNITION COIL | | SPARK PLUG | | SPARK PLUG | |
| 0040102169 | ZSE169 | 0001335910 | Z171 | 0002240902 | Z233 |
| 0040102170 | ZSE170 | 0001335911 | Z176 | 0002240907 | Z336 |
| 0040102171 | ZSE171 | 0001335914 | Z188 | 0002240909 | Z318 |
| 0040102172 | ZSE172 | 0001335917 | Z321 | 0002240910 | Z274 |
| 0040102173 | ZSE173 | 0001335919 | Z170 | 0002240911 | Z332 |
| 0040102174 | ZSE174 | 0001340103 | Z89 | 0002240913 | Z333 |
| 0040102175 | ZSE175 | 0001340702 | Z22 | 0002245703 | Z286 |
| 0040102176 | ZSE176 | 0001340704 | Z51 | 0002245704 | Z291 |
| 0040102502 | ZSE502 | 0001340706 | Z52 | 0002245900 | Z355 |
| 0040103007 | ZS313 | 0001340717 | Z53 | 0002250900 | Z338 |
| 0040104100 | ZS375 | 0001340806 | Z105 | 0002250901 | Z357 |
| 0040402001 | ZSE001 | 0001340903 | Z104 | 0002325700 | Z82 |
| 0040402002 | ZSE002 | 0001340908 | Z185 | 0002325723 | Z220 |
| 0040402003 | ZSE003 | 0001340910 | Z236 | 0002325900 | Z285 |
| 0040402004 | ZSE004 | 0001340915 | Z295 | 0002330102 | Z173 |
| 0040402005 | ZSE005 | 0001340916 | Z322 | 0002330104 | Z190 |
| 0040402006 | ZSE006 | 0001340917 | Z349 | 0002330203 | Z248 |
| 0040402007 | ZSE007 | 0001345702 | Z42 | 0002330204 | Z249 |
| 0040402008 | ZSE008 | 0001345704 | Z44 | 0002330205 | Z254 |
| 0040402009 | ZSE009 | 0001345720 | Z29 | 0002330206 | Z255 |
| 0040402010 | ZSE010 | 0001345906 | Z277 | 0002330215 | Z287 |
| 0040402011 | ZSE011 | 0001345912 | Z317 | 0002330217 | Z334 |
| SPARK PLUG | | 0001345914 | Z347 | 0002330701 | Z8 |
| 0001240901 | Z306 | 0001345915 | Z348 | 0002330702 | Z9 |
| 0001245901 | Z359 | 0001350910 | Z339 | 0002330703 | Z72 |
| 0001325701 | Z76 | 0001350911 | Z345 | 0002330704 | Z73 |
| 0001325705 | Z79 | 0001355700 | Z38 | 0002330706 | Z94 |
| 0001325710 | Z78 | 0001430700 | Z118 | 0002330709 | Z119 |
| 0001330104 | Z75 | 0001430701 | Z68 | 0002330710 | Z74 |
| 0001330112 | Z93 | 0001435700 | Z10 | 0002330712 | Z152 |
| 0001330113 | Z92 | 0001435705 | Z57 | 0002330713 | Z153 |
| 0001330116 | Z121 | 0001440700 | Z48 | 0002330714 | Z154 |
| 0001330117 | Z126 | 0001445700 | Z41 | 0002330716 | Z183 |
| 0001330119 | Z246 | 0001445702 | Z40 | 0002330794 | Z203 |
| 0001330501 | Z101 | 0001450702 | Z39 | 0002330795 | Z208 |
| 0001330702 | Z1 | 0001529302 | Z112 | 0002330796 | Z223 |
| 0001330709 | Z2 | 0001630101 | Z207 | 0002330902 | Z211 |
| 0001330717 | Z4 | 0001630700 | Z6 | 0002330903 | Z229 |
| 0001330718 | Z3 | 0001630704 | Z7 | 0002330904 | Z219 |
| 0001330725 | Z5 | 0001635700 | Z17 | 0002330905 | Z238 |
| 0001330726 | Z70 | 0001635709 | Z18 | 0002330918 | Z278 |
| 0001330731 | Z100 | 0001640700 | Z25 | 0002330925 | Z311 |
| 0001330780 | Z227 | 0001640705 | Z56 | 0002330926 | Z302 |
| 0001330904 | Z122 | 0001645700 | Z31 | 0002330930 | Z343 |
| 0001330905 | Z240 | 0001645703 | Z46 | 0002335100 | Z60 |
| 0001335107 | Z90 | 0001700901 | Z108 | 0002335104 | Z172 |
| 0001335108 | Z91 | 0001735700 | Z32 | 0002335128 | Z213 |
| 0001335110 | Z120 | 0001740700 | Z33 | 0002335131 | Z239 |
| 0001335702 | Z11 | 0002135700 | Z341 | 0002335137 | Z304 |
| 0001335707 | Z58 | 0002140900 | Z210 | 0002335138 | Z324 |
| 0001335709 | Z12 | 0002230300 | Z243 | 0002335139 | Z360 |
| 0001335714 | Z61 | 0002230900 | Z242 | 0002335500 | Z98 |
| 0001335725 | Z63 | 0002230901 | Z320 | 0002335503 | Z257 |
| 0001335729 | Z13 | 0002235700 | Z234 | 0002335606 | UXT1 |
| 0001335732 | Z14 | 0002235901 | Z288 | 0002335607 | UXT2 |
| 0001335737 | Z62 | 0002235905 | Z325 | 0002335701 | Z20 |
| 0001335742 | Z200 | 0002240701 | Z293 | 0002335704 | Z59 |
| 0001335788 | Z344 | 0002240702 | Z292 | 0002335706 | Z21 |
| 0001335789 | Z272 | 0002240703 | Z308 | 0002335707 | Z15 |
| 0001335905 | Z282 | 0002240707 | Z358 | 0002335708 | Z16 |

Long Code → Short Code

| Long Code | Short Code | Long Code | Short Code | Long Code | Short Code |
|-------------------|------------|-------------------------------------|------------|-------------------------------------|------------|
| SPARK PLUG | | SPARK PLUG | | SWITCH UNIT, IGNITION SYSTEM | |
| 0002335709 | Z123 | 0002345504 | Z198 | 0040401019 | ZM019 |
| 0002335712 | Z155 | 0002345600 | UX56 | 0040401020 | ZM020 |
| 0002335713 | Z156 | 0002345606 | UXT5 | 0040401022 | ZM022 |
| 0002335714 | Z157 | 0002345701 | Z47 | 0040401023 | ZM023 |
| 0002335715 | Z158 | 0002345702 | Z30 | 0040401024 | ZM024 |
| 0002335717 | Z193 | 0002345704 | Z45 | 0040401025 | ZM025 |
| 0002335719 | Z184 | 0002345731 | Z253 | 0040401026 | ZM026 |
| 0002335802 | Z299 | 0002345902 | UXT12 | 0040401027 | ZM027 |
| 0002335901 | Z130 | 0002345903 | UXT14 | 0040401029 | ZM029 |
| 0002335902 | Z149 | 0002345904 | Z323 | 0040401031 | ZM031 |
| 0002335903 | Z150 | 0002345906 | Z354 | 0040401032 | ZM032 |
| 0002335904 | Z151 | 0002435701 | Z19 | 0040401033 | ZM033 |
| 0002335911 | Z237 | 0002620708 | Z216 | 0040401034 | ZM034 |
| 0002335912 | Z224 | 0002625700 | Z117 | 0040401035 | ZM035 |
| 0002335914 | Z228 | 0002630701 | Z177 | 0040401036 | ZM036 |
| 0002335915 | Z235 | 0002630715 | Z222 | 0040401037 | ZM037 |
| 0002335925 | Z279 | 0002630900 | Z148 | 0040401038 | ZM038 |
| 0002335926 | Z280 | 0002630903 | Z298 | 0040401039 | ZM039 |
| 0002335928 | UXT3 | 0002630904 | Z309 | 0040401040 | ZM040 |
| 0002335930 | UXT9 | 0002630905 | Z310 | 0040401041 | ZM041 |
| 0002335931 | UXT10 | 0002635100 | Z127 | 0040401043 | ZM043 |
| 0002335932 | UXT11 | 0002635601 | UXT4 | 0040401045 | ZM045 |
| 0002335934 | UXT13 | 0002635700 | Z95 | 0040401046 | ZM046 |
| 0002335935 | Z301 | 0002635701 | Z67 | 0040401047 | ZM047 |
| 0002335936 | Z297 | 0002635900 | UXT7 | 0040401048 | ZM048 |
| 0002335937 | Z307 | 0002635901 | UXT8 | 0040401049 | ZM049 |
| 0002335938 | Z312 | 0002635902 | Z296 | 0040401050 | ZM050 |
| 0002335939 | Z326 | 0002635903 | Z356 | 0040401051 | ZM051 |
| 0002335940 | Z206 | 0002635904 | Z342 | 0040401052 | ZM052 |
| 0002335946 | Z337 | 0002640100 | Z144 | 0040401053 | ZM053 |
| 0002335947 | Z346 | 0002640700 | Z26 | 0040401054 | ZM054 |
| 0002336715 | Z225 | 0002640701 | Z49 | 0040401055 | ZM055 |
| 0002336724 | Z247 | 0002640712 | Z305 | 0040401056 | ZM056 |
| 0002336725 | Z250 | 0002640900 | Z97 | 0040401057 | ZM057 |
| 0002336726 | Z251 | 0002640904 | Z209 | 0040401058 | ZM058 |
| 0002336734 | Z303 | 0002640907 | Z230 | 0040401059 | ZM059 |
| 0002336738 | Z273 | 0002640909 | UXT15 | 0040401060 | ZM060 |
| 0002340101 | Z129 | 0002640910 | Z315 | 0040401061 | ZM061 |
| 0002340102 | Z145 | 0002645600 | UXK56 | 0040401062 | ZM062 |
| 0002340117 | Z204 | 0003335401 | Z111 | 0040401063 | ZM063 |
| 0002340123 | Z300 | 0004535300 | Z266 | | |
| 0002340500 | Z116 | 0004535700 | Z267 | | |
| 0002340501 | Z194 | SWITCH UNIT, IGNITION SYSTEM | | | |
| 0002340504 | Z245 | 0040401001 | ZM001 | | |
| 0002340701 | Z27 | 0040401002 | ZM002 | | |
| 0002340702 | Z24 | 0040401003 | ZM003 | | |
| 0002340703 | Z28 | 0040401004 | ZM004 | | |
| 0002340704 | Z99 | 0040401005 | ZM005 | | |
| 0002340768 | Z252 | 0040401006 | ZM006 | | |
| 0002340771 | Z335 | 0040401007 | ZM007 | | |
| 0002340903 | Z159 | 0040401008 | ZM008 | | |
| 0002340905 | Z221 | 0040401009 | ZM009 | | |
| 0002340906 | Z226 | 0040401010 | ZM010 | | |
| 0002340908 | Z284 | 0040401012 | ZM012 | | |
| 0002340909 | Z313 | 0040401013 | ZM013 | | |
| 0002340910 | Z314 | 0040401014 | ZM014 | | |
| 0002340915 | Z340 | 0040401015 | ZM015 | | |
| 0002340918 | Z275 | 0040401016 | ZM016 | | |
| 0002345118 | Z294 | 0040401017 | ZM017 | | |
| 0002345501 | Z192 | 0040401018 | ZM018 | | |

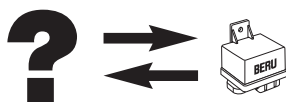

| BOSCH | |
|---------------|--------------|
| 0 281 003 005 | GR034 |
| 0 281 003 009 | GR054 |
| 0 281 003 096 | GR049 |
| 0 281 003 099 | GR031 |
| 0 333 402 006 | GR066 |
| 0 333 402 501 | GR059 |
| 0 333 402 505 | GR069 |
| 0 333 402 506 | GR069 |
| 0 333 402 507 | GR071 |
| 0 333 402 508 | GR071 |
| 0 333 402 509 | GR065 |
| 0 333 402 512 | GR001 |
| 0 333 402 513 | GR066 |
| 0 333 402 515 | GR070 |
| 0 333 402 516 | GR070 |
| 0 333 402 517 | GR065 |
| 0 333 402 524 | GR065 |

| HELLA | |
|-----------------|----------------|
| 4RV 008 188-001 | GR069 |
| 4RV 008 188-011 | GR070 |
| 4RV 008 188-021 | GR071 |
| 4RV 008 188-041 | GR073-B |
| 4RV 008 188-051 | GR074 |
| 4RV 008 188-061 | GR075 |
| 4RV 008 188-071 | GR076 |
| 4RV 008 188-081 | GR059 |
| 4RV 008 188-091 | GR065 |
| 4RV 008 188-101 | GR066 |
| 4RV 008 188-161 | GR064 |
| 4RV 008 188-171 | GR001 |
| 4RV 008 188-181 | GR031 |
| 4RV 008 188-241 | GR067 |
| 4RV 008 188-281 | GR034 |
| 4RV 008 188-321 | GR054 |

| HERTH+BUSS ELPARTS | |
|-------------------------------|----------------|
| 10 899 149 | GR076 |
| 10 899 151 | GR073-B |
| 10 899 152 | GR075 |
| 10 899 153 | GR074 |
| 10 899 179 | GR069 |
| 10 899 180 | GR071 |
| 10 899 195 | GR070 |

| HÜCO | |
|-------------|----------------|
| 13 2030 | GR069 |
| 13 2031 | GR070 |
| 13 2032 | GR071 |
| 13 2034 | GR073-B |
| 13 2035 | GR074 |
| 13 2036 | GR075 |
| 13 2037 | GR076 |
| 13 2050 | GR059 |
| 13 2051 | GR065 |
| 13 2052 | GR066 |
| 13 2060 | GR064 |
| 13 2061 | GR001 |
| 13 2085 | GR054 |

| HUECO | |
|--------------|--------------|
| 13 2075 | GR067 |
| 13 2081 | GR034 |

| LUCAS ELECTRICAL | |
|-------------------------|--------------|
| DSC 03 | GR066 |
| DSC 08 | GR064 |
| HDC 101 | GR059 |
| HDC 102 | GR065 |
| HDC 103 | GR066 |
| HDC 106 | GR064 |
| HDC 108 | GR064 |
| HDC 116 | GR069 |
| HDC 117 | GR071 |
| HDC 118 | GR070 |
| HDC 124 | GR067 |
| HDC 125 | GR054 |
| HDC 127 | GR031 |
| R 04090001 B | GR054 |
| R 0409001 B | GR054 |

| MAGNETI MARELLI | |
|------------------------|--------------|
| REP 1A | GR059 |

| MONARK | |
|---------------|--------------|
| 90 290 001 | GR001 |

| PARIS-RHONE | |
|--------------------|--------------|
| 102180 M | GR059 |
| 102696 | GR065 |
| 105857 | GR059 |

| STRIBEL | |
|----------------|--------------|
| 89 90 26 01 | GR031 |
| 899 019 | GR064 |
| 899 020 | GR064 |
| 899 102 | GR064 |
| 899 121 | GR064 |
| 899 125 | GR064 |
| 899 189 | GR064 |

| VALEO | |
|--------------|--------------|
| 10 21 80 | GR059 |
| 10 26 96 | GR065 |
| 13 10 10 02 | GR059 |
| 24 56 00 | GR059 |
| 24 56 03 | GR065 |
| 24 56 04 | GR066 |
| 73 10 01 22 | GR059 |
| 73 10 34 02 | GR065 |
| 73 10 48 22 | GR066 |
| 73 10 49 02 | GR054 |
| 73 10 50 02 | GR065 |

| WEHRLE J. | |
|------------------|--------------|
| 51 216 001 | GR064 |
| 51 216 003 | GR064 |
| 51 216 901 | GR064 |

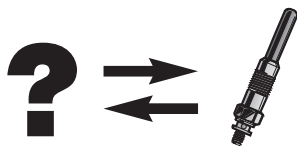



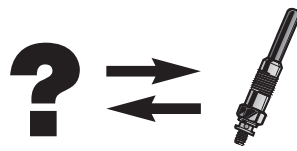



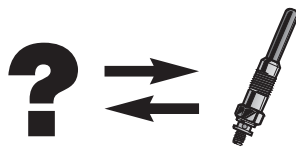









| ...BOSCH | | ...BOSCH | | ...BOSCH | | ...CHAMPION | |
|---------------|-------|----------------|--------|-------------------|-------|-------------|-------|
| 0 250 202 052 | GV967 | 0 250 404 001 | GE121A | KE/GA 1/24 | GD318 | CH 203 | GN024 |
| 0 250 202 053 | GV968 | 0 250 503 003 | GN073 | KE/GA 1/8 | GD214 | CH 204 | GN961 |
| 0 250 202 054 | GV894 | 0 257 202 002 | GF683 | KE/GA 2/12 | GD318 | CH 205 | GN022 |
| 0 250 202 058 | GV897 | 0 257 202 004 | GF683 | KE/GA 2/2 | GD318 | CH 206 | GN991 |
| 0 250 202 059 | GV685 | 0 257 204 002 | GF683 | KE/GSA 10/1J | GV107 | CH 208 | GN964 |
| 0 250 202 060 | GV921 | 0 257 204 003 | GF974 | | | CH 209 | GN030 |
| 0 250 202 062 | GV888 | 0250402005 | GE100 | BREMI | | CH 210 | GN064 |
| 0 250 202 064 | GN044 | 80002 | GD348 | 26093 | GE122 | CH 215 | GN008 |
| 0 250 202 065 | GN061 | 80003 | GD382 | 26094 | GE117 | CH 216 | GN012 |
| 0 250 202 069 | GV890 | 80004 | GV108 | 26508 | GE125 | CH 217 | GN963 |
| 0 250 202 071 | GV887 | 80005 | GV108 | BRÜGGEMANN | | CH 218 | GN003 |
| 0 250 202 073 | GV001 | 80006 | GV603 | "STELLA" | | CH 219 | GN010 |
| 0 250 202 076 | GV895 | 80007 | GV636 | D 22 | GD214 | CH 222/002 | GN041 |
| 0 250 202 077 | GV920 | 80008 | GN909 | CHAMP | | CH 223 | GN053 |
| 0 250 202 079 | GN043 | 80009 | GN858 | CH 230 | GE123 | CH 224/002 | GN059 |
| 0 250 202 085 | GV946 | 80010 | GN857 | CHAMPION | | CH 225 | GN955 |
| 0 250 202 086 | GV945 | 80011 | GN860 | AG 28 | GD214 | CH 226/002 | GN035 |
| 0 250 202 087 | GV947 | 80012 | GN855 | AG 4 | GD318 | CH 227/002 | GN997 |
| 0 250 202 092 | GN107 | 80013 | GN948 | CH 102 | GV889 | CH 228/002 | GN015 |
| 0 250 202 093 | GN854 | 80014 | GV685 | CH 103 | GV688 | CH 229 | GN939 |
| 0 250 202 094 | GV921 | 80015 | GV705 | CH 104 | GV895 | CH 230 | GN109 |
| 0 250 202 095 | GN043 | 80016 | GV749 | CH 110 | GV749 | CH 232 | GN026 |
| 0 250 202 096 | GV968 | 80017 | GV888 | CH 129/002 | GV892 | CH 234 | GN057 |
| 0 250 202 102 | GN008 | 80018 | GV886 | CH 132 | GV894 | CH 239 | GN989 |
| 0 250 202 103 | GN024 | 80019 | GV894 | CH 133 | GV897 | CH 242 | GN005 |
| 0 250 202 124 | GN070 | 80031 | GN858 | CH 137 | GV727 | CH 252 | GN042 |
| 0 250 202 125 | GN065 | F 002 G50 048 | GN037 | CH 147 | GV661 | CH 256/002 | GN107 |
| 0 250 202 128 | GN026 | F 005 X04 828 | GN061 | CH 147 | GV666 | CH 258 | GN065 |
| 0 250 202 129 | GN019 | F 005 X04 868 | GN101 | CH 154 | GV968 | CH 260 | GN959 |
| 0 250 202 130 | GN939 | F 005 X04 869 | GN102 | CH 155 | GV852 | CH 263 | GN070 |
| 0 250 202 131 | GN993 | F 005 X12 910 | GV886 | CH 156 | GN858 | CH 271 | GN855 |
| 0 250 202 132 | GN097 | F 005 X12 968 | GV892 | CH 157 | GV946 | CH 273/002 | GN060 |
| 0 250 202 135 | GN054 | F 005 X12 977 | GN101 | CH 158 | GV947 | CH 275/002 | GN050 |
| 0 250 202 137 | GN104 | F 005 X12 978 | GN102 | CH 161 | GV920 | CH 28 | GD214 |
| 0 250 202 140 | GN961 | F 005 X12 981 | GN854 | CH 162 | GV921 | CH 28 | GD318 |
| 0 250 202 141 | GN003 | F 005 X12 983 | GN101 | CH 163 | GN909 | CH 306/002 | GN061 |
| 0 250 202 142 | GN003 | F 005 X13 002 | GN043 | CH 163/002 | GN908 | CH 32 | GV112 |
| 0 250 203 001 | GN059 | F 005 X13 006 | GN065 | CH 165 | GV004 | CH 60 | GN857 |
| 0 250 203 002 | GN053 | GLP 001 | GN954 | CH 166 | GN017 | CH 600 | GN102 |
| 0 250 203 004 | GN045 | GLP 066 | GN097 | CH 167/002 | GN908 | CH 602/002 | GN107 |
| 0 250 203 009 | GN037 | GLP 114 | GE123 | CH 169 | GN905 | CH 603 | GN104 |
| 0 250 203 011 | GE109 | GLP 137 | GN070 | CH 170/002 | GN027 | CH 607 | GN067 |
| 0 250 203 012 | GN063 | GLP 194 | GE115 | CH 172 | GN999 | CH 608 | GN110 |
| 0 250 204 001 | GN047 | GLP 203 | GN035 | CH 173/002 | GV852 | CH 608/002 | GN110 |
| 0 250 204 002 | GN056 | GLP 210 | GN063 | CH 174 | GN917 | CH 613/002 | GN101 |
| 0 250 212 006 | GN035 | GLP 224 | GN018 | CH 175 | GN860 | CH 62 | GV657 |
| 0 250 212 009 | GN018 | GLP 2-4 | GN063 | CH 176 | GN858 | CH 63 | GV604 |
| 0 250 212 011 | GN062 | GLP 2-HS | GE123 | CH 177 | GN948 | CH 64 | GV130 |
| 0 250 251 471 | GN970 | GLP008 | GN003 | CH 179 | GN959 | CH 65 | GV108 |
| 0 250 312 001 | GN101 | GLP008 | GN003 | CH 180/002 | GN055 | CH 66 | GV106 |
| 0 250 312 002 | GN102 | GLP023 | GN046 | CH 181 | GN007 | CH 66 | GV137 |
| 0 250 312 003 | GN103 | GLP050 | GE100 | CH 184 | GN018 | CH 68 | GV636 |
| 0 250 312 007 | GN107 | GLP202 | GE105 | CH 185 | GN016 | CH 68 | GV663 |
| 0 250 402 001 | GE100 | GPM 902 | GN067 | CH 186 | GN039 | CH 68 | GV727 |
| 0 250 402 002 | GE102 | GS 2 A S 10 | GD318 | CH 187 | GN039 | CH 69 | GN857 |
| 0 250 402 004 | GE119 | GS 2 A S 8 | GD318 | CH 188 | GV945 | CH 70 | GV657 |
| 0 250 403 001 | GE123 | GS 2 D 6 | GD318 | CH 189/002 | GN908 | CH 700/002 | GE100 |
| 0 250 403 002 | GE101 | GS 2 D 14 | GD318 | CH 190 | GN944 | CH 701 | GE102 |
| 0 250 403 003 | GE125 | GS 2 D 22 | GD318 | CH 196 | GN993 | CH 702 | GE101 |
| 0 250 403 005 | GE114 | GS 2 D 8 | GD318 | CH 200 | GN047 | CH 79 | GV631 |
| 0 250 403 006 | GE105 | GSA 10/1 | GV107 | | | CH 88 | GV642 |
| 0 250 403 007 | GE115 | GSA 11/29 | GV112 | | | CH 88 | GV636 |
| 0 250 403 008 | GE105 | GSA 9/1 | GV108 | | | CH 90 | GV730 |
| 0 250 403 009 | GE115 | GSD 26 | GD318 | | | CH 95 | GV886 |
| 0 250 403 010 | GE125 | GSD 27 | GD318 | | | CH 96 | GV888 |
| 0 250 403 011 | GE114 | KE/GA 1/(21/1) | GD348 | | | CH 97 | GV705 |
| 0 250 403 012 | GE110 | KE/GA 1/21 | GD348 | | | CH 98 | GV685 |



| ...CHAMPION | | DENSO | | ...DENSO | | ...EYQUEM | |
|-------------|-------|-------------|-------|---------------|-------|------------|-------|
| CH 99 | GV685 | 067100-1220 | GV895 | DG 145 | GN024 | 0911101202 | GE101 |
| CH159/002 | GV719 | 067100-1270 | GV688 | DG 146 | GN005 | 0911101203 | GN056 |
| CH160/002 | GN857 | 067100-1330 | GV897 | DG 155 | GN010 | 0911101231 | GE115 |
| CH168/002 | GN912 | 067100-1370 | GV894 | DG 157 | GV920 | 0911101232 | GN065 |
| CH185/002 | GN912 | 067100-1430 | GV886 | DG 161 | GN964 | 0911101233 | GN109 |
| CH207/002 | GN992 | 067100-1460 | GV895 | DG 171 | GN053 | G 1 | GN005 |
| CH61/002 | GD382 | 067100-1500 | GV001 | DG 172 | GN955 | G 20 | GN008 |
| CH87/002 | GV602 | 067100-1530 | GV886 | DG 173 | GN035 | G 30 | GN054 |
| CH94/002 | GV673 | 067100-1591 | GN061 | DG 174 | GN107 | G 31 | GN955 |
| X 510 | GV727 | 067100-1630 | GV688 | DG 175 | GV004 | G 32 | GV921 |
| XCH 512 | GV730 | 067100-1690 | GV967 | DG 176 | GN055 | G 33 | GN101 |
| | | 067100-1710 | GV968 | DG 177 | GE100 | G 38 | GN102 |
| | | 067100-1840 | GV688 | DG 178 | GE102 | G 5 | GN045 |
| | | 067100-1841 | GV688 | DG 180 | GN056 | G 54 | GN963 |
| | | 067100-1860 | GV897 | DG 181 | GN054 | G 72 | GN056 |
| | | 067100-1861 | GV897 | DG 182 | GN985 | G 75 | GN065 |
| | | 997261 | GV657 | DG 184 | GN015 | G 76 | GN109 |
| | | DG 001 | GN013 | DG 186 | GN997 | G 77 | GN057 |
| | | DG 002 | GN857 | DG 188 | GN060 | G 9 | GN037 |
| | | DG 003 | GN016 | DG 189 | GN057 | GPE 70 | GE100 |
| | | DG 004 | GN927 | DG 190 | GE101 | GPE 71 | GE101 |
| | | DG 004 | GV661 | DG 191 | GE103 | GPE 73 | GE102 |
| | | DG 005 | GN855 | DG 192 | GE104 | GPE 74 | GE115 |
| | | DG 005 | GN018 | DG 194 | GE105 | KTB 501 | GV666 |
| | | DG 006 | GV852 | DG 195 | GN037 | KTB 601 | GN857 |
| | | DG 007 | GN022 | DG 196 | GN097 | KTB 602 | GN959 |
| | | DG 008 | GN963 | DG 198 | GV673 | KTD 602 | GN917 |
| | | DG 009 | GN991 | DG 202 | GV657 | KTD 603 | GN013 |
| | | DG 010 | GN858 | DG 211 | GV968 | KTD 603 | GN909 |
| | | DG 012 | GN959 | DG 212 | GV688 | KTE 601 | GN948 |
| | | DG 101 | GN905 | DG 213 | GV001 | KTE 602 | GV657 |
| | | DG 101 | GN999 | DG 214 | GV897 | KWE 501 | GN912 |
| | | DG 102 | GN970 | DG 215 | GV894 | PTA 601 | GN022 |
| | | DG 103 | GN857 | DG 216 | GV967 | PTB 501 | GV666 |
| | | DG 104 | GV947 | DG 217 | GN068 | PTB 601 | GN857 |
| | | DG 105 | GV673 | DG 218 | GV688 | PTB 602 | GN959 |
| | | DG 106 | GN948 | DG 221 | GV688 | PTB 603 | GV666 |
| | | DG 108 | GN061 | DG 222 | GV895 | PTC 601 | GN858 |
| | | DG 109 | GN007 | DG 223 | GV886 | PTD 501 | GN991 |
| | | DG 109 | GN046 | DG 232 | GV897 | PTD 502 | GN970 |
| | | DG 110 | GN961 | DG 240 | GN042 | PTD 601 | GV852 |
| | | DG 111 | GN012 | DG 245 | GN065 | PTD 603 | GN909 |
| | | DG 112 | GN019 | DG 246 | GN068 | PTE 502 | GN961 |
| | | DG 113 | GN047 | DG 300 | GN103 | PTE 601 | GN860 |
| | | DG 114 | GV705 | DG 301 | GN107 | PTE 602 | GV657 |
| | | DG 115 | GV783 | DG 302 | GN104 | PTE 603 | GN948 |
| | | DG 116 | GN027 | DG 304 | GN102 | PVC 503 | GV673 |
| | | DG 117 | GN003 | DG 305 | GN110 | PVC 504 | GV705 |
| | | DG 118 | GN992 | DG 306 | GN067 | PVE 502 | GV886 |
| | | DG 119 | GN860 | DG 307 | GN101 | PWD 501 | GN018 |
| | | DG 120 | GV921 | DG 312 | GN106 | PWD 503 | GN855 |
| | | DG 121 | GN993 | DG 502 | GN064 | PWD 504 | GN963 |
| | | DG 122 | GN041 | DG 702 | GN044 | PWD 505 | GN041 |
| | | DG 123 | GV631 | DG-140 | GN045 | PWD 506 | GN012 |
| | | DG 124 | GV946 | DG-170 | GN059 | PWD 507 | GV730 |
| | | DG 126 | GN026 | | | PWD 508 | GN017 |
| | | DG 127 | GN017 | | | PWD 509 | GN993 |
| | | DG 129 | GN030 | EYQUEM | | PWD 510 | GN019 |
| | | DG 130 | GN939 | 0 911 101 138 | GN008 | PWE 501 | GN912 |
| | | DG 132 | GV730 | 0 911 101 195 | GN005 | PWE 502 | GN027 |
| | | DG 133 | GN944 | 0 911 101 196 | GN955 | PWE 503 | GV783 |
| | | DG 135 | GD214 | 0 911 101 197 | GV921 | PWE 504 | GN944 |
| | | DG 137 | GN039 | 0 911 101 198 | GN101 | PWE 505 | GN003 |
| | | DG 139 | GN989 | 0 911 101 230 | GE102 | PWE 506 | GN992 |
| | | DG 142 | GN033 | 0 911 101 234 | GN057 | PWF 501 | GN010 |
| | | DG 143 | GV749 | 0911101199 | GN102 | PWF 502 | GN016 |
| | | DG 144 | GN008 | 0911101201 | GE100 | PWF 503 | GN007 |



| | | | | | | | |
|--|--------------|---|--------------|--|--------------|---|--------------|
| ...EYQUEM  | | ...FEBI BILSTEIN  | | ...HERTH+BUSS JAKOPARTS  | | ...JAPCAR  | |
| PWG 501 | GN024 | 26757 | GN064 | J5710500 | GV921 | CP 07 | GN107 |
| PWG 502 | GN964 | 26885 | GN106 | J5711017 | GN854 | JKC 64031 | GN043 |
| PWG 503 | GN008 | 27190 | GN073 | J5711026 | GN109 | KAGER  | |
| PWG 504 | GN939 | 27226 | GN046 | J5712004 | GV894 | 65-2054 | GE101 |
| STB 502 | GV689 | 29276 | GN104 | J5712015 | GN068 | 65-2085 | GN067 |
| STB 602 | GV888 | 31233 | GN039 | J5713007 | GN064 | LETRIKA  | |
| SVA 504 | GV947 | 31248 | GN056 | J5714002 | GN073 | 11 721 003 | GN857 |
| SVB 501 | GV890 | 34828 | GE105 | J5715000 | GV673 | 11 721 004 | GV603 |
| SVC 501 | GV705 | 39517 | GE122 | J5715010 | GN070 | 11 721 005 | GV657 |
| SVC 504 | GV921 | 39518 | GE117 | J5715011 | GN067 | LUCAS  | |
| SVD 501 | GV946 | FLENNOR  | | J5716002 | GV886 | LP 145 | GE123 |
| SVE 501 | GV967 | FG9908 | GN067 | J5719004 | GV945 | LUCAS CAV  | |
| SVE 503 | GV897 | HELLA  | | INTERMOTOR  | | HDS 396 | GN026 |
| SVG 501 | GV968 | 8EG 008 497-491 | GN003 | 80000 | GV602 | HDS 420 | GN057 |
| SVG 502 | GV688 | 8EG 008 497-501 | GN008 | 80001 | GV108 | LUCAS ELECTRICAL  | |
| SWD 501 | GV730 | 8EG 008 497-511 | GN010 | 80003 | GV137 | 6415-4 | GV636 |
| SWD 502 | GV685 | 8EG 008 497-521 | GN012 | 80011 | GV657 | DS 001 | GV603 |
| XFE 601 | GV137 | 8EG 008 497-531 | GN015 | 80015 | GV719 | DS 003 | GV642 |
| XHE 101 | GD382 | 8EG 008 497-541 | GN017 | 80021 | GN857 | DS 003 | GV636 |
| XVB 501 | GV889 | 8EG 008 497-571 | GN024 | 80024 | GN855 | DS 005 | GV137 |
| FEBI BILSTEIN  | | 8EG 008 497-581 | GN030 | 80026 | GN857 | DS 006 | GV602 |
| 01002 | GN019 | 8EG 008 497-601 | GN964 | 80030 | GD382 | DS 007 | GV604 |
| 15949 | GN007 | 8EG 008 498-101 | GF006 | 80031 | GV636 | DS 009 | GV130 |
| 15953 | GN022 | 8EG 008 498-111 | GF859 | 80034 | GV663 | DS 010 | GV108 |
| 15956 | GN857 | 8EG 008 497-551 | GN018 | 80040 | GV604 | DS 014 | GV852 |
| 15957 | GN027 | 8EG 008 497-561 | GN019 | 80041 | GV631 | DS 015 | GV685 |
| 15959 | GN041 | 8EH 008 497-611 | GN993 | 80044 | GV666 | DS 016 | GV888 |
| 15960 | GN909 | PF 810 | GF006 | 80060 | GV852 | DS 017 | GV673 |
| 15961 | GV642 | PF 811 | GF859 | 80100 | GV673 | DS 019 | GV688 |
| 15962 | GN927 | PO 749 | GN003 | 80110 | GV685 | DS 020 | GV894 |
| 15963 | GV719 | PO 750 | GN008 | 80121 | GV688 | DS 024 | GV889 |
| 15964 | GN860 | PO 751 | GN010 | 80122 | GV886 | DS 026 | GV705 |
| 15965 | GN954 | PO 752 | GN012 | 80123 | GV894 | DS 032 | GV749 |
| 15966 | GN948 | PO 753 | GN015 | 80124 | GV749 | DS 038 | GV685 |
| 15967 | GN964 | PO 754 | GN017 | 80130 | GV705 | DS 040 | GV636 |
| 17699 | GN103 | PO 755 | GN018 | 80134 | GV946 | DS 043 | GV689 |
| 17700 | GN908 | PO 756 | GN019 | 80135 | GV945 | DS 052 | GV657 |
| 17788 | GN992 | PO 757 | GN024 | 80136 | GV947 | DS 056 | GV631 |
| 17979 | GN855 | PO 758 | GN030 | 80138 | GV886 | DS 058 | GV666 |
| 17981 | GN999 | PO 760 | GN964 | 80140 | GN909 | DS 065 | GV892 |
| 18404 | GN961 | PO 761 | GN993 | 80142 | GV783 | DS 068 | GV920 |
| 18408 | GN010 | HERTH+BUSS ELPARTS  | | 80144 | GV661 | DS 101 | GD348 |
| 19099 | GN016 | 29 200 010 | GN857 | 80151 | GV657 | DS 104 | GD214 |
| 19103 | GV968 | 29 200 011 | GV602 | 80152 | GN857 | DS 122 | GV636 |
| 19223 | GN858 | 29 200 012 | GN857 | 80153 | GV689 | DS 850 | GV666 |
| 19249 | GN963 | 29 200 013 | GV130 | 80154 | GV888 | HDS 211 | GV602 |
| 19447 | GN993 | 29 200 014 | GV636 | 80155 | GV603 | HDS 216 | GV603 |
| 19882 | GN024 | 29 200 015 | GV604 | 80156 | GV657 | HDS 218 | GV636 |
| 19941 | GN101 | 29 200 016 | GV137 | 80157 | GN970 | HDS 220 | GV137 |
| 21864 | GN939 | J 571 2013 | GN110 | 80158 | GN905 | HDS 222 | GV604 |
| 21866 | GN026 | J 5711023 | GN039 | 80159 | GV920 | HDS 224 | GV130 |
| 21957 | GN030 | J5713008 | GN005 | 80161 | GV968 | HDS 225 | GV108 |
| 22836 | GN003 | HERTH+BUSS JAKOPARTS  | | 80162 | GV890 | HDS 229 | GV852 |
| 24094 | GE102 | J 5711000 | GV889 | JAPANPARTS  | | HDS 230 | GV685 |
| 24095 | GN045 | J 5711008 | GN101 | CP 22 | GN110 | HDS 231 | GV888 |
| 24176 | GE100 | J 5711016 | GN102 | CP52 | GN106 | HDS 232 | GV673 |
| 24428 | GN033 | J 5711023 | GN039 | JAPCAR  | | | |
| 24483 | GN059 | | | CP 01 | GN101 | | |
| 24484 | GN053 | | | CP 02 | GN102 | | |
| 24771 | GN035 | | | | | | |
| 24917 | GN005 | | | | | | |
| 26112 | GN068 | | | | | | |
| 26221 | GN047 | | | | | | |
| 26585 | GN043 | | | | | | |
| 26685 | GE101 | | | | | | |

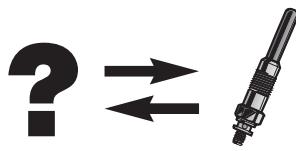

| ...NGK | | ...NGK | | ...NGK | | ...NGK | |
|--------|-------|--------|--------|-----------|--------|--------|--------|
| 5207 | GN056 | 6382 | GN033 | 8944 | GN107 | DP1 | GN954 |
| 5264 | GN103 | 6382 | GV945 | 90002 | GN097 | DP1 | GN908 |
| 5267 | GN013 | 6416 | GN019 | 90050 | GE102 | DP1 | GN033 |
| 5267 | GN908 | 6461 | GN003 | 90828 | GN097 | DP1 | GN016 |
| 5267 | GN954 | 6557 | GN991 | 90916 | GN047 | DP1 | GN013 |
| 5274 | GN912 | 6573 | GN855 | 91322 | GN056 | DP1 | GN917 |
| 5285 | GN053 | 6592 | GN107 | 9138 | GN992 | DP10 | GN016 |
| 5287 | GN107 | 6599 | GN959 | 91430 | GN939 | DP11 | GN003 |
| 5317 | GV852 | 6599 | GV844 | 91440 | GE123 | DP12 | GN019 |
| 5376 | GV968 | 6600 | GN015 | 91648 | GE118 | DP13 | GN107 |
| 5413 | GV852 | 6639 | GV730 | 91766 | GN026 | DP14 | GN992 |
| 5467 | GN065 | 6649 | GN992 | 91843 | GN062 | DP15 | GV852 |
| 5471 | GV130 | 6670 | GE102 | 92083 | GN108 | DP16 | GN948 |
| 5486 | GN994 | 6679 | GN019 | 92848 | GE100 | DP17 | GN905 |
| 5513 | GN042 | 6704 | GN905 | 93293 | GN109 | DP18 | GN018 |
| 5540 | GN041 | 6707 | GN939 | 93520 | GN056 | DP19 | GN991 |
| 5568 | GN860 | 6792 | GN022 | 93707 | GE112 | DP2 | GN857 |
| 5605 | GN855 | 6848 | GN948 | 94103 | GE110 | DP20 | GN007 |
| 5618 | GN015 | 6850 | GN999 | 94251 | GE114 | DP20 | GN046 |
| 5661 | GE101 | 6892 | GN018 | 94288 | GN110 | DP21 | GN107 |
| 5665 | GN042 | 6897 | GN024 | 94470 | GN110 | DP22 | GN999 |
| 5700 | GN970 | 6900 | GV947 | 9456 | GN993 | DP23 | GN927 |
| 5718 | GN016 | 6929 | GV108 | 94629 | GN037 | DP23 | GV661 |
| 5740 | GN948 | 6943 | GN046 | 94832 | GN939 | DP24 | GN027 |
| 5837 | GV945 | 6943 | GN007 | 95061 | GN060 | DP25 | GN959 |
| 5849 | GE115 | 7119 | GN925 | 95836 | GE114 | DP25 | GV844 |
| 5906 | GN858 | 7464 | GN005 | 95970 | GN055 | DP26 | GN017 |
| 5909 | GN855 | 7492 | GV886 | 96037 | GN939 | DP27 | GN993 |
| 5915 | GN927 | 7493 | GV897 | 96187 | GN062 | DP28 | GN103 |
| 5915 | GV661 | 7494 | GV137 | 96289 | GN055 | DP29 | GN970 |
| 5939 | GN072 | 7503 | GN022 | 96614 | GE110 | DP3 | GV661 |
| 5941 | GN041 | 7545 | GV661 | 96853 | GN037 | DP3 | GV666 |
| 5968 | GE102 | 7560 | GE100 | 97199 | GE123 | DP30 | GN860 |
| 5979 | GN030 | 7629 | GV888 | 97219 | GE112 | DP31 | GN008 |
| 5986 | GN993 | 7648 | GN963 | 97256 | GN053 | DP32 | GN024 |
| 5996 | GN991 | 7694 | GN959 | 97719 | GE112 | DP33 | GV661 |
| 6001 | GN855 | 7694 | GV844 | 9776 | GE100 | DP34 | GV783 |
| 6003 | GN961 | 7694 | GV844 | 97930 | GN108 | DP35 | GN939 |
| 6042 | GN027 | 7717 | GN007 | 9810 | CGP002 | DP36 | GN041 |
| 6074 | GE115 | 7717 | GN046 | 9826 | CGP002 | DP37 | GN033 |
| 6092 | GN059 | 7768 | GE101 | 9835 | CGP003 | DP37 | GV945 |
| 6136 | GV844 | 7771 | GN044 | 9864 | CGP003 | DP38 | GN010 |
| 6136 | GN959 | 7794 | GN045 | 9974 | GN955 | DP39 | GN005 |
| 6140 | GN854 | 7906 | GN954 | CY01 | GN101 | DP4 | GN855 |
| 6158 | GN905 | 7906 | GV719 | CY02 | GN102 | DP40 | GN047 |
| 6160 | GN103 | 7906 | GV663 | CY03 | GN103 | DP41 | GN961 |
| 6214 | GV852 | 7906 | GN033 | CY07 | GN107 | DP42 | GN104 |
| 6244 | GV749 | 7906 | GV642 | CY08 | GN994 | DP43 | GN030 |
| 6246 | GN027 | 7906 | GV945 | CY51 | GN101 | DP44 | GN065 |
| 6281 | GN912 | 7906 | GN908 | CY52 | GN102 | DP45 | GN042 |
| 6285 | GN857 | 7906 | GN016 | CY53 | GN103 | DP46 | GN015 |
| 6286 | GE105 | 7906 | GN013 | CY57 | GN107 | DP47 | GE102 |
| 6287 | GE105 | 7906 | GN909 | CY58 | GN994 | DP48 | GE101 |
| 6298 | GN033 | 7906 | GN917 | CZ101 | CGP002 | DP49 | GE115 |
| 6298 | GV945 | 7925 | GN939 | CZ104 | CGP002 | DP5 | GN022 |
| 6305 | GN954 | 7947 | GN959 | CZ21 | GN072 | DP50 | GE100 |
| 6305 | GV945 | 7947 | GV844 | CZ22 | GN104 | DP51 | GE105 |
| 6305 | GV719 | 7957 | GN054 | CZ24 | GN106 | DP52 | CGP002 |
| 6305 | GV663 | 7992 | GN010 | CZ301 | CGP003 | DP55 | CGP003 |
| 6305 | GV642 | 7995 | GN061 | CZ304 | CGP003 | DP56 | GN054 |
| 6305 | GN909 | 8838 | GN103 | DG 200 AL | GD214 | DP57 | GE115 |
| 6305 | GN908 | 8851 | GE121A | DG 237 | GD382 | DP58 | GE121A |
| 6305 | GN033 | 8888 | GE115 | DP1 | GN909 | DP59 | GN070 |
| 6305 | GN013 | 8902 | GN070 | DP1 | GV945 | DP6 | GN858 |
| 6305 | GN016 | 8904 | GE121A | DP1 | GV719 | DP60 | GN103 |
| 6305 | GN917 | 8926 | GE115 | DP1 | GV663 | DP61 | GN109 |
| 6346 | GN003 | 8939 | GN054 | DP1 | GV642 | DP62 | GN053 |

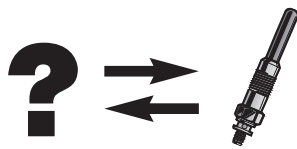

| ...NGK | | ...NGK | | ...NGK | | ...NGK | |
|------------|-------|------------|--------|----------|-------|---------|--------|
| DP63 | GN110 | D-Power 40 | GN047 | Y-204RS | GV888 | Y-739R | GV730 |
| DP64 | GN037 | D-Power 41 | GN961 | Y-204SS | GV888 | Y-740U | GN999 |
| DP65 | GN108 | D-Power 42 | GN104 | Y-204TS | GN857 | Y-741U | GN007 |
| DP66 | GN026 | D-Power 43 | GN030 | Y-204TS1 | GV689 | Y-741U | GN046 |
| DP67 | GN062 | D-Power 44 | GN065 | Y-204V | GN857 | Y-745U | GN003 |
| DP7 | GN963 | D-Power 45 | GN042 | Y-206T | GV602 | Y-746J | GN010 |
| DP70 | GN097 | D-Power 46 | GN015 | Y-207T | GN857 | Y-746R | GN010 |
| DP71 | GN055 | D-Power 47 | GE102 | Y-207TS | GN857 | Y-747U | GN017 |
| DP72 | GE112 | D-Power 48 | GE101 | Y-208T | GV602 | Y-748U | GN992 |
| DP73 | GN056 | D-Power 49 | GE115 | Y-302 | GV112 | Y-749J | GN035 |
| DP74 | GE123 | D-Power 5 | GN022 | Y-306R | GV749 | Y-752M | GN013 |
| DP75 | GN939 | D-Power 50 | GE100 | Y-307R | GV945 | Y-755RS | GN044 |
| DP77 | GE110 | D-Power 51 | GE105 | Y-403T | GV137 | Y8001AS | GE121A |
| DP78 | GE114 | D-Power 52 | CGP002 | Y-405 | GV130 | Y8002AS | GE105 |
| DP8 | GN103 | D-Power 55 | CGP003 | Y-501U | GN008 | Y8003J | GN053 |
| DP80 | GE118 | D-Power 56 | GN054 | Y-502R | GN012 | Y8005J | GN037 |
| DP81 | GN060 | D-Power 57 | GE115 | Y-503J | GN016 | Y8008AS | GE123 |
| DP9 | GN912 | D-Power 58 | GE121A | Y-503R | GN016 | Y-810 | GV108 |
| D-Power 1 | GN954 | D-Power 59 | GN070 | Y-504J | GN027 | Y9001AS | GE112 |
| D-Power 1 | GV945 | D-Power 6 | GN858 | Y-504R | GN027 | Y9003AS | GE114 |
| D-Power 1 | GV719 | D-Power 60 | GN103 | Y-506J | GN963 | Y-901R | GN857 |
| D-Power 1 | GV663 | D-Power 61 | GN109 | Y-506R | GN963 | Y-902R | GN908 |
| D-Power 1 | GN016 | D-Power 62 | GN053 | Y-507J | GN024 | Y-902R | GV663 |
| D-Power 1 | GV642 | D-Power 63 | GN110 | Y-507R | GN024 | Y-902R | GV945 |
| D-Power 1 | GN909 | D-Power 64 | GN037 | Y-508J | GN057 | Y-902R | GV642 |
| D-Power 1 | GN033 | D-Power 65 | GN108 | Y-509J | GN853 | Y-902R | GN033 |
| D-Power 1 | GN908 | D-Power 66 | GN026 | Y-515J | GN018 | Y-902R | GV636 |
| D-Power 1 | GN013 | D-Power 67 | GN062 | Y-516J | GN019 | Y-902R | GN954 |
| D-Power 1 | GN917 | D-Power 7 | GN963 | Y-517J | GN026 | Y-904M1 | GN061 |
| D-Power 10 | GN016 | D-Power 70 | GN097 | Y-519J | GN109 | Y-907R | GV631 |
| D-Power 11 | GN003 | D-Power 71 | GN055 | Y-522J | GN072 | Y-908R | GV642 |
| D-Power 12 | GN019 | D-Power 72 | GE112 | Y-523J | GV945 | Y-909R | GV657 |
| D-Power 13 | GN107 | D-Power 73 | GN056 | Y-523J | GN033 | Y-910J | GV661 |
| D-Power 14 | GN992 | D-Power 74 | GE123 | Y-524J | GN993 | Y-910J | GV666 |
| D-Power 15 | GV852 | D-Power 75 | GN939 | Y-525J | GN939 | Y-910R | GV666 |
| D-Power 16 | GN948 | D-Power 77 | GE110 | Y-527J | GN062 | Y-911J | GV661 |
| D-Power 17 | GN905 | D-Power 78 | GE114 | Y-529J | GN064 | Y-911R | GV661 |
| D-Power 18 | GN018 | D-Power 8 | GN103 | Y-531J | GN065 | Y-912M | GV852 |
| D-Power 19 | GN991 | D-Power 80 | GE118 | Y-534J | GN041 | Y-912R | GV661 |
| D-Power 2 | GN857 | D-Power 81 | GN060 | Y-536J | GN060 | Y-913J | GV852 |
| D-Power 20 | GN007 | D-Power 9 | GN912 | Y-541J | GN104 | Y-913M | GV852 |
| D-Power 20 | GN046 | Y03 | GN103 | Y-542J | GN042 | Y-914U | GN908 |
| D-Power 21 | GN107 | Y03X | GV889 | Y-543J | GN015 | Y-914U | GN917 |
| D-Power 22 | GN999 | Y1002AS | GE115 | Y-547AS | GE102 | Y-914U | GN954 |
| D-Power 23 | GN927 | Y1005J | GN054 | Y-548J | GN939 | Y-916J | GN858 |
| D-Power 23 | GV661 | Y1007J | GN070 | Y-603J | GN103 | Y-916R | GN858 |
| D-Power 24 | GN027 | Y1012J | GN108 | Y-607AS | GE100 | Y-917U | GV719 |
| D-Power 25 | GV844 | Y1013J | GN110 | Y-609AS | GE115 | Y-918J | GN857 |
| D-Power 25 | GN959 | Y1030J | GN097 | Y-701J | GN005 | Y-918R | GN857 |
| D-Power 26 | GN017 | Y1031J | GN055 | Y-701R | GN005 | Y-920R | GN908 |
| D-Power 27 | GN993 | Y1035AS | GE110 | Y-703R | GV967 | Y-920R | GN954 |
| D-Power 28 | GN103 | Y1039AS | GE118 | Y-705RS | GV920 | Y-920R | GV663 |
| D-Power 29 | GN970 | Y-104R | GV749 | Y-707RS | GV921 | Y-922R | GN908 |
| D-Power 3 | GV661 | Y-112M1 | GV889 | Y-710R | GV946 | Y-922R | GN954 |
| D-Power 3 | GV666 | Y-112R1 | GV892 | Y-711J | GN103 | Y-923U | GN909 |
| D-Power 30 | GN860 | Y-115T | GV673 | Y-711RS | GV947 | Y-924J | GN013 |
| D-Power 31 | GN008 | Y-115T1 | GV673 | Y-712RS | GN854 | Y-924J | GN016 |
| D-Power 32 | GN024 | Y-117RS | GV685 | Y-715R | GV968 | Y-924J | GN033 |
| D-Power 33 | GV661 | Y-118R | GV894 | Y-719RS1 | GV947 | Y-924J | GN908 |
| D-Power 34 | GV783 | Y-118T | GV688 | Y-722J | GN955 | Y-924J | GN909 |
| D-Power 35 | GN939 | Y-118T1 | GV688 | Y-722JS | GN955 | Y-924J | GN917 |
| D-Power 36 | GN041 | Y-146R | GV886 | Y-729U | GV783 | Y-924J | GN954 |
| D-Power 37 | GN033 | Y-147T | GV897 | Y-730U | GN905 | Y-924J | GV642 |
| D-Power 37 | GV945 | Y-162R1 | GV890 | Y-731U | GN912 | Y-924J | GV663 |
| D-Power 38 | GN010 | Y-181T | GV887 | Y-732J | GN855 | Y-924J | GV719 |
| D-Power 39 | GN005 | Y-197R | GV895 | Y-732U | GN855 | Y-924J | GV945 |
| D-Power 4 | GN855 | Y-203 | GV106 | Y-733J | GN107 | Y-924U | GN954 |

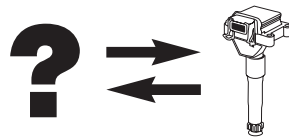

| AIRTEX | | ...BBT | | ...BBT | | ...BOSCH | |
|-----------------|--------|---------------|--------|-------------------|--------|-----------------|-------|
| 5C 1071 | ZSE136 | IC03100 | ZSE001 | IC15118 | ZS315 | 0 221 102 017 | ZS106 |
| 5C 1092 | ZS431 | IC03102 | ZSE043 | IC15119 | ZS345 | 0 221 102 031 | ZS115 |
| 5C 1095 | ZS405 | IC03105 | ZS123 | IC15120 | ZS354 | 0 221 102 032 | ZS106 |
| 5C 1159 | ZSE086 | IC03105 | ZS124 | IC15123 | ZS346 | 0 221 102 036 | ZS115 |
| 5C 1163 | ZSE077 | IC03106 | ZS016 | IC15125 | ZS347 | 0 221 102 037 | ZS106 |
| 5C 1165 | ZSE071 | IC03107 | ZS017 | IC15126 | ZSE045 | 0 221 102 038 | ZS106 |
| 5C 1166 | ZSE073 | IC03109 | ZSE002 | IC15127 | ZSE046 | 0 221 102 041 | ZS106 |
| 5C 1171 | ZSE074 | IC03110 | ZSE142 | IC15128 | ZS348 | 0 221 102 044 | ZS106 |
| 5C 1208 | ZSE083 | IC03110 | ZSE033 | IC15129 | ZS351 | 0 221 102 045 | ZS106 |
| 5C 1241 | ZSE076 | IC03111 | ZSE032 | IC15130 | ZS352 | 0 221 102 046 | ZS115 |
| 5C 1287 | ZSE072 | IC03112 | ZSE031 | IC15131 | ZS353 | 0 221 102 049 | ZS106 |
| 5C 1394 | ZSE081 | IC03114 | ZSE039 | IC15138 | ZSE066 | 0 221 102 051 | ZS115 |
| 5C 1396 | ZS437 | IC03114 | ZSE040 | IC16100 | ZS276 | 0 221 102 052 | ZS106 |
| 5C 1397 | ZS435 | IC03118 | ZSE063 | IC16101 | ZS275 | 0 221 102 053 | ZS109 |
| 5C 1402 | ZSE089 | IC03119 | ZSE029 | IC16102 | ZS263 | 0 221 102 055 | ZS106 |
| 5C 1403 | ZSE079 | IC03121 | ZSE051 | IC16113 | ZSE056 | 0 221 102 056 | ZS106 |
| 5C 1428 | ZSE087 | IC03122 | ZSE059 | IC16116 | ZSE166 | 0 221 102 058 | ZS106 |
| 5C 1430 | ZSE132 | IC03123 | ZSE044 | IC16117 | ZS521 | 0 221 102 059 | ZS106 |
| 5C 1488 | ZS430 | IC03127 | ZSE067 | IC16118 | ZS477 | 0 221 102 060 | ZS115 |
| 5C 16127 | ZSE080 | IC03127 | ZSE126 | IC16120 | ZS487 | 0 221 102 061 | ZS109 |
| 5C1153 | ZS521 | IC03128 | ZSE068 | IC16131 | ZS475 | 0 221 102 066 | ZS109 |
| 5C1157 | ZS522 | IC04101 | ZS313 | IC16132 | ZS476 | 0 221 102 067 | ZS106 |
| 5C1317 | ZS429 | IC04102 | ZS340 | IC16133 | ZS478 | 0 221 102 068 | ZS106 |
| | | IC04104 | ZS339 | IC-16135 | ZSE170 | 0 221 102 069 | ZS115 |
| | | IC04105 | ZS298 | IC1622 | ZS486 | 0 221 102 071 | ZS109 |
| | | IC04108 | ZS340 | IC17100 | ZS279 | 0 221 102 072 | ZS115 |
| ANGLI | | IC04110 | ZSE146 | IC17101 | ZSE011 | 0 221 102 074 | ZS106 |
| 15067 | ZS375 | IC04112 | ZS053 | IC17102 | ZS356 | 0 221 102 075 | ZS106 |
| 15138 | ZS376 | IC04119 | ZSE093 | IC17103 | ZS473 | 0 221 102 076 | ZS106 |
| | | IC07100 | ZS344 | IC17105 | ZSE173 | 0 221 102 077 | ZS106 |
| ASHUKI | | IC07102 | ZS259 | IC17106 | ZSE168 | 0 221 102 078 | ZS109 |
| H595-03 | ZSE169 | IC07103 | ZS252 | IC17107 | ZSE172 | 0 221 102 079 | ZS109 |
| | | IC07105 | ZS342 | IC17113 | ZSE165 | 0 221 102 081 | ZS110 |
| | | IC07106 | ZS358 | IC17114 | ZSE502 | 0 221 102 082 | ZS106 |
| AURADIA | | IC07107 | ZSE147 | IC17115 | ZSE167 | 0 221 118 002 | ZS400 |
| 21724 | ZS052 | IC07108 | ZSE151 | IC17119 | ZS480 | 0 221 118 003 | ZS400 |
| | | IC07109 | ZS427 | IC17120 | ZS479 | 0 221 118 307 | ZS117 |
| | | IC07113 | ZS451 | IC17121 | ZS483 | 0 221 118 329 | ZS118 |
| AUTOMEGA | | IC07114 | ZS450 | IC-17131 | ZSE171 | 0 221 118 335 | ZS122 |
| 3012080071 | ZS344 | IC07116 | ZSE152 | IC18100 | ZS281 | 0 221 118 351 | ZS119 |
| 3012080306 | ZS358 | IC07117 | ZSE153 | IC18101 | ZS350 | 0 221 118 387 | ZS119 |
| 3012080307 | ZS259 | IC07121 | ZSE150 | IC18106 | ZS387 | 0 221 118 398 | ZS119 |
| | | IC07122 | ZS359 | ZK15102 | ZSE047 | 0 221 118 442 | ZS122 |
| | | IC09100 | ZS014 | ZK15106 | ZSE047 | 0 221 119 001 | ZS106 |
| | | IC09102 | ZS014 | ZK15132 | ZSE048 | 0 221 119 005 | ZS109 |
| | | IC09103 | ZS302 | | | 0 221 119 006 | ZS109 |
| | | IC09107 | ZS324 | BorgWarner | | 0 221 119 008 | ZS106 |
| | | IC10101 | ZS309 | E 233 | ZS380 | 0 221 119 009 | ZS115 |
| | | IC10104 | ZSE148 | | | 0 221 119 011 | ZS109 |
| | | IC12101 | ZS469 | BOSCH | | 0 221 119 014 | ZS106 |
| | | IC12102 | ZS088 | 0 221 100 053 | ZS109 | 0 221 119 015 | ZS109 |
| | | IC13101 | ZS244 | 0 221 101 001 | ZS105 | 0 221 119 016 | ZS115 |
| | | IC13102 | ZS248 | 0 221 101 003 | ZS106 | 0 221 119 017 | ZS115 |
| | | IC13105 | ZS029 | 0 221 101 005 | ZS105 | 0 221 119 018 | ZS106 |
| | | IC13106 | ZS320 | 0 221 101 007 | ZS105 | 0 221 119 020 | ZS106 |
| | | IC13108 | ZS361 | 0 221 101 010 | ZS105 | 0 221 119 021 | ZS115 |
| | | IC15100 | ZS052 | 0 221 101 014 | ZS105 | 0 221 119 022 | ZS115 |
| | | IC15101 | ZS231 | 0 221 101 016 | ZS106 | 0 221 119 025 | ZS106 |
| | | IC15103 | ZS232 | 0 221 101 017 | ZS106 | 0 221 119 026 | ZS106 |
| | | IC15105 | ZS256 | 0 221 101 027 | ZS105 | 0 221 119 027 | ZS106 |
| | | IC15108 | ZS242 | 0 221 101 029 | ZS105 | 0 221 119 028 | ZS106 |
| | | IC15110 | ZS257 | 0 221 101 030 | ZS105 | 0 221 119 030 | ZS109 |
| | | IC15111 | ZS249 | 0 221 102 001 | ZS106 | 0 221 119 031 | ZS110 |
| | | IC15112 | ZS250 | 0 221 102 003 | ZS106 | 0 221 119 034 | ZS106 |
| | | IC15114 | ZS258 | 0 221 102 012 | ZS106 | 0 221 119 035 | ZS106 |
| | | IC15116 | ZS255 | 0 221 102 016 | ZS106 | 0 221 119 036 | ZS115 |
| | | IC15117 | ZS243 | | | 0 221 119 037 | ZS115 |

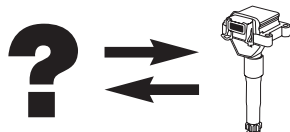

| ...BOSCH | BERU | ...BOSCH | BERU | ...BOSCH | BERU | ...BOSCH | BERU |
|-------------------|--------|-------------------|--------|---------------|--------|---------------|--------|
| 0 221 119 038 | ZS115 | 0 221 503 471 | ZS359 | 0 986 221 009 | ZS017 | F 000 ZSO 113 | ZS257 |
| 0 221 119 039 | ZS106 | 0 221 503 472 | ZS338 | 0 986 221 010 | ZS263 | F 000 ZSO 114 | ZS247 |
| 0 221 119 040 | ZS106 | 0 221 503 485 | ZS387 | 0 986 221 011 | ZS016 | F 000 ZSO 115 | ZS251 |
| 0 221 119 044 | ZS115 | 0 221 503 489 | ZS307 | 0 986 221 012 | ZS261 | F 000 ZSO 116 | ZS275 |
| 0 221 119 048 | ZS106 | 0 221 503 489-7G8 | ZS307 | 0 986 221 013 | ZS265 | F 000 ZSO 117 | ZS356 |
| 0 221 119 053 | ZS109 | 0 221 503 490 | ZS422 | 0 986 221 014 | ZS043 | F 000 ZSO 202 | ZS300 |
| 0 221 119 355 | ZS115 | 0 221 503 490 | ZS422 | 0 986 221 015 | ZSE004 | F 000 ZSO 205 | ZS300 |
| 0 221 122 001 | ZS400 | 0 221 504 004 | ZS302 | 0 986 221 016 | ZS031 | F 000 ZSO 209 | ZSE003 |
| 0 221 122 003 | ZS400 | 0 221 504 005 | ZS310 | 0 986 221 017 | ZS037 | F 000 ZSO 210 | ZSE003 |
| 0 221 122 010 | ZS400 | 0 221 504 006 | ZS310 | 0 986 221 018 | ZSE502 | F 000 ZSO 211 | ZS395 |
| 0 221 122 030 | ZS126 | 0 221 504 014 | ZS311 | 0 986 221 019 | ZS269 | F 000 ZSO 212 | ZS281 |
| 0 221 122 031 | ZS126 | 0 221 504 017 | ZS337 | 0 986 221 020 | ZSE010 | F 000 ZSO 221 | ZS354 |
| 0 221 122 304 | ZS120 | 0 221 504 020 | ZS449 | 0 986 221 022 | ZSE010 | F 005 X03 210 | ZS376 |
| 0 221 122 323 | ZS120 | 0 221 504 024 | ZS095 | 0 986 221 023 | ZSE030 | TJ 12/1 | ZS220 |
| 0 221 122 327 | ZS121 | 0 221 504 027 | ZS535 | 0 986 221 024 | ZSE043 | TJ 6/1 | ZS215 |
| 0 221 122 334 | ZS120 | 0 221 504 029 | ZS302 | 0 986 221 025 | ZS242 | TZ 61 | ZSE005 |
| 0 221 122 349 | ZS124 | 0 221 504 030 | ZSE161 | 0 986 221 026 | ZS243 | ZS-K 1X1 | ZS250 |
| 0 221 122 357 | ZS120 | 0 221 504 035 | ZS090 | 0 986 221 027 | ZS244 | ZS-K 1X1 | ZS257 |
| 0 221 122 362 | ZS126 | 0 221 504 100 | ZS324 | 0 986 221 028 | ZS248 | ZS-K 1X1 | ZS314 |
| 0 221 122 399 | ZS123 | 0 221 504 410 | ZS014 | 0 986 221 029 | ZS249 | ZS-K 1X2 | ZS283 |
| 0 221 122 402 | ZS125 | 0 221 504 456 | ZS428 | 0 986 221 030 | ZS254 | ZS-K 2X2 | ZS300 |
| 0 221 122 403 | ZS125 | 0 221 504 460 | ZS321 | 0 986 221 031 | ZS255 | ZS-K 2X2 | ZSE003 |
| 0 221 122 408 | ZS127 | 0 221 504 464 | ZS324 | 0 986 221 032 | ZS277 | ZS-K 2X2 | ZS239 |
| 0 221 122 409 | ZS127 | 0 221 504 465 | ZSE145 | 0 986 221 033 | ZS315 | ZS-K-1X1PM | ZS090 |
| 0 221 122 418 | ZS123 | 0 221 504 470 | ZSE143 | 0 986 221 034 | ZS381 | ZS-K-2X2 | ZS422 |
| 0 221 122 446 | ZS109 | 0 221 504 471 | ZSE144 | 0 986 221 035 | ZSE047 | | |
| 0 221 122 450 | ZS126 | 0 221 505 423 | ZS308 | 0 986 221 039 | ZS259 | | |
| 0 221 124 001 | ZS105 | 0 221 505 437 | ZS313 | 0 986 221 040 | ZS053 | | |
| 0 221 501 003 | ZS296 | 0 221 506 002 | ZS340 | 0 986 221 041 | ZSE036 | | |
| 0 221 501 007 | ZS339 | 0 221 506 453 | ZS360 | 0 986 221 042 | ZS320 | | |
| 0 221 501 374 | ZS298 | 0 221 600 009 | ZS120 | 0 986 221 043 | ZS322 | | |
| 0 221 501 376 | ZS299 | 0 221 600 011 | ZS123 | 0 986 221 044 | ZS501 | | |
| 0 221 502 007 | ZS280 | 0 221 600 050 | ZSE005 | 0 986 221 045 | ZS052 | | |
| 0 221 502 429 | ZS296 | 0 221 601 001 | ZSE002 | 0 986 221 048 | ZSE003 | | |
| 0 221 502 431 | ZS339 | 0 221 601 002 | ZSE002 | 0 986 221 052 | ZSE032 | | |
| 0 221 502 433 | ZS298 | 0 221 601 003 | ZSE001 | 0 986 221 056 | ZSE041 | | |
| 0 221 502 435 | ZS299 | 0 221 601 004 | ZSE001 | 0 986 221 062 | ZS474 | | |
| 0 221 502 460 | ZS357 | 0 221 601 005 | ZSE001 | 0 986 221 063 | ZS475 | | |
| 0 221 503 001 | ZS300 | 0 221 601 012 | ZSE037 | 0 986 JG1 211 | ZSE021 | | |
| 0 221 503 002 | ZS301 | 0 221 603 003 | ZSE162 | 0 986 JG1 212 | ZSE081 | | |
| 0 221 503 003 | ZS231 | 0 221 603 009 | ZSE003 | 0 986 JG1 213 | ZSE080 | | |
| 0 221 503 004 | ZS341 | 0 221 603 010 | ZSE003 | 0 986 JG1 214 | ZSE073 | | |
| 0 221 503 005 | ZS307 | 0 221 604 001 | ZSE019 | 0 986 JG1 215 | ZSE074 | | |
| 0 221 503 005-7G8 | ZS307 | 0 221 604 008 | ZSE019 | 0 986 JG1 216 | ZSE071 | | |
| 0 221 503 006 | ZS231 | 0 221 604 010 | ZSE055 | 0 986 JG1 222 | ZSE082 | | |
| 0 221 503 007 | ZS341 | 0 221 604 014 | ZSE056 | 0221 604 034 | ZSE093 | | |
| 0 221 503 010 | ZS451 | 0 221 604 103 | ZSE148 | 1 227 020 015 | ZS120 | | |
| 0 221 503 011 | ZS450 | 0 221 604 112 | ZSE174 | 1 227 020 017 | ZS126 | | |
| 0 221 503 012 | ZS297 | 0 221 604 115 | ZSE142 | 1 227 020 026 | ZS120 | | |
| 0 221 503 014 | ZS358 | 0 222 002 002 | ZS215 | 1 227 020 027 | ZS120 | | |
| 0 221 503 015 | ZSE147 | 0 222 002 004 | ZS215 | 1 227 020 028 | ZS123 | | |
| 0 221 503 017 | ZS306 | 0 222 003 001 | ZS220 | 1 227 020 029 | ZS125 | | |
| 0 221 503 022 | ZS304 | 0 222 003 003 | ZS220 | 1 227 020 035 | ZS127 | | |
| 0 221 503 024 | ZS231 | 0 222 003 032 | ZS220 | 1 227 030 062 | ZS309 | | |
| 0 221 503 025 | ZS232 | 0 222 003 036 | ZS220 | 1 227 030 071 | ZS361 | | |
| 0 221 503 026 | ZSE152 | 0 222 003 039 | ZS220 | 9 220 081 030 | ZS106 | | |
| 0 221 503 027 | ZSE153 | 0 222 003 040 | ZS220 | 9 220 081 054 | ZS106 | | |
| 0 221 503 031 | ZSE150 | 0 222 003 042 | ZS220 | 9 220 081 504 | ZS314 | | |
| 0 221 503 033 | ZSE146 | 0 222 003 043 | ZS220 | 9 220 081 505 | ZS250 | | |
| 0 221 503 035 | ZS297 | 0 986 221 000 | ZSE001 | 9 221 334 411 | ZS123 | | |
| 0 221 503 407 | ZS234 | 0 986 221 001 | ZS052 | 9 221 334 412 | ZS123 | | |
| 0 221 503 417 | ZS230 | 0 986 221 002 | ZSE002 | 9 221 334 416 | ZS120 | | |
| 0 221 503 421 | ZS231 | 0 986 221 003 | ZS029 | A 221 F10 029 | ZS126 | | |
| 0 221 503 422 | ZS341 | 0 986 221 004 | ZS264 | F 000 ZSO 001 | ZS127 | | |
| 0 221 503 457 | ZS234 | 0 986 221 005 | ZS266 | F 000 ZSO 103 | ZS283 | | |
| 0 221 503 468 | ZSE151 | 0 986 221 006 | ZSE011 | F 000 ZSO 105 | ZS314 | | |
| 0 221 503 469 | ZSE149 | 0 986 221 007 | ZS041 | F 000 ZSO 111 | ZS253 | | |
| | | 0 986 221 008 | ZS267 | F 000 ZSO 112 | ZS252 | | |

| BOUGICORD | BERU |
|-------------|--------|
| 151401 | ZS454 |
| 154301 | ZS381 |
| 154302 | ZSE047 |
| 15430200001 | ZSE047 |
| 154303 | ZSE048 |
| 155003 | ZS358 |
| 155006 | ZS361 |
| 155007 | ZS088 |
| 155008 | ZS365 |
| 155010 | ZS350 |
| 155011 | ZS281 |
| 155013 | ZS242 |
| 155014 | ZS243 |
| 155015 | ZS315 |
| 155016 | ZS354 |
| 155021 | ZS347 |
| 155028 | ZSE165 |
| 155030 | ZS346 |
| 155031 | ZS351 |
| 155032 | ZSE045 |
| 155039 | ZS427 |
| 155040 | ZS352 |
| 155041 | ZS353 |
| 155043 | ZSE046 |
| 155045 | ZS359 |
| 155052 | ZSE026 |
| 155054 | ZSE044 |
| 155055 | ZS349 |
| 155057 | ZS344 |
| 155067 | ZS469 |
| 155071 | ZS356 |
| 155074 | ZS079 |
| 155093 | ZS479 |
| 155099 | ZSE502 |
| 155100 | ZS014 |
| 155101 | ZSE031 |
| 155103 | ZSE062 |
| 155104 | ZSE059 |
| 155106 | ZSE063 |

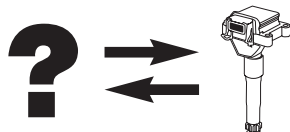

| | | | | | | | |
|--------------------|--------|------------------|--------|------------|--------|---------------|--------|
| BSG | | ...DELPHI | | ERA | | ...ERA | |
| BSG 30-835-002 | ZS387 | DS10000-12B1 | ZSE026 | 880003 | ZSE003 | 880161 | ZSE082 |
| CHAMPION | | GN 10199-12B1 | ZS451 | 880006 | ZSE030 | 880163 | ZSE010 |
| AMC800B | ZS283 | GN 10204-12B1 | ZSE147 | 880007 | ZSE043 | 880164 | ZS477 |
| AMC920A | ZS029 | GN10208-12B1 | ZSE089 | 880009 | ZS052 | 880166 | ZSE059 |
| BAE 403 AE/245 | ZSE030 | GN10221 | ZS532 | 880015 | ZS106 | 880180 | ZS340 |
| BAE 403 B | ZS320 | GN10235-12B1 | ZSE140 | 880015 | ZS344 | 880182 | ZS371 |
| BAE 403 C | ZS322 | GN10243 | ZSE134 | 880022 | ZS106 | 880183 | ZS282 |
| BAE 403 D | ZS321 | GN10244 | ZSE158 | 880035 | ZSE047 | 880184 | ZS234 |
| BAE 403 H | ZS068 | GN10246 | ZSE132 | 880039 | ZS259 | 880186 | ZS433 |
| BAE 403 H/245 | ZS068 | GN10247 | ZSE156 | 880040 | ZSE026 | 880188 | ZS483 |
| BAE 408 AE | ZSE030 | GN10309-12B1 | ZSE174 | 880048 | ZS239 | 880191 | ZS501 |
| BAE 409 A | ZS052 | DENSO | | 880049 | ZS350 | 880193 | ZS365 |
| BAE 504 L | ZS250 | 029 700-8291 | ZS052 | 880052 | ZS276 | 880196 | ZS434 |
| BAE 506 D | ZS244 | 029 700-848 | ZS502 | 880053 | ZS275 | 880201 | ZSE166 |
| BAE 506 F | ZS248 | DIC-0102 | ZSE171 | 880054 | ZS279 | 880203 | ZS480 |
| BAE 507 AK | ZS257 | DIC-0110 | ZS480 | 880055 | ZS263 | 880204 | ZSE086 |
| BAE 507 BK | ZS249 | DIC-0110 | ZS480 | 880056 | ZS345 | 880205 | ZSE087 |
| BAE 700 AK | ZS323 | DIC-0113 | ZS482 | 880057 | ZS469 | 880207 | ZS277 |
| BAE 800 B | ZS283 | GCL 209 | ZS501 | 880058 | ZS354 | 880213 | ZSE056 |
| BAE 801 AK | ZS317 | GCL 219 | ZS502 | 880059 | ZSE011 | 880214 | ZS436 |
| BAE 801 BK | ZS318 | MB 029700-8230 | ZS501 | 880065 | ZSE032 | 880224 | ZS511 |
| BAE 801 CK | ZS319 | MB 029700-848 | ZS502 | 880066 | ZSE031 | 880225 | ZS274 |
| BAE 801 EK | ZS315 | DODUCO | | 880067 | ZS068 | 880241 | ZSE173 |
| BAE 851 AE | ZSE001 | 7401 | ZS106 | 880071 | ZSE165 | 880243 | ZSE164 |
| BAE 907 AE | ZSE003 | 7402 | ZS115 | 880072 | ZS356 | 880245 | ZSE171 |
| BAE 920 AX | ZS029 | 7403 | ZS110 | 880073 | ZS348 | 880246 | ZS474 |
| BAE 940 A | ZS079 | DUCELLIER | | 880074 | ZSE154 | 880254 | ZS367 |
| BAE 940 A/245 | ZS079 | 2526009 | ZS257 | 880076 | ZSE021 | 880255 | ZSE167 |
| BAE 945 A | ZS381 | 2526009 A | ZS257 | 880078 | ZS358 | 880256 | ZSE172 |
| BAE 945 A/245 | ZS381 | 2526023 | ZS251 | 880079 | ZS361 | 880257 | ZSE168 |
| BAE 946 A | ZSE047 | 2526023 A | ZS251 | 880084 | ZS346 | 880258 | ZSE169 |
| BAE 947 A | ZS325 | 2526044A | ZS258 | 880085 | ZSE045 | 880259 | ZS475 |
| BAE 947 A | ZS375 | 2526049 A | ZS253 | 880086 | ZS349 | 880266 | ZSE170 |
| BAE 960 AE | ZSE039 | 2526050 A | ZS252 | 880087 | ZS351 | 880270 | ZSE089 |
| BAE 961 AE | ZSE040 | 520 073 A | ZS247 | 880088 | ZS325 | 880271 | ZS532 |
| BAE 965 A | ZS259 | 520064 | ZS251 | 880088 | ZS375 | 880273 | ZS482 |
| BAE 965 A/245 | ZS259 | EPS | | 880091 | ZS079 | 880274 | ZSE066 |
| CONTINENTAL | | 1.970.199 | ZS356 | 880095 | ZS347 | 880278 | ZS095 |
| 5WY2407A | ZS518 | 1.970.220 | ZS511 | 880098 | ZS337 | 880294 | ZS410 |
| DELCO REMY | | 1.970.261 | ZS274 | 880103 | ZS387 | 880295 | ZS372 |
| 3474221 | ZS252 | 1.970.272 | ZS344 | 880109 | ZS234 | 880296 | ZS281 |
| 3474232 | ZS252 | 1.970.352 | ZS437 | 880111 | ZS106 | 880297 | ZS380 |
| 3474282 | ZS252 | 1.970.365 | ZS345 | 880117 | ZSE048 | 880298 | ZS481 |
| DELPHI | | 1.970.377 | ZS354 | 880118 | ZS352 | 880301 | ZSE076 |
| CE10000-12B1 | ZS259 | 1.970.379 S | ZS350 | 880119 | ZS353 | 880302 | ZSE080 |
| CE10027-12B1 | ZS088 | 1.970.380 S | ZS365 | 880121 | ZSE046 | 880307 | ZS445 |
| CE10512-12B1 | ZS501 | 1.970.397 | ZS361 | 880122 | ZSE041 | 880318 | ZSE088 |
| CE20009-12B1 | ZS427 | 1.970.425 | ZSE062 | 880122 | ZSE044 | 880318 | ZSE158 |
| CE20010-12B1 | ZS381 | 1.970.427 | ZSE032 | 880124 | ZSE081 | 880325 | ZS453 |
| CE2001112B1 | ZSE047 | 1.970.429 | ZSE043 | 880125 | ZS359 | 880326 | ZS476 |
| CE20018-12B1 | ZS375 | 1.970.431 | ZSE059 | 880129 | ZS309 | 880327 | ZS478 |
| CE20024-12B1 | ZS349 | 1.970.433 | ZSE061 | 880131 | ZS234 | 880339 | ZSE126 |
| CE20030-12B1 | ZSE030 | 1.970.434 | ZSE044 | 880138 | ZS266 | 880342 | ZSE157 |
| CE20039-12B1 | ZS309 | 1.970.435 | ZSE063 | 880139 | ZS264 | 880345 | ZSE137 |
| CE20042-12B1 | ZS365 | 1.970.436 | ZSE051 | 880140 | ZS479 | 880345 | ZSE068 |
| CE20048-12B1 | ZS354 | 1.970.437 | ZSE065 | 880141 | ZS267 | 880348 | ZSE140 |
| CE20058-12B1 | ZS283 | EUROCABLE | | 880142 | ZS261 | 880358 | ZS446 |
| DLB101 | ZS106 | DC-1203 | ZS486 | 880143 | ZS265 | 880373 | ZS395 |
| DLB102 | ZS109 | DC-1225 | ZSE140 | 880144 | ZS485 | 880375 | ZS090 |
| | | | | 880145 | ZSE502 | 880391 | ZS470 |
| | | | | 880146 | ZS522 | 880399 | ZSE159 |
| | | | | 880148 | ZS486 | 880416 | ZS455 |
| | | | | 880149 | ZS487 | | |
| | | | | 880150 | ZS521 | | |
| | | | | 880151 | ZS447A | | |
| | | | | 880152 | ZSE136 | | |
| | | | | 880153 | ZS427 | | |

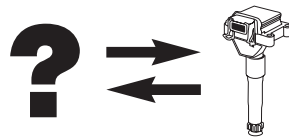

| EYQUEM | | ...FACET | | ...FACET | | ...FACET | |
|---------------|--------|-----------------|--------|-----------------|--------|-----------------|--------|
| B 6040 | ZS232 | 1.970.382 | ZS311 | 470284 | ZS263 | 9.6133 | ZS279 |
| | | 1.970.387 | ZS309 | 470299 S | ZS281 | 9.6161 | ZS274 |
| FACET | | 1.970.394 | ZSE011 | 470307 | ZS307 | 9.6172 | ZS344 |
| | | 1.970.412 | ZS014 | 470341 | ZS252 | 9.6173 | ZS300 |
| 1.970.102 | ZS248 | 1.970.414 | ZS304 | 470345 | ZS029 | 9.6175 | ZS317 |
| 1.970.105 | ZS247 | 1.970.417 | ZS297 | 470355 | ZS245 | 9.6176 | ZS318 |
| 1.970.106 | ZS257 | 1.970.450 | ZS427 | 470355 | ZS254 | 9.6177 | ZS319 |
| 1.970.107 | ZS251 | 1.990.316 | ZSE036 | 470356 | ZS246 | 9.6183 | ZS261 |
| 1.970.108 | ZS244 | 1.990.317 | ZSE005 | 470356 | ZS255 | 9.6184 | ZS263 |
| 1.970.110 | ZS252 | 1.990.420 | ZSE003 | 470376 | ZS242 | 9.6199 | ZS239 |
| 1.970.111 | ZS252 | 1.990.423 | ZSE037 | 470378 | ZS243 | 9.6199 S | ZS281 |
| 1.970.124 | ZS119 | 470 124 | ZS119 | 470379 S | ZS350 | 9.6207 | ZS307 |
| 1.970.124 | ZS120 | 470 125 | ZS124 | 470394 | ZSE011 | 9.6213 | ZS428 |
| 1.970.125 | ZS124 | 470 126 | ZS123 | 470412 | ZS014 | 9.6214 | ZS310 |
| 1.970.126 | ZS123 | 470 169 | ZS126 | 470417 | ZS297 | 9.6216 | ZS340 |
| 1.970.135 | ZS281 | 470 178 | ZS339 | 490 423 | ZSE037 | 9.6217 | ZS313 |
| 1.970.140 | ZS253 | 470 179 | ZS298 | 490316 | ZSE036 | 9.6223 | ZSE173 |
| 1.970.141 | ZS120 | 470 188 | ZS341 | 490317 | ZSE005 | 9.6241 | ZS252 |
| 1.970.146 | ZS283 | 470 191 | ZS125 | 490420 | ZSE003 | 9.6245 | ZS029 |
| 1.970.155 | ZS249 | 470 192 | ZS127 | 9 6247 | ZS532 | 9.6254 | ZS016 |
| 1.970.156 | ZS258 | 470 196 | ZS315 | 9.6001 | ZS106 | 9.6255 | ZS245 |
| 1.970.158 | ZS248 | 470 196 | ZS327 | 9.6002 | ZS248 | 9.6255 | ZS254 |
| 1.970.159 | ZSE002 | 470 273 | ZS300 | 9.6005 | ZS247 | 9.6256 | ZS246 |
| 1.970.168 | ZS234 | 470 299 | ZS239 | 9.6006 | ZS257 | 9.6256 | ZS255 |
| 1.970.169 | ZS126 | 470 314 | ZS310 | 9.6007 | ZS251 | 9.6264 | ZS237 |
| 1.970.171 | ZS230 | 470 316 | ZS340 | 9.6008 | ZS244 | 9.6265 | ZS345 |
| 1.970.174 | ZS234 | 470 317 | ZS313 | 9.6010 | ZS252 | 9.6276 | ZS242 |
| 1.970.178 | ZS296 | 470 352 | ZS302 | 9.6011 | ZS252 | 9.6277 | ZS354 |
| 1.970.178 | ZS339 | 470 354 | ZS016 | 9.6018 | ZS238 | 9.6278 | ZS243 |
| 1.970.179 | ZS298 | 470 382 | ZS311 | 9.6024 | ZS119 | 9.6279 S | ZS350 |
| 1.970.180 | ZS117 | 470 387 | ZS309 | 9.6024 | ZS120 | 9.6280 S | ZS365 |
| 1.970.188 | ZS341 | 470 450 | ZS427 | 9.6025 | ZS124 | 9.6282 | ZS311 |
| 1.970.188 | ZS232 | 470.414 | ZS304 | 9.6026 | ZS123 | 9.6287 | ZS309 |
| 1.970.189 | ZS231 | 470102 | ZS248 | 9.6035 | ZS281 | 9.6289 | ZS450 |
| 1.970.191 | ZS125 | 470105 | ZS247 | 9.6040 | ZS253 | 9.6294 | ZSE011 |
| 1.970.192 | ZS127 | 470106 | ZS257 | 9.6041 | ZS120 | 9.6297 | ZS361 |
| 1.970.196 | ZS315 | 470107 | ZS251 | 9.6046 | ZS283 | 9.6300 | ZSE147 |
| 1.970.196 | ZS327 | 470108 | ZS244 | 9.6055 | ZS249 | 9.6305 | ZSE047 |
| 1.970.213 | ZS276 | 470110 | ZS252 | 9.6056 | ZS258 | 9.6312 | ZS014 |
| 1.970.214 | ZS275 | 470111 | ZS252 | 9.6058 | ZS248 | 9.6313 | ZS435 |
| 1.970.215 | ZS278 | 470124 | ZS120 | 9.6059 | ZSE002 | 9.6314 | ZS304 |
| 1.970.221 | ZS277 | 470135 | ZS281 | 9.6062 | ZS014 | 9.6317 | ZS297 |
| 1.970.228 | ZS250 | 470140 | ZS253 | 9.6068 | ZS234 | 9.6325 | ZSE062 |
| 1.970.229 | ZS274 | 470141 | ZS120 | 9.6069 | ZS126 | 9.6326 | ZSE142 |
| 1.970.233 | ZS279 | 470146 | ZS283 | 9.6071 | ZS230 | 9.6327 | ZSE032 |
| 1.970.273 | ZS300 | 470155 | ZS249 | 9.6074 | ZS234 | 9.6329 | ZSE043 |
| 1.970.275 | ZS317 | 470156 | ZS258 | 9.6075 | ZS115 | 9.6331 | ZSE059 |
| 1.970.276 | ZS318 | 470158 | ZS248 | 9.6076 | ZS110 | 9.6333 | ZSE061 |
| 1.970.277 | ZS319 | 470159 | ZSE002 | 9.6078 | ZS296 | 9.6334 | ZSE044 |
| 1.970.283 | ZS261 | 470168 | ZS234 | 9.6078 | ZS339 | 9.6335 | ZSE089 |
| 1.970.284 | ZS263 | 470171 | ZS230 | 9.6079 | ZS298 | 9.6336 | ZSE051 |
| 1.970.299 | ZS239 | 470174 | ZS234 | 9.6080 | ZS117 | 9.6337 | ZSE065 |
| 1.970.299 S | ZS281 | 470178 | ZS296 | 9.6088 | ZS232 | 9.6350 | ZS427 |
| 1.970.307 | ZS307 | 470180 | ZS117 | 9.6088 | ZS341 | 9.6361 | ZSE164 |
| 1.970.314 | ZS310 | 470188 | ZS232 | 9.6089 | ZS231 | 9.6374 | ZSE030 |
| 1.970.316 | ZS340 | 470189 | ZS231 | 9.6091 | ZS125 | 9.6375 | ZSE143 |
| 1.970.317 | ZS313 | 470213 | ZS276 | 9.6092 | ZS127 | 9.6375 | ZSE145 |
| 1.970.341 | ZS252 | 470214 | ZS275 | 9.6096 | ZS315 | 9.6381 | ZS387 |
| 1.970.345 | ZS029 | 470215 | ZS278 | 9.6096 | ZS327 | 9.6407 | ZSE151 |
| 1.970.354 | ZS016 | 470221 | ZS277 | 9.6099 | ZS356 | 9.6432 | ZS422 |
| 1.970.355 | ZS245 | 470228 | ZS250 | 9.6113 | ZS276 | 9.6479 | ZS536 |
| 1.970.355 | ZS254 | 470229 | ZS274 | 9.6114 | ZS275 | 9.8016 | ZSE036 |
| 1.970.356 | ZS246 | 470233 | ZS279 | 9.6115 | ZS278 | 9.8017 | ZSE005 |
| 1.970.356 | ZS255 | 470275 | ZS317 | 9.6120 | ZS511 | 9.8120 | ZSE003 |
| 1.970.376 | ZS242 | 470276 | ZS318 | 9.6121 | ZS277 | 9.8123 | ZSE037 |
| 1.970.378 | ZS243 | 470277 | ZS319 | 9.6128 | ZS250 | EPS 1.970.377 | ZS354 |
| 1.970.379 S | ZS350 | 470283 | ZS261 | 9.6129 | ZS274 | EPS 1.970.532 | ZS422 |

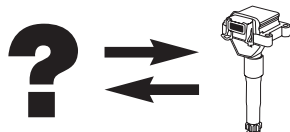

| | | | | | | | |
|----------------------|--------|-------------------------|--------|-------------------------------|--------|----------------------------------|--------|
| ...FACET | | ...FEBI BILSTEIN | | ...HELLA | | ...HERTH+BUSS ELPARTS | |
| KW 470 377 | ZS354 | 36080 | ZSE144 | 5DA 749 475-221 | ZS014 | 19050004 | ZSE030 |
| KW 470 532 | ZS422 | 36100 | ZSE143 | 5DA 749 475-231 | ZS259 | 19050005 | ZS014 |
| FAE | | 36113 | ZSE145 | 5DA 749 475-281 | ZS304 | 19050007 | ZS302 |
| 80209 | ZS259 | 36358 | ZSE033 | 5DA 749 475-311 | ZS302 | 19050008 | ZS309 |
| 80210 | ZSE026 | 36999 | ZS422 | 5DA 749 475-321 | ZS315 | 19050010 | ZS052 |
| 80216 | ZS437 | FISPA | | 5DA 749 475-331 | ZS317 | 19050016 | ZS310 |
| 80229 | ZS361 | 85 30368 | ZSE137 | 5DA 749 475-341 | ZS309 | 19050017 | ZS361 |
| 80241 | ZS356 | 85.30020 | ZS521 | 5DA 749 475-351 | ZSE162 | 19050018 | ZS311 |
| 80250 | ZS532 | 85.30072 | ZSE051 | 5DA 749 475-381 | ZS371 | 19050019 | ZS052 |
| 80254 | ZS501 | 85.30110 | ZSE063 | 5DA 749 475-401 | ZS308 | 19050020 | ZSE032 |
| FARCOM | | 85.30110 | ZSE089 | 5DA 749 475-411 | ZS387 | 19050022 | ZS307 |
| 103006 | ZSE174 | 85.30110 | ZSE047 | 5DA 749 475-441 | ZS342 | 19050025 | ZS259 |
| 103011 | ZSE152 | 85.30166 | ZSE026 | 5DA 749 475-451 | ZS358 | 19050026 | ZS313 |
| 103013 | ZSE150 | 85.30196 | ZSE061 | 5DA 749 475-461 | ZSE045 | 19050029 | ZS358 |
| FEBI BILSTEIN | | 85.30197 | ZSE062 | 5DA 749 475-561 | ZS501 | 19050033 | ZSE055 |
| 17194 | ZSE001 | 85.30218 | ZS532 | 5DA 749 475-571 | ZS502 | 19050034 | ZS346 |
| 19032 | ZSE003 | 85.30250 | ZS095 | 5DA 749 475-581 | ZS451 | 19050036 | ZS347 |
| 19929 | ZS283 | 85.30267 | ZSE136 | 5DA 749 475-601 | ZS352 | 19050037 | ZSE045 |
| 21109 | ZS014 | 85.30347 | ZS395 | 5DA 749 475-611 | ZS351 | 19050038 | ZSE046 |
| 21524 | ZS354 | 85.30366 | ZSE067 | 5DA 749 475-621 | ZS256 | 19050039 | ZS348 |
| 21525 | ZS345 | 85.30366 | ZSE126 | 5DA 749 475-631 | ZS338 | 19050040 | ZS351 |
| 21526 | ZS243 | 85.30368 | ZSE068 | 5DA 749 475-641 | ZSE047 | 19050041 | ZS352 |
| 21527 | ZS242 | 85.30373 | ZSE140 | 5DA 749 475-651 | ZS241 | 19050042 | ZS353 |
| 21528 | ZS251 | FRIESEN | | 5DA 749 475-671 | ZS428 | 19050043 | ZSE048 |
| 21528 | ZS316 | XIC8259 | ZS088 | 5DA 749 475-691 | ZSE059 | 19050048 | ZSE051 |
| 21529 | ZS315 | HAVAM | | 5DA 749 475-701 | ZSE061 | 19050049 | ZS427 |
| 21569 | ZS350 | 1970188 | ZS341 | 5DA 749 475-711 | ZSE089 | HITACHI | |
| 21666 | ZS052 | 1970199 | ZS356 | 5DA 749 475-771 | ZS016 | CM11-201D | ZSE009 |
| 22038 | ZSE030 | 1970272 | ZS344 | 5DA 749 475-781 | ZS052 | CM11-205 | ZSE021 |
| 22389 | ZS259 | 1970293 | ZS376 | 5DA 749 475-791 | ZS053 | CM1T-204B | ZSE005 |
| 22581 | ZS231 | 1970308 S | ZS365 | 5DA 749 475-801 | ZS077 | CM1T-204E-1 | ZSE036 |
| 22697 | ZS029 | 1970365 | ZS345 | 5DA 749 475-811 | ZS259 | CM1T-204F | ZSE006 |
| 22875 | ZS317 | 1970377 | ZS354 | 5DA 749 475-821 | ZSE003 | HOFFER | |
| 23187 | ZS342 | HELLA | | 5DA 749 475-831 | ZSE009 | 8010310 | ZS361 |
| 23258 | ZSE033 | 5DA 006 623 711 | ZSE001 | 5DA 749 475-851 | ZSE145 | 8010315 | ZS259 |
| 23258 | ZSE142 | 5DA 006 623 621 | ZSE001 | 5DA 749 475-851 | ZSE143 | 8010320 | ZS361 |
| 23260 | ZSE032 | 5DA 006 623 701 | ZSE002 | 5DA 749 475-861 | ZSE030 | 8010324 | ZSE047 |
| 24106 | ZSE043 | 5DA 749 245-291 | ZS297 | 5DA 749 475-871 | ZSE043 | 8010326 | ZS358 |
| 24108 | ZSE009 | 5DA 749 475-001 | ZS283 | 5DA 749 475-881 | ZSE142 | 8010328 | ZSE043 |
| 24435 | ZS347 | 5DA 749 475-011 | ZS231 | 5DA 749 475-941 | ZSE081 | 8010329 | ZSE030 |
| 24500 | ZSE059 | 5DA 749 475-021 | ZS232 | 5DA 749 475-951 | ZSE080 | 8010336 | ZS354 |
| 24996 | ZS381 | 5DA 749 475-031 | ZS354 | 5DA 749 475-971 | ZSE132 | 8010350 | ZS532 |
| 24997 | ZSE047 | 5DA 749 475-041 | ZS234 | 5DA749475-661 | ZS350 | 8010370 | ZS371 |
| 26496 | ZS375 | 5DA 749 475-051 | ZS307 | HERTH+BUSS ELPARTS | | 8010372 | ZSE031 |
| 26869 | ZS350 | 5DA 749 475-061 | ZS340 | 19 050 028 | ZSE147 | 8010378 | ZS309 |
| 27132 | ZSE003 | 5DA 749 475-071 | ZS313 | 19 050 031 | ZSE146 | 8010384 | ZS344 |
| 27168 | ZS358 | 5DA 749 475-091 | ZS029 | 19 050 032 | ZSE151 | 8010387 | ZS356 |
| 27470 | ZSE043 | 5DA 749 475-101 | ZS245 | 19 050 046 | ZSE142 | 8010389 | ZS088 |
| 27522 | ZS359 | 5DA 749 475-101 | ZS254 | 19020001 | ZSE001 | 8010395 | ZS079 |
| 28108 | ZS427 | 5DA 749 475-111 | ZS242 | 19020002 | ZSE002 | 8010401 | ZSE045 |
| 28487 | ZSE033 | 5DA 749 475-121 | ZS016 | 19020004 | ZS106 | 8010405 | ZSE045 |
| 28533 | ZS339 | 5DA 749 475-131 | ZS361 | 19020005 | ZSE002 | 8010409 | ZS380 |
| 28538 | ZS340 | 5DA 749 475-141 | ZSE021 | 19020007 | ZSE003 | 8010410 | ZS511 |
| 28548 | ZSE146 | 5DA 749 475-151 | ZS281 | 19020008 | ZS283 | 8010416 | ZS346 |
| 28645 | ZS356 | 5DA 749 475-161 | ZS052 | 19020009 | ZS422 | 8010417 | ZS349 |
| 29147 | ZS302 | 5DA 749 475-171 | ZSE003 | 19020010 | ZSE001 | 8010418 | ZS347 |
| 29319 | ZSE029 | 5DA 749 475-191 | ZSE026 | 19020012 | ZS281 | 8010419 | ZS351 |
| 29412 | ZS016 | 5DA 749 475-201 | ZS255 | 19020022 | ZS344 | 8010420 | ZS376 |
| 29859 | ZSE051 | 5DA 749 475-211 | ZS243 | 19020030 | ZS354 | 8010421 | ZSE048 |
| 30261 | ZSE502 | | | 19020035 | ZS387 | 8010424 | ZS376 |
| 33666 | ZSE147 | | | 19020059 | ZS422 | | |
| | | | | 19050001 | ZSE002 | | |
| | | | | 19050002 | ZSE043 | | |
| | | | | 19050003 | ZSE047 | | |
| | | | | | ZSE047 | | |

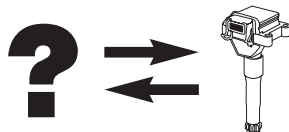

| ...HOFFER | | ...HÜCO | | ...HUECO | | ...INTERMOTOR | |
|-------------|--------|--------------|--------|-------------------|--------|---------------|--------|
| 8010433 | ZS274 | 138724 | ZS486 | 13 8817 | ZS372 | 12660 | ZS278 |
| 8010458 | ZS521 | 138725 | ZS487 | 133858 | ZSE021 | 12662 | ZS250 |
| 8010460 | ZSE059 | 138828 | ZSE159 | 133911 | ZSE021 | 12678 | ZS344 |
| 8010462 | ZS387 | 138865 | ZS356 | 138717 | ZS395 | 12679 | ZS317 |
| 8010470 | ZSE046 | 138877 | ZS469 | 138811 | ZS422 | 12680 | ZS318 |
| 8010472 | ZS352 | | | 138824 | ZS456 | 12681 | ZS319 |
| 8010473 | ZS353 | | | | | 12683 | ZS261 |
| 8010478 | ZSE030 | HUECO | | INTERMOTOR | | 12699 | ZS239 |
| 8010480 | ZS427 | 024-138811 | ZS422 | 11000 | ZS106 | 12700 | ZS029 |
| 8010483 | ZS359 | 13 3800 | ZS052 | 11030 | ZS106 | 12701 | ZS254 |
| 8010497 | ZSE051 | 13 3801 | ZS322 | 11060 | ZS109 | 12702 | ZS255 |
| 8010498 | ZSE089 | 13 3802 | ZS068 | 11070 | ZS109 | 12703 | ZS281 |
| 8010498 | ZSE063 | 13 3803 | ZS347 | 11150 | ZS115 | 12705 | ZS345 |
| 8010500 | ZSE056 | 13 3804 | ZS437 | 11200 | ZS106 | 12709 | ZSE011 |
| 8010501 | ZSE031 | 13 3805 | ZS016 | 11220 | ZS115 | 12710 | ZS307 |
| 8010503 | ZSE065 | 13 3806 | ZSE043 | 11330 | ZS126 | 12714 | ZS350 |
| 8010504 | ZSE061 | 13 3807 | ZSE030 | 11410 | ZS121 | 12715 | ZS365 |
| 8010505 | ZSE062 | 13 3808 | ZSE033 | 11480 | ZS124 | 12717 | ZS309 |
| 8010512 | ZSE136 | 13 3811 | ZS014 | 11500 | ZS125 | 12720 | ZSE047 |
| 8010541 | ZS095 | 13 3816 | ZSE147 | 11500 | ZS127 | 12722 | ZS358 |
| 8010573 | ZS395 | 13 3822 | ZSE146 | 11510 | ZS119 | 12723 | ZS259 |
| 8010576 | ZS436 | 13 3825 | ZS324 | 11510 | ZS123 | 12724 | ZS342 |
| 8010578 | ZSE066 | 13 3827 | ZS320 | 11510 | ZS120 | 12726 | ZSE029 |
| 8010599 | ZSE126 | 13 3836 | ZSE142 | 11800 | ZS400 | 12731 | ZS256 |
| 8010599 | ZSE067 | 13 3847 | ZSE044 | 12200 | ZS252 | 12736 | ZS340 |
| 8010600 | ZSE140 | 13 3848 | ZSE089 | 12202 | ZS252 | 12737 | ZS320 |
| 8010602 | ZSE137 | 13 3850 | ZS429 | 12203 | ZS253 | 12739 | ZS501 |
| 8010742 | ZSE157 | 13 3855 | ZSE152 | 12271 | ZS367 | 12745 | ZS361 |
| 8810391 | ZS348 | 13 3875 | ZSE143 | 12301 | ZS251 | 12747 | ZS348 |
| | | 13 3876 | ZSE144 | 12302 | ZS247 | 12749 | ZSE045 |
| HÜCO | | 13 3879 | ZSE151 | 12303 | ZS257 | 12750 | ZS349 |
| 13 3809 | ZS259 | 13 3880 | ZSE150 | 12305 | ZS258 | 12755 | ZS346 |
| 13 3812 | ZSE059 | 13 3901 | ZSE088 | 12428 | ZS372 | 12756 | ZS351 |
| 13 3817 | ZS381 | 13 3906 | ZSE132 | 12589 | ZS242 | 12758 | ZS324 |
| 13 3832 | ZS427 | 13 8416 | ZSE002 | 12596 | ZS354 | 12764 | ZS345 |
| 13 3852 | ZS408 | 13 8419 | ZSE001 | 12598 | ZS300 | 12766 | ZS347 |
| 13 3856 | ZSE153 | 13 8425 | ZSE003 | 12601 | ZS244 | 12767 | ZSE046 |
| 13 3860 | ZSE081 | 13 8430 | ZSE026 | 12602 | ZS248 | 12772 | ZS387 |
| 13 3907 | ZSE080 | 13 8437 | ZSE013 | 12606 | ZS248 | 12773 | ZS068 |
| 13 3921 | ZSE082 | 13 8701 | ZSE002 | 12607 | ZS016 | 12778 | ZSE059 |
| 13 3922 | ZSE077 | 13 8702 | ZSE001 | 12610 | ZS243 | 12788 | ZSE089 |
| 13 3923 | ZSE076 | 13 8704 | ZSE003 | 12611 | ZS277 | 12790 | ZSE044 |
| 13 8705 | ZS280 | 13 8707 | ZS314 | 12613 | ZS274 | 12791 | ZSE065 |
| 13 8801 | ZS370 | 13 8709 | ZS297 | 12613 | ZS232 | 12812 | ZSE502 |
| 13 8802 | ZS371 | 13 8710 | ZS304 | 12614 | ZS341 | 12818 | ZSE055 |
| 13 8814 | ZS276 | 13 8713 | ZS283 | 12615 | ZS281 | 12832 | ZSE056 |
| 13 8842 | ZS263 | 13 8736 | ZS317 | 12616 | ZS282 | 12859 | ZSE055 |
| 13 8850 | ZS282 | 13 8738 | ZS315 | 12617 | ZS231 | 12901 | ZSE005 |
| 133810 | ZS342 | 13 8750 | ZS316 | 12618 | ZS263 | 12904 | ZSE005 |
| 133814 | ZS340 | 13 8752 | ZS251 | 12619 | ZS276 | 12916 | ZSE001 |
| 133815 | ZS358 | 13 8754 | ZS249 | 12621 | ZS283 | 12919 | ZSE003 |
| 133830 | ZSE031 | 13 8754 | ZS247 | 12622 | ZSE002 | | |
| 133834 | ZSE051 | 13 8756 | ZS231 | 12623 | ZS014 | JANMOR | |
| 133837 | ZS501 | 13 8757 | ZS254 | 12624 | ZS234 | JM5002 | ZS437 |
| 133841 | ZS361 | 13 8758 | ZS255 | 12626 | ZS279 | JM5009 | ZS068 |
| 133851 | ZS446 | 13 8759 | ZS242 | 12635 | ZS252 | JM5011 | ZSE030 |
| 133864 | ZSE174 | 13 8760 | ZS232 | 12636 | ZS371 | JM5022 | ZS361 |
| 133867 | ZSE161 | 13 8761 | ZS451 | 12637 | ZS230 | JM5028 | ZS354 |
| 133872 | ZS473 | 13 8766 | ZS243 | 12639 | ZS234 | JM5070 | ZS380 |
| 133878 | ZSE172 | 13 8780 | ZS253 | 12640 | ZS339 | JM5071 | ZS379 |
| 133902 | ZSE158 | 13 8781 | ZS252 | 12646 | ZS298 | JM5072 | ZS405 |
| 133908 | ZSE157 | 13 8800 | ZS238 | 12649 | ZS315 | JM5084 | ZSE059 |
| 138434 | ZSE004 | 13 8803 | ZS350 | 12659 | ZS356 | JM5085 | ZS501 |
| 138435 | ZSE162 | 13 8808 | ZS387 | | ZS275 | JM5093 | ZS387 |
| 138438 | ZSE029 | 13 8810 | ZS532 | | | JM5103 | ZS436 |
| 138708 | ZSE004 | 13 8812 | ZS275 | | | JM5108 | ZS521 |
| | | 13 8813 | ZS278 | | | | |

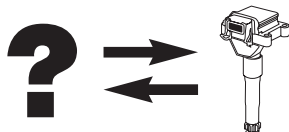

| | | | | | | | |
|------------------|--------|-------------------------|--------|---------------------------|--------|-------------------------|--------|
| ...JANMOR | | ...KW | | ...MAGNETI MARELLI | | ...MAPCO | |
| JM5111 | ZSE502 | 470 433 | ZSE061 | 060796105010 | ZSE040 | 80894 | ZSE051 |
| JM5253 | ZSE061 | 470 434 | ZSE044 | 060801008010 | ZS259 | | |
| JM5254 | ZSE062 | 470 435 | ZSE063 | 060810226010 | ZSE174 | MEAT & DORIA | |
| JM5266 | ZSE089 | 470 436 | ZSE051 | 60690002 | ZS106 | 0880190 | ZSE140 |
| JM5268 | ZSE065 | 470 437 | ZSE065 | 60705404 | ZS248 | 10302 | ZS283 |
| JM5372 | ZSE088 | | | 60705409 | ZS250 | 10303 | ZS029 |
| JM5392 | ZSE157 | | | 60705604 | ZS244 | 10304 | ZS248 |
| JM5431 | ZSE140 | LUCAS | | 60705606 | ZS248 | 10305 | ZS244 |
| JM5485 | ZSE156 | DMB 1013 | ZS434 | 60707038 | ZS323 | 10306 | ZSE002 |
| ODM251 | ZS259 | DMB 1026 | ZS433 | 60708038 | ZS283 | 10307 | ZSE003 |
| ODM253 | ZS358 | DMB 1075 | ZSE086 | 60740303 | ZS322 | 10308 | ZSE001 |
| ODM258 | ZS427 | DMB 897 | ZS387 | 60740304 | ZS321 | 10310 | ZS361 |
| | | DMB 984 | ZSE084 | 60792001 | ZS029 | 10311 | ZS234 |
| JP GROUP | | | | BAE 403 B | ZS320 | 10314 | ZS281 |
| 881208307 | ZS259 | LUCAS ELECTRICAL | | BAE 403 C | ZS322 | 10315 | ZS259 |
| 905062001 | ZSE003 | DLB 101 | ZS106 | BAE 403 D | ZS321 | 10320 | ZS361 |
| 905066001 | ZSE030 | DLB 102 | ZS109 | BAE 403 H | ZS068 | 10324 | ZSE047 |
| | | DLB 204 | ZS251 | BAE 504 L | ZS250 | 10326 | ZS358 |
| KAGER | | DLB 205 | ZS247 | BAE 506 | ZS244 | 10328 | ZSE043 |
| 00-0911 | ZSE040 | DLB 233 | ZS249 | BAE 506 D | ZS244 | 10329 | ZSE030 |
| 00-0912 | ZSE003 | DLB 801 | ZS248 | BAE 506 F | ZS248 | 10331 | ZS320 |
| 00-0914 | ZSE030 | DLJ 431 | ZS356 | BAE 608 F | ZS259 | 10333 | ZSE040 |
| 00-0915 | ZSE043 | DMB 1102 | ZS429 | BAE 700 AK | ZS323 | 10336 | ZS354 |
| 00-0916 | ZSE029 | DMB 408 | ZS354 | BAE 800 AK | ZS283 | 10342 | ZS016 |
| 60-0002 | ZS356 | DMB 808 | ZSE043 | BAE 800 B | ZS283 | 10343 | ZS232 |
| 60-0017 | ZS346 | DMB 810 | ZS365 | BAE 800 DK | ZS283 | 10344 | ZS341 |
| 60-0020 | ZSE043 | DMB 816 | ZS259 | BAE 801 AK | ZS317 | 10345 | ZS275 |
| 60-0035 | ZSE045 | DMB 851 | ZS309 | BAE 801 BK | ZS318 | 10346 | ZS242 |
| 60-0036 | ZS088 | DMB 868 | ZSE045 | BAE 801 CK | ZS319 | 10347 | ZS230 |
| 60-0042 | ZS354 | DMB 874 | ZS346 | BAE 801 EK | ZS315 | 10348 | ZS243 |
| 60-0057 | ZS361 | DMB 875 | ZS351 | BAE 920 A | ZS029 | 10349 | ZS249 |
| 60-0061 | ZSE030 | DMB 886 | ZSE046 | BAE 920 AX | ZS029 | 10350 | ZS234 |
| 60-0067 | ZS349 | DMB 893 | ZS367 | BAE 9961 EA | ZSE040 | 10351 | ZS532 |
| 60-0068 | ZSE047 | DMB 903 | ZS375 | BAE504D | ZS248 | 10353 | ZS324 |
| 60-0070 | ZS348 | DMB 907 | ZSE059 | BAE680CF | ZSE174 | 10354 | ZS014 |
| 60-0076 | ZSE032 | DMB 910 | ZSE063 | BK2A | ZS106 | 10355 | ZS014 |
| 60-0078 | ZS351 | DMB 912 | ZSE044 | | | 10356 | ZS315 |
| 60-0079 | ZS345 | DMB 970 | ZS355 | MAPCO | | 10361 | ZSE011 |
| 60-0080 | ZS259 | DMB2016 | ZS452 | 80042 | ZS283 | 10362 | ZS297 |
| 60-0086 | ZS358 | | | 80043 | ZS244 | 10366 | ZS313 |
| 60-0094 | ZSE048 | LUO'S | | 80100 | ZS251 | 10370 | ZS371 |
| 60-0095 | ZS352 | L630310 | ZSE502 | 80103 | ZS354 | 10372 | ZSE031 |
| 60-0096 | ZS353 | L740401 | ZSE030 | 80401 | ZS249 | 10373 | ZSE032 |
| 60-0098 | ZSE046 | L830106 | ZS380 | 80402 | ZS232 | 10374 | ZSE029 |
| 60-0108 | ZS359 | | | 80402 | ZS341 | 10375 | ZS256 |
| 60-0109 | ZS079 | MAGNETI MARELLI | | 80403 | ZS258 | 10378 | ZS309 |
| 60-0113 | ZS347 | 0 60708038010 | ZS283 | 80404 | ZS257 | 10380 | ZS255 |
| 60-0114 | ZS427 | 0 60740303010 | ZS322 | 80501 | ZS532 | 10382 | ZS307 |
| 60-0121 | ZSE066 | 0 60740304010 | ZS321 | 80530 | ZS277 | 10383 | ZS317 |
| | | 0 60740308010 | ZS068 | 80531 | ZS376 | 10386 | ZS300 |
| KW | | 0 60780002010 | ZS283 | 80562 | ZS356 | 10387 | ZS356 |
| 470 199 | ZS356 | 0 60794001010 | ZS079 | 80563 | ZS449 | 10388 | ZS231 |
| 470 220 | ZS511 | 0 60801012010 | ZS427 | 80570 | ZS511 | 10389 | ZS088 |
| 470 261 | ZS274 | 060690002010 | ZS106 | 80571 | ZSE502 | 10391 | ZS348 |
| 470 272 | ZS344 | 060705404010 | ZS248 | 80613 | ZS252 | 10394 | ZSE039 |
| 470 365 | ZS345 | 060705409010 | ZS250 | 80616 | ZS259 | 10395 | ZS079 |
| 470 377 | ZS354 | 060705604010 | ZS244 | 80618 | ZS358 | 10398 | ZS342 |
| 470 379 S | ZS350 | 060705606010 | ZS248 | 80619 | ZSE147 | 10401 | ZSE502 |
| 470 380 S | ZS365 | 060705738010 | ZS257 | 80751 | ZS281 | 10405 | ZSE045 |
| 470 397 | ZS361 | 060707038010 | ZS323 | 80752 | ZS350 | 10409 | ZS380 |
| 470 425 | ZSE062 | 060707038010 | ZS323 | 80752 | ZS422 | 10410 | ZS511 |
| 470 427 | ZSE032 | 060708049010 | ZS327 | 80882 | ZS280 | 10416 | ZS346 |
| 470 429 | ZSE043 | 060708149010 | ZS315 | 80883 | ZSE043 | 10417 | ZS349 |
| 470 431 | ZSE059 | 060740302010 | ZS320 | 80885 | ZSE001 | 10418 | ZS347 |
| | | 060792001010 | ZS029 | 80886 | ZSE030 | 10419 | ZS351 |
| | | | | 80888 | ZSE003 | 10420 | ZS375 |

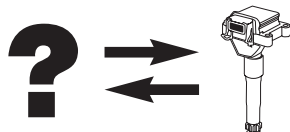

| ...NGK | | ...NGK | | ...NGK | | ...NGK | |
|--------|--------|--------|--------|--------|--------|--------|--------|
| 48169 | ZS079 | 48298 | ZS106 | U1071 | ZS119 | U3009 | ZS245 |
| 48170 | ZS266 | 48299 | ZS105 | U1074 | ZS299 | U3009 | ZS254 |
| 48171 | ZS429 | 48300 | ZS109 | U1075 | ZS419 | U3010 | ZS304 |
| 48172 | ZS321 | 48302 | ZS115 | U1076 | ZS117 | U3012 | ZS318 |
| 48173 | ZS264 | 48303 | ZS115 | U1076 | ZS120 | U3014 | ZS319 |
| 48174 | ZSE174 | 48308 | ZS119 | U1077 | ZS126 | U4001 | ZS501 |
| 48176 | ZSE011 | 48311 | ZS299 | U1079 | ZS106 | U4002 | ZS502 |
| 48178 | ZSE152 | 48312 | ZS395 | U1080 | ZS124 | U4004 | ZS361 |
| 48179 | ZSE166 | 48313 | ZSE087 | U1083 | ZS127 | U4005 | ZS308 |
| 48179 | ZSE170 | 48314 | ZSE086 | U1084 | ZS282 | U4006 | ZSE502 |
| 48183 | ZSE136 | 48315 | ZS480 | U2001 | ZS350 | U4007 | ZS309 |
| 48184 | ZSE171 | 48316 | ZS521 | U2001 | ZS365 | U4009 | ZS429 |
| 48185 | ZS380 | 48318 | ZS508 | U2001 | ZS422 | U4010 | ZSE136 |
| 48189 | ZS265 | 48322 | ZS453 | U2003 | ZSE003 | U4011 | ZSE083 |
| 48190 | ZS319 | 48324 | ZS419 | U2004 | ZSE026 | U4013 | ZSE084 |
| 48192 | ZSE153 | 48326 | ZS430 | U2005 | ZS281 | U4016 | ZS473 |
| 48193 | ZS301 | 48327 | ZSE074 | U2005 | ZS239 | U4019 | ZS436 |
| 48195 | ZS379 | 48329 | ZSE076 | U2005 | ZS237 | U4020 | ZS434 |
| 48197 | ZS230 | 48330 | ZSE077 | U2005 | ZS238 | U4021 | ZS433 |
| 48203 | ZS396 | 48331 | ZSE075 | U2006 | ZS234 | U4022 | ZSE087 |
| 48204 | ZS394 | 48332 | ZSE079 | U2007 | ZS354 | U4023 | ZSE086 |
| 48206 | ZSE143 | 48333 | ZSE082 | U2008 | ZS387 | U4024 | ZS430 |
| 48207 | ZS077 | 48337 | ZSE140 | U2009 | ZS341 | U4026 | ZS340 |
| 48208 | ZSE083 | 48339 | ZS117 | U2011 | ZSE029 | U5001 | ZS052 |
| 48209 | ZS479 | 48339 | ZS120 | U2013 | ZSE008 | U5002 | ZSE030 |
| 48216 | ZSE145 | 48340 | ZS126 | U2014 | ZS029 | U5003 | ZSE043 |
| 48218 | ZS355 | 48342 | ZS106 | U2015 | ZS300 | U5004 | ZS016 |
| 48219 | ZS452 | 48343 | ZS124 | U2016 | ZS344 | U5005 | ZS302 |
| 48220 | ZS405 | 48346 | ZS125 | U2017 | ZS231 | U5006 | ZSE059 |
| 48221 | ZS031 | 48346 | ZS127 | U2019 | ZS345 | U5008 | ZS347 |
| 48221 | ZS036 | 48347 | ZSE088 | U2020 | ZS371 | U5009 | ZS324 |
| 48223 | ZSE084 | 48348 | ZSE158 | U2023 | ZS372 | U5010 | ZS320 |
| 48226 | ZSE080 | 48350 | ZSE132 | U2024 | ZSE004 | U5011 | ZSE063 |
| 48230 | ZS482 | 48351 | ZSE157 | U2025 | ZS451 | U5012 | ZS014 |
| 48234 | ZSE039 | 48356 | ZSE078 | U2026 | ZSE013 | U5013 | ZSE051 |
| 48235 | ZSE172 | 48357 | ZS282 | U2027 | ZS306 | U5014 | ZSE032 |
| 48236 | ZS109 | 4837 | ZSE154 | U2028 | ZS325 | U5015 | ZSE033 |
| 48236 | ZS106 | U1001 | ZSE001 | U2029 | ZS370 | U5015 | ZSE142 |
| 48237 | ZS446 | U1002 | ZS252 | U2030 | ZS307 | U5016 | ZS311 |
| 48239 | ZS475 | U1003 | ZSE002 | U2032 | ZS450 | U5017 | ZSE031 |
| 48240 | ZSE168 | U1004 | ZS275 | U2033 | ZS037 | U5018 | ZS322 |
| 48241 | ZSE161 | U1005 | ZS253 | U2035 | ZS267 | U5019 | ZS408 |
| 48243 | ZSE071 | U1006 | ZS469 | U2038 | ZS079 | U5020 | ZSE044 |
| 48244 | ZSE073 | U1007 | ZS247 | U2039 | ZS266 | U5021 | ZS346 |
| 48245 | ZS474 | U1008 | ZS244 | U2040 | ZS264 | U5022 | ZSE009 |
| 48247 | ZS481 | U1009 | ZS249 | U2041 | ZS380 | U5024 | ZSE061 |
| 48248 | ZS473 | U1012 | ZS316 | U2042 | ZS265 | U5025 | ZS041 |
| 48249 | ZS485 | U1013 | ZS356 | U2043 | ZS301 | U5026 | ZS068 |
| 48251 | ZS487 | U1016 | ZS276 | U2044 | ZS379 | U5026 | ZS088 |
| 48259 | ZS432 | U1017 | ZS278 | U2046 | ZS230 | U5027 | ZSE165 |
| 48260 | ZS455 | U1020 | ZS532 | U2048 | ZS479 | U5029 | ZSE164 |
| 48261 | ZS470 | U1021 | ZS274 | U2049 | ZS405 | U5030 | ZS449 |
| 48262 | ZS431 | U1022 | ZS263 | U2060 | ZS483 | U5031 | ZS367 |
| 48269 | ZSE172 | U1023 | ZS118 | U2063 | ZS477 | U5032 | ZSE021 |
| 48270 | ZS436 | U1023 | ZS296 | U2065 | ZS395 | U5033 | ZSE019 |
| 48276 | ZS410 | U1024 | ZS277 | U2066 | ZS480 | U5034 | ZS053 |
| 48278 | ZSE167 | U1026 | ZS250 | U2067 | ZS521 | U5036 | ZSE081 |
| 48281 | ZSE072 | U1029 | ZS257 | U3001 | ZS283 | U5037 | ZSE055 |
| 48284 | ZSE066 | U1034 | ZS261 | U3002 | ZS242 | U5038 | ZS368 |
| 48286 | ZS095 | U1035 | ZSE037 | U3003 | ZS243 | U5039 | ZSE144 |
| 48287 | ZS483 | U1036 | ZS279 | U3004 | ZS297 | U5040 | ZS428 |
| 48288 | ZS486 | U1037 | ZSE011 | U3005 | ZS317 | U5041 | ZS337 |
| 48290 | ZS477 | U1056 | ZS106 | U3006 | ZS313 | U5043 | ZSE056 |
| 48291 | ZS434 | U1061 | ZS106 | U3007 | ZS255 | U5044 | ZS323 |
| 48294 | ZS433 | U1063 | ZS109 | U3007 | ZS246 | U5046 | ZSE065 |
| 48295 | ZSE169 | U1065 | ZS115 | U3008 | ZS315 | U5047 | ZS310 |
| 48297 | ZSE173 | U1066 | ZS115 | U3008 | ZS327 | U5048 | ZS321 |

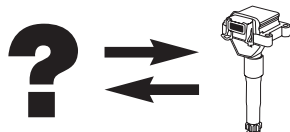

| ...STANDARD | | ...STANDARD | | ...SWAG | | TRISCAN | |
|-------------------|--------|-------------|--------|---------------|--------|--------------|--------|
| 12649 Interomotor | ZS356 | CU1282 | ZS482 | 20 93 6080 | ZSE144 | 8860 11008 | ZS435 |
| 12652 Interomotor | ZS445 | CU1291 | ZSE167 | 20 93 6100 | ZSE143 | 8860 15014 | ZS309 |
| 12678 Interomotor | ZS344 | CU1313 | ZSE164 | 20 93 6113 | ZSE145 | 8860 15015 | ZS361 |
| 12705 Interomotor | ZS345 | CU1334 | ZS446 | 26 92 2581 | ZS231 | 8860 15016 | ZS428 |
| 12707 Interomotor | ZS469 | CU1372 | ZS453 | 30 91 7194 | ZSE001 | 8860 17008 | ZS088 |
| 12709 Interomotor | ZSE011 | CU1403 | ZSE172 | 30 91 9032 | ZSE003 | 8860 24011 | ZS358 |
| 12715 Interomotor | ZS365 | CU1430 | ZS474 | 30 92 2038 | ZSE030 | 8860 24012 | ZS259 |
| 12720 Interomotor | ZSE047 | CU1432 | ZSE168 | 30 92 4500 | ZSE059 | 8860 28002 | ZSE047 |
| 12722 Interomotor | ZS358 | CU1451 | ZS452 | 30 92 9859 | ZSE051 | 8860 28004 | ZSE045 |
| 12726 Interomotor | ZSE029 | CU1458 | ZS470 | 32 92 3258 | ZSE142 | 8860 28005 | ZS349 |
| 12727 Interomotor | ZSE030 | CU1503 | ZSE158 | 32 92 3260 | ZSE032 | 8860 29020 | ZSE043 |
| 12728 Interomotor | ZSE043 | DMB406 | ZS345 | 40 92 3187 | ZS259 | 8860 29023 | ZSE032 |
| 12736 Interomotor | ZS340 | DMB408 | ZS354 | 40 92 3187 | ZS342 | 8860 29024 | ZSE030 |
| 12739 Interomotor | ZS501 | DMB813 | ZSE047 | 40 92 7168 | ZS358 | 8860 43007 | ZSE502 |
| 12745 Interomotor | ZS361 | IIS 022 | ZSE072 | 40 92 7522 | ZS359 | 886011012 | ZSE145 |
| 12749 Interomotor | ZSE045 | IIS 024 | ZSE087 | 40 92 8108 | ZS427 | 886011013 | ZSE143 |
| 12755 Interomotor | ZS346 | IIS 028 | ZSE071 | 40 93 3666 | ZSE147 | 886011014 | ZSE144 |
| 12757 Interomotor | ZS532 | IIS 029 | ZSE073 | 50926869 | ZS350 | 886012001 | ZSE148 |
| 12764 Interomotor | ZS345 | IIS 058 | ZSE083 | 60 92 1524 | ZS354 | 886013017 | ZS449 |
| 12766 Interomotor | ZS347 | IIS 160 | ZS437 | 60 92 1525 | ZS345 | 8860-17009 | ZS501 |
| 12767 Interomotor | ZSE046 | IIS 174 | ZSE081 | 60 92 1526 | ZS243 | 886023010 | ZSE146 |
| 12771 Interomotor | ZS367 | IIS 182 | ZS532 | 60 92 1527 | ZS242 | 886024009 | ZSE147 |
| 12772 Interomotor | ZS387 | IIS 220 | ZSE136 | 60 92 1529 | ZS315 | 886024016 | ZSE149 |
| 12778 Interomotor | ZSE059 | IIS 231 | ZSE089 | 60 92 1666 | ZS052 | 886029025 | ZSE142 |
| 12788 Interomotor | ZSE089 | IIS 241 | ZS405 | 60 92 2875 | ZS317 | | |
| 12790 Interomotor | ZSE041 | IIS 247 | ZSE084 | 60 92 4435 | ZS347 | | |
| 12791 Interomotor | ZSE065 | IIS 252 | ZSE080 | 62 92 4997 | ZSE047 | | |
| 12798 Interomotor | ZSE081 | IIS 270 | ZS095 | 70 91 9929 | ZS283 | VALEO | |
| 12801 Interomotor | ZS437 | IIS 289 | ZSE140 | 70 92 2697 | ZS029 | 138419 | ZSE001 |
| 12802 Interomotor | ZS427 | IIS 297 | ZSE086 | 81 92 8645 | ZS356 | 2 526 037 A | ZS232 |
| 12810 Interomotor | ZSE136 | IIS 300 | ZSE132 | 90 93 0261 | ZSE502 | 2 526 040 | ZS232 |
| 12813 Interomotor | ZS265 | IIS 301 | ZSE133 | | | 2 526 040 A | ZS232 |
| 12818 Interomotor | ZSE055 | IIS 339 | ZS436 | | | 21597716-4 | ZS352 |
| 12832 Interomotor | ZSE056 | IIS 349 | ZS410 | TESLA | | 21603800-7 | ZS353 |
| 12835 Interomotor | ZS355 | IIS 366 | ZSE074 | CL 032 | ZSE137 | 245 040 | ZS232 |
| 12841 Interomotor | ZS405 | IIS 368 | ZSE076 | CL 548 | ZS434 | 245 040 | ZS341 |
| 12850 Interomotor | ZSE167 | IIS 369 | ZSE077 | CL003 | ZSE030 | 245000 | ZS110 |
| 12851 Interomotor | ZSE154 | IIS 370 | ZSE079 | CL024 | ZSE065 | 245001 | ZS257 |
| 12855 Interomotor | ZSE166 | IIS 372 | ZSE082 | CL021 | ZSE126 | 245010 | ZS106 |
| 12856 Interomotor | ZSE084 | IIS 389 | ZSE126 | CL031 | ZS427 | 245027 | ZS247 |
| 12864 Interomotor | ZSE083 | IIS 390 | ZSE137 | CL221 | ZS427 | 245038 | ZS258 |
| 12867 Interomotor | ZSE080 | IIS001 | ZSE043 | CL323 | ZS095 | 245039 | ZS249 |
| 12877 Interomotor | ZSE072 | IIS026 | ZSE170 | CL403 | ZS387 | 245041 | ZS231 |
| 12884 Interomotor | ZS095 | IIS030 | ZSE165 | CL515 | ZSE502 | 245042 | ZS253 |
| 12888 Interomotor | ZS477 | IIS034 | ZS068 | CL532 | ZS521 | 245043 | ZS252 |
| 12889 Interomotor | ZSE140 | IIS036 | ZS501 | CL533 | ZSE136 | 245046 | ZS256 |
| 12897 Interomotor | ZSE169 | IIS079 | ZS469 | CL600 | ZS437 | 245047 | ZS106 |
| 12916 Interomotor | ZSE001 | IIS-080 | ZS365 | CL621 | ZSE140 | 245049 | ZS244 |
| 12919 Interomotor | ZSE003 | IIS081 | ZS445 | CL707 | ZS429 | 245052 | ZS248 |
| CP 018 | ZS437 | IIS125 | ZSE041 | CL711 | ZS501 | 245054 | ZS251 |
| CU 1118 | ZS437 | IIS217 | ZS265 | | | 245057 | ZS344 |
| CU 1225 | ZS532 | IIS239 | ZS452 | TOPRAN | | 245058 | ZS115 |
| CU 1300 | ZS436 | IIS243 | ZS355 | 109039 | ZSE030 | 245062 | ZS252 |
| CU 1374 | ZS095 | IIS273 | ZS477 | 109541 | ZSE043 | 245064 | ZS123 |
| CU 1385 | ZSE140 | IIS292 | ZS475 | 111 741 | ZSE142 | 245066 | ZS254 |
| CU 1409 | ZSE132 | IIS359 | ZS453 | 206 642 | ZSE147 | 245067 | ZS255 |
| CU 1489 | ZSE137 | IIS363 | ZS446 | 206638 | ZS344 | 245068 | ZS250 |
| CU 1490 | ZSE126 | IIS417 | ZS478 | 206640 | ZS259 | 245076 | ZS245 |
| CU 1509 | ZS395 | IIS427 | ZSE158 | 206641 | ZS358 | 245077 | ZS246 |
| CU1043 | ZSE166 | IIS443 | ZSE093 | 207 472 | ZSE151 | 245079 | ZS345 |
| CU1057 | ZS265 | ISS 364 | ZS430 | 207466 | ZS427 | 245080 | ZS296 |
| CU1093 | ZS486 | UF103 | ZS356 | 302 104 | ZS422 | 245081 | ZS119 |
| CU1211 | ZSE041 | | | 302104 | ZS350 | 245085 | ZS346 |
| CU1248 | ZS487 | SWAG | | 501401 | ZS382 | 245086 | ZS241 |
| CU1253 | ZS477 | 10 92 8548 | ZSE146 | 721405 | ZSE047 | 245088 | ZS343 |
| CU1273 | ZSE172 | 20 92 1109 | ZS014 | 721409 | ZS347 | 245092 | ZSE001 |
| CU1274 | ZS445 | | | | | 245093 | ZSE002 |
| | | | | | | 245094 | ZS347 |

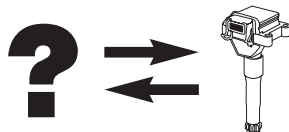

| ...VALEO | | VEMO | | ...VEMO | |
|-----------|--------|---------------|--------|-------------|--------|
| 245095 | ZSE045 | 10-70-0012 | ZSE030 | V40-70-0067 | ZSE150 |
| 245096 | ZSE046 | 10-70-0013 | ZSE043 | V40-70-0069 | ZSE152 |
| 245097 | ZSE047 | 10-70-0014 | ZSE002 | V40-70-0071 | ZSE149 |
| 245098 | ZS348 | 10-70-0044 | ZSE003 | V40-70-0072 | ZSE153 |
| 245099 | ZS349 | 10-70-0045 | ZS016 | V40-70-0074 | ZSE174 |
| 245100 | ZS351 | 10-70-0046 | ZSE029 | V42-70-0001 | ZSE047 |
| 245101 | ZS352 | 10-70-0047 | ZSE040 | V45-70-0001 | ZS036 |
| 245102 | ZS353 | 10-70-0058 | ZSE031 | V46-70-0001 | ZS052 |
| 245103 | ZSE048 | 20-70-0011 | ZS014 | V46-70-0002 | ZS354 |
| 245104 | ZS052 | 20-70-0012 | ZS302 | V49-70-0003 | ZS501 |
| 245105 | ZS354 | 20-70-0013 | ZS324 | V52-70-0014 | ZS536 |
| 245106 | ZS242 | 20-70-0014 | ZS324 | V64-70-0009 | ZSE136 |
| 245107 | ZS243 | 25-70-0001 | ZS350 | V70-70-0015 | ZS449 |
| 245108 | ZS342 | 25-70-0003 | ZS281 | V95-70-0007 | ZS429 |
| 245111 | ZS283 | 30-70-0012 | ZS340 | | |
| 245116 | ZS320 | 40-70-0011 | ZS253 | | |
| 245121 | ZS068 | 40-70-0015 | ZS342 | | |
| 245139 | ZS350 | 40-70-0016 | ZS259 | | |
| 245141 | ZSE030 | V 26-70-0005 | ZS532 | | |
| 245164 | ZSE142 | V 37-70-0032 | ZS395 | | |
| 245178 | ZSE164 | V10-70-0010 | ZSE001 | | |
| 245179 | ZSE026 | V10-70-0012 | ZSE030 | | |
| 2526009 | ZS257 | V10-70-0013 | ZSE043 | | |
| 2526015 | ZS248 | V10-70-0013-1 | ZSE043 | | |
| 2526018 | ZS106 | V10-70-0044 | ZSE003 | | |
| 2526023 | ZS251 | V10-70-0046 | ZSE029 | | |
| 2526024 | ZS258 | V10-70-0054 | ZSE032 | | |
| 2526024A | ZS258 | V10-70-0059 | ZSE059 | | |
| 2526030 | ZS244 | V10-70-0060 | ZSE033 | | |
| 2526034 | ZS250 | V10-70-0060 | ZSE142 | | |
| 2526035 A | ZS231 | V10-70-0062 | ZSE051 | | |
| 2526039 | ZS231 | V10-70-0063 | ZSE044 | | |
| 2526048 | ZS251 | V10-70-0064 | ZSE063 | | |
| 2526049 | ZS253 | V10-70-0066 | ZSE065 | | |
| 2526050 | ZS252 | V10-70-0067 | ZSE062 | | |
| 2526051 | ZS254 | V10-70-0068 | ZSE061 | | |
| 2526052 | ZS255 | V10-70-0069 | ZSE004 | | |
| 2526059 | ZS256 | V10-70-0098 | ZSE067 | | |
| 2526062 | ZS252 | V10-70-0098 | ZSE126 | | |
| 2526086 | ZS343 | V10-70-0099 | ZSE137 | | |
| 2526110 | ZS245 | V20-70-0013 | ZSE144 | | |
| 2526111 | ZS246 | V20-70-0013 | ZS324 | | |
| 2526116A | ZS342 | V20-70-0013 | ZSE143 | | |
| 2790 | ZS106 | V20-70-0014 | ZS324 | | |
| 520019 | ZS110 | V20-70-0017 | ZSE143 | | |
| 520041 | ZS115 | V24-70-0003 | ZS283 | | |
| 520064 A | ZS251 | V24-70-0004 | ZS320 | | |
| B 6051 | ZS254 | V24-70-0008 | ZS428 | | |
| B 6052 | ZS255 | V25-70-0001 | ZS350 | | |
| B 6114 | ZS242 | V25-70-0001 | ZS422 | | |
| CD 303 | ZS106 | V25-70-0001-1 | ZS350 | | |
| CD 308 | ZS247 | V25-70-0001-1 | ZS422 | | |
| CD 309 | ZS106 | V25-70-0003 | ZS281 | | |
| CD 314 | ZS105 | V25-70-0009 | ZS387 | | |
| CD 315 | ZS106 | V30-70-0012 | ZS340 | | |
| CD 321 | ZS257 | V30-70-0015 | ZSE146 | | |
| CD 323 | ZS106 | V38-70-0002 | ZS376 | | |
| CD 325 | ZS251 | V40-70-0010 | ZSE026 | | |
| CD 326 | ZS258 | V40-70-0015 | ZS342 | | |
| CD 330 | ZS249 | V40-70-0015-1 | ZS342 | | |
| CD 331 | ZS232 | V40-70-0017 | ZS427 | | |
| CD 336 | ZS106 | V40-70-0044 | ZS358 | | |
| CD 338 | ZS253 | V40-70-0045 | ZSE147 | | |
| CD 339 | ZS252 | V40-70-0047 | ZSE151 | | |
| CD 440 | ZS344 | V40-70-0048 | ZS359 | | |
| CD 443 | ZS252 | V40-70-0050 | ZS451 | | |
| | | V40-70-0057 | ZS450 | | |

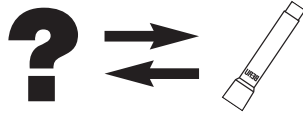
**CONNECTOR, COIL****BOSCH**

| | |
|---------------|--------|
| 0 356 100 100 | ZLE234 |
| 0 356 100 104 | ZLE276 |
| 0 356 100 107 | ZLE288 |
| 1 354 489 085 | ZLE232 |

ERA

| | |
|--------|--------|
| 880212 | ZLE234 |
|--------|--------|

**CONNECTOR, SPARK PLUG
AND COILS****BOSCH**

| | |
|---------------|--------|
| 0 356 100 100 | ZLE234 |
| 0 356 100 104 | ZLE276 |
| 0 356 100 107 | ZLE288 |
| 1 354 489 085 | ZLE232 |

ERA

| | |
|--------|--------|
| 880212 | ZLE234 |
|--------|--------|

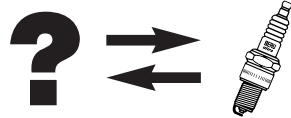

| ACDelco | BERU | ...ACDelco | BERU | ...ACDelco | BERU | ...BOSCH | BERU |
|-------------|------|-------------|------|----------------|-------------|-----------------------|-------|
| 2500 | Z42 | CFR 2 CLS | Z13 | R 5608 | Z156 | +39 Super Plus | Z177 |
| 2501 | Z29 | CFR 3 CLS | Z15 | R 5609 | Z157 | +39 Super Plus | UXT7 |
| 2502 | Z31 | CR 41 CXLS | Z47 | R 5610 | Z158 | +4 Super Plus | UXT2 |
| 2503 | Z44 | CR 42 CFS | Z19 | R 6600 | Z3 | +4 Super Plus | Z92 |
| 3500 | Z51 | CR 42 CLTS | Z95 | R 6601 | Z4 | +40 Super Plus | Z243 |
| 3501 | Z25 | CR 42 CXLSX | Z21 | R 6602 | Z95 | +41 Super Plus | Z234 |
| 41 F | Z42 | CR 42 XLSX | Z21 | R 6603 | Z67 | +43 Super Plus | UXT10 |
| 41-2 XLS | Z42 | CR 425 FS | Z19 | R 6604 | Z204 | +43 Super Plus | Z153 |
| 41-8 XLS | Z11 | CR 43 CXLS | Z82 | R 6605 | Z16 | +44 Super Plus | UXT9 |
| 42 F | Z39 | FR 1 LS | Z15 | R 6606 | Z9 | +44 Super Plus | Z121 |
| 42 FF | Z57 | FR 2 LS | Z16 | R 6607 | Z75 | +45 Super Plus | UXT9 |
| 42 FS | Z48 | FR 3 CLS | Z72 | R 6608 | Z74 | +45 Super Plus | Z240 |
| 42 LTS | Z25 | FR 3 LS | Z72 | R 6609 | Z193 | +46 Super Plus | Z67 |
| 42 LZ | Z57 | FR 3 LS 6 | Z73 | R 6612 | Z183 | +46 Super Plus | UXT4 |
| 42 XLS | Z11 | N 700 | Z41 | R 7600 | Z72 | +47 Super Plus | UXT10 |
| 420 Z | Z57 | N 701 | Z40 | R 7601 | Z73 | +47 Super Plus | Z155 |
| 422 Z | Z57 | R 2601 | Z30 | R 7602 | Z74 | +48 Super Plus | UXT3 |
| 42-5 F | Z57 | R 2603 | Z45 | R 7603 | Z248 | +48 Super Plus | Z237 |
| 425 Z | Z57 | R 3600 | Z27 | R 83 CTS | Z32 | +49 Super Plus | UXT15 |
| 42-6 FS | Z10 | R 3601 | Z28 | R 84 TS | Z32 | +5 Super Plus | UXT4 |
| 43 F | Z57 | R 3602 | Z26 | R 8600 | Z82 | +5 Super Plus | Z95 |
| 43 FO | Z57 | R 41 CF | Z39 | R 8601 | Z82 | +50 Super Plus | UXT12 |
| 43 FS | Z10 | R 41 CXL | Z38 | S 41 F | Z39 | +50 Super Plus | Z188 |
| 43 N | Z58 | R 41 CXLS | Z47 | S 44 F | Z57 | +51 Super Plus | Z272 |
| 43 XLS | Z1 | R 41-4 XLS | Z27 | S 44 XL | Z58 | +52 Super Plus | Z176 |
| 430 Z | Z39 | R 42 CF | Z39 | | | +54 Super Plus | UXT14 |
| 43-5 XLS | Z1 | R 42 CFS | Z48 | | | +54 Super Plus | Z313 |
| 44 F | Z57 | R 42 CLTS | Z95 | BOSCH | BERU | +6 Super Plus | UXT1 |
| 44 XL | Z58 | R 42 CLTS 6 | Z95 | +1 Super Plus | UXT2 | +6 Super Plus | UXT3 |
| 44 XLS | Z76 | R 42 CXLS | Z20 | +1 Super Plus | Z20 | +6 Super Plus | Z72 |
| 45 F | Z57 | R 42 T | Z49 | +10 Super Plus | Z19 | +7 Super Plus | Z98 |
| 45 XL | Z58 | R 42 TS | Z49 | +11 Super Plus | UXT11 | +7 Super Plus | UXT1 |
| 45 XLS | Z76 | R 42 XLS | Z20 | +11 Super Plus | Z16 | +7 Super Plus | UXT3 |
| 4500 | Z91 | R 42 XLS 6 | Z21 | +12 Super Plus | Z27 | +8 Super Plus | Z15 |
| 4501 | Z17 | R 42 XLS-11 | Z21 | +13 Super Plus | UXT5 | +8 Super Plus | UXT9 |
| 4502 | Z40 | R 42-6 FS | Z19 | +13 Super Plus | Z24 | +8 Super Plus | UXT1 |
| 4503 | Z52 | R 43 CFS | Z19 | +14 Super Plus | UXT4 | +8 Super Plus | UXT3 |
| 46 TS | Z32 | R 43 CXL | Z59 | +15 Super Plus | Z47 | +9 Super Plus | UXT1 |
| 46 XL | Z58 | R 43 CXLS | Z82 | +16 Super Plus | UXT2 | +9 Super Plus | UXT3 |
| 46 XLS | Z1 | R 43 N | Z8 | +16 Super Plus | Z82 | +9 Super Plus | UXT9 |
| 47 XL | Z58 | R 43 XLS | Z119 | +17 Super Plus | UXT8 | +9 Super Plus | Z74 |
| 5500 | Z63 | R 44 CF | Z57 | +17 Super Plus | Z97 | 0 241 225 012 | Z3 |
| 6500 | Z2 | R 44 CXL | Z58 | +18 Super Plus | Z26 | 0 241 225 013 | Z76 |
| 6501 | Z17 | R 44 CXLS | Z82 | +19 Super Plus | Z73 | 0 241 225 545 | Z76 |
| 6502 | Z1 | R 44 XLS | Z82 | +19 Super Plus | UXT11 | 0 241 225 550 | Z76 |
| 6503 | Z63 | R 44 XLS-11 | Z9 | +2 Super Plus | Z91 | 0 241 225 556 | Z76 |
| 7500 | Z100 | R 45 NS | Z82 | +2 Super Plus | UXT2 | 0 241 225 574 | Z79 |
| 7501 | Z207 | R 45 XLS | Z82 | +21 Super Plus | UXT2 | 0 241 225 576 | Z78 |
| 7502 | Z48 | R 46 XLS | Z82 | +21 Super Plus | Z21 | 0 241 225 589 | Z266 |
| 83 TS | Z32 | R 4601 | Z99 | +22 Super Plus | UXT2 | 0 241 225 825 | Z266 |
| 84 TS | Z32 | R 4602 | Z24 | +22 Super Plus | Z9 | 0 241 229 059 | Z3 |
| 85 TS | Z32 | R 4603 | Z52 | +23 Super Plus | UXT1 | 0 241 229 060 | Z2 |
| 8500 | Z68 | R 4604 | Z52 | +23 Super Plus | UXT3 | 0 241 229 560 | Z266 |
| 8501 | Z76 | R 4605 | Z48 | +24 Super Plus | UXT10 | 0 241 229 565 | Z68 |
| 8502 | Z118 | R 4606 | Z24 | +24 Super Plus | Z206 | 0 241 229 574 | Z1 |
| 9500 | Z76 | R 4607 | Z89 | +27 Super Plus | Z82 | 0 241 229 578 | Z118 |
| C 41 CLTS | Z31 | R 5601 | Z60 | +3 Super Plus | UXT2 | 0 241 229 579 | Z58 |
| C 41 CXLS | Z22 | R 5602 | Z14 | +3 Super Plus | Z8 | 0 241 229 580 | Z112 |
| C 42 CFS | Z10 | R 5602 | Z257 | +30 Super Plus | UXT15 | 0 241 229 588 | Z1 |
| C 42 CLTS | Z56 | R 5602 | Z98 | +31 Super Plus | UXT11 | 0 241 229 596(EA 1,1) | Z1 |
| C 42 CLTS 9 | Z56 | R 5603 | Z123 | +31 Super Plus | Z157 | 0 241 229 600 | Z58 |
| C 42 CXLS | Z22 | R 5604 | Z16 | +32 Super Plus | Z158 | 0 241 229 604 | Z68 |
| C 42 LTS | Z25 | R 5605 | Z193 | +35 Super Plus | UXT4 | 0 241 229 612 | Z68 |
| C 43 CXLS | Z11 | R 5606 | Z90 | +35 Super Plus | Z67 | 0 241 229 617 | Z6 |
| C 44 NS | Z22 | R 5607 | Z91 | +36 Super Plus | Z208 | 0 241 229 617 | Z7 |
| C 44 XL | Z58 | R 5607 | Z92 | +37 Super Plus | UXT15 | 0 241 229 619 | Z2 |
| CFR 1 CLS | Z15 | R 5608 | Z155 | +38 Super Plus | Z312 | 0 241 229 633 | Z2 |

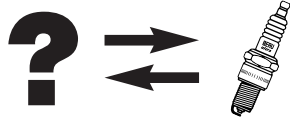

| ...BOSCH | BERU | ...BOSCH | BERU | ...BOSCH | BERU | ...BOSCH | BERU |
|------------------------|------|---------------|-------|---------------|-------|---------------|------|
| 0 241 229 634 | Z100 | 0 241 235 720 | Z188 | 0 242 135 802 | Z234 | 0 242 229 865 | Z74 |
| 0 241 229 638 | Z2 | 0 241 235 735 | Z200 | 0 242 140 512 | Z359 | 0 242 229 877 | Z177 |
| 0 241 229 639 | Z4 | 0 241 235 750 | Z63 | 0 242 222 503 | UXT1 | 0 242 229 878 | Z74 |
| 0 241 229 641 | Z118 | 0 241 235 752 | Z90 | 0 242 222 503 | UXT3 | 0 242 229 879 | UXT4 |
| 0 241 229 649 | Z7 | 0 241 235 753 | Z17 | 0 242 222 505 | UXT1 | 0 242 229 880 | Z8 |
| 0 241 229 650 | Z5 | 0 241 235 754 | Z10 | 0 242 222 505 | UXT3 | 0 242 229 882 | Z92 |
| 0 241 229 656 | Z14 | 0 241 235 755 | Z11 | 0 242 225 524 | Z82 | 0 242 229 883 | Z72 |
| 0 241 229 657 | Z4 | 0 241 235 755 | Z61 | 0 242 225 534 | Z117 | 0 242 229 884 | Z73 |
| 0 241 229 658 | Z94 | 0 241 235 756 | Z12 | 0 242 225 548 | Z82 | 0 242 229 885 | Z9 |
| 0 241 229 663 | Z93 | 0 241 235 757 | Z91 | 0 242 225 550 | Z82 | 0 242 229 902 | UXT7 |
| 0 241 229 665 | Z92 | 0 241 235 769 | Z272 | 0 242 225 599 | Z82 | 0 242 229 902 | Z177 |
| 0 241 229 676 | Z121 | 0 241 235 804 | Z10 | 0 242 225 624 | Z82 | 0 242 229 924 | Z121 |
| 0 241 229 685 | Z100 | 0 241 240 057 | Z22 | 0 242 225 859 | Z82 | 0 242 229 925 | Z240 |
| 0 241 229 689 | Z122 | 0 241 240 058 | Z22 | 0 242 229 518 | Z8 | 0 242 230 500 | UXT9 |
| 0 241 229 704 | Z122 | 0 241 240 524 | Z25 | 0 242 229 530 | Z73 | 0 242 230 500 | Z240 |
| 0 241 229 715 | Z1 | 0 241 240 532 | Z48 | 0 242 229 531 | Z8 | 0 242 232 501 | UXT1 |
| 0 241 229 716 | Z2 | 0 241 240 539 | Z22 | 0 242 229 555 | Z311 | 0 242 232 501 | UXT3 |
| 0 241 229 855 | Z118 | 0 241 240 542 | Z24 | 0 242 229 566 | Z9 | 0 242 232 502 | UXT1 |
| 0 241 229 857 | Z68 | 0 241 240 547 | Z25 | 0 242 229 568 | Z72 | 0 242 232 502 | UXT3 |
| 0 241 229 887 | Z68 | 0 241 240 558 | Z51 | 0 242 229 570 | Z8 | 0 242 232 504 | UXT2 |
| 0 241 229 918 | Z68 | 0 241 240 563 | Z25 | 0 242 229 579 | Z229 | 0 242 232 505 | UXT2 |
| 0 241 229 919 | Z118 | 0 241 240 564 | Z52 | 0 242 229 586 | Z19 | 0 242 232 507 | UXT4 |
| 0 241 229 923 | Z68 | 0 241 240 578 | Z56 | 0 242 229 587 | Z72 | 0 242 235 511 | Z20 |
| 0 241 229 961 | Z100 | 0 241 240 580 | Z24 | 0 242 229 590 | Z248 | 0 242 235 522 | Z19 |
| 0 241 235 001 | Z57 | 0 241 240 581 | Z56 | 0 242 229 591 | Z74 | 0 242 235 529 | Z20 |
| 0 241 235 089 | Z58 | 0 241 240 585 | Z105 | 0 242 229 594 | Z72 | 0 242 235 530 | Z21 |
| 0 241 235 098 | Z58 | 0 241 240 587 | Z24 | 0 242 229 605 | Z74 | 0 242 235 532 | Z59 |
| 0 241 235 102 | Z61 | 0 241 240 590 | Z53 | 0 242 229 606 | Z74 | 0 242 235 537 | Z20 |
| 0 241 235 102 | Z62 | 0 241 240 592 | Z89 | 0 242 229 607 | Z119 | 0 242 235 538 | Z95 |
| 0 241 235 103 | Z61 | 0 241 240 609 | Z53 | 0 242 229 611 | Z8 | 0 242 235 542 | Z95 |
| 0 241 235 103 | Z62 | 0 241 242 502 | UXK56 | 0 242 229 613 | Z173 | 0 242 235 544 | Z16 |
| 0 241 235 515 | Z57 | 0 241 242 802 | UXK56 | 0 242 229 615 | Z74 | 0 242 235 549 | Z15 |
| 0 241 235 536 | Z10 | 0 241 243 501 | Z104 | 0 242 229 626 | Z74 | 0 242 235 551 | Z250 |
| 0 241 235 563 | Z11 | 0 241 245 070 | Z44 | 0 242 229 630 | Z183 | 0 242 235 567 | Z158 |
| 0 241 235 564 | Z10 | 0 241 245 071 | Z42 | 0 242 229 634 | Z211 | 0 242 235 587 | Z193 |
| 0 241 235 574 | Z58 | 0 241 245 552 | Z42 | 0 242 229 635 | Z249 | 0 242 235 589 | Z98 |
| 0 241 235 585 | Z10 | 0 241 245 553 | Z41 | 0 242 229 648 | Z173 | 0 242 235 592 | Z67 |
| 0 241 235 594 | Z267 | 0 241 245 580 | Z40 | 0 242 229 650 | Z177 | 0 242 235 597 | Z15 |
| 0 241 235 601 | Z57 | 0 241 245 593 | Z29 | 0 242 229 652 | UXT15 | 0 242 235 599 | Z156 |
| 0 241 235 602 | Z11 | 0 241 245 599 | Z42 | 0 242 229 652 | Z148 | 0 242 235 599 | Z155 |
| 0 241 235 607 | Z57 | 0 241 245 601 | Z31 | 0 242 229 654 | Z74 | 0 242 235 602 | Z157 |
| 0 241 235 609 | Z58 | 0 241 245 602 | Z40 | 0 242 229 655 | UXT4 | 0 242 235 607 | Z127 |
| 0 241 235 610 (EA 1,1) | Z11 | 0 241 245 615 | Z29 | 0 242 229 656 | Z8 | 0 242 235 609 | Z123 |
| 0 241 235 633 | Z12 | 0 241 245 619 | Z41 | 0 242 229 658 | Z92 | 0 242 235 610 | Z150 |
| 0 241 235 635 | Z17 | 0 241 245 636 | Z46 | 0 242 229 659 | Z255 | 0 242 235 615 | Z60 |
| 0 241 235 636 | Z17 | 0 241 245 642 | Z29 | 0 242 229 659 | Z72 | 0 242 235 617 | Z237 |
| 0 241 235 643 | Z12 | 0 241 246 001 | Z42 | 0 242 229 660 | Z73 | 0 242 235 624 | Z193 |
| 0 241 235 650 | Z63 | 0 241 248 531 | Z39 | 0 242 229 661 | Z222 | 0 242 235 636 | Z184 |
| 0 241 235 664 | Z63 | 0 241 248 532 | Z38 | 0 242 229 666 | UXT9 | 0 242 235 640 | Z15 |
| 0 241 235 666 | Z11 | 0 241 248 534 | Z38 | 0 242 229 671 | Z208 | 0 242 235 642 | Z145 |
| 0 241 235 668 | Z17 | 0 241 248 538 | Z38 | 0 242 229 673 | Z72 | 0 242 235 643 | Z97 |
| 0 241 235 669 | Z63 | 0 241 248 540 | Z39 | 0 242 229 687 | Z9 | 0 242 235 644 | Z15 |
| 0 241 235 673 | Z63 | 0 241 256 513 | Z38 | 0 242 229 698 | Z203 | 0 242 235 656 | Z172 |
| 0 241 235 675 | Z18 | 0 241 256 522 | Z38 | 0 242 229 699 | Z203 | 0 242 235 658 | Z97 |
| 0 241 235 676 | Z63 | 0 241 329 520 | Z32 | 0 242 229 706 | Z121 | 0 242 235 660 | Z309 |
| 0 241 235 681 | Z18 | 0 241 335 516 | Z32 | 0 242 229 712 | Z4 | 0 242 235 661 | UXT4 |
| 0 241 235 682 | Z13 | 0 241 340 501 | Z33 | 0 242 229 713 | Z240 | 0 242 235 661 | Z95 |
| 0 241 235 685 | Z63 | 0 241 368 003 | Z108 | 0 242 229 715 | Z287 | 0 242 235 663 | Z20 |
| 0 241 235 686 | Z14 | 0 242 040 502 | Z210 | 0 242 229 724 | UXT9 | 0 242 235 664 | Z91 |
| 0 241 235 690 | Z14 | 0 242 129 500 | Z242 | 0 242 229 724 | Z227 | 0 242 235 665 | Z19 |
| 0 241 235 693 | Z62 | 0 242 129 508 | Z243 | 0 242 229 739 | Z342 | 0 242 235 666 | Z193 |
| 0 241 235 697 | Z90 | 0 242 129 510 | Z243 | 0 242 229 775 | Z67 | 0 242 235 666 | Z247 |
| 0 241 235 698 | Z91 | 0 242 129 801 | Z243 | 0 242 229 782 | Z208 | 0 242 235 666 | Z15 |
| 0 241 235 705 | Z61 | 0 242 135 501 | Z234 | 0 242 229 785 | Z177 | 0 242 235 667 | Z16 |
| 0 241 235 706 | Z120 | 0 242 135 515 | Z234 | 0 242 229 798 | Z153 | 0 242 235 668 | Z257 |
| 0 241 235 715 | Z176 | 0 242 135 524 | Z325 | 0 242 229 799 | Z121 | 0 242 235 668 | Z98 |
| 0 241 235 718 | Z176 | 0 242 135 528 | Z308 | 0 242 229 864 | Z119 | 0 242 235 690 | Z228 |

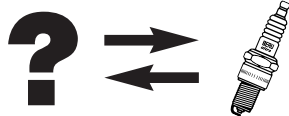

| ...BOSCH | BERU | ...BOSCH | BERU | ...BOSCH | BERU | ...BOSCH | BERU |
|---------------|-------|------------------|-------|----------------|-------|---------------|-------|
| 0 242 235 692 | Z225 | 0 242 240 548 | Z151 | F 7 HPP22 | Z176 | FR 7 DC+ | Z247 |
| 0 242 235 699 | Z206 | 0 242 240 557 | Z116 | F 7 HPP222 | Z176 | FR 7 DC2 | Z193 |
| 0 242 235 707 | Z21 | 0 242 240 566 | Z245 | F 7 HPP222U | Z176 | FR 7 DCO | Z15 |
| 0 242 235 733 | Z209 | 0 242 240 569 | Z144 | F 7 KPP 332 U | Z321 | FR 7 DCX | Z16 |
| 0 242 235 740 | Z206 | 0 242 240 577 | Z252 | F 7 KTCR | Z120 | FR 7 DCX+ | Z16 |
| 0 242 235 740 | Z188 | 0 242 240 584 | Z194 | F 7 LDCR | Z14 | FR 7 DE | Z15 |
| 0 242 235 743 | Z326 | 0 242 240 587 | Z129 | F 7 LTCR | Z90 | FR 7 DE2 | Z193 |
| 0 242 235 746 | Z97 | 0 242 240 590 | Z300 | F 8 DC | Z100 | FR 7 DPP 332 | Z282 |
| 0 242 235 746 | UXT8 | 0 242 240 591 | Z26 | F 8 DC4 | Z100 | FR 7 DPP+ | UXT10 |
| 0 242 235 748 | UXT1 | 0 242 240 592 | Z27 | F 8 DCO | Z5 | FR 7 DPP+ | Z206 |
| 0 242 235 748 | Z204 | 0 242 240 593 | UXT5 | F 8 DER | Z227 | FR 7 DPP10 | Z206 |
| 0 242 235 749 | UXT10 | 0 242 240 593 | Z24 | F 8 DPER | Z122 | FR 7 DPP22U | Z228 |
| 0 242 235 749 | Z206 | 0 242 240 606 | Z151 | F 8 DPP 222U | Z122 | FR 7 DPP33 | Z206 |
| 0 242 235 756 | Z235 | 0 242 240 615 | Z284 | F 8 DPP 332 | Z122 | FR 7 DPP33 | Z188 |
| 0 242 235 758 | Z235 | 0 242 240 619 | Z226 | F 8 DPP33 | Z122 | FR 7 HC+ | Z272 |
| 0 242 235 764 | Z176 | 0 242 240 620 | Z230 | F 8 KTCR | Z121 | FR 7 HCOX | Z225 |
| 0 242 235 766 | Z120 | 0 242 240 621 | Z313 | F 8 LCR | Z4 | FR 7 HE2 | Z200 |
| 0 242 235 767 | Z356 | 0 242 240 621 | Z221 | F 9 DCO | Z79 | FR 7 HPP222 | Z176 |
| 0 242 235 776 | Z301 | 0 242 240 625 | Z221 | FGR 6 HQEO | Z300 | FR 7 HPP33+ | Z176 |
| 0 242 235 788 | Z344 | 0 242 240 635 | Z294 | FGR 6 KQC | Z129 | FR 7 KC | Z155 |
| 0 242 235 791 | Z184 | 0 242 240 649 | UXT14 | FGR 6 NQEO | Z294 | FR 7 KC | Z156 |
| 0 242 235 797 | Z193 | 0 242 240 649 | Z313 | FGR 7 DQC | Z60 | FR 7 KC+ | UXT10 |
| 0 242 235 894 | Z247 | 0 242 240 848 | Z26 | FGR 7 DQE+ | UXT1 | FR 7 KC+ | Z155 |
| 0 242 235 908 | Z95 | 0 242 240 849 | Z27 | FGR 7 DQEO | Z145 | FR 7 KCW | Z150 |
| 0 242 235 909 | Z20 | 0 242 240 850 | Z24 | FGR 7 DQP | Z237 | FR 7 KCX | Z157 |
| 0 242 235 910 | Z91 | 0 242 242 501 | UXT5 | FGR 7 DQP+ | Z237 | FR 7 KCX+ | UXT11 |
| 0 242 235 911 | Z19 | 0 242 242 505 | UX56 | FGR 7 KQE | Z172 | FR 7 KCX+ | Z157 |
| 0 242 235 912 | Z15 | 0 242 242 801 | UXT5 | FGR 8 DE | UXT9 | FR 7 KPP 332 | Z301 |
| 0 242 235 913 | Z16 | 0 242 245 018 | Z192 | FGR 8 KQC | Z173 | FR 7 KPP 33U+ | Z312 |
| 0 242 235 914 | Z98 | 0 242 245 515 | Z30 | FGR 8 KQE | Z173 | FR 7 KPP33+ | Z188 |
| 0 242 235 915 | Z21 | 0 242 245 516 | Z47 | FGR 8 KQE 0 | Z173 | FR 7 LCX | Z158 |
| 0 242 235 916 | Z97 | 0 242 245 536 | Z30 | FGR 8 MQPE | Z211 | FR 7 LCX+ | Z158 |
| 0 242 235 917 | UXT1 | 0 242 245 537 | Z47 | FL 7 HTCOR | Z344 | FR 7 LDC | Z98 |
| 0 242 235 918 | Z206 | 0 242 245 539 | Z45 | FLR 7 HTCO | Z344 | FR 7 LDC+ | Z257 |
| 0 242 235 957 | UXT11 | 0 242 245 546 | Z130 | FLR 8 LDCU+ | Z74 | FR 7 LDC+ | Z98 |
| 0 242 235 979 | Z67 | 0 242 245 548 | Z130 | FQR 7 ME | Z184 | FR 7 ME | Z184 |
| 0 242 235 980 | Z155 | 0 242 245 552 | Z47 | FQR 8 DE | Z227 | FR 7 MPP 10 | Z326 |
| 0 242 235 981 | Z237 | 0 242 245 576 | Z347 | FQR 8 LE2 | Z287 | FR 7 NPP33 | Z235 |
| 0 242 235 982 | Z188 | 0 242 245 812 | Z47 | FQR 8 LEU2 | Z203 | FR 7 NPP332 | Z235 |
| 0 242 235 985 | Z157 | 0 242 250 506 | Z39 | FR 5 DC | Z30 | FR 7 SE | Z235 |
| 0 242 235 986 | Z158 | 0 242 329 503 | Z32 | FR 5 DPI | Z130 | FR 78 | UXT1 |
| 0 242 235 987 | Z312 | 0 242 329 504 | Z32 | FR 5 DPI X | Z130 | FR 78 | UXT3 |
| 0 242 236 510 | Z235 | 0 242 340 501 | Z33 | FR 5 DTC | Z45 | FR 78 X | UXT1 |
| 0 242 236 511 | Z282 | D 6 BC | Z33 | FR 5 KPP 332 S | Z347 | FR 78 X | UXT3 |
| 0 242 236 539 | Z176 | D 7 BC | Z32 | FR 5 LDC | Z192 | FR 8 DC | Z72 |
| 0 242 236 541 | Z157 | D 8 BC | Z32 | FR 56 | UXT5 | FR 8 DC | Z254 |
| 0 242 236 542 | Z158 | DR 6 BC | Z33 | FR 6 DC | Z24 | FR 8 DC | Z255 |
| 0 242 236 544 | Z312 | DR 7 BC | Z32 | FR 6 DC | Z252 | FR 8 DC+ | Z72 |
| 0 242 236 560 | Z67 | DR 8 BC | Z32 | FR 6 DC | UXT5 | FR 8 DCX+ | Z73 |
| 0 242 236 561 | UXT10 | F 03 DAR | Z14 | FR 6 DC+ | Z24 | FR 8 DE | Z254 |
| 0 242 236 561 | Z155 | F 04 DAR | Z14 | FR 6 DP | Z151 | FR 8 DE | Z255 |
| 0 242 236 562 | Z237 | F 5 DC | Z29 | FR 6 DP 1 | Z151 | FR 8 DE | Z72 |
| 0 242 236 563 | UXT15 | F 5 KPP 332 SBN | Z347 | FR 6 DPP 22 | Z221 | FR 8 DPP 33+ | UXT9 |
| 0 242 236 564 | Z188 | F 6 DCO | Z24 | FR 6 DPP22U | Z221 | FR 8 DPP 33+ | Z240 |
| 0 242 236 565 | Z272 | F 6 DCOR | Z24 | FR 6 DPP33X | Z284 | FR 8 DPP33 | Z240 |
| 0 242 236 566 | Z176 | F 6 DPP 332 | Z322 | FR 6 KDEO | Z194 | FR 8 HC | Z248 |
| 0 242 236 583 | Z321 | F 6 DSR | Z105 | FR 6 KPP 33x+ | UXT14 | FR 8 HDC | Z208 |
| 0 242 236 593 | Z235 | F 6 DTC | Z52 | FR 6 KPP33x | Z313 | FR 8 HDC+ | Z208 |
| 0 242 240 511 | Z27 | F 6 DTC (EA 1,0) | Z53 | FR 6 LDC | Z116 | FR 8 KC+ | Z153 |
| 0 242 240 514 | Z26 | F 6 LTCR | Z89 | FR 6 LDC | Z245 | FR 8 KCO | Z154 |
| 0 242 240 520 | Z49 | F 7 DC | Z63 | FR 6 MPP332 | Z226 | FR 8 KCU | Z249 |
| 0 242 240 522 | Z300 | F 7 DCO | Z63 | FR 7 DC | Z15 | FR 8 KTC | Z121 |
| 0 242 240 523 | Z26 | F 7 DCOR | Z13 | FR 7 DC | Z250 | FR 8 KTC+ | Z121 |
| 0 242 240 526 | Z24 | F 7 DCX(EA1,1) | Z63 | FR 7 DC 9 | Z15 | FR 8 LC | Z4 |
| 0 242 240 530 | Z151 | F 7 DPER | Z282 | FR 7 DC 9 | Z247 | FR 8 LPX | Z229 |
| 0 242 240 531 | Z28 | F 7 DPP 222T | Z188 | FR 7 DC+ | UXT9 | FR 8 ME | Z183 |
| 0 242 240 539 | Z99 | F 7 HER2 | Z200 | FR 7 DC+ | Z15 | FR 91 | UXT1 |

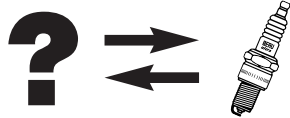



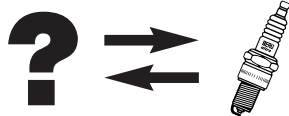



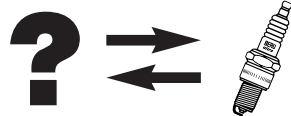



| ...BOSCH | BERU | ...BOSCH | BERU | ...BOSCH | BERU | ...BOSCH | BERU |
|----------------|-------|--------------|------|-------------------|------|-----------------|------|
| FR 91 | UXT3 | N 22 | Z68 | W 6 BC | Z48 | WS 9 EC | Z266 |
| FR 91 X | UXT1 | N 23 | Z73 | W 6 DC | Z22 | Y 6 NPP 332 | Z359 |
| FR 91 X | UXT3 | N 24 | Z95 | W 6 DCO | Z22 | YR 6 NPP 332 | Z359 |
| H 5 DC | Z31 | N 25 | Z234 | W 6 DPO | Z104 | YR 7 DC+ | Z234 |
| H 5 DCO | Z46 | N 26 | Z19 | W 6 DTC | Z51 | YR 7 DE | Z234 |
| H 56 | UXK56 | N 27 | Z30 | W 7 AC | Z57 | ZR 8 TPP15 | Z242 |
| H 6 DC | Z25 | N 28 | Z183 | W 7 BC | Z10 | | |
| H 6 DCO | Z56 | N 29 | Z26 | W 7 CC | Z58 | BRISK | BERU |
| H 7 DC | Z17 | N 30 | Z188 | W 7 CCO | Z58 | F 14 YC | Z33 |
| H 7 DCO | Z18 | N 34 | Z243 | W 7 DC | Z11 | F 15 YC | Z32 |
| H 8 DC | Z6 | N 35 | Z150 | W 7 DCO | Z61 | | |
| H 8 DC | Z7 | N 36 | Z11 | W 7 DCO | Z62 | CHAMPION | BERU |
| H 8 DCO | Z7 | N 38 | Z10 | W 7 DCX (EA 1,1) | Z11 | 3071 | Z150 |
| HGR 6 KQC | Z144 | UR 6 DE | Z210 | W 7 DTC | Z12 | BN 12 Y | Z17 |
| HGR 7 HQPEO | Z309 | VR 8 SC+ | Z243 | W 7 EC | Z267 | BN 6 Y | Z31 |
| HLR 8 STEX | Z222 | VR 8 SEW | Z243 | W 7 LTRC | Z91 | BN 7 Y | Z31 |
| HR 6 BC | Z49 | W 125 T 30 | Z76 | W 8 AC | Z68 | BN 79 Y | Z31 |
| HR 6 DC | Z26 | W 125 TR 30 | Z82 | W 8 BC | Z118 | BN 9 Y | Z25 |
| HR 6 DC+ | Z26 | W 145 M 1 | Z68 | W 8 CC | Z58 | C 12 YCC | Z79 |
| HR 6 DPP33V | Z230 | W 145 M 2 | Z58 | W 8 DC | Z1 | C 281 YC | Z63 |
| HR 7 DC | UXT4 | W 145 T 1 | Z68 | W 8 DCX | Z1 | C 6 BYC | Z52 |
| HR 7 DC | Z95 | W 145 T 2 | Z58 | W 8 DTC | Z2 | C 6 YCC | Z29 |
| HR 7 DC+ | Z95 | W 145 T 3 | Z112 | W 8 EC | Z112 | C 6 YCX | Z29 |
| HR 7 DCX | Z67 | W 145 T 30 | Z1 | W 8 LCR | Z3 | C 7 YC | Z24 |
| HR 7 DCX+ | Z67 | W 145 T 35 | Z118 | W 8 LTRC | Z92 | C 7 YCC | Z24 |
| HR 7 DPP22 | Z209 | W 145 TR 2 | Z59 | W 8 LTRC | Z93 | C 7 YCX | Z24 |
| HR 7 KPP 33+ | UXT15 | W 145 TR 30 | Z8 | W 9 DC | Z76 | C 9 BMC | Z14 |
| HR 7 MPP 22 U | Z97 | W 175 M 2 | Z58 | W 9 DCO | Z76 | C 9 YC | Z63 |
| HR 7 MPP 302X | Z356 | W 175 T 1 | Z57 | W 9 DTC | Z78 | C 9 YCC | Z63 |
| HR 7 MPP+ | UXT8 | W 175 T 2 | Z58 | W 9 LC | Z3 | C 9 YCX | Z63 |
| HR 7 MPP+ | Z97 | W 175 T 27 | Z62 | WA 125 TR 30 | Z117 | C10YCC/124 | Z5 |
| HR 78 | UXT4 | W 175 T 30 | Z11 | WA 175 T30 | Z17 | C11 YCC | Z100 |
| HR 8 DC+ | UXT4 | W 175 T 35 | Z10 | WA 200 T 30 | Z25 | CJ 8 | Z266 |
| HR 8 DCX | Z67 | W 175 TR 2 | Z59 | WA 200 T 40 | Z49 | EON 1 | UXT5 |
| HR 8 DCX+ | Z67 | W 175 TR 35 | Z19 | WA 200 TR 30 | Z26 | EON 2 | UXT3 |
| HR 8 DPP 15V | UXT15 | W 190 M 11 S | Z57 | WA 200 TR 40 | Z49 | EON 2 | UXT1 |
| HR 8 DPP15V | Z148 | W 200 RT 27 | Z27 | WA 225 T 30 | Z31 | EON 3 | UXT4 |
| HR 8 MCV+ | UXT17 | W 200 RT 30 | Z27 | WR 175 TR 30 | Z20 | EON 4 | Z97 |
| HR 8 MCV+ | Z177 | W 200 T 27 | Z22 | WR 4 AC | Z39 | EON 5 | UX56 |
| HR 8 MEV | Z177 | W 200 T 30 | Z22 | WR 5 DC | Z47 | EON 6 | UXT2 |
| HR 8 NPP302 | Z342 | W 200 T 35 | Z48 | WR 5 DC+ | Z47 | F 7 Y | Z33 |
| HR 9 DCX | Z117 | W 215 P 21 | Z104 | WR 56 | UX56 | F 7 YC | Z33 |
| MA 175 T 7 | Z32 | W 215 T 30 | Z22 | WR 6 DC | Z27 | F 9 Y | Z32 |
| MA 200 T 7 | Z33 | W 225 P 11 S | Z40 | WR 6 DC+ | Z27 | H 88 | Z57 |
| MAG 310 T 2 SP | Z108 | W 225 T 1 | Z40 | WR 6 DCX | Z28 | J 6 J | Z267 |
| MAG 340 T 2 SP | Z108 | W 225 T 27 | Z42 | WR 7 BC | Z19 | J 7 | Z112 |
| N 01 | Z250 | W 225 T 28 | Z42 | WR 7 BC+ | Z19 | J 8 | Z112 |
| N 02 | Z20 | W 225 T 30 | Z29 | WR 7 CC | Z59 | J 8 C | Z112 |
| N 03 | Z74 | W 225 T 35 | Z41 | WR 7 CCX (EA 1,1) | Z59 | J 8 J | Z112 |
| N 04 | Z98 | W 225 T 7 | Z41 | WR 7 DC | Z20 | J 9 | Z112 |
| N 05 | Z91 | W 225 TR 30 | Z47 | WR 7 DC+ | Z20 | KC8ZMCC | Z200 |
| N 06 | Z16 | W 230 T 30 | Z42 | WR 7 DCX+ | Z21 | KC8ZPYPB4 | Z176 |
| N 07 | Z8 | W 240 P 11 S | Z39 | WR 7 LTC+ | Z91 | L 11 S | Z40 |
| N 08 | Z72 | W 240 T 1 | Z39 | WR 78 | UXT2 | L 12 Y | Z10 |
| N 09 | Z177 | W 250 T 1 | Z39 | WR 78X | UXT2 | L 288 | Z57 |
| N 10 | Z95 | W 260 T 1 | Z39 | WR 8 BC | Z19 | L 4 G | Z39 |
| N 11 | Z9 | W 260 T 2 | Z38 | WR 8 DC+ | Z8 | L 4 J | Z39 |
| N 12 | Z24 | W 275 T 2 | Z38 | WR 8 DC4 | Z119 | L 5 | Z39 |
| N 13 | Z67 | W 3 CC | Z38 | WR 8 DCX | Z9 | L 6 G | Z40 |
| N 14 | Z94 | W 4 AC | Z39 | WR 8 DCX+ | Z9 | L 60 R | Z39 |
| N 15 | Z27 | W 4 CC | Z38 | WR 8 DP | Z311 | L 62 R | Z39 |
| N 16 | Z176 | W 5 AC | Z40 | WR 8 LTC+ | Z92 | L 66 Y | Z48 |
| N 17 | Z19 | W 5 BC | Z41 | WR 8 LTC+ | Z94 | L 7 | Z57 |
| N 18 | Z121 | W 5 DC | Z42 | WR 9 DC+ | Z82 | L 7 J | Z57 |
| N 19 | Z21 | W 5 DCO | Z42 | WR 9 DCX E.A. 1,1 | Z82 | | |
| N 20 | UXT1 | W 5 DTC | Z44 | WR 9 DCX+ | Z82 | | |
| N 21 | Z82 | W 56 | UX56 | WS 8 E | Z266 | | |







| ...CHAMPION | | ...CHAMPION | | ...CHAMPION | | ...CHAMPION | |
|-------------|------|-------------|------|-------------|------|-------------|------|
| L 81 | Z40 | N 8 Y | Z22 | OE 199 | Z358 | RF 7 YCC | Z33 |
| L 82 | Z40 | N 88 | Z58 | OE 199/T10 | Z358 | RF 7YC | Z33 |
| L 82 C | Z40 | N 89 Y | Z11 | OE032/T10 | Z120 | RF 9 Y | Z32 |
| L 82 Y | Z41 | N 9 BMC | Z75 | OE176 | Z176 | RF 9 Y4 | Z32 |
| L 82 YC | Z48 | N 9 BYC | Z2 | OE177 | Z200 | RF 9 YC | Z32 |
| L 82 YCC | Z48 | N 9 BYC 4 | Z2 | OE188/R04 | Z312 | RF 9Y5 | Z32 |
| L 85 | Z57 | N 9 Y | Z11 | OE188/T10 | Z312 | RJ 8 C | Z112 |
| L 86 | Z57 | N 9 YC | Z11 | OE190/R04 | Z235 | RL 82 | Z40 |
| L 86 C | Z68 | N 9 YC 4 | Z21 | OE190/T10 | Z235 | RL 82 C | Z40 |
| L 86 CC | Z68 | N 9 YCC | Z62 | OE190/T10 | Z235 | RL 82 YC | Z19 |
| L 87 Y | Z10 | N 9 YCX | Z62 | OE201/T10 | Z308 | RL 85 | Z57 |
| L 87 YC | Z10 | N 92 Y | Z76 | OE207 | Z325 | RL 86/C | Z57 |
| L 87 YCC | Z10 | OE 003 | Z63 | OE209 | Z295 | RL 87 Y | Z19 |
| L 88 | Z57 | OE 004 | Z20 | OE225 | Z274 | RL 87 YC | Z19 |
| L 88 A | Z57 | OE 005 | Z15 | OE63/T10 | Z73 | RN 10 PYP4 | Z311 |
| L 89 CM | Z57 | OE 006 | Z20 | ON 11 Y | Z8 | RN 10 VTYC4 | Z92 |
| L 9 G | Z57 | OE 007 | Z10 | ON 12 Y | Z8 | RN 10 Y | Z20 |
| L 92 Y | Z118 | OE 010 | Z22 | QL 77 JC 4 | Z39 | RN 10 Y 4 | Z21 |
| L 92 YC | Z118 | OE 011 | Z95 | QN 3 | Z38 | RN 11 Y | Z8 |
| L 95 Y | Z118 | OE 012 | Z12 | RA 4 HCX | Z234 | RN 11 YC | Z8 |
| N 10 Y | Z11 | OE 013 | Z72 | RA 7 YC | Z358 | RN 11 YC 4 | Z9 |
| N 11 Y | Z1 | OE 014 | Z24 | RBN 13 Y | Z26 | RN 11 YCC | Z82 |
| N 11 YC | Z1 | OE 015 | Z1 | RBN 14 Y 4 | Z117 | RN 12 Y | Z82 |
| N 11 YC4 | Z9 | OE 016 | Z72 | RBN 9 Y | Z26 | RN 12 YC | Z82 |
| N 11 YCC | Z76 | OE 019 | Z74 | RC 10 DMC | Z74 | RN 12 YCC | Z82 |
| N 12 Y | Z1 | OE 020 | Z95 | RC 10 PYP4 | Z343 | RN 13 Y | Z82 |
| N 12 YC | Z1 | OE 021 | Z116 | RC 10 VTYC4 | Z90 | RN 14 PMP5 | Z285 |
| N 12 YCC | Z1 | OE 022 | Z62 | RC 10 YC | Z72 | RN 14 Y | Z82 |
| N 13 Y | Z76 | OE 024 | Z16 | RC 10 YCC | Z72 | RN 14 YC | Z82 |
| N 13 YC | Z76 | OE 026 | Z14 | RC 10 YCL | Z15 | RN 3 | Z38 |
| N 14 Y | Z76 | OE 027 | Z92 | RC 11 PYPB4 | Z122 | RN 3 C | Z38 |
| N 14 YC | Z76 | OE 028 | Z2 | RC 12 LYC | Z152 | RN 3 G | Z38 |
| N 14 YCC | Z76 | OE 029 | Z97 | RC 12 MCC4 | Z220 | RN 4 | Z59 |
| N 16 YC | Z76 | OE 030 | Z245 | RC 12 PYP | Z150 | RN 4 C | Z59 |
| N 178 B | Z38 | OE 030 | Z98 | RC 12 YC | Z72 | RN 5 C | Z59 |
| N 179 BC | Z38 | OE 031 | Z177 | RC 6 YC | Z30 | RN 6 Y | Z47 |
| N 180 B | Z38 | OE 032 | Z90 | RC 6 YCC | Z30 | RN 6 YC | Z47 |
| N 2 | Z38 | OE 033 | Z15 | RC 7 BMC | Z116 | RN 7 Y | Z27 |
| N 2 C | Z38 | OE 034 | Z193 | RC 7 YC | Z24 | RN 7 YC | Z27 |
| N 2 G | Z38 | OE 036 | Z18 | RC 7 YC | Z252 | RN 7 YC 4 | Z28 |
| N 279 YC | Z22 | OE 037 | Z10 | RC 7 YC4 | Z99 | RN 7 YCC | Z27 |
| N 288 | Z58 | OE 042 | Z82 | RC 7 YCC | Z24 | RN 8 | Z59 |
| N 3 | Z38 | OE 043 | Z252 | RC 7 YCC | Z252 | RN 8 VTYC4 | Z91 |
| N 4 | Z58 | OE 044 | Z2 | RC 7 YCC4 | Z99 | RN 9 Y | Z20 |
| N 4 C | Z58 | OE 048 | Z21 | RC 8 BYC | Z245 | RN 9 YC | Z20 |
| N 5 | Z58 | OE 052 | Z234 | RC 8 DMC | Z14 | RN 9 YC4 | Z21 |
| N 5 C | Z58 | OE 054 | Z32 | RC 8 PYP | Z188 | RN 9 YCC | Z20 |
| N 6 | Z58 | OE 055 | Z1 | RC 8 VTYC4 | Z90 | RN 9 YCC4 | Z21 |
| N 6 BYC | Z44 | OE 064 | Z19 | RC 8 YCL | Z193 | RS 12 YC | Z95 |
| N 6 Y | Z42 | OE 071 | Z19 | RC 89 PYC | Z238 | RS 9 PYC | Z148 |
| N 6 YC | Z42 | OE 084 | Z42 | RC 89 TMC | Z204 | RS 9 PYP4 | Z209 |
| N 6 YCC | Z42 | OE 089 | Z225 | RC 89 YCC | Z151 | RS 9 YC | Z95 |
| N 6 YCX | Z42 | OE 093 | Z151 | RC 9 MCC4 | Z225 | RS 9 YCC | Z95 |
| N 62 R | Z38 | OE 100 | Z75 | RC 9 YC | Z15 | RS 9 YCC4 | Z67 |
| N 64 Y | Z42 | OE 105 | Z285 | RC 9 YC 4 | Z16 | RV 12 YC | Z49 |
| N 64 YCC | Z42 | OE 120 | Z204 | RC 9 YCC | Z15 | RV 9 YC/YCC | Z49 |
| N 7 | Z58 | OE 122 | Z210 | RC12YC/101 | Z73 | S 10 YC | Z6 |
| N 7 BMC | Z91 | OE 124 | Z343 | RC8BYC/101 | Z98 | S 10 YCC | Z7 |
| N 7 BYC | Z12 | OE 124/T10 | Z343 | RC8YC4/012 | Z73 | S 12 YC | Z6 |
| N 7 Y | Z22 | OE 130 | Z243 | RC9BMC/101 | Z98 | S 12 YCC | Z7 |
| N 7 YC | Z22 | OE 136 | Z188 | RE 14 MCC5 | Z216 | S 279 YC | Z25 |
| N 7 YCC | Z22 | OE 141 | Z343 | RE 7 PYC5 | Z97 | S 281 YC | Z25 |
| N 7 YCX | Z22 | OE 141/T10 | Z343 | RE 7 YCC | Z97 | S 379 YC | Z31 |
| N 79 Y | Z11 | OE 145 | Z238 | REA 8 MCL | Z243 | S 6 YC | Z31 |
| N 79 YC | Z11 | OE 154 | Z220 | REC 9 MCLX | Z223 | S 6 YCC | Z46 |
| N 8 | Z58 | OE 163/T04 | Z216 | RES 9 YCC4 | Z177 | S 7 YC | Z25 |
| N 8 B | Z58 | OE 178/T10 | Z223 | RF 7 YC | Z32 | S 7 YCC | Z56 |

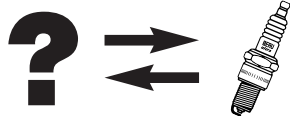

| ...EYQUEM  | ...EYQUEM  | ...KREIDLER  | ...MAGNETI MARELLI  | | |
|---|---|--|--|-------|-----|
| K 550 JS | Z32 | 215 02 03 | Z57 | | |
| KC 52 JS | Z32 | LETRIKA  | CW 8 N | Z39 | |
| KC 62 JS | Z33 | | CW 8 NP | Z41 | |
| L 65 | Z11 | | CW 89 LP | Z42 | |
| L 87 | Z42 | | CW 9 L | Z38 | |
| N 43 | Z10 | | CWP 7 L | Z22 | |
| R 850 | Z39 | | F 6 NC | Z10 | |
| RC 32 LS | Z82 | | F 7 LCR | Z20 | |
| RC 32 LSS | Z82 | | F 8 LCR | Z27 | |
| RC 42 HJS3E5 | Z222 | | MOTORCRAFT  | AE 2 | Z39 |
| RC 42 S | Z19 | | | AE 22 | Z48 |
| RC 52 LJS | Z95 | | | AE 3 | Z57 |
| RC 52 LJS 5 | Z67 | | | AE 32 | Z10 |
| RC 52 LS | Z119 | | | AE 4 | Z57 |
| RC 52 LS 5 | Z9 | | | AE 42 | Z10 |
| RC 52 LZ 3 EX | Z75 | | | AE 52 | Z57 |
| RC 52 LZ 3 EX | Z94 | AE 6 | | Z57 | |
| RC 52 LZ E | Z3 | AE 62 | | Z57 | |
| RC 58 LZ 3 EX | Z92 | AE 82 | | Z57 | |
| RC 58 LZ3EX | Z91 | AER 32 | | Z19 | |
| RC 62 HJS6 | Z177 | AG 12 C | | Z42 | |
| RC 62 HJSDP | Z97 | AG 12 Racing | | Z42 | |
| RC 62 LJS | Z95 | AG 2 | | Z58 | |
| RC 62 LS | Z20 | AG 22 | | Z22 | |
| RC 62 LS 5 | Z21 | AG 22 C | Z22 | | |
| RC 62 S | Z48 | AG 3 | Z58 | | |
| RC 72 | Z39 | AG 32 | Z11 | | |
| RC 72 LJS | Z26 | AG 42 | Z76 | | |
| RC 72 LS | Z27 | AG 52 | Z1 | | |
| RC 72 LS 5 | Z28 | AGF 22 | Z25 | | |
| RC 82 L | Z38 | AGF 22 C | Z25 | | |
| RC 82 LS | Z47 | AGFS 22 C | Z95 | | |
| RFC 42 HZDP5 | Z219 | AGFS 22 C 1 | Z67 | | |
| RFC 42 LS | Z72 | AGFS 22 F 13J | Z230 | | |
| RFC 42 LS 2E | Z74 | AGFS 22 IPJ | Z209 | | |
| RFC 42 LS 5 | Z73 | AGFS 32 C 1 | Z117 | | |
| RFC 42 LZ 2E | Z74 | AGFS K022FQ16B | Z309 | | |
| RFC 42 LZDP | Z229 | AGN 42 | Z1 | | |
| RFC 50 LZ 2E | Z74 | AGP 12 C | Z29 | | |
| RFC 52 LS | Z15 | AGP 22 C | Z24 | | |
| RFC 52 LS 2E | Z98 | AGP 22 CD | Z24 | | |
| RFC 52 LS 3 | Z204 | AGP 32 C | Z63 | | |
| RFC 52 LS5 | Z16 | AGPR 12 C | Z30 | | |
| RFC 52 LSP | Z224 | AGPR 12 C 1 | Z30 | | |
| RFC 52 LZ | Z15 | AGPR 12 P | Z130 | | |
| RFC 52 LZ E | Z4 | AGPR 22 C | Z24 | | |
| RFC 52 LZDP | Z151 | AGPR 22 C 1 | Z99 | | |
| RFC 52 LZDP5 | Z149 | AGPR 22 CD | Z24 | | |
| RFC 56 LZK | Z255 | AGPR 22 CD 1 | Z99 | | |
| RFC 56 LZK | Z334 | AGPR 22 P 1 | Z159 | | |
| RFC 58 HZEDP5 | Z235 | AGPR 22 PP | Z159 | | |
| RFC 58 LS | Z13 | AGPR 22 PPJ | Z284 | | |
| RFC 58 LS 2E | Z15 | AGPR 32 C | Z15 | | |
| RFC 58 LS 3 | Z98 | AGPR 32 C 1 | Z16 | | |
| RFC 58 LS 3X | Z60 | AGPR 32 CD | Z15 | | |
| RFC 58 LS2E | Z257 | AGPR 32 CD 1 | Z16 | | |
| RFC 58 LS5 | Z16 | AGPR 32 PD | Z173 | | |
| RFC 58 LZ | Z156 | AGPS 12 C | Z30 | | |
| RFC 58 LZ 2E | Z155 | AGPS 12 C 1 | Z253 | | |
| RFC 58 LZ 3EX | Z14 | AGPS 12 P 1 | Z130 | | |
| RFC 58 LZ2 | Z90 | AGPS 22 C | Z24 | | |
| RFC 58 LZ3EX | Z123 | AGPS 22 C 1 | Z99 | | |
| RFC 58 LZ5 | Z120 | AGPS 22 P 1 | Z159 | | |
| RFC 58 LZDP | Z157 | AGPS 32 C 1 | Z16 | | |
| RFC 58 LZDP | Z224 | AGPS 44 F11J | Z176 | | |
| RFC 58 LZES | Z158 | | | | |
| RFC 58 LZ F5 | Z225 | | | | |
| RFC 58 LZK | Z158 | | | | |
| RFC 58 LZP | Z224 | | | | |
| RFC 58 LZP4 | Z237 | | | | |
| RFC 62 LS | Z24 | | | | |
| RFC 62 LS 3 | Z52 | | | | |
| RFC 62 LS 3X | Z52 | | | | |
| RFC 62 LS 5 | Z99 | | | | |
| RFC 62 LZ 3 EX | Z89 | | | | |
| RFC 62 LZ2 | Z145 | | | | |
| RFC 82 LS | Z30 | | | | |
| RFC 82 LS 3 | Z45 | | | | |
| RFN 42 LZG5 | Z248 | | | | |
| RFN 42 LZP | Z238 | | | | |
| RFN 52 HZ | Z183 | | | | |
| RFN 52 HZ3A | Z223 | | | | |
| RFN 52 LZ | Z193 | | | | |
| RFN 52 LZDPF5 | Z176 | | | | |
| RFN 58 HZ | Z184 | | | | |
| RFN 58 LZ | Z193 | | | | |
| RFN 58 LZDP5 | Z228 | | | | |
| RFN 62 LZ | Z24 | | | | |
| RFN 62 LZ | Z252 | | | | |
| RFN 62 LZ | Z335 | | | | |
| RFN 62 LZDP5 | Z221 | | | | |
| RKC 52 JS | Z32 | | | | |
| RKC 62 JS | Z33 | | | | |
| RN 22 HJSE6 | Z216 | | | | |
| RWC 52 HSK | Z243 | | | | |
| RXC 58 HSEDP | Z288 | | | | |
| RXC 62 HSEDP | Z233 | | | | |
| RZC 58 LS | Z234 | | | | |
| XKC 62 JS | Z33 | | | | |
| XRC 52 JS | Z32 | | | | |
| HERCULES  | | | | | |
| 029 808 70 06 | Z57 | | | | |
| 099 800 40 01 | Z57 | | | | |
| HERTH+BUSS ELPARTS  | | | | | |
| LOPK 20R13 | Z150 | | | | |
| HITACHI  | | | | | |
| L 43 | Z38 | | | | |
| L 44 | Z38 | | | | |
| L 44 P | Z42 | | | | |
| L 45 PW | Z22 | | | | |
| L 45 PW-11 | Z11 | | | | |
| L 45 PX | Z11 | | | | |
| L 45 W | Z58 | | | | |
| L 45 X | Z58 | | | | |
| L 46 X | Z58 | | | | |
| M 43 W | Z39 | | | | |
| M 44 | Z57 | | | | |
| M 44 P | Z41 | | | | |
| M 44 W | Z57 | | | | |
| M 45 | Z57 | | | | |
| M 45 PW | Z57 | | | | |
| M 46 | Z57 | | | | |
| KREIDLER  | | | | | |
| 08 1103 | Z57 | | | | |
| | | MAGNETI MARELLI  | | | |
| | | 7 LC | Z24 | | |
| | | 7 LCR | Z24 | | |
| | | CW 10 L | Z38 | | |
| | | CW 4 C | Z112 | | |
| | | CW 4 CJ | Z112 | | |
| | | CW 5 N | Z57 | | |
| | | CW 55 N | Z57 | | |
| | | CW 6 L | Z58 | | |
| | | CW 6 LP | Z1 | | |
| | | CW 6 N | Z57 | | |
| | | CW 6 NP | Z48 | | |
| | | CW 7 LP | Z11 | | |
| | | CW 7 N | Z39 | | |
| | | CW 7 NJ | Z39 | | |
| | | CW 7 NP | Z48 | | |
| | | CW 78 LP | Z22 | | |
| | | CW 8 J | Z38 | | |
| | | CW 8 LP | Z42 | | |
| | | CW 8 LPS | Z42 | | |



| ...MOTORCRAFT  | ...MOTORCRAFT  | ...NGK  | ...NGK  |
|---|---|--|--|
| AGR 12 C | Z47 | 2550 | Z150 |
| AGR 22 | Z20 | 2609 | Z95 |
| AGR 22 BC | Z27 | 2611 | Z38 |
| AGR 22 C | Z20 | 2621 | Z39 |
| AGR 22-3 C | Z27 | 2623 | Z49 |
| AGR 252 C | Z20 | 2647 | Z228 |
| AGR 31 | Z8 | 2680 | Z266 |
| AGR 32 | Z8 | 2710 | Z32 |
| AGR 32 C | Z8 | 2710 | Z33 |
| AGR 42 | Z82 | 2756 | UXT10 |
| AGR 42 C | Z82 | 2756 | Z16 |
| AGR 52 | Z82 | 2789 | Z246 |
| AGR 52-6 | Z8 | 2792 | Z40 |
| AGRF 22 | Z95 | 2828 | Z8 |
| AGRF 22 C | Z95 | 2848 | Z98 |
| AGRF 22 C 1 | Z67 | 2876 | Z91 |
| AGRF 22 CD | Z95 | 2890 | Z173 |
| AGRF 22 CD 1 | Z67 | 2921 | Z58 |
| AGRF 32 C 1 | Z117 | 2941 | Z3 |
| AGS 22 C | Z20 | 3014 | Z39 |
| AGS 42 C | Z82 | 302 | Z267 |
| AGSF 22 FE13J | Z209 | 3028 | Z9 |
| AGSF 22 FSCM | Z296 | 303 | Z266 |
| AGSF 22 PPJ | Z209 | 3045 | Z90 |
| AGSF 32 FM | Z148 | 3100 | Z314 |
| AGSP 092 P | Z130 | 3116 | Z279 |
| AGSP 32 | Z24 | 3121 | Z38 |
| AGSP 32 C | Z24 | 3132 | Z16 |
| AGSP 33 C | Z158 | 3153 | Z2 |
| AJFS 32 CJ | Z177 | 3153 | Z8 |
| AWF 22 | Z25 | 3172 | Z91 |
| AWRF 42 | Z95 | 3199 | Z237 |
| AWSF 22 | Z31 | 3210 | Z112 |
| AWSF 22 C | Z31 | 3232 | Z28 |
| AWSF 32 | Z17 | 3306 | UXT1 |
| AWSF 32 C | Z17 | 3311 | Z10 |
| AWSF 32 F | Z148 | 3321 | Z38 |
| AWSF 42 | Z95 | 3330 | Z30 |
| AWSF 42 C | Z95 | 3350 | Z149 |
| AWSF 52 | Z117 | 3355 | Z22 |
| AWSF 52 C | Z117 | 3377 | Z92 |
| AYFS 092 FEC | Z315 | 3500 | Z188 |
| AYFS 22 C | Z177 | 3510 | Z267 |
| AYFS 22 CB | Z177 | 3524 | Z73 |
| AYFS 22 CJ | Z305 | 3526 | Z31 |
| AYFS 22 F | Z97 | 3539 | Z206 |
| AYFS 22 PP 1 | Z97 | 3540 | Z159 |
| AYFS 32 CJ | Z177 | 3577 | Z21 |
| AYRF 22 FF | Z97 | 3583 | Z98 |
| AYRF 22 PP | Z97 | 3584 | Z145 |
| BF 22 | Z33 | 3586 | Z176 |
| BF 22 C | Z33 | 3588 | Z226 |
| BF 22 CX | Z33 | 3611 | Z10 |
| BF 32 | Z32 | 3623 | Z95 |
| BF 32 C | Z32 | 3696 | Z155 |
| BF 32 CX | Z32 | 3712 | Z6 |
| BF 42 | Z32 | 3720 | Z157 |
| BFS 22 C | Z33 | 3783 | Z15 |
| BFS 32 C | Z32 | 3783 | Z120 |
| BFS 32 C1 | Z32 | 3784 | Z67 |
| BRF 22 | Z32 | 3789 | Z310 |
| BRF 22 C | Z32 | 3811 | Z342 |
| BRF 22 CX | Z32 | 3812 | Z18 |
| BRF 22 X | Z33 | 3837 | Z150 |
| BRF 32 | Z32 | 3923 | Z47 |
| BRF 32 C | Z32 | 3932 | Z234 |
| BRF 32 CX | Z32 | 3967 | Z208 |
| BRF 32 X | Z32 | | |
| BRF 42 | Z32 | | |
| BRF 42 C | Z32 | | |
| BRF 42 X | Z32 | | |
| BSF 42 | Z32 | | |
| NGK  | | | |
| 0005 | Z97 | | |
| 1015 | Z38 | | |
| 1041 | Z158 | | |
| 1048 | Z148 | | |
| 1080 | Z63 | | |
| 1095 | Z30 | | |
| 1146 | Z155 | | |
| 1149 | Z28 | | |
| 1183 | Z95 | | |
| 1208 | Z235 | | |
| 1212 | Z21 | | |
| 1263 | Z51 | | |
| 1266 | Z72 | | |
| 1267 | Z99 | | |
| 1272 | Z24 | | |
| 1273 | Z73 | | |
| 1578 | Z308 | | |
| 1662 | Z73 | | |
| 1664 | Z176 | | |
| 1667 | Z72 | | |
| 1669 | Z302 | | |
| 1675 | Z347 | | |
| 1691 | Z293 | | |
| 1748 | Z346 | | |
| 201 | Z38 | | |
| 2023 | Z27 | | |
| 203 | Z57 | | |
| 204 | Z40 | | |
| 205 | Z39 | | |
| 206 | Z22 | | |
| 2074 | Z248 | | |
| 2078 | Z52 | | |
| 208 | Z38 | | |
| 2087 | UXT10 | | |
| 2087 | Z154 | | |
| 2128 | Z82 | | |
| 214 | Z19 | | |
| 2164 | Z45 | | |
| 2197 | Z204 | | |
| 2215 | Z151 | | |
| 2249 | Z156 | | |
| 2262 | Z158 | | |
| 2268 | Z20 | | |
| 2288 | Z14 | | |
| 2288 | Z257 | | |
| 2319 | Z267 | | |
| 2330 | Z15 | | |
| 2351 | Z79 | | |
| 2357 | Z42 | | |
| 2364 | Z1 | | |
| 2382 | Z73 | | |
| 2397 | Z90 | | |
| 2411 | Z38 | | |
| 2412 | Z22 | | |
| 2417 | Z57 | | |
| 2467 | Z97 | | |
| 2470 | Z92 | | |
| 2513 | Z237 | | |
| 2526 | Z249 | | |
| 3975 | Z10 | | |
| 3978 | Z221 | | |
| 3988 | Z38 | | |
| 4045 | Z313 | | |
| 4073 | Z157 | | |
| 4080 | Z278 | | |
| 4120 | Z73 | | |
| 4179 | Z234 | | |
| 4210 | Z68 | | |
| 4228 | Z21 | | |
| 4259 | Z210 | | |
| 4288 | Z359 | | |
| 4291 | Z158 | | |
| 4292 | Z240 | | |
| 4294 | Z301 | | |
| 4339 | Z234 | | |
| 4368 | Z157 | | |
| 4377 | Z337 | | |
| 4388 | UXT1 | | |
| 4388 | Z14 | | |
| 4392 | Z95 | | |
| 4421 | Z72 | | |
| 4424 | Z9 | | |
| 4435 | Z225 | | |
| 4477 | Z209 | | |
| 4477 | UXT15 | | |
| 4483 | Z74 | | |
| 4510 | Z57 | | |
| 4511 | Z10 | | |
| 4553 | Z19 | | |
| 4559 | Z177 | | |
| 4563 | UXT1 | | |
| 4589 | Z280 | | |
| 4619 | Z193 | | |
| 4632 | Z48 | | |
| 4685 | Z159 | | |
| 4691 | Z76 | | |
| 4696 | Z122 | | |
| 4704 | Z294 | | |
| 4775 | Z302 | | |
| 4783 | Z100 | | |
| 4824 | Z21 | | |
| 4856 | Z15 | | |
| 4904 | Z235 | | |
| 4922 | Z59 | | |
| 4930 | Z63 | | |
| 4983 | Z292 | | |
| 5030 | Z29 | | |
| 5110 | Z40 | | |
| 5111 | Z41 | | |
| 5118 | Z325 | | |
| 5156 | Z2 | | |
| 5165 | Z152 | | |
| 5214 | Z286 | | |
| 5216 | Z74 | | |
| 5266 | Z275 | | |
| 5282 | Z16 | | |
| 5282 | UXT11 | | |
| 5328 | Z22 | | |
| 5339 | Z21 | | |
| 5343 | Z19 | | |
| 5344 | UXT12 | | |
| 5344 | Z170 | | |
| 5411 | Z76 | | |
| 5428 | Z28 | | |
| 5444 | Z216 | | |
| 5461 | Z90 | | |

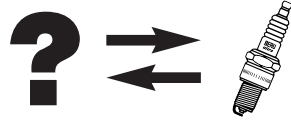

| ...NGK | BERU | ...NGK | BERU | ...NGK | BERU | ...NGK | BERU |
|--------|-------|---------|-------|----------------|-------|---------------|-------|
| 5510 | Z39 | 6714 | Z72 | B 5 ES | Z58 | BKR 5 E-11 | Z73 |
| 5521 | Z51 | 6717 | Z15 | B 5 HS | Z68 | BKR 5 EK | Z74 |
| 5539 | Z39 | 6717 | Z193 | B 6 E | Z58 | BKR 5 EKB-11 | Z208 |
| 5547 | Z295 | 6723 | Z20 | B 6 EB | Z58 | BKR 5 EKC | Z74 |
| 5553 | Z73 | 6799 | Z243 | B 6 EM | Z58 | BKR 5 EKUP | Z173 |
| 5555 | UXT9 | 6837 | Z127 | B 6 ES | Z58 | BKR 5 ES | Z72 |
| 5555 | Z221 | 6840 | Z295 | B 6 H | Z57 | BKR 5 ES | Z254 |
| 5584 | Z158 | 6872 | Z239 | B 6 HS | Z57 | BKR 5 ES | Z255 |
| 5585 | Z158 | 6893 | Z200 | B 6 S | Z267 | BKR 5 ES-11 | Z73 |
| 5592 | Z295 | 6895 | Z98 | B 7 E | Z58 | BKR 5 EY | Z153 |
| 5621 | Z51 | 6928 | Z76 | B 7 EM | Z38 | BKR 5 EYA | Z154 |
| 5637 | Z11 | 6953 | Z73 | B 7 ET | Z38 | BKR 5 EYA-11 | Z249 |
| 5649 | Z194 | 6962 | Z15 | B 7 H | Z39 | BKR 5 EZ | Z72 |
| 5685 | Z94 | 6989 | Z209 | B 7 HC | Z57 | BKR 6 E | Z15 |
| 5692 | Z291 | 6992 | Z304 | B 7 HS | Z40 | BKR 6 E-11 | UXT11 |
| 5703 | Z312 | 6994 | Z354 | B 7 HV | Z39 | BKR 6 E-11 | Z16 |
| 5705 | Z312 | 7004 | Z341 | B 7 HZ | Z39 | BKR 6 EK | Z14 |
| 5722 | Z38 | 7022 | Z19 | B 77 EC | Z38 | BKR 6 EKB-11 | Z98 |
| 5724 | Z16 | 7038 | Z82 | B 8 EE | Z38 | BKR 6 EKC | Z98 |
| 5730 | Z47 | 7113 | Z183 | B 8 ES | Z38 | BKR 6 EKE | Z194 |
| 5742 | Z360 | 7121 | Z16 | B 8 EV | Z38 | BKR 6 EKPA | Z237 |
| 5756 | Z338 | 7164 | Z148 | B 8 H | Z39 | BKR 6 EKUB | Z145 |
| 5757 | Z321 | 7210 | Z63 | B 8 HCS | Z39 | BKR 6 EKUE | Z213 |
| 5758 | Z349 | 7222 | Z82 | B 8 HS | Z39 | BKR 6 E-N-11 | Z16 |
| 5760 | Z311 | 7226 | Z28 | B 9 E | Z38 | BKR 6 EP-13 | Z150 |
| 5773 | Z188 | 7264 | Z93 | B 9 ES | Z38 | BKR 6 EP-8 | Z151 |
| 5776 | Z249 | 7265 | Z27 | BCP 4 ES | Z79 | BKR 6 EQU | Z239 |
| 5788 | Z273 | 7281 | Z119 | BCP 5 E | Z100 | BKR 6 EQUA | Z239 |
| 5809 | Z230 | 7281 | Z8 | BCP 5 ES | Z100 | BKR 6 EQUP | Z237 |
| 5811 | Z1 | 7310 | Z58 | BCP 5 ES | Z5 | BKR 6 ES | Z15 |
| 5823 | Z20 | 7311 | Z9 | BCP 5 ES-11 | Z73 | BKR 6 EVX | Z206 |
| 5832 | Z104 | 7327 | Z1 | BCP 6 E | Z63 | BKR 6 EVX-11 | Z159 |
| 5839 | Z3 | 7354 | Z198 | BCP 6 E-11 | Z63 | BKR 6 EY | UXT10 |
| 5843 | Z332 | 7390 | UXT10 | BCP 6 ES | Z63 | BKR 6 EY | Z155 |
| 5847 | Z308 | 7390 | Z153 | BCP 6 ES-11 | Z63 | BKR 6 EY-11 | Z157 |
| 5921 | Z266 | 7422 | Z8 | BCP 6 ET | UXT1 | BKR 6 EYA | UXT10 |
| 5932 | Z93 | 7496 | Z100 | BCP 6 EY | Z63 | BKR 6 EYA | Z156 |
| 5960 | Z272 | 7550 | Z229 | BCP 7 ES | Z29 | BKR 6 EYA-11 | Z157 |
| 6002 | Z239 | 7563 | Z306 | BCP 7 ET | Z52 | BKR 6 EZ | Z193 |
| 6043 | Z355 | 7569 | UXT15 | BCPR 5 E | Z72 | BKR 6EK | Z257 |
| 6044 | Z298 | 7569 | Z209 | BCPR 5 E-11 | Z73 | BKR 7 E | Z24 |
| 6097 | Z24 | 7586 | Z97 | BCPR 5 EIX-11 | UXT1 | BKR 7 E-11 | Z24 |
| 6129 | Z252 | 7586 | UXT8 | BCPR 5 ES | Z72 | BKR 7 EKC | Z198 |
| 6129 | Z15 | 7642 | Z72 | BCPR 5 ES-11 | Z73 | BKR 7 EVX-11 | Z159 |
| 6130 | Z72 | 7727 | Z11 | BCPR 5 EY | Z72 | BKUR 5 ET | Z246 |
| 6211 | Z11 | 7742 | Z236 | BCPR 5 EY-11 | Z73 | BKUR 5 ET-10 | Z121 |
| 6223 | Z21 | 7743 | Z176 | BCPR 6 E | Z15 | BKUR 6 EK | Z98 |
| 6237 | Z63 | 7772 | Z323 | BCPR 6 E-11 | UXT11 | BKUR 6 ET | Z90 |
| 6240 | Z219 | 7810 | Z73 | BCPR 6 E-11 | Z16 | BKUR 6 ET-10 | Z90 |
| 6262 | Z99 | 7811 | Z11 | BCPR 6 EP-11 | Z149 | BKUR 6 ETB | Z304 |
| 6290 | UXT14 | 7822 | Z20 | BCPR 6 EP-13 | Z150 | BKUR 6 ETB-10 | Z360 |
| 6342 | Z246 | 7873 | Z89 | BCPR 6 ER | Z14 | BKUR 7 ET | Z89 |
| 6343 | Z237 | 7938 | Z72 | BCPR 6 ES | Z15 | BM 6 A | Z266 |
| 6344 | Z67 | 7938 | Z255 | BCPR 6 ES-11 | Z16 | BP 2 E | Z76 |
| 6345 | Z72 | 7938 | Z254 | BCPR 6 ET | Z204 | BP 4 E | Z1 |
| 6376 | Z303 | 7956 | Z74 | BCPR 6 EY | Z155 | BP 4 ES | Z76 |
| 6376 | UXT13 | 7963 | Z317 | BCPR 6 EY-11 | Z157 | BP 4 H | Z10 |
| 6410 | Z58 | 7968 | Z176 | BCPR 6 EY-N-11 | Z99 | BP 4 HS | Z10 |
| 6411 | Z11 | 7980 | Z333 | BCPR 7 E | Z24 | BP 4 HS | Z118 |
| 6427 | Z20 | 7994 | Z73 | BCPR 7 E-11 | Z99 | BP 5 E | Z1 |
| 6437 | Z90 | 91432 | Z274 | BCPR 7 ER | Z14 | BP 5 EA | Z1 |
| 6458 | UXT10 | 93311 | Z338 | BCPR 7 ES | Z30 | BP 5 EA-L | Z11 |
| 6458 | Z188 | 94460 | Z347 | BCPR 7 ET | Z45 | BP 5 EA-L-11 | Z11 |
| 6465 | UXT11 | 94786 | Z357 | BCPR 7ES-11 | Z30 | BP 5 EFS | Z6 |
| 6465 | Z16 | AP 6 FS | Z32 | BCRE 527Y | Z248 | BP 5 EFS | Z7 |
| 6466 | Z18 | AP 6 FS | Z33 | BKR 4 E | Z72 | BP 5 EK-A | Z12 |
| 6511 | Z1 | B 4 | Z112 | BKR 5 E | Z72 | BP 5 ES | Z1 |

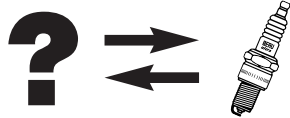



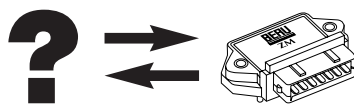



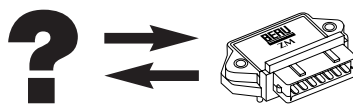













| ...NGK | | ...NGK | | ...NGK | | ...NGK | |
|---------------|------|--------------|-------|---------------|-------|-------------|-------|
| BP 5 ES-11 | Z9 | BU 7 EA-11 | Z42 | PGR 5 C-11 | Z311 | V-Line 27 | UXT3 |
| BP 5 ESZ | Z76 | BU 7 EB-11 | Z38 | PLFR 5A-11 | Z219 | V-Line 27 | Z90 |
| BP 5 ET-10 | Z2 | BUR 5 EB-11 | Z28 | PLKR 7 A | Z359 | V-Line 28 | UXT3 |
| BP 5 EY | Z1 | BUR 5 ET | Z92 | PLKR 9 C8 | Z357 | V-Line 28 | Z15 |
| BP 5 EZ | Z1 | BUR 5 ET-10 | Z93 | PLZKAR 6 A-11 | Z325 | V-Line 28 | UXT1 |
| BP 6 E | Z11 | BUR 6 EA-11 | Z28 | PLZKBR 7 A-G | Z332 | V-Line 29 | Z246 |
| BP 6 EF | Z17 | BUR 6 EB-11 | Z47 | PMR 7 A | Z210 | V-Line 3 | Z19 |
| BP 6 EFS | Z18 | BUR 6 EFSZ | Z127 | PTR 5 A-10 | Z97 | V-Line 30 | Z237 |
| BP 6 EFS | Z17 | BUR 6 ET | Z91 | PTR 5 A-13 | UXT8 | V-Line 31 | Z67 |
| BP 6 EK | Z51 | CR 7 EKC | Z341 | PTR 5 A-13 | Z97 | V-Line 32 | Z72 |
| BP 6 EK-A | Z51 | DCPR 7 E | Z234 | PTR 5 D-10 | Z67 | V-Line 33 | Z73 |
| BP 6 ES | Z11 | DCPR 7 EN-10 | Z292 | PTR 6 D-13G | Z209 | V-Line 34 | Z176 |
| BP 6 ES-11 | Z21 | DCPR 8 E | Z234 | PTR 6 F13 | Z209 | V-Line 35 | Z72 |
| BP 6 ESZ | Z61 | DCPR 8 E-N | Z291 | PTR 6 F-13 | UXT15 | V-Line 36 | Z72 |
| BP 6 ESZ | Z62 | GR 4 | Z82 | PZFR 5 N-11T | Z236 | V-Line 36 | UXT1 |
| BP 6 ET | Z51 | IFR 5 D 10 | Z122 | PZFR 5 N-11TG | Z236 | V-Line 37 | UXT10 |
| BP 6 EVX | Z104 | IFR 5E-11 | Z73 | PZFR 6 R | Z349 | V-Line 37 | Z188 |
| BP 6 EY | Z11 | IFR 6 D 10 | Z170 | PZFR 6F | Z229 | V-Line 38 | UXT1 |
| BP 6 EZ | Z11 | IFR 6 D-10 | UXT12 | PZFR5D-11 | Z176 | V-Line 38 | Z193 |
| BP 6 FS | Z49 | IFR 6T-11 | Z280 | PZFR5J-11 | Z176 | V-Line 39 | Z249 |
| BP 6 H | Z10 | IKR 6 G11 | Z333 | PZFR5Q-11 | Z176 | V-Line 4 | Z11 |
| BP 6 HS | Z10 | IKR 9 F-8 | Z338 | PZFR6J-11 | Z176 | V-Line 5 | Z17 |
| BP 7 E | Z42 | ILFR 6 A | Z226 | TR 4 | Z95 | V-Line 5 | Z18 |
| BP 7 EFS | Z31 | ILKAR 7 A7 | Z274 | TR 5 A-10 | Z97 | V-Line 6 | Z119 |
| BP 7 EFS | Z46 | ILTR 5A-13G | Z342 | TR 55 | Z148 | V-Line 6 | Z8 |
| BP 7 ES | Z22 | ILTR 6A-13G | Z310 | TR 55 IX | Z148 | V-Line 7 | Z95 |
| BP 7 HS | Z41 | ILZFR 6D-11 | Z235 | TR 6 AP 13 | Z230 | V-Line 8 | Z1 |
| BPR 2 E | Z82 | ILZKAR 7 A10 | Z355 | TR 6 B-10 | Z305 | V-Line 9 | Z2 |
| BPR 4 E | Z82 | ITR 5 F-13 | Z298 | TR5B-13 | Z177 | V-Line 9 | Z8 |
| BPR 4 ES | Z82 | ITR 6 F-13 | UXT15 | V-Line 1 | Z91 | ZF 5A-11 | Z4 |
| BPR 4 EY | Z82 | ITR 6 F-13 | Z209 | V-Line 10 | Z21 | ZFR 5 E-11 | Z225 |
| BPR 5 E | Z8 | IZFR 5B | Z278 | V-Line 11 | UXT11 | ZFR 5 F-11 | UXT1 |
| BPR 5 EA-11 | Z9 | IZFR 6 B | Z279 | V-Line 11 | UXT3 | ZFR 5 F-11 | Z158 |
| BPR 5 EA-L | Z20 | IZFR 6 H-11 | Z301 | V-Line 11 | Z16 | ZFR 5 J-11 | Z158 |
| BPR 5 EA-L-11 | Z21 | IZFR 6 K-11 | Z354 | V-Line 12 | UXT1 | ZFR 5F | Z152 |
| BPR 5 EKU | Z94 | IZFR6 K-11TS | Z275 | V-Line 12 | UXT3 | ZFR 5P-G | Z200 |
| BPR 5 ES | Z8 | IZKR 7 B | Z306 | V-Line 12 | Z15 | ZFR 6 A-11 | Z158 |
| BPR 5 ES-11 | Z9 | LFR 5 A-11 | UXT13 | V-Line 13 | Z21 | ZFR 6 BP-G | Z346 |
| BPR 5 EY | Z8 | LFR 5 AP-11 | Z302 | V-Line 14 | UXT11 | ZFR 6 F-11 | Z158 |
| BPR 5 EY-11 | Z9 | LFR 5 B | Z183 | V-Line 14 | Z16 | ZFR 6 F-11 | UXT1 |
| BPR 6 E | Z20 | LFR 5 E-11 | Z302 | V-Line 15 | Z3 | ZFR 6 F-11G | Z158 |
| BPR 6 E-11 | Z21 | LFR 5A-11 | Z303 | V-Line 16 | UXT1 | ZFR 6 FR | Z98 |
| BPR 6 EF | Z95 | LFR 6 C-11 | Z273 | V-Line 16 | UXT3 | ZFR 6 J-11 | Z158 |
| BPR 6 EFS | Z95 | LFR 6 D | Z294 | V-Line 16 | Z100 | ZFR 6 T-11G | Z272 |
| BPR 6 ES | Z20 | LKR 7 B-9 | Z308 | V-Line 17 | UXT1 | ZGR 5 A | Z3 |
| BPR 6 ES-11 | Z21 | LKR 8 A | Z286 | V-Line 17 | UXT3 | ZKR 7 A-10 | Z293 |
| BPR 6 ES-13 | Z21 | LKR 9 C1-8 | Z357 | V-Line 17 | Z63 | | |
| BPR 6 ES-N-11 | Z21 | LZKAR 7A | Z243 | V-Line 18 | Z10 | | |
| BPR 6 EY | Z20 | LZTR 4A-11 | Z216 | V-Line 19 | Z27 | | |
| BPR 6 EY-11 | Z21 | PFR 5 R-11 | Z240 | V-Line 2 | Z20 | PAL | |
| BPR 6 FS | Z49 | PFR 5G-11 | Z228 | V-Line 20 | UXT1 | D 12 YC | Z29 |
| BPR 6 H | Z19 | PFR 6 A-11 | Z313 | V-Line 20 | UXT3 | D 14 Y | Z24 |
| BPR 6 HS | Z19 | PFR 6 B-9 | Z314 | V-Line 20 | Z14 | D 14 YC | Z24 |
| BPR 6 HSA | Z48 | PFR 6 G-11 | UXT9 | V-Line 21 | Z93 | D 15 Y | Z63 |
| BPR 7 E | Z27 | PFR 6 G-9 | Z337 | V-Line 21 | Z93 | D 15 YC | Z63 |
| BPR 7 ES | Z27 | PFR 6 H-10 | UXT14 | V-Line 22 | Z92 | D 17 Y | Z100 |
| BPR 7 ES-11 | Z28 | PFR 6 Q | UXT10 | V-Line 22 | UXT1 | D 17 YC | Z100 |
| BPR 7 EY-11 | Z28 | PFR 6B | Z188 | V-Line 23 | UXT3 | DR 14 YC | Z24 |
| BPR 8 ES | Z47 | PFR 6G-11 | Z221 | V-Line 23 | Z74 | DR 15 TC | Z238 |
| BR 6 EB | Z20 | PFR 6Q | Z188 | V-Line 24 | UXT3 | DR 15 YC | Z15 |
| BR 6 EB-11 | Z21 | PFR 7 Q | Z317 | V-Line 24 | Z90 | DR 17 YC | Z72 |
| BR 6 ES | Z59 | PFR 7 S 8EG | Z347 | V-Line 24 | UXT1 | G 12 YC | Z31 |
| BR 8 HSA | Z39 | PFR 7G-11S | Z323 | V-Line 25 | Z97 | G 14 Y | Z25 |
| BR 9 ES | Z38 | PFR 7H-10 | Z221 | V-Line 25 | UXT8 | G 14 YC | Z25 |
| BU 5 EB-11 | Z22 | PFR6W-TG | Z295 | V-Line 26 | UXT1 | G 15 Y | Z17 |
| BU 6 EA-11 | Z22 | PFR7W-T | Z295 | V-Line 26 | UXT3 | G 15 YC | Z17 |
| BU 6 EB-11 | Z42 | PFR7W-TG | Z295 | V-Line 26 | Z98 | G 17 Y | Z6 |
| | | | | V-Line 27 | UXT1 | G 17 Y | Z7 |





| BOSCH | | ...BOSCH | | DENSO | | ...HELLA | |
|---------------|-------|-----------------|-------|----------------------|-------|-------------------|-------|
| 0 221 600 002 | ZM001 | 1 227 022 034 | ZM036 | 131000-0011 | ZM059 | 5DA 006 623-151 | ZM022 |
| 0 221 600 014 | ZM001 | 1 227 030 030 | ZM013 | 131000-0511 | ZM058 | 5DA 006 623-161 | ZM009 |
| 0 221 600 015 | ZM001 | 1 227 030 049 | ZM014 | 131000-0920 | ZM058 | 5DA 006 623-181 | ZM004 |
| 0 221 600 016 | ZM001 | 1 237 010 014 | ZM008 | 131000-920 | ZM058 | 5DA 006 623-191 | ZM015 |
| 0 221 600 017 | ZM001 | 1 237 010 028 | ZM003 | 13100-511 | ZM058 | 5DA 006 623-201 | ZM040 |
| 0 221 600 052 | ZM001 | 1 237 010 029 | ZM003 | 131300-0011 | ZM059 | 5DA 006 623-241 | ZM020 |
| 0 221 600 055 | ZM029 | 1 237 010 031 | ZM003 | 131300-0033 | ZM057 | 5DA 006 623-251 | ZM018 |
| 0 221 600 056 | ZM033 | 1 237 010 038 | ZM003 | 131300-0072 | ZM057 | 5DA 006 623-271 | ZM038 |
| 0 221 600 066 | ZM033 | 9 222 067 034 | ZM049 | 131300-0120 | ZM059 | 5DA 006 623-281 | ZM017 |
| 0 227 100 023 | ZM004 | 916X0227100 | ZM004 | 131300-0121 | ZM059 | 5DA 006 623-291 | ZM048 |
| 0 227 100 024 | ZM004 | | | 131300-0330 | ZM057 | 5DA 006 623-311 | ZM019 |
| 0 227 100 029 | ZM005 | | | | | 5DA 006 623-321 | ZM047 |
| 0 227 100 042 | ZM004 | BREMI | | DODUCO | | 5DA 006 623-351 | ZM059 |
| 0 227 100 043 | ZM004 | 14001 | ZM002 | 0 040 302 313 | ZM025 | 5DA 006 623-361 | ZM058 |
| 0 227 100 100 | ZM002 | 14002 | ZM001 | 2313 | ZM025 | 5DA 006 623-371 | ZM057 |
| 0 227 100 101 | ZM002 | 14003 | ZM003 | | | 5DA 006 623-381 | ZM046 |
| 0 227 100 102 | ZM001 | 14004 | ZM012 | DUCELLIER | | 5DA 006 623-391 | ZM056 |
| 0 227 100 103 | ZM002 | 14005 | ZM039 | 245 509 | ZM017 | 5DA 006 623-401 | ZM023 |
| 0 227 100 104 | ZM002 | 14006 | ZM004 | 245 510 | ZM001 | 5DA 006 623-411 | ZM053 |
| 0 227 100 110 | ZM001 | 14007 | ZM013 | 2528001A | ZM017 | 5DA 006 623-421 | ZM024 |
| 0 227 100 111 | ZM001 | 14008 | ZM014 | 521 007 | ZM001 | 5DA 006 623-431 | ZM061 |
| 0 227 100 112 | ZM001 | 14009 | ZM032 | 521 013 | ZM001 | 5DA 006 623-461 | ZM060 |
| 0 227 100 113 | ZM002 | 14010 | ZM034 | | | 5DA 006 623-471 | ZM045 |
| 0 227 100 114 | ZM004 | 14011 | ZM015 | ECHLIN | | 5DA 006 623-481 | ZM025 |
| 0 227 100 115 | ZM004 | 14012 | ZM040 | INTERNATIONAL | | 5DA 006 623-491 | ZM051 |
| 0 227 100 116 | ZM002 | 14015 | ZM035 | 93-061 | ZM012 | 5DA 006 623-501 | ZM050 |
| 0 227 100 118 | ZM002 | 14016 | ZM037 | 9458 | ZM015 | 5DA 006 623-511 | ZM049 |
| 0 227 100 120 | ZM039 | 14017 | ZM029 | 96 20 | ZM023 | 5DA 006 623-531 | ZM013 |
| 0 227 100 121 | ZM004 | 14018 | ZM036 | 96 91 | ZM024 | 5DA 006 623-541 | ZM014 |
| 0 227 100 122 | ZM004 | 14021 | ZM033 | 96 97 | ZM015 | 5DA 006 623-551 | ZM032 |
| 0 227 100 123 | ZM001 | 14022 | ZM026 | 9674 | ZM019 | 5DA 006 623-561 | ZM034 |
| 0 227 100 124 | ZM015 | 14050 | ZM038 | TP 31 | ZM019 | 5DA 006 623-571 | ZM043 |
| 0 227 100 126 | ZM004 | 14052 | ZM063 | TP 45 | ZM005 | 5DA 006 623-581 | ZM016 |
| 0 227 100 129 | ZM004 | 14053 | ZM062 | TP 49 | ZM016 | 5DA 006 623-601 | ZM026 |
| 0 227 100 136 | ZM004 | 14100 | ZM005 | | | 5DA 006 623-631 | ZM052 |
| 0 227 100 137 | ZM002 | 14101 | ZM006 | ERA | | 5DA 006 623-641 | ZM055 |
| 0 227 100 138 | ZM002 | 14102 | ZM007 | DM1951 | ZM007 | 5DA 006 623-681 | ZM037 |
| 0 227 100 139 | ZM002 | 14103 | ZM008 | | | 5DA 006 623-691 | ZM029 |
| 0 227 100 140 | ZM003 | 14104 | ZM016 | EYQUEM | | 5DA 006 623-771 | ZM062 |
| 0 227 100 142 | ZM012 | 14151 | ZM019 | M 5015 | ZM026 | HERTH+BUSS | |
| 0 227 100 143 | ZM012 | 14153 | ZM020 | | | ELPARTS | |
| 0 227 100 145 | ZM040 | 14154 | ZM018 | FACET | | 19 010 062 | ZM046 |
| 0 227 100 147 | ZM012 | 14155 | ZM047 | 1.965.035 | ZM040 | 19010006 | ZM001 |
| 0 227 100 148 | ZM001 | 14156 | ZM041 | 1.965.051 | ZM027 | 19010007 | ZM003 |
| 0 227 100 200 | ZM026 | 14200 | ZM054 | 465 051 | ZM027 | 19010008 | ZM005 |
| 0 227 100 207 | ZM035 | 14201 | ZM056 | 465035 | ZM040 | 19010011 | ZM043 |
| 0 227 100 209 | ZM063 | 14203 | ZM046 | 9.4035 | ZM040 | 19010028 | ZM019 |
| 0 227 100 210 | ZM063 | 14250 | ZM010 | 9.4051 | ZM027 | 19010029 | ZM039 |
| 0 227 100 211 | ZM062 | 14290 | ZM060 | | | 19010034 | ZM013 |
| 1 137 010 025 | ZM003 | 14300 | ZM009 | HELLA | | 19010035 | ZM032 |
| 1 227 010 001 | ZM002 | 14301 | ZM061 | 5DA 006 623 591 | ZM063 | 19010036 | ZM031 |
| 1 227 010 002 | ZM001 | 14350 | ZM022 | 5DA 006 623-001 | ZM001 | 19010037 | ZM034 |
| 1 227 010 003 | ZM001 | 14352 | ZM050 | 5DA 006 623-011 | ZM002 | 19010039 | ZM035 |
| 1 227 010 003 | ZM015 | 14353 | ZM051 | 5DA 006 623-021 | ZM039 | 19010040 | ZM036 |
| 1 227 010 004 | ZM002 | 14354 | ZM025 | 5DA 006 623-031 | ZM012 | 19010044 | ZM015 |
| 1 227 010 005 | ZM015 | 14355 | ZM049 | 5DA 006 623-041 | ZM003 | 19010047 | ZM040 |
| 1 227 010 006 | ZM015 | 14400 | ZM017 | 5DA 006 623-051 | ZM005 | 19010052 | ZM048 |
| 1 227 010 008 | ZM001 | 14450 | ZM048 | 5DA 006 623-061 | ZM006 | 19010053 | ZM061 |
| 1 227 010 039 | ZM015 | 14500 | ZM059 | 5DA 006 623-071 | ZM007 | 19010054 | ZM048 |
| 1 227 010 100 | ZM002 | 14501 | ZM058 | 5DA 006 623-081 | ZM008 | 19010056 | ZM017 |
| 1 227 022 003 | ZM008 | 14502 | ZM057 | 5DA 006 623-141 | ZM054 | 19010060 | ZM049 |
| 1 227 022 008 | ZM002 | 14550 | ZM024 | | | 19010064 | ZM050 |
| 1 227 022 017 | ZM003 | 14651 | ZM031 | | | 19010065 | ZM051 |
| 1 227 022 018 | ZM003 | 14750 | ZM053 | | | 19010069 | ZM052 |
| 1 227 022 024 | ZM032 | 14800 | ZM045 | | | 19010072 | ZM053 |
| 1 227 022 028 | ZM034 | 8539 | ZM049 | | | | |
| 1 227 022 031 | ZM003 | | | | | | |

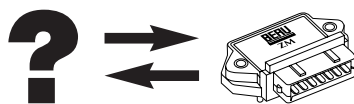

| | | | |
|---|--|---|--|
| HERTH+BUSS ÉLPARTS  | ...LUCAS ELECTRICAL  | ...MAGNETI MARELLI  | ...MOTORCRAFT  |
| 19010077 ZM056 | DAB 101 ZM008 | 581701070000 ZM009 | DYE 923 ZM022 |
| 19010078 ZM057 | DAB 109 ZM037 | 581701080000 ZM003 | EDY 7 ZM019 |
| 19010080 ZM059 | DAB 118 ZM020 | 605133190 ZM037 | MOTOROLA  |
| HITACHI  | DAB 119 ZM047 | 648 330 10 ZM005 | AM 2 ZM005 |
| CM1T204B ZM031 | DAB 120 ZM047 | 648 330 20 010 ZM001 | GM 1 ZM005 |
| CM1T204D ZM031 | DAB 121 ZM047 | 648 330 32 ZM002 | PAL  |
| CM1T204E ZM031 | DAB 125 ZM005 | 648 330 40 ZM009 | TZP 443 213 221 020 ZM060 |
| DIS4-05 ZM027 | DAB 126 ZM041 | 648 330 60 ZM003 | SEV-MARCHAL  |
| DIS4-08 ZM028 | DAB 126 ZM018 | 64833031 ZM061 | 73503702 ZM001 |
| E12302 ZM045 | DAB 127 ZM020 | 64833036 ZM061 | SIEMENS  |
| E12303 ZM045 | DAB 127 ZM047 | 64833100010 ZM003 | 175607 ZM001 |
| E1261 ZM046 | DAB 128 ZM010 | 940 038 500 ZM002 | 2576 12.70.01 ZM002 |
| E1288 ZM046 | DAB 129 ZM020 | 940 038 502 ZM003 | 5 WK 6 ZM038 |
| HOFFER  | DAB 132 ZM048 | 940 038 503 ZM012 | 5 WK 6105 ZM002 |
| 8010013 ZM007 | DAB 133 ZM048 | 940 038 504 ZM013 | 5 WKG 222 ZM041 |
| HÜCO  | DAB 134 ZM018 | 940 038 505 ZM039 | 5 WKG 6208 ZM041 |
| 138021 ZM005 | DAB 134 ZM041 | 940 038 506 ZM004 | 5WK 6101 ZM002 |
| 138043 ZM020 | DAB 135 ZM020 | 940 038 506 ZM004 | 6116 ZM038 |
| 138052 ZM063 | DAB 135 ZM047 | 940 038 507 ZM014 | STANDARD  |
| 138055 ZM062 | DAB 200 ZM001 | 940 038 508 ZM015 | 15881 Intermotor ZM060 |
| 138406 ZM029 | DAB 201 ZM001 | 940 038 509 ZM032 | VALEO  |
| 138451 ZM025 | DAB 202 ZM017 | 940 038 512 ZM031 | 245509 ZM017 |
| HUECO  | DAB 214 ZM024 | 940 038 518 ZM017 | 245513 ZM008 |
| 13 8042 ZM019 | DAB 400 ZM002 | 940 038 520 ZM006 | 245514 ZM020 |
| INTERMOTOR  | DAB 401 ZM003 | 940 038 521 ZM005 | 245515 ZM005 |
| 15881 ZM060 | DAB 402 ZM012 | 940 038 522 ZM007 | 245516 ZM018 |
| LETRIKA  | DAB 403 ZM039 | 940 038 525 ZM043 | 245517 ZM047 |
| AEV 14 0112 ZM001 | DAB 404 ZM004 | 940 038 526 ZM016 | 245518 ZM039 |
| AEV 1401 ZM001 | DAB 405 ZM015 | 940 038 527 ZM008 | 245519 ZM002 |
| LUCAS ELECTRICAL  | DAB 406 ZM040 | 940 038 542 ZM019 | 245520 ZM003 |
| 544 01 850 ZM008 | DAB 407 ZM032 | 940 038 543 ZM043 | 245521 ZM012 |
| 544 03 549 ZM001 | DAB 408 ZM034 | 940 038 544 ZM020 | 245522 ZM006 |
| 544 03 575 ZM001 | DAB 416 ZM038 | 940 038 545 ZM047 | 245523 ZM007 |
| 54896 ZM047 | DAB 420 ZM035 | 940 038 550 ZM023 | 245524 ZM019 |
| 549 87 086 ZM018 | DAB 424 ZM060 | 940 038 570 ZM010 | 245525 ZM026 |
| 80 428 ZM047 | DAB 441 ZM031 | 940 038 571 ZM018 | 245527 ZM009 |
| 803 34A ZM018 | DAB 700 ZM006 | 940 138 501 ZM001 | 245531 ZM013 |
| 803 34A ZM041 | DAB 701 ZM043 | 940038510 ZM034 | 245532 ZM014 |
| 84 403 ZM020 | DAB 702 ZM007 | 940038515 ZM037 | 245534 ZM004 |
| 84 453 ZM047 | DAB 703 ZM016 | 940038535 ZM038 | 245535 ZM040 |
| 84193 ZM047 | DAB 750 ZM019 | 940038535 ZM061 | 245536 ZM015 |
| 844 03D ZM020 | DAB 800 ZM009 | 940038546 ZM048 | 245538 ZM010 |
| 84453B ZM047 | DAB 801 ZM061 | 940038547 ZM048 | 245539 ZM022 |
| 84504B ZM047 | DAB 801 ZM061 | 940038555 ZM046 | 245541 ZM038 |
| 84567 ZM047 | DAB 953 ZM010 | 940038555 ZM046 | 245547 ZM032 |
| 84567B ZM047 | DAB 954 ZM013 | 943251220010 ZM034 | 245548 ZM034 |
| 848 90D ZM018 | DAJ 106 ZM046 | BKL 1 A ZM005 | 245550 ZM023 |
| 848 96A ZM020 | DAJ 204 ZM022 | BKL 3 B ZM061 | 245551 ZM024 |
| 849 50A ZM020 | DAJ 901 ZM054 | BKL 3 BD ZM061 | 2528001 ZM017 |
| 8490 D ZM041 | DAJ 904 ZM023 | BKL 4 A ZM009 | 2528001A ZM017 |
| 84987 ZM048 | DBA 410 ZM033 | BKL2A ZM001 | 2528008 ZM001 |
| 84988 ZM048 | MAGNETI MARELLI  | BKL3C ZM002 | 2528008A ZM001 |
| | 0 940038509 ZM032 | MTR01 ZM001 | 259 5028 ZM022 |
| | 0 940038535 ZM038 | MTR02 ZM003 | 2595001 ZM008 |
| | 064833010010 ZM005 | MTR2 ZM003 | 2595002 ZM020 |
| | 064833036010 ZM061 | TZP 443 213 221 ZM060 | |
| | 064833040 ZM009 | MAPCO  | |
| | 0940 038 506 ZM004 | 80560 ZM059 | |
| | 0940038510 ZM034 | MEAT & DORIA  | |
| | 0940038511 ZM033 | 10013 ZM007 | |
| | 0940038515 ZM037 | MOTORCRAFT  | |
| | 0940038522 ZM007 | DY 425 ZM019 | |
| | 0940038570 ZM010 | | |
| | 0941038520 ZM006 | | |
| | 581701010000 ZM061 | | |
| | 581701020000 ZM061 | | |



| ...VALEO | |  | | | | | |
|-----------------|-------|---|--|--|--|--|--|
| 2595003 | ZM005 | | | | | | |
| 2595004 | ZM047 | | | | | | |
| 2595005 | ZM039 | | | | | | |
| 2595006 | ZM001 | | | | | | |
| 2595007 | ZM002 | | | | | | |
| 2595008 | ZM003 | | | | | | |
| 2595009 | ZM012 | | | | | | |
| 2595010 | ZM006 | | | | | | |
| 2595011 | ZM007 | | | | | | |
| 2595013 | ZM009 | | | | | | |
| 2595016 | ZM018 | | | | | | |
| 2595017 | ZM017 | | | | | | |
| 2595020 | ZM013 | | | | | | |
| 2595021 | ZM014 | | | | | | |
| 2595023 | ZM004 | | | | | | |
| 2595024 | ZM040 | | | | | | |
| 2595025 | ZM015 | | | | | | |
| 2595027 | ZM010 | | | | | | |
| 2595030 | ZM038 | | | | | | |
| 2595038 | ZM032 | | | | | | |
| 2595039 | ZM034 | | | | | | |
| 73502602 | ZM017 | | | | | | |
| CD 863 | ZM005 | | | | | | |
| CD 866 | ZM039 | | | | | | |
| CD 867 | ZM002 | | | | | | |
| CD 870 | ZM006 | | | | | | |
| CD 871 | ZM007 | | | | | | |
| CD 873 | ZM009 | | | | | | |
| CD 880 | ZM004 | | | | | | |
| CD 884 | ZM038 | | | | | | |
| CD 885 | ZM008 | | | | | | |
| CD604 | ZM003 | | | | | | |
| CD605 | ZM017 | | | | | | |
| CD856 | ZM001 | | | | | | |
| CD868 | ZM003 | | | | | | |
| VEMO | |  | | | | | |
| 10-70-0051 | ZM062 | | | | | | |
| 30-70-0002 | ZM004 | | | | | | |

OE ?

ALFA ROMEO

116 61 96 016 00 **GR066**

BMW

12 21 7 786 821 **GSE101**
 12 21 7 788 327 **GSE102**
 12 21 7 788 956 **GSE103**
 12 21 7 801 200 **GSE101**
 12 21 7 801 201 **GSE102**
 7 786 821 **GSE101**
 7 788 327 **GSE102**
 7 788 956 **GSE103**
 7 801 200 **GSE101**
 7 801 201 **GSE102**

CITROËN

5981 10 **GR059**
 5981 13 **GR059**
 5981 15 **GR065**
 5981 19 **GR034**
 5981 21 **GR054**
 5981 27 **GR054**
 7920 076 593 **GR059**
 91 51 58 69 **GR065**
 92 51 58 67 **GR065**
 92 51 58 67 80 **GR065**
 92 51 58 69 **GR065**
 9250 883 280 **GR059**
 9250 888 280 **GR059**
 95 492 99 580 **GR059**
 95 534 787 **GR059**
 96 141 677 **GR034**
 96 16 28 00 80 **GR054**
 96 16 58 23 80 **GR054**

FIAT

46423043 **GR054**
 4792112 **GR065**
 5946920 **GR065**
 5990986 **GR065**
 961416778 **GR034**
 9615938380 **GR054**

FORD

61 43 688 **GR064**
 61 88 591 **GR064**
 83 BB 6 M 092 A1A **GR064**
 83 BB 6 M 092 AA **GR064**
 83 BB 6 M 092 BA **GR064**
 88 BB 6 M 092 BA **GR064**
 88 BG 8 B 658 AA **GR064**

IVECO

4792112 **GR065**
 9462703 **GR065**

KÄSSBOHRER

737515000 **GR071**
 7375155000 **GR071**
 73751591000 **GR069**

LANCIA

5946920 **GR065**
 5990986 **GR065**

MAGIRUS-DEUTZ

4792112 **GR065**

MERCEDES-BENZ

000 545 35 16 **GSE140**
 000 545 36 16 **GSE141**
 001 545 05 32 **GR071**
 001 545 06 32 **GR071**
 001 545 97 32 **GR069**
 001 545 98 32 **GR071**
 002 545 05 32 **GR069**
 002 545 06 32 **GR071**
 002 545 08 32 **GR069**
 002 545 09 32 **GR071**
 002 545 41 32 **GR069**
 002 545 42 32 **GR070**
 002 545 43 32 **GR070**
 005 545 40 32 **GR075**
 006 545 88 32 **GR074**
 006 545 89 32 **GR073-B**
 006 545 90 32 **GR075**
 007 545 16 32 **GR076**
 007 545 98 32 **GR073-B**
 007 545 99 32 **GR075**
 008 545 00 32 **GR074**
 013 545 24 32 **GR075**
 018 545 72 32 **GR080**
 019 545 69 32 **GSE141**
 025 545 28 32 **GSE140**
 025 545 29 32 **GSE141**
 025 545 54 32 **GR049**
 028 545 40 32 **GSE141**
 646 153 65 79 **GSE140**
 648 900 00 00 **GSE141**
 A 000 545 35 16 **GSE140**
 A 000 545 36 16 **GSE141**
 A 018 545 72 32 **GR080**
 A 019 545 69 32 **GSE141**
 A 025 545 28 32 **GSE140**
 A 025 545 29 32 **GSE141**
 A 028 545 40 32 **GSE141**
 A 642 153 03 79 **GSE114**
 A 642 153 19 79 **GSE114**
 A 642 153 20 79 **GSE114**
 A 642 153 37 79 **GSE116**
 A 642 900 27 00 **GSE116**
 A 642 900 28 00 **GSE114**
 A 642 900 57 01 **GSE116**
 A 642 900 58 01 **GSE114**
 A 646 153 65 79 **GSE140**
 A 648 900 00 00 **GSE141**

NISSAN

75 80 00 05-1/2 **GR065**

OPEL

12 38 532 **GR064**
 12 38 537 **GR064**
 12 38 565 **GR064**
 12 38 627 **GR064**

...OPEL

1232076 **GSE144**
 1232077 **GSE145**
 55353011 **GSE142**
 55354141 **GSE143**
 55557760 **GSE144**
 55557761 **GSE145**
 62 37 339 **GR064**
 6235240 **GSE142**
 6235303 **GSE143**
 90 040 992 **GR064**
 90 228 928 **GR064**
 90 240 651 **GR064**
 90 276 101 **GR064**
 90 341 822 **GR064**
 90 464 952 **GR064**

PEUGEOT

5981 10 **GR059**
 5981 11 **GR065**
 5981 13 **GR059**
 5981 15 **GR065**
 5981 19 **GR034**
 5981 21 **GR054**
 5981 26 **GR054**
 5981 27 **GR054**
 7920 076 593 **GR059**
 91 51 58 69 80 **GR065**
 92 51 58 67 80 **GR065**
 92 51 58 69 80 **GR065**
 9250 883 280 **GR059**
 9250 888 280 **GR059**
 95 534 787 **GR059**
 96 141 677 **GR034**
 96 16 28 00 80 **GR054**
 96 16 58 23 80 **GR054**
 96 252 036 **GR034**
 96 252 036 80 **GR034**

RENAULT

77 00 702 747 **GR066**
 77 00 751 089 **GR066**
 77 00 757 776 **GR066**
 77 00 790 579 **GR067**
 77 00 851 443 **GR067**
 77 00 856 789 **GR067**
 77 00 863 454 **GR067**
 77 00 867 374 **GR067**

ROVER

NCJ 100110 **GR054**
 PRC 5020 **GR065**
 PRC 5020 **GR066**

SAME

000871074 **GR066**

SEAT

05 81 CR 01 **GR065**

STEYR

754 516 32 **GR076**
 754 599 32 **GR075**

TALBOT

9121586980 **GR065**
 9251586780 **GR065**
 9251586980 **GR065**
 96 141 677 80 **GR034**
 B 515867 **GR065**

VAG

03G 907 282 **GSE100**
 171 911 261 A **GR001**
 171 911 261 B **GR001**
 357911253 **GR081**

VAUXHALL

090040992 **GR064**
 090228928 **GR064**
 090341822 **GR064**
 091097769 **GR064**
 091108750 **GR064**

VOLVO

35601160 **GR064**
 36501116 **GR064**

VW

171 911 261 D **GR031**
 171 911 261 E **GR031**
 191 911 261 A **GR031**
 191 911 261 C **GR031**
 321 911 261 **GR031**
 321 911 261 C **GR031**
 443 911 261 **GR031**
 443 911 261 C **GR031**
 867 911 261 C **GR031**

OE ? ⇒



| | | | |
|-------------------------------|------------------------|------------------------------|------------------------------|
| ALFA ROMEO | ...CITROËN | ...CITROËN | ...DAIHATSU |
| 116 61 05 358 00 GV657 | 5 460 556 GV130 | 5962 T3 GV749 | 1985087701 GV886 |
| 116 76 05 358 01 GV657 | 5 477 234 GV130 | 5962 W2 GN912 | 19850-87701 000 GV886 |
| 46072001 GN909 | 5 491 387 GV130 | 5962 W8 GV636 | 19850-87702-000 GV967 |
| 464 51 951 GN017 | 5 500 842 GV130 | 5962 X1 GN909 | |
| 46754154 GN017 | 5 962 58 GN909 | 5962 X1 GV602 | FENDT |
| 472 95 95 GV602 | 5960 12 GN047 | 5962 X1 GV642 | X 830 030 126 GF683 |
| 55208177 GN069 | 5960 19 GN047 | 75 492 325 GV130 | |
| 55210051 GE112 | 5960 64 GN054 | 9 633 214 380 GN013 | FIAT |
| 605 07 123 GV657 | 5960 65 GN054 | 90 041 002 80 GV661 | 0000060800110 GV642 |
| 605 96 245 GN908 | 5960 66 GN027 | 91 536 646 GV636 | 0000060816139 GN041 |
| 606 17 002 GN007 | 5960 67 GN027 | 91 538 910 99 GV661 | 0000071772815 GE114 |
| 606517002 GN007 | 5960 69 GN016 | 95 493 206 GN909 | 0000071772815 GE112 |
| 608 16 139 GN017 | 5960 77 GN045 | 95 493 206 GV602 | 0000071772817 GN037 |
| 717 34 087 GN017 | 5960 78 GN056 | 95 493 206 GV642 | 0000071772818 GN097 |
| 71735458 GN041 | 5960 99 GN063 | 95 534 788 GV642 | 07029585 GV602 |
| 71735461 GN908 | 5960 A0 GN063 | 95 534 788 GN909 | 4393814 GV602 |
| 71735461 GV657 | 5960 A4 GN037 | 95 534 788 GV602 | 4474413 GV642 |
| 71735465 GN007 | 5960 E6 GE121A | 96 070 388 80 GV661 | 46447610 GN970 |
| | 5960 E9 GN047 | 96 076 258 GV661 | 46451951 GN017 |
| BMW | 5960 F4 GN054 | 96 076 258 GN909 | 46530556 GN030 |
| 0 038 490 CGP001 | 5960 F5 GN027 | 96 141 678 GN909 | 46751764 GN030 |
| 12 12 1 286 059 GV636 | 5960 G6 GN063 | 96 165 724 GN909 | 46754154 GN041 |
| 12 12 1 288 161 GV636 | 5960 G7 GN909 | 96 236 383 GN027 | 46779614 GN053 |
| 12 12 1 288 245 GV749 | 5960 L4 GE112 | 96 316 589 80 GN912 | 46792355 GN059 |
| 12 23 0 038 490 CGP001 | 596072 GN012 | 96 389 858 GN027 | 46796050 GN053 |
| 12 23 1 286 058 GV636 | 5960F6 GN016 | 96 831 952 80 GE121A | 4714294 GV602 |
| 12 23 1 288 245 GV636 | 5960F6 GN912 | E161001 GN857 | 4729585 GV602 |
| 12 23 2 240 255 GV636 | 5960F9 GN056 | E161003 GN909 | 4754011 GV602 |
| 12 23 2 241 387 GV719 | 5960G7 GN013 | E161003 GV663 | 4774412 GV602 |
| 12 23 2 241 388 GV719 | 5960G7 GV636 | E161003 GV602 | 4774413 GV642 |
| 12 23 2 241 389 GV719 | 5960H6 GN964 | E161005 GV666 | 4776085 GF683 |
| 12 23 2 248 059 GN024 | 5960K0 GV661 | E161020 GV844 | 4781356 GV642 |
| 12 23 22 48 422 GN025 | 5960K5 GN012 | E161021 GV852 | 4832279 GF683 |
| 12 23 7 786 869 GE102 | 5961 05 GV107 | HG 2621 GV107 | 4833643 GN908 |
| 12 23 7 788 957 GE103 | 5961 22 GV107 | MKP 000 65 GN909 | 4833643 GV727 |
| 12 23 7 791 101 GN042 | 5961 54 GV642 | MKP 000 65 GV642 | 4849406 GV727 |
| 12 23 7 798 001 GE118 | 5962 008 GV636 | MKP 000 70 GD382 | 500303569 GF683 |
| 12 23 9 061 353 GV636 | 5962 1P GN964 | MKP 000 71 GN857 | 500314583 GF006 |
| 12 23 9 061 354 GV719 | 5962 1Q GN964 | | 500316493 GN012 |
| 7 810 858 CGP001 | 5962 1R GV603 | CITROEN/PEUGEOT | 500351992 GN037 |
| 7 810 858 01 CGP001 | 5962 1S GV631 | 5960 88 GN939 | 5415813 GV108 |
| 7 810 858 02 CGP001 | 5962 1T GV642 | 5960 89 GN939 | 5493206 GV602 |
| 77 86 869 GE102 | 5962 1V GV663 | 5960 G2 GN939 | 5500842 GV130 |
| 77 88 957 GE103 | 5962 1W GV666 | 9637469980 GN047 | 55187863 GN059 |
| | 5962 1X GV844 | 9637469980 GN047 | 55200755 GE114 |
| BOMAG | 5962 1Y GV852 | | 55200817 GN097 |
| 057 199 03 GV108 | 5962 1Z GN857 | DACIA | 55210051 GE112 |
| | 5962 2Z GN016 | 82 00 682 592 GE110 | 5950464 GV602 |
| CHEVROLET | 5962 2Z GN912 | 82 00 794 920 GE111 | 5951861 GV602 |
| 55 664 219 GE112 | 5962 3C GN027 | | 5951879 GV602 |
| 71735458 GN041 | 5962 3E GN027 | DAF | 5951881 GV663 |
| 89 417 515 81 GN061 | 5962 3H GN013 | 0192618 GN954 | 5951882 GV642 |
| | 5962 3J GN013 | 105977 GV603 | 60507123 GV657 |
| CHRYSLER | 5962 5A GN012 | 1353958 GN954 | 60596245 GN909 |
| 05066840 AA GN055 | 5962 7F GN027 | | 606 17 002 GN007 |
| KJ0741144 GN909 | 5962 7G GN027 | DAIHATSU | 60812292 GN908 |
| T0701 130 GN909 | 5962 7Z GV844 | 19850-54030-000 GV688 | 60814613 GN017 |
| | 5962 C7 GV107 | 19850-54050-000 GV894 | 71719015 GV663 |
| CITROËN | 5962 J3 GV661 | 19850-54090-000 GV968 | 71734087 GN017 |
| 5 414 326 GV130 | 5962 J4 GN909 | 19850-64010-000 GV886 | 71735458 GN041 |
| 5 415 813 GV108 | 5962 J4 GV642 | 19850-64020-000 GV967 | 71735460 GN927 |
| 5 415 813 GV107 | 5962 J7 GN857 | 19850-68010 GV897 | 71735461 GN908 |
| | 5962 R8 GN909 | 19850-68060-000 GV895 | 71735462 GN012 |
| | 5962 S8 GN909 | | 71735463 GV730 |
| | 5962 T1 GV852 | | |
| | 5962 T1 GN909 | | |
| | 5962 T2 GV844 | | |

OE ? ⇌



| ...FIAT | BERU | ...FORD | BERU | ...FORD | BERU | ...GENERAL MOTORS | BERU |
|---------------|---------|------------------|---------|-----------------------|--------|-------------------|-------|
| 71735464 | GN030 | 1724842 | GE112 | 95 VB-9N424-BB | GF983 | 91 153 919 | GN007 |
| 7632587 | GV730 | 256Q 6M090 AA | GN047 | 95 VW 6M090 AA | GN855 | 91 182 01 | GN992 |
| 7634328 | GV663 | 256Q 6M090 AB | GN047 | 95 VW 6M090 AB | GN855 | 91 611 11 | GF984 |
| 7648199 | GV663 | 256Q 6M090 BB | GN056 | 96 FF 6M090 AA | GN022 | 9111145 | GN927 |
| 7658628 | GV730 | 3601370 | GN005 | 96 FF 6M090 AB | GN022 | 9196669 | GN033 |
| 7702960 | GV663 | 3M5Q 6M090AB | GN054 | 96 FF 6M090 BA | GN022 | 9201698 | GN026 |
| 7735920 | GN908 | 3M5Q 6M090AC | GN054 | 96 FF 6M090 BB | GN022 | 93 183 738 | GV947 |
| 77359200 | GN909 | 4 025 139 | GN005 | 96 FF 6M090 CA | GN022 | 93 183 739 | GN103 |
| 7777837 | GN927 | 4 612 191 | GN939 | 99 FF 6M090 AA | GN022 | 93 183 740 | GV719 |
| 8122193 | GF683 | 4U3Q-6M090-AA | GN045 | AV6Q6M090BA | GE121A | 93 183 990 | GN944 |
| 96 515 836 80 | GN054 | 4U3Q-6M090-AB | GN045 | BK3Q6M090AB | GE122 | 93 187 927 | GN104 |
| 96165724 | GN909 | 4U3Q-AA | GN045 | BS 516M 090 AA | GE112 | 93 191 771 | GE114 |
| 9616572480 | GN013 | 4U3Q-AB | GN045 | EZD40 | GN047 | 93161342 | GN026 |
| 9623638380 | GN027 | 5023371 | GV107 | XM 34 12A342 BA | GN005 | 93161489 | GN026 |
| 9631658980 | GN016 | 5023372 | GV602 | XS 7U 6M090 BA | GN939 | 93178047 | GN053 |
| 9633214380 | GN013 | 6 048 827 | GV107 | XS 7U 6M090 BB | GN939 | 93178225 | GN033 |
| 9638985980 | GN027 | 6 063 505 | GV602 | XS4U6M090AB | GN993 | 93178411 | GN059 |
| 9650100080 | GN056 | 6 075 812 | GV631 | | | 93180295 | GN041 |
| 9651029780 | GN027 | 6 075 812 | GV604 | FORD OTOSAN | BERU | 93190433 | GN097 |
| 9651029880 | GN016 | 6 075 812 | GN927 | 1C10 6M090 AA | GN939 | 93197244 | GN033 |
| 9659279280 | GN939 | 6 132 244 | GV631 | | | 94 133 759 | GN061 |
| 98459883 | GN925 | 6 132 246 | GV631 | GENERAL MOTORS | BERU | 94 140 115 | GN061 |
| 98462490 | GN917 | 6 154 593 | GN909 | 12 64 03 84 | GE123 | 94 175 158 | GN061 |
| 98462491 | GN925 | 6 163 811 | GV666 | 12563554 | GV004 | 94 387 612 | GV947 |
| 98462492 | GN925 | 6 748 697 | GF859 | 25168651 | GV004 | 94 481 972 | GV947 |
| 98498630 | GN927 | 6137454 | GV631 | 55 564 162 | GE114 | 95 508 490 | GV719 |
| 99450396 | GF974 | 6154593 | GV636 | 55 564 219 | GE112 | 95 508 508 | GV947 |
| 99473620 | GF984 | 6590445 | GF859 | 55 565 634 | PSG003 | 95508487 | GN059 |
| F 2 VB | GV602 | 6776964 | GN909 | 55 568 366 | PSG004 | 95508488 | GN033 |
| F 4 VB | GV602 | 6852967 | GN909 | 55 577 419 | PSG003 | 95508489 | GN041 |
| FU 2 A | GV663 | 6G9Q 6M090 AA | GN063 | 55 580 403 | PSG003 | 95508493 | GN026 |
| FU 4 A | GV642 | 7 072 673 | GN909 | 55 590 466 | PSG004 | 96440144 | GE125 |
| | | 7 088 988 | GV666 | 55564163 | PSG001 | 97 044 037 | GV947 |
| FORD | BERU | 71 F 6L055 AC | GH760 | 55567737 | GE117 | 97 080 554 | GN103 |
| 1 001 049 | GN022 | 715 F 11390 CA | GH760 | 55570037 | GE126 | 97 210 818 | GN104 |
| 1 008 792 | GN022 | 7214665 | GF983 | 55571600 | PSG005 | 97 358 626 | GN104 |
| 1 037 204 | GN855 | 78 GB 6 M 090 CA | GV602 | 55579436 | PSG001 | 97 364 968 | GE109 |
| 1 045 261 | GN022 | 78 GB 6M090 BA | GV107 | 55590467 | PSG006 | 97 389 905 | GN104 |
| 1 079 401 | GN993 | 785 F 6M090 BA | GV602 | 88 900 715 | GN003 | 97 464 737 | GN033 |
| 1 148 105 | GN047 | 785 F 6M090 CB | GV602 | 88 900 716 | GN007 | | |
| 1 207 068 | GN046 | 786 B 6M090 CA | GV602 | 88 900 717 | GN008 | GLAS | BERU |
| 1 309 471 | GN939 | 795 F 6M090 AA | GV604 | 88 900 718 | GN010 | 1102 | GD382 |
| 1 313 809 | GN054 | 795 F 6M090 CA | GV604 | 88 900 719 | GN015 | 1103 | GV603 |
| 1 427 905 | GN063 | 795F6M090 AA | GV631 | 88 900 720 | GN022 | B 18 N | GV604 |
| 1 473 356 | GN054 | 83 BB 6M090 A1A | GV636 | 88 900 721 | GN024 | B 19 N | GV602 |
| 1 525 910 | GN047 | 83 BB 6M090 A2A | GV636 | 88 900 722 | GN855 | B 20 N | GV602 |
| 1 587 444 | GV602 | 84 BB 6M090 AA | GV636 | 88 900 723 | GN857 | B 22 N | GV602 |
| 1 590 417 | GV604 | 84 BB 6M090 AA | GN909 | 88 900 724 | GN860 | B 23 R | GV642 |
| 1 669 977 | GN855 | 84 FF 6M090 B1A | GV631 | 88 900 728 | GN954 | B 24 SR | GV657 |
| 1 690 048 | GN007 | 84 FF 6M090 B2A | GV631 | 88 900 729 | GN970 | B 26 SR | GV852 |
| 1 717 631 | GE122 | 84 FF 6M091 BA | GN909 | 88 900 730 | GV602 | B 27 SR | GV666 |
| 1 952 464 | GN854 | 844 FF 9N424 AA | GF859 | 88 900 731 | GV603 | B 28 SR | GV631 |
| 1029446 | GN909 | 89 FF 6M090 AA | GV666 | 88 900 732 | GV631 | B 29 SR | GV663 |
| 1029461 | GN909 | 89 FF 6M091 AA | GN909 | 88 900 734 | GV642 | B 3 N | GV130 |
| 105 68 57 | GN022 | 89 FF 6M091 AA | GV666 | 88 900 735 | GV661 | B 30 SR | GV727 |
| 1073697 | GF983 | 910 X 6M090 AA | GF852 | 88 900 736 | GV663 | B 31 SR | GV603 |
| 1073698 | GF982-B | 910 X 6M090 BA | GV602 | 88 900 737 | GV666 | B 32 R | GV642 |
| 1090519 | GN909 | 92 VB 9424 AA | GF859 | 88 900 739 | GV749 | B 4 N | GV137 |
| 1096527 | GN939 | 92 VB 9N424 BA | GF859 | 88 900 741 | GN858 | B 40 | GD382 |
| 1231944 | GN054 | 93 FF 6M090 AA | GV666 | 90 464 737 | GN944 | B 41 SR | GN858 |
| 1447128 | GN056 | 94 DD 6M090 AA | GN909 | 90 487 858 | GV719 | B 42 SR | GV661 |
| 1517247 | GN007 | 95 DD 6M 090 AA | GN007 | 90 509 368 | GV719 | B 44 SR | GV719 |
| 1536023 | GN005 | 95 VB 9N424 AA | GF859 | 90 540 864 | GV719 | B 48 R | GV852 |
| 1649459 | GV631 | 95 VB-9N424-AB | GF982-B | 90 569 338 | GN992 | B 5 N | GV106 |
| 1668398 | GF859 | 95 VB-9N424-BA | GF983 | | | | |

OE ? ⇒ ⇐



| | | | | | | | |
|----------------------------|--------|-----------------|-------|--------------------|-------|----------------------|--------|
| HANOMAG | | ...ISUZU | | ...KHD | | LAND ROVER | |
| 151 126 000 | GD214 | 8 97143 674 1 | GN997 | 116 3694 | GH760 | LR 001 302 | GN063 |
| HANOMAG HENSCHTEL | | 8 97364 968 0 | GE109 | 116 9117 | GV108 | LR029960 | GE122 |
| 135 906 129 | GV107 | 8 97364 968 1 | GE109 | 117 0841 | GD214 | MAN | |
| 151 120 106 | GV108 | 8-94133-759-0 | GN061 | 117 5818 | GH760 | 000 159 24 01 | GD214 |
| HINO | | 8-94133-759-1 | GN061 | 244 6328 | GD214 | 000 159 2501 | GD348 |
| 1985A-64060 | GV895 | 8-94133-759-4 | GN061 | 472 9585 | GV602 | 000 159 6001 | GD382 |
| 1985A-68060 | GV895 | 8-94133-759-7 | GN061 | 478 1356 | GV642 | 000 159 6101 | GD382 |
| HONDA | | 8941337599 | GN061 | 812 2193 | GF683 | 000 159 8101 | GV603 |
| 12291-PLZ-D00 | GN104 | 8-94144-412-0 | GV946 | B 12 VH 7632 | GF683 | 000 159 83 01 | GV603 |
| 12291-RBD-E01 | GN073 | 8-94241-490 | GV749 | D 11 H 7631 | GH760 | 90 80112 4105 | GD214 |
| 31812-ZG5-0030 | GV967 | 8-94249-692-1 | GV749 | S 95 H 7631 | GV108 | 90 80112 4113 | GD318 |
| HYUNDAI | | 8-94319-700 1 | GV946 | KIA | | MAZDA | |
| 36710-27000 | GN035 | 8-94319-700-2 | GV946 | 36710-2A 100 | GN062 | RF 1M-18-601 | GN005 |
| 36710-27010 | GN035 | 8-94319-700-2 | GN061 | 36710-2A 200 | GN062 | RF2A-18-601 | GN064 |
| 36710-2A 100 | GN062 | 8-94751-581 | GN061 | 367103A000 | GE113 | RFG 1 18 601 | GN005 |
| 367103A000 | GE113 | 8-97073-641-0 | GN061 | 36710-42000 | GN955 | RFN 1 18 601 | GN005 |
| 36710-42000 | GN955 | 8-97080-554-0 | GN103 | 36710-42010 | GN955 | RFN 1 18 601 A | GN005 |
| 36710-42010 | GN955 | 8-97210-818-2 | GN104 | 36710-42020 | GN955 | RFR 1 18 601 | GN005 |
| 36710-42020 | GN955 | 8-97389-905-0 | GN104 | 36710-42021 | GN955 | S 210 18 140 | GN005 |
| 36710-42021 | GN955 | 8-9801-3392-0 | GN095 | 36710-42060 | GN955 | WL 01 18 601 | GN005 |
| 36710-42060 | GN955 | 8-9817-4898-0 | GN095 | 3671042500 | GN107 | WL 03 18 601 | GN005 |
| 3671042500 | GN107 | 8982000510 | GN095 | 3671042510 | GN107 | WL 81-18-601 | GN005 |
| 36710-42510 | GN955 | 9-82511-957-0 | GV749 | 36710-4A 000 | GN057 | WL25-18-61X | GN005 |
| 36710-4A 000 | GN057 | 9-82511-964-0 | GV749 | 36710-4A 100 | GN057 | WLy518601 | GN005 |
| 36710-4A 100 | GN057 | 9-82511-978-0 | GV749 | OK 054-18-140 | GN005 | Y 401-18-601 | GN047 |
| md197511 | GN107 | 9-82511-978-1 | GV749 | OK 710-18-140 | GN005 | Y401-18-601A | GN047 |
| IFA | | 9-82511-978-2 | GV749 | OK 71E-18-140A | GN005 | Y650-18-601 | GE121A |
| 834019 | GN857 | 9-82511-978-3 | GV749 | OK 75A-18-140 | GN005 | MERCEDES-BENZ | |
| INTERNATIONAL HARV. | | IVECO | | OK 75B-18-140 | GN005 | 000 159 04 01 | GV736 |
| 7 103 48 R 1 | GD214 | 004 729 585 | GV602 | LAMBORGHINI | | 000 159 06 01 | GD214 |
| 7 638 37 R 92 | GD318 | 27600323 | GN037 | 276590130 | GF683 | 000 159 24 01 | GD214 |
| ISUZU | | 2997077 | GV642 | LANCIA | | 000 159 25 01 | GD348 |
| 5 81410058 3 | GN008 | 4783047 | GV642 | 4 849 06 | GN925 | 000 159 26 01 | GD348 |
| 5-81410-040-0 | GV897 | 48 49 601 | GF984 | 46447610 | GN970 | 000 159 26 01 | GD382 |
| 5814100570 | GN008 | 4832279 | GF683 | 46451951 | GN017 | 000 159 26 01 | GD382 |
| 5814100571 | GN008 | 4841294 | GV642 | 4781356 | GN017 | 000 159 26 01 | GD382 |
| 5-8141-0057-2 | GN008 | 4849406 | GV727 | 4781356 | GN909 | 000 159 26 01 | GD382 |
| 5-81410-057-3 | GN008 | 500303569 | GF683 | 4833643 | GV642 | 000 159 26 01 | GD382 |
| 5814100580 | GN008 | 500314583 | GF006 | 4849406 | GV642 | 000 159 26 01 | GD382 |
| 5814100582 | GN008 | 500316493 | GN012 | 5500842 | GV130 | 000 159 26 01 | GD382 |
| 5814100584 | GN008 | 500351992 | GN037 | 55210051 | GE112 | 000 159 26 01 | GD382 |
| 8 94133 759 2 | GN061 | 7632587 | GV730 | 60 812 292 | GN908 | 000 159 26 01 | GD382 |
| 8 94133 759 3 | GN061 | 98459883 | GN927 | 606 17 002 | GN007 | 000 159 26 01 | GD382 |
| 8 94133 759 5 | GN061 | 98462490 | GN917 | 71734087 | GN017 | 000 159 26 01 | GD382 |
| 8 94133 759 6 | GN061 | 98462492 | GN925 | 71735458 | GN041 | 000 159 26 01 | GD382 |
| 8 94140 153 | GN061 | 98498630 | GN927 | 71735459 | GN970 | 000 159 26 01 | GD382 |
| 8 94175 158 0 | GN061 | 99450396 | GF974 | 71735459 | GV642 | 000 159 26 01 | GD382 |
| 8 94175 158 1 | GN061 | JAGUAR | | 7632587 | GV730 | 000 159 26 01 | GD382 |
| 8 94402 303 1 | GV945 | 02 JD 61164 | GN939 | 7735920 | GN908 | 000 159 26 01 | GD382 |
| 8 94481 972 0 | GV947 | 02 JD 61604 | GN045 | 77359200 | GN909 | 000 159 26 01 | GD382 |
| 8 97143 674 0 | GN997 | JEEP | | 7777837 | GN970 | 000 159 26 01 | GD382 |
| LAND ROVER | | 0 50 800 47 AA | GN003 | 9623638380 | GN027 | 000 159 26 01 | GD382 |
| MAN | | 0 50 800 47 AB | GN003 | 9638985980 | GN027 | 000 159 26 01 | GD382 |
| 000 159 24 01 | GD214 | 0 506 6840 AA | GN055 | 9651029780 | GN027 | 000 159 26 01 | GD382 |
| 000 159 2501 | GD348 | 04 86 38 26 | GN007 | 98459883 | GN925 | 000 159 26 01 | GD382 |
| 000 159 6001 | GD382 | 04 86 38 26 AA | GN007 | 98462491 | GN925 | 000 159 26 01 | GD382 |
| 000 159 6101 | GD382 | 0517 5756 AA | GE105 | 98462492 | GN925 | 000 159 26 01 | GD382 |
| 000 159 8101 | GV603 | KHD | | LANCIA | | 000 159 26 01 | GV603 |
| 000 159 83 01 | GV603 | 0 117 9016 | GH760 | 4 849 06 | GN925 | 000 159 26 01 | GV603 |
| 90 80112 4105 | GD214 | 116 1134 | GF683 | 46447610 | GN970 | 000 159 26 01 | GV603 |
| 90 80112 4113 | GD318 | IVECO | | 46451951 | GN017 | 000 159 26 01 | GV603 |
| MAZDA | | 004 729 585 | GV602 | 4781356 | GN909 | 000 159 26 01 | GV603 |
| RF 1M-18-601 | GN005 | 27600323 | GN037 | 4833643 | GV642 | 000 159 26 01 | GV603 |
| RF2A-18-601 | GN064 | 2997077 | GV642 | 4849406 | GV642 | 000 159 26 01 | GV603 |
| RFG 1 18 601 | GN005 | 4783047 | GV642 | 5500842 | GV130 | 000 159 26 01 | GV603 |
| RFN 1 18 601 | GN005 | 48 49 601 | GF984 | 55210051 | GE112 | 000 159 26 01 | GV603 |
| RFN 1 18 601 A | GN005 | 4832279 | GF683 | 60 812 292 | GN908 | 000 159 26 01 | GV603 |
| RFR 1 18 601 | GN005 | 4841294 | GV642 | 606 17 002 | GN007 | 000 159 26 01 | GV603 |
| S 210 18 140 | GN005 | 4849406 | GV727 | 71734087 | GN017 | 000 159 26 01 | GV603 |
| WL 01 18 601 | GN005 | 500303569 | GF683 | 71735458 | GN041 | 000 159 26 01 | GV603 |
| WL 03 18 601 | GN005 | 500314583 | GF006 | 71735459 | GN970 | 000 159 26 01 | GV603 |
| WL 81-18-601 | GN005 | 500316493 | GN012 | 71735459 | GV642 | 000 159 26 01 | GV603 |
| WL25-18-61X | GN005 | 500351992 | GN037 | 7632587 | GV730 | 000 159 26 01 | GV603 |
| WLy518601 | GN005 | 7632587 | GV730 | 7735920 | GN908 | 000 159 26 01 | GV603 |
| Y 401-18-601 | GN047 | 98459883 | GN927 | 77359200 | GN909 | 000 159 26 01 | GV603 |
| Y401-18-601A | GN047 | 98462490 | GN917 | 7777837 | GN970 | 000 159 26 01 | GV603 |
| Y650-18-601 | GE121A | 98462492 | GN925 | 9623638380 | GN027 | 000 159 26 01 | GV603 |
| MERCEDES-BENZ | | 98498630 | GN927 | 9638985980 | GN027 | 000 159 26 01 | GV603 |
| 000 159 04 01 | GV736 | 99450396 | GF974 | 9651029780 | GN027 | 000 159 26 01 | GV603 |
| 000 159 06 01 | GD214 | JAGUAR | | 98459883 | GN925 | 000 159 26 01 | GV603 |
| 000 159 24 01 | GD214 | 02 JD 61164 | GN939 | 98462491 | GN925 | 000 159 26 01 | GV603 |
| 000 159 25 01 | GD348 | 02 JD 61604 | GN045 | 98462492 | GN925 | 000 159 26 01 | GV603 |
| 000 159 26 01 | GD348 | JEEP | | LANCIA | | 000 159 26 01 | GV603 |
| 000 159 26 01 | GD348 | 0 50 800 47 AA | GN003 | 4 849 06 | GN925 | 000 159 26 01 | GV603 |
| 000 159 26 01 | GD348 | 0 50 800 47 AB | GN003 | 46447610 | GN970 | 000 159 26 01 | GV603 |
| 000 159 26 01 | GD348 | 0 506 6840 AA | GN055 | 46451951 | GN017 | 000 159 26 01 | GV603 |
| 000 159 26 01 | GD348 | 04 86 38 26 | GN007 | 4781356 | GN909 | 000 159 26 01 | GV603 |
| 000 159 26 01 | GD348 | 04 86 38 26 AA | GN007 | 4833643 | GV642 | 000 159 26 01 | GV603 |
| 000 159 26 01 | GD348 | 0517 5756 AA | GE105 | 4849406 | GV642 | 000 159 26 01 | GV603 |
| 000 159 26 01 | GD348 | KHD | | 5500842 | GV130 | 000 159 26 01 | GV603 |
| 000 159 26 01 | GD348 | 0 117 9016 | GH760 | 55210051 | GE112 | 000 159 26 01 | GV603 |
| 000 159 26 01 | GD348 | 116 1134 | GF683 | 60 812 292 | GN908 | 000 159 26 01 | GV603 |
| 000 159 26 01 | GD348 | IVECO | | 606 17 002 | GN007 | 000 159 26 01 | GV603 |
| 000 159 26 01 | GD348 | 004 729 585 | GV602 | 71734087 | GN017 | 000 159 26 01 | GV603 |
| 000 159 26 01 | GD348 | 27600323 | GN037 | 71735458 | GN041 | 000 159 26 01 | GV603 |
| 000 159 26 01 | GD348 | 2997077 | GV642 | 71735459 | GN970 | 000 159 26 01 | GV603 |
| 000 159 26 01 | GD348 | 4783047 | GV642 | 71735459 | GV642 | 000 159 26 01 | GV603 |
| 000 159 26 01 | GD348 | 48 49 601 | GF984 | 7632587 | GV730 | 000 159 26 01 | GV603 |
| 000 159 26 01 | GD348 | 4832279 | GF683 | 7735920 | GN908 | 000 159 26 01 | GV603 |
| 000 159 26 01 | GD348 | 4841294 | GV642 | 77359200 | GN909 | 000 159 26 01 | GV603 |
| 000 159 26 01 | GD348 | 4849406 | GV727 | 7777837 | GN970 | 000 159 26 01 | GV603 |
| 000 159 26 01 | GD348 | 500303569 | GF683 | 9623638380 | GN027 | 000 159 26 01 | GV603 |
| 000 159 26 01 | GD348 | 500314583 | GF006 | 9638985980 | GN027 | 000 159 26 01 | GV603 |
| 000 159 26 01 | GD348 | 500316493 | GN012 | 9651029780 | GN027 | 000 159 26 01 | GV603 |
| 000 159 26 01 | GD348 | 500351992 | GN037 | 98459883 | GN925 | 000 159 26 01 | GV603 |
| 000 159 26 01 | GD348 | 7632587 | GV730 | 98462491 | GN925 | 000 159 26 01 | GV603 |
| 000 159 26 01 | GD348 | 98459883 | GN927 | 98462492 | GN925 | 000 159 26 01 | GV603 |
| 000 159 26 | | | | | | | |

OE ? ⇌

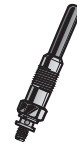

| ...MERCEDES-BENZ | BERU | MWM | BERU | OPEL | BERU | ...OPEL | BERU |
|------------------|-------|------------------|-------|------------|--------|------------|--------|
| 001 159 35 01 | GN909 | 6 0579 411 0003 | GD214 | 09 110 945 | GN963 | 1214076 | GN944 |
| 001 159 36 01 | GN858 | | | 12 14 018 | GN024 | 18 26 354 | PSG001 |
| 001 159 37 01 | GN003 | | | 12 14 020 | GN018 | 18 26 357 | GE112 |
| 001 159 38 01 | GN003 | NISSAN | BERU | 12 14 028 | GN106 | 34 48 796 | GV106 |
| 001 159 42 01 | GN003 | 11065-00 Q00 | GN018 | 12 14 032 | GN053 | 43 00 425 | GN061 |
| 001 159 46 01 | GN058 | 11065-00Q0A | GN026 | 12 14 033 | GN033 | 43 00 615 | GN061 |
| 001 159 48 01 | GN003 | 1106500Q0E | GE110 | 12 14 034 | GN059 | 44 02 724 | GN018 |
| 001 159 49 01 | GN003 | 11065-00QAA | GN018 | 12 14 035 | GN104 | 44 02 945 | GN963 |
| 001 159 50 01 | GE105 | -11065-00QAB | GN026 | 12 14 036 | GN106 | 44 03 145 | GN927 |
| 001 159 51 01 | GE116 | -11065-00QAE | GN026 | 12 14 040 | GN041 | 44 09 469 | GN018 |
| 001 159 52 01 | GE104 | 11065-00QAF | GN018 | 12 14 042 | GV947 | 44 16 912 | GN018 |
| 001 159 71 01 | GE105 | 11065-00QAG | GN018 | 12 14 043 | GN103 | 44 30 069 | GN026 |
| 660 159 00 01 | GN015 | 11065-10G00 | GV920 | 12 14 044 | GV719 | 44 30 920 | GN026 |
| 660 159 02 01 | GN015 | 11065-16A05 | GV685 | 12 14 045 | GN944 | 4418163 | GN963 |
| A 000 159 75 01 | GV603 | 11065-16A15 | GV685 | 12 14 054 | GN992 | 45 00 811 | GF984 |
| A 000 159 81 01 | GV603 | 11065-2W202 | GN072 | 12 14 056 | GN033 | 45 06 155 | GN026 |
| A 000 159 83 01 | GV603 | 11065-2W204 | GN072 | 12 14 057 | PSG003 | 4805511 | GE125 |
| A 001 159 04 01 | GV736 | 110652W20A | GN072 | 12 14 061 | PSG003 | 55 187 863 | GN059 |
| A 001 159 08 01 | GH011 | 11065-2W211 | GN072 | 12 14 062 | GN104 | 55 577 419 | PSG003 |
| A 001 159 14 01 | GN066 | 11065-2W212 | GN072 | 12 14 063 | GN104 | 55 588 475 | GN104 |
| A 001 159 20 01 | GN948 | 11065-2W21A | GN072 | 12 14 064 | GN097 | 55565634 | PSG003 |
| A 001 159 21 01 | GN948 | 11065-31N00 | GN854 | 12 14 067 | GE117 | 55568366 | PSG004 |
| A 001 159 26 01 | GN961 | 11065-34W00 | GV889 | 12 14 070 | GN053 | 55580403 | PSG003 |
| A 001 159 27 01 | GN010 | 11065-43G01 | GV921 | 12 14 071 | GN059 | 56 14 217 | GD382 |
| A 001 159 28 01 | GN003 | 11065-4P400 | GN075 | 12 14 072 | GN033 | 56 14 218 | GV603 |
| A 001 159 37 01 | GN003 | -11065-4P40A | GN075 | 12 14 073 | GN041 | 56 14 221 | GV749 |
| A 001 159 38 01 | GN003 | 11065-57J00 | GN102 | 12 14 074 | GV719 | 88 900 715 | GN003 |
| A 001 159 42 01 | GN003 | 11065-5C900 | GN102 | 12 14 080 | GN026 | 88 900 716 | GN007 |
| A 001 159 48 01 | GN003 | -11065-5C90A | GN102 | 12 14 082 | GN018 | 88 900 717 | GN008 |
| A 001 159 49 01 | GN003 | 11065-63G00 | GV921 | 12 14 084 | GN992 | 88 900 718 | GN010 |
| A 001 159 50 01 | GE105 | 1106565N01 | GN101 | 12 14 085 | GV947 | 88 900 719 | GN015 |
| A 001 159 51 01 | GE105 | 1106565N0A | GN101 | 12 14 086 | PSG003 | 88 900 720 | GN022 |
| A 001 159 51 01 | GE116 | 11065-7C000 | GN039 | 12 14 087 | PSG001 | 88 900 721 | GN024 |
| A 001 159 52 01 | GE104 | 11065-7F400 | GN994 | 12 14 088 | PSG004 | 88 900 722 | GN855 |
| A 001 159 71 01 | GE105 | -11065-7F40A | GN994 | 12 14 096 | GN104 | 88 900 723 | GN857 |
| A 415 159 00 01 | GE110 | 11065-9C600 | GN853 | 12 14 098 | GE126 | 88 900 724 | GN860 |
| A 660 159 00 01 | GN015 | 11065-AD 200 | GN109 | 12 14 099 | PSG005 | 88 900 725 | GN954 |
| A 660 159 02 01 | GN015 | 11065-AD 201 | GN109 | 12 14 101 | PSG006 | 88 900 728 | GN954 |
| A001159280164 | GN003 | 11065-AD 20A | GN109 | 12 14 104 | PSG004 | 88 900 729 | GN970 |
| | | 11065-AD 21A | GN109 | 12 14 300 | GV107 | 88 900 730 | GV602 |
| | | 11065-BN 701 | GN018 | 12 14 301 | GN104 | 88 900 731 | GV603 |
| | | 11065-C8600 | GN044 | 12 14 302 | GV106 | 88 900 732 | GV631 |
| | | 11065-G 5501 | GN101 | 12 14 303 | GV137 | 88 900 734 | GV642 |
| | | 11065-G2400 | GN854 | 12 14 304 | GV602 | 88 900 735 | GV661 |
| | | 11065-HA300 | GN005 | 12 14 305 | GN033 | 88 900 736 | GV663 |
| | | 11065-T3400 | GV887 | 12 14 306 | GV636 | 88 900 737 | GV666 |
| | | 11065-T3470 | GV887 | 12 14 307 | GV636 | 88 900 739 | GV749 |
| | | 11065-T8200 | GV892 | 12 14 308 | GV749 | 88 900 740 | GV852 |
| | | 11065-T8201 | GV890 | 12 14 309 | GV945 | 88 900 741 | GN858 |
| | | 11065-T8202 | GV892 | 12 14 310 | GV947 | 88 900 743 | GV946 |
| | | 11065-T8203 | GV890 | 12 14 311 | GV946 | 90 003 450 | GV106 |
| | | 11065-V0700 | GV689 | 12 14 312 | GV946 | 90 019 495 | GV137 |
| | | 11065-V0710 | GV689 | 12 14 316 | GN103 | 90 033 357 | GV137 |
| | | 11065-W2500 | GV888 | 12 14 317 | GV719 | 90 040 991 | GV631 |
| | | 11065-W2510 | GV888 | 12 14 318 | GV719 | 90 051 950 | GV602 |
| | | 11065-W3400 | GV888 | 12 14 319 | GN954 | 90 093 867 | GV602 |
| | | 11065-W3410 | GV888 | 12 14 320 | GV947 | 90 093 897 | GV602 |
| | | 11065-Y 9703 | GN857 | 12 14 321 | GN061 | 90 166 155 | GN954 |
| | | 758 000 06-0 | GV636 | 12 14 322 | GN944 | 90 166 155 | GV636 |
| | | -75800001-1 | GV636 | 12 14 323 | GN061 | 90 210 824 | GV636 |
| | | 7700111323 | GN018 | 12 14 324 | GV719 | 90 510 924 | GN954 |
| | | 8200012099 | GN026 | 12 14 334 | GE114 | 90 569 338 | GN992 |
| | | | | 12 14 427 | GN007 | 90464737 | GN944 |
| | | | | 12 14 456 | GN992 | 91 10 724 | GN018 |
| | | | | 12 14 457 | GN992 | 91 10 945 | GN963 |
| | | | | 12 14 459 | GN997 | 91 111 45 | GN927 |
| | | | | 1214052 | GN997 | 91 182 01 | GN992 |
| | | O & K | BERU | | | | |
| | | 244 934 4 | GH760 | | | | |

| MITSUBISHI | BERU |
|------------|-------|
| 3671042020 | GN107 |
| 3671042500 | GN107 |
| M 816 732 | GN857 |
| M 883 828 | GN018 |
| MD 050 212 | GV673 |
| MD 070 194 | GV921 |
| MD 077 167 | GV921 |
| MD 197511 | GN107 |
| MD 301950 | GN107 |
| MD 344469 | GN107 |
| MD 354500 | GN107 |
| ME 201632 | GN067 |
| ME 202785 | GN067 |
| ME 203 539 | GN070 |
| ME 203583 | GN067 |
| ME 203754 | GN067 |
| MN 960 270 | GN058 |
| MN 980234 | GE101 |
| MN960296 | GN058 |
| MQ 901659 | GN005 |
| MR 577131 | GN107 |
| MW30756065 | GN018 |

OE ? ⇒



| ...OPEL | | ...PEUGEOT | | ...PEUGEOT | | ...RENAULT | |
|----------------|--------|---------------|-------|----------------|--------|---------------|-------|
| 93 171 875 | GN024 | 596078 | GN056 | 95 534 788 | GN909 | 77 01 039 387 | GN917 |
| 93 178 047 | GN053 | 5960A0 | GN063 | 95 534 788 | GV602 | 77 01 039 387 | GN909 |
| 93 178 411 | GN059 | 5960F5 | GN027 | 95 943 206 | GV642 | 77 01 040 208 | GN927 |
| 93 189 648 | GN018 | 5960F9 | GN056 | 96 009 783 | GN927 | 77 01 052 949 | GN106 |
| 93 197 242 | GN992 | 5960G7 | GN013 | 96 009 783 | GN909 | 77 01 057 806 | GN106 |
| 93186025 | GN997 | 5960G7 | GN909 | 96 076 258 | GN909 | 77 01 069 730 | GN018 |
| 93186027 | GN007 | 5960G7 | GV602 | 96 141 678 | GN909 | 77 01 069 731 | GN909 |
| 93187927 | GN104 | 5960K0 | GV661 | 96 165 724 | GN909 | 77 01 349 475 | GN909 |
| 93192629 | GN963 | 5960K5 | GN012 | 96 236 383 | GN027 | 77 01 349 475 | GV642 |
| 93197243 | GN954 | 5961 05 | GV107 | 96 316 589 80 | GN912 | 77 01 349 943 | GN909 |
| 93197243 | GV636 | 5961 22 | GV108 | 96 389 858 | GN027 | 77 01 349 949 | GV844 |
| 94 319 700 | GV946 | 5961 22 | GV107 | 96 831 952 80 | GE121A | 77 01 414 072 | GV636 |
| 94 402 303 | GV945 | 5961 35 | GV108 | HG 262 1 | GV107 | 77 01 414 076 | GV602 |
| 94 422 1719 | GV749 | 5961 39 | GV636 | MKP 000 065 | GV642 | 77 01 414 077 | GN857 |
| 94 439 218 | GV749 | 5961 40 | GV602 | MKP 000 65 | GN909 | 77 01 414 078 | GV631 |
| 94419854 | GV945 | 5961 53 | GV636 | MKP 000 70 | GD382 | 77 01 414 079 | GV603 |
| 95 508 201 | GN992 | 5961 54 | GN909 | MKP 000 71 | GN857 | 77 01 414 080 | GV663 |
| 95 508 487 | GN059 | 5961 54 | GV602 | | | 77 01 414 081 | GV666 |
| 95 508 494 | GN018 | 5961 54 | GV642 | PORSCHE | | 77 01 414 083 | GV661 |
| 95508485 | GN024 | 5961 57 | GV636 | 955 170 320 90 | GE115 | 77 01 414 084 | GV657 |
| 95508486 | GN053 | 5961 58 | GV602 | | | 77 01 414 086 | GV636 |
| 95508491 | GN944 | 5962 03 | GN013 | | | 77 01 414 088 | GN857 |
| 95508495 | GV636 | 5962 1P | GN964 | PUCH | | 77 01 414 089 | GN909 |
| 97 127 646 | GN106 | 5962 1Q | GN964 | 000 159 61 01 | GD382 | 77 01 414 089 | GV661 |
| 97 143 674 | GN997 | 5962 1Z | GN857 | 159 61 01 | GD382 | 77 01 414 108 | GV719 |
| 97 357 290 | GN106 | 5962 2Y | GN912 | | | 77 01 414 123 | GN909 |
| 97011725 | GV946 | 5962 35 | GV663 | RENAULT | | 77 01 414 157 | GN858 |
| 97210818 | GN104 | 5962 3C | GN027 | 08 54 997 100 | GV107 | 77 01 414 162 | GN909 |
| 97358626 | GN104 | 5962 3E | GN027 | 11065 1492 R | GE124 | 77 01 414 162 | GN954 |
| 97389905 | GN104 | 5962 3H | GN013 | 50 01 001 587 | GV602 | 7701031105 | GV642 |
| 97725357 | GV107 | 5962 3J | GN013 | 50 01 829 283 | GV107 | 79 32 563 970 | GV108 |
| | | 5962 4Z | GN012 | 6001545515 | GN963 | 79 32 563 970 | GV107 |
| PERKINS | | 5962 74 | GV636 | 77 00 100 558 | GN963 | 79 32 567 717 | GN954 |
| K 166 AF 01 | GV636 | 5962 7A | GN013 | 77 00 100 586 | GN999 | 82 00 012 099 | GN026 |
| | | 5962 7F | GN027 | 77 00 100 635 | GN019 | 82 00 090 817 | GN909 |
| PEUGEOT | | 5962 7G | GN027 | 77 00 103 674 | GN026 | 82 00 421 091 | GN855 |
| 5 414 326 | GV130 | 5962 C7 | GV107 | 77 00 105 290 | GN991 | 82 00 423 224 | GN963 |
| 5 415 813 | GV107 | 5962 G7 | GV636 | 77 00 111 323 | GN018 | 82 00 423 227 | GN963 |
| 5 460 556 | GV130 | 5962 G7 | GV642 | 77 00 111 940 | GN019 | 82 00 434 855 | GN018 |
| 5 477 234 | GV130 | 5962 J2 | GV852 | 77 00 662 199 | GV602 | 82 00 445 627 | GN026 |
| 5 491 387 | GV130 | 5962 J3 | GN909 | 77 00 673 874 | GN909 | 82 00 464 077 | GN018 |
| 5 500 842 | GV130 | 5962 J3 | GV661 | 77 00 673 874 | GV602 | 82 00 490 950 | GN018 |
| 5932 565 882 | GV108 | 5962 J4 | GN909 | 77 00 673 874 | GV642 | 82 00 517 313 | GN026 |
| 5960 12 | GN047 | 5962 J4 | GV642 | 77 00 673 874 | GV642 | 82 00 682 592 | GE110 |
| 5960 64 | GN054 | 5962 J5 | GV603 | 77 00 701 130 | GN909 | 82 00 787 721 | GN019 |
| 5960 65 | GN054 | 5962 J6 | GV663 | 77 00 701 130 | GV642 | 82 00 794 920 | GE111 |
| 5960 66 | GN027 | 5962 J7 | GN857 | 77 00 704 185 | GN909 | 86 71 004 016 | GN857 |
| 5960 67 | GN027 | 5962 K5 | GV636 | 77 00 715 768 | GN909 | 86 71 004 018 | GN954 |
| 5960 68 | GN912 | 5962 R8 | GN909 | 77 00 715 768 | GV642 | | |
| 5960 76 | GN045 | 5962 S8 | GN909 | 77 00 733 076 | GV642 | ROVER | |
| 5960 79 | GN056 | 5962 T1 | GV852 | 77 00 734 956 | GV852 | ERC 8450 | GV602 |
| 5960 99 | GN063 | 5962 T2 | GN844 | 77 00 741 144 | GN909 | ERR 6066 | GN985 |
| 5960 A3 | GN037 | 5962 T3 | GV749 | 77 00 741 144 | GV642 | ETC 8847 | GV783 |
| 5960 A4 | GN037 | 5962 T7 | GV666 | 77 00 854 538 | GV844 | NCC 100050 | GN905 |
| 5960 E6 | GE121A | 5962 W3 | GN912 | 77 00 855 865 | GN909 | NCC 100120 | GN024 |
| 5960 E9 | GN047 | 5962 X1 | GV642 | 77 00 856 238 | GN909 | NCC 100120 L | GN024 |
| 5960 F4 | GN054 | 5962 Z7 | GV844 | 77 00 856 292 | GV844 | | |
| 5960 F6 | GN912 | 75 492 325 | GV130 | 77 00 858 208 | GN905 | SAAB | |
| 5960 F8 | GN045 | 7932 565 882 | GV108 | 77 00 860 796 | GN905 | 05954839 | GN106 |
| 5960 G6 | GN063 | 7932 567 619 | GV107 | 77 00 861 906 | GN999 | 93 178 047 | GE114 |
| 5960 H6 | GN964 | 7932 567 718 | GV602 | 77 00 867 002 | GN991 | 93 191 771 | GE114 |
| 5960 K0 | GN909 | 9 633 214 380 | GN013 | 77 00 867 617 | GN959 | 97357290 | GN106 |
| 5960 K4 | GN037 | 9150 860 280 | GV636 | 77 00 874 336 | GN991 | | |
| 5960 L4 | GE112 | 9150 861 080 | GV636 | 77 01 029 762 | GV642 | | |
| 596071 | GN012 | 9152 184 980 | GV636 | 77 01 033 403 | GN909 | | |
| | | 9153 664 680 | GV636 | 77 01 035 956 | GV727 | | |
| | | 95 493 206 | GN909 | | | | |

OE ? ⇌



| | | | | | |
|-------------------|-------|----------------|--------|-----------------|--------|
| SAME | | TALBOT | | VAUXHALL | |
| 276590130 | GF683 | 91 507 715 80 | GV636 | 900 33357 | GV602 |
| | | 91 507 719 80 | GV636 | 900 93897 | GV602 |
| SAVIEM | | TOYOTA | | 902 10824 | GV602 |
| 79 32 563 970 | GV107 | 19850-0L010 | GN068 | 902 10824 | GV636 |
| 79 32 563 970 | GV108 | 19850-0R010 | GN108 | | |
| 85 49 971 00 | GV107 | 19850-0R020 | GN108 | VM | |
| SEAT | | 198500R022 | GN108 | 46 072 007 F | GN055 |
| 0003940685 | GV602 | 19850-0W 010 | GN042 | 46072016 F | GE114 |
| N 105 792 01 | GN046 | 19850-0W020 | GN096 | | |
| N 105 792 02 | GN046 | 19850-26010 | GN108 | VOLVO | |
| SE 138919 000 A | GV602 | 19850-26020 | GN108 | 1257141 | GN857 |
| X 0396 550 20 | GV663 | 19850-26021 | GN108 | 1257142 | GN857 |
| | | 19850-26022 | GN108 | 1257889 | GN857 |
| SMART | | 19850-27010 | GN065 | 1324683 | GN857 |
| 0004562V003000000 | GN015 | 1985027020 | GN065 | 1542319 | GV657 |
| A 001 159 46 01 | GN058 | 19850-30010 | GN068 | 1542411 | GV657 |
| | | 19850-45030 | GV688 | 30 72 506 9 | GN054 |
| SSANGYONG | | 19850-45031 | GV688 | 30725678 | GE121A |
| 664 159 00 01 | GN060 | 19850-54010 | GV968 | 30862690 | GN999 |
| 664 159 01 01 | GN060 | 19850-54010 ND | GV968 | 31216248 | GN056 |
| 665 159 00 01 | GN060 | 19850-54030 | GV688 | 3121624-8 | GN047 |
| 665 159 01 01 | GN060 | 19850-54031 | GV688 | 31251138 | GN054 |
| A 664 159 00 01 | GN060 | 19850-54050 | GV894 | 840643 | GV602 |
| A 664 159 01 01 | GN060 | 19850-54050 ND | GV894 | 86 53 698 | GN054 |
| A 665 159 00 01 | GN060 | 19850-54070 | GV001 | 8631607 | GN045 |
| A 665 159 01 01 | GN060 | 19850-54071 | GV001 | 8653880 | GE123 |
| A 671 159 01 01 | GE120 | 19850-54090 | GV968 | 870325 | GD214 |
| | | 19850-64010 | GV886 | 870680 | GV107 |
| STEINBOCK | | 1985064010ND | GV886 | 870846 | GV107 |
| 007488 | GD214 | 19850-64020 | GV967 | 870846 | GV108 |
| | | 19850-64020 ND | GV967 | | |
| SUZUKI | | 19850-64030 | GN043 | VW | |
| 09900-HD101 | GN027 | 19850-64031 | GN043 | 03L 963 319 | GE115 |
| 09900-RF001 | GN005 | 19850-64031 B | GN043 | 03L 963 319 A | GE115 |
| 18550-67G00 | GN054 | 19850-64050 | GN043 | 059 963 319 | GN008 |
| 18550-67G10 | GN054 | 19850-67020 | GN110 | 059 963 319 A | GN008 |
| 18550-67G11 | GN054 | 19850-67030 | GN110 | 059 963 319 C | GE115 |
| 18550-67JG0 | GN018 | 19850-68010 | GV897 | 059 963 319 E | GE115 |
| 18550-67JG0-000 | GN018 | 19850-68060 | GV895 | 059 963 319 F | GE115 |
| 18550-78E00 | GN005 | 19850-68060 ND | GV895 | 059 963 319 H | GN008 |
| 18550-78E10 | GN005 | SU001-00351 | GN016 | 059 963 319 J | GE115 |
| 18550-78E11 | GN005 | SU001-00671 | GN047 | 062 905 061 | GN989 |
| 18550-79J50 | GN097 | VAG | | 068 905 061 | GN857 |
| 18550-79J50 000 | GN097 | 03L 905 061 D | PSG002 | N 019 081 1 | GN857 |
| 18550-79J81 | GE114 | 03L 905 061 E | PSG002 | N 019 081 2 | GN857 |
| 18550-79J81 000 | GE114 | 03L 905 061 F | PSG002 | N 019 081 4 | GN857 |
| 18550-80KA0-000 | GE111 | 062 905 061 A | GN050 | N 019 097 1 | GN857 |
| 18550-84A00 | GN018 | 637 0601 | GD214 | N 019 10 01 | GN857 |
| 18550-84A00-000 | GN018 | N 105 798 03 | CGP003 | N 019 100 01 | GN857 |
| 18550-84A00-LCP | GN018 | N 105 798 05 | CGP003 | N 019 100 2 | GN857 |
| 18550-84A50-000 | GN018 | N 105 916 04 | CGP002 | N 019 100 5 | GN857 |
| 18550-84A51-000 | GN018 | N 105 916 08 | CGP002 | N 019 100 6 | GN857 |
| 18550-DG116-A00 | GN054 | N 101 401 01 | GN855 | N 102 130 01 | GN857 |
| 18550-DG122-A00 | GN097 | N 101 401 02 | GN855 | N 102 130 02 | GN857 |
| 18550-DG146-A00 | GN005 | N 101 401 03 | GN855 | N 105 798 02 | GE101 |
| 99912-78E00 | GN005 | N 101 401 04 | GN855 | N 105 916 02 | GE100 |
| 99912-78E01 | GN005 | N 101 401 05 | GN855 | N 105 916 03 | GE100 |
| | | N 105 792 01 | GN046 | N 105 916 07 | GE119 |
| | | N 105 792 02 | GN046 | | |

OE ? ⇒

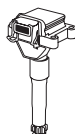

| | | | | | | | |
|---------------------|--------|-----------------|--------|------------------|--------|--------------------|-------|
| AGRIA | | ...BMW | | ...BMW | | ...CHRYSLER | |
| 1137 42 597 1 | ZS106 | 1 731 178 B | ZS014 | 12 14 1 360 675 | ZS400 | 2495531 | ZS106 |
| | | 1 742 925 | ZS014 | 1213 1 487 707 | ZS382 | 4443971 | ZS405 |
| ALFA ROMEO | | 1 748 394 | ZS014 | 1213 7510 738 | ZS382 | 4557468 | ZS379 |
| 105 26 65 079 00 | ZS106 | 1 777 666 | ZS014 | 1247281 | ZS307 | 4609080 | ZS379 |
| 116 55 65 079 00/00 | ZS115 | 12 13 0 148 594 | ZS324 | 1404309 | ZS302 | 4609140AB | ZS470 |
| 116 55 65 079 01/00 | ZS115 | 12 13 0 390 064 | ZS324 | 1703825 | ZS302 | 4671025 | ZS379 |
| 46467542 | ZS311 | 12 13 0 495 289 | ZS324 | 1748017 | ZS302 | 4762312 | ZS393 |
| 46469863 | ZS309 | 12 13 1 247 281 | ZS307 | 1748018 | ZS302 | 4797293 | ZS394 |
| 46548037 | ZS283 | 12 13 1 286 087 | ZS122 | 7 551 260 | ZS324 | 5269670 | ZS380 |
| 46755605 | ZS361 | 12 13 1 317 585 | ZS014 | 7 599 218 | ZS014 | 56028172 | ZS396 |
| 46794782 | ZSE148 | 12 13 1 326 684 | ZS115 | 7 841 558 | ZS324 | 56028172AB | ZS396 |
| 510 897 | ZS106 | 12 13 1 350 051 | ZS106 | 9 066 468 | ZS014 | 56029098AA | ZS456 |
| 605 641 42 | ZS230 | 12 13 1 357 240 | ZS109 | | | 56029098AB | ZS456 |
| 60558152 | ZS234 | 12 13 1 357 294 | ZS115 | BUICK | | 56032520AB | ZS455 |
| 60562701 | ZS428 | 12 13 1 357 295 | ZS115 | 12629037 | ZSE174 | 56032520AC | ZS455 |
| 60586072 | ZS234 | 12 13 1 357 296 | ZS106 | 96 415 010 | ZS508 | 56032520AE | ZS455 |
| 608 08059 | ZS230 | 12 13 1 359 637 | ZS106 | | | 56032520AF | ZS455 |
| 60805420 | ZS283 | 12 13 1 360 671 | ZS400 | CADILLAC | | 56032521 | ZS380 |
| 60809492 | ZS283 | 12 13 1 363 629 | ZS400 | 12570616 | ZSE159 | 56032521AB | ZS380 |
| 60809606 | ZS234 | 12 13 1 402 440 | ZS014 | 12611424 | ZSE159 | 56032521AC | ZS380 |
| 60810690 | ZS428 | 12 13 1 402 713 | ZS014 | 12629037 | ZSE174 | K 04609088 AF | ZS432 |
| 71716152 | ZS119 | 12 13 1 703 227 | ZS302 | | | K 04609088 AH | ZS432 |
| 71739725 | ZS427 | 12 13 1 703 228 | ZS302 | CHERY | | K 04609095 AD | ZS431 |
| 71744369 | ZS427 | 12 13 1 703 228 | ZS302 | S11-3705100 | ZS518 | K 04609095 AE | ZS431 |
| 7648797 | ZS234 | 12 13 1 703 359 | ZS014 | | | K 04609095 AF | ZS431 |
| 76487970 | ZS234 | 12 13 1 703 825 | ZS302 | CHEVROLET | | K 04609095 AG | ZS431 |
| 7672018 | ZS283 | 12 13 1 712 219 | ZS324 | 12570616 | ZSE159 | K 04609095 AH | ZS431 |
| | | 12 13 1 712 223 | ZS324 | 12611424 | ZSE159 | K 04609095 AI | ZS431 |
| | | 12 13 1 720 166 | ZS014 | 12629037 | ZSE174 | K 04609095 AJ | ZS431 |
| | | 12 13 1 726 176 | ZS014 | | | K04609103 | ZS380 |
| | | 12 13 1 726 177 | ZS014 | CHRYSLER | | K04609103AB | ZS380 |
| | | 12 13 1 726 178 | ZS014 | 0000K04557468 | ZS380 | K04609103AC | ZS380 |
| ASTON MARTIN | | 12 13 1 726 310 | ZS122 | 0000K05234210 | ZS394 | K04609140AB | ZS470 |
| 4G4E-12A366-AA | ZS426 | 12 13 1 727 108 | ZS014 | 25182496 | ZS447A | K04797293 | ZS394 |
| 6G33-12A366-CA | ZS389 | 12 13 1 729 842 | ZS014 | 96 415 010 | ZS508 | K05252577 | ZS394 |
| 9G33-12A366-AA | ZS389 | 12 13 1 730 765 | ZS014 | 96253555 | ZS447A | K56029098AA | ZS456 |
| | | 12 13 1 730 766 | ZS014 | | | T1031135 | ZS251 |
| | | 12 13 1 731 134 | ZS014 | CITROËN | | V7203971AA | ZS406 |
| | | 12 13 1 731 884 | ZS014 | 0000597055 | ZS346 | | |
| AUDI | | 12 13 1 731 884 | ZS014 | 0000597057 | ZS343 | | |
| 034 905 101 | ZS043 | 12 13 1 748 017 | ZS302 | 0000597073 | ZS349 | | |
| 034 905 105 | ZS043 | 12 13 1 748 018 | ZS302 | 0000597075 | ZS348 | | |
| 058905101A | ZSE162 | 12 13 1 748 394 | ZS014 | 0000597076 | ZS351 | | |
| 078 905 101 A | ZSE007 | 12 13 1 777 666 | ZS014 | 0000597077 | ZS347 | | |
| 078 905 101 C | ZSE008 | 12 13 1 777 666 | ZS014 | 0000597078 | ZSE047 | | |
| 078 905 104 | ZSE154 | 12 13 7 523 345 | ZSE145 | 0000597079 | ZSE047 | | |
| 078 905 104 A | ZSE154 | 12 13 7 548 553 | ZSE145 | 0000597080 | ZSE045 | | |
| 376 815 090 100 00 | ZS106 | 12 13 7 550 012 | ZSE143 | 0000597084 | ZS351 | | |
| 443 905 105 B | ZSE005 | 12 13 7 551 049 | ZSE143 | 0000597087 | ZS352 | | |
| 443 905 105 C | ZSE005 | 12 13 7 551 260 | ZS324 | 0000597090 | ZSE048 | | |
| 443 905 105 D | ZSE005 | 12 13 7 559 842 | ZSE144 | 0000597092 | ZS353 | | |
| 892 031 071 000 00 | ZS106 | 12 13 7 562 744 | ZSE143 | 0000597094 | ZS347 | | |
| 8A0 905 105 | ZSE005 | 12 13 7 562 745 | ZSE144 | 0000597097 | ZSE048 | | |
| | | 12 13 7 571 643 | ZSE143 | 0000597098 | ZS348 | | |
| BMW | | 12 13 7 571 644 | ZSE144 | 0000597099 | ZSE045 | | |
| 0 495 289 | ZS324 | 12 13 7 582 627 | ZSE144 | 00005970A0 | ZS352 | | |
| 1 286 087 | ZS122 | 12 13 7 594 935 | ZSE144 | 00005970A4 | ZS349 | | |
| 1 703 227 | ZS302 | 12 13 7 594 936 | ZSE145 | 00005970A5 | ZS351 | | |
| 1 703 359 | ZS014 | 12 13 7 594 937 | ZSE143 | 00005970A6 | ZS353 | | |
| 1 712 219 | ZS324 | 12 13 7 594 938 | ZS324 | 00005970A8 | ZSE047 | | |
| 1 712 223 | ZS324 | 12 13 7 599 219 | ZS302 | 5 412 342 | ZS110 | | |
| 1 720 166 | ZS014 | 12 13 7 619 385 | ZS472 | 5 412 977 | ZS110 | | |
| 1 720 877 | ZS014 | 12 13 7 638 477 | ZSE144 | 5 490 504 | ZS115 | | |
| 1 726 176 | ZS014 | 12 13 7 638 477 | ZSE144 | 5 491 302 | ZS115 | | |
| 1 726 177 | ZS014 | 12 13 7 703 359 | ZS014 | | | | |
| 1 726 178 | ZS014 | 12 13 7 841 558 | ZS324 | | | | |
| 1 726 178 B | ZS014 | 12 13 8 630 004 | ZS106 | | | | |
| 1 730 765 | ZS014 | 12 13 8 730 002 | ZS115 | | | | |
| 1 731 134 B | ZS014 | 12 13 9 066 468 | ZS014 | | | | |
| | | 12 13 9 067 830 | ZS302 | | | | |
| | | 12 14 1 360 672 | ZS400 | | | | |

OE ? ⇌



| ...CITROËN | | FAUN | | ...FIAT | | ...FORD | |
|------------------------|--------|----------------|--------|----------------|--------|----------------|--------|
| 5 491 559 | ZS115 | 4796501 | ZS105 | 7789346 | ZS029 | 2W4Z-12029-BC | ZS368 |
| 5970 64 | ZSE143 | | | 82303852 | ZS106 | 2W4Z-12029-BD | ZS368 |
| 5970.53 | ZS234 | FERRARI | | 96 074 054 80 | ZS341 | 4088000 | ZS372 |
| 5970.80 | ZSE045 | 134386 | ZS234 | 96 228 897 80 | ZS232 | 4093748 | ZS410 |
| 5970.85 | ZSE472 | 248404 | ZSE128 | 96 228 897 80 | ZS341 | 4424413 | ZS368 |
| 5970.99 | ZSE045 | 248406 | ZSE127 | 9604137880 | ZS258 | 4448245 | ZS410 |
| 5970A1 | ZS343 | | | 9634131380 | ZS348 | 448 298 | ZS115 |
| 7400269207 | ZS400 | FIAT | | | | 4586554 | ZS368 |
| 75 455 219 | ZS115 | 0009633001580 | ZS347 | FORD | | 4619092 | ZS410 |
| 96 062 288 | ZS231 | 0009663278480 | ZS347 | 1008464 | ZSE004 | 4667153 | ZS368 |
| 96 074 054 | ZS341 | 04606869AC | ZS453 | 1008886 | ZS237 | 4751265 | ZS372 |
| 96 165 97 080 | ZS231 | 04606869AC | ZS453 | 1008887 | ZS237 | 47E-12A366-AA | ZS369 |
| 96 165 970 | ZS341 | 4071394 | ZS106 | 1018139 | ZS237 | 47E-12A366-AB | ZS369 |
| 96 211 048 | ZS256 | 4261940 | ZS106 | 1018140 | ZS237 | 4L7Z12029AA | ZS369 |
| 96 213 086 80 | ZS241 | 4324184 | ZS106 | 1027286 | ZS126 | 4L7Z-12029-AB | ZS369 |
| 96 228 897 | ZS232 | 4384184 | ZS106 | 1052492 | ZS350 | 4M5E12A366AA | ZS408 |
| 96010513 | ZS247 | 46403328 | ZS310 | 1053904 | ZS350 | 4M5G-12029-ZA | ZS387 |
| 96035284 | ZS249 | 46446039 | ZS029 | 1066102 | ZS350 | 4M5G-12029-ZB | ZS387 |
| 96041378 | ZS258 | 46467542 | ZS311 | 1067601 | ZS350 | 4M5G12A366BA | ZS408 |
| 9611412080 | ZS323 | 46469863 | ZS309 | 1075786 | ZS350 | 4M5G12A366BB | ZS408 |
| 96213181 | ZS346 | 46472440 | ZS029 | 11111213 | ZS422 | 4M5G-12A366-BC | ZS408 |
| 96292106 | ZS349 | 46480361 | ZS029 | 1119835 | ZS365 | 4M5G12A366-BD | ZS408 |
| 96292106 80 | ZS349 | 46543562 | ZS283 | 1120169 | ZSE089 | 4M5U-12A366-BC | ZS408 |
| 96341314 | ZS348 | 46548037 | ZS283 | 1130402 | ZS350 | 5 008 049 | ZS367 |
| 9634131480 | ZS348 | 46755605 | ZS361 | 1133237 | ZS308 | 5006104 | ZS106 |
| 96358649 | ZSE047 | 46776830 | ZS321 | 12029AB | ZS365 | 5008050 | ZS368 |
| 9654347080 | ZSE048 | 46777286 | ZS320 | 12029AB | ZS422 | 5008190 | ZS372 |
| 97530780 | ZS247 | 46777287 | ZS321 | 12029AB | ZS350 | 5008196 | ZS371 |
| 97531206 | ZS257 | 46777288 | ZS322 | 1224925 | ZS408 | 5047437 | ZS408 |
| DM 21208 B | ZS106 | 46790073 | ZS283 | 1229419 | ZS308 | 5F2E-12029-AA | ZS372 |
| MA 5455 219 | ZS115 | 55180004 | ZS320 | 1252407 | ZSE089 | 5F2E-12029-AB | ZS372 |
| | | 55200112 | ZS079 | 1314271 | ZS408 | 6077429 | ZS126 |
| CITROEN/PEUGEOT | | 55200486 | ZS079 | 1317972 | ZS350 | 6181956 | ZS238 |
| 59070 C1 | ZSE164 | 55208723 | ZS079 | 1319788 | ZS365 | 6485688 | ZS308 |
| 5970 88 | ZSE164 | 55209603 | ZS095 | 1319929 | ZS422 | 6489415 | ZS371 |
| 5970 C0 | ZSE164 | 55213613 | ZS095 | 1322402 | ZS408 | 6503277 | ZS238 |
| 5970.80 | ZSE045 | 55224494 | ZS095 | 1331283 | ZSE089 | 6503278 | ZS238 |
| 5970.99 | ZSE045 | 55231256 | ZS090 | 1350562 | ZS387 | 6630365 | ZS371 |
| | | 55234131 | ZS090 | 1362718 | ZSE089 | 6860288 | ZS239 |
| | | 55234133 | ZS090 | 1371601 | ZSE055 | 6860288 | ZS281 |
| DACIA | | 55246099 | ZS322 | 1459278 | ZS387 | 6958305 | ZS371 |
| 224332428R | ZSE131 | 60558152 | ZS234 | 1474549 | ZS109 | 6M21-12029-AA | ZSE089 |
| 6001543604 | ZS354 | 60562701 | ZS428 | 1505155 | ZS106 | 6M5G12029AA | ZSE055 |
| 82 00 360 911 | ZS325 | 60564142 | ZS230 | 1517813 | ZS422 | 71 HM 12024 BA | ZS109 |
| 82 00 360 911 | ZS375 | 60572202 | ZS122 | 1535713 | ZS079 | 710M12K018E2A | ZS106 |
| 82 00 702 693 | ZS325 | 60623365 | ZS122 | 1578771 | ZS408 | 7390767 | ZS360 |
| 82 00 702 693 | ZS375 | 60808059 | ZS230 | 1619343 | ZS365 | 798B12024AA | ZS126 |
| | | 60809606 | ZS234 | 1619343 | ZS422 | 7U2J-12029-AB | ZS281 |
| | | 60810690 | ZS428 | 1671690 | ZS079 | 88SF-12029-A2A | ZS281 |
| DAEWOO | | 71716152 | ZS119 | 1673468 | ZSE089 | 88SF-12029-A2B | ZS281 |
| 0001587503 | ZS340 | 71739725 | ZS427 | 1727629 | ZS387 | 88SF-12029-AA | ZS238 |
| | | 71744369 | ZS427 | 1953302 | ZS277 | 919F-12029-AA | ZS371 |
| | | 7553120 | ZS248 | 1953306 | ZS277 | 91XF 12029 AA | ZS308 |
| DAF | | 7582152 | ZS244 | 1953306 | ZS277 | 91XF 12029 BA | ZS308 |
| 315447 | ZS106 | 7588435 | ZS248 | 1S7G-12029-AB | ZS365 | 928F-12029-CA | ZS239 |
| 345061 | ZS106 | 7612954 | ZS119 | 1S7G-12029-AC | ZS365 | 928F-12029-CA | ZS281 |
| | | 7612954 | ZS120 | 1S7Z-12029AA | ZS350 | 92GB12024AA | ZS126 |
| | | 7626232 | ZS283 | 1S7Z-12029AA | ZS365 | 938F-12024-DA | ZS239 |
| | | 7646974 | ZS248 | 1S7Z-12029AA | ZS422 | 95VW12029AA | ZSE004 |
| DAIMLER | | 7648797 | ZS234 | 2C6Z12029AA | ZS369 | 96FB-12257-AB | ZS237 |
| 276 906 45 00 | ZSE094 | 7648797 | ZS234 | 2W4E-12A366-AC | ZS367 | 988F1 2029 BA | ZS422 |
| 276 906 51 00 | ZSE094 | 7663177 | ZS244 | 2W4E-12A366-AD | ZS367 | 988F12029AA | ZS350 |
| A 276 906 45 00 | ZSE094 | 7672018 | ZS283 | 2W4E-12A366-BB | ZS368 | 988F12029AB | ZS350 |
| A 276 906 51 00 | ZSE094 | 7698431 | ZS244 | 2W4E-12A366-BC | ZS368 | 988F12029AC | ZS350 |
| | | 7746152 | ZS244 | 2W4E-12A366-BD | ZS368 | 988F12029AD | ZS350 |
| | | 7746153 | ZS248 | 2W4E-12A366-BE | ZS368 | 988F12024AB | ZS350 |
| | | 7746154 | ZS244 | 2W4Z-12029-B | ZS368 | 98E-12A366-AA | ZS410 |

OE ? ⇒



| | | | | | | | |
|-----------------------|--------|--------------------------|--------|-------------------|--------|-------------------|--------|
| ...FORD | | ...GENERAL MOTORS | | ...HYUNDAI | | ...JEEP | |
| 955 112 029 AA | ZS079 | 90449739 | ZS253 | OK9BV-18-10X | ZS487 | 56032520AC | ZS455 |
| 955 112 029 AB | ZS079 | 90510386 | ZS253 | 27300-39000 | ZSE086 | 56032520AE | ZS455 |
| A71012K018E2A | ZS106 | 90532618 | ZS358 | 27300-39050 | ZSE086 | 56032520AF | ZS455 |
| A790X12K018CA | ZS106 | 90543059 | ZS358 | 27300-39700 | ZSE087 | 56041019 | ZS452 |
| AM5E-12A366-AA | ZS408 | 9119567 | ZS342 | 27301-02100 | ZS480 | 56041476AA | ZS452 |
| AM5E-12A366-AB | ZS408 | 93177212 | ZS338 | 27301-02502 | ZSE011 | K56041476AA | ZS452 |
| CM5G-12029-FA | ZS387 | 93180806 | ZS359 | 27301-02600 | ZS266 | | |
| CM5G-12029-FB | ZS387 | 94404545 | ZS356 | 27301-02700 | ZS477 | KHD | |
| E8GY12029B | ZS274 | 94853695 | ZS356 | 27301-02710 | ZS477 | 117 7427 | ZS120 |
| E92Z12029B | ZS274 | 96253555 | ZS447A | 27301-03000 | ZS536 | | |
| E9SF-12029-AA | ZS371 | | | 27301-03010 | ZS536 | | |
| E9SZ-12029-A | ZS371 | HANOMAG | | 27301-03030 | ZS536 | | |
| E9TF-12029-AA | ZS281 | HENSCHEL | | 27301-03110 | ZS478 | KIA | |
| F1CZ12029A | ZS279 | 000 158 320 3 | ZS106 | 27301-04000 | ZS476 | OK 011-18-100 | ZS234 |
| F1SU-12029-AA | ZS371 | 540 146 030 | ZS106 | 27301-22040 | ZS264 | OK 013-18-100 | ZS434 |
| F3XA-12029-AA | ZS277 | 547 935 731 | ZS106 | 27301-22050 | ZS264 | OK 247-18100 | ZS433 |
| F3XY-12029-A | ZS277 | 547 935 733 | ZS106 | 27301-22600 | ZS479 | OK 247-18100 A | ZS433 |
| F57U-12029-AA | ZS370 | | | 27301-23003 | ZS267 | OK 2A 318 100A | ZS436 |
| F57U-12029-AB | ZS370 | | | 27301-23700 | ZS482 | OK30E-18-10X | ZS486 |
| F5SU-12029-AA | ZS371 | | | 27301-23710 | ZS482 | OK9BV-18-10X | ZS487 |
| F5SU-12029-AB | ZS371 | HOLDEN | | 27301-23710 | ZS482 | 27300-39000 | ZSE086 |
| F5XZ-12029-AA | ZS277 | 90 444 184 | ZS301 | 27301-23900 | ZS482 | 27300-39050 | ZSE086 |
| F6DU-12A366-AB | ZS366 | 90541062 | ZS306 | 27301-24510 | ZS263 | 27301-02700 | ZS477 |
| F6DU-12A366-AC | ZS366 | | | 27301-24520 | ZS263 | 27301-02710 | ZS477 |
| V93HF 12029 AA | ZS360 | HONDA | | 27301-26600 | ZS483 | 27301-03110 | ZS478 |
| YM21-12029 AD | ZSE089 | 30500-634-015 | ZS106 | 27301-26640 | ZS481 | 27301-04000 | ZS476 |
| YM21-12029-AA | ZSE089 | 30500-634-671 | ZS106 | 27301-28000 | ZS474 | 27301-23700 | ZS482 |
| YM21-12029-AB | ZSE089 | 30500-642-000 | ZS106 | 27301-28010 | ZS475 | 27301-26600 | ZS483 |
| YM21-12029-AC | ZSE089 | 30500P0AA01 | ZS532 | 27301-32800 | ZS261 | 27301-26640 | ZS481 |
| YM2F 12029 AD | ZS350 | 30500PCA003 | ZS532 | 27301-33010 | ZS265 | 27301-28000 | ZS474 |
| YM2F-12024-AB | ZS422 | 30500PDAE01 | ZS532 | 27301-33020 | ZS265 | 27301-28010 | ZS475 |
| YM2F-12024-AC | ZS422 | 30500PDAE02 | ZS532 | 27301-33510 | ZS521 | KK137-18-10XB | ZS511 |
| YM2F-12029-AB | ZS422 | 30500PMA02 | ZS276 | 27301-33520 | ZS521 | KK137-18-10XC | ZS511 |
| | | 30500PMA03 | ZS276 | 27301-37100 | ZS269 | OK 011-18-100 | ZS234 |
| | | 30500PRA02 | ZS278 | 27301-37105 | ZS522 | | |
| | | 30510P73A01 | ZS275 | 27301-37120 | ZS485 | LADA | |
| | | 30510P73A02 | ZS275 | 27301-38020 | ZSE502 | 2101-37050-560 | ZS106 |
| | | 30510PT2006 | ZS275 | | | 2108 3705 010 | ZS120 |
| | | 30520 PDFE 00 | ZS234 | ISUZU | | 21110370501000 | ZS395 |
| | | 30520-PGK-A01 | ZSE170 | 8-01103-830-0 | ZS355 | 21113705010 | ZS395 |
| | | 30520-PH6-900 | ZS417 | 8-10468-391-0 | ZS355 | | |
| | | 30520-PH6-902 | ZS417 | 8-10472-401-0 | ZS355 | LANCIA | |
| | | 30520-PNA-007 | ZSE169 | 8125965470 | ZSE133 | 46403328 | ZS310 |
| | | 30520-PT-3-A02 | ZS419 | 8-94404-545-0 | ZS356 | 46467542 | ZS311 |
| | | 30520-PVF-A01 | ZSE170 | 981360005 | ZS106 | 46469863 | ZS309 |
| | | 30520-PVJ-A01 | ZSE170 | 982511535 | ZS106 | 71716152 | ZS119 |
| | | 30520PWA003 | ZSE175 | 982513509 | ZS106 | 7582152 | ZS244 |
| | | 30520PWA013 | ZSE175 | | | 7612954 | ZS119 |
| | | 30520PWAS01 | ZSE175 | JAGUAR | | 7663177 | ZS244 |
| | | 30520-RAA-007 | ZSE169 | AJ81373 | ZS368 | 7698431 | ZS244 |
| | | 30520-RCA-A01 | ZSE166 | AJ82545 | ZS368 | 7746152 | ZS244 |
| | | 30520-RCA-A02 | ZSE166 | AJ86468 | ZS368 | 7746154 | ZS244 |
| | | 30520-RCA-S01 | ZSE166 | C2S42751 | ZS367 | 82 281 560 | ZS115 |
| | | 30520REAZ01 | ZSE175 | C2S42751 | ZS367 | | |
| | | 30520-RJA-A01 | ZSE166 | FOR6077429 | ZS126 | LAND ROVER | |
| | | 30520-RRA-007 | ZSE169 | XR814052 | ZS367 | NEC000070 L | ZS068 |
| | | 30521PWA003 | ZSE176 | XR816250 | ZS367 | NEC000110 L | ZS068 |
| | | 30521PWA013 | ZSE176 | XR827823 | ZS368 | NEC000120 L | ZS501 |
| | | 30521PWAS01 | ZSE176 | XR842741 | ZS367 | NEC100730 L | ZS501 |
| | | 30521REAZ01 | ZSE176 | | | | |
| | | 30521RLB003 | ZSE176 | JEEP | | | |
| | | | | 00K56041476AB | ZS452 | MAN | |
| | | HYUNDAI | | 56029098AA | ZS456 | 51 25919 0016 | ZS297 |
| | | OK 013-18-100 | ZS434 | 56029098AB | ZS456 | 93 21200 6070 | ZS120 |
| | | OK 247-18100 | ZS433 | 56032520AB | ZS455 | | |
| | | OK 2A 318 100A | ZS436 | | | | |
| GENERAL MOTORS | | | | | | | |
| 03 474 233 | ZS253 | | | | | | |
| 03474232 | ZS252 | | | | | | |
| 03474282 | ZS252 | | | | | | |
| 09 119 567 | ZS342 | | | | | | |
| 10458316 | ZS427 | | | | | | |
| 10467067 | ZS355 | | | | | | |
| 10468391 | ZS355 | | | | | | |
| 10472401 | ZS355 | | | | | | |
| 1208047 | ZS125 | | | | | | |
| 120875 | ZS306 | | | | | | |
| 12596547 | ZSE133 | | | | | | |
| 12612369 | ZSE133 | | | | | | |
| 12629037 | ZSE174 | | | | | | |
| 19005212 | ZS259 | | | | | | |
| 3474233 | ZS253 | | | | | | |
| 90 358 386 | ZS301 | | | | | | |
| 90 444 148 | ZS301 | | | | | | |
| 90 444 184 | ZS301 | | | | | | |
| 90 449 740 | ZS252 | | | | | | |
| 90 458 250 | ZS344 | | | | | | |
| 90 510 387 | ZS252 | | | | | | |
| 90 536 194 | ZS342 | | | | | | |
| 90 541 062 | ZS306 | | | | | | |
| 90 563 160 | ZS306 | | | | | | |
| 90277970 | ZS125 | | | | | | |
| 90348296 | ZS125 | | | | | | |
| 90350021 | ZS127 | | | | | | |
| 90350987 | ZS127 | | | | | | |
| 90369434 | ZS127 | | | | | | |
| 90443900 | ZS300 | | | | | | |
| 90449572 | ZS300 | | | | | | |

OE ? ⇌



| MAZDA | BERU | ...MERCEDES-BENZ | BERU | ...MITSUBISHI | BERU | ...NISSAN | BERU |
|----------------------|-------------|-------------------------|-------------|----------------------|-------------|------------------|-------------|
| 18E05 18 100 | ZS239 | 000 158 61 03 | ZS296 | MD 126461 | ZS265 | 22448-31U01 | ZSE073 |
| 18E05 18 100 A | ZS239 | 000 158 62 03 | ZS339 | MD104696 | ZS261 | 22448-31U05 | ZSE071 |
| 1E03-18-10X | ZS350 | 000 158 64 03 | ZS298 | MD113551 | ZS282 | 22448-31U06 | ZSE071 |
| 1E04-18-10X | ZS350 | 000 158 65 03 | ZS299 | MD114994 | ZS263 | 22448-31U15 | ZSE071 |
| 1E05-18-100B | ZS350 | 000 158 68 03 | ZS313 | MD131711 | ZS282 | 22448-31U16 | ZSE071 |
| 1E08-18-10X | ZS350 | 000 158 71 03 | ZS340 | | | 22448-37J10 | ZS376 |
| 1E09-18-10X | ZS350 | 000 158 73 03 | ZS297 | | | 22448-37J11 | ZS376 |
| B6S71810XA | ZS279 | 000 158 75 03 | ZS340 | MWM | BERU | 22448-37J20 | ZS376 |
| B6S81010XA | ZS279 | 000 158 77 03 | ZS304 | 6 0579 120 0002 | ZS106 | 22448-3H000 | ZSE074 |
| BP 6D 18 100 A | ZSE084 | 000 158 78 03 | ZS297 | | | 22448-4W011 | ZSE076 |
| C201-18-100 | ZS350 | 000150048081 | ZS313 | NISSAN | BERU | 22448-6N000 | ZSE081 |
| C201-18-100A | ZS350 | 003 158 50 01 | ZSE004 | 22433 55S10 | ZS277 | 22448-6N002 | ZSE081 |
| C201-18-100B | ZS350 | 160 158 77 03 | ZS304 | 22433 56E11 | ZS277 | 22448-6N010 | ZSE081 |
| E5D3-18-100B | ZS274 | 272 150 02 80 | ZSE093 | 22433-0B00 | ZS277 | 22448-6N011 | ZS052 |
| E5D718100A | ZS274 | 272 906 00 60 | ZSE140 | 22433-0B000 | ZS277 | 22448-6N012 | ZSE081 |
| F21018100 | ZS274 | 276 150 00 80 | ZSE093 | 22433-0B001 | ZS277 | 22448-6N015 | ZSE081 |
| F21018100B | ZS274 | 276 906 01 60 | ZSE093 | 22433-0B010 | ZS277 | 22448-7S015 | ZSE134 |
| F21118100A | ZS274 | 276 906 02 59 | ZSE093 | 22433-14800 | ZS106 | 22448-8H310 | ZSE080 |
| FFY 118 100 | ZSE083 | 276 906 02 60 | ZSE093 | 22433-14805 | ZS106 | 22448-8H311 | ZSE080 |
| FP 85 18 100 A | ZSE083 | 276 906 35 00 | ZSE093 | 22433-14806 | ZS106 | 22448-8H314 | ZSE080 |
| FP 85 18 100 B | ZSE083 | 276 906 37 00 | ZSE093 | 22433-14810 | ZS106 | 22448-8H315 | ZSE080 |
| FP 85 18 100 C | ZSE083 | 607 158 00 03 | ZS106 | 22433-14811 | ZS106 | 224488J100 | ZSE079 |
| FPY 118 100 | ZSE083 | A 000 150 04 80 | ZS313 | 22433-14811 | ZS106 | 224488J110 | ZSE079 |
| FSD7 18 100 | ZS281 | A 000 150 05 80 | ZS313 | 22433-14815 | ZS106 | 224488J111 | ZSE079 |
| JF0118100B | ZS274 | A 000 150 13 80 | ZSE146 | 22433-14816 | ZS106 | 224488J115 | ZSE079 |
| K 013-18-100 | ZS434 | A 000 150 15 80 | ZS053 | 22433-14900 | ZS106 | 22448-8J11C | ZSE079 |
| K 247-18100 | ZS433 | A 000 150 17 80 | ZS041 | 22433-14905 | ZS106 | 22448-AL615 | ZSE132 |
| K 2A 318 100A | ZS436 | A 000 150 19 80 | ZSE140 | 22433-31300 | ZS106 | 22448-AL61C | ZSE132 |
| YF091810X | ZS350 | A 000 150 25 80 | ZS077 | 22433-31303 | ZS106 | 22448-AR210 | ZSE157 |
| | | A 000 150 27 80 | ZSE140 | 22433-43110 | ZS109 | 22448-AR215 | ZSE157 |
| | | A 000 150 28 80 | ZS041 | 22433-51J10 | ZS277 | 22448-D4000 | ZS277 |
| | | A 000 150 29 80 | ZS053 | 22433-53F00 | ZS376 | 22448-ED00 0 | ZSE088 |
| MERCEDES-BENZ | BERU | A 000 158 40 03 | ZS117 | 22433-53J20 | ZS277 | 22448-ED800 | ZSE056 |
| 000 150 04 80 | ZS313 | A 000 158 45 03 | ZS118 | 22433-55Y00 | ZS376 | 22448-ED800EP | ZSE056 |
| 000 150 05 80 | ZS313 | A 000 158 48 03 | ZS296 | 22433-56E12 | ZS277 | 22448-JA00 A | ZSE088 |
| 000 150 07 80 | ZSE146 | A 000 158 61 03 | ZS296 | 22433-58000 | ZS106 | 22448-JA00 C | ZSE088 |
| 000 150 12 80 | ZSE146 | A 000 158 62 03 | ZS339 | 22433-65Y10 | ZS376 | 22448-JA10A | ZSE158 |
| 000 150 13 80 | ZSE146 | A 000 158 64 03 | ZS298 | 22433-78500 | ZS106 | 22448-JA10C | ZSE158 |
| 000 150 15 80 | ZS053 | A 000 158 65 03 | ZS299 | 22433-78510 | ZS106 | 22448-ZE00C | ZSE156 |
| 000 150 17 80 | ZS041 | A 000 158 68 03 | ZS313 | 22433-79011 | ZS106 | 7700107177 | ZS052 |
| 000 150 19 80 | ZSE140 | A 000 158 71 03 | ZS340 | 22433-79012 | ZS106 | | |
| 000 150 25 80 | ZS077 | A 000 158 73 03 | ZS297 | 22433-8J115 | ZSE079 | NSU | BERU |
| 000 150 27 80 | ZSE140 | A 000 158 75 03 | ZS340 | 22433-8J11C | ZSE079 | 376 81 50 901 | ZS106 |
| 000 150 28 80 | ZS041 | A 000 158 78 03 | ZS297 | 22433-L1610 | ZS106 | 380 83 50 701 | ZS109 |
| 000 150 29 80 | ZS053 | A 003 158 50 01 | ZSE004 | 22433-L6801 | ZS106 | | |
| 000 158 00 03 | ZS106 | A 272 150 02 80 | ZSE093 | 22448 1F700 | ZS337 | OPEL | BERU |
| 000 158 02 03 | ZS106 | A 272 906 00 60 | ZSE140 | 22448 4M500 | ZSE021 | 03474233 | ZS253 |
| 000 158 06 03 | ZS115 | A 276 150 00 80 | ZSE093 | 22448 4M50A | ZSE021 | 03474283 | ZS253 |
| 000 158 24 03 | ZS400 | A 276 906 01 60 | ZSE093 | 22448 00Q0A | ZS052 | 10 45 7075 | ZSE026 |
| 000 158 26 03 | ZS109 | A 276 906 02 59 | ZSE093 | 22448 00Q0B | ZS052 | 10468391 | ZS355 |
| 000 158 27 03 | ZS109 | A 276 906 02 60 | ZSE093 | 22448 00Q0C | ZS052 | 11 03 872 | ZSE026 |
| 000 158 28 03 | ZS400 | A 276 906 35 00 | ZSE093 | 22448 00Q0D | ZS454 | 11 03 905 | ZSE026 |
| 000 158 32 03 | ZS106 | A 276 906 37 00 | ZSE093 | 22448 00Q0E | ZS052 | 12 08 002 | ZS252 |
| 000 158 34 03 | ZS106 | | | 22448 00Q0F | ZS375 | 12 08 003 | ZS253 |
| 000 158 37 03 | ZS109 | MITSUBISHI | BERU | 22448 00Q0G | ZS052 | 12 08 004 | ZS252 |
| 000 158 38 03 | ZS106 | 04609103AB | ZS380 | 22448 00Q0H | ZS052 | 12 08 006 | ZS355 |
| 000 158 39 03 | ZS109 | 9311600 | ZS395 | 22448 00Q0I | ZS277 | 12 08 007 | ZS451 |
| 000 158 40 03 | ZS117 | HQ808700 | ZSE010 | 22448 00Q0J | ZS277 | 12 08 008 | ZS342 |
| 000 158 43 03 | ZS400 | M04557468 | ZS379 | 22448 00Q0K | ZS052 | 12 08 009 | ZS106 |
| 000 158 45 03 | ZS118 | M04609103 | ZS380 | 22448 00Q0L | ZS052 | 12 08 011 | ZS106 |
| 000 158 48 03 | ZS296 | M05269670 | ZS380 | 22448 00Q0M | ZSE078 | 12 08 012 | ZSE147 |
| 000 158 49 03 | ZS109 | MD 001 800 | ZS106 | 22448 00Q0N | ZSE075 | 12 08 013 | ZS106 |
| 000 158 50 03 | ZS339 | MD 001 804 | ZS106 | 22448 00Q0O | ZSE082 | 12 08 014 | ZS106 |
| 000 158 55 03 | ZS299 | MD 003 820 | ZS110 | 22448 00Q0P | ZSE077 | 12 08 015 | ZS115 |
| 000 158 56 03 | ZS298 | MD 003 821 | ZS110 | 22448 00Q0Q | ZSE077 | 12 08 017 | ZS115 |
| 000 158 57 03 | ZS299 | MD 017 612 | ZS106 | 22448 00Q0R | ZSE073 | | |
| 000 158 58 03 | ZS298 | | | 22448 00Q0S | ZS052 | | |

OE ? ⇒



| ...OPEL | | PEUGEOT | | ...PORSCHE | | ...RENAULT | |
|------------|--------|------------------------|--------|-----------------|--------|-----------------------|--------|
| 12 08 018 | ZS106 | 5940 29 | ZS250 | 948 602 104 04 | ZSE042 | 77 00 863 021 | ZS255 |
| 12 08 020 | ZS338 | 5970 10 | ZS106 | 948 602 104 05 | ZSE012 | 77 00 865 923 | ZS254 |
| 12 08 021 | ZS427 | 5970 13 | ZS110 | 948 602 104 06 | ZSE042 | 77 00 872 834 | ZS345 |
| 12 08 028 | ZS359 | 5970 15 | ZS110 | 948 602 104 07 | ZSE012 | 77 00 875 000 | ZS052 |
| 12 08 036 | ZS252 | 5970 17 | ZS400 | 948 602 104 08 | ZSE012 | 77 01 031 135 | ZS251 |
| 12 08 046 | ZS125 | 5970 26 | ZS106 | 948 602 104 09 | ZSE012 | 77 01 031 135 | ZS316 |
| 12 08 047 | ZS125 | 5970 64 | ZSE143 | 948 602 104 10 | ZSE042 | 77 01 041 607 | ZS245 |
| 12 08 048 | ZS252 | 5970 72 (ohne Stecker) | ZS381 | 948 602 104 11 | ZSE042 | 77 01 041 608 | ZS246 |
| 12 08 053 | ZS127 | 5970 74 | ZS381 | 948 602 104 12 | ZSE042 | 77 01 348 252 | ZS106 |
| 12 08 054 | ZS253 | 5970 A3 | ZSE046 | 948 602 104 13 | ZSE042 | 77 02 218 697 | ZS250 |
| 12 08 061 | ZS355 | 5970 A4 | ZS349 | 948 602 104 20 | ZSE012 | 7700854306 | ZS317 |
| 12 08 063 | ZSE026 | 5970 A6 | ZS353 | 955 602 101 03 | ZSE044 | 7700854307 | ZS318 |
| 12 08 068 | ZS301 | 5970 A7 | ZS256 | 955 602 101 05 | ZSE044 | 7700858320 | ZS319 |
| 12 08 070 | ZS253 | 5970 A8 | ZSE047 | 958 602 101 00 | ZSE044 | 7700872265 | ZS317 |
| 12 08 071 | ZS344 | 5970 A9 | ZS381 | 958 602 102 00 | ZSE032 | 7700872692 | ZS318 |
| 12 08 075 | ZS306 | 5970.42 | ZS257 | 958 905 110 00 | ZSE068 | 7700872693 | ZS319 |
| 12 08 076 | ZS450 | 5970.43 | ZS247 | 980 602 904 00 | ZSE054 | 7701479027 | ZS347 |
| 12 08 209 | ZSE152 | 5970.45 | ZS249 | 980 602 904 01 | ZSE054 | 82 00 035 420 | ZS052 |
| 12 08 210 | ZSE153 | 5970.47 | ZS258 | 993 602 071 00 | ZS357 | 82 00 141 149 | ZS345 |
| 12 08 213 | ZSE150 | 5970.48 | ZS341 | 993 602 071 01 | ZS357 | 82 00 154 186 | ZS052 |
| 12 08 306 | ZS358 | 5970.49 | ZS231 | 996 602 101 01 | ZS031 | 82 00 154 186 A | ZS052 |
| 12 08 307 | ZS259 | 5970.50 | ZS323 | 996 602 102 00 | ZS031 | 82 00 208 611 | ZS052 |
| 1208039 | ZSE174 | 5970.51 | ZS256 | 996.602.104.00 | ZS036 | 82 00 360 911 | ZS325 |
| 1208065 | ZS300 | 5970.53 | ZS234 | 997 602 107 00 | ZS031 | 82 00 360 911 | ZS375 |
| 12629037 | ZSE174 | 5970.55 | ZS346 | 997.602.104.00 | ZS036 | 82 00 380 267 | ZS052 |
| 12768422 | ZS115 | 5970.56 | ZS241 | 9A1 602 104 00 | ZSE052 | 82 00 405 098 | ZS052 |
| 24 420 584 | ZS338 | 5970.57 | ZS343 | 9A1 602 104 01 | ZSE052 | 82 00 568 671 | ZS052 |
| 24 420 622 | ZS359 | 5970.60 | ZS341 | 9A1 602 104 02 | ZSE052 | 82 00 672 564 | ZS052 |
| 4408 389 | ZS052 | 5970.70 | ZS232 | 9A1 602 104 03 | ZSE052 | 82 00 702 693 | ZS325 |
| 4408389 | ZS052 | 5970.73 | ZS349 | 9A1 602 104 04 | ZSE052 | 82 00 702 693 | ZS375 |
| 4413 233 | ZS052 | 5970.75 | ZS348 | 9A1 602 104 05 | ZSE052 | 82 00 726 341 | ZSE066 |
| 4805507 | ZS447A | 5970.77 | ZS347 | 9A1 602 104 06 | ZSE052 | 82 00 765 882 | ZS052 |
| 62 35 037 | ZSE151 | 5970.80 | ZSE045 | | | 82 00 959 964 | ZSE066 |
| 62 35 124 | ZSE149 | 5970.81 | ZSE046 | PROTON | | 8200025256 | ZS454 |
| 90 297 487 | ZS125 | 5970.84 | ZS351 | 8200051128 | ZS454 | 8200084401 | ZS454 |
| 90 348 296 | ZS125 | 5970.85 | ZSE472 | A2C 5328 3940 | ZS438 | 8200699627 | ZSE161 |
| 90 358 386 | ZS301 | 5970.87 | ZS352 | | | 9619025280 | ZS343 |
| 90 424 480 | ZSE151 | 5970.90 | ZSE048 | RENAULT | | 9633001580 | ZS347 |
| 90 443 900 | ZS300 | 5970.92 | ZS353 | 08 54 243 200 | ZS106 | 9664401880 | ZS347 |
| 90 444 148 | ZS301 | 5970.94 | ZS347 | 08 54 269 800 | ZS106 | | |
| 90 444 184 | ZS301 | 5970.97 | ZSE048 | 08 54 337 600 | ZS106 | RENAULT TRUCKS | |
| 90 449 572 | ZS300 | 5970.98 | ZS348 | 22 43 324 28R | ZSE131 | 77 01 205 906 | ZS343 |
| 90 492 255 | ZS451 | 5970.99 | ZSE045 | 22 43 361 34R | ZS354 | | |
| 90 506 102 | ZS450 | 5970.A0 | ZS352 | 22433 7085R | ZSE066 | ROLLS-ROYCE | |
| 90 511 450 | ZS451 | 5970.A1 | ZS343 | 22448-ED00 0 | ZSE088 | UD 70828 | ZS117 |
| 90 541 062 | ZS306 | 5970.A2 | ZS241 | 22448-JA00 A | ZSE088 | | |
| 90 543 253 | ZSE147 | 5970.A5 | ZS351 | 22448-JA00 C | ZSE088 | ROVER | |
| 90 560 110 | ZSE147 | 597076 | ZS351 | 2526180A | ZS052 | ERR6045 | ZS234 |
| 90 563 160 | ZS306 | 597078 | ZSE047 | 60 00 581 617 | ZS234 | GCL 195 | ZS275 |
| 90 564 334 | ZSE150 | 597079 | ZSE047 | 7401275174 | ZSE037 | GCL 219 | ZS502 |
| 90065294 | ZS301 | | | 77 00 100 589 | ZS242 | GCL 307 | ZS302 |
| 90277970 | ZS125 | PORSCHE | | 77 00 100 643 | ZS243 | GCL161 | ZS276 |
| 90449739 | ZS253 | 547 602 102 00 | ZS109 | 77 00 107 177 | ZS052 | NEC 101000 L | ZS437 |
| 90510386 | ZS253 | 616 602 109 00 | ZS106 | 77 00 107 269 | ZS315 | NEC 101010 L | ZS435 |
| 90510387 | ZS252 | 901 602 102 00 | ZS109 | 77 00 113 357 | ZS052 | NEC000070 | ZS088 |
| 90532618 | ZS358 | 901 602 102 01 | ZS115 | 77 00 113 357 A | ZS052 | NEC000110 | ZS088 |
| 90536194 | ZS342 | 901 602 502 01 | ZS109 | 77 00 274 008 | ZS354 | NEC000120 | ZS501 |
| 91 53 250 | ZSE149 | 928 602 116 00 | ZS122 | 77 00 552 370 | ZS106 | NEC000130 | ZS502 |
| 91 95 819 | ZSE150 | 928 602 501 00 | ZS115 | 77 00 669 324 | ZS110 | NEC100530 | ZS275 |
| 91 98 834 | ZSE151 | 928 602 502 00 | ZS106 | 77 00 737 461 | ZS106 | NEC100630 | ZS469 |
| 91159996 | ZS052 | 928 602 502 00 | ZS106 | 77 00 737 461 | ZS106 | NEC100730 | ZS501 |
| 91159996 | ZS052 | 928 602 503 00 | ZS400 | 77 00 738 322 | ZS106 | NEC100870 | ZS502 |
| 93161188 | ZS052 | 928 602 702 02 | ZS400 | 77 00 742 132 | ZS106 | NEC101000 | ZS302 |
| 97136325 | ZS106 | 948 602 104 00 | ZSE012 | 77 00 749 450 | ZS250 | NEC101000SLP | ZS302 |
| | | 948 602 104 01 | ZSE012 | 77 00 858 138 | ZS250 | NEC101010 | ZS302 |
| | | 948 602 104 02 | ZSE042 | 77 00 863 020 | ZS254 | | |
| | | 948 602 104 03 | ZSE012 | | | | |

OE ? ⇔

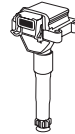

| | | | | | | | |
|------------------------|--------|------------------|--------|------------------|--------|-----------------------|--------|
| SAAB | | SSANGYONG | | ...SUZUKI | | TRACK MARSHALL | |
| 12629037 | ZSE174 | A 172 158 00 03 | ZS537 | 33400-83E00-000 | ZSE069 | ME 72-14 | ZS408 |
| 30584237 | ZS127 | A 172 158 01 03 | ZS537 | 33400-83E10 | ZSE069 | UAZ | |
| 42 26 031 | ZS127 | STANDARD | | 33400M79F00 | ZSE069 | 3163-00-3705013 | ZS535 |
| 45 04 536 | ZS301 | 12143 | ZSE093 | 33410-64B10-000 | ZS274 | VAG | |
| 47 70 046 | ZS301 | 12434 | ZS455 | 33410-66D00 | ZSE136 | 021 905 106 | ZSE004 |
| 51 71 111 | ZS127 | 12435 | ZS470 | 33410-66D00-000 | ZSE136 | 021 905 106 A | ZSE004 |
| 73 09 859 | ZS115 | 12469 | ZS453 | 33410-66D01 | ZSE136 | 022 905 100 B | ZSE041 |
| 7308604 | ZS106 | 12473 | ZS446 | 33410-66D01-000 | ZSE136 | 022 905 100 B | ZSE044 |
| 7308737 | ZS106 | 12774 | ZSE165 | 33410-66D10 | ZSE136 | 022 905 100 E | ZSE041 |
| 83 00 584 | ZS115 | 12825 | ZSE171 | 33410-66D10-000 | ZSE136 | 022 905 100 E | ZSE044 |
| 85 02 098 | ZS115 | 12839 | ZS452 | 33410-77E20 | ZSE072 | 022 905 100 H | ZSE041 |
| 85 06 636 | ZS115 | 12855 | ZSE170 | 33410-77E21 | ZSE072 | 022 905 100 H | ZSE044 |
| 85 73 834 | ZS121 | 12866 | ZSE164 | 33410-77E22 | ZSE072 | 022 905 100 L | ZSE041 |
| 8522328 | ZS106 | 12868 | ZSE172 | TALBOT | | 022 905 100 L | ZSE044 |
| 95 73 834 | ZS121 | 12874 | ZS482 | 91 505 890 80 | ZS106 | 022 905 100 L | ZSE044 |
| SAIC HUIZHONG | | 12886 | ZS486 | TOYOTA | | 022 905 100 P | ZSE044 |
| NEC90012A | ZS501 | 1513 | ZS478 | 19080-46020 | ZSE173 | 022 905 100 P | ZSE041 |
| NEC90013A | ZS502 | CP0020 | ZSE165 | 90080-19015 | ZSE164 | 022 905 100 S | ZSE041 |
| SCANIA | | CU1043 | ZSE170 | 90080-19016 | ZSE173 | 022 905 100 S | ZSE044 |
| 1789358 | ZS297 | CU1119 | ZS469 | 90080-19017 | ZS449 | 022 905 100 T | ZSE041 |
| 30584237 | ZS127 | CU1178 | ZSE165 | 90080-19017 | ZS449 | 022 905 715 | ZSE041 |
| SEAT | | CU1207 | ZSE154 | 90080-1901700 | ZS449 | 022 905 715 | ZSE044 |
| 032 905 106 | ZSE003 | CU1317 | ZSE171 | 90080-19019 | ZSE164 | 022 905 715 A | ZSE041 |
| 032 905 106 B | ZSE003 | CU1331 | ZS475 | 90080-19019 | ZSE164 | 022 905 715 B | ZSE041 |
| 032 905 106 E | ZSE003 | CU1337 | ZSE169 | 90080-19021 | ZSE165 | 022 905 715 B | ZSE044 |
| 6N0905104 | ZSE002 | CU1501 | ZS452 | 9019-02004 | ZS106 | 028 905 115 A | ZS109 |
| 867 905 104 | ZSE001 | CU1505 | ZS482 | 9019-02007 | ZS106 | 028 905 115 B | ZS109 |
| 867 905 105 A | ZSE002 | CU1517 | ZSE093 | 9019-02008 | ZS106 | 032 905 106 | ZSE003 |
| SE028915.000B | ZS327 | CU1520 | ZS455 | 9019-02013 | ZS106 | 032 905 106 B | ZSE003 |
| SKODA | | CU1531 | ZS476 | 9019-02014 | ZS106 | 032 905 106 D | ZSE003 |
| 004 050 014 | ZSE001 | IIS004 | ZSE164 | 9019-02015 | ZS106 | 032 905 106 E | ZSE003 |
| 004 050 016 | ZSE001 | IIS026 | ZSE166 | 9019-02016 | ZS106 | 034 905 101 | ZS043 |
| 032 905 106 | ZSE003 | IIS234 | ZSE171 | 9019-02017 | ZS106 | 034 905 105 | ZS043 |
| 032 905 106 B | ZSE003 | IIS259 | ZS482 | 9019-02019 | ZS106 | 036 905 100 A | ZSE030 |
| 032 905 106 E | ZSE003 | IIS261 | ZSE154 | 9019-02020 | ZS106 | 036 905 100 B | ZSE030 |
| 03D 905 115 | ZSE059 | IIS276 | ZS486 | 9019-02026 | ZS106 | 036 905 100 C | ZSE030 |
| 03D 905 115 A | ZSE059 | IIS282 | ZSE169 | 9019-02027 | ZS106 | 036 905 100 D | ZSE030 |
| 03D 905 115 B | ZSE059 | IIS287 | ZSE167 | 9019-02030 | ZS106 | 036 905 715 | ZSE030 |
| 03D 905 115 C | ZSE059 | IIS293 | ZSE168 | 9019-02031 | ZS106 | 036 905 715 A | ZSE030 |
| 03D 905 115 D | ZSE059 | IIS295 | ZS474 | 9019-02043 | ZS106 | 036 905 715 C | ZSE030 |
| 03D 905 115 E | ZSE059 | IIS304 | ZS487 | 9019-02094 | ZS109 | 036 905 715 E | ZSE030 |
| 03D 905 115 F | ZSE059 | IIS324 | ZS455 | 9019-02164 | ZS356 | 036 905 715 F | ZSE030 |
| 03D 905 115 G | ZSE059 | IIS325 | ZS470 | 901902197 | ZS445 | 036 905 715 G | ZSE030 |
| 03D 905 715 A | ZSE059 | IIS325 | ZS470 | 9019-02207 | ZSE173 | 047 905 104 | ZSE039 |
| 078 905 104 | ZSE154 | IIS336 | ZSE172 | 9019-02212 | ZS473 | 047 905 104 A | ZSE040 |
| 078 905 104 A | ZSE154 | IIS424 | ZS452 | 9019-02215 | ZS430 | 047 905 104 B | ZSE040 |
| 6 NO 905 104 | ZSE001 | IIS429 | ZS482 | 9019-02229 | ZSE165 | 04C 905 110 A | ZSE067 |
| SMART | | IIS519 | ZS476 | 9019-02230 | ZSE172 | 04C 905 110 B | ZSE067 |
| 000 3100 V003 | ZS304 | STEYR | | 9019-02234 | ZSE173 | 04C 905 110 D | ZSE067 |
| 000 3100 V004 | ZS304 | 721 185 0320 | ZS109 | 9019-02238 | ZSE168 | 04C 905 110 F | ZSE067 |
| 000 3100 V005 | ZS304 | 721 285 0320 | ZS109 | 9019-02239 | ZSE164 | 04C 905 110 H | ZSE067 |
| C 000 3100 V003 | ZS304 | 9010757 | ZS106 | 9019-02240 | ZSE165 | 04C 905 110 J | ZSE067 |
| C 000 3100 V004 | ZS304 | SUBARU | | 9019-02243 | ZSE171 | 04C 905 110 K | ZSE067 |
| C 000 3100 V005 | ZS304 | 82988-4110 | ZS106 | 9019-02244 | ZSE167 | 04E 905 110 | ZSE126 |
| Q 000 3100 V005 000000 | ZS304 | SUZUKI | | 9019-02248 | ZSE167 | 04E 905 110 A | ZSE126 |
| | | 33090 0115A | ZS280 | 9019-02250 | ZSE172 | 04E 905 110 B | ZSE126 |
| | | 33400-62J00 | ZSE069 | 9019-02260 | ZSE167 | 04E 905 110 C | ZSE126 |
| | | 33400-62J00-000 | ZSE069 | 9019-02262 | ZSE164 | 058 905 101 | ZS016 |
| | | 33400-83E00 | ZSE069 | 9019-02265 | ZSE165 | 058 905 105 | ZS016 |
| | | | | 9019-02266 | ZSE171 | 058 905 105 | ZS017 |
| | | | | 9019-A2001 | ZSE167 | 066 905 100 | ZSE065 |
| | | | | 9019-C2002 | ZSE167 | 066 905 100 B | ZSE065 |
| | | | | 9019-T2002 | ZSE164 | 066 905 100 C | ZSE065 |

OE ? ⇒





| ...VAG | | ...VAG | | ...VW | | ...VW | | | |
|---------------|--------|---------------------|--------|----------------|--------|--------------------|--------|---------------|--------|
| 066 905 100 D | ZSE065 | 8D0 905 105 | ZSE006 | 021 905 115 | ZS106 | 077 905 115 K | ZSE061 | | |
| 066 905 100 G | ZSE065 | VAUXHALL | | 022 905 100 A | ZSE063 | 077 905 115 M | ZSE062 | | |
| 06B 905 115 | ZSE009 | | | 022 905 100 D | ZSE063 | 077 905 115 P | ZSE061 | | |
| 06B 905 115 B | ZSE009 | | | 022 905 100 G | ZSE063 | 077 905 115 Q | ZSE061 | | |
| 06B 905 115 E | ZSE009 | | | 022 905 100 K | ZSE063 | 077 905 115 R | ZSE062 | | |
| 06D 905 115 | ZSE032 | 90458250 | ZS344 | 022 905 100 N | ZSE063 | 077 905 115 S | ZSE062 | | |
| 06D 905 115 A | ZSE032 | 9118114 | ZSE152 | 022 905 115 | ZS106 | 077 905 115 T | ZSE061 | | |
| 06D 905 115 C | ZSE032 | 9118115 | ZSE153 | 022 905 115 B | ZS106 | 078 905 104 | ZSE154 | | |
| 06D 905 115 D | ZSE032 | VOLVO | | 022 905 115 C | ZS106 | 078 905 104 A | ZSE154 | | |
| 06D 905 115 F | ZSE032 | | | 1 275 602 | ZS429 | 022 905 715 C | ZSE063 | 07P 905 715 | ZSE138 |
| 06D 905 115 G | ZSE032 | | | 1207458 | ZS115 | 035 905 105 A | ZS120 | 111 905 105 H | ZS106 |
| 06D 905 115 J | ZSE032 | | | 12719189 | ZS106 | 03D 905 115 | ZSE059 | 111 905 115 | ZS106 |
| 06D 905 115 K | ZSE032 | | | 1219189 | ZS106 | 03D 905 115 A | ZSE059 | 111 905 115 B | ZS106 |
| 06E 905 115 | ZSE032 | | | 1275174 | ZSE037 | 03D 905 115 B | ZSE059 | 112 905 115 | ZS106 |
| 06E 905 115 A | ZSE032 | | | 1275971 | ZS446 | 03D 905 115 C | ZSE059 | 112 905 115 B | ZS106 |
| 06E 905 115 B | ZSE032 | | | 1317810 | ZS120 | 03D 905 115 D | ZSE059 | 122 905 115 B | ZS106 |
| 06E 905 115 C | ZSE032 | | | 1317815 | ZS120 | 03D 905 115 E | ZSE059 | 171 905 115 A | ZS115 |
| 06E 905 115 D | ZSE032 | | | 1346070 | ZS122 | 03D 905 115 F | ZSE059 | 191 905 115 | ZS124 |
| 06E 905 115 E | ZSE032 | 1346071 | ZS119 | 03D 905 115 G | ZSE059 | 191 905 115 A | ZS123 | | |
| 06F 905 115 | ZSE033 | 240523 | ZS106 | 03D 905 715 A | ZSE059 | 211 905 115 D | ZS124 | | |
| 06F 905 115 A | ZSE033 | 241086 | ZS115 | 043 905 115 A | ZS106 | 221 100 019 | ZS106 | | |
| 06F 905 115 B | ZSE033 | 241609 | ZS106 | 043 905 115 C | ZS106 | 251 905 115 | ZS106 | | |
| 06F 905 115 C | ZSE033 | 241611 | ZS106 | 0489051051 | ZS234 | 251905115A | ZS124 | | |
| 06F 905 115 D | ZSE033 | 241688 | ZS106 | 052 905 105 | ZS106 | 311 905 115 B | ZS106 | | |
| 06F 905 115 E | ZSE033 | 241688-1 | ZS106 | 058905101A | ZSE162 | 311 905 115 C | ZS106 | | |
| 06F 905 115 F | ZSE033 | 269207 | ZS400 | 059 905 105 | ZS115 | 376 815 090 100 00 | ZS106 | | |
| 06H 905 115 | ZSE142 | 2867906 | ZS119 | 059 905 105 B | ZS115 | 377 905 105 D | ZS314 | | |
| 06H 905 115 A | ZSE142 | 30713416 | ZSE019 | 06A 905 097 | ZSE029 | 6N0905104 | ZSE002 | | |
| 06H 905 115 B | ZSE142 | 30713417 | ZSE055 | 06A 905 104 | ZSE029 | 701 905 104 | ZSE002 | | |
| 06J 905 110 B | ZSE068 | 30731416 | ZS387 | 06A 905 115 | ZSE043 | 701 905 104 A | ZSE002 | | |
| 06J 905 110 C | ZSE068 | 30731419 | ZS387 | 06A 905 115 A | ZSE043 | 867 905 105 A | ZSE002 | | |
| 06J 905 110 D | ZSE068 | 30735759 | ZS350 | 06A 905 115 B | ZSE043 | 892 031 071 | ZS106 | | |
| 06J 905 110 E | ZSE068 | 31216444 | ZS387 | 06A 905 115 C | ZSE043 | | | | |
| 06J 905 110 F | ZSE068 | 31216444 | ZS350 | 06A 905 115 D | ZSE043 | | | | |
| 06J 905 110 G | ZSE068 | 31359976 | ZS350 | 06B 905 115 D | ZSE043 | | | | |
| 06K 905 110 G | ZSE137 | 316447 | ZS106 | 06B 905 115 G | ZSE043 | | | | |
| 06K 905 110 J | ZSE068 | 3287677 | ZS251 | 06B 905 115 H | ZSE043 | | | | |
| 06K 905 110 K | ZSE068 | 3287677-3 | ZS251 | 06B 905 115 J | ZSE043 | | | | |
| 06L 905 110 B | ZSE068 | 345061 | ZS106 | 06B 905 115 L | ZSE043 | | | | |
| 06L 905 110 C | ZSE068 | 35254 | ZS106 | 06B 905 115 M | ZSE043 | | | | |
| 06L 905 110 D | ZSE068 | 464324 | ZS400 | 06B 905 115 N | ZSE043 | | | | |
| 077 905 104 | ZS017 | 7035254 | ZS106 | 06B 905 115 P | ZSE043 | | | | |
| 07C 905 115 | ZSE031 | 70863020 | ZS254 | 06B 905 115 Q | ZSE043 | | | | |
| 07C 905 115 C | ZSE031 | 70863020-7 | ZS245 | 06B 905 115 R | ZSE043 | | | | |
| 07C 905 115 D | ZSE031 | 70863021 | ZS255 | 06B 905 115 S | ZSE043 | | | | |
| 07C 905 115 E | ZSE031 | 70863021-5 | ZS246 | 06C 905 115 A | ZSE051 | | | | |
| 07C 905 115 F | ZSE031 | 76834 | ZS105 | 06C 905 115 B | ZSE051 | | | | |
| 07C 905 115 H | ZSE031 | 826490 | ZS115 | 06C 905 115 C | ZSE043 | | | | |
| 07C 905 115 J | ZSE031 | 834461 | ZS106 | 06C 905 115 D | ZSE051 | | | | |
| 07C 905 715 | ZSE031 | 834462 | ZS106 | 06C 905 115 E | ZSE051 | | | | |
| 07C 905 715 A | ZSE031 | 841931 | ZS115 | 06C 905 115 F | ZSE051 | | | | |
| 07K 905 715 | ZSE033 | 8522328 | ZS106 | 06C 905 115 G | ZSE051 | | | | |
| 07K 905 715 A | ZSE033 | 8573834 | ZS121 | 06C 905 115 H | ZSE051 | | | | |
| 07K 905 715 B | ZSE033 | 8677837 | ZSE055 | 06C 905 115 K | ZSE051 | | | | |
| 07K 905 715 C | ZSE033 | 870700 | ZS106 | 06C 905 115 L | ZSE051 | | | | |
| 07K 905 715 D | ZSE033 | 870909 | ZS115 | 06C 905 115 M | ZSE051 | | | | |
| 07K 905 715 E | ZSE033 | 870943 | ZS115 | 06H 905 110 D | ZSE137 | | | | |
| 07K 905 715 F | ZSE033 | 9125601 | ZSE019 | 06H 905 110 E | ZSE137 | | | | |
| 171 905 115 | ZS115 | 9438228 | ZS120 | 071 905 106 | ZS037 | | | | |
| 310 880 01 | ZSE004 | 9438230 | ZS400 | 077 905 115 AA | ZSE062 | | | | |
| 330 905 115 A | ZS280 | 9438231 | ZS122 | 077 905 115 B | ZSE061 | | | | |
| 357 905 104 | ZSE001 | | | 077 905 115 C | ZSE061 | | | | |
| 443 905 105 E | ZSE036 | VW | | 077 905 115 E | ZSE061 | | | | |
| 4A0 905 105 B | ZSE036 | | | 000 395 308 1 | ZS120 | 077 905 115 F | ZSE061 | | |
| 6N0 905 104 | ZSE001 | | | 021 905 106 B | ZSE013 | 077 905 115 G | ZSE062 | | |
| 867 905 104 | ZSE001 | | | 021 905 106 C | ZSE013 | 077 905 115 H | ZSE061 | | |
| 867 905 104 A | ZSE001 | | | | | 077 905 115 J | ZSE062 | | |

OE ?

CONNECTOR, COIL

ALFA ROMEO 
71713719 ZLE288

AUDI 
034 905 447 ZLE233
077 905 447 A ZLE277

BMW 
12 12 1 730 521 ZLE232
12 13 1 730 521 ZLE232
12 13 9 067 831 ZLE232

MERCEDES-BENZ 
000 159 35 42 ZLE234
000 159 36 42 ZLE234
A 000 159 35 42 ZLE234
A 000 159 36 42 ZLE234

PORSCHE 
996 602 103 01 ZLE278
996.602.105.00 ZLE255

VAG 
034 905 447 ZLE233

VW 
058 905 447 C ZLE276

CONNECTOR, SPARK PLUG AND COILS

ALFA ROMEO 
71713719 ZLE288

AUDI 
034 905 447 ZLE233
077 905 447 A ZLE277

BMW 
12 12 1 730 521 ZLE232
12 13 1 730 521 ZLE232
12 13 1 740 477 ZLE232
12 13 9 067 831 ZLE232













MERCEDES-BENZ 
000 159 35 42 ZLE234
000 159 36 42 ZLE234
A 000 159 35 42 ZLE234
A 000 159 36 42 ZLE234

PORSCHE 
996 602 103 01 ZLE278
996.602.105.00 ZLE255

VAG 
034 905 447 ZLE233

VW 
058 905 447 C ZLE276

OE ? \rightleftharpoons

| | | | |
|---|--|---|---|
| AGRIA  | ...AUTO UNION  | ...BMW  | ...CITROËN  |
| 031 150 Z57 | N 017 811 1 Z58 | 12 12 9 057 190 Z1 | 5960 L3 Z320 |
| 031 160 Z57 | N 017 811 19 Z58 | 12 12 9 057 749 Z1 | 5960.01 Z242 |
| 031 170 Z39 | N 017 811 20 Z22 | 12 12 9 057 750 Z1 | 5960.54 Z223 |
| 1137 51 680 1 Z57 | N 017 811 23 Z42 | 12 12 9 057 992 Z1 | 5960.73 Z223 |
| 283 340 Z57 | N 017 812 13 Z22 | 12 12 9 059 162 Z14 | 5960.84 Z243 |
| 426 43 Z57 | | 12 12 9 059 794 Z14 | 5962 2T Z123 |
| 509 12 Z10 | BMW  | 12 12 9 059 869 Z3 | 5962 5M Z183 |
| 516 80 Z57 | 1 265 595 Z11 | 12 12 9 059 870 Z4 | 5962 7E Z211 |
| 599 99 Z1 | 12 12 0 030 548 Z237 | 12 12 9 061 383 Z3 | 5962 7S Z193 |
| ALFA ROMEO  | 12 12 0 032 134 Z301 | 12 12 9 061 811 Z14 | 5962 7W Z184 |
| 0046550992 Z341 | 12 12 0 032 135 Z301 | 12 12 9 061 869 Z3 | 5962 8A Z211 |
| 462 29 251 Z11 | 12 12 0 032 136 Z239 | 12 12 9 061 870 Z4 | 5962 H8 Z255 |
| 46521529 Z237 | 12 12 0 032 137 Z235 | 12 12 9 063 428 Z14 | 5962 S9 Z24 |
| 46521530 Z210 | 12 12 0 032 138 Z235 | 12 12 9 064 619 Z14 | 5962.5G Z193 |
| 46550991 Z304 | 12 12 0 034 098 Z332 | 12 12 9 071 003 Z237 | 75 491 694 Z22 |
| 46550992 Z341 | 12 12 0 034 677 Z233 | 12 12 9 976 330 Z39 | 75 491 695 Z22 |
| 589 45 85 Z27 | 12 12 0 035 915 Z235 | 12 65 5 95 Z61 | 75 491 697 Z22 |
| 589 45 86 Z24 | 12 12 0 035 933 Z233 | 12 79 5 264 Z1 | 75 492 406 Z31 |
| 589 45 87 Z20 | 12 12 0 037 607 Z237 | 12121338145 Z22 | 75 492 437 Z48 |
| 589 45 88 Z24 | 12 12 0 037 608 Z237 | 2 158 165 Z336 | 75 492 438 Z25 |
| 589 61 77 Z98 | 12 12 0 141 871 Z237 | 7 749 743 Z145 | 75492437 Z48 |
| 598 40 36 Z20 | 12 12 1 257 081 Z22 | BOMAG  | 78 260 993 00 Z11 |
| 605 04 563 Z42 | 12 12 1 257 082 Z22 | 057 439 95 Z39 | 79 100 129 96 Z25 |
| 605 12 848 Z29 | 12 12 1 257 513 Z11 | CHEVROLET  | 79 100 129 98 Z25 |
| 605 12 929 Z42 | 12 12 1 258 158 Z11 | 92 06 7204 Z356 | 79 100 329 20 Z31 |
| 605 97 490 Z29 | 12 12 1 258 159 Z11 | 96 307 729 Z304 | 91 506 338 Z25 |
| 60599495 Z210 | 12 12 1 258 973 Z11 | 96 417 176 Z304 | 91 517 002 Z11 |
| 608 00 325 Z27 | 12 12 1 262 360 Z1 | 96 464 000 Z358 | 91 517 008 Z17 |
| 608 10 689 Z130 | 12 12 1 262 361 Z1 | EC 229626 Z74 | 91 517 014 Z25 |
| 717 116 38 Z15 | 12 12 1 263 070 Z1 | CHRYSLER  | 95 492 862 Z31 |
| 717 116 39 Z27 | 12 12 1 265 595 Z11 | 4727114 Z285 | 95 496 692 Z41 |
| 717 116 40 Z20 | 12 12 1 267 485 Z11 | 56028189 Z248 | 95 605 398 Z40 |
| 717 118 06 Z15 | 12 12 1 269 333 Z76 | 56028236 AA Z220 | 95 611 941 Z17 |
| 71741208 Z356 | 12 12 1 276 283 Z1 | S2RE 14 MCC5 Z216 | 95 618 380 Z10 |
| 754 651 9 Z15 | 12 12 1 279 526 Z1 | CITROËN  | 95 619 043 Z11 |
| 755 443 6 Z27 | 12 12 1 286 682 Z1 | 5 403 277 Z48 | 96 009 090 Z13 |
| 755 444 4 Z20 | 12 12 1 288 234 Z1 | 5 403 277 X Z48 | 96 020 779 Z29 |
| 755 444 5 Z48 | 12 12 1 334 315 Z1 | 5 416 222 D Z57 | 96 037 952 Z100 |
| 756 547 6 Z38 | 12 12 1 338 145 Z22 | 5 417 768 Z11 | 96 040 824 Z15 |
| 776 038 1 Z27 | 12 12 1 338 146 Z42 | 5 417 768 H Z11 | 96 064 066 Z13 |
| 776 038 2 Z20 | 12 12 1 351 716 Z58 | 5 417 769 U Z11 | 96 073 353 Z60 |
| 776 038 3 Z15 | 12 12 1 353 286 Z22 | 5 417 998 Z11 | 96 088 669 Z24 |
| 776 038 4 Z24 | 12 12 1 353 673 Z11 | 5 417 998 H Z11 | 96 145 071 Z60 |
| 777 245 3 Z24 | 12 12 1 435 955 Z237 | 5 425 202 Z11 | 97 533 994 Z25 |
| 915 170 018 0 Z70 | 12 12 1 435 956 Z237 | 5 425 202 H Z11 | 97 535 383 Z17 |
| 961 473 868 0 Z98 | 12 12 1 714 751 Z3 | 5 425 202 M Z11 | A 212 7C Z39 |
| 961 962 458 0 Z74 | 12 12 1 715 539 Z4 | 5 433 737 Z48 | AM 212 207 A Z40 |
| 962 800 028 0 Z14 | 12 12 1 882 34 Z11 | 5 433 737 J Z48 | AYB 212-7 Z39 |
| AUDI  | 12 12 2 158 165 Z336 | 5 433 738 Z48 | AZ 212 7A Z39 |
| 101 000 054 AC Z172 | 12 12 2 158 252 Z301 | 5 433 738 V Z48 | DS 212 7G Z10 |
| 101 905 611 A Z321 | 12 12 2 158 253 Z235 | 5 451 444 Z41 | DV 212 207 A Z10 |
| 101 905 626 Z349 | 12 12 2 163 332 Z318 | 5 451 444 B Z41 | DX 212 7A Z10 |
| 101 905 631 G Z347 | 12 12 2 293 697 Z332 | 5432 057 Y Z1 | DX 212 7B Z57 |
| 101925621 Z295 | 12 12 7 653 771 Z198 | 5960 90 Z184 | DX 212 7C Z10 |
| AUTO UNION  | 12 12 8 353 286 Z22 | 5960 91 Z184 | DY 212 207 A Z41 |
| 001 270 051 700 9 Z22 | 12 12 8 636 155 Z42 | 5960 92 Z332 | GX 06 188 02 A Z38 |
| 005 62 00 517 009 Z38 | 12 12 8 636 166 Z22 | 5960 E2 Z332 | GX 06 188 06 1 Z41 |
| 009 33 02 331 009 Z58 | 12 12 8 636 167 Z42 | 5960 H9 Z332 | GX 06 188 08 A Z22 |
| 011 18 00 068 000 Z57 | 12 12 8 636 168 Z22 | | GX 06 188 10 A Z42 |
| 725 02 03 390 009 Z38 | 12 12 8 636 169 Z42 | | MKP 000 73 Z42 |
| 7821 700 10 10 000 Z42 | 12 12 9 005 913 Z1 | | ZA 3406 176 Z22 |
| | 12 12 9 005 914 Z76 | | ZA 4233 922 Z22 |
| | 12 12 9 055 912 Z11 | | ZC 9456 074 U Z39 |
| | 12 12 9 056 446 Z1 | | ZC 9457 707 U Z39 |
| | 12 12 9 056 447 Z1 | | ZC 9852 109 U Z39 |
| | 12 12 9 057 189 Z1 | | ZC 9862 090 U Z1 |
| | | | ZCT 000 012 Z22 |



















OE ? ⇄



| CITROEN/PEUGEOT | ...FIAT | ...FIAT | ...FORD |
|-----------------------------|-----------------------|---------------------------|----------------------------|
| 5960E8 Z242 | 46531918 Z255 | 9 GYSSR Z193 | 5 099 731 Z32 |
| 9673 806 380 Z320 | 46531919 Z234 | 9151700180 Z70 | 5 099 732 Z32 |
| DACIA | 46531935 Z255 | 9614738680 Z98 | 5 099 733 Z32 |
| 6001544293 Z15 | 46750545 Z291 | 9619624580 Z74 | 5 099 735 Z32 |
| 82 00 662 185 Z243 | 46799928 Z234 | 9628000280 Z14 | 5 099 741 Z95 |
| DAF | 46823299 Z234 | 9636393480 Z183 | 5 099 846 Z32 |
| 215206 Z58 | 55188857 Z292 | V 45 LSR Z27 | 5 099 848 Z32 |
| 225190 Z57 | 55190788 Z293 | FORD | 5 099 884 Z20 |
| DAIHATSU | 55198201 Z234 | 01505812 Z326 | 5 099 885 Z11 |
| 90048-51163 Z157 | 55210685 Z338 | 1 012 639 Z95 | 5 099 937 Z26 |
| 90048-51164 Z324 | 552106850 Z338 | 1 023 706 Z159 | 5 099 949 Z42 |
| 90048-51168-000 Z360 | 55229633 Z357 | 1 032 705 Z173 | 5 099 950 Z47 |
| 90048-51197 Z234 | 55233997 Z357 | 1 088 847 Z177 | 5 099 952 Z24 |
| FERRARI | 5882087 Z10 | 1 097 080 Z177 | 5 099 961 Z22 |
| 113538 Z58 | 5894586 Z193 | 1 120 170 Z176 | 5 099 962 Z27 |
| FIAT | 5894587 Z20 | 1 120 818 Z32 | 5M5G12405AA Z230 |
| 1 L 4 J Z11 | 5894588 Z24 | 1 128 053 Z209 | 6 073 379 Z27 |
| 1 L 4 JR Z20 | 5896177 Z98 | 1 143 127 Z315 | 6 080 256 Z24 |
| 1 L 45 J Z22 | 5896824-1 Z98 | 1 151 999 Z315 | 6 173 150 Z95 |
| 1 L 45 JR Z27 | 5984036 Z20 | 1 202 935 Z177 | 6 726 180 Z97 |
| 1 S 3 Z57 | 60504563 Z42 | 1 204 572 Z209 | 6080256 Z24 |
| 1 S 5 J Z41 | 60512848 Z29 | 1 233 897 Z177 | 6M5J 12405 AA Z326 |
| 2284662 Z22 | 60512929 Z42 | 1 240 5AD Z32 | 6M8G 12405 BB Z342 |
| 2301710 Z42 | 60569957 Z130 | 1 240 5JE Z33 | 7 335 128 Z130 |
| 2301711 Z22 | 60597490 Z29 | 1 255 464 Z177 | 73 OF 12405 AA Z33 |
| 3233922 Z22 | 60800325 Z27 | 1 307 093 Z209 | 73 OF 12405 JA Z24 |
| 4113022 Z57 | 60810689 Z130 | 1 315 691 Z209 | 77 BF 12405 AA Z26 |
| 4170472 Z42 | 7 FYSSR Z27 | 1 327 341 Z177 | 78 GB 12405 CA Z27 |
| 4172173 Z42 | 7 GBMSR Z98 | 1 335 367 Z177 | 78 GB 12405 HA Z27 |
| 4249164 Z22 | 7 GYSSR Z24 | 1 350 742 Z177 | 78 HF 12405 AA Z32 |
| 4345041 Z22 | 71377139 Z234 | 1 362 012 Z177 | 78 IF 12405 AA Z47 |
| 4346196 Z20 | 71711638 Z15 | 1 379 739 Z342 | 78 IF 12405 BA Z27 |
| 4346796 Z20 | 71711639 Z27 | 1 493 001 Z177 | 78 TF 12405 AA Z27 |
| 4346797 Z27 | 71711640 Z20 | 1 506 413 Z22 | 78 TF 12405 BA Z20 |
| 4347776 Z27 | 71711806 Z20 | 1 506 415 Z11 | 79 OF 12405 ACA Z27 |
| 4359422 Z11 | 71719244 Z255 | 1 507 572 Z33 | 79 OF 12405 YA Z27 |
| 4359423 Z11 | 71736278 Z27 | 1 518 878 Z27 | 80 GB 12405 AA Z47 |
| 4359424 Z20 | 71741208 Z356 | 1 523 608 Z20 | 80 OF 12405 CA Z30 |
| 4361799 Z10 | 72002410 Z38 | 1 542 499 Z293 | 80 OF 12405 DA Z47 |
| 4361800 Z10 | 7546519 Z15 | 1000996 Z284 | 80 OF 12405 EA Z42 |
| 4378107 Z19 | 7554419 Z22 | 1086020 Z228 | 81 GB 12405 AA Z27 |
| 4401547 Z41 | 7554420 Z11 | 1223 294 Z309 | 81 OF 12405 AAA Z24 |
| 4401549 Z11 | 7554421 Z11 | 1324 211 Z309 | 81 SF 12405 BA Z24 |
| 4401550 Z20 | 7554436 Z27 | 1369704 Z230 | 81 SF 12405 DA Z30 |
| 4401551 Z11 | 7554437 Z27 | 1M50 12405 CA Z177 | 83 BB 12405 CA Z32 |
| 4401552 Z27 | 7554438 Z42 | 1S7J 12405 DA Z209 | 83 OF Z33 |
| 4401586 Z57 | 7554444 Z20 | 1S7J 12405 EB Z209 | 83 SF 12405 GA Z30 |
| 4425057 Z41 | 7554445 Z48 | 2M5V-12405-BA Z315 | 840F 12405 JD Z32 |
| 46417010 Z255 | 7554447 Z10 | 2M5V-12405-CA Z315 | 88 HF Z32 |
| 46461873 Z234 | 7554448 Z10 | 2M5V-12405-CB Z315 | 959 F 12405 AA Z284 |
| 46463801 Z98 | 7554449 Z47 | 2S7E 12405 AA Z296 | 96 XF 12405 BB Z228 |
| 46472021 Z98 | 7554451 Z20 | 2S7E 12405 AB Z296 | D 3 PF 12405 BA Z47 |
| 46480307 Z98 | 7554452 Z42 | 2S7G 12405 AC Z309 | DZPF 12405 Z33 |
| 46480309 Z74 | 7554453 Z22 | 2S7J 12405 AC Z309 | DZPF 12405 BUA Z33 |
| 46480362 Z15 | 7565476 Z38 | 2U7J 12405 AA Z177 | XS6F 12405 BA Z177 |
| 46480363 Z15 | 7565853 Z52 | 4 440 367 Z296 | XS6F 12405 CA Z177 |
| 46531917 Z234 | 7571541 Z255 | 4 454 955 Z296 | YN2F 12405 AA Z177 |
| | 7760381 Z27 | 4M5G 12405 XA Z177 | YN2J 12405 AA Z177 |
| | 7760382 Z20 | 4M5G 12405 XB Z177 | |
| | 7760383 Z15 | 4M5G 12405 XC Z177 | GENERAL MOTORS |
| | 7760384 Z24 | 5 086 351 Z315 | 25 324 618 Z222 |
| | 7769243 Z98 | 5 099 295 Z24 | 90542918 Z74 |
| | 7772453 Z24 | 5 099 721 Z15 | 91 99 038 Z222 |
| | 7772515 Z27 | 5 099 727 Z24 | 92 06 7204 Z356 |
| | 9 FY Z11 | 5 099 728 Z99 | 92 702 93 Z206 |
| | 9 FYSR Z20 | | 93 175 994 Z206 |
| | 9 FYSSR Z20 | | |

OE ? ⇌



| ...GENERAL MOTORS  | ...HONDA  | ...LANCIA  | MERCEDES-BENZ  |
|---|---|--|---|
| 93 180 485 Z287 | 98079-5714H Z323 | 60 512 848 Z29 | 000 159 10 03 Z11 |
| 93 193 723 Z333 | 9807B-5615P Z299 | 60 512 929 Z42 | 000 159 12 03 Z57 |
| GLAS  | 9807B-5615W Z297 | 60 597 490 Z29 | 000 159 15 03 Z41 |
| 103 Z26 | 9807-B5617W Z354 | 60 800 325 Z27 | 000 159 36 03 Z39 |
| 156 Z32 | 9807B-561BW Z275 | 60 810 689 Z130 | 000 159 43 03 Z10 |
| 273 Z48 | 9807B-561CW Z275 | 71 711 638 Z15 | 000 159 54 03 Z27 |
| 274 Z10 | HYUNDAI  | 71 711 639 Z27 | 000 159 65 03 Z10 |
| 275 Z10 | 17710-12930 Z312 | 71 711 640 Z20 | 000 159 68 03 Z11 |
| 284 Z19 | 18811-11061 Z9 | 71 711 806 Z20 | 000 159 71 03 Z38 |
| 33 Z33 | 18813-11051 Z311 | 75 444 44 Z20 | 000 159 72 03 Z10 |
| 34 Z32 | 18814-11051 Z73 | 75 444 45 Z48 | 000 159 74 03 Z38 |
| 35 Z32 | 18817-11051 Z228 | 75 465 19 Z15 | 000 159 79 03 Z57 |
| 393 Z58 | 18818-11051 Z311 | 75 544 36 Z27 | 000 159 94 03 Z27 |
| 394 Z58 | 18825-11101 Z311 | 75 654 76 Z38 | 000 159 98 03 Z38 |
| 397 Z58 | 18826-11101 Z228 | 77 603 81 Z27 | 000 162 94 01 Z6 |
| 404 Z8 | 18829 11050 Z158 | 77 603 82 Z20 | 000 162 94 01 Z7 |
| 413 Z39 | 18835-11161 Z311 | 77 603 83 Z15 | 001 158 88 03 Z42 |
| 414 Z57 | 1884610060 Z308 | 77 603 84 Z24 | 001 159 19 03 Z42 |
| 415 Z57 | 18854-09080 Z308 | 77 724 53 Z24 | 001 159 27 03 Z42 |
| 416 Z57 | 1885510060 Z308 | 9151700180 Z70 | 001 159 29 03 Z57 |
| 44 Z32 | JAGUAR  | 96 147 386 80 Z98 | 001 159 31 03 Z42 |
| 53 Z22 | EBL 11480 Z15 | 96 196 245 80 Z74 | 001 159 34 03 Z42 |
| 64 Z21 | EBL 2230 Z15 | 9628000280 Z14 | 001 159 45 03 Z42 |
| 646 Z8 | JEEP  | MAN  | 001 159 47 03 Z22 |
| 65 Z8 | 56027275 Z152 | 51 25923 0020 Z22 | 001 159 50 03 Z42 |
| 66 Z8 | KHD  | 51 25923 0022 Z22 | 001 159 51 03 Z22 |
| 745 Z32 | 345 9769 Z57 | 51 25923 0023 Z22 | 001 159 52 03 Z42 |
| 764 Z95 | 350 3132 Z57 | MAZDA  | 001 159 53 03 Z42 |
| 765 Z95 | 419 11680 Z57 | 1A02-18-110 Z234 | 001 159 55 03 Z42 |
| GMC  | KIA  | 3 953 18110 Z8 | 001 159 60 03 Z57 |
| 96 307 729 Z304 | 1882911050 Z158 | 8 914 18110 Z8 | 001 159 61 03 Z42 |
| 96 417 176 Z304 | 1884610060 Z308 | BP 01-18-110 Z73 | 001 159 62 03 Z42 |
| HANOMAG  | 1885409080 Z308 | BP 02-18-110 Z16 | 001 159 65 03 Z58 |
| 151 123 014 Z57 | 1885510060 Z308 | BP 03-18-110 Z16 | 001 159 68 03 Z22 |
| HANOMAG HENSCHEL  | LADA  | BP 04-18-110 Z16 | 001 159 69 03 Z42 |
| 151 123 014 Z57 | 2112-3707010 Z16 | C 401-18-110 Z177 | 001 159 71 03 Z22 |
| HOLDEN  | LANCIA  | C 402-18-110 A Z177 | 001 159 76 03 Z121 |
| 92 06 7204 Z356 | 2 284 662 Z22 | C 402-18-110A Z177 | 001 159 81 03 Z11 |
| HONDA  | 2 301 710 Z42 | F 20118101 Z158 | 001 159 82 03 Z11 |
| 12290-PNDA01 Z354 | 2 301 711 Z22 | F 220-18-110 Z16 | 001 159 84 03 Z22 |
| 12290-PNE004 Z299 | 4 170 472 Z42 | F 285 18110 Z158 | 001 159 84 04 Z42 |
| 98079-55846 Z20 | 4 172 173 Z42 | F 286 18110 Z158 | 001 159 85 03 Z22 |
| 98079-55871 Z20 | 4 233 922 Z22 | F 287 18110 Z158 | 001 159 87 03 Z42 |
| 98079-55881 Z20 | 4 249 164 Z22 | F 288 18110 Z158 | 001 159 88 03 Z42 |
| 98079-55946 Z20 | 4 345 040 Z22 | JE 41 18 110 Z228 | 001 159 89 03 Z42 |
| 98079-56148 Z99 | 4 345 041 Z22 | KJ 14 18 110 Z229 | 001 159 93 03 Z42 |
| 98079-561-4E Z158 | 46 229 251 Z11 | L 303 18 110 Z298 | 001 159 94 03 Z22 |
| 98079-561-4G Z158 | 58 945 85 Z27 | L3G2-18-110 Z310 | 001 159 95 03 Z11 |
| 98079-561-4P Z158 | 58 945 86 Z24 | L3Y 2-18-110 Z342 | 001 635 400 Z17 |
| 98079-56832 Z20 | 58 945 87 Z20 | L3Y1-18-110 Z310 | 001 690 400 Z25 |
| 98079-56846 Z20 | 58 961 77 Z98 | L813 18 110 Z230 | 002 159 04 03 Z1 |
| 98079-56846-02 Z20 | 59 840 36 Z20 | LFG 18-110 Z342 | 002 159 05 03 Z1 |
| 98079-56946 Z20 | 60 504 563 Z42 | LFG 18-110 Z342 | 002 159 06 03 Z1 |
| 98079-571 BH Z323 | | LFG 18-110 Z342 | 002 159 07 03 Z1 |
| | | SKIT BKG 12020 Z342 | 002 159 08 03 Z22 |
| | | SKIT BKG 18020 Z342 | 002 159 09 03 Z22 |
| | | SKIT GG1 00F3 Z342 | 002 159 10 03 Z11 |
| | | SKIT GG2 00F0 Z342 | 002 159 11 03 Z11 |
| | | SKIT GG2 00F3 Z342 | 002 159 14 03 Z22 |
| | | SKIT GG3 100F0 Z342 | 002 159 15 03 Z22 |
| | | ZJ46-18-110 Z307 | 002 159 16 03 Z1 |
| | | ZJY6-18-110 Z307 | 002 159 17 03 Z1 |
| | | | 002 159 18 03 Z42 |
| | | | 002 159 19 03 Z11 |
| | | | 002 159 20 03 Z11 |
| | | | 002 159 21 03 Z11 |
| | | | 002 159 24 03 Z11 |

OE ? ⇌



| ...OPEL | | ...PEUGEOT | | ...PEUGEOT | | ...PORSCHE | |
|----------------|------|------------|------|----------------|------|----------------|------|
| 12 14 112 | Z27 | 5960.83 | Z243 | 5962 72 | Z17 | 999 170 056 90 | Z42 |
| 12 14 119 | Z27 | 5961 07 | Z39 | 5962 7E | Z211 | 999 170 060 90 | Z38 |
| 12 14 122 | Z27 | 5961 08 | Z57 | 5962 7R | Z193 | 999 170 068 90 | Z38 |
| 12 14 123 | Z112 | 5961 09 | Z57 | 5962 7W | Z184 | 999 170 103 90 | Z185 |
| 12 14 132 | Z27 | 5961 10 | Z39 | 5962 87 | Z25 | 999 170 111 90 | Z42 |
| 12 14 139 | Z20 | 5961 12 | Z58 | 5962 8A | Z211 | 999 170 116 90 | Z38 |
| 12 14 144 | Z15 | 5961 15 | Z58 | 5962 A 2 | Z1 | 999 170 119 90 | Z11 |
| 12 14 145 | Z158 | 5961 19 | Z11 | 5962 A0 | Z42 | 999 170 126 90 | Z11 |
| 12 14 148 | Z16 | 5961 20 | Z42 | 5962 A1 | Z22 | 999 170 132 90 | Z1 |
| 12 14 149 | Z119 | 5961 23 | Z58 | 5962 A3 | Z10 | 999 170 133 90 | Z1 |
| 12 14 193 | Z20 | 5961 26 | Z42 | 5962 A4 | Z11 | 999 170 135 90 | Z42 |
| 12 14 455 | Z74 | 5961 27 | Z22 | 5962 C0 | Z17 | 999 170 136 90 | Z1 |
| 12 14 462 | Z343 | 5961 28 | Z38 | 5962 C1 | Z26 | 999 170 138 90 | Z22 |
| 12 14 527 | Z235 | 5961 29 | Z42 | 5962 C2 | Z26 | 999 170 139 90 | Z22 |
| 12 14 528 | Z346 | 5961 30 | Z25 | 5962 C5 | Z24 | 999 170 140 90 | Z38 |
| 12 14 702 | Z27 | 5961 33 | Z25 | 5962 C8 | Z29 | 999 170 141 90 | Z20 |
| 12 14 802 | Z27 | 5961 41 | Z42 | 5962 E2 | Z100 | 999 170 142 90 | Z20 |
| 12 14 803 | Z21 | 5961 42 | Z42 | 5962 F6 | Z24 | 999 170 146 90 | Z11 |
| 12 14 804 | Z15 | 5961 43 | Z22 | 5962 F8 | Z63 | 999 170 148 90 | Z11 |
| 12 14 805 | Z19 | 5961 44 | Z25 | 5962 H1 | Z31 | 999 170 150 90 | Z38 |
| 12 14 806 | Z27 | 5961 47 | Z11 | 5962 H2 | Z13 | 999 170 156 90 | Z20 |
| 12 14 807 | Z20 | 5961 48 | Z42 | 5962 H3 | Z29 | 999 170 158 90 | Z20 |
| 12 59 746 4 | Z342 | 5961 49 | Z25 | 5962 H7 | Z60 | 999 170 162 90 | Z38 |
| 12 78 888 4 | Z235 | 5961 50 | Z31 | 5962 H8 | Z255 | 999 170 165 90 | Z42 |
| 44 08 937 | Z337 | 5961 52 | Z25 | 5962 H9 | Z15 | 999 170 167 90 | Z48 |
| 44 10 220 | Z337 | 5961 60 | Z31 | 5962 J1 | Z72 | 999 170 168 90 | Z22 |
| 44 13 288 | Z337 | 5961 92 | Z31 | 5962 K0 | Z15 | 999 170 170 90 | Z1 |
| 44 32 200 | Z337 | 5961 93 | Z11 | 5962 K1 | Z24 | 999 170 182 90 | Z45 |
| 47 08 892 | Z333 | 5961 96 | Z11 | 5962 K4 | Z15 | 999 170 183 90 | Z45 |
| 48 05 484 | Z356 | 5962 05 | Z17 | 5962 K7 | Z60 | 999 170 195 90 | Z116 |
| 55 350 481 | Z190 | 5962 07 | Z25 | 5962 R5 | Z60 | 999 170 201 90 | Z98 |
| 55 564 763 | Z346 | 5962 09 | Z25 | 7401 269 280 | Z31 | 999 170 207 91 | Z129 |
| 90 350 018 | Z20 | 5962 11 | Z11 | 7401 269 915 | Z26 | 999 170 210 90 | Z192 |
| 90 359 815 | Z8 | 5962 13 | Z11 | 7910 026 903 | Z25 | 999 170 216 90 | Z192 |
| 90 444 723 | Z74 | 5962 14 | Z31 | 9151 400 080 | Z11 | 999 170 218 90 | Z129 |
| 91 160 172 | Z337 | 5962 15 | Z25 | 9151 700 080 | Z11 | 999 170 219 90 | Z129 |
| 91 463 69 | Z74 | 5962 16 | Z22 | 9151 700 380 | Z17 | 999 170 220 90 | Z116 |
| 91 95 868 | Z173 | 5962 19 | Z11 | 9151 700 680 | Z17 | 999 170 221 90 | Z185 |
| 92 063 303 | Z343 | 5962 21 | Z12 | 9151 700 980 | Z25 | 999 170 229 90 | Z277 |
| 93 160 201 | Z337 | 5962 2T | Z123 | 9151 701 280 | Z25 | 999 170 229 90 | Z277 |
| 93 161 199 | Z337 | 5962 30 | Z25 | 9151 873 580 | Z12 | 99917000290 | Z41 |
| 93 161 947 | Z337 | 5962 31 | Z25 | 9151 944 680 | Z17 | | |
| 93 175 880 | Z190 | 5962 36 | Z25 | 9151873580 | Z12 | PUCH | |
| 93 175 935 | Z190 | 5962 37 | Z25 | 9152 106 780 | Z11 | 905 0714 | Z1 |
| 93 176 801 | Z203 | 5962 44 | Z42 | 9561 837 880 | Z22 | | |
| 93 190 948 | Z177 | 5962 45 | Z22 | AOP | Z22 | | |
| 97 125 696 | Z228 | 5962 46 | Z25 | CC 10 | Z17 | RENAULT | |
| 97 125 969 | Z343 | 5962 47 | Z17 | CC 8 | Z25 | 08 51 798 700 | Z57 |
| 97 170 268 | Z343 | 5962 48 | Z17 | CP 10 | Z11 | 08 51 798 800 | Z48 |
| | | 5962 49 | Z25 | Super 14-7 | Z57 | 08 54 407 100 | Z57 |
| PEUGEOT | | 5962 50 | Z25 | Super 14-8 | Z39 | 08 54 864 700 | Z57 |
| 0 269 03 | Z25 | 5962 51 | Z11 | Super 14-9 | Z39 | 08 55 800 600 | Z58 |
| 1105 693 600 | Z57 | 5962 52 | Z11 | XC 6 | Z25 | 08 55 836 400 | Z10 |
| 5960 16 | Z184 | 5962 57 | Z31 | | | 08 55 836 500 | Z10 |
| 5960 17. | Z183 | 5962 58 | Z57 | PORSCHE | | 08 55 939 100 | Z58 |
| 5960 18 | Z123 | 5962 59 | Z31 | 905 071 4 | Z1 | 60 00 007 570 | Z31 |
| 5960 90 | Z184 | 5962 5M | Z183 | 928 094 602 03 | Z11 | 60 01 040 356 | Z60 |
| 5960 91 | Z184 | 5962 60 | Z11 | 999 020 802 10 | Z57 | 60 01 040 357 | Z60 |
| 5960 E1 | Z288 | 5962 61 | Z25 | 999 170 007 90 | Z38 | 60 01 040 543 | Z7 |
| 5960 E2 | Z288 | 5962 63 | Z31 | 999 170 014 90 | Z38 | 60 01 544 293 | Z15 |
| 5960 K9 | Z318 | 5962 65 | Z22 | 999 170 023 90 | Z40 | 73 10 012 998 | Z25 |
| 5960 L3 | Z320 | 5962 67 | Z57 | 999 170 044 90 | Z38 | 74 33 517 980 | Z15 |
| 5960.02 | Z242 | 5962 68 | Z17 | 999 170 050 90 | Z42 | 74 39 146 775 | Z60 |
| 5960.15 | Z193 | 5962 69 | Z25 | 999 170 051 90 | Z42 | 77 00 100 403 | Z257 |
| 5960.53 | Z223 | 5962 6K | Z193 | 999 170 052 90 | Z42 | 77 00 101 401 | Z15 |
| 5960.75 | Z223 | 5962 70 | Z11 | 999 170 055 90 | Z42 | 77 00 103 502 | Z119 |
| | | 5962 71 | Z13 | | | 77 00 103 503 | Z119 |

OE ? ⇌





| ...VAG | | ...VAG | | ...VOLVO | | ...VOLVO | |
|--------------|-----|-----------------|------|-------------|------|----------------|------|
| N 017 811 63 | Z76 | N 017 813 26 | Z11 | 000057023 A | Z22 | 8642660 | Z204 |
| N 017 811 64 | Z12 | N 017 813 3 | Z58 | 1269280 | Z31 | 8642661 | Z204 |
| N 017 811 65 | Z2 | N 017 813 30 | Z22 | 1269915 | Z26 | 8670057 | Z206 |
| N 017 811 66 | Z11 | N 017 813 32 | Z42 | 1276056 | Z11 | 8692070 | Z206 |
| N 017 811 67 | Z44 | N 017 813 39 | Z42 | 1276057 | Z42 | 9146775 | Z204 |
| N 017 811 68 | Z12 | N 017 813 40 | Z11 | 1276058 | Z42 | RF 80 H3 | Z204 |
| N 017 811 69 | Z44 | N 017 813 42 | Z11 | 1276514 | Z22 | X 9146775 | Z204 |
| N 017 811 70 | Z58 | N 017 813 43 | Z42 | 1306604 | Z22 | | |
| N 017 811 71 | Z42 | N 017 813 45 | Z44 | 1306605 | Z11 | | |
| N 017 811 72 | Z12 | N 017 813 46 | Z51 | 1346541 | Z20 | | |
| N 017 811 73 | Z51 | N 017 813 47 | Z12 | 1357828 | Z10 | | |
| N 017 811 74 | Z51 | N 017 813 50 | Z12 | 135827 | Z48 | | |
| N 017 811 75 | Z1 | N 017 813 53 | Z42 | 1367528 | Z20 | | |
| N 017 811 76 | Z42 | N 017 813 54 | Z22 | 1367529 | Z27 | | |
| N 017 811 77 | Z22 | N 017 813 6 | Z22 | 1457826 | Z41 | | |
| N 017 811 78 | Z61 | N 017 813 7 | Z22 | 1467015 | Z27 | | |
| N 017 811 8 | Z58 | N 017 813 8 | Z42 | 2301710 | Z42 | | |
| N 017 812 1 | Z58 | N 017 813 9 | Z22 | 238624 | Z39 | | |
| N 017 812 11 | Z38 | N 017 821 1 | Z11 | 238808 | Z39 | | |
| N 017 812 12 | Z22 | N 017 832 1 | Z42 | 239446 | Z57 | | |
| N 017 812 13 | Z22 | N 017 832 2 | Z42 | 241402 | Z48 | | |
| N 017 812 15 | Z58 | N 100 807 02 | Z52 | 241627 | Z41 | | |
| N 017 812 18 | Z42 | N 100 807 1 | Z52 | 241946 | Z10 | | |
| N 017 812 19 | Z11 | N 101 172 01 | Z52 | 245703 | Z25 | | |
| N 017 812 20 | Z22 | Z 057 003 | Z57 | 246106 | Z25 | | |
| N 017 812 21 | Z42 | Z 057 004 | Z58 | 269465 | Z31 | | |
| N 017 812 22 | Z58 | Z 057 005 | Z1 | 270746-1 | Z20 | | |
| N 017 812 23 | Z22 | Z 057 008 | Z58 | 271239 | Z279 | | |
| N 017 812 24 | Z1 | Z 057 011 | Z11 | 271239-6 | Z279 | | |
| N 017 812 25 | Z58 | Z 057 012 | Z42 | 271409 | Z20 | | |
| N 017 812 27 | Z11 | Z 057 020 | Z52 | 271410 | Z41 | | |
| N 017 812 30 | Z11 | Z 057 023 | Z22 | 271411 | Z48 | | |
| N 017 812 34 | Z1 | Z 057 037 | Z58 | 271412 | Z10 | | |
| N 017 812 35 | Z42 | Z 057 040 | Z22 | 271636-3 | Z15 | | |
| N 017 812 36 | Z11 | Z 057 047 | Z108 | 271727-0 | Z16 | | |
| N 017 812 37 | Z22 | Z 057 056 | Z11 | 272207 | Z204 | | |
| N 017 812 39 | Z42 | Z 057 057 | Z58 | 272344 | Z206 | | |
| N 017 812 4 | Z22 | Z 057 058 | Z42 | 272371 | Z204 | | |
| N 017 812 40 | Z22 | Z 057 059 | Z58 | 273525 | Z10 | | |
| N 017 812 41 | Z1 | Z 057 060 | Z57 | 273546 | Z22 | | |
| N 017 812 44 | Z42 | Z 057 062 | Z22 | 273558 | Z10 | | |
| N 017 812 46 | Z12 | Z 057 064 | Z57 | 273579 | Z31 | | |
| N 017 812 47 | Z44 | Z 057 065 | Z58 | 273591 | Z22 | | |
| N 017 812 48 | Z51 | Z 057 066 | Z44 | 273596 | Z22 | | |
| N 017 812 49 | Z12 | Z 057 067 | Z51 | 273599 | Z25 | | |
| N 017 812 50 | Z2 | Z 057 068 | Z12 | 30637385 | Z294 | | |
| N 017 812 51 | Z44 | Z 057 069 | Z2 | 30650379 | Z326 | | |
| N 017 812 52 | Z12 | Z 057 073 | Z52 | 30650843 | Z294 | | |
| N 017 812 56 | Z2 | Z 057 127 | Z1 | 30731425 | Z177 | | |
| N 017 812 58 | Z61 | Z 057 136 | Z1 | 30731877 | Z177 | | |
| N 017 812 6 | Z42 | Z 057 140 | Z42 | 30735760 | Z177 | | |
| N 017 812 60 | Z42 | Z 057 141 | Z22 | 3104124 | Z57 | | |
| N 017 812 7 | Z12 | Z 057 142 | Z61 | 3104530 | Z10 | | |
| N 017 812 9 | Z42 | Z 057 173 | Z105 | 3344898-6 | Z20 | | |
| N 017 813 1 | Z58 | | | 3551943 | Z39 | | |
| N 017 813 10 | Z22 | | | 3551945 | Z39 | | |
| N 017 813 11 | Z1 | | | 3551946 | Z39 | | |
| N 017 813 12 | Z22 | | | 3576753 | Z41 | | |
| N 017 813 13 | Z22 | | | 3576846 | Z10 | | |
| N 017 813 14 | Z58 | | | 460540 | Z41 | | |
| N 017 813 15 | Z58 | | | 463511 | Z11 | | |
| N 017 813 16 | Z42 | | | 463512 | Z22 | | |
| N 017 813 17 | Z42 | | | 463513 | Z42 | | |
| N 017 813 18 | Z22 | | | 570306 | Z57 | | |
| N 017 813 19 | Z11 | | | 570334 | Z39 | | |
| N 017 813 20 | Z11 | | | 7072153 | Z57 | | |
| N 017 813 24 | Z22 | | | 72153 | Z57 | | |
| | | VAUXHALL | | | | | |
| | | 90 509 739 | Z98 | | | | |
| | | 92 06 7204 | Z356 | | | | |
| | | 93 175 935 | Z190 | | | | |
| | | VOLVO | | | | | |
| | | 000057007 | Z58 | | | | |
| | | 000057011 | Z11 | | | | |
| | | 000057015 | Z57 | | | | |
| | | 000057022 | Z22 | | | | |
| | | | | | | VW | |
| | | | | | | 06H 905 601 A | Z347 |
| | | | | | | 06H 905 611 | Z347 |
| | | | | | | 06H 905 621 | Z347 |
| | | | | | | 06K 905 601 B | Z348 |
| | | | | | | 06K 905 611 C | Z348 |
| | | | | | | 06K 905 621 | Z348 |
| | | | | | | 079 905 626 B | Z339 |
| | | | | | | 079 905 626 D | Z345 |
| | | | | | | 079 905 626 E | Z339 |
| | | | | | | 079 905 626 G | Z345 |
| | | | | | | 101 000 005 AF | Z78 |
| | | | | | | 101 000 009 AA | Z58 |
| | | | | | | 101 000 012 AA | Z58 |
| | | | | | | 101 000 015 AA | Z18 |
| | | | | | | 101 000 015 AB | Z56 |
| | | | | | | 101 000 016 AA | Z317 |
| | | | | | | 101 000 033 AC | Z246 |
| | | | | | | 101 000 035 AH | Z173 |
| | | | | | | 101 000 035 HJ | Z145 |
| | | | | | | 101 000 036 AB | Z92 |
| | | | | | | 101 000 036 AC | Z93 |
| | | | | | | 101 000 038 AB | Z94 |
| | | | | | | 101 000 039 AB | Z94 |
| | | | | | | 101 000 040 AC | Z92 |
| | | | | | | 101 000 040 AE | Z93 |
| | | | | | | 101 000 041 AF | Z246 |
| | | | | | | 101 000 050 AA | Z92 |
| | | | | | | 101 000 050 AB | Z92 |
| | | | | | | 101 000 062 AB | Z176 |
| | | | | | | 101 000 063 AC | Z317 |
| | | | | | | 101 000 068 AA | Z300 |
| | | | | | | 101 905 600 | Z176 |
| | | | | | | 101 905 600 A | Z176 |
| | | | | | | 101 905 600 C | Z176 |
| | | | | | | 101 905 601 | Z176 |
| | | | | | | 101 905 601 B | Z200 |
| | | | | | | 101 905 603 B | Z200 |
| | | | | | | 101 905 606 | Z306 |
| | | | | | | 101 905 606 A | Z306 |
| | | | | | | 101 905 607 | Z213 |
| | | | | | | 101 905 609 | Z344 |
| | | | | | | 101 905 615 A | Z239 |
| | | | | | | 101 905 616 | Z239 |
| | | | | | | 101 905 617 | Z200 |
| | | | | | | 101 905 626 | Z349 |
| | | | | | | 101 905 631 | Z347 |
| | | | | | | 101 905 631 B | Z347 |
| | | | | | | 101 905 631 F | Z321 |
| | | | | | | 101 905 631 H | Z347 |
| | | | | | | 101 905 641 | Z339 |
| | | | | | | N 017 813 33 | Z11 |
| | | | | | | N 101 251 05 | Z18 |
| | | | | | | Z 057 145 | Z18 |

OE ? ⇒

| ALFA ROMEO  | |
|--|-------|
| 116 975 607 900 | ZM037 |
| 116976507900 | ZM001 |
| 116976507901 | ZM001 |
| 195 360 507 902 | ZM037 |
| 542162000000 | ZM001 |
| 605 133 190 | ZM037 |
| 605 722 910 | ZM035 |
| 605042880 | ZM001 |
| 605229970 | ZM001 |

| AUSTIN  | |
|--|-------|
| BAU 5100 | ZM047 |
| BAU 5332 | ZM001 |
| BAU 5538 | ZM047 |
| RTC 5089 | ZM047 |

| BMW  | |
|---|-------|
| 12 14 1 244 477 | ZM002 |
| 12 14 1 244 478 | ZM002 |
| 12 14 1 287 757 | ZM038 |
| 12 14 1 705 607 | ZM038 |
| 12 14 1 705 608 | ZM038 |
| 12 14 1 706 439 | ZM038 |
| 12 14 1244 089 | ZM002 |
| 12 14 1244 191 | ZM002 |
| 12 14 1244 226 | ZM002 |
| 12 14 1244 481 | ZM002 |
| 12 14 1266 702 | ZM001 |
| 12 14 1273 217 | ZM001 |
| 12 14 1273 298 | ZM001 |
| 12 14 1274 698 | ZM001 |
| 12 14 1461 441 | ZM026 |

| CHRYSLER  | |
|--|-------|
| A50633880 | ZM001 |
| MD 112479 | ZM049 |
| MD 164475 | ZM049 |

| CITROËN  | |
|---|-------|
| 592790 | ZM001 |
| 594502 | ZM001 |
| 594545 | ZM003 |
| 594555 | ZM003 |
| 594560 | ZM001 |
| 79 1 003 510 0 | ZM001 |
| 91 5 049 128 0 | ZM001 |
| 91 5 049 448 0 | ZM001 |
| 91 5 063 388 0 | ZM001 |
| 91504912 | ZM001 |
| 94531304 | ZM003 |
| 9453130480 | ZM003 |
| 9607361280 | ZM026 |
| 97 5 228 758 0 | ZM001 |
| 97 5 301 258 0 | ZM001 |
| 97 522 876 | ZM001 |
| 97 530 125 | ZM001 |
| 97 531 304 80 | ZM003 |
| 97531304 | ZM003 |
| 97532831 | ZM001 |
| 97533831 | ZM001 |
| N594503 | ZM001 |

| DAF  | |
|---|-------|
| 285230 | ZM039 |
| 34333468 | ZM033 |
| 3501921 | ZM040 |
| 3501921-5 | ZM040 |
| 3501922 | ZM039 |

| FIAT  | |
|--|-------|
| 4419628 | ZM005 |
| 60 51 3319 | ZM037 |
| 60504288 | ZM001 |
| 60572291 | ZM035 |
| 60590028 | ZM001 |
| 60590029 | ZM001 |
| 60755012 | ZM003 |
| 60755094 | ZM003 |
| 7612955 | ZM040 |
| 82369531 | ZM005 |
| 9 942 040 | ZM017 |
| 9612955 | ZM040 |
| 975301258 | ZM001 |
| 9940095 | ZM009 |

| FORD  | |
|--|-------|
| 1629456 | ZM019 |
| 6086506 | ZM008 |
| 6135656 | ZM008 |
| 6153380 | ZM020 |
| 6153451 | ZM003 |
| 6159437 | ZM003 |
| 81SF12K059AB | ZM008 |
| 81SF12KA059AB | ZM008 |
| 83SF12K059AA | ZM008 |
| 84SF12K057AA | ZM020 |
| 84SF12K059AA | ZM020 |
| 84SF12K067BA | ZM003 |
| 86BF12K062A | ZM003 |
| 86BF12K062AA | ZM003 |
| 98VW 12A223 AA | ZM062 |
| B3124Q03A | ZM022 |
| E2FS12A297B | ZM043 |
| E3EF12A297A1A | ZM019 |
| E3EF12A297A2A | ZM019 |
| E43Z12A297A | ZM019 |
| E43Z12Z297A | ZM019 |
| E5RF12A297BA | ZM019 |
| E6EF12A297AA | ZM019 |
| E8FZ12A297A | ZM019 |
| E92Z12A297A | ZM024 |
| E9Z12A297A | ZM024 |
| ESFZ12Z297 | ZM043 |
| F02Z12A297A | ZM024 |
| F02Z12A297B | ZM048 |
| F3XY12A297A | ZM048 |
| F3XY12D072A | ZM048 |
| F3XY12K072A | ZM048 |
| F0BZ12A297A | ZM050 |

| GENERAL MOTORS  | |
|--|-------|
| 10482825 | ZM007 |
| 1976 908 | ZM043 |
| 1977 907 | ZM043 |
| 1977 958 | ZM016 |
| 1978 617 | ZM043 |
| 1979 107 | ZM016 |

| ...GENERAL MOTORS  | |
|---|-------|
| 1979 571 | ZM016 |
| 1985703 | ZM007 |
| 1987 744 | ZM043 |
| 90 241 775 | ZM034 |
| 90 273 966 | ZM032 |
| 90 274 682 | ZM032 |
| 90 279 786 | ZM034 |
| 90 295 498 | ZM001 |
| 90 295 499 | ZM001 |
| 90 296 502 | ZM034 |
| 90 297 486 | ZM034 |
| 90 297 786 | ZM034 |
| 90 320 586 | ZM034 |
| 90 350 987 | ZM034 |
| 90 414 405 | ZM001 |
| 90006145 | ZM002 |
| 90008145 | ZM002 |
| 90056698 | ZM002 |
| 90062964 | ZM002 |
| 90114676 | ZM002 |
| 90140187 | ZM002 |
| 90187341 | ZM002 |
| 90243618 | ZM018 |
| 90243618 | ZM041 |
| 90243630 | ZM041 |
| 90360314 | ZM018 |
| 90360314 | ZM041 |
| 90360315 | ZM018 |
| 90360315 | ZM041 |
| 9404544 | ZM057 |
| 94243344 | ZM046 |
| 94840126 | ZM058 |

| GEO  | |
|---|-------|
| 96056317 | ZM049 |
| 96065317 | ZM049 |
| 96067829 | ZM049 |

| HONDA  | |
|---|-------|
| 06302PT2-000 | ZM023 |
| 06302PT2-A00 | ZM023 |
| 30120 PA 6921 | ZM056 |
| 30120 PB 1006 | ZM056 |
| 30120 PH 7006 | ZM056 |
| 30120 PJ 7003 | ZM056 |
| 30120-PA-921 | ZM059 |
| 30120-PA0-661 | ZM046 |
| 30120-PH0-661 | ZM046 |
| 30120-PH4-005 | ZM046 |
| 30120PMS-A01 | ZM023 |
| 30120PMA01 | ZM023 |
| 30120PR3-003 | ZM023 |
| 30130-P06-006 | ZM045 |
| 30550 PH 3004 | ZM055 |
| 30550689-003 | ZM054 |
| 30550692-004 | ZM054 |
| 30550-692-014 | ZM054 |
| 30550-692-2014 | ZM054 |

| HYUNDAI  | |
|---|-------|
| 27120-21020 | ZM053 |
| 27120-21050 | ZM053 |
| 27360-22010 | ZM035 |
| 27360-32800 | ZM049 |

| ...HYUNDAI  | |
|--|-------|
| 96056317 | ZM049 |
| 96067829 | ZM049 |

| ISUZU  | |
|---|-------|
| 8942433440 | ZM046 |
| 8-94404-544-0 | ZM057 |

| IVECO  | |
|---|-------|
| 4419628 | ZM005 |
| 7612955 | ZM040 |
| 975301258 | ZM001 |

| KHD  | |
|---|-------|
| 415 4913 | ZM039 |

| LADA  | |
|--|-------|
| 2108 3734910-10 | ZM039 |
| 2108 3734910-10 | ZM010 |
| 2108 3734910-80 | ZM010 |
| 363 734 | ZM039 |

| LANCIA  | |
|--|-------|
| 4419628 | ZM005 |
| 60 513 319 | ZM037 |
| 60504288 | ZM001 |
| 60572291 | ZM035 |
| 60590028 | ZM001 |
| 60590029 | ZM001 |
| 60755012 | ZM003 |
| 60755094 | ZM003 |
| 7612955 | ZM040 |
| 82369531 | ZM005 |
| 9612955 | ZM040 |
| 9940095 | ZM009 |

| MAZDA  | |
|---|-------|
| 58 57 42 49 10 | ZM022 |
| 8174 24 910 | ZM022 |
| 8574 24 910 | ZM022 |
| AM 15-18-V20 | ZM053 |
| B541-18-V20 | ZM025 |
| BP 01 18251 | ZM050 |
| E 730-12-491-0 | ZM053 |
| F 829-18-V20 | ZM024 |

| MERCEDES-BENZ  | |
|---|-------|
| 001 545 86 32 | ZM004 |
| 002 545 18 32 | ZM004 |
| 002 545 58 32 | ZM004 |
| 002 545 59 32 | ZM004 |
| 002 545 90 32 | ZM004 |
| 003 545 16 32 | ZM004 |
| 003 545 40 32 | ZM004 |
| A 001 545 86 32 | ZM004 |
| A 002 545 18 32 | ZM004 |
| A 002 545 58 32 | ZM004 |
| A 002 545 59 32 | ZM004 |
| A 002 545 90 32 | ZM004 |
| A 003 545 16 32 | ZM004 |
| A 003 545 17 32 | ZM004 |

OE ? ⇌

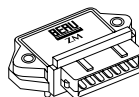

| | | | | | | | |
|-------------------|-------|----------------|-------|---------------|-------|---------------|-------|
| MITSUBISHI | | ...OPEL | | ROVER | | VAG | |
| 112955 | ZM049 | 12 08 241 | ZM002 | BAU 5100 | ZM047 | 115 915 080 | ZM060 |
| 132243 | ZM049 | 12 08 243 | ZM015 | BAU 5538 | ZM047 | 191 905 351 A | ZM012 |
| 2371771 | ZM049 | 12 08 246 | ZM002 | BNP 3661 | ZM054 | 191 905 351 B | ZM012 |
| 5201 A | ZM052 | 12 08 247 | ZM032 | CKP 7061 | ZM054 | 191 905 351 C | ZM012 |
| CY-GS 065A | ZM057 | 12 08 248 | ZM001 | RTC 5089 | ZM047 | 211 905 351 | ZM002 |
| EJN 902 | ZM053 | 12 08 56 | ZM001 | | | 211 905 351 A | ZM002 |
| J 007X03471 | ZM052 | 12 11 560 | ZM006 | | | 211 905 351 B | ZM002 |
| J 152 | ZM053 | 12 11 561 | ZM007 | SAAB | | 211 905 351 D | ZM002 |
| J 304 | ZM052 | 12 11 582 | ZM016 | 75 38 796 | ZM029 | 211 905 351 E | ZM002 |
| J007X00871 | ZM024 | 12 11 591 | ZM016 | 750 3600 | ZM015 | 440 905 105 | ZM031 |
| J007X00971 | ZM049 | 12 37 306 | ZM034 | 857 3826 | ZM002 | 443 905 105 B | ZM031 |
| J007X01271 | ZM049 | 12 37 334 | ZM041 | 898 0534 | ZM012 | 443 905 105 C | ZM031 |
| J009T02071 | ZM049 | 12 37 464 | ZM018 | 939 0220 | ZM002 | 4A0 905 351 | ZM027 |
| J117 | ZM024 | 12 37 464 | ZM041 | | | 4A0 905 351 A | ZM063 |
| J120 | ZM025 | 12 37 504 | ZM016 | SCANIA | | 4D0 905 351 | ZM062 |
| J121 | ZM049 | 16 05 130 | ZM043 | 257 3826 | ZM002 | 4D0 997 351 | ZM062 |
| J131 | ZM048 | 18 759 90 | ZM005 | 7503600 | ZM015 | 535 905 115 | ZM036 |
| J153 | ZM051 | 62 37 777 | ZM041 | | | 867 905 351 | ZM014 |
| J170 | ZM025 | 6237752 | ZM006 | SEAT | | 8D0 905 351 | ZM028 |
| J170-9910A | ZM025 | 6237754 | ZM007 | 3939219 | ZM001 | | |
| J701 | ZM050 | 83 093 1 | ZM005 | 3980641 | ZM001 | VOLVO | |
| J9T03372 | ZM049 | 90 241 775 | ZM034 | XO 339678.30 | ZM015 | 1 298 429 | ZM001 |
| MD 112479 | ZM049 | 90 296 502 | ZM034 | XO 394160.00 | ZM002 | 1 317 809 | ZM002 |
| MD 129550 | ZM049 | 90 297 486 | ZM034 | XO 396783.60 | ZM002 | 1 332 584 | ZM015 |
| MD 1312243 | ZM049 | 90 297 786 | ZM034 | | | 1 367 777 | ZM036 |
| MD 164475 | ZM049 | 90 320 586 | ZM034 | SKODA | | 1 389 939 | ZM002 |
| MD 607478 | ZM022 | 90 350 787 | ZM034 | 115 915 080 | ZM060 | 1317820 | ZM001 |
| MD 607814 | ZM053 | 90006499 | ZM015 | | | 285230 | ZM039 |
| MD 611384 | ZM053 | 90062964 | ZM015 | SUBARU | | 3 501 922 | ZM039 |
| MD 618268 | ZM049 | 90187341 | ZM002 | 49146-7401 | ZM046 | 3 507 934 | ZM036 |
| MD 618293 | ZM051 | 90188755 | ZM015 | | | 3433338 | ZM033 |
| | | 90444650 | ZM026 | SUZUKI | | 3460220 | ZM033 |
| | | | | 33370641311 | ZM049 | 3501921 | ZM040 |
| NISSAN | | PEUGEOT | | 3337064811 | ZM049 | 3501921-5 | ZM040 |
| 22020-0B000 | ZM048 | 5927.90 | ZM001 | | | 433346 | ZM033 |
| 22020-15M00 | ZM046 | 5945.02 | ZM001 | TALBOT | | 460220 | ZM033 |
| 22020-15M20 | ZM046 | 5945.03 | ZM001 | 9150491280 | ZM001 | | |
| 22020-53J10 | ZM048 | 5945.03 | ZM001 | 9150633880 | ZM001 | VW | |
| 22020-53J20 | ZM048 | 5945.24 | ZM001 | A50633880 | ZM001 | 867 905 352 | ZM013 |
| 22020-55Y00 | ZM048 | 5945.25 | ZM001 | | | | |
| 22020-56E11 | ZM048 | 5945.31 | ZM001 | TOYOTA | | | |
| 22020-56E16 | ZM048 | 5945.33 | ZM001 | 78512-12310 | ZM058 | | |
| 22020-56E17 | ZM048 | 5945.39 | ZM001 | 89612-12310 | ZM058 | | |
| 22020-70J00 | ZM048 | 5945.48 | ZM001 | 89612-12320 | ZM058 | | |
| 22020-71J00 | ZM048 | 5945.51 | ZM015 | 89612-16080 | ZM058 | | |
| 22020-D0210 | ZM052 | 5945.54 | ZM026 | 89620-10090 | ZM057 | | |
| 22020-P4005 | ZM046 | 5945.60 | ZM001 | 89620-10120 | ZM057 | | |
| PRW1A | ZM048 | 7910035100 | ZM001 | 89620-10290 | ZM058 | | |
| PRW2 | ZM048 | 91504912 | ZM001 | 89620-12290 | ZM058 | | |
| PRW2A | ZM048 | 9150494480 | ZM001 | 89620-12310 | ZM058 | | |
| PRW3 | ZM048 | 9150633880 | ZM001 | 89620-12320 | ZM058 | | |
| | | 94048070 | ZM015 | 89620-12340 | ZM057 | | |
| | | 97532831 | ZM001 | 89620-14210 | ZM059 | | |
| OPEL | | PORSCHE | | 89620-16070 | ZM057 | | |
| 12 08 033 | ZM002 | 928 602 70601 | ZM015 | 89620-16080 | ZM058 | | |
| 12 08 033 | ZM015 | 993 602 706 00 | ZM026 | 89620-26080 | ZM058 | | |
| 12 08 037 | ZM002 | 993 602 706 01 | ZM026 | 89620-32020 | ZM059 | | |
| 12 08 040 | ZM032 | | | L1305046 | ZM059 | | |
| 12 08 040 | ZM034 | | | | | | |
| 12 08 043 | ZM001 | RENAULT | | | | | |
| 12 08 045 | ZM034 | 7401269084 | ZM002 | | | | |
| 12 08 049 | ZM001 | 77 01 021 955 | ZM005 | | | | |
| 12 08 050 | ZM001 | | | | | | |
| 12 08 055 | ZM001 | | | | | | |
| 12 08 056 | ZM015 | | | | | | |
| 12 08 057 | ZM034 | | | | | | |
| 12 08 074 | ZM026 | | | | | | |

TECHNICAL NOTES

EN

| | | |
|--|--|--|
| [1] Product installed must be determined on vehicle or engine. | [56] For OE Number: 18550-84A51 | [116] For OE Number: 90919-02262 |
| [2] Alternatively | [57] For OE Number: 19080-46020 | [117] For OE Number: 90919-02266 |
| [3] for vehicles with ABS | [58] For OE Number: 1M21-18B515-AA | [118] For OE Number: 91132006 |
| [4] for vehicles with catalytic converter | [59] For OE Number: 224336134R;7700274008 | [119] For OE Number: 928F12029CA |
| [5] for vehicles with catalytic converter;for vehicles with catalyst arrangement | [60] For OE Number: 224481KT0A | [120] For OE Number: 93176801 |
| [6] for vehicles without catalytic convertor | [61] For OE Number: 22448-31U00-01 | [121] For OE Number: 93177212 |
| [7] with 2 way catalyst | [62] For OE Number: 22448-31U05-06 | [122] For OE Number: 95VW-6M090-AB |
| [8] with 3 way catalyst | [63] For OE Number: 22448ED800 | [123] For OE Number: 96 415 010 |
| [9] for cold climates | [64] For OE Number: 22448-ZE00C | [124] For OE Number: 9638985980 |
| [10] Black | [65] For OE Number: 27300-39000;27300-39050 | [125] For OE Number: 9651583680 |
| [11] Blue | [66] For OE Number: 27300-39700 | [126] For OE Number: 988F12029AD; FORD 1317972 |
| [12] Brown | [67] For OE Number: 2730103100 | [127] For OE Number: 999 170 023 90 |
| [13] Grey | [68] For OE Number: 2730103110 | [128] For OE Number: A 001 159 14 01 |
| [14] Green;Blue | [69] For OE Number: 2730123700 | [129] For OE Number: A 001 159 15 01; A 001 159 16 01 |
| [15] Orange | [70] For OE Number: 27301-23700 | [130] For OE Number: A 001 159 20 01; A 001 159 21 01 |
| [16] Red | [71] For OE Number: 27301-26640 | [131] For OE Number: A 001 159 26 01 |
| [17] Exclude Austria | [72] For OE Number: 2769064500;2769065100 | [132] For OE Number: A 001 545 97 32; A 002 545 05 32 |
| [18] Fitting position: Inlet | [73] For OE Number: 2S6Q-6M090-AB | [133] For OE Number: A 007 545 98 32 |
| [19] Fitting position: Left | [74] For OE Number: 2S6Q-6M090-BB | [134] For OE Number: A 642 900 57 01 |
| [20] Fitting position: Outlet | [75] For OE Number: 357911253 | [135] For OE Number: A 642 900 58 01 |
| [21] Fitting position: Right | [76] For OE Number: 46754154 | [136] For OE Number: CHRYSLER 4797293 |
| [22] For cylinder 1;2;3;4;Upper | [77] For OE Number: 46754154;71735458 | [137] For OE Number: CHRYSLER 56028172AB |
| [23] For cylinder 1;3;5 | [78] For OE Number: 46796050 | [138] For OE Number: HYUNDAI 27301-37100 |
| [24] For cylinder 1;4 | [79] For OE Number: 55200817 | [139] For OE Number: HYUNDAI 27301-37105 |
| [25] For cylinder 2 | [80] For OE Number: 55210051 | [140] For OE Number: HYUNDAI 27301-33510; HYUNDAI 27301-33520 |
| [26] For cylinder 2;3 | [81] For OE Number: 56041019 | [141] For OE Number: MD003823 |
| [27] For cylinder 2;4;6 | [82] For OE Number: 5960 66 | [142] For OE Number: MD104696 |
| [28] For cylinder 2;5 | [83] For OE Number: 5960 F4 | [143] For OE Number: MD111950; MD114994;MD120167 |
| [29] For cylinder 3 | [84] For OE Number: 5970 51 | [144] For OE Number: MD114 994 |
| [30] For cylinder 5;6;7;8;Lateral Installation | [85] For OE Number: 5970 73 | [145] For OE Number: N 105 916 04 |
| [31] For cylinder 3;4;5 | [86] For OE Number: 5970.56 | [146] For OE Number: N 105 916 08 |
| [32] For cylinder 4 | [87] For OE Number: 5970.60 | [147] For OE Number: N 105 916 02;N 105 916 03 |
| [33] For exhaust norm D3 | [88] For OE Number: 5970.72 nur Spule;5970.74;5970.A9 | [148] For OE Number: N 105 916 04 |
| [34] For exhaust norm D4 | [89] For OE Number: 5970.81 | [149] For OE Number: NEC100630 |
| [35] For exhaust norm Euro 3 (D3);Euro 4 (D4) | [90] For OE Number: 5970.84 | [150] For OE Number: OPEL 1208008 |
| [36] For exhaust norm Euro 4 (D4) | [91] For OE Number: 5970.92 | [151] For OE Number: OPEL 1208063 |
| [37] For exhaust norm Euro 5 | [92] For OE Number: 70863020 | [152] For OE Number: OPEL 1208307 |
| [38] For exhaust norm L3 | [93] For OE Number: 70863021 | [153] For OE Number: PEUGEOT 5970.70 |
| [39] For OE Number: 000 158 62 03 | [94] For OE Number: 7700100586 | [154] For OE Number: RENAULT 224336134R; Renault 7700274008 |
| [40] For OE Number: 032 905 106 B | [95] For OE Number: 7700107269 | [155] For OE Number: RENAULT 8200141149 |
| [41] For OE Number: 036 905 715 F | [96] For OE Number: 7700500180 | [156] For OE Number: RENAULT 8200360911 |
| [42] For OE Number: 04C 905 110 A; 04C 905 110 B;04C 905 110 D | [97] For OE Number: 7700737612 | [157] For OE Number: RENAULT 8200702693 |
| [43] For OE Number: 04E 905 110; 04E 905 110 A;04E 905 110 B | [98] For OE Number: 7700743137 | [158] From RP nr. 10784 |
| [44] For OE Number: 058905101A | [99] For OE Number: 7700872265 | [159] From RP nr. 5783 |
| [45] For OE Number: 06A 905 097 | [100] For OE Number: 7701069730 | [160] From RP nr. 07609 |
| [46] For OE Number: 06E 905 115 E | [101] For OE Number: 8200025256;8200084401 | [161] From RP nr. 07875 |
| [47] For OE Number: 06F 905 115; 07K 905 715;A-F | [102] For OE Number: 8200490950 | [162] From RP nr. 09667 |
| [48] For OE Number: 06H 905 115 A; 06H 905 115 B | [103] For OE Number: 8200587901 | [163] From RP nr. 10221 |
| [49] For OE Number: 07K 905 715 F | [104] For OE Number: 8200682592 | [164] From RP nr. 10227 |
| [50] For OE Number: OK 247-18100 | [105] For OE Number: 90080-19021 | [165] From RP nr. 10444 |
| [51] For OE Number: 100630 | [106] For OE Number: 90543253 | [166] Gap to be set 0.5mm |
| [52] For OE Number: 101 000 062 AB | [107] For OE Number: 90919-02164 | [167] Gap to be set 0.6mm |
| [53] For OE Number: 12137594937 | [108] For OE Number: 90919-02207;90919-02234 | [168] Gap to be set 0.7mm |
| [54] For OE Number: 1275971 | [109] For OE Number: 90919-02215 | [169] Gap to be set 0.8mm |
| [55] For OE Number: 18550-80KA0 | [110] For OE Number: 90919-02234 | |

TECHNICAL NOTES

| | | | |
|-------|-----------------------------------|-------|--|
| [170] | Gap to be set 0.9mm | [231] | Specification: TG1 |
| [171] | Gap to be set 1.0mm | [232] | Specification: TH1 |
| [172] | Gap to be set 1.1mm | [233] | Specification: TM4 |
| [173] | nur für FSI-Motoren | [234] | Specification: Transmission DP0;JB3 |
| [174] | BERU | [235] | Specification: Transmission JB3 |
| [175] | BOSCH | [236] | Specification: Transmission JC5 |
| [176] | BOSCH FGR8MQPE | [237] | Specification: Transmission JH3;JR5 |
| [177] | BREMI | [238] | Specification: Transmission JR5 |
| [178] | CHAMPION | [239] | Specification: TS8 |
| [179] | CHAMPION RC87YCL; RENAULT RFN58LZ | [240] | To production nr. 970401 |
| [180] | CITROEN;FIAT | [241] | To production nr. Peugeot 7727 |
| [181] | DUCELLIER | [242] | To RP nr. 02BF1476 |
| [182] | ELDOR | [243] | To RP nr. 07608 |
| [183] | ETHANOL (E85) | [244] | To RP nr. 07874 |
| [184] | EYQUEM FC52LS | [245] | To RP nr. 09666 |
| [185] | EYQUEM RFC58LZ2E | [246] | To RP nr. 10220 |
| [186] | FORMEL E | [247] | To RP nr. 10226 |
| [187] | Fzg. mit diagnose | [248] | To RP nr. 10443 |
| [188] | HITACHI | [249] | To RP nr. 10783 |
| [189] | ILKAR7A7 | [250] | To RP nr. 10784 |
| [190] | JOHSON-RFC58LZP | [251] | Automatic Transmission |
| [191] | KEGEKDICHTSITZ | [252] | CVT (Stepless) |
| [192] | LUCAS | [253] | Manual Transmission |
| [193] | MARELLI | [254] | for vehicles with distributor |
| [194] | MARELLI;SIEMENS | [255] | for vehicles with immobilizer |
| [195] | Mit Ladeluftk3hlung | [256] | for vehicles without distributor |
| [196] | NGK BCP5ES | [257] | for vehicles without immobilizer |
| [197] | NGK PFR6G-9 | [258] | for vehicles with 24V main current |
| [198] | NGK PFR7Z-TG | [259] | 0221504030 |
| [199] | Not for FSI-Motor | [260] | 6-polig |
| [200] | Niederverdichtung | [261] | A-115T1 |
| [201] | ohne Endstufe | [262] | Anderungsjahr 02/2 |
| [202] | PEUGEOT | [263] | CF3 |
| [203] | RENAULT | [264] | CF4 |
| [204] | RENAULT RFC58LZ2E | [265] | Duratorq / SID 206 |
| [205] | SAGEM | [266] | EA17 041 |
| [206] | SIEMENS / MARELLI | [267] | LCI |
| [207] | STECKER 165 mm | [268] | not LCI |
| [208] | BOSCH / TEMIC | [269] | S-QGS |
| [209] | DELCO REMY | [270] | TK 12/A3 |
| [210] | FEMSA | [271] | TK 6 A/3 |
| [211] | FORD | [272] | Type AK |
| [212] | LADA | [273] | Type BK |
| [213] | VALEO | [274] | Type CK |
| [214] | Transistorzündung | [275] | Y-115T1 |
| [215] | UK | [276] | zu 0221506007 |
| [216] | ZM ohne Zundspule | [277] | M47N |
| [217] | Observe technical data | [278] | Specification: N57Z |
| [218] | To RP Nr. Peugeot ->7727 | [279] | Exclude United States of America |
| [219] | Specification: CF3 | [280] | Include Canada |
| [220] | Specification: CF4 | [281] | Include United States of America |
| [221] | Specification DP0;JB3;JC5;JC7;SD1 | [282] | At mainly short distance travel and regular cold starts. |
| [222] | Specification GAMME EVOLUTION | [283] | With heat shield pipe |
| [223] | Specification: JB0;JB1;JB2;JB3 | [284] | Without heat shield pipe |
| [224] | Specification: JB1; JB3 | | |
| [225] | Specification: JB1;JB3 | | |
| [226] | Specification: T41 | | |
| [227] | Specification: T41;TF1 | | |
| [228] | Specification: TD1 | | |
| [229] | Specification: TE1 | | |
| [230] | Specification: TF1 | | |