

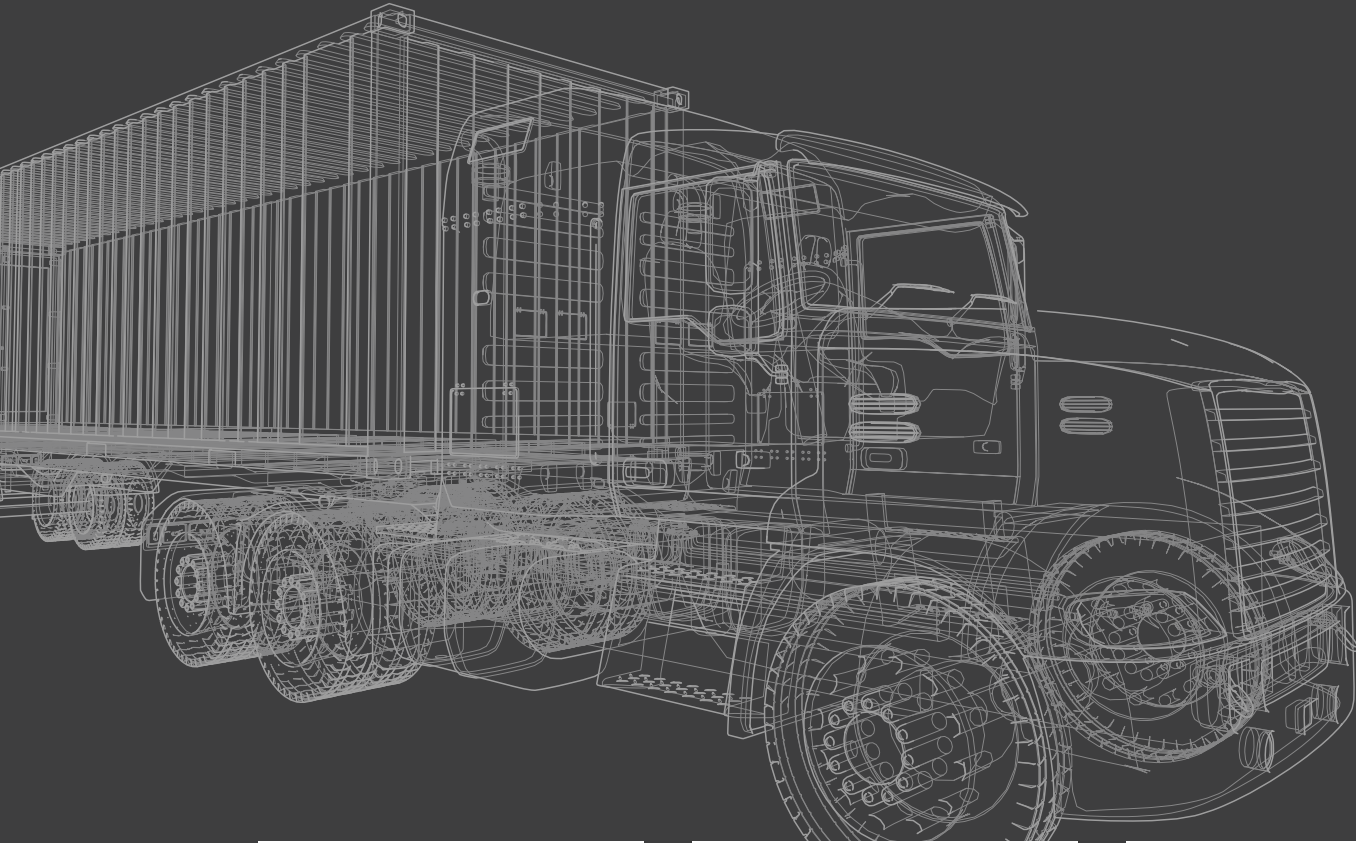

Form 562-20  
Supersedes  
Form 562-18



**2020**  
CATALOG



# FAST FACTS

## YOUR SINGLE SOURCE FOR QUALITY FILTRATION BROADEST COVERAGE IN THE INDUSTRY

As leaders in the industry, Baldwin has a reputation for protecting heavy-duty engines in a wide range of markets and applications. From the big city to the remote countryside and everywhere in between, Baldwin provides protection you can rely on no matter where you're headed.

### FILTRATION EXPERTISE

**FOUNDED 1936** Baldwin's longevity has resulted in a sophisticated level of understanding across a broad range of industries.

### TOUGH HEAVY-DUTY

	<b>ON-HIGHWAY</b> Class 4-8 Trucks
	<b>CONSTRUCTION</b> Backhoes, Loaders, Excavators
	<b>OIL &amp; GAS</b> Generators, Industrial Engines, Trucks
	<b>MINING</b> Earth Movers, Excavators, Haul Trucks
	<b>AGRICULTURE</b> Tractors, Loaders, Combines
	<b>MARINE</b> Tug Boats, Generators

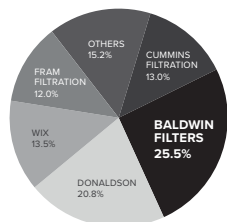

**NORTH AMERICAN CLASS 4-8 MARKET SHARE**

### PREMIUM LIGHT-DUTY

	<b>DIESEL PICKUPS</b>
	<b>GAS PICKUPS</b>
	<b>SUVS</b>
	<b>LAW ENFORCEMENT VEHICLES</b>
	<b>COMMERCIAL VEHICLES</b>

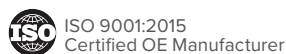

**80+ YEARS**

### UNSURPASSED PERFORMANCE

- Products designed to fully meet or exceed application requirements
- Efficiency to protect the most advanced modern engines
- Capacity to meet OE recommended service intervals
- Products tested over and beyond industry standards
- Industry leading fill rate of 97%

### KNOWLEDGEABLE SERVICE

Largest, most experienced field and inside technical support team



### RELIABLE QUALITY

- Vertical integration for world-class quality exceeding 6 Sigma
- Application specific filter design and unique, proprietary media development
- Complete process control, vertical integration from media development through component production and final assembly
- Cutting edge innovation center and on-site test labs to validate high performance

**45000+**  
CASES SHIPPED PER DAY

**7500+**  
OE QUALITY PARTS

**150+**  
BRAND PARTNERSHIPS

### MORE COVERAGE

BALDWIN VS. COMPETITOR A

**68%**

**46%**

BALDWIN VS. COMPETITOR B

**77%**

**54%**

BALDWIN VS. COMPETITOR C

**84%**

**68%**

BALDWIN VS. COMPETITOR D

**82%**

**46%**

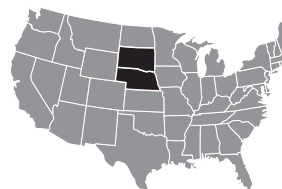

**95%** TOP 200 SALES  
MADE IN THE USA

**AIR | FUEL | LUBE | HYDRAULIC | COOLANT | TRANSMISSION | EMISSIONS**

Table of Contents .....	1
Form 123, Form 124, Form 125, Form 560 and Form 561 List of Contents.....	2
Baldwin New Products.....	3-22
Baldwin Obsolete Products .....	23-31
Abbreviations Used Anywhere in Our Catalogs .....	32-40
Prefixes and Suffixes .....	41-49

**PRODUCT GUIDE .....50-602**

How Product Guide is Arranged .....	50-54
Product Guide (Numerical Sequence Master List) .....	55-560
Filter Bases .....	143-145
Vacuum/Pressure Gauges .....	145
Farr Tube-Type Air Filters .....	168-169
Coolant Filters/Products .....	326-331
Automatic Transmission Filters.....	366-367, 540-549
Truck Service Kits .....	367-381
Hydraulic Bases & Indicators .....	456-457
Oil/Air Separators.....	642-650
Stanadyne Fuel Additives .....	651
Gaskets .....	652-659
Caterpillar Gaskets .....	660
 DAHL .....	 661-677

**SIZE CHARTS.....678-746**

O-Ring Uniform Dash Numbers .....	678
Round Gaskets Arranged by O.D. ....	679-680
Spin-on Filters by Tap Size (U.S. Thread) .....	681-694
Spin-on Filters by Tap Size (British Standard Pipe Thread) .....	695
Spin-on Filters by Tap Size (Metric Thread) .....	696-701
Liquid Elements by Length.....	702-716
Round Air Filters by Length.....	717-732
Panel Air Filters .....	733-740
Oval, Oblong & Miscellaneous Air Filters.....	741
Box-Style and Can-Type Fuel Filters .....	742
Oil/Air Separator Elements by Length.....	743
Oil/Air Separator Spin-on Filters by Tap Size (Metric Thread).....	744
In-Line Filters by Inlet Size.....	745-746
 Decimal Equivalents Chart .....	 747
UPC Code Explanation.....	748
Baldwin to UPC (Individual Parts) .....	749-768
UPC to Baldwin (Individual Parts) .....	769-788
Baldwin Case to I 2/5 (Shipping Cases).....	789-798
I 2/5 to Baldwin Case (Shipping Cases).....	799-808
Baldwin Weights and Volumes .....	809-841
Filter Wrenches.....	842-845
Baldwin Filter Date Coding Methods .....	846-854
A Word About Warranties .....	846-854
Baldwin Filter Warranty.....	855-860
Product Investigation .....	861
Field Report Form.....	862
Filter Survey.....	863-864

# TABLE OF CONTENTS

Product Guide

# Form 123-20, Form 124-19, Form 125-19, Form 560-18 & Form 561-19 List of Contents

## **FORM 123-20 AUTOMOTIVE APPLICATIONS**

Refer to the following list of contents for information contained in the Baldwin Automotive Filter Applications Catalog, Form 123-20.

### **AUTOMOTIVE APPLICATIONS**

- *Automotive and Light-Duty Truck Applications 1980-on (Includes Imports)*
- *Automotive and Light-Duty Truck Applications Pre-1980 (Includes Imports)*

## **FORM 124-19 OFF-HIGHWAY APPLICATIONS**

Refer to the following list of contents for information contained in the Baldwin Off-Highway Filter Applications Catalog, Form 124-19.

### **OFF-HIGHWAY APPLICATIONS**

- *Off-Highway Applications*

## **FORM 125-19 TRUCKS & BUSES APPLICATIONS**

Refer to the following list of contents for information contained in the Baldwin Trucks & Buses Filter Applications Catalog, Form 125-19.

### **TRUCKS & BUSES APPLICATIONS**

- *Trucks & Buses Applications*

## **FORM 560-18 MANUFACTURERS' CROSS-REFERENCE**

Refer to the following list of contents for information contained in the Baldwin Manufacturers' Cross-Reference Catalog, Form 560-18.

### **MANUFACTURERS' CROSS-REFERENCE**

- *Cross-Reference Information Arranged by Manufacturer*

## **FORM 561-19 NUMBER-FINDER CROSS-REFERENCE**

Refer to the following list of contents for information contained in the Baldwin Number-Finder Cross-Reference Catalog, Form 561-19.

### **NUMBER-FINDER CROSS-REFERENCE**

- *Cross-Reference Information Arranged in Number-Finder Format*

### **ALSO INCLUDED**

- *Manufacturers' Codes*

## BALDWIN NEW PRODUCTS

BALDWIN NUMBER	DESCRIPTION	REPLACES	APPLICATIONS
BF955 KIT	Fuel Filter Kit Assembly		Fuel Filter Kit Assembly
BF1058	In-Line Fuel Filter	Chrysler 4495950, 4546679	Chrysler Automotive
BF1120	In-Line Fuel Filter	Honda 16900-SH3-A30	Honda Automotive
BF1379-0	Fuel/Water Separator with Open Port for Bowl	Ditch Witch 159047; Racor R12SUL; Fleetguard FS19628	Idlebuster, Truck Gen Auxiliary Power Units (APU's); Next Generations Generators all with Kubota Engines
BF1380-0	Fuel/Water Separator Spin-on with Open Port for Bowl	Racor R12T	Ampac, Bandit, Kubota Equipment
PA2188	Air Element	Chrysler 4307787	Dodge Light-Duty Trucks, Vans
PA2220	Panel Air Element	Ford F1CZ-9601-A; Mazda B6S7-13-Z40	Ford, Mazda Automotive
PA2228	Panel Air Element	Ford F3LY-9601-A	1993-98 Lincoln Mark VIII
RS3516XP	Extreme Performance Nano Radial Seal Outer Air Element	Donaldson DBA5106	Freightliner, International, Peterbilt Trucks
RS3750XP	Extreme Performance Nano Radial Seal Air Element	Donaldson DBA5107	Kenworth, Peterbilt Trucks
RS3870XP	Extreme Performance Nano Outer Air Element	Donaldson DBA5116	Ag-Chem, Case, Doosan, Hitachi, Hyundai, John Deere, Liebherr, Link-Belt, New Holland, Terex, Volvo Equipment
PA4026	Air Element	GMC 96055470; Suzuki 13780-82400	Chevrolet, Pontiac, Suzuki Automotive
PA4047	Panel Air Element	BMW 13721707050, 13721715881	BMW Automotive
PA4061	Air Element	Toyota 17801-50010; Wix 46058	Lexus Automotive
PA4090	Panel Air Element	Honda 17220-POG-A00	Acura, Honda Automotive
PA4101	Air Element	ACDelco A1388C; Acura 17220-P72-000	1994-2001 Acura Integra
SA4137	Crankcase Breather Filter	Ford E6TZ-6A768-A, F1BZ-6A768-A	Ford, Mercury Automotive, Light-Duty Trucks
SA4142	Polyester Crankcase Breather Filter	Chrysler 4459657, 5277665; Wix 46964	Chrysler, Dodge, Plymouth Automotive
PA4155 KIT	Set of 2 Cabin Air Elements	General Motors Corp. 52470574, 52482929; Wix 524811, 24811	Chevrolet, Oldsmobile, Pontiac Light-Duty Trucks, Vans
PA4354	Panel Air Element	Toyota 17801-46080	Lexus Automotive
PA4369	Panel Air Element	Acura 17220-RWC-A00; Honda 17220-RWC-A00, 17220-RWC-A01	Acura RDX
PA4408	Cabin Air Element	Subaru 3B451-30361, 72880-FE000, G3210-FE100	Subaru Automotive, Light-Duty Trucks
PA4415	Cabin Air Element	BMW 64311496710	2006-06 Mini Cooper, Cooper S
PA4424	Cabin Air Element	Subaru 72880-SA000, G3010-SA100	Subaru Automotive, Light-Duty Trucks
RS5287	Radial Seal Outer Air Element	Donaldson P625128	Kenworth, Peterbilt Trucks
RS5288	Radial Seal Outer Air Element	Donaldson P625287	Kenworth C500, C550, T800, W900; Peterbilt 367, 388, 389 Trucks
6017	Transmission Filter	GMC 6438815	Pow-R-Flo, Powerglide M35 Transmission
BK6095	Service Kit for Volvo	Donaldson P559143	Volvo Engines
BK6096	Service Kit	Donaldson P559665	Detroit DD13, DD15, DD16; Mercedes-Benz OM471LA, OM473LA Engines
BK6097	Service Kit for Cummins	Donaldson P559144	Cummins Engines
BK6098	Service Kit		Detroit DD13, DD15, DD16 Engines
BK6099	Service Kit		
BK6102	Service Kit		
BK6103	Service Kit		
BK6104	Service Kit		
BK6105	Service Kit		
BK6106	Service Kit		
BK6107	Service Kit		
BK6108	Service Kit		
BK6110	Service Kit	Thermo-King 10-417; Fleetguard MK14252	Thermo-King Refrigeration Units
BK6114	Service Kit		Cummins Engines
BK6115	Service Kit		
BK6116	Service Kit for Mack/Volvo		
BK6120	Service Kit		



**WARNING:** These products can expose you to chemicals, including Diisononyl Phthalate, Carbon black extracts, Nickel, 1,3 Butadiene, Ethylene Oxide, Epichlorohydrin, which are known to the State of California to cause cancer, and Bisphenol-A, Ethylene Glycol, Ethylene Oxide, 1,3 Butadiene, Epichlorohydrin, which are known to the State of California to cause birth defects or other reproductive harm.

**BALDWIN NEW PRODUCTS**

BALDWIN NUMBER	DESCRIPTION	REPLACES	APPLICATIONS
BK6121	Service Kit		
BK6124	Service Kit		
B7516	Lube Spin-on	John Deere RE506178; Fleetguard LF3941	John Deere Gen Set Power Units
BF7662	In-Line Fuel Filter	GMC 25313812; Toyota 23300-11150, 23300-19385	Toyota Automotive
BF7798-O	Fuel/Water Separator Spin-on with Open Port for Bowl	Alliance ABPN/12232-FRT03; Caterpillar 1986378; Racor S3201S	Autocar, Ford, Freightliner, Peterbilt, Sterling, Western Star Trucks; Blue Bird, Thomas Buses
BF7806-O	Fuel/Water Separator with Open Port for Bowl	Ford 5C4Z9N-184AB; International 2587803C1; Motorcraft FD4608; Racor S6494	Ford F750 with Cat 3126, Cummins ISB 200 Engine
PA10046	Panel Air Element	Chrysler 68247339AA, K68247339AA; Fiat 51977574	Jeep Renegade
PA10059	Panel Air Element	Honda 172205BAA00	2016-20 Honda Civic
PA10063	Panel Air Element with Foam Pad	General Motors 23248945; ACDelco A3216C	2016-19 Chevrolet Colorado, 2016-19 GMC Canyon with 2.8L Turbo Diesel Engine
PA10069	Panel Air Element	Honda 172205G0A00, 172205J2A00	2015-19 Acura TLX, 2013-17 Honda Accord
PA10075	Panel Air Element with Foam Pad	BMW 13718513944	2016-20 BMW X1, 2018-20 X2; 2015-19 Mini Cooper, 2016-19 Cooper Clubman, 2017-20 Cooper Countryman
PA10076	Panel Air Element	General Motors 23321606; ACDelco A3212C	2018-20 Buick Enclave; 2017-20 Cadillac XT5; 2019-20 Chevrolet Blazer, 2018-20 Traverse; 2017-20 GMC Acadia
PA10077	Panel Air Element	General Motors 23430312; ACDelco A3208C	2016-18 Chevrolet Malibu, 2017-19 Buick LaCrosse
PA10078	Panel Air Element	ACDelco A3217C	2016-19 Chevrolet Volt
PA10081	Cabin Air Element	Hyundai 97133F2000	2017-18 Hyundai Elantra, 2018-19 Elantra GT; 2018-19 Kia Rio
PA10082	Cabin Air Element	Nissan 272771KK0A, 272781KK0A	Nissan Versa, Versa Note, Tiida
PA10083	Cabin Air Element	Chrysler 68267921AA	2018 Fiat 500L, 2016-17 500X; 2015-17 Jeep Renegade
PA10084	Panel Air Element	Chrysler 68214516AA	2017-19 Chrysler Pacifica with (3.6L) Engine
PA10085	Cabin Air Element	Chrysler 68103578AA	2015-18 RAM ProMaster City
PA10086	Panel Air Element	Hyundai 28113F2000	2017-19 Hyundai Elantra, 2018-19 Elantra GT, Kona, 2019 Veloster; 2019 Kia Forte
PA10087	Panel Air Element	Nissan 16546EZ31A	2018-19 Nissan Titan
PA10089	Panel Air Element	Volkswagen 5Q0129620B, 5Q0129620D	Audi, Volkswagen Automotive, Light-Duty Vehicles
PA10090	Panel Air Element	Honda 172206B2A00	2018-19 Honda Accord with 2.0L Turbo Diesel Engine
PA10091	Panel Air Element with Foam and Pull Tab	ACDelco A3226C; General Motors 23279657	2018-19 Chevrolet Equinox, GMC Terrain
PA10093	Panel Air Element with Foam Pad	Motorcraft FA1916	2015-19 Ford Transit-150, Transit-250, Transit-350, Transit-350 HD
PA10094	Panel Air Element	General Motors 23323508; ACDelco A3223C	2017-19 Chevrolet Camaro
PA10095	Panel Air Element with Foam Pad		2017-19 Chevrolet Silverado 2500 HD, Silverado 3500 HD; GMC Sierra 2500 HD, Sierra 3500 HD
PA10096	Panel Air Element	Nissan 16546EZ40A	2016-19 Nissan Titan XD
PA10097	Cabin Air Element	Toyota 871390E040, 8713958010, 871390K070	Lexus and Toyota Models
PA10098	Cab Air Element	Volvo 31407748	Volvo Trucks
PA10099	Cabin Air Element	Nissan 272779NM0A; Wix WP10009	2018-19 Infiniti QX60, Nissan Maxima, Murano, Pathfinder; 2018 Nissan Altima. (07/19/19)
SA10100	Foam Air Filter	Ford CK4Z-9601-C; Motorcraft FA1921	2015-19 Ford Transit with 5-195 (3.2L) Engine
PA10101	Panel Air Element with Foam Pad	Volkswagen 3QF129620	2018-19 Volkswagen Atlas with 2.0L and 3.6L Engine
PA10102	Panel Air Element	Volkswagen 5QM129620	2016-18 Volkswagen Golf SportWagen, 2016-19 GTI, 2017-18 Volkswagen Golf, Golf Alltrack, 2018 Golf R
PA10103	Cabin Air Element	Ford FL3Z19N619A; Motorcraft FP79	2018-20 Ford Expedition; 2015-19 F-150; 2017-19 F-250 Super Duty, F-350 Super Duty, F-450 Super Duty, F-550 Super Duty; 2018-20 Lincoln Navigator
PA10104	Cabin Air Element	Ford DR3Z-19N619-A; Motorcraft FP72	2013-14 Ford Mustang



**WARNING:** These products can expose you to chemicals, including Diisononyl Phthalate, Carbon black extracts, Nickel, 1,3 Butadiene, Ethylene Oxide, Epichlorohydrin, which are known to the State of California to cause cancer, and Bisphenol-A, Ethylene Glycol, Ethylene Oxide, 1,3 Butadiene, Epichlorohydrin, which are known to the State of California to cause birth defects or other reproductive harm.

## BALDWIN NEW PRODUCTS

BALDWIN NUMBER	DESCRIPTION	REPLACES	APPLICATIONS
PA10106	Panel Air Element	Hyundai 28113G2700; Kia 28113G2100	2017-19 Kia Niro, Hyundai Ioniq
PA10108	Cabin Air Element	Toyota 8713928020	2019 Toyota Corolla, 2017-19 Prius, 2017-18 Prius Prime, 2019 Prius AWD-e, 2019 RAV 4
PA10109	Air Element	Audi 8K0133843; Hengst E675LD157; Mahle LX2091D; Mann & Hummel C16114X	2008-on Audi Automotive
PA10110	Air Element	Audi 4F0133843; Mann & Hummel C171371X; Wix 49846	2005-11 Audi Automotive
PA10111	Air Element with Foam Wrap	Volkswagen 4G0133843; Knecht LX20494; Mahle LX20494; Mann & Hummel C16005	2012-14 Volkswagen Automotive
PA10112	Air Element	Mercedes-Benz 120943702	1980-85 Mercedes-Benz Automotive
PA10113	Air Element	VAG (Volkswagen/Audi/Audi Group) 3C0129620; Volkswagen 1F0129620	2015 Audi A1; 2009-10 Seat Altea, Leon; 2015 Volkswagen Caddy, 2012-15 Jetta
PA10114	Air Element	Mercedes-Benz 6460940104, A6460940104	2005-06 Mercedes-Benz E320 CDI
PA10115	Air Element	Saab 7514722; Wix 46329, 42320	1986-93 Saab Automotive
PA10116	Oblong Air Element	Mercedes-Benz 10947804	1976-91 Mercedes-Benz Automotive
PA10117	Air Element with Foam Wrap	Volkswagen 4G0133843K; Mahle LX26072	2012-14 Audi A6, 2013-14 A6 Quattro
PA10118	Air Element with Handle	Honda 17220-PCX-003	2000-05 Honda S2000
PA10119	Air Element	Audi 4E0129620	2004-on Audi A8 L, 2005 A8 Quattro
PA10120	Oblong Air Element	Mercedes-Benz 20948704	Mercedes-Benz Automotive
PA10121	Air Element with Foam Wrap	Land Rover PHE000050; Mann & Hummel C18161; Wix 42892	2003-07 Land Rover Range Rover
PA10122	Air Element	Porsche 99711013030, 99711013031	Porsche 911
PA10123	Air Element	Saab 4572491, 5173166, 55560911	1999- 2000 Saab 9-3, 1999-2009 9-5
PA10124	Oblong Cabin Air Element	Volkswagen 4E0819439A	2004-10 Audi A8 Quattro, 2007-10 S8
PA10125	Oval Air Element	Porsche 98711013300	2006-15 Porsche Boxster, 2007-15 Cayman
PA10126	Air Element	Audi 4E0129620D; Volkswagen 4E0129620D	2005-09 Audi Automotive
SA10127	Crankcase Breather Element	Ford B2TZ-6A631-A	1953-57 Ford Automotive, Light-Duty Trucks
PA10128	Cabin Air Element	Hyundai 97133C2000, C2H79AP000	2015-19 Hyundai Sonata
PA10129	Cabin Air Element	Honda 80292TBAA11, 80292-TF0-G01, 80291TF0G01, 80291TF0E01, 80291T5RA01	2019 Acura RDX; 2016-19 Honda Civic, HRV, 2017-19 CR-V, 2011-15 CR-Z, 2009-19 Fit, 2010-19 Insight, 2018-19 Odyssey
PA10130	Cabin Air Element	General Motors 13271191	Buick, Cadillac, Chevrolet, Saab Automotive
PA10131	Cabin Air Element	Hyundai 87902E250A, 971332E250	2008-09 Hyundai Tucson
PA10132	Cabin Air Element	Toyota 8712930100	2016-19 Lexus GS F, 2017 GS Turbo, RC Turbo, 2016-17 GS200t, IS200t, RC200t, 2018 GS300, 2013-19 GS350, 2013-18 GS450h, 2017 IS Turbo, 2014-15 IS250, 2016-19 IS300, RC300, 2014-19 IS350, 2015-19 RC F, RC350
PA10133	Cabin Air Element	Ford AE5Z-19N619-A; Motorcraft FP67	Ford, Lincoln, Mercury Automotive
PA10134	Cabin Air Element	BMW 64119237554, 64119237555	BMW Automotive
PA10135	Cabin Air Element	Motorcraft FP78	2015-19 Ford Mustang
PA10136	Cabin Air Element	Mazda EG2-16-1P11	2007-on Mazda CX-7
PA10137	Cabin Air Element	Nissan 999M1VS007	Nissan Automotive
PA10138	Cabin Air Element	Volkswagen 4H0819439	Audi A6 Quattro, A7 Quattro, A8 Quattro, S7, S8
PA10139	Cabin Air Element	Hyundai 87903J000A, 971333J00, 97133J000A, 97133J100; Mann & Hummel CU26001	2008-12 Hyundai Veracruz
PA10140	Cabin Air Element	General Motors 93172129;	2008-11 Saab 9-3, 2010-11 9-3X



**WARNING:** These products can expose you to chemicals, including Diisononyl Phthalate, Carbon black extracts, Nickel, 1,3 Butadiene, Ethylene Oxide, Epichlorohydrin, which are known to the State of California to cause cancer, and Bisphenol-A, Ethylene Glycol, Ethylene Oxide, 1,3 Butadiene, Epichlorohydrin, which are known to the State of California to cause birth defects or other reproductive harm.

**BALDWIN NEW PRODUCTS**

BALDWIN NUMBER	DESCRIPTION	REPLACES	APPLICATIONS
		Saab 93172129	
PA10141	Cabin Air Element	Toyota 87139-50010, 87139-YZ02; Wix 24481	1995-2000 Lexus LS400
PA10142	Cabin Air Element	Ford XS4H-16N619-AB, XS4Z-19N619-AA, Y S4Z-19N619-DB; Motorcraft FP32, FP38	Ford Automotive, Light-Duty Trucks
PA10143	Cabin Air Element	Audi 8K0819439A; Hengst E2948LC; Mahle LAK386	Audi Automotive; Porsche Macan
PA10144	Cabin Air Element	Ford 4R3Z-19N619-AA; Motorcraft FP53	2006 Ford GT, 2005-on Mustang
PA10145 KIT	Set of 2 Cabin Air Elements	Nissan 999M1VP055	Nissan Automotive, Light-Duty Trucks
PA10146	Cabin Air Element	Chrysler 68096453AA	2012-14 Fiat 500
PA10147	Cabin Air Element	Ford BE8Z-19N-619A	2011-on Ford Automotive
PA10148	Cabin Air Element	Hyundai 87903M000A, 971333M000	Hyundai Equus, Genesis
PA10149	Cabin Air Element	Mazda GS3L61148	2009-on Mazda6
PA10150	Cabin Air Element	Chrysler 5058040AA, 82206886	2001-on Chrysler PT Cruiser
PA10152 KIT	Set of 2 Cabin Air Elements	Mercedes-Benz 1648300218, A1648300218, A164830021864	Mercedes-Benz Automotive
PA10153	Cabin Air Element	Volvo 9204626	1999-on Volvo Automotive
PA10154	Cabin Air Element	Fiat 68212070AA	2014-15 Fiat 500L with 4-1368cc (1.4L) FI Turbo Engine
PA10155	Cabin Air Element	Kia 97133-2F000, 97133-2F010	2007-09 Kia Spectra, Spectra5; 2009-on Borrego
PA10156	Cabin Air Element	Volvo 30676484, 30780377	2005-14 Volvo Automotive
PA10157	Cabin Air Element	Scion SU003032112	2013-14 Scion FR-S
PA10158	Cabin Air Element	Nissan B72771CA0A, B72771CA1A	2012 - 14 Infiniti Automotive
PA10159	Cabin Air Element	Kia 97133-2K000; Mahle LA531	Kia Soul
PA10160	Cabin Air Element	Suzuki 9586164J01, 9586164J00	2006-13 Suzuki Grand Vitara
PA10161	Cabin Air Element	ACDelco CF131C; GM 10345066; Wix 24480	Cadillac, Chevrolet Automotive
PA10162	Cabin Air Element	Porsche 97057362300	Porsche Panamera
PA10163	Cabin Air Element	Nissan B72771EA0A, B72771EA0B	Nissan 370Z with (3.7L) Engine
PA10164	Cabin Air Element	GMC 1562718, 25740404	Cadillac Automotive
PA10165	Cabin Air Element	Suzuki 9586157L00	2010-13 Suzuki Kizashi
PA10166	Cabin Air Element	Volvo 8687389	Volvo Automotive
PA10167	Cabin Air Element	Honda 79830S2A003	2000-09 Honda S2000
PA10168	Cabin Air Element	BMW 64319127516	Mini Cooper Automotive
PA10169	Cabin Air Element	Porsche 99757121900, 99657121901; Mahle LAK321	Porsche Automotive
PA10170 KIT	Set of 2 Cabin Air Elements	BMW 64119163328, 64119163329, 64119272642; Hengst E2978LC-2; Mahle LAK467/S; Mann CUK2533-2	BMW Automotive
PA10171	Cabin Air Element with Pull Tab	Mazda GK3J61148	2003-on Mazda6
PA10172	Cabin Air Element	Volvo 30767024	Volvo Automotive
PA10173	Cabin Air Element	Saturn 88997039, 90464424	Saturn Automotive
PA10174	Cabin Air Element	Volvo 91712968, 9184130	Volvo Automotive
PA10175 KIT	Set of 2 Cabin Air Elements	Mercedes-Benz 2308300418; Hengst E1919LC2; Mahle LAK278S	2003-13 Mercedes-Benz Automotive
PA10176	Cabin Air Element	Kia 97133-3E260, 97133-3E270	2007-09 Kia Sorento
PA10177	Cabin Air Element	General Motors 93172299; Saab 9179905X	2005-11 Saab, 2010-11 9-3
PA10178	Cabin Air Element	Mercedes-Benz 1718300418, 1728350047, A1718300418, A1728350047	2005-14 Mercedes-Benz Automotive



**WARNING:** These products can expose you to chemicals, including Diisononyl Phthalate, Carbon black extracts, Nickel, 1,3 Butadiene, Ethylene Oxide, Epichlorohydrin, which are known to the State of California to cause cancer, and Bisphenol-A, Ethylene Glycol, Ethylene Oxide, 1,3 Butadiene, Epichlorohydrin, which are known to the State of California to cause birth defects or other reproductive harm.



## BALDWIN NEW PRODUCTS

BALDWIN NUMBER	DESCRIPTION	REPLACES	APPLICATIONS
PA10179	Cabin Air Element	Toyota 87139-50030, 87139-YZZ01; Wix 24893	Lexus Automotive
PA10180 KIT	Set of 2 Cabin Air Elements	Mercedes-Benz 2218300718, A2218300718	Mercedes-Benz Automotive
PA10181	Cabin Air Element	General Motors 92184248; ACDelco CF182	2008-09 Pontiac G8; 2011-on Chevrolet Caprice
PA10182	Cabin Air Element	Nissan 272771ME0B	2011-13 Infiniti M56, 2012-13 M35H, M37, 2014-on Q70
PA10183	Cabin Air Element	Mercedes-Benz 1638350047; Mann & Hummel CU2338	Mercedes-Benz Automotive
PA10184	Cabin Air Element	Land Rover JKR500020; Mann & Hummel CUK2747; Wix 49369	Land Rover, Range Rover Sport
PA10185	Cabin Air Element	Mercedes-Benz 4518300018, A518300018; Hengst E2946LC	2008-on Smart Fortwo
PA10186 KIT	Set of 2 Cabin Air Elements	Mercedes-Benz 2108300018, 2108301018, A2108300018, A2108301018	Maybach, Mercedes-Benz Automotive
PA10188	Cabin Air Element	Ford 2R8Z-19N619-BA; Motorcraft FP45	2003-06 Lincoln LS
PA10189	Cabin Air Element	Volkswagen 4B0819439C	Audi Automotive
PA10190	Cabin Air Element	Toyota 8713950060; Wix 24160	2007-on Toyota Automotive
PA10191 KIT	Set of 2 Cabin Air Elements	Mazda D65161J6X; Mann CU230012	2011-13 Mazda2
PA10192	Cabin Air Element	BMW 64319142115; Hengst E1959LC; Mahle LAK248	BMW Automotive
PA10193 KIT	Set of 2 Cabin Air Elements	Subaru G3210FC200	2001-02 Subaru Forester
PA10194	Cabin Air Element	Mazda D09W-61-J6X, DB9L-61-J6X, 87139-WB001	Mazda CX-3 with (2.0L) Engine
PA10195 KIT	Set of 2 Cabin Air Elements	Mazda BBM461J6X	2011-12 Mazda3, MazdaSpeed3
PA10196 KIT	Set of 2 Cabin Air Elements	Audi 4F0898438A, 4F0819439A	Audi Automotive
PA10197	Cabin Air Element	Mercedes-Benz 2128300318; Hengst E2954LC02; Mann & Hummel CUK2551	2008-on Mercedes-Benz Automotive
PA10198 KIT	Set of 2 Cabin Air Elements	BMW 64319171858, 64316935822, 64316935823; Hengst E1909LC, E2963LC; Mahle LAK197	BMW Automotive
PA10199 KIT	Set of 2 Cabin Air Elements	Hyundai 97619-3D000	Hyundai Santa Fe, Sonata, XG350
PA10200	Cabin Air Element	Volvo 9171756	Volvo Automotive
PA10201	Cabin Air Element	Hyundai 97133-2D000; Wix 24689	Hyundai, Kia Automotive
PA10202	Cabin Air Element	Suzuki 9586080J00	2007-10 Suzuki SX4
PA10203 KIT	Set of 3 Cabin Air Elements	GMC 52472175, 52482839	Buick, Cadillac Automotive
PA10204 KIT	Set of 2 Cabin Air Elements	Mazda LDY4-61-J6X; Wix 24826	2004-06 Mazda MPV Van, 2004-on RX8
PA10205 KIT	Set of 2 Cabin Air Elements	Mercedes-Benz 2108300218	Maybach, Mercedes-Benz Automotive
PA10206 KIT	Set of 2 Cabin Air Elements	Land Rover BTR8037	Land Rover Discovery, Range Rover
PA10207	Cabin Air Element	Mercedes-Benz 2118300018, A2118300018; Wix 24726	Mercedes-Benz Automotive
PA10208 KIT	Set of 2 Cabin Air Elements	BMW 64316945586	BMW Automotive
PA10209 KIT	Set of 2 Cabin Air Elements	Nissan B7200-3S500	2000-04 Nissan Frontier, Xterra
PA10210 KIT	Set of 2 Cabin Air Elements	Toyota 88880-33020	1992-2001 Lexus ES300
PA10211 KIT	Set of 2 Cabin Air Elements	GMC 91175923; Suzuki 9586165D00	Chevrolet, Suzuki Light-Duty Trucks
PA10212 KIT	Cabin Air Element	Saab 12758728	1999-2000 Saab 9-5



**WARNING:** These products can expose you to chemicals, including Diisononyl Phthalate, Carbon black extracts, Nickel, 1,3 Butadiene, Ethylene Oxide, Epichlorohydrin, which are known to the State of California to cause cancer, and Bisphenol-A, Ethylene Glycol, Ethylene Oxide, 1,3 Butadiene, Epichlorohydrin, which are known to the State of California to cause birth defects or other reproductive harm.

**BALDWIN NEW PRODUCTS**

BALDWIN NUMBER	DESCRIPTION	REPLACES	APPLICATIONS
PA10213	Cabin Air Element	General Motors 92234714; ACDelco CF178	2010-12 Chevrolet Camaro
PA10214	Cabin Air Element	Ford XW4Z-19N619-AC	Ford Thunderbird; Lincoln LS
PA10215 KIT	Set of 2 Cabin Air Elements	Toyota 88568-60010	Lexus, Toyota Light-Duty Trucks
PA10216 KIT	Set of 2 Cabin Air Elements	Nissan 27274-7J125, 999M1VP003; Wix 24863	Nissan Automotive, Light-Duty Trucks
PA10217	Panel Air Element	Ford 5M6H19N619AD, 5M6Z-19N619-AA	Ford, Mercury Automotive, Light-Duty Trucks
PA10218	Panel Air Element	Toyota 1780140040; Hengst E1050L; Mahle LX2751; Mann & Hummel C34003	2012-on Scion iQ
PA10219	Panel Air Element	Mazda ZJ0113Z40	Mazda 2 with 4-1498cc (1.5L) FI Engine
PA10220	Panel Air Element	Honda 172205R0008	Honda Fit with 4-1497cc (1.5L) FI Engine
PA10221	Panel Air Element	Acura 17220-RYE-A10	2010-13 Acura MDX, ZDX
PA10222	Panel Air Element	Nissan 16546-EG000	2006-08 Infiniti M35
PA10223	Panel Air Element	Hyundai 28113C1500	2015 Hyundai Sonata
PA10224	Panel Air Element	Suzuki 13780-80J00	2007-on Suzuki SX4
PA10225	Panel Air Element	Mitsubishi MR404849, MR571476	2001-06 Mitsubishi Montero
PA10226	Panel Air Element	Jaguar EAC1828, GFE1088, JLM9548	Jaguar Automotive
PA10227	Panel Air Element	Honda 17220RW0A01	Acura ILX, Honda Civic Hybrid with 4-1497cc (1.5L) FI Engine
PA10228	Panel Air Element	Honda 17220-RDA-A10	2007-08 Acura TL
PA10229	Panel Air Element	Mercedes-Benz 6040940504, 6040940604	1996-2002 Mercedes-Benz Automotive
PA10230	Panel Air Element	Kia 281133W500	Kia Sportage with 4-122 (2.0L) FI Turbo Engine
PA10231	Panel Air Element	Mazda FS0-513-Z40	Mazda Automotive
PA10232	Panel Air Element	Hyundai 28113-3M100	2009-on Hyundai Genesis, 2011 Equus
PA10233	Panel Air Element	Toyota 17801-50060	Lexus Automotive
PA10235	Panel Air Element	Nissan 16546-60U00	Infiniti FX45, Q45
PA10236	Panel Air Element	Suzuki 1378057L00	2010-12 Suzuki Kizashi
PA10237	Panel Air Element	Hyundai 281132M000	2010-12 Hyundai Genesis Coup
PA10238	Panel Air Element	Suzuki 13780-78K00	2009-on Suzuki Grand Vitara
PA10239	Panel Air Element	Nissan 165463KY0A	Nissan Murano, Pathfinder
PA10240	Panel Air Element	Suzuki 13780-52D00	2004-06 Suzuki XL-7
PA10241	Panel Air Element	Hyundai 28113-3M000	2009-on Hyundai Genesis
PA10242	Panel Air Element	Mazda N3H1-13-Z40	2004-09 Mazda RX8
PA10243	Oval Air Element	Mercedes-Benz 6510940104, A6510940104	2014-16 Mercedes-Benz E250
PA10244	Panel Air Element	GMC 96328718; Suzuki 13780-86Z00	Chevrolet, Suzuki Automotive
PA10245	Panel Air Element	Mitsubishi MD620837; Wix 46308	Mitsubishi Montero, Montero Sport
PA10246	Set of 2 Air Elements	Mercedes-Benz 6420942304, 6420942404	Mercedes-Benz Automotive
PA10247	Panel Air Element	Honda 17220-PHM-000; Wix 46499	2000-06 Honda Insight
PA10248	Panel Air Element	Mazda LFG1-13-Z40	2006-07 Mazda MX-5, 2008-on Miata MX-5
PA10249	Panel Air Element	GMC 15287103; ACDelco A3076C; Wix 49066	Pontiac, Saturn Automotive
PA10250	Panel Air Element	Kia 28113-3F900	2007-09 Kia Amanti
PA10251	Panel Air Element	Kia 28113A5800; Wix WA10059	2014-15 Kia Forte, Forte Coup
PA10253	Panel Air Element	Mitsubishi MR187912; Wix 546456, 46456	1997-2004 Mitsubishi Diamante
PA10254	Panel Air Element	Hyundai 281132M200; Wix WA10022	Hyundai Applications
PA10255	Panel Air Element	Nissan 16546EH000; ACDelco AF3939x	Hyundai Applications
PA10256	Panel Air Element	Honda 172205K0A00	2014-15, 2017 Honda Accord Hybrid



**WARNING:** These products can expose you to chemicals, including Diisononyl Phthalate, Carbon black extracts, Nickel, 1,3 Butadiene, Ethylene Oxide, Epichlorohydrin, which are known to the State of California to cause cancer, and Bisphenol-A, Ethylene Glycol, Ethylene Oxide, 1,3 Butadiene, Epichlorohydrin, which are known to the State of California to cause birth defects or other reproductive harm.

# BALDWIN NEW PRODUCTS

BALDWIN NUMBER	DESCRIPTION	REPLACES	APPLICATIONS
PA10257	Panel Air Element	BMW 13717577458; Mahle LX16845	BMW Automotive - Left hand side
PA10258	Panel Air Element	Honda 17220-P13-000; Wix 46110	1985 Honda Accord, 1992-2001 Prelude
PA10259	Panel Air Element	Chrysler 5019443AA; Wix 42156	Jeep Liberty, TJ, Wrangler
PA10260	Panel Air Element	Acura 17220-PY3-000; Wix 46092	1991-95 Acura Legend, 1996-98 TL
PA10261	Panel Air Element	Hyundai 28113M500	2012-14 Hyundai Genesis with V8-5038cc (5.0L) FI Engine
PA10262	Panel Air Element	BMW (Bavarian Motor Works) 13717577457	BMW Automotive - Right hand side
PA10263	Panel Air Element	Honda 17220-PGE-A00	2001-05 Acura, 2002-03 TL Type S
PA10264	Panel Air Element	Honda 17220-P5A-000	Acura RL
PA10265	Panel Air Element	Hyundai 281132M010	2010-12 Hyundai Genesis Coup with V6-3778cc Eng
PA10266	Panel Air Element	Honda 17220-RTW-000	2011-on Honda CR-Z Hybrid
PA10267	Panel Air Element	Toyota 17810-31110	2007-11 Lexus GS350, 2006-07 GS430, 2006-13 IS250, 2006-13 IS350
PA10268	Panel Air Element	Suzuki 1378054L00	2010-13 Suzuki SX4
PA10269	Panel Air Element	Honda 17220-RBJ-000	Honda Insight
PA10270	Panel Air Element	Acura 17220-RL5A00	Acura TSX with 4-2354cc (2.4L) Engine
PA10271	Panel Air Element	Kia 281133S100	Hyundai, Kia Automotive
PA10272	Panel Air Element	Kia 28113-2K000	2010-on Kia Soul
PA10273	Panel Air Element	Hyundai 28113B1000	Hyundai Genesis
PA10274	Air Element	General Motors 13367308; ACDelco A3202C	2016-18 Cadillac ATS
PA10275	Panel Air Element	Toyota 17801-21060	2016-18 Toyota Prius, 2019 Prius AWD-e, 2012-19 Prius C, 2017-19 Prius Prime
PA10276	Panel Air Element	Toyota 17801-331170	2017 Lexus GS Turbo, IS Turbo, RC Turbo, 2016-17 GS200t, IS200t, RC200t, 2018-19 GS300, 2013-19 GS350, 2013-18 GS450h, 2014-15 IS250, 2016-19 IS300, RC300, 2014-19 IS350, 2015-19 RC350
PA10277	Panel Air Element	BMW 13717571355, 13717605913	Various BMW automotive
PA10278	Panel Air Element	BMW 13717542294	BMW Automotive
PA10279	Panel Air Element	Volkswagen 7L0129620; Wix 42859	Audi, Porsche, Volkswagen Automotive
PA10280	Panel Air Element with Foam Pad	Volvo 30637444	Volvo Automotive
PA10281	Panel Air Element	BMW 13717568728	2011-12 BMW Z4; 2007-16 MINI Cooper, 012-17 Cooper Countryman, 2013-16 Cooper Paceman
PA10282	Panel Air Element	Volkswagen 4E129620	2016-18 Audi A3 Sportback e-tron; 2013-18 Volkswagen Jetta
PA10283	Panel Air Element	General Motors 55557597; Saab 12786800	Saab Automotive
PA10284	Panel Air Element	Land Rover LR011593	2010-13 Land Rover LR4, Range Rover, Range Rover Sport
PA10285	Panel Air Element with Foam Pad	Audi 8K0133843E	Audi Automotive
PA10286	Panel Air Element	Mercedes-Benz 10940301, A0010940301	2008-15 Smart ForTwo
PA10287	Panel Air Element	Porsche 99611013152; Mann & Hummel C54165	Porsche Automotive
PA10288	Panel Air Element	Mercedes-Benz 6040940004, 6040940104, 6040941404	1994-2009 Mercedes-Benz Automotive
PA10289	Panel Air Element	BMW 13721477840; Mann & Hummel C2237	2002-08 Mini Cooper
PA10290	Panel Air Element	Volkswagen 7K129620	Volkswagen Automotive
PA10291	Panel Air Element	General Motors 55560894	Buick, Saab Automotive
PA10292	Panel Air Element	Volvo 8638600, 30741594	2003-06 Volvo XC90
PA10293	Set of 2 Panel Air Elements	Chrysler 5098424AA; Mercedes-Benz A1120940304	Chrysler, Mercedes-Benz Automotive
PA10294	Panel Air Element	BMW 13717582908	BMW Automotive
PA10295	Set of 2 Panel Air Elements	Mercedes-Benz 6420940404; Wix 42468	Mercedes-Benz Automotive



**WARNING:** These products can expose you to chemicals, including Diisononyl Phthalate, Carbon black extracts, Nickel, 1,3 Butadiene, Ethylene Oxide, Epichlorohydrin, which are known to the State of California to cause cancer, and Bisphenol-A, Ethylene Glycol, Ethylene Oxide, 1,3 Butadiene, Epichlorohydrin, which are known to the State of California to cause birth defects or other reproductive harm.

**BALDWIN NEW PRODUCTS**

BALDWIN NUMBER	DESCRIPTION	REPLACES	APPLICATIONS
PA10296	Panel Air Element	BMW 13721491749; Mann C2851	Cooper Automotive
PA10297	Panel Air Element	ACDelco A2945C; General Motors Corp. 10342024; Wix 42821	Cadillac, Chevrolet Automotive
PA10298	Panel Air Element	Mercedes-Benz 40941604	1999-2003 Mercedes-Benz CLK430
PA10299	Panel Air Element	Mercedes-Benz 2760940004, A2760940004	Mercedes-Benz Automotive
PA10300	Panel Air Element	Jaguar 1X439601AA, C2S00002; Wix 42625	Jaguar Automotive
PA10301	Panel Air Element with Foam Pad	Volvo 3068029-3; Wix 49293	2007-on Volvo XC90
PA10302	Panel Air Element	Land Rover PHE000112; Wix 49112	Land Rover LR3, Range Rover Sport
PA10303	Panel Air Element	BMW (Bavarian Motor Works) 13717548888; Wix 49888	2007-10 BMW X5 with 6-2996cc (3.0L) Engine
PA10304	Panel Air Element	Jaguar AJ82766, C2Z15037	Jaguar Automotive
PA10305	Panel Air Element	Mercedes-Benz 2710940304, A2710940304	Mercedes-Benz C250, SLK250
PA10306	Panel Air Element	Mercedes-Benz 6040940904; Wix 42620	1998-2004 Mercedes-Benz Automotive
PA10307	Panel Air Element	Fiat 682020151AA	2014-15 Fiat 500L
PA10308	Panel Air Element	Mercedes-Benz 1120940104, 1120940204	2000-02 Mercedes-Benz E320
PA10309	Panel Air Element	BMW (Bavarian Motor Works) 13717556961; Wix 49461	2007-on BMW Automotive
PA10310	Panel Air Element	Volkswagen 6C133843	Audi Automotive
PA10311	Panel Air Element	BMW 13717521033	BMW Automotive
PA10312	Panel Air Element	Volvo 9186361	Volvo S80
PA10313	Panel Air Element	Mopar 52022346AA	2012-15 Fiat 500 1.4L Turbo Abarth
PA10314	Set of 2 Panel Air Elements	Mercedes-Benz 1560940504, A1560940404, A1560940504	Mercedes-Benz Automotive
PA10315	Panel Air Element	Jaguar NJA3558AA	Jaguar Automotive
PA10316	Panel Air Element	GMC 25750701; ACDelco A1623C	Cadillac, VW Auto; Land Rover
PA10317	Panel Air Element	Volvo 3063655-1	Volvo Automotive
PA10318	Panel Air Element	Briggs & Stratton 805113	Briggs & Stratton Engines
PA10319	Panel Air Element	BMW 13717599285	BMW Automotive
PA10320	Panel Air Element with Foam Pad	Volvo 30745344; Wix 49344	Volvo Automotive
PA10321	Panel Air Element	BMW 13721247405	BMW Automotive
PA10323	Panel Air Element	Honda 17220-PM7-000; Wix 546158, 46158	1988-91 Honda Civic, CRX
PA10324	Panel Air Element	Mercedes-Benz 2780940004	2011-13 Mercedes-Benz Automotive
PA10325	Panel Air Element	Chrysler 68073648AA	2012-13 Fiat 500
PA10326	Panel Air Element	BMW 13717548897	2008-10 BMW X5
PA10327	Panel Air Element with Foam Precleaner	Volkswagen 5QM129620A	2015 Volkswagen Gold with 4-1968cc (2.0L) FI Turbo Diesel Engine
PA10328	Panel Air Element	Ford E9BZ-9601-A; Motorcraft FA1064	1989-93 Ford Automotive
PA10329	Panel Air Element	BMW 13717548898	2008-10 BMW X5
PA10330	Panel Air Element	General Motors Corp. 92082656; Wix 46913	2004-06 Pontiac GTO
PA10331	Panel Air Element with Foam	Volvo 30850831	2000-04 Volvo S40, V40
PA10332	Panel Air Element	Saab 4876074	1999-2003 Saab 9-3
PA10333	Panel Air Element	BMW 13727843283	2013-15 BMW Automotive
PA10334	Panel Air Element	BMW 13727843284	2013-15 BMW Automotive
PA10335	Panel Air Element with Foam Pad	BMX 13717798342	BMW Automotive



**WARNING:** These products can expose you to chemicals, including Diisononyl Phthalate, Carbon black extracts, Nickel, 1,3 Butadiene, Ethylene Oxide, Epichlorohydrin, which are known to the State of California to cause cancer, and Bisphenol-A, Ethylene Glycol, Ethylene Oxide, 1,3 Butadiene, Epichlorohydrin, which are known to the State of California to cause birth defects or other reproductive harm.

# BALDWIN NEW PRODUCTS

BALDWIN NUMBER	DESCRIPTION	REPLACES	APPLICATIONS
PA10336	Panel Air Element	BMW 13717534825; ACDelco AF3604	2007, 2010-16 Mini Cooper, 2011-14 Countryman
PA10337	Panel Air Element	Jaguar C2916933	2010-15 Jaguar XK, XKR
PA10338	Panel Air Element	Porsche 97011022001	2010-16 Porsche Panamera
PA10339	Panel Air Element	Porsche 99611013171	2004-11 Porsche 911
PA10340	Panel Air Element with Foam Pad	Volkswagen 7P0129620A	Porsche Cayenne; Volkswagen Touareg
PA10341	Panel Air Element	Volvo 1336397-3	Volvo Automotive
PA10342	Panel Air Element	BMW 13727529261; Hengst E729L; Mahle LX1213; Mann & Hummel C2245	2013-14 BMW; 2007-98 Mini Cooper Automotive
PA10343	Panel Air Element with Foam Pad	Toyota 1780131141	2013-15 Lexus RX450h; 2012-15 Toyota Highlander
PA10344	Panel Air Element	General Motors 22844634; ACDelco A3185C	2014 Cadillac CTS
PA10345	Panel Air Element with Foam Pad	GMC 13319421; ACDelco A3172C; Mahle LX3062; Mann C29012	2012-13 Buick Regal; 2010-12 Saab 9-5
PA10346	Panel Air Element	Ford AR3Z-9601-B; Motorcraft FA1897; Wix 49201	2010-on Ford Mustang
RS10347	Radial Seal Air Element	Mercedes-Benz 2710940204, A2710940204	2003-05 Mercedes-Benz C230
RS10348	Radial Seal Air Element	General Motors 20774655; ACDelco A3099C	Chevrolet HHR with 4-122 (2.0L) FI Turbo
RS10349	Radial Seal Air Element	Motorcraft FA1895	2008-09 Ford Mustang V8-281 (4.6L) FI Engine
RS10350	Conical-Shaped Air Element	Motorcraft FA1896	2010-14 Ford Mustang
RS10351	Air Element with Foam Wrap	Volvo 8671488	2004-07 Volvo S60 R, V70 R
PA10352	Air Element	Ford C3AZ-9601-B, C4AZ-9601-A; Motorcraft FA6	1963-67 Ford Automotive, Engines, Trucks
PA10353	Air Element	Mann & Hummel C1041	Smart Fortwo with 3-799cc (0.8L) Engine
PA10355	Air Element	Ford C0AE-9601-B; Motorcraft FA5	Ford, Lincoln, Mercury Automotive
PA10356	Air Element	Ford D5ZF-9601-AA; Motorcraft FA605	1975-76 Ford Mustang II
PA10357	Air Element	Nissan 16546-U6710	1968-79 Nissan Automotive, 1986-92 Light-Duty Trucks
PA10358	Panel Air Element	Mercedes-Benz 30946104	1992-99 Mercedes-Benz Automotive
SA10359	Crankcase Breather Filter in Metal Housing	GMC 557240, 6424244	General Motors Automotive
SA10360	Crankcase Breather Filter in Plastic Housing	GMC 8996724, 25096399	General Motors Automotive
SA10361	Crankcase Breather Filter in Plastic Housing	Chrysler 3236695, J3236695	1975-87 AMC Automotive, 1975-90 Jeep
PA10362	Cabin Air Element	GMC 88970273	Pontiac, Toyota Automotive
PA10363	Cabin Air Element	Toyota 87139-33010, 87139-YZZ03	2003-09 Lexus GX470, 2004-06 RX330
PA10364	Cabin Air Element	Hyundai 87902-H000A	2010 Hyundai Elantra
PA10365 KIT	Set of 2 Cabin Air Elements	Chrysler 68033193AA	2009-11 Dodge Nitro; 2009-12 Jeep Liberty
PA10367	Cabin Air Ele. with Pull Tab	Nissan 278913DF0A	2009-14 Nissan Cube, 2011-14 Juke, Leaf, 2013-14 Sentra
PA10368	Cabin Air Element	Mercedes-Benz 2038300118, 2038300918, 203830091864	Mercedes-Benz Automotive
PA10369	Cabin Air Element	General Motors 13356914, 13356916; ACDelco CF184	2013-14 Cadillac ATS; 2014-on Chevrolet Impala
PA10370 KIT	2 Cabin Air Elements	BMW 64319237157, 64319237158, 64319312318, 64319313316	2014-15 BMW X3, 2015 X4
PA10371	Cabin Air Element	Hyundai 87902L000A	Hyundai Automotive
PA10372	Cabin Air Element	Mitsubishi 7850A002	2014-17 Mitsubishi Marage, 2017 Mirage G4
PA10373	Cabin Air Element	GMC 96435888, 96539649	Chevrolet, Pontiac Automotive
PA10374	Cabin Air Element	BMW 64318409044	BMW X5; Land Rover Range Rover
PA10375	Cabin Air Element	BMW 64319071935	BMW Automotive
PA10376	Cabin Air Element	Nissan 27891EL00A	2007-12 Nissan Versa
PA10378	Panel Air Element	Honda 17220-RMX-000	Honda Automotive
PA10379	Panel Air Element	Mitsubishi 1500A023	Mitsubishi Light-Duty Trucks
PA10380	Panel Air Element	Honda 17220-RB0-000	Honda Fit with 4-1497cc (1.5L) Engine



**WARNING:** These products can expose you to chemicals, including Diisononyl Phthalate, Carbon black extracts, Nickel, 1,3 Butadiene, Ethylene Oxide, Epichlorohydrin, which are known to the State of California to cause cancer, and Bisphenol-A, Ethylene Glycol, Ethylene Oxide, 1,3 Butadiene, Epichlorohydrin, which are known to the State of California to cause birth defects or other reproductive harm.

**BALDWIN NEW PRODUCTS**

BALDWIN NUMBER	DESCRIPTION	REPLACES	APPLICATIONS
PA10381	Panel Air Element	Honda 17220R4HA00	2016-19 Acura ILX
PA10382	Panel Air Element	Toyota 17801-16040; Donaldson P500026; Fleetguard AF4964	Geo, Toyota Automotive
PA10383	Panel Air Element	BMW 13721702907	1996-2001 BMW 750iL, 2001-06 X5
PA10384	Panel Air Element	Ford XL3Z-9601-AA	Ford Light-Duty Trucks
PA10385	Panel Air Element with Foam Pad	BMW 13717505007	BMW, Rolls Royce Automotive
PA10386	Panel Air Element	General Motors 90531003, 93192885; Saturn 9117557	2006 Chevrolet Astra; 2008-09 Saturn Astra
PA10387	Panel Air Element	General Motors 92196275; ACDelco A3137C	2010-on Chevrolet Camaro
PA10388	Panel Air Element	Toyota 17801F0020, 178010T080, 1780177050	2019-20 Lexus UX200, ES300h; Toyota Avalon, Corolla, 2016-19 Mirai, 2018-20 Camry Hybrid, C-HR, 2019 RAV4
PA10389	Panel Air Element	General Motors 20871244; ACDelco A3148C	2011-on Chevrolet Volt
PA10390	Panel Air Element	General Motors 20857930; ACDelco A3178C	2014 Cadillac ATS
PA10391	Panel Air Element	General Motors 95021102	2013-14 Chevrolet Trax
PA10392	Panel Air Element	Land Rover LR029078	2012-14 Land Rover Range Rover Evoque, 2013-14 LR2
PA10393	Panel Air Element	BMW 13717601868	2013-15 BMW Automotive
PA10394	Panel Air Element	BMW 13717602643	2013-on BMW Automotive
PA10395	Panel Air Element	BMW 13718507320	BMW Automotive
PA10396	Cabin Air Element	Chrysler 68301863AA	2018-20 Jeep Wrangler, 2020 Gladiator
PA10397	Panel Air Element	GMC 25043246	1985-92 Chevrolet Automotive
PA10398	Panel Air Element	Volkswagen 859129620	1992-98 Audi, 1988-97 Volkswagen Automotive
PA10399	Air Element	GMC 6422468	
PA10400	Cabin Air Element	Honda 80291-ST3-505, 80291-ST3-E01	1997-2001 Honda CR-V, 2000-06 Insight
PA10401	Cabin Air Element	Chrysler 68308950AB	2017-20 Chrysler Pacifica
PA10402	Cabin Air Element	Nissan 272774BU0A	2015-20 Nissan Rogue, 2019-20 Rogue Sport
PA10403	Panel Air Element	General Motors 95238310; ACDelco A3227C	2016-2020 Chevrolet Spark
PA10404	Cabin Air Element	Volkswagen 5Q0819653	2015-19 Audi A3, A3 Quattro; 2015-16 S3; 2016-17 A3 Sportback e-tron, TT Quattro; 2015 Volkswagen Golf SportWagen; 2015-17 Golf; 2015-18 e-Golf, Golf; 2015-19 Golf R, GTI; 2018-19 Atlas; Volkswagen European Light Duty Vehicles
PA10405	Oval Air Element	General Motors 23107355; ACDelco A3191C	2014-19 Chevrolet Corvette
PA10407	Panel Air Element		2017-20 Honda Civic with 2.0L Turbo Engine
PA10409	Panel Air Element		2019-20 Jeep Cherokee with 2.4L & 3.2L Engines
PA10411	Cabin Air Element	Hyundai 97133D3000	2016-20 Hyundai Tucson, 2019 Veloster, 2019-20 Veloster N; 2017-19 Kia Sportage
PA10412	Cabin Air Element	Toyota 8850804010	2016-20 Toyota Tacoma
CV15007	Crankcase Breather	Caterpillar 3286272, 3805839; International 3007357C1; Racor CV55603-02, CV55603-03	Caterpillar C13, C15 On-Hwy Engines
CV15008	Crankcase Breather	Caterpillar 2968325, 3805840; Racor CV55603; Fleetguard CV50304	Caterpillar C13, C15 Diesel Truck
CV15010	Crankcase Breather		Blue Bird, IC Corporation, New Flyer, Solaris, Thomas Buses; Autocar, Capacity of Texas, Ford, Freightliner, International, Kenworth, Mack Ottawa, Peterbilt, Rainier, RAM, Sterling Medium/Heavy-Duty Trucks; RAM Light-Duty Trucks
CV15011	Crankcase Breather	Isuzu 8976063180; Mitsubishi ME302763	Mitsubishi Trucks; Tadano Cranes
PE17000	Diesel Exhaust Fluid Filter	Cummins 21516229, 2880298, 2888182, 5303604; Fleetguard UF101	Autocar, Blue Bird, DAF, Ford, Foton, Freightliner, Heuliez, Hino, International, Isuzu, Iveco, Kenworth, Mack, Peterbilt, R.V.I., Spartan, Solaris, Volvo, Western Star Trucks & Off-Highway Equipment with Diesel Exhaust Fluid



**WARNING:** These products can expose you to chemicals, including Diisononyl Phthalate, Carbon black extracts, Nickel, 1,3 Butadiene, Ethylene Oxide, Epichlorohydrin, which are known to the State of California to cause cancer, and Bisphenol-A, Ethylene Glycol, Ethylene Oxide, 1,3 Butadiene, Epichlorohydrin, which are known to the State of California to cause birth defects or other reproductive harm.

## BALDWIN NEW PRODUCTS

BALDWIN NUMBER	DESCRIPTION	REPLACES	APPLICATIONS
18002	Transmission Filter	Ford F2VY-7A098-A	Ford Automotive, Light-Duty Trucks, Vans
18009	Transmission Filter	GMC 8684953	GM Automotive
18011	Transmission Filter	Nissan 31728-80X03	Ford, Nissan Automotive, Vans
18012	Transmission Filter	Toyota 35303-30060	Kia, Suzuki, Toyota Automotive, Light-Duty Trucks, Vans
18013	Transmission Filter	Toyota 35330-32022	Toyota Automotive
18031	Transmission Filter	GMC 8641910	GM Automotive
18139	Transmission Filter	GMC 8682471	GM Automotive
18163	Transmission Filter	Toyota 35330-20010	Chevrolet, Geo, Toyota Automotive
18268	Transmission Filter	Ford F1CZ-7A098-A; Mazda FU61-21-500B	Ford, Kia Automotive
20006	Transmission Filter	Ford 3W4Z-7A098-AB; Motorcraft FT142	Ford, Lincoln Automotive
20007	Transmission Filter	Ford XW4Z-7A098-BB; Motorcraft FT117	Ford, Jaguar, Lincoln Automotive
20018	Transmission Filter	Ford 6L2Z-7A098-AA; Motorcraft FT160	Ford, Mercury Light-Duty Trucks
20026	Transmission Filter	Chrysler 5191890AA	2007-12 Dodge Caliber, 2007-17 Jeep Compass, Patriot
20027	Transmission Filter	Chrysler 68018555AA	Chrysler & Dodge Models
20028	Transmission Filter	Ford BC3Z7A098B, BC3P7G186BE; Motorcraft FT187	Ford Trucks, Blue Bird Vision School Bus
20029	Transmission Filter	Ford BL3Z7A098A; Motorcraft FT188	2017-19 F-250 Super Duty Pickup, 2013 Ford Lobo, 2011-19 Mustang; 2015-18 Lincoln Navigator; 2015-17 Mobility Ventures MV-1; 2019 Ford F-450 Super Duty Pickup; 2019 Ford F-550 Super Duty Pickup
20030	Transmission Filter	General Motors 29542824	2013 Chevrolet Silverado 2500 HD, Silverado 3500 HD; 2013 GMC Sierra 2500 HD, Sierra 3500 HD
20031	Magnetic In-Line Universal Transmission Filter	ATP JX150	Magnetic In-Line Universal Trans Filter
20033	Transmission Filter	BMW (Bavarian Motor Works) 24236595	BMW Automotive
20035	Transmission Filter	Toyota 35330-32030	Lexus, Toyota Automotive
20037	Transmission Filter	Nissan 31728-31X01	Infiniti, Nissan Automotive
20041	Transmission Filter	BMW 24111218899	BMW, Cadillac Automotive
20042	Transmission Filter	GMC 94853372; Toyota 35330-12030	Chevrolet, Geo, Toyota Automotive
20043	Transmission Filter	Toyota 35330-33010	Lexus, Toyota Automotive
20044	Transmission Filter	Toyota 35330-60020	Toyota Light-Duty Trucks
20045	Transmission Filter	Volkswagen 1M325429	Audi, Volkswagen Automotive
20046	Transmission Filter	Honda 25420-PY4-000	Acura Automotive
20048	Transmission Filter	Mercedes-Benz 1402770095; Filtran F281	Chrysler, Mercedes-Benz Auto; Jeep
20050	Transmission Filter	Toyota 35330-30050	Lexus Automotive
20051	Transmission Filter	Toyota 35330-20020, 35330-0W020	Scion, Toyota Automotive
20052	Transmission Filter	BMW 24722000	BMW, Pontiac, Saturn Auto; Land Rover
20053	Transmission Filter	Ford C5AZ-7A098-C; Motorcraft FT36, FT36-A	Ford Automotive
20054	Transmission Filter	Toyota 35330-12040; Wix 58040	Pontiac, Toyota Automotive
20055	Transmission Filter	GMC 25010641	Chevrolet, GMC, Pontiac, Suzuki Light-Duty Trucks
20057	Transmission Filter	Ford E9FZ-7A098-A	Ford Automotive
20058	Transmission Filter	GMC 8634223	General Motors Automotive, Light-Duty Trucks
20060	Transmission Filter	Toyota 35303-30050; Volvo 1239829-3; Fleetguard TF15057	Dodge, Isuzu, Mitsubishi, Toyota Automotive, Light-Duty Trucks
20061	Transmission Filter	Toyota 35330-30011	Lexus, Toyota Automotive
20062	Transmission Filter	Toyota 35330-35010	Isuzu, Mitsubishi, Toyota Light-Duty Trucks
20063	Transmission Filter	Honda 25450P4V013	1996-2005 Honda Accord, Civic with 4MVA-CVT Transmission
20064	Transmission Filter	Isuzu 8-96015-062-0	Acura, Honda, Isuzu Light-Duty Trucks
20065	Transmission Filter	Toyota 35330-50010	Lexus, Toyota Automotive
20066	Transmission Filter	Subaru 31728-AA011	Subaru Automotive
20067	Transmission Filter	Ford C6AZ-7A098-A; Motorcraft FT37A, FT38A	Ford, Mercury Automotive, Light-Duty Trucks; Jeep



**WARNING:** These products can expose you to chemicals, including Diisononyl Phthalate, Carbon black extracts, Nickel, 1,3 Butadiene, Ethylene Oxide, Epichlorohydrin, which are known to the State of California to cause cancer, and Bisphenol-A, Ethylene Glycol, Ethylene Oxide, 1,3 Butadiene, Epichlorohydrin, which are known to the State of California to cause birth defects or other reproductive harm.

**BALDWIN NEW PRODUCTS**

BALDWIN NUMBER	DESCRIPTION	REPLACES	APPLICATIONS
20068	Transmission Filter	Hyundai 46321-22050	Hyundai, Nissan Automotive
20069	Transmission Filter	Audi 1L325429; Jaguar JLM20216	Audi, Jaguar, Volkswagen Automotive
20070	Transmission Filter	Ram 68224232AA	RAM 3500, 4500, 5500 with 6.4L & 6.7L Engine
PT23545-MPG	Maximum Performance Glass Hydraulic Element	Volvo 14569658, 14690316	Volvo Excavators, Pipelayers
PT23546-MPG	Maximum Performance Glass Hydraulic Element with Blank Band	Volvo 14539482, 14688861; Donaldson P502494; Fleetguard HF3551	Volvo Excavators
BT23555-MPG	Maximum Performance Glass Hydraulic Spin-on		Case-International Tractors; New Holland Tractors; Steyr Tractors
PT23561-MPG	Maximum Performance Glass Hydraulic Element with Blank Band	Bobcat 7024037	Bobcat Loaders
PT23597-MPG	Maximum Performance Glass Hydraulic Element	Komatsu 20Y9701820, 706311046; Fleetguard HF35530	Komatsu PC220LC-8 Excavators
PT23598-MPG	Maximum Performance Glass Hydraulic Element	Takeuchi 1551103900	Takeuchi Loaders
BT23604	Hydraulic Spin-on	Komatsu 4181834160; Donaldson P502622	Komatsu Loaders
BT23605-MPG	Maximum Performance Glass Hydraulic Spin-on		Case-International Tractors; New Holland Tractors; Steyr Tractors
PT23613-MPG	Maximum Performance Glass Hydraulic Element with Bail Handle	Liebherr 11065673; Donaldson P784036	Liebherr R954C Litronic Excavator
BT23617	Hydraulic Spin-on	Komatsu 4171834130; Fleetguard HF8144	Komatsu Loaders
BT23619-MPG	Maximum Performance Glass Hydraulic Spin-on	John Deere AT367635	John Deere Forestry Equipment, Loaders
BT23628	Hydraulic Spin-on	John Deere AT466863	John Deere Loaders
PT23629	Hydraulic Steering Element	Freightliner 1417927000; Fleetguard HF35387	Freightliner 108SD, 114SD, 122SD, Business Class M2 106, Business Class M2 112, Business Class M2, Cascadia, Cascadia Evolution, Coronado, Coronado SD, M2 106, M2 112, MT45, MT55; Western Star 4700, 4900EX, 4900FA, 4900SA, 5700XE, 6900XD Trucks
BT23630	Spin-on Transmission Filter	Hyundai 46322-39000; Kia 46322-39000	Freightliner 108SD, 114SD, 122SD, Business Class M2 106, Hyundai, Kia Automotive, Light-Duty Trucks
BT23631	Transmission Filter	Subaru 38325-AA032, 38325-KA000	Subaru Light-Duty Trucks
PT23633	Oval Hydraulic Element	International 388081-R1, 3888081-R2, 388085-R1, 388085-R2, 403431-R92	IHC Wheel Tractors
PA30193-FN	Outer Air Element with Fins	Iveco 8019342	Iveco Cursor 87 Engine; Winpower DR25014 Generator with Iveco Cursor 87 TE1D Engine
PA30194	Inner Air Element	Iveco 8034304	Iveco Cursor 87 Engine; Winpower DR25014 Generator with Iveco Cursor 87 TE1D Engine
RS30212	Radial Seal Outer Air Element	Agco 6223618M1; John Deere DQ59138, SJ17532; Massey Ferguson 6223618M1; New Holland 87344135	John Deere Tractors; Massey Ferguson Wheel Tractors; New Holland Tractors
RS30213	Radial Seal Inner Air Element	Agco 6223619M1; John Deere DQ59139; Massey Ferguson 6223619M1; New Holland 87344136	John Deere Tractors; Massey Ferguson Wheel Tractors; New Holland Tractors
RS30220	Radial Seal Outer Air Element	JLG Industries 70005008	JLG Industries Inc. 600S, 600SJ, 800A, 800AJ Aerial Lifts with Ford 2.5L Engine
RS30221	Radial Seal Inner Air Element	John Deere AT336803; Donaldson P629465	Freeman Balers, John Deere Loaders, Swinger Loaders
RS30222XP	Extreme Performance Nano Radial Seal Outer Air Element	Ford F3HZ-9601-A; General Motors 15619013; Nissan 16546NY108; Baldwin RS2863XP	Chevrolet, Ford, GMC, Nissan UD Medium-Duty Trucks
PA30249	Cab Air Element	Caterpillar 3657606	Caterpillar Loaders, Lift Trucks
PA30253	Cab Air Element	Atlas Copco 3222325376; Donaldson P953330	Atlas Copco Equipment
PA30255	Foam Cab Air Element in Plastic Housing	Bobcat 7193354	Bobcat Loaders
RS30257	Radial Seal Outer Air Element	Tata Cummins 252709130143; Donaldson P613334; Fleetguard AF26483	



**WARNING:** These products can expose you to chemicals, including Diisononyl Phthalate, Carbon black extracts, Nickel, 1,3 Butadiene, Ethylene Oxide, Epichlorohydrin, which are known to the State of California to cause cancer, and Bisphenol-A, Ethylene Glycol, Ethylene Oxide, 1,3 Butadiene, Epichlorohydrin, which are known to the State of California to cause birth defects or other reproductive harm.



## BALDWIN NEW PRODUCTS

BALDWIN NUMBER	DESCRIPTION	REPLACES	APPLICATIONS
PA30258	Cab Air Element	Liebherr 10097542; Fleetguard AF55860	Liebherr Equipment
PA30260	Felt Cabin Air Element with Foam Pad	International CFFN6100	International WorkStar Trucks
PA30261	Cab Air Element	Kubota 6A67175090	Kubota Excavators, Loaders, Tractors
PA30262	Nylon Mesh Screen	Hyundai 11N690770	Case Loaders, Hyundai Loaders, Hyundai Excavators
PA30263	Panel Air Element	Polaris 7081706	Polaris Rangers Utility Vehicles
PA30264	Cab Air Element with Pull Tab	Caterpillar 1510914	Caterpillar Loaders, Tractors
PA30268	Secondary Air Element	Caterpillar 3466694; New Holland 73337833	Case-International, New Holland Tractors
PA30269	Cabin Panel Element	Paccar F371018	Kenworth Trucks T800, T880
PA30270	Panel Air Element	Caterpillar 2902288	Caterpillar Loaders
PA30271	Cab Air Element	Case 9707323	New Holland, Versatile Tractors
PA30272	Cab Air Element	Komatsu 4230752410	Komatsu Loaders
PA30275	Primary Air Element	Case 73337834; Caterpillar 3466693; New Holland 73337834	Case-International, New Holland, Caterpillar Equipment
PA30276	Foam Cab Air Element	Case 76303499, 84389987; New Holland 76303499, 84389987	Case, New Holland Loaders
PA30277	Foam Cab Air Element	Mack 3543H9638	Mack Trucks
PA30279	Panel Air Element	Honda 17210ZJ1841, 17210ZJ182; Oregon 30436; Stens 102164	Honda Small Engines
PA30281	Foam Cab Air Element	Kenworth SR2000059	Kenworth Trucks
RS30285	Radial Seal Air Element	Perkins 2652C831	Perkins Generators
PA30287	Foam Cab Air Element	Kenworth R19501	Kenworth W900 Trucks
RS30290	Radial Seal Outer Air Element	Caterpillar 3754301	Caterpillar 374F L, 390F L Excavators; MH3295 Material Handler; PM620, PM622, RM500B Paving Equipment
PA30292	Cab Air Element with Foam Pad and Pull Tabs	John Deere AT315957	John Deere 450H Series, 450J, 550H, 550J, 550J Series, 550K, 650H, 650J, 650J Series, 650K, 700H LGP, 700J Series, 700K, 750J Series, 750K, 850J, 850J Series, 850JR, 850K, 1050K Dozers, Motor Graders; 605K, 655K, 755K Loaders
PA30293	Cab Air Element	Komatsu ND1455301210; Nippon 1455301210	Komatsu PC78US-8, PC78UU-8, PC228US-8, PC228USLC-8 Excavators
PA30299	Cab Air Element	John Deere AZ43412	Caterpillar 1450, 1450AL, 1450CWS, 1450WTS, 1470, 1550 CWS, 1550 WTS. 1570, 2054, 2056, 2058, 2064, 2066, W330 Combines; 6610, 6650, 6710, 6750, 6810, 6850, 6910, 6950 Forage Harvesters
PA30301	Air Element	Gardner Denver 2010945; Ingersoll-Rand W104069; Schramm OUH37810A	Gardner-Denver, I-R, Schramm Air Compressors
PA30303	Oblong Air Element	Briggs & Stratton 393292	Briggs & Stratton Engines
PA30304	Cab Air Element	Case 84376814	Case Loaders; New Holland Loaders, Telehandlers, Trenchers
RS30305	Radial Seal Outer Air Element	Claas 05006151; GPC FC2247; Iveco 42553413; Mann+Hummel C301530; Mercedes-Benz A0040943704, 40943704; Power System 490031, 480031; Pozarli AJ159; Wirtgen 182496	Claas Tractors; Iveco Buses; Tadano Cranes; Wirtgen Paving Equipment
RS30306	Radial Seal Inner Air Element	Claas 005006161, 500616, 500616.1; Liebherr 11291030; Mann+Hummel CF1830; M.A.N. 81.08405-0028; Mercedes-Benz A0040943904, 40943904; Pozarli AJ169; Sullair 88291008-317; Wirtgen 18249	Claas Tractors; Neoplan Buses; Wirtgen Paving Equipment
RS30307	Radial Seal Outer Air Element	Liebherr 10278562; Mann+Hummel C301330	Liebherr Dump Trucks, Excavators; Terex Loaders



**WARNING:** These products can expose you to chemicals, including Diisononyl Phthalate, Carbon black extracts, Nickel, 1,3 Butadiene, Ethylene Oxide, Epichlorohydrin, which are known to the State of California to cause cancer, and Bisphenol-A, Ethylene Glycol, Ethylene Oxide, 1,3 Butadiene, Epichlorohydrin, which are known to the State of California to cause birth defects or other reproductive harm.

**BALDWIN NEW PRODUCTS**

BALDWIN NUMBER	DESCRIPTION	REPLACES	APPLICATIONS
RS30308	Radial Seal Inner Air Element	Kamaz CF1820; Mann+Hummel CF1820; Pozarli AV785	
PA30309	Replacement for Ecolite Air Element in Disposable Housing	Racor 400820020	
PA30310	Cab Air Element with Pull Tabs	Caterpillar 3293243	Caterpillar Loaders, Crawler Tractors
RS30311	Radial Seal Outer Air Element	Case 84443964; New Holland 84443964; Donaldson P786106; Fleetguard AF27952	New Holland Harvesters
RS30313	Radial Seal Outer Air Element		Blue Bird All-American Buses
PA30314	Air Element in Disposable Housing	Farr 71338005; Racor 71338005; Fleetguard AH1195	Mobile and stationary gas and diesel engines
PA30315	Air Element in Disposable Housing	Racor 71338007; Fleetguard AH19056	Mobile and stationary gas and diesel engines
PA30316	Air Element in Disposable Housing	Racor 71338013	Custom applications
PA30317	Air Element in Disposable Housing		Custom mobile and stationary gas and diesel engines
PA30318	Air Element in Disposable Housing		Custom applications
PA30319	Air Element in Disposable Housing	Racor 124923000	Small mobile and stationary engines for under the hood or outside, direct or remote applications
PA30320	Air Element in Disposable Housing		Custom applications.
PA30321	Air Element in Disposable Housing	Racor 400820026	Mobile and stationary gas and diesel engines
PA30322	Air Element in Disposable Housing		Blue Bird Wanderlodge Buses with Detroit Diesel Series 60 Engine
PA30323	Air Element in Disposable Housing	Farr 76955000; Racor 76955000	Mobile and stationary gas and diesel engines
PA30324	Cab Air Element	Case 84376815	Case Loaders; New Holland Loaders, Telehandlers, Trenchers
PA30325	Cab Air Element	Mack 85151124, 85112361; Donaldson P636368	Mack Anthem, Granite Pinnacle Trucks
RS30327	Radial Seal Outer Air Element	Donaldson P785426, X770687; Fleetguard AF4271	Custom Applications Using Donaldson 15 Inch ERB2 Air Housing
RS30328	Radial Seal Inner Air Element	Donaldson P785427, X770687	Custom Applications Using Donaldson 15 Inch ERB2 Air Housing
PA30329	Cab Air Element	Komatsu 4230752440	Komatsu Loaders
PA30330	Cab Air Element	Mack 82745222	Mack LR613 with MP7 Engine (To 2017)
PA31008	Primary EnduraPanel Air	Fleetguard AF55024; Wirtgen 2392907	Cummins QSM 12, QSX15 (Final Tier 4) Engines
PA31009	Secondary EnduraPanel Air	Fleetguard AF55318; John Deere R344420	Cummins Engines; John Deere Tractors
PA31012	Primary EnduraPanel Air	Cummins 5261248; Ford CC4Z-9601-A; Donaldson DBA5291; Fleetguard AF55005; Motorcraft FA1917	Cummins QSB6.7 (Final Tier 4, Interim Tier 4, Tier 4) Engine
PA31013	Primary EnduraPanel Air Element	Bobcat 7221933, 7286322	Bobcat Loaders
PA31014	Secondary EnduraPanel Air Element	Bobcat 7221934	Bobcat Loaders
PA32000	EnduraCube Air Element	Paccar P621725; Donaldson P621725	Kenworth T680, T800, T880, Peterbilt 567, 579 Trucks
PA32001	Primary EnduraCube Air	International 2517298C1, 2602212C1, P616050; Donaldson P623400, P635170; Fleetguard AF4222	International 4300, 4400 Trucks with Cummins Engine
PA32002	EnduraCube Air Element	Freightliner 336867002, 336867010; Donaldson P629641	Freightliner, Western Star Trucks
PA32003	EnduraCube Air Element	Paccar P621730; Donaldson P637454	Kenworth T680, T800, Peterbilt 579 Trucks
PA32004	Secondary EnduraCube Air	International 2602211C1	International 4300, 4400 Trucks with Cummins Engine
BT40029	Hydraulic Spin-on	Atlas Copco 1626088200	Atlas Copco XAS750 JD7 & XATS1050 CD7 Compressors
P40037	Lube Element	Mitsubishi QC000001, QCC000001; Iveco 504385104; Nissan 15208-HJ00A	Mitsubishi Fuso Canter FE125, FE130, FE160, FE180, FG4x4 Trucks with (3.0L) Engines



**WARNING:** These products can expose you to chemicals, including Diisononyl Phthalate, Carbon black extracts, Nickel, 1,3 Butadiene, Ethylene Oxide, Epichlorohydrin, which are known to the State of California to cause cancer, and Bisphenol-A, Ethylene Glycol, Ethylene Oxide, 1,3 Butadiene, Epichlorohydrin, which are known to the State of California to cause birth defects or other reproductive harm.

## BALDWIN NEW PRODUCTS

BALDWIN NUMBER	DESCRIPTION	REPLACES	APPLICATIONS
P40042	Lube Element	M.A.N. 51055010009, 51055010013, 51055040115; Fleetguard LF17529	M.A.N. European Trucks
B40051	Lube Spin-on	Cummins 5266016; Donaldson P557356; Fleetguard LF17356	Cummins QSF 2.8 Engines
PF40052	Fuel Element	General Motors 98165375; Isuzu 8981653759; Fleetguard FS20128	Isuzu Trucks with 4HK1 (5.2L) Engine
B40063	Lube Spin-on	John Deere RS539279; Donaldson P551910	Atlas Copco Compressors; John Deere Equipment, Generators, Industrial Engines
BT40065	Lube Spin-on	McNeilus 604428	McNeilus refuse systems
BT40066-MPG	Maximum Performance Glass Hydraulic Spin-on	Caterpillar 4656506	Caterpillar Crawler Tractors, Off-Highway Trucks
B40070	Lube Spin-on	Bobcat 7012303	Bobcat Equipment
S40071	Foam Lube Element	General 1A30; Kralinator F900; Fram C1250RO	Master Portable Heaters; Heating-Fuel Storage Tanks
B40073	Lube Spin-on	Caterpillar 3776969	Caterpillar Excavators, Loaders, Paving Equipment
P40074	Lube Element	General Motors 12670806, 12679114; ACDelco PF2262G	2018-19 Chevrolet Colorado and GMC Canyon all with 2.8L Diesel Engine
OB40078	Replacement Filter Base		Spin-on conversion kit for Chevrolet Engine
P40076	Lube Element	BMW 11428583898	BMW Automobiles
OB40079	Full-Flow Lube Filter Base for Remote Mount Filter		Filter Base for Remote Mount
P40081	Lube Element	BMW 11421727300	BMW Automotive
P40083	Lube Element	BMW 11421730389	BMW Automotive
P40085	Lube Element	Yamaha 1L913440-91	Yamaha Motorcycles
P40086	Lube Element	Honda 15412-413-005, 154A1-413-005	Honda Motorcycles
P40089	Lube Element	Yamaha 4X71344090	Yamaha ATVs, Motorcycles
P40090	Lube Element	Kawasaki 16099004	Kawasaki Motorcycles
P40091	Lube Element	Yamaha 4X71344090	Yamaha ATVs, Motorcycles
P40093	Lube Element	Honda 15410-426001-0	Honda Motorcycles
P40094	Lube Element	Porsche 99610722552	Porsche Automotive
P40095	Lube Element	Volkswagen 79115561B, 79198405	Audi, Volkswagen Automotive
P40096	Lube Element	Volkswagen 77115562	Volkswagen Light-Duty Trucks
P40098	Lube Element	Mercedes-Benz 2751800009, A2751800009; Wix 57198	Maybach, Mercedes-Benz Automotive
P40099	Lube Element	Mercedes-Benz 2711800009, 2711800109, 2711840125, A2711800009; Mahle OX1831DECO	Mercedes-Benz Light-Duty Trucks
P40100	Lube Element	BMW 11427542021	BMW Automotive
P40101	Lube Element	Mercedes-Benz 1601840225, A1601840225, 19727V001	Smart Fortwo
P40102	Lube Element	Hyundai 26320-3C30A, 26320-3C700; Mahle OX351D ECO	Hyundai Equus, Genesis; Kia Borrego, K900
P40103	Lube Element	Audi 79198405B; Hengst E813H01D188; Mahle OX3504DECO; Mann & Hummel HU7005X	Audi Q7, R8; Volkswagen Touareg
P40104	Lube Element	BMW 11427583220	BMW, Rolls Royce Automotive
P40105	Lube Element	BMW 11427840594, 11427834734; Porsche 94810722200	BMW, Porsche Automotive
P40106	Lube Element	BMW 11427837997	2008-12 BMW M3
P40107	Lube Element	BMW 11427788454, 11427788460, 11427788461	BMW Automotive
P40108	Lube Element	Mercedes-Benz 4803009, A0001803009	Mercedes-Benz Automotive
P40109	Lube Element	Toyota 415251010; Mahle OX554D1 ECO	2008-on Lexus, Toyota Automotive



**WARNING:** These products can expose you to chemicals, including Diisononyl Phthalate, Carbon black extracts, Nickel, 1,3 Butadiene, Ethylene Oxide, Epichlorohydrin, which are known to the State of California to cause cancer, and Bisphenol-A, Ethylene Glycol, Ethylene Oxide, 1,3 Butadiene, Epichlorohydrin, which are known to the State of California to cause birth defects or other reproductive harm.

**BALDWIN NEW PRODUCTS**

BALDWIN NUMBER	DESCRIPTION	REPLACES	APPLICATIONS
P40110	Lube Element	Mahle OX196/3D; Mann & Hummel HU8001X; Volkswagen 57115561M	2009-13 Audi Q7; 2009-12 Volkswagen Touareg
P40111	Lube Element	Volkswagen 59198405	Audi, Volkswagen Automotive
P40112	Lube Element	Mercedes-Benz 2711800409, 2711800509, A2711800409, A2711800509; Wix WL10059	2012-14 Mercedes-Benz C250, SLK250
P40113	Lube Element	BMW 11427640862	2012-14 BMW Automotive
P40114	Lube Element	General Motors 55577033	Chevrolet Cruze with 4-119 (2.0L) FI Turbo Diesel Engine
P40115	Lube Element	Volkswagen 07C115562E, 7C115562E; Hengst E314H01D58	Audi, Bentley, Volkswagen Automotive
P40116	Lube Element with Plastic Drain	Toyota 415240060	2012-14 Scion iQ with 4-1329cc (1.3L) FI Engine
P40117	Lube Element	Mahle OX4456D; Volkswagen 7Z15562	2005-08 Volkswagen Touareg with V10-4921cc (5.0L) Turbo Diesel Engine
P40118	Lube Element	Porsche 9A1.107.224.00	Porsche Automotive
P40119	Lube Element	Mercedes-Benz 2701800009, 2701800109, 2701840025, 2701840125, A2701800009, A2701800109, A2701840025, A 2701840125	Mercedes-Benz Automotive
B40120	Lube Spin-on	Jaguar C42797	1980-94 Jaguar
B40122	Lube Spin-on	GMC 89017527; ACDelco PF26	2006-09 Cadillac STS V, XLR V
B40124	Lube Spin-on	General Motors 55352643, 93178952, ACDelco PF65	2006 Chevrolet Astra, 2011-on Volt
B40125	Lube Spin-on	Porsche 92810720103	1978-95 Porsche 928, 1995-98 911
B40126	Lube Spin-on	GMC 25013451	Eagle, Geo, Isuzu Automotive
B40127	Lube Spin-on	Volkswagen 77115561G	Audi Automotive
B40128	Lube Spin-on	Chrysler 5003558AA	Jeep Liberty with 2.8L Turbo Diesel Engine
B40129	Lube Spin-on	Porsche 94410720108	Porsche Automotive
P40130	Lube Element	Yamaha 1UY1344002	Yamaha ATVs
P40131	Lube Element	Yamaha 5H01344009	Yamaha ATVs, Motorcycles
P40132	Lube Element	Suzuki 1651029F00	Suzuki, Kawasaki ATVs, Motorcycles
B40133	Lube Spin-on	Perkins 4627133; Fleetguard LF16401	Perkins 1104D-E44TA (4.4L), 1206F-E70TTA (7.0L) Engines
B40136	Lube Spin-on	Cummins 4982627; Fleetguard LF16097	Cummins QSB3.3 Engine, B3.3 Generator Engine
B40137	Lube Spin-on	Isuzu 2906544040, 2946542000; Fleetguard LF17537	Isuzu NPR Trucks
B40138	Lube Spin-on	Isuzu 2906542700, 2946541000; Fleetguard LF17538	Isuzu NPR, NQR Trucks
BD40139	Dual Flow Lube Spin-on	Komatsu 600-211-1341	Komatsu Dozers, Dump Trucks, Excavators, Tractors, Wheel Loaders
B40140	Lube Spin-on	Bobcat 7257441; Kohler 2175282	Bobcat 3400, 3400 XL, 3600, 3650 Utility Vehicles
B40142	Lube Spin-on	Cummins 5444774; Fleetguard LF14009NN; Donaldson DBL7300	Autocar, Dennis Eagle, Freightliner, International, Mack, Western Star Trucks; Blue Bird, IC Corporation, New Flyer, Thomas, Van Hool Buses
B40145	Lube Spin-on		Cummins X12, X15 Engines
PF46059	Fuel Element	General Motors Corp. 94561104, 98147525; Isuzu 2945611040, 8981475250, 97780197, FE0040A; Fleetguard FF5877	Isuzu 4HK1 (5.2L), 4JJ1-TC- (3.0L) Engines Isuzu FTR, NPR, NPR-HD, NPR-XD, NQR, NRR Trucks
BF46064-D	Fuel/Water Separator Element with Drain and Tab Keys	Mack 705836525	Mack Freedom MV with Renault E3 Engine
BF46069	Fuel/Water Separator with Drain	New Holland 84526251; Fleetguard FS19927	Case-International, New Holland Tractors
BF46073	Fuel/Water Separator Spin-on with Sensor Port	Bomag 11110248; Deutz 02113831, 2113831, 02113837,	Leibherr Excavator with Deutz Engine and Utility Vehicles with Deutz Engine



**WARNING:** These products can expose you to chemicals, including Diisononyl Phthalate, Carbon black extracts, Nickel, 1,3 Butadiene, Ethylene Oxide, Epichlorohydrin, which are known to the State of California to cause cancer, and Bisphenol-A, Ethylene Glycol, Ethylene Oxide, 1,3 Butadiene, Epichlorohydrin, which are known to the State of California to cause birth defects or other reproductive harm.

# BALDWIN NEW PRODUCTS

BALDWIN NUMBER	DESCRIPTION	REPLACES	APPLICATIONS
		2113837, 02937814, 2937814; Liebherr 11110248; Fleetguard FS1094; Mann & Hummel PL6011	
PF46076	Fuel Element	Fiat 500054702; Iveco 500054702, 5801354114; Mitsubishi MK667920	2012-17 Mitsubishi Canter FE125, Canter FE130, Canter FE160, Canter FE180, Canter FG4x4 Trucks with 4P10 Engine
PF46079	Stacked Fuel/Water Separator Element	Fleetguard FS53014; Davco 69001	Cummins Engines
PF46080	Fuel/Water Separator Element	Fleetguard FS53015; Davco 68001	Terex TR60 Dump Truck with Cummins Engine
PF46081	Fuel Element	Paccar K371011, K371029	Kenworth, Peterbilt Trucks
PF46082	Fuel Element	Paccar K371012	Kenworth, Peterbilt Trucks
PF46091	Fuel/Water Separator Element	Fleetguard FS19764G	International, Kenworth, Peterbilt, Volvo Trucks with Cummins ISX Engines
PF46094	Fuel/Water Separator Element	Fleetguard FS19765G	International, Mack, and Peterbilt Trucks
BF46101-O	Fuel/Water Separator Spin-on with Open End for Bowl	Volvo 3817517; Racor R120S-HD; Fleetguard FS19896	Volvo-Penta Marine Diesel Engines
BF46104	Fuel Spin-on	New Holland 84534796	Case Dozers, Loaders; New Holland Loaders, Tractors
BF46105-O	Fuel/Water Separator Spin-on with Open End for Bowl	Mercedes-Benz A0004771702, 4771702; Racor R160P, R90DMER03; Fleetguard FS19737	Mercedes-Benz European, South American Trucks
PF46106	Fuel/Water Separator Element	Paccar 1852006PE, 1852006, 2133096PE, 2133096	Kenworth, Peterbilt Trucks
PF46108	Fuel Element with Bail Handle	Chrysler 68157291AA; Cummins 5260529; Fleetguard FS53000; Mopar MQ291e	Dodge Pickups, 4500, 5500 Chassis Cabs; Ram Pickups, 4500HD, 5500HD Chassis Cabs all with 6-408 (6.7L) FI Turbo Diesel Engin
BF46109-O	Fuel/Water Separator Spin-on with Open End for Bowl	Mercedes-Benz A384477015, A9794770015, A9794770015AZ; Racor R120MB, R12030MB	Mercedes-Benz Latin America Buses, South America Trucks, Buses, & Vans
BF46116 KIT	Set of 2 Fuel Filters	John Deere RS556406; Racor PFF51572	John Deere Combines, Crawler Dozers, Excavators, Feller Bunchers, Forestry Machines, Generators, Loaders, Motor Graders, Skidders, Sprayers, Tractors, Windrowers
PF46118	Fuel Element	Volkswagen 2E0127159, 2E0127177	Volkswagen European Crafters; 2009-11 Mexico Crafters
BF46123-O	Fuel/Water Separator Spin-on with Open End for Bowl	Ford 9C459C349AB, BH0X9N074AA; Mercedes-Benz A384477015, A9584770115, 9584770115; Racor R12010MBAQil	Mercedes-Benz Buses and Trucks
BF46124-O	Fuel/Water Separator Spin-on with Open End for Bowl	Racor R90RDRCR01	Racor's line of Spin-on Series fuel filter / water separator assemblies
PF46126	Fuel Element	General Motors 22937279, 23149526; ACDelco TP1014, TP1015	2017-18 Chevrolet, GMC Light Duty Trucks
BF46128-D	Primary Fuel/Water Separator Element with Drain	Wix SF10169, WF10169	Doosan Engines
BF46131	Fuel Spin-on	Racor RS175RRCR01; Renault 7421764961; Volvo 21764952, 21764961, 22253547	R.V.I. Trucks with Volvo DTI 11 Engines
PF46135	Fuel/Water Separator Element	Parker R61691T; Racor 6600R10; Tigercat 213473	Compatible with GreenMAX fuel filter water separator housings (4400, 6600); Tigercat Feller Bunchers, Loaders, Skidders
PF46137	Fuel Element	Caterpillar 3608958	Bron Drainage Plow; Caterpillar Excavators; Prinoth Carrier Vehicles
PF46137 KIT	Fuel Element in Plastic Housing	Caterpillar 3608958	Bron Drainage Plow; Caterpillar Excavators; Prinoth Carrier Vehicles



**WARNING:** These products can expose you to chemicals, including Diisononyl Phthalate, Carbon black extracts, Nickel, 1,3 Butadiene, Ethylene Oxide, Epichlorohydrin, which are known to the State of California to cause cancer, and Bisphenol-A, Ethylene Glycol, Ethylene Oxide, 1,3 Butadiene, Epichlorohydrin, which are known to the State of California to cause birth defects or other reproductive harm.

**BALDWIN NEW PRODUCTS**

BALDWIN NUMBER	DESCRIPTION	REPLACES	APPLICATIONS
PF46138	Fuel Element	Case VH23304EV040, VH23304EV041; New Holland VH23304EV040, VH23304EV041; Hino 23304EV360; Kobelco VH23304EV040, VH23304EV041J1L	Kobelco, New Holland Excavators; Hino Trucks
PF46140	Fuel Element	Cummins 4378483; Nissan 16403-EZ41A; Fleetguard FF63017NN	2016-19 Nissan Titan XD
BF46141	Fuel Spin-on	Cim-Tek 260AHS30, 70007, 70066; Petro Clear 40930WA; Fleetguard FS19749	Used on fuel dispensing pumps that have a 1 3/8" thread adapter
PF46142	Fuel/Water Separator Element	John Deere MIU801025	Hitachi, John Deere Excavators; John Deere Loaders
BF46143	Fuel/Water Separator Spin-on with Drain	Cim-Tek 70804; Donaldson P550828; Fleetguard FS1023	
PF46145	Fuel/Water Separator Element	Detroit Diesel A0000905051; Freightliner A485007; Fleetguard FS20083	Freightliner 114SD, 112SD, Cascadia, Cascadia Evolution, Coronado, Coronado SD, M2 112; Western Star 4700, 4800, 4900EX, 4900FA, 4900SA, 5700XE, 6900XD
BF46149-SP	Fuel/Water Separator Spin-on	Kubota 1J43043060	Kubota Engines
BF46150-O	Fuel/Water Separator Spin-on with Open End for Bowl	Case 84423586; Racor S3207P	Case-International, New Holland Harvesters, Tractors
PF46151	Fuel Element	Gehl 50352550; John Deere MIU802421; Takeuchi Y129A0055730	John Deere Lawn & Garden Equipment, Loaders, Tractors; Gehl Loaders, Manitou Loaders, Mustang Loaders
PF46152	Fuel Element	Chrysler 68436631AA	2019-20 RAM 2500, 3500, 2019 4500, 5500 Trucks
BF46161	Fuel Spin-on		Volvo Buses, European Trucks & Vans, North America Trucks, Dump Trucks, Excavators, Loaders, Motor Graders; Winpower Generators
BF46162-O	Fuel/Water Separator Spin-on with Open End for Bowl	Northern Lights/Lugger 2450014; Racor R15P; Fleetguard FS19824	Racor 215R Fuel Filter Assembly
BF46163-O	Fuel/Water Separator Spin-on with Open End for Bowl	Alliance ABPN122R50424; Donaldson P551856; Fleetguard FS20094	Western Star 4900, 4900E, 4900EX, 4900FA, 4900SA Trucks with Cat C15 (14.6L) Engine (05/16/19)
BF46164-O	Fuel/Water Separator Spin-on with Open End for Bowl	Racor R13P	Replacement element for Racor 120A and 120B assemblies
BF46169-O	Fuel/Water Separator with Open Port	Blue Bird 10054676, R34000BB01; International 4080114C1, 4080114C2; Racor R3388DCM	International 4300, 4300LP, 4400, 7300, 7400, 7500, HV507 Trucks
BF46170	Fuel/Water Separator Spin-on with Drain	Fleetguard FS19652	Cummins S3.8-G7 Engines; C22 D5T, C44 D5, C55 D5, C66 D5 Power Generators
PF46171	Fuel/Water Separator Element		Autocar, Freightliner, Western Star Trucks
BF46173-O	Fuel/Water Separator Spin-on with Open End for Bowl	Racor S3238T; Volvo 85121709	Volvo North America Trucks with Cummins ISX Engines
BF46175	Fuel Spin-on	Kubota 1J30143170, AFK1J30143170, K1J30143170; Takeuchi 1J30143170, AFK1J30143170, K1J30143170	Takeuchi TL6R, TL8, TL10, TL10V2, TL12, TL12V2, TL12R2 Loaders
BF46176	Fuel Spin-on	AirDog FF100-2, FF803; 3 Fuel Preperator FF1002; Fleetguard FF561	AirDog I, AirDog II, and AirDog II-4G Fuel Systems
BF46179	Fuel Spin-on	Donaldson DBF5811; Fleetguard FF5811	International, Kenworth, Peterbilt, Volvo, Western Star Trucks
BF46181-O	Fuel/Water Separator Spin-on with Open End for Bowl	International 2514003C1; Racor R33838	International, Mack Trucks
BF46182-O	Fuel/Water Separator Spin-on with Open End for Bowl	Mack 22094987; Volvo 21764964	Mack, Volvo North America Trucks
FB46183	Fuel Storage Tank Filter Base		Fuel Storage Tanks
FB46184	Replacement Filter Base for Fuel/Water Separators		Replacement Filter Base
FB46185	Fuel Spin-on Replacement Base		Replacement Filter Base



**WARNING:** These products can expose you to chemicals, including Diisononyl Phthalate, Carbon black extracts, Nickel, 1,3 Butadiene, Ethylene Oxide, Epichlorohydrin, which are known to the State of California to cause cancer, and Bisphenol-A, Ethylene Glycol, Ethylene Oxide, 1,3 Butadiene, Epichlorohydrin, which are known to the State of California to cause birth defects or other reproductive harm.

## BALDWIN NEW PRODUCTS

BALDWIN NUMBER	DESCRIPTION	REPLACES	APPLICATIONS
PF46186	Fuel Element with Bail Handle	Volkswagen 7L6127434C; Bosch 1457070010; Mahle KX192D	Audi Q7
PF46187	Fuel Element	Volkswagen 7P6127177	2014-15 Volkswagen Touareg Diesel with 3.0L Engine
PF46188	Fuel Element	Audi 3C0127434; Wix 33256	Audi, Volkswagen Automotive
PF46189	Fuel Element	Volkswagen 7N0127177B	2012-14 Volkswagen Passat with 2.0L Diesel Engine
BF46192	In-Line Fuel Filter	Volkswagen 1H0127401E	1993-99 Volkswagen Automotive
BF46193	In-Line Fuel Filter	GMC 25055066	1984 Chevrolet Corvette
BF46194	In-Line Fuel Filter	Volkswagen 133133511	Volkswagen Automotive, Light-Duty Trucks
BF46195	In-Line Fuel Filter	Volkswagen 447133511; Volvo 1389450-6	Audi, Ferrari, Saab, VW, Volvo Automotive
BF46196	In-Line Fuel Filter	Honda 16235-PE0-003	1984-87 Honda Civic CRX
BF46197	In-Line Fuel Filter	Nissan 16400-06W00, 16400-Q0500	1980-84 Nissan Light-Duty Trucks
BF46198	In-Line Fuel Filter	Mitsubishi MB504754; Toyota 23300-49155	Dodge, Mitsubishi, Toyota Light-Duty Trucks
BF46199	In-Line Fuel Filter with Drain	Volkswagen 191127401	1986-88 Volkswagen Automotive
BF46200	In-Line Fuel Filter	BMW 13311269244; Porsche 92811014202	1980-83 BMW, 1980-98 Porsche Automotive
BF46201	In-Line Fuel Filter	Honda 16900-SK7-A30	1990-93 Acura Integra
BF46202	In-Line Fuel Filter	Mazda G602-20-490, G607-20-490-A, G607-20-490-B	1989-94 Mazda MPV Van, Light-Duty Trucks
BF46203	In-Line Fuel Filter	Mazda B61P-20-490	1990-97 Mazda Miata, MX5
BF46204	In-Line Fuel Filter	Toyota 23300-19145	1989-92 Geo, Toyota Automotive
BF46205	In-Line Fuel Filter with Clamps and Hose	Ford C5AZ-9155-A, C5AZ-9155B; Motorcraft FG15	1966-66 Ford Automotive
BF46206	In-Line Fuel Filter	Toyota 23300-69045	Toyota, Lexus Light-Duty Trucks
BF46207	In-Line Fuel Filter	Mitsubishi MR239580	1997-2004 Mitsubishi Montero Sport
BF46208	In-Line Fuel Filter	Kia K08A-20-490A; Mazda K801-20-490	Kia, Mazda Automotive
BF46209	In-Line Fuel Filter	Toyota 23300-50090	Lexus, Toyota Light-Duty Trucks
BF46210	In-Line Fuel Filter	Mazda BP4W-13-480, BP4W-20-490B	Mazda Automotive
BF46211	In-Line Fuel Filter	Suzuki 15410-65D00	Chevrolet, Suzuki Light-Duty Trucks
BF46212	In-Line Fuel Filter	Hyundai 31911-25000; Wix 33235	2001-06 Hyundai Accent
BF46213	In-Line Fuel Filter	Chrysler 52100402AE	2002-04 Jeep Liberty
BF46214	In-Line Fuel Filter	BMW 13327503413, 16126750475	2009 BMW 740i, 2002-05 745i, 745Li, 2006-09 750i, 2006-08 750Li
BF46215	In-Line Fuel Filter	Toyota 23030-50010	2001-04 Toyota Sequoia
BF46216	In-Line Fuel Filter	Toyota 23300-20101	2001-04 Toyota Avalon
BF46218	In-Line Fuel Filter	Volvo 30620512	Volvo Automotive, Light-Duty Trucks
BF46219	In-Line Fuel Filter	Volvo 30817997; Wix 33603	Volvo Automotive
BF46220	In-Line Fuel Filter	Suzuki 15410-86Z00; Wix 33850	2004-06 Suzuki Verona
BF46221	In-Line Fuel Filter	Volkswagen 1K0201051C	Audi, Volkswagen Automotive
BF46222	In-Line Fuel Filter	Chrysler 68086606AA	Fiat 500
BF46223	In-Line Fuel Filter	General Motors 25993215	2010-on Cadillac SRX, 2011, 2014-on CTS
BF46224	In-Line Fuel Filter	Suzuki 1541052D20	2004-06 Suzuki XL-7
BF46225	In-Line Fuel Filter with Clamps and Hose	Ford D32E-9155-A; Motorcraft FG19B, FG19C; Wix 33019	Ford, Lincoln, Mercury Automotive, Light-Duty Trucks
BF46227	Fuel Spin-on with Open Port	New Holland 84278636	Case Diesel Engines, Loaders; Case-International, New Holland, Steyer Tractors
BF46228	Fuel Spin-on	Kubota HHV0051640, V063151640	Kubota SVL75-2, SVL75-2C, SVL95-2S, SVL95-2SC Loaders
BF46229	In-Line Fuel Filter	Thermo King 13864; Donaldson P553890; Fleetguard FF5864	Thermo King Tripac Auxiliary Power Unit
BF46233	Fuel Spin-on	Renault 7423044513; Volvo 22988765, 23044511	Volvo VAH200, VAH430, VAH630, VHD200, VNL300, VLN430, VNL630, VNL670, VNL730, VNL780, VNM200, VNX630 North America Trucks



**WARNING:** These products can expose you to chemicals, including Diisononyl Phthalate, Carbon black extracts, Nickel, 1,3 Butadiene, Ethylene Oxide, Epichlorohydrin, which are known to the State of California to cause cancer, and Bisphenol-A, Ethylene Glycol, Ethylene Oxide, 1,3 Butadiene, Epichlorohydrin, which are known to the State of California to cause birth defects or other reproductive harm.

**BALDWIN NEW PRODUCTS**

<b>BALDWIN NUMBER</b>	<b>DESCRIPTION</b>	<b>REPLACES</b>	<b>APPLICATIONS</b>
PF46235	Fuel/Water Separator	Detroit Diesel DDER61709; Racor R61709; Fleetguard FS20176	Freightliner Trucks
PF46236	Fuel/Water Separator Element	Paccar K371021; Racor R6176XL10	Kenworth, Peterbilt Trucks with Cummins Engine
PF46237	Fuel/Water Separator Element	Paccar K371022; Racor R61716XL30	Kenworth, Peterbilt Trucks with Paccar MX-13 Engine
PF46238	Fuel Element	Paccar K371017; Racor R61716DCM	Peterbilt 365, 520 Trucks
BF63000	Fuel Spin-on	Cummins 5289121, 5303743, 5304214; Fleetguard FF63004, FF63008, FF63009; Hyster 4103452	Autocar, Blue Bird, Capacity of Texas, Dennis Eagle, Ford, Freightliner, International, Kenworth, Mack, Peterbilt, Western Star Trucks; Blue Bird, Gilig, New Flyer, Temsa, Thomas, Van Hool Buses; Spartan Truck Chassis; Doosan Compressors



**WARNING:** These products can expose you to chemicals, including Diisononyl Phthalate, Carbon black extracts, Nickel, 1,3 Butadiene, Ethylene Oxide, Epichlorohydrin, which are known to the State of California to cause cancer, and Bisphenol-A, Ethylene Glycol, Ethylene Oxide, 1,3 Butadiene, Epichlorohydrin, which are known to the State of California to cause birth defects or other reproductive harm.



# BALDWIN OBSOLETE PRODUCTS

OBSOLETE NUMBER	REPLACED BY	OBSOLETE NUMBER	REPLACED BY	OBSOLETE NUMBER	REPLACED BY	OBSOLETE NUMBER	REPLACED BY	OBSOLETE NUMBER	REPLACED BY
EHL		C-52-MS	P52	PT-119-5DL	(2) PT119-5	V-233-F	B233	WG-404	
B-1/2		C-53-MJ	P53	PT-119-5TR	(3) PT119-5	B-234	B296	JC-405-B	JC405
B-1/2-S		C-54-M	P54	PF-120		PT-236		CU-406-B	CU406
BO-1A		PT-55	T55-M*	B-121	B50	P-237		CU-406-I	CU406
B-1	B2	T55-M		B-122		P-238		CU-406-WO	CU406
V-1-F	V2-F*	T-56-M	V835-M*	PT123-5		PF-239		P-406	CU406
DL2	B2	T57-M		B-127		P-241	PT29	VCU-406	CU406
V-2-A	B9	T58-M		C130-C		PT-242		VCU-406-HD	CU406
V2-F	B2	C59-C		C-132-C Series		PT-243	PT82-HD	SD407	
B-3	B9	P-59	C59-C*	C-134-EL		P-244		VSD-407	SD407*
V-3-A	B9	C-60-C	P60	BT136		B245		VDF-408	DF408
C-5-K	C-50-MH*	PT-61	PT61-HD	PT-139		PT-245		T-409-PE	
E-5		T-62-P	PT62	B-140		PT-246		T-410-PE	
ME-6-F		T-63-P	PT63-1	C-141-F		V-247-M		TA410-CPE5	
V-6-A	B6	C64-P	P64*	B-142		B-249	B2 or V2-F*	T-411-PE	
D-7		P64		B-145	B243	P250		TB411-CPE25	
B-8	B27	BT65		PT147		PD-250		TC411-CPE10	
V-9-A	B9	C-65-P	T77-P*	P149		P-252		TC411-CPE2	
B-10	B10-AL	P-65	T77-P*	T-153-M		B-254	B50	TC411-CPE5	
B-10 Bowl	B10-AL Bowl	PT-66	PT66-HD	V-156-M		PT-255		TC411-OPE2	
B-10-HD	B10-AL	C-67-P	P67	PT-157	P80 or P80-HD	V-261-A		TC411-OPE5	
B-10-HD Bowl	B10-AL Bowl	C-68-P	P68	PT158(2)		PT-262		P412-25	
B-13	B10-AL	C-69-P	P69*	PT-159	PT385	P-263		P412-25A	
B-13 Bowl	B10-AL Bowl	P69		PT-159-E	PT385-E	BT-266	B2 or V2-F*	P412-5	
P-13		T70-P	PT70	PT-160		P270		P412-5A	
P-14		T71-P	PT71	B-161	B161-S	BT272	B7082	T-412-PE	
EO-16-A		T72-P	PT72	P165		P-272		TA412-CPE10	
S-16	S16-1	C-73-P	P73	P-168		P276 KIT		TA412-CPE10A	
P17		C-73-PS	P73	P169		B-278		TA412-CPE5	
C18-A	P18 or P18-HD	PT-73	P73	B-173	B173-S	B-280	B39	TB412-CPE25	
C-19-A	P19	T-73-P	P73	P-173		BT-281	B975	TB412-OPE25	
P-20	P20-HD	C-74-P		B175	B1422	BT282	BT8449	TC412-CPE10	
P-20-E	P20-HDE*	T-75-P		P-175		BT282-10	BT8449-10	TC412-CPE2	
P20-HDE	P20-HD	B76-B	B76	P-178		PT-286		TC412-CPE25	
C21-A		B76-HPG	B76-SS	P-179	P177	PT-288	PT288-HD	TC412-CPE25A	
P-21	C21-A*	PT-77	T77-P*	P180		B-290		TC412-CPE5	
C22-A		T77-P		B291		PT-291		TC412-CPE50	
P-22	C22-A*	C78-P		PT-291	P184	PT293		TC412-OPE10	
C23-A		C80-P	P80	PT293		PT-294		TC412-OPE5	
C24-A		C81-P	P81	PT-294		B297	B2	TC412-OPE5A	
V24-A2		C-84-P1	C84-P2*	PT-195	P15	B-298	BT223	TS412-CPE50	
C25-A	P25	C84-P2	P84-2	B196-MPG		VT-299	V842-O*	T-413-PE	
C-26-A	P26	P-84-1	P84-2	P-196		T-301-M	T300-M	TA413-CPE10	
V-27-A	B27	T-85-P	PT85	B-197	B243	T-302-M	T303-M	TA413-CPE10S	
C-28-A		PT-86	PT86-HD	P-197		T304-M	PT304	TB413-CPE25	
C-30-B		PT-87	PT87-S	C200-K		T-305-M	T304-M*	TC413-CPE10	
C-31-B		PT-87-HD	PT87-S	P-200	C200-K*	T-306-M		TC413-CPE10AS	
C-32-B		PT88	PT88-HD	T-200-K	C200-K*	T-307-M		TS413-CPE50	
PT32-H		PT-90	PT90-10	B-201	B201-S	P315		TS413-CPE75	
C-33-B		PT92		C-201-K	P42	PT317	PT317-MPG	F-414-B	
P-33	C-33-B*	PT94				PT318	PT318-MPG	PF-414-10	
C-34-M		B95-B	B95	P-202	PT154	PT319	PT319-MPG	PF-414-15	
P-34		B95-HPG	B95-SS	P-205		PT320	PT320-MPG	PF-414-25	
B-35	B35-S	C-95-IL		PT-208-10		BD321	BD325	PF-415	P415-5
C-35-M		B-96 Kit	BK6311*	P-209		BD322	BD232	P-415-2A	P415-5A
C36-M		B96-B	B96	PT-211		BD323	BD232	S-416	PT416
P-36	C36-M*	B96-HPG	B96-SS	PT-212	PT212-5	C327-O		S417	
C-37-M		C-96-IL		PT-215	P41	B328	BT8417	S-418	
P-37	C-37-M*	B97-B	B97			BF335		S419	
B38		C-97-G		PT-216	P198	BT-344	BT344-S	PT-420	
V-39-A	B39	B99-HPG	B99-SS	P-217		BT-352	BT486	S-421	PT435
C-40-F	P40	C-100-C		C-218-A		BF362	BF7629	S422	
C-41-F	P41	C-101-W	T101-W* w/G115-A	P219		BF363	BF984	S-424	
C-42-F	P42	PT-101	T101-W*	V-220-R		PT384		PT-425	
B43	B43-S	T101-W		V-221-R		PT390	PT390-MPG	S-426	
PT-43	PT29	C-102-W		F-222-P		PT391	PT391-MPG	S-427	
T44-M		T-103-W	P42 w/G143	P-105		PT-394	P194-HD	BT428	BT372-MPG
PT-45		P107		F225-F	PF225	PT394-5		V-428-B	
T-45-F	PT-45*	P-109		F226-F	PF226	PT399		V-428-FF	
PT46		P-110		PT-227		WG-400		V-429-BP	V429-B
T-46-F	PT46*	P-113		P-228	P190	PT401	PT401-MPG	PF-430	
C-47-P	P47	V-117-F	PT117	C-229-A		WG-401		PT-430-B	
C-49-F		V-118-MN		P-230		WG-402		PT432	
C-50-MH		PT119-HD5DL		B-232	B233	WG-403		S-433	
PT-51	T51-M*	PT-119-TR	(3) PT119	B233-HPG				PT-436-WO	PT436
T51-M								S-438	

\* These Part Numbers are also Obsolete.



**WARNING:** These products can expose you to chemicals, including Diisononyl Phthalate, Carbon black extracts, Nickel, 1,3 Butadiene, Ethylene Oxide, Epichlorohydrin, which are known to the State of California to cause cancer, and Bisphenol-A, Ethylene Glycol, Ethylene Oxide, 1,3 Butadiene, Epichlorohydrin, which are known to the State of California to cause birth defects or other reproductive harm.

# BALDWIN OBSOLETE PRODUCTS

OBSOLETE NUMBER	REPLACED BY	OBSOLETE NUMBER	REPLACED BY	OBSOLETE NUMBER	REPLACED BY	OBSOLETE NUMBER	REPLACED BY	OBSOLETE NUMBER	REPLACED BY
PT-439-HD20		EL-527		BF660	BF1179	BT746	BT8845	BF850-K	
PT-439-HD40	PT-439-HD20*	B530	B1402	PA-660		BT747	BT8846	BF851	BF833
S-440		PT-530	PT390* or PT391*	T-660-P		BT748	BT8840-MPG	PF-851	
S-441		S-530		BF661		BT749	BT8852-MPG	PF-852	
PT442	PT442-MPG	PT531		PA-661		C-750-EP		PF-853	
S-442		S-531		PA-663	PA675	C-750-L Poly	C750-L	PF-854	
S-443		PT-532-10	PT482*	PA-664	PA664-1*	C-750-LS	C750-L	V-854-O	V854-T*
S444		S-532		PA664 Foam	PA664-1 Foam*	F-750-L	P7500	V854-T	
PT445	PT445-MPG	PT533	PT8331-MPG	PA664-1		PT754		PF-855	
S-445	S423	S-533		PA-664-1 Ele.		PT755		PF-856	PF859
S-447	S444*	P540-S	P540	PA664-1 FOAM		PT756		PF-858	
S448		PT542		PA-664-1 Scr.		PT-757-5		F-861-C	
PT449		PT544		PA-665		BT758	BT8850-MPG	F-862-C	F924-C*
PT-452		PT-544-10		PA-667		C759		F-863-C	
BT453	BT260-10	PT-547		PA-668		PT-760	PT760-10 or PT760-25	PF-865	
PT-453		PT552		PA-672		PT762		BF867	BF7713
PT-454		BF553		PA-673		PT769	PT8395 or PT8396	F-867-M	
P457		PT-553-10		PA-674		BT770	BT8861	PF-867	
PT457	PT457-MPG	BT-556		PA-676		BT771	BT8863	PF-868	
S458		PT557-10		PA-679		PT773	PT773-MPG	PF870	PF7521*
T-460-PE		PT559		PT679	PT23490-MPG	PT776	PT776-MPG	F871-F	
TB460-CPE25		PT562		PA-681		V-780-S		F-872-A	
BT464	BT8860	PT569-10		PT681	PT23489-MPG	BF785-MPG		PF-873	
P-464		P-570		PA-682		BF787	BF1280	BF875	
PT465		PT570-10		PA-682(2)		BF793		BF876-B	BF876
P-466		PT572-10		PA-683		BF796	BF7546	BF877-B	BF877
P-467		PT574-10		PA-684		BF799-D	BF7639-D	F878-F	
PT467	PT467-MPG	PT575		PT684	PT8400-MPG	F800-A		BF880	BF880-FP
PT468	PT468-MPG	B-576 Kit		PA-685		F801-P		PF-880	
T-468-R		BF580	BF5800	PT685	PT685-MPG	F-802-A	PF802	PF-881	
P-470		BF580-B	BF5800-B*	PA-686		F-803-A		PF-885	
PT-472 Kit		BF581	BF5810	PT686		PF803		BF887	
S-473		BF581-B	BF5810-B*	PA-687		F-804-A	PF804	BF889	
PT-474		PF589	PF7789*	PT687		F-805-A		PF-889	
PT478	PT478-MPG*	PF589-10	PF7789-10*	PA-689		F-806-C		PF-893-GR	PF893
PT478-MPG		PF589-30	PF7789-30*	PA-690		F808-A		PF-894-GR	PF894
S-478		PF589-30E		PA-692		F-808-P	PF828	BF895	
PT-481	P446	PF589-E		PA-694	PA642	F-809-P	PF809	PF-895	
PT482	PT482-MPG*	PF590	PF7790*	PA695		F-811-A		SF-898-GR	SF898
PT482-MPG	PT725-MPG	PF590-10	PF7790-10*	PA-698		PF-812	PF906	F901-C	
S-482		PF590-30	PF7790-30*	C701-L		F813-F		PF-902-3	
S-483		PF590-30E		C702-L		PF-813	F813-F*	F902-C1	
PT484		PF590-E		C703-L		B-815-O		F-902-S	PF902-S
P-486		C-59-C3	C59-C*	C-704-L Poly	C704-L	BF815	BF7713	F-903-C	PF-903*
PT487 KIT	PT487	PA-801	PA602	C-704-LS	C704-L	F-815-A		PF-903	
P-488		PF601		F-704-L	P7040*	F817-F		F-904-C	PF904*
PT491(2)	(2) PT491	PA-603		C705-L		F-818-A	F800-A*	PF904	
BK495-A		PA-605		PV706-M	P706-M	F-820-P	PF820-S	F905-C	
BK495-B		BT606	BT606-MPG	PV-706-M Poly	PV706-M*	F-820-S		F-905-W	
P-495		PA-606		PT-707	PT707-HD	PF-821	PF821-S	F906-C	
PT-499	PT499-5	B608	B227	PT-707-10	PT707-HD10	F-823-P	PF823	PF-906-S	PF906
T500-MD		PA-608		PT-707-HD5		PF823(2)	(2) PF823-E w/5H-5601	F-910-C	PF910
T502-AMD		PA-609		VT-708		PF823(3)	(3) PF823-E w/8M-7830	F911-C	PF926
T-503-MD		BT610	BT610-MPG	C-709-L		PF823(4)	(4) PF823-E w/7M-8286*	F911-DL	PF952
V504-MD		PA-610		VT-710		PF823(6)	(6) PF823-E w/G219	F-911-W	
P505		BT611	BT611-MPG	V-711		(2) 4L-8212-R		PF-911	F911-C* (Depth); PF926 (Paper)
P-506		PA-611		V-712		(2) PF824		V-911-C	F911-C*
PT508	PT508-MPG	PA-614	PA650	V-713		F828-F		F-912-W	
P-509		PA-619		P718		PF-830		PF-914	
PT509 Kit	PT509-MPG Kit	PA-620		V-718-FF	P718*	BF832	BF7713	R915	BF915
T-509-E		PA-622		P-719		PF-832		F917-C	
F-510-S		PA-623	PA602	P-720		F-833-P		BF918	BF918-K
V-510-S		SA-624		PT-727	PT727-HD	F-835-M		PT-918	
P-511		PA-626		PT-727-10	PT727-HD10	V835-M		F-919-C3	(3) F919-C
P-511-HD		PA-627		PT728	PT728-MPG	F-836-F			w/5B-1581, 7B-8037
F-515-O		PA-628	PA634	V-728-O		PF-837		F-919-C4	(4) F919-C
EL-518		PA-629		PT730	PT8361	BF-839	BT839		w/(2) 7B-7635
F-518-O		PA-630		BT731 Kit	BT8308-MPG Kit	BF-840-K2	BF833-K2	F-919-C5	(5) F919-C
V-518-O		PA-635	PA-603*	BT734	BT8851-MPG	BF-840-K3	BF836-K3		w/3H-5671*, 3H5673*
B519	B1400	PA-636		V736-O		BF-840-K4	BF836-K4	F-919-A6	(6) F919-C
P-519		PA-637		PT-737-5		BF-841			w/(2) 7B-7635
PT520-10		PA-640-HD		BT742	BT8870-MPG	BT841		F-919-C6	(6) F919-C
BT523	BT8803-MPG	PA-646	PA2007	V-743-O		V842-O	VT842-O		w/(2) 7B-7999*
PT-523	PT561	PA647		VT-43-T		F848-A		F-919-A9	(9) F919-C
BT-524	B2	PA656 FOAM		BT744	BT8862	PF-849	PT849		w/2F-9341*, 2F-9342*
P524	P294	PA659		BT745	BT8844	BF850			

\* These Part Numbers are also Obsolete.



**WARNING:** These products can expose you to chemicals, including Diisononyl Phthalate, Carbon black extracts, Nickel, 1,3 Butadiene, Ethylene Oxide, Epichlorohydrin, which are known to the State of California to cause cancer, and Bisphenol-A, Ethylene Glycol, Ethylene Oxide, 1,3 Butadiene, Epichlorohydrin, which are known to the State of California to cause birth defects or other reproductive harm.

# BALDWIN OBSOLETE PRODUCTS

OBSOLETE NUMBER	REPLACED BY	OBSOLETE NUMBER	REPLACED BY	OBSOLETE NUMBER	REPLACED BY	OBSOLETE NUMBER	REPLACED BY	OBSOLETE NUMBER	REPLACED BY
F-919-B9	(9) F919-C w/1H-4511*, 1H4514-R*	P-999-B Kit		BF1175		F-1510-R	P1510	PA-1714 Foam	
F-919-C9	(9) F919-C w/(2) 7B-7664	B1000-CD	P996	BF1183		PF-1510-R	P1510	PA-1714 Scr.	
F-919-C10	(10) F919-C w/8F-7715*, 8F-7716*	B1001-N		BF1192		V-1510-R	P1510	PA-1715	
F-919-C12	(12) F919-C w/6B-2955*, 7B-8017	B-1002-CD	B1000-CD*	BF1194		V-1515-R		PA-1716	
F-919-A17	(17) F919-C w/9F-1805*, 9F-1806*	F1002-C		BF1196		V-1530-FF		PA-1716-FN	
F-919-C17	(17) F919-C w/2F-9228*, 2F-9231*	B-1003-N		BF1202	BF1237*	V1530-R		PA-1717	
P-920		BF1003		BF1203	BF1236*	F-1540-C		PA-1720	
F921-C		B-1004-N		BF1212-HP	BF1212	P1564		PA-1722	
F922-C		BF1004		BF1212-W		P1569		PA-1723	
F923-C		B1005-N		BF1229	BF1230*	P1570		PA-1724	
F924-C	PF924	BF1006		BF1230	BF1222 or BF1222-SP	P1571		PA-1725	
F-925-C		B-1007-N		BF1234	BF1205 or BF1205-SP	P1572		PA-1727	
F927-C		BF1007		BF1235	BF1257	P1573		PA-1728	
PF-928		B-1008-N		BF1236	BF7673*	P1574		PA-1729	
PF-929		BF1010		BF1237	BF7674*	P1576		PA-1730	
F-930-C		P-1010-L	P-1010-L*	BF1238	BF7672*	P1579		PA-1731	
PF-930		PV-1010-L		F-1240-C		PF1580		PA-1732	
T931-3T		F-1030-C		V1240-O		PF1581		PA-1733	
V931-W(8)		V-1030-C		BF1241	BF7679*	PF1582		PA-1734	
V-931-W(57)	V931-W(8)*	B1031		F-1241-C		PF1583		PA-1736	
F-932-C		B-1032		V-1241-C		PF1586		PA-1737	
F-933-C		F-1033-O		V-1250-O		PF1588		PA-1738	
BF934		V-1033-O		V-1251-O		PF1590		PA-1738(3)	
P-937-C8		F-1035-C		BF1254	BF7681*	PA-1601		PA-1739	
F-934-C		V-1035-C		BF1255	BF7677*	PA-1604		PA-1740	
F-941-C		T-1036-B		BF1259-W		PA-1605		PA-1741	
BF944		V-1037-A		BF1260	BF1283	PA-1611		PA-1741 Foam	
PF-944	PF947	V-1038-T		BF1260-SP	BF1283-SP	PA-1612		PA-1741-WPC	
BF948-B	BF948	F-1040-O		BF1263-SP	BF1272-SP*	PA-1616		PA-1742	
BF948-D	BF948-D*	V1040-C		BF1264-SP	BF1274-SP*	PA-1617		PA-1743	
F-949-F	PF949	F-1050-O			or BF1274-SPS	PA1622		PA-1744	
P-951	PT951	BF1051		BF1272-SP		PA-1623-S		PA-1744-FN	
BF-953		BF1054		BF1272-SPS (Oval Sensor) or BF1293-SPS (Rectangular Sensor)		PA-1624		PA-1744-K	
F-954-F		V-1055-O		F-1280-C		PA-1628		PA-1745	
PF-956		BF1059		BF1284-SP	BF1399-SP	PA1632 FOAM		PA-1746	
BF957-B	BF957	V-1060-O		BF1295-O		PA-1638		PA-1747	
BF-957-D	BF957-D	V-1074-O		CK1300	FB1301, FB1302, OB1303	PA-1640	PA2007	PA-1751	
B-958	BT839-10	BF1103		FK1304		V1650-O		PA-1752	
BT-958	BT839-10	BF1106	BF1100	BF1321	BF1212	PA-1651(2)		PA-1753	
F-959-C		BF1107	BF1155*	BF1322	BF5813	PA-1652		PA-1756	
PF-960	P960	BF1108	BF1179	BF1323	BF1214	PA-1654		PA-1759	
F961-C		BF1109	BF1108*	BF1324	BF1220	PA-1655		PA-1760	
BF964		BF1111		BK1327	B7577, OB1308	PA-1656	PA2140 (Cars) PA2139 (Comp.)	PA-1761	
F-964-C		BF1112		BK1328	B95, OB1303	V-1657-O		PA-1762	
BF965		BF1116	BF1120*	BF1329-O	BF46083-O	PA1658		PA-1764	
PF-965		BF1117		BF1341	BF1212	PA-1659		PA-1766	
PF-966		BF1118		BF1342	BF5813	PA-1662		PA-1767	
F-969-M		BF1121	BF1123	BF1343	BF1214	PA-1665		PA-1770	
BF972		BF1122		BF1344	BF1220	PA-1668		PA-1793	
BF-973	BF970	BF1130		BF1351-SP	BF9811-SP	PA-1671		PA-1796	PA1815
PF-973		BF1131		BF1352-SP	BF1352-SPS	PA-1672		PA-1796-K	PA1815
PF-973 Kit	PF-973*	BF1133		BF1354-SP	BF1354-SPS	PA-1676	PA1863	PA-1799	PA1848
BF976-B	BF976	BF1135	BF1100	BF1366	BF1366-O	PA-1677		PA1800 FOAM	
F-976-W		BF1136	BF1100	BF1383	BF1383-O	PA-1678(2)		PA-1801	
B-977 Kit	BK6710	V-1136-O		B1401	B1400	PA-1685		PA-1803	
BF-977		BF1137	BF1100	B1403	BD1403	PA-1690		PA1804	
PF-980		BF1138		B1404	B245*	PA-1691		PA1807	
BF-981		BF1139	BF1105	B1408		PA-1693		PA-1808	
BF982		BF1144	BF1100	B1412	B33	PA-1694		SA-1809	
BF-983	BF970	BF1145		B1415		PA-1695		PA1810-WPC	
BF-985	BF991	BF1149	BF1191	B1420	B173-S	PA-1700 Ele.		PA-1811	
PF-988		BF1152	BF1100	B1423	B113	PA1700 FOAM		PA-1812	
BF-989 Kit		BF1153	BF1100	B1424		PA-1700 Scr.		PA-1813-FN	
BF990		BF1155		B1427	B421	PA-1701 Scr.		PA-1820	
BF-993	BF988	V-1155-C		HC-1430		PA1702 Ele.		PA-1822	
PF994		BF1156		P1439	P1445	PA-1702 Scr.		PA-1829	
P-997		BF1157	BF1100	B1442	B1429	PA-1703 Ele.		PA-1833	
P999	P999-HD	BF1158	BF1100	P1445	P7442	PA1703 FOAM		PA-1835	
P-999 Kit		BF1162		V1500-R		PA-1703 Scr.		PA-1837	
		BF1165		V1506-FF		PA-1708-FN	PA2657-FN	PA-1838	
		BF1167	BF1057	V1506-R		PA-1711		PA-1838-K	
		BF1168	BF1057	V-1507-R		PA1713		PA1839-FN	
		BF1169		V1509-R		PA-1714 Ele.		PA-1842	

\* These Part Numbers are also Obsolete.



**WARNING:** These products can expose you to chemicals, including Diisononyl Phthalate, Carbon black extracts, Nickel, 1,3 Butadiene, Ethylene Oxide, Epichlorohydrin, which are known to the State of California to cause cancer, and Bisphenol-A, Ethylene Glycol, Ethylene Oxide, 1,3 Butadiene, Epichlorohydrin, which are known to the State of California to cause birth defects or other reproductive harm.

# BALDWIN OBSOLETE PRODUCTS

OBSOLETE NUMBER	REPLACED BY	OBSOLETE NUMBER	REPLACED BY	OBSOLETE NUMBER	REPLACED BY	OBSOLETE NUMBER	REPLACED BY	OBSOLETE NUMBER	REPLACED BY
PA-1843		PA-1990		PA2133		PA2449-K		PA2901	
PA-1844		PA-1991-FN		PA2137		LL2461.....	PA2461	PA2907	
LL1847-FN		LL1992-FN		PA2141		LL2465.....	PA2465	PA2910	
PA-1847		PA1992.....	LL1992	PA2142		PA-2470.....	PA2667	PA2911	
PA-1850		PA-1993.....	PA2546	PA2143		PA-2471.....	PA2668	PA2916-FN.....	PA3664-FN
PA-1853		PA-1994.....	PA2547	SA2144		PA2492		PA2919	
PA1853-FN		PA-1999		PA2145		LL2494.....	PA2494	PA2920	
PA-1853-K		PA-2000		PA2146		PA2501.....	PA3951	PA2926-FN	
PA-1854		PA-2003		PA2151		PA-2505		PA2927-FN	
PA1855		PA2004		PA2155		PA2506		PA2929	
PA-1856.....	PA-2000*	PA2008 FOAM		PA2157		LL2515		PA2929-FN	
PA-1862.....	PA1885	PA-2011		V-2160-O		LL2516.....	PA2516	PA2934.....	PA3445*
LL1864-FN		PA-2012		PA2161		LL2520.....	PA2520	PA2937.....	PA2698
PA-1869		PA-2013.....	PA1802	PA2165		LL2531.....	PA2531	PA2939.....	PA2855
PA-1870		PA2014		PA2166		LL2532.....	PA2532	PA2940	
PA-1871		PA2015		PA2170		LL2533.....	PA2533	PA2941	
PA-1872		PA-2016		PA2172		PA-2537		PA2965	
PA-1874.....	PA1884	PA-2017		PA2173		PA2543		PA2966	
PA-1876		PA-2018		PA2174		LL2555.....	PA2555	PA2969.....	PA2689
PA-1878		PA-2019		PA2175		LL2556.....	PA2556	PA2972-FN	
PA-1879		PA-2020		PA2176		LL2558.....	PA2558	PA2974	
PA-1883		PA-2021		PA2177		PA2560		PA2975	
PA1887		PA-2022		PA2179		PA2561		PA2983	
PA-1890		PA2025		PA2180		PA2565		PA2985	
PA-1902		PA-2026		PA2184		PA2584		PA2986	
PA-1903		PA-2028		PA2185		PA2590		PA2987	
PA-1908		PA-2029		PA2187		PA2594		AD2990	
PA-1910		PA-2030		PA2190		LL2596.....	PA2596	AK2990	
PA-1914		PA-2032		PA2192		PA2597		AD2991	
PA-1917		PA-2033		PA2195		PA2603		AK2991.....	AD2991* & PA2735
PA-1918		PA2034		PA2197		PA-2627 Ele.		AD2992	
PA-1918-K.....	PA1667-FN	SA2035		PA2198		PA2639		AK2992.....	AD2992* & PA2737
LL1922-FN.....	PA1922-FN	SA-2038.....	SA2045 (Pad Only)	PA2199		PA-2639		AD2993	
PA-1923		SA2040		PA2201		LL2641		AK2993.....	AD2993* & PA2625
PA-1924		PA-2043		PA2202		LL2656.....	PA2656	AD2994	
PA1925		SA2045		PA2203		LL2659.....	PA2659	AK2994.....	AD2994* & PA2738
LL1926.....	PA1926	SA2046		PA2205		LL2663-FN.....	PA2663-FN	AD2995	
PA-1927		PA-2047		PA2206		PA2671		AK2995	
PA-1927-FN		PA-2048.....	PA648	PA2209		LL2675.....	PA2675	AD2997	
PA-1928.....	PA1848	SA2048		PA2210		LL2679.....	PA2679	AK2997.....	AD2997* & PA2739
PA-1929		PA-2049		PA2211		PA2681		AD2998	
PA-1930-FN		PA2054		PA2213		PA2682-FN		AK2998	
PA-1931(2)		PA2055		PA2217		PA2683		AD2999	
PA-1933		PA-2056		PA2219		PA2685.....	LL2685	AK2999	
PA-1935		PA2057		PA2220		PA2686		AD3000	
PA-1938		PA-2058		PA2227		PA2695		AK3000	
PA-1939		PA2059		PA2229		PA2697		HSG3000	
PA-1939-FN		PA-2060		PA2236		PA2698-K		AD3001	
PA-1939-K		PA2062		PA2238		PA2720		AK3001	
PA1942		PA2066		PA2239		LL2734.....	PA2734	HSG3001	
PA1943		PA2078		PA2242		PA2741.....	PA3467	AD3002	
PA-1944		PA-2080		PA2245.....	PA2243	LL2749.....	PA2749	AK3002	
PA-1947		PA2082		PA2246		PA2760		HSG3002	
PA-1948		SA2086		PA2259		PA2770		HSG3003	
F-1950-O		SA2087		PA2309		LL2780.....	LL2503	HSG3004	
PA-1950		PA2088		PA-2311-FN		PA2780.....	PA2503	HSG3005	
V1950-O		PA2089		LL2316.....	PA2316	LL2783		HSG3006	
PA1954		PA2090		PA-2324.....	PA-2324-1*	PA2795		HSG3007	
PA-1955		PA-2098		PA-2324-K.....	PA-2324-1*	PA2802.....	PA3499	HSG3008	
PA-1958		PA-2101.....	PA2101A	PA2325		PA2804 KIT.....	PA2804	HSG3009	
PA-1959		PA2105		PA-2326-WO.....	PA2326	PA2808		HSG3010	
PA-1962		PA2108		PA2327		PA2809		HSG3011	
PA-1964		PA2111		PA-2334		PA2810		HSG3012	
PA-1965		PA2112		PA-2336		PA2811		HSG3013	
PA-1966		PA2115 FOAM		PA2348-FN		PA2841		HSG3014	
PA-1968-FN		PA2118		PA-2355		PA2850		HSG3015	
PA-1968-K		PA2119		LL2357.....	PA2357	PA2859.....	PA2859-FN	HSG3016	
PA-1970		PA2120		PA-2365.....	PA2546	PA2863.....	RS2863	HSG3017	
PA1971		PA2122		PA-2366.....	PA2547	PA2868-FN.....	PA2778-FN	HSG3018	
PA1974		PA2123		PA2373		PA2873		HSG3019	
LL1979-FN.....	PA1979-FN	PA2126		LL2382.....	PA2382	PA2879-FN		HSG3020	
LL1980-FN		PA2128		LL2389-FN.....	PA2389-FN	PA2882		HSG3021	
PA1983		PA2129		C2400-A		PA2893.....	PA3477	HSG3022	
PA-1986 Kit.....	PA1986-K	PA2130		V-2400-A.....	C2400-A*	PA2894-FN		HSG3023	
PA-1987 Kit.....	PA-1987-K*	PA2131		PA2416.....	PA2845	PA2898		HSG3024	
PA-1987-K		PA2132		LL2438.....	PA2438	PA2899		HSG3025	

\* These Part Numbers are also Obsolete.



**WARNING:** These products can expose you to chemicals, including Diisononyl Phthalate, Carbon black extracts, Nickel, 1,3 Butadiene, Ethylene Oxide, Epichlorohydrin, which are known to the State of California to cause cancer, and Bisphenol-A, Ethylene Glycol, Ethylene Oxide, 1,3 Butadiene, Epichlorohydrin, which are known to the State of California to cause birth defects or other reproductive harm.

# BALDWIN OBSOLETE PRODUCTS

OBSOLETE NUMBER	REPLACED BY	OBSOLETE NUMBER	REPLACED BY	OBSOLETE NUMBER	REPLACED BY	OBSOLETE NUMBER	REPLACED BY	OBSOLETE NUMBER	REPLACED BY
HSG3026		AE3223		AC3299		RS3546.....	<b>RS3954</b>	PA4082	
HSG3027		AE3224		AC3300		PA3552		PA4083.....	<b>PA4081</b>
HSG3028		AE3225		AC3301		PA3561		PA4086.....	<b>PA4416 KIT</b>
HSG3029		AE3226		AH3302		PA3564.....	<b>PA3606</b>	PA4087	
HSG3030		AE3227		AH3303		PA3567		PA4095	
HSG3031		AE3228		AH3304		PA3570.....	<b>PA3691</b>	PA4097	
HSG3032		AE3229		AS3305		PA3571		PA4098	
HSG3033		AE3230		AS3306		PA3574		PA4115.....	<b>PA4154</b>
HSG3034		AE3231		AB3307		PA3577		PA4116	
HSG3035		AE3232		AB3308		PA3582-FN.....	<b>PA3671-FN</b>	PA4117	
HSG3036		AE3233		AB3309		PA3583.....	<b>PA3672</b>	PA4122.....	<b>PA4163</b>
HSG3037		AE3234		AB3310		PA3586		PA4125	
HSG3038		AE3235		AB3311.....	<b>AB3278*</b>	PA3589		PA4135	
HSG3039		AE3236		AB3312		PA3590		PA4136.....	<b>PA4155 KIT</b>
HSG3040		AE3237		AB3313		PA3591		SA4137	
HSG3041.....	<b>HSG3069*</b>	AE3238		AB3314		PA3592		SA4139	
HSG3042		AH3239		AB3315		PA3593		PA4140	
HSG3043		AH3240		AV3316		PA3594		SA4142	
HSG3044		AH3241		AV3317		PA3599		SA4143	
HSG3045		AH3242		AV3318		PA3603		PA4155 KIT	
HSG3046		AH3243		AV3319		PA3634		PA4186	
HSG3047		AH3244		AC3320		PA3639		OAS4200	
HSG3048		AH3245		AC3321		PA3646-FN		OAS4201	
HSG3049		AH3246		AC3322		PA3647		OAS4202	
HSG3050		AH3247		AR3323		PA3648		OAS4203	
HSG3051		AH3248		AR3324		PA3659		OAS4204	
HSG3052		AH3249		AR3325		PA3662		OAS4205	
HSG3053		AH3250		AR3326		PA3663		OAS4206	
HSG3054		AH3251		AR3327		PA3665		OAS4207	
HSG3055		AH3252		AR3328		PA3666-FN		OAS4208	
HSG3056		AH3253		AR3329		PA3673		OAS4209	
HSG3057.....	<b>HSG3070*</b>	AH3254		AR3330		PA3677		OAS4210	
HSG3058		AH3255		AW3332		RS3702.....	<b>RS3988</b>	OAS4211	
HSG3059		AH3256		AW3333		PA3751-FN		OAS4212	
HSG3060		AH3257		AW3334		PA3762		OAS4213	
HSG3061		AH3258		AW3335		PA3769		OAS4214	
HSG3062		AH3259		AW3336		PA3770		OAS4215	
HSG3063		AH3260		AW3337		PA3771		OAS4216	
HSG3064		AH3261		AW3338		PA3776		OAS4217	
HSG3065.....	<b>HSG3064*</b>	AS3262		AW3339		PA3784		OAS4218	
HSG3066.....	<b>HSG3059*</b>	AS3263		AW3340		PA3845		OAS4219	
HSG3067.....	<b>HSG3068*</b>	AS3264		AW3341		PA3856		OAS4220	
HSG3068		AS3265		AS3343		PA3858		OAS4221	
HSG3069		AS3266		AS3344		PA3866.....	<b>PA2489</b>	OAS4222	
HSG3070		AS3267		AD3345		PA3947		OAS4223	
HSG3072		AS3268		AS3346		PA3962		OAS4224	
HSG3073		AS3269		AD3347		BF-4000		OAS4225	
HSG3074		AS3270.....	<b>AS3269*</b>	AS3348		PF4001		OAS4226	
HSG3075		AS3271		PA3400		WF4002-M		OAS4227	
HSG3076		AS3272		PA3401		WF4003-M		OAS4228	
HSG3079		AS3273		PA3402		PA4004		OAS4229	
HSG3080		AS3274		PA3403		BF-4010		OAS4230	
AE3200		AS3275		PA3407		PF4011		OAS4231	
AS3200		AB3276		PA3409		WF4012-A		OAS4232	
AE3201		AB3277		PA3410.....	<b>PA3410-FN*</b>	WF4013-A		OAS4233	
AE3202		AB3278		PA3410-FN		PA4014		OAS4234	
AE3203		AB3279		PA3413		PA4019		OAS4235	
AE3204		AB3280.....	<b>AB3312*</b>	PA3418		PA4020		OAS4236	
AE3205		AB3281.....	<b>AB3314*</b>	PA3423-FN		PA4031		OAS4237	
AE3206		AB3282		PA3424-FN		WG-4033		OAS4238	
AE3207		AB3283		PA3425		PA4034		OAS4239	
AE3208		AB3284		PA3441		PA4036		OAS4240	
AE3209		AB3285		PA3445		PA4038		OAS4241	
AE3210		AC3286		PA3450		PA4039		OAS4242	
AE3211		AC3287		PA3451		PA4040		OAS4243	
AE3212		AC3288		PA3454		PA4051		OAS4244	
AE3213		AC3289		PA3459		PA4052		OAS4245	
AE3214		AC3290		PA3462		PA4053		OAS4246	
AE3215		AC3291		PA3465		PA4054		OAS4247	
AE3216		AC3292		PA3468		PA4058		OAS4248	
AE3217		AC3293		AD3522		PA4061		OAS4249	
AE3218		AC3294		AD3523		PA4064		OAS4250	
AE3219		AC3295		AD3524		PA4067		OAS4251	
AE3220		AC3296		AD3525		PA4068		OAS4252	
AE3221		AC3297		AD3526		PA4074.....	<b>PA3763</b>	OAS4253	
AE3222		AC3298		AD3527		PA4076		OAS4254	

\* These Part Numbers are also Obsolete.



**WARNING:** These products can expose you to chemicals, including Diisononyl Phthalate, Carbon black extracts, Nickel, 1,3 Butadiene, Ethylene Oxide, Epichlorohydrin, which are known to the State of California to cause cancer, and Bisphenol-A, Ethylene Glycol, Ethylene Oxide, 1,3 Butadiene, Epichlorohydrin, which are known to the State of California to cause birth defects or other reproductive harm.

# BALDWIN OBSOLETE PRODUCTS

OBSOLETE NUMBER	REPLACED BY	OBSOLETE NUMBER	REPLACED BY	OBSOLETE NUMBER	REPLACED BY	OBSOLETE NUMBER	REPLACED BY	OBSOLETE NUMBER	REPLACED BY
OAS4255		PA4717		PA4847		CW5130-P		RS5593	RS5593XP
OAS4256		PA4718		PA4850		CW-5130-PWP	CW5130-P* & WF4002-M*	PA5596	
OAS4257		PA4719		PA4851				PA5634	
OAS4258		PA4721		PA4854 FOAM		CWC-5130-P		PA5635	
OAS4259		PA4722-FN		PA4856		CWC-5130-PWP		PA5643	
OAS4260		PA4724-FN		PA4868-FN		CW5131-P		PA5647	
OAS4261		PA4725		PA4869		CWC-5131-P		PA5659	
OAS4262		PA4726		PA4875		CW-5132-P	(2) CW5131-P*	PA5660	
OAS4263		PA4728		PA4880		CW5132-PWP	(2) CW5131-P* & WF4003-M*	PA5667	
OAS4264		PA4729		PA4882				RS5701	
OAS4265		PA4739		PA4884		CWC-5132-P		PA5702	
OAS4266		PA4742		PA4892		CWC-5132-PWP		PA5704	
OAS4267		PA4744		PA4894		BW-5133	BW5139	PA5705	
OAS4268		PA4745		PA4898		BW-5133-A	BW-5133*	PA5714	
OAS4269		PA4746		PA4901		BW-5133-Z	BW-5133*	PA5715	
OAS4270		PA4747		PA4904		BWC-5133		PA5717	
OAS4271		PA4748		PA4909		BWC-5133-Z		PA5718 KIT	
OAS4272		PA4748 FOAM		PA4913		BW-5134	BW5137	PA5724	
OAS4273		PA4749		PA4914		BW-5134-Z	BW-5134*	PA5724 FOAM	
OAS4274		PA4751		PA4915		BWC-5134		PA5726	
OAS4275		PA4752		PA4916		BWC-5134-A		PA5737 KIT	
OAS4276		PA4757		PA4917		BWC-5134-Z		PA5740	
OAS4277		PA4759		PA4920		BW-5135	BW5136	PA5799	
OAS4278		PA4761		PA4921		CW5150-L		BF5800-B	BF5800
OAS4279		PA4762 FOAM		PA4922		BW5170	BW5070	BF5810-B	BF5810
OAS4280		PA4765 FOAM		PA4923		BW5171	BW5071	6010	
OAS4281		PA4767		PA4924		BW5173	BW5073	6011	
OAS4282		PA4768		PA4926		BW5174	BW5074	6012	
OAS4283		PA4770		PA4927		BW-5176	BW5178	6013	
OAS4284		PA4771	PA4689	PA4933		BW-5177	BW5179	6014	
OAS4285		PA4772		PA4936		BW5180		6015	
OAS4286		PA4774		PA4937		BW5181		6016	
OAS4287		PA4776		PA4940		PA5307		6018	
OAS4288		PA4777		PA4943		RS5362	RS30065, RS30065 KIT (w/Lid)	6019	
OAS4289		PA4779		PA4944		BA5372		BK6200	
OAS4290		PA4780		PA4946	PA4938	PA5394		BK6203	
OAS4291		PA4780 FOAM		PA4948		PA5402		BK6206	
OAS4292		PA4782		PA4949		PA5444-FN		BK6209	
OAS4293		PA4783		PA4950		PA5469		BK6210	
OAS4294		PA4784		PA4951	PA4947	PA5474		BK6211	
OAS4295		PA4786		PA4952		PA5480		BK6212	
OAS4296		PA4787		PA4953		PA5481		BK6217	
OAS4297		PA4788	PA4389	PA4954		PA5488		BK6220	
OAS4298		PA4789		PA4957		RS5488		BK6221	
OAS4299		PA4791		PA4958		PA5501	RS5782	BK6223	
OAS4300		PA4792		PA4964-FN		PA5502	RS5783	BK6226	
OAS4301		PA4796		PA4965		PA5518		BK6227	
OAS4302		PA4797		PA4974		PA5519		BK6229	
PA4357		PA4798		PA4976	PA3872	PA5521		BK6230	
PA4375		PA4799		PA4980		PA5522		BK6231	
PA4395		PA4800		PA4981		PA5523		BK6233	
PA4406 KIT		PA4805		PA4982		PA5524		BK6236	
PA4407		PA4808		PA4998	PA4820	PA5525		BK6237	
PA4420		PA4811		CS-5001		PA5526		BK6238	
PA4427		PA4812	PA3672	CS-5002	CS5008	PA5527		BK6239	
PA4556		PA4815		CS-5003	CS5009	PA5531		BK6240	
RS4584	RS4634	PA4816		CS-5004	CS5011	RS5542	RS30142, RS30142 KIT	BK6243	
PA4607		PA4817		CS-5005	CS5010	PA5551		BK6247	
PA4615		PA4818		CK5006B		PA5553		BK6254	
PA4626		PA4821		CT5006A		PA5555		BK6259	
PA4640	PA4640-FN	PA4822		CTK5006	CTK5029	PA5560		BK6260	
PA4658		PA4826		CSC5014		PA5564		BK6261	
PA4669		PA4828		CT5026A		PA5565		BK6266	
PA4670		PA4832		CT5026B		PA5567		BK6269	
PA4684		PA4835		CTK5026	CTK5029	PA5568		BK6271	
PA4685		PA4836		CTK5027	CTK5029	PA5569		BK6284	
RS4686	RS4678	PA4837		CS5055		PA5570		BK6289	
RS4687	RS4679	PA4838		OTK5062		PA5571		BK6300	
PA4688		PA4839		LB-5100 Kit		PA5572		BK6301	
PA4688 FOAM		PA4840		WF5100		PA5575		BK6302	
PA4689 FOAM		PA4841		WF5101		PA5576		BK6303	
PA4690		PA4842		BW-5120		PA5577		BK6310	
PA4691		PA4843		BWC-5120		PA5578		BK6311	
PA4699		PA4844		BW-5121		PA5579		BK6312	
PA4710		PA4845		BWC-5121		PA5582	PA30026	BK6313	
PA4712		PA4846		C5130-P		RS5591	RS5591XP	BK6314	

\* These Part Numbers are also Obsolete.



**WARNING:** These products can expose you to chemicals, including Diisononyl Phthalate, Carbon black extracts, Nickel, 1,3 Butadiene, Ethylene Oxide, Epichlorohydrin, which are known to the State of California to cause cancer, and Bisphenol-A, Ethylene Glycol, Ethylene Oxide, 1,3 Butadiene, Epichlorohydrin, which are known to the State of California to cause birth defects or other reproductive harm.

# BALDWIN OBSOLETE PRODUCTS

OBSOLETE NUMBER	REPLACED BY	OBSOLETE NUMBER	REPLACED BY	OBSOLETE NUMBER	REPLACED BY	OBSOLETE NUMBER	REPLACED BY	OBSOLETE NUMBER	REPLACED BY
BK6316		BK6589		B7085.....	B7144	BF7539.....	BF7644	H8007.....	H9007
BK6317		BK6590		P7087		BF7542		H8008	
BK6318		BK6592		P7088		BF7543		H8009	
BK6321		BK6593		BD7100		PF7547		H8010.....	H9010*
BK6327		BK6594		B7108.....	B7004	PF7548.....		H8011	
BK6342		BK6596		B7109.....	B7585		PF7620* (Cat, Cummins)	H8012	
BK6348		BK6602		B7118.....	B7144		PF7621* (Detroit)	H8013.....	H9013
BK6350.....	BK6371*	BK6603		BD7120		K-7550 Kit.....	BK6355*	H8014.....	H9014
BK6351		BK6604		BC7140.....	BC7194	BF7557-B.....	BF7557	H8015	
BK6352		BK6605		B7149		B7575.....	B7577	H8016	
BK6355		BK6606		B7150.....	B7180	B7577-B.....	B7577	H8017	
BK6370		BK6609		P7198.....	P1443	K-7577 Kit.....	BK6401	H8018.....	H9018
BK6371		BK6611		BT7237-MPG.....	BT7237	PF7578.....	PF7678	H8019	
BK6374		BK6612		BD7244.....	BD7105	BF7581.....	BF7646*	H8020.....	H9020
BK6381		BK6614		C7253		BF7582.....	BF7647*	H8021.....	H9021
BK6384		BK6660		P7254		PF7583		H8022	
BK6385		BK6669		P7257		K-7596 Kit.....	BK6350*	H8023	
BK6386		BK6671		P7258		P7599		H8024.....	H9024
BK6388		BK6674		P7262		BF7601.....	BF954	H8025	
BK6389		BK6701		P7265		BF7609		H8026	
BK6395		BK6708		P7266		PF7610.....	PF7651*	H8027	
BK6398		BK6709		B7272.....	B7402	PF7611		H8028	
BK6400		BK6712		PT-727-HD5		PF7620.....	PF7680	H8029.....	H9029*
BK6401		BK6718		B7278		PF7621.....	PF7680	H8030	
BK6404		BK6722		B7279		P7642		H8031	
BK6411		BK6742		B7282		BF7643.....	BF7682*	H8032	
BK6413		BK6788		B7284		BF7646.....	BF7674*	H8033	
BK6416		BK6792		B7288.....	B7217	BF7647.....	BF7681*	H8034	
BK6418		BK6793		B7296		BF7649.....	BF7672*	H8035	
BK6419		BK6800		P7300.....	P1562	BF7650.....	BF7679*	H8036.....	H9036
BK6420		BK6802		P7301		PF7651.....	PF7751	H8037.....	H9037
BK6421		BK6804		P7302		BF7652.....	BF7674-D	H8038	
BK6423		BK6806		C7304		PF7654.....	PF7777	H8039.....	H9039
BK6430		BK6807		BT7339.....	BT7349	BF7660.....	BF1163	H8040.....	H9040
BK6431		BK6808		BD7353.....	BD40027	BF7662		H8041.....	H9041
BK6432		BK6810		P7354.....	P40019	BF7665.....	BF7675*	H8042.....	H9042
BK6433		BK6811		B7369		BF7672.....	BF7672-D	H8043.....	H9043
BK6435		BK6818		P7371		BF7673.....	BF7673-D	H8044.....	H9044
BK6439		BK6826		P7381		BF7674.....	BF7674-D	H8045.....	H9045
BK6456		BK6829		B7392		BF7675.....	BF7675-D	H8046.....	H9046
BK6471		BK6830		P7405.....	P7505	BF7677.....	BF7677-D	H8047.....	H9047
BK6475		BK6831		B7460		BF7679.....	BF7679-D	H8048.....	H9048
BK6479		BK6832		B7464.....	B7370	BF7681.....	BF7681-D	H8049.....	H9049
BK6481		BK6834		B7465		BF7682.....	BF7682-D	H8050.....	H9050
BK6485		BK6838		B7470		PF7688.....	PF7698	H8051.....	H9051
BK6496		BK6839		B7472		BF7689.....	BF788	H8052	
BK6498		BK6900		B7473		BF7710.....	BF7765	H8053.....	H9053*
BK6500		BK6901		B7475		BF7723		H8054.....	H9054
BK6504		BK6902		B7476		BF7724		H8055.....	H9055
BK6509		BK6906		B7478		BF7727.....	BF7827*	H8056.....	H9056
BK6510		BK6907		B7481		BF7739.....	BF7801	H8057.....	H9057
BK6511		BK6908		B7482		PF7789.....	PF7889	H8058.....	H9058
BK6514		BK6939		P7484		PF7789-10.....	PF7889-10	H8059	
BK6516		BK6940		B-7500.....	B7500A*	PF7789-30.....	PF7889-30	H8060.....	H9060
BK6520		BK6941		B-7500 Kit		PF7790.....	PF7890	H8061	
BK6523		B7006		B7500A		PF7790-10.....	PF7890-10	H8062.....	H9062
BK6526		B7008-D.....	B7019	B7500A-CH		PF7790-30.....	PF7890-30	H8063	
BK6530		B7026.....	B7026-MPG	B-7500-CH.....	B7500A-CH*	BF7827.....	BF9882*, BF46062	H8064	
BK6531		B7027.....	B7085*	B-7500-PR.....	B7500A*	PF7831		H8065	
BK6534		B7032.....	B7130	BF7500.....	BF7500-A*	PF7835		H8066	
BK6537		B7040.....	B7040-A*	BF7500-A		BF7846		H8067	
BK6540		B7040-A		BH-7500.....	B7500A*	BF7856		H8068	
BK6547		B7040-CH.....	B7040-A*	BH-7500-CH.....	B7500A-CH*	BF7858.....	BF7693	H8069.....	H9069
BK6553		B7040-PR.....	B7040-A*	BH-7500-PR.....	B7500A*	BF7867		H8070.....	H9070
BK6555		BF7040		C-7500-M.....	P7500	BF7868		H8071.....	H9071
BK6556.....	BK6575*	BH7040.....	B7040-A*	P7500 POLY.....	P7500	PF7902.....	FD7926 & BF7925	H8072.....	H9072
BK6557		BH7040-CH.....	B7040-A*	P7500 SINGLE.....	P7500	BF7918.....	BF7972	H8073.....	H9073
BK6558		BH7040-PR.....	B7040-A*	EL7518		BF7933 KIT.....	BF9918 KIT	H8074.....	H9074
BK6565		F7040		PF7520.....	PF7799	BF7953-D.....	BF7951-D	H8075.....	H9075
BK6573		P7040.....	C704-L	PF7521.....	PF7655	H8000		H8076.....	H9076
BK6575		P7040 POLY.....	P7040*	BF7523		H8001.....	H9001	H8077.....	H9077
BK6580		BD7041.....	BD7166	BF7524.....	BF788	H8002		H8078.....	H9078
BK6582		B7043		BF7525.....	BF970	H8003		H8079.....	H9079
BK6584		B7046		BF7526.....	B605	H8004		H8080.....	H9080
BK6585		P7055		BF7530-MPG.....	BF7632	H8005		H8081.....	H9081
BK6588		B7079		BF7533.....	BF7535	H8006.....	H9006*	H8082.....	H9082

\* These Part Numbers are also Obsolete.



**WARNING:** These products can expose you to chemicals, including Diisononyl Phthalate, Carbon black extracts, Nickel, 1,3 Butadiene, Ethylene Oxide, Epichlorohydrin, which are known to the State of California to cause cancer, and Bisphenol-A, Ethylene Glycol, Ethylene Oxide, 1,3 Butadiene, Epichlorohydrin, which are known to the State of California to cause birth defects or other reproductive harm.

# BALDWIN OBSOLETE PRODUCTS

OBSOLETE NUMBER	REPLACED BY	OBSOLETE NUMBER	REPLACED BY	OBSOLETE NUMBER	REPLACED BY	OBSOLETE NUMBER	REPLACED BY	OBSOLETE NUMBER	REPLACED BY
H8083	H9083	PT8516-MPG KIT		PT9201		PA-1636-2K		19852	
H8084	H9084		PT9416-MPG KIT	PT9202		PA-1728-1		19861	
H8085	H9085	OS8702		PT9204		18000		19879	
H8086	H9086	OS8705		PT9206		18001		19887	
H8087		OS8706		PT9207		18003		19895	
H8088		OS8717		BT9211	BT8474	18005		19909	
H8089		OS8718		PT9216		18006	18033	19917	
H8090		OB8726		PT9218		18008	18022	19925	
H8091		OB8740		PT9219		18011		19933	
H8092	H9092	OB8746		PT9220		18012		19941	
H8093	H9093	OB8781		PT9226		18014		19950	18032
H8094		OB8783		H9229		18015		19968	18032
H8095	H9095*	BT8806-MPG		H9230		18016		19976	
H8096	H9096	BT8807-MPG	BT8800-MPG	H9232		18017		19984	
H8097	H9097	BT8860	BT8861	H9233	PT320-MPG	18018		19993	
H8098		BT8871-MPG	BT8876-MPG	H9234		18019		19994	
H8099		BT8923		PT9235-MPG	PT9350-MPG	18020		19995	
H8100		BT8924		PT9236-MPG		18021		19997	
H8101		BT8925		PT9241		18023		19998	18010
H8102		BT8929		PT9243		18026		20001	
H8103	H9103	BT8932		PT9246		18028		PT23021	
H8104		BT8933		PT9249		18030		PT23099-MPG	
H8105		BT8934		PT9252		18031		PT23134-MPG	
H8106		BT8936		PT9253-MPG		18040		PT23171	
H8107	H9107	BT8938-MPG		PT9259		18058		PT23208-MPG	
H8108	H9108	PT8942-MPG		PT9262-MPG		18066	18155	PT23225-MPG	
H8109		PT8944-MPG		PT9263		18074		PA-2324-1	
H8110	H9110	PT8949-MPG		PT9265		18082		PT23256-MPG	
H8111	H9111	PT8953-MPG		PT9269		18091		PT23268-MPG	H9001
H8112	H9112	PT8961-MPG	PT9337-MPG	PT9270		18112		PT23466	PA4876
H8113	H9113	PT8963-MPG		PT9271		18121		PF46086	
H8114	H9114	PT8964-MPG	PT9403-MPG	PT9273		18147		OAS98030	
H8115		PT8965-MPG		PT9274		18163		OAS98047	
H8116		PT8966-MPG		PT9275		18180	18025	OAS98048	
H8117		PT8968-MPG		PT9276		18201		OAS98051	OAS98057
H8118		PT8973-MPG	PT8458-MPG	PT9280		18210		OAS98055	OAS98010
H8119		PT8976-MPG		PT9281		18228		OAS99000	
H8120		PT8977-MPG		PT9285-MPG		18253		OAS99007	
H8121		PT8979-MPG		PT9292-MPG		18254	18264	OAS99009	
H8122		PT8983-MPG		PT9294-MPG		18255	18265	OAS99011	
H8123	H9123	PT8988-MPG		PT9295-MPG		18256		OAS99012	
BT8300	BT8871-MPG*	PT9000-MPG		PT9298-MPG		18257		OAS99013	
BT8303	BT8304	H9006		PT9299-MPG		18258		OAS99016	
BT8311	BT8873	H9010		PT9301-MPG	PT9359-MPG	18261		OAS99019	
BT8313	BT8874-MPG	H9015		PT9302-MPG		18262		OAS99021	
BT8315	BT8512	H9018		H9305		18266		OAS99022	
PT8321	PT8378-MPG	H9029		PT9312-MPG		18269		OAS99026	
BT8324		H9037		PT9314-MPG		18270		OAS99027	
BT8325		H9039		PT9317-MPG	PT8975-MPG	18273		OAS99030	
BT8327	BT8856-MPG	H9040		BT9319-MPG		18274		OAS99031	
PT8336		H9042-V		BT9322		18275		OAS99033	
PT8337		H9053		BT9323		18277		OAS99036	
BT8340-MPG	BT8876-MPG	H9057		BT9325		18278		OAS99037	
C8342		H9095		PT9333		18281		OAS99039	
PT8343		PT9124-MPG		PT9334-MPG		18283		OAS99040	
PT8358		PT9125		PT9336		18284		OAS99041	
BT8360	BT8871-MPG	PT9125-MPG		PT9412-MPG		18286		OAS99042	
PT8362		PT9126		PT9474		18287		OAS99044	
PT8364	PT8370-MPG	PT9128		PF9806 KIT	PF9924 KIT	18288	18024	OAS99045	
PT8374-MPG		PT9130		BF9819		18289		OAS99046	
BT8377-MPG		PT9133		BF9832		18290		500-MFVBP	500-MFVBP22
	BT8853-MPG	PT9138		PF9838		18291		200-11	200-GK
BT8379	BT8437	PT9141		BF9840		19551		200-12	200-GK
BT8380	PT8380	PT9146		BF9843		19569		200-13	200-GK
PT8389	PT23282-MPG	PT9151		PF9845		19577		200-17	200-GK
BT8399	BT8444	PT9154		BF9849		19585		200-19A	200-GK
PT8405-MPG KIT		PT9156		BF9853		19607	18112	200-22	200-GK
	PT8515-MPG KIT*	PT9159		BF9854		19615	19739	200-23	200-GK
PT8406-MPG KIT		PT9160		CA9872		19623		200-24	200-DEPR KIT
	PT8516-MPG KIT*	PT9166		BF9882	BF46062	19631		200-25,26,27	200-DEPR KIT
BT8424-MPG		PT9173		BF9926-O		19658		150-15	150-GK
BT8434	B114	PT9177		V-1240-O1		19666		150-17	150-GK
BT8454	BT9422	PT9184		PF-1510-7		19674		150-22	150-GK
PT8469-MPG		PT9192		PA-1612-1A	PA1754	19682		150-32	150-GK
PT8515-MPG KIT		PT9194		PA-1620-2S	PA1620-S	19691		100-10	100-MNTG KIT
	PT9415-MPG KIT	PT9198		PA-1636-2		19801		100-11	100-MNTG KIT

\* These Part Numbers are also Obsolete.



**WARNING:** These products can expose you to chemicals, including Diisononyl Phthalate, Carbon black extracts, Nickel, 1,3 Butadiene, Ethylene Oxide, Epichlorohydrin, which are known to the State of California to cause cancer, and Bisphenol-A, Ethylene Glycol, Ethylene Oxide, 1,3 Butadiene, Epichlorohydrin, which are known to the State of California to cause birth defects or other reproductive harm.



## BALDWIN OBSOLETE PRODUCTS

OBSOLETE NUMBER	REPLACED BY	OBSOLETE NUMBER	REPLACED BY	OBSOLETE NUMBER	REPLACED BY	OBSOLETE NUMBER	REPLACED BY	OBSOLETE NUMBER	REPLACED BY
200-32	100-GK, 150-GK, 200-GK	100-MPC		200-DGK		300-MMV3-30		1020-10x10	
100-22	100-GK, 150-GK, 100-DEPR KIT	100-W/O		200-HBP		300-MMV3BP		1020-12x10	
100-23	100-GK, 150-GK, 100-DEPR KIT	100-W/OBP		200-HN		300-MMV30		1020-12x12	
100-19	100-GK, 150-GK	101-A		200-M30		300-MPC		1028-F	
100-15	100-GK	140 KIT		200-MBP		300-SB		1030-4x4	
100-17	100-GK	140-12		200-MMV30		300-SB5		1030-6x6	
100-24	100-DEPR KIT	140-25 KIT		200-MPC		300-SB12V		1030-8x8	
100-25,26,27	100-DEPR KIT	143-6L KIT		200-SR		300-SB22		1030-10x10	
85-VK6x6		143-6L9 KIT		200-W		300-SBBP		1030-12x12	
85-VK10x8		150-10		300-14		300-SR		1040-6x4	
85-VK10x10		150-14		300-16		300-W		1040-6x4B	
85-VK12x10		150-16		300-35		500-BK1		1040-6x6	
85-VK12x12		150-24		300-AL		500-SBBP W/O		1040-10x6	
100-13		150-35		300-BP		1010-6x4		1040-10x8	
100-14		150-AL		300-DB		1010-6x4DTD		1040-10x12	
100-16		150-BP		300-DB W/O		1010-6x6		1040-12x8	
100-20		150-HBP		300-DB5		1010-6x6DTC		1040-12x12	
100-21H		150-MFV		300-DB5 W/O		1010-6x6DTD		1063-BK1	
100-21HBP		150-W		300-DB5220		1010-10x8		1063-BK2	
100-33		186-11		300-DBA		1010-10x8DTA		1063-BK3	
100-35		186-12		300-DBA5		1010-10x8DTB		1063-D	
100-36		186-21		300-DBA220		1010-10x8DTC		1063-F	
100-AL		186-22		300-DR		1010-10x8DTD		1072-B	
100-BMK		200-10P		300-DR W/O		1010-10x10		DEMO-100 MINI	
100-BMKBP		200-14		300-DR5		1010-10x10DTB		EA-002	
100-BMKH		200-16		300-DR5 W/O		1010-12x10		EC-005	
100-CUT		200-18		300-DR220		1010-12x10DTB		EC-112	
100-DGK		200-20		300-DR5220		1010-12x12		EM-03D11	
100-HBP		200-30T		300-DRA		1010-12x12DTB		EM-05D11	
100-M30		200-33		300-MBP		1015-DDT		HH4	
100-MMV30		200-34		300-MF		1015-F		HH6	
100-MMVBP		200-AL		300-MF3		1020-6x4		HH8	
		200-BP		300-MM		1020-6x6		HH10	
		200-CUT		300-MM30		1020-10x8		HH12	

\* These Part Numbers are also Obsolete.



**WARNING:** These products can expose you to chemicals, including Diisononyl Phthalate, Carbon black extracts, Nickel, 1,3 Butadiene, Ethylene Oxide, Epichlorohydrin, which are known to the State of California to cause cancer, and Bisphenol-A, Ethylene Glycol, Ethylene Oxide, 1,3 Butadiene, Epichlorohydrin, which are known to the State of California to cause birth defects or other reproductive harm.

# ABBREVIATIONS USED ANYWHERE IN OUR CATALOGS

2WD .....2-Wheel Drive  
4WD .....4-Wheel Drive

**A. Gskt.** .....Attached Gasket(s)  
**ABS** .....Anti-Lock Braking System  
**AD** .....Anti-Drainback Valve  
**ADP** .....Anti-Drainback Pipe  
**AirCond.** .....Air Conditioned  
or Air Conditioner  
**Alum.** .....Aluminum  
**AMC** .....American Motors  
**Amp** .....Ampere  
**App.** .....Approved  
**Approx.** .....Approximately  
**Arr.** .....Arrangement  
**A.T.** .....Automatic Transmission  
**ATAAC** .....Air-to-Air Aftercooling  
**Attach.** .....Attachment  
**AutoTrans.** .....Automatic Transmission  
**Aux.** .....Auxiliary  
**AWD** .....All Wheel Drive

**Bbl.** .....Barrel  
**BP** .....By-Pass Valve (8-10 PSID)  
**B-P** .....By-Pass  
**BPS** .....By-Pass Screen  
**BSP** .....British Standard Pipe Thread  
**BSP-PL** .....British Standard  
Pipe Parallel Thread  
**BTA PLUS** .....Balanced Treatment  
Additive Plus  
**BTE** .....Balanced Treatment for  
Ethylene Glycol Antifreeze  
**BTU** .....British Thermal Unit

**C** .....Celsius, Centigrade  
**Calif.** .....California  
**Carb.** .....Carburetor, Carbureted  
**Cat** .....Caterpillar  
**cc** .....Cubic Centimeters  
**CCLS** .....Closed Center Load Sensing  
**CES** .....Closed Emission System  
**CFM** .....Cubic Feet per Minute  
**CID** .....Cubic Inch Displacement  
**CLN&R** .....Clean & Reuse  
Present Filter  
**CNG** .....Compressed Natural Gas  
**Co.** .....Company  
**COE** .....Cab Over Engine  
**Comp.** .....Compressor  
**Cont'd.** .....Continued  
**Corp.** .....Corporation  
**CPI** .....Center Port Injection  
**CSC** .....Coolant System Cleaner  
**Cu.** .....Cubic  
**CVT** .....Continuously Variable  
Transmission  
**Cyl.** .....Cylinder

**D. Pan.** .....Deep Pan  
**Dbl.** .....Double  
**DC** .....Direct Current  
**DDA** .....Detroit Diesel Allison  
**DEF** .....Diesel Exhaust Fluid  
**DI** .....Direct Injection  
**Div.** .....Division  
**DOHC** .....Dual Overhead Cam  
**Don.** .....Donaldson

**ea.** .....Each  
**EFI** .....Electronic Fuel Injection  
**EGR** .....Exhaust Gas Recirculation

**EHSS** .....Electro-Hydraulic  
Shuttle Shift  
**Ele.** .....Element  
**Elec.** .....Electric  
**E.M.D.** .....Electro-Motive Division  
**Eng(s).** .....Engine(s)  
**Equip.** .....Equipment  
**Etc.** .....Et cetera (and so forth)  
**EUI** .....Electronic Unit Injector  
**Exc.** .....Except  
**ExHiPres.** .....Extra High Pressure  
**ExpHsg.** .....Exposed Housing  
**ExpTank** .....Expansion Tank  
**Ext.** .....Extended

**F** .....Fahrenheit  
**F. Drive** .....Final Drive  
**F. Fuel** .....Final Fuel  
**F. Gskt.** .....Furnished Gasket(s)  
**FECV** .....Front-End Check Valve  
**F-F** .....Full-Flow  
**FFV** .....Flex Fuel Vehicle  
**FI** .....Fuel Injection  
**FldC/O** .....Field Change-Over  
**FldInst.** .....Field Installation  
**FP** .....Fill Port  
**FRM** .....Flame Retardant Media  
**Ft.** .....Foot  
**FWD** .....Front Wheel Drive  
**FWS** .....Fuel/Water Separator

**[G]** .....Gasket  
**Gal.** .....Gallon(s)  
**GM, GMC** .....General Motors  
Corporation  
**gph** .....Gallons per Hour  
**gpm** .....Gallons per Minute  
**Gskt.** .....Gasket(s)  
**GVW** .....Gross Vehicle Weight

**[H]** .....Base or Housing Number  
**HBP** .....High Pressure  
By-Pass Valve (18-25 PSID)  
**HEUI** .....Hydraulic Electronic  
Unit Injector  
**Hgt.** .....Height  
**Hi** .....High  
**HiPerf.** .....High Performance  
**HiPres.** .....High Pressure  
**HLT** .....High-Low Transmission  
**HO** .....High Output  
**HP** .....Horsepower  
**Hsg.** .....Housing  
**HVAC** .....Heating, Ventilation  
and Air Conditioning  
**HvyDty.** .....Heavy-Duty  
**Hyd.** .....Hydraulic  
**Hz** .....Hertz

**I. Air** .....Inner Air  
**I. Gskt.** .....Integral Gasket(s)  
**I.D.** .....Inside Diameter  
**IH, IHC** .....International Harvester,  
International Navistar  
**In.** .....Inch(es)  
**Inc.** .....Incorporated  
**Incl.** .....Included  
**Ind.** .....Industrial  
**Info** .....Information  
**Int.** .....International  
**ISO** .....Inside-Out Flow Direction  
**IVT** .....Infinitely Variable Transmission

**J.C.W.** .....John Cooper Works  
**JD** .....John Deere  
**JIC** .....Joint Industry Conference  
**Jr.** .....Junior

**KHD** .....Klockner-Humboldt-Deutz  
**Kw** .....Kilowatt

**L** .....Liters  
**LBP** .....Low Pressure  
By-Pass Valve (2-7 PSID)  
**Lb(s)** .....Pound(s)  
**LGP** .....Low Ground Pressure  
**L.H.** .....Left Hand  
**LoPres.** .....Low Pressure  
**LPG** .....Liquefied Petroleum Gas  
**LPH** .....Liters per Hour  
**Ltd.** .....Limited

**M-F** .....Massey Ferguson  
**MBP** .....Medium Pressure  
By-Pass Valve (11-17 PSID)  
**Mfg.** .....Manufacturing  
**Mfr.** .....Manufacturer  
**MichFIPow.** .....Michigan Fluid Power  
**Min.** .....Minimum Order Quantity  
**mm** .....Millimeter  
**M-M** .....Minneapolis-Moline  
**MO** .....Metering Orifice  
**M.T.** .....Manual Transmission  
**Mtd.** .....Mounted  
**Mtr.** .....Motor

**NPSF** .....National Pipe Straight Fine  
**NPT** .....National Pipe Thread  
**N/R** .....Not Required  
**N/S** .....Non-Serviceable

**O. Air** .....Outer Air  
**O. Gskt.** .....Optional Gasket(s)  
**OBS** .....Obsolete  
**O.D.** .....Outside Diameter  
**OE** .....Original Equipment  
**OEM** .....Original Equipment  
Manufacturer  
**OES** .....Open Emission System  
**Off-Hwy** .....Off-Highway  
**OHC** .....Overhead Cam  
**OHV** .....Overhead Valve  
**Olds** .....Oldsmobile  
**Opt.** .....Optional  
**oz.** .....Ounce(s)

**P. Cab** .....Pressurized Cab  
**P. Fuel** .....Primary Fuel  
**Perf.** .....Performance  
**PCV** .....Positive Crankcase Ventilation  
**PEEC** .....Programmable Electronic  
Engine Control  
**Pkg.** .....Package  
**Pld.** .....Pleated  
**PowBrakes** .....Power Brakes  
**PowDr.** .....Power Drive  
**PowrQuad** .....Power Quad  
**PowShift** .....Power Shift  
**PowSteer.** .....Power Steering  
**Pri** .....Primary  
**PRWD** .....Power Rear Wheel Drive  
**PS** .....Integral Post Seal Gasket  
**PSI** .....Pounds per Square Inch  
**PSID** .....Pounds per Square Inch  
Displacement

**PSR** .....Post Seal Required  
**Pt.** .....Pint  
**PTO** .....Power Take-Off  
**PZEV** .....Partial Zero Emissions Vehicle

**QR/SR** .....Quad Range or Syncro Range  
**Qt.** .....Quart  
**Qty.** .....Quantity

**RC** .....Reinforced Centertube  
**Recirc.** .....Recirculation  
**Rect.** .....Rectangular  
**Res.** .....Reservoir  
**RetLine** .....Return Line  
**R.H.** .....Right Hand  
**ROPS** .....Roll Over Protection System  
**Rpl.** .....Replaced, Replacement  
**rpm** .....Revolutions per Minute  
**R.R.** .....Railroad  
**RWD** .....Rear Wheel Drive

**S. Eng.** .....Starter Engine  
**S. Fuel** .....Secondary Fuel  
**S. Pan** .....Shallow Pan  
**SCA** .....Supplemental Coolant Additive  
**SCR** .....Selective Catalytic Reduction  
**Sec.** .....Secondary  
**Sgl.** .....Single  
**SHBP** .....Super High Pressure  
By-Pass Valve (30-45 PSID)  
**SHO** .....Super High Output  
**SintBronze** .....Sintered Bronze  
**S/N** .....Serial Number(s)  
**SOHC** .....Single Overhead Cam  
**SP** .....Sensor Port  
**Spd.** .....Speed  
**Spec(s).** .....Specification(s)  
**SPI** .....Sequential Port Injection  
**Sr.** .....Senior  
**SSS** .....Synchro Shuttle Shift  
**Std.** .....Standard  
**Steer.** .....Steering  
**Sub.** .....Substitute  
**SuctLine** .....Suction Line  
**Sys.** .....System

**TBA** .....To Be Announced  
**TBI** .....Throttle Boded Injection  
**Temp.** .....Temperature  
**Thd.** .....Thread  
**THM** .....Turbo-Hydrumatic  
**TorqConv.** .....Torque Converter  
**Trans.** .....Transmission  
**Turbo** .....Turbocharger, Turbocharged  
**UK** .....United Kingdom  
**UL, U.L.** .....Underwriters Lab Listed  
**UNF** .....Universal National Fine  
**U.S.** .....United States  
**U.S.C.G.** .....U.S. Coast Guard Accepted  
**V** .....Volt  
**VapDiv.** .....Vapor Diverter  
**Veh.** .....Vehicle  
**Vers.** .....Version  
**VIN** .....Vehicle Identification Number  
**VW** .....Volkswagen  
**w/** .....With  
**w/o** .....Without  
**W.B.** .....Wheel Base  
**XHBP** .....Extra High Pressure  
By-Pass Valve (50+ PSID)  
**XP** .....Extreme Performance  
**Yd.** .....Yard(s)

## PREFIXES AND SUFFIXES

### PREFIXES

<b>AB</b>	Air Housing Mounting Band	<b>H</b>	Pall-Type Hydraulic Element
<b>AC</b>	Air Housing Accessory - Air Inlet Hoods or Clamps	<b>HH</b>	Hose
<b>AD</b>	Air Housing Dust Bowl, Air Filter Adapter	<b>HSG</b>	Air Filter Housing
<b>AE</b>	Air Housing Elbow	<b>LL</b>	Long Life Air Filter Element
<b>AFG</b>	Air Filter Restriction Gauge	<b>OAS</b>	Oil/Air Separator
<b>AH</b>	Air Housing Hump Hose	<b>OB</b>	Lube or Hydraulic Filter Base
<b>AR</b>	Air Housing O-Ring	<b>OP</b>	Plug
<b>AS</b>	Air Housing Sleeve, Stack Cap	<b>OS</b>	Electrical Indicator
<b>AV</b>	Air Housing Dust Ejector Valve	<b>OTK</b>	Oil Test Kit
<b>AW</b>	Air Housing Wing or Metric Nut	<b>OV</b>	Visual Indicator
<b>B</b>	Spin-on or Bag-Type Filter *	<b>P</b>	Paper Lube or Hydraulic Element
<b>BA</b>	Bag Air or Air Dryer	<b>PA</b>	Paper Air Element
<b>BC</b>	Centrifugal Element	<b>PF</b>	Paper Fuel Element
<b>BD</b>	Dual-Flow Lube Spin-on	<b>PG</b>	Pressure Gauge
<b>BF</b>	Spin-on, Can-Type or In-Line Fuel Filter	<b>PKG</b>	Package, Premium Item
<b>BK</b>	Baldwin Kit	<b>PT</b>	Paper Lube or Hydraulic Element
<b>BT</b>	Spin-on Lube or Hydraulic/Transmission Filter	<b>PV</b>	Paper and Vac-Cel Element *
<b>BW</b>	Coolant Spin-on with Chemicals	<b>RS</b>	Radial Seal Air Filter
<b>C</b>	Cotton Lube Element	<b>S, SA, SF</b>	Special Material *
<b>CA</b>	Channel Flow® Air Filter	<b>T</b>	Cotton Lube Element *
<b>CFB</b>	Coolant Filter Base	<b>TA</b>	Acrylic and Other Synthetic Fibers for Most Fluids; Medium Flow; 5 or 10 Micron Retention (Peco Prefix AF)
<b>CS</b>	Chemical Supplement	<b>TB</b>	Blend of Cotton and Sisal for Non-Acid Fluids; Medium to High Flow; 25 to 40 Micron Retention (Peco Prefix FTE)
<b>CSC</b>	Coolant System Cleaner	<b>TC</b>	All Cotton for Non-Acid Fluids; Low Flow Rates; 2, 5, or 10 Micron Retention (Peco Prefix FT)
<b>CTK</b>	Coolant Test Kit	<b>V</b>	Vac-Cel (Cotton) Lube Element *
<b>CV</b>	Crankcase Ventilation Breather	<b>VG</b>	Vacuum Gauge
<b>CW</b>	Coolant Sock-Type Element with Chemicals	<b>VT</b>	Vac-Cel (Cotton) Lube Element *
<b>ES</b>	End Seal		
<b>F</b>	Cotton Fuel Element		
<b>FB</b>	Fuel Filter Base		
<b>FD</b>	Fuel Filter Adapter		
<b>G</b>	Gasket		

### SUFFIXES

Multiple letter suffixes may need to be read as single letters. Suffixes often indicate the maker of the filter housing in which the element fits. When the suffix is not used for this purpose, it most often indicates the following:

<b>-1</b>	Specification Change	<b>-FN</b>	Air Filter with Fins
<b>-2</b>	Double Length or Air Element with 2 Inch Pleats	<b>-FP</b>	Contains Fill Port
<b>(2), (3), (4)</b>	Number of Elements in a Kit	<b>-H</b>	Hydraulic Element
<b>-3, -5, -10, -25, -30</b>	Nominal Micron Retention	<b>-HD</b>	Heavy-Duty or Hydraulic
<b>-A</b>	Closed End, Conversion Kit, Aluminum, Version # *	<b>-HPG</b>	High Performance Glass Media
<b>-AF</b>	Normally on Air Filters	<b>-K</b>	Kit, Includes Reusable Parts, Fittings *
<b>-AL</b>	Can be Used with Fluids Containing Alcohol	<b>-M</b>	Magnesium, Mason Jar Screw Neck *
<b>-B</b>	By-Pass Lube, Boxed, Version # *	<b>-MPG</b>	Maximum Performance Glass Media
<b>-BSP</b>	British Standard Pipe	<b>-O</b>	Open End *
<b>-CPE</b>	Cotton Sock for Use with Non-Acid Fluids Flowing at Moderate Temperatures	<b>-OPE</b>	Orlon Sock for Use with Most Fluids; Particularly Recommended for High Heat or Acid-Content Fluids
<b>-CS</b>	Water Absorbent Media	<b>-OW</b>	Orlon Wrap
<b>-D</b>	Drain, Direct Mount *	<b>-RV</b>	Roll-Over Valve
<b>-DL</b>	Double Length	<b>-S</b>	Specification Change on Liquid Filters; Smaller, Solid Lid on Air Filters *
<b>-DM</b>	Drain - Marine Applications	<b>-SP</b>	With Sensor Port
<b>-E</b>	Economy or Fleet Pack *	<b>-SPS</b>	With Reusable Sensor Port
<b>-F</b>	Wound Cotton or Felt Media	<b>-SS</b>	Filter for Severe Service
<b>-FF</b>	Full-Flow Lube Element	<b>-T</b>	Sisal Sock for High Flow Applications *
		<b>-V</b>	Viton O-Ring
		<b>-W</b>	With Wrap, Winter - Cold Weather Applications *
		<b>-WO</b>	Without - See Specifications
		<b>-WPC</b>	With Pre-Cleaner
		<b>XP</b>	Extreme Performance

\* See Specific Number in Product Guide for Details and Exceptions.

## HOW PRODUCT GUIDE IS ARRANGED

# PRODUCT GUIDE

Filter Master List  
Gasket Master List  
Air Filter Housings  
DAHL Filters  
Filter Size Charts

### MEASUREMENTS ARE TIP-TO-TIP

We use overall measurements unless stated otherwise. Some catalogs show size of element only. We show overall size including gaskets and other protrusions that extend the farthest. You can then make sure there is sufficient clearance when this is a critical factor. Measurements are shown in inches and millimeters.

### IMPORTANT NOTICE

All specifications in this catalog are based on the latest authoritative information available at press time. However, changes are made by equipment manufacturers without notice, which necessitates changes in our product. Keep your stock rotated so that you always use your oldest stock first. If a filter does not seal when installed, it should not be used. We cannot be responsible for misapplications.

Original equipment manufacturer's tradenames or trademarks are for identification purposes only. There is no affiliation, sponsorship or connection with the original equipment parts or manufacturer.

All products are arranged in numerical order, ignoring prefixes and suffixes in the arrangement. The Filter Master List is first, followed by Gaskets, DAHL Filters and Filter Size Charts.

---

**B2** Full-Flow Lube Spin-on (Also Used as Hydraulic or Transmission)



**Notes:** Can be used with OB40079 base.  
**Contains:** Anti-Drainback Valve  
 8 PSID By-Pass Valve  
 Front End By-Pass Valve  
**Fits:** Chrysler, Ford, Mazda, Toyota Automotive, Light-Duty Trucks; Freightliner, International, Kenworth, Mack, Volvo Trucks; Allis Chalmers, Case, Caterpillar, Ford, John Deere, New Holland Equipment  
**Replaces:** Allis Chalmers 7023700-0; Case A146696; Ford B7A-6714-A, C9NN-6714-A  
**Thread:** 3/4 -16  
**O.D.:** 3 11/16 (93.7)  
**Height:** 5 13/32 (137.3)  
**I.Gskt:** G381-A  
**Related To:** B34 (Short Version)

**B2-HPG** High Performance Glass Full-Flow Lube Spin-on (Also Used as Hydraulic or Transmission)



**Contains:** Anti-Drainback Valve  
 8 PSID Front End By-Pass Valve  
**Fits:** Antonio Carraro, Hagie, Hymac, Steyr-Daimler-Puch Equipment; Iveco, R.V.I. Trucks  
**Replaces:** Allis Chalmers 7023700-0; Case A146696; Ford B7A-6714-A, C9NN-6714-A  
**Thread:** 3/4 -16  
**O.D.:** 3 11/16 (93.7)  
**Height:** 5 13/32 (137.3)  
**I.Gskt:** G381-A

**B4** Full-Flow Lube Spin-on



**Fits:** Chevrolet Automotive  
**Replaces:** GMC 5575425  
**Thread:** 7/16 -20  
**O.D.:** 3 7/16 (87.3)  
**Height:** 4 13/16 (122.2)  
**I.Gskt:** [1] Included  
**F. Gskt:** ES1001

**BT5** Full-Flow Lube Spin-on (Also Used as Hydraulic or Transmission)



**Notes:** Can be used with OB40079 base.  
**Contains:** Anti-Drainback Valve  
 8 PSID By-Pass Valve  
**Fits:** Fiat Automotive; Ford, Massey Ferguson, Minneapolis-Moline, Same Equipment; Interceptor Marine; Iveco Trucks  
**Replaces:** Ford B8NN-6714-A  
**Thread:** 3/4 -16  
**O.D.:** 4 1/4 (108.0)  
**Height:** 3 15/16 (100.0)  
**I.Gskt:** G381-A

**B6** Full-Flow Lube Spin-on



**Notes:** 1 Quart Capacity  
**Fits:** Chevrolet, GM Automotive, Light-Duty Trucks, Vans  
**Replaces:** GMC 25013454  
**Thread:** 13/16 -16  
**O.D.:** 3 11/16 (93.7)  
**Height:** 5 11/32 (135.7)  
**I.Gskt:** [1] Included  
**Related To:** B1428 (with Anti-Drainback Valve)

**B6-HPG** High Performance Glass Full-Flow Lube Spin-on



**Notes:** 1 Quart Capacity  
**Fits:** Chevrolet, GM Automotive, Light-Duty Trucks, Vans  
**Replaces:** GMC 25013454  
**Thread:** 13/16 -16  
**O.D.:** 3 11/16 (93.7)  
**Height:** 5 11/32 (135.7)  
**I.Gskt:** [1] Included  
**Related To:** B1428 (with Anti-Drainback Valve)

**B7** Full-Flow Lube Spin-on



**Notes:** 2 Quart Capacity  
**Fits:** Chevrolet, GMC Trucks, Buses  
**Replaces:** GMC 25010754  
**Thread:** 13/16 -16  
**O.D.:** 3 11/16 (93.7)  
**Height:** 8 11/16 (220.7)  
**I.Gskt:** [1] Included

**B9** Full-Flow Lube Spin-on



**Contains:** Anti-Drainback Valve  
**Fits:** Allis Chalmers, Case Equipment; Chrysler, GMC, International Light-Duty Trucks; Jeep; Crusader Marine  
**Replaces:** GMC 5515104, 6435678  
**Thread:** 13/16 -16  
**O.D.:** 3 11/16 (93.7)  
**Height:** 5 3/8 (136.5)  
**I.Gskt:** [1] Included  
**Related To:** B39 (Short Version)  
 BT112 (Turbo Version)

**B10-AL** Fuel Storage Tank Assembly with Drain



**Notes:** Removes damaging particles and water from fuels.  
 Easily installed on fuel tanks or pumps.  
 Gives effective filtration at flow rates to 25 gpm or gravity flow of 10 gpm with 30 In. head.  
 To convert to Spin-on, use FB1307 and BF915.  
**Contains:** [1] B10-AL CAP  
 [1] B10-AL BOWL  
 [1] PF10 Element  
**Replaces:** Fleetguard 3307454S  
**O.D.:** 4 5/32 (105.6)  
**Inlet:** 1 In. NPT  
**Outlet:** 1 In. NPT  
**Height:** 9 25/32 (248.4)  
**F. Gskt:** G264-A

**B10-AL BOWL** Transparent Amber Bowl with Drain



**Thread:** 3 3/8 -12  
**O.D.:** 3 7/8 (98.4)  
**Height:** 8 1/8 (206.4)  
**F. Gskt:** [1] Included

Measurements Are Shown In Inches And (Millimeters)

**WARNING:** These products can expose you to chemicals, including Diisononyl Phthalate, Carbon black extracts, Nickel, 1,3 Butadiene, Ethylene Oxide, Epichlorohydrin, which are known to the State of California to cause cancer, and Bisphenol, Ethylene Glycol, Ethylene Oxide, 1,3 Butadiene, Epichlorohydrin, which are known to the State of California to cause birth defects or other reproductive harm.

**B10-AL BSP**

Fuel Storage Tank Assembly with Drain



**Notes:** Removes damaging particles and water from fuels. Easily installed on fuel tanks or pumps. Gives effective filtration at flow rates to 25 gpm or gravity flow of 10 gpm with 30 in. head.

**Contains:** [1] CAP  
[1] B10-AL BOWL  
[1] PF10 Element  
**O.D.:** 4 5/32 (105.6)  
**Inlet:** 1 In. BSP  
**Outlet:** 1 In. BSP  
**Height:** 9 25/32 (248.4)  
**F. Gskt:** G264-A

**B10-AL BSPCS**

Fuel Storage Tank Assembly with Water Absorbing Media and Drain



**Notes:** Removes damaging particles and water from fuels. Easily installed on fuel tanks or pumps. Gives effective filtration at flow rates to 25 gpm or gravity flow of 10 gpm with 30 in. head.

**Contains:** [1] CAP  
[1] B10-AL BOWL  
[1] PF10-CS Element  
**O.D.:** 4 5/32 (105.6)  
**Inlet:** 1 In. BSP  
**Outlet:** 1 In. BSP  
**Height:** 9 25/32 (248.4)  
**F. Gskt:** G264-A

**B10-AL CAP**

Inlet-Outlet Cap for B10-AL Only



**Inlet:** 1 In. NPT  
**Outlet:** 1 In. NPT

**PF10**

Fuel Storage Tank Element



**Contains:** 1 1/8-12 Mounting Stud  
**Fits Inside:** B10-AL, B10-AL BSP Assembly  
**O.D.:** 3 (76.2)  
**Height:** 4 7/8 (123.8)  
**F. Gskt:** G264-A  
**End Seals:** [1] Attached  
**Related To:** PF10-CS (Water Absorbing Media Version)

**PF10-CS**

Water Absorbing Fuel Storage Tank Element



**Contains:** 1 1/8-12 Mounting Stud  
**O.D.:** 3 (76.2)  
**Height:** 4 7/8 (123.8)  
**F. Gskt:** G264-A  
**End Seals:** [1] Attached  
**Related To:** PF10 (Standard Version)

**PT11**

Full-Flow Lube Element



**Fits:** Detroit Diesel, GMC Engines  
**Replaces:** GMC 5574978  
**O.D.:** 4 7/16 (112.7)  
**I.D.:** 1 17/32 (38.9)  
**Height:** 5 3/4 (146.0)  
**F. Gskt:** G115-MSB, G143  
**O. Gskt:** G280  
**End Seals:** [2] Attached

**PT11-HD**

Heavy-Duty Full-Flow Lube or Hydraulic Clutch Element



**Fits:** Detroit Diesel, GMC Engines  
**Replaces:** GMC 5574978  
**O.D.:** 4 7/16 (112.7)  
**I.D.:** 1 17/32 (38.9)  
**Height:** 5 3/4 (146.0)  
**F. Gskt:** G115-MSB, G143  
**O. Gskt:** G280  
**End Seals:** [2] Attached

**PT12**

Full-Flow Lube Element



**Fits:** Claas, Ford, Perkins Engines; Hymac, Hyster, J.C. Bamford, Massey Ferguson, New Holland Equipment  
**Replaces:** Perkins 1531639  
**O.D.:** 3 3/4 (95.3)  
**I.D.:** 1 5/16 (33.3)  
**Height:** 4 11/16 (119.1)  
**F. Gskt:** G168-B  
**O. Gskt:** G140-A  
**End Seals:** [2] Attached

**BF13**

Fuel Spin-on



**Fits:** Isuzu, Nissan Trucks  
**Replaces:** Nissan 16403-Z9003  
**Thread:** 3/4 -16  
**O.D.:** 3 1/32 (77.0)  
**Height:** 4 13/16 (122.2)  
**I.Gskt:** [1] Included

**P15**

Full-Flow Lube Element



**Fits:** Ford, Perkins Engines  
**Replaces:** Ford C2TZ-6714-A  
**O.D.:** 3 3/4 (95.3)  
**I.D.:** 1 5/16 (33.3)  
**Height:** 3 13/16 (96.8)  
**F. Gskt:** G168-B  
**End Seals:** [2] Attached

**S16-1**

Transmission Element with Screen Reinforced Pleats



**Fits:** Allison Transmissions  
**Replaces:** GMC 6437221  
**O.D.:** 2 7/8 (73.0)  
**I.D.:** 1 3/16 (30.2)  
**Height:** 8 7/16 (214.3)  
**F. Gskt:** [1] Copper Washer, [1] Cork Gasket, [2] O-Rings  
**End Seals:** [2] Attached

**P18**

Full-Flow Lube Element



**Fits:** Chevrolet, GMC Trucks; Crusader, Mercruiser Marine  
**Replaces:** Chris-Craft 5574540; Cruisemaster 204; GMC 25010471  
**O.D.:** 3 17/32 (89.7)  
**I.D.:** 1 5/16 (33.3)  
**Height:** 5 21/32 (143.7)  
**F. Gskt:** G153  
**End Seals:** [2] Attached

Measurements Are Shown In Inches And (Millimeters)

**WARNING:** These products can expose you to chemicals, including Diisononyl Phthalate, Carbon black extracts, Nickel, 1,3 Butadiene, Ethylene Oxide, Epichlorohydrin, which are known to the State of California to cause cancer, and Bisphenol, Ethylene Glycol, Ethylene Oxide, 1,3 Butadiene, Epichlorohydrin, which are known to the State of California to cause birth defects or other reproductive harm.

**P18-HD** Heavy-Duty Racing Lube or Hydraulic Element  
**Fits:** Allison Transmissions; Joy Compressors; Volvo Trucks  
**Replaces:** Joy 1224973; Volvo 1526895-6  
**O.D.:** 3 17/32 (89.7)  
**I.D.:** 1 5/16 (33.3)  
**Height:** 5 21/32 (143.7)  
**F. Gskt:** G153  
**End Seals:** [2] Attached



**BD28** Dual-Flow Lube Spin-on  
**Contains:** Anti-Drainback Valve  
 20 PSID By-Pass Valve  
**Fits:** Ford Light-Duty Trucks  
**Replaces:** Ford E5TZ-6731-A  
**Thread:** M26 x 1.5  
**O.D.:** 3 11/16 (93.7)  
**Height:** 5 3/8 (136.5)  
**I.Gskt:** G381-A



**P19** Full-Flow Lube Element  
**Fits:** Chevrolet Trucks  
**Replaces:** GMC 5573976  
**O.D.:** 3 1/2 (88.9)  
**I.D.:** 1 1/4 (31.8)  
**Height:** 6 1/4 (158.8)  
**F. Gskt:** G153



**PT29** Full-Flow Lube Element  
**Fits:** Caterpillar Lift Trucks; Ford (British) Tractors; Claas, Massey Ferguson, Timberjack Equipment  
**Replaces:** Ford E1ADKN-18662-A, E1ADKN-18662-B  
**O.D.:** 2 13/16 (71.4)  
**I.D.:** 1 1/4 (31.8) & 1 5/16 (33.3)  
**Height:** 5 17/32 (140.5)  
**F. Gskt:** G147-A, G161, [2] Included  
**End Seals:** [2] Attached



**P20-HD** Full-Flow Lube Element  
**Notes:** To convert to spin-on, use OB1303 base and B95 filter.  
 For copper bolt seal, use ES1071.  
**Fits:** Allis Chalmers, Case, Clark, Euclid, Gardner Denver, Gradall, Terex Equipment; Detroit Diesel Engines; IHC, Iveco, Kenworth, Mack Trucks  
**Replaces:** GMC 5573013, 25013194  
**O.D.:** 4 7/16 (112.7)  
**I.D.:** 1 1/2 (38.1)  
**Height:** 9 1/16 (230.2)  
**F. Gskt:** ES1032, G115-MSB, G143A  
**O. Gskt:** G143, G280, G336, G340  
**End Seals:** [2] Attached  
**Related To:** PT159, PT159-E (Transmission Versions)



**AFG30** Air Filter Restriction Gauge  
**Notes:** Murphy switch gauge shows exact degree of air filter restriction at a glance. Mounts in dash (2 1/16 In. diameter hole) and shows both inches and cubic centimeters. Measures 0-30 inches water column vacuum.  
**Contains:** Mounting Bracket  
**Replaces:** Fleetguard 3826036S



**P25** Full-Flow Lube Element  
**Contains:** Reinforced Centertube  
**Fits:** Buick, Oldsmobile, Pontiac Automotive; GMC Light-Duty Trucks; Crusader, GMC, Hyster, DAF Engines  
**Replaces:** GMC 5572188  
**O.D.:** 3 15/16 (100.0)  
**I.D.:** 1 1/16 (27.0)  
**Height:** 6 1/4 (158.8)  
**F. Gskt:** [1] Included  
**End Seals:** [2] Attached



**B30** Full-Flow Lube Spin-on  
**Fits:** GM Automotive  
**Replaces:** GMC 25010324  
**Thread:** 13/16 -16  
**O.D.:** 3 (76.2)  
**Height:** 5 1/8 (130.2)  
**A. Gskt:** G449-B



**P26** By-Pass Lube Element with Bail Handle  
**Fits:** ACDelco Optional Filter Housings; Buick Automotive  
**Replaces:** GMC 5572202  
**O.D.:** 4 7/32 (107.2)  
**I.D.:** 17/32 (13.5)  
**Height:** 4 11/16 (119.1)  
**F. Gskt:** G115-A  
**Grommets:** [2] Attached



**B31** Full-Flow Lube Spin-on  
**Contains:** Anti-Drainback Valve  
**Fits:** AMC, GM Automotive, Light-Duty Trucks, Vans  
**Replaces:** GMC 25010251  
**Thread:** 13/16 -16  
**O.D.:** 3 (76.2)  
**Height:** 3 1/2 (88.9)  
**A. Gskt:** G449-B



**B27** Full-Flow Lube Spin-on  
**Fits:** Buick, Chevrolet Automotive; GMC Light-Duty Trucks, Vans  
**Replaces:** GMC 6437412  
**Thread:** 13/16 -16  
**O.D.:** 3 13/16 (96.8)  
**Height:** 4 3/8 (111.1)  
**I.Gskt:** [1] Included



**B33** Full-Flow Lube Spin-on  
**Contains:** Anti-Drainback Valve  
 14 PSID By-Pass Valve  
**Fits:** Daihatsu, GMC, Toyota Automotive, Light-Duty Trucks; Generac Generators; John Deere Equipment  
**Replaces:** GMC 25161880; John Deere AM107423; Toyota 90915-03001  
**Thread:** 3/4 -16  
**O.D.:** 2 11/16 (68.3)  
**Height:** 3 (76.2)  
**I.Gskt:** [1] Included



Measurements Are Shown In Inches And (Millimeters)

**WARNING:** These products can expose you to chemicals, including Diisononyl Phthalate, Carbon black extracts, Nickel, 1,3 Butadiene, Ethylene Oxide, Epichlorohydrin, which are known to the State of California to cause cancer, and Bisphenol, Ethylene Glycol, Ethylene Oxide, 1,3 Butadiene, Epichlorohydrin, which are known to the State of California to cause birth defects or other reproductive harm.

**B34** Lube Spin-on



**Notes:** Can be used with OB40079 base.  
**Contains:** Anti-Drainback Valve  
 8 PSID By-Pass Valve  
**Fits:** Chrysler, Mitsubishi, Volkswagen Automotive, Light-Duty Trucks, Vans  
**Replaces:** Chrysler 5281090  
**Thread:** 3/4 -16  
**O.D.:** 3 11/16 (93.7)  
**Height:** 3 7/8 (98.4)  
**I.Gskt:** G381-A  
**Related To:** B2 (Long Version)

**P40** Full-Flow Lube Element with Bail Handle



**Fits:** Clark, Galion, Hyster in Fram F3 Series Housings; Allis Chalmers, Bobcat, Case, Caterpillar, Fiat, Onan, Massey Ferguson Equipment  
**Replaces:** Clark 604081; Hyster 60518-24; Massey Ferguson 1014219-M91  
**O.D.:** 3 23/32 (94.5)  
**I.D.:** 1/2 (12.7)  
**Height:** 4 7/16 (112.7)  
**F. Gskt:** G105  
**O. Gskt:** G115-A, G402  
**Grommets:** [2] Attached

**B35-S** Full-Flow Lube Spin-on



**Contains:** Anti-Drainback Valve  
**Fits:** GM Automotive, Light-Duty Trucks, Vans  
**Replaces:** GMC 25012760  
**Thread:** M18 x 1.5  
**O.D.:** 3 (76.2)  
**Height:** 4 27/32 (123.0)  
**A. Gskt:** G449-B  
**Related To:** B43-S (Short Version)

**P41** By-Pass Lube Element with Bail Handle



**Fits:** Allis Chalmers, Case, Clark, Continental, Deutz, Ford, Huber Equipment; Hercules, Mercedes-Benz Engines  
**Replaces:** Allis Chalmers 4502495-4; Case G54008; Clark 4502495; Ford C7NN-6N605-A  
**O.D.:** 4 7/32 (107.2)  
**I.D.:** 1/2 (12.7)  
**Height:** 4 7/8 (123.8)  
**F. Gskt:** G104  
**Grommets:** [2] Attached  
**Related To:** PF809 (Fuel Version)

**AFG37R** Remote Mount Air Filter Restriction Gauge



**Notes:** Mounts on instrument panel or firewall. Maintains the highest reading until it is reset, which enables the gauge to be monitored whether the engine is running or not. Allows the user to get maximum life of an air filter without wasting fuel.  
**Contains:** 10 foot rubber hose  
 Push-on brass 1/8 In NPT fitting with brass coupling  
 Mounting screws  
 Service decal  
 Installation instructions  
**Replaces:** GMC 25095861; Fleetguard 3303943S

**P42** By-Pass Lube Element with Bail Handle



**Fits:** Allis Chalmers, Case, Caterpillar, Continental, Deutz Equipment; Mercedes-Benz Engines  
**Replaces:** Case A28008; Caterpillar 63-6372; Deutz 1168469  
**O.D.:** 4 7/32 (107.2)  
**I.D.:** 1/2 (12.7)  
**Height:** 7 3/4 (196.9)  
**F. Gskt:** G104  
**O. Gskt:** G103  
**Grommets:** [2] Attached

**B37** Full-Flow Lube Spin-on



**Contains:** Anti-Drainback Valve  
 14 PSID By-Pass Valve  
**Fits:** GMC Imports, Suzuki, Toyota Automotive  
**Replaces:** GMC 94848478; Toyota 90915-10004  
**Thread:** 3/4 -16  
**O.D.:** 2 9/16 (65.1)  
**Height:** 3 1/2 (88.9)  
**I.Gskt:** [1] Included

**B43-S** Full-Flow Lube Spin-on



**Contains:** Anti-Drainback Valve  
**Fits:** AMC, GM, Isuzu Automotive  
**Replaces:** GMC 25010766  
**Thread:** M18 x 1.5  
**O.D.:** 2 29/32 (73.8)  
**Height:** 3 1/2 (88.9)  
**A. Gskt:** G449-B  
**Related To:** B35-S (Long Version)

**AFG38D** Direct Mount Air Filter Restriction Gauge



**Notes:** Mounts directly on air intake system. Maintains the highest reading until it is reset, which enables the gauge to be monitored whether the engine is running or not. Allows user to get maximum life of an air filter without wasting fuel.  
**Contains:** 2-piece, 90 degree brass 1/8 Inch NPT fitting  
 Service decal  
 Installation instructions  
**Replaces:** GMC 25095863; Fleetguard 3304584S

**B45** Full-Flow Lube Spin-on



**Fits:** Nissan Engines, Trucks  
**Replaces:** Nissan 15208-Z9003  
**Thread:** 1 1/8 -16  
**O.D.:** 4 5/16 (109.5)  
**Height:** 9 5/32 (232.6)  
**I.Gskt:** [1] Included

**B39** Full-Flow Lube Spin-on



**Contains:** Anti-Drainback Valve  
**Fits:** AMC, GM Automotive; GMC, International Engines  
**Replaces:** GMC 6437462  
**Thread:** 13/16 -16  
**O.D.:** 3 11/16 (93.7)  
**Height:** 4 3/8 (111.1)  
**A. Gskt:** G381-A  
**Related To:** B9 (Long Version)

**P47** Full-Flow Lube Element



**Fits:** Ford Equipment  
**Replaces:** Ford B8QH-6714-A  
**O.D.:** 4 1/2 (114.3)  
**I.D.:** 13/16 (20.6)  
**Height:** 4 15/16 (125.4)  
**F. Gskt:** G164-A, [2] Included  
**End Seals:** [1] Attached

Measurements Are Shown In Inches And (Millimeters)

**WARNING:** These products can expose you to chemicals, including Diisononyl Phthalate, Carbon black extracts, Nickel, 1,3 Butadiene, Ethylene Oxide, Epichlorohydrin, which are known to the State of California to cause cancer, and Bisphenol, Ethylene Glycol, Ethylene Oxide, 1,3 Butadiene, Epichlorohydrin, which are known to the State of California to cause birth defects or other reproductive harm.



**PT48** Hydraulic or Transmission Element with Bail Handle  
**Fits:** Allis Chalmers, Clark, Hyster Equipment; Iveco Trucks  
**Replaces:** Allis Chalmers 618478; Fiat 70618478; Hyster 236093-12  
**O.D.:** 2 7/8 (73.0)  
**I.D.:** 25/32 (19.8) & 13/16 (20.6)  
**Height:** 3 31/32 (100.8)  
**F. Gskt:** [1] Included  
**End Seals:** [2] Attached



**P54** By-Pass Shunt-Type Lube Element with Bail Handle (Also Used as Fuel or Power Steering)  
**Fits:** Crane Carrier, Davey, Oliver Equipment; Ingersoll-Rand Compressors  
**Replaces:** Davey M14402; Oliver AS5507B  
**O.D.:** 3 23/32 (94.5)  
**I.D.:** 1/2 (12.7)  
**Height:** 6 23/32 (170.7)  
**F. Gskt:** G123, [1] Included  
**Grommets:** [2] Attached



**B49** Full-Flow Lube Spin-on  
**Fits:** Caterpillar Equipment  
**Replaces:** Fleetguard LF691  
**Thread:** 1 1/2 -16  
**O.D.:** 4 21/32 (118.3)  
**Height:** 11 1/4 (285.8)  
**I.Gskt:** G498-A  
**Related To:** B99 (Long Version)



**B56** Lube Spin-on  
**Contains:** 19 PSID By-Pass Valve  
**Fits:** Onan Engines  
**Replaces:** Onan 122-0602  
**Thread:** M22 x 1.5  
**O.D.:** 3 (76.2)  
**Height:** 4 27/32 (123.0)  
**I.Gskt:** G449-B



**B50** By-Pass Lube Spin-on  
**Notes:** Can be used with OB1305 base.  
**Contains:** Flow Control Orifice  
**Fits:** Allis Chalmers, Caterpillar Engines, Equipment; Massey Ferguson, Oliver Equipment  
**Replaces:** Allis Chalmers 4512207-3; Caterpillar 666-3172; Chrysler J0936407; Massey Ferguson 1069954-M91  
**Thread:** 5/8 -18  
**O.D.:** 3 11/16 (93.7)  
**Height:** 5 3/8 (136.5)  
**I.Gskt:** G381-A  
**Related To:** B164 (Long Version) BT341 (Short Version)



**P60** Full-Flow Lube Element  
**Fits:** Chrysler Industrial, Marine Engines; Purolator P800 Series Housings  
**Replaces:** Purolator P82  
**O.D.:** 3 5/16 (84.1)  
**I.D.:** 1 1/4 (31.8)  
**Height:** 6 3/4 (171.5)  
**F. Gskt:** G106, G162, [1] Included



**P52** By-Pass Lube Element with Bail Handle  
**Fits:** ACDelco S2 Military Senior Housing; Atlas Copco, Clark, Euclid, Grove, Link-Belt, Terex Equipment; Detroit Diesel, Deutz, GMC, Waukesha Engines  
**Replaces:** GMC 5570092; ACDelco P117  
**O.D.:** 4 7/32 (107.2)  
**I.D.:** 1/2 (12.7)  
**Height:** 8 (203.2)  
**F. Gskt:** G115-A, G115-MSB  
**O. Gskt:** ES1071, G208-A, G280  
**Grommets:** [2] Attached



**61** DAHL Fuel Element  
**Notes:** 4 Micron Nominal (20 Absolute)  
**Fits:** DAHL 60 Series Fuel Filter/Water Separator Unit  
**O.D.:** 2 29/32 (73.8)  
**I.D.:** 1/2 (12.7) & 23/32 (18.3)  
**Height:** 1 23/32 (43.7)  
**A. Gskt:** [1] Included  
**F. Gskt:** [1] Included  
**Grommets:** [1] Attached



**P53** By-Pass Lube Element with Bail Handle  
**Fits:** Equipment, Trucks with Chevrolet, Continental, GMC, Hercules, Waukesha, White, Wisconsin Engines  
**Replaces:** GMC 5570098  
**O.D.:** 4 7/32 (107.2)  
**I.D.:** 1/2 (12.7)  
**Height:** 5 (127.0)  
**F. Gskt:** G115-A  
**Grommets:** [2] Attached



**61-W** DAHL Fuel Element  
**Notes:** 5 Micron Nominal (25 Absolute)  
**Fits:** DAHL 60 Series Fuel Filter/Water Separator Unit  
**O.D.:** 2 29/32 (73.8)  
**I.D.:** 1/2 (12.7) & 23/32 (18.3)  
**Height:** 1 23/32 (43.7)  
**A. Gskt:** [1] Included  
**F. Gskt:** [1] Included  
**Grommets:** [1] Attached



**PT61-HD** Full-Flow Lube or Hydraulic Element  
**Contains:** Reinforced Centertube  
**Fits:** Caterpillar Engines, Equipment  
**Replaces:** Caterpillar 5B8934, 8B5935  
**O.D.:** 3 1/2 (88.9)  
**I.D.:** 1 15/32 (37.3)  
**Height:** 5 29/32 (150.0)  
**O. Gskt:** G115-MSB, G171, G333



Measurements Are Shown In Inches And (Millimeters)

**WARNING:** These products can expose you to chemicals, including Diisononyl Phthalate, Carbon black extracts, Nickel, 1,3 Butadiene, Ethylene Oxide, Epichlorohydrin, which are known to the State of California to cause cancer, and Bisphenol, Ethylene Glycol, Ethylene Oxide, 1,3 Butadiene, Epichlorohydrin, which are known to the State of California to cause birth defects or other reproductive harm.

**PT62** Full-Flow Lube Element  
**Fits:** John Deere Equipment  
**Replaces:** John Deere AH1081R  
**O.D.:** 3 5/16 (84.1)  
**I.D.:** 1 1/8 (28.6)  
**Height:** 4 1/8 (104.8)  
**A. Gskt:** [1] Attached  
**F. Gskt:** G107



**PT63-1** Full-Flow Lube Element  
**Fits:** John Deere Equipment  
**Replaces:** John Deere AT15088  
**O.D.:** 3 9/32 (83.3)  
**I.D.:** 1 19/32 (40.5)  
**Height:** 6 1/2 (165.1)  
**O. Gskt:** G220, G251



**66** DAHL Fuel Element  
**Notes:** 4 Micron Nominal (20 Absolute)  
**Fits:** DAHL 65 and 75 Series Fuel Filter/Water Separator Units  
**O.D.:** 2 15/16 (74.6)  
**I.D.:** 13/32 (10.3) & 1/2 (12.7)  
**Height:** 1 13/16 (46.0)  
**A. Gskt:** [1] Included  
**O-Ring:** [1] Included  
**Grommets:** [1] Attached



**66-30** DAHL Fuel Element  
**Notes:** 9 Micron Nominal (40 Absolute)  
**Fits:** DAHL 65 and 75 Series Fuel Filter/Water Separator Units  
**O.D.:** 2 15/16 (74.6)  
**I.D.:** 13/32 (10.3) & 1/2 (12.7)  
**Height:** 1 13/16 (46.0)  
**A. Gskt:** [1] Included  
**O-Ring:** [1] Included  
**Grommets:** [1] Attached



**66-W** DAHL Fuel Element  
**Notes:** 5 Micron Nominal (25 Absolute)  
**Fits:** DAHL 65 and 75 Series Fuel Filter/Water Separator Units  
**O.D.:** 2 15/16 (74.6)  
**I.D.:** 13/32 (10.3) & 1/2 (12.7)  
**Height:** 1 13/16 (46.0)  
**A. Gskt:** [1] Included  
**O-Ring:** [1] Included  
**Grommets:** [1] Attached



**PT66-HD** Full-Flow Lube or Hydraulic Element  
**Notes:** Can be used independently or with PT88-HD as outer lube.  
**Contains:** Reinforced Centertube  
**Fits:** Caterpillar, Clark, Gardner Denver, LeRoi, Link-Belt Equipment  
**Replaces:** Caterpillar 1S9150; LeRoi 24901-2, A43-208, A43-208-A  
**O.D.:** 2 7/8 (73.0)  
**I.D.:** 1 13/32 (35.7)  
**Height:** 9 (228.6)  
**O. Gskt:** G171, G270, G283, G376, G410, G432, G435, G436, G442  
**End Seals:** [2] Attached



**P67** By-Pass Lube Element with Bail Handle  
**Fits:** Massey Ferguson Engines; Purolator N1600 Series Housings  
**Replaces:** Case 10017-2; Chrysler 557218  
**O.D.:** 3 23/32 (94.5)  
**I.D.:** 21/32 (16.7)  
**Height:** 5 1/4 (133.4)  
**F. Gskt:** [1] Included  
**End Seals:** [2] Attached



**P68** By-Pass Lube or Torque Converter Element with Bail Handle  
**Fits:** Caterpillar, International Engines; Purolator N1700 Series Housings  
**Replaces:** Caterpillar 1L6946; International 259630-R91  
**O.D.:** 3 23/32 (94.5)  
**I.D.:** 25/32 (19.8)  
**Height:** 5 7/8 (149.2)  
**F. Gskt:** [1] Included  
**End Seals:** [2] Included



**PT70** By-Pass Lube Element  
**Fits:** International Engines  
**Replaces:** International 360431-R91  
**O.D.:** 3 1/2 (88.9)  
**I.D.:** 1/2 (12.7) & 15/16 (23.8)  
**Height:** 7 11/32 (186.5)  
**F. Gskt:** G107



**PT71** By-Pass Lube Element  
**Fits:** International Engines, Equipment  
**Replaces:** International 376374-R91  
**O.D.:** 3 15/32 (88.1)  
**I.D.:** 17/32 (13.5) & 31/32 (24.6)  
**Height:** 5 11/32 (135.7)  
**F. Gskt:** G107



**PT72** By-Pass Lube Element  
**Fits:** Galion, International, LeRoi, Link-Belt, Oliver Equipment; Hercules, International Engines  
**Replaces:** International 257867-R91  
**O.D.:** 3 15/16 (100.0)  
**I.D.:** 5/8 (15.9) & 27/32 (21.4)  
**Height:** 7 1/4 (184.2)  
**O. Gskt:** G115-MSB, G280





**P73** By-Pass Lube Element with Bail Handle  
**Fits:** Lid-Type Remote-Mounted By-Pass Filter Housings on Caterpillar, Massey Ferguson, Oliver, Palmer, Pettibone Equipment  
**Replaces:** Caterpillar A68660  
**O.D.:** 3 15/32 (88.1)  
**I.D.:** 9/16 (14.3) & 13/16 (20.6)  
**Height:** 4 3/16 (106.4)  
**F. Gskt:** G106  
**Grommets:** [1] Attached  
**Related To:** P81 (Shunt-Type Version)





Measurements Are Shown In Inches And (Millimeters)

**WARNING:** These products can expose you to chemicals, including Diisononyl Phthalate, Carbon black extracts, Nickel, 1,3 Butadiene, Ethylene Oxide, Epichlorohydrin, which are known to the State of California to cause cancer, and Bisphenol, Ethylene Glycol, Ethylene Oxide, 1,3 Butadiene, Epichlorohydrin, which are known to the State of California to cause birth defects or other reproductive harm.

**B74** Lube Spin-on  

**Notes:** Can be used with OB40079 base.  
**Contains:** Anti-Drainback Valve  
 20 PSID By-Pass Valve  
**Fits:** Caterpillar, Ford, New Holland Equipment; Land Rover Light-Duty Trucks  
**Replaces:** Ford E8NN-6714-AA  
**Thread:** 3/4 -16  
**O.D.:** 3 3/4 (95.3)  
**Height:** 3 31/32 (100.8)  
**I.Gskt:** G381-A

**PT79** Full-Flow Lube Element  

**Fits:** Galion, International Equipment; Ingersoll-Rand, Joy, LeRoi Compressors  
**Replaces:** International 262146-R91  
**O.D.:** 4 9/16 (115.9)  
**I.D.:** 1 1/4 (31.8) & 1 11/16 (42.9)  
**Height:** 9 (228.6)  
**F. Gskt:** [1] Included  
**End Seals:** [1] Attached

**B75** Full-Flow Lube Spin-on  

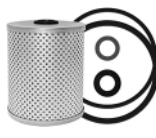
**Fits:** Caterpillar, Iveco, J.C. Bamford, Kawasaki, Kobelco, Koehring, Link-Belt, MDI/Yutani, New Holland, Tamrock, White Equipment; Caterpillar, Isuzu Engines; Chevrolet, GMC, Isuzu, Iveco, Mitsubishi Trucks  
**Replaces:** Caterpillar 9N6007; Isuzu 1-13240-122-0  
**Thread:** 1 1/8 -16  
**O.D.:** 4 1/4 (108.0)  
**Height:** 5 27/32 (148.4)  
**I.Gskt:** [1] Included

**P80** Full-Flow Lube Element  

**Fits:** Allis Chalmers, Case, Grove, New Holland Equipment  
**Replaces:** Ford CPN-6731-A; Fuller A2007, 12039  
**O.D.:** 3 15/16 (100.0)  
**I.D.:** 23/32 (18.3)  
**Height:** 4 13/16 (122.2)  
**F. Gskt:** G132, G208-A, [2] Included  
**O. Gskt:** G171  
**Grommets:** [2] Attached

**B76** Full-Flow Lube Spin-on  

**Fits:** Akerman, Mack, V.M.E., Volvo, R.V.I. Engines, Equipment  
**Replaces:** Mack 485GB3191  
**Thread:** 1 1/8 -16  
**O.D.:** 4 1/4 (108.0)  
**Height:** 10 7/16 (265.1)  
**I.Gskt:** [1] Included  
**Related To:** B76-MPG (Maximum Performance Glass Version)  
 B76-SS (Severe Service Version)  
 BT556-10 (Hydraulic Version)  
 B7225 (Media Difference)  
 B7600, B7600-SS (Short Versions)  
 B7700 (High Performance, Short Version)

**P80-HD** Heavy-Duty Full-Flow Lube or Hydraulic Element  

**Fits:** Various Equipment with Dana, Fuller Transmissions  
**Replaces:** Ford CPN-6731-A; Fuller A2007, 12039  
**O.D.:** 3 15/16 (100.0)  
**I.D.:** 23/32 (18.3)  
**Height:** 4 13/16 (122.2)  
**F. Gskt:** G132, G208-A, [2] Included  
**O. Gskt:** G171  
**Grommets:** [2] Attached

**B76-MPG** Maximum Performance Glass Full-Flow Lube Spin-on  

**Fits:** Akerman, Mack, V.M.E., Volvo, R.V.I. Engines, Equipment  
**Replaces:** Mack 485GB3191; Donaldson DBL7483  
**Thread:** 1 1/8 -16  
**O.D.:** 4 1/4 (108.0)  
**Height:** 10 7/16 (265.1)  
**I.Gskt:** [1] Included  
**Related To:** B76 (Standard Version)  
 B76-SS (Severe Service Version)  
 BT556-10 (Hydraulic Version)  
 B7225 (Media Difference)  
 B7600, B7600-SS (Short Versions)  
 B7700 (High Performance, Short Version)

**P81** Shunt-Type Lube Element  

**Fits:** Purolator P704 Shunt-Type Filter Housing on Chrysler Engines  
**Replaces:** Chrysler 1123151  
**O.D.:** 3 5/16 (84.1)  
**I.D.:** 15/16 (23.8)  
**Height:** 4 1/16 (103.2)  
**F. Gskt:** G106  
**Related To:** P73 (By-Pass Version)













**B76-SS** Severe Service Lube Spin-on  

**Fits:** Akerman, Mack, V.M.E., Volvo, R.V.I. Engines, Equipment  
**Replaces:** Mack 485GB3191  
**Thread:** 1 1/8 -16  
**O.D.:** 4 1/4 (108.0)  
**Height:** 10 7/16 (265.1)  
**I.Gskt:** [1] Included  
**Related To:** B76 (Standard Version)  
 B76-MPG (Maximum Performance Glass Version)  
 BT556-10 (Hydraulic Version)  
 B7225 (Media Difference)  
 B7600, B7600-SS (Short Versions)  
 B7700 (High Performance, Short Version)

**P82** Full-Flow Lube Element  

**Fits:** Allis Chalmers, Case, Caterpillar, Deutz Equipment; Chrysler, Hercules Engines  
**Replaces:** Allis Chalmers 73035376; Case D45338; Caterpillar 5B5935; Clark 957577  
**O.D.:** 3 15/16 (100.0)  
**I.D.:** 1 1/16 (27.0)  
**Height:** 5 15/16 (150.8)  
**F. Gskt:** G106, [2] Included  
**O. Gskt:** G219, G222-B  
**Related To:** PF822 (Fuel Version)

**PT82-HD** Heavy-Duty Lube or Hydraulic Element  

**Fits:** Akerman, Allis Chalmers, Case, Caterpillar, Clark, Deutz, Link-Belt Equipment  
**Replaces:** Allis Chalmers 4513108-2; Case D45338; Caterpillar 3K5487; Clark 957572  
**O.D.:** 3 15/16 (100.0)  
**I.D.:** 1 1/16 (27.0)  
**Height:** 5 15/16 (150.8)  
**F. Gskt:** [4] Included  
**O. Gskt:** G219, G222-B  
**Related To:** PF822 (Fuel Version)

Measurements Are Shown In Inches And (Millimeters)

**WARNING:** These products can expose you to chemicals, including Diisononyl Phthalate, Carbon black extracts, Nickel, 1,3 Butadiene, Ethylene Oxide, Epichlorohydrin, which are known to the State of California to cause cancer, and Bisphenol, Ethylene Glycol, Ethylene Oxide, 1,3 Butadiene, Epichlorohydrin, which are known to the State of California to cause birth defects or other reproductive harm.

<p><b>PT82-HD10</b></p> 	<p>Hydraulic Element  <b>Fits:</b> Case, Ingersoll-Rand Equipment  <b>Replaces:</b> Allis Chalmers 4513108-2; Case D45338; Caterpillar 3K5487; Clark 957572  <b>O.D.:</b> 3 15/16 (100.0)  <b>I.D.:</b> 1 1/16 (27.0)  <b>Height:</b> 5 15/16 (150.8)  <b>F. Gskt:</b> [4] Included  <b>O. Gskt:</b> G219, G222-B  <b>Related To:</b> PF822 (Fuel Version)</p>	<p><b>PT87-S</b></p> 	<p>Full-Flow Lube, Hydraulic or Transmission Element  <b>Fits:</b> John Deere Equipment  <b>Replaces:</b> John Deere AR28271, AR75603, AT34670  <b>O.D.:</b> 4 9/16 (115.9)  <b>I.D.:</b> 2 1/4 (57.2)  <b>Height:</b> 5 1/2 (139.7)  <b>F. Gskt:</b> G307, G397  <b>End Seals:</b> [2] Attached</p>
<p><b>PT83</b></p> 	<p>Hydraulic Element  <b>Notes:</b> Inside-Out Flow Direction. Use ES4008 for stacked elements.  <b>Contains:</b> Reinforced Centertube  <b>Fits:</b> Caterpillar Equipment  <b>Replaces:</b> Caterpillar 9J5461  <b>O.D.:</b> 5 1/16 (128.6)  <b>I.D.:</b> 3 11/32 (84.9)  <b>Height:</b> 11 (279.4)  <b>O. Gskt:</b> ES4008, G247, G263, G416, G433  <b>Related To:</b> PT83-MPG (Maximum Performance Glass Version)</p>	<p><b>PT88-HD</b></p> 	<p>Full-Flow Lube or Hydraulic Element  <b>Notes:</b> Use ES4008 for stacked elements. Can be used independently or with PT66-HD as inner lube.  <b>Fits:</b> Caterpillar, Clark, Hyster, Komatsu, LeRoI Equipment  <b>Replaces:</b> Caterpillar 5S485, 5S0485  <b>O.D.:</b> 5 1/8 (130.2)  <b>I.D.:</b> 3 3/8 (85.7)  <b>Height:</b> 8 15/16 (227.0)  <b>F. Gskt:</b> G196-B  <b>O. Gskt:</b> ES4008, G303, G304, G306, G354</p>
<p><b>PT83-MPG</b></p> 	<p>Maximum Performance Glass Hydraulic Element  <b>Notes:</b> Inside-Out Flow Direction. Use ES4008 for stacked elements.  <b>Contains:</b> Reinforced Centertube  <b>Fits:</b> Caterpillar Equipment  <b>Replaces:</b> Caterpillar 9J5461  <b>O.D.:</b> 5 1/16 (128.6)  <b>I.D.:</b> 3 11/32 (84.9)  <b>Height:</b> 11 (279.4)  <b>O. Gskt:</b> ES4008, G247, G263, G416, G433  <b>Related To:</b> PT83 (Standard Version)</p>	<p><b>PT89</b></p> 	<p>Hydraulic Steering or Power Control Element  <b>Fits:</b> Allis Chalmers Tractors; Caterpillar Equipment  <b>Replaces:</b> Caterpillar 5J8877  <b>O.D.:</b> 5 1/8 (130.2)  <b>I.D.:</b> 3 3/8 (85.7)  <b>Height:</b> 6 (152.4)  <b>O. Gskt:</b> G265</p>
<p><b>P84-2</b></p> 	<p>Full-Flow Lube Element  <b>Fits:</b> Chrysler Engines; Link-Belt, Massey Ferguson, Oliver Equipment  <b>Replaces:</b> Chrysler 1557376  <b>O.D.:</b> 3 5/16 (84.1)  <b>I.D.:</b> 15/16 (23.8)  <b>Height:</b> 4 1/16 (103.2)  <b>F. Gskt:</b> [5] Included</p>	<p><b>PT90-10</b></p> 	<p>Hydraulic Element  <b>Notes:</b> Use ES4008 for stacked elements.  <b>Contains:</b> Reinforced Centertube  <b>Fits:</b> Allis Chalmers, Caterpillar, Fiat-Allis, Komatsu Equipment  <b>Replaces:</b> Caterpillar 4J806, 4J6064  <b>O.D.:</b> 5 1/8 (130.2)  <b>I.D.:</b> 3 3/8 (85.7)  <b>Height:</b> 9 (228.6)  <b>O. Gskt:</b> ES4008, G196-B, G265, G347, G360  <b>Related To:</b> PT90-MPG (Glass Media Version) PT568 (as Specified in Applications)</p>
<p><b>PT85</b></p> 	<p>Full-Flow Lube Element  <b>Fits:</b> Cleveland, Hough, International, Link-Belt Equipment  <b>Replaces:</b> International 323863-R91  <b>O.D.:</b> 4 5/8 (117.5)  <b>I.D.:</b> 1 5/16 (33.3)  <b>Height:</b> 5 1/8 (130.2)  <b>O. Gskt:</b> G203  <b>End Seals:</b> [1] Attached</p>	<p><b>PT90-MPG</b></p> 	<p>Maximum Performance Glass Hydraulic Element  <b>Notes:</b> Use ES4008 for stacked elements.  <b>Contains:</b> Reinforced Centertube  <b>Fits:</b> Caterpillar Equipment  <b>Replaces:</b> Caterpillar 4J806, 4J6064  <b>O.D.:</b> 5 1/8 (130.2)  <b>I.D.:</b> 3 3/8 (85.7)  <b>Height:</b> 9 (228.6)  <b>O. Gskt:</b> ES4008, G196-B, G265, G347, G360  <b>Related To:</b> PT90-10 (Standard Media Version) PT568 (as Specified in Applications)</p>
<p><b>PT86-HD</b></p> 	<p>Full-Flow Lube or Hydraulic Element  <b>Fits:</b> Dresser, Galion, Hough, International, LeRoI, Link-Belt Equipment  <b>Replaces:</b> International 346609-R91  <b>O.D.:</b> 4 1/2 (114.3)  <b>I.D.:</b> 1 25/32 (45.2)  <b>Height:</b> 8 15/16 (227.0)  <b>F. Gskt:</b> [2] Included  <b>O. Gskt:</b> G280  <b>End Seals:</b> [2] Attached</p>	<p><b>PT91</b></p> 	<p>Hydraulic Element  <b>Notes:</b> Inside-Out Flow Direction  <b>Contains:</b> Reinforced Centertube  <b>Fits:</b> Caterpillar Equipment  <b>Replaces:</b> Caterpillar 4T0522  <b>O.D.:</b> 5 1/8 (130.2)  <b>I.D.:</b> 3 3/8 (85.7)  <b>Height:</b> 7 (177.8)</p>

Measurements Are Shown In Inches And (Millimeters)

**WARNING:** These products can expose you to chemicals, including Diisononyl Phthalate, Carbon black extracts, Nickel, 1,3 Butadiene, Ethylene Oxide, Epichlorohydrin, which are known to the State of California to cause cancer, and Bisphenol, Ethylene Glycol, Ethylene Oxide, 1,3 Butadiene, Epichlorohydrin, which are known to the State of California to cause birth defects or other reproductive harm.

**PT93** Full-Flow Lube or Hydraulic Element  
**Contains:** Reinforced Centertube  
**Fits:** Caterpillar Equipment  
**Replaces:** Caterpillar 4J816  
**O.D.:** 3 1/8 (79.4)  
**I.D.:** 1 7/8 (47.6)  
**Height:** 8 31/32 (227.8)  
**O. Gskt:** G162, G323, G434



**B96-MPG** Maximum Performance Glass Full-Flow Lube Spin-on  
**Notes:** Can be used with OB1368, OB1369 bases.  
**Contains:** Integral Post Seal  
**Fits:** Cummins Engines  
**Replaces:** Cummins 3313287  
**Thread:** 1 1/2 -12  
**O.D.:** 4 11/16 (119.1)  
**Height:** 11 9/32 (286.5)  
**I.Gskt:** [1] Included  
**Related To:** B196, B205 (Short Versions)



**PT93-MPG** Maximum Performance Glass Hydraulic Element  
**Contains:** Reinforced Centertube  
**Fits:** Caterpillar Equipment  
**Replaces:** Caterpillar 4J816  
**O.D.:** 3 1/8 (79.4)  
**I.D.:** 1 7/8 (47.6)  
**Height:** 8 31/32 (227.8)  
**O. Gskt:** G162, G323, G434



**B96-SS** Severe Service Lube Spin-on  
**Notes:** Can be used with OB1368, OB1369 bases.  
**Contains:** Integral Post Seal  
**Fits:** Cummins Engines  
**Replaces:** Cummins 3313287  
**Thread:** 1 1/2 -12  
**O.D.:** 4 11/16 (119.1)  
**Height:** 11 9/32 (286.5)  
**I.Gskt:** [1] Included  
**Related To:** B196, B205 (Short Versions)



**B95** Full-Flow Lube Spin-on  
**Notes:** Can be used with OB1303 base.  
**Contains:** Integral Post Seal  
**Fits:** Detroit Diesel Engines  
**Replaces:** GMC 25010495  
**Thread:** 1 1/2 -12  
**O.D.:** 4 21/32 (118.3)  
**Height:** 9 15/16 (252.4)  
**I.Gskt:** [1] Included  
**Related To:** B105 (Short Version)



**B97** Full-Flow Lube Spin-on  
**Fits:** Hough, International Equipment  
**Replaces:** International 684206-C1  
**Thread:** 1 1/2 -16  
**O.D.:** 4 21/32 (118.3)  
**Height:** 9 29/32 (251.6)  
**I.Gskt:** G498-A



**B95-MPG** Maximum Performance Glass Full-Flow Lube Spin-on  
**Notes:** Can be used with OB1303 base.  
**Contains:** Integral Post Seal  
**Fits:** Detroit Diesel Engines  
**Replaces:** GMC 25010495  
**Thread:** 1 1/2 -12  
**O.D.:** 4 21/32 (118.3)  
**Height:** 9 15/16 (252.4)  
**I.Gskt:** [1] Included



**PT98-10** Hydraulic Element  
**Notes:** Use ES4008 for stacked elements.  
**Contains:** Reinforced Centertube  
**Fits:** Caterpillar Equipment  
**Replaces:** Caterpillar 7J670, 7J0670  
**O.D.:** 6 25/32 (172.2)  
**I.D.:** 3 15/16 (100.0)  
**Height:** 9 (228.6)  
**O. Gskt:** ES4008, G412, G438



**B95-SS** Severe Service Full-Flow Lube Spin-on  
**Notes:** Can be used with OB1303 base.  
**Contains:** Integral Post Seal  
**Fits:** Detroit Diesel Engines  
**Replaces:** GMC 25010495  
**Thread:** 1 1/2 -12  
**O.D.:** 4 21/32 (118.3)  
**Height:** 9 15/16 (252.4)  
**I.Gskt:** [1] Included



**PT98-MPG** Maximum Performance Glass Hydraulic Element  
**Notes:** Use ES4008 for stacked elements.  
**Contains:** Reinforced Centertube  
**Fits:** Caterpillar Equipment  
**Replaces:** Caterpillar 7J670, 7J0670  
**O.D.:** 6 25/32 (172.2)  
**I.D.:** 3 15/16 (100.0)  
**Height:** 9 (228.6)  
**O. Gskt:** ES4008, G412, G438



**B96** Full-Flow Lube Spin-on  
**Notes:** Can be used with OB1368, OB1369 bases.  
**Contains:** Integral Post Seal  
**Fits:** Cummins Engines  
**Replaces:** Cummins 3313287  
**Thread:** 1 1/2 -12  
**O.D.:** 4 11/16 (119.1)  
**Height:** 11 9/32 (286.5)  
**I.Gskt:** [1] Included  
**Related To:** B196, B205 (Short Versions)



**B99** Full-Flow Lube Spin-on  
**Fits:** Atlas Copco, Demag, Caterpillar Equipment  
**Replaces:** Caterpillar 1R0716  
**Thread:** 1 1/2 -16  
**O.D.:** 5 3/8 (136.5)  
**Height:** 12 3/32 (307.2)  
**I.Gskt:** [1] Included  
**Related To:** B49 (Short Version)  
 B7249-MPG, B7299 (High Efficiency Versions)



Measurements Are Shown In Inches And (Millimeters)

**WARNING:** These products can expose you to chemicals, including Diisononyl Phthalate, Carbon black extracts, Nickel, 1,3 Butadiene, Ethylene Oxide, Epichlorohydrin, which are known to the State of California to cause cancer, and Bisphenol, Ethylene Glycol, Ethylene Oxide, 1,3 Butadiene, Epichlorohydrin, which are known to the State of California to cause birth defects or other reproductive harm.

**B99-B** Full-Flow Lube Spin-on (Boxed Version)  
**Fits:** Atlas Copco, Demag, Caterpillar Equipment  
**Replaces:** Caterpillar 1R0716  
**Thread:** 1 1/2 -16  
**O.D.:** 5 3/8 (136.5)  
**Length:** 12 3/32 (307.2)  
**I.Gskt:** [1] Included  
**Related To:** B49 (Short Version)  
 B7249-MPG (High Efficiency Version)  
 B7299 (High Efficiency Version)



**P102** 2-Section Full-Flow/By-Pass Lube Element with Bail Handle  
**Contains:** Grommet Seal Between Sections  
**Fits:** Mercedes-Benz Buses, Trucks  
**Replaces:** Mercedes-Benz 6171840025, 6171840125  
**O.D.:** 3 15/32 (88.1)  
**I.D.:** 7/16 (11.1) & 31/32 (24.6)  
**Height:** 7 5/8 (193.7)  
**F. Gskt:** [1] Included  
**Grommets:** [3] Attached



**B99-MPG** Maximum Performance Glass Full-Flow Lube Spin-on  
**Fits:** Atlas Copco, Demag, Caterpillar Equipment  
**Replaces:** Caterpillar 1R0716  
**Thread:** 1 1/2 -16  
**O.D.:** 5 3/8 (136.5)  
**Height:** 12 3/32 (307.2)  
**I.Gskt:** [1] Included  
**Related To:** B49 (Short Version)  
 B7249-MPG (High Efficiency Version)  
 B7299 (High Efficiency Version)



**BD103** Dual-Flow Lube Spin-on  
**Fits:** Cummins Engines  
**Replaces:** Cummins 3318853; Fleetguard LF3000  
**Thread:** 2 1/4 -12  
**O.D.:** 4 21/32 (118.3)  
**Height:** 11 13/32 (289.7)  
**I.Gskt:** G293-B  
**Related To:** BD103-MPG (Maximum Performance Glass Version)  
 BD103-SS (Severe Service Version)  
 BD324 (Short Version)  
 BD7309 (High Velocity Version)



**B99-SS** Severe Service Lube Spin-on  
**Fits:** Atlas Copco, Demag, Caterpillar Equipment  
**Replaces:** Caterpillar 1R0716  
**Thread:** 1 1/2 -16  
**O.D.:** 5 3/8 (136.5)  
**Height:** 12 3/32 (307.2)  
**I.Gskt:** [1] Included  
**Related To:** B49 (Short Version)  
 B7249-MPG (High Efficiency Version)  
 B7299 (High Efficiency Version)



**BD103-MPG** Maximum Performance Glass Dual-Flow Lube Spin-on  
**Fits:** Cummins Engines  
**Replaces:** Cummins 3318853; Fleetguard LF3000  
**Thread:** 2 1/4 -12  
**O.D.:** 4 21/32 (118.3)  
**Height:** 11 13/32 (289.7)  
**I.Gskt:** G293-B  
**Related To:** BD103 (Standard Version)  
 BD103-SS (Severe Service Version)  
 BD324 (Short Version)  
 BD7309 (High Velocity Version)



**101** DAHL Fuel Element  
**Notes:** 4 Micron Nominal (20 Absolute)  
**Fits:** DAHL 100 Series Fuel Filter/Water Separator Units  
**O.D.:** 4 7/32 (107.2)  
**I.D.:** 5/8 (15.9) & 1 11/16 (42.9)  
**Height:** 2 5/16 (58.7)  
**A. Gskt:** [1] Included  
**F. Gskt:** [1] Included  
**Grommets:** [1] Attached



**BD103-SS** Severe Service Dual-Flow Lube Spin-on  
**Fits:** Cummins Engines  
**Replaces:** Cummins 3318853; Fleetguard LF3000  
**Thread:** 2 1/4 -12  
**O.D.:** 4 21/32 (118.3)  
**Height:** 11 13/32 (289.7)  
**I.Gskt:** G293-B  
**Related To:** BD103 (Standard Version)  
 BD103-MPG (Maximum Performance Glass Version)  
 BD324 (Short Version)  
 BD7309 (High Velocity Version)



**101-30** DAHL Fuel Element  
**Notes:** 9 Micron Nominal (40 Absolute)  
**Fits:** DAHL 100 Series Fuel Filter/Water Separator Units  
**O.D.:** 4 7/32 (107.2)  
**I.D.:** 5/8 (15.9) & 1 11/16 (42.9)  
**Height:** 2 5/16 (58.7)  
**A. Gskt:** [1] Attached  
**F. Gskt:** [1] Included  
**Grommets:** [1] Attached



**P104** Full-Flow Lube Element  
**Fits:** Rolls-Royce Engines  
**Replaces:** Rolls-Royce OE12448  
**O.D.:** 3 15/16 (100.0)  
**I.D.:** 19/32 (15.1) & 1 15/32 (37.3)  
**Height:** 5 23/32 (145.3)  
**F. Gskt:** [1] Included  
**End Seals:** [1] Attached



**101-W** DAHL Fuel Element  
**Notes:** 5 Micron Nominal (25 Absolute)  
**Fits:** DAHL 100 Series Fuel Filter/Water Separator Units  
**O.D.:** 4 7/32 (107.2)  
**I.D.:** 5/8 (15.9) & 1 11/16 (42.9)  
**Height:** 2 5/16 (58.7)  
**A. Gskt:** [1] Included  
**F. Gskt:** [1] Included  
**Grommets:** [1] Attached



Measurements Are Shown In Inches And (Millimeters)

**WARNING:** These products can expose you to chemicals, including Diisononyl Phthalate, Carbon black extracts, Nickel, 1,3 Butadiene, Ethylene Oxide, Epichlorohydrin, which are known to the State of California to cause cancer, and Bisphenol, Ethylene Glycol, Ethylene Oxide, 1,3 Butadiene, Epichlorohydrin, which are known to the State of California to cause birth defects or other reproductive harm.

**B105** Full-Flow Lube Spin-on  
**Notes:** Can be used with OB1303 base.  
**Fits:** Detroit Diesel Engines  
**Replaces:** GMC 25014120  
**Thread:** 1 1/2 -12  
**O.D.:** 4 21/32 (118.3)  
**Height:** 6 9/32 (159.5)  
**I.Gskt:** [1] Included  
**Related To:** B95 (Long Version)



**BT111** Lube Spin-on  
**Contains:** 20 PSID By-Pass Valve  
**Fits:** Ford Tractors; New Holland Equipment  
**Replaces:** Bosch 451-203-059; New Holland 86546614  
**Thread:** 3/4 -16  
**O.D.:** 3 11/16 (93.7)  
**Height:** 5 3/8 (136.5)  
**I.Gskt:** G381-A



**P106** Full-Flow Lube Element  
**Notes:** Outside-In Flow Direction  
**Fits:** Iveco Engines  
**Replaces:** Mercedes-Benz 11507425104  
**O.D.:** 2 5/16 (58.7)  
**I.D.:** 11/16 (17.5)  
**Height:** 3 31/32 (100.8)  
**F. Gskt:** [1] Included  
**O. Gskt:** G232



**BT112** Turbocharger Lube Spin-on  
**Contains:** 8 PSID By-Pass Valve  
**Fits:** Cummins Engines; Euclid Equipment  
**Replaces:** Cummins 152499  
**Thread:** 13/16 -16  
**O.D.:** 3 11/16 (93.7)  
**Height:** 5 3/8 (136.5)  
**I.Gskt:** G381-A  
**Related To:** B9 (Lube Version)



**P106-HD** Power Steering Element  
**Notes:** Inside-Out Flow Direction  
**Fits:** DAF, Iveco, M.A.N., Mercedes-Benz, R.V.I. Trucks  
**Replaces:** Mercedes-Benz 11507425104  
**O.D.:** 2 5/16 (58.7)  
**I.D.:** 11/16 (17.5)  
**Height:** 3 31/32 (100.8)  
**F. Gskt:** [1] Included  
**O. Gskt:** G232



**B113** Full-Flow Lube Spin-on  
**Contains:** Anti-Drainback Valve  
**Fits:** Ford Vans; Nissan, Subaru, Volkswagen Automotive, Light-Duty Trucks; Kubota Lift Trucks  
**Replaces:** Nissan 15208-H8916; Subaru 15208-AA001  
**Thread:** 3/4 -16  
**O.D.:** 3 1/32 (77.0)  
**Height:** 4 1/16 (103.2)  
**I.Gskt:** [1] Included



**PT108** Full-Flow Lube Element  
**Fits:** Allis Chalmers, Caterpillar, Ford, Hyster, Massey Ferguson, Perkins, Timberjack Engines, Equipment  
**Replaces:** Hyster 156952; Massey Ferguson 1851766-M1; Perkins 26540132  
**O.D.:** 2 29/32 (73.8)  
**I.D.:** 27/32 (21.4)  
**Height:** 4 1/2 (114.3)  
**F. Gskt:** G147-A



**B114** Full-Flow Lube Spin-on  
**Contains:** Anti-Drainback Valve  
 30 PSID By-Pass Valve  
**Fits:** Audi, Volkswagen, Volvo Automotive, Light-Duty Trucks; R.V.I. Trucks  
**Replaces:** Volkswagen 68115561; Volvo 13281611  
**Thread:** 3/4 -16  
**O.D.:** 3 3/4 (95.3)  
**Height:** 5 9/32 (134.1)  
**I.Gskt:** G381-A



**PT108-HD** Heavy-Duty Lube or Hydraulic Element  
**Fits:** Massey Ferguson Equipment  
**Replaces:** Hyster 156952; Massey Ferguson 1851766-M1; Perkins 26540132  
**O.D.:** 2 29/32 (73.8)  
**I.D.:** 27/32 (21.4)  
**Height:** 4 1/2 (114.3)  
**F. Gskt:** G147-A



**PT115** Full-Flow Lube Element  
**Fits:** Allis Chalmers Equipment  
**Replaces:** Allis Chalmers 4349986  
**O.D.:** 4 7/16 (112.7)  
**I.D.:** 1 17/32 (38.9)  
**Height:** 7 7/8 (200.0)  
**F. Gskt:** [1] Included  
**End Seals:** [2] Attached



**B109** Full-Flow Lube Spin-on  
**Contains:** Anti-Drainback Valve  
 20 PSID By-Pass Valve  
**Fits:** Caterpillar, Kobelco, Mustang Equipment; GMC, Isuzu Automotive  
**Replaces:** GMC 94428931  
**Thread:** M20 x 1.5  
**O.D.:** 3 3/4 (95.3)  
**Height:** 5 5/16 (134.9)  
**I.Gskt:** [1] Included



**P116** By-Pass Lube Element with Bail Handle  
**Notes:** Used in Fram F43P housing.  
**Fits:** Cummins, Deutz Engines  
**Replaces:** Cummins 151858; Deutz P4H4120  
**O.D.:** 5 27/32 (148.4)  
**I.D.:** 31/32 (24.6)  
**Height:** 9 13/16 (249.2)  
**F. Gskt:** G102-A  
**Grommets:** [2] Attached













**BC110** Centrifugal By-Pass Lube Element  
**Fits:** Mack Engines  
**Replaces:** Mack 57GC286, 236GB244  
**O.D.:** 3 27/32 (97.6)  
**I.D.:** 9/16 (14.3) & 5/8 (15.9)  
**Height:** 4 1/2 (114.3)  
**F. Gskt:** G118  
**End Seals:** ES3012 Included



Measurements Are Shown In Inches And (Millimeters)

**WARNING:** These products can expose you to chemicals, including Diisononyl Phthalate, Carbon black extracts, Nickel, 1,3 Butadiene, Ethylene Oxide, Epichlorohydrin, which are known to the State of California to cause cancer, and Bisphenol, Ethylene Glycol, Ethylene Oxide, 1,3 Butadiene, Epichlorohydrin, which are known to the State of California to cause birth defects or other reproductive harm.

<p><b>PF116</b></p> 	<p>Fuel Element with Bail Handle  <b>Notes:</b> Used in Fram F1143PBM housing. Optional gasket G356 used in Fleetguard housing.  <b>Fits:</b> Cummins Engines  <b>Replaces:</b> Cummins 139097  <b>O.D.:</b> 5 27/32 (148.4)  <b>I.D.:</b> 31/32 (24.6)  <b>Height:</b> 9 13/16 (249.2)  <b>F. Gskt:</b> G102-A, [1] Included  <b>O. Gskt:</b> G356  <b>Grommets:</b> [2] Attached</p>	<p><b>PT119-HD</b> Heavy-Duty Hydraulic Sump Element  <b>Fits:</b> Clark Equipment  <b>Replaces:</b> Clark 943559  <b>O.D.:</b> 6 (152.4)  <b>I.D.:</b> 3 1/2 (88.9)  <b>Height:</b> 14 1/2 (368.3)  <b>A. Gskt:</b> [2] Included  <b>O. Gskt:</b> G210</p>
<p><b>PT117</b></p> 	<p>By-Pass Lube Element with Bail Handle  <b>Fits:</b> Equipment with Fram F54 Series Housings  <b>Replaces:</b> Fram C54  <b>O.D.:</b> 6 (152.4)  <b>I.D.:</b> 1 1/8 (28.6)  <b>Height:</b> 14 1/2 (368.3)  <b>O. Gskt:</b> G102-A  <b>End Seals:</b> [2] Attached</p>	<p><b>PT119-HD5</b> Heavy-Duty Hydraulic Sump Element  <b>Fits:</b> Clark Equipment  <b>Replaces:</b> Clark 943559  <b>O.D.:</b> 6 (152.4)  <b>I.D.:</b> 3 1/2 (88.9)  <b>Height:</b> 14 1/2 (368.3)  <b>A. Gskt:</b> [2] Attached  <b>O. Gskt:</b> G210</p>
<p><b>PT117-25</b></p> 	<p>Full-Flow Lube Element with Bail Handle  <b>Fits:</b> Equipment with Fram F54 Series Housings  <b>Replaces:</b> Fram C54  <b>O.D.:</b> 6 (152.4)  <b>I.D.:</b> 1 1/8 (28.6)  <b>Height:</b> 14 1/2 (368.3)  <b>O. Gskt:</b> G102-A  <b>End Seals:</b> [2] Attached</p>	<p><b>B120</b> Full-Flow Lube Spin-on  <b>Contains:</b> Anti-Drainback Valve  <b>Fits:</b> Nissan Automotive, Engines  <b>Replaces:</b> Nissan 15208-W1116  <b>Thread:</b> 3/4 -16  <b>O.D.:</b> 3 11/16 (93.7)  <b>Height:</b> 3 7/8 (98.4)  <b>I.Gskt:</b> G381-A</p> 
<p><b>B118</b></p> 	<p>Full-Flow Lube Spin-on  <b>Contains:</b> Anti-Drainback Valve  <b>Fits:</b> Ford, Isuzu, Nissan Engines  <b>Replaces:</b> Isuzu 8-94414-778  <b>Thread:</b> 3/4 -16  <b>O.D.:</b> 3 11/16 (93.7)  <b>Height:</b> 5 3/8 (136.5)  <b>I.Gskt:</b> G381-A</p>	<p><b>PT121</b> Fuel Element  <b>Replaces:</b> John Deere TY5029, TY15218  <b>O.D.:</b> 3 9/32 (83.3)  <b>I.D.:</b> 1 1/4 (31.8) One End  <b>Height:</b> 5 1/8 (130.2)  <b>O. Gskt:</b> G229  <b>End Seals:</b> [1] Attached</p> 
<p><b>PT119</b></p> 	<p>Hydraulic Sump Element  <b>Notes:</b> Used in Fram FH58PL or FH258PL housings.  <b>Fits:</b> Clark Equipment  <b>Replaces:</b> Clark 943559  <b>O.D.:</b> 6 (152.4)  <b>I.D.:</b> 3 1/2 (88.9)  <b>Height:</b> 14 1/2 (368.3)  <b>A. Gskt:</b> [2] Attached  <b>O. Gskt:</b> G210</p>	<p><b>PT122-5</b> Hydraulic Element  <b>Fits:</b> Peco Housings  <b>Replaces:</b> Peco PP618-5  <b>O.D.:</b> 6 (152.4)  <b>I.D.:</b> 3 1/2 (88.9)  <b>Height:</b> 18 (457.2)  <b>A. Gskt:</b> [2] Attached</p> 
<p><b>PT119-5</b></p> 	<p>Special Fluid Element  <b>Notes:</b> Used in Bowser-Briggs 845, 852 housings.  <b>Fits:</b> Clark Equipment  <b>Replaces:</b> Clark 943559  <b>O.D.:</b> 6 (152.4)  <b>I.D.:</b> 3 1/2 (88.9)  <b>Height:</b> 14 1/2 (368.3)  <b>A. Gskt:</b> [2] Attached  <b>O. Gskt:</b> G210</p>	<p><b>BT124</b> Full-Flow Lube Spin-on  <b>Contains:</b> Anti-Drainback Valve  20 PSID By-Pass Valve  <b>Fits:</b> Oliver, White Equipment  <b>Replaces:</b> White 40-0000406  <b>Thread:</b> 7/8 -16  <b>O.D.:</b> 4 1/4 (108.0)  <b>Height:</b> 7 11/32 (186.5)  <b>I.Gskt:</b> G381-A</p> 

Measurements Are Shown In Inches And (Millimeters)

**WARNING:** These products can expose you to chemicals, including Diisononyl Phthalate, Carbon black extracts, Nickel, 1,3 Butadiene, Ethylene Oxide, Epichlorohydrin, which are known to the State of California to cause cancer, and Bisphenol, Ethylene Glycol, Ethylene Oxide, 1,3 Butadiene, Epichlorohydrin, which are known to the State of California to cause birth defects or other reproductive harm.



**P125**



Full-Flow Lube Element with 2 Bail Handles

**Fits:** Mercedes-Benz Automotive  
**Replaces:** Mercedes-Benz 11849925  
**O.D.:** 3 1/4 (82.6)  
**I.D.:** 7/16 (11.1) & 1 13/32 (35.7)  
**Height:** 4 3/4 (120.7)  
**F. Gskt:** [3] Metal Washers  
**O-Ring:** [1] Included  
**Grommets:** [2] Attached

**B132**



Full-Flow Lube Spin-on

**Notes:** Can be used with OB40079 base.  
**Contains:** Anti-Drainback Valve  
 8 PSID By-Pass Valve  
**Fits:** AMC, Chrysler, Renault Automotive;  
 Volvo Engines  
**Replaces:** Chrysler 4419970, 4419970-0;  
 Renault 7701348028  
**Thread:** 3/4 -16  
**O.D.:** 3 11/16 (93.7)  
**Height:** 3 1/4 (82.6)  
**I.Gskt:** G381-A

**BT126**



Full-Flow Lube Spin-on

**Contains:** Anti-Drainback Valve  
 8 PSID By-Pass Valve  
**Fits:** Minneapolis-Moline, Oliver, White  
 Equipment  
**Replaces:** Oliver 169019-A  
**Thread:** 7/8 -14  
**O.D.:** 3 11/16 (93.7)  
**Height:** 7 1/8 (181.0)  
**I.Gskt:** G381-A  
**Related To:** BT264 (Short Version)

**C133-OW**



Wound Cotton Full-Flow Lube Orlon Sock

**Notes:** For use with high heat applications.  
**Fits:** Waukesha Engines  
**Replaces:** Waukesha 168660, 168660B  
**O.D.:** 4 3/8 (111.1)  
**I.D.:** 1 1/16 (27.0) & 1 5/8 (41.3)  
**Height:** 31 (787.4)  
**End Seals:** [1] Attached  
**Related To:** V1656-O, V1656-T (Single-Length  
 Versions)

**P127**



Full-Flow Lube Element

**Replaces:** Leyland 801779  
**O.D.:** 3 31/32 (100.8)  
**I.D.:** 1 5/8 (41.3)  
**Height:** 5 1/32 (127.8)  
**End Seals:** [2] Attached

**C133-W**



Wound Cotton Full-Flow Lube Cotton Sock

**Fits:** Waukesha Engines  
**Replaces:** Waukesha 168660, 168660B  
**O.D.:** 4 3/8 (111.1)  
**I.D.:** 1 1/16 (27.0) & 1 5/8 (41.3)  
**Height:** 31 (787.4)  
**End Seals:** [1] Attached  
**Related To:** V1656-O, V1656-T (Single-Length  
 Versions)

**B128**



By-Pass Lube Spin-on

**Fits:** Thermo King Refrigeration Units  
**Replaces:** Thermo King 11-3746  
**Thread:** 3/4 -20  
**O.D.:** 4 1/4 (108.0)  
**Height:** 7 3/8 (187.3)  
**I.Gskt:** G401

**B134**



Full-Flow Lube Spin-on

**Fits:** Ford Automotive, Light-Duty Trucks,  
 Vans; Ford, International Equipment  
**Replaces:** Ford E3TZ-6731-A; International  
 1804442-C1  
**Thread:** 1 1/2 -16  
**O.D.:** 4 1/4 (108.0)  
**Height:** 5 7/8 (149.2)  
**I.Gskt:** [1] Included

**B129**



Full-Flow Lube Spin-on

**Fits:** Thermo King Refrigeration Units  
**Replaces:** Thermo King 11-3871  
**Thread:** 1 -12  
**O.D.:** 4 1/4 (108.0)  
**Height:** 7 3/8 (187.3)  
**I.Gskt:** G401

**PT135**



By-Pass Lube Element

**Fits:** Eaton, International, Universal Equipment  
**Replaces:** International 251404-R91  
**O.D.:** 2 9/16 (65.1)  
**I.D.:** 7/16 (11.1) & 17/32 (13.5)  
**Height:** 4 5/8 (117.5)  
**O. Gskt:** G379

**B131**



Full-Flow Lube Spin-on

**Contains:** Anti-Drainback Valve  
 8 PSID By-Pass Valve  
**Fits:** Chevrolet, Toyota Automotive; Datsun,  
 Nissan Lift Trucks; John Deere Lawn & Garden  
 Equipment; Northern Lights Equipment  
**Replaces:** Nissan 31725-L1000; Toyota  
 11501-01270  
**Thread:** 3/4 -16  
**O.D.:** 3 1/32 (77.0)  
**Height:** 3 7/16 (87.3)  
**I.Gskt:** [1] Included

**PT137**











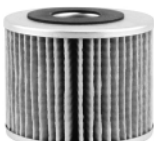

Full-Flow Lube Element

**Fits:** Allis Chalmers, Oliver Equipment  
**Replaces:** Hercules 380221  
**O.D.:** 4 7/16 (112.7)  
**I.D.:** 1 1/2 (38.1)  
**Height:** 7 (177.8)  
**F. Gskt:** [1] Included  
**End Seals:** [2] Attached

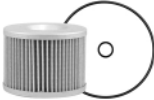











Measurements Are Shown In Inches And (Millimeters)

**WARNING:** These products can expose you to chemicals, including Diisononyl Phthalate, Carbon black extracts, Nickel, 1,3 Butadiene, Ethylene Oxide, Epichlorohydrin, which are known to the State of California to cause cancer, and Bisphenol, Ethylene Glycol, Ethylene Oxide, 1,3 Butadiene, Epichlorohydrin, which are known to the State of California to cause birth defects or other reproductive harm.

<p><b>PT138-10</b></p> 	<p>Hydraulic Element  <b>Fits:</b> Case Equipment  <b>Replaces:</b> Case D45378, G33058 Element in A61235 Kit  <b>O.D.:</b> 3 15/16 (100.0)  <b>I.D.:</b> 1 1/16 (27.0)  <b>Height:</b> 6 1/16 (154.0)  <b>F. Gskt:</b> G376, [1] Included  <b>End Seals:</b> [2] Attached</p>	<p><b>B143</b></p> 	<p>Full-Flow Lube Spin-on  <b>Contains:</b> Anti-Drainback Valve  <b>Fits:</b> Toyota Automotive, Lift Trucks  <b>Replaces:</b> Toyota 15601-33020  <b>Thread:</b> 3/4 -16  <b>O.D.:</b> 3 (76.2)  <b>Height:</b> 5 3/32 (129.4)  <b>I.Gskt:</b> [1] Included  <b>Related To:</b> B295 (Long Version)</p>
<p><b>PT138-25</b></p> 	<p>Hydraulic, Power Steering or Brake Element  <b>Fits:</b> Case Equipment  <b>Replaces:</b> Case A60524, A61234  <b>O.D.:</b> 3 15/16 (100.0)  <b>I.D.:</b> 1 1/16 (27.0)  <b>Height:</b> 6 1/16 (154.0)  <b>F. Gskt:</b> G376, [1] Included  <b>End Seals:</b> [2] Attached</p>	<p><b>P144</b></p> 	<p>Full-Flow Lube Element  <b>Replaces:</b> Citroen N223/1; Purflux L108  <b>O.D.:</b> 3 3/16 (81.0)  <b>I.D.:</b> 1 1/16 (27.0)  <b>Height:</b> 2 9/16 (65.1)  <b>End Seals:</b> [2] Attached</p>
<p><b>PT139-10</b></p> 	<p>Pressure-Type Hydraulic Element with Exposed Pleats  <b>Fits:</b> Caterpillar Lift Trucks; Marvel TB578366 Housing  <b>Replaces:</b> Marvel 578366-5110  <b>O.D.:</b> 4 1/2 (114.3)  <b>I.D.:</b> 2 1/4 (57.2) One End  <b>Height:</b> 9 3/4 (247.7)  <b>A. Gskt:</b> [1] Attached</p>	<p><b>PT146</b></p> 	<p>Full-Flow Lube Element  <b>Contains:</b> Reinforced Centertube  <b>Fits:</b> Komatsu Equipment  <b>Replaces:</b> Komatsu 6610-50-5100, 6610-51-4400  <b>O.D.:</b> 5 (127.0)  <b>I.D.:</b> 2 3/16 (55.6)  <b>Height:</b> 9 5/16 (236.5)  <b>O. Gskt:</b> G164-A  <b>End Seals:</b> [2] Attached</p>
<p><b>P140</b></p> 	<p>Full-Flow Lube Element  <b>Fits:</b> GM Automotive  <b>Replaces:</b> GMC 25012305  <b>O.D.:</b> 2 29/32 (73.8)  <b>I.D.:</b> 1 1/16 (17.5) One End  <b>Height:</b> 2 3/4 (69.9)  <b>O-Ring:</b> [1] Attached  <b>Grommets:</b> [1] Attached</p>	<p><b>P148</b></p> 	<p>Full-Flow Lube Element  <b>Fits:</b> Honda, Kawasaki, Yamaha Motorcycles  <b>Replaces:</b> Honda 15412-300-024  <b>O.D.:</b> 3 1/32 (77.0)  <b>I.D.:</b> 7/8 (22.2)  <b>Height:</b> 2 1/4 (57.2)  <b>F. Gskt:</b> [2] Included  <b>Grommets:</b> [2] Attached</p>
<p><b>B141</b></p> 	<p>Full-Flow Lube Spin-on  <b>Contains:</b> Anti-Drainback Valve  20 PSID By-Pass Valve  <b>Fits:</b> Buick, Chevrolet, Chrysler, Eagle, Jeep, Peugeot Automotive  <b>Replaces:</b> GMC 6439354  <b>Thread:</b> M20 x 1.5  <b>O.D.:</b> 3 11/16 (93.7)  <b>Height:</b> 3 7/8 (98.4)  <b>I.Gskt:</b> G381-A</p>	<p><b>P150</b></p> 	<p>Full-Flow Lube Element with Bail Handle  <b>Fits:</b> Isuzu Engines; Komatsu, TCM Lift Trucks  <b>Replaces:</b> Isuzu 13240-045; Komatsu 13240045  <b>O.D.:</b> 2 7/8 (73.0)  <b>I.D.:</b> 9/16 (14.3)  <b>Height:</b> 6 5/8 (168.3)  <b>Grommets:</b> [2] Attached</p>
<p><b>BD142</b></p> 	<p>Dual-Flow Lube Spin-on  <b>Contains:</b> Anti-Drainback Valve  Integral Post Seal  Standpipe  <b>Fits:</b> GMC, Isuzu, Nissan Automotive  <b>Replaces:</b> Isuzu 8-94143-205-0  <b>Thread:</b> 1 -12  <b>O.D.:</b> 4 7/32 (107.2)  <b>Height:</b> 5 1/8 (130.2)  <b>I.Gskt:</b> [1] Included</p>	<p><b>151</b></p> 	<p>DAHL Fuel Element  <b>Notes:</b> 4 Micron Nominal (20 Absolute)  <b>Fits:</b> DAHL 150 Series Fuel Filter/Water Separator Unit  <b>O.D.:</b> 4 7/32 (107.2)  <b>I.D.:</b> 27/32 (21.4) &amp; 1 11/16 (42.9)  <b>Height:</b> 4 9/32 (108.7)  <b>A. Gskt:</b> [1] Included  <b>O-Ring:</b> [1] Included  <b>Grommets:</b> [1] Attached</p>

Measurements Are Shown In Inches And (Millimeters)

**WARNING:** These products can expose you to chemicals, including Diisononyl Phthalate, Carbon black extracts, Nickel, 1,3 Butadiene, Ethylene Oxide, Epichlorohydrin, which are known to the State of California to cause cancer, and Bisphenol, Ethylene Glycol, Ethylene Oxide, 1,3 Butadiene, Epichlorohydrin, which are known to the State of California to cause birth defects or other reproductive harm.

<p><b>151-30</b></p>  <p>DAHL Fuel Element  <b>Notes:</b> 9 Micron Nominal (40 Absolute)  <b>Fits:</b> DAHL 150 Series Fuel Filter/Water Separator Unit  <b>O.D.:</b> 4 7/32 (107.2)  <b>I.D.:</b> 27/32 (21.4) &amp; 1 11/16 (42.9)  <b>Height:</b> 4 9/32 (108.7)  <b>F. Gskt:</b> 150-15  <b>O-Ring:</b> [1] Included  <b>Grommets:</b> [1] Attached</p>	<p><b>PF155</b></p>  <p>Fuel Element  <b>Notes:</b> Used in Luber-finer F155C, F170 housings.  <b>Fits:</b> Cummins Engines  <b>Replaces:</b> Cummins 130909  <b>O.D.:</b> 4 1/2 (114.3)  <b>I.D.:</b> 7/8 (22.2)  <b>Height:</b> 8 3/16 (208.0)  <b>O. Gskt:</b> ES1066, ES1074, G169, G363  <b>End Seals:</b> [2] Attached</p>
<p><b>151-W</b></p>  <p>DAHL Fuel Element  <b>Notes:</b> 5 Micron Nominal (25 Absolute)  <b>Fits:</b> DAHL 150 Series Fuel Filter/Water Separator Unit  <b>O.D.:</b> 4 7/32 (107.2)  <b>I.D.:</b> 27/32 (21.4) &amp; 1 11/16 (42.9)  <b>Height:</b> 4 9/32 (108.7)  <b>A. Gskt:</b> [1] Included  <b>O-Ring:</b> [1] Included  <b>Grommets:</b> [1] Attached</p>	<p><b>B156</b></p>  <p>Full-Flow Lube Spin-on  <b>Contains:</b> Anti-Drainback Valve          20 PSID By-Pass Valve  <b>Fits:</b> Honda Automotive  <b>Replaces:</b> Honda 15400-689-004  <b>Thread:</b> M22 x 1.5  <b>O.D.:</b> 3 11/16 (93.7)  <b>Height:</b> 3 1/4 (82.6)  <b>I.Gskt:</b> G324-A</p>
<p><b>PT151</b></p>  <p>Full-Flow Lube Element with Bail Handle  <b>Fits:</b> Minneapolis-Moline Tractors  <b>Replaces:</b> LeTourneau 10P732, 10R1322  <b>O.D.:</b> 3 23/32 (94.5)  <b>I.D.:</b> 9/16 (14.3)  <b>Height:</b> 4 13/32 (111.9)  <b>F. Gskt:</b> G123  <b>Grommets:</b> [2] Attached</p>	<p><b>B157</b></p>  <p>Full-Flow Lube Spin-on  <b>Notes:</b> 1 1/2 Quart Capacity  <b>Contains:</b> 20 PSID By-Pass Valve  <b>Fits:</b> Ford Engines, Trucks  <b>Replaces:</b> Ford E7HZ-6731-A  <b>Thread:</b> 1 -12  <b>O.D.:</b> 4 1/4 (108.0)  <b>Height:</b> 7 3/8 (187.3)  <b>I.Gskt:</b> G401</p>
<p><b>PT152</b></p>  <p>Full-Flow Lube Element  <b>Fits:</b> Minneapolis-Moline, Oliver Tractors  <b>Replaces:</b> Minneapolis-Moline 10A10423, 10R1323  <b>O.D.:</b> 4 17/32 (115.1)  <b>I.D.:</b> 7/8 (22.2)  <b>Height:</b> 6 1/4 (158.8)  <b>O. Gskt:</b> G380</p>	<p><b>B159</b></p>  <p>Full-Flow Lube Spin-on  <b>Contains:</b> Anti-Drainback Valve          8 PSID By-Pass Valve  <b>Fits:</b> GMC Imports, Suzuki Automotive  <b>Replaces:</b> GMC 96058042; Suzuki 16510-83011  <b>Thread:</b> 3/4 -16  <b>O.D.:</b> 3 (76.2)  <b>Height:</b> 4 1/16 (103.2)  <b>I.Gskt:</b> [1] Included</p>
<p><b>PT153</b></p>  <p>Full-Flow Lube Element  <b>Fits:</b> International Light-Duty Trucks; Nissan Lift Trucks  <b>Replaces:</b> Nissan 15208-61525  <b>O.D.:</b> 3 15/16 (100.0)  <b>I.D.:</b> 19/32 (15.1) &amp; 1 5/8 (41.3)  <b>Height:</b> 6 3/8 (161.9)  <b>F. Gskt:</b> [2] Included  <b>End Seals:</b> [1] Attached</p>	<p><b>B160</b></p>  <p>Full-Flow Lube Spin-on  <b>Contains:</b> Anti-Drainback Valve          20 PSID By-Pass Valve  <b>Fits:</b> Cadillac, GMC Light-Duty Trucks; VM Engines  <b>Replaces:</b> GMC 89017524; VM Engines 4115031  <b>Thread:</b> M22 x 1.5  <b>O.D.:</b> 3 (76.2)  <b>Height:</b> 3 1/2 (88.9)  <b>I.Gskt:</b> G449-B</p>
<p><b>PT154</b></p>  <p>Full-Flow Lube Element  <b>Contains:</b> Reinforced Centertube  <b>Fits:</b> Case, Grove, International Engines  <b>Replaces:</b> Case A20822; International 193187-R91  <b>O.D.:</b> 4 17/32 (115.1)  <b>I.D.:</b> 1/2 (12.7) &amp; 1 25/32 (45.2)  <b>Height:</b> 7 1/16 (179.4)  <b>F. Gskt:</b> G184-A  <b>O. Gskt:</b> G115-MSB, G280  <b>End Seals:</b> [1] Attached  <b>Grommets:</b> [1] Attached</p>	<p><b>B161-S</b></p>  <p>Full-Flow Lube Spin-on  <b>Contains:</b> Anti-Drainback Valve          20 PSID By-Pass Valve  <b>Fits:</b> Acura, Ford, Honda, Mazda Automotive; Kubota Engines  <b>Replaces:</b> Ford D87Z-6731-A; Mazda 8173-23-802  <b>Thread:</b> M20 x 1.5  <b>O.D.:</b> 3 1/32 (77.0)  <b>Height:</b> 4 1/16 (103.2)  <b>I.Gskt:</b> [1] Included</p>

Measurements Are Shown In Inches And (Millimeters)

**WARNING:** These products can expose you to chemicals, including Diisononyl Phthalate, Carbon black extracts, Nickel, 1,3 Butadiene, Ethylene Oxide, Epichlorohydrin, which are known to the State of California to cause cancer, and Bisphenol, Ethylene Glycol, Ethylene Oxide, 1,3 Butadiene, Epichlorohydrin, which are known to the State of California to cause birth defects or other reproductive harm.

**P162** Full-Flow Lube Element  
**Fits:** Lamborghini, Maserati Automotive  
**Replaces:** Lamborghini 11880; Maserati 421242874  
**O.D.:** 2 5/8 (66.7)  
**I.D.:** 1 7/32 (31.0)  
**Height:** 8 11/16 (220.7)  
**End Seals:** [2] Attached



**P170** Full-Flow Lube Element  
**Fits:** Komatsu Lift Trucks; Nissan Engines  
**Replaces:** Nissan 15208-32225, 15208-43800  
**O.D.:** 2 13/16 (71.4)  
**I.D.:** 1 5/16 (33.3)  
**Height:** 5 13/32 (137.3)  
**End Seals:** [2] Attached



**B163** Full-Flow Lube or Transmission Spin-on  
**Notes:** Can be used with OB40079 base.  
**Contains:** Anti-Drainback Valve  
 8 PSID By-Pass Valve  
**Fits:** Allis Chalmers, Atlas Copco, Bolens, Case, Ford, International, John Deere, Oliver, Onan, White Equipment; Ford, Volvo Automotive  
**Replaces:** Ford E8NN-6714-CA; Mack 6432PER17; Onan 122-0185; White 156513A  
**Thread:** 3/4 -16  
**O.D.:** 3 11/16 (93.7)  
**Height:** 3 7/8 (98.4)  
**I.Gskt:** G381-A



**P171** Full-Flow Lube Element  
**Fits:** J.C. Bamford Equipment; Leyland Engines  
**Replaces:** Chrysler 2067263; Nissan 15208-31300  
**O.D.:** 2 7/8 (73.0)  
**I.D.:** 1 5/16 (33.3)  
**Height:** 4 1/4 (108.0)  
**F. Gskt:** G147-A, G161  
**O. Gskt:** G183  
**Related To:** P172 (with End Seals)



**B164** By-Pass Lube Spin-on  
**Notes:** Can be used with OB1305 base.  
**Contains:** Flow Control Orifice  
**Fits:** Carrier Refrigeration Units  
**Replaces:** Carrier-Transicold 30-00304-00  
**Thread:** 5/8 -18  
**O.D.:** 3 11/16 (93.7)  
**Height:** 6 5/8 (168.3)  
**I.Gskt:** G381-A  
**Related To:** B50, BT341 (Short Versions)



**P172** Full-Flow Lube Element  
**Fits:** Leyland Engines, Equipment  
**Replaces:** Leyland 162429  
**O.D.:** 2 29/32 (73.8)  
**I.D.:** 1 5/16 (33.3)  
**Height:** 4 7/16 (112.7)  
**F. Gskt:** G147-A, G165, [1] Included  
**End Seals:** [2] Attached  
**Related To:** P171 (without End Seals)



**B166** Full-Flow Lube Spin-on  
**Contains:** Anti-Drainback Valve  
 20 PSID By-Pass Valve  
**Fits:** Honda Automotive; Ford Tractors  
**Replaces:** Honda 15400-634-003  
**Thread:** M20 x 1.5  
**O.D.:** 3 25/32 (96.0)  
**Height:** 3 1/4 (82.6)  
**I.Gskt:** [1] Included



**B173-S** Full-Flow Lube Spin-on  
**Contains:** Anti-Drainback Valve  
 20 PSID By-Pass Valve  
**Fits:** AMC, Chrysler, Eagle, Hyundai, Isuzu, Mitsubishi Automotive, Light-Duty Trucks  
**Replaces:** Chrysler 4186267  
**Thread:** M20 x 1.5  
**O.D.:** 3 11/16 (93.7)  
**Height:** 3 1/4 (82.6)  
**A. Gskt:** G381-A



**B167** Full-Flow Lube Spin-on  
**Notes:** 1 1/2 Quart Capacity  
**Contains:** Anti-Drainback Valve  
 8 PSID By-Pass Valve  
**Fits:** Dresser, Hough, International Engines, Equipment  
**Replaces:** International 427207-C3, 528250-R91, 3059246-R91, 3059247-R91  
**Thread:** 1 -12  
**O.D.:** 3 11/16 (93.7)  
**Height:** 7 1/8 (181.0)  
**I.Gskt:** G381-A



**P174** Full-Flow Lube Element  
**Fits:** International, Leyland, Lister, Petter Engines  
**Replaces:** International 3043283-R91; Leyland ABU8912; Lister 419-3265; Nissan 15208-32200  
**O.D.:** 2 7/8 (73.0)  
**I.D.:** 1 5/16 (33.3)  
**Height:** 5 9/16 (141.3)  
**F. Gskt:** G147-A, G165, [2] Included  
**O. Gskt:** G161, G239  
**End Seals:** [2] Attached



**B168** Full-Flow Lube Spin-on  
**Contains:** Anti-Drainback Valve  
 8 PSID By-Pass Valve  
**Fits:** Takeuchi Equipment; Yanmar Engines  
**Replaces:** John Deere CH10467; Thermo King 11-4928; Yanmar 124550-35110  
**Thread:** M20 x 1.5  
**O.D.:** 3 (76.2)  
**Height:** 5 3/32 (129.4)  
**I.Gskt:** [1] Included



**P176** Full-Flow Lube Element  
**Fits:** Lister Engines  
**Replaces:** Lister 419-3038, 201-26020  
**O.D.:** 2 7/8 (73.0)  
**I.D.:** 1 5/16 (33.3)  
**Height:** 3 15/32 (88.1)  
**F. Gskt:** G239  
**O. Gskt:** G402  
**Related To:** PF820-S (Fuel Version)



Measurements Are Shown In Inches And (Millimeters)

**WARNING:** These products can expose you to chemicals, including Diisononyl Phthalate, Carbon black extracts, Nickel, 1,3 Butadiene, Ethylene Oxide, Epichlorohydrin, which are known to the State of California to cause cancer, and Bisphenol, Ethylene Glycol, Ethylene Oxide, 1,3 Butadiene, Epichlorohydrin, which are known to the State of California to cause birth defects or other reproductive harm.

**P177** Full-Flow Lube Element  
**Fits:** Coventry Climax Engines, Lift Trucks; Perkins Engines  
**Replaces:** Perkins 26540055  
**O.D.:** 2 7/8 (73.0)  
**I.D.:** 1 5/16 (33.3)  
**Height:** 6 (152.4)  
**F. Gskt:** G161, [2] Included  
**O. Gskt:** G147-A  
**End Seals:** [2] Attached



**P184** Full-Flow Lube Element  
**Fits:** Ford, Iveco Engines, Trucks  
**Replaces:** Ford B8C-6731-A  
**O.D.:** 3 5/16 (84.1)  
**I.D.:** 15/16 (23.8)  
**Height:** 4 27/32 (123.0)  
**F. Gskt:** G132, G268, [2] Included



**B178** Full-Flow Lube Spin-on  
**Contains:** Anti-Drainback Valve  
 30 PSID By-Pass Valve  
**Fits:** Audi, BMW, Dodge, Porsche, Volkswagen Automotive; Bobcat, Deutz, Ingersoll-Rand, Vermeer Equipment  
**Replaces:** Chrysler J3232126; Volkswagen 56115561G  
**Thread:** 3/4 -16  
**O.D.:** 2 15/16 (74.6)  
**Height:** 4 27/32 (123.0)  
**I.Gskt:** G449-B  
**Related To:** B228 (Short Version)



**PT185** Full-Flow Lube Element  
**Fits:** Dresser, Drott, Galion, Gradall, Hough, International Equipment; International Engines  
**Replaces:** International 279994-R91  
**O.D.:** 3 15/16 (100.0)  
**I.D.:** 1 19/32 (40.5)  
**Height:** 5 9/16 (141.3)  
**F. Gskt:** G273  
**End Seals:** [2] Attached



**B179** Full-Flow Lube Spin-on  
**Contains:** Anti-Drainback Valve  
 8 PSID By-Pass Valve  
**Fits:** Honda Automotive; Kubota, Yanmar Engines  
**Replaces:** Kubota 70000-15241; Transcold 2535206; Yanmar 124450-35100  
**Thread:** M20 x 1.5  
**O.D.:** 3 (76.2)  
**Height:** 2 27/32 (72.2)  
**I.Gskt:** [1] Included



**P186** Power Steering Element  
**Fits:** Allis Chalmers, Massey Ferguson Equipment  
**Replaces:** Allis Chalmers 79170-7; International 168743-R91  
**O.D.:** 3 17/32 (89.7)  
**I.D.:** 1 1/8 (28.6)  
**Height:** 2 1/2 (63.5)



**PT181 KIT** 3-Part Hydraulic Kit  
**Contains:** Reinforced Centertube  
 [2] Elements  
 [1] S423 Resin Ribbon Spacer Element  
 [2] Gaskets  
**Fits:** Allis Chalmers Crawler Tractors, Excavators, Loaders  
**Replaces:** Allis Chalmers 3019695, 3033507  
**Larger Element**  
**O.D.:** 3 5/16 (84.1)  
**I.D.:** 1 1/8 (28.6)  
**Height:** 8 7/8 (225.4)  
**F. Gskt:** [2] Included  
**Smaller Element**  
**O.D.:** 3 5/16 (84.1)  
**I.D.:** 1 5/32 (29.4)  
**Height:** 4 13/32 (111.9)



**P187** Transmission or Air Shift Breather Element  
**Fits:** Dana, Fuller Transmissions; Euclid, Massey Ferguson, WABCO Equipment; GMC Trucks  
**Replaces:** GMC 2354770  
**O.D.:** 2 7/8 (73.0)  
**I.D.:** 1 1/16 (27.0)  
**Height:** 3 (76.2)  
**F. Gskt:** [1] Included



**P183** Power Steering or Hydraulic Element  
**Fits:** Case, Caterpillar, Ford, International, Massey Ferguson Equipment; Chrysler, Ford Automotive  
**Replaces:** Case A22279; International 133205-R91  
**O.D.:** 3 3/16 (81.0)  
**I.D.:** 1 1/16 (27.0)  
**Height:** 1 9/16 (39.7)  
**End Seals:** [2] Attached



**PT189** Hydraulic or Transmission Element  
**Notes:** Use ES4007 for stacked elements.  
**Contains:** Reinforced Centertube  
**Fits:** Caterpillar Equipment  
**Replaces:** Caterpillar 2M3943  
**O.D.:** 3 15/16 (100.0)  
**I.D.:** 2 9/32 (57.9)  
**Height:** 9 3/16 (233.4)  
**O. Gskt:** ES1049, ES1074, ES4007, G229, G310, G315, G333, G342, G376, G403, G433, G445, G447



**PT189-MPG** Maximum Performance Glass Hydraulic or Transmission Element  
**Notes:** Use ES4007 for stacked elements.  
**Contains:** Reinforced Centertube  
**Fits:** Caterpillar Equipment  
**Replaces:** Caterpillar 2M3943  
**O.D.:** 3 15/16 (100.0)  
**I.D.:** 2 9/32 (57.9)  
**Height:** 9 3/16 (233.4)  
**O. Gskt:** ES1049, ES1074, ES4007, G229, G310, G315, G333, G342, G376, G403, G433, G445, G447



Measurements Are Shown In Inches And (Millimeters)

**WARNING:** These products can expose you to chemicals, including Diisononyl Phthalate, Carbon black extracts, Nickel, 1,3 Butadiene, Ethylene Oxide, Epichlorohydrin, which are known to the State of California to cause cancer, and Bisphenol, Ethylene Glycol, Ethylene Oxide, 1,3 Butadiene, Epichlorohydrin, which are known to the State of California to cause birth defects or other reproductive harm.

**P190**

Full-Flow Lube Element



**Fits:** Case, David Brown Equipment; Ford Buses, Trucks  
**Replaces:** David Brown 902125; Ford 528E-6731-A  
**O.D.:** 3 3/4 (95.3)  
**I.D.:** 1 5/16 (33.3)  
**Height:** 2 7/8 (73.0)  
**F. Gskt:** G168-B  
**End Seals:** [2] Attached

**PT193-3**

Hydraulic Element



**Notes:** For Terex Kit 9038953, Add Optional Gaskets [2] G253-A and [1] G289  
**Fits:** Euclid, Terex Equipment  
**Replaces:** Euclid 9190077  
**O.D.:** 6 (152.4)  
**I.D.:** 3 17/32 (89.7)  
**Height:** 8 17/32 (216.7)  
**O. Gskt:** G289

**PT191**

Hydraulic Sump Element



**Fits:** Clark, Euclid, Gradall Equipment; Sullair Compressors  
**Replaces:** Clark 141676; Euclid 4008687  
**O.D.:** 6 (152.4)  
**I.D.:** 3 17/32 (89.7)  
**Height:** 8 (203.2)  
**O. Gskt:** G253-A, G314, G359

**P194**

Full-Flow Lube Element



**Fits:** Caterpillar, Quincy Equipment; Mack Engines  
**Replaces:** Allis Chalmers 3010360-0; Case A26984; Euclid 9029081  
**O.D.:** 6 1/32 (153.2)  
**I.D.:** 1 23/32 (43.7)  
**Height:** 7 5/8 (193.7)  
**O. Gskt:** G193  
**End Seals:** [2] Attached  
**Related To:** PT394-5, PT394-15 (Different Microns)

**PT191-5**

Hydraulic Element



**Fits:** Clark, Euclid, Gradall Equipment; Sullair Compressors  
**Replaces:** Clark 141676; Euclid 4008687  
**O.D.:** 6 (152.4)  
**I.D.:** 3 17/32 (89.7)  
**Height:** 8 (203.2)  
**O. Gskt:** G253-A, G314, G359

**P194-HD**

Hydraulic Element



**Fits:** Allis Chalmers, Case, Euclid, Gradall, John Deere, Koehring Equipment  
**Replaces:** Allis Chalmers 3010360-0; Case A26984; Euclid 9029081  
**O.D.:** 6 1/32 (153.2)  
**I.D.:** 1 23/32 (43.7)  
**Height:** 7 5/8 (193.7)  
**O. Gskt:** G193  
**End Seals:** [2] Attached  
**Related To:** PT394-5, PT394-15 (Different Microns)

**PT191-10**

Hydraulic Element



**Fits:** Clark, Euclid, Gradall Equipment; Sullair Compressors  
**Replaces:** Clark 141676; Euclid 4008687  
**O.D.:** 6 (152.4)  
**I.D.:** 3 17/32 (89.7)  
**Height:** 8 (203.2)  
**O. Gskt:** G253-A, G314, G359

**P194-HD10**

Hydraulic Element



**Fits:** CMC, Gardner Denver, Ingersoll-Rand Equipment  
**Replaces:** Caterpillar 6B8217; Ingersoll-Rand 35252154  
**O.D.:** 6 1/32 (153.2)  
**I.D.:** 1 23/32 (43.7)  
**Height:** 7 5/8 (193.7)  
**O. Gskt:** G193  
**End Seals:** [2] Attached  
**Related To:** PT394-5, PT394-15 (Different Microns)

**PT193**

Hydraulic or Full-Flow Lube Element



**Fits:** Euclid, Terex Equipment  
**Replaces:** Euclid 9190077  
**O.D.:** 6 (152.4)  
**I.D.:** 3 17/32 (89.7)  
**Height:** 8 17/32 (216.7)  
**O. Gskt:** G289

**PF194**

Fuel Element



**Fits:** Caterpillar Engines  
**Replaces:** Caterpillar 2H7254  
**O.D.:** 6 1/32 (153.2)  
**I.D.:** 1 23/32 (43.7)  
**Height:** 7 5/8 (193.7)  
**O. Gskt:** G193  
**End Seals:** [2] Attached  
**Related To:** PT394-5, PT394-15 (Different Microns)

**PT193 KIT**

Hydraulic Element Plus Gaskets



**Contains:** [1] PT193  
 [2] G253-A  
 [1] G288  
 [1] G289  
**Fits:** Euclid, Terex Equipment  
**Replaces:** Euclid 9190077  
**O.D.:** 6 (152.4)  
**I.D.:** 3 17/32 (89.7)  
**Height:** 8 17/32 (216.7)  
**F. Gskt:** [4] Included

**B195**

Full-Flow Lube Spin-on



**Contains:** Anti-Drainback Valve  
**Fits:** Peugeot Automotive, Light-Duty Trucks  
**Replaces:** Peugeot 1109-35,-59  
**Thread:** M18 x 1.5  
**O.D.:** 3 1/8 (79.4)  
**Height:** 3 1/2 (88.9)  
**I.Gskt:** [1] Included

Measurements Are Shown In Inches And (Millimeters)

**WARNING:** These products can expose you to chemicals, including Diisononyl Phthalate, Carbon black extracts, Nickel, 1,3 Butadiene, Ethylene Oxide, Epichlorohydrin, which are known to the State of California to cause cancer, and Bisphenol, Ethylene Glycol, Ethylene Oxide, 1,3 Butadiene, Epichlorohydrin, which are known to the State of California to cause birth defects or other reproductive harm.

**B196** Full-Flow Lube Spin-on  
**Notes:** Can be used with OB1368, OB1369 bases.  
**Contains:** Integral Post Seal  
**Fits:** Cummins Engines  
**Replaces:** Fleetguard LF670SC  
**Thread:** 1 1/2 -12  
**O.D.:** 4 21/32 (118.3)  
**Height:** 9 15/16 (252.4)  
**I.Gskt:** [1] Included  
**Related To:** B96, B96-MPG (Long Versions)



**B201-S** By-Pass Lube Spin-on  
**Fits:** Ford, Mazda Automotive, Light-Duty Trucks  
**Replaces:** Ford E3TZ-6731-B; Mazda 8259-23-802,-0  
**Thread:** M20 x 1.5  
**O.D.:** 4 1/4 (108.0)  
**Height:** 3 3/16 (81.0)  
**I.Gskt:** [1] Included



**P198** Full-Flow Lube or Transmission Element  
**Fits:** Broom & Wade Compressors; Dorman, Lister, Petter Engines  
**Replaces:** Broom & Wade A1413302; Dorman L111/4, Q429/4; Lister 291-40910  
**O.D.:** 3 1/2 (88.9)  
**I.D.:** 2 (50.8)  
**Height:** 6 15/16 (176.2)  
**F. Gskt:** [1] Included  
**O. Gskt:** G202



**B202** Full-Flow Lube Spin-on  
**Contains:** Anti-Drainback Valve  
**20 PSID By-Pass Valve**  
**Fits:** Chrysler, Ford, Mazda, Mitsubishi Automotive, Light-Duty Trucks  
**Replaces:** Ford E37A-6714-BA; Mazda S213-23-802  
**Thread:** M20 x 1.5  
**O.D.:** 3 11/16 (93.7)  
**Height:** 5 3/8 (136.5)  
**I.Gskt:** G381-A



**B199** Full-Flow Lube Spin-on  
**Contains:** Anti-Drainback Valve  
**8 PSID By-Pass Valve**  
**Fits:** Ford, Mercury Automotive  
**Replaces:** Ford D2PJ-6714-AA  
**Thread:** M20 x 1.5  
**O.D.:** 3 (76.2)  
**Height:** 5 1/8 (130.2)  
**I.Gskt:** G449-B



**P203** Full-Flow Lube Element  
**Contains:** Reinforced Centertube  
**Fits:** Austin-Western Equipment; International Engines, Equipment  
**Replaces:** Chrysler 2647018; Ford C5R-6731-A; International 213388-R91  
**O.D.:** 4 17/32 (115.1)  
**I.D.:** 1/2 (12.7) & 2 9/32 (57.9)  
**Height:** 5 1/16 (128.6)  
**F. Gskt:** [2] Included  
**O. Gskt:** G115-MSB, G280  
**End Seals:** [1] Attached  
**Grommets:** [1] Attached



**201** DAHL Fuel Element  
**Notes:** 4 Micron Nominal (20 Absolute)  
**Fits:** DAHL 200 Series Fuel Filter/Water Separator Units  
**O.D.:** 6 1/16 (154.0)  
**I.D.:** 1 15/32 (37.3) & 3 9/32 (83.3)  
**Height:** 4 5/8 (117.5)  
**A. Gskt:** [1] Included  
**F. Gskt:** 200-15A  
**O-Ring:** [1] Attached



**P203-HD** Hydraulic Element  
**Contains:** Reinforced Centertube  
**Fits:** Dresser, International, Racine Equipment  
**Replaces:** Chrysler 2647018; Ford C5R-6731-A; International 213388-R91  
**O.D.:** 4 17/32 (115.1)  
**I.D.:** 1/2 (12.7) & 2 9/32 (57.9)  
**Height:** 5 1/16 (128.6)  
**F. Gskt:** [1] Included  
**O. Gskt:** G115-MSB, G280  
**End Seals:** [1] Attached  
**Grommets:** [1] Attached



**201-30** DAHL Fuel Element  
**Notes:** 9 Micron Nominal (40 Absolute)  
**Fits:** DAHL 200 Series Fuel Filter/Water Separator Units  
**O.D.:** 6 1/16 (154.0)  
**I.D.:** 1 15/32 (37.3) & 3 9/32 (83.3)  
**Height:** 4 5/8 (117.5)  
**A. Gskt:** [1] Attached  
**F. Gskt:** 200-15A  
**O-Ring:** [1] Attached



**P203-HD10** Hydraulic Element  
**Contains:** Reinforced Centertube  
**Fits:** Cessna, Challenger Equipment  
**Replaces:** Chrysler 2647018; Ford C5R-6731-A; International 213388-R91  
**O.D.:** 4 17/32 (115.1)  
**I.D.:** 1/2 (12.7) & 2 9/32 (57.9)  
**Height:** 5 1/16 (128.6)  
**O. Gskt:** G115-MSB, G280  
**End Seals:** [1] Attached  
**Grommets:** [1] Attached



**201-W** DAHL Fuel Element  
**Notes:** 4 Micron Nominal (20 Absolute)  
**Fits:** DAHL 200 Series Fuel Filter/Water Separator Units  
**O.D.:** 6 1/16 (154.0)  
**I.D.:** 1 15/32 (37.3) & 3 9/32 (83.3)  
**Height:** 4 5/8 (117.5)  
**A. Gskt:** [1] Included  
**F. Gskt:** 200-15A  
**O-Ring:** [1] Attached













**P204** Full-Flow Lube Element  
**Contains:** Reinforced Centertube  
**Fits:** Clark, Crane Carrier, Galion, Gradall, Grove, Hough, International Equipment  
**Replaces:** Caterpillar 63-6083; International 213445-R91  
**O.D.:** 4 17/32 (115.1)  
**I.D.:** 1/2 (12.7) & 2 9/32 (57.9)  
**Height:** 7 1/16 (179.4)  
**O. Gskt:** G184-A, G211, G280, G362  
**End Seals:** [1] Attached  
**Grommets:** [1] Attached

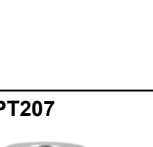

Measurements Are Shown In Inches And (Millimeters)

**WARNING:** These products can expose you to chemicals, including Diisononyl Phthalate, Carbon black extracts, Nickel, 1,3 Butadiene, Ethylene Oxide, Epichlorohydrin, which are known to the State of California to cause cancer, and Bisphenol, Ethylene Glycol, Ethylene Oxide, 1,3 Butadiene, Epichlorohydrin, which are known to the State of California to cause birth defects or other reproductive harm.

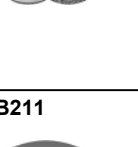
<p><b>P204-HD</b> Hydraulic Element</p>  <p><b>Contains:</b> Reinforced Centertube  <b>Fits:</b> Case, Caterpillar, Dresser, International Equipment  <b>Replaces:</b> Caterpillar 63-6083; International 213445-R91  <b>O.D.:</b> 4 17/32 (115.1)  <b>I.D.:</b> 1/2 (12.7) &amp; 2 9/32 (57.9)  <b>Height:</b> 7 1/16 (179.4)  <b>O. Gskt:</b> G184-A, G211, G280, G362  <b>End Seals:</b> [1] Attached  <b>Grommets:</b> [1] Attached</p>	<p><b>PT207-10</b> Hydraulic Element</p>  <p><b>Notes:</b> Use in Gresen in-line housing.  <b>Fits:</b> Allis Chalmers, Case, Caterpillar, John Deere, Massey Ferguson, New Holland, Oliver, Steiger, Versatile Equipment  <b>Replaces:</b> Gresen 1509, 1567, 3143, 3144  <b>O.D.:</b> 4 1/2 (114.3)  <b>I.D.:</b> 1 7/8 (47.6)  <b>Height:</b> 6 31/32 (177.0)  <b>F. Gskt:</b> [2] ES1092  <b>O. Gskt:</b> ES3029, G236-A, G385, G386  <b>Related To:</b> PT554, PT573 (Long Versions)</p>
<p><b>P204-HD10</b> Hydraulic Element</p>  <p><b>Contains:</b> Reinforced Centertube  <b>Fits:</b> Case, Michigan, P&amp;H Harnischfeger, Vickers Equipment  <b>Replaces:</b> Caterpillar 63-6083; International 213445-R91  <b>O.D.:</b> 4 17/32 (115.1)  <b>I.D.:</b> 1/2 (12.7) &amp; 2 9/32 (57.9)  <b>Height:</b> 7 1/16 (179.4)  <b>O. Gskt:</b> G184-A, G211, G280, G362  <b>End Seals:</b> [1] Attached  <b>Grommets:</b> [1] Attached</p>	<p><b>PT207-HD</b> Heavy-Duty Hydraulic Element</p>  <p><b>Notes:</b> Use in Gresen in-line housing.  <b>Fits:</b> Allis Chalmers, Case, Caterpillar, John Deere, Massey Ferguson, New Holland, Oliver, Steiger, Versatile Equipment  <b>Replaces:</b> Gresen 1509, 1567, 3143, 3144  <b>O.D.:</b> 4 1/2 (114.3)  <b>I.D.:</b> 1 7/8 (47.6)  <b>Height:</b> 6 31/32 (177.0)  <b>F. Gskt:</b> [2] ES1092  <b>O. Gskt:</b> ES3029, G236-A, G385, G386  <b>Related To:</b> PT554, PT573 (Long Versions)</p>
<p><b>B205</b> Full-Flow Lube Spin-on</p>  <p><b>Notes:</b> Can be used with OB1368, OB1369 bases.  <b>Contains:</b> Integral Post Seal  <b>Fits:</b> Ag-Chem, Case, Case-International, Champion, Daewoo, Dresser, Fiat-Allis, Gradall, Grove, Hyster, Hyundai, Ingersoll-Rand, Kawasaki, Link-Belt, Rickel, Steiger, Timberjack, White Equipment; Case, Cummins  <b>Replaces:</b> Case A77537; Cummins 3313281  <b>Thread:</b> 1 1/2 -12  <b>O.D.:</b> 4 2 1/32 (118.3)  <b>Height:</b> 8 3/32 (205.6)  <b>I.Gskt:</b> [1] Included  <b>Related To:</b> B96 (Long Version)</p>	<p><b>PT207-HD10</b> Heavy-Duty Hydraulic Element</p>  <p><b>Notes:</b> Use in Gresen in-line housing.  <b>Fits:</b> Allis Chalmers, Case, Caterpillar, John Deere, Massey Ferguson, New Holland, Oliver, Steiger, Versatile Equipment  <b>Replaces:</b> Gresen 1509, 1567, 3143, 3144  <b>O.D.:</b> 4 1/2 (114.3)  <b>I.D.:</b> 1 7/8 (47.6)  <b>Height:</b> 6 31/32 (177.0)  <b>F. Gskt:</b> [2] ES1092  <b>O. Gskt:</b> ES3029, G236-A, G385, G386  <b>Related To:</b> PT554, PT573 (Long Versions)</p>
<p><b>P206</b> Full-Flow Lube Element</p>  <p><b>Fits:</b> International Engines, Trucks  <b>Replaces:</b> International 236649-R91, 871867-R91, 871868-R91  <b>O.D.:</b> 4 17/32 (115.1)  <b>I.D.:</b> 1/2 (12.7) &amp; 2 1/4 (57.2)  <b>Height:</b> 3 3/4 (95.3)  <b>F. Gskt:</b> G115-MSB  <b>O. Gskt:</b> G280  <b>End Seals:</b> [1] Attached  <b>Grommets:</b> [1] Attached</p>	<p><b>PT208</b> Hydraulic Reservoir Element</p>  <p><b>Fits:</b> Clark Lift Trucks  <b>Replaces:</b> Clark 733289, 883687, 1810143  <b>O.D.:</b> 6 (152.4)  <b>I.D.:</b> 3 1/2 (88.9)  <b>Height:</b> 4 3/16 (106.4)  <b>O. Gskt:</b> G314  <b>End Seals:</b> [2] Attached</p>
<p><b>PT207</b> Hydraulic Element</p>  <p><b>Notes:</b> Use in Gresen in-line housing.  <b>Fits:</b> Allis Chalmers, Case, Caterpillar, John Deere, Massey Ferguson, New Holland, Oliver, Steiger, Versatile Equipment  <b>Replaces:</b> Gresen 1509, 1567, 3143, 3144  <b>O.D.:</b> 4 1/2 (114.3)  <b>I.D.:</b> 1 7/8 (47.6)  <b>Height:</b> 6 31/32 (177.0)  <b>F. Gskt:</b> [2] ES1092  <b>O. Gskt:</b> ES3029, G236-A, G385, G386  <b>Related To:</b> PT554, PT573 (Long Versions)</p>	<p><b>PT210</b> Hydraulic Element</p>  <p><b>Fits:</b> Minneapolis-Moline Equipment  <b>Replaces:</b> White 10A23992, 10P1851  <b>O.D.:</b> 2 15/32 (62.7)  <b>I.D.:</b> 1 1/16 (27.0)  <b>Height:</b> 7 25/32 (197.6)  <b>F. Gskt:</b> G274  <b>End Seals:</b> [2] Attached</p>
<p><b>PT207</b> Hydraulic Element</p>  <p><b>Notes:</b> Use in Gresen in-line housing.  <b>Fits:</b> Allis Chalmers, Case, Caterpillar, John Deere, Massey Ferguson, New Holland, Oliver, Steiger, Versatile Equipment  <b>Replaces:</b> Gresen 1509, 1567, 3143, 3144  <b>O.D.:</b> 4 1/2 (114.3)  <b>I.D.:</b> 1 7/8 (47.6)  <b>Height:</b> 6 31/32 (177.0)  <b>F. Gskt:</b> [2] ES1092  <b>O. Gskt:</b> ES3029, G236-A, G385, G386  <b>Related To:</b> PT554, PT573 (Long Versions)</p>	<p><b>B211</b> Full-Flow Lube Spin-on</p>  <p><b>Contains:</b> 20 PSID By-Pass Valve  <b>Fits:</b> Hyster Lift Trucks  <b>Replaces:</b> Hyster 360974  <b>Thread:</b> M20 x 1.5  <b>O.D.:</b> 4 1/4 (108.0)  <b>Height:</b> 5 27/32 (148.4)  <b>I.Gskt:</b> [1] Included</p>

Measurements Are Shown In Inches And (Millimeters)

**WARNING:** These products can expose you to chemicals, including Diisononyl Phthalate, Carbon black extracts, Nickel, 1,3 Butadiene, Ethylene Oxide, Epichlorohydrin, which are known to the State of California to cause cancer, and Bisphenol, Ethylene Glycol, Ethylene Oxide, 1,3 Butadiene, Epichlorohydrin, which are known to the State of California to cause birth defects or other reproductive harm.



**PT212-5** Hydraulic Element  
**Notes:** Inside-Out Flow Direction  
**Fits:** Hough, International Wheel Loaders; Lorain Equipment  
**Replaces:** International 176028-H2  
**O.D.:** 6 (152.4)  
**I.D.:** 2 5/8 (66.7)  
**Height:** 18 1/16 (458.8)  
**End Seals:** [2] Attached  
**Related To:** PT499-5 (Single-Length Version)



**B218** Full-Flow Lube Spin-on  
**Contains:** Anti-Drainback Valve  
 30 PSID By-Pass Valve  
**Fits:** Agco, Liebherr, O & K, Poclain Equipment; Deutz Engines  
**Replaces:** Deutz 1173765  
**Thread:** 1 1/8 -16  
**O.D.:** 4 1/4 (108.0)  
**Height:** 10 7/16 (265.1)  
**I.Gskt:** [1] Included



**PT213** Hydraulic Element  
**Fits:** Atlas Copco, Compair Compressors; Volvo Equipment  
**Replaces:** Atlas Copco 1619-0355; Volvo 4786319  
**O.D.:** 3 17/32 (89.7)  
**I.D.:** 2 1/32 (51.6)  
**Height:** 10 (254.0)  
**F. Gskt:** G202



**B220** Full-Flow Lube Spin-on  
**Fits:** Hitachi Equipment  
**Replaces:** Hitachi 4192527  
**Thread:** 1 3/8 -16  
**O.D.:** 4 21/32 (118.3)  
**Height:** 9 7/8 (250.8)  
**I.Gskt:** G498-A



**PT214(2)** Set of 2 Hydraulic Elements  
**Fits:** International Crawler, Wheel Tractors  
**Replaces:** International 375085-R91  
**O.D.:** 2 7/8 (73.0)  
**I.D.:** 1 1/16 (27.0)  
**Height:** 1 17/32 (38.9)  
**F. Gskt:** [2] Included



**BT221** Full-Flow Lube Spin-on  
**Contains:** 32 PSID By-Pass Valve  
**Fits:** Toyota Lift Trucks  
**Replaces:** Toyota 15601-68010  
**Thread:** M30 x 1.5  
**O.D.:** 4 1/4 (108.0)  
**Height:** 5 5/8 (142.9)  
**I.Gskt:** [1] Included



**BT215** Full-Flow Lube Spin-on  
**Contains:** Anti-Drainback Valve  
 8 PSID By-Pass Valve  
 Standpipe  
**Fits:** Allis Chalmers, Compair, Eicher, Landini, Massey Ferguson Equipment; Perkins Engines  
**Replaces:** Perkins 2654408  
**Thread:** 3/4 -16  
**O.D.:** 3 (76.2)  
**Height:** 5 1/8 (130.2)  
**I.Gskt:** G449-B



**B222** By-Pass Lube Spin-on  
**Fits:** Isuzu Engines  
**Replaces:** Isuzu 8-94169-779-0, 8-94169-779-1, 8-94169-779-2  
**Thread:** 5/8 -18  
**O.D.:** 4 1/4 (108.0)  
**Height:** 3 3/16 (81.0)  
**I.Gskt:** [1] Included



**BT216** Full-Flow Lube Spin-on  
**Contains:** Anti-Drainback Valve  
 8 PSID By-Pass Valve  
 Standpipe  
**Fits:** Allis Chalmers, Bobcat, Caterpillar, Claas, J.C. Bamford, Landini, Massey Ferguson, New Holland, Vermeer, Volvo Equipment; Perkins Engines  
**Replaces:** Perkins 2654403  
**Thread:** 3/4 -16  
**O.D.:** 3 11/16 (93.7)  
**Height:** 5 3/8 (136.5)  
**I.Gskt:** G381-A  
**Related To:** BT237 (Long Version)



**BT223** Full-Flow Lube Spin-on  
**Contains:** Anti-Drainback Valve  
 8 PSID By-Pass Valve  
**Fits:** BMW, Chrysler, Dodge, GMC, Saab, Saturn, Suzuki, Toyota Automotive; Bobcat, Cub Cadet, Interceptor, John Deere Equipment  
**Replaces:** Chrysler 2647020; Lister 201-55370; Onan 122-0645; Toyota 15601-13051  
**Thread:** 3/4 -16  
**O.D.:** 2 29/32 (73.8)  
**Height:** 3 1/2 (88.9)  
**A. Gskt:** G449-B



**BT217** Full-Flow Lube Spin-on  
**Notes:** Can be used with OB40079 base.  
**Contains:** Anti-Drainback Valve  
 8 PSID By-Pass Valve  
 Standpipe  
**Fits:** Hanomag, Hyster Equipment; Transicold Refrigeration Units  
**Replaces:** Transicold 3000323, 3000323-00  
**Thread:** 3/4 -16  
**O.D.:** 3 11/16 (93.7)  
**Height:** 7 1/8 (181.0)  
**I.Gskt:** G381-A



**PF224** Fuel Element  
**Fits:** Ensign Carburetors; International Engines, Equipment  
**Replaces:** Ensign 6261B; International 64400-DC  
**O.D.:** 1 7/8 (47.6)  
**I.D.:** 23/32 (18.3)  
**Height:** 2 15/32 (62.7)  
**F. Gskt:** [2] Included  
**O. Gskt:** G204-A  
**End Seals:** [2] Attached



Measurements Are Shown In Inches And (Millimeters)

**WARNING:** These products can expose you to chemicals, including Diisononyl Phthalate, Carbon black extracts, Nickel, 1,3 Butadiene, Ethylene Oxide, Epichlorohydrin, which are known to the State of California to cause cancer, and Bisphenol, Ethylene Glycol, Ethylene Oxide, 1,3 Butadiene, Epichlorohydrin, which are known to the State of California to cause birth defects or other reproductive harm.

**PF225** Fuel Element  
**Fits:** Dresser, Galion, Hough Equipment; International Engines, Equipment, Trucks  
**Replaces:** International 266840-R91  
**O.D.:** 4 7/32 (107.2)  
**I.D.:** 13/16 (20.6) & 1 (25.4)  
**Height:** 6 3/4 (171.5)  
**O. Gskt:** G104, G115-MSB, G240, G302  
**End Seals:** [1] Attached



**PF231** Fuel Element  
**Fits:** Deutz, International, Mercedes-Benz Engines; M.A.N., R.V.I. Buses, Trucks  
**Replaces:** Deutz R1H4155,-H; International 3029244-R91; Mercedes-Benz 4773515  
**O.D.:** 2 7/8 (73.0)  
**I.D.:** 9/16 (14.3)  
**Height:** 5 27/32 (148.4)  
**Grommets:** [2] Attached



**PF226** Secondary Fuel Element  
**Fits:** Adams, Austin-Western, Galion, International, Link-Belt Equipment; International Engines, Equipment  
**Replaces:** International 266839-R91  
**O.D.:** 3 15/32 (88.1)  
**I.D.:** 9/16 (14.3) & 1 (25.4)  
**Height:** 6 3/4 (171.5)  
**O-Ring:** [1] Attached  
**O. Gskt:** G241  
**Grommets:** [1] Attached



**BD232** Dual-Flow Lube Spin-on  
**Contains:** 36 PSID By-Pass Valve Standpipe  
**Fits:** Allis Chalmers, Fiat Equipment; Iveco, R.V.I. Trucks  
**Replaces:** Fiat 1902076, 4787410, 5983900  
**Thread:** 3/4 -16  
**O.D.:** 4 1/4 (108.0)  
**Height:** 5 11/16 (144.5)  
**I.Gskt:** [1] Included



**B227** Full-Flow Lube Spin-on  
**Contains:** Anti-Drainback Valve 20 PSID By-Pass Valve  
**Fits:** Chrysler, Ford, GMC, Honda, Isuzu, Mitsubishi Automotive; Kubota, Yanmar Engines  
**Replaces:** Kubota 15241-39092; Yanmar 1196-6035150  
**Thread:** M20 x 1.5  
**O.D.:** 3 (76.2)  
**Height:** 2 27/32 (72.2)  
**I.Gskt:** [1] Included



**B233** Full-Flow Lube Spin-on  
**Notes:** Can be used with OB40079 base.  
**Contains:** Anti-Drainback Valve 8 PSID By-Pass Valve  
**Fits:** Chrysler, Ford, Toyota, Volkswagen Automotive, Light-Duty Trucks, Vans  
**Replaces:** Chrysler 3549957; Ford C5ZZ-6731-A  
**Thread:** 3/4 -16  
**O.D.:** 3 11/16 (93.7)  
**Height:** 4 3/8 (111.1)  
**A. Gskt:** G381-A



**B228** Full-Flow Lube Spin-on  
**Contains:** Anti-Drainback Valve 30 PSID By-Pass Valve  
**Fits:** Atlas Copco Compressors; Audi, BMW, GM Automotive; Bobcat, Claas, Gehl Equipment; Deutz Engines  
**Replaces:** Deutz 1163420; GMC 6696776  
**Thread:** 3/4 -16  
**O.D.:** 3 (76.2)  
**Height:** 3 1/2 (88.9)  
**I.Gskt:** G449-B  
**Related To:** B178 (Long Version)



**BT234** Full-Flow Lube Spin-on  
**Fits:** Nissan Engines  
**Replaces:** Nissan 15274-99186, 15274-99626  
**Thread:** 1 1/8 -16  
**O.D.:** 4 9/32 (108.7)  
**Height:** 8 1/32 (204.0)  
**I.Gskt:** [1] Included



**B229** Full-Flow Lube Spin-on  
**Contains:** Anti-Drainback Valve 20 PSID By-Pass Valve  
**Fits:** Case Equipment; David Brown, Isuzu Engines; Toyota Automotive, Light-Duty Trucks  
**Replaces:** Case A46158; Isuzu X13201-001; Toyota 15601-44011  
**Thread:** 3/4 -16  
**O.D.:** 3 11/16 (93.7)  
**Height:** 4 3/8 (111.1)  
**I.Gskt:** G381-A



**P235** Full-Flow Lube Element  
**Fits:** DAF, Iveco, M.A.N., R.V.I, Volvo Trucks; Deutz Engines; Fiat Equipment  
**Replaces:** Deutz 1168446; Fiat 1909123  
**O.D.:** 3 17/32 (89.7)  
**I.D.:** 1 5/16 (33.3)  
**Height:** 7 13/16 (198.4)  
**F. Gskt:** G202  
**End Seals:** [2] Attached



**BT230** Full-Flow Lube Spin-on  
**Fits:** Ag-Chem, Caterpillar, Grove, Hitachi, New Holland, Takeuchi, White Equipment; Hino, International, Mack, Volvo Trucks  
**Replaces:** Caterpillar 8N9586  
**Thread:** 1 1/8 -16  
**O.D.:** 3 11/16 (93.7)  
**Height:** 5 3/8 (136.5)  
**I.Gskt:** G381-A  
**Related To:** BT260, BT260-10 (Transmission Versions)



**B236** Full-Flow Lube or Hydraulic Spin-on  
**Contains:** Anti-Drainback Valve 30 PSID By-Pass Valve  
**Fits:** Atlas Copco Compressors; Bomag, Case, Caterpillar, Demag, Deutz, Drott, Fendt, John Deere, Liebherr Equipment; Deutz Engines  
**Replaces:** Case A44081; Deutz 1173430; John Deere AZ22878  
**Thread:** 1 -12  
**O.D.:** 3 11/16 (93.7)  
**Height:** 8 1/8 (206.4)  
**I.Gskt:** G381-A  
**Related To:** B7031 (Short Version)



Measurements Are Shown In Inches And (Millimeters)

**WARNING:** These products can expose you to chemicals, including Diisononyl Phthalate, Carbon black extracts, Nickel, 1,3 Butadiene, Ethylene Oxide, Epichlorohydrin, which are known to the State of California to cause cancer, and Bisphenol, Ethylene Glycol, Ethylene Oxide, 1,3 Butadiene, Epichlorohydrin, which are known to the State of California to cause birth defects or other reproductive harm.

**BT237** Full-Flow Lube Spin-on  
**Notes:** Can be used with OB40079 base.  
**Contains:** Anti-Drainback Valve  
 8 PSID By-Pass Valve  
 Standpipe  
**Fits:** Bobcat, Caterpillar, Hymac, Hyster, J.C. Bamford, Komatsu, Landini, Massey Ferguson Equipment; Perkins Engines  
**Replaces:** Perkins 2654407  
**Thread:** 3/4 -16  
**O.D.:** 3 11/16 (93.7)  
**Height:** 7 1/8 (181.0)  
**I.Gskt:** G381-A  
**Related To:** BT216 (Short Version)



**B243** Full-Flow Lube Spin-on  
**Contains:** Anti-Drainback Valve  
 8 PSID By-Pass Valve  
**Fits:** Chrysler, Ford, Mazda, Toyota, Volkswagen Automotive, Light-Duty Trucks, Vans; Ford, Gehl, Kubota Equipment; Kohler, Onan Engines  
**Replaces:** Ford E4FZ-6731-AB; Kohler 277233; Onan 122-0680  
**Thread:** 3/4 -16  
**O.D.:** 3 (76.2)  
**Height:** 4 27/32 (123.0)  
**A. Gskt:** G449-B



**BT238** Full-Flow Lube Spin-on  
**Contains:** Anti-Drainback Valve  
 20 PSID By-Pass Valve  
**Fits:** Kubota, Thomas Equipment  
**Replaces:** Kubota 70000-15451  
**Thread:** 3/4 -16  
**O.D.:** 4 1/4 (108.0)  
**Height:** 7 11/32 (186.5)  
**I.Gskt:** G381-A



**B244** Full-Flow Lube Spin-on  
**Contains:** Anti-Drainback Valve  
 20 PSID By-Pass Valve  
**Fits:** GMC, Isuzu Engines, Trucks  
**Replaces:** GMC 94169778; Isuzu 8-94169-778-0, 8-94169-778-1, 8-94169-778-2  
**Thread:** 3/4 -16  
**O.D.:** 3 11/16 (93.7)  
**Height:** 5 3/8 (136.5)  
**I.Gskt:** G324-A



**B239** Full-Flow Lube Spin-on  
**Contains:** 30 PSID By-Pass Valve  
**Fits:** John Deere Equipment  
**Replaces:** John Deere AZ36942  
**Thread:** 1 1/2 -16  
**O.D.:** 5 3/8 (136.5)  
**Height:** 12 3/32 (307.2)  
**I.Gskt:** [1] Included



**B246** Lube Spin-on  
**Contains:** Anti-Drainback Valve  
**Replaces:** Nissan 15208-W3401  
**Thread:** 3/4 -16  
**O.D.:** 3 3/4 (95.3)  
**Height:** 5 9/32 (134.1)  
**I.Gskt:** G381-A



**P240** Full-Flow Lube Element  
**Fits:** David Brown Equipment  
**Replaces:** Ford 105E-6731-A  
**O.D.:** 2 7/8 (73.0)  
**I.D.:** 27/32 (21.4)  
**Height:** 3 5/32 (80.2)  
**F. Gskt:** [1] Included



**B247** Full-Flow Lube Spin-on  
**Contains:** Anti-Drainback Valve  
 8 PSID By-Pass Valve  
**Fits:** Komatsu Equipment; Thermo King Refrigeration Units  
**Replaces:** Thermo King 11-5522  
**Thread:** M20 x 1.5  
**O.D.:** 3 (76.2)  
**Height:** 4 13/16 (122.2)  
**I.Gskt:** [1] Included



**BT241** Full-Flow Lube Spin-on  
**Contains:** Anti-Drainback Valve  
 8 PSID By-Pass Valve  
**Fits:** Wisconsin Engines  
**Replaces:** Wisconsin RV51  
**Thread:** 13/16 -16  
**O.D.:** 3 13/16 (96.8)  
**Height:** 4 3/8 (111.1)  
**I.Gskt:** [1] Included



**BT248** Full-Flow Lube Spin-on  
**Contains:** Anti-Drainback Valve  
 8 PSID By-Pass Valve  
**Fits:** New Holland Equipment; Wisconsin Engines  
**Replaces:** Wisconsin RV38-S  
**Thread:** 5/8 -18  
**O.D.:** 3 11/16 (93.7)  
**Height:** 5 13/32 (137.3)  
**I.Gskt:** G381-A



**P242** Full-Flow Lube Element  
**Contains:** Reinforced Centertube  
**Fits:** Mercedes-Benz Engines, Equipment  
**Replaces:** Mercedes-Benz 4011800009  
**O.D.:** 4 25/32 (121.4)  
**I.D.:** 17/32 (13.5) & 2 5/32 (54.8)  
**Height:** 7 13/32 (188.1)  
**F. Gskt:** [3] Washers  
**O-Ring:** [1] Included  
**Spring:** [1] Attached















**P249** Full-Flow Lube Element  
**Fits:** Caterpillar, Kobelco Equipment; Mitsubishi Engines  
**Replaces:** Mitsubishi ME034611  
**O.D.:** 4 11/32 (110.3)  
**I.D.:** 3/4 (19.0)  
**Height:** 7 5/8 (193.7)  
**A. Gskt:** [1] Attached  
**F. Gskt:** [1] Included  
**O-Ring:** [1] Included  
**Grommets:** [2] Attached



Measurements Are Shown In Inches And (Millimeters)

**WARNING:** These products can expose you to chemicals, including Diisononyl Phthalate, Carbon black extracts, Nickel, 1,3 Butadiene, Ethylene Oxide, Epichlorohydrin, which are known to the State of California to cause cancer, and Bisphenol, Ethylene Glycol, Ethylene Oxide, 1,3 Butadiene, Epichlorohydrin, which are known to the State of California to cause birth defects or other reproductive harm.

<p><b>BT251</b></p> 	<p>Full-Flow Lube Spin-on  <b>Notes:</b> Can be used with OB40079 base.  <b>Contains:</b> Anti-Drainback Valve            8 PSID By-Pass Valve  <b>Fits:</b> Ford, Oliver Tractors  <b>Replaces:</b> Ford D2NN-6714-C  <b>Thread:</b> 3/4 -16  <b>O.D.:</b> 3 11/16 (93.7)  <b>Height:</b> 7 1/8 (181.0)  <b>I.Gskt:</b> G381-A</p>	<p><b>PT257</b></p> 	<p>Hydraulic Element  <b>Contains:</b> Reinforced Centertube  <b>Fits:</b> Caterpillar Excavators; Army-Navy Hydraulic Systems  <b>Replaces:</b> Army-Navy AN6235-3A; Vickers 62343  <b>O.D.:</b> 1 21/32 (42.1)  <b>I.D.:</b> 7/8 (22.2) One End  <b>Height:</b> 3 1/2 (88.9)  <b>O-Ring:</b> [1] Attached</p>
<p><b>B252</b></p> 	<p>Transmission Spin-on  <b>Contains:</b> Anti-Drainback Valve            20 PSID By-Pass Valve  <b>Fits:</b> Allison Transmissions  <b>Replaces:</b> GMC 25010441  <b>Thread:</b> 3/4 -16  <b>O.D.:</b> 3 11/16 (93.7)  <b>Height:</b> 5 15/32 (138.9)  <b>I.Gskt:</b> G401</p>	<p><b>PT258</b></p> 	<p>Hydraulic Element  <b>Contains:</b> Reinforced Centertube  <b>Fits:</b> Army-Navy Hydraulic Systems; International Combines; Massey Ferguson Tractors; Vickers Optional Filter Housings  <b>Replaces:</b> Army-Navy AN6235-4A; Bendix 572759; International 573201-R91  <b>O.D.:</b> 1 25/32 (45.2)  <b>I.D.:</b> 1 (25.4) One End  <b>Height:</b> 4 1/2 (114.3)  <b>O-Ring:</b> [1] Attached</p>
<p><b>B253</b></p> 	<p>Full-Flow Heavy-Duty Lube Spin-on  <b>Notes:</b> Can be used with OB40079 base. Can be used in racing applications.  <b>Contains:</b> Anti-Drainback Valve            20 PSID By-Pass Valve            Standpipe  <b>Fits:</b> Ferrari, Porsche Automotive  <b>Replaces:</b> Ferrari 45384000; Lancia 2220425; Porsche 901-107-203-02  <b>Thread:</b> 3/4 -16  <b>O.D.:</b> 3 11/16 (93.7)  <b>Height:</b> 5 15/32 (138.9)  <b>I.Gskt:</b> G401</p>	<p><b>BT259</b></p> 	<p>Full-Flow Lube or Hydraulic Spin-on  <b>Contains:</b> 20 PSID By-Pass Valve  <b>Fits:</b> Blaw Knox, Caterpillar, Ditch Witch, Dynapac, John Deere, Rayco, Vermeer, Zetor Equipment; Ingersoll-Rand Compressors  <b>Replaces:</b> John Deere AR58956, T19044  <b>Thread:</b> 13/16 -16  <b>O.D.:</b> 3 11/16 (93.7)  <b>Height:</b> 5 13/32 (137.3)  <b>I.Gskt:</b> G401</p>
<p><b>P254</b></p> 	<p>Lube Element  <b>Notes:</b> OBSOLETE. Availability Limited to Dealer Stock.  <b>Fits:</b> Bray Construction Equipment with Leyland-DAF Engines  <b>Replaces:</b> Leyland 602426  <b>O.D.:</b> 3 1/8 (79.4)  <b>I.D.:</b> 15/32 (11.9) &amp; 3/4 (19.0)  <b>Height:</b> 9 3/8 (238.1)  <b>F. Gskt:</b> [3] Included  <b>End Seals:</b> [1] Attached</p>	<p><b>BT260</b></p> 	<p>Hydraulic or Transmission Spin-on  <b>Fits:</b> Cessna Hydraulic Systems; International, John Deere, New Holland, Yale &amp; Towne Equipment  <b>Replaces:</b> Cessna 60187-6  <b>Thread:</b> 1 1/8 -16  <b>O.D.:</b> 3 11/16 (93.7)  <b>Height:</b> 5 3/8 (136.5)  <b>I.Gskt:</b> G381-A  <b>Related To:</b> BT230 (Lube Version)</p>
<p><b>B255</b></p> 	<p>Full-Flow Lube Spin-on  <b>Fits:</b> Sullair Compressors  <b>Replaces:</b> Sullair 408107  <b>Thread:</b> 1 -12  <b>O.D.:</b> 3 11/16 (93.7)  <b>Height:</b> 5 15/32 (138.9)  <b>I.Gskt:</b> G401</p>	<p><b>BT260-10</b></p> 	<p>Hydraulic or Transmission Spin-on  <b>Fits:</b> Cessna Hydraulic Systems; Bobcat, Case, Ford, John Deere, Kobelco, Massey Ferguson, New Holland Equipment  <b>Replaces:</b> Cessna 60187-6  <b>Thread:</b> 1 1/8 -16  <b>O.D.:</b> 3 11/16 (93.7)  <b>Height:</b> 5 3/8 (136.5)  <b>I.Gskt:</b> G381-A  <b>Related To:</b> BT230 (Lube Version)</p>
<p><b>PT256</b></p> 	<p>Hydraulic Element  <b>Contains:</b> Reinforced Centertube  <b>Fits:</b> Army-Navy Hydraulic Systems  <b>Replaces:</b> Army-Navy AN6235-2A; Bendix 572760  <b>O.D.:</b> 1 5/32 (29.4)  <b>I.D.:</b> 5/8 (15.9) One End  <b>Height:</b> 4 11/16 (119.1)  <b>O-Ring:</b> [1] Attached</p>	<p><b>BT261</b></p> 	<p>Full-Flow Lube Spin-on  <b>Contains:</b> Anti-Drainback Valve            Standpipe  <b>Fits:</b> Case, Dresser, Drott, Galion, Hough, International, John Deere Equipment  <b>Replaces:</b> Case A58672, A75294  <b>Thread:</b> 1 -12  <b>O.D.:</b> 3 11/16 (93.7)  <b>Height:</b> 7 1/8 (181.0)  <b>I.Gskt:</b> G381-A  <b>Related To:</b> B299 (High Performance Version)</p>

Measurements Are Shown In Inches And (Millimeters)

**WARNING:** These products can expose you to chemicals, including Diisononyl Phthalate, Carbon black extracts, Nickel, 1,3 Butadiene, Ethylene Oxide, Epichlorohydrin, which are known to the State of California to cause cancer, and Bisphenol, Ethylene Glycol, Ethylene Oxide, 1,3 Butadiene, Epichlorohydrin, which are known to the State of California to cause birth defects or other reproductive harm.

**B262**

Full-Flow Lube Spin-on



**Contains:** 30 PSID By-Pass Valve  
**Fits:** Atlas Copco Compressors; Gardner Denver Drills; Yanmar Engines  
**Replaces:** Atlas Copco 1619-3771  
**Thread:** 1 -12  
**O.D.:** 3 11/16 (93.7)  
**Height:** 8 23/32 (221.5)  
**I.Gskt:** G381-A

**PT268**

Hydraulic Element



**Fits:** Case, Dresser, International Equipment  
**Replaces:** International 390560-R91, 528507-R91  
**O.D.:** 5 (127.0)  
**I.D.:** 2 13/16 (71.4)  
**Height:** 6 1/8 (155.6)  
**F. Gskt:** G261, G307, G360, G368  
**O. Gskt:** G260, G362, G382  
**End Seals:** [2] Attached

**B263**

Full-Flow Lube Spin-on



**Fits:** Mercedes-Benz Engines  
**Replaces:** Mercedes-Benz 31841701  
**Thread:** 1 -12  
**O.D.:** 4 1/4 (108.0)  
**Height:** 9 1/8 (231.8)  
**I.Gskt:** G401

**PT269**

Full-Flow Lube Element



**Fits:** Deutz, Hyster Equipment  
**Replaces:** Deutz 150154012; Hyster 136853  
**O.D.:** 3 5/16 (84.1)  
**I.D.:** 15/16 (23.8)  
**Height:** 4 5/8 (117.5)

**BT264**

Full-Flow Lube Spin-on



**Contains:** Anti-Drainback Valve  
 8 PSID By-Pass Valve  
**Fits:** Caterpillar Engines, Equipment  
**Replaces:** Caterpillar 2S5262, 2S9969  
**Thread:** 7/8 -14  
**O.D.:** 3 11/16 (93.7)  
**Height:** 4 3/8 (111.1)  
**I.Gskt:** G381-A  
**Related To:** BT126 (Long Version)

**P271**

Full-Flow Lube Element



**Fits:** OMC Engines  
**Replaces:** Ford 113E-6731-A  
**O.D.:** 2 7/8 (73.0)  
**I.D.:** 27/32 (21.4)  
**Height:** 4 3/16 (106.4)  
**F. Gskt:** [1] Included

**PT265**

Transmission Element

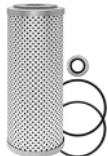

**Fits:** Allis Chalmers, Fiat-Allis Equipment  
**Replaces:** Allis Chalmers 631828, 4995265  
**O.D.:** 3 (76.2)  
**I.D.:** 1 1/16 (27.0)  
**Height:** 7 23/32 (196.1)  
**F. Gskt:** ES1030, G270, [1] Included  
**O. Gskt:** G133  
**End Seals:** [2] Attached

**PT273**

Hydraulic Element



**Replaces:** Allis Chalmers 631827  
**O.D.:** 2 7/8 (73.0)  
**I.D.:** 1 1/16 (27.0)  
**Height:** 4 15/16 (125.4)  
**F. Gskt:** [1] Included, [1] Metal Washer  
**O-Ring:** [1] Included  
**End Seals:** [2] Attached

**P266**

Full-Flow Lube Element



**Fits:** Isuzu Engines; Kobelco, Koehring, Multiquip Equipment  
**Replaces:** Isuzu 9-88513-106-1  
**O.D.:** 3 9/32 (83.3)  
**I.D.:** 23/32 (18.3) & 1 5/8 (41.3)  
**Height:** 5 11/16 (144.5)  
**F. Gskt:** [4] Included  
**End Seals:** [1] Attached  
**Grommets:** [1] Attached

**BT274**

Hydraulic Spin-on



**Contains:** 10 PSID By-Pass Valve  
**Fits:** Case, International, Wayne Equipment  
**Replaces:** Case A32297  
**Thread:** 1 -12  
**O.D.:** 3 11/16 (93.7)  
**Height:** 5 3/8 (136.5)  
**I.Gskt:** G381-A

**BT267**

Full-Flow Lube Spin-on



**Contains:** Anti-Drainback Valve  
 20 PSID By-Pass Valve  
**Fits:** Allis Chalmers, Fiat-Allis, Ford, Hanomag, Iveco Equipment  
**Replaces:** Allis Chalmers 2089505; Ford D5NN-6714-A  
**Thread:** 3/4 -16  
**O.D.:** 4 1/4 (108.0)  
**Height:** 5 13/16 (147.6)  
**I.Gskt:** G381-A

**PT275**

Transmission Element



**Contains:** Reinforced Centertube  
**Fits:** FWD, Racine, Wagner, Yale & Towne Equipment  
**Replaces:** Racine 493144  
**O.D.:** 4 17/32 (115.1)  
**I.D.:** 1/2 (12.7) & 2 9/32 (57.9)  
**Height:** 9 1/16 (230.2)  
**O. Gskt:** G211  
**End Seals:** [1] Attached  
**Grommets:** [1] Attached

Measurements Are Shown In Inches And (Millimeters)

**WARNING:** These products can expose you to chemicals, including Diisononyl Phthalate, Carbon black extracts, Nickel, 1,3 Butadiene, Ethylene Oxide, Epichlorohydrin, which are known to the State of California to cause cancer, and Bisphenol, Ethylene Glycol, Ethylene Oxide, 1,3 Butadiene, Epichlorohydrin, which are known to the State of California to cause birth defects or other reproductive harm.

**PT275-10** Transmission Element  
**Contains:** Reinforced Centertube  
**Fits:** Dresser, International, Racine Equipment  
**Replaces:** Eaton 493144  
**O.D.:** 4 17/32 (115.1)  
**I.D.:** 1/2 (12.7) & 2 9/32 (57.9)  
**Height:** 9 1/16 (230.2)  
**O. Gskt:** G211  
**End Seals:** [1] Attached  
**Grommets:** [1] Attached

**PT283** Hydraulic Element  
**Fits:** Barber-Greene Loaders with International Engines  
**Replaces:** Bendix 47197  
**O.D.:** 1 1/16 (27.0)  
**I.D.:** 5/8 (15.9)  
**Height:** 3 5/32 (80.2)

**P276** Full-Flow Lube Element  
**Fits:** Ag-Chem Fertilizer Applicators, Sprayers; International Buses, Engines, Trucks  
**Replaces:** International 244572-R92, 313117-C92  
**O.D.:** 4 1/2 (114.3)  
**I.D.:** 1 1/16 (27.0)  
**Height:** 6 5/8 (168.3)  
**Grommets:** [2] Attached

**PT284** Hydraulic Element  
**Fits:** Barber-Greene Loaders with International Engines  
**Replaces:** Bendix 47198  
**O.D.:** 1 3/8 (34.9)  
**I.D.:** 7/8 (22.2)  
**Height:** 4 1/32 (102.4)

**PT277** Hydraulic Element  
**Notes:** Inside-Out Flow Direction  
**Fits:** Massey Ferguson Equipment  
**Replaces:** Massey Ferguson 228529-M1; Timberjack 101465  
**O.D.:** 3 15/16 (100.0)  
**I.D.:** 2 (50.8)  
**Height:** 7 1/2 (190.5)

**PT285** Hydraulic Element  
**Fits:** International Equipment  
**Replaces:** International 613788-C91  
**O.D.:** 5 (127.0)  
**I.D.:** 2 13/16 (71.4)  
**Height:** 11 1/16 (281.0)

**B279** Full-Flow Lube Spin-on  
**Notes:** Can be used in racing applications.  
**Contains:** Anti-Drainback Valve  
 20 PSID By-Pass Valve  
**Fits:** Mercruiser Marine  
**Replaces:** GMC 6438868  
**Thread:** 13/16 -16  
**O.D.:** 3 11/16 (93.7)  
**Height:** 5 11/32 (135.7)  
**I.Gskt:** [1] Included

**BT287** Full-Flow Lube or Hydraulic Spin-on  
**Notes:** CAUTION: Use G372 (yellow striped) gasket ONLY on Case and G369-B (blue striped) gasket on John Deere. Installing wrong gasket prevents seal. Can use with OB1313, OB1314, OB1315, OB1316 bases (requires optional G286-C gasket).  
**Fits:** Ag-Chem, Bobcat, Case, Demag, Hydra-Mac, Hyster, John Deere, Manitowoc, Michigan Fluid Power, Steiger Equipment  
**Replaces:** Bobcat 6552507, Case A57857; Demag 25577440; Hydra-Mac 3401-307; John Deere AR43261, AR43634  
**Thread:** 1 1/2 -16  
**O.D.:** 5 1/32 (127.8)  
**Height:** 7 (177.8)  
**F. Gskt:** G369-B (Blue Striped), G372 (Yellow Striped)  
**O. Gskt:** G286-C, G369-V, G447, G483, G704, G710

**P280** Full-Flow Lube Element  
**Fits:** Isuzu Engines; John Deere Loaders  
**Replaces:** Isuzu 9-88513-107-01; John Deere GV10805  
**O.D.:** 2 7/8 (73.0)  
**I.D.:** 1 5/16 (33.3)  
**Height:** 5 15/32 (138.9)  
**F. Gskt:** [3] Included  
**End Seals:** [2] Attached

**B281** Full-Flow Lube Spin-on  
**Contains:** Anti-Drainback Valve  
 20 PSID By-Pass Valve  
**Fits:** Komatsu, New Holland Equipment; Onan Generators; VM Engines  
**Replaces:** Onan 122-0550; VM Engines 4115030  
**Thread:** M22 x 1.5  
**O.D.:** 3 11/16 (93.7)  
**Height:** 5 3/8 (136.5)  
**I.Gskt:** G381-A

Measurements Are Shown In Inches And (Millimeters)

**WARNING:** These products can expose you to chemicals, including Diisononyl Phthalate, Carbon black extracts, Nickel, 1,3 Butadiene, Ethylene Oxide, Epichlorohydrin, which are known to the State of California to cause cancer, and Bisphenol, Ethylene Glycol, Ethylene Oxide, 1,3 Butadiene, Epichlorohydrin, which are known to the State of California to cause birth defects or other reproductive harm.

## BT287-10

### Hydraulic Spin-on



**Notes:** CAUTION: Use furnished G369-B (blue striped) gasket on John Deere. Use optional G372 (yellow striped) gasket ONLY on Case. Installing wrong gasket prevents seal.

Can use with OB1313, OB1314, OB1315, OB1316 bases (requires opt. G286-C gasket)

**Fits:** Case, Case-International, Caterpillar, Champion, Ditch Witch, Dynamic Industries, Ford, Gehl, Hesston, John Deere, Manitou, Michigan Fluid Power, New Holland, Steiger Equipment

**Replaces:** Case 87027972; Caterpillar 9T5664; Champion 13028; Ditch Witch 155-954; Dynamic 1H1234; John Deere AT58368; Michigan Fluid Power 200-0600; New Holland 86542664

**Thread:** 1 1/2 -16

**O.D.:** 5 1/32 (127.8)

**Height:** 7 (177.8)

**F. Gskt:** G369-B (Blue Striped)

**O. Gskt:** G286-C, G369-V, G372, G447, G483, G704, G710

## PT289-10

### Hydraulic Element

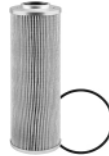

**Fits:** Agco, Franklin Equipment

**Replaces:** Franklin 1503007

**O.D.:** 2 5/8 (66.7)

**I.D.:** 1 1/4 (31.8) One End

**Height:** 7 5/16 (185.7)

**I.Gskt:** [1] Included

**F. Gskt:** G247

## BT287-3

### High Efficiency Hydraulic Spin-on



**Notes:** Can be used with OB1313, OB1314, OB1315, OB1316 bases (requires optional G286-C gasket).

**Fits:** Agco Combines

**Replaces:** Gresen K23020; Zinga SE3

**Thread:** 1 1/2 -16

**O.D.:** 5 1/16 (128.6)

**Height:** 7 (177.8)

**F. Gskt:** G369-B (Blue Striped)

**O. Gskt:** G286-C, G369-V, G372, G447, G483, G704, G710

## PT290

### Hydraulic Element



**Fits:** Allis Chalmers Equipment

**Replaces:** Marvel 5602065125

**O.D.:** 2 5/8 (66.7)

**I.D.:** 1 1/4 (31.8) One End

**Height:** 7 5/16 (185.7)

**F. Gskt:** G247

**O-Ring:** [1] Attached

## PT288-HD

### Hydraulic Element



**Fits:** Case Loaders, Optional Equipment; Link-Belt Backhoes

**Replaces:** Case D35995; Ford D3NN-F882-A; John Deere AT45811; Link-Belt 20P14

**O.D.:** 4 1/2 (114.3)

**I.D.:** 2 7/32 (56.4)

**Height:** 7 7/16 (188.9)

**I.Gskt:** [2] Included

**O. Gskt:** G307, G397

**Related To:** PT550-10 (Double-Length Version)

## BT292

### Full-Flow Lube Spin-on



**Contains:** Anti-Drainback Valve  
30 PSID By-Pass Valve

**Fits:** Atlas Copco Compressors; Blaw-Knox, Bomag, Caterpillar, Claas, Demag, Deutz, Ditch Witch, Dynapac, Fendt, Hanomag, Komatsu, Liebherr, New Holland, Nissan, Poclain, Vermeer Equipment

**Replaces:** Atlas Copco 9712540103; Deutz 150157510

**Thread:** 1 -12

**O.D.:** 3 11/16 (93.7)

**Height:** 5 3/8 (136.5)

**I.Gskt:** G381-A

## PT288-HD10

### Hydraulic Element



**Fits:** Ford Loaders; John Deere Equipment

**Replaces:** Case D35995; Ford D3NN-F882-A; John Deere AT45811; Link-Belt 20P14

**O.D.:** 4 1/2 (114.3)

**I.D.:** 2 7/32 (56.4)

**Height:** 7 7/16 (188.9)

**I.Gskt:** [2] Included

**O. Gskt:** G307, G397

**Related To:** PT550-10 (Double-Length Version)

## P294

### Full-Flow Lube Element



**Contains:** Reinforced Centertube

**Fits:** M.A.N., Mercedes-Benz, R.V.I. Buses, Engines, Trucks

**Replaces:** Mercedes-Benz 4031840025

**O.D.:** 4 25/32 (121.4)

**I.D.:** 17/32 (13.5) & 2 5/32 (54.8)

**Height:** 10 13/32 (264.3)

**F. Gskt:** [3] Metal Washers

**O-Ring:** [1] Included

**End Seals:** [1] Attached

**Grommets:** [2] Attached

## PT289

### Hydraulic Element



**Fits:** Austin-Western, Case Equipment

**Replaces:** Case D43567, D75831

**O.D.:** 2 5/8 (66.7)

**I.D.:** 1 1/4 (31.8) One End

**Height:** 7 5/16 (185.7)

**I.Gskt:** [1] Included

**F. Gskt:** G247

## B295

### Full-Flow Lube Spin-on



**Contains:** Anti-Drainback Valve

**Fits:** Mercedes-Benz, Nissan, Toyota Automotive; Ford, Hitachi, International Equipment; Komatsu, Nissan Lift Trucks

**Replaces:** GMC 25011623; Nissan 15209-J1800; Toyota 15601-22010

**Thread:** 3/4 -16

**O.D.:** 3 1/32 (77.0)

**Height:** 5 27/32 (148.4)

**I.Gskt:** [1] Included

**Related To:** B143 (Short Version)

Measurements Are Shown In Inches And (Millimeters)

**WARNING:** These products can expose you to chemicals, including Diisononyl Phthalate, Carbon black extracts, Nickel, 1,3 Butadiene, Ethylene Oxide, Epichlorohydrin, which are known to the State of California to cause cancer, and Bisphenol, Ethylene Glycol, Ethylene Oxide, 1,3 Butadiene, Epichlorohydrin, which are known to the State of California to cause birth defects or other reproductive harm.

**B296** By-Pass Lube Spin-on  
**Contains:** Flow Control Orifice  
**Fits:** Clark Lift Trucks; Ingersoll-Rand Compressors  
**Replaces:** Clark 906540  
**Thread:** 5/8 -18  
**O.D.:** 3 11/16 (93.7)  
**Height:** 3 7/8 (98.4)  
**I.Gskt:** G381-A



**PT298-10** Transmission Element  
**Fits:** Gomaco Paving Equipment  
**Replaces:** Marvel 676366-7110  
**O.D.:** 4 1/2 (114.3)  
**I.D.:** 2 1/4 (57.2)  
**Height:** 7 3/8 (187.3)  
**I.Gskt:** [2] Included



**B299** High Performance Full-Flow Lube Spin-on  
**Contains:** Anti-Drainback Valve Standpipe  
**Fits:** Case, International Equipment  
**Replaces:** International 1808896-C1  
**Thread:** 1 -12  
**O.D.:** 3 11/16 (93.7)  
**Height:** 7 5/32 (181.8)  
**I.Gskt:** G401  
**Related To:** BT261 (Standard Version)



**T300-M** Vac-Cel By-Pass Lube Spin-on with Mason Jar Screw Neck  
**Fits:** Allis Chalmers, Case, Clark, Hyster, Kohler, Massey Ferguson, New Holland, Oliver Equipment  
**Replaces:** Allis Chalmers 70240912; Case A36136; Clark 872790; Hyster 28714; Kohler 270197; Massey Ferguson 835652-M91; White TO11663  
**Thread:** 2 3/4 -4  
**O.D.:** 3 17/32 (89.7)  
**Height:** 4 27/32 (123.0)  
**F. Gskt:** [1] Included



**301** DAHL Fuel Element  
**Notes:** 4 Micron Absolute  
**Fits:** DAHL 300 Series Fuel Filter/Water Separator Units  
**O.D.:** 6 1/16 (154.0)  
**I.D.:** 1 15/32 (37.3) & 3 1/4 (82.6)  
**Height:** 9 11/16 (246.1)  
**A. Gskt:** [1] Included  
**F. Gskt:** 200-15A  
**O-Ring:** [1] Attached



**301-30** DAHL Fuel Element  
**Notes:** 9 Micron Nominal (40 Absolute)  
**Fits:** DAHL 300 Series Fuel Filter/Water Separator Units  
**O.D.:** 6 1/16 (154.0)  
**I.D.:** 1 15/32 (37.3) & 3 1/4 (82.6)  
**Height:** 9 11/16 (246.1)  
**A. Gskt:** [1] Included  
**F. Gskt:** 200-15A  
**O-Ring:** [1] Attached



**301-CS** DAHL Fuel Element with Water Absorbing Media  
**Contains:** Water Absorbent Media  
**Fits:** DAHL 300 Series Fuel Filter/Water Separator Units  
**O.D.:** 6 1/16 (154.0)  
**I.D.:** 1 15/32 (37.3) & 3 1/4 (82.6)  
**Height:** 9 11/16 (246.1)  
**A. Gskt:** [1] Included  
**F. Gskt:** 200-15A  
**O-Ring:** [1] Attached



**301-MPG** Maximum Performance Glass DAHL Fuel Element  
**Fits:** DAHL 300 Series Fuel Filter/Water Separator Units  
**O.D.:** 6 1/16 (154.0)  
**I.D.:** 1 15/32 (37.3) & 3 1/4 (82.6)  
**Height:** 9 11/16 (246.1)  
**A. Gskt:** [1] Included  
**F. Gskt:** 200-15A  
**O-Ring:** [1] Attached



**301-W** DAHL Fuel Element  
**Notes:** 3 Micron Nominal (9 Absolute)  
**Fits:** DAHL 300 Series Fuel Filter/Water Separator Units  
**O.D.:** 6 1/16 (154.0)  
**I.D.:** 1 15/32 (37.3) & 3 1/4 (82.6)  
**Height:** 9 11/16 (246.1)  
**A. Gskt:** [1] Included  
**F. Gskt:** 200-15A  
**O-Ring:** [1] Attached



**B301** Lube Spin-on  
**Contains:** 8 PSID By-Pass Valve  
**Fits:** Subaru Automotive  
**Replaces:** Subaru 15208-AA021  
**Thread:** M20 x 1.5  
**O.D.:** 3 (76.2)  
**Height:** 2 27/32 (72.2)  
**I.Gskt:** [1] Included



**PT302** By-Pass Lube Spin-on with Mason Jar Screw Neck  
**Fits:** Oliver, White Equipment  
**Replaces:** Oliver 100126ASA; White 1LA5507  
**Thread:** 2 3/4 -4  
**O.D.:** 3 7/8 (98.4)  
**Height:** 6 3/8 (161.9)  
**F. Gskt:** [1] Included



**T303-M** Vac-Cel By-Pass Lube Spin-on with Mason Jar Screw Neck  
**Fits:** Allis Chalmers Engines; Joy Compressors; Oliver Equipment  
**Replaces:** Allis Chalmers 8009129; Joy 202317; Oliver 100929ASA  
**Thread:** 2 3/4 -4  
**O.D.:** 3 7/8 (98.4)  
**Height:** 6 13/32 (162.7)  
**F. Gskt:** [1] Included



Measurements Are Shown In Inches And (Millimeters)

**WARNING:** These products can expose you to chemicals, including Diisononyl Phthalate, Carbon black extracts, Nickel, 1,3 Butadiene, Ethylene Oxide, Epichlorohydrin, which are known to the State of California to cause cancer, and Bisphenol, Ethylene Glycol, Ethylene Oxide, 1,3 Butadiene, Epichlorohydrin, which are known to the State of California to cause birth defects or other reproductive harm.



**PT304** By-Pass Lube Spin-on with Mason Jar Screw Neck



**Fits:** Kohler, Link-Belt, Oliver Equipment; Waukesha Engines  
**Replaces:** Oliver 250046, 100125ASA; Waukesha 119390A, K5507  
**Thread:** 2 3/4 -4  
**O.D.:** 3 7/8 (98.4)  
**Height:** 7 5/8 (193.7)  
**F. Gskt:** [1] Included

**PF311** Fuel Element



**Fits:** Daewoo, Hitachi Equipment; Hino, Isuzu Trucks; Kawasaki Loaders  
**Replaces:** Isuzu 9-88511-191-1  
**O.D.:** 2 7/8 (73.0)  
**I.D.:** 9/16 (14.3)  
**Height:** 4 11/32 (110.3)  
**F. Gskt:** ES1036, [2] Included  
**Grommets:** [2] Attached

**BT305** Hydraulic Spin-on



**Fits:** Caterpillar Equipment  
**Replaces:** Caterpillar 93-7521  
**Thread:** 1 1/8 -16  
**O.D.:** 3 11/16 (93.7)  
**Height:** 7 1/8 (181.0)  
**A. Gskt:** G381-A

**PF312** Primary Fuel Element



**Fits:** Allis Chalmers, Fiat-Allis, New Holland Equipment; Iveco Trucks  
**Replaces:** Allis Chalmers 4964323; Fiat 1902096; Iveco 1902096  
**O.D.:** 3 23/32 (94.5)  
**I.D.:** 1/2 (12.7) & 1 1/32 (26.2)  
**Height:** 7 17/32 (191.3)  
**F. Gskt:** G480  
**End Seals:** [1] Attached  
**Grommets:** [1] Attached

**B307** Full-Flow Lube or Hydraulic Spin-on



**Contains:** Anti-Drainback Valve  
 8 PSID By-Pass Valve  
**Fits:** R.V.I. Trucks  
**Replaces:** Renault 5000791145  
**Thread:** M20 x 1.5  
**O.D.:** 3 (76.2)  
**Height:** 2 7/8 (73.0)  
**I.Gskt:** G449-B

**PF313** Fuel Element



**Fits:** Isuzu Engines, Trucks  
**Replaces:** Isuzu 5-87810-050-0  
**O.D.:** 2 7/8 (73.0)  
**I.D.:** 9/16 (14.3)  
**Height:** 3 5/16 (84.1)  
**F. Gskt:** [1] Included  
**Grommets:** [2] Attached

**T308-M** Vac-Cel By-Pass Lube Spin-on with Mason Jar Screw Neck



**Fits:** Bobcat, Case, Ditch Witch, Gehl, John Deere, New Holland, Vermeer Equipment; Wisconsin Engines  
**Replaces:** Wisconsin RV40  
**Thread:** 2 3/4 -5 1/2  
**O.D.:** 3 17/32 (89.7)  
**Height:** 4 27/32 (123.0)  
**F. Gskt:** [1] Included

**PF314** Fuel Element



**Fits:** Ford Light-Duty Trucks, Vans  
**Replaces:** Ford E6TZ-9365-A  
**O.D.:** 2 3/4 (69.9)  
**I.D.:** 9/16 (14.3) One End  
**Height:** 1 1/2 (38.1)  
**F. Gskt:** [1] Included  
**Grommets:** [1] Attached

**B309** High Performance Full-Flow Lube Spin-on



**Fits:** Case, International Equipment  
**Replaces:** International 1811953-C1  
**Thread:** 1 -12  
**O.D.:** 4 1/4 (108.0)  
**Height:** 7 3/8 (187.3)  
**I.Gskt:** G401

**PF316** Fuel/Water Separator Element with Bail Handle



**Fits:** Caterpillar, Cummins, Detroit Diesel, M.A.N. Engines; Grove Cranes  
**Replaces:** Caterpillar 8N0205; Cummins 256559  
**O.D.:** 5 27/32 (148.4)  
**I.D.:** 31/32 (24.6)  
**Height:** 8 3/4 (222.3)  
**A. Gskt:** [1] Attached  
**F. Gskt:** ES1036  
**O-Ring:** [1] Included  
**Grommets:** [2] Attached

**BT310** Full-Flow Lube Spin-on



**Contains:** Anti-Drainback Valve  
 2 PSID By-Pass Valve  
**Fits:** Yale Equipment  
**Replaces:** Yale 1500176-00  
**Thread:** M20 x 1.5  
**O.D.:** 3 (76.2)  
**Height:** 3 17/32 (89.7)  
**I.Gskt:** G449-B

**PT317-MPG** Maximum Performance Glass Hydraulic Element



**Fits:** Allison Transmissions  
**Replaces:** GMC 23018850  
**O.D.:** 3 3/32 (78.6)  
**I.D.:** 1 11/16 (42.9) One End  
**Height:** 12 7/8 (327.0)  
**O-Ring:** [1] Attached

Measurements Are Shown In Inches And (Millimeters)

**WARNING:** These products can expose you to chemicals, including Diisononyl Phthalate, Carbon black extracts, Nickel, 1,3 Butadiene, Ethylene Oxide, Epichlorohydrin, which are known to the State of California to cause cancer, and Bisphenol, Ethylene Glycol, Ethylene Oxide, 1,3 Butadiene, Epichlorohydrin, which are known to the State of California to cause birth defects or other reproductive harm.

**PT318-MPG** Maximum Performance Glass Hydraulic Element



**Fits:** Allison Transmissions  
**Replaces:** GMC 23018851  
**O.D.:** 3 3/32 (78.6)  
**I.D.:** 1 11/16 (42.9) One End  
**Height:** 12 7/8 (327.0)  
**O-Ring:** [1] Attached

**PT319-MPG** Maximum Performance Glass Hydraulic Element



**Fits:** Allison Transmissions  
**Replaces:** GMC 23018852  
**O.D.:** 3 25/32 (96.0)  
**I.D.:** 2 3/16 (55.6) One End  
**Height:** 16 13/16 (427.0)

**PT320-MPG** Maximum Performance Glass Hydraulic Element



**Fits:** Allison Transmissions  
**Replaces:** GMC 23018853  
**O.D.:** 3 25/32 (96.0)  
**I.D.:** 2 3/16 (55.6) One End  
**Height:** 16 13/16 (427.0)  
**O-Ring:** [1] Attached

**BD324** Dual-Flow Lube Spin-on



**Fits:** Agco, Case, Fiat-Allis, Grove, Ingersoll-Rand, Komatsu, Link-Belt Equipment  
**Replaces:** Case J919562  
**Thread:** 2 1/4 -12  
**O.D.:** 4 21/32 (118.3)  
**Height:** 9 5/8 (244.5)  
**I.Gskt:** G293-B  
**Related To:** BD103 (Long Version)

**BD325** Dual-Flow Lube Spin-on



**Contains:** 35 PSID By-Pass Valve  
**Fits:** Allis Chalmers, Fiat-Allis, New Holland Equipment; Iveco Buses, Trucks  
**Replaces:** Iveco 1903715  
**Thread:** M30 x 2.0  
**O.D.:** 4 1/4 (108.0)  
**Height:** 8 7/16 (214.3)  
**I.Gskt:** [1] Included

**B326** Lube Spin-on



**Contains:** Anti-Drainback Valve  
**Fits:** Volvo Loaders  
**Replaces:** Volvo 4804406-9  
**Thread:** 7/8 -16  
**O.D.:** 4 1/4 (108.0)  
**Height:** 7 3/8 (187.3)  
**I.Gskt:** G401

**B329** Lube Spin-on



**Contains:** Anti-Drainback Valve  
 20 PSID By-Pass Valve  
**Fits:** Chrysler, Ford, Mazda Automotive, Light-Duty Trucks, Vans  
**Replaces:** Ford F1AZ-6731-A  
**Thread:** M22 x 1.5  
**O.D.:** 3 11/16 (93.7)  
**Height:** 3 7/8 (98.4)  
**I.Gskt:** G381-A

**BF330** Fuel Spin-on



**Fits:** Cummins, Komatsu Engines, Equipment  
**Replaces:** Komatsu 6136-71-6120  
**Thread:** 3/4 -16  
**O.D.:** 3 1/32 (77.0)  
**Height:** 5 7/8 (149.2)  
**I.Gskt:** G449-B

**PF332** Fuel Element



**Fits:** Hitachi Equipment; Isuzu, Yanmar Engines  
**Replaces:** Hitachi 4514801  
**O.D.:** 3 19/32 (91.3)  
**I.D.:** 9/16 (14.3)  
**Height:** 5 1/2 (139.7)  
**F. Gskt:** [2] Included  
**Grommets:** [2] Attached

**B333** Full-Flow Lube Spin-on



**Fits:** Engines originally equipped with the BD103, which have since added an optional remote mount by-pass filter such as the Baldwin B7577 or BC110 centrifuge filter.  
**Thread:** 2 1/4 -12  
**O.D.:** 4 21/32 (118.3)  
**Height:** 11 13/32 (289.7)  
**I.Gskt:** G293-B

**BT334** Hydraulic or Lube Spin-on



**Fits:** Case, Hyundai, J.C. Bamford, Link-Belt, Volvo Equipment  
**Replaces:** Link-Belt KNJ0288  
**Thread:** 1 1/8 -16  
**O.D.:** 3 11/16 (93.7)  
**Height:** 5 3/8 (136.5)  
**I.Gskt:** G381-A

**B336** Lube Spin-on



**Contains:** Anti-Drainback Valve  
 14 PSID By-Pass Valve  
 Standpipe  
**Fits:** Ford, New Holland, Versatile Tractors; Timberjack Equipment  
**Replaces:** Ford E8NN-6714-BA  
**Thread:** 3/4 -16  
**O.D.:** 3 11/16 (93.7)  
**Height:** 5 3/8 (136.5)  
**I.Gskt:** G381-A

Measurements Are Shown In Inches And (Millimeters)

**WARNING:** These products can expose you to chemicals, including Diisononyl Phthalate, Carbon black extracts, Nickel, 1,3 Butadiene, Ethylene Oxide, Epichlorohydrin, which are known to the State of California to cause cancer, and Bisphenol, Ethylene Glycol, Ethylene Oxide, 1,3 Butadiene, Epichlorohydrin, which are known to the State of California to cause birth defects or other reproductive harm.

**BT337** By-Pass Lube Spin-on  
**Fits:** Isuzu Engines; Link-Belt Equipment  
**Replaces:** Isuzu 1-13240-123-0  
**Thread:** M20 x 1.5  
**O.D.:** 4 1/4 (108.0)  
**Height:** 5 27/32 (148.4)  
**I.Gskt:** [1] Included



**BT343** Full-Flow Lube Spin-on  
**Contains:** Anti-Drainback Valve  
**18-20 PSID By-Pass Valve**  
**Fits:** Ford Equipment  
**Replaces:** Ford D8NN-6714-DA  
**Thread:** 1 1/8 -16  
**O.D.:** 5 3/8 (136.5)  
**Height:** 6 1/32 (153.2)  
**I.Gskt:** [1] Included



**BT338** By-Pass Lube Spin-on  
**Contains:** Integral Post Seal  
**Fits:** Caterpillar, Kobelco, MDI-Yutani Excavators; Mitsubishi Engines  
**Replaces:** Mitsubishi ME014838  
**Thread:** M18 x 1.5  
**O.D.:** 3 11/16 (93.7)  
**Height:** 3 7/8 (98.4)  
**I.Gskt:** G324-A



**BT344-S** Hydraulic Spin-on  
**Contains:** 20 PSID By-Pass Valve  
**Fits:** Caterpillar, Daewoo Equipment  
**Replaces:** Caterpillar 4T7948  
**Thread:** 13/16 -16  
**O.D.:** 3 23/32 (94.5)  
**Height:** 4 15/32 (113.5)  
**I.Gskt:** G401



**BT339** Full-Flow Lube Spin-on  
**Notes:** BT7349 may be used in place of BT339. Do NOT substitute BT339 for BT7349.  
**Fits:** Ag-Chem, Case, Champion, Dresser, Dynapac, Fiat-Allis, Grove, Ingersoll-Rand, J.C. Bamford, Komatsu, Timberjack, Vermeer, White Equipment; Case, Cummins, DAF Engines  
**Replaces:** Case J903264; Consolidated Diesel 3903264; Cummins 3914395  
**Thread:** 1 -16  
**O.D.:** 3 11/16 (93.7)  
**Height:** 7 1/8 (181.0)  
**I.Gskt:** G381-A  
**Related To:** BT427 (Short Version)



**BT345 KIT** Set of 2 Hydraulic Spin-ons  
**Contains:** 20 PSID By-Pass Valve  
**Fits:** Case Tractors  
**Replaces:** Case A161846 KIT  
**Thread:** 1 1/2 -16  
**O.D.:** 5 1/16 (128.6)  
**Height:** 10 25/32 (273.8)  
**F. Gskt:** [2] G483 (One Per Filter)  
**O. Gskt:** G286-C, G369-V, G447, G483, G704, G710



**BT340** By-Pass Lube Spin-on  
**Fits:** Allis Chalmers Equipment  
**Replaces:** Allis Chalmers 4036791  
**Thread:** 1 1/8 -16  
**O.D.:** 4 1/4 (108.0)  
**Height:** 10 7/16 (265.1)  
**I.Gskt:** [1] Included



**BT346** Hydraulic Spin-on  
**Contains:** 8 PSID By-Pass Valve  
**Fits:** CMI Equipment; Mahindra Tractors  
**Replaces:** Racine 493308  
**Thread:** 1 -12  
**O.D.:** 3 11/16 (93.7)  
**Height:** 3 1/4 (82.6)  
**I.Gskt:** G381-A



**BT341** By-Pass Lube Spin-on  
**Notes:** Can be used with OB1305 base.  
**Contains:** Flow Control Orifice  
**Fits:** Bobcat, Case, Grove, International, Vermeer Equipment; Wisconsin Engines  
**Replaces:** Wisconsin RV52  
**Thread:** 5/8 -18  
**O.D.:** 3 11/16 (93.7)  
**Height:** 4 3/8 (111.1)  
**I.Gskt:** G381-A  
**Related To:** B50, B164 (Long Versions)



**BT347** Full-Flow Lube Spin-on  
**Contains:** Anti-Drainback Valve  
**30 PSID By-Pass Valve**  
**Standpipe**  
**Fits:** Allis Chalmers, Antonio Carraro, Fiat, Ford, Hesston, New Holland Equipment; Iveco Engines, Trucks  
**Replaces:** Fiat 1909101  
**Thread:** 3/4 -16  
**O.D.:** 4 1/4 (108.0)  
**Height:** 7 11/32 (186.5)  
**I.Gskt:** G381-A



**BT342** Hydraulic Spin-on  
**Contains:** 20 PSID By-Pass Valve  
**Fits:** Ford Tractors  
**Replaces:** Ford C7NN-F933-A  
**Thread:** 1 -12  
**O.D.:** 3 11/16 (93.7)  
**Height:** 6 5/8 (168.3)  
**I.Gskt:** G381-A



**BT348** Full-Flow Lube Spin-on  
**Contains:** Anti-Drainback Valve  
**30 PSID By-Pass Valve**  
**Standpipe**  
**Fits:** Allis Chalmers, Caterpillar, Fiat, Ford, Hesston, New Holland Equipment  
**Replaces:** Fiat 1909102  
**Thread:** 3/4 -16  
**O.D.:** 4 1/4 (108.0)  
**Height:** 5 13/16 (147.6)  
**I.Gskt:** G381-A



Measurements Are Shown In Inches And (Millimeters)

**WARNING:** These products can expose you to chemicals, including Diisononyl Phthalate, Carbon black extracts, Nickel, 1,3 Butadiene, Ethylene Oxide, Epichlorohydrin, which are known to the State of California to cause cancer, and Bisphenol, Ethylene Glycol, Ethylene Oxide, 1,3 Butadiene, Epichlorohydrin, which are known to the State of California to cause birth defects or other reproductive harm.

**BT349** Full-Flow Lube Spin-on  
**Contains:** Anti-Drainback Valve  
 20 PSID By-Pass Valve  
**Fits:** Allis Chalmers, Astra, Case Equipment; Fiat, Iveco Engines  
**Replaces:** Fiat 1909137  
**Thread:** 1 -12  
**O.D.:** 4 1/4 (108.0)  
**Height:** 9 1/8 (231.8)  
**I.Gskt:** G401



**BT354** Transmission Spin-on  
**Contains:** 8 PSID By-Pass Valve  
**Fits:** Ford, Massey Ferguson, New Holland Equipment  
**Replaces:** Ford D8NN-B486-EA  
**Thread:** 1 1/8 -16  
**O.D.:** 3 11/16 (93.7)  
**Height:** 5 3/8 (136.5)  
**I.Gskt:** G381-A



**BT350** Hydraulic Spin-on  
**Fits:** Allis Chalmers Equipment  
**Replaces:** Allis Chalmers 267600  
**Thread:** 13/16 -16  
**O.D.:** 4 1/4 (108.0)  
**Height:** 7 11/32 (186.5)  
**I.Gskt:** G381-A



**BT355** Full-Flow Lube Spin-on  
**Contains:** 20 PSID By-Pass Valve  
**Fits:** Ford, New Holland Equipment  
**Replaces:** Ford D8NN-6714-AA  
**Thread:** 1 -12  
**O.D.:** 4 1/4 (108.0)  
**Height:** 5 7/8 (149.2)  
**I.Gskt:** G401



**BT351** Hydraulic Spin-on  
**Notes:** Can be used with OB1313, OB1314, OB1315 and OB1316 bases.  
**Fits:** Aveling-Barford, Braud, J.C. Bamford, Liebherr, New Holland Equipment  
**Replaces:** J.C. Bamford 32/901401  
**Thread:** 1 1/4 -11 BSP-PL  
**O.D.:** 5 (127.0)  
**Height:** 7 3/32 (180.2)  
**I.Gskt:** [1] Included  
**Related To:** BT8450 (with Anti-Drainback Valve, 15 PSID By-Pass Valve)



**P356** Lube Element  
**Fits:** Bedford Buses, Trucks; Hymac, J.C. Bamford Equipment; Perkins Engines  
**Replaces:** Perkins 26560076  
**O.D.:** 3 21/32 (92.9)  
**I.D.:** 1 11/32 (34.1)  
**Height:** 6 (152.4)  
**F. Gskt:** [1] Included  
**End Seals:** [2] Attached



**BT351-MPG** Maximum Performance Glass Hydraulic Spin-on  
**Replaces:** U.C.C. UCMXR9550; Fleetguard HF7980; Woodgate WGUC9550  
**Thread:** 1 1/4 -11 BSP-PL  
**O.D.:** 5 (127.0)  
**Height:** 7 (177.8)  
**I.Gskt:** [1] Included



**BT357** Hydraulic Spin-on  
**Contains:** 2 PSID By-Pass Valve  
**Fits:** International, New Holland Equipment  
**Replaces:** International 404886-R1, 404886-R91  
**Thread:** 1 -12  
**O.D.:** 3 11/16 (93.7)  
**Height:** 3 1/4 (82.6)  
**I.Gskt:** G381-A



**P352** Lube Element  
**Fits:** ERF Trucks; Leyland Buses, Trucks  
**Replaces:** Leyland GL21779  
**O.D.:** 3 3/16 (81.0)  
**I.D.:** 7/16 (11.1)  
**Height:** 8 9/16 (217.5)  
**Spring:** [1] Attached  
**Grommets:** [1] Attached



**BT359** Transmission Spin-on  
**Fits:** Allison Transmissions  
**Replaces:** GMC 25010335  
**Thread:** 1 5/16 -12  
**O.D.:** 4 5/8 (117.5)  
**Height:** 10 9/32 (261.1)  
**I.Gskt:** [1] Included



**BT353** Full-Flow Lube Spin-on  
**Contains:** Anti-Drainback Valve  
 20 PSID By-Pass Valve  
**Fits:** Allis Chalmers, Massey Ferguson Tractors  
**Replaces:** Allis Chalmers 20797690-8; Massey Ferguson 3280185-M91  
**Thread:** 3/4 -16  
**O.D.:** 3 1/32 (77.0)  
**Height:** 5 27/32 (148.4)  
**I.Gskt:** [1] Included



**B360** Full-Flow Lube Spin-on  
**Contains:** Anti-Drainback Valve  
**Fits:** Mercruiser Marine Engines  
**Replaces:** Quicksilver 14957  
**Thread:** 13/16 -16  
**O.D.:** 3 13/16 (96.8)  
**Height:** 4 3/8 (111.1)  
**I.Gskt:** [1] Included



Measurements Are Shown In Inches And (Millimeters)

**WARNING:** These products can expose you to chemicals, including Diisononyl Phthalate, Carbon black extracts, Nickel, 1,3 Butadiene, Ethylene Oxide, Epichlorohydrin, which are known to the State of California to cause cancer, and Bisphenol, Ethylene Glycol, Ethylene Oxide, 1,3 Butadiene, Epichlorohydrin, which are known to the State of California to cause birth defects or other reproductive harm.

**BT361** Hydraulic Spin-on  
**Contains:** 8 PSID By-Pass Valve  
**Fits:** Cessna Hydraulic Systems; Owatonna Equipment  
**Replaces:** Cessna Fluid Power 62200G  
**Thread:** 7/8 -14  
**O.D.:** 3 11/16 (93.7)  
**Height:** 5 3/8 (136.5)  
**I.Gskt:** G381-A



**BT367-S** Air Breather Spin-on  
**Fits:** Liebherr, McNeilus, Vermeer Equipment  
**Replaces:** Schroeder ABF3/10 (without Adapter)  
**Thread:** 1 1/8 -16  
**O.D.:** 3 11/16 (93.7)  
**Height:** 3 7/32 (81.8)  
**O. Gskt:** ES3028  
**Related To:** B7024 (with Adapter)



**BT364** Full-Flow Lube or Hydraulic Spin-on  
**Contains:** 20 PSID By-Pass Valve  
**Fits:** Ag-Chem, Caterpillar, CMI, Dynapac, Grove, New Holland, White Equipment; Caterpillar Engines; Ford, GMC, International, Mack, WhiteGMC Trucks  
**Replaces:** Caterpillar 9N5680, 1R0734  
**Thread:** 1 -12  
**O.D.:** 3 11/16 (93.7)  
**Height:** 5 3/8 (136.5)  
**I.Gskt:** G381-A



**BT368** Air Breather Spin-on  
**Fits:** Allis Chalmers Optional Equipment  
**Replaces:** Allis Chalmers 4835378  
**Thread:** 3/4 -14 BSP-PL  
**O.D.:** 3 11/16 (93.7)  
**Height:** 3 7/32 (81.8)



**BT365** Lube or Hydraulic Spin-on  
**Fits:** Case, Hydra-Mac, Perkins Engines, Equipment; Thermo King Refrigeration Units  
**Replaces:** Hydra-Mac 3408-305; Thermo King 11-3712  
**Thread:** 1 -12  
**O.D.:** 3 11/16 (93.7)  
**Height:** 7 3/16 (182.6)  
**I.Gskt:** G401



**B369** Air Breather Spin-on  
**Replaces:** Mack 2MD3131  
**Thread:** 3/4 -20  
**O.D.:** 3 11/16 (93.7)  
**Height:** 4 3/8 (111.1)  
**I.Gskt:** G381-A



**BT365-10** Lube or Hydraulic Spin-on  
**Fits:** Hydra-Mac Equipment  
**Replaces:** Hydra-Mac 1309-108  
**Thread:** 1 -12  
**O.D.:** 3 11/16 (93.7)  
**Height:** 7 3/16 (182.6)  
**I.Gskt:** G401



**PT370** Hydraulic Element  
**Fits:** Massey Ferguson Industrial Equipment  
**Replaces:** Massey Ferguson 1430492-M92  
**O.D.:** 6 25/32 (172.2)  
**I.D.:** 4 7/32 (107.2)  
**Height:** 15 5/16 (388.9)  
**A. Gskt:** [2] Attached



**BT366-10** Hydraulic Spin-on  
**Fits:** Bedford, J.C. Bamford, New Holland, Thwaites Equipment; U.C.C. Hydraulic Systems  
**Replaces:** U.C.C. UC-MS1518-4-10  
**Thread:** 3/4 -14 BSP-PL  
**O.D.:** 3 11/16 (93.7)  
**Height:** 5 13/32 (137.3)  
**I.Gskt:** G401



**BT371-10** Hydraulic or Transmission Spin-on  
**Fits:** Case, International, John Deere, New Holland Equipment  
**Replaces:** Hyster 27749012; John Deere AE37594; Pall HC9540SUJ4H  
**Thread:** 1 1/2 -16  
**O.D.:** 3 13/16 (96.8)  
**Height:** 5 13/32 (137.3)  
**I.Gskt:** [1] Included  
**Related To:** BT372-10, BT372-MPG (Long Versions)



**BT366-MPG** Maximum Performance Glass Hydraulic Spin-on  
**Replaces:** U.C.C. UCMXR8550; Fleetguard HF7983; Woodgate WGUC8550  
**Thread:** 3/4 -14 BSP-PL  
**O.D.:** 3 25/32 (96.0)  
**Height:** 5 23/32 (145.3)  
**I.Gskt:** [1] Included



**BT371-5** Hydraulic Spin-on  
**Notes:** OBSOLETE. Availability Limited to Dealer Stock.  
**Replaces:** Woodgate WGH6606  
**Thread:** 1 1/2 -16  
**O.D.:** 3 25/32 (96.0)  
**Height:** 5 23/32 (145.3)  
**I.Gskt:** [1] Included



**BT367** Air Breather Spin-on  
**Fits:** Steiger Equipment  
**Replaces:** Steiger 18-1633  
**Thread:** 1 1/8 -16  
**O.D.:** 3 11/16 (93.7)  
**Height:** 4 11/32 (110.3)  
**O. Gskt:** ES3028















**BT371-MPG** Maximum Performance Glass Hydraulic or Transmission Spin-on  
**Fits:** Case, International, John Deere, New Holland Equipment  
**Replaces:** Pall HC7400SUT4H  
**Thread:** 1 1/2 -16  
**O.D.:** 3 13/16 (96.8)  
**Height:** 5 13/32 (137.3)  
**I.Gskt:** [1] Included  
**Related To:** BT372-10, BT372-MPG (Long Versions)



Measurements Are Shown In Inches And (Millimeters)

**WARNING:** These products can expose you to chemicals, including Diisononyl Phthalate, Carbon black extracts, Nickel, 1,3 Butadiene, Ethylene Oxide, Epichlorohydrin, which are known to the State of California to cause cancer, and Bisphenol, Ethylene Glycol, Ethylene Oxide, 1,3 Butadiene, Epichlorohydrin, which are known to the State of California to cause birth defects or other reproductive harm.

<p><b>BT372-10</b></p> 	<p>Hydraulic or Transmission Spin-on  <b>Fits:</b> Caterpillar, Dresser, Galion, Gehl, International Equipment  <b>Replaces:</b> Caterpillar 3T8642; Galion 149661; International 562871-C91; John Deere AT63557  <b>Thread:</b> 1 1/2 -16  <b>O.D.:</b> 3 11/16 (93.7)  <b>Height:</b> 8 1/16 (204.8)  <b>I.Gskt:</b> [1] Included  <b>Related To:</b> BT371-10, BT371-MPG (Short Versions)</p>	<p><b>PT377</b></p> 	<p>Hydraulic Element  <b>Fits:</b> Michigan Fluid Power Systems  <b>Replaces:</b> Michigan Fluid Power C69  <b>O.D.:</b> 3 1/32 (77.0)  <b>I.D.:</b> 1 1/4 (31.8) One End  <b>Height:</b> 6 15/32 (164.3)  <b>F. Gskt:</b> G458  <b>End Seals:</b> [1] Attached</p>
<p><b>BT372-MPG</b></p> 	<p>Maximum Performance Glass Hydraulic or Transmission Spin-on  <b>Fits:</b> International, John Deere, Mustang, Owatonna Equipment  <b>Replaces:</b> John Deere AT69852, AT73307  <b>Thread:</b> 1 1/2 -16  <b>O.D.:</b> 3 11/16 (93.7)  <b>Height:</b> 8 1/16 (204.8)  <b>I.Gskt:</b> [1] Included  <b>Related To:</b> BT371-10, BT371-MPG (Short Versions)</p>	<p><b>PT377-10</b></p> 	<p>Hydraulic Element  <b>Fits:</b> Michigan Fluid Power Systems  <b>Replaces:</b> Michigan Fluid Power C68  <b>O.D.:</b> 3 1/32 (77.0)  <b>I.D.:</b> 1 1/4 (31.8) One End  <b>Height:</b> 6 15/32 (164.3)  <b>F. Gskt:</b> G458  <b>End Seals:</b> [1] Attached</p>
<p><b>PT373</b></p> 	<p>Hydraulic Element  <b>Fits:</b> Massey Ferguson Equipment  <b>Replaces:</b> Massey Ferguson 516069-M94  <b>O.D.:</b> 4 1/2 (114.3)  <b>I.D.:</b> 1 29/32 (48.4)  <b>Height:</b> 7 (177.8)  <b>F. Gskt:</b> [2] ES1092, G236-A, [1] Included  <b>O. Gskt:</b> ES3029</p>	<p><b>B378</b></p> 	<p>Full-Flow Lube Spin-on  <b>Fits:</b> Gardner Denver, Ingersoll-Rand, LeRoi Compressors; Volvo, Yanmar Equipment  <b>Replaces:</b> Ingersoll-Rand 35296920  <b>Thread:</b> 1 1/4 -12  <b>O.D.:</b> 3 11/16 (93.7)  <b>Height:</b> 8 23/32 (221.5)  <b>I.Gskt:</b> G381-A  <b>O. Gskt:</b> G401</p>
<p><b>PT374</b></p> 	<p>Hydraulic Element  <b>Contains:</b> 20 PSID By-Pass Valve  <b>Fits:</b> Allison Transmissions; Versatile Equipment  <b>Replaces:</b> Versatile SW6502  <b>O.D.:</b> 3 15/32 (88.1)  <b>I.D.:</b> 1 11/32 (34.1) One End  <b>Height:</b> 4 23/32 (119.9)  <b>F. Gskt:</b> [2] Included</p>	<p><b>B378-10</b></p> 	<p>Full-Flow Lube or Hydraulic Spin-on  <b>Fits:</b> Gardner Denver, Ingersoll-Rand, LeRoi Compressors; Volvo, Yanmar Equipment  <b>Replaces:</b> Gardner Denver 2109412; Ingersoll-Rand 39138433  <b>Thread:</b> 1 1/4 -12  <b>O.D.:</b> 3 11/16 (93.7)  <b>Height:</b> 8 23/32 (221.5)  <b>I.Gskt:</b> G381-A  <b>O. Gskt:</b> G401</p>
<p><b>PT375</b></p> 	<p>Hydraulic Element  <b>Contains:</b> 20 PSID By-Pass Valve  <b>Fits:</b> New Holland, Versatile Equipment  <b>Replaces:</b> Versatile 36169  <b>O.D.:</b> 3 15/32 (88.1)  <b>I.D.:</b> 1 11/32 (34.1) One End  <b>Height:</b> 9 3/16 (233.4)  <b>F. Gskt:</b> [2] Included</p>	<p><b>PT379 KIT</b></p> 	<p>Set of 2 Hydraulic Elements  <b>Fits:</b> International Tractors  <b>Replaces:</b> International 133736-C1  <b>O.D.:</b> 5 (127.0)  <b>I.D.:</b> 2 15/16 (74.6)  <b>Height:</b> 3 (76.2)  <b>F. Gskt:</b> G368</p>
<p><b>PT376</b></p> 	<p>Transmission Element  <b>Contains:</b> Reinforced Centertube  <b>Fits:</b> Dresser, Hough, International Equipment  <b>Replaces:</b> International 1140079-C1  <b>O.D.:</b> 4 1/2 (114.3)  <b>I.D.:</b> 2 1/4 (57.2)  <b>Height:</b> 9 3/16 (233.4)  <b>O. Gskt:</b> G211  <b>End Seals:</b> [2] Attached</p>	<p><b>PT380 KIT</b></p> 	<p>Set of 2 Hydraulic Elements  <b>Contains:</b> Reinforced Centertube  <b>Fits:</b> Case Tractors  <b>Replaces:</b> Case A46403 Kit  <b>O.D.:</b> 4 1/2 (114.3)  <b>I.D.:</b> 2 9/32 (57.9)  <b>Height:</b> 7 1/8 (181.0)  <b>F. Gskt:</b> [1] Included for Stacked Elements  <b>O. Gskt:</b> G305 for Side-By-Side Elements  <b>End Seals:</b> [2] Attached to Each Element</p>

Measurements Are Shown In Inches And (Millimeters)

**WARNING:** These products can expose you to chemicals, including Diisononyl Phthalate, Carbon black extracts, Nickel, 1,3 Butadiene, Ethylene Oxide, Epichlorohydrin, which are known to the State of California to cause cancer, and Bisphenol, Ethylene Glycol, Ethylene Oxide, 1,3 Butadiene, Epichlorohydrin, which are known to the State of California to cause birth defects or other reproductive harm.

**PT381**

Hydraulic Element



**Notes:** Inside-Out Flow Direction  
**Fits:** Caterpillar Lift Trucks  
**Replaces:** Towmotor 349804  
**O.D.:** 4 1/2 (114.3)  
**I.D.:** 2 1/4 (57.2)  
**Height:** 9 (228.6)

**PT382**

Hydraulic Element



**Replaces:** Tennant 51885  
**O.D.:** 2 7/8 (73.0)  
**I.D.:** 1 5/16 (33.3) One End  
**Height:** 4 3/8 (111.1)  
**End Seals:** [1] Attached

**PT383**

Hydraulic Element



**Fits:** John Deere Equipment  
**Replaces:** John Deere AH91274  
**O.D.:** 5 (127.0)  
**I.D.:** 2 13/16 (71.4)  
**Height:** 6 3/16 (157.2)  
**O. Gskt:** G263  
**End Seals:** [2] Attached

**PT385**

Transmission Element with Gaskets



**Fits:** ACDelco Housings; Allis Chalmers, Case, Euclid, Steiger, Terex, Volvo, WABCO Equipment  
**Replaces:** Euclid 6439400; Fiat 70197121; Volvo 66175068; WABCO PB5038  
**O.D.:** 4 7/16 (112.7)  
**I.D.:** 1 1/2 (38.1)  
**Height:** 9 1/16 (230.2)  
**F. Gskt:** ES1071, G115-MSB, G211  
**End Seals:** [2] Attached  
**Related To:** P20-HD (Lube Version)

**PT385-E**

Transmission Element without Gaskets



**Fits:** Allis Chalmers, Case, Galion, Grove, Hough, Letourneau, Link-Belt, Michigan, Terex, WABCO Equipment  
**Replaces:** Euclid 6439400; Fiat 70197121; Volvo 66175068; WABCO PB5038  
**O.D.:** 4 7/16 (112.7)  
**I.D.:** 1 1/2 (38.1)  
**Height:** 9 1/16 (230.2)  
**End Seals:** [2] Attached  
**Related To:** P20-HD (Lube Version)

**PT386**

Hydraulic Element



**Contains:** Reinforced Centertube  
**Fits:** Hough Equipment  
**Replaces:** International 927535-C91  
**O.D.:** 4 1/2 (114.3)  
**I.D.:** 1 25/32 (45.2)  
**Height:** 11 (279.4)  
**F. Gskt:** [3] Included  
**End Seals:** [2] Attached

**BT387**

Hydraulic Spin-on



**Notes:** Can be used with OB1313, OB1314, OB1315, OB1316 bases.  
**Fits:** Gresen Hydraulic Systems; Sellick, Toro Equipment  
**Replaces:** Gresen 7521001  
**Thread:** 1 1/2 -16  
**O.D.:** 5 1/32 (127.8)  
**Height:** 7 (177.8)  
**F. Gskt:** G286-C  
**O. Gskt:** G369-B, G369-V, G372, G447, G483, G704, G710  
**Related To:** BT388, BT388-10 (Long Versions)

**BT387-10**

Hydraulic Spin-on



**Notes:** Can be used with OB1313, OB1314, OB1315, OB1316 bases.  
**Fits:** Gresen Hydraulic Systems; Sellick, Toro Equipment  
**Replaces:** Cross 1A9251; Gresen 7521001  
**Thread:** 1 1/2 -16  
**O.D.:** 5 1/32 (127.8)  
**Height:** 7 (177.8)  
**F. Gskt:** G286-C  
**O. Gskt:** G369-B, G369-V, G372, G447, G483, G704, G710  
**Related To:** BT388, BT388-10 (Long Versions)

**BT388**

Hydraulic Spin-on



**Notes:** Can be used with OB1313, OB1314, OB1315, OB1316 bases.  
**Fits:** Champion, Rexworks Equipment; Cross Hydraulic Systems  
**Thread:** 1 1/2 -16  
**O.D.:** 5 1/32 (127.8)  
**Height:** 10 3/4 (273.1)  
**F. Gskt:** G286-C  
**O. Gskt:** G369-B, G369-V, G372, G447, G483, G704, G710  
**Related To:** BT387, BT387-10 (Short Versions)

**BT388-10**

Hydraulic Spin-on



**Notes:** Can be used with OB1313, OB1314, OB1315, OB1316 bases.  
**Fits:** Cross Hydraulic Systems  
**Replaces:** Cross 1A9253  
**Thread:** 1 1/2 -16  
**O.D.:** 5 1/32 (127.8)  
**Height:** 10 3/4 (273.1)  
**F. Gskt:** G286-C  
**O. Gskt:** G369-B, G369-V, G372, G447, G483, G704, G710  
**Related To:** BT387, BT387-10 (Short Versions)

**BT389**

Hydraulic Spin-on



**Fits:** Bandit, Case, Koehring Equipment; Special AMBAC Base  
**Replaces:** Zinga LE10  
**Thread:** 1 1/2 -16  
**O.D.:** 5 1/16 (128.6)  
**Height:** 10 3/4 (273.1)  
**F. Gskt:** G372  
**O. Gskt:** G286-C, G369-B, G369-V, G372, G447, G483, G704, G710, G725

Measurements Are Shown In Inches And (Millimeters)

**WARNING:** These products can expose you to chemicals, including Diisononyl Phthalate, Carbon black extracts, Nickel, 1,3 Butadiene, Ethylene Oxide, Epichlorohydrin, which are known to the State of California to cause cancer, and Bisphenol, Ethylene Glycol, Ethylene Oxide, 1,3 Butadiene, Epichlorohydrin, which are known to the State of California to cause birth defects or other reproductive harm.

**BT389-10**

Hydraulic Spin-on



**Fits:** Bandit, Case, Koehring Equipment; Special AMBAC Base  
**Replaces:** Zinga LE10  
**Thread:** 1 1/2 -16  
**O.D.:** 5 1/16 (128.6)  
**Height:** 10 3/4 (273.1)  
**F. Gskt:** G369-B  
**O. Gskt:** G286-C, G369-B, G369-V, G372, G447, G483, G704, G710, G725

**PT394-15**

Hydraulic Element



**Replaces:** Ingersoll-Rand 39101704  
**O.D.:** 6 1/32 (153.2)  
**I.D.:** 1 23/32 (43.7)  
**Height:** 7 5/8 (193.7)  
**O. Gskt:** G193  
**End Seals:** [2] Attached  
**Related To:** P194 Series (Micron Difference)

**PT390-MPG**

Maximum Performance Glass Hydraulic Element



**Contains:** Reinforced Centertube  
**Fits:** John Deere Equipment  
**Replaces:** John Deere AR94510  
**O.D.:** 4 9/16 (115.9)  
**I.D.:** 2 7/32 (56.4)  
**Height:** 7 31/32 (202.4)  
**O. Gskt:** G397  
**End Seals:** [2] Attached

**BT395**

Hydraulic Spin-on



**Contains:** 20 PSID By-Pass Valve  
**Fits:** Dresser, International Equipment  
**Replaces:** International 709014-C1  
**Thread:** 7/8 -14  
**O.D.:** 3 11/16 (93.7)  
**Height:** 5 3/8 (136.5)  
**I.Gskt:** G381-A

**PT391-MPG**

Maximum Performance Glass Hydraulic Element



**Contains:** Reinforced Centertube  
**Fits:** John Deere Equipment  
**Replaces:** John Deere AR98098  
**O.D.:** 4 9/16 (115.9)  
**I.D.:** 2 7/32 (56.4)  
**Height:** 7 31/32 (202.4)  
**O. Gskt:** G397  
**End Seals:** [2] Attached

**PT396**

Hydraulic Element



**Contains:** Spring Reinforced Centertube  
**Fits:** Komatsu Equipment  
**Replaces:** Komatsu 101-60-15171  
**O.D.:** 2 9/16 (65.1)  
**I.D.:** 1 3/32 (27.8)  
**Height:** 5 5/8 (142.9)

**PT392**

Differential Element



**Fits:** Allis Chalmers Tractors  
**Replaces:** Allis Chalmers 270781  
**O.D.:** 5 (127.0)  
**I.D.:** 2 13/16 (71.4)  
**Height:** 6 1/8 (155.6)  
**F. Gskt:** [2] Included  
**End Seals:** [2] Attached

**PT397**

Hydraulic Element



**Fits:** Kobelco, Komatsu Equipment  
**Replaces:** Komatsu 195-60-16320  
**O.D.:** 5 29/32 (150.0)  
**I.D.:** 4 11/32 (110.3)  
**Height:** 11 13/16 (300.0)

**PT393**

Hydraulic Element



**Fits:** Allis Chalmers Tractors  
**Replaces:** Allis Chalmers 270782  
**O.D.:** 5 (127.0)  
**I.D.:** 2 15/16 (74.6)  
**Height:** 9 (228.6)  
**O-Ring:** [2] Included

**BT398**

Hydraulic Spin-on



**Fits:** Komatsu Equipment; Nissan Trucks  
**Replaces:** Komatsu 113-60-23160  
**Thread:** 1 1/8 -16  
**O.D.:** 4 1/4 (108.0)  
**Height:** 9 1/8 (231.8)  
**I.Gskt:** [1] Included

**PT394-5**

Hydraulic Element



**Replaces:** Ingersoll-Rand 39101704  
**O.D.:** 6 1/32 (153.2)  
**I.D.:** 1 23/32 (43.7)  
**Height:** 7 5/8 (193.7)  
**O. Gskt:** G193  
**End Seals:** [2] Attached  
**Related To:** P194 Series (Micron Difference)

**PT400**

Hydraulic Element



**Fits:** J.C. Bamford, Kobelco, Komatsu, Takeuchi Equipment  
**Replaces:** Komatsu 198-49-11440  
**O.D.:** 4 13/32 (111.9)  
**I.D.:** 2 3/4 (69.9)  
**Height:** 11 9/16 (293.7)

Measurements Are Shown In Inches And (Millimeters)

**WARNING:** These products can expose you to chemicals, including Diisononyl Phthalate, Carbon black extracts, Nickel, 1,3 Butadiene, Ethylene Oxide, Epichlorohydrin, which are known to the State of California to cause cancer, and Bisphenol, Ethylene Glycol, Ethylene Oxide, 1,3 Butadiene, Epichlorohydrin, which are known to the State of California to cause birth defects or other reproductive harm.



**PT401-MPG**



Maximum Performance Glass Hydraulic Element  
**Fits:** Case Dozers; Dresser Loggers, Pay Loaders; Hough Wheel Loaders  
**Replaces:** Case D83130; International 930654-C1  
**O.D.:** 4 1/2 (114.3)  
**I.D.:** 1 25/32 (45.2)  
**Height:** 9 1/8 (231.8)  
**O. Gskt:** G392  
**End Seals:** [2] Attached

**BT402**



Full-Flow Lube Spin-on  
**Contains:** 30 PSID By-Pass Valve  
**Replaces:** Mitsubishi 3254001600; Onan 1220774  
**Thread:** 1 1/8 -16  
**O.D.:** 4 1/4 (108.0)  
**Height:** 9 1/8 (231.8)  
**I.Gskt:** [1] Included

**B403**



Full-Flow Lube Spin-on  
**Contains:** Anti-Drainback Valve  
 50 PSID By-Pass Valve  
**Fits:** R.V.I., Volvo Buses, Trucks; Renault Engines  
**Replaces:** Renault 5000670670  
**Thread:** 1 -12  
**O.D.:** 3 11/16 (93.7)  
**Height:** 8 1/8 (206.4)  
**I.Gskt:** G381-A

**B404**



Full-Flow Lube Spin-on  
**Fits:** Hino Trucks  
**Replaces:** Hino 15607-1670  
**Thread:** 1 1/2 -12  
**O.D.:** 4 21/32 (118.3)  
**Height:** 6 1/4 (158.8)  
**I.Gskt:** G498-A

**JC405**



Cotton and Fiber By-Pass Lube Sock with Pull-Out Bail Handle  
**Fits:** Clark Lift Trucks; Dodge Trucks; Hercules Engines  
**Replaces:** Chrysler 1504092; Clark 955290  
**O.D.:** 4 (101.6)  
**I.D.:** 9/16 (14.3) & 1 5/16 (33.3)  
**Height:** 5 1/4 (133.4)  
**F. Gskt:** G127  
**End Seals:** [1] Attached

**CU406**



Cotton and Fiber By-Pass Lube Sock with Pull-Out Bail Handle  
**Fits:** ACF-Brill, Aero Coach, Beaver, Brockway, Duplex Buses; International, WhiteGMC Trucks; Allis Chalmers, Barber-Greene, Bucyrus-Erie, Clark, Grove, Hough, International, Link-Belt Equipment  
**Replaces:** ACF-Brill 275633; Beaver 70609H; Brockway 106704; International 649729-R93; White 1267529  
**O.D.:** 4 1/8 (104.8)  
**I.D.:** 9/16 (14.3) & 1 13/16 (46.0)  
**Height:** 5 1/2 (139.7)  
**F. Gskt:** [1] Included  
**O. Gskt:** G127  
**End Seals:** [1] Attached

**DF408**



Cotton and Fiber By-Pass Lube Sock with Pull-Out Bail Handle  
**Fits:** Oshkosh Trucks; Adams, Bucyrus-Erie, Euclid, Ingersoll-Rand, Schramm Equipment; Allis Chalmers, Waukesha Engines  
**Replaces:** Allis Chalmers 4041082; Bucyrus-Erie P70162; Euclid 9045063  
**O.D.:** 5 3/4 (146.0)  
**I.D.:** 7/8 (22.2) & 1 9/16 (39.7)  
**Height:** 10 (254.0)  
**F. Gskt:** G148  
**End Seals:** [1] Attached

**TC413-CPE5**



All Cotton Sock Element with Bail Handle  
**Notes:** Cotton sock for most non-acid fluids, flowing at moderate temperatures.  
**Contains:** Spring Reinforced Centertube  
**Replaces:** Peco FT318C5, FTE318C5  
**O.D.:** 3 (76.2)  
**I.D.:** 3/4 (19.0) & 1 11/16 (42.9)  
**Height:** 19 1/2 (495.3)

**V414-B**



Vac-Cel By-Pass Lube Sock  
**Fits:** Bowser-Briggs Housings  
**Replaces:** Bowser-Briggs A414 with A413 Holder  
**O.D.:** 6 3/16 (157.2)  
**I.D.:** 2 7/32 (56.4)  
**Height:** 15 1/2 (393.7)

**V414-FF**



Vac-Cel Dual-Stage Full-Flow Lube Sock  
**Fits:** Bowser-Briggs Housings  
**Replaces:** Bowser-Briggs A414 with A413 Holder  
**O.D.:** 6 3/16 (157.2)  
**I.D.:** 2 7/32 (56.4)  
**Height:** 15 1/2 (393.7)

**F415-B**



Special Vac-Cel Fuel Sock  
**Notes:** Use ONLY as a fuel filter on Bowser-Briggs, Commercial, Hilco, Nugent, Winslow applications.  
**O.D.:** 6 3/16 (157.2)  
**I.D.:** 2 13/32 (61.1)  
**Height:** 18 (457.2)

**P415-10**



Full-Flow Lube Element with Bail Handle  
**Replaces:** Commercial D4674  
**O.D.:** 6 (152.4)  
**I.D.:** 2 1/8 (54.0)  
**Height:** 18 (457.2)  
**O. Gskt:** G309-B  
**End Seals:** [2] Attached

**P415-10A**



Full-Flow Lube Element with Bail Handle  
**Replaces:** Large Center Hole Bowser-Briggs BP718  
**O.D.:** 6 (152.4)  
**I.D.:** 2 5/8 (66.7)  
**Height:** 18 (457.2)  
**O. Gskt:** G309-B  
**End Seals:** [2] Attached

Measurements Are Shown In Inches And (Millimeters)

**WARNING:** These products can expose you to chemicals, including Diisononyl Phthalate, Carbon black extracts, Nickel, 1,3 Butadiene, Ethylene Oxide, Epichlorohydrin, which are known to the State of California to cause cancer, and Bisphenol, Ethylene Glycol, Ethylene Oxide, 1,3 Butadiene, Epichlorohydrin, which are known to the State of California to cause birth defects or other reproductive harm.

**P415-25** Full-Flow Lube Element with Bail Handle  
**Replaces:** Commercial D4674  
**O.D.:** 6 (152.4)  
**I.D.:** 2 1/8 (54.0)  
**Height:** 18 (457.2)  
**O. Gskt:** G309-B  
**End Seals:** [2] Attached



**P415-25A** Full-Flow Lube Element with Bail Handle  
**Replaces:** Large Center Hole Bowser-Briggs BP718  
**O.D.:** 6 (152.4)  
**I.D.:** 2 5/8 (66.7)  
**Height:** 18 (457.2)  
**O. Gskt:** G309-B  
**End Seals:** [2] Attached



**P415-5** Full-Flow Lube Element with Bail Handle  
**Replaces:** Commercial D4674  
**O.D.:** 6 (152.4)  
**I.D.:** 2 1/8 (54.0)  
**Height:** 18 (457.2)  
**O. Gskt:** G309-B  
**End Seals:** [2] Attached



**P415-5A** Full-Flow Lube Element with Bail Handle  
**Replaces:** Large Center Hole Bowser-Briggs BP718  
**O.D.:** 6 (152.4)  
**I.D.:** 2 5/8 (66.7)  
**Height:** 18 (457.2)  
**O. Gskt:** G309-B  
**End Seals:** [2] Attached



**P415-5AN** Full-Flow Lube Element with Neoprene End Seals and Bail Handle  
**Replaces:** Bowser-Briggs BP718  
**O.D.:** 6 (152.4)  
**I.D.:** 2 5/8 (66.7)  
**Height:** 17 3/4 (450.9)  
**O. Gskt:** G309-B  
**End Seals:** [2] Attached



**P415-GM** GM Version Full-Flow Lube Element with Bail Handle  
**Contains:** Spring Reinforced Centertube  
**Replaces:** Large Center Hole Bowser-Briggs BP718  
**O.D.:** 6 17/32 (165.9)  
**I.D.:** 2 17/32 (64.3)  
**Height:** 18 (457.2)  
**O. Gskt:** G309-B  
**End Seals:** [2] Attached



**V415-B** Vac-Cel By-Pass Lube Sock  
**Fits:** Bowser-Briggs, Commercial, Hilco, Winslow Housings  
**O.D.:** 6 3/16 (157.2)  
**I.D.:** 2 13/32 (61.1)  
**Height:** 18 (457.2)



**V415-FF** Vac-Cel Dual-Stage Full-Flow Lube Sock  
**Fits:** Bowser-Briggs, Commercial, Hilco, Winslow Housings  
**Replaces:** Allis Chalmers 4369208, 4369208-8; Bowser-Briggs A418; Fiat 74369208; General Motors 6438006; White A014040  
**O.D.:** 6 3/16 (157.2)  
**I.D.:** 2 13/32 (61.1)  
**Height:** 18 (457.2)



**PT416** Hydraulic Element  
**Fits:** Oliver Tractors; White Equipment  
**Replaces:** Oliver 165442-A  
**O.D.:** 1 31/32 (50.0)  
**I.D.:** 29/32 (23.0) One End  
**Height:** 5 9/16 (141.3)  
**F. Gskt:** G247  
**End Seals:** [1] Attached



**PT418** Hydraulic Element  
**Notes:** Inside-Out Flow Direction  
**Fits:** International Equipment  
**Replaces:** International 666220-C1  
**O.D.:** 6 1/2 (165.1)  
**I.D.:** 5 1/2 (139.7)  
**Height:** 15 3/32 (383.4)



**BT420** Transmission Spin-on  
**Contains:** Anti-Drainback Valve  
**8 PSID By-Pass Valve**  
**Fits:** Hyster Lift Trucks  
**Replaces:** Hyster 309112  
**Thread:** 3/4 -16  
**O.D.:** 3 11/16 (93.7)  
**Height:** 4 15/32 (113.5)  
**I.Gskt:** G401



**B421** Lube Spin-on  
**Contains:** Anti-Drainback Valve  
**14 PSID By-Pass Valve**  
**Fits:** Isuzu Automotive  
**Replaces:** Isuzu 8-94430-411-1  
**Thread:** M20 x 1.5  
**O.D.:** 3 (76.2)  
**Height:** 2 27/32 (72.2)  
**I.Gskt:** [1] Included





**S423** Resin Ribbon Hydraulic Breather Element  
**Notes:** Element is also in PT181 KIT.  
**Fits:** Bantam Carriers, Cranes; Case Loaders, Tractors; LeRoi Compressors; McCoy Dump Boxes  
**Replaces:** Bendix R32-20; Case A10059; Hyster 78122  
**O.D.:** 2 (50.8)  
**I.D.:** 1 5/8 (41.3)  
**Height:** 1 1/4 (31.8)





Measurements Are Shown In Inches And (Millimeters)

**WARNING:** These products can expose you to chemicals, including Diisononyl Phthalate, Carbon black extracts, Nickel, 1,3 Butadiene, Ethylene Oxide, Epichlorohydrin, which are known to the State of California to cause cancer, and Bisphenol, Ethylene Glycol, Ethylene Oxide, 1,3 Butadiene, Epichlorohydrin, which are known to the State of California to cause birth defects or other reproductive harm.

**BT424** Hydraulic Spin-on  
  
**Contains:** 10 PSID By-Pass Valve By-Pass Screen  
**Fits:** Ford Tractors  
**Replaces:** Ford D8NN-F914-BA, D8NN-F914-CA, D8NN-M903-AA, D8NN-M903-FA  
**Thread:** 1 1/2 -16  
**O.D.:** 5 1/32 (127.8)  
**Height:** 6 31/32 (177.0)  
**F. Gskt:** G369-B  
**O. Gskt:** G369-V, G704, G710

**PT431** All Fluids Element  
  
**Fits:** Nugent Optional Filter Housings  
**Replaces:** Nugent 1555D1R  
**O.D.:** 4 31/32 (126.2)  
**I.D.:** 1 9/16 (39.7)  
**Height:** 9 1/16 (230.2)  
**F. Gskt:** G164-A  
**O-Ring:** [2] Included  
**Related To:** PT490 (Double-Length Version)

**BT425** Hydraulic Spin-on  
  
**Contains:** 9 PSID By-Pass Valve By-Pass Screen  
**Fits:** Ford Tractors  
**Replaces:** Ford D8NN-M903-EA, D8NN-F914-AA  
**Thread:** 1 1/2 -16  
**O.D.:** 5 1/16 (128.6)  
**Height:** 8 15/16 (227.0)  
**F. Gskt:** [1] Included

**PT433** Hydraulic Element  
  
**Fits:** John Deere Equipment  
**Replaces:** John Deere AT79080  
**O.D.:** 4 1/2 (114.3)  
**I.D.:** 1 25/32 (45.2)  
**Height:** 7 1/8 (181.0)  
**O. Gskt:** G236-A, G385, G386  
**End Seals:** [2] Attached

**PT426** Hydraulic Element  
  
**Fits:** John Deere Equipment  
**Replaces:** Marvel M3401-5110  
**O.D.:** 4 1/2 (114.3)  
**I.D.:** 2 1/4 (57.2) One End  
**Height:** 7 1/4 (184.2)  
**I.Gskt:** [1] Included  
**F. Gskt:** G397

**PT434** Hydraulic Element  
  
**Notes:** NOT interchangeable with PT477 or PT492.  
**Fits:** Case, Hough, International Equipment  
**Replaces:** Case D71352; International 185531-H1  
**O.D.:** 2 5/8 (66.7)  
**I.D.:** 1 7/32 (31.0) One End  
**Height:** 4 13/16 (122.2)  
**F. Gskt:** G247  
**End Seals:** [1] Attached

**BT427** Full-Flow Lube Spin-on  
  
**Fits:** Agco, Bandit, Bomag, Case, Dresser, Dynapac, Grove, Komatsu, MacDon, Vermeer Equipment; Cummins Engines  
**Replaces:** Cummins 3903224  
**Thread:** 1 -16  
**O.D.:** 3 11/16 (93.7)  
**Height:** 5 3/8 (136.5)  
**I.Gskt:** [1] Included  
**Related To:** BT339 (Long Version)

**PT434-10** Hydraulic Element  
  
**Notes:** NOT interchangeable with PT477 or PT492.  
**Fits:** Case, Hough, International Equipment  
**Replaces:** Case D71352; International 185531-H1  
**O.D.:** 2 5/8 (66.7)  
**I.D.:** 1 7/32 (31.0) One End  
**Height:** 4 13/16 (122.2)  
**F. Gskt:** G247  
**End Seals:** [1] Attached

**V429-B** Vac-Cel Standard-Flow Lube Sock  
  
**Replaces:** Michiana 12900, 17800, 17900  
**O.D.:** 6 3/16 (157.2)  
**I.D.:** 2 1/2 (63.5)  
**Height:** 29 1/4 (742.9)

**PT435** Hydraulic Element  
  
**Notes:** Inside-Out Flow Direction  
**Contains:** [1] Metal Bushing  
**Fits:** Case, International Equipment  
**Replaces:** Case G13113  
**O.D.:** 2 5/16 (58.7)  
**I.D.:** 1 11/32 (34.1)  
**Height:** 6 (152.4)  
**O. Gskt:** G173-C

**V429-FF** Vac-Cel Dual-Stage Fast-Flow Lube Sock  
  
**Replaces:** Michiana 12900, 17800, 17900  
**O.D.:** 6 3/16 (157.2)  
**I.D.:** 2 1/2 (63.5)  
**Height:** 29 1/4 (742.9)

**PT436** Hydraulic or Lube Element  
  
**Contains:** Reinforced Centertube  
**Fits:** Bowser-Briggs Optional Filter Housings; Allis Chalmers, Fiat-Allis, International Equipment  
**Replaces:** Allis Chalmers 6407803; Bowser-Briggs BP509-2; International 172595-H1  
**O.D.:** 4 1/2 (114.3)  
**I.D.:** 1 25/32 (45.2)  
**Height:** 9 1/16 (230.2)  
**F. Gskt:** [3] Included  
**End Seals:** [2] Attached

**PT430-FF** All Fluids Element  
  
**Fits:** Bowser-Briggs Optional Filter Housings; Hill Diesel Engines  
**Replaces:** Bowser-Briggs BP518-1; Commercial 100257  
**O.D.:** 4 1/2 (114.3)  
**I.D.:** 1 25/32 (45.2)  
**Height:** 18 1/8 (460.4)  
**End Seals:** [2] Attached

Measurements Are Shown In Inches And (Millimeters)

**WARNING:** These products can expose you to chemicals, including Diisononyl Phthalate, Carbon black extracts, Nickel, 1,3 Butadiene, Ethylene Oxide, Epichlorohydrin, which are known to the State of California to cause cancer, and Bisphenol, Ethylene Glycol, Ethylene Oxide, 1,3 Butadiene, Epichlorohydrin, which are known to the State of California to cause birth defects or other reproductive harm.

**BT437**

Hydraulic Element



**Fits:** Cessna Hydraulic Systems; New Holland, Oliver, White Equipment  
**Replaces:** Cessna 62300S; New Holland 86546065; White 197650AS  
**O.D.:** 3 15/16 (100.0)  
**I.D.:** 1/2 (12.7) & 2 1/4 (57.2)  
**Height:** 5 1/16 (128.6)  
**F. Gskt:** ES1036, G310  
**End Seals:** [1] Attached  
**Grommets:** [1] Attached

**BT443**

Hydraulic Spin-on



**Contains:** Integral Post Seal  
**Fits:** Massey Ferguson Wheel Tractors  
**Replaces:** Massey Ferguson 3322234-M2  
**Thread:** 1 1/4 -12  
**O.D.:** 4 21/32 (118.3)  
**Height:** 8 3/32 (205.6)  
**I.Gskt:** [1] Included

**BT438**

Hydraulic Spin-on



**Fits:** Case, Hesston Equipment  
**Replaces:** Hesston 8040461  
**Thread:** 13/16 -16  
**O.D.:** 3 23/32 (94.5)  
**Height:** 5 15/32 (138.9)  
**I.Gskt:** G401

**PT445-MPG**

Maximum Performance Glass Hydraulic Element



**Fits:** John Deere Equipment  
**Replaces:** John Deere AT67960  
**O.D.:** 2 7/8 (73.0)  
**I.D.:** 1 1/8 (28.6)  
**Height:** 7 1/2 (190.5)  
**End Seals:** [2] Attached

**PT439**

Hydraulic Element



**Contains:** Reinforced Centertube  
**Fits:** Joy Compressors  
**Replaces:** Joy 1139451; Parker 862F  
**O.D.:** 2 3/4 (69.9)  
**I.D.:** 1 1/4 (31.8)  
**Height:** 8 5/8 (219.1)  
**F. Gskt:** [2] Included

**P446**

Power Steering Element



**Notes:** Inside-Out Flow Direction  
**Fits:** Case, Caterpillar Equipment; International Trucks  
**Replaces:** Case A18061; Caterpillar 32-1504; Ford C5TZ-3C602-A; International 974707-R92  
**O.D.:** 2 15/32 (62.7)  
**I.D.:** 1 3/32 (27.8)  
**Height:** 3 9/16 (90.5)  
**F. Gskt:** G296

**BT440**

Full-Flow Lube Spin-on



**Fits:** Allis Chalmers Engines, Equipment  
**Replaces:** Allis Chalmers 4037047  
**Thread:** 1 -16  
**O.D.:** 4 1/4 (108.0)  
**Height:** 7 11/32 (186.5)  
**I.Gskt:** G381-A  
**Related To:** BT564 (Short Version)

**B447**

Full-Flow Lube Spin-on



**Contains:** Anti-Drainback Valve  
 20 PSID By-Pass Valve  
**Fits:** Volvo Marine Engines  
**Replaces:** Volvo 471034, 471034-9  
**Thread:** 1 -12  
**O.D.:** 4 1/4 (108.0)  
**Height:** 4 11/16 (119.1)  
**I.Gskt:** G381-A

**PT441**

Hydraulic Element



**Contains:** Spring Reinforced Centertube  
**Fits:** Fai, Komatsu Equipment  
**Replaces:** Komatsu 130-60-48210  
**O.D.:** 2 9/16 (65.1)  
**I.D.:** 1 3/32 (27.8)  
**Height:** 10 29/32 (277.0)

**P450**

Power Steering Element



**Fits:** International Balers, Combines  
**Replaces:** International 276259-C91  
**O.D.:** 2 15/32 (62.7)  
**I.D.:** 1 1/16 (27.0)  
**Height:** 1 9/16 (39.7)  
**O. Gskt:** G296

**PT442-MPG**

Maximum Performance Glass Hydraulic Element



**Notes:** Inside-Out Flow Direction  
**Fits:** John Deere Equipment  
**Replaces:** John Deere AT78414  
**O.D.:** 4 17/32 (115.1)  
**I.D.:** 2 1/4 (57.2)  
**Height:** 8 3/32 (205.6)  
**End Seals:** [2] Attached

**S451**

Resin Ribbon Power Steering Element



**Fits:** FWD Corporation, Patrick Equipment; Mack Trucks  
**Replaces:** FWD Corporation 7D213984; Mack 63SL12; Vickers 213984  
**O.D.:** 2 1/4 (57.2)  
**I.D.:** 1 7/8 (47.6)  
**Height:** 1 13/16 (46.0)

Measurements Are Shown In Inches And (Millimeters)

**WARNING:** These products can expose you to chemicals, including Diisononyl Phthalate, Carbon black extracts, Nickel, 1,3 Butadiene, Ethylene Oxide, Epichlorohydrin, which are known to the State of California to cause cancer, and Bisphenol, Ethylene Glycol, Ethylene Oxide, 1,3 Butadiene, Epichlorohydrin, which are known to the State of California to cause birth defects or other reproductive harm.

**BT452**

Hydraulic Spin-on



**Contains:** 20 PSID By-Pass Valve  
**Fits:** Daewoo Lift Trucks; Case, International, Steiger Equipment  
**Replaces:** Daewoo D141099; International 70203-C1  
**Thread:** 1 -12  
**O.D.:** 3 11/16 (93.7)  
**Height:** 5 13/32 (137.3)  
**I.Gskt:** G401  
**Related To:** BT839 (without By-Pass Valve)

**PT461**

Transmission Element



**Contains:** 20 PSID By-Pass Valve  
**Fits:** Allis Chalmers, Clark, International, Minneapolis-Moline, Oliver Equipment  
**Replaces:** Allis Chalmers 1137201, 1137201-8; Clark 891105; International 392532-R91  
**O.D.:** 1 11/16 (42.9)  
**I.D.:** 1 1/32 (26.2) One End  
**Height:** 4 3/16 (106.4)  
**F. Gskt:** [1] Included  
**End Seals:** [1] Attached

**P454**

Power Steering Element



**Notes:** Inside-Out Flow Direction  
**Fits:** Ford, Peterbilt, White/GMC Trucks; International-Harvester Planters  
**Replaces:** Ford D0HZ-3C602-B; International 507809-C91  
**O.D.:** 2 15/32 (62.7)  
**I.D.:** 1 1/16 (27.0) One End  
**Height:** 3 9/16 (90.5)

**PT462**

Hydraulic Element



**Fits:** Ford Equipment  
**Replaces:** Ford C5NN-F882-B, C7NN-F882-A  
**O.D.:** 6 (152.4)  
 Bottom 6 1/2 (165.1)  
**I.D.:** 2 13/32 (61.1) & 3 1/2 (88.9)  
**Height:** 6 (152.4)  
**End Seals:** [1] Attached

**S455**

Resin Ribbon Fuel Element or Hydraulic Breather



**Fits:** Austin-Western, Bendix, Case, Franklin, Raygo Equipment  
**Replaces:** Bendix 479135; Case A40314  
**O.D.:** 1 1/2 (38.1)  
**I.D.:** 1 1/8 (28.6)  
**Height:** 1 3/8 (34.9)

**PT463**

Hydraulic Element



**Fits:** Nicholson Equipment with Purolator Hydraulic Filters  
**Replaces:** Purolator 7500501  
**O.D.:** 2 1/32 (51.6)  
**I.D.:** 1 7/32 (31.0) One End  
**Height:** 7 1/16 (179.4)  
**O-Ring:** [1] Attached

**S456**

Resin Ribbon Hydraulic Breather Element



**Fits:** Link-Belt Equipment  
**Replaces:** Link-Belt 1PX316  
**O.D.:** 2 (50.8)  
**I.D.:** 1 5/8 (41.3)  
**Height:** 5 (127.0)

**PT466**

Hydraulic Element



**Contains:** Reinforced Centertube  
**Fits:** Hitachi, Isuzu, TCM Equipment  
**Replaces:** Hitachi 4505384  
**O.D.:** 4 1/4 (108.0)  
**I.D.:** 9/16 (14.3) & 1 15/16 (49.2)  
**Height:** 9 15/16 (252.4)  
**A. Gskt:** [1] Attached  
**F. Gskt:** [2] Included  
**Grommets:** [1] Attached

**PT457-MPG**

Maximum Performance Glass Hydraulic Element



**Contains:** Reinforced Centertube  
**Fits:** John Deere Tractors  
**Replaces:** John Deere AR99661  
**O.D.:** 5 1/2 (139.7)  
**I.D.:** 2 5/8 (66.7)  
**Height:** 7 7/8 (200.0)  
**O-Ring:** [2] Attached

**PT467-MPG**

Maximum Performance Glass Hydraulic Element



**Fits:** White Equipment; Agco Tractors  
**Replaces:** White 30-3343111B  
**O.D.:** 4 1/2 (114.3)  
**I.D.:** 1 7/8 (47.6)  
**Height:** 6 31/32 (177.0)  
**F. Gskt:** [4] Included

**PT459**

Hydraulic Element



**Fits:** Cessna Hydraulic Systems; Massey Ferguson, New Holland Equipment  
**Replaces:** Cessna 20416-43; Massey Ferguson 1023057-M1; New Holland 167495  
**O.D.:** 2 3/32 (53.2)  
**I.D.:** 23/32 (18.3)  
**Height:** 2 1/16 (52.4)

**PT468-MPG**













Maximum Performance Glass Hydraulic Element



**Fits:** Massey Ferguson Equipment  
**Replaces:** Massey Ferguson 535040-M1  
**O.D.:** 3 3/4 (95.3)  
**I.D.:** 1 1/8 (28.6) One End  
**Height:** 5 (127.0)

Measurements Are Shown In Inches And (Millimeters)

**WARNING:** These products can expose you to chemicals, including Diisononyl Phthalate, Carbon black extracts, Nickel, 1,3 Butadiene, Ethylene Oxide, Epichlorohydrin, which are known to the State of California to cause cancer, and Bisphenol, Ethylene Glycol, Ethylene Oxide, 1,3 Butadiene, Epichlorohydrin, which are known to the State of California to cause birth defects or other reproductive harm.

<p><b>PT469</b></p>  <p>Hydraulic Element  <b>Fits:</b> Galion Equipment  <b>Replaces:</b> Galion D67373A  <b>O.D.:</b> 5 (127.0)  <b>I.D.:</b> 2 1/2 (63.5)  <b>Height:</b> 11 7/8 (301.6)  <b>End Seals:</b> [2] Attached</p>	<p><b>P476</b></p>  <p>Full-Flow Lube Element  <b>Fits:</b> GM Automotive, Engines, Trucks  <b>Replaces:</b> GMC 6437562  <b>O.D.:</b> 3 1/2 (88.9)  <b>I.D.:</b> 1 5/16 (33.3)  <b>Height:</b> 8 7/16 (214.3)  <b>F. Gskt:</b> G153</p>
<p><b>BT470</b></p>  <p>Hydraulic Spin-on  <b>Fits:</b> Fiat, Ford, Hesston, New Holland Equipment  <b>Replaces:</b> Fiat 1909130  <b>Thread:</b> 1 1/8 -16  <b>O.D.:</b> 4 1/4 (108.0)  <b>Height:</b> 7 3/8 (187.3)  <b>I.Gskt:</b> [1] Included</p>	<p><b>PT477</b></p>  <p>Hydraulic Element  <b>Notes:</b> NOT interchangeable with PT434, PT434-10 or PT492.  <b>Fits:</b> Case, Hough Equipment; Marvel Hydraulic Systems  <b>Replaces:</b> Case D51411; Marvel 529206-5125  <b>O.D.:</b> 2 5/8 (66.7)  <b>I.D.:</b> 1 7/32 (31.0) One End  <b>Height:</b> 4 13/16 (122.2)  <b>O-Ring:</b> [1] Attached</p>
<p><b>PT471</b></p>  <p>Hydraulic Element  <b>Notes:</b> Inside-Out Flow Direction  <b>Fits:</b> John Deere, Minneapolis-Moline Equipment  <b>Replaces:</b> John Deere AT45422  <b>O.D.:</b> 4 3/8 (111.1)  <b>I.D.:</b> 11/16 (17.5) &amp; 3 5/8 (92.1)  <b>Height:</b> 9 9/16 (242.9)  <b>End Seals:</b> [1] Attached</p>	<p><b>S479</b></p>  <p>Resin Ribbon Breather Element  <b>Notes:</b> OBSOLETE. Availability Limited to Dealer Stock.  <b>Fits:</b> LeRoi Compressors  <b>Replaces:</b> LeRoi 43-356  <b>O.D.:</b> 2 (50.8)  <b>I.D.:</b> 1 5/8 (41.3)  <b>Height:</b> 6 1/2 (165.1)</p>
<p><b>BT472</b></p>  <p>Full-Flow Lube Spin-on  <b>Contains:</b> Anti-Drainback Valve  20 PSID By-Pass Valve  <b>Fits:</b> Allis Chalmers, Fiat-Allis Equipment  <b>Replaces:</b> Fiat-Allis 4744707  <b>Thread:</b> M30 x 2.0  <b>O.D.:</b> 4 1/4 (108.0)  <b>Height:</b> 9 1/8 (231.8)  <b>I.Gskt:</b> [1] Included</p>	<p><b>PT480</b></p>  <p>Hydraulic Element  <b>Contains:</b> Reinforced Centertube  <b>Fits:</b> Allis Chalmers, Case, Caterpillar, Minneapolis-Moline, Nicholson Equipment  <b>Replaces:</b> Allis Chalmers 2460855; Case A20902  <b>O.D.:</b> 3 (76.2)  <b>I.D.:</b> 1 1/16 (27.0) One End  <b>Height:</b> 5 21/32 (143.7)  <b>O. Gskt:</b> G366  <b>Grommets:</b> [1] Attached</p>
<p><b>B474</b></p>  <p>Full-Flow Lube Spin-on  <b>Contains:</b> 8 PSID By-Pass Valve  <b>Replaces:</b> Quincy 110814  <b>Thread:</b> M16 x 1.5  <b>O.D.:</b> 3 (76.2)  <b>Height:</b> 3 17/32 (89.7)  <b>I.Gskt:</b> G449-B</p>	<p><b>PT480-10</b></p>  <p>Hydraulic Element  <b>Contains:</b> Reinforced Centertube  <b>Fits:</b> Allis Chalmers, Case, Caterpillar, Minneapolis-Moline, Nicholson Equipment  <b>Replaces:</b> Allis Chalmers 2460855; Case A20902  <b>O.D.:</b> 3 (76.2)  <b>I.D.:</b> 1 1/16 (27.0) One End  <b>Height:</b> 5 21/32 (143.7)  <b>O. Gskt:</b> G366  <b>Grommets:</b> [1] Attached</p>
<p><b>PT475</b></p>  <p>Power Steering Element  <b>Fits:</b> Dresser Industrial Equipment; Galion Rollers  <b>Replaces:</b> Galion D98524; GMC 6439020  <b>O.D.:</b> 4 1/2 (114.3)  <b>I.D.:</b> 1 23/32 (43.7)  <b>Height:</b> 8 15/16 (227.0)  <b>O. Gskt:</b> G252  <b>End Seals:</b> [2] Attached</p>	<p><b>PT480-MPG</b></p>  <p>Maximum Performance Glass Hydraulic Element  <b>Contains:</b> Reinforced Centertube  <b>Fits:</b> Allis Chalmers, Case, Caterpillar, Minneapolis-Moline, Nicholson Equipment  <b>Replaces:</b> Allis Chalmers 2460855; Case A20902  <b>O.D.:</b> 3 (76.2)  <b>I.D.:</b> 1 1/16 (27.0) One End  <b>Height:</b> 5 21/32 (143.7)  <b>O. Gskt:</b> G366  <b>Grommets:</b> [1] Attached</p>

Measurements Are Shown In Inches And (Millimeters)

**WARNING:** These products can expose you to chemicals, including Diisononyl Phthalate, Carbon black extracts, Nickel, 1,3 Butadiene, Ethylene Oxide, Epichlorohydrin, which are known to the State of California to cause cancer, and Bisphenol, Ethylene Glycol, Ethylene Oxide, 1,3 Butadiene, Epichlorohydrin, which are known to the State of California to cause birth defects or other reproductive harm.

**B481**

Full-Flow Lube Spin-on



**Contains:** 50 PSID By-Pass Valve  
**Replaces:** Worthington FLR412  
**Thread:** 3/4 -16  
**O.D.:** 3 11/16 (93.7)  
**Height:** 6 5/8 (168.3)  
**I.Gskt:** G381-A

**S489**

Felt Disk Turbocharger Lube Element



**Fits:** International, John Deere Equipment;  
M & W Gear Co. Supercharger  
**Replaces:** M & W Gear Co. 4E005  
**O.D.:** 3 1/4 (82.6)  
**I.D.:** 3/4 (19.0)  
**Height:** 4 11/16 (119.1)  
**F. Gskt:** G105, [2] Included

**PT483**

Hydraulic Element



**Fits:** Daewoo, Fiat, Hokuetsu, Komatsu  
Equipment  
**Replaces:** Komatsu 205-60-51430  
**O.D.:** 5 29/32 (150.0)  
**I.D.:** 4 11/32 (110.3)  
**Height:** 17 23/32 (450.1)

**PT490**

Hydraulic Element



**Fits:** Nugent Optional Filter Housings  
**Replaces:** Gardner Denver 5E14; Nugent  
1555D1S  
**O.D.:** 4 15/16 (125.4)  
**I.D.:** 1 17/32 (38.9)  
**Height:** 18 (457.2)  
**End Seals:** [2] Attached  
**Related To:** PT431 (Single-Length Version)

**S485**

Resin Ribbon Full-Flow Lube Element



**O.D.:** 1 1/2 (38.1)  
**I.D.:** 1 1/8 (28.6)  
**Height:** 3 1/2 (88.9)

**PT491**

Hydraulic Element



**Notes:** Inside-Out Flow Direction  
**Contains:** Reinforced Centertube  
**Fits:** Michigan Equipment  
**Replaces:** Clark 1530600  
**O.D.:** 6 (152.4)  
**I.D.:** 2 23/32 (69.1)  
**Height:** 18 (457.2)  
**O. Gskt:** G382  
**End Seals:** [1] Attached

**BT486**

Full-Flow Lube Spin-on



**Fits:** Ag-Chem, Bandit, John Deere Equipment  
**Replaces:** John Deere AR98329, AR101278  
**Thread:** 1 1/2 -12  
**O.D.:** 5 1/16 (128.6)  
**Height:** 6 31/32 (177.0)  
**F. Gskt:** [1] Included

**PT491-10**

Hydraulic Element



**Notes:** Inside-Out Flow Direction  
**Contains:** Reinforced Centertube  
**Fits:** Austin, Western, Clark, Michigan, V.M.E.,  
Volvo Equipment  
**Replaces:** Clark 1530600  
**O.D.:** 6 (152.4)  
**I.D.:** 2 23/32 (69.1)  
**Height:** 18 (457.2)  
**O. Gskt:** G382  
**End Seals:** [1] Attached

**PT487**

Hydraulic Element



**Contains:** Reinforced Centertube  
**Fits:** Allis Chalmers, Case, Fiat-Allis  
Equipment  
**Replaces:** Allis Chalmers 647256; Fiat  
70647256; GMC 25012559  
**O.D.:** 3 15/16 (100.0)  
**I.D.:** 1 5/8 (41.3)  
**Height:** 9 1/4 (235.0)  
**O. Gskt:** ES3012, G368

**PT492**

Hydraulic Element



**Notes:** NOT interchangeable with PT434,  
PT434-10 or PT477.  
**Replaces:** Marvel 629206-5110  
**O.D.:** 2 5/8 (66.7)  
**I.D.:** 1 7/32 (31.0)  
**Height:** 5 (127.0)  
**O-Ring:** [2] Attached

**B488**

Lube Spin-on



**Contains:** Anti-Drainback Valve  
20 PSID By-Pass Valve  
**Fits:** Daewoo, John Deere, Komatsu, Yanmar  
Equipment  
**Replaces:** John Deere M801209  
**Thread:** M20 x 1.5  
**O.D.:** 3 11/16 (93.7)  
**Height:** 3 1/4 (82.6)  
**I.Gskt:** G324-A

**PT493**

Hydraulic Element



**Notes:** Inside-Out Flow Direction  
**Fits:** Gardner Denver Compressors  
**Replaces:** Gardner Denver 5E30  
**O.D.:** 4 31/32 (126.2)  
**I.D.:** 1 3/16 (30.2)  
**Height:** 18 5/8 (473.1)  
**F. Gskt:** [1] Included  
**End Seals:** [2] Attached

Measurements Are Shown In Inches And (Millimeters)

**WARNING:** These products can expose you to chemicals, including Diisononyl Phthalate, Carbon black extracts, Nickel, 1,3 Butadiene, Ethylene Oxide, Epichlorohydrin, which are known to the State of California to cause cancer, and Bisphenol, Ethylene Glycol, Ethylene Oxide, 1,3 Butadiene, Epichlorohydrin, which are known to the State of California to cause birth defects or other reproductive harm.

**B494** By-Pass Lube Spin-on  
**Fits:** GMC Trucks; Isuzu Engines  
**Replaces:** GMC 94360419; Isuzu 8-94360-419-0  
**Thread:** 5/8 -18  
**O.D.:** 4 1/4 (108.0)  
**Height:** 3 3/16 (81.0)  
**I.Gskt:** [1] Included



**B495** Full-Flow Lube Spin-on  
**Fits:** Detroit Diesel Engines  
**Replaces:** Detroit Diesel 23518480  
**Thread:** 1 5/8 -12  
**O.D.:** 4 21/32 (118.3)  
**Height:** 9 15/16 (252.4)  
**I.Gskt:** [1] Included



**B495-MPG** Maximum Performance Glass Lube Spin-on  
**Fits:** Detroit Diesel Engines  
**Replaces:** Detroit Diesel 23518480  
**Thread:** 1 5/8 -12  
**O.D.:** 4 21/32 (118.3)  
**Height:** 9 15/16 (252.4)  
**I.Gskt:** [1] Included



**B495-SS** Severe Service Lube Spin-on  
**Fits:** Detroit Diesel Engines  
**Replaces:** Detroit Diesel 23518480  
**Thread:** 1 5/8 -12  
**O.D.:** 4 21/32 (118.3)  
**Height:** 9 15/16 (252.4)  
**I.Gskt:** [1] Included



**P496** Full-Flow Lube Element  
**Fits:** Toyota Lift Trucks  
**Replaces:** Toyota 4152-21010, 4152-40010, 4512-40011  
**O.D.:** 2 7/8 (73.0)  
**I.D.:** 21/32 (16.7)  
**Height:** 4 3/8 (111.1)  
**F. Gskt:** ES1049, [1] Included  
**End Seals:** [2] Attached

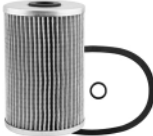

**P497** Full-Flow Lube Element  
**Fits:** Toyota Lift Trucks, Light-Duty Trucks  
**Replaces:** Toyota 4152-40020, 4152-40030, 15600-40012  
**O.D.:** 2 7/8 (73.0)  
**I.D.:** 21/32 (16.7)  
**Height:** 5 1/16 (128.6)  
**F. Gskt:** ES1049, G233-A  
**End Seals:** [2] Attached



**PT498** Hydraulic Element  
**Fits:** Austin-Western, Dynahoe, Nicholson Equipment  
**Replaces:** Allis Chalmers 706795132; Clark 993611; Ford 3900612; International 8968811-C1; John Deere AT45810  
**O.D.:** 4 1/2 (114.3)  
**I.D.:** 2 1/4 (57.2) One End  
**Height:** 7 1/4 (184.2)  
**I.Gskt:** [1] Included  
**O. Gskt:** G307, G397



**PT498-10** Hydraulic Element  
**Fits:** Allis Chalmers, Fiat-Allis, Ford, Hough Equipment  
**Replaces:** Allis Chalmers 706795132; Clark 993611; Ford 3900612; International 8968811-C1; John Deere AT45810  
**O.D.:** 4 1/2 (114.3)  
**I.D.:** 2 1/4 (57.2) One End  
**Height:** 7 1/4 (184.2)  
**I.Gskt:** [1] Included  
**O. Gskt:** G307, G397



**PT499-5** Hydraulic Element  
**Fits:** Gradall, Hough, International Equipment  
**Replaces:** International 26328-M1, 878015-C3  
**O.D.:** 6 (152.4)  
**I.D.:** 2 5/8 (66.7)  
**Height:** 9 (228.6)  
**End Seals:** [2] Attached  
**Related To:** PT212 (Double-Length Version)



**501** DAHL Fuel Element  
**Notes:** 4 Micron Nominal (20 Absolute)  
**Fits:** DAHL 500 Series Fuel Filter/Water Separator Units  
**O.D.:** 6 1/16 (154.0)  
**I.D.:** 1 15/32 (37.3)  
**Height:** 9 23/32 (246.9)  
**O-Ring:** [2] Attached



**501-30** DAHL Fuel Element  
**Notes:** 9 Micron Nominal (40 Absolute)  
**Fits:** DAHL 500 Series Fuel Filter/Water Separator Units  
**O.D.:** 6 1/16 (154.0)  
**I.D.:** 1 15/32 (37.3)  
**Height:** 9 23/32 (246.9)  
**O-Ring:** [2] Attached

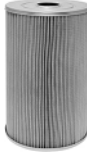

**501-W** DAHL Fuel Element  
**Notes:** 5 Micron Nominal (25 Absolute)  
**Fits:** DAHL 500 Series Fuel Filter/Water Separator Units  
**O.D.:** 6 1/16 (154.0)  
**I.D.:** 1 15/32 (37.3)  
**Height:** 9 23/32 (246.9)  
**O-Ring:** [2] Attached



Measurements Are Shown In Inches And (Millimeters)

**WARNING:** These products can expose you to chemicals, including Diisononyl Phthalate, Carbon black extracts, Nickel, 1,3 Butadiene, Ethylene Oxide, Epichlorohydrin, which are known to the State of California to cause cancer, and Bisphenol, Ethylene Glycol, Ethylene Oxide, 1,3 Butadiene, Epichlorohydrin, which are known to the State of California to cause birth defects or other reproductive harm.



**F501-MD**



**Cotton Batting Fuel Sock**  
**Fits:** Murphy Diesel Engines; Northwest Equipment  
**Replaces:** Murphy MD13924A  
**Thread:** 1/4 -18 NPT  
**O.D.:** 2 3/8 (60.3)  
**Height:** 36 3/4 (933.5)  
**F. Gskt:** [1] Included

**PT510**



**Hydraulic Element**  
**Contains:** Reinforced Centertube  
**Fits:** Komatsu Equipment  
**Replaces:** Komatsu 424-16-11140, 385-10100021, 385-10100022  
**O.D.:** 4 1/2 (114.3)  
**I.D.:** 1 23/32 (43.7)  
**Height:** 8 15/16 (227.0)  
**A. Gskt:** [2] Attached

**PT503**



**Hydraulic Element**  
**Fits:** Dresser, International Equipment  
**Replaces:** International 666219-C1  
**O.D.:** 6 1/2 (165.1)  
**I.D.:** 5 1/2 (139.7)  
**Height:** 12 3/16 (309.6)

**PT512**



**Full-Flow Lube Element**  
**Fits:** E.M.D. Locomotives  
**Replaces:** E.M.D. 8322064  
**O.D.:** 4 1/2 (114.3)  
**I.D.:** 1 23/32 (43.7) One End  
**Height:** 20 (508.0)  
**A. Gskt:** [1] Attached

**PF506**



**Fuel Element**  
**Fits:** Ford Light-Duty Trucks  
**Replaces:** Ford E5TZ-9365-B  
**O.D.:** 2 3/4 (69.9)  
**I.D.:** 9/16 (14.3) One End  
**Height:** 2 9/16 (65.1)  
**F. Gskt:** [1] Included  
**Grommets:** [1] Attached

**PT513**



**Full-Flow Lube Element**  
**Fits:** E.M.D. Locomotives  
**Replaces:** E.M.D. 8340000  
**O.D.:** 2 29/32 (73.8)  
**I.D.:** 1 (25.4) One End  
**Height:** 7 7/16 (188.9)  
**A. Gskt:** [1] Attached

**P507**



**Full-Flow Lube Element**  
**Contains:** Reinforced Centertube  
**Fits:** Mercedes-Benz Engines, Trucks, Vans  
**Replaces:** Mercedes-Benz 11843925  
**O.D.:** 4 3/4 (120.7)  
**I.D.:** 2 1/4 (57.2)  
**Height:** 8 31/32 (227.8)  
**A. Gskt:** [2] Included  
**O. Gskt:** G439

**PT514**



**Differential Element**  
**Fits:** Allis Chalmers Equipment  
**Replaces:** Allis Chalmers 267300  
**O.D.:** 5 (127.0)  
**I.D.:** 2 13/16 (71.4)  
**Height:** 6 1/8 (155.6)  
**F. Gskt:** [2] Included  
**End Seals:** [2] Attached

**PT508-MPG**



**Maximum Performance Glass Hydraulic Element**  
**Fits:** John Deere Equipment  
**Replaces:** John Deere RE11889  
**O.D.:** 4 9/16 (115.9)  
**I.D.:** 2 7/32 (56.4)  
**Height:** 5 15/32 (138.9)  
**End Seals:** [2] Attached

**PT515**



**Hydraulic Element**  
**Fits:** Case Equipment  
**Replaces:** Case L50384  
**O.D.:** 6 15/32 (164.3)  
**I.D.:** 1 27/32 (46.8)  
**Height:** 9 23/32 (246.9)  
**O-Ring:** [2] Attached

**PT509-MPG KIT** Kit of 2 Maximum Performance Glass Hydraulic Elements



**Contains:** Reinforced Centertube  
**Fits:** Case Tractors  
**Replaces:** Case A176593 KIT  
**O.D.:** 4 1/2 (114.3)  
**I.D.:** 2 1/4 (57.2)  
**Height:** 7 5/32 (181.8)  
**A. Gskt:** [2] Attached on Each Element













**PT516**



**Hydraulic Element**  
**Fits:** Bobcat Excavators; Komatsu Equipment  
**Replaces:** Komatsu 1546-01-2170  
**O.D.:** 3 15/16 (100.0)  
**I.D.:** 2 11/32 (59.5)  
**Height:** 8 5/16 (211.1)

Measurements Are Shown In Inches And (Millimeters)

**WARNING:** These products can expose you to chemicals, including Diisononyl Phthalate, Carbon black extracts, Nickel, 1,3 Butadiene, Ethylene Oxide, Epichlorohydrin, which are known to the State of California to cause cancer, and Bisphenol, Ethylene Glycol, Ethylene Oxide, 1,3 Butadiene, Epichlorohydrin, which are known to the State of California to cause birth defects or other reproductive harm.

<p><b>PT517</b></p> 	<p>Hydraulic Element  <b>Fits:</b> Komatsu Equipment  <b>Replaces:</b> Komatsu 1446-01-1160  <b>O.D.:</b> 3 15/16 (100.0)  <b>I.D.:</b> 2 11/32 (59.5)  <b>Height:</b> 11 1/16 (281.0)</p>	<p><b>PT522</b></p>  <p>Hydraulic Element  <b>Fits:</b> John Deere Equipment  <b>Replaces:</b> John Deere AH76668  <b>O.D.:</b> 3 3/4 (95.3)  <b>I.D.:</b> 2 9/16 (65.1)  <b>Height:</b> 8 (203.2)</p>
<p><b>PT518</b></p> 	<p>Hydraulic Element  <b>Fits:</b> American Hoist &amp; Derrick Backhoes;  Ingersoll-Rand Compressors  <b>Replaces:</b> American Hoist &amp; Derrick 9832252;  Ingersoll-Rand 35222981  <b>O.D.:</b> 7 7/16 (188.9)  <b>I.D.:</b> 4 3/4 (120.7) One End  <b>Height:</b> 22 (558.8)  <b>End Seals:</b> [1] Attached</p>	<p><b>AF525-WN</b></p>  <p>Wing Nut  <b>Thread:</b> 7/16 -20  <b>Length:</b> 1 31/32 (50.0)  <b>Height:</b> 31/32 (24.6)</p>
<p><b>PT518-10</b></p> 	<p>Hydraulic Element  <b>Fits:</b> American Hoist &amp; Derrick, Insley  Backhoes  <b>Replaces:</b> American Hoist &amp; Derrick 9832252;  Ingersoll-Rand 35222981  <b>O.D.:</b> 7 7/16 (188.9)  <b>I.D.:</b> 4 3/4 (120.7) One End  <b>Height:</b> 22 (558.8)  <b>End Seals:</b> [1] Attached</p>	<p><b>BT525</b></p>  <p>Hydraulic Spin-on  <b>Contains:</b> Anti-Drainback Valve  <b>Fits:</b> Allis Chalmers Equipment  <b>Replaces:</b> Allis Chalmers 253952  <b>Thread:</b> 13/16 -16  <b>O.D.:</b> 3 11/16 (93.7)  <b>Height:</b> 8 23/32 (221.5)  <b>I.Gskt:</b> G381-A</p>
<p><b>PT520</b></p> 	<p>Hydraulic Element  <b>Fits:</b> Gradall Construction Equipment; Marvel  Hydraulic Systems  <b>Replaces:</b> Marvel M25415125, M25415140  <b>O.D.:</b> 6 1/2 (165.1)  <b>I.D.:</b> 3 15/32 (88.1)  <b>Height:</b> 7 1/2 (190.5)  <b>I.Gskt:</b> [2] G366</p>	<p><b>BT526</b></p>  <p>Hydraulic Spin-on  <b>Fits:</b> Allis Chalmers, Char-Lynn,  Ingersoll-Rand, Massey Ferguson Equipment  <b>Replaces:</b> Char-Lynn 5604  <b>Thread:</b> 1 1/4 -12  <b>O.D.:</b> 3 11/16 (93.7)  <b>Height:</b> 5 3/8 (136.5)  <b>I.Gskt:</b> G381-A</p>
<p><b>AF521-WN</b></p> 	<p>Wing Nut  <b>Thread:</b> 7/16 -20  <b>Length:</b> 2 1/16 (52.4)  <b>Height:</b> 15/16 (23.8)</p>	<p><b>BT526-10</b></p>  <p>Hydraulic Spin-on  <b>Fits:</b> Allis Chalmers, Blaw-Knox, Bobcat, Case,  Char-Lynn, Gehl, Ingersoll-Rand, Massey  Ferguson, New Holland Equipment  <b>Replaces:</b> Char-Lynn 5610  <b>Thread:</b> 1 1/4 -12  <b>O.D.:</b> 3 11/16 (93.7)  <b>Height:</b> 5 3/8 (136.5)  <b>I.Gskt:</b> G381-A</p>
<p><b>BT521</b></p> 	<p>Full-Flow Lube Spin-on  <b>Notes:</b> CAUTION: Use ONLY on Case  applications.  Contains NO by-pass valve.  Do NOT substitute for any other filter.  <b>Contains:</b> Anti-Drainback Valve  <b>Fits:</b> Case Tractors  <b>Replaces:</b> Case A62423  <b>Thread:</b> 7/8 -16  <b>O.D.:</b> 4 1/4 (108.0)  <b>Height:</b> 7 11/32 (186.5)  <b>I.Gskt:</b> G381-A</p>	<p><b>PT527</b></p>  <p>Hydraulic Element  <b>Contains:</b> Spring Reinforced Centertube  <b>Fits:</b> Koehring Equipment  <b>Replaces:</b> Koehring 288B1212  <b>O.D.:</b> 6 1/2 (165.1)  <b>I.D.:</b> 2 31/32 (75.4)  <b>Height:</b> 18 5/8 (473.1)  <b>I.Gskt:</b> [2] Included</p>
<p>Measurements Are Shown In Inches And (Millimeters)</p> <p><b>WARNING:</b> These products can expose you to chemicals, including Diisononyl Phthalate, Carbon black extracts, Nickel, 1,3 Butadiene, Ethylene Oxide, Epichlorohydrin, which are known to the State of California to cause cancer, and Bisphenol, Ethylene Glycol, Ethylene Oxide, 1,3 Butadiene, Epichlorohydrin, which are known to the State of California to cause birth defects or other reproductive harm.</p> <p><b>100</b></p>	<p><b>P528</b></p>  <p>Hydraulic and Power Steering Element  <b>Notes:</b> Inside-Out Flow Direction  <b>Fits:</b> Freightliner, International, Kenworth,  Mack, Peterbilt, Volvo Trucks  <b>Replaces:</b> White 3105264  <b>O.D.:</b> 4 3/4 (120.7)  <b>I.D.:</b> 15/16 (23.8) &amp; 1 9/16 (39.7)  <b>Height:</b> 4 3/16 (106.4)  <b>O. Gskt:</b> G252, G356  <b>End Seals:</b> [2] Attached</p>	

**P529**



Hydraulic Element with Handle

**Fits:** Marvel Hydraulic Systems; Rexworks Equipment  
**Replaces:** Marvel M2801; Rex 298-00133-53  
**O.D.:** 6 1/2 (165.1)  
**I.D.:** 1 19/32 (40.5) One End  
**Height:** 7 25/32 (197.6)  
**I.Gskt:** [1] Included

**PT539**



Hydraulic Element

**Contains:** Reinforced Centertube  
**Fits:** Komatsu, Samsung Equipment  
**Replaces:** Komatsu 1756-02-7380  
**O.D.:** 5 1/8 (130.2)  
**I.D.:** 3 3/8 (85.7)  
**Height:** 11 9/16 (293.7)

**PT534**



Hydraulic Element

**Fits:** International Wheel Tractors  
**Replaces:** International 113618-C1  
**O.D.:** 5 (127.0)  
**I.D.:** 2 29/32 (73.8)  
**Height:** 2 9/16 (65.1)

**P540**



Full-Flow Lube Element

**Fits:** Lister, Petter Engines  
**Replaces:** Lister 268678; Petter 268378  
**O.D.:** 1 31/32 (50.0)  
**I.D.:** 29/32 (23.0)  
**Height:** 2 1/8 (54.0)  
**O. Gskt:** G431  
**End Seals:** [2] Attached

**PT535**



Hydraulic Element

**Fits:** Caterpillar Equipment  
**Replaces:** Caterpillar 9T9054  
**O.D.:** 3 (76.2)  
**I.D.:** 1 1/16 (27.0) One End  
**Height:** 8 3/16 (208.0)  
**Grommets:** [1] Attached

**BT541**



Turbocharger Lube Spin-on

**Notes:** Tilt filter to let air out while you fill with oil before installing filter.  
**Contains:** Flow Control Orifice  
 8 PSID By-Pass Valve  
**Fits:** International, John Deere, M & W Gear Co., Same Equipment  
**Replaces:** M & W Gear Co. 4E023  
**Thread:** 5/8 -18  
**O.D.:** 3 11/16 (93.7)  
**Height:** 5 3/8 (136.5)  
**I.Gskt:** G381-A

**BT536**



Full-Flow Lube Spin-on

**Contains:** 30 PSID By-Pass Valve  
**Fits:** Case, International Equipment  
**Replaces:** International 3136046-R93  
**Thread:** 1 -12  
**O.D.:** 3 11/16 (93.7)  
**Height:** 4 3/8 (111.1)  
**I.Gskt:** G381-A

**PT543 KIT**



Kit of 2 Hydraulic Elements

**Fits:** Allis Chalmers Tractors; Gardner Denver Drills  
**Replaces:** Allis Chalmers 647255; Gardner Denver 165335  
**O.D.:** 2 7/8 (73.0)  
**I.D.:** 1 1/16 (27.0)  
**Height:** 9 5/8 (244.5)  
**A. Gskt:** [2] Attached on Each Element  
**F. Gskt:** [2] G366

**P537**



Full-Flow Lube Element

**Replaces:** Bofors 91-471-068-01  
**O.D.:** 6 (152.4)  
**I.D.:** 3 17/32 (89.7)  
**Height:** 13 (330.2)

**P545**



Power Steering Element

**Fits:** WhiteGMC Trucks  
**Replaces:** White 3107499  
**O.D.:** 3 15/16 (100.0)  
**I.D.:** 1 1/8 (28.6)  
**Height:** 5 1/8 (130.2)  
**A. Gskt:** [2] Attached

**PT538**



Hydraulic Element

**Fits:** International Wheel Tractors  
**Replaces:** International 113940-C1  
**O.D.:** 4 27/32 (123.0)  
**I.D.:** 2 7/8 (73.0)  
**Height:** 9 (228.6)  
**F. Gskt:** [1] Included  
**End Seals:** [2] Attached

**PT546**



Hydraulic Element

**Fits:** International Equipment  
**Replaces:** International 406669-R1, 406705-R91  
**O.D.:** 2 7/8 (73.0)  
**I.D.:** 1 3/16 (30.2) One End  
**Height:** 5 19/32 (142.1)  
**A. Gskt:** [1] Attached  
**O-Ring:** [1] Included

Measurements Are Shown In Inches And (Millimeters)

**WARNING:** These products can expose you to chemicals, including Diisononyl Phthalate, Carbon black extracts, Nickel, 1,3 Butadiene, Ethylene Oxide, Epichlorohydrin, which are known to the State of California to cause cancer, and Bisphenol, Ethylene Glycol, Ethylene Oxide, 1,3 Butadiene, Epichlorohydrin, which are known to the State of California to cause birth defects or other reproductive harm.

**PT548**

Steering Element



**Notes:** Inside-Out Flow Direction  
**Fits:** Case, Ford, New Holland Equipment  
**Replaces:** Ford EDPN-3K758-A  
**O.D.:** 3 15/16 (100.0)  
**I.D.:** 1 1/16 (27.0)  
**Height:** 1 3/8 (34.9)  
**End Seals:** [2] Attached

**PT549**

Transmission Element



**Fits:** Allis Chalmers, Case, Fiat-Allis, Ford, Galion, International, John Deere, Massey Ferguson, Owatonna Equipment  
**Replaces:** Allis Chalmers 10049229; Case D52932; International 630939-C91; Massey Ferguson 1088695-M91; Owatonna 42532521  
**O.D.:** 3 7/16 (87.3)  
**I.D.:** 1 3/16 (30.2) One End  
**Height:** 5 11/16 (144.5)  
**A. Gskt:** [1] Attached  
**F. Gskt:** G402

**PT550-10**

Hydraulic Element

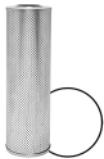

**Fits:** Insley Shovels  
**Replaces:** Insley H8412; Marvel M3251-5110  
**O.D.:** 4 1/2 (114.3)  
**I.D.:** 2 1/4 (57.2)  
**Height:** 15 (381.0)  
**I.Gskt:** [2] Included  
**F. Gskt:** G260  
**Related To:** PT288-HD10 (Single-Length Version)

**PT551-10**

Hydraulic Element



**Fits:** CMI, Driteltech, Gomaco, LeRoi, Lorain Equipment  
**Replaces:** Insley H8357, H8409; Schroeder BB10  
**O.D.:** 5 (127.0)  
**I.D.:** 3 1/4 (82.6)  
**Height:** 18 5/16 (465.1)  
**End Seals:** [2] Attached

**BF553**

Fuel Spin-on with Drain



**Notes:** OBSOLETE. Availability Limited to Dealer Stock.  
**Fits:** Ryco Head #15  
**Replaces:** Ryco R15  
**Thread:** 1 -11 BSP-PL  
**O.D.:** 3 13/16 (96.8)  
**Height:** 5 1/4 (133.4)  
**F. Gskt:** [1] Included

**PT554**

Hydraulic Element



**Fits:** Clark Lift Trucks  
**Replaces:** Clark 1618480, 1810437  
**O.D.:** 4 1/2 (114.3)  
**I.D.:** 1 29/32 (48.4)  
**Height:** 10 3/16 (258.8)  
**F. Gskt:** [2] ES1092, [1] Included  
**O. Gskt:** G236-A  
**Related To:** PT207, PT207-10, PT207-HD, PT207-HD10 (Short Versions) PT573 (Long Version)

**P555**

Hydraulic Element



**Notes:** Inside-Out Flow Direction  
**Fits:** Kobelco, LeTourneau-Westinghouse, WABCO Equipment  
**Replaces:** LeTourneau DA2980; WABCO WA9652  
**O.D.:** 5 1/8 (130.2)  
**I.D.:** 3 3/8 (85.7)  
**Height:** 9 1/4 (235.0)  
**A. Gskt:** [1] Attached

**BT556-10**

Hydraulic Spin-on



**Fits:** John Deere, Owatonna Loaders  
**Replaces:** John Deere GG17031266; Owatonna 17031266  
**Thread:** 1 1/8 -16  
**O.D.:** 4 1/4 (108.0)  
**Height:** 10 7/16 (265.1)  
**I.Gskt:** [1] Included  
**Related To:** B76 (Lube Version)

**PT558**

Oval Hydraulic Element



**Fits:** International Wheel Tractors  
**Replaces:** International 388080-R93, 388084-R93  
**O.D.:** 4 5/8 (117.5) to 7 1/4 (184.2)  
**I.D.:** 1 1/2 (38.1) & 2 7/8 (73.0)  
**Height:** 2 17/32 (64.3)  
**A. Gskt:** [1] Attached  
**F. Gskt:** [2] Included

**PT560 KIT**

Kit of 2 Hydraulic Elements



**Contains:** Reinforced Centertube  
**Fits:** Case Tractors  
**Replaces:** Case A44012 KIT  
**O.D.:** 4 17/32 (115.1)  
**I.D.:** 1/2 (12.7) & 2 9/32 (57.9)  
**Height:** 7 1/16 (179.4)  
**F. Gskt:** [1] Included  
**End Seals:** [1] Attached Each Element  
**Grommets:** [1] Attached Each Element

**PT561**

Hydraulic Element



**Notes:** Inside-Out Flow Direction  
**Replaces:** John Deere AT63548  
**O.D.:** 4 1/2 (114.3)  
**I.D.:** 2 1/4 (57.2)  
**Height:** 8 1/16 (204.8)  
**O. Gskt:** G400

**PT562-10**

Hydraulic Element



**Fits:** Insley Shovels  
**Replaces:** Insley H5898  
**O.D.:** 3 3/8 (85.7)  
**I.D.:** 1 7/8 (47.6)  
**Height:** 7 7/16 (188.9)  
**I.Gskt:** [2] Included

Measurements Are Shown In Inches And (Millimeters)

**WARNING:** These products can expose you to chemicals, including Diisononyl Phthalate, Carbon black extracts, Nickel, 1,3 Butadiene, Ethylene Oxide, Epichlorohydrin, which are known to the State of California to cause cancer, and Bisphenol, Ethylene Glycol, Ethylene Oxide, 1,3 Butadiene, Epichlorohydrin, which are known to the State of California to cause birth defects or other reproductive harm.

**PT563** Hydraulic Element  
**Notes:** NOT interchangeable with PT566.  
**Fits:** Allis Chalmers, John Deere Equipment  
**Replaces:** Allis Chalmers 70269922; John Deere AH76991  
**O.D.:** 5 (127.0)  
**I.D.:** 2 13/16 (71.4)  
**Height:** 9 (228.6)  
**O-Ring:** [2] Included  
**End Seals:** [2] Attached



**PT568** Hydraulic Element  
**Notes:** Inside-Out Flow Direction  
**Fits:** Timberjack Logging Equipment  
**Replaces:** Timberjack 205882  
**O.D.:** 5 1/8 (130.2)  
**I.D.:** 13/32 (10.3) & 3 3/8 (85.7)  
**Height:** 9 3/32 (231.0)  
**A. Gskt:** [2] G120-A  
**Related To:** PT90 (As Specified in Applications)



**BT564** Full-Flow Lube Spin-on  
**Fits:** Allis Chalmers, Bantam, Bomag, Champion, Fiat-Allis, Freeman, New Idea Equipment  
**Replaces:** Allis Chalmers 4023548-3; New Idea 731607  
**Thread:** 1 -16  
**O.D.:** 4 1/4 (108.0)  
**Height:** 5 13/16 (147.6)  
**I.Gskt:** G381-A  
**Related To:** BT440 (Long Version)



**PT571** Hydraulic Element  
**Contains:** Reinforced Centertube  
**Fits:** Allis Chalmers, Fiat-Allis Equipment  
**Replaces:** Allis Chalmers 669434 KIT, 676022 Element  
**O.D.:** 4 7/16 (112.7)  
**I.D.:** 1 3/4 (44.4)  
**Height:** 12 3/4 (323.8)  
**A. Gskt:** [2] Attached  
**F. Gskt:** [3] Included

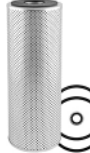

**PT565** Hydraulic Element  
**Fits:** Case, International Equipment  
**Replaces:** International 530144-R92  
**O.D.:** 5 (127.0)  
**I.D.:** 2 13/16 (71.4)  
**Height:** 3 (76.2)  
**A. Gskt:** [2] Attached  
**F. Gskt:** [1] Included  
**Related To:** PT8907-MPG (Glass Media Version)



**PT573** Hydraulic Element  
**Fits:** Clark Lift Trucks, Loaders  
**Replaces:** Clark 1810528, 1810889  
**O.D.:** 4 1/2 (114.3)  
**I.D.:** 1 29/32 (48.4)  
**Height:** 12 1/4 (311.2)  
**F. Gskt:** [2] ES1092, G417  
**Related To:** PT207, PT207-10, PT207-HD, PT207-HD10  
 PT554 (Short Versions)



**PT566** Hydraulic Element  
**Notes:** NOT interchangeable with PT563.  
**Fits:** Case, Dresser, International Equipment  
**Replaces:** International 623017-C1  
**O.D.:** 5 (127.0)  
**I.D.:** 2 13/16 (71.4)  
**Height:** 9 (228.6)  
**A. Gskt:** [2] Attached



**BF577** Primary Fuel Spin-on  
**Contains:** Integral Post Seal  
**Thread:** 1 -14  
**O.D.:** 3 11/16 (93.7)  
**Height:** 8 25/32 (223.0)  
**I.Gskt:** G401



**PT567** Hydraulic Element  
**Fits:** Equipment with Ripley Hydraulic Systems  
**Replaces:** Ripley 4P13  
**O.D.:** 3 3/4 (95.3)  
**I.D.:** 1 31/32 (50.0) One End  
**Height:** 7 13/16 (198.4)  
**A. Gskt:** [1] Attached



**PT578** Hydraulic Element  
**Fits:** International Equipment  
**Replaces:** International 541275-R1, 547412-R91  
**O.D.:** 5 (127.0)  
**I.D.:** 2 13/16 (71.4)  
**Height:** 4 13/16 (122.2)  
**O-Ring:** [1] Included



**PT567-10** Hydraulic Element  
**Fits:** Equipment with Ripley Hydraulic Systems  
**Replaces:** Ripley 8P13  
**O.D.:** 3 3/4 (95.3)  
**I.D.:** 1 31/32 (50.0) One End  
**Height:** 7 13/16 (198.4)  
**A. Gskt:** [1] Attached



**PT579** Hydraulic Element  
**Fits:** Gradall, LeRoi, Lorain, Northwest, Prentice Equipment  
**Replaces:** Gradall 86671045; Lorain D87282A  
**O.D.:** 4 1/4 (108.0)  
**I.D.:** 3 1/8 (79.4)  
**Height:** 9 23/32 (246.9)  
**A. Gskt:** [2] Attached



Measurements Are Shown In Inches And (Millimeters)

**WARNING:** These products can expose you to chemicals, including Diisononyl Phthalate, Carbon black extracts, Nickel, 1,3 Butadiene, Ethylene Oxide, Epichlorohydrin, which are known to the State of California to cause cancer, and Bisphenol, Ethylene Glycol, Ethylene Oxide, 1,3 Butadiene, Epichlorohydrin, which are known to the State of California to cause birth defects or other reproductive harm.

**BF582** Secondary Fuel Spin-on  
**Notes:** CAUTION: Furnished O-Ring must be installed to seal. Part of BF897 KIT.  
**Fits:** Allis Chalmers, Case, Fiat-Allis, Grimmer Schmidt Equipment  
**Replaces:** Case A58713  
**Thread:** 15/16 -16  
**O.D.:** 3 11/16 (93.7)  
**Height:** 5 13/32 (137.3)  
**I.Gskt:** G401  
**O-Ring:** ES24-B



**BF586-D** Primary Fuel Spin-on with Drain  
**Fits:** Atlas Copco Compressors; Deutz Engines; Deutz, Hanomag, International Equipment  
**Replaces:** Deutz 2133558; International 3136187-R91  
**Thread:** M16 x 1.5  
**O.D.:** 3 1/32 (77.0)  
**Height:** 5 27/32 (148.4)  
**I.Gskt:** G449-B



**BF583** Fuel Spin-on  
**Contains:** Integral Post Seal  
**Fits:** Caterpillar, Oliver Engines; CMI, Dynapac, Gradall, International, New Holland, Steiger, Wiggins Equipment  
**Replaces:** Caterpillar 1R0710  
**Thread:** 15/16 -16  
**O.D.:** 3 11/16 (93.7)  
**Height:** 5 3/8 (136.5)  
**I.Gskt:** G381-A



**BF587** Secondary Fuel Spin-on  
**Fits:** Atlas-Copco Compressors; Deutz, Volvo-Penta Engines; Case, Deutz, Dresser, Fendt, Ford, Galion, Hough, International, John Deere, New Holland Equipment; Fiat, M.A.N. Trucks  
**Replaces:** Deutz 2133943; International 3132428-R91; Volvo-Penta 8385932  
**Thread:** M16 x 1.5  
**O.D.:** 3 1/32 (77.0)  
**Height:** 6 1/8 (155.6)  
**I.Gskt:** G449-B



**BF584** Fuel Spin-on  
**Notes:** Can be used with FB46185 base.  
**Contains:** Integral Post Seal  
**Fits:** Caterpillar Paving Equipment  
**Thread:** 1 -14  
**O.D.:** 4 1/4 (108.0)  
**Height:** 10 7/16 (265.1)  
**I.Gskt:** G381-A  
**Related To:** BF1218 (Fuel/Water Separator Version)



**BF587-D** Secondary Fuel Spin-on with Drain  
**Fits:** Atlas-Copco Compressors; Deutz, Volvo-Penta Engines; Case, Deutz, Dresser, Fendt, Ford, Galion, Hough, International, John Deere, New Holland Equipment; Fiat, M.A.N. Trucks  
**Replaces:** Deutz 2133943; International 3132428-R91; Volvo-Penta 8385932  
**Thread:** M16 x 1.5  
**O.D.:** 3 1/32 (77.0)  
**Height:** 6 1/8 (155.6)  
**I.Gskt:** G449-B  
**Related To:** BF5587-D (with Trapped O-Ring)



**BF584-B** Fuel Spin-on (Boxed Version)  
**Contains:** Integral Post Seal  
**Fits:** Caterpillar Paving Equipment  
**Thread:** 1 -14  
**O.D.:** 4 1/4 (108.0)  
**Height:** 10 7/16 (265.1)  
**I.Gskt:** G381-A  
**Related To:** BF1218 (Fuel/Water Separator Version)



**BF588** Secondary Fuel Spin-on  
**Notes:** Use BF7629 on International Engines having a single fuel filter.  
**Contains:** Integral Post Seal  
**Fits:** Allis Chalmers, Case, Dresser, Galion, Hough, John Deere, Oliver Equipment; International Engines, Equipment  
**Replaces:** International 672603-C2, 672603-C3  
**Thread:** 7/8 -14  
**O.D.:** 4 1/4 (108.0)  
**Height:** 7 11/32 (186.5)  
**I.Gskt:** G381-A



**BF585** Fuel Spin-on  
**Fits:** Ford, Ottawa Trucks  
**Replaces:** Ford D3HZ-9155-A, D3HZ-9365-A  
**Thread:** 1 -14  
**O.D.:** 3 11/16 (93.7)  
**Height:** 5 11/32 (135.7)  
**I.Gskt:** [1] Included



**BF591** Secondary Fuel Spin-on  
**Notes:** CAUTION: Furnished O-Ring must be installed on post for seal.  
**Contains:** Integral Post Seal  
**Fits:** Case, Drott Equipment  
**Replaces:** Case A77220  
**Thread:** 15/16 -16  
**O.D.:** 3 11/16 (93.7)  
**Height:** 7 3/16 (182.6)  
**I.Gskt:** G401  
**O-Ring:** ES24-B



**BF586** Primary Fuel Spin-on  
**Fits:** Atlas Copco Compressors; Deutz Engines; Deutz, Hanomag, International Equipment  
**Replaces:** Deutz 2133558; International 3136187-R91  
**Thread:** M16 x 1.5  
**O.D.:** 3 1/32 (77.0)  
**Height:** 5 27/32 (148.4)  
**I.Gskt:** G449-B



**BF592** Primary Fuel Spin-on  
**Notes:** Can be used with FB1301 base.  
**Fits:** Detroit Diesel Engines  
**Replaces:** Detroit Diesel 23518527  
**Thread:** 1 -12  
**O.D.:** 3 11/16 (93.7)  
**Height:** 4 11/32 (110.3)  
**I.Gskt:** [1] Included  
**Related To:** BF5800 (Long Version)



Measurements Are Shown In Inches And (Millimeters)

**WARNING:** These products can expose you to chemicals, including Diisononyl Phthalate, Carbon black extracts, Nickel, 1,3 Butadiene, Ethylene Oxide, Epichlorohydrin, which are known to the State of California to cause cancer, and Bisphenol, Ethylene Glycol, Ethylene Oxide, 1,3 Butadiene, Epichlorohydrin, which are known to the State of California to cause birth defects or other reproductive harm.

**BF593** Secondary Fuel Spin-on  
**Notes:** Can be used with FB1302 base.  
**Contains:** Integral Post Seal  
**Fits:** Detroit Diesel Engines  
**Replaces:** GMC 23518526, 23518669  
**Thread:** 13/16 -12  
**O.D.:** 3 23/32 (94.5)  
**Height:** 4 13/32 (111.9)  
**I.Gskt:** [1] Included



**F594-F** Fuel Element with Bail Handle  
**Replaces:** Deutz R2H4115  
**O.D.:** 4 5/32 (105.6)  
**I.D.:** 3/4 (19.0)  
**Height:** 6 23/32 (170.7)  
**A. Gskt:** [2] Attached



**PF594** Primary Fuel Element  
**Fits:** Deutz Diesel Engines  
**Replaces:** Deutz W2H4115  
**O.D.:** 3 15/16 (100.0)  
**I.D.:** 23/32 (18.3)  
**Height:** 6 5/8 (168.3)  
**Grommets:** [2] Attached



**BT595** Full-Flow Lube or Hydraulic Spin-on  
**Fits:** Caterpillar Lift Trucks; Cummins Engines  
**Replaces:** Caterpillar 91-7336  
**Thread:** 1 1/8 -16  
**O.D.:** 3 11/16 (93.7)  
**Height:** 7 3/16 (182.6)  
**I.Gskt:** G401



**BF596** Fuel Spin-on  
**Contains:** Integral Post Seal  
**Fits:** Cummins Engines; Euclid, Komatsu Equipment; International, Kenworth, Mack Trucks  
**Replaces:** Cummins 3313306  
**Thread:** 1 1/4 -12  
**O.D.:** 4 21/32 (118.3)  
**Height:** 11 7/32 (285.0)  
**I.Gskt:** G498-A  
**Related To:** BF1216 (Fuel/Water Separator Version)



**BF597** Fuel Spin-on with Drain  
**Notes:** CAUTION: Furnished O-Ring must be installed on post for seal.  
**Fits:** Allis Chalmers, Fiat-Allis, New Idea Equipment  
**Replaces:** Allis Chalmers 4321716, 4321716-5  
**Thread:** 15/16 -16  
**O.D.:** 3 11/16 (93.7)  
**Height:** 7 17/32 (191.3)  
**I.Gskt:** G401  
**O-Ring:** ES24-B



**PF598** Fuel/Water Separator with Bail Handle  
**Fits:** Racor 500 Series Housings  
**Replaces:** Racor 2010 Series  
**O.D.:** 3 7/32 (81.8)  
**I.D.:** 5/8 (15.9)  
**Height:** 2 3/4 (69.9)  
**F. Gskt:** G458, [1] Included  
**Grommets:** [2] Attached



**PF598-10** Fuel/Water Separator with Bail Handle  
**Fits:** Racor 500 Series Housings  
**Replaces:** Racor 2010 Series  
**O.D.:** 3 7/32 (81.8)  
**I.D.:** 5/8 (15.9)  
**Height:** 2 3/4 (69.9)  
**F. Gskt:** G458, [1] Included  
**Grommets:** [2] Attached



**PF598-30** Fuel/Water Separator with Bail Handle  
**Fits:** Racor 500 Series Housings  
**Replaces:** Racor 2010 Series  
**O.D.:** 3 7/32 (81.8)  
**I.D.:** 5/8 (15.9)  
**Height:** 2 3/4 (69.9)  
**F. Gskt:** G458, [1] Included  
**Grommets:** [2] Attached



**PF599** Fuel/Water Separator Element  
**Fits:** Racor 200 Series Housings  
**Replaces:** Racor 2000 Series  
**O.D.:** 1 3/4 (44.4)  
**I.D.:** 15/32 (11.9) One End  
**Height:** 2 27/32 (72.2)  
**I.Gskt:** [1] Included  
**O. Gskt:** G467, G468



**PF599-10** Fuel/Water Separator Element  
**Fits:** Racor 200 Series Housings  
**Replaces:** Racor 2000 Series  
**O.D.:** 1 3/4 (44.4)  
**I.D.:** 15/32 (11.9) One End  
**Height:** 2 27/32 (72.2)  
**I.Gskt:** [1] Included  
**O. Gskt:** G467, G468



**PF599-30** Fuel/Water Separator Element  
**Notes:** OBSOLETE. Availability Limited to Dealer Stock.  
**Fits:** Racor 200 Series Housings  
**Replaces:** Racor 2000 Series  
**O.D.:** 1 3/4 (44.4)  
**I.D.:** 15/32 (11.9) One End  
**Height:** 2 27/32 (72.2)  
**I.Gskt:** [1] Included  
**O. Gskt:** G467, G468



**PA602** Air Element  
**Fits:** Chevrolet, Ford, Jeep Automotive; Continental, Hercules, Kohler Engines  
**Replaces:** Continental RD6F453; Diamond Reo 2325H2; Ford ECB-9601-A; Hercules 260820; International 863725-C91  
**O.D.:** 9 1/16 (230.2)  
**I.D.:** 6 3/4 (171.5)  
**Height:** 3 5/8 (92.1)



Measurements Are Shown In Inches And (Millimeters)

**WARNING:** These products can expose you to chemicals, including Diisononyl Phthalate, Carbon black extracts, Nickel, 1,3 Butadiene, Ethylene Oxide, Epichlorohydrin, which are known to the State of California to cause cancer, and Bisphenol, Ethylene Glycol, Ethylene Oxide, 1,3 Butadiene, Epichlorohydrin, which are known to the State of California to cause birth defects or other reproductive harm.

**PA604** Air Element  
**Fits:** International Engines  
**Replaces:** International 118791-R91  
**O.D.:** 9 1/16 (230.2)  
**I.D.:** 6 3/4 (171.5)  
**Height:** 3 7/8 (98.4)



**B605** Full-Flow Lube Spin-on  
**Fits:** Hitachi Equipment; Nissan, Volvo Engines, Trucks  
**Replaces:** Nissan 15201-Z9007, FL201-Z9010; Volvo 422994  
**Thread:** 1 1/8 -16  
**O.D.:** 4 1/4 (108.0)  
**Height:** 5 27/32 (148.4)  
**I.Gskt:** [1] Included



**BT606-MPG** Maximum Performance Glass Hydraulic Spin-on  
**Fits:** Sullair Compressors  
**Replaces:** Sullair 250025-524  
**Thread:** 31/32 -20  
**O.D.:** 3 21/32 (92.9)  
**Height:** 5 5/8 (142.9)  
**I.Gskt:** G381-A



**PA607** Air Element  
**Fits:** AMC, Chrysler Light-Duty Trucks  
**Replaces:** AMC 3191205; Chrysler 8991451  
**O.D.:** 10 (254.0)  
 Top 10 1/4 (260.3)  
**I.D.:** 7 5/8 (193.7)  
**Height:** 3 1/4 (82.6)



**BT610-MPG** Maximum Performance Glass Lube Spin-on  
**Contains:** Integral Post Seal  
**Fits:** Sullair Compressors  
**Replaces:** Sullair 250025-526  
**Thread:** 1 1/4 -11 BSP-PL  
**O.D.:** 4 5/8 (117.5)  
**Height:** 11 9/32 (286.5)  
**I.Gskt:** G498-A



**BT611-MPG** Maximum Performance Glass Lube Spin-on  
**Contains:** Integral Post Seal  
**Fits:** Sullair Compressors  
**Replaces:** Sullair 250025-525  
**Thread:** 1 1/4 -11 BSP-PL  
**O.D.:** 4 5/8 (117.5)  
**Height:** 6 9/32 (159.5)  
**I.Gskt:** G498-A



**PA612** Air Element  
**Fits:** Chrysler Automotive  
**Replaces:** Chrysler 1739549, 1739649  
**O.D.:** 8 (203.2)  
**I.D.:** 5 3/4 (146.0)  
**Height:** 3 1/2 (88.9)



**PA613** Oval Air Element  
**Fits:** Chrysler Automotive  
**Replaces:** Chrysler 1739546  
**O.D.:** 6 3/8 (161.9)  
 to 11 1/8 (282.6)  
**I.D.:** 4 1/8 (104.8) & 8 7/8 (225.4)  
**Height:** 3 1/2 (88.9)

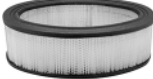

**BF614** Fuel Spin-on  
**Notes:** Can be used with FB46185 base.  
**Fits:** American Hoist & Derrick, Aveling-Barford, Caterpillar, CMI, Demag, Driltech, Grove, Steiger, Vermeer Equipment; Caterpillar Engines; Chevrolet, Ford, Freightliner, GMC, International, Kenworth, Mack,  
**Replaces:** Caterpillar 1R0712  
**Thread:** 1 -14  
**O.D.:** 3 11/16 (93.7)  
**Height:** 10 1/2 (266.7)  
**I.Gskt:** G381-A  
**Related To:** BF7587 (High Efficiency Version)



**PA615** Air Element  
**Fits:** AMC, Chrysler, Jeep Automotive, Light-Duty Trucks  
**Replaces:** Chrysler J8992661; Jeep 999103  
**O.D.:** 10 1/16 (255.6)  
**I.D.:** 7 21/32 (194.5)  
**Height:** 2 3/4 (69.9)



**PA616** Air Element  
**Contains:** Integral Post Seal  
 Flame Retardant Media  
**Fits:** Cummins Engines; Hyster Equipment  
**Replaces:** Cummins 3001690; Hyster 202951  
**O.D.:** 10 7/32 (259.6)  
**I.D.:** 7/16 (11.1) & 7 7/8 (200.0)  
**Height:** 12 (304.8)  
**Related To:** PA1913 (Closed End Version for Use in Donaldson Housing)



**PA617** Air Element  
**Contains:** Integral Post Seal  
 Flame Retardant Media  
**Fits:** Autocar Trucks; Cummins Engines; Gradall, Hyster Equipment  
**Replaces:** Autocar 860393; Gradall 106338  
**O.D.:** 9 (228.6)  
**I.D.:** 7/16 (11.1) & 6 5/8 (168.3)  
**Height:** 10 (254.0)  
**A. Gskt:** [1] Attached  
**Related To:** PA1700 (Heavy-Duty Version for Use in Fram Housing)



**PA618** Air Element  
**Notes:** Used as Cab Air on Massey Ferguson applications.  
**Fits:** Caterpillar, Clark, Hough, Ingersoll-Rand, Marion, Massey Ferguson Equipment; Diamond Reo Trucks  
**Use With:** PA618 FOAM  
**Replaces:** Caterpillar 4L8465  
**O.D.:** 10 7/32 (259.6)  
**I.D.:** 5 1/2 (139.7)  
**Height:** 12 (304.8)



**PA618 FOAM** Foam Blanket for PA618  
**Use With:** PA618  
**Length:** 34 1/4 (870.0)  
**Width:** 11 1/2 (292.1)



Measurements Are Shown In Inches And (Millimeters)

**WARNING:** These products can expose you to chemicals, including Diisononyl Phthalate, Carbon black extracts, Nickel, 1,3 Butadiene, Ethylene Oxide, Epichlorohydrin, which are known to the State of California to cause cancer, and Bisphenol, Ethylene Glycol, Ethylene Oxide, 1,3 Butadiene, Epichlorohydrin, which are known to the State of California to cause birth defects or other reproductive harm.



**PA618-S**

Air Element



**Fits:** Caterpillar, CMI, Grove Equipment  
**Replaces:** Caterpillar 4L9852  
**O.D.:** 10 7/32 (259.6)  
**I.D.:** 6 1/16 (154.0) One End  
**Height:** 12 (304.8)  
**A. Gskt:** [1] Attached

**PA638**

Air Element



**Fits:** International Equipment  
**Replaces:** International 204514-R91  
**O.D.:** 9 1/8 (231.8)  
**I.D.:** 6 7/8 (174.6)  
**Height:** 6 5/8 (168.3)

**PA621**

Air Element



**Contains:** Flame Retardant Media  
**Fits:** Chevrolet Trucks; EVO Trash Compactors  
**Replaces:** GMC 5645166  
**O.D.:** 10 1/32 (254.8)  
**I.D.:** 8 17/32 (216.7)  
**Height:** 3 (76.2)

**PA639**

Air Element



**Fits:** Allis Chalmers, Caterpillar, LeTourneau-Westinghouse Equipment; Gardner Denver Compressors  
**Replaces:** Allis Chalmers 70622893; Caterpillar 5M4118; Gardner Denver 2010500  
**O.D.:** 10 1/2 (266.7)  
**I.D.:** 5 5/32 (131.0) & 7 3/4 (196.9)  
**Height:** 10 1/2 (266.7)  
**A. Gskt:** [2] Attached  
**O. Gskt:** [2] G31-AF

**PA625**

Air Element



**Fits:** GMC Engines, Trucks  
**Replaces:** GMC 25041181  
**O.D.:** 11 5/16 (287.3)  
**I.D.:** 8 17/32 (216.7)  
**Height:** 3 1/16 (77.8)

**PA640**

Air Element



**Contains:** Flame Retardant Media  
**Fits:** Chevrolet Automotive; Clark, Eaton Lift Trucks; Ingersoll-Rand, Minneapolis-Moline Equipment; Thermo King Refrigeration Units  
**Replaces:** Clark 668788; Thermo King 11-1282  
**O.D.:** 4 13/32 (111.9)  
**I.D.:** 2 15/16 (74.6)  
**Height:** 7 1/32 (178.6)

**PA631**

Air Element



**Fits:** Buick, Cadillac, Chevrolet, Oldsmobile, Pontiac Automotive  
**Replaces:** GMC 6421030  
**O.D.:** 17 5/16 (439.7)  
 Flange 18 5/16 (465.1)  
**I.D.:** 14 15/16 (379.4)  
**Height:** 2 3/16 (55.6)

**PA641**

Air Element



**Contains:** Integral Post Seal  
 Flame Retardant Media  
**Fits:** Caterpillar Engines; Diamond Reo Trucks; Gradall, Link-Belt Equipment  
**Replaces:** Caterpillar 5L5035; Diamond Reo 302106PS; White 884310  
**O.D.:** 6 5/8 (168.3)  
**I.D.:** 1/4 (6.4) & 4 1/4 (108.0)  
**Height:** 7 7/8 (200.0)  
**A. Gskt:** [1] Attached  
**End Seals:** [1] Attached

**PA632**

Oval Air Element



**Fits:** Ford Automotive  
**Replaces:** Ford EDK-9601-A  
 20 23/32 (526.3)  
**I.D.:** 7 5/16 (185.7) & 18 5/16 (465.1)  
**Height:** 1 3/4 (44.4)

**PA633(2)**

Set of 2 Draft Tube Air Breathers



**Fits:** Ford Trucks; Clark, Grove, Seamaster Equipment  
**Replaces:** Ford C2TZ-6768-A  
**O.D.:** 3 7/8 (98.4)  
**I.D.:** 2 1/2 (63.5)  
**Height:** 1 5/8 (41.3)

**PA642**

Air Element



**Fits:** AMC; Dodge, Ford Trucks, Vans; Jeep; Plymouth Voyager  
**Replaces:** AMC 3190562; Ford 3CAZ-9601-A; International 332623-C91; Jeep J3190562  
**O.D.:** 9 11/16 (246.1)  
**I.D.:** 7 15/16 (201.6)  
**Height:** 2 1/4 (57.2)

**PA634**

Air Element



**Contains:** Flame Retardant Media  
**Fits:** Caterpillar Lift Trucks; Continental, Kohler Engines; Divco Trucks  
**Replaces:** Caterpillar 33-3660; Continental F600F428; Divco 6426  
**O.D.:** 6 3/8 (161.9)  
 Flange 6 5/8 (168.3)  
**I.D.:** 5 (127.0)  
**Height:** 3 (76.2)

**PA643**

Air Breather Element



**Fits:** Adams, Clark, Euclid, Hymac, Koehring, LeTourneau-Marathon, LeTourneau-Westinghouse, Massey Ferguson, Michigan, Versatile, Yale Equipment; Kenworth, Mack Trucks  
**Replaces:** Clark 945345; Euclid 123716; LeTourneau VF2049  
**O.D.:** 2 7/8 (73.0)  
**I.D.:** 1 3/8 (34.9)  
**Height:** 2 11/16 (68.3)

Measurements Are Shown In Inches And (Millimeters)

**WARNING:** These products can expose you to chemicals, including Diisononyl Phthalate, Carbon black extracts, Nickel, 1,3 Butadiene, Ethylene Oxide, Epichlorohydrin, which are known to the State of California to cause cancer, and Bisphenol, Ethylene Glycol, Ethylene Oxide, 1,3 Butadiene, Epichlorohydrin, which are known to the State of California to cause birth defects or other reproductive harm.

**PA644**

**Air Breather Element**



**Fits:** Euclid, Hitachi, Terex Equipment; GMC Engines  
**Replaces:** Euclid 9023871; GMC 6483993  
**O.D.:** 3 1/16 (77.8)  
**I.D.:** 1 9/16 (39.7)  
**Height:** 3 5/8 (92.1)

**PA653**

**Air Element**



**Fits:** American LaFrance Trucks; International Engines  
**Replaces:** American LaFrance 303E5852; Daimler 2732031; International 156073-C91  
**O.D.:** 6 (152.4)  
**I.D.:** 4 5/8 (117.5)  
**Height:** 8 9/16 (217.5)

**PA645**

**Air Element**



**Fits:** Allis Chalmers, Broyt, Caterpillar, Consolidated, Gardner Denver, Michigan Equipment  
**Replaces:** Allis Chalmers 70620717; Caterpillar 7M2654; Gardner Denver 2008185  
**O.D.:** 12 13/16 (325.4)  
**I.D.:** 5 29/32 (150.0) & 8 11/32 (211.9)  
**Height:** 11 17/32 (292.9)  
**A. Gskt:** [2] Attached  
**O. Gskt:** G34-AF

**PA654**

**Air Element**



**Fits:** Ford Engines; FWD Corporation Trucks  
**Replaces:** Ford C0TZ-9601-A  
**O.D.:** 12 1/4 (311.2)  
**I.D.:** 9 7/16 (239.7)  
**Height:** 5 3/16 (131.8)

**PA648**

**Air Element**



**Fits:** GM Automotive, Light-Duty Trucks, Vans  
**Replaces:** GMC 5648003  
**O.D.:** 9 3/4 (247.7)  
**I.D.:** 7 15/16 (201.6)  
**Height:** 3 (76.2)

**PA655**

**Air Element**



**Contains:** Integral Post Seal  
 Flame Retardant Media  
**Fits:** International Buses, Engines, Trucks  
**Replaces:** International 150868-R91  
**O.D.:** 8 1/16 (204.8)  
**I.D.:** 7/16 (11.1) & 5 3/4 (146.0)  
**Height:** 7 5/8 (193.7)  
**A. Gskt:** [1] Attached  
**End Seals:** [1] Attached

**PA649**

**Air Element**



**Fits:** Cushman, GMC, Outboard Marine Corporation Engines  
**Replaces:** Cushman 111316; GMC 6420249; Outboard Marine Corporation 111949  
**O.D.:** 5 3/8 (136.5)  
**I.D.:** 3 13/16 (96.8)  
**Height:** 3 1/8 (79.4)

**PA656**

**Air Element**



**Fits:** Athey, Bros Equipment; Cummins Engines; ERF Trucks  
**Replaces:** Cummins 650051  
**O.D.:** 8 7/8 (225.4)  
**I.D.:** 4 11/32 (110.3)  
**Height:** 10 (254.0)

**PA650**

**Air Element**



**Fits:** Chrysler Automotive, Light-Duty Trucks, Vans  
**Replaces:** Chrysler 2463980  
**O.D.:** 8 (203.2)  
 Top 8 1/4 (209.6)  
**I.D.:** 6 1/2 (165.1)  
**Height:** 3 (76.2)

**PA657**

**Air Element**



**Fits:** Ford Light-Duty Trucks, Vans  
**Replaces:** Ford C4OZ-9601-A  
**O.D.:** 8 13/32 (213.5)  
**I.D.:** 6 19/32 (167.5)  
**Height:** 3 1/4 (82.6)  
**Related To:** PA2107 (with Foam Wrap)

**PA651**

**Cab Air Element**



**Fits:** Allis Chalmers, Case, Ford, Massey Ferguson, New Holland Equipment  
**Replaces:** Allis Chalmers 11433412; Case F22437; Ford C7NN-19N551-A; Massey Ferguson 1032944-M1  
**O.D.:** 9 1/8 (231.8)  
**I.D.:** 6 7/8 (174.6)  
**Height:** 7 7/32 (183.4)

**PA658**

**Air Element**



**Fits:** Chrysler Automotive; GMC Light-Duty Trucks, Vans; Jeep  
**Replaces:** GMC 5648136  
**O.D.:** 9 11/16 (246.1)  
**I.D.:** 8 3/16 (208.0)  
**Height:** 1 7/8 (47.6)  
**Related To:** PA1680 (Long Version)

**PA652**

**Air Element**



**Contains:** Flame Retardant Media  
**Fits:** Allis Chalmers, Continental, Pettibone-Mulliken Equipment  
**Replaces:** Allis Chalmers 49881320; Continental F600F432; Pettibone Y400F404; Worthington FLR218  
**O.D.:** 6 (152.4)  
**I.D.:** 4 5/8 (117.5)  
**Height:** 3 7/8 (98.4)

**PA662**

**Air Element**



**Contains:** Integral Post Seal  
 Flame Retardant Media  
**Fits:** Purolator Optional Filter Housings; Sullair Compressors  
**Replaces:** Mack 81SD14  
**O.D.:** 8 1/16 (204.8)  
**I.D.:** 1/4 (6.4) & 5 3/4 (146.0)  
**Height:** 4 (101.6)  
**A. Gskt:** [1] Attached  
**F. Gskt:** [1] Included

Measurements Are Shown In Inches And (Millimeters)

**WARNING:** These products can expose you to chemicals, including Diisononyl Phthalate, Carbon black extracts, Nickel, 1,3 Butadiene, Ethylene Oxide, Epichlorohydrin, which are known to the State of California to cause cancer, and Bisphenol, Ethylene Glycol, Ethylene Oxide, 1,3 Butadiene, Epichlorohydrin, which are known to the State of California to cause birth defects or other reproductive harm.

**PA666**

Outer Air Element



**Fits:** Case, Caterpillar, Clark, Galion Equipment  
**Use With:** PA1726  
**Replaces:** Case L32943; Caterpillar 4L4134; Clark 1566067; Galion D63931  
**O.D.:** 12 1/16 (306.4)  
**I.D.:** 7 11/16 (195.3)  
**Height:** 15 (381.0)

**PA675**

Air Element



**Contains:** Flame Retardant Media  
**Fits:** Clark Lift Trucks; Onan Engines, Generators  
**Replaces:** Clark 1800562; Fiat 2019740; Onan 140B495  
**O.D.:** 4 1/4 (108.0)  
**I.D.:** 3 (76.2)  
**Height:** 3 5/16 (84.1)

**PA669**

Air Element with Bail Handle



**Contains:** Integral Post Seal Flame Retardant Media  
**Fits:** Hyster, Ingersoll-Rand, LeRoi Equipment  
**Replaces:** Hyster 118643; LeRoi H43435; Pettibone 8326  
**O.D.:** 5 15/16 (150.8)  
**I.D.:** 1/4 (6.4) & 3 1/4 (82.6)  
**Height:** 4 (101.6)  
**A. Gskt:** [1] Attached  
**O. Gskt:** G1086-AF

**PT676**

Hydraulic Element



**Fits:** Aveling-Barford, Hymac, Kalmar, Moxy Equipment  
**Replaces:** Fairey-Arlon 370L210  
**O.D.:** 3 11/16 (93.7)  
**I.D.:** 1 7/8 (47.6)  
**Height:** 7 27/32 (199.2)  
**F. Gskt:** [1] Included  
**O-Ring:** [1] Attached

**PT670**

Full-Flow Lube or Hydraulic Element with Furnished Gaskets



**Contains:** Reinforced Centertube  
**Fits:** American Hoist & Derrick, Caterpillar, Clark, Gardner Denver, Koehring, Komatsu, LeRoi, Link-Belt Equipment  
**Replaces:** Caterpillar 1R0659; Deutz 1161212; Komatsu 611-4505-100  
**O.D.:** 3 15/16 (100.0)  
**I.D.:** 1 19/32 (40.5)  
**Height:** 9 9/32 (235.7)  
**F. Gskt:** G171, G214, [1] Included  
**O. Gskt:** G115-MSB, G342, G435  
**End Seals:** [2] Attached  
**Related To:** PT7332 (with Metal Wrapper)

**PA677**

Air Element



**Fits:** Bolens, Briggs & Stratton, Kohler Engines  
**Replaces:** Briggs & Stratton 296186; International 385163-R91; Kohler 236840  
**O.D.:** 4 1/4 (108.0)  
**I.D.:** 3 (76.2)  
**Height:** 1 1/2 (38.1)

**PA678**

Air Element



**Fits:** Lawn & Garden Tractors with Kohler, Tecumseh Engines  
**Replaces:** Kohler 235116, 4708302; Tecumseh 10059, 32008  
**O.D.:** 6 1/16 (154.0)  
**I.D.:** 4 5/8 (117.5)  
**Height:** 1 15/16 (49.2)

**PT670-E**

Full-Flow Lube or Hydraulic Element without Furnished Gaskets



**Contains:** Reinforced Centertube  
**Fits:** Caterpillar, DMI, Komatsu, KW-Dart, Unit Rig, WABCO Equipment  
**Replaces:** Caterpillar 1R0659; Deutz 1161212; Komatsu 611-4505-100  
**O.D.:** 3 15/16 (100.0)  
**I.D.:** 1 19/32 (40.5)  
**Height:** 9 9/32 (235.7)  
**O. Gskt:** G115-MSB, G342, G435  
**End Seals:** [2] Attached

**PA680**

Cab Air Element



**Fits:** Hough Loaders; International, John Deere, Massey Ferguson Equipment with Excello Cabs  
**Replaces:** Case K963803; Hough 87924-C1; Wayne 6049133  
**O.D.:** 7 (177.8)  
**I.D.:** 4 7/8 (123.8)  
**Height:** 4 7/16 (112.7)

**PA671**

Air Element for Purolator Housing



**Contains:** Flame Retardant Media  
**Fits:** Chrysler Trucks; Jeep  
**Replaces:** Chrysler 2120933  
**O.D.:** 10 7/32 (259.6)  
**I.D.:** 5 1/2 (139.7)  
**Height:** 6 (152.4)

**PT682**

Hydraulic Element



**Fits:** Hymac Equipment  
**Replaces:** Hymac 2700210  
**O.D.:** 4 31/32 (126.2)  
**I.D.:** 13/32 (10.3) & 3 5/8 (92.1)  
**Height:** 8 9/32 (210.3)

**PA671-1**

Air Element for Fram Housing



**Fits:** Chrysler, Mack Engines  
**Replaces:** Mack 3076145756  
**O.D.:** 10 1/4 (260.3)  
**I.D.:** 7 3/8 (187.3)  
**Height:** 6 (152.4)

**PT683**

Wire Backed Hydraulic Element



**Replaces:** Fairey-Arlon 370L310  
**O.D.:** 3 21/32 (92.9)  
**I.D.:** 1 1/4 (31.8) & 1 7/8 (47.6)  
**Height:** 12 15/32 (316.7)  
**I.Gskt:** [1] Included  
**O-Ring:** [1] Included  
**Spring:** [1] Included

Measurements Are Shown In Inches And (Millimeters)

**WARNING:** These products can expose you to chemicals, including Diisononyl Phthalate, Carbon black extracts, Nickel, 1,3 Butadiene, Ethylene Oxide, Epichlorohydrin, which are known to the State of California to cause cancer, and Bisphenol, Ethylene Glycol, Ethylene Oxide, 1,3 Butadiene, Epichlorohydrin, which are known to the State of California to cause birth defects or other reproductive harm.

**PT685-MPG**

Hydraulic Element



**Fits:** Ford Loaders  
**O.D.:** 3 3/32 (78.6)  
**I.D.:** 1 11/16 (42.9)  
**Height:** 8 3/16 (208.0)  
**O-Ring:** [1] Attached

**PA691**

Air Element



**Fits:** AMC, Fiat, Lada, Renault Automotive  
**Replaces:** Renault 8983500079  
**O.D.:** 9 (228.6)  
**I.D.:** 7 1/2 (190.5)  
**Height:** 2 15/32 (62.7)

**PT691**

Hydraulic Element



**Fits:** Iveco, Kassbohrer, M.A.N., Mercedes-Benz Buses; DAF, Iveco, M.A.N., Mercedes-Benz, R.V.I., Volvo Trucks  
**Replaces:** Bosch 1-457-429-165; Deutz 1267900; Volvo 323139  
**O.D.:** 3 9/32 (83.3)  
**I.D.:** 17/32 (13.5)  
**Height:** 4 9/16 (115.9)  
**Grommets:** [2] Attached

**PA693**

Air Element



**Fits:** Chrysler Automotive, Light-Duty Trucks, Vans  
**Replaces:** Chrysler 2402677  
**O.D.:** 12 3/4 (323.8)  
**I.D.:** 11 (279.4)  
**Height:** 3 1/2 (88.9)

**PT694**

Hydraulic Element

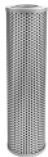

**Notes:** Inside-Out Flow Direction  
**Fits:** John Deere Equipment  
**Replaces:** John Deere AT78046  
**O.D.:** 4 3/8 (111.1)  
**I.D.:** 2 7/16 (61.9) One End  
**Height:** 16 (406.4)

**PA696**

Air Element



**Fits:** David Brown Tractors  
**Replaces:** Davis 913601  
**O.D.:** 5 3/4 (146.0)  
**I.D.:** 3 1/2 (88.9)  
**Height:** 2 9/16 (65.1)

**PA697**

Air Element



**Fits:** BMW Motorcycles; Mercedes-Benz Trucks, Vans; Stihl Saws  
**Replaces:** BMW 13720043524  
**O.D.:** 3 7/8 (98.4)  
**I.D.:** 2 11/32 (59.5)  
**Height:** 2 3/4 (69.9)

**PA699**

Air Element



**Fits:** CompAir Compressors  
**Replaces:** Joy RA221375  
**O.D.:** 6 13/16 (173.0)  
**I.D.:** 5 1/16 (128.6)  
**Height:** 3 1/16 (77.8)

**C704-L**

Vac-Cel By-Pass Lube Element with Bail Handle



**Fits:** Ag-Chem, Allis Chalmers, Fiat-Allis, Hymac, Versatile Equipment; Luber-finer Model 500 Housing  
**Replaces:** GMC 25010761; Komatsu 667-150-5300; Mack 485GB3116P1; Volvo 1695007  
**O.D.:** 7 11/16 (195.3)  
**I.D.:** 7/8 (22.2)  
**Height:** 10 (254.0)  
**O. Gskt:** ES1376, ES1377, G155, G157, G238, G252, G309-B

**P706-M**

Dual-Flow Lube Element with Bail Handle



**Notes:** Inside-Out Flow Direction  
**Fits:** Mack Trucks  
**Replaces:** Mack 236GB311A; WGB S118CP  
**O.D.:** 7 1/2 (190.5)  
**I.D.:** 23/32 (18.3)  
**Height:** 14 15/16 (379.4)  
**A. Gskt:** [2] Attached  
**O. Gskt:** G157

**PT707-HD**

Hydraulic Element



**Fits:** Allis Chalmers, Big Bud, Schroeder, WABCO Equipment  
**Replaces:** Allis Chalmers 1900201; Caterpillar 9Y4522; Komatsu 145-491-1580; Schroeder K-Series  
**O.D.:** 3 15/16 (100.0)  
**I.D.:** 1 19/32 (40.5)  
**Height:** 9 9/32 (235.7)  
**O. Gskt:** G417  
**Grommets:** [2] Attached  
**Related To:** PT757, PT757-10 (Double-Length Versions)

**PT707-HD10**

Hydraulic Element



**Fits:** Bantam, Caterpillar, Lorain, Massey Ferguson, Schroeder Equipment  
**Replaces:** Allis Chalmers 1900201; Caterpillar 9Y4522; Komatsu 145-491-1580; Schroeder K-Series  
**O.D.:** 3 15/16 (100.0)  
**I.D.:** 1 19/32 (40.5)  
**Height:** 9 9/32 (235.7)  
**O. Gskt:** G417  
**Grommets:** [2] Attached  
**Related To:** PT757, PT757-10 (Double-Length Versions)

**PT707-HD3**

Hydraulic Element



**Fits:** Gardner Denver, Ingersoll-Rand, Timbco Equipment  
**Replaces:** Allis Chalmers 1900201; Caterpillar 9Y4522; Komatsu 145-491-1580; Schroeder K-Series  
**O.D.:** 3 15/16 (100.0)  
**I.D.:** 1 19/32 (40.5)  
**Height:** 9 9/32 (235.7)  
**O. Gskt:** G417  
**Grommets:** [2] Attached  
**Related To:** PT757, PT757-10 (Double-Length Versions)

Measurements Are Shown In Inches And (Millimeters)

**WARNING:** These products can expose you to chemicals, including Diisononyl Phthalate, Carbon black extracts, Nickel, 1,3 Butadiene, Ethylene Oxide, Epichlorohydrin, which are known to the State of California to cause cancer, and Bisphenol, Ethylene Glycol, Ethylene Oxide, 1,3 Butadiene, Epichlorohydrin, which are known to the State of California to cause birth defects or other reproductive harm.

**PT708-HD**

Hydraulic Element



**Fits:** Komatsu Equipment  
**Replaces:** Komatsu 281-16-11290  
**O.D.:** 3 15/16 (100.0)  
**I.D.:** 1 5/8 (41.3)  
**Height:** 9 1/4 (235.0)  
**End Seals:** [2] Attached

**BF720**

Fuel Spin-on



**Contains:** Integral Post Seal  
**Fits:** Caterpillar, Kobelco, MDI, Mitsubishi Equipment  
**Replaces:** Caterpillar 96-6396; Kobelco 2451U-1722A; Mitsubishi ME035829  
**Thread:** M20 x 1.5  
**O.D.:** 3 11/16 (93.7)  
**Height:** 4 3/8 (111.1)  
**I.Gskt:** G324-A

**PT714**

Hydraulic Element



**Notes:** OBSOLETE. Availability Limited to Dealer Stock.  
**Fits:** WABCO Earth Moving Equipment  
**Replaces:** WABCO PB4545  
**O.D.:** 5 1/8 (130.2)  
**I.D.:** 3 3/8 (85.7)  
**Height:** 18 5/8 (473.1)  
**End Seals:** [2] Attached

**P721**

Full-Flow Lube Element



**Fits:** Claas Combines; M.A.N., R.V.I. Trucks; Mercedes-Benz Buses, Trucks; Zettelmeyer Equipment  
**Replaces:** Claas 1334990; M.A.N. 81-05504-0025; Mercedes-Benz 3521800209; Zettelmeyer 2132170  
**O.D.:** 4 1/2 (114.3)  
**I.D.:** 2 1/4 (57.2)  
**Height:** 7 11/16 (195.3)

**PT716**

In-Line Hydraulic Filter



**Fits:** Hyster, Toyota Lift Trucks  
**Replaces:** Hyster 313796, 1360557; Toyota 67502-20540-71  
**O.D.:** 4 13/16 (122.2)  
**Inlet:** 1  
**Outlet:** 1  
**Height:** 7 7/8 (200.0)  
**Related To:** PT8435-MPG (Maximum Performance Glass Version with 25 PSI By-Pass Valve)

**PT722**

Hydraulic Element



**Fits:** Broyt Excavators; Poclain, Volvo Loaders  
**Replaces:** Volvo 6210359-3  
**O.D.:** 4 31/32 (126.2)  
**I.D.:** 13/32 (10.3) & 3 5/8 (92.1)  
**Height:** 11 7/16 (290.5)  
**Grommets:** [1] Attached  
**Related To:** PT8414-MPG (Maximum Performance Glass Version)

**PF717**

Fuel Element



**Fits:** Daewoo, Ford, Gehl, John Deere, Kobelco, Komatsu, Kubota, Massey Ferguson, Mustang, New Holland, Takeuchi, Thomas, Yanmar Equipment  
**Replaces:** Ford SBA130366060; John Deere T111383; Kubota 15521-43160  
**O.D.:** 1 31/32 (50.0)  
**I.D.:** 25/32 (19.8)  
**Height:** 3 1/2 (88.9)

**P723**

Full-Flow Lube Element



**Contains:** Reinforced Centertube  
**Fits:** Furukawa, Hino, Hitachi, Kawasaki, Kobelco, Koehring, Link-Belt, Sakai Equipment; Hino, Nissan Trucks; Isuzu Engines  
**Replaces:** Hino 15607-1410; Hitachi 4092039; Isuzu 1-87810-075-01; Nissan 15208-Z9025  
**O.D.:** 3 15/16 (100.0)  
**I.D.:** 1/2 (12.7) & 2 1/4 (57.2)  
**Height:** 6 1/2 (165.1)  
**F. Gskt:** [2] Included

**P718-5**

Hydraulic Element



**Fits:** Hilco Optional Housings  
**O.D.:** 6 (152.4)  
**I.D.:** 2 5/8 (66.7)  
**Height:** 16 (406.4)  
**End Seals:** [2] Attached

**PT725-MPG**

Maximum Performance Glass Hydraulic Element



**Fits:** Barber-Greene, John Deere Equipment  
**Replaces:** John Deere AT120544  
**O.D.:** 4 1/2 (114.3)  
**I.D.:** 2 1/4 (57.2) One End  
**Height:** 9 11/16 (246.1)  
**I.Gskt:** [1] Included

**BF719**

Fuel Spin-on



**Fits:** Iveco, R.V.I. Trucks  
**Replaces:** Renault 870175600, 947718018  
**Thread:** 3/4 -16  
**O.D.:** 3 11/16 (93.7)  
**Height:** 4 3/8 (111.1)  
**I.Gskt:** G324-A

**PT727-DL**











Double-Length Hydraulic Element



**Fits:** Schroeder Equipment  
**Replaces:** Schroeder AA25  
**O.D.:** 3 (76.2)  
**I.D.:** 1 (25.4)  
**Height:** 9 13/16 (249.2)  
**O-Ring:** [2] Included

Measurements Are Shown In Inches And (Millimeters)

**WARNING:** These products can expose you to chemicals, including Diisononyl Phthalate, Carbon black extracts, Nickel, 1,3 Butadiene, Ethylene Oxide, Epichlorohydrin, which are known to the State of California to cause cancer, and Bisphenol, Ethylene Glycol, Ethylene Oxide, 1,3 Butadiene, Epichlorohydrin, which are known to the State of California to cause birth defects or other reproductive harm.

<p><b>PT727-HD</b></p> 	<p>Hydraulic Element  <b>Fits:</b> Bomag, Schroeder Equipment  <b>Replaces:</b> Schroeder A25  <b>O.D.:</b> 3 (76.2)  <b>I.D.:</b> 1 (25.4)  <b>Height:</b> 4 7/8 (123.8)  <b>O-Ring:</b> [2] Attached</p>	<p><b>PT737</b></p>  <p>Hydraulic Element  <b>Fits:</b> Ingersoll-Rand, Jaeger, Joy Equipment; Schroeder Hydraulic Systems  <b>Replaces:</b> Schroeder J25  <b>O.D.:</b> 3 17/32 (89.7)  <b>I.D.:</b> 1 5/8 (41.3)  <b>Height:</b> 9 1/4 (235.0)  <b>End Seals:</b> [2] Attached</p>
<p><b>PT727-HD10</b></p> 	<p>Hydraulic Element  <b>Fits:</b> Bomag, Schroeder Equipment  <b>Replaces:</b> Schroeder A10  <b>O.D.:</b> 3 (76.2)  <b>I.D.:</b> 1 (25.4)  <b>Height:</b> 4 7/8 (123.8)  <b>O-Ring:</b> [2] Attached</p>	<p><b>PT737-10</b></p>  <p>Hydraulic Element  <b>Fits:</b> Ingersoll-Rand, Jaeger, Joy Equipment; Schroeder Hydraulic Systems  <b>Replaces:</b> Schroeder J10  <b>O.D.:</b> 3 17/32 (89.7)  <b>I.D.:</b> 1 5/8 (41.3)  <b>Height:</b> 9 1/4 (235.0)  <b>End Seals:</b> [2] Attached</p>
<p><b>PT728-MPG</b></p> 	<p>Maximum Performance Glass Hydraulic Element  <b>Fits:</b> John Deere Equipment  <b>Replaces:</b> John Deere AT67957  <b>O.D.:</b> 2 7/8 (73.0)  <b>I.D.:</b> 1 1/8 (28.6)  <b>Height:</b> 3 5/8 (92.1)  <b>A. Gskt:</b> [2] Attached</p>	<p><b>V738-O</b></p>  <p>Vac-Cel Dual-Stage Full-Flow Lube Sock  <b>Fits:</b> Oliver, Winslow Equipment  <b>Replaces:</b> Joy 243211; Oliver 175526AS; Winslow CP7380  <b>O.D.:</b> 3 5/8 (92.1)  <b>I.D.:</b> 19/32 (15.1) &amp; 1 1/16 (27.0)  <b>Height:</b> 7 3/16 (182.6)  <b>F. Gskt:</b> G127, [1] Included</p>
<p><b>PT729</b></p> 	<p>Transmission Element  <b>Fits:</b> Bobcat Loaders  <b>Replaces:</b> Clark 233333  <b>O.D.:</b> 6 (152.4)  <b>I.D.:</b> 2 5/32 (54.8)  <b>Height:</b> 17 5/32 (435.8)  <b>I.Gskt:</b> [2] Included  <b>F. Gskt:</b> G206, [1] Included</p>	<p><b>BT739</b></p>  <p>Transmission Spin-on  <b>Contains:</b> 30 PSID By-Pass Valve          Stud Thread: M24 x 1.5  <b>Fits:</b> Case, John Deere, Moxy Equipment  <b>Replaces:</b> John Deere AT102377, AT140030  <b>Thread:</b> 1 -12  <b>O.D.:</b> 3 23/32 (94.5)  <b>Height:</b> 8 7/8 (225.4)  <b>I.Gskt:</b> G401  <b>Related To:</b> BT735 (without Adapter)</p>
<p><b>BT732</b></p> 	<p>Glass Hydraulic Spin-on  <b>Notes:</b> Can be used with OB8711, OB8712, OB8720, OB8721, OB8722, OB8724, OB8731, OB8732, OB8741, OB8742, OB8743, OB8744, OB8745, OB8746 bases.  <b>Fits:</b> Caterpillar Paving Equipment  <b>Replaces:</b> Caterpillar 8T7478  <b>Thread:</b> 1 3/8 -12  <b>O.D.:</b> 3 3/4 (95.3)  <b>Height:</b> 6 1/8 (155.6)  <b>I.Gskt:</b> [1] Included</p>	<p><b>C740-S</b></p>  <p>Wound Cotton Glycol Sock  <b>Replaces:</b> Stay Ready SRPSP68  <b>O.D.:</b> 3 1/16 (77.8)  <b>I.D.:</b> 1 11/16 (42.9)  <b>Height:</b> 7 9/32 (184.9)</p>
<p><b>BT735</b></p> 	<p>Hydraulic Spin-on  <b>Contains:</b> 30 PSID By-Pass Valve  <b>Fits:</b> Atlas-Weyhausen, Bomag, Demag, Kramer, Liebherr, Moxy, V.M.E., Volvo Equipment  <b>Replaces:</b> Volvo 4787923-4  <b>Thread:</b> 1 -12  <b>O.D.:</b> 3 23/32 (94.5)  <b>Height:</b> 8 7/32 (208.8)  <b>I.Gskt:</b> G401  <b>Related To:</b> BT739 (with Adapter)</p>	

Measurements Are Shown In Inches And (Millimeters)

**WARNING:** These products can expose you to chemicals, including Diisononyl Phthalate, Carbon black extracts, Nickel, 1,3 Butadiene, Ethylene Oxide, Epichlorohydrin, which are known to the State of California to cause cancer, and Bisphenol, Ethylene Glycol, Ethylene Oxide, 1,3 Butadiene, Epichlorohydrin, which are known to the State of California to cause birth defects or other reproductive harm.

**C750-E**

750 Size Depth-Pack By-Pass Lube Element with Bail Handle



**Notes:** To convert to spin-on, use OB1308 and B7577.  
C750-L has 1.5 pounds additional media.  
**Fits:** Allis Chalmers, Clark, Demag, Fiat-Allis, Foden, Hymac, Komatsu, M.A.N., Steiger, Volvo Equipment; Luber-finer Model 750 Housing and All Model 750 Housings Except Stay Ready Housing  
**Replaces:** Luber-finer 750, 750B, 750M1C, 2091, 3118, 3730  
**O.D.:** 7 23/32 (196.1)  
**I.D.:** 29/32 (23.0)  
**Height:** 15 3/32 (383.4)  
**O. Gskt:** ES1376, ES1377, G155, G157, G238, G252, G309-B  
**Related To:** C750-L (1.5 pounds more media) F7500 (Fuel Version) P7500 (Extended Life Version)

**C750-L**

750 Size Vac-Cel By-Pass Lube Element with Bail Handle



**Notes:** To convert to spin-on, use OB1308 and B7577.  
C750-L has 1.5 pounds additional media.  
**Fits:** Allis Chalmers, Clark, Demag, Fiat-Allis, Foden, Hymac, Komatsu, M.A.N., Steiger, Volvo Equipment; Luber-finer Model 750 Housing and All Model 750 Housings Except Stay Ready Housing  
**Replaces:** Luber-finer 750, 750B, 750M1C, 2091, 3118, 3730  
**O.D.:** 7 23/32 (196.1)  
**I.D.:** 29/32 (23.0)  
**Height:** 15 3/32 (383.4)  
**O. Gskt:** ES1376, ES1377, G155, G157, G238, G252, G309-B  
**Related To:** C750-E (Different amount of media) F7500 (Fuel Version) P7500 (Extended Life Version)

**C750-L SINGLE** Individually Boxed Version of C750-L



**Notes:** To convert to spin-on, use OB1308 and B7577.  
**Fits:** Allis Chalmers, Clark, Demag, Fiat-Allis, Foden, Hymac, Komatsu, M.A.N., Steiger, Volvo Equipment; Luber-finer Model 750 Housing and All Model 750 Housings Except Stay Ready Housing  
**Replaces:** Luber-finer 750, 750B, 750M1C, 2091, 3118, 3730  
**O.D.:** 7 23/32 (196.1)  
**I.D.:** 29/32 (23.0)  
**Height:** 15 3/32 (383.4)  
**O. Gskt:** ES1376, ES1377, G155, G157, G238, G252, G309-B  
**Related To:** F7500 (Fuel Version) P7500 (Extended Life Version)

**PT751**

Hydraulic Element



**Notes:** Inside-Out Flow Direction  
**Contains:** Standpipe  
**Fits:** Hyster Lift Trucks  
**Replaces:** Hyster 190786  
**O.D.:** 4 (101.6)  
**I.D.:** 1 1/4 (31.8) & 1 9/16 (39.7)  
**Height:** 14 7/8 (377.8)  
**I.Gskt:** [1] Included

**PT752**

Hydraulic Element



**Contains:** Reinforced Centertube  
**Replaces:** Clark 2526831  
**O.D.:** 4 3/8 (111.1)  
**I.D.:** 2 13/32 (61.1)  
**Height:** 16 1/16 (408.0)  
**A. Gskt:** [2] Attached

**PT753**

Hydraulic Element



**Fits:** Case Equipment  
**Replaces:** Fairey-Arlon TXX12-R-10  
**O.D.:** 8 (203.2)  
**I.D.:** 9/16 (14.3) & 6 3/16 (157.2)  
**Height:** 21 1/2 (546.1)  
**I.Gskt:** [1] Included  
**F. Gskt:** [2] Included

**PT757**

Hydraulic Element



**Fits:** Schroeder Hydraulic Systems  
**Replaces:** Schroeder KK Series  
**O.D.:** 3 15/16 (100.0)  
**I.D.:** 1 19/32 (40.5)  
**Height:** 18 1/2 (469.9)  
**Grommets:** [2] Attached  
**Related To:** PT707, PT707-10 (Single-Length Versions)

**PT757-10**

Hydraulic Element



**Fits:** Schroeder Hydraulic Systems  
**Replaces:** Schroeder KK Series  
**O.D.:** 3 15/16 (100.0)  
**I.D.:** 1 19/32 (40.5)  
**Height:** 18 1/2 (469.9)  
**Grommets:** [2] Attached  
**Related To:** PT707, PT707-10 (Single-Length Versions)

**PT760-10**

Hydraulic Element



**Notes:** Inside-Out Flow Direction  
**Fits:** Allis Chalmers, Case, Dresser, Galion, Massey Ferguson Equipment  
**Replaces:** Allis Chalmers 2698561; Case S232253; Galion D141064; Ingersoll-Rand 35290444  
**O.D.:** 4 3/8 (111.1)  
**I.D.:** 23/32 (18.3) & 2 7/16 (61.9)  
**Height:** 8 (203.2)  
**O. Gskt:** G439  
**Grommets:** [1] Attached

**PT760-25**











Hydraulic Element

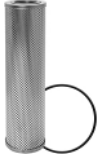

**Notes:** Inside-Out Flow Direction  
**Fits:** Allis Chalmers, Galion, Ingersoll-Rand, Massey Ferguson Equipment  
**Replaces:** Galion D136601; Ingersoll-Rand 35328509; Massey Ferguson 1051399-M91  
**O.D.:** 4 3/8 (111.1)  
**I.D.:** 23/32 (18.3) & 2 7/16 (61.9)  
**Height:** 8 (203.2)  
**O. Gskt:** G439  
**Grommets:** [1] Attached

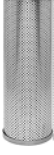
Measurements Are Shown In Inches And (Millimeters)

**WARNING:** These products can expose you to chemicals, including Diisononyl Phthalate, Carbon black extracts, Nickel, 1,3 Butadiene, Ethylene Oxide, Epichlorohydrin, which are known to the State of California to cause cancer, and Bisphenol, Ethylene Glycol, Ethylene Oxide, 1,3 Butadiene, Epichlorohydrin, which are known to the State of California to cause birth defects or other reproductive harm.

<p><b>PT761</b></p> 	<p>Hydraulic Element  <b>Fits:</b> Ingersoll-Rand, Massey Ferguson Equipment  <b>Replaces:</b> Ingersoll-Rand 35280825  <b>O.D.:</b> 4 3/8 (111.1)  <b>I.D.:</b> 2 7/16 (61.9)  <b>Height:</b> 8 1/16 (204.8)  <b>A. Gskt:</b> [2] Attached</p>	<p><b>PT768</b></p> 	<p>Hydraulic Element  <b>Notes:</b> Inside-Out Flow Direction  <b>Fits:</b> Case, New Holland, Versatile Tractors  <b>Replaces:</b> Versatile 63297  <b>O.D.:</b> 4 13/32 (111.9)  <b>I.D.:</b> 23/32 (18.3) &amp; 2 7/16 (61.9)  <b>Height:</b> 16 1/16 (408.0)  <b>A. Gskt:</b> [1] Attached  <b>Grommets:</b> [1] Attached</p>
<p><b>PT763</b></p> 	<p>Hydraulic Element  <b>Notes:</b> Inside-Out Flow Direction  <b>Fits:</b> Grove Cranes; Ingersoll-Rand Equipment  <b>Replaces:</b> Grove 9437100156; Ingersoll-Rand 35997352  <b>O.D.:</b> 4 3/8 (111.1)  <b>I.D.:</b> 23/32 (18.3) &amp; 2 7/16 (61.9)  <b>Height:</b> 16 1/16 (408.0)  <b>A. Gskt:</b> [1] Attached  <b>Grommets:</b> [1] Attached</p>	<p><b>PT772</b></p> 	<p>Hydraulic Element  <b>Notes:</b> Inside-Out Flow Direction  <b>Fits:</b> Case, Drott, Michigan Equipment  <b>Replaces:</b> Case S111118; Clark 960641  <b>O.D.:</b> 4 3/8 (111.1)  <b>I.D.:</b> 23/32 (18.3) &amp; 2 13/32 (61.1)  <b>Height:</b> 13 1/32 (331.0)  <b>A. Gskt:</b> [1] Attached  <b>Grommets:</b> [1] Attached</p>
<p><b>PT764</b></p> 	<p>Hydraulic Element  <b>Fits:</b> Ingersoll-Rand Compressors  <b>Replaces:</b> Ingersoll-Rand 35280809  <b>O.D.:</b> 4 3/8 (111.1)  <b>I.D.:</b> 2 13/32 (61.1)  <b>Height:</b> 5 (127.0)  <b>A. Gskt:</b> [2] Attached</p>	<p><b>PT773-MPG</b></p> 	<p>Maximum Performance Glass Hydraulic Element  <b>Notes:</b> Inside-Out Flow Direction  <b>Replaces:</b> Ingersoll-Rand 35330133  <b>O.D.:</b> 4 3/8 (111.1)  <b>I.D.:</b> 3/4 (19.0) &amp; 2 7/16 (61.9)  <b>Height:</b> 16 1/16 (408.0)  <b>A. Gskt:</b> [1] Included  <b>O-Ring:</b> [1] Included  <b>Grommets:</b> [1] Attached</p>
<p><b>PT765</b></p> 	<p>Hydraulic Element  <b>Notes:</b> Inside-Out Flow Direction  <b>Fits:</b> Ingersoll-Rand Compressors  <b>Replaces:</b> Ingersoll-Rand 50469055  <b>O.D.:</b> 4 3/8 (111.1)  <b>I.D.:</b> 23/32 (18.3) &amp; 2 13/32 (61.1)  <b>Height:</b> 5 (127.0)  <b>A. Gskt:</b> [1] Attached  <b>Grommets:</b> [1] Attached</p>	<p><b>BT774</b></p> 	<p>Hydraulic Spin-on  <b>Fits:</b> Dresser, Hough Equipment  <b>Replaces:</b> International 1106643-C1, 1106643-C2  <b>Thread:</b> 3 -8  <b>O.D.:</b> 5 (127.0)  <b>Height:</b> 12 1/4 (311.2)</p>
<p><b>PT766</b></p> 	<p>Hydraulic Element  <b>Notes:</b> Inside-Out Flow Direction  <b>Fits:</b> Case, Drott Equipment  <b>Replaces:</b> Case S111605  <b>O.D.:</b> 4 3/8 (111.1)  <b>I.D.:</b> 23/32 (18.3) &amp; 2 13/32 (61.1)  <b>Height:</b> 13 1/32 (331.0)  <b>A. Gskt:</b> [1] Attached  <b>Grommets:</b> [1] Attached</p>	<p><b>BT775</b></p> 	<p>Hydraulic Spin-on  <b>Fits:</b> Dresser, Hough Equipment  <b>Replaces:</b> International 1103462-C1, 1103462-C2  <b>Thread:</b> 3 -8  <b>O.D.:</b> 5 (127.0)  <b>Height:</b> 8 13/16 (223.8)</p>
<p><b>PT767</b></p> 	<p>Hydraulic Element  <b>Notes:</b> Inside-Out Flow Direction  <b>Fits:</b> Case Equipment; Ingersoll-Rand Compressors  <b>Replaces:</b> Ingersoll-Rand 50693886  <b>O.D.:</b> 4 3/8 (111.1)  <b>I.D.:</b> 23/32 (18.3) &amp; 2 7/16 (61.9)  <b>Height:</b> 16 1/16 (408.0)  <b>A. Gskt:</b> [1] Attached  <b>Grommets:</b> [1] Attached</p>	<p><b>PT776-MPG</b></p> 	<p>Maximum Performance Glass Hydraulic Element  <b>Notes:</b> Inside-Out Flow Direction  <b>Replaces:</b> Gardner Denver 2109093  <b>O.D.:</b> 4 3/8 (111.1)  <b>I.D.:</b> 3/4 (19.1) &amp; 2 7/16 (61.9)  <b>Height:</b> 8 1/16 (204.8)  <b>A. Gskt:</b> [1] Attached  <b>F. Gskt:</b> [1] Washer  <b>O-Ring:</b> [2] Included  <b>Grommets:</b> [1] Attached</p>

Measurements Are Shown In Inches And (Millimeters)

**WARNING:** These products can expose you to chemicals, including Diisononyl Phthalate, Carbon black extracts, Nickel, 1,3 Butadiene, Ethylene Oxide, Epichlorohydrin, which are known to the State of California to cause cancer, and Bisphenol, Ethylene Glycol, Ethylene Oxide, 1,3 Butadiene, Epichlorohydrin, which are known to the State of California to cause birth defects or other reproductive harm.



**PT777**

Hydraulic Element



**Notes:** Inside-Out Flow Direction  
**Replaces:** Ingersoll-Rand 39123211  
**O.D.:** 4 3/8 (111.1)  
**I.D.:** 5/8 (15.9) & 23/32 (18.3)  
**Height:** 8 (203.2)  
**A. Gskt:** [1] Attached  
**O-Ring:** [1] Included  
**Grommets:** [1] Attached

**BF784**

Primary Fuel Spin-on



**Notes:** Can be used with FB1309 base.  
**Contains:** Integral Post Seal  
**Fits:** American Hoist & Derrick, Demag, Dresser, Komatsu, Terex Equipment; Detroit Diesel Engines  
**Replaces:** Detroit Diesel 23518528  
**Thread:** 1 1/4 -12  
**O.D.:** 4 21/32 (118.3)  
**Height:** 9 1/2 (241.3)  
**I.Gskt:** [1] Included

**BT778**

Hydraulic Spin-on



**Contains:** 15 PSID Front-End Check Valve  
 30 PSID By-Pass Valve  
**Fits:** Allis Chalmers, Deutz Equipment  
**Replaces:** Deutz 4305722  
**Thread:** 1 -12  
**O.D.:** 3 11/16 (93.7)  
**Height:** 8 23/32 (221.5)  
**I.Gskt:** G381-A

**BF785**

Secondary Fuel Spin-on



**Notes:** Can be used with FB1310 base.  
**Contains:** Integral Post Seal  
**Fits:** American Hoist & Derrick, Demag, Dresser, Komatsu, Terex Equipment; Detroit Diesel Engines  
**Thread:** 1 1/16 -16  
**O.D.:** 4 21/32 (118.3)  
**Height:** 9 1/2 (241.3)  
**I.Gskt:** [1] Included

**BT779**

Transmission Spin-on



**Fits:** Caterpillar Equipment  
**Replaces:** Caterpillar 9T1119  
**Thread:** 13/16 -16  
**O.D.:** 3 11/16 (93.7)  
**Height:** 2 29/32 (73.8)  
**I.Gskt:** G401

**BF786**

Fuel Spin-on



**Contains:** Integral Post Seal  
**Fits:** Ford Light-Duty Trucks, Vans; International Diesel Engines  
**Replaces:** International 1804459-C1  
**Thread:** 7/8 -14  
**O.D.:** 4 1/4 (108.0)  
**Height:** 4 11/16 (119.1)  
**I.Gskt:** G381-A

**BF781**

Primary Fuel Spin-on with Drain



**Notes:** Can be used with FB1301 base.  
**Contains:** Drain Hose Adapter  
**Fits:** GMC Buses, Light-Duty Trucks, Vans; Detroit Diesel Engines; Generac RV Generators  
**Replaces:** GMC 25011285  
**Thread:** 1 -12  
**O.D.:** 3 11/16 (93.7)  
**Height:** 6 1/8 (155.6)  
**I.Gskt:** [1] Included

**BF788**

Secondary Fuel Spin-on



**Notes:** CAUTION: Furnished O-Ring must be installed on post for seal.  
**Contains:** Standpipe  
**Fits:** Case, Consolidated Diesel, Cummins Engines; Komatsu Equipment  
**Replaces:** Case J903640; Cummins 3903640  
**Thread:** M16 x 1.5  
**O.D.:** 3 1/32 (77.0)  
**Height:** 4 27/32 (123.0)  
**I.Gskt:** G449-B  
**O-Ring:** [1] Included

**BF782**

Secondary Fuel Spin-on



**Contains:** Integral Post Seal  
**Fits:** GMC Buses, Light-Duty Trucks, Vans; Detroit Diesel Engines  
**Replaces:** GMC 25011214  
**Thread:** M16 x 1.5  
**O.D.:** 3 (76.2)  
**Height:** 4 27/32 (123.0)  
**I.Gskt:** G449-B

**BF789**

Fuel Spin-on



**Fits:** Ford Light-Duty Trucks; Gehl, John Deere, Kohler, Thomas, Westerbeke Equipment  
**Replaces:** Ford E3TZ-9155-B  
**Thread:** M20 x 1.5  
**O.D.:** 3 11/16 (93.7)  
**Height:** 3 7/8 (98.4)  
**I.Gskt:** G381-A

**BF783**

Secondary Fuel Spin-on



**Fits:** Allis Chalmers, Astra, Benfra, Fiat-Allis, New Holland Equipment; Iveco Buses, Engines, Trucks  
**Replaces:** Fiat 1909103  
**Thread:** 3/4 -16  
**O.D.:** 4 1/4 (108.0)  
**Height:** 7 11/32 (186.5)  
**I.Gskt:** G381-A

**BF790**

Fuel Spin-on



**Fits:** Atlas Copco, Bandit, Bobcat, Bomag, Case, Demag, Ditch Witch, Dynapac, Grove, International, Manitou, Vermeer, Volvo Equipment; Deutz, MWM Engines  
**Replaces:** Bosch 1-457-434-069; Deutz 1161341; Melroe-Bobcat 4121609  
**Thread:** M16 x 1.5  
**O.D.:** 3 1/32 (77.0)  
**Height:** 3 15/32 (88.1)  
**I.Gskt:** G449-B  
**Related To:** BF7915 (Short Version)

Measurements Are Shown In Inches And (Millimeters)

**WARNING:** These products can expose you to chemicals, including Diisononyl Phthalate, Carbon black extracts, Nickel, 1,3 Butadiene, Ethylene Oxide, Epichlorohydrin, which are known to the State of California to cause cancer, and Bisphenol, Ethylene Glycol, Ethylene Oxide, 1,3 Butadiene, Epichlorohydrin, which are known to the State of California to cause birth defects or other reproductive harm.

**BF791** Fuel/Water Separator Spin-on  
**Fits:** Crusader, Mercruiser, Volvo-Penta Engines  
**Replaces:** Mercruiser 3560494  
**Thread:** 11/16 -16  
**O.D.:** 3 11/16 (93.7)  
**Height:** 3 7/8 (98.4)  
**I.Gskt:** G381-A



**BF791-O** Fuel/Water Separator with Open Port for Bowl  
**Contains:** Port Thread: 3 1/4-10  
**Fits:** Quicksilver Outboard Applications  
**Replaces:** Racor S3213  
**Thread:** 11/16 -16  
**O.D.:** 3 25/32 (96.0)  
**Height:** 4 1/32 (102.4)  
**F. Gskt:** [2] Included  
**O-Ring:** [1] Included



**BF792** Fuel Spin-on  
**Contains:** Integral Post Seal  
**Fits:** Caterpillar, Kobelco, MDI, Mitsubishi Equipment  
**Replaces:** Mitsubishi ME016823  
**Thread:** M20 x 1.5  
**O.D.:** 3 23/32 (94.5)  
**Height:** 3 7/8 (98.4)  
**I.Gskt:** G324-A



**BF794** In-Line Fuel Filter  
**Fits:** Chrysler Automotive, Vans  
**Replaces:** Chrysler 4443462  
**O.D.:** 2 5/32 (54.8)  
**Inlet:** 5/16  
**Outlet:** 5/16  
**Length:** 4 (101.6)



**BF795** In-Line Fuel Filter  
**Fits:** Chrysler Automotive, Vans  
**Replaces:** Chrysler 4443463  
**O.D.:** 2 5/16 (58.7)  
**Inlet:** 5/16  
**Outlet:** 5/16  
**Length:** 4 11/32 (110.3)



**BF797** Fuel Spin-on  
**Fits:** Iveco, R.V.I. Trucks  
**Replaces:** Renault 3036404  
**Thread:** 3/4 -16  
**O.D.:** 3 11/16 (93.7)  
**Height:** 5 3/8 (136.5)  
**I.Gskt:** G381-A



**BF798** Fuel Spin-on  
**Contains:** Integral Post Seal  
**Fits:** Case, Caterpillar, Hitachi, Kobelco, Link-Belt, Mitsubishi, Tadano Equipment  
**Replaces:** Caterpillar 96-9625; Kobelco 2451U-2112; Mitsubishi ME056280  
**Thread:** M24 x 1.5  
**O.D.:** 3 11/16 (93.7)  
**Height:** 6 9/16 (166.7)  
**I.Gskt:** [1] Included



**BF799** Fuel Spin-on  
**Contains:** Integral Post Seal  
**Fits:** Caterpillar Equipment  
**Replaces:** Caterpillar 1R0715, 8N3080  
**Thread:** 1 3/8 -16  
**O.D.:** 5 3/8 (136.5)  
**Height:** 12 3/32 (307.2)  
**I.Gskt:** [1] Included



**PF802** Fuel Element  
**Fits:** Allis Chalmers Tractors; Detroit Diesel Engines  
**Replaces:** Allis Chalmers 853361; GMC 853695  
**O.D.:** 2 7/8 (73.0)  
**I.D.:** 1/2 (12.7) & 1 (25.4)  
**Height:** 4 7/32 (107.2)  
**A. Gskt:** [2] Attached  
**F. Gskt:** [1] Included



**PF804** Fuel Element  
**Fits:** Detroit Diesel Engines; Gorman Rupp Pumps  
**Replaces:** GMC 6438498  
**O.D.:** 3 7/16 (87.3)  
**I.D.:** 7/16 (11.1) & 1/2 (12.7)  
**Height:** 5 23/32 (145.3)  
**F. Gskt:** [1] Included  
**Grommets:** [2] Attached



**BF805** In-Line Fuel Filter  
**Fits:** Chevrolet, GEO, Isuzu, Subaru, Toyota Automotive, Light-Duty Trucks, Vans  
**Replaces:** Toyota 23300-34100  
**O.D.:** 3 1/8 (79.4)  
**Inlet:** 5/16  
**Outlet:** 5/16  
**Length:** 2 1/4 (57.2)



**BF806** Box-Style Fuel/Water Separator  
**Fits:** Buick, Cadillac, Chevrolet, Oldsmobile, Pontiac Diesel Automotive, Light-Duty Trucks, Vans; GMC Light-Duty Diesel Trucks  
**Replaces:** GMC 25010487  
**Inlet:** 3/8  
**Outlet:** 1/4  
**Length:** 4 3/8 (111.1)  
**Width:** 3 9/32 (83.3)  
**Height:** 2 5/8 (66.7)



**PF807** Fuel Element  
**Fits:** John Deere Tractors  
**Replaces:** John Deere AT11929T, AT20541T  
**O.D.:** 3 1/32 (77.0)  
**I.D.:** 23/32 (18.3) One End  
**Height:** 4 (101.6)  
**F. Gskt:** [1] Included  
**Grommets:** [1] Attached



Measurements Are Shown In Inches And (Millimeters)

**WARNING:** These products can expose you to chemicals, including Diisononyl Phthalate, Carbon black extracts, Nickel, 1,3 Butadiene, Ethylene Oxide, Epichlorohydrin, which are known to the State of California to cause cancer, and Bisphenol, Ethylene Glycol, Ethylene Oxide, 1,3 Butadiene, Epichlorohydrin, which are known to the State of California to cause birth defects or other reproductive harm.

**PF809** Fuel Element with Bail Handle  
**Fits:** Allis Chalmers, Case, Caterpillar, Continental, Euclid, Massey Ferguson, Oliver Equipment  
**Replaces:** Allis Chalmers 43711640; Case 73220; Massey Ferguson 1006589-M92  
**O.D.:** 4 7/32 (107.2)  
**I.D.:** 1/2 (12.7)  
**Height:** 4 7/8 (123.8)  
**F. Gskt:** G104  
**Grommets:** [2] Attached  
**Related To:** P41 (By-Pass Lube Version)



**PF816-S** Fuel Element  
**Fits:** Atlas Copco Compressors; Ford, Perkins Engines; Hymac, Hyster, Massey Ferguson, Timberjack Equipment  
**Replaces:** Ford E1ADDN-99162-B2; Hyster 985220; Perkins 30497; Timberjack 402540  
**O.D.:** 2 7/8 (73.0)  
**I.D.:** 15/16 (23.8)  
**Height:** 3 1/16 (77.8)  
**F. Gskt:** G147-A



**PF810** Fuel Element  
**Fits:** Allis Chalmers, Caterpillar, Clark, Waukesha Engines, Equipment  
**Replaces:** Allis Chalmers 43711650; Clark 944475; Waukesha 151137  
**O.D.:** 3 (76.2)  
**I.D.:** 1 1/16 (27.0)  
**Height:** 7 13/16 (198.4)  
**A. Gskt:** [2] Attached  
**F. Gskt:** [3] Included  
**O. Gskt:** G344



**PF818** Fuel Element  
**Fits:** Bennett Fuel Pumps  
**Replaces:** Bennett A3119  
**O.D.:** 2 1/4 (57.2)  
**I.D.:** 1 1/16 (27.0) One End  
**Height:** 3 31/32 (100.8)  
**A. Gskt:** [1] Attached



**PF811** Fuel Element with Bail Handle  
**Fits:** Kawasaki Loaders; Komatsu Equipment  
**Replaces:** Komatsu 6610-72-8600  
**O.D.:** 5 (127.0)  
**I.D.:** 31/32 (24.6)  
**Height:** 9 31/32 (253.2)  
**F. Gskt:** [1] Included  
**Grommets:** [2] Attached



**PF819** Fuel Element  
**Fits:** Mack Engines, Trucks  
**Replaces:** Mack 237GB13  
**O.D.:** 3 15/16 (100.0)  
**I.D.:** 7/8 (22.2)  
**Height:** 6 7/32 (158.0)  
**A. Gskt:** [2] Attached  
**F. Gskt:** G106, [1] Included



**BF812** Can-Type Fuel Filter  
**Fits:** Massey Ferguson Equipment; Perkins Engines  
**Replaces:** Massey Ferguson 1896202-M91; Perkins 26560097  
**O.D.:** 3 15/32 (88.1)  
**I.D.:** 3/4 (19.0)  
**Height:** 5 13/32 (137.3)  
**F. Gskt:** [2] Included  
**O-Ring:** [2] Included  
**End Seals:** [1] Attached  
**Related To:** BF825, BF874, BF884 (Short Versions)



**PF819-HD** Heavy-Duty Fuel or Hydraulic Element  
**Notes:** OBSOLETE. Availability Limited to Dealer Stock.  
**Fits:** Koehring Equipment  
**Replaces:** Mack 237GB13  
**O.D.:** 3 15/16 (100.0)  
**I.D.:** 7/8 (22.2)  
**Height:** 6 7/32 (158.0)  
**A. Gskt:** [2] Attached  
**F. Gskt:** G106, [1] Included



**PF814** Fuel Element  
**Fits:** John Deere Equipment  
**Replaces:** John Deere AR28611R, AR44077  
**O.D.:** 3 7/16 (87.3)  
**I.D.:** 23/32 (18.3) One End  
**Height:** 4 3/16 (106.4)  
**F. Gskt:** [1] Included  
**O. Gskt:** G406  
**Grommets:** [1] Attached



**PF820-S** Fuel Element  
**Fits:** David Brown, Massey Ferguson Equipment; Dorman, Lister, Perkins, Petter Engines  
**Replaces:** Dorman 73130020; Massey Ferguson 1845766-M1; Perkins 26540183  
**O.D.:** 2 7/8 (73.0)  
**I.D.:** 1 5/16 (33.3)  
**Height:** 3 5/16 (84.1)  
**F. Gskt:** G147-A, G161  
**Related To:** P176 (Full-Flow Lube Version)



**PF816** Fuel Element  
**Fits:** Ford, Perkins, Westerbeke Marine Engines; J.C. Bamford, Landini, Massey Ferguson Equipment  
**Replaces:** Ford EPN-99062-A; Massey Ferguson 1850450-M2  
**O.D.:** 2 15/16 (74.6)  
**I.D.:** 1 1/4 (31.8)  
**Height:** 3 1/8 (79.4)  
**F. Gskt:** G147-A, G161, [1] Included  
**End Seals:** [2] Attached



**PF821-S** Fuel Element  
**Fits:** Fixible, Ford, International Trucks; Cummins Engines; Euclid, Hough, Michigan, Oliver Equipment  
**Replaces:** Allis Chalmers BM33761; Cummins BM33761; Ford EDL-9176-A; International 3054750-R91  
**O.D.:** 3 15/16 (100.0)  
**I.D.:** 23/32 (18.3)  
**Height:** 4 13/16 (122.2)  
**F. Gskt:** G104  
**End Seals:** [2] Included



Measurements Are Shown In Inches And (Millimeters)

**WARNING:** These products can expose you to chemicals, including Diisononyl Phthalate, Carbon black extracts, Nickel, 1,3 Butadiene, Ethylene Oxide, Epichlorohydrin, which are known to the State of California to cause cancer, and Bisphenol, Ethylene Glycol, Ethylene Oxide, 1,3 Butadiene, Epichlorohydrin, which are known to the State of California to cause birth defects or other reproductive harm.

**PF822**

Fuel Element



**Fits:** Cummins Engines; Euclid, P & H Harnischfeger Equipment  
**Replaces:** Cummins C44758; Mack 236GB238; White 609673FS  
**O.D.:** 3 15/16 (100.0)  
**I.D.:** 1 1/16 (27.0)  
**Height:** 5 31/32 (151.6)  
**F. Gskt:** G106  
**End Seals:** [2] Included  
**Related To:** P82 (Lube Version) PT243, PT82-HD10 (Hydraulic Versions)

**PF826**

Fuel Element



**Contains:** Reinforced Centertube  
**Fits:** Mack Trucks  
**Replaces:** Mack 237GB29, 237GB29-A  
**O.D.:** 3 15/16 (100.0)  
**I.D.:** 1 1/16 (27.0)  
**Height:** 6 1/4 (158.8)  
**A. Gskt:** [2] Attached  
**F. Gskt:** [1] Included

**PF823**

Fuel Element



**Contains:** Reinforced Centertube  
**Fits:** Bucyrus-Erie, Caterpillar, Clark, Gardner Denver Equipment; Kenworth, Peterbilt Trucks  
**Replaces:** Caterpillar 9H4729, 9H8792, 9M9641  
**O.D.:** 3 5/16 (84.1)  
**I.D.:** 1 1/16 (27.0)  
**Height:** 6 1/2 (165.1)  
**A. Gskt:** [2] Attached  
**F. Gskt:** [2] 7B-7635  
**Related To:** PF824 (Different Gasket)

**PF827**

Fuel Element



**Fits:** Chrysler, GM Automotive, Light-Duty Trucks; Ford, International Heavy-Duty Trucks; Hobart, Huber, Hyster, International, Lorain, New Holland Equipment; Waukesha Engines  
**Replaces:** Clark 999478; GMC 854606; Hyster 97372; International 998429-R91; New Holland 500660; Versatile 608T119  
**O.D.:** 2 1/16 (52.4)  
**I.D.:** 7/16 (11.1)  
**Height:** 3 15/32 (88.1)  
**F. Gskt:** G204-A  
**Grommets:** [1] Attached

**PF823-E**

Fuel Element



**Contains:** Reinforced Centertube  
**Fits:** Caterpillar, DMI, Unit Rig, WABCO Equipment  
**Replaces:** Caterpillar 4H8792  
**O.D.:** 3 5/16 (84.1)  
**I.D.:** 1 1/16 (27.0)  
**Height:** 6 1/2 (165.1)  
**A. Gskt:** [2] Attached  
**Related To:** PF823 (with Furnished Gaskets)

**PF828**

Secondary Fuel Element



**Fits:** Clark, Galion, Hough, International, Massey Ferguson Equipment; International, Mack Engines  
**Replaces:** Galion 85832; International 610309-C91; Mack 483GB215  
**O.D.:** 3 3/16 (81.0)  
**I.D.:** 1 1/16 (27.0)  
**Height:** 4 1/2 (114.3)  
**A. Gskt:** [2] Attached  
**F. Gskt:** G106

**PF824**

Fuel Element



**Contains:** Reinforced Centertube  
**Fits:** American Hoist & Derrick, Caterpillar, Gardner Denver, Gradall, Koehring, Link-Belt Equipment; Atlas Copco Compressors; Caterpillar Diesel Engines, Trucks; Clark Shovels  
**Replaces:** Caterpillar 9H4729  
**O.D.:** 3 5/16 (84.1)  
**I.D.:** 1 1/16 (27.0)  
**Height:** 6 1/2 (165.1)  
**A. Gskt:** [2] Attached  
**F. Gskt:** 5M-954  
**O. Gskt:** 1S-9133 (For use with Stacked Elements)  
**Related To:** PF823 (Different Gaskets)

**PF829(2)**

Set of 2 Fuel Elements



**Contains:** Reinforced Centertube  
**Fits:** Caterpillar Equipment  
**Replaces:** Caterpillar 9H1252  
**O.D.:** 3 5/16 (84.1)  
**I.D.:** 1 1/16 (27.0)  
**Height:** 6 1/2 (165.1)  
**A. Gskt:** [2] Attached on Each Element  
**F. Gskt:** [1] Included

**BF825**

Can-Type Fuel Filter



**Fits:** Agco, Akerman, Allis Chalmers, Bobcat, Case, Caterpillar, Fiat, Ford, Hesston, International, J.C. Bamford, John Deere, Kubota, Massey Ferguson, New Holland, Oliver, Perkins, White Equipment  
**Replaces:** Allis Chalmers 1919100; Case K915319; Ford E7NN-9176-AA; International 757836-R91; Massey Ferguson 1013891-M1; New Holland 505776; Perkins 868014  
**O.D.:** 3 7/16 (87.3)  
**I.D.:** 3/4 (19.0)  
**Height:** 2 13/16 (71.4)  
**F. Gskt:** ES1049, [2] G233-A, G233-B  
**O-Ring:** [1] Included  
**O. Gskt:** ES3063 (IHC Installations)  
**Related To:** BF812, BF874, BF884 (Long Versions)

**BF830**

In-Line Fuel Filter



**Fits:** Subaru Automotive  
**Replaces:** Subaru 74207-2040  
**O.D.:** 3 3/16 (81.0)  
**Inlet:** 5/16  
**Outlet:** 5/16  
**Length:** 5 1/8 (130.2)

**PF831**

Fuel Element



**Fits:** ERF Trucks; Gardner Denver Compressors; Leyland Buses, Trucks; Lister, Rolls-Royce Diesel Engines  
**Replaces:** Gardner Denver GFF310; Leyland GRS05516; Rolls-Royce OD3928; Transicold 25-50110-09  
**O.D.:** 2 7/8 (73.0)  
**I.D.:** 1 5/16 (33.3)  
**Height:** 5 1/2 (139.7)  
**F. Gskt:** [1] Included

Measurements Are Shown In Inches And (Millimeters)

**WARNING:** These products can expose you to chemicals, including Diisononyl Phthalate, Carbon black extracts, Nickel, 1,3 Butadiene, Ethylene Oxide, Epichlorohydrin, which are known to the State of California to cause cancer, and Bisphenol, Ethylene Glycol, Ethylene Oxide, 1,3 Butadiene, Epichlorohydrin, which are known to the State of California to cause birth defects or other reproductive harm.

**BF833** In-Line Fuel Filter  
**Fits:** Dodge, Jeep, Nissan Automotive; Bobcat, Case, Caterpillar, Gehl, Grove, John Deere, Mitsubishi, New Holland Equipment  
**Replaces:** Case D59949; Caterpillar 9Y4444; Chrysler 2455808; GMC 25055223; John Deere AM116178, AM116304; Mitsubishi MB554970; New Holland 269212; Nissan 16400-A0600, 16400-A0601  
**O.D.:** 1 29/32 (48.4)  
**Inlet:** 1/4  
**Outlet:** 1/4  
**Length:** 4 1/16 (103.2)



**BF836-K4** In-Line Fuel Filter with Clamps  
**Contains:** [4] Clamps  
**Fits:** GMC Engines  
**Replaces:** GMC 25055360  
**O.D.:** 1 29/32 (48.4)  
**Inlet:** 3/8  
**Outlet:** 3/8  
**Length:** 3 7/8 (98.4)



**BF833-K2** In-Line Fuel Filter with Clamps and Hoses  
**Contains:** [4] Clamps  
**[2] Hoses**  
**Fits:** Dodge, Jeep, Nissan Automotive; Bobcat, Case, Caterpillar, Gehl, Grove, John Deere, Mitsubishi, New Holland Equipment  
**Replaces:** Case D59949; Caterpillar 9Y4444; Chrysler 2455808; GMC 25055223; John Deere AM116178, AM116304; Mitsubishi MB554970; New Holland 269212; Nissan 16400-A0600, 16400-A0601  
**O.D.:** 1 29/32 (48.4)  
**Inlet:** 1/4  
**Outlet:** 1/4  
**Length:** 4 1/16 (103.2)



**BF837** In-Line Fuel Filter  
**Fits:** Ford, Honda, Mazda, Subaru, Toyota Automotive, Light-Duty Trucks  
**Replaces:** Ford E8BZ-9155-A; GMC 25055660; Honda 16900-SA-5000; Mazda E508-13-470  
**O.D.:** 4 1/16 (103.2)  
**Inlet:** 5/16  
**Outlet:** 5/16  
**Length:** 2 5/16 (58.7)



**F834-F** Felt Fuel Element with Handle  
**Fits:** Mercedes-Benz, R.V.I. Buses, Trucks  
**Replaces:** Mercedes-Benz 3524700092  
**O.D.:** 2 11/16 (68.3)  
**I.D.:** 29/32 (23.0)  
**Height:** 4 1/2 (114.3)  
**F. Gskt:** [1] Included  
**Grommets:** [2] Attached



**BF838-F2** Can-Type Fuel Filter  
**Fits:** Case, Ford, Minneapolis-Moline, Oliver, White Equipment  
**Replaces:** Case A39937; Ford C3TZ-9365-B; Stanadyne 26001A; White 609689FS  
**O.D.:** 3 7/16 (87.3)  
**I.D.:** 3/4 (19.0)  
**Height:** 2 13/16 (71.4)  
**F. Gskt:** [2] Included  
**O-Ring:** [1] Included



**PF834** Fuel Element with Bail Handle  
**Fits:** Deutz, Mercedes-Benz Diesel Engines; M.A.N. Buses, Trucks  
**Replaces:** Deutz Q05H4115; Mercedes-Benz 926901  
**O.D.:** 2 9/16 (65.1)  
**I.D.:** 1/2 (12.7)  
**Height:** 4 9/32 (108.7)  
**F. Gskt:** [2] Included  
**O. Gskt:** G233-B  
**Grommets:** [2] Attached



**PF838** Fuel Element  
**Fits:** Carrier-Transicold Refrigeration Units; David Brown, International, Massey Ferguson, Oliver Equipment; Perkins, Rolls-Royce Engines  
**Replaces:** Carrier-Transicold 11649; David Brown 62594; International 844644-R91; Massey Ferguson 1021351-M1; Perkins 33425  
**O.D.:** 3 5/16 (84.1)  
**I.D.:** 5/8 (15.9) & 13/16 (20.6)  
**Height:** 2 3/4 (69.9)  
**A. Gskt:** [1] Included  
**F. Gskt:** G153  
**O-Ring:** [1] Included



**BF836** In-Line Fuel Filter  
**Fits:** GMC Engines  
**Replaces:** GMC 25055360  
**O.D.:** 1 29/32 (48.4)  
**Inlet:** 3/8  
**Outlet:** 3/8  
**Length:** 3 7/8 (98.4)



**BT839** Hydraulic Spin-on  
**Notes:** Can be used with OB1317, OB1318, OB1319, OB1320 bases.  
**Fits:** Bobcat, Ford, Toro, Vermeer, Versatile Equipment; Cross, Gresen, Michigan Fluid Power Hydraulic Systems  
**Replaces:** Cross 1A9023; Gresen 8057000; Michigan Fluid Power 201026  
**Thread:** 1 -12  
**O.D.:** 3 11/16 (93.7)  
**Height:** 5 13/32 (137.3)  
**I.Gskt:** G401  
**Related To:** BT452 (with By-Pass Valve) BT8420 (Stainless Steel Mesh Version) BT8428-MPG (Maximum Performance Glass Version)



**BF836-K3** In-Line Fuel Filter with Clamps and Hoses  
**Contains:** [4] Clamps  
**[2] Hoses**  
**Fits:** GMC Engines  
**Replaces:** GMC 25055360  
**O.D.:** 1 29/32 (48.4)  
**Inlet:** 3/8  
**Outlet:** 3/8  
**Length:** 3 7/8 (98.4)



Measurements Are Shown In Inches And (Millimeters)

**WARNING:** These products can expose you to chemicals, including Diisononyl Phthalate, Carbon black extracts, Nickel, 1,3 Butadiene, Ethylene Oxide, Epichlorohydrin, which are known to the State of California to cause cancer, and Bisphenol, Ethylene Glycol, Ethylene Oxide, 1,3 Butadiene, Epichlorohydrin, which are known to the State of California to cause birth defects or other reproductive harm.

**BT839-10**

Hydraulic Spin-on



**Notes:** Can be used with OB1317, OB1318, OB1319, OB1320 bases.  
**Fits:** Bobcat, Ford, Toro, Vermeer, Versatile Equipment; Cross, Gresen, Michigan Fluid Power Hydraulic Systems  
**Replaces:** Cross 1A9023; Gresen 8057000; Michigan Fluid Power 201026  
**Thread:** 1 -12  
**O.D.:** 3 11/16 (93.7)  
**Height:** 5 13/32 (137.3)  
**I.Gskt:** G401  
**Related To:** BT452 (with By-Pass Valve) BT8420 (Stainless Steel Mesh Version) BT8428-MPG (Maximum Performance Glass Version)

**BF840**

In-Line Fuel Filter



**Fits:** Chrysler, GMC Automotive; Case, International, Massey Ferguson Equipment  
**Replaces:** Chrysler 5214626; Ford A780X-9155-AA; GMC 94020398; Isuzu 8-78107-910; Case D139225; Massey Ferguson 800848-M91  
**O.D.:** 1 29/32 (48.4)  
**Inlet:** 5/16  
**Outlet:** 5/16  
**Length:** 4 5/32 (105.6)  
**Related To:** BF840-K1 (w/Clamps, Hoses) BF7736 (Plastic Version)

**BF840-K1**

In-Line Fuel Filter with Clamps and Hoses



**Contains:** [4] Clamps [2] Hoses  
**Fits:** Chrysler, GMC Automotive; Case, International, Massey Ferguson Equipment  
**Replaces:** Chrysler 5214626; Ford A780X-9155-AA; GMC 94020398; Isuzu 8-78107-910; Massey Ferguson 800848-M91  
**O.D.:** 1 29/32 (48.4)  
**Inlet:** 5/16  
**Outlet:** 5/16  
**Length:** 4 5/32 (105.6)  
**Related To:** BF840 (Filter Only) BF7736 (Plastic Version)

**VT842-O**

Off-Highway Vac-Cel Full-Flow Lube Sock



**Fits:** Oliver, White Equipment; Waukesha Engines  
**Replaces:** Oliver 156149AS; Waukesha 493009; White 872946  
**O.D.:** 3 1/8 (79.4)  
**I.D.:** 1 1/16 (27.0)  
**Height:** 7 3/4 (196.9)  
**F. Gskt:** G115-A, G243-A  
**O. Gskt:** G127  
**Related To:** V852-O (By-Pass Version)

**BF843**

In-Line Fuel Filter



**Fits:** Ford Automotive; John Deere, Melroe Equipment  
**Replaces:** Ford C0DZ-9155-A; John Deere T19743T  
**O.D.:** 2 (50.8)  
**Inlet:** 1/8-27  
**Outlet:** 1/2-20  
**Length:** 3 7/16 (87.3)

**F844-A**

Cotton and Fiber Primary Fuel Sock



**Notes:** To convert to spin-on, use FB1309 base and BF784.  
**Fits:** Detroit Diesel Engines  
**Replaces:** GMC 5574980, 6438518  
**O.D.:** 4 (101.6)  
**I.D.:** 1 1/2 (38.1)  
**Height:** 9 (228.6)  
**F. Gskt:** ES1001, G115-A

**F845-A**

Automatic Wound Sisal Primary Fuel Sock



**Notes:** To convert to spin-on, use FB1301 base and BF5800.  
**Contains:** Reinforced Centertube  
**O.D.:** 2 7/8 (73.0)  
**I.D.:** 1 1/4 (31.8)  
**Height:** 8 7/16 (214.3)  
**F. Gskt:** ES1034, [2] Included

**PF845**

Primary Fuel Element



**Notes:** To convert to spin-on, use FB1301 base and BF5800.  
**Contains:** Reinforced Centertube  
**Fits:** GMC, International, Mack, Peterbilt, Western Star Buses, Trucks  
**Replaces:** GMC 9717391; International 998446-R91  
**O.D.:** 2 7/8 (73.0)  
**I.D.:** 13/32 (10.3) & 1 3/16 (30.2)  
**Height:** 8 5/16 (211.1)  
**A. Gskt:** [2] Attached  
**F. Gskt:** [3] Included

**PF846**

Secondary Fuel Element



**Notes:** To convert to spin-on, use FB1310 base and BF785.  
**Fits:** Detroit Diesel Engines  
**Replaces:** GMC 6437284  
**O.D.:** 4 17/32 (115.1)  
**I.D.:** 11/16 (17.5)  
**Height:** 8 1/4 (209.6)  
**A. Gskt:** [1] Attached  
**F. Gskt:** ES1034, G143  
**Grommets:** [2] Attached

**PF847**

Fuel Element



**Fits:** J.C. Bamford Equipment; Lister, Petter Engines  
**Replaces:** J.C. Bamford S1246; Lister 201-13117; Petter 284539  
**O.D.:** 2 1/4 (57.2)  
**I.D.:** 9/32 (7.1) & 27/32 (21.4)  
**Height:** 1 15/32 (37.3)  
**F. Gskt:** G103, [3] Included

**PT849**

Hydraulic Element





**Fits:** Case, Caterpillar, Clark, Hough, International, John Deere, Michigan, New Holland Equipment  
**Replaces:** Case F88379; Clark 789644; International 876949-C91; John Deere AE25453; New Holland 270565  
**O.D.:** 2 7/8 (73.0)  
**I.D.:** 7/16 (11.1) & 1 3/16 (30.2)  
**Height:** 4 3/8 (111.1)  
**A. Gskt:** [1] Attached  
**F. Gskt:** G255  
**Grommets:** [1] Attached

Measurements Are Shown In Inches And (Millimeters)

**WARNING:** These products can expose you to chemicals, including Diisononyl Phthalate, Carbon black extracts, Nickel, 1,3 Butadiene, Ethylene Oxide, Epichlorohydrin, which are known to the State of California to cause cancer, and Bisphenol, Ethylene Glycol, Ethylene Oxide, 1,3 Butadiene, Epichlorohydrin, which are known to the State of California to cause birth defects or other reproductive harm.

**PT849-10** Hydraulic Element  
  
**Fits:** Case, Caterpillar, Clark, Hough, International, John Deere, Michigan, New Holland Equipment  
**Replaces:** Case F88379; Caterpillar 5J8879; Clark 789644; International 876949-C91; John Deere AE25453; New Holland 270565  
**O.D.:** 2 7/8 (73.0)  
**I.D.:** 7/16 (11.1) & 1 3/16 (30.2)  
**Height:** 4 3/8 (111.1)  
**A. Gskt:** [1] Attached  
**F. Gskt:** G255  
**Grommets:** [1] Attached

**PF859** Fuel Element  
  
**Fits:** AMC, Dodge, Ford, International, Jeep Light-Duty Trucks; Interceptor, Mercruiser, Palmer Marine Engines; International Equipment  
**Replaces:** Chrysler 3173674; Ford C3TA-9162-A; International 918472-R1; Jeep J8990953; Mercruiser B3549088  
**O.D.:** 1 3/8 (34.9)  
**I.D.:** 9/16 (14.3) One End  
**Height:** 1 7/8 (47.6)  
**F. Gskt:** [2] Included

**V852-O** Vac-Cel By-Pass Lube Sock  
  
**Fits:** Oliver Equipment  
**Replaces:** Oliver 165928AS  
**O.D.:** 4 1/8 (104.8)  
**I.D.:** 1 1/16 (27.0)  
**Height:** 8 (203.2)  
**F. Gskt:** G115-A  
**Related To:** V842-O (Full-Flow Version)

**PF860** Fuel Element  
  
**Fits:** GMC, White Trucks  
**Replaces:** GMC 854435; White 871646  
**O.D.:** 2 7/8 (73.0)  
**I.D.:** 17/32 (13.5)  
**Height:** 2 1/8 (54.0)  
**A. Gskt:** [2] Attached  
**F. Gskt:** [1] Included

**BF853** In-Line Fuel Filter  
  
**Fits:** GMC, Jaguar, Land Rover Automotive, Light-Duty Trucks  
**Replaces:** GMC 25171792  
**O.D.:** 2 5/16 (58.7)  
**Inlet:** M16 x 1.5  
**Outlet:** M16 x 1.5  
**Length:** 4 7/16 (112.7)

**PF861** Fuel Element  
  
**Fits:** Datsun, Nissan, TCM Lift Trucks; International Light-Duty Trucks  
**Replaces:** Nissan 16403-37700  
**O.D.:** 2 15/16 (74.6)  
**I.D.:** 5/8 (15.9)  
**Height:** 2 7/32 (56.4)  
**F. Gskt:** ES1036, ES3063, [3] Included

**BF855** Box-Style Secondary Fuel/Water Separator  
  
**Fits:** GMC Light-Duty Trucks; Onan Engines  
**Replaces:** GMC 25011763; Joy 19005224; Stanadyne 23248  
**Length:** 4 5/8 (117.5)  
**Width:** 2 27/32 (72.2)  
**Height:** 2 15/32 (62.7)  
**F. Gskt:** [1] Included

**BF862** Secondary Fuel Spin-on with Removal Nut  
  
**Notes:** CAUTION: Furnished O-Ring must be installed on post for seal.  
**Fits:** Case, Davis, Drott Equipment  
**Replaces:** Case A39867  
**Thread:** 15/16 -16  
**O.D.:** 3 11/16 (93.7)  
**Height:** 4 23/32 (119.9)  
**I.Gskt:** G401  
**O-Ring:** ES24-B

**BF856** Box-Style Fuel/Water Separator  
  
**Fits:** GMC Light-Duty Trucks with Diesel Engines  
**Replaces:** GMC 10149549; Stanadyne 24262  
**Length:** 6 11/32 (161.1)  
**Width:** 3 9/32 (83.3)  
**Height:** 2 21/32 (67.5)  
**Grommets:** [4] Attached

**BF863** Primary Fuel Spin-on with Removal Nut  
  
**Fits:** Case, Davis, Drott Equipment  
**Replaces:** Case A39868  
**Thread:** 13/16 -18  
**O.D.:** 3 11/16 (93.7)  
**Height:** 4 11/16 (119.1)  
**I.Gskt:** G401

**PF857** Fuel Element  
  
**Fits:** Ford, GMC Automotive, Light-Duty Trucks; Gray, Mercruiser Marine Engines  
**Replaces:** Ford B5A-9365-A; GMC 854982; Gray G80084  
**O.D.:** 1 3/4 (44.4)  
**I.D.:** 15/32 (11.9)  
**Height:** 1 1/16 (27.0)  
**F. Gskt:** [1] Included

**PF864** Fuel Element with 12 Bolt Holes on Flange  
  
**Fits:** Cadillac, Chevrolet, Oldsmobile Automotive  
**Replaces:** GMC 8449253  
**O.D.:** 1 3/8 (34.9)  
**Flange:** 1 13/16 (46.0)  
**I.D.:** 15/32 (11.9) One End  
**Height:** 1 5/16 (33.3)

**BF858** In-Line Fuel Filter  
  
**Fits:** Cadillac Automotive  
**Replaces:** GMC 5651944  
**O.D.:** 2 9/32 (57.9)  
**Inlet:** 5/8-18  
**Outlet:** 3/8  
**Length:** 4 3/4 (120.7)

**BF865** In-Line Fuel Filter  
  
**Contains:** 1/4 Inch Universal Vapor Diverter  
**Fits:** Chrysler Automotive  
**Replaces:** Chrysler 3870548, 4041540  
**O.D.:** 1 31/32 (50.0)  
**Inlet:** 5/16  
**Outlet:** 5/16  
**Length:** 3 15/16 (100.0)  
**Related To:** BF865-K (w/Clamps and Hoses)

Measurements Are Shown In Inches And (Millimeters)

**WARNING:** These products can expose you to chemicals, including Diisononyl Phthalate, Carbon black extracts, Nickel, 1,3 Butadiene, Ethylene Oxide, Epichlorohydrin, which are known to the State of California to cause cancer, and Bisphenol, Ethylene Glycol, Ethylene Oxide, 1,3 Butadiene, Epichlorohydrin, which are known to the State of California to cause birth defects or other reproductive harm.

**BF865-K** In-Line Fuel Filter with Clamps and Hoses  
**Contains:** 1/4 Inch Universal Vapor Diverter  
 [5] Clamps  
 [2] Hoses  
**Fits:** Chrysler Automotive  
**Replaces:** Chrysler 3870548, 4041540  
**O.D.:** 1 31/32 (50.0)  
**Inlet:** 5/16  
**Outlet:** 5/16  
**Length:** 3 15/16 (100.0)  
**Related To:** BF865 (w/o Clamps and Hoses)



**PF866** Suction Side Fuel Element  
**Fits:** Ferrari Automotive  
**Replaces:** Alfa Romeo 105500460000  
**O.D.:** 2 9/16 (65.1)  
**I.D.:** 17/32 (13.5) & 11/16 (17.5)  
**Height:** 2 31/32 (75.4)  
**A. Gskt:** [2] Attached  
**F. Gskt:** [1] Included



**BF868** In-Line Fuel Filter  
**Fits:** GMC Automotive  
**Replaces:** GMC 250055481  
**O.D.:** 2 5/32 (54.8)  
**Inlet:** 3/8  
**Outlet:** M16 x 1.5  
**Length:** 4 7/8 (123.8)



**PF869** Fuel Element  
**Fits:** Purolator PAGR50 Through PAGR200 Housings  
**Replaces:** Purolator 8001716, 8003100  
**O.D.:** 3 15/16 (100.0)  
**I.D.:** 1 21/32 (42.1)  
**Height:** 12 1/4 (311.2)  
**A. Gskt:** [2] Attached



**PF872** Fuel Element  
**Fits:** Bobcat, Hitachi, Kubota Equipment  
**Replaces:** Kubota 15231-43560, 15231-43560-1, 15231-43560-2  
**O.D.:** 1 1/8 (28.6)  
**I.D.:** 1/2 (12.7) One End  
**Height:** 3 7/16 (87.3)



**BF873** In-Line Fuel Filter  
**Replaces:** Toyota 23300-15010  
**O.D.:** 3 1/8 (79.4)  
**Inlet:** 9/32  
**Outlet:** 9/32  
**Length:** 2 9/32 (57.9)



**BF874** Can-Type Fuel Filter  
**Fits:** Hercules Engines; Oliver, Winpower Equipment; Quincy, Sullair Compressors  
**Replaces:** Hercules 266536; Stanadyne 16637  
**O.D.:** 3 15/32 (88.1)  
**I.D.:** 3/4 (19.0)  
**Height:** 3 13/16 (96.8)  
**I.Gskt:** [1] Included  
**F. Gskt:** [2] Included  
**O-Ring:** [2] Included  
**Related To:** BF812, BF884 (Long Versions) BF825 (Short Version)



**BF876** Secondary Fuel Spin-on  
**Contains:** Integral Post Seal  
**Fits:** Iveco, Mack, Scania-Vabis Trucks; R.V.I. Buses, Trucks  
**Replaces:** Iveco 4733112; Mack 483GB441  
**Thread:** 7/8 -16  
**O.D.:** 4 1/4 (108.0)  
**Height:** 7 11/32 (186.5)  
**I.Gskt:** G381-A



**BF877** Primary Fuel Spin-on  
**Contains:** Integral Post Seal  
**Fits:** Mack, Scania-Vabis Trucks; R.V.I. Buses, Trucks  
**Replaces:** Mack 483GB444  
**Thread:** 13/16 -18  
**O.D.:** 4 1/4 (108.0)  
**Height:** 7 11/32 (186.5)  
**I.Gskt:** G381-A  
**Related To:** BF1219 (Fuel/Water Separator Version)



**BF879** Screw-in Carburetor In-Line Fuel Filter  
**Contains:** [1] Hose  
 [1] Clamp  
**Fits:** AMC, Ford Automotive, Trucks; Massey Ferguson, Ottawa Equipment; Onan Generators  
**Replaces:** AMC 3193898, 8992430; Ford C7AE-9155-A; Jeep J8992430; Massey Ferguson 521248-M91; Onan 149-1353  
**O.D.:** 1 (25.4)  
**Inlet:** 3/8  
**Outlet:** 1/8-27  
**Length:** 2 5/8 (66.7)



**BF880-FP** Fuel Spin-on with Fill Port  
**Contains:** Integral Post Seal  
 Port Thread: 1 1/4-10  
**Fits:** Davco Fuel Pro 321 Housings  
**Replaces:** Davco 4807329  
**Thread:** 1 -14  
**O.D.:** 4 1/4 (108.0)  
**Height:** 7 29/32 (200.8)  
**I.Gskt:** [1] Included



**BF881** In-Line Fuel Filter  
**Fits:** GMC Light-Duty Trucks  
**Replaces:** GMC 25055032  
**O.D.:** 1 7/16 (36.5)  
**Inlet:** 5/16  
**Outlet:** 5/16  
**Length:** 3 15/32 (88.1)



Measurements Are Shown In Inches And (Millimeters)

**WARNING:** These products can expose you to chemicals, including Diisononyl Phthalate, Carbon black extracts, Nickel, 1,3 Butadiene, Ethylene Oxide, Epichlorohydrin, which are known to the State of California to cause cancer, and Bisphenol, Ethylene Glycol, Ethylene Oxide, 1,3 Butadiene, Epichlorohydrin, which are known to the State of California to cause birth defects or other reproductive harm.



**PF882**

Fuel Element



**Fits:** ACDelco Housings; Carrier Refrigeration Units; Perkins Engines  
**Replaces:** Carrier 29-11705-80; Perkins 26560088  
**O.D.:** 2 7/8 (73.0)  
**I.D.:** 27/32 (21.4)  
**Height:** 6 13/16 (173.0)  
**F. Gskt:** G147-A

**PF883**

Fuel Element



**Fits:** Wix Housings  
**Replaces:** Wix 24390  
**O.D.:** 3 1/32 (77.0)  
**I.D.:** 23/32 (18.3) One End  
**Height:** 6 (152.4)  
**O. Gskt:** G247  
**Grommets:** [1] Attached

**BF884**

Can-Type Fuel Filter



**Fits:** Agco, Ford, Hanomag, J.C. Bamford, Massey Ferguson, New Holland, Same, Volvo Equipment; Bedford, Pegaso, R.V.I. Buses, Trucks  
**Replaces:** Ford 78GB-9150-AA; Massey Ferguson 3621009-M1  
**O.D.:** 3 15/32 (88.1)  
**I.D.:** 3/4 (19.0)  
**Height:** 4 7/16 (112.7)  
**F. Gskt:** [2] Included  
**O-Ring:** [2] Included  
**End Seals:** [1] Attached  
**Related To:** BF812 (Long Version) BF825, BF874 (Short Versions)

**BF885**

In-Line Fuel Filter



**Fits:** Audi, Volkswagen, Volvo Automotive, Light-Duty Trucks  
**Replaces:** Audi 441204511C; Fiat 82434499; Volkswagen 431133511D; Volvo 12760500  
**O.D.:** 3 1/8 (79.4)  
**Inlet:** M14 x 1.5  
**Outlet:** M12 x 1.5  
**Length:** 5 11/32 (135.7)  
**F. Gskt:** [4] Copper Washers

**BF886**

In-Line Fuel Filter



**Contains:** 1/4 Inch Universal Vapor Diverter [6] Clamps [2] Hoses  
**Fits:** AMC, Chrysler, GMC, Jeep Automotive, Light-Duty Trucks  
**Replaces:** Jeep J8121753  
**O.D.:** 1 31/32 (50.0)  
**Inlet:** 5/16  
**Outlet:** 5/16  
**Length:** 3 15/16 (100.0)

**BF888**

Secondary Fuel Spin-on



**Contains:** Integral Post Seal  
**Fits:** Ag-Chem, Dresser, Galion, Hough, International, Thermo King Equipment  
**Replaces:** Galion 120301; International 359251-C1, 674293-C1; Thermo King 11-3855  
**Thread:** 7/8 -14  
**O.D.:** 3 11/16 (93.7)  
**Height:** 8 11/16 (220.7)  
**I.Gskt:** G381-A

**BF890**

In-Line Fuel Filter



**Fits:** AMC, Jeep, Renault Automotive  
**Replaces:** AMC 8933000076  
**O.D.:** 3 1/16 (77.8)  
**Inlet:** 3/8  
**Outlet:** 5/16  
**Length:** 6 1/16 (154.0)

**BF891**

Primary Fuel/Water Separator Spin-on with Drain



**Notes:** Can be used with FB46185 base.  
**Contains:** Integral Post Seal  
**Fits:** Dresser, Hough, International Equipment  
**Replaces:** International 702255-C1  
**Thread:** 1 -14  
**O.D.:** 3 11/16 (93.7)  
**Height:** 5 11/16 (144.5)  
**I.Gskt:** G381-A

**BF892**

Primary Fuel/Water Separator Spin-on with Drain



**Notes:** Can be used with FB46185 base.  
**Contains:** Integral Post Seal  
**Fits:** Agco, Allis Chalmers, Case-International, Fiat-Allis, International, White Equipment  
**Replaces:** Allis Chalmers 74394407; International 702256-C1  
**Thread:** 1 -14  
**O.D.:** 3 11/16 (93.7)  
**Height:** 9 1/32 (229.4)  
**I.Gskt:** G381-A

**PF893**

Carburetor Fuel Element



**Fits:** GM Automotive, Gas Engines; Crusader, Flagship Marine Engines  
**Replaces:** GMC 5651920  
**O.D.:** 11/16 (17.5)  
**I.D.:** 9/32 (7.1) One End  
**Height:** 1 1/32 (26.2)  
**Related To:** PF893-RV (with Roll-Over Valve)

**PF893-RV**

Carburetor Fuel Element with Roll-Over Valve



**Fits:** GM Automotive, Gas Engines; Crusader, Flagship Marine Engines  
**Replaces:** GMC 5651920  
**O.D.:** 11/16 (17.5)  
**I.D.:** 9/32 (7.1) One End  
**Height:** 1 1/32 (26.2)  
**Related To:** PF893 (without Roll-Over Valve)

**PF894**

Carburetor Fuel Element



**Fits:** Buick, Chevrolet, Pontiac Automotive, Gas Engines; GMC Light-Duty Trucks  
**Replaces:** GMC 5651921  
**O.D.:** 11/16 (17.5)  
**I.D.:** 9/32 (7.1) One End  
**Height:** 2 1/32 (51.6)  
**Related To:** PF894-RV (with Roll-Over Valve)

Measurements Are Shown In Inches And (Millimeters)

**WARNING:** These products can expose you to chemicals, including Diisononyl Phthalate, Carbon black extracts, Nickel, 1,3 Butadiene, Ethylene Oxide, Epichlorohydrin, which are known to the State of California to cause cancer, and Bisphenol, Ethylene Glycol, Ethylene Oxide, 1,3 Butadiene, Epichlorohydrin, which are known to the State of California to cause birth defects or other reproductive harm.

**PF894-RV**



Carburetor Fuel Element with Roll-Over Valve  
**Fits:** Buick, Chevrolet, Pontiac Automotive, Gas Engines; GMC Light-Duty Trucks  
**Replaces:** GMC 5651921  
**O.D.:** 1 1/16 (17.5)  
**I.D.:** 9/32 (7.1) One End  
**Height:** 2 1/32 (51.6)  
**Related To:** PF894 (without Roll-Over Valve)

**BF900**



Fuel Spin-on  
**Fits:** Agco, Bomag, Case, Claas, Deutz-Allis, Iveco, Poclain, Terex Equipment; DAF Buses, Trucks  
**Replaces:** Bomag N9675; Claas 1780340; DAF 247139; Deutz 1174422; Iveco 1902133; Poclain 1050595  
**Thread:** M16 x 1.5  
**O.D.:** 3 11/16 (93.7)  
**Height:** 5 3/8 (136.5)  
**I.Gskt:** G381-A

**BF896**



Primary Fuel Spin-on with Drain  
**Notes:** Part of BF897 KIT.  
**Fits:** Carrier Refrigeration Units; Case, Drott, Grimmer Schmidt Equipment  
**Replaces:** Carrier 30-00301; Case A58712  
**Thread:** 13/16 -18  
**O.D.:** 3 11/16 (93.7)  
**Height:** 5 21/32 (143.7)  
**I.Gskt:** G401

**PF902**



Secondary Fuel Element  
**Fits:** Cummins, GMC Engines; Euclid Road Building Equipment  
**Replaces:** Cummins 146823; Euclid 9044268; GMC 5574508  
**O.D.:** 3 (76.2)  
**I.D.:** 1 1/16 (27.0)  
**Height:** 7 13/16 (198.4)  
**A. Gskt:** [2] Attached  
**F. Gskt:** [3] Included  
**O. Gskt:** ES1032

**BF897 KIT**



Set of Primary and Secondary Fuel Spin-ons  
**Notes:** On BF582 (Secondary), Furnished O-Ring must be installed on post for seal.  
**Contains:** [1] BF896  
 [1] BF582  
**Fits:** Case, David Brown, Drott Equipment  
**Replaces:** Case A41745  
**BF896 (Primary)**  
**Thread:** 13/16 -18  
**O.D.:** 3 11/16 (93.7)  
**Height:** 5 21/32 (143.7)  
**I.Gskt:** G401  
**BF582 (Secondary)**  
**O.D.:** 3 11/16  
**I.D. Thread:** 15/16-16  
**Height:** 5 13/32  
**O-Ring:** G401

**PF902-S**



Railroad Fuel Element  
**Fits:** E.M.D. Locomotives  
**Replaces:** Clark 60024229  
**O.D.:** 3 (76.2)  
**I.D.:** 1 1/16 (27.0)  
**Height:** 7 13/16 (198.4)  
**A. Gskt:** [2] Attached  
**O. Gskt:** ES1032

**SF898**



Sintered Bronze Fuel Element  
**Fits:** Ford, GMC Automotive, Light-Duty Trucks  
**Replaces:** Ford D9PZ-9155-A; GMC 5651924  
**O.D.:** 5/8 (15.9)  
**I.D.:** 7/32 (5.6) One End  
**Height:** 25/32 (19.8)

**PT903**



Hydraulic Steering Element  
**Notes:** Inside-Out Flow Direction.  
 2 Quart Capacity  
**Fits:** International, Kenworth, Mack, Peterbilt, Volvo Trucks  
**Replaces:** Case 279294C92; International 379294-C92; Mack 9424LF634; Volvo 874487  
**O.D.:** 3 15/32 (88.1)  
**I.D.:** 29/32 (23.0) & 1 15/32 (37.3)  
**Height:** 2 25/32 (70.6)  
**F. Gskt:** G115-A  
**End Seals:** [2] Attached  
**Related To:** P951 (without Furnished Gasket)

**PF899**



Fuel Element  
**Contains:** Reinforced Centertube  
**Replaces:** GMC 3317990  
**O.D.:** 3 15/16 (100.0)  
**I.D.:** 7/8 (22.2)  
**Height:** 6 7/32 (158.0)  
**A. Gskt:** [2] Attached  
**F. Gskt:** G257

**PF906**



Secondary Fuel Element  
**Notes:** To convert to spin-on, use FB1302 and BF593.  
**Fits:** Detroit Diesel Engines  
**Replaces:** GMC 3290851  
**O.D.:** 3 (76.2)  
**I.D.:** 1 1/16 (27.0)  
**Height:** 3 5/8 (92.1)  
**A. Gskt:** [2] Attached  
**F. Gskt:** [4] Included, [1] Metal Washer  
**O. Gskt:** G344

**PF907**



Fuel Element  
**Fits:** Allis Chalmers Equipment  
**Replaces:** Allis Chalmers 59898  
**O.D.:** 3 (76.2)  
**I.D.:** 1 1/16 (27.0)  
**Height:** 7 23/32 (196.1)  
**A. Gskt:** [2] Attached  
**F. Gskt:** [2] Included, [2] Loose Seals

Measurements Are Shown In Inches And (Millimeters)

**WARNING:** These products can expose you to chemicals, including Diisononyl Phthalate, Carbon black extracts, Nickel, 1,3 Butadiene, Ethylene Oxide, Epichlorohydrin, which are known to the State of California to cause cancer, and Bisphenol, Ethylene Glycol, Ethylene Oxide, 1,3 Butadiene, Epichlorohydrin, which are known to the State of California to cause birth defects or other reproductive harm.

**BF908-A** Wound Cotton Primary Fuel Sock  
**Fits:** Detroit Diesel Engines  
**Replaces:** GMC 6436839  
**O.D.:** 5 1/2 (139.7)  
**I.D.:** 2 15/32 (62.7)  
**Height:** 10 (254.0)  
**F. Gskt:** ES1066, [1] Included



**BF914** Set of Filter Base and Spin-on for Fuel Storage Tank  
**Contains:** [1] BF915 Fuel Filter  
 [1] FB1307 Base  
**BF915**  
**Thread:** 1 -12  
**O.D.:** 3 11/16 (93.7)  
**Height:** 7 7/16 (188.9)  
**FB1307**  
**O.D.:** 3 3/4 (95.3)  
**I.D. Inlet:** 1 In. NPT  
**Height:** 2 21/32 (67.5)



**BF909** Dual-Stage Box-Style Glass Fuel/Water Separator  
**Notes:** BF909 may be used in place of BF909. Do NOT substitute BF909 for the metal version. Often a companion to BF912.  
**Contains:** Air Bleed Vent  
 Water Drain with Window  
**Fits:** Allis Chalmers, Caterpillar, John Deere, Minneapolis-Moline, Oliver, Vermeer, White Equipment; Joy, Ingersoll-Rand Compressors  
**Replaces:** Allis Chalmers 4024232; John Deere AR50041; Stanadyne 18786; White 20-0006803  
**Length:** 4 15/16 (125.4)  
**Width:** 3 11/16 (93.7)  
**Height:** 3 11/32 (84.9)



**BF915** Fuel Storage Tank Spin-on with Drain  
**Notes:** Part of BF914. Can be used with FB1307 base.  
**Replaces:** Cim-Tek 700-02  
**Thread:** 1 -12  
**O.D.:** 3 11/16 (93.7)  
**Height:** 7 7/16 (188.9)  
**I.Gskt:** G381-A  
**Related To:** BF956 (with Water Absorbent Media)



**PF910** Secondary Fuel Element  
**Fits:** Allis Chalmers Equipment  
**Replaces:** Allis Chalmers 4052172  
**O.D.:** 3 (76.2)  
**I.D.:** 1 1/16 (27.0)  
**Height:** 7 13/16 (198.4)  
**A. Gskt:** [2] Attached  
**F. Gskt:** [3] Included



**F916-C** Wound Cotton Primary Fuel Sock  
**Notes:** To convert to spin-on, use FB1301 base and BF592.  
**Fits:** Allis Chalmers Equipment; Detroit Diesel Engines  
**Replaces:** Allis Chalmers 4055533; Detroit Diesel 5192854  
**O.D.:** 2 7/8 (73.0)  
**I.D.:** 1 (25.4)  
**Height:** 5 3/4 (146.0)  
**F. Gskt:** [4] Included



**BF912** Box-Style Glass Fuel/Water Separator/Coalescer  
**Notes:** Often a companion to BF909.  
**Fits:** Ag-Chem, Allis Chalmers, Caterpillar, Dynapac, John Deere, Koehring, Link-Belt, New Holland Equipment; Ford, GMC, International, Kenworth, Mack, White Trucks  
**Replaces:** Allis Chalmers 4024223; Caterpillar 6N7617; John Deere AR86755; Stanadyne 19797; White 40-0002519  
**Length:** 4 15/16 (125.4)  
**Width:** 3 11/16 (93.7)  
**Height:** 3 11/32 (84.9)



**PF916** Secondary Fuel or Hydraulic Element  
**Notes:** To convert to spin-on, use FB1302 base and BF593.  
**Fits:** AgChem, Allis Chalmers, Case, Fiat-Allis, Kato, Vermeer Equipment; Detroit Diesel Engines; Thermo King Refrigeration Units  
**Replaces:** Case 9980AB; Detroit Diesel 5192845  
**O.D.:** 3 (76.2)  
**I.D.:** 1 1/16 (27.0)  
**Height:** 5 5/8 (142.9)  
**A. Gskt:** [2] Attached  
**F. Gskt:** [4] Included  
**O. Gskt:** ES1032



**PF913** Fuel Element  
**Fits:** E.M.D. Locomotives  
**Replaces:** GMC 8363264  
**O.D.:** 2 1/2 (63.5)  
 Flange 2 7/8 (73.0)  
**I.D.:** 27/32 (21.4) One End  
**Height:** 4 1/4 (108.0)  
**A. Gskt:** [1] Attached



**BF918-K** In-Line Fuel Filter with Clamps and Hoses  
**Contains:** 1/4 Inch Universal Vapor Diverter  
 [6] Clamps  
 [3] Hoses  
**Fits:** Dodge, Plymouth Automotive  
**Replaces:** Chrysler 5214692  
**O.D.:** 1 1/2 (38.1)  
**Inlet:** 5/16  
**Outlet:** 5/16  
**Length:** 3 7/16 (87.3)



**F919-C** Wound Cotton Fuel or Hydraulic Sock  
**Fits:** Caterpillar Engines, Equipment  
**Replaces:** Caterpillar 2A5886  
**O.D.:** 1 3/4 (44.4)  
**I.D.:** 7/16 (11.1)  
**Height:** 7 7/8 (200.0)  
**O. Gskt:** 7B-7635, 7B-8017



Measurements Are Shown In Inches And (Millimeters)

**WARNING:** These products can expose you to chemicals, including Diisononyl Phthalate, Carbon black extracts, Nickel, 1,3 Butadiene, Ethylene Oxide, Epichlorohydrin, which are known to the State of California to cause cancer, and Bisphenol, Ethylene Glycol, Ethylene Oxide, 1,3 Butadiene, Epichlorohydrin, which are known to the State of California to cause birth defects or other reproductive harm.

**BF920**

Nylon Screen Screw-in Carburetor Fuel Filter



**Fits:** Ford Automotive  
**Replaces:** Ford E0ZE-9155-BA  
**O.D.:** 1 11/32 (34.1)  
**Inlet:** 1/2-20  
**Outlet:** 1/8-27  
**Height:** 1 15/16 (49.2)

**PF924**

Fuel Element



**Fits:** Purolator PAG25D Series Housings  
**Replaces:** GMC 8164725, 8302891  
**O.D.:** 2 7/8 (73.0)  
**I.D.:** 1 13/32 (35.7)  
**Height:** 10 (254.0)  
**End Seals:** [2] Attached

**BF925**

In-Line Fuel Filter



**Fits:** Mazda Automotive  
**Replaces:** Mazda B630-13-480A  
**O.D.:** 2 13/16 (71.4)  
**Inlet:** 5/16  
**Outlet:** M12 x 1 1/4  
**Length:** 5 3/16 (131.8)  
**F. Gskt:** [2] Copper Washers

**PF926**

Fuel or Hydraulic Element



**Fits:** Cooper-Bessemer  
**Replaces:** Cooper-Bessemer P227815  
**O.D.:** 2 9/16 (65.1)  
**I.D.:** 1 1/16 (27.0)  
**Height:** 9 3/4 (247.7)  
**A. Gskt:** [2] Attached

**BF928**

In-Line Fuel Filter



**Fits:** Chrysler, Hyundai, Isuzu, Mitsubishi, Nissan Automotive; Nissan Lift Trucks  
**Replaces:** Chrysler MB129591; Hyundai 3191021000; Isuzu 8-94250-176-1; Mitsubishi MB052676; Nissan 16400-C6400  
**O.D.:** 2 3/4 (69.9)  
**Inlet:** 11/32  
**Outlet:** 11/32  
**Length:** 3 19/32 (91.3)

**BF929**

In-Line Fuel Filter



**Fits:** Mazda Automotive  
**Replaces:** Mazda N326-20-490  
**O.D.:** 2 13/16 (71.4)  
**Inlet:** 5/16  
**Outlet:** 5/16  
**Length:** 6 17/32 (165.9)

**BF930**

In-Line Fuel Filter



**Contains:** 1/4 Inch Universal Vapor Diverter  
[6] Clamps  
[3] Hoses  
**Fits:** Chrysler Automotive  
**Replaces:** Chrysler 4241824  
**O.D.:** 1 1/4 (31.8)  
**Inlet:** 5/16  
**Outlet:** 5/16  
**Length:** 3 15/32 (88.1)

**BF932**

In-Line Fuel Filter



**Fits:** Nissan, Toyota Automotive; Nissan, TCM Lift Trucks  
**Replaces:** Nissan 16400-E3001; TCM 16400-E3000; Toyota 23300-24050  
**O.D.:** 1 7/8 (47.6)  
**Inlet:** 9/32  
**Outlet:** 9/32  
**Length:** 3 17/32 (89.7)

**BF933**

In-Line Fuel Filter



**Fits:** Chevrolet, Mazda, Nissan, Toyota Automotive  
**Replaces:** GMC 25175542; Nissan 16400-D0100; Toyota 23300-25020  
**O.D.:** 4 1/16 (103.2)  
**Inlet:** 9/32  
**Outlet:** 9/32  
**Length:** 2 1/4 (57.2)

**PF935**

Primary Fuel Element



**Fits:** Caterpillar Equipment  
**Replaces:** Caterpillar 5M7650, 9M2341  
**O.D.:** 2 1/4 (57.2)  
**I.D.:** 13/32 (10.3)  
**Height:** 3 (76.2)  
**O. Gskt:** ES1030, G323

**PF936**

2-Section Fuel/Water Separator Element



**Contains:** Grommet Seal Between Sections  
**Fits:** Fram Housing FCS1136  
**Replaces:** Fram CCS1136  
**O.D.:** 3 3/32 (78.6)  
**I.D.:** 9/16 (14.3)  
**Height:** 3 13/16 (96.8)  
**A. Gskt:** [2] Attached  
**F. Gskt:** G344

**PF937**

Fuel Element



**Fits:** Bolens, Ford, John Deere, Komatsu, Massey Ferguson, Takeuchi, Yanmar Equipment  
**Replaces:** Bolens 1862499; Ford SBA130366040; John Deere CH15553; Komatsu 104-500-5571; Massey Ferguson 3283343-M1; Yanmar 104500-55710  
**O.D.:** 1 3/8 (34.9)  
**I.D.:** 1/2 (12.7) One End  
**Height:** 2 23/32 (69.1)  
**O-Ring:** [1] Included

**BF938**

Primary Fuel Spin-on with Drain



**Fits:** Allmand Equipment; Onan Engines  
**Replaces:** Onan 122B325  
**Thread:** 7/16 -20  
**O.D.:** 3 7/16 (87.3)  
**Height:** 4 13/16 (122.2)  
**I.Gskt:** [1] Included  
**F. Gskt:** ES1001

Measurements Are Shown In Inches And (Millimeters)

**WARNING:** These products can expose you to chemicals, including Diisononyl Phthalate, Carbon black extracts, Nickel, 1,3 Butadiene, Ethylene Oxide, Epichlorohydrin, which are known to the State of California to cause cancer, and Bisphenol, Ethylene Glycol, Ethylene Oxide, 1,3 Butadiene, Epichlorohydrin, which are known to the State of California to cause birth defects or other reproductive harm.

## BF939



Secondary Fuel Spin-on with Drain

**Fits:** Allmand Equipment; Onan Engines  
**Replaces:** Onan 122B326  
**Thread:** 3/8 -24  
**O.D.:** 3 7/16 (87.3)  
**Height:** 4 13/16 (122.2)  
**I.Gskt:** [1] Included  
**A. Gskt:** [1] Included  
**F. Gskt:** ES1001

## BF940



Fuel Spin-on

**Fits:** Allis Chalmers, Kubota, Massey Ferguson Equipment; Yanmar Engines  
**Replaces:** Allis Chalmers 2098616; Kubota 15221-43081  
**Thread:** M20 x 1.5  
**O.D.:** 3 (76.2)  
**Height:** 2 27/32 (72.2)  
**I.Gskt:** [1] Included

## BF941



Fuel Spin-on

**Replaces:** Komatsu 600-311-8220  
**Thread:** 3/4 -16  
**O.D.:** 3 1/32 (77.0)  
**Height:** 5 13/16 (147.6)  
**I.Gskt:** [1] Included  
**Related To:** BF954 (Short Version)

## PF942



Fuel/Water Coalescer Element

**Fits:** Cerlist, Cruisair, Cummins Engines; Fram FCS1133PL Housing  
**Use With:** PF943  
**Replaces:** Cerlist 151222904; Cummins 136198  
**O.D.:** 2 7/8 (73.0)  
**I.D.:** 1 1/16 (27.0)  
**Height:** 7 19/32 (192.9)  
**A. Gskt:** [2] Attached  
**F. Gskt:** G344, [1] Included

## PF943



Fuel/Water Separator Element

**Fits:** Case, Cerlist, Cruisair, Cummins Engines; Fram FCS1133PL Housing  
**Use With:** PF942  
**Replaces:** Cerlist 1512903; Cummins 136197  
**O.D.:** 2 7/8 (73.0)  
**I.D.:** 1 1/16 (27.0)  
**Height:** 4 13/16 (122.2)  
**A. Gskt:** [2] Attached  
**F. Gskt:** G344, [1] Included

## PF945



Fuel or Hydraulic Element

**Fits:** Frigiking, Hyster, Michigan, Minneapolis-Moline Equipment; Fram FBM1110PL Housings  
**Replaces:** Frigiking 5100154; Hyster 201641  
**O.D.:** 2 7/8 (73.0)  
**I.D.:** 9/16 (14.3) & 21/32 (16.7)  
**Height:** 2 9/16 (65.1)  
**A. Gskt:** [2] Attached  
**F. Gskt:** [1] Included

## PF946



Secondary Fuel Element with Bail Handle

**Fits:** Allis Chalmers, Ingersoll-Rand, International Equipment  
**Replaces:** Allis Chalmers 138267; International 367378-R91  
**O.D.:** 2 7/8 (73.0)  
**I.D.:** 3/4 (19.0) & 13/16 (20.6)  
**Height:** 4 1/16 (103.2)  
**F. Gskt:** [3] Included

## PF947



Primary Fuel Element with Bail Handle

**Fits:** Allis Chalmers, Ingersoll-Rand, International Equipment; Kohler Generators  
**Replaces:** Allis Chalmers 40487894; International 368278-R91  
**O.D.:** 2 7/8 (73.0)  
**I.D.:** 9/16 (14.3) & 1/2 (12.7)  
**Height:** 4 (101.6)  
**F. Gskt:** [3] Included  
**Grommets:** [2] Attached

## BF948



Fuel Spin-on

**Notes:** CAUTION: Do NOT use for John Deere applications.  
 CAUTION: Furnished D-Ring must be installed on post for seal.  
 Can be used with FB1311 base.  
**Fits:** Cummins Engines; Hino Trucks  
**Replaces:** Cummins 154711; Fleetguard FF104  
**Thread:** 1 -14  
**O.D.:** 3 11/16 (93.7)  
**Height:** 4 3/8 (111.1)  
**I.Gskt:** G381-A  
**O-Ring:** ES24-D  
**Related To:** BF957 (Extended Life, Long Version)  
 BF7557, BF7558 (Extended Life Versions)

## BF948-JD



Fuel Spin-on with Drain

**Notes:** CAUTION: Furnished End Seal must be installed on post for seal.  
**Fits:** John Deere Loaders, Tractors ONLY  
**Replaces:** John Deere AR21627R  
**Thread:** 1 -14  
**O.D.:** 3 11/16 (93.7)  
**Height:** 4 11/16 (119.1)  
**I.Gskt:** G381-A  
**F. Gskt:** [1] Included

## PF949



Fuel or Lube Element with Bail Handle

**Fits:** Chicago-Pneumatic Compressors; Cooper-Bessemer Engines; Euclid, Hyster Equipment  
**Replaces:** Euclid 9040974; Hyster 235872  
**O.D.:** 6 1/32 (153.2)  
**I.D.:** 1 (25.4)  
**Height:** 14 1/2 (368.3)  
**F. Gskt:** G102-A, G210  
**End Seals:** [2] Attached

## PF950-F



Felt Fuel Element with Bail Handle

**Fits:** Akerman, Claas, Demag, Liebherr Equipment; Kassbohrer, Mercedes-Benz, Scania, Volvo Buses, Trucks  
**Replaces:** Liebherr 550770208; Mercedes-Benz 4220920005  
**O.D.:** 3 1/4 (82.6)  
**I.D.:** 17/32 (13.5)  
**Height:** 5 5/8 (142.9)  
**F. Gskt:** [1] Included  
**Grommets:** [2] Attached

Measurements Are Shown In Inches And (Millimeters)

**WARNING:** These products can expose you to chemicals, including Diisononyl Phthalate, Carbon black extracts, Nickel, 1,3 Butadiene, Ethylene Oxide, Epichlorohydrin, which are known to the State of California to cause cancer, and Bisphenol, Ethylene Glycol, Ethylene Oxide, 1,3 Butadiene, Epichlorohydrin, which are known to the State of California to cause birth defects or other reproductive harm.

**F950-F WO**



Felt Fuel Element with Bail Handle  
**Fits:** Claas Combines; Iveco, M.A.N., R.V.I. Buses, Trucks  
**Replaces:** Claas 133035, 1330350  
**O.D.:** 3 3/16 (81.0)  
**I.D.:** 1/2 (12.7)  
**Height:** 5 5/8 (142.9)  
**Grommets:** [2] Attached

**BF955**



Fuel Storage Tank Spin-on  
**Notes:** Can be used with FB1307, FB46183 bases.  
**Fits:** Purolator Optional Filter Housings  
**Replaces:** Cim-Tek 700-10; Purolator F54725, F71601  
**Thread:** 1 -12  
**O.D.:** 3 11/16 (93.7)  
**Height:** 5 3/8 (136.5)  
**I.Gskt:** G381-A  
**Related To:** BF971 (Long Version)

**PF950**



Fuel Element  
**Fits:** Atlas Copco, Daewoo, Deutz, International, Michigan Equipment; Iveco, M.A.N., Mercedes-Benz, Scania-Vabis, Volvo Buses, Trucks  
**Replaces:** Deutz 1289054; International 3059245-R91; Mercedes-Benz 4777901; Volvo 233239  
**O.D.:** 2 7/8 (73.0)  
**I.D.:** 7/16 (11.1)  
**Height:** 5 9/16 (141.3)  
**F. Gskt:** G332  
**Grommets:** [2] Attached

**BF955 KIT**



Fuel Filter Kit Assembly  
**Notes:** Post Thread: 1-12  
**Contains:** [1] BF955  
 [1] FB1307  
**Inlet:** 1 In. NPT  
**Outlet:** 1 In. NPT

**PT951**



Power Steering Element  
**Notes:** Inside-Out Flow Direction  
**Fits:** Galion Equipment; International, Mack Buses, Trucks  
**Replaces:** Galion 255027; International 279294-C92; Mack 485GB3160  
**O.D.:** 3 15/32 (88.1)  
**I.D.:** 29/32 (23.0) & 1 15/32 (37.3)  
**Height:** 2 25/32 (70.6)  
**O. Gskt:** G115-A  
**End Seals:** [2] Attached  
**Related To:** PT903 (with Furnished Gasket)

**BF956**



Fuel Storage Tank Spin-on  
**Notes:** Can be used with FB1307, FB46183 bases.  
**Contains:** Water Absorbent Media  
**Fits:** Fuel Pumps; Fuel Storage Tanks  
**Replaces:** Cim-Tek 700-14  
**Thread:** 1 -12  
**O.D.:** 3 11/16 (93.7)  
**Height:** 5 3/8 (136.5)  
**I.Gskt:** G381-A  
**Related To:** BF915 (Standard Media Version)

**PF952**



Fuel Element  
**Replaces:** Cuno CF31  
**O.D.:** 2 7/8 (73.0)  
**I.D.:** 1 1/16 (27.0)  
**Height:** 19 1/2 (495.3)  
**F. Gskt:** G237  
**End Seals:** [2] Attached  
**Related To:** F911-DL (Wound Cotton Version)

**BF957**



Fuel Spin-on  
**Notes:** CAUTION: Furnished D-Ring must be installed on post for seal.  
 Can be used with FB1311 base.  
**Fits:** Cummins Engines  
**Replaces:** Cummins 158172  
**Thread:** 1 -14  
**O.D.:** 3 11/16 (93.7)  
**Height:** 5 7/16 (138.1)  
**I.Gskt:** G381-A  
**O-Ring:** ES24-D  
**Related To:** BF948 (Short Version)  
 BF1212 (Fuel/Water Separator Version)  
 BF7557, BF7558 (Extended Life Versions)

**F953-F**



Felt Fuel Element  
**Fits:** Claas Combines; Iveco, M.A.N. Buses, Trucks; Deutz Engines  
**Replaces:** Deutz 1168403  
**O.D.:** 2 3/4 (69.9)  
**I.D.:** 7/16 (11.1)  
**Height:** 4 17/32 (115.1)  
**A. Gskt:** [2] Attached  
**F. Gskt:** [1] Included

**BF957-D**



Fuel Spin-on with Drain  
**Notes:** CAUTION: Furnished D-Ring must be installed on post for seal.  
 Can be used with FB1311 base.  
**Fits:** Cummins Engines  
**Replaces:** Cummins 154789  
**Thread:** 1 -14  
**O.D.:** 3 11/16 (93.7)  
**Height:** 5 7/16 (138.1)  
**I.Gskt:** G381-A  
**O-Ring:** ES24-D  
**Related To:** BF948 (Short Version)  
 BF1212 (Fuel/Water Separator Version)  
 BF7557, BF7558 (Extended Life Versions)

**BF954**



Fuel Spin-on  
**Fits:** Isuzu, Toyota Trucks; Case, Ford, Hitachi, John Deere, Kobelco, Komatsu Equipment; Isuzu Engines; Nissan Lift Trucks  
**Replaces:** Isuzu 1-3240-018; John Deere GV10809; Nissan 16403-Z7000  
**Thread:** 3/4 -16  
**O.D.:** 3 1/16 (77.8)  
**Height:** 3 7/16 (87.3)  
**I.Gskt:** [1] Included  
**Related To:** BF941 (Long Version)

Measurements Are Shown In Inches And (Millimeters)

**WARNING:** These products can expose you to chemicals, including Diisononyl Phthalate, Carbon black extracts, Nickel, 1,3 Butadiene, Ethylene Oxide, Epichlorohydrin, which are known to the State of California to cause cancer, and Bisphenol, Ethylene Glycol, Ethylene Oxide, 1,3 Butadiene, Epichlorohydrin, which are known to the State of California to cause birth defects or other reproductive harm.

**BF958**

Storage Tank Fuel/Water Separator Spin-on with Drain



**Fits:** Fuel Pumps, Fuel Storage Tanks  
**Replaces:** Amoco A08, AO8; Cim-Tek 700-04  
**Thread:** 1 3/8 -12  
**O.D.:** 3 11/16 (93.7)  
**Height:** 7 7/16 (188.9)  
**I.Gskt:** [1] Included

**BF966**

In-Line Fuel Filter



**Contains:** [2] Plastic Retainer Clips  
**Fits:** Ford, Lincoln, Mercury Automotive  
**Replaces:** Ford E9TZ-9B072-CA  
**O.D.:** 3 1/8 (79.4)  
**Inlet:** 5/16  
**Outlet:** 5/16  
**Length:** 5 13/16 (147.6)

**BF959**

Dual-Stage Box-Style Metal Fuel Filter



**Notes:** Heavy-duty metal version of BF909. Do NOT substitute BF909.  
**Contains:** Air Bleed Vent Water Drain  
**Fits:** Allis Chalmers, John Deere Equipment  
**Replaces:** Allis Chalmers 4036432; John Deere AR86745, RE27091; Stanadyne 22177  
**Length:** 5 1/8 (130.2)  
**Width:** 3 11/16 (93.7)  
**Height:** 3 7/32 (81.8)

**PF967**

Primary Fuel Element



**Fits:** Clark, Michigan Equipment  
**Replaces:** Clark 945444, 945624  
**O.D.:** 3 (76.2)  
**I.D.:** 1 1/16 (27.0)  
**Height:** 5 5/8 (142.9)  
**A. Gskt:** [2] Attached  
**F. Gskt:** G264-A, G299

**P960**

By-Pass Lube Element with Bail Handle



**Fits:** Deutz Engines  
**Replaces:** Deutz 155150610  
**O.D.:** 2 7/8 (73.0)  
**I.D.:** 1/2 (12.7) & 9/16 (14.3)  
**Height:** 4 1/4 (108.0)  
**F. Gskt:** [1] Included  
**Grommets:** [2] Attached

**BF968**

Fuel Spin-on



**Fits:** International Engines  
**Replaces:** International 392301-R91  
**Thread:** 5/8 -11  
**O.D.:** 3 11/16 (93.7)  
**Height:** 5 3/8 (136.5)  
**I.Gskt:** G381-A

**BF962**

Fuel Spin-on



**Notes:** CAUTION: Furnished O-Ring must be installed on post for seal.  
**Fits:** Allis Chalmers, Fiat-Allis Equipment  
**Replaces:** Allis Chalmers 4025230; Fiat-Allis 40289456  
**Thread:** 15/16 -16  
**O.D.:** 3 11/16 (93.7)  
**Height:** 5 3/8 (136.5)  
**I.Gskt:** G381-A  
**O-Ring:** [1] Included

**BF970**

Fuel Spin-on



**Notes:** Do NOT use on Cummins engines. Can be used with FB46185 base.  
**Contains:** Integral Post Seal  
**Fits:** Caterpillar, International, Link-Belt, New Holland Equipment  
**Replaces:** Caterpillar 1P2299  
**Thread:** 1 -14  
**O.D.:** 3 11/16 (93.7)  
**Height:** 7 1/8 (181.0)  
**I.Gskt:** G381-A  
**Related To:** BF1214 (Fuel/Water Separator Version)

**PF963**

Fuel Element



**Fits:** Komatsu Equipment  
**Replaces:** Komatsu 611-073-6130  
**O.D.:** 3 7/16 (87.3)  
**I.D.:** 19/32 (15.1)  
**Height:** 5 5/8 (142.9)  
**F. Gskt:** [1] Included  
**Grommets:** [2] Attached

**BF971**

Fuel Storage Tank Spin-on



**Notes:** Can be used with FB1307 base.  
**Fits:** EMD Locomotive; Fuel Storage Tanks  
**Replaces:** Cim-Tek 700-03  
**Thread:** 1 -12  
**O.D.:** 3 11/16 (93.7)  
**Height:** 7 1/8 (181.0)  
**I.Gskt:** G381-A  
**Related To:** BF955 (Short Version)

**BF964**

In-Line Fuel Filter



**Notes:** OBSOLETE. Availability Limited to Dealer Stock.  
**Fits:** Chrysler, Dodge, Plymouth Automotive, Light-Duty Trucks  
**Replaces:** Chrysler MD026581  
**O.D.:** 1 15/16 (49.2)  
**Inlet:** 5/16  
**Outlet:** 5/16  
**Length:** 3 1/32 (77.0)  
**Grommets:** [1] Attached

**BF974-D**

Fuel Spin-on with Drain



**Fits:** Galion Graders  
**Replaces:** Galion D73246  
**Thread:** 13/16 -16  
**O.D.:** 3 11/16 (93.7)  
**Height:** 7 7/16 (188.9)  
**I.Gskt:** G381-A

Measurements Are Shown In Inches And (Millimeters)

**WARNING:** These products can expose you to chemicals, including Diisononyl Phthalate, Carbon black extracts, Nickel, 1,3 Butadiene, Ethylene Oxide, Epichlorohydrin, which are known to the State of California to cause cancer, and Bisphenol, Ethylene Glycol, Ethylene Oxide, 1,3 Butadiene, Epichlorohydrin, which are known to the State of California to cause birth defects or other reproductive harm.

**B975**

Full-Flow Lube Spin-on



**Notes:** Do NOT use on Case, Deutz or International applications. See application sections and B167, B236, BT261, B262.

**Contains:** Anti-Drainback Valve  
8 PSID By-Pass Valve

**Fits:** Akerman, Broyt Equipment; Thermo King Refrigeration Units; Volvo Buses, Equipment, Trucks

**Replaces:** Carrier 70-000011; Thermo King 11-4565; Volvo 423135, 423135-3

**Thread:** 1 -12

**O.D.:** 3 11/16 (93.7)

**Height:** 7 1/8 (181.0)

**I.Gskt:** G381-A

**BF976**

Secondary Fuel Spin-on



**Contains:** Integral Post Seal

**Fits:** Mack Trucks

**Replaces:** Mack 483GB431

**Thread:** 1 1/16 -16

**O.D.:** 4 1/4 (108.0)

**Height:** 10 7/16 (265.1)

**I.Gskt:** [1] Included

**BF978**

Secondary Fuel Spin-on



**Notes:** Can be used with FB46185 base.

**Contains:** Integral Post Seal

**Fits:** International Engines, Equipment

**Replaces:** International 702253-C1, 703419-C91

**Thread:** 1 -14

**O.D.:** 3 11/16 (93.7)

**Height:** 8 23/32 (221.5)

**I.Gskt:** G381-A

**BF979**

Primary Fuel Spin-on



**Notes:** Can be used with FB46185 base.

**Contains:** Integral Post Seal

**Fits:** International Engines

**Replaces:** International 702251-C1, 703420-C91

**Thread:** 1 -14

**O.D.:** 3 11/16 (93.7)

**Height:** 8 23/32 (221.5)

**I.Gskt:** G381-A

**Related To:** BF1225 (Fuel/Water Separator Version)

**BF980**

Fuel Spin-on



**Fits:** DAF Buses, Trucks

**Replaces:** DAF 247138

**Thread:** M16 x 1.5

**O.D.:** 3 11/16 (93.7)

**Height:** 8 1/8 (206.4)

**I.Gskt:** G381-A

**PF981**

Fuel Element



**Fits:** Case, Hitachi, John Deere, Komatsu, Kubota, Mustang, Takeuchi, Yanmar Equipment

**Replaces:** John Deere CH10479; Komatsu YM12455055700; Kubota 16271-43560; Yanmar 124550-55700

**O.D.:** 1 3/8 (34.9)

**I.D.:** 1/2 (12.7) One End

**Height:** 3 1/2 (88.9)

**I.Gskt:** [1] Included

**O-Ring:** [1] Included

**BF984**

Primary Fuel Spin-on



**Contains:** Integral Post Seal

**Fits:** Hino, Nissan Trucks; International Engines

**Replaces:** International 625625-C1

**Thread:** 1 -14

**O.D.:** 3 11/16 (93.7)

**Height:** 5 5/16 (134.9)

**I.Gskt:** G381-A

**PF986**

Fuel Element with Bail Handle



**Fits:** Komatsu Equipment; Volvo-Penta, Yanmar Engines

**Replaces:** Volvo 6604946, 6643218

**O.D.:** 2 9/16 (65.1)

**I.D.:** 7/16 (11.1) & 1/2 (12.7)

**Height:** 2 5/8 (66.7)

**Grommets:** [2] Attached

**PF987**

Fuel Element



**Fits:** Bennett Fuel Pumps

**Replaces:** Bennett 3112

**O.D.:** 3 15/16 (100.0)

**I.D.:** 1 5/8 (41.3) One End

**Height:** 4 1/2 (114.3)

**BF988**

Fuel Spin-on



**Fits:** Deutz, Volvo Engines; R.V.I. Trucks

**Replaces:** Bosch 1-457-434-062; Deutz 1180597; Volvo 4669875

**Thread:** M16 x 1.5

**O.D.:** 3 1/32 (77.0)

**Height:** 4 27/32 (123.0)

**I.Gskt:** G449-B

**Related To:** BF1221 (Fuel/Water Separator Version)

**BF989**

Nylon Screen In-Line Fuel Filter



**Contains:** [4] Clamps  
[2] Hoses

**Fits:** Ford Automotive, Light-Duty Trucks; International, Versatile, Wheel Horse Equipment

**Replaces:** Ford D1FZ-9155-A, D2RY-9155-A, D3FZ-9155-A; Motorcraft FG44A

**O.D.:** 15/16 (23.8)

**Inlet:** 5/16

**Outlet:** 5/16

**Length:** 3 1/32 (77.0)

Measurements Are Shown In Inches And (Millimeters)

**WARNING:** These products can expose you to chemicals, including Diisononyl Phthalate, Carbon black extracts, Nickel, 1,3 Butadiene, Ethylene Oxide, Epichlorohydrin, which are known to the State of California to cause cancer, and Bisphenol, Ethylene Glycol, Ethylene Oxide, 1,3 Butadiene, Epichlorohydrin, which are known to the State of California to cause birth defects or other reproductive harm.



**BF991**

Primary Fuel Spin-on



**Contains:** Integral Post Seal  
**Fits:** Thermo King Refrigeration Units; International Equipment, Trucks  
**Replaces:** Carrier 20-113692; International 702143-C1; Thermo King 11-3692  
**Thread:** 1 -14  
**O.D.:** 3 11/16 (93.7)  
**Height:** 7 1/8 (181.0)  
**I.Gskt:** G381-A

**BF992**

Secondary Fuel Spin-on



**Contains:** Integral Post Seal  
**Fits:** Thermo King Refrigeration Units  
**Replaces:** Carrier 20-113693; Thermo King 11-3726  
**Thread:** 7/8 -14  
**O.D.:** 3 11/16 (93.7)  
**Height:** 5 3/8 (136.5)  
**I.Gskt:** [1] Included

**BF995**

Nylon Screen Screw-in Carburetor Fuel Filter



**Fits:** Ford Automotive  
**Replaces:** Ford D7TE-9155-A  
**O.D.:** 31/32 (24.6)  
**Inlet:** 5/16  
**Outlet:** 1/8-27  
**Height:** 2 5/16 (58.7)

**P996**

Full-Flow Lube Element



**Notes:** If a conversion kit is already installed, or if originally equipped with element-type, use P999-HD.  
**Contains:** Two-Way 8 PSID By-Pass Valve  
**Replaces:** Nugent lube bag without a kit and without switching lines because of Baldwins two-way by-pass valve.  
**O.D.:** 5 1/16 (128.6)  
**I.D.:** 11/16 (17.5) & 1 1/4 (31.8)  
**Height:** 12 5/32 (308.8)  
**A. Gskt:** [1] Attached  
**Spring:** [1] Attached  
**O. Gskt:** G164-A, G263, G269, G281

**PF997**

Fuel Element



**Fits:** Lister Engines  
**Replaces:** Lister 201-13116  
**O.D.:** 2 5/32 (54.8)  
**I.D.:** 9/32 (7.1) & 29/32 (23.0)  
**Height:** 3 19/32 (91.3)  
**F. Gskt:** [3] Included  
**O-Ring:** [2] Included

**P998**

Full-Flow Lube Element



**Contains:** Reinforced Centertube  
**Fits:** Cummins Engines  
**Replaces:** Cummins 173174  
**O.D.:** 4 3/4 (120.7)  
**I.D.:** 11/16 (17.5) & 1 9/16 (39.7)  
**Height:** 7 1/2 (190.5)  
**O. Gskt:** G354  
**End Seals:** [2] Attached

**P999-HD**

Heavy-Duty Full-Flow Lube Element



**Notes:** To convert to spin-on use OB1368 or OB1369 base and B96  
**CAUTION:** When converting from bag-type with any conversion kit, lines must be switched so oil flows outside-in (see P996 for Baldwin solution)  
**Contains:** Reinforced Centertube  
**Fits:** Cummins Engines  
**Replaces:** Cummins 256843  
**O.D.:** 4 31/32 (126.2)  
**I.D.:** 11/16 (17.5) & 1 9/16 (39.7)  
**Height:** 9 11/16 (246.1)  
**O. Gskt:** G164-A, G263, G269, G278, G336  
**End Seals:** [2] Attached

**BF1008**

In-Line Fuel Filter



**Fits:** Dodge Dakota, Ramcharger  
**Replaces:** Chrysler 52004611, 52018646  
**O.D.:** 2 5/32 (54.8)  
**Inlet:** 5/16  
**Outlet:** 5/16  
**Length:** 6 3/8 (161.9)

**V1009-W**

Cotton Full-Flow Lube Sock



**Fits:** LeRoi, Roiline Power Units; Waukesha Engines  
**Replaces:** LeRoi 431002; Roiline 810079  
**O.D.:** 4 3/4 (120.7)  
**I.D.:** 13/16 (20.6) One End  
**Height:** 10 (254.0)  
**F. Gskt:** [1] Included

**V1044-O**

Vac-Cel Dual-Stage Full-Flow Lube Sock



**Fits:** WhiteGMC Trucks  
**Replaces:** White 883451  
**O.D.:** 4 1/8 (104.8)  
**I.D.:** 1 1/4 (31.8)  
**Height:** 9 3/4 (247.7)  
**F. Gskt:** G115-A

**BF1045**

In-Line Fuel Filter



**Contains:** [2] Plastic Retainer Clips  
**Fits:** Buick Roadmaster, Cadillac Fleetwood Brougham, Chevrolet Caprice, Impala  
**Replaces:** GMC 25121978  
**O.D.:** 2 9/32 (57.9)  
**Inlet:** 3/8  
**Outlet:** 3/8  
**Length:** 6 15/32 (164.3)

**BF1046**













In-Line Fuel Filter



**Contains:** [2] Plastic Retainer Clips  
**Fits:** Chevrolet, Saturn Automotive; GMC Light-Duty Trucks, Express Vans  
**Replaces:** GMC 25121468  
**O.D.:** 2 9/32 (57.9)  
**Inlet:** 3/8  
**Outlet:** 3/8  
**Length:** 6 13/32 (162.7)

Measurements Are Shown In Inches And (Millimeters)

**WARNING:** These products can expose you to chemicals, including Diisononyl Phthalate, Carbon black extracts, Nickel, 1,3 Butadiene, Ethylene Oxide, Epichlorohydrin, which are known to the State of California to cause cancer, and Bisphenol, Ethylene Glycol, Ethylene Oxide, 1,3 Butadiene, Epichlorohydrin, which are known to the State of California to cause birth defects or other reproductive harm.

<p><b>BF1047</b> In-Line Fuel Filter</p> <p><b>Notes:</b> Reverse Flow  <b>Fits:</b> Volvo Trucks  <b>Replaces:</b> Volvo 3507416-0, 9142658  <b>O.D.:</b> 3 5/16 (84.1)  <b>Inlet:</b> 5/16  <b>Outlet:</b> 5/16  <b>Length:</b> 7 17/32 (191.3)</p> 	<p><b>BF1056</b> Fuel Spin-on</p> <p><b>Fits:</b> Mercedes-Benz Buses, Trucks  <b>Replaces:</b> Mercedes-Benz 10920501  <b>Thread:</b> M14 x 1.5  <b>O.D.:</b> 3 1/32 (77.0)  <b>Height:</b> 3 15/32 (88.1)  <b>I.Gskt:</b> G449-B</p> 
<p><b>BF1048</b> In-Line Fuel Filter</p> <p><b>Fits:</b> Subaru Baja, Forester, Impreza, Legacy, SVX  <b>Replaces:</b> Subaru 42072-AA011, 42072-AA120, 42072-PA010  <b>O.D.:</b> 3 3/8 (85.7)  <b>Inlet:</b> 5/16  <b>Outlet:</b> 5/16  <b>Length:</b> 4 7/8 (123.8)</p> 	<p><b>BF1057</b> In-Line Fuel Filter</p> <p><b>Fits:</b> Chrysler Automotive  <b>Replaces:</b> Chrysler 4495780, 4495781, 4636686, 4636687  <b>O.D.:</b> 2 5/32 (54.8)  <b>Inlet:</b> 5/16  <b>Outlet:</b> 5/16  <b>Length:</b> 4 5/16 (109.5)</p> 
<p><b>BF1049</b> In-Line Fuel Filter</p> <p><b>Fits:</b> Acura SLX; Chevrolet LUV; Honda Passport; Isuzu Amigo, Rodeo, Trooper  <b>Replaces:</b> Isuzu 8-25053-640, 8-25121-778-0  <b>O.D.:</b> 2 5/16 (58.7)  <b>Inlet:</b> 5/16  <b>Outlet:</b> 5/16  <b>Length:</b> 5 15/32 (138.9)</p> 	<p><b>BF1058</b> In-Line Fuel Filter</p> <p><b>Fits:</b> 1995-96 Dodge, Plymouth Neon  <b>Replaces:</b> Chrysler 4495950, 4546679; Wix 33346  <b>O.D.:</b> 2 5/32 (54.8)  <b>Inlet:</b> 3/8  <b>Outlet:</b> [2] 5/16  <b>Length:</b> 9 17/32 (242.1)</p> 
<p><b>BF1050</b> In-Line Fuel Filter</p> <p><b>Fits:</b> Geo Prizm; Toyota Automotive  <b>Replaces:</b> Toyota 23300-19295  <b>O.D.:</b> 2 3/4 (69.9)  <b>Inlet:</b> M14 x 1.5  <b>Outlet:</b> M12 x 1 1/4  <b>Length:</b> 4 9/32 (108.7)  <b>F. Gskt:</b> [2] Copper Washers</p> 	<p><b>BF1059</b> In-Line Fuel Filter</p> <p><b>Notes:</b> OBSOLETE. Availability Limited to Dealer Stock.  <b>Fits:</b> Toyota Automotive  <b>Replaces:</b> Toyota 23300-74210, 23300-79425  <b>O.D.:</b> 2 9/16 (65.1)  <b>Inlet:</b> M14 x 1.5  <b>Outlet:</b> M12 x 1 1/4  <b>Length:</b> 4 (101.6)  <b>F. Gskt:</b> [2] Copper Washers</p> 
<p><b>BF1052</b> Wire Cloth In-Line Fuel Filter</p> <p><b>Fits:</b> Case Excavators, Loaders  <b>Replaces:</b> Case D145357  <b>O.D.:</b> 1 29/32 (48.4)  <b>Inlet:</b> 3/8  <b>Outlet:</b> 3/8  <b>Length:</b> 3 13/16 (96.8)</p> 	<p><b>BF1061</b> In-Line Fuel Filter</p> <p><b>Fits:</b> Mitsubishi, Toyota Automotive  <b>Replaces:</b> Toyota 23300-74260, 23300-79495  <b>O.D.:</b> 2 9/16 (65.1)  <b>Inlet:</b> M14 x 1.5  <b>Outlet:</b> M12 x 1 1/4  <b>Length:</b> 4 1/32 (102.4)  <b>F. Gskt:</b> [2] Metal Washers</p> 
<p><b>BF1053</b> In-Line Fuel Filter</p> <p><b>Contains:</b> 5/16 Inch Return Line  Steel Braided Ground Wire  <b>Fits:</b> Chrysler Automotive  <b>Replaces:</b> Chrysler 4682370  <b>O.D.:</b> 1 29/32 (48.4)  <b>Inlet:</b> 3/8  <b>Outlet:</b> 5/16  <b>Length:</b> 36 (914.4)</p> 	<p><b>BF1100</b> In-Line Fuel Filter</p> <p><b>Fits:</b> Chrysler, Dodge, Geo, Hyundai, Mitsubishi, Suzuki, Toyota Automotive  <b>Replaces:</b> Chrysler MB504732, MB504750; Suzuki 15410-61A00; Toyota 23300-19175, 23300-49145, 23300-69025, 23300-79055  <b>O.D.:</b> 2 3/4 (69.9)  <b>Inlet:</b> M12 x 1 1/4  <b>Outlet:</b> M12 x 1 1/4  <b>Length:</b> 4 29/32 (124.6)  <b>F. Gskt:</b> [4] Metal Washers</p> 
<p><b>BF1054</b> In-Line Fuel Filter</p> <p><b>Notes:</b> OBSOLETE. Availability Limited to Dealer Stock.  <b>Contains:</b> 5/16 Inch Return Line  <b>Fits:</b> Chrysler Cirrus; Dodge Stratus; Plymouth Breeze  <b>Replaces:</b> Chrysler 4695049  <b>O.D.:</b> 2 5/32 (54.8)  <b>Inlet:</b> 3/8  <b>Outlet:</b> 5/16  <b>Length:</b> 9 1/2 (241.3)</p> 	<p><b>BF1102</b> Fuel Spin-on</p> <p><b>Contains:</b> Anti-Drainback Valve  Standpipe  <b>Fits:</b> ERF, Leyland Trucks; Rolls-Royce Engines  <b>Replaces:</b> Rolls-Royce OD19596  <b>Thread:</b> M24 x 1.5  <b>O.D.:</b> 3 11/16 (93.7)  <b>Height:</b> 7 3/16 (182.6)  <b>I.Gskt:</b> G401  <b>O. Gskt:</b> ES24-B</p> 

Measurements Are Shown In Inches And (Millimeters)

**WARNING:** These products can expose you to chemicals, including Diisononyl Phthalate, Carbon black extracts, Nickel, 1,3 Butadiene, Ethylene Oxide, Epichlorohydrin, which are known to the State of California to cause cancer, and Bisphenol, Ethylene Glycol, Ethylene Oxide, 1,3 Butadiene, Epichlorohydrin, which are known to the State of California to cause birth defects or other reproductive harm.

**BF1104** In-Line Fuel Filter  
**Fits:** Isuzu, Nissan Automotive  
**Replaces:** Nissan 16400-F5100  
**O.D.:** 2 17/32 (64.3)  
**Inlet:** 5/16  
**Outlet:** 5/16  
**Length:** 4 11/16 (119.1)



**BF1148** In-Line Fuel Filter  
**Fits:** Hyundai, Kia, Toyota Automotive  
**Replaces:** Toyota 23300-65010  
**O.D.:** 2 3/4 (69.9)  
**Inlet:** M14 x 1.5  
**Outlet:** M14 x 1.5  
**Length:** 4 9/32 (108.7)



**BF1105** In-Line Fuel Filter  
**Fits:** Ford, Isuzu, Jaguar, Nissan Automotive  
**Replaces:** Ford F3XY-9155-F; Nissan 16400-N8601  
**O.D.:** 3 1/8 (79.4)  
**Inlet:** 5/16  
**Outlet:** 5/16  
**Length:** 5 3/8 (136.5)



**BF1150** In-Line Fuel Filter  
**Fits:** Suzuki Automotive  
**Replaces:** Suzuki 15410-80000  
**O.D.:** 3 5/16 (84.1)  
**Inlet:** 5/16  
**Outlet:** 5/16  
**Length:** 2 15/16 (74.6)



**BF1110** Fuel Spin-on  
**Contains:** Integral Post Seal  
**Fits:** Caterpillar, John Deere, Mitsubishi Equipment  
**Replaces:** Mitsubishi 34462-00300  
**Thread:** M20 x 1.5  
**O.D.:** 3 1/32 (77.0)  
**Height:** 4 3/32 (104.0)  
**I.Gskt:** [1] Included



**BF1160** Primary In-Line Fuel Filter  
**Fits:** Honda Automotive  
**Replaces:** Honda 16900-SE0-004  
**O.D.:** 2 25/32 (70.6)  
**Inlet:** 5/16  
**Outlet:** 5/16  
**Length:** 2 19/32 (65.9)





**BF1112** In-Line Fuel Filter  
**Notes:** OBSOLETE. Availability Limited to Dealer Stock.  
**Fits:** Toyota Automotive, Vans  
**Replaces:** Toyota 23300-29065, 23300-46060; GMC 25176332  
**O.D.:** 2 9/16 (65.1)  
**Inlet:** M14 x 1.5  
**Outlet:** M12 x 1 1/4  
**Length:** 3 31/32 (100.8)  
**F. Gskt:** [2] Metal Washers





**BF1163** In-Line Fuel Filter  
**Fits:** Nissan Automotive  
**Replaces:** Nissan 16400-72L00  
**O.D.:** 2 17/32 (64.3)  
**Inlet:** 5/16  
**Outlet:** 5/16  
**Length:** 5 (127.0)



**BF1120** In-Line Fuel Filter  
**Fits:** 1988-91 Honda Civic, 1989-91 CRX  
**Replaces:** Honda 16900-SH3-A30; Wix 33330  
**O.D.:** 3 13/32 (86.5)  
**Inlet:** M12 x 1.25  
**Outlet:** M12 x 1.25  
**Length:** 3 7/8 (98.4)  
**F. Gskt:** [4] Metal Washers



**BF1166** In-Line Fuel Filter  
**Contains:** [2] Plastic Retainer Clips  
**Fits:** Ford Pickups, Vans  
**Replaces:** Ford F0TZ-9155-B  
**O.D.:** 3 1/8 (79.4)  
**Inlet:** 5/16  
**Outlet:** 5/16  
**Length:** 6 25/32 (172.2)

**BF1123** In-Line Fuel Filter  
**Replaces:** Isuzu 8-94125-784-0  
**O.D.:** 2 7/16 (61.9)  
**Inlet:** 5/16  
**Outlet:** 5/16  
**Length:** 4 13/16 (122.2)



**BF1170** In-Line Fuel Filter  
**Contains:** [2] Plastic Retainer Clips  
**Fits:** Ford Automotive  
**Replaces:** Ford F1SZ-9155-A  
**O.D.:** 2 7/32 (56.4)  
**Inlet:** 5/16  
**Outlet:** 3/8  
**Length:** 6 3/8 (161.9)

**BF1140** In-Line Fuel Filter  
**Fits:** Subaru, Toyota Automotive  
**Replaces:** Subaru 7420-23020  
**O.D.:** 3 5/32 (80.2)  
**Inlet:** 5/16  
**Outlet:** 5/16  
**Length:** 2 9/32 (57.9)



**BF1171** In-Line Fuel Filter  
**Contains:** [1] Plastic Retainer Clip  
**Fits:** GM Automotive  
**Replaces:** GMC 25121293  
**O.D.:** 2 5/32 (54.8)  
**Inlet:** 3/8  
**Outlet:** M16 x 1.5  
**Length:** 5 3/8 (136.5)



Measurements Are Shown In Inches And (Millimeters)

**WARNING:** These products can expose you to chemicals, including Diisononyl Phthalate, Carbon black extracts, Nickel, 1,3 Butadiene, Ethylene Oxide, Epichlorohydrin, which are known to the State of California to cause cancer, and Bisphenol, Ethylene Glycol, Ethylene Oxide, 1,3 Butadiene, Epichlorohydrin, which are known to the State of California to cause birth defects or other reproductive harm.

**BF1172**

In-Line Fuel Filter



**Contains:** [1] 12 Inch Length of 3/8 Inch Fuel Line  
[1] Plastic Retainer Clip  
**Fits:** Buick Century; Oldsmobile Cutlass Ciera; Pontiac Automotive  
**Replaces:** GMC 10140514, 25121656  
**O.D.:** 2 5/32 (54.8)  
**Inlet:** 3/8  
**Outlet:** 3/8  
**Length:** 6 15/32 (164.3)

**BF1173**

Wire Cloth In-Line Fuel Strainer



**Notes:** Inside-Out Flow Direction  
**Fits:** Cummins Engines; Case, Caterpillar, Gradall, New Holland, Vermeer, Volvo Equipment  
**Replaces:** Cummins 3826094  
**O.D.:** 1 29/32 (48.4)  
**Inlet:** 3/8  
**Outlet:** 3/8  
**Length:** 3 13/16 (96.8)

**BF1174**

In-Line Fuel Filter



**Contains:** [2] Plastic Retainer Clips  
**Fits:** Chevrolet, Pontiac Automotive  
**Replaces:** GMC 10091791  
**O.D.:** 2 5/32 (54.8)  
**Inlet:** 3/8  
**Outlet:** 3/8  
**Length:** 6 5/16 (160.3)

**BF1177**

In-Line Fuel Filter



**Fits:** Mercedes-Benz Automotive  
**Replaces:** Mercedes-Benz 24770701  
**O.D.:** 3 13/32 (86.5)  
**Inlet:** M12 x 1.5  
**Outlet:** M14 x 1.5  
**Length:** 5 23/32 (145.3)  
**F. Gskt:** [2] Washers

**BF1178**

In-Line Fuel Filter



**Fits:** Chrysler, Mitsubishi Automotive  
**Replaces:** Mitsubishi MB433774  
**O.D.:** 2 1/8 (54.0)  
**Inlet:** 5/16  
**Outlet:** 5/16  
**Length:** 2 15/16 (74.6)

**BF1179**

Universal In-Line Fuel Filter



**Fits:** Chrysler, Daihatsu, Mitsubishi, Toyota Automotive, Light-Duty Trucks  
**Replaces:** Mitsubishi MB504753, MB658689; Toyota 23030-74020, 23300-19045  
**O.D.:** 2 3/4 (69.9)  
**Inlet:** M14 x 1.5  
**Outlet:** M12 x 1 1/4  
**Length:** 4 3/8 (111.1)  
**F. Gskt:** [2] Metal Washers

**BF1181**

In-Line Fuel Filter



**Fits:** Chrysler Automotive  
**Replaces:** Chrysler 4554040  
**O.D.:** 2 5/32 (54.8)  
**Inlet:** 3/8  
**Outlet:** 5/16  
**Length:** 6 13/32 (162.7)

**BF1182**

In-Line Fuel Filter



**Fits:** Dodge Vans, Viper  
**Replaces:** Chrysler 4708317, 52019023, 52020016  
**O.D.:** 2 5/32 (54.8)  
**Inlet:** 5/16  
**Outlet:** 5/16  
**Length:** 6 1/4 (158.8)

**BF1184**

In-Line Fuel Filter



**Contains:** [2] Plastic Retainer Clips  
**Fits:** Ford Escort, Thunderbird; Mercury Cougar  
**Replaces:** Ford E9SZ-9155-A; Motorcraft FG862  
**O.D.:** 2 1/4 (57.2)  
**Inlet:** 5/16  
**Outlet:** 5/16  
**Length:** 6 (152.4)

**BF1185**

In-Line Fuel Filter



**Contains:** [2] Plastic Retainer Clips  
**Fits:** Daewoo, GMC Automotive  
**Replaces:** GMC 25121129  
**O.D.:** 2 3/16 (55.6)  
**Inlet:** 5/16  
**Outlet:** 5/16  
**Length:** 6 5/16 (160.3)

**BF1186**

In-Line Fuel Filter



**Fits:** Geo, Isuzu Automotive  
**Replaces:** GMC 25121141, 25121150, 25121160  
**O.D.:** 2 5/32 (54.8)  
**Inlet:** M14 x 1.5  
**Outlet:** M14 x 1.5  
**Length:** 4 7/16 (112.7)

**BF1188**

In-Line Fuel Filter



**Notes:** OBSOLETE. Availability Limited to Dealer Stock.  
**Fits:** Honda Automotive  
**Replaces:** Honda 16010-SM4-931, 16010-SM4-932  
**O.D.:** 3 3/8 (85.7)  
**Inlet:** M14 x 1.5  
**Outlet:** M12 x 1 1/4  
**Length:** 3 21/32 (92.9)  
**F. Gskt:** [2] Metal Washers

**BF1190**

In-Line Fuel Filter



**Notes:** OBSOLETE. Availability Limited to Dealer Stock.  
**Fits:** Ford, Suzuki Automotive  
**Replaces:** Ford F4BZ-9155-A  
**O.D.:** 2 3/4 (69.9)  
**Inlet:** 5/16  
**Outlet:** 5/16  
**Length:** 5 3/4 (146.0)

Measurements Are Shown In Inches And (Millimeters)

**WARNING:** These products can expose you to chemicals, including Diisononyl Phthalate, Carbon black extracts, Nickel, 1,3 Butadiene, Ethylene Oxide, Epichlorohydrin, which are known to the State of California to cause cancer, and Bisphenol, Ethylene Glycol, Ethylene Oxide, 1,3 Butadiene, Epichlorohydrin, which are known to the State of California to cause birth defects or other reproductive harm.

**BF1191**

In-Line Fuel Filter



**Fits:** Toyota Automotive  
**Replaces:** Toyota 23300-39035  
**O.D.:** 2 3/4 (69.9)  
**Inlet:** M12 x 1 1/4  
**Outlet:** M12 x 1 1/4  
**Length:** 4 13/32 (111.9)  
**F. Gskt:** [4] Copper Washers

**BF1193**

In-Line Fuel Filter



**Fits:** Acura Integra, Honda Accord, Civic  
**Replaces:** Honda 16010-ST5-931  
**O.D.:** 2 15/16 (74.6)  
**Inlet:** M14 x 1.5  
**Outlet:** M12 x 1 1/4  
**Length:** 4 7/16 (112.7)  
**F. Gskt:** [2] Metal Washers

**BF1194**

In-Line Fuel Filter



**Notes:** OBSOLETE. Availability Limited to Dealer Stock.  
**Fits:** Ford, Mazda Automotive  
**Replaces:** Ford F32Z-9155-A; Mazda FS11-20-490A  
**O.D.:** 3 1/8 (79.4)  
**Inlet:** 5/16  
**Outlet:** 5/16  
**Length:** 5 31/32 (151.6)

**BF1195**

In-Line Fuel Filter



**Fits:** Alfa Romeo, Audi, BMW, Land Rover, Mercedes-Benz, Renault, Volkswagen Automotive  
**Replaces:** BMW 13321269231, 13321269548, 13321270038, 13329063165  
**O.D.:** 3 3/16 (81.0)  
**Inlet:** 5/16  
**Outlet:** 5/16  
**Length:** 6 1/4 (158.8)

**BF1199**

In-Line Fuel Filter



**Fits:** Dodge Monaco, Eagle Premier, Jeep Grand Cherokee  
**Replaces:** Chrysler 33003007, 8933003007  
**O.D.:** 2 5/8 (66.7)  
**Inlet:** 3/8  
**Outlet:** 5/16  
**Length:** 6 9/16 (166.7)

**BF1201**

Fuel/Water Separator Element with Drain



**Fits:** GMC Trucks  
**Replaces:** GMC 10154635  
**O.D.:** 2 9/16 (65.1)  
**I.D.:** 3/4 (19.0)  
**Height:** 5 15/32 (138.9)  
**Grommets:** [1] Attached

**BF1204**

Secondary Fuel/Water Separator Spin-on with Drain



**Notes:** Inside-Out Flow Direction  
**Contains:** Integral Post Seal  
 Sensor Port Thread: 1/2-20  
**Fits:** Ford Diesel Engines  
**Thread:** 1 -14  
**O.D.:** 3 11/16 (93.7)  
**Height:** 6 1/16 (154.0)  
**I.Gskt:** [1] Included  
**Related To:** BF1204-O (with Open Port)  
 BF1204-SP (with Sensor Port)

**BF1204-O**

Fuel/Water Separator Spin-on with Open End for Bowl



**Contains:** Bowl Thread: 1 1/4-10  
 Integral Post Seal  
**Fits:** Racor 225R Assembly  
**Replaces:** Racor R26S  
**Thread:** 1 -14  
**O.D.:** 3 3/4 (95.3)  
**Height:** 4 11/16 (119.1)  
**F. Gskt:** [1] Included  
**O-Ring:** [1] Included  
**Related To:** BF1204 (Drain Version)  
 BF1204-SP (Sensor Port Version)

**BF1204-SP**

Secondary Fuel/Water Separator Spin-on with Drain and Sensor Port



**Notes:** Inside-Out Flow Direction.  
 May use OP8752 to plug Sensor Port.  
**Contains:** Integral Post Seal  
 Sensor Port Thread: 1/2-20  
**Fits:** Ford Diesel Engines  
**Thread:** 1 -14  
**O.D.:** 3 11/16 (93.7)  
**Height:** 6 1/16 (154.0)  
**I.Gskt:** [1] Included  
**F. Gskt:** [1] Included  
**Related To:** BF1204 (with Drain)  
 BF1204-O (with Open Port)

**BF1205**

Primary Fuel/Water Separator Spin-on with Drain



**Notes:** Inside-Out Flow Direction  
**Contains:** Integral Post Seal  
 Sensor Port Thread: 1/2-20  
**Fits:** Ford, John Deere Engines  
**Replaces:** Ford E7HZ-9N184-B, E8HT-9J288-AA  
**Thread:** 1 -14  
**O.D.:** 3 11/16 (93.7)  
**Height:** 6 1/16 (154.0)  
**I.Gskt:** [1] Included  
**Related To:** BF1205-SP (with Sensor Port)

**BF1205-SP**

Primary Fuel/Water Separator Spin-on with Drain and Sensor Port



**Notes:** Inside-Out Flow Direction.  
 May use OP8752 to plug Sensor Port.  
**Contains:** Integral Post Seal  
 Sensor Port Thread: 1/2-20  
**Fits:** Ford, John Deere Engines  
**Replaces:** Ford E7HZ-9N184-B, E8HT-9J288-AA  
**Thread:** 1 -14  
**O.D.:** 3 11/16 (93.7)  
**Height:** 6 1/16 (154.0)  
**I.Gskt:** [1] Included  
**F. Gskt:** [1] Included  
**Related To:** BF1205 (with Drain)

Measurements Are Shown In Inches And (Millimeters)

**WARNING:** These products can expose you to chemicals, including Diisononyl Phthalate, Carbon black extracts, Nickel, 1,3 Butadiene, Ethylene Oxide, Epichlorohydrin, which are known to the State of California to cause cancer, and Bisphenol, Ethylene Glycol, Ethylene Oxide, 1,3 Butadiene, Epichlorohydrin, which are known to the State of California to cause birth defects or other reproductive harm.

**BF1210**



Fuel/Water Separator Spin-on with Drain  
**Notes:** Inside-Out Flow Direction  
**Fits:** Cummins Engines  
**Replaces:** Fleetguard FS19540; Luber-finer LFP2000C  
**Thread:** 15/16 -16  
**O.D.:** 4 1/4 (108.0)  
**Height:** 11 11/32 (288.1)  
**I.Gskt:** G401

**BF1214**



Fuel/Water Separator Spin-on with Drain  
**Notes:** Can be used with FB46185 base.  
**Contains:** Integral Post Seal  
**Fits:** Caterpillar Engines  
**Replaces:** Fleetguard FS1214  
**Thread:** 1 -14  
**O.D.:** 3 11/16 (93.7)  
**Height:** 7 13/32 (188.1)  
**I.Gskt:** G381-A  
**Related To:** BF970 (Fuel Version)

**BF1211**



Fuel Spin-on with Drain  
**Notes:** Inside-Out Flow Direction  
**Replaces:** Luber-finer LFP2100C  
**Thread:** 15/16 -16  
**O.D.:** 4 1/4 (108.0)  
**Height:** 8 17/32 (216.7)  
**I.Gskt:** G401

**BF1215**



In-Line Fuel/Water Separator with Water Relief Valve  
**Fits:** Volkswagen Golf, Jetta  
**Replaces:** Volkswagen 191127401A  
**O.D.:** 3 3/8 (85.7)  
**Inlet:** 5/16  
**Outlet:** 5/16  
**Length:** 6 5/8 (168.3)

**BF1212**



Fuel/Water Separator Spin-on with Drain  
**Notes:** CAUTION: Furnished D-Ring must be installed on post for seal. Can be used with FB1311 base.  
**Fits:** Cummins Engines  
**Use With:** BF1212 FOAM  
**Replaces:** Cummins 3308638  
**Thread:** 1 -14  
**O.D.:** 3 11/16 (93.7)  
**Height:** 7 7/16 (188.9)  
**I.Gskt:** G381-A  
**F. Gskt:** ES24-D  
**Related To:** BF957, BF957-D (Fuel Versions) BF7798-SP (Sensor Port Version) BF7798-O (Open Port Version)

**BF1216**



Fuel/Water Separator Spin-on with Drain  
**Notes:** Can be used with FB1306 base.  
**Contains:** Integral Post Seal  
**Fits:** Cummins Engines  
**Replaces:** Cummins 3309437  
**Thread:** 1 1/4 -12  
**O.D.:** 4 11/16 (119.1)  
**Height:** 12 3/32 (307.2)  
**I.Gskt:** [1] Included  
**Related To:** BF596 (Fuel Version)

**BF1212 FOAM**



Foam Wrap for BF1212  
**Use With:** BF1212  
**O.D.:** 4 5/8 (117.5)  
**Height:** 8 (203.2)

**BF1217**



Fuel/Water Separator Spin-on with Drain  
**Fits:** Iveco EuroCargo, EuroStar, EuroTech Series Trucks  
**Replaces:** Iveco 1907539  
**Thread:** M14 x 1.5  
**O.D.:** 3 11/16 (93.7)  
**Height:** 7 11/32 (186.5)  
**I.Gskt:** [1] Included

**BF1213**



Fuel/Water Separator Spin-on with Drain  
**Fits:** Detroit Diesel Engines  
**Replaces:** ACDelco TP1009  
**Thread:** 1 -12  
**O.D.:** 3 11/16 (93.7)  
**Height:** 7 13/32 (188.1)  
**I.Gskt:** [1] Included

**BF1218**



Fuel/Water Separator Spin-on with Drain  
**Notes:** Can be used with FB46185 base.  
**Contains:** Integral Post Seal  
**Fits:** Caterpillar Engines  
**Replaces:** Fleetguard FS1218  
**Thread:** 1 -14  
**O.D.:** 4 1/4 (108.0)  
**Height:** 11 5/16 (287.3)  
**I.Gskt:** G401  
**Related To:** BF584 (Fuel Version)

**BF1219**



Fuel/Water Separator Spin-on with Drain  
**Contains:** Integral Post Seal  
**Fits:** Mack Trucks  
**Replaces:** Mack 483GB433B  
**Thread:** 13/16 -18  
**O.D.:** 4 1/4 (108.0)  
**Height:** 8 1/8 (206.4)  
**I.Gskt:** G381-A  
**Related To:** BF877 (Fuel Version)

Measurements Are Shown In Inches And (Millimeters)

**WARNING:** These products can expose you to chemicals, including Diisononyl Phthalate, Carbon black extracts, Nickel, 1,3 Butadiene, Ethylene Oxide, Epichlorohydrin, which are known to the State of California to cause cancer, and Bisphenol, Ethylene Glycol, Ethylene Oxide, 1,3 Butadiene, Epichlorohydrin, which are known to the State of California to cause birth defects or other reproductive harm.

**BF1220**



Fuel/Water Separator Spin-on with Drain  
**Notes:** CAUTION: Furnished D-Ring must be installed on post for seal.  
 Can be used with FB46185 base.  
**Contains:** Integral Post Seal  
**Fits:** Case, International Equipment  
**Replaces:** Racor B32004, S3204  
**Thread:** 1 -14  
**O.D.:** 3 11/16 (93.7)  
**Height:** 6 3/16 (157.2)  
**I.Gskt:** G381-A  
**F. Gskt:** ES24-D

**BF1223**



Fuel/Water Separator Spin-on with Drain  
**Contains:** Integral Post Seal  
**Fits:** Carrier-Transcold, Ford, Hino Trucks; Ingersoll-Rand Compressors  
**Replaces:** Carrier 30-01079; Ford F1HZ-9365-A  
**Thread:** 1 -14  
**O.D.:** 4 1/4 (108.0)  
**Height:** 6 25/32 (172.2)  
**I.Gskt:** [1] Included  
**Related To:** BF1223-O (with Open Port for Bowl)  
 BF1223-SP (with Sensor Port)  
 BF1224 (without Drain or Sensor Port)

**BF1221**



Fuel/Water Separator Spin-on with Drain  
**Contains:** Standpipe  
**Fits:** Deutz, Volvo Engines  
**Replaces:** Fleetguard FS1221  
**Thread:** M16 x 1.5  
**O.D.:** 3 1/32 (77.0)  
**Height:** 6 21/32 (169.1)  
**I.Gskt:** G449-B  
**Related To:** BF988 (Fuel Version)  
 BF1232 (Sensor Port Version)

**BF1223-O**



Fuel/Water Separator Spin-on with Open End for Bowl  
**Contains:** Bowl Thread: 3 3/4-10  
 Integral Post Seal  
**Fits:** Ford Trucks  
**Replaces:** Ford F1HZ-9365-A; Motorcraft FD3368  
**Thread:** 1 -14  
**O.D.:** 4 1/4 (108.0)  
**Height:** 5 7/32 (132.6)  
**I.Gskt:** [1] Included  
**F. Gskt:** [2] Included  
**Related To:** BF1223 (Drain Version)  
 BF1223-SP (Sensor Port Version)

**BF1222**



Fuel/Water Separator Spin-on with Drain  
**Contains:** Integral Post Seal  
**Fits:** Ford Engines  
**Replaces:** Ford E8TZ-9N184-A  
**Thread:** 1 -14  
**O.D.:** 4 9/32 (108.7)  
**Height:** 5 1/4 (133.4)  
**I.Gskt:** [1] Included  
**Related To:** BF1222-O (with Open Port)  
 BF1222-SP (with Sensor Port)

**BF1223-SP**



Fuel/Water Separator Spin-on with Drain and Sensor Port  
**Notes:** May use OP8750 to plug Sensor Port.  
**Contains:** Integral Post Seal  
 Sensor Port Thread: 9/16-18  
**Fits:** Carrier-Transcold, Ford, Hino Trucks; Ingersoll-Rand Compressors  
**Replaces:** Carrier 30-01079; Ford F1HZ-9365-A  
**Thread:** 1 -14  
**O.D.:** 4 1/4 (108.0)  
**Height:** 6 25/32 (172.2)  
**I.Gskt:** [1] Included  
**O-Ring:** [1] Included  
**Related To:** BF1223-O (Open Port Version)  
 BF1223 (Drain Version)

**BF1222-O**



Fuel/Water Separator Spin-on with Open End for Bowl  
**Contains:** Bowl Thread: 3-12  
 Integral Post Seal  
**Fits:** Ford Engines  
**Replaces:** Ford F2TZ-9N-184-A; Motorcraft FD3375  
**Thread:** 1 -14  
**O.D.:** 4 1/4 (108.0)  
**Height:** 4 1/8 (104.8)  
**I.Gskt:** [1] Included  
**O-Ring:** [1] Included  
**Related To:** BF1222 (with Drain)  
 BF1222-SP (with Sensor Port)

**BF1224**



Fuel/Water Separator Spin-on  
**Contains:** Integral Post Seal  
**Fits:** Carrier-Transcold Refrigeration Units  
**Replaces:** Carrier 30-01090-00  
**Thread:** 1 -14  
**O.D.:** 4 1/4 (108.0)  
**Height:** 5 29/32 (150.0)  
**I.Gskt:** [1] Included  
**Related To:** BF1223 (Drain Version)  
 BF1223-O (Open End Version)  
 BF1223-SP (Drain and Sensor Port Version)

**BF1222-SP**



Fuel/Water Separator Spin-on with Drain and Sensor Port  
**Notes:** May use OP8751 to plug Sensor Port.  
**Contains:** Integral Post Seal  
 Sensor Port Thread: 7/16-20  
**Fits:** Ford Engines  
**Replaces:** Ford E8TZ-9N184-A  
**Thread:** 1 -14  
**O.D.:** 4 9/32 (108.7)  
**Height:** 5 1/4 (133.4)  
**I.Gskt:** [1] Included  
**F. Gskt:** [1] Included  
**Related To:** BF1222 (with Drain)  
 BF1222-O (with Open Port)

**BF1225**



Fuel/Water Separator Spin-on with Drain  
**Notes:** Can be used with FB46185 base.  
**Contains:** Integral Post Seal  
**Fits:** Case Combines  
**Replaces:** GMC 25011691  
**Thread:** 1 -14  
**O.D.:** 3 11/16 (93.7)  
**Height:** 7 3/8 (187.3)  
**I.Gskt:** G381-A  
**Related To:** BF979 (Fuel Version)

Measurements Are Shown In Inches And (Millimeters)

**WARNING:** These products can expose you to chemicals, including Diisononyl Phthalate, Carbon black extracts, Nickel, 1,3 Butadiene, Ethylene Oxide, Epichlorohydrin, which are known to the State of California to cause cancer, and Bisphenol, Ethylene Glycol, Ethylene Oxide, 1,3 Butadiene, Epichlorohydrin, which are known to the State of California to cause birth defects or other reproductive harm.

**BF1226**



Fuel/Water Separator Spin-on with Drain  
**Notes:** CAUTION: Furnished O-Ring must be installed on post for seal.  
**Contains:** Standpipe  
**Fits:** Cummins Engines  
**Replaces:** Cummins 3903202  
**Thread:** M16 x 1.5  
**O.D.:** 3 1/32 (77.0)  
**Height:** 5 11/16 (144.5)  
**I.Gskt:** G449-B  
**O-Ring:** [1] Included

**V1240-C**



Vac-Cel By-Pass Lube Sock  
**Fits:** Hall-Scott, Hercules Equipment; Waukesha Engines  
**Replaces:** Hall-Scott 6412240A; Hercules 7611970  
**O.D.:** 4 1/8 (104.8)  
**I.D.:** 1 1/16 (27.0)  
**Height:** 12 (304.8)  
**F. Gskt:** G115-A

**BF1231**



Fuel/Water Separator Spin-on with Drain  
**Contains:** Integral Post Seal  
**Fits:** Ford, New Holland Equipment  
**Replaces:** Ford 87840136  
**Thread:** 1 -14  
**O.D.:** 4 5/16 (109.5)  
**Height:** 6 25/32 (172.2)  
**I.Gskt:** [1] Included

**BF1248**



Fuel/Water Separator Spin-on with Drain  
**Notes:** CAUTION: Furnished O-Ring must be installed on post for seal.  
**Contains:** Integral Post Seal  
**Fits:** Komatsu Engines, Equipment  
**Replaces:** Komatsu 600-311-8293  
**Thread:** 1 -14  
**O.D.:** 3 11/16 (93.7)  
**Height:** 5 5/8 (142.9)  
**I.Gskt:** G381-A  
**F. Gskt:** ES3028

**BF1232**



Fuel/Water Separator Spin-on with Sensor Port  
**Contains:** Integral Post Seal  
 Sensor Port Thread: 1 1/4-10  
**Fits:** 1989-93 Dodge Pickup with 5.9L Diesel Engine  
**Replaces:** Chrysler 4429107  
**Thread:** M16 x 1.5  
**O.D.:** 3 1/32 (77.0)  
**Height:** 4 11/16 (119.1)  
**I.Gskt:** G449-B  
**O-Ring:** [2] Included  
**Related To:** BF1221 (without Sensor Port)

**BF1249**



Fuel/Water Separator Spin-on with Drain  
**Notes:** CAUTION: Furnished D-Ring must be installed on post for seal.  
 Can be used with FB1311 base.  
**Fits:** Blue Bird, Ford, Freightliner, International Buses, Trucks; Hamm Rollers; Hyundai, Liebherr Equipment; Optional on Cummins Engines  
**Replaces:** Alliance ABPN/N10G-FS1242; Bomag 31701061, 31701062; Cummins 3355903, 3353904; Hamm 1236385; John Deere RE61554; Kobelco YN02PU1004S002; Liebherr 7381816; Massey Ferguson 108615W1, 108614W91; Nissan FL6442N  
**Thread:** 1 -14  
**O.D.:** 3 11/16 (93.7)  
**Height:** 8 29/32 (226.2)  
**I.Gskt:** G381-A  
**F. Gskt:** ES24-D  
**Related To:** BF1249-O (Open Port Version)  
 BF1249-SP (Sensor Port Version)  
 BF1393-SP (High Efficiency Version)

**BF1233**



Fuel/Water Separator Spin-on with Sensor Port  
**Contains:** Sensor Port Thread: 1 1/4-10  
**Fits:** Dodge Light-Duty, Peterbilt Trucks  
**Replaces:** Chrysler 4741689  
**Thread:** M20 x 1.5  
**O.D.:** 3 11/16 (93.7)  
**Height:** 4 3/8 (111.1)  
**I.Gskt:** G401  
**F. Gskt:** [2] Included

**BF1239**



Fuel/Water Separator Spin-on  
**Contains:** Water Absorbent Media  
**Fits:** Various Fuel Islands  
**Replaces:** Cim-Tek 700-23, 700-68  
**Thread:** 1 1/2 -16  
**O.D.:** 5 1/16 (128.6)  
**Height:** 10 3/4 (273.1)  
**F. Gskt:** G369-B  
**O. Gskt:** G286-C, G369-V, G372, G447, G483, G704, G710

**BF1249-O**



Fuel/Water Separator Spin-on with Open End for Bowl  
**Notes:** CAUTION: Furnished O-Ring must be installed on Post for seal.  
**Contains:** Integral Post Seal  
 Bowl Thread: 1 1/4-10  
**Fits:** Blue Bird, Ford, Freightliner, International Buses, Trucks; Hamm Rollers; Hyundai, Liebherr Equipment; Optional on Cummins Engines  
**Replaces:** Nissan FL6442N  
**Thread:** 1 -14  
**O.D.:** 3 21/32 (92.9)  
**Height:** 6 5/8 (168.3)  
**I.Gskt:** ES24-D  
**O-Ring:** [1] Included  
**Related To:** BF1249 (Standard Version)  
 BF1249-SP (Sensor Port Version)

**BF1240**



Fuel/Water Separator Spin-on with Drain  
**Notes:** Can be used with FB46185 base.  
**Contains:** Integral Post Seal  
**Fits:** John Deere Scrapers  
**Replaces:** John Deere AT77587  
**Thread:** 1 -14  
**O.D.:** 4 1/4 (108.0)  
**Height:** 6 25/32 (172.2)  
**I.Gskt:** G401

Measurements Are Shown In Inches And (Millimeters)

**WARNING:** These products can expose you to chemicals, including Diisononyl Phthalate, Carbon black extracts, Nickel, 1,3 Butadiene, Ethylene Oxide, Epichlorohydrin, which are known to the State of California to cause cancer, and Bisphenol, Ethylene Glycol, Ethylene Oxide, 1,3 Butadiene, Epichlorohydrin, which are known to the State of California to cause birth defects or other reproductive harm.



## BF1249-SP



Fuel/Water Separator Spin-on with Drain and Sensor Port

**Notes:** CAUTION: Furnished D-Ring must be installed on post for seal.  
Can be used with FB1311 base.  
May use OP8752 to plug Sensor Port.  
**Contains:** Sensor Port Thread: 1/2-20  
**Fits:** Blue Bird, Ford, Freightliner, International Buses, Trucks; Hamm Rollers; Hyundai, Liebherr Equipment; Optional on Cummins Engines  
**Replaces:** Alliance ABPN/N10G-FS1242; Bomag 31701062; Cummins 3355903, 3353904; Hamm 1236385; John Deere RE61554; Kobelco YN02PU1004S002; Liebherr 7381816; Massey Ferguson 108615W1, 108614W91; Nissan FL6442N  
**Thread:** 1 -14  
**O.D.:** 3 11/16 (93.7)  
**Height:** 8 29/32 (226.2)  
**I.Gskt:** G381-A  
**F. Gskt:** ES24-D  
**Related To:** BF1249 (Standard Version)  
BF1249-O (Open Port Version)

## BF1252



Primary Fuel/Water Separator Spin-on with Drain

**Notes:** CAUTION: Furnished D-Ring must be installed on post for seal.  
Can be used with FB1311 base.  
**Fits:** Blue Bird Buses  
**Replaces:** Racor S3230  
**Thread:** 1 -14  
**O.D.:** 3 11/16 (93.7)  
**Height:** 7 13/32 (188.1)  
**I.Gskt:** G381-A  
**F. Gskt:** ES24-D

## BF1253



Fuel/Water Separator Spin-on with Drain

**Notes:** Inside-Out Flow Direction  
**Fits:** Racor 220 Series Fuel/Water Separators  
**Replaces:** Racor R24S  
**Thread:** 1 -14  
**O.D.:** 3 11/16 (93.7)  
**Height:** 5 7/32 (132.6)  
**I.Gskt:** [1] Included

## BF1256



Primary Fuel/Water Separator Spin-on with Drain

**Contains:** Integral Post Seal  
**Fits:** Mack Trucks  
**Replaces:** Mack 483GB472M  
**Thread:** M22 x 1.5  
**O.D.:** 4 1/4 (108.0)  
**Height:** 9 15/16 (252.4)  
**I.Gskt:** [1] Included

## BF1257



Fuel/Water Separator Spin-on with Drain

**Contains:** Integral Post Seal  
**Fits:** Bobcat Loaders; Cummins Engines; Gehl Equipment  
**Replaces:** Clark 6647773; Melroe-Bobcat 6667352  
**Thread:** M16 x 1.5  
**O.D.:** 3 (76.2)  
**Height:** 4 7/32 (107.2)  
**I.Gskt:** G449-B

## BF1258



Fuel/Water Separator Spin-on with Drain

**Notes:** CAUTION: Furnished D-Ring must be installed on post for seal.  
Can be used with FB1311 base.  
**Contains:** Standpipe  
**Fits:** Case, Daewoo Equipment; Peterbilt Trucks; Cummins N14 Plus Engines  
**Replaces:** Fleetguard FS1001  
**Thread:** 1 -14  
**O.D.:** 3 11/16 (93.7)  
**Height:** 7 7/16 (188.9)  
**I.Gskt:** G381-A  
**F. Gskt:** ES24-D

## BF1259



Fuel/Water Separator Spin-on with Drain

**Notes:** CAUTION: Furnished D-Ring must be installed on post for seal.  
Can be used with FB1311 base.  
**Contains:** Standpipe  
**Fits:** Caterpillar, Cummins Engines; Euclid Rear Dumps; Kenworth, Volvo Trucks; Versatile Tractors  
**Replaces:** Cummins 3329289; Fleetguard FS1000  
**Thread:** 1 -14  
**O.D.:** 3 11/16 (93.7)  
**Height:** 9 17/32 (242.1)  
**I.Gskt:** G381-A  
**F. Gskt:** ES24-D

## BF1261



Fuel/Water Separator Spin-on with Drain

**Fits:** Lister-Petter Engines  
**Replaces:** Lister-Petter 75118100  
**Thread:** M16 x 1.5  
**O.D.:** 3 (76.2)  
**Height:** 4 7/32 (107.2)  
**I.Gskt:** G449-B  
**F. Gskt:** [1] Included

## BF1262



Fuel/Water Separator Spin-on with Drain

**Contains:** Integral Post Seal  
**Fits:** Cummins Engines  
**Replaces:** Cummins 3089916; Fleetguard FS1006  
**Thread:** 1 1/4 -12  
**O.D.:** 4 21/32 (118.3)  
**Height:** 12 1/16 (306.4)  
**I.Gskt:** [1] Included

## BF1265



Fuel/Water Separator Spin-on with Drain

**Contains:** Integral Post Seal  
**Fits:** John Deere Combines, Loaders, Tractors  
**Replaces:** Caterpillar 133-5673; John Deere RE502203  
**Thread:** 1 -14  
**O.D.:** 4 9/32 (108.7)  
**Height:** 11 5/16 (287.3)  
**I.Gskt:** [1] Included  
**Related To:** BF1395-O (Open Port Version)  
BF1395-SP (Sensor Port Version)

Measurements Are Shown In Inches And (Millimeters)

**WARNING:** These products can expose you to chemicals, including Diisononyl Phthalate, Carbon black extracts, Nickel, 1,3 Butadiene, Ethylene Oxide, Epichlorohydrin, which are known to the State of California to cause cancer, and Bisphenol, Ethylene Glycol, Ethylene Oxide, 1,3 Butadiene, Epichlorohydrin, which are known to the State of California to cause birth defects or other reproductive harm.

**BF1266**

Fuel/Water Separator Spin-on with Drain



**Notes:** CAUTION: Furnished D-Ring must be installed on post for seal.  
**Fits:** Detroit Diesel Engines  
**Replaces:** GMC 12542374; Racor S3212  
**Thread:** 1 -12  
**O.D.:** 3 11/16 (93.7)  
**Height:** 6 5/32 (156.4)  
**I.Gskt:** [1] Included  
**F. Gskt:** ES24-D  
**Related To:** BF1278-O (Open Port Version)

**BF1267**

Fuel/Water Separator Spin-on with Drain



**Fits:** Onan Generators; Toro Greensmaster Mowers with Mitsubishi Engines  
**Replaces:** Onan 149-2106; Toro 63-8300  
**Thread:** M16 x 1.5  
**O.D.:** 3 1/32 (77.0)  
**Height:** 3 1/8 (79.4)  
**I.Gskt:** [1] Included

**BF1268**

Suction Line Fuel/Water Separator Spin-on with Drain



**Contains:** Integral Post Seal  
**Fits:** Chevrolet, Ford, Freightliner Trucks; Caterpillar Engines  
**Replaces:** Caterpillar 175-2949  
**Thread:** 1 -14  
**O.D.:** 3 11/16 (93.7)  
**Height:** 7 3/8 (187.3)  
**A. Gskt:** G381-A

**BF1269**

Fuel/Water Separator Spin-on with Drain



**Fits:** DAF Trucks  
**Replaces:** DAF 1319159  
**Thread:** M16 x 1.5  
**O.D.:** 3 1/32 (77.0)  
**Height:** 5 7/32 (132.6)  
**I.Gskt:** G449-B

**BF1270-SP**

Fuel/Water Separator Spin-on with Drain and Sensor Port



**Notes:** CAUTION: Furnished O-Ring must be installed on post for seal.  
**Contains:** Sensor Port Thread: 1/2-20  
**Replaces:** Teledyne 504598  
**Thread:** 1 -14  
**O.D.:** 3 11/16 (93.7)  
**Height:** 6 1/16 (154.0)  
**I.Gskt:** [1] Included  
**O-Ring:** [1] Included

**BF1271**

Fuel/Water Separator Spin-on with Sensor Port



**Notes:** CAUTION: Furnished O-Ring must be installed on post for seal.  
**Contains:** Sensor Port Thread: 1 1/4-10 Integral Post Seal  
**Fits:** Cummins ISB Series Engines  
**Replaces:** Cummins 3942533  
**Thread:** M20 x 1.5  
**O.D.:** 3 11/16 (93.7)  
**Height:** 5 3/8 (136.5)  
**I.Gskt:** G401  
**O-Ring:** [1] Included  
**End Seals:** [1] Included

**BF1272-SPS**

Fuel/Water Separator Spin-on with Drain, Sensor Port and Reusable Sensor



**Notes:** CAUTION: Furnished D-Ring must be installed on post for seal.  
 For use with Delphi oval sensor.  
 Not interchangeable with BF1293-SPS.  
**Contains:** Sensor Port Thread: M14 x 2.0 Standpipe  
**Fits:** Cummins Engines  
**Replaces:** Case J800394; Cummins 3800394; Donaldson P551022; Fleetguard FS1022  
**Thread:** 1 -14  
**O.D.:** 3 11/16 (93.7)  
**Height:** 9 15/32 (240.5)  
**I.Gskt:** G381-A  
**F. Gskt:** ES24-D

**BF1273-SP**

Fuel/Water Separator Spin-on with Drain and Sensor Port



**Contains:** Integral Post Seal  
 Sensor Port Thread: 1/2-20  
**Fits:** Nissan UD Trucks  
**Replaces:** Nissan 16400-Z5511  
**Thread:** 1 -14  
**O.D.:** 4 1/4 (108.0)  
**Height:** 6 9/16 (166.7)  
**I.Gskt:** G401  
**O-Ring:** [1] Included

**BF1274-SP**

Fuel/Water Separator Spin-on with Drain and Sensor Port



**Notes:** May use OP8753 to plug Sensor Port. For service, retain reusable sensor from BF1274-SPS, and attach to BF1274-SP.  
**Contains:** Sensor Port Thread: M14 x 2.0  
**Fits:** Cummins Signature 600 Engines  
**Replaces:** Cummins 3331096; Fleetguard FS1007  
**Thread:** M85 x 2.0  
**O.D.:** 4 21/32 (118.3)  
**Height:** 11 5/8 (295.3)  
**I.Gskt:** [1] Included  
**O-Ring:** [1] Included  
**Related To:** BF1274-SPS (with Sensor Port and Reusable Sensor)

**BF1274-SPS**

Fuel/Water Separator Spin-on with Drain, Sensor Port and Reusable Sensor



**Notes:** May use OP8753 to plug Sensor Port. For service, retain reusable sensor from BF1274-SPS, and attach to BF1274-SP.  
**Contains:** Sensor Port Thread: M14 x 2.0  
**Fits:** Cummins Signature 600 Engines  
**Replaces:** Cummins 3331096; Fleetguard FS1007  
**Thread:** M85 x 2.0  
**O.D.:** 4 21/32 (118.3)  
**Height:** 11 5/8 (295.3)  
**I.Gskt:** [1] Included  
**Related To:** BF1274-SP (with Sensor Port)

**BF1275**

Fuel/Water Separator Spin-on with Drain



**Contains:** Integral Post Seal  
**Fits:** Equipment with Cummins B3.3 Engine Requiring a Fuel/Water Separator  
**Replaces:** Fleetguard FS19594  
**Thread:** 3/4 -16  
**O.D.:** 3 1/32 (77.0)  
**Height:** 5 11/16 (144.5)  
**I.Gskt:** G449-B

Measurements Are Shown In Inches And (Millimeters)

**WARNING:** These products can expose you to chemicals, including Diisononyl Phthalate, Carbon black extracts, Nickel, 1,3 Butadiene, Ethylene Oxide, Epichlorohydrin, which are known to the State of California to cause cancer, and Bisphenol, Ethylene Glycol, Ethylene Oxide, 1,3 Butadiene, Epichlorohydrin, which are known to the State of California to cause birth defects or other reproductive harm.

**BF1276**



Fuel/Water Separator Spin-on with Drain  
**Notes:** CAUTION: Furnished O-Ring must be installed on post for seal.  
**Fits:** R.V.I. Trucks  
**Replaces:** Renault 7701030546  
**Thread:** M16 x 1.5  
**O.D.:** 3 1/32 (77.0)  
**Height:** 6 21/32 (169.1)  
**I.Gskt:** G449-B  
**O-Ring:** [1] Included

**BF1279**



Fuel/Water Separator Spin-on with Drain  
**Notes:** CAUTION: Furnished O-Ring must be installed on post for seal.  
**Fits:** Freightliner Argosy, Century Class, Condor  
**Replaces:** Alliance ABP/32FRT02, RA1320RFRT02; Racor RA132FRT02  
**Thread:** 1 -14  
**O.D.:** 3 23/32 (94.5)  
**Height:** 7 15/16 (201.6)  
**I.Gskt:** G381-A  
**F. Gskt:** [1] Included

**BF1277-SP**



Fuel/Water Separator Spin-on with Drain and Sensor Port  
**Notes:** May use OP8753 to plug Sensor Port. For service, retain reusable sensor from BF1277-SPS, and attach to BF1277-SP.  
**Contains:** Sensor Port Thread: M14 x 2.0  
**Fits:** Cummins ISX, Signature 600 Engines  
**Replaces:** Case 419858A1, 441701A1; Manitowoc A047930  
**Thread:** M85 x 2.0  
**O.D.:** 4 21/32 (118.3)  
**Height:** 11 5/8 (295.3)  
**I.Gskt:** [1] Included  
**O-Ring:** [1] Included  
**Related To:** BF1277-SPS (with Sensor Port and Reusable Sensor)

**BF1280**



Fuel/Water Separator Spin-on with Drain  
**Notes:** CAUTION: Furnished O-Ring must be installed on post for seal.  
**Fits:** Cummins Engines  
**Replaces:** Cummins 3925274  
**Thread:** 13/16 -18  
**O.D.:** 3 11/16 (93.7)  
**Height:** 6 1/4 (158.8)  
**I.Gskt:** G401  
**F. Gskt:** [1] Included  
**Related To:** BF7879 (without Drain)

**BF1277-SPS**



Fuel/Water Separator Spin-on with Drain, Sensor Port and Reusable Sensor  
**Notes:** For service, retain reusable sensor from BF1277-SPS, and attach to BF1277-SP.  
**Contains:** Sensor Port Thread: M14 x 2.0  
**Fits:** Cummins ISX, Signature 600 Engines  
**Replaces:** Caterpillar 3964605; Cummins 3101872, 4010651; Fleetguard FS1040  
**Thread:** M85 x 2.0  
**O.D.:** 4 21/32 (118.3)  
**Height:** 11 5/8 (295.3)  
**I.Gskt:** [1] Included  
**Related To:** BF1277-SP (with Sensor Port)

**BF1281**



Primary Fuel/Water Separator Spin-on with Drain  
**Contains:** Integral Post Seal  
**Fits:** Primary Fuel for Racor 4120 Series Fuel/Water Separators  
**Replaces:** Racor R120P  
**Thread:** 1 -14  
**O.D.:** 4 9/32 (108.7)  
**Height:** 11 5/16 (287.3)  
**F. Gskt:** [1] Included  
**Related To:** BF1281-O (Open Port Version)

**BF1278**



Fuel/Water Separator Spin-on with Drain  
**Fits:** Ingersoll-Rand Compressors  
**Replaces:** Ingersoll-Rand 54468178  
**Thread:** 1 -12  
**O.D.:** 3 11/16 (93.7)  
**Height:** 6 7/32 (158.0)  
**I.Gskt:** [1] Included  
**Related To:** BF1278-O (Open End)

**BF1281-O**



Primary Fuel/Water Separator Spin-on with Open End for Bowl  
**Contains:** Bowl Thread: M95 x 2.5 Integral Post Seal  
**Fits:** Primary Fuel for Racor 4120 Series Fuel/Water Separators  
**Replaces:** Racor R120P; Donaldson P550177; Fleetguard FS19754  
**Thread:** 1 -14  
**O.D.:** 4 13/32 (111.9)  
**Height:** 8 19/32 (218.3)  
**F. Gskt:** [2] Included  
**Related To:** BF1281 (with Drain)

**BF1278-O**



Fuel/Water Separator Spin-on with Open End for Bowl  
**Contains:** Bowl Thread: M80 x 2.5 Integral Post Seal  
**Fits:** Ingersoll-Rand Compressors  
**Replaces:** Ingersoll-Rand 54468178  
**Thread:** 1 -12  
**O.D.:** 3 11/16 (93.7)  
**Height:** 4 1/8 (104.8)  
**I.Gskt:** [1] Included  
**F. Gskt:** [1] Included  
**O-Ring:** [1] Included  
**Related To:** BF1278 (Drain Version)

**BF1282**



Fuel/Water Separator Spin-on with Drain  
**Notes:** CAUTION: Furnished D-Ring must be installed on post for seal. Can be used with FB1311 base.  
**Fits:** Cummins M11 Engines; Komatsu Equipment  
**Replaces:** Cummins 3843447; Komatsu 1304800-H1  
**Thread:** 1 -14  
**O.D.:** 3 11/16 (93.7)  
**Height:** 6 5/32 (156.4)  
**I.Gskt:** G381-A  
**F. Gskt:** ES24-D  
**Related To:** BF1282-O (Open Port Version)

Measurements Are Shown In Inches And (Millimeters)

**WARNING:** These products can expose you to chemicals, including Diisononyl Phthalate, Carbon black extracts, Nickel, 1,3 Butadiene, Ethylene Oxide, Epichlorohydrin, which are known to the State of California to cause cancer, and Bisphenol, Ethylene Glycol, Ethylene Oxide, 1,3 Butadiene, Epichlorohydrin, which are known to the State of California to cause birth defects or other reproductive harm.

**BF1282-O**

Fuel/Water Separator Spin-on with Open End for Bowl



**Notes:** CAUTION: Furnished D-Ring must be installed on post for seal.  
**Contains:** Bowl Thread: 1 1/4-2B  
**Fits:** Agco, Komatsu Equipment; Case Dump Trucks; Cummins Engines  
**Replaces:** Fleetguard FS1241  
**Thread:** 1 -14  
**O.D.:** 3 21/32 (92.9)  
**Height:** 4 19/32 (116.7)  
**I.Gskt:** [1] Included  
**F. Gskt:** ES24-D  
**O-Ring:** [1] Included  
**Related To:** BF1282 (with Drain)

**BF1283**

Fuel/Water Separator Spin-on with Drain



**Contains:** Integral Post Seal  
**Fits:** Caterpillar Equipment, Industrial, Marine, Truck Engines; Racor 4120 Series  
**Replaces:** Caterpillar 129-0373; Racor R120S  
**Thread:** 1 -14  
**O.D.:** 4 9/32 (108.7)  
**Height:** 11 7/32 (285.0)  
**I.Gskt:** [1] Included  
**Related To:** BF1283-SP (Sensor Port Version) BF1283-O (Open Port Version)

**BF1283-O**

Fuel/Water Separator Spin-on with Open End for Bowl



**Contains:** Bowl Thread: M95 x 2.5  
 Integral Post Seal  
**Fits:** Caterpillar Equipment, Industrial, Marine, Truck Engines; Racor 4120 Series  
**Replaces:** Racor R120S; Donaldson P550175; Fleetguard FS1071  
**Thread:** 1 -14  
**O.D.:** 4 13/32 (111.9)  
**Height:** 8 19/32 (218.3)  
**I.Gskt:** [2] Included  
**F. Gskt:** [1] Included  
**Related To:** BF1283 (Drain Version) BF1283-SP (Sensor Port Version)

**BF1283-SP**

Fuel/Water Separator Spin-on with Sensor Port and Drain



**Notes:** CAUTION: Furnished O-Ring must be installed on post for seal.  
 May use OP8752 to plug Sensor Port.  
**Contains:** Sensor Port Thread: 1/2-20UNF-2B  
 Integral Post Seal  
**Fits:** Detroit Diesel Series 60 Engines  
**Replaces:** Alliance ABP/N122-R50407  
**Thread:** 1 -14  
**O.D.:** 4 9/32 (108.7)  
**Height:** 11 5/16 (287.3)  
**I.Gskt:** [1] Included  
**O-Ring:** [1] Included  
**Related To:** BF1283 (Drain Version) BF1283-O (Open Port Version)

**BF1285-SP**

Fuel/Water Separator Spin-on with Sensor Port and Drain



**Contains:** Integral Post Seal  
 Sensor Port Thread: 1/2-20  
**Fits:** John Deere Equipment  
**Replaces:** John Deere RE519608  
**Thread:** 1 -12  
**O.D.:** 4 9/32 (108.7)  
**Height:** 11 7/32 (285.0)  
**I.Gskt:** [1] Included  
**O-Ring:** [1] Included

**BF1286**

Fuel/Water Separator Spin-on with Drain



**Contains:** Integral Post Seal  
**Fits:** Mack Engines  
**Replaces:** Mack 483GB477M  
**Thread:** M30 x 1.5  
**O.D.:** 4 1/4 (108.0)  
**Height:** 8 11/32 (211.9)  
**I.Gskt:** [1] Included

**BF1287-O**

Fuel/Water Separator Spin-on with Open End for Bowl



**Contains:** Bowl Thread: M95 x 2.5  
 Integral Post Seal  
**Fits:** Komatsu HD465-7, HD605-7 Dump Trucks  
**Replaces:** Komatsu 600-311-3210, 600-319-3240  
**Thread:** 1 1/4 -12  
**O.D.:** 4 7/8 (123.8)  
**Height:** 9 29/32 (251.6)  
**I.Gskt:** [1] Included  
**A. Gskt:** [1] Attached  
**F. Gskt:** [1] Included

**BF1288-O**

Fuel/Water Separator Spin-on with Open End for Bowl



**Contains:** Bowl Thread: M95 x 2.5  
 Integral Post Seal  
**Fits:** Komatsu Dump Trucks, Equipment  
**Replaces:** Komatsu 600-311-4510, 600-319-4500  
**Thread:** 1 1/4 -12  
**O.D.:** 4 7/8 (123.8)  
**Height:** 9 29/32 (251.6)  
**I.Gskt:** [1] Included  
**F. Gskt:** [1] Included  
**Related To:** BF1357 (Drain Version)

**BF1289-SP**

Fuel/Water Separator Spin-on with Drain and Sensor Port



**Contains:** Sensor Port Thread: M12 x 1.75  
**Fits:** Caterpillar, Challenger, Perkins Equipment  
**Replaces:** Agco 529435D1; Caterpillar 2715076, 3087298; Perkins 2656F853  
**Thread:** M22 x 1.5  
**O.D.:** 3 11/16 (93.7)  
**Height:** 7 15/16 (201.6)  
**I.Gskt:** [1] Included  
**O-Ring:** [1] Included

**BF1290-O**

Fuel/Water Separator Spin-on with Open End for Bowl



**Notes:** OBSOLETE. Availability Limited to Dealer Stock.  
**Contains:** Bowl Thread: B80 x 3 8A Metric Buttress  
**Replaces:** Parker China Division WBF219B; Foton Lovol 1307211500005  
**Thread:** 1 -14  
**O.D.:** 4 11/32 (110.3)  
**Height:** 6 13/32 (162.7)  
**I.Gskt:** [1] Included  
**O-Ring:** [1] Included

Measurements Are Shown In Inches And (Millimeters)

**WARNING:** These products can expose you to chemicals, including Diisononyl Phthalate, Carbon black extracts, Nickel, 1,3 Butadiene, Ethylene Oxide, Epichlorohydrin, which are known to the State of California to cause cancer, and Bisphenol, Ethylene Glycol, Ethylene Oxide, 1,3 Butadiene, Epichlorohydrin, which are known to the State of California to cause birth defects or other reproductive harm.

**PF1291** Water Sensor Element  
**Fits:** Wix 24843 Assembly  
**Replaces:** Cim-Tek EHS30, 300-07; Fleetguard FS1286; Wix 24844  
**O.D.:** 4 17/32 (115.1)  
**I.D.:** 1/2 (12.7) & 1 3/32 (27.8)  
**Height:** 9 3/16 (233.4)  
**F. Gskt:** [2] Included, [1] Metal Washer  
**Grommets:** [1] Attached

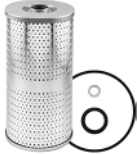

**BF1296-O** Fuel Spin-on with Open End for Bowl  
**Contains:** Bowl Thread: B80 x 3 8A Metric Buttress  
**Fits:** Doosan Equipment  
**Replaces:** Parker China Division WBF219B1; Sinotruk 13050733  
**Thread:** 1 -14  
**O.D.:** 4 1/4 (108.0)  
**Height:** 6 13/32 (162.7)  
**I.Gskt:** [1] Included  
**O-Ring:** [1] Included



**BF1292-O** Fuel/Water Separator Spin-on with Open End for Bowl  
**Contains:** Bowl Thread: M95 x 2.5 Integral Post Seal  
**Fits:** Deutz Engines; Deutz-Fahr, Fendt Tractors; Iveco Trucks  
**Replaces:** Deutz 4291642; Fendt F339202060120; Iveco 42549295; Mercedes-Benz 4771602, A0004771602; Racor R90TDMAX  
**Thread:** 1 -14  
**O.D.:** 4 5/32 (105.6)  
**Height:** 6 5/16 (160.3)  
**I.Gskt:** [1] Included  
**F. Gskt:** [1] Included



**BF1297-O** Fuel Spin-on with Open End for Bowl  
**Contains:** Bowl Thread: B80 x 3 8A Metric Buttress  
**Integral Post Seal**  
**Replaces:** Parker China Division WBF219H; Weichai Power 61230080088  
**Thread:** 1 -14  
**O.D.:** 4 9/32 (108.7)  
**Height:** 9 3/32 (231.0)  
**I.Gskt:** [1] Included  
**O-Ring:** [1] Included



**BF1293-SPS** Fuel/Water Separator Spin-on with Drain, Sensor Port and Reusable Sensor  
**Notes:** CAUTION: Furnished O-Ring must be installed on post for seal.  
 For use with Deutz square sensor.  
 NOT Interchangeable with BF1272-SPS.  
**Contains:** Sensor Port Thread: M14 x 2.0 Standpipe  
**Fits:** Cummins Engines  
**Replaces:** Cummins 3406889; Donaldson P551003; Fleetguard FS1003  
**Thread:** 1 -14  
**O.D.:** 3 11/16 (93.7)  
**Height:** 10 1/32 (254.8)  
**I.Gskt:** G381-A  
**F. Gskt:** ES24-D



**BF1298-O** Fuel/Water Separator Spin-on with Open End for Bowl  
**Contains:** Bowl Thread: M95 x 2.5 Integral Post Seal  
**Replaces:** Foton Lovol 1105111500002; CAMC 1125A86D-010; Parker China Division CX1014A  
**Thread:** 1 -14  
**O.D.:** 4 1/4 (108.0)  
**Height:** 6 5/32 (156.4)  
**I.Gskt:** [1] Included  
**O-Ring:** [1] Included



**BF1294-O** Fuel/Water Separator Spin-on with Open End for Bowl  
**Contains:** Bowl Thread: 3 3/4-10 2B Integral Post Seal  
**Replaces:** Scania 1518512; SF-Filter SK3360  
**Thread:** 1 -14  
**O.D.:** 4 1/4 (108.0)  
**Height:** 7 5/32 (181.8)  
**I.Gskt:** [1] Included  
**F. Gskt:** [1] Included



**BF1299-O** Fuel/Water Separator Spin-on with Open End for Bowl  
**Contains:** Bowl Thread: 3 3/4-10 2B Integral Post Seal  
**Replaces:** Yuchai Watyuan 612630080205  
**Thread:** 1 -14  
**O.D.:** 4 1/4 (108.0)  
**Height:** 7 13/16 (198.4)  
**I.Gskt:** [1] Included  
**F. Gskt:** [1] Included



**BF1295-O** Fuel Spin-on with Open End for Bowl  
**Notes:** OBSOLETE. Availability Limited to Dealer Stock.  
**Contains:** Bowl Thread: 3 3/4-10 2B  
**Replaces:** Parker China Division CX1010; DCD 4102H1520  
**Thread:** 1 -14  
**O.D.:** 4 1/4 (108.0)  
**Height:** 5 1/32 (127.8)  
**I.Gskt:** [1] Included  
**F. Gskt:** [1] Included



**FB1301** Primary Fuel Filter Base for Detroit Diesel Engines  
**Notes:** Converts F845-A, PF845, F916-C or PF916 from element to spin-on.  
**Contains:** Threaded Stud: 1-12  
**Use With:** BF592, BF781, BF5800, BF5813  
**O.D.:** 4 11/16 (119.1)  
**Inlet:** [1] 3/8-18 In. NPT  
**Outlet:** [2] 3/8-18 In. NPT  
**Height:** 3 3/32 (78.6)



**FB1302** Secondary Fuel Filter Base for Detroit Diesel Engines  
**Notes:** Converts PF906 from element to spin-on.  
**Contains:** Threaded Stud: 13/16-12  
**Use With:** BF593, BF5810  
**O.D.:** 4 11/16 (119.1)  
**Inlet:** [1] 1/4-18 In. NPT  
**Outlet:** [2] 1/4-18 In. NPT  
**Height:** 3 3/32 (78.6)



Measurements Are Shown In Inches And (Millimeters)

**WARNING:** These products can expose you to chemicals, including Diisononyl Phthalate, Carbon black extracts, Nickel, 1,3 Butadiene, Ethylene Oxide, Epichlorohydrin, which are known to the State of California to cause cancer, and Bisphenol, Ethylene Glycol, Ethylene Oxide, 1,3 Butadiene, Epichlorohydrin, which are known to the State of California to cause birth defects or other reproductive harm.

**OB1303** Full-Flow Lube Filter Base for Detroit Diesel Engines



**Notes:** Converts P20-HD from element to spin-on.  
**Contains:** Threaded Stud: 1 1/2-18 Lock Plate  
**Use With:** B95, B96  
**O.D.:** 5 1/32 (127.8)  
**Height:** 3 1/2 (88.9)  
**F. Gskt:** [4] Included

**FB1310** Secondary Fuel Filter Base for Detroit Diesel Engines



**Notes:** Converts PF846 from element to spin-on.  
**Contains:** Threaded Stud: 1 1/16-16  
**Use With:** BF785  
**O.D.:** 5 1/2 (139.7)  
**Inlet:** 3/8-18 NPSF & 1/2-14 NPSF  
**Outlet:** [4] 3/8-18 NPSF  
**Height:** 2 13/16 (71.4)

**OB1305** By-Pass Lube Filter Base



**Contains:** Threaded Stud: 5/8-18  
**Use With:** B50, B164, BT341  
**O.D.:** 4 1/4 (108.0)  
**Inlet:** 1/8 In. NPT  
**Outlet:** 1/8 In. NPT  
**Height:** 2 3/4 (69.9)

**FB1311** Fuel/Water Separator Base



**Notes:** This base requires the D-Ring, furnished with filter, for installation. Permits the addition of a remote mount fuel/water separator spin-on to most equipment. This is standard Cummins engine fuel filter mount.  
**Contains:** Bracket Bolt Holes 3/8-16 UNC-2B Threaded Stud: 1-14  
**Use With:** BF948, BF957, BF957-D, BF1212, BF1249, BF1252, BF1258, BF1259, BF1282, BF5801, BF5812, BF7557, BF7558  
**O.D.:** 3 19/32 (91.3)  
**Inlet:** 7/8-14  
**Outlet:** 7/8-14  
**Height:** 1 15/16 (49.2)

**FB1306** Fuel Filter Base



**Contains:** Threaded Stud: 1 1/4-12  
**Use With:** BF1216  
**Replaces:** Fleetguard 3302367S  
**Inlet:** 7/8-14  
**Outlet:** 7/8-14  
**Height:** 5 7/32 (132.6)

**OB1313** Hydraulic Filter Base



**Notes:** This base requires the use of the G286-C gasket (furnished with BT387, BT387-10, BT388, BT388-10 and BT8424-MPG, optional on others) for installation of the filters listed below. For use on the suction side.  
**Contains:** 3 PSID By-Pass valve  
Threaded Stud: 1 1/2-16  
Threaded Stud: 1 1/4-11 BSP  
**Use With:** BT287, BT287-10, BT287-3, BT351, BT387, BT387-10, BT388, BT388-10, BT389, BT389-10, BT8368, BT8423  
**O.D.:** 5 1/2 (139.7)  
**Inlet:** 1 1/4-11 1/2 NPT  
**Outlet:** 1 1/4-11 1/2 NPT  
**Height:** 5 5/16 (134.9)

**FB1307** Fuel Storage Tank Filter Base



**Notes:** Part of BF914  
**Contains:** Threaded Stud: 1-12  
**Use With:** BF915, BF955, BF956, BF971  
**O.D.:** 3 3/4 (95.3)  
**Inlet:** 1 In. NPT  
**Outlet:** 1 In. NPT  
**Height:** 2 21/32 (67.5)

**OB1308** By-Pass Lube Filter Base for Cummins and Other Engines



**Notes:** Converts element to spin-on, or can be installed as an auxiliary filter for additional protection.  
**Contains:** Threaded Stud: 1 3/8-16  
**Use With:** B7577  
**O.D.:** 5 7/32 (132.6)  
**Inlet:** 3/8  
**Outlet:** 3/8  
**Height:** 4 23/32 (119.9)

**OB1314** Hydraulic Filter Base



**Notes:** This base requires the use of the G286-C gasket (furnished with BT387, BT387-10, BT388, BT388-10 and BT8424-MPG, optional on others) for installation of the filters listed below. For use on the return side.  
**Contains:** 25 PSID By-Pass Valve  
Threaded Stud: 1 1/2-16  
Threaded Stud: 1 1/4-11 BSP  
**Use With:** BT287, BT287-10, BT287-3, BT351, BT387, BT387-10, BT388, BT388-10, BT389, BT389-10, B7011, BT8307-MPG, BT8308-MPG, BT8308-MPG KIT, BT8309-MPG, BT8310-MPG, BT8368, BT8421-MPG, BT8422-MPG, BT8423  
**O.D.:** 5 1/2 (139.7)  
**Inlet:** 1 1/4 In. NPT  
**Outlet:** 1 1/4 In. NPT  
**Height:** 5 5/16 (134.9)

**FB1309** Primary Fuel Filter Base for Detroit Diesel Engines



**Notes:** Converts F844-A from element to spin-on.  
**Contains:** Threaded Stud: 1 1/4-12  
**Use With:** BF784  
**O.D.:** 5 1/2 (139.7)  
**Inlet:** 1/2-14 NPSF  
**Outlet:** [2] 1/2-14 NPSF  
**Height:** 2 23/32 (69.1)

Measurements Are Shown In Inches And (Millimeters)

**WARNING:** These products can expose you to chemicals, including Diisononyl Phthalate, Carbon black extracts, Nickel, 1,3 Butadiene, Ethylene Oxide, Epichlorohydrin, which are known to the State of California to cause cancer, and Bisphenol, Ethylene Glycol, Ethylene Oxide, 1,3 Butadiene, Epichlorohydrin, which are known to the State of California to cause birth defects or other reproductive harm.

**OB1315**

Hydraulic Filter Base



**Notes:** This base requires the use of the G286-C gasket (furnished with BT387, BT387-10, BT388, BT388-10 and BT8424-MPG, optional on others) for installation of the filters listed below. For use on the suction side.  
**Contains:** 5 PSID By-Pass Valve  
 Threaded Stud: 1 1/2-16  
 Threaded Stud: 1 1/4-11 BSP  
**Use With:** BT287, BT287-10, BT287-3, BT351, BT387, BT387-10, BT388, BT388-10, BT389, BT389-10, B7011, BT8368, BT8423  
**O.D.:** 5 13/32 (137.3)  
**Inlet:** 1 5/8-12 In. SAE  
**Outlet:** 1 5/8-12 In. SAE  
**Height:** 5 5/16 (134.9)

**OB1316**

Hydraulic Filter Base



**Notes:** This base requires the use of the G286-C gasket (furnished with BT387, BT387-10, BT388, BT388-10 and BT8424-MPG, optional on others) for installation of the filters listed below. For use on the return side.  
**Contains:** 25 PSID By-Pass Valve  
 Threaded Stud: 1 1/2-16  
 Threaded Stud: 1 1/4-11 BSP  
**Use With:** BT287, BT287-10, BT287-3, BT351, BT387, BT387-10, BT388, BT388-10, BT389, BT389-10, B7011, BT8307-MPG, BT8308-MPG, BT8308-MPG KIT, BT8309-MPG, BT8310-MPG, BT8368, BT8421-MPG, BT8422-MPG, BT8423, BT8424-MPG  
**O.D.:** 5 13/32 (137.3)  
**Inlet:** 1 5/8-12 In. SAE  
**Outlet:** 1 5/8-12 In. SAE  
**Height:** 5 5/16 (134.9)

**OB1317**

Hydraulic Filter Base



**Notes:** Has [2] 1/8 In. NPT indicator ports that are designed to accept the VG1325 vacuum gauge. Top-mount bracket holes can be used for easy installation. For use on suction side.  
**Contains:** 5 PSID By-Pass Valve  
 Threaded Stud: 1-12  
**Use With:** BT839, BT839-10, BT8420  
**O.D.:** 3 3/4 (95.3)  
**Inlet:** 3/4-14 NPT  
**Outlet:** 3/4-14 NPT  
**Height:** 3 (76.2)

**OB1318**

Hydraulic Filter Base



**Notes:** Has [2] 1/8 In. NPT indicator ports that are designed to accept the PG1326 pressure gauge. Top-mount bracket holes can be used for easy installation. For use on return side.  
**Contains:** 25 PSID By-Pass Valve  
 Threaded Stud: 1-12  
**Use With:** BT839, BT839-10, BT8420, BT8428-MPG, BT8443  
**O.D.:** 3 (76.2)  
**Inlet:** 3/4 In. NPT  
**Outlet:** 3/4 In. NPT  
**Height:** 3 3/4 (95.3)

**OB1319**

Hydraulic Filter Base



**Notes:** Has [2] 1/8 In. NPT indicator ports that are designed to accept the VG1325 vacuum gauge. Top-mount bracket holes can be used for easy installation. For use on suction side.  
**Contains:** 5 PSID By-Pass Valve  
 Threaded Stud: 1-12  
**Use With:** BT839, BT839-10, BT8420  
**O.D.:** 3 3/4 (95.3)  
**Inlet:** 1 1/16-12 ORB  
**Outlet:** 1 1/16-12 ORB  
**Height:** 3 (76.2)

**OB1320**

Hydraulic Filter Base



**Notes:** Has [2] 1/8 In. NPT indicator ports that are designed to accept the PG1326 pressure gauge. Top-mount bracket holes can be used for easy installation. For use on return side.  
**Contains:** 25 PSID By-Pass Valve  
 Threaded Stud: 1-12  
**Use With:** BT839, BT839-10, BT8420, BT8428-MPG, BT8443  
**O.D.:** 3 3/4 (95.3)  
**Inlet:** 1 1/16-12 ORB  
**Outlet:** 1 1/16-12 ORB  
**Height:** 3 (76.2)

**VG1325**

Vacuum Gauge



**Notes:** This 0-30 vacuum gauge is for use with a 3-5 PSI by-pass filter base. Mounts directly to base with 1/8" In. NPT.  
**Replaces:** Donaldson P777021

**PG1326**

Pressure Gauge



**Notes:** This pressure gauge is for use with a 25 PSI by-pass filter base. Mounts directly to base with 1/8 Inch NPT. The indicator is 2 inches in diameter and measures 0-60 psi.  
**Replaces:** Donaldson P777004

**BF1329**

Fuel/Water Separator Spin-on with Drain



**Contains:** Integral Post Seal  
**Fits:** Racor 690R Series Assemblies; Scania, Volvo Trucks  
**Replaces:** Racor R90P; John Deere RE500186  
**Thread:** 1 -14  
**O.D.:** 4 9/32 (108.7)  
**Height:** 8 1/8 (206.4)  
**I.Gskt:** [1] Included  
**Related To:** BF1329-SP (SP Thd. 9/16-18)  
 BF1339-SP (SP Thd. 1/2-20)  
 BF46072 (Bowl Version)  
 BF46083-O (Open Port Version)

Measurements Are Shown In Inches And (Millimeters)

**WARNING:** These products can expose you to chemicals, including Diisononyl Phthalate, Carbon black extracts, Nickel, 1,3 Butadiene, Ethylene Oxide, Epichlorohydrin, which are known to the State of California to cause cancer, and Bisphenol, Ethylene Glycol, Ethylene Oxide, 1,3 Butadiene, Epichlorohydrin, which are known to the State of California to cause birth defects or other reproductive harm.

**BF1329-SP**

Fuel/Water Separator Spin-on with Drain and Sensor Port



**Notes:** May use OP8750 to plug Sensor Port.  
**Contains:** Integral Post Seal  
 Sensor Port Thread: 9/16-18  
**Fits:** Racor 690R Series Assemblies; Scania, Volvo Trucks  
**Replaces:** Racor R90P; GMC 23514654; John Deere RE500186  
**Thread:** 1 -14  
**O.D.:** 4 9/32 (108.7)  
**Height:** 8 1/8 (206.4)  
**I.Gskt:** [1] Included  
**O-Ring:** [1] Included  
**Related To:** BF1329 (Drain Version)  
 BF1339-SP (SP Thd. 1/2-20)  
 BF46072 (Bowl Version)  
 BF46083-O (Open Port Version)

**BF1330-SP**

Fuel/Water Separator Spin-on with Drain and Sensor Port



**Notes:** CAUTION: Furnished O-Ring must be installed on post for seal.  
**Contains:** Integral Post Seal  
 Sensor Port Thread: 9/16-18  
**Fits:** Detroit Diesel Engines  
**Replaces:** Detroit Diesel 23514654  
**Thread:** 1 -14  
**O.D.:** 4 9/32 (108.7)  
**Height:** 8 1/8 (206.4)  
**I.Gskt:** [1] Included  
**O-Ring:** [1] Included

**BF1339-SP**

Fuel/Water Separator Spin-on with Drain and Sensor Port



**Notes:** CAUTION: Furnished O-Ring must be installed on post for seal.  
**Contains:** Integral Post Seal  
 Sensor Port Thread: 1/2-20  
**Fits:** Freightliner, Volvo Buses, Trucks; Racor 690R Series Assemblies  
**Replaces:** Racor R90P  
**Thread:** 1 -14  
**O.D.:** 4 9/32 (108.7)  
**Height:** 8 1/8 (206.4)  
**I.Gskt:** [1] Included  
**O-Ring:** [1] Included  
**Related To:** BF1329-SP (SP Thd. 9/16-18)  
 BF9898-O (Open Port Version)  
 BF46083-O (Bowl Version)  
 BF1329 (Drain Version)

**BF1345**

Fuel/Water Separator Spin-on with Drain



**Contains:** Integral Post Seal  
**Fits:** International Engines  
**Replaces:** International 1618385-C91, 1677004-C91  
**Thread:** 1 -14  
**O.D.:** 4 1/4 (108.0)  
**Height:** 6 9/16 (166.7)  
**I.Gskt:** [1] Included  
**Related To:** BF1345-O (Open Port Version)  
 BF1345-SP (Sensor Port Version)

**BF1345-O**

Fuel/Water Separator Spin-on with Open End for Bowl



**Contains:** Bowl Thread: 3-12  
**Fits:** International Engines, Trucks  
**Replaces:** International 1618385-C91; Donaldson P550729  
**Thread:** 1 -14  
**O.D.:** 4 1/4 (108.0)  
**Height:** 5 9/32 (134.1)  
**F. Gskt:** [1] Included  
**O-Ring:** [1] Included  
**Related To:** BF1345 (Standard Version)  
 BF1345-SP (Sensor Port Version)

**BF1345-SP**

Fuel/Water Separator Spin-on with Drain and Sensor Port



**Notes:** May use OP8751 to plug Sensor Port.  
**Contains:** Integral Post Seal  
 Sensor Port Thread: 7/16-20  
**Fits:** International Engines  
**Replaces:** International 1618385-C91, 1677004-C91  
**Thread:** 1 -14  
**O.D.:** 4 1/4 (108.0)  
**Height:** 6 9/16 (166.7)  
**I.Gskt:** [1] Included  
**F. Gskt:** [1] Included  
**Related To:** BF1345 (Drain Version)  
 BF1345-O (Open Port Version)

**BF1346**

Fuel/Water Separator Spin-on with Drain



**Contains:** Integral Post Seal  
**Fits:** Ford, Freightliner, International, Sterling, Western Star Trucks; Mercedes-Benz Engines; Racor Housings  
**Replaces:** International 1685159-C91  
**Thread:** 1 -14  
**O.D.:** 4 1/4 (108.0)  
**Height:** 8 9/32 (210.3)  
**I.Gskt:** [1] Included  
**Related To:** BF1346-SP (Sensor Port Version)  
 BF1346-O (Open Port Version)

**BF1346-O**

Fuel/Water Separator Spin-on with Open End for Bowl



**Contains:** Bowl Thread: M95 x 2.5  
 Integral Post Seal  
**Fits:** Ford, Freightliner, International, Sterling, Western Star Trucks; Mercedes-Benz Engines; Racor Housings  
**Replaces:** Racor S3226P; Donaldson P550554; Fleetguard FS19593  
**Thread:** 1 -14  
**O.D.:** 4 1/4 (108.0)  
**Height:** 6 5/16 (160.3)  
**I.Gskt:** [1] Included  
**F. Gskt:** [1] Included  
**Related To:** BF1346 (Drain Version)  
 BF1346-SP (Sensor Port Version)

Measurements Are Shown In Inches And (Millimeters)

**WARNING:** These products can expose you to chemicals, including Diisononyl Phthalate, Carbon black extracts, Nickel, 1,3 Butadiene, Ethylene Oxide, Epichlorohydrin, which are known to the State of California to cause cancer, and Bisphenol, Ethylene Glycol, Ethylene Oxide, 1,3 Butadiene, Epichlorohydrin, which are known to the State of California to cause birth defects or other reproductive harm.



## BF1346-SP

Fuel/Water Separator Spin-on with Drain and Sensor Port



**Notes:** May use OP8752 to plug Sensor Port.  
**Contains:** Integral Post Seal  
 Sensor Port Thread: 1/2-20  
**Fits:** Ford, Freightliner, International, Sterling, Western Star Trucks; Mercedes-Benz Engines; Racor Housings  
**Replaces:** Alliance ABP/N122-S3226FL02; International 1685159-C91  
**Thread:** 1 -14  
**O.D.:** 4 1/4 (108.0)  
**Height:** 8 9/32 (210.3)  
**I.Gskt:** [1] Included  
**O-Ring:** [1] Included  
**Related To:** BF1346 (Drain Version)  
 BF1346-O (Open Port Version)

## BF1347

Fuel/Water Separator Spin-on with Drain



**Contains:** Integral Post Seal  
**Fits:** Optional Fuel/Water Separator on Various Truck Engines with Maximum Flow Rate of 75 GPH (U.S.)  
**Replaces:** Alliance ABP/N122-S3226FL01; Racor S3226T  
**Thread:** 1 -14  
**O.D.:** 4 1/4 (108.0)  
**Height:** 8 9/32 (210.3)  
**I.Gskt:** [1] Included  
**Related To:** BF1347-O (Open Port Version)

## BF1347-O

Fuel/Water Separator Spin-on with Open End for Bowl



**Contains:** Bowl Thread 3.75-10 UNS-2B  
 Integral Post Seal  
**Fits:** Freightliner Chassis; Freightliner, International, Kenworth Trucks; Thomas Buses  
**Replaces:** Racor S3226T; AC Delco TP1348; Donaldson P551034; Fleetguard FS19933, FS19798; Wix 33813  
**Thread:** 1 -14 UNS-2B  
**O.D.:** 4 3/8 (111.1)  
**Height:** 6 7/32 (158.0)  
**F. Gskt:** [2] Included  
**Related To:** BF1347 (Drain Version)

## BF1348

Fuel/Water Separator Spin-on with Drain



**Contains:** Integral Post Seal  
**Fits:** Blue Bird Buses; Freightliner, Hino, Peterbilt Trucks; Racor 325 Series  
**Replaces:** Racor S3225P  
**Thread:** 1 -14  
**O.D.:** 4 5/16 (109.5)  
**Height:** 6 25/32 (172.2)  
**I.Gskt:** [1] Included  
**Related To:** BF1348-O (Open Port Version)  
 BF1348-SP (Sensor Port Version)

## BF1348-O

Fuel/Water Separator Spin-on with Open End for Bowl



**Contains:** Bowl Thread: M95 x 2.5  
 Integral Post Seal  
**Fits:** Blue Bird Buses; Freightliner, Hino, Peterbilt Trucks; Racor 325 Series  
**Replaces:** Racor S3225P  
**Thread:** 1 -14  
**O.D.:** 4 1/4 (108.0)  
**Height:** 5 3/16 (131.8)  
**I.Gskt:** [1] Included  
**A. Gskt:** [1] Included  
**O-Ring:** [1] Included  
**Related To:** BF1348 (Standard Version)  
 BF1348-SP (Sensor Port Version)

## BF1348-SP

Fuel/Water Separator Spin-on with Drain and Sensor Port



**Notes:** May use OP8752 to plug Sensor Port.  
**Contains:** Integral Post Seal  
 Sensor Port Thread: 1/2-20  
**Fits:** Blue Bird Buses; Freightliner, Hino, Peterbilt Trucks; Racor 325 Series  
**Replaces:** Racor S3225P  
**Thread:** 1 -14  
**O.D.:** 4 5/16 (109.5)  
**Height:** 6 25/32 (172.2)  
**I.Gskt:** [1] Included  
**O-Ring:** [1] Included  
**Related To:** BF1348 (Drain Version)  
 BF1348-O (Open Port Version)

## BF1349

Fuel/Water Separator Spin-on with Drain



**Contains:** Integral Post Seal  
**Fits:** Cummins Engines; Volvo Trucks  
**Replaces:** Racor R90T  
**Thread:** 1 -14  
**O.D.:** 4 9/32 (108.7)  
**Height:** 8 7/32 (208.8)  
**I.Gskt:** [1] Included

## BF1350-SP

Fuel/Water Separator Spin-on with Drain and Sensor Port



**Notes:** CAUTION: Furnished O-Ring must be installed on post for seal.  
**Contains:** Sensor Port Thread: 1/2-20  
**Fits:** Caterpillar Engines; Equipment  
**Replaces:** Caterpillar 146-6695  
**Thread:** 1 -14  
**O.D.:** 3 11/16 (93.7)  
**Height:** 7 13/16 (198.4)  
**I.Gskt:** [1] Included  
**O-Ring:** [1] Included  
**Related To:** BF46030-O (Open Port Version)

## BF1352-SPS

Fuel/Water Separator Spin-on with Drain, Sensor Port and Reusable Sensor



**Notes:** CAUTION: Furnished D-Ring must be installed on post for seal.  
**Contains:** Sensor Port Thread: M14 x 2.0  
**Fits:** Agco, Hesston, Hyundai, Massey Ferguson Equipment; Cummins B4.5, B5.9L, QSB4.5 Engines  
**Replaces:** Cummins 3991498; Fleetguard FS19616  
**Thread:** M20 x 1.5  
**O.D.:** 3 11/16 (93.7)  
**Height:** 7 3/8 (187.3)  
**I.Gskt:** [1] Included  
**F. Gskt:** [1] Included

## BF1353-SPS

Fuel/Water Separator Spin-on with Drain, Sensor Port and Sensor



**Contains:** Integral Post Seal  
 Sensor Port Thread: M14 x 2.0  
**Fits:** John Deere Engines, Equipment, Trucks  
**Replaces:** John Deere RE522372; Fleetguard FS19688  
**Thread:** 1 -12  
**O.D.:** 4 1/4 (108.0)  
**Height:** 11 11/16 (296.9)  
**I.Gskt:** [1] Included

Measurements Are Shown In Inches And (Millimeters)

**WARNING:** These products can expose you to chemicals, including Diisononyl Phthalate, Carbon black extracts, Nickel, 1,3 Butadiene, Ethylene Oxide, Epichlorohydrin, which are known to the State of California to cause cancer, and Bisphenol, Ethylene Glycol, Ethylene Oxide, 1,3 Butadiene, Epichlorohydrin, which are known to the State of California to cause birth defects or other reproductive harm.

**BF1354-SPS**

Primary Fuel/Water Separator Spin-on with Drain, Sensor Port and Reusable Sensor  
**Contains:** Integral Post Seal  
 Sensor Port Thread: M14 x 2.0  
**Fits:** John Deere Engines, Equipment, Trucks  
**Replaces:** John Deere RE531703; Donaldson P550668; Fleetguard FS19701  
**Thread:** 1 -14  
**O.D.:** 4 1/4 (108.0)  
**Height:** 11 11/16 (296.9)  
**I.Gskt:** [1] Included



**BF1357**

Fuel/Water Separator Spin-on with Drain  
**Contains:** Integral Post Seal  
**Fits:** Komatsu Equipment  
**Replaces:** Komatsu 600-311-3410, 600-319-3400  
**Thread:** 1 1/4 -12  
**O.D.:** 4 11/16 (119.1)  
**Height:** 12 3/32 (307.2)  
**I.Gskt:** [1] Included  
**Related To:** BF1288-O (Open Port Version)



**BF1355**

Fuel/Water Separator Spin-on with Drain  
**Contains:** Integral Post Seal  
**Fits:** Thermo King Refrigeration Units; Volvo Trucks  
**Thread:** 1 1/4 -12  
**O.D.:** 4 11/16 (119.1)  
**Height:** 8 29/32 (226.2)  
**I.Gskt:** [1] Included  
**Related To:** BF1355-SP (Sensor Port Version)  
 BF1355-O (Open Port Version)



**BF1358-O**

Fuel/Water Separator Spin-on with Open End for Bowl  
**Contains:** Integral Post Seal  
 Bowl Thread: 3 3/4-10  
**Fits:** Volvo Dump Trucks, Equipment  
**Replaces:** Volvo 11110474, 11110668  
**Thread:** 1 -14  
**O.D.:** 4 13/32 (111.9)  
**Height:** 8 19/32 (218.3)  
**I.Gskt:** [1] Included  
**F. Gskt:** [1] Included  
**Related To:** BF1358-SP (Sensor Port Version)



**BF1355-O**

Fuel/Water Separator Spin-on with Open End for Bowl  
**Contains:** Bowl Thread: M95 x 2.5  
 Integral Post Seal  
**Fits:** Volvo VN Series, VN730, VNL300, VNL430, VNL730 Trucks  
**Replaces:** Racor S3238P; Thermo King 11-9982, Volvo 85104856  
**Thread:** 1 1/4 -12  
**O.D.:** 4 7/8 (123.8)  
**Height:** 6 5/16 (160.3)  
**I.Gskt:** [1] Included  
**F. Gskt:** [1] Included  
**Grommets:** [1] Included  
**Related To:** BF1355 (Drain Version)  
 BF1355-SP (Sensor Port Version)



**BF1358-SP**

Fuel/Water Separator Spin-on with Drain and Sensor Port  
**Notes:** CAUTION: Furnished O-Ring must be installed on post for seal.  
**Contains:** Integral Post Seal  
 Sensor Port Thread: 9/16-18  
**Fits:** Volvo Dump Trucks, Equipment  
**Replaces:** Volvo 11110474, 11110668  
**Thread:** 1 -14  
**O.D.:** 4 9/32 (108.7)  
**Height:** 11 (279.4)  
**I.Gskt:** [1] Included  
**O-Ring:** [1] Included  
**Related To:** BF1358-O (Open Port Version)



**BF1355-SP**

Fuel/Water Separator Spin-on with Drain and Sensor Port  
**Notes:** May use OP8752 to plug Sensor Port.  
**Contains:** Integral Post Seal  
 Sensor Port Thread: 1/2-20  
**Fits:** Thermo King Refrigeration Units; Volvo Trucks  
**Replaces:** Racor S3238P; Thermo King 11-9982  
**Thread:** 1 1/4 -12  
**O.D.:** 4 11/16 (119.1)  
**Height:** 8 7/8 (225.4)  
**I.Gskt:** [1] Included  
**O-Ring:** [1] Included  
**Related To:** BF1355 (Drain Version)  
 BF1355-O (Open Port Version)



**BF1359-SP**

Fuel/Water Separator Spin-on with Drain and Sensor Port  
**Notes:** CAUTION: Furnished O-Ring must be installed on post for seal.  
**Contains:** Integral Post Seal  
 Sensor Port Thread: 1/2-20  
**Fits:** Volvo Dump Trucks, Loaders  
**Thread:** 1 -14  
**O.D.:** 4 1/4 (108.0)  
**Height:** 11 1/8 (282.6)  
**I.Gskt:** [1] Included  
**O-Ring:** [1] Included  
**Related To:** BF1391-O (Open Port Version)



**BF1356**

Fuel/Water Separator Spin-on with Drain  
**Fits:** Cummins Engines  
**Replaces:** Cummins 3991350; Fleetguard FS19608  
**Thread:** M20 x 1.5  
**O.D.:** 3 11/16 (93.7)  
**Height:** 7 13/32 (188.1)  
**I.Gskt:** G381-A  
**F. Gskt:** [1] Included  
**End Seals:** [1] Included



**BF1360**

Fuel/Water Separator Spin-on with Drain  
**Contains:** Integral Post Seal  
**Fits:** Hino Trucks  
**Replaces:** Hino 23401-1700  
**Thread:** 1 -14  
**O.D.:** 4 9/32 (108.7)  
**Height:** 8 7/32 (208.8)  
**I.Gskt:** [1] Included  
**Related To:** BF1360-O (Open Port Version)  
 BF1360-SP (Sensor Port Version)



Measurements Are Shown In Inches And (Millimeters)

**WARNING:** These products can expose you to chemicals, including Diisononyl Phthalate, Carbon black extracts, Nickel, 1,3 Butadiene, Ethylene Oxide, Epichlorohydrin, which are known to the State of California to cause cancer, and Bisphenol, Ethylene Glycol, Ethylene Oxide, 1,3 Butadiene, Epichlorohydrin, which are known to the State of California to cause birth defects or other reproductive harm.

**BF1360-O** Fuel/Water Separator Spin-on with Open End for Bowl  
**Contains:** Bowl Thread: 3 3/4-10 Butress  
**Fits:** Blue Bird All-American, Vision Buses  
**Replaces:** Racor R90S; Donaldson P551854; Fleetguard FS20028  
**Thread:** 1 -14  
**O.D.:** 4 9/32 (108.7)  
**Height:** 5 21/32 (143.7)  
**F. Gskt:** [2] Included  
**Related To:** BF1360 (Standard Version) BF1360-SP (Sensor Port Version)



**BF1365** Fuel/Water Separator Spin-on with Drain  
**Fits:** Iveco Trucks  
**Replaces:** Iveco 2992662; Mann & Hummel WK950/19  
**Thread:** M16 x 1.5  
**O.D.:** 3 11/16 (93.7)  
**Height:** 7 13/32 (188.1)  
**I.Gskt:** G381-A



**BF1360-SP** Fuel/Water Separator Spin-on with Drain and Sensor Port  
**Notes:** CAUTION: Furnished O-Ring must be installed on post for seal. May use OP8752 to plug Sensor Port.  
**Contains:** Integral Post Seal  
**Sensor Port Thread:** 1/2-20  
**Fits:** Blue Bird Buses; Caterpillar, Cummins Engines  
**Replaces:** Racor R90S  
**Thread:** 1 -14  
**O.D.:** 4 9/32 (108.7)  
**Height:** 8 1/8 (206.4)  
**I.Gskt:** [1] Included  
**O-Ring:** [1] Included  
**Related To:** BF1360 (Standard Version) BF1360-O (Open Port Version)



**BF1366-O** Fuel/Water Separator Spin-on with Open End for Bowl  
**Contains:** Bowl Thread: M80 x 2.5  
**Integral Post Seal**  
**Fits:** R.V.I., Volvo Trucks  
**Replaces:** Volvo 20998367; Donaldson P559628; Fleetguard FS19735  
**Thread:** 1 -14  
**O.D.:** 3 21/32 (92.9)  
**Height:** 5 5/8 (142.9)  
**F. Gskt:** [2] Included  
**O-Ring:** [1] Included



**BF1361** Fuel Spin-on with Drain  
**Fits:** Case-International Tractors  
**Replaces:** Case 47128205; New Holland 19305811  
**Thread:** M14 x 1.5  
**O.D.:** 3 11/16 (93.7)  
**Height:** 4 11/16 (119.1)  
**I.Gskt:** G381-A



**BF1367** Fuel/Water Separator Spin-on with Drain  
**Fits:** Iveco Engines  
**Replaces:** Iveco 504048025; New Holland 87803192, 87803196; Fleetguard FS19597  
**Thread:** M16 x 1.5  
**O.D.:** 3 1/32 (77.0)  
**Height:** 6 21/32 (169.1)  
**I.Gskt:** G449-B  
**F. Gskt:** [1] Included



**BF1362** Fuel Spin-on with Drain  
**Fits:** Freightliner, Sterling Trucks  
**Replaces:** Alliance ABP/N122-R50404; Fleetguard FS19807; Racor R50404  
**Thread:** 1 -14  
**O.D.:** 4 1/4 (108.0)  
**Height:** 6 13/16 (173.0)  
**I.Gskt:** [1] Included



**OB1368** Full-Flow Lube Filter Base for Cummins Engines  
**Notes:** Converts P999-HD from element to spin-on.  
**Contains:** Threaded Stud: 1 1/2-12 [1] Instruction Sheet  
**Fits:** 1968 and Earlier Cummins Engines  
**Use With:** B96, B196, B205  
**O.D.:** 6 5/8 (168.3)  
**Height:** 4 1/4 (108.0)  
**F. Gskt:** [1] Capscrew, [3] Included, [2] Washers



**BF1363** Fuel Spin-on with Drain  
**Fits:** Doppstadt AK430 Shredder with Mercedes-Benz OM501LA Engine  
**Replaces:** Mercedes-Benz A0004771302, 4771302  
**Thread:** 1 -14  
**O.D.:** 4 1/4 (108.0)  
**Height:** 11 7/32 (285.0)  
**I.Gskt:** [1] Included



**OB1369** Full-Flow Lube Filter Base for Cummins Engines  
**Notes:** Converts P999-HD from element to spin-on.  
**Contains:** Threaded Stud: 1 1/2-12  
**Fits:** 1969-on Cummins Engines  
**Use With:** B96, B196, B205  
**O.D.:** 6 5/8 (168.3)  
**Height:** 3 5/16 (84.1)  
**F. Gskt:** [2] Included, [2] Washers



**BF1370** Fuel/Water Separator Spin-on with Drain  
**Contains:** Integral Post Seal  
**Fits:** New Holland Equipment  
**Replaces:** New Holland 8446332  
**Thread:** 1 -14  
**O.D.:** 4 5/16 (109.5)  
**Height:** 6 25/32 (172.2)  
**I.Gskt:** [1] Included



Measurements Are Shown In Inches And (Millimeters)

**WARNING:** These products can expose you to chemicals, including Diisononyl Phthalate, Carbon black extracts, Nickel, 1,3 Butadiene, Ethylene Oxide, Epichlorohydrin, which are known to the State of California to cause cancer, and Bisphenol, Ethylene Glycol, Ethylene Oxide, 1,3 Butadiene, Epichlorohydrin, which are known to the State of California to cause birth defects or other reproductive harm.

**BF1371**

Fuel/Water Separator Spin-on with Drain and Sensor Port



**Notes:** CAUTION: Furnished O-Ring must be installed on post for seal.  
Remove rubber paint plug before installation.  
**Contains:** Sensor Port Thread: M10 x 1.5  
**Fits:** Case Loaders, Tractors  
**Replaces:** Case 87803182; Cummins 2830359; Fleetguard FS19772  
**Thread:** M16 x 1.5  
**O.D.:** 3 11/16 (93.7)  
**Height:** 7 31/32 (202.4)  
**I.Gskt:** G401  
**O-Ring:** [1] Included

**BF1372**

Fuel/Water Separator Spin-on with Drain



**Contains:** Integral Post Seal  
**Fits:** Liebherr Equipment; M.A.N. Trucks  
**Replaces:** Liebherr 7008775, 7382048; M.A.N. 51.12503.0040; Donaldson P550498; Fleetguard FS19599  
**Thread:** M16 x 1.5  
**O.D.:** 3 1/32 (77.0)  
**Height:** 5 29/32 (150.0)  
**I.Gskt:** [1] Included

**BF1373-SP**

Fuel/Water Separator Spin-on with Drain and Sensor Port



**Contains:** Integral Post Seal  
Sensor Port Thread: 1/2-20  
**Fits:** Freightliner Trucks  
**Replaces:** Alliance ABP/N122-R50419, ABP/N122-S3226FL01; Freightliner ABPS3226FL01  
**Thread:** 1 -14  
**O.D.:** 4 9/32 (108.7)  
**Height:** 8 1/8 (206.4)  
**I.Gskt:** [1] Included  
**O-Ring:** [1] Included  
**Related To:** BF46098-O (Open End Version)

**BF1374-SP**

Fuel/Water Separator Spin-on with Drain and Sensor Port



**Contains:** Sensor Port Thread: 9/16-18  
**Fits:** Caterpillar Excavators, Material Handlers  
**Replaces:** Caterpillar 1R0781  
**Thread:** 1 -14  
**O.D.:** 4 1/4 (108.0)  
**Height:** 9 7/32 (234.2)  
**I.Gskt:** [1] Included  
**O-Ring:** [1] Included

**BF1375**

Fuel Spin-on with Drain



**Contains:** Integral Post Seal  
**Fits:** Freightliner Coronado, CC132, FLD Trucks with Detroit Diesel Series 60 Engine  
**Replaces:** Alliance ABP/N122-R50422  
**Thread:** 1 -14  
**O.D.:** 4 9/32 (108.7)  
**Height:** 9 31/32 (253.2)  
**I.Gskt:** [1] Included

**BF1376**

Fuel Spin-on with Drain



**Fits:** Freightliner, Sterling Trucks with Caterpillar Engines  
**Replaces:** Alliance ABP/N12232FRT02  
**Thread:** 1 -14  
**O.D.:** 3 11/16 (93.7)  
**Height:** 7 13/32 (188.1)  
**I.Gskt:** G381-A  
**F. Gskt:** [1] Included

**BF1377**

Fuel/Water Separator Spin-on with Drain



**Fits:** Freightliner Coronado, CC132 with Detroit Diesel Series 60 Engine  
**Replaces:** Alliance ABP/N122-R50416  
**Thread:** 1 -14  
**O.D.:** 4 1/4 (108.0)  
**Height:** 9 31/32 (253.2)  
**I.Gskt:** [1] Included

**BF1378-SPS**

Fuel/Water Separator Spin-on with Sensor Port, Drain and Reusable Sensor



**Notes:** CAUTION: Furnished D-Ring must be installed on post for seal.  
May use OP8753 to plug Sensor Port.  
**Contains:** Sensor Port Thread: M14 x 2.0  
**Fits:** Cummins, Paccar Engines; Freightliner, Kenworth, Peterbilt Trucks  
**Replaces:** Cummins 4934879; Fleetguard FS1065  
**Thread:** 1 -14  
**O.D.:** 3 23/32 (94.5)  
**Height:** 10 1/32 (254.8)  
**I.Gskt:** G381-A  
**O-Ring:** ES24-D

**BF1379**

Fuel/Water Separator Spin-on with Drain and Sensor Port



**Notes:** Inside-Out Flow Direction  
**Contains:** Integral Post Seal  
Sensor Port Thread: 1/2-20  
**Fits:** Next Generations UCM1 Generators; Truck Gen Hybrid, UCRV 1-3.5, UCT 1-3.5 Auxiliary Power Units  
**Replaces:** Racor R12S; Fleetguard FS19628  
**Thread:** M18 x 1.5  
**O.D.:** 3 1/32 (77.0)  
**Height:** 4 19/32 (116.7)  
**I.Gskt:** [1] Included  
**Related To:** BF1379-O (with Open End for Bowl)

**BF1379-O**

Fuel/Water Separator with Open End for Bowl



**Notes:** Inside-Out Flow Direction  
**Contains:** Bowl Thread 2 3/8 - 10 BSW  
**Fits:** Idlebuster, Truck Gen Auxiliary Power Units (APUs); Next Generations Generators all with Kubota Eng's.  
**Replaces:** Ditch Witch 159047; Racor R12S, R12SUL; Fleetguard FS19628; Fram PS10975; Luber-finer LFF8676; Wix 33582, 533582  
**Thread:** M18 x 1.5  
**O.D.:** 3 1/32 (77.0)  
**Height:** 2 3/8 (60.2)  
**F. Gskt:** [1] Included  
**O-Ring:** [1] Included  
**Related To:** BF1379 (with Drain and Sensor Port)

Measurements Are Shown In Inches And (Millimeters)

**WARNING:** These products can expose you to chemicals, including Diisononyl Phthalate, Carbon black extracts, Nickel, 1,3 Butadiene, Ethylene Oxide, Epichlorohydrin, which are known to the State of California to cause cancer, and Bisphenol, Ethylene Glycol, Ethylene Oxide, 1,3 Butadiene, Epichlorohydrin, which are known to the State of California to cause birth defects or other reproductive harm.

**BF1380** Fuel/Water Separator Spin-on with Drain and Sensor Port

**Notes:** Inside-Out Flow Direction  
**Contains:** Integral Post Seal  
 Sensor Port Thread: 1/2-20  
**Fits:** Ampac P33/24 Compactor; Powerpac APUC, APUK, Power Tech Auxiliary Power Units; Toro Reelmaster Mowers  
**Replaces:** Racor R12T; Fleetguard FS19802  
**Thread:** M18 x 1.5  
**O.D.:** 3 1/32 (77.0)  
**Height:** 4 19/32 (116.7)  
**I.Gskt:** [1] Included  
**Related To:** BF1380-O (Open End Version)



**BF1383-O** Fuel/Water Separator Spin-on with Open End for Bowl

**O-Ring:** [1] Included

**Contains:** Bowl Thread: B80 x 3 8A Metric Buttress  
**Fits:** DAF Engines, Trucks; Doosan, Terex Equipment  
**Replaces:** M.A.N. 51.12501.7288, 51.12503.0052; Daewoo K1006529; Parker China Division WBF219  
**Thread:** 1 -14  
**O.D.:** 4 9/32 (108.7)  
**Height:** 9 3/32 (231.0)  
**I.Gskt:** [1] Included  
**O-Ring:** [1] Included



**BF1380-O** Fuel/Water Separator Spin-on with Open End for Bowl

**Notes:** Inside-Out Flow Direction  
**Fits:** Ampac P33/24 Compactor w/Lister LPA2 Engine; Bandit Industries 2100SP Stump Grinder w/Lombardini 6LBDL1.25910 Engine; Idlebuster Auxiliary Power Unit w/Kubota Z482 Engine; Power Tech Auxiliary Power Units Models w/Cat C0.5 Eng., Kubota Z482 Engine  
**Replaces:** Racor R12T  
**Thread:** M18 x 1.5  
**O.D.:** 3 (75.9)  
**Height:** 2 7/16 (62.3)  
**A. Gskt:** [1] Included  
**F. Gskt:** [1] Included  
**O-Ring:** [1] Included  
**Related To:** BF1380 (with Drain and Sensor Port)



**BF1384-SP** Fuel/Water Separator Spin-on with Drain and Sensor Port

**Notes:** CAUTION: Furnished D-Ring must be installed on post for seal.  
**Contains:** Sensor Port Thread: 1/2-20  
**Fits:** Mack Trucks with MP7, MP8 Engines  
**Replaces:** Mack 20539578  
**Thread:** 1 -14  
**O.D.:** 3 11/16 (93.7)  
**Height:** 7 13/16 (198.4)  
**I.Gskt:** [1] Included  
**F. Gskt:** [1] Included  
**O-Ring:** [1] Included



**BF1381** Fuel/Water Separator Spin-on with Drain and Sensor Port

**Notes:** Inside-Out Flow Direction  
**Contains:** Integral Post Seal  
 Sensor Port Thread: 1/2-20  
**Fits:** Genie S100, S105, S120, S125 Lifts; Volvo VHD430 Trucks  
**Replaces:** Racor R12P; Donaldson P551768; Fleetguard FS19627  
**Thread:** M18 x 1.5  
**O.D.:** 3 1/32 (77.0)  
**Height:** 4 19/32 (116.7)  
**I.Gskt:** [1] Included  
**Related To:** BF1381-O (Open End Version)



**BF1385-SPS** Fuel/Water Separator Spin-on with Drain, Sensor Port and Reusable Sensor

**Contains:** Sensor Port Thread: M14 x 2.0  
**Fits:** Case Equipment; Cummins Engines  
**Replaces:** Case 87356193; Cummins 3973233; Fleetguard FS19732; SF-Filter SK3183  
**Thread:** 1 -14  
**O.D.:** 3 11/16 (93.7)  
**Height:** 7 3/8 (187.3)  
**I.Gskt:** G381-A  
**F. Gskt:** ES24-D



**BF1381-O** Fuel/Water Separator Spin-on with Open End for Bowl

**Notes:** Bowl Thread: 2 3/8  
**Fits:** Genie S100, S105, S120, S125 Lifts; Volvo VHD430 Trucks  
**Replaces:** Racor R12P; Donaldson P551768; Fleetguard FS19627  
**Thread:** M18 x 1.5  
**O.D.:** 3 3/32 (78.6)  
**Height:** 2 15/32 (62.7)  
**F. Gskt:** [1] Included  
**O-Ring:** [1] Included  
**Related To:** BF1381 (Drain Version)



**BF1386-O** Fuel/Water Separator Spin-on with Open End for Bowl

**Contains:** Bowl Thread: M80 x 2.5  
 Integral Post Seal  
**Fits:** Mack, Volvo Engines, Trucks  
**Replaces:** Mack 21017305; Volvo 20879806  
**Thread:** 1 -14  
**O.D.:** 4 1/4 (108.0)  
**Height:** 5 3/16 (131.8)  
**F. Gskt:** [1] Included  
**O-Ring:** [1] Included



**BF1382-SP** Fuel/Water Separator Spin-on with Drain and Sensor Port

**Contains:** Sensor Port Thread: 9/16-18  
**Fits:** Challenger Tractors  
**Replaces:** Caterpillar 1R0771  
**Thread:** 1 -14  
**O.D.:** 4 1/4 (108.0)  
**Height:** 9 3/8 (238.1)  
**I.Gskt:** [1] Included



**BF1387-O** Fuel/Water Separator Spin-on with Open End for Bowl

**Contains:** Bowl Thread: M80 x 2.5  
 Integral Post Seal  
**Fits:** Volvo Engines, Trucks  
**Replaces:** Volvo 20879812  
**Thread:** 1 -14  
**O.D.:** 4 1/4 (108.0)  
**Height:** 6 5/16 (160.3)  
**I.Gskt:** [1] Included  
**O-Ring:** [1] Included



Measurements Are Shown In Inches And (Millimeters)

**WARNING:** These products can expose you to chemicals, including Diisononyl Phthalate, Carbon black extracts, Nickel, 1,3 Butadiene, Ethylene Oxide, Epichlorohydrin, which are known to the State of California to cause cancer, and Bisphenol, Ethylene Glycol, Ethylene Oxide, 1,3 Butadiene, Epichlorohydrin, which are known to the State of California to cause birth defects or other reproductive harm.

**BF1388-O**

Fuel/Water Separator Spin-on with Open End for Bowl



**Contains:** Bowl Thread: M95 x 2.5  
Integral Post Seal  
**Fits:** R.V.I., Volvo Trucks  
**Replaces:** R.V.I. 7420851191; Volvo 20853583; Racor R60P-D-MAX; Fleetguard FS19895  
**Thread:** 1 -14  
**O.D.:** 4 1/4 (108.0)  
**Height:** 5 1/8 (130.2)  
**I.Gskt:** [1] Included  
**F. Gskt:** [1] Included  
**O-Ring:** [1] Included

**BF1389-O**

Fuel/Water Separator Spin-on with Open End for Bowl



**Contains:** Bowl Thread: 3 3/4-10 2B Buttress  
Integral Post Seal  
**Fits:** Volvo Engines, Trucks  
**Replaces:** Volvo 20381204; Racor R45T; Donaldson P550746; Fleetguard FS19734  
**Thread:** 1 -14  
**O.D.:** 4 1/4 (108.0)  
**Height:** 3 17/32 (89.7)  
**I.Gskt:** [1] Included  
**F. Gskt:** [1] Included

**BF1390-O**

Fuel/Water Separator Spin-on with Open End for Bowl



**Contains:** Bowl Thread: 3 3/4-10 2B Buttress  
Integral Post Seal  
**Fits:** Volvo Trucks  
**Replaces:** Racor R90T; Volvo 20450423; Fleetguard FS19551  
**Thread:** 1 -14  
**O.D.:** 4 11/32 (110.3)  
**Height:** 6 3/16 (157.2)  
**I.Gskt:** [1] Included  
**F. Gskt:** [1] Included

**BF1391-O**

Fuel/Water Separator Spin-on with Open End for Bowl



**Contains:** Bowl Thread: M95 x 2.5  
Integral Post Seal  
**Fits:** Mercedes-Benz Engines, Trucks  
**Replaces:** Mercedes-Benz 4771302, A0004771302; Fleetguard FS19914  
**Thread:** 1 -14  
**O.D.:** 4 1/4 (108.0)  
**Height:** 8 21/32 (219.9)  
**I.Gskt:** [1] Included  
**F. Gskt:** [1] Included  
**Related To:** BF1359-SP (Sensor Port Version)

**BF1392-SPS KIT**

Fuel/Water Separator Element with Drain, Sensor Port and Reusable Sensor



**Notes:** Replacement Element is PF1392.  
**Fits:** Dodge Light-Duty Trucks, Sterling Bullet all with 6-408 (6.7L) Turbo Diesel Engine  
**Replaces:** Chrysler 5183410AA; Mopar 4936025  
**O.D.:** 4 15/32 (113.5)  
**I.D.:** 3/4 (19.0) One End  
**Height:** 9 3/16 (233.4)  
**O-Ring:** [1] Included  
**Grommets:** [1] Attached

**PF1392**

Fuel Element



**Fits Inside:** BF1392-SPS KIT  
**Fits:** Dodge Light-Duty Trucks, Sterling Bullet all with 6-408 (6.7L) Turbo Diesel Engine  
**Replaces:** Chrysler 68061634AA; Cummins 5257768  
**O.D.:** 3 27/32 (97.6)  
**I.D.:** 1 3/16 (30.2) One End  
**Height:** 5 29/32 (150.0)  
**O-Ring:** [1] Included  
**Grommets:** [1] Attached

**BF1393-SP**

High Efficiency Fuel/Water Separator Spin-on with Drain and Sensor Port



**Notes:** CAUTION: Furnished O-Ring must be installed on post for seal.  
Can be used with FB1311 base.  
**Contains:** Integral Post Seal  
Sensor Port Thread: 1/2-20  
**Replaces:** Fleetguard FS1015  
**Thread:** 1 -14  
**O.D.:** 3 11/16 (93.7)  
**Height:** 8 13/16 (223.8)  
**I.Gskt:** G381-A  
**O-Ring:** [2] Included  
**Related To:** BF1249, BF1249-SP (Standard Versions)

**BF1394-SP**

Fuel/Water Separator Spin-on with Drain and Sensor Port



**Contains:** Sensor Port Thread: M14 x 2.0  
**Fits:** Komatsu Equipment  
**Replaces:** Komatsu 600-311-3610, 600-311-3620, 600-319-3610, 600-319-3620  
**Thread:** 1 -14  
**O.D.:** 3 11/16 (93.7)  
**Height:** 8 7/8 (225.4)  
**I.Gskt:** G401

**BF1395-O**

Fuel/Water Separator Spin-on with Open End for Bowl



**Contains:** Bowl Thread: M95 x 2.5  
Integral Post Seal  
**Fits:** Freightliner Cascadia with Detroit Diesel Series 60 Engine  
**Replaces:** Alliance ABPN122R50421; Racor R120T; Donaldson P551075  
**Thread:** 1 -14  
**O.D.:** 4 13/32 (111.9)  
**Height:** 8 19/32 (218.3)  
**I.Gskt:** [2] Included  
**F. Gskt:** [1] Included  
**Related To:** BF1395-SP (Sensor Port Version)  
BF1265 (Drain Version)

**BF1395-SP**

Fuel/Water Separator Spin-on with Drain and Sensor Port



**Notes:** CAUTION: Furnished O-Ring must be installed on post for seal.  
**Contains:** Integral Post Seal  
Sensor Port Thread: 1/2-20  
**Fits:** Freightliner Trucks  
**Replaces:** Alliance ABPN122R50421; Freightliner RD591300  
**Thread:** 1 -14  
**O.D.:** 4 9/32 (108.7)  
**Height:** 11 7/32 (285.0)  
**I.Gskt:** G579  
**O-Ring:** [1] Included  
**Related To:** BF1395-O (Open End Version)

Measurements Are Shown In Inches And (Millimeters)

**WARNING:** These products can expose you to chemicals, including Diisononyl Phthalate, Carbon black extracts, Nickel, 1,3 Butadiene, Ethylene Oxide, Epichlorohydrin, which are known to the State of California to cause cancer, and Bisphenol, Ethylene Glycol, Ethylene Oxide, 1,3 Butadiene, Epichlorohydrin, which are known to the State of California to cause birth defects or other reproductive harm.

**BF1396**



Fuel/Water Separator Spin-on with Drain  
**Fits:** M.A.N. Engines  
**Replaces:** M.A.N. 51.12503.0059, 51.12503.0060  
**Thread:** M16 x 1.5  
**O.D.:** 3 1/32 (77.0)  
**Height:** 5 29/32 (150.0)  
**I.Gskt:** [1] Included

**BF1397-SP**



Fuel/Water Separator Spin-on with Drain and Sensor Port  
**Notes:** CAUTION: Furnished O-Ring must be installed on post for seal.  
**Contains:** Sensor Port Thread: 9/16-18 Standpipe  
**Fits:** Caterpillar Equipment  
**Replaces:** Caterpillar 326-1643  
**Thread:** 1 -14  
**O.D.:** 4 1/4 (108.0)  
**Height:** 9 11/32 (237.3)  
**I.Gskt:** [1] Included  
**F. Gskt:** [1] Included  
**O-Ring:** [1] Included

**BF1398-O**



Fuel/Water Separator Spin-on with Open End for Bowl  
**Notes:** Inside-Out Flow Direction  
**Contains:** Bowl Thread: M80 x 2.5 Integral Post Seal  
**Fits:** Volvo Trucks with D6B Engine  
**Replaces:** Volvo 20386080; Racor R25P; Fleetguard FS19704  
**Thread:** 1 -14  
**O.D.:** 3 21/32 (92.9)  
**Height:** 5 5/8 (142.9)  
**I.Gskt:** [1] Included  
**O-Ring:** [1] Included

**BF1399-SP**



Fuel/Water Separator Spin-on with Drain and Sensor Port  
**Notes:** CAUTION: Furnished O-Ring must be installed on post for seal.  
**Contains:** Sensor Port Thread: 9/16-18 Standpipe  
**Fits:** Caterpillar Equipment  
**Replaces:** Caterpillar 326-1644  
**Thread:** 1 -14  
**O.D.:** 4 1/4 (108.0)  
**Height:** 7 5/8 (193.7)  
**I.Gskt:** [1] Included  
**F. Gskt:** [1] Included  
**O-Ring:** [1] Included

**B1400**



Lube Spin-on  
**Contains:** Anti-Drainback Valve 14 PSID By-Pass Valve  
**Fits:** Ford, Kia, Honda, Mazda, Nissan, Subaru Automotive, Light-Duty Trucks; Kawasaki Motorcycles  
**Replaces:** Mazda B6Y1-14-302, FEY0-14-302  
**Thread:** M20 x 1.5  
**O.D.:** 2 21/32 (67.5)  
**Height:** 2 5/8 (66.7)  
**I.Gskt:** [1] Included  
**Related To:** B1402, B1431 (Long Versions)

**B1402**



Lube Spin-on  
**Contains:** Anti-Drainback Valve 14 PSID By-Pass Valve  
**Fits:** Dodge, Eagle, Ford, Honda, Infiniti, Mazda, Mitsubishi, Nissan, Plymouth Automotive  
**Replaces:** Chrysler MD135737; Ford F32Z-6731-A; Mazda JEYO-14-302; Nissan 15208-31U00  
**Thread:** M20 x 1.5  
**O.D.:** 2 9/16 (65.1)  
**Height:** 3 1/2 (88.9)  
**I.Gskt:** [1] Included  
**Related To:** B1400 (Short Version) B1431 (Long Version)

**BD1403**



Dual-Flow Lube Spin-on  
**Contains:** Integral Post Seal  
**Fits:** Caterpillar Excavators, Lift Trucks; Mitubishi Engines, Excavators, Trucks; Nissan Trucks  
**Replaces:** Mitsubishi ME074013, ME074235  
**Thread:** M36 x 1.5  
**O.D.:** 5 1/8 (130.2)  
**Height:** 8 21/32 (219.9)  
**I.Gskt:** [1] Included

**B1405**



Lube Spin-on  
**Contains:** Anti-Drainback Valve 20 PSID By-Pass Valve  
**Fits:** Toyota Automotive  
**Replaces:** Toyota 90915-20002  
**Thread:** 3/4 -16  
**O.D.:** 3 1/32 (77.0)  
**Height:** 3 1/2 (88.9)  
**I.Gskt:** G449-B

**B1406**



Lube Spin-on  
**Contains:** Anti-Drainback Valve  
**Fits:** Infiniti, Nissan Automotive  
**Replaces:** Nissan 15208-53J00  
**Thread:** 3/4 -16  
**O.D.:** 2 11/16 (68.3)  
**Height:** 3 1/2 (88.9)  
**I.Gskt:** [1] Included

**B1407**



Lube Spin-on  
**Contains:** Anti-Drainback Valve  
**Fits:** Ford, Gehl, Snorkel Equipment  
**Replaces:** Ford 77BM-6714-C1A; Toyota 90915-YZZB5  
**Thread:** 3/4 -16  
**O.D.:** 3 1/32 (77.0)  
**Height:** 3 1/2 (88.9)  
**I.Gskt:** G449-B

**B1410**



Lube Spin-on  
**Contains:** Anti-Drainback Valve 8 PSID By-Pass Valve  
**Fits:** Cub Cadet, Ford, Grasshopper, John Deere Lawn Tractors with Kohler Engines  
**Replaces:** Kohler 1205001  
**Thread:** 3/4 -16  
**O.D.:** 3 (76.2)  
**Height:** 2 7/8 (73.0)  
**I.Gskt:** G449-B

Measurements Are Shown In Inches And (Millimeters)

**WARNING:** These products can expose you to chemicals, including Diisononyl Phthalate, Carbon black extracts, Nickel, 1,3 Butadiene, Ethylene Oxide, Epichlorohydrin, which are known to the State of California to cause cancer, and Bisphenol, Ethylene Glycol, Ethylene Oxide, 1,3 Butadiene, Epichlorohydrin, which are known to the State of California to cause birth defects or other reproductive harm.

**B1413**

Lube Spin-on



**Contains:** 8 PSID By-Pass Valve  
**Fits:** Harley-Davidson Motorcycles; Mazda Automotive  
**Replaces:** Harley-Davidson 63805-80A  
**Thread:** 3/4 -16  
**O.D.:** 3 (76.2)  
**Height:** 3 1/2 (88.9)  
**I.Gskt:** G449-B

**B1416**

Lube Spin-on



**Contains:** Anti-Drainback Valve  
 14 PSID By-Pass Valve  
 Front End Check Valve  
**Fits:** Ford, Mazda Automotive  
**Replaces:** Ford F8CA-6731-AA  
**Thread:** 3/4 -16  
**O.D.:** 2 29/32 (73.8)  
**Height:** 4 27/32 (123.0)  
**I.Gskt:** [1] Included

**P1418**

Lube Element with Bail Handle



**Fits:** Mercedes-Benz Automotive  
**Replaces:** Mercedes-Benz 11849125,  
 1191800009  
**O.D.:** 2 25/32 (70.6)  
**I.D.:** 3/8 (9.5) & 27/32 (21.4)  
**Height:** 6 1/32 (153.2)  
**F. Gskt:** [3] Included  
**Grommets:** [2] Attached

**P1419**

Lube Element



**Fits:** Mercedes-Benz Automotive  
**Replaces:** Mercedes-Benz 1041800109,  
 1041840225, 1041840325, 1041840425  
**O.D.:** 2 7/16 (61.9)  
**I.D.:** 27/32 (21.4) One End  
**Height:** 6 9/32 (159.5)  
**A. Gskt:** [1] Attached  
**O-Ring:** [1] Included

**B1421**

Lube Spin-on



**Contains:** Anti-Drainback Valve  
 14 PSID By-Pass Valve  
**Fits:** Acura, Honda Automotive  
**Replaces:** Honda 15400-POH-305,  
 15400-PR3-406  
**Thread:** M20 x 1.5  
**O.D.:** 3 1/32 (77.0)  
**Height:** 3 7/16 (87.3)  
**I.Gskt:** [1] Included

**B1422**

Lube Spin-on



**Contains:** Anti-Drainback Valve  
 20 PSID By-Pass Valve  
**Fits:** Acura Automotive  
**Replaces:** Honda 15400-PL2-004,  
 15400-PL2-005, 15400-PL2-305  
**Thread:** M22 x 1.5  
**O.D.:** 3 1/32 (77.0)  
**Height:** 3 1/2 (88.9)  
**I.Gskt:** G449-B

**B1425**

Lube Spin-on



**Contains:** Anti-Drainback Valve  
 20 PSID By-Pass Valve  
**Fits:** Acura, Honda, Isuzu Automotive,  
 Light-Duty Trucks  
**Replaces:** Isuzu 8-94456-741-1, 8-97140-666-0  
**Thread:** M20 x 1.5  
**O.D.:** 3 1/32 (77.0)  
**Height:** 3 7/16 (87.3)  
**I.Gskt:** [1] Included

**B1428**

Lube Spin-on



**Contains:** Anti-Drainback Valve  
**Fits:** Chevrolet, GM Automotive, Light-Duty  
 Trucks  
**Replaces:** GMC 25160561  
**Thread:** 13/16 -16  
**O.D.:** 3 11/16 (93.7)  
**Height:** 5 11/32 (135.7)  
**I.Gskt:** [1] Included  
**Related To:** B6 (without Anti-Drainback Valve)

**B1429**

Lube Spin-on



**Contains:** Anti-Drainback Valve  
 30 PSID By-Pass Valve  
**Fits:** Audi, Volkswagen Automotive  
**Replaces:** Volkswagen 78115561J  
**Thread:** 3/4 -16  
**O.D.:** 3 11/16 (93.7)  
**Height:** 4 7/16 (112.7)  
**I.Gskt:** G401

**B1430**

Lube Spin-on



**Contains:** Anti-Drainback Valve  
 20 PSID By-Pass Valve  
**Fits:** Geo Tracker  
**Replaces:** GMC 2501441  
**Thread:** 3/4 -16  
**O.D.:** 3 (76.2)  
**Height:** 4 1/16 (103.2)  
**I.Gskt:** [1] Included

**B1431**

Lube Spin-on



**Contains:** Anti-Drainback Valve  
 14 PSID By-Pass Valve  
**Fits:** Mitsubishi Automotive  
**Replaces:** Mitsubishi AW343979, MD352627  
**Thread:** M20 x 1.5  
**O.D.:** 2 21/32 (67.5)  
**Height:** 4 (101.6)  
**I.Gskt:** [1] Included  
**Related To:** B1400, B1402 (Short Versions)

**B1432**

Lube Spin-on



**Contains:** Anti-Drainback Valve  
**Fits:** Chevrolet, GMC Light-Duty Trucks  
**Replaces:** GMC 25014748  
**Thread:** 13/16 -16  
**O.D.:** 3 (76.2)  
**Height:** 4 3/32 (104.0)  
**I.Gskt:** G449-B

**P1433**

Lube Element



**Fits:** Cadillac, Oldsmobile Automotive  
**Replaces:** GMC 25177917  
**O.D.:** 2 1/8 (54.0)  
**I.D.:** 23/32 (18.3)  
**Height:** 3 13/16 (96.8)  
**O-Ring:** [1] Included  
**Grommets:** [2] Attached

Measurements Are Shown In Inches And (Millimeters)

**WARNING:** These products can expose you to chemicals, including Diisononyl Phthalate, Carbon black extracts, Nickel, 1,3 Butadiene, Ethylene Oxide, Epichlorohydrin, which are known to the State of California to cause cancer, and Bisphenol, Ethylene Glycol, Ethylene Oxide, 1,3 Butadiene, Epichlorohydrin, which are known to the State of California to cause birth defects or other reproductive harm.



**B1434** Lube Spin-on  
**Notes:** Can be used with OB40079 base.  
**Contains:** Anti-Drainback Valve  
 20 PSID By-Pass Valve  
**Fits:** Volvo Automotive  
**Replaces:** Volvo 35178573  
**Thread:** 3/4 -16  
**O.D.:** 3 11/16 (93.7)  
**Height:** 3 1/4 (82.6)  
**I.Gskt:** G381-A



**B1446** Lube Spin-on  
**Contains:** 20 PSID By-Pass Valve  
**Fits:** Chevrolet, Isuzu Light-Duty Trucks;  
 Hitachi, Kobelco Equipment  
**Replaces:** Isuzu 8-97049-708-1, X132010140  
**Thread:** M20 x 1.5  
**O.D.:** 3 23/32 (94.5)  
**Height:** 3 27/32 (97.6)  
**I.Gskt:** [1] Included  
**O-Ring:** [3] Included



**B1435** Lube Spin-on  
**Contains:** Anti-Drainback Valve  
 20 PSID By-Pass Valve  
**Fits:** Jaguar, Land Rover, Lincoln Automotive,  
 Light-Duty Trucks  
**Replaces:** Ford XW4Z-6731-BA  
**Thread:** 1 -12  
**O.D.:** 3 (76.2)  
**Height:** 4 27/32 (123.0)  
**I.Gskt:** G449-B



**B1447** Lube Spin-on  
**Contains:** 14 PSID By-Pass Valve  
**Fits:** Land Rover Freelander  
**Replaces:** Land Rover AHU2880, CDU1268,  
 LPW100230  
**Thread:** 13/16 -16  
**O.D.:** 3 1/32 (77.0)  
**Height:** 4 1/8 (104.8)  
**I.Gskt:** G449-B



**B1438** Lube Spin-on  
**Contains:** Anti-Drainback Valve  
**Fits:** Chevrolet, GMC Light-Duty Trucks with  
 7.4L, 8.1L Engines  
**Replaces:** GMC 25324052  
**Thread:** 13/16 -16  
**O.D.:** 3 11/16 (93.7)  
**Height:** 3 3/16 (81.0)  
**I.Gskt:** [1] Included



**P1510** Lube Element  
**Fits:** E.M.D. Cageless Series  
**Replaces:** E.M.D. 8345482  
**O.D.:** 6 1/2 (165.1)  
**I.D.:** 1 15/32 (37.3) One End  
**Height:** 29 3/8 (746.1)  
**End Seals:** [1] Included



**P1440** Lube Element  
**Fits:** Cadillac, Saturn Automotive  
**Replaces:** GMC 90536362; Saturn 21018826  
**O.D.:** 2 7/16 (61.9)  
**I.D.:** 1 7/32 (31.0) One End  
**Height:** 3 3/32 (78.6)  
**A. Gskt:** [1] Attached  
**O-Ring:** [1] Included



**P1511** Lube Element  
**Fits:** Industrial Engines  
**Replaces:** Alco 16011911  
**O.D.:** 6 13/32 (162.7)  
**I.D.:** 1 15/32 (37.3) One End  
**Height:** 33 7/8 (860.4)  
**Spring:** [1] Attached



**B1441** Lube Spin-on  
**Contains:** Anti-Drainback Valve  
 15 PSID By-Pass Valve  
**Fits:** Chevrolet, GMC Light-Duty Trucks  
**Replaces:** GMC 97214983; Isuzu 8-97214-983-1  
**Thread:** 13/16 -16  
**O.D.:** 3 11/16 (93.7)  
**Height:** 5 5/16 (134.9)  
**I.Gskt:** [1] Included



**V1520-R** Vac-Cel Lube Sock with Bail Pull  
**Fits:** Nugent Filter Housings  
**Replaces:** Alco 1601198  
**O.D.:** 6 3/16 (157.2)  
**I.D.:** 1 23/32 (43.7)  
**Height:** 30 1/2 (774.7)  
**I.Gskt:** [2] Included



**P1443** Lube Element  
**Fits:** Dodge, Freightliner Sprinter Vans;  
 Mercedes-Benz Automotive, Light-Duty Trucks,  
 Vans  
**Replaces:** Chrysler 5086301AA; Mann &  
 Hummel HU7181, HU7181X, HU7184;  
 Mercedes-Benz 1121800009, 1121840025,  
 A1121840225  
**O.D.:** 2 17/32 (64.3)  
**I.D.:** 1 1/4 (31.8)  
**Height:** 4 9/16 (115.9)  
**O-Ring:** [6] Included



**V1542-C** Vac-Cel Full-Flow Lube Sock  
**Fits:** Winslow Filter Housings  
**Replaces:** Winslow 1542 Series  
**O.D.:** 3 3/4 (95.3)  
**Height:** 15 1/2 (393.7)



**B1444** Lube Spin-on  
**Contains:** 8 PSID By-Pass Valve  
**Fits:** Subaru Outback, Outback Sport, Tribeca  
**Replaces:** Subaru SOA51-65109  
**Thread:** M20 x 1.5  
**O.D.:** 3 (76.2)  
**Height:** 2 27/32 (72.2)  
**I.Gskt:** [1] Included



**V1560** Crankcase Emission Absorber  
**Fits:** Various Oil Field Equipment  
**Replaces:** Nelson 88465A  
**O.D.:** 6 1/2 (165.1)  
**I.D.:** 3 3/4 (95.3)  
**Height:** 32 (812.8)



Measurements Are Shown In Inches And (Millimeters)

**WARNING:** These products can expose you to chemicals, including Diisononyl Phthalate, Carbon black extracts, Nickel, 1,3 Butadiene, Ethylene Oxide, Epichlorohydrin, which are known to the State of California to cause cancer, and Bisphenol, Ethylene Glycol, Ethylene Oxide, 1,3 Butadiene, Epichlorohydrin, which are known to the State of California to cause birth defects or other reproductive harm.

**P1561**

Lube Element

**Replaces:** Vokes 6360109, C6360229, C6370812  
**O.D.:** 6 5/8 (168.3)  
**I.D.:** 3 13/32 (86.5)  
**Height:** 17 3/32 (434.2)  
**O-Ring:** [2] Attached



**P1568**

Lube Element

**Replaces:** Vokes 6360110, C6360230, C6370064  
**O.D.:** 8 13/16 (223.8)  
**I.D.:** 4 1/16 (103.2)  
**Height:** 13 7/32 (335.8)  
**O-Ring:** [2] Attached



**P1562**

Lube Element

**Replaces:** Vokes C6360112, C6360232, C6370012  
**O.D.:** 8 13/16 (223.8)  
**I.D.:** 4 1/16 (103.2)  
**Height:** 18 7/32 (462.8)  
**O-Ring:** [2] Attached



**P1575**

Lube Element

**Notes:** Inside-Out Flow Direction  
**Replaces:** Vokes B63331  
**O.D.:** 3 21/32 (92.9)  
**I.D.:** 5/8 (15.9) & 1 23/32 (43.7)  
**Height:** 3 29/32 (99.2)  
**A. Gskt:** [1] Attached



**P1563**

Lube Element

**Replaces:** Vokes B6352910  
**O.D.:** 5 29/32 (150.0)  
**I.D.:** 2 13/16 (71.4)  
**Height:** 6 7/8 (174.6)  
**A. Gskt:** [2] Attached



**P1577**

Lube Element

**Notes:** Inside-Out Flow Direction  
**Replaces:** Vokes B62982  
**O.D.:** 3 21/32 (92.9)  
**I.D.:** 21/32 (16.7) & 1 23/32 (43.7)  
**Height:** 8 31/32 (227.8)  
**A. Gskt:** [1] Attached



**P1565**

Lube Element

**Notes:** Inside-Out Flow Direction  
**Replaces:** Vokes B62966  
**O.D.:** 2 13/16 (71.4)  
**I.D.:** 13/32 (10.3) & 1 5/16 (33.3)  
**Height:** 6 5/32 (156.4)  
**A. Gskt:** [1] Attached



**P1578**

Lube Element

**Notes:** OBSOLETE. Availability Limited to Dealer Stock.  
**Replaces:** Vokes 6360106, C6360226, C6370051  
**O.D.:** 4 9/32 (108.7)  
**I.D.:** 2 3/32 (53.2)  
**Height:** 14 7/16 (366.7)  
**A. Gskt:** [2] Attached



**P1566**

Lube Element

**Notes:** Inside-Out Flow Direction  
**Replaces:** Vokes B60942  
**O.D.:** 2 27/32 (72.2)  
**I.D.:** 13/32 (10.3) & 1 11/32 (34.1)  
**Height:** 3 29/32 (99.2)  
**A. Gskt:** [1] Attached



**PF1584**

Fuel Element

**Replaces:** Vokes C6360352  
**O.D.:** 8 25/32 (223.0)  
**I.D.:** 4 3/32 (104.0)  
**Height:** 18 5/32 (461.2)  
**O-Ring:** [2] Attached



**P1567**

Lube Element

**Replaces:** Vokes C6323149, C6370462  
**O.D.:** 6 (152.4)  
**I.D.:** 2 25/32 (70.6)  
**Height:** 12 1/4 (311.2)  
**A. Gskt:** [2] Attached



**PF1585**

Fuel Element

**Replaces:** Vokes B6436169  
**O.D.:** 3 21/32 (92.9)  
**I.D.:** 21/32 (16.7) & 2 5/32 (54.8)  
**Height:** 8 31/32 (227.8)  
**A. Gskt:** [1] Attached



Measurements Are Shown In Inches And (Millimeters)

**WARNING:** These products can expose you to chemicals, including Diisononyl Phthalate, Carbon black extracts, Nickel, 1,3 Butadiene, Ethylene Oxide, Epichlorohydrin, which are known to the State of California to cause cancer, and Bisphenol, Ethylene Glycol, Ethylene Oxide, 1,3 Butadiene, Epichlorohydrin, which are known to the State of California to cause birth defects or other reproductive harm.

**PF1587**



Fuel Element

**Replaces:** Vokes B6436168  
**O.D.:** 3 21/32 (92.9)  
**I.D.:** 5/8 (15.9) & 1 23/32 (43.7)  
**Height:** 3 7/8 (98.4)  
**A. Gskt:** [1] Attached

**PA1607**



Air Element

**Replaces:** GMC 6488322  
**O.D.:** 10 7/32 (259.6)  
**I.D.:** 7 7/8 (200.0)  
**Height:** 11 15/32 (291.3)

**PF1589**



Fuel Element

**Replaces:** Vokes D6357734  
**O.D.:** 3 21/32 (92.9)  
**I.D.:** 21/32 (16.7) & 1 23/32 (43.7)  
**Height:** 17 15/16 (455.6)  
**A. Gskt:** [1] Attached

**LL1608**



Long Life Air Element

**Notes:** Inside-Out Flow Direction  
**Contains:** Flame Retardant Media  
**Fits:** Bray, Case, Galion, International Equipment  
**Replaces:** Case L10327; International 124010-R1  
**O.D.:** 6 5/8 (168.3)  
**I.D.:** 4 1/4 (108.0) One End  
**Height:** 9 (228.6)  
**Related To:** PA1608 (Standard Media Version)

**PA1600**

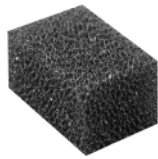

Poly Foam Air Breather

**Fits:** GMC Buses, Trucks; Various Air Compressors  
**Replaces:** Bendix 239262; Cummins 299365; GMC 9028042  
**Length:** 2 1/2 (63.5)  
**Width:** 1 3/4 (44.4)  
**Height:** 1 3/8 (34.9)

**PA1608**



Air Element

**Notes:** Inside-Out Flow Direction  
**Contains:** Flame Retardant Media  
**Fits:** Bray, Case, Galion, International Equipment  
**Replaces:** Case L10327; International 124010-R1  
**O.D.:** 6 5/8 (168.3)  
**I.D.:** 4 1/4 (108.0) One End  
**Height:** 9 (228.6)  
**Related To:** LL1608 (Long-Life Media Version)

**PA1602**



Air Element

**Fits:** Purolator AF100 Series Housings  
**Replaces:** Deutz 3476295; GMC 1553686  
**O.D.:** 6 5/8 (168.3)  
**I.D.:** 4 1/4 (108.0)  
**Height:** 7 7/8 (200.0)

**PA1609**



Outer Air Element with Lift Tabs

**Fits:** Allis Chalmers, Ford Equipment  
**Use With:** PA2306  
**Replaces:** Allis Chalmers 70630088; Ford C9NN-9601-A  
**O.D.:** 6 (152.4)  
**I.D.:** 3 5/8 (92.1) One End  
**Height:** 14 3/16 (360.4)  
**A. Gskt:** [1] Attached

**PA1603**



Air Breather Element

**Fits:** Chevrolet, GMC Trucks; Kohler Engines  
**Replaces:** GMC 2325376; Kohler 24908  
**O.D.:** 2 15/16 (74.6)  
**I.D.:** 1 7/8 (47.6)  
**Height:** 2 9/16 (65.1)

**PA1610**



Air Element with Lift Tabs

**Fits:** Drott, International Equipment  
**Replaces:** Drott 76237; International 321595-R91  
**O.D.:** 6 (152.4)  
**I.D.:** 3 5/8 (92.1) One End  
**Height:** 18 5/16 (465.1)  
**A. Gskt:** [1] Attached

**PA1606**



Air Element

**Contains:** Flame Retardant Media  
**Replaces:** GMC 6488318  
**O.D.:** 10 7/32 (259.6)  
**I.D.:** 7 7/8 (200.0)  
**Height:** 7 1/2 (190.5)

**PA1613**



Air Element

**Notes:** Inside-Out Flow Direction  
**Fits:** Allis Chalmers, International, Yale & Towne Equipment  
**Replaces:** Allis Chalmers 630418; International D58575; White 866520  
**O.D.:** 8 1/4 (209.6)  
**I.D.:** 1/2 (12.7) & 5 3/4 (146.0)  
**Height:** 9 (228.6)  
**F. Gskt:** [1] Included

Measurements Are Shown In Inches And (Millimeters)

**WARNING:** These products can expose you to chemicals, including Diisononyl Phthalate, Carbon black extracts, Nickel, 1,3 Butadiene, Ethylene Oxide, Epichlorohydrin, which are known to the State of California to cause cancer, and Bisphenol, Ethylene Glycol, Ethylene Oxide, 1,3 Butadiene, Epichlorohydrin, which are known to the State of California to cause birth defects or other reproductive harm.

**PA1613-S**

**Air Element**



**Notes:** Inside-Out Flow Direction  
**Fits:** Allis Chalmers, International, Yale & Towne Equipment  
**Replaces:** International 968718-R91  
**O.D.:** 8 1/4 (209.6)  
**I.D.:** 5 3/4 (146.0) One End  
**Height:** 9 (228.6)

**PA1618**

**Air Element**



**Fits:** Hyster Lift Trucks; OBAC Optional Filter Housings  
**Replaces:** GMC 6424682; OBAC HOB1004  
**O.D.:** 10 7/32 (259.6)  
**I.D.:** 5 1/2 (139.7)  
**Height:** 4 (101.6)

**LL1614**

**Long Life Air Element**



**Notes:** Inside-Out Flow Direction  
**Fits:** Allis Chalmers, Caterpillar, Dynapac, Franklin, Galion, J.C. Bamford Equipment, Gardner Denver, Sullair Compressors  
**Replaces:** Allis Chalmers 71132849; Continental SD802F546; Galion 79266  
**O.D.:** 8 1/4 (209.6)  
**I.D.:** 1/2 (12.7) & 5 3/4 (146.0)  
**Height:** 11 (279.4)  
**F. Gskt:** [1] Included  
**Related To:** PA1614 (Standard Media Version)

**PA1619**

**Air Element**



**Fits:** Case Equipment; Ford Engines  
**Replaces:** Case A15483  
**O.D.:** 10 7/32 (259.6)  
**I.D.:** 5 1/2 (139.7)  
**Height:** 5 (127.0)  
**F. Gskt:** [3] Included

**PA1614**

**Air Element**



**Notes:** Inside-Out Flow Direction  
**Fits:** Allis Chalmers, Caterpillar, Dynapac, Franklin, Galion, J.C. Bamford Equipment, Gardner Denver, Sullair Compressors  
**Replaces:** Allis Chalmers 71132849; Continental SD802F546; Galion 79266  
**O.D.:** 8 1/4 (209.6)  
**I.D.:** 1/2 (12.7) & 5 3/4 (146.0)  
**Height:** 11 (279.4)  
**F. Gskt:** [1] Included  
**Related To:** LL1614 (Long-Life Media Version)

**PA1620**

**Air Element**



**Fits:** Case Equipment  
**Replaces:** Case A14956, A15903  
**O.D.:** 10 7/32 (259.6)  
**I.D.:** 5 1/2 (139.7)  
**Height:** 8 3/16 (208.0)  
**A. Gskt:** [2] Attached

**LL1615**

**Long Life Outer Air Element**



**Fits:** Caterpillar Equipment  
**Use With:** PA1647, PA2719, [PA2736]  
**Replaces:** Caterpillar 4M8047, 8N5389  
**O.D.:** 9 1/4 (235.0)  
**I.D.:** 4 27/32 (123.0) One End  
**Height:** 12 1/2 (317.5)  
**A. Gskt:** [1] Attached  
**Related To:** PA1615 (Standard Media Version)  
 PA1615XP (Extreme Performance Nano Version)

**PA1620-S**

**Air Element**



**Fits:** Caterpillar Engines  
**Replaces:** Caterpillar 4L9851  
**O.D.:** 10 7/32 (259.6)  
**I.D.:** 6 1/16 (154.0) One End  
**Height:** 7 27/32 (199.2)  
**A. Gskt:** [1] Attached

**PA1615**

**Outer Air Element**



**Fits:** Caterpillar Equipment  
**Use With:** PA1647, PA2719, PA2736  
**Replaces:** Caterpillar 4M8047, 8N5389  
**O.D.:** 9 1/4 (235.0)  
**I.D.:** 4 27/32 (123.0) One End  
**Height:** 12 1/2 (317.5)  
**A. Gskt:** [1] Attached  
**Related To:** LL1615 (Long-Life Media Version)  
 PA1615XP (Extreme Performance Nano Version)

**LL1621-2**

**Long Life Air Element with 2-Inch Pleats**



**Notes:** Inside-Out Flow Direction  
**Fits:** Austin-Western, Aveling-Barford, Dresser, Euclid, Galion, Hancock, Hough, J.C. Bamford, Versatile, Washington Iron Works, Yale Equipment  
**Replaces:** Versatile 6017725; Yale 512556805  
**O.D.:** 10 7/32 (259.6)  
**I.D.:** 1/2 (12.7) & 6 1/16 (154.0)  
**Height:** 9 (228.6)  
**F. Gskt:** [1] Included  
**Related To:** PA1621-2 (Standard Media Version)

**PA1615XP**

**Extreme Performance Nano Outer Air Element**



**Fits:** Caterpillar Equipment  
**Use With:** PA1647, PA2719, PA2736  
**Replaces:** Caterpillar 4M8047, 8N5389  
**O.D.:** 9 1/4 (235.0)  
**I.D.:** 4 27/32 (123.0) One End  
**Height:** 12 1/2 (317.5)  
**A. Gskt:** [1] Attached  
**Related To:** LL1615 (Long-Life Media Version)  
 PA1615 (Standard Media Version)

**PA1621**

**Air Element**



**Notes:** Inside-Out Flow Direction  
**Fits:** Euclid, Hough, Versatile Equipment  
**Replaces:** International 155209; White 882681  
**O.D.:** 10 7/32 (259.6)  
**I.D.:** 1/2 (12.7) & 7 7/8 (200.0)  
**Height:** 9 (228.6)  
**F. Gskt:** [1] Included

Measurements Are Shown In Inches And (Millimeters)

**WARNING:** These products can expose you to chemicals, including Diisononyl Phthalate, Carbon black extracts, Nickel, 1,3 Butadiene, Ethylene Oxide, Epichlorohydrin, which are known to the State of California to cause cancer, and Bisphenol, Ethylene Glycol, Ethylene Oxide, 1,3 Butadiene, Epichlorohydrin, which are known to the State of California to cause birth defects or other reproductive harm.

**PA1621-2** Air Element with 2-Inch Pleats  
**Notes:** Inside-Out Flow Direction  
**Fits:** Austin-Western, Aveling-Barford, Dresser, Euclid, Galion, Hancock, Hough, J.C. Bamford, Versatile, Washington Iron Works, Yale Equipment  
**Replaces:** Versatile 6017725; Yale 512556805  
**O.D.:** 10 7/32 (259.6)  
**I.D.:** 1/2 (12.7) & 6 1/16 (154.0)  
**Height:** 9 (228.6)  
**F. Gskt:** [1] Included  
**Related To:** LL1621-2 (Long-Life Media Version)



**PA1627** Rocker Arm Air Breather Element  
**Fits:** Cummins Engines  
**Replaces:** Cummins 255180  
**O.D.:** 5 (127.0)  
**I.D.:** 2 5/8 (66.7)  
**Height:** 1 5/16 (33.3)



**PA1621-S** Air Element  
**Notes:** OBSOLETE. Availability limited to Dealer Stock.  
 Inside-Out Flow Direction  
**Fits:** Euclid, Hough, Versatile Equipment  
**Replaces:** GMC 25096131  
**O.D.:** 10 7/32 (259.6)  
**I.D.:** 7 7/8 (200.0) One End  
**Height:** 9 (228.6)



**PA1629-S** Air Element  
**Fits:** Caterpillar Engines  
**Replaces:** Caterpillar 4L9853  
**O.D.:** 13 13/16 (350.8)  
**I.D.:** 9 1/2 (241.3) One End  
**Height:** 12 1/8 (308.0)  
**A. Gskt:** [1] Attached



**PA1625** Air Element  
**Fits:** Caterpillar, Michigan Equipment  
**Replaces:** Caterpillar 9M8373  
**O.D.:** 11 21/32 (296.1)  
**I.D.:** 6 1/8 (155.6) & 8 31/32 (227.8)  
**Height:** 10 1/2 (266.7)  
**A. Gskt:** [2] Attached  
**O. Gskt:** [2] G37-AF



**LL1630-2** Long Life Air Element with 2-Inch Pleats  
**Notes:** Inside-Out Flow Direction  
**Fits:** Caterpillar, Cummins Engines; Compair, Consolidated, Gardner Denver, Ingersoll-Rand, Joy Compressors  
**Replaces:** Caterpillar 9L3420; Cummins 130752; GMC 247059  
**O.D.:** 13 13/16 (350.8)  
**I.D.:** 1/2 (12.7) & 9 1/2 (241.3)  
**Height:** 14 (355.6)  
**F. Gskt:** [1] Included  
**Related To:** PA1630-2 (Standard Media Version)



**LL1626-2** Long Life Air Element with 2-Inch Pleats  
**Notes:** Inside-Out Flow Direction  
**Fits:** Euclid, Hough Equipment  
**Replaces:** Euclid 9038805; International 425615-R91  
**O.D.:** 12 1/8 (308.0)  
**I.D.:** 1/2 (12.7) & 7 11/16 (195.3)  
**Height:** 10 (254.0)  
**F. Gskt:** [1] Included  
**Related To:** PA1626-2 (Standard Media Version)



**PA1630** Air Element  
**Notes:** Inside-Out Flow Direction  
**Fits:** Allis Chalmers, Euclid Equipment  
**Replaces:** Allis Chalmers 43790692; Euclid 9175490  
**O.D.:** 13 27/32 (351.6)  
**I.D.:** 1/2 (12.7) & 11 1/8 (282.6)  
**Height:** 14 (355.6)  
**F. Gskt:** [1] Included  
**Related To:** PA1706 (with Attached Gasket)



**PA1626** Air Element  
**Notes:** Inside-Out Flow Direction  
**Fits:** Euclid, Hough Equipment  
**Replaces:** Euclid 9228197; International 425970-R91  
**O.D.:** 12 1/32 (305.6)  
**I.D.:** 1/2 (12.7) & 9 1/4 (235.0)  
**Height:** 10 (254.0)  
**F. Gskt:** [1] Included



**PA1630-2** Air Element with 2-Inch Pleats  
**Notes:** Inside-Out Flow Direction  
**Fits:** Caterpillar, Cummins Engines; Compair, Consolidated, Gardner Denver, Ingersoll-Rand, Joy Compressors  
**Replaces:** Caterpillar 9L3420; Cummins 130752; GMC 247059  
**O.D.:** 13 13/16 (350.8)  
**I.D.:** 1/2 (12.7) & 9 1/2 (241.3)  
**Height:** 14 (355.6)  
**F. Gskt:** [1] Included  
**Related To:** LL1630-2 (Long-Life Media Version)



**PA1626-2** Air Element with 2-Inch Pleats  
**Notes:** Inside-Out Flow Direction  
**Fits:** Euclid, Hough Equipment  
**Replaces:** Euclid 9038805; International 425615-R91  
**O.D.:** 12 1/8 (308.0)  
**I.D.:** 1/2 (12.7) & 7 11/16 (195.3)  
**Height:** 10 (254.0)  
**F. Gskt:** [1] Included  
**Related To:** LL1626-2 (Long-Life Media Version)



**PA1631-S** Air Element  
**Fits:** Caterpillar Engines  
**Replaces:** Caterpillar 5L1203  
**O.D.:** 13 13/16 (350.8)  
**I.D.:** 9 1/2 (241.3) One End  
**Height:** 18 1/8 (460.4)  
**A. Gskt:** [1] Attached



Measurements Are Shown In Inches And (Millimeters)

**WARNING:** These products can expose you to chemicals, including Diisononyl Phthalate, Carbon black extracts, Nickel, 1,3 Butadiene, Ethylene Oxide, Epichlorohydrin, which are known to the State of California to cause cancer, and Bisphenol, Ethylene Glycol, Ethylene Oxide, 1,3 Butadiene, Epichlorohydrin, which are known to the State of California to cause birth defects or other reproductive harm.

**PA1632**

**Air Element**



**Fits:** GMC Engines; Ingersoll-Rand Compressors  
**Replaces:** GMC 6422964; Ingersoll-Rand 40070  
**O.D.:** 16 5/8 (422.3)  
**I.D.:** 12 (304.8)  
**Height:** 16 (406.4)

**PA1635**

**Air Element**



**Fits:** Allis Chalmers, Case, Hough, John Bean Equipment  
**Replaces:** Allis Chalmers 4824451; Case L48583  
**O.D.:** 5 1/4 (133.4)  
**I.D.:** 2 5/8 (66.7) One End  
**Height:** 8 (203.2)

**PA1633**

**Air Element**



**Fits:** Caterpillar Equipment, Industrial, Marine, Starter Engines  
**Replaces:** Caterpillar 8M3120  
**O.D.:** 4 1/4 (108.0)  
**I.D.:** 1 5/8 (41.3) One End  
**Height:** 4 3/4 (120.7)  
**A. Gskt:** [1] Attached

**LL1636-FN**

**Long Life Air Element with Fins**



**Fits:** Allis Chalmers, Case, Caterpillar, Hitachi, Hough, Ingersoll-Rand, John Deere, Michigan Equipment; Mitsubishi Trucks  
**Replaces:** Allis Chalmers 24472812; Case L35913; John Deere AR30644  
**O.D.:** 7 15/16 (201.6)  
 Fins 10 1/16 (255.6)  
**I.D.:** 1/2 (12.7) & 3 9/16 (90.5)  
**Height:** 10 1/4 (260.3)  
**A. Gskt:** [1] Attached  
**F. Gskt:** [1] Included  
**Related To:** PA1636-FN (Standard Media Version)

**LL1634**

**Long Life Outer Air Element**



**Fits:** Caterpillar Truck Engines, Equipment  
**Use With:** PA1675, PA2310, PA2737  
**Replaces:** Caterpillar 4M9334, 8N5317; General Motors 6421540; Mitsubishi 4574070210; Poclain P2050509  
**O.D.:** 11 1/8 (282.6)  
**I.D.:** 6 23/32 (170.7) One End  
**Height:** 13 1/2 (342.9)  
**A. Gskt:** [1] Attached  
**Related To:** PA1634 (Standard Media Version)  
 PA1634XP (Extreme Performance Nano Version)

**PA1636-FN**

**Air Element with Fins**



**Fits:** Allis Chalmers, Case, Caterpillar, Hitachi, Hough, Ingersoll-Rand, John Deere, Michigan Equipment; Mitsubishi Trucks  
**Replaces:** Allis Chalmers 24472812; Case L35913; John Deere AR30644  
**O.D.:** 7 15/16 (201.6)  
 Fins 10 1/16 (255.6)  
**I.D.:** 1/2 (12.7) & 3 9/16 (90.5)  
**Height:** 10 1/4 (260.3)  
**A. Gskt:** [1] Attached  
**F. Gskt:** [1] Included  
**Related To:** LL1636-FN (Long-Life Media Version)

**PA1634**

**Outer Air Element**



**Fits:** Caterpillar Truck Engines, Equipment  
**Use With:** PA1675, PA2310, PA2737  
**Replaces:** Caterpillar 4M9334, 8N5317; General Motors 6421540; Mitsubishi 4574070210; Poclain P2050509  
**O.D.:** 11 1/8 (282.6)  
**I.D.:** 6 23/32 (170.7) One End  
**Height:** 13 1/2 (342.9)  
**A. Gskt:** [1] Attached  
**Related To:** LL1634 (Long-Life Media Version)  
 PA1634XP (Extreme Performance Nano Version)

**LL1637-FN**

**Long Life Air Element with Fins**



**Fits:** Clark, Euclid, Grove, Hitachi, Koehring, Link-Belt, Michigan, Vermeer Equipment; Hino, International, Kenworth, Mitsubishi Trucks  
**Replaces:** Clark 941089; International 877600-C9; Kenworth 944809  
**O.D.:** 11 1/8 (282.6)  
 Fins 13 3/4 (349.3)  
**I.D.:** 5/8 (15.9) & 6 23/32 (170.7)  
**Height:** 12 1/2 (317.5)  
**A. Gskt:** [1] Attached  
**F. Gskt:** [1] Included  
**Related To:** PA1637-FN (Standard Media Version)

**PA1634XP**

**Extreme Performance Nano Outer Air Element**



**Fits:** Caterpillar Truck Engines, Equipment  
**Use With:** PA1675, PA2310, PA2737  
**Replaces:** Caterpillar 4M9334, 8N5317; General Motors 6421540; Mitsubishi 4574070210; Poclain P2050509  
**O.D.:** 11 1/8 (282.6)  
**I.D.:** 6 23/32 (170.7) One End  
**Height:** 13 1/2 (342.9)  
**A. Gskt:** [1] Attached  
**Related To:** LL1634 (Long-Life Media Version)  
 PA1634 (Standard Media Version)

**PA1637-FN**

**Air Element with Fins**



**Fits:** Clark, Euclid, Grove, Hitachi, Koehring, Link-Belt, Michigan, Vermeer Equipment; Hino, International, Kenworth, Mitsubishi Trucks  
**Replaces:** Clark 941089; International 877600-C9; Kenworth 944809  
**O.D.:** 11 1/8 (282.6)  
 Fins 13 3/4 (349.3)  
**I.D.:** 5/8 (15.9) & 6 23/32 (170.7)  
**Height:** 12 1/2 (317.5)  
**A. Gskt:** [1] Attached  
**F. Gskt:** [1] Included  
**Related To:** LL1637-FN (Long-Life Media Version)

Measurements Are Shown In Inches And (Millimeters)

**WARNING:** These products can expose you to chemicals, including Diisononyl Phthalate, Carbon black extracts, Nickel, 1,3 Butadiene, Ethylene Oxide, Epichlorohydrin, which are known to the State of California to cause cancer, and Bisphenol, Ethylene Glycol, Ethylene Oxide, 1,3 Butadiene, Epichlorohydrin, which are known to the State of California to cause birth defects or other reproductive harm.

**PA1639**

Air Element



**Fits:** Craftsman, John Deere, Lambert, Pennsylvania Lawn & Garden Equipment; Mercedes-Benz Trucks  
**Replaces:** GMC 6486857; John Deere AM31000; Mercedes-Benz 942804  
**O.D.:** 4 13/32 (111.9)  
**I.D.:** 2 15/16 (74.6)  
**Height:** 5 (127.0)

**PA1641**

Air Element



**Fits:** GMC Engines  
**Replaces:** GMC 6484302  
**O.D.:** 13 27/32 (351.6)  
**I.D.:** 1/2 (12.7) & 11 1/8 (282.6)  
**Height:** 7 1/2 (190.5)  
**A. Gskt:** [1] Attached  
**F. Gskt:** [1] Included

**LL1642-2**

Long Life Air Element with 2-Inch Pleats



**Notes:** Inside-Out Flow Direction  
**Fits:** Austin-Western, Gardner Denver, KW-Dart Equipment; Kenworth Trucks  
**Replaces:** Gardner Denver 5B345; GMC 6424683; Kenworth 461396  
**O.D.:** 12 1/32 (305.6)  
**I.D.:** 9/16 (14.3) & 7 11/16 (195.3)  
**Height:** 13 (330.2)  
**F. Gskt:** [1] Included  
**Related To:** PA1642-2 (Standard Media Version)

**PA1642-2**

Air Element with 2-Inch Pleats



**Notes:** Inside-Out Flow Direction  
**Fits:** Austin-Western, Gardner Denver, KW-Dart Equipment; Kenworth Trucks  
**Replaces:** Gardner Denver 5B345; GMC 6424683; Kenworth 461396  
**O.D.:** 12 1/32 (305.6)  
**I.D.:** 9/16 (14.3) & 7 11/16 (195.3)  
**Height:** 13 (330.2)  
**F. Gskt:** [1] Included  
**Related To:** LL1642-2 (Long-Life Media Version)

**PA1643**

Air Element



**Replaces:** Euclid 9192471; GMC 9038908  
**O.D.:** 13 27/32 (351.6)  
**I.D.:** 1/2 (12.7) & 11 1/8 (282.6)  
**Height:** 14 (355.6)  
**F. Gskt:** [1] Included

**PA1644**

Air Element with Lift Tab



**Contains:** Flame Retardant Media  
**Fits:** Allis Chalmers, Caterpillar, Hyster, International Equipment  
**Replaces:** Allis Chalmers 23589378; Hyster 23471906; International 391852-R92; Towmotor 343008  
**O.D.:** 3 9/16 (90.5)  
**I.D.:** 2 1/32 (51.6) One End  
**Height:** 11 (279.4)  
**A. Gskt:** [1] Attached

**F1645-DS**

Special Vac-Cel Fuel Sock



**Fits:** Winslow 1645 Series Housings  
**Replaces:** Winslow W1645T  
**O.D.:** 4 1/4 (108.0)  
**I.D.:** 1 1/16 (27.0)  
**Height:** 16 (406.4)  
**F. Gskt:** G140-A Included with V1645-C Only

**V1645-C**

Vac-Cel Full-Flow Lube Sock



**Fits:** Winslow 1645 Series Housings  
**Replaces:** Winslow W1645T  
**O.D.:** 4 1/4 (108.0)  
**I.D.:** 1 1/16 (27.0)  
**Height:** 16 (406.4)  
**F. Gskt:** G140-A

**LL1646-FN**

Long Life Air Element with Fins



**Fits:** Case, Caterpillar, Dresser, Drott, Galion, Grove, Hitachi, Hydro-Ax, Koehring, Michigan Equipment; Iveco, R.V.I. Trucks  
**Replaces:** Case A60743; Caterpillar 9Y6834; Drott 221313; Galion D73499; Hitachi D911762; Iveco 9917881  
**O.D.:** 9 7/32 (234.2)  
Fins 11 5/8 (295.3)  
**I.D.:** 21/32 (16.7) & 4 27/32 (123.0)  
**Height:** 10 1/2 (266.7)  
**A. Gskt:** [1] Attached  
**F. Gskt:** [1] Included  
**Related To:** PA1646-FN (Standard Media Version)

**PA1646**

Air Element



**Replaces:** Donaldson P107643  
**O.D.:** 9 7/32 (234.2)  
**I.D.:** 21/32 (16.7) & 4 27/32 (123.0)  
**Height:** 10 1/2 (266.7)  
**A. Gskt:** [1] Attached  
**F. Gskt:** [1] Included

**PA1646-FN**

Air Element with Fins



**Fits:** Case, Caterpillar, Dresser, Drott, Galion, Grove, Hitachi, Hydro-Ax, Koehring, Michigan Equipment; Iveco, R.V.I. Trucks  
**Replaces:** Case A60743; Caterpillar 9Y6834; Drott 221313; Galion D73499; Hitachi D911762; Iveco 9917881  
**O.D.:** 9 7/32 (234.2)  
Fins 11 5/8 (295.3)  
**I.D.:** 21/32 (16.7) & 4 27/32 (123.0)  
**Height:** 10 1/2 (266.7)  
**A. Gskt:** [1] Attached  
**F. Gskt:** [1] Included  
**Related To:** LL1646-FN (Long-Life Media Version)

**PA1647**

Inner Air Element with 6 Bolts



**Fits Inside:** LL1615, PA1615, PA1615XP  
**Fits:** Caterpillar Equipment  
**Replaces:** Caterpillar 2S1285  
**O.D.:** 4 3/4 (120.7)  
Flange 7 5/16 (185.7)  
**I.D.:** 3 5/8 (92.1) One End  
**Height:** 12 (304.8)  
**A. Gskt:** [1] Attached  
**F. Gskt:** [1] Included

Measurements Are Shown In Inches And (Millimeters)

**WARNING:** These products can expose you to chemicals, including Diisononyl Phthalate, Carbon black extracts, Nickel, 1,3 Butadiene, Ethylene Oxide, Epichlorohydrin, which are known to the State of California to cause cancer, and Bisphenol, Ethylene Glycol, Ethylene Oxide, 1,3 Butadiene, Epichlorohydrin, which are known to the State of California to cause birth defects or other reproductive harm.

**PA1648**

Air Element



**Contains:** Flame Retardant Media  
**Fits:** Allis Chalmers Lift Trucks  
**Replaces:** Allis Chalmers 49931583  
**O.D.:** 6 13/32 (162.7)  
 Top 6 21/32 (169.1)  
**I.D.:** 4 3/32 (104.0)  
**Height:** 3 (76.2)

**LL1649**

Long Life Air Element



**Notes:** Inside-Out Flow Direction  
**Fits:** Caterpillar, Cummins Engines; Euclid, Terex, Volvo Equipment  
**Replaces:** Caterpillar 6L3313; Cummins 707664; Euclid 9395885; Terex 9030854; Volvo 79230041  
**O.D.:** 13 13/16 (350.8)  
**I.D.:** 1/2 (12.7) & 9 1/2 (241.3)  
**Height:** 16 (406.4)  
**F. Gskt:** [1] Included  
**Related To:** PA1649 (Standard Media Version)

**PA1649**

Air Element



**Notes:** Inside-Out Flow Direction  
**Fits:** Caterpillar, Cummins Engines; Euclid, Terex, Volvo Equipment  
**Replaces:** Caterpillar 6L3313; Cummins 707664; Euclid 9395885; Terex 9030854; Volvo 79230041  
**O.D.:** 13 13/16 (350.8)  
**I.D.:** 1/2 (12.7) & 9 1/2 (241.3)  
**Height:** 16 (406.4)  
**F. Gskt:** [1] Included  
**Related To:** LL1649 (Long-Life Media Version)

**PA1650-FN**

Air Element with Fins



**Fits:** Dresser, International Loaders, Tractors  
**Replaces:** International 343731-R91  
**O.D.:** 7 15/16 (201.6)  
 Fins 10 1/16 (255.6)  
**I.D.:** 1/2 (12.7) & 3 9/16 (90.5)  
**Height:** 16 3/8 (415.9)  
**A. Gskt:** [1] Attached  
**F. Gskt:** [1] Included

**PA1653**

Air Compressor Element



**Fits:** Joy Compressors  
**Replaces:** Joy 1222941  
**O.D.:** 6 7/8 (174.6)  
**I.D.:** 5 1/8 (130.2)  
**Height:** 7 (177.8)  
**Related To:** PA2102 (for Engine Air)

**V1656-O**

Vac-Cel Dual-Stage Full-Flow Orlon Lube Sock



**Notes:** For use with high heat applications.  
**Fits:** Clark, Gradall, Grove Equipment; Waukesha Engines  
**Replaces:** Waukesha 167602B  
**O.D.:** 4 1/2 (114.3)  
**I.D.:** 1 1/16 (27.0)  
**Height:** 16 (406.4)  
**F. Gskt:** G144  
**Related To:** C133-W, C133-OW (Double-Length Versions)

**V1656-T**

Vac-Cel Dual-Stage Full-Flow Cotton Lube Sock



**Notes:** Use V1656-O for use with high heat applications.  
**Fits:** Clark, Gradall, Grove Equipment; Waukesha Engines  
**Replaces:** Waukesha 167602B  
**O.D.:** 4 1/2 (114.3)  
**I.D.:** 1 1/16 (27.0)  
**Height:** 16 (406.4)  
**F. Gskt:** G144  
**Related To:** C133-W, C133-OW (Double-Length Versions)

**PA1657**

Air Element



**Fits:** GMC, Isuzu, Nissan Automotive, Light-Duty Trucks  
**Replaces:** GMC 94213709; Isuzu 8-94206-007-0  
**O.D.:** 10 1/8 (257.2)  
**I.D.:** 7 15/16 (201.6)  
**Height:** 2 3/8 (60.3)

**PA1661(3)**

Set of 3 Air Elements



**Fits:** California Custom Accessories  
**Replaces:** California Custom PC15658  
**O.D.:** 4 (101.6)  
**I.D.:** 2 3/4 (69.9)  
**Height:** 2 1/32 (51.6)

**PA1663**

Outer Air Element



**Fits:** Case Equipment  
**Use With:** PA1664  
**Replaces:** Case A17741  
**O.D.:** 12 1/16 (306.4)  
**I.D.:** 7 13/16 (198.4)  
**Height:** 10 7/16 (265.1)  
**A. Gskt:** [2] Attached

**PA1664**

Inner Air Element



**Fits Inside:** PA1663  
**Fits:** Case Equipment  
**Replaces:** Case A17742  
**O.D.:** 6 5/8 (168.3)  
**I.D.:** 4 1/4 (108.0)  
**Height:** 9 13/16 (249.2)  
**A. Gskt:** [2] Attached

**PA1666**

Conical-Shaped Air Element



**Fits:** Ariens, Bush Hog, Craftsman, Cub Cadet, Ford, International, John Deere, Lambert, Lawn Boy Lawn & Garden Equipment  
**Replaces:** International 488619-R1; John Deere AM30900; Lawn Boy 10063; Tecumseh 30727  
**O.D.:** 2 31/32 (75.4)  
 to 3 3/4 (95.3)  
**I.D.:** 2 1/32 (51.6) One End  
**Height:** 2 1/8 (54.0)

Measurements Are Shown In Inches And (Millimeters)

**WARNING:** These products can expose you to chemicals, including Diisononyl Phthalate, Carbon black extracts, Nickel, 1,3 Butadiene, Ethylene Oxide, Epichlorohydrin, which are known to the State of California to cause cancer, and Bisphenol, Ethylene Glycol, Ethylene Oxide, 1,3 Butadiene, Epichlorohydrin, which are known to the State of California to cause birth defects or other reproductive harm.



## LL1667-FN



### Long Life Outer Air Element with Fins

**Fits:** Allis Chalmers, Benford, Bobcat, Case, Ditch Witch, Fiat, Ford, Hesston, International, John Deere, Komatsu, Kubota, New Holland, Versatile Equipment

**Use With:** PA2489 on Melroe Equipment

**Replaces:** Allis Chalmers 74996245; Case A59998; International 204002-H1; John Deere AH19852

**O.D.:** 5 3/16 (131.8)

Fins 6 3/8 (161.9)

**I.D.:** 2 1/32 (16.7) & 2 5/8 (66.7)

**Height:** 11 1/2 (292.1)

**A. Gskt:** [1] Attached

**F. Gskt:** G103-N

**Related To:** PA1667-FN (Standard Media Version)

## PA1667-FN



### Outer Air Element with Fins

**Fits:** Allis Chalmers, Benford, Bobcat, Case, Ditch Witch, Fiat, Ford, Hesston, International, John Deere, Komatsu, Kubota, New Holland, Versatile Equipment

**Use With:** PA2489 on Melroe Equipment

**Replaces:** Allis Chalmers 74996245; Case A59998; International 204002-H1; John Deere AH19852

**O.D.:** 5 3/16 (131.8)

Fins 6 3/8 (161.9)

**I.D.:** 2 1/32 (16.7) & 2 5/8 (66.7)

**Height:** 11 1/2 (292.1)

**A. Gskt:** [1] Attached

**F. Gskt:** G103-N

**Related To:** LL1667-FN (Long-Life Media Version)

## LL1669



### Long Life Outer Air Element

**Fits:** Caterpillar Equipment

**Use With:** PA1670, PA2733, PA2739

**Replaces:** Caterpillar 7M9045, 8N5316

**O.D.:** 11 1/8 (282.6)

**I.D.:** 6 23/32 (170.7) One End

**Height:** 16 1/2 (419.1)

**A. Gskt:** [1] Attached

**Related To:** PA1669 (Standard Media Version)

## PA1669



### Outer Air Element

**Fits:** Caterpillar Equipment

**Use With:** PA1670, PA2733, PA2739

**Replaces:** Caterpillar 7M9045, 8N5316

**O.D.:** 11 1/8 (282.6)

**I.D.:** 6 23/32 (170.7) One End

**Height:** 16 1/2 (419.1)

**A. Gskt:** [1] Attached

**Related To:** LL1669 (Long-Life Media Version)

## PA1670



### Inner Air Element with 8 Bolts

**Notes:** On Caterpillar using a Fleetguard or Heavy Duty Air conversion bracket, use PA2739.

**Fits Inside:** LL1669, PA1669

**Fits:** Caterpillar Equipment

**Replaces:** Caterpillar 2S1287

**O.D.:** 6 1/4 (158.8)

Flange 9 1/16 (230.2)

**I.D.:** 4 5/8 (117.5) One End

**Height:** 16 (406.4)

**A. Gskt:** [1] Attached

**F. Gskt:** G42-AF

## PA1673



### Outer Air Element

**Fits:** Caterpillar Equipment

**Use With:** PA1674, PA3471

**Replaces:** Caterpillar 4M9378, 7W3920

**O.D.:** 8 3/8 (212.7)

**I.D.:** 4 (101.6) One End

**Height:** 10 1/2 (266.7)

**A. Gskt:** [1] Attached

## PA1674



### Inner Air Element with 6 Bolts

**Fits Inside:** PA1673

**Fits:** Caterpillar Equipment

**Replaces:** Caterpillar 2S1288, 9M1829

**O.D.:** 3 3/4 (95.3)

Flange 6 11/16 (169.9)

**I.D.:** 2 5/8 (66.7) One End

**Height:** 10 3/32 (256.4)

**A. Gskt:** [1] Attached

**F. Gskt:** [1] Included

## PA1675



### Inner Air Element with 8 Bolts

**Fits Inside:** LL1634, PA1634, PA1634XP

**Fits:** Caterpillar Equipment

**Replaces:** Caterpillar 2S1286

**O.D.:** 6 1/4 (158.8)

Flange 9 1/16 (230.2)

**I.D.:** 4 5/8 (117.5) One End

**Height:** 13 3/32 (332.6)

**A. Gskt:** [1] Attached

**F. Gskt:** [1] Included

## LL1676-FN



### Long Life Air Element with Fins

**Fits:** Cummins, Waukesha Engines

**Replaces:** Cummins 156773; Waukesha 163631

**O.D.:** 12 1/32 (305.6)

Fins 15 3/4 (400.0)

**I.D.:** 17/32 (13.5) & 7 11/16 (195.3)

**Height:** 14 1/2 (368.3)

**A. Gskt:** [1] Attached

**F. Gskt:** [1] Included

**Related To:** PA1676-FN (Standard Media Version)

## PA1676-FN



### Air Element with Fins

**Fits:** Cummins, Waukesha Engines

**Replaces:** Cummins 156773; Waukesha 163631

**O.D.:** 12 1/32 (305.6)

Fins 15 3/4 (400.0)

**I.D.:** 17/32 (13.5) & 7 11/16 (195.3)

**Height:** 14 1/2 (368.3)

**A. Gskt:** [1] Attached

**F. Gskt:** [1] Included

**Related To:** LL1676-FN (Long-Life Media Version)

## PA1679



### Air Breather Element

**Fits:** Caterpillar Equipment, Starter Engines

**Replaces:** Caterpillar 8M3119

**O.D.:** 3 1/8 (79.4)

**I.D.:** 1 1/2 (38.1)

**Height:** 3 3/4 (95.3)

**A. Gskt:** [2] Attached

Measurements Are Shown In Inches And (Millimeters)

**WARNING:** These products can expose you to chemicals, including Diisononyl Phthalate, Carbon black extracts, Nickel, 1,3 Butadiene, Ethylene Oxide, Epichlorohydrin, which are known to the State of California to cause cancer, and Bisphenol, Ethylene Glycol, Ethylene Oxide, 1,3 Butadiene, Epichlorohydrin, which are known to the State of California to cause birth defects or other reproductive harm.

**PA1680**

Air Element

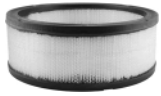

**Fits:** GM Automotive, Light-Duty Trucks, Vans; Jeep Vehicles  
**Replaces:** GMC 3902837; Jeep 948516  
**O.D.:** 9 21/32 (245.3)  
**I.D.:** 8 1/4 (209.6)  
**Height:** 3 9/16 (90.5)  
**Related To:** PA658 (Short Version)

**LL1681-FN**

Long Life Outer Air Element with Fins



**Fits:** GMC, Mack Trucks; Allis Chalmers, Case, Caterpillar, John Deere Equipment  
**Use With:** PA2321, PA2570  
**Replaces:** GMC 6424690; Mack 2MD455AP2  
**O.D.:** 6 3/32 (154.8)  
     Fins 7 13/16 (198.4)  
**I.D.:** 3/4 (19.0) & 3 15/32 (88.1)  
**Height:** 12 3/8 (314.3)  
**A. Gskt:** [1] Attached  
**F. Gskt:** G103-N  
**Related To:** PA1681-FN (Standard Media Version)

**PA1681-FN**

Outer Air Element with Fins



**Fits:** GMC, Mack Trucks; Allis Chalmers, Case, Caterpillar, John Deere Equipment  
**Use With:** PA2321, PA2570  
**Replaces:** GMC 6424690; Mack 2MD455AP2  
**O.D.:** 6 3/32 (154.8)  
     Fins 7 13/16 (198.4)  
**I.D.:** 3/4 (19.0) & 3 15/32 (88.1)  
**Height:** 12 3/8 (314.3)  
**A. Gskt:** [1] Attached  
**F. Gskt:** G103-N  
**Related To:** LL1681-FN (Long-Life Media Version)

**PA1682**

Air Element with Lift Tab



**Fits:** Allis Chalmers Equipment  
**Replaces:** Allis Chalmers 236650  
**O.D.:** 5 1/2 (139.7)  
**I.D.:** 3 1/8 (79.4) One End  
**Height:** 14 1/4 (362.0)  
**A. Gskt:** [1] Attached

**PA1683**

Outer Air Element with Lift Tab



**Contains:** Flame Retardant Media  
**Fits:** Allis Chalmers, Ford, International, Massey Ferguson Equipment  
**Use With:** PA1809  
**Replaces:** Allis Chalmers 237395; Ford E6NN9B618AB; Massey Ferguson 1026191-M91  
**O.D.:** 4 1/2 (114.3)  
**I.D.:** 2 1/4 (57.2) One End  
**Height:** 10 3/4 (273.1)  
**A. Gskt:** [1] Attached

**PA1684**

Outer Air Element with Lift Bar



**Contains:** Flame Retardant Media  
**Fits:** Allis Chalmers, Bobcat, Caterpillar, Hyster, International, John Deere Equipment; Bobcat Loaders  
**Use With:** PA1809  
**Replaces:** Allis Chalmers 235449; Case S63738; Caterpillar 65-6140; John Deere AH19853  
**O.D.:** 4 1/2 (114.3)  
**I.D.:** 2 1/4 (57.2) One End  
**Height:** 12 5/8 (320.7)  
**A. Gskt:** [1] Attached

**PA1686**

Inner Air Element



**Fits Inside:** PA1687  
**Fits:** Bobcat Loaders; Case Equipment  
**Replaces:** Case L31277; Clark 1804278  
**O.D.:** 8 1/16 (204.8)  
**I.D.:** 5 3/4 (146.0)  
**Height:** 15 1/4 (387.3)

**PA1687**

Outer Air Element



**Fits:** Case Equipment  
**Use With:** PA1686  
**Replaces:** Case L31276; Clark 1805389  
**O.D.:** 14 5/32 (359.6)  
**I.D.:** 9 1/2 (241.3)  
**Height:** 15 15/16 (404.8)

**PA1688**

Air Element



**Contains:** Flame Retardant Media  
**Fits:** Caterpillar Lift Trucks  
**Replaces:** Caterpillar 35-8896; GMC 25041709  
**O.D.:** 2 15/16 (74.6)  
     Flange 3 1/4 (82.6)  
**I.D.:** 2 (50.8) One End  
**Height:** 3 15/16 (100.0)

**PA1689**

Air Element



**Replaces:** White 3399-H2, 877834  
**O.D.:** 7 5/16 (185.7)  
**I.D.:** 5 5/16 (134.9)  
**Height:** 6 1/2 (165.1)  
**A. Gskt:** [2] Attached

Measurements Are Shown In Inches And (Millimeters)

**WARNING:** These products can expose you to chemicals, including Diisononyl Phthalate, Carbon black extracts, Nickel, 1,3 Butadiene, Ethylene Oxide, Epichlorohydrin, which are known to the State of California to cause cancer, and Bisphenol, Ethylene Glycol, Ethylene Oxide, 1,3 Butadiene, Epichlorohydrin, which are known to the State of California to cause birth defects or other reproductive harm.

**LL1690-FN**

Long Life Air Element with Fins



**Notes:** Outer element on some applications.  
**Fits:** Allis Chalmers, Benford, Bobcat, Case, Case-International, Clark, Ford, Gehl, John Deere, Komatsu, Kubota Equipment; Thermo King Refrigeration Units  
**Use With:** PA2861, PA4740  
**Replaces:** Allis Chalmers 2103129; Case 542276; Caterpillar 9Y6839; Clark 1642645  
**O.D.:** 4 3/32 (104.0)  
**Fins:** 5 1/8 (130.2)  
**I.D.:** 25/32 (19.8) & 2 15/32 (62.7)  
**Height:** 10 11/32 (262.7)  
**A. Gskt:** [1] Attached  
**F. Gskt:** G103-N  
**Related To:** PA1690-FN (Standard Media Version)

**PA1698**

Air Element



**Contains:** Flame Retardant Media  
**Replaces:** Donaldson P133672, P133708  
**O.D.:** 8 1/16 (204.8)  
**I.D.:** 5 3/4 (146.0)  
**Height:** 4 (101.6)

**PA1690-FN**

Air Element with Fins



**Notes:** Outer element on some applications.  
**Fits:** Allis Chalmers, Benford, Bobcat, Case, Case-International, Clark, Ford, Gehl, John Deere, Komatsu, Kubota Equipment; Thermo King Refrigeration Units  
**Use With:** PA2861, PA4740  
**Replaces:** Allis Chalmers 2103129; Case 542276; Caterpillar 9Y6839; Clark 1642645  
**O.D.:** 4 3/32 (104.0)  
**Fins:** 5 1/8 (130.2)  
**I.D.:** 25/32 (19.8) & 2 15/32 (62.7)  
**Height:** 10 11/32 (262.7)  
**A. Gskt:** [1] Attached  
**F. Gskt:** G103-N  
**Related To:** LL1690-FN (Long-Life Media Version)

**PA1699-FN**

Air Element with Fins



**Fits:** Allis Chalmers, Case Equipment  
**Replaces:** Allis Chalmers 239622; Case A59586  
**O.D.:** 6 3/32 (154.8)  
**Fins:** 7 13/16 (198.4)  
**I.D.:** 25/32 (19.8) & 3 15/32 (88.1)  
**Height:** 14 15/32 (367.5)  
**A. Gskt:** [1] Attached  
**F. Gskt:** G103-N

**PA1692**

Air Element with Lift Tab



**Fits:** Dresser, Drott, Elgin, International, Wayne Equipment  
**Replaces:** Drott 71405; Elgin 7075795; International 338744-R91; Wayne 47180  
**O.D.:** 5 1/2 (139.7)  
**I.D.:** 3 1/8 (79.4) One End  
**Height:** 17 1/4 (438.2)  
**A. Gskt:** [1] Attached

**PA1700**

Dual-Stage Air Element with Blanket and Screen



**Fits:** Autocar, Brockway, Diamond Reo Trucks; Allis Chalmers, Caterpillar, Gradall, Hyster Equipment  
**Replaces:** Allis Chalmers 4051919; Brockway 22115; Towmotor 633075  
**O.D.:** 8 11/32 (211.9)  
**I.D.:** 3 7/8 (98.4) One End  
**Height:** 9 11/16 (246.1)  
**Related To:** PA617 (Standard Version)

**PA1701**

Dual-Stage Air Element with Blanket and Screen



**Fits:** Diamond Reo Trucks; Allis Chalmers Equipment  
**Use With:** PA1701 FOAM  
**Replaces:** Allis Chalmers 4051918; Hough 165935-H1  
**O.D.:** 9 9/16 (242.9)  
**I.D.:** 5 1/8 (130.2) One End  
**Height:** 11 19/32 (294.5)  
**Related To:** PA1913 (Other Housings) PA2627 (Both Ends Open)

**PA1696**

Air Element



**Fits:** Austin, MG Automotive  
**Replaces:** Leyland 17H2538  
**O.D.:** 5 (127.0)  
**I.D.:** 3 9/16 (90.5)  
**Height:** 3 11/16 (93.7)

**PA1701 ELE**

Air Element



**Fits:** Diamond Reo Trucks; Allis Chalmers Equipment  
**Use With:** PA1701 FOAM  
**Replaces:** Allis Chalmers 4051918; Hough 165935-H1  
**O.D.:** 9 9/16 (242.9)  
**I.D.:** 5 1/8 (130.2) One End  
**Height:** 11 19/32 (294.5)  
**Related To:** PA1913 (Other Housings) PA2627 (Both Ends Open)

**PA1697**

Air Element



**Fits:** MG Automotive  
**Replaces:** Austin-Healey 37H732  
**O.D.:** 4 5/16 (109.5)  
**I.D.:** 2 7/8 (73.0)  
**Height:** 3 11/16 (93.7)

**PA1701 FOAM**

Foam Blanket for PA1701 ELE



**Use With:** PA1701 ELE  
**Length:** 29 (736.6)  
**Width:** 10 1/2 (266.7)  
**Height:** 1 (25.4)

**PA1702**

Dual-Stage Air Element with Blanket and Screen



**Fits:** Cummins, Waukesha Engines; Ingersoll-Rand Compressors  
**Use With:** PA1702 FOAM  
**Replaces:** Allis Chalmers 4052520; Cummins 3001692; Waukesha 163972B  
**O.D.:** 12 15/32 (316.7)  
**I.D.:** 7 7/8 (200.0) One End  
**Height:** 16 (406.4)

Measurements Are Shown In Inches And (Millimeters)

**WARNING:** These products can expose you to chemicals, including Diisononyl Phthalate, Carbon black extracts, Nickel, 1,3 Butadiene, Ethylene Oxide, Epichlorohydrin, which are known to the State of California to cause cancer, and Bisphenol, Ethylene Glycol, Ethylene Oxide, 1,3 Butadiene, Epichlorohydrin, which are known to the State of California to cause birth defects or other reproductive harm.

**PA1702 FOAM**

Foam Blanket for PA1702



**Use With:** PA1702  
**Length:** 37 1/2 (952.5)  
**Width:** 15 3/4 (400.0)  
**Height:** 1 (25.4)

**PA1703**

Dual-Stage Air Element with Blanket and Screen



**Fits:** Caterpillar Engines  
**Replaces:** Caterpillar 4L8465  
**O.D.:** 9 15/16 (252.4)  
**I.D.:** 5 1/2 (139.7)  
**Height:** 12 (304.8)

**PA1704**

Air Compressor Breather Element



**Fits:** Bendix-Westinghouse Air Compressors; Brockway, Caterpillar, GMC, Kenworth, Mack Trucks  
**Replaces:** Bendix-Westinghouse 243009; Brockway 243009; Caterpillar 9L2169; GMC 2495698  
**O.D.:** 3 (76.2)  
**I.D.:** 1 5/8 (41.3)  
**Height:** 1 3/8 (34.9)

**PA1705-2**

Air Element with 2-Inch Pleats



**Fits:** Dresser, Hough, International Equipment  
**Replaces:** International 346777-R91  
**O.D.:** 12 1/32 (305.6)  
**I.D.:** 17/32 (13.5) & 7 11/16 (195.3)  
**Height:** 10 3/8 (263.5)  
**A. Gskt:** [1] Attached  
**F. Gskt:** [1] Included  
**Related To:** LL1626-2, PA1626-2 (without Attached Gasket)

**PA1706**

Air Element



**Notes:** Inside-Out Flow Direction  
**Fits:** Atlas Copco, Hough, International Equipment  
**Replaces:** Atlas Copco 16193784; International 346779-R91  
**O.D.:** 13 25/32 (350.0)  
**I.D.:** 1/2 (12.7) & 9 7/16 (239.7)  
**Height:** 14 1/2 (368.3)  
**A. Gskt:** [1] Attached  
**F. Gskt:** [1] Included  
**Related To:** PA1630 (without Attached Gasket) PA1706XP (Extreme Performance Nano Version)

**PA1706XP**

Extreme Performance Nano Air Element



**Notes:** OBSOLETE. Availability limited to Dealer Stock.  
Inside-Out Flow Direction  
**Fits:** Atlas Copco, Hough, International Equipment  
**Replaces:** Atlas Copco 16193784; International 346779-R91  
**O.D.:** 13 25/32 (350.0)  
**I.D.:** 1/2 (12.7) & 9 7/16 (239.7)  
**Height:** 14 1/2 (368.3)  
**A. Gskt:** [1] Attached  
**F. Gskt:** [1] Included  
**Related To:** PA1630 (without Attached Gasket) PA1706 (Standard Media Version)

**PA1707-FN**

Air Element with Fins



**Fits:** International, Minneapolis-Moline, Oliver, White Combines, Tractors  
**Replaces:** International 399631-R91; Oliver 158613A5; White 20-7002170  
**O.D.:** 5 1/4 (133.4)  
Fins 6 3/8 (161.9)  
**I.D.:** 2 1/32 (16.7) & 2 5/8 (66.7)  
**Height:** 14 1/4 (362.0)  
**A. Gskt:** [1] Attached  
**F. Gskt:** G103-N

**PA1709**

Cab Air Element



**Fits:** International, Steiger Equipment  
**Replaces:** International 383711-R94; Steiger 64-084  
**O.D.:** 6 3/32 (154.8)  
**I.D.:** 3/4 (19.0) & 3 15/32 (88.1)  
**Height:** 16 1/4 (412.8)  
**A. Gskt:** [1] Attached  
**F. Gskt:** G103-N

**PA1710**

Air Element



**Fits:** International Wheel Tractors  
**Replaces:** International 383732-R93  
**O.D.:** 6 3/32 (154.8)  
**I.D.:** 3/4 (19.0) & 3 15/32 (88.1)  
**Height:** 11 1/4 (285.8)  
**A. Gskt:** [1] Attached  
**F. Gskt:** G103-N

**PA1712**

Air Element



**Fits:** Burns, Cub Cadet, Ford, Gilson, Jacobsen, John Deere, Lambert, Massey Ferguson, Roper, Springfield Lawn & Garden Tractors; Kohler, Tecumseh Engines; Ingersoll-Rand Compressors  
**Replaces:** John Deere AM30800; Kohler 231847; Tecumseh-Lauson 31925; Massey Ferguson 231847  
**O.D.:** 4 13/32 (111.9)  
**I.D.:** 2 15/16 (74.6)  
**Height:** 2 3/8 (60.3)

**PA1718**

Air Element



**Fits:** Lister-Petter, Rolls-Royce Engines  
**Replaces:** Lister-Petter 20126010  
**O.D.:** 5 1/2 (139.7)  
**I.D.:** 3 1/4 (82.6)  
**Height:** 4 1/2 (114.3)

**PA1719**

Air Element



**Fits:** Case, David Brown, Eddison Equipment; Lister Engines  
**Replaces:** Case K922630; David Brown 922630; Lister 194010  
**O.D.:** 8 1/4 (209.6)  
**I.D.:** 5 7/8 (149.2)  
**Height:** 3 15/16 (100.0)

Measurements Are Shown In Inches And (Millimeters)

**WARNING:** These products can expose you to chemicals, including Diisononyl Phthalate, Carbon black extracts, Nickel, 1,3 Butadiene, Ethylene Oxide, Epichlorohydrin, which are known to the State of California to cause cancer, and Bisphenol, Ethylene Glycol, Ethylene Oxide, 1,3 Butadiene, Epichlorohydrin, which are known to the State of California to cause birth defects or other reproductive harm.

**PA1721**

Air Element



**Replaces:** Gardner Denver 2010265  
**O.D.:** 5 3/4 (146.0)  
**I.D.:** 4 1/8 (104.8)  
**Height:** 5 31/32 (151.6)

**PA1752-FN**

Air Element with Fins



**Fits:** John Deere Tractors  
**Replaces:** John Deere AH19848  
**O.D.:** 5 1/4 (133.4)  
Fins 6 3/8 (161.9)  
**I.D.:** 2 1/32 (16.7) & 2 5/8 (66.7)  
**Height:** 9 3/8 (238.1)  
**A. Gskt:** [1] Attached  
**F. Gskt:** G103-N

**PA1726**

Inner Air Element



**Fits Inside:** PA666  
**Fits:** Galion Graders; Optional Purolator Housings  
**Replaces:** Purolator 6659367  
**O.D.:** 6 5/8 (168.3)  
**I.D.:** 4 1/4 (108.0)  
**Height:** 14 1/2 (368.3)

**PA1753-FN**

Air Element with Fins



**Fits:** John Deere Equipment  
**Replaces:** John Deere AH69798  
**O.D.:** 6 3/32 (154.8)  
Fins 7 13/16 (198.4)  
**I.D.:** 3/4 (19.0) & 3 15/32 (88.1)  
**Height:** 10 13/32 (264.3)  
**A. Gskt:** [1] Attached  
**F. Gskt:** G103-N

**PA1735**

Air Element



**Fits:** AMC, Chrysler, Ford, International Automotive, Light-Duty Trucks  
**Replaces:** Chrysler 8992873; Ford C7AF-9600-N  
**O.D.:** 10 1/16 (255.6)  
**I.D.:** 7 21/32 (194.5)  
**Height:** 2 3/8 (60.3)

**PA1754**

Air Element with Lift Tab



**Fits:** Bantam, Bros, Dresser, Drott, International, Wayne Equipment  
**Replaces:** GMC 6483853; International 603889-C91; White 1739647  
**O.D.:** 7 (177.8)  
**I.D.:** 4 13/32 (111.9) One End  
**Height:** 20 1/4 (514.4)  
**A. Gskt:** [1] Attached

**PA1748**

Air Element



**Fits:** Gravely Tractors  
**Replaces:** Gravely L823D, L832E, 13042P1  
**O.D.:** 3 11/16 (93.7)  
**I.D.:** 2 3/16 (55.6)  
**Height:** 4 1/8 (104.8)

**PA1755-FN**

Air Element with Fins



**Fits:** Allis Chalmers Equipment  
**Replaces:** Allis Chalmers 3038732-9  
**O.D.:** 7 15/16 (201.6)  
Fins 10 1/16 (255.6)  
**I.D.:** 1/2 (12.7) & 3 9/16 (90.5)  
**Height:** 13 3/8 (339.7)  
**A. Gskt:** [1] Attached  
**F. Gskt:** [1] Included

**PA1749-FN**

Air Element with Fins



**Fits:** GMC Trucks; Murphy Diesel Engines  
**Replaces:** GMC 5197106; Murphy MD24618  
**O.D.:** 7 15/16 (201.6)  
Fins 10 1/16 (255.6)  
**I.D.:** 1/2 (12.7) & 3 9/16 (90.5)  
**Height:** 12 1/4 (311.2)  
**A. Gskt:** [1] Attached  
**F. Gskt:** [1] Included

**PA1757**

Air Breather Element



**Fits:** Jay Tampers  
**Replaces:** Davey 200595  
**O.D.:** 3 7/16 (87.3)  
**I.D.:** 2 3/8 (60.3)  
**Height:** 2 1/16 (52.4)

**PA1750-FN**

Air Element with Fins



**Fits:** Hino, International, Mitsubishi Trucks  
**Replaces:** GMC 6486936; Hino 17801-1150; International 381667-C91; Mitsubishi 30930-35100  
**O.D.:** 9 7/32 (234.2)  
Fins 11 5/8 (295.3)  
**I.D.:** 5/8 (15.9) & 4 27/32 (123.0)  
**Height:** 10 3/8 (263.5)  
**A. Gskt:** [1] Attached  
**F. Gskt:** [1] Included

**PA1758**

Air Element



**Contains:** Flame Retardant Media  
**Fits:** GM Automotive, Light-Duty Trucks  
**Replaces:** GMC 6424140  
**O.D.:** 13 7/8 (352.4)  
**I.D.:** 11 5/8 (295.3)  
**Height:** 3 (76.2)

Measurements Are Shown In Inches And (Millimeters)

**WARNING:** These products can expose you to chemicals, including Diisononyl Phthalate, Carbon black extracts, Nickel, 1,3 Butadiene, Ethylene Oxide, Epichlorohydrin, which are known to the State of California to cause cancer, and Bisphenol, Ethylene Glycol, Ethylene Oxide, 1,3 Butadiene, Epichlorohydrin, which are known to the State of California to cause birth defects or other reproductive harm.

**PA1763**



Air Breather Element  
**Fits:** Galion Equipment  
**Replaces:** Galion D59585  
**O.D.:** 2 7/32 (56.4)  
**I.D.:** 1 1/32 (26.2)  
**Height:** 2 5/16 (58.7)

**PA1772**



Tube-Type Air Filter  
**Contains:** 6 Tubes--2 x 3  
**Fits:** Blaw-Knox, CMI Equipment; Farr  
 Optional Housings  
**Replaces:** Farr P6  
**Length:** 8 1/4 (209.6)  
**Width:** 5 31/32 (151.6)  
**Height:** 8 1/8 (206.4)

**PA1765**



Panel Air Element  
**Notes:** Do NOT use in cab air ventilation  
 systems.  
**Fits:** Atlas Copco Compressors; Caterpillar  
 Industrial, Marine Engines  
**Use With:** PA1765 FOAM  
**Replaces:** Caterpillar 6L4714  
**Length:** 24 (609.6)  
**Width:** 24 (609.6)  
**Height:** 2 9/16 (65.1)  
**A. Gskt:** [1] Attached

**PA1773**



Tube-Type Air Filter  
**Contains:** 9 Tubes--3 x 3  
**Fits:** Farr Optional Housings  
**Replaces:** Farr P9  
**Length:** 8 5/16 (211.1)  
**Width:** 8 5/16 (211.1)  
**Height:** 8 1/16 (204.8)

**PA1765 FOAM**



Foam Blanket for PA1765  
**Use With:** PA1765  
**Length:** 26 (660.4)  
**Width:** 24 (609.6)

**PA1774**



Tube-Type Air Filter  
**Contains:** 12 Tubes--3 x 4  
**Fits:** Dynahoe, Pettibone Equipment; Farr  
 Optional Housings  
**Replaces:** Farr P12  
**Length:** 10 9/16 (268.3)  
**Width:** 8 1/4 (209.6)  
**Height:** 8 1/16 (204.8)

**PA1768**



Air Element  
**Fits:** Joy Compressors  
**Replaces:** Joy 1224040  
**O.D.:** 11 1/8 (282.6)  
**I.D.:** 3/8 (9.5) & 6 3/16 (157.2)  
**Height:** 18 1/8 (460.4)  
**A. Gskt:** [1] Attached  
**F. Gskt:** [1] Included, [1] Wing Bolt

**PA1775**



Tube-Type Air Filter  
**Contains:** 12 Tubes--2 x 6  
**Fits:** Allis Chalmers, Blaw-Knox Equipment;  
 Farr Optional Housings  
**Replaces:** Farr P12-26  
**Length:** 15 3/16 (385.8)  
**Width:** 5 15/16 (150.8)  
**Height:** 8 5/32 (207.2)

**PA1769**



Air Element with Lift Bar  
**Fits:** International, Michigan Equipment  
**Replaces:** Eaton 509081800  
**O.D.:** 7 (177.8)  
**I.D.:** 4 3/8 (111.1) One End  
**Height:** 9 1/4 (235.0)  
**A. Gskt:** [1] Attached

**PA1776**



Tube-Type Air Filter  
**Contains:** 16 Tubes--4 x 4  
**Fits:** Dresser, International, Taylor, Timberjack  
 Equipment; Farr Optional Housings  
**Replaces:** Farr P16  
**Length:** 10 9/16 (268.3)  
**Width:** 10 9/16 (268.3)  
**Height:** 8 1/8 (206.4)

**PA1771**



Tube-Type Air Filter  
**Contains:** 4 Tubes--2 x 2  
**Fits:** Bobcat Loaders; Farr Optional Housings;  
 Lister Engines  
**Replaces:** Farr P4  
**Length:** 8 1/16 (204.8)  
**Width:** 6 (152.4)  
**Height:** 6 (152.4)

**PA1777**



Tube-Type Air Filter  
**Contains:** 16 Tubes--2 x 8  
**Fits:** Clark, Michigan Equipment; Farr Optional  
 Housings  
**Replaces:** Farr P16-28  
**Length:** 19 27/32 (504.0)  
**Width:** 5 31/32 (151.6)  
**Height:** 8 5/32 (207.2)

**PA1778**



Tube-Type Air Filter  
**Contains:** 20 Tubes--4 x 5  
**Fits:** Farr Optional Housings; Taylor  
 Equipment  
**Replaces:** Farr P20  
**Length:** 12 13/16 (325.4)  
**Width:** 10 9/16 (268.3)  
**Height:** 8 5/32 (207.2)

Measurements Are Shown In Inches And (Millimeters)

**WARNING:** These products can expose you to chemicals, including Diisononyl Phthalate, Carbon black extracts, Nickel, 1,3 Butadiene, Ethylene Oxide, Epichlorohydrin, which are known to the State of California to cause cancer, and Bisphenol, Ethylene Glycol, Ethylene Oxide, 1,3 Butadiene, Epichlorohydrin, which are known to the State of California to cause birth defects or other reproductive harm.

**PA1779**

Tube-Type Air Filter



**Contains:** 24 Tubes--4 x 6  
**Fits:** Allis Chalmers, Clark, Dresser, Euclid, International, Massey Ferguson Equipment; Farr Optional Housings  
**Replaces:** Farr P24  
**Length:** 15 3/16 (385.8)  
**Width:** 10 9/16 (268.3)  
**Height:** 8 5/32 (207.2)

**PA1780**

Tube-Type Air Filter

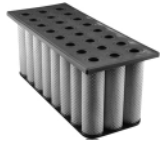

**Contains:** 24 Tubes--3 x 8  
**Fits:** Dodge, Leyland Trucks; Farr Optional Housings; Rolls-Royce Engines  
**Replaces:** Farr P24-38  
**Length:** 19 7/8 (504.8)  
**Width:** 8 1/4 (209.6)  
**Height:** 8 5/32 (207.2)

**PA1781**

Tube-Type Air Filter



**Contains:** 32 Tubes--4 x 8  
**Fits:** Allis Chalmers, International, Michigan, M-R-S Equipment; Farr Optional Housings; Ingersoll-Rand Compressors  
**Replaces:** Farr P32  
**Length:** 19 7/8 (504.8)  
**Width:** 10 9/16 (268.3)  
**Height:** 8 5/32 (207.2)

**PA1782**

Tube-Type Air Filter

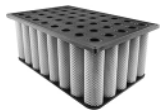

**Contains:** 40 Tubes--5 x 8  
**Fits:** Allis Chalmers, International, Michigan, Equipment; Farr Optional Housings; Ingersoll-Rand, Sullair Compressors  
**Replaces:** Farr P40  
**Length:** 19 29/32 (505.6)  
**Width:** 12 25/32 (324.6)  
**Height:** 8 5/32 (207.2)

**PA1783**

Tube-Type Air Filter

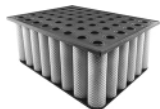

**Contains:** 48 Tubes--6 x 8  
**Fits:** Allis Chalmers, Caterpillar, CMI, Michigan Equipment; Cummins Engines; Dodge Trucks; Farr Optional Housings  
**Replaces:** Farr P48  
**Length:** 19 7/8 (504.8)  
**Width:** 15 7/32 (386.6)  
**Height:** 8 5/32 (207.2)

**PA1784**

Tube-Type Air Filter

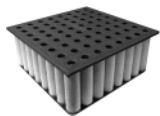

**Contains:** 64 Tubes--8 x 8  
**Fits:** Euclid, International, Kawasaki, WABCO Equipment; Farr Optional Housings  
**Replaces:** Farr P64  
**Length:** 19 13/16 (503.2)  
**Width:** 19 13/16 (503.2)  
**Height:** 8 1/8 (206.4)

**PA1786**

Air Element



**Fits:** GMC, International Buses, Trucks  
**Replaces:** GMC 3906250  
**O.D.:** 12 15/16 (328.6)  
**I.D.:** 10 7/16 (265.1)  
**Height:** 3 (76.2)

**PA1787**

Air Element



**Fits:** Chrysler Industrial Engines; Cleveland Equipment  
**Replaces:** GMC 6487076  
**O.D.:** 6 3/32 (154.8)  
**I.D.:** 7/16 (11.1) & 2 31/32 (75.4)  
**Height:** 8 7/8 (225.4)  
**A. Gskt:** [1] Attached  
**F. Gskt:** [1] Included

**PA1788**

Air Element



**Fits:** Cummins Engines; Yale & Towne Cranes, Loaders  
**Replaces:** Vortex VF120A; Yale 6952220  
**O.D.:** 8 7/8 (225.4)  
**I.D.:** 7/16 (11.1) & 5 (127.0)  
**Height:** 10 1/8 (257.2)  
**A. Gskt:** [1] Attached  
**F. Gskt:** [1] Included

**PA1789**

Air Element



**Fits:** Mack Trucks  
**Replaces:** GMC 6486928  
**O.D.:** 10 3/8 (263.5)  
**I.D.:** 1/2 (12.7) & 5 1/2 (139.7)  
**Height:** 10 3/8 (263.5)  
**A. Gskt:** [1] Included  
**F. Gskt:** [1] Included

**PA1790**

Air Element



**Fits:** International Trucks  
**Replaces:** GMC 6488334; International 397549-C91  
**O.D.:** 11 7/8 (301.6)  
**I.D.:** 7/16 (11.1) & 7 1/8 (181.0)  
**Height:** 13 3/8 (339.7)  
**A. Gskt:** [1] Attached  
**F. Gskt:** [1] Included

**PA1794-FN**

Outer Air Element with Fins



**Fits:** John Deere Equipment  
**Use With:** PA1921, PA2622  
**Replaces:** John Deere AR39799  
**O.D.:** 6 27/32 (173.8)  
**I.D.:** 2 1/32 (16.7) & 4 5/32 (105.6)  
**Height:** 10 1/2 (266.7)  
**A. Gskt:** [1] Attached  
**F. Gskt:** G103-N

**PA1795**

Air Element



**Fits:** Air Refiner ARH27 Housing  
**Replaces:** Air Refiner ARP27  
**O.D.:** 9 1/8 (231.8)  
**I.D.:** 6 7/8 (174.6)  
**Height:** 12 (304.8)

Measurements Are Shown In Inches And (Millimeters)

**WARNING:** These products can expose you to chemicals, including Diisononyl Phthalate, Carbon black extracts, Nickel, 1,3 Butadiene, Ethylene Oxide, Epichlorohydrin, which are known to the State of California to cause cancer, and Bisphenol, Ethylene Glycol, Ethylene Oxide, 1,3 Butadiene, Epichlorohydrin, which are known to the State of California to cause birth defects or other reproductive harm.

**PA1797** Inner Air Element  
**Notes:** Flange contains [9] bolt holes.  
**Fits Inside:** PA1815  
**Fits:** Caterpillar Equipment  
**Replaces:** Caterpillar 3S4745  
**O.D.:** 8 5/8 (219.1)  
 Flange 12 (304.8)  
**I.D.:** 6 31/32 (177.0) One End  
**Height:** 15 11/32 (389.7)  
**A. Gskt:** [1] Attached



**PA1810** Air Element  
**Replaces:** Cummins 701645  
**O.D.:** 9 5/8 (244.5)  
**I.D.:** 5 3/8 (136.5)  
**Height:** 12 3/16 (309.6)  
**A. Gskt:** [2] Attached



**PA1798** Air Element  
**Notes:** Sometimes used as Cab Air on Steiger Tractors.  
**Fits:** Chevrolet, GMC Buses, Trucks; Steiger Tractors  
**Replaces:** GMC 6423239  
**O.D.:** 11 5/16 (287.3)  
**I.D.:** 8 17/32 (216.7)  
**Height:** 5 9/16 (141.3)  
**Related To:** PA1800 (with Foam Wrap)



**PA1814** Air Element  
**Fits:** Fiat, Triumph Automotive  
**Replaces:** Fiat 4110530  
**O.D.:** 6 7/8 (174.6)  
**I.D.:** 5 1/8 (130.2)  
**Height:** 2 (50.8)



**PA1800** Air Element with Foam Wrap  
**Notes:** Sometimes used as Cab Air on Ford, Steiger Equipment.  
**Fits:** Ford, Steiger Equipment; GMC Buses, Trucks  
**Replaces:** Ford SFD54304; GMC 8877141  
**O.D.:** 12 (304.8)  
**I.D.:** 8 17/32 (216.7)  
**Height:** 5 9/16 (141.3)  
**Related To:** PA1798 (without Foam Wrap)



**PA1815** Outer Air Element with Lid  
**Fits:** Caterpillar Equipment  
**Use With:** PA1797, PA2625  
**Replaces:** Caterpillar 5S4282  
**O.D.:** 13 5/8 (346.1)  
 Lid 16 7/16 (417.5)  
**I.D.:** 15/16 (23.8) & 9 15/16 (252.4)  
**Height:** 16 5/32 (410.4)  
**A. Gskt:** [2] Attached



**PA1802** Air Element  
**Fits:** BMW, Ford Automotive, Light-Duty Trucks  
**Replaces:** Ford E4TE-9601-AA  
**O.D.:** 11 13/16 (300.0)  
**I.D.:** 9 13/16 (249.2)  
**Height:** 2 1/8 (54.0)



**PA1816** Outer Air Element with Lid  
**Fits:** Caterpillar Equipment  
**Use With:** PA1817  
**Replaces:** Caterpillar 4S8833  
**O.D.:** 12 3/4 (323.8)  
 Lid 14 17/32 (369.1)  
**I.D.:** 15/16 (23.8) & 8 11/32 (211.9)  
**Height:** 9 13/16 (249.2)  
**A. Gskt:** [2] Attached  
**F. Gskt:** [1] Included



**PA1805** Air Element  
**Fits:** Allmand Equipment with Optional United Housings  
**Replaces:** United 250A13  
**O.D.:** 6 11/32 (161.1)  
**I.D.:** 4 5/32 (105.6)  
**Height:** 3 1/32 (77.0)



**PA1817** Inner Air Element with 8 Bolt Holes  
**Fits Inside:** PA1816  
**Fits:** Caterpillar Equipment  
**Replaces:** Caterpillar 4S8834  
**O.D.:** 7 5/8 (193.7)  
 Flange 10 1/4 (260.3)  
**I.D.:** 6 (152.4) One End  
**Height:** 8 25/32 (223.0)  
**A. Gskt:** [1] Attached



**PA1806** Tube-Type Air Filter  
**Contains:** 18 Tubes--3 x 6  
**Fits:** Allis Chalmers Tractors; Farr Optional Housings  
**Replaces:** Allis Chalmers 70644042; Farr P18  
**Length:** 15 3/16 (385.8)  
**Width:** 8 1/4 (209.6)  
**Height:** 8 1/8 (206.4)



**PA1818** Outer Air Element with Lid  
**Fits:** Caterpillar Equipment  
**Use With:** PA1819, PA2738  
**Replaces:** Caterpillar 4S8337  
**O.D.:** 12 3/4 (323.8)  
 Lid 14 17/32 (369.1)  
**I.D.:** 15/16 (23.8) & 8 3/8 (212.7)  
**Height:** 14 1/2 (368.3)  
**A. Gskt:** [2] Attached



**PA1809** Inner Air Element  
**Fits Inside:** PA1683, PA1684, PA2331, PA2431, PA2496  
**Fits:** Caterpillar, Ford, Massey Ferguson Equipment  
**Replaces:** Ford E6NN-9R500-DA  
**O.D.:** 2 1/8 (54.0)  
 Flange 2 11/32 (59.5)  
**I.D.:** 5/8 (15.9) & 1 7/8 (47.6)  
**Height:** 9 7/8 (250.8)  
**F. Gskt:** [1] Included  
**O-Ring:** [1] Attached



Measurements Are Shown In Inches And (Millimeters)

**WARNING:** These products can expose you to chemicals, including Diisononyl Phthalate, Carbon black extracts, Nickel, 1,3 Butadiene, Ethylene Oxide, Epichlorohydrin, which are known to the State of California to cause cancer, and Bisphenol, Ethylene Glycol, Ethylene Oxide, 1,3 Butadiene, Epichlorohydrin, which are known to the State of California to cause birth defects or other reproductive harm.



**PA1819** Inner Air Element with 8 Bolt Holes  
**Fits Inside:** PA1818  
**Fits:** Caterpillar Equipment  
**Replaces:** Caterpillar 4S8340  
**O.D.:** 7 5/8 (193.7)  
 Flange 10 1/4 (260.3)  
**I.D.:** 6 (152.4) One End  
**Height:** 13 15/32 (342.1)  
**A. Gskt:** [1] Attached



**PA1826** Inner Air Element with 8 Bolts  
**Fits Inside:** PA1827  
**Fits:** International Equipment  
**Replaces:** International 390643-R91  
**O.D.:** 4 9/16 (115.9)  
 Flange 7 (177.8)  
**I.D.:** 3 3/8 (85.7) One End  
**Height:** 15 (381.0)  
**A. Gskt:** [1] Attached



**PA1821** Air Element  
**Fits:** Massey Ferguson Tractors  
**Replaces:** Massey Ferguson 1029945-M92  
**O.D.:** 4 3/32 (104.0)  
**I.D.:** 3/8 (9.5) & 2 15/32 (62.7)  
**Height:** 9 3/8 (238.1)  
**A. Gskt:** [1] Attached  
**F. Gskt:** [1] Included, [1] Wing Bolt



**PA1827** Outer Air Element  
**Fits:** International Equipment  
**Use With:** PA1826  
**Replaces:** International 390642-R91  
**O.D.:** 9 7/32 (234.2)  
**I.D.:** 4 27/32 (123.0) One End  
**Height:** 16 3/8 (415.9)  
**A. Gskt:** [1] Attached



**PA1822-FN** Outer Air Element with Fins  
**Fits:** J.C. Bamford, Massey Ferguson, Oliver Equipment  
**Use With:** PA2305  
**Replaces:** Massey Ferguson 726199-M1; Oliver 159089A  
**O.D.:** 6 3/32 (154.8)  
 Fins 7 13/16 (198.4)  
**I.D.:** 3/4 (19.0) & 3 15/32 (88.1)  
**Height:** 15 5/16 (388.9)  
**A. Gskt:** [1] Attached  
**F. Gskt:** G103-N  
**Related To:** PA2418-FN (Different Gasket)



**PA1828** Air Element  
**Fits:** Ford Automotive  
**Replaces:** Ford C7SF-9601-A  
**O.D.:** 13 9/32 (337.3)  
**I.D.:** 11 9/32 (286.5)  
**Height:** 2 7/32 (56.4)



**PA1823** Air Element  
**Fits:** International Payhaulers  
**Replaces:** International 606029-C91  
**O.D.:** 11 1/8 (282.6)  
**I.D.:** 5/8 (15.9) & 6 23/32 (170.7)  
**Height:** 18 1/2 (469.9)  
**A. Gskt:** [1] Attached  
**F. Gskt:** [1] Included



**PA1830-FN** Air Element with Fins  
**Fits:** International Tractors  
**Replaces:** International 381344-R91  
**O.D.:** 5 1/4 (133.4)  
 Fins 6 3/8 (161.9)  
**I.D.:** 21/32 (16.7) & 2 5/8 (66.7)  
**Height:** 10 1/4 (260.3)  
**A. Gskt:** [1] Attached  
**F. Gskt:** G103-N



**PA1824** Outer Air Element  
**Fits:** Dresser, International Equipment  
**Use With:** PA1825  
**Replaces:** International 606860-C91  
**O.D.:** 9 7/32 (234.2)  
**I.D.:** 4 27/32 (123.0) One End  
**Height:** 18 3/8 (466.7)  
**A. Gskt:** [1] Attached



**PA1831** Air Element  
**Fits:** Massey Ferguson Tractors; Perkins Engines  
**Replaces:** Massey Ferguson 1028094-M91  
**O.D.:** 6 1/16 (154.0)  
**I.D.:** 3/8 (9.5) & 3 15/32 (88.1)  
**Height:** 15 1/2 (393.7)  
**A. Gskt:** [1] Attached  
**F. Gskt:** [1] Included, [1] Wing Bolt



**PA1825** Inner Air Element with 8 Bolts  
**Fits Inside:** PA1824  
**Fits:** Dresser, International Equipment  
**Replaces:** International 606861-C91  
**O.D.:** 4 9/16 (115.9)  
 Flange 7 (177.8)  
**I.D.:** 3 3/8 (85.7) One End  
**Height:** 17 1/32 (432.6)  
**A. Gskt:** [1] Attached



**PA1832** Air Element  
**Fits:** Petter Engines; V.M.E. Loaders; Volvo Equipment  
**Replaces:** Petter ZFP35/6  
**O.D.:** 5 1/2 (139.7)  
**I.D.:** 3 1/4 (82.6)  
**Height:** 2 5/16 (58.7)



**PA1834** Air Element  
**Fits:** Benford Equipment; Petter Engines  
**Replaces:** Petter AAF449/6  
**O.D.:** 3 17/32 (89.7)  
**I.D.:** 2 (50.8)  
**Height:** 2 (50.8)



Measurements Are Shown In Inches And (Millimeters)

**WARNING:** These products can expose you to chemicals, including Diisononyl Phthalate, Carbon black extracts, Nickel, 1,3 Butadiene, Ethylene Oxide, Epichlorohydrin, which are known to the State of California to cause cancer, and Bisphenol, Ethylene Glycol, Ethylene Oxide, 1,3 Butadiene, Epichlorohydrin, which are known to the State of California to cause birth defects or other reproductive harm.

**PA1836**

Inner Air Element



**Fits Inside:** PA1837-FN, PA2338-FN  
**Fits:** International Equipment  
**Replaces:** International 392516-R91  
**O.D.:** 5 1/4 (133.4)  
**I.D.:** 5/8 (15.9) & 4 1/8 (104.8)  
**Height:** 13 3/8 (339.7)  
**A. Gskt:** [1] Attached  
**F. Gskt:** [1] Included

**PA1837-FN**

Outer Air Element with Fins



**Fits:** International Equipment  
**Use With:** PA1836  
**Replaces:** International 392517-R91  
**O.D.:** 7 15/16 (201.6)  
 Fins 10 1/16 (255.6)  
**I.D.:** 5 3/8 (136.5) One End  
**Height:** 14 5/16 (363.5)  
**A. Gskt:** [1] Attached

**PA1840**

Air Element



**Replaces:** Ford C5TF-9600-Y  
**O.D.:** 9 7/32 (234.2)  
**I.D.:** 5/8 (15.9) & 4 27/32 (123.0)  
**Height:** 10 3/32 (256.4)  
**A. Gskt:** [1] Attached  
**F. Gskt:** [1] Included  
**Related To:** PA2412 (with Air Restriction Gauge Fitting)

**PA1841**

Air Element



**Fits:** Chevrolet, GMC Light-Duty Trucks  
**Replaces:** GMC 6485194  
**O.D.:** 10 1/8 (257.2)  
**I.D.:** 7 1/2 (190.5)  
**Height:** 3 1/8 (79.4)

**PA1845**

Air Element



**Fits:** Ford Trucks  
**Replaces:** Ford C7TZ-9601-D  
**O.D.:** 9 3/4 (247.7)  
**I.D.:** 7/16 (11.1) & 5 1/4 (133.4)  
**Height:** 13 29/32 (353.2)  
**A. Gskt:** [1] Attached  
**F. Gskt:** [1] Included, [1] Wing Bolt

**LL1846**

Long Life Outer Air Element



**Fits:** Chevrolet, Ford, GMC, Nissan, R.V.I., Scania Trucks; Allis Chalmers, Euclid, Fiat-Allis, Grove, Koehring, Michigan, WABCO Equipment  
**Use With:** PA1880  
**Replaces:** Allis Chalmers 659386; Euclid 9232508; Fiat 70198780; Ford D0HZ-9601-H; GMC 6489643  
**O.D.:** 12 1/8 (308.0)  
**I.D.:** 5/8 (15.9) & 7 11/16 (195.3)  
**Height:** 18 1/2 (469.9)  
**A. Gskt:** [1] Attached  
**F. Gskt:** G103-N  
**Related To:** PA1846 (Standard Version)  
 PA1846XP (Extreme Performance Nano Version)

**PA1846**

Outer Air Element



**Fits:** Chevrolet, Ford, GMC, Nissan, R.V.I., Scania Trucks; Allis Chalmers, Euclid, Fiat-Allis, Grove, Koehring, Michigan, WABCO Equipment  
**Use With:** PA1880  
**Replaces:** Allis Chalmers 659386; Euclid 9232508; Fiat 70198780; Ford D0HZ-9601-H; GMC 6489643  
**O.D.:** 12 1/8 (308.0)  
**I.D.:** 5/8 (15.9) & 7 11/16 (195.3)  
**Height:** 18 1/2 (469.9)  
**A. Gskt:** [1] Attached  
**F. Gskt:** G103-N  
**Related To:** LL1846 (Long-Life Media Version)  
 PA1846XP (Extreme Performance Nano Version)

**PA1846XP**

Extreme Performance Nano Outer Air Element



**Fits:** Chevrolet, Ford, GMC, Nissan, R.V.I., Scania Trucks; Allis Chalmers, Euclid, Fiat-Allis, Grove, Koehring, Michigan, WABCO Equipment  
**Use With:** PA1880  
**Replaces:** Allis Chalmers 659386; Euclid 9232508; Fiat 70198780; Ford D0HZ-9601-H; GMC 6489643  
**O.D.:** 12 1/8 (308.0)  
**I.D.:** 5/8 (15.9) & 7 11/16 (195.3)  
**Height:** 18 1/2 (469.9)  
**A. Gskt:** [1] Attached  
**F. Gskt:** G103-N  
**Related To:** LL1846 (Long-Life Media Version)  
 PA1846 (Standard Media Version)

**PA1847-FN**

Outer Air Element with Fins



**Fits:** Joy Compressors  
**Use With:** PA1880  
**Replaces:** Joy 1224974  
**O.D.:** 12 (304.8)  
 Fins 15 3/4 (400.0)  
**I.D.:** 5/8 (15.9) & 7 11/16 (195.3)  
**Height:** 18 9/16 (471.5)  
**A. Gskt:** [1] Attached  
**F. Gskt:** G103-N

**PA1848**

Air Element



**Fits:** Ford Trucks  
**Replaces:** Ford C7TZ-9601-C  
**O.D.:** 8 9/32 (210.3)  
**I.D.:** 3/8 (9.5) & 4 7/16 (112.7)  
**Height:** 11 1/2 (292.1)  
**A. Gskt:** [1] Attached  
**F. Gskt:** [1] Included, [1] Wing Bolt

**PA1849**

Air Element with Lift Tab



**Fits:** Case Equipment  
**Replaces:** Case D46062  
**O.D.:** 7 (177.8)  
**I.D.:** 4 13/32 (111.9) One End  
**Height:** 12 5/8 (320.7)  
**A. Gskt:** [1] Attached

Measurements Are Shown In Inches And (Millimeters)

**WARNING:** These products can expose you to chemicals, including Diisononyl Phthalate, Carbon black extracts, Nickel, 1,3 Butadiene, Ethylene Oxide, Epichlorohydrin, which are known to the State of California to cause cancer, and Bisphenol, Ethylene Glycol, Ethylene Oxide, 1,3 Butadiene, Epichlorohydrin, which are known to the State of California to cause birth defects or other reproductive harm.

**PA1850-FN**

Air Element with Fins



**Fits:** Clark, Huber Equipment  
**Replaces:** Clark 1990272  
**O.D.:** 6 3/32 (154.8)  
**Fins:** 7 13/16 (198.4)  
**I.D.:** 3/4 (19.0) & 3 15/32 (88.1)  
**Height:** 16 1/4 (412.8)  
**A. Gskt:** [1] Attached  
**F. Gskt:** G103-N

**PA1860**

Air Element



**Replaces:** Worthington ELM13  
**O.D.:** 7 15/16 (201.6)  
**I.D.:** 6 9/32 (159.5)  
**Height:** 4 3/16 (106.4)

**PA1851**

Air Element



**Fits:** Barber-Greene, Winpower Equipment; Hercules Engines  
**Replaces:** GMC 6486930; White 40-0000619  
**O.D.:** 7 5/16 (185.7)  
**I.D.:** 7/16 (11.1) & 3 1/2 (88.9)  
**Height:** 10 3/8 (263.5)  
**A. Gskt:** [1] Attached  
**F. Gskt:** G39-AF

**PA1861**

Air Element



**Fits:** Chicago-Pneumatic, Sullair Compressors  
**Replaces:** Sullair 40099  
**O.D.:** 9 3/4 (247.7)  
**I.D.:** 6 1/16 (154.0)  
**Height:** 3 11/16 (93.7)

**PA1852**

Air Element



**Fits:** Mercedes-Benz, Opel Automotive  
**Replaces:** BMW 13720642102; Mercedes-Benz 947704; Opel 834252  
**O.D.:** 5 7/8 (149.2)  
**Top:** 6 1/2 (165.1)  
**I.D.:** 3 1/2 (88.9)  
**Height:** 4 9/32 (108.7)

**PA1863**

Air Element



**Replaces:** International 308504-C91  
**O.D.:** 12 1/32 (305.6)  
**I.D.:** 17/32 (13.5) & 7 11/16 (195.3)  
**Height:** 14 1/2 (368.3)  
**A. Gskt:** [1] Attached  
**F. Gskt:** [1] Included  
**Related To:** PA1676-FN (with Fins)

**PA1857**

Air Element



**Fits:** Worthington Compressors  
**Replaces:** Worthington FLR313  
**O.D.:** 5 3/4 (146.0)  
**I.D.:** 4 1/4 (108.0)  
**Height:** 4 1/8 (104.8)

**PA1864-FN**

Outer Air Element with Fins



**Fits:** Joy Compressors  
**Use With:** PA2455  
**Replaces:** Joy 519002  
**O.D.:** 11 1/8 (282.6)  
**Fins:** 13 3/4 (349.3)  
**I.D.:** 5/8 (15.9) & 6 23/32 (170.7)  
**Height:** 15 1/2 (393.7)  
**A. Gskt:** [1] Attached  
**F. Gskt:** G103-N

**PA1858**

Air Element



**Fits:** Bolens, Lockwood, Richmond Equipment; Wisconsin Engines  
**Replaces:** Wisconsin LO175B  
**O.D.:** 4 3/16 (106.4)  
**I.D.:** 1 15/16 (49.2)  
**Height:** 4 1/8 (104.8)

**PA1865-FN**

Air Element with Fins



**Fits:** Allis Chalmers, Bolens, Case, Ford, Gehl, John Deere, Kubota, Vermeer, Yanmar Equipment  
**Replaces:** Allis Chalmers 70246364; Bolens 1872002; Case D82571; John Deere M73009; Kubota 15227-87481  
**O.D.:** 3 1/4 (82.6)  
**Fins:** 4 1/4 (108.0)  
**I.D.:** 13/32 (10.3) & 1 27/32 (46.8)  
**Height:** 7 1/4 (184.2)  
**A. Gskt:** [1] Attached  
**F. Gskt:** [1] Included

**PA1859**

Air Element



**Fits:** Benford, Bolens, Midland Equipment; Wisconsin Engines  
**Replaces:** Wisconsin LO173B  
**O.D.:** 3 9/16 (90.5)  
**I.D.:** 2 1/8 (54.0)  
**Height:** 4 3/16 (106.4)

**PA1866**

Air Element



**Contains:** Flame Retardant Media  
**Fits:** Cummins Engines  
**Replaces:** Cummins 209892  
**O.D.:** 9 5/8 (244.5)  
**I.D.:** 5 (127.0)  
**Height:** 6 9/16 (166.7)  
**A. Gskt:** [2] Attached  
**Related To:** PA1867 (Long Version)

**PA1867**











Air Element



**Contains:** Flame Retardant Media  
**Fits:** Cummins Engines  
**Replaces:** Cummins 209893  
**O.D.:** 9 5/8 (244.5)  
**I.D.:** 5 (127.0)  
**Height:** 8 1/16 (204.8)  
**A. Gskt:** [2] Attached  
**Related To:** PA1866 (Short Version)

Measurements Are Shown In Inches And (Millimeters)

**WARNING:** These products can expose you to chemicals, including Diisononyl Phthalate, Carbon black extracts, Nickel, 1,3 Butadiene, Ethylene Oxide, Epichlorohydrin, which are known to the State of California to cause cancer, and Bisphenol, Ethylene Glycol, Ethylene Oxide, 1,3 Butadiene, Epichlorohydrin, which are known to the State of California to cause birth defects or other reproductive harm.

<p><b>PA1868</b></p>  <p>Air Element  <b>Fits:</b> Atlas Copco Compressors  <b>Replaces:</b> Atlas Copco 1619-1613  <b>O.D.:</b> 6 7/16 (163.5)  <b>I.D.:</b> 4 1/16 (103.2)  <b>Height:</b> 10 1/2 (266.7)  <b>A. Gskt:</b> [2] Attached</p>	<p><b>PA1881</b></p>  <p>Air Element  <b>Fits:</b> Diamond Reo Buses, Trucks  <b>Replaces:</b> Diamond Reo 3107361-H2  <b>O.D.:</b> 11 1/8 (282.6)  <b>I.D.:</b> 5/8 (15.9) &amp; 6 23/32 (170.7)  <b>Height:</b> 13 3/8 (339.7)  <b>A. Gskt:</b> [1] Attached  <b>F. Gskt:</b> G103-N</p>
<p><b>PA1873</b></p>  <p>Air Element  <b>Replaces:</b> Worthington FLR319  <b>O.D.:</b> 7 7/8 (200.0)  <b>I.D.:</b> 6 1/8 (155.6)  <b>Height:</b> 5 3/16 (131.8)</p>	<p><b>PA1882</b></p>  <p>Outer Air Element  <b>Fits:</b> Iveco Trucks; Hitachi, John Deere, Massey Ferguson Equipment  <b>Use With:</b> PA2570  <b>Replaces:</b> Iveco 9985779; John Deere AT65088; Massey Ferguson 1030543-M91  <b>O.D.:</b> 6 3/32 (154.8)  <b>I.D.:</b> 3/4 (19.0) &amp; 3 15/32 (88.1)  <b>Height:</b> 12 15/32 (316.7)  <b>A. Gskt:</b> [1] Attached  <b>F. Gskt:</b> G103-N</p>
<p><b>V1874-T</b></p>  <p>Vac-Cel Full-Flow Lube Sock  <b>Fits:</b> Waukesha Engines; Winslow Optional Filter Housings  <b>Replaces:</b> Winslow 1874 Series  <b>O.D.:</b> 6 1/2 (165.1)  <b>I.D.:</b> 2 3/4 (69.9)  <b>Height:</b> 17 (431.8)  <b>O. Gskt:</b> G206</p>	<p><b>PA1883-FN</b></p>  <p>Air Element with Fins  <b>Fits:</b> Case, John Deere Tractors  <b>Replaces:</b> Case D73225; John Deere AR44774  <b>O.D.:</b> 5 1/4 (133.4)  <b>Fins:</b> 6 3/8 (161.9)  <b>I.D.:</b> 21/32 (16.7) &amp; 2 5/8 (66.7)  <b>Height:</b> 13 3/8 (339.7)  <b>A. Gskt:</b> [1] Attached  <b>F. Gskt:</b> G103-N</p>
<p><b>PA1875</b></p>  <p>Air Element  <b>Fits:</b> Master Equipment  <b>Replaces:</b> Master C6001  <b>O.D.:</b> 3 7/16 (87.3)  <b>I.D.:</b> 2 3/8 (60.3)  <b>Height:</b> 3 1/2 (88.9)</p>	<p><b>LL1884</b></p>  <p>Long Life Outer Air Element  <b>Fits:</b> Allis Chalmers, Case, Caterpillar, Daewoo, Doosan, Drott, Fiat-Allis, Grove, Hitachi, J.C. Bamford, Massey Ferguson, New Holland, Volvo Equipment; Foden, Ford Europe, Iveco, Leyland, R.V.I. Buses, Trucks  <b>Use With:</b> PA1911  <b>Replaces:</b> Ag-Chem 721237023A; Case S231996; Drott 609421; Fiat 1909136; J.C. Bamford 32/201602  <b>O.D.:</b> 9 7/32 (234.2)  <b>I.D.:</b> 21/32 (16.7) &amp; 4 27/32 (123.0)  <b>Height:</b> 13 1/2 (342.9)  <b>A. Gskt:</b> [1] Attached  <b>F. Gskt:</b> G103-N  <b>Related To:</b> PA1941-FN (with Fins)            PA1874 (Standard Media Version)            PA1884XP (Extreme Performance Nano Version)</p>
<p><b>PA1877</b></p>  <p>Air Element  <b>Replaces:</b> Mack 2MD49303A; White 27-074455  <b>O.D.:</b> 12 1/32 (305.6)  <b>I.D.:</b> 17/32 (13.5) &amp; 7 11/16 (195.3)  <b>Height:</b> 12 1/2 (317.5)  <b>A. Gskt:</b> [1] Attached  <b>F. Gskt:</b> [1] Included</p>	<p><b>PA1884</b></p>  <p>Outer Air Element  <b>Fits:</b> Allis Chalmers, Case, Caterpillar, Daewoo, Doosan, Drott, Fiat-Allis, Grove, Hitachi, J.C. Bamford, Massey Ferguson, New Holland, Volvo Equipment; Foden, Ford Europe, Iveco, Leyland, R.V.I. Buses, Trucks  <b>Use With:</b> PA1911  <b>Replaces:</b> Ag-Chem 721237023A; Case S231996; Drott 609421; Fiat 1909136; J.C. Bamford 32/201602  <b>O.D.:</b> 9 7/32 (234.2)  <b>I.D.:</b> 21/32 (16.7) &amp; 4 27/32 (123.0)  <b>Height:</b> 13 1/2 (342.9)  <b>A. Gskt:</b> [1] Attached  <b>F. Gskt:</b> G103-N  <b>Related To:</b> PA1941-FN (with Fins)            LL1884 (Long-Life Media Version)            PA1884XP (Extreme Performance Nano Version)</p>
<p><b>PA1880</b></p>  <p>Inner Air Element  <b>Fits Inside:</b> LL1846, PA1846, PA1846XP, PA1847-FN, PA2478  <b>Fits:</b> Allis Chalmers, Euclid, Fiat-Allis, International, Kobelco, Komatsu, Terex Equipment; Gardner Denver, Ingersoll-Rand Compressors  <b>Replaces:</b> Allis Chalmers 1975888; International 511967-C91; Kobelco 2446U-212-S2  <b>O.D.:</b> 7 5/16 (185.7)  <b>Flange Gasket:</b> 8 15/32 (215.1)  <b>I.D.:</b> 11/16 (17.5) &amp; 6 3/16 (157.2)  <b>Height:</b> 17 19/32 (446.9)  <b>A. Gskt:</b> [1] Attached  <b>F. Gskt:</b> G103-N</p>	

Measurements Are Shown In Inches And (Millimeters)

**WARNING:** These products can expose you to chemicals, including Diisononyl Phthalate, Carbon black extracts, Nickel, 1,3 Butadiene, Ethylene Oxide, Epichlorohydrin, which are known to the State of California to cause cancer, and Bisphenol, Ethylene Glycol, Ethylene Oxide, 1,3 Butadiene, Epichlorohydrin, which are known to the State of California to cause birth defects or other reproductive harm.

## PA1884XP



### Extreme Performance Nano Outer Air Element

**Fits:** Allis Chalmers, Case, Caterpillar, Daewoo, Doosan, Drott, Fiat-Allis, Grove, Hitachi, J.C. Bamford, Massey Ferguson, New Holland, Volvo Equipment; Foden, Ford Europe, Iveco, Leyland, R.V.I. Buses, Trucks

**Use With:** PA1911

**Replaces:** Ag-Chem 721237023A; Case S231996; Drott 609421; Fiat 1909136; J.C. Bamford 32/201602

**O.D.:** 9 7/32 (234.2)

**I.D.:** 2 1/32 (16.7) & 4 27/32 (123.0)

**Height:** 13 1/2 (342.9)

**A. Gskt:** [1] Attached

**F. Gskt:** G103-N

**Related To:** PA1941-FN (with Fins)  
LL1884 (Long-Life Media Version)  
PA1874 (Standard Media Version)

## LL1886



### Long Life Outer Air Element

**Fits:** Case, Drott, Liebherr Excavators; Champion Graders; Euclid Equipment; Hino, Iveco Trucks; Hough Loaders; Ingersoll-Rand Drills; New Holland, Versatile Tractors

**Use With:** PA1904, PA3832

**Replaces:** Allis Chalmers 663856; Euclid 4003970; International 619763-C91; Iveco 1901780; John Deere AT69308; Liebherr 5604682; New Holland V30924; Terex 9038899

**O.D.:** 12 1/8 (308.0)

**I.D.:** 29/32 (23.0) & 7 11/16 (195.3)

**Height:** 16 1/2 (419.1)

**A. Gskt:** [1] Attached

**F. Gskt:** [1] Included

**O. Gskt:** G225-AF

**Related To:** PA1886 (Standard Media Version)  
PA1886XP (Extreme Performance Nano Version)

## LL1885



### Long Life Outer Air Element

**Fits:** Ag-Chem, Allis Chalmers, Caterpillar, Fiat-Allis, Gradall, Hitachi, John Deere, Kobelco, Komatsu, Massey Ferguson, Mitsubishi, New Holland Equipment; Foden, Iveco, Leland, M.A.N., Mitsubishi, R.V.I. Buses, Trucks

**Use With:** PA1893

**Replaces:** Ag-Chem 702455; Case L56041; Fiat-Allis 70662618; Hitachi 4237663; Iveco 1901902; Komatsu 600-181-3800

**O.D.:** 11 1/8 (282.6)

**I.D.:** 5/8 (15.9) & 6 23/32 (170.7)

**Height:** 16 1/2 (419.1)

**A. Gskt:** [1] Attached

**F. Gskt:** G103-N

**Related To:** PA1862 (Standard Media Version)  
PA1885XP (Extreme Performance Nano Version)

## PA1886



### Outer Air Element

**Fits:** Case, Drott, Liebherr Excavators; Champion Graders; Euclid Equipment; Hino, Iveco Trucks; Hough Loaders; Ingersoll-Rand Drills; New Holland, Versatile Tractors

**Use With:** PA1904, PA3832

**Replaces:** Allis Chalmers 663856; Euclid 4003970; International 619763-C91; Iveco 1901780; John Deere AT69308; Liebherr 5604682; New Holland V30924; Terex 9038899

**O.D.:** 12 1/8 (308.0)

**I.D.:** 29/32 (23.0) & 7 11/16 (195.3)

**Height:** 16 1/2 (419.1)

**A. Gskt:** [1] Attached

**F. Gskt:** [1] Included

**O. Gskt:** G225-AF

**Related To:** LL1886 (Long-Life Media Version)  
PA1886XP (Extreme Performance Nano Version)

## PA1885



### Outer Air Element

**Fits:** Ag-Chem, Allis Chalmers, Caterpillar, Fiat-Allis, Gradall, Hitachi, John Deere, Kobelco, Komatsu, Massey Ferguson, Mitsubishi, New Holland Equipment; Foden, Iveco, Leyland, M.A.N., Mitsubishi, R.V.I. Buses, Trucks

**Use With:** PA1893

**Replaces:** Ag-Chem 702455; Case L56041; Fiat-Allis 70662618; Hitachi 4237663; Iveco 1901902; Komatsu 600-181-3800

**O.D.:** 11 1/8 (282.6)

**I.D.:** 5/8 (15.9) & 6 23/32 (170.7)

**Height:** 16 1/2 (419.1)

**A. Gskt:** [1] Attached

**F. Gskt:** G103-N

**Related To:** LL1885 (Long-Life Media Version)  
PA1885XP (Extreme Performance Nano Version)

## PA1886XP



### Extreme Performance Nano Outer Air Element

**Fits:** Case, Drott, Liebherr Excavators; Champion Graders; Euclid Equipment; Hino, Iveco Trucks; Hough Loaders; Ingersoll-Rand Drills; New Holland, Versatile Tractors

**Use With:** PA1904, PA3832

**Replaces:** Allis Chalmers 663856; Euclid 4003970; International 619763-C91; Iveco 1901780; John Deere AT69308; Liebherr 5604682; New Holland V30924; Terex 9038899

**O.D.:** 12 1/8 (308.0)

**I.D.:** 29/32 (23.0) & 7 11/16 (195.3)

**Height:** 16 1/2 (419.1)

**A. Gskt:** [1] Attached

**F. Gskt:** [1] Included

**O. Gskt:** G225-AF

**Related To:** LL1886 (Long-Life Media Version)  
PA1886 (Standard Media Version)

## PA1885XP



### Extreme Performance Nano Outer Air Element

**Fits:** Ag-Chem, Allis Chalmers, Caterpillar, Fiat-Allis, Gradall, Hitachi, John Deere, Kobelco, Komatsu, Massey Ferguson, Mitsubishi, New Holland Equipment; Foden, Iveco, Leyland, M.A.N., Mitsubishi, R.V.I. Buses, Trucks

**Use With:** PA1893

**Replaces:** Ag-Chem 702455; Case L56041; Fiat-Allis 70662618; Hitachi 4237663; Iveco 1901902; Komatsu 600-181-3800

**O.D.:** 11 1/8 (282.6)

**I.D.:** 5/8 (15.9) & 6 23/32 (170.7)

**Height:** 16 1/2 (419.1)

**A. Gskt:** [1] Attached

**F. Gskt:** G103-N

**Related To:** LL1885 (Long-Life Media Version)  
PA1885 (Standard Media Version)

## PA1888



### Air Element

**Replaces:** White 892007

**O.D.:** 7 (177.8)

**I.D.:** 4 3/8 (111.1)

**Height:** 6 (152.4)

Measurements Are Shown In Inches And (Millimeters)

**WARNING:** These products can expose you to chemicals, including Diisononyl Phthalate, Carbon black extracts, Nickel, 1,3 Butadiene, Ethylene Oxide, Epichlorohydrin, which are known to the State of California to cause cancer, and Bisphenol, Ethylene Glycol, Ethylene Oxide, 1,3 Butadiene, Epichlorohydrin, which are known to the State of California to cause birth defects or other reproductive harm.

**PA1889**

**Air Element**



**Fits:** Ingersoll-Rand Compressors  
**Replaces:** Ingersoll-Rand 35103217  
**O.D.:** 7 7/8 (200.0)  
**I.D.:** 4 1/8 (104.8)  
**Height:** 3 (76.2)

**PA1891**

**Cab Air Element**



**Contains:** Flame Retardant Media  
**Fits:** Toyota Lift Trucks  
**Replaces:** Toyota 17801-23020  
**O.D.:** 7 (177.8)  
**I.D.:** 4 7/8 (123.8)  
**Height:** 4 5/8 (117.5)

**PA1892-FN**

**Air Element with Fins**



**Fits:** Chevrolet, GMC Trucks; Cummins Engines  
**Replaces:** GMC 8994738  
**O.D.:** 11 1/8 (282.6)  
 Fins 13 3/4 (349.3)  
**I.D.:** 5/8 (15.9) & 6 23/32 (170.7)  
**Height:** 8 1/2 (215.9)  
**A. Gskt:** [1] Attached  
**F. Gskt:** [1] Included

**PA1893**

**Inner Air Element**



**Fits Inside:** LL1885, PA1885, PA1885XP, PA1979-FN  
**Fits:** Ag-Chem, Allis Chalmers, Broyt, Caterpillar, Fiat-Allis, Grove, Hitachi, John Deere, Komatsu, Massey Ferguson, Michigan, Vermeer Equipment  
**Replaces:** Ag-Chem 702463; Fiat-Allis 70662618; John Deere AU43090; Massey Ferguson 1495414-M91  
**O.D.:** 6 13/32 (162.7)  
 Flange 7 1/2 (190.5)  
**I.D.:** 5/8 (15.9) & 5 1/4 (133.4)  
**Height:** 16 (406.4)  
**A. Gskt:** [1] Attached  
**F. Gskt:** [1] Included

**LL1894**

**Long Life Outer Air Element**



**Fits:** Caterpillar, Dresser, Euclid, Ingersoll-Rand, Kawasaki, Michigan, Steiger, Terex, Volvo, WABCO Equipment  
**Use With:** PA1905  
**Replaces:** Caterpillar 8L5897; Euclid 9035866; Gardner Denver 166392; Terex 9035992  
**O.D.:** 13 13/16 (350.8)  
**I.D.:** 15/16 (23.8) & 9 1/2 (241.3)  
**Height:** 18 1/2 (469.9)  
**A. Gskt:** [1] Attached  
**F. Gskt:** [1] Included  
**Related To:** PA1894 (Standard Media Version)  
 PA1894XP (Extreme Performance Nano Version)  
 PA2749 (with Boot and Bail Handle)

**PA1894**

**Outer Air Element**



**Fits:** Caterpillar, Dresser, Euclid, Ingersoll-Rand, Kawasaki, Michigan, Steiger, Terex, Volvo, Wabco Equipment  
**Use With:** PA1905  
**Replaces:** Caterpillar 8L5897; Euclid 9035866; Gardner Denver 166392; Terex 9035992  
**O.D.:** 13 13/16 (350.8)  
**I.D.:** 15/16 (23.8) & 9 1/2 (241.3)  
**Height:** 18 1/2 (469.9)  
**A. Gskt:** [1] Attached  
**F. Gskt:** [1] Included  
**Related To:** LL1894 (Long-Life Media Version)  
 PA1894XP (Extreme Performance Nano Version)  
 PA2749 (with Boot and Bail Handle)

**PA1894XP**

**Extreme Performance Nano Outer Air Element**



**Fits:** Caterpillar, Dresser, Euclid, Ingersoll-Rand, Kawasaki, Michigan, Steiger, Terex, Volvo, Wabco Equipment  
**Use With:** PA1905  
**Replaces:** Caterpillar 8L5897; Euclid 9035866; Gardner Denver 166392; Terex 9035992  
**O.D.:** 13 13/16 (350.8)  
**I.D.:** 15/16 (23.8) & 9 1/2 (241.3)  
**Height:** 18 1/2 (469.9)  
**A. Gskt:** [1] Attached  
**F. Gskt:** [1] Included  
**Related To:** LL1894 (Long-Life Media Version)  
 PA1894 (Standard Media Version)  
 PA2749 (with Boot and Bail Handle)

**LL1895**

**Long Life Outer Air Element**



**Fits:** Euclid, Michigan, Poclain, Steiger, Terex, Vermeer Equipment  
**Use With:** PA1906  
**Replaces:** Clark 1564734; Euclid 4005113; Steiger 45-213; Terex 4001155  
**O.D.:** 10 7/32 (259.6)  
**I.D.:** 15/16 (23.8) & 6 1/16 (154.0)  
**Height:** 14 1/2 (368.3)  
**A. Gskt:** [1] Attached  
**F. Gskt:** [1] Included  
**Related To:** PA1895 (Standard Media Version)

**PA1895**

**Outer Air Element**



**Fits:** Euclid, Michigan, Poclain, Steiger, Terex, Vermeer Equipment  
**Use With:** PA1906  
**Replaces:** Clark 1564734; Euclid 4005113; Steiger 45-213; Terex 4001155  
**O.D.:** 10 7/32 (259.6)  
**I.D.:** 15/16 (23.8) & 6 1/16 (154.0)  
**Height:** 14 1/2 (368.3)  
**A. Gskt:** [1] Attached  
**F. Gskt:** [1] Included  
**Related To:** LL1895 (Long-Life Media Version)

**PA1896**

**Air Element**



**Replaces:** GMC 6487818  
**O.D.:** 13 13/16 (350.8)  
**I.D.:** 1/2 (12.7) & 9 1/2 (241.3)  
**Height:** 8 7/8 (225.4)  
**A. Gskt:** [1] Attached  
**F. Gskt:** [1] Included

Measurements Are Shown In Inches And (Millimeters)

**WARNING:** These products can expose you to chemicals, including Diisononyl Phthalate, Carbon black extracts, Nickel, 1,3 Butadiene, Ethylene Oxide, Epichlorohydrin, which are known to the State of California to cause cancer, and Bisphenol, Ethylene Glycol, Ethylene Oxide, 1,3 Butadiene, Epichlorohydrin, which are known to the State of California to cause birth defects or other reproductive harm.

**PA1897**



Inner Air Element

**Fits Inside:** PA1898  
**Fits:** International Wheel Tractors  
**Replaces:** International 398519-R91  
**O.D.:** 4 1/8 (104.8)  
**I.D.:** 13/32 (10.3) & 3 (76.2)  
**Height:** 14 5/8 (371.5)  
**A. Gskt:** [1] Attached  
**F. Gskt:** [1] Included, [1] Wing Nut

**PA1898**



Outer Air Element with Bail Handle

**Fits:** International Wheel Tractors  
**Use With:** PA1897  
**Replaces:** International 401270-R1  
**O.D.:** 6 5/8 (168.3)  
 Flange Gasket 6 7/8 (174.6)  
**I.D.:** 4 1/4 (108.0) One End  
**Height:** 15 7/16 (392.1)  
**A. Gskt:** [1] Attached

**PA1899**



Inner Air Element

**Fits Inside:** PA1900  
**Fits:** Elgin Sweepers; International Wheel Tractors  
**Replaces:** International 398513-R91  
**O.D.:** 4 1/8 (104.8)  
**I.D.:** 13/32 (10.3) & 3 1/16 (77.8)  
**Height:** 12 1/4 (311.2)  
**A. Gskt:** [1] Attached  
**F. Gskt:** [1] Included, [1] Wing Nut

**PA1900**



Outer Air Element with Bail Handle

**Fits:** Elgin Sweepers; International Wheel Tractors  
**Use With:** PA1899  
**Replaces:** International 401269-R1  
**O.D.:** 6 5/8 (168.3)  
 Flange Gasket 6 7/8 (174.6)  
**I.D.:** 4 1/4 (108.0) One End  
**Height:** 12 7/8 (327.0)  
**A. Gskt:** [2] Attached

**PA1901**



Air Element

**Fits:** Mercedes-Benz, Porsche Automotive; Akerman Excavators; Volvo Loaders  
**Replaces:** Volvo 7820580  
**O.D.:** 6 (152.4)  
**I.D.:** 3 1/2 (88.9)  
**Height:** 8 5/8 (219.1)

**LL1902-FN**



Long Life Outer Air Element with Fins

**Fits:** Mercedes-Benz Trucks; Akerman, Allis Chalmers, Case, Daewoo, Dynapac, John Deere, Kawasaki, Komatsu, Michigan, White Equipment  
**Use With:** PA1912, PA1981, PA1982  
**Replaces:** Allis Chalmers 666432; Case R36360; Daewoo 24749020; John Deere AR45784  
**O.D.:** 7 15/16 (201.6)  
 Fins 10 (254.0)  
**I.D.:** 11/16 (17.5) & 5 3/8 (136.5)  
**Height:** 16 5/16 (414.3)  
**A. Gskt:** [1] Attached  
**F. Gskt:** G103-N  
**Related To:** PA1902-FN (Standard Media Version)

**PA1902-FN**



Outer Air Element with Fins

**Fits:** Mercedes-Benz Trucks; Akerman, Allis Chalmers, Case, Daewoo, Dynapac, John Deere, Kawasaki, Komatsu, Michigan, White Equipment  
**Use With:** PA1912, PA1981, PA1982  
**Replaces:** Allis Chalmers 666432; Case R36360; Daewoo 24749020; John Deere AR45784  
**O.D.:** 7 15/16 (201.6)  
 Fins 10 (254.0)  
**I.D.:** 11/16 (17.5) & 5 3/8 (136.5)  
**Height:** 16 5/16 (414.3)  
**A. Gskt:** [1] Attached  
**F. Gskt:** G103-N  
**Related To:** LL1902-FN (Long-Life Media Version)

**PA1904**



Inner Air Element

**Fits Inside:** LL1886, PA1886, PA1886XP  
**Fits:** Allis Chalmers, Case, Dresser, Drott, Euclid, Hough, International, John Deere, Liebherr, New Holland, Terex, Vermeer, Versatile Equipment  
**Replaces:** Euclid 4003970; Gardner Denver 175246; International 619763-C91; Versatile 30927  
**O.D.:** 7 5/8 (193.7)  
**I.D.:** 7/8 (22.2) & 6 1/16 (154.0)  
**Height:** 15 13/32 (391.3)  
**A. Gskt:** [1] Attached  
**F. Gskt:** [1] Included

**PA1905**













Inner Air Element

**Fits Inside:** LL1894, PA1894, PA1894XP, PA2749  
**Fits:** Caterpillar, Dresser, Euclid, Hitachi, Michigan, Steiger, Volvo, WABCO Equipment  
**Replaces:** Caterpillar 8L5897; Euclid 4005102; Hitachi 4206273; Steiger 45-253  
**O.D.:** 8 5/8 (219.1)  
**I.D.:** 15/16 (23.8) & 7 1/32 (178.6)  
**Height:** 17 1/32 (432.6)  
**A. Gskt:** [1] Attached  
**F. Gskt:** G110-AF

Measurements Are Shown In Inches And (Millimeters)

**WARNING:** These products can expose you to chemicals, including Diisononyl Phthalate, Carbon black extracts, Nickel, 1,3 Butadiene, Ethylene Oxide, Epichlorohydrin, which are known to the State of California to cause cancer, and Bisphenol, Ethylene Glycol, Ethylene Oxide, 1,3 Butadiene, Epichlorohydrin, which are known to the State of California to cause birth defects or other reproductive harm.

<p><b>PA1906</b></p> 	<p>Inner Air Element  <b>Fits Inside:</b> LL1895, PA1895  <b>Fits:</b> Euclid, Michigan, Poclain, Steiger, Terex, Vermeer Equipment  <b>Replaces:</b> Euclid 4000823; Terex 9038408  <b>O.D.:</b> 5 15/16 (150.8)  <b>I.D.:</b> 15/16 (23.8) &amp; 4 27/32 (123.0)  <b>Height:</b> 12 1/2 (317.5)  <b>A. Gskt:</b> [1] Attached  <b>F. Gskt:</b> [1] Included</p>	<p><b>PA1913</b></p> 	<p>Air Element  <b>Fits:</b> Donaldson EDG130010 Housing  <b>Replaces:</b> FWD Corporation 10175493; Oshkosh 17230F  <b>O.D.:</b> 10 3/8 (263.5)  <b>I.D.:</b> 7 13/16 (198.4) One End  <b>Height:</b> 12 (304.8)  <b>Related To:</b> PA616, PA1701 ELE (Other Housings)</p>
<p><b>PA1907-FN</b></p> 	<p>Outer Air Element with Fins  <b>Fits:</b> John Deere, Massey Ferguson Equipment  <b>Use With:</b> PA2535  <b>Replaces:</b> John Deere AM102746; Massey Ferguson 103262-M91  <b>O.D.:</b> 4 3/32 (104.0)            Fins 5 1/8 (130.2)  <b>I.D.:</b> 25/32 (19.8) &amp; 2 15/32 (62.7)  <b>Height:</b> 9 5/16 (236.5)  <b>A. Gskt:</b> [1] Attached  <b>F. Gskt:</b> G103-N</p>	<p><b>PA1915</b></p> 	<p>Air Breather Element for Hydraulic Reservoir  <b>Fits:</b> Mack Electra Haul  <b>Replaces:</b> International 427781  <b>O.D.:</b> 2 15/16 (74.6)  <b>I.D.:</b> 1 15/16 (49.2)  <b>Height:</b> 2 3/16 (55.6)</p>
<p><b>PA1909</b></p> 	<p>Air Breather Element  <b>Fits:</b> Bendix, Midland Air Compressors; GMC, International Trucks  <b>Replaces:</b> Bendix 100783; GMC 2457476; Midland 100696A  <b>O.D.:</b> 2 13/16 (71.4)  <b>I.D.:</b> 1 5/16 (33.3)  <b>Height:</b> 1 (25.4)</p>	<p><b>PA1916</b></p> 	<p>Air Compressor Element  <b>Fits:</b> Ingersoll-Rand, Joy, Sullair Compressors  <b>Replaces:</b> Ingersoll-Rand 35104793; Joy 1224813; Sullair 40899  <b>O.D.:</b> 9 3/4 (247.7)  <b>I.D.:</b> 6 1/16 (154.0)  <b>Height:</b> 5 13/32 (137.3)</p>
<p><b>PA1911</b></p> 	<p>Inner Air Element  <b>Fits Inside:</b> LL1884, PA1844, PA1884XP, PA2788, PA3629  <b>Fits:</b> Ag-Chem, Allis Chalmers, Case, Caterpillar, Clark, Daewoo, Fiat-Allis, Hitachi, International, J.C. Bamford, Kobelco, Komatsu, Massey Ferguson, Mitsubishi, New Holland, Steiger Equipment  <b>Replaces:</b> Allis Chalmers 3053290; Case P850561; Caterpillar 616582; Clark 1518700; Daewoo 24746025; International 530751-R1; Massey Ferguson 1495439-M91; Steiger 9003  <b>O.D.:</b> 4 19/32 (116.7)            Flange 5 3/4 (146.0)  <b>I.D.:</b> 5/8 (15.9) &amp; 3 7/16 (87.3)  <b>Height:</b> 13 (330.2)  <b>A. Gskt:</b> [1] Attached  <b>F. Gskt:</b> G103-N</p>	<p><b>PA1919-FN</b></p> 	<p>Air Element with Fins  <b>Fits:</b> Allis Chalmers Tractors  <b>Replaces:</b> Allis Chalmers 2565687  <b>O.D.:</b> 7 15/16 (201.6)            Fins 10 1/16 (255.6)  <b>I.D.:</b> 1/2 (12.7) &amp; 3 9/16 (90.5)  <b>Height:</b> 9 3/8 (238.1)  <b>A. Gskt:</b> [1] Attached  <b>F. Gskt:</b> [1] Included</p>
<p><b>PA1912</b></p> 	<p>Inner Air Element  <b>Fits Inside:</b> LL1902-FN, PA1902-FN, PA2523, PA2641, PA4650-FN  <b>Fits:</b> Allis Chalmers, Case, Daewoo, Dynapac, Kobelco, Komatsu, White Equipment; Cummins, Detroit Diesel, Deutz, Fiat, International Engines  <b>Replaces:</b> Allis Chalmers 3053289; Case R36360; White 31-2755077  <b>O.D.:</b> 4 9/16 (115.9)            Flange 5 3/4 (146.0)  <b>I.D.:</b> 21/32 (16.7) &amp; 3 7/16 (87.3)  <b>Height:</b> 15 21/32 (397.7)  <b>A. Gskt:</b> [1] Attached  <b>F. Gskt:</b> G103-N</p>	<p><b>PA1920</b></p> 	<p>Air Element  <b>Replaces:</b> Autocar 6GT0330; Diamond Reo 10392-H2  <b>O.D.:</b> 12 1/32 (305.6)  <b>I.D.:</b> 5/8 (15.9) &amp; 7 11/16 (195.3)  <b>Height:</b> 13 3/8 (339.7)  <b>A. Gskt:</b> [1] Attached  <b>F. Gskt:</b> G103-N</p>
	<p><b>PA1921</b></p> 	<p>Inner Air Element  <b>Fits Inside:</b> PA1794-FN  <b>Fits:</b> John Deere Equipment  <b>Replaces:</b> John Deere AT25219  <b>O.D.:</b> 4 3/32 (104.0)  <b>I.D.:</b> 25/32 (19.8) &amp; 2 15/32 (62.7)  <b>Height:</b> 7 5/16 (185.7)  <b>A. Gskt:</b> [1] Attached  <b>F. Gskt:</b> G103-N</p>	

Measurements Are Shown In Inches And (Millimeters)

**WARNING:** These products can expose you to chemicals, including Diisononyl Phthalate, Carbon black extracts, Nickel, 1,3 Butadiene, Ethylene Oxide, Epichlorohydrin, which are known to the State of California to cause cancer, and Bisphenol, Ethylene Glycol, Ethylene Oxide, 1,3 Butadiene, Epichlorohydrin, which are known to the State of California to cause birth defects or other reproductive harm.





**PA1922** Air Element  
  
**Replaces:** Blue Bird 2105773  
**O.D.:** 9 7/32 (234.2)  
**I.D.:** 21/32 (16.7) & 4 27/32 (123.0)  
**Height:** 8 5/16 (211.1)  
**A. Gskt:** [1] Attached  
**F. Gskt:** G103-N  
**Related To:** PA1922-FN (with Fins)

**PA1937** Inner Air Element  
  
**Fits Inside:** PA1936  
**Fits:** Dresser, Hough, International Equipment; Quincy Compressors  
**Replaces:** International 702673-C1; Quincy 21099  
**O.D.:** 7 3/8 (187.3)  
**I.D.:** 3/4 (19.0) & 6 1/8 (155.6)  
**Height:** 25 7/8 (657.2)  
**A. Gskt:** [1] Attached  
**F. Gskt:** G103-N

**PA1922-FN** Air Element with Fins  
  
**Fits:** Caterpillar Engines; Chevrolet, Ford, GMC Buses, Trucks  
**Replaces:** Caterpillar 7W7419; Ford C8HZ-9601-A; GMC 8994760  
**O.D.:** 9 7/32 (234.2)  
**Fins:** 11 5/8 (295.3)  
**I.D.:** 21/32 (16.7) & 4 27/32 (123.0)  
**Height:** 8 5/16 (211.1)  
**A. Gskt:** [1] Attached  
**F. Gskt:** G103-N  
**Related To:** PA1922 (without Fins)

**PA1940** Air Element  
  
**Fits:** Iveco Trucks; John Deere Tractors  
**Replaces:** Iveco 1902040; John Deere AR46976  
**O.D.:** 6 7/8 (174.6)  
**I.D.:** 21/32 (16.7) & 3 1/2 (88.9)  
**Height:** 14 3/8 (365.1)  
**A. Gskt:** [1] Attached  
**F. Gskt:** G103-N

**PA1926** Outer Air Element  
  
**Fits:** John Deere Equipment  
**Use With:** PA2413  
**Replaces:** John Deere AR43605  
**O.D.:** 6 7/8 (174.6)  
**I.D.:** 3 1/2 (88.9) One End  
**Height:** 12 3/8 (314.3)  
**A. Gskt:** [1] Attached

**PA1941-FN** Outer Air Element with Fins  
  
**Fits:** John Deere, Komatsu Equipment  
**Use With:** PA1967  
**Replaces:** John Deere AT27824; Komatsu 381-980-7031  
**O.D.:** 9 7/32 (234.2)  
**Fins:** 11 5/8 (295.3)  
**I.D.:** 21/32 (16.7) & 4 27/32 (123.0)  
**Height:** 13 1/2 (342.9)  
**A. Gskt:** [1] Attached  
**F. Gskt:** G103-N  
**Related To:** LL1884, PA1874, PA1884XP (without Fins)

**PA1932** Air Element  
  
**Replaces:** Ford C8AZ-9601-C  
**O.D.:** 9 7/32 (234.2)  
**I.D.:** 21/32 (16.7) & 4 27/32 (123.0)  
**Height:** 11 1/2 (292.1)  
**A. Gskt:** [1] Attached  
**F. Gskt:** G103-N

**PA1945** Air Element with Lift Bar  
  
**Fits:** International Wheel Tractors  
**Replaces:** International 403889-R1  
**O.D.:** 5 1/4 (133.4)  
**I.D.:** 2 1/4 (57.2) One End  
**Height:** 10 13/16 (274.6)  
**A. Gskt:** [1] Attached

**PA1934** Air Element  
  
**Fits:** Joy Compressors; Perkins Engines  
**Replaces:** Joy 1222940  
**O.D.:** 7 7/8 (200.0)  
**I.D.:** 6 1/8 (155.6)  
**Height:** 8 1/32 (204.0)

**PA1946** Air Element  
  
**Fits:** WABCO AVC Compressors  
**Replaces:** WABCO H43-534  
**O.D.:** 4 3/16 (106.4)  
**I.D.:** 1 15/16 (49.2)  
**Height:** 5 3/4 (146.0)

**PA1936** Outer Air Element  
  
**Fits:** Dresser, Hough, International Equipment; Quincy Compressors  
**Use With:** PA1937  
**Replaces:** International 702672-C1; Quincy 21098  
**O.D.:** 12 1/2 (317.5)  
**I.D.:** 3/4 (19.0) & 7 1/2 (190.5)  
**Height:** 27 1/2 (698.5)  
**A. Gskt:** [1] Attached  
**F. Gskt:** [1] Included

**PA1949** Air Element  
  
**Fits:** Joy, Sullair Compressors  
**Replaces:** Sullair 40186  
**O.D.:** 7 7/8 (200.0)  
**I.D.:** 4 1/8 (104.8)  
**Height:** 4 (101.6)

Measurements Are Shown In Inches And (Millimeters)

**WARNING:** These products can expose you to chemicals, including Diisononyl Phthalate, Carbon black extracts, Nickel, 1,3 Butadiene, Ethylene Oxide, Epichlorohydrin, which are known to the State of California to cause cancer, and Bisphenol, Ethylene Glycol, Ethylene Oxide, 1,3 Butadiene, Epichlorohydrin, which are known to the State of California to cause birth defects or other reproductive harm.

**PA1951**

Air Element



**Replaces:** Joy 543048  
**O.D.:** 5 11/16 (144.5)  
**I.D.:** 2 (50.8)  
**Height:** 3 1/4 (82.6)

**PA1952**

Air Element



**Fits:** Joy, Sullair Compressors  
**Replaces:** Joy 1225150; Sullair 40406  
**O.D.:** 12 1/16 (306.4)  
**I.D.:** 3/8 (9.5) & 6 3/32 (154.8)  
**Height:** 21 1/16 (535.0)  
**A. Gskt:** [1] Attached  
**F. Gskt:** [1] Included

**PA1953**

Air Element



**Fits:** Air Maze Housings; Joy Compressors  
**Replaces:** Air Maze CD1623503-826  
**O.D.:** 12 1/16 (306.4)  
**I.D.:** 3/8 (9.5) & 6 3/32 (154.8)  
**Height:** 21 1/16 (535.0)  
**A. Gskt:** [1] Attached  
**F. Gskt:** [1] Included

**PA1956-FN**

Outer Air Element with Fins



**Fits:** Case Loaders  
**Use With:** PA1957  
**Replaces:** Case L32512  
**O.D.:** 11 1/8 (282.6)  
Fins 13 3/4 (349.3)  
**I.D.:** 5/8 (15.9) & 6 3/4 (171.5)  
**Height:** 9 3/8 (238.1)  
**A. Gskt:** [1] Attached  
**F. Gskt:** G103-N

**PA1957**

Inner Air Element



**Fits Inside:** PA1956-FN  
**Fits:** Case Loaders  
**Replaces:** Case L32513  
**O.D.:** 6 3/8 (161.9)  
Flange Gasket 7 1/2 (190.5)  
**I.D.:** 5/8 (15.9) & 5 1/4 (133.4)  
**Height:** 9 (228.6)  
**A. Gskt:** [1] Attached  
**F. Gskt:** G103-N

**PA1960**

Panel Air Element

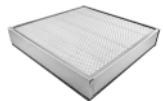

**Notes:** Sometimes used as Cab Air on John Deere Combines.  
**Fits:** Caterpillar Engines, Equipment; John Deere Combines  
**Replaces:** Caterpillar 6L8485  
**Length:** 15 (381.0)  
**Width:** 15 (381.0)  
**Height:** 2 9/16 (65.1)  
**A. Gskt:** [1] Attached

**PA1961**

Cab Air Element

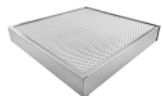

**Fits:** Allis Chalmers, John Deere Equipment  
**Replaces:** John Deere AH66302  
**Length:** 15 (381.0)  
**Width:** 15 (381.0)  
**Height:** 2 3/16 (55.6)

**PA1963**

Air Element



**Contains:** Flame Retardant Media  
**Fits:** Datsun Lift Trucks  
**Replaces:** Nissan 16546-48200  
**O.D.:** 6 5/16 (160.3)  
**I.D.:** 3 11/16 (93.7)  
**Height:** 5 (127.0)  
**O. Gskt:** [2] G120-A

**PA1967**

Inner Air Element



**Fits Inside:** PA1941-FN, PA2304-FN, PA2351, PA2421  
**Fits:** Agco, Case, John Deere, Massey Ferguson, Vermeer, White Equipment  
**Replaces:** Agco 72163296; Case A47136; John Deere AT34895; Massey Ferguson 3385734-M1; Vermeer 100489009; White 168698-AS  
**O.D.:** 4 9/16 (115.9)  
**I.D.:** 21/32 (16.7) & 3 7/16 (87.3)  
**Height:** 11 1/4 (285.8)  
**A. Gskt:** [1] Attached  
**F. Gskt:** G103-N

**PA1969**

Air Element



**Fits:** Davis, Ditch Witch, International, John Deere, New Holland Equipment; Wisconsin Engines  
**Replaces:** Ditch Witch 195352; International 405716-R1; Wisconsin LO185  
**O.D.:** 4 3/16 (106.4)  
**I.D.:** 1 15/16 (49.2)  
**Height:** 6 1/8 (155.6)

**PA1972**

Air Element



**Fits:** International Equipment; Iveco Trucks  
**Replaces:** International 529373-R1  
**O.D.:** 6 7/8 (174.6)  
**I.D.:** 21/32 (16.7) & 3 1/2 (88.9)  
**Height:** 14 3/8 (365.1)  
**A. Gskt:** [1] Attached  
**F. Gskt:** G103-N

**PA1973**

Air Element



**Contains:** Flame Retardant Media  
**Fits:** Datsun, Nissan, TCM Lift Trucks  
**Replaces:** Nissan 16546-19900; TCM 20801-03121  
**O.D.:** 5 23/32 (145.3)  
**I.D.:** 3 1/16 (77.8)  
**Height:** 3 1/8 (79.4)

**PA1975**

Outer Air Element



**Fits:** Case, Dresser, New Holland, Steiger, Versatile Tractors  
**Use With:** PA1976, PA2672  
**Replaces:** Steiger 13-898; Versatile 63971  
**O.D.:** 13 13/16 (350.8)  
**I.D.:** 15/16 (23.8) & 9 1/2 (241.3)  
**Height:** 22 1/2 (571.5)  
**A. Gskt:** [1] Attached  
**F. Gskt:** [1] Included  
**O. Gskt:** G285-AF  
**Related To:** PA2675 (with Boot)

Measurements Are Shown In Inches And (Millimeters)

**WARNING:** These products can expose you to chemicals, including Diisononyl Phthalate, Carbon black extracts, Nickel, 1,3 Butadiene, Ethylene Oxide, Epichlorohydrin, which are known to the State of California to cause cancer, and Bisphenol, Ethylene Glycol, Ethylene Oxide, 1,3 Butadiene, Epichlorohydrin, which are known to the State of California to cause birth defects or other reproductive harm.

**PA1976**

Inner Air Element



**Fits Inside:** PA1975, PA2675  
**Fits:** Allis Chalmers, Dresser, Euclid, Fiat Allis, Terex Equipment  
**Replaces:** Allis Chalmers 70690304; Fiat Allis 70686821; Terex 9036293  
**O.D.:** 8 5/8 (219.1)  
**I.D.:** 15/16 (23.8) & 7 1/16 (179.4)  
**Height:** 21 1/32 (534.2)  
**A. Gskt:** [1] Attached  
**F. Gskt:** [1] Included

**PA1982**

Inner Air Element



**Fits Inside:** LL1902-FN, PA1902-FN, PA1989-FN  
**Fits:** Case, John Deere Equipment  
**Replaces:** Case A62255; John Deere AR45785  
**O.D.:** 5 1/4 (133.4)  
**I.D.:** 5/8 (15.9) & 4 1/8 (104.8)  
**Height:** 11 1/4 (285.8)  
**A. Gskt:** [1] Attached  
**F. Gskt:** G103-N

**PA1977-FN**

Air Element with Fins



**Fits:** Ford Buses, Trucks  
**Replaces:** Ford D0HZ-9601-B  
**O.D.:** 11 1/8 (282.6)  
 Fins 13 3/4 (349.3)  
**I.D.:** 5/8 (15.9) & 6 3/4 (171.5)  
**Height:** 10 3/8 (263.5)  
**A. Gskt:** [1] Attached  
**F. Gskt:** G103-N

**PA1985**

Air Element



**Fits:** Jay Tamperers; Wacker Equipment  
**Replaces:** Wacker 2-5308  
**O.D.:** 3 (76.2)  
**I.D.:** 1 5/8 (41.3)  
**Height:** 3 (76.2)

**PA1978-FN**

Air Element with Fins



**Fits:** Ford Trucks  
**Replaces:** Ford D0HZ-9601-C  
**O.D.:** 11 1/8 (282.6)  
 Fins 13 3/4 (349.3)  
**I.D.:** 5/8 (15.9) & 6 3/4 (171.5)  
**Height:** 14 3/8 (365.1)  
**A. Gskt:** [1] Attached  
**F. Gskt:** G103-N

**PA1986**

Air Element



**Fits:** Ford Trucks  
**Replaces:** Motorcraft FA1008  
**O.D.:** 9 1/16 (230.2)  
**I.D.:** 4 15/16 (125.4)  
**Height:** 10 5/16 (261.9)  
**A. Gskt:** [2] Included  
**F. Gskt:** G39-AF

**PA1979-FN**

Outer Air Element with Fins



**Fits:** Ford Trucks  
**Use With:** PA1893  
**Replaces:** Ford D0HZ-9601-A  
**O.D.:** 11 1/8 (282.6)  
 Fins 13 3/4 (349.3)  
**I.D.:** 5/8 (15.9) & 6 3/4 (171.5)  
**Height:** 16 3/8 (415.9)  
**A. Gskt:** [1] Attached  
**F. Gskt:** G103-N

**PA1986-K**

Air Element with Reusable Lid-Fin Assembly



**Replaces:** Motorcraft FA1008  
**O.D.:** 9 1/16 (230.2)  
 Lid 12 3/8 (314.3)  
**I.D.:** 3/8 (9.5) & 4 15/16 (125.4)  
**Height:** 10 3/8 (263.5)  
**A. Gskt:** [2] Attached  
**F. Gskt:** G39-AF  
**Related To:** PA1986 (Filter only)

**PA1980-FN**

Air Element with Fins



**Fits:** Ford Buses, Trucks  
**Use With:** PA30026  
**Replaces:** Ford D0HZ-9601-F  
**O.D.:** 12 (304.8)  
 Fins 15 3/4 (400.0)  
**I.D.:** 5/8 (15.9) & 7 11/16 (195.3)  
**Height:** 10 3/8 (263.5)  
**A. Gskt:** [1] Attached  
**F. Gskt:** G103-N

**PA1987**

Air Element



**Replaces:** Wix 42773  
**O.D.:** 9 1/16 (230.2)  
**I.D.:** 4 15/16 (125.4)  
**Height:** 9 5/16 (236.5)  
**A. Gskt:** [2] Attached  
**F. Gskt:** G39-AF

**PA1981**

Inner Air Element



**Fits Inside:** LL1902-FN, PA1902-FN, PA3675, PA3849  
**Fits:** Fiat-Allis, International, John Deere, Liebherr, Oliver, White Equipment  
**Replaces:** International 920803-C91; John Deere T46317; White 166277-AS  
**O.D.:** 4 9/16 (115.9)  
**I.D.:** 21/32 (16.7) & 3 7/16 (87.3)  
**Height:** 15 3/8 (390.5)  
**A. Gskt:** [1] Attached  
**F. Gskt:** G103-N

**PA1989-FN**











Outer Air Element with Fins



**Fits:** Case Tractors  
**Use With:** PA1982  
**Replaces:** Case A43264  
**O.D.:** 7 15/16 (201.6)  
 Fins 10 1/16 (255.6)  
**I.D.:** 11/16 (17.5) & 5 3/8 (136.5)  
**Height:** 13 1/4 (336.5)  
**A. Gskt:** [1] Attached  
**F. Gskt:** G103-N

Measurements Are Shown In Inches And (Millimeters)

**WARNING:** These products can expose you to chemicals, including Diisononyl Phthalate, Carbon black extracts, Nickel, 1,3 Butadiene, Ethylene Oxide, Epichlorohydrin, which are known to the State of California to cause cancer, and Bisphenol, Ethylene Glycol, Ethylene Oxide, 1,3 Butadiene, Epichlorohydrin, which are known to the State of California to cause birth defects or other reproductive harm.

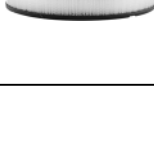
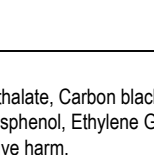
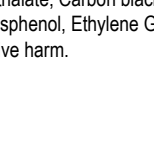
<p><b>LL1992</b></p> 	<p>Long Life Air Element  <b>Fits:</b> Ford Trucks  <b>Replaces:</b> Ford D5HZ-9601-B  <b>O.D.:</b> 12 1/32 (305.6)  <b>I.D.:</b> 5/8 (15.9) &amp; 7 11/16 (195.3)  <b>Height:</b> 16 3/8 (415.9)  <b>A. Gskt:</b> [1] Attached  <b>F. Gskt:</b> G103-N</p>	<p><b>PA2001</b></p> 	<p>Air Element  <b>Fits:</b> Atlas Copco Compressors; Petter Engines  <b>Use With:</b> PA2001 FOAM  <b>Replaces:</b> Atlas Copco 16191269; Petter CF4223LT  <b>O.D.:</b> 5 1/2 (139.7)  <b>I.D.:</b> 3 1/4 (82.6)  <b>Height:</b> 4 23/32 (119.9)</p>
<p><b>PA1992-FN</b></p> 	<p>Air Element with Fins  <b>Replaces:</b> International 407172-C91; White 27-074987  <b>O.D.:</b> 12 1/32 (305.6)            Fins 15 3/4 (400.0)  <b>I.D.:</b> 5/8 (15.9) &amp; 7 11/16 (195.3)  <b>Height:</b> 16 3/8 (415.9)  <b>A. Gskt:</b> [1] Attached  <b>F. Gskt:</b> G103-N</p>	<p><b>PA2001 FOAM</b></p> 	<p>Foam Blanket for PA2001  <b>Use With:</b> PA2001  <b>Length:</b> 17 1/8 (435.0)  <b>Width:</b> 4 1/2 (114.3)  <b>Height:</b> 1/2 (12.7)</p>
<p><b>PA1995</b></p> 	<p>Outer Air Element with Bail Handles and Lid  <b>Fits:</b> John Deere Tractors  <b>Use With:</b> PA1996  <b>Replaces:</b> John Deere AR51431  <b>O.D.:</b> 13 7/8 (352.4)            Lid 15 1/16 (382.6)  <b>I.D.:</b> 11/16 (17.5) &amp; 7 7/16 (188.9)  <b>Height:</b> 7 1/4 (184.2)  <b>A. Gskt:</b> [2] Attached  <b>F. Gskt:</b> G103-N</p>	<p><b>PA2002</b></p> 	<p>Air Element  <b>Fits:</b> Ford Automotive, Light-Duty Trucks, Vans  <b>Replaces:</b> Ford E4TE-9601-EA  <b>O.D.:</b> 13 9/32 (337.3)  <b>I.D.:</b> 11 9/32 (286.5)  <b>Height:</b> 2 25/32 (70.6)</p>
<p><b>PA1996</b></p> 	<p>Inner Air Element  <b>Fits Inside:</b> PA1995, PA2343  <b>Fits:</b> Case, John Deere, Oliver, White Equipment  <b>Replaces:</b> Case A44186; John Deere AR53502, AR64624  <b>O.D.:</b> 6 7/8 (174.6)  <b>I.D.:</b> 5/8 (15.9) &amp; 4 3/16 (106.4)  <b>Height:</b> 6 3/16 (157.2)  <b>A. Gskt:</b> [1] Attached  <b>F. Gskt:</b> G103-N</p>	<p><b>PA2005</b></p> 	<p>Air Element  <b>Fits:</b> Ford Automotive, Light-Duty Trucks  <b>Replaces:</b> Ford E4ZE-9601-AA  <b>O.D.:</b> 10 7/8 (276.2)  <b>I.D.:</b> 9 (228.6)  <b>Height:</b> 2 3/16 (55.6)</p>
<p><b>PA1997</b></p> 	<p>Outer Air Element  <b>Fits:</b> Massey Ferguson, Minneapolis-Moline, Oliver Equipment  <b>Use With:</b> PA1998, PA2469  <b>Replaces:</b> Massey Ferguson 1038944-M91  <b>O.D.:</b> 7 5/8 (193.7)            Boot 8 5/8 (219.1)  <b>I.D.:</b> 4 1/4 (108.0) One End  <b>Height:</b> 16 3/8 (415.9)  <b>A. Gskt:</b> [1] Attached</p>	<p><b>PA2006</b></p> 	<p>Air Element  <b>Fits:</b> GM Automotive, Light-Duty Trucks  <b>Replaces:</b> GMC 6484963  <b>O.D.:</b> 11 13/16 (300.0)  <b>I.D.:</b> 9 13/16 (249.2)  <b>Height:</b> 2 1/2 (63.5)</p>
<p><b>PA1998</b></p> 	<p>Inner Air Element  <b>Fits Inside:</b> PA1997, PA2495, PA2523  <b>Fits:</b> Massey Ferguson, Minneapolis-Moline, Oliver, White Equipment  <b>Replaces:</b> Massey Ferguson 1038945-M91; White 20-7000316  <b>O.D.:</b> 4 1/8 (104.8)            Flange 4 5/8 (117.5)  <b>I.D.:</b> 25/32 (19.8) &amp; 3 11/16 (93.7)  <b>Height:</b> 14 27/32 (377.0)  <b>A. Gskt:</b> [1] Attached  <b>F. Gskt:</b> G103-N</p>	<p><b>PA2007</b></p> 	<p>Air Element  <b>Fits:</b> GM Automotive  <b>Replaces:</b> GMC 6484294  <b>O.D.:</b> 10 3/4 (273.1)  <b>I.D.:</b> 8 5/8 (219.1)  <b>Height:</b> 2 9/16 (65.1)</p>
		<p><b>PA2008</b></p> 	<p>Air Element  <b>Fits:</b> GM Automotive, Light-Duty Trucks, Vans  <b>Replaces:</b> GMC 6484235  <b>O.D.:</b> 11 13/16 (300.0)  <b>I.D.:</b> 9 13/16 (249.2)  <b>Height:</b> 3 15/32 (88.1)</p>
		<p><b>PA2009</b></p> 	<p>Air Element  <b>Fits:</b> Cadillac Automotive  <b>Replaces:</b> GMC 6483644  <b>O.D.:</b> 12 5/16 (312.7)  <b>I.D.:</b> 10 13/16 (274.6)  <b>Height:</b> 2 5/8 (66.7)</p>













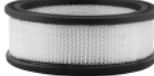
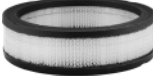
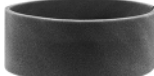

Measurements Are Shown In Inches And (Millimeters)

**WARNING:** These products can expose you to chemicals, including Diisononyl Phthalate, Carbon black extracts, Nickel, 1,3 Butadiene, Ethylene Oxide, Epichlorohydrin, which are known to the State of California to cause cancer, and Bisphenol, Ethylene Glycol, Ethylene Oxide, 1,3 Butadiene, Epichlorohydrin, which are known to the State of California to cause birth defects or other reproductive harm.

<p><b>PA2010</b> Air Element  <b>Fits:</b> Chrysler Automotive, Light-Duty Trucks, Vans  <b>Replaces:</b> Chrysler 2863349; Ford E3ZZ-9601-B  <b>O.D.:</b> 12 3/4 (323.8)  <b>I.D.:</b> 11 (279.4)  <b>Height:</b> 2 3/4 (69.9)</p> 	<p><b>SA2039</b> Crankcase Breather Filter in Plastic Housing  <b>Contains:</b> 9/16 Inch Fitting            [1] Metal Clip  <b>Fits:</b> Ford Automotive, Light-Duty Trucks, Vans  <b>Replaces:</b> Ford D1AZ-6D695-A  <b>Length:</b> 3 15/16 (100.0)  <b>Width:</b> 1 23/32 (43.7)</p> 
<p><b>PA2023</b> Air Element  <b>Fits:</b> Porsche, Saab Automotive  <b>Replaces:</b> Saab-Scania 800181  <b>O.D.:</b> 6 7/32 (158.0)  <b>I.D.:</b> 4 27/32 (123.0)  <b>Height:</b> 3 1/32 (77.0)</p> 	<p><b>PA2041</b> Panel Air Element  <b>Fits:</b> Geo, Toyota Automotive  <b>Replaces:</b> GMC 25098522; Toyota 17801-74020  <b>Length:</b> 12 5/32 (308.8)  <b>Width:</b> 6 1/8 (155.6)  <b>Height:</b> 1 21/32 (42.1)</p> 
<p><b>PA2024</b> Air Element  <b>Fits:</b> Ford Automotive, Light-Duty Trucks  <b>Replaces:</b> Ford D0GY-9601-A  <b>O.D.:</b> 13 (330.2)  <b>I.D.:</b> 11 9/32 (286.5)  <b>Height:</b> 2 1/2 (63.5)</p> 	<p><b>PA2042</b> Air Element  <b>Fits:</b> Toyota Automotive, Light-Duty Trucks  <b>Replaces:</b> Toyota 17801-60040  <b>O.D.:</b> 8 29/32 (226.2)  <b>I.D.:</b> 4 9/32 (108.7)  <b>Height:</b> 5 23/32 (145.3)</p> 
<p><b>SA2027</b> Poly Foam Oil Vapor Emission Filter  <b>Fits:</b> GM Automotive, Light-Duty Trucks, Vans  <b>Replaces:</b> GMC 6484966  <b>Width:</b> 1 25/32 (45.2)  <b>Height:</b> 1 5/8 (41.3)</p> 	<p><b>PA2044</b> Air Element  <b>Fits:</b> BMW Motorcycles  <b>Replaces:</b> BMW 13721254382  <b>O.D.:</b> 5 1/16 (128.6)  <b>I.D.:</b> 3 1/16 (77.8)  <b>Height:</b> 4 1/2 (114.3)</p> 
<p><b>PA2031</b> Air Element  <b>Fits:</b> Mazda, Nissan, Subaru Automotive; Nissan, TCM Lift Trucks  <b>Replaces:</b> Nissan 16546-18000; Subaru 42145-4110; TCM 16546-L3200  <b>O.D.:</b> 9 (228.6)  <b>I.D.:</b> 6 7/8 (174.6)  <b>Height:</b> 1 15/16 (49.2)</p> 	<p><b>SA2047</b> Crankcase Breather Filter in Plastic Housing  <b>Contains:</b> 5/8 Inch Fitting  <b>Fits:</b> Ford Light-Duty Trucks, Vans  <b>Replaces:</b> Ford F4TZ-9D695-A  <b>Width:</b> 2 5/8 (66.7)  <b>Height:</b> 1 1/4 (31.8)</p> 
<p><b>PA2036</b> Air Element  <b>O.D.:</b> 6 11/16 (169.9)  <b>I.D.:</b> 4 15/16 (125.4)  <b>Height:</b> 2 3/8 (60.3)</p> 	<p><b>PA2050</b> Air Element  <b>Replaces:</b> Imperial Machine Products FI-5  <b>O.D.:</b> 6 5/8 (168.3)  <b>I.D.:</b> 5 (127.0)  <b>Height:</b> 2 1/16 (52.4)</p> 
<p><b>PA2037</b> Air Element  <b>Fits:</b> Toyota Automotive  <b>Replaces:</b> Toyota 17801-22010  <b>O.D.:</b> 7 7/16 (188.9)  <b>I.D.:</b> 4 9/32 (108.7)  <b>Height:</b> 2 3/4 (69.9)</p> 	<p><b>PA2051</b> Air Element  <b>Fits:</b> Ford Automotive, Light-Duty Trucks, Vans  <b>Replaces:</b> Ford D2AZ-9601-A  <b>O.D.:</b> 11 3/16 (284.2)  <b>I.D.:</b> 9 1/16 (230.2)  <b>Height:</b> 2 11/16 (68.3)</p> 
<p><b>PA2038</b> Air Element with Wire Reinforced Media  <b>Fits:</b> Ingersoll-Rand Compressors  <b>Replaces:</b> Ingersoll-Rand 32012957  <b>O.D.:</b> 4 13/32 (111.9)  <b>I.D.:</b> 3 1/32 (77.0)  <b>Height:</b> 4 25/32 (121.4)</p> 	<p><b>PA2052</b> Air Element  <b>Fits:</b> Dodge, Plymouth Light-Duty Trucks, Vans  <b>Replaces:</b> Chrysler 3614353; GMC 6487801  <b>O.D.:</b> 10 7/8 (276.2)  <b>I.D.:</b> 9 (228.6)  <b>Height:</b> 3 17/32 (89.7)</p> 

Measurements Are Shown In Inches And (Millimeters)

**WARNING:** These products can expose you to chemicals, including Diisononyl Phthalate, Carbon black extracts, Nickel, 1,3 Butadiene, Ethylene Oxide, Epichlorohydrin, which are known to the State of California to cause cancer, and Bisphenol, Ethylene Glycol, Ethylene Oxide, 1,3 Butadiene, Epichlorohydrin, which are known to the State of California to cause birth defects or other reproductive harm.

<p><b>PA2053</b> Air Element  <b>Fits:</b> GM Automotive  <b>Replaces:</b> GMC 7988027  <b>O.D.:</b> 5 3/4 (146.0)  <b>I.D.:</b> 3 1/2 (88.9)  <b>Height:</b> 2 5/32 (54.8)</p> 	<p><b>PA2068 FOAM</b> Foam Blanket for PA2068  <b>Use With:</b> PA2068  <b>O.D.:</b> 6 23/32 (170.7)  <b>I.D.:</b> 6 7/32 (158.0)  <b>Height:</b> 1 25/32 (45.2)</p> 
<p><b>PA2061</b> Air Element  <b>Fits:</b> International Trucks  <b>Replaces:</b> International 446661-C1, 446910-C1  <b>O.D.:</b> 12 5/8 (320.7)  <b>I.D.:</b> 9 3/4 (247.7)  <b>Height:</b> 5 (127.0)</p> 	<p><b>PA2069</b> Air Element  <b>Fits:</b> Bolens, Cub Cadet, Ford, John Deere  Lawn &amp; Garden Tractors; Kohler Engines  <b>Use With:</b> PA2069 FOAM  <b>Replaces:</b> John Deere M47494; Kohler 4708303  <b>O.D.:</b> 7 (177.8)  <b>I.D.:</b> 5 9/16 (141.3)  <b>Height:</b> 2 15/32 (62.7)  <b>Related To:</b> PA2068 (Short Version)</p> 
<p><b>PA2063</b> Air Element  <b>Fits:</b> John Deere Lawn &amp; Garden Equipment;  New Holland Loaders; Onan Engines  <b>Replaces:</b> John Deere AM106953; Onan  140-2628  <b>O.D.:</b> 7 29/32 (200.8)  <b>I.D.:</b> 6 1/2 (165.1)  <b>Height:</b> 2 1/8 (54.0)</p> 	<p><b>PA2069 FOAM</b> Foam Blanket for PA2069  <b>Use With:</b> PA2069  <b>O.D.:</b> 6 5/8 (168.3)  <b>I.D.:</b> 6 7/32 (158.0)  <b>Height:</b> 2 3/16 (55.6)</p> 
<p><b>PA2064</b> Air Element  <b>Fits:</b> Bolens, Ford, Husky, Hustler, Jacobsen  Lawn &amp; Garden Tractors, Mowers; Kohler  Engines  <b>Replaces:</b> Kohler 277138  <b>O.D.:</b> 6 (152.4)  <b>I.D.:</b> 4 5/8 (117.5)  <b>Height:</b> 4 1/16 (103.2)  <b>Related To:</b> PA2067 (Short Version)</p> 	<p><b>PA2070</b> Air Element  <b>Replaces:</b> Atlas Copco 1503-0188  <b>O.D.:</b> 5 5/32 (131.0)  <b>I.D.:</b> 3 3/8 (85.7)  <b>Height:</b> 1 13/32 (35.7)  <b>Related To:</b> PA2071 (Long Version)</p> 
<p><b>PA2065</b> Air Element  <b>Fits:</b> BMW, Toyota Automotive, Light-Duty  Trucks  <b>Replaces:</b> Toyota 17801-41060  <b>O.D.:</b> 12 7/16 (315.9)  <b>I.D.:</b> 9 3/8 (238.1)  <b>Height:</b> 2 (50.8)</p> 	<p><b>PA2071</b> Air Element  <b>Fits:</b> Atlas Copco Compressors  <b>Replaces:</b> Atlas Copco 1503-0189  <b>O.D.:</b> 5 5/32 (131.0)  <b>I.D.:</b> 3 3/8 (85.7)  <b>Height:</b> 1 15/16 (49.2)  <b>Related To:</b> PA2070 (Short Version)</p> 
<p><b>PA2067</b> Air Element  <b>Fits:</b> Allis Chalmers, Ariens, Case, Cub Cadet,  Ford, Jacobsen, Power King, Simplicity Lawn &amp;  Garden Mowers, Tractors; Kohler, Onan  Engines  <b>Use With:</b> PA2067 FOAM  <b>Replaces:</b> Allis Chalmers 2067783; Kohler  4508302; Onan 140-1216  <b>O.D.:</b> 6 (152.4)  <b>I.D.:</b> 4 5/8 (117.5)  <b>Height:</b> 3 1/8 (79.4)  <b>Related To:</b> PA2064 (Long Version)</p> 	<p><b>PA2072</b> Air Element  <b>Fits:</b> Atlas Copco Compressors  <b>Replaces:</b> Atlas Copco 1503-0190  <b>O.D.:</b> 5 31/32 (151.6)  <b>I.D.:</b> 3 15/32 (88.1)  <b>Height:</b> 2 25/32 (70.6)</p> 
<p><b>PA2067 FOAM</b> Foam Blanket for PA2067  <b>Use With:</b> PA2067  <b>O.D.:</b> 6 5/32 (156.4)  <b>I.D.:</b> 5 11/16 (144.5)  <b>Height:</b> 2 27/32 (72.2)</p> 	<p><b>PA2073</b> Air Element with Foam Wrap  <b>Fits:</b> GMC Light-Duty Trucks, Vans  <b>Replaces:</b> GMC 8996118  <b>O.D.:</b> 13 7/8 (352.4)  <b>I.D.:</b> 11 5/8 (295.3)  <b>Height:</b> 4 (101.6)  <b>Related To:</b> PA2079 (without Foam Wrap)</p> 
<p><b>PA2068</b> Air Element  <b>Fits:</b> Allis Chalmers, Cub Cadet, Dixon, Ford,  Power King Lawn &amp; Garden Mowers, Tractors;  International Wheel Tractors; Kohler Engines  <b>Use With:</b> PA2068 FOAM  <b>Replaces:</b> International 117210-C1; Kohler  4708301  <b>O.D.:</b> 7 (177.8)  <b>I.D.:</b> 5 9/16 (141.3)  <b>Height:</b> 1 25/32 (45.2)  <b>Related To:</b> PA2069 (Long Version)</p> 	<p><b>PA2074</b> Air Element  <b>Fits:</b> Ford Automotive, Light-Duty Trucks  <b>Replaces:</b> Ford D7FZ-9601-A  <b>O.D.:</b> 11 7/32 (285.0)  <b>I.D.:</b> 9 3/8 (238.1)  <b>Height:</b> 1 23/32 (43.7)</p> 
<p><b>PA2075</b> Air Element  <b>Fits:</b> Ford, Honda, Mazda Automotive,  Light-Duty Trucks  <b>Replaces:</b> Ford D7ZZ-9601-A; Honda  17220-PC2611  <b>O.D.:</b> 11 3/32 (281.8)  <b>I.D.:</b> 8 1/2 (215.9)  <b>Height:</b> 2 3/16 (55.6)</p> 	

Measurements Are Shown In Inches And (Millimeters)

**WARNING:** These products can expose you to chemicals, including Diisononyl Phthalate, Carbon black extracts, Nickel, 1,3 Butadiene, Ethylene Oxide, Epichlorohydrin, which are known to the State of California to cause cancer, and Bisphenol, Ethylene Glycol, Ethylene Oxide, 1,3 Butadiene, Epichlorohydrin, which are known to the State of California to cause birth defects or other reproductive harm.

**PA2076** Oblong Air Element  
**Fits:** GM Automotive  
**Replaces:** GMC 8996555  
**O.D.:** 9 3/8 (238.1)  
to 10 9/16 (268.3)  
**I.D.:** 7 7/8 (200.0) & 9 1/16 (230.2) to  
**Height:** 2 1/8 (54.0)



**PA2077** Air Element  
**Fits:** GM Automotive, Light-Duty Trucks, Vans  
**Replaces:** GMC 8996587  
**O.D.:** 10 1/32 (254.8)  
**I.D.:** 8 17/32 (216.7)  
**Height:** 2 1/4 (57.2)



**PA2079** Air Element  
**Fits:** GM Automotive, Light-Duty Trucks  
**Replaces:** GMC 8997189  
**O.D.:** 13 7/8 (352.4)  
**I.D.:** 11 5/8 (295.3)  
**Height:** 4 (101.6)  
**Related To:** PA2073 (with Foam Wrap)



**PA2081** Air Element  
**Fits:** Mercedes-Benz Automotive  
**Replaces:** Mercedes-Benz 10949504  
**O.D.:** 11 5/16 (287.3)  
**I.D.:** 8 17/32 (216.7)  
**Height:** 3 3/8 (85.7)

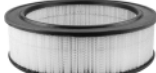

**PA2083** Air Element  
**Fits:** Dodge, Plymouth Automotive  
**Replaces:** Chrysler 5240668  
**O.D.:** 4 13/32 (111.9)  
**I.D.:** 2 15/16 (74.6)  
**Height:** 5 3/4 (146.0)



**SA2084** Crankcase Breather Filter in Plastic Housing  
**Fits:** Ford Automotive, Light-Duty Trucks, Vans  
**Replaces:** Ford D7FZ-9D695-A  
**Width:** 1 13/32 (35.7)  
**Height:** 2 7/8 (73.0)



**SA2085** Crankcase Breather Filter in Plastic Housing  
**Contains:** 1/2 Inch Fitting  
[1] Metal Clip  
**Fits:** Ford Automotive, Light-Duty Trucks, Vans  
**Replaces:** Ford D8AZ-9D695-A  
**Width:** 1 31/32 (50.0)  
**F. Gskt:** [1] Foam Washer



**PA2091** Air Element  
**Fits:** GMC Light-Duty Trucks, Vans  
**Replaces:** GMC 8997890  
**O.D.:** 11 13/16 (300.0)  
**I.D.:** 9 13/16 (249.2)  
**Height:** 5 7/16 (138.1)  
**Related To:** PA2148 (with Foam Wrap)



**PA2092** Air Element  
**Fits:** Ford, International Light-Duty Trucks, Vans  
**Replaces:** Ford E7TZ-9600-A; International 446661-C2  
**O.D.:** 11 7/16 (290.5)  
**I.D.:** 8 5/8 (219.1)  
**Height:** 5 (127.0)  
**Related To:** PA2115 (with Foam Wrap)



**PA2093** Oblong Air Element  
**Replaces:** Tecnocar A202  
**O.D.:** 5 1/2 (139.7)  
to 24 1/4 (615.9)  
**I.D.:** 4 1/16 (103.2) & 22 27/32 (580.2)  
**Height:** 2 9/16 (65.1)

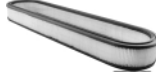

**PA2094** Rectangular Air Element  
**Fits:** Ferrari Automotive  
**Replaces:** Ferrari 108545  
**O.D.:** 12 3/8 (314.3)  
to 14 9/16 (369.9)  
**I.D.:** 11 1/32 (280.2) & 13 1/4 (336.5)  
**Height:** 2 1/8 (54.0)



**PA2095** Air Element  
**Fits:** Kellogg Compressors  
**Replaces:** Kellogg 55669  
**O.D.:** 9 3/4 (247.7)  
**I.D.:** 7 1/4 (184.2)  
**Height:** 4 (101.6)



**PA2096** Air Element  
**Fits:** Benford Equipment; Lister Engines  
**Replaces:** Lister 366-6227; Rootes 5058925  
**O.D.:** 5 19/32 (142.1)  
**I.D.:** 4 (101.6)  
**Height:** 2 15/32 (62.7)



**PA2099** Air Element  
**Fits:** Renault Automotive  
**Replaces:** Renault 7701005514  
**O.D.:** 4 31/32 (126.2)  
**I.D.:** 3 11/32 (84.9)  
**Height:** 6 11/16 (169.9)



**PA2100** Air Element  
**Fits:** Sullair Compressors  
**Replaces:** Sullair 40187  
**O.D.:** 8 1/32 (204.0)  
**I.D.:** 5 5/16 (134.9)  
**Height:** 4 3/16 (106.4)





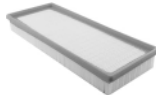







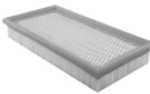



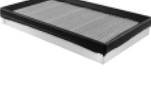

**PA2101A** Panel Air Element  
**Fits:** Audi, Chrysler, Eagle, Jeep Volkswagen Automotive, Light-Duty Trucks; Case-International, Liebherr Equipment; Volvo Trucks  
**Replaces:** Chrysler 53006317; Volkswagen 34133837  
**Length:** 13 3/16 (335.0)  
**Width:** 5 11/32 (135.7)  
**Height:** 1 21/32 (42.1)

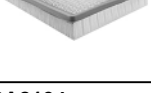

Measurements Are Shown In Inches And (Millimeters)











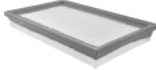

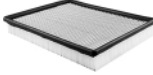

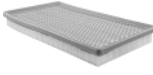
**WARNING:** These products can expose you to chemicals, including Diisononyl Phthalate, Carbon black extracts, Nickel, 1,3 Butadiene, Ethylene Oxide, Epichlorohydrin, which are known to the State of California to cause cancer, and Bisphenol, Ethylene Glycol, Ethylene Oxide, 1,3 Butadiene, Epichlorohydrin, which are known to the State of California to cause birth defects or other reproductive harm.

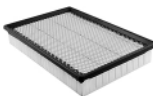
<p><b>PA2102</b></p> 	<p><b>Air Element</b>  <b>Contains:</b> Flame Retardant Media  <b>Replaces:</b> Impco F1-15  <b>O.D.:</b> 6 7/8 (174.6)  <b>I.D.:</b> 5 1/8 (130.2)  <b>Height:</b> 5 13/16 (147.6)  <b>Related To:</b> PA1653 (for Compressor Air)</p>	<p><b>PA2115</b> <b>Air Element with Foam Wrap</b>  <b>Fits:</b> Ford Light-Duty Trucks, Vans  <b>Replaces:</b> Ford E3TZ-9601-C  <b>O.D.:</b> 11 7/16 (290.5)  <b>I.D.:</b> 8 5/8 (219.1)  <b>Height:</b> 5 (127.0)  <b>Related To:</b> PA2092 (without Foam Wrap)</p> 
<p><b>PA2103</b></p> 	<p><b>Panel Air Element</b>  <b>Fits:</b> Audi, Chrysler, Ford, Volkswagen Automotive, Light-Duty Trucks  <b>Replaces:</b> Chrysler 4342800; Ford E59Z-9601-A; Volkswagen 49133843  <b>Length:</b> 10 3/4 (273.1)  <b>Width:</b> 5 1/4 (133.4)  <b>Height:</b> 1 19/32 (40.5)</p>	<p><b>PA2116</b> <b>Air Element</b>  <b>Fits:</b> International Buses, Trucks  <b>Replaces:</b> International 588213-C1  <b>O.D.:</b> 11 7/16 (290.5)  <b>I.D.:</b> 8 5/8 (219.1)  <b>Height:</b> 7 (177.8)</p> 
<p><b>PA2104</b></p> 	<p><b>Panel Air Element</b>  <b>Fits:</b> Chrysler Automotive, Light-Duty Trucks, Vans  <b>Replaces:</b> Chrysler 4227087, 4306113, 4342801  <b>Length:</b> 8 1/16 (204.8)  <b>Width:</b> 5 1/4 (133.4)  <b>Height:</b> 1 5/8 (41.3)</p>	<p><b>PA2117</b> <b>Air Element</b>  <b>Fits:</b> Chrysler, Mitsubishi Light-Duty Trucks  <b>Replaces:</b> Chrysler MD604880  <b>O.D.:</b> 10 1/4 (260.3)  <b>I.D.:</b> 8 (203.2)  <b>Height:</b> 2 7/16 (61.9)</p> 
<p><b>PA2106</b></p> 	<p><b>Air Element</b>  <b>Fits:</b> GMC, Isuzu Automotive, Light-Duty Trucks  <b>Replaces:</b> GMC 25040929; Isuzu 8-25040-929-0  <b>O.D.:</b> 9 11/16 (246.1)  <b>I.D.:</b> 8 3/16 (208.0)  <b>Height:</b> 2 13/16 (71.4)  <b>Related To:</b> PA4135 (with Foam Wrap)</p>	<p><b>PA2121</b> <b>Panel Air Element</b>  <b>Fits:</b> Nissan, Subaru Automotive  <b>Replaces:</b> Nissan 16546-N4200; Subaru SOA51-65101  <b>Length:</b> 10 5/8 (269.9)  <b>Width:</b> 6 3/32 (154.8)  <b>Height:</b> 1 3/8 (34.9)</p> 
<p><b>PA2107</b></p> 	<p><b>Air Element with Foam Wrap</b>  <b>Fits:</b> Ford Light-Duty Trucks, Vans  <b>Replaces:</b> Ford E0TZ-9601-B  <b>O.D.:</b> 9 (228.6)  <b>I.D.:</b> 6 1/2 (165.1)  <b>Height:</b> 3 1/4 (82.6)  <b>Related To:</b> PA657 (without Foam Wrap)</p>	<p><b>PA2124</b> <b>Air Element</b>  <b>Fits:</b> Chevrolet, Toyota Automotive  <b>Replaces:</b> GMC 94840272; Toyota 17801-15010  <b>O.D.:</b> 11 17/32 (292.9)  <b>I.D.:</b> 8 3/4 (222.3)  <b>Height:</b> 1 19/32 (40.5)</p> 
<p><b>PA2109</b></p> 	<p><b>Air Element</b>  <b>Fits:</b> GM Automotive, Light-Duty Trucks  <b>Replaces:</b> GMC 25040881  <b>O.D.:</b> 8 1/2 (215.9)  <b>I.D.:</b> 6 15/16 (176.2)  <b>Height:</b> 2 7/16 (61.9)</p>	<p><b>PA2125</b> <b>Air Element</b>  <b>Fits:</b> Toyota Automotive, Light-Duty Trucks, Lift Trucks  <b>Replaces:</b> Toyota 17801-25010, 17801-31010  <b>O.D.:</b> 9 23/32 (246.9)  <b>I.D.:</b> 6 7/8 (174.6)  <b>Height:</b> 2 1/4 (57.2)</p> 
<p><b>PA2110</b></p> 	<p><b>Air Element with Foam Wrap</b>  <b>Fits:</b> GM Automotive  <b>Replaces:</b> GMC 25041208  <b>O.D.:</b> 13 7/8 (352.4)  <b>I.D.:</b> 11 5/8 (295.3)  <b>Height:</b> 2 5/8 (66.7)</p>	<p><b>PA2127</b> <b>Panel Air Element</b>  <b>Fits:</b> Ford, Mercury Automotive  <b>Replaces:</b> Ford E43Z-9601-C  <b>Length:</b> 7 7/8 (200.0)  <b>Width:</b> 7 (177.8)  <b>Height:</b> 1 19/32 (40.5)</p> 
<p><b>PA2113</b></p> 	<p><b>Air Element</b>  <b>Fits:</b> GMC Light-Duty Trucks  <b>Replaces:</b> GMC 25041542  <b>O.D.:</b> 10 1/32 (254.8)  <b>I.D.:</b> 8 17/32 (216.7)  <b>Height:</b> 2 1/2 (63.5)</p>	<p><b>PA2134</b> <b>Air Element</b>  <b>Fits:</b> GM Automotive  <b>Replaces:</b> GMC 25043119  <b>O.D.:</b> 5 3/4 (146.0)  <b>I.D.:</b> 3 1/2 (88.9)  <b>Height:</b> 4 15/16 (125.4)</p> 
<p><b>PA2114</b></p> 	<p><b>Air Element</b>  <b>Fits:</b> Ford Bronco, Ranger  <b>Replaces:</b> Ford E37E-9601-BB  <b>O.D.:</b> 9 11/16 (246.1)  <b>I.D.:</b> 7 15/16 (201.6)  <b>Height:</b> 2 3/32 (53.2)</p>	

Measurements Are Shown In Inches And (Millimeters)















**WARNING:** These products can expose you to chemicals, including Diisononyl Phthalate, Carbon black extracts, Nickel, 1,3 Butadiene, Ethylene Oxide, Epichlorohydrin, which are known to the State of California to cause cancer, and Bisphenol, Ethylene Glycol, Ethylene Oxide, 1,3 Butadiene, Epichlorohydrin, which are known to the State of California to cause birth defects or other reproductive harm.

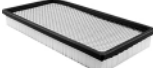

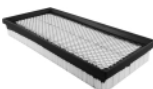
<p><b>PA2135</b> Panel Air Element  <b>Fits:</b> Isuzu, Nissan, Subaru Automotive, Trucks  <b>Replaces:</b> Isuzu 8-94132-678-0; Nissan 16546-V0100; Subaru 16546-AA020  <b>Length:</b> 11 1/16 (281.0)  <b>Width:</b> 6 9/16 (166.7)  <b>Height:</b> 1 5/16 (33.3)</p> 	<p><b>PA2148</b> Air Element with Foam Wrap  <b>Fits:</b> GMC Light-Duty Trucks, Vans, Trucks  <b>Replaces:</b> GMC 25043585  <b>O.D.:</b> 11 13/16 (300.0)  <b>I.D.:</b> 9 13/16 (249.2)  <b>Height:</b> 5 7/16 (138.1)  <b>Related To:</b> PA2091 (without Foam Wrap)</p> 
<p><b>PA2136</b> Air Element  <b>Notes:</b> Inside-Out Flow Direction  <b>Fits:</b> GM Automotive  <b>Replaces:</b> GMC 25043504  <b>O.D.:</b> 5 3/4 (146.0)  <b>I.D.:</b> 3 5/8 (92.1)  <b>Height:</b> 6 (152.4)</p> 	<p><b>PA2149</b> Panel Air Element  <b>Fits:</b> Ford Automotive  <b>Replaces:</b> Ford E6SZ-9601-B  <b>Length:</b> 11 9/32 (286.5)  <b>Width:</b> 8 29/32 (226.2)  <b>Height:</b> 1 19/32 (40.5)</p> 
<p><b>PA2138</b> Panel Air Element  <b>Fits:</b> GM Automotive  <b>Replaces:</b> GMC 25043334  <b>Length:</b> 9 17/32 (242.1)  <b>Width:</b> 4 1/2 (114.3)  <b>Height:</b> 1 1/4 (31.8)</p> 	<p><b>PA2150</b> Panel Air Element  <b>Fits:</b> Ford, Mazda Automotive, Light-Duty Trucks  <b>Replaces:</b> Ford E6AZ-9601-B  <b>Length:</b> 11 7/32 (285.0)  <b>Width:</b> 6 1/8 (155.6)  <b>Height:</b> 1 7/32 (31.0)</p> 
<p><b>PA2139</b> Air Element  <b>Fits:</b> Gardner Denver Compressors  <b>Use With:</b> PA2139 FOAM  <b>Replaces:</b> Gardner Denver 2008219  <b>O.D.:</b> 5 1/8 (130.2)  <b>I.D.:</b> 3 3/8 (85.7)  <b>Height:</b> 5 7/32 (132.6)</p> 	<p><b>PA2152</b> Panel Air Element  <b>Fits:</b> Ford Automotive, Light-Duty Trucks  <b>Replaces:</b> Ford E5TZ-9601-B  <b>Length:</b> 11 7/32 (285.0)  <b>Width:</b> 7 17/32 (191.3)  <b>Height:</b> 1 25/32 (45.2)</p> 
<p><b>PA2139 FOAM</b> Foam Blanket for PA2139  <b>Use With:</b> PA2139  <b>O.D.:</b> 5 1/2 (139.7)  <b>I.D.:</b> 4 7/8 (123.8)  <b>Height:</b> 5 (127.0)</p> 	<p><b>PA2153</b> Air Element  <b>Fits:</b> Chevrolet, Pontiac Automotive  <b>Replaces:</b> GMC 25095707  <b>O.D.:</b> 5 3/4 (146.0)  <b>I.D.:</b> 3 1/2 (88.9)  <b>Height:</b> 3 31/32 (100.8)</p> 
<p><b>PA2140</b> Air Element  <b>Fits:</b> GM Automotive  <b>Replaces:</b> GMC 8994941  <b>O.D.:</b> 5 (127.0)  <b>I.D.:</b> 3 9/16 (90.5)  <b>Height:</b> 5 5/16 (134.9)</p> 	<p><b>PA2154</b> Air Element  <b>Replaces:</b> Chrysler 4306393  <b>O.D.:</b> 9 11/16 (246.1)  <b>I.D.:</b> 7 1/2 (190.5)  <b>Height:</b> 2 15/16 (74.6)</p> 
<p><b>PA2147</b> Air Element  <b>Fits:</b> Honda Automotive  <b>Replaces:</b> Honda 17220-PEO-661  <b>O.D.:</b> 10 3/8 (263.5)  <b>I.D.:</b> 7 13/16 (198.4)  <b>Height:</b> 1 23/32 (43.7)</p> 	<p><b>PA2156</b> Air Element  <b>Fits:</b> Toyota Automotive, Light-Duty Trucks  <b>Replaces:</b> Toyota 17801-41110, 17801-54060  <b>O.D.:</b> 7 7/16 (188.9)  <b>I.D.:</b> 4 9/32 (108.7)  <b>Height:</b> 5 1/2 (139.7)</p> 
<p><b>PA2147</b> Air Element  <b>Fits:</b> Honda Automotive  <b>Replaces:</b> Honda 17220-PEO-661  <b>O.D.:</b> 10 3/8 (263.5)  <b>I.D.:</b> 7 13/16 (198.4)  <b>Height:</b> 1 23/32 (43.7)</p> 	<p><b>PA2158</b> Oval Air Element  <b>Fits:</b> Chrysler Automotive  <b>Replaces:</b> Chrysler 4288009  <b>O.D.:</b> 7 9/32 (184.9)  to 8 27/32 (224.6)  <b>I.D.:</b> 5 23/32 (145.3) &amp; 7 9/32 (184.9)  <b>Height:</b> 2 7/32 (56.4)</p> 

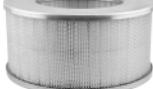
Measurements Are Shown In Inches And (Millimeters)

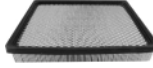
**WARNING:** These products can expose you to chemicals, including Diisononyl Phthalate, Carbon black extracts, Nickel, 1,3 Butadiene, Ethylene Oxide, Epichlorohydrin, which are known to the State of California to cause cancer, and Bisphenol, Ethylene Glycol, Ethylene Oxide, 1,3 Butadiene, Epichlorohydrin, which are known to the State of California to cause birth defects or other reproductive harm.

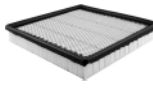
<p><b>SA2159</b></p> 	<p>Crankcase Breather Filter  <b>Contains:</b> [1] Metal Clip  <b>Fits:</b> Ford Automotive, Light-Duty Trucks, Vans  <b>Replaces:</b> Ford E5TZ-9D695-A  <b>Width:</b> 2 3/8 (60.3)  <b>Height:</b> 1 1/4 (31.8)  <b>F. Gskt:</b> [1] Included</p>	<p><b>PA2171</b></p> 	<p>Air Element  <b>Fits:</b> Toyota Automotive, Light-Duty Trucks  <b>Replaces:</b> Toyota 17801-70020  <b>O.D.:</b> 8 19/32 (218.3)  <b>Height:</b> 2 23/32 (69.1)</p>
<p><b>PA2160</b></p> 	<p>Panel Air Element  <b>Fits:</b> GM Automotive, Light-Duty Trucks, Vans  <b>Replaces:</b> GMC 25095333  <b>Length:</b> 7 5/8 (193.7)  <b>Width:</b> 6 1/32 (153.2)  <b>Height:</b> 1 17/32 (38.9)</p>	<p><b>PA2178</b></p> 	<p>Panel Air Element  <b>Fits:</b> GM Automotive  <b>Replaces:</b> GMC 25042562  <b>Length:</b> 15 7/8 (403.2)  <b>Width:</b> 7 27/32 (199.2)  <b>Height:</b> 1 19/32 (40.5)</p>
<p><b>PA2162</b></p> 	<p>Air Element  <b>Fits:</b> GM Automotive  <b>Replaces:</b> GMC 25096829  <b>O.D.:</b> 5 3/8 (136.5)  <b>I.D.:</b> 3 13/16 (96.8)  <b>Height:</b> 4 15/16 (125.4)</p>	<p><b>PA2181</b></p> 	<p>Panel Air Element  <b>Fits:</b> Volvo Automotive  <b>Replaces:</b> Volvo 463505, 463505-8  <b>Length:</b> 13 1/16 (331.8)  <b>Width:</b> 6 15/32 (164.3)  <b>Height:</b> 1 15/32 (37.3)</p>
<p><b>PA2163</b></p> 	<p>Panel Air Element  <b>Fits:</b> Dodge Light-Duty Trucks; Jeep Briarwood, Cherokee; Mitsubishi Automotive  <b>Replaces:</b> AMC 8953004383; Chrysler 53004383  <b>Length:</b> 13 17/32 (343.7)  <b>Width:</b> 6 21/32 (169.1)  <b>Height:</b> 1 19/32 (40.5)</p>	<p><b>PA2182</b></p> 	<p>Air Element  <b>Fits:</b> Isuzu Impulse  <b>Replaces:</b> Isuzu 5-14215-023-0  <b>O.D.:</b> 6 13/32 (162.7)  <b>I.D.:</b> 3 1/32 (77.0)  <b>Height:</b> 4 1/8 (104.8)</p>
<p><b>PA2164</b></p> 	<p>Panel Air Element  <b>Fits:</b> Ford Light-Duty Trucks, Vans  <b>Replaces:</b> Ford E7TZ-9601-B  <b>Length:</b> 12 27/32 (326.2)  <b>Width:</b> 5 7/8 (149.2)  <b>Height:</b> 1 21/32 (42.1)</p>	<p><b>PA2183</b></p> 	<p>Air Element  <b>Fits:</b> Chrysler Light-Duty Trucks  <b>Replaces:</b> Chrysler 4428325  <b>O.D.:</b> 7 15/16 (201.6)  <b>I.D.:</b> 7/16 (11.1) &amp; 4 5/8 (117.5)  <b>Height:</b> 9 9/16 (242.9)  <b>A. Gskt:</b> [1] Attached  <b>F. Gskt:</b> [1] Included</p>
<p><b>PA2167</b></p> 	<p>Air Element  <b>Fits:</b> Toyota Automotive  <b>Replaces:</b> Toyota 17801-22000-71  <b>O.D.:</b> 7 3/8 (187.3)  <b>I.D.:</b> 4 5/16 (109.5)  <b>Height:</b> 3 1/2 (88.9)</p>	<p><b>PA2188</b></p> 	<p>Air Element  <b>Fits:</b> Dodge Dakota, Ramcharger Vans  <b>Replaces:</b> Chrysler 4307787; Wix 546152, 46152  <b>O.D.:</b> 13 (330.2)  <b>I.D.:</b> 9 1/8 (231.8)  <b>Height:</b> 2 21/32 (67.5)</p>
<p><b>PA2168</b></p> 	<p>Panel Air Element  <b>Fits:</b> Toyota Automotive, Light-Duty Trucks, Vans  <b>Replaces:</b> Toyota 17801-70010  <b>Length:</b> 10 1/4 (260.3)  <b>Width:</b> 6 3/4 (171.5)  <b>Height:</b> 2 (50.8)</p>	<p><b>PA2189</b></p> 	<p>Panel Air Element  <b>Fits:</b> Buick, Cadillac, Chevrolet, Oldsmobile, Pontiac Automotive  <b>Replaces:</b> GMC 25096932  <b>Length:</b> 10 19/32 (269.1)  <b>Width:</b> 7 7/8 (200.0)  <b>Height:</b> 1 21/32 (42.1)</p>
<p><b>PA2169</b></p> 	<p>Panel Air Element  <b>Fits:</b> Daihatsu Charade; Toyota Camry, Corolla  <b>Replaces:</b> Daihatsu 17801-87104-000; Toyota 17801-01020, 17801-74010  <b>Length:</b> 8 13/16 (223.8)  <b>Width:</b> 6 5/8 (168.3)  <b>Height:</b> 1 31/32 (50.0)</p>	<p><b>PA2191</b></p> 	<p>Panel Air Element  <b>Fits:</b> Ford Thunderbird; Mercury Cougar  <b>Replaces:</b> Ford E9SE-9601-AB  <b>Length:</b> 9 17/32 (242.1)  <b>Width:</b> 9 17/32 (242.1)  <b>Height:</b> 1 9/16 (39.7)</p>

Measurements Are Shown In Inches And (Millimeters)

**WARNING:** These products can expose you to chemicals, including Diisononyl Phthalate, Carbon black extracts, Nickel, 1,3 Butadiene, Ethylene Oxide, Epichlorohydrin, which are known to the State of California to cause cancer, and Bisphenol, Ethylene Glycol, Ethylene Oxide, 1,3 Butadiene, Epichlorohydrin, which are known to the State of California to cause birth defects or other reproductive harm.

**PA2192** Oblong Air Element  
**Notes:** OBSOLETE. Availability Limited to Dealer Stock.  
**Fits:** Chrysler Light-Duty Trucks  
**Replaces:** Chrysler 4300787  
**O.D.:** 9 3/16 (233.4)  
to 12 15/16 (328.6)  
**I.D.:** 6 1/16 (154.0) & 9 13/16 (249.2)  
**Height:** 3 3/16 (81.0)



**PA2208** Panel Air Element  
**Fits:** Audi, Jaguar, Porsche, Volkswagen, Volvo Automotive, Light-Duty Trucks  
**Replaces:** Audi 21129620; Porsche 29129620A; Volkswagen 39129620A; Volvo 12573051  
**Length:** 8 3/8 (212.7)  
**Width:** 8 3/8 (212.7)  
**Height:** 2 7/32 (56.4)

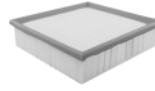

**PA2193** Air Element  
**Fits:** GM Automotive  
**Replaces:** GMC 25096763  
**O.D.:** 5 (127.0)  
**I.D.:** 3 9/16 (90.5)  
**Height:** 6 13/16 (173.0)



**PA2212** Panel Air Element  
**Fits:** Mazda Light-Duty Trucks, Vans  
**Replaces:** Mazda JF01-13-Z00  
**Length:** 9 9/32 (235.7)  
**Width:** 7 15/16 (201.6)  
**Height:** 1 9/16 (39.7)



**PA2194** Oval Air Element  
**Fits:** Chrysler, Eagle, Hyundai, Mitsubishi Automotive  
**Replaces:** Hyundai 28177-32520; Mitsubishi MD603932  
**O.D.:** 7 13/16 (198.4)  
Flange 8 1/16 (204.8)  
**I.D.:** 5 9/32 (134.1) & 4 3/8 (111.1)  
**Height:** 6 7/8 (174.6)  
**A. Gskt:** [1] Attached



**PA2214** Panel Air Element  
**Fits:** Isuzu, Mazda, Toyota Automotive, Light-Duty Trucks, Vans  
**Replaces:** Isuzu 8-94376-353-0; Mazda JE48-13-Z50; Toyota 17801-35020  
**Length:** 9 27/32 (250.0)  
**Width:** 6 11/16 (169.9)  
**Height:** 2 (50.8)



**PA2196** Panel Air Element  
**Fits:** Buick, Oldsmobile, Pontiac, Cadillac, Chevrolet Automotive  
**Replaces:** GMC 25097453  
**Length:** 11 1/2 (292.1)  
**Width:** 7 1/32 (178.6)  
**Height:** 1 21/32 (42.1)

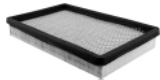

**PA2215** Air Element  
**Fits:** Suzuki Samurai  
**Replaces:** Suzuki 13780-83000  
**O.D.:** 7 9/32 (184.9)  
**I.D.:** 4 21/32 (118.3)  
**Height:** 4 13/32 (111.9)  
**A. Gskt:** [2] Attached



**PA2200** Panel Air Element  
**Fits:** Ford Automotive  
**Replaces:** Ford F5RZ-9601-B  
**Length:** 12 19/32 (319.9)  
**Width:** 5 29/32 (150.0)  
**Height:** 1 5/8 (41.3)

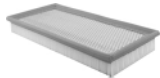

**PA2216** Air Element  
**Fits:** Chevrolet, Geo, Pontiac, Suzuki Automotive  
**Replaces:** GMC 96055471; Suzuki 13780-860A0  
**O.D.:** 9 5/8 (244.5)  
**Height:** 1 5/8 (41.3)



**PA2201** Panel Air Element  
**Notes:** OBSOLETE. Availability Limited to Dealer Stock.  
**Fits:** Ford, Mazda Automotive  
**Replaces:** Ford F92Z-9601-A; Mazda F201-13Z-409-A  
**Length:** 10 3/32 (256.4)  
**Width:** 7 (177.8)  
**Height:** 1 5/16 (33.3)

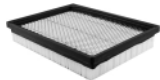

**PA2218** Panel Air Element  
**Fits:** GM Automotive  
**Replaces:** GMC 25097917  
**Length:** 13 3/4 (349.3)  
**Width:** 4 5/32 (105.6)  
**Height:** 1 19/32 (40.5)



**PA2204** Panel Air Element  
**Fits:** Honda Accord  
**Replaces:** Honda 17220-PT2-000  
**Length:** 9 21/32 (245.3)  
**Width:** 5 7/16 (138.1)  
**Height:** 1 9/16 (39.7)



**PA2220** Panel Air Element  
**Fits:** Ford Escort, Mercury Tracer, Mazda Miata, MX5  
**Replaces:** Ford F1CZ-9601-A; Mazda B6S7-13-Z40; Wix 546097, 46097  
**Length:** 9 7/8 (250.8)  
**Width:** 5 29/32 (150.0)  
**Height:** 1 7/16 (36.5)

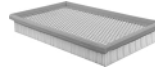

**PA2207** Air Element  
**Fits:** Toyota Tercel  
**Replaces:** Toyota 17801-10030  
**O.D.:** 10 3/32 (256.4)  
**Height:** 1 13/16 (46.0)



**PA2221** Panel Air Element  
**Fits:** Clark Lift Trucks  
**Replaces:** Clark 2373789  
**Length:** 8 1/2 (215.9)  
**Width:** 8 1/2 (215.9)  
**Height:** 1 5/8 (41.3)

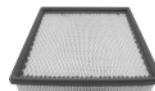









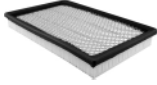

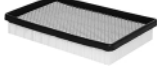
**PA2222** Panel Air Element  
**Fits:** Briggs & Stratton Engines; Cub Cadet Mowers; John Deere Lawn & Garden Tractors  
**Replaces:** Briggs & Stratton 491588  
**Length:** 5 5/32 (131.0)  
**Width:** 4 7/16 (112.7)  
**Height:** 25/32 (19.8)

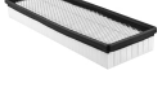
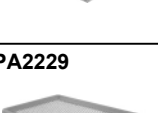

Measurements Are Shown In Inches And (Millimeters)

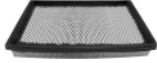
**WARNING:** These products can expose you to chemicals, including Diisononyl Phthalate, Carbon black extracts, Nickel, 1,3 Butadiene, Ethylene Oxide, Epichlorohydrin, which are known to the State of California to cause cancer, and Bisphenol, Ethylene Glycol, Ethylene Oxide, 1,3 Butadiene, Epichlorohydrin, which are known to the State of California to cause birth defects or other reproductive harm.

<p><b>PA2223</b></p> 	<p><b>Air Element</b>  <b>Fits:</b> Briggs &amp; Stratton Engines  <b>Use With:</b> PA2223 FOAM  <b>Replaces:</b> Briggs &amp; Stratton 393957  <b>O.D.:</b> 4 1/4 (108.0)  <b>I.D.:</b> 2 (50.8)  <b>Height:</b> 3 3/4 (95.3)</p>	<p><b>PA2230</b> <b>Panel Air Element</b>  <b>Fits:</b> Chrysler, Eagle Automotive  <b>Replaces:</b> Chrysler 4573031  <b>Length:</b> 12 7/16 (315.9)  <b>Width:</b> 7 1/32 (178.6)  <b>Height:</b> 1 7/16 (36.5)</p> 
<p><b>PA2223 FOAM</b></p> 	<p><b>Foam Blanket for PA2223</b>  <b>Use With:</b> PA2223  <b>O.D.:</b> 4 1/32 (102.4)  <b>I.D.:</b> 3 17/32 (89.7)  <b>Height:</b> 3 23/32 (94.5)</p>	<p><b>PA2231</b> <b>Panel Air Element</b>  <b>Fits:</b> GM, Saturn Automotive, Vans  <b>Replaces:</b> GMC 25099149  <b>Length:</b> 9 5/16 (236.5)  <b>Width:</b> 7 3/32 (180.2)  <b>Height:</b> 1 19/32 (40.5)</p> 
<p><b>PA2224</b></p> 	<p><b>Air Element</b>  <b>Fits:</b> Briggs &amp; Stratton Engines  <b>Replaces:</b> Briggs &amp; Stratton 390492  <b>O.D.:</b> 3 13/16 (96.8)  <b>I.D.:</b> 1 5/16 (33.3)  <b>Height:</b> 2 7/8 (73.0)</p>	<p><b>PA2232</b> <b>Panel Air Element with Foam Pad</b>  <b>Fits:</b> GMC Light-Duty Trucks, Vans  <b>Replaces:</b> GMC 25099849  <b>Length:</b> 15 31/32 (405.6)  <b>Width:</b> 7 29/32 (200.8)  <b>Height:</b> 2 5/32 (54.8)</p> 
<p><b>PA2225</b></p> 	<p><b>Air Element</b>  <b>Fits:</b> Briggs &amp; Stratton Engines  <b>Replaces:</b> Briggs &amp; Stratton 396424  <b>O.D.:</b> 2 3/4 (69.9)  <b>I.D.:</b> 3/16 (4.8) &amp; 1 1/4 (31.8)  <b>Height:</b> 2 3/4 (69.9)</p>	<p><b>PA2233</b> <b>Oval Air Element with Foam Wrap</b>  <b>Fits:</b> Ford Light-Duty Trucks  <b>Replaces:</b> Ford F5TZ-9601-A  <b>O.D.:</b> 6 7/32 (158.0)  to 12 31/32 (329.4)  <b>I.D.:</b> 3 5/32 (80.2) &amp; 9 7/8 (250.8)  <b>Height:</b> 6 1/32 (153.2)</p> 
<p><b>PA2226</b></p> 	<p><b>Air Element</b>  <b>Fits:</b> Briggs &amp; Stratton Engines; Cub Cadet, John Deere, Simplicity, Toro Lawn &amp; Garden Tractors  <b>Replaces:</b> Briggs &amp; Stratton 394018  <b>O.D.:</b> 6 29/32 (175.4)  <b>I.D.:</b> 5 9/16 (141.3)  <b>Height:</b> 2 1/4 (57.2)</p>	<p><b>PA2234</b> <b>Panel Air Element</b>  <b>Fits:</b> Dodge Light-Duty Trucks  <b>Replaces:</b> Chrysler 53040025  <b>Length:</b> 13 3/4 (349.3)  <b>Width:</b> 5 3/16 (131.8)  <b>Height:</b> 2 5/16 (58.7)</p> 
<p><b>PA2228</b></p> 	<p><b>Panel Air Element</b>  <b>Fits:</b> Lincoln Mark VIII  <b>Replaces:</b> Ford F3LY-9601-A; Wix 46052  <b>Length:</b> 8 29/32 (226.2)  <b>Width:</b> 8 3/16 (208.0)  <b>Height:</b> 1 25/32 (45.2)</p>	<p><b>PA2235</b> <b>Panel Air Element</b>  <b>Fits:</b> BMW Automotive  <b>Replaces:</b> BMW 13721726916  <b>Length:</b> 13 (330.2)  <b>Width:</b> 5 7/8 (149.2)  <b>Height:</b> 2 3/16 (55.6)</p> 
<p><b>PA2229</b></p> 	<p><b>Panel Air Element</b>  <b>Notes:</b> OBSOLETE. Availability Limited to Dealer Stock.  <b>Fits:</b> Ford, Mazda Automotive  <b>Replaces:</b> Ford F32Z-9601-A; Mazda FS11-13-Z40  <b>Length:</b> 10 11/32 (262.7)  <b>Width:</b> 6 13/32 (162.7)  <b>Height:</b> 1 19/32 (40.5)</p>	<p><b>PA2237</b> <b>Panel Air Element</b>  <b>Notes:</b> Uses 2 filters per application.  <b>Fits:</b> Ford Vans  <b>Replaces:</b> Ford F5UZ-9601-A  <b>Length:</b> 11 1/4 (285.8)  <b>Width:</b> 6 19/32 (167.5)  <b>Height:</b> 1 21/32 (42.1)</p> 
<p><b>PA2240</b></p> 	<p><b>Air Element</b>  <b>Fits:</b> Ford, Mazda Light-Duty Trucks, Vans  <b>Replaces:</b> Ford F57Z-9601-A; Mazda ZZM2-23-603  <b>O.D.:</b> 6 1/2 (165.1)  Flange 6 29/32 (175.4)  <b>I.D.:</b> 3 3/32 (78.6) One End  <b>Height:</b> 7 15/32 (189.7)</p>	<p><b>PA2241</b> <b>Panel Air Element</b>  <b>Fits:</b> Chevrolet Automotive  <b>Replaces:</b> GMC 25096933  <b>Length:</b> 17 5/16 (439.7)  <b>Width:</b> 10 19/32 (269.1)  <b>Height:</b> 1 17/32 (38.9)</p> 

Measurements Are Shown In Inches And (Millimeters)

**WARNING:** These products can expose you to chemicals, including Diisononyl Phthalate, Carbon black extracts, Nickel, 1,3 Butadiene, Ethylene Oxide, Epichlorohydrin, which are known to the State of California to cause cancer, and Bisphenol, Ethylene Glycol, Ethylene Oxide, 1,3 Butadiene, Epichlorohydrin, which are known to the State of California to cause birth defects or other reproductive harm.

**PA2243** Panel Air Element  
**Fits:** Chevrolet, Mazda, Toyota Automotive  
**Replaces:** Mazda KJ01-13-A40, KJ01-13-Z40; Toyota 17801-02030, 17801-15070  
**Length:** 10 1/2 (266.7)  
**Width:** 6 23/32 (170.7)  
**Height:** 1 21/32 (42.1)



**PA2244** Panel Air Element  
**Fits:** Volvo Automotive  
**Replaces:** Volvo 9186262-3  
**Length:** 13 13/16 (350.8)  
**Width:** 7 9/32 (184.9)  
**Height:** 2 3/16 (55.6)

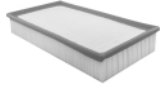

**PA2256** Air Breather Element  
**Fits:** Midland Compressors  
**Replaces:** Midland 100696E  
**O.D.:** 4 (101.6)  
**I.D.:** 1 11/32 (34.1)  
**Height:** 1 3/8 (34.9)



**PA2257** Panel Air Element  
**Fits:** Chevrolet, GMC, Isuzu Automotive, Light-Duty Trucks, Vans  
**Replaces:** GMC 25098463  
**Length:** 11 17/32 (292.9)  
**Width:** 6 1/32 (153.2)  
**Height:** 1 5/8 (41.3)



**PA2258** Oval Air Element  
**Fits:** Lauson-Tecumseh Engines  
**Replaces:** Tecumseh 33268  
**O.D.:** 2 23/32 (69.1) to 4 15/32 (113.5)  
**I.D.:** 1 15/32 (37.3) & 3 7/32 (81.8)  
**Height:** 2 5/16 (58.7)



**PA2260** Air Element  
**Replaces:** Vortex VF57  
**O.D.:** 5 3/4 (146.0)  
**I.D.:** 4 7/32 (107.2)  
**Height:** 12 3/32 (307.2)



**PA2300** Outer Air Element  
**Fits:** Dresser, International, John Deere Equipment  
**Use With:** PA2301  
**Replaces:** International 624977-C91; John Deere AE30508  
**O.D.:** 10 3/8 (263.5)  
**Boot:** 11 (279.4)  
**I.D.:** 15/16 (23.8) & 6 1/32 (153.2)  
**Height:** 16 1/2 (419.1)  
**A. Gskt:** [2] Attached  
**F. Gskt:** [1] Included



**PA2301** Inner Air Element  
**Fits Inside:** PA2300  
**Fits:** Dresser, International, John Deere Equipment  
**Replaces:** International 624978-C91; John Deere AE30507  
**O.D.:** 5 3/4 (146.0)  
**I.D.:** 15/16 (23.8) & 4 13/16 (122.2)  
**Height:** 14 5/16 (363.5)  
**A. Gskt:** [1] Attached  
**F. Gskt:** [1] Included



**PA2302-FN** Outer Air Element with Fins  
**Fits:** Dresser, International Equipment  
**Use With:** PA2303  
**Replaces:** International 622036-C91  
**O.D.:** 6 7/8 (174.6)  
**Fins:** 8 3/4 (222.3)  
**I.D.:** 21/32 (16.7) & 4 3/16 (106.4)  
**Height:** 14 5/16 (363.5)  
**A. Gskt:** [1] Included  
**F. Gskt:** G103-N



**PA2303** Inner Air Element  
**Fits Inside:** PA2302-FN  
**Fits:** Dresser, International Equipment  
**Replaces:** International 622041-C91  
**O.D.:** 4 3/32 (104.0)  
**I.D.:** 3/4 (19.0) & 2 15/32 (62.7)  
**Height:** 13 7/16 (341.3)  
**A. Gskt:** [1] Attached  
**F. Gskt:** G103-N



**PA2304-FN** Outer Air Element with Fins  
**Fits:** John Deere, Minneapolis-Moline, Oliver, White Equipment  
**Use With:** PA1967  
**Replaces:** John Deere AT43867; Oliver 303002128  
**O.D.:** 7 31/32 (202.4)  
**Fins:** 9 29/32 (251.6)  
**I.D.:** 11/16 (17.5) & 5 3/8 (136.5)  
**Height:** 12 1/2 (317.5)  
**A. Gskt:** [1] Attached  
**F. Gskt:** G103-N  
**Related To:** PA2351 (without Fins)



**PA2305** Inner Air Element  
**Fits Inside:** PA1822-FN, LL2418-FN, PA2418-FN  
**Fits:** Case, Daewoo, Hough, John Deere, Komatsu Equipment  
**Replaces:** Daewoo 24749014; John Deere TH106446; Komatsu 300-181-9500  
**O.D.:** 3 3/8 (85.7)  
**I.D.:** 11/16 (17.5) & 2 1/4 (57.2)  
**Height:** 13 1/4 (336.5)  
**A. Gskt:** [1] Attached  
**F. Gskt:** G103-N



**PA2306** Inner Air Element  
**Fits Inside:** PA1609  
**Fits:** Ford Tractors  
**Replaces:** Ford C9NN-9R500-A  
**O.D.:** 3 17/32 (89.7)  
**I.D.:** 7/16 (11.1) & 2 3/8 (60.3)  
**Height:** 14 (355.6)  
**F. Gskt:** [1] Included, [1] Wing Nut



Measurements Are Shown In Inches And (Millimeters)

**WARNING:** These products can expose you to chemicals, including Diisononyl Phthalate, Carbon black extracts, Nickel, 1,3 Butadiene, Ethylene Oxide, Epichlorohydrin, which are known to the State of California to cause cancer, and Bisphenol, Ethylene Glycol, Ethylene Oxide, 1,3 Butadiene, Epichlorohydrin, which are known to the State of California to cause birth defects or other reproductive harm.

**PA2307**

Outer Air Element with Lift Bar  
**Notes:** Reuse OEM boot.  
**Fits:** Ford Tractors  
**Use With:** PA2308  
**Replaces:** Ford D0NN-9601-A  
**O.D.:** 7 (177.8)  
**I.D.:** 4 19/32 (116.7) One End  
**Height:** 14 7/16 (366.7)  
**A. Gskt:** [1] Attached



**PA2314**

Outer Air Element with Bail Handle  
**Fits:** Elgin, Hough, International Equipment  
**Use With:** PA2332  
**Replaces:** Elgin 7072935; International 529851-R2  
**O.D.:** 6 3/32 (154.8)  
**I.D.:** 3 15/32 (88.1) One End  
**Height:** 15 5/16 (388.9)  
**A. Gskt:** [1] Attached  
**Related To:** PA2392 (Short Version)



**PA2308**

Inner Air Element  
**Fits Inside:** PA2307, PA2433  
**Fits:** Ford, Versatile Tractors  
**Replaces:** Ford D2NN-9R500-B; Versatile 24574  
**O.D.:** 4 17/32 (115.1)  
**I.D.:** 7/16 (11.1) & 3 7/16 (87.3)  
**Height:** 13 9/16 (344.5)  
**F. Gskt:** [1] Included, [1] Wing Nut



**PA2315**

DynaCell Panel Air Element  
**Replaces:** GMC 8469003  
**Length:** 22 15/16 (582.6)  
**Width:** 14 (355.6)  
**Height:** 5 5/16 (134.9) to 6 7/32 158.0

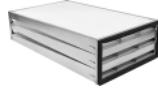

**PA2310**

Inner Air Element with 8 Bolt Holes  
**Fits Inside:** LL1634, PA1634, PA1634XP  
**Fits:** Caterpillar Equipment  
**Replaces:** Caterpillar 9S9972  
**O.D.:** 6 1/4 (158.8)  
 Flange 9 1/16 (230.2)  
**I.D.:** 4 5/8 (117.5) One End  
**Height:** 13 3/32 (332.6)  
**A. Gskt:** [1] Attached  
**F. Gskt:** [1] Included



**PA2316**

Air Element  
**Fits:** Chevrolet, GMC Trucks  
**Replaces:** GMC 684743716  
**O.D.:** 12 1/16 (306.4)  
**I.D.:** 5/8 (15.9) & 6 3/32 (154.8)  
**Height:** 14 1/4 (362.0)  
**A. Gskt:** [1] Attached  
**F. Gskt:** G103-N



**LL2312**

Long Life Air Element  
**Notes:** Inside-Out Flow Direction  
**Fits:** Kenworth, Mack, Peterbilt, R.V.I. Trucks  
**Replaces:** GMC 15586905; Kenworth KW853M; Mack 2MD2147  
**O.D.:** 10 3/8 (263.5)  
**I.D.:** 6 1/32 (153.2) One End  
**Height:** 22 13/16 (579.4)  
**A. Gskt:** [2] Attached  
**F. Gskt:** G21-AF  
**O. Gskt:** G499-AF  
**Related To:** PA2312 (Standard Media Version)



**LL2317**

Long Life Air Element  
**Notes:** Inside-Out Flow Direction  
**Fits:** Brockway, Freightliner, GMC, Kenworth, Mack, Peterbilt Trucks  
**Replaces:** Brockway 534564; Caterpillar 7W7422; GMC 15529143; Mack 2MD2153  
**O.D.:** 12 3/4 (323.8)  
**I.D.:** 8 11/32 (211.9) One End  
**Height:** 23 (584.2)  
**A. Gskt:** [2] Attached  
**F. Gskt:** G25-AF  
**Related To:** PA2317 (Standard Media Version)



**PA2312**

Air Element  
**Notes:** Inside-Out Flow Direction  
**Fits:** Kenworth, Mack, Peterbilt, R.V.I. Trucks  
**Replaces:** GMC 15586905; Kenworth KW853M; Mack 2MD2147  
**O.D.:** 10 3/8 (263.5)  
**I.D.:** 6 1/32 (153.2) One End  
**Height:** 22 13/16 (579.4)  
**A. Gskt:** [2] Attached  
**F. Gskt:** G21-AF  
**O. Gskt:** G499-AF  
**Related To:** LL2312 (Long-Life Media Version)



**PA2317**

Air Element  
**Notes:** Inside-Out Flow Direction  
**Fits:** Brockway, Freightliner, GMC, Kenworth, Mack, Peterbilt Trucks  
**Replaces:** Brockway 534564; Caterpillar 7W7422; GMC 15529143; Mack 2MD2153  
**O.D.:** 12 3/4 (323.8)  
**I.D.:** 8 11/32 (211.9) One End  
**Height:** 23 (584.2)  
**A. Gskt:** [2] Attached  
**F. Gskt:** G25-AF  
**Related To:** LL2317 (Long-Life Media Version)



**PA2313**

DynaCell Panel Air Element  
**Replaces:** White 27-074049  
**Length:** 22 3/4 (577.9)  
**Width:** 20 1/4 (514.4)  
**Height:** 3 9/32 (83.3) to 4 1/4 108.0

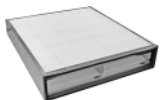

**LL2318**

Long Life Outer Air Element  
**Fits:** International Equipment  
**Use With:** PA2319  
**Replaces:** International 537337-R1  
**O.D.:** 8 15/32 (215.1)  
 Boot 9 7/16 (239.7)  
**I.D.:** 4 17/32 (115.1) One End  
**Height:** 15 1/2 (393.7)  
**A. Gskt:** [2] Attached  
**Related To:** PA2318 (Standard Media)



Measurements Are Shown In Inches And (Millimeters)

**WARNING:** These products can expose you to chemicals, including Diisononyl Phthalate, Carbon black extracts, Nickel, 1,3 Butadiene, Ethylene Oxide, Epichlorohydrin, which are known to the State of California to cause cancer, and Bisphenol, Ethylene Glycol, Ethylene Oxide, 1,3 Butadiene, Epichlorohydrin, which are known to the State of California to cause birth defects or other reproductive harm.

**PA2318**



Outer Air Element

**Fits:** International Equipment  
**Use With:** PA2319  
**Replaces:** International 537337-R1  
**O.D.:** 8 15/32 (215.1)  
**Boot** 9 7/16 (239.7)  
**I.D.:** 4 17/32 (115.1) One End  
**Height:** 15 1/2 (393.7)  
**A. Gskt:** [2] Attached  
**Related To:** LL2318 (Long-Life Media)

**PA2319**



Inner Air Element

**Fits Inside:** LL2318, PA2318  
**Fits:** International Equipment  
**Replaces:** International 537338-R2  
**O.D.:** 4 15/32 (113.5)  
**I.D.:** 3/8 (9.5) & 3 7/16 (87.3)  
**Height:** 14 (355.6)  
**A. Gskt:** [1] Attached  
**F. Gskt:** [1] Included, [1] Wing Nut

**PA2320-FN**



Outer Air Element with Fins

**Fits:** Minneapolis-Moline, Oliver Tractors  
**Use With:** PA2321  
**Replaces:** International 3115560-R91  
**O.D.:** 6 3/32 (154.8)  
**Fins** 7 13/16 (198.4)  
**I.D.:** 3/4 (19.0) & 3 15/32 (88.1)  
**Height:** 13 1/2 (342.9)  
**A. Gskt:** [1] Attached  
**F. Gskt:** G103-N

**PA2321**



Inner Air Element

**Fits Inside:** LL1681-FN, PA1681-FN, PA2320-FN  
**Fits:** Case Equipment; Oliver Tractors  
**Replaces:** Case D78336; White 30-3003477  
**O.D.:** 3 3/8 (85.7)  
**Flange** 3 25/32 (96.0)  
**I.D.:** 21/32 (16.7) & 2 7/8 (73.0)  
**Height:** 11 1/16 (281.0)  
**A. Gskt:** [1] Attached  
**F. Gskt:** G103-N

**PA2322**



Outer Air Element with Lift Bar

**Fits:** Massey Ferguson Wheel Tractors  
**Use With:** PA2323  
**Replaces:** Massey Ferguson 1039044-M91  
**O.D.:** 5 5/16 (134.9)  
**I.D.:** 3 13/32 (86.5) One End  
**Height:** 14 3/16 (360.4)  
**A. Gskt:** [1] Attached

**PA2323**



Inner Air Element

**Fits Inside:** PA2322, PA2486  
**Fits:** Massey Ferguson Wheel Tractors  
**Replaces:** Massey Ferguson 1039045-M91  
**O.D.:** 3 5/16 (84.1)  
**I.D.:** 5/8 (15.9) & 2 1/4 (57.2)  
**Height:** 13 21/32 (346.9)

**LL2326**



Long Life Air Element

**Fits:** Peterbilt Trucks  
**Replaces:** White 27-088627; Donaldson EAF5057  
**O.D.:** 12 3/4 (323.8)  
**Boot Gasket** 13 3/8 (339.7)  
**I.D.:** 15/16 (23.8) & 8 3/8 (212.7)  
**Height:** 17 1/2 (444.5)  
**A. Gskt:** [2] Attached  
**F. Gskt:** [1] Included  
**Related To:** PA2326 (Standard Media Version)  
 PA2326XP (Extreme Performance Nano Version)

**PA2326**



Air Element

**Fits:** Peterbilt Trucks  
**Replaces:** White 27-088627; Donaldson EAF5057  
**O.D.:** 12 3/4 (323.8)  
**Boot Gasket** 13 3/8 (339.7)  
**I.D.:** 15/16 (23.8) & 8 3/8 (212.7)  
**Height:** 17 1/2 (444.5)  
**A. Gskt:** [2] Attached  
**F. Gskt:** [1] Included  
**Related To:** LL2326 (Long-Life Media Version)  
 PA2326XP (Extreme Performance Nano Version)

**PA2326XP**



Extreme Performance Nano Air Element

**Fits:** Peterbilt Trucks  
**Replaces:** White 27-088627; Donaldson EAF5057  
**O.D.:** 12 3/4 (323.8)  
**Boot Gasket** 13 3/8 (339.7)  
**I.D.:** 15/16 (23.8) & 8 3/8 (212.7)  
**Height:** 17 1/2 (444.5)  
**A. Gskt:** [2] Attached  
**F. Gskt:** [1] Included  
**Related To:** LL2326 (Long-Life Media Version)  
 PA2326 (Standard Media Version)

**PA2328**



Air Element

**Replaces:** White 31-15782  
**O.D.:** 11 1/16 (281.0)  
**Flange** 11 11/16 (296.9)  
**I.D.:** 7 25/32 (197.6)  
**Height:** 7 (177.8)

**PA2329**

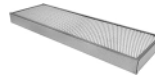

Cab Air Element

**Fits:** Massey Ferguson Equipment  
**Replaces:** Massey Ferguson 525446-M1  
**Length:** 29 (736.6)  
**Width:** 9 1/4 (235.0)  
**Height:** 2 3/16 (55.6)

**LL2330**



Long Life Outer Air Element

**Fits:** International Trucks  
**Use With:** PA2579  
**Replaces:** International 424700-C92  
**O.D.:** 12 1/32 (305.6)  
**I.D.:** 5/8 (15.9) & 7 11/16 (195.3)  
**Height:** 15 5/16 (388.9)  
**A. Gskt:** [1] Attached  
**F. Gskt:** G103-N  
**Related To:** PA2330 (Standard Media Version)

Measurements Are Shown In Inches And (Millimeters)

**WARNING:** These products can expose you to chemicals, including Diisononyl Phthalate, Carbon black extracts, Nickel, 1,3 Butadiene, Ethylene Oxide, Epichlorohydrin, which are known to the State of California to cause cancer, and Bisphenol, Ethylene Glycol, Ethylene Oxide, 1,3 Butadiene, Epichlorohydrin, which are known to the State of California to cause birth defects or other reproductive harm.

**PA2330** Outer Air Element  
**Fits:** International Trucks  
**Use With:** PA2579  
**Replaces:** International 424700-C92  
**O.D.:** 12 1/32 (305.6)  
**I.D.:** 5/8 (15.9) & 7 11/16 (195.3)  
**Height:** 15 5/16 (388.9)  
**A. Gskt:** [1] Attached  
**F. Gskt:** G103-N  
**Related To:** LL2330 (Long-Life Media Version)



**PA2337** Air Element  
**Fits:** Atlas Copco Compressors  
**Replaces:** Atlas Copco 1030-1070  
**O.D.:** 11 7/8 (301.6)  
**I.D.:** 7 1/2 (190.5)  
**Height:** 4 11/32 (110.3)



**PA2331** Outer Air Element with Lift Tab  
**Contains:** Flame Retardant Media  
**Fits:** Ford Equipment  
**Use With:** PA1809  
**Replaces:** Ford DONN-9B618-A  
**O.D.:** 4 1/2 (114.3)  
 Boot 4 7/8 (123.8)  
**I.D.:** 2 1/4 (57.2) One End  
**Height:** 10 3/4 (273.1)  
**A. Gskt:** [2] Attached



**PA2338-FN** Outer Air Element with Fins  
**Fits:** International Wheel Tractors  
**Use With:** PA1836  
**Replaces:** International 537336-R1  
**O.D.:** 7 15/16 (201.6)  
 Fins 10 (254.0)  
**I.D.:** 5 3/8 (136.5) One End  
**Height:** 15 1/2 (393.7)  
**A. Gskt:** [1] Attached



**PA2332** Inner Air Element  
**Fits Inside:** PA2314, LL2418-FN, PA2418-FN, PA2524-FN, PA2541-FN, PA2551  
**Fits:** Bobcat, Case, Dresser, Hough, International, Massey Ferguson, Melroe, New Holland Equipment; Spra-Coupe Sprayers  
**Replaces:** Case P250566; International 406130-R91; Massey Ferguson 1037735-M91; Melroe 6598898; New Holland 377059  
**O.D.:** 3 3/8 (85.7)  
 Flange 3 25/32 (96.0)  
**I.D.:** 21/32 (16.7) & 2 7/8 (73.0)  
**Height:** 14 1/16 (357.2)  
**A. Gskt:** [1] Attached  
**F. Gskt:** G103-N



**PA2339** Outer Air Element with Lift Tabs  
**Fits:** Case Equipment  
**Use With:** PA2340  
**Replaces:** Case A43734  
**O.D.:** 11 5/8 (295.3)  
 Boot 12 3/8 (314.3)  
**I.D.:** 7/16 (11.1) & 7 3/16 (182.6)  
**Height:** 7 5/16 (185.7)  
**A. Gskt:** [2] Attached  
**F. Gskt:** [1] Included



**LL2333** Long Life Air Element with Lid and 6 Bolt Holes  
**Fits:** Peterbilt Trucks  
**Replaces:** Donaldson P182006, P182099; Fleetguard AF872M, AF4871M  
**O.D.:** 13 13/16 (350.8)  
 Lid 16 5/32 (410.4)  
**I.D.:** 7 7/16 (188.9) One End  
**Height:** 18 9/16 (471.5)  
**A. Gskt:** [2] Attached  
**Related To:** PA2333 (Standard Media Version)



**PA2340** Inner Air Element  
**Fits Inside:** PA2339  
**Fits:** Case Equipment  
**Replaces:** Case A43735  
**O.D.:** 6 7/8 (174.6)  
**I.D.:** 5/8 (15.9) & 5 9/16 (141.3)  
**Height:** 6 1/16 (154.0)  
**A. Gskt:** [1] Attached  
**F. Gskt:** [1] Included



**PA2333** Air Element with Lid and 6 Bolt Holes  
**Fits:** Freightliner, GMC, International Trucks  
**Replaces:** GMC 25096450; International 1685307-C1; White 22-0010240  
**O.D.:** 13 13/16 (350.8)  
 Lid 16 5/32 (410.4)  
**I.D.:** 9 1/2 (241.3) One End  
**Height:** 18 9/16 (471.5)  
**A. Gskt:** [2] Attached  
**Related To:** LL2333 (Long-Life Media Version)



**PA2341** Outer Air Element  
**Fits:** Massey Ferguson Wheel Tractors  
**Use With:** PA2342  
**Replaces:** Massey Ferguson 1038946-M91  
**O.D.:** 6 7/8 (174.6)  
 Boot 7 7/16 (188.9)  
**I.D.:** 4 3/16 (106.4) One End  
**Height:** 14 5/8 (371.5)  
**A. Gskt:** [2] Attached



**PA2335** Air Element  
**Replaces:** United 250B18, 250B18-S  
**O.D.:** 4 13/32 (111.9)  
**I.D.:** 2 15/16 (74.6)  
**Height:** 4 3/4 (120.7)



**PA2342** Inner Air Element  
**Fits Inside:** PA2341  
**Fits:** Massey Ferguson Wheel Tractors  
**Replaces:** Massey Ferguson 1038947-M91  
**O.D.:** 4 3/32 (104.0)  
**I.D.:** 5/8 (15.9) & 3 1/8 (79.4)  
**Height:** 12 15/16 (328.6)  
**F. Gskt:** G40-AF



Measurements Are Shown In Inches And (Millimeters)

**WARNING:** These products can expose you to chemicals, including Diisononyl Phthalate, Carbon black extracts, Nickel, 1,3 Butadiene, Ethylene Oxide, Epichlorohydrin, which are known to the State of California to cause cancer, and Bisphenol, Ethylene Glycol, Ethylene Oxide, 1,3 Butadiene, Epichlorohydrin, which are known to the State of California to cause birth defects or other reproductive harm.



**PA2343**



Outer Air Element

**Fits:** Case, John Deere, Oliver, White Equipment  
**Use With:** PA1996  
**Replaces:** John Deere AR64624; White 30-3089258  
**O.D.:** 13 7/8 (352.4)  
**I.D.:** 5/8 (15.9) & 7 7/16 (188.9)  
**Height:** 6 29/32 (175.4)  
**A. Gskt:** [1] Attached  
**F. Gskt:** G103-N

**PA2347**



Air Element

**Fits:** Onan Engines  
**Replaces:** Onan 140-B1071  
**O.D.:** 4 5/8 (117.5)  
 Flange Gasket 5 3/16 (131.8)  
**I.D.:** 1 1/2 (38.1) One End  
**Height:** 2 19/32 (65.9)  
**A. Gskt:** [1] Attached

**LL2344-FN**



Long Life Outer Air Element with Fins

**Fits:** Case, Ford, Gehl, John Deere, New Holland, Thomas Equipment; Ingersoll-Rand Compressors  
**Use With:** PA2602  
**Replaces:** Case R39392; Gehl 263638; John Deere MG221406; New Holland 221406  
**O.D.:** 4 3/32 (104.0)  
 Fins 5 1/8 (130.2)  
**I.D.:** 25/32 (19.8) & 2 15/32 (62.7)  
**Height:** 14 5/16 (363.5)  
**A. Gskt:** [1] Attached  
**F. Gskt:** G103-N  
**Related To:** PA2344-FN (Standard Media Version)

**PA2349-FN**



Air Element with Fins and Lift Tabs

**Replaces:** White 27-011685  
**O.D.:** 13 7/8 (352.4)  
 Fins 15 25/32 (400.8)  
**I.D.:** 5/8 (15.9) & 7 7/16 (188.9)  
**Height:** 10 3/8 (263.5)  
**A. Gskt:** [1] Attached  
**F. Gskt:** G103-N

**PA2344-FN**



Outer Air Element with Fins

**Fits:** Case, Ford, Gehl, John Deere, New Holland, Thomas Equipment; Ingersoll-Rand Compressors  
**Use With:** PA2602  
**Replaces:** Case R39392; Gehl 263638; John Deere MG221406; New Holland 221406  
**O.D.:** 4 3/32 (104.0)  
 Fins 5 1/8 (130.2)  
**I.D.:** 25/32 (19.8) & 2 15/32 (62.7)  
**Height:** 14 5/16 (363.5)  
**A. Gskt:** [1] Attached  
**F. Gskt:** G103-N  
**Related To:** LL2344-FN (Long-Life Media Version)

**PA2350**

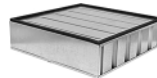

DynaCell Panel Air Element

**Notes:** Back is closed.  
**Fits:** Ford, GMC Trucks; Cummins Engines  
**Replaces:** Ford D8HZ-9601-C; GMC 6488476  
**Length:** 19 (482.6)  
**Width:** 19 (482.6)  
**Height:** 5 3/8 (136.5)  
**Related To:** PA2375 (Front and Back are Open)

**PA2351**



Outer Air Element

**Fits:** Dresser, International, John Deere Equipment  
**Use With:** PA1967  
**Replaces:** International 634269-C1; John Deere AT35155  
**O.D.:** 7 31/32 (202.4)  
**I.D.:** 11/16 (17.5) & 5 3/8 (136.5)  
**Height:** 12 3/8 (314.3)  
**A. Gskt:** [1] Attached  
**F. Gskt:** G103-N  
**Related To:** PA2304-FN (with Fins)

**PA2345**



Outer Air Element with Bail Handle

**Fits:** Case, International, John Deere, New Holland Equipment  
**Use With:** PA2346, PA2388  
**Replaces:** International 640968-C91; John Deere AT49022; New Holland 614103  
**O.D.:** 11 1/8 (282.6)  
**I.D.:** 5/8 (15.9) & 6 3/4 (171.5)  
**Height:** 20 1/2 (520.7)  
**A. Gskt:** [1] Attached  
**F. Gskt:** G103-N

**PA2352**



Cab Air Element

**Fits:** John Deere Equipment  
**Replaces:** John Deere AR49986  
**Length:** 28 (711.2)  
**Width:** 7 1/2 (190.5)  
**Height:** 2 9/16 (65.1)  
**A. Gskt:** [1] Attached  
**Related To:** PA2353 (Thin Version)

**PA2346**



Inner Air Element

**Fits Inside:** PA2345  
**Fits:** Case, International, New Holland Equipment  
**Replaces:** International 923611-C91; New Holland 614104  
**O.D.:** 6 3/8 (161.9)  
 Flange 7 1/2 (190.5)  
**I.D.:** 5/8 (15.9) & 5 1/4 (133.4)  
**Height:** 20 (508.0)  
**A. Gskt:** [1] Attached  
**F. Gskt:** G103-N

**PA2353**



Cab Air Element

**Fits:** Allis Chalmers, Case, Ford, John Deere, Melroe, New Holland, Versatile Equipment; Spra-Coupe Sprayers  
**Replaces:** Allis Chalmers 134692; Case F84818; Ford D2NN-19N-551A; John Deere AN112705; New Holland 70569300  
**Length:** 28 (711.2)  
**Width:** 7 1/2 (190.5)  
**Height:** 2 3/16 (55.6)  
**Related To:** PA2352 (Thick Version)

**PA2354**



Cab Air Element

**Fits:** Bell Equipment; Insley Shovels; Komatsu Dump Trucks  
**Replaces:** Hinson 3000020  
**Length:** 20 (508.0)  
**Width:** 7 1/2 (190.5)  
**Height:** 2 3/16 (55.6)  
**Related To:** PA5315 (with Attached Gasket)

Measurements Are Shown In Inches And (Millimeters)

**WARNING:** These products can expose you to chemicals, including Diisononyl Phthalate, Carbon black extracts, Nickel, 1,3 Butadiene, Ethylene Oxide, Epichlorohydrin, which are known to the State of California to cause cancer, and Bisphenol, Ethylene Glycol, Ethylene Oxide, 1,3 Butadiene, Epichlorohydrin, which are known to the State of California to cause birth defects or other reproductive harm.

**PA2356**

Cab Air Element



**Fits:** Case, Caterpillar, Versatile Equipment  
**Replaces:** Case T39515; Caterpillar 8S468; Versatile 15942  
**Length:** 23 1/2 (596.9)  
**Width:** 7 (177.8)  
**Height:** 2 3/16 (55.6)

**PA2357**

Air Element



**Notes:** Inside-Out Flow Direction  
**Fits:** Caterpillar, Cummins Engines; Kenworth Trucks  
**Replaces:** Caterpillar 7W7421; GMC 8994222; Kenworth 21401091  
**O.D.:** 12 3/4 (323.8)  
**I.D.:** 8 3/8 (212.7) One End  
**Height:** 27 (685.8)  
**A. Gskt:** [2] Attached  
**F. Gskt:** G25-AF  
**Related To:** LL2317 , PA2317 (Short Versions) PA2608 (with Bolt Hole)

**LL2358**

Long Life Outer Air Element



**Fits:** Caterpillar, DJB, Hough, Iveco Equipment  
**Use With:** PA2359, PA2738  
**Replaces:** Caterpillar 8N5495, 7W5495  
**O.D.:** 11 1/2 (292.1)  
**I.D.:** 8 1/16 (204.8) One End  
**Height:** 13 1/2 (342.9)  
**A. Gskt:** [1] Attached  
**Related To:** PA2358 (Standard Media Version)

**PA2358**

Outer Air Element



**Fits:** Caterpillar, DJB, Hough, Iveco Equipment  
**Use With:** PA2359, PA2738  
**Replaces:** Caterpillar 8N5495, 7W5495  
**O.D.:** 11 1/2 (292.1)  
**I.D.:** 8 1/16 (204.8) One End  
**Height:** 13 1/2 (342.9)  
**A. Gskt:** [1] Attached  
**Related To:** LL2358 (Long-Life Media Version)

**PA2359**

Inner Air Element with 8 Bolt Holes



**Fits Inside:** LL2358, PA2358  
**Fits:** Caterpillar, DJB, Hough Equipment  
**Replaces:** Caterpillar 1P7360  
**O.D.:** 7 5/8 (193.7)  
 Flange 10 1/4 (260.3)  
**I.D.:** 6 (152.4) One End  
**Height:** 13 1/2 (342.9)  
**A. Gskt:** [1] Attached

**LL2360-FN**

Long Life Outer Air Element with Fins



**Fits:** Bobcat, Case, Ditch Witch, Gehl, Grove, J.C. Bamford, Mustang, New Holland, Vermeer, Vibromax Equipment; Ingersoll-Rand Compressors  
**Use With:** PA2487  
**Replaces:** Case A173290; Ditch Witch 195690; Grove 9304100077; Ingersoll-Rand 35291970; New Holland 266221  
**O.D.:** 5 1/4 (133.4)  
 Fins 6 3/8 (161.9)  
**I.D.:** 21/32 (16.7) & 3 1/4 (82.6)  
**Height:** 15 3/8 (390.5)  
**A. Gskt:** [1] Attached  
**F. Gskt:** G103-N  
**Related To:** PA2360-FN (Standard Media Version)

**PA2360-FN**

Outer Air Element with Fins



**Fits:** Bobcat, Case, Ditch Witch, Gehl, Grove, J.C. Bamford, Mustang, New Holland, Vermeer, Vibromax Equipment; Ingersoll-Rand Compressors  
**Use With:** PA2487  
**Replaces:** Case A173290; Ditch Witch 195690; Grove 9304100077; Ingersoll-Rand 35291970; New Holland 266221  
**O.D.:** 5 1/4 (133.4)  
 Fins 6 3/8 (161.9)  
**I.D.:** 21/32 (16.7) & 3 1/4 (82.6)  
**Height:** 15 3/8 (390.5)  
**A. Gskt:** [1] Attached  
**F. Gskt:** G103-N  
**Related To:** LL2360-FN (Long-Life Media Version)

**LL2361**

Long Life Outer Air Element



**Fits:** Allis Chalmers, Fiat-Allis, New Holland, Samsung Equipment  
**Use With:** PA2362  
**Replaces:** Allis Chalmers 70671838; Fiat 70671809; New Holland 703409  
**O.D.:** 12 1/32 (305.6)  
 Boot 12 3/4 (323.8)  
**I.D.:** 15/16 (23.8) & 7 23/32 (196.1)  
**Height:** 23 1/2 (596.9)  
**A. Gskt:** [2] Attached  
**F. Gskt:** [1] Metal Washer  
**Related To:** PA2361 (Standard Media Version) PA2361XP (Extreme Performance Nano Version)

**PA2361**

Outer Air Element



**Fits:** Allis Chalmers, Fiat-Allis, New Holland, Samsung Equipment  
**Use With:** PA2362  
**Replaces:** Allis Chalmers 70671838; Fiat 70671809; New Holland 703409  
**O.D.:** 12 1/32 (305.6)  
 Boot Gasket 12 3/4 (323.9)  
**I.D.:** 15/16 (23.8) & 7 23/32 (196.1)  
**Height:** 23 1/2 (596.9)  
**A. Gskt:** [2] Attached  
**F. Gskt:** [1] Metal Washer  
**Related To:** LL2361 (Long-Life Media Version) PA2361XP (Extreme Performance Nano Version)

Measurements Are Shown In Inches And (Millimeters)

**WARNING:** These products can expose you to chemicals, including Diisononyl Phthalate, Carbon black extracts, Nickel, 1,3 Butadiene, Ethylene Oxide, Epichlorohydrin, which are known to the State of California to cause cancer, and Bisphenol, Ethylene Glycol, Ethylene Oxide, 1,3 Butadiene, Epichlorohydrin, which are known to the State of California to cause birth defects or other reproductive harm.

**PA2361XP**



Extreme Performance Nano Outer Air Element

**Fits:** Allis Chalmers, Fiat-Allis, New Holland, Samsung Equipment  
**Use With:** PA2362  
**Replaces:** Allis Chalmers 70671838; Fiat 70671809; New Holland 703409  
**O.D.:** 12 1/32 (305.6)  
 Boot 12 3/4 (323.8)  
**I.D.:** 15/16 (23.8) & 7 23/32 (196.1)  
**Height:** 23 1/2 (596.9)  
**A. Gskt:** [2] Attached  
**F. Gskt:** [1] Metal Washer  
**Related To:** LL2361 (Long-Life Media Version) PA2361 (Standard Media Version)

**PA2362**



Inner Air Element

**Fits Inside:** LL2361, PA2361  
**Fits:** Allis Chalmers, Fiat-Allis, New Holland, Samsung Equipment  
**Replaces:** Allis Chalmers 70671839; Fiat 70671809; New Holland 703408  
**O.D.:** 7 5/8 (193.7)  
**I.D.:** 7/8 (22.2) & 6 1/16 (154.0)  
**Height:** 21 15/32 (545.3)  
**A. Gskt:** [1] Attached  
**F. Gskt:** [1] Included

**LL2363**



Long Life Outer Air Element with Bail Handle

**Fits:** Caterpillar, Euclid, Hitachi, KW-Dart, Terex, Unit Rig, WABCO Equipment  
**Use With:** PA2364  
**Replaces:** Caterpillar 9Y6835; KW-Dart 3040562; Terex 6945659; WABCO VA2186  
**O.D.:** 17 5/8 (447.7)  
 Boot 18 5/16 (465.1)  
**I.D.:** 15/16 (23.8) & 11 (279.4)  
**Height:** 23 17/32 (597.7)  
**A. Gskt:** [2] Attached  
**F. Gskt:** [1] Included  
**Related To:** PA2363 (Standard Media Version) PA2363XP (Extreme Performance Nano Version)

**PA2363**



Outer Air Element with Bail Handle

**Fits:** Caterpillar, Euclid, Hitachi, KW-Dart, Terex, Unit Rig, WABCO Equipment  
**Use With:** PA2364  
**Replaces:** Caterpillar 9Y6835; KW-Dart 3040562; Terex 6945659; WABCO VA2186  
**O.D.:** 17 5/8 (447.7)  
 Boot 18 5/16 (465.1)  
**I.D.:** 15/16 (23.8) & 11 (279.4)  
**Height:** 23 17/32 (597.7)  
**A. Gskt:** [2] Attached  
**F. Gskt:** [1] Included  
**Related To:** LL2363 (Long-Life Media Version) PA2363XP (Extreme Performance Nano Version)

**PA2363XP**



Extreme Performance Nano Outer Air Element with Lift Bar

**Fits:** Caterpillar, Euclid, Hitachi, KW-Dart, Terex, Unit Rig, WABCO Equipment  
**Use With:** PA2364  
**Replaces:** Caterpillar 9Y6835; KW-Dart 3040562; Terex 6945659; WABCO VA2186  
**O.D.:** 17 5/8 (447.7)  
 Boot 18 5/16 (465.1)  
**I.D.:** 15/16 (23.8) & 11 (279.4)  
**Height:** 23 17/32 (597.7)  
**A. Gskt:** [2] Attached  
**F. Gskt:** [1] Included  
**Related To:** LL2363 (Long-Life Media Version) PA2363 (Standard Media Version)

**PA2364**



Inner Air Element

**Fits Inside:** LL2363, PA2363, PA2363XP, LL2453, PA2453, PA2453XP  
**Fits:** Caterpillar, Euclid, Hitachi, KW-Dart, Terex, Unit Rig, WABCO Equipment  
**Replaces:** Caterpillar 9Y7663; KW-Dart 3040562; Terex 6945658; WABCO VS122185  
**O.D.:** 10 29/32 (277.0)  
**I.D.:** 29/32 (23.0) & 8 5/32 (207.2)  
**Height:** 22 3/16 (563.6)  
**A. Gskt:** [1] Attached  
**F. Gskt:** [1] Included

**PA2367**



Outer Air Element

**Fits:** Galion, John Deere, Komatsu, New Holland Equipment; Onan Generators  
**Use With:** PA2368  
**Replaces:** John Deere AR57024; New Holland 279627; Onan 140-1969  
**O.D.:** 9 3/32 (231.0)  
**I.D.:** 1/2 (12.7) & 4 13/16 (122.2)  
**Height:** 19 7/8 (504.8)  
**A. Gskt:** [1] Attached  
**F. Gskt:** [1] Included

**PA2368**



Inner Air Element

**Fits Inside:** PA2367  
**Fits:** Galion, John Deere, Komatsu, New Holland Equipment  
**Replaces:** John Deere AR57025  
**O.D.:** 4 21/32 (118.3)  
**I.D.:** 5/8 (15.9) & 3 15/16 (100.0)  
**Height:** 16 7/16 (417.5)  
**A. Gskt:** [1] Attached  
**F. Gskt:** G103-N

**PA2369**



Outer Air Element

**Fits:** Allis Chalmers, John Deere Equipment  
**Use With:** PA2370  
**Replaces:** Allis Chalmers 70263435; John Deere AR54336  
**O.D.:** 7 11/32 (186.5)  
**I.D.:** 7/16 (11.1) & 3 31/32 (100.8)  
**Height:** 15 5/32 (385.0)  
**A. Gskt:** [1] Attached  
**F. Gskt:** [1] Included

**PA2370**



Inner Air Element

**Fits Inside:** PA2369  
**Fits:** Allis Chalmers, John Deere Equipment  
**Replaces:** Allis Chalmers 263434; John Deere AR54337  
**O.D.:** 3 7/8 (98.4)  
**I.D.:** 5/8 (15.9) & 3 3/16 (81.0)  
**Height:** 13 3/16 (335.0)  
**A. Gskt:** [1] Attached  
**F. Gskt:** G103-N

**PA2371**













Outer Air Element

**Fits:** Case, Dresser, International Equipment  
**Use With:** PA2372  
**Replaces:** Case A47145  
**O.D.:** 10 3/8 (263.5)  
**I.D.:** 15/16 (23.8) & 6 1/32 (153.2)  
**Height:** 12 1/2 (317.5)  
**A. Gskt:** [1] Attached  
**F. Gskt:** [2] Included

Measurements Are Shown In Inches And (Millimeters)

**WARNING:** These products can expose you to chemicals, including Diisononyl Phthalate, Carbon black extracts, Nickel, 1,3 Butadiene, Ethylene Oxide, Epichlorohydrin, which are known to the State of California to cause cancer, and Bisphenol, Ethylene Glycol, Ethylene Oxide, 1,3 Butadiene, Epichlorohydrin, which are known to the State of California to cause birth defects or other reproductive harm.

<p><b>PA2372</b></p> 	<p>Inner Air Element  <b>Fits Inside:</b> PA2371  <b>Fits:</b> Case, Dresser, International Equipment  <b>Replaces:</b> Case A47146  <b>O.D.:</b> 5 31/32 (151.6)  <b>I.D.:</b> 5/8 (15.9) &amp; 4 27/32 (123.0)  <b>Height:</b> 10 3/8 (263.5)  <b>A. Gskt:</b> [1] Attached  <b>F. Gskt:</b> G103-N</p>	<p><b>PA2379</b> Air Element  <b>Fits:</b> Ford Trucks  <b>Replaces:</b> Ford B4HF-9601-DA  <b>O.D.:</b> 10 (254.0)            Lid 12 (304.8)  <b>I.D.:</b> 3/8 (9.5) &amp; 4 15/16 (125.4)  <b>Height:</b> 9 7/16 (239.7)  <b>A. Gskt:</b> [2] Attached  <b>F. Gskt:</b> G39-AF  <b>Related To:</b> PA2379-K (with Reusable Lid Assembly)</p> 
<p><b>PA2374</b></p> 	<p>Air Element  <b>Fits:</b> Gardner Denver Compressors  <b>Replaces:</b> Gardner Denver 2010253  <b>O.D.:</b> 9 5/8 (244.5)  <b>I.D.:</b> 3/8 (9.5) &amp; 4 3/32 (104.0)  <b>Height:</b> 15 1/16 (382.6)  <b>A. Gskt:</b> [1] Attached  <b>F. Gskt:</b> [1] Included</p>	<p><b>PA2379-K</b> Air Element with Reusable Lid Assembly  <b>Fits:</b> Ford Trucks  <b>Replaces:</b> Ford B4HF-9601-DA  <b>O.D.:</b> 10 (254.0)            Lid 12 (304.8)  <b>I.D.:</b> 3/8 (9.5) &amp; 4 15/16 (125.4)  <b>Height:</b> 9 7/16 (239.7)  <b>A. Gskt:</b> [2] Attached  <b>F. Gskt:</b> G39-AF  <b>Related To:</b> PA2379 (Filter only)</p> 
<p><b>PA2375</b></p> 	<p>DynaCell Panel Air Element  <b>Notes:</b> Open on both ends.  <b>Fits:</b> Ford Trucks; Ingersoll-Rand Compressors  <b>Replaces:</b> Ford D8HZ-9601-E; Ingersoll-Rand 35258177  <b>Length:</b> 19 (482.6)  <b>Width:</b> 19 (482.6)  <b>Height:</b> 5 3/8 (136.5)  <b>Related To:</b> PA2350 (Back is Closed)</p>	<p><b>PA2380-FN</b> Outer Air Element with Fins  <b>Fits:</b> Allis Chalmers, Atlas-Weyhausen, Fiat-Allis, Hough, International, J.C. Bamford, John Deere, Massey Ferguson Equipment  <b>Use With:</b> PA2381  <b>Replaces:</b> Allis Chalmers 1909128; Fiat 72099164; International 924779-C1; J.C. Bamford 32/203702; John Deere AE31723  <b>O.D.:</b> 5 1/4 (133.4)            Fins 6 3/8 (161.9)  <b>I.D.:</b> 21/32 (16.7) &amp; 3 1/4 (82.6)  <b>Height:</b> 12 15/32 (316.7)  <b>A. Gskt:</b> [1] Attached  <b>F. Gskt:</b> G103-N</p> 
<p><b>PA2376</b></p> 	<p>Air Element  <b>Fits:</b> International Engines  <b>Replaces:</b> International 439723-C91  <b>O.D.:</b> 12 1/32 (305.6)  <b>I.D.:</b> 5/8 (15.9) &amp; 7 11/16 (195.3)  <b>Height:</b> 19 31/32 (507.2)  <b>A. Gskt:</b> [1] Attached  <b>F. Gskt:</b> G103-N</p>	<p><b>PA2381</b> Inner Air Element  <b>Fits Inside:</b> PA2380-FN, PA2392, PA3778  <b>Fits:</b> Allis Chalmers, Fiat-Allis, Hough, International, J.C. Bamford, John Deere, Massey Ferguson Equipment  <b>Replaces:</b> Allis Chalmers 1909129; Fiat 79022026; International 537335-R3; J.C. Bamford 32/203703; John Deere AE31724  <b>O.D.:</b> 2 31/32 (75.4)            Flange 3 21/32 (92.9)  <b>I.D.:</b> 5/8 (15.9) &amp; 2 7/16 (61.9)  <b>Height:</b> 11 1/8 (282.6)  <b>A. Gskt:</b> [1] Attached  <b>F. Gskt:</b> G39-AF</p> 
<p><b>PA2377</b></p> 	<p>Outer Air Element  <b>Fits:</b> Hough, International Equipment  <b>Use With:</b> PA2378  <b>Replaces:</b> International 925761-C1  <b>O.D.:</b> 10 (254.0)  <b>I.D.:</b> 3/8 (9.5) &amp; 5 1/2 (139.7)  <b>Height:</b> 20 7/8 (530.2)  <b>A. Gskt:</b> [1] Attached  <b>F. Gskt:</b> [1] Included</p>	<p><b>PA2382</b> Air Element  <b>Replaces:</b> Blue Bird 3022107241  <b>O.D.:</b> 10 3/8 (263.5)  <b>I.D.:</b> 6 1/32 (153.2) One End  <b>Height:</b> 17 13/16 (452.4)  <b>A. Gskt:</b> [2] Attached  <b>F. Gskt:</b> G21-AF</p> 
<p><b>PA2378</b></p> 	<p>Inner Air Element  <b>Fits Inside:</b> PA2377  <b>Fits:</b> Hough, International Equipment  <b>Replaces:</b> International 925762-C1  <b>O.D.:</b> 5 1/4 (133.4)  <b>I.D.:</b> 5/8 (15.9) &amp; 4 1/8 (104.8)  <b>Height:</b> 19 7/16 (493.7)  <b>A. Gskt:</b> [1] Attached  <b>F. Gskt:</b> G103-N</p>	

Measurements Are Shown In Inches And (Millimeters)

**WARNING:** These products can expose you to chemicals, including Diisononyl Phthalate, Carbon black extracts, Nickel, 1,3 Butadiene, Ethylene Oxide, Epichlorohydrin, which are known to the State of California to cause cancer, and Bisphenol, Ethylene Glycol, Ethylene Oxide, 1,3 Butadiene, Epichlorohydrin, which are known to the State of California to cause birth defects or other reproductive harm.

**PA2383**

Air Element



**Fits:** International Wheel Tractors  
**Replaces:** International 529957-R1  
**O.D.:** 5 7/16 (138.1)  
 Boot 6 3/8 (161.9)  
**I.D.:** 2 27/32 (72.2) One End  
**Height:** 10 7/8 (276.2)  
**A. Gskt:** [2] Attached

**PA2387**

Outer Air Element with Lift Tabs



**Fits:** Versatile Tractors  
**Use With:** PA2388  
**Replaces:** Versatile 15803  
**O.D.:** 9 5/8 (244.5)  
 Flange 11 1/2 (292.1)  
**I.D.:** 6 3/16 (157.2) One End  
**Height:** 20 7/16 (519.1)  
**A. Gskt:** [2] Attached

**LL2384**

Long Life Outer Air Element



**Fits:** Caterpillar Equipment, Industrial Engines  
**Use With:** PA2385, PA2625, PA2647, PA2735  
**Replaces:** Caterpillar 1P8483, 8N5313  
**O.D.:** 12 1/2 (317.5)  
**I.D.:** 9 1/8 (231.8) One End  
**Height:** 15 1/2 (393.7)  
**A. Gskt:** [1] Attached  
**Related To:** PA2384 (Standard Media Version)  
 PA2384XP (Extreme Performance Nano Version)

**PA2388**

Inner Air Element



**Fits Inside:** PA2345, PA2386, PA2387  
**Fits:** John Deere Equipment; New Holland, Versatile Tractors  
**Replaces:** John Deere AT49021  
**O.D.:** 6 1/8 (155.6)  
**I.D.:** 1/2 (12.7) & 4 15/16 (125.4)  
**Height:** 18 5/16 (465.1)  
**A. Gskt:** [1] Attached  
**F. Gskt:** G20-AF, [1] Wing Nut

**PA2384**

Outer Air Element



**Fits:** Caterpillar Equipment, Industrial Engines  
**Use With:** PA2385, PA2625, PA2647, PA2735  
**Replaces:** Caterpillar 1P8483, 8N5313  
**O.D.:** 12 1/2 (317.5)  
**I.D.:** 9 1/8 (231.8) One End  
**Height:** 15 1/2 (393.7)  
**A. Gskt:** [1] Attached  
**Related To:** LL2384 (Long-Life Media Version)  
 PA2384XP (Extreme Performance Nano Version)

**PA2389-FN**

Air Element with Fins and Lift Tabs



**Replaces:** White 27-077288  
**O.D.:** 13 7/8 (352.4)  
 Fins 15 3/4 (400.0)  
**I.D.:** 5/8 (15.9) & 7 7/16 (188.9)  
**Height:** 12 1/2 (317.5)  
**A. Gskt:** [1] Attached  
**F. Gskt:** G103-N

**PA2384XP**

Extreme Performance Nano Outer Air Element



**Fits:** Caterpillar Equipment, Industrial Engines  
**Use With:** PA2385, PA2625, PA2647, PA2735  
**Replaces:** Caterpillar 1P8483, 8N5313  
**O.D.:** 12 1/2 (317.5)  
**I.D.:** 9 1/8 (231.8) One End  
**Height:** 15 1/2 (393.7)  
**A. Gskt:** [1] Attached  
**Related To:** LL2384 (Long-Life Media Version)  
 PA2384 (Standard Media Version)

**PA2390**

Set of 2 DynaCell Panel Air Elements



**Notes:** Uses 2 filters per application.  
**Fits:** Industrial Applications  
**Replaces:** Farr C29360-2, R300  
**Each Filter:**  
**Length:** 45 3/8 (1152.5)  
**Width:** 14 (355.6)  
**Height:** 6 3/16 (157.2)

**PA2385**

Inner Air Element with 10 Bolt Holes



**Fits Inside:** LL2384, PA2384, PA2384XP, LL2609, PA2609  
**Fits:** Caterpillar Equipment, Industrial Engines  
**Replaces:** Caterpillar 1P8482, 7N1308  
**O.D.:** 8 5/8 (219.1)  
 Flange 11 3/8 (288.9)  
**I.D.:** 6 31/32 (177.0) One End  
**Height:** 15 1/4 (387.3)  
**A. Gskt:** [1] Attached

**PA2391**

Outer Air Element



**Fits:** International Wheel Tractors  
**Use With:** PA2489, PA2700  
**Replaces:** International 529854-R2  
**O.D.:** 5 7/16 (138.1)  
 Boot 6 3/8 (161.9)  
**I.D.:** 2 27/32 (72.2) One End  
**Height:** 11 7/8 (301.6)  
**A. Gskt:** [2] Attached

**PA2386**

Outer Air Element with Lift Tab



**Fits:** New Holland, Versatile Tractors  
**Use With:** PA2388  
**Replaces:** New Holland V22930; Versatile 22930  
**O.D.:** 10 17/32 (267.5)  
 Boot 12 (304.8)  
**I.D.:** 6 7/8 (174.6) One End  
**Height:** 20 3/8 (517.5)  
**A. Gskt:** [2] Attached

**PA2392**

Outer Air Element with Bail Handle



**Fits:** International Wheel Tractors  
**Use With:** PA2381  
**Replaces:** International 537334-R1  
**O.D.:** 6 3/32 (154.8)  
**I.D.:** 3 15/32 (88.1) One End  
**Height:** 13 5/16 (338.1)  
**A. Gskt:** [1] Attached  
**Related To:** PA2314 (Long Version)

Measurements Are Shown In Inches And (Millimeters)

**WARNING:** These products can expose you to chemicals, including Diisononyl Phthalate, Carbon black extracts, Nickel, 1,3 Butadiene, Ethylene Oxide, Epichlorohydrin, which are known to the State of California to cause cancer, and Bisphenol, Ethylene Glycol, Ethylene Oxide, 1,3 Butadiene, Epichlorohydrin, which are known to the State of California to cause birth defects or other reproductive harm.

**LL2393**

Long Life Air Element with Lid and 6 Bolt Holes  
**Fits:** WhiteGMC Trucks  
**Replaces:** White 27-092086  
**O.D.:** 12 3/4 (323.8)  
 Lid 16 5/32 (410.4)  
**I.D.:** 7 7/16 (188.9) One End  
**Height:** 19 1/2 (495.3)  
**A. Gskt:** [2] Attached  
**Related To:** PA2393 (Standard Media Version)



**PA2398**

Air Element  
**Fits:** R.V.I. Trucks  
**Replaces:** Renault 5000819342  
**O.D.:** 12 3/4 (323.8)  
**I.D.:** 8 11/32 (211.9) One End  
**Height:** 21 (533.4)  
**A. Gskt:** [2] Attached  
**F. Gskt:** G25-AF  
**Related To:** PA2437 (Short Version)



**PA2393**

Air Element with Lid and 6 Bolt Holes  
**Fits:** WhiteGMC Trucks  
**Replaces:** White 27-092086  
**O.D.:** 12 3/4 (323.8)  
 Lid 16 5/32 (410.4)  
**I.D.:** 7 7/16 (188.9) One End  
**Height:** 19 1/2 (495.3)  
**A. Gskt:** [2] Attached  
**Related To:** LL2398 (Long-Life Media Version)



**PA2399**

Air Element  
**Fits:** American LaFrance Trucks;  
 Ingersoll-Rand Compressors  
**Replaces:** American LaFrance 1020900;  
 Ingersoll-Rand 35253921  
**O.D.:** 17 5/8 (447.7)  
**I.D.:** 15/16 (23.8) & 11 1/32 (280.2)  
**Height:** 8 1/32 (204.0)  
**A. Gskt:** [2] Attached  
**F. Gskt:** [1] Included



**PA2394**

Air Element with Lid and 6 Bolt Holes  
**Fits:** Allmand Equipment; International Trucks  
**Replaces:** International 417075-C91  
**O.D.:** 13 7/8 (352.4)  
 Lid 16 1/8 (409.6)  
**I.D.:** 7 7/16 (188.9) One End  
**Height:** 21 1/2 (546.1)  
**A. Gskt:** [2] Attached



**PA2401**

Outer Air Element  
**Fits:** Massey Ferguson Wheel Tractors  
**Use With:** PA2402  
**Replaces:** Massey Ferguson 1041845-M91  
**O.D.:** 7 15/16 (201.6)  
 Boot 9 (228.6)  
**I.D.:** 11/16 (17.5) & 5 3/8 (136.5)  
**Height:** 13 3/8 (339.7)  
**A. Gskt:** [2] Attached  
**F. Gskt:** G103-N



**PA2395**

Set of 2 DynaCell Panel Air Elements  
**Notes:** Uses 2 filters per application.  
**Fits:** Industrial Applications  
**Replaces:** Farr C55445-1, RC250  
**Each Filter:**  
**Length:** 36 7/16 (925.5)  
**Width:** 14 (355.6)  
**Height:** 6 3/16 (157.2)

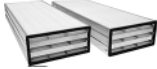

**PA2402**

Inner Air Element  
**Fits Inside:** PA2401  
**Fits:** Massey Ferguson Wheel Tractors  
**Replaces:** Massey Ferguson 1041846-M91  
**O.D.:** 5 1/4 (133.4)  
**I.D.:** 5/8 (15.9) & 4 1/8 (104.8)  
**Height:** 12 1/4 (311.2)  
**A. Gskt:** [1] Attached  
**F. Gskt:** G103-N



**PA2396**

Outer Air Element with Lift Tabs  
**Fits:** Versatile Tractors  
**Use With:** PA2397  
**Replaces:** Versatile 22934  
**O.D.:** 12 1/16 (306.4)  
 Boot 14 (355.6)  
**I.D.:** 7 11/16 (195.3) One End  
**Height:** 20 3/8 (517.5)  
**A. Gskt:** [2] Attached



**PA2403**

Outer Air Element with Lift Tabs  
**Fits:** Case Tractors  
**Use With:** PA2404  
**Replaces:** Case A44694  
**O.D.:** 12 1/16 (306.4)  
 Boot 13 (330.2)  
**I.D.:** 5/8 (15.9) & 7 11/16 (195.3)  
**Height:** 7 1/8 (181.0)  
**A. Gskt:** [2] Attached  
**F. Gskt:** G103-N



**PA2397**

Inner Air Element  
**Fits Inside:** PA2396  
**Fits:** Versatile Tractors  
**Replaces:** Versatile 22935  
**O.D.:** 7 1/8 (181.0)  
**I.D.:** 17/32 (13.5) & 5 13/16 (147.6)  
**Height:** 18 1/4 (463.6)  
**A. Gskt:** [1] Attached  
**F. Gskt:** [1] Included



**PA2404**

Inner Air Element  
**Fits Inside:** PA2403  
**Fits:** Case Tractors  
**Replaces:** Case A44695  
**O.D.:** 6 7/8 (174.6)  
**I.D.:** 21/32 (16.7) & 4 3/16 (106.4)  
**Height:** 5 1/4 (133.4)  
**A. Gskt:** [1] Attached  
**F. Gskt:** G103-N



Measurements Are Shown In Inches And (Millimeters)

**WARNING:** These products can expose you to chemicals, including Diisononyl Phthalate, Carbon black extracts, Nickel, 1,3 Butadiene, Ethylene Oxide, Epichlorohydrin, which are known to the State of California to cause cancer, and Bisphenol, Ethylene Glycol, Ethylene Oxide, 1,3 Butadiene, Epichlorohydrin, which are known to the State of California to cause birth defects or other reproductive harm.

**PA2405** Outer Air Element  
**Fits:** Atlas Copco Compressors; Bomag, Claas, Dynapac, Iveco, John Deere, Liebherr, Volvo Equipment; DAF, Iveco, Mercedes-Benz, R.V.I., Scania Buses, Trucks  
**Use With:** PA2835  
**Replaces:** Atlas Copco 16192487; Bomag 5851012; Iveco 4776902; Mercedes-Benz 130941802; Volvo 7362224, 7362224-3  
**O.D.:** 7 13/16 (198.4)  
**I.D.:** 11/32 (8.7) & 4 3/32 (104.0)  
**Height:** 14 3/4 (374.7)  
**A. Gskt:** [1] Attached  
**F. Gskt:** [1] Included



**PA2406** Air Element with Lid and 6 Bolt Holes  
**Notes:** OBSOLETE. Availability Limited to Dealer Stock.  
**Fits:** International Trucks  
**Replaces:** International 424181-C91  
**O.D.:** 13 7/8 (352.4)  
 Lid 16 1/8 (409.6)  
**I.D.:** 7 7/16 (188.9) One End  
**Height:** 7 1/2 (190.5)  
**A. Gskt:** [2] Attached



**PA2407** Cab Air Element  
**Notes:** If gasket is removed from International housing, use PA2619 instead.  
**Fits:** Case, International, John Deere, Minneapolis-Moline, Versatile, White Equipment  
**Replaces:** Case A42573; International 109215-C1; Versatile 105382; White 20-7000329  
**Length:** 38 (965.2)  
**Width:** 6 (152.4)  
**Height:** 2 3/16 (55.6)  
**Related To:** PA2619 (with Attached Gasket)



**PA2408** Cab Air Element  
**Fits:** John Deere, White Equipment  
**Replaces:** John Deere AH80212  
**Length:** 37 (939.8)  
**Width:** 6 (152.4)  
**Height:** 2 3/16 (55.6)



**PA2409** Outer Air Element  
**Fits:** Dresser, Hough, International, Steiger Equipment  
**Use With:** PA2410  
**Replaces:** International 680587-C2  
**O.D.:** 12 1/32 (305.6)  
**I.D.:** 7/8 (22.2) & 7 11/16 (195.3)  
**Height:** 18 1/2 (469.9)  
**A. Gskt:** [1] Attached  
**F. Gskt:** G129-N



**PA2410** Inner Air Element  
**Fits Inside:** PA2409, PA5751  
**Fits:** Dresser, Gleaner, Hough, International, Massey Ferguson Steiger Equipment  
**Replaces:** International 681911-C91  
**O.D.:** 7 5/8 (193.7)  
**I.D.:** 5/8 (15.9) & 6 1/16 (154.0)  
**Height:** 17 3/8 (441.3)  
**A. Gskt:** [1] Attached  
**F. Gskt:** G103-N



**PA2411** Cab Air Element  
**Fits:** Ag-Chem, Hesston, International, Rickel Mfg. Equipment  
**Replaces:** International 537268-R1  
**Length:** 38 (965.2)  
**Width:** 5 (127.0)  
**Height:** 2 3/16 (55.6)



**PA2412** Air Element with Air Restriction Gauge Fitting  
**Fits:** Ford Buses, Trucks  
**Replaces:** Ford D2HZ-9601-A  
**O.D.:** 9 5/16 (236.5)  
**I.D.:** 17/32 (13.5) & 4 27/32 (123.0)  
**Height:** 10 7/16 (265.1)  
**A. Gskt:** [1] Attached  
**F. Gskt:** [1] Included  
**Related To:** PA1840 (without Air Restriction Gauge Fitting)



**PA2413** Inner Air Element  
**Fits Inside:** PA1926, PA3698  
**Fits:** Caterpillar Equipment; Mitsubishi Lift Trucks  
**Replaces:** Caterpillar 4N313, 4N0313  
**O.D.:** 3 3/8 (85.7)  
**I.D.:** 11/16 (17.5) & 2 1/4 (57.2)  
**Height:** 10 1/4 (260.3)  
**A. Gskt:** [1] Attached  
**F. Gskt:** G103-N



**PA2414** Outer Air Element  
**Fits:** Dresser, Hough, International Equipment  
**Use With:** PA2415  
**Replaces:** International 672019-C1  
**O.D.:** 12 1/32 (305.6)  
**I.D.:** 5/8 (15.9) & 7 11/16 (195.3)  
**Height:** 13 1/2 (342.9)  
**F. Gskt:** G103-N



**PA2415** Inner Air Element  
**Fits Inside:** PA2414  
**Fits:** Dresser, Hough, International Equipment  
**Replaces:** International 672020-C1  
**O.D.:** 7 5/8 (193.7)  
**I.D.:** 5/8 (15.9) & 6 1/16 (154.0)  
**Height:** 12 3/8 (314.3)  
**A. Gskt:** [1] Attached  
**F. Gskt:** G103-N



**PA2417-FN** Air Element with Fins  
**Fits:** Grove Cranes  
**Replaces:** Grove 9304100069  
**O.D.:** 12 1/16 (306.4)  
 Fins 13 3/4 (349.3)  
**I.D.:** 5/8 (15.9) & 5 11/16 (144.5)  
**Height:** 12 7/16 (315.9)  
**A. Gskt:** [1] Attached  
**F. Gskt:** G103-N



Measurements Are Shown In Inches And (Millimeters)

**WARNING:** These products can expose you to chemicals, including Diisononyl Phthalate, Carbon black extracts, Nickel, 1,3 Butadiene, Ethylene Oxide, Epichlorohydrin, which are known to the State of California to cause cancer, and Bisphenol, Ethylene Glycol, Ethylene Oxide, 1,3 Butadiene, Epichlorohydrin, which are known to the State of California to cause birth defects or other reproductive harm

**LL2418-FN**



Long Life Outer Air Element with Fins  
**Fits:** Allis Chalmers, Case, Caterpillar, Dresser, Fiat-Allis, John Deere, Kobelco, Komatsu, New Holland Equipment  
**Use With:** PA2305, PA2332, PA2419  
**Replaces:** Allis Chalmers 79011386; Case D56453; Caterpillar 7E0975; Fiat 73067507; Kobelco 2451U124-3A; Komatsu 600-181-9240  
**O.D.:** 6 3/32 (154.8)  
**Fins:** 7 13/16 (198.4)  
**I.D.:** 3/4 (19.0) & 3 15/32 (88.1)  
**Height:** 15 5/16 (388.9)  
**A. Gskt:** [1] Attached  
**F. Gskt:** G103-N  
**Related To:** PA2418-FN (Standard Media Version)

**PA2418-FN**



Outer Air Element with Fins  
**Fits:** Allis Chalmers, Case, Caterpillar, Dresser, Fiat-Allis, John Deere, Kobelco, Komatsu, New Holland Equipment  
**Use With:** PA2305, PA2332, PA2419  
**Replaces:** Allis Chalmers 79011386; Case D56453; Caterpillar 7E0975; Fiat 73067507; Kobelco 2451U124-3A; Komatsu 600-181-9240  
**O.D.:** 6 3/32 (154.8)  
**Fins:** 7 13/16 (198.4)  
**I.D.:** 3/4 (19.0) & 3 15/32 (88.1)  
**Height:** 15 5/16 (388.9)  
**A. Gskt:** [1] Attached  
**F. Gskt:** G103-N  
**Related To:** LL2418-FN (Long-Life Media Version)

**PA2419**



Inner Air Element  
**Fits Inside:** LL2418-FN, PA2418-FN, PA2420, PA2977-FN, PA3669-FN, PA3690, PA3751-FN, PA4697-FN  
**Fits:** Allis Chalmers, Case, Caterpillar, Fiat-Allis, Hanomag, J.C. Bamford, Massey Ferguson, New Holland Equipment  
**Replaces:** Allis Chalmers 79011387; Case L55204; Caterpillar 5W5890; Fiat 70257029; J.C. Bamford 32/202601; Massey Ferguson 1093683-M92  
**O.D.:** 3 3/8 (85.7)  
**Flange:** 4 5/32 (105.6)  
**I.D.:** 5/8 (15.9) & 2 29/32 (73.8)  
**Height:** 14 3/32 (358.0)  
**A. Gskt:** [1] Attached  
**F. Gskt:** G103-N

**PA2420**



Outer Air Element  
**Use With:** PA2419  
**Replaces:** Massey Ferguson 1428748-M91  
**O.D.:** 6 3/32 (154.8)  
**I.D.:** 3/4 (19.0) & 3 15/32 (88.1)  
**Height:** 15 5/16 (388.9)  
**A. Gskt:** [1] Attached  
**F. Gskt:** G103-N

**PA2421**



Outer Air Element with Lift Bar  
**Fits:** Agco, Case, John Deere, White Equipment  
**Use With:** PA1967  
**Replaces:** Agco 72162545; John Deere AT43963; White 20-7002186  
**O.D.:** 9 7/32 (234.2)  
**I.D.:** 5/8 (15.9) & 4 27/32 (123.0)  
**Height:** 12 1/2 (317.5)  
**A. Gskt:** [1] Attached  
**F. Gskt:** G103-N

**PA2422**



Outer Air Element with Lift Bar  
**Fits:** Allis Chalmers, Deutz, Fendt Tractors  
**Use With:** PA3682, PA3684  
**Replaces:** Deutz 2311565  
**O.D.:** 6 15/32 (164.3)  
**I.D.:** 3 11/32 (84.9) One End  
**Height:** 8 1/4 (209.6)  
**A. Gskt:** [1] Attached  
**Related To:** PA2423 (Long Version)

**PA2423**



Outer Air Element with Lift Bar  
**Fits:** Allis Chalmers, Bomag, Davis, Deutz Equipment  
**Use With:** PA3683, PA3685  
**Replaces:** Allis Chalmers 99100307; Deutz 2322855  
**O.D.:** 6 15/32 (164.3)  
**I.D.:** 3 11/32 (84.9) One End  
**Height:** 13 3/32 (332.6)  
**A. Gskt:** [1] Attached  
**Related To:** PA2422 (Short Version)

**LL2425**



Long Life Air Element  
**Fits:** Ag-Chem Equipment; Ford Trucks  
**Replaces:** Ford D5HZ-9601-D  
**O.D.:** 10 3/8 (263.5)  
**I.D.:** 6 1/32 (153.2) One End  
**Height:** 16 (406.4)  
**A. Gskt:** [2] Attached  
**F. Gskt:** G21-AF  
**O. Gskt:** G499-AF  
**Related To:** PA2425 (Standard Media Version)

**PA2425**



Air Element  
**Fits:** Ag-Chem Equipment; Ford Trucks  
**Replaces:** Ford D5HZ-9601-D  
**O.D.:** 10 3/8 (263.5)  
**I.D.:** 6 1/32 (153.2) One End  
**Height:** 16 (406.4)  
**A. Gskt:** [2] Attached  
**F. Gskt:** G21-AF  
**O. Gskt:** G499-AF  
**Related To:** LL2425 (Long-Life Media Version)

Measurements Are Shown In Inches And (Millimeters)

**WARNING:** These products can expose you to chemicals, including Diisononyl Phthalate, Carbon black extracts, Nickel, 1,3 Butadiene, Ethylene Oxide, Epichlorohydrin, which are known to the State of California to cause cancer, and Bisphenol, Ethylene Glycol, Ethylene Oxide, 1,3 Butadiene, Epichlorohydrin, which are known to the State of California to cause birth defects or other reproductive harm.



**LL2426-FN**



Long Life Outer Air Element with Fins

**Fits:** Allis Chalmers, Atlas-Weyhausen, Clark, John Deere, Kobelco, Massey Ferguson, Michigan, Vermeer, Versatile Equipment  
**Use With:** PA2427  
**Replaces:** Clark 961000; Grove 9437100309; John Deere AZ25868; Kobelco 2446R277S5; Versatile V103344  
**O.D.:** 6 7/8 (174.6)  
**Fins:** 8 3/4 (222.3)  
**I.D.:** 21/32 (16.7) & 4 3/16 (106.4)  
**Height:** 16 3/8 (415.9)  
**A. Gskt:** [1] Attached  
**F. Gskt:** G103-N  
**Related To:** PA2426-FN (Standard Media Version)

**PA2426-FN**



Outer Air Element with Fins

**Fits:** Allis Chalmers, Atlas-Weyhausen, Clark, John Deere, Kobelco, Massey Ferguson, Michigan, Vermeer, Versatile Equipment  
**Use With:** PA2427  
**Replaces:** Clark 961000; Grove 9437100309; John Deere AZ25868; Kobelco 2446R277S5; Versatile V103344  
**O.D.:** 6 7/8 (174.6)  
**Fins:** 8 3/4 (222.3)  
**I.D.:** 21/32 (16.7) & 4 3/16 (106.4)  
**Height:** 16 3/8 (415.9)  
**A. Gskt:** [1] Attached  
**F. Gskt:** G103-N  
**Related To:** LL2426-FN (Long-Life Media Version)

**PA2427**



Inner Air Element

**Fits Inside:** LL2426-FN, PA2426-FN  
**Fits:** Allis Chalmers, Atlas-Weyhausen, Clark, Grove, John Deere, Kobelco, Massey Ferguson, Michigan, New Holland, Vermeer, Versatile Equipment  
**Replaces:** Clark 961001; John Deere AZ25867; Kobelco 2446R277S6; Versatile V90183  
**O.D.:** 4 3/32 (104.0)  
**Flange:** 4 25/32 (121.4)  
**I.D.:** 25/32 (19.8) & 3 5/8 (92.1)  
**Height:** 15 3/32 (383.4)  
**A. Gskt:** [1] Attached  
**F. Gskt:** G103-N

**PA2428**



Air Element

**Replaces:** International 472099-C1  
**O.D.:** 12 1/16 (306.4)  
**I.D.:** 5/8 (15.9) & 5 11/16 (144.5)  
**Height:** 17 11/16 (449.3)  
**A. Gskt:** [1] Attached  
**F. Gskt:** G103-N  
**Related To:** PA2429 (Short Version)

**PA2429**



Air Element

**Fits:** International, WhiteGMC Trucks  
**Replaces:** GMC 8995417; International 472088-C91  
**O.D.:** 12 1/16 (306.4)  
**I.D.:** 5/8 (15.9) & 5 11/16 (144.5)  
**Height:** 15 11/16 (398.5)  
**A. Gskt:** [1] Attached  
**F. Gskt:** G103-N  
**Related To:** PA2428 (Long Version)

**PA2430**



Air Element

**Fits:** Ford Buses, Trucks  
**Replaces:** Ford D5HZ-9601-C  
**O.D.:** 10 3/8 (263.5)  
**I.D.:** 6 1/32 (153.2) One End  
**Height:** 20 15/16 (531.8)  
**A. Gskt:** [2] Attached  
**F. Gskt:** G21-AF  
**O. Gskt:** G499-AF  
**Related To:** PA2425 (Short Version)

**PA2431**



Outer Air Element with Lift Bar

**Fits:** Ford, New Holland Equipment  
**Use With:** PA1809, PA2432  
**Replaces:** Ford D1NN-9601-A  
**O.D.:** 6 11/16 (169.9)  
**Boot Gasket:** 7 1/2 (190.5)  
**I.D.:** 1/2 (12.7) & 3 3/4 (95.3)  
**Height:** 15 5/16 (388.9)  
**A. Gskt:** [2] Attached  
**F. Gskt:** [1] Included

**PA2432**



Inner Air Element

**Fits Inside:** PA2431  
**Fits:** Ford, New Holland Equipment  
**Replaces:** Ford D1NN-9R500-A  
**O.D.:** 3 5/8 (92.1)  
**I.D.:** 1/2 (12.7) & 2 15/16 (74.6)  
**Height:** 13 7/8 (352.4)  
**A. Gskt:** [1] Attached  
**F. Gskt:** [1] Included

**PA2433**



Outer Air Element with Lift Bar

**Fits:** Ford, Versatile Tractors  
**Use With:** PA2308  
**Replaces:** Ford D2NN-9601-A; Versatile 24575  
**O.D.:** 7 15/16 (201.6)  
**Boot:** 10 (254.0)  
**I.D.:** 1/2 (12.7) & 4 5/8 (117.5)  
**Height:** 14 1/2 (368.3)  
**A. Gskt:** [2] Attached  
**F. Gskt:** [1] Included

**PA2434**



Outer Air Element with Lift Tab

**Fits:** Allis Chalmers, Case-International, John Deere, New Idea Equipment  
**Use With:** PA2435  
**Replaces:** Allis Chalmers 70264739; International 67685-C92; John Deere AT44631; New Idea 730760  
**O.D.:** 9 (228.6)  
**Boot Gasket:** 10 (254.0)  
**I.D.:** 5 11/16 (144.5) One End  
**Height:** 16 9/16 (420.7)  
**A. Gskt:** [2] Attached

**PA2435**



Inner Air Element

**Fits Inside:** PA2434, PA2569  
**Fits:** Allis Chalmers, Case-International, Ford, John Deere, New Idea Equipment  
**Replaces:** Allis Chalmers 70264740; Ford D5NN-9R500-C; International 67685-C92; John Deere AT44632; New Idea 730761  
**O.D.:** 5 9/16 (141.3)  
**I.D.:** 1/2 (12.7) & 4 13/32 (111.9)  
**Height:** 15 21/32 (397.7)  
**F. Gskt:** G20-AF, [1] Wing Nut

Measurements Are Shown In Inches And (Millimeters)

**WARNING:** These products can expose you to chemicals, including Diisononyl Phthalate, Carbon black extracts, Nickel, 1,3 Butadiene, Ethylene Oxide, Epichlorohydrin, which are known to the State of California to cause cancer, and Bisphenol, Ethylene Glycol, Ethylene Oxide, 1,3 Butadiene, Epichlorohydrin, which are known to the State of California to cause birth defects or other reproductive harm.

**PA2436**

Cab Air Element with Pull Tabs

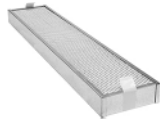

**Fits:** International Equipment; Stolper Fresh Air Blowers  
**Replaces:** International 175568-C1  
**Length:** 32 (812.8)  
**Width:** 6 3/4 (171.5)  
**Height:** 2 3/16 (55.6)

**PA2437**

Air Element



**Replaces:** Brockway 221389  
**O.D.:** 12 3/4 (323.8)  
**I.D.:** 8 11/32 (211.9) One End  
**Height:** 18 (457.2)  
**A. Gskt:** [2] Attached  
**F. Gskt:** G25-AF  
**Related To:** PA2398 (Long Version)

**PA2438**

Inter-Cooler Air Element



**Notes:** Inside-Out Flow Direction. Sometimes used with LL2439, PA2439 in vertical housing or PA2494 in horizontal housing.  
**Fits:** Brockway, Mack Trucks  
**Replaces:** Mack 57MD21  
**O.D.:** 12 3/4 (323.8)  
**I.D.:** 8 11/32 (211.9)  
**Height:** 9 (228.6)  
**A. Gskt:** [2] Attached  
**F. Gskt:** G25-AF  
**O. Gskt:** G422-AF

**LL2439**

Long Life Air Element



**Notes:** Inside-Out Flow Direction. Sometimes used with PA2438 in vertical housing.  
**Fits:** Brockway, Mack Trucks  
**Replaces:** Mack 57MD31  
**O.D.:** 12 3/4 (323.8)  
**I.D.:** 8 11/32 (211.9) One End  
**Height:** 15 (381.0)  
**A. Gskt:** [2] Attached  
**F. Gskt:** G25-AF  
**O. Gskt:** G422-AF  
**Related To:** PA2439 (Standard Media Version)

**PA2439**

Air Element



**Notes:** Inside-Out Flow Direction. Sometimes used with PA2438 in vertical housing.  
**Fits:** Brockway, Mack Trucks  
**Replaces:** Mack 57MD31  
**O.D.:** 12 3/4 (323.8)  
**I.D.:** 8 11/32 (211.9) One End  
**Height:** 15 (381.0)  
**A. Gskt:** [2] Attached  
**F. Gskt:** G25-AF  
**O. Gskt:** G422-AF  
**Related To:** LL2439 (Long-Life Media Version)

**PA2440**

Cab Air Element



**Fits:** Case-International, Hesston, Hough, Massey Ferguson, Michigan Equipment  
**Replaces:** Case 8022345  
**Length:** 33 (838.2)  
**Width:** 6 1/2 (165.1)  
**Height:** 2 3/16 (55.6)

**PA2441**

Air Element



**Notes:** OBSOLETE. Availability Limited to Dealer Stock.  
**Replaces:** Brockway 221399  
**O.D.:** 10 3/8 (263.5)  
**I.D.:** 6 1/32 (153.2) One End  
**Height:** 19 13/16 (503.2)  
**A. Gskt:** [2] Attached  
**F. Gskt:** G21-AF

**PA2442**

Outer Air Element



**Fits:** International, Massey Ferguson Equipment  
**Use With:** PA2443  
**Replaces:** International 702641-C1  
**O.D.:** 10 (254.0)  
**I.D.:** 3/8 (9.5) & 5 1/2 (139.7)  
**Height:** 17 5/16 (439.7)  
**A. Gskt:** [1] Attached  
**F. Gskt:** [1] Included

**PA2443**

Inner Air Element



**Fits Inside:** PA2442  
**Fits:** International, Massey Ferguson Equipment  
**Replaces:** International 702642-C1  
**O.D.:** 5 1/4 (133.4)  
**I.D.:** 21/32 (16.7) & 4 1/8 (104.8)  
**Height:** 16 3/32 (408.8)  
**A. Gskt:** [1] Attached  
**F. Gskt:** G103-N

**PA2444**

DynaCell Panel Air Element

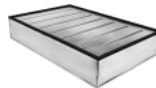

**Notes:** Front is open, sides are closed.  
**Replaces:** Farr C51800, T528; White 22-0010087  
**Length:** 28 1/2 (723.9)  
**Width:** 19 (482.6)  
**Height:** 5 3/8 (136.5)  
**Related To:** PA2564 (Both Sides Open)

**PA2445**

Outer Air Element



**Fits:** Case Equipment  
**Use With:** PA2446  
**Replaces:** Case A44804  
**O.D.:** 13 7/8 (352.4)  
**I.D.:** 11/16 (17.5) & 7 7/16 (188.9)  
**Height:** 9 1/2 (241.3)  
**A. Gskt:** [1] Attached  
**F. Gskt:** G103-N

**PA2446**

Inner Air Element



**Fits Inside:** PA2445  
**Fits:** Case Equipment  
**Replaces:** Case A44805  
**O.D.:** 6 7/8 (174.6)  
**I.D.:** 21/32 (16.7) & 4 3/16 (106.4)  
**Height:** 8 3/8 (212.7)  
**A. Gskt:** [1] Attached  
**F. Gskt:** G103-N

Measurements Are Shown In Inches And (Millimeters)

**WARNING:** These products can expose you to chemicals, including Diisononyl Phthalate, Carbon black extracts, Nickel, 1,3 Butadiene, Ethylene Oxide, Epichlorohydrin, which are known to the State of California to cause cancer, and Bisphenol, Ethylene Glycol, Ethylene Oxide, 1,3 Butadiene, Epichlorohydrin, which are known to the State of California to cause birth defects or other reproductive harm.

**LL2447-FN** Long Life Air Element with Fins  
**Replaces:** Donaldson P181066  
**O.D.:** 13 7/8 (352.4)  
**Fins:** 15 25/32 (400.8)  
**I.D.:** 5/8 (15.9) & 9 1/2 (241.3)  
**Height:** 14 3/8 (365.1)  
**A. Gskt:** [1] Attached  
**F. Gskt:** [1] Included  
**Related To:** PA2447-FN (Standard Media Version)



**PA2447-FN** Air Element with Fins  
**Replaces:** Donaldson P181066  
**O.D.:** 13 7/8 (352.4)  
**Fins:** 15 25/32 (400.8)  
**I.D.:** 5/8 (15.9) & 9 1/2 (241.3)  
**Height:** 14 3/8 (365.1)  
**A. Gskt:** [1] Attached  
**F. Gskt:** [1] Included  
**Related To:** LL2447-FN (Long-Life Media Version)



**PA2448** Cab Air Element  
**Fits:** Allis Chalmers Tractors  
**Replaces:** Allis Chalmers 579916  
**Length:** 26 3/4 (679.4)  
**Width:** 7 3/4 (196.9)  
**Height:** 2 3/16 (55.6)



**PA2450** DynaCell Panel Air Element  
**Fits:** Blaw-Knox, Cedarapids Road Building Equipment; Ottawa Trucks  
**Replaces:** Farr T512, C49261; Ottawa 99105821  
**Length:** 15 (381.0)  
**Width:** 11 1/2 (292.1)  
**Height:** 5 1/2 (139.7)



**PA2451** Outer Air Element  
**Fits:** Komatsu Equipment  
**Use With:** PA2452  
**Replaces:** Komatsu 600-181-3300  
**O.D.:** 9 7/32 (234.2)  
**I.D.:** 21/32 (16.7) & 4 27/32 (123.0)  
**Height:** 15 1/2 (393.7)  
**A. Gskt:** [1] Attached  
**F. Gskt:** G103-N



**PA2452** Inner Air Element  
**Fits Inside:** PA2451  
**Fits:** Komatsu Equipment  
**Replaces:** Komatsu 669-181-7310  
**O.D.:** 4 9/16 (115.9)  
**Flange:** 5 23/32 (145.3)  
**I.D.:** 21/32 (16.7) & 3 7/16 (87.3)  
**Height:** 14 23/32 (373.9)  
**A. Gskt:** [1] Attached  
**F. Gskt:** G103-N



**LL2453** Long Life Outer Air Element with Bail Handle  
**Fits:** Case, Caterpillar, Driltech, KW-Dart, Terex, WABCO Equipment; Euclid, Komatsu Trucks  
**Use With:** PA2364, PA2454  
**Replaces:** Caterpillar 1W3637; Driltech 103653; Euclid 9038350; Komatsu 581-021-2120; WABCO VJ5175  
**O.D.:** 17 5/8 (447.7)  
**Boot:** 18 5/16 (465.1)  
**I.D.:** 15/16 (23.8) & 12 1/8 (308.0)  
**Height:** 23 17/32 (597.7)  
**A. Gskt:** [2] Attached  
**F. Gskt:** [1] Included  
**Related To:** PA2453 (Standard Media Version) PA2453XP (Extreme Performance Nano Version)



**PA2453** Outer Air Element with Bail Handle  
**Fits:** Case, Caterpillar, Driltech, KW-Dart, Terex, WABCO Equipment; Euclid, Komatsu Trucks  
**Use With:** PA2364, PA2454  
**Replaces:** Caterpillar 1W3637; Driltech 103653; Euclid 9038350; Komatsu 581-021-2120; WABCO VJ5175  
**O.D.:** 17 5/8 (447.7)  
**Boot:** 18 5/16 (465.1)  
**I.D.:** 15/16 (23.8) & 12 1/8 (308.0)  
**Height:** 23 17/32 (597.7)  
**A. Gskt:** [2] Attached  
**F. Gskt:** [1] Included  
**Related To:** LL2453 (Long-Life Media Version) PA2453XP (Extreme Performance Nano Version)



**PA2453XP** Extreme Performance Nano Outer Air Element with Bail Handle  
**Fits:** Case, Caterpillar, Driltech, KW-Dart, Terex, WABCO Equipment; Euclid, Komatsu Trucks  
**Use With:** PA2364, PA2454  
**Replaces:** Caterpillar 1W3637; Driltech 103653; Euclid 9038350; Komatsu 581-021-2120; WABCO VJ5175  
**O.D.:** 17 5/8 (447.7)  
**Boot:** 18 5/16 (465.1)  
**I.D.:** 15/16 (23.8) & 12 1/8 (308.0)  
**Height:** 23 17/32 (597.7)  
**A. Gskt:** [2] Attached  
**F. Gskt:** [1] Included  
**Related To:** LL2453 (Long-Life Media Version) PA2453 (Standard Media Version)



**PA2454** Inner Air Element  
**Fits Inside:** PA2453, PA2453XP  
**Fits:** Case, Caterpillar, Driltech, KW-Dart, Terex, WABCO Equipment; Euclid, Komatsu Trucks  
**Replaces:** Caterpillar 1W3636; Driltech 103661; Euclid 9038349; Komatsu 581-021-2130; WABCO VJ5176  
**O.D.:** 11 7/8 (301.6)  
**I.D.:** 7/8 (22.2) & 10 1/4 (260.3)  
**Height:** 22 1/2 (571.5)  
**A. Gskt:** [1] Attached  
**F. Gskt:** [1] Included



Measurements Are Shown In Inches And (Millimeters)

**WARNING:** These products can expose you to chemicals, including Diisononyl Phthalate, Carbon black extracts, Nickel, 1,3 Butadiene, Ethylene Oxide, Epichlorohydrin, which are known to the State of California to cause cancer, and Bisphenol, Ethylene Glycol, Ethylene Oxide, 1,3 Butadiene, Epichlorohydrin, which are known to the State of California to cause birth defects or other reproductive harm.

**PA2455**



Inner Air Element

**Fits Inside:** PA1864-FN  
**Fits:** Joy Compressors  
**Replaces:** Joy 3606283-21  
**O.D.:** 6 3/8 (161.9)  
 Flange 7 1/2 (190.5)  
**I.D.:** 5/8 (15.9) & 5 1/4 (133.4)  
**Height:** 15 (381.0)  
**A. Gskt:** [1] Attached  
**F. Gskt:** G103-N

**LL2458**



Long Life Air Element

**Fits:** Kenworth Trucks  
**Replaces:** GMC 25041399; Kenworth KW1600M  
**O.D.:** 13 7/8 (352.4)  
**I.D.:** 7 7/16 (188.9) One End  
**Height:** 27 (685.8)  
**A. Gskt:** [2] Attached  
**F. Gskt:** G145-AF  
**Related To:** PA2458 (Standard Media)

**LL2456**



Long Life Outer Air Element

**Fits:** CMI, Grove, Insley, Michigan, Morbark Equipment; Ingersoll-Rand, LeRoi, Sullair Compressors  
**Use With:** PA2457  
**Replaces:** Grove 9304100036; Ingersoll-Rand 35711209; Insley 453043; Sullair 48462  
**O.D.:** 12 11/16 (322.3)  
 Boot 12 25/32 (324.6)  
**I.D.:** 29/32 (23.0) & 8 3/8 (212.7)  
**Height:** 24 1/32 (610.4)  
**A. Gskt:** [2] Attached  
**F. Gskt:** [1] Included  
**Related To:** PA2456 (Standard Media Version)  
 PA2456XP (Extreme Performance Nano Version)

**PA2458**



Air Element

**Fits:** Kenworth Trucks  
**Replaces:** GMC 25041399; Kenworth KW1600M  
**O.D.:** 13 7/8 (352.4)  
**I.D.:** 7 7/16 (188.9) One End  
**Height:** 27 (685.8)  
**A. Gskt:** [2] Attached  
**F. Gskt:** G145-AF  
**Related To:** LL2458 (Long-Life Version)

**PA2456**



Outer Air Element

**Fits:** CMI, Grove, Insley, Michigan, Morbark Equipment; Ingersoll-Rand, Sullair Compressors  
**Use With:** PA2457  
**Replaces:** Grove 9304100036; Ingersoll-Rand 35711209; Insley 453043; Sullair 48462  
**O.D.:** 12 11/16 (322.3)  
 Boot 12 25/32 (324.6)  
**I.D.:** 29/32 (23.0) & 8 3/8 (212.7)  
**Height:** 24 1/32 (610.4)  
**A. Gskt:** [2] Attached  
**F. Gskt:** [1] Included  
**Related To:** LL2456 (Long-Life Media Version)  
 PA2456XP (Extreme Performance Nano Version)

**PA2459**



Outer Air Element with Lift Tabs

**Fits:** White Equipment  
**Use With:** PA2460  
**Replaces:** White 30-3071219  
**O.D.:** 9 5/8 (244.5)  
**I.D.:** 6 3/16 (157.2) One End  
**Height:** 16 5/16 (414.3)  
**A. Gskt:** [1] Attached

**PA2456XP**



Extreme Performance Nano Outer Air Element

**Fits:** CMI, Grove, Insley, Michigan, Morbark Equipment; Ingersoll-Rand, Sullair Compressors  
**Use With:** PA2457  
**Replaces:** Grove 9304100036; Ingersoll-Rand 35711209; Insley 453043; Sullair 48462  
**O.D.:** 12 11/16 (322.3)  
 Boot 12 25/32 (324.6)  
**I.D.:** 29/32 (23.0) & 8 3/8 (212.7)  
**Height:** 24 1/32 (610.4)  
**A. Gskt:** [2] Attached  
**F. Gskt:** [1] Included  
**Related To:** LL2456 (Long-Life Media Version)  
 PA2456 (Standard Media Version)

**PA2460**



Inner Air Element

**Fits Inside:** PA2459  
**Fits:** White Equipment  
**Replaces:** White 30-3130509  
**O.D.:** 6 1/8 (155.6)  
**I.D.:** 17/32 (13.5) & 4 15/16 (125.4)  
**Height:** 14 3/8 (365.1)  
**A. Gskt:** [1] Attached  
**F. Gskt:** [1] Included

**PA2457**



Inner Air Element

**Fits Inside:** LL2456, PA2456, PA2456XP  
**Fits:** CMI, Grove, Insley, Michigan, Morbark Equipment; Ingersoll-Rand, Sullair Compressors  
**Replaces:** Grove 9304100037; Ingersoll-Rand 35123520; Insley 914621; Sullair 48463  
**O.D.:** 8 1/4 (209.6)  
**I.D.:** 15/16 (23.8) & 7 3/32 (180.2)  
**Height:** 22 3/8 (568.3)  
**A. Gskt:** [1] Attached  
**F. Gskt:** [1] Included

**PA2461**



Outer Air Element

**Fits:** Hanomag, John Deere, Terex Equipment; R.V.I. Trucks  
**Use With:** PA2462  
**Replaces:** Hanomag 3074306-M1; John Deere AR70106  
**O.D.:** 10 3/8 (263.5)  
**I.D.:** 15/16 (23.8) & 6 1/32 (153.2)  
**Height:** 20 3/8 (517.5)  
**A. Gskt:** [1] Attached  
**F. Gskt:** [1] Included

**PA2462**



Inner Air Element

**Fits Inside:** PA2461  
**Fits:** Hanomag, John Deere, Terex Equipment  
**Replaces:** Hanomag 3074309-M1; John Deere AR70107  
**O.D.:** 5 15/16 (150.8)  
**I.D.:** 21/32 (16.7) & 4 27/32 (123.0)  
**Height:** 18 3/8 (466.7)  
**A. Gskt:** [1] Attached  
**F. Gskt:** G103-N

Measurements Are Shown In Inches And (Millimeters)

**WARNING:** These products can expose you to chemicals, including Diisononyl Phthalate, Carbon black extracts, Nickel, 1,3 Butadiene, Ethylene Oxide, Epichlorohydrin, which are known to the State of California to cause cancer, and Bisphenol, Ethylene Glycol, Ethylene Oxide, 1,3 Butadiene, Epichlorohydrin, which are known to the State of California to cause birth defects or other reproductive harm.

**PA2463** Cab Air Element  
**Fits:** Allis Chalmers Optional Equipment  
**Replaces:** Allis Chalmers 566900  
**Length:** 28 (711.2)  
**Width:** 6 3/4 (171.5)  
**Height:** 2 3/16 (55.6)



**PA2464** Cab Air Element  
**Fits:** Massey Ferguson Equipment  
**Replaces:** Massey Ferguson 529760-M1  
**Length:** 47 (1193.8)  
**Width:** 6 (152.4)  
**Height:** 2 9/16 (65.1)  
**A. Gskt:** [1] Attached



**PA2465** Air Element with Bolt  
**Contains:** Bolt Thread: 5/16-18  
**Fits:** GMC, International Buses, Trucks  
**Replaces:** GMC 25040533; International 470289-C1  
**O.D.:** 10 3/8 (263.5)  
**I.D.:** 6 1/32 (153.2) One End  
**Height:** 10 1/2 (266.7)  
**A. Gskt:** [1] Attached



**PA2466** Outer Air Element  
**Fits:** Case, Case-International, Furukawa, John Deere, Komatsu, Minneapolis-Moline, Oliver Equipment  
**Use With:** PA2467  
**Replaces:** Furukawa 550106009; International 932391-C1; Komatsu 381-982-8121  
**O.D.:** 9 7/32 (234.2)  
**I.D.:** 21/32 (16.7) & 5 27/32 (148.4)  
**Height:** 18 3/8 (466.7)  
**A. Gskt:** [1] Attached  
**F. Gskt:** G103-N



**PA2467** Inner Air Element  
**Fits Inside:** PA2466  
**Fits:** Case, Case-International, Furukawa, John Deere, Komatsu, Minneapolis-Moline, Oliver Equipment  
**Replaces:** Furukawa 550106008; International 932390-C1; Komatsu 381-928-8111  
**O.D.:** 5 23/32 (145.3)  
**I.D.:** 21/32 (16.7) & 4 19/32 (116.7)  
**Height:** 16 3/8 (415.9)  
**A. Gskt:** [1] Attached  
**F. Gskt:** G103-N



**PA2468** Air Element  
**Fits:** GMC Buses, Trucks  
**Replaces:** GMC 89946615  
**O.D.:** 13 7/8 (352.4)  
**I.D.:** 11/16 (17.5) & 7 7/16 (188.9)  
**Height:** 18 1/2 (469.9)  
**A. Gskt:** [1] Attached  
**F. Gskt:** G103-N



**PA2469** Inner Air Element  
**Fits Inside:** PA1997  
**Fits:** Massey Ferguson Equipment  
**Replaces:** Massey Ferguson 1041911-M91  
**O.D.:** 4 3/32 (104.0)  
 Flange 4 13/16 (122.2)  
**I.D.:** 3/4 (19.0) & 3 5/8 (92.1)  
**Height:** 14 23/32 (373.9)  
**A. Gskt:** [1] Attached  
**F. Gskt:** G103-N



**PA2472** Air Element  
**Contains:** Flame Retardant Media  
**Fits:** Ford Buses, Trucks  
**Replaces:** Ford E1HZ-9601-A  
**O.D.:** 12 5/8 (320.7)  
**I.D.:** 9 3/4 (247.7)  
**Height:** 5 1/2 (139.7)



**PA2473** Air Element  
**Fits:** International Buses, Trucks  
**Replaces:** International 461236-C1  
**O.D.:** 12 1/32 (305.6)  
**I.D.:** 5/8 (15.9) & 7 11/16 (195.3)  
**Height:** 8 1/2 (215.9)  
**A. Gskt:** [1] Attached  
**F. Gskt:** [1] Included



**PA2474** Outer Air Element  
**Fits:** Atlas Copco, CompAir Compressors; Bomag, John Deere, Kobelco, V.M.E., Volvo Equipment; DAF, Iveco, M.A.N., Mercedes-Benz, R.V.I., Scania, Volvo Buses, Trucks  
**Use With:** PA2836  
**Replaces:** Atlas Copco 1619279800; Bomag 5821018; DAF 112294; Iveco 1902465; Mercedes-Benz 130941702; Volvo 6644990,-1  
**O.D.:** 8 15/16 (227.0)  
**I.D.:** 1/2 (12.7) & 4 19/32 (116.7)  
**Height:** 15 (381.0)  
**A. Gskt:** [1] Attached  
**F. Gskt:** [1] Included



**PA2475** Outer Air Element  
**Fits:** Atlas Copco Compressors; DAF, Iveco, M.A.N., Mercedes-Benz, Scania Buses, Trucks; Kobelco, Liebherr, New Holland, V.M.E., Volvo Equipment  
**Use With:** PA2814  
**Replaces:** Atlas Copco 16192799; Iveco 1901779; Liebherr 9367183; Mercedes-Benz 10947904; Volvo 47857487  
**O.D.:** 9 17/32 (242.1)  
**I.D.:** 1/2 (12.7) & 5 5/32 (131.0)  
**Height:** 19 9/16 (496.9)  
**A. Gskt:** [1] Attached  
**F. Gskt:** [1] Included















**PA2476** Air Element  
**Fits:** Benford Equipment; Petter Engines  
**Replaces:** Petter ACF499-6  
**O.D.:** 3 5/8 (92.1)  
**I.D.:** 1 31/32 (50.0)  
**Height:** 2 27/32 (72.2)



Measurements Are Shown In Inches And (Millimeters)

**WARNING:** These products can expose you to chemicals, including Diisononyl Phthalate, Carbon black extracts, Nickel, 1,3 Butadiene, Ethylene Oxide, Epichlorohydrin, which are known to the State of California to cause cancer, and Bisphenol, Ethylene Glycol, Ethylene Oxide, 1,3 Butadiene, Epichlorohydrin, which are known to the State of California to cause birth defects or other reproductive harm.

<p><b>PA2477</b> Air Element  <b>Replaces:</b> Petter BAF423  <b>O.D.:</b> 4 3/8 (111.1)  <b>I.D.:</b> 1 31/32 (50.0)  <b>Height:</b> 2 19/32 (65.9)</p> 	<p><b>PA2482</b> Air Element  <b>Notes:</b> Inside-Out Flow Direction  <b>Fits:</b> GMC, Kenworth, Mack Trucks  <b>Replaces:</b> GMC 25040009  <b>O.D.:</b> 8 27/32 (224.6)  <b>I.D.:</b> 5 15/32 (138.9) One End  <b>Height:</b> 23 (584.2)  <b>A. Gskt:</b> [2] Attached  <b>F. Gskt:</b> G207-AF  <b>O. Gskt:</b> G472-AF  <b>Related To:</b> LL2482 (Long-Life Media Version)</p> 
<p><b>PA2478</b> Outer Air Element with Lid and Lift Tab  <b>Fits:</b> Komatsu Equipment  <b>Use With:</b> PA1880  <b>Replaces:</b> Komatsu 612-881-7320  <b>O.D.:</b> 12 1/16 (306.4)  Lid 14 13/16 (376.2)  <b>I.D.:</b> 15/16 (23.8) &amp; 7 11/16 (195.3)  <b>Height:</b> 18 1/2 (469.9)  <b>A. Gskt:</b> [2] Attached  <b>F. Gskt:</b> [1] Included</p> 	<p><b>PA2483</b> Air Element  <b>Fits:</b> Ford Trucks  <b>Replaces:</b> Ford E1HZ-9601-B  <b>O.D.:</b> 12 19/32 (319.9)  <b>I.D.:</b> 8 9/32 (210.3)  <b>Height:</b> 5 1/2 (139.7)</p> 
<p><b>PA2479</b> Air Element  <b>Fits:</b> Chrysler-Nissan Industrial Engines  <b>Replaces:</b> Nissan 16546-90114  <b>O.D.:</b> 8 17/32 (216.7)  <b>I.D.:</b> 4 3/8 (111.1)  <b>Height:</b> 3 5/16 (84.1)</p> 	<p><b>PA2484</b> Air Element  <b>Fits:</b> Chicago-Pneumatic, Dritelch Drills; Joy Compressors  <b>Replaces:</b> Dritelch 221551  <b>O.D.:</b> 7 15/16 (201.6)  <b>I.D.:</b> 11/16 (17.5) &amp; 3 9/16 (90.5)  <b>Height:</b> 16 1/2 (419.1)  <b>A. Gskt:</b> [1] Attached  <b>F. Gskt:</b> G103-N</p> 
<p><b>PA2480</b> Air Element  <b>Notes:</b> OBSOLETE. Availability Limited to Dealer Stock.  <b>Fits:</b> R.V.I. Trucks  <b>Replaces:</b> Renault 5000802163  <b>O.D.:</b> 7 1/8 (181.0)  Flange 8 7/8 (225.4)  <b>I.D.:</b> 5/8 (15.9) &amp; 4 1/8 (104.8)  <b>Height:</b> 16 9/16 (420.7)  <b>A. Gskt:</b> [1] Attached</p> 	<p><b>PA2485</b> Cab Air Element  <b>Fits:</b> Agco, Deutz-Allis, Minneapolis-Moline, Oliver, White Equipment  <b>Replaces:</b> White 20-7000164  <b>Length:</b> 47 (1193.8)  <b>Width:</b> 7 (177.8)  <b>Height:</b> 2 3/16 (55.6)</p> 
<p><b>PA2481</b> Air Element with Lid  <b>Notes:</b> OBSOLETE. Availability Limited to Dealer Stock.  <b>Fits:</b> R.V.I. Buses, Trucks  <b>Replaces:</b> Renault 5000559387  <b>O.D.:</b> 6 (152.4)  Lid 7 31/32 (202.4)  <b>I.D.:</b> 3/8 (9.5) &amp; 3 5/16 (84.1)  <b>Height:</b> 13 3/8 (339.7)  <b>A. Gskt:</b> [1] Attached</p> 	<p><b>PA2486</b> Outer Air Element with Lift Bar  <b>Fits:</b> Massey Ferguson, Ramacher Equipment  <b>Use With:</b> PA2323  <b>Replaces:</b> Massey Ferguson 1042216-M91  <b>O.D.:</b> 5 5/16 (134.9)  <b>I.D.:</b> 5/8 (15.9) &amp; 3 13/32 (86.5)  <b>Height:</b> 14 3/8 (365.1)  <b>A. Gskt:</b> [1] Attached</p> 
<p><b>LL2482</b> Long Life Air Element  <b>Notes:</b> Inside-Out Flow Direction  <b>Fits:</b> GMC, Kenworth, Mack Trucks  <b>Replaces:</b> GMC 25040009  <b>O.D.:</b> 8 27/32 (224.6)  <b>I.D.:</b> 5 15/32 (138.9) One End  <b>Height:</b> 23 (584.2)  <b>A. Gskt:</b> [2] Attached  <b>F. Gskt:</b> G207-AF  <b>O. Gskt:</b> G472-AF  <b>Related To:</b> PA2482 (Standard Media Version)</p> 	<p><b>PA2487</b> Inner Air Element  <b>Fits Inside:</b> LL2360-FN, PA2360-FN  <b>Fits:</b> Bobcat, Bomag, Case, Davis, Ditch Witch, Gehl, J.C. Bamford, Massey Ferguson, New Holland, Vermeer, Versatile Equipment  <b>Replaces:</b> Case A173291; Clark 6630940; Davis 87859; Ditch Witch 195809; J.C. Bamford 32/205703; Melroe-Bobcat 6630940; Versatile 51934  <b>O.D.:</b> 2 31/32 (75.4)  Flange 3 5/8 (92.1)  <b>I.D.:</b> 5/8 (15.9) &amp; 2 7/16 (61.9)  <b>Height:</b> 14 3/32 (358.0)  <b>A. Gskt:</b> [1] Attached  <b>F. Gskt:</b> G103-N</p> 

Measurements Are Shown In Inches And (Millimeters)

**WARNING:** These products can expose you to chemicals, including Diisononyl Phthalate, Carbon black extracts, Nickel, 1,3 Butadiene, Ethylene Oxide, Epichlorohydrin, which are known to the State of California to cause cancer, and Bisphenol, Ethylene Glycol, Ethylene Oxide, 1,3 Butadiene, Epichlorohydrin, which are known to the State of California to cause birth defects or other reproductive harm.

**PA2488-FN**

Outer Air Element with Fins



**Fits:** Bobcat Loaders; Massey Ferguson Equipment  
**Use With:** PA2489  
**Replaces:** Fiat 71909139; Massey Ferguson 1043326-M91  
**O.D.:** 5 1/4 (133.4)  
 Fins 6 3/8 (161.9)  
**I.D.:** 2 1/32 (16.7) & 2 5/8 (66.7)  
**Height:** 11 1/4 (285.8)  
**A. Gskt:** [1] Attached  
**F. Gskt:** G103-N

**PA2489**

Inner Air Element



**Fits Inside:** LL1667-FN, PA1667-FN, PA2391, PA2488-FN, PA3791-FN  
**Fits:** Bobcat, Ditch Witch, Fiat, Ford, Hesston, John Deere, Kubota, Massey Ferguson, New Holland Equipment  
**Replaces:** Ditch Witch 195818; Fiat 1909138; John Deere RE45826; Kubota 17381-11181; Massey Ferguson 1043327-M91; New Holland 86504143  
**O.D.:** 2 17/32 (64.3)  
 Flange 3 3/32 (78.6)  
**I.D.:** 5/8 (15.9) & 2 5/32 (54.8)  
**Height:** 10 1/8 (257.2)  
**A. Gskt:** [1] Attached  
**F. Gskt:** G103-N

**PA2490**

Outer Air Element



**Fits:** Quincy, Worthington Compressors  
**Use With:** PA2491  
**Replaces:** Quincy 234583; Worthington ELM64  
**O.D.:** 12 1/2 (317.5)  
**I.D.:** 13/32 (10.3) & 7 1/2 (190.5)  
**Height:** 21 1/4 (539.8)  
**A. Gskt:** [1] Attached  
**F. Gskt:** [1] Included

**PA2491**

Inner Air Element



**Fits Inside:** PA2490  
**Fits:** Quincy, Worthington Compressors  
**Replaces:** Quincy 120382; Worthington ELM89  
**O.D.:** 7 3/8 (187.3)  
**I.D.:** 3/4 (19.0) & 6 1/8 (155.6)  
**Height:** 19 1/2 (495.3)  
**A. Gskt:** [1] Attached  
**F. Gskt:** G103-N

**LL2493**

Long Life Air Element



**Notes:** Inside-Out Flow Direction  
**Fits:** Western Star Trucks  
**Replaces:** White 22-0054401  
**O.D.:** 10 3/8 (263.5)  
**I.D.:** 6 1/32 (153.2) One End  
**Height:** 27 (685.8)  
**A. Gskt:** [2] Attached  
**F. Gskt:** G21-AF  
**Related To:** PA2493 (Standard Media Version)

**PA2493**

Air Element



**Notes:** Inside-Out Flow Direction  
**Fits:** Western Star Trucks  
**Replaces:** White 22-0054401  
**O.D.:** 10 3/8 (263.5)  
**I.D.:** 6 1/32 (153.2) One End  
**Height:** 27 (685.8)  
**A. Gskt:** [2] Attached  
**F. Gskt:** G21-AF  
**Related To:** LL2493 (Long-Life Media Version)

**PA2494**

Air Element



**Notes:** Inside-Out Flow Direction. Sometimes used with PA2438 in horizontal housing.  
**Replaces:** Mack 57MD29301  
**O.D.:** 12 3/4 (323.8)  
**I.D.:** 8 11/32 (211.9)  
**Height:** 15 (381.0)  
**A. Gskt:** [2] Attached  
**F. Gskt:** G25-AF

**PA2495**

Outer Air Element



**Fits:** Minneapolis-Moline Tractors  
**Use With:** PA1998  
**Replaces:** White 30-3108732  
**O.D.:** 7 5/8 (193.7)  
 Boot 8 5/8 (219.1)  
**I.D.:** 5/8 (15.9) & 4 1/4 (108.0)  
**Height:** 16 7/16 (417.5)  
**A. Gskt:** [2] Attached  
**F. Gskt:** G103-N

**PA2496**

Outer Air Element with Lift Bar



**Contains:** Flame Retardant Media  
**Fits:** Massey Ferguson Equipment  
**Use With:** PA1809  
**Replaces:** Massey Ferguson 1094056-M91  
**O.D.:** 5 11/32 (135.7)  
**I.D.:** 7/16 (11.1) & 2 7/32 (56.4)  
**Height:** 10 11/16 (271.5)  
**A. Gskt:** [1] Attached  
**F. Gskt:** [1] Included

**PA2497**

Cab Air Element

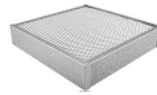

**Fits:** Allis Chalmers Equipment  
**Replaces:** Allis Chalmers 246580  
**Length:** 11 (279.4)  
**Width:** 11 (279.4)  
**Height:** 2 3/16 (55.6)

**PA2498**

Pressurized Cab Air Element



**Fits:** Caterpillar Crawler Tractors  
**Replaces:** Caterpillar 6P6664  
**O.D.:** 6 7/8 (174.6)  
**I.D.:** 2 1/32 (16.7) & 4 3/16 (106.4)  
**Height:** 12 3/8 (314.3)  
**A. Gskt:** [1] Attached  
**F. Gskt:** [1] Included, [1] Wing Nut

**PA2499**

Cab Air Element



**Fits:** Caterpillar Equipment  
**Replaces:** Caterpillar 6K9606  
**Length:** 23 1/2 (596.9)  
**Width:** 7 1/8 (181.0)  
**Height:** 15/16 (23.8)

Measurements Are Shown In Inches And (Millimeters)

**WARNING:** These products can expose you to chemicals, including Diisononyl Phthalate, Carbon black extracts, Nickel, 1,3 Butadiene, Ethylene Oxide, Epichlorohydrin, which are known to the State of California to cause cancer, and Bisphenol, Ethylene Glycol, Ethylene Oxide, 1,3 Butadiene, Epichlorohydrin, which are known to the State of California to cause birth defects or other reproductive harm.

**PA2500**



Conical-Shaped Air Element

**Notes:** Inside-Out Flow Direction  
**Fits:** Ford, GMC, International, WhiteGMC Trucks; Advance Mixer, Gradall Equipment  
**Replaces:** Ford F8HZ-9601-A; GMC 8997221; International 503634-C91; Mack 57MD29503  
**O.D.:** 5 13/16 (147.6) to 8 11/16 (220.7)  
**I.D.:** 2 3/16 (55.6) One End  
**Height:** 29 (736.6)  
**A. Gskt:** [2] Attached  
**F. Gskt:** [1] Included  
**Related To:** PA2540 (Short Version)

**PA2502**



Cab Air Element

**Fits:** Allis Chalmers, Egging Tractors  
**Replaces:** Allis Chalmers 3107280  
**Length:** 23 1/2 (596.9)  
**Width:** 6 1/2 (165.1)  
**Height:** 2 3/16 (55.6)

**LL2503**



Long Life Air Element

**Notes:** Inside-Out Flow Direction  
**Fits:** GMC Trucks  
**Replaces:** GMC 25041712  
**O.D.:** 8 27/32 (224.6)  
**I.D.:** 5 13/16 (147.6) One End  
**Height:** 29 (736.6)  
**A. Gskt:** [2] Attached  
**O. Gskt:** G207-AF  
**Related To:** PA2503 (Standard Media Version)

**PA2503**



Air Element

**Notes:** Inside-Out Flow Direction  
**Fits:** GMC Trucks  
**Replaces:** GMC 25041712  
**O.D.:** 8 27/32 (224.6)  
**I.D.:** 5 13/16 (147.6) One End  
**Height:** 29 (736.6)  
**A. Gskt:** [2] Attached  
**O. Gskt:** G207-AF  
**Related To:** LL2503 (Long-Life Media Version)

**PA2504**



Outer Air Element

**Fits:** Chevrolet, International, Isuzu, Nissan Trucks; Clark, Hitachi, Taylor Machine, Timberjack Equipment  
**Use With:** PA2545  
**Replaces:** Clark 2521682; GMC 25043888; Hitachi 4147010  
**O.D.:** 8 27/32 (224.6)  
**I.D.:** 15/16 (23.8) & 5 13/16 (147.6)  
**Height:** 13 1/2 (342.9)  
**A. Gskt:** [1] Attached  
**F. Gskt:** [1] Included

**LL2507**



Long Life Outer Air Element

**Fits:** Benford, Terex Equipment  
**Use With:** PA2508  
**Replaces:** GMC 9059570; Terex 9039993  
**O.D.:** 17 5/8 (447.7)  
 Boot 18 5/16 (465.1)  
**I.D.:** 13/32 (10.3) & 12 1/8 (308.0)  
**Height:** 19 17/32 (496.1)  
**A. Gskt:** [2] Attached  
**F. Gskt:** G39-AF  
**Related To:** PA2507 (Standard Media Version)

**PA2507**



Outer Air Element

**Fits:** Benford, Terex Equipment  
**Use With:** PA2508  
**Replaces:** GMC 9059570; Terex 9039993  
**O.D.:** 17 5/8 (447.7)  
 Boot 18 5/16 (465.1)  
**I.D.:** 13/32 (10.3) & 12 1/8 (308.0)  
**Height:** 19 17/32 (496.1)  
**A. Gskt:** [2] Attached  
**F. Gskt:** G39-AF  
**Related To:** LL2507 (Long-Life Media Version)

**PA2508**



Inner Air Element

**Fits Inside:** LL2507, PA2507  
**Fits:** Terex Tractors  
**Replaces:** GMC 9059992; Terex 9039992  
**O.D.:** 11 7/8 (301.6)  
**I.D.:** 7/8 (22.2) & 10 1/4 (260.3)  
**Height:** 18 5/32 (461.2)  
**A. Gskt:** [1] Included  
**F. Gskt:** [1] Included

**PA2509**



Outer Air Element

**Fits:** Agco, Allis Chalmers, Ford, Gleaner, Steiger Equipment  
**Use With:** PA2510  
**Replaces:** Allis Chalmers 70269244; Ford SFD07-1011  
**O.D.:** 10 3/8 (263.5)  
**I.D.:** 15/16 (23.8) & 6 1/32 (153.2)  
**Height:** 18 3/8 (466.7)  
**A. Gskt:** [1] Attached  
**F. Gskt:** [1] Included

**PA2510**



Inner Air Element

**Fits Inside:** PA2509, PA2591  
**Fits:** Agco, Allis Chalmers, Ford, Gleaner, Steiger Equipment  
**Replaces:** Allis Chalmers 279245; Case A45695; Ford SFD07-1010  
**O.D.:** 5 15/16 (150.8)  
**I.D.:** 21/32 (16.7) & 4 27/32 (123.0)  
**Height:** 16 3/8 (415.9)  
**A. Gskt:** [1] Attached  
**F. Gskt:** G103-N

**PA2511**



Outer Air Element

**Fits:** Dresser, International Equipment  
**Use With:** PA2512  
**Replaces:** International 631421-C1  
**O.D.:** 7 11/32 (186.5)  
**I.D.:** 7/16 (11.1) & 4 (101.6)  
**Height:** 14 3/4 (374.7)  
**A. Gskt:** [1] Attached  
**F. Gskt:** [1] Included

**PA2512**



Inner Air Element

**Fits Inside:** PA2511  
**Fits:** Dresser, International Equipment  
**Replaces:** International 631422-C1  
**O.D.:** 3 7/8 (98.4)  
**I.D.:** 5/8 (15.9) & 2 1/2 (63.5)  
**Height:** 12 1/16 (306.4)  
**A. Gskt:** [1] Attached  
**F. Gskt:** G103-N

Measurements Are Shown In Inches And (Millimeters)

**WARNING:** These products can expose you to chemicals, including Diisononyl Phthalate, Carbon black extracts, Nickel, 1,3 Butadiene, Ethylene Oxide, Epichlorohydrin, which are known to the State of California to cause cancer, and Bisphenol, Ethylene Glycol, Ethylene Oxide, 1,3 Butadiene, Epichlorohydrin, which are known to the State of California to cause birth defects or other reproductive harm.



**PA2513**



Outer Air Element with Lift Bar  
**Fits:** Ford Equipment  
**Use With:** PA2514  
**Replaces:** Ford D5NN-9601-B  
**O.D.:** 5 5/16 (134.9)  
 Boot 5 3/4 (146.0)  
**I.D.:** 7/16 (11.1) & 3 1/16 (77.8)  
**Height:** 11 1/2 (292.1)  
**A. Gskt:** [2] Attached  
**F. Gskt:** [1] Included

**PA2518**



Outer Air Element  
**Fits:** Ag-Chem, Terex Equipment; Ingersoll-Rand, Joy, Sullair Compressors  
**Use With:** PA2519  
**Replaces:** Ag-Chem 718569; Euclid 9013550; Ingersoll-Rand 35355395; Joy 360628329; Sullair 46968  
**O.D.:** 12 1/8 (308.0)  
 Boot 12 13/16 (325.4)  
**I.D.:** 29/32 (23.0) & 7 11/16 (195.3)  
**Height:** 20 3/8 (517.5)  
**A. Gskt:** [2] Attached  
**F. Gskt:** [1] Included  
**Related To:** LL2518 (Long-Life Media Version)  
 PA2518XP (Extreme Performance Nano Version)

**PA2514**



Inner Air Element  
**Fits Inside:** PA2513  
**Fits:** Ford Equipment  
**Replaces:** Ford D5NN-9R500-B  
**O.D.:** 2 15/16 (74.6)  
**I.D.:** 17/32 (13.5) & 2 13/32 (61.1)  
**Height:** 9 15/16 (252.4)  
**A. Gskt:** [2] Attached  
**F. Gskt:** [1] Included

**PA2518XP**



Extreme Performance Nano Outer Air Element  
**Fits:** Ag-Chem, Terex Equipment; Ingersoll-Rand, Joy, Sullair Compressors  
**Use With:** PA2519  
**Replaces:** Ag-Chem 718569; Euclid 9013550; Ingersoll-Rand 35355395; Joy 360628329; Sullair 46968  
**O.D.:** 12 1/8 (308.0)  
 Boot 12 13/16 (325.4)  
**I.D.:** 29/32 (23.0) & 7 11/16 (195.3)  
**Height:** 20 3/8 (517.5)  
**A. Gskt:** [2] Attached  
**F. Gskt:** [1] Included  
**Related To:** LL2518 (Long-Life Media Version)  
 PA2518 (Standard Media Version)

**PA2515**



Air Element  
**Fits:** GMC Buses, Trucks  
**Replaces:** GMC 25177168  
**O.D.:** 13 7/8 (352.4)  
**I.D.:** 7 7/16 (188.9) One End  
**Height:** 20 (508.0)  
**A. Gskt:** [2] Included  
**F. Gskt:** G145-AF

**PA2516**



Air Element  
**Fits:** GMC Buses, Trucks  
**Replaces:** GMC 25040535  
**O.D.:** 13 7/8 (352.4)  
**I.D.:** 7 7/16 (188.9) One End  
**Height:** 26 (660.4)  
**A. Gskt:** [2] Attached  
**F. Gskt:** G145-AF

**PA2519**



Inner Air Element  
**Fits Inside:** LL2518, PA2518, PA2518XP  
**Fits:** Terex Equipment; Ingersoll-Rand, Joy, Sullair Compressors  
**Replaces:** Ingersoll-Rand 46981; Joy 360628328; Terex 9031711  
**O.D.:** 7 5/8 (193.7)  
**I.D.:** 7/8 (22.2) & 6 1/16 (154.0)  
**Height:** 18 3/8 (466.7)  
**A. Gskt:** [1] Attached  
**F. Gskt:** [1] Included

**PA2517**



Air Element with Lid and 6 Bolt Holes  
**Replaces:** Ford D6HS-9601-B  
**O.D.:** 13 7/8 (352.4)  
 Lid 16 1/8 (409.6)  
**I.D.:** 7 7/16 (188.9) One End  
**Height:** 13 17/32 (343.7)  
**A. Gskt:** [2] Attached

**PA2520**



Outer Air Element  
**Fits:** International Buses, Trucks  
**Use With:** PA2586  
**Replaces:** International 478974-C1  
**O.D.:** 10 3/8 (263.5)  
**I.D.:** 6 1/32 (153.2) One End  
**Height:** 12 3/8 (314.3)  
**A. Gskt:** [1] Attached

**LL2518**



Long Life Outer Air Element  
**Fits:** Ag-Chem, Terex Equipment; Ingersoll-Rand, Joy, Sullair Compressors  
**Use With:** PA2519  
**Replaces:** Ag-Chem 718569; Euclid 9013550; Ingersoll-Rand 35355395; Joy 360628329; Sullair 46968  
**O.D.:** 12 1/8 (308.0)  
 Boot 12 13/16 (325.4)  
**I.D.:** 29/32 (23.0) & 7 11/16 (195.3)  
**Height:** 20 3/8 (517.5)  
**A. Gskt:** [2] Attached  
**F. Gskt:** [1] Included  
**Related To:** PA2518 (Standard Media Version)  
 PA2518XP (Extreme Performance Nano Version)

**LL2521**



Long Life Outer Air Element with Lift Tab  
**Fits:** International, Kenworth, Mercedes-Benz, Peterbilt Trucks; Thomas Buses  
**Use With:** PA2522  
**Replaces:** International 476741-C1  
**O.D.:** 10 3/8 (263.5)  
**I.D.:** 6 1/32 (153.2) One End  
**Height:** 16 7/16 (417.5)  
**A. Gskt:** [1] Attached  
**Related To:** PA2521 (Standard Media Version)

Measurements Are Shown In Inches And (Millimeters)

**WARNING:** These products can expose you to chemicals, including Diisononyl Phthalate, Carbon black extracts, Nickel, 1,3 Butadiene, Ethylene Oxide, Epichlorohydrin, which are known to the State of California to cause cancer, and Bisphenol, Ethylene Glycol, Ethylene Oxide, 1,3 Butadiene, Epichlorohydrin, which are known to the State of California to cause birth defects or other reproductive harm.

**PA2521** Outer Air Element  
**Fits:** International, Kenworth, Mercedes-Benz, Peterbilt Trucks; Thomas Buses  
**Use With:** PA2522  
**Replaces:** International 476741-C1  
**O.D.:** 10 3/8 (263.5)  
**I.D.:** 6 1/32 (153.2) One End  
**Height:** 16 7/16 (417.5)  
**A. Gskt:** [1] Attached  
**Related To:** LL2521 (Long-Life Media Version)



**PA2526** Inner Air Element  
**Fits Inside:** LL2525, PA2525  
**Fits:** Fram Optional Housings; International Trucks  
**Replaces:** International 482646-C91; Fram CA1599SY  
**O.D.:** 7 5/8 (193.7)  
**I.D.:** 21/32 (16.7) & 6 1/16 (154.0)  
**Height:** 15 7/8 (403.2)  
**A. Gskt:** [1] Attached  
**F. Gskt:** G103-N



**PA2522** Inner Air Element  
**Fits Inside:** LL2521, PA2521  
**Fits:** International Trucks; Thomas Buses  
**Replaces:** International 482644-C1  
**O.D.:** 5 15/16 (150.8)  
**I.D.:** 21/32 (16.7) & 4 27/32 (123.0)  
**Height:** 13 7/8 (352.4)  
**A. Gskt:** [1] Attached  
**F. Gskt:** G103-N



**PA2527** Air Element  
**Replaces:** Caterpillar 310177; GMC 25096334  
**O.D.:** 6 7/8 (174.6)  
**I.D.:** 21/32 (16.7) & 3 1/2 (88.9)  
**Height:** 13 7/16 (341.3)  
**A. Gskt:** [1] Attached  
**F. Gskt:** G103-N, [1] Wing Nut



**PA2523** Outer Air Element  
**Fits:** Allis Chalmers, White Equipment; Ford Trucks  
**Use With:** PA1912, PA1998  
**Replaces:** Allis Chalmers 1325203; Ford E6HZ-9601-A  
**O.D.:** 7 15/16 (201.6)  
**I.D.:** 11/16 (17.5) & 5 3/8 (136.5)  
**Height:** 16 1/2 (419.1)  
**A. Gskt:** [1] Attached  
**F. Gskt:** G103-N



**PA2528** Air Element  
**Fits:** Sullair Compressors  
**Replaces:** Sullair 40853  
**O.D.:** 8 1/2 (215.9)  
**I.D.:** 7/16 (11.1) & 4 1/16 (103.2)  
**Height:** 14 1/16 (357.2)  
**A. Gskt:** [1] Attached  
**F. Gskt:** [1] Included



**PA2524-FN** Outer Air Element with Fins  
**Fits:** Case, Hough, International Equipment  
**Use With:** PA2332  
**Replaces:** International 690049-C1  
**O.D.:** 6 7/8 (174.6)  
**I.D.:** 21/32 (16.7) & 3 1/2 (88.9)  
**Height:** 15 3/8 (390.5)  
**A. Gskt:** [1] Attached  
**F. Gskt:** G103-N



**PA2529** Outer Air Element  
**Fits:** John Deere, New Holland Equipment  
**Use With:** PA2530  
**Replaces:** John Deere AR80652  
**O.D.:** 9 1/16 (230.2)  
**I.D.:** 3/8 (9.5) & 5 3/8 (136.5)  
**Height:** 19 5/8 (498.5)  
**A. Gskt:** [1] Attached  
**F. Gskt:** [1] Included



**LL2525** Long Life Outer Air Element with Lift Tabs  
**Fits:** International Buses, Trucks  
**Use With:** PA2526, PA3480  
**Replaces:** International 470186-C91  
**O.D.:** 12 1/32 (305.6)  
**I.D.:** 7 11/16 (195.3) One End  
**Height:** 18 1/2 (469.9)  
**A. Gskt:** [1] Attached  
**Related To:** PA2525 (Standard Media Version)



**PA2530** Inner Air Element  
**Fits Inside:** PA2529  
**Fits:** Hitachi, John Deere Equipment  
**Replaces:** John Deere AR80653; Kobelco 2446U249S1  
**O.D.:** 5 5/32 (131.0)  
**I.D.:** 5/8 (15.9) & 4 1/32 (102.4)  
**Height:** 16 5/32 (410.4)  
**A. Gskt:** [1] Attached  
**F. Gskt:** G103-N



**PA2525** Outer Air Element with Lift Tabs  
**Fits:** International Buses, Trucks  
**Use With:** PA2526, PA3480  
**Replaces:** International 470186-C91  
**O.D.:** 12 1/32 (305.6)  
**I.D.:** 7 11/16 (195.3) One End  
**Height:** 18 1/2 (469.9)  
**A. Gskt:** [1] Attached  
**Related To:** LL2525 (Long-Life Media Version)



**PA2531** Air Element  
**Fits:** Detroit Diesel Engines; GMC Trucks  
**Replaces:** GMC 2050330  
**O.D.:** 9 (228.6)  
**I.D.:** 5 11/16 (144.5)  
**Height:** 22 19/32 (573.9)  
**A. Gskt:** [2] Attached  
**O. Gskt:** G472-AF



Measurements Are Shown In Inches And (Millimeters)

**WARNING:** These products can expose you to chemicals, including Diisononyl Phthalate, Carbon black extracts, Nickel, 1,3 Butadiene, Ethylene Oxide, Epichlorohydrin, which are known to the State of California to cause cancer, and Bisphenol, Ethylene Glycol, Ethylene Oxide, 1,3 Butadiene, Epichlorohydrin, which are known to the State of California to cause birth defects or other reproductive harm.

**PA2532**

Air Element



**Fits:** Detroit Diesel Engines; GMC Trucks  
**Replaces:** GMC 2030100  
**O.D.:** 9 (228.6)  
**I.D.:** 5 11/16 (144.5)  
**Height:** 28 1/2 (723.9)  
**A. Gskt:** [2] Attached  
**O. Gskt:** G472-AF

**PA2539**

Inner Air Element



**Fits Inside:** PA2538, PA2777  
**Fits:** Agco, Case, Dresser, Hough, International Equipment  
**Replaces:** Case A171256; International 935693-C1  
**O.D.:** 5 15/16 (150.8)  
**I.D.:** 2 1/32 (16.7) & 4 27/32 (123.0)  
**Height:** 14 1/2 (368.3)  
**A. Gskt:** [1] Attached  
**F. Gskt:** G103-N

**PA2533**

Air Element with Lid and 6 Bolt Holes



**Fits:** Ford Buses, Trucks  
**Replaces:** Ford D5HZ-9601-A  
**O.D.:** 12 1/32 (305.6)  
 Lid 14 3/16 (360.4)  
**I.D.:** 6 23/32 (170.7) One End  
**Height:** 16 1/2 (419.1)  
**A. Gskt:** [1] Attached

**PA2540**

Conical-Shaped Air Element



**Fits:** GMC, Mack Trucks; Caterpillar Loaders  
**Replaces:** GMC 25040529; Mack 57MD27  
**O.D.:** 5 3/4 (146.0)  
 to 8 21/32 (219.9)  
**I.D.:** 5 3/16 (131.8)  
**Height:** 16 (406.4)  
**A. Gskt:** [2] Attached  
**F. Gskt:** [1] Included  
**Related To:** PA2500 (Long Version)

**PA2534**

Cab Air Element



**Fits:** Caterpillar, Elgin, Owatonna Equipment  
**Replaces:** Caterpillar 8P5142; Thermo King 2052B70G01  
**Length:** 17 (431.8)  
**Width:** 10 (254.0)  
**Height:** 2 3/16 (55.6)

**PA2541-FN**

Outer Air Element with Fins



**Fits:** Benfra, Demag, Fiat-Allis, Hanomag, Massey Ferguson, New Holland Equipment  
**Use With:** PA2332  
**Replaces:** Benfra 40155; Demag 5150574; Fiat-Allis 79049791; Massey Ferguson 1428739-M91  
**O.D.:** 5 1/4 (133.4)  
 Fins 6 3/8 (161.9)  
**I.D.:** 2 1/32 (16.7) & 3 5/8 (92.1)  
**Height:** 15 15/32 (392.9)  
**A. Gskt:** [1] Attached  
**F. Gskt:** G103-N

**PA2535**

Inner Air Element



**Fits Inside:** PA1907-FN  
**Fits:** Bobcat Loaders; Massey Ferguson Industrial Equipment, Wheel Tractors  
**Replaces:** Massey Ferguson 523419-M91  
**O.D.:** 2 3/8 (60.3)  
 Flange 4 1/2 (114.3)  
**I.D.:** 13/32 (10.3) & 2 (50.8)  
**Height:** 8 15/32 (215.1)  
**A. Gskt:** [2] Attached  
**F. Gskt:** [1] Included

**PA2542**

Outer Air Element with Lift Bars



**Fits:** Dresser, International Equipment  
**Use With:** PA2543  
**Replaces:** International 627114-C1  
**O.D.:** 6 19/32 (167.5)  
**I.D.:** 3 21/32 (92.9) One End  
**Height:** 17 3/16 (436.6)  
**A. Gskt:** [1] Attached

**PA2536**

Air Element



**Contains:** Flame Retardant Media  
**Fits:** Nissan Automotive; Datsun, Nissan Lift Trucks  
**Replaces:** Nissan 16546-76015, 16546-L3000  
**O.D.:** 5 1/4 (133.4)  
**I.D.:** 3/8 (9.5) & 2 27/32 (72.2)  
**Height:** 6 23/32 (170.7)  
**F. Gskt:** [1] Included

**PA2544**

Air Element with Lid and 6 Bolt Holes



**Fits:** WhiteGMC Trucks  
**Replaces:** White 22-005009  
**O.D.:** 13 7/8 (352.4)  
 Lid 16 1/8 (409.6)  
**I.D.:** 7 7/16 (188.9) One End  
**Height:** 16 1/32 (407.2)  
**A. Gskt:** [2] Attached

**PA2538**

Outer Air Element



**Fits:** Agco, Dresser, Hough, International, Massey Ferguson, White Equipment  
**Use With:** PA2539  
**Replaces:** International 935694-C1  
**O.D.:** 10 3/8 (263.5)  
**I.D.:** 2 1/32 (16.7) & 6 1/32 (153.2)  
**Height:** 16 1/2 (419.1)  
**A. Gskt:** [1] Attached  
**F. Gskt:** G103-N

**PA2545**













Inner Air Element



**Fits Inside:** PA2504, PA2779  
**Fits:** Ag-Chem, Caterpillar, Clark, Hitachi, Kawasaki, Timberjack Equipment; GMC, International, Isuzu, Nissan Buses, Trucks  
**Replaces:** GMC 94037809; Isuzu 1-14215-078-1; Nissan D6546-Z9006  
**O.D.:** 5 11/16 (144.5)  
**I.D.:** 1 1/16 (17.5) & 4 19/32 (116.7)  
**Height:** 12 3/8 (314.3)  
**A. Gskt:** [1] Attached  
**F. Gskt:** G103-N

Measurements Are Shown In Inches And (Millimeters)

**WARNING:** These products can expose you to chemicals, including Diisononyl Phthalate, Carbon black extracts, Nickel, 1,3 Butadiene, Ethylene Oxide, Epichlorohydrin, which are known to the State of California to cause cancer, and Bisphenol, Ethylene Glycol, Ethylene Oxide, 1,3 Butadiene, Epichlorohydrin, which are known to the State of California to cause birth defects or other reproductive harm.

<p><b>PA2546</b></p> 	<p>Outer Air Element  <b>Fits:</b> Dresser, Ford, Hitachi, John Deere Equipment  <b>Use With:</b> PA2547  <b>Replaces:</b> John Deere AR79679  <b>O.D.:</b> 9 3/32 (231.0)  <b>I.D.:</b> 1/2 (12.7) &amp; 5 7/32 (132.6)  <b>Height:</b> 17 (431.8)  <b>A. Gskt:</b> [1] Attached  <b>F. Gskt:</b> [1] Included</p>	<p><b>PA2553</b></p> 	<p>Air Element  <b>Notes:</b> OBSOLETE. Availability Limited to Dealer Stock.  <b>Fits:</b> DAF, R.V.I., Volvo Buses, Trucks  <b>Replaces:</b> DAF 693076; R.V.I. 5000242911; Volvo 1517842  <b>O.D.:</b> 8 3/8 (212.7)  <b>I.D.:</b> 4 (101.6)  <b>Height:</b> 12 5/8 (320.7)  <b>A. Gskt:</b> [2] Attached</p>
<p><b>PA2547</b></p> 	<p>Inner Air Element  <b>Fits Inside:</b> PA2546  <b>Fits:</b> Dresser, Hitachi, John Deere Equipment  <b>Replaces:</b> John Deere AR79680  <b>O.D.:</b> 4 21/32 (118.3)  <b>I.D.:</b> 21/32 (16.7) &amp; 3 15/16 (100.0)  <b>Height:</b> 14 19/32 (370.7)  <b>A. Gskt:</b> [1] Attached  <b>F. Gskt:</b> G103-N</p>	<p><b>PA2554</b></p> 	<p>Panel Air Element  <b>Notes:</b> Do NOT use in cab air ventilation systems.  <b>Fits:</b> Caterpillar Industrial, Marine Engines  <b>Use With:</b> PA2554 FOAM  <b>Replaces:</b> Caterpillar 4N15, 4N0015  <b>Length:</b> 15 (381.0)  <b>Width:</b> 15 (381.0)  <b>Height:</b> 5 1/2 (139.7)</p>
<p><b>PA2548</b></p> 	<p>Air Element with Lid and Air Restriction Gauge Fitting  <b>Fits:</b> Ford Trucks  <b>Replaces:</b> Ford F6HZ-9601-B  <b>O.D.:</b> 10 (254.0)            Lid 12 (304.8)  <b>I.D.:</b> 17/32 (13.5) &amp; 4 15/16 (125.4)  <b>Height:</b> 8 1/16 (204.8)  <b>A. Gskt:</b> [1] Attached  <b>F. Gskt:</b> [1] Washer</p>	<p><b>PA2554 FOAM</b></p> 	<p>Foam Blanket for PA2554  <b>Use With:</b> PA2554  <b>Length:</b> 24 (609.6)  <b>Width:</b> 15 (381.0)  <b>Height:</b> 1/2 (12.7)</p>
<p><b>PA2550</b></p> 	<p>Air Element  <b>Fits:</b> GMC Trucks  <b>Replaces:</b> GMC 2054757  <b>O.D.:</b> 8 27/32 (224.6)  <b>I.D.:</b> 5 15/32 (138.9) One End  <b>Height:</b> 15 (381.0)  <b>A. Gskt:</b> [2] Attached  <b>F. Gskt:</b> G207-AF</p>	<p><b>PA2555</b></p> 	<p>Inter-Cooler Air Element  <b>Notes:</b> Sometimes used with PA2556.  <b>Replaces:</b> GMC 25042417; Mack 57MD29305P1  <b>O.D.:</b> 10 13/32 (264.3)  <b>I.D.:</b> 6 15/16 (176.2)  <b>Height:</b> 12 (304.8)  <b>A. Gskt:</b> [2] Attached</p>
<p><b>PA2551</b></p> 	<p>Outer Air Element with Bail Handle  <b>Fits:</b> International Wheel Tractors  <b>Use With:</b> PA2332  <b>Replaces:</b> International 71912-C1  <b>O.D.:</b> 6 27/32 (173.8)  <b>I.D.:</b> 3 15/32 (88.1) One End  <b>Height:</b> 15 3/8 (390.5)  <b>A. Gskt:</b> [1] Attached</p>	<p><b>PA2556</b></p> 	<p>Inter-Cooler Air Element  <b>Notes:</b> Sometimes used with PA2555.  <b>Replaces:</b> GMC 25042415; Mack 57MD29305P2  <b>O.D.:</b> 10 3/8 (263.5)  <b>I.D.:</b> 6 1/32 (153.2)  <b>Height:</b> 15 (381.0)  <b>A. Gskt:</b> [2] Attached</p>
<p><b>PA2552</b></p> 	<p>Air Element  <b>Replaces:</b> International 466400-C1  <b>O.D.:</b> 12 5/8 (320.7)  <b>I.D.:</b> 8 13/32 (213.5)  <b>Height:</b> 8 5/8 (219.1)  <b>A. Gskt:</b> [2] Attached</p>	<p><b>LL2557</b></p> 	<p>Long Life Air Element  <b>Fits:</b> Caterpillar Industrial Engines  <b>Replaces:</b> Caterpillar 7N1225  <b>O.D.:</b> 10 3/8 (263.5)  <b>I.D.:</b> 6 1/32 (153.2) One End  <b>Height:</b> 9 1/2 (241.3)  <b>A. Gskt:</b> [1] Attached  <b>Related To:</b> PA2557 (Standard Media Version)</p>

Measurements Are Shown In Inches And (Millimeters)

**WARNING:** These products can expose you to chemicals, including Diisononyl Phthalate, Carbon black extracts, Nickel, 1,3 Butadiene, Ethylene Oxide, Epichlorohydrin, which are known to the State of California to cause cancer, and Bisphenol, Ethylene Glycol, Ethylene Oxide, 1,3 Butadiene, Epichlorohydrin, which are known to the State of California to cause birth defects or other reproductive harm.

**PA2557** Air Element  
**Fits:** Caterpillar Industrial Engines  
**Replaces:** Caterpillar 7N1225  
**O.D.:** 10 3/8 (263.5)  
**I.D.:** 6 1/32 (153.2) One End  
**Height:** 9 1/2 (241.3)  
**A. Gskt:** [1] Attached  
**Related To:** LL2557 (Long-Life Media Version)



**PA2558** Air Element  
**Fits:** Mack Trucks  
**Replaces:** Mack 2MD4004, 57MD32  
**O.D.:** 8 27/32 (224.6)  
**I.D.:** 11/16 (17.5) & 5 15/32 (138.9)  
**Height:** 7 1/2 (190.5)  
**A. Gskt:** [1] Attached  
**F. Gskt:** G103-N



**LL2559** Long Life Air Element  
**Replaces:** GMC 25041976  
**O.D.:** 13 7/8 (352.4)  
**I.D.:** 7 7/16 (188.9) One End  
**Height:** 24 (609.6)  
**A. Gskt:** [2] Attached  
**F. Gskt:** G145-AF  
**Related To:** PA2559 (Standard Media Version)



**PA2559** Air Element  
**Replaces:** GMC 25041976  
**O.D.:** 13 7/8 (352.4)  
**I.D.:** 7 7/16 (188.9) One End  
**Height:** 24 (609.6)  
**A. Gskt:** [2] Attached  
**F. Gskt:** G145-AF  
**Related To:** LL2559 (Long-Life Media Version)



**LL2562** Long Life Outer Air Element with Bail Handle  
**Fits:** Ingersoll-Rand Compressors; Hitachi, Koehring, Liebherr, Terex, Volvo, WABCO Equipment  
**Use With:** PA2563  
**Replaces:** Hitachi 4206272; Ingersoll-Rand 35298108; WABCO VE1062  
**O.D.:** 14 11/16 (373.1)  
**I.D.:** 29/32 (23.0) & 10 11/32 (262.7)  
**Height:** 24 1/2 (622.3)  
**A. Gskt:** [1] Attached  
**F. Gskt:** [1] Included  
**Related To:** PA2562 (Standard Media Version)  
 PA2562XP (Extreme Performance Nano Version)



**PA2562** Outer Air Element with Bail Handle  
**Fits:** Ingersoll-Rand Compressors; Hitachi, Koehring, Liebherr, Terex, Volvo, Wabco Equipment  
**Use With:** PA2563  
**Replaces:** Hitachi 4206272; Ingersoll-Rand 35298108; WABCO VE1062  
**O.D.:** 14 11/16 (373.1)  
**I.D.:** 29/32 (23.0) & 10 11/32 (262.7)  
**Height:** 24 1/2 (622.3)  
**A. Gskt:** [1] Attached  
**F. Gskt:** [1] Included  
**Related To:** LL2562 (Long-Life Media Version)  
 PA2562XP (Extreme Performance Nano Version)



**PA2562XP** Extreme Performance Nano Outer Air Element with Bail Handle  
**Fits:** Ingersoll-Rand Compressors; Hitachi, Koehring, Liebherr, Terex, Volvo, Wabco Equipment  
**Use With:** PA2563  
**Replaces:** Hitachi 4206272; Ingersoll-Rand 35298108; WABCO VE1062  
**O.D.:** 14 11/16 (373.1)  
**I.D.:** 29/32 (23.0) & 10 11/32 (262.7)  
**Height:** 24 1/2 (622.3)  
**A. Gskt:** [1] Attached  
**F. Gskt:** [1] Included  
**Related To:** LL2562 (Long-Life Media Version)  
 PA2562 (Standard Media Version)



**PA2563** Inner Air Element  
**Fits Inside:** LL2562, PA2562, PA2562XP, PA2849  
**Fits:** Caterpillar, Hitachi, Ingersoll-Rand, Koehring, Terex, Wabco Equipment  
**Replaces:** Caterpillar 1N4864; Ingersoll-Rand 35298116; WABCO VE1061  
**O.D.:** 10 1/4 (260.3)  
**I.D.:** 29/32 (23.0) & 9 1/8 (231.8)  
**Height:** 22 1/2 (571.5)  
**A. Gskt:** [1] Attached  
**F. Gskt:** [1] Included



**PA2564** DynaCell Air Element Replacement  
**Notes:** Both sides are open.  
**Replaces:** Caterpillar 7C8343; Farr C49812, T528D; Ford D8HZ-9601-D; GMC 25040430; White 22-0050004  
**Length:** 28 1/2 (723.9)  
**Width:** 19 (482.6)  
**Height:** 5 3/8 (136.5)  
**Related To:** PA2444 (Sides are Closed)

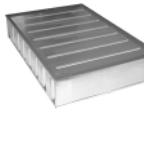

**PA2566** Air Element  
**Fits:** Design Engineering Optional Equipment  
**Replaces:** Design Engineering DEP1126  
**O.D.:** 9 5/8 (244.5)  
**I.D.:** 3/8 (9.5) & 5 (127.0)  
**Height:** 10 5/32 (258.0)  
**A. Gskt:** [1] Attached  
**F. Gskt:** [1] Included



**PA2567** Outer Air Element  
**Fits:** White Equipment  
**Use With:** PA2568  
**Replaces:** White 30-3216535  
**O.D.:** 9 1/16 (230.2)  
**I.D.:** 15/16 (23.8) & 5 3/8 (136.5)  
**Height:** 17 3/8 (441.3)  
**A. Gskt:** [1] Attached  
**F. Gskt:** [1] Included



Measurements Are Shown In Inches And (Millimeters)

**WARNING:** These products can expose you to chemicals, including Diisononyl Phthalate, Carbon black extracts, Nickel, 1,3 Butadiene, Ethylene Oxide, Epichlorohydrin, which are known to the State of California to cause cancer, and Bisphenol, Ethylene Glycol, Ethylene Oxide, 1,3 Butadiene, Epichlorohydrin, which are known to the State of California to cause birth defects or other reproductive harm.

**PA2568** Inner Air Element  
**Fits Inside:** PA2567  
**Fits:** White Equipment  
**Replaces:** White 30-3216543  
**O.D.:** 5 1/4 (133.4)  
**I.D.:** 5/8 (15.9) & 4 1/8 (104.8)  
**Height:** 15 1/2 (393.7)  
**A. Gskt:** [1] Included  
**F. Gskt:** G103-N



**PA2573XP** Extreme Performance Nano Outer Air Element  
**Fits:** Ag-Chem, Dynapac, Tamrock, V.M.E., Volvo Equipment; Sullair Compressors  
**Use With:** PA2574  
**Replaces:** Ag-Chem 700282; Dynapac 499505; Sullair 46299; V.M.E. M12565177  
**O.D.:** 13 13/16 (350.8)  
**I.D.:** 15/16 (23.8) & 9 1/2 (241.3)  
**Height:** 20 1/2 (520.7)  
**A. Gskt:** [1] Attached  
**F. Gskt:** G285-AF, [1] Included  
**Related To:** PA2573 (Standard Media Version)



**PA2569** Outer Air Element with Lift Tab  
**Fits:** Ford Tractors  
**Use With:** PA2435  
**Replaces:** Ford D5NN-9B618-B  
**O.D.:** 9 (228.6)  
 Boot 10 (254.0)  
**I.D.:** 1/2 (12.7) & 5 11/16 (144.5)  
**Height:** 16 3/8 (415.9)  
**A. Gskt:** [2] Attached  
**F. Gskt:** [1] Included



**PA2574** Inner Air Element  
**Fits Inside:** PA2573, PA2573XP  
**Fits:** Ag-Chem, Dynapac, Tamrock, V.M.E., Volvo Equipment; Sullair Compressors  
**Replaces:** Ag-Chem 700270; Dynapac 499509; Sullair 47523; V.M.E. M12565176  
**O.D.:** 8 5/8 (219.1)  
**I.D.:** 15/16 (23.8) & 7 1/16 (179.4)  
**Height:** 18 1/2 (469.9)  
**A. Gskt:** [1] Attached  
**F. Gskt:** [1] Included



**PA2570** Inner Air Element  
**Fits Inside:** LL1681-FN, PA1681-FN, PA1882, PA2666, PA2709  
**Fits:** Bobcat, Gehl, John Deere Equipment; Tymo Sweeps  
**Replaces:** Gehl 131853; John Deere AT44378  
**O.D.:** 3 3/8 (85.7)  
 Flange 4 5/32 (105.6)  
**I.D.:** 5/8 (15.9) & 2 29/32 (73.8)  
**Height:** 11 3/32 (281.8)  
**A. Gskt:** [1] Attached  
**F. Gskt:** G103-N



**LL2575** Long Life Outer Air Element  
**Fits:** Caterpillar Equipment, Lift Trucks  
**Use With:** PA2576, PA2730  
**Replaces:** Caterpillar 7N9028, 8N5504  
**O.D.:** 8 3/8 (212.7)  
**I.D.:** 4 (101.6) One End  
**Height:** 5 27/32 (148.4)  
**A. Gskt:** [1] Attached  
**Related To:** PA2575 (Standard Media Version)



**PA2571** Air Element  
**Replaces:** GMC 25041990, 25166966  
**O.D.:** 12 3/4 (323.8)  
**I.D.:** 8 11/32 (211.9) One End  
**Height:** 17 (431.8)  
**A. Gskt:** [2] Attached  
**F. Gskt:** G25-AF



**PA2575** Outer Air Element  
**Fits:** Caterpillar Equipment  
**Use With:** PA2576, PA2730  
**Replaces:** Caterpillar 7N9028, 8N5504  
**O.D.:** 8 3/8 (212.7)  
**I.D.:** 4 (101.6) One End  
**Height:** 5 27/32 (148.4)  
**A. Gskt:** [1] Attached  
**Related To:** LL2575 (Long-Life Media Version)



**PA2572** Cab Air Element  
**Fits:** Caterpillar Equipment  
**Replaces:** Caterpillar 6P1290  
**Length:** 25 1/2 (647.7)  
**Width:** 6 1/16 (154.0)  
**Height:** 2 3/16 (55.6)



**PA2576** Inner Air Element with 6 Bolts  
**Fits Inside:** LL2575, PA2575  
**Fits:** Caterpillar Equipment  
**Replaces:** Caterpillar 7N9027  
**O.D.:** 3 3/4 (95.3)  
 Flange 6 11/16 (169.9)  
**I.D.:** 2 5/8 (66.7) One End  
**Height:** 5 1/8 (130.2)  
**F. Gskt:** [1] Included



**PA2573** Outer Air Element  
**Fits:** Ag-Chem, Dynapac, Tamrock, V.M.E., Volvo Equipment; Sullair Compressors  
**Use With:** PA2574  
**Replaces:** Ag-Chem 700282; Dynapac 499505; Sullair 46299; V.M.E. M12565177  
**O.D.:** 13 13/16 (350.8)  
**I.D.:** 15/16 (23.8) & 9 1/2 (241.3)  
**Height:** 20 1/2 (520.7)  
**A. Gskt:** [1] Attached  
**F. Gskt:** G285-AF, [1] Included  
**Related To:** PA2573XP (Extreme Performance Nano Version)



**PA2577** Outer Air Element  
**Fits:** GMC, Isuzu, Nissan Buses, Trucks; Hitachi, John Deere, Kobelco, Komatsu, Link-Belt, MDI/Yutani, Mitsubishi, Timberjack, Timbco Equipment  
**Use With:** PA2578  
**Replaces:** GMC 94048864; Hitachi 4288963; Isuzu 1-14214-126-0; John Deere T52223; Kobelco 2446U191-S3; Mitsubishi ME063130; Nissan 16546-96071; Timberjack 8410616  
**O.D.:** 10 27/32 (275.4)  
**I.D.:** 15/16 (23.8) & 6 1/2 (165.1)  
**Height:** 15 1/2 (393.7)  
**A. Gskt:** [1] Attached  
**F. Gskt:** [1] Included



Measurements Are Shown In Inches And (Millimeters)

**WARNING:** These products can expose you to chemicals, including Diisononyl Phthalate, Carbon black extracts, Nickel, 1,3 Butadiene, Ethylene Oxide, Epichlorohydrin, which are known to the State of California to cause cancer, and Bisphenol, Ethylene Glycol, Ethylene Oxide, 1,3 Butadiene, Epichlorohydrin, which are known to the State of California to cause birth defects or other reproductive harm.

**PA2578**



Inner Air Element

**Fits Inside:** PA2577  
**Fits:** GMC, Isuzu, Nissan Buses, Trucks; Hitachi, John Deere, Kobelco, Komatsu, MDI/Yutani, Timberjack, Timbco Equipment  
**Replaces:** GMC 25096436; Isuzu 1-14215-125-1; John Deere T52224; Nissan 16546-96072  
**O.D.:** 6 3/8 (161.9)  
**I.D.:** 5/8 (15.9) & 5 9/32 (134.1)  
**Height:** 14 3/8 (365.1)  
**A. Gskt:** [1] Attached  
**F. Gskt:** G103-N

**PA2582**



Outer Air Element

**Fits:** Case, Champion, Hitachi, John Deere, Kawasaki, Kobelco, V.M.E., Volvo Equipment  
**Use With:** PA2583, PA3896  
**Replaces:** Case 150783A1; Champion 37398; John Deere AT136708; Kawasaki 30981-70100  
**O.D.:** 10 27/32 (275.4)  
**I.D.:** 15/16 (23.8) & 6 1/2 (165.1)  
**Height:** 20 1/2 (520.7)  
**A. Gskt:** [1] Attached  
**F. Gskt:** [1] Included  
**Related To:** LL2582 (Long-Life Media Version)

**PA2579**



Inner Air Element

**Fits Inside:** LL2330, PA2330, PA2612  
**Fits:** International Trucks  
**Replaces:** GMC 25096133; International 530560-C1  
**O.D.:** 7 3/16 (182.6)  
**I.D.:** 21/32 (16.7) & 5 11/16 (144.5)  
**Height:** 14 3/8 (365.1)  
**A. Gskt:** [1] Attached  
**F. Gskt:** G103-N

**PA2583**



Inner Air Element

**Fits Inside:** LL2582, PA2582  
**Fits:** Case, Champion, FMC, Hitachi, John Deere, Kawasaki, Kobelco, Kubota, Volvo Equipment  
**Replaces:** Champion 37399; John Deere AT136707; Kubota 12499-11210  
**O.D.:** 6 3/8 (161.9)  
**I.D.:** 5/8 (15.9) & 5 9/32 (134.1)  
**Height:** 19 1/2 (495.3)  
**A. Gskt:** [1] Attached  
**F. Gskt:** G103-N

**PA2580**



Air Element

**Contains:** Flame Retardant Media  
**Fits:** R.V.I. Trucks  
**Replaces:** GMC 9093553  
**O.D.:** 12 3/4 (323.8)  
**I.D.:** 8 11/32 (211.9)  
**Height:** 23 1/2 (596.9)  
**A. Gskt:** [1] Attached

**PA2585**



Air Element with Air Restriction Gauge Fitting

**Fits:** Ford Buses, Trucks  
**Replaces:** Ford D6HZ-9601-A  
**O.D.:** 9 7/32 (234.2)  
 9 5/16 (236.5)  
**I.D.:** 17/32 (13.5) & 4 27/32 (123.0)  
**Height:** 9 1/32 (229.4)  
**A. Gskt:** [1] Attached  
**F. Gskt:** [1] Included

**PA2581**



Air Element

**Fits:** Cummins, Deutz, Perkins Engines; Ford Trucks; Leyland Buses  
**Replaces:** Cummins 650931; Leyland 37H3737  
**O.D.:** 7 15/16 (201.6)  
**I.D.:** 11/16 (17.5) & 3 9/16 (90.5)  
**Height:** 13 3/8 (339.7)  
**A. Gskt:** [1] Attached  
**F. Gskt:** G103-N

**PA2586**



Inner Air Element

**Fits Inside:** PA2520  
**Fits:** Caterpillar Marine Engines; International Trucks  
**Replaces:** Caterpillar 8N5006  
**O.D.:** 5 15/16 (150.8)  
**I.D.:** 21/32 (16.7) & 4 27/32 (123.0)  
**Height:** 9 5/8 (244.5)  
**A. Gskt:** [1] Attached

**LL2582**



Long Life Outer Air Element

**Fits:** Case, Champion, Hitachi, John Deere, Kawasaki, Kobelco, V.M.E., Volvo Equipment  
**Use With:** PA2583, PA3896  
**Replaces:** Case 150783A1; Champion 37398; John Deere AT136708; Kawasaki 30981-70100  
**O.D.:** 10 27/32 (275.4)  
**I.D.:** 15/16 (23.8) & 6 1/2 (165.1)  
**Height:** 20 1/2 (520.7)  
**A. Gskt:** [1] Attached  
**F. Gskt:** [1] Included  
**Related To:** PA2582 (Standard Media Version)

**PA2587**



Outer Air Element

**Fits:** Ford, Koehring, New Holland Equipment  
**Use With:** PA2588  
**Replaces:** Ford D5NN-9B618-A; Koehring 8825161  
**O.D.:** 5 5/16 (134.9)  
 Boot 5 3/4 (146.0)  
**I.D.:** 7/16 (11.1) & 3 1/16 (77.8)  
**Height:** 14 21/32 (372.3)  
**A. Gskt:** [2] Attached  
**F. Gskt:** [1] Included

**PA2588**













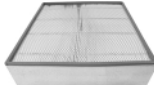

Inner Air Element

**Fits Inside:** PA2587  
**Fits:** Ford, Koehring, New Holland Equipment  
**Replaces:** Ford D6NN-9R500-B; Koehring 8825162  
**O.D.:** 2 15/16 (74.6)  
**I.D.:** 1/2 (12.7) & 2 13/32 (61.1)  
**Height:** 13 3/8 (339.7)  
**A. Gskt:** [1] Attached  
**F. Gskt:** [1] Included

Measurements Are Shown In Inches And (Millimeters)

**WARNING:** These products can expose you to chemicals, including Diisononyl Phthalate, Carbon black extracts, Nickel, 1,3 Butadiene, Ethylene Oxide, Epichlorohydrin, which are known to the State of California to cause cancer, and Bisphenol, Ethylene Glycol, Ethylene Oxide, 1,3 Butadiene, Epichlorohydrin, which are known to the State of California to cause birth defects or other reproductive harm.

<p><b>PA2589-FN</b> Air Element with Fins  <b>Fits:</b> Kubota Tractors  <b>Replaces:</b> Kubota 70000-17500  <b>O.D.:</b> 6 3/32 (154.8)            Fins 7 13/16 (198.4)  <b>I.D.:</b> 1/2 (12.7) &amp; 3 15/32 (88.1)  <b>Height:</b> 6 3/32 (154.8)  <b>A. Gskt:</b> [1] Attached  <b>F. Gskt:</b> [1] Included</p> 	<p><b>PA2599</b> Air Element  <b>Fits:</b> Ford, GMC Buses, Trucks  <b>Replaces:</b> Ford E0HZ-9601-B; GMC 25041372  <b>O.D.:</b> 12 1/32 (305.6)  <b>I.D.:</b> 6 23/32 (170.7)  <b>Height:</b> 8 (203.2)  <b>A. Gskt:</b> [2] Attached</p> 
<p><b>PA2591</b> Outer Air Element with Lift Tab  <b>Fits:</b> Case, International Tractors  <b>Use With:</b> PA2510  <b>Replaces:</b> Case A45694  <b>O.D.:</b> 10 3/8 (263.5)            Boot 11 (279.4)  <b>I.D.:</b> 21/32 (16.7) &amp; 6 1/32 (153.2)  <b>Height:</b> 18 3/8 (466.7)  <b>A. Gskt:</b> [2] Attached  <b>F. Gskt:</b> G103-N, [1] Wing Nut</p> 	<p><b>PA2600</b> Air Element with Lid  <b>Notes:</b> OBSOLETE. Availability Limited to Dealer Stock.  <b>Fits:</b> R.V.I. Trucks  <b>Replaces:</b> Renault 5000814944  <b>O.D.:</b> 9 29/32 (251.6)            Lid 14 15/32 (367.5)  <b>I.D.:</b> 5/8 (15.9) &amp; 6 15/32 (164.3)  <b>Height:</b> 15 1/2 (393.7)  <b>A. Gskt:</b> [2] Attached  <b>F. Gskt:</b> G103-N</p> 
<p><b>PA2592</b> Air Element for Pressurized Cab  <b>Fits:</b> Caterpillar Equipment  <b>Replaces:</b> Caterpillar 2V0036, 2V36  <b>O.D.:</b> 6 5/8 (168.3)  <b>I.D.:</b> 4 1/4 (108.0) One End  <b>Height:</b> 9 9/32 (235.7)  <b>A. Gskt:</b> [1] Attached</p> 	<p><b>PA2601</b> Cab Air Element  <b>Fits:</b> New Holland, Versatile Tractors  <b>Replaces:</b> New Holland V30986; Versatile 30986  <b>Length:</b> 44 (1117.6)  <b>Width:</b> 4 (101.6)  <b>Height:</b> 2 9/16 (65.1)  <b>A. Gskt:</b> [1] Attached</p> 
<p><b>PA2593</b> Panel Air Element  <b>Replaces:</b> International 947965-C2  <b>Length:</b> 19 1/2 (495.3)  <b>Width:</b> 19 1/2 (495.3)  <b>Height:</b> 5 9/16 (141.3)</p> 	<p><b>PA2602</b> Inner Air Element  <b>Fits Inside:</b> LL2344-FN, PA2344-FN  <b>Fits:</b> Case, Ford, Gehl, John Deere, New Holland, Thomas Equipment  <b>Replaces:</b> Case D82775; Ford 9809915; Gehl 263638; John Deere MG272744; New Holland 221688  <b>O.D.:</b> 2 3/8 (60.3)            Flange 4 1/2 (114.3)  <b>I.D.:</b> 21/32 (16.7) &amp; 2 (50.8)  <b>Height:</b> 13 1/4 (336.5)  <b>A. Gskt:</b> [2] Attached  <b>F. Gskt:</b> G103-N</p> 
<p><b>PA2595</b> Outer Air Element with Lid  <b>Replaces:</b> White 22-0050010  <b>O.D.:</b> 12 3/4 (323.8)            Lid 16 1/8 (409.6)  <b>I.D.:</b> 7 7/16 (188.9) One End  <b>Height:</b> 18 13/32 (467.5)  <b>A. Gskt:</b> [2] Attached</p> 	<p><b>PA2604</b> Outer Air Element  <b>Fits:</b> LeRoi Compressors  <b>Use With:</b> PA2605  <b>Replaces:</b> LeRoi 43-654  <b>O.D.:</b> 11 1/2 (292.1)  <b>I.D.:</b> 13/32 (10.3) &amp; 7 1/4 (184.2)  <b>Height:</b> 15 7/8 (403.2)  <b>A. Gskt:</b> [1] Attached  <b>F. Gskt:</b> [1] Included</p> 
<p><b>PA2596</b> Air Element  <b>Fits:</b> Ford, GMC Buses, Trucks  <b>Replaces:</b> Ford E0HT-9600-B; GMC 25041370  <b>O.D.:</b> 12 3/32 (307.2)  <b>I.D.:</b> 8 11/16 (220.7)  <b>Height:</b> 8 (203.2)  <b>A. Gskt:</b> [2] Attached</p> 	<p><b>PA2605</b> Inner Air Element  <b>Fits Inside:</b> PA261  <b>Fits:</b> Massey Ferguson Wheel Tractors  <b>Replaces:</b> Massey Ferguson 1044274-M91  <b>O.D.:</b> 6 7/8 (174.6)  <b>I.D.:</b> 21/32 (16.7) &amp; 5 9/16 (141.3)  <b>Height:</b> 14 3/8 (365.1)  <b>A. Gskt:</b> [1] Attached  <b>F. Gskt:</b> G103-N</p> 
<p><b>PA2598</b> Air Element  <b>Fits:</b> Design Engineering Optional Equipment  <b>Replaces:</b> Design Engineering DEP1226  <b>O.D.:</b> 9 11/32 (237.3)  <b>I.D.:</b> 3/8 (9.5) &amp; 6 1/4 (158.8)  <b>Height:</b> 10 1/8 (257.2)  <b>A. Gskt:</b> [1] Attached  <b>F. Gskt:</b> [1] Included</p> 	

Measurements Are Shown In Inches And (Millimeters)

**WARNING:** These products can expose you to chemicals, including Diisononyl Phthalate, Carbon black extracts, Nickel, 1,3 Butadiene, Ethylene Oxide, Epichlorohydrin, which are known to the State of California to cause cancer, and Bisphenol, Ethylene Glycol, Ethylene Oxide, 1,3 Butadiene, Epichlorohydrin, which are known to the State of California to cause birth defects or other reproductive harm.



**PA2606**



Outer Air Element with Lift Tab  
**Fits:** Franklin Loggers  
**Use With:** PA2607  
**Replaces:** Franklin 1504917  
**O.D.:** 9 (228.6)  
 Boot 10 (254.0)  
**I.D.:** 5 11/16 (144.5) One End  
**Height:** 13 9/16 (344.5)  
**A. Gskt:** [2] Attached

**PA2610**



Cab Air Element  
**Fits:** John Deere Equipment  
**Replaces:** John Deere AH115833  
**O.D.:** 10 27/32 (275.4)  
**I.D.:** 21/32 (16.7) & 6 1/2 (165.1)  
**Height:** 7 1/2 (190.5)  
**F. Gskt:** G103-N

**PA2607**



Inner Air Element  
**Fits Inside:** PA2606  
**Fits:** Franklin Loggers  
**Replaces:** Franklin 1504918  
**O.D.:** 5 9/16 (141.3)  
**I.D.:** 13/32 (10.3) & 4 1/2 (114.3)  
**Height:** 12 1/2 (317.5)  
**F. Gskt:** G15-AF

**PA2611**



Outer Air Element  
**Fits:** Massey Ferguson Wheel Tractors  
**Use With:** PA2605  
**Replaces:** Massey Ferguson 1044273-M91  
**O.D.:** 11 1/2 (292.1)  
**I.D.:** 13/32 (10.3) & 7 1/4 (184.2)  
**Height:** 15 11/16 (398.5)  
**A. Gskt:** [1] Attached  
**F. Gskt:** [1] Included

**LL2608**



Long Life Air Element  
**Fits:** Peterbilt Trucks with Vortex Housing  
**Replaces:** GMC 25096184; Vortex VF160R  
**O.D.:** 12 3/4 (323.8)  
**I.D.:** 21/32 (16.7) & 8 11/32 (211.9)  
**Height:** 27 (685.8)  
**A. Gskt:** [2] Attached  
**F. Gskt:** [1] Included  
**Related To:** PA2608 (Standard Media Version)

**PA2612**



Outer Air Element with Lift Tabs  
**Fits:** International Trucks  
**Use With:** PA2579  
**Replaces:** International 494730-C91  
**O.D.:** 12 1/32 (305.6)  
**I.D.:** 5/8 (15.9) & 7 11/16 (195.3)  
**Height:** 17 3/4 (450.9)  
**A. Gskt:** [2] Attached  
**F. Gskt:** G103-N

**PA2608**



Air Element  
**Notes:** Inside-Out Flow Direction  
**Fits:** Peterbilt Trucks; Vortex Housings  
**Replaces:** GMC 25096184; Vortex VF160R  
**O.D.:** 12 3/4 (323.8)  
**I.D.:** 21/32 (16.7) & 8 11/32 (211.9)  
**Height:** 27 (685.8)  
**A. Gskt:** [2] Attached  
**F. Gskt:** [1] Included  
**Related To:** LL2608 (Long-Life Media Version)

**PA2613**



Cab Air Element  
**Fits:** Caterpillar Equipment  
**Replaces:** Caterpillar 7G8116  
**O.D.:** 6 3/32 (154.8)  
**I.D.:** 21/32 (16.7) & 3 15/32 (88.1)  
**Height:** 7 9/32 (184.9)  
**A. Gskt:** [1] Attached  
**F. Gskt:** [1] Wing Nut

**LL2609**



Long Life Outer Air Element  
**Fits:** Caterpillar Industrial Engines, Equipment  
**Use With:** PA2385, PA2625  
**Replaces:** Caterpillar 1W2516  
**O.D.:** 12 1/2 (317.5)  
**I.D.:** 9 1/8 (231.8) One End  
**Height:** 19 (482.6)  
**A. Gskt:** [1] Attached  
**Related To:** PA2609 (Standard Media Version)

**PA2614**



Outer Air Element with Lift Tab  
**Fits:** Massey Ferguson Wheel Tractors;  
 Winpower Generators  
**Use With:** PA2615  
**Replaces:** Massey Ferguson 1051374-M91  
**O.D.:** 12 1/2 (317.5)  
**I.D.:** 13/32 (10.3) & 7 1/2 (190.5)  
**Height:** 22 1/4 (565.2)  
**A. Gskt:** [1] Attached  
**F. Gskt:** [1] Included

**PA2609**

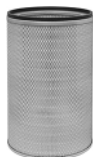

Outer Air Element  
**Fits:** Caterpillar Industrial Engines, Equipment  
**Use With:** PA2385, PA2625  
**Replaces:** Caterpillar 1W2516  
**O.D.:** 12 1/2 (317.5)  
**I.D.:** 9 1/8 (231.8) One End  
**Height:** 19 (482.6)  
**A. Gskt:** [1] Attached  
**Related To:** LL2609 (Long-Life Media Version)

**PA2615**



Inner Air Element  
**Fits Inside:** PA2614  
**Fits:** Massey Ferguson Wheel Tractors  
**Replaces:** Massey Ferguson 1051373-M91  
**O.D.:** 7 3/8 (187.3)  
**I.D.:** 25/32 (19.8) & 6 1/8 (155.6)  
**Height:** 20 7/8 (530.2)  
**A. Gskt:** [1] Attached  
**F. Gskt:** G103-N

Measurements Are Shown In Inches And (Millimeters)

**WARNING:** These products can expose you to chemicals, including Diisononyl Phthalate, Carbon black extracts, Nickel, 1,3 Butadiene, Ethylene Oxide, Epichlorohydrin, which are known to the State of California to cause cancer, and Bisphenol, Ethylene Glycol, Ethylene Oxide, 1,3 Butadiene, Epichlorohydrin, which are known to the State of California to cause birth defects or other reproductive harm.

**PA2616**

Outer Air Element



**Fits:** John Deere Graders  
**Use With:** PA2687  
**Replaces:** Alliance ABPN10GAF1896M;  
 Caterpillar 3I0331; General Motors 25177201;  
 John Deere AT75035  
**O.D.:** 10 3/8 (263.5)  
**I.D.:** 21/32 (16.7) & 6 1/32 (153.2)  
**Height:** 13 3/8 (339.7)  
**A. Gskt:** [1] Attached  
**F. Gskt:** G103-N  
**Related To:** PA2616XP (Extreme Performance  
 Nano Version)

**PA2616XP**

Extreme Performance Nano Outer Air Element



**Fits:** John Deere Graders  
**Use With:** PA2687  
**Replaces:** Alliance ABPN10GAF1896M;  
 Caterpillar 3I0331; General Motors 25177201;  
 John Deere AT75035  
**O.D.:** 10 3/8 (263.5)  
**I.D.:** 21/32 (16.7) & 6 1/32 (153.2)  
**Height:** 13 3/8 (339.7)  
**A. Gskt:** [1] Attached  
**F. Gskt:** G103-N  
**Related To:** PA2616 (Standard Media Version)

**PA2617**

Cab Air Element



**Fits:** Case Equipment  
**Replaces:** Case F64318  
**Length:** 38 (965.2)  
**Width:** 7 (177.8)  
**Height:** 2 3/16 (55.6)

**LL2618**

Long Life Air Element with Lift Tabs



**Fits:** Cummins Engines  
**Replaces:** Cummins 3013205  
**O.D.:** 13 7/8 (352.4)  
**I.D.:** 11/16 (17.5) & 7 7/16 (188.9)  
**Height:** 18 1/2 (469.9)  
**A. Gskt:** [1] Included  
**F. Gskt:** G103-N  
**Related To:** PA2618 (Standard Media Version)

**PA2618**

Air Element with Lift Tabs



**Fits:** Cummins Engines  
**Replaces:** Cummins 3013205  
**O.D.:** 13 7/8 (352.4)  
**I.D.:** 11/16 (17.5) & 7 7/16 (188.9)  
**Height:** 18 1/2 (469.9)  
**A. Gskt:** [1] Included  
**F. Gskt:** G103-N  
**Related To:** LL2618 (Long-Life Media Version)

**PA2619**

Cab Air Element with Pull Tab



**Fits:** Case, International, New Holland,  
 Versatile Equipment  
**Replaces:** International 143481-C91; Versatile  
 V105382  
**Length:** 38 (965.2)  
**Width:** 6 (152.4)  
**Height:** 2 9/16 (65.1)  
**A. Gskt:** [1] Attached  
**Related To:** PA2407 (without Attached Gasket)

**PA2620**

Outer Air Element with Lift Tab



**Fits:** Ford Tractors  
**Use With:** PA2621  
**Replaces:** Ford D8NN-9B618-AA  
**O.D.:** 9 1/8 (231.8)  
 Boot 9 3/4 (247.7)  
**I.D.:** 1/2 (12.7) & 5 13/16 (147.6)  
**Height:** 18 1/2 (469.9)  
**A. Gskt:** [2] Attached  
**F. Gskt:** [1] Included, [1] Wing Nut

**PA2621**

Inner Air Element



**Fits Inside:** PA2620, LL2688, PA2688  
**Fits:** Case, Champion, Ford, Hitachi, John  
 Deere, Komatsu, Volvo Equipment; Hino Trucks  
**Replaces:** Case S238647; Ford  
 D8NN-9R500-AA; Hino 17801-2460; John Deere  
 AT81019; Komatsu 600-181-8370  
**O.D.:** 5 23/32 (145.3)  
**I.D.:** 11/16 (17.5) & 4 19/32 (116.7)  
**Height:** 17 1/2 (444.5)  
**A. Gskt:** [1] Attached  
**F. Gskt:** G103-N

**PA2622**

Inner Air Element



**Fits Inside:** PA1794-FN  
**Fits:** John Deere Tractors  
**Replaces:** John Deere AL27160  
**O.D.:** 3 3/8 (85.7)  
 Flange 4 5/32 (105.6)  
**I.D.:** 21/32 (16.7) & 2 7/8 (73.0)  
**Height:** 9 1/16 (230.2)  
**A. Gskt:** [1] Attached  
**F. Gskt:** [1] Included, [1] Wing Nut

**PA2623**

Conical-Shaped Air Element



**Fits:** Cummins Engines; International Trucks  
**Replaces:** International 503647-C91  
**O.D.:** 5 3/4 (146.0)  
 to 8 21/32 (219.9)  
**I.D.:** 5 3/16 (131.8) One End  
**Height:** 23 (584.2)  
**A. Gskt:** [2] Attached  
**F. Gskt:** [1] Included

**PA2624**

Outer Air Element



**Use With:** PA2625  
**Replaces:** Ingersoll-Rand 35254903  
**O.D.:** 13 13/16 (350.8)  
 Boot 14 1/2 (368.3)  
**I.D.:** 15/16 (23.8) & 9 1/2 (241.3)  
**Height:** 15 1/2 (393.7)  
**A. Gskt:** [2] Attached  
**F. Gskt:** [1] Included

**PA2625**

Inner Air Element



**Fits Inside:** PA1815, LL2384, PA2384,  
 PA2384XP, LL2609, PA2609, PA2624  
**Fits:** Caterpillar Applications Converted from  
 Flanged Air Systems Previously Using PA1797  
 or PA2385  
**Replaces:** Ingersoll-Rand 35254895  
**O.D.:** 8 5/8 (219.1)  
**I.D.:** 15/16 (23.8) & 7 1/16 (179.4)  
**Height:** 14 1/2 (368.3)  
**A. Gskt:** [1] Attached  
**F. Gskt:** [1] Included

Measurements Are Shown In Inches And (Millimeters)

**WARNING:** These products can expose you to chemicals, including Diisononyl Phthalate, Carbon black extracts, Nickel, 1,3 Butadiene, Ethylene Oxide, Epichlorohydrin, which are known to the State of California to cause cancer, and Bisphenol, Ethylene Glycol, Ethylene Oxide, 1,3 Butadiene, Epichlorohydrin, which are known to the State of California to cause birth defects or other reproductive harm.

**PA2626**

Cab Air Element



**Fits:** Caterpillar Equipment  
**Replaces:** Caterpillar 8P5343  
**Length:** 23 1/2 (596.9)  
**Width:** 6 (152.4)  
**Height:** 2 3/16 (55.6)

**PA2627**

Dual-Stage Air Element with Blanket and Screen



**Replaces:** Fram CA3440  
**O.D.:** 9 9/16 (242.9)  
**I.D.:** 5 1/8 (130.2)  
**Height:** 11 19/32 (294.5)  
**Related To:** PA1701 (One End Closed)

**PA2628**

Air Element



**Fits:** Peterbilt Trucks  
**Replaces:** GMC 25043068; Peterbilt 513200  
**O.D.:** 9 1/2 (241.3)  
**I.D.:** 6 1/2 (165.1)  
**Height:** 28 1/2 (723.9)  
**A. Gskt:** [2] Attached

**PA2629**

Outer Air Element with Lid



**Use With:** PA2630  
**Replaces:** GMC 25043813; Ingersoll-Rand 58179359; International 505633-C1  
**O.D.:** 12 3/4 (323.8)  
**Lid:** 16 1/8 (409.6)  
**I.D.:** 8 11/32 (211.9) One End  
**Height:** 19 17/32 (496.1)  
**A. Gskt:** [2] Attached

**PA2630**

Inner Air Element



**Fits Inside:** PA2629  
**Replaces:** GMC 25096454; Ingersoll-Rand 58179367; International 501276-C1  
**O.D.:** 8 1/4 (209.6)  
**I.D.:** 15/16 (23.8) & 7 1/8 (181.0)  
**Height:** 16 3/8 (415.9)  
**A. Gskt:** [1] Attached  
**F. Gskt:** [1] Included

**PA2631**

Conical-Shaped Air Element



**Fits:** Freightliner Buses, Trucks; New Flyer Transit Buses  
**Replaces:** Caterpillar 7C8320; GMC 8881300; International 594240-C1; Universal Coach T121022  
**O.D.:** 9 25/32 (248.4) to 12 3/4 (323.8)  
**I.D.:** 8 11/32 (211.9) One End  
**Height:** 25 (635.0)  
**A. Gskt:** [2] Attached  
**F. Gskt:** G501-AF

**PA2632**

Conical-Shaped Air Element



**Notes:** Inside-Out Flow Direction  
**Fits:** Ford, Freightliner Buses, Trucks  
**Replaces:** Caterpillar 7C8318; Ford E2HZ-9601-A; GMC 25095857; Mack 57MD41M  
**O.D.:** 9 25/32 (248.4) to 12 3/4 (323.8)  
**I.D.:** 8 11/32 (211.9) One End  
**Height:** 29 (736.6)  
**A. Gskt:** [2] Attached  
**F. Gskt:** G501-AF

**PA2633-FN**

Outer Air Element with Fins



**Fits:** Case Equipment  
**Use With:** PA2634  
**Replaces:** Case A47032  
**O.D.:** 6 7/8 (174.6)  
**Fins:** 8 13/16 (223.8)  
**I.D.:** 21/32 (16.7) & 4 3/16 (106.4)  
**Height:** 14 1/2 (368.3)  
**A. Gskt:** [1] Attached  
**F. Gskt:** G103-N

**PA2634**

Inner Air Element



**Fits Inside:** PA2633-FN  
**Fits:** Case Equipment  
**Replaces:** Case A47033  
**O.D.:** 4 3/32 (104.0)  
**Flange:** 4 27/32 (123.0)  
**I.D.:** 25/32 (19.8) & 3 5/8 (92.1)  
**Height:** 13 3/32 (332.6)  
**A. Gskt:** [1] Attached  
**F. Gskt:** G103-N

**PA2635-FN**

Outer Air Element with Fins and Lid



**Fits:** John Deere Tractors  
**Use With:** PA2644  
**Replaces:** John Deere AL30394  
**O.D.:** 6 11/32 (161.1)  
**Lid:** 8 3/8 (212.7)  
**I.D.:** 5/8 (15.9) & 3 15/32 (88.1)  
**Height:** 14 5/8 (371.5)  
**A. Gskt:** [1] Attached  
**F. Gskt:** [1] Included, [1] Wing Nut

**PA2636**

Air Element



**Contains:** Flame Retardant Media  
**Fits:** Caterpillar Lift Trucks  
**Replaces:** Towmotor 348547  
**O.D.:** 4 17/32 (115.1)  
**I.D.:** 2 1/4 (57.2)  
**Height:** 11 (279.4)

**PA2637**

Outer Air Element



**Fits:** Case Tractors  
**Replaces:** Case A42758  
**O.D.:** 6 5/8 (168.3)  
**I.D.:** 3/8 (9.5) & 4 11/32 (110.3)  
**Height:** 14 5/16 (363.5)  
**A. Gskt:** [1] Attached  
**F. Gskt:** [1] Included

Measurements Are Shown In Inches And (Millimeters)

**WARNING:** These products can expose you to chemicals, including Diisononyl Phthalate, Carbon black extracts, Nickel, 1,3 Butadiene, Ethylene Oxide, Epichlorohydrin, which are known to the State of California to cause cancer, and Bisphenol, Ethylene Glycol, Ethylene Oxide, 1,3 Butadiene, Epichlorohydrin, which are known to the State of California to cause birth defects or other reproductive harm.

**PA2638**

Cab Air Element



**Fits:** White Equipment  
**Replaces:** White 30-3175154  
**Length:** 36 (914.4)  
**Width:** 6 1/2 (165.1)  
**Height:** 2 3/16 (55.6)

**PA2640**

Outer Air Element



**Fits:** Allis Chalmers Tractors  
**Replaces:** Allis Chalmers 259792  
**O.D.:** 12 1/32 (305.6)  
**I.D.:** 5/8 (15.9) & 7 11/16 (195.3)  
**Height:** 19 1/2 (495.3)  
**A. Gskt:** [1] Attached  
**F. Gskt:** G103-N

**PA2641**

Outer Air Element



**Fits:** Ford Trucks; Allis Chalmers, Deutz, Liebherr, Same, Yale Equipment  
**Use With:** PA1912  
**Replaces:** Deutz 4319263; Ford 83DB-9601-AA; Liebherr 7401993; Massey Ferguson 3074305-M1  
**O.D.:** 9 7/32 (234.2)  
**I.D.:** 21/32 (16.7) & 4 27/32 (123.0)  
**Height:** 16 1/2 (419.1)  
**A. Gskt:** [1] Included  
**F. Gskt:** G103-N

**LL2642**

Long Life Air Element



**Fits:** Ford Trucks  
**Replaces:** Ford E2HZ-9601-B  
**O.D.:** 13 7/8 (352.4)  
**I.D.:** 11/16 (17.5) & 7 7/16 (188.9)  
**Height:** 10 1/2 (266.7)  
**A. Gskt:** [1] Attached  
**F. Gskt:** G103-N  
**Related To:** PA2642 (Standard Media Version)

**PA2642**

Air Element



**Fits:** Ford Trucks  
**Replaces:** Ford E2HZ-9601-B  
**O.D.:** 13 7/8 (352.4)  
**I.D.:** 11/16 (17.5) & 7 7/16 (188.9)  
**Height:** 10 1/2 (266.7)  
**A. Gskt:** [1] Attached  
**F. Gskt:** G103-N  
**Related To:** LL2642 (Long-Life Media Version)

**PA2643**

Air Element



**Replaces:** White 22-0050012  
**O.D.:** 12 1/32 (305.6)  
**I.D.:** 6 23/32 (170.7)  
**Height:** 16 (406.4)  
**A. Gskt:** [2] Attached

**PA2644**

Inner Air Element



**Fits Inside:** PA2635-FN  
**Fits:** John Deere Tractors  
**Replaces:** John Deere AL30395  
**O.D.:** 3 3/8 (85.7)  
Flange 3 25/32 (96.0)  
**I.D.:** 21/32 (16.7) & 2 7/8 (73.0)  
**Height:** 13 1/16 (331.8)  
**A. Gskt:** [1] Attached  
**F. Gskt:** [1] Included, [1] Wing Nut

**PA2645**

Outer Air Element with Lift Tab



**Fits:** Massey Ferguson Wheel Tractors  
**Use With:** PA2646  
**Replaces:** Massey Ferguson 1633719-M1  
**O.D.:** 8 1/4 (209.6)  
Boot 9 1/8 (231.8)  
**I.D.:** 3/8 (9.5) & 5 1/4 (133.4)  
**Height:** 12 5/8 (320.7)  
**A. Gskt:** [2] Attached

**PA2646**

Inner Air Element



**Fits Inside:** PA2645  
**Fits:** Massey Ferguson Wheel Tractors  
**Replaces:** Massey Ferguson 1633720-M1  
**O.D.:** 5 5/32 (131.0)  
**I.D.:** 3/8 (9.5) & 4 1/32 (102.4)  
**Height:** 11 1/2 (292.1)  
**A. Gskt:** [1] Attached  
**F. Gskt:** [1] Included

**PA2647**

Inner Air Element with 10 Bolt Holes



**Fits Inside:** LL2384, PA2384, PA2384XP  
**Fits:** Caterpillar Industrial, Marine Engines, Equipment; Ford Trucks  
**Replaces:** Caterpillar 1W8161, 6N6444, 8N8934  
**O.D.:** 8 5/8 (219.1)  
Flange 11 3/8 (288.9)  
**I.D.:** 6 31/32 (177.0) One End  
**Height:** 12 (304.8)  
**A. Gskt:** [1] Attached

**PA2648**

Air Element with Lid and 6 Bolt Holes



**Fits:** White/GMC Trucks  
**Replaces:** White 22-0050013  
**O.D.:** 13 7/8 (352.4)  
Lid 16 1/8 (409.6)  
**I.D.:** 7 7/16 (188.9) One End  
**Height:** 15 17/32 (394.5)  
**A. Gskt:** [2] Attached

**PA2649**

Air Element



**Fits:** Volvo Trucks  
**Replaces:** Volvo 475975, 475975-1, 475975-9  
**O.D.:** 7 15/16 (201.6)  
**I.D.:** 7/16 (11.1) & 4 5/8 (117.5)  
**Height:** 24 1/8 (612.8)  
**A. Gskt:** [1] Included  
**F. Gskt:** [1] Included

Measurements Are Shown In Inches And (Millimeters)

**WARNING:** These products can expose you to chemicals, including Diisononyl Phthalate, Carbon black extracts, Nickel, 1,3 Butadiene, Ethylene Oxide, Epichlorohydrin, which are known to the State of California to cause cancer, and Bisphenol, Ethylene Glycol, Ethylene Oxide, 1,3 Butadiene, Epichlorohydrin, which are known to the State of California to cause birth defects or other reproductive harm.

**PA2650**



Replacement for Ecolite Air Element in Disposable Housing  
**Fits:** Freightliner, Kenworth Trucks  
**Replaces:** Caterpillar 7C8339; Farr C71338-2 Series; GMC 25043580  
**O.D.:** 11 1/32 (280.2)  
**Inlet:** 10 23/32  
**Outlet:** 7  
**Height:** 25 7/8 (657.2)

**PA2655**



Inner Air Element  
**Fits Inside:** PA2654  
**Fits:** Massey Ferguson Wheel Tractors  
**Replaces:** Massey Ferguson 1051375-M91  
**O.D.:** 6 7/8 (174.6)  
**I.D.:** 5/8 (15.9) & 5 13/32 (137.3)  
**Height:** 19 1/16 (484.2)  
**A. Gskt:** [1] Attached  
**F. Gskt:** G103-N

**PA2651**



Outer Air Element  
**Fits:** Komatsu Equipment  
**Use With:** PA2652  
**Replaces:** Komatsu 600-181-9220  
**O.D.:** 8 1/4 (209.6)  
**I.D.:** 13/32 (10.3) & 4 3/16 (106.4)  
**Height:** 12 15/16 (328.6)  
**A. Gskt:** [1] Attached  
**F. Gskt:** [1] Included

**PA2656**



Air Element  
**Fits:** GMC Buses, Trucks  
**Replaces:** GMC 15583321  
**O.D.:** 10 3/8 (263.5)  
**I.D.:** 6 1/32 (153.2) One End  
**Height:** 10 1/2 (266.7)  
**A. Gskt:** [1] Attached

**PA2652**



Inner Air Element  
**Fits Inside:** PA2651  
**Fits:** Komatsu Equipment  
**Replaces:** Komatsu 600-181-9320  
**O.D.:** 4 1/8 (104.8)  
**I.D.:** 21/32 (16.7) & 3 (76.2)  
**Height:** 11 9/16 (293.7)  
**A. Gskt:** [1] Attached  
**F. Gskt:** G103-N

**PA2657-FN**



Outer Air Element with Fins  
**Fits:** Case, Dresser, Hough, International, Oliver Equipment  
**Use With:** PA2700  
**Replaces:** International 3125199-R1,-R2  
**O.D.:** 5 1/4 (133.4)  
**Fins:** 6 3/8 (161.9)  
**I.D.:** 21/32 (16.7) & 2 3/4 (69.9)  
**Height:** 11 9/32 (286.5)  
**A. Gskt:** [1] Attached  
**F. Gskt:** G103-N

**PA2653**



Outer Air Element  
**Fits:** Caterpillar Industrial, Marine Engines  
**Use With:** PA2653 FOAM, PA2848  
**Replaces:** Caterpillar 8N6309  
**O.D.:** 19 9/32 (489.7)  
**I.D.:** 12 7/8 (327.0) One End  
**Height:** 10 11/32 (262.7)  
**A. Gskt:** [1] Attached

**PA2658**



Air Element  
**Notes:** Inside-Out Flow Direction  
**Fits:** GMC Buses, Trucks  
**Replaces:** GMC 25043235  
**O.D.:** 9 1/2 (241.3)  
**I.D.:** 7/16 (11.1) & 6 1/2 (165.1)  
**Height:** 28 7/16 (722.3)  
**A. Gskt:** [2] Attached  
**F. Gskt:** G31-AF

**PA2653 FOAM**



Foam Blanket for PA2653  
**Use With:** PA2653  
**Length:** 60 5/16 (1531.9)  
**Width:** 9 1/2 (241.3)  
**Height:** 1/2 (12.7)

**PA2659**



Air Element  
**Fits:** Volvo Buses, Trucks  
**Replaces:** Volvo 6872683, 6872683-5  
**O.D.:** 7 15/16 (201.6)  
**I.D.:** 7/16 (11.1) & 4 5/8 (117.5)  
**Height:** 20 3/8 (517.5)  
**A. Gskt:** [1] Attached  
**F. Gskt:** [1] Included

**PA2654**



Outer Air Element with Lift Bars  
**Fits:** Massey Ferguson Wheel Tractors  
**Use With:** PA2655  
**Replaces:** Massey Ferguson 1051376-M91  
**O.D.:** 11 1/2 (292.1)  
**I.D.:** 13/32 (10.3) & 7 1/4 (184.2)  
**Height:** 20 1/2 (520.7)  
**A. Gskt:** [1] Attached  
**F. Gskt:** [1] Included

**PA2660**



Conical-Shaped Air Element  
**Fits:** Caterpillar, Cummins, Detroit Diesel Engines; Ford, International, Kenworth, Peterbilt Trucks  
**Replaces:** GMC 25096137  
**O.D.:** 7 13/32 (188.1) to 10 13/32 (264.3)  
**I.D.:** 6 15/16 (176.2) One End  
**Height:** 28 1/2 (723.9)  
**A. Gskt:** [1] Attached

Measurements Are Shown In Inches And (Millimeters)

**WARNING:** These products can expose you to chemicals, including Diisononyl Phthalate, Carbon black extracts, Nickel, 1,3 Butadiene, Ethylene Oxide, Epichlorohydrin, which are known to the State of California to cause cancer, and Bisphenol, Ethylene Glycol, Ethylene Oxide, 1,3 Butadiene, Epichlorohydrin, which are known to the State of California to cause birth defects or other reproductive harm.

**LL2661**

Long Life Air Element



**Fits:** Volvo Trucks  
**Replaces:** White 22-0013205  
**O.D.:** 12 1/16 (306.4)  
**I.D.:** 7 11/16 (195.3)  
**Height:** 16 (406.4)  
**A. Gskt:** [2] Attached  
**Related To:** PA2661 (Standard Media Version)

**PA2666**

Outer Air Element with Lift Bar



**Notes:** Sometimes used as Cab Air.  
**Fits:** John Deere Equipment  
**Use With:** PA2570  
**Replaces:** John Deere AT65296, RE24619  
**O.D.:** 6 7/8 (174.6)  
**I.D.:** 2 1/2 (63.5) & 3 1/2 (88.9)  
**Height:** 12 13/32 (315.1)  
**A. Gskt:** [1] Attached  
**F. Gskt:** G103-N

**PA2661**

Air Element



**Fits:** Volvo Trucks  
**Replaces:** White 22-0013205  
**O.D.:** 12 1/16 (306.4)  
**I.D.:** 7 11/16 (195.3)  
**Height:** 16 (406.4)  
**A. Gskt:** [2] Attached  
**Related To:** LL2661 (Long-Life Media Version)

**LL2667**

Long Life Outer Air Element



**Fits:** Komatsu Equipment  
**Use With:** PA2668  
**Replaces:** Komatsu 600-181-2300  
**O.D.:** 9 5/8 (244.5)  
**I.D.:** 2 1/2 (63.5) & 5 7/32 (132.6)  
**Height:** 15 1/2 (393.7)  
**A. Gskt:** [1] Attached  
**F. Gskt:** G103-N  
**Related To:** PA2667 (Standard Media Version)

**PA2662**

Outer Air Element



**Fits:** Case Tractors  
**Use With:** PA2678  
**Replaces:** Case K200379  
**O.D.:** 5 3/16 (131.8)  
**I.D.:** 2 1/2 (63.5) & 3 7/32 (81.8)  
**Height:** 11 1/2 (292.1)  
**A. Gskt:** [1] Attached  
**F. Gskt:** G103-N

**PA2667**

Outer Air Element



**Fits:** Komatsu Equipment  
**Use With:** PA2668  
**Replaces:** Komatsu 600-181-2300  
**O.D.:** 9 5/8 (244.5)  
**I.D.:** 2 1/2 (63.5) & 5 7/32 (132.6)  
**Height:** 15 1/2 (393.7)  
**A. Gskt:** [1] Attached  
**F. Gskt:** G103-N  
**Related To:** LL2667 (Long-Life Media Version)

**PA2663-FN**

Air Element with Fins and Lift Tabs



**Fits:** Grove Equipment  
**Replaces:** Grove 9304100072  
**O.D.:** 13 13/16 (350.8)  
     Fins 15 25/32 (400.8)  
**I.D.:** 11/16 (17.5) & 9 1/2 (241.3)  
**Height:** 18 1/2 (469.9)  
**A. Gskt:** [1] Attached  
**F. Gskt:** G103-N

**PA2668**

Inner Air Element



**Fits Inside:** LL2667, PA2667  
**Fits:** Komatsu Equipment  
**Replaces:** Komatsu 600-181-2350  
**O.D.:** 5 1/16 (128.6)  
**I.D.:** 2 1/2 (63.5) & 3 13/16 (96.8)  
**Height:** 13 19/32 (345.3)  
**A. Gskt:** [1] Attached  
**F. Gskt:** G103-N

**PA2664**

Outer Air Element



**Fits:** Komatsu Equipment  
**Use With:** PA2665  
**Replaces:** Komatsu 600-181-2450  
**O.D.:** 9 3/4 (247.7)  
**I.D.:** 5/8 (15.9) & 5 5/8 (142.9)  
**Height:** 13 1/16 (331.8)  
**A. Gskt:** [1] Attached  
**F. Gskt:** G103-N

**PA2669-FN**

Outer Air Element with Fins



**Fits:** Allis Chalmers, Deutz, Fiat, Hesston Tractors  
**Use With:** PA2670  
**Replaces:** Deutz 4319257; Fiat 1909116  
**O.D.:** 6 3/32 (154.8)  
     Fins 7 13/16 (198.4)  
**I.D.:** 3/4 (19.0) & 3 15/32 (88.1)  
**Height:** 13 1/2 (342.9)  
**A. Gskt:** [1] Attached  
**F. Gskt:** G103-N

**PA2665**

Inner Air Element



**Fits Inside:** PA2664  
**Fits:** Komatsu Equipment  
**Replaces:** Komatsu 600-181-2460  
**O.D.:** 5 9/16 (141.3)  
**I.D.:** 5/8 (15.9) & 4 7/32 (107.2)  
**Height:** 10 25/32 (273.8)  
**A. Gskt:** [1] Attached  
**F. Gskt:** G103-N

**PA2670**

Inner Air Element



**Fits Inside:** PA2669-FN, PA3779-FN, PA3852-FN  
**Fits:** Allis Chalmers, Deutz, Fiat, Hesston, John Deere, New Holland Tractors  
**Replaces:** Deutz 4319256; Fiat 1909117  
**O.D.:** 3 3/8 (85.7)  
     Flange 3 25/32 (96.0)  
**I.D.:** 2 1/2 (63.5) & 2 7/8 (73.0)  
**Height:** 12 1/16 (306.4)  
**A. Gskt:** [1] Attached  
**F. Gskt:** G103-N

Measurements Are Shown In Inches And (Millimeters)

**WARNING:** These products can expose you to chemicals, including Diisononyl Phthalate, Carbon black extracts, Nickel, 1,3 Butadiene, Ethylene Oxide, Epichlorohydrin, which are known to the State of California to cause cancer, and Bisphenol, Ethylene Glycol, Ethylene Oxide, 1,3 Butadiene, Epichlorohydrin, which are known to the State of California to cause birth defects or other reproductive harm.

**PA2672**



Inner Air Element

**Fits Inside:** PA1975  
**Fits:** Case-International, New Holland, Steiger, Versatile Tractors  
**Replaces:** Case 13899; New Holland V63972; Steiger 13-899; Versatile 63972  
**O.D.:** 8 5/8 (219.1)  
**I.D.:** 5/8 (15.9) & 7 1/16 (179.4)  
**Height:** 21 (533.4)  
**A. Gskt:** [1] Attached  
**F. Gskt:** G103-N

**PA2673**



Outer Air Element with Lift Bar

**Fits:** Allis Chalmers, Case-International, Steiger Tractors  
**Use With:** PA2674  
**Replaces:** Allis Chalmers 264744  
**O.D.:** 9 7/32 (234.2)  
**I.D.:** 21/32 (16.7) & 5 27/32 (148.4)  
**Height:** 17 1/2 (444.5)  
**A. Gskt:** [1] Attached  
**F. Gskt:** G103-N

**PA2674**



Inner Air Element

**Fits Inside:** PA2673  
**Fits:** Allis Chalmers, Case-International, Steiger Tractors  
**Replaces:** Allis Chalmers 264745; Steiger 90-6444T1  
**O.D.:** 5 9/16 (141.3)  
**I.D.:** 5/8 (15.9) & 4 7/16 (112.7)  
**Height:** 15 9/16 (395.3)  
**A. Gskt:** [1] Attached  
**F. Gskt:** G103-N

**PA2675**



Outer Air Element

**Fits:** Allis Chalmers, Euclid, Fiat-Allis, Terex, Versatile Equipment  
**Use With:** PA1976  
**Replaces:** Allis Chalmers 686821; Euclid 9038907; Fiat 70686821  
**O.D.:** 13 13/16 (350.8)  
 Boot 14 1/2 (368.3)  
**I.D.:** 15/16 (23.8) & 9 1/2 (241.3)  
**Height:** 22 1/2 (571.5)  
**A. Gskt:** [2] Attached  
**F. Gskt:** [1] Included  
**Related To:** PA1975 (without Boot)

**LL2676**



Long Life Outer Air Element

**Fits:** Fiat-Hitachi, Hitachi, John Deere, New Holland, Versatile Equipment; Komatsu Dump Trucks; Nissan Trucks  
**Use With:** PA2708, PA3668  
**Replaces:** Hino 17801-2490; John Deere AR95758; New Holland V95611  
**O.D.:** 12 1/8 (308.0)  
**I.D.:** 29/32 (23.0) & 7 11/16 (195.3)  
**Height:** 19 1/2 (495.3)  
**A. Gskt:** [1] Attached  
**F. Gskt:** [1] Included  
**Related To:** PA2676 (Standard Media Version) PA2676XP (Extreme Performance Nano Version)

**PA2676**



Outer Air Element

**Fits:** Fiat-Hitachi, Hitachi, John Deere, New Holland, Versatile Equipment; Komatsu Dump Trucks; Nissan Trucks  
**Use With:** PA2708, PA3668  
**Replaces:** Hino 17801-2490; John Deere AR95758; New Holland V95611  
**O.D.:** 12 1/8 (308.0)  
**I.D.:** 29/32 (23.0) & 7 11/16 (195.3)  
**Height:** 19 1/2 (495.3)  
**A. Gskt:** [1] Attached  
**F. Gskt:** [1] Included  
**Related To:** LL2676 (Long-Life Media Version) PA2676XP (Extreme Performance Nano Version)

**PA2676XP**



Extreme Performance Nano Outer Air Element

**Fits:** Fiat-Hitachi, Hitachi, John Deere, New Holland, Versatile Equipment; Komatsu Dump Trucks; Nissan Trucks  
**Use With:** PA2708, PA3668  
**Replaces:** Hino 17801-2490; John Deere AR95758; New Holland V95611  
**O.D.:** 12 1/8 (308.0)  
**I.D.:** 29/32 (23.0) & 7 11/16 (195.3)  
**Height:** 19 1/2 (495.3)  
**A. Gskt:** [1] Attached  
**F. Gskt:** [1] Included  
**Related To:** LL2676 (Long-Life Media Version) PA2676 (Standard Performance Nano Version)

**PA2677**



Conical-Shaped Air Element with Lid

**Fits:** Mack Trucks  
**Replaces:** Mack 2191P13-8427  
**O.D.:** 8 21/32 (219.9)  
 Lid 9 13/16 (249.2)  
**I.D.:** 21/32 (16.7) & 5 3/16 (131.8)  
**Height:** 15 9/16 (395.3)  
**A. Gskt:** [2] Attached  
**F. Gskt:** G103-N, [1] Wing Nut

**PA2678**



Inner Air Element

**Fits Inside:** PA2662  
**Fits:** Case Tractors  
**Replaces:** Case K200380  
**O.D.:** 2 15/16 (74.6)  
**I.D.:** 7/16 (11.1) & 1 7/8 (47.6)  
**Height:** 9 31/32 (253.2)  
**A. Gskt:** [1] Attached  
**F. Gskt:** [1] Included

**PA2679**



Air Element with Lid and 6 Bolt Holes

**Replaces:** Mack 57MD37M  
**O.D.:** 13 7/8 (352.4)  
 Lid 16 5/32 (410.4)  
**I.D.:** 7 7/16 (188.9) One End  
**Height:** 22 17/32 (572.3)  
**A. Gskt:** [2] Attached

Measurements Are Shown In Inches And (Millimeters)

**WARNING:** These products can expose you to chemicals, including Diisononyl Phthalate, Carbon black extracts, Nickel, 1,3 Butadiene, Ethylene Oxide, Epichlorohydrin, which are known to the State of California to cause cancer, and Bisphenol, Ethylene Glycol, Ethylene Oxide, 1,3 Butadiene, Epichlorohydrin, which are known to the State of California to cause birth defects or other reproductive harm.

**PA2680**

**Air Element with Lid**



**Fits:** Freightliner, Mack Trucks  
**Replaces:** Mack 57MD42M  
**O.D.:** 10 5/8 (269.9)  
 Lid 11 11/16 (296.9)  
**I.D.:** 6 11/16 (169.9) One End  
**Height:** 28 13/32 (721.5)  
**A. Gskt:** [1] Attached

**PA2684-FN**

**Outer Air Element with Fins**



**Fits:** Case, International Tractors  
**Use With:** PA2689  
**Replaces:** International 3125342-R1,  
 3125342-R2  
**O.D.:** 6 3/32 (154.8)  
 Fins 7 13/16 (198.4)  
**I.D.:** 3/4 (19.0) & 3 15/32 (88.1)  
**Height:** 11 1/2 (292.1)  
**A. Gskt:** [1] Attached  
**F. Gskt:** G103-N

**LL2685**

**Long Life Air Element**



**Fits:** Autocar, Volvo, WhiteGMC Trucks  
**Replaces:** White 22-0055039  
**O.D.:** 13 13/16 (350.8)  
**I.D.:** 9 1/2 (241.3) One End  
**Height:** 16 (406.4)  
**A. Gskt:** [1] Attached

**PA2687**

**Inner Air Element**



**Fits Inside:** PA2616, PA2616XP  
**Fits:** John Deere Equipment  
**Replaces:** John Deere AT75036  
**O.D.:** 5 15/16 (150.8)  
**I.D.:** 21/32 (16.7) & 4 27/32 (123.0)  
**Height:** 11 3/8 (288.9)  
**A. Gskt:** [1] Attached  
**F. Gskt:** [1] Included

**LL2688**

**Long Life Outer Air Element**



**Fits:** Case, Caterpillar, Champion, Dresser,  
 Drott, Hitachi, John Deere, Kawasaki, Kobelco,  
 Komatsu, Volvo Equipment; Hino Trucks  
**Use With:** PA2621  
**Replaces:** Case S238646; Caterpillar 9Y6845;  
 Dresser 1249057-H1; Hino 17801-2260; John  
 Deere AT81018; Komatsu 600-181-8270  
**O.D.:** 9 1/8 (231.8)  
**I.D.:** 15/16 (23.8) & 5 13/16 (147.6)  
**Height:** 18 1/2 (469.9)  
**A. Gskt:** [1] Attached  
**F. Gskt:** [1] Included  
**Related To:** PA2688 (Standard Media Version)

**PA2688**

**Outer Air Element**



**Fits:** Case, Caterpillar, Champion, Dresser,  
 Drott, Hitachi, John Deere, Kawasaki, Kobelco,  
 Komatsu, Volvo Equipment; Hino Trucks  
**Use With:** PA2621  
**Replaces:** Case S238646; Caterpillar 9Y6845;  
 Dresser 1249057-H1; Hino 17801-2260; John  
 Deere AT81018; Komatsu 600-181-8270  
**O.D.:** 9 1/8 (231.8)  
**I.D.:** 15/16 (23.8) & 5 13/16 (147.6)  
**Height:** 18 1/2 (469.9)  
**A. Gskt:** [1] Attached  
**F. Gskt:** [1] Included  
**Related To:** LL2688 (Long-Life Media Version)

**PA2689**

**Inner Air Element**



**Fits Inside:** PA2684-FN, PA2970, PA3466-FN,  
 PA3924-FN  
**Fits:** Case, International, J.C. Bamford, John  
 Deere, Massey Ferguson, Zetor Equipment  
**Replaces:** J.C. Bamford 32/903202, 32/906802;  
 Massey Ferguson 1096469-M91  
**O.D.:** 3 3/8 (85.7)  
 Flange 4 5/32 (105.6)  
**I.D.:** 11/16 (17.5) & 2 29/32 (73.8)  
**Height:** 10 3/32 (256.4)  
**A. Gskt:** [1] Attached  
**F. Gskt:** G103-N

**PA2690**

**Panel Air Element**

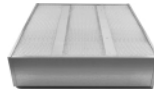

**Fits:** Waukesha Engines  
**Replaces:** Waukesha 169180, 169180B,  
 169180H  
**Length:** 19 7/16 (493.7)  
**Width:** 19 7/16 (493.7)  
**Height:** 5 5/16 (134.9)  
**A. Gskt:** [1] Attached

**PA2691**

**Panel Air Element**

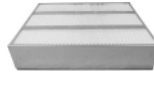

**Fits:** Waukesha Engines  
**Replaces:** Waukesha 169180A, 169180C  
**Length:** 25 7/16 (646.1)  
**Width:** 19 7/16 (493.7)  
**Height:** 5 5/8 (142.9)  
**A. Gskt:** [2] Attached

**PA2692**

**Panel Air Element**

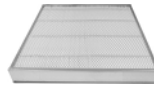

**Fits:** Waukesha Engines  
**Replaces:** Waukesha 169180F  
**Length:** 19 1/2 (495.3)  
**Width:** 19 1/2 (495.3)  
**Height:** 2 19/32 (65.9)

**PA2693**

**Panel Air Element**

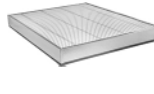

**Fits:** Waukesha Engines  
**Replaces:** Waukesha 169180G  
**Length:** 25 1/2 (647.7)  
**Width:** 19 1/2 (495.3)  
**Height:** 2 5/32 (54.8)  
**A. Gskt:** [1] Attached

**PA2694**

**Tube-Type Air Filter**



**Contains:** 25 Tubes--5 x 5  
**Fits:** Waukesha Engines  
**Replaces:** Waukesha 1691802  
**Length:** 19 7/16 (493.7)  
**Width:** 19 7/16 (493.7)  
**Height:** 8 1/16 (204.8)  
**A. Gskt:** [2] Attached

Measurements Are Shown In Inches And (Millimeters)

**WARNING:** These products can expose you to chemicals, including Diisononyl Phthalate, Carbon black extracts, Nickel, 1,3 Butadiene, Ethylene Oxide, Epichlorohydrin, which are known to the State of California to cause cancer, and Bisphenol, Ethylene Glycol, Ethylene Oxide, 1,3 Butadiene, Epichlorohydrin, which are known to the State of California to cause birth defects or other reproductive harm.



**PA2696**

Panel Air Element

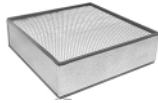

**Notes:** OBSOLETE. Availability Limited to Dealer Stock.  
**Fits:** Waukesha Engines  
**Replaces:** Waukesha 569180B  
**Length:** 19 1/2 (495.3)  
**Width:** 19 1/2 (495.3)  
**Height:** 5 11/16 (144.5)  
**A. Gskt:** [2] Attached

**PA2698**

Air Element



**Notes:** Inside-Out Flow Direction  
**Fits:** Torit Air Cleaning Systems  
**Replaces:** Torit 8PP18583-01  
**O.D.:** 12 3/4 (323.8)  
**I.D.:** 1 3/16 (30.2) & 8 11/32 (211.9)  
**Height:** 22 1/2 (571.5)  
**A. Gskt:** [1] Attached

**PA2699**

Air Element



**Fits:** Ingersoll-Rand Compressors  
**Replaces:** Ingersoll-Rand 39708466  
**O.D.:** 10 27/32 (275.4)  
**I.D.:** 6 1/2 (165.1)  
**Height:** 5 1/32 (127.8)  
**A. Gskt:** [2] Attached

**PA2700**

Inner Air Element



**Fits Inside:** PA2391, PA2657-FN, PA2846-FN, PA2976-FN  
**Fits:** Case, Fiat-Allis, International, Massey Ferguson, Zetor Equipment  
**Replaces:** Fiat 700053475; International 3115569-R2; Massey Ferguson 3595519-M1  
**O.D.:** 2 23/32 (69.1)  
 Flange 3 21/32 (92.9)  
**I.D.:** 2 1/32 (16.7) & 2 3/8 (60.3)  
**Height:** 10 3/32 (256.4)  
**F. Gskt:** [1] Included

**PA2701**

Outer Air Element with Lift Bar



**Fits:** Massey Ferguson Equipment with Perkins Engines  
**Use With:** PA2702, PA2748  
**Replaces:** Massey Ferguson 1670260-M1  
**O.D.:** 4 5/8 (117.5)  
 Boot 5 3/4 (146.0)  
**I.D.:** 9/16 (14.3) & 3 1/32 (77.0)  
**Height:** 9 11/32 (237.3)  
**A. Gskt:** [2] Attached  
**F. Gskt:** [1] Included

**PA2702**

Inner Air Element



**Fits Inside:** PA2701  
**Fits:** Massey Ferguson Equipment with Perkins Engines  
**Replaces:** Massey Ferguson 1670261-M1  
**O.D.:** 2 15/16 (74.6)  
**I.D.:** 7/16 (11.1) & 1 7/8 (47.6)  
**Height:** 8 1/4 (209.6)  
**A. Gskt:** [1] Attached  
**F. Gskt:** [1] Included

**PA2703**

Conical-Shaped Air Element

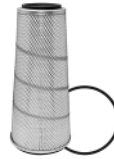

**Fits:** Freightliner Trucks  
**Replaces:** Nelson 84831S  
**O.D.:** 7 13/32 (188.1)  
 to 10 13/32 (264.3)  
**I.D.:** 6 15/16 (176.2) One End  
**Height:** 23 (584.2)  
**A. Gskt:** [2] Attached  
**F. Gskt:** G298-AF

**PA2704**

Air Element with Lid



**Fits:** Freightliner Trucks  
**Replaces:** Caterpillar 9Y0307; GMC 25096292  
**O.D.:** 10 5/8 (269.9)  
 Lid 11 11/16 (296.9)  
**I.D.:** 6 11/16 (169.9) One End  
**Height:** 20 17/32 (521.5)  
**A. Gskt:** [1] Attached

**PA2705**

Air Element with Lid



**Fits:** Freightliner, Kenworth, Peterbilt, Western Star Trucks  
**Replaces:** White 22-0055064  
**O.D.:** 10 5/8 (269.9)  
 Lid 11 11/16 (296.9)  
**I.D.:** 6 23/32 (170.7) One End  
**Height:** 22 15/32 (570.7)  
**A. Gskt:** [1] Attached

**PA2706**

Cab Air Element

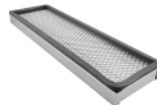

**Fits:** John Deere Equipment  
**Replaces:** John Deere AH92463  
**Length:** 16 7/16 (417.5)  
**Width:** 5 (127.0)  
**Height:** 1 7/16 (36.5)

**PA2707**

Outer Air Element



**Fits:** Iveco, Volvo Buses, Trucks  
**Use With:** PA2773  
**Replaces:** Volvo 1542743-8, 1660619-1  
**O.D.:** 12 1/32 (305.6)  
**I.D.:** 17/32 (13.5) & 7 7/8 (200.0)  
**Height:** 14 1/2 (368.3)  
**A. Gskt:** [1] Attached  
**F. Gskt:** [1] Included

**PA2708**













Inner Air Element



**Fits Inside:** LL2676, PA2676, PA2676XP  
**Fits:** Ford, John Deere, New Holland, Versatile Equipment  
**Replaces:** John Deere AR95759; New Holland V95612  
**O.D.:** 7 5/8 (193.7)  
**I.D.:** 2 1/32 (16.7) & 6 1/16 (154.0)  
**Height:** 18 3/8 (466.7)  
**A. Gskt:** [1] Attached  
**F. Gskt:** G103-N

Measurements Are Shown In Inches And (Millimeters)

**WARNING:** These products can expose you to chemicals, including Diisononyl Phthalate, Carbon black extracts, Nickel, 1,3 Butadiene, Ethylene Oxide, Epichlorohydrin, which are known to the State of California to cause cancer, and Bisphenol, Ethylene Glycol, Ethylene Oxide, 1,3 Butadiene, Epichlorohydrin, which are known to the State of California to cause birth defects or other reproductive harm.

<p><b>PA2709</b></p> 	<p>Outer Air Element  <b>Fits:</b> John Deere Equipment  <b>Use With:</b> PA2570  <b>Replaces:</b> John Deere AT76215  <b>O.D.:</b> 7 11/32 (186.5)  <b>I.D.:</b> 7/16 (11.1) &amp; 3 31/32 (100.8)  <b>Height:</b> 13 3/8 (339.7)  <b>A. Gskt:</b> [1] Attached  <b>F. Gskt:</b> [1] Included</p>	<p><b>PA2715</b></p> 	<p>Conical-Shaped Air Element  <b>Fits:</b> Freightliner, Kenworth, Mack Trucks  <b>Replaces:</b> Donaldson P154575  <b>O.D.:</b> 7 13/32 (188.1)  to 10 13/32 (264.3)  <b>I.D.:</b> 6 15/16 (176.2) One End  <b>Height:</b> 22 1/2 (571.5)  <b>A. Gskt:</b> [1] Attached</p>
<p><b>PA2710</b></p> 	<p>Outer Air Element  <b>Fits:</b> Case, David Brown Tractors  <b>Use With:</b> PA2711  <b>Replaces:</b> Case K945043  <b>O.D.:</b> 6 3/32 (154.8)  <b>I.D.:</b> 3/4 (19.0) &amp; 3 25/32 (96.0)  <b>Height:</b> 10 3/4 (273.1)  <b>A. Gskt:</b> [1] Attached  <b>F. Gskt:</b> G103-N</p>	<p><b>PA2716</b></p> 	<p>Outer Air Element  <b>Fits:</b> John Deere Equipment  <b>Use With:</b> PA2717  <b>Replaces:</b> John Deere AT68183  <b>O.D.:</b> 6 3/32 (154.8)  <b>I.D.:</b> 3/4 (19.0) &amp; 3 15/32 (88.1)  <b>Height:</b> 10 3/8 (263.5)  <b>A. Gskt:</b> [1] Attached  <b>F. Gskt:</b> G103-N</p>
<p><b>PA2711</b></p> 	<p>Inner Air Element  <b>Fits Inside:</b> PA2710  <b>Fits:</b> Case, David Brown Tractors  <b>Replaces:</b> Case K952344  <b>O.D.:</b> 3 11/16 (93.7)  <b>I.D.:</b> 7/16 (11.1) &amp; 2 9/16 (65.1)  <b>Height:</b> 10 (254.0)  <b>A. Gskt:</b> [1] Attached  <b>F. Gskt:</b> [1] Included</p>	<p><b>PA2717</b></p> 	<p>Inner Air Element  <b>Fits Inside:</b> PA2716  <b>Fits:</b> John Deere Equipment  <b>Replaces:</b> John Deere AT68184  <b>O.D.:</b> 2 31/32 (75.4)  Flange 3 5/8 (92.1)  <b>I.D.:</b> 5/8 (15.9) &amp; 2 13/32 (61.1)  <b>Height:</b> 9 3/32 (231.0)  <b>A. Gskt:</b> [1] Attached  <b>F. Gskt:</b> G103-N</p>
<p><b>PA2712</b></p> 	<p>Air Element  <b>Fits:</b> GMC, Isuzu, Nissan Buses, Trucks; J.C. Bamford, Kubota Equipment  <b>Replaces:</b> GMC 94156052; Isuzu 8-934156-052-0; Kubota 15484-11210; Nissan 16546-T9031  <b>O.D.:</b> 7 15/16 (201.6)  <b>I.D.:</b> 7/8 (22.2) &amp; 5 3/8 (136.5)  <b>Height:</b> 10 1/2 (266.7)  <b>A. Gskt:</b> [1] Attached  <b>F. Gskt:</b> [1] Included</p>	<p><b>PA2718</b></p> 	<p>Air Element with Lid  <b>Fits:</b> International Trucks  <b>Replaces:</b> International 1651566-C1  <b>O.D.:</b> 8 21/32 (219.9)  Lid 9 11/16 (246.1)  <b>I.D.:</b> 5 3/16 (131.8) One End  <b>Height:</b> 28 1/2 (723.9)  <b>A. Gskt:</b> [1] Attached</p>
<p><b>PA2713</b></p> 	<p>Outer Air Element  <b>Fits:</b> Agco, Case-International, Steiger Equipment  <b>Use With:</b> PA2714  <b>Replaces:</b> Steiger 90-4203T1  <b>O.D.:</b> 12 1/32 (305.6)  <b>I.D.:</b> 15/16 (23.8) &amp; 7 11/16 (195.3)  <b>Height:</b> 21 1/2 (546.1)  <b>A. Gskt:</b> [1] Attached</p>	<p><b>PA2719</b></p> 	<p>Inner Air Element with 8 Bolt Holes  <b>Fits Inside:</b> LL1615, PA1615, PA1615XP  <b>Fits:</b> Caterpillar Equipment  <b>Replaces:</b> Caterpillar 8N4901  <b>O.D.:</b> 4 3/4 (120.7)  Flange 7 5/16 (185.7)  <b>I.D.:</b> 3 5/8 (92.1) One End  <b>Height:</b> 12 1/32 (305.6)  <b>A. Gskt:</b> [1] Attached</p>
<p><b>PA2714</b></p> 	<p>Inner Air Element  <b>Fits Inside:</b> PA2713  <b>Fits:</b> Agco, Case-International, Steiger Equipment  <b>Replaces:</b> Steiger 90-4204T1  <b>O.D.:</b> 7 5/8 (193.7)  <b>I.D.:</b> 21/32 (16.7) &amp; 6 1/16 (154.0)  <b>Height:</b> 20 3/8 (517.5)  <b>A. Gskt:</b> [1] Attached</p>	<p><b>PA2721</b></p> 	<p>Replacement for Ecolite Air Element in Disposable Housing  <b>Fits:</b> Farr Optional Filter Housings  <b>Replaces:</b> Farr C62891-1 Series  <b>O.D.:</b> 9 25/32 (248.4)  <b>Inlet:</b> 6  <b>Outlet:</b> 6  <b>Height:</b> 25 7/8 (657.2)</p>

Measurements Are Shown In Inches And (Millimeters)

**WARNING:** These products can expose you to chemicals, including Diisononyl Phthalate, Carbon black extracts, Nickel, 1,3 Butadiene, Ethylene Oxide, Epichlorohydrin, which are known to the State of California to cause cancer, and Bisphenol, Ethylene Glycol, Ethylene Oxide, 1,3 Butadiene, Epichlorohydrin, which are known to the State of California to cause birth defects or other reproductive harm.

**PA2722**

Replacement for Ecolite Air Element in Disposable Housing



**Fits:** Farr Optional Filter Housings  
**Replaces:** Farr C62891-2 Series  
**O.D.:** 11 1/32 (280.2)  
**Inlet:** 7  
**Outlet:** 7  
**Height:** 25 7/8 (657.2)

**PA2728**

Inner Air Element



**Fits Inside:** PA2727  
**Fits:** Massey Ferguson Equipment  
**Replaces:** Massey Ferguson 1678295-M1  
**O.D.:** 2 15/16 (74.6)  
**I.D.:** 7/16 (11.1) & 1 7/8 (47.6)  
**Height:** 11 9/16 (293.7)  
**A. Gskt:** [1] Attached  
**F. Gskt:** [1] Included

**PA2723**

Replacement for Ecolite Air Element in Disposable Housing



**Fits:** Farr Optional Filter Housings  
**Replaces:** Farr C62891-3 Series  
**O.D.:** 13 17/32 (343.7)  
**Inlet:** 7  
**Outlet:** 7  
**Height:** 25 7/8 (657.2)

**PA2729**

Conical-Shaped Air Element



**Fits:** Peterbilt Trucks  
**Replaces:** Donaldson P521598  
**O.D.:** 9 25/32 (248.4)  
to 11 7/8 (301.6)  
**I.D.:** 7 3/8 (187.3) One End  
**Height:** 25 (635.0)  
**A. Gskt:** [2] Attached  
**F. Gskt:** G501-AF

**PA2724**

Replacement for Ecolite Air Element in Disposable Housing



**Fits:** Farr Optional Filter Housings  
**Replaces:** Farr C71338-3 Series  
**O.D.:** 13 17/32 (343.7)  
**Inlet:** 10 23/32  
**Outlet:** 7  
**Height:** 25 7/8 (657.2)

**PA2730**

Inner Air Element with 6 Bolt Holes



**Fits Inside:** LL2575, PA2575  
**Fits:** Caterpillar Equipment  
**Replaces:** Caterpillar 7W3754  
**O.D.:** 3 15/16 (100.0)  
Flange 6 11/16 (169.9)  
**I.D.:** 2 11/32 (59.5) One End  
**Height:** 5 13/32 (137.3)  
**A. Gskt:** [1] Attached

**PA2725**

Air Element



**Contains:** Flame Retardant Media  
**Fits:** Caterpillar Industrial Engines, Lift Trucks  
**Replaces:** Caterpillar 2W4246  
**O.D.:** 6 5/8 (168.3)  
**I.D.:** 4 1/4 (108.0)  
**Height:** 5 7/16 (138.1)  
**A. Gskt:** [2] Attached

**PA2731**

Replacement for Ecolite Air Element in Disposable Housing



**Contains:** Bleed Valve  
**Fits:** Kenworth Trucks  
**Replaces:** Farr C78897-1 Series  
**O.D.:** 13 17/32 (343.7)  
**Inlet:** 6 29/32  
**Outlet:** 7  
**Height:** 25 17/32 (648.5)

**PA2726**

Air Element



**Fits:** Ford Buses, Trucks  
**Replaces:** Ford E7HZ-9601-A  
**O.D.:** 7 11/32 (186.5)  
**I.D.:** 7/16 (11.1) & 5 5/16 (134.9)  
**Height:** 23 1/2 (596.9)  
**A. Gskt:** [1] Attached  
**F. Gskt:** [1] Included

**PA2732**

Conical-Shaped Air Element



**Notes:** Inside-Out Flow Direction  
**Fits:** Freightliner, Peterbilt Trucks  
**Replaces:** Donaldson P522293  
**O.D.:** 7 13/32 (188.1)  
to 10 13/32 (264.3)  
**I.D.:** 6 15/16 (176.2) One End  
**Height:** 29 (736.6)  
**A. Gskt:** [2] Included  
**F. Gskt:** G348-AF

**PA2727**

Outer Air Element with Lift Bar



**Fits:** Massey Ferguson Equipment  
**Use With:** PA2728  
**Replaces:** Massey Ferguson 1678294-M1  
**O.D.:** 5 3/16 (131.8)  
Boot 5 7/8 (149.2)  
**I.D.:** 7/16 (11.1) & 2 31/32 (75.4)  
**Height:** 12 9/16 (319.1)  
**A. Gskt:** [2] Attached  
**F. Gskt:** [1] Included

**PA2733**













Inner Air Element with 8 Bolt Holes



**Fits Inside:** LL1669, PA1669  
**Fits:** Caterpillar Equipment  
**Replaces:** Caterpillar 8N6883  
**O.D.:** 6 1/4 (158.8)  
Flange 9 1/16 (230.2)  
**I.D.:** 4 5/8 (117.5) One End  
**Height:** 16 7/32 (412.0)  
**A. Gskt:** [1] Attached

Measurements Are Shown In Inches And (Millimeters)

**WARNING:** These products can expose you to chemicals, including Diisononyl Phthalate, Carbon black extracts, Nickel, 1,3 Butadiene, Ethylene Oxide, Epichlorohydrin, which are known to the State of California to cause cancer, and Bisphenol, Ethylene Glycol, Ethylene Oxide, 1,3 Butadiene, Epichlorohydrin, which are known to the State of California to cause birth defects or other reproductive harm.

<p><b>PA2734</b></p>  <p>Air Element with 6 Bolt Holes  <b>Replaces:</b> Donaldson P181185  <b>O.D.:</b> 13 13/16 (350.8)            Lid 16 5/32 (410.4)  <b>I.D.:</b> 9 1/2 (241.3) One End  <b>Height:</b> 21 17/32 (546.9)  <b>A. Gskt:</b> [2] Attached</p>	<p><b>PA2740</b></p>  <p>Cab Air Element  <b>Fits:</b> Caterpillar Equipment  <b>Replaces:</b> Caterpillar 9G1518  <b>O.D.:</b> 6 7/8 (174.6)  <b>I.D.:</b> 21/32 (16.7) &amp; 4 3/16 (106.4)  <b>Height:</b> 9 1/2 (241.3)  <b>A. Gskt:</b> [1] Attached  <b>F. Gskt:</b> [1] Wing Nut</p>
<p><b>PA2735</b></p>  <p>Inner Air Element  <b>Fits Inside:</b> LL2384, PA2384, PA2384XP  <b>Fits:</b> Caterpillar Applications Converted from Flanged Air Systems Previously Using PA2647  <b>O.D.:</b> 8 5/8 (219.1)  <b>I.D.:</b> 15/16 (23.8) &amp; 7 1/16 (179.4)  <b>Height:</b> 11 1/2 (292.1)  <b>A. Gskt:</b> [1] Attached  <b>F. Gskt:</b> [1] Included</p>	<p><b>PA2742</b></p>  <p>Outer Air Element with Bail Handle  <b>Fits:</b> American Grape Harvester Equipment; Atlas Copco Generators  <b>Use With:</b> PA2743  <b>Replaces:</b> Air Maze CD1219610-826  <b>O.D.:</b> 10 (254.0)  <b>I.D.:</b> 3/8 (9.5) &amp; 5 7/8 (149.2)  <b>Height:</b> 17 19/32 (446.9)  <b>A. Gskt:</b> [1] Attached  <b>F. Gskt:</b> [1] Included</p>
<p><b>PA2736</b></p>  <p>Inner Air Element  <b>Fits Inside:</b> LL1615, PA1615, PA1615XP  <b>Fits:</b> Caterpillar Applications Converted from Flanged Air Systems Previously Using PA1647 or PA2719  <b>O.D.:</b> 4 3/4 (120.7)  <b>I.D.:</b> 29/32 (23.0) &amp; 3 5/8 (92.1)  <b>Height:</b> 11 1/2 (292.1)  <b>A. Gskt:</b> [1] Attached  <b>F. Gskt:</b> [1] Included</p>	<p><b>PA2743</b></p>  <p>Inner Air Element  <b>Fits Inside:</b> PA2742  <b>Fits:</b> American Grape Harvester Equipment; Atlas Copco Generators  <b>Replaces:</b> Air Maze CD1219610-830  <b>O.D.:</b> 5 11/16 (144.5)  <b>I.D.:</b> 5/8 (15.9) &amp; 4 15/16 (125.4)  <b>Height:</b> 15 9/16 (395.3)  <b>A. Gskt:</b> [1] Attached  <b>F. Gskt:</b> [1] Washer</p>
<p><b>PA2737</b></p>  <p>Inner Air Element  <b>Fits Inside:</b> LL1634, PA1634, PA1634XP  <b>Fits:</b> Caterpillar Applications Converted from Flanged Air Systems Previously Using PA1675 or PA2310  <b>O.D.:</b> 6 1/4 (158.8)  <b>I.D.:</b> 29/32 (23.0) &amp; 4 5/8 (117.5)  <b>Height:</b> 12 3/8 (314.3)  <b>A. Gskt:</b> [1] Attached  <b>F. Gskt:</b> [1] Included</p>	<p><b>PA2744</b></p>  <p>Outer Air Element with Lift Tab  <b>Use With:</b> PA2745  <b>Replaces:</b> Air Maze CD1628610-826  <b>O.D.:</b> 12 1/2 (317.5)  <b>I.D.:</b> 13/32 (10.3) &amp; 7 1/2 (190.5)  <b>Height:</b> 27 1/16 (687.4)  <b>A. Gskt:</b> [1] Attached  <b>F. Gskt:</b> [1] Included</p>
<p><b>PA2738</b></p>  <p>Inner Air Element  <b>Fits Inside:</b> PA1818, LL2358, PA2358  <b>Fits:</b> Caterpillar Applications Converted from Flanged Air Systems Previously Using PA1819 or PA2359  <b>O.D.:</b> 7 5/8 (193.7)  <b>I.D.:</b> 7/8 (22.2) &amp; 6 1/16 (154.0)  <b>Height:</b> 12 1/2 (317.5)  <b>A. Gskt:</b> [1] Attached  <b>F. Gskt:</b> [1] Included</p>	<p><b>PA2745</b></p>  <p>Inner Air Element  <b>Fits Inside:</b> PA2744  <b>Replaces:</b> Air Maze CD1628610-827  <b>O.D.:</b> 7 3/8 (187.3)  <b>I.D.:</b> 25/32 (19.8) &amp; 6 1/8 (155.6)  <b>Height:</b> 25 3/4 (654.1)  <b>F. Gskt:</b> G103-N</p>
<p><b>PA2739</b></p>  <p>Inner Air Element  <b>Fits Inside:</b> LL1669, PA1669  <b>Fits:</b> Caterpillar Applications Converted from Flanged Air Systems Previously Using PA1670 or PA2733  <b>O.D.:</b> 6 1/4 (158.8)  <b>I.D.:</b> 29/32 (23.0) &amp; 4 5/8 (117.5)  <b>Height:</b> 14 1/2 (368.3)  <b>A. Gskt:</b> [1] Attached  <b>F. Gskt:</b> [1] Included</p>	<p><b>PA2746</b></p>  <p>Outer Air Element with Lift Tab  <b>Use With:</b> PA2747  <b>Replaces:</b> Air Maze CD1830610-826  <b>O.D.:</b> 13 7/8 (352.4)  <b>I.D.:</b> 17/32 (13.5) &amp; 10 (254.0)  <b>Height:</b> 29 1/2 (749.3)  <b>F. Gskt:</b> [1] Included</p>

Measurements Are Shown In Inches And (Millimeters)

**WARNING:** These products can expose you to chemicals, including Diisononyl Phthalate, Carbon black extracts, Nickel, 1,3 Butadiene, Ethylene Oxide, Epichlorohydrin, which are known to the State of California to cause cancer, and Bisphenol, Ethylene Glycol, Ethylene Oxide, 1,3 Butadiene, Epichlorohydrin, which are known to the State of California to cause birth defects or other reproductive harm.

**PA2747**



Inner Air Element

**Fits Inside:** PA2746  
**Replaces:** Air Maze CD1830610-827  
**O.D.:** 9 29/32 (251.6)  
**I.D.:** 17/32 (13.5) & 8 1/16 (204.8)  
**Height:** 28 1/4 (717.6)  
**F. Gskt:** [1] Included

**PA2748**



Inner Air Element

**Fits Inside:** PA2701  
**Fits:** Massey Ferguson Wheel Tractors  
**Replaces:** Massey Ferguson 1688093-M1  
**O.D.:** 2 29/32 (73.8)  
**I.D.:** 15/32 (11.9) & 2 3/8 (60.3)  
**Height:** 8 1/8 (206.4)  
**A. Gskt:** [1] Attached  
**End Seals:** [1] Included

**PA2749**



Outer Air Element with Bail Handle

**Fits:** Caterpillar Equipment  
**Use With:** PA1905  
**Replaces:** Caterpillar 4W5716  
**O.D.:** 13 13/16 (350.8)  
 Boot 14 1/2 (368.3)  
**I.D.:** 15/16 (23.8) & 9 1/2 (241.3)  
**Height:** 18 1/2 (469.9)  
**A. Gskt:** [1] Attached, G285-AF  
**F. Gskt:** [1] Included  
**Related To:** LL1894, PA1894 (without Boot and Bail Handle)  
 PA1894XP (Extreme Performance Nano Version)

**PA2750**



Conical-Shaped Air Element

**Fits:** Blue Bird Buses; ERF, Leyland Trucks  
**Replaces:** Leyland BBU8383; Nelson 70470N  
**O.D.:** 7 3/16 (182.6)  
 to 8 1/4 (209.6)  
**I.D.:** 21/32 (16.7) & 4 23/32 (119.9) to  
**Height:** 18 1/2 (469.9)  
**F. Gskt:** G103-N

**PA2751**



Conical-Shaped Air Element

**Fits:** Blue Bird Buses; Bedford, ERF, Foden, Leyland Trucks  
**Replaces:** Leyland BBU2734  
**O.D.:** 7 15/16 (201.6)  
 to 9 27/32 (250.0)  
**I.D.:** 11/16 (17.5) & 6 1/4 (158.8) to  
**Height:** 19 1/2 (495.3)  
**A. Gskt:** [1] Included  
**F. Gskt:** G103-N

**PA2752**



Cab Air Element

**Fits:** John Deere Equipment  
**Replaces:** John Deere AT73529  
**Length:** 29 1/2 (749.3)  
**Width:** 5 (127.0)  
**Height:** 2 9/16 (65.1)

**PA2753**



Cab Air Element

**Fits:** Allis Chalmers Tractors  
**Replaces:** Allis Chalmers 1504385  
**Length:** 26 (660.4)  
**Width:** 7 (177.8)  
**Height:** 2 9/16 (65.1)

**PA2754**



Air Element with Lift Bar

**Fits:** Sullair Compressors  
**Replaces:** Sullair 250022-888  
**O.D.:** 6 11/16 (169.9)  
**I.D.:** 1/2 (12.7) & 3 3/4 (95.3)  
**Height:** 11 11/32 (288.1)  
**A. Gskt:** [1] Attached  
**F. Gskt:** [1] Included

**PA2755**



Air Element

**Fits:** Mack Trucks  
**Replaces:** Mack 57MD44M  
**O.D.:** 8 27/32 (224.6)  
**I.D.:** 5 13/16 (147.6)  
**Height:** 28 1/2 (723.9)  
**A. Gskt:** [1] Attached

**PA2756**



Conical-Shaped Air Element

**Fits:** Blue Bird Buses; Ford Trucks  
**Replaces:** Blue Bird 4280574; Ford 81DB-9601-JB; Nelson 70469N  
**O.D.:** 5 15/16 (150.8)  
 to 7 (177.8)  
**I.D.:** 21/32 (16.7) & 3 5/8 (92.1)  
**Height:** 15 1/2 (393.7)  
**A. Gskt:** [1] Attached  
**F. Gskt:** G103-N

**PA2757**



Air Element

**Fits:** Volvo Trucks  
**Replaces:** Volvo 1660375-5  
**O.D.:** 10 5/8 (269.9)  
**I.D.:** 7/16 (11.1) & 6 1/4 (158.8)  
**Height:** 22 11/16 (576.3)  
**A. Gskt:** [1] Attached  
**F. Gskt:** [1] Included

**PA2759**



Air Element

**Fits:** Bedford Trucks  
**Replaces:** Chrysler 75062482; GMC 7972953; Leyland ABU8526  
**O.D.:** 7 23/32 (196.1)  
**I.D.:** 11/16 (17.5) & 5 3/32 (129.4)  
**Height:** 14 7/16 (366.7)  
**A. Gskt:** [1] Attached

Measurements Are Shown In Inches And (Millimeters)

**WARNING:** These products can expose you to chemicals, including Diisononyl Phthalate, Carbon black extracts, Nickel, 1,3 Butadiene, Ethylene Oxide, Epichlorohydrin, which are known to the State of California to cause cancer, and Bisphenol, Ethylene Glycol, Ethylene Oxide, 1,3 Butadiene, Epichlorohydrin, which are known to the State of California to cause birth defects or other reproductive harm.

**PA2761** Air Element with Lid  
**Fits:** GMC, Isuzu, Mitsubishi Trucks  
**Replaces:** GMC 94430250; Isuzu 8-94430-250-0; Mitsubishi ME033717  
**O.D.:** 8 11/16 (220.7)  
**Lid:** 10 3/8 (263.5)  
**I.D.:** 7/8 (22.2) & 5 11/32 (135.7)  
**Height:** 13 1/2 (342.9)  
**A. Gskt:** [2] Attached  
**F. Gskt:** [1] Included



**PA2774** Outer Air Element  
**Fits:** Volvo Buses, Trucks  
**Use With:** PA2775  
**Replaces:** Volvo 1544449  
**O.D.:** 13 13/16 (350.8)  
**I.D.:** 5/8 (15.9) & 8 9/32 (210.3)  
**Height:** 14 1/2 (368.3)  
**A. Gskt:** [1] Attached  
**F. Gskt:** [1] Included



**PA2763** Air Element  
**Replaces:** Leyland 10621312  
**O.D.:** 8 1/8 (206.4)  
**I.D.:** 3 25/32 (96.0)  
**Height:** 7 1/8 (181.0)



**PA2775** Inner Air Element  
**Fits Inside:** PA2774  
**Fits:** Volvo Buses, Trucks  
**Replaces:** Volvo 1660903  
**O.D.:** 7 13/16 (198.4)  
**I.D.:** 7/16 (11.1) & 6 17/32 (165.9)  
**Height:** 12 5/8 (320.7)  
**A. Gskt:** [1] Attached  
**F. Gskt:** [1] Included



**PA2767** Outer Air Element  
**Fits:** Claas, Fendt, International, John Deere, Kobelco, Liebherr Equipment; Iveco Trucks  
**Use With:** PA3686  
**Replaces:** Iveco 1904581; John Deere AZ18968; Leyland BBU6549; Nelson 70604S  
**O.D.:** 5 7/8 (149.2)  
**I.D.:** 7/16 (11.1) & 2 13/16 (71.4)  
**Height:** 13 1/4 (336.5)  
**A. Gskt:** [1] Attached



**PA2776** Outer Air Element  
**Fits:** Claas, Liebherr, V.M.E., Volvo Equipment; Iveco, M.A.N., Mercedes-Benz Trucks  
**Use With:** PA3494, PA3857  
**Replaces:** Claas 709050; Iveco 1902129; Liebherr 5106191; M.A.N. 81.08304.0044; Mercedes-Benz 90940502; Volvo 11033128  
**O.D.:** 11 15/16 (303.2)  
**I.D.:** 13/32 (10.3) & 7 17/32 (191.3)  
**Height:** 18 21/32 (473.9)  
**A. Gskt:** [1] Attached  
**F. Gskt:** [1] Included



**PA2771** Replacement for Ecolite Air Element in Disposable Housing  
**Fits:** Akerman Excavators; Volvo Engines, Equipment  
**Replaces:** Volvo 823701  
**O.D.:** 7 3/4 (196.9)  
**I.D.:** 4 (101.6) One End  
**Height:** 28 3/16 (716.0)



**PA2777** Outer Air Element  
**Fits:** Case, International Tractors; Cummins Engines  
**Use With:** PA2539  
**Replaces:** Case A171255  
**O.D.:** 9 29/32 (251.6)  
**I.D.:** 11/16 (17.5) & 6 1/16 (154.0)  
**Height:** 16 1/2 (419.1)  
**A. Gskt:** [1] Attached  
**F. Gskt:** G103-N



**PA2772** Outer Air Element  
**Fits:** 1993-96 Volkswagen Eurovan; Bomag, Demag, Fendt Equipment; Sullair Compressors  
**Use With:** PA3684  
**Replaces:** Demag 29504476; Fendt 5821301; Volkswagen 44129620A  
**O.D.:** 6 15/32 (164.3)  
**I.D.:** 3 11/32 (84.9) One End  
**Height:** 9 3/8 (238.1)  
**A. Gskt:** [1] Attached



**PA2778-FN** Air Element with Fins  
**Contains:** Flame Retardant Media  
**Fits:** Komatsu Equipment; Nissan Lift Trucks  
**Replaces:** Nissan 16546-00H10  
**O.D.:** 4 3/32 (104.0)  
**Fins:** 5 1/8 (130.2)  
**I.D.:** 25/32 (19.8) & 2 15/32 (62.7)  
**Height:** 7 23/32 (196.1)  
**A. Gskt:** [1] Attached  
**F. Gskt:** G103-N



**PA2773** Inner Air Element  
**Fits Inside:** PA2707  
**Fits:** Volvo Trucks  
**Replaces:** Volvo 1544298  
**O.D.:** 7 25/32 (197.6)  
**I.D.:** 13/32 (10.3) & 6 15/16 (176.2)  
**Height:** 12 5/8 (320.7)  
**A. Gskt:** [1] Attached  
**F. Gskt:** G15-AF



**LL2779** Long Life Outer Air Element  
**Fits:** Caterpillar, Link-Belt Equipment; GMC, Hino, Isuzu, Nissan Buses, Trucks  
**Use With:** PA2545  
**Replaces:** Hino 17801-2280; Isuzu 1-14215-172-0; Nissan 16546-Z9004  
**O.D.:** 9 1/8 (231.8)  
**I.D.:** 15/16 (23.8) & 5 13/16 (147.6)  
**Height:** 13 1/2 (342.9)  
**A. Gskt:** [1] Attached  
**F. Gskt:** [1] Included  
**Related To:** PA2779 (Standard Media Version)



Measurements Are Shown In Inches And (Millimeters)

**WARNING:** These products can expose you to chemicals, including Diisononyl Phthalate, Carbon black extracts, Nickel, 1,3 Butadiene, Ethylene Oxide, Epichlorohydrin, which are known to the State of California to cause cancer, and Bisphenol, Ethylene Glycol, Ethylene Oxide, 1,3 Butadiene, Epichlorohydrin, which are known to the State of California to cause birth defects or other reproductive harm.

**PA2779**



Outer Air Element

**Fits:** Caterpillar, Link-Belt Equipment; GMC, Hino, Isuzu, Nissan Buses, Trucks  
**Use With:** PA2545  
**Replaces:** Hino 17801-2280; Isuzu 1-14215-172-0; Nissan 16546-Z9004  
**O.D.:** 9 1/8 (231.8)  
**I.D.:** 15/16 (23.8) & 5 13/16 (147.6)  
**Height:** 13 1/2 (342.9)  
**A. Gskt:** [1] Attached  
**F. Gskt:** [1] Included  
**Related To:** LL2779 (Long-Life Media Version)

**PA2785**



Air Element with Lid

**Fits:** Volvo Trucks  
**Replaces:** Volvo 6792554  
**O.D.:** 7 3/8 (187.3)  
 Lid 8 1/8 (206.4)  
**I.D.:** 13/32 (10.3) & 4 11/16 (119.1)  
**Height:** 23 1/4 (590.6)  
**A. Gskt:** [2] Attached  
**F. Gskt:** [1] Included

**PA2781**



Outer Air Element

**Fits:** Caterpillar Equipment  
**Use With:** PA2782, PA3551  
**Replaces:** Caterpillar 7W9853  
**O.D.:** 14 1/4 (362.0)  
**I.D.:** 9 29/32 (251.6) One End  
**Height:** 18 21/32 (473.9)  
**A. Gskt:** [1] Attached

**PA2786**



Outer Air Element

**Fits:** Volvo Trucks  
**Use With:** PA2787  
**Replaces:** Volvo 1660600  
**O.D.:** 10 3/16 (258.8)  
**I.D.:** 13/32 (10.3) & 6 5/16 (160.3)  
**Height:** 21 3/8 (542.9)  
**A. Gskt:** [1] Attached  
**F. Gskt:** [1] Included

**PA2782**



Inner Air Element with 12 Bolt Holes

**Fits Inside:** PA2781  
**Fits:** Caterpillar Equipment  
**Replaces:** Caterpillar 7W9567  
**O.D.:** 9 13/16 (249.2)  
 Flange 12 3/32 (307.2)  
**I.D.:** 8 1/8 (206.4) One End  
**Height:** 18 3/32 (459.6)  
**A. Gskt:** [1] Attached

**PA2787**



Inner Air Element

**Fits Inside:** PA2786  
**Fits:** Volvo Trucks  
**Replaces:** Volvo 1660601, 1665886  
**O.D.:** 6 1/8 (155.6)  
**I.D.:** 13/32 (10.3) & 4 15/16 (125.4)  
**Height:** 20 1/2 (520.7)  
**A. Gskt:** [1] Attached  
**F. Gskt:** [1] Included

**PA2783**



Air Element

**Fits:** Caterpillar, Fiat-Allis, Hanomag, Liebherr, Trojan Equipment; R.V.I. Buses  
**Replaces:** Caterpillar 7E0973; Fiat 79042202; Hanomag 3074304-M1; Liebherr 7401179  
**O.D.:** 7 5/8 (193.7)  
**I.D.:** 5/8 (15.9) & 4 1/4 (108.0)  
**Height:** 16 1/2 (419.1)  
**A. Gskt:** [1] Attached  
**F. Gskt:** G103-N  
**Related To:** LL2783 (Long-Life Media Version)

**PA2788**



Outer Air Element with Lid

**Fits:** Case, Daewoo, Hitachi, Kobelco, Komatsu, MDI/Yutani Equipment  
**Use With:** PA1911  
**Replaces:** Case 161863A1; Hitachi 4129907; Kobelco 2447U242S2; Komatsu 600-181-6540  
**O.D.:** 7 3/8 (187.3)  
 Lid 9 9/32 (235.7)  
**I.D.:** 21/32 (16.7) & 4 11/16 (119.1)  
**Height:** 15 1/2 (393.7)  
**A. Gskt:** [2] Attached  
**F. Gskt:** G103-N

**PA2784**



Outer Air Element with Lid

**Fits:** Daewoo, Kawasaki, Kobelco, Komatsu Equipment; Hino, Mitsubishi Trucks  
**Use With:** PA3578  
**Replaces:** Hino 17801-2800; Kawasaki 30980-70070; Kobelco 2446R312S2; Komatsu 600-181-6820; Mitsubishi ME033603  
**O.D.:** 8 11/16 (220.7)  
 Lid 10 3/8 (263.5)  
**I.D.:** 7/8 (22.2) & 5 11/32 (135.7)  
**Height:** 17 29/32 (454.8)  
**A. Gskt:** [2] Attached  
**F. Gskt:** [1] Included

**PA2789**



Air Element

**Fits:** Ford Trucks  
**Replaces:** Ford E8HZ-9601-A  
**O.D.:** 13 7/8 (352.4)  
**I.D.:** 11/16 (17.5) & 7 7/16 (188.9)  
**Height:** 7 1/2 (190.5)  
**A. Gskt:** [1] Attached  
**F. Gskt:** G103-N

**PA2790-FN**



Outer Air Element with Fins and Lid

**Fits:** J.C. Bamford Equipment  
**Use With:** PA2791  
**Replaces:** J.C. Bamford 32/206002  
**O.D.:** 5 1/4 (133.4)  
 Lid 6 1/2 (165.1)  
**I.D.:** 21/32 (16.7) & 2 27/32 (72.2)  
**Height:** 14 1/16 (357.2)  
**A. Gskt:** [1] Attached  
**F. Gskt:** [1] Included, [1] Wing Nut

Measurements Are Shown In Inches And (Millimeters)

**WARNING:** These products can expose you to chemicals, including Diisononyl Phthalate, Carbon black extracts, Nickel, 1,3 Butadiene, Ethylene Oxide, Epichlorohydrin, which are known to the State of California to cause cancer, and Bisphenol, Ethylene Glycol, Ethylene Oxide, 1,3 Butadiene, Epichlorohydrin, which are known to the State of California to cause birth defects or other reproductive harm.

**PA2791**

Inner Air Element



**Fits Inside:** PA2790-FN, PA3859  
**Fits:** Case, J.C. Bamford, New Holland Equipment  
**Replaces:** J.C. Bamford 32/206003  
**O.D.:** 2 23/32 (69.1)  
 Flange Gasket 3 21/32 (92.9)  
**I.D.:** 21/32 (16.7) & 2 3/8 (60.3)  
**Height:** 12 1/32 (305.6)  
**A. Gskt:** [1] Attached  
**F. Gskt:** [1] Washer  
**End Seals:** [1] Included

**PA2792**

Outer Air Element



**Fits:** Allis Chalmers, Demag, Eicher, Fendt, Fiat, International Equipment  
**Use With:** PA3687  
**Replaces:** Allis Chalmers 99100059; Demag 99054; Eicher 1871933-M91; Fendt X810270073; Fiat 9293140; International 3146927-R91  
**O.D.:** 5 (127.0)  
**I.D.:** 11/32 (8.7) & 2 9/16 (65.1)  
**Height:** 11 17/32 (292.9)  
**A. Gskt:** [1] Attached  
**F. Gskt:** G39-AF

**PA2793**

Outer Air Element with Lift Tab



**Fits:** Massey Ferguson Wheel Tractors  
**Use With:** PA2794  
**Replaces:** Massey Ferguson 1055534-M91  
**O.D.:** 8 1/2 (215.9)  
**I.D.:** 7/16 (11.1) & 5 3/8 (136.5)  
**Height:** 12 3/4 (323.8)  
**A. Gskt:** [1] Attached  
**F. Gskt:** [1] Included

**PA2794**

Inner Air Element



**Fits Inside:** PA2793  
**Fits:** Massey Ferguson Wheel Tractors  
**Replaces:** Massey Ferguson 1055533-M91  
**O.D.:** 5 1/4 (133.4)  
**I.D.:** 5/8 (15.9) & 4 1/8 (104.8)  
**Height:** 11 5/16 (287.3)  
**A. Gskt:** [1] Attached  
**F. Gskt:** G103-N

**PA2796**

Air Element



**Fits:** Pneumafil Dust Collectors  
**Replaces:** Pneumafil A37536B-2  
**O.D.:** 12 3/4 (323.8)  
**I.D.:** 3/4 (19.0) & 8 3/8 (212.7)  
**Height:** 29 3/4 (755.7)  
**A. Gskt:** [1] Attached

**PA2797**

Outer Air Element



**Fits:** Volvo Trucks  
**Use With:** PA4627  
**Replaces:** Volvo V1115700  
**O.D.:** 12 3/4 (323.8)  
**I.D.:** 8 11/32 (211.9) One End  
**Height:** 16 21/32 (423.1)  
**A. Gskt:** [2] Attached

**PA2798**

Air Breather Element



**Contains:** Clamp  
**Fits:** V.M.E., Volvo Equipment, Trucks  
**Replaces:** Volvo 1586882-1  
**O.D.:** 3 15/32 (88.1)  
**I.D.:** 31/32 (24.6) One End  
**Height:** 3 15/32 (88.1)  
**Grommets:** [1] Attached  
**Related To:** PA5700 (with Check Valve)

**PA2799**

Air Element



**Notes:** Inside-Out Flow Direction  
**Fits:** Torit Air Cleaning Systems  
**Replaces:** Torit 8PP22269-00  
**O.D.:** 12 3/4 (323.8)  
**I.D.:** 8 11/32 (211.9)  
**Height:** 26 1/2 (673.1)  
**A. Gskt:** [1] Included

**PA2800-FN**

Air Element with Fins



**Notes:** OBSOLETE. Availability Limited to Dealer Stock.  
**Replaces:** Multiparts BAU1475  
**O.D.:** 5 1/4 (133.4)  
 Fins 6 13/32 (162.7)  
**I.D.:** 21/32 (16.7) & 2 25/32 (70.6)  
**Height:** 18 1/4 (463.6)  
**A. Gskt:** [1] Attached  
**F. Gskt:** [2] Included

**PA2801**

Air Element with Lid



**Fits:** Scania Trucks  
**Replaces:** Saab-Scania 370754  
**O.D.:** 11 7/8 (301.6)  
 Lid 15 1/32 (381.8)  
**I.D.:** 13/32 (10.3) & 9 9/16 (242.9)  
**Height:** 18 3/4 (476.3)  
**A. Gskt:** [2] Attached

**PA2803**

Replacement for Ecolite Air Element in Disposable Housing



**Fits:** Carrier-Transicold Refrigeration Units  
**Replaces:** Carrier 30-01077-01  
**O.D.:** 6 5/8 (168.3)  
**I.D.:** 2 (50.8) One End  
**Height:** 10 11/32 (262.7)

**PA2804**

Replacement for Ecolite Air Element in Disposable Housing



**Fits:** Thermo King Refrigeration Units  
**Replaces:** Thermo King 11-5978, 11-7400  
**O.D.:** 6 5/8 (168.3)  
**I.D.:** 1 13/32 (35.7) One End  
**Height:** 11 11/32 (288.1)

Measurements Are Shown In Inches And (Millimeters)

**WARNING:** These products can expose you to chemicals, including Diisononyl Phthalate, Carbon black extracts, Nickel, 1,3 Butadiene, Ethylene Oxide, Epichlorohydrin, which are known to the State of California to cause cancer, and Bisphenol, Ethylene Glycol, Ethylene Oxide, 1,3 Butadiene, Epichlorohydrin, which are known to the State of California to cause birth defects or other reproductive harm.



**PA2805**

Replacement for Ecolite Air Element in Disposable Housing



**Fits:** LeRoi Compressors; Ditch Witch, Volvo, Wacker Equipment  
**Replaces:** LeRoi 43-867-2  
**O.D.:** 8 9/16 (217.5)  
**I.D.:** 2 31/32 (75.4) One End  
**Height:** 10 13/16 (274.6)

**PA2815**

Air Element



**Replaces:** Cummins 3905326; Ingersoll-Rand 39824115; Onan 140-2660  
**O.D.:** 8 1/2 (215.9)  
**I.D.:** 3 (76.2) One End  
**Height:** 12 3/8 (314.3)  
**Related To:** PA3868 (with Flame Retardant Media)

**PA2806**

Replacement for Ecolite Air Element in Disposable Housing



**Fits:** Godwin Pumps  
**Replaces:** Donaldson C105004  
**O.D.:** 10 9/16 (268.3)  
**I.D.:** 4 1/4 (108.0) One End  
**Height:** 11 13/16 (300.0)

**PA2816**

Replacement for Ecolite Air Element in Disposable Housing



**Replaces:** Donaldson ECB085008  
**O.D.:** 8 9/16 (217.5)  
**Inlet:** 3 15/32  
**Outlet:** 4 11/32  
**Height:** 9 27/32 (250.0)

**PA2807**

Replacement for Ecolite Air Element in Disposable Housing



**Replaces:** Gehl 77628; John Deere AM100258  
**O.D.:** 5 1/2 (139.7)  
**I.D.:** 1 3/4 (44.4) One End  
**Height:** 8 3/8 (212.7)

**PA2817**

Air Element



**Replaces:** Donaldson ECB085009  
**O.D.:** 8 1/2 (215.9)  
**I.D.:** 3 (76.2) One End  
**Height:** 4 3/8 (111.1)

**PA2812**

Air Element with Lid



**Fits:** Mercedes-Benz Buses, Trucks  
**Replaces:** Mercedes-Benz 10949304  
**O.D.:** 10 7/8 (276.2)  
Lid 13 5/16 (338.1)  
**I.D.:** 13/32 (10.3) & 5 1/4 (133.4)  
**Height:** 10 (254.0)  
**A. Gskt:** [2] Attached

**PA2818**

Air Element



**Replaces:** Donaldson ECB085011  
**O.D.:** 8 1/2 (215.9)  
**I.D.:** 4 (101.6) One End  
**Height:** 12 3/8 (314.3)

**PA2813**

Outer Air Element



**Fits:** DAF, Iveco, M.A.N., Scania Buses, Trucks  
**Use With:** PA4809  
**Replaces:** DAF 667078; Iveco 8122408  
**O.D.:** 11 29/32 (302.4)  
**I.D.:** 13/32 (10.3) & 7 17/32 (191.3)  
**Height:** 14 7/8 (377.8)  
**A. Gskt:** [1] Attached  
**F. Gskt:** [1] Included

**PA2819**

Replacement for Ecolite Air Element in Disposable Housing



**Replaces:** Donaldson ECB105003  
**O.D.:** 10 9/16 (268.3)  
**Inlet:** 4 15/32  
**Outlet:** 4  
**Height:** 11 13/16 (300.0)

**PA2814**

Inner Air Element



**Fits Inside:** PA2475  
**Fits:** DAF, Iveco, M.A.N., R.V.I., Volvo Buses, Trucks; Claas, Demag, Fendt, Liebherr, New Holland, V.M.E. Equipment  
**Replaces:** DAF 691280; Demag 988765; Iveco 1909132; New Holland 430287; Volvo 4785749, 4785749-5  
**O.D.:** 5 1/8 (130.2)  
Boot Gasket 5 9/16 (141.3)  
**I.D.:** 11/16 (17.5) & 4 11/16 (119.1)  
**Height:** 18 5/8 (473.1)  
**A. Gskt:** [1] Attached  
**F. Gskt:** [1] Included

**PA2820**

Air Element



**Replaces:** Donaldson ECB105006  
**O.D.:** 10 1/2 (266.7)  
**I.D.:** 4 (101.6) One End  
**Height:** 11 7/8 (301.6)

Measurements Are Shown In Inches And (Millimeters)

**WARNING:** These products can expose you to chemicals, including Diisononyl Phthalate, Carbon black extracts, Nickel, 1,3 Butadiene, Ethylene Oxide, Epichlorohydrin, which are known to the State of California to cause cancer, and Bisphenol, Ethylene Glycol, Ethylene Oxide, 1,3 Butadiene, Epichlorohydrin, which are known to the State of California to cause birth defects or other reproductive harm.

**PA2821**

Air Element



**Replaces:** Donaldson ECB125003  
**O.D.:** 12 1/2 (317.5)  
**I.D.:** 6 (152.4) One End  
**Height:** 16 3/8 (415.9)

**PA2827**

Replacement for Ecolite Air Element in Disposable Housing



**Fits:** Godwin Pumps  
**Replaces:** Cummins 3910946; Lister 3043  
**O.D.:** 8 9/16 (217.5)  
**I.D.:** 3 1/4 (82.6) One End  
**Height:** 6 5/16 (160.3)

**PA2822**

Replacement for Ecolite Air Element in Disposable Housing



**Fits:** Gehl Loaders  
**Replaces:** Gehl 75986, 79388  
**O.D.:** 5 1/2 (139.7)  
**I.D.:** 1 3/4 (44.4) One End  
**Height:** 8 3/8 (212.7)

**PA2828**

Replacement for Ecolite Air Element in Disposable Housing



**Replaces:** Donaldson C085005  
**O.D.:** 8 19/32 (218.3)  
**I.D.:** 2 1/2 (63.5) One End  
**Height:** 6 3/8 (161.9)

**PA2823**

Replacement for Ecolite Air Element in Disposable Housing



**Replaces:** Jacobsen 330811  
**O.D.:** 6 5/8 (168.3)  
**I.D.:** 2 (50.8) One End  
**Height:** 5 11/32 (135.7)

**PA2829**

Replacement for Ecolite Air Element in Disposable Housing



**Replaces:** Isuzu X14210-031; LeRoi 43-867-1  
**O.D.:** 8 9/16 (217.5)  
**I.D.:** 2 1/2 (63.5) One End  
**Height:** 10 13/16 (274.6)

**PA2824**

Replacement for Ecolite Air Element in Disposable Housing



**Fits:** Godwin Pumps; Isuzu Engines  
**Replaces:** Donaldson C065002  
**O.D.:** 6 5/8 (168.3)  
**I.D.:** 2 (50.8) One End  
**Height:** 8 27/32 (224.6)

**PA2830**

Replacement for Ecolite Air Element in Disposable Housing



**Fits:** Godwin Pumps  
**Replaces:** LeRoi 438673  
**O.D.:** 10 9/16 (268.3)  
**I.D.:** 4 1/4 (108.0) One End  
**Height:** 7 5/16 (185.7)

**PA2825**

Replacement for Ecolite Air Element in Disposable Housing



**Fits:** Northern Lights Generators  
**Replaces:** Broderon 60012047  
**O.D.:** 8 9/16 (217.5)  
**I.D.:** 2 1/2 (63.5) One End  
**Height:** 5 5/16 (134.9)

**PA2831**

Replacement for Ecolite Air Element in Disposable Housing



**Fits:** Godwin Pumps  
**Replaces:** Fiat 73253513  
**O.D.:** 12 9/16 (319.1)  
**I.D.:** 5 (127.0) One End  
**Height:** 12 5/16 (312.7)

**PA2826**

Replacement for Ecolite Air Element in Disposable Housing



**Fits:** Godwin Pumps; Isuzu, John Deere Industrial Engines  
**Replaces:** Donaldson C085002  
**O.D.:** 8 9/16 (217.5)  
**I.D.:** 2 1/2 (63.5) One End  
**Height:** 7 13/16 (198.4)

**PA2832**

Replacement for Ecolite Air Element in Disposable Housing



**Replaces:** Ingersoll-Rand 8524575; Thermo King 11-6488  
**O.D.:** 4 1/2 (114.3)  
**I.D.:** 1 1/2 (38.1) One End  
**Height:** 5 7/8 (149.2)

Measurements Are Shown In Inches And (Millimeters)

**WARNING:** These products can expose you to chemicals, including Diisononyl Phthalate, Carbon black extracts, Nickel, 1,3 Butadiene, Ethylene Oxide, Epichlorohydrin, which are known to the State of California to cause cancer, and Bisphenol, Ethylene Glycol, Ethylene Oxide, 1,3 Butadiene, Epichlorohydrin, which are known to the State of California to cause birth defects or other reproductive harm.

**PA2833**

Outer Air Element



**Fits:** R.V.I. Trucks  
**Use With:** PA2834  
**Replaces:** Renault 5000814797  
**O.D.:** 12 1/8 (308.0)  
**I.D.:** 5/8 (15.9) & 7 11/16 (195.3)  
**Height:** 15 1/4 (387.3)  
**A. Gskt:** [1] Attached  
**F. Gskt:** G103-N

**PA2838**

Air Element with Lid

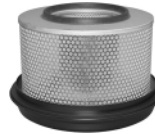

**Fits:** Mercedes-Benz Buses, Trucks, Vans  
**Replaces:** Mercedes-Benz 10948304  
**O.D.:** 12 7/8 (327.0)  
 Lid 15 1/4 (387.3)  
**I.D.:** 13/32 (10.3) & 6 9/16 (166.7)  
**Height:** 10 1/16 (255.6)  
**A. Gskt:** [1] Attached  
**End Seals:** [1] Attached

**PA2834**

Inner Air Element



**Fits Inside:** PA2833  
**Fits:** John Deere Equipment; R.V.I. Trucks  
**Replaces:** Renault 5000814798  
**O.D.:** 7 1/4 (184.2)  
 Flange 8 13/32 (213.5)  
**I.D.:** 11/16 (17.5) & 6 3/16 (157.2)  
**Height:** 14 17/32 (369.1)  
**A. Gskt:** [1] Attached  
**F. Gskt:** G103-N

**PA2839**

Air Element with Lift Tabs



**Fits:** MCI, Prevost Buses  
**Replaces:** Flxible 97342400210; TCM 9G3-37;  
 Universal Coach T121009  
**O.D.:** 15 3/32 (383.4)  
 Boot 16 1/16 (408.0)  
**I.D.:** 13/16 (20.6) & 8 21/32 (219.9)  
**Height:** 15 15/16 (404.8)  
**A. Gskt:** [2] Attached  
**F. Gskt:** [1] Included

**PA2835**

Inner Air Element



**Fits Inside:** PA2405  
**Fits:** Bomag, Claas, Demag, Fendt,  
 International, John Deere, Kobelco, Liebherr  
 Equipment; DAF, Iveco, R.V.I. Buses, Trucks  
**Replaces:** Bomag 5821014; Claas 1761680;  
 Iveco 1902131; John Deere AZ30758  
**O.D.:** 4 1/32 (102.4)  
 Flange Gasket 4 13/32 (111.9)  
**I.D.:** 11/16 (17.5) & 3 5/16 (84.1)  
**Height:** 14 5/8 (371.5)  
**A. Gskt:** [1] Attached  
**F. Gskt:** [1] Included

**PA2840**

Outer Air Element



**Fits:** Astra Dump Trucks with Iveco Engine;  
 New Holland Equipment  
**Use With:** PA3861  
**Replaces:** Iveco 107029  
**O.D.:** 12 1/8 (308.0)  
**I.D.:** 21/32 (16.7) & 7 23/32 (196.1)  
**Height:** 20 1/2 (520.7)  
**A. Gskt:** [1] Attached  
**F. Gskt:** [1] Included

**PA2836**

Inner Air Element



**Fits Inside:** PA2474  
**Fits:** Atlas Copco, Compair Compressors;  
 DAF, Iveco, M.A.N., R.V.I. Buses, Trucks;  
 Bomag, John Deere, Kobelco, Liebherr, Volvo  
 Equipment  
**Replaces:** Atlas Copco 29000501; Bomag  
 5821019; Iveco 2243946; John Deere AZ26007;  
 Liebherr 5601963; Volvo 4785746  
**O.D.:** 4 13/32 (111.9)  
 Flange Gasket 4 25/32 (121.4)  
**I.D.:** 11/16 (17.5) & 3 11/16 (93.7)  
**Height:** 14 15/16 (379.4)  
**A. Gskt:** [1] Attached  
**F. Gskt:** [1] Included

**PA2843**

Air Element



**Replaces:** Air Refiner ARM18-1200; Donaldson  
 P181200  
**O.D.:** 10 3/8 (263.5)  
**I.D.:** 6 1/32 (153.2) One End  
**Height:** 10 1/2 (266.7)  
**A. Gskt:** [1] Attached

**PA2837**

Inner Air Element



**Fits Inside:** PA2845  
**Fits:** Bomag, Claas, Demag, Fendt, Liebherr,  
 V.M.E., Volvo Equipment; Iveco, M.A.N., R.V.I.  
 Trucks  
**Replaces:** Bomag 5821015; Claas 176169;  
 Demag 39468640; Iveco 2415950; Liebherr  
 7361346; Volvo 4785611-7  
**O.D.:** 3 9/32 (83.3)  
 Flange Gasket 3 5/8 (92.1)  
**I.D.:** 11/16 (17.5) & 2 27/32 (72.2)  
**Height:** 13 7/16 (341.3)  
**A. Gskt:** [1] Attached  
**F. Gskt:** [1] Included

**PA2844**

Cab Air Element



**Fits:** Caterpillar Crawler Tractors  
**Replaces:** Caterpillar 7T1890  
**Length:** 26 1/8 (663.6)  
**Width:** 5 7/16 (138.1)  
**Height:** 2 9/16 (65.1)  
**A. Gskt:** [1] Attached

**PA2845**

Outer Air Element



**Fits:** Atlas Copco Compressors; Bomag,  
 Claas, Demag, Fendt, Ford, John Deere,  
 Liebherr, V.M.E., Volvo Equipment; Iveco,  
 M.A.N., R.V.I. Buses, Trucks  
**Use With:** PA2837, PA3601  
**Replaces:** Atlas Copco 1619-2797; Bomag  
 5821013; Demag 964013; Ford A830X-9601-ABA;  
 Iveco 1902127; John Deere AZ20623; Volvo  
 6644839  
**O.D.:** 6 15/32 (164.3)  
**I.D.:** 13/32 (10.3) & 3 5/8 (92.1)  
**Height:** 13 3/4 (349.3)  
**A. Gskt:** [1] Attached

Measurements Are Shown In Inches And (Millimeters)

**WARNING:** These products can expose you to chemicals, including Diisononyl Phthalate, Carbon black extracts, Nickel, 1,3 Butadiene, Ethylene Oxide, Epichlorohydrin, which are known to the State of California to cause cancer, and Bisphenol, Ethylene Glycol, Ethylene Oxide, 1,3 Butadiene, Epichlorohydrin, which are known to the State of California to cause birth defects or other reproductive harm.

**PA2846-FN**

Outer Air Element with Fins



**Fits:** Case, International Equipment  
**Use With:** PA2700  
**Replaces:** International 1265510-C1  
**O.D.:** 5 1/4 (133.4)  
 Fins 6 3/8 (161.9)  
**I.D.:** 21/32 (16.7) & 3 1/4 (82.6)  
**Height:** 11 3/8 (288.9)  
**A. Gskt:** [1] Attached  
**F. Gskt:** G103-N

**PA2853**

Inner Air Element



**Fits Inside:** PA2852  
**Fits:** Dresser Motor Graders  
**Replaces:** International 1249056-H1  
**O.D.:** 6 3/8 (161.9)  
**I.D.:** 5/8 (15.9) & 5 9/32 (134.1)  
**Height:** 17 1/2 (444.5)  
**A. Gskt:** [1] Attached  
**F. Gskt:** G103-N

**PA2847**

Air Element with Lid



**Fits:** Fendt, Hanomag, John Deere Equipment;  
 Iveco, M.A.N., Mercedes-Benz, Volvo Buses,  
 Trucks  
**Replaces:** Hanomag 2872977-M1; Iveco  
 2164590; John Deere AZ23440; Mercedes-Benz  
 10941004; Volvo 500858  
**O.D.:** 8 15/16 (227.0)  
 Lid 10 15/16 (277.8)  
**I.D.:** 13/32 (10.3) & 4 9/16 (115.9)  
**Height:** 15 3/32 (383.4)  
**A. Gskt:** [2] Included

**PA2854**

Panel Air Element



**Replaces:** Tennant 81363  
**Length:** 30 (762.0)  
**Width:** 20 (508.0)  
**Height:** 3 9/16 (90.5)

**PA2848**

Inner Air Element



**Fits Inside:** PA2653  
**Fits:** Caterpillar Generators, Industrial, Marine  
 Engines  
**Replaces:** Caterpillar 8N2556  
**O.D.:** 12 25/32 (324.6)  
 Flange 15 5/8 (396.9)  
**I.D.:** 10 9/32 (261.1) One End  
**Height:** 10 5/16 (261.9)  
**A. Gskt:** [1] Attached

**PA2855**

Air Element



**Fits:** Torit Air Cleaning Systems  
**Replaces:** Torit 8PP19215-01  
**O.D.:** 12 3/4 (323.8)  
**I.D.:** 17/32 (13.5) & 8 11/32 (211.9)  
**Height:** 26 1/2 (673.1)  
**A. Gskt:** [1] Attached  
**F. Gskt:** [1] Included

**PA2849**

Outer Air Element with Bail Handle



**Fits:** Caterpillar Equipment  
**Use With:** PA2563  
**Replaces:** Caterpillar 4W5228  
**O.D.:** 14 11/16 (373.1)  
 Boot 15 3/8 (390.5)  
**I.D.:** 29/32 (23.0) & 10 11/32 (262.7)  
**Height:** 24 1/2 (622.3)  
**A. Gskt:** [2] Attached  
**F. Gskt:** [1] Included

**PA2856**

Air Element



**Fits:** Torit Air Cleaning Systems  
**Replaces:** Torit 8PP21586-00  
**O.D.:** 7 15/16 (201.6)  
**I.D.:** 11/16 (17.5) & 3 9/16 (90.5)  
**Height:** 16 1/2 (419.1)  
**A. Gskt:** [1] Attached  
**F. Gskt:** [1] Included

**PA2851**

Conical-Shaped Air Element



**Fits:** Mack Trucks  
**Replaces:** Mack 57MD45M  
**O.D.:** 7 13/32 (188.1)  
 to 10 13/32 (264.3)  
**I.D.:** 6 15/16 (176.2) One End  
**Height:** 20 1/2 (520.7)  
**A. Gskt:** [1] Included

**PA2857**

Air Element



**Notes:** Inside-Out Flow Direction  
**Fits:** Torit Air Cleaning Systems  
**Replaces:** Torit 8PP21347-00  
**O.D.:** 12 3/4 (323.8)  
**I.D.:** 17/32 (13.5) & 8 11/32 (211.9)  
**Height:** 26 1/2 (673.1)  
**A. Gskt:** [1] Attached  
**F. Gskt:** [1] Included

**PA2852**

Outer Air Element



**Fits:** Dresser Motor Graders  
**Use With:** PA2853  
**Replaces:** Dresser 1249055-H1  
**O.D.:** 10 27/32 (275.4)  
**I.D.:** 15/16 (23.8) & 6 1/2 (165.1)  
**Height:** 18 1/2 (469.9)  
**A. Gskt:** [1] Attached  
**F. Gskt:** [1] Included

**PA2858**

Air Element



**Contains:** Flame Retardant Media  
**Fits:** Nissan Lift Trucks  
**Replaces:** Nissan 16546-K4046B  
**O.D.:** 7 (177.8)  
**I.D.:** 3 21/32 (92.9)  
**Height:** 5 (127.0)

Measurements Are Shown In Inches And (Millimeters)

**WARNING:** These products can expose you to chemicals, including Diisononyl Phthalate, Carbon black extracts, Nickel, 1,3 Butadiene, Ethylene Oxide, Epichlorohydrin, which are known to the State of California to cause cancer, and Bisphenol, Ethylene Glycol, Ethylene Oxide, 1,3 Butadiene, Epichlorohydrin, which are known to the State of California to cause birth defects or other reproductive harm.

**PA2859-FN**

Air Element with Fins



**Fits:** Case Tractors; DAF, Leyland Trucks  
**Replaces:** Case K306535; Leyland MAK1629  
**O.D.:** 7 15/16 (201.6)  
**Fins:** 10 1/32 (254.8)  
**I.D.:** 5/8 (15.9) & 5 5/16 (134.9)  
**Height:** 13 7/16 (341.3)  
**A. Gskt:** [1] Attached  
**F. Gskt:** [1] Included, [1] Metal Washer

**RS2863XP**

Extreme Performance Nano Radial Seal Outer Air Element



**Fits:** Caterpillar, Cummins Engines; Ford, Freightliner, GMC, Hino, IHC, Kenworth, Ottawa, Peterbilt, Sterling Trucks; John Deere Tractors; Massey Ferguson Combines  
**Use With:** RS3501  
**Replaces:** Ford F3HZ-9601-A; GMC 15619013; John Deere RE34962  
**O.D.:** 9 9/32 (235.7)  
**I.D.:** 5 5/32 (131.0) One End  
**Height:** 12 3/4 (323.8)  
**Related To:** RS2863 (Standard Media Version)

**PA2860-FN**

Air Element with Fins



**Replaces:** Leyland RTC2478  
**O.D.:** 5 1/4 (133.4)  
**Fins:** 6 3/8 (161.9)  
**I.D.:** 21/32 (16.7) & 2 5/8 (66.7)  
**Height:** 8 15/32 (215.1)  
**A. Gskt:** [1] Attached  
**F. Gskt:** [1] Included

**PA2865**

Air Element with Lid



**Fits:** R.V.I. Trucks  
**Replaces:** Renault 5000809894  
**O.D.:** 9 3/16 (233.4)  
**Lid:** 10 5/32 (258.0)  
**I.D.:** 4 3/32 (104.0) One End  
**Height:** 11 11/16 (296.9)  
**A. Gskt:** [2] Attached

**PA2861**

Inner Air Element



**Fits Inside:** LL1690-FN, PA1690-FN  
**Fits:** Hitachi, John Deere, Kubota, Yanmar Equipment  
**Replaces:** John Deere CH12881; Kubota 15287-11490  
**O.D.:** 2 7/16 (61.9)  
**I.D.:** 21/32 (16.7) & 1 15/16 (49.2)  
**Height:** 9 1/8 (231.8)  
**A. Gskt:** [1] Attached  
**F. Gskt:** G103-N

**PA2866**

Air Element



**Fits:** Hanomag, John Deere, Steyr-Daimler-Puch, Zettelmeyer Equipment; M.A.N. Trucks  
**Replaces:** Deutz 2241034; M.A.N. 81.08304.0028; Zettelmeyer 2121270  
**O.D.:** 7 25/32 (197.6)  
**Flange:** 9 3/4 (247.7)  
**I.D.:** 11/32 (8.7) & 4 1/16 (103.2)  
**Height:** 14 13/16 (376.2)  
**A. Gskt:** [1] Attached

**PA2862**

Air Element



**Fits:** Guldner Lift Trucks  
**Use With:** PA2862 FOAM  
**Replaces:** Guldner 9830715  
**O.D.:** 3 7/8 (98.4)  
**I.D.:** 2 3/8 (60.3)  
**Height:** 2 3/4 (69.9)

**PA2867-FN**

Outer Air Element with Fins



**Replaces:** Donaldson P900509  
**O.D.:** 13 7/8 (352.4)  
**Fins:** 15 25/32 (400.8)  
**I.D.:** 5/8 (15.9) & 9 1/2 (241.3)  
**Height:** 14 11/16 (373.1)  
**A. Gskt:** [1] Attached  
**F. Gskt:** [1] Included

**PA2862 FOAM**

Foam Blanket for PA2862



**Use With:** PA2862  
**O.D.:** 3 7/8 (98.4)  
**I.D.:** 3 11/16 (93.7)  
**Height:** 2 3/4 (69.9)

**PA2869**

Air Element



**Fits:** Volvo Buses, Trucks  
**Replaces:** Volvo 347436  
**O.D.:** 8 17/32 (216.7)  
**I.D.:** 11/32 (8.7) & 6 1/32 (153.2)  
**Height:** 10 11/32 (262.7)  
**A. Gskt:** [1] Attached

**RS2863**

Radial Seal Outer Air Element



**Fits:** Caterpillar, Cummins Engines; Ford, Freightliner, GMC, Hino, IHC, Kenworth, Ottawa, Peterbilt, Sterling Trucks; John Deere Tractors; Massey Ferguson Combines  
**Use With:** RS3501  
**Replaces:** Ford F3HZ-9601-A; GMC 15619013; John Deere RE34962  
**O.D.:** 9 9/32 (235.7)  
**I.D.:** 5 5/32 (131.0) One End  
**Height:** 12 3/4 (323.9)  
**Related To:** RS2863XP (Extreme Performance Nano Version)

**PA2870-FN**













Air Element with Fins



**Fits:** Air Refiner Housings; Ford Trucks  
**Replaces:** Air Refiner ARM90-0408  
**O.D.:** 11 1/8 (282.6)  
**Fins:** 13 13/16 (350.8)  
**I.D.:** 7/8 (22.2) & 6 23/32 (170.7)  
**Height:** 13 1/2 (342.9)  
**A. Gskt:** [1] Attached  
**F. Gskt:** [1] Included

Measurements Are Shown In Inches And (Millimeters)

**WARNING:** These products can expose you to chemicals, including Diisononyl Phthalate, Carbon black extracts, Nickel, 1,3 Butadiene, Ethylene Oxide, Epichlorohydrin, which are known to the State of California to cause cancer, and Bisphenol, Ethylene Glycol, Ethylene Oxide, 1,3 Butadiene, Epichlorohydrin, which are known to the State of California to cause birth defects or other reproductive harm.

<p><b>PA2871</b></p> 	<p>Air Element  <b>Fits:</b> Air Refiner Housings; Ford Trucks  <b>Replaces:</b> Air Refiner ARM90-0405  <b>O.D.:</b> 6 3/8 (161.9)            Flange 7 1/2 (190.5)  <b>I.D.:</b> 5/8 (15.9) &amp; 5 1/4 (133.4)  <b>Height:</b> 13 (330.2)  <b>A. Gskt:</b> [1] Attached  <b>F. Gskt:</b> [1] Included</p>	<p><b>PA2880</b></p> 	<p>Air Element  <b>Fits:</b> Hino Trucks  <b>Replaces:</b> Hino 17801-2200  <b>O.D.:</b> 8 1/2 (215.9)  <b>I.D.:</b> 7/8 (22.2) &amp; 5 3/8 (136.5)  <b>Height:</b> 12 7/8 (327.0)  <b>A. Gskt:</b> [1] Attached  <b>F. Gskt:</b> [1] Included</p>
<p><b>PA2874</b></p> 	<p>Replacement for Ecolite Air Element in Disposable Housing  <b>Contains:</b> Bleed Valve  <b>Fits:</b> Farr ECO-CM Housings; Freightliner Trucks  <b>Replaces:</b> Farr C78105-000  <b>O.D.:</b> 11 (279.4)  <b>Inlet:</b> 8  <b>Outlet:</b> 6  <b>Height:</b> 25 13/32 (645.3)</p>	<p><b>PA2881</b></p> 	<p>Oblong Air Element  <b>Replaces:</b> Nissan 16546-06J00  <b>O.D.:</b> 8 (203.2)            to 14 9/16 (369.9)  <b>I.D.:</b> 5 9/32 (134.1) &amp; 11 13/16 (300.0)  <b>Height:</b> 2 7/8 (73.0)</p>
<p><b>PA2875</b></p> 	<p>Replacement for Ecolite Air Element in Disposable Housing  <b>Fits:</b> Farr Optional Filter Housings  <b>Replaces:</b> Farr C71338-004  <b>O.D.:</b> 13 17/32 (343.7)  <b>Inlet:</b> 10 23/32  <b>Outlet:</b> 7  <b>Height:</b> 19 13/16 (503.2)</p>	<p><b>PA2883</b></p> 	<p>Inner Air Element  <b>Fits Inside:</b> PA3786-FN  <b>Fits:</b> Ford Trucks  <b>Replaces:</b> GMC 25095991  <b>O.D.:</b> 8 1/2 (215.9)  <b>I.D.:</b> 21/32 (16.7) &amp; 6 7/32 (158.0)  <b>Height:</b> 15 25/32 (400.8)  <b>A. Gskt:</b> [1] Attached  <b>F. Gskt:</b> [1] Included</p>
<p><b>PA2876</b></p> 	<p>Replacement for Ecolite Air Element in Disposable Housing  <b>Fits:</b> Farr Optional Filter Housings  <b>Replaces:</b> Farr C71338-001  <b>O.D.:</b> 9 3/4 (247.7)  <b>Inlet:</b> 10 23/32  <b>Outlet:</b> 6  <b>Height:</b> 25 7/8 (657.2)</p>	<p><b>PA2884</b></p> 	<p>Air Element  <b>Fits:</b> Isuzu Trucks  <b>Replaces:</b> Isuzu 8-94334-906-0  <b>O.D.:</b> 6 1/16 (154.0)  <b>I.D.:</b> 3 7/8 (98.4) &amp; 4 (101.6)  <b>Height:</b> 6 3/8 (161.9)  <b>A. Gskt:</b> [1] Attached</p>
<p><b>PA2877-FN</b></p> 	<p>Air Element with Fins  <b>Replaces:</b> Isuzu 1-14215-196-0  <b>O.D.:</b> 6 1/16 (154.0)            Fins 7 13/16 (198.4)  <b>I.D.:</b> 1/2 (12.7) &amp; 3 15/32 (88.1)  <b>Height:</b> 12 3/8 (314.3)  <b>A. Gskt:</b> [1] Attached  <b>F. Gskt:</b> [1] Included</p>	<p><b>PA2885</b></p> 	<p>Air Element  <b>Replaces:</b> Nissan 16546-06J11  <b>O.D.:</b> 6 3/32 (154.8)  <b>I.D.:</b> 3 15/32 (88.1)  <b>Height:</b> 6 1/8 (155.6)  <b>A. Gskt:</b> [2] Attached</p>
<p><b>PA2878</b></p> 	<p>Air Element  <b>Replaces:</b> Ford 81DB-9601-DB; GMC 93152751  <b>O.D.:</b> 12 5/8 (320.7)  <b>I.D.:</b> 8 17/32 (216.7)  <b>Height:</b> 4 5/16 (109.5)</p>	<p><b>PA2887-FN</b></p> 	<p>Outer Air Element with Fins  <b>Replaces:</b> International 3244397-R1  <b>O.D.:</b> 7 31/32 (202.4)            Fins 9 29/32 (251.6)  <b>I.D.:</b> 11/16 (17.5) &amp; 5 3/8 (136.5)  <b>Height:</b> 15 1/2 (393.7)  <b>A. Gskt:</b> [1] Attached  <b>F. Gskt:</b> [1] Included</p>

Measurements Are Shown In Inches And (Millimeters)

**WARNING:** These products can expose you to chemicals, including Diisononyl Phthalate, Carbon black extracts, Nickel, 1,3 Butadiene, Ethylene Oxide, Epichlorohydrin, which are known to the State of California to cause cancer, and Bisphenol, Ethylene Glycol, Ethylene Oxide, 1,3 Butadiene, Epichlorohydrin, which are known to the State of California to cause birth defects or other reproductive harm.

**PA2888**

Air Element



**Fits:** Mercedes-Benz Trucks, Vans  
**Replaces:** Mercedes-Benz 20947004  
**O.D.:** 5 29/32 (150.0)  
**I.D.:** 7/16 (11.1) & 2 25/32 (70.6)  
**Height:** 12 (304.8)  
**A. Gskt:** [2] Attached

**PA2897**

Outer Air Element with 2 Lift Bars



**Use With:** PA2896  
**Replaces:** Ryco HDA5495  
**O.D.:** 8 13/32 (213.5)  
**I.D.:** 21/32 (16.7) & 5 25/32 (146.8)  
**Height:** 12 3/8 (314.3)  
**A. Gskt:** [1] Attached  
**F. Gskt:** [1] Included

**PA2889**

Inner Air Element



**Fits Inside:** PA2890  
**Fits:** Massey Ferguson Wheel Tractors  
**Replaces:** Massey Ferguson 1886638-M91  
**O.D.:** 2 23/32 (69.1)  
**I.D.:** 19/32 (15.1) & 1 31/32 (50.0)  
**Height:** 8 (203.2)  
**F. Gskt:** [1] Included

**PA2899**

Air Element



**Notes:** OBSOLETE. Availability Limited to Dealer Stock.  
**Replaces:** Air Refiner ARM90-0442  
**O.D.:** 6 3/8 (161.9)  
Flange Gasket 7 1/2 (190.5)  
**I.D.:** 5/8 (15.9) & 5 1/4 (133.4)  
**Height:** 18 (457.2)  
**A. Gskt:** [1] Attached  
**F. Gskt:** [1] Included

**PA2890**

Outer Air Element with Pull Tab



**Fits:** Massey Ferguson Wheel Tractors  
**Use With:** PA2889  
**Replaces:** Massey Ferguson 1886637-M91  
**O.D.:** 4 19/32 (116.7)  
**I.D.:** 21/32 (16.7) & 2 15/32 (62.7)  
**Height:** 9 11/32 (237.3)  
**A. Gskt:** [1] Attached  
**F. Gskt:** [1] Washer

**PA2900**

Air Element



**Replaces:** Heavy Duty Air A02028  
**O.D.:** 11 7/8 (301.6)  
**I.D.:** 17/32 (13.5) & 7 1/8 (181.0)  
**Height:** 26 1/2 (673.1)  
**A. Gskt:** [1] Attached

**PA2891**

Air Element



**Fits:** Iveco Buses, Trucks  
**Replaces:** Iveco 1902128, 3168629  
**O.D.:** 8 15/16 (227.0)  
**I.D.:** 7/16 (11.1) & 4 19/32 (116.7)  
**Height:** 11 5/8 (295.3)  
**A. Gskt:** [1] Attached  
**F. Gskt:** [1] Washer

**PA2902**

Outer Air Element



**Fits:** Caterpillar, Hitachi, John Deere, Kawasaki, Komatsu Equipment  
**Use With:** PA2903  
**Replaces:** Caterpillar 7Y1196; Hitachi 4240294; Kawasaki 3098170130; Komatsu 5610-21-2330  
**O.D.:** 12 1/8 (308.0)  
**I.D.:** 29/32 (23.0) & 7 11/16 (195.3)  
**Height:** 24 1/2 (622.3)  
**A. Gskt:** [1] Attached  
**F. Gskt:** [1] Included

**PA2895**

Air Element



**Replaces:** Mazda SLA2-13-Z40A  
**O.D.:** 7 15/16 (201.6)  
**I.D.:** 29/32 (23.0) & 4 31/32 (126.2)  
**Height:** 8 15/32 (215.1)  
**A. Gskt:** [1] Attached  
**F. Gskt:** [1] Included

**PA2903**

Inner Air Element



**Fits Inside:** PA2902  
**Fits:** Caterpillar, Hitachi, John Deere, Kawasaki, Komatsu Equipment  
**Replaces:** Caterpillar 7Y1197; Hitachi 4240295; Kawasaki 3098170140; Komatsu 5610-21-2320  
**O.D.:** 7 1/4 (184.2)  
**I.D.:** 11/16 (17.5) & 6 3/16 (157.2)  
**Height:** 23 1/2 (596.9)  
**A. Gskt:** [1] Attached  
**F. Gskt:** G103-N

**PA2896**

Inner Air Element



**Fits Inside:** PA2897  
**Replaces:** Donaldson P128486  
**O.D.:** 4 19/32 (116.7)  
**I.D.:** 21/32 (16.7) & 3 11/32 (84.9)  
**Height:** 10 3/4 (273.1)  
**A. Gskt:** [1] Attached  
**F. Gskt:** [1] Included

**PA2904**











Air Element



**Replaces:** Isuzu 8-94135-886-0; Nissan 16546-T3400  
**O.D.:** 6 3/32 (154.8)  
**I.D.:** 1/2 (12.7) & 3 15/32 (88.1)  
**Height:** 7 7/8 (200.0)  
**A. Gskt:** [1] Attached  
**F. Gskt:** [1] Included

Measurements Are Shown In Inches And (Millimeters)

**WARNING:** These products can expose you to chemicals, including Diisononyl Phthalate, Carbon black extracts, Nickel, 1,3 Butadiene, Ethylene Oxide, Epichlorohydrin, which are known to the State of California to cause cancer, and Bisphenol, Ethylene Glycol, Ethylene Oxide, 1,3 Butadiene, Epichlorohydrin, which are known to the State of California to cause birth defects or other reproductive harm.

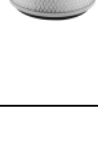
<p><b>PA2905</b></p> 	<p>Air Element with Lid  <b>Replaces:</b> Fendt F135201090020; Volvo 4541565  <b>O.D.:</b> 5 (127.0)            Lid 6 7/32 (158.0)  <b>I.D.:</b> 11/32 (8.7) &amp; 2 17/32 (64.3)  <b>Height:</b> 11 17/32 (292.9)  <b>A. Gskt:</b> [1] Attached  <b>End Seals:</b> [1] Attached</p>	<p><b>PA2915</b></p> 	<p>Air Element  <b>Fits:</b> Volvo Trucks  <b>Replaces:</b> Volvo 1660377, 16618084  <b>O.D.:</b> 6 7/8 (174.6)  <b>I.D.:</b> 13/32 (10.3) &amp; 5 7/16 (138.1)  <b>Height:</b> 21 19/32 (548.5)  <b>A. Gskt:</b> [1] Attached</p>
<p><b>PA2906</b></p> 	<p>Air Element  <b>Replaces:</b> Mann &amp; Hummel C15124/1  <b>O.D.:</b> 6 1/16 (154.0)  <b>I.D.:</b> 3 1/2 (88.9)  <b>Height:</b> 9 1/32 (229.4)</p>	<p><b>PA2932</b></p> 	<p>Air Element  <b>Fits:</b> Industrial Applications  <b>Replaces:</b> Heavy Duty Air A02067  <b>O.D.:</b> 6 27/32 (173.8)  <b>I.D.:</b> 7/16 (11.1) &amp; 4 3/16 (106.4)  <b>Height:</b> 9 (228.6)  <b>F. Gskt:</b> [1] Included</p>
<p><b>PA2909</b></p> 	<p>Air Element with Lift Bars  <b>Replaces:</b> Air Refiner ARM12-8487  <b>O.D.:</b> 8 1/4 (209.6)  <b>I.D.:</b> 5/8 (15.9) &amp; 5 3/4 (146.0)  <b>Height:</b> 10 1/2 (266.7)  <b>A. Gskt:</b> [1] Attached  <b>F. Gskt:</b> [1] Included</p>	<p><b>PA2933</b></p> 	<p>Air Element  <b>Fits:</b> Mining Drills  <b>Replaces:</b> Heavy Duty Air A100195-192  <b>O.D.:</b> 1 31/32 (50.0)  <b>I.D.:</b> 1 1/8 (28.6)  <b>Height:</b> 1 13/16 (46.0)</p>
<p><b>PA2912</b></p> 	<p>Air Element  <b>Replaces:</b> Knecht AG300  <b>O.D.:</b> 5 3/16 (131.8)  <b>I.D.:</b> 1/2 (12.7) &amp; 2 5/8 (66.7)  <b>Height:</b> 6 25/32 (172.2)  <b>A. Gskt:</b> [1] Attached  <b>F. Gskt:</b> [1] Included</p>	<p><b>PA2935</b></p> 	<p>Panel Air Element  <b>Notes:</b> OBSOLETE. Availability Limited to Dealer Stock.  <b>Fits:</b> Industrial Applications  <b>Replaces:</b> Heavy Duty Air A6083  <b>Length:</b> 26 (660.4)  <b>Width:</b> 11 (279.4)  <b>Height:</b> 2 3/16 (55.6)</p>
<p><b>PA2913</b></p> 	<p>Air Element  <b>Replaces:</b> Isuzu 8-94107-690  <b>O.D.:</b> 6 3/32 (154.8)  <b>I.D.:</b> 1/2 (12.7) &amp; 3 15/32 (88.1)  <b>Height:</b> 9 19/32 (243.7)  <b>A. Gskt:</b> [1] Attached  <b>F. Gskt:</b> [1] Included</p>	<p><b>PA2936</b></p> 	<p>Panel Air Element  <b>Fits:</b> Industrial Applications  <b>Replaces:</b> Heavy Duty Air A7523  <b>Length:</b> 15 (381.0)  <b>Width:</b> 7 (177.8)  <b>Height:</b> 2 3/16 (55.6)</p>
<p><b>PA2914</b></p> 	<p>Air Element  <b>Fits:</b> Volvo Trucks  <b>Replaces:</b> Volvo 1660376  <b>O.D.:</b> 10 5/8 (269.9)  <b>I.D.:</b> 13/32 (10.3) &amp; 7 1/4 (184.2)  <b>Height:</b> 22 27/32 (580.2)  <b>A. Gskt:</b> [2] Attached</p>	<p><b>PA2938</b></p> 	<p>Air Element  <b>Fits:</b> Industrial Applications  <b>Replaces:</b> Heavy Duty Air A3347  <b>O.D.:</b> 8 1/32 (204.0)  <b>I.D.:</b> 6 1/16 (154.0)  <b>Height:</b> 12 (304.8)  <b>A. Gskt:</b> [2] Attached</p>

Measurements Are Shown In Inches And (Millimeters)

**WARNING:** These products can expose you to chemicals, including Diisononyl Phthalate, Carbon black extracts, Nickel, 1,3 Butadiene, Ethylene Oxide, Epichlorohydrin, which are known to the State of California to cause cancer, and Bisphenol, Ethylene Glycol, Ethylene Oxide, 1,3 Butadiene, Epichlorohydrin, which are known to the State of California to cause birth defects or other reproductive harm.



**PA2942** Outer Air Element  
**Fits:** Mercedes-Benz Trucks, Vans  
**Replaces:** Mercedes-Benz 30944204  
**O.D.:** 12 3/4 (323.8)  
**I.D.:** 7/16 (11.1) & 6 5/16 (160.3)  
**Height:** 10 1/16 (255.6)  
**A. Gskt:** [1] Attached  
**F. Gskt:** [1] Included



**PA2948** Air Element  
**Replaces:** Hino 17801-2440  
**O.D.:** 7 1/2 (190.5)  
**I.D.:** 4 1/8 (104.8)  
**Height:** 11 13/32 (289.7)  
**A. Gskt:** [1] Attached  
**F. Gskt:** [1] Included



**PA2944-FN** Air Element with Fins  
**Fits:** Ford, New Holland Equipment  
**Replaces:** Ford E9NN-9601-EA, SBA314531126  
**O.D.:** 4 3/32 (104.0)  
 Fins 5 1/8 (130.2)  
**I.D.:** 13/32 (10.3) & 2 15/32 (62.7)  
**Height:** 10 5/16 (261.9)  
**A. Gskt:** [1] Attached  
**F. Gskt:** [1] Included



**PA2949-FN** Air Element with Fins  
**Contains:** Flame Retardant Media  
**Fits:** Nissan Lift Trucks  
**Replaces:** Nissan 16546-51H10B  
**O.D.:** 5 1/4 (133.4)  
 Fins 6 3/8 (161.9)  
**I.D.:** 21/32 (16.7) & 2 27/32 (72.2)  
**Height:** 9 1/2 (241.3)  
**A. Gskt:** [1] Attached  
**F. Gskt:** [1] Included



**LL2945** Long Life Outer Air Element  
**Fits:** John Deere, Tamrock Equipment; R.V.I.,  
 Volvo Buses, Trucks  
**Replaces:** John Deere AZ39761; Renault  
 5000953712  
**O.D.:** 12 1/32 (305.6)  
**I.D.:** 5/8 (15.9) & 7 11/16 (195.3)  
**Height:** 16 11/16 (423.9)  
**A. Gskt:** [1] Attached  
**F. Gskt:** G103-N  
**Related To:** PA2945 (Standard Media Version)



**PA2950** Air Element  
**Replaces:** Air Refiner ARM913  
**O.D.:** 9 7/32 (234.2)  
**I.D.:** 29/32 (23.0) & 4 27/32 (123.0)  
**Height:** 13 15/32 (342.1)  
**A. Gskt:** [1] Attached  
**F. Gskt:** [1] Included



**PA2945** Outer Air Element  
**Fits:** John Deere, Tamrock Equipment; R.V.I.,  
 Volvo Buses, Trucks  
**Replaces:** John Deere AZ39761; Renault  
 5000953712  
**O.D.:** 12 1/32 (305.6)  
**I.D.:** 5/8 (15.9) & 7 11/16 (195.3)  
**Height:** 16 11/16 (423.9)  
**A. Gskt:** [1] Attached  
**F. Gskt:** G103-N  
**Related To:** LL2945 (Long-Life Media Version)



**PA2951** Air Element  
**Replaces:** Air Refiner ARM13-7982  
**O.D.:** 11 1/8 (282.6)  
**I.D.:** 7/8 (22.2) & 6 23/32 (170.7)  
**Height:** 16 1/2 (419.1)  
**A. Gskt:** [1] Attached  
**F. Gskt:** [1] Included



**PA2946** Air Element  
**O.D.:** 6 5/8 (168.3)  
**I.D.:** 3/8 (9.5) & 4 1/4 (108.0)  
**Height:** 15 17/32 (394.5)  
**A. Gskt:** [1] Attached  
**F. Gskt:** [1] Included



**PA2952** Air Element  
**Replaces:** Air Refiner ARM13-7981  
**O.D.:** 12 3/32 (307.2)  
**I.D.:** 7/8 (22.2) & 7 11/16 (195.3)  
**Height:** 18 1/2 (469.9)  
**A. Gskt:** [1] Attached  
**F. Gskt:** [1] Included



**PA2947** Panel Air Element  
**Fits:** American Lincoln Floor Cleaning  
 Equipment  
**Replaces:** American Lincoln 82404070  
**Length:** 24 (609.6)  
**Width:** 19 11/16 (500.1)  
**Height:** 2 9/16 (65.1)  
**A. Gskt:** [1] Attached

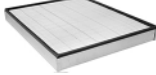

**PA2953** Air Element  
**Replaces:** Air Refiner ARM14-0925  
**O.D.:** 9 7/32 (234.2)  
**I.D.:** 29/32 (23.0) & 4 27/32 (123.0)  
**Height:** 15 3/8 (390.5)  
**A. Gskt:** [1] Attached  
**F. Gskt:** [1] Included



Measurements Are Shown In Inches And (Millimeters)

**WARNING:** These products can expose you to chemicals, including Diisononyl Phthalate, Carbon black extracts, Nickel, 1,3 Butadiene, Ethylene Oxide, Epichlorohydrin, which are known to the State of California to cause cancer, and Bisphenol, Ethylene Glycol, Ethylene Oxide, 1,3 Butadiene, Epichlorohydrin, which are known to the State of California to cause birth defects or other reproductive harm.

**PA2954-FN**

Outer Air Element with Fins



**Replaces:** Air Refiner ARM12-7172  
**O.D.:** 7 15/16 (201.6)  
 Fins 9 13/16 (249.2)  
**I.D.:** 11/16 (17.5) & 3 9/16 (90.5)  
**Height:** 10 3/8 (263.5)  
**A. Gskt:** [1] Attached  
**F. Gskt:** G103-N

**PA2960**

Inner Air Element



**Fits Inside:** PA2959-FN  
**Fits:** Ford Buses, Trucks  
**Replaces:** Air Refiner ARM90-0024; Motorcraft AFA94  
**O.D.:** 8 1/4 (209.6)  
**I.D.:** 21/32 (16.7) & 7 1/8 (181.0)  
**Height:** 14 3/8 (365.1)  
**A. Gskt:** [1] Attached  
**F. Gskt:** G103-N

**PA2955**

Air Element with Lid



**Fits:** Mercedes-Benz Trucks, Vans  
**Replaces:** Mercedes-Benz 29042404  
**O.D.:** 12 7/8 (327.0)  
 Lid 15 1/4 (387.3)  
**I.D.:** 13/32 (10.3) & 6 9/16 (166.7)  
**Height:** 14 1/32 (356.4)  
**A. Gskt:** [2] Attached

**PA2961-FN**

Outer Air Element with Fins



**Fits:** Hino Buses, Trucks  
**Replaces:** Hino 17801-1580, 17801-1720  
**O.D.:** 7 15/16 (201.6)  
 Fins 9 31/32 (253.2)  
**I.D.:** 1/2 (12.7) & 3 13/16 (96.8)  
**Height:** 11 7/8 (301.6)  
**A. Gskt:** [1] Attached  
**F. Gskt:** [1] Included

**PA2956-FN**

Outer Air Element with Fins



**Fits:** Ford Trucks  
**Use With:** PA2957  
**Replaces:** Donaldson P900471; Motorcraft AFA106  
**O.D.:** 13 13/16 (350.8)  
 Fins 15 25/32 (400.8)  
**I.D.:** 29/32 (23.0) & 9 1/2 (241.3)  
**Height:** 18 13/32 (467.5)  
**A. Gskt:** [1] Attached  
**F. Gskt:** [1] Included

**PA2962**

Air Element



**Replaces:** Air Refiner ARM90-0556; Donaldson P900556  
**O.D.:** 12 3/32 (307.2)  
**I.D.:** 7/8 (22.2) & 7 23/32 (196.1)  
**Height:** 23 1/2 (596.9)  
**A. Gskt:** [1] Attached  
**F. Gskt:** [1] Included

**PA2957**

Inner Air Element



**Fits Inside:** PA2956-FN  
**Fits:** Ford Trucks  
**Replaces:** Donaldson P900472; Motorcraft AFA107  
**O.D.:** 8 1/4 (209.6)  
**I.D.:** 21/32 (16.7) & 7 1/8 (181.0)  
**Height:** 17 1/8 (435.0)  
**A. Gskt:** [1] Attached  
**F. Gskt:** G103-N

**PA2963**

Air Element



**Fits:** Volvo Trucks  
**Replaces:** Volvo 6897063  
**O.D.:** 10 5/8 (269.9)  
**I.D.:** 21/32 (16.7) & 7 1/4 (184.2)  
**Height:** 22 13/16 (579.4)  
**A. Gskt:** [1] Attached  
**F. Gskt:** G103-N

**PA2958**

Air Element



**Fits:** Bedford Buses, Trucks  
**Replaces:** GMC 7964609  
**O.D.:** 8 5/16 (211.1)  
**I.D.:** 6 1/32 (153.2)  
**Height:** 8 1/32 (204.0)  
**A. Gskt:** [1] Attached

**PA2964**

Air Element



**Fits:** Volvo Trucks  
**Replaces:** Volvo 6897064  
**O.D.:** 7 1/8 (181.0)  
**I.D.:** 21/32 (16.7) & 5 1/2 (139.7)  
**Height:** 21 9/16 (547.7)  
**A. Gskt:** [1] Attached  
**F. Gskt:** [1] Included

**PA2959-FN**

Outer Air Element with Fins



**Fits:** Ford Buses, Trucks  
**Use With:** PA2960  
**Replaces:** Air Refiner ARM90-0023; Motorcraft AFA93  
**O.D.:** 13 7/8 (352.4)  
 Fins 15 25/32 (400.8)  
**I.D.:** 29/32 (23.0) & 9 1/2 (241.3)  
**Height:** 15 1/2 (393.7)  
**A. Gskt:** [1] Attached  
**F. Gskt:** [1] Included

**PA2967**

Air Element



**Replaces:** Air Refiner ARM13-8789; Donaldson P138789  
**O.D.:** 7 1/4 (184.2)  
**I.D.:** 21/32 (16.7) & 6 3/16 (157.2)  
**Height:** 16 1/2 (419.1)  
**A. Gskt:** [1] Attached  
**F. Gskt:** [1] Included

Measurements Are Shown In Inches And (Millimeters)

**WARNING:** These products can expose you to chemicals, including Diisononyl Phthalate, Carbon black extracts, Nickel, 1,3 Butadiene, Ethylene Oxide, Epichlorohydrin, which are known to the State of California to cause cancer, and Bisphenol, Ethylene Glycol, Ethylene Oxide, 1,3 Butadiene, Epichlorohydrin, which are known to the State of California to cause birth defects or other reproductive harm.

**PA2968-FN** Air Element with Fins and Lid  
**Fits:** J.C. Bamford Equipment  
**Replaces:** J.C. Bamford 32/906801  
**O.D.:** 6 25/32 (172.2)  
 Lid 8 3/8 (212.7)  
**I.D.:** 5/8 (15.9) & 3 15/32 (88.1)  
**Height:** 11 1/2 (292.1)  
**A. Gskt:** [1] Attached, [1] Wing Nut



**PA2978** Air Element  
**Fits:** Benford Construction Equipment  
**Replaces:** Gardner L22045  
**O.D.:** 5 1/2 (139.7)  
**I.D.:** 3 1/8 (79.4)  
**Height:** 4 27/32 (123.0)



**PA2970** Outer Air Element with Lid  
**Fits:** J.C. Bamford Equipment  
**Use With:** PA2689  
**Replaces:** J.C. Bamford 32/903201  
**O.D.:** 6 15/16 (176.2)  
 Lid 8 3/8 (212.7)  
**I.D.:** 5/8 (15.9) & 3 7/16 (87.3)  
**Height:** 11 9/16 (293.7)  
**A. Gskt:** [1] Attached  
**F. Gskt:** [1] Wing Nut



**PA2980** Set of 2 Air Elements  
**Contains:** Outer and Inner Elements  
**Replaces:** Ford 2708E-9601-A  
**Outer**  
**O.D.:** 11 31/32 (304.0)  
**I.D.:** 8 17/32 (216.7)  
**Height:** 3 7/32 (81.8)  
**Inner**  
**O.D.:** 6 21/32 (169.1)  
**I.D.:** 3 3/16 (81.0)  
**Height:** 3 7/16 (87.3)



**PA2971** Air Element  
**Replaces:** Leyland ACU8498  
**O.D.:** 9 5/32 (232.6)  
**I.D.:** 5/8 (15.9) & 4 7/8 (123.8)  
**Height:** 15 15/32 (392.9)  
**F. Gskt:** [1] Included, [1] Metal Washer



**PA2981** Air Element  
**Notes:** OBSOLETE. Availability Limited to Dealer Stock.  
**Contains:** [1] Dust Ejector Valve  
 [1] Clamp  
**Fits:** Scania Trucks  
**Replaces:** Saab-Scania 370750  
**O.D.:** 9 17/32 (242.1)  
 Lid 12 5/32 (308.8)  
**I.D.:** 13/32 (10.3) & 5 3/16 (131.8)  
**Height:** 20 9/16 (522.3)  
**A. Gskt:** [1] Attached



**PA2973** Air Element  
**Fits:** Torit Air Cleaning Systems  
**Replaces:** Torit 8PP22343-00  
**O.D.:** 12 3/4 (323.8)  
**I.D.:** 8 11/32 (211.9)  
**Height:** 26 1/2 (673.1)  
**A. Gskt:** [1] Attached



**PA2982** Air Element with 4 Bolt Holes in Flange  
**Fits:** Volvo Trucks  
**Replaces:** Volvo 1665563  
**O.D.:** 10 5/32 (258.0)  
 Flange 10 15/16 (277.8)  
**I.D.:** 6 9/32 (159.5) One End  
**Height:** 21 17/32 (546.9)  
**A. Gskt:** [1] Attached



**PA2976-FN** Outer Air Element with Fins and Lid  
**Fits:** Fiat-Allis, Massey Ferguson Equipment;  
 Lister Engines  
**Use With:** PA2700  
**Replaces:** Fiat 79062702; Lister 36607282;  
 Massey Ferguson 3310358-M1  
**O.D.:** 6 13/32 (162.7)  
 Lid 6 25/32 (172.2)  
**I.D.:** 5/8 (15.9) & 2 3/4 (69.9)  
**Height:** 12 (304.8)  
**A. Gskt:** [1] Attached, [1] Wing Nut



**PA2984** Air Element  
**Fits:** Ford Trucks  
**Replaces:** Ford 87HX-9601-AA  
**O.D.:** 9 9/16 (242.9)  
**I.D.:** 7 1/4 (184.2)  
**Height:** 3 3/4 (95.3)



**PA2977-FN** Outer Air Element with Fins and Lid  
**Fits:** J.C. Bamford Equipment  
**Use With:** PA2419  
**Replaces:** J.C. Bamford 32/903601  
**O.D.:** 6 3/32 (154.8)  
 Lid 8 3/8 (212.7)  
**I.D.:** 21/32 (16.7) & 3 15/32 (88.1)  
**Height:** 15 1/2 (393.7)  
**I.Gskt:** [1] Included  
**A. Gskt:** [1] Attached  
**F. Gskt:** [1] Wing Nut



**PA2988** Air Element  
**Fits:** Industrial Dust Collectors  
**Replaces:** Farr C72518-001; Torit 8PP32582-00  
**O.D.:** 12 3/4 (323.8)  
 Flange 15 31/32 x 14 1/4 (405.6 x 362.0)  
**I.D.:** 8 5/16 (211.1) One End  
**Height:** 26 5/8 (676.3)  
**A. Gskt:** [1] Attached  
**Related To:** PA3580 (with Flame Retardant Media)



Measurements Are Shown In Inches And (Millimeters)

**WARNING:** These products can expose you to chemicals, including Diisononyl Phthalate, Carbon black extracts, Nickel, 1,3 Butadiene, Ethylene Oxide, Epichlorohydrin, which are known to the State of California to cause cancer, and Bisphenol, Ethylene Glycol, Ethylene Oxide, 1,3 Butadiene, Epichlorohydrin, which are known to the State of California to cause birth defects or other reproductive harm.

**PA2989**

Air Element



**Fits:** Industrial Dust Collectors  
**Replaces:** Endustra 51013; Farr 84378; TDC 10000156  
**O.D.:** 12 3/4 (323.8)  
**Flange:** 15 31/32 x 14 7/32 (405.6 x 361.2)  
**I.D.:** 8 5/16 (211.1) One End  
**Height:** 22 5/8 (574.7)  
**A. Gskt:** [1] Attached

**HSG3077**

Housing and Radial Seal Air Element



**Notes:** May use AB3349 Mounting Band.  
**Contains:** RS3715 Radial Seal Air Element  
 Dump Valve  
**Housing**  
**O.D.:** 5 17/32 (140.5)  
**Inlet:** 1 3/4  
**Outlet:** 1 7/8  
**Height:** 10 11/16 (271.5)  
**RS3715**  
**O.D.** 3 17/32 (89.7)  
**I.D.** 1 3/4 (44.5)  
**Height** 7 (177.8)  
**Related To:** HSG3078 (Vertical Outlet)

**HSG3078**

Housing and Radial Seal Air Element



**Notes:** May use AB3349 Mounting Band.  
**Contains:** RS3715 Radial Seal Air Element  
 Dump Valve  
**Housing**  
**O.D.:** 5 17/32 (140.5)  
**Inlet:** 1 3/4  
**Outlet:** 1 7/8  
**Height:** 10 11/16 (271.5)  
**RS3715**  
**O.D.** 3 17/32 (89.7)  
**I.D.** 1 3/4 (44.5)  
**Height** 7 (177.8)  
**Related To:** HSG3077 (Horizontal Outlet)

**HSG3079**

Housing and Radial Seal Air Element



**Notes:** OBSOLETE. Availability Limited to Dealer Stock.  
**Contains:** RS3988 Radial Seal Element  
 Indicator Port  
 Mounting Band  
 Dump Valve  
**Housing**  
**O.D.:** 5 17/32 (140.5)  
**Inlet:** 2 1/2  
**Outlet:** 2 19/32  
**Height:** 15 3/4 (400.0)  
**RS3988**  
**O.D.** 5 1/32 (127.8)  
**I.D.** 3 5/32 (80.2)  
**Height** 12 5/16 (312.7)  
**Related To:** HSG3080 (Vertical Outlet)

**HSG3080**

Housing and Radial Seal Air Element



**Notes:** OBSOLETE. Availability Limited to Dealer Stock.  
**Contains:** RS3988 Radial Seal Element  
 Indicator Port  
 Mounting Band  
 Dump Valve  
**Housing**  
**O.D.:** 5 17/32 (140.5)  
**Inlet:** 2 1/2  
**Outlet:** 2 19/32  
**Height:** 15 3/4 (400.0)  
**RS3988**  
**O.D.** 5 1/32 (127.8)  
**I.D.** 3 5/32 (80.2)  
**Height** 12 5/16 (312.7)  
**Related To:** HSG3079 (Horizontal Outlet)

**AB3349**

Mounting Band



**Contains:** [1] Mounting Band  
 [1] Bolt  
 [1] Nut  
 [1] Spring  
 [1] Washer  
**Use With:** HSG3077, HSG3078

**PA3404**

Air Element



**Fits:** Torit ECB Housings  
**Replaces:** Torit 8PP21028-00  
**O.D.:** 12 25/32 (324.6)  
**I.D.:** 17/32 (13.5) & 8 11/32 (211.9)  
**Height:** 26 1/2 (673.1)  
**A. Gskt:** [1] Attached  
**F. Gskt:** [1] Included

**PA3405**

Air Element with Lift Tab



**Fits:** Bedford Trucks  
**Replaces:** GMC 91107151  
**O.D.:** 6 15/32 (164.3)  
**Flange Gasket** 7 7/8 (200.0)  
**I.D.:** 21/32 (16.7) & 3 7/8 (98.4)  
**Height:** 14 11/32 (364.3)  
**A. Gskt:** [2] Attached  
**F. Gskt:** [2] Included

**PA3406-FN**

Air Element with Fins



**Fits:** White Equipment  
**Replaces:** White 33-0032042  
**O.D.:** 6 3/32 (154.8)  
**Fins** 7 13/16 (198.4)  
**I.D.:** 3/4 (19.0) & 3 15/32 (88.1)  
**Height:** 7 7/8 (200.0)  
**A. Gskt:** [1] Attached  
**F. Gskt:** G103-N

Measurements Are Shown In Inches And (Millimeters)

**WARNING:** These products can expose you to chemicals, including Diisononyl Phthalate, Carbon black extracts, Nickel, 1,3 Butadiene, Ethylene Oxide, Epichlorohydrin, which are known to the State of California to cause cancer, and Bisphenol, Ethylene Glycol, Ethylene Oxide, 1,3 Butadiene, Epichlorohydrin, which are known to the State of California to cause birth defects or other reproductive harm.

**PA3408** Air Element with Lid  
**Notes:** OBSOLETE. Availability Limited to Dealer Stock.  
**Fits:** R.V.I. Trucks  
**Replaces:** Renault 5000807196  
**O.D.:** 11 13/16 (300.0)  
 Lid 14 19/32 (370.7)  
**I.D.:** 7/16 (11.1) & 5 5/16 (134.9)  
**Height:** 16 11/32 (415.1)  
**A. Gskt:** [2] Attached  
**F. Gskt:** [1] Included



**PA3417** Air Element  
**Fits:** Mitsubishi Trucks  
**Replaces:** Mitsubishi ME033773  
**O.D.:** 5 1/4 (133.4)  
**I.D.:** 21/32 (16.7) & 4 1/8 (104.8)  
**Height:** 11 25/32 (299.2)  
**A. Gskt:** [1] Attached  
**F. Gskt:** [1] Included



**PA3411-FN** Air Element with Fins  
**Replaces:** Daihatsu 17801-87303; Toyota 17801-87304  
**O.D.:** 6 1/16 (154.0)  
 Fins 7 7/8 (200.0)  
**I.D.:** 1/2 (12.7) & 3 15/32 (88.1)  
**Height:** 8 9/32 (210.3)  
**A. Gskt:** [1] Attached  
**F. Gskt:** [1] Metal Washer



**PA3419** Air Element  
**Fits:** Lister Engines  
**Replaces:** Lister-Petter 366-07188  
**O.D.:** 5 7/8 (149.2)  
**I.D.:** 3 7/16 (87.3)  
**Height:** 2 7/8 (73.0)  
**A. Gskt:** [1] Attached



**PA3412** Air Breather Element  
**Fits:** ERF, Leyland Trucks; Terex Dump Trucks, Scrapers  
**Replaces:** ERF 932833; Euclid 9356460, 9368796; GMC 9373285; Leyland 729090, 10906323  
**O.D.:** 3 15/32 (88.1)  
**I.D.:** 1 9/16 (39.7) One End  
**Height:** 2 13/16 (71.4)



**PA3420** Panel Air Element  
**Replaces:** Donaldson P123440  
**Length:** 17 (431.8)  
**Width:** 8 (203.2)  
**Height:** 2 3/16 (55.6)



**PA3421** Panel Air Element  
**Replaces:** Donaldson P131231; Heavy Duty Air A1231  
**Length:** 32 (812.8)  
**Width:** 9 (228.6)  
**Height:** 2 9/16 (65.1)



**PA3414** Cab Air Element  
**Fits:** V.M.E., Volvo Loaders, Trucks  
**Replaces:** Volvo 4771477  
**Length:** 10 5/8 (269.9)  
**Width:** 7 13/32 (188.1)  
**Height:** 1 25/32 (45.2)

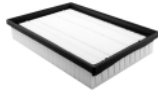

**PA3430** Inner Air Element  
**Fits Inside:** PA3439-FN  
**Fits:** Dresser Equipment  
**Replaces:** Dresser 1129112-C1  
**O.D.:** 4 1/8 (104.8)  
**I.D.:** 21/32 (16.7) & 3 (76.2)  
**Height:** 14 1/4 (362.0)  
**A. Gskt:** [1] Attached  
**F. Gskt:** G103-N



**PA3415** Air Element with Lid  
**Replaces:** Isuzu 1-14215-156-0  
**O.D.:** 7 3/8 (187.3)  
 Lid 9 9/32 (235.7)  
**I.D.:** 21/32 (16.7) & 4 11/16 (119.1)  
**Height:** 11 5/16 (287.3)  
**A. Gskt:** [2] Attached  
**F. Gskt:** [1] Included



**PA3435-FN** Air Element with Fins  
**Fits:** Manitou Equipment  
**Use With:** PA4881  
**Replaces:** Manitou 177129  
**O.D.:** 5 3/16 (131.8)  
 Fins 6 3/8 (161.9)  
**I.D.:** 21/32 (16.7) & 2 5/8 (66.7)  
**Height:** 11 1/16 (281.0)  
**A. Gskt:** [1] Attached  
**F. Gskt:** [1] Included, [1] Wing Nut



**PA3416** Air Element  
**Fits:** Isuzu Trucks  
**Replaces:** Isuzu 1-14215-157-0  
**O.D.:** 4 19/32 (116.7)  
 Boot 5 13/16 (147.6)  
**I.D.:** 5/8 (15.9) & 3 7/16 (87.3)  
**Height:** 10 (254.0)  
**A. Gskt:** [1] Attached  
**F. Gskt:** [1] Included



**PA3438** Panel Air Element  
**Fits:** FMC Sweepers  
**Replaces:** FMC 304973  
**Length:** 29 15/16 (760.4)  
**Width:** 6 (152.4)  
**Height:** 2 9/16 (65.1)

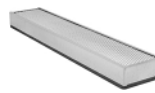













**PA3439-FN** Outer Air Element with Fins  
**Fits:** Dresser Equipment  
**Use With:** PA3430  
**Replaces:** Dresser 1129111-C1, 1129111-C2  
**O.D.:** 6 7/8 (174.6)  
 Fins 8 3/4 (222.3)  
**I.D.:** 21/32 (16.7) & 4 3/16 (106.4)  
**Height:** 15 5/16 (388.9)  
**A. Gskt:** [1] Included  
**F. Gskt:** G103-N



Measurements Are Shown In Inches And (Millimeters)

**WARNING:** These products can expose you to chemicals, including Diisononyl Phthalate, Carbon black extracts, Nickel, 1,3 Butadiene, Ethylene Oxide, Epichlorohydrin, which are known to the State of California to cause cancer, and Bisphenol, Ethylene Glycol, Ethylene Oxide, 1,3 Butadiene, Epichlorohydrin, which are known to the State of California to cause birth defects or other reproductive harm.

<p><b>PA3440</b> Cab Air Element    <b>Fits:</b> Caterpillar Equipment  <b>Replaces:</b> Caterpillar 6T0988  <b>Length:</b> 21 1/4 (539.8)  <b>Width:</b> 5 29/32 (150.0)  <b>Height:</b> 2 11/16 (68.3)  <b>A. Gskt:</b> [1] Attached</p>	<p><b>PA3453</b> Air Element    <b>Replaces:</b> Fleetguard AF263  <b>O.D.:</b> 12 1/32 (305.6)  <b>I.D.:</b> 7 7/8 (200.0) One End  <b>Height:</b> 16 1/2 (419.1)  <b>A. Gskt:</b> [1] Attached</p>
<p><b>PA3442</b> Panel Air Element    <b>Replaces:</b> Pixall 6007-0024  <b>Length:</b> 31 (787.4)  <b>Width:</b> 5 (127.0)  <b>Height:</b> 2 3/16 (55.6)</p>	<p><b>PA3457</b> Air Element    <b>Fits:</b> Bucyrus-Erie Blast Hole Drill Dust Collectors  <b>Replaces:</b> Heavy Duty Air A07-200  <b>O.D.:</b> 5 11/16 (144.5)  <b>I.D.:</b> 3 9/16 (90.5)  <b>Height:</b> 4 27/32 (123.0)  <b>A. Gskt:</b> [2] Attached</p>
<p><b>PA3446</b> Air Element    <b>Fits:</b> R.V.I. Buses, Trucks  <b>Replaces:</b> Renault 5000243970  <b>O.D.:</b> 8 7/8 (225.4)  <b>I.D.:</b> 5/8 (15.9) &amp; 4 1/8 (104.8)  <b>Height:</b> 13 3/8 (339.7)  <b>A. Gskt:</b> [1] Attached</p>	<p><b>PA3458</b> Air Element    <b>Fits:</b> Torit DownFlo EAC Dust Collectors  <b>Replaces:</b> Endustra 51053A; Torit 8PP23099-00  <b>O.D.:</b> 12 3/4 (323.8)  <b>I.D.:</b> 8 11/32 (211.9)  <b>Height:</b> 26 1/2 (673.1)  <b>A. Gskt:</b> [1] Attached</p>
<p><b>PA3447</b> Air Element with Lid    <b>Fits:</b> Lister Engines  <b>Replaces:</b> Lister 382-07898  <b>O.D.:</b> 6 11/32 (161.1)  Lid 7 1/8 (181.0)  <b>I.D.:</b> 11/16 (17.5) &amp; 2 27/32 (72.2)  <b>Height:</b> 12 (304.8)  <b>A. Gskt:</b> [1] Attached  <b>F. Gskt:</b> G103-N, [1] Wing Nut</p>	<p><b>PA3460</b> Air Element    <b>Fits:</b> Torit Air Cleaning Systems  <b>Replaces:</b> Endustra 51049; Torit 8PP18803-00  <b>O.D.:</b> 7 15/16 (201.6)  <b>I.D.:</b> 11/16 (17.5) &amp; 3 9/16 (90.5)  <b>Height:</b> 16 1/2 (419.1)  <b>A. Gskt:</b> [1] Included  <b>F. Gskt:</b> [1] Included</p>
<p><b>PA3448</b> Outer Air Element with Lid    <b>Fits:</b> Hino Trucks  <b>Use With:</b> PA3657  <b>Replaces:</b> Hino 17801-2620  <b>O.D.:</b> 7 3/8 (187.3)  Lid 9 9/32 (235.7)  <b>I.D.:</b> 21/32 (16.7) &amp; 4 11/16 (119.1)  <b>Height:</b> 13 1/2 (342.9)  <b>A. Gskt:</b> [2] Attached  <b>F. Gskt:</b> G103-N</p>	<p><b>PA3461</b> Air Element    <b>Fits:</b> Torit DownFlo II Dust Collectors  <b>Replaces:</b> Torit 8PP32537-00  <b>O.D.:</b> 13 13/16 (350.8)  <b>I.D.:</b> 9 1/2 (241.3)  <b>Height:</b> 26 1/2 (673.1)  <b>A. Gskt:</b> [1] Attached</p>
<p><b>PA3449</b> Air Element    <b>Notes:</b> OBSOLETE. Availability Limited to Dealer Stock.  <b>Fits:</b> DAF, R.V.I. Buses, Trucks  <b>Replaces:</b> DAF 693075; Renault 5000802170  <b>O.D.:</b> 8 25/32 (223.0)  Flange 11 1/4 (285.8)  <b>I.D.:</b> 1/2 (12.7) &amp; 4 3/4 (120.7)  <b>Height:</b> 14 3/4 (374.7)  <b>A. Gskt:</b> [1] Attached</p>	<p><b>PA3463</b> Air Element    <b>Notes:</b> Inside-Out Flow Direction  <b>Fits:</b> Torit DownFlo II Dust Collectors  <b>Replaces:</b> Torit 8PP42057-00  <b>O.D.:</b> 13 13/16 (350.8)  <b>I.D.:</b> 9 1/2 (241.3)  <b>Height:</b> 26 1/2 (673.1)  <b>A. Gskt:</b> [1] Attached  <b>Related To:</b> PA3614 (with Flame Retardant Media)</p>

Measurements Are Shown In Inches And (Millimeters)

**WARNING:** These products can expose you to chemicals, including Diisononyl Phthalate, Carbon black extracts, Nickel, 1,3 Butadiene, Ethylene Oxide, Epichlorohydrin, which are known to the State of California to cause cancer, and Bisphenol, Ethylene Glycol, Ethylene Oxide, 1,3 Butadiene, Epichlorohydrin, which are known to the State of California to cause birth defects or other reproductive harm.

**PA3464**

**Air Element**



**Fits:** Quincy Compressors  
**Replaces:** Quincy 23458-5  
**O.D.:** 12 1/2 (317.5)  
**I.D.:** 13/32 (10.3) & 7 1/2 (190.5)  
**Height:** 22 1/2 (571.5)  
**A. Gskt:** [1] Attached  
**F. Gskt:** [1] Included

**PA3472**

**Outer Air Element**



**Fits:** John Deere Lawn & Garden Tractors  
**Use With:** PA3565  
**Replaces:** John Deere AM108242; Woodgate WGA1856  
**O.D.:** 3 1/4 (82.6)  
**I.D.:** 21/32 (16.7) & 2 1/8 (54.0)  
**Height:** 7 1/2 (190.5)  
**A. Gskt:** [1] Attached  
**F. Gskt:** [1] Washer, [1] Wing Nut

**PA3466-FN**

**Air Element with Fins**



**Notes:** Sometimes used with PA2689 Inner Air Element  
**Fits:** Massey Ferguson Equipment  
**Replaces:** Massey Ferguson 1096468-M91  
**O.D.:** 6 3/32 (154.8)  
 Fins 7 13/16 (198.4)  
**I.D.:** 3/4 (19.0) & 3 15/32 (88.1)  
**Height:** 11 1/2 (292.1)  
**A. Gskt:** [1] Attached  
**F. Gskt:** G103-N

**PA3472-FN**

**Outer Air Element with Fins**



**Fits:** John Deere Equipment  
**Use With:** PA3565  
**Replaces:** John Deere AM108243  
**O.D.:** 3 1/4 (82.6)  
 Fins 4 1/4 (108.0)  
**I.D.:** 21/32 (16.7) & 2 1/8 (54.0)  
**Height:** 7 1/2 (190.5)  
**A. Gskt:** [1] Attached  
**F. Gskt:** G103-N

**PA3467**

**Air Element with Lift Tab**



**Fits:** Bartco Equipment; Gardner Denver Compressors  
**Replaces:** Gardner Denver 1157641  
**O.D.:** 8 1/2 (215.9)  
**I.D.:** 7/16 (11.1) & 5 3/8 (136.5)  
**Height:** 15 1/4 (387.4)  
**A. Gskt:** [1] Attached  
**F. Gskt:** [1] Included

**PA3473**

**Panel Air Element**



**Replaces:** Donaldson P105958  
**Length:** 10 (254.0)  
**Width:** 10 (254.0)  
**Height:** 2 9/16 (65.1)

**PA3469**

**Outer Air Element with Lift Tab**



**Fits:** John Deere Tractors  
**Use With:** PA3470  
**Replaces:** John Deere RE46310  
**O.D.:** 9 1/8 (231.8)  
**I.D.:** 7/16 (11.1) & 5 13/16 (147.6)  
**Height:** 17 (431.8)  
**A. Gskt:** [1] Attached  
**F. Gskt:** [1] Included

**PA3474**

**Air Element**



**Fits:** Blue Bird Buses  
**Replaces:** Blue Bird 4298501  
**O.D.:** 9 7/32 (234.2)  
**I.D.:** 21/32 (16.7) & 4 27/32 (123.0)  
**Height:** 12 3/8 (314.3)  
**A. Gskt:** [1] Attached  
**F. Gskt:** G103-N

**PA3470**

**Inner Air Element**



**Contains:** Flame Retardant Media  
**Fits Inside:** PA3469  
**Fits:** John Deere Tractors  
**Replaces:** John Deere RE46311  
**O.D.:** 5 11/16 (144.5)  
**I.D.:** 7/16 (11.1) & 4 13/32 (111.9)  
**Height:** 15 (381.0)  
**A. Gskt:** [1] Attached  
**F. Gskt:** [1] Included

**PA3475**

**Air Element**



**Fits:** Ford Buses, Trucks  
**Replaces:** Ford F1HZ-9601-A, F1HZ-9601-C  
**O.D.:** 7 11/32 (186.5)  
**I.D.:** 7/16 (11.1) & 5 3/8 (136.5)  
**Height:** 13 7/8 (352.4)  
**A. Gskt:** [1] Attached  
**F. Gskt:** [1] Included

**PA3471**

**Inner Air Element with 8 Bolt Holes**



**Fits Inside:** PA1673  
**Fits:** Caterpillar Equipment  
**Replaces:** Caterpillar 7C1062  
**O.D.:** 3 3/4 (95.3)  
 Flange 6 11/16 (169.9)  
**I.D.:** 2 5/8 (66.7) One End  
**Height:** 10 1/16 (255.6)  
**A. Gskt:** [1] Attached

**PA3476**

**Air Element**



**Fits:** Kubota Equipment  
**Replaces:** Kubota 15741-11080  
**O.D.:** 4 3/32 (104.0)  
 Flange 5 13/16 (147.6)  
**I.D.:** 9/32 (7.1) & 2 1/2 (63.5)  
**Height:** 10 5/16 (261.9)  
**A. Gskt:** [2] Attached  
**F. Gskt:** [1] Included

Measurements Are Shown In Inches And (Millimeters)

**WARNING:** These products can expose you to chemicals, including Diisononyl Phthalate, Carbon black extracts, Nickel, 1,3 Butadiene, Ethylene Oxide, Epichlorohydrin, which are known to the State of California to cause cancer, and Bisphenol, Ethylene Glycol, Ethylene Oxide, 1,3 Butadiene, Epichlorohydrin, which are known to the State of California to cause birth defects or other reproductive harm.

**PA3477**



Air Element with Lid  
**Fits:** DAF, R.V.I., Scania, Volvo Buses, Trucks;  
 Faun Frisch, Hanomag Equipment  
**Replaces:** DAF 110376; Faun Frisch 746385;  
 Hanomag 195946201; Scania 365727  
**O.D.:** 9 17/32 (242.1)  
 Lid 12 1/4 (311.2)  
**I.D.:** 7/16 (11.1) & 5 5/32 (131.0)  
**Height:** 19 3/8 (492.1)  
**A. Gskt:** [2] Attached  
**F. Gskt:** [1] Included

**PA3483**



Replacement for Ecolite Air Element in  
 Disposable Housing  
**Fits:** Volvo-Penta Industrial, Marine Engines  
**Replaces:** Volvo 842280  
**O.D.:** 7 3/4 (196.9)  
**I.D.:** 4 (101.6) One End  
**Height:** 12 15/16 (328.6)

**PA3478**



Conical-Shaped Air Element  
**Replaces:** GMC 25096444  
**O.D.:** 5 13/16 (147.6)  
 to 8 21/32 (219.9)  
**I.D.:** 5 3/16 (131.8) One End  
**Height:** 28 1/2 (723.9)  
**A. Gskt:** [1] Attached  
**F. Gskt:** [1] Included  
**Related To:** PA3478XP (Extreme Performance  
 Nano Version)

**PA3484**



Outer Air Element with 4 Bolt Holes  
**Fits:** Volvo Trucks  
**Use With:** PA3865  
**Replaces:** Volvo 1080918  
**O.D.:** 10 21/32 (270.7)  
 Flange 11 13/16 (300.0)  
**I.D.:** 6 5/16 (160.3) One End  
**Height:** 23 7/32 (589.8)  
**A. Gskt:** [2] Attached

**PA3478XP**



Extreme Performance Nano Conical-Shaped Air  
 Element  
**Replaces:** Donaldson P604430  
**O.D.:** 5 13/16 (147.6)  
 to 8 21/32 (219.9)  
**I.D.:** 5 3/16 (131.8) One End  
**Height:** 28 1/2 (723.9)  
**A. Gskt:** [1] Attached  
**F. Gskt:** [1] Included  
**Related To:** PA3478 (Standard Media Version)

**PA3486**



Air Element  
**Fits:** Ford Buses, Trucks  
**Replaces:** Donaldson P150703  
**O.D.:** 13 7/8 (352.4)  
**I.D.:** 7 7/16 (188.9) One End  
**Height:** 13 1/2 (342.9)  
**A. Gskt:** [1] Attached

**PA3479**



Outer Air Element with Lid  
**Fits:** Hitachi Equipment  
**Use With:** PA3783  
**Replaces:** Hitachi 4206098  
**O.D.:** 7 31/32 (202.4)  
 Lid 9 15/16 (252.4)  
**I.D.:** 7/8 (22.2) & 5 1/4 (133.4)  
**Height:** 10 15/16 (277.8)  
**A. Gskt:** [1] Attached  
**F. Gskt:** [1] Included

**PA3487**



Air Element with Bail Handle  
**Fits:** Donaldson Air Cleaners; Elgin Sweepers  
**Replaces:** Donaldson P525423  
**O.D.:** 6 1/32 (153.2)  
 Flange Gasket 7 3/32 (180.2)  
**I.D.:** 3 15/32 (88.1) One End  
**Height:** 15 3/8 (390.5)  
**A. Gskt:** [2] Attached

**PA3480**



Inner Air Element  
**Fits Inside:** LL2525, PA2525  
**Fits:** International Trucks  
**Replaces:** International 1674319-C1  
**O.D.:** 7 5/8 (193.7)  
**I.D.:** 21/32 (16.7) & 6 1/16 (154.0)  
**Height:** 15 7/8 (403.2)  
**A. Gskt:** [1] Attached  
**F. Gskt:** G103-N

**PA3491**



Outer Air Element  
**Fits:** Ford, New Holland Tractors  
**Use With:** PA3492  
**Replaces:** Ford E9NN-9B618-BA; New Holland  
 82003726  
**O.D.:** 8 1/8 (206.4)  
**I.D.:** 21/32 (16.7) & 3 3/4 (95.3)  
**Height:** 13 3/16 (335.0)  
**A. Gskt:** [2] Attached  
**F. Gskt:** [1] Included

**PA3481**



Cab Air Element  
**Fits:** Crenlo Tractor Cabs  
**Replaces:** Crenlo 80255  
**Length:** 18 7/16 (468.3)  
**Width:** 5 1/4 (133.4)  
**Height:** 2 3/16 (55.6)

**PA3492**



Inner Air Element  
**Fits Inside:** PA3491, PA4683  
**Fits:** Ford, New Holland Tractors  
**Replaces:** Ford E9NN-9R500-AB; New Holland  
 82008601  
**O.D.:** 3 5/8 (92.1)  
 Boot 4 7/16 (112.7)  
**I.D.:** 1/2 (12.7) & 3 (76.2)  
**Height:** 11 15/32 (291.3)  
**A. Gskt:** [1] Attached  
**F. Gskt:** [1] Included

**PA3482**

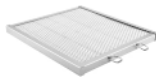

Cab Air Element with Lift Tabs  
**Fits:** Caterpillar Equipment, Off-Highway  
 Trucks  
**Replaces:** Caterpillar 2G1946, 9P5174  
**Length:** 13 1/4 (336.5)  
**Width:** 11 15/16 (303.2)  
**Height:** 13/16 (20.6)

Measurements Are Shown In Inches And (Millimeters)

**WARNING:** These products can expose you to chemicals, including Diisononyl Phthalate, Carbon black extracts, Nickel, 1,3 Butadiene, Ethylene Oxide, Epichlorohydrin, which are known to the State of California to cause cancer, and Bisphenol, Ethylene Glycol, Ethylene Oxide, 1,3 Butadiene, Epichlorohydrin, which are known to the State of California to cause birth defects or other reproductive harm.



**PA3493**



Replacement for Ecolite Air Element in Disposable Housing  
**Fits:** Freightliner Chassis; Ottawa Trucks  
**Replaces:** Farr 114880-003A  
**O.D.:** 9 25/32 (248.4)  
**Inlet:** 6  
**Outlet:** 5  
**Height:** 19 7/16 (493.7)

**PA3499**



Conical-Shaped Air Element  
**Fits:** ERF, Foden Trucks  
**Replaces:** ERF 990199; Foden Y05590000  
**O.D.:** 10 3/8 (263.5)  
 to 11 17/32 (292.9)  
**I.D.:** 21/32 (16.7) & 6 17/32 (165.9)  
**Height:** 19 1/2 (495.3)  
**A. Gskt:** [1] Attached  
**F. Gskt:** G103-N

**PA3494**



Inner Air Element  
**Fits Inside:** PA2776  
**Fits:** Claas Combines; Iveco, M.A.N. Trucks; Liebherr Cranes  
**Replaces:** Claas 722390; Iveco 1905620; M.A.N. 81.08405.0011  
**O.D.:** 6 1/16 (154.0)  
 Boot 6 3/8 (161.9)  
**I.D.:** 21/32 (16.7) & 5 19/32 (142.1)  
**Height:** 18 9/16 (471.5)  
**A. Gskt:** [1] Attached  
**F. Gskt:** [1] Included

**RS3501**



Radial Seal Inner Air Element  
**Fits Inside:** RS2863, RS2863XP, RS30222XP  
**Fits:** Ford, GMC Trucks; John Deere, Magnum Equipment  
**Replaces:** GMC 12544543; Ford F3HZ-9R500-A; John Deere RE34963  
**O.D.:** 5 1/4 (133.4)  
**I.D.:** 3 23/32 (94.5) One End  
**Height:** 12 1/32 (305.6)

**PA3495**

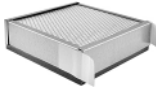

Cab Air Element  
**Fits:** Caterpillar Equipment  
**Replaces:** Caterpillar 7T8945  
**Length:** 9 (228.6)  
**Width:** 9 (228.6)  
**Height:** 2 9/16 (65.1)

**RS3502**



Radial Seal Outer Air Element  
**Fits:** Caterpillar Equipment  
**Use With:** RS3503  
**Replaces:** Caterpillar 6I2499  
**O.D.:** 9 5/32 (232.6)  
**I.D.:** 4 5/8 (117.5) One End  
**Height:** 12 1/2 (317.5)

**PA3496**



Outer Air Element with Bail Handle  
**Fits:** Sullair Compressors  
**Use With:** PA3498  
**Replaces:** Sullair 2250051-238  
**O.D.:** 15 1/8 (384.2)  
 Boot 15 25/32 (400.8)  
**I.D.:** 13/16 (20.6) & 10 (254.0)  
**Height:** 24 1/2 (622.3)  
**A. Gskt:** [2] Included  
**F. Gskt:** [1] Included

**RS3503**



Radial Seal Inner Air Element  
**Fits Inside:** RS3502  
**Fits:** Caterpillar Equipment  
**Replaces:** Caterpillar 6I2500  
**O.D.:** 4 23/32 (119.9)  
**I.D.:** 3 3/16 (81.0) One End  
**Height:** 11 25/32 (299.2)

**PA3497**



Conical-Shaped Outer Air Element  
**Replaces:** Nelson 70855N  
**O.D.:** 12 3/32 (307.2)  
 to 13 23/32 (348.5)  
**I.D.:** 21/32 (16.7) & 9 1/4 (235.0)  
**Height:** 19 1/2 (495.3)  
**I.Gskt:** [1] Included  
**A. Gskt:** [1] Attached

**RS3504**



Radial Seal Outer Air Element  
**Fits:** Agco, Massey Ferguson Tractors; Caterpillar Equipment  
**Use With:** RS3505  
**Replaces:** Caterpillar 6I2501  
**O.D.:** 10 31/32 (278.6)  
**I.D.:** 5 13/16 (147.6) One End  
**Height:** 13 3/8 (339.7)  
**Related To:** RS3504XP (Extreme Performance Nano Version)

**PA3498**



Inner Air Element  
**Fits Inside:** PA3496  
**Fits:** Sullair Compressors  
**Replaces:** Sullair 2250051-239  
**O.D.:** 9 29/32 (251.6)  
**I.D.:** 13/16 (20.6) & 8 1/16 (204.8)  
**Height:** 23 1/2 (596.9)  
**A. Gskt:** [1] Included  
**F. Gskt:** [1] Included













**RS3504XP**



Extreme Performance Nano Radial Seal Outer Air Element  
**Fits:** Agco, Massey Ferguson Tractors; Caterpillar Equipment  
**Use With:** RS3505  
**Replaces:** Caterpillar 6I2501  
**O.D.:** 10 31/32 (278.6)  
**I.D.:** 5 13/16 (147.6) One End  
**Height:** 13 3/8 (339.7)  
**Related To:** RS3504 (Standard Media Version)

Measurements Are Shown In Inches And (Millimeters)

**WARNING:** These products can expose you to chemicals, including Diisononyl Phthalate, Carbon black extracts, Nickel, 1,3 Butadiene, Ethylene Oxide, Epichlorohydrin, which are known to the State of California to cause cancer, and Bisphenol, Ethylene Glycol, Ethylene Oxide, 1,3 Butadiene, Epichlorohydrin, which are known to the State of California to cause birth defects or other reproductive harm.

<p><b>RS3505</b></p> 	<p>Radial Seal Inner Air Element  <b>Fits Inside:</b> RS3504, RS3504XP  <b>Fits:</b> Caterpillar Equipment  <b>Replaces:</b> Caterpillar 6I2502  <b>O.D.:</b> 5 7/8 (149.2)  <b>I.D.:</b> 4 1/8 (104.8) One End  <b>Height:</b> 12 5/8 (320.7)</p>	<p><b>RS3509</b></p> 	<p>Radial Seal Inner Air Element  <b>Fits Inside:</b> RS3508, RS3508XP  <b>Fits:</b> Caterpillar Equipment  <b>Replaces:</b> Caterpillar 6I0274  <b>O.D.:</b> 7 1/4 (184.2)  <b>I.D.:</b> 5 9/32 (134.1) One End  <b>Height:</b> 13 3/16 (335.0)</p>
<p><b>RS3506</b></p> 	<p>Radial Seal Outer Air Element  <b>Fits:</b> Caterpillar, John Deere, Komatsu Equipment; Freightliner Buses  <b>Use With:</b> RS3507, RS5392  <b>Replaces:</b> Caterpillar 6I2503  <b>O.D.:</b> 10 31/32 (278.6)  <b>I.D.:</b> 5 13/16 (147.6) One End  <b>Height:</b> 16 7/16 (417.5)  <b>Related To:</b> RS3506XP (Extreme Performance Nano Version)</p>	<p><b>RS3510</b></p> 	<p>Radial Seal Outer Air Element  <b>Fits:</b> Caterpillar Equipment; Challenger Tractors  <b>Use With:</b> RS3511  <b>Replaces:</b> Caterpillar 6I2505  <b>O.D.:</b> 12 13/32 (315.1)  <b>I.D.:</b> 8 3/16 (208.0) One End  <b>Height:</b> 15 1/2 (393.7)  <b>Related To:</b> RS3510XP (Extreme Performance Nano Media)</p>
<p><b>RS3506XP</b></p> 	<p>Extreme Performance Nano Radial Seal Outer Air Element  <b>Fits:</b> Caterpillar, John Deere, Komatsu Equipment; Freightliner Buses  <b>Use With:</b> RS3507, RS5392  <b>Replaces:</b> Caterpillar 6I2503  <b>O.D.:</b> 10 31/32 (278.6)  <b>I.D.:</b> 5 13/16 (147.6) One End  <b>Height:</b> 16 7/16 (417.5)  <b>Related To:</b> RS3506 (Standard Media Version)</p>	<p><b>RS3510XP</b></p> 	<p>Extreme Performance Nano Radial Seal Outer Air Element  <b>Fits:</b> Caterpillar Equipment; Challenger Tractors  <b>Use With:</b> RS3511  <b>Replaces:</b> Caterpillar 6I2505  <b>O.D.:</b> 12 13/32 (315.1)  <b>I.D.:</b> 8 3/16 (208.0) One End  <b>Height:</b> 15 1/2 (393.7)  <b>Related To:</b> RS3510 (Standard Media Version)</p>
<p><b>RS3507</b></p> 	<p>Radial Seal Inner Air Element  <b>Fits Inside:</b> RS3506, RS3506XP  <b>Fits:</b> Caterpillar Equipment  <b>Replaces:</b> Caterpillar 6I2504  <b>O.D.:</b> 5 9/16 (141.3)  <b>I.D.:</b> 4 13/32 (111.9) One End  <b>Height:</b> 15 11/16 (398.5)</p>	<p><b>RS3511</b></p> 	<p>Radial Seal Inner Air Element  <b>Fits Inside:</b> RS3510, RS3510XP  <b>Fits:</b> Caterpillar Equipment  <b>Replaces:</b> Caterpillar 6I2506  <b>O.D.:</b> 8 5/16 (211.1)  <b>I.D.:</b> 6 1/32 (153.2) One End  <b>Height:</b> 15 7/32 (386.6)</p>
<p><b>RS3508</b></p> 	<p>Radial Seal Outer Air Element  <b>Fits:</b> Caterpillar Equipment; Challenger Tractors; Wirtgen Equipment  <b>Use With:</b> RS3509  <b>Replaces:</b> Caterpillar 122-1674; Wirtgen 162084  <b>O.D.:</b> 11 15/32 (291.3)  <b>I.D.:</b> 7 1/8 (181.0) One End  <b>Height:</b> 13 1/2 (342.9)  <b>Related To:</b> RS3508XP (Extreme Performance Nano Version)</p>	<p><b>RS3512</b></p> 	<p>Radial Seal Outer Air Element  <b>Fits:</b> Caterpillar Equipment  <b>Use With:</b> RS3513  <b>Replaces:</b> Caterpillar 6I2507  <b>O.D.:</b> 12 13/32 (315.1)  <b>I.D.:</b> 8 3/16 (208.0) One End  <b>Height:</b> 15 1/2 (393.7)</p>
<p><b>RS3508XP</b></p> 	<p>Extreme Performance Nano Radial Seal Outer Air Element  <b>Fits:</b> Caterpillar Equipment; Challenger Tractors; Wirtgen Equipment  <b>Use With:</b> RS3509  <b>Replaces:</b> Caterpillar 122-1674; Wirtgen 162084  <b>O.D.:</b> 11 15/32 (291.3)  <b>I.D.:</b> 7 1/8 (181.0) One End  <b>Height:</b> 13 1/2 (342.9)  <b>Related To:</b> RS3508 (Standard Media Version)</p>	<p><b>RS3513</b></p> 	<p>Radial Seal Inner Air Element  <b>Fits Inside:</b> RS3512  <b>Fits:</b> Caterpillar Equipment  <b>Replaces:</b> Caterpillar 6I2508  <b>O.D.:</b> 8 5/16 (211.1)  <b>I.D.:</b> 6 1/32 (153.2) One End  <b>Height:</b> 11 3/4 (298.5)</p>

Measurements Are Shown In Inches And (Millimeters)

**WARNING:** These products can expose you to chemicals, including Diisononyl Phthalate, Carbon black extracts, Nickel, 1,3 Butadiene, Ethylene Oxide, Epichlorohydrin, which are known to the State of California to cause cancer, and Bisphenol, Ethylene Glycol, Ethylene Oxide, 1,3 Butadiene, Epichlorohydrin, which are known to the State of California to cause birth defects or other reproductive harm.

**RS3514**



Radial Seal Outer Air Element  
**Fits:** Caterpillar Equipment  
**Use With:** RS3515  
**Replaces:** Caterpillar 6I2509  
**O.D.:** 12 13/32 (315.1)  
**I.D.:** 8 3/16 (208.0) One End  
**Height:** 19 1/32 (483.4)  
**Related To:** RS3514XP (Extreme Performance Nano Version)

**RS3517XP**



Extreme Performance Nano Radial Seal Outer Air Element  
**Fits:** Ford, Freightliner Trucks; Case-International, Doosan, John Deere, Komatsu, New Holland Equipment  
**Use With:** RS3717  
**Replaces:** Donaldson P532966  
**O.D.:** 9 9/32 (235.7)  
**I.D.:** 5 5/32 (131.0) One End  
**Height:** 18 15/16 (481.0)  
**Related To:** RS3517 (Standard Media Version)

**RS3514XP**



Extreme Performance Nano Radial Seal Outer Air Element  
**Fits:** Caterpillar Equipment  
**Use With:** RS3515  
**Replaces:** Caterpillar 6I2509  
**O.D.:** 12 13/32 (315.1)  
**I.D.:** 8 3/16 (208.0) One End  
**Height:** 19 1/32 (483.4)  
**Related To:** RS3514 (Standard Media Version)

**RS3518**



Radial Seal Outer Air Element  
**Fits:** Ford, Freightliner, International, Sterling, White/GMC Trucks  
**Use With:** RS3519  
**Replaces:** Ford F1HZ-9601-B; GMC 25177196; International 3520400-C1; White 22-0013212  
**O.D.:** 12 31/32 (329.4)  
**I.D.:** 6 13/16 (173.0) One End  
**Height:** 15 1/4 (387.3)  
**Related To:** RS30187XP (Premium Housing Gasket)

**RS3515**



Radial Seal Inner Air Element  
**Fits Inside:** RS3514, RS3514XP  
**Fits:** Caterpillar Equipment  
**Replaces:** Caterpillar 6I2510  
**O.D.:** 8 5/16 (211.1)  
**I.D.:** 6 1/32 (153.2) One End  
**Height:** 15 7/32 (386.6)

**RS3518XP**



Extreme Performance Nano Radial Seal Outer Air Element  
**Fits:** Autocar, Ford, Freightliner, International, Peterbilt, Sterling, Volvo, White/GMC Trucks; Mercedes-Benz Latin America Buses; Taylor Sprayers  
**Use With:** RS3519  
**Replaces:** Donaldson DBA5069; Fleetguard AF25139M  
**O.D.:** 12 31/32 (329.4)  
**I.D.:** 6 13/16 (173.0) One End  
**Height:** 15 1/4 (387.3)  
**Related To:** RS3518 (Standard Gasket Version)

**RS3516**



Radial Seal Outer Air Element  
**Fits:** Freightliner, Peterbilt Trucks  
**Replaces:** Donaldson P531026  
**O.D.:** 9 9/32 (235.7)  
**I.D.:** 5 25/32 (146.8) One End  
**Height:** 23 7/16 (595.3)  
**Related To:** RS3516XP (Extreme Performance Nano Media)

**RS3519**



Radial Seal Inner Air Element  
**Fits Inside:** RS3518  
**Fits:** Freightliner, Sterling, White/GMC Trucks  
**Replaces:** Air-Refiner ARM52-7683  
**O.D.:** 6 7/8 (174.6)  
**I.D.:** 5 5/32 (131.0) One End  
**Height:** 14 13/32 (365.9)

**RS3516XP**



Extreme Performance Nano Radial Seal Outer Air Element  
**Fits:** Freightliner, International, Peterbilt Trucks  
**Replaces:** Donaldson DBA5106  
**O.D.:** 9 5/16 (236.5)  
**I.D.:** 5 3/4 (146.0) One End  
**Height:** 23 15/32 (595.9)  
**Related To:** RS3516 (Standard Version)

**RS3520**



Radial Seal Outer Air Element  
**Fits:** Freightliner Trucks  
**Use With:** RS3521  
**Replaces:** Donaldson P526678  
**O.D.:** 9 9/32 (235.7)  
**I.D.:** 5 5/32 (131.0) One End  
**Height:** 15 (381.0)

**RS3517**



Radial Seal Outer Air Element  
**Fits:** Ford, Freightliner Trucks; Case-International, Doosan, John Deere, Komatsu, New Holland Equipment  
**Use With:** RS3717  
**Replaces:** Donaldson P532966  
**O.D.:** 9 9/32 (235.7)  
**I.D.:** 5 5/32 (131.0) One End  
**Height:** 18 15/16 (481.0)  
**Related To:** RS3517XP (Extreme Performance Nano Version)

**RS3521**



Radial Seal Inner Air Element  
**Fits Inside:** RS3520  
**Fits:** Freightliner Trucks  
**Replaces:** Donaldson P529548  
**O.D.:** 5 1/4 (133.4)  
**I.D.:** 3 23/32 (94.5) One End  
**Height:** 14 7/32 (361.2)

Measurements Are Shown In Inches And (Millimeters)

**WARNING:** These products can expose you to chemicals, including Diisononyl Phthalate, Carbon black extracts, Nickel, 1,3 Butadiene, Ethylene Oxide, Epichlorohydrin, which are known to the State of California to cause cancer, and Bisphenol, Ethylene Glycol, Ethylene Oxide, 1,3 Butadiene, Epichlorohydrin, which are known to the State of California to cause birth defects or other reproductive harm.

**RS3528**

Radial Seal Outer Air Element



**Fits:** Caterpillar, Daewoo Equipment  
**Use With:** RS3529  
**Replaces:** Caterpillar 6L1450; Daewoo D141107  
**O.D.:** 8 5/32 (207.2)  
**I.D.:** 4 3/16 (106.4) One End  
**Height:** 6 5/8 (168.3)

**RS3533**

Radial Seal Inner Air Element



**Fits Inside:** RS3532  
**Fits:** John Deere Equipment  
**Replaces:** John Deere RE34967  
**O.D.:** 5 1/4 (133.4)  
**I.D.:** 3 23/32 (94.5) One End  
**Height:** 14 27/32 (377.0)

**RS3529**

Radial Seal Inner Air Element



**Fits Inside:** RS3528  
**Fits:** Caterpillar, Daewoo Equipment  
**Replaces:** Caterpillar 6L1451; Daewoo D141106  
**O.D.:** 4 1/4 (108.0)  
**I.D.:** 2 3/4 (69.9) One End  
**Height:** 5 27/32 (148.4)

**RS3534**

Radial Seal Outer Air Element



**Contains:** 4 5/8 Inch Dust Ejector Hole  
**Fits:** Kenworth, Peterbilt, Western Star Trucks  
**Replaces:** Donaldson P534925  
**O.D.:** 12 3/32 (307.2)  
**I.D.:** 7 3/8 (187.3) One End  
**Height:** 25 13/16 (655.6)  
**F. Gskt:** [2] Included

**RS3530**

Radial Seal Outer Air Element



**Fits:** International Trucks; John Deere Equipment  
**Use With:** RS3531  
**Replaces:** International 2005895-C1; John Deere RE63931  
**O.D.:** 12 31/32 (329.4)  
**I.D.:** 6 13/16 (173.0) One End  
**Height:** 18 5/8 (473.1)  
**Related To:** RS3530XP (Extreme Performance Nano Media)

**RS3535**

Radial Seal Inner Air Element



**Fits Inside:** RS3538  
**Fits:** Hitachi, John Deere Equipment  
**Replaces:** Hitachi 4286130  
**O.D.:** 5 1/4 (133.4)  
**I.D.:** 3 23/32 (94.5) One End  
**Height:** 13 27/32 (351.6)

**RS3530XP**

Extreme Performance Nano Radial Seal Outer Air Element



**Fits:** International Trucks; John Deere Equipment  
**Use With:** RS3531  
**Replaces:** International 2005895-C1; John Deere RE63931  
**O.D.:** 12 31/32 (329.4)  
**I.D.:** 6 13/16 (173.0) One End  
**Height:** 18 5/8 (473.1)  
**Related To:** RS3530 (Standard Media Version)

**RS3536**

Radial Seal Outer Air Element



**Fits:** Barber-Greene, Caterpillar Equipment  
**Use With:** RS3537  
**Replaces:** Caterpillar 102-9388  
**O.D.:** 8 5/32 (207.2)  
**I.D.:** 4 3/16 (106.4) One End  
**Height:** 7 1/2 (190.5)

**RS3531**

Radial Seal Inner Air Element



**Fits Inside:** RS3530, RS3530XP  
**Fits:** International Buses, Trucks; John Deere Equipment  
**Replaces:** International 2022289-C1; John Deere RE63932  
**O.D.:** 6 7/8 (174.6)  
**I.D.:** 5 5/32 (131.0) One End  
**Height:** 17 23/32 (450.1)

**RS3537**

Radial Seal Inner Air Element



**Fits Inside:** RS3536  
**Fits:** Barber-Greene, Caterpillar Equipment  
**Replaces:** Caterpillar 102-9387  
**O.D.:** 4 1/4 (108.0)  
**I.D.:** 2 3/4 (69.9) One End  
**Height:** 6 21/32 (169.1)

**RS3532**

Radial Seal Outer Air Element



**Fits:** John Deere Equipment  
**Use With:** RS3533  
**Replaces:** John Deere RE34966  
**O.D.:** 9 9/32 (235.7)  
**I.D.:** 5 5/32 (131.0) One End  
**Height:** 15 5/8 (396.9)

**RS3538**

Radial Seal Outer Air Element



**Fits:** Hitachi, John Deere Equipment  
**Use With:** RS3535  
**Replaces:** Hitachi 4286128  
**O.D.:** 9 9/32 (235.7)  
**I.D.:** 5 5/32 (131.0) One End  
**Height:** 14 19/32 (370.7)

Measurements Are Shown In Inches And (Millimeters)

**WARNING:** These products can expose you to chemicals, including Diisononyl Phthalate, Carbon black extracts, Nickel, 1,3 Butadiene, Ethylene Oxide, Epichlorohydrin, which are known to the State of California to cause cancer, and Bisphenol, Ethylene Glycol, Ethylene Oxide, 1,3 Butadiene, Epichlorohydrin, which are known to the State of California to cause birth defects or other reproductive harm.

**RS3539**



Radial Seal Outer Air Element  
**Notes:** Inside-Out Flow Direction  
**Contains:** 3 3/4 Inch Dust Ejector Hole  
**Fits:** Freightliner, Kenworth, Peterbilt, Western Star Trucks  
**Replaces:** Donaldson P534816  
**O.D.:** 11 13/32 (289.7)  
**I.D.:** 3 25/32 (96.0) & 6 23/32 (170.7)  
**Height:** 23 23/32 (602.5)  
**F. Gskt:** G501-AF  
**Related To:** RS3539XP (Extreme Performance Nano Version)

**RS3543**



Radial Seal Inner Air Element  
**Fits Inside:** RS3542  
**Fits:** Bobcat, Case, Ford, J.C. Bamford, John Deere, Landini, Massey Ferguson, New Holland, Thomas, Volvo Equipment  
**Replaces:** Case 222429A1; Fiat 1930588; John Deere AP33331; Massey Ferguson 3540047-M1; Melroe-Bobcat 6666376; New Holland 86982523; Thomas 42403  
**O.D.:** 3 5/16 (84.1)  
**I.D.:** 2 15/32 (62.7) One End  
**Height:** 12 9/16 (319.1)

**RS3539XP**



Extreme Performance Nano Radial Seal Outer Air Element  
**Notes:** Inside-Out Flow Direction  
**Contains:** 3 3/4 Inch Dust Ejector Hole  
**Fits:** Freightliner, Kenworth, Peterbilt, Western Star Trucks  
**Replaces:** Donaldson EAF5100, DBA5100  
**O.D.:** 11 13/32 (289.7)  
**I.D.:** 3 25/32 (96.0) & 6 23/32 (170.7)  
**Height:** 23 23/32 (602.5)  
**F. Gskt:** G501-AF  
**Related To:** RS3539 (Standard Media Version)

**RS3544**



Radial Seal Outer Air Element  
**Fits:** Case, Caterpillar, Gehl, John Deere, New Holland, Vermeer, Volvo Equipment  
**Use With:** RS3545  
**Replaces:** Case 222421A1; Caterpillar 110-6326; Gehl L99453; John Deere AT171853; New Holland 86982524  
**O.D.:** 6 1/2 (165.1)  
**I.D.:** 3 9/16 (90.5) One End  
**Height:** 14 1/32 (356.4)  
**Related To:** RS5517 (Flame Retardant Media)

**RS3540**



Radial Seal Outer Air Element  
**Fits:** Case, Caterpillar, Hitachi, John Deere Equipment  
**Use With:** RS3541  
**Replaces:** Caterpillar 135-5788; Hitachi 4283861  
**O.D.:** 8 5/32 (207.2)  
**I.D.:** 4 27/32 (123.0) One End  
**Height:** 14 19/32 (370.7)

**RS3545**



Radial Seal Inner Air Element  
**Fits Inside:** RS3544, RS5517  
**Fits:** Case, Caterpillar, Gehl, John Deere, New Holland, Vermeer, Volvo Equipment  
**Replaces:** Case 222422A1; Caterpillar 110-6331; Gehl L99967; John Deere AT171854; New Holland 86982525  
**O.D.:** 3 21/32 (92.9)  
**I.D.:** 2 7/8 (73.0) One End  
**Height:** 13 1/2 (342.9)

**RS3541**



Radial Seal Inner Air Element  
**Fits Inside:** RS3540  
**Fits:** Case, Caterpillar, Hitachi, John Deere Equipment  
**Replaces:** Caterpillar 135-5787; Hitachi 4287060  
**O.D.:** 4 15/16 (125.4)  
**I.D.:** 3 31/32 (100.8) One End  
**Height:** 13 15/16 (354.0)

**RS3547**



Radial Seal Inner Air Element  
**Fits Inside:** RS3954  
**Fits:** Bomag, Gehl, New Holland Equipment  
**Replaces:** Fiat 1930592; Gehl 321201111002  
**O.D.:** 2 13/32 (61.1)  
**I.D.:** 1 3/4 (44.4) One End  
**Height:** 11 7/16 (290.5)

**RS3542**



Radial Seal Outer Air Element  
**Fits:** Bobcat, Case, Caterpillar, Ford, J.C. Bamford, John Deere, Landini, Massey Ferguson, New Holland, Thomas, Volvo Equipment; Ingersoll-Rand Compressors  
**Use With:** RS3543  
**Replaces:** Case 222425A1; J.C. Bamford 32/919001; Massey Ferguson 3540046-M1; Melroe-Bobcat 6666375; Thomas 42402  
**O.D.:** 5 13/32 (137.3)  
**I.D.:** 3 3/16 (81.0) One End  
**Height:** 12 31/32 (329.4)  
**Related To:** RS4578 (Flame Retardant Media)

**RS3548**



Radial Seal Outer Air Element  
**Fits:** Ford, GMC, Isuzu, Kenworth, Sterling Trucks; John Deere Equipment  
**Use With:** RS3722  
**Replaces:** John Deere RE51629  
**O.D.:** 10 31/32 (278.6)  
**I.D.:** 5 13/16 (147.6) One End  
**Height:** 15 5/8 (396.9)  
**Related To:** RS3548XP (Extreme Performance Nano Version)













**RS3548XP**



Extreme Performance Nano Radial Seal Outer Air Element  
**Fits:** Ford, GMC, Isuzu, Kenworth, Sterling Trucks; John Deere Equipment  
**Use With:** RS3722  
**Replaces:** John Deere RE51629  
**O.D.:** 10 31/32 (278.6)  
**I.D.:** 5 13/16 (147.6) One End  
**Height:** 15 5/8 (396.9)  
**Related To:** RS3548 (Standard Media Version)

Measurements Are Shown In Inches And (Millimeters)

**WARNING:** These products can expose you to chemicals, including Diisononyl Phthalate, Carbon black extracts, Nickel, 1,3 Butadiene, Ethylene Oxide, Epichlorohydrin, which are known to the State of California to cause cancer, and Bisphenol, Ethylene Glycol, Ethylene Oxide, 1,3 Butadiene, Epichlorohydrin, which are known to the State of California to cause birth defects or other reproductive harm.

<p><b>RS3549</b></p> 	<p>Radial Seal Outer Air Element  <b>Contains:</b> Flame Retardant Media  <b>Fits:</b> Clark, John Deere Equipment  <b>Use With:</b> RS3703, RS3747  <b>Replaces:</b> Clark 2791707  <b>O.D.:</b> 5 1/32 (127.8)  <b>I.D.:</b> 3 5/32 (80.2) One End  <b>Height:</b> 12 5/16 (312.7)  <b>Related To:</b> RS3702 (without Flame Retardant Media)</p>	<p><b>PA3557-FN</b></p> 	<p>Outer Air Element with Fins  <b>Fits:</b> John Deere Tractors  <b>Use With:</b> PA3632  <b>Replaces:</b> John Deere AM108184  <b>O.D.:</b> 4 3/32 (104.0)                Fins 5 1/8 (130.2)  <b>I.D.:</b> 25/32 (19.8) &amp; 2 15/32 (62.7)  <b>Height:</b> 8 3/8 (212.7)  <b>A. Gskt:</b> [1] Attached  <b>F. Gskt:</b> G103-N</p>
<p><b>RS3550</b></p> 	<p>Radial Seal Air Element  <b>Fits:</b> Dodge Light-Duty Trucks  <b>Replaces:</b> Chrysler 4713953  <b>O.D.:</b> 8 5/32 (207.2)  <b>I.D.:</b> 4 3/16 (106.4) One End  <b>Height:</b> 10 (254.0)</p>	<p><b>PA3558</b></p> 	<p>Outer Air Element  <b>Fits:</b> R.V.I. Buses, Trucks  <b>Use With:</b> PA3566  <b>Replaces:</b> Renault 5010064371  <b>O.D.:</b> 12 1/16 (306.4)  <b>I.D.:</b> 11/16 (17.5) &amp; 7 11/16 (195.3)  <b>Height:</b> 15 11/16 (398.5)  <b>A. Gskt:</b> [1] Attached  <b>F. Gskt:</b> G103-N</p>
<p><b>PA3551</b></p> 	<p>Inner Air Element  <b>Fits Inside:</b> PA2781  <b>Replaces:</b> Fleetguard AF4771  <b>O.D.:</b> 9 11/16 (246.1)  <b>I.D.:</b> 21/32 (16.7) &amp; 8 1/8 (206.4)  <b>Height:</b> 17 13/16 (452.4)  <b>A. Gskt:</b> [1] Attached  <b>F. Gskt:</b> G103-N</p>	<p><b>PA3559</b></p> 	<p>Air Element  <b>Notes:</b> OBSOLETE. Availability Limited to Dealer Stock.  <b>Fits:</b> Metroplex Dust Collectors  <b>Replaces:</b> Metroplex M00-709-102; Reed 70814  <b>O.D.:</b> 12 (304.8)  <b>I.D.:</b> 7 11/16 (195.3)  <b>Height:</b> 21 (533.4)  <b>A. Gskt:</b> [2] Attached</p>
<p><b>PA3554</b></p> 	<p>Replacement for Ecolite Air Element in Disposable Housing  <b>Fits:</b> Farr Optional Housings  <b>Replaces:</b> Farr 114500-001  <b>O.D.:</b> 7 1/8 (181.0)  <b>I.D.:</b> 3 (76.2) One End  <b>Height:</b> 14 3/16 (360.4)</p>	<p><b>PA3560</b></p> 	<p>Air Element  <b>Notes:</b> Inside-Out Flow Direction  <b>Fits:</b> Wheelabrator Dust Collectors  <b>Replaces:</b> TDC 10000045; Wheelabrator 661394  <b>O.D.:</b> 12 3/4 (323.8)                Flange 13 7/8 (352.4)  <b>I.D.:</b> 8 7/16 (214.3) One End  <b>Height:</b> 26 5/8 (676.3)  <b>A. Gskt:</b> [1] Attached</p>
<p><b>PA3555</b></p> 	<p>Replacement for Ecolite Air Element in Disposable Housing  <b>Fits:</b> Farr Optional Housings  <b>Replaces:</b> Farr 114500-002  <b>O.D.:</b> 8 1/8 (206.4)  <b>I.D.:</b> 4 (101.6) One End  <b>Height:</b> 17 3/16 (436.6)</p>	<p><b>PA3562</b></p> 	<p>Air Element  <b>Contains:</b> Flame Retardant Media  <b>Replaces:</b> Donaldson P823295  <b>O.D.:</b> 7 15/16 (201.6)  <b>I.D.:</b> 11/16 (17.5) &amp; 3 9/16 (90.5)  <b>Height:</b> 20 1/4 (514.4)  <b>A. Gskt:</b> [1] Attached  <b>F. Gskt:</b> G103-N</p>
<p><b>PA3556</b></p> 	<p>Replacement for Ecolite Air Element in Disposable Housing  <b>Fits:</b> Farr Optional Housings  <b>Replaces:</b> Farr 114500-003  <b>O.D.:</b> 9 5/8 (244.5)  <b>I.D.:</b> 5 (127.0) One End  <b>Height:</b> 20 1/8 (511.2)</p>	<p><b>PA3563</b></p> 	<p>Air Element  <b>Contains:</b> Flame Retardant Media  <b>Fits:</b> Torit DownFlo EAC Environmental Dust Collectors  <b>Replaces:</b> Torit 8PP40766-00  <b>O.D.:</b> 12 25/32 (324.6)  <b>I.D.:</b> 8 11/32 (211.9)  <b>Height:</b> 26 1/2 (673.1)  <b>A. Gskt:</b> [1] Attached</p>

Measurements Are Shown In Inches And (Millimeters)

**WARNING:** These products can expose you to chemicals, including Diisononyl Phthalate, Carbon black extracts, Nickel, 1,3 Butadiene, Ethylene Oxide, Epichlorohydrin, which are known to the State of California to cause cancer, and Bisphenol, Ethylene Glycol, Ethylene Oxide, 1,3 Butadiene, Epichlorohydrin, which are known to the State of California to cause birth defects or other reproductive harm.

**PA3565**



Inner Air Element

**Fits Inside:** PA3472, PA3472-FN  
**Fits:** John Deere Lawn & Garden Mowers, Tractors  
**Replaces:** John Deere M94734  
**O.D.:** 2 (50.8)  
 Flange 3 1/8 (79.4)  
**I.D.:** 2 1/32 (16.7) & 1 17/32 (38.9)  
**Height:** 6 1/4 (158.8)  
**A. Gskt:** [1] Attached  
**F. Gskt:** G103-N

**PA3576**



Air Element

**Fits:** Wheelabrator Dust Collectors  
**Replaces:** Wheelabrator 8036082  
**O.D.:** 12 3/4 (323.8)  
 Flange 13 7/8 (352.4)  
**I.D.:** 8 3/8 (212.7) One End  
**Height:** 36 5/8 (930.3)  
**A. Gskt:** [1] Attached

**PA3566**



Inner Air Element

**Fits Inside:** PA3558, PA3688  
**Fits:** R.V.I. Buses, Trucks  
**Replaces:** Renault 5010064372  
**O.D.:** 6 3/8 (161.9)  
 Flange 7 1/2 (190.5)  
**I.D.:** 5/8 (15.9) & 5 1/4 (133.4)  
**Height:** 14 7/8 (377.8)  
**A. Gskt:** [1] Attached  
**F. Gskt:** G103-N

**PA3578**



Inner Air Element

**Fits Inside:** PA2784  
**Fits:** Daewoo, Kawasaki, Komatsu Equipment; Mitsubishi Trucks  
**Replaces:** Komatsu 600-181-6730  
**O.D.:** 5 1/4 (133.4)  
**I.D.:** 2 1/32 (16.7) & 4 1/8 (104.8)  
**Height:** 16 11/32 (415.1)  
**A. Gskt:** [1] Attached  
**F. Gskt:** G103-N

**PA3568**



Air Element

**Fits:** Wheelabrator Dust Collectors  
**Replaces:** Wheelabrator 833600882  
**O.D.:** 12 3/4 (323.8)  
 Flange 15 x 16 1/2 (381.0 x 419.1)  
**I.D.:** 8 3/8 (212.7) One End  
**Height:** 36 5/8 (930.3)  
**A. Gskt:** [1] Attached

**PA3579**



Air Element

**Notes:** Inside-Out Flow Direction  
**Fits:** Torit Small TD Dust Collectors; Some Small Gas Turbines  
**Replaces:** Torit 8PP18583-00  
**O.D.:** 12 3/4 (323.8)  
**I.D.:** 17/32 (13.5) & 8 11/32 (211.9)  
**Height:** 22 1/2 (571.5)  
**A. Gskt:** [1] Attached  
**F. Gskt:** [1] Included

**PA3569**



Air Element

**Fits:** Torit DownFlo II Dust Collectors  
**Replaces:** Heavy Duty Air A09268  
**O.D.:** 13 13/16 (350.8)  
**I.D.:** 9 1/2 (241.3)  
**Height:** 28 1/2 (723.9)  
**A. Gskt:** [1] Attached

**PA3580**



Air Element

**Notes:** OBSOLETE. Availability Limited to Dealer Stock.  
**Contains:** Flame Retardant Media  
**Fits:** Farr Mark III Dust Collectors  
**Replaces:** Farr 72518-004  
**O.D.:** 12 3/4 (323.8)  
 Flange 15 31/32 x 14 11/32 (405.6 x 364.3)  
**I.D.:** 8 11/32 (211.9) One End  
**Height:** 26 5/8 (676.3)  
**A. Gskt:** [1] Attached  
**Related To:** PA2988 (without Flame Retardant Media)

**PA3572**



Air Element

**Fits:** M.A.N. Buses, Trucks  
**Replaces:** M.A.N. 90-80115.5191  
**O.D.:** 9 17/32 (242.1)  
**I.D.:** 5 5/32 (131.0) One End  
**Height:** 19 1/2 (495.3)  
**A. Gskt:** [1] Attached

**PA3581**



Air Element

**Fits:** Torit Small TD Dust Collectors  
**Replaces:** Torit 8PP21967-00  
**O.D.:** 7 15/16 (201.6)  
**I.D.:** 11/16 (17.5) & 3 9/16 (90.5)  
**Height:** 22 1/2 (571.5)  
**A. Gskt:** [1] Attached  
**F. Gskt:** [1] Included

**PA3573**



Air Element

**Replaces:** Flxible 9754091  
**O.D.:** 13 7/8 (352.4)  
**I.D.:** 9 13/32 (238.9) One End  
**Height:** 17 (431.8)  
**A. Gskt:** [2] Attached  
**F. Gskt:** [1] Included

**PA3584**















Air Element

**Fits:** Gardner Denver Rock Drills; Tipton Filter Clone Dust Collectors  
**Replaces:** Tipton FC15-1001  
**O.D.:** 16 5/8 (422.3)  
**I.D.:** 12 (304.8)  
**Height:** 25 (635.0)  
**A. Gskt:** [2] Attached

Measurements Are Shown In Inches And (Millimeters)

**WARNING:** These products can expose you to chemicals, including Diisononyl Phthalate, Carbon black extracts, Nickel, 1,3 Butadiene, Ethylene Oxide, Epichlorohydrin, which are known to the State of California to cause cancer, and Bisphenol, Ethylene Glycol, Ethylene Oxide, 1,3 Butadiene, Epichlorohydrin, which are known to the State of California to cause birth defects or other reproductive harm.

<p><b>PA3587</b></p> 	<p>Air Element  <b>Fits:</b> Ingersoll-Rand Dust Collectors  <b>Replaces:</b> Ingersoll-Rand 36858405  <b>O.D.:</b> 13 13/16 (350.8)  <b>I.D.:</b> 9 1/2 (241.3)  <b>Height:</b> 27 1/2 (698.5)  <b>A. Gskt:</b> [1] Attached</p>	<p><b>PA3601</b></p> 	<p>Inner Air Element  <b>Contains:</b> Insert Thread: M16 x 2.0  <b>Fits Inside:</b> PA2845  <b>Fits:</b> John Deere Tractors  <b>Replaces:</b> John Deere AL67195  <b>O.D.:</b> 3 11/32 (84.9)            Flange 4 3/32 (104.0)  <b>I.D.:</b> 5/8 (15.9) &amp; 3 (76.2)  <b>Height:</b> 9 1/4 (235.0)</p>
<p><b>PA3588</b></p> 	<p>Air Element  <b>Contains:</b> Flame Retardant Media  <b>Fits:</b> Torit Dust Collectors  <b>Replaces:</b> Torit 8PP25370-00  <b>O.D.:</b> 13 13/16 (350.8)  <b>I.D.:</b> 9 1/2 (241.3)  <b>Height:</b> 22 1/2 (571.5)  <b>A. Gskt:</b> [1] Attached  <b>Related To:</b> PA5699 (Different Media)</p>	<p><b>PA3602</b></p> 	<p>Air Element  <b>Fits:</b> Industrial Dust Collectors  <b>Replaces:</b> Air Refiner ARM1416R  <b>O.D.:</b> 13 13/16 (350.8)  <b>I.D.:</b> 9 1/2 (241.3)  <b>Height:</b> 15 3/4 (400.0)</p>
<p><b>PA3595</b></p> 	<p>Air Element with Twist Lock Mounting Tabs  <b>Fits:</b> Pneumafil ABB Dust Collectors  <b>Replaces:</b> Pneumafil A38738C-2  <b>O.D.:</b> 12 3/4 (323.8)  <b>I.D.:</b> 8 3/8 (212.7) One End  <b>Height:</b> 34 5/8 (879.5)  <b>A. Gskt:</b> [1] Attached</p>	<p><b>PA3604</b></p> 	<p>Air Element  <b>Notes:</b> Inside-Out Flow Direction  <b>Fits:</b> Industrial Dust Collectors  <b>Replaces:</b> Air Refiner ARM17057  <b>O.D.:</b> 13 27/32 (351.6)  <b>I.D.:</b> 3/4 (19.0) &amp; 11 1/8 (282.6)  <b>Height:</b> 14 (355.6)  <b>F. Gskt:</b> [1] Included</p>
<p><b>PA3597</b></p> 	<p>Air Element  <b>Fits:</b> Iveco Trucks  <b>Replaces:</b> Iveco 1905983  <b>O.D.:</b> 9 9/16 (242.9)  <b>I.D.:</b> 13/32 (10.3) &amp; 5 3/16 (131.8)  <b>Height:</b> 11 23/32 (297.7)  <b>A. Gskt:</b> [1] Attached  <b>F. Gskt:</b> [1] Washer</p>	<p><b>PA3605</b></p> 	<p>Air Element  <b>Fits:</b> M.A.N. Buses, Trucks  <b>Replaces:</b> M.A.N. 90.80115.5196  <b>O.D.:</b> 8 15/16 (227.0)  <b>I.D.:</b> 4 19/32 (116.7) One End  <b>Height:</b> 15 (381.0)  <b>A. Gskt:</b> [1] Attached</p>
<p><b>PA3598</b></p> 	<p>Air Element  <b>Contains:</b> Flame Retardant Media  <b>Fits:</b> Airflow PC Dust Collectors  <b>Replaces:</b> Airflow 7FRO-2912  <b>O.D.:</b> 12 3/32 (307.2)  <b>I.D.:</b> 7 11/16 (195.3) One End  <b>Height:</b> 12 (304.8)  <b>A. Gskt:</b> [1] Attached</p>	<p><b>PA3606</b></p> 	<p>Outer Air Element  <b>Fits:</b> Claas, Liebherr, New Holland Equipment; Iveco, M.A.N. Trucks  <b>Use With:</b> PA3787  <b>Replaces:</b> Claas 773670; M.A.N. 81.08401.6082  <b>O.D.:</b> 12 29/32 (327.8)  <b>I.D.:</b> 13/32 (10.3) &amp; 8 1/2 (215.9)  <b>Height:</b> 24 1/4 (615.9)  <b>A. Gskt:</b> [1] Attached  <b>F. Gskt:</b> [1] Included</p>
<p><b>PA3600</b></p> 	<p>Air Element  <b>Fits:</b> Hino Trucks  <b>Replaces:</b> Hino 17801-2810  <b>O.D.:</b> 9 7/32 (234.2)  <b>I.D.:</b> 21/32 (16.7) &amp; 4 27/32 (123.0)  <b>Height:</b> 18 1/2 (469.9)  <b>A. Gskt:</b> [1] Attached  <b>F. Gskt:</b> G103-N</p>	<p><b>PA3607-FN</b></p> 	<p>Air Element with Fins  <b>Fits:</b> Sullair Compressors  <b>Replaces:</b> Sullair 2250044-537  <b>O.D.:</b> 6 3/32 (154.8)            Fins 7 13/16 (198.4)  <b>I.D.:</b> 3/4 (19.0) &amp; 3 7/8 (98.4)  <b>Height:</b> 12 1/2 (317.5)  <b>A. Gskt:</b> [1] Attached  <b>F. Gskt:</b> G103-N</p>

Measurements Are Shown In Inches And (Millimeters)

**WARNING:** These products can expose you to chemicals, including Diisononyl Phthalate, Carbon black extracts, Nickel, 1,3 Butadiene, Ethylene Oxide, Epichlorohydrin, which are known to the State of California to cause cancer, and Bisphenol, Ethylene Glycol, Ethylene Oxide, 1,3 Butadiene, Epichlorohydrin, which are known to the State of California to cause birth defects or other reproductive harm.



**PA3608-FN**



Outer Air Element with Fins and Lid  
**Contains:** Flame Retardant Media  
**Fits:** Toyota Lift Trucks  
**Replaces:** Toyota 17808-23800-71  
**O.D.:** 5 11/32 (135.7)  
 Lid 7 27/32 (199.2)  
**I.D.:** 15/32 (11.9) & 2 5/8 (66.7)  
**Height:** 11 7/16 (290.5)  
**A. Gskt:** [2] Attached  
**F. Gskt:** [1] Included

**PA3614**



Air Element  
**Notes:** Inside-Out Flow Direction  
**Contains:** Flame Retardant Media  
**Fits:** Torit DownFlo II Series Dust Collectors  
**Replaces:** Torit 8PP42058-00  
**O.D.:** 13 13/16 (350.8)  
**I.D.:** 9 1/2 (241.3)  
**Height:** 26 1/2 (673.1)  
**A. Gskt:** [1] Attached  
**Related To:** PA3463 (Standard Media Version)

**PA3609**



Outer Air Element  
**Fits:** Komatsu Equipment  
**Use With:** PA3610  
**Replaces:** Komatsu 600-181-8210  
**O.D.:** 8 1/2 (215.9)  
**I.D.:** 5/8 (15.9) & 4 5/32 (105.6)  
**Height:** 16 3/4 (425.5)  
**A. Gskt:** [1] Attached  
**F. Gskt:** G103-N  
**Related To:** PA4581 (One Closed End)

**PA3627**



Air Element  
**Fits:** Industrial Applications  
**Replaces:** Heavy Duty Air A1234-1  
**O.D.:** 7 15/16 (201.6)  
**I.D.:** 1/2 (12.7) & 3 9/16 (90.5)  
**Height:** 10 1/2 (266.7)  
**A. Gskt:** [1] Attached  
**F. Gskt:** [1] Included

**PA3610**



Inner Air Element  
**Notes:** OBSOLETE. Availability Limited to Dealer Stock.  
**Fits Inside:** PA3609  
**Fits:** Komatsu Equipment  
**Replaces:** Komatsu 600-181-8310  
**O.D.:** 4 1/8 (104.8)  
**I.D.:** 21/32 (16.7) & 3 (76.2)  
**Height:** 15 1/4 (387.3)  
**A. Gskt:** [1] Attached  
**F. Gskt:** G103-N

**PA3628**



Woven Aluminum Air Element  
**Fits:** Industrial Applications  
**Replaces:** Heavy Duty Air A09214  
**O.D.:** 6 23/32 (170.7)  
**I.D.:** 5 1/2 (139.7)  
**Height:** 2 3/4 (69.9)

**PA3611**



Air Element  
**Fits:** Farr-Type D Dust Collectors  
**Replaces:** Farr 101400-1  
**O.D.:** 12 3/4 (323.8)  
 Flange 15 31/32 x 14 1/4 (405.6 x 362.0)  
**I.D.:** 8 5/16 (211.1) One End  
**Height:** 34 5/8 (879.5)  
**A. Gskt:** [1] Attached

**PA3629**



Outer Air Element with Lid  
**Fits:** Caterpillar Equipment  
**Use With:** PA1911  
**Replaces:** Caterpillar 417575, 96-4175  
**O.D.:** 7 3/8 (187.3)  
 Lid 9 9/32 (235.7)  
**I.D.:** 21/32 (16.7) & 4 11/16 (119.1)  
**Height:** 15 1/2 (393.7)  
**A. Gskt:** [2] Attached  
**F. Gskt:** G103-N

**PA3612**



Air Element  
**Fits:** Atlas, Fendt, Guldner Equipment; Fiat Lift Trucks  
**Replaces:** Atlas Copco 16192867; Fiat 9292365; Guldner 9839012  
**O.D.:** 4 3/8 (111.1)  
**I.D.:** 5/8 (15.9) & 1 15/16 (49.2)  
**Height:** 8 31/32 (227.8)  
**A. Gskt:** [1] Attached  
**F. Gskt:** [1] Included

**PA3630-FN**



Outer Air Element with Fins  
**Fits:** Kobelco, MDI/Yutani Equipment  
**Use With:** PA3631  
**Replaces:** Kobelco 2446R255-S5  
**O.D.:** 6 7/8 (174.6)  
 Fins 8 3/4 (222.3)  
**I.D.:** 21/32 (16.7) & 4 3/16 (106.4)  
**Height:** 20 1/2 (520.7)  
**A. Gskt:** [1] Attached  
**F. Gskt:** G103-N

**PA3613**



Cab Air Element  
**Fits:** Komatsu Loaders  
**Replaces:** Komatsu 421-07-12312  
**Length:** 10 (254.0)  
**Width:** 6 (152.4)  
**Height:** 2 3/16 (55.6)

**PA3631**



Inner Air Element  
**Fits Inside:** PA3630-FN  
**Fits:** Kobelco, MDI/Yutani Equipment  
**Replaces:** Kobelco 2446R255-S6  
**O.D.:** 4 3/32 (104.0)  
 Flange 4 15/16 (125.4)  
**I.D.:** 25/32 (19.8) & 3 5/8 (92.1)  
**Height:** 19 5/16 (490.5)  
**A. Gskt:** [1] Attached  
**F. Gskt:** G103-N

Measurements Are Shown In Inches And (Millimeters)

**WARNING:** These products can expose you to chemicals, including Diisononyl Phthalate, Carbon black extracts, Nickel, 1,3 Butadiene, Ethylene Oxide, Epichlorohydrin, which are known to the State of California to cause cancer, and Bisphenol, Ethylene Glycol, Ethylene Oxide, 1,3 Butadiene, Epichlorohydrin, which are known to the State of California to cause birth defects or other reproductive harm.

**PA3632** Inner Air Element  
**Fits Inside:** PA3557-FN  
**Fits:** John Deere Equipment  
**Replaces:** John Deere AM108185  
**O.D.:** 2 3/8 (60.3)  
 Flange 4 1/2 (114.3)  
**I.D.:** 21/32 (16.7) & 2 (50.8)  
**Height:** 7 3/16 (182.6)  
**A. Gskt:** [1] Attached  
**F. Gskt:** G103-N



**PA3640** Air Element  
**Fits:** Wheelabrator WTB-3 Tumbblast Machine  
**Replaces:** Wheelabrator 713200881  
**O.D.:** 7 15/16 (201.6)  
**I.D.:** 11/16 (17.5) & 3 9/16 (90.5)  
**Height:** 32 1/2 (825.5)  
**A. Gskt:** [1] Attached  
**F. Gskt:** G103-N



**PA3633** Air Element  
**Fits:** Caterpillar Generators  
**Use With:** PA3633 FOAM  
**Replaces:** Caterpillar 4W5452, 105-9741  
**O.D.:** 22 (558.8)  
**I.D.:** 15 9/16 (395.3) One End  
**Height:** 24 3/4 (628.7)  
**A. Gskt:** [1] Attached



**PA3643** Hydraulic Tank Breather  
**Fits:** Caterpillar Equipment, Off-Highway Trucks; Generac Generators  
**Replaces:** Caterpillar 8X4575  
**O.D.:** 4 19/32 (116.7)  
**I.D.:** 1 5/8 (41.3) One End  
**Height:** 5 7/8 (149.2)



**PA3633 FOAM** Foam Blanket for PA3633  
**Use With:** PA3633  
**Replaces:** Caterpillar 4W7103  
**Length:** 68 13/16 (1747.8)  
**Width:** 23 1/2 (596.9)



**PA3644** Conical-Shaped Air Element  
**Fits:** Kenworth Trucks  
**Replaces:** Fleetguard AF25092M  
**O.D.:** 8 5/32 (207.2)  
 to 10 7/8 (276.2)  
**I.D.:** 3 31/32 (100.8) & 6 23/32 (170.7) to  
**Height:** 24 3/4 (628.7)  
**A. Gskt:** [2] Attached



**PA3636** Air Element  
**Fits:** Hitachi Excavators  
**Replaces:** Hitachi 4206099  
**O.D.:** 6 3/32 (154.8)  
**I.D.:** 3/4 (19.0) & 4 3/32 (104.0)  
**Height:** 12 3/8 (314.3)  
**A. Gskt:** [1] Attached  
**F. Gskt:** G103-N



**PA3645** Air Element  
**Notes:** Inside-Out Flow Direction  
**Fits:** Stork Model Laser Engraver  
**O.D.:** 9 7/32 (234.2)  
**I.D.:** 21/32 (16.7) & 4 27/32 (123.0)  
**Height:** 11 1/2 (292.1)  
**A. Gskt:** [1] Attached  
**F. Gskt:** G103-N



**PA3637** Air Element  
**Fits:** Industrial Applications  
**Replaces:** Donaldson P150232  
**O.D.:** 17 5/8 (447.7)  
**I.D.:** 11 1/32 (280.2)  
**Height:** 23 17/32 (597.7)  
**A. Gskt:** [1] Attached



**PA3650** Outer Air Element with Lid  
**Contains:** Flame Retardant Media  
**Fits:** Komatsu Equipment  
**Use With:** PA4548  
**Replaces:** Komatsu 600-181-6350  
**O.D.:** 4 7/8 (123.8)  
 Lid 6 5/16 (160.3)  
**I.D.:** 21/32 (16.7) & 3 7/32 (81.8)  
**Height:** 10 1/4 (260.3)  
**A. Gskt:** [1] Attached  
**F. Gskt:** G103-N



**PA3638** Air Element  
**Fits:** Wheelabrator Dust Collectors  
**Replaces:** Wheelabrator 213600881  
**O.D.:** 12 25/32 (324.6)  
**I.D.:** 17/32 (13.5) & 8 11/32 (211.9)  
**Height:** 36 1/2 (927.1)  
**A. Gskt:** [1] Attached  
**F. Gskt:** [1] Included



**PA3651-FN** Outer Air Element with Fins and Lid  
**Contains:** Flame Retardant Media  
**Fits:** Caterpillar Lift Trucks  
**Replaces:** Caterpillar 101-5412  
**O.D.:** 4 3/32 (104.0)  
 Lid 5 31/32 (151.6)  
**I.D.:** 5/8 (15.9) & 2 7/32 (56.4)  
**Height:** 9 1/8 (231.8)  
**A. Gskt:** [2] Attached  
**F. Gskt:** G103-N



Measurements Are Shown In Inches And (Millimeters)

**WARNING:** These products can expose you to chemicals, including Diisononyl Phthalate, Carbon black extracts, Nickel, 1,3 Butadiene, Ethylene Oxide, Epichlorohydrin, which are known to the State of California to cause cancer, and Bisphenol, Ethylene Glycol, Ethylene Oxide, 1,3 Butadiene, Epichlorohydrin, which are known to the State of California to cause birth defects or other reproductive harm.

**PA3652**



Outer Air Element with Lid  
**Fits:** Fiat-Allis, Liebherr Equipment  
**Use With:** PA3847  
**Replaces:** Fiat 700052343; Liebherr 7403953  
**O.D.:** 10 1/2 (266.7)  
 Lid 12 1/2 (317.5)  
**I.D.:** 21/32 (16.7) & 6 (152.4)  
**Height:** 16 1/2 (419.1)  
**A. Gskt:** [1] Attached  
**F. Gskt:** [1] Included, [1] Wing Nut

**PA3653**



Outer Air Element  
**Fits:** Fiat-Allis Equipment  
**Use With:** PA3654  
**Replaces:** Fiat 8322128  
**O.D.:** 8 3/4 (222.3)  
**I.D.:** 6 1/16 (154.0)  
**Height:** 8 1/16 (204.8)  
**A. Gskt:** [2] Attached

**PA3654**



Inner Air Element  
**Fits Inside:** PA3653  
**Fits:** Fiat-Allis Equipment  
**Replaces:** Fiat 8322129  
**O.D.:** 5 3/8 (136.5)  
**I.D.:** 3 31/32 (100.0)  
**Height:** 6 7/8 (174.6)  
**A. Gskt:** [2] Attached

**PA3655**



Outer Air Element  
**Fits:** Ford, New Holland Equipment  
**Use With:** PA3656  
**Replaces:** New Holland 9846494  
**O.D.:** 9 29/32 (251.6)  
**I.D.:** 11/16 (17.5) & 6 1/16 (154.0)  
**Height:** 16 (406.4)  
**A. Gskt:** [1] Attached  
**F. Gskt:** G103-N

**PA3656**



Inner Air Element  
**Fits Inside:** PA3655  
**Fits:** Ford, New Holland Equipment  
**Replaces:** New Holland 9846495  
**O.D.:** 5 15/16 (150.8)  
**I.D.:** 21/32 (16.7) & 4 29/32 (124.6)  
**Height:** 15 (381.0)  
**A. Gskt:** [1] Attached  
**F. Gskt:** G103-N

**PA3657**



Inner Air Element  
**Fits Inside:** PA3448  
**Fits:** Hino Trucks  
**Replaces:** Hino 17801-2610  
**O.D.:** 4 9/16 (115.9)  
 Flange 5 23/32 (145.3)  
**I.D.:** 21/32 (16.7) & 3 7/16 (87.3)  
**Height:** 12 (304.8)  
**A. Gskt:** [1] Attached  
**F. Gskt:** G103-N

**PA3658**



Cab Air Element  
**Fits:** Caterpillar Equipment  
**Replaces:** Caterpillar 7T1889  
**Length:** 23 1/2 (596.9)  
**Width:** 6 (152.4)  
**Height:** 2 9/16 (65.1)  
**A. Gskt:** [1] Attached

**PA3660-FN**



Air Element with Fins  
**Fits:** Mitsubishi Trucks  
**Replaces:** Mitsubishi MB120298  
**O.D.:** 7 15/16 (201.6)  
 Fins 9 31/32 (253.2)  
**I.D.:** 1/2 (12.7) & 4 31/32 (126.2)  
**Height:** 7 3/8 (187.3)  
**A. Gskt:** [1] Attached  
**F. Gskt:** [1] Included

**PA3664-FN**



Outer Air Element with Fins and Lid  
**Fits:** Bomag, Komatsu, Kubota Equipment  
**Replaces:** Kubota 15852-11082  
**O.D.:** 3 9/32 (83.3)  
 Lid 5 (127.0)  
**I.D.:** 13/32 (10.3) & 1 27/32 (46.8)  
**Height:** 7 1/4 (184.2)  
**A. Gskt:** [2] Attached  
**F. Gskt:** [1] Included

**PA3667-FN**



Air Element with Fins  
**Contains:** Flame Retardant Media  
**Fits:** Toyota Lift Trucks  
**Replaces:** Toyota 17752-20540-71  
**O.D.:** 5 1/4 (133.4)  
 Fins 6 3/8 (161.9)  
**I.D.:** 21/32 (16.7) & 2 5/8 (66.7)  
**Height:** 11 5/16 (287.3)  
**A. Gskt:** [1] Attached  
**F. Gskt:** G103-N  
**Related To:** PA1667-FN (without Flame Retardant Media)

**PA3668**



Inner Air Element  
**Fits Inside:** LL2676, PA2676, PA2676XP  
**Fits:** Hitachi, John Deere Equipment; Komatsu, Nissan Trucks  
**Replaces:** John Deere AT201036  
**O.D.:** 7 1/4 (184.2)  
**I.D.:** 11/16 (17.5) & 6 3/16 (157.2)  
**Height:** 18 1/2 (469.9)  
**A. Gskt:** [1] Attached  
**F. Gskt:** G103-N













**PA3669-FN**



Outer Air Element with Fins and Lid  
**Fits:** Agco, Braud, Case, Ford, Massey Ferguson, Same, White Equipment  
**Use With:** PA2419  
**Replaces:** Case P1950555; New Holland 1930765; Same 242491300  
**O.D.:** 6 3/32 (154.8)  
 Lid 8 3/8 (212.7)  
**I.D.:** 21/32 (16.7) & 3 15/32 (88.1)  
**Height:** 15 1/2 (393.7)  
**A. Gskt:** [1] Attached  
**F. Gskt:** [1] Included, [1] Wing Nut

Measurements Are Shown In Inches And (Millimeters)

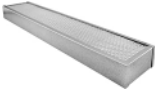
**WARNING:** These products can expose you to chemicals, including Diisononyl Phthalate, Carbon black extracts, Nickel, 1,3 Butadiene, Ethylene Oxide, Epichlorohydrin, which are known to the State of California to cause cancer, and Bisphenol, Ethylene Glycol, Ethylene Oxide, 1,3 Butadiene, Epichlorohydrin, which are known to the State of California to cause birth defects or other reproductive harm.

<p><b>PA3670</b></p>  <p>Outer Air Element with Lid  <b>Contains:</b> Flame Retardant Media  <b>Fits:</b> Komatsu Equipment  <b>Use With:</b> PA3985  <b>Replaces:</b> Komatsu 600-182-1320  <b>O.D.:</b> 6 3/32 (154.8)            Lid 7 5/8 (193.7)  <b>I.D.:</b> 21/32 (16.7) &amp; 3 15/32 (88.1)  <b>Height:</b> 12 3/8 (314.3)  <b>A. Gskt:</b> [2] Attached  <b>F. Gskt:</b> G103-N, [1] Wing Nut</p>	<p><b>PA3679</b></p>  <p>Air Breather Element  <b>Fits:</b> Volvo Trucks  <b>Replaces:</b> Volvo 1082368-0  <b>O.D.:</b> 3 7/16 (87.3)  <b>I.D.:</b> 31/32 (24.6) One End  <b>Height:</b> 5 3/16 (131.8)  <b>A. Gskt:</b> [1] Attached</p>
<p><b>PA3671-FN</b></p>  <p>Outer Air Element with Fins  <b>Contains:</b> Flame Retardant Media  <b>Fits:</b> Kobelco, Komatsu Equipment  <b>Use With:</b> PA3672, PA3674  <b>Replaces:</b> Kobelco 2451U154-3N; Komatsu 600-181-7260  <b>O.D.:</b> 5 1/4 (133.4)            Fins 6 11/32 (161.1)  <b>I.D.:</b> 21/32 (16.7) &amp; 3 5/16 (84.1)  <b>Height:</b> 11 9/32 (286.5)  <b>A. Gskt:</b> [1] Attached  <b>F. Gskt:</b> G103-N</p>	<p><b>PA3680</b></p>  <p>Foam Cab Air Element  <b>Fits:</b> Caterpillar Equipment  <b>Replaces:</b> Caterpillar 6P1319  <b>Length:</b> 10 11/16 (271.5)  <b>Width:</b> 4 11/16 (119.1)  <b>Height:</b> 4 3/16 (106.4)</p>
<p><b>PA3672</b></p>  <p>Inner Air Element  <b>Fits Inside:</b> PA3671-FN  <b>Replaces:</b> Toyota 17804-23000-71  <b>O.D.:</b> 3 3/16 (81.0)  <b>I.D.:</b> 15/32 (11.9) &amp; 2 17/32 (64.3)  <b>Height:</b> 10 3/8 (263.5)  <b>A. Gskt:</b> [1] Attached  <b>F. Gskt:</b> [1] Included</p>	<p><b>PA3681</b></p>  <p>Air Element  <b>Fits:</b> Mercedes-Benz Trucks, Vans  <b>Replaces:</b> Mercedes-Benz 20947304  <b>O.D.:</b> 7 13/16 (198.4)  <b>I.D.:</b> 11/32 (8.7) &amp; 4 1/16 (103.2)  <b>Height:</b> 10 1/32 (254.8)  <b>A. Gskt:</b> [1] Attached</p>
<p><b>PA3674</b></p>  <p>Inner Air Element  <b>Fits Inside:</b> PA3671-FN  <b>Fits:</b> Komatsu, Mitsubishi Equipment  <b>Replaces:</b> Komatsu 600-181-7360; Mitsubishi 91461-11400  <b>O.D.:</b> 3 1/4 (82.6)  <b>I.D.:</b> 21/32 (16.7) &amp; 2 1/8 (54.0)  <b>Height:</b> 9 17/32 (242.1)  <b>A. Gskt:</b> [1] Attached  <b>F. Gskt:</b> G103-N</p>	<p><b>PA3682</b></p>  <p>Inner Air Element  <b>Fits Inside:</b> PA2422  <b>Fits:</b> Deutz Tractors  <b>Replaces:</b> Deutz 2379161, 4308634  <b>O.D.:</b> 2 11/16 (68.3)            Flange 3 5/32 (80.2)  <b>I.D.:</b> 5/8 (15.9) &amp; 2 13/32 (61.1)  <b>Height:</b> 7 27/32 (199.2)  <b>A. Gskt:</b> [1] Attached</p>
<p><b>PA3675</b></p>  <p>Outer Air Element with Lid  <b>Fits:</b> Braud, Daewoo, Liebherr, Same Equipment  <b>Use With:</b> PA1981  <b>Replaces:</b> Daewoo 94749001; Liebherr 7405233; Same 242493801  <b>O.D.:</b> 10 1/32 (254.8)            Lid 10 7/8 (276.2)  <b>I.D.:</b> 4 13/16 (122.2) One End  <b>Height:</b> 16 1/2 (419.1)  <b>A. Gskt:</b> [1] Attached  <b>F. Gskt:</b> [1] Included, [1] Wing Nut</p>	<p><b>PA3683</b></p>  <p>Inner Air Element  <b>Fits Inside:</b> PA2423  <b>Fits:</b> Deutz Tractors  <b>Replaces:</b> Deutz 2379163, 4308636  <b>O.D.:</b> 3 1/4 (82.6)            Flange 3 17/32 (89.7)  <b>I.D.:</b> 7/16 (11.1) &amp; 2 3/4 (69.9)  <b>Height:</b> 12 13/16 (325.4)  <b>A. Gskt:</b> [1] Attached</p>
<p><b>PA3676</b></p>  <p>Cab Air Element  <b>Replaces:</b> GMC 25043797  <b>Length:</b> 24 (609.6)  <b>Width:</b> 5 (127.0)  <b>Height:</b> 2 3/16 (55.6)</p>	<p><b>PA3684</b></p>  <p>Inner Air Element  <b>Fits Inside:</b> PA2422, PA2772  <b>Fits:</b> Deutz, Eicher, Fendt Tractors  <b>Replaces:</b> Fendt X810270072  <b>O.D.:</b> 3 11/32 (84.9)  <b>I.D.:</b> 5/8 (15.9) &amp; 2 27/32 (72.2)  <b>Height:</b> 7 17/32 (191.3)  <b>A. Gskt:</b> [1] Attached</p>

Measurements Are Shown In Inches And (Millimeters)

**WARNING:** These products can expose you to chemicals, including Diisononyl Phthalate, Carbon black extracts, Nickel, 1,3 Butadiene, Ethylene Oxide, Epichlorohydrin, which are known to the State of California to cause cancer, and Bisphenol, Ethylene Glycol, Ethylene Oxide, 1,3 Butadiene, Epichlorohydrin, which are known to the State of California to cause birth defects or other reproductive harm.

**PA3685**



Inner Air Element

**Fits Inside:** PA2423  
**Fits:** Bomag, Deutz Equipment  
**Replaces:** Deutz 2243522, 4930377  
**O.D.:** 3 5/16 (84.1)  
**I.D.:** 5/8 (15.9) & 2 27/32 (72.2)  
**Height:** 12 5/16 (312.7)  
**A. Gskt:** [1] Attached

**PA3691**



Air Element

**Fits:** Duraquip Equipment  
**Replaces:** Duraquip 90603; Guardian G119253  
**O.D.:** 9 1/4 (235.0)  
**I.D.:** 9/16 (14.3) & 6 3/4 (171.5)  
**Height:** 24 1/2 (622.3)  
**A. Gskt:** [1] Attached  
**F. Gskt:** G103-N

**PA3686**



Inner Air Element

**Fits Inside:** PA2767  
**Fits:** Bomag, Claas, Fendt, Hanomag, International, Kobelco, Liebherr Equipment; Iveco Trucks  
**Replaces:** Deutz 4144897  
**O.D.:** 2 9/16 (65.1)  
 Boot 3 5/32 (80.2)  
**I.D.:** 21/32 (16.7) One End  
**Height:** 12 27/32 (326.2)  
**A. Gskt:** [1] Attached

**PA3697**



Air Element

**Fits:** Toyota Lift Trucks  
**Replaces:** Toyota 17801-20540, 17801-20540-71  
**O.D.:** 10 7/32 (259.6)  
**I.D.:** 7 7/32 (183.4) One End  
**Height:** 1 13/16 (46.0)  
**A. Gskt:** [2] Attached

**PA3687**



Inner Air Element

**Fits Inside:** PA2792  
**Fits:** Atlas, Eicher, Fendt, Hough, International, Steyr-Daimler-Puch Equipment  
**Replaces:** International 3148080-R1; Steyr-Daimler-Benz 31100190019  
**O.D.:** 2 13/32 (61.1)  
 Boot 2 3/4 (69.9)  
**I.D.:** 21/32 (16.7) & 2 1/16 (52.4)  
**Height:** 11 3/16 (284.2)  
**A. Gskt:** [1] Attached  
**F. Gskt:** [1] Plastic Washer

**PA3698**



Outer Air Element

**Fits:** Caterpillar Equipment  
**Use With:** PA2413  
**Replaces:** Caterpillar 4N0326  
**O.D.:** 6 27/32 (173.8)  
**I.D.:** 5/8 (15.9) & 3 15/32 (88.1)  
**Height:** 12 3/8 (314.3)  
**A. Gskt:** [1] Attached  
**F. Gskt:** G103-N

**PA3688**



Outer Air Element

**Contains:** Flame Retardant Media  
**Fits:** R.V.I. Trucks  
**Use With:** PA3566  
**Replaces:** Renault 5010066304  
**O.D.:** 12 1/16 (306.4)  
**I.D.:** 11/16 (17.5) & 7 11/16 (195.3)  
**Height:** 18 1/2 (469.9)  
**A. Gskt:** [1] Attached  
**F. Gskt:** G103-N

**PA3699**



Outer Air Element

**Fits:** R.V.I. Trucks  
**Replaces:** Renault 5000751674, 5010094092, 5010094146  
**O.D.:** 11 1/8 (282.6)  
**I.D.:** 21/32 (16.7) & 6 23/32 (170.7)  
**Height:** 15 5/16 (388.9)  
**A. Gskt:** [1] Attached  
**F. Gskt:** G103-N

**PA3689**



Air Element

**Fits:** Komatsu Equipment  
**Replaces:** Komatsu 600-181-1680  
**O.D.:** 6 3/8 (161.9)  
**I.D.:** 5/8 (15.9) & 5 9/32 (134.1)  
**Height:** 14 3/16 (360.4)  
**A. Gskt:** [1] Attached  
**F. Gskt:** G103-N

**RS3700**



Radial Seal Outer Air Element

**Fits:** Caterpillar Equipment  
**Use With:** RS3701  
**Replaces:** Caterpillar 106-3969  
**O.D.:** 14 7/32 (361.2)  
**I.D.:** 8 15/16 (227.0) One End  
**Height:** 18 11/32 (465.9)  
**Related To:** RS3700XP (Extreme Performance Nano Version)

**PA3690**

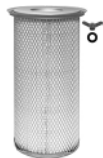

Outer Air Element with Lid

**Fits:** Lister Engines; Massey Ferguson Tractors  
**Use With:** PA2419  
**Replaces:** Lister 38207906; Massey Ferguson 1062501-M91  
**O.D.:** 6 11/16 (169.9)  
 Lid 8 13/32 (213.5)  
**I.D.:** 21/32 (16.7) & 3 15/32 (88.1)  
**Height:** 15 7/16 (392.1)  
**A. Gskt:** [1] Attached  
**F. Gskt:** [1] Rubber Washer, [1] Wing Nut

**RS3700XP**















Extreme Performance Nano Radial Seal Outer Air Element

**Fits:** Caterpillar Equipment  
**Use With:** RS3701  
**Replaces:** Caterpillar 106-3969  
**O.D.:** 14 7/32 (361.2)  
**I.D.:** 8 15/16 (227.0) One End  
**Height:** 18 11/32 (465.9)  
**Related To:** RS3700 (Standard Media Version)

Measurements Are Shown In Inches And (Millimeters)

**WARNING:** These products can expose you to chemicals, including Diisononyl Phthalate, Carbon black extracts, Nickel, 1,3 Butadiene, Ethylene Oxide, Epichlorohydrin, which are known to the State of California to cause cancer, and Bisphenol, Ethylene Glycol, Ethylene Oxide, 1,3 Butadiene, Epichlorohydrin, which are known to the State of California to cause birth defects or other reproductive harm.

<p><b>RS3701</b></p> 	<p>Radial Seal Inner Air Element  <b>Fits Inside:</b> RS3700, RS3700XP  <b>Fits:</b> Caterpillar Equipment  <b>Replaces:</b> Caterpillar 106-3973  <b>O.D.:</b> 9 3/32 (231.0)  <b>I.D.:</b> 6 29/32 (175.4) One End  <b>Height:</b> 17 27/32 (453.2)</p>	<p><b>RS3708</b></p> 	<p>Radial Seal Outer Air Element  <b>Fits:</b> Case Equipment  <b>Use With:</b> RS3709  <b>Replaces:</b> Case 128781A1  <b>O.D.:</b> 5 13/32 (137.3)  <b>I.D.:</b> 3 3/16 (81.0) One End  <b>Height:</b> 15 15/32 (392.9)</p>
<p><b>RS3703</b></p> 	<p>Radial Seal Inner Air Element  <b>Fits Inside:</b> RS3549, RS3988  <b>Fits:</b> Bobcat, Case-International, Caterpillar, John Deere, Kubota, Mustang, Terex, Timberjack Equipment  <b>Replaces:</b> Case 133721-A1; Melroe-Bobcat 6666334; Owatonna 42035599  <b>O.D.:</b> 3 5/16 (84.1)  <b>I.D.:</b> 2 15/32 (62.7) One End  <b>Height:</b> 11 31/32 (304.0)</p>	<p><b>RS3709</b></p> 	<p>Radial Seal Inner Air Element  <b>Fits Inside:</b> RS3708, RS5395-FN  <b>Fits:</b> Case Equipment  <b>Replaces:</b> Case 128782A1  <b>O.D.:</b> 3 5/16 (84.1)  <b>I.D.:</b> 2 15/32 (62.7) One End  <b>Height:</b> 14 7/8 (377.8)</p>
<p><b>RS3704</b></p> 	<p>Radial Seal Outer Air Element  <b>Fits:</b> Isuzu, Yanmar Engines; Bobcat, Caterpillar, John Deere, Komatsu, Kubota Equipment  <b>Use With:</b> RS3705  <b>Replaces:</b> John Deere M131802; Kubota TA040-93230; Melroe-Bobcat 6672467; Yanmar 119808-12520  <b>O.D.:</b> 4 1/8 (104.8)  <b>I.D.:</b> 2 5/16 (58.7) One End  <b>Height:</b> 10 13/16 (274.6)  <b>Related To:</b> RS3716 (with Flame Retardant Media)</p>	<p><b>RS3710</b></p> 	<p>Radial Seal Outer Air Element  <b>Fits:</b> Nissan Trucks  <b>Use With:</b> RS3711  <b>Replaces:</b> Nissan 16546-Z9100  <b>O.D.:</b> 10 29/32 (277.0)  <b>I.D.:</b> 6 25/32 (172.2) One End  <b>Height:</b> 14 23/32 (373.9)</p>
<p><b>RS3705</b></p> 	<p>Radial Seal Inner Air Element  <b>Fits Inside:</b> RS3704, RS3716  <b>Fits:</b> Isuzu, Yanmar Engines; Bobcat, Caterpillar, John Deere, Komatsu, Kubota Equipment  <b>Replaces:</b> Hitachi 4423981; John Deere M131803; Kubota TA040-93220; Melroe-Bobcat 6672468; Donaldson P822858  <b>O.D.:</b> 2 13/32 (61.1)  <b>I.D.:</b> 1 3/4 (44.4) One End  <b>Height:</b> 10 13/32 (264.3)</p>	<p><b>RS3711</b></p> 	<p>Radial Seal Inner Air Element  <b>Fits Inside:</b> RS3710  <b>Fits:</b> Nissan Trucks  <b>Replaces:</b> Nissan 16546-Z9101  <b>O.D.:</b> 6 7/8 (174.6)  <b>I.D.:</b> 6 1/2 (165.1) One End  <b>Height:</b> 14 1/32 (356.4)</p>
<p><b>RS3706</b></p> 	<p>Radial Seal Heavy-Duty Air Element  <b>Fits:</b> Chevrolet, GMC Light-Duty Trucks, Vans  <b>Replaces:</b> GMC 15986275, 25168082  <b>O.D.:</b> 7 11/32 (186.5)  <b>I.D.:</b> 3 19/32 (91.3) One End  <b>Height:</b> 11 3/32 (281.8)  <b>Related To:</b> RS3707 (Standard Version)  RS3735 (Standard Version with Foam Wrap)</p>	<p><b>RS3712</b></p> 	<p>Radial Seal Outer Air Element  <b>Fits:</b> Caterpillar Equipment  <b>Use With:</b> RS3713  <b>Replaces:</b> Caterpillar 123-6855  <b>O.D.:</b> 14 7/32 (361.2)  <b>I.D.:</b> 8 15/16 (227.0) One End  <b>Height:</b> 15 17/32 (394.5)</p>
<p><b>RS3707</b></p> 	<p>Radial Seal Air Element  <b>Fits:</b> Chevrolet, GMC Light-Duty Trucks, Vans  <b>Replaces:</b> GMC 15998574, 25168081  <b>O.D.:</b> 6 1/2 (165.1)  <b>I.D.:</b> 3 9/16 (90.5) One End  <b>Height:</b> 11 1/32 (280.2)  <b>Related To:</b> RS3706 (Heavy-Duty Version)  RS3735 (with Foam Wrap)</p>	<p><b>RS3713</b></p> 	<p>Radial Seal Inner Air Element  <b>Fits Inside:</b> RS3712  <b>Fits:</b> Caterpillar Equipment  <b>Replaces:</b> Caterpillar 123-6856  <b>O.D.:</b> 9 3/32 (231.0)  <b>I.D.:</b> 6 29/32 (175.4) One End  <b>Height:</b> 15 7/32 (386.6)</p>

Measurements Are Shown In Inches And (Millimeters)

**WARNING:** These products can expose you to chemicals, including Diisononyl Phthalate, Carbon black extracts, Nickel, 1,3 Butadiene, Ethylene Oxide, Epichlorohydrin, which are known to the State of California to cause cancer, and Bisphenol, Ethylene Glycol, Ethylene Oxide, 1,3 Butadiene, Epichlorohydrin, which are known to the State of California to cause birth defects or other reproductive harm.

**RS3714**



Radial Seal Outer Air Element  
**Fits:** M.A.N. Trucks  
**Use With:** RS4549  
**Replaces:** M.A.N. 81.08304.0083  
**O.D.:** 11 29/32 (302.4)  
**I.D.:** 6 5/8 (168.3) One End  
**Height:** 19 3/32 (485.0)

**RS3720**



Radial Seal Outer Air Element  
**Fits:** Case-International, Steiger Equipment  
**Use With:** RS3721  
**Replaces:** Steiger 90-8300T1  
**O.D.:** 12 13/32 (315.1)  
**I.D.:** 8 3/16 (208.0) One End  
**Height:** 21 5/8 (549.3)

**RS3715**



Radial Seal Outer Air Element  
**Notes:** Also available in HSG3077 or HSG3078 Housings.  
**Fits:** Exmark Lawn & Garden Tractors; Bobcat, John Deere Equipment  
**Use With:** RS3930  
**Replaces:** John Deere M113621  
**O.D.:** 3 17/32 (89.7)  
**I.D.:** 1 3/4 (44.4) One End  
**Height:** 7 (177.8)

**RS3721**



Radial Seal Inner Air Element  
**Fits Inside:** RS3720  
**Fits:** Case-International, Steiger Tractors  
**Replaces:** Steiger 90-8301T1  
**O.D.:** 8 5/16 (211.1)  
**I.D.:** 6 1/32 (153.2) One End  
**Height:** 20 31/32 (532.6)

**RS3716**



Radial Seal Outer Air Element  
**Contains:** Flame Retardant Media  
**Fits:** TCM Lift Trucks  
**Use With:** RS3705  
**Replaces:** TCM 5365172061  
**O.D.:** 4 1/8 (104.8)  
**I.D.:** 2 5/16 (58.7) One End  
**Height:** 10 13/16 (274.6)  
**Related To:** RS3704 (without Flame Retardant Media)

**RS3722**



Radial Seal Inner Air Element  
**Fits Inside:** RS3548, RS3548XP  
**Fits:** John Deere Equipment  
**Replaces:** John Deere RE51630  
**O.D.:** 5 29/32 (150.0)  
**I.D.:** 4 13/32 (111.9) One End  
**Height:** 15 (381.0)

**RS3717**



Radial Seal Inner Air Element  
**Fits Inside:** RS3517, RS3517XP  
**Fits:** Freightliner Trucks; John Deere, Komatsu Equipment  
**Replaces:** Donaldson P533781  
**O.D.:** 5 1/4 (133.4)  
**I.D.:** 4 15/16 (125.4) One End  
**Height:** 18 7/32 (462.8)

**RS3724**

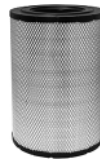

Radial Seal Air Element  
**Fits:** Scania Trucks  
**Replaces:** Scania 1335679  
**O.D.:** 11 29/32 (302.4)  
**I.D.:** 6 5/8 (168.3) One End  
**Height:** 17 19/32 (446.9)

**RS3718**



Radial Seal Outer Air Element  
**Fits:** Case-International, John Deere, Steiger Equipment  
**Use With:** RS3719  
**Replaces:** Case 132151A1; John Deere AT203050  
**O.D.:** 10 31/32 (278.6)  
**I.D.:** 5 27/32 (148.4) One End  
**Height:** 21 5/8 (549.3)

**RS3726**



Radial Seal Outer Air Element  
**Fits:** Scania Trucks  
**Use With:** RS5313  
**Replaces:** Scania 1335678  
**O.D.:** 11 29/32 (302.4)  
**I.D.:** 6 5/8 (168.3) One End  
**Height:** 20 23/32 (526.3)

**RS3719**



Radial Seal Inner Air Element  
**Fits Inside:** RS3718  
**Fits:** Case-International, John Deere, Steiger Equipment  
**Replaces:** Case 1321419A1; John Deere AT203051  
**O.D.:** 5 29/32 (150.0)  
**I.D.:** 4 13/32 (111.9) One End  
**Height:** 21 1/16 (535.0)

**RS3727**



Radial Seal Outer Air Element  
**Fits:** R.V.I. Trucks  
**Replaces:** Renault 5010230841  
**O.D.:** 12 9/32 (311.9)  
**I.D.:** 6 31/32 (177.0) One End  
**Height:** 18 11/32 (465.9)  
**Related To:** RS5390 (Flame Retardant Media)

Measurements Are Shown In Inches And (Millimeters)

**WARNING:** These products can expose you to chemicals, including Diisononyl Phthalate, Carbon black extracts, Nickel, 1,3 Butadiene, Ethylene Oxide, Epichlorohydrin, which are known to the State of California to cause cancer, and Bisphenol, Ethylene Glycol, Ethylene Oxide, 1,3 Butadiene, Epichlorohydrin, which are known to the State of California to cause birth defects or other reproductive harm.

**RS3728**



Radial Seal Outer Air Element  
**Fits:** R.V.I. Buses, Trucks  
**Use With:** RS3729  
**Replaces:** Renault 5010230916  
**O.D.:** 12 9/32 (311.9)  
**I.D.:** 6 31/32 (177.0) One End  
**Height:** 21 7/8 (555.6)

**RS3734**



Radial Seal Outer Air Element  
**Fits:** Caterpillar, Agco, Case, John Deere, Komatsu, Liebherr, Massey Ferguson, New Holland, Volvo Equipment  
**Use With:** RS3885  
**Replaces:** Caterpillar 130-4678; John Deere AT203469  
**O.D.:** 8 5/32 (207.2)  
**I.D.:** 4 3/16 (106.4) One End  
**Height:** 16 9/16 (420.7)  
**Related To:** RS3734XP (Extreme Performance Nano Version)

**RS3729**



Radial Seal Inner Air Element  
**Fits Inside:** RS3728  
**Fits:** R.V.I. Trucks  
**Replaces:** Renault 5010269584  
**O.D.:** 6 7/8 (174.6)  
**I.D.:** 5 11/16 (144.5) One End  
**Height:** 21 1/8 (536.6)

**RS3734XP**



Extreme Performance Nano Radial Seal Outer Air Element  
**Fits:** Caterpillar, Agco, Case, John Deere, Komatsu, Liebherr, Massey Ferguson, New Holland, Volvo Equipment  
**Use With:** RS3885  
**Replaces:** Caterpillar 130-4678; John Deere AT203469  
**O.D.:** 8 5/32 (207.2)  
**I.D.:** 4 3/16 (106.4) One End  
**Height:** 16 9/16 (420.7)  
**Related To:** RS3734 (Standard Media Version)

**RS3730**



Radial Seal Air Element  
**Fits:** Freightliner Trucks  
**Replaces:** Vortex VF120W  
**O.D.:** 11 (279.4)  
**I.D.:** 5 13/16 (147.6)  
**Height:** 19 3/8 (492.1)

**RS3735**



Radial Seal Air Element with Foam Wrap  
**Fits:** Chevrolet, GMC Light-Duty Trucks  
**Replaces:** GMC 25173426  
**O.D.:** 7 9/32 (184.9)  
**I.D.:** 3 9/16 (90.5) One End  
**Height:** 11 1/32 (280.2)  
**Related To:** RS3707 (without Foam Wrap)  
 RS3706 (Heavy-Duty Version without Foam Wrap)

**RS3731**



Radial Seal Outer Air Element  
**Fits:** Mitsubishi Trucks  
**Use With:** RS3732  
**Replaces:** Mitsubishi ME073160, ME073597, ME073821  
**O.D.:** 9 9/32 (235.7)  
**I.D.:** 5 5/32 (131.0) One End  
**Height:** 16 11/32 (415.1)

**RS3736**



Radial Seal Outer Air Element  
**Fits:** Caterpillar Equipment  
**Use With:** RS3737  
**Replaces:** Caterpillar 131-8822  
**O.D.:** 9 9/32 (235.7)  
**I.D.:** 5 5/32 (131.0) One End  
**Height:** 13 1/2 (342.9)

**RS3732**



Radial Seal Inner Air Element  
**Fits Inside:** RS3731; RS5546  
**Fits:** Mitsubishi Trucks  
**Replaces:** Mitsubishi ME291563  
**O.D.:** 5 1/4 (133.4)  
**I.D.:** 3 23/32 (94.5) One End  
**Height:** 15 23/32 (399.3)

**RS3737**



Radial Seal Inner Air Element  
**Fits Inside:** RS3736  
**Fits:** Caterpillar Equipment  
**Replaces:** Caterpillar 131-8821  
**O.D.:** 5 1/4 (133.4)  
**I.D.:** 3 23/32 (94.5) One End  
**Height:** 12 23/32 (323.1)

**RS3733**



Radial Seal Air Element  
**Fits:** Hino Trucks  
**Replaces:** Hino 17801-3000  
**O.D.:** 9 9/32 (235.7)  
**I.D.:** 5 5/32 (131.0) One End  
**Height:** 13 23/32 (348.5)

**RS3738**



Radial Seal Outer Air Element  
**Fits:** Ford Louisville Trucks  
**Use With:** RS3739  
**Replaces:** Ford F6HZ-9601-CA  
**O.D.:** 13 15/32 (342.1)  
**I.D.:** 8 5/32 (207.2) One End  
**Height:** 17 3/4 (450.9)

Measurements Are Shown In Inches And (Millimeters)

**WARNING:** These products can expose you to chemicals, including Diisononyl Phthalate, Carbon black extracts, Nickel, 1,3 Butadiene, Ethylene Oxide, Epichlorohydrin, which are known to the State of California to cause cancer, and Bisphenol, Ethylene Glycol, Ethylene Oxide, 1,3 Butadiene, Epichlorohydrin, which are known to the State of California to cause birth defects or other reproductive harm.



**RS3739**



Radial Seal Inner Air Element  
**Fits Inside:** RS3738  
**Fits:** Ford Louisville Trucks  
**Replaces:** Ford F6HZ-9602-AA  
**O.D.:** 8 5/16 (211.1)  
**I.D.:** 6 1/32 (153.2) One End  
**Height:** 16 13/16 (427.0)

**RS3745**



Radial Seal Inner Air Element  
**Fits Inside:** RS3744, RS3744XP  
**Fits:** Ag-Chem, Case, Caterpillar, Hitachi, John Deere, New Holland, Volvo Equipment  
**Replaces:** John Deere AT175224  
**O.D.:** 5 29/32 (150.0)  
**I.D.:** 4 13/32 (111.9) One End  
**Height:** 19 19/32 (497.7)

**RS3740**



Radial Seal Outer Air Element  
**Fits:** Volvo Trucks  
**Use With:** RS3741  
**Replaces:** Volvo 8076195  
**O.D.:** 12 31/32 (329.4)  
**I.D.:** 7 3/4 (196.9) One End  
**Height:** 16 7/16 (417.5)

**RS3746**



Radial Seal Cab Air Element  
**Fits:** John Deere Tractors  
**Replaces:** John Deere R119168  
**O.D.:** 6 1/2 (165.1)  
**I.D.:** 3 9/16 (90.5) One End  
**Height:** 12 17/32 (318.3)

**RS3741**



Radial Seal Inner Air Element  
**Fits Inside:** RS3740  
**Fits:** Volvo Trucks  
**Replaces:** Volvo 8079756  
**O.D.:** 7 7/8 (200.0)  
**I.D.:** 6 3/16 (157.2) One End  
**Height:** 15 21/32 (397.7)

**RS3747**



Radial Seal Inner Air Element  
**Fits Inside:** RS3549, RS4595  
**Fits:** Clark Lift Trucks  
**Replaces:** Toyota 17744-U2100-71  
**O.D.:** 3 5/16 (84.1)  
**I.D.:** 2 15/32 (62.7) One End  
**Height:** 12 1/32 (305.6)

**RS3743**



Radial Seal Air Element  
**Notes:** Inside-Out Flow Direction.  
 Uses 2 filters per application (left/right housings).  
**Contains:** 3 3/32 (78.6) Inch Dust Evacuation Hole  
**Fits:** International Trucks  
**Replaces:** International 3507421-C1, 3517842-C1  
**O.D.:** 9 21/32 (245.3)  
**I.D.:** 5 5/32 (131.0)  
**Height:** 23 17/32 (597.7)  
**F. Gskt:** [1] Included

**RS3749**



Radial Seal Air Element  
**Fits:** Sterling Trucks  
**Replaces:** Ford F6HZ-9601-BA  
**O.D.:** 12 31/32 (329.4)  
**I.D.:** 6 13/16 (173.0) One End  
**Height:** 17 5/16 (439.7)

**RS3744**



Radial Seal Outer Air Element  
**Fits:** Ag-Chem, Case, Caterpillar, Hitachi, J.C. Bamford, John Deere, Link-Belt, New Holland, Volvo Equipment; DAF Trucks  
**Use With:** RS3745  
**Replaces:** DAF 1295090; John Deere AT175223  
**O.D.:** 10 31/32 (278.6)  
**I.D.:** 5 13/16 (147.6) One End  
**Height:** 20 9/16 (522.3)  
**Related To:** RS3744XP (Extreme Performance Nano Version)

**RS3750**



Radial Seal Air Element  
**Fits:** Kenworth, Peterbilt Trucks  
**Replaces:** Donaldson P542101  
**O.D.:** 10 29/32 (277.0)  
**I.D.:** 6 25/32 (172.2) One End  
**Height:** 15 21/32 (397.7)  
**Related To:** RS3750XP (Extreme Performance)

**RS3744XP**



Extreme Performance Nano Radial Seal Outer Air Element  
**Fits:** Ag-Chem, Case, Caterpillar, Hitachi, J.C. Bamford, John Deere, Link-Belt, New Holland, Volvo Equipment; DAF Trucks  
**Use With:** RS3745  
**Replaces:** DAF 1295090; John Deere AT175223  
**O.D.:** 10 31/32 (278.6)  
**I.D.:** 5 13/16 (147.6) One End  
**Height:** 20 9/16 (522.3)  
**Related To:** RS3744 (Standard Media Version)

**RS3750XP**



Extreme Performance Nano Radial Seal Air Element  
**Fits:** Kenworth, Peterbilt Trucks  
**Replaces:** Donaldson DBA5107  
**O.D.:** 10 29/32 (277.1)  
**I.D.:** 6 3/4 (171.7)  
**Height:** 15 5/32 (384.8)  
**Related To:** RS3750 (Standard Media)

Measurements Are Shown In Inches And (Millimeters)

**WARNING:** These products can expose you to chemicals, including Diisononyl Phthalate, Carbon black extracts, Nickel, 1,3 Butadiene, Ethylene Oxide, Epichlorohydrin, which are known to the State of California to cause cancer, and Bisphenol, Ethylene Glycol, Ethylene Oxide, 1,3 Butadiene, Epichlorohydrin, which are known to the State of California to cause birth defects or other reproductive harm.

**PA3752**

Air Element with Lid



**Fits:** Bomag, Hamm, Zettelmeyer Equipment; Mercedes-Benz Buses, Trucks  
**Replaces:** Hamm 278947; Mercedes-Benz 10949604; Zettelmeyer 20782411  
**O.D.:** 6 17/32 (165.9)  
**Lid 7 13/16 (198.4)**  
**I.D.:** 11/32 (8.7) & 3 3/8 (85.7)  
**Height:** 13 27/32 (351.6)  
**A. Gskt:** [1] Attached

**PA3758**

Air Element with Lid



**Replaces:** Volvo 7354867  
**O.D.:** 4 11/32 (110.3)  
**Lid 5 3/8 (136.5)**  
**I.D.:** 11/32 (8.7) & 1 31/32 (50.0)  
**Height:** 8 15/16 (227.0)  
**A. Gskt:** [2] Attached

**PA3753**

Air Element



**Fits:** Mercedes-Benz Trucks, Vans  
**Replaces:** Mercedes-Benz 30943904  
**O.D.:** 5 29/32 (150.0)  
**I.D.:** 3/8 (9.5) & 2 13/16 (71.4)  
**Height:** 9 1/32 (229.4)  
**A. Gskt:** [1] Attached  
**Grommets:** [1] Attached

**PA3759**

Air Element with Lid



**Notes:** OBSOLETE. Availability Limited to Dealer Stock.  
**Fits:** Eicher, Hurlimann, Valmet, Zettelmeyer Equipment  
**Replaces:** Zettelmeyer 2133207  
**O.D.:** 5 7/8 (149.2)  
**Lid 7 (177.8)**  
**I.D.:** 11/32 (8.7) & 2 13/16 (71.4)  
**Height:** 13 3/16 (335.0)  
**A. Gskt:** [1] Attached

**PA3754**

Air Element



**Fits:** Iveco Trucks  
**Replaces:** Iveco 1905710  
**O.D.:** 12 7/8 (327.0)  
**I.D.:** 13/32 (10.3) & 8 1/2 (215.9)  
**Height:** 18 3/4 (476.3)  
**A. Gskt:** [2] Attached

**PA3760**

Outer Air Element



**Fits:** DAF, Iveco, M.A.N., Pegaso Buses, Trucks  
**Replaces:** DAF 393561; Iveco 1907533; Pegaso 173260  
**O.D.:** 9 17/32 (242.1)  
**I.D.:** 7/16 (11.1) & 5 3/16 (131.8)  
**Height:** 14 27/32 (377.0)  
**A. Gskt:** [1] Attached  
**F. Gskt:** [1] Included

**PA3755**

Outer Air Element



**Fits:** Volvo Loaders  
**Replaces:** Volvo 6631290, 6631299  
**O.D.:** 10 1/16 (255.6)  
**I.D.:** 7 9/16 (192.1)  
**Height:** 7 11/16 (195.3)

**PA3761-FN**

Outer Air Element with Fins



**Fits:** Ford Tractors  
**Replaces:** Ford E9NN-9601-GA, SBA314531128; New Holland 86512889  
**O.D.:** 5 1/4 (133.4)  
**Fins 6 3/8 (161.9)**  
**I.D.:** 3/8 (9.5) & 2 5/8 (66.7)  
**Height:** 11 9/32 (286.5)  
**A. Gskt:** [1] Attached  
**F. Gskt:** [1] Included

**PA3756**

Cab Air Element



**Fits:** Caterpillar Equipment  
**Replaces:** Caterpillar 5G1913  
**Length:** 16 (406.4)  
**Width:** 8 (203.2)  
**Height:** 2 3/16 (55.6)

**PA3763**

Panel Air Element with Foam Pad

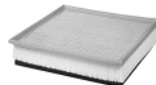

**Fits:** Dodge Light-Duty Trucks  
**Replaces:** Chrysler 4728406, 4856649, 4864442  
**Length:** 11 13/16 (300.0)  
**Width:** 10 25/32 (273.8)  
**Height:** 2 11/16 (68.3)

**PA3757**

Air Element



**Fits:** Atlas Copco Compressors; Atlas-Weyhausen, Fiat Equipment  
**Replaces:** Atlas Copco 16196220; Atlas-Weyhausen 2673698  
**O.D.:** 3 11/16 (93.7)  
**I.D.:** 11/32 (8.7) & 1 11/16 (42.9)  
**Height:** 6 25/32 (172.2)  
**A. Gskt:** [1] Attached

**RS3764**

Radial Seal Air Element



**Replaces:** Donaldson P778674  
**O.D.:** 12 9/32 (311.9)  
**I.D.:** 6 31/32 (177.0) One End  
**Height:** 22 29/32 (581.8)

Measurements Are Shown In Inches And (Millimeters)

**WARNING:** These products can expose you to chemicals, including Diisononyl Phthalate, Carbon black extracts, Nickel, 1,3 Butadiene, Ethylene Oxide, Epichlorohydrin, which are known to the State of California to cause cancer, and Bisphenol, Ethylene Glycol, Ethylene Oxide, 1,3 Butadiene, Epichlorohydrin, which are known to the State of California to cause birth defects or other reproductive harm.

**PA3765** Outer Air Element  
**Fits:** Mercedes-Benz Trucks, Vans  
**Replaces:** Mercedes-Benz 30947004  
**O.D.:** 12 29/32 (327.8)  
**I.D.:** 7/16 (11.1) & 7 17/32 (191.3)  
**Height:** 18 7/8 (479.4)  
**A. Gskt:** [1] Attached



**PA3774** Inner Air Element  
**Fits Inside:** PA3775  
**Fits:** Agco, White Tractors  
**Replaces:** Deutz 72162544  
**O.D.:** 5 15/16 (150.8)  
**I.D.:** 21/32 (16.7) & 4 27/32 (123.0)  
**Height:** 13 1/2 (342.9)  
**A. Gskt:** [1] Included  
**F. Gskt:** G103-N



**PA3766** Air Element  
**Fits:** M.A.N. Buses  
**Replaces:** M.A.N. 83.08405.0000  
**O.D.:** 11 29/32 (302.4)  
**I.D.:** 13/32 (10.3) & 7 17/32 (191.3)  
**Height:** 13 1/4 (336.5)  
**A. Gskt:** [1] Attached  
**F. Gskt:** [1] Included



**PA3775** Outer Air Element  
**Fits:** Agco, White Equipment  
**Use With:** PA3774  
**Replaces:** Deutz 72162543; White 30-3435318  
**O.D.:** 9 29/32 (251.6)  
**I.D.:** 7/8 (22.2) & 6 1/16 (154.0)  
**Height:** 15 9/16 (395.3)  
**A. Gskt:** [1] Attached  
**F. Gskt:** [1] Included



**PA3767** Air Element with 4 Bolt Holes in Flange  
**Contains:** [1] Grease packet  
**Fits:** Volvo Trucks  
**Replaces:** Volvo 1665898  
**O.D.:** 12 3/4 (323.8)  
 Flange 14 (355.6)  
**I.D.:** 7 25/32 (197.6) One End  
**Height:** 16 19/32 (421.5)  
**A. Gskt:** [2] Attached



**PA3777** Cab Air Element  
**Fits:** Caterpillar Equipment  
**Replaces:** Caterpillar 3E0410  
**Length:** 9 (228.6)  
**Width:** 7 (177.8)  
**Height:** 1 3/8 (34.9)  
**A. Gskt:** [1] Attached



**PA3768** Air Element with 4 Bolt Holes in Flange  
**Fits:** Volvo Trucks  
**Replaces:** Volvo 1665908  
**O.D.:** 14 1/32 (356.4)  
 Flange 14 7/8 (377.8)  
**I.D.:** 7 7/8 (200.0) One End  
**Height:** 16 5/16 (414.3)  
**A. Gskt:** [2] Attached



**PA3778** Outer Air Element  
**Fits:** John Deere Tractors  
**Use With:** PA2381  
**Replaces:** John Deere AL65051  
**O.D.:** 5 1/4 (133.4)  
**I.D.:** 21/32 (16.7) & 3 1/4 (82.6)  
**Height:** 12 1/2 (317.5)  
**A. Gskt:** [1] Attached  
**F. Gskt:** G103-N



**PA3772** Outer Air Element  
**Fits:** Volvo Trucks  
**Replaces:** Volvo 1661667  
**O.D.:** 11 3/32 (281.8)  
 Flange 13 9/32 (337.3)  
**I.D.:** 7 5/32 (181.8) One End  
**Height:** 26 7/32 (666.0)  
**A. Gskt:** [2] Attached



**PA3779-FN** Outer Air Element with Fins  
**Fits:** John Deere, New Holland Equipment  
**Use With:** PA2670  
**Replaces:** John Deere RE45827; New Holland 86529587  
**O.D.:** 6 3/32 (154.8)  
 Fins 7 13/16 (198.4)  
**I.D.:** 3/4 (19.0) & 3 15/32 (88.1)  
**Height:** 13 9/32 (337.3)  
**A. Gskt:** [1] Attached  
**F. Gskt:** G103-N, [1] Wing Nut



**PA3773** Air Element  
**Fits:** Saab, Volkswagen Automotive, Vans  
**Replaces:** Saab 4023420; Volkswagen 25129620, 25129620-A  
**O.D.:** 7 3/16 (182.6)  
**I.D.:** 3 15/16 (100.0)  
**Height:** 4 1/16 (103.2)



**PA3780** Outer Air Element  
**Replaces:** Renault 5010317060  
**O.D.:** 12 1/16 (306.4)  
**I.D.:** 11/16 (17.5) & 7 11/16 (195.3)  
**Height:** 18 23/32 (475.5)  
**A. Gskt:** [1] Attached  
**F. Gskt:** G103-N, [1] Wing Nut



Measurements Are Shown In Inches And (Millimeters)

**WARNING:** These products can expose you to chemicals, including Diisononyl Phthalate, Carbon black extracts, Nickel, 1,3 Butadiene, Ethylene Oxide, Epichlorohydrin, which are known to the State of California to cause cancer, and Bisphenol, Ethylene Glycol, Ethylene Oxide, 1,3 Butadiene, Epichlorohydrin, which are known to the State of California to cause birth defects or other reproductive harm.

**PA3781** Cab Air Element  
**Fits:** Caterpillar Equipment  
**Replaces:** Caterpillar 7X6041  
**Length:** 12 1/4 (311.2)  
**Width:** 9 9/16 (242.9)  
**Height:** 2 9/16 (65.1)  
**A. Gskt:** [1] Attached

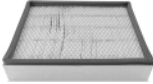

**PA3782** Cab Air Element  
**Fits:** Caterpillar Equipment, Off-Highway Trucks  
**Replaces:** Caterpillar 8C9657  
**Length:** 17 1/2 (444.5)  
**Width:** 6 (152.4)  
**Height:** 2 9/16 (65.1)

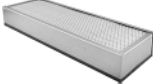

**PA3783** Inner Air Element  
**Fits Inside:** PA3479  
**Fits:** Hitachi Excavators; Isuzu Engines  
**Replaces:** Hitachi 4247974  
**O.D.:** 5 3/16 (131.8)  
**I.D.:** 2 1/32 (16.7) & 3 31/32 (100.8)  
**Height:** 9 9/16 (242.9)  
**A. Gskt:** [1] Attached  
**F. Gskt:** G103-N



**PA3785-FN** Outer Air Element with Fins and Lid  
**Fits:** John Deere Tractors  
**Replaces:** John Deere M802606  
**O.D.:** 4 3/32 (104.0)  
 Lid 5 29/32 (150.0)  
**I.D.:** 2 1/32 (16.7) & 2 1/2 (63.5)  
**Height:** 10 1/2 (266.7)  
**A. Gskt:** [1] Attached  
**F. Gskt:** G103-N



**PA3786-FN** Outer Air Element with Fins  
**Fits:** Ford Buses, Trucks  
**Use With:** PA2883  
**Replaces:** Donaldson P900006; Motorcraft AFA92  
**O.D.:** 12 1/8 (308.0)  
 Fins 15 3/4 (400.0)  
**I.D.:** 7/8 (22.2) & 7 11/16 (195.3)  
**Height:** 16 1/2 (419.1)  
**A. Gskt:** [1] Attached  
**F. Gskt:** G129-N



**PA3787** Inner Air Element  
**Fits Inside:** PA3606  
**Fits:** Claas, Liebherr, New Holland Equipment; M.A.N. Trucks  
**Replaces:** Claas 773820; Liebherr 7368215; M.A.N. 81.08304.0066  
**O.D.:** 7 15/16 (201.6)  
 Flange 8 5/16 (211.1)  
**I.D.:** 2 1/32 (16.7) & 7 11/32 (186.5)  
**Height:** 23 31/32 (608.8)  
**I.Gskt:** [1] Included



**PA3790** Outer Air Element with Lid  
**Fits:** Massey Ferguson Tractors  
**Use With:** PA3950  
**Replaces:** GMC 25313867; Massey Ferguson 3595500-M1  
**O.D.:** 7 13/16 (198.4)  
 Lid 8 13/32 (213.5)  
**I.D.:** 5/8 (15.9) & 3 7/16 (87.3)  
**Height:** 11 1/32 (280.2)  
**A. Gskt:** [1] Attached  
**F. Gskt:** [1] Wing Nut



**PA3791-FN** Outer Air Element with Fins  
**Fits:** New Holland Equipment  
**Use With:** PA2489  
**Replaces:** New Holland 86504145  
**O.D.:** 5 1/4 (133.4)  
 Fins 6 3/8 (161.9)  
**I.D.:** 2 1/32 (16.7) & 2 5/8 (66.7)  
**Height:** 11 1/2 (292.1)  
**A. Gskt:** [1] Attached  
**F. Gskt:** G103-N



**PA3792** Outer Air Element  
**Fits:** Kubota Tractors  
**Replaces:** Kubota T0070-16323  
**O.D.:** 4 3/32 (104.0)  
**I.D.:** 2 1/2 (63.5)  
**Height:** 9 15/16 (252.4)  
**A. Gskt:** [2] Attached



**PA3793** Replacement for Ecolite Air Element in Disposable Housing  
**Notes:** OBSOLETE. Availability Limited to Dealer Stock.  
**Fits:** Massey Ferguson Wheel Tractors  
**Replaces:** Bosch 1457433005; Mercedes-Benz 30945104  
**O.D.:** 5 31/32 (151.6)  
 Housing 6 29/32 (175.4)  
**I.D.:** 2 13/16 (71.4) One End  
**Height:** 13 1/8 (333.4)



**PA3794** Outer Air Element  
**Fits:** Scania Trucks  
**Replaces:** Scania 395776  
**O.D.:** 12 3/32 (307.2)  
**I.D.:** 2 1/32 (16.7) & 7 23/32 (196.1)  
**Height:** 17 5/32 (435.8)  
**A. Gskt:** [1] Attached  
**F. Gskt:** G103-N



**PA3795** Outer Air Element  
**Fits:** Yanmar Tractors  
**Replaces:** Yanmar 124764-12510  
**O.D.:** 4 3/32 (104.0)  
**I.D.:** 25/32 (19.8) & 2 15/32 (62.7)  
**Height:** 7 25/32 (197.6)  
**A. Gskt:** [1] Attached  
**F. Gskt:** G103-N



Measurements Are Shown In Inches And (Millimeters)

**WARNING:** These products can expose you to chemicals, including Diisononyl Phthalate, Carbon black extracts, Nickel, 1,3 Butadiene, Ethylene Oxide, Epichlorohydrin, which are known to the State of California to cause cancer, and Bisphenol, Ethylene Glycol, Ethylene Oxide, 1,3 Butadiene, Epichlorohydrin, which are known to the State of California to cause birth defects or other reproductive harm.

**PA3796** Outer Air Element  
**Fits:** John Deere Tractors  
**Use With:** PA3797  
**Replaces:** John Deere AL78223  
**O.D.:** 7 9/32 (184.9)  
 Flange 9 9/32 (235.7)  
**I.D.:** 3 19/32 (91.3) One End  
**Height:** 12 1/4 (311.2)  
**A. Gskt:** [1] Attached



**PA3797** Inner Air Element with 3 Bolts  
**Fits Inside:** PA3796  
**Fits:** John Deere Tractors  
**Replaces:** John Deere AL78224  
**O.D.:** 5 1/32 (127.8)  
 Flange 7 13/16 (198.4)  
**I.D.:** 3 5/8 (92.1) One End  
**Height:** 5 3/16 (131.8)  
**I.Gskt:** [1] Included  
**O-Ring:** [3] Included



**PA3798** Cab Air Element  
**Fits:** Ford Tractors  
**Replaces:** Ford E4NN-94000N20-AE,  
 E4NN-94000N20-AF  
**Length:** 18 1/4 (463.6)  
**Width:** 3 7/8 (98.4)  
**Height:** 3 3/16 (81.0)  
**A. Gskt:** [1] Attached



**PA3800** Replacement for Ecolite Air Element in Disposable Housing  
**Fits:** Blue Bird Buses; Farr Air Cleaners  
**Replaces:** Farr 117122-000  
**O.D.:** 11 1/2 (292.1)  
**I.D.:** 7 (177.8) One End  
**Height:** 25 19/32 (650.1)



**PA3801-FN** Outer Air Element with Fins  
**Replaces:** Caterpillar 97-1293  
**O.D.:** 5 1/4 (133.4)  
 Fins 6 11/32 (161.1)  
**I.D.:** 2 1/32 (16.7) & 3 5/16 (84.1)  
**Height:** 11 1/2 (292.1)  
**A. Gskt:** [1] Attached  
**F. Gskt:** G103-N



**PA3802** Cab Air Element  
**Fits:** Caterpillar Equipment  
**Replaces:** Caterpillar 7T3519  
**Length:** 19 11/16 (500.1)  
**Width:** 3 15/16 (100.0)  
**Height:** 3 9/16 (90.5)  
**A. Gskt:** [1] Included



**PA3803** Cab Air Element  
**Fits:** Caterpillar Equipment  
**Replaces:** Caterpillar 7T7358  
**Length:** 12 7/8 (327.0)  
**Width:** 12 (304.8)  
**Height:** 2 9/16 (65.1)  
**A. Gskt:** [1] Attached

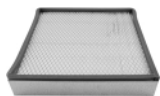

**PA3804** Cab Air Element  
**Fits:** Caterpillar Equipment  
**Replaces:** Caterpillar 9X3352  
**Length:** 9 (228.6)  
**Width:** 9 (228.6)  
**Height:** 2 9/16 (65.1)  
**A. Gskt:** [1] Attached

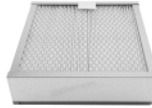

**PA3805-FN** Air Element with Fins  
**Contains:** Flame Retardant Media  
**Fits:** Hyster Lift Trucks  
**Replaces:** Hyster 1377093  
**O.D.:** 4 3/32 (104.0)  
 Fins 5 1/8 (130.2)  
**I.D.:** 2 5/32 (19.8) & 2 15/32 (62.7)  
**Height:** 14 5/16 (363.5)  
**A. Gskt:** [1] Attached  
**F. Gskt:** G103-N



**PA3806** Outer Air Element with Bail Handle  
**Fits:** Ingersoll-Rand Compressors  
**Use With:** PA3810  
**Replaces:** Ingersoll-Rand 36864361  
**O.D.:** 13 13/16 (350.8)  
 Boot 14 1/2 (368.3)  
**I.D.:** 15/16 (23.8) & 9 1/2 (241.3)  
**Height:** 27 5/16 (693.7)  
**A. Gskt:** [2] Attached  
**F. Gskt:** [1] Included



**PA3807** Air Element with Lid  
**Fits:** Mercedes-Benz Trucks, Vans  
**Replaces:** Mercedes-Benz 10949404  
**O.D.:** 8 9/32 (210.3)  
 Lid 9 29/32 (251.6)  
**I.D.:** 11/32 (8.7) & 4 1/16 (103.2)  
**Height:** 8 11/16 (220.7)  
**A. Gskt:** [1] Attached



**PA3808-FN** Outer Air Element with Fins and Lid  
**Fits:** Komatsu Excavators  
**Use With:** PA3809  
**Replaces:** Komatsu 205-017-3570,  
 205-017-3750  
**O.D.:** 11 (279.4)  
**I.D.:** 2 1/32 (16.7) & 5 3/8 (136.5)  
**Height:** 17 15/16 (455.6)  
**A. Gskt:** [1] Attached  
**F. Gskt:** G103-N, [1] Wing Nut













**PA3809** Inner Air Element  
**Fits Inside:** PA3808-FN  
**Fits:** Komatsu Excavators  
**Replaces:** Komatsu 20501-K1480  
**O.D.:** 4 9/16 (115.9)  
**I.D.:** 2 1/32 (16.7) & 3 7/16 (87.3)  
**Height:** 16 1/2 (419.1)  
**A. Gskt:** [1] Attached  
**F. Gskt:** G103-N

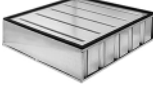

Measurements Are Shown In Inches And (Millimeters)

**WARNING:** These products can expose you to chemicals, including Diisononyl Phthalate, Carbon black extracts, Nickel, 1,3 Butadiene, Ethylene Oxide, Epichlorohydrin, which are known to the State of California to cause cancer, and Bisphenol, Ethylene Glycol, Ethylene Oxide, 1,3 Butadiene, Epichlorohydrin, which are known to the State of California to cause birth defects or other reproductive harm.

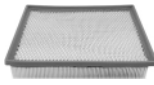
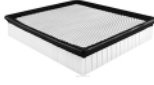
<p><b>PA3810</b></p>  <p>Inner Air Element  <b>Fits Inside:</b> PA3806  <b>Replaces:</b> Ingersoll-Rand 36864379  <b>O.D.:</b> 9 11/32 (237.3)  <b>I.D.:</b> 13/16 (20.6) &amp; 8 1/8 (206.4)  <b>Height:</b> 25 9/32 (642.1)  <b>A. Gskt:</b> [1] Attached  <b>F. Gskt:</b> [1] Included</p>	<p><b>PA3817</b></p>  <p>Inner Air Element  <b>Fits Inside:</b> PA3816  <b>Fits:</b> J.C. Bamford Equipment  <b>Replaces:</b> J.C. Bamford 32/903002  <b>O.D.:</b> 2 11/16 (68.3)            Flange 3 17/32 (89.7)  <b>I.D.:</b> 21/32 (16.7) &amp; 2 7/16 (61.9)  <b>Height:</b> 9 3/32 (231.0)  <b>F. Gskt:</b> [1] Included</p>
<p><b>PA3811-FN</b></p>  <p>Outer Air Element with Fins and Lid  <b>Fits:</b> J.C. Bamford Equipment  <b>Use With:</b> PA3812  <b>Replaces:</b> J.C. Bamford 32/905301  <b>O.D.:</b> 5 1/8 (130.2)            Lid 5 21/32 (143.7)  <b>I.D.:</b> 2 15/32 (62.7) One End  <b>Height:</b> 8 13/32 (213.5)  <b>A. Gskt:</b> [1] Attached, [1] Wing Nut</p>	<p><b>PA3818-FN</b></p>  <p>Outer Air Element with Fins and Lid  <b>Fits:</b> J.C. Bamford Equipment  <b>Use With:</b> PA3819  <b>Replaces:</b> J.C. Bamford 32/905001  <b>O.D.:</b> 5 1/2 (139.7)            Lid 6 25/32 (172.2)  <b>I.D.:</b> 2 13/16 (71.4)  <b>Height:</b> 8 5/8 (219.1)  <b>A. Gskt:</b> [1] Attached, [1] Wing Nut</p>
<p><b>PA3812</b></p>  <p>Inner Air Element  <b>Fits Inside:</b> PA3811-FN  <b>Fits:</b> J.C. Bamford Equipment  <b>Replaces:</b> J.C. Bamford 32/905302  <b>O.D.:</b> 2 3/8 (60.3)            Flange 2 3/4 (69.9)  <b>I.D.:</b> 21/32 (16.7) &amp; 1 31/32 (50.0)  <b>Height:</b> 6 31/32 (177.0)  <b>A. Gskt:</b> [1] Attached  <b>F. Gskt:</b> [1] Included</p>	<p><b>PA3819</b></p>  <p>Inner Air Element  <b>Fits Inside:</b> PA3818-FN; PA4614  <b>Fits:</b> J.C. Bamford Equipment  <b>Replaces:</b> J.C. Bamford 32/905002  <b>O.D.:</b> 2 11/16 (68.3)            Flange 3 17/32 (89.7)  <b>I.D.:</b> 21/32 (16.7) &amp; 2 13/32 (61.1)  <b>Height:</b> 6 31/32 (177.0)  <b>A. Gskt:</b> [1] Attached  <b>F. Gskt:</b> [1] Included</p>
<p><b>PA3814</b></p>  <p>DynaCell Air Element Replacement  <b>Fits:</b> Various Oil Field, Marine Applications  <b>Replaces:</b> Farr T520  <b>Length:</b> 19 1/2 (495.3)  <b>Width:</b> 19 1/2 (495.3)  <b>Height:</b> 5 1/4 (133.4)  <b>A. Gskt:</b> [1] Attached  <b>Related To:</b> PA3815 (Top Open)</p>	<p><b>PA3820-FN</b></p>  <p>Air Element with Fins and Lid  <b>Fits:</b> Hitachi, J.C. Bamford Excavators  <b>Replaces:</b> J.C. Bamford KAP0482  <b>O.D.:</b> 4 3/32 (104.0)            Lid 5 29/32 (150.0)  <b>I.D.:</b> 19/32 (15.1) &amp; 2 17/32 (64.3)  <b>Height:</b> 10 9/16 (268.3)  <b>A. Gskt:</b> [1] Attached, [1] Wing Nut</p>
<p><b>PA3815</b></p>  <p>DynaCell Air Element Replacement  <b>Fits:</b> Various Oil Field, Marine Applications  <b>Replaces:</b> Farr T520D  <b>Length:</b> 19 1/2 (495.3)  <b>Width:</b> 19 1/2 (495.3)  <b>Height:</b> 5 1/4 (133.4)  <b>A. Gskt:</b> [1] Attached  <b>Related To:</b> PA3814 (Top Closed)</p>	<p><b>PA3821</b></p>  <p>Air Element  <b>Fits:</b> J.C. Bamford Equipment  <b>Replaces:</b> J.C. Bamford 98/800031; GMC 25096242  <b>O.D.:</b> 4 3/4 (120.7)  <b>I.D.:</b> 2 1/8 (54.0) One End  <b>Height:</b> 11 1/4 (285.8)  <b>A. Gskt:</b> [1] Attached, [1] Wing Nut</p>
<p><b>PA3816</b></p>  <p>Outer Air Element with Lid  <b>Fits:</b> J.C. Bamford Equipment  <b>Use With:</b> PA3817  <b>Replaces:</b> J.C. Bamford 32/903001  <b>O.D.:</b> 6 9/32 (159.5)            Lid 6 25/32 (172.2)  <b>I.D.:</b> 2 27/32 (72.2) One End  <b>Height:</b> 10 3/32 (256.4)  <b>A. Gskt:</b> [1] Attached, [1] Wing Nut</p>	<p><b>PA3822</b></p>  <p>Cab Air Element  <b>Fits:</b> Caterpillar Equipment  <b>Replaces:</b> Caterpillar 112-7448  <b>Length:</b> 11 9/32 (286.5)  <b>Width:</b> 8 15/16 (227.0)  <b>Height:</b> 1 29/32 (48.4)</p>
	<p><b>PA3823</b></p>  <p>Cab Air Element  <b>Fits:</b> Caterpillar Equipment  <b>Replaces:</b> Caterpillar 107-0266  <b>Length:</b> 11 13/16 (300.0)  <b>Width:</b> 10 3/4 (273.1)  <b>Height:</b> 2 3/16 (55.6)</p>

Measurements Are Shown In Inches And (Millimeters)

**WARNING:** These products can expose you to chemicals, including Diisononyl Phthalate, Carbon black extracts, Nickel, 1,3 Butadiene, Ethylene Oxide, Epichlorohydrin, which are known to the State of California to cause cancer, and Bisphenol, Ethylene Glycol, Ethylene Oxide, 1,3 Butadiene, Epichlorohydrin, which are known to the State of California to cause birth defects or other reproductive harm.

**PA3824** Cab Air Element  
**Fits:** Ford, New Holland Tractors  
**Replaces:** New Holland 9823782  
**Length:** 26 15/16 (684.2)  
**Width:** 6 1/4 (158.8)  
**Height:** 2 9/16 (65.1)  
**A. Gskt:** [1] Attached



**PA3825** Cab Air Element  
**Fits:** Caterpillar Crawler Tractors, Loaders  
**Replaces:** Caterpillar 6T5068  
**Length:** 12 19/32 (319.9)  
**Width:** 10 5/8 (269.9)  
**Height:** 5/8 (15.9)



**RS3826** Radial Seal Outer Air Element  
**Fits:** Caterpillar Gen Sets; New Holland, Volvo Equipment  
**Use With:** RS3827  
**Replaces:** Volvo 11033998-3  
**O.D.:** 12 9/32 (311.9)  
**I.D.:** 6 31/32 (177.0) One End  
**Height:** 22 29/32 (581.8)



**RS3827** Radial Seal Inner Air Element  
**Fits Inside:** RS3826  
**Fits:** Caterpillar Gen Sets; New Holland, Volvo Equipment  
**Replaces:** Volvo 11033999-1  
**O.D.:** 7 1/16 (179.4)  
**I.D.:** 5 11/16 (144.5) One End  
**Height:** 22 3/32 (561.2)



**PA3828** Cab Air Element  
**Fits:** Case Equipment  
**Replaces:** Case R53519  
**Length:** 12 1/4 (311.2)  
**Width:** 4 (101.6)  
**Height:** 2 9/16 (65.1)  
**A. Gskt:** [1] Attached



**PA3829** Cab Air Element  
**Fits:** Caterpillar Motor Graders  
**Replaces:** Caterpillar 9X4986  
**Length:** 14 13/16 (376.2)  
**Width:** 4 (101.6)  
**Height:** 2 11/16 (68.3)  
**A. Gskt:** [1] Included

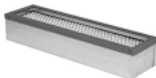

**PA3832** Inner Air Element  
**Fits Inside:** LL1886, PA1886, PA1886XP  
**Fits:** Komatsu Excavators  
**Replaces:** Komatsu 20801-68510  
**O.D.:** 7 5/16 (185.7)  
**I.D.:** 21/32 (16.7) & 6 5/32 (156.4)  
**Height:** 15 1/2 (393.7)  
**A. Gskt:** [1] Attached  
**F. Gskt:** [1] Metal Washer



**PA3833** Air Element  
**Fits:** Caterpillar, Mitsubishi Lift Trucks  
**Replaces:** Caterpillar 108-5330; Hyster 3111230; Mitsubishi 91361-13300  
**O.D.:** 4 1/4 (108.0)  
**Flange:** 6 3/32 (154.8)  
**I.D.:** 2 5/16 (58.7) One End  
**Height:** 9 3/32 (231.0)  
**A. Gskt:** [2] Attached



**PA3834** Foam Cab Air Element  
**Fits:** Caterpillar Equipment  
**Replaces:** Caterpillar 7T3549  
**Length:** 14 5/8 (371.5)  
**Width:** 4 1/2 (114.3)  
**Height:** 1/2 (12.7)

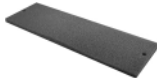

**PA3835** Foam Replacement Pad  
**Fits:** Caterpillar Equipment  
**Replaces:** Caterpillar 3E0411  
**Length:** 9 (228.6)  
**Width:** 7 (177.8)  
**Height:** 1/4 (6.4)



**PA3836** Air Element  
**Fits:** Citroen, Fiat, Iveco, Peugeot Trucks, Vans  
**Replaces:** Citroen 1444A1; Iveco 1902457; Peugeot 144409  
**O.D.:** 6 5/16 (160.3)  
**I.D.:** 3 29/32 (99.2)  
**Height:** 6 31/32 (177.0)



**PA3837** Air Element  
**Notes:** OBSOLETE. Availability Limited to Dealer Stock.  
**Fits:** Iveco Trucks  
**Replaces:** Iveco 1902486  
**O.D.:** 6 3/8 (161.9)  
**I.D.:** 3 31/32 (100.0)  
**Height:** 9 5/16 (236.5)

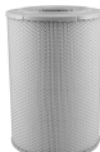

**PA3838** Air Element  
**Fits:** Mercedes-Benz Trucks, Vans  
**Replaces:** Mercedes-Benz A0030949204  
**O.D.:** 16 13/16 (427.0)  
**I.D.:** 13/32 (10.3) & 10 (254.0)  
**Height:** 10 5/16 (261.9)  
**F. Gskt:** [1] Included



**PA3839** Cab Air Element  
**Fits:** Volvo Trucks  
**Replaces:** Volvo 8143691, 8143691-7, 8144430  
**Length:** 8 9/32 (210.3)  
**Width:** 8 9/32 (210.3)  
**Height:** 1 15/16 (49.2)



**PA3840** Panel Air Element  
**Fits:** Thermo King Refrigeration Units  
**Replaces:** Thermo King 11-7234  
**Length:** 7 5/8 (193.7)  
**Width:** 6 1/16 (154.0)  
**Height:** 1 3/32 (27.8)

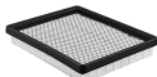

Measurements Are Shown In Inches And (Millimeters)

**WARNING:** These products can expose you to chemicals, including Diisononyl Phthalate, Carbon black extracts, Nickel, 1,3 Butadiene, Ethylene Oxide, Epichlorohydrin, which are known to the State of California to cause cancer, and Bisphenol, Ethylene Glycol, Ethylene Oxide, 1,3 Butadiene, Epichlorohydrin, which are known to the State of California to cause birth defects or other reproductive harm.

**PA3842** Panel Air Element  
**Notes:** OBSOLETE. Availability Limited to Dealer Stock.  
**Fits:** Mercedes-Benz Buses, Trucks, Vans  
**Replaces:** Mercedes-Benz 20949204  
**Length:** 23 17/32 (597.7)  
**Width:** 6 23/32 (170.7)  
**Height:** 2 13/32 (61.1)  
**A. Gskt:** [1] Attached



**PA3843** Panel Air Element  
**Fits:** Mercedes-Benz Buses, Trucks, Vans  
**Replaces:** Mercedes-Benz 20949304  
**Length:** 23 17/32 (597.7)  
**Width:** 6 23/32 (170.7)  
**Height:** 3 3/16 (81.0)

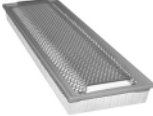

**PA3844** Air Element  
**Fits:** Mercedes-Benz Trucks, Vans  
**Replaces:** Mercedes-Benz A0030949104  
**O.D.:** 16 17/32 (419.9)  
**I.D.:** 13/32 (10.3) & 10 (254.0)  
**Height:** 12 17/32 (318.3)  
**F. Gskt:** [1] Included



**PA3847** Inner Air Element  
**Fits Inside:** PA3652, PA3860, PA3862-FN  
**Fits:** Fiat-Allis, John Deere, Liebherr, Massey Ferguson, New Holland, Sisu Equipment  
**Replaces:** Fiat 1930792; John Deere RE42762; Liebherr 7403951; Massey Ferguson 3580724-M1  
**O.D.:** 5 15/16 (150.8)  
**I.D.:** 21/32 (16.7) & 4 27/32 (123.0)  
**Height:** 15 (381.0)  
**A. Gskt:** [1] Attached  
**F. Gskt:** [1] Included



**PA3848-FN** Outer Air Element with Fins  
**Fits:** Manitou Equipment  
**Use With:** PA4827  
**Replaces:** Manitou 177130  
**O.D.:** 6 3/32 (154.8)  
**Fins:** 7 27/32 (199.2)  
**I.D.:** 3 15/32 (88.1)  
**Height:** 12 1/16 (306.4)  
**A. Gskt:** [1] Attached  
**F. Gskt:** [1] Included



**PA3849** Outer Air Element with Lid  
**Fits:** Fiat, Same Tractors  
**Use With:** PA1981  
**Replaces:** Fiat 1930786, 221190599  
**O.D.:** 9 7/32 (234.2)  
**Lid:** 11 (279.4)  
**I.D.:** 4 27/32 (123.0)  
**Height:** 16 3/8 (415.9)  
**A. Gskt:** [1] Attached  
**F. Gskt:** [1] Wing Nut



**PA3850** Outer Air Element with Lid  
**Fits:** Fiat Tractors  
**Use With:** PA3851  
**Replaces:** Fiat 1930174  
**O.D.:** 9 29/32 (251.6)  
**Lid:** 10 27/32 (275.4)  
**I.D.:** 4 13/16 (122.2)  
**Height:** 13 3/8 (339.7)  
**A. Gskt:** [1] Attached, [1] Wing Nut



**PA3851** Inner Air Element  
**Notes:** Sometimes used as Inner Air Element with PA1884 on Fiat tractors.  
**Fits Inside:** PA3850, PA3864  
**Fits:** Fiat Tractors  
**Replaces:** Fiat 1930175; Massey Ferguson 3385734-M1  
**O.D.:** 4 9/16 (115.9)  
**I.D.:** 3 17/32 (89.7) One End  
**Height:** 12 1/4 (311.2)  
**A. Gskt:** [1] Attached



**PA3852-FN** Outer Air Element with Fins and Lid  
**Fits:** Fiat-Allis Equipment  
**Use With:** PA2670  
**Replaces:** Fiat 71405431  
**O.D.:** 6 3/32 (154.8)  
**Lid:** 8 13/32 (213.5)  
**I.D.:** 3 15/32 (88.1) One End  
**Height:** 13 15/16 (354.0)  
**A. Gskt:** [1] Attached, [1] Wing Nut



**PA3853-FN** Air Element with Fins and Lid  
**Fits:** Ferrec, Massey Ferguson Equipment  
**Replaces:** Massey Ferguson 3515586-M1, 3595503-M1  
**O.D.:** 7 5/8 (193.7)  
**Lid:** 8 5/16 (211.1)  
**I.D.:** 3 7/16 (87.3)  
**Height:** 11 1/16 (281.0)  
**A. Gskt:** [1] Attached  
**F. Gskt:** [1] Included, [1] Wing Nut



**PA3854-FN** Air Element with Fins and Lid  
**Fits:** Ammann, Fiat, Fiat-Allis, Hitachi, Vibromax Equipment  
**Replaces:** Fiat 1930603, 1930826, 71415282  
**O.D.:** 9 13/16 (249.2)  
**Lid:** 11 (279.4)  
**I.D.:** 5 3/8(136.5) One End  
**Height:** 16 7/16 (417.5)  
**A. Gskt:** [1] Attached  
**F. Gskt:** [1] Washer, [1] Wing Nut



**PA3855-FN** Air Element with Fins and Lid  
**Fits:** Fiat-Allis, Hitachi Equipment  
**Replaces:** Fiat 1930602, 71420350, 700055856  
**O.D.:** 9 13/16 (249.2)  
**Lid:** 12 15/32 (316.7)  
**I.D.:** 21/32 (16.7) & 6 3/16 (157.2)  
**Height:** 16 1/2 (419.1)  
**A. Gskt:** [1] Attached  
**F. Gskt:** [1] Washer, [1] Wing Nut



Measurements Are Shown In Inches And (Millimeters)

**WARNING:** These products can expose you to chemicals, including Diisononyl Phthalate, Carbon black extracts, Nickel, 1,3 Butadiene, Ethylene Oxide, Epichlorohydrin, which are known to the State of California to cause cancer, and Bisphenol, Ethylene Glycol, Ethylene Oxide, 1,3 Butadiene, Epichlorohydrin, which are known to the State of California to cause birth defects or other reproductive harm.



**PA3857**



Inner Air Element

**Notes:** OBSOLETE. Availability Limited to Dealer Stock.  
**Fits Inside:** PA2776  
**Fits:** Mercedes-Benz Trucks, Vans  
**Replaces:** Mercedes-Benz 30941604  
**O.D.:** 5 13/16 (147.6)  
 Boot 6 5/16 (160.3)  
**I.D.:** 2 1/32 (16.7)  
**Height:** 18 7/16 (468.3)  
**F. Gskt:** [2] Included

**PA3864**



Outer Air Element with Lid

**Fits:** Massey Ferguson Equipment  
**Use With:** PA3851  
**Replaces:** Massey Ferguson 3385733-M1  
**O.D.:** 9 5/32 (232.6)  
 Lid 11 (279.4)  
**I.D.:** 4 27/32 (123.0)  
**Height:** 13 19/32 (345.3)  
**A. Gskt:** [1] Attached  
**F. Gskt:** [1] Wing Nut

**PA3859**



Outer Air Element with Lid

**Fits:** Case-International, Fiat, New Holland Equipment  
**Use With:** PA2791  
**Replaces:** Fiat 1930536  
**O.D.:** 5 7/16 (138.1)  
 Lid 7 1/16 (179.4)  
**I.D.:** 2 13/16 (71.4)  
**Height:** 13 15/16 (354.0)  
**A. Gskt:** [1] Attached, [1] Wing Nut

**PA3865**



Inner Air Element

**Fits Inside:** PA3484  
**Fits:** Volvo Trucks  
**Replaces:** Volvo 1080920  
**O.D.:** 5 15/16 (150.8)  
 Boot 6 25/32 (172.2)  
**I.D.:** 15/32 (11.9) & 5 3/8 (136.5)  
**Height:** 22 27/32 (580.2)  
**A. Gskt:** [1] Attached  
**F. Gskt:** [1] Included

**PA3860**



Outer Air Element with Lid

**Fits:** Laverda, Massey Ferguson Equipment  
**Use With:** PA3847  
**Replaces:** Fiat 1930783; New Holland 452529  
**O.D.:** 10 13/32 (264.3)  
 Lid 12 1/2 (317.5)  
**I.D.:** 19/32 (15.1) & 6 (152.4)  
**Height:** 16 1/2 (419.1)  
**A. Gskt:** [1] Attached  
**F. Gskt:** [1] Washer, [1] Wing Nut

**PA3867**



Air Element

**Fits:** Various Marine Applications  
**Replaces:** Cummins 3924540; Donaldson B085046  
**O.D.:** 8 1/2 (215.9)  
**I.D.:** 4 (101.6) One End  
**Height:** 12 3/8 (314.3)

**PA3861**



Inner Air Element

**Fits Inside:** PA2840  
**Fits:** Astra Trucks  
**Replaces:** Astra 107030  
**O.D.:** 7 5/16 (185.7)  
 Flange 8 15/32 (215.1)  
**I.D.:** 11/16 (17.5) & 6 5/32 (156.4)  
**Height:** 19 5/32 (486.6)  
**A. Gskt:** [1] Attached  
**F. Gskt:** [1] Included

**PA3868**



Air Element

**Contains:** Flame Retardant Media  
**Fits:** Various Marine Applications  
**Replaces:** Cummins 3924893; Donaldson B085048  
**O.D.:** 8 17/32 (216.7)  
**I.D.:** 3 (76.2) One End  
**Height:** 12 3/8 (314.3)  
**Related To:** PA2815 (without Flame Retardant Media)

**PA3862-FN**



Outer Air Element with Fins

**Fits:** Fiat-Allis, New Holland Equipment  
**Use With:** PA3847  
**Replaces:** Fiat 1930604  
**O.D.:** 9 13/16 (249.2)  
 Fins 11 7/16 (290.5)  
**I.D.:** 5/8 (15.9) & 6 3/16 (157.2)  
**Height:** 16 1/2 (419.1)  
**A. Gskt:** [1] Attached

**PA3869**

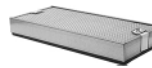

Cab Air Element with Lift Tabs

**Notes:** Uses 2 filters per application.  
**Fits:** Case Loaders  
**Replaces:** International 1970006-C2  
**Length:** 20 (508.0)  
**Width:** 9 (228.6)  
**Height:** 2 9/16 (65.1)  
**A. Gskt:** [1] Attached

**PA3863**



Air Element

**Fits:** Hino Trucks  
**Replaces:** Hino 1780B-44070, 1780B-G8011  
**O.D.:** 7 17/32 (191.3)  
**I.D.:** 3 5/16 (84.1)  
**Height:** 5 11/16 (144.5)

**RS3870**



Radial Seal Outer Air Element

**Contains:** Blank Band  
**Fits:** Ag-Chem, Case, Crane Carrier, Doosan, Hitachi, Hyster, John Deere, Liebherr, Link-Belt, New Holland, Terex, Volvo Off-Highway Equipment; Peterbilt Trucks  
**Use With:** RS3871, RS4639  
**Replaces:** Terex 15270188; Volvo 11033996  
**O.D.:** 12 9/32 (311.9)  
**I.D.:** 6 31/32 (177.0) One End  
**Height:** 20 17/32 (521.5)  
**Related To:** RS3870XP (Extreme Performance), RS4638 (without Blank Band)

Measurements Are Shown In Inches And (Millimeters)

**WARNING:** These products can expose you to chemicals, including Diisononyl Phthalate, Carbon black extracts, Nickel, 1,3 Butadiene, Ethylene Oxide, Epichlorohydrin, which are known to the State of California to cause cancer, and Bisphenol, Ethylene Glycol, Ethylene Oxide, 1,3 Butadiene, Epichlorohydrin, which are known to the State of California to cause birth defects or other reproductive harm.

**RS3870XP**

Extreme Performance Nano Radial Seal Outer Air Element



**Contains:** Blank Band  
**Fits:** Ag-Chem, Case, Crane Carrier, Doosan, Hitachi, Hyster, John Deere, Liebherr, Link-Belt, New Holland, Terex, Volvo Off-Highway Equipment; Peterbilt Trucks  
**Use With:** RS3871, RS4639  
**Replaces:** Donaldson DBA5116  
**O.D.:** 12 9/32 (311.9)  
**I.D.:** 6 15/16 (176.5) One End  
**Height:** 20 9/16 (522)  
**Related To:** RS3870 (Standard Version) RS4638 (without Blank Band)

**RS3871**

Radial Seal Inner Air Element



**Fits Inside:** RS3870, RS3870XP, RS4638  
**Fits:** Caterpillar, Hitachi, John Deere, Terex, Volvo Equipment  
**Replaces:** Terex 15270189; Volvo 11033997-5  
**O.D.:** 7 1/16 (179.4)  
**I.D.:** 5 11/16 (144.5) One End  
**Height:** 19 31/32 (507.2)  
**Related To:** RS4639 (with Flame Retardant Media)

**PA3872**

Reinforced Cotton Fiber Panel Air Element

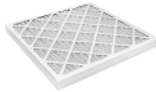

**Replaces:** Airguard DP40-205  
**Length:** 23 3/8 (593.7)  
**Width:** 23 3/8 (593.7)  
**Height:** 1 3/4 (44.4)

**PA3873**

Reinforced Cotton Fiber Panel Air Element



**Fits:** Farr Air Cleaners  
**Replaces:** Farr 49880012  
**Length:** 23 3/8 (593.7)  
**Width:** 19 3/8 (492.1)  
**Height:** 1 3/4 (44.4)

**PA3874**

Air Element



**Fits:** Sullair Compressors  
**Replaces:** Sullair 225005-1136  
**O.D.:** 9 7/32 (234.2)  
**I.D.:** 21/32 (16.7) & 5 5/16 (134.9)  
**Height:** 11 15/16 (303.2)  
**A. Gskt:** [1] Attached  
**F. Gskt:** G103-N

**PA3875-FN**

Air Element with Fins and Lid



**Fits:** Kobelco, Komatsu Equipment  
**Replaces:** Kobelco 2446U271-S2; Komatsu 3EC-01-11630, 3EC-01-11630-L, Z76-01-11630  
**O.D.:** 6 3/8 (161.9)  
 Lid 7 1/8 (181.0)  
**I.D.:** 21/32 (16.7) & 2 5/8 (66.7)  
**Height:** 11 1/2 (292.1)  
**A. Gskt:** [1] Attached  
**F. Gskt:** G103-N

**PA3876**

Air Element



**Fits:** Iveco Trucks  
**Replaces:** Iveco 1907695  
**O.D.:** 12 29/32 (327.8)  
**I.D.:** 13/32 (10.3) & 8 5/8 (219.1)  
**Height:** 20 3/16 (512.8)  
**A. Gskt:** [1] Attached  
**F. Gskt:** [1] Included, [1] Steel Washer

**PA3877**

Cab Air Element



**Fits:** Caterpillar Equipment  
**Replaces:** Caterpillar 9X8216  
**Length:** 26 15/16 (684.2)  
**Width:** 5 15/16 (150.8)  
**Height:** 2 19/32 (65.9)  
**A. Gskt:** [1] Attached

**PA3878**

Cab Air Element

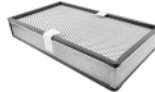

**Fits:** Hitachi, John Deere Equipment  
**Replaces:** John Deere AT103629, AT166805  
**Length:** 18 (457.2)  
**Width:** 10 (254.0)  
**Height:** 2 15/16 (74.6)  
**A. Gskt:** [2] Attached

**PA3879-FN**

Air Element with Fins and Lid



**Fits:** Massey Ferguson Tractors  
**Replaces:** Massey Ferguson 3595518-M1  
**O.D.:** 5 7/16 (138.1)  
 Lid 7 1/16 (179.4)  
**I.D.:** 2 27/32 (72.2) One End  
**Height:** 11 27/32 (300.8)  
**A. Gskt:** [1] Attached

**PA3880**

Air Element



**Fits:** Yamaha Golf Carts  
**Replaces:** Yamaha J381445000  
**O.D.:** 4 1/8 (104.8)  
**I.D.:** 1 7/32 (31.0) One End  
**Height:** 5 13/16 (147.6)

**PA3881**

Cab Air Element

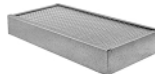

**Fits:** Caterpillar Excavators  
**Replaces:** Caterpillar 8C4120; Nelson 87249N  
**Length:** 15 1/4 (387.3)  
**Width:** 7 5/16 (185.7)  
**Height:** 2 3/16 (55.6)

**RS3882**

Radial Seal Outer Air Element



**Fits:** Barber-Greene, Caterpillar, John Deere Equipment  
**Use With:** RS3883  
**Replaces:** Caterpillar 108-0671; John Deere AT175344  
**O.D.:** 8 5/32 (207.2)  
**I.D.:** 4 1/4 (108.0) One End  
**Height:** 11 5/8 (295.3)

Measurements Are Shown In Inches And (Millimeters)

**WARNING:** These products can expose you to chemicals, including Diisononyl Phthalate, Carbon black extracts, Nickel, 1,3 Butadiene, Ethylene Oxide, Epichlorohydrin, which are known to the State of California to cause cancer, and Bisphenol, Ethylene Glycol, Ethylene Oxide, 1,3 Butadiene, Epichlorohydrin, which are known to the State of California to cause birth defects or other reproductive harm.

**RS3882XP**



Extreme Performance Nano Radial Seal Outer Air Element

**Fits:** John Deere Excavators  
**Use With:** RS3883  
**Replaces:** John Deere AP35310  
**O.D.:** 8 5/32 (207.2)  
**I.D.:** 4 3/16 (106.4) One End  
**Height:** 11 5/8 (295.3)

**RS3888**



Radial Seal Air Element

**Fits:** DAF Trucks  
**Replaces:** DAF 1317409  
**O.D.:** 10 31/32 (278.6)  
**I.D.:** 5 13/16 (147.6) One End  
**Height:** 18 7/8 (479.4)

**RS3883**



Radial Seal Inner Air Element

**Fits Inside:** RS3882; RS3882XP  
**Fits:** Barber-Greene, Caterpillar, John Deere Equipment  
**Replaces:** Caterpillar 108-0672; John Deere AT175345  
**O.D.:** 4 1/4 (108.0)  
**I.D.:** 2 3/4 (69.9) One End  
**Height:** 10 25/32 (273.8)

**PA3889**



Inner Air Element

**Fits Inside:** PA3887  
**Fits:** John Deere Equipment  
**Replaces:** John Deere AZ45867  
**O.D.:** 7 1/4 (184.2)  
 Flange 8 13/32 (213.5)  
**I.D.:** 11/16 (17.5) & 6 3/16 (157.2)  
**Height:** 21 13/16 (554.0)  
**A. Gskt:** [1] Attached  
**F. Gskt:** G103-N

**RS3884**



Radial Seal Outer Air Element

**Fits:** Benford, Case-International, Dynapac, J.C. Bamford, New Holland, Pro-Tec Equipment  
**Use With:** RS3885  
**Replaces:** J.C. Bamford 32/912901  
**O.D.:** 8 5/32 (207.2)  
**I.D.:** 4 3/16 (106.4) One End  
**Height:** 16 9/16 (420.7)

**PA3890**



Air Element with Foam Wrap

**Fits:** Kohler Engines  
**Replaces:** Kohler 253107  
**O.D.:** 8 3/4 (222.3)  
**I.D.:** 4 3/32 (104.0)  
**Height:** 5 31/32 (151.6)

**RS3885**



Radial Seal Inner Air Element

**Fits Inside:** RS3734, RS3734XP, RS3884, RS30059-FN  
**Fits:** Benford, Case-International, Caterpillar, Dynapac, J.C. Bamford, John Deere, Liebherr, New Holland, Pro-Tec Equipment  
**Replaces:** J.C. Bamford 32/912902  
**O.D.:** 4 1/4 (108.0)  
**I.D.:** 3 3/8 (85.7) One End  
**Height:** 16 1/16 (408.0)

**PA3891**



Replacement for Ecolite Air Filter in Disposable Housing

**Contains:** Water Drain Valve  
**Fits:** Farr Air Cleaners; Thomas Buses  
**Replaces:** Farr 119862-001, 119862-001G; Thomas 61100179  
**O.D.:** 9 11/16 (246.1)  
**Inlet:** 6  
**Outlet:** 6  
**Height:** 19 13/16 (503.2)

**PA3886**



Cab Air Element with Bail Handle

**Fits:** John Deere Equipment  
**Replaces:** John Deere AH112712, AH115836  
**Length:** 14 21/32 (372.3)  
**Width:** 3 3/8 (85.7) to 5 1/4 (133.4)  
**Height:** 2 7/16 (61.9)  
**A. Gskt:** [2] Attached

**PA3892**



Outer Air Element with Lift Tab

**Fits:** Ingersoll-Rand Compressors  
**Use With:** PA3893  
**Replaces:** Ingersoll-Rand 36867786  
**O.D.:** 12 (304.8)  
 Boot 12 15/32 (316.7)  
**I.D.:** 7/8 (22.2) & 7 7/8 (200.0)  
**Height:** 20 1/2 (520.7)  
**A. Gskt:** [2] Attached  
**F. Gskt:** [1] Metal Washer

**PA3887**



Outer Air Element

**Fits:** John Deere Equipment  
**Use With:** PA3889  
**Replaces:** John Deere AZ45868  
**O.D.:** 12 3/32 (307.2)  
**I.D.:** 21/32 (16.7) & 7 11/16 (195.3)  
**Height:** 22 1/2 (571.5)  
**A. Gskt:** [1] Attached  
**F. Gskt:** G103-N

**PA3893**



Inner Air Element

**Fits Inside:** PA3892  
**Fits:** Ingersoll-Rand Compressors  
**Replaces:** Ingersoll-Rand 36876019  
**O.D.:** 7 5/8 (193.7)  
**I.D.:** 7/8 (22.2) & 6 3/16 (157.2)  
**Height:** 18 1/2 (469.9)  
**A. Gskt:** [1] Attached  
**F. Gskt:** [1] Metal Washer

Measurements Are Shown In Inches And (Millimeters)

**WARNING:** These products can expose you to chemicals, including Diisononyl Phthalate, Carbon black extracts, Nickel, 1,3 Butadiene, Ethylene Oxide, Epichlorohydrin, which are known to the State of California to cause cancer, and Bisphenol, Ethylene Glycol, Ethylene Oxide, 1,3 Butadiene, Epichlorohydrin, which are known to the State of California to cause birth defects or other reproductive harm.

**PA3894**

**Air Element**



**Fits:** Various Industrial Equipment  
**Replaces:** Nelson 70459A, 70459N  
**O.D.:** 7 29/32 (200.8)  
**I.D.:** 4 3/32 (104.0)  
**Height:** 11 1/2 (292.1)

**PA3901**

**Air Element**



**Fits:** Exmark Lawn & Garden Tractors; Kohler Engines  
**Use With:** PA3901 FOAM  
**Replaces:** Kohler 2408303  
**O.D.:** 6 31/32 (177.0)  
**I.D.:** 5 19/32 (142.1)  
**Height:** 3 (76.2)

**PA3895-FN**

**Air Element with Fins**



**Fits:** Bobcat Equipment  
**Replaces:** Melroe-Bobcat 897064B  
**O.D.:** 3 1/4 (82.6)  
 Fins 4 1/4 (108.0)  
**I.D.:** 13/32 (10.3) & 1 27/32 (46.8)  
**Height:** 7 1/4 (184.2)  
**A. Gskt:** [1] Attached  
**F. Gskt:** [1] Included

**PA3901 FOAM**

**Foam Blanket for PA3901**



**Use With:** PA3901  
**O.D.:** 6 25/32 (172.2)  
**I.D.:** 6 5/16 (160.3)  
**Height:** 2 23/32 (69.1)

**PA3896**

**Air Element**



**Notes:** Sometimes used as Inner Air Element with PA2582.  
**Fits:** Champion Graders; Ingersoll-Rand Compressors  
**Replaces:** Ingersoll-Rand 35384627  
**O.D.:** 6 3/8 (161.9)  
**I.D.:** 5/8 (15.9) & 5 7/16 (138.1)  
**Height:** 19 (482.6)  
**A. Gskt:** [1] Attached  
**F. Gskt:** G103-N

**PA3902**

**Outer Air Element with Lift Bar**



**Fits:** New Holland Tractors  
**Use With:** PA3903  
**Replaces:** New Holland 82008596  
**O.D.:** 8 1/2 (215.9)  
 Flange Gasket 10 (254.0)  
**I.D.:** 19/32 (15.1) & 4 27/32 (123.0)  
**Height:** 12 3/8 (314.3)  
**A. Gskt:** [2] Attached  
**F. Gskt:** [1] Included

**PA3897**

**Cab Air Element**



**Fits:** John Deere Equipment  
**Replaces:** John Deere AT74377  
**Length:** 11 31/32 (304.0)  
**Width:** 9 15/16 (252.4)  
**Height:** 2 23/32 (69.1)  
**A. Gskt:** [1] Attached

**PA3903**

**Inner Air Element**



**Fits Inside:** PA3902  
**Fits:** New Holland Tractors  
**Replaces:** New Holland 82008597  
**O.D.:** 4 23/32 (119.9)  
 Flange 5 29/32 (150.0)  
**I.D.:** 13/32 (10.3) & 3 31/32 (100.8)  
**Height:** 12 1/4 (311.2)  
**A. Gskt:** [2] Attached

**PA3898**

**Outer Air Element**



**Fits:** Kobelco Equipment  
**Use With:** PA3899  
**Replaces:** Kobelco 2446R254-S5  
**O.D.:** 8 1/8 (206.4)  
**I.D.:** 21/32 (16.7) & 4 27/32 (123.0)  
**Height:** 21 1/2 (546.1)  
**A. Gskt:** [1] Attached  
**F. Gskt:** G103-N

**PA3904**

**Outer Air Element**



**Fits:** Caterpillar Generators, Industrial, Marine Engines  
**Use With:** PA3905  
**Replaces:** Caterpillar 4P0710  
**O.D.:** 19 9/32 (489.7)  
**I.D.:** 12 7/8 (327.0) One End  
**Height:** 13 27/32 (351.6)  
**A. Gskt:** [1] Attached

**PA3899**

**Inner Air Element**



**Fits Inside:** PA3898  
**Fits:** Kobelco Equipment  
**Replaces:** Kobelco 2446R254-S6  
**O.D.:** 4 9/16 (115.9)  
 Boot 5 3/4 (146.0)  
**I.D.:** 21/32 (16.7) & 3 7/16 (87.3)  
**Height:** 20 13/32 (518.3)  
**A. Gskt:** [1] Attached  
**F. Gskt:** G103-N

**PA3905**

**Inner Air Element with 8 Bolt Holes**



**Fits Inside:** PA3904  
**Fits:** Caterpillar Generators, Industrial, Marine Engines  
**Replaces:** Caterpillar 4P0711  
**O.D.:** 12 25/32 (324.6)  
 Flange 15 5/8 (396.9)  
**I.D.:** 10 9/32 (261.1) One End  
**Height:** 14 1/4 (362.0)  
**A. Gskt:** [1] Attached

**PA3900**

**Cab Air Element**

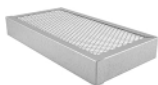

**Fits:** John Deere Tractors  
**Replaces:** John Deere RE70742  
**Length:** 12 1/2 (317.5)  
**Width:** 6 1/2 (165.1)  
**Height:** 1 3/4 (44.4)

**PA3906**

**Outer Air Element**



**Fits:** Mitsubishi Trucks  
**Use With:** PA5412  
**Replaces:** Mitsubishi ME073252  
**O.D.:** 9 1/8 (231.8)  
**I.D.:** 15/16 (23.8) & 5 13/16 (147.6)  
**Height:** 17 19/32 (446.9)  
**A. Gskt:** [1] Attached  
**F. Gskt:** [1] Included

Measurements Are Shown In Inches And (Millimeters)

**WARNING:** These products can expose you to chemicals, including Diisononyl Phthalate, Carbon black extracts, Nickel, 1,3 Butadiene, Ethylene Oxide, Epichlorohydrin, which are known to the State of California to cause cancer, and Bisphenol, Ethylene Glycol, Ethylene Oxide, 1,3 Butadiene, Epichlorohydrin, which are known to the State of California to cause birth defects or other reproductive harm.

**PA3907** Replacement for Ecolite Air Filter in Disposable Housing



**Fits:** Farr Air Cleaners; Ottawa Trucks  
**Replaces:** Farr 400292-000, 400292-000-A  
**O.D.:** 11 1/2 (292.1)  
**Inlet:** 6  
**Outlet:** 7  
**Height:** 16 29/32 (429.4)

**PA3915** Inner Air Element



**Fits Inside:** PA3914  
**Fits:** Hino Equipment  
**Replaces:** Hino 17801-2900, 17801-2900M  
**O.D.:** 6 3/8 (161.9)  
**I.D.:** 5/8 (15.9) & 5 9/32 (134.1)  
**Height:** 12 3/8 (314.3)  
**A. Gskt:** [1] Attached  
**F. Gskt:** G103-N

**PA3908** Outer Air Element



**Fits:** Kubota Tractors  
**Use With:** PA3909  
**Replaces:** Kubota 17301-11080  
**O.D.:** 6 (152.4)  
**I.D.:** 5/8 (15.9) & 4 (101.6)  
**Height:** 7 3/4 (196.9)  
**A. Gskt:** [1] Attached  
**F. Gskt:** G103-N

**PA3916** Air Element



**Fits:** MCI, Universal Coach Buses  
**Replaces:** MCI 9031073; Universal Coach T12-1111  
**O.D.:** 12 3/32 (307.2)  
**I.D.:** 7/8 (22.2) & 7 11/16 (195.3)  
**Height:** 19 1/2 (495.3)  
**A. Gskt:** [1] Attached  
**F. Gskt:** [1] Included

**PA3909** Inner Air Element



**Fits Inside:** PA3908  
**Fits:** Kubota Tractors  
**Replaces:** Kubota 17301-11180  
**O.D.:** 3 7/8 (98.4)  
**I.D.:** 5/8 (15.9) & 3 3/16 (81.0)  
**Height:** 7 1/32 (178.6)  
**A. Gskt:** [1] Attached  
**F. Gskt:** [1] Included

**PA3917** Cab Air Element



**Fits:** Caterpillar Equipment  
**Replaces:** Caterpillar 1212761, 6T9504, 7G6599; Fleetguard AF27700  
**Length:** 17 15/32 (443.7)  
**Width:** 8 1/2 (215.9)  
**Height:** 5/8 (15.9)

**PA3910-FN** Outer Air Element with Fins and Lid



**Fits:** J.C. Bamford Equipment  
**Use With:** PA3911  
**Replaces:** J.C. Bamford 32/911801  
**O.D.:** 7 13/16 (198.4)  
Lid 8 3/8 (212.7)  
**I.D.:** 19/32 (15.1) & 3 15/32 (88.1)  
**Height:** 9 5/16 (236.5)  
**A. Gskt:** [1] Attached  
**F. Gskt:** [1] Included, [1] Wing Nut

**PA3918** Outer Air Element with Lift Bar



**Fits:** John Deere Tractors  
**Use With:** PA3919  
**Replaces:** John Deere AL78869  
**O.D.:** 8 29/32 (226.2)  
Flange 11 7/32 (285.0)  
**I.D.:** 4 21/32 (118.3) One End  
**Height:** 12 7/32 (310.4)  
**A. Gskt:** [1] Attached

**PA3911** Inner Air Element



**Fits Inside:** PA3910-FN  
**Fits:** J.C. Bamford Equipment  
**Replaces:** J.C. Bamford 32/911802  
**O.D.:** 3 3/8 (85.7)  
Flange 4 5/32 (105.6)  
**I.D.:** 21/32 (16.7) & 2 29/32 (73.8)  
**Height:** 7 21/32 (194.5)  
**A. Gskt:** [1] Attached  
**F. Gskt:** [1] Metal Washer

**PA3919** Inner Air Element with 3 Bolts



**Fits Inside:** PA3918  
**Fits:** John Deere Tractors  
**Replaces:** John Deere AL78870  
**O.D.:** 6 11/32 (161.1)  
Flange 9 3/8 (238.1)  
**I.D.:** 4 21/32 (118.3) One End  
**Height:** 5 1/8 (130.2)  
**A. Gskt:** [1] Attached  
**O-Ring:** [3] Included

**PA3914** Outer Air Element



**Fits:** Hino Equipment  
**Use With:** PA3915  
**Replaces:** Hino 17801-2910, 17801-2910M  
**O.D.:** 10 27/32 (275.4)  
**I.D.:** 15/16 (23.8) & 6 1/2 (165.1)  
**Height:** 14 1/2 (368.3)  
**A. Gskt:** [1] Attached  
**F. Gskt:** [1] Included

**RS3920** Radial Seal Outer Air Element



**Fits:** J.C. Bamford, Massey Ferguson, Volvo Equipment  
**Use With:** RS3921  
**Replaces:** J.C. Bamford 32/915802  
**O.D.:** 5 31/32 (151.6)  
**I.D.:** 3 3/8 (85.7) One End  
**Height:** 14 1/8 (358.8)

Measurements Are Shown In Inches And (Millimeters)

**WARNING:** These products can expose you to chemicals, including Diisononyl Phthalate, Carbon black extracts, Nickel, 1,3 Butadiene, Ethylene Oxide, Epichlorohydrin, which are known to the State of California to cause cancer, and Bisphenol, Ethylene Glycol, Ethylene Oxide, 1,3 Butadiene, Epichlorohydrin, which are known to the State of California to cause birth defects or other reproductive harm.

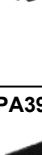
<p><b>RS3921</b></p> 	<p>Radial Seal Inner Air Element  <b>Fits Inside:</b> RS3920  <b>Fits:</b> J.C. Bamford, Massey Ferguson Equipment  <b>Replaces:</b> J.C. Bamford 32/915801  <b>O.D.:</b> 3 3/32 (78.6)  <b>I.D.:</b> 2 15/16 (74.6) One End  <b>Height:</b> 13 19/32 (345.3)</p>	<p><b>RS3927</b></p> 	<p>Radial Seal Inner Air Element  <b>Fits Inside:</b> RS3926  <b>Fits:</b> Case-International Equipment  <b>Replaces:</b> Case 243969A1  <b>O.D.:</b> 6 7/8 (174.6)  <b>I.D.:</b> 5 5/32 (131.0) One End  <b>Height:</b> 21 15/32 (545.3)</p>
<p><b>RS3922</b></p> 	<p>Radial Seal Outer Air Element  <b>Fits:</b> Deutz, Deutz-Fahr, Fendt, Gehl, Massey Ferguson Tractors; J.C. Bamford Excavators, Loaders; Terex Lift Trucks  <b>Use With:</b> RS3923  <b>Replaces:</b> J.C. Bamford 32/917804  <b>O.D.:</b> 6 3/8 (161.9)  <b>I.D.:</b> 3 3/4 (95.3) One End  <b>Height:</b> 14 3/4 (374.7)</p>	<p><b>PA3928</b></p> 	<p>Set of 2 Cab Air Elements  <b>Notes:</b> Uses 2 filters per application.  <b>Fits:</b> John Deere Tractors  <b>Replaces:</b> John Deere AL115625, AL111748  <b>Each Filter:</b>  <b>Length:</b> 23 5/16 (592.1)  <b>Width:</b> 5 3/16 (131.8)  to 5 3/8 (136.5)  <b>Height:</b> 3 11/32 (84.9)  <b>A. Gskt:</b> [1] Included</p>
<p><b>RS3923</b></p> 	<p>Radial Seal Inner Air Element  <b>Fits Inside:</b> RS3922  <b>Fits:</b> Deutz, Deutz-Fahr, Fendt, Massey Ferguson Tractors; J.C. Bamford Excavators, Loaders; Terex Lift Trucks  <b>Replaces:</b> J.C. Bamford 32/917805  <b>O.D.:</b> 3 17/32 (89.7)  <b>I.D.:</b> 3 13/32 (86.5) One End  <b>Height:</b> 14 7/32 (361.2)</p>	<p><b>PA3929</b></p> 	<p>Cab Air Element  <b>Fits:</b> John Deere Tractors  <b>Replaces:</b> John Deere RE48882  <b>Length:</b> 9 1/32 (229.4)  <b>Width:</b> 7 3/16 (182.6)  <b>Height:</b> 1 5/8 (41.3)</p>
<p><b>PA3924-FN</b></p> 	<p>Outer Air Element with Fins and Lid  <b>Fits:</b> John Deere, Zetor Tractors  <b>Use With:</b> PA2689  <b>Replaces:</b> Zetor 79011284  <b>O.D.:</b> 7 13/16 (198.4)  Lid 8 3/8 (212.7)  <b>I.D.:</b> 19/32 (15.1) &amp; 3 15/32 (88.1)  <b>Height:</b> 11 1/2 (292.1)  <b>A. Gskt:</b> [1] Attached  <b>F. Gskt:</b> [1] Included, [1] Wing Nut</p>	<p><b>RS3930</b></p> 	<p>Radial Seal Inner Air Element  <b>Fits Inside:</b> RS3715  <b>Fits:</b> Allmand, Bobcat, Exmark, John Deere Equipment  <b>Replaces:</b> John Deere M123378; Walker 5090-3  <b>O.D.:</b> 1 11/16 (42.9)  <b>I.D.:</b> 1 3/16 (30.2) One End  <b>Height:</b> 6 5/8 (168.3)</p>
<p><b>PA3925</b></p> 	<p>Inner Air Element  <b>Fits Inside:</b> RS4967  <b>Fits:</b> Volvo Trucks  <b>Replaces:</b> Volvo 1665937, 1665937-7  <b>O.D.:</b> 7 31/32 (202.4)  <b>I.D.:</b> 7 (177.8) One End  <b>Height:</b> 17 19/32 (446.9)</p>	<p><b>PA3931</b></p> 	<p>Foam Inside Cab Air Element  <b>Fits:</b> John Deere Tractors  <b>Replaces:</b> John Deere R120501  <b>Length:</b> 13 (330.2)  <b>Width:</b> 7 (177.8)  <b>Height:</b> 1/2 (12.7)</p>
<p><b>RS3926</b></p> 	<p>Radial Seal Outer Air Element  <b>Fits:</b> Case-International Equipment  <b>Use With:</b> RS3927  <b>Replaces:</b> Case 243968A1  <b>O.D.:</b> 12 31/32 (329.4)  <b>I.D.:</b> 6 13/16 (173.0) One End  <b>Height:</b> 22 9/32 (565.9)</p>	<p><b>PA3932</b></p> 	<p>Outer Air Element  <b>Notes:</b> Uses 2 filters per application.  <b>Fits:</b> Caterpillar Generators, Industrial, Marine Engines  <b>Use With:</b> PA3933  <b>Replaces:</b> Caterpillar 113-1578  <b>O.D.:</b> 19 9/32 (489.7)  <b>I.D.:</b> 12 7/8 (327.0) One End  <b>Height:</b> 18 5/16 (465.1)  <b>A. Gskt:</b> [1] Attached</p>
		<p><b>PA3933</b></p> 	<p>Inner Air Element with 8 Bolt Holes  <b>Fits Inside:</b> PA3932  <b>Fits:</b> Caterpillar Generators, Industrial, Marine Engines  <b>Replaces:</b> Caterpillar 113-1579  <b>O.D.:</b> 12 25/32 (324.6)  Flange 15 5/8 (396.9)  <b>I.D.:</b> 10 9/32 (261.1) One End  <b>Height:</b> 17 3/4 (450.9)  <b>A. Gskt:</b> [1] Attached</p>

Measurements Are Shown In Inches And (Millimeters)

**WARNING:** These products can expose you to chemicals, including Diisononyl Phthalate, Carbon black extracts, Nickel, 1,3 Butadiene, Ethylene Oxide, Epichlorohydrin, which are known to the State of California to cause cancer, and Bisphenol, Ethylene Glycol, Ethylene Oxide, 1,3 Butadiene, Epichlorohydrin, which are known to the State of California to cause birth defects or other reproductive harm.

**RS3934**



Radial Seal Outer Air Element  
**Fits:** Case-International Equipment  
**Use With:** RS3935  
**Replaces:** Case 187471A1  
**O.D.:** 8 5/32 (207.2)  
**I.D.:** 4 3/16 (106.4) One End  
**Height:** 15 5/8 (396.9)

**RS3940**



Radial Seal Outer Air Element  
**Contains:** Flame Retardant Media  
**Fits:** Toyota Lift Trucks  
**Use With:** RS4962  
**Replaces:** Toyota 17741-23600-71,  
 17743-23600-71  
**O.D.:** 5 13/32 (137.3)  
**I.D.:** 3 3/16 (81.0) One End  
**Height:** 11 1/32 (280.2)

**RS3935**



Radial Seal Inner Air Element  
**Fits Inside:** RS3934, RS3971  
**Fits:** Case-International Equipment  
**Replaces:** Case 187472A1  
**O.D.:** 4 1/4 (108.0)  
**I.D.:** 2 3/4 (69.9) One End  
**Height:** 15 (381.0)

**PA3941**



Air Element  
**Fits:** Hatz Diesel Engines; Bitelli Paving  
 Equipment  
**Replaces:** Hatz 1493000  
**O.D.:** 6 1/2 (165.1)  
**I.D.:** 3 15/32 (88.1)  
**Height:** 3 21/32 (92.9)

**RS3936**



Radial Seal Air Element  
**Fits:** Mack Trucks  
**Replaces:** Mack 2MD4139M, 57MD46M  
**O.D.:** 9 9/32 (235.7)  
**I.D.:** 5 25/32 (146.8) One End  
**Height:** 25 17/32 (648.5)

**RS3942**



Radial Seal Outer Air Element  
**Fits:** Ahlmann, Massey Ferguson Tractors;  
 Atlas Copco Compressors; Bomag Compactors;  
 Melroe-Bobcat Lift Trucks  
**Use With:** RS3943  
**Replaces:** Mann & Hummel C14200  
**O.D.:** 4 31/32 (126.2)  
**I.D.:** 2 31/32 (75.4) One End  
**Height:** 12 17/32 (318.3)

**PA3937**

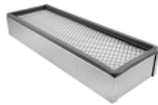

Cab Air Element  
**Notes:** Uses 2 filters per application.  
**Fits:** Caterpillar Equipment  
**Replaces:** Caterpillar 113-0305  
**Length:** 16 7/16 (417.5)  
**Width:** 5 9/16 (141.3)  
**Height:** 2 9/16 (65.1)  
**A. Gskt:** [1] Attached

**RS3943**



Radial Seal Inner Air Element  
**Fits Inside:** RS3942  
**Fits:** Ahlmann, Massey Ferguson Tractors;  
 Atlas Copco Compressors; Bomag Compactors;  
 Melroe-Bobcat Lift Trucks  
**Replaces:** Deutz 1180869; Massey Ferguson  
 3901463-M1  
**O.D.:** 2 3/4 (69.9)  
**I.D.:** 2 11/16 (68.3) One End  
**Height:** 12 1/16 (306.4)

**PA3938**



Air Element  
**Fits:** Mack Trucks  
**Replaces:** Mack 57MD47  
**O.D.:** 10 27/32 (275.4)  
**I.D.:** 15/16 (23.8) & 6 1/2 (165.1)  
**Height:** 20 15/32 (519.9)  
**A. Gskt:** [1] Attached  
**F. Gskt:** [1] Included

**PA3944**



Panel Air Element  
**Replaces:** Dart 625081, 842408; Euclid 1004320  
**Length:** 20 (508.0)  
**Width:** 15 (381.0)  
**Height:** 2 3/16 (55.6)

**PA3945**

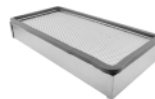

Cab Air Element  
**Fits:** Hitachi Equipment  
**Replaces:** Hitachi 4206637  
**Length:** 17 1/8 (435.0)  
**Width:** 8 7/16 (214.3)  
**Height:** 2 11/16 (68.3)  
**A. Gskt:** [1] Attached

**PA3939**

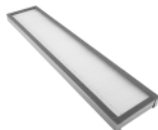

Cab Air Element  
**Fits:** Caterpillar Excavators  
**Replaces:** Caterpillar 411278  
**Length:** 23 5/8 (600.1)  
**Width:** 4 7/8 (123.8)  
**Height:** 1 1/16 (27.0)

**PA3946**



Air Element  
**Fits:** Volvo Trucks  
**Replaces:** Volvo 6778729  
**O.D.:** 7 15/16 (201.6)  
**I.D.:** 7/16 (11.1) & 4 5/8 (117.5)  
**Height:** 22 19/32 (573.9)  
**A. Gskt:** [1] Attached  
**F. Gskt:** [1] Included

Measurements Are Shown In Inches And (Millimeters)

**WARNING:** These products can expose you to chemicals, including Diisononyl Phthalate, Carbon black extracts, Nickel, 1,3 Butadiene, Ethylene Oxide, Epichlorohydrin, which are known to the State of California to cause cancer, and Bisphenol, Ethylene Glycol, Ethylene Oxide, 1,3 Butadiene, Epichlorohydrin, which are known to the State of California to cause birth defects or other reproductive harm.

**PA3948**

Outer Air Element with Lift Bar

**Fits:** New Holland Tractors  
**Use With:** PA3949  
**Replaces:** New Holland 82001819, 82008606  
**O.D.:** 8 1/2 (215.9)  
 Boot Gasket 10 (254.0)  
**I.D.:** 19/32 (15.1) & 4 27/32 (123.0)  
**Height:** 15 9/16 (395.3)  
**A. Gskt:** [2] Attached  
**F. Gskt:** [1] Included



**RS3954**

Radial Seal Outer Air Element

**Fits:** New Holland, Terex, Volvo Equipment  
**Use With:** RS3547  
**Replaces:** Perkins 26510362  
**O.D.:** 4 1/8 (104.8)  
**I.D.:** 2 5/16 (58.7) One End  
**Height:** 11 27/32 (300.8)



**PA3949**

Inner Air Element with Lift Tabs

**Notes:** Oil Wetted Media  
**Fits Inside:** PA3948  
**Fits:** New Holland Tractors  
**Replaces:** New Holland 82001820, 82008607  
**O.D.:** 4 23/32 (119.9)  
 Flange 5 29/32 (150.0)  
**I.D.:** 13/32 (10.3) & 3 31/32 (100.8)  
**Height:** 15 3/8 (390.5)  
**A. Gskt:** [2] Attached



**PA3956**

Air Element with Foam Wrap

**Fits:** Kohler Generators  
**Replaces:** Cummins 3903876, 3903879; Kohler 253108  
**O.D.:** 8 1/32 (204.0)  
**I.D.:** 5 5/16 (134.9)  
**Height:** 10 15/16 (277.8)



**PA3950**

Inner Air Element

**Fits Inside:** PA3790  
**Fits:** Massey Ferguson Tractors  
**Replaces:** Massey Ferguson 3515587-M1, 3595501-M1  
**O.D.:** 3 3/8 (85.7)  
 Flange 3 25/32 (96.0)  
**I.D.:** 21/32 (16.7) & 2 7/8 (73.0)  
**Height:** 9 1/32 (229.4)  
**A. Gskt:** [1] Attached  
**F. Gskt:** [1] Washer



**PA3957**

Oval Air Element with Foam Wrap

**Fits:** American Sportsworks Utility Vehicles; Genie Lifts; Honda Engines; Toro Loaders  
**Use With:** PA3957 FOAM  
**Replaces:** Honda 17210-ZE3-010, 17210-ZE3-505  
**O.D.:** 3 25/32 (96.0) to 4 13/32 (111.9)  
**I.D.:** 1/4 (6.4) & 1 5/8 (41.3)  
**Height:** 3 5/8 (92.1)  
**A. Gskt:** [1] Metal Washer  
**Grommets:** [1] Attached



**PA3951**

Conical-Shaped Air Element

**Notes:** Inside-Out Flow Direction  
**Fits:** Ford, GMC, Mack Trucks  
**Replaces:** Ford D8HZ-9601-B; GMC 8997222; International 526059-C91  
**O.D.:** 7 13/32 (188.1) to 10 13/32 (264.3)  
**I.D.:** 6 15/16 (176.2) One End  
**Height:** 29 (736.6)  
**A. Gskt:** [2] Attached  
**F. Gskt:** G298-AF



**PA3957 FOAM**

Foam Blanket for PA3957

**Use With:** PA3957  
**O.D.:** 3 27/32 (97.6)  
**I.D.:** 3 3/8 (85.7)  
**Length:** 3 3/16 (81.0)  
**Height:** 2 27/32 (72.2)



**RS3952**

Radial Seal Air Element

**Fits:** DAF Trucks  
**Replaces:** DAF 1353115  
**O.D.:** 10 31/32 (278.6)  
**I.D.:** 5 13/16 (147.6) One End  
**Height:** 19 29/32 (505.6)



**PA3958**

Foam Wrap

**Fits:** Detroit Diesel Marine Engines  
**Replaces:** GMC 6422214, 25177939  
**O.D.:** 8 19/32 (218.3)  
**I.D.:** 7 19/32 (192.9)  
**Height:** 7 (177.8)



**PA3953**

Panel Air Element

**Fits:** Genie Industrial Lifts  
**Replaces:** Lombardini 2175.164, 107.2175.160  
**Length:** 8 7/8 (225.4)  
**Width:** 5 5/16 (134.9)  
**Height:** 1 5/8 (41.3)



**PA3959**

Air Element

**Fits:** Kubota Equipment  
**Replaces:** Kubota 11420-11180  
**O.D.:** 4 23/32 (119.9)  
**I.D.:** 1 31/32 (50.0)  
**Height:** 1 31/32 (50.0)  
**A. Gskt:** [2] Attached



Measurements Are Shown In Inches And (Millimeters)

**WARNING:** These products can expose you to chemicals, including Diisononyl Phthalate, Carbon black extracts, Nickel, 1,3 Butadiene, Ethylene Oxide, Epichlorohydrin, which are known to the State of California to cause cancer, and Bisphenol, Ethylene Glycol, Ethylene Oxide, 1,3 Butadiene, Epichlorohydrin, which are known to the State of California to cause birth defects or other reproductive harm.



**PA3961**

Air Element



**Notes:** OBSOLETE. Availability Limited to Dealer Stock.  
**Fits:** Iveco Trucks  
**Replaces:** Iveco 1908233, 1908868  
**O.D.:** 6 3/32 (154.8)  
**I.D.:** 3 5/32 (80.2) One End  
**Height:** 13 17/32 (343.7)

**PA3970**

Air Element



**Fits:** Hatz Engines  
**Replaces:** Hatz 40084500  
**O.D.:** 6 1/2 (165.1)  
**I.D.:** 3 1/2 (88.9)  
**Height:** 3 21/32 (92.9)

**BA3964(4)**

Set of 4 Nylon Screen Supported Bag Air Elements



**Notes:** Oil Wetted Media  
**Fits:** Railroad Applications  
**Replaces:** Clark EG2; EMD 9522063  
**Length:** 22 (558.8)  
**Width:** 18 3/4 (476.3)  
**Height:** 5 (127.0)

**RS3971**

Radial Seal Outer Air Element



**Fits:** Gradall, Volvo Equipment  
**Use With:** RS3935, RS5304  
**Replaces:** Gradall 91343059  
**O.D.:** 7 11/32 (186.5)  
**I.D.:** 4 5/32 (105.6) One End  
**Height:** 15 21/32 (397.7)

**BA3965(4)**

Set of 4 Nylon Screen Supported Bag Air Elements



**Notes:** Oil Wetted Media  
**Fits:** Railroad Applications  
**Replaces:** Clark EG1; EMD 8470903; General Electric 41A218313P1  
**Length:** 29 3/8 (746.1)  
**Width:** 27 3/8 (695.3)  
**Height:** 6 3/8 (161.9)

**PA3972**

Outer Air Element



**Fits:** Kubota Tractors  
**Use With:** PA3973  
**Replaces:** Kubota 15724-11080  
**O.D.:** 6 3/32 (154.8)  
**I.D.:** 21/32 (16.7) & 4 3/32 (104.0)  
**Height:** 9 5/8 (244.5)  
**A. Gskt:** [1] Attached  
**F. Gskt:** [1] Washer

**PA3966**

Air Element



**Fits:** EMD, GE Locomotives  
**Replaces:** EMD 8402068; Farr 116367-001; General Electric 41A216205P1  
**O.D.:** 8 (203.2)  
**I.D.:** 6 1/8 (155.6)  
**Height:** 12 5/32 (308.8)

**PA3973**

Inner Air Element



**Fits Inside:** PA3972  
**Fits:** Kubota Tractors  
**Replaces:** Kubota 15724-11180  
**O.D.:** 3 7/8 (98.4)  
**I.D.:** 5/8 (15.9) & 3 7/32 (81.8)  
**Height:** 8 13/16 (223.8)  
**A. Gskt:** [1] Attached  
**F. Gskt:** [1] Metal Washer

**PA3967**

Air Element



**Fits:** John Deere Lawn & Garden Equipment  
**Replaces:** John Deere AM101812; Onan 140-1911, 140-2523  
**O.D.:** 8 1/4 (209.6)  
**I.D.:** 6 13/32 (162.7)  
**Height:** 3 13/16 (96.8)

**RS3974**

Radial Seal Outer Air Element



**Fits:** John Deere, New Holland Loaders  
**Use With:** RS3975  
**Replaces:** John Deere AT178583  
**O.D.:** 9 9/32 (235.7)  
**I.D.:** 5 5/32 (131.0) One End  
**Height:** 21 7/8 (555.6)

**PA3969**

Air Element



**Replaces:** Mitsubishi 91261-08200  
**O.D.:** 5 5/16 (134.9)  
**I.D.:** 7/16 (11.1) & 3 1/16 (77.8)  
**Height:** 10 3/8 (263.5)  
**A. Gskt:** [1] Attached

**RS3975**













Radial Seal Inner Air Element

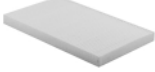

**Fits Inside:** RS3974  
**Fits:** John Deere, New Holland Loaders  
**Replaces:** John Deere AT178584  
**O.D.:** 5 1/4 (133.4)  
**I.D.:** 3 5/8 (92.1) One End  
**Height:** 21 7/32 (539.0)

Measurements Are Shown In Inches And (Millimeters)

**WARNING:** These products can expose you to chemicals, including Diisononyl Phthalate, Carbon black extracts, Nickel, 1,3 Butadiene, Ethylene Oxide, Epichlorohydrin, which are known to the State of California to cause cancer, and Bisphenol, Ethylene Glycol, Ethylene Oxide, 1,3 Butadiene, Epichlorohydrin, which are known to the State of California to cause birth defects or other reproductive harm.

<p><b>PA3978</b></p> 	<p>Air Element  <b>Fits:</b> Sullair Compressors  <b>Replaces:</b> Sullair 405158, 405158S  <b>O.D.:</b> 12 3/32 (307.2)  <b>I.D.:</b> 13/32 (10.3) &amp; 6 3/32 (154.8)  <b>Height:</b> 15 15/32 (392.9)  <b>A. Gskt:</b> [1] Attached  <b>F. Gskt:</b> [1] Metal Washer</p>	<p><b>PA3987</b></p> 	<p>Replacement for Ecolite Air Element in Disposable Housing  <b>Contains:</b> Bleeder Valve  <b>Fits:</b> Blue Bird, Thomas Buses  <b>Replaces:</b> Farr 119861-003  <b>O.D.:</b> 11 (279.4)  <b>Inlet:</b> 7  <b>Outlet:</b> 6  <b>Height:</b> 19 11/16 (500.1)</p>
<p><b>PA3979</b></p> 	<p>Air Element with Lid  <b>Fits:</b> Kubota Equipment  <b>Replaces:</b> Kubota 17351-11080, 17351-11083  <b>O.D.:</b> 5 1/4 (133.4)            Lid 7 (177.8)  <b>I.D.:</b> 9/16 (14.3) &amp; 2 27/32 (72.2)  <b>Height:</b> 11 1/2 (292.1)  <b>A. Gskt:</b> [2] Attached</p>	<p><b>RS3988</b></p> 	<p>Radial Seal Outer Air Element  <b>Notes:</b> Also available in HSG3079 or HSG3080 Housings.  <b>Fits:</b> Case, Caterpillar, Hitachi, Kubota, Mustang Equipment  <b>Use With:</b> RS3703  <b>Replaces:</b> Case 133720A1; Caterpillar 134-8726; Hitachi 4290940; John Deere AM129028  <b>O.D.:</b> 5 1/32 (127.8)  <b>I.D.:</b> 3 5/32 (80.2) One End  <b>Height:</b> 12 5/16 (312.7)  <b>Related To:</b> RS3549 (with Flame Retardant Media)</p>
<p><b>PA3980</b></p> 	<p>Cab Air Element  <b>Fits:</b> M.A.N. Buses, Trucks  <b>Replaces:</b> M.A.N. 81.69100.011  <b>Length:</b> 15 23/32 (399.3)  <b>Width:</b> 7 3/32 (180.2)  <b>Height:</b> 1 9/16 (39.7)</p>	<p><b>PA3989-FN</b></p> 	<p>Air Element with Fins  <b>Contains:</b> Flame Retardant Media  <b>Fits:</b> Caterpillar, Mitsubishi Lift Trucks  <b>Replaces:</b> Mitsubishi 91861-01600  <b>O.D.:</b> 6 3/32 (154.8)            Fins 7 13/16 (198.4)  <b>I.D.:</b> 3/4 (19.0) &amp; 3 15/32 (88.1)  <b>Height:</b> 12 1/8 (308.0)  <b>A. Gskt:</b> [1] Attached  <b>F. Gskt:</b> [1] Washer</p>
<p><b>PA3983-FN</b></p> 	<p>Air Element with Fins  <b>Fits:</b> Kubota Engines  <b>Replaces:</b> Kubota 14971-11180  <b>O.D.:</b> 3 3/8 (85.7)            Fins 4 5/32 (105.6)  <b>I.D.:</b> 1 7/32 (31.0) &amp; 1 1/4 (31.8)  <b>Height:</b> 4 1/32 (102.4)</p>	<p><b>RS3990</b></p> 	<p>Radial Seal Outer Air Element  <b>Fits:</b> Kubota Engines  <b>Use With:</b> RS3991  <b>Replaces:</b> Atlas Copco 29149300-00; KHD 1319141; Worthington 6211455100  <b>O.D.:</b> 4 9/16 (115.9)  <b>I.D.:</b> 2 5/8 (66.7) One End  <b>Height:</b> 9 7/8 (250.8)</p>
<p><b>PA3984</b></p> 	<p>Air Element with Lid  <b>Fits:</b> Lister Engines  <b>Replaces:</b> Lister 38207903  <b>O.D.:</b> 5 (127.0)            Lid 7 1/8 (181.0)  <b>I.D.:</b> 11/16 (17.5) &amp; 2 27/32 (72.2)  <b>Height:</b> 13 29/32 (353.2)  <b>A. Gskt:</b> [1] Attached  <b>F. Gskt:</b> [1] Included, [1] Wing Nut</p>	<p><b>RS3991</b></p> 	<p>Radial Seal Inner Air Element  <b>Fits Inside:</b> RS3990  <b>Fits:</b> Kubota Engines  <b>Replaces:</b> KHD 1180868  <b>O.D.:</b> 2 7/32 (56.4)            to 2 1/4 (57.2)  <b>I.D.:</b> 1 5/8 (41.3) One End  <b>Height:</b> 9 13/32 (238.9)</p>
<p><b>PA3985</b></p> 	<p>Inner Air Element  <b>Fits Inside:</b> PA3670  <b>Fits:</b> Komatsu Excavators  <b>Replaces:</b> Komatsu 600-181-9480  <b>O.D.:</b> 3 3/8 (85.7)            Flange 4 3/16 (106.4)  <b>I.D.:</b> 11/16 (17.5) &amp; 2 19/32 (65.9)  <b>Height:</b> 11 (279.4)  <b>A. Gskt:</b> [1] Attached  <b>F. Gskt:</b> [1] Included</p>	<p><b>RS3992</b></p> 	<p>Radial Seal Outer Air Element  <b>Fits:</b> Deutz, Massey Ferguson, Liebherr, Volvo Equipment  <b>Use With:</b> RS3993  <b>Replaces:</b> Atlas Copco 2914930800; Demag 11323374  <b>O.D.:</b> 7 11/16 (195.3)  <b>I.D.:</b> 4 17/32 (115.1) One End  <b>Height:</b> 15 23/32 (399.3)</p>
<p><b>PA3986</b></p> 	<p>Cab Air Element  <b>Fits:</b> Volvo Trucks  <b>Replaces:</b> Volvo 8089705  <b>Length:</b> 11 13/32 (289.7)  <b>Width:</b> 4 23/32 (119.9)  <b>Height:</b> 1 23/32 (43.7)</p>		

Measurements Are Shown In Inches And (Millimeters)

**WARNING:** These products can expose you to chemicals, including Diisononyl Phthalate, Carbon black extracts, Nickel, 1,3 Butadiene, Ethylene Oxide, Epichlorohydrin, which are known to the State of California to cause cancer, and Bisphenol, Ethylene Glycol, Ethylene Oxide, 1,3 Butadiene, Epichlorohydrin, which are known to the State of California to cause birth defects or other reproductive harm.

**RS3993**



Radial Seal Inner Air Element  
**Fits Inside:** RS3992  
**Fits:** Deutz, Massey Ferguson, Liebherr, Volvo Equipment  
**Replaces:** Atlas Copco 16158928, 29149309; Bomag 5821148; Deutz 1180872, 4415903; Liebherr 7026329; Massey Ferguson 3901478-M1  
**O.D.:** 4 11/32 (110.3)  
**I.D.:** 3 9/16 (90.5) One End  
**Height:** 15 5/32 (385.0)

**RS3998XP**



Extreme Performance Nano Radial Seal Outer Air Element  
**Fits:** Caterpillar Equipment; Demag, Grove, Liebherr Cranes  
**Use With:** RS3999  
**Replaces:** Atlas Copco 2914-5017-00; CompAir 11516/974; Ingersoll-Rand 89288971  
**O.D.:** 11 23/32 (297.7)  
**I.D.:** 8 1/32 (204.0) One End  
**Height:** 23 5/16 (592.1)  
**Related To:** RS3998 (Standard Media Version)

**RS3994**



Radial Seal Outer Air Element  
**Fits:** Atlas Copco Compressors; Caterpillar, Massey Ferguson Equipment  
**Use With:** RS3995  
**Replaces:** Atlas Copco 16138004, 29149310; Bomag 5821149; Claas 7521980; Deutz 1181003; Massey Ferguson 3902783-M1  
**O.D.:** 8 11/16 (220.7)  
**I.D.:** 4 15/16 (125.4) One End  
**Height:** 15 27/32 (402.4)

**RS3999**



Radial Seal Inner Air Element  
**Fits Inside:** RS3998, RS3998XP  
**Fits:** Caterpillar Loaders, Motor Graders; Demag, Grove, Liebherr Cranes  
**Replaces:** Atlas Copco 2914-5018-00  
**O.D.:** 7 29/32 (200.8)  
**I.D.:** 7 9/16 (192.1) One End  
**Height:** 22 5/8 (574.7)

**RS3995**



Radial Seal Inner Air Element  
**Contains:** [1] Grease packet  
**Fits Inside:** RS3994  
**Fits:** Atlas Copco Compressors; Caterpillar, Massey Ferguson Equipment  
**Replaces:** Bomag 5821150; Claas 751199.0, 752199.0; Deutz 1181004; Massey Ferguson 392782-M1  
**O.D.:** 4 23/32 (119.9)  
**I.D.:** 4 (101.6) One End  
**Height:** 15 1/4 (387.3)

**PA4005**



Air Element  
**Fits:** Ford Vans  
**Replaces:** Ford E1VZ-9601-A, F1UZ-9601-A  
**O.D.:** 12 (304.8)  
**I.D.:** 8 19/32 (218.3)  
**Height:** 4 13/32 (111.9)

**RS3996**



Radial Seal Outer Air Element  
**Fits:** Atlas Copco Compressors; Demag, Grove, Liebherr Cranes  
**Use With:** RS3997  
**Replaces:** Atlas Copco 2914-5023-00; Massey Ferguson 3902806-M1  
**O.D.:** 9 1/2 (241.3)  
**I.D.:** 5 3/4 (146.0) One End  
**Height:** 21 5/32 (537.4)

**PA4015**



Panel Air Element  
**Fits:** Chrysler, Eagle, Mazda, Mitsubishi Automotive  
**Replaces:** Mazda KL47-13-Z40; Mitsubishi MB906051  
**Length:** 9 1/32 (229.4)  
**Width:** 7 9/32 (184.9)  
**Height:** 2 1/16 (52.4)

**RS3997**



Radial Seal Inner Air Element with Bail Handle  
**Fits Inside:** RS3996  
**Fits:** Atlas Copco Compressors; Demag, Grove, Liebherr Cranes  
**Replaces:** Atlas Copco 2914-5024-00; Massey Ferguson 3902812-M1  
**O.D.:** 5 17/32 (140.5)  
**I.D.:** 4 25/32 (121.4) One End  
**Height:** 20 9/16 (522.3)

**PA4018**

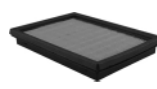

Panel Air Element  
**Fits:** Infiniti FX50, FX35; Nissan 300ZX, Lucino, Rogue, Sentra  
**Replaces:** General Motors 25147124; Nissan 1654630P00, 1654673C10  
**Length:** 9 1/32 (229.4)  
**Width:** 6 5/8 (168.3)  
**Height:** 1 7/32 (31.0)

**RS3998**



Radial Seal Outer Air Element  
**Fits:** Caterpillar Equipment; Demag, Grove, Liebherr Cranes  
**Use With:** RS3999  
**Replaces:** Atlas Copco 2914-5017-00; CompAir 11516/974; Ingersoll-Rand 89288971  
**O.D.:** 11 23/32 (297.7)  
**I.D.:** 8 1/32 (204.0) One End  
**Height:** 23 5/16 (592.1)  
**Related To:** RS3998XP (Extreme Performance Nano Version)

**PA4023**

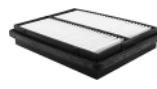

Panel Air Element  
**Fits:** Chevrolet, Geo Tracker; Suzuki Sidekick  
**Replaces:** GMC 96057994; Suzuki 13780-61A00  
**Length:** 10 1/8 (257.2)  
**Width:** 8 9/32 (210.3)  
**Height:** 1 11/16 (42.9)

**PA4026**



Air Element  
**Fits:** Chevrolet Metro, Sprint; Pontiac Firefly; Suzuki Swift  
**Replaces:** GMC 25099251; Suzuki 13780-82400; WIX 546182, 46182  
**O.D.:** 6 25/32 (172.2)  
**Height:** 2 23/32 (69.1)

Measurements Are Shown In Inches And (Millimeters)

**WARNING:** These products can expose you to chemicals, including Diisononyl Phthalate, Carbon black extracts, Nickel, 1,3 Butadiene, Ethylene Oxide, Epichlorohydrin, which are known to the State of California to cause cancer, and Bisphenol, Ethylene Glycol, Ethylene Oxide, 1,3 Butadiene, Epichlorohydrin, which are known to the State of California to cause birth defects or other reproductive harm.

<p><b>PA4028</b> Panel Air Element  <b>Fits:</b> Lexus, Toyota Automotive  <b>Replaces:</b> Toyota 17801-74060  <b>Length:</b> 12 3/16 (309.6)  <b>Width:</b> 7 3/8 (187.3)  <b>Height:</b> 1 11/16 (42.9)</p> 	<p><b>PA4048</b> Panel Air Element  <b>Fits:</b> BMW Automotive  <b>Replaces:</b> BMW 13721730946  <b>Length:</b> 9 21/32 (245.3)  <b>Width:</b> 7 (177.8)  <b>Height:</b> 2 5/16 (58.7)</p> 
<p><b>PA4031</b> Panel Air Element  <b>Notes:</b> OBSOLETE. Availability Limited to Dealer Stock.  <b>Fits:</b> Toyota Automotive  <b>Replaces:</b> Toyota 17801-11080  <b>Length:</b> 9 13/16 (249.2)  <b>Width:</b> 4 11/16 (119.1)  <b>Height:</b> 2 (50.8)</p> 	<p><b>PA4049</b> Panel Air Element  <b>Fits:</b> Saturn Automotive  <b>Replaces:</b> Saturn 21000938  <b>Length:</b> 9 27/32 (250.0)  <b>Width:</b> 5 15/32 (138.9)  <b>Height:</b> 2 1/16 (52.4)  <b>A. Gskt:</b> [1] Attached</p> 
<p><b>PA4041</b> Air Element  <b>Fits:</b> Daihatsu Automotive  <b>Replaces:</b> Daihatsu 17801-87601-000  <b>O.D.:</b> 6 1/8 (155.6)  <b>I.D.:</b> 15/32 (11.9) &amp; 3 3/8 (85.7)  <b>Height:</b> 6 7/32 (158.0)  <b>A. Gskt:</b> [1] Attached</p> 	<p><b>PA4050</b> Panel Air Element  <b>Fits:</b> Honda Automotive  <b>Replaces:</b> Honda 17220-P07-000  <b>Length:</b> 8 7/32 (208.8)  <b>Width:</b> 7 1/4 (184.2)  <b>Height:</b> 1 21/32 (42.1)  <b>A. Gskt:</b> [1] Attached</p> 
<p><b>PA4042</b> Panel Air Element  <b>Fits:</b> Porsche Automotive  <b>Replaces:</b> Porsche 91111018502  <b>Length:</b> 15 13/16 (401.6)  <b>Width:</b> 7 3/32 (180.2)  <b>Height:</b> 1 5/8 (41.3)</p> 	<p><b>PA4060</b> Panel Air Element  <b>Fits:</b> Lexus, Toyota Automotive  <b>Replaces:</b> Toyota 17801-46060  <b>Length:</b> 9 21/32 (245.3)  <b>Width:</b> 8 1/8 (206.4)  <b>Height:</b> 2 1/16 (52.4)</p> 
<p><b>PA4043</b> Panel Air Element  <b>Fits:</b> Hyundai Automotive  <b>Replaces:</b> Hyundai 28113-22051  <b>Length:</b> 9 21/32 (245.3)  <b>Width:</b> 6 5/16 (160.3)  <b>Height:</b> 1 15/32 (37.3)</p> 	<p><b>PA4061</b> Air Element  <b>Fits:</b> Lexus Automotive  <b>Replaces:</b> Toyota 17801-50010; Wix 46058  <b>O.D.:</b> 10 1/32 (254.8)  <b>Height:</b> 2 5/8 (66.7)</p> 
<p><b>PA4044</b> Panel Air Element  <b>Fits:</b> Ford Automotive  <b>Replaces:</b> Ford F6DX-9601-BA, F6DZ-9601-B  <b>Length:</b> 9 15/16 (252.4)  <b>Width:</b> 7 1/32 (178.6)  <b>Height:</b> 1 9/16 (39.7)</p> 	<p><b>PA4069</b> Panel Air Element  <b>Fits:</b> Ford Automotive  <b>Replaces:</b> Ford F23E-9601-BB, F23Z-9601-B  <b>Length:</b> 10 1/16 (255.6)  <b>Width:</b> 7 5/32 (181.8)  <b>Height:</b> 1 9/16 (39.7)</p> 
<p><b>PA4045</b> Panel Air Element  <b>Fits:</b> Ford Automotive  <b>Replaces:</b> Ford F4BZ-9601-A  <b>Length:</b> 8 7/32 (208.8)  <b>Width:</b> 5 7/8 (149.2)  <b>Height:</b> 1 15/32 (37.3)</p> 	<p><b>PA4070</b> Air Element  <b>Fits:</b> Nissan Light-Duty Trucks  <b>Replaces:</b> Nissan 16546-89G00; GMC 25147122  <b>O.D.:</b> 13 1/16 (331.8)  <b>Height:</b> 2 3/8 (60.3)  <b>I.Gskt:</b> [2] Included</p> 
<p><b>PA4046</b> Panel Air Element  <b>Fits:</b> Jeep Grand Cherokee; Nissan Automotive  <b>Replaces:</b> Chrysler 53007386  <b>Length:</b> 11 3/8 (288.9)  <b>Width:</b> 9 3/4 (247.7)  <b>Height:</b> 1 15/32 (37.3)</p> 	<p><b>PA4071</b> Air Element  <b>Fits:</b> Ford Automotive  <b>Replaces:</b> Ford F4ZZ-9601-A  <b>O.D.:</b> 4 5/8 (117.5)  <b>Flange:</b> 6 13/32 (162.7)  <b>I.D.:</b> 3 3/16 (81.0) One End  <b>Height:</b> 7 15/32 (189.7)</p> 
<p><b>PA4047</b> Panel Air Element  <b>Fits:</b> BMW Automotive  <b>Replaces:</b> BMW (Bavarian Motor Works) 13721707050, 13721715881; Wix 46221  <b>Length:</b> 10 3/16 (258.8)  <b>Width:</b> 5 7/8 (149.2)  <b>Height:</b> 2 7/32 (56.4)</p> 	<p><b>PA4072</b> Air Element  <b>Replaces:</b> Ingersoll-Rand 39449293  <b>O.D.:</b> 7 7/8 (200.0)  <b>I.D.:</b> 4 1/8 (104.8)  <b>Height:</b> 4 27/32 (123.0)</p> 

Measurements Are Shown In Inches And (Millimeters)

**WARNING:** These products can expose you to chemicals, including Diisononyl Phthalate, Carbon black extracts, Nickel, 1,3 Butadiene, Ethylene Oxide, Epichlorohydrin, which are known to the State of California to cause cancer, and Bisphenol, Ethylene Glycol, Ethylene Oxide, 1,3 Butadiene, Epichlorohydrin, which are known to the State of California to cause birth defects or other reproductive harm.

**PA4073** Air Element with Foam Pad  
**Fits:** Ford Trucks  
**Replaces:** Ford F3TZ-9601-Z  
**Length:** 10 13/32 (264.3)  
**Width:** 8 3/8 (212.7)  
**Height:** 1 25/32 (45.2)

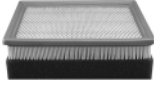

**PA4075** Air Element  
**Fits:** Ford Automotive, Light-Duty Trucks  
**Replaces:** Ford F50Y-9601-A  
**O.D.:** 7 (177.8)  
 Flange 8 1/8 (206.4)  
**I.D.:** 4 7/32 (107.2) One End  
**Height:** 7 9/16 (192.1)



**PA4076** Panel Air Element  
**Notes:** OBSOLETE. Availability Limited to Dealer Stock.  
**Fits:** Ford, Nissan Automotive  
**Replaces:** Ford F3XY-9601-A; Nissan 16546-0B000  
**Length:** 10 29/32 (277.0)  
**Width:** 7 3/32 (180.2)  
**Height:** 1 19/32 (40.5)

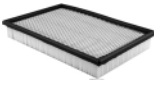

**PA4077** Panel Air Element  
**Fits:** Acura, Honda, Isuzu Automotive  
**Replaces:** Honda 17220-P0A-A00; Isuzu 5-86202-255-0  
**Length:** 12 1/16 (306.4)  
**Width:** 7 9/32 (184.9)  
**Height:** 2 1/8 (54.0)  
**A. Gskt:** [1] Attached



**PA4078** Panel Air Element  
**Fits:** Chevrolet, Geo, Suzuki Automotive  
**Replaces:** GMC 25175325; Suzuki 13780-58B00  
**Length:** 11 5/8 (295.3)  
**Width:** 5 9/32 (134.1)  
**Height:** 2 3/32 (53.2)



**PA4079** Panel Air Element  
**Fits:** Buick Skylark; Chevrolet Berette, Corsica  
**Replaces:** GMC 25099735  
**Length:** 10 3/4 (273.1)  
**Width:** 6 1/2 (165.1)  
**Height:** 1 21/32 (42.1)

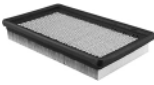

**PA4081** Panel Air Element  
**Fits:** Honda, Isuzu, Toyota Automotive  
**Replaces:** Isuzu 8-97035-303-0, 8-97111-423-0; Toyota 17801-0W010  
**Length:** 12 1/8 (308.0)  
**Width:** 7 27/32 (199.2)  
**Height:** 1 11/16 (42.9)



**PA4084** Panel Air Element  
**Fits:** Mazda Automotive  
**Replaces:** Mazda B595-13-Z40  
**Length:** 9 11/16 (246.1)  
**Width:** 6 5/16 (160.3)  
**Height:** 1 15/32 (37.3)



**PA4085** Panel Air Element  
**Fits:** Chrysler Automotive  
**Replaces:** Chrysler 4573624, 4874153  
**Length:** 8 7/8 (225.4)  
**Width:** 7 13/32 (188.1)  
**Height:** 1 1/2 (38.1)

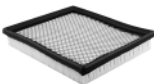

**PA4088** Air Element  
**Fits:** Ford Automotive  
**Replaces:** Ford F7CZ-9601-A  
**O.D.:** 5 27/32 (148.4)  
 Flange 6 13/16 (173.0)  
**I.D.:** 3 3/32 (78.6) One End  
**Height:** 7 15/32 (189.7)



**PA4089** Air Element  
**Fits:** Ford Automotive  
**Replaces:** Ford F67Z-9601-AA  
**O.D.:** 5 5/32 (131.0)  
 Flange 6 23/32 (170.7)  
**I.D.:** 3 1/32 (77.0) One End  
**Height:** 5 29/32 (150.0)



**PA4090** Panel Air Element  
**Fits:** Acura CL; Honda Accord  
**Replaces:** Honda 17220-P0G-A00; WIX 546395, 46395  
**Length:** 12 3/8 (314.3)  
**Width:** 6 3/16 (157.2)  
**Height:** 2 23/32 (69.1)



**PA4091** Panel Air Element  
**Fits:** Audi, BMW, Volkswagen Automotive  
**Replaces:** Audi 58133843; BMW 13711736675, 13721702158, 13721736675  
**Length:** 10 1/8 (257.2)  
**Width:** 8 7/16 (214.3)  
**Height:** 2 3/16 (55.6)



**PA4092** Panel Air Element with Foam Pad  
**Fits:** Jeep Wrangler  
**Replaces:** Chrysler 4797777  
**Length:** 13 1/2 (342.9)  
**Width:** 6 1/4 (158.8)  
**Height:** 1 5/16 (33.3)

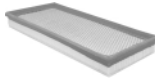

**PA4093** Oval Air Element  
**Fits:** Hatz Engines  
**Replaces:** Hatz 952900  
**O.D.:** 6 17/32 (165.9) to 9 3/4 (247.7)  
**I.D.:** 2 9/32 (57.9) & 5 1/2 (139.7)  
**Height:** 3 5/8 (92.1)













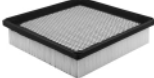

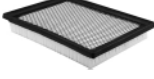
**PA4094** Foam Air Pump Element  
**Notes:** OBSOLETE. Availability Limited to Dealer Stock.  
**Contains:** Instruction Sheet  
**Fits:** GMC Light-Duty Trucks, Vans  
**Replaces:** GMC 25043951  
**Length:** 3 27/32 (97.6)  
**Width:** 3 19/32 (91.3)  
**Height:** 23/32 (18.3)

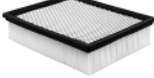
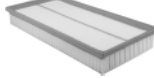

Measurements Are Shown In Inches And (Millimeters)

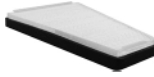
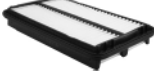
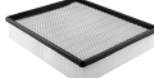
**WARNING:** These products can expose you to chemicals, including Diisononyl Phthalate, Carbon black extracts, Nickel, 1,3 Butadiene, Ethylene Oxide, Epichlorohydrin, which are known to the State of California to cause cancer, and Bisphenol, Ethylene Glycol, Ethylene Oxide, 1,3 Butadiene, Epichlorohydrin, which are known to the State of California to cause birth defects or other reproductive harm.

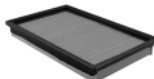
<p><b>PA4096</b></p> 	<p>Cabin Air Element  <b>Notes:</b> OBSOLETE. Availability Limited to Dealer Stock.  <b>Fits:</b> BMW Automotive  <b>Replaces:</b> BMW 64111393489, 64119069895  <b>Length:</b> 11 5/8 (295.3)  <b>Width:</b> 6 1/2 (165.1)  <b>Height:</b> 31/32 (24.6)  <b>A. Gskt:</b> [1] Attached</p>	<p><b>PA4106</b></p> 	<p>Panel Air Element  <b>Fits:</b> Acura, Honda Automotive  <b>Replaces:</b> Honda 17220-P8C-A00  <b>Length:</b> 12 5/8 (320.7)  <b>Width:</b> 6 11/32 (161.1)  <b>Height:</b> 2 15/16 (74.6)  <b>A. Gskt:</b> [1] Attached</p>
<p><b>PA4099</b></p> 	<p>Panel Air Element  <b>Fits:</b> Honda Automotive  <b>Replaces:</b> Honda 17220-P2N-A01  <b>Length:</b> 7 19/32 (192.9)  <b>Width:</b> 7 7/8 (200.0)  <b>Height:</b> 1 7/8 (47.6)</p>	<p><b>PA4107</b></p> 	<p>Panel Air Element  <b>Fits:</b> GM Automotive  <b>Replaces:</b> GMC 25161977  <b>Length:</b> 12 2/32 (306.4)  <b>Width:</b> 7 5/8 (193.7)  <b>Height:</b> 1 19/32 (40.5)</p>
<p><b>PA4100</b></p> 	<p>Panel Air Element  <b>Fits:</b> Honda Automotive  <b>Replaces:</b> Honda 17220-P2F-A01  <b>Length:</b> 8 7/8 (225.4)  <b>Width:</b> 6 21/32 (169.1)  <b>Height:</b> 1 5/16 (33.3)</p>	<p><b>PA4108</b></p> 	<p>Panel Air Element  <b>Fits:</b> Chevrolet Tracker; Suzuki Automotive  <b>Replaces:</b> GMC 25311970; Suzuki 13780-77E00  <b>Length:</b> 9 1/16 (230.2)  <b>Width:</b> 7 7/8 (200.0)  <b>Height:</b> 2 5/32 (54.8)</p>
<p><b>PA4101</b></p> 	<p>Air Element  <b>Fits:</b> Acura Automotive  <b>Replaces:</b> Honda 17220-P7Z-000  <b>O.D.:</b> 5 5/32 (131.0)  <b>I.D.:</b> 3 9/32 (83.3) One End  <b>Height:</b> 12 5/16 (312.7)  <b>End Seals:</b> [1] Attached  <b>Grommets:</b> [1] Attached</p>	<p><b>PA4109</b></p> 	<p>Panel Air Element  <b>Fits:</b> Chrysler Automotive  <b>Replaces:</b> Chrysler 4591100AB, 4591100AC  <b>Length:</b> 9 17/32 (242.1)  <b>Width:</b> 7 3/32 (180.2)  <b>Height:</b> 1 19/32 (40.5)</p>
<p><b>PA4102</b></p> 	<p>Panel Air Element  <b>Fits:</b> Ford, Mazda Automotive, Light-Duty Trucks  <b>Replaces:</b> Ford F77X-9601-AA, F77Z-9601-AA  <b>Length:</b> 8 25/32 (223.0)  <b>Width:</b> 7 9/16 (192.1)  <b>Height:</b> 2 1/8 (54.0)  <b>A. Gskt:</b> [1] Included</p>	<p><b>PA4111</b></p> 	<p>Panel Air Element  <b>Fits:</b> Audi, Volkswagen Automotive  <b>Replaces:</b> Volkswagen 1J0129620  <b>Length:</b> 14 5/16 (363.5)  <b>Width:</b> 7 1/4 (184.2)  <b>Height:</b> 1 31/32 (50.0)</p>
<p><b>PA4103</b></p> 	<p>Panel Air Element  <b>Fits:</b> Mitsubishi Automotive  <b>Replaces:</b> Mitsubishi MR188657  <b>Length:</b> 8 3/8 (212.7)  <b>Width:</b> 8 1/16 (204.8)  <b>Height:</b> 1 31/32 (50.0)  <b>A. Gskt:</b> [1] Attached</p>	<p><b>PA4112</b></p> 	<p>Cabin Air Element  <b>Fits:</b> Ford Automotive  <b>Replaces:</b> Ford F6DZ-19N619-BA, F6DZ-19N619-C, F7DZ-19N619-A  <b>Length:</b> 10 15/16 (277.8)  <b>Width:</b> 3 1/4 (82.6) to 7 (177.8)  <b>Height:</b> 1 1/8 (28.6)  <b>A. Gskt:</b> [1] Attached</p>
<p><b>PA4104</b></p> 	<p>Panel Air Element  <b>Fits:</b> Honda Automotive  <b>Replaces:</b> Honda 17220-PAA-000, 17220-PAA-A00  <b>Length:</b> 10 25/32 (273.8)  <b>Width:</b> 6 5/8 (168.3)  <b>Height:</b> 1 21/32 (42.1)  <b>A. Gskt:</b> [1] Attached</p>	<p><b>PA4113</b></p> 	<p>Panel Air Element  <b>Fits:</b> Chevrolet, GMC Light-Duty Trucks  <b>Replaces:</b> GMC 25313348  <b>Length:</b> 12 9/32 (311.9)  <b>Width:</b> 9 23/32 (246.9)  <b>Height:</b> 2 5/16 (58.7)</p>
<p><b>PA4105</b></p> 	<p>Panel Air Element  <b>Fits:</b> Suzuki Automotive  <b>Replaces:</b> Suzuki 13780-60G00  <b>Length:</b> 7 7/16 (188.9)  <b>Width:</b> 6 1/16 (154.0)  <b>Height:</b> 2 1/16 (52.4)  <b>A. Gskt:</b> [1] Attached</p>	<p><b>PA4114</b></p> 	<p>Panel Air Element  <b>Fits:</b> Mazda Automotive  <b>Replaces:</b> Mazda FSD7-13-Z40  <b>Length:</b> 10 7/16 (265.1)  <b>Width:</b> 6 19/32 (167.5)  <b>Height:</b> 1 5/16 (33.3)</p>

Measurements Are Shown In Inches And (Millimeters)

 **WARNING:** These products can expose you to chemicals, including Diisononyl Phthalate, Carbon black extracts, Nickel, 1,3 Butadiene, Ethylene Oxide, Epichlorohydrin, which are known to the State of California to cause cancer, and Bisphenol, Ethylene Glycol, Ethylene Oxide, 1,3 Butadiene, Epichlorohydrin, which are known to the State of California to cause birth defects or other reproductive harm.

**PA4118**

Air Element



**Fits:** Dodge, Plymouth Automotive  
**Replaces:** Chrysler 4891097AA  
**O.D.:** 5 5/8 (142.9)  
**I.D.:** 2 13/32 (61.1) One End  
**Height:** 6 9/16 (166.7)

**RS4130**

Radial Seal Air Element



**Fits:** Chrysler Automotive  
**Replaces:** Chrysler 5011836AA  
**O.D.:** 5 1/32 (127.8)  
**I.D.:** 3 5/32 (80.2) One End  
**Height:** 6 1/4 (158.8)

**PA4120**

Panel Air Element



**Fits:** Ford Light-Duty Trucks  
**Replaces:** Ford XC3Z-9601-AA  
**Length:** 13 3/8 (339.7)  
**Width:** 7 1/4 (184.2)  
**Height:** 2 5/16 (58.7)

**RS4131**

Radial Seal Air Element



**Fits:** Chevrolet, GMC Vans  
**Replaces:** GMC 15153904  
**O.D.:** 5 13/32 (137.3)  
**I.D.:** 3 3/16 (81.0) One End  
**Height:** 13 5/32 (334.2)

**PA4121**

Panel Air Element



**Fits:** Saturn Automotive  
**Replaces:** Saturn 90571362  
**Length:** 12 19/32 (319.9)  
**Width:** 9 11/32 (237.3)  
**Height:** 1 13/32 (35.7)

**PA4132**

Panel Air Element

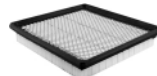

**Fits:** Chrysler, Dodge Vans  
**Replaces:** Chrysler 4861480AA  
**Length:** 9 11/32 (237.3)  
**Width:** 8 7/16 (214.3)  
**Height:** 1 21/32 (42.1)

**PA4123**

Panel Air Element

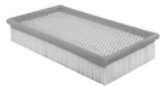

**Fits:** Ford Automotive  
**Replaces:** Ford YS4Z-9601-CC  
**Length:** 10 7/16 (265.1)  
**Width:** 5 3/4 (146.0)  
**Height:** 1 7/8 (47.6)

**PA4133**

Cabin Air Element



**Fits:** Ford, Lincoln Light-Duty Trucks  
**Replaces:** Ford F65Z-19N619-AB  
**Length:** 10 9/16 (268.3)  
**Width:** 9 31/32 (253.2)  
**Height:** 1 7/32 (31.0)

**PA4124**

Panel Air Element



**Fits:** Kia Automotive  
**Replaces:** Kia K2A5-13-Z40A, OK2A5-13-Z40A  
**Length:** 13 5/16 (338.1)  
**Width:** 6 23/32 (170.7)  
**Height:** 1 17/32 (38.9)

**PA4134**

Panel Air Element

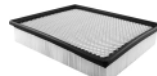

**Fits:** Chevrolet, GMC Light-Duty Trucks, Suburbans with 6.6L Turbo Diesel Engine  
**Replaces:** GMC 25332443; ACDelco A1618C  
**Length:** 12 9/32 (311.9)  
**Width:** 9 23/32 (246.9)  
**Height:** 2 5/16 (58.7)

**PA4126**

Panel Air Element



**Fits:** Land Rover Discovery  
**Replaces:** Land Rover ESR1445  
**Length:** 10 1/4 (260.3)  
**Width:** 8 (203.2)  
**Height:** 2 1/4 (57.2)

**PA4127**

Panel Air Element

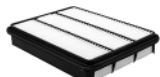

**Fits:** Lexus, Toyota Automotive, Light-Duty Trucks  
**Replaces:** Toyota 17801-07010, 17801-50040  
**Length:** 12 1/4 (311.2)  
**Width:** 9 1/8 (231.8)  
**Height:** 2 1/16 (52.4)

**SA4137**

Crankcase Breather Filter in Plastic Housing



**Fits:** Ford, Mercury Automotive, Light-Duty Trucks, Vans  
**Replaces:** Ford E6TZ-6A768-A, F1BZ-6A768-A  
**O.D.:** 3 1/4 (82.6)  
**I.D.:** 1/2 (12.7) & 3/4 (19.0)  
**Height:** 1 7/8 (47.6)

**PA4128**

Panel Air Element

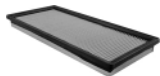

**Fits:** Subaru Light-Duty Trucks  
**Replaces:** Subaru 16546-AA070, 16546-AA07A  
**Length:** 14 21/32 (372.3)  
**Width:** 6 7/16 (163.5)  
**Height:** 1 9/32 (32.5)  
**A. Gskt:** [1] Attached

**PA4138**

Panel Air Element



**Fits:** Hyundai Automotive  
**Replaces:** Hyundai 28113-23001  
**Length:** 10 1/4 (260.3)  
**Width:** 7 3/32 (180.2)  
**Height:** 1 17/32 (38.9)

**PA4129**

Panel Air Element



**Fits:** Honda Automotive  
**Replaces:** Honda 17220-P8F-A00  
**Length:** 11 1/4 (285.8)  
**Width:** 5 1/2 (139.7)  
**to 6 13/32 (162.7)**  
**Height:** 2 9/16 (65.1)

**SA4141**







Crankcase Breather Filter in Metal Housing

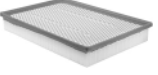

**Fits:** Chrysler, Dodge, Jeep, Plymouth Automotive, Light-Duty Trucks  
**Replaces:** Chrysler 3462094, 4273322, 5214561, 53030254  
**O.D.:** 3 1/32 (77.0)  
**Inlet:** 1  
**Outlet:** 5/8  
**Height:** 2 5/8 (66.7)

Measurements Are Shown In Inches And (Millimeters)

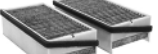
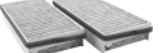
**WARNING:** These products can expose you to chemicals, including Diisononyl Phthalate, Carbon black extracts, Nickel, 1,3 Butadiene, Ethylene Oxide, Epichlorohydrin, which are known to the State of California to cause cancer, and Bisphenol, Ethylene Glycol, Ethylene Oxide, 1,3 Butadiene, Epichlorohydrin, which are known to the State of California to cause birth defects or other reproductive harm.

<p><b>SA4142</b></p> 	<p>Polyester Crankcase Breather Filter  <b>Fits:</b> Chrysler, Dodge, Plymouth Automotive  <b>Replaces:</b> Chrysler 4459657, 5277665; Wix 46964  <b>Length:</b> 3 1/4 (82.6)  <b>Width:</b> 1 3/4 (44.4)  <b>Height:</b> 5/8 (15.9)</p>	<p><b>PA4151</b></p> 	<p>Panel Air Element  <b>Fits:</b> Dodge Light-Duty Trucks  <b>Replaces:</b> Chrysler 53032404AA  <b>Length:</b> 13 3/4 (349.3)  <b>Width:</b> 9 11/32 (237.3)  <b>Height:</b> 1 15/16 (49.2)  <b>A. Gskt:</b> [1] Attached</p>
<p><b>PA4144</b></p> 	<p>Panel Air Element  <b>Replaces:</b> Mazda WL81-13-Z40  <b>Length:</b> 9 29/32 (251.6)  <b>Width:</b> 7 27/32 (199.2)  <b>Height:</b> 2 1/16 (52.4)  <b>A. Gskt:</b> [1] Attached</p>	<p><b>PA4152</b></p> 	<p>Cabin Air Element  <b>Fits:</b> Ford, Mercury Vans  <b>Replaces:</b> Ford XF2Z-19N619-AB  <b>Length:</b> 11 3/8 (288.9)  <b>Width:</b> 5 1/16 (128.6)  <b>Height:</b> 15/16 (23.8)  <b>A. Gskt:</b> [1] Attached</p>
<p><b>PA4145</b></p> 	<p>Air Element with Lift Tab  <b>Fits:</b> Hummer Light-Duty Trucks  <b>Replaces:</b> GMC 12342870  <b>O.D.:</b> 9 3/32 (231.0)  <b>I.D.:</b> 15/32 (11.9) &amp; 5 7/32 (132.6)  <b>Height:</b> 13 9/32 (337.3)  <b>A. Gskt:</b> [1] Attached  <b>F. Gskt:</b> [1] Included</p>	<p><b>PA4153</b></p> 	<p>Cabin Air Element  <b>Fits:</b> Ford, Mercury Automotive  <b>Replaces:</b> Ford F5RZ-19N619-BA  <b>Length:</b> 20 11/32 (516.7)  <b>Width:</b> 4 1/8 (104.8)  <b>Height:</b> 1 1/8 (28.6)  <b>A. Gskt:</b> [1] Attached</p>
<p><b>PA4146</b></p> 	<p>Panel Air Element  <b>Fits:</b> Buick, Chevrolet, Pontiac, Oldsmobile Automotive  <b>Replaces:</b> GMC 24508572; ACDelco A1614C  <b>Length:</b> 10 1/2 (266.7)  <b>Width:</b> 7 7/8 (200.0)  <b>Height:</b> 1 9/16 (39.7)</p>	<p><b>PA4154</b></p> 	<p>Cabin Air Element with Pull Tab  <b>Fits:</b> Buick, Chevrolet, Pontiac Automotive  <b>Replaces:</b> GMC 10261703, 10406026, 10446783  <b>Length:</b> 11 15/32 (291.3)  <b>Width:</b> 7 11/32 (186.5)  <b>Height:</b> 1 5/32 (29.4)  <b>A. Gskt:</b> [1] Attached</p>
<p><b>PA4147</b></p> 	<p>Panel Air Element  <b>Fits:</b> Ford, Mercury Light-Duty Trucks  <b>Replaces:</b> Ford 1L2Z-9601-AA  <b>Length:</b> 11 1/2 (292.1)  <b>Width:</b> 7 3/32 (180.2)  <b>Height:</b> 2 1/4 (57.2)</p>	<p><b>PA4155 KIT</b></p> 	<p>Set of 2 Cabin Air Elements  <b>Notes:</b> Uses 2 filters per application.  <b>Fits:</b> Chevrolet, Oldsmobile, Pontiac Vans  <b>Replaces:</b> General Motors Corp. 52470574, 52482929; Wix 524811, 24811  <b>Each Filter:</b>  <b>Length:</b> 9 1/32 (229.4)  <b>Width:</b> 4 9/16 (115.9)  <b>Height:</b> 2 7/32 (56.4)  <b>A. Gskt:</b> [1] Included on Each</p>
<p><b>PA4148</b></p> 	<p>Panel Air Element  <b>Fits:</b> Ford Light-Duty Trucks  <b>Replaces:</b> Ford 1C3Z-9601-AA  <b>Length:</b> 13 3/8 (339.7)  <b>Width:</b> 7 5/16 (185.7)  <b>Height:</b> 3 13/32 (86.5)</p>	<p><b>PA4156 KIT</b></p> 	<p>Set of 2 Cabin Air Elements  <b>Notes:</b> Uses 2 filters per application.  <b>Contains:</b> Charcoal Impregnated Media for Odor Control.  <b>Fits:</b> Buick, Chevrolet, Oldsmobile, Pontiac, Saturn Light-Duty Trucks, Vans  <b>Replaces:</b> GMC 10302760, 10322538  <b>Each Filter:</b>  <b>Length:</b> 8 11/16 (220.7)  <b>Width:</b> 4 1/4 (108.0)  <b>Height:</b> 1 17/32 (38.9)  <b>A. Gskt:</b> [1] Included on Each</p>
<p><b>PA4149 KIT</b></p> 	<p>Set of 2 Cabin Air Elements  <b>Notes:</b> Uses 2 filters per application.  <b>Fits:</b> Cadillac, Chevrolet Light-Duty Trucks  <b>Replaces:</b> GMC 52485513  <b>Each Filter:</b>  <b>Length:</b> 9 11/32 (237.3)  <b>Width:</b> 5 7/16 (138.1)  <b>Height:</b> 29/32 (23.0)</p>	<p><b>PA4157</b></p> 	<p>Panel Air Element  <b>Fits:</b> Buick, Cadillac, Chevrolet, Pontiac, Saturn Automotive  <b>Replaces:</b> Saturn 22676970  <b>Length:</b> 10 15/16 (277.8)  <b>Width:</b> 9 11/32 (237.3)  <b>Height:</b> 1 15/32 (37.3)</p>
<p><b>PA4150</b></p> 	<p>Panel Air Element  <b>Fits:</b> Lexus, Toyota Automotive, Light-Duty Trucks  <b>Replaces:</b> Toyota 17801-20040, 17801-0H010, 17801-0H020  <b>Length:</b> 12 17/32 (318.3)  <b>Width:</b> 7 19/32 (192.9)  <b>Height:</b> 1 11/16 (42.9)  <b>A. Gskt:</b> [1] Attached</p>		

Measurements Are Shown In Inches And (Millimeters)

**WARNING:** These products can expose you to chemicals, including Diisononyl Phthalate, Carbon black extracts, Nickel, 1,3 Butadiene, Ethylene Oxide, Epichlorohydrin, which are known to the State of California to cause cancer, and Bisphenol, Ethylene Glycol, Ethylene Oxide, 1,3 Butadiene, Epichlorohydrin, which are known to the State of California to cause birth defects or other reproductive harm.



**PA4158**

Air Element



**Fits:** Euclid Dump Trucks  
**Replaces:** Euclid 9029495, E9029495; Fleetguard AF4728  
**O.D.:** 3 17/32 (89.7)  
**I.D.:** 1 17/32 (38.9)  
**Height:** 4 1/2 (114.3)

**PA4166**

Air Element



**Fits:** Hatz Engines  
**Replaces:** Bomag 5727220; Hatz 4030100; Fleetguard AF25481  
**O.D.:** 5 1/2 (139.7)  
**I.D.:** 3 1/4 (82.6)  
**Height:** 3 9/32 (83.3)

**PA4159**

Cabin Air Element

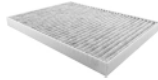

**Contains:** Charcoal Impregnated Media for Odor Control.  
**Fits:** Chrysler Pacifica, Town and Country, Voyager; Dodge Caravan, Grand Caravan  
**Replaces:** Chrysler 82205905  
**Length:** 12 7/32 (310.4)  
**Width:** 9 7/32 (234.2)  
**Height:** 29/32 (23.0)

**PA4167**

Panel Air Element

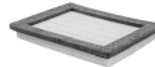

**Fits:** Ford, Lincoln Light-Duty Trucks  
**Replaces:** Ford 4L3Z-9601-BA; Motorcraft FA1754  
**Length:** 11 11/32 (288.1)  
**Width:** 8 15/32 (215.1)  
**Height:** 1 13/32 (35.7)  
**A. Gskt:** [1] Attached

**PA4160**

Panel Air Element

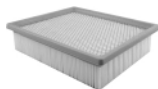

**Fits:** Ford, Mazda Light-Duty Trucks  
**Replaces:** Motorcraft FA1744  
**Length:** 9 (228.6)  
**Width:** 7 3/4 (196.9)  
**Height:** 2 7/32 (56.4)

**PA4168**

Cabin Air Element



**Fits:** Jeep Grand Cherokee  
**Replaces:** Chrysler 5013595AB, 82208300  
**Length:** 18 5/16 (465.1)  
**Width:** 3 1/16 (77.8)  
**Height:** 1 5/8 (41.3)

**RS4161**

Radial Seal Air Element



**Fits:** Buick, Chevrolet, GMC Light-Duty Trucks  
**Replaces:** GMC 15036141  
**O.D.:** 5 31/32 (151.6)  
**I.D.:** 3 7/32 (81.8) One End  
**Height:** 8 (203.2)

**PA4169**

Cabin Air Element

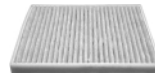

**Contains:** Charcoal Impregnated Media for Odor Control  
**Fits:** Cadillac Escalade; Chevrolet Silverado, Suburban, Tahoe; GMC Sierra, Yukon  
**Replaces:** GMC 88986533; ACDelco CF127  
**Length:** 10 5/8 (269.9)  
**Width:** 9 7/16 (239.7)  
**Height:** 1 (25.4)  
**A. Gskt:** [1] Attached

**PA4162**

Panel Air Element with Foam Pad

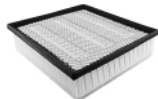

**Fits:** Dodge Light-Duty Trucks  
**Replaces:** Chrysler 53032700AA  
**Length:** 10 29/32 (277.0)  
**Width:** 9 7/8 (250.8)  
**Height:** 2 23/32 (69.1)  
**A. Gskt:** [1] Attached

**PA4170**

Panel Air Element

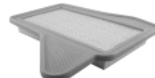

**Fits:** Chrysler Pacifica  
**Replaces:** Chrysler 5510026AA  
**Length:** 12 5/32 (308.8)  
**Width:** 7 1/4 (184.2)  
**to 12 19/32 (319.9)**  
**Height:** 1 25/32 (45.2)  
**A. Gskt:** [1] Attached

**PA4163**

Panel Air Element

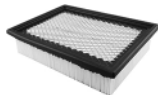

**Fits:** Ford, Mazda, Mercury Automotive  
**Replaces:** Ford YL8Z-9601-AA; Mazda YF09-13-Z40  
**Length:** 9 15/16 (252.4)  
**Width:** 7 1/32 (178.6)  
**Height:** 2 3/16 (55.6)

**PA4171**

Panel Air Element



**Fits:** Ford Vans  
**Replaces:** Ford 4C2U-9601-AB  
**Length:** 12 5/16 (312.7)  
**Width:** 6 23/32 (170.7)  
**Height:** 3 5/16 (84.1)

**PA4164**

Panel Air Element

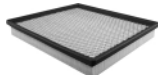

**Fits:** Jeep Grand Cherokee  
**Replaces:** Chrysler 5015610AA  
**Length:** 10 23/32 (272.3)  
**Width:** 9 11/16 (246.1)  
**Height:** 1 17/32 (38.9)

**PA4172**

Panel Air Element

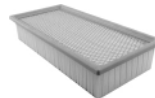

**Fits:** Ford Super Duty Pickups  
**Replaces:** Ford 5C3Z-9601-AA; Motorcraft FA1782  
**Length:** 14 23/32 (373.9)  
**Width:** 6 13/16 (173.0)  
**Height:** 2 3/4 (69.9)

**PA4165**

Panel Air Element



**Fits:** Toyota Light-Duty Trucks  
**Replaces:** Toyota 17801-31090  
**Length:** 13 31/32 (354.8)  
**Width:** 3 1/8 (79.4)  
**to 6 17/32 (165.9)**  
**Height:** 2 7/16 (61.9)  
**A. Gskt:** [1] Attached

**PA4173**











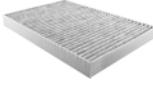
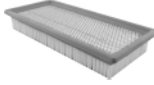

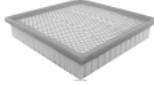

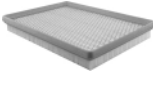
Air Element

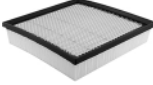

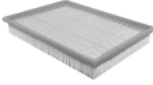
**Fits:** Chevrolet Colorado, GMC Canyon; Hummer  
**Replaces:** GMC 15202408; ACDelco A1624C  
**O.D.:** 5 27/32 (148.4)  
**I.D.:** 3 5/8 (92.1) One End  
**Height:** 8 5/8 (219.1)



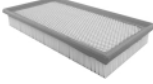







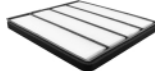



Measurements Are Shown In Inches And (Millimeters)

**WARNING:** These products can expose you to chemicals, including Diisononyl Phthalate, Carbon black extracts, Nickel, 1,3 Butadiene, Ethylene Oxide, Epichlorohydrin, which are known to the State of California to cause cancer, and Bisphenol, Ethylene Glycol, Ethylene Oxide, 1,3 Butadiene, Epichlorohydrin, which are known to the State of California to cause birth defects or other reproductive harm.

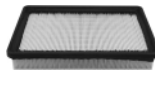
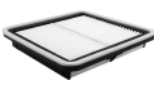
<p><b>PA4174</b> Cabin Air Element  <b>Contains:</b> Charcoal Impregnated Media for Odor Control.  <b>Fits:</b> Chrysler 300; Dodge Charger, Magnum  <b>Replaces:</b> Chrysler 4596501AB  <b>Length:</b> 12 5/32 (308.8)  <b>Width:</b> 8 5/16 (211.1)  <b>Height:</b> 1 3/16 (30.2)</p> 	<p><b>PA4183</b> Panel Air Element  <b>Fits:</b> Ford, Mercury Automotive  <b>Replaces:</b> Ford 5F9Z-9601-AA; Motorcraft FA1771  <b>Length:</b> 11 23/32 (297.7)  <b>Width:</b> 5 11/32 (135.7)  <b>Height:</b> 1 27/32 (46.8)</p> 
<p><b>PA4175</b> Panel Air Element  <b>Fits:</b> Ford, Mercury Automotive  <b>Replaces:</b> Ford 6E5Z-9601-EA; Motorcraft FA1785  <b>Length:</b> 10 9/16 (268.3)  <b>Width:</b> 6 5/16 (160.3)  <b>Height:</b> 1 31/32 (50.0)</p> 	<p><b>PA4184</b> Panel Air Element  <b>Fits:</b> Dodge Durango  <b>Replaces:</b> Chrysler 53032527AA  <b>Length:</b> 8 29/32 (226.2)  <b>Width:</b> 8 5/8 (219.1)  <b>Height:</b> 1 3/4 (44.4)</p> 
<p><b>PA4176</b> Panel Air Element  <b>Fits:</b> Ford, Mercury Automotive  <b>Replaces:</b> Ford 6E5Z-9601-GA; Motorcraft FA1786  <b>Length:</b> 8 13/32 (213.5)  <b>Width:</b> 6 5/16 (160.3)  <b>Height:</b> 1 31/32 (50.0)</p> 	<p><b>PA4185</b> Panel Air Element  <b>Fits:</b> 2006-on Ford Explorer, Mercury Mountaineer all with V8-281 (4.6L) Engine  <b>Replaces:</b> Motorcraft FA1780; Wix 49145  <b>Length:</b> 15 5/32 (385.0)  <b>Width:</b> 8 1/16 (204.8)  <b>Height:</b> 1 9/32 (32.5)</p> 
<p><b>PA4177</b> Panel Air Element  <b>Fits:</b> Chrysler, Dodge Automotive, Light-Duty Trucks  <b>Replaces:</b> Chrysler 5019002AA, 5037615AA  <b>Length:</b> 11 15/32 (291.3)  <b>Width:</b> 8 11/32 (211.9)  <b>Height:</b> 1 1/2 (38.1)</p> 	<p><b>PA4187</b> Foam Wrap  <b>Notes:</b> Can be used as a replacement wrap for PA4553.  <b>Contains:</b> Oil Wetted Media  <b>Fits:</b> John Deere Mowers, Lawn &amp; Garden Tractors  <b>Replaces:</b> John Deere M76076  <b>O.D.:</b> 7 (177.8)  <b>I.D.:</b> 6 3/4 (171.5)  <b>Height:</b> 1 31/32 (50.0)</p> 
<p><b>PA4178</b> Panel Air Element  <b>Fits:</b> Chevrolet, Pontiac Automotive  <b>Replaces:</b> GMC 10350737  <b>Length:</b> 9 3/8 (238.1)  <b>Width:</b> 8 27/32 (224.6)  <b>Height:</b> 1 31/32 (50.0)</p> 	<p><b>PA4188</b> Cabin Air Element  <b>Fits:</b> Mitsubishi, Subaru, Toyota Automotive  <b>Replaces:</b> Toyota 87139-47010  <b>Length:</b> 8 15/32 (215.1)  <b>Width:</b> 8 15/32 (215.1)  <b>Height:</b> 21/32 (16.7)</p> 
<p><b>PA4179</b> Panel Air Element  <b>Fits:</b> Jeep Cherokee, Commander, Liberty  <b>Replaces:</b> Chrysler 5018777AA  <b>Length:</b> 11 15/32 (291.3)  <b>Width:</b> 8 5/16 (211.1)  <b>Height:</b> 1 19/32 (40.5)</p> 	<p><b>RS4189</b> Radial Seal Air Element  <b>Fits:</b> Acura, Honda Automotive  <b>Replaces:</b> Honda 17220-PNA-003, 17220-PNB-003; Wix 42188  <b>O.D.:</b> 5 7/16 (138.1)  <b>I.D.:</b> 3 5/32 (80.2)  <b>Height:</b> 6 27/32 (173.8)</p> 
<p><b>PA4180</b> Panel Air Element  <b>Fits:</b> Pontiac, Scion, Toyota Automotive  <b>Replaces:</b> Toyota 17801-0D020  <b>Length:</b> 11 3/8 (288.9)  <b>Width:</b> 5 29/32 (150.0)  <b>Height:</b> 2 (50.8)  <b>A. Gskt:</b> [1] Attached</p> 	<p><b>PA4190</b> Panel Air Element  <b>Fits:</b> Acura, Honda Automotive  <b>Replaces:</b> Honda 17220-PGK-A00; ACDelco A2964C  <b>Length:</b> 11 3/8 (288.9)  <b>Width:</b> 2 1/8 (54.0)  <b>to 6 15/32 (164.3)</b>  <b>Height:</b> 1 5/8 (41.3)  <b>A. Gskt:</b> [1] Attached</p> 
<p><b>PA4181</b> Panel Air Element  <b>Fits:</b> Ford, Jaguar, Lincoln, Mercury Automotive  <b>Replaces:</b> Ford XW4Z-9601-AC; Motorcraft FA1679  <b>Length:</b> 12 7/32 (310.4)  <b>Width:</b> 6 17/32 (165.9)  <b>Height:</b> 1 3/4 (44.4)</p> 	<p><b>PA4191</b> Panel Air Element  <b>Fits:</b> Acura, Honda Automotive  <b>Replaces:</b> Honda 17220-RAA-A00; ACDelco A2950C  <b>Length:</b> 13 7/16 (341.3)  <b>Width:</b> 4 7/16 (112.7)  <b>to 5 15/16 (150.8)</b>  <b>Height:</b> 1 25/32 (45.2)  <b>A. Gskt:</b> [1] Attached</p> 
<p><b>PA4182</b> Panel Air Element  <b>Fits:</b> Acura, Honda Automotive  <b>Replaces:</b> Honda 17220-PLC-000; Wix 42564  <b>Length:</b> 12 19/32 (319.9)  <b>Width:</b> 7 3/4 (196.9)  <b>Height:</b> 1 15/32 (37.3)  <b>A. Gskt:</b> [1] Attached</p> 	





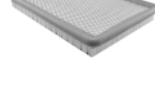







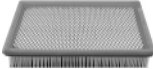
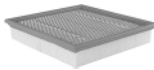

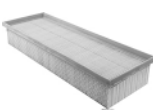
Measurements Are Shown In Inches And (Millimeters)

**WARNING:** These products can expose you to chemicals, including Diisononyl Phthalate, Carbon black extracts, Nickel, 1,3 Butadiene, Ethylene Oxide, Epichlorohydrin, which are known to the State of California to cause cancer, and Bisphenol, Ethylene Glycol, Ethylene Oxide, 1,3 Butadiene, Epichlorohydrin, which are known to the State of California to cause birth defects or other reproductive harm.

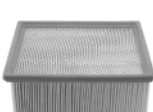
<p><b>PA4192</b> Panel Air Element    <b>Fits:</b> 2004-09 Toyota Prius  <b>Replaces:</b> Toyota 17801-21040  <b>Length:</b> 11 11/32 (288.1)  <b>Width:</b> 7 1/4 (184.2)  <b>Height:</b> 1 1/16 (27.0)  <b>A. Gskt:</b> [1] Attached</p>	<p><b>PA4304</b> Cabin Air Element    <b>Fits:</b> Acura MDX; Honda Odyssey, Pilot  <b>Replaces:</b> Honda 80290-S0X-A01  <b>Length:</b> 11 5/8 (295.3)  <b>Width:</b> 10 3/8 (263.5)  <b>Height:</b> 25/32 (19.8)  <b>A. Gskt:</b> [1] Attached</p>
<p><b>PA4193</b> Panel Air Element    <b>Fits:</b> Acura, Honda Automotive  <b>Replaces:</b> Honda 17220-RRA-A00  <b>Length:</b> 10 7/8 (276.2)  <b>Width:</b> 6 11/32 (161.1)  <b>Height:</b> 2 1/8 (54.0)  <b>A. Gskt:</b> [1] Attached</p>	<p><b>PA4305</b> Panel Air Element    <b>Fits:</b> Scion, Toyota Automotive  <b>Replaces:</b> Toyota 17801-21030  <b>Length:</b> 9 13/16 (249.2)  <b>Width:</b> 4 3/4 (120.7)  <b>Height:</b> 2 3/32 (53.2)</p>
<p><b>PA4194</b> Cabin Air Element    <b>Fits:</b> Lexus, Toyota Automotive  <b>Replaces:</b> Toyota 87139-32010  <b>Length:</b> 8 3/8 (212.7)  <b>Width:</b> 8 5/16 (211.1)  <b>Height:</b> 21/32 (16.7)  <b>A. Gskt:</b> [2] Attached</p>	<p><b>PA4306</b> Panel Air Element    <b>Fits:</b> 2003-05 Honda Accord with V6-183 (3.0L) Engine  <b>Replaces:</b> Honda 17220-RCA-A00; ACDelco A2951C  <b>Length:</b> 12 29/32 (327.8)  <b>Width:</b> 5 27/32 (148.4)  <b>Height:</b> 1 19/32 (40.5)  <b>A. Gskt:</b> [1] Attached</p>
<p><b>PA4195 KIT</b> Set of 2 Cabin Air Elements    <b>Notes:</b> Uses 2 filters per application.  <b>Fits:</b> Acura, Honda Automotive  <b>Replaces:</b> Honda 80292-S5D-A01, 80292-S5A-003  <b>Each Filter:</b>  <b>Length:</b> 8 27/32 (224.6)  <b>Width:</b> 4 13/32 (111.9)  <b>Height:</b> 1 1/8 (28.6)</p>	<p><b>PA4307</b> Panel Air Element    <b>Fits:</b> 2001-05 Toyota RAV4  <b>Replaces:</b> Toyota 17801-28010  <b>Length:</b> 14 3/4 (374.7)  <b>Width:</b> 3 7/8 (98.4)  <b>to 5 11/32 (135.7)</b>  <b>Height:</b> 2 1/8 (54.0)</p>
<p><b>PA4196</b> Cabin Air Element    <b>Fits:</b> Acura, Honda Automotive  <b>Replaces:</b> Honda 80292-SEC-A01  <b>Length:</b> 9 7/32 (234.2)  <b>Width:</b> 8 21/32 (219.9)  <b>Height:</b> 1 1/8 (28.6)</p>	<p><b>PA4308</b> Panel Air Element    <b>Fits:</b> Hyundai, Kia Automotive  <b>Replaces:</b> Hyundai 28113-2D000  <b>Length:</b> 10 (254.0)  <b>Width:</b> 6 7/8 (174.6)  <b>Height:</b> 1 5/8 (41.3)</p>
<p><b>PA4197</b> Panel Air Element    <b>Fits:</b> Subaru Automotive, Light-Duty Trucks  <b>Replaces:</b> Subaru 16546-AA10A  <b>Length:</b> 8 11/16 (220.7)  <b>Width:</b> 8 15/32 (215.1)  <b>Height:</b> 1 1/4 (31.8)  <b>A. Gskt:</b> [1] Attached</p>	<p><b>PA4309</b> Panel Air Element    <b>Fits:</b> Hyundai Santa Fe  <b>Replaces:</b> Hyundai 28113-26000  <b>Length:</b> 10 3/16 (258.8)  <b>Width:</b> 7 (177.8)  <b>Height:</b> 1 31/32 (50.0)</p>
<p><b>PA4198</b> Panel Air Element    <b>Fits:</b> Mitsubishi Automotive  <b>Replaces:</b> Mitsubishi MR571396  <b>Length:</b> 9 1/8 (231.8)  <b>Width:</b> 8 17/32 (216.7)  <b>Height:</b> 1 31/32 (50.0)</p>	<p><b>PA4310</b> Panel Air Element    <b>Fits:</b> 2000-06 Mazda MPV Van, 2003-on Mazda6  <b>Replaces:</b> Mazda RF2A-13-Z40A9U, RF2A-13-Z40A;  <b>Length:</b> 12 19/32 (319.9)  <b>Width:</b> 6 15/16 (176.2)  <b>Height:</b> 1 27/32 (46.8)</p>
<p><b>PA4199</b> Cabin Air Element    <b>Fits:</b> Infiniti, Mitsubishi, Nissan Automotive, Light-Duty Trucks  <b>Replaces:</b> Nissan B7200-5M000  <b>Length:</b> 8 11/16 (220.7)  <b>Width:</b> 7 27/32 (199.2)  <b>Height:</b> 1 3/16 (30.2)</p>	<p><b>PA4311</b> Panel Air Element    <b>Fits:</b> Hyundai Accent  <b>Replaces:</b> Hyundai 28113-22600; ACDelco A2936C  <b>Length:</b> 9 13/16 (249.2)  <b>Width:</b> 6 5/8 (168.3)  <b>Height:</b> 1 17/32 (38.9)</p>
<p><b>PA4303</b> Panel Air Element    <b>Fits:</b> 2002-04 Honda Odyssey  <b>Replaces:</b> Honda 17220-P8F-A10  <b>Length:</b> 11 7/32 (285.0)  <b>Width:</b> 6 11/32 (161.1)  <b>Height:</b> 1 5/8 (41.3)  <b>A. Gskt:</b> [1] Attached</p>	<p><b>PA4312</b> Panel Air Element    <b>Fits:</b> Saturn Automotive  <b>Replaces:</b> GMC 22679620; ACDelco A2953C  <b>Length:</b> 11 29/32 (302.4)  <b>Width:</b> 8 15/32 (215.1)  <b>Height:</b> 1 13/32 (35.7)</p>

Measurements Are Shown In Inches And (Millimeters)

 **WARNING:** These products can expose you to chemicals, including Diisononyl Phthalate, Carbon black extracts, Nickel, 1,3 Butadiene, Ethylene Oxide, Epichlorohydrin, which are known to the State of California to cause cancer, and Bisphenol, Ethylene Glycol, Ethylene Oxide, 1,3 Butadiene, Epichlorohydrin, which are known to the State of California to cause birth defects or other reproductive harm.

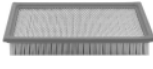
<p><b>PA4313</b> Panel Air Element  <b>Fits:</b> Hyundai Sonata; Kia Optima, Magentis  <b>Replaces:</b> Hyundai 28113-37101  <b>Length:</b> 9 3/8 (238.1)  <b>Width:</b> 7 1/2 (190.5)  <b>Height:</b> 1 9/16 (39.7)</p> 	<p><b>PA4322</b> Panel Air Element  <b>Fits:</b> Toyota Light-Duty Trucks  <b>Replaces:</b> Toyota 17801-0S010  <b>Length:</b> 12 7/16 (315.9)  <b>Width:</b> 11 11/16 (296.9)  <b>Height:</b> 2 (50.8)  <b>A. Gskt:</b> [1] Attached</p> 
<p><b>PA4314</b> Panel Air Element  <b>Fits:</b> Chrysler PT Cruiser  <b>Replaces:</b> Chrysler 4891176AA; ACDelco A2937C  <b>Length:</b> 10 1/32 (254.8)  <b>Width:</b> 7 7/16 (188.9)  <b>Height:</b> 1 15/32 (37.3)</p> 	<p><b>PA4323</b> Panel Air Element  <b>Fits:</b> Ford, Lincoln Light-Duty Trucks  <b>Replaces:</b> Ford 7C3Z-9601-A; Motorcraft FA1883  <b>Length:</b> 10 15/32 (265.9)  <b>Width:</b> 9 29/32 (251.6)  <b>Height:</b> 1 7/8 (47.6)</p> 
<p><b>SA4315</b> Crankcase Breather Filter in Plastic Housing  <b>Fits:</b> Buick, Chevrolet, GMC, Oldsmobile, Pontiac Automotive, Light-Duty Trucks, Vans  <b>Replaces:</b> GMC 25041487, 25047377; ACDelco FB82  <b>Width:</b> 1 15/32 (37.3)  <b>Height:</b> 1 3/8 (34.9)</p> 	<p><b>PA4324</b> Panel Air Element  <b>Fits:</b> Pontiac Solstice, Saturn Sky Red Line  <b>Replaces:</b> GMC 15925738; ACDelco A3084C  <b>Length:</b> 14 9/16 (369.9)  <b>Width:</b> 9 9/16 (242.9)  <b>Height:</b> 1 5/32 (29.4)  <b>A. Gskt:</b> [1] Attached</p> 
<p><b>PA4316</b> Panel Air Element  <b>Fits:</b> Chevrolet HHR  <b>Replaces:</b> GMC 22731072; ACDelco A3054C  <b>Length:</b> 13 7/8 (352.4)  <b>Width:</b> 4 29/32 (124.6)  <b>Height:</b> 2 9/32 (57.9)</p> 	<p><b>PA4325</b> Panel Air Element  <b>Fits:</b> 2006-10 Chrysler PT Cruiser  <b>Replaces:</b> Chrysler 4891691AA  <b>Length:</b> 10 5/32 (258.0)  <b>Width:</b> 6 1/2 (165.1)  <b>Height:</b> 1 11/16 (42.9)</p> 
<p><b>PA4317</b> Cabin Air Element  <b>Fits:</b> Chevrolet, Pontiac, Saturn Automotive  <b>Replaces:</b> GMC 52493319, ACDelco CF125  <b>Length:</b> 9 23/32 (246.9)  <b>Width:</b> 8 1/2 (215.9)  <b>Height:</b> 29/32 (23.0)  <b>A. Gskt:</b> [2] Attached</p> 	<p><b>PA4327</b> Cabin Air Element  <b>Fits:</b> Scion, Toyota Automotive, Light-Duty Trucks  <b>Replaces:</b> Toyota 87139-YZZ08  <b>Length:</b> 8 7/16 (214.3)  <b>Width:</b> 7 11/16 (195.3)  <b>Height:</b> 1 1/8 (28.6)</p> 
<p><b>PA4318</b> Panel Air Element  <b>Fits:</b> Dodge Light-Duty Trucks; Sterling Bullet  <b>Replaces:</b> Chrysler 53034051AB  <b>Length:</b> 10 15/16 (277.8)  <b>Width:</b> 9 29/32 (251.6)  <b>Height:</b> 4 3/8 (111.1)</p> 	<p><b>PA4328</b> Air Element  <b>Fits:</b> Toyota Automotive, Light-Duty Trucks  <b>Replaces:</b> Toyota 17801-31050, 17801-54080, 17801-54120; Donaldson P500021; Fleetguard AF25295  <b>O.D.:</b> 6 3/32 (154.8)  <b>I.D.:</b> 1/2 (12.7) &amp; 3 15/32 (88.1)  <b>Height:</b> 7 3/4 (196.9)  <b>F. Gskt:</b> [1] Metal Washer</p> 
<p><b>PA4319</b> Panel Air Element  <b>Fits:</b> Opel, Renault Light-Duty Trucks  <b>Replaces:</b> GMC 93187335; Opel 4402614, 4416403; Renault 7701047285, 7701476258, 8200457286  <b>Length:</b> 12 11/32 (313.5)  <b>Width:</b> 4 (101.6)  <b>Height:</b> 1 5/8 (41.3)</p> 	<p><b>PA4329</b> Panel Air Element  <b>Fits:</b> Chevrolet Cobalt; Pontiac G5, Pursuit  <b>Replaces:</b> GMC 21999324; ACDelco A2956C  <b>Length:</b> 9 3/8 (238.1)  <b>Width:</b> 4 1/2 (114.3)  <b>to 8 3/8 (212.7)</b>  <b>Height:</b> 1 25/32 (45.2)</p> 
<p><b>PA4320</b> Panel Air Element  <b>Fits:</b> 2006 Honda Civic 4-1799cc (1.8L) MFI, 2007-on Civic 4-1799cc (1.8L) FI, Natural Gas Engines  <b>Replaces:</b> Honda 17220-RNA-A00; Wix 49065  <b>Length:</b> 8 15/16 (227.0)  <b>Width:</b> 7 3/4 (196.9)  <b>Height:</b> 1 3/4 (44.4)  <b>A. Gskt:</b> [1] Attached</p> 	<p><b>PA4330</b> Cabin Air Element  <b>Fits:</b> Buick, Cadillac, Oldsmobile, Pontiac Automotive  <b>Replaces:</b> GMC 25654414; ACDelco CF117  <b>Length:</b> 11 1/4 (285.8)  <b>Width:</b> 8 5/8 (219.1)  <b>Height:</b> 29/32 (23.0)  <b>Related To:</b> PA4384 (Charcoal Media Version)</p> 
<p><b>PA4321</b> Panel Air Element  <b>Fits:</b> Ford, Mercury, Lincoln Automotive  <b>Replaces:</b> Ford 7T4Z-9601-A; Motorcraft FA1884  <b>Length:</b> 11 31/32 (304.0)  <b>Width:</b> 6 11/16 (169.9)  <b>Height:</b> 1 3/4 (44.4)</p> 	

Measurements Are Shown In Inches And (Millimeters)

**WARNING:** These products can expose you to chemicals, including Diisononyl Phthalate, Carbon black extracts, Nickel, 1,3 Butadiene, Ethylene Oxide, Epichlorohydrin, which are known to the State of California to cause cancer, and Bisphenol, Ethylene Glycol, Ethylene Oxide, 1,3 Butadiene, Epichlorohydrin, which are known to the State of California to cause birth defects or other reproductive harm.

**PA4331** Cabin Air Element  
**Contains:** Charcoal Impregnated Media for Odor Control.  
**Fits:** Audi, Volkswagen Automotive  
**Replaces:** Volkswagen 1J0819644, 1J0819644A  
**Length:** 11 3/32 (281.8)  
**Width:** 8 3/16 (208.0)  
**Height:** 1 3/16 (30.2)

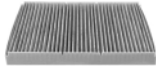

**PA4340** Cabin Air Element  
**Fits:** Chevrolet Equinox; Pontiac Torrent; Saturn Sky, VUE  
**Replaces:** Saturn 22665802  
**Length:** 16 3/4 (425.5)  
**Width:** 4 13/32 (111.9)  
**Height:** 1 1/8 (28.6)



**PA4332** Cabin Air Element  
**Fits:** Toyota Corolla, Matrix  
**Replaces:** Toyota 88568-02020; Wix 24873  
**Length:** 8 21/32 (219.9)  
**Width:** 7 27/32 (199.2)  
**Height:** 25/32 (19.8)



**PA4341** Panel Air Element  
**Fits:** Kia Sorento  
**Replaces:** Kia 28113-3E000, 28113-3E500  
**Length:** 11 21/32 (296.1)  
**Width:** 9 3/8 (238.1)  
**Height:** 1 5/16 (33.3)

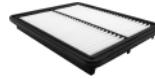

**PA4333** Panel Air Element  
**Fits:** Lexus, Scion, Toyota Automotive, Light-Duty Trucks  
**Replaces:** Toyota 17801-31120, 17801-AD010  
**Length:** 10 (254.0)  
**Width:** 5 1/2 (139.7) to 9 3/8 (238.1)  
**Height:** 2 1/4 (57.2)  
**A. Gskt:** [1] Attached



**PA4344** Panel Air Element  
**Fits:** Chevrolet Aveo, Pontiac Wave  
**Replaces:** GMC 96536696  
**Length:** 8 3/4 (222.3)  
**Width:** 7 3/8 (187.3)  
**Height:** 1 25/32 (45.2)  
**A. Gskt:** [1] Attached



**PA4334** Cabin Air Element  
**Fits:** Hyundai, Kia Automotive, Light-Duty Trucks, Vans  
**Replaces:** Hyundai 97133-2B010, 97133-3K000  
**Length:** 9 7/8 (250.8)  
**Width:** 8 23/32 (221.5)  
**Height:** 1 3/16 (30.2)



**PA4345** Panel Air Element  
**Fits:** Mazda3, Mazda5, MazdaSpeed3  
**Replaces:** Mazda LF50-13-Z40A, LF50-13-Z40-9U  
**Length:** 10 27/32 (275.4)  
**Width:** 7 3/8 (187.3)  
**Height:** 2 3/32 (53.2)  
**A. Gskt:** [1] Attached

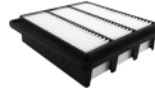

**PA4335** Panel Air Element  
**Fits:** Chrysler, Dodge Automotive  
**Replaces:** Chrysler 4891926AA  
**Length:** 9 9/32 (235.7)  
**Width:** 8 7/16 (214.3)  
**Height:** 1 17/32 (38.9)

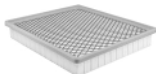

**PA4348** Panel Air Element  
**Fits:** Hyundai Tucson, Kia Sportage  
**Replaces:** Hyundai 28113-08000  
**Length:** 9 31/32 (253.2)  
**Width:** 6 13/16 (173.0)  
**Height:** 1 23/32 (43.7)  
**A. Gskt:** [1] Attached

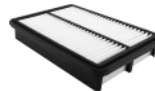

**PA4336** Cabin Air Element  
**Contains:** Charcoal Impregnated Media for Odor Control.  
**Fits:** Dodge, Freightliner, Mercedes-Benz Sprinter Vans  
**Replaces:** Chrysler 68012876AA; Mercedes-Benz AA9068300318  
**Length:** 14 9/16 (369.9)  
**Width:** 11 5/32 (283.4)  
**Height:** 1 3/8 (34.9)  
**Related To:** PA4488 (Standard Media Version)



**PA4349** Panel Air Element  
**Fits:** Hyundai Automotive  
**Replaces:** Hyundai 38113-3K200  
**Length:** 9 9/32 (235.7)  
**Width:** 8 13/16 (223.8)  
**Height:** 2 5/16 (58.7)  
**A. Gskt:** [1] Attached



**PA4337** Panel Air Element  
**Fits:** Chevrolet, Pontiac Automotive  
**Replaces:** General Motors 10366901; ACDelco A2930C  
**Length:** 11 5/8 (295.3)  
**Width:** 7 3/32 (180.2)  
**Height:** 1 23/32 (43.7)



**PA4350** Panel Air Element  
**Fits:** Toyota Camry, Venza  
**Replaces:** Toyota 17801-28030, 17801-0H050  
**Length:** 11 17/32 (292.9)  
**Width:** 7 7/8 (200.0)  
**Height:** 1 11/16 (42.9)



**PA4338** Panel Air Element  
**Fits:** Ford, Mercury Automotive  
**Replaces:** Ford 3W3Z-9601-AA; Motorcraft FA1745; Wix 46814  
**Length:** 11 13/32 (289.7)  
**Width:** 7 19/32 (192.9)  
**Height:** 1 31/32 (50.0)

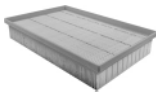

**PA4351** Panel Air Element  
**Fits:** 2007-09 Acura MDX; 2005-10 Honda Odyssey  
**Replaces:** Honda 17220-RGL-A00, 17220-RGL-A10  
**Length:** 11 13/16 (300.0)  
**Width:** 6 7/8 (174.6)  
**Height:** 1 19/32 (40.5)  
**A. Gskt:** [1] Attached

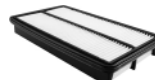



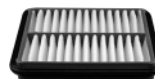









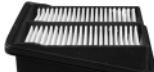

**PA4352** Panel Air Element  
**Fits:** Toyota Prius  
**Replaces:** Toyota 17801-21020  
**Length:** 7 5/16 (185.7)  
**Width:** 6 23/32 (170.7)  
**Height:** 1 1/16 (27.0)

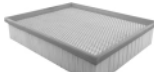
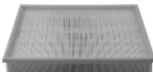

Measurements Are Shown In Inches And (Millimeters)

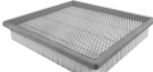
**WARNING:** These products can expose you to chemicals, including Diisononyl Phthalate, Carbon black extracts, Nickel, 1,3 Butadiene, Ethylene Oxide, Epichlorohydrin, which are known to the State of California to cause cancer, and Bisphenol, Ethylene Glycol, Ethylene Oxide, 1,3 Butadiene, Epichlorohydrin, which are known to the State of California to cause birth defects or other reproductive harm.

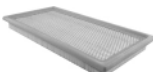
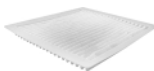
<p><b>PA4353</b> Panel Air Element</p> <p><b>Notes:</b> OBSOLETE. Availability Limited to Dealer Stock.</p> <p><b>Fits:</b> Kia Sportage</p> <p><b>Replaces:</b> Kia OK011-13-Z40</p> <p><b>Length:</b> 10 7/16 (265.1)</p> <p><b>Width:</b> 7 1/8 (181.0)</p> <p><b>Height:</b> 1 7/16 (36.5)</p> 	<p><b>PA4363</b> Panel Air Element</p> <p><b>Fits:</b> Hyundai, Kia Automotive</p> <p><b>Replaces:</b> Hyundai 28113-1G000; Kia 28113-1G000</p> <p><b>Length:</b> 10 11/32 (262.7)</p> <p><b>Width:</b> 5 9/32 (134.1)</p> <p><b>Height:</b> 2 3/16 (55.6)</p> 
<p><b>PA4354</b> Panel Air Element</p> <p><b>Fits:</b> Lexus Automotive</p> <p><b>Replaces:</b> Toyota 17801-46080; WIX 46465</p> <p><b>Length:</b> 9 3/4 (247.7)</p> <p><b>Width:</b> 8 9/32 (210.3)</p> <p><b>Height:</b> 2 3/32 (53.2)</p> <p><b>A. Gskt:</b> [1] Attached</p> 	<p><b>PA4364</b> Panel Air Element</p> <p><b>Fits:</b> Acura, Honda Automotive</p> <p><b>Replaces:</b> Honda 17220-R70-A00</p> <p><b>Length:</b> 10 5/16 (261.9)</p> <p><b>Width:</b> 8 3/32 (205.6)</p> <p><b>Height:</b> 1 3/4 (44.4)</p> <p><b>A. Gskt:</b> [1] Attached</p> 
<p><b>PA4355</b> Panel Air Element</p> <p><b>Fits:</b> Acura, Honda Automotive</p> <p><b>Replaces:</b> Honda 17220-RDA-A00</p> <p><b>Length:</b> 12 27/32 (326.2)</p> <p><b>Width:</b> 5 25/32 (146.8)</p> <p><b>Height:</b> 2 1/8 (54.0)</p> <p><b>A. Gskt:</b> [1] Attached</p> 	<p><b>PA4365</b> Cabin Air Element</p> <p><b>Fits:</b> Ford, Lincoln Automotive</p> <p><b>Replaces:</b> Ford 7T4Z-19N619-B</p> <p><b>Length:</b> 7 7/8 (200.0)</p> <p><b>Width:</b> 7 7/16 (188.9)</p> <p><b>Height:</b> 23/32 (18.3)</p> 
<p><b>PA4356</b> Panel Air Element</p> <p><b>Fits:</b> Toyota Tacoma Light-Duty Truck</p> <p><b>Replaces:</b> Toyota 17801-0C040</p> <p><b>Length:</b> 12 19/32 (319.9)</p> <p><b>Width:</b> 9 1/2 (241.3)</p> <p><b>Height:</b> 2 1/16 (52.4)</p> 	<p><b>PA4366</b> Panel Air Element</p> <p><b>Fits:</b> Honda Automotive</p> <p><b>Replaces:</b> Honda 17220-PWA-J10, 17315-SLN-A01</p> <p><b>Length:</b> 6 21/32 (169.1)</p> <p><b>Width:</b> 5 13/16 (147.6)</p> <p><b>Height:</b> 2 7/32 (56.4)</p> <p><b>A. Gskt:</b> [1] Attached</p> 
<p><b>PA4358</b> Panel Air Element</p> <p><b>Fits:</b> Cadillac CTS</p> <p><b>Replaces:</b> General Motors 25728874</p> <p><b>Length:</b> 3 15/32 (88.1)</p> <p><b>Width:</b> 10 7/8 (276.2)</p> <p><b>Height:</b> 1 1/4 (31.8)</p> 	<p><b>PA4367</b> Panel Air Element</p> <p><b>Fits:</b> 2007-10 Dodge Nitro; 2008-11 Jeep Liberty</p> <p><b>Replaces:</b> Chrysler 5189933AA</p> <p><b>Length:</b> 11 15/32 (291.3)</p> <p><b>Width:</b> 9 1/16 (230.2)</p> <p><b>Height:</b> 2 5/16 (58.7)</p> 
<p><b>PA4359</b> Panel Air Element</p> <p><b>Fits:</b> Volvo Automotive</p> <p><b>Replaces:</b> Volvo 9454647, 9454647-0</p> <p><b>Length:</b> 13 (330.2)</p> <p><b>Width:</b> 8 1/2 (215.9)</p> <p><b>Height:</b> 2 9/32 (57.9)</p> 	<p><b>PA4368</b> Panel Air Element</p> <p><b>Fits:</b> Chevrolet, Suzuki Light-Duty Trucks</p> <p><b>Replaces:</b> GMC 96553450; Suzuki 13780-85Z00</p> <p><b>Length:</b> 7 3/4 (196.9) to 8 3/4 (222.3)</p> <p><b>Width:</b> 11 5/16 (287.3)</p> <p><b>Height:</b> 1 7/16 (36.5)</p> <p><b>A. Gskt:</b> [1] Attached</p> 
<p><b>PA4360</b> Panel Air Element</p> <p><b>Fits:</b> 2003-08 Mazda6, 2006-07 MazdaSpeed6, 2007-on CX7</p> <p><b>Replaces:</b> Mazda AJ57-13-Z40, AJ57-13-Z409U</p> <p><b>Length:</b> 12 5/16 (312.7)</p> <p><b>Width:</b> 6 15/16 (176.2)</p> <p><b>Height:</b> 1 27/32 (46.8)</p> <p><b>A. Gskt:</b> [1] Attached</p> 	<p><b>PA4369</b> Panel Air Element</p> <p><b>Fits:</b> Acura RDX</p> <p><b>Replaces:</b> Acura 17220-RWC-A00; Honda 17220-RWC-A00; Wix 49123</p> <p><b>Length:</b> 13 7/32 (335.8)</p> <p><b>Width:</b> 6 17/32 (165.9)</p> <p><b>Height:</b> 2 1/8 (24.0)</p> 
<p><b>PA4361</b> Panel Air Element</p> <p><b>Fits:</b> 2005-10 Ford Mustang</p> <p><b>Replaces:</b> Ford 4R3Z-9601-AA; Motorcraft FA1773</p> <p><b>Length:</b> 9 31/32 (253.2)</p> <p><b>Width:</b> 9 3/16 (233.4)</p> <p><b>Height:</b> 1 23/32 (43.7)</p> 	<p><b>PA4370</b> Cabin Air Element</p> <p><b>Fits:</b> Ford, Mazda Automotive, Light-Duty Trucks</p> <p><b>Replaces:</b> Ford YL8Z-19N619-AB, YL84-19N619-AB; Motorcraft FP46, FP49</p> <p><b>Length:</b> 10 11/32 (262.7)</p> <p><b>Width:</b> 6 23/32 (170.7)</p> <p><b>Height:</b> 1 13/32 (35.7)</p> <p><b>A. Gskt:</b> [1] Attached</p> 
<p><b>PA4362</b> Panel Air Element</p> <p><b>Fits:</b> 2007-10 Dodge Caliber, Jeep Compass, Patriot</p> <p><b>Replaces:</b> Chrysler 4891694AA</p> <p><b>Length:</b> 12 27/32 (326.2)</p> <p><b>Width:</b> 6 5/8 (168.3)</p> <p><b>Height:</b> 1 1/4 (31.8)</p> 	<p><b>PA4371</b> Cabin Air Element</p> <p><b>Fits:</b> Lexus, Toyota Light-Duty Trucks</p> <p><b>Replaces:</b> Toyota 87139-48020</p> <p><b>Length:</b> 9 7/32 (234.2)</p> <p><b>Width:</b> 8 7/16 (214.3)</p> <p><b>Height:</b> 23/32 (18.3)</p> 

Measurements Are Shown In Inches And (Millimeters)

**WARNING:** These products can expose you to chemicals, including Diisononyl Phthalate, Carbon black extracts, Nickel, 1,3 Butadiene, Ethylene Oxide, Epichlorohydrin, which are known to the State of California to cause cancer, and Bisphenol, Ethylene Glycol, Ethylene Oxide, 1,3 Butadiene, Epichlorohydrin, which are known to the State of California to cause birth defects or other reproductive harm.

**PA4372** Cabin Air Element  
**Fits:** Scion, Toyota Automotive; Komatsu Excavators  
**Replaces:** Toyota 88568-52010  
**Length:** 8 1/2 (215.9)  
**Width:** 7 11/16 (195.3)  
**Height:** 5/8 (15.9)



**PA4373** Cabin Air Element  
**Contains:** Charcoal Impregnated Media for Odor Control.  
**Fits:** Chrysler, Dodge, Jeep Automotive  
**Replaces:** Chrysler 5058381AA, 5058693AA  
**Length:** 8 1/2 (215.9)  
**Width:** 7 21/32 (194.5)  
**Height:** 31/32 (24.6)

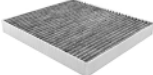

**PA4374** Panel Air Element  
**Fits:** Honda Automotive  
**Replaces:** Honda 17220-R40-A00  
**Length:** 10 9/16 (268.3)  
**Width:** 5 (127.0) to 8 21/32 (219.9)  
**Height:** 2 1/32 (51.6)  
**A. Gskt:** [1] Attached



**PA4375** Panel Air Element  
**Notes:** OBSOLETE. Availability Limited to Dealer Stock.  
**Fits:** Hyundai, Kia Automotive  
**Replaces:** Hyundai 28113-39000; ACDelco A2992C  
**Length:** 9 17/32 (242.1)  
**Width:** 7 5/8 (193.7)  
**Height:** 2 1/32 (51.6)  
**A. Gskt:** [1] Attached



**PA4376** Panel Air Element  
**Fits:** Kia Automotive  
**Replaces:** Kia K30C-13-Z40A, OK30C-13-Z40A  
**Length:** 10 5/16 (261.9)  
**Width:** 5 21/32 (143.7)  
**Height:** 1 1/2 (38.1)



**PA4377** Panel Air Element  
**Fits:** 2006-on Honda Ridgeline  
**Replaces:** Honda 17220-RJE-A00  
**Length:** 13 1/8 (333.4)  
**Width:** 6 15/16 (176.2)  
**Height:** 1 25/32 (45.2)  
**A. Gskt:** [1] Attached

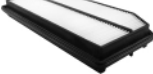

**PA4380** Panel Air Element  
**Notes:** OBSOLETE. Availability Limited to Dealer Stock.  
**Fits:** Lexus Automotive  
**Replaces:** Toyota 17801-50030  
**Length:** 9 7/8 (250.8)  
**Width:** 8 13/32 (213.5)  
**Height:** 2 3/32 (53.2)  
**A. Gskt:** [1] Attached



**PA4381** Panel Air Element  
**Fits:** Honda Civic Hybrid  
**Replaces:** Honda 17220-PZA-000  
**Length:** 8 7/8 (225.4)  
**Width:** 5 31/32 (151.6)  
**Height:** 1 9/16 (39.7)  
**A. Gskt:** [1] Attached



**PA4382** Panel Air Element  
**Notes:** OBSOLETE. Availability Limited to Dealer Stock.  
**Fits:** Suzuki Aerio  
**Replaces:** Suzuki 13780-54G10  
**Length:** 9 9/16 (242.9)  
**Width:** 6 15/32 (164.3)  
**Height:** 2 1/8 (54.0)  
**A. Gskt:** [1] Attached



**PA4383** Panel Air Element  
**Fits:** Audi, Volkswagen Automotive  
**Replaces:** Audi 6F133843A; Volkswagen 6F133843A  
**Length:** 15 29/32 (404.0)  
**Width:** 6 25/32 (172.2)  
**Height:** 1 13/32 (35.7)



**PA4384** Cabin Air Element  
**Contains:** Charcoal Impregnated Media for Odor Control.  
**Fits:** Buick, Cadillac, Oldsmobile, Pontiac Automotive  
**Replaces:** GMC 25689297; ACDelco CF105C, CF118C  
**Length:** 11 21/32 (296.1)  
**Width:** 8 13/16 (223.8)  
**Height:** 7/8 (22.2)  
**Related To:** PA4330 (Non-Charcoal Version)

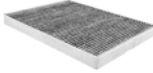

**PA4385** Panel Air Element  
**Fits:** 2005-on Ford Escape Hybrid; 2006-on Mercury Mariner Hybrid  
**Replaces:** Ford 5M6Z-9601-AA; Motorcraft FA1772  
**Length:** 12 7/8 (327.0)  
**Width:** 5 17/32 (140.5)  
**Height:** 1 23/32 (43.7)



**PA4386** Panel Air Element  
**Fits:** Land Rover Discovery, Freelander, Range Rover  
**Replaces:** Land Rover ESR4238  
**Length:** 9 7/16 (239.7)  
**Width:** 8 1/32 (204.0)  
**Height:** 1 13/16 (46.0)



**PA4387** Panel Air Element  
**Notes:** OBSOLETE. Availability Limited to Dealer Stock.  
**Fits:** Hyundai Santa Fe  
**Replaces:** Hyundai 28113-26350  
**Length:** 10 5/8 (269.9)  
**Width:** 7 17/32 (191.3)  
**Height:** 1 31/32 (50.0)  
**A. Gskt:** [1] Attached



**PA4388** Air Element  
**Fits:** Citroen, Peugeot Automotive  
**Replaces:** Citroen 1444.H1; Peugeot 1444-H2  
**O.D.:** 4 1/2 (114.3)  
**I.D.:** 2 5/8 (66.7)  
**Height:** 8 9/16 (217.5)



Measurements Are Shown In Inches And (Millimeters)

**WARNING:** These products can expose you to chemicals, including Diisononyl Phthalate, Carbon black extracts, Nickel, 1,3 Butadiene, Ethylene Oxide, Epichlorohydrin, which are known to the State of California to cause cancer, and Bisphenol, Ethylene Glycol, Ethylene Oxide, 1,3 Butadiene, Epichlorohydrin, which are known to the State of California to cause birth defects or other reproductive harm.

**PA4389**

Air Element



**Replaces:** Citroen 1444F5; Peugeot 1444-F5  
**O.D.:** 6 5/8 (168.3)  
**I.D.:** 4 23/32(119.9)  
**Height:** 4 27/32 (123.0)

**PA4390**

Panel Air Element

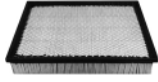

**Fits:** 2007-10 Dodge Sprinter, Freightliner Sprinter  
**Replaces:** Chrysler 68013676AA; Mercedes-Benz A0000902651  
**Length:** 13 29/32 (353.2)  
**Width:** 10 7/16 (265.1)  
**Height:** 2 1/4 (57.2)

**PA4391**

Cabin Air Element



**Fits:** Hyundai, Kia Automotive, Light-Duty Trucks  
**Replaces:** Kia 97133-2E200, 97133-2E210  
**Length:** 8 15/16 (227.0)  
**Width:** 7 29/32 (200.8)  
**Height:** 21/32 (16.7)

**PA4392**

Foam Cabin Air Element



**Notes:** OBSOLETE. Availability Limited to Dealer Stock.  
**Fits:** Mazda 626  
**Replaces:** Mazda GD7A-61-J6X; Wix 24486  
**Length:** 9 1/8 (231.8)  
**Width:** 8 21/32 (219.9)  
**Height:** 5/16 (7.9)

**PA4393**

Cabin Air Element



**Fits:** Lexus, Toyota Automotive, Light-Duty Trucks  
**Replaces:** Toyota 87139-07010  
**Length:** 8 15/32 (215.1)  
**Width:** 7 19/32 (192.9)  
**Height:** 1 1/8 (28.6)

**PA4394**

Cabin Air Element



**Fits:** Ford, Mazda, Mercury Light-Duty Trucks  
**Replaces:** Ford 8L8Z-19N619-B; Motorcraft FP66  
**Length:** 12 3/16 (309.6)  
**Width:** 4 (101.6)  
**to** 7 1/16 (179.4)  
**Height:** 25/32 (19.8)  
**A. Gskt:** [1] Attached

**PA4397**

Panel Air Element



**Fits:** Saturn Automotive  
**Replaces:** Saturn 96815102  
**Length:** 5 11/16 (144.5) to 11 1/8 (282.6)  
**Width:** 8 13/16 (223.8)  
**Height:** 5 1/4 (133.4)

**PA4398**

Cabin Air Element



**Fits:** Saturn Automotive  
**Replaces:** Saturn 19130294  
**Length:** 10 1/16 (255.6)  
**Width:** 8 3/4 (222.3)  
**Height:** 11/16 (17.5)

**PA4399**

Panel Air Element



**Fits:** Nissan Automotive  
**Replaces:** Nissan 16546-JA00A, 16546-JA00B  
**Length:** 12 11/32 (313.5)  
**Width:** 5 7/32 (132.6)  
**Height:** 2 1/4 (57.2)

**PA4400**

Panel Air Element

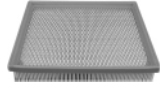

**Fits:** Kia Automotive  
**Replaces:** Kia 28113-2G000  
**Length:** 10 3/32 (256.4)  
**Width:** 7 15/16 (201.6)  
**Height:** 1 23/32 (43.7)

**PA4401**

Panel Air Element



**Fits:** Hyundai, Kia Automotive  
**Replaces:** Hyundai 28113-2H000  
**Length:** 7 3/4 (196.9)  
**Width:** 7 13/32 (188.1)  
**Height:** 1 15/16 (49.2)  
**A. Gskt:** [1] Attached

**PA4402**

Panel Air Element



**Fits:** 2007-09 Hyundai Santa Fe  
**Replaces:** Hyundai 28113-2B000  
**Length:** 10 9/16 (268.3)  
**Width:** 6 7/8 (174.6)  
**Height:** 2 3/8 (60.3)  
**A. Gskt:** [1] Attached

**PA4403**

Set of 2 Cabin Air Elements



**Notes:** OBSOLETE. Availability Limited to Dealer Stock.  
 Uses 2 filters per application.  
**Fits:** Mazda Automotive  
**Replaces:** Mazda BP4K-61-J6X  
**Larger Filter**  
**Length:** 9 1/4 (235.0) to 9 5/16 (236.5)  
**Width:** 4 (101.6)  
**to** 3 25/32 (96.0)  
**Height:** 7/8 (22.2)  
**to** 7/8 22.2  
**A. Gskt:** [1] Attached to Smaller Filter  
**Smaller Filter**

**PA4404**

Cabin Air Element



**Fits:** Hyundai Automotive  
**Replaces:** Hyundai 87901-E000A, 971331-E000  
**Length:** 9 21/32 (245.3)  
**Width:** 8 1/32 (204.0)  
**Height:** 3/4 (19.0)  
**A. Gskt:** [1] Attached

**PA4405**

Cabin Air Element



**Fits:** Chrysler, Dodge Vans; Infiniti Automotive  
**Replaces:** Nissan 27277-EG025  
**Length:** 9 (228.6)  
**Width:** 7 13/16 (198.4)  
**Height:** 1 1/4 (31.8)

**PA4408**

Cabin Air Element



**Fits:** Subaru Automotive, Light-Duty Trucks  
**Replaces:** Subaru 3B451-30361; 72880-FE000; G3210-FE100; WIX 24485  
**Length:** 8 3/8 (212.7)  
**Width:** 7 1/4 (184.2)  
**Height:** 1 1/8 (28.6)

Measurements Are Shown In Inches And (Millimeters)

**WARNING:** These products can expose you to chemicals, including Diisononyl Phthalate, Carbon black extracts, Nickel, 1,3 Butadiene, Ethylene Oxide, Epichlorohydrin, which are known to the State of California to cause cancer, and Bisphenol, Ethylene Glycol, Ethylene Oxide, 1,3 Butadiene, Epichlorohydrin, which are known to the State of California to cause birth defects or other reproductive harm.



**PA4409** Cabin Air Element  
**Contains:** Charcoal Impregnated Media for Odor Control.  
**Fits:** Dodge, Freightliner Sprinter Vans  
**Replaces:** Chrysler 5103600AA; Mercedes-Benz A9018300418  
**Length:** 14 13/16 (376.2)  
**Width:** 6 5/8 (168.3)  
**Height:** 1 3/32 (27.8)  
**A. Gskt:** [1] Attached  
**Related To:** PA4489 (Standard Media Version)



**PA4416 KIT** Set of 2 Cabin Air Elements  
**Notes:** Uses 2 filters per application.  
**Fits:** Acura, Honda Automotive  
**Replaces:** Honda 80291-S84-A01  
**Each Filter:**  
**Length:** 11 19/32 (294.5)  
**Width:** 3 3/4 (95.3)  
**Height:** 1 3/16 (30.2)



**PA4410 KIT** Set of 2 Cabin Air Elements  
**Notes:** Uses 2 filters per application.  
**Fits:** Nissan Frontier, Pathfinder, Xterra; Suzuki Equator  
**Replaces:** Nissan 999M1-VR056  
**Each Filter:**  
**Length:** 10 5/32 (258.0)  
**Width:** 3 31/32 (100.8)  
**Height:** 31/32 (24.6)



**PA4417** Panel Air Element  
**Fits:** 2007-09 Honda CR-V  
**Replaces:** Honda 17220-RZA-000  
**Length:** 10 17/32 (267.5)  
**Width:** 2 5/8 (66.7)  
**to 6 23/32 (170.7)**  
**Height:** 1 15/16 (49.2)  
**A. Gskt:** [1] Attached



**PA4411** Cabin Air Element  
**Fits:** Honda Fit  
**Replaces:** Honda 80291-SAA-J01; Wix 24524  
**Length:** 7 3/16 (182.6)  
**Width:** 7 1/16 (179.4)  
**Height:** 1 1/8 (28.6)



**PA4418** Panel Air Element  
**Fits:** 2008-on Buick Enclave; 2009-on Chevrolet Traverse; 2007-on GMC Acadia, 2007-10 Saturn Outlook  
**Replaces:** GMC 15278634; ACDelco A3083C  
**Length:** 5 1/2 (139.7) to 13 3/4 (349.3)  
**Width:** 2 1/4 (57.2)  
**to 11 3/4 (298.5)**  
**Height:** 1 23/32 (43.7)  
**A. Gskt:** [1] Attached



**PA4412** Panel Air Element  
**Fits:** Chevrolet, GMC, Hummer, Isuzu Light-Duty Trucks  
**Replaces:** General Motors 15942429; ACDelco A3095C  
**Length:** 12 9/32 (311.9)  
**Width:** 10 (254.0)  
**Height:** 2 (50.8)  
**A. Gskt:** [1] Included



**PA4419** Panel Air Element  
**Fits:** 2008-on Ford Focus  
**Replaces:** Ford 8S4Z-9601-A; Motorcraft FA1890  
**Length:** 3 3/4 (95.3) to 8 7/16 (214.3)  
**Width:** 2 13/16 (71.4)  
**to 7 3/4 (196.9)**  
**Height:** 2 3/16 (55.6)



**PA4413** Panel Air Element  
**Fits:** 2007-09 Hyundai Entourage; 2006-on Kia Sedona  
**Replaces:** Hyundai 28113-4D000; Kia 28113-4D000  
**Length:** 11 31/32 (304.0)  
**Width:** 6 9/32 (159.5)  
**Height:** 2 1/8 (54.0)  
**A. Gskt:** [1] Attached



**PA4421** Panel Air Element  
**Fits:** 2006-08 Suzuki Grand Vitara  
**Replaces:** Suzuki 13780-65J00; Wix 49085  
**Length:** 9 (228.6)  
**Width:** 5 1/8 (130.2)  
**to 7 (177.8)**  
**Height:** 1 15/16 (49.2)  
**A. Gskt:** [1] Attached



**PA4414** Panel Air Element  
**Notes:** OBSOLETE. Availability Limited to Dealer Stock.  
**Fits:** BMW Automotive  
**Replaces:** BMW 13717561235  
**Length:** 14 1/4 (362.0)  
**Width:** 5 3/32 (129.4)  
**Height:** 1 31/32 (50.0)



**PA4422** Panel Air Element  
**Fits:** Nissan Frontier; Suzuki Equator  
**Replaces:** Nissan 16546-EA000  
**Length:** 15 1/16 (382.6)  
**Width:** 7 9/32 (184.9)  
**Height:** 1 5/16 (33.3)



**PA4415** Cabin Air Element  
**Fits:** 2002-08 Mini Cooper, Cooper S  
**Replaces:** BMW 64311496710; WIX 24478, 24758  
**Length:** 18 5/8 (473.1)  
**Width:** 4 23/32 (119.9)  
**Height:** 1 3/8 (34.9)



**PA4423** Panel Air Element  
**Fits:** Saturn Ion  
**Replaces:** General Motors 15893542; Saturn 15800986  
**Length:** 11 15/16 (303.2)  
**Width:** 7 23/32 (196.1)  
**Height:** 1 5/16 (33.3)











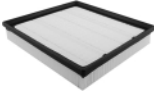
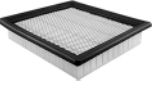
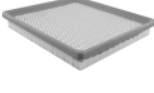

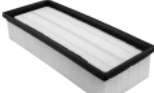

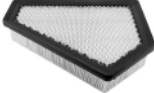
**PA4424** Cabin Air Element  
**Fits:** Subaru Automotive, Light-Duty Trucks  
**Replaces:** Subaru 72880-SA000, G3010-SA100; WIX 49359  
**Length:** 8 11/16 (220.7)  
**Width:** 7 7/8 (200.0)  
**Height:** 1 25/32 (45.2)

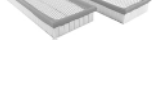

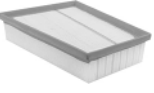
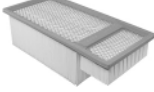
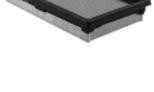
Measurements Are Shown In Inches And (Millimeters)

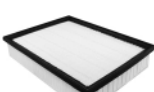
**WARNING:** These products can expose you to chemicals, including Diisononyl Phthalate, Carbon black extracts, Nickel, 1,3 Butadiene, Ethylene Oxide, Epichlorohydrin, which are known to the State of California to cause cancer, and Bisphenol, Ethylene Glycol, Ethylene Oxide, 1,3 Butadiene, Epichlorohydrin, which are known to the State of California to cause birth defects or other reproductive harm.

<p><b>PA4425</b></p> 	<p>Panel Air Element <b>Fits:</b> Ford Transit 2.2 TDCI Van (7/06-on) <b>Replaces:</b> Ford 1373667, 6C11-9601-CB <b>Length:</b> 10 3/4 (273.1) <b>Width:</b> 9 13/16 (249.2) <b>Height:</b> 1 27/32 (46.8)</p>	<p><b>PA4436</b></p> 	<p>Panel Air Element <b>Fits:</b> Chrysler Cirrus; Dodge Journey <b>Replaces:</b> Chrysler 4891916AA <b>Length:</b> 9 5/32 (232.6) <b>Width:</b> 8 15/32 (215.1) <b>Height:</b> 1 27/32 (46.8)</p>
<p><b>PA4426</b></p> 	<p>Panel Air Element <b>Fits:</b> Chrysler, Dodge, Volkswagen Automotive, Vans <b>Replaces:</b> Chrysler 4891713AA; Volkswagen 7B0129620 <b>Length:</b> 9 11/32 (237.3) <b>Width:</b> 8 7/16 (214.3) <b>Height:</b> 1 3/8 (34.9)</p>	<p><b>PA4437</b></p> 	<p>Panel Air Element <b>Fits:</b> 2007-on Jeep Wrangler <b>Replaces:</b> Chrysler 53034018AD, 53034018AE <b>Length:</b> 11 1/2 (292.1) <b>Width:</b> 8 3/16 (208.0) <b>Height:</b> 1 23/32 (43.7) <b>A. Gskt:</b> [1] Attached</p>
<p><b>PA4428</b></p> 	<p>Panel Air Element <b>Fits:</b> Audi, Volkswagen Automotive <b>Replaces:</b> Volkswagen 1K0129620D, 1K0129620G, 3C0129620B <b>Length:</b> 13 9/16 (344.5) <b>Width:</b> 5 11/32 (135.7) <b>Height:</b> 2 25/32 (70.6)</p>	<p><b>PA4438</b></p> 	<p>Panel Air Element <b>Fits:</b> Dodge Durango, Jeep Grand Cherokee <b>Replaces:</b> Chrysler 4861756AA <b>Length:</b> 9 5/8 (244.5) <b>Width:</b> 8 3/4 (222.3) <b>Height:</b> 2 3/16 (55.6)</p>
<p><b>PA4429</b></p> 	<p>Panel Air Element <b>Fits:</b> Cadillac CTS <b>Replaces:</b> General Motors 15875795; ACDelco A3096C <b>Length:</b> 11 3/8 (288.9) <b>Width:</b> 9 3/8 (238.1) <b>Height:</b> 2 3/32 (53.2)</p>	<p><b>PA4439</b></p> 	<p>Panel Air Element <b>Fits:</b> 2004-09 Cadillac SRX, 2005-on STS <b>Replaces:</b> General Motors 25735595, 25798271; ACDelco A2944C <b>Length:</b> 13 7/8 (352.4) <b>Width:</b> 9 (228.6) <b>Height:</b> 1 1/4 (31.8) <b>A. Gskt:</b> [1] Attached</p>
<p><b>PA4430</b></p> 	<p>Panel Air Element <b>Fits:</b> Ford Transit Connect <b>Replaces:</b> Ford 9T1Z-9601-A, 9T16-9601-AA; Motorcraft FA1900 <b>Length:</b> 2 11/16 (68.3) to 10 1/32 (254.8) <b>Width:</b> 1 1/32 (26.2) to 8 3/16 (208.0) <b>Height:</b> 2 13/32 (61.1)</p>	<p><b>PA4440 KIT</b></p> 	<p>Set of 2 Panel Air Elements <b>Notes:</b> Uses 2 filters per application. <b>Fits:</b> Mercedes-Benz Automotive <b>Replaces:</b> Mercedes-Benz 1120940004, 1120940604, 1120910004, 1130940004 <b>Each Filter:</b> <b>Length:</b> 13 29/32 (353.2) <b>Width:</b> 5 1/4 (133.4) <b>Height:</b> 1 3/4 (44.4)</p>
<p><b>PA4431</b></p> 	<p>Panel Air Element with Felt Pad <b>Fits:</b> Chevrolet Equinox, GMC Terrain <b>Replaces:</b> General Motors 25899727; ACDelco A3138C <b>Length:</b> 10 15/16 (277.8) <b>Width:</b> 8 27/32 (224.6) <b>Height:</b> 2 1/32 (51.6)</p>	<p><b>PA4441</b></p> 	<p>Panel Air Element <b>Fits:</b> 2007-12 Nissan Sentra <b>Replaces:</b> Nissan 16546-ET000 <b>Length:</b> 9 1/16 (230.2) <b>Width:</b> 7 7/16 (188.9) <b>Height:</b> 2 9/32 (57.9)</p>
<p><b>PA4433</b></p> 	<p>Panel Air Element <b>Fits:</b> Ford Super Duty F450, F550 Trucks with V8-406 (6.7L) FI Turbo Diesel Engine <b>Replaces:</b> Ford BC3Z-9601-A; Motorcraft FA1902 <b>Length:</b> 14 1/16 (357.2) <b>Width:</b> 6 11/16 (169.9) <b>Height:</b> 4 9/32 (108.7)</p>	<p><b>PA4442</b></p> 	<p>Panel Air Element <b>Fits:</b> Nissan Cube, Tiida, Versa <b>Replaces:</b> Nissan 16546-ED000 <b>Length:</b> 9 1/16 (230.2) <b>Width:</b> 5 5/16 (134.9) <b>Height:</b> 1 11/32 (34.1) <b>A. Gskt:</b> [1] Included</p>
<p><b>PA4434</b></p> 	<p>Panel Air Element <b>Fits:</b> Honda Pilot <b>Replaces:</b> Honda 17220-RN0-A00 <b>Length:</b> 11 27/32 (300.8) <b>Width:</b> 6 7/8 (174.6) <b>Height:</b> 1 27/32 (46.8) <b>A. Gskt:</b> [1] Included</p>	<p><b>PA4443</b></p> 	<p>Panel Air Element <b>Fits:</b> Infiniti G35, EX35, G37, QX50; Nissan 350Z, 370Z <b>Replaces:</b> Nissan 16546-JK20A <b>Length:</b> 7 1/8 (181.0) <b>Width:</b> 6 5/8 (168.3) <b>Height:</b> 1 5/16 (33.3)</p>
<p><b>PA4435</b></p> 	<p>Panel Air Element with Foam Pad <b>Fits:</b> Lexus GX460; Toyota 4Runner, FJ Cruiser <b>Replaces:</b> Toyota 17801-38050 <b>Length:</b> 12 19/32 (319.9) <b>Width:</b> 9 11/32 (237.3) <b>Height:</b> 2 7/16 (61.9)</p>	<p><b>PA4444</b></p> 	<p>Cabin Air Element with Pull Tab <b>Fits:</b> Nissan Altima, Murano, Maxima, Quest <b>Replaces:</b> Nissan 27277-JA000, 27277-JA00A, B7277-JN20A <b>Length:</b> 11 1/16 (281.0) <b>Width:</b> 10 9/16 (268.3) <b>Height:</b> 13/16 (20.6)</p>

Measurements Are Shown In Inches And (Millimeters)

 **WARNING:** These products can expose you to chemicals, including Diisononyl Phthalate, Carbon black extracts, Nickel, 1,3 Butadiene, Ethylene Oxide, Epichlorohydrin, which are known to the State of California to cause cancer, and Bisphenol, Ethylene Glycol, Ethylene Oxide, 1,3 Butadiene, Epichlorohydrin, which are known to the State of California to cause birth defects or other reproductive harm.

**RS4445**



Radial Seal Air Element

**Fits:** Ford Escape, Mazda Tribute, Mercury Mariner  
**Replaces:** Ford 9L8Z-9601-A; Mazda ZZC423603  
**O.D.:** 5 31/32 (151.6)  
**I.D.:** 3 1/32 (77.0) One End  
**Height:** 10 1/8 (257.2)

**PA4453**

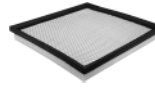

Panel Air Element with Foam Pad

**Fits:** Chevrolet Cruze; Buick Verano  
**Replaces:** General Motors 13272719  
**Length:** 10 15/32 (265.9)  
**Width:** 10 3/16 (258.8)  
**Height:** 1 15/32 (37.3)

**PA4446**

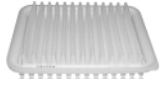

Panel Air Element

**Fits:** 2009-10 Pontiac Vibe; 2008-on Scion xD; 2006-on Toyota Yaris, 2009-on Corolla, Matrix  
**Replaces:** General Motors 88975792; Toyota 17801-0D060, 17801-0T030, 17801-21050  
**Length:** 9 7/16 (239.7)  
**Width:** 6 31/32 (177.0)  
**Height:** 2 3/32 (53.2)  
**A. Gskt:** [1] Attached

**PA4454**

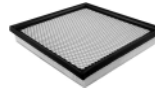

Panel Air Element with Foam Pad

**Fits:** Buick, Chevrolet Automotive  
**Replaces:** General Motors 13272720  
**Length:** 10 3/32 (256.4)  
**Width:** 9 13/16 (249.2)  
**Height:** 1 21/32 (42.1)

**PA4455**

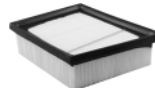

Panel Air Element

**Fits:** Ford Fiesta  
**Replaces:** Ford BE8Z-9601-A; Motorcraft FA1904  
**Length:** 7 23/32 (196.1)  
**Width:** 6 1/4 (158.8)  
**Height:** 2 5/16 (58.7)

**PA4447**

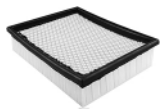

Panel Air Element

**Fits:** 2006-10 Hyundai Sonata  
**Replaces:** Hyundai 28113-3K010  
**Length:** 9 1/8 (231.8)  
**Width:** 7 15/32 (189.7)  
**Height:** 2 9/32 (57.9)

**PA4456**



Panel Air Element

**Fits:** Chrysler Town & Country, Dodge Grand Caravan; Ram Cargo Van; Volkswagen Routan  
**Replaces:** Chrysler 4861737AA  
**Length:** 12 3/4 (323.8)  
**Width:** 9 23/32 (246.9)  
**Height:** 1 25/32 (45.2)

**PA4448**



Panel Air Element

**Fits:** Lexus RX400h; Toyota Highlander  
**Replaces:** Toyota 17801-20050  
**Length:** 14 5/16 (363.5)  
**Width:** 6 3/16 (157.2)  
**Height:** 1 29/32 (48.4)  
**A. Gskt:** [1] Included

**PA4458**

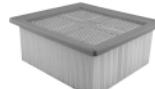

Panel Air Element

**Fits:** Dodge Pickups with 6-360 (5.9L) FI Turbo Diesel Engine  
**Replaces:** Chrysler 53034249AA  
**Length:** 10 15/16 (277.8)  
**Width:** 9 15/16 (252.4)  
**Height:** 4 13/32 (111.9)

**PA4449**

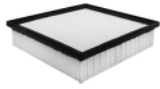

Panel Air Element

**Fits:** Lexus RX350; Toyota Sienna  
**Replaces:** Toyota 17801-0P050, 17801-31130  
**Length:** 9 9/16 (242.9)  
**Width:** 8 29/32 (226.2)  
**Height:** 2 1/8 (54.0)

**PA4460 KIT**



Set of 2 Cabin Air Elements

**Fits:** Jeep Wrangler  
**Replaces:** Chrysler 55111302AA  
**Each Filter:**  
**Length:** 6 1/16 (154.0)  
**Width:** 2 15/16 (74.6)  
**Height:** 25/32 (19.8)

**RS4450**



Radial Seal Air Element

**Fits:** Ford Escape, Focus; Lincoln MKC  
**Replaces:** Ford CV6Z-9601-A; Motorcraft FA1908  
**O.D.:** 6 3/16 (157.2)  
**I.D.:** 2 3/4 (69.9) One End  
**Height:** 8 5/16 (211.1)  
**I.Gskt:** [1] Included

**PA4461**



Cabin Air Element

**Fits:** Ford Explorer, Flex, Taurus, Lincoln MKS, MKT  
**Replaces:** Ford AE9Z19N619A; Motorcraft FP68  
**Length:** 8 15/16 (227.0)  
**Width:** 7 9/32 (184.9)  
**Height:** 1 1/32 (26.2)  
**A. Gskt:** [2] Included

**PA4451**



Panel Air Element

**Fits:** BMW X3, Z4  
**Replaces:** BMW 13717542545  
**Length:** 11 3/16 (284.2)  
**Width:** 8 15/16 (227.0)  
**Height:** 1 7/8 (47.6)

**PA4462**



Cabin Air Element

**Fits:** Dodge Durango, Jeep Grand Cherokee  
**Replaces:** Chrysler 68079487AA  
**Length:** 10 3/8 (263.5)  
**Width:** 9 19/32 (243.7)  
**Height:** 1 3/16 (30.2)

**PA4452**



Panel Air Element

**Fits:** Acura ILX, Honda Civic  
**Replaces:** Honda 17220R1AA01  
**Length:** 9 11/16 (246.1)  
**Width:** 7 5/16 (185.7)  
**Height:** 1 15/16 (49.2)  
**A. Gskt:** [1] Included

**PA4463**











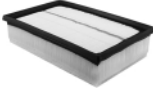

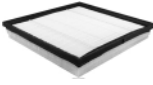

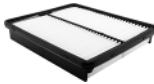
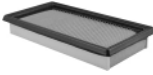

Panel Air Element

**Fits:** Acura ILX, NSX, Honda Civic  
**Replaces:** Honda 17220RX0A00  
**Length:** 10 7/32 (259.6)  
**Width:** 6 15/32 (164.3)  
**Height:** 2 13/32 (61.1)  
**A. Gskt:** [1] Included

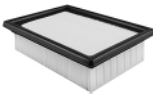
Measurements Are Shown In Inches And (Millimeters)

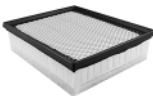
**WARNING:** These products can expose you to chemicals, including Diisononyl Phthalate, Carbon black extracts, Nickel, 1,3 Butadiene, Ethylene Oxide, Epichlorohydrin, which are known to the State of California to cause cancer, and Bisphenol, Ethylene Glycol, Ethylene Oxide, 1,3 Butadiene, Epichlorohydrin, which are known to the State of California to cause birth defects or other reproductive harm.

<p><b>PA4464</b> Panel Air Element with Foam Pad  <b>Fits:</b> Chevrolet Impala with V6-217 (3.6L) Engine  <b>Replaces:</b> General Motors 20862288; ACDelco A3171C  <b>Length:</b> 11 13/16 (300.0)  <b>Width:</b> 7 3/16 (182.6)  <b>Height:</b> 2 29/32 (73.8)</p> 	<p><b>PA4472</b> Air Element  <b>Fits:</b> Citroen, Fiat, Peugeot Vans  <b>Replaces:</b> Citroen 1444QV; Fiat 1349042080, 1359643080; Peugeot 1444QT  <b>O.D.:</b> 6 5/8 (168.3)  <b>I.D.:</b> 3 13/16 (96.8) One End  <b>Height:</b> 11 15/16 (303.2)</p> 
<p><b>PA4465</b> Panel Air Element with Foam Pad  <b>Fits:</b> Cadillac SRX; Saab 9-4X  <b>Replaces:</b> General Motors 15913344, 20897358; ACDelco A3139C, A3147C  <b>Length:</b> 10 7/16 (265.1)  <b>Width:</b> 10 13/32 (264.3)  <b>Height:</b> 1 23/32 (43.7)</p> 	<p><b>PA4473</b> Panel Air Element  <b>Fits:</b> Dodge Dart  <b>Replaces:</b> Chrysler 4627127AB  <b>Length:</b> 7 23/32 (196.1)  <b>Width:</b> 7 15/32 (189.7)  <b>Height:</b> 2 5/16 (58.7)</p> 
<p><b>PA4466</b> Panel Air Element with Foam Pad  <b>Fits:</b> Chevrolet Silverado, GMC Sierra Light-Duty Trucks with V8-400 (6.6L) Turbo Diesel Engine  <b>Replaces:</b> General Motors 25945271; ACDelco A3141C  <b>Length:</b> 13 (330.2)  <b>Width:</b> 9 1/2 (241.3)  <b>Height:</b> 2 29/32 (73.8)</p> 	<p><b>PA4474</b> Cabin Air Element  <b>Fits:</b> Ford Focus, C-Max, Escape, Transit Connect; Lincoln MKC  <b>Replaces:</b> Motorcraft FP70  <b>Length:</b> 9 27/32 (250.0)  <b>Width:</b> 8 (203.2)  <b>Height:</b> 1 13/32 (35.7)  <b>A. Gskt:</b> [2] Included</p> 
<p><b>PA4467</b> Panel Air Element with Foam Pad  <b>Fits:</b> Nissan Interstar 2.2 DCI, Interstar 2.5 DCI Vans; Opel Movano II 2.2 CDTI, Movano II 2.5 CDTI Vans; Renault Master III 2.2 DCI, Master III 2.5 DCI, Master III 3.0 DCI Vans  <b>Replaces:</b> Nissan 1654600QAD; Opel 4405238, 4416481; Renault 8200259359, 8200505566  <b>Length:</b> 11 9/32 (286.5)  <b>Width:</b> 9 13/16 (249.2)  <b>Height:</b> 2 23/32 (69.1)</p> 	<p><b>PA4475</b> Cabin Air Element  <b>Fits:</b> Ford Fusion, Lincoln MKZ  <b>Replaces:</b> Motorcraft FP71  <b>Length:</b> 10 15/16 (277.8)  <b>Width:</b> 8 13/16 (223.8)  <b>Height:</b> 3/4 (19.0)</p> 
<p><b>PA4468</b> Panel Air Element  <b>Fits:</b> Honda CR-V with 4-2354cc (2.4L) Engine  <b>Replaces:</b> Honda 17220R5AA00  <b>Length:</b> 10 1/8 (257.2)  <b>Width:</b> 7 3/4 (196.9)  <b>Height:</b> 1 11/16 (42.9)  <b>A. Gskt:</b> [1] Included</p> 	<p><b>PA4476</b> Panel Air Element  <b>Fits:</b> Hyundai Azera, Sonata; Kia Optima, Sorento  <b>Replaces:</b> Kia 281132P100; Knecht LX2957; Mahle LX2957  <b>Length:</b> 10 29/32 (277.0)  <b>Width:</b> 8 31/32 (227.8)  <b>Height:</b> 1 5/8 (41.3)  <b>A. Gskt:</b> [1] Included</p> 
<p><b>PA4469</b> Panel Air Element  <b>Fits:</b> Nissan Versa with 4-1598cc (1.6L) Engine  <b>Replaces:</b> Nissan 165461HK0A  <b>Length:</b> 9 1/8 (231.8)  <b>Width:</b> 4 9/16 (115.9)  <b>Height:</b> 1 11/32 (34.1)</p> 	<p><b>PA4477</b> Panel Air Element  <b>Fits:</b> Honda CR-V  <b>Replaces:</b> Honda 17220REZA00  <b>Length:</b> 10 13/32 (264.3)  <b>Width:</b> 7 1/2 (190.5)  <b>Height:</b> 2 3/32 (53.2)  <b>A. Gskt:</b> [1] Included</p> 
<p><b>PA4470</b> Panel Air Element  <b>Fits:</b> Ford Escape, Transit Connect  <b>Replaces:</b> Ford CJ5Z-9601-A; Motorcraft FA1910  <b>Length:</b> 8 5/32 (207.2)  <b>Width:</b> 6 3/32 (154.8)  <b>Height:</b> 2 3/16 (55.6)</p> 	<p><b>PA4478</b> Panel Air Element  <b>Fits:</b> Chrysler 300, Dodge Challenger, Charger  <b>Replaces:</b> Chrysler 4861746AA  <b>Length:</b> 14 1/4 (362.0)  <b>Width:</b> 9 1/8 (231.8)  <b>Height:</b> 1 15/32 (37.3)</p> 
<p><b>PA4471</b> Panel Air Element with Foam Pad  <b>Fits:</b> Ford Fusion; Lincoln MKZ  <b>Replaces:</b> Ford DS7Z-9601-A; Motorcraft FA1912, FA1912A  <b>Length:</b> 9 23/32 (246.9)  <b>Width:</b> 7 29/32 (200.8)  <b>Height:</b> 1 29/32 (48.4)</p> 	<p><b>PA4479</b> Panel Air Element  <b>Fits:</b> Hyundai Accent, Veloster; Kia Rio, Soul  <b>Replaces:</b> Hyundai 281131R100  <b>Length:</b> 10 5/32 (258.0)  <b>Width:</b> 5 3/4 (146.0)  <b>Height:</b> 1 7/8 (47.6)  <b>A. Gskt:</b> [1] Included</p> 

Measurements Are Shown In Inches And (Millimeters)

**WARNING:** These products can expose you to chemicals, including Diisononyl Phthalate, Carbon black extracts, Nickel, 1,3 Butadiene, Ethylene Oxide, Epichlorohydrin, which are known to the State of California to cause cancer, and Bisphenol, Ethylene Glycol, Ethylene Oxide, 1,3 Butadiene, Epichlorohydrin, which are known to the State of California to cause birth defects or other reproductive harm.

**PA4480** Panel Air Element  
**Fits:** Hyundai Elantra; Kia Forte  
**Replaces:** Hyundai 281133X000  
**Length:** 10 5/32 (258.0)  
**Width:** 6 13/32 (162.7)  
**Height:** 2 1/16 (52.4)  
**A. Gskt:** [1] Included



**PA4481** Panel Air Element  
**Fits:** Hyundai Santa Fe; Kia Sorento  
**Replaces:** Hyundai 281133-2W100  
**Length:** 11 27/32 (300.8)  
**Width:** 9 (228.6)  
**Height:** 1 15/32 (37.3)  
**A. Gskt:** [1] Included

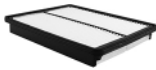

**PA4483** Panel Air Element  
**Fits:** Jeep Grand Cherokee  
**Replaces:** Chrysler 4861688AA  
**Length:** 8 11/16 (220.7)  
**Width:** 8 9/32 (210.3)  
**Height:** 1 15/16 (49.2)



**PA4484** Panel Air Element  
**Fits:** Jeep Cherokee  
**Replaces:** Chrysler 52022378AA  
**Length:** 10 19/32 (269.1)  
**Width:** 7 9/32 (184.9)  
**Height:** 1 21/32 (42.1)



**PA4485** Panel Air Element  
**Contains:** Flame Retardant Media  
**Fits:** Chevrolet Malibu, Impala  
**Replaces:** General Motors 20972654  
**Length:** 11 3/16 (284.2)  
**Width:** 9 15/16 (252.4)  
**Height:** 1 9/16 (39.7)  
**Related To:** PA4487 (with Foam Pad)

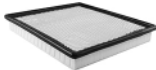

**PA4486** Cabin Air Element  
**Fits:** General Motors Light-Duty Trucks  
**Replaces:** General Motors 22808781  
**Length:** 9 3/4 (247.7)  
**Width:** 9 5/32 (232.6)  
**Height:** 1 3/16 (30.2)



**PA4487** Panel Air Element with Foam Pad  
**Contains:** Flame Retardant Media  
**Fits:** Buick Regal; Cadillac XTS; Chevrolet Malibu  
**Replaces:** General Motors 20972655  
**Length:** 11 3/16 (284.2)  
**Width:** 9 15/16 (252.4)  
**Height:** 1 11/16 (42.9)  
**Related To:** PA4485 (without Foam Pad)

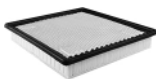

**PA4488** Cabin Air Element  
**Fits:** Dodge, Freightliner, Mercedes-Benz Sprinter Light-Duty Trucks  
**Replaces:** Mercedes-Benz 9068300218, A9068300218; Donaldson P787452  
**Length:** 13 31/32 (354.8)  
**Width:** 9 7/32 (234.2)  
**Height:** 1 3/8 (34.9)  
**A. Gskt:** [1] Attached  
**Related To:** PA4336 (Charcoal Media Version)



**PA4489** Cabin Air Element  
**Fits:** Sprinter Vans  
**Replaces:** Mercedes-Benz 8303318, 9018300018, A00083603318, A901830018  
**Length:** 14 9/16 (369.9)  
**Width:** 6 7/16 (163.5)  
**Height:** 31/32 (24.6)  
**A. Gskt:** [1] Attached  
**Related To:** PA4409 (Charcoal Media Version)



**PA4548** Inner Air Element  
**Fits Inside:** PA3650  
**Fits:** Komatsu Excavators  
**Replaces:** Komatsu 600-181-6360  
**O.D.:** 3 5/32 (80.2)  
**I.D.:** 5/8 (15.9) & 2 5/32 (54.8)  
**Height:** 9 1/32 (229.4)  
**A. Gskt:** [1] Attached  
**F. Gskt:** [1] Included



**RS4549** Radial Seal Inner Air Element  
**Fits Inside:** RS3714  
**Fits:** M.A.N. Trucks  
**Replaces:** M.A.N. 81.08304.0084; Donaldson P778453  
**O.D.:** 6 7/8 (174.6)  
**I.D.:** 6 7/16 (163.5) One End  
**Height:** 18 1/2 (469.9)



**PA4551** Oval Air Element with Foam Wrap  
**Fits:** Honda GX110 Engine  
**Replaces:** Honda 17201-ZE0-822, 17210-ZE0-505  
**O.D.:** 2 7/8 (73.0) to 4 (101.6)  
**I.D.:** 1/4 (6.4) & 1 5/16 (33.3)  
**Height:** 2 1/16 (52.4)  
**A. Gskt:** [1] Metal Washer  
**Grommets:** [1] Attached



**PA4552** Oval Air Element with Foam Wrap  
**Fits:** Honda GX240, GX270 Engines  
**Replaces:** Honda 17210-ZE2-505, 17210-ZE2-822  
**O.D.:** 3 1/2 (88.9) to 3 31/32 (100.8)  
**I.D.:** 1 1/2 (38.1) & 1 5/8 (41.3)  
**Height:** 3 3/32 (78.6)  
**A. Gskt:** [1] Metal Washer  
**Grommets:** [1] Attached



**PA4553** Oval Air Element with Foam Wrap  
**Notes:** Replacement foam wrap is PA4187.  
**Fits:** John Deere Garden Tractors, Transporters  
**Replaces:** John Deere M117254  
**O.D.:** 4 21/32 (118.3) to 7 7/8 (200.0)  
**I.D.:** 2 21/32 (67.5) & 5 7/8 (149.2)  
**Height:** 2 9/16 (65.1)



**PA4554** Panel Air Element  
**Replaces:** Elgin 7070010  
**Length:** 13 15/16 (354.0)  
**Width:** 6 (152.4)  
**Height:** 2 9/16 (65.1)  
**A. Gskt:** [1] Attached



Measurements Are Shown In Inches And (Millimeters)

**WARNING:** These products can expose you to chemicals, including Diisononyl Phthalate, Carbon black extracts, Nickel, 1,3 Butadiene, Ethylene Oxide, Epichlorohydrin, which are known to the State of California to cause cancer, and Bisphenol, Ethylene Glycol, Ethylene Oxide, 1,3 Butadiene, Epichlorohydrin, which are known to the State of California to cause birth defects or other reproductive harm.

**PA4555** Panel Air Element  
**Fits:** Briggs & Stratton Engines  
**Replaces:** Briggs & Stratton 397795; GMC 25177524  
**Length:** 6 5/16 (160.3)  
**Width:** 4 7/16 (112.7)  
**Height:** 13/16 (20.6)

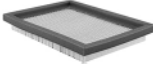

**PA4556** Air Element  
**Notes:** OBSOLETE. Availability Limited to Dealer Stock.  
**Fits:** Briggs & Stratton Engines  
**Replaces:** Briggs & Stratton 392308  
**O.D.:** 2 3/4 (69.9)  
**I.D.:** 1 1/4 (31.8)  
**Height:** 2 25/32 (70.6)



**PA4557** Air Element  
**Fits:** Onan RV Generators  
**Replaces:** Onan 140-1891, 140-2379  
**O.D.:** 4 (101.6)  
**I.D.:** 2 3/4 (69.9)  
**Height:** 3 5/32 (80.2)



**PA4559** Foam Cab Air Element  
**Fits:** Volvo Loaders  
**Replaces:** Volvo 11007847  
**Length:** 18 5/32 (461.2)  
**Width:** 15 9/16 (395.3)  
**Height:** 19/32 (15.1)



**PA4560** Cab Air Element  
**Fits:** Volvo Construction Equipment  
**Replaces:** Volvo 11007848  
**Length:** 15 19/32 (396.1)  
**Width:** 12 27/32 (326.2)  
**Height:** 2 3/4 (69.9)



**RS4561** Radial Seal Air Element  
**Fits:** Caterpillar Engines  
**Replaces:** Caterpillar 289-2348  
**O.D.:** 10 31/32 (278.6)  
**I.D.:** 5 13/16 (147.6) One End  
**Height:** 16 7/16 (417.5)



**RS4562** Radial Seal Air Element  
**Fits:** DAF Trucks  
**Replaces:** DAF 1346885, 1385791  
**O.D.:** 9 11/16 (246.1)  
**I.D.:** 4 29/32 (124.6) One End  
**Height:** 17 7/16 (442.9)



**RS4563** Conical-Shaped Radial Seal Air Element  
**Fits:** Freightliner Trucks  
**Replaces:** Fleetguard AF25693; Nelson 870710A, 870710N  
**O.D.:** 7 3/4 (196.9)  
to 10 13/32 (264.3)  
**I.D.:** 3 1/8 (79.4) & 5 27/32 (148.4)  
**Height:** 22 3/16 (563.6)  
**F. Gskt:** [1] Included



**RS4564** Radial Seal Air Element  
**Notes:** Uses 2 filters per application. Inside-Out Flow Direction  
**Contains:** 3 3/4 Inch Dust Ejector Hole  
**Fits:** Peterbilt Trucks  
**Replaces:** Donaldson P542753  
**O.D.:** 11 3/8 (288.9)  
**I.D.:** 6 13/16 (173.0) One End  
**Height:** 21 11/32 (542.1)  
**F. Gskt:** G501-AF



**PA4566** Air Element  
**Fits:** Caterpillar Equipment  
**Replaces:** Caterpillar 8T6288; Ingersoll-Rand 39322201  
**O.D.:** 12 3/4 (323.8)  
Boot Gasket 13 11/32 (338.9)  
**I.D.:** 15/16 (23.8) & 8 11/32 (211.9)  
**Height:** 24 1/2 (622.3)  
**A. Gskt:** [2] Attached  
**F. Gskt:** [1] Washer



**PA4567** Cab Air Element  
**Fits:** John Deere Equipment  
**Replaces:** John Deere AT141209; Nelson 87387N  
**Length:** 14 5/8 (371.5)  
**Width:** 4 7/8 (123.8)  
**Height:** 2 9/16 (65.1)  
**A. Gskt:** [1] Attached

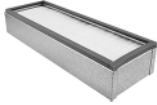

**PA4570** Set of 2 Cab Air Elements  
**Notes:** Uses 2 filters per application.  
**Fits:** John Deere Tractors  
**Replaces:** John Deere AL112954, AL112955, AL71259  
**Each Filter:**  
**Length:** 8 (203.2)  
**Width:** 4 1/4 (108.0)  
to 6 1/4 (158.8)  
**Height:** 1 7/16 (36.5)  
**A. Gskt:** [1] Attached Each Element



**PA4571** Air Element with Lid  
**Notes:** Lid contains [6] bolt holes.  
**Replaces:** Cummins 3630778; Fleetguard AF25278  
**O.D.:** 13 13/16 (350.8)  
Lid 16 1/4 (412.8)  
**I.D.:** 9 1/2 (241.3) One End  
**Height:** 18 1/2 (469.9)  
**A. Gskt:** [1] Attached



Measurements Are Shown In Inches And (Millimeters)

**WARNING:** These products can expose you to chemicals, including Diisononyl Phthalate, Carbon black extracts, Nickel, 1,3 Butadiene, Ethylene Oxide, Epichlorohydrin, which are known to the State of California to cause cancer, and Bisphenol, Ethylene Glycol, Ethylene Oxide, 1,3 Butadiene, Epichlorohydrin, which are known to the State of California to cause birth defects or other reproductive harm.

**RS4572** Radial Seal Air Element  
**Fits:** Peterbilt Trucks  
**Replaces:** Donaldson P544243  
**O.D.:** 12 3/32 (307.2)  
**I.D.:** 7 3/8 (187.3) One End  
**Height:** 21 11/16 (550.9)  
**F. Gskt:** [1] Included



**RS4579** Radial Seal Outer Air Element  
**Fits:** Atlas Copco Drilling Rigs;  
 Case-International, New Holland Tractors; Volvo  
 Dump Trucks  
**Use With:** RS4580  
**Replaces:** Volvo 11110217; Donaldson  
 P781398  
**O.D.:** 14 7/32 (361.2)  
**I.D.:** 8 15/16 (227.0) One End  
**Height:** 19 3/8 (492.1)



**PA4573** Outer Air Element with Lift Bars  
**Fits:** New Holland Equipment  
**Use With:** PA4574  
**Replaces:** New Holland 86512479  
**O.D.:** 11 1/2 (292.1)  
**I.D.:** 13/32 (10.3) & 7 1/4 (184.2)  
**Height:** 20 3/4 (527.1)  
**A. Gskt:** [1] Attached  
**F. Gskt:** [1] Included



**RS4580** Radial Seal Inner Air Element  
**Fits Inside:** RS4579  
**Fits:** Atlas Copco Drilling Rigs;  
 Case-International, New Holland Tractors; Volvo  
 Dump Trucks  
**Replaces:** Volvo 11110218; Donaldson  
 P781399  
**O.D.:** 9 3/32 (231.0)  
**I.D.:** 6 29/32 (175.4) One End  
**Height:** 19 3/32 (485.0)



**PA4574** Inner Air Element  
**Fits Inside:** PA4573  
**Fits:** New Holland Equipment  
**Replaces:** New Holland 86512478  
**O.D.:** 6 7/8 (174.6)  
**I.D.:** 5/8 (15.9) & 5 13/32 (137.3)  
**Height:** 19 1/8 (485.8)  
**A. Gskt:** [1] Attached  
**F. Gskt:** [1] Included



**PA4581** Outer Air Element  
**Fits:** Komatsu Dozers, Graders  
**Use With:** PA4582  
**Replaces:** Komatsu 600-300-0110  
**O.D.:** 8 1/2 (215.9)  
**I.D.:** 4 5/32 (105.6) One End  
**Height:** 16 3/4 (425.5)  
**A. Gskt:** [1] Attached  
**Related To:** PA3609 (with Bolt Hole in Closed  
 End)



**RS4576** Radial Seal Outer Air Element  
**Fits:** Case Tractors  
**Use With:** RS4577  
**Replaces:** Case 294292A1  
**O.D.:** 13 7/16 (341.3)  
**I.D.:** 7 29/32 (200.8) One End  
**Height:** 11 9/16 (293.7)



**PA4582** Inner Air Element with 6 Bolts  
**Fits Inside:** PA4581  
**Fits:** Komatsu Dozers, Graders  
**Replaces:** Komatsu 600-300-0121,  
 6110-80-7300, 6610-80-7300  
**O.D.:** 4 5/32 (105.6)  
 Flange 6 11/16 (169.9)  
**I.D.:** 2 27/32 (72.2) One End  
**Height:** 16 7/16 (417.5)  
**A. Gskt:** [1] Attached



**RS4577** Radial Seal Inner Air Element  
**Fits Inside:** RS4576  
**Fits:** Case Tractors  
**Replaces:** Case 294293A1  
**O.D.:** 8 1/8 (206.4)  
**I.D.:** 6 1/8 (155.6) One End  
**Height:** 10 9/16 (268.3)



**PA4583-FN** Air Element with Fins  
**Fits:** Caterpillar Lift Trucks  
**Replaces:** Mitsubishi 91461-11500  
**O.D.:** 5 1/4 (133.4)  
 Fins 6 3/8 (161.9)  
**I.D.:** 2 1/32 (16.7) & 3 5/16 (84.1)  
**Height:** 11 3/8 (288.9)  
**A. Gskt:** [1] Attached  
**F. Gskt:** [1] Included



**RS4578** Radial Seal Air Element  
**Contains:** Flame Retardant Media  
**Fits:** Hyster Lift Trucks  
**Replaces:** Hyster 8500534  
**O.D.:** 5 13/32 (137.3)  
**I.D.:** 3 3/16 (81.0) One End  
**Height:** 12 31/32 (329.4)  
**Related To:** RS3542 (Standard Media Version)



**PA4585** Air Element with Lid  
**Replaces:** Fleetguard AF1968  
**O.D.:** 10 5/8 (269.9)  
 Lid 11 11/16 (296.9)  
**I.D.:** 6 23/32 (170.7) One End  
**Height:** 22 15/32 (570.7)  
**A. Gskt:** [1] Attached



Measurements Are Shown In Inches And (Millimeters)

**WARNING:** These products can expose you to chemicals, including Diisononyl Phthalate, Carbon black extracts, Nickel, 1,3 Butadiene, Ethylene Oxide, Epichlorohydrin, which are known to the State of California to cause cancer, and Bisphenol, Ethylene Glycol, Ethylene Oxide, 1,3 Butadiene, Epichlorohydrin, which are known to the State of California to cause birth defects or other reproductive harm.

**PA4592** Cab Air Element  
**Fits:** Caterpillar Equipment  
**Replaces:** Caterpillar 7R2258  
**Length:** 17 (431.8)  
**Width:** 6 (152.4)  
**Height:** 2 3/16 (55.6)



**PA4593** Outer Air Element  
**Fits:** Komatsu Dozers  
**Use With:** PA4594  
**Replaces:** Komatsu 600-181-7210; Donaldson P181144  
**O.D.:** 7 1/16 (179.4)  
**I.D.:** 7/16 (11.1) & 3 15/16 (100.0)  
**Height:** 12 3/8 (314.3)  
**A. Gskt:** [1] Attached  
**Grommets:** [1] Attached



**PA4594** Inner Air Element  
**Fits Inside:** PA4593  
**Fits:** Komatsu Dozers  
**Replaces:** Komatsu 600-181-7310  
**O.D.:** 3 13/16 (96.8)  
**I.D.:** 5/8 (15.9) & 2 3/8 (60.3)  
**Height:** 11 7/16 (290.5)  
**A. Gskt:** [1] Attached  
**F. Gskt:** [1] Included



**RS4595** Radial Seal Outer Air Element  
**Fits:** Fleetguard/Nelson AH19087, AH19088, AH19089, AH19090 Housings  
**Use With:** RS3747  
**Replaces:** Nelson 87797N; Fleetguard AF25553  
**O.D.:** 5 1/32 (127.8)  
**I.D.:** 3 5/32 (80.2) One End  
**Height:** 12 7/16 (315.9)



**RS4597** Radial Seal Cab Air Element  
**Fits:** John Deere Loaders  
**Replaces:** John Deere T168220  
**O.D.:** 6 1/2 (165.1)  
**I.D.:** 3 9/16 (90.5) One End  
**Height:** 11 19/32 (294.5)



**RS4598** Radial Seal Outer Air Element  
**Fits:** New Holland Tractors  
**Use With:** RS4599  
**Replaces:** New Holland 82983412  
**O.D.:** 6 1/2 (165.1)  
**I.D.:** 3 11/16 (93.7) One End  
**Height:** 14 5/8 (371.5)



**RS4599** Radial Seal Inner Air Element  
**Fits Inside:** RS4598  
**Fits:** New Holland Tractors  
**Replaces:** New Holland 82983413  
**O.D.:** 3 29/32 (99.2)  
**I.D.:** 3 1/16 (77.8) One End  
**Height:** 14 1/32 (356.4)



**PA4600** Panel Air Element  
**Fits:** Dodge, Freightliner, Mercedes-Benz, Volkswagen Trucks, Vans  
**Replaces:** Mercedes-Benz 30947504, 30948204, 40942604, A0030947504; Volkswagen 2D0129620  
**Length:** 12 13/32 (315.1)  
**Width:** 10 7/8 (276.2)  
**Height:** 2 25/32 (70.6)  
**A. Gskt:** [1] Attached

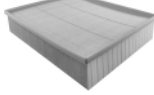

**PA4601** Panel Air Element with Foam Pad  
**Fits:** Dodge, Freightliner, Mercedes-Benz, Volkswagen Trucks, Vans  
**Replaces:** Mercedes-Benz 30948304, A0030948304; Volkswagen 2D0129620A  
**Length:** 12 13/32 (315.1)  
**Width:** 10 7/8 (276.2)  
**Height:** 3 3/16 (81.0)

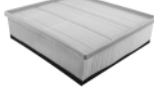

**PA4602** Outer Air Element  
**Fits:** Hitachi Excavators  
**Use With:** PA4603  
**Replaces:** Hitachi 4285623  
**O.D.:** 6 3/32 (154.8)  
 Flange 7 7/8 (200.0)  
**I.D.:** 21/32 (16.7) & 4 3/32 (104.0)  
**Height:** 12 7/8 (327.0)  
**A. Gskt:** [1] Attached  
**F. Gskt:** [1] Included



**PA4603** Inner Air Element  
**Fits Inside:** PA4602  
**Fits:** Hitachi Excavators  
**Replaces:** Hitachi 4247975  
**O.D.:** 3 7/8 (98.4)  
**I.D.:** 5/8 (15.9) & 3 3/16 (81.0)  
**Height:** 11 19/32 (294.5)  
**A. Gskt:** [1] Attached  
**F. Gskt:** [1] Washer



**PA4604-FN** Air Element with Fins  
**Replaces:** Nelson 70757H; Fleetguard AF25543K  
**O.D.:** 4 3/32 (104.0)  
 Fins 5 1/16 (128.6)  
**I.D.:** 21/32 (16.7) & 2 15/32 (62.7)  
**Height:** 10 3/8 (263.5)  
**A. Gskt:** [1] Attached  
**F. Gskt:** [1] Included





Measurements Are Shown In Inches And (Millimeters)

**WARNING:** These products can expose you to chemicals, including Diisononyl Phthalate, Carbon black extracts, Nickel, 1,3 Butadiene, Ethylene Oxide, Epichlorohydrin, which are known to the State of California to cause cancer, and Bisphenol, Ethylene Glycol, Ethylene Oxide, 1,3 Butadiene, Epichlorohydrin, which are known to the State of California to cause birth defects or other reproductive harm.





**PA4605** Air Element  
  
**Replaces:** Fleetguard AF25409M  
**O.D.:** 13 13/16 (350.8)  
**I.D.:** 15/16 (23.8) & 9 1/2 (241.3)  
**Height:** 12 21/32 (321.5)  
**A. Gskt:** [2] Attached  
**F. Gskt:** [1] Included

**PA4612** Cab Air Element with Pull Tabs  
  
**Fits:** DAF XF Trucks  
**Replaces:** DAF 1322255; Fleetguard AF25840  
**Length:** 12 21/32 (321.5)  
**Width:** 9 1/4 (235.0)  
**Height:** 15/16 (23.8)  
**A. Gskt:** [1] Attached

**PA4606** Air Element with Bail Handle  
  
**Replaces:** Ingersoll-Rand 39333372  
**O.D.:** 13 13/16 (350.8)  
 Boot Gasket 14 1/2 (368.3)  
**I.D.:** 15/16 (23.8) & 9 1/2 (241.3)  
**Height:** 27 5/16 (693.7)  
**A. Gskt:** [2] Attached  
**F. Gskt:** [1] Included

**RS4613** Radial Seal Air Element  
  
**Notes:** Inside-Out Flow Direction  
**Contains:** 4 5/8 Inch Dust Ejector Hole  
**Replaces:** Mack 57MD318  
**O.D.:** 12 3/32 (307.2)  
**I.D.:** 7 3/8 (187.3) One End  
**Height:** 21 11/16 (550.9)  
**F. Gskt:** [1] Included

**PA4607** Inner Air Element  
  
**Notes:** OBSOLETE. Availability Limited to Dealer Stock.  
**Fits Inside:** PA4626  
**Fits:** Nissan Trucks  
**Replaces:** Nissan 16546-97002  
**O.D.:** 6 1/16 (154.0)  
**I.D.:** 21/32 (16.7) & 4 3/4 (120.7)  
**Height:** 15 29/32 (404.0)  
**A. Gskt:** [1] Attached

**PA4614** Outer Air Element  
  
**Fits:** J.C. Bamford Loaders  
**Use With:** PA3819  
**Replaces:** J.C. Bamford 32/909101  
**O.D.:** 6 1/4 (158.8)  
 Flange 6 7/8 (174.6)  
**I.D.:** 19/32 (15.1) & 2 25/32 (70.6)  
**Height:** 8 1/2 (215.9)  
**A. Gskt:** [1] Attached  
**F. Gskt:** [1] Included, [1] Wing Nut

**PA4608** Air Element  
  
**Fits:** Toyota Vans  
**Replaces:** Toyota 17801-64030  
**O.D.:** 5 3/16 (131.8)  
**I.D.:** 15/32 (11.9) & 2 17/32 (64.3)  
**Height:** 11 1/32 (280.2)  
**F. Gskt:** [1] Included

**PA4615** Air Element  
  
**Notes:** OBSOLETE. Availability Limited to Dealer Stock.  
**Replaces:** Toyota 23301-30205-71  
**O.D.:** 7 11/16 (195.3)  
**I.D.:** 3 5/16 (84.1)  
**Height:** 5 11/16 (144.5)

**PA4610 KIT** Set of 2 Outer Air Elements  
  
**Notes:** Contains 2 elements that stack.  
**Use With:** PA4611  
**Replaces:** Komatsu 66758-17021 and 66758-17231; Fleetguard AF25088 and AF25048  
**Each Element**  
**O.D.:** 9 21/32 (245.3)  
**I.D.:** 5 7/32 (132.6)  
**Height:** 8 27/32 (224.6)  
**A. Gskt:** [2] Attached to Element













**RS4616** Radial Seal Outer Air Element  
  
**Fits:** Terex Dump Trucks  
**Use With:** RS4617  
**Replaces:** Terex 15273424  
**O.D.:** 14 7/32 (361.2)  
**I.D.:** 8 15/16 (227.0) One End  
**Height:** 20 1/2 (520.7)

**PA4611** Inner Air Element  
  
**Fits Inside:** PA4610 KIT  
**Replaces:** Komatsu 67758-17031; Fleetguard AF25049  
**O.D.:** 5 1/16 (128.6)  
**I.D.:** 13/32 (10.3) & 3 13/16 (96.8)  
**Height:** 16 15/16 (430.2)  
**A. Gskt:** [1] Attached  
**F. Gskt:** [1] Included

**RS4617** Radial Seal Inner Air Element  
  
**Fits Inside:** RS4616  
**Fits:** Terex Dump Trucks  
**Replaces:** Terex 15243425  
**O.D.:** 9 3/32 (231.0)  
**I.D.:** 6 29/32 (175.4) One End  
**Height:** 20 11/32 (516.7)

Measurements Are Shown In Inches And (Millimeters)

 **WARNING:** These products can expose you to chemicals, including Diisononyl Phthalate, Carbon black extracts, Nickel, 1,3 Butadiene, Ethylene Oxide, Epichlorohydrin, which are known to the State of California to cause cancer, and Bisphenol, Ethylene Glycol, Ethylene Oxide, 1,3 Butadiene, Epichlorohydrin, which are known to the State of California to cause birth defects or other reproductive harm.

<p><b>RS4618</b></p> 	<p>Radial Seal Air Element  <b>Notes:</b> Inside-Out Flow Direction  <b>Contains:</b> Drainage hole in bottom.  <b>Fits:</b> Mack Trucks  <b>Replaces:</b> Mack 57MD317  <b>O.D.:</b> 11 3/8 (288.9)  <b>I.D.:</b> 5 13/16 (147.6) One End  <b>Height:</b> 20 13/32 (518.3)  <b>F. Gskt:</b> G501-AF</p>	<p><b>PA4624</b></p> 	<p>Outer Air Element  <b>Fits:</b> Kobelco Excavators  <b>Use With:</b> PA4625  <b>Replaces:</b> Kobelco LQ11PU0001S002  <b>O.D.:</b> 9 7/32 (234.2)  <b>I.D.:</b> 21/32 (16.7) &amp; 5 27/32 (148.4)  <b>Height:</b> 14 3/4 (374.7)  <b>A. Gskt:</b> [1] Attached  <b>F. Gskt:</b> [1] Included</p>
<p><b>PA4619</b></p> 	<p>Replacement for Ecolite Air Element in Disposable Housing  <b>Fits:</b> Onan Generators  <b>Replaces:</b> Donaldson C055003; Onan 1402680  <b>O.D.:</b> 5 1/2 (139.7)  <b>I.D.:</b> 1 3/4 (44.4) One End  <b>Height:</b> 5 3/8 (136.5)</p>	<p><b>PA4625</b></p> 	<p>Inner Air Element  <b>Fits Inside:</b> PA4624  <b>Fits:</b> Kobelco Excavators  <b>Replaces:</b> Kobelco LQ11PU0001S001  <b>O.D.:</b> 5 9/16 (141.3)  <b>I.D.:</b> 21/32 (16.7) &amp; 4 7/16 (112.7)  <b>Height:</b> 12 29/32 (327.8)  <b>A. Gskt:</b> [1] Attached  <b>F. Gskt:</b> G103-N</p>
<p><b>RS4620</b></p> 	<p>Radial Seal Outer Air Element  <b>Fits:</b> John Deere, Volvo Equipment  <b>Use With:</b> RS4621  <b>Replaces:</b> Volvo 11110175; Donaldson P778905  <b>O.D.:</b> 9 9/32 (235.7)  <b>I.D.:</b> 5 5/32 (131.0) One End  <b>Height:</b> 18 19/32 (472.3)</p>	<p><b>PA4626</b></p> 	<p>Outer Air Element  <b>Notes:</b> OBSOLETE. Availability Limited to Dealer Stock.  <b>Fits:</b> Nissan Trucks  <b>Use With:</b> PA4607  <b>Replaces:</b> Nissan 16546-97001  <b>O.D.:</b> 8 7/8 (225.4)  <b>I.D.:</b> 21/32 (16.7) &amp; 6 1/4 (158.8)  <b>Height:</b> 16 15/16 (430.2)  <b>A. Gskt:</b> [1] Attached  <b>F. Gskt:</b> [1] Included</p>
<p><b>RS4621</b></p> 	<p>Radial Seal Inner Air Element  <b>Fits Inside:</b> RS4620  <b>Fits:</b> John Deere, Volvo Equipment  <b>Replaces:</b> Volvo 11110176  <b>O.D.:</b> 5 1/4 (133.4)  <b>I.D.:</b> 3 3/4 (95.3) One End  <b>Height:</b> 17 7/8 (454.0)</p>	<p><b>PA4627</b></p> 	<p>Inner Air Element  <b>Fits Inside:</b> PA2797  <b>Replaces:</b> Volvo V1114450; Donaldson P521692  <b>O.D.:</b> 8 1/4 (209.6)  <b>I.D.:</b> 21/32 (16.7) &amp; 7 3/32 (180.2)  <b>Height:</b> 13 3/8 (339.7)  <b>A. Gskt:</b> [1] Attached  <b>F. Gskt:</b> [1] Included</p>
<p><b>RS4622</b></p> 	<p>Radial Seal Outer Air Element  <b>Fits:</b> John Deere Tractors  <b>Use With:</b> RS4623  <b>Replaces:</b> John Deere RE164839  <b>O.D.:</b> 12 31/32 (329.4)  <b>I.D.:</b> 6 13/16 (173.0) One End  <b>Height:</b> 11 11/16 (296.9)</p>	<p><b>PA4628</b></p> 	<p>Inner Air Element  <b>Fits Inside:</b> PA4656  <b>Fits:</b> Case Tractors  <b>Replaces:</b> Case A171254  <b>O.D.:</b> 4 3/32 (104.0)            Flange 4 27/32 (123.0)  <b>I.D.:</b> 21/32 (16.7) &amp; 3 5/8 (92.1)  <b>Height:</b> 13 19/32 (345.3)  <b>A. Gskt:</b> [1] Attached  <b>F. Gskt:</b> [1] Metal Washer</p>
<p><b>RS4623</b></p> 	<p>Radial Seal Inner Air Element  <b>Fits Inside:</b> RS4622  <b>Fits:</b> John Deere Tractors  <b>Replaces:</b> John Deere RE172447  <b>O.D.:</b> 6 7/8 (174.6)  <b>I.D.:</b> 5 5/16 (134.9) One End  <b>Height:</b> 10 7/8 (276.2)</p>	<p><b>RS4629</b></p> 	<p>Radial Seal Inner Air Element  <b>Fits Inside:</b> RS4989  <b>Fits:</b> John Deere Dump Trucks; New Holland Equipment  <b>Replaces:</b> John Deere TT221378; Donaldson P781102  <b>O.D.:</b> 9 3/32 (231.0)  <b>I.D.:</b> 7 (177.8) One End  <b>Height:</b> 24 5/8 (625.5)</p>

Measurements Are Shown In Inches And (Millimeters)

**WARNING:** These products can expose you to chemicals, including Diisononyl Phthalate, Carbon black extracts, Nickel, 1,3 Butadiene, Ethylene Oxide, Epichlorohydrin, which are known to the State of California to cause cancer, and Bisphenol, Ethylene Glycol, Ethylene Oxide, 1,3 Butadiene, Epichlorohydrin, which are known to the State of California to cause birth defects or other reproductive harm.

**PA4630** Replacement for Ecolite Air Element in Disposable Housing  
**Fits:** Motor Homes with Cummins Engine  
**Replaces:** Farr 99842-009; Donaldson P537455  
**O.D.:** 13 1/2 (342.9)  
**Inlet:** 7  
**Outlet:** 7 1/16  
**Height:** 16 27/32 (427.8)



**PA4635** Cab Air Element  
**Fits:** John Deere Dozers, Motor Graders  
**Replaces:** John Deere AT170037; Fleetguard AF25786  
**Length:** 14 3/4 (374.7)  
**Width:** 6 7/8 (174.6)  
**Height:** 2 7/16 (61.9)  
**A. Gskt:** [1] Attached



**PA4631-FN** Air Element with Fins  
**Fits:** Komatsu Equipment  
**Replaces:** Komatsu 8481-01-155  
**O.D.:** 6 3/32 (154.8)  
**Fins:** 7 3/4 (196.9)  
**I.D.:** 3/4 (19.0) & 3 15/32 (88.1)  
**Height:** 15 9/16 (395.3)  
**A. Gskt:** [1] Attached



**RS4636** Radial Seal Outer Air Element  
**Fits:** International Buses, Trucks  
**Use With:** RS4637  
**Replaces:** International 3532799-C1  
**O.D.:** 10 1/4 (260.3)  
**I.D.:** 7 15/16 (201.6) One End  
**Height:** 15 29/32 (404.0)



**PA4632** Outer Air Element  
**Contains:** Grease packet  
**Fits:** Kubota Excavators, Tractors  
**Use With:** PA4633  
**Replaces:** Kubota 6A10082630, 6A10082632  
**O.D.:** 3 17/32 (89.7)  
**I.D.:** 1 25/32 (45.2) One End  
**Height:** 6 15/16 (176.2)



**RS4637** Conical-Shaped Radial Seal Inner Air Element  
**Fits Inside:** RS4636  
**Fits:** International Buses, Trucks  
**Replaces:** International 3532800-C1; Fleetguard AF25732  
**O.D.:** 3 1/2 (88.9)  
**to:** 8 1/32 (204.0)  
**I.D.:** 5 1/32 (127.8) One End  
**Height:** 15 11/32 (389.7)



**PA4633** Inner Air Element  
**Fits Inside:** PA4632, RS5273  
**Fits:** Kubota Excavators, Tractors  
**Replaces:** Kubota 32721-58242  
**O.D.:** 1 21/32 (42.1)  
**I.D.:** 1 7/32 (31.0) One End  
**Height:** 6 7/16 (163.5)  
**I.Gskt:** [1] Included



**RS4638** Radial Seal Outer Air Element  
**Fits:** Komatsu Equipment; Scania Trucks  
**Use With:** RS3871, RS4639  
**Replaces:** Caterpillar 1421340; Komatsu 600-185-6110; Donaldson P777868; Fleetguard AF25627  
**O.D.:** 12 9/32 (311.9)  
**I.D.:** 6 31/32 (177.0) One End  
**Height:** 20 9/16 (522.3)  
**Related To:** RS3870 (with Blank Band), RS3870XP (Extreme Performance)



**RS4634** Radial Seal Air Element  
**Notes:** Features recessed closed end.  
**Fits:** Mack Trucks  
**Replaces:** Mack 57MD48M, 57MD320M; Donaldson EAF5114  
**O.D.:** 9 9/32 (235.7)  
**I.D.:** 5 25/32 (146.8) One End  
**Height:** 25 1/2 (647.7)  
**Related To:** RS4634XP (Extreme Performance Nano Version)



**RS4639** Radial Seal Inner Air Element  
**Contains:** Flame Retardant Media  
**Fits Inside:** RS3870, RS3870XP, RS4638  
**Fits:** Caterpillar Equipment  
**Replaces:** Caterpillar 142-1403  
**O.D.:** 7 1/16 (179.4)  
**I.D.:** 5 11/16 (144.5) One End  
**Height:** 19 31/32 (507.2)  
**Related To:** RS3871 (without Flame Retardant Media)



**RS4634XP** Extreme Performance Nano Air Element  
**Notes:** Features recessed closed end.  
**Fits:** Mack Trucks  
**Replaces:** Donaldson DBA5114  
**O.D.:** 9 9/32 (235.7)  
**I.D.:** 5 25/32 (146.8) One End  
**Height:** 25 1/2 (647.7)  
**Related To:** RS4634 (Standard Version)















**PA4640-FN** Air Element with Lid and Fins  
**Fits:** Caterpillar Excavators  
**Replaces:** Caterpillar 6I6434  
**O.D.:** 6 3/32 (154.8)  
**Lid:** 8 21/32 (219.9)  
**I.D.:** 21/32 (16.7) & 3 15/32 (88.1)  
**Height:** 12 1/2 (317.5)  
**A. Gskt:** [1] Attached  
**F. Gskt:** [1] Metal Washer

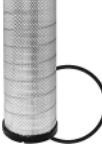
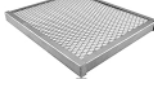

Measurements Are Shown In Inches And (Millimeters)

**WARNING:** These products can expose you to chemicals, including Diisononyl Phthalate, Carbon black extracts, Nickel, 1,3 Butadiene, Ethylene Oxide, Epichlorohydrin, which are known to the State of California to cause cancer, and Bisphenol, Ethylene Glycol, Ethylene Oxide, 1,3 Butadiene, Epichlorohydrin, which are known to the State of California to cause birth defects or other reproductive harm.

<p><b>PA4641</b> Air Element    <b>Replaces:</b> Toyota 17801-67070  <b>O.D.:</b> 9 15/32 (240.5)  <b>I.D.:</b> 4 11/32 (110.3)  <b>Height:</b> 4 3/4 (120.7)</p>	<p><b>PA4647</b> Air Element    <b>Replaces:</b> Toyota 17801-58010  <b>O.D.:</b> 7 3/4 (196.9)  <b>I.D.:</b> 3 1/4 (82.6)  <b>Height:</b> 5 3/4 (146.0)</p>
<p><b>RS4642</b> Radial Seal Outer Air Element    <b>Fits:</b> Volvo Trucks  <b>Use With:</b> RS4643  <b>Replaces:</b> Volvo 20411815; Donaldson P605551  <b>O.D.:</b> 13 (330.2)  <b>I.D.:</b> 9 1/8 (231.8) One End  <b>Height:</b> 19 1/2 (495.3)</p>	<p><b>PA4648</b> Air Element    <b>Replaces:</b> Toyota 17801-67060; Fleetguard AF25584M  <b>O.D.:</b> 8 5/8 (219.1)  <b>I.D.:</b> 4 9/32 (108.7) One End  <b>Height:</b> 5 11/16 (144.5)</p>
<p><b>RS4643</b> Radial Seal Inner Air Element    <b>Fits Inside:</b> RS4642  <b>Fits:</b> Volvo Trucks  <b>Replaces:</b> Volvo 20411816; Donaldson P605552  <b>O.D.:</b> 8 17/32 (216.7)  <b>I.D.:</b> 7 11/16 (195.3) One End  <b>Height:</b> 18 1/2 (469.9)</p>	<p><b>PA4649</b> Air Element    <b>Replaces:</b> Toyota 17801-54180  <b>O.D.:</b> 8 5/8 (219.1)  <b>I.D.:</b> 4 5/16 (109.5)  <b>Height:</b> 4 13/16 (122.2)</p>
<p><b>PA4644</b> Cab Air Element    <b>Fits:</b> John Deere Tractors  <b>Replaces:</b> John Deere RE67829  <b>O.D.:</b> 6 7/8 (174.6)  <b>I.D.:</b> 21/32 (16.7) &amp; 3 1/2 (88.9)  <b>Height:</b> 12 13/32 (315.1)  <b>A. Gskt:</b> [1] Attached  <b>F. Gskt:</b> G103-N</p>	<p><b>PA4650-FN</b> Outer Air Element with Fins    <b>Fits:</b> Samsung Excavators  <b>Use With:</b> PA1912  <b>Replaces:</b> Volvo 991240700  <b>O.D.:</b> 7 15/16 (201.6)                Fins 10 (254.0)  <b>I.D.:</b> 11/16 (17.5) &amp; 5 3/8 (136.5)  <b>Height:</b> 16 1/2 (419.1)  <b>A. Gskt:</b> [1] Attached  <b>F. Gskt:</b> [1] Metal Washer</p>
<p><b>PA4645-FN</b> Air Element with Fins    <b>Notes:</b> OBSOLETE. Availability Limited to Dealer Stock.  <b>Fits:</b> Komatsu Excavators  <b>Replaces:</b> Yanmar 129436-12900  <b>O.D.:</b> 4 1/8 (104.8)                Fins 5 1/8 (130.2)  <b>I.D.:</b> 21/32 (16.7) &amp; 2 1/2 (63.5)  <b>Height:</b> 10 3/4 (273.1)  <b>A. Gskt:</b> [1] Attached  <b>F. Gskt:</b> [1] Steel Washer</p>	<p><b>PA4651</b> Outer Air Element    <b>Fits:</b> Kubota Tractors  <b>Replaces:</b> Kubota 32751-96260  <b>O.D.:</b> 4 3/32 (104.0)                Flange 5 3/4 (146.0)  <b>I.D.:</b> 19/32 (15.1) &amp; 2 1/2 (63.5)  <b>Height:</b> 10 3/8 (263.5)  <b>A. Gskt:</b> [2] Attached</p>
<p><b>RS4646</b> Radial Seal Air Element    <b>Fits:</b> Freightliner Trucks  <b>Replaces:</b> Donaldson P537355  <b>O.D.:</b> 9 21/32 (245.3)  <b>I.D.:</b> 3 3/32 (78.6) &amp; 5 5/32 (131.0)  <b>Height:</b> 24 27/32 (631.0)  <b>F. Gskt:</b> [1] Included</p>	<p><b>PA4652</b> Cab Air Element    <b>Fits:</b> Caterpillar Equipment  <b>Replaces:</b> Caterpillar 6C9226; Donaldson P777576; Fleetguard AF25713  <b>Length:</b> 11 13/16 (300.0)  <b>Width:</b> 9 13/16 (249.2)  <b>Height:</b> 1 1/16 (27.0)</p>
	<p><b>PA4653</b> Replacement for Ecolite Air Filter in Disposable Housing    <b>Replaces:</b> Farr 400820-014  <b>O.D.:</b> 11 1/32 (280.2)  <b>Inlet:</b> 7  <b>Outlet:</b> 7  <b>Height:</b> 19 13/16 (503.2)</p>

Measurements Are Shown In Inches And (Millimeters)

**WARNING:** These products can expose you to chemicals, including Diisononyl Phthalate, Carbon black extracts, Nickel, 1,3 Butadiene, Ethylene Oxide, Epichlorohydrin, which are known to the State of California to cause cancer, and Bisphenol, Ethylene Glycol, Ethylene Oxide, 1,3 Butadiene, Epichlorohydrin, which are known to the State of California to cause birth defects or other reproductive harm.

**PA4654 KIT** Set of 2 Cab Air Elements  
**Notes:** Uses 2 filters per application.  
**Fits:** Case Tractors  
**Replaces:** Case 240883A1, 303748A1  
**Each Filter:**  
**Length:** 14 1/8 (358.8)  
**Width:** 7 1/8 (181.0)  
**Height:** 2 9/16 (65.1)  
**A. Gskt:** [1] Attached Each Filter



**PA4655** Replacement for Ecolite Air Filter in Disposable Housing  
**Fits:** Freightliner Buses, Trucks  
**Replaces:** Farr 114880-005 Series; Fleetguard AH19057  
**O.D.:** 8 3/32 (205.6)  
**Inlet:** 4  
**Outlet:** 6  
**Height:** 17 3/16 (436.6)



**PA4656** Air Element with Lift Bar  
**Fits:** Case Tractors  
**Use With:** PA4628  
**Replaces:** Case A171253  
**O.D.:** 7 15/16 (201.6)  
**I.D.:** 21/32 (16.7) & 4 5/8 (117.5)  
**Height:** 15 1/2 (393.7)  
**A. Gskt:** [1] Attached  
**F. Gskt:** [1] Included



**PA4657** Replacement for Ecolite Air Element in Disposable Housing  
**Fits:** Pierce Fire Trucks  
**Replaces:** Farr 99842-005  
**O.D.:** 13 1/2 (342.9)  
**Inlet:** 7  
**Outlet:** 7  
**Height:** 25 19/32 (650.1)



**PA4658** Inner Air Element  
**Notes:** OBSOLETE. Availability Limited to Dealer Stock.  
**Fits Inside:** PA4645-FN  
**Fits:** Komatsu Excavators  
**Replaces:** Yanmar 129436-12910  
**O.D.:** 2 9/16 (65.1)  
**I.D.:** 11/16 (17.5) & 2 1/16 (52.4)  
**Height:** 9 3/32 (231.0)



**PA4659** Cab Air Element  
**Notes:** Uses 2 filters per application.  
**Fits:** Caterpillar Loaders, Telehandlers  
**Replaces:** Caterpillar 116-7376; Donaldson P609445  
**Length:** 12 1/2 (317.5)  
**Width:** 7 1/16 (179.4)  
**Height:** 1 7/16 (36.5)



**PA4660** Air Element  
**Replaces:** Donaldson P527566  
**O.D.:** 13 7/8 (352.4)  
**I.D.:** 9 1/2 (241.3) One End  
**Height:** 13 1/2 (342.9)  
**A. Gskt:** [1] Attached  
**F. Gskt:** [1] Included



**PA4661** Wire Supported Cotton Polyester Industrial Air Element  
**Fits:** Industrial Applications  
**Replaces:** Airguard DP40-203; Farr 49880-002  
**Length:** 19 1/2 (495.3)  
**Width:** 19 1/2 (495.3)  
**Height:** 1 3/4 (44.4)

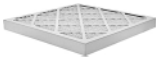

**PA4662** Wire Supported Cotton Polyester Industrial Air Element  
**Fits:** Industrial Applications  
**Replaces:** Airguard DP40-202; Farr 49880-004  
**Length:** 24 1/2 (622.3)  
**Width:** 15 1/2 (393.7)  
**Height:** 1 3/4 (44.4)

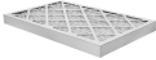

**PA4663** Wire Supported Cotton Polyester Industrial Air Element  
**Fits:** Industrial Applications  
**Replaces:** Airguard DP40-210; Farr 49880-006  
**Length:** 23 3/8 (593.7)  
**Width:** 11 3/8 (288.9)  
**Height:** 1 3/4 (44.4)



**PA4664** Wire Supported Cotton Polyester Industrial Air Element  
**Fits:** Industrial Applications  
**Replaces:** Airguard DP40-201; Farr 49880-001  
**Length:** 19 1/2 (495.3)  
**Width:** 15 1/2 (393.7)  
**Height:** 1 3/4 (44.4)



**PA4665-FN** Outer Air Element with Fins  
**Fits:** Kubota Excavators, Tractors  
**Use With:** PA4666  
**Replaces:** Kubota 6C040-94240  
**O.D.:** 3 5/16 (84.1)  
**Fins:** 4 1/4 (108.0)  
**I.D.:** 21/32 (16.7) & 2 1/8 (54.0)  
**Height:** 7 5/32 (181.8)  
**A. Gskt:** [1] Attached  
**F. Gskt:** [1] Included



**PA4666** Inner Air Element  
**Fits Inside:** PA4665-FN  
**Fits:** Kubota Excavators, Tractors  
**Replaces:** Kubota 6C040-94350; Fleetguard AF25702  
**O.D.:** 2 5/32 (54.8)  
**I.D.:** 5/8 (15.9) & 1 17/32 (38.9)  
**Height:** 6 1/4 (158.8)



**PA4668** Industrial Panel Air Element  
**Notes:** OBSOLETE. Availability Limited to Dealer Stock.  
**Fits:** Industrial Applications  
**Replaces:** Airguard DP40-411; Farr 59413-008; Fleetguard AF4987  
**Length:** 23 3/8 (593.7)  
**Width:** 10 3/8 (263.5)  
**Height:** 3 3/4 (95.3)



Measurements Are Shown In Inches And (Millimeters)

**WARNING:** These products can expose you to chemicals, including Diisononyl Phthalate, Carbon black extracts, Nickel, 1,3 Butadiene, Ethylene Oxide, Epichlorohydrin, which are known to the State of California to cause cancer, and Bisphenol, Ethylene Glycol, Ethylene Oxide, 1,3 Butadiene, Epichlorohydrin, which are known to the State of California to cause birth defects or other reproductive harm.

**PA4669**

Industrial Panel Air Element

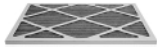

**Notes:** OBSOLETE. Availability Limited to Dealer Stock.  
**Fits:** Industrial Applications  
**Replaces:** Airguard DP40-102; Farr 119303-004; Fleetguard AF25233  
**Length:** 24 1/2 (622.3)  
**Width:** 15 1/2 (393.7)  
**Height:** 3/4 (19.0)

**RS4672**

Radial Seal Outer Air Element



**Fits:** Chevrolet, GMC, Isuzu Trucks  
**Use With:** RS4673  
**Replaces:** GMC 88937525; ACDelco A2031C  
**O.D.:** 7 7/8 (200.0)  
**I.D.:** 4 3/4 (120.7) One End  
**Height:** 18 1/2 (469.9)

**RS4673**

Radial Seal Inner Air Element



**Fits Inside:** RS4672  
**Fits:** Chevrolet, GMC, Isuzu Trucks  
**Replaces:** GMC 88937548; ACDelco A2035C  
**O.D.:** 4 7/16 (112.7)  
**I.D.:** 3 5/16 (84.1) One End  
**Height:** 17 23/32 (450.1)

**PA4674-FN**

Air Element with Lid and Fins



**Replaces:** Toyota 17807-23800-71  
**O.D.:** 5 5/16 (134.9)  
 Lid 7 13/16 (198.4)  
**I.D.:** 15/32 (11.9) & 3 5/16 (84.1)  
**Height:** 11 17/32 (292.9)  
**A. Gskt:** [2] Attached

**RS4676**

Radial Seal Outer Air Element



**Fits:** John Deere Dozers, Loaders  
**Use With:** RS4677  
**Replaces:** John Deere AT225338; Donaldson P600072  
**O.D.:** 9 9/32 (235.7)  
**I.D.:** 5 5/32 (131.0) One End  
**Height:** 17 (431.8)

**RS4677**

Radial Seal Inner Air Element



**Fits Inside:** RS4676  
**Fits:** John Deere Dozers, Loaders  
**Replaces:** John Deere AT225339; Donaldson P600076  
**O.D.:** 5 1/4 (133.4)  
**I.D.:** 3 3/4 (95.3) One End  
**Height:** 16 13/32 (416.7)

**RS4678**

Radial Seal Outer Air Element



**Fits:** Manitou Equipment  
**Use With:** RS4679  
**Replaces:** Manitou 563416; Fleetguard AF25795  
**O.D.:** 6 1/2 (165.1)  
**I.D.:** 3 9/16 (90.5) One End  
**Height:** 13 7/16 (341.3)

**RS4679**

Radial Seal Inner Air Element



**Fits Inside:** RS4678, RS5641  
**Fits:** Manitou Equipment  
**Replaces:** Manitou 563415; Fleetguard AF25794  
**O.D.:** 3 21/32 (92.9)  
**I.D.:** 2 7/8 (73.0) One End  
**Height:** 13 1/8 (333.4)

**RS4680**

Radial Seal Air Element



**Fits:** Lister Petter Engines  
**Replaces:** Lister 624-50610; Woodgate WGA1652  
**O.D.:** 5 23/32 (145.3)  
**I.D.:** 3 (76.2) One End  
**Height:** 12 5/8 (320.7)

**PA4681**

Cab Air Element



**Fits:** Volvo Trucks  
**Replaces:** Volvo 20435801; Donaldson P606555  
**Length:** 12 3/4 (323.8)  
**Width:** 11 9/16 (293.7)  
**Height:** 1 1/8 (28.6)

**PA4682**

Cab Air Element



**Fits:** Volvo Trucks  
**Replaces:** Volvo 3948712  
**Length:** 13 7/16 (341.3)  
**Width:** 8 3/8 (212.7)  
**Height:** 25/32 (19.8)

**PA4683**

Outer Air Element with Lift Bar



**Fits:** New Holland Tractors  
**Use With:** PA3492  
**Replaces:** New Holland 82011402, 82027153  
**O.D.:** 7 3/16 (182.6)  
 Flange 8 21/32 (219.9)  
**I.D.:** 15/32 (11.9) & 3 27/32 (97.6)  
**Height:** 13 13/32 (340.5)  
**A. Gskt:** [2] Attached

**PA4688 FOAM**

Foam Blanket for PA4688



**Notes:** OBSOLETE. Availability Limited to Dealer Stock.  
**Use With:** PA4688  
**O.D.:** 8 (203.2)  
**I.D.:** 5 5/16 (134.9)  
**Height:** 21/32 (16.7)

Measurements Are Shown In Inches And (Millimeters)

**WARNING:** These products can expose you to chemicals, including Diisononyl Phthalate, Carbon black extracts, Nickel, 1,3 Butadiene, Ethylene Oxide, Epichlorohydrin, which are known to the State of California to cause cancer, and Bisphenol, Ethylene Glycol, Ethylene Oxide, 1,3 Butadiene, Epichlorohydrin, which are known to the State of California to cause birth defects or other reproductive harm.

**PA4689** Oblong Air Element  
**Replaces:** Woodgate WGA1638  
**O.D.:** 3 11/16 (93.7)  
to 5 25/32 (146.8)  
**I.D.:** 2 3/32 (53.2) & 4 5/32 (105.6)  
**Height:** 3 7/32 (81.8)



**PA4698** Oblong Air Element with Foam Wrap  
**Fits:** Honda Engines  
**Replaces:** Honda 17210-ZE7-003,  
17210-ZE7-013; Woodgate WGA1177  
**O.D.:** 2 1/2 (63.5)  
to 7 17/32 (191.3)  
**I.D.:** 1 1/16 (27.0) & 6 1/32 (153.2)  
**Height:** 1 15/16 (49.2)  
**A. Gskt:** [1] Attached  
**Grommets:** [2] Attached



**PA4692** Inner Air Element  
**Fits Inside:** PA3852-FN  
**Replaces:** Woodgate WGA1147S  
**O.D.:** 3 13/32 (86.5)  
Flange 4 5/32 (105.6)  
**I.D.:** 1 1/16 (17.5) & 2 5/16 (58.7)  
**Height:** 12 (304.8)  
**A. Gskt:** [1] Attached



**CA4700** Channel Flow Air Element  
**Fits:** Freightliner Buses, Trucks  
**Use With:** PA4701  
**Replaces:** Donaldson P548070, P607955;  
Fleetguard AF26154  
**O.D.:** 9 29/32 (251.6)  
Flange 12 25/32 (324.6)  
**Height:** 8 1/32 (204.0)  
**A. Gskt:** [1] Attached  
**Related To:** CA5420 (Flame Retardant Media  
Version)



**PA4693** Air Element  
**Fits:** Volkswagen Eurovan  
**Replaces:** Volkswagen 44129620; Woodgate  
WGA1148  
**O.D.:** 6 3/8 (161.9)  
**I.D.:** 3 11/16 (93.7)  
**Height:** 9 11/32 (237.3)



**PA4701** Channel Flow Air Secondary Element  
**Fits:** Freightliner Buses, Trucks  
**Use With:** CA4700  
**Replaces:** Donaldson P544432, P616400;  
Fleetguard AF26153  
**O.D.:** 9 13/32 (238.9)  
**Height:** 31/32 (24.6)  
**A. Gskt:** [1] Attached



**PA4694** Air Element with Foam Wrap  
**Fits:** Honda Engines  
**Replaces:** Honda 17210-ZG3-003,  
17210-ZG3-505, 17210-ZG3-801; Woodgate  
WGA1157  
**O.D.:** 4 13/16 (122.2)  
**I.D.:** 1/4 (6.4) & 2 5/16 (58.7)  
**Height:** 2 11/16 (68.3)  
**A. Gskt:** [1] Attached  
**Grommets:** [1] Attached



**CA4702** Channel Flow Air Element  
**Fits:** John Deere Tractors  
**Use With:** PA4704  
**Replaces:** John Deere AL119839, AL172780;  
Donaldson P606119; Fleetguard AF26157  
**O.D.:** 4 7/8 (123.8)  
to 12 7/32 (310.4)  
**Height:** 7 11/32 (186.5)  
**A. Gskt:** [1] Included



**PA4695** Oblong Air Element with Foam Wrap  
**Fits:** Honda Engines  
**Replaces:** Honda 17210-ZE8-003,  
17210-ZE8-013; Woodgate WGA1159  
**O.D.:** 3 1/8 (79.4)  
to 5 3/32 (129.4)  
**I.D.:** 1 3/32 (27.8) & 3 9/16 (90.5)  
**Height:** 3 1/8 (79.4)  
**Grommets:** [1] Attached



**CA4703** Channel Flow Air Element  
**Fits:** John Deere Sprayers, Tractors  
**Use With:** PA4704  
**Replaces:** John Deere AL150285, AL172781;  
Donaldson P606120; Fleetguard AF26156  
**O.D.:** 4 7/8 (123.8)  
to 12 7/32 (310.4)  
**Height:** 11 3/16 (284.2)  
**A. Gskt:** [1] Included



**PA4696 FOAM** Foam Blanket  
**Width:** 3 3/16 (81.0)  
**Height:** 7/32 (5.6)



**PA4704** Channel Flow Air Secondary Element  
**Notes:** Sometimes used with CA5278, Channel  
Flow Air Element.  
**Fits:** John Deere Tractors  
**Use With:** CA4702, CA4703  
**Replaces:** John Deere AL150288; Donaldson  
P606121; Fleetguard AF26155; Wix 42795  
**O.D.:** 4 9/32 (108.7)  
to 11 25/32 (299.2)  
**Height:** 1 13/16 (46.0)  
**A. Gskt:** [1] Included



**PA4697-FN** Outer Air Element with Fins  
**Fits:** Manitou Telehandlers; New Holland  
Equipment  
**Use With:** PA2419  
**Replaces:** New Holland 85807057; Woodgate  
WGA1176K  
**O.D.:** 6 1/16 (154.0)  
Fins 7 17/32 (191.3)  
**I.D.:** 2 1/32 (16.7) & 3 7/16 (87.3)  
**Height:** 15 3/32 (383.4)  
**A. Gskt:** [1] Attached  
**F. Gskt:** [1] Included



Measurements Are Shown In Inches And (Millimeters)

**WARNING:** These products can expose you to chemicals, including Diisononyl Phthalate, Carbon black extracts, Nickel, 1,3 Butadiene, Ethylene Oxide, Epichlorohydrin, which are known to the State of California to cause cancer, and Bisphenol, Ethylene Glycol, Ethylene Oxide, 1,3 Butadiene, Epichlorohydrin, which are known to the State of California to cause birth defects or other reproductive harm.

**PA4705**

Air Element



**Replaces:** M.A.N. 45.0095.3105; Woodgate WGA1282  
**O.D.:** 2 17/32 (64.3)  
**I.D.:** 1 1/2 (38.1) One End  
**Height:** 2 23/32 (69.1)  
**F. Gskt:** [1] Included

**PA4706**

Air Element



**Replaces:** Mann & Hummel C1337; Woodgate WGA1286  
**O.D.:** 5 (127.0)  
**I.D.:** 2 17/32 (64.3)  
**Height:** 4 15/16 (125.4)  
**Grommets:** [2] Included

**PA4707**

Air Element



**Replaces:** M.A.N. 45.07554.166; Woodgate WGA1287  
**O.D.:** 9 1/2 (241.3)  
**I.D.:** 6 11/32 (161.1)  
**Height:** 3 15/32 (88.1)

**PA4708**

Air Element



**Replaces:** M.A.N. 45.02155.104; Woodgate WGA1288  
**O.D.:** 3 7/8 (98.4)  
**I.D.:** 2 3/8 (60.3) One End  
**Height:** 2 29/32 (73.8)  
**A. Gskt:** [1] Attached

**PA4709**

Outer Air Element



**Use With:** PA2419  
**Replaces:** J.C. Bamford 32/914700; Woodgate WGA1307  
**O.D.:** 7 5/8 (193.7)  
 Flange 8 3/16 (208.0)  
**I.D.:** 19/32 (15.1) & 3 11/16 (93.7)  
**Height:** 15 21/32 (397.7)  
**A. Gskt:** [1] Attached, [1] Wing Nut

**PA4711**

Air Element



**Replaces:** Hydrovane 52438; Woodgate WGA1318  
**O.D.:** 13 23/32 (348.5)  
**I.D.:** 11 5/8 (295.3)  
**Height:** 4 3/16 (106.4)

**PA4713**

Air Element



**Replaces:** Ceccato 640110; Woodgate WGA1339  
**O.D.:** 6 5/16 (160.3)  
**I.D.:** 4 1/2 (114.3)  
**Height:** 4 25/32 (121.4)

**PA4714**

Panel Air Element



**Replaces:** Leyland ABU8516; Fleetguard AF4049; Woodgate WGA135  
**Length:** 12 3/4 (323.8)  
**Width:** 4 7/8 (123.8)  
**Height:** 1 7/32 (31.0)

**PA4715**

Air Element



**Replaces:** Becker 84040910; Woodgate WGA1354  
**O.D.:** 5 29/32 (150.0)  
**I.D.:** 3 15/32 (88.1)  
**Height:** 4 31/32 (126.2)

**PA4716**

Air Element



**Replaces:** Busch 532013; Woodgate WGA1392  
**O.D.:** 5 (127.0)  
**I.D.:** 2 17/32 (64.3)  
**Height:** 6 3/32 (154.8)  
**F. Gskt:** [2] Included

**PA4720**

Air Element with Attached Spring



**Replaces:** Rietschle 731143; Woodgate WGA1412  
**O.D.:** 2 17/32 (64.3)  
**I.D.:** 1 1/2 (38.1)  
**Height:** 7 27/32 (199.2)  
**A. Gskt:** [1] Attached  
**Spring:** [1] Attached

**PA4723**

Panel Air Element



**Notes:** OBSOLETE. Availability Limited to Dealer Stock.  
**Fits:** Mercedes-Benz European Vans  
**Replaces:** Mercedes-Benz 6380900151; Fleetguard AF25719; Woodgate WGA1548  
**Length:** 12 15/16 (328.6)  
**Width:** 10 7/16 (265.1)  
**Height:** 2 23/32 (69.1)

**PA4727**

Air Element with Foam Wrap

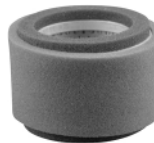

**Fits:** Robin Engines  
**Replaces:** Robin 1573620101; Woodgate WGA1565  
**O.D.:** 3 17/32 (89.7)  
**I.D.:** 2 7/16 (61.9)  
**Height:** 2 3/8 (60.3)  
**A. Gskt:** [2] Attached

**PA4729**

Oval Air Element in Disposable Housing



**Notes:** OBSOLETE. Availability Limited to Dealer Stock.  
**Contains:** [2] Bolt Holes in Housing  
**Replaces:** Wacker 78842; Woodgate WGA1567  
**O.D.:** 6 13/16 (173.0)  
 to 10 11/16 (271.5)  
**I.D.:** 1 31/32 (50.0) One End  
**Height:** 1 11/16 (42.9)  
**Grommets:** [1] Attached

Measurements Are Shown In Inches And (Millimeters)

**WARNING:** These products can expose you to chemicals, including Diisononyl Phthalate, Carbon black extracts, Nickel, 1,3 Butadiene, Ethylene Oxide, Epichlorohydrin, which are known to the State of California to cause cancer, and Bisphenol, Ethylene Glycol, Ethylene Oxide, 1,3 Butadiene, Epichlorohydrin, which are known to the State of California to cause birth defects or other reproductive harm.



**PA4730** Panel Air Element  
**Fits:** Ruggerini Engines  
**Replaces:** Ruggerini 17540; Woodgate WGA1569  
**Length:** 6 9/32 (159.5)  
**Width:** 6 3/16 (157.2)  
**Height:** 1 17/32 (38.9)



**PA4738** Foam Oblong Air Element  
**Fits:** Robin EC08, EY08, EY15D Engines  
**Replaces:** Robin 2273600203; Woodgate WGA1593  
**Width:** 3 9/32 (83.3)  
**Height:** 1 1/4 (31.8)



**PA4731** Oblong Air Element  
**Fits:** Wacker Equipment  
**Replaces:** Wacker 95711; Woodgate WGA1570  
**O.D.:** 2 3/4 (69.9)  
**4 25/32 (121.4)**  
**I.D.:** 1 29/32 (48.4) & 3 15/16 (100.0)  
**Height:** 1 7/32 (31.0)



**PA4740** Inner Air Element  
**Fits Inside:** PA1690-FN  
**Replaces:** Petter 397080; Woodgate WGA15S  
**O.D.:** 2 13/32 (61.1)  
**Flange 2 3/4 (69.9)**  
**I.D.:** 2 1/32 (16.7) & 2 (50.8)  
**Height:** 9 1/32 (229.4)  
**A. Gskt:** [2] Attached



**PA4732** Air Element  
**Replaces:** Petter 334643; Woodgate WGA1574  
**O.D.:** 3 13/16 (96.8)  
**I.D.:** 1 31/32 (50.0)  
**Height:** 4 3/16 (106.4)



**PA4741** Air Element  
**Fits:** Lister-Petter TR3, TS3 Engines  
**Replaces:** Lister 366-07723; Woodgate WGA1601  
**O.D.:** 5 29/32 (150.0)  
**I.D.:** 3 13/32 (86.5)  
**Height:** 3 5/8 (92.1)



**PA4733** Air Element with Foam Wrap  
**Fits:** Lombardini 15LD315 Engine  
**Replaces:** Lombardini 196.2175.120; Woodgate WGA1575  
**O.D.:** 4 11/32 (110.3)  
**I.D.:** 5/8 (15.9) & 2 7/16 (61.9)  
**Height:** 2 15/16 (74.6)  
**A. Gskt:** [1] Attached  
**Grommets:** [1] Attached



**PA4743** Air Element  
**Notes:** OBSOLETE. Availability Limited to Dealer Stock.  
**Replaces:** Hydrovane 57713; Woodgate WGA1605  
**O.D.:** 9 23/32 (246.9)  
**I.D.:** 7 5/16 (185.7)  
**Height:** 4 1/16 (103.2)



**PA4734** Panel Air Element with Foam Pad  
**Replaces:** Kubota 12812-11210; Woodgate WGA1576  
**Length:** 4 9/32 (108.7)  
**Width:** 3 29/32 (99.2)  
**Height:** 1 3/8 (34.9)  
**O-Ring:** [1] Included

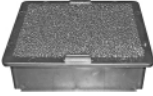

**PA4750** Panel Air Element  
**Fits:** Briggs & Stratton Engines  
**Replaces:** Briggs & Stratton 494511; Woodgate WGA1619  
**Length:** 6 31/32 (177.0)  
**Width:** 3 15/32 (88.1)  
**Height:** 1 9/32 (32.5)



**PA4735** Foam Air Filter  
**Fits:** Honda G100, G110 Engines  
**Replaces:** Honda 17211-896-000; Woodgate WGA1578  
**Length:** 3 7/8 (98.4)  
**Width:** 3 3/32 (78.6)  
**Height:** 15/16 (23.8)



**PA4753** Inner Air Element  
**Fits Inside:** PA2360-FN, PA4865-FN  
**Replaces:** Johnson Sweepers 13086; Woodgate WGA162S  
**O.D.:** 2 23/32 (69.1)  
**Flange 3 17/32 (89.7)**  
**I.D.:** 2 1/32 (16.7) & 2 13/32 (61.1)  
**Height:** 13 31/32 (354.8)  
**F. Gskt:** [1] Included



**PA4736 FOAM** Foam Blanket  
**Fits:** Exmark Lawn & Garden Tractors  
**O.D.:** 6 19/32 (167.5)  
**I.D.:** 6 3/32 (154.8)  
**Height:** 2 5/32 (54.8)



**PA4754** Panel Air Element  
**Notes:** Can be used with PA4911 Foam Pad.  
**Fits:** Honda Engines  
**Replaces:** Honda 17211-ZL8-A000; Woodgate WGA163S  
**Length:** 5 5/32 (131.0)  
**Width:** 4 1/2 (114.3)  
**Height:** 29/32 (23.0)

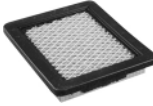

**PA4737** Air Element with Foam Wrap  
**Fits:** Kubota OC60E, OC95E Engines  
**Replaces:** Kubota 11460-11180; Woodgate WGA1583  
**O.D.:** 4 13/16 (122.2)  
**Boot 4 31/32 (126.2)**  
**I.D.:** 1/4 (6.4) & 2 5/16 (58.7)  
**Height:** 2 23/32 (69.1)  
**A. Gskt:** [2] Attached



Measurements Are Shown In Inches And (Millimeters)

**WARNING:** These products can expose you to chemicals, including Diisononyl Phthalate, Carbon black extracts, Nickel, 1,3 Butadiene, Ethylene Oxide, Epichlorohydrin, which are known to the State of California to cause cancer, and Bisphenol, Ethylene Glycol, Ethylene Oxide, 1,3 Butadiene, Epichlorohydrin, which are known to the State of California to cause birth defects or other reproductive harm.

**PA4755** Oval Air Element  
**Contains:** 7/16 Inch bolt hole on closed end  
**Fits:** Partner K950, K1250 Saws  
**Replaces:** Partner 506231801; Woodgate WGA1639  
**O.D.:** 3 15/16 (100.0)  
to 6 3/32 (154.8)  
**I.D.:** 2 1/32 (51.6) & 4 1/16 (103.2)  
**Height:** 2 19/32 (65.9)



**PA4756** Foam Air Filter  
**Notes:** [2] Small holes and [1] large, irregular hole cut in pad.  
**Fits:** Partner K1200 Saws  
**Replaces:** Partner 506231901; Woodgate WGA1640  
**Length:** 10 13/32 (264.3)  
**Width:** 5 5/8 (142.9)  
**Height:** 11/16 (17.5)



**PA4758** Air Element  
**Fits:** Rig Master Auxilliary Power Units  
**Replaces:** Atlas Copco 1613-9001-00; Woodgate WGA1647  
**O.D.:** 3 31/32 (100.8)  
**I.D.:** 2 21/32 (67.5)  
**Height:** 3 1/8 (79.4)  
**A. Gskt:** [2] Attached



**PA4760** Oval Air Element with Foam Wrap  
**Fits:** Honda GXV390 Engines  
**Replaces:** Honda 17211-ZF5-001; Woodgate WGA1651  
**O.D.:** 2 15/16 (74.6)  
to 5 9/32 (134.1)  
**I.D.:** 11/32 (8.7) & 3 1/2 (88.9)  
**Height:** 3 7/16 (87.3)



**PA4763** Conical-Shaped Air Element with Foam Wrap  
**Fits:** Robin EH25, EY28 Engines  
**Replaces:** Robin 2343260407; Woodgate WGA1672  
**O.D.:** 2 9/16 (65.1)  
to 4 21/32 (118.3)  
**I.D.:** 2 3/4 (69.9) One End  
**Height:** 3 9/32 (83.3)  
**A. Gskt:** [1] Attached



**PA4764** Air Element  
**Replaces:** Petter 340660; Woodgate WGA1674  
**O.D.:** 4 7/32 (107.2)  
**I.D.:** 2 1/32 (51.6)  
**Height:** 4 5/32 (105.6)



**PA4766** Air Element  
**Replaces:** Kubota 16616-11013; Woodgate WGA1697  
**O.D.:** 4 3/32 (104.0)  
**I.D.:** 2 1/32 (16.7) & 2 15/32 (62.7)  
**Height:** 10 1/4 (260.3)  
**A. Gskt:** [1] Attached  
**F. Gskt:** [1] Included



**PA4769** Oblong Air Element with Foam Wrap  
**Fits:** Toro Lawn & Garden Tractors with Kawasaki Engines  
**Replaces:** Kawasaki 11013-2110; Woodgate WGA1708  
**O.D.:** 2 7/8 (73.0)  
to 6 5/32 (156.4)  
**I.D.:** 1 13/32 (35.7) & 4 23/32 (119.9)  
**Height:** 3 3/16 (81.0)  
**A. Gskt:** [2] Attached



**PA4773** Oval Air Element  
**Notes:** Has 5/16 In. bolt hole on closed end.  
**Fits:** Ford Lawn & Garden Tractors  
**Replaces:** Briggs & Stratton 493909; Woodgate WGA1714  
**O.D.:** 2 7/8 (73.0)  
to 7 1/4 (184.2)  
**I.D.:** 15/16 (23.8) & 3 29/32 (99.2)  
**Height:** 3 1/32 (77.0)



**RS4775** Radial Seal Air Element  
**Fits:** M.A.N. Trucks  
**Replaces:** M.A.N. 81.08304.0087; Fleetguard AF25496; Woodgate WGA1743  
**O.D.:** 9 21/32 (245.3)  
**I.D.:** 4 23/32 (119.9) One End  
**Height:** 15 (381.0)



**PA4777** Air Element  
**Notes:** OBSOLETE. Availability Limited to Dealer Stock.  
**Replaces:** Tecumseh 23410051; Woodgate WGA1756  
**O.D.:** 1 23/32 (43.7)  
**I.D.:** 7/8 (22.2)  
**Height:** 2 7/8 (73.0)



**PA4778** Air Element  
**Replaces:** Woodgate WGA1758  
**O.D.:** 2 29/32 (73.8)  
**I.D.:** 1 19/32 (40.5)  
**Height:** 1 21/32 (42.1)



Measurements Are Shown In Inches And (Millimeters)

**WARNING:** These products can expose you to chemicals, including Diisononyl Phthalate, Carbon black extracts, Nickel, 1,3 Butadiene, Ethylene Oxide, Epichlorohydrin, which are known to the State of California to cause cancer, and Bisphenol, Ethylene Glycol, Ethylene Oxide, 1,3 Butadiene, Epichlorohydrin, which are known to the State of California to cause birth defects or other reproductive harm.

**PA4781** Air Element  
**Replaces:** Samsung 60131062; Woodgate WGA1777  
**O.D.:** 7 15/16 (201.6)  
**I.D.:** 17/32 (13.5) & 4 31/32 (126.2)  
**Height:** 3 13/16 (96.8)



**PA4785** Panel Air Element  
**Notes:** OBSOLETE. Availability Limited to Dealer Stock.  
**Replaces:** Peugeot 144508; Woodgate WGA1785  
**Length:** 12 23/32 (323.1)  
**Width:** 6 3/32 (154.8)  
**Height:** 2 5/16 (58.7)



**PA4790** Panel Air Element  
**Notes:** OBSOLETE. Availability Limited to Dealer Stock.  
**Replaces:** Ford 88VB-9601-AA; Fleetguard AF4918; Woodgate WGA1809  
**Length:** 9 7/16 (239.7)  
**Width:** 8 7/8 (225.4)  
**Height:** 2 1/4 (57.2)



**PA4793** Panel Air Element  
**Fits:** Ford European Light-Duty Trucks  
**Replaces:** Motorcraft EFA184; Woodgate WGA1835  
**Length:** 11 3/32 (281.8)  
**Width:** 7 1/8 (181.0)  
**Height:** 2 9/32 (57.9)



**RS4794** Radial Seal Air Element  
**Fits:** DAF Trucks  
**Replaces:** Leyland ACHD040; Fleetguard AF25478; Woodgate WGA1837  
**O.D.:** 8 1/8 (206.4)  
**I.D.:** 4 3/16 (106.4) One End  
**Height:** 20 7/8 (530.2)



**PA4795** Air Element with Lid  
**Replaces:** Iseki 157210325000; Woodgate WGA1852  
**O.D.:** 4 3/32 (104.0)  
 Lid 5 7/8 (149.2)  
**I.D.:** 9/16 (14.3) & 2 15/32 (62.7)  
**Height:** 10 3/8 (263.5)  
**A. Gskt:** [2] Attached



**PA4801** Panel Air Element with Pull Tab  
**Replaces:** J.C. Bamford 12/304176; Woodgate WGA1867  
**Length:** 22 3/4 (577.9)  
**Width:** 4 (101.6)  
**Height:** 2 9/32 (57.9)  
**A. Gskt:** [1] Attached

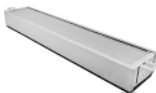

**PA4802** Air Element  
**Fits:** Carrier Refrigeration Units  
**Replaces:** Carrier 30-0043022; Fleetguard AF25888; Woodgate WGA1869  
**O.D.:** 4 1/8 (104.8)  
 Top 4 15/32 (113.5)  
**I.D.:** 2 21/32 (67.5) One End  
**Height:** 10 5/32 (258.0)



**RS4803** Radial Seal Air Element  
**Replaces:** Kubota T0270-16321; Woodgate WGA1872  
**O.D.:** 4 7/32 (107.2)  
**I.D.:** 2 5/32 (54.8) One End  
**Height:** 9 19/32 (243.7)



**RS4804** Radial Seal Air Element  
**Fits:** Massey Ferguson Equipment  
**Replaces:** Iseki 167510421300; Woodgate WGA1873  
**O.D.:** 3 3/4 (95.3)  
**I.D.:** 1 21/32 (42.1)  
**Height:** 6 15/16 (176.2)



**RS4806** Radial Seal Air Element  
**Fits:** Mitsubishi Trucks  
**Replaces:** Mitsubishi ME017246; Woodgate WGA1882  
**O.D.:** 9 1/8 (231.8)  
**I.D.:** 4 23/32 (119.9) One End  
**Height:** 11 7/32 (285.0)



**RS4807** Radial Seal Air Element  
**Notes:** OBSOLETE. Availability Limited to Dealer Stock.  
**Fits:** Mitsubishi European Light-Duty Trucks  
**Replaces:** Mitsubishi ML126032; Woodgate WGA1887  
**O.D.:** 9 1/32 (229.4)  
**I.D.:** 4 5/8 (117.5) One End  
**Height:** 11 3/8 (288.9)



**PA4809** Inner Air Element  
**Fits Inside:** PA2813  
**Fits:** Scania Trucks  
**Replaces:** Scania 397813; Fleetguard AF4727; Woodgate WGA458S  
**O.D.:** 5 15/16 (150.8)  
 Flange 6 1/4 (158.8)  
**I.D.:** 21/32 (16.7) & 5 11/16 (144.5)  
**Height:** 14 25/32 (375.4)



Measurements Are Shown In Inches And (Millimeters)

**WARNING:** These products can expose you to chemicals, including Diisononyl Phthalate, Carbon black extracts, Nickel, 1,3 Butadiene, Ethylene Oxide, Epichlorohydrin, which are known to the State of California to cause cancer, and Bisphenol, Ethylene Glycol, Ethylene Oxide, 1,3 Butadiene, Epichlorohydrin, which are known to the State of California to cause birth defects or other reproductive harm.

**PA4810**

Air Element



**Replaces:** CompAir 982621014; Woodgate WGA471  
**O.D.:** 5 1/16 (128.6)  
**I.D.:** 3 7/16 (87.3)  
**Height:** 3 11/32 (84.9)

**PA4824**

Air Element



**Fits:** Yanmar Engines, Generators  
**Replaces:** Yanmar 114250-12580; Fleetguard AF25607; Woodgate WGA948  
**O.D.:** 3 15/16 (100.0)  
 Flange 4 1/8 (104.8)  
**I.D.:** 2 1/8 (54.0) One End  
**Height:** 1 25/32 (45.2)  
**Grommets:** [1] Attached

**PA4813**

Air Element



**Replaces:** CompAir 982621015; Woodgate WGA639  
**O.D.:** 6 3/16 (157.2)  
**I.D.:** 4 13/16 (122.2)  
**Height:** 5 19/32 (142.1)

**PA4825**

Air Element



**Replaces:** Orenstein & Koppel 1499267; Fleetguard AF4065; Woodgate WGA95  
**O.D.:** 5 7/16 (138.1)  
 Boot 6 15/32 (164.3)  
**I.D.:** 2 27/32 (72.2) One End  
**Height:** 15 5/8 (396.9)  
**A. Gskt:** [1] Attached

**PA4814**

Air Element



**Replaces:** Ford A700X-9K600-BA; GMC 7988055; Fleetguard AF4023; Woodgate WGA920  
**O.D.:** 5 21/32 (143.7)  
**I.D.:** 3 1/2 (88.9)  
**Height:** 5 3/16 (131.8)

**PA4827**

Inner Air Element



**Fits Inside:** PA3848-FN  
**Fits:** Manitou Equipment  
**Replaces:** New Holland 85807052; Fleetguard AF25321; Woodgate WGA964S  
**O.D.:** 3 11/32 (84.9)  
 Flange 4 3/16 (106.4)  
**I.D.:** 23/32 (18.3) & 2 15/16 (74.6)  
**Height:** 11 7/32 (285.0)  
**A. Gskt:** [1] Attached

**PA4819**

Air Element



**Fits:** Farymann Marine Engines; Wacker Equipment  
**Replaces:** Farymann 5410522; Fleetguard AF25433; Woodgate WGA925  
**O.D.:** 3 27/32 (97.6)  
 4 3/32 (104.0)  
**I.D.:** 1 13/32 (35.7)  
**Height:** 5 3/16 (131.8)  
**Grommets:** [1] Attached

**PA4829**

Conical-Shaped Air Element with Foam Wrap



**Fits:** Robin Engines  
**Replaces:** Robin 2053600404; Woodgate WGA967  
**O.D.:** 2 15/32 (62.7)  
 Flange 4 1/4 (108.0)  
**I.D.:** 2 1/4 (57.2)  
**Height:** 2 3/8 (60.3)  
**A. Gskt:** [1] Attached

**PA4820**

Oval Air Element with Foam Wrap



**Fits:** Dynapac Equipment; Honda Engines  
**Replaces:** Honda 17210-ZE1-822; Fleetguard AF25472; Woodgate WGA935  
**O.D.:** 2 29/32 (73.8)  
 to 3 31/32 (100.8)  
**I.D.:** 1/4 (6.4) & 1 1/4 (31.8)  
**Height:** 2 11/16 (68.3)  
**Grommets:** [1] Attached

**PA4830**

Air Element



**Fits:** Robin Engines  
**Replaces:** Robin 2433260008; Woodgate WGA969  
**O.D.:** 3 15/16 (100.0)  
**I.D.:** 1/4 (6.4) & 2 23/32 (69.1)  
**Height:** 2 3/32 (53.2)

**PA4823**

Conical-Shaped Air Element with Foam Wrap

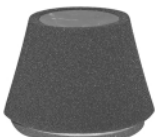

**Fits:** Robin Engines  
**Replaces:** Robin 2073260107; Woodgate WGA944  
**O.D.:** 2 15/32 (62.7)  
 to 4 5/32 (105.6)  
**I.D.:** 2 13/16 (71.4) One End  
**Height:** 3 7/32 (81.8)  
**A. Gskt:** [1] Attached

**PA4833-FN**

Air Element with Lid and Fins



**Fits:** Hitachi Excavators  
**Replaces:** Hitachi 4294845; Fleetguard AF25200K; Woodgate WGA982K  
**O.D.:** 3 5/16 (84.1)  
 Lid 5 1/32 (127.8)  
**I.D.:** 7/16 (11.1) & 1 13/16 (46.0)  
**Height:** 7 3/8 (187.3)  
**A. Gskt:** [1] Attached

Measurements Are Shown In Inches And (Millimeters)

**WARNING:** These products can expose you to chemicals, including Diisononyl Phthalate, Carbon black extracts, Nickel, 1,3 Butadiene, Ethylene Oxide, Epichlorohydrin, which are known to the State of California to cause cancer, and Bisphenol, Ethylene Glycol, Ethylene Oxide, 1,3 Butadiene, Epichlorohydrin, which are known to the State of California to cause birth defects or other reproductive harm.

**PA4834-FN**

Air Element with Fins



**Replaces:** Gehl 49140111110; Woodgate WGA999K  
**O.D.:** 4 3/32 (104.0)  
**Fins** 5 1/8 (130.2)  
**I.D.:** 2 1/32 (16.7) & 2 15/32 (62.7)  
**Height:** 6 1/32 (153.2)  
**A. Gskt:** [1] Attached  
**F. Gskt:** [1] Included

**PA4855**

Plastic Mesh Secondary Air Element



**Fits:** Makita Saws  
**Use With:** PA4854  
**Replaces:** Makita 394173020; Woodgate WGA1568S  
**Length:** 3 9/16 (90.5)  
**Width:** 2 9/16 (65.1)  
**Height:** 2 1/32 (16.7)

**PA4848**

Air Element



**Replaces:** Woodgate WGD800020  
**O.D.:** 7 1/32 (178.6)  
**I.D.:** 5 7/16 (138.1)  
**Height:** 5 5/8 (142.9)

**PA4857**

Cab Air Element



**Fits:** Freightliner Trucks  
**Replaces:** Freightliner 91559, BOA91559  
**Length:** 10 5/8 (269.9)  
**Width:** 10 5/8 (269.9)  
**Height:** 3 1/32 (24.6)

**PA4858**

Cab Air Element



**Fits:** John Deere Loaders, Toolcarriers  
**Replaces:** John Deere T156471  
**Length:** 16 3/8 (415.9)  
**Width:** 8 9/16 (217.5)  
**Height:** 1 9/16 (39.7)  
**A. Gskt:** [2] Attached

**PA4849**

Conical-Shaped Air Element



**Notes:** OBSOLETE. Availability Limited to Dealer Stock.  
**Replaces:** Woodgate WGD800027  
**O.D.:** 5 19/32 (142.1)  
**Flange** 8 21/32 (219.9)  
**I.D.:** 4 5/8 (117.5)  
**Height:** 12 3/4 (323.8)  
**A. Gskt:** [1] Attached

**RS4859**

Radial Seal Air Element



**Fits:** Chevrolet Kodiak, GMC Topkick Trucks  
**Replaces:** GMC 88937527, 88937528; ACDelco A2032C, A2033C  
**O.D.:** 7 7/8 (200.0)  
**I.D.:** 4 9/16 (115.9) One End  
**Height:** 17 13/32 (442.1)

**PA4852**

Panel Air Element



**Fits:** Stihl TS400 Chain Saws  
**Use With:** PA4852 FOAM; PA4853  
**Replaces:** Stihl 42231410300; Fleetguard AF25855; Woodgate WGA1187  
**Length:** 5 13/32 (137.3)  
**Width:** 3 3/8 (85.7)  
**Height:** 1 13/16 (46.0)

**PA4860**

Air Element in Disposable Housing



**Replaces:** Farr 40082-0022  
**O.D.:** 11 (279.4)  
**Inlet:** 7  
**Outlet:** 6  
**Height:** 19 13/16 (503.2)

**PA4852 FOAM**

Foam Blanket for PA4852



**Notes:** Has [2] holes drilled through foam blanket.  
**Fits:** Stihl TS400 Chain Saws  
**Use With:** PA4852  
**Width:** 3 5/32 (80.2)  
**Height:** 3/4 (19.0)

**RS4861**

Radial Seal Air Element



**Contains:** 5/16 Inch bolt on closed end  
**Fits:** DAF Trucks  
**Replaces:** DAF 1318919; Fleetguard AF25237; Woodgate WGA1245  
**O.D.:** 9 17/32 (242.1)  
**I.D.:** 4 13/16 (122.2) One End  
**Height:** 16 15/32 (418.3)

**PA4853**

Air Element



**Contains:** Tube on one end  
**Fits:** Stihl TS400 Chain Saws  
**Use With:** PA4852  
**Replaces:** Stihl 42231401800; Woodgate WGA1187S  
**Length:** 4 5/8 (117.5)  
**Width:** 2 11/16 (68.3)  
**Height:** 1 5/32 (29.4)

**RS4862**

Radial Seal Outer Air Element



**Fits:** International Trucks  
**Use With:** RS4863  
**Replaces:** International 3551814-C1  
**O.D.:** 12 1/16 (306.4)  
**I.D.:** 9 7/8 (250.8) One End  
**Height:** 16 3/32 (408.8)

**PA4854**

Panel Air Element

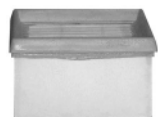

**Fits:** Makita Saws  
**Use With:** PA4854 FOAM; PA4855  
**Replaces:** Makita 394173010; Woodgate WGA1568  
**Length:** 4 1/8 (104.8)  
**Width:** 3 5/32 (80.2)  
**Height:** 2 5/16 (58.7)

Measurements Are Shown In Inches And (Millimeters)

**WARNING:** These products can expose you to chemicals, including Diisononyl Phthalate, Carbon black extracts, Nickel, 1,3 Butadiene, Ethylene Oxide, Epichlorohydrin, which are known to the State of California to cause cancer, and Bisphenol, Ethylene Glycol, Ethylene Oxide, 1,3 Butadiene, Epichlorohydrin, which are known to the State of California to cause birth defects or other reproductive harm.

**RS4863**

Conical-Shaped Radial Seal Inner Air Element



**Fits Inside:** RS4862  
**Fits:** International Trucks  
**Replaces:** International 3551815-C1  
**O.D.:** 5 3/8 (136.5)  
 to 9 15/16 (252.4)  
**I.D.:** 6 15/16 (176.2) One End  
**Height:** 15 13/32 (391.3)

**PA4873**

Wire Mesh Supported Conical-Shaped Air Element with Foam Wrap



**Notes:** OBSOLETE. Availability Limited to Dealer Stock.  
**Fits:** Robin Engines  
**Replaces:** Robin 2263261500; Woodgate WGA968  
**O.D.:** 1 31/32 (50.0)  
 to 3 25/32 (96.0)  
**I.D.:** 2 1/32 (51.6) One End  
**Height:** 2 5/32 (54.8)  
**A. Gskt:** [1] Attached

**RS4864**

Radial Seal Air Element with 2 Blank Bands



**Replaces:** Coopers AEM2620; Fleetguard AF25635; Woodgate WGA1634  
**O.D.:** 8 3/8 (212.7)  
**I.D.:** 4 27/32 (123.0) One End  
**Height:** 14 17/32 (369.1)

**PA4874**

Panel Air Element

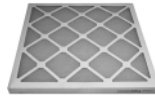

**Notes:** For air conditioning  
**Replaces:** Woodgate WGD20202  
**Length:** 19 1/2 (495.3)  
**Width:** 19 1/2 (495.3)  
**Height:** 1 25/32 (45.2)

**PA4865-FN**

Outer Air Element with Fins



**Notes:** OBSOLETE. Availability Limited to Dealer Stock.  
**Use With:** PA4753  
**Replaces:** Johnson Sweepers 13085; Woodgate WGA162K  
**O.D.:** 5 1/4 (133.4)  
 Fins 6 5/16 (160.3)  
**I.D.:** 21/32 (16.7) & 2 13/16 (71.4)  
**Height:** 15 (381.0)

**PA4876**

Air Element



**Contains:** Threaded hex nut for removal.  
**Replaces:** Atlas Copco 3214-6239-00; Fleetguard AF26147; Woodgate WGD852600  
**Thread:** M76 x 4.0  
**O.D.:** 4 23/32 (119.9)  
**I.D.:** 2 15/16 (74.6) One End  
**Height:** 23 5/8 (600.1)  
**A. Gskt:** [1] Attached

**PA4870-FN**

Outer Air Element with Lid and Fins



**Fits:** J.C. Bamford Loaders; Zetor Tractors  
**Use With:** PA2700  
**Replaces:** J.C. Bamford 32/913601; Fleetguard AF25958K; Woodgate WGA1059K  
**O.D.:** 5 1/4 (133.4)  
 Lid 6 27/32 (173.8)  
**I.D.:** 19/32 (15.1) & 2 13/16 (71.4)  
**Height:** 12 3/32 (307.2)  
**A. Gskt:** [1] Attached, [1] Wing Nut

**PA4877**

Air Element



**Replaces:** Becker 84040112; Woodgate WGA1270  
**O.D.:** 8 1/16 (204.8)  
**I.D.:** 5 23/32 (145.3)  
**Height:** 6 15/32 (164.3)

**PA4871**

Air Element



**Replaces:** Tamrock 81166609; Woodgate WGA937  
**O.D.:** 8 7/32 (208.8)  
**I.D.:** 5 15/16 (150.8)  
**Height:** 4 (101.6)

**PA4878**

Air Element



**Replaces:** CompAir AP111581443; Woodgate WGA1679  
**O.D.:** 3 (76.2)  
**I.D.:** 1 21/32 (42.1)  
**Height:** 4 19/32 (116.7)  
**A. Gskt:** [2] Attached  
**Related To:** PA4939 (Long Version)

**PA4872**

Air Element



**Replaces:** Becker 909506000; Woodgate WGA962  
**O.D.:** 3 5/16 (84.1)  
**I.D.:** 2 3/8 (60.3) One End  
**Height:** 2 13/16 (71.4)  
**A. Gskt:** [1] Attached

**PA4879**

Foam Air Filter

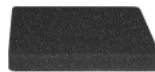

**Replaces:** Woodgate WGA1896  
**Width:** 3 15/32 (88.1)  
**Height:** 13/32 (10.3)

**PA4881**

Inner Air Element



**Fits Inside:** PA3435-FN  
**Fits:** Manitou Equipment  
**Replaces:** Manitou 177178; Woodgate WGA1054S  
**O.D.:** 2 9/16 (65.1)  
 Flange 2 29/32 (73.8)  
**I.D.:** 11/32 (8.7) & 2 7/32 (56.4)  
**Height:** 10 1/4 (260.3)  
**A. Gskt:** [1] Attached

Measurements Are Shown In Inches And (Millimeters)

**WARNING:** These products can expose you to chemicals, including Diisononyl Phthalate, Carbon black extracts, Nickel, 1,3 Butadiene, Ethylene Oxide, Epichlorohydrin, which are known to the State of California to cause cancer, and Bisphenol, Ethylene Glycol, Ethylene Oxide, 1,3 Butadiene, Epichlorohydrin, which are known to the State of California to cause birth defects or other reproductive harm.

**PA4883** Air Element  
**Replaces:** Wacker 18419; Woodgate WGA1155  
**O.D.:** 3 3/32 (78.6)  
**I.D.:** 2 9/32 (57.9)  
**Height:** 3 1/8 (79.4)  
**A. Gskt:** [2] Attached



**PA4890** Air Element  
**Replaces:** Renault 5001000878; Fleetguard AF4910; Woodgate WGA1255  
**O.D.:** 5 1/8 (130.2)  
**I.D.:** 3 9/16 (90.5)  
**Height:** 12 1/4 (311.2)



**PA4885** Panel Air Element  
**Fits:** Briggs & Stratton Engines  
**Replaces:** Briggs & Stratton 399877; Woodgate WGA1167  
**Length:** 4 5/8 (117.5)  
**Width:** 4 5/8 (117.5)  
**Height:** 25/32 (19.8)



**PA4891** Air Element  
**Replaces:** Becker 84040405; Woodgate WGA1283  
**O.D.:** 2 17/32 (64.3)  
**I.D.:** 1 1/2 (38.1) One End  
**Height:** 2 23/32 (69.1)  
**A. Gskt:** [1] Attached



**PA4886** Oblong Air Element with Foam Wrap  
**Fits:** Komatsu Excavators; Yanmar Engines  
**Replaces:** Yanmar 1146501-2540; Woodgate WGA1169  
**O.D.:** 3 7/8 (98.4) to 5 19/32 (142.1)  
**I.D.:** 1/4 (6.4) & 3 11/16 (93.7)  
**Height:** 2 7/8 (73.0)  
**Grommets:** [1] Attached



**PA4893** Air Element  
**Replaces:** Hydrovane HY0119; Woodgate WGA1316  
**O.D.:** 8 11/16 (220.7)  
**I.D.:** 5 29/32 (150.0)  
**Height:** 2 1/4 (57.2)



**PA4887** Air Element in Disposable Housing  
**Fits:** Vogele Paving Equipment  
**Replaces:** Volvo 3826215; Fleetguard AF25312; Woodgate WGA1242  
**O.D.:** 10 (254.0)  
**I.D.:** 4 23/32 (119.9) One End  
**Height:** 27 5/8 (701.7)



**PA4895** Air Element  
**Replaces:** Rietschle 731142; Woodgate WGA1409  
**O.D.:** 2 23/32 (69.1)  
**I.D.:** 1 5/16 (33.3) One End  
**Height:** 3 5/32 (80.2)



**PA4888** Panel Air Element  
**Notes:** OBSOLETE. Availability Limited to Dealer Stock.  
**Fits:** Ford European Light-Duty Trucks  
**Replaces:** Volvo 3434495; Fleetguard AF25709; Woodgate WGA1243  
**Length:** 12 19/32 (319.9)  
**Width:** 5 31/32 (151.6)  
**Height:** 2 9/32 (57.9)



**PA4896** Air Element with Attached Spring  
**Replaces:** Rietschle 731148; Woodgate WGA1410  
**O.D.:** 2 1/8 (54.0)  
**I.D.:** 1 5/16 (33.3) One End  
**Height:** 7 27/32 (199.2)  
**A. Gskt:** [1] Attached  
**Spring:** [1] Attached



**PA4889** Air Element  
**Replaces:** Leyland ACU8456; Fleetguard AF25087; Woodgate WGA1252  
**O.D.:** 11 3/32 (281.8)  
**I.D.:** 21/32 (16.7) & 6 3/4 (171.5)  
**Height:** 14 7/16 (366.7)  
**A. Gskt:** [1] Attached  
**F. Gskt:** [1] Washer



**PA4897** Air Breather Element in Disposable Housing  
**Replaces:** Ingersoll-Rand 93191542; Woodgate WGA1415  
**O.D.:** 6 15/32 (164.3)  
**I.D.:** 3 (76.2) One End  
**Height:** 5 1/2 (139.7)  
**A. Gskt:** [1] Attached



Measurements Are Shown In Inches And (Millimeters)

**WARNING:** These products can expose you to chemicals, including Diisononyl Phthalate, Carbon black extracts, Nickel, 1,3 Butadiene, Ethylene Oxide, Epichlorohydrin, which are known to the State of California to cause cancer, and Bisphenol, Ethylene Glycol, Ethylene Oxide, 1,3 Butadiene, Epichlorohydrin, which are known to the State of California to cause birth defects or other reproductive harm.

**PA4900**

Air Element



**Replaces:** CompAir 9826281; Woodgate WGA1531  
**O.D.:** 3 7/8 (98.4)  
**I.D.:** 2 3/8 (60.3)  
**Height:** 4 3/32 (104.0)

**PA4902**

Air Element



**Fits:** Hatz Engines  
**Replaces:** Hatz 504260001001; Woodgate WGA1571  
**O.D.:** 4 15/32 (113.5)  
**I.D.:** 1/4 (6.4) & 2 (50.8)  
**Height:** 3 3/32 (78.6)  
**Grommets:** [1] Included

**PA4903**

Air Element



**Replaces:** Nissan 16546-1G000; Fleetguard AF25353; Woodgate WGA1573  
**O.D.:** 4 15/16 (125.4)  
**I.D.:** 11/32 (8.7) & 2 3/4 (69.9)  
**Height:** 9 1/4 (235.0)  
**A. Gskt:** [2] Attached

**PA4905**

Panel Air Element



**Fits:** Stihl Chain Saws  
**Replaces:** Stihl 41341410300B; Woodgate WGA1579  
**Length:** 3 7/16 (87.3)  
**Width:** 2 23/32 (69.1)  
**Height:** 1 1/32 (26.2)

**PA4906**

Panel Air Element



**Notes:** OBSOLETE. Availability Limited to Dealer Stock.  
**Fits:** Honda Engines  
**Replaces:** Honda 17211-883-W21; Woodgate WGA1580  
**Length:** 7 (177.8)  
**Width:** 3 1/2 (88.9)  
**Height:** 1 1/16 (27.0)

**PA4907**

Oblong Air Element with Foam Wrap



**Fits:** Robin Engines  
**Replaces:** Robin 2623260107; Woodgate WGA1585  
**O.D.:** 3 1/32 (77.0) to 5 3/4 (146.0)  
**I.D.:** 1/4 (6.4) & 4 1/16 (103.2)  
**Height:** 3 1/16 (77.8)  
**A. Gskt:** [1] Attached

**PA4908**

Foam Air Filter



**Notes:** Has 1 3/16 In. hole in center.  
**Fits:** Honda Engines  
**Replaces:** Honda 17211-ZE1-000; Woodgate WGA1587  
**Length:** 4 31/32 (126.2)  
**Width:** 3 27/32 (97.6)  
**Height:** 1 19/32 (40.5)

**PA4910**

Air Element with Foam Wrap



**Notes:** OBSOLETE. Availability Limited to Dealer Stock.  
**Fits:** Kubota Engines  
**Replaces:** Kubota 12182-11080; Woodgate WGA1629  
**O.D.:** 4 1/2 (114.3) to 4 13/16 (122.2)  
**I.D.:** 1/4 (6.4) & 2 5/16 (58.7)  
**Height:** 2 5/8 (66.7)  
**A. Gskt:** [1] Attached  
**Grommets:** [1] Attached

**PA4911**

Foam Pad for PA4754

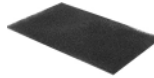

**Replaces:** Woodgate WGA1635-PF  
**Width:** 3 3/32 (78.6)  
**Height:** 7/32 (5.6)

**PA4912**

Cabin Air Element



**Fits:** Mercedes-Benz Trucks, Vans  
**Replaces:** Mercedes-Benz 8301218, A0008301218  
**Length:** 15 1/32 (381.8)  
**Width:** 5 3/16 (131.8)  
**Height:** 1 19/32 (40.5)  
**A. Gskt:** [1] Attached  
**Related To:** PA5492 (Charcoal Impregnated Media Version)

**PA4918**

Replacement for Ecolite Air Element in Disposable Housing



**Replaces:** CompAir 982625141; Donaldson C065004; Woodgate WGA1692  
**O.D.:** 6 1/2 (165.1)  
**I.D.:** 2 1/4 (57.2) One End  
**Height:** 10 3/8 (263.5)

**PA4919**

Inner Air Element



**Fits Inside:** PA1681-FN  
**Replaces:** Nissan 16546-L9011; Woodgate WGA16S  
**O.D.:** 3 11/32 (84.9)  
 Flange 4 1/8 (104.8)  
**I.D.:** 21/32 (16.7) & 2 29/32 (73.8)  
**Height:** 11 1/16 (281.0)  
**A. Gskt:** [1] Attached  
**F. Gskt:** [1] Included

**PA4925**

Air Element



**Replaces:** Leyland ACU2376; Fleetguard AF4989; Woodgate WGA182  
**O.D.:** 9 3/16 (233.4)  
**I.D.:** 21/32 (16.7) & 4 13/16 (122.2)  
**Height:** 16 15/32 (418.3)  
**A. Gskt:** [1] Attached

Measurements Are Shown In Inches And (Millimeters)

**WARNING:** These products can expose you to chemicals, including Diisononyl Phthalate, Carbon black extracts, Nickel, 1,3 Butadiene, Ethylene Oxide, Epichlorohydrin, which are known to the State of California to cause cancer, and Bisphenol, Ethylene Glycol, Ethylene Oxide, 1,3 Butadiene, Epichlorohydrin, which are known to the State of California to cause birth defects or other reproductive harm.



**PA4928** Panel Cab Air Element  
**Fits:** DAF Trucks  
**Replaces:** DAF 1322259; Fleetguard AF26139; Woodgate WGA1832  
**Length:** 16 7/16 (417.5)  
**Width:** 6 5/32 (156.4)  
**Height:** 29/32 (23.0)  
**A. Gskt:** [1] Attached

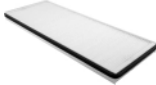

**PA4935** Oval Air Element  
**Notes:** Lid measures 5 13/16 x 3 5/32 (147.6 x 80.2)  
**Replaces:** Kawasaki 110132132; Woodgate WGA1860  
**O.D.:** 5 1/16 (128.6) to 6 (152.4)  
**I.D.:** 25/32 (19.8) & 3 27/32 (97.6)  
**Height:** 2 7/16 (61.9)  
**A. Gskt:** [1] Attached



**PA4929** Oval Air Element with Lid and Air Restriction Gauge Fitting  
**Fits:** Volvo Trucks  
**Replaces:** Volvo 3120490; Woodgate WGA1840  
**O.D.:** 7 3/8 to 12 1/8 (187.3 to 308.0)  
 Lid 9 9/32 to 13 31/32 (235.7 to 354.8)  
**I.D.:** 5 7/16 (138.1) One End  
**Height:** 25 (635.0)



**PA4938** Panel Cab Air Element  
**Fits:** Scania Trucks  
**Replaces:** Scania 1420197; Woodgate WGA1885  
**Length:** 9 3/32 (231.0)  
**Width:** 6 7/8 (174.6)  
**Height:** 2 23/32 (69.1)  
**A. Gskt:** [1] Attached



**PA4930** Air Element  
**Notes:** Can be used with PA4931 Foam Blanket.  
**Contains:** Plastic Clamp with Screw on Open End Fitting Attachment on Closed End  
**Fits:** Kawasaki Mules  
**Replaces:** Kawasaki 110291004; Woodgate WGA1849  
**O.D.:** 5 1/32 (127.8)  
**I.D.:** 2 27/32 (72.2)  
**Height:** 4 7/16 (112.7)



**PA4939** Air Element  
**Replaces:** Woodgate WGA1886  
**O.D.:** 2 31/32 (75.4)  
**I.D.:** 1 21/32 (42.1)  
**Height:** 5 1/4 (133.4)  
**Related To:** PA4878 (Short Version)



**PA4931** Foam Blanket for PA4930  
**Replaces:** Kawasaki 110131217; Woodgate WGA1849PF  
**O.D.:** 4 15/16 (125.4)  
**I.D.:** 4 19/32 (116.7)  
**Height:** 3 9/16 (90.5)



**PA4941** Panel Air Element  
**Replaces:** Volkswagen 55129620A; Woodgate WGA855  
**Length:** 7 25/32 (197.6)  
**Width:** 3 5/8 (92.1)  
**Height:** 1 13/16 (46.0)



**PA4932** Panel Air Element  
**Replaces:** Jacobsen 72368G01; Woodgate WGA1850  
**Length:** 11 15/32 (291.3)  
**Width:** 5 3/32 (129.4)  
**Height:** 1 13/16 (46.0)



**PA4942** Air Element with Lid  
**Replaces:** Mercedes-Benz 120948502; Woodgate WGA88  
**O.D.:** 10 7/16 (265.1)  
 Lid 13 5/32 (334.2)  
**I.D.:** 13/32 (10.3) & 5 1/4 (133.4)  
**Height:** 9 1/32 (229.4)  
**A. Gskt:** [1] Attached



**PA4934** Air Element  
**Fits:** Kubota Tractors  
**Replaces:** Kubota 67980-82630; Woodgate WGA1859  
**O.D.:** 3 11/32 (84.9)  
**I.D.:** 1 13/16 (46.0)  
**Height:** 7 7/16 (188.9)  
**A. Gskt:** [2] Attached



**PA4945** Cabin Air Element with Lift Tabs  
**Fits:** Mercedes-Benz Trucks, Vans  
**Replaces:** Mercedes-Benz 9408350047  
**Length:** 17 3/4 (450.9)  
**Width:** 7 13/32 (188.1)  
**Height:** 1 7/32 (31.0)  
**A. Gskt:** [1] Attached





**PA4947** Panel Air Element  
**Notes:** OBSOLETE. Availability Limited to Dealer Stock.  
**Contains:** [3] Screws  
**Fits:** Iveco Trucks  
**Replaces:** Iveco 3799020  
**Length:** 17 5/16 (439.7)  
**Width:** 3 29/32 (99.2)  
**Height:** 1 1/2 (38.1)





Measurements Are Shown In Inches And (Millimeters)

**WARNING:** These products can expose you to chemicals, including Diisononyl Phthalate, Carbon black extracts, Nickel, 1,3 Butadiene, Ethylene Oxide, Epichlorohydrin, which are known to the State of California to cause cancer, and Bisphenol, Ethylene Glycol, Ethylene Oxide, 1,3 Butadiene, Epichlorohydrin, which are known to the State of California to cause birth defects or other reproductive harm.

**PA4954** Cabin Air Element  
  
**Notes:** OBSOLETE. Availability Limited to Dealer Stock.  
**Contains:** Charcoal Impregnated Media for Odor Control  
**Fits:** Iveco European Light-Duty Vehicles  
**Replaces:** Iveco 93162491  
**Length:** 11 13/32 (289.7)  
**Width:** 6 5/16 (160.3)  
**Height:** 1 3/16 (30.2)

**PA4955** Cab Air Element  
  
**Fits:** M.A.N. Trucks  
**Replaces:** M.A.N. 81.61910.0018  
**Length:** 18 3/8 (466.7)  
**Width:** 7 9/32 (184.9)  
**Height:** 2 13/16 (71.4)  
**Related To:** PA5477 (Charcoal Media Version)

**PA4956** Cabin Air Element  
  
**Fits:** Mercedes-Benz Trucks, Vans  
**Replaces:** Mercedes-Benz 8301118  
**Length:** 14 15/16 (379.4)  
**Width:** 5 5/16 (134.9)  
**Height:** 1 17/32 (38.9)

**RS4959** Radial Seal Air Element  
  
**Contains:** Flame Retardant Media  
**Fits:** DAF Trucks  
**Replaces:** DAF 1638006, 1726060  
**O.D.:** 10 1/2 (266.7)  
**I.D.:** 6 11/16 (169.9)  
**Height:** 18 7/8 (479.4)

**PA4960-FN** Outer Air Element with Fins  
  
**Use With:** PA4961  
**Replaces:** Sofiltra 124005  
**O.D.:** 7 7/8 (200.0)  
 Fins 9 1/2 (241.3)  
**I.D.:** 25/32 (19.8) & 3 9/16 (90.5)  
**Height:** 14 1/16 (357.2)  
**A. Gskt:** [1] Attached

**PA4961** Inner Air Element  
  
**Fits Inside:** PA4960-FN  
**Replaces:** Sofiltra 125001  
**O.D.:** 3 11/32 (84.9)  
 Flange 4 5/8 (117.5)  
**I.D.:** 7/16 (11.1) & 3 1/32 (77.0)  
**Height:** 13 9/32 (337.3)  
**A. Gskt:** [1] Attached

**RS4962** Radial Seal Inner Air Element  
  
**Fits Inside:** RS3940  
**Replaces:** Toyota 17744-23600-71; Fleetguard AF25483; Woodgate WGA1289S  
**O.D.:** 3 1/16 (77.8)  
 Flange 3 5/32 (80.2)  
**I.D.:** 2 7/16 (61.9) One End  
**Height:** 10 15/32 (265.9)

**RS4963** Radial Seal Air Element  
  
**Fits:** Scania Trucks  
**Replaces:** Scania 1387549; Mann & Hummel C311254; Fleetguard AF25614; Woodgate WGA1529  
**O.D.:** 12 3/16 (309.6)  
**I.D.:** 7 1/32 (178.6) One End  
**Height:** 18 5/16 (465.1)

**RS4966** Radial Seal Outer Air Element  
  
**Fits:** Volvo Trucks  
**Use With:** RS5408  
**Replaces:** Volvo 8149064; Fleetguard AF25631  
**O.D.:** 11 31/32 (304.0)  
 Flange 12 13/16 (325.4)  
**I.D.:** 5 15/16 (150.8) One End  
**Height:** 16 1/8 (409.6)

**RS4967** Radial Seal Outer Air Element  
  
**Fits:** Volvo Trucks  
**Use With:** PA3925  
**Replaces:** Volvo 814996-1; Fleetguard AF25632  
**O.D.:** 13 1/16 (331.8)  
 Flange 13 25/32 (350.0)  
**I.D.:** 7 15/16 (201.6) One End  
**Height:** 16 11/32 (415.1)  
**A. Gskt:** [2] Attached  
**Related To:** RS5776 (Flame Retardant Media)

**RS4968** Radial Seal Air Element  
  
**Fits:** Iveco Trucks  
**Replaces:** Iveco 42471161; Fleetguard AF25875  
**O.D.:** 9 21/32 (245.3)  
**I.D.:** 5 7/16 (138.1) One End  
**Height:** 13 1/16 (331.8)

**RS4969** Radial Seal Air Element  
  
**Fits:** Iveco Trucks  
**Replaces:** Iveco 42471166; Fleetguard AF25876  
**O.D.:** 9 19/32 (243.7)  
**I.D.:** 5 7/16 (138.1) One End  
**Height:** 16 5/16 (414.3)

**RS4970** Radial Seal Air Element  
  
**Fits:** DAF, Kenworth Trucks  
**Replaces:** Fleetguard AF25873  
**O.D.:** 8 3/8 (212.7)  
**I.D.:** 4 11/16 (119.1) One End  
**Height:** 16 7/16 (417.5)  
**Related To:** RS5433 (Flame Retardant Media)

Measurements Are Shown In Inches And (Millimeters)

 **WARNING:** These products can expose you to chemicals, including Diisononyl Phthalate, Carbon black extracts, Nickel, 1,3 Butadiene, Ethylene Oxide, Epichlorohydrin, which are known to the State of California to cause cancer, and Bisphenol, Ethylene Glycol, Ethylene Oxide, 1,3 Butadiene, Epichlorohydrin, which are known to the State of California to cause birth defects or other reproductive harm.

**RS4971**



Radial Seal Outer Air Element  
**Contains:** Flame Retardant Media  
**Fits:** M.A.N. Trucks  
**Use With:** RS5361  
**Replaces:** M.A.N. 81.08405.0016; Fleetguard AF25894  
**O.D.:** 10 11/16 (271.5)  
**I.D.:** 6 11/16 (169.9) One End  
**Height:** 20 (508.0)

**RS4972**



Radial Seal Air Element  
**Fits:** Deutz-Fahr Tractors  
**Use With:** RS5684  
**Replaces:** Fleetguard AF25504  
**O.D.:** 8 5/32 (207.2)  
**I.D.:** 4 9/32 (108.7) One End  
**Height:** 15 1/16 (382.6)

**PA4973**



Rectangular Air Element  
**Fits:** Ingersoll-Rand Compressors  
**Replaces:** Ingersoll-Rand 51322881; Woodgate WGD800016  
**Length:** 32 3/16 (817.6)  
**Width:** 9 13/32 (238.9)  
**Height:** 3 1/2 (88.9)

**PA4975**



Panel Air Element  
**Notes:** OBSOLETE. Availability Limited to Dealer Stock.  
**Replaces:** Woodgate WGD12122  
**Length:** 11 3/8 (288.9)  
**Width:** 11 3/8 (288.9)  
**Height:** 1 3/4 (44.4)

**PA4977-FN**



Air Element with Fins  
**Replaces:** Fiat 8016660; Woodgate WGA1553  
**O.D.:** 9 5/32 (232.6)  
 Fins 11 13/32 (289.7)  
**I.D.:** 25/32 (19.8) & 4 29/32 (124.6)  
**Height:** 13 19/32 (345.3)

**PA4978**



Air Element  
**Replaces:** Becker 909536; Woodgate WGA956  
**O.D.:** 2 9/32 (57.9)  
**I.D.:** 3/16 (4.8) & 23/32 (18.3)  
**Height:** 1 19/32 (40.5)  
**A. Gskt:** [1] Attached

**PA4979**



Panel Air Element  
**Fits:** Lombardini Engines  
**Replaces:** Lombardini 55.02175.096; Woodgate WGA1618  
**Length:** 6 9/32 (159.5)  
**Width:** 6 5/32 (156.4)  
**Height:** 1 17/32 (38.9)

**PA4983**



Inner Air Element  
**Fits Inside:** PA4984-FN  
**Fits:** Hyundai Excavators, Loaders  
**Replaces:** Hyundai 11EM21051  
**O.D.:** 5 5/32 (131.0)  
**I.D.:** 3/4 (19.0) & 4 1/32 (102.4)  
**Height:** 19 7/16 (493.7)  
**A. Gskt:** [1] Attached

**PA4984-FN**



Outer Air Element with Fins  
**Fits:** Hyundai Excavators, Loaders  
**Use With:** PA4983  
**Replaces:** Hyundai 11EM21041  
**O.D.:** 7 31/32 (202.4)  
 Fins 9 13/16 (249.2)  
**I.D.:** 3/4 (19.0) & 5 3/8 (136.5)  
**Height:** 19 13/16 (503.2)  
**A. Gskt:** [1] Attached

**PA4985**



Cab Air Element  
**Fits:** International Trucks  
**Replaces:** International 2506656-C1  
**Length:** 12 19/32 (319.9)  
**Width:** 7 1/4 (184.2)  
**Height:** 31/32 (24.6)

**PA4986**

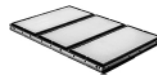

Cab Air Element  
**Fits:** Komatsu Equipment  
**Replaces:** Komatsu 77Z9-70-0020  
**Length:** 12 (304.8)  
**Width:** 7 13/16 (198.4)  
**Height:** 3/4 (19.1)  
**A. Gskt:** [1] Attached

**PA4987**



Cab Air Element  
**Fits:** Komatsu Dozers  
**Replaces:** Komatsu 77Z9-70-0010  
**Length:** 8 9/32 (210.3)  
**Width:** 8 1/32 (204.0)  
**Height:** 25/32 (19.8)  
**A. Gskt:** [1] Attached











**RS4988**



Radial Seal Air Element  
**Fits:** Caterpillar D9R Crawler Tractor  
**Replaces:** Caterpillar 165-1689; Donaldson P606220  
**O.D.:** 13 15/32 (342.1)  
**I.D.:** 8 5/32 (207.2) One End  
**Height:** 15 17/32 (394.5)

Measurements Are Shown In Inches And (Millimeters)

**WARNING:** These products can expose you to chemicals, including Diisononyl Phthalate, Carbon black extracts, Nickel, 1,3 Butadiene, Ethylene Oxide, Epichlorohydrin, which are known to the State of California to cause cancer, and Bisphenol, Ethylene Glycol, Ethylene Oxide, 1,3 Butadiene, Epichlorohydrin, which are known to the State of California to cause birth defects or other reproductive harm.

<p><b>RS4989</b></p> 	<p>Radial Seal Outer Air Element  <b>Notes:</b> Sometimes used with RS4629.  <b>Fits:</b> Caterpillar, John Deere, New Holland Equipment  <b>Replaces:</b> Perkins SEV551F14  <b>O.D.:</b> 14 7/32 (361.2)  <b>I.D.:</b> 8 15/16 (227.0) One End  <b>Height:</b> 24 27/32 (631.0)</p>	<p><b>CA4996</b></p> 	<p>Channel Flow Primary Air Element  <b>Fits:</b> Caterpillar Crawler Tractors, Loaders; Valtra Tractors  <b>Use With:</b> PA4997  <b>Replaces:</b> Caterpillar 2277448, 2934053  <b>O.D.:</b> 7 7/8 (200.0) to 9 1/8 (231.8)  <b>Height:</b> 6 7/8 (174.6)</p>
<p><b>PA4991</b></p> 	<p>Cab Air Element  <b>Fits:</b> Volvo Dump Trucks, Loaders  <b>Replaces:</b> Volvo 11703980  <b>Length:</b> 19 1/8 (485.8)  <b>Width:</b> 11 1/4 (285.8)  <b>Height:</b> 2 7/16 (61.9)  <b>A. Gskt:</b> [1] Included</p>	<p><b>PA4997</b></p> 	<p>Channel Flow Secondary Air Element  <b>Fits:</b> Caterpillar Crawler Tractors, Loaders  <b>Use With:</b> CA4996  <b>Replaces:</b> Caterpillar 2277449; J.C. Bamford 32/926072  <b>O.D.:</b> 5 9/16 (141.3) to 8 7/32 (208.8)  <b>Height:</b> 1 19/32 (40.5)</p>
<p><b>RS4992</b></p> 	<p>Radial Seal Outer Air Element  <b>Fits:</b> John Deere Equipment  <b>Use With:</b> RS5329  <b>Replaces:</b> John Deere AT300487  <b>O.D.:</b> 8 27/32 (224.6)  <b>I.D.:</b> 7 1/8 (181.0) One End  <b>Height:</b> 16 23/32 (424.7)</p>	<p><b>CA4999</b></p> 	<p>Channel Flow Air Element  <b>Fits:</b> Ford Excursion, Super Duty Trucks all with 6.0L Turbo Diesel Engine  <b>Replaces:</b> Ford 3C3U-9601-BC; Motorcraft FA1746; Donaldson P603577; Fleetguard AF26152; Wix 42731  <b>O.D.:</b> 7 31/32 (202.4) to 12 3/32 (307.2)  <b>Height:</b> 9 5/16 (236.5)  <b>A. Gskt:</b> [1] Attached</p>
<p><b>RS4993</b></p> 	<p>Radial Seal Air Element  <b>Replaces:</b> Fleetguard AF25708M; Nelson 870904A, 870904N  <b>O.D.:</b> 11 3/32 (281.8)  <b>I.D.:</b> 8 (203.2) One End  <b>Height:</b> 20 15/32 (519.9)</p>	<p><b>CFB5000</b></p> 	<p>Coolant Filter Base  <b>Contains:</b> 11/16-16 Threaded Stud  <b>Use With:</b> All Coolant Spin-ons with 11/16-16 Thread  <b>O.D.:</b> 4 11/16 (119.1)  <b>Inlet:</b> 3/8-18 NPTF  <b>Outlet:</b> 3/8-18 NPTF  <b>Height:</b> 3 3/32 (78.6)</p>
<p><b>RS4994</b></p> 	<p>Radial Seal Outer Air Element  <b>Fits:</b> Caterpillar Crawler Tractors  <b>Use With:</b> RS4995  <b>Replaces:</b> Caterpillar 180-5474; Donaldson P606804  <b>O.D.:</b> 6 1/2 (165.1)  <b>I.D.:</b> 3 9/16 (90.5) One End  <b>Height:</b> 12 17/32 (318.3)</p>	<p><b>CS5007</b></p> 	<p>BTA PLUS Formula Liquid Additive (Pint Plastic Bottle)  <b>Notes:</b> NOT compatible with Long Life Organic Acid-based Coolant.            For systems containing 0% to 60% Ethylene Glycol antifreeze.  <b>Contains:</b> 4 Units BTA PLUS            Pre-Charge treatment is 1 1/4 units per gallon of cooling system capacity.            Maintenance treatment is 1 1/4 units per 4 gallons of cooling system capacity every 12,000-15,000 miles or 300-350 hours of operation.  <b>Replaces:</b> Case B91245; Cummins 3305372, 3315459; John Deere RE23182, TY16004  <b>Related To:</b> CS5055 (55 Gallon Drum) CS5057 (5 Gallon Jug) CS5058 (Half Gallon Jug)</p>
<p><b>RS4995</b></p> 	<p>Radial Seal Inner Air Element  <b>Fits Inside:</b> RS4994  <b>Fits:</b> Caterpillar Crawler Tractors  <b>Replaces:</b> Caterpillar 180-5475  <b>O.D.:</b> 3 21/32 (92.9)  <b>I.D.:</b> 2 7/8 (73.0) One End  <b>Height:</b> 12 3/32 (307.2)</p>		

Measurements Are Shown In Inches And (Millimeters)

**WARNING:** These products can expose you to chemicals, including Diisononyl Phthalate, Carbon black extracts, Nickel, 1,3 Butadiene, Ethylene Oxide, Epichlorohydrin, which are known to the State of California to cause cancer, and Bisphenol, Ethylene Glycol, Ethylene Oxide, 1,3 Butadiene, Epichlorohydrin, which are known to the State of California to cause birth defects or other reproductive harm.

**CS5008**



BTE Liquid Coolant Additive (Pint Plastic Bottle)  
**Notes:** NOT compatible with Long Life Organic Acid-based Coolant.  
 For systems containing 40% to 60% Ethylene Glycol antifreeze.  
 Compatible with all Ethylene Glycol antifreezes. Heavy-Duty antifreeze containing sodium nitrite needs no initial treatment.  
**Contains:** Pre-Charge treatment is one pint to each 4 gallons of cooling system capacity or fraction.  
 Maintenance treatment is one pint for each 20 gallons of cooling system capacity or fraction.  
 Every 12,000-15,000 miles or 300-350 hours of operation.

**CS5009**



BTE Liquid Coolant Additive (Half Gallon Plastic Jug)  
**Notes:** NOT compatible with Long Life Organic Acid-based Coolant.  
 For systems containing 40% to 60% Ethylene Glycol antifreeze.  
 Compatible with all Ethylene Glycol antifreezes. Heavy-Duty antifreeze containing sodium nitrite needs no initial treatment.  
**Contains:** Pre-Charge treatment is one pint to each 4 gallons of cooling system capacity or fraction.  
 Maintenance treatment is one pint for each 20 gallons of cooling system capacity or fraction.  
 Every 12,000-15,000 miles or 300-350 hours of operation.

**CS5010**



BTE Liquid Coolant Additive (5 Gallon Bucket)  
**Notes:** NOT compatible with Long Life Organic Acid-based Coolant.  
 For systems containing 40% to 60% Ethylene Glycol antifreeze.  
 Compatible with all Ethylene Glycol antifreezes. Heavy-Duty antifreeze containing sodium nitrite needs no initial treatment.  
**Contains:** Pre-Charge treatment is one pint to each 4 gallons of cooling system capacity or fraction.  
 Maintenance treatment is one pint for each 20 gallons of cooling system capacity or fraction.  
 Every 12,000-15,000 miles or 300-350 hours of operation.

**CS5011**



BTE Liquid Coolant Additive (55 Gallon No Return Plastic Drum)  
**Notes:** NOT compatible with Long Life Organic Acid-based Coolant.  
 For systems containing 40% to 60% Ethylene Glycol antifreeze.  
 Compatible with all Ethylene Glycol antifreezes. Heavy-Duty antifreeze containing sodium nitrite needs no initial treatment.  
**Contains:** Pre-Charge treatment is one pint to each 4 gallons of cooling system capacity or fraction.  
 Maintenance treatment is one pint for each 20 gallons of cooling system capacity or fraction.  
 Every 12,000-15,000 miles or 300-350 hours of operation.

**CSC5012**



Liquid Coolant Cleaner (1 Gallon Plastic Bottle)  
**Notes:** An inhibited neutral chelating cooling system cleaner. CSC is formulated to dissolve scale and corrosion products while removing silica gel and oil found in engine cooling systems.  
**Contains:** Recommended treatment is 1 gallon to each 10 gallons of cooling system capacity. While you may get improved performance from a higher concentration of CSC, do not use CSC at more than twice the recommended concentration levels.

**CSC5013**



Liquid Coolant Cleaner (5 Gallon Jug)  
**Notes:** An inhibited neutral chelating cooling system cleaner. CSC is formulated to dissolve scale and corrosion products while removing silica gel and oil found in engine cooling systems.  
**Contains:** Recommended treatment is 1 gallon to each 10 gallons of cooling system capacity. While you may get improved performance from a higher concentration of CSC, do not use CSC at more than twice the recommended concentration levels.

**CTK5028**



Correcting Refractometer  
**Notes:** This refractometer measures Ethylene and Propylene Glycol based fluids.  
**Contains:** Internal Light Source  
 Syringe  
 Dip Stick

**CTK5029**



FleetStrip Coolant Test Kit  
**Notes:** Kit is designed to test SCAs by measuring freeze point, nitrite and molybdate. Does not test Long Life Organic Acid-based coolant.  
**Contains:** [1] Sample Vial  
 [1] Extraction Pipet  
 Instructions  
 Color Chart  
 Plastic Carrying Case  
 [50] Test Strips  
**Replaces:** Fleetguard CC2602

**CTK5029-1**



FleetStrip Coolant Test Strip Only  
**Contains:** [1] Test Strip, Color Chart, Instruction Sheet  
**Replaces:** Fleetguard CC2602B

**CTK5029-4**



FleetStrip Coolant Test Strips Only  
**Contains:** [4] Test Strips, Color Chart, Instruction Sheet

Measurements Are Shown In Inches And (Millimeters)

**WARNING:** These products can expose you to chemicals, including Diisononyl Phthalate, Carbon black extracts, Nickel, 1,3 Butadiene, Ethylene Oxide, Epichlorohydrin, which are known to the State of California to cause cancer, and Bisphenol, Ethylene Glycol, Ethylene Oxide, 1,3 Butadiene, Epichlorohydrin, which are known to the State of California to cause birth defects or other reproductive harm.

**CTK5029-M**

**FleetStrip Coolant Test Kit**



**Notes:** CTK5029-M Color Chart measurement is metric.  
Kit is designed to test SCAs by measuring freeze point, nitrite and molybdate.  
Does not test Long Life Organic Acid-based coolant.

**Contains:** [1] Sample Vial  
[1] Extraction Pipet  
Instructions  
Color Chart  
Plastic Carrying Case  
[50] Test Strips

**CS5055**

**BTA PLUS Liquid Additive (55 Gallon No Return Plastic Drum)**



**Notes:** OBSOLETE. Availability Limited to Dealer Stock.  
NOT compatible with Long Life Organic Acid-based Coolant.  
Pre-Charge treatment is 1 1/4 units per gallon of cooling system capacity.  
Maintenance treatment is 1 1/4 units per 4 gallons of cooling system  
**Related To:** CS5007 (Pint Bottle)  
CS5057 (5 Gallon Bucket)  
CS5058 (Half Gallon Jug)

**CS5057**

**BTA PLUS Liquid Additive (5 Gallon Jug)**



**Notes:** NOT compatible with Long Life Organic Acid-based Coolant.  
Pre-Charge treatment is 1 1/4 units per gallon of cooling system capacity.  
Maintenance treatment is 1 1/4 units per 4 gallons of cooling system  
**Replaces:** Caterpillar 8C3680  
**Related To:** CS5007 (Pint Bottle)  
CS5055 (55 Gallon No Return Plastic Drum)  
CS5058 (Half Gallon Jug)

**CS5058**

**BTA PLUS Formula Liquid Additive (Half Gallon Jug)**



**Notes:** NOT compatible with Long Life Organic Acid-based Coolant.  
Pre-Charge treatment is 1 1/4 units per gallon of cooling system capacity.  
Maintenance treatment is 1 1/4 units per 4 gallons of cooling system  
**Replaces:** Cummins 3305373; Komatsu 1258390-H1  
**Related To:** CS5007 (Pint Bottle)  
CS5055 (55 Gallon No Return Plastic Drum)  
CS5057 (5 Gallon Bucket)

**OTK5060**

**Live Oil Sample Kit with Processing**



**Notes:** Purchase of kit includes testing charges.  
Testing includes 23 Elements, Antifreeze, Fuel Dilution, Viscosity @ 100 C, Complete Oil Condition (Soot, Oxidation, Nitration, Sulfation)  
**Contains:** [1] 2.5 oz. Bottle with Lid, Live Sample Cap for Sample Extraction  
Label for Sample Information  
Ziploc, Bubble Mailer for Return (Return Postage is not included)  
**Fits:** Engines, Transmissions, Hydraulics  
**Use With:** Systems with Pressurized Probalyzer Ports - OTK5061 (Marine Applications)  
**Replaces:** Titan OD1020

**OTK5061**

**Stainless Steel Probalyzer Plug**



**Notes:** Installs into standard NPT 1/8 In. pressure ports, allows fluid samples to be drawn during operation using live sample caps, handles up to 5000 psi.  
**Contains:** Stainless Steel Plug with Instructions  
**Fits:** Can be installed on any pressurized line for oil and coolant. Best used in Marine applications as it does not corrode in salt water.  
**Use With:** OTK5060  
**Replaces:** Titan OD1015

**OTK5063**

**Oil Test Kit**



**Notes:** Purchase of kit includes testing charges.  
Testing includes 23 Elements, Antifreeze, Fuel Dilution, Viscosity @ 100 C, Complete Oil Condition (Soot, Oxidation, Nitration, Sulfation)  
**Contains:** [1] 2.5 oz. Bottle with Lid  
Label for Sample Information  
Ziploc, Bubble Mailer for Return (Return Postage is not included)  
**Fits:** Extractor Pumps and Tubing as well as mid-drain sampling.  
**Replaces:** Titan OD8011

**BW5070**

**Coolant Spin-on with BTA PLUS Formula**



**Notes:** Maintenance filter for systems with 1-6 gallons capacity.  
Can be used with CFB5000 base, or CFB8784 dual base.  
**Contains:** 2 Units BTA PLUS  
**Fits:** Cummins Engines  
**Replaces:** Cummins 3318157; Fleetguard WF2070  
**Thread:** 11/16 -16  
**O.D.:** 3 11/16 (93.7)  
**Height:** 4 3/8 (111.1)  
**I.Gskt:** G381-A

**BW5071**

**Coolant Spin-on with BTA PLUS Formula**



**Notes:** Maintenance filter for systems with 7-16 gallons capacity.  
Can be used with CFB5000 base or CFB8784 dual base.  
**Contains:** 4 Units BTA PLUS  
**Fits:** Cummins Engines  
**Replaces:** Ag-Chem 709939; Case 1822627C1; Caterpillar 226-6565; Cummins 3315116; Demag 692338; Ford E5NN-8A424-A; General Motors 25012893; Hitachi 4127340; John Deere RE42052; Mack 25MF214; Fleetguard WF2071  
**Thread:** 11/16 -16  
**O.D.:** 3 11/16 (93.7)  
**Height:** 4 3/8 (111.1)  
**I.Gskt:** G381-A

**BW5072**

**Coolant Spin-on with BTA PLUS Formula**



**Notes:** Maintenance filter for systems with 17-21 gallons capacity.  
Can be used with CFB5000 base or CFB8784 dual base.  
**Contains:** 6 Units BTA PLUS  
**Fits:** Cummins Engines  
**Replaces:** Cummins 3318201; Ford E8NN-8A424-B; Hough 1257937H1; John Deere F434679; Komatsu 6742-01-3970; Onan 133-3538; Volvo 129680286; Fleetguard WF2072  
**Thread:** 11/16 -16  
**O.D.:** 3 11/16 (93.7)  
**Height:** 4 3/8 (111.1)  
**I.Gskt:** G381-A

Measurements Are Shown In Inches And (Millimeters)

**WARNING:** These products can expose you to chemicals, including Diisononyl Phthalate, Carbon black extracts, Nickel, 1,3 Butadiene, Ethylene Oxide, Epichlorohydrin, which are known to the State of California to cause cancer, and Bisphenol, Ethylene Glycol, Ethylene Oxide, 1,3 Butadiene, Epichlorohydrin, which are known to the State of California to cause birth defects or other reproductive harm.

## BW5073



Coolant Spin-on with BTA PLUS Formula

**Notes:** Maintenance filter for systems with 22-32 gallons capacity. Can be used with CFB5000 base or CFB8784 dual base.

**Contains:** 8 Units BTA PLUS

**Fits:** Cummins Engines

**Replaces:** Agco 1076751M1; Case 690139C1; Caterpillar 226-6567; Cummins 3315115; Daewoo 9912-15115; Demag 692336; Hitachi 19305494; Versatile 104040; Volvo M12968028; Fleetguard WF2073

**Thread:** 11/16 -16

**O.D.:** 3 11/16 (93.7)

**Height:** 5 3/8 (136.5)

**I.Gskt:** G381-A

## BW5086



Coolant Spin-on with BTA PLUS Formula

**Contains:** 11 1/2 Units BTA PLUS

**Fits:** Cummins Engines

**Replaces:** Cummins 3680433; Fleetguard WF2126

**Thread:** M36 x 2.0

**O.D.:** 3 3/4 (95.3)

**Height:** 5 13/32 (137.3)

**I.Gskt:** [1] Included

## BW5074



Coolant Spin-on with BTA PLUS Formula

**Notes:** Maintenance filter for systems with 33-43 gallons capacity. Can be used with CFB5000 base or CFB8784 dual base.

**Contains:** 12 Units BTA PLUS

**Fits:** Cummins Engines

**Replaces:** Cummins 3315114; Fleetguard WF2074

**Thread:** 11/16 -16

**O.D.:** 3 11/16 (93.7)

**Height:** 5 3/8 (136.5)

**I.Gskt:** G381-A

## B5087



Coolant Spin-on without Chemicals

**Notes:** Long Life (150,000 miles) used with Extended Service coolant.

**Fits:** Cummins Engines

**Replaces:** Cummins 3680434

**Thread:** M36 x 2.0

**O.D.:** 3 3/4 (95.3)

**Height:** 5 15/32 (138.9)

**F. Gskt:** [1] Included

## BW5075



Coolant Spin-on with BTA PLUS Formula

**Notes:** Maintenance filter for systems with 44-51 gallons capacity. Can be used with CFB5000 base or CFB8784 dual base.

**Contains:** 15 Units BTA PLUS

**Fits:** Cummins Engines

**Replaces:** Cummins 3318318; Fleetguard WF2075

**Thread:** 11/16 -16

**O.D.:** 3 11/16 (93.7)

**Height:** 5 3/8 (136.5)

**I.Gskt:** G381-A

## B5088



Coolant Spin-on without Chemicals

**Notes:** Long Life (150,000 miles) used with Extended Service coolant. Can be used with CFB5000 base or CFB8784 dual base.

**Fits:** Caterpillar, Cummins Engines

**Replaces:** Cummins 3098689

**Thread:** 11/16 -16

**O.D.:** 3 11/16 (93.7)

**Height:** 4 3/8 (111.1)

**I.Gskt:** G381-A

**Related To:** B5090 (Long Version)

## BW5076



Coolant Spin-on with BTA PLUS Formula

**Notes:** Maintenance filter for systems with 52-70 gallons capacity. Can be used with CFB5000 base or CFB8784 dual base.

**Contains:** 23 Units BTA PLUS

**Fits:** Cummins Engines

**Replaces:** Cummins 3318319; Fleetguard WF2076

**Thread:** 11/16 -16

**O.D.:** 3 11/16 (93.7)

**Height:** 7 5/32 (181.8)

**I.Gskt:** G381-A

## B5089



Coolant Spin-on without Chemicals

**Notes:** Can be used with CFB5000 base or CFB8784 dual base.

**Fits:** Scania Trucks

**Replaces:** International 1825314-C1; Fleetguard WF2107

**Thread:** 11/16 -16

**O.D.:** 3 11/16 (93.7)

**Height:** 4 3/8 (111.1)

**I.Gskt:** G381-A

**Related To:** B5134 (Long Version)

## BW5082



Coolant Spin-on with BTA PLUS Formula

**Notes:** Maintenance filter for systems with 7-16 gallons capacity. Can be used with CFB5000 base or CFB8784 dual base.

**Contains:** 4 Units BTA PLUS

**Fits:** International Equipment

**Replaces:** International 1822313-C1; Fleetguard WF2106

**Thread:** 11/16 -16

**O.D.:** 3 11/16 (93.7)

**Height:** 5 3/8 (136.5)

**I.Gskt:** G381-A

## B5090



Coolant Spin-on without Chemicals

**Notes:** Long Life (150,000 miles) used with Extended Service coolant. Can be used with CFB5000 base or CFB8784 dual base.

**Fits:** International, Kenworth Trucks

**Replaces:** Cummins 3098690; Fleetguard WF2123

**Thread:** 11/16 -16

**O.D.:** 3 11/16 (93.7)

**Height:** 5 3/8 (136.5)

**I.Gskt:** G381-A

**Related To:** B5088 (Short Version)

## B5091



Coolant Spin-on without Chemicals

**Fits:** Mack Trucks

**Replaces:** Mack 20575545

**Thread:** M16 x 1.5

**O.D.:** 3 11/16 (93.7)

**Height:** 5 13/32 (137.3)

**A. Gskt:** G401

Measurements Are Shown In Inches And (Millimeters)

**WARNING:** These products can expose you to chemicals, including Diisononyl Phthalate, Carbon black extracts, Nickel, 1,3 Butadiene, Ethylene Oxide, Epichlorohydrin, which are known to the State of California to cause cancer, and Bisphenol, Ethylene Glycol, Ethylene Oxide, 1,3 Butadiene, Epichlorohydrin, which are known to the State of California to cause birth defects or other reproductive harm.

**P5092**

Coolant Element without Chemicals



**Notes:** Has a Bail Handle.  
**Fits:** Detroit Diesel DD15 (14.8L) Engine; Freightliner, Mercedes-Benz, Sterling, Western Star Trucks  
**Replaces:** Detroit Diesel A4722030155, A4722030255; Mercedes-Benz A4722030255  
**O.D.:** 3 21/32 (92.9)  
**I.D.:** 1 5/8 (41.3) One End  
**Height:** 5 9/32 (134.1)  
**O-Ring:** [1] Included

**B5134**

Coolant Spin-on without Chemicals



**Notes:** Can be used with CFB5000 base or CFB8784 dual base.  
**Fits:** John Deere Equipment  
**Replaces:** Caterpillar 9Y4528; Cummins 3300721; Ford E7NN-8A469-AA; GMC 25010844; Hino 16304-41015; John Deere RE11992  
**Thread:** 11/16 -16  
**O.D.:** 3 11/16 (93.7)  
**Height:** 5 13/32 (137.3)  
**I.Gskt:** G381-A  
**Related To:** B5089 (Short Version)

**BW5136**

Coolant Spin-on with BTE Formula



**Notes:** Maintenance filter for systems with 1-10 gallons capacity.  
 Can be used with CFB5000 base or CFB8784 dual base.  
**Contains:** 2 Units BTE  
**Fits:** Allis Chalmers, Case, International, John Deere Equipment  
**Replaces:** Allis Chalmers 40290892; Case A151931; Caterpillar 7E6014; Ford E7HZ-8A424-C; John Deere AR89381; Komatsu 600-411-1190  
**Thread:** 11/16 -16  
**O.D.:** 3 11/16 (93.7)  
**Height:** 4 3/8 (111.1)  
**I.Gskt:** G381-A

**BW5137**

Coolant Spin-on with BTE Formula



**Notes:** Maintenance filter for systems with 11-20 gallons capacity.  
 Can be used with CFB5000 base or CFB8784 dual base.  
**Contains:** 4 Units BTE  
**Fits:** Allis Chalmers, Caterpillar, Fiat-Allis, International, Komatsu Equipment; Chevrolet, Freightliner, GMC, International, Iveco, Kenworth, Peterbilt Trucks  
**Replaces:** Allis Chalmers 4681776; Caterpillar 9N3368; Cummins 209606; GMC 23507545; Ford D2HZ-8A424-A; International 1801090-C1; Komatsu 600-411-1020  
**Thread:** 11/16 -16  
**O.D.:** 3 11/16 (93.7)  
**Height:** 4 13/32 (111.9)  
**I.Gskt:** G381-A

**BW5138**

Coolant Spin-on with BTE Formula



**Notes:** Maintenance filter for systems with 21-30 gallons capacity.  
 Can be used with CFB5000 base or CFB8784 dual base.  
**Contains:** 6 Units BTE  
**Fits:** Komatsu Equipment  
**Replaces:** Allis Chalmers 70697635; Fiat 70697635; GMC 25011791; Komatsu 600-411-1140  
**Thread:** 11/16 -16  
**O.D.:** 3 11/16 (93.7)  
**Height:** 5 3/8 (136.5)  
**I.Gskt:** G381-A

**BW5139**

Coolant Spin-on with BTE Formula



**Notes:** Maintenance filter for systems with 31-40 gallons capacity.  
 Can be used with CFB5000 base or CFB8784 dual base.  
**Contains:** 8 Units BTE  
**Fits:** Caterpillar, Komatsu Equipment  
**Replaces:** Allis Chalmers 4393504, 4393504-8; Case A152819; Caterpillar 9N3366; Cummins 209607; GMC 6439698; Hino 16304-1011; International 1801089-C1; John Deere AR88276; Komatsu 600-411-1040  
**Thread:** 11/16 -16  
**O.D.:** 3 11/16 (93.7)  
**Height:** 5 11/32 (135.7)  
**I.Gskt:** G381-A

**BW5140**

Coolant Spin-on with BTE Formula



**Notes:** Maintenance filter for systems with 41-50 gallons capacity.  
 Can be used with CFB5000 base or CFB8784 dual base.  
**Contains:** 16 Units BTE  
**Fits:** Caterpillar, Komatsu Equipment  
**Replaces:** Caterpillar 1W5518; Clark 963797; Cummins 3315788; GMC 23507189; John Deere AR94652; Komatsu 600-411-1420  
**Thread:** 11/16 -16  
**O.D.:** 3 11/16 (93.7)  
**Height:** 7 5/32 (181.8)  
**I.Gskt:** G381-A

**BW5141**

Coolant Spin-on with BTE Formula



**Notes:** Maintenance filter for systems with 1-10 gallons capacity.  
**Contains:** 2 Units BTE  
**Fits:** Volvo Equipment  
**Replaces:** Volvo 1661964-5, 1699830, 1699830-7  
**Thread:** M16 x 1.5  
**O.D.:** 3 11/16 (93.7)  
**Height:** 5 13/32 (137.3)  
**I.Gskt:** G401

**BW5142**

Coolant Spin-on with BTE Formula



**Contains:** 8 Units BTE  
**Fits:** Volvo Engines  
**Replaces:** Volvo 3945411  
**Thread:** M16 x 1.5  
**O.D.:** 3 11/16 (93.7)  
**Height:** 5 13/32 (137.3)  
**I.Gskt:** G401

Measurements Are Shown In Inches And (Millimeters)

**WARNING:** These products can expose you to chemicals, including Diisononyl Phthalate, Carbon black extracts, Nickel, 1,3 Butadiene, Ethylene Oxide, Epichlorohydrin, which are known to the State of California to cause cancer, and Bisphenol, Ethylene Glycol, Ethylene Oxide, 1,3 Butadiene, Epichlorohydrin, which are known to the State of California to cause birth defects or other reproductive harm.



**BW5143** Coolant Spin-on with BTE Formula  
**Notes:** Can be used with CFB5000 base or CFB8784 dual base.  
**Contains:** 11 Units BTE  
**Fits:** Iveco Trucks  
**Replaces:** Iveco 1901776  
**Thread:** 11/16 -16  
**O.D.:** 3 11/16 (93.7)  
**Height:** 5 3/8 (136.5)  
**I.Gskt:** G381-A



**BW5182** Coolant Spin-on with BTE Formula  
**Notes:** Can be used with CFB5000 base or CFB8784 dual base.  
**Contains:** 8 Units BTE  
**Fits:** Komatsu Excavators, Loaders  
**Replaces:** Komatsu 600-411-1181  
**Thread:** 11/16 -16  
**O.D.:** 3 11/16 (93.7)  
**Height:** 3 7/32 (81.8)  
**I.Gskt:** G381-A



**B5144** Coolant By-Pass Spin-on Canister  
**Notes:** For use with Long Life Coolant. DO NOT replace with spin-on containing chemicals.  
**Fits:** Volvo Engines  
**Replaces:** Volvo 3969696; Fleetguard WF2109  
**Thread:** M16 x 1.5  
**O.D.:** 3 11/16 (93.7)  
**Height:** 5 7/16 (138.1)  
**I.Gskt:** G401



**BW5183** Coolant Spin-on with BTE Formula  
**Contains:** 12 Units BTE  
**Fits:** Mack Trucks  
**Replaces:** Mack 20539991  
**Thread:** M16 x 1.5  
**O.D.:** 3 11/16 (93.7)  
**Height:** 4 7/16 (112.7)  
**I.Gskt:** G401



**B5145** Coolant Spin-on without Chemicals  
**Notes:** Long Life (150,000 miles) used with Extended Service coolant.  
**Fits:** Volvo Equipment  
**Replaces:** Volvo 20458771; Fleetguard WF2129  
**Thread:** M16 x 1.5  
**O.D.:** 3 11/16 (93.7)  
**Height:** 4 7/16 (112.7)  
**I.Gskt:** G401



**BW5200** Controlled Release Coolant Spin-on with BTE Formula  
**Notes:** Can be used with CFB5000 base or CFB8784 dual base.  
**Contains:** Flow Control Orifice that meters flow of coolant through filter to allow coolant additives to be released in the amount required to maintain proper system balance for up to 150,000 miles of service.  
**Fits:** Applications Using a "Controlled Release" Coolant Additive  
**Replaces:** Nalcool NF2088  
**Thread:** 11/16 -16  
**O.D.:** 3 11/16 (93.7)  
**Height:** 5 13/32 (137.3)  
**I.Gskt:** G381-A



**B5176** Coolant Spin-on without Chemicals  
**Fits:** Mack Engines, Trucks  
**Replaces:** Fleetguard WF2078  
**Thread:** 3/4 -20  
**O.D.:** 3 11/16 (93.7)  
**Height:** 5 3/8 (136.5)  
**I.Gskt:** G381-A



**BW5201** Controlled Release Coolant Spin-on with BTE Formula  
**Contains:** Flow Control Orifice that meters flow of coolant through filter to allow coolant additives to be released in the amount required to maintain proper system balance for up to 150,000 miles of service.  
**Fits:** Applications Using a "Controlled Release" Coolant Additive  
**Replaces:** Nalcool NF2089, NF2089-1, NFC2089  
**Thread:** 3/4 -20  
**O.D.:** 3 11/16 (93.7)  
**Height:** 5 3/8 (136.5)  
**I.Gskt:** G381-A



**B5177** Coolant Spin-on without Chemicals  
**Fits:** Mack Engines, Trucks  
**Replaces:** Fleetguard WF2079  
**Thread:** 1 -16  
**O.D.:** 4 1/4 (108.0)  
**Height:** 5 13/16 (147.6)  
**I.Gskt:** [1] Included



**BW5178** Coolant Spin-on with BTE Formula  
**Contains:** 10 Units BTE  
**Fits:** Mack Engines, Trucks  
**Replaces:** GMC 6439296; Mack 25MF428, 25MF428-A; White 27-077522  
**Thread:** 3/4 -20  
**O.D.:** 3 11/16 (93.7)  
**Height:** 5 3/8 (136.5)  
**I.Gskt:** G381-A



**BW5250** Controlled Release Coolant Spin-on with BTA PLUS Formula  
**Notes:** Can be used with CFB5000 base or CFB8784 dual base.  
**Contains:** Flow Control Orifice that meters flow of coolant through filter to allow coolant additives to be released in the amount required to maintain proper system balance for up to 150,000 miles of service.  
**Fits:** Applications using a "Controlled Release" Coolant Additive  
**Replaces:** Cummins XWF4242; Fleetguard WF2121  
**Thread:** 11/16 -16  
**O.D.:** 3 11/16 (93.7)  
**Height:** 5 13/32 (137.3)  
**I.Gskt:** G381-A



**BW5179** Coolant Spin-on with BTE Formula  
**Contains:** 16 Units BTE  
**Fits:** Mack Engines, Trucks  
**Replaces:** GMC 25010921; Mack 25MF418  
**Thread:** 1 -16  
**O.D.:** 4 1/4 (108.0)  
**Height:** 5 13/16 (147.6)  
**I.Gskt:** [1] Included



Measurements Are Shown In Inches And (Millimeters)

**WARNING:** These products can expose you to chemicals, including Diisononyl Phthalate, Carbon black extracts, Nickel, 1,3 Butadiene, Ethylene Oxide, Epichlorohydrin, which are known to the State of California to cause cancer, and Bisphenol, Ethylene Glycol, Ethylene Oxide, 1,3 Butadiene, Epichlorohydrin, which are known to the State of California to cause birth defects or other reproductive harm.

**PE5270**



**Urea Diesel Exhaust Fluid Filter**  
**Contains:** [1] Plastic Drain Plug  
 [1] Steel Mesh Strainer  
 [1] Foam Absorber  
**Fits:** DAF, M.A.N., Volvo Trucks  
**Replaces:** Cummins 3967874; DAF 1649425, 1674485, 1789050, 1815766, 1819795; Iveco 42553548, 42561571, 42562233; M.A.N. 81154036015, 81154036089; Nissan 20421-NY00J; Volvo 207136  
**O.D.:** 2 23/32 (69.1)  
**I.D.:** 31/32 (24.6) One End  
**Height:** 3 (76.2)  
**F. Gskt:** [1] Included  
**O-Ring:** [1] Attached, [1] Included

**PE5271**



**Urea Diesel Exhaust Fluid Filter**  
**Contains:** [1] Plastic Drain Plug  
**Fits:** Challenger, Fendt, Massey Ferguson Tractors; Volvo Trucks  
**Replaces:** Agco V837062993; Deutz 2934622; Iveco 42555073, 42561605; Renault 7420877950, 7420877953; Volvo 20876498, 20876502  
**O.D.:** 2 19/32 (65.9)  
**I.D.:** 7/16 (11.1)  
**Height:** 3 15/16 (100.0)  
**F. Gskt:** [1] Included  
**O-Ring:** [2] Attached

**PE5272**



**Urea Diesel Exhaust Fluid Filter in Plastic Shell**  
**Fits:** Freightliner, Mercedes-Benz, Western Star Buses, Trucks  
**Replaces:** Freightliner A0001420089, A0001420289; Mercedes-Benz A0001420089, A0001420289  
**Element**  
**O.D.:** 1 11/16 (42.9)  
**I.D.:** 1 1/32 (26.2)  
**Height:** 3 3/8 (85.7)  
**O-Ring:** [1] Attached  
**Shell**  
**O.D.** 2 13/16 (71.4)  
**I.D.** 1 3/4 (44.5)  
**Height** 3 29/32 (99.2)

**RS5273**



**Radial Seal Outer Air Element**  
**Fits:** Case-IH, Kubota, New Holland Equipment  
**Use With:** PA4633  
**Replaces:** Case 87300190, SBA314531174; Kubota 6C6099410  
**O.D.:** 3 17/32 (89.7)  
**I.D.:** 1 17/32 (38.9) One End  
**Height:** 7 (177.8)

**PA5274**



**Outer Air Element**  
**Use With:** PA5275  
**Replaces:** Dongfeng 1109N12020; Donaldson P500940; Fleetguard AF25276  
**O.D.:** 11 13/16 (300.0)  
**I.D.:** 11/32 (8.7) & 7 7/8 (200.0)  
**Height:** 18 3/4 (476.3)  
**A. Gskt:** [1] Attached

**PA5275**



**Inner Air Element**  
**Fits Inside:** PA5274  
**Replaces:** Dongfeng 1109N12030; Donaldson P500941; Fleetguard AF25277  
**O.D.:** 7 15/32 (189.7)  
**I.D.:** 11/16 (17.5) & 6 1/2 (165.1)  
**Height:** 17 19/32 (446.9)  
**A. Gskt:** [1] Attached

**PA5276**



**Hydraulic Breather Element**  
**Fits:** Komatsu Dump Trucks, Equipment  
**Replaces:** Komatsu 4216035170  
**O.D.:** 2 5/32 (54.8)  
**I.D.:** 7/8 (22.2) & 1 1/32 (26.2)  
**Height:** 1 9/32 (32.5)

**CA5278**



**Channel Flow Air Element**  
**Notes:** Sometimes used with PA4704 Secondary Air Element  
**Fits:** Valtra Tractors  
**Replaces:** Valtra 36539600  
**O.D.:** 5 1/8 (130.2)  
 to 12 13/16 (325.4)  
**Height:** 7 5/16 (185.7)

**PA5281**



**Cab Air Element with Foam Wrap**  
**Contains:** Charcoal Impregnated Media for Odor Control.  
**Fits:** John Deere Sprayers, Tractors  
**Replaces:** John Deere RE199681  
**O.D.:** 7 15/16 (201.6)  
**I.D.:** 9/16 (14.3) & 3 17/32 (89.7)  
**Height:** 12 1/4 (311.2)

**PA5282**

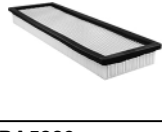

**Cab Air Element**  
**Fits:** John Deere Tractors  
**Replaces:** John Deere RE73220  
**Length:** 15 11/32 (389.7)  
**Width:** 4 29/32 (124.6)  
**Height:** 1 7/16 (36.5)

**PA5283**

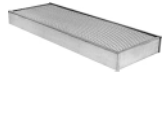

**Cab Air Element**  
**Fits:** Gleaner, Massey Ferguson, White Combines  
**Replaces:** Agco 71362389  
**Length:** 23 29/32 (607.2)  
**Width:** 9 (228.6)  
**Height:** 2 1/4 (57.2)

**BA5284**



**Coalescer Air Dryer Spin-on**  
**Fits:** Van Hool CL915, CL916 Buses with DAF Engines; DAF Trucks  
**Replaces:** DAF 1681575, 1821580; Donaldson P951411  
**Thread:** M41 x 1.5  
**O.D.:** 5 7/16 (138.1)  
**Height:** 6 9/16 (166.7)  
**I.Gskt:** [1] Included  
**O-Ring:** [1] Included  
**Related To:** BA5376 (Desiccant Version)

Measurements Are Shown In Inches And (Millimeters)

**WARNING:** These products can expose you to chemicals, including Diisononyl Phthalate, Carbon black extracts, Nickel, 1,3 Butadiene, Ethylene Oxide, Epichlorohydrin, which are known to the State of California to cause cancer, and Bisphenol, Ethylene Glycol, Ethylene Oxide, 1,3 Butadiene, Epichlorohydrin, which are known to the State of California to cause birth defects or other reproductive harm.

**RS5285**



Radial Seal Cab Air Element

**Fits:** Case Loaders; New Holland Motor Graders, Wheel Loaders  
**Replaces:** Case 87712194, 76303305; New Holland 87712194, 76303305  
**O.D.:** 6 1/4 (158.8)  
**I.D.:** 2 3/4 (69.9) One End  
**Height:** 10 29/32 (277.0)

**PA5290**



Secondary Oval Air Element

**Fits:** Caterpillar Equipment  
**Use With:** PA5289  
**Replaces:** Caterpillar 3466688  
**O.D.:** 5 3/16 (131.8) to 10 5/16 (261.9)  
**Height:** 1 1/2 (38.1)

**RS5287**



Radial Seal Outer Air Element

**Contains:** Inlet Adapter  
**Fits:** Kenworth, Peterbilt Trucks  
**Replaces:** Donaldson P625128  
**O.D.:** 13 1/8 (333.0)  
**I.D.:** 7 5/8 (193.8) & 4 5/8 (117.6)  
**Height:** 24 13/16 (630.2)  
**F. Gskt:** [1] Included  
**Related To:** RS5287XP (Extreme Performance Nano Version)

**RS5291**



Radial Seal Outer Air Element

**Fits:** New Holland TF210, TG230, TG255, 285 Tractors  
**Use With:** RS5292  
**Replaces:** New Holland 451525A1  
**O.D.:** 11 (279.4)  
**I.D.:** 7 3/32 (180.2) One End  
**Height:** 15 3/4 (400.0)

**RS5287XP**



Extreme Performance Nano Radial Seal Outer Air Element

**Contains:** Inlet Adapter  
**Fits:** Kenworth W900 Truck; Peterbilt 388, 389 Trucks  
**Replaces:** Paccar P614556, X011622  
**O.D.:** 12 3/32 (307.2)  
**I.D.:** 4 5/8 (117.5) & 7 5/8 (193.7)  
**Height:** 24 13/16 (630.2)  
**F. Gskt:** [1] Included  
**Related To:** RS30187XP (Premium Housing Gasket), RS5287 (Standard Version)

**RS5292**



Radial Seal Inner Air Element

**Fits Inside:** RS5291  
**Fits:** New Holland TF210, TG230, TG255, TG285 Tractors  
**Replaces:** New Holland 451526A1  
**O.D.:** 6 11/16 (169.9)  
 Flange 7 1/4 (184.2)  
**I.D.:** 5 7/16 (138.1) One End  
**Height:** 15 (381.0)

**RS5288**



Radial Seal Outer Air Element

**Contains:** Inlet Adapter  
**Fits:** Kenworth C500, C550, T800, W900; Peterbilt 367, 388, 389 Trucks  
**Replaces:** Donaldson P625287  
**O.D.:** 11 13/32 (289.6)  
**I.D.:** 7 5/8 (193.5) & 3 25/32 (96.0)  
**Height:** 22 15/16 (582.4)  
**F. Gskt:** [1] Included  
**Related To:** RS5288XP (Extreme Performance Nano Version)

**RS5293**



Radial Seal Outer Air Element

**Fits:** Caterpillar Off-Highway Trucks; Donaldson G200088, G290055 Housings  
**Use With:** RS5294  
**Replaces:** Caterpillar 2777837, 4199172; Donaldson P609519; Fleetguard AF27698  
**O.D.:** 17 23/32 (450.1)  
**I.D.:** 11 7/16 (290.5) One End  
**Height:** 30 1/32 (762.8)  
**Related To:** RS5293XP (Extreme Performance Nano Version)

**RS5288XP**



Extreme Performance Nano Radial Seal Outer Air Element

**Contains:** Inlet Adapter  
**Fits:** Kenworth, Peterbilt Trucks  
**Replaces:** Paccar P614986  
**O.D.:** 11 13/32 (289.7)  
**I.D.:** 3 25/32 (96.0) & 7 5/8 (193.7)  
**Height:** 22 29/32 (581.8)  
**F. Gskt:** [1] Included  
**Related To:** RS5288 (Standard Version)

**RS5293XP**



Extreme Performance Nano Radial Seal Outer Air Element

**Fits:** Caterpillar Off-Highway Trucks; Donaldson G200088, G290055 Housings  
**Use With:** RS5294  
**Replaces:** Caterpillar 2777837, 4199172; Donaldson P609519; Fleetguard AF27698  
**O.D.:** 17 23/32 (450.1)  
**I.D.:** 11 7/16 (290.5) One End  
**Height:** 30 1/32 (762.8)  
**Related To:** RS5293 (Standard Media Version)

**PA5289**



Primary Oval Air Element with Lid

**Notes:** Open one end only.  
**Fits:** Caterpillar Equipment  
**Use With:** PA5290 Secondary  
**Replaces:** Caterpillar 3466687  
**O.D.:** 5 5/8 to 11 1/4 (142.9 to 285.8)  
 Lid 5 5/16 to 11 7/8 (134.9 to 301.6)  
**I.D.:** 7/8 (22.2) & 6 (152.4) to  
**Height:** 8 3/8 (212.7)

**RS5294**



Radial Seal Inner Air Element

**Fits Inside:** RS5293  
**Fits:** Caterpillar Off-Highway Trucks; Donaldson G200088, G290055 Housings  
**Replaces:** Caterpillar 2777838; Donaldson P609518; Fleetguard AF27698  
**O.D.:** 11 9/16 (293.7)  
**I.D.:** 9 (228.6) One End  
**Height:** 24 3/8 (619.1)

Measurements Are Shown In Inches And (Millimeters)

**WARNING:** These products can expose you to chemicals, including Diisononyl Phthalate, Carbon black extracts, Nickel, 1,3 Butadiene, Ethylene Oxide, Epichlorohydrin, which are known to the State of California to cause cancer, and Bisphenol, Ethylene Glycol, Ethylene Oxide, 1,3 Butadiene, Epichlorohydrin, which are known to the State of California to cause birth defects or other reproductive harm.

**PA5297** Outer Air Element  
**Notes:** Metal washer welded on one end.  
**Fits:** Valtra Tractors  
**Use With:** PA5298  
**Replaces:** Agco 836862573; Valtra V836862573; Fleetguard AF26665  
**O.D.:** 7 27/32 (199.2)  
**I.D.:** 13/32 (10.3) & 5 (127.0)  
**Height:** 15 9/16 (395.3)  
**A. Gskt:** [1] Attached



**RS5304** Radial Seal Inner Air Element  
**Fits Inside:** RS3971  
**Fits:** Volvo Excavators, Loaders  
**Replaces:** Agco 4270036M1; Case KLH10560; J.C. Bamford 32/925402; New Holland 87682992; Volvo 11110284  
**O.D.:** 4 1/4 (108.0)  
**I.D.:** 3 3/8 (85.7) One End  
**Height:** 15 5/32 (385.0)



**PA5298** Inner Air Element  
**Notes:** Metal washer welded on one end.  
**Fits Inside:** PA5297  
**Fits:** Valtra Tractors  
**Replaces:** Agco 836862574; Valtra V836862574; Fleetguard AF27681  
**O.D.:** 4 29/32 (124.6)  
**I.D.:** 7/16 (11.1) & 3 31/32 (100.8)  
**Height:** 16 21/32 (423.1)  
**A. Gskt:** [1] Attached



**RS5305** Radial Seal Cab Air Element  
**Fits:** Caterpillar Loaders  
**Replaces:** Caterpillar 149-1912; Donaldson P195930, P609447  
**O.D.:** 6 1/2 (165.1)  
**I.D.:** 3 9/16 (90.5) One End  
**Height:** 11 27/32 (300.8)  
**Related To:** RS5761 (Charcoal Media Version)



**PA5299** Cab Air Element  
**Fits:** Massey Ferguson Equipment  
**Replaces:** Massey Ferguson 1078061M1  
**Length:** 33 (838.2)  
**Width:** 4 (101.6)  
**Height:** 2 7/32 (56.4)



**PA5306** Cab Air Element  
**Fits:** Kenworth Trucks  
**Replaces:** Kenworth 525507, 525507BSM  
**Length:** 13 7/8 (352.4)  
**Width:** 10 3/32 (256.4)  
**Height:** 7/8 (22.2)

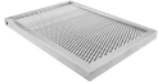

**PA5300** Cab Air Element with Pull Tabs  
**Fits:** Caterpillar Equipment  
**Replaces:** Caterpillar 180-7487; Donaldson P606762; Fleetguard AF25780  
**Length:** 16 13/16 (427.0)  
**Width:** 11 11/16 (296.9)  
**Height:** 2 9/16 (65.1)  
**A. Gskt:** [1] Included



**PA5310** Pre-Filter Cab Air Element  
**Fits:** Volvo Equipment  
**Replaces:** Volvo 11703979  
**Length:** 17 1/8 (435.0)  
**Width:** 4 13/16 (122.2)  
**Height:** 1 3/4 (44.4)  
**A. Gskt:** [1] Included



**RS5301** Radial Seal Air Element  
**Fits:** Mack Trucks  
**Replaces:** Renault 5010315990; Donaldson P782137; Fleetguard AF25898  
**O.D.:** 9 11/16 (246.1)  
**I.D.:** 4 7/8 (123.8) One End  
**Height:** 14 5/8 (371.5)



**PA5311** Air Breather Element  
**Fits:** Volvo Equipment  
**Replaces:** Volvo 11707077, 11707077-1  
**O.D.:** 4 5/32 (105.6)  
**I.D.:** 2 15/32 (62.7)  
**Height:** 2 7/8 (73.0)



**PA5302** Air Element in Disposable Housing  
**Fits:** Winpower Generators  
**Replaces:** Fleetguard AH1100  
**O.D.:** 15 5/16 (388.9)  
**Outlet:** 5 1/2  
**Height:** 12 1/4 (311.2)  
**F. Gskt:** [4] Included



**PA5312 KIT** Air Element Kit  
**Contains:** [1] Panel Air Element  
 [1] Breather Element  
**Fits:** Scania Trucks  
**Replaces:** Scania 1485187, 1485188, 1486634  
**Panel Air**  
**Length:** 1 3/16 (30.2)  
**Width:** 6 31/32 (177.0)  
**Height:** 2 5/8 (66.7)  
**Breather**  
**O.D.:** 3 27/32 (97.6)  
**Height:** 1 3/16 (30.2)



**PA5303** Air Element in Disposable Housing  
**Replaces:** Cummins 3315742; Fleetguard AH1101  
**O.D.:** 17 5/8 (447.7)  
**Outlet:** 5 1/2  
**Height:** 19 13/16 (503.2)  
**F. Gskt:** [4] Included



**RS5313** Radial Seal Inner Air Element  
**Fits Inside:** RS3726  
**Fits:** Scania Trucks  
**Replaces:** Scania 1335680; Fleetguard AF25969  
**O.D.:** 6 7/8 (174.6)  
**I.D.:** 5 5/32 (131.0) One End  
**Height:** 19 23/32 (500.9)



Measurements Are Shown In Inches And (Millimeters)

**WARNING:** These products can expose you to chemicals, including Diisononyl Phthalate, Carbon black extracts, Nickel, 1,3 Butadiene, Ethylene Oxide, Epichlorohydrin, which are known to the State of California to cause cancer, and Bisphenol, Ethylene Glycol, Ethylene Oxide, 1,3 Butadiene, Epichlorohydrin, which are known to the State of California to cause birth defects or other reproductive harm.

**PA5314** Cab Air Element  
**Fits:** John Deere Equipment  
**Replaces:** John Deere AT191102  
**Length:** 9 5/16 (236.5)  
**Width:** 6 11/32 (161.1)  
**Height:** 2 9/32 (57.9)

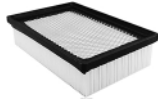

**PA5315** Panel Air Element  
**Fits:** John Deere Equipment  
**Replaces:** Elgin 7172355; Donaldson P113407  
**Length:** 20 (508.0)  
**Width:** 7 1/2 (190.5)  
**Height:** 2 3/16 (55.6)  
**A. Gskt:** [1] Attached  
**Related To:** PA2354 (without Attached Gasket)



**PA5316** Wire Mesh Supported Hydraulic Breather  
**Fits:** Case, J.C. Bamford, Kobelco, Link-Belt, Volvo Excavators  
**Replaces:** Volvo 14500233  
**O.D.:** 2 5/32 (54.8)  
**I.D.:** 1 7/32 (31.0)  
**Height:** 1 1/2 (38.1)  
**A. Gskt:** [2] Attached



**PA5317** Cab Air Element with Handle  
**Fits:** Volvo Excavators  
**Replaces:** Volvo 14503269  
**Length:** 12 13/16 (325.4)  
**Width:** 6 1/32 (153.2)  
**Height:** 2 9/32 (57.9)  
**A. Gskt:** [1] Attached



**PA5318** Set of 2 Cab Air Elements  
**Notes:** Uses 2 filters per application.  
**Fits:** Western Star Trucks  
**Replaces:** Alliance 384160, RD384160  
**Each Filter:**  
**Length:** 11 15/16 (303.2)  
**Width:** 5 7/16 (138.1)  
**Height:** 7/8 (22.2)

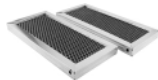

**PA5319** Cab Air Element  
**Fits:** Freightliner Trucks  
**Replaces:** Alliance ABPN83328345, N8328345; Freightliner 22446600, 2244665000; Fleetguard AF25697  
**Length:** 10 19/32 (269.1)  
**Width:** 10 19/32 (269.1)  
**Height:** 3/4 (19.0)

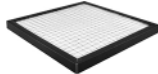

**PA5320** Insert for Cab Air Element  
**Fits:** Peterbilt Trucks  
**Replaces:** Elixaire 5X010007  
**Length:** 10 13/16 (274.6)  
**Width:** 8 1/8 (206.4)  
**Height:** 25/32 (19.8)  
**A. Gskt:** [2] Attached



**PA5321** Cab Air Element  
**Fits:** Peterbilt Trucks  
**Replaces:** Elixaire 5X000180, 5X000190  
**Length:** 11 1/8 (282.6)  
**Width:** 6 25/32 (172.2)  
**Height:** 25/32 (19.8)



**PA5323** Air Element with Lid and 6 Bolt Holes  
**Replaces:** Fleetguard AF25593; Nelson 64288P  
**O.D.:** 12 3/32 (307.2)  
**Lid 16 1/4 (412.8)**  
**I.D.:** 7 23/32 (196.1) One End  
**Height:** 23 3/4 (603.3)  
**A. Gskt:** [2] Attached



**PA5324-FN** Air Element with Fins  
**Notes:** OBSOLETE. Availability Limited to Dealer Stock.  
**Fits:** Bobcat Excavators  
**Replaces:** Melroe-Bobcat 1916711080  
**O.D.:** 3 1/4 (82.6)  
**Fins 4 7/32 (107.2)**  
**I.D.:** 7/16 (11.1) & 1 11/16 (42.9)  
**Height:** 7 1/4 (184.2)  
**A. Gskt:** [1] Attached



**RS5325** Radial Seal Air Element  
**Fits:** Carrier Refrigeration Units  
**Replaces:** Carrier 300042624, 300042627  
**O.D.:** 4 5/32 (105.6)  
**I.D.:** 3 (76.2) One End  
**Height:** 10 23/32 (272.3)



**PA5326** Air Element in Disposable Housing  
**Fits:** Ingersoll-Rand Equipment  
**Replaces:** Ingersoll-Rand 85413458; Donaldson ECC065003  
**O.D.:** 6 5/8 (168.3)  
**I.D.:** 2 5/16 (58.7) One End  
**Height:** 6 5/16 (160.3)



**PA5327** Cab Air Element  
**Fits:** Komatsu Equipment  
**Replaces:** Komatsu 20Y-979-6261  
**Length:** 10 (254.0)  
**Width:** 5 5/8 (142.9)  
**Height:** 25/32 (19.8)

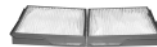

**PA5328** Cab Air Element  
**Fits:** Komatsu Equipment  
**Replaces:** Komatsu 17M-911-3530  
**Length:** 8 15/16 (227.0)  
**Width:** 6 19/32 (167.5)  
**Height:** 2 1/8 (54.0)



**RS5329** Radial Seal Inner Air Element  
**Fits Inside:** RS4992  
**Fits:** John Deere Equipment  
**Replaces:** John Deere AT300488, AT314583  
**O.D.:** 4 25/32 (121.4)  
**Flange 7 1/4 (184.2)**  
**I.D.:** 3 5/8 (92.1) One End  
**Height:** 16 1/8 (409.6)





Measurements Are Shown In Inches And (Millimeters)

**WARNING:** These products can expose you to chemicals, including Diisononyl Phthalate, Carbon black extracts, Nickel, 1,3 Butadiene, Ethylene Oxide, Epichlorohydrin, which are known to the State of California to cause cancer, and Bisphenol, Ethylene Glycol, Ethylene Oxide, 1,3 Butadiene, Epichlorohydrin, which are known to the State of California to cause birth defects or other reproductive harm.

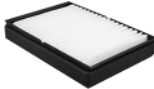
**PA5330** Foam Cab Air Element  
  
**Notes:** OBSOLETE. Availability Limited to Dealer Stock.  
**Fits:** DAF, Renault Trucks  
**Replaces:** DAF 1600428; Renault 5001833354  
**Length:** 8 31/32 (227.8)  
**Width:** 4 3/16 (106.4)  
**Height:** 25/32 (19.8)

**PA5337** Cab Air Element  
  
**Fits:** Sterling Trucks  
**Replaces:** Ford F6HZ-19N619-AA  
**Length:** 8 5/8 (219.1)  
**Width:** 6 3/16 (157.2)  
**Height:** 1 11/32 (34.1)  
**A. Gskt:** [1] Included

**PA5331** Cab Air Element  
  
**Fits:** Volvo Motor Graders  
**Replaces:** Volvo 12725424  
**Length:** 12 9/32 (311.9)  
**Width:** 7 9/16 (192.1)  
**Height:** 2 7/16 (61.9)  
**A. Gskt:** [1] Attached

**PA5338-FN** Air Element with Lid and Fins  
  
**Fits:** J.C. Bamford Equipment  
**Replaces:** J.C. Bamford 32/925594  
**O.D.:** 6 13/16 (173.0)  
**I.D.:** 19/32 (15.1) & 2 27/32 (72.2)  
**Height:** 11 23/32 (297.7)  
**A. Gskt:** [1] Attached  
**F. Gskt:** [1] Wing Nut

**RS5332** Radial Seal Air Element  
  
**Fits:** Volvo Equipment  
**Replaces:** Volvo Penta 3827643  
**O.D.:** 11 31/32 (304.0)  
**I.D.:** 7 3/8 (187.3) One End  
**Height:** 19 1/8 (485.8)

**PA5339** Cab Air Element  
  
**Fits:** M.A.N. Trucks  
**Replaces:** M.A.N. 85.619.500.025; Fleetguard AF26231  
**Length:** 13 31/32 (354.8)  
**Width:** 6 3/16 (157.2)  
**Height:** 1 19/32 (40.5)  
**A. Gskt:** [2] Attached

**PA5333** Cab Air Element  
  
**Fits:** New Holland Equipment  
**Replaces:** Case/New Holland 86504784  
**Length:** 8 3/32 (205.6)  
**Width:** 5 9/32 (134.1)  
**Height:** 1 5/8 (41.3)

**PA5340** Cab Air Element  
  
**Fits:** Mercedes-Benz Trucks  
**Replaces:** Mercedes-Benz 9738350147; Fleetguard AF26144  
**Length:** 22 23/32 (577.1)  
**Width:** 6 7/16 (163.5)  
**Height:** 1 15/32 (37.3)  
**A. Gskt:** [1] Attached

**RS5334** Radial Seal Outer Air Element  
  
**Fits:** Caterpillar, Komatsu Equipment  
**Use With:** RS5335  
**Replaces:** Komatsu 600-185-2510, 600-185-2500  
**O.D.:** 7 11/32 (186.5)  
**I.D.:** 4 5/32 (105.6) One End  
**Height:** 15 17/32 (394.5)

**PA5341** Cab Air Element  
  
**Fits:** DAF Trucks  
**Replaces:** DAF 1362124; Fleetguard AF26145  
**Length:** 10 11/32 (262.7)  
**Width:** 6 1/2 (165.1)  
**Height:** 1 9/16 (39.7)  
**A. Gskt:** [1] Attached

**RS5335** Radial Seal Inner Air Element  
  
**Fits Inside:** RS5334  
**Fits:** Caterpillar, Komatsu Equipment  
**Replaces:** Komatsu 600-185-2500, 600-185-2520  
**O.D.:** 4 1/4 (108.0)  
**I.D.:** 3 3/8 (85.7) One End  
**Height:** 15 (381.0)

**RS5342** Radial Seal Air Element with Lid  
  
**Fits:** Mercedes-Benz Trucks  
**Replaces:** Mercedes-Benz 60949604, A0030949604; Fleetguard AF25653  
**O.D.:** 11 7/32 (285.0)  
**Lid:** 13 15/32 (342.1)  
**I.D.:** 5 1/32 (127.8) One End  
**Height:** 13 25/32 (350.0)

**PA5336** Cab Air Element  
  
**Fits:** Iveco Trucks  
**Replaces:** Iveco 504024890; Fleetguard AF26146  
**Length:** 17 21/32 (448.5)  
**Width:** 8 1/8 (206.4)  
**Height:** 1 (25.4)  
**Related To:** PA5476 (Charcoal Media Version)

**RS5343** Radial Seal Air Element with Lid  
  
**Fits:** Mercedes-Benz Trucks  
**Replaces:** Mercedes-Benz 40940204, A0040940204; Fleetguard AF25476  
**O.D.:** 11 7/32 (285.0)  
**Lid:** 13 17/32 (343.7)  
**I.D.:** 5 1/32 (127.8) One End  
**Height:** 15 31/32 (405.6)

Measurements Are Shown In Inches And (Millimeters)

 **WARNING:** These products can expose you to chemicals, including Diisononyl Phthalate, Carbon black extracts, Nickel, 1,3 Butadiene, Ethylene Oxide, Epichlorohydrin, which are known to the State of California to cause cancer, and Bisphenol, Ethylene Glycol, Ethylene Oxide, 1,3 Butadiene, Epichlorohydrin, which are known to the State of California to cause birth defects or other reproductive harm.

**RS5344**



Radial Seal Outer Air Element

**Use With:** RS5345  
**Replaces:** Reytor IT2000; Fleetguard AF25856  
**O.D.:** 10 1/32 (254.8)  
**I.D.:** 4 31/32 (126.2) One End  
**Height:** 16 7/16 (417.5)

**CA5352**



Channel Flow Air Element

**Fits:** Chevrolet Silverado, GMC Sierra  
**Replaces:** GMC 15282462; Donaldson P605313, P610875  
**O.D.:** 9 5/16 (236.5)  
**Height:** 6 9/32 (159.5)  
**A. Gskt:** [1] Attached

**RS5345**



Radial Seal Inner Air Element

**Fits Inside:** RS5344  
**Replaces:** Reytor IT2000S; Fleetguard AF25857  
**O.D.:** 5 1/8 (130.2)  
**I.D.:** 4 3/8 (111.1) One End  
**Height:** 15 (381.0)

**PA5353**



Panel Air Element

**Fits:** Stihl TS700 Saw  
**Replaces:** Stihl 42241410300A; SF Filter SL1551  
**Length:** 5 5/8 (142.9)  
**Width:** 4 1/32 (102.4)  
**Height:** 1 7/8 (47.6)

**RS5347**



Radial Seal Inner Air Element

**Fits Inside:** RS5348  
**Replaces:** Reytor IT2002S; Luber-finer LAF5764  
**O.D.:** 5 3/4 (146.0)  
**I.D.:** 4 7/8 (123.8) One End  
**Height:** 15 1/2 (393.7)

**RS5354**



Radial Seal Outer Air Element

**Fits:** John Deere Sprayers, Tractors  
**Use With:** RS5355  
**Replaces:** John Deere RE210102; Fleetguard AF26337  
**O.D.:** 12 3/32 (307.2)  
**I.D.:** 7 13/16 (198.4) One End  
**Height:** 12 11/16 (322.3)

**RS5348**



Radial Seal Outer Air Element

**Use With:** RS5347  
**Replaces:** Reytor IT2004  
**O.D.:** 9 15/32 (240.5)  
**I.D.:** 5 9/16 (141.3) One End  
**Height:** 16 11/32 (415.1)

**RS5355**



Radial Seal Inner Air Element

**Fits Inside:** RS5354  
**Fits:** John Deere Sprayers, Tractors  
**Replaces:** John Deere RE210103; Fleetguard AF26336  
**O.D.:** 7 5/32 (181.8)  
**I.D.:** 5 27/32 (148.4) One End  
**Height:** 11 23/32 (297.7)

**PA5350**

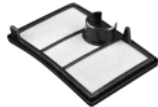

Air Element

**Fits:** Stihl Saws  
**Replaces:** Stihl 42241401801A  
**Length:** 4 11/16 (119.1)  
**Width:** 3 9/32 (83.3)  
**Height:** 15/16 (23.8)

**RS5356**



Radial Seal Air Element

**Contains:** Flame Retardant Media  
**Fits:** Iveco Trucks  
**Replaces:** Iveco 41272124; Donaldson P785352; Fleetguard AF26241  
**O.D.:** 12 7/32 (310.4)  
**I.D.:** 8 1/32 (204.0) One End  
**Height:** 18 7/32 (462.8)

**RS5351**



Radial Seal Air Element

**Notes:** Sometimes used as Inner Air Element with RS3727.  
**Fits:** R.V.I. Trucks  
**Replaces:** Renault 5010317187; Fleetguard AF25634; Donaldson P780624  
**O.D.:** 7 1/16 (179.4)  
**I.D.:** 5 11/16 (144.5) One End  
**Height:** 17 1/2 (444.5)

**PA5357**



Outer Air Element with Lift Bar

**Fits:** Case, New Holland Tractors  
**Replaces:** Case 82034446  
**O.D.:** 8 1/2 (215.9)  
Boot Gasket 10 (254.0)  
**I.D.:** 19/32 (15.1) & 4 27/32 (123.0)  
**Height:** 15 19/32 (396.1)  
**A. Gskt:** [2] Attached  
**F. Gskt:** [2] Included

Measurements Are Shown In Inches And (Millimeters)

**WARNING:** These products can expose you to chemicals, including Diisononyl Phthalate, Carbon black extracts, Nickel, 1,3 Butadiene, Ethylene Oxide, Epichlorohydrin, which are known to the State of California to cause cancer, and Bisphenol, Ethylene Glycol, Ethylene Oxide, 1,3 Butadiene, Epichlorohydrin, which are known to the State of California to cause birth defects or other reproductive harm.

**RS5358** Radial Seal Outer Air Element  
**Contains:** Flame Retardant Media  
**Fits:** Mercedes-Benz Trucks  
**Use With:** RS5549  
**Replaces:** Mercedes-Benz 40943504, A0040943504; Fleetguard AF26242  
**O.D.:** 10 17/32 (267.5)  
**I.D.:** 6 19/32 (167.5) One End  
**Height:** 20 13/16 (528.6)  
**Related To:** RS5508 (without Flame Retardant Media)



**PA5365** Inner Air Element  
**Fits Inside:** PA5364  
**Fits:** Iveco Trucks with Cursor 13 Engine  
**Replaces:** Iveco 2996157, 41214149; Fleetguard AF26245  
**O.D.:** 7 7/8 (200.0)  
**I.D.:** 21/32 (16.7) & 7 5/8 (193.7)  
**Height:** 18 5/32 (461.2)  
**A. Gskt:** [2] Attached



**PA5359** Cab Air Element  
**Fits:** Freightliner Trucks; Thomas Buses  
**Replaces:** Alliance ABP/N10G-36000006; Freightliner 36000006, VCC36000006  
**Length:** 8 5/8 (219.1)  
**Width:** 8 11/32 (211.9)  
**Height:** 31/32 (24.6)



**CA5366** Channel Flow Air Element  
**Fits:** Ford Trucks  
**Replaces:** Ford 4C4Z-9601-AA; Motorcraft FA1753; Donaldson P609086; Fleetguard AF26493  
**O.D.:** 7 5/16 (185.7) to 11 7/16 (290.5)  
**Height:** 9 3/16 (233.4)  
**A. Gskt:** [1] Included



**RS5360** Radial Seal Air Element  
**Fits:** DAF Trucks  
**Replaces:** DAF 1363025, 1640920, 1657522; Fleetguard AF25976  
**O.D.:** 10 7/16 (265.1)  
**I.D.:** 6 3/16 (157.2) One End  
**Height:** 16 15/32 (418.3)



**CA5368** Channel Flow Air Element  
**Fits:** Freightliner Business Class M2 Trucks  
**Replaces:** Donaldson P607965, P544325  
**O.D.:** 11 31/32 (304.0) 14 7/8 (377.8)  
**Height:** 8 1/32 (204.0)  
**Related To:** CA5419 (Flame Retardant Media Version)



**RS5361** Radial Seal Inner Air Element  
**Fits Inside:** RS4971; RS5534  
**Fits:** ERF, ECM, ECT Series Trucks; M.A.N. Buses, Trucks  
**Replaces:** M.A.N. 81.084.050.017; Donaldson P782937; Fleetguard AF25896  
**O.D.:** 6 3/32 (154.8)  
**I.D.:** 5 11/32 (135.7) One End  
**Height:** 16 (406.4)  
**I.Gskt:** [1] Included



**CA5369** Channel Flow Air Element  
**Fits:** Ford Super Duty Trucks with V8-391 (6.4L) Turbo Diesel Engine  
**Replaces:** Ford 7C3Z-9601-B; Motorcraft FA1886; Donaldson P613522  
**O.D.:** 6 1/32 (153.2) to 11 7/8 (301.6)  
**Height:** 8 23/32 (221.5)  
**A. Gskt:** [1] Included



**PA5363** Cab Air Element  
**Fits:** Caterpillar Loaders  
**Replaces:** Caterpillar 170-7272; Donaldson P609444  
**Length:** 15 5/8 (396.9)  
**Width:** 10 1/32 (254.8)  
**Height:** 1 1/32 (26.2)  
**A. Gskt:** [1] Attached



**CA5370** Channel Flow Air Element  
**Fits:** Chevrolet Express Van, GMC Savana  
**Replaces:** General Motors 15102546  
**O.D.:** 5 31/32 (151.6) to 10 29/32 (277.0)  
**Height:** 6 9/32 (159.5)  
**A. Gskt:** [1] Included



**PA5364** Outer Air Element  
**Contains:** Flame Retardant Media  
**Fits:** Iveco Trucks with Cursor 13 Engine  
**Use With:** PA5365  
**Replaces:** Iveco 2992374, 41272211; Fleetguard AF26204  
**O.D.:** 12 7/8 (327.0)  
**I.D.:** 13/32 (10.3) & 8 1/2 (215.9)  
**Height:** 18 11/32 (465.9)  
**A. Gskt:** [1] Attached  
**F. Gskt:** [1] Washer



**BA5371** Desiccant Air Dryer Spin-on  
**Fits:** Haldex Pure Air Plus DA33100, DA33105, DA33110, DA33200 Air Dryers  
**Replaces:** Haldex DA33120  
**Thread:** 2 1/2 -12  
**O.D.:** 5 7/32 (132.6)  
**Height:** 6 5/8 (168.3)  
**I.Gskt:** [1] Included



Measurements Are Shown In Inches And (Millimeters)

**WARNING:** These products can expose you to chemicals, including Diisononyl Phthalate, Carbon black extracts, Nickel, 1,3 Butadiene, Ethylene Oxide, Epichlorohydrin, which are known to the State of California to cause cancer, and Bisphenol, Ethylene Glycol, Ethylene Oxide, 1,3 Butadiene, Epichlorohydrin, which are known to the State of California to cause birth defects or other reproductive harm.



**BA5372** Desiccant Air Dryer  
**Notes:** OBSOLETE. Availability Limited to Dealer Stock.  
**Contains:** [4] Bolts  
 [4] Lock Washers  
 Grease Tube  
**Fits:** Freightliner FLD Trucks  
**Replaces:** Bendix 103981, 104358  
**O.D.:** 4 17/32 (115.1)  
 Lid 5 27/32 (148.4)  
**Height:** 9 23/32 (246.9)  
**O-Ring:** [1] Included



**BA5378** Coalescer Air Dryer Spin-on  
**Fits:** Scania Trucks  
**Replaces:** Scania 1774598; Donaldson P783753  
**Thread:** 1 1/4 -11 BSP-PL  
**O.D.:** 5 11/32 (135.7)  
**Height:** 7 (177.8)  
**I.Gskt:** [1] Included  
**O-Ring:** [1] Included  
**Related To:** BA5375 (Desiccant Version)



**BA5373** Desiccant Air Dryer Spin-on  
**Contains:** Grease Tube  
**Fits:** Ford, Freightliner, Hino, Kenworth, Peterbilt Trucks  
**Replaces:** Bendix 065624, 109493  
**Thread:** 1 1/4 -17  
**O.D.:** 7 9/32 (184.9)  
 Flange 8 3/8 (212.7)  
**Height:** 7 17/32 (191.3)  
**O-Ring:** [2] Attached, [2] Included



**BA5379** Coalescer Air Dryer Spin-on  
**Fits:** M.A.N. TGA Series, TGM Series, TGS Series, TGX Series Trucks  
**Replaces:** Volvo 20557234, 20972915; DAF 1506635; M.A.N. 81.52108.6025; WABCO R950068  
**Thread:** M39 x 1.5  
**O.D.:** 5 3/8 (136.5)  
**Height:** 6 9/16 (166.7)  
**I.Gskt:** [1] Included  
**O-Ring:** [1] Included  
**Related To:** BA5374 (Desiccant Version)



**BA5374** Desiccant Air Dryer Spin-on  
**Fits:** Blue Bird, Kassbohrer, Setra Buses; DAF, E.R.F., Freightliner, IHC, Iveco, Kenworth, Mack, M.A.N., Mercedes-Benz, Peterbilt, R.V.I., Sterling, Volvo Trucks; Liebherr Cranes  
**Replaces:** Caterpillar 2032389; Iveco 2992261; Ford 4C452A131AA; General Motors 89040662; Hengst T250W; Mann & Hummel TB1374x  
**Thread:** M39 x 1.5  
**O.D.:** 5 1/2 (139.7)  
**Height:** 6 9/16 (166.7)  
**I.Gskt:** [1] Included  
**O-Ring:** [1] Included  
**Related To:** BA5379 (Coalescer Version)



**RS5387 KIT** Radial Seal Air Element with Lid  
**Contains:** Plastic lid with dump valve.  
**Fits:** Thermo King Refrigeration Units  
**Replaces:** Thermo King 11-9300 Element  
**O.D.:** 5 (127.0)  
**I.D.:** 1 29/32 (48.4) One End  
**Height:** 9 29/32 (251.6)



**BA5375** Desiccant Air Dryer Spin-on  
**Fits:** R.V.I., Scania Trucks  
**Replaces:** Scania 1384549, 1455253  
**Thread:** 1 1/4 -11 BSP-PL  
**O.D.:** 5 1/2 (139.7)  
**Height:** 6 31/32 (177.0)  
**I.Gskt:** [1] Included  
**O-Ring:** [1] Included  
**Related To:** BA5378 (Coalescer Version)



**PA5388** Air Element with Lid  
**Fits:** Case-International, New Holland Tractors  
**Replaces:** Case 1931168; Donaldson P778702; Fleetguard AF25342  
**O.D.:** 6 3/32 (154.8)  
 Lid 8 3/8 (212.7)  
**I.D.:** 19/32 (15.1) & 3 15/32 (88.1)  
**Height:** 13 1/2 (342.9)  
**A. Gskt:** [1] Attached  
**F. Gskt:** [1] Included, [1] Wing Nut



**BA5376** Desiccant Air Dryer Spin-on  
**Fits:** Van Hool CL915, CL916 Buses with DAF Engines  
**Replaces:** DAF 1391510; Hengst T200W  
**Thread:** M41 x 1.5  
**O.D.:** 5 1/2 (139.7)  
**Height:** 5 15/32 (138.9)  
**I.Gskt:** [1] Included  
**O-Ring:** [1] Included  
**Related To:** BA5284 (Coalescer Version)



**RS5389-FN** Radial Seal Outer Air Element with Fins  
**Fits:** International WorkStar Trucks  
**Use With:** RS4863  
**Replaces:** International 3551816-C1  
**O.D.:** 12 1/16 (306.4)  
 Fins 13 5/16 (338.1)  
**I.D.:** 9 7/8 (250.8) One End  
**Height:** 16 1/32 (407.2)



**BA5377** Desiccant Air Dryer  
**Contains:** Threaded Stud: 5/8-11  
 Grease Tube  
**Fits:** Blue Bird, Thomas Buses; Autocar, Capacity, Freightliner, IHC, Kenworth, Mack, Oshkosh, Peterbilt, Sterling, Western Star Trucks  
**Replaces:** Bendix 107794, 107796  
**O.D.:** 4 17/32 (115.1)  
 Lid 5 27/32 (148.4)  
**Height:** 10 23/32 (272.3)  
**O-Ring:** [2] Included



**RS5390** Radial Seal Air Element  
**Contains:** Flame Retardant Media  
**Fits:** R.V.I., Volvo Trucks  
**Replaces:** Volvo 20732726; R.V.I. 5001865723; Donaldson P780622, P785522, Fleetguard AF26244  
**O.D.:** 12 9/32 (311.9)  
**I.D.:** 6 31/32 (177.0) One End  
**Height:** 18 11/32 (465.9)  
**Related To:** RS3727 (Standard Media Version)



Measurements Are Shown In Inches And (Millimeters)

**WARNING:** These products can expose you to chemicals, including Diisononyl Phthalate, Carbon black extracts, Nickel, 1,3 Butadiene, Ethylene Oxide, Epichlorohydrin, which are known to the State of California to cause cancer, and Bisphenol, Ethylene Glycol, Ethylene Oxide, 1,3 Butadiene, Epichlorohydrin, which are known to the State of California to cause birth defects or other reproductive harm.

<p><b>RS5391</b></p> 	<p>Radial Seal Air Element  <b>Replaces:</b> Iveco 8041419  <b>O.D.:</b> 9 1/2 (241.3)  <b>I.D.:</b> 4 7/8 (123.8) One End  <b>Height:</b> 19 1/2 (495.3)</p>	<p><b>RS5398</b></p> 	<p>Radial Seal Inner Air Element  <b>Fits Inside:</b> RS5397  <b>Fits:</b> Case, New Holland Tractors  <b>Replaces:</b> Case 82034435, 82034436, 82027574; New Holland 82034435, 82034436, 82027574  <b>O.D.:</b> 5 15/32 (138.9)  <b>I.D.:</b> 4 1/2 (114.3) One End  <b>Height:</b> 16 19/32 (421.5)</p>
<p><b>RS5392</b></p> 	<p>Radial Seal Inner Air Element  <b>Fits Inside:</b> RS3506, RS3506XP, RS30285  <b>Fits:</b> John Deere Feller Bunchers, Loaders  <b>Replaces:</b> John Deere F435742; Perkins 2652C832  <b>O.D.:</b> 5 29/32 (150.0)  <b>I.D.:</b> 4 3/8 (111.1) One End  <b>Height:</b> 15 23/32 (399.3)</p>	<p><b>PA5399</b></p> 	<p>Cab Air Element  <b>Fits:</b> Case, New Holland Tractors  <b>Replaces:</b> Case 87302687; New Holland 87302687  <b>Length:</b> 14 31/32 (380.2)  <b>Width:</b> 5 1/8 (130.2)  <b>Height:</b> 1 31/32 (50.0)</p>
<p><b>PA5393</b></p> 	<p>Foam Cab Air Element  <b>Fits:</b> Sterling Trucks  <b>Replaces:</b> Ford F6HZ-19N619-BA  <b>Length:</b> 5 27/32 (148.4)  <b>Width:</b> 4 17/32 (115.1)  <b>Height:</b> 1 (25.4)</p>	<p><b>PA5400</b></p> 	<p>Cab Air Element with Foam  <b>Fits:</b> Case-International, New Holland Tractors  <b>Replaces:</b> Case 87311194; New Holland 87311194  <b>Length:</b> 14 31/32 (380.2)  <b>Width:</b> 5 1/8 (130.2)  <b>Height:</b> 2 1/8 (54.0)</p>
<p><b>RS5395-FN</b></p> 	<p>Radial Seal Outer Air Element with Fins  <b>Fits:</b> ASV PT70, PT80 Loaders  <b>Use With:</b> RS3709  <b>Replaces:</b> Donaldson P601437  <b>O.D.:</b> 6 7/8 (174.6)            Fins 8 3/8 (212.7)  <b>I.D.:</b> 3 1/8 (79.4) One End  <b>Height:</b> 15 13/32 (391.3)</p>	<p><b>PA5401</b></p> 	<p>Cab Air Element  <b>Replaces:</b> J.C. Bamford 33/125629  <b>Length:</b> 17 1/32 (432.6)  <b>Width:</b> 2 7/8 (73.0)  <b>Height:</b> 1 7/8 (47.6)  <b>A. Gskt:</b> [1] Attached</p>
<p><b>PA5396</b></p> 	<p>Cab Air Element with Foam  <b>Notes:</b> Uses 2 filters per application.  <b>Fits:</b> Case-International, New Holland Tractors  <b>Replaces:</b> Case 82022328, 820223280, 82034664; New Holland 82022328, 820223280, 82034664  <b>Length:</b> 21 21/32 (550.1)  <b>Width:</b> 3 15/16 (100.0)  <b>Height:</b> 2 1/2 (63.5)  <b>A. Gskt:</b> [1] Attached</p>	<p><b>PA5403</b></p> 	<p>Cab Air Element  <b>Fits:</b> Case-International Tractors  <b>Replaces:</b> Case 82029888, 82034665, 82034663; New Holland 82029888, 82034665, 82034663  <b>Length:</b> 8 3/16 (208.0)  <b>Width:</b> 4 9/16 (115.9)  <b>Height:</b> 1 13/16 (46.0)</p>
<p><b>RS5397</b></p> 	<p>Radial Seal Outer Air Element  <b>Fits:</b> Case-International, New Holland Tractors  <b>Use With:</b> RS5398  <b>Replaces:</b> Case 82027573, 82034433, 82034434, 82034440; New Holland 82027573, 82034433, 82034434, 82034440  <b>O.D.:</b> 9 7/8 (250.8)  <b>I.D.:</b> 5 5/16 (134.9) One End  <b>Height:</b> 17 3/16 (436.6)</p>	<p><b>PA5404</b></p> 	<p>Cab Air Element  <b>Fits:</b> Case-International, New Holland Tractors  <b>Replaces:</b> Case C001723, C001896, 82034661, 87385322; New Holland C001723, C001896, 82034661, 87385322  <b>Length:</b> 20 15/32 (519.9)  <b>Width:</b> 4 3/32 (104.0)  <b>Height:</b> 2 (50.8)  <b>A. Gskt:</b> [1] Attached</p>
<p><b>RS5397</b></p> 	<p>Radial Seal Outer Air Element  <b>Fits:</b> Case-International, New Holland Tractors  <b>Use With:</b> RS5398  <b>Replaces:</b> Case 82027573, 82034433, 82034434, 82034440; New Holland 82027573, 82034433, 82034434, 82034440  <b>O.D.:</b> 9 7/8 (250.8)  <b>I.D.:</b> 5 5/16 (134.9) One End  <b>Height:</b> 17 3/16 (436.6)</p>	<p><b>PA5405</b></p> 	<p>Cab Air Element  <b>Replaces:</b> J.C. Bamford 30/925759  <b>Length:</b> 11 11/32 (288.1)  <b>Width:</b> 3 15/32 (88.1)  <b>Height:</b> 25/32 (19.8)  <b>A. Gskt:</b> [1] Attached</p>
<p><b>RS5397</b></p> 	<p>Radial Seal Outer Air Element  <b>Fits:</b> Case-International, New Holland Tractors  <b>Use With:</b> RS5398  <b>Replaces:</b> Case 82027573, 82034433, 82034434, 82034440; New Holland 82027573, 82034433, 82034434, 82034440  <b>O.D.:</b> 9 7/8 (250.8)  <b>I.D.:</b> 5 5/16 (134.9) One End  <b>Height:</b> 17 3/16 (436.6)</p>	<p><b>PA5406-FN</b></p> 	<p>Air Element with Lid &amp; Fins  <b>Notes:</b> OBSOLETE. Availability Limited to Dealer Stock.  <b>Replaces:</b> Schmidt 1297503131  <b>O.D.:</b> 8 5/16 (211.1)  <b>I.D.:</b> 3 7/16 (87.3) One End  <b>Height:</b> 11 1/32 (280.2)  <b>A. Gskt:</b> [1] Attached, [1] Wing Nut</p>

Measurements Are Shown In Inches And (Millimeters)

**WARNING:** These products can expose you to chemicals, including Diisononyl Phthalate, Carbon black extracts, Nickel, 1,3 Butadiene, Ethylene Oxide, Epichlorohydrin, which are known to the State of California to cause cancer, and Bisphenol, Ethylene Glycol, Ethylene Oxide, 1,3 Butadiene, Epichlorohydrin, which are known to the State of California to cause birth defects or other reproductive harm.

**PA5407**



**Air Element**

**Notes:** OBSOLETE. Availability Limited to Dealer Stock.  
**Fits:** Citroen, Fiat, Peugeot Automotive  
**Replaces:** Citroen 144499; Fiat 1310636080; Fleetguard AF25296; SF-Filter SL8327  
**O.D.:** 6 3/4 (171.5)  
**I.D.:** 3 11/32 (84.9)  
**Height:** 11 15/32 (291.3)

**RS5413**



**Radial Seal Air Element**

**Notes:** Features recessed closed end.  
**Contains:** Flame Retardant Media  
**Fits:** DAF Trucks  
**Replaces:** DAF 1638054; Donaldson P786443  
**O.D.:** 10 31/32 (278.6)  
**I.D.:** 5 13/16 (147.6) One End  
**Height:** 20 1/32 (508.8)

**RS5408**



**Radial Seal Inner Air Element**

**Contains:** Grease packet  
**Fits Inside:** RS4966  
**Fits:** Volvo Trucks  
**Replaces:** Volvo 3979928; Fleetguard AF26162; Wix Europe 93250E  
**O.D.:** 6 5/8 (168.3)  
**I.D.:** 5 (127.0) One End  
**Height:** 17 5/16 (439.7)

**RS5414**



**Radial Seal Outer Air Element**

**Fits:** John Deere Equipment  
**Use With:** RS5415  
**Replaces:** John Deere AH164062; Donaldson P612469  
**O.D.:** 12 31/32 (329.4)  
**I.D.:** 6 13/16 (173.0) One End  
**Height:** 23 9/32 (591.3)

**RS5409**



**Radial Seal Air Element**

**Fits:** M.A.N. Trucks  
**Replaces:** M.A.N. 81.08405.0022; Donaldson P785002; Fleetguard AF26261  
**O.D.:** 9 3/32 (231.0)  
**I.D.:** 5 7/16 (138.1) One End  
**Height:** 16 5/16 (414.3)

**RS5415**



**Radial Seal Inner Air Element**

**Fits Inside:** RS5414  
**Fits:** John Deere Equipment  
**Replaces:** John Deere AH164063  
**O.D.:** 6 7/8 (174.6)  
**I.D.:** 5 7/16 (138.1) One End  
**Height:** 22 9/16 (573.1)

**PA5410-FN**



**Air Element with Fins**

**Contains:** Flame Retardant Media  
**O.D.:** 4 1/8 (104.8)  
**Fins:** 5 1/8 (130.2)  
**I.D.:** 25/32 (19.8) & 2 1/2 (63.5)  
**Height:** 10 3/8 (263.5)  
**A. Gskt:** [1] Attached  
**F. Gskt:** [1] Metal Washer  
**Related To:** PA1690-FN (Standard Media Version)

**CA5416**



**Channel Flow Air Element**

**Fits:** Hummer H2  
**Replaces:** General Motors 15286805, 88944151; ACDelco A2948C, A3100C  
**O.D.:** 5 31/32 (151.6)  
**to:** 10 29/32 (277.0)  
**Height:** 7 7/32 (183.4)  
**A. Gskt:** [1] Included

**RS5411**



**Radial Seal Air Element**

**Replaces:** Volvo 3827589; Fleetguard AF26237; Alco MD7580  
**O.D.:** 9 27/32 (250.0)  
**I.D.:** 4 3/4 (120.7) One End  
**Height:** 17 9/16 (446.1)

**CA5417**



**Channel Flow Primary Air Element**

**Fits:** John Deere Tractors  
**Use With:** PA5418  
**Replaces:** John Deere RE196945  
**O.D.:** 9 29/32 (251.6)  
**Height:** 9 1/8 (231.8)  
**A. Gskt:** [1] Included

**PA5412**



**Inner Air Element**

**Fits Inside:** PA3906  
**Fits:** Mitsubishi Trucks  
**Replaces:** Mitsubishi AE073385, DC073385, ME073385; Donaldson P815403; Fleetguard AF25582M  
**O.D.:** 5 23/32 (145.3)  
**I.D.:** 21/32 (16.7) & 4 19/32 (116.7)  
**Height:** 16 5/8 (422.3)  
**A. Gskt:** [1] Attached  
**F. Gskt:** [1] Metal Washer

**PA5418**



**Channel Flow Secondary Air Element**

**Fits:** John Deere Sprayers, Tractors  
**Use With:** CA5417  
**Replaces:** John Deere RE181915  
**O.D.:** 9 3/8 (238.1)  
**Height:** 2 3/16 (55.6)  
**A. Gskt:** [1] Included

Measurements Are Shown In Inches And (Millimeters)

**WARNING:** These products can expose you to chemicals, including Diisononyl Phthalate, Carbon black extracts, Nickel, 1,3 Butadiene, Ethylene Oxide, Epichlorohydrin, which are known to the State of California to cause cancer, and Bisphenol, Ethylene Glycol, Ethylene Oxide, 1,3 Butadiene, Epichlorohydrin, which are known to the State of California to cause birth defects or other reproductive harm.

**CA5419**

Channel Flow Air Element



**Contains:** Flame Retardant Media  
**Fits:** Freightliner Business Class M2 Series Trucks  
**Replaces:** Donaldson P605960  
**O.D.:** 11 31/32 (304.0)  
 Flange 14 7/8 (377.8)  
**Height:** 8 1/32 (204.0)  
**A. Gskt:** [1] Attached  
**Related To:** CA5368 (Standard Media Version)

**CA5420**

Channel Flow Air Element



**Contains:** Flame Retardant Media  
**Fits:** Freightliner Business Class M2 Series Trucks  
**Replaces:** Donaldson P607960; Wix 49959  
**O.D.:** 9 29/32 (251.6)  
 Flange 12 25/32 (324.6)  
**Height:** 8 1/32 (204.0)  
**A. Gskt:** [1] Attached  
**Related To:** CA4700 (Standard Media Version)

**CA5421**

Channel Flow Air Element



**Replaces:** Volvo 70320440  
**O.D.:** 12 1/32 (305.6)  
**Height:** 8 3/16 (208.0)  
**A. Gskt:** [1] Attached

**RS5422**

Radial Seal Air Element



**Fits:** EvoBus, Mercedes-Benz/Setra Buses  
**Replaces:** Mercedes-Benz 40941804, A0040941804; Donaldson P783117; Fleetguard AF26172; Hengst E626L  
**O.D.:** 7 11/32 (186.5)  
**I.D.:** 4 5/32 (105.6) One End  
**Height:** 14 1/32 (356.4)

**PA5423-FN**

Air Element with Fins



**Replaces:** Case 808039R1; John Deere CM18213; Donaldson P900247; Fleetguard AF25027K  
**O.D.:** 5 3/16 (131.8)  
 Fins 6 7/16 (163.5)  
**I.D.:** 5/8 (15.9) & 3 5/8 (92.1)  
**Height:** 11 9/16 (293.7)  
**A. Gskt:** [1] Attached

**RS5424**

Radial Seal Air Element



**Fits:** Blue Bird Vision Buses  
**Replaces:** Blue Bird 0061519, 61519, BB0061519; Racor 500353001  
**O.D.:** 9 5/8 (244.5)  
**I.D.:** 4 7/8 (123.8) One End  
**Height:** 11 11/32 (288.1)

**PA5425**

Air Element with Lid



**Replaces:** Cummins 3351735; Fleetguard AF25688  
**O.D.:** 11 1/8 (282.6)  
 Lid 15 3/32 (383.4)  
**I.D.:** 21/32 (16.7) & 6 23/32 (170.7)  
**Height:** 15 27/32 (402.4)  
**A. Gskt:** [2] Attached

**PA5426**

Panel Air Element with Foam Pad and Lift Tabs



**Fits:** Mercedes-Benz Trucks  
**Replaces:** Mercedes-Benz 40941104, A0040941104; Fleetguard AF25731  
**Length:** 24 29/32 (632.6)  
**Width:** 22 1/2 (571.5)  
**Height:** 3 3/32 (78.6)  
**A. Gskt:** [2] Attached

**PA5428**

Panel Air Element



**Fits:** Chevrolet Trucks  
**Replaces:** General Motors 19152817; ACDelco A3102C  
**Length:** 16 11/16 (423.9)  
**Width:** 8 7/8 (225.4)  
**Height:** 2 1/4 (57.2)

**RS5429**

Radial Seal Outer Air Element



**Fits:** John Deere, Liebherr, MacDon Equipment  
**Use With:** RS5430  
**Replaces:** Fleetguard AF26124; Wix 49148  
**O.D.:** 10 1/4 (260.3)  
**I.D.:** 6 17/32 (165.9) One End  
**Height:** 20 7/16 (519.1)

**RS5430**

Radial Seal Inner Air Element



**Fits Inside:** RS5429  
**Fits:** John Deere, Liebherr, MacDon Equipment  
**Replaces:** Fleetguard AF26125; Wix 49149  
**O.D.:** 5 13/32 (137.3)  
 Flange 8 1/32 (204.0)  
**I.D.:** 5 3/16 (131.8) One End  
**Height:** 19 17/32 (496.1)

**RS5431**

Radial Seal Air Element



**Fits:** DAF Trucks  
**Replaces:** DAF 1433690, 1644642, 1667999, 1672463, APUC543; Alco MD-7622  
**O.D.:** 8 13/32 (213.5)  
**I.D.:** 4 29/32 (124.6) One End  
**Height:** 13 3/8 (339.7)

Measurements Are Shown In Inches And (Millimeters)

**WARNING:** These products can expose you to chemicals, including Diisononyl Phthalate, Carbon black extracts, Nickel, 1,3 Butadiene, Ethylene Oxide, Epichlorohydrin, which are known to the State of California to cause cancer, and Bisphenol, Ethylene Glycol, Ethylene Oxide, 1,3 Butadiene, Epichlorohydrin, which are known to the State of California to cause birth defects or other reproductive harm.

**RS5432**



Radial Seal Air Element

**Fits:** Volvo-Penta Generators  
**Replaces:** Deutz 1182786; M.A.N. 83.08405.0001; Volvo 21377909  
**O.D.:** 9 29/32 (251.6)  
**I.D.:** 6 3/16 (157.2) One End  
**Height:** 18 29/32 (480.2)

**RS5438**



Radial Seal Air Element

**Contains:** Flame Retardant Media  
**Fits:** M.A.N. TGL Series, TGM Series Trucks  
**Replaces:** M.A.N. 81.08405.0023; Donaldson P785001; Fleetguard AF26262  
**O.D.:** 8 29/32 (226.2)  
**I.D.:** 4 21/32 (118.3) One End  
**Height:** 12 (304.8)  
**Related To:** RS5536 (Standard Media Version)

**RS5433**



Radial Seal Air Element

**Contains:** Flame Retardant Media  
**Fits:** DAF, Kenworth Trucks  
**Replaces:** DAF 1668000, 1672464  
**O.D.:** 8 13/32 (213.5)  
**I.D.:** 4 11/16 (119.1) One End  
**Height:** 16 17/32 (419.9)  
**Related To:** RS4970 (Standard Media Version)

**RS5440**



Radial Seal Air Element

**Use With:** RS5548  
**Replaces:** Deutz 1182912  
**O.D.:** 9 15/32 (240.5)  
**I.D.:** 5 15/32 (138.9) One End  
**Height:** 18 5/16 (465.1)

**RS5434**



Radial Seal Air Element

**Fits:** Isuzu Trucks  
**Replaces:** Isuzu 8-97062-294-0; Donaldson P543614, P828633  
**O.D.:** 9 9/32 (235.7)  
**I.D.:** 5 5/32 (131.0) One End  
**Height:** 11 3/8 (288.9)

**RS5441**



Radial Seal Air Element

**Fits:** Nissan Atleon Trucks with Cummins ISB4 Series Engine  
**Use With:** RS5547  
**Replaces:** Nissan 16546-LA40A  
**O.D.:** 9 3/32 (231.0)  
**I.D.:** 5 7/16 (138.1) One End  
**Height:** 16 5/16 (414.3)

**RS5435**



Radial Seal Air Element

**Fits:** J.C. Bamford Fastrac Tractors  
**Replaces:** J.C. Bamford 32/210101; Perkins 26510387  
**O.D.:** 8 13/32 (213.5)  
**I.D.:** 4 29/32 (124.6) One End  
**Height:** 15 19/32 (396.1)

**RS5442**



Radial Seal Outer Air Element

**Use With:** RS5443  
**Replaces:** Donaldson P601767; Wix 49767  
**O.D.:** 9 5/32 (232.6)  
**I.D.:** 4 5/8 (117.5) One End  
**Height:** 13 7/16 (341.3)

**PA5436**



Outer Air Element

**Fits:** Challenger, Massey Ferguson Tractors  
**Use With:** PA5437  
**Replaces:** Massey Ferguson 3703703-M91; Wix 46497  
**O.D.:** 4 3/32 (104.0)  
 Flange 5 11/16 (144.5)  
**I.D.:** 17/32 (13.5) & 2 1/2 (63.5)  
**Height:** 10 3/8 (263.5)  
**A. Gskt:** [1] Attached  
**F. Gskt:** [1] Included

**RS5443**



Radial Seal Inner Air Element

**Fits Inside:** RS5442  
**Replaces:** Donaldson P601774; Wix 49766  
**O.D.:** 4 23/32 (119.9)  
**I.D.:** 3 1/4 (82.6) One End  
**Height:** 12 25/32 (324.6)

**PA5437**



Inner Air Element

**Fits Inside:** PA5436  
**Fits:** Agco, Challenger, Massey Ferguson Tractors  
**Replaces:** Massey Ferguson 3703704-M91  
**O.D.:** 2 3/8 (60.3)  
**I.D.:** 7/16 (11.1) & 2 (50.8)  
**Height:** 8 7/8 (225.4)

**PA5444-FN**



Air Element with Fins

**Notes:** OBSOLETE. Availability Limited to Dealer Stock.  
**Replaces:** Foton D136703E; CLARCOR Filtration (China) KQ1317A8  
**O.D.:** 5 1/8 (130.2)  
 Fins 6 15/32 (164.3)  
**I.D.:** 3/8 (9.5) & 2 15/32 (62.7)  
**Height:** 6 11/16 (169.9)  
**A. Gskt:** [1] Attached  
**F. Gskt:** [1] Washer

Measurements Are Shown In Inches And (Millimeters)

**WARNING:** These products can expose you to chemicals, including Diisononyl Phthalate, Carbon black extracts, Nickel, 1,3 Butadiene, Ethylene Oxide, Epichlorohydrin, which are known to the State of California to cause cancer, and Bisphenol, Ethylene Glycol, Ethylene Oxide, 1,3 Butadiene, Epichlorohydrin, which are known to the State of California to cause birth defects or other reproductive harm.

**PA5445**

Outer Air Element with Lift Tabs

**Fits:** Hualing 280HP Heavy Truck  
**Use With:** PA5446  
**Replaces:** CLARCOR Filtration (China) K3250  
**O.D.:** 12 7/8 (327.0)  
**I.D.:** 27/32 (21.4) & 8 11/32 (211.9)  
**Height:** 19 13/32 (492.9)



**PA5451**

Channel Flow Secondary Air Element with Pull Handle

**Fits:** Case, Case-IH, J.C. Bamford, John Deere, New Holland Equipment  
**Use With:** CA5450  
**Replaces:** Case 82988917, 87037985, 87356353; New Holland 82988917, 87037985, 87356353; J.C. Bamford 32/925683; John Deere FG6340592, RE253519  
**O.D.:** 4 1/4 (108.0) to 8 1/4 (209.6)  
**Height:** 2 9/16 (65.1)  
**A. Gskt:** [1] Attached



**PA5446**

Inner Air Element

**Fits Inside:** PA5445  
**Replaces:** CLARCOR Filtration (China) K3250  
**O.D.:** 8 9/32 (210.3)  
**I.D.:** 29/32 (23.0) & 7 3/32 (180.2)  
**Height:** 17 17/32 (445.3)  
**A. Gskt:** [1] Attached  
**F. Gskt:** [1] Washer



**RS5452**

Radial Seal Outer Air Element

**Fits:** Mercedes-Benz Buses, Trucks  
**Replaces:** Mercedes-Benz A3740947104; Reyltor IT3095  
**O.D.:** 10 29/32 (277.0)  
**I.D.:** 6 25/32 (172.2) One End  
**Height:** 16 1/2 (419.1)



**RS5447**

Radial Seal Outer Air Element

**Fits:** Dynapac Rollers  
**Replaces:** Dynapac 909270; Donaldson P781470; Fleetguard AF25612  
**O.D.:** 8 5/32 (207.2)  
**I.D.:** 4 3/16 (106.4) One End  
**Height:** 20 5/8 (523.9)



**RS5453**

Radial Seal Inner Air Element

**Fits:** Mercedes-Benz Buses  
**Replaces:** Mercedes-Benz A3740947204; Reyltor IT3095S  
**O.D.:** 6 1/4 (158.8)  
**I.D.:** 5 1/4 (133.4) One End  
**Height:** 15 5/32 (385.0)



**RS5448**

Radial Seal Inner Air Element

**Fits:** Dynapac Rollers  
**Replaces:** Dynapac 909271; Donaldson P781471  
**O.D.:** 4 1/4 (108.0)  
**I.D.:** 3 7/16 (87.3) One End  
**Height:** 19 15/16 (506.4)



**PA5454**

Panel Air Element

**Contains:** Flame Retardant Media  
**Fits:** Waukesha VHP 12, 16 Cylinder Stationary Engines  
**Replaces:** Waukesha 214275A  
**Length:** 25 1/4 (641.3)  
**Width:** 19 1/4 (489.0)  
**Height:** 3 3/4 (95.3)  
**A. Gskt:** [2] Attached



**RS5449**

Radial Seal Air Element

**Fits:** Caterpillar Generator Sets; Caterpillar, Lister-Petter Industrial Engines  
**Replaces:** Caterpillar 246-5011; Lister 75727890; Perkins 135326205  
**O.D.:** 4 1/8 (104.8)  
**I.D.:** 2 7/16 (61.9) One End  
**Height:** 10 3/4 (273.1)



**RS5455**

Radial Seal Outer Air Element

**Fits:** Case-International Equipment; New Holland Tractors  
**Use With:** RS5456  
**Replaces:** Case 367349A1, 87409371  
**O.D.:** 12 1/8 (308.0)  
**I.D.:** 8 1/2 (215.9) One End  
**Height:** 13 3/4 (349.3)



**CA5450**

Channel Flow Primary Air Element

**Fits:** Case, Case-IH, J.C. Bamford, John Deere, New Holland Equipment  
**Use With:** PA5451  
**Replaces:** Case 82988916, 87037984, 87356351; J.C. Bamford 32/925682; John Deere FG6340591, RE253518; New Holland 82988916, 87037984, 87356351  
**O.D.:** 5 27/32 (148.4) to 9 13/16 (249.2)  
**Height:** 7 1/8 (181.0)



**RS5456**

Radial Seal Inner Air Element

**Fits Inside:** RS5455  
**Fits:** Case-International, New Holland Equipment  
**Replaces:** Case 367350A1, 87409407; Fleetguard AF25711  
**O.D.:** 8 1/8 (206.4)  
**I.D.:** 6 (152.4) One End  
**Height:** 12 31/32 (329.4)



Measurements Are Shown In Inches And (Millimeters)

**WARNING:** These products can expose you to chemicals, including Diisononyl Phthalate, Carbon black extracts, Nickel, 1,3 Butadiene, Ethylene Oxide, Epichlorohydrin, which are known to the State of California to cause cancer, and Bisphenol, Ethylene Glycol, Ethylene Oxide, 1,3 Butadiene, Epichlorohydrin, which are known to the State of California to cause birth defects or other reproductive harm.

**PA5457** Wire Supported Cotton Polyester Industrial Air Element  
**Replaces:** Airguard DP40-204  
**Length:** 24 1/2 (622.3)  
**Width:** 19 1/2 (495.3)  
**Height:** 1 3/4 (44.4)

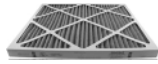

**RS5458** Radial Seal Air Element  
**Fits:** Blue Bird Vision Buses  
**Replaces:** Blue Bird 87782  
**O.D.:** 9 31/32 (253.2)  
**Lid:** 11 1/2 (292.1)  
**I.D.:** 4 13/16 (122.2) One End  
**Height:** 11 3/8 (288.9)



**RS5459** Radial Seal Outer Air Element  
**Fits:** Volvo Dump Trucks, Excavators, Loaders  
**Use With:** RS5460  
**Replaces:** Volvo 11110531, 11110532, 15193232  
**O.D.:** 14 7/32 (361.2)  
**I.D.:** 8 15/16 (227.0) One End  
**Height:** 22 7/16 (569.9)



**RS5460** Radial Seal Inner Air Element  
**Fits Inside:** RS5459  
**Fits:** Volvo Dump Trucks, Excavators, Loaders  
**Replaces:** Volvo 11110533; Fleetguard AF26491  
**O.D.:** 9 3/32 (231.0)  
**I.D.:** 6 7/8 (174.6) One End  
**Height:** 22 3/32 (561.2)



**RS5461** Radial Seal Outer Air Element  
**Fits:** J.C. Bamford Equipment  
**Use With:** RS5462  
**Replaces:** J.C. Bamford 32/210001; Coopers AEM2756  
**O.D.:** 9 27/32 (250.0)  
**I.D.:** 7 13/32 (188.1) One End  
**Height:** 19 21/32 (499.3)



**RS5462** Radial Seal Inner Air Element  
**Contains:** [1] Grease packet  
**Fits Inside:** RS5461  
**Fits:** J.C. Bamford Equipment  
**Replaces:** J.C. Bamford 32/210002  
**O.D.:** 7 5/32 (181.8)  
**I.D.:** 5 1/2 (139.7) One End  
**Height:** 19 1/16 (484.2)



**PA5463** Outer Air Element  
**Use With:** PA5464  
**Replaces:** Cummins 3237954; Fleetguard AF25804  
**O.D.:** 14 (355.6)  
**Boot:** 14 13/16 (376.2)  
**I.D.:** 21/32 (16.7) & 9 19/32 (243.7)  
**Height:** 26 1/32 (661.2)  
**A. Gskt:** [2] Attached  
**F. Gskt:** [1] Included, [1] Wing Nut



**PA5464** Inner Air Element  
**Fits Inside:** PA5463  
**Replaces:** Cummins 4055279; Donaldson P500922; Fleetguard AF25803  
**O.D.:** 8 13/32 (213.5)  
**I.D.:** 11/16 (17.5) & 6 3/16 (157.2)  
**Height:** 16 3/4 (425.5)  
**A. Gskt:** [1] Attached  
**F. Gskt:** [1] Included, [1] Wing Nut



**PA5465** Air Element  
**Replaces:** Perkins SEV5514  
**O.D.:** 12 23/32 (323.1)  
**I.D.:** 1 1/16 (27.0) & 9 9/32 (235.7)  
**Height:** 22 3/16 (563.6)



**PA5467** Outer Air Element  
**Use With:** PA5468  
**Replaces:** Cummins 3814695; Fleetguard AF25910  
**O.D.:** 7 25/32 (197.6)  
**I.D.:** 11/32 (8.7) & 4 11/32 (110.3)  
**Height:** 12 3/32 (307.2)  
**A. Gskt:** [1] Attached  
**F. Gskt:** [1] Included



**PA5468** Inner Air Element  
**Fits Inside:** PA5467  
**Replaces:** Cummins 3814696; Fleetguard AF25911  
**O.D.:** 4 3/32 (104.0)  
**I.D.:** 21/32 (16.7) & 3 17/32 (89.7)  
**Height:** 10 29/32 (277.0)  
**A. Gskt:** [1] Attached  
**F. Gskt:** [1] Included



**PA5469** Outer Air Element  
**Notes:** OBSOLETE. Availability Limited to Dealer Stock.  
**Fits:** Guangxi Liugong Machinery Co., Ltd. Loaders, Rollers; Xuzhou Construction Machinery Group Loaders; Zhengzhou Yutong Group Co., Ltd. Buses  
**Use With:** PA5521  
**Replaces:** Sinotruck WG9719190001; Fleetguard Shanghai A749-020  
**O.D.:** 12 (304.8)  
**I.D.:** 7/16 (11.1) & 7 11/16 (195.3)  
**Height:** 18 11/16 (474.7)  
**A. Gskt:** [1] Attached



Measurements Are Shown In Inches And (Millimeters)

**WARNING:** These products can expose you to chemicals, including Diisononyl Phthalate, Carbon black extracts, Nickel, 1,3 Butadiene, Ethylene Oxide, Epichlorohydrin, which are known to the State of California to cause cancer, and Bisphenol, Ethylene Glycol, Ethylene Oxide, 1,3 Butadiene, Epichlorohydrin, which are known to the State of California to cause birth defects or other reproductive harm.

**RS5470**

Radial Seal Outer Air Element



**Fits:** John Deere Combines, Cotton Pickers  
**Use With:** RS5471  
**Replaces:** John Deere AH212294; Donaldson P618930  
**O.D.:** 11 11/16 (296.9)  
**I.D.:** 7 27/32 (199.2) One End  
**Height:** 24 5/8 (625.5)

**PA5477**

Cab Air Element



**Contains:** Charcoal Impregnated Media for Odor Control  
**Fits:** M.A.N. Trucks  
**Replaces:** M.A.N. 81.61910.0019; Donaldson P786092; Hengst E954LC; Mahle LAK154; Mann & Hummel CUK4795  
**Length:** 18 19/32 (472.3)  
**Width:** 7 7/16 (188.9)  
**Height:** 2 13/16 (71.4)  
**A. Gskt:** [1] Attached  
**Related To:** PA4955 (Standard Media Version)

**RS5471**

Radial Seal Inner Air Element



**Fits Inside:** RS5470, RS5472  
**Fits:** John Deere Combines, Cotton Pickers  
**Replaces:** John Deere AH212295; Donaldson P618932; Fleetguard AF26438  
**O.D.:** 7 1/16 (179.4)  
**I.D.:** 6 13/32 (162.7) One End  
**Height:** 22 1/2 (571.5)  
**O-Ring:** [1] Attached

**RS5478-FN**

Radial Seal Outer Air Element with Fins



**Fits:** Donaldson FRG09 Housings  
**Use With:** RS5479  
**Replaces:** Donaldson P601280; Wix 49280  
**O.D.:** 7 (177.8)  
 Fins 8 1/2 (215.9)  
**I.D.:** 4 (101.6) One End  
**Height:** 16 7/16 (417.5)

**RS5472**

Radial Seal Outer Air Element



**Fits:** John Deere Equipment  
**Use With:** RS5471  
**Replaces:** John Deere AH222225; Donaldson P618931  
**O.D.:** 12 23/32 (323.1)  
**I.D.:** 7 13/16 (198.4) One End  
**Height:** 24 5/8 (625.5)

**RS5479**

Radial Seal Inner Air Element



**Fits Inside:** RS5478-FN  
**Fits:** Donaldson FRG09 Housings  
**Replaces:** Donaldson P601286  
**O.D.:** 4 1/8 (104.8)  
**I.D.:** 3 7/16 (87.3) One End  
**Height:** 15 9/16 (395.3)

**PA5473**

Outer Air Element



**Notes:** OBSOLETE. Availability Limited to Dealer Stock.  
**Fits:** Tata Engines  
**Use With:** PA5474  
**Replaces:** Tata Cummins 252509140134; Fleetguard AF25884  
**O.D.:** 7 25/32 (197.6)  
**I.D.:** 11/32 (8.7) & 3 15/16 (100.0)  
**Height:** 14 25/32 (375.4)  
**A. Gskt:** [1] Attached  
**F. Gskt:** [1] Included

**PA5482**

Cab Air Element

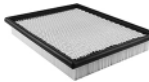

**Fits:** Komatsu Dump Trucks, Loaders  
**Replaces:** Komatsu 427-07-22120  
**Length:** 12 9/32 (311.9)  
**Width:** 10 1/16 (255.6)  
**Height:** 1 13/16 (46.0)

**PA5475**

Cabin Air Element



**Fits:** Iveco Light-Duty Trucks  
**Replaces:** Iveco 3802821; Hengst E2593LI; Mahle LA439; Mann & Hummel CU2952  
**Length:** 11 17/32 (292.9)  
**Width:** 7 9/16 (192.1)  
**Height:** 1 3/16 (30.2)  
**A. Gskt:** [2] Attached

**RS5483**

Radial Seal Air Element



**Fits:** Kassbohrer Buses  
**Replaces:** EvoBus 8.319.150.192.0; Irisbus 5010423885; Donaldson P780731; Fleetguard AF25626  
**O.D.:** 11 27/32 (300.8)  
**I.D.:** 6 9/16 (166.7) One End  
**Height:** 13 1/16 (331.8)

**PA5476**

Cab Air Element



**Contains:** Charcoal Impregnated Media for Odor Control  
**Fits:** Iveco Trucks  
**Replaces:** Iveco 2994583; Hengst E1908LC; Mann & Hummel CUK4594  
**Length:** 17 21/32 (448.5)  
**Width:** 8 1/8 (206.4)  
**Height:** 1 (25.4)  
**Related To:** PA5366 (Standard Media)

**RS5484**

Radial Seal Air Element



**Fits:** Kassbohrer Buses  
**Replaces:** EvoBus 8.319.147.187, 8.319.147.187.0; Mercedes-Benz 40942204, A0040942204; Donaldson P778924; Fleetguard AF25522  
**O.D.:** 11 27/32 (300.8)  
**I.D.:** 6 9/16 (166.7) One End  
**Height:** 18 17/32 (470.7)

Measurements Are Shown In Inches And (Millimeters)

**WARNING:** These products can expose you to chemicals, including Diisononyl Phthalate, Carbon black extracts, Nickel, 1,3 Butadiene, Ethylene Oxide, Epichlorohydrin, which are known to the State of California to cause cancer, and Bisphenol, Ethylene Glycol, Ethylene Oxide, 1,3 Butadiene, Epichlorohydrin, which are known to the State of California to cause birth defects or other reproductive harm.



**PA5485-FN**



Outer Air Element with Fins  
**Use With:** PA5486  
**Replaces:** Arrow Filter 13023273  
**O.D.:** 7 15/16 (201.6)  
 Fins 10 (254.0)  
**I.D.:** 1/2 (12.7) & 4 31/32 (126.2)  
**Height:** 15 3/4 (400.0)  
**A. Gskt:** [1] Attached  
**F. Gskt:** [1] Washer

**PA5492**



Cab Air Element  
**Contains:** Charcoal Impregnated Media for Odor Control  
**Fits:** Mercedes-Benz Trucks, Vans  
**Replaces:** Mercedes-Benz 8301318, 8303418, A0008301318, A0008303408  
**Length:** 14 7/8 (377.8)  
**Width:** 5 1/2 (139.7)  
**Height:** 1 9/16 (39.7)  
**A. Gskt:** [1] Attached  
**Related To:** PA4912 (Standard Media Version)

**PA5486**



Inner Air Element  
**Fits Inside:** PA5485-FN  
**Replaces:** Arrow Filter 13023273  
**O.D.:** 4 9/16 (115.9)  
 Flange 5 3/4 (146.0)  
**I.D.:** 1/2 (12.7) & 3 7/16 (87.3)  
**Height:** 14 23/32 (373.9)  
**A. Gskt:** [1] Attached  
**F. Gskt:** [1] Included

**PA5493**



Cab Air Element  
**Fits:** Scania Serie G, Serie P, Serie R Trucks  
**Replaces:** Scania 1770813, 1913500; Fleetguard AF27692  
**Length:** 14 23/32 (373.9)  
**Width:** 5 5/16 (134.9)  
**Height:** 25/32 (19.8)  
**A. Gskt:** [1] Attached

**PA5487**



Outer Air Element  
**Notes:** OBSOLETE. Availability Limited to Dealer Stock.  
**Replaces:** Ashok Leyland X3973800; Fleetguard AF26010  
**O.D.:** 12 3/32 (307.2)  
**I.D.:** 5/8 (15.9) & 7 11/16 (195.3)  
**Height:** 18 7/16 (468.3)  
**A. Gskt:** [1] Attached  
**F. Gskt:** [1] Included

**PA5494**



Foam Cab Air Element  
**Fits:** Freightliner Trucks  
**Replaces:** Freightliner 91595, BOA91595; Alliance ABP/N10G-91595  
**Length:** 7 7/8 (200.0)  
**Width:** 6 5/16 (160.3)  
**Height:** 5/8 (15.9)

**RS5489**



Radial Seal Outer Air Element  
**Use With:** RS5490  
**Replaces:** Donaldson P785589; Sandvik 55089266  
**O.D.:** 8 (203.2)  
**I.D.:** 4 3/8 (111.1) One End  
**Height:** 16 21/32 (423.1)

**PA5495**



Foam Cab Air Element  
**Replaces:** Freightliner 803190015900, BOA803190015900, ZGG20010; Alliance ABPN10G803190015900; Donaldson P614225  
**Length:** 8 1/2 (215.9)  
**Width:** 7 5/8 (193.7)  
**Height:** 3/4 (19.0)

**RS5490**



Radial Seal Inner Air Element  
**Fits Inside:** RS5489  
**Replaces:** Donaldson P785389  
**O.D.:** 4 1/16 (103.2)  
**I.D.:** 3 5/16 (84.1) One End  
**Height:** 14 3/8 (365.1)

**PA5496**



Outer Air Element  
**Fits:** Guangxi Liugong Machinery Company, LTD Equipment  
**Use With:** PA5497  
**Replaces:** Dongfeng Motor Corp. 1109N-020; Fleetguard AF25270; Sakura A-8636  
**O.D.:** 9 7/32 (234.2)  
**I.D.:** 15/32 (11.9) & 5 5/16 (134.9)  
**Height:** 16 7/8 (428.6)  
**A. Gskt:** [1] Attached

**PA5497**



Inner Air Element  
**Fits Inside:** PA5496  
**Fits:** Guangxi Liugong Machinery Company, LTD Equipment  
**Replaces:** Dongfeng Motor Corp. 1109N-030; Fleetguard AF25277; Sakura A-8637  
**O.D.:** 5 3/16 (131.8)  
 Flange 5 29/32 (150.0)  
**I.D.:** 15/32 (11.9) & 4 1/32 (102.4)  
**Height:** 16 5/16 (414.3)  
**A. Gskt:** [1] Attached

**PA5491**



Air Element  
**Replaces:** Caterpillar 7C1572  
**O.D.:** 10 19/32 (269.1)  
**I.D.:** 6 (152.4) One End  
**Height:** 8 3/8 (212.7)

**PA5498**



Outer Air Element  
**Fits:** Zhengzhou Yutong Group Company, LTD Buses  
**Use With:** PA5499  
**Replaces:** Dongfeng Motor Corp. 1109-00135; Fleetguard AF25452  
**O.D.:** 11 (279.4)  
**I.D.:** 23/32 (18.3) & 6 1/2 (165.1)  
**Height:** 20 3/16 (512.8)  
**A. Gskt:** [1] Attached

Measurements Are Shown In Inches And (Millimeters)

**WARNING:** These products can expose you to chemicals, including Diisononyl Phthalate, Carbon black extracts, Nickel, 1,3 Butadiene, Ethylene Oxide, Epichlorohydrin, which are known to the State of California to cause cancer, and Bisphenol, Ethylene Glycol, Ethylene Oxide, 1,3 Butadiene, Epichlorohydrin, which are known to the State of California to cause birth defects or other reproductive harm.

**PA5499** Inner Air Element  
**Fits Inside:** PA5498  
**Fits:** Zhengzhou Yutong Group Company, LTD Buses  
**Replaces:** Dongfeng Motor Corp. 1109-00135; Fleetguard AF25453  
**O.D.:** 6 1/8 (155.6)  
**I.D.:** 23/32 (18.3) & 5 7/32 (132.6)  
**Height:** 19 (482.6)  
**A. Gskt:** [1] Attached



**RS5507** Radial Seal Air Element  
**Contains:** [2] Washers  
 [2] Lock Washers  
 [2] O-Rings  
 [2] Nuts  
**Fits:** Cummins 500KVA Generator with QSX15-C Tier 3 Diesel Engine  
**Replaces:** Cummins 4946497; Fleetguard AF26173  
**O.D.:** 11 31/32 (304.0)  
**I.D.:** 5 27/32 (148.4) One End  
**Height:** 16 1/4 (412.8)



**CA5500** Channel Flow EXO Air Element  
**Fits:** Kenworth Trucks  
**Replaces:** Kenworth P611696; Donaldson P616056  
**O.D.:** 11 3/16 (284.2) to 17 11/32 (440.5)  
**Height:** 9 27/32 (250.0)



**RS5508** Radial Seal Air Element  
**Replaces:** Iveco 42537392, 500394100; Donaldson P784456  
**O.D.:** 10 17/32 (267.5)  
**I.D.:** 6 19/32 (167.5) One End  
**Height:** 20 13/16 (528.6)  
**Related To:** RS5358 (Flame Retardant Media)



**PA5503** Outer Air Element  
**Fits:** Guangxi Liugong Machinery Company, LTD Equipment  
**Use With:** PA5504  
**Replaces:** Dongfeng Motor Corp. 1109.6B-020-B; Fleetguard AF25268  
**O.D.:** 8 9/32 (210.3)  
**I.D.:** 11/32 (8.7) & 5 5/32 (131.0)  
**Height:** 14 23/32 (373.9)  
**A. Gskt:** [1] Attached



**RS5509** Radial Seal Outer Air Element  
**Fits:** John Deere 824K, 844J, 844K Loaders  
**Use With:** RS5510  
**Replaces:** John Deere AT311066  
**O.D.:** 12 3/32 (307.2)  
**I.D.:** 7 11/16 (195.3) One End  
**Height:** 20 9/16 (522.3)



**PA5504** Inner Air Element  
**Fits Inside:** PA5503  
**Fits:** Guangxi Liugong Machinery Company, LTD Equipment  
**Replaces:** Dongfeng Motor Corp. 1109.6B-030-B; Fleetguard AF25269  
**O.D.:** 4 7/8 (123.8)  
**I.D.:** 23/32 (18.3) & 3 3/8 (85.7)  
**Height:** 14 11/32 (364.3)  
**A. Gskt:** [1] Attached



**RS5510** Radial Seal Inner Air Element  
**Fits Inside:** RS5509  
**Fits:** John Deere 824K, 844J, 844K Loaders  
**Replaces:** John Deere AT311067  
**O.D.:** 7 5/32 (181.8)  
**I.D.:** 5 27/32 (148.4) One End  
**Height:** 19 21/32 (499.3)



**PA5505** Air Element  
**Fits:** Some MTU 12V2000, 16V2000, 18V2000 Marine Engines  
**Replaces:** Donaldson B120376, ECB120376; Mann & Hummel C311195; SF-Filter SL12942  
**O.D.:** 12 19/32 (319.9)  
**I.D.:** 7 13/16 (198.4) One End  
**Height:** 17 9/16 (446.1)



**PA5511** Cab Air Element  
**Fits:** Fendt Tractors  
**Replaces:** Fendt H931812140511  
**Length:** 11 13/16 (300.0)  
**Width:** 7 15/32 (189.7)  
**Height:** 1 25/32 (45.2)  
**A. Gskt:** [1] Attached

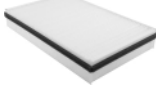

**RS5506** Radial Seal Air Element  
**Fits:** M.A.N. TGL Series, TGM Series Trucks  
**Replaces:** M.A.N. 81.08405.0018; Alco MD-7664; Donaldson P788809  
**O.D.:** 10 (254.0)  
**I.D.:** 5 1/32 (127.8) One End  
**Height:** 18 (457.2)



**PA5512** Panel Air Element  
**Replaces:** Liebherr 10287303  
**Length:** 16 (406.4)  
**Width:** 7 1/16 (179.4)  
**Height:** 1 3/16 (30.2)  
**A. Gskt:** [1] Attached

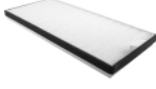

Measurements Are Shown In Inches And (Millimeters)

**WARNING:** These products can expose you to chemicals, including Diisononyl Phthalate, Carbon black extracts, Nickel, 1,3 Butadiene, Ethylene Oxide, Epichlorohydrin, which are known to the State of California to cause cancer, and Bisphenol, Ethylene Glycol, Ethylene Oxide, 1,3 Butadiene, Epichlorohydrin, which are known to the State of California to cause birth defects or other reproductive harm.

**CA5514** Channel Flow Primary Air Element  
**Fits:** Agco, Caterpillar, Challenger, John Deere, Massey Ferguson Equipment; Ford, IHC IHC Trucks  
**Use With:** PA5515  
**Replaces:** Agco 4286473M2; Caterpillar 3045632; International 2591005C1; John Deere F071150  
**O.D.:** 8 1/4 (209.6) to 13 3/8 (339.7)  
**Height:** 7 7/16 (188.9)



**PA5521** Inner Air Element  
**Notes:** OBSOLETE. Availability Limited to Dealer Stock.  
**Fits Inside:** PA5469  
**Replaces:** CLARCOR Filtration (China) WG9719190001; Fleetguard Shanghai A749-030  
**O.D.:** 7 1/4 (184.2)  
**I.D.:** 9/16 (14.3) & 6 1/16 (154.0)  
**Height:** 17 5/16 (439.7)  
**A. Gskt:** [1] Attached



**PA5515** Channel Flow Secondary Air Element with Pull Handle  
**Fits:** Ag-Chem, Agco, Caterpillar, Challenger, J.C. Bamford, John Deere, Massey Ferguson, Valtra Equipment; IHC Trucks  
**Use With:** CA5514, CA5788  
**Replaces:** Agco 4286474M1; Caterpillar 3045633; International 2591007C1; J.C. Bamford 32/925753; John Deere F071151  
**O.D.:** 7 1/2 (190.5) to 12 13/16 (325.4)  
**Height:** 2 5/16 (58.7)  
**A. Gskt:** [1] Attached



**PA5527** Inner Air Element  
**Notes:** OBSOLETE. Availability Limited to Dealer Stock.  
**Fits Inside:** PA5526  
**Replaces:** CLARCOR Filtration (China) KW2139-2000; Foton Lovol 13023273; Huafeng Power 13023273  
**O.D.:** 3 29/32 (99.2)  
**I.D.:** 5/8 (15.9) & 3 7/16 (87.3)  
**Height:** 15 9/16 (395.3)  
**A. Gskt:** [1] Attached



**PA5516** Cab Air Element  
**Replaces:** Liebherr 10323466  
**Length:** 10 5/8 (269.9)  
**Width:** 9 1/16 (230.2)  
**Height:** 1 3/16 (30.2)  
**A. Gskt:** [1] Attached

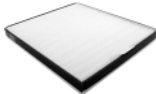

**PA5528** Outer Air Element  
**Use With:** PA5529  
**Replaces:** CLARCOR Filtration (China) KX2640-2000; Shantui 612600110540  
**O.D.:** 10 7/32 (259.6)  
**I.D.:** 1/2 (12.7) & 6 1/2 (165.1)  
**Height:** 16 1/4 (412.8)  
**A. Gskt:** [1] Attached



**RS5517** Radial Seal Outer Air Element  
**Contains:** Flame Retardant Media  
**Use With:** RS3545  
**Replaces:** Donaldson P604996; Komatsu 3EC02A541E; Toyota 17741-U3330-71  
**O.D.:** 6 1/2 (165.1)  
**I.D.:** 3 9/16 (90.5) One End  
**Height:** 14 1/32 (356.4)  
**Related To:** RS3544 (Standard Media Version)



**PA5529** Inner Air Element  
**Fits Inside:** PA5528  
**Replaces:** CLARCOR Filtration (China) KX2640-3000; Shantui 612600110540  
**O.D.:** 6 1/4 (158.8)  
**I.D.:** 1/2 (12.7) & 4 7/8 (123.8)  
**Height:** 14 15/32 (367.5)  
**A. Gskt:** [1] Attached



**PA5518** Air Element  
**Notes:** OBSOLETE. Availability Limited to Dealer Stock.  
**Replaces:** CLARCOR Filtration (China) KY1530-2000; Huafeng Power 88290006013  
**O.D.:** 6 1/8 (155.6)  
**I.D.:** 9/16 (14.3) & 3 3/8 (85.7)  
**Height:** 11 15/16 (303.2)  
**A. Gskt:** [1] Attached



**PA5530** Outer Air Element  
**Notes:** OBSOLETE. Availability Limited to Dealer Stock.  
**Use With:** PA5531  
**Replaces:** CLARCOR Filtration (China) KY2337-2000  
**O.D.:** 8 31/32 (227.8)  
**I.D.:** 3/8 (9.5) & 4 7/16 (112.7)  
**Height:** 15 1/16 (382.6)  
**A. Gskt:** [1] Attached



**PA5519** Air Element  
**Notes:** OBSOLETE. Availability Limited to Dealer Stock.  
**Replaces:** CLARCOR Filtration (China) KY1833-2000; Foton Lovol FT75011B010  
**O.D.:** 7 3/32 (180.2)  
**I.D.:** 1/2 (12.7) & 3 7/8 (98.4)  
**Height:** 13 1/2 (342.9)  
**A. Gskt:** [1] Attached



**PA5532** Cab Air Element  
**Notes:** OBSOLETE. Availability Limited to Dealer Stock.  
**Replaces:** M.A.N. 81.77910.0012, 81.77972.0155  
**Length:** 18 1/8 (460.4)  
**Width:** 9 7/16 (239.7)  
**Height:** 1 3/16 (30.2)  
**A. Gskt:** [1] Attached

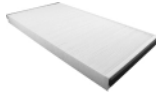

Measurements Are Shown In Inches And (Millimeters)

**WARNING:** These products can expose you to chemicals, including Diisononyl Phthalate, Carbon black extracts, Nickel, 1,3 Butadiene, Ethylene Oxide, Epichlorohydrin, which are known to the State of California to cause cancer, and Bisphenol, Ethylene Glycol, Ethylene Oxide, 1,3 Butadiene, Epichlorohydrin, which are known to the State of California to cause birth defects or other reproductive harm.

**PA5533**

Cab Air Element



**Notes:** OBSOLETE. Availability Limited to Dealer Stock.  
**Replaces:** M.A.N. 81.77972.0121; Donaldson P789258  
**Length:** 33 5/16 (846.1)  
**Width:** 9 23/32 (246.9)  
**Height:** 27/32 (21.4)

**RS5534**

Radial Seal Outer Air Element



**Fits:** Liebherr LTM1080/1 Crane  
**Use With:** RS5361  
**Replaces:** Kassbohrer 83191752020; Liebherr 571755608; M.A.N. 81083040100; Mercedes-Benz 40941704, A0040941704  
**O.D.:** 10 17/32 (267.5)  
**I.D.:** 6 19/32 (167.5) One End  
**Height:** 18 23/32 (475.5)

**RS5535**

Radial Seal Air Element



**Fits:** Iveco EuroCargo Trucks  
**Replaces:** Iveco 2992388, 42553258  
**O.D.:** 9 1/8 (231.8)  
**I.D.:** 5 13/16 (147.6) One End  
**Height:** 16 5/32 (410.4)

**RS5536**

Radial Seal Outer Air Element



**Use With:** RS5550  
**Replaces:** Sullair 68562431; Mann & Hummel C23513  
**O.D.:** 9 (228.6)  
**I.D.:** 4 7/8 (123.8) One End  
**Height:** 11 7/8 (301.6)  
**Related To:** RS5438 (Flame Retardant Media)

**RS5537**

Radial Seal Outer Air Element



**Replaces:** Faun Frisch 99707008877; FAW Hanwei 1109060385; Hitachi 59004040; M.A.N. 81083040101, 81083040103; Sullair 68562430; CLARCOR Filtration (China) KU2437  
**O.D.:** 9 25/32 (248.4)  
**I.D.:** 5 21/32 (143.7) One End  
**Height:** 16 5/32 (410.4)

**RS5538**

Radial Seal Outer Air Element



**Fits:** Faw-Xichai 6DL Diesel Engine  
**Use With:** RS5539  
**Replaces:** Faw-Xichai 110907050A; Donaldson R000753  
**O.D.:** 11 3/32 (281.8)  
**I.D.:** 7 7/16 (188.9) One End  
**Height:** 17 21/32 (448.5)

**RS5539**

Radial Seal Inner Air Element



**Fits Inside:** RS5538  
**Replaces:** Faw-Xichai 110906050A  
**O.D.:** 7 5/16 (185.7)  
**I.D.:** 6 19/32 (167.5) One End  
**Height:** 15 7/16 (392.1)  
**O-Ring:** [1] Attached

**RS5540**

Radial Seal Outer Air Element



**Fits:** Isuzu 6WA1 Engine  
**Use With:** RS5541  
**Replaces:** FAW Hanwei 110907055A; CLARCOR Filtration (China) KU2845  
**O.D.:** 11 3/32 (281.8)  
**I.D.:** 7 7/16 (188.9) One End  
**Height:** 19 13/32 (492.9)

**RS5541**

Radial Seal Inner Air Element



**Fits Inside:** RS5540  
**Fits:** Isuzu 6WA1 Engine  
**Replaces:** FAW Hanwei 110906055A; CLARCOR Filtration (China) KU2845  
**O.D.:** 7 5/16 (185.7)  
**I.D.:** 6 5/16 (160.3) One End  
**Height:** 17 3/16 (436.6)  
**O-Ring:** [1] Included

**RS5543**

Radial Seal Outer Air Element



**Fits:** Manitou MLT523, MLT523A, MT523 Telescopic Handlers  
**Use With:** RS5544  
**Replaces:** Manitou 227959  
**O.D.:** 5 13/32 (137.3)  
**I.D.:** 3 3/16 (81.0) One End  
**Height:** 12 19/32 (319.9)

**RS5544**

Radial Seal Inner Air Element



**Fits Inside:** RS5543  
**Fits:** Manitou MLT523, MLT523A, MT523 Telescopic Handlers  
**Replaces:** Manitou 227960  
**O.D.:** 3 5/16 (84.1)  
**I.D.:** 2 15/32 (62.7) One End  
**Height:** 12 7/32 (310.4)

**PA5545**

Cab Air Element

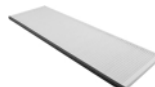

**Notes:** OBSOLETE. Availability Limited to Dealer Stock.  
**Replaces:** M.A.N. 83.77972.0608; Mercedes-Benz 18355547  
**Length:** 19 3/8 (492.1)  
**Width:** 5 3/4 (146.0)  
**Height:** 3/8 (9.5)  
**A. Gskt:** [1] Attached

Measurements Are Shown In Inches And (Millimeters)

**WARNING:** These products can expose you to chemicals, including Diisononyl Phthalate, Carbon black extracts, Nickel, 1,3 Butadiene, Ethylene Oxide, Epichlorohydrin, which are known to the State of California to cause cancer, and Bisphenol, Ethylene Glycol, Ethylene Oxide, 1,3 Butadiene, Epichlorohydrin, which are known to the State of California to cause birth defects or other reproductive harm.

**RS5546** Radial Seal Outer Air Element  
**Use With:** RS3732  
**Replaces:** Fleetguard AF25746; Nelson 70991N  
**O.D.:** 8 13/16 (223.8)  
**I.D.:** 5 5/32 (131.0) One End  
**Height:** 16 7/8 (428.6)



**PA5552** Air Element  
**Notes:** OBSOLETE. Availability Limited to Dealer Stock.  
**Replaces:** CLARCOR Filtration (China) 12VB36M40; Jinan Diesel Engine Co. 12VB.36M.40  
**O.D.:** 15 1/32 (381.8)  
**I.D.:** 29/32 (23.0) & 10 9/16 (268.3)  
**Height:** 19 9/32 (489.7)  
**A. Gskt:** [1] Attached



**RS5547** Radial Seal Inner Air Element  
**Fits Inside:** RS5441  
**Fits:** King Long XMQ6120, XMQ6900 Buses  
**Replaces:** Hitachi 59004050; King Long 4574556159; M.A.N. 81084050026; Mann & Hummel CF1430  
**O.D.:** 5 5/16 (134.9)  
**I.D.:** 4 1/4 (108.0) One End  
**Height:** 13 15/16 (354.0)  
**O-Ring:** [1] Included



**PA5554** Air Element  
**Replaces:** CLARCOR Filtration (China) KY1520-2000; Foton Lovol SM1021-1109010  
**O.D.:** 6 1/8 (155.6)  
**I.D.:** 7/16 (11.1) & 3 3/8 (85.7)  
**Height:** 7 11/16 (195.3)



**RS5548** Radial Seal Inner Air Element  
**Fits Inside:** RS5440  
**Replaces:** FAW Group 1109070297; CLARCOR Filtration (China) KU2337, KU2437; Mann & Hummel CF1440  
**O.D.:** 5 5/16 (134.9)  
**I.D.:** 4 3/8 (111.1) One End  
**Height:** 15 29/32 (404.0)  
**O-Ring:** [1] Included



**PA5555** Air Element  
**Notes:** OBSOLETE. Availability Limited to Dealer Stock.  
**Replaces:** CLARCOR Filtration (China) KY1522-2000; Foton Lovol D20010.48.1  
**O.D.:** 6 1/8 (155.6)  
**I.D.:** 7/16 (11.1) & 3 3/8 (85.7)  
**Height:** 8 13/16 (223.8)  
**A. Gskt:** [1] Attached



**RS5549** Radial Seal Inner Air Element  
**Fits Inside:** RS5358  
**Fits:** Heuliez, Irisbus, Iveco Autobus, M.A.N., Neoplan, Renault, Scania Buses  
**Replaces:** Bomag 5821450; Irisbus 5006307754, 503131284; M.A.N. 81084050027; Scania 1510942  
**O.D.:** 6 1/8 (155.6)  
**I.D.:** 5 1/8 (130.2) One End  
**Height:** 18 7/16 (468.3)  
**O-Ring:** [1] Included



**PA5556** Outer Air Element  
**Use With:** PA5557  
**Replaces:** CLARCOR Filtration (China) KY2139-1000; Weichai Power 13023273 (Outer)  
**O.D.:** 8 1/2 (215.9)  
**I.D.:** 15/32 (11.9) & 4 13/16 (122.2)  
**Height:** 15 29/32 (404.0)  
**A. Gskt:** [1] Attached



**RS5550** Radial Seal Inner Air Element  
**Fits Inside:** RS5536 (NOT for use with RS5438)  
**Replaces:** Mann & Hummel CF1240  
**O.D.:** 4 1/2 (114.3)  
**I.D.:** 3 9/16 (90.5) One End  
**Height:** 9 1/2 (241.3)  
**O-Ring:** [1] Included



**PA5557** Inner Air Element  
**Fits Inside:** PA5556  
**Replaces:** CLARCOR Filtration (China) KY2139-2000; Weichai Power 13023273 (Inner)  
**O.D.:** 4 21/32 (118.3)  
 Flange 5 9/32 (134.1)  
**I.D.:** 15/32 (11.9) & 3 7/16 (87.3)  
**Height:** 14 3/4 (374.7)  
**A. Gskt:** [1] Attached



**PA5551** Air Element  
**Notes:** OBSOLETE. Availability Limited to Dealer Stock.  
**Replaces:** CLARCOR Filtration (China) 30123630; Jinan Diesel Engine Co. 3012.36.30  
**O.D.:** 19 9/32 (489.7)  
**I.D.:** 12 7/16 (315.9)  
**Height:** 10 3/4 (273.1)  
**A. Gskt:** [2] Attached



**RS5558** Radial Seal Outer Air Element  
**Fits:** Ingersoll-Rand Compressors  
**Use With:** RS5559  
**Replaces:** Ingersoll-Rand 54717145  
**O.D.:** 8 13/16 (223.8)  
**I.D.:** 5 17/32 (140.5) One End  
**Height:** 16 23/32 (424.7)



Measurements Are Shown In Inches And (Millimeters)

**WARNING:** These products can expose you to chemicals, including Diisononyl Phthalate, Carbon black extracts, Nickel, 1,3 Butadiene, Ethylene Oxide, Epichlorohydrin, which are known to the State of California to cause cancer, and Bisphenol, Ethylene Glycol, Ethylene Oxide, 1,3 Butadiene, Epichlorohydrin, which are known to the State of California to cause birth defects or other reproductive harm.

**RS5559**



Radial Seal Inner Air Element  
**Fits Inside:** RS5558  
**Fits:** Ingersoll-Rand 10/105 VHP300WIR, 375, XP375WIR, P425WIR Compressors with Ingersoll-Rand 4IRD5AE Engine  
**Replaces:** Ingersoll-Rand 54717152  
**O.D.:** 5 1/2 (139.7)  
**I.D.:** 3 3/4 (95.3) One End  
**Height:** 15 3/4 (400.0)

**PA5561**



Outer Air Element  
**Notes:** OBSOLETE. Availability Limited to Dealer Stock.  
**Use With:** PA5562  
**Replaces:** CLARCOR Filtration (China) K3251-1000; Foton Lovol 1331311982010, K3251-1000  
**O.D.:** 12 3/4 (323.8)  
**I.D.:** 7/16 (11.1) & 8 3/8 (212.7)  
**Height:** 20 (508.0)  
**A. Gskt:** [1] Attached

**PA5562**



Inner Air Element  
**Notes:** OBSOLETE. Availability Limited to Dealer Stock.  
**Fits Inside:** PA5561  
**Replaces:** CLARCOR Filtration (China) K3251-2000; Foton Lovol 1331311982010, K3251-2000  
**O.D.:** 8 9/32 (210.3)  
**I.D.:** 7/16 (11.1) & 7 3/32 (180.2)  
**Height:** 18 1/2 (469.9)  
**A. Gskt:** [1] Attached

**PA5563**



Air Element  
**Replaces:** CLARCOR Filtration (China) K2007-1000; Weichai Power K2007-1000, 13023208  
**O.D.:** 7 27/32 (199.2)  
**I.D.:** 4 27/32 (123.0)  
**Height:** 3 9/32 (83.3)  
**A. Gskt:** [2] Attached

**PA5564**



Outer Air Element  
**Notes:** OBSOLETE. Availability Limited to Dealer Stock.  
**Use With:** PA5565  
**Replaces:** CLARCOR Filtration (China) KL2851-0100, 612600113988; Foton Lovol KL2851-0100; Sinotruk KL2851-0100  
**O.D.:** 10 27/32 (275.4)  
**I.D.:** 13/32 (10.3) & 6 1/2 (165.1)  
**Height:** 19 7/8 (504.8)  
**A. Gskt:** [1] Attached

**PA5565**



Inner Air Element  
**Notes:** OBSOLETE. Availability Limited to Dealer Stock.  
**Fits Inside:** PA5564  
**Replaces:** CLARCOR Filtration (China) KL2851-0200, 612600113988; Foton Lovol KL2851-0200; Sinotruk KL2851-0200  
**O.D.:** 6 13/32 (162.7)  
**I.D.:** 13/32 (10.3) & 5 9/32 (134.1)  
**Height:** 18 5/8 (473.1)  
**A. Gskt:** [1] Attached

**BA5566**



Desiccant Air Dryer Spin-on  
**Contains:** Left Hand Threads  
**Fits:** Volvo Trucks  
**Replaces:** Knorr-Bremse K005686, K014712, K039453; Renault 5001865404, 7421267793; Volvo 20754416, 21267818; WABCO 4329012452; Mahle AL26  
**Thread:** M39 x 1.5 LH  
**O.D.:** 5 3/8 (136.5)  
**Height:** 6 9/16 (166.7)  
**I.Gskt:** [1] Included  
**O-Ring:** [1] Included

**PA5568**



Outer Air Element with Lift Tabs  
**Notes:** OBSOLETE. Availability Limited to Dealer Stock.  
**Use With:** PA5569  
**Replaces:** Shaanqi Group DZ93259190101; CLARCOR Filtration (China) K3260-2000  
**O.D.:** 12 3/4 (323.8)  
**Boot:** 12 31/32 (329.4)  
**I.D.:** 29/32 (23.0) & 8 3/8 (212.7)  
**Height:** 24 7/16 (620.7)  
**A. Gskt:** [1] Attached

**PA5569**



Inner Air Element with Lift Tab  
**Notes:** OBSOLETE. Availability Limited to Dealer Stock.  
**Fits Inside:** PA5568  
**Replaces:** Shaanqi Group DZ93259190101; CLARCOR Filtration (China) K3260-3000  
**O.D.:** 8 9/32 (210.3)  
**I.D.:** 29/32 (23.0) & 7 3/32 (180.2)  
**Height:** 22 1/4 (565.2)  
**A. Gskt:** [1] Attached

**PA5570**



Outer Air Element  
**Notes:** OBSOLETE. Availability Limited to Dealer Stock.  
**Use With:** PA5572  
**Replaces:** Foton Lovol KW1532A1; Huafeng Power KW1532A1-2000; CLARCOR Filtration (China) KW1532A1-2000  
**O.D.:** 6 1/8 (155.6)  
**I.D.:** 7/16 (11.1) & 3 9/32 (83.3)  
**Height:** 12 29/32 (327.8)  
**A. Gskt:** [1] Attached

**PA5571**



Air Element  
**Notes:** OBSOLETE. Availability Limited to Dealer Stock.  
**Replaces:** Foton Lovol KW1532-1000; CLARCOR Filtration (China) KW1532-1000  
**O.D.:** 6 1/8 (155.6)  
**I.D.:** 7/16 (11.1) & 3 3/8 (85.7)  
**Height:** 12 29/32 (327.8)  
**A. Gskt:** [1] Attached

**PA5573**



Outer Air Element  
**Notes:** OBSOLETE. Availability Limited to Dealer Stock.  
**Use With:** PA5574  
**Replaces:** Sullair 88290001466; CLARCOR Filtration (China) KQ3856-1000  
**O.D.:** 15 1/32 (381.8)  
**I.D.:** 29/32 (23.0) & 10 9/16 (268.3)  
**Height:** 22 7/16 (569.9)  
**A. Gskt:** [1] Attached

Measurements Are Shown In Inches And (Millimeters)

**WARNING:** These products can expose you to chemicals, including Diisononyl Phthalate, Carbon black extracts, Nickel, 1,3 Butadiene, Ethylene Oxide, Epichlorohydrin, which are known to the State of California to cause cancer, and Bisphenol, Ethylene Glycol, Ethylene Oxide, 1,3 Butadiene, Epichlorohydrin, which are known to the State of California to cause birth defects or other reproductive harm.

**PA5574**



Inner Air Element

**Notes:** OBSOLETE. Availability Limited to Dealer Stock.  
**Fits Inside:** PA5573  
**Replaces:** Sullair 88290001467; CLARCOR Filtration (China) KQ3856-2000  
**O.D.:** 9 3/8 (238.1)  
**I.D.:** 29/32 (23.0) & 8 1/16 (204.8)  
**Height:** 19 9/32 (489.7)  
**A. Gskt:** [1] Attached

**PA5575**



Outer Air Element

**Notes:** OBSOLETE. Availability Limited to Dealer Stock.  
**Use With:** PA5576  
**Replaces:** CLARCOR Filtration (China) KY2030-1000; Foton Lovol TD82011A11  
**O.D.:** 7 13/16 (198.4)  
**I.D.:** 3/8 (9.5) & 4 5/32 (105.6)  
**Height:** 12 3/16 (309.6)  
**A. Gskt:** [1] Attached

**PA5577**



Outer Air Element

**Notes:** OBSOLETE. Availability Limited to Dealer Stock.  
**Use With:** PA5578  
**Replaces:** Shaanqi Group DZ93259190115; CLARCOR Filtration (China) KY3051-2000  
**O.D.:** 12 (304.8)  
**I.D.:** 7/16 (11.1) & 7 11/16 (195.3)  
**Height:** 20 25/32 (527.8)  
**A. Gskt:** [1] Attached

**PA5578**



Inner Air Element

**Notes:** OBSOLETE. Availability Limited to Dealer Stock.  
**Fits Inside:** PA5577  
**Replaces:** Shaanqi Group DZ93259190115; CLARCOR Filtration (China) KY3051-3000  
**O.D.:** 7 1/4 (184.2)  
**I.D.:** 7/16 (11.1) & 6 3/16 (157.2)  
**Height:** 19 7/8 (504.8)  
**A. Gskt:** [1] Attached

**PA5579**



Air Element

**Notes:** OBSOLETE. Availability Limited to Dealer Stock.  
**Replaces:** Shanghai Screw Compressor Co. 25150014071; CLARCOR Filtration (China) K1016-2000  
**O.D.:** 4 3/32 (104.0)  
**I.D.:** 21/32 (16.7) & 2 15/32 (62.7)  
**Height:** 6 5/8 (168.3)  
**A. Gskt:** [1] Attached

**PA5580**



Cab Air Element

**Fits:** John Deere, Volvo, Zetor Equipment  
**Replaces:** John Deere RE187966  
**Length:** 12 19/32 (319.9)  
**Width:** 6 1/2 (165.1)  
**Height:** 1 7/8 (47.6)

**PA5581**



Cab Air Element

**Fits:** Caterpillar D3G, D4G, D5G Crawler Tractors  
**Replaces:** Caterpillar 1832813  
**Length:** 20 13/16 (528.6)  
**Width:** 5 11/32 (135.7)  
**Height:** 2 9/32 (57.9)

**PA5583**



Air Element

**Fits:** Ditch Witch, Hyster, Yale Equipment  
**Replaces:** Hyster 1574111; Yale 580053908; Donaldson P611859  
**O.D.:** 4 1/32 (102.4)  
**Flange:** 5 9/16 (141.3)  
**I.D.:** 2 13/16 (71.4) One End  
**Height:** 12 7/8 (327.0)

**PA5584**



Outer Air Element

**Contains:** Flame Retardant Media  
**Fits:** Hyster, Yale Equipment  
**Use With:** PA30163  
**Replaces:** Hyster 1559418; Yale 580048838; Donaldson P611858  
**O.D.:** 3 13/32 (86.5)  
**Flange:** 4 3/4 (120.7)  
**I.D.:** 2 1/4 (57.2) One End  
**Height:** 10 17/32 (267.5)

**PA5585**



Cab Air Element

**Fits:** M.A.N., Neoplan Buses  
**Replaces:** M.A.N. 88779100003; Donaldson P787437; Fleetguard AF55709  
**Length:** 8 21/32 (219.9)  
**Width:** 5 29/32 (150.0)  
**Height:** 25/32 (19.8)

**PA5586**



Cab Air Element

**Fits:** EvoBus, Konvekta, M.A.N., Neoplan, Solaris Buses  
**Replaces:** M.A.N. 88779100002; Mercedes-Benz 18352747; Konvekta H14002499; Donaldson P788729; Fleetguard AF55708  
**Length:** 15 3/4 (400.0)  
**Width:** 5 3/16 (131.8)  
**Height:** 25/32 (19.8)

**BF5587-D**



Secondary Fuel Spin-on with Drain

**Fits:** Massey Ferguson, Volvo Equipment  
**Replaces:** Volvo 3976655, 3976655-5; Mann & Hummel WK842/2; Sinfa FG758; Woodgate WGF842-2  
**Thread:** M16 x 1.5  
**O.D.:** 3 7/16 (87.3)  
**Height:** 6 13/32 (162.7)  
**I.Gskt:** [1] Included  
**O-Ring:** [1] Attached  
**Related To:** BF587-D (without Trapped O-Ring)

**PA5588**



Outer Air Element

**Use With:** PA5589  
**Replaces:** Dongfeng Tianlong A660-020; Fleetguard AF26413  
**O.D.:** 11 13/16 (300.0)  
**I.D.:** 11/16 (17.5) & 7 7/8 (200.0)  
**Height:** 18 19/32 (472.3)  
**A. Gskt:** [1] Attached  
**F. Gskt:** [1] Included

Measurements Are Shown In Inches And (Millimeters)

**WARNING:** These products can expose you to chemicals, including Diisononyl Phthalate, Carbon black extracts, Nickel, 1,3 Butadiene, Ethylene Oxide, Epichlorohydrin, which are known to the State of California to cause cancer, and Bisphenol, Ethylene Glycol, Ethylene Oxide, 1,3 Butadiene, Epichlorohydrin, which are known to the State of California to cause birth defects or other reproductive harm.

**PA5589**

Inner Air Element



**Fits Inside:** PA5588  
**Replaces:** Dongfeng Tianlong A660-030;  
 Fleetguard AF26414  
**O.D.:** 7 15/32 (189.7)  
**I.D.:** 11/16 (17.5) & 6 7/32 (158.0)  
**Height:** 17 7/16 (442.9)  
**A. Gskt:** [1] Attached  
**F. Gskt:** [1] Included

**RS5591XP**

Extreme Performance Nano Radial Seal Cab Air Element

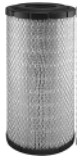

**Fits:** Case-International Sprayers;  
 Case-International, New Holland Tractors  
**Replaces:** Case 259288A1, 87684088  
**O.D.:** 6 1/8 (155.6)  
**I.D.:** 2 1/2 (63.5) One End  
**Height:** 13 21/32 (346.9)

**BA5592**

Desiccant Air Dryer Spin-on



**Fits:** Freightliner, Mack, Volvo Trucks  
**Replaces:** Volvo 8235R950068, 85110799  
**Thread:** M39 x 1.5  
**O.D.:** 5 1/2 (139.7)  
**Height:** 6 9/16 (166.7)  
**I.Gskt:** [1] Included  
**O-Ring:** [1] Included

**RS5593XP**

Extreme Performance Nano Radial Seal Cab Air Element



**Fits:** Case-IH Combines  
**Replaces:** Case 247752A1  
**O.D.:** 7 3/32 (180.2)  
**I.D.:** 2 15/32 (62.7) One End  
**Height:** 21 15/16 (557.2)

**PA5594**

Cab Air Element



**Notes:** OBSOLETE. Availability Limited to Dealer Stock.  
**Fits:** M.A.N. Neoplan Buses  
**Replaces:** M.A.N. 83779100519; Mann & Hummel CU3933; SF-Filter SKL46339  
**Length:** 15 7/16 (392.1)  
**Width:** 6 3/32 (154.8)  
**Height:** 21/32 (16.7)

**PA5597**

Cab Air Element



**Fits:** EvoBus, M.A.N., Vison Buses  
**Replaces:** EvoBus 18359247; Konvekta H14003495; M.A.N. 83779720656; Mercedes-Benz A0018359247  
**Length:** 17 29/32 (454.8)  
**Width:** 5 15/16 (150.8)  
**Height:** 15/32 (11.9)  
**A. Gskt:** [1] Attached

**PA5598**

Cab Air Element



**Notes:** OBSOLETE. Availability Limited to Dealer Stock.  
**Fits:** EvoBus Buses  
**Replaces:** EvoBus 18356147; Mercedes-Benz 18356147  
**Length:** 23 3/8 (593.7)  
**Width:** 4 9/16 (115.9)  
**Height:** 15/32 (11.9)

**PA5599**

Panel Air Element



**Notes:** OBSOLETE. Availability Limited to Dealer Stock.  
**Fits:** EvoBus Buses  
**Replaces:** EvoBus 18358447; Konvekta T140009005; Mercedes-Benz A0018358447; Mann & Hummel CU3935  
**Length:** 15 3/8 (390.5)  
**Width:** 5 19/32 (142.1)  
**Height:** 23/32 (18.3)

**PA5618**

Cab Air Element



**Fits:** Bobcat Loaders  
**Replaces:** Bobcat 6677983  
**Length:** 24 13/32 (619.9)  
**Width:** 4 3/16 (106.4)  
**Height:** 1 3/32 (27.8)

**PA5619**

Oval Air Element



**Notes:** Recommend using with PA4187 (Oiled Foam)  
**Fits:** John Deere Lawn & Garden Tractors  
**Replaces:** John Deere M76077, MIU10778  
**O.D.:** 3 1/2 (88.9) to 8 5/8 (219.1)  
**I.D.:** 1 21/32 (42.1) & 6 27/32 (173.8)  
**Height:** 2 29/32 (73.8)  
**A. Gskt:** [2] Attached

**PA5620**

Cab Air Element



**Fits:** New Holland Excavators  
**Replaces:** Komatsu YT20M00004S050; New Holland YT20M00004S050  
**Length:** 8 5/32 (207.2)  
**Width:** 7 5/16 (185.7)  
**Height:** 1 5/32 (29.4)

**PA5621**

Cab Air Element with Handle



**Fits:** Fiat-Hitachi, Hitachi, John Deere Excavators; John Deere Loggers  
**Replaces:** Hitachi 4350249, 4S00640  
**Length:** 13 9/32 (337.3)  
**Width:** 8 21/32 (219.9)  
**Height:** 2 13/16 (71.4)  
**A. Gskt:** [1] Attached

**PA5622**

Cab Air Element with Pull Tab



**Fits:** Komatsu Dozers, Excavators  
**Replaces:** Komatsu 2039796840  
**Length:** 9 5/32 (232.6)  
**Width:** 7 29/32 (200.8)  
**Height:** 15/16 (23.8)

**PA5623**

Cab Air Element

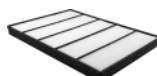





**Fits:** Volvo Equipment  
**Replaces:** Volvo 14506997, VOE14506997; Fleetguard AF26668  
**Length:** 16 3/32 (408.8)  
**Width:** 11 23/32 (297.7)  
**Height:** 1 3/16 (30.2)  
**A. Gskt:** [1] Attached

Measurements Are Shown In Inches And (Millimeters)

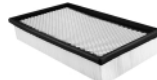







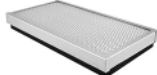
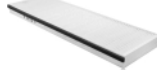

**WARNING:** These products can expose you to chemicals, including Diisononyl Phthalate, Carbon black extracts, Nickel, 1,3 Butadiene, Ethylene Oxide, Epichlorohydrin, which are known to the State of California to cause cancer, and Bisphenol, Ethylene Glycol, Ethylene Oxide, 1,3 Butadiene, Epichlorohydrin, which are known to the State of California to cause birth defects or other reproductive harm.

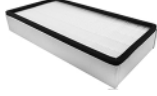

<p><b>PA5624</b> Cab Air Element  <b>Fits:</b> Hitachi Excavators; John Deere Excavators, Forestry Swing Machines  <b>Replaces:</b> Hitachi 4484453  <b>Length:</b> 11 11/32 (288.1)  <b>Width:</b> 6 5/8 (168.3)  <b>Height:</b> 1 7/16 (36.5)</p> 	<p><b>PA5632</b> Cab Air Element  <b>Fits:</b> Caterpillar Equipment  <b>Replaces:</b> Caterpillar 2098217  <b>Length:</b> 12 7/16 (315.9)  <b>Width:</b> 7 1/16 (179.4)  <b>Height:</b> 2 5/32 (54.8)</p> 
<p><b>PA5625</b> Cab Air Element  <b>Fits:</b> Bobcat Loaders  <b>Replaces:</b> Bobcat 6678207  <b>Length:</b> 14 5/8 (371.5)  <b>Width:</b> 4 5/8 (117.5)  <b>Height:</b> 1 3/16 (30.2)</p> 	<p><b>PA5633</b> Cab Air Element  <b>Fits:</b> Caterpillar Crawler Tractors  <b>Replaces:</b> Caterpillar 3E7904; Donaldson P618641  <b>Length:</b> 9 23/32 (246.9)  <b>Width:</b> 6 17/32 (165.9)  <b>Height:</b> 1 3/8 (34.9)</p> 
<p><b>PA5626</b> Cab Air Element  <b>Fits:</b> Agco, Challenger, Massey Ferguson Tractors  <b>Replaces:</b> Massey Ferguson 3388840M2, 3388840M3  <b>Length:</b> 34 17/32 (877.1)  <b>Width:</b> 5 5/16 (134.9)  <b>Height:</b> 2 13/32 (61.1)</p> 	<p><b>PA5636</b> Cab Air Element  <b>Fits:</b> Komatsu Dump Trucks  <b>Replaces:</b> Komatsu PB7001  <b>Length:</b> 20 (508.0)  <b>Width:</b> 14 19/32 (370.7)  <b>Height:</b> 2 3/16 (55.6)</p> 
<p><b>RS5627</b> Radial Seal Outer Air Element  <b>Fits:</b> Mercedes-Benz O 500 M, O 500 R, O 500 U, OF 1721, OF 1518, OH 1520, OH1618, OH 1621 L, OF1622 L Latin America Buses, 2726, 2726 B-36, 2726 K-36 South America Trucks  <b>Use With:</b> RS5628  <b>Replaces:</b> Mercedes-Benz 6345280306, A6345280306; Racor AR5626RS; Donaldson P618941  <b>O.D.:</b> 10 3/8 (263.5)  <b>I.D.:</b> 5 3/4 (146.0) One End  <b>Height:</b> 15 7/8 (403.2)</p> 	<p><b>PA5637</b> Cab Air Element  <b>Fits:</b> International Trucks  <b>Replaces:</b> International 1699956C1; Donaldson P617005; Fleetguard AF55700  <b>Length:</b> 13 21/32 (346.9)  <b>Width:</b> 10 1/32 (254.8)  <b>Height:</b> 19/32 (15.1)</p> 
<p><b>RS5628</b> Radial Seal Inner Air Element  <b>Fits Inside:</b> RS5627  <b>Fits:</b> Volkswagen 26.220, 26.260, 26.260 E, 26.300, 26.310 Trucks  <b>Replaces:</b> Volkswagen 2S0129620A  <b>O.D.:</b> 5 3/4 (146.0)  <b>I.D.:</b> 4 3/8 (111.1) One End  <b>Height:</b> 16 1/2 (419.1)</p> 	<p><b>PA5638</b> Cab Air Element  <b>Fits:</b> Caterpillar Equipment  <b>Replaces:</b> Caterpillar 2457823  <b>Length:</b> 7 15/16 (201.6)  <b>Width:</b> 7 7/8 (200.0)  <b>Height:</b> 23/32 (18.3)</p> 
<p><b>PA5629</b> Cab Air Element  <b>Fits:</b> Kobelco, New Holland Excavators  <b>Replaces:</b> Kobelco YN50V01006P1P; New Holland YN50V01006P1, YN50V01006P1P  <b>Length:</b> 8 17/32 (216.7)  <b>Width:</b> 7 15/16 (201.6)  <b>Height:</b> 1 31/32 (50.0)  <b>A. Gskt:</b> [1] Attached</p> 	<p><b>PA5642</b> Cab Air Element with Foam Pad  <b>Fits:</b> EvoBus Buses; Mercedes-Benz Trucks  <b>Replaces:</b> EvoBus 18359147; Mercedes-Benz A0018359147  <b>Length:</b> 20 5/32 (512.0)  <b>Width:</b> 9 7/32 (234.2)  <b>Height:</b> 1 7/8 (47.6)  <b>A. Gskt:</b> [2] Attached</p> 
<p><b>PA5630</b> Cab Air Element  <b>Fits:</b> Hitachi Zaxis 75US-A, ZX75US-A Excavators  <b>Replaces:</b> Hitachi 4S00687  <b>Length:</b> 17 1/2 (444.5)  <b>Width:</b> 4 1/4 (108.0)  <b>Height:</b> 3/16 (4.8)</p> 	<p><b>PA5643</b> Cab Air Element  <b>Notes:</b> OBSOLETE. Availability Limited to Dealer Stock.  <b>Fits:</b> EvoBus Buses with Mercedes-Benz Engines  <b>Replaces:</b> EvoBus 18356247; Mercedes-Benz A0018356247  <b>Length:</b> 10 31/32 (278.6)  <b>Width:</b> 4 9/16 (115.9)  <b>Height:</b> 1/2 (12.7)  <b>A. Gskt:</b> [2] Velco Strips Attached</p> 
<p><b>PA5631</b> Cab Air Element  <b>Fits:</b> Case, Link-Belt Excavators  <b>Replaces:</b> Case KHR2772, MMR80010  <b>Length:</b> 9 (228.6)  <b>Width:</b> 7 1/8 (181.0)  <b>Height:</b> 1 27/32 (46.8)</p> 	

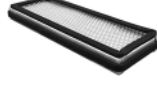
Measurements Are Shown In Inches And (Millimeters)

 **WARNING:** These products can expose you to chemicals, including Diisononyl Phthalate, Carbon black extracts, Nickel, 1,3 Butadiene, Ethylene Oxide, Epichlorohydrin, which are known to the State of California to cause cancer, and Bisphenol, Ethylene Glycol, Ethylene Oxide, 1,3 Butadiene, Epichlorohydrin, which are known to the State of California to cause birth defects or other reproductive harm.

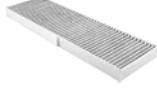
<p><b>PA5644</b> Cab Air Element</p>  <p><b>Notes:</b> OBSOLETE. Availability Limited to Dealer Stock. <b>Fits:</b> EvoBus Buses with Mercedes-Benz Engines <b>Replaces:</b> EvoBus 18357147; Mercedes-Benz A0018357147 <b>Length:</b> 19 13/32 (492.9) <b>Width:</b> 5 27/32 (148.4) <b>Height:</b> 1 3/16 (30.2) <b>A. Gskt:</b> [1] Attached</p>	<p><b>PA5652</b> Cab Air Element</p>  <p><b>Fits:</b> John Deere Backhoe/Loaders <b>Replaces:</b> John Deere AT184590 <b>Length:</b> 12 9/16 (319.1) <b>Width:</b> 6 1/2 (165.1) <b>Height:</b> 1 7/16 (36.5) <b>A. Gskt:</b> [1] Attached</p>
<p><b>PA5645</b> Cab Air Element</p>  <p><b>Notes:</b> OBSOLETE. Availability Limited to Dealer Stock. <b>Fits:</b> EvoBus CapaCity, Intouro, Integro, Setra Turismo, Travego Buses; Irisbus Crossway, Arway Buses <b>Replaces:</b> EvoBus 18357047; Mercedes-Benz A0018357047 <b>Length:</b> 17 29/32 (454.8) <b>Width:</b> 5 27/32 (148.4) <b>Height:</b> 1 3/16 (30.2) <b>A. Gskt:</b> [1] Attached</p>	<p><b>PA5653</b> Cab Air Element</p>  <p><b>Fits:</b> John Deere, Timberjack Feller Bunchers <b>Replaces:</b> John Deere 700093800; Timberjack 700093800 <b>Length:</b> 17 (431.8) <b>Width:</b> 10 1/32 (254.8) <b>Height:</b> 2 3/16 (55.6)</p>
<p><b>PA5646</b> Foam Cab Air Element</p>  <p><b>Notes:</b> OBSOLETE. Availability Limited to Dealer Stock. <b>Fits:</b> EvoBus Integro, Setra Buses with Mercedes-Benz Engines <b>Replaces:</b> EvoBus 18351347, 8441000941; Mercedes-Benz A0018351347 <b>Length:</b> 60 5/8 (1539.9) <b>Width:</b> 9 21/32 (245.3) <b>Height:</b> 25/32 (19.8)</p>	<p><b>PA5654</b> Cab Air Element</p>  <p><b>Fits:</b> Caterpillar Off-Highway Trucks, Wheel Tractors <b>Replaces:</b> Caterpillar 1748145 <b>Length:</b> 16 1/8 (409.6) <b>Width:</b> 5 31/32 (151.6) <b>Height:</b> 2 19/32 (65.9) <b>A. Gskt:</b> [1] Attached</p>
<p><b>PA5648</b> Cab Air Element</p>  <p><b>Notes:</b> OBSOLETE. Availability Limited to Dealer Stock. <b>Fits:</b> EvoBus CapaCity, Citaro Buses with Mercedes-Benz Engines <b>Replaces:</b> EvoBus 18351547; Konvekta H14002484; Mercedes-Benz A0018351547 <b>Length:</b> 19 27/32 (504.0) <b>Width:</b> 8 7/8 (225.4) <b>Height:</b> 1 3/16 (30.2) <b>A. Gskt:</b> [2] Attached</p>	<p><b>PA5655</b> Cab Air Element</p>  <p><b>Fits:</b> Caterpillar Off-Highway Trucks, Equipment <b>Replaces:</b> Caterpillar 1193355 <b>Length:</b> 15 29/32 (404.0) <b>Width:</b> 7 7/8 (200.0) <b>Height:</b> 2 3/16 (55.6) <b>A. Gskt:</b> [1] Attached</p>
<p><b>PA5649</b> Cab Air Element</p>  <p><b>Fits:</b> Case-IH, McCormick Equipment <b>Replaces:</b> Case 248124A1, 87761808 <b>Length:</b> 18 1/2 (469.9) <b>Width:</b> 4 9/16 (115.9) <b>Height:</b> 2 1/4 (57.2)</p>	<p><b>PA5656</b> Cab Air Element</p>  <p><b>Fits:</b> Hitachi, John Deere Excavators <b>Replaces:</b> Hitachi 4632689, 4S00686, 4S00686SH <b>Length:</b> 12 9/16 (319.1) <b>Width:</b> 8 (203.2) <b>Height:</b> 3 1/16 (77.8) <b>A. Gskt:</b> [1] Attached</p>
<p><b>PA5650</b> Cab Air Element</p>  <p><b>Fits:</b> Caterpillar Equipment <b>Replaces:</b> Caterpillar 2318132 <b>Length:</b> 10 23/32 (272.3) <b>Width:</b> 4 3/32 (104.0) <b>Height:</b> 1 3/32 (27.8) <b>A. Gskt:</b> [2] Attached</p>	<p><b>PA5657</b> Cab Air Element with Pull Tabs</p>  <p><b>Fits:</b> Case, New Holland Equipment <b>Replaces:</b> Case 627749 <b>Length:</b> 29 29/32 (759.6) <b>Width:</b> 9 17/32 (242.1) <b>Height:</b> 2 3/16 (55.6)</p>
<p><b>PA5651</b> Set of 2 Cab Air Elements</p>  <p><b>Notes:</b> Uses 2 filters per application. <b>Fits:</b> Komatsu Excavators <b>Replaces:</b> Komatsu 22B9791730 <b>Each Filter:</b> <b>Length:</b> 8 1/8 (206.4) <b>Width:</b> 4 1/2 (114.3) <b>Height:</b> 19/32 (15.1) <b>A. Gskt:</b> [1] Attached Each Filter</p>	<p><b>PA5658</b> Oval Air Element</p>  <p><b>Fits:</b> Onan RV Generators <b>Replaces:</b> Onan 1402897 <b>O.D.:</b> 4 7/16 (112.7) to 6 19/32 (167.5) <b>I.D.:</b> 2 15/16 (74.6) &amp; 5 1/32 (127.8) <b>Height:</b> 4 1/16 (103.2)</p>
	<p><b>PA5660</b> Cab Air Element</p>  <p><b>Notes:</b> OBSOLETE. Availability Limited to Dealer Stock. <b>Contains:</b> Charcoal Impregnated Media for Odor Control. <b>Fits:</b> Case Loaders <b>Replaces:</b> Case 87029691, 87681240 <b>Length:</b> 14 1/2 (368.3) <b>Width:</b> 4 9/32 (108.7) <b>Height:</b> 15/16 (23.8) <b>A. Gskt:</b> [2] Attached</p>

Measurements Are Shown In Inches And (Millimeters)

**WARNING:** These products can expose you to chemicals, including Diisononyl Phthalate, Carbon black extracts, Nickel, 1,3 Butadiene, Ethylene Oxide, Epichlorohydrin, which are known to the State of California to cause cancer, and Bisphenol, Ethylene Glycol, Ethylene Oxide, 1,3 Butadiene, Epichlorohydrin, which are known to the State of California to cause birth defects or other reproductive harm.

**PA5661** Panel Air Element with Foam Pre-Cleaner  
**Fits:** L100, 102, LA105, L108, LA110, X110, 115, LA115, X 120, Z225 EZTrak Lawn & Garden Equipment  
**Replaces:** John Deere GY20573; Stens 102871 and 102875  
**Length:** 8 31/32 (227.8)  
**Width:** 6 5/16 (160.3)  
**Height:** 1 1/2 (38.1)

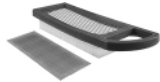

**PA5662** Cab Air Element  
**Fits:** Hitachi Excavators  
**Replaces:** Hitachi 4441139, 4S00684; John Deere 4S00684  
**Length:** 11 3/8 (288.9)  
**Width:** 6 9/16 (166.7)  
**Height:** 3/8 (9.5)



**PA5663** Cab Air Element with Bail Handle  
**Fits:** Komatsu HM350-1, HM400-1 Dump Trucks  
**Replaces:** Komatsu 2099796260  
**Length:** 9 31/32 (253.2)  
**Width:** 6 1/32 (153.2)  
**Height:** 2 3/16 (55.6)



**PA5664** Air Element  
**Fits:** Volvo-Penta Marine Engines  
**Replaces:** Volvo 858488  
**O.D.:** 7 31/32 (202.4)  
**I.D.:** 3 27/32 (97.6)  
**Height:** 3 15/16 (100.0)



**PA5665** Air Element  
**Replaces:** Air Refiner ARP1063; Universal Silencer 811063; Wix 42788  
**O.D.:** 9 23/32 (246.9)  
**I.D.:** 7 9/32 (184.9)  
**Height:** 6 (152.4)



**PA5666** Cab Air Element  
**Fits:** Hitachi, John Deere Excavators  
**Replaces:** Hitachi 4643580, 4S00685  
**Length:** 11 1/32 (280.2)  
**Width:** 6 5/16 (160.3)  
**Height:** 1 25/32 (45.2)



**PA5667** Cab Air Element  
**Fits:** Fiat-Hitachi Excavators; Hitachi, New Holland Loaders  
**Replaces:** New Holland 154227500  
**Length:** 18 5/16 (465.1)  
**Width:** 5 5/16 (134.9)  
**Height:** 2 5/32 (54.8)



**PA5668** Cab Air Element  
**Fits:** Case Loaders  
**Replaces:** Case 360260A2  
**Length:** 29 3/32 (739.0)  
**Width:** 5 9/16 (141.3)  
**Height:** 2 3/16 (55.6)  
**A. Gskt:** [1] Attached



**PA5669** Cab Air Element  
**Fits:** John Deere Dozers, Feller Bunchers, Loaders  
**Replaces:** John Deere AT307501  
**Length:** 12 17/32 (318.3)  
**Width:** 7 1/16 (179.4)  
**Height:** 1 5/8 (41.3)

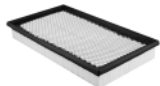

**RS5670** Radial Seal Air Element  
**Fits:** Nissan, Renault Trucks  
**Replaces:** Nissan 16546MA70A, 16546MA70C; Renault 5001869822  
**O.D.:** 6 27/32 (173.8)  
**I.D.:** 3 3/4 (95.3) One End  
**Height:** 7 1/4 (184.2)



**RS5672** Radial Seal Outer Air Element  
**Use With:** RS5673  
**Replaces:** DongFeng Tianlong 11043911210; Fleetguard AF26433  
**O.D.:** 11 25/32 (299.2)  
**I.D.:** 7 3/4 (196.9) One End  
**Height:** 20 (508.0)



**RS5673** Radial Seal Inner Air Element  
**Fits Inside:** RS5672  
**Replaces:** DongFeng Tianlong 11043911216; Fleetguard AF26434  
**O.D.:** 7 1/16 (179.4)  
**I.D.:** 6 15/32 (164.3) One End  
**Height:** 19 5/32 (486.6)



**PA5674** Air Element in Disposable Housing  
**Fits:** Pierce-Arrow Fire Trucks  
**Replaces:** Farr 99842002; Wix 46813  
**O.D.:** 10 31/32 (278.6)  
**Inlet:** 7  
**Outlet:** 7 1/16  
**Height:** 25 23/32 (653.3)



**RS5675** Radial Seal Outer Air Element  
**Use With:** RS5676  
**Replaces:** Scania 1931040  
**O.D.:** 10 31/32 (278.6)  
**I.D.:** 5 17/32 (140.5) One End  
**Height:** 18 3/8 (466.7)













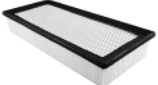
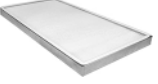

**RS5676** Radial Seal Inner Air Element  
**Fits Inside:** RS5675, RS30130  
**Replaces:** Scania 1931041  
**O.D.:** 5 29/32 (150.0)  
**I.D.:** 4 5/16 (109.5) One End  
**Height:** 16 7/32 (412.0)

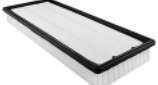

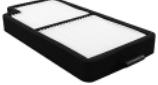
Measurements Are Shown In Inches And (Millimeters)

**WARNING:** These products can expose you to chemicals, including Diisononyl Phthalate, Carbon black extracts, Nickel, 1,3 Butadiene, Ethylene Oxide, Epichlorohydrin, which are known to the State of California to cause cancer, and Bisphenol, Ethylene Glycol, Ethylene Oxide, 1,3 Butadiene, Epichlorohydrin, which are known to the State of California to cause birth defects or other reproductive harm.

<p><b>PA5678</b></p> 	<p>Foam Cab Air Element  <b>Fits:</b> New Holland Bale Wagons  <b>Replaces:</b> New Holland 593939  <b>Length:</b> 24 9/32 (616.7)  <b>Width:</b> 4 11/32 (110.3)  <b>Height:</b> 31/32 (24.6)</p>	<p><b>PA5686</b></p> 	<p>Cab Air Element with Pull Tabs  <b>Fits:</b> John Deere 643G, 843G Feller Bunchers, 544G, 624G Loaders  <b>Replaces:</b> John Deere AT171176  <b>Length:</b> 19 21/32 (499.3)  <b>Width:</b> 5 9/32 (134.1)  <b>Height:</b> 2 19/32 (65.9)  <b>A. Gskt:</b> [1] Attached</p>
<p><b>PA5679</b></p> 	<p>Cab Air Element  <b>Fits:</b> IHC 7400 WorkStar, 7500 WorkStar, 7600 WorkStar, 8600 TranStar Trucks  <b>Replaces:</b> International 3839141C1; MicronAir IN10215P  <b>Length:</b> 12 1/4 (311.2)  <b>Width:</b> 6 5/32 (156.4)  <b>Height:</b> 1 3/16 (30.2)</p>	<p><b>PA5687</b></p> 	<p>Air Element  <b>Notes:</b> OBSOLETE. Availability Limited to Dealer Stock.  <b>Fits:</b> Evobus, Mercedes-Benz, Setra Buses  <b>Replaces:</b> Evobus 6285280606; Mercedes-Benz A6285280606; Donaldson P786816  <b>O.D.:</b> 11 7/8 (301.6)  <b>I.D.:</b> 13/32 (10.3) &amp; 7 17/32 (191.3)  <b>Height:</b> 18 7/8 (479.4)</p>
<p><b>PA5680</b></p> 	<p>Cab Air Element  <b>Fits:</b> Caterpillar Engines, Off-Highway Trucks, Wheel Tractors  <b>Replaces:</b> Caterpillar 2593222  <b>Length:</b> 14 7/16 (366.7)  <b>Width:</b> 6 1/32 (153.2)  <b>Height:</b> 2 9/32 (57.9)</p>	<p><b>PA5688</b></p> 	<p>Cab Air Element  <b>Notes:</b> OBSOLETE. Availability Limited to Dealer Stock.  <b>Fits:</b> Fendt, Massey Ferguson Combines  <b>Replaces:</b> Massey Ferguson 28980100, D28980100; Hifi/Jura Filtration SC60028  <b>Length:</b> 25 9/16 (649.3)  <b>Width:</b> 13 7/8 (352.4)  <b>Height:</b> 1 1/2 (38.1)  <b>A. Gskt:</b> [1] Attached</p>
<p><b>PA5681</b></p> 	<p>Cab Air Element  <b>Fits:</b> Euclid, Hitachi Dump Trucks  <b>Replaces:</b> Euclid E12630763; Hitachi 12630763; Donaldson P123229  <b>Length:</b> 16 (406.4)  <b>Width:</b> 11 31/32 (304.0)  <b>Height:</b> 2 3/16 (55.6)</p>	<p><b>PA5689</b></p> 	<p>Cab Air Element  <b>Fits:</b> John Deere Tractors  <b>Replaces:</b> John Deere RE291412; Mann &amp; Hummel CU33128  <b>O.D.:</b> 12 15/16 (328.6)  <b>I.D.:</b> 9 9/16 (242.9)  <b>Height:</b> 2 29/32 (73.8)</p>
<p><b>PA5682</b></p> 	<p>Cab Air Element  <b>Fits:</b> Agco, Challenger Tractors  <b>Replaces:</b> Agco 3786649M1, 3786649M2, 3786649M3; Mahle LX1151  <b>Length:</b> 19 11/16 (500.1)  <b>Width:</b> 7 7/8 (200.0)  <b>Height:</b> 2 5/32 (54.8)</p>	<p><b>PA5690</b></p> 	<p>Foam Cab Air Element  <b>Fits:</b> International 5000 PayStar, 5600 Series, 9100i, 9300, 9900i Trucks  <b>Replaces:</b> International 498144C1  <b>Length:</b> 13 3/8 (339.7)  <b>Width:</b> 12 13/16 (325.4)  <b>Height:</b> 25/32 (19.8)</p>
<p><b>PA5683</b></p> 	<p>Cab Air Element with Pull Tab  <b>Fits:</b> Komatsu Equipment  <b>Replaces:</b> Komatsu 22B9791740  <b>Length:</b> 8 19/32 (218.3)  <b>Width:</b> 4 5/32 (105.6)  <b>Height:</b> 31/32 (24.6)  <b>A. Gskt:</b> [1] Attached</p>	<p><b>PA5691</b></p> 	<p>Foam cab Air Element  <b>Fits:</b> International Trucks  <b>Replaces:</b> International 1696834C1  <b>Length:</b> 11 13/16 (300.0)  <b>Width:</b> 11 7/32 (285.0)  <b>Height:</b> 17/32 (13.5)</p>
<p><b>RS5684</b></p> 	<p>Radial Seal Inner Air Element  <b>Fits Inside:</b> RS4972  <b>Fits:</b> Deutz-Fahr Tractors  <b>Replaces:</b> Deutz 90000592; Renault 7700039510; Donaldson P777779  <b>O.D.:</b> 4 1/8 (104.8)  <b>I.D.:</b> 3 29/32 (99.2) One End  <b>Height:</b> 14 3/32 (358.0)</p>	<p><b>RS5692</b></p> 	<p>Radial Seal Air Element  <b>Contains:</b> Flame Retardant Media  <b>Fits:</b> DAF Trucks  <b>Replaces:</b> DAF 1679397  <b>O.D.:</b> 9 23/32 (246.9)  <b>I.D.:</b> 6 5/16 (160.3) One End  <b>Height:</b> 15 11/32 (389.7)</p>
<p><b>RS5685</b></p> 	<p>Radial Seal Cab Air Element  <b>Contains:</b> Carbon Activated Inner Core  <b>Fits:</b> Case-International Sprayers, Tractors; New Holland Tractors  <b>Replaces:</b> Case 87267363  <b>O.D.:</b> 6 3/32 (154.8)  <b>I.D.:</b> 2 7/16 (61.9) One End  <b>Height:</b> 13 31/32 (354.8)</p>		

Measurements Are Shown In Inches And (Millimeters)

**WARNING:** These products can expose you to chemicals, including Diisononyl Phthalate, Carbon black extracts, Nickel, 1,3 Butadiene, Ethylene Oxide, Epichlorohydrin, which are known to the State of California to cause cancer, and Bisphenol, Ethylene Glycol, Ethylene Oxide, 1,3 Butadiene, Epichlorohydrin, which are known to the State of California to cause birth defects or other reproductive harm.

**RS5693**



**Radial Seal Air Element**

**Fits:** Volvo-Penta D12D (12.0L) Engine  
**Replaces:** Volvo 21196919, 3828811  
**O.D.:** 9 25/32 (248.4)  
 to 11 1/16 (281.0)  
**I.D.:** 7 11/32 (186.5) One End  
**Height:** 12 5/16 (312.7)

**PA5701**



**Outer Air Element**

**Notes:** OBSOLETE. Availability Limited to Dealer Stock.  
**Fits:** Quangqi Hino Trucks  
**Use With:** PA5702  
**Replaces:** Hino S178013530; Weifang APPA11201  
**O.D.:** 12 15/16 (328.6)  
**I.D.:** 13/16 (20.6) & 8 19/32 (218.3)  
**Height:** 16 1/4 (412.8)  
**A. Gskt:** [1] Attached

**PA5694**



**Foam Cab Air Element**

**Fits:** Peterbilt 387, 587 Trucks  
**Replaces:** Peterbilt 525838BSM  
**Length:** 13 11/16 (347.7)  
**Width:** 10 1/32 (254.8)  
**Height:** 25/32 (19.8)

**PA5702**



**Inner Air Element**

**Notes:** OBSOLETE. Availability Limited to Dealer Stock.  
**Fits Inside:** PA5701  
**Fits:** Hino Trucks  
**Replaces:** Hino S178013540; Weifang WPPA11202  
**O.D.:** 7 1/4 (184.2)  
**I.D.:** 13/16 (20.6) & 6 3/16 (157.2)  
**Height:** 14 3/32 (358.0)  
**A. Gskt:** [1] Attached

**PA5695**



**Cab Air Element**

**Fits:** Fendt Combines, Tractors  
**Replaces:** Agco 72478600; Fendt H816810140070, H816810140071  
**Length:** 16 1/16 (408.0)  
**Width:** 4 23/32 (119.9)  
**Height:** 2 5/16 (58.7)

**PA5704**



**Outer Air Element**

**Notes:** OBSOLETE. Availability Limited to Dealer Stock.  
**Fits:** Jingtang Trucks  
**Use With:** PA5705  
**Replaces:** Hongyan 1109-52/30 Outer; Weifang K3052 Outer  
**O.D.:** 12 (304.8)  
**I.D.:** 9/16 (14.3) & 7 11/16 (195.3)  
**Height:** 20 9/32 (515.1)  
**A. Gskt:** [1] Attached

**PA5696**



**Cab Air Element**

**Fits:** John Deere Combines, Tractors  
**Replaces:** John Deere RE284091; Fleetguard AF55740  
**Length:** 24 1/32 (610.4)  
**Width:** 4 1/16 (103.2)  
**Height:** 3 7/16 (87.3)

**PA5697**

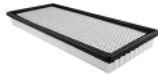

**Cab Air Element**

**Fits:** Caterpillar Loaders, Motor Graders  
**Replaces:** Caterpillar 2112660  
**Length:** 15 21/32 (397.7)  
**Width:** 6 7/16 (163.5)  
**Height:** 1 17/32 (38.9)

**RS5707**



**Radial Seal Outer Air Element**

**Fits:** Yutong Buses  
**Use With:** RS5708  
**Replaces:** Yutong AA90141 Outer; Weifang K3043 Outer; Fleetguard AF26597  
**O.D.:** 11 25/32 (299.2)  
**I.D.:** 7 3/4 (196.9) One End  
**Height:** 17 (431.8)

**PA5698**



**Cab Air Element**

**Fits:** John Deere Loaders  
**Replaces:** John Deere AT359416  
**Length:** 10 19/32 (269.1)  
**Width:** 3 9/16 (90.5)  
**Height:** 1 3/32 (27.8)

**RS5708**



**Radial Seal Inner Air Element**

**Fits Inside:** RS5707  
**Fits:** Yutong Buses  
**Replaces:** Yutong AA90141 Inner; Weifang K3043 Inner; Fleetguard AF26598  
**O.D.:** 7 1/16 (179.4)  
**I.D.:** 5 29/32 (150.0) One End  
**Height:** 16 1/4 (412.8)

**PA5699**



**Air Element**

**Contains:** Flame Retardant Media  
**Fits:** LeTourneau Equipment  
**Replaces:** LeTourneau 4219820  
**O.D.:** 13 7/8 (352.4)  
**I.D.:** 9 1/2 (241.3)  
**Height:** 22 1/2 (571.5)  
**A. Gskt:** [1] Attached  
**Related To:** PA3588 (Different Media)

**PA5700**



**Air Breather Element**

**Contains:** Check Valve  
 Clamp  
**Fits:** Volvo Dump Trucks, Equipment  
**Replaces:** Volvo 11172907; Donaldson P528708; Fleetguard AF27819  
**O.D.:** 3 7/16 (87.3)  
**I.D.:** 31/32 (24.6) One End  
**Height:** 3 9/16 (90.5)  
**Grommets:** [1] Attached  
**Related To:** PA2798 (without Check Valve)

**PA5710**











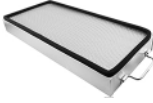

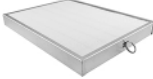

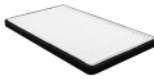
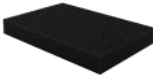
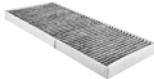
**Cab Air Element**

**Fits:** Case-IH, New Holland Tractors  
**Replaces:** New Holland 47128151, 73402760, 82012057; Donaldson P784574  
**Length:** 20 7/16 (519.1)  
**Width:** 4 1/8 (104.8)  
**Height:** 1 31/32 (50.0)  
**A. Gskt:** [1] Attached

Measurements Are Shown In Inches And (Millimeters)

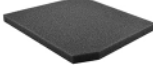
**WARNING:** These products can expose you to chemicals, including Diisononyl Phthalate, Carbon black extracts, Nickel, 1,3 Butadiene, Ethylene Oxide, Epichlorohydrin, which are known to the State of California to cause cancer, and Bisphenol, Ethylene Glycol, Ethylene Oxide, 1,3 Butadiene, Epichlorohydrin, which are known to the State of California to cause birth defects or other reproductive harm.

<p><b>PA5711</b> Cab Air Element with Bail Handle  <b>Fits:</b> Case Loaders  <b>Replaces:</b> Case 330014A1  <b>Length:</b> 19 31/32 (507.2)  <b>Width:</b> 9 1/16 (230.2)  <b>Height:</b> 2 19/32 (65.9)  <b>A. Gskt:</b> [1] Attached</p> 	<p><b>PA5721</b> Foam Cab Air Element  <b>Notes:</b> OBSOLETE. Availability Limited to Dealer Stock.  <b>Fits:</b> Volvo Motor Graders  <b>Replaces:</b> Volvo 96913  <b>Length:</b> 11 11/16 (296.9)  <b>Width:</b> 5 1/8 (130.2)  <b>Height:</b> 3/8 (9.5)</p> 
<p><b>PA5712</b> Cab Air Element with Lift Tab  <b>Fits:</b> John Deere Dump Trucks  <b>Replaces:</b> John Deere TT226019  <b>Length:</b> 14 1/4 (362.0)  <b>Width:</b> 10 23/32 (272.3)  <b>Height:</b> 1 13/32 (35.7)</p> 	<p><b>PA5722</b> Cab Air Element  <b>Fits:</b> Freightliner Trucks  <b>Replaces:</b> Freightliner 2246891000  <b>Length:</b> 8 5/8 (219.1)  <b>Width:</b> 7 11/16 (195.3)  <b>Height:</b> 31/32 (24.6)</p> 
<p><b>PA5713</b> Foam Cab Air Element  <b>Fits:</b> John Deere Tractors  <b>Replaces:</b> John Deere R65450  <b>Length:</b> 29 17/32 (750.1)  <b>Width:</b> 4 1/8 (104.8)  <b>Height:</b> 31/32 (24.6)</p> 	<p><b>PA5723</b> Cab Air Element  <b>Fits:</b> Hitachi, John Deere Excavators  <b>Replaces:</b> Hitachi 4455778, 4S00688; John Deere 4455778, 4S00688  <b>Length:</b> 8 21/32 (219.9)  <b>Width:</b> 4 7/8 (123.8)  <b>Height:</b> 19/32 (15.1)  <b>A. Gskt:</b> [1] Attached</p> 
<p><b>PA5714</b> Foam Cab Air Element  <b>Notes:</b> OBSOLETE. Availability Limited to Dealer Stock.  <b>Fits:</b> Volvo Loaders  <b>Replaces:</b> Volvo 2815618  <b>Length:</b> 9 1/16 (230.2)  <b>Width:</b> 6 1/8 (155.6)  <b>Height:</b> 1 3/16 (30.2)</p> 	<p><b>PA5725</b> Cab Air Element  <b>Contains:</b> Charcoal Impregnated Media for Odor Control  <b>Fits:</b> Case Loaders  <b>Replaces:</b> Case 87656118; New Holland 87656118  <b>Length:</b> 14 1/2 (368.3)  <b>Width:</b> 6 11/32 (161.1)  <b>Height:</b> 15/16 (23.8)</p> 
<p><b>PA5715</b> Foam Cab Air Element  <b>Notes:</b> OBSOLETE. Availability Limited to Dealer Stock.  <b>Fits:</b> Komatsu Dump Trucks  <b>Replaces:</b> Komatsu XA3004  <b>Length:</b> 18 29/32 (480.2)  <b>Width:</b> 3 15/32 (88.1)  <b>Height:</b> 1/2 (12.7)</p> 	<p><b>PA5726</b> Foam Cab Air Element  <b>Notes:</b> OBSOLETE. Availability Limited to Dealer Stock.  <b>Fits:</b> John Deere Tractors  <b>Replaces:</b> John Deere R131204  <b>Length:</b> 29 29/32 (759.6)  <b>Width:</b> 4 5/32 (105.6)  <b>Height:</b> 1/2 (12.7)</p> 
<p><b>PA5716</b> Foam Cab Air Element  <b>Fits:</b> Komatsu Dump Trucks  <b>Replaces:</b> Komatsu BF5467  <b>Length:</b> 18 13/16 (477.8)  <b>Width:</b> 4 1/8 (104.8)  <b>Height:</b> 1/2 (12.7)</p> 	<p><b>PA5727</b> Foam Cab Air Element  <b>Fits:</b> John Deere Skidders  <b>Replaces:</b> John Deere T183432  <b>Length:</b> 12 29/32 (327.8)  <b>Width:</b> 3 17/32 (89.7)  <b>Height:</b> 1/2 (12.7)</p> 
<p><b>PA5718 KIT</b> Set of 2 Foam Cab Air Elements  <b>Notes:</b> OBSOLETE. Availability Limited to Dealer Stock.            Uses 2 filters per application.  <b>Fits:</b> New Holland Loaders  <b>Replaces:</b> New Holland 76043561  <b>Each Filter:</b>  <b>Length:</b> 18 17/32 (470.7)  <b>Width:</b> 3 17/32 (89.7)  <b>Height:</b> 1/2 (12.7)</p> 	<p><b>PA5728</b> Oval Air Element  <b>Fits:</b> John Deere Lawn &amp; Garden Equipment  <b>Use With:</b> PA5728 FOAM  <b>Replaces:</b> John Deere M150949; Kawasaki 110137027  <b>O.D.:</b> 3 9/16 (90.5) to 7 5/16 (185.7)  <b>I.D.:</b> 1 3/16 (30.2) &amp; 5 7/16 (138.1)  <b>Height:</b> 3 1/4 (82.6)  <b>A. Gskt:</b> [1] Attached</p> 
<p><b>PA5719</b> Foam Cab Air Element  <b>Fits:</b> Caterpillar Loaders  <b>Replaces:</b> Caterpillar 1429291  <b>Length:</b> 7 (177.8)  <b>Width:</b> 5 15/32 (138.9)  <b>Height:</b> 1/2 (12.7)</p> 	<p><b>PA5728 FOAM</b> Foam Wrap for PA5728  <b>Fits:</b> John Deere Lawn &amp; Garden Equipment  <b>Use With:</b> PA5728  <b>Replaces:</b> John Deere M140295  <b>O.D.:</b> 8 1/32 (204.0)  <b>I.D.:</b> 7 3/32 (180.2)  <b>Height:</b> 2 23/32 (69.1)</p> 
<p><b>PA5720</b> Cab Air Element  <b>Fits:</b> Caterpillar Excavators  <b>Replaces:</b> Caterpillar 3276618  <b>Length:</b> 10 15/16 (277.8)  <b>Width:</b> 7 7/16 (188.9)  <b>Height:</b> 1 9/16 (39.7)  <b>A. Gskt:</b> [1] Attached</p> 	

Measurements Are Shown In Inches And (Millimeters)

**WARNING:** These products can expose you to chemicals, including Diisononyl Phthalate, Carbon black extracts, Nickel, 1,3 Butadiene, Ethylene Oxide, Epichlorohydrin, which are known to the State of California to cause cancer, and Bisphenol, Ethylene Glycol, Ethylene Oxide, 1,3 Butadiene, Epichlorohydrin, which are known to the State of California to cause birth defects or other reproductive harm.

**PA5729** Cab Air Element with Handle and Foam Pre-Cleaner  
**Fits:** John Deere Lawn & Garden Equipment  
**Replaces:** Briggs & Stratton 499486S; John Deere GY20575  
**Length:** 5 29/32 (150.0)  
**Width:** 4 7/32 (107.2)  
**Height:** 1 17/32 (38.9)

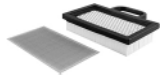

**PA5736** Cab Air Element  
**Fits:** Caterpillar Scrapers, Wheel Tractors  
**Replaces:** Caterpillar 3E7319  
**Length:** 18 19/32 (472.3)  
**Width:** 7 7/8 (200.0)  
**Height:** 2 19/32 (65.9)  
**A. Gskt:** [1] Attached



**RS5730** Radial Seal Outer Air Element  
**Fits:** Volvo Trucks with D13C Engine  
**Use With:** RS5731  
**Replaces:** Volvo 21115483  
**O.D.:** 12 3/32 (307.2)  
**I.D.:** 8 9/32 (210.3)  
**Height:** 16 1/8 (409.6)



**PA5737 KIT** Air Element with Foam Wrap  
**Notes:** OBSOLETE. Availability Limited to Dealer Stock.  
**Fits:** John Deere, Sabre, Scotts Lawn & Garden Equipment  
**Replaces:** John Deere GY20576; Kohler 2408303  
**O.D.:** 6 15/16 (176.2)  
**I.D.:** 5 9/16 (141.3)  
**Height:** 2 15/16 (74.6)



**RS5731** Radial Seal Inner Air Element  
**Fits Inside:** RS5730  
**Fits:** Volvo Trucks  
**Replaces:** Volvo 21115501; Hengst E1024LS; Mahle LXS300  
**O.D.:** 7 21/32 (194.5)  
**I.D.:** 6 31/32 (177.0) One End  
**Height:** 14 9/32 (362.7)  
**O-Ring:** [1] Attached



**PA5738** Cab Air Element  
**Fits:** Caterpillar Loaders  
**Replaces:** Caterpillar 2318130, 3036658  
**Length:** 8 11/32 (211.9)  
**Width:** 3 21/32 (92.9)  
**Height:** 1 17/32 (38.9)  
**A. Gskt:** [2] Attached



**PA5732** Foam Cab Air Element  
**Fits:** Case, New Holland Dozers  
**Replaces:** Case 76092242; New Holland 76092242  
**Length:** 15 9/16 (395.3)  
**Width:** 8 9/32 (210.3)  
**Height:** 3/16 (4.8)



**PA5739** Cab Air Element  
**Fits:** Case, New Holland Loaders  
**Replaces:** Case 139768A1; Donaldson P784574  
**Length:** 12 1/16 (306.4)  
**Width:** 4 1/32 (102.4)  
**Height:** 2 7/16 (61.9)  
**A. Gskt:** [1] Attached



**PA5733** Panel Air Element  
**Fits:** Onan Generators  
**Replaces:** Onan 1403116  
**Length:** 10 1/4 (260.3)  
**Width:** 6 17/32 (165.9)  
**Height:** 1 13/32 (35.7)



**PA5740** Cab Air Element  
**Notes:** OBSOLETE. Availability Limited to Dealer Stock.  
**Fits:** Case, New Holland Dozers  
**Replaces:** Case 76092248  
**Length:** 14 31/32 (380.2)  
**Width:** 5 27/32 (148.4)  
**Height:** 2 3/32 (53.2)

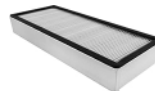

**PA5734** Cab Air Element  
**Fits:** Case, New Holland Loaders  
**Replaces:** Case 78314367; New Holland 87314367  
**Length:** 16 3/8 (415.9)  
**Width:** 9 27/32 (250.0)  
**Height:** 27/32 (21.4)  
**A. Gskt:** [1] Attached

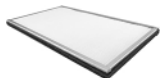

**RS5741** Radial Seal Outer Air Element  
**Fits:** Bobcat Loaders  
**Use With:** RS5742  
**Replaces:** Bobcat 6698057  
**O.D.:** 6 1/8 (155.6)  
**I.D.:** 3 9/16 (90.5) One End  
**Height:** 12 1/16 (306.4)



**PA5735** Air Element in Disposable Housing  
**Fits:** Peterbilt Trucks  
**Replaces:** Farr 400820023; Paccar 400820023; Parker 400820023; Racor 400820023  
**O.D.:** 10 31/32 (278.6)  
**Inlet:** 7  
**Outlet:** 5 29/32  
**Height:** 14 29/32 (378.6)















**RS5742** Radial Seal Inner Air Element  
**Fits Inside:** RS5741  
**Fits:** Bobcat Loaders  
**Replaces:** Bobcat 6698058; Fleetguard AF26365  
**O.D.:** 3 3/8 (85.7)  
**Flange:** 5 3/32 (129.4)  
**I.D.:** 2 11/16 (68.3) One End  
**Height:** 10 15/16 (277.8)



Measurements Are Shown In Inches And (Millimeters)

**WARNING:** These products can expose you to chemicals, including Diisononyl Phthalate, Carbon black extracts, Nickel, 1,3 Butadiene, Ethylene Oxide, Epichlorohydrin, which are known to the State of California to cause cancer, and Bisphenol, Ethylene Glycol, Ethylene Oxide, 1,3 Butadiene, Epichlorohydrin, which are known to the State of California to cause birth defects or other reproductive harm.

<p><b>RS5743</b></p> 	<p>Radial Seal Outer Air Element with Bail Handle  <b>Fits:</b> Komatsu Dump Trucks  <b>Replaces:</b> Komatsu XA4292; Donaldson P608306; Fleetguard AF27696  <b>O.D.:</b> 17 23/32 (450.1)  <b>I.D.:</b> 11 7/16 (290.5) One End  <b>Height:</b> 24 7/8 (631.8)</p>	<p><b>RS5748</b></p>  <p>Radial Seal Inner Air Element  <b>Fits Inside:</b> RS5747  <b>Fits:</b> Bobcat Loaders  <b>Replaces:</b> Bobcat 7008044  <b>O.D.:</b> 3 3/8 (85.7)            Flange 5 3/32 (129.4)  <b>I.D.:</b> 2 3/4 (69.9) One End  <b>Height:</b> 9 3/16 (233.4)</p>
<p><b>RS5743XP</b></p> 	<p>Extreme Performance Nano Radial Seal Outer Air Element with Bail Handle  <b>Fits:</b> Caterpillar Off-Highway Trucks  <b>Use With:</b> RS5744  <b>Replaces:</b> Caterpillar 4199162; Donaldson P608306; Fleetguard AF27696  <b>O.D.:</b> 17 23/32 (450.1)  <b>I.D.:</b> 11 7/16 (290.5) One End  <b>Height:</b> 24 7/8 (631.8)</p>	<p><b>RS5749</b></p>  <p>Radial Seal Outer Air Element  <b>Fits:</b> Harlo HP5000, HP6500 Lift Trucks; Reed B20 Concrete Pump  <b>Replaces:</b> Fleetguard AF26120  <b>O.D.:</b> 7 1/2 (190.5)  <b>I.D.:</b> 5 11/16 (144.5) One End  <b>Height:</b> 14 13/16 (376.2)</p>
<p><b>RS5744</b></p> 	<p>Radial Seal Inner Air Element  <b>Fits Inside:</b> RS5743XP  <b>Fits:</b> Caterpillar Off-Highway Trucks  <b>Replaces:</b> Caterpillar 2673005; Donaldson P608305; Fleetguard AF27695  <b>O.D.:</b> 11 9/16 (293.7)  <b>I.D.:</b> 9 (228.6) One End  <b>Height:</b> 19 1/4 (489.0)</p>	<p><b>RS5750</b></p>  <p>Radial Seal Inner Air Element  <b>Fits:</b> Harlo HP5000, HP6500 Lift Trucks  <b>Replaces:</b> Fleetguard AF26121; Nelson 871402N  <b>O.D.:</b> 4 1/8 (104.8)            Flange 5 7/8 (149.2)  <b>I.D.:</b> 2 15/16 (74.6) One End  <b>Height:</b> 14 1/8 (358.8)</p>
<p><b>RS5745</b></p> 	<p>Radial Seal Outer Air Element  <b>Fits:</b> Yale Equipment using 8 Inch OptiAir Series Housings  <b>Use With:</b> RS5746  <b>Replaces:</b> Yale 580088196  <b>O.D.:</b> 6 1/4 (158.8)  <b>I.D.:</b> 3 9/16 (90.5) One End  <b>Height:</b> 14 1/16 (357.2)</p>	<p><b>PA5751</b></p>  <p>Outer Air Element  <b>Fits:</b> Challenger, Gleaner, Massey Ferguson Combines  <b>Use With:</b> PA2410  <b>Replaces:</b> Agco 71368961  <b>O.D.:</b> 12 3/32 (307.2)  <b>I.D.:</b> 7/8 (22.2) &amp; 7 23/32 (196.1)  <b>Height:</b> 18 1/32 (458.0)  <b>F. Gskt:</b> [1] Steel Washer</p>
<p><b>RS5746</b></p> 	<p>Radial Seal Inner Air Element  <b>Fits Inside:</b> RS5745  <b>Fits:</b> Yale Equipment using 8 Inch OptiAir Series Housings  <b>Replaces:</b> Fleetguard AF25961; Wix 49868  <b>O.D.:</b> 3 3/8 (85.7)            Flange 5 3/32 (129.4)  <b>I.D.:</b> 2 7/8 (73.0) One End  <b>Height:</b> 13 3/32 (332.6)</p>	<p><b>PA5752</b></p>  <p>Cab Air Element  <b>Fits:</b> Caterpillar Loaders  <b>Replaces:</b> Caterpillar 2112661; Donaldson P627028; Fleetguard AF27911  <b>O.D.:</b> 6 1/8 (155.6)  <b>I.D.:</b> 21/32 (16.7) &amp; 3 15/32 (88.1)  <b>Height:</b> 9 1/2 (241.3)  <b>A. Gskt:</b> [1] Attached  <b>F. Gskt:</b> [1] Wing Nut</p>
<p><b>RS5747</b></p> 	<p>Radial Seal Outer Air Element  <b>Fits:</b> Bobcat Loaders  <b>Use With:</b> RS5748  <b>Replaces:</b> Bobcat 7008043  <b>O.D.:</b> 6 1/4 (158.8)  <b>I.D.:</b> 3 9/16 (90.5) One End  <b>Height:</b> 10 1/16 (255.6)</p>	<p><b>PA5753</b></p>  <p>Cab Air Element with Pull Tab  <b>Fits:</b> Kobelco, New Holland Excavators  <b>Replaces:</b> Case YN50V01015P3, YN50V01015P3P; New Holland YN50V01015P3, YN50V01015P3P  <b>Length:</b> 8 11/32 (211.9)  <b>Width:</b> 7 1/2 (190.5)  <b>Height:</b> 1 1/16 (27.0)  <b>A. Gskt:</b> [1] Attached</p>

Measurements Are Shown In Inches And (Millimeters)

 **WARNING:** These products can expose you to chemicals, including Diisononyl Phthalate, Carbon black extracts, Nickel, 1,3 Butadiene, Ethylene Oxide, Epichlorohydrin, which are known to the State of California to cause cancer, and Bisphenol, Ethylene Glycol, Ethylene Oxide, 1,3 Butadiene, Epichlorohydrin, which are known to the State of California to cause birth defects or other reproductive harm.



**RS5754**



Radial Seal Air Element with Lid  
**Contains:** Bleed Valve  
 Flame Retardant Media  
**Fits:** DAF Trucks with PACCAR Engines  
**Replaces:** Daf 1854407, 1931681, 1931685;  
 Donaldson P951919  
**O.D.:** 10 31/32 (278.6)  
 Lid 13 19/32 (345.3)  
**I.D.:** 5 25/32 (146.8) One End  
**Height:** 20 5/32 (512.0)

**RS5761**



Radial Seal Cab Air Element  
**Contains:** Charcoal Impregnated Media for  
 Odor Control  
**Fits:** Caterpillar Motor Graders, Off-Highway  
 Trucks  
**Replaces:** Caterpillar 2208800  
**O.D.:** 6 15/32 (164.3)  
**I.D.:** 3 5/8 (92.1) One End  
**Height:** 11 21/32 (296.1)  
**Related To:** RS5305 (Standard Media Version)

**PA5755**



Cab Air Element  
**Fits:** Caterpillar Crawler Tractors  
**Replaces:** Caterpillar 2653857, 3197944  
**Length:** 20 25/32 (527.8)  
**Width:** 3 31/32 (100.8)  
**Height:** 3 5/8 (92.1)  
**A. Gskt:** [1] Attached  
**F. Gskt:** [1] Included

**PA5762**



Air Element  
**Fits:** Caterpillar Gen Sets, Gen Set Engines  
**Replaces:** Caterpillar 9Y3879  
**O.D.:** 12 19/32 (319.9)  
**I.D.:** 6 (152.4) One End  
**Height:** 13 11/32 (338.9)

**RS5756**



Radial Seal Outer Air Element  
**Fits:** Blue Bird Buses  
**Use With:** RS30237  
**Replaces:** Blue Bird 10004113; Racor  
 500454001, 500454001BB  
**O.D.:** 11 3/8 (288.9)  
**I.D.:** 6 3/8 (161.9) One End  
**Height:** 19 11/16 (500.1)  
**F. Gskt:** [1] Included

**PA5763**



Outer Air Element  
**Fits:** Valmet, Valtra Tractors  
**Use With:** PA5764  
**Replaces:** Agco 20228310, 836462568  
**O.D.:** 6 1/2 (165.1)  
**I.D.:** 13/32 (10.3) & 3 3/8 (85.7)  
**Height:** 15 (381.0)  
**A. Gskt:** [1] Attached

**PA5757**



Cab Air Element  
**Fits:** Caterpillar Crawler Tractors  
**Replaces:** Caterpillar 2380479  
**Length:** 20 (508.0)  
**Width:** 3 15/16 (100.0)  
**Height:** 3 9/16 (90.5)  
**A. Gskt:** [1] Attached

**PA5764**



Inner Air Element  
**Fits Inside:** PA5763  
**Fits:** Valtra Tractors  
**Replaces:** Agco 20228410, 836462569  
**O.D.:** 3 1/2 (88.9)  
**I.D.:** 13/32 (10.3) & 2 13/16 (71.4)  
**Height:** 14 3/4 (374.7)  
**A. Gskt:** [1] Attached

**RS5758**



Radial Seal Outer Air Element with Pull Tabs  
**Use With:** RS5759  
**Replaces:** Longgong 612600114993 Outer;  
 Weifang KX2400 Outer  
**O.D.:** 9 1/2 (241.3)  
**I.D.:** 8 1/8 (206.4) One End  
**Height:** 16 9/32 (413.5)  
**A. Gskt:** [1] Attached

**PA5765**



Foam Cab Air Element  
**Fits:** Peterbilt Trucks  
**Replaces:** Peterbilt 5S013817, 5X013817  
**Length:** 13 11/32 (338.9)  
**Width:** 9 3/32 (231.0)  
**Height:** 5/8 (15.9)

**RS5759**



Radial Seal Inner Air Element  
**Fits Inside:** RS5758  
**Replaces:** Longgong 612600114993 Inner;  
 Weifang KX2400 Inner  
**O.D.:** 5 21/32 (143.7)  
**I.D.:** 4 7/16 (112.7) One End  
**Height:** 16 1/4 (412.8)

**PA5766**



Cab Air Element  
**Fits:** Komatsu Dump Trucks, Loaders  
**Replaces:** Komatsu 4260732441  
**Length:** 12 1/4 (311.2)  
**Width:** 9 31/32 (253.2)  
**Height:** 1 3/4 (44.4)

**RS5767**



Radial Seal Air Element  
**Contains:** Air Divider Hose Connection  
**Fits:** Chevrolet, GMC, Isuzu Trucks; Isuzu  
 6HK1-TC 7.8L Engine  
**Replaces:** General Motors 19179832; Isuzu  
 19179832; ACDelco A3101C  
**O.D.:** 7 13/16 (198.4)  
**I.D.:** 4 27/32 (123.0) One End  
**Height:** 19 23/32 (500.9)

Measurements Are Shown In Inches And (Millimeters)

**WARNING:** These products can expose you to chemicals, including Diisononyl Phthalate, Carbon black extracts, Nickel, 1,3 Butadiene, Ethylene Oxide, Epichlorohydrin, which are known to the State of California to cause cancer, and Bisphenol, Ethylene Glycol, Ethylene Oxide, 1,3 Butadiene, Epichlorohydrin, which are known to the State of California to cause birth defects or other reproductive harm.

<p><b>PA5768</b> Cab Air Element  <b>Fits:</b> John Deere Equipment  <b>Replaces:</b> John Deere RE195491  <b>Length:</b> 12 3/32 (307.2)  <b>Width:</b> 4 7/32 (107.2)  <b>Height:</b> 1 3/16 (30.2)</p> 	<p><b>PA5778</b> Cab Air Element  <b>Notes:</b> OBSOLETE. Availability Limited to Dealer Stock.  <b>Fits:</b> Tourismo Buses  <b>Replaces:</b> Mercedes-Benz A3568304218; Evobus 3568304218  <b>Length:</b> 13 11/16 (347.7)  <b>Width:</b> 5 11/16 (144.5)  <b>Height:</b> 9/16 (14.3)  <b>A. Gskt:</b> [1] Attached</p> 
<p><b>PA5770</b> Cab Air Element  <b>Fits:</b> Caterpillar Equipment  <b>Replaces:</b> Caterpillar 2656618  <b>Length:</b> 12 23/32 (323.1)  <b>Width:</b> 5 27/32 (148.4)  <b>Height:</b> 2 7/32 (56.4)</p> 	<p><b>PA5779</b> Cab Air Element  <b>Notes:</b> OBSOLETE. Availability Limited to Dealer Stock.  <b>Fits:</b> Citroen Jumper, Fiat Ducato Trucks  <b>Replaces:</b> Fiat 1312764080, 1312766080  <b>Length:</b> 17 9/32 (438.9)  <b>Width:</b> 5 21/32 (143.7)  <b>Height:</b> 21/32 (16.7)</p> 
<p><b>PA5771</b> Cab Air Element  <b>Fits:</b> John Deere Dozers  <b>Replaces:</b> John Deere AT315958  <b>Length:</b> 26 7/32 (666.0)  <b>Width:</b> 6 1/2 (165.1)  <b>Height:</b> 2 7/32 (56.4)</p> 	<p><b>PA5780</b> Cab Air Element with Handle  <b>Contains:</b> 8 Inch Metal Handle  <b>Fits:</b> Volvo Motor Graders  <b>Replaces:</b> Volvo 12742527  <b>Length:</b> 33 31/32 (862.8)  <b>Width:</b> 5 15/16 (150.8)  <b>Height:</b> 1 21/32 (42.1)  <b>A. Gskt:</b> [2] Attached</p> 
<p><b>PA5772</b> Cab Air Element  <b>Fits:</b> Caterpillar Off-Highway Trucks, Pipelayers, Telehandlers  <b>Replaces:</b> Caterpillar 2015023  <b>Length:</b> 10 3/8 (263.5)  <b>Width:</b> 7 (177.8)  <b>Height:</b> 1 13/32 (35.7)</p> 	<p><b>PA5781</b> Cab Air Element with Pull Strap  <b>Fits:</b> Volvo Motor Graders  <b>Replaces:</b> Volvo 12742526  <b>Length:</b> 25 31/32 (659.6)  <b>Width:</b> 5 15/16 (150.8)  <b>Height:</b> 1 21/32 (42.1)  <b>A. Gskt:</b> [2] Attached</p> 
<p><b>PA5773</b> Foam Cab Air Element  <b>Fits:</b> Freightliner Trucks  <b>Replaces:</b> Alliance ABPN/10G/91621  <b>Length:</b> 10 1/8 (257.2)  <b>Width:</b> 5 1/32 (127.8)  <b>Height:</b> 3/16 (4.8)</p> 	<p><b>RS5782</b> Radial Seal Conical Shaped Outer Air Element  <b>Notes:</b> MUST be used with RS5783 Inner Air Element  <b>Fits:</b> John Deere Excavators, Loaders; New Holland Excavators  <b>Use With:</b> RS5783  <b>Replaces:</b> John Deere AT332908; Baldwin PA5501  <b>O.D.:</b> 6 1/16 (154.0) to 7 23/32 (196.1)  <b>I.D.:</b> 4 11/16 (119.1) One End  <b>Height:</b> 14 (355.6)</p> 
<p><b>PA5774</b> Cab Air Element  <b>Fits:</b> Caterpillar Loaders, Skid Steers  <b>Replaces:</b> Caterpillar 2656619  <b>Length:</b> 10 5/8 (269.9)  <b>Width:</b> 4 3/4 (120.7)  <b>Height:</b> 2 7/32 (56.4)</p> 	<p><b>RS5783</b> Radial Seal Conical Shaped Inner Air Element  <b>Fits Inside:</b> RS5782  <b>Fits:</b> John Deere Excavators, Loaders; New Holland Excavators  <b>Replaces:</b> John Deere AT332909; Baldwin PA5502  <b>O.D.:</b> 3 3/16 (81.0) to 4 31/32 (126.2)  <b>I.D.:</b> 4 3/16 (106.4) One End  <b>Height:</b> 13 11/16 (347.7)</p> 
<p><b>RS5776</b> Radial Seal Air Element  <b>Contains:</b> Flame Retardant Media  <b>Fits:</b> Volvo Trucks  <b>Replaces:</b> Volvo 21834210; Fleetguard AF25632; Mahle LX1281  <b>O.D.:</b> 14 (355.6)  <b>I.D.:</b> 7 25/32 (197.6) One End  <b>Height:</b> 16 1/4 (412.8)  <b>Related To:</b> RS4967 (Standard Media Version)</p> 	<p><b>RS5784</b> Radial Seal Air Element  <b>Fits:</b> Ingersoll Rand Compressors  <b>Replaces:</b> Ingersoll Rand 54471834  <b>O.D.:</b> 6 1/2 (165.1)  <b>I.D.:</b> 3 3/4 (95.3) One End  <b>Height:</b> 14 (355.6)</p> 
<p><b>PA5777</b> Cab Air Element  <b>Notes:</b> OBSOLETE. Availability Limited to Dealer Stock.  <b>Fits:</b> Valtra Tractors  <b>Replaces:</b> Agco 20531310  <b>Length:</b> 18 11/32 (465.9)  <b>Width:</b> 7 (177.8)  <b>Height:</b> 2 5/32 (54.8)  <b>A. Gskt:</b> [2] Attached</p> 	

Measurements Are Shown In Inches And (Millimeters)

**WARNING:** These products can expose you to chemicals, including Diisononyl Phthalate, Carbon black extracts, Nickel, 1,3 Butadiene, Ethylene Oxide, Epichlorohydrin, which are known to the State of California to cause cancer, and Bisphenol, Ethylene Glycol, Ethylene Oxide, 1,3 Butadiene, Epichlorohydrin, which are known to the State of California to cause birth defects or other reproductive harm.

**PA5785**



Outer Air Element with Blank Band  
**Fits:** Valmet Forestry Equipment, Tractors  
**Use With:** PA5786  
**Replaces:** Agco 836128654; Valmet V836128654  
**O.D.:** 6 5/8 (168.3)  
 Flange 7 11/16 (195.3)  
**I.D.:** 11/32 (8.7) & 4 21/32 (118.3)  
**Height:** 13 7/8 (352.4)  
**A. Gskt:** [2] Attached

**CA5791**



Channel Flow Primary Air Element  
**Fits:** Case, Case-IH, New Holland Equipment  
**Use With:** PA5792  
**Replaces:** Case 87356545; New Holland 87356545  
**O.D.:** 11 1/4 (285.8)  
 to 15 1/16 (382.6)  
**Height:** 9 5/16 (236.5)

**PA5786**



Inner Air Element  
**Fits Inside:** PA5785, PA5787  
**Fits:** Valmet Forestry Equipment, Tractors; Valtra Tractors  
**Replaces:** Agco 836128655; Valmet V836128655  
**O.D.:** 4 1/2 (114.3)  
**I.D.:** 11/32 (8.7) & 3 3/32 (78.6)  
**Height:** 13 (330.2)

**PA5792**



Channel Flow Secondary Air Element with Pull Handle  
**Fits:** Case, Case-IH, New Holland Equipment  
**Use With:** CA5789, CA5791  
**Replaces:** Case 87356547  
**O.D.:** 9 7/16 (239.7)  
 to 14 3/4 (374.7)  
**Height:** 2 5/16 (58.7)  
**A. Gskt:** [1] Attached

**PA5787**



Outer Air Element with Blank Band and Lift Tab  
**Fits:** Valmet Forestry Equipment, Tractors  
**Use With:** PA5786  
**Replaces:** Agco 836136409; Valmet V836136409  
**O.D.:** 6 5/8 (168.3)  
 Flange 7 11/16 (195.3)  
**I.D.:** 11/32 (8.7) & 4 21/32 (118.3)  
**Height:** 13 25/32 (350.0)  
**A. Gskt:** [2] Attached

**CA5793**



Channel Flow Air Element  
**Fits:** 1999-2003 Ford F450 Super Duty, F550 Super Duty Trucks, 2000-03 Excursion all with V8-445 (7.3L) Turbo Diesel Engine  
**Replaces:** Ford 2U2Z9601BA, 2U2J9601BA; Motorcraft FA1757  
**O.D.:** 5 5/8 to 12 7/8 (142.9 to 327.0)  
 Flange 8 to 14 3/8 (203.2 to 365.1)  
**Height:** 6 (152.4)

**CA5788**



Channel Flow Primary Air Element  
**Fits:** Ag-Chem, Agco, Apache, Challenger, Fendt, Massey Ferguson, Valtra Equipment  
**Use With:** PA5515  
**Replaces:** Fendt H931202090410; J.C. Bamford 32/925752; Massey Ferguson 4286479M2  
**O.D.:** 8 9/32 (210.3)  
 to 13 13/32 (340.5)  
**Height:** 11 7/32 (285.0)

**PA5796**

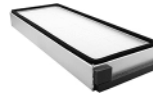

Cab Air Element  
**Fits:** Challenger, Valtra Tractors  
**Replaces:** Agco 20531300; Donaldson P750026  
**Length:** 19 1/16 (484.2)  
**Width:** 6 15/16 (176.2)  
**Height:** 2 1/8 (54.0)  
**A. Gskt:** [2] Attached

**CA5789**



Channel Flow Primary Air Element  
**Fits:** Mack Trucks  
**Use With:** PA5792  
**Replaces:** Mack 57MD321M, 21020786; Case/New Holland N102191; Volvo 43863232  
**O.D.:** 10 7/32 (259.6)  
 to 15 5/8 (396.9)  
**Height:** 13 1/4 (336.5)

**PA5797**

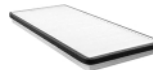

Cab Air Element  
**Fits:** Volvo Buses  
**Replaces:** Volvo 20746873, 2130158, 70326723, 85107862  
**Length:** 15 31/32 (405.6)  
**Width:** 7 1/16 (179.4)  
**Height:** 1 3/16 (30.2)  
**A. Gskt:** [1] Attached

**PA5798**



Cab Air Element  
**Fits:** Citroen, Fiat, Peugeot Trucks  
**Replaces:** Citroen 6447YA, 6479C9; Peugeot 6447YA  
**Length:** 9 27/32 (250.0)  
**Width:** 9 1/4 (235.0)  
**Height:** 31/32 (24.6)

**CA5790**



Channel Flow Air Element  
**Fits:** Freightliner Trucks  
**Replaces:** Freightliner 333648001, P610260; Donaldson P618478  
**Length:** 26 1/8 (663.6)  
**Width:** 5 1/4 (133.4)  
**Height:** 9 9/32 (235.7)

**PA5799**



Air Element  
**Notes:** OBSOLETE. Availability Limited to Dealer Stock.  
**Replaces:** Jinan Diesel 301236M1030  
**O.D.:** 19 9/32 (489.7)  
**I.D.:** 12 7/16 (315.9)  
**Height:** 14 9/32 (362.7)  
**A. Gskt:** [2] Attached

Measurements Are Shown In Inches And (Millimeters)

**WARNING:** These products can expose you to chemicals, including Diisononyl Phthalate, Carbon black extracts, Nickel, 1,3 Butadiene, Ethylene Oxide, Epichlorohydrin, which are known to the State of California to cause cancer, and Bisphenol, Ethylene Glycol, Ethylene Oxide, 1,3 Butadiene, Epichlorohydrin, which are known to the State of California to cause birth defects or other reproductive harm.

**BF5800** Primary Fuel Spin-on  
**Notes:** Can be used with FB1301 base.  
**Fits:** Detroit Diesel Engines  
**Replaces:** Detroit Diesel 6438839; GMC 25010793  
**Thread:** 1 -12  
**O.D.:** 3 11/16 (93.7)  
**Height:** 8 (203.2)  
**I.Gskt:** [1] Included  
**Related To:** BF592 (Short Version)  
 BF5813 (Fuel/Water Separator Version)



**BF5813-O** Fuel/Water Separator with Open End for Bowl  
**Fits:** Isuzu Trucks  
**Replaces:** Racor S3202T; Isuzu 8156189210; General Motors Corp. 156189210  
**Thread:** 1 -12 UNF-2B  
**O.D.:** 3 3/4 (95.3)  
**Height:** 7 13/32 (188.1)  
**F. Gskt:** [2] Included  
**O-Ring:** [1] Included  
**Related To:** BF5813 (Drain Version)  
 BF5800 (Fuel Version)



**BF5801** Primary Fuel Spin-on  
**Notes:** CAUTION: Do NOT use on Cummins engines. Furnished D-Ring must be installed on post for seal.  
 Can be used with FB1311 base.  
**Fits:** Detroit Diesel Engines Using Cummins Fuel Filter Base  
**Thread:** 1 -14  
**O.D.:** 3 11/16 (93.7)  
**Height:** 8 1/32 (204.0)  
**I.Gskt:** G381-A  
**F. Gskt:** ES24-D



**BF5815** Secondary Fuel Spin-on  
**Contains:** Integral Post Seal  
**Fits:** Detroit Diesel Engines  
**Replaces:** Detroit Diesel 23518530  
**Thread:** 13/16 -12  
**O.D.:** 3 11/16 (93.7)  
**Height:** 7 3/32 (180.2)  
**I.Gskt:** [1] Included



**BF5810** Secondary Fuel Spin-on  
**Notes:** Can be used with FB1302 base.  
**Contains:** Integral Post Seal  
**Fits:** Detroit Diesel Engines  
**Replaces:** Detroit Diesel 23518482  
**Thread:** 13/16 -12  
**O.D.:** 3 11/16 (93.7)  
**Height:** 7 3/32 (180.2)  
**I.Gskt:** [1] Included



**BF5816** High Efficiency Secondary Fuel Spin-on  
**Contains:** Integral Post Seal  
**Fits:** Detroit Diesel Engines  
**Replaces:** Detroit Diesel 23533726  
**Thread:** 13/16 -12  
**O.D.:** 3 11/16 (93.7)  
**Height:** 7 3/32 (180.2)  
**I.Gskt:** [1] Included



**BF5812** Primary Fuel/Water Separator Spin-on with Drain  
**Notes:** CAUTION: Do NOT use on Cummins engines. Furnished D-Ring must be installed on post for seal.  
 Can be used with FB1311 base.  
**Fits:** Detroit Diesel Engines with Cummins Fuel Filter Base  
**Replaces:** Detroit Diesel 23516189  
**Thread:** 1 -14  
**O.D.:** 3 11/16 (93.7)  
**Height:** 8 27/32 (224.6)  
**I.Gskt:** G381-A  
**F. Gskt:** ES24-D



**6017** Transmission Filter  
**Notes:** Pan gasket contains [14] bolt holes.  
**Fits:** 1962-73 Chevrolet, 1963-73 GMC, 1963-72 Pontiac Automotive, Light-Duty Trucks with Powerglide Transmission (RWD, Aluminum Case)  
**Replaces:** General Motors Corp. 6438815; Wix 51883, 58883  
**Length:** 5 13/32 (137.3)  
**Width:** 5 7/32 (132.6)  
**Pan Gasket:** [1] Included, Plus One Small Irregular Gasket

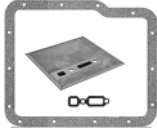

**BF5813** Primary Fuel/Water Separator Spin-on with Drain  
**Notes:** Can be used with FB1301 base.  
**Fits:** Detroit Diesel Engines  
**Replaces:** GMC 23512317  
**Thread:** 1 -12  
**O.D.:** 3 11/16 (93.7)  
**Height:** 8 13/16 (223.8)  
**I.Gskt:** [1] Included  
**O. Gskt:** ES24-D (for Caterpillar Engines)  
**Related To:** BF5800 (Fuel Version)  
 BF5813-O (with Open End for Bowl)



**6020** Transmission Filter  
**Notes:** Pan gasket contains [13] bolt holes.  
**Fits:** 1967-80 Buick, Oldsmobile, Pontiac, 1963-84, 1988-90 Cadillac, 1968-90 Chevrolet, 1967-90 GMC, 1992-93 Hummer, 1975-92 Jaguar; 1972 International Light-Duty Trucks; 1968-79 Jeep Automotive with THM375  
**Replaces:** GMC 12337210  
**Length:** 11 23/32 (297.7)  
**Width:** 6 1/2 (165.1)  
**Height:** 5/8 (15.9)  
**Grommets:** [1] Attached  
**Pan Gasket:** [1] Included, Plus One Small O-Ring



Measurements Are Shown In Inches And (Millimeters)

**WARNING:** These products can expose you to chemicals, including Diisononyl Phthalate, Carbon black extracts, Nickel, 1,3 Butadiene, Ethylene Oxide, Epichlorohydrin, which are known to the State of California to cause cancer, and Bisphenol, Ethylene Glycol, Ethylene Oxide, 1,3 Butadiene, Epichlorohydrin, which are known to the State of California to cause birth defects or other reproductive harm.

6021

Transmission Filter

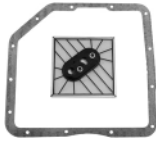

**Notes:** Pan gasket contains [13] bolt holes.  
**Fits:** 1966-74, 1982-84 Buick, 1982 Cadillac, 1967-84, 1986 Chevrolet, 1969-84, 1986 GMC Light-Duty Trucks, 1968-74, 1981-84 Oldsmobile, 1969-83 Pontiac Automotive, 1965-67 Jeep with THM250C, THM350, THM350C  
**Replaces:** GMC 6433856  
**Width:** 5 5/8 (142.9)  
**O-Ring:** [1] Included  
**Pan Gasket:** [1] Included

BK6028

Service Kit for Cummins



**Contains:** [1] BD7153 Dual-Flow Lube  
 [2] BF1212 Pri. Fuel  
 [1] BW5073 Coolant  
 [2] BT8873 Hydraulic  
 [1] BT839-10 Hydraulic

BK6022

Service Kit for Detroit Diesel



**Contains:** [2] B495 Lube  
 [1] PF7744 Pri. Fuel  
 [1] BF5810 Sec. Fuel  
 [1] CTK5029-1 Coolant Test Strip

BK6029

Service Kit for Mack/Volvo



**Contains:** [2] B76 F-F Lube  
 [1] BC7228 B-P Lube Spinner  
 [1] BF7656 Pri. Fuel  
 [1] BF7657 Sec. Fuel

BK6023

Service Kit for Detroit Diesel



**Contains:** [2] B495 Lube  
 [1] BF1395-SP Fuel/Water Separator  
 [1] CTK5029-1 Coolant Test Strip

BK6030

Service Kit for Perkins



**Contains:** [1] BT215 Lube  
 [1] PF717 Pri. Fuel  
 [1] BT351 Hydraulic  
 [1] PT9167 Hydraulic

BK6024

Service Kit for Cummins



**Contains:** [1] BD7154 Dual-Flow Lube  
 [1] PF7680 Fuel/Water Separator  
 [1] CTK5029-1 Coolant Test Strip

BK6031

Service Kit for Paccar



**Contains:** [1] B7177 Lube  
 [1] BF1378-SPS Fuel/Water Separator  
 [1] BF7940 Fuel

BK6025

Service Kit for Cummins



**Contains:** [1] BD7154 Dual-Flow Lube  
 [1] BF7766 Fuel  
 [1] CTK5029-1 Coolant Test Strip

BK6032

Service Kit for Paccar



**Contains:** [1] BD7309 Dual-Flow Lube  
 [1] BF1378-SPS Fuel/Water Separator  
 [1] BF7924 Fuel

BK6026

Service Kit for Mercedes-Benz



**Contains:** [1] P7230 Lube  
 [1] PF7744 Pri. Fuel  
 [1] PF7761 Fuel  
 [1] CTK5029-1 Coolant Test Strip

BK6033

Service Kit for International



**Contains:** [1] P7329 Lube  
 [1] PF7748 Fuel/Water Separator  
 [1] PF7928 Fuel

BK6027

Service Kit for Mack/Volvo



**Contains:** [2] B76 F-F Lube  
 [1] BC7242 B-P Lube  
 [1] BF1384-SP Fuel/Water Separator  
 [1] BF7814 Fuel

BK6034

Service Kit for International



**Notes:** OBSOLETE. Availability Limited to Dealer Stock.  
**Contains:** [1] B7030 Lube  
 [1] BF7629 Pri. Fuel  
 [1] BF7584 Fuel/Water Separator

Measurements Are Shown In Inches And (Millimeters)

**WARNING:** These products can expose you to chemicals, including Diisononyl Phthalate, Carbon black extracts, Nickel, 1,3 Butadiene, Ethylene Oxide, Epichlorohydrin, which are known to the State of California to cause cancer, and Bisphenol, Ethylene Glycol, Ethylene Oxide, 1,3 Butadiene, Epichlorohydrin, which are known to the State of California to cause birth defects or other reproductive harm.

**BK6035**

Service Kit for Cummins

**Contains:** [1] BD7309 Dual-Flow Lube  
[1] BF7924 Fuel



**BK6047**

Service Kit

**Notes:** OBSOLETE. Availability Limited to Dealer Stock.

**Contains:** [1] BT339 Lube  
[1] BF1212 Fuel/Water Separator  
[1] BF1352-SPS Fuel/Water Separator  
[1] BT839-10 Hydraulic



**BK6041**

Service Kit

**Notes:** OBSOLETE. Availability Limited to Dealer Stock.

**Contains:** [1] B7030 Lube  
[1] BF7531 Pri. Fuel  
[1] PT8487 Steering



**BK6048**

Service Kit

**Notes:** OBSOLETE. Availability Limited to Dealer Stock.

**Contains:** [1] BD7309 Dual-Flow Lube  
[1] BF7924 Fuel  
[1] BW5074 Coolant



**BK6043**

Service Kit

**Notes:** OBSOLETE. Availability Limited to Dealer Stock.

**Contains:** [1] BD7309 Dual-Flow Lube  
[1] BF1272-SPS Fuel/Water Separator  
[1] BW5071 Coolant  
[1] PT8487 Steering



**BK6049**

Service Kit for Chevrolet/GMC

**Contains:** [1] B1428 Lube  
[1] BF781 Pri. Fuel  
[2] BT839-10 Hydraulic  
[1] P106-HD Steering  
[1] PA2256 Air Breather



**BK6050**

Service Kit for Mack/Volvo

**Contains:** [1] BT287 F-F Lube  
[2] B7600 F-F Lube  
[1] B7685 B-P Lube  
[1] BF7814 Pri. Fuel  
[1] BF1366-O Fuel/Water Separator  
[1] BW5141 Coolant  
[2] BT8851-MPG Hydraulic



**BK6044**

Service Kit for Mack

**Notes:** OBSOLETE. Availability Limited to Dealer Stock.

**Contains:** [2] B76 F-F Lube  
[1] B7409 B-P Lube  
[1] BF1386-O Fuel/Water Separator  
[1] BF7943 Fuel  
[1] B5091 Coolant



**BK6051**

Service Kit for Mack/Volvo

**Contains:** [2] B76 F-F Lube  
[1] B7685 B-P Lube  
[1] BF7814 Pri. Fuel  
[1] BF1386-O Fuel/Water Separator



**BK6045**

Service Kit for Cummins

**Contains:** [1] BD7309 Dual-Flow Lube  
[1] BF7815 Fuel  
[1] BW5074 Coolant



**BK6052**

Service Kit

**Notes:** OBSOLETE. Availability Limited to Dealer Stock.

**Contains:** [1] BD7154 Dual-Flow Lube  
[2] BF1212 Pri. Fuel  
[1] BW5075 Coolant  
[2] BT8873 Hydraulic  
[1] BT8847 Hydraulic



**BK6053**

Service Kit for Mack/Volvo

**Contains:** [2] B76 F-F Lube  
[1] BC7242 B-P Lube  
[1] BF7656 Pri. Fuel  
[1] BF7773 Fuel



**BK6046**

Service Kit

**Notes:** OBSOLETE. Availability Limited to Dealer Stock.

**Contains:** [1] B99 Lube  
[1] BF7632 Fuel  
[1] BW5139 Coolant



**BK6054**

Service Kit for Mack/Volvo

**Contains:** [2] B76 F-F Lube  
[1] BC7242 B-P Lube  
[1] BF7943 Fuel  
[1] BF1386-O Fuel/Water Separator



Measurements Are Shown In Inches And (Millimeters)

**WARNING:** These products can expose you to chemicals, including Diisononyl Phthalate, Carbon black extracts, Nickel, 1,3 Butadiene, Ethylene Oxide, Epichlorohydrin, which are known to the State of California to cause cancer, and Bisphenol, Ethylene Glycol, Ethylene Oxide, 1,3 Butadiene, Epichlorohydrin, which are known to the State of California to cause birth defects or other reproductive harm.

**BK6055**

Service Kit for Cummins

- Contains:** [1] BD7153 Dual-Flow Lube  
[1] BF7766 Fuel  
[1] PF7755 Fuel/Water Separator



**BK6062**

Service Kit for Mack/Volvo

- Contains:** [2] B7600 F-F Lube  
[1] B7685 B-P Lube  
[1] BF7814 Fuel  
[1] PF7782 Fuel/Water Separator  
**Fits:** Volvo Equipment  
**Replaces:** Fleetguard MK13185; Wix 24039



**BK6056**

Service Kit for Cummins

- Contains:** [1] B7177 Lube  
[1] BF7940 Fuel  
[1] BF1378-SPS Fuel/Water Separator  
[1] BT287-10 Hydraulic



**BK6063**

Service Kit for Cummins

- Notes:** OBSOLETE. Availability Limited to Dealer Stock.  
**Contains:** [1] BD7154 Dual-Flow Lube  
[1] BF7766 Fuel  
[1] PF7782 Fuel/Water Separator  
**Fits:** Cummins Engines  
**Replaces:** Fleetguard MK13195; Wix 24305



**BK6057**

Service Kit for Mack/Volvo

- Contains:** (2) B7225 F-F Lube  
(1) B7685 B-P Lube  
(1) BF1386-O Fuel/Water Separator with Open End for Bowl  
(1) BF7814 Fuel  
(1) BW5141 Coolant Spin-on with BTE Formula  
**Fits:** Mack Trucks



**BK6064**

Service Kit for Cummins

- Contains:** [1] BD7154 Dual-Flow Lube  
[1] PF9814 Fuel  
[1] BF9860 Fuel  
**Fits:** Cummins Engines  
**Replaces:** Fleetguard MK13448



**BK6058**

Service Kit for Mack/Volvo

- Contains:** [2] B76 F-F Lube  
[1] BC7242 B-P Lube  
[1] BF7814 Fuel  
[1] BF1386-O Fuel/Water Separator



**BK6065**

Service Kit for Kubota

- Contains:** [2] B113 F-F Lube  
[1] B7152 B-P Lube  
[1] BF840-K1 In-Line Fuel



**BK6059**

Service Kit for Caterpillar

- Contains:** [1] B99 Lube  
[1] BF7587 Fuel  
[1] BF1212 Fuel/Water Separator  
[1] BW5137 Coolant  
[1] P528 Steering



**BK6066**

Service Kit

- Notes:** OBSOLETE. Availability Limited to Dealer Stock.  
**Contains:** [2] B113 F-F Lube  
[1] B7285 B-P Lube  
[1] BF840-K1 In-Line Fuel



**BK6060**

Service Kit for Cummins

- Contains:** [1] B7177 F-F Lube  
[1] B7577 B-P Lube  
[1] BF7966 Pri. Fuel  
[1] BF1210 Fuel/Water Separator  
[1] BF1385-SPS Fuel/Water Separator  
[1] BT839-10 Hydraulic  
[1] PT951 Steering



**BK6067**

Service Kit for Carrier

- Contains:** [1] B7139 Lube  
[1] BF988 Pri. Fuel  
[1] RS3715 Radial Seal Outer Air



**BK6061**

Service Kit for Detroit Diesel

- Contains:** [2] B495-SS Lube  
[1] PF7748 Fuel/Water Separator  
**Fits:** International Trucks  
**Replaces:** Fleetguard MK12941



**BK6068**

Service Kit for Mack / Volvo

- Contains:** [2] B76 F-F Lube  
[1] B7409 B-P Lube  
[1] BF1386-O Fuel/Water Separator  
[1] BF46117 Fuel



**BK6069**

Service Kit for Mack / Volvo

- Contains:** [2] B76 F-F Lube  
[1] B7409 B-P Lube  
[1] BF1386-O Fuel/Water Separator  
[1] BF46117 Fuel  
[1] BW5183 Coolant



Measurements Are Shown In Inches And (Millimeters)

**WARNING:** These products can expose you to chemicals, including Diisononyl Phthalate, Carbon black extracts, Nickel, 1,3 Butadiene, Ethylene Oxide, Epichlorohydrin, which are known to the State of California to cause cancer, and Bisphenol, Ethylene Glycol, Ethylene Oxide, 1,3 Butadiene, Epichlorohydrin, which are known to the State of California to cause birth defects or other reproductive harm.

**BK6070**

Service Kit for Mack / Volvo  
**Contains:** [2] B76 F-F Lube  
 [1] B7409 B-P Lube  
 [1] BF7943 Pri. Fuel



**BK6077**

Service Kit  
**Notes:** OBSOLETE. Availability Limited to Dealer Stock.  
**Contains:** [2] B495 Lube  
 [1] PF7748 Fuel/Water Separator



**BK6071**

Service Kit for Mack / Volvo  
**Contains:** [2] B76 F-F Lube  
 [1] BC7242 B-P Lube  
 [1] BF7773 Pri. Fuel



**BK6078**

Service Kit  
**Notes:** OBSOLETE. Availability Limited to Dealer Stock.  
**Contains:** [1] BD7153 Dual-Flow Lube  
 [1] PF7748 Fuel/Water Separator



**BK6072**

Service Kit  
**Notes:** OBSOLETE. Availability Limited to Dealer Stock.  
**Contains:** [2] B7225 F-F Lube  
 [1] BC7242 B-P Lube  
 [1] BF7656 Pri. Fuel  
 [1] BF7657 Sec. Fuel  
 [1] B5176 Coolant



**BK6079**

Service Kit  
**Notes:** OBSOLETE. Availability Limited to Dealer Stock.  
**Contains:** [1] BD103 Dual-Flow Lube  
 [1] BF5810 Fuel



**BK6073**

Service Kit for Mack / Volvo  
**Contains:** [2] B76 F-F Lube  
 [1] B7409 B-P Lube  
 [1] BF7943 Fuel  
 [1] BF1386-O Fuel/Water Separator  
 [1] B5145 Coolant



**BK6080**

Service Kit for Cummins  
**Contains:** [1] BD103 Dual-Flow Lube  
 [1] BF880-FP Pri. Fuel



**BK6074**

Service Kit  
**Notes:** OBSOLETE. Availability Limited to Dealer Stock.  
**Contains:** [1] BD103 Dual-Flow Lube  
 [1] BF7815 Fuel  
 [1] BF1293-SPS Fuel/Water Separator  
 [1] B5134 Coolant



**BK6081**

Service Kit for Cummins  
**Contains:** [1] BD7154 Dual-Flow Lube  
 [1] PF9814 Fuel Element  
 [1] BF9885 Fuel Spin-on



**BK6075**

Service Kit for Mack / Volvo  
**Contains:** [2] B7225 F-F Lube  
 [1] BC7242 B-P Lube  
 [1] BF7656 Pri. Fuel  
 [1] BF7773 Fuel  
 [1] B5176 Coolant



**BK6076**

Service Kit for Caterpillar  
**Contains:** [1] B7299 Lube  
 [1] BF7587 Fuel  
 [1] BF1212 Fuel/Water Separator



**BK6082**

Service Kit for Mack/Volvo  
**Contains:** [2] B76 F-F Lube  
 [1] B7409 B-P Lube  
 [1] BF46034 Fuel



Measurements Are Shown In Inches And (Millimeters)

**WARNING:** These products can expose you to chemicals, including Diisononyl Phthalate, Carbon black extracts, Nickel, 1,3 Butadiene, Ethylene Oxide, Epichlorohydrin, which are known to the State of California to cause cancer, and Bisphenol, Ethylene Glycol, Ethylene Oxide, 1,3 Butadiene, Epichlorohydrin, which are known to the State of California to cause birth defects or other reproductive harm.



**BK6083** Service Kit for Mack/Volvo  
**Contains:** (2) B7225 - F-F Lube  
 (1) B7685 - B-P Lube  
 (1) BF1386-O - Fuel/Water Separator with Open End for Bowl  
 (1) BF46117 - Fuel



**BK6085** Service Kit for Mack/Volvo  
**Contains:** [2] B76 F-F Lube  
 [1] B7685 B-P Lube  
 [1] BF46117 Fuel



**BK6086** Service Kit for Cummins  
**Contains:** [1] BD7154 Dual-Flow Lube  
 [1] BF9885 Fuel  
 [1] PF9928 Fuel/Water Separator



**BK6087** Service Kit for Thermo King  
**Contains:** [1] B161-S Lube  
 [1] BF9894 Pri. Fuel  
 [1] RS3715 Radial Seal Outer Air



**BK6088** Service Kit for Detroit Diesel  
**Contains:** [1] P7505 Lube  
 [1] PF9924 Kit Fuel Filter Kit  
 [1] P5092 Coolant  
**Fits:** Freightliner Coronado SD



**BK6089** Service Kit for Thermo King  
**Contains:** [1] B7375 Lube  
 [1] BF9893 Fuel  
 [1] RS5387 KIT Radial Seal Air Element with Lid  
**Fits:** Thermo King Refrigeration Units  
**Replaces:** Thermo King 10-449



**BK6090** Service Kit for Mack/Volvo  
**Contains:** [2] B7225 F-F Lube  
 [1] B7685 B-P Lube  
 [1] BF1386-O Fuel/Water Separator  
 [1] BF7814 Fuel  
**Replaces:** Donaldson P559106; Fleetguard FF5507, LF3654, LF3973, FS19966



**BK6092** Service Kit for Cummins  
**Contains:** [1] BD50000 Lube  
 [1] PF9814 Fuel/Water Separator  
 [1] BF9885 Fuel



**BK6093** Service Kit for Mack/Volvo  
**Contains:** (2) B7700 High Efficiency Lube  
 (1) B7685 B-P Lube  
 (1) BF1386-O Fuel/Water Separator with Open End for Bowl  
 (1) BF7814 Fuel  
 (1) BW5142 Coolant



**BK6094** Service Kit for Mack/Volvo  
**Contains:** [2] B76 F-F Lube  
 [1] B7409 B-P Lube  
 [1] BF1386-O Fuel/Water Separator with Open End for Bowl  
 [1] BF7943 Fuel  
 [1] B5176 Coolant



**BK6095** Service Kit for Mack/Volvo  
**Contains:** [2] B7600 F-F Lube  
 [1] B7685 B-P Lube  
 [1] BF7814 Fuel  
**Fits:** Volvo Engines  
**Replaces:** Donaldson P559143



**BK6096** Service Kit for Detroit Diesel  
**Contains:** [1] P7505 Lube Element  
 [1] PF9908 KIT Fuel Filter Kit  
**Fits:** Detroit DD13, DD15, DD16; Mercedes-Benz OM471LA, OM473LA Engines  
**Replaces:** Donaldson P559665



**BK6097** Service Kit for Cummins  
**Contains:** [1] BT7237 Lube  
 [1] BF1385-SPS Fuel/Water Separator  
 [1] BF7813 Fuel  
**Fits:** Cummins Engines  
**Replaces:** Donaldson P559144



**BK6098** Service Kit for Detroit Diesel  
**Contains:** [1] P7505, [1] PF9924 KIT  
**Fits:** Detroit DD13, DD15, DD16 Engines  
**Replaces:** Donaldson P559646



Measurements Are Shown In Inches And (Millimeters)

**WARNING:** These products can expose you to chemicals, including Diisononyl Phthalate, Carbon black extracts, Nickel, 1,3 Butadiene, Ethylene Oxide, Epichlorohydrin, which are known to the State of California to cause cancer, and Bisphenol, Ethylene Glycol, Ethylene Oxide, 1,3 Butadiene, Epichlorohydrin, which are known to the State of California to cause birth defects or other reproductive harm.

**BK6099**

Service Kit for Mack/Volvo

**Contains:** [2] B7700 High Efficiency Lube Filter  
[1] B7685 B-P Lube  
[1] BF46117 Fuel



**BK6108**

Service Kit for Detroit Diesel

**Contains:** [1] P7505 Lube Element  
[1] PF9804 Fuel/Water Separator  
[1] PF9908 KIT Fuel Kit



**BK6102**

Service Kit for Cummins

**Contains:** [1] BD7153 Dual-Flow Lube  
[1] BF7766 Fuel Spin-on  
[1] BF7760 Fuel Spin-on



**BK6110**

Service Kit for Thermo King

**Notes:** Biodiesel compatible outer wrap and grommet  
**Contains:** [1] B7375 Lube  
[1] BF9894 Fuel/Water Separator  
[1] RS5387 KIT Radial Seal Air Element with Lid  
**Fits:** Thermo King Refrigeration Units  
**Replaces:** Thermo-King 10-417



**BK6103**

Service Kit for Detroit Diesel

**Contains:** [2] B495-SS Lube  
[1] PF7744 Fuel/Water Separator



**BK6112**

Service Kit for GasJack

**Contains:** [1] BT251 Full-Flow Lube  
[1] BF840-K1 In-Line Fuel Filter with Clamps & Hoses  
[1] PA638 Air Element  
**Fits:** GasJack Compressors with Ford 460 Engine



**BK6104**

Service Kit for Volvo

**Contains:** [2] B7600 F-F Lube  
[1] B7685 B-P Lube  
[1] PF7744 Fuel/Water Separator  
[1] BF7814 Fuel



**BK6114**

Service Kit for Cummins

**Contains:** [1] BD50000 Lube  
[1] PF46081 Fuel/Water Separator  
[1] BF46129 Fuel  
**Fits:** Cummins Engines



**BK6105**

Service Kit for Caterpillar

**Contains:** [1] B99-MPG Full-Flow Lube  
[1] BF7587 High Efficiency Fuel  
[1] BF5800 Pri. Fuel  
[1] BW5071 Coolant



**BK6115**

Service Kit for Caterpillar

**Contains:** [1] B7299 High Efficiency Lube  
[1] BF7587 High Efficiency Fuel  
[1] BF5800 Pri. Fuel  
[1] BW5071 Coolant



**BK6106**

Service Kit for Cummins

**Contains:** [2] B495-SS Lube  
[1] PF7895 Fuel/Water Separator



**BK6116**

Service Kit for Mack/Volvo

**Contains:** [2] B76 F-F Lube  
[1] B7409 B-P Lube  
[1] PF7930 Fuel/Water Separator  
[1] BF46117 Fuel



**BK6107**

Service Kit for Caterpillar

**Contains:** [1] B99-MPG Full-Flow Lube  
[1] BF5800 Pri. Fuel  
[1] BF7587 High Efficiency Fuel



**BK6117**

Service Kit for Volvo

**Contains:** [2] B7700 High Efficiency Lube  
[1] B7685 B-P Lube  
[1] PF7680 Fuel/Water Separator  
[1] BW5142 Coolant with BTE Formula



Measurements Are Shown In Inches And (Millimeters)

**WARNING:** These products can expose you to chemicals, including Diisononyl Phthalate, Carbon black extracts, Nickel, 1,3 Butadiene, Ethylene Oxide, Epichlorohydrin, which are known to the State of California to cause cancer, and Bisphenol, Ethylene Glycol, Ethylene Oxide, 1,3 Butadiene, Epichlorohydrin, which are known to the State of California to cause birth defects or other reproductive harm.

**BK6118** Service Kit for Cummins ISX, X15 Engines  
**Contains:** [1] BD50000 High Efficiency Dual-Flow Lube  
 [1] PF9814 Fuel/Water Separator  
 [1] BF46129 Fuel



**BK6167** Service Kit for Cummins  
**Contains:** [1] BD7309 Dual-Flow Lube  
 [1] BF1293-SPS Fuel/Water Separator



**BK6120** Service Kit for Caterpillar  
**Contains:** [1] B7299 High Efficiency Fuel  
 [1] BF5800 Pri. Fuel  
 [1] BF614 Fuel  
 [1] BW5071 Coolant



**BK6181** Service Kit for Caterpillar  
**Notes:** OBSOLETE. Availability Limited to Dealer Stock.  
**Contains:** [1] B7600 Lube  
 [1] PF935 Pri. Fuel  
 [1] BF7632 Fuel



**BK6121** Service Kit for Mack/Volvo  
**Contains:** [2] B76 F-F Lube  
 [1] B7409 B-P Lube  
 [1] BF46117 Fuel  
 [1] PF7782 Fuel/Water Separator Element with Relief Valve



**BK6183** Service Kit for Caterpillar  
**Contains:** [1] B7299 Lube  
 [1] BF7587 Fuel  
 [1] BF1259 Fuel/Water Separator



**BK6124** Service Kit  
**Contains:** [2] B76 F-F Lube  
 [1] B7409 B-P Lube  
 [1] BF46117 Fuel Spin-on  
 [1] BF46182-O Fuel/Water Separator with Open End for Bowl



**BK6184** Service Kit for Caterpillar  
**Contains:** [1] B7299 High Efficiency Lube  
 [1] BF7587 Fuel



**BK6138** Service Kit for Volvo  
**Contains:** [2] B7700 High Efficiency Lube  
 [1] B7685 B-P Lube  
 [1] PF7680 Fuel/Water Separator  
 [1] BF7814 Fuel  
 [1] BW5142 Coolant  
**Replaces:** Donaldson P559632



**BK6140** Service Kit for Mack/Volvo  
**Contains:** [2] B76 F-F Lube  
 [1] B7685 B-P Lube  
 [1] BF7814 Fuel



**BK6185** Service Kit for Mack/Volvo  
**Contains:** [2] B7225 F-F Lube  
 [1] BC7242 B-P Lube Spinner  
 [1] BF7656 Pri. Fuel  
 [1] BF7773 Sec. Fuel  
 [1] BW5178 Coolant



**BK6161** Service Kit for Mercedes-Benz  
**Contains:** [1] P7188 Lube  
 [1] BC7326 B-P Lube Spinner  
 [1] PF7735 Fuel



**BK6186** Service Kit for Detroit Diesel  
**Notes:** OBSOLETE. Availability Limited to Dealer Stock.  
**Contains:** [2] B495 Lube  
 [1] BF5810 Fuel



Measurements Are Shown In Inches And (Millimeters)

**WARNING:** These products can expose you to chemicals, including Diisononyl Phthalate, Carbon black extracts, Nickel, 1,3 Butadiene, Ethylene Oxide, Epichlorohydrin, which are known to the State of California to cause cancer, and Bisphenol, Ethylene Glycol, Ethylene Oxide, 1,3 Butadiene, Epichlorohydrin, which are known to the State of California to cause birth defects or other reproductive harm.

**BK6187**

Service Kit for Caterpillar  
**Contains:** [1] B7299 Lube  
 [1] BF596 Pri. Fuel  
 [1] BF7587 Fuel



**BK6299**

Service Kit for Caterpillar  
**Notes:** OBSOLETE. Availability Limited to Dealer Stock.  
**Contains:** [1] B99 F-F Lube  
 [1] B7577 B-P Lube  
 [1] BF7587 Fuel



**BK6189**

Service Kit for Caterpillar  
**Notes:** OBSOLETE. Availability Limited to Dealer Stock.  
**Contains:** [1] B99 Lube  
 [1] BF7587 Fuel  
 [1] BF1212 Fuel/Water Separator



**BK6341**

Service Kit for Cummins  
**Contains:** [1] BD7154 Dual-Flow Lube  
 [1] BF1259 Fuel/Water Separator



**BK6195**

Service Kit for Caterpillar  
**Contains:** [1] B99 Lube  
 [1] BF7587 Fuel  
**Replaces:** Donaldson P559519; Fleetguard MK12673



**BK6375**

Service Kit for Cummins  
**Contains:** [1] BD103 Dual-Flow Lube  
 [1] BF1259 Fuel/Water Separator  
 [1] BW5071 Coolant  
**Replaces:** Donaldson P559303; Fleetguard MK12119, MK11811; Fram FK8139; Luber-finer LK208C



**BK6196**

Service Kit for Caterpillar  
**Contains:** [1] B99 Lube  
 [1] BF7587 Fuel  
 [1] BW5137 Coolant



**BK6376**

Service Kit for Cummins  
**Contains:** [1] BD103 Dual-Flow Lube  
 [1] BF1259 Fuel/Water Separator  
**Replaces:** Donaldson P559468; Fleetguard MK11807, MK12557; Luber-finer LK228C



**BK6215**

Service Kit for Caterpillar  
**Contains:** [1] B99 Lube  
 [1] BF957 Pri. Fuel  
 [1] BF7587 Fuel  
 [1] B5134 Coolant



**BK6380**

Service Kit for Cummins  
**Contains:** [1] BD103 Dual-Flow Lube  
 [1] BF1212 Fuel/Water Separator  
 [1] BW5071 Coolant  
**Replaces:** Donaldson P559047; Fleetguard MK11997, MK1105300; Fram FK7132; Luber-finer LK143C, LK177C



**BK6287**

Service Kit for Caterpillar  
**Contains:** [1] B7600 Lube  
 [1] BF7632 Fuel



**BK6426**

Service Kit for Cummins  
**Contains:** [1] BD7154 Dual-Flow Lube  
 [1] BF7760 Pri. Fuel  
 [1] BF7766 Fuel  
 [1] BW5086 Coolant



Measurements Are Shown In Inches And (Millimeters)

**WARNING:** These products can expose you to chemicals, including Diisononyl Phthalate, Carbon black extracts, Nickel, 1,3 Butadiene, Ethylene Oxide, Epichlorohydrin, which are known to the State of California to cause cancer, and Bisphenol, Ethylene Glycol, Ethylene Oxide, 1,3 Butadiene, Epichlorohydrin, which are known to the State of California to cause birth defects or other reproductive harm.

**BK6429**

Service Kit for Cummins

- Contains:** [1] BD103 Dual-Flow Lube  
[1] BF7815 Fuel  
[1] BF1293-SPS Fuel/Water Separator



**BK6457**

Service Kit for Mack/Volvo

- Contains:** [2] B7225 F-F Lube  
[1] B7685 B-P Lube  
[1] BF7814 Fuel  
[1] BF1386-O Fuel/Water Separator  
[1] PT9394-MPG Steering



**BK6438**

Service Kit for Cummins

- Contains:** [1] BD7154 Dual-Flow Lube  
[1] BF1259 Fuel/Water Separator  
[1] B5134 Coolant



**BK6463**

Service Kit for Cummins

- Notes:** OBSOLETE. Availability Limited to Dealer Stock.  
**Contains:** [1] BD7154 Dual-Flow Lube  
[1] BF7760 Pri. Fuel  
[1] BF7766 Fuel  
[1] BW5086 Coolant



**BK6440**

Service Kit for Cummins

- Contains:** [1] BD7154 Dual-Flow Lube  
[1] BF7760 Fuel  
[1] BF7766 Fuel



**BK6464**

Service Kit for Cummins

- Contains:** [1] BD7154 Dual-Flow Lube  
[1] PF7755 Fuel/Water Separator  
[1] BF7766 Fuel



**BK6444**

Service Kit for Cummins

- Notes:** OBSOLETE. Availability Limited to Dealer Stock.  
**Contains:** [1] BD7153 Dual-Flow Lube  
[1] BF1259 Fuel/Water Separator  
[1] BW5072 Coolant



**BK6467**

Service Kit for Cummins

- Contains:** [1] BD7309 Dual-Flow Lube  
[1] BF1272-SPS Fuel/Water Separator



**BK6451**

Service Kit for Cummins

- Contains:** [1] BD103 Dual-Flow Lube  
[1] BF1259 Fuel/Water Separator  
[1] BW5072 Coolant



**BK6561**

Service Kit for Detroit Diesel

- Contains:** [2] B495 Lube  
[1] BF5800 Pri. Fuel  
[1] BF5810 Sec. Fuel  
[1] BW5137 Coolant  
**Replaces:** Fleetguard MK11518, MK11660



**BK6452**

Service Kit for Cummins

- Contains:** [1] BD7154 Dual-Flow Lube  
[1] BF1259 Fuel/Water Separator  
[1] BW5072 Coolant



**BK6562**

Service Kit for Detroit Diesel

- Contains:** [2] B495 Lube  
[1] BF5800 Pri. Fuel  
[1] BF5810 Sec. Fuel  
**Replaces:** GMC 23518686, 25014736; Donaldson P559251; Fleetguard MK11562; Fram FK7646; Luber-finer LK161D; Wix 24537



**BK6579**

Service Kit for Detroit Diesel

- Contains:** [2] B495 Lube  
[1] BF5800 Pri. Fuel  
[1] BF5810 Sec. Fuel  
[1] BW5071 Coolant  
**Replaces:** Donaldson P559299, P559466; Fleetguard MK11666; Luber-finer LK162D



Measurements Are Shown In Inches And (Millimeters)

**WARNING:** These products can expose you to chemicals, including Diisononyl Phthalate, Carbon black extracts, Nickel, 1,3 Butadiene, Ethylene Oxide, Epichlorohydrin, which are known to the State of California to cause cancer, and Bisphenol, Ethylene Glycol, Ethylene Oxide, 1,3 Butadiene, Epichlorohydrin, which are known to the State of California to cause birth defects or other reproductive harm.

**BK6583** Service Kit for Detroit Diesel  
**Contains:** [2] B495 Lube  
 [1] PF7680 Fuel Element  
**Replaces:** Donaldson P559474; Fleetguard MK12358, MK12499



**BK6649** Service Kit  
**Notes:** OBSOLETE. Availability Limited to Dealer Stock.  
**Contains:** [1] B76-MPG Lube  
 [1] BF948 Pri. Fuel  
 [1] BF7634 Fuel  
 [1] BT387-10 Hydraulic



**BK6595** Service Kit for Detroit Diesel  
**Contains:** [2] B495 Lube  
 [1] PF7680 Fuel  
 [1] BW5137 Coolant



**BK6650** Service Kit for Mack/Volvo  
**Contains:** [2] B76-SS F-F Lube  
 [1] B7685 B-P Lube  
 [1] BF7943 Fuel



**BK6600** Service Kit for International  
**Contains:** [2] BT261 Lube  
 [1] BF979 Pri. Fuel  
 [1] BF588 Sec. Fuel  
 [1] BW5137 Coolant  
**Replaces:** Donaldson P559217; Fleetguard MK151900; Fram FK3888; Luber-finer LK321



**BK6652** Service Kit for International  
**Contains:** [1] BD7250 Dual Flow Lube  
 [1] PF7779 Fuel



**BK6601** Service Kit for International  
**Contains:** [2] BT261 Lube  
 [1] BF979 Pri. Fuel  
 [1] BF588 Sec. Fuel  
**Replaces:** Donaldson P559009; Fleetguard MK12427, MK146600; Fram FK3887, FK3905; Luber-finer LK91



**BK6653** Service Kit for Mack/Volvo  
**Contains:** [2] B7225 F-F Lube  
 [1] BC7242 B-P Lube  
 [1] BF7656 Pri. Fuel  
 [1] BF1286 Fuel/Water Separator  
 [1] BW5178 Coolant  
**Fits:** Mack ASET-CEGR Engine  
**Replaces:** Mack 57GC2245



**BK6610** Service Kit for International  
**Contains:** [2] B299 Lube  
 [1] BF979 Pri. Fuel  
 [1] BF588 Sec. Fuel  
**Replaces:** Fleetguard MK11029; Luber-finer LK1151



**BK6654** Service Kit for Mack/Volvo  
**Contains:** [2] B7600 F-F Lube  
 [1] B7685 B-P Lube  
 [1] BF7814 Fuel  
 [1] BF1329 Fuel/Water Separator  
 [1] B5145 Coolant



**BK6613** Service Kit for Mack/Volvo  
**Contains:** [2] B76 F-F Lube  
 [1] BC7242 Centrifugal By-Pass Lube  
 [1] BF7656 Pri. Fuel  
 [1] BF7657 Sec. Fuel



**BK6656** Service Kit for Mack/Volvo  
**Contains:** [2] B76 Lube  
 [1] B7409 B-P Lube  
 [1] BF1386-O Fuel/Water Separator  
 [1] BF7943 Fuel  
 [1] BW5183 Coolant



**BK6619** Service Kit for International  
**Contains:** [1] B7030 Lube  
 [1] BF7629 Fuel  
 [1] BW5137 Coolant  
**Replaces:** Luber-finer LK2041; Wix 24567



**BK6657** Service Kit for Mack/Volvo  
**Contains:** [2] B7225 F-F Lube  
 [1] BC7242 B-P Lube  
 [1] BF7656 Pri. Fuel  
 [1] BF7657 Sec. Fuel  
 [1] BW5178 Coolant  
**Fits:** Mack ASET-IEGR Engine  
**Replaces:** Mack 57GC2234



**BK6634** Service Kit for International  
**Contains:** [1] B7030 Lube  
 [1] BF7629 Fuel  
 [1] BW5071 } Coolant



Measurements Are Shown In Inches And (Millimeters)

**WARNING:** These products can expose you to chemicals, including Diisononyl Phthalate, Carbon black extracts, Nickel, 1,3 Butadiene, Ethylene Oxide, Epichlorohydrin, which are known to the State of California to cause cancer, and Bisphenol, Ethylene Glycol, Ethylene Oxide, 1,3 Butadiene, Epichlorohydrin, which are known to the State of California to cause birth defects or other reproductive harm.

**BK6658** Service Kit for Mack/Volvo  
**Contains:** [2] B7225 F-F Lube  
 [1] BC7242 B-P Spinner Lube  
 [1] BF1256 Fuel/Water Separator  
 [1] BF7657 Sec. Fuel

**BK6659** Service Kit for Mack/Volvo  
**Contains:** [2] B7225 F-F Lube  
 [1] BC7242 B-P Spinner Lube  
 [1] BF1256 Fuel/Water Separator  
 [1] BF7773 Fuel

**BK6661** Service Kit for Mercedes-Benz  
**Contains:** [1] P7188 Lube  
 [1] PF7735 Fuel

**BK6662** Service Kit for Mack/Volvo  
**Contains:** [2] B7225 F-F Lube  
 [1] BC7242 B-P Lube Spinner  
 [1] BF7656 Pri. Fuel  
 [1] BF1286 Fuel/Water Separator

**BK6663** Service Kit for Mack/Volvo  
**Contains:** [2] B76-SS F-F Lube  
 [1] B7685 B-P Lube  
 [1] BF7814 Fuel

**BK6665** Service Kit for Mack/Volvo  
**Contains:** [2] B7225 F-F Lube  
 [1] BC7242 B-P Lube Spinner  
 [1] BF7656 Pri. Fuel  
 [1] BF7773 Fuel

**BK6666** Service Kit for Mack/Volvo  
**Contains:** [2] B7225 F-F Lube  
 [1] BC7228 B-P Lube  
 [1] BF7657 Fuel  
 [1] BF1256 Pri. Fuel/Water Separator

**BK6670** Service Kit for Mack/Volvo  
**Contains:** [2] B76-SS F-F Lube  
 [1] B7685 B-P Lube  
 [1] PF7744 Pri. Fuel  
 [1] BF7814 Fuel

**BK6675** Service Kit for Mercedes-Benz  
**Contains:** [1] P7230 Lube  
 [1] PF7761 Fuel

**BK6676** Service Kit for Mercedes-Benz  
**Contains:** [1] P7230 Lube  
 [1] PF7748 Fuel/Water Separator  
 [1] PF7761 Fuel

**BK6683** Service Kit for Mack/Volvo  
**Contains:** [2] B76-SS F-F Lube  
 [1] B7685 B-P Lube  
 [1] BF7653 Pri. Fuel

**BK6685** Service Kit for Caterpillar  
**Notes:** OBSOLETE. Availability Limited to Dealer Stock.  
**Contains:** [1] B7600 Lube  
 [1] BF1173 Pri. Fuel  
 [1] BF7632 Fuel

**BK6686** Service Kit for Caterpillar  
**Contains:** [1] B99 Lube  
 [1] BF957 Pri. Fuel  
 [1] BF7587 Fuel

**BK6691** Service Kit for Volvo  
**Notes:** OBSOLETE. Availability Limited to Dealer Stock.  
**Contains:** [2] B76-SS F-F Lube  
 [1] B7685 B-P Lube  
 [1] PF7744 Pri. Fuel  
 [1] BF7814 Fuel  
 [1] BW5142 Coolant

Measurements Are Shown In Inches And (Millimeters)

**WARNING:** These products can expose you to chemicals, including Diisononyl Phthalate, Carbon black extracts, Nickel, 1,3 Butadiene, Ethylene Oxide, Epichlorohydrin, which are known to the State of California to cause cancer, and Bisphenol, Ethylene Glycol, Ethylene Oxide, 1,3 Butadiene, Epichlorohydrin, which are known to the State of California to cause birth defects or other reproductive harm.

**BK6693**

Service Kit for Mack/Volvo



**Contains:** [2] B7225 F-F Lube  
[1] BC7242 B-P Lube Spinner  
[1] BF7656 Pri. Fuel  
[1] BF7657 Sec. Fuel

**BK6720**

Service Kit for Mack/Volvo



**Contains:** [2] B76 F-F Lube  
[1] BC110 B-P Lube Spinner  
[1] BF877 Pri. Fuel  
[1] BF976 Sec. Fuel  
[1] BW5179 Coolant  
**Replaces:** Mack 57GC298, 57GC2136; Fleetguard MK11057; Fram FK7121; Luber-finer LK107M; Purolator K50005; Wix 24561

**BK6694**

Service Kit for Mack/Volvo



**Contains:** [2] B76 F-F Lube  
[1] BC7173 B-P Lube Spinner  
[1] BF7656 Pri. Fuel  
[1] BF7657 Sec. Fuel  
[1] BW5178 Coolant  
**Replaces:** Fleetguard MK12790

**BK6721**

Service Kit for Mack/Volvo



**Contains:** [2] B76 F-F Lube  
[1] BC110 B-P Lube Spinner  
[1] BF877 Pri. Fuel  
[1] BF976 Sec. Fuel  
**Replaces:** Mack 215SB210, 215SB210A; Donaldson P559222; Fleetguard MK11362; Fram FK8064; Luber-finer LK170M; Wix 24564

**BK6696**

Service Kit for Mack/Volvo



**Contains:** [2] B76 F-F Lube  
[1] BC7173 B-P Lube Spinner  
[1] BF7656 Pri. Fuel  
[1] BF7657 Sec. Fuel  
**Replaces:** Mack 57GC2188A; Fleetguard MK12698

**BK6723**

Service Kit for Mack/Volvo



**Contains:** [2] B76 F-F Lube  
[1] BC110 B-P Lube Spinner  
[1] BF877 Pri. Fuel  
[1] BF976 Sec. Fuel  
[1] BW5178 Coolant  
**Replaces:** Mack 57GC2120, 57GC2120B; Donaldson P559051; Fleetguard MK11412; Fram FK7120; Hastings KF23; Luber-finer LK109M; Purolator K50015

**BK6700**

Service Kit for Mack/Volvo



**Contains:** [2] B76 Lube  
[1] BF877 Pri. Fuel  
[1] BF876 Sec. Fuel  
[1] BW5178 Coolant  
**Replaces:** Mack 57GC294, 215SB192A; Donaldson P559001; Fleetguard MK31M; Fram FK3352; Luber-finer LK1M; Purolator K50001; Wix 24210

**BK6764**

Service Kit for International



**Contains:** [1] B7030 Lube  
[1] BF7629 Fuel  
**Replaces:** Fleetguard MK11663, MK12150; Luber-finer LK209I

**BK6702**

Service Kit for Mack/Volvo



**Contains:** [2] B76 Lube  
[1] BF877 Pri. Fuel  
[1] BF976 Sec. Fuel  
**Replaces:** Donaldson P559205; Fleetguard MK11116; Luber-finer LK77M

**BK6780**

Service Kit for Mack/Volvo



**Contains:** [1] PA2438 Inter-Cooler Air Element  
[1] PA2439 Air Element  
[2] G25-AF Gaskets  
**Replaces:** Mack 215SB194; Donaldson X005582; Fram KA1549; Luber-finer LK1MA

**BK6704**

Service Kit for Mack/Volvo



**Contains:** [2] B76 F-F Lube  
[1] BC110 B-P Lube Spinner  
[1] BF7656 Pri. Fuel  
[1] BF7657 Sec. Fuel  
[1] BW5178 Coolant  
**Replaces:** Mack 57GC2177; Fram FK8454; Luber-finer LK236M; Wix 24566

**BK6799**

Service Kit for Thermo King



**Contains:** [1] BD7095 Dual-Flow Lube  
[1] BF7579 Box-Style Fuel Filter  
[1] BF7580 Box-Style Fuel/Water Separator  
**Replaces:** Fleetguard MK12073; Luber-finer LK195T

**BK6705**

Service Kit for Mack/Volvo



**Contains:** [2] B76 F-F Lube  
[1] BC110 B-P Lube Spinner  
[1] BF7656 Pri. Fuel  
[1] BF7657 Sec. Fuel  
**Replaces:** Mack 57GC2177A, 57GC2177B; Hastings KF48

**BK6710**

Service Kit for Mack/Volvo



**Contains:** [3] B76 Lube  
[1] BF877 Pri. Fuel  
[1] BF976 Sec. Fuel  
[1] BW5179 Coolant  
**Replaces:** Mack 57GC295A, 215SB134A; Donaldson P559031; Fleetguard MK33M; Fram FK3434; Luber-finer LK3M; Purolator K50002; Wix 24222

**BK6903**

Service Kit for Mack/Volvo



**Contains:** [1] B76 F-F Lube  
[1] B7685 By-Pass Lube  
[2] BF988 Fuel

Measurements Are Shown In Inches And (Millimeters)

**WARNING:** These products can expose you to chemicals, including Diisononyl Phthalate, Carbon black extracts, Nickel, 1,3 Butadiene, Ethylene Oxide, Epichlorohydrin, which are known to the State of California to cause cancer, and Bisphenol, Ethylene Glycol, Ethylene Oxide, 1,3 Butadiene, Epichlorohydrin, which are known to the State of California to cause birth defects or other reproductive harm.



**BK6923** Service Kit for Mack/Volvo  
**Contains:** [2] B7225 F-F Lube  
 [1] BC7242 B-P Lube  
 [1] PF7680 Fuel/Water Separator



**BK6930** Service Kit for Mack/Volvo  
**Contains:** [2] B76 F-F Lube  
 [1] B7685 B-P Lube  
 [1] BF7814 Fuel  
 [1] BF1329 Fuel/Water Separator  
 [1] BW5142 Coolant



**BK6931** Service Kit for Mack/Volvo  
**Contains:** [2] B76 F-F Lube  
 [1] B7685 B-P Lube  
 [1] BF7814 Fuel  
 [1] BF1366-O Fuel/Water Separator  
 [1] BW5142 Coolant



**BK6933** Service Kit for Caterpillar, Mitsubishi Lift Trucks  
**Contains:** [1] B7049 Lube  
 [1] RS3716 Radial Seal Outer Air



**BK6934** Service Kit for Detroit Diesel  
**Contains:** [2] B495-SS Severe Service Lube  
 [1] PF7680 Fuel/Water Separator



**BK6942** Service Kit for Mack/Volvo  
**Contains:** [2] B7225 F-F Lube  
 [1] B7409 B-P Lube  
 [1] BF7943 Fuel  
 [1] BF1386-O Fuel/Water Separator



**BK6943** Service Kit for Caterpillar  
**Notes:** OBSOLETE. Availability Limited to Dealer Stock.  
**Contains:** [1] B99 Lube  
 [1] BF5800 Pri. Fuel  
 [1] B5134 Coolant  
 [1] BF614 Fuel  
 [1] BF1212 Fuel/Water Separator



**BK6944** Service Kit for Cummins  
**Notes:** OBSOLETE. Availability Limited to Dealer Stock.  
**Contains:** [1] BD7154 Dual-Flow Lube  
 [1] PF7733 Fuel/Water Separator  
 [1] B5134 Coolant



**BK6945** Service Kit for Caterpillar  
**Notes:** OBSOLETE. Availability Limited to Dealer Stock.  
**Contains:** [1] B99 Lube  
 [1] BF584 Fuel  
 [1] PF7733 Fuel/Water Separator  
 [1] B5134 Coolant



**BK6946** Service Kit for Cummins  
**Notes:** OBSOLETE. Availability Limited to Dealer Stock.  
**Contains:** [1] BD103 Dual-Flow Lube  
 [1] BF1272-SPS Fuel/Water Separator  
 [1] PF7733 Fuel/Water Separator  
 [1] B5134 Coolant



**BK6947** Service Kit for Mack  
**Notes:** OBSOLETE. Availability Limited to Dealer Stock.  
**Contains:** [2] B76 F-F Lube  
 [1] BC7173 B-P Lube  
 [1] BF7656 Pri. Fuel  
 [1] BF7657 Fuel  
 [1] B5176 Coolant



**BK6948** Service Kit for Mack  
**Notes:** OBSOLETE. Availability Limited to Dealer Stock.  
**Contains:** [2] B7225 F-F Lube  
 [1] BC7242 B-P Lube  
 [1] BF7773 Fuel  
 [1] BF1256 Pri. Fuel/Water Separator  
 [1] B5176 Coolant  
 [1] BT9408 Air Coalescer



**BK6949** Service Kit for Sterling  
**Notes:** OBSOLETE. Availability Limited to Dealer Stock.  
**Contains:** [1] P7230 Lube  
 [1] PF7761 Fuel  
 [1] BF1339-SP Fuel/Water Separator



Measurements Are Shown In Inches And (Millimeters)

**WARNING:** These products can expose you to chemicals, including Diisononyl Phthalate, Carbon black extracts, Nickel, 1,3 Butadiene, Ethylene Oxide, Epichlorohydrin, which are known to the State of California to cause cancer, and Bisphenol, Ethylene Glycol, Ethylene Oxide, 1,3 Butadiene, Epichlorohydrin, which are known to the State of California to cause birth defects or other reproductive harm.

**BK6950**

Service Kit for Caterpillar

**Notes:** OBSOLETE. Availability Limited to Dealer Stock.

- Contains:** [1] B7299 Lube  
[1] BF7587 Fuel  
[1] BF1216 Fuel/Water Separator



**BK6956**

Service Kit for Mack/Volvo

- Contains:** [2] B76 F-F Lube  
[1] B7409 B-P Lube  
[1] BF1386-O Fuel/Water Separator  
[1] BF7943 Fuel



**BK6951**

Service Kit for Mack

**Notes:** OBSOLETE. Availability Limited to Dealer Stock.

- Contains:** [2] B76 F-F Lube  
[1] B7409 B-P Lube  
[1] PF7744 Pri. Fuel  
[1] BF7943 Fuel  
[1] B5144 Coolant



**BK6980**

Service Kit for Cummins

- Contains:** [1] BT339 F-F Lube  
[1] B7577 B-P Lube  
[1] BF1210 Fuel/Water Separator  
[1] BT839-10 Hydraulic  
[1] PT951 Steering



**BK6952**

Service Kit for Caterpillar

**Notes:** OBSOLETE. Availability Limited to Dealer Stock.

- Contains:** [1] B99 Lube  
[1] BF7587 Fuel  
[1] PF7890-30 Fuel/Water Separator  
[1] BC7456 KIT Paper Insert



**BK6981**

Service Kit

**Notes:** OBSOLETE. Availability Limited to Dealer Stock.

- Contains:** [1] BT339 Lube  
[1] BF7519 In-Line Fuel  
[1] BF988 Fuel  
[1] BF1280 Fuel/Water Separator  
[2] BT389 Hydraulic  
[1] PT951 Steering



**BK6953**

Service Kit for Caterpillar

- Contains:** [1] B99 Lube  
[1] BF7587 Fuel  
[1] BW5071 Coolant



**BK6982**

Service Kit for Cummins

- Contains:** [1] BT339 Lube  
[1] BF7519 Fuel  
[1] BF1356 Fuel/Water Separator  
[1] BT839 Hydraulic  
[1] PT951 Steering  
[1] PT9415-MPG KIT Transmission



**BK6983**

Service Kit for Cummins

- Contains:** [1] B7177 Lube  
[1] BF7540 Fuel  
[1] BF1378-SPS Fuel/Water Separator  
[1] BT839-10 Hydraulic  
[1] PT951 Steering  
[1] PT9415-MPG KIT Transmission



**BK6954**

Service Kit for Caterpillar

- Contains:** [1] B99 Lube  
[1] BF7587 Fuel  
[1] BF1259 Fuel/Water Separator



**BK6984**

Service Kit for Cummins

- Contains:** [2] BF1212 Pri. Fuel  
[1] BT8847 Hydraulic  
[2] BT8873 Hydraulic  
[3] PT752 Hydraulic  
[1] BW5071 Coolant



**BK6955**

Service Kit for Cummins

- Contains:** [1] BD7154 Dual-Flow Lube  
[1] BF7766 Fuel  
[1] BF1212 Fuel/Water Separator



**BK6985**

Service Kit for Cummins

- Contains:** [1] B7177 Lube  
[1] BF7940 Fuel  
[1] BF1378-SPS Fuel/Water Separator  
[1] BT839-10 Hydraulic



**BK6986**

Service Kit for Cummins

- Contains:** [1] B7177 Lube  
[1] BF1212 Fuel/Water Separator  
[1] BF1378-SPS Fuel/Water Separator  
[1] BT839-10 Hydraulic



Measurements Are Shown In Inches And (Millimeters)

**WARNING:** These products can expose you to chemicals, including Diisononyl Phthalate, Carbon black extracts, Nickel, 1,3 Butadiene, Ethylene Oxide, Epichlorohydrin, which are known to the State of California to cause cancer, and Bisphenol, Ethylene Glycol, Ethylene Oxide, 1,3 Butadiene, Epichlorohydrin, which are known to the State of California to cause birth defects or other reproductive harm.



**BK6987** Service Kit for Cummins  
**Contains:** [1] BT339 Lube  
 [1] BF7695 Pri. Fuel  
 [1] BT839-10 Hydraulic



**BK6988** Service Kit  
**Notes:** OBSOLETE. Availability Limited to Dealer Stock.  
**Contains:** [1] B7177 F-F Lube  
 [1] B7577 B-P Lube  
 [1] BF7966 Pri. Fuel  
 [1] BF1210 Fuel/Water Separator  
 [1] BF1385-SPS Fuel  
 [1] BT839-10 Hydraulic  
 [1] PT9415-MPG KIT Transmission  
 [1] PT951 Steering



**BK6993** Service Kit for Mack  
**Notes:** OBSOLETE. Availability Limited to Dealer Stock.  
**Contains:** [2] B7225 F-F Lube  
 [1] BC7228 B-P Lube  
 [1] BF7656 Pri. Fuel  
 [1] BF7657 Fuel



**BK6996** Service Kit  
**Notes:** OBSOLETE. Availability Limited to Dealer Stock.  
**Contains:** [1] BT339 Lube  
 [1] BF988 Fuel  
 [1] BF1280 Fuel/Water Separator  
 [1] BT839-10 Hydraulic



**BK6997** Service Kit for Carrier  
**Contains:** [1] B7139 Lube  
 [1] BF840 In-Line Fuel  
 [1] BF954 Fuel  
 [1] RS3715 Radial Seal Outer Air



**P7000 KIT** Kit of 2 Lube Elements  
**Contains:** [1] P7092  
 [1] P7093  
**Fits:** Case, Furukawa, Kobelco, MDI/Yutani, Mitsubishi, Tadano Equipment  
**Replaces:** Case 151197A1; Kobelco 2451U-1801; Mitsubishi ME064356  
**P7092**  
**O.D.:** 5 1/16 (128.6)  
**I.D.:** 2 11/32 (59.5)  
**Height:** 5 7/8 (149.2)  
**P7093**  
**O.D.** 5 1/16  
**I.D.** 19/32  
**Height** 6 23/32



**B7001** Lube Spin-on  
**Contains:** Anti-Drainback Valve  
 14 PSID By-Pass Valve  
**Fits:** Ford (Europe) Transit  
**Replaces:** Ford 914F-6714-A, 914F-6714-AA  
**Thread:** M22 x 1.5  
**O.D.:** 3 11/16 (93.7)  
**Height:** 3 3/4 (95.3)  
**I.Gskt:** [1] Included



**P7003** Full-Flow Lube Element  
**Fits:** Caterpillar Industrial, Marine Engines  
**Replaces:** Caterpillar 1R0726, 4P2839, 7N7500  
**O.D.:** 7 3/8 (187.3)  
**I.D.:** 2 27/32 (72.2)  
**Height:** 10 9/32 (261.1)  
**A. Gskt:** [2] Attached



**B7004** Lube Spin-on  
**Fits:** Hitachi Equipment  
**Replaces:** Hitachi 4206079  
**Thread:** 1 1/2 -12  
**O.D.:** 4 21/32 (118.3)  
**Height:** 8 3/32 (205.6)  
**I.Gskt:** [1] Included



**B7005** Full-Flow Lube Spin-on  
**Fits:** Hino Trucks; Hitachi Equipment  
**Replaces:** Detroit Diesel 23530411; Hino 15607-1380, 15607-1740; Hitachi 4178801, 4283859; Isuzu 1-13240-046-0, 1-13240-075-0  
**Thread:** 1 1/2 -12  
**O.D.:** 4 21/32 (118.3)  
**Height:** 8 3/32 (205.6)  
**I.Gskt:** [1] Included



**P7007** Lube Element  
**Replaces:** Deutz 1172637  
**O.D.:** 7 5/8 (193.7)  
**I.D.:** 4 21/32 (118.3)  
**Height:** 7 3/32 (180.2)  
**A. Gskt:** [2] Attached



**B7009** Lube Spin-on  
**Contains:** 8 PSID By-Pass Valve  
**Fits:** Ford Tractors  
**Replaces:** Ford F0NN-6714-AA  
**Thread:** 1 -12  
**O.D.:** 4 1/4 (108.0)  
**Height:** 5 7/8 (149.2)  
**I.Gskt:** G401



**B7010** Lube Spin-on  
**Fits:** GM, Saturn Automotive  
**Replaces:** GMC 25014377  
**Thread:** 13/16 -16  
**O.D.:** 3 (76.2)  
**Height:** 4 3/32 (104.0)  
**I.Gskt:** [1] Included

Measurements Are Shown In Inches And (Millimeters)

**WARNING:** These products can expose you to chemicals, including Diisononyl Phthalate, Carbon black extracts, Nickel, 1,3 Butadiene, Ethylene Oxide, Epichlorohydrin, which are known to the State of California to cause cancer, and Bisphenol, Ethylene Glycol, Ethylene Oxide, 1,3 Butadiene, Epichlorohydrin, which are known to the State of California to cause birth defects or other reproductive harm.

**B7011**

Lube or Hydraulic Spin-on



**Notes:** Can be used with OB1314 and OB1316 bases (requires optional G286-C gasket).  
**Fits:** Transit Buses  
**Replaces:** Zinga LE-3  
**Thread:** 1 1/2 -16  
**O.D.:** 5 1/16 (128.6)  
**Height:** 10 3/4 (273.1)  
**F. Gskt:** [1] Included  
**O. Gskt:** G286-C, G369-V, G372, G447, G483, G704, G710

**P7012**

Lube Element



**Fits:** Caterpillar Industrial, Marine Engines  
**Replaces:** Caterpillar 1W4136  
**O.D.:** 7 5/16 (185.7)  
**I.D.:** 3 13/32 (86.5)  
**Height:** 13 19/32 (345.3)  
**A. Gskt:** [2] Attached

**P7013**

Lube Element



**Fits:** Hino Engines; Hitachi Equipment  
**Replaces:** Hitachi 4507886  
**O.D.:** 3 15/16 (100.0)  
**I.D.:** 19/32 (15.1)  
**Height:** 5 29/32 (150.0)  
**F. Gskt:** [1] Included  
**Grommets:** [2] Attached

**B7014**

Lube Spin-on



**Contains:** Anti-Drainback Valve  
 14 PSID By-Pass Valve  
**Fits:** Hino Engines; Kobelco Loaders  
**Replaces:** Hino 15607-1630  
**Thread:** 1 -16  
**O.D.:** 3 11/16 (93.7)  
**Height:** 5 3/8 (136.5)  
**I.Gskt:** G381-A

**P7015**

Lube Element



**Fits:** Claas, Demag Equipment; M.A.N., Mercedes-Benz Buses, Trucks  
**Replaces:** Claas 1335300; Demag 760017; Mann & Hummel H9471, H9471X  
**O.D.:** 3 5/16 (84.1)  
**I.D.:** 29/32 (23.0)  
**Height:** 7 27/32 (199.2)  
**F. Gskt:** [2] Metal Washers  
**O-Ring:** [1] Included  
**Grommets:** [2] Attached

**P7016**

Lube Element



**Fits:** Mercedes-Benz Trucks, Vans  
**Replaces:** Mercedes-Benz 4411800009  
**O.D.:** 3 9/32 (83.3)  
**I.D.:** 13/16 (20.6)  
**Height:** 7 27/32 (199.2)  
**O-Ring:** [2] Included  
**Grommets:** [2] Attached

**P7017**

Lube Element



**Fits:** DAF, Mercedes-Benz, R.V.I. Buses, Trucks  
**Replaces:** Mercedes-Benz 3661840225  
**O.D.:** 3 9/32 (83.3)  
**I.D.:** 13/16 (20.6)  
**Height:** 5 3/8 (136.5)  
**I.Gskt:** [2] Included  
**F. Gskt:** [1] Copper Washer, [1] Metal Washer  
**O-Ring:** [1] Included

**B7018**

By-Pass Lube Spin-on



**Fits:** Nissan Trucks  
**Replaces:** Nissan 15201-Z9008  
**Thread:** 3/4 -16  
**O.D.:** 4 1/4 (108.0)  
**Height:** 5 7/8 (149.2)  
**I.Gskt:** G401

**B7019**

Lube Spin-on



**Contains:** Integral Post Seal  
**Fits:** Hitachi, J.C. Bamford, Link-Belt Equipment; Isuzu Engines  
**Replaces:** Fiat 76561779; Isuzu 1-13240-105-21  
**Thread:** 1 3/8 -16  
**O.D.:** 4 21/32 (118.3)  
**Height:** 9 29/32 (251.6)  
**I.Gskt:** [1] Included

**B7020**

Lube Spin-on



**Contains:** Anti-Drainback Valve  
 14 PSID By-Pass Valve  
**Fits:** Lexus, Toyota Light-Duty Trucks, Vans  
**Thread:** 3/4 -16  
**O.D.:** 3 (76.2)  
**Height:** 4 3/32 (104.0)  
**I.Gskt:** [1] Included

**P7021**

Lube Element



**Fits:** Mitsubishi Equipment, Trucks  
**Replaces:** Mitsubishi 30840-06010, ME021074, ME034481  
**O.D.:** 3 15/16 (100.0)  
**I.D.:** 11/16 (17.5) & 1 1/8 (28.6)  
**Height:** 7 27/32 (199.2)  
**A. Gskt:** [2] Attached  
**F. Gskt:** [2] Included

**B7022**

Lube Spin-on



**Contains:** Anti-Drainback Valve  
**Fits:** Nissan Buses  
**Replaces:** Nissan 15208-05D00  
**Thread:** 3/4 -16  
**O.D.:** 3 25/32 (96.0)  
**Height:** 5 9/32 (134.1)  
**I.Gskt:** G381-A

**B7023**

Lube Spin-on



**Contains:** 14 PSID By-Pass Valve  
**Fits:** Ingersoll-Rand Compressors  
**Replaces:** Ingersoll-Rand 39460456  
**Thread:** 1 1/4 -12  
**O.D.:** 3 11/16 (93.7)  
**Height:** 5 3/8 (136.5)  
**I.Gskt:** G381-A

Measurements Are Shown In Inches And (Millimeters)

**WARNING:** These products can expose you to chemicals, including Diisononyl Phthalate, Carbon black extracts, Nickel, 1,3 Butadiene, Ethylene Oxide, Epichlorohydrin, which are known to the State of California to cause cancer, and Bisphenol, Ethylene Glycol, Ethylene Oxide, 1,3 Butadiene, Epichlorohydrin, which are known to the State of California to cause birth defects or other reproductive harm.

**B7024** Air Breather Spin-on  
**Contains:** Integral Post Seal  
 Adapter Thread: 3/4-14 NPT  
**Fits:** Boart, Fletcher Drills; Gehl, Liebherr, Oldenburg Equipment  
**Replaces:** Schroeder ABF3/10 (with Adapter)  
**Thread:** 1 1/8 -16  
**O.D.:** 3 11/16 (93.7)  
**Height:** 4 5/16 (109.5)  
**Related To:** BT367-S (without Adapter)



**B7031** Full-Flow Lube Spin-on  
**Contains:** Anti-Drainback Valve  
 30 PSID By-Pass Valve  
**Fits:** Claas, Zetor Equipment; DAF, Iveco Buses, Trucks; Deutz Engines  
**Replaces:** Claas 568440; DAF 661049; Deutz 1174419; Iveco 1161934; Zetor 4061130  
**Thread:** 1 -12  
**O.D.:** 3 11/16 (93.7)  
**Height:** 6 5/8 (168.3)  
**I.Gskt:** G381-A  
**Related To:** B236 (Long Version)



**B7025** Lube Spin-on  
**Fits:** Thermo King Refrigeration Units  
**Replaces:** Thermo King 11-6228  
**Thread:** 3/4 -20  
**O.D.:** 3 11/16 (93.7)  
**Height:** 5 3/8 (136.5)  
**I.Gskt:** G381-A



**B7033** Full-Flow Lube Spin-on  
**Contains:** Anti-Drainback Valve  
 14 PSID By-Pass Valve  
**Replaces:** Isuzu 8-94463-713-0  
**Thread:** M22 x 1.5  
**O.D.:** 3 1/32 (77.0)  
**Height:** 4 1/16 (103.2)  
**I.Gskt:** [1] Included



**B7026-MPG** Maximum Performance Glass Hydraulic Spin-on  
**Fits:** Massey Ferguson Tractors  
**Replaces:** Massey Ferguson 3595175-M1  
**Thread:** M24 x 2.0  
**O.D.:** 3 21/32 (92.9)  
**Height:** 5 5/8 (142.9)  
**I.Gskt:** G381-A



**B7034** By-Pass Lube Spin-on  
**Thread:** M20 x 1.5  
**O.D.:** 3 25/32 (96.0)  
**Height:** 4 11/32 (110.3)  
**I.Gskt:** [1] Included



**BD7028** Dual-Flow Lube Spin-on  
**Contains:** 20 PSID By-Pass Valve  
**Fits:** Kobelco Excavators; Mitsubishi Engines, Trucks  
**Replaces:** Mitsubishi ME013307  
**Thread:** M26 x 1.5  
**O.D.:** 4 1/4 (108.0)  
**Height:** 5 27/32 (148.4)  
**I.Gskt:** G401



**P7035** Lube Element  
**Fits:** Belarus Tractors  
**Replaces:** Belarus 2401017040A3  
**O.D.:** 3 15/16 (100.0)  
**I.D.:** 1 19/32 (40.5)  
**Height:** 7 3/4 (196.9)  
**End Seals:** [2] Attached



**BD7029** Dual-Flow Lube Spin-on  
**Contains:** Anti-Drainback Valve  
 5-8 PSID By-Pass Valve  
**Fits:** Toyota Camry with Diesel Engine  
**Replaces:** Toyota 90915-03006, 90915-30002  
**Thread:** M24 x 1.5  
**O.D.:** 3 31/32 (100.8)  
**Height:** 4 27/32 (123.0)  
**I.Gskt:** [1] Included



**B7039** Lube Spin-on  
**Fits:** Ford Light-Duty Trucks, Vans; International Trucks  
**Replaces:** Ford F4TZ-6731-A  
**Thread:** 1 1/2 -16  
**O.D.:** 4 1/4 (108.0)  
**Height:** 7 3/8 (187.3)  
**I.Gskt:** [1] Included



**B7030** Full-Flow Lube Spin-on  
**Contains:** 30 PSID By-Pass Valve  
**Fits:** Agco, Terex Equipment; Detroit Diesel, International Engines; International Buses, Trucks  
**Replaces:** GMC 25171955; International 1819452-C1  
**Thread:** M36 x 1.5  
**O.D.:** 5 3/8 (136.5)  
**Height:** 12 3/32 (307.2)  
**I.Gskt:** [1] Included



**B7042** Lube Spin-on  
**Contains:** Anti-Drainback Valve  
 14 PSID By-Pass Valve  
**Fits:** Caterpillar Lift Trucks; Citroen Trucks; Peugeot Automotive, Light-Duty Trucks  
**Replaces:** Caterpillar 1N4402; Citroen 95638903; Peugeot 110987  
**Thread:** M20 x 1.5  
**O.D.:** 3 11/16 (93.7)  
**Height:** 5 3/8 (136.5)  
**I.Gskt:** G381-A



Measurements Are Shown In Inches And (Millimeters)

**WARNING:** These products can expose you to chemicals, including Diisononyl Phthalate, Carbon black extracts, Nickel, 1,3 Butadiene, Ethylene Oxide, Epichlorohydrin, which are known to the State of California to cause cancer, and Bisphenol, Ethylene Glycol, Ethylene Oxide, 1,3 Butadiene, Epichlorohydrin, which are known to the State of California to cause birth defects or other reproductive harm.

**B7044**

Lube Spin-on



**Contains:** Anti-Drainback Valve  
**Replaces:** Nissan 15209-Z6502  
**Thread:** 1 -12  
**O.D.:** 3 23/32 (94.5)  
**Height:** 6 23/32 (170.7)  
**I.Gskt:** G401

**P7053**

Lube Element



**Contains:** Reinforced Centertube  
**Fits:** Hino Engines, Tractors, Trucks  
**Replaces:** Hino 15607-1560  
**O.D.:** 3 15/16 (100.0)  
**I.D.:** 19/32 (15.1) & 1 15/16 (49.2)  
**Height:** 7 9/32 (184.9)  
**F. Gskt:** [2] Included  
**O. Gskt:** ES1074  
**End Seals:** [1] Attached  
**Grommets:** [1] Attached

**B7045**

Lube Spin-on



**Contains:** 14 PSID By-Pass Valve  
**Fits:** Toyota Engines  
**Replaces:** Toyota 15601-78010  
**Thread:** M26 x 1.5  
**O.D.:** 4 1/4 (108.0)  
**Height:** 5 27/32 (148.4)  
**I.Gskt:** G401

**P7058**

Lube Element



**Fits:** Nissan Trucks  
**Replaces:** Nissan 15274-99025, 15274-99285  
**O.D.:** 4 11/32 (110.3)  
**I.D.:** 5/8 (15.9) & 2 27/32 (46.8)  
**Height:** 8 11/32 (211.9)  
**A. Gskt:** [1] Attached

**B7047**

Full-Flow Lube Spin-on



**Contains:** Anti-Drainback Valve  
**Fits:** Nissan Engines, Trucks  
**Replaces:** Nissan FL208-05D01  
**Thread:** 3/4 -16  
**O.D.:** 3 23/32 (94.5)  
**Height:** 4 15/32 (113.5)  
**I.Gskt:** G401

**P7059**

Lube Element



**Fits:** Nissan Trucks  
**Replaces:** Nissan 15274-99085, 15274-99087  
**O.D.:** 5 1/32 (127.8)  
**I.D.:** 5/8 (15.9) & 2 15/32 (62.7)  
**Height:** 6 15/32 (164.3)  
**A. Gskt:** [1] Attached  
**F. Gskt:** [3] Copper Washers, [1] Included  
**Grommets:** [1] Attached

**B7049**

Lube Spin-on



**Contains:** Anti-Drainback Valve  
**Fits:** Caterpillar, Komatsu, Mitsubishi Lift Trucks; Nissan Engines  
**Replaces:** Nissan 15208-01B01  
**Thread:** 3/4 -16  
**O.D.:** 3 (76.2)  
**Height:** 2 27/32 (72.2)  
**I.Gskt:** [1] Included

**P7081**

Full-Flow Lube Element



**Fits:** Toyota Lift Trucks  
**Replaces:** Toyota 4152-46010  
**O.D.:** 3 5/8 (92.1)  
**I.D.:** 23/32 (18.3)  
**Height:** 5 15/32 (138.9)  
**F. Gskt:** [4] Included, [1] Metal Washer

**P7050**

Lube Element



**Fits:** Hitachi Excavators; Isuzu Trucks  
**Replaces:** Isuzu 9-88511-194-2  
**O.D.:** 3 9/32 (83.3)  
**I.D.:** 5/8 (15.9) & 1 5/8 (41.3)  
**Height:** 5 25/32 (146.8)  
**F. Gskt:** [3] Included  
**End Seals:** [1] Attached  
**Grommets:** [1] Attached

**B7082**

Lube Spin-on



**Contains:** Anti-Drainback Valve  
 8 PSID By-Pass Valve  
**Fits:** Bobcat Loaders  
**Replaces:** Melroe-Bobcat 6659329  
**Thread:** M20 x 1.5  
**O.D.:** 3 11/16 (93.7)  
**Height:** 5 3/32 (129.4)  
**I.Gskt:** [1] Included

**B7051**

Lube Spin-on



**Contains:** Anti-Drainback Valve  
 30 PSID By-Pass Valve  
 Standpipe  
**Fits:** Komatsu Equipment  
**Replaces:** Komatsu 6134-51-5120  
**Thread:** 1 1/8 -16  
**O.D.:** 4 1/4 (108.0)  
**Height:** 5 27/32 (148.4)  
**I.Gskt:** [1] Included

**P7083**

Lube Element



**Fits:** Nissan Lift Trucks  
**Replaces:** Nissan 15208-76225  
**O.D.:** 3 3/32 (78.6)  
**I.D.:** 7/8 (22.2) & 1 5/8 (41.3)  
**Height:** 5 7/16 (138.1)  
**F. Gskt:** [3] Included  
**End Seals:** [1] Attached

**P7052**

Lube Element



**Contains:** Reinforced Centertube  
**Fits:** Mercedes-Benz Buses, Trucks, Vans  
**Replaces:** Mercedes-Benz 3551800009  
**O.D.:** 3 15/16 (100.0)  
**I.D.:** 1/2 (12.7) & 19/32 (15.1)  
**Height:** 9 5/8 (244.5)  
**F. Gskt:** [4] Included  
**End Seals:** [1] Attached  
**Grommets:** [1] Attached

Measurements Are Shown In Inches And (Millimeters)

**WARNING:** These products can expose you to chemicals, including Diisononyl Phthalate, Carbon black extracts, Nickel, 1,3 Butadiene, Ethylene Oxide, Epichlorohydrin, which are known to the State of California to cause cancer, and Bisphenol, Ethylene Glycol, Ethylene Oxide, 1,3 Butadiene, Epichlorohydrin, which are known to the State of California to cause birth defects or other reproductive harm.

**P7084** Lube Element  
**Contains:** Reinforced Centertube  
**Fits:** Isuzu Trucks  
**Replaces:** Isuzu 9-88513-264-1  
**O.D.:** 4 1/4 (108.0)  
**I.D.:** 9/16 (14.3) & 1 15/16 (49.2)  
**Height:** 7 1/16 (179.4)  
**A. Gskt:** [1] Attached  
**F. Gskt:** [4] Included  
**End Seals:** [1] Attached



**B7089** Lube Spin-on  
**Contains:** 40 PSID By-Pass Valve  
**Fits:** Ford, New Holland Equipment  
**Replaces:** Ford F2NN-6714-AA, F2NN-6714-AB  
**Thread:** 1 -12  
**O.D.:** 3 11/16 (93.7)  
**Height:** 6 5/8 (168.3)  
**I.Gskt:** G381-A



**B7091** Lube Spin-on  
**Contains:** Anti-Drainback Valve  
 18-20 PSID By-Pass Valve  
**Fits:** Ford Tractors  
**Replaces:** Ford SBA140516230  
**Thread:** 3/4 -16  
**O.D.:** 3 1/32 (77.0)  
**Height:** 5 13/16 (147.6)  
**I.Gskt:** [1] Included



**P7092** Full-Flow Lube Element  
**Notes:** Included in P7000 KIT  
**Contains:** Reinforced Centertube  
**Fits:** Caterpillar, Furukawa Equipment;  
 Mitsubishi Engines  
**Replaces:** Mitsubishi 31240-53054  
**O.D.:** 5 1/16 (128.6)  
**I.D.:** 2 11/32 (59.5)  
**Height:** 5 7/8 (149.2)  
**A. Gskt:** [1] Attached  
**F. Gskt:** [2] Included  
**End Seals:** [1] Attached



**P7093** By-Pass Lube Element  
**Notes:** Included in P7000 KIT  
**Contains:** Bleed Hole  
**Fits:** Caterpillar Excavators; Mitsubishi  
 Engines  
**Replaces:** Caterpillar 94-8385; Mitsubishi  
 ME054236, ME054238  
**O.D.:** 5 1/16 (128.6)  
**I.D.:** 19/32 (15.1)  
**Height:** 6 23/32 (170.7)  
**F. Gskt:** [2] Included  
**Grommets:** [2] Attached



**BD7095** Dual-Flow Lube Spin-on  
**Contains:** Anti-Drainback Valve  
**Fits:** Thermo King Refrigeration Units  
**Replaces:** Thermo King 11-7382  
**Thread:** M26 x 1.5  
**O.D.:** 3 11/16 (93.7)  
**Height:** 7 1/8 (181.0)  
**I.Gskt:** G381-A



**B7097** Dual-Flow Lube Spin-on  
**Contains:** 10-15 PSID By-Pass Valve  
**Fits:** Ford Cargo Trucks  
**Replaces:** Ford 826F-6714-AA2A  
**Thread:** M60 x 3.0  
**O.D.:** 5 15/32 (138.9)  
**Height:** 6 3/4 (171.5)  
**I.Gskt:** [1] Included



**B7099** Lube Spin-on  
**Contains:** 30 PSID By-Pass Valve  
**Fits:** Fendt, International, Kubota Equipment  
**Replaces:** Fendt F139215310010; International  
 3132023-R92  
**Thread:** 3/4 -16  
**O.D.:** 3 11/16 (93.7)  
**Height:** 4 7/16 (112.7)  
**I.Gskt:** G401



**P7102** By-Pass Lube Element with Handle  
**Fits:** Hitachi Excavators  
**Replaces:** Hitachi 4231195  
**Thread:** M16 x 2.0  
**O.D.:** 6 1/2 (165.1)  
**Height:** 5 3/32 (129.4)  
**F. Gskt:** [1] Included, [2] Metal Washers



**P7103** Fuel Element  
**Fits:** Mitsubishi Equipment, Trucks; Nissan  
 Trucks; Yanmar Engines  
**Replaces:** Mitsubishi ME023833, ME023838;  
 Nissan 16444-Z9000  
**O.D.:** 2 7/8 (73.0)  
**I.D.:** 15/32 (11.9)  
**Height:** 3 9/16 (90.5)  
**F. Gskt:** [1] Included  
**O-Ring:** [1] Included  
**Grommets:** [2] Attached



**P7104** Lube Element  
**Fits:** Nissan Trucks  
**Replaces:** Nissan 15274-99428  
**O.D.:** 3 25/32 (96.0)  
**I.D.:** 19/32 (15.1) & 1 23/32 (43.7)  
**Height:** 6 1/16 (154.0)  
**A. Gskt:** [1] Attached  
**F. Gskt:** [4] Included



**BD7105** Dual-Flow Lube Spin-on with Drain  
**Contains:** Standpipe  
**Fits:** Hino, Nissan Trucks; Hitachi, Kobelco  
 Equipment  
**Replaces:** Hino 15607-1600; Hitachi 4285963  
**Thread:** 1 1/2 -16  
**O.D.:** 4 7/16 (112.7)  
**Height:** 8 11/32 (211.9)  
**I.Gskt:** [1] Included



**P7106** Lube Element  
**Contains:** Reinforced Centertube  
**Fits:** Hino Trucks  
**Replaces:** Hino 15607-1320  
**O.D.:** 4 5/32 (105.6)  
**I.D.:** 19/32 (15.1) & 1 7/8 (47.6)  
**Height:** 6 3/4 (171.5)  
**A. Gskt:** [1] Attached  
**F. Gskt:** [4] Included



Measurements Are Shown In Inches And (Millimeters)

**WARNING:** These products can expose you to chemicals, including Diisononyl Phthalate, Carbon black extracts, Nickel, 1,3 Butadiene, Ethylene Oxide, Epichlorohydrin, which are known to the State of California to cause cancer, and Bisphenol, Ethylene Glycol, Ethylene Oxide, 1,3 Butadiene, Epichlorohydrin, which are known to the State of California to cause birth defects or other reproductive harm.

**P7107**

Lube Element



**Contains:** Reinforced Centertube  
**Fits:** Kobelco Loaders; Nissan Trucks  
**Replaces:** Kobelco 2451R131-1F; Nissan 15274-90225  
**O.D.:** 3 15/16 (100.0)  
**I.D.:** 5/8 (15.9) & 1 23/32 (43.7)  
**Height:** 7 9/16 (192.1)  
**A. Gskt:** [1] Attached  
**F. Gskt:** [3] Included

**B7121**

Dual-Flow Lube Spin-on



**Contains:** 14-16 PSID By-Pass Valve  
**Fits:** Kobelco Equipment; Mitsubishi Trucks  
**Replaces:** Kobelco 2446R-332D11; 2451U-3431  
**Thread:** M26 x 1.5  
**O.D.:** 4 1/4 (108.0)  
**Height:** 7 11/32 (186.5)  
**I.Gskt:** [1] Included

**B7113**

Full-Flow Lube Spin-on



**Contains:** Anti-Drainback Valve  
 30 PSID By-Pass Valve  
**Fits:** Pegaso Buses, Trucks  
**Replaces:** Pegaso 649092  
**Thread:** 1 1/8 -16  
**O.D.:** 4 1/4 (108.0)  
**Height:** 7 11/32 (186.5)  
**I.Gskt:** [1] Included

**B7124**

By-Pass Lube Spin-on



**Fits:** GMC, Hino, Isuzu Trucks  
**Replaces:** GMC 94054123; Hino 15607-1860; Isuzu 1-13240-089-0  
**Thread:** 5/8 -18  
**O.D.:** 4 1/4 (108.0)  
**Height:** 5 7/8 (149.2)  
**I.Gskt:** G401

**P7114**

Lube Element



**Fits:** BMW Automotive  
**Replaces:** BMW 11421267268, 11429063138  
**O.D.:** 3 3/16 (81.0)  
**I.D.:** 1 3/32 (27.8)  
**Height:** 5 3/32 (129.4)  
**A. Gskt:** [2] Attached  
**F. Gskt:** [4] Included

**B7125**

Full-Flow Lube Spin-on



**Contains:** 20 PSID By-Pass Valve  
**Fits:** Ditch Witch, John Deere, Lincoln Equipment; Atlas Copco, Ingersoll-Rand Compressors  
**Replaces:** Ingersoll-Rand 36881696; John Deere RE59754  
**Thread:** 1 1/2 -16  
**O.D.:** 3 11/16 (93.7)  
**Height:** 5 3/4 (146.0)  
**I.Gskt:** [1] Included

**B7116**

Lube Spin-on



**Contains:** 30 PSID By-Pass Valve  
**Fits:** M.A.N. Trucks  
**Replaces:** M.A.N. 51.05501.7160, 51.05501.7161, 51.05501.7165  
**Thread:** M30 x 2.0  
**O.D.:** 4 1/4 (108.0)  
**Height:** 7 13/32 (188.1)  
**I.Gskt:** [1] Included

**P7126**

Lube Element with Handle



**Contains:** Reinforced Centertube  
**Fits:** Hitachi Equipment  
**Replaces:** Hitachi 4225367  
**Thread:** M16 x 2.0  
**O.D.:** 6 1/2 (165.1)  
**Height:** 11 15/16 (303.2)  
**F. Gskt:** [3] Included

**B7117**

Lube Spin-on



**Replaces:** Mann & Hummel W940/34  
**Thread:** 1 -16  
**O.D.:** 3 11/16 (93.7)  
**Height:** 5 3/8 (136.5)  
**I.Gskt:** G381-A

**P7127**

Lube Element



**Fits:** Hino Equipment, Trucks  
**Replaces:** Hino 15607-1010, 15607-1010A, 15607-1011  
**O.D.:** 4 27/32 (123.0)  
**I.D.:** 21/32 (16.7)  
**Height:** 8 7/8 (225.4)  
**F. Gskt:** [5] Included

**B7119**

Full-Flow Lube Spin-on



**Contains:** Anti-Drainback Valve  
 16 PSID By-Pass Valve  
**Fits:** Allis Chalmers, Massey Ferguson Tractors  
**Replaces:** Allis Chalmers 2100723; Massey Ferguson 3283341-M1  
**Thread:** 3/4 -16  
**O.D.:** 3 1/4 (82.6)  
**Height:** 3 5/32 (80.2)  
**I.Gskt:** [1] Included

**B7128**

Lube Spin-on



**Contains:** Anti-Drainback Valve  
 50 PSID By-Pass Valve  
**Fits:** Fendt, Renault Tractors; Sullair Compressors  
**Replaces:** Mann & Hummel W930  
**Thread:** 3/4 -16  
**O.D.:** 3 11/16 (93.7)  
**Height:** 4 7/16 (112.7)  
**I.Gskt:** G401

**V7129-C**

Cotton/Sisal Lube Sock



**Replaces:** Nelson 82620D; Winslow CP3245-T0  
**O.D.:** 4 3/8 (111.1)  
**I.D.:** 1 5/32 (29.4)  
**Height:** 31 1/4 (793.8)

Measurements Are Shown In Inches And (Millimeters)

**WARNING:** These products can expose you to chemicals, including Diisononyl Phthalate, Carbon black extracts, Nickel, 1,3 Butadiene, Ethylene Oxide, Epichlorohydrin, which are known to the State of California to cause cancer, and Bisphenol, Ethylene Glycol, Ethylene Oxide, 1,3 Butadiene, Epichlorohydrin, which are known to the State of California to cause birth defects or other reproductive harm.



**B7130** Lube Spin-on  
**Contains:** 14 PSID By-Pass Valve  
**Fits:** Gehl, TCM Loaders  
**Replaces:** Gehl 127389; TCM 20801-01261  
**Thread:** 1 -12  
**O.D.:** 4 1/4 (108.0)  
**Height:** 5 13/16 (147.6)  
**I.Gskt:** [1] Included



**B7131** Lube Spin-on  
**Contains:** Anti-Drainback Valve  
 30 PSID By-Pass Valve  
**Fits:** Caterpillar Lift Trucks; Mitsubishi  
 Engines  
**Replaces:** Caterpillar 103-9737; Wako  
 32A4000100  
**Thread:** 1 -12  
**O.D.:** 4 1/4 (108.0)  
**Height:** 4 1/32 (102.4)  
**I.Gskt:** [1] Included



**P7132** Lube Element  
**Contains:** 60 PSID By-Pass Valve  
**Fits:** Honda ATVs, Motorcycles  
**Replaces:** Honda 15410-KF0-315,  
 15412-KF0-000  
**O.D.:** 1 31/32 (50.0)  
**I.D.:** 15/32 (11.9) One End  
**Height:** 1 7/16 (36.5)  
**A. Gskt:** [1] Attached  
**F. Gskt:** [1] Included



**P7134** Power Steering Element  
**Notes:** Inside-Out Flow Direction  
**Fits:** International Buses, Trucks  
**Replaces:** International 1653998-C91  
**O.D.:** 2 15/32 (62.7)  
**I.D.:** 1 3/32 (27.8)  
**Height:** 3 9/16 (90.5)  
**F. Gskt:** [8] Included



**B7135** Full-Flow Lube Spin-on  
**Fits:** Detroit Diesel Engines  
**Replaces:** GMC 23550401  
**Thread:** M45 x 1.5  
**O.D.:** 5 3/8 (136.5)  
**Height:** 12 3/32 (307.2)  
**I.Gskt:** [1] Included



**P7136** Lube Element  
**Fits:** Audi, Volkswagen Automotive  
**Replaces:** GMC 25313731; Volkswagen  
 21115561B, 21115562A  
**O.D.:** 3 1/4 (82.6)  
**I.D.:** 15/16 (23.8) & 1 9/16 (39.7)  
**Height:** 4 11/32 (110.3)  
**A. Gskt:** [2] Attached  
**O-Ring:** [1] Included



**P7137** Lube Element  
**Fits:** BMW Automotive  
**Replaces:** BMW 11421745390, 11421745391  
**O.D.:** 3 1/4 (82.6)  
**I.D.:** 1 1/32 (26.2) & 1 9/16 (39.7)  
**Height:** 6 3/8 (161.9)  
**A. Gskt:** [1] Attached  
**F. Gskt:** [1] Metal Washer  
**O-Ring:** [1] Included



**P7138** Lube Element  
**Fits:** BMW Automotive  
**Replaces:** BMW 11421427908, 11421740534  
**O.D.:** 3 1/4 (82.6)  
**I.D.:** 1 9/16 (39.7)  
**Height:** 4 1/8 (104.8)  
**A. Gskt:** [2] Attached  
**F. Gskt:** [1] Metal Washer  
**O-Ring:** [1] Included



**B7139** Full-Flow Lube Spin-on  
**Contains:** Anti-Drainback Valve  
 30 PSID By-Pass Valve  
**Fits:** Carrier-Transcold Refrigeration Units;  
 Massey Ferguson Tractors  
**Replaces:** Agco 72118856, 74920158; Carrier  
 941172, 25-34602-00; Massey Ferguson  
 3281019-M1, 3435171-M1  
**Thread:** 3/4 -16  
**O.D.:** 3 1/32 (77.0)  
**Height:** 4 3/32 (104.0)  
**I.Gskt:** [1] Included



**BD7141** Dual-Flow Lube Spin-on  
**Replaces:** Isuzu 8-94396-375-4  
**Thread:** 1 1/2 -12  
**O.D.:** 4 21/32 (118.3)  
**Height:** 8 3/32 (205.6)  
**I.Gskt:** [1] Included



**B7142** Full-Flow Lube Spin-on  
**Contains:** 20 PSID By-Pass Valve  
**Replaces:** Hyster 1313454; Perkins CV2473  
**Thread:** M30 x 1.5  
**O.D.:** 4 1/4 (108.0)  
**Height:** 7 9/16 (192.1)  
**I.Gskt:** [1] Included



**B7143** Full-Flow Lube Spin-on  
**Contains:** 50 PSID By-Pass Valve  
**Fits:** Atlas Copco, Kaeser Compressors  
**Replaces:** Kaeser 6-1981, 6-1981-0,  
 6-1981-0/A1  
**Thread:** 1 -12  
**O.D.:** 3 11/16 (93.7)  
**Height:** 8 1/8 (206.4)  
**I.Gskt:** G381-A



Measurements Are Shown In Inches And (Millimeters)

**WARNING:** These products can expose you to chemicals, including Diisononyl Phthalate, Carbon black extracts, Nickel, 1,3 Butadiene, Ethylene Oxide, Epichlorohydrin, which are known to the State of California to cause cancer, and Bisphenol, Ethylene Glycol, Ethylene Oxide, 1,3 Butadiene, Epichlorohydrin, which are known to the State of California to cause birth defects or other reproductive harm.

**B7144**

Lube Spin-on



**Contains:** Anti-Drainback Valve  
14 PSID By-Pass Valve  
**Fits:** Case, Hitachi, Kobelco, Link-Belt, Massey Ferguson, Mitsubishi Equipment; Isuzu Engines  
**Replaces:** Hitachi 4183853; Isuzu 8-94321-219-1; Kobelco 2451U309-1; Link-Belt KNH0324  
**Thread:** 1 -12  
**O.D.:** 4 1/4 (108.0)  
**Height:** 5 27/32 (148.4)  
**I.Gskt:** [1] Included

**B7155**

Lube Spin-on



**Fits:** Hino Trucks  
**Replaces:** Hino 15607-2050  
**Thread:** 1 1/2 -16  
**O.D.:** 4 21/32 (118.3)  
**Height:** 8 1/8 (206.4)  
**I.Gskt:** [1] Included

**P7145**

Lube Element



**Fits:** Deutz Engines; Deutz Tractors; M.A.N. Engines, Trucks  
**Replaces:** M.A.N. 51.055040.096; Renault 5001846993  
**O.D.:** 3 9/32 (83.3)  
**I.D.:** 1 5/8 (41.3) One End  
**Height:** 8 13/32 (213.5)  
**A. Gskt:** [1] Attached  
**O-Ring:** [1] Included

**B7156**

Lube Spin-on



**Contains:** Anti-Drainback Valve  
40 PSID By-Pass Valve  
**Fits:** Hatz Diesel Engines; Renault Tractors  
**Replaces:** Hatz 40065300  
**Thread:** 3/4 -16  
**O.D.:** 3 11/16 (93.7)  
**Height:** 5 3/8 (136.5)  
**I.Gskt:** G381-A

**B7151**

Lube Spin-on



**Contains:** 40 PSID By-Pass Valve  
**Fits:** DAF Trucks  
**Replaces:** DAF 1306549  
**Thread:** 1 -12  
**O.D.:** 4 1/4 (108.0)  
**Height:** 9 1/8 (231.8)  
**I.Gskt:** G401

**B7157**

Lube Spin-on



**Contains:** Anti-Drainback Valve  
35 PSID By-Pass Valve  
**Fits:** MWM Engines  
**Replaces:** MWM 605412970039  
**Thread:** 1 1/2 -16  
**O.D.:** 5 3/8 (136.5)  
**Height:** 12 3/32 (307.2)  
**I.Gskt:** [1] Included

**B7152**

Lube Spin-on



**Contains:** Anti-Drainback Valve  
20 PSID By-Pass Valve  
**Fits:** Case, Hitachi, Kubota Equipment  
**Replaces:** Kubota 17321-32430  
**Thread:** 3/4 -16  
**O.D.:** 3 11/16 (93.7)  
**Height:** 3 1/4 (82.6)  
**I.Gskt:** G381-A

**BD7158**

Dual-Flow Lube Spin-on



**Contains:** Integral Post Seal  
25-31 PSID By-Pass Valve  
**Fits:** Caterpillar Excavators, Industrial Engines  
**Replaces:** Caterpillar 517950, 517950X  
**Thread:** M32 x 1.5  
**O.D.:** 4 1/4 (108.0)  
**Height:** 8 25/32 (223.0)  
**I.Gskt:** [1] Included

**BD7153**

High Velocity Dual-Flow Lube Spin-on



**Contains:** Venturi-Type Cone  
**Fits:** Cummins Engines  
**Replaces:** Cummins 3406810, 340681000; Fleetguard LF9070  
**Thread:** M95 x 2.5  
**O.D.:** 4 21/32 (118.3)  
**Height:** 14 7/32 (361.2)  
**I.Gskt:** [1] Included  
**Related To:** BD7154 (Short Version)

**BD7159**

Dual-Flow Lube Spin-on



**Contains:** 40 PSID By-Pass Valve  
**Fits:** Isuzu Engines, Trucks  
**Replaces:** Isuzu 8-94338-181-0, 8-94338-181-1, 8-97096-777-0  
**Thread:** 1 1/2 -12  
**O.D.:** 4 21/32 (118.3)  
**Height:** 4 15/16 (125.4)  
**I.Gskt:** [1] Included

**BD7154**

High Velocity Dual-Flow Lube Spin-on



**Contains:** Venturi-Type Cone  
**Fits:** Cummins Engines  
**Replaces:** Cummins 3406809; Fleetguard LF9001  
**Thread:** M95 x 2.5  
**O.D.:** 4 21/32 (118.3)  
**Height:** 11 25/32 (299.2)  
**I.Gskt:** [1] Included  
**Related To:** BD7153 (Long Version)  
BD7509 (Vamac Gasket)  
BD50000 (High Efficiency Version)

**BD7160**

Dual-Flow Lube Spin-on



**Contains:** 11-17 PSID By-Pass Valve  
**Replaces:** GMC 94360427; Isuzu 8-94360-427-1, 8-97021-576-0; Mazda RFT1-1A-302, RYF0-14-302; Mitsubishi MD336080; Nissan 15208-HC200, 15208-89TA0  
**Thread:** M26 x 1.5  
**O.D.:** 3 17/32 (89.7)  
**Height:** 4 15/16 (125.4)  
**I.Gskt:** [1] Included  
**O-Ring:** [3] Included

Measurements Are Shown In Inches And (Millimeters)

**WARNING:** These products can expose you to chemicals, including Diisononyl Phthalate, Carbon black extracts, Nickel, 1,3 Butadiene, Ethylene Oxide, Epichlorohydrin, which are known to the State of California to cause cancer, and Bisphenol, Ethylene Glycol, Ethylene Oxide, 1,3 Butadiene, Epichlorohydrin, which are known to the State of California to cause birth defects or other reproductive harm.

**B7161** Lube Spin-on  
**Contains:** 35 PSID By-Pass Valve  
 Hex nut for removal  
**Fits:** DAF Trucks  
**Replaces:** DAF 1331057, 1345332  
**Thread:** M42 x 2.0  
**O.D.:** 5 3/8 (136.5)  
**Height:** 8 7/8 (225.4)  
**I.Gskt:** [1] Included



**B7167** Lube Spin-on  
**Contains:** Anti-Drainback Valve  
 20 PSID By-Pass Valve  
**Fits:** Bobcat Loaders; Citroen, Peugeot Trucks; Suzuki Automotive  
**Replaces:** Melroe-Bobcat 6661011  
**Thread:** M20 x 1.5  
**O.D.:** 3 1/32 (77.0)  
**Height:** 3 1/2 (88.9)  
**I.Gskt:** G449-B



**B7162** Lube Spin-on  
**Contains:** 35 PSID By-Pass Valve  
 Hex nut for removal  
**Fits:** DAF Engines, Trucks  
**Replaces:** DAF 1310901  
**Thread:** M42 x 2.0  
**O.D.:** 5 3/8 (136.5)  
**Height:** 12 3/8 (314.3)  
**I.Gskt:** [1] Included



**BD7168** Dual-Flow Lube Spin-on  
**Contains:** Anti-Drainback Valve  
 23 PSID By-Pass Valve  
**Fits:** Iveco Trucks  
**Replaces:** Iveco 1905704, 1907571  
**Thread:** M30 x 2.0  
**O.D.:** 4 5/16 (109.5)  
**Height:** 10 3/8 (263.5)  
**I.Gskt:** [1] Included  
**F. Gskt:** [1] Included



**B7163** Lube Spin-on  
**Contains:** 35 PSID By-Pass Valve  
**Replaces:** Atlas Copco 1202-8040-00  
**Thread:** M20 x 1.5  
**O.D.:** 3 23/32 (94.5)  
**Height:** 8 3/32 (205.6)  
**I.Gskt:** [1] Included



**BD7169** Dual-Flow Lube Spin-on  
**Contains:** 19 PSID By-Pass Valve  
**Fits:** GMC, Isuzu Buses, Trucks  
**Replaces:** GMC 97148270; Isuzu 2-90654-800-0, 8-97148-270-0  
**Thread:** 1 1/2 -12  
**O.D.:** 4 21/32 (118.3)  
**Height:** 4 15/16 (125.4)  
**I.Gskt:** [1] Included



**B7164** By-Pass Lube Spin-on  
**Fits:** Hitachi, Kobelco Excavators; Isuzu Engines  
**Replaces:** Hitachi 4285642; Isuzu 8-97026-134-2  
**Thread:** M20 x 1.5  
**O.D.:** 4 1/4 (108.0)  
**Height:** 7 5/8 (193.7)  
**I.Gskt:** [1] Included



**B7170** Lube Spin-on  
**Contains:** Anti-Drainback Valve  
 2 PSID Front-End Check Valve  
 50 PSID By-Pass Valve  
**Fits:** John Deere, Liebherr Equipment  
**Replaces:** Liebherr 5700043, 570004323  
**Thread:** 1 -12  
**O.D.:** 3 11/16 (93.7)  
**Height:** 8 1/8 (206.4)  
**I.Gskt:** G381-A



**B7165** Lube Spin-on  
**Contains:** Anti-Drainback Valve  
 8 PSID Front End By-Pass Valve  
**Fits:** Ariens, Bush Hog, Cub Cadet, Gravely, Husqvarna, John Deere, Snapper, White Lawn & Garden Tractors; Briggs & Stratton Engines  
**Replaces:** Briggs & Stratton 492932  
**Thread:** 3/4 -16  
**O.D.:** 3 1/32 (77.0)  
**Height:** 2 5/16 (58.7)  
**I.Gskt:** G449-B



**B7171** Lube Spin-on  
**Contains:** Anti-Drainback Valve  
 Front End Check Valve  
 35 PSID By-Pass Valve  
**Fits:** Liebherr Equipment  
**Replaces:** Liebherr 7381111, 738111123  
**Thread:** M30 x 2.0  
**O.D.:** 4 1/4 (108.0)  
**Height:** 9 1/8 (231.8)  
**I.Gskt:** [1] Included



**BD7166** Dual-Flow Lube Spin-on  
**Contains:** 15 PSID By-Pass Valve  
**Fits:** GMC Trucks; Isuzu Engines  
**Replaces:** GMC 97719921; Isuzu 2-90654-600-0, 8-97049-282-0  
**Thread:** 1 1/2 -12  
**O.D.:** 4 21/32 (118.3)  
**Height:** 8 1/16 (204.8)  
**I.Gskt:** [1] Included



**B7172** Lube Spin-on  
**Contains:** Anti-Drainback Valve  
 20 PSID By-Pass Valve  
**Fits:** Perkins Engines  
**Replaces:** Perkins 140516990  
**Thread:** 3/4 -16  
**O.D.:** 3 1/32 (77.0)  
**Height:** 4 3/32 (104.0)  
**I.Gskt:** [1] Included



**BC7173** Centrifugal By-Pass Lube Element  
**Fits:** Mack, R.V.I. Engines  
**Replaces:** Mack 57GC2187, 236GB245M  
**O.D.:** 3 27/32 (97.6)  
**I.D.:** 3/8 (9.5) & 1/2 (12.7)  
**Height:** 4 1/2 (114.3)  
**F. Gskt:** [1] Included



Measurements Are Shown In Inches And (Millimeters)

**WARNING:** These products can expose you to chemicals, including Diisononyl Phthalate, Carbon black extracts, Nickel, 1,3 Butadiene, Ethylene Oxide, Epichlorohydrin, which are known to the State of California to cause cancer, and Bisphenol, Ethylene Glycol, Ethylene Oxide, 1,3 Butadiene, Epichlorohydrin, which are known to the State of California to cause birth defects or other reproductive harm.

**B7174-MPG** Maximum Performance Glass Lube Spin-on  
**Fits:** Case Dump Trucks; Case-IH Harvesters, Tractors; Iveco Engines, Trucks; New Holland Combines, Forage Harvesters, Tractors; Winpower Generators  
**Replaces:** Iveco 99445200  
**Thread:** M30 x 2.0  
**O.D.:** 4 1/4 (108.0)  
**Height:** 9 1/8 (231.8)  
**I.Gskt:** [1] Included



**B7180** Lube Spin-on  
**Notes:** For Vertical Installation Only.  
**Contains:** 35 PSID By-Pass Valve  
**Fits:** Atlas Copco Mining Trucks; Coleman Generators; Detroit Diesel Engines; Hitachi, Terex, Unit Rig Dump Trucks; LeTourneau Loaders; MTU Diesel Engines  
**Replaces:** Detroit Diesel 23526919  
**Thread:** 1 1/2 -16  
**O.D.:** 5 3/8 (136.5)  
**Height:** 12 3/32 (307.2)  
**I.Gskt:** [1] Included



**B7175** Lube Spin-on  
**Fits:** Detroit Diesel Engines  
**Replaces:** Detroit Diesel 23540000  
**Thread:** M45 x 1.5  
**O.D.:** 5 3/8 (136.5)  
**Height:** 12 3/32 (307.2)  
**I.Gskt:** [1] Included



**B7181** Lube Spin-on  
**Contains:** Anti-Drainback Valve  
**Fits:** Daewoo, Komatsu Equipment  
**Replaces:** Daewoo 65055105015  
**Thread:** 1 -16  
**O.D.:** 3 11/16 (93.7)  
**Height:** 7 1/8 (181.0)  
**I.Gskt:** G381-A



**BD7176** High Velocity Dual-Flow Lube Spin-on  
**Contains:** Venturi-Type Cone  
**Fits:** Cummins Engines  
**Replaces:** Cummins 4016657; Fleetguard LF9050  
**Thread:** M90 x 2.0  
**O.D.:** 4 23/32 (119.9)  
**Height:** 11 5/8 (295.3)  
**I.Gskt:** [1] Included



**B7182** Lube Spin-on  
**Contains:** 35 PSID By-Pass Valve  
**Fits:** DAF Trucks  
**Replaces:** DAF 1316123, 1346986, 267715  
**Thread:** 1 1/2 -16  
**O.D.:** 5 3/8 (136.5)  
**Height:** 8 7/8 (225.4)  
**I.Gskt:** [1] Included  
**Related To:** B7187 (Long Version)



**B7177** Lube Spin-on  
**Fits:** Equipment, Motor Homes and Trucks with Cummins ISB 5.9L, QSB 5.9L Engines  
**Replaces:** Cummins 3937144  
**Thread:** 1 1/8 -16  
**O.D.:** 3 11/16 (93.7)  
**Height:** 7 3/16 (182.6)  
**I.Gskt:** G401



**P7183** Lube Element  
**Fits:** Railroad Applications  
**Replaces:** Clark C52; GE 2X4223, 41C615890  
**O.D.:** 6 13/32 (162.7)  
**I.D.:** 1 15/32 (37.3) One End  
**Height:** 30 3/32 (764.4)  
**I.Gskt:** [1] Included  
**A. Gskt:** [1] Attached

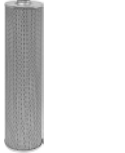

**P7178** Power Steering Element  
**Notes:** Inside-Out Flow Direction  
**Contains:** 14 PSID By-Pass Valve  
**Fits:** International Trucks  
**Replaces:** International 1696766-C1  
**O.D.:** 2 3/4 (69.9)  
**I.D.:** 7/16 (11.1) One End  
**Height:** 3 (76.2)  
**Grommets:** [1] Attached



**P7185** By-Pass Lube Element  
**Fits:** Hino Trucks  
**Replaces:** Hino 15607-1210, 15607-1340, 15607-2160; Donaldson P502191; Fleetguard LF3709  
**O.D.:** 4 25/32 (121.4)  
**I.D.:** 29/32 (23.0)  
**Height:** 9 3/4 (247.7)  
**F. Gskt:** [2] Included  
**O-Ring:** [2] Included  
**Grommets:** [1] Included



**B7179** Lube Spin-on  
**Contains:** Anti-Drainback Valve  
**20 PSID By-Pass Valve**  
**Fits:** Agco, Case, Massey Ferguson, Valtra, Valmet Equipment  
**Replaces:** Agco 836647133  
**Thread:** M24 x 1.5  
**O.D.:** 4 1/4 (108.0)  
**Height:** 5 27/32 (148.4)  
**I.Gskt:** G401



**BC7186 KIT** Paper Insert  
**Notes:** Paper insert for Spinner II Models 36/60/66/76/96  
**Fits:** Peterbilt Trucks  
**Replaces:** Spinner II 70669, 71429  
**Length:** 15 5/32 (385.0)  
**Width:** 2 1/2 (63.5)  
**O-Ring:** [2] Included



Measurements Are Shown In Inches And (Millimeters)

**WARNING:** These products can expose you to chemicals, including Diisononyl Phthalate, Carbon black extracts, Nickel, 1,3 Butadiene, Ethylene Oxide, Epichlorohydrin, which are known to the State of California to cause cancer, and Bisphenol, Ethylene Glycol, Ethylene Oxide, 1,3 Butadiene, Epichlorohydrin, which are known to the State of California to cause birth defects or other reproductive harm.

**B7187**

Lube Spin-on



**Contains:** 35 PSID By-Pass Valve  
**Fits:** DAF Trucks  
**Replaces:** DAF 267714  
**Thread:** 1 1/2 -16  
**O.D.:** 5 3/8 (136.5)  
**Height:** 12 3/8 (314.3)  
**I.Gskt:** [1] Included  
**Related To:** B7182 (Short Version)

**P7193**

Lube Element



**Notes:** Uses 4 filters per application.  
**Fits:** Superior Compressors with Natural Gas Engines  
**Replaces:** Superior 870078A  
**O.D.:** 6 1/32 (153.2)  
**I.D.:** 5/8 (15.9) & 2 (50.8)  
**Height:** 11 13/32 (289.7)  
**A. Gskt:** [1] Attached  
**F. Gskt:** [1] Included  
**Grommets:** [1] Attached

**P7188**

Lube Element



**Fits:** Equipment, Trucks with Deutz, Mercedes-Benz Engines; Fendt Tractors  
**Replaces:** Deutz 2931095, 4252248; Mercedes-Benz 1801709, 9061800009, A0001801709  
**O.D.:** 3 9/32 (83.3)  
**I.D.:** 3/8 (9.5) & 1 9/16 (39.7)  
**Height:** 8 3/8 (212.7)  
**O-Ring:** [1] Included  
**End Seals:** [1] Attached

**BC7194**

Centrifugal By-Pass Lube Element



**Fits:** DAF Trucks  
**Replaces:** DAF 1310891, 1376481  
**O.D.:** 3 27/32 (97.6)  
**I.D.:** 9/16 (14.3)  
**Height:** 4 1/2 (114.3)  
**F. Gskt:** [1] Included  
**O-Ring:** [1] Included

**B7189**

Lube Spin-on



**Contains:** Anti-Drainback Valve  
 20 PSID By-Pass Valve  
**Fits:** MDI/Yutani Equipment; Mitsubishi Engines, Trucks  
**Replaces:** Mitsubishi ME014833  
**Thread:** M20 x 1.5  
**O.D.:** 4 1/4 (108.0)  
**Height:** 4 3/4 (120.7)  
**I.Gskt:** [1] Included

**P7195**

Lube Element



**Fits:** Komatsu Dump Trucks, Engines  
**Replaces:** Komatsu 6128-51-5030  
**O.D.:** 6 5/16 (160.3)  
**I.D.:** 7/8 (22.2)  
**Height:** 15 (381.0)  
**O-Ring:** [2] Included

**P7190**

Lube Element

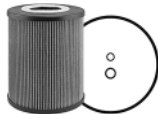

**Fits:** M.A.N. Engines, Trucks  
**Replaces:** M.A.N. 51.055040.098  
**O.D.:** 4 3/4 (120.7)  
**I.D.:** 2 7/32 (56.4)  
**Height:** 5 27/32 (148.4)  
**A. Gskt:** [2] Attached  
**O-Ring:** [3] Included

**P7196**

Lube Element

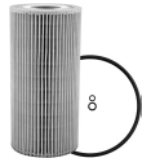

**Fits:** Fendt Tractors; M.A.N. Trucks; Mercedes-Benz Automotive, Engines  
**Replaces:** Mercedes-Benz 6021800009, 8021840025; Renault 6005019830  
**O.D.:** 3 1/4 (82.6)  
**I.D.:** 1 7/16 (36.5)  
**Height:** 6 31/32 (177.0)  
**O-Ring:** [3] Included  
**Grommets:** [2] Attached

**B7191**

Lube Spin-on



**Contains:** Anti-Drainback Valve  
 30 PSID By-Pass Valve  
 Standpipe  
**Replaces:** Waukesha 304126  
**Thread:** 1 1/8 -16  
**O.D.:** 4 1/4 (108.0)  
**Height:** 10 7/16 (265.1)  
**I.Gskt:** [1] Included

**B7197**

Lube Spin-on



**Contains:** Anti-Drainback Valve  
 14 PSID By-Pass Valve  
**Fits:** Ingersoll-Rand Compressors, Engines  
**Replaces:** Ingersoll-Rand 54381314; Fleetguard LF3983  
**Thread:** M20 x 1.5  
**O.D.:** 3 11/16 (93.7)  
**Height:** 3 27/32 (97.6)  
**I.Gskt:** [1] Included

**P7192**

Lube Element



**Fits:** Demag, Grove Equipment; Mercedes-Benz Engines, Trucks, Vans  
**Replaces:** Mercedes-Benz 5411800009, 5411240225; Renault 5001846632  
**O.D.:** 4 21/32 (118.3)  
**I.D.:** 2 1/8 (54.0) One End  
**Height:** 12 1/4 (311.2)  
**O-Ring:** [2] Included

**P7199**













Lube Element



**Fits:** Buses, Trucks with Mercedes-Benz Engines  
**Replaces:** Mercedes-Benz 1801609, A0001801609; Fleetguard LF3827  
**O.D.:** 3 9/32 (83.3)  
**I.D.:** 3/8 (9.5) & 1 9/16 (39.7)  
**Height:** 5 15/16 (150.8)  
**A. Gskt:** [1] Attached  
**O-Ring:** [1] Included

Measurements Are Shown In Inches And (Millimeters)

**WARNING:** These products can expose you to chemicals, including Diisononyl Phthalate, Carbon black extracts, Nickel, 1,3 Butadiene, Ethylene Oxide, Epichlorohydrin, which are known to the State of California to cause cancer, and Bisphenol, Ethylene Glycol, Ethylene Oxide, 1,3 Butadiene, Epichlorohydrin, which are known to the State of California to cause birth defects or other reproductive harm.

<p><b>B7215</b> Lube Spin-on</p>  <p><b>Contains:</b> 20 PSID By-Pass Valve  <b>Fits:</b> Case-International, New Holland Equipment  <b>Replaces:</b> New Holland 86605897  <b>Thread:</b> 1 -12  <b>O.D.:</b> 3 11/16 (93.7)  <b>Height:</b> 6 5/8 (168.3)  <b>I.Gskt:</b> G381-A</p>	<p><b>B7222</b> Lube Spin-on</p>  <p><b>Contains:</b> Anti-Drainback Valve          20 PSID By-Pass Valve  <b>Fits:</b> Lincoln Ranger 8 Welder with Ruggerini Diesel Engine; Lister-Petter Industrial, Marine Engines  <b>Replaces:</b> Ruggerini 17524; Fleetguard LF3826  <b>Thread:</b> 3/4 -16  <b>O.D.:</b> 3 1/16 (77.8)  <b>Height:</b> 2 11/32 (59.5)  <b>I.Gskt:</b> G449-B</p>
<p><b>B7216</b> Lube Spin-on</p>  <p><b>Contains:</b> Anti-Drainback Valve          30 PSID By-Pass Valve  <b>Fits:</b> John Deere Mowers, Tractors all with Yanmar Engines  <b>Replaces:</b> John Deere M806419  <b>Thread:</b> M20 x 1.5  <b>O.D.:</b> 3 (76.2)  <b>Height:</b> 2 27/32 (72.2)  <b>I.Gskt:</b> [1] Included</p>	<p><b>B7223</b> Lube Spin-on</p>  <p><b>Contains:</b> 30 PSID By-Pass Valve  <b>Fits:</b> Komatsu Equipment  <b>Replaces:</b> Komatsu 6136-51-5120, 6136-51-5121  <b>Thread:</b> 1 1/8 -16  <b>O.D.:</b> 4 1/4 (108.0)  <b>Height:</b> 5 27/32 (148.4)  <b>I.Gskt:</b> [1] Included</p>
<p><b>B7217</b> Lube Spin-on</p>  <p><b>Contains:</b> 20 PSID By-Pass Valve  <b>Fits:</b> Hitachi, John Deere, Link-Belt Excavators  <b>Replaces:</b> Hitachi 4448336  <b>Thread:</b> 1 1/2 -12  <b>O.D.:</b> 4 21/32 (118.3)  <b>Height:</b> 8 3/32 (205.6)  <b>I.Gskt:</b> [1] Included</p>	<p><b>B7224</b> Lube Spin-on</p>  <p><b>Contains:</b> 35 PSID By-Pass Valve  <b>Fits:</b> DAF Trucks  <b>Replaces:</b> DAF 1327672  <b>Thread:</b> M42 x 2.0  <b>O.D.:</b> 5 3/8 (136.5)  <b>Height:</b> 12 3/8 (314.3)  <b>I.Gskt:</b> [1] Included</p>
<p><b>B7219</b> Lube Spin-on</p>  <p><b>Contains:</b> Anti-Drainback Valve          30 PSID By-Pass Valve          2 PSID Front-End Check Valve  <b>Fits:</b> New Holland Tractors  <b>Replaces:</b> New Holland 1931018  <b>Thread:</b> 3/4 -16  <b>O.D.:</b> 4 1/4 (108.0)  <b>Height:</b> 4 3/8 (111.1)  <b>A. Gskt:</b> G381-A</p>	<p><b>B7225</b> Full-Flow Lube Spin-on</p>  <p><b>Notes:</b> Uses 2 filters per application.  <b>Fits:</b> Mack Trucks  <b>Replaces:</b> Mack 485GB3232, 485GB3236  <b>Thread:</b> 1 1/8 -16  <b>O.D.:</b> 4 1/4 (108.0)  <b>Height:</b> 10 7/16 (265.1)  <b>I.Gskt:</b> [1] Included  <b>Related To:</b> B76 (Media Difference)</p>
<p><b>B7220</b> Lube Spin-on</p>  <p><b>Contains:</b> Anti-Drainback Valve          30 PSID By-Pass Valve  <b>Fits:</b> Komatsu Equipment  <b>Replaces:</b> Komatsu 600-211-6240, 600-211-6242  <b>Thread:</b> 1 -12  <b>O.D.:</b> 3 11/16 (93.7)  <b>Height:</b> 3 1/4 (82.6)  <b>I.Gskt:</b> G381-A</p>	<p><b>B7227</b> Lube Spin-on</p>  <p><b>Fits:</b> R.V.I. Trucks  <b>Replaces:</b> Renault 5010240400, 5010295195, 5010295196  <b>Thread:</b> 1 1/8 -16  <b>O.D.:</b> 4 1/4 (108.0)  <b>Height:</b> 7 3/8 (187.3)  <b>I.Gskt:</b> [1] Included</p>
<p><b>B7221</b> Lube Spin-on</p>  <p><b>Contains:</b> Anti-Drainback Valve          8 PSID Front-End By-Pass Valve  <b>Fits:</b> Equipment Using Lister-Petter LPA3A Engine  <b>Replaces:</b> Lister 751-10620  <b>Thread:</b> 3/4 -16  <b>O.D.:</b> 3 11/16 (93.7)  <b>Height:</b> 2 9/16 (65.1)  <b>I.Gskt:</b> G381-A</p>	<p><b>BC7228</b> Centrifugal By-Pass Lube Element</p>  <p><b>Fits:</b> Mack Engines  <b>Replaces:</b> Mack 57GC2206, 236GB41M  <b>O.D.:</b> 3 27/32 (97.6)  <b>I.D.:</b> 1/2 (12.7) &amp; 5/8 (15.9)  <b>Height:</b> 7 (177.8)  <b>F. Gskt:</b> [1] Included</p>

Measurements Are Shown In Inches And (Millimeters)

**WARNING:** These products can expose you to chemicals, including Diisononyl Phthalate, Carbon black extracts, Nickel, 1,3 Butadiene, Ethylene Oxide, Epichlorohydrin, which are known to the State of California to cause cancer, and Bisphenol, Ethylene Glycol, Ethylene Oxide, 1,3 Butadiene, Epichlorohydrin, which are known to the State of California to cause birth defects or other reproductive harm.

**B7229**

Lube Spin-on



**Contains:** By-Pass Screen  
35 PSID By-Pass Valve  
**Fits:** Detroit Diesel 4000 Series Engines  
**Replaces:** Detroit Diesel 5241840301; Euclid E12980181; Donaldson P550512  
**Thread:** M36 x 1.5  
**O.D.:** 5 3/8 (136.5)  
**Height:** 12 3/32 (307.2)  
**I.Gskt:** [1] Included

**BT7237**

Lube Spin-on



**Fits:** Case, New Holland Equipment  
**Replaces:** Case 87803261; DAF 1399494; Iveco 504074043; New Holland 87803260  
**Thread:** M27 x 2.0  
**O.D.:** 3 11/16 (93.7)  
**Height:** 6 5/8 (168.3)  
**I.Gskt:** [1] Included

**P7230**

Lube Element



**Fits:** Freightliner, Sterling, Western Star Trucks; Mercedes-Benz Engines  
**Replaces:** Mercedes-Benz 1802109, 4571840125, A0001802109, A4571840125  
**O.D.:** 4 3/4 (120.7)  
**I.D.:** 9/16 (14.3) & 2 1/16 (52.4)  
**Height:** 10 15/32 (265.9)  
**A. Gskt:** [1] Attached  
**O-Ring:** [1] Included

**B7238**

Lube Spin-on



**Contains:** Anti-Drainback Valve  
14 PSID By-Pass Valve  
**Fits:** Onan Generators  
**Replaces:** Onan 122-0836  
**Thread:** 3/4 -16  
**O.D.:** 2 9/16 (65.1)  
**Height:** 4 3/4 (120.7)  
**I.Gskt:** [1] Included

**B7231**

Lube Spin-on



**Replaces:** E.M.D. 40058635; Clark TL3FSO  
**Thread:** 3/4 -16  
**O.D.:** 3 11/16 (93.7)  
**Height:** 7 1/8 (181.0)  
**I.Gskt:** G381-A

**B7239**

Lube Spin-on



**Contains:** Anti-Drainback Valve  
Integral Post Seal  
**Fits:** Daewoo Excavators  
**Replaces:** Daewoo 65-05510-5016  
**Thread:** 1 1/2 -12  
**O.D.:** 4 21/32 (118.3)  
**Height:** 8 3/32 (205.6)  
**I.Gskt:** [1] Included

**P7232**

Lube Element



**Fits:** DAF Trucks  
**Replaces:** DAF 1397764  
**O.D.:** 4 11/32 (110.3)  
**I.D.:** 2 1/4 (57.2)  
**Height:** 5 7/8 (149.2)  
**A. Gskt:** [2] Attached  
**O-Ring:** [1] Included

**B7240**

Lube Spin-on



**Contains:** Anti-Drainback Valve  
14 PSID By-Pass Valve  
**Fits:** Kubota Equipment  
**Replaces:** Kubota 70000-74035  
**Thread:** 3/4 -16  
**O.D.:** 3 11/16 (93.7)  
**Height:** 3 1/4 (82.6)  
**I.Gskt:** G401

**P7233**

Lube Element



**Fits:** John Deere Engines, Equipment  
**Replaces:** John Deere RE509672; Fleetguard LF16043  
**O.D.:** 4 3/4 (120.7)  
**I.D.:** 5/8 (15.9) & 2 1/16 (52.4)  
**Height:** 5 25/32 (146.8)  
**A. Gskt:** [1] Attached  
**O-Ring:** [1] Included

**B7241**

Lube Spin-on



**Contains:** Anti-Drainback Valve  
**Fits:** Daewoo Engines, Excavators  
**Replaces:** Daewoo 65055105017, 65055105020; Fleetguard LF3716  
**Thread:** 1 1/2 -12  
**O.D.:** 4 21/32 (118.3)  
**Height:** 9 15/16 (252.4)  
**I.Gskt:** [1] Included

**P7235**

Lube Element



**Fits:** Ford Light-Duty Trucks; International Engines  
**Replaces:** Ford 3C3Z-6731-AA; International 1840752-C91, 1844588-C91  
**O.D.:** 3 9/32 (83.3)  
**I.D.:** 3/8 (9.5) & 1 9/16 (39.7)  
**Height:** 6 11/16 (169.9)  
**O-Ring:** [1] Included  
**Related To:** P7436, P7437 (with Lid)

**BC7242**

Centrifugal By-Pass Lube Element



**Fits:** 8/19/03-on Mack ASET Engines S/N 300079-up, 11/11/03-on ASET AI, AMI Engines S/N 3V0313-up  
**Replaces:** Mack 57GC2231, 236GB42M  
**O.D.:** 3 27/32 (97.6)  
**I.D.:** 3/8 (9.5)  
**Height:** 7 (177.8)  
**F. Gskt:** [1] Included  
**O-Ring:** [1] Included

Measurements Are Shown In Inches And (Millimeters)

**WARNING:** These products can expose you to chemicals, including Diisononyl Phthalate, Carbon black extracts, Nickel, 1,3 Butadiene, Ethylene Oxide, Epichlorohydrin, which are known to the State of California to cause cancer, and Bisphenol, Ethylene Glycol, Ethylene Oxide, 1,3 Butadiene, Epichlorohydrin, which are known to the State of California to cause birth defects or other reproductive harm.

**B7243**

Lube Spin-on



**Contains:** Anti-Drainback Valve  
20 PSID By-Pass Valve  
**Fits:** Chrysler, Dodge, Hyundai, Kia, Mitsubishi Automotive, Light-Duty Trucks  
**Replaces:** Mitsubishi MD352626, MZ690116; Hyundai 26300-35500, 26300-35501  
**Thread:** M20 x 1.5  
**O.D.:** 3 1/32 (77.0)  
**Height:** 3 7/16 (87.3)  
**I.Gskt:** [1] Included

**B7245**

High Efficiency Lube Spin-on



**Fits:** Gas Compression Industry  
**Thread:** 1 1/2 -16  
**O.D.:** 5 3/8 (136.5)  
**Height:** 12 3/32 (307.2)  
**I.Gskt:** [1] Included

**B7246**

Lube Spin-on with Drain Plug



**Fits:** Hitachi Cranes, Excavators  
**Replaces:** Hitachi 4266385, 4430378; Fleetguard LF3603  
**Thread:** 1 3/8 -16  
**O.D.:** 4 29/32 (124.6)  
**Height:** 10 1/16 (255.6)  
**I.Gskt:** [1] Included

**P7247**

Transmission Filter



**Fits:** Ford Super Duty Pickups, E Series Vans  
**Replaces:** Ford 3C3Z-7B155-BA; Motorcraft FT145  
**O.D.:** 1 13/16 (46.0)  
**I.D.:** 3/8 (9.5)  
**Height:** 3 3/8 (85.7)  
**O-Ring:** [1] Included

**B7249-MPG**

Maximum Performance Glass Lube Spin-on



**Replaces:** Donaldson ELF7405; Fleetguard LF3566  
**Thread:** 1 1/2 -16  
**O.D.:** 5 3/8 (136.5)  
**Height:** 12 3/32 (307.2)  
**I.Gskt:** [1] Included  
**Related To:** B99, B99-MPG, B99-SS (Different Media)

**BD7250**

High Velocity Dual-Flow Lube Spin-on



**Contains:** Venturi-Type Cone  
**Fits:** International Engines, Trucks  
**Replaces:** International 1841606-C1, 1842639-C91; Donaldson P550656; Fleetguard LF9025  
**Thread:** M95 x 2.0  
**O.D.:** 4 21/32 (118.3)  
**Height:** 14 7/32 (361.2)  
**I.Gskt:** [1] Included  
**O-Ring:** [2] Viton Included

**BD7252**

High Velocity Dual-Flow Lube Spin-on



**Contains:** Venturi-Type Cone  
**Fits:** International Engines, Trucks  
**Replaces:** International 1842543-C1, 1842655-C91; Fleetguard LF90035  
**Thread:** M92 x 2.0  
**O.D.:** 4 21/32 (118.3)  
**Height:** 10 11/32 (262.7)  
**I.Gskt:** [1] Included  
**O-Ring:** [2] Included

**P7255**

Lube Element



**Replaces:** Ford XS7Q-6744-AA; Fleetguard LF16113; Woodgate WGL9206  
**O.D.:** 3 9/16 (90.5)  
**I.D.:** 1 11/32 (34.1)  
**Height:** 2 7/16 (61.9)

**P7256**

Lube Element



**Replaces:** Petter 393204; Woodgate WGL3456  
**O.D.:** 2 1/32 (51.6)  
**I.D.:** 29/32 (23.0)  
**Height:** 2 25/32 (70.6)  
**A. Gskt:** [2] Attached  
**F. Gskt:** [1] Included  
**O-Ring:** [1] Included

**P7259**

Lube Element



**Contains:** By-Pass Valve  
**Fits:** Hatz Engines  
**Replaces:** Hatz 3795700; Fleetguard LF3794; Woodgate WGL9104  
**O.D.:** 1 21/32 (42.1)  
**I.D.:** 1/2 (12.7) One End  
**Height:** 2 17/32 (64.3)  
**Grommets:** [1] Attached

**P7260**

Lube Element



**Replaces:** Robin 2286430101; Woodgate WGL9121  
**O.D.:** 1 7/32 (31.0)  
Flange 1 25/32 x 2 9/16 (45.2 x 65.1)  
**I.D.:** 15/32 (11.9) One End  
**Height:** 2 17/32 (64.3)  
**O-Ring:** [1] Attached

**P7261**

Wire Mesh Lube Element



**Notes:** OBSOLETE. Availability Limited to Dealer Stock.  
Closed end has tabs on end cap.  
**Fits:** Honda Engines  
**Replaces:** Honda 15221-ZG3-000; Woodgate WGL9122  
**O.D.:** 1 3/16 (30.2)  
to 1 13/32 (35.7)  
**I.D.:** 5/8 (15.9) One End  
**Height:** 2 11/32 (59.5)  
**Grommets:** [1] Attached

Measurements Are Shown In Inches And (Millimeters)

**WARNING:** These products can expose you to chemicals, including Diisononyl Phthalate, Carbon black extracts, Nickel, 1,3 Butadiene, Ethylene Oxide, Epichlorohydrin, which are known to the State of California to cause cancer, and Bisphenol, Ethylene Glycol, Ethylene Oxide, 1,3 Butadiene, Epichlorohydrin, which are known to the State of California to cause birth defects or other reproductive harm.



**P7262**



Lube Element with Lift Tab

**Notes:** OBSOLETE. Availability Limited to Dealer Stock.  
**Contains:** By-Pass Valve  
**Fits:** Lombardini Engines  
**Replaces:** Lombardini 500.2175.19; Woodgate WGL9123  
**O.D.:** 29/32 (23.0)  
**I.D.:** 13/32 (10.3) One End  
**Height:** 2 11/32 (59.5)  
**A. Gskt:** [1] Attached

**B7271**



Lube Spin-on

**Contains:** Anti-Drainback Valve  
8-12 PSID By-Pass Valve  
Standpipe  
**Fits:** Case, Terex Equipment  
**Replaces:** Massey Ferguson 3621292-M1; Woodgate WGL3353  
**Thread:** 3/4 -16  
**O.D.:** 3 11/16 (93.7)  
**Height:** 4 1/2 (114.3)  
**I.Gskt:** [1] Included

**P7263**



Lube Element with Lift Tab

**Contains:** By-Pass Valve  
**Fits:** Ruggerini Engines  
**Replaces:** Ruggerini 17505; Woodgate WGL9125  
**O.D.:** 29/32 (23.0)  
**I.D.:** 13/32 (10.3)  
**Height:** 2 7/8 (73.0)  
**A. Gskt:** [1] Attached

**B7273**



Lube Spin-on

**Contains:** Anti-Drainback Valve  
By-Pass Valve  
**Fits:** J.C. Bamford Excavators  
**Replaces:** J.C. Bamford 2/800176; Woodgate WGL3528  
**Thread:** M20 x 1.5  
**O.D.:** 3 5/8 (92.1)  
**Height:** 5 1/16 (128.6)  
**I.Gskt:** [1] Included

**P7264**



Lube Element

**Contains:** By-Pass Valve  
**Fits:** Hitachi, John Deere Excavators  
**Replaces:** Hitachi 4294132; Woodgate WGL9126  
**O.D.:** 3 9/16 (90.5)  
**I.D.:** 1 5/8 (41.3) One End  
**Height:** 8 7/32 (208.8)  
**O-Ring:** [1] Attached

**B7274**



Lube Spin-on

**Contains:** 20 PSID By-Pass Valve  
Standpipe  
**Fits:** J.C. Bamford Equipment  
**Replaces:** J.C. Bamford 32/915500; Woodgate WGL9035  
**Thread:** 1 -12  
**O.D.:** 3 11/16 (93.7)  
**Height:** 4 3/8 (111.1)  
**I.Gskt:** [1] Included

**P7267**



Lube Element

**Replaces:** Hino 15607-1531; Woodgate WGL9195  
**O.D.:** 4 13/16 (122.2)  
**I.D.:** 2 1/32 (16.7)  
**Height:** 8 21/32 (219.9)  
**F. Gskt:** [3] Included  
**O-Ring:** [2] Included

**B7275**



Lube Spin-on

**Contains:** Anti-Drainback Valve  
By-Pass Valve  
**Replaces:** Ford 89FF-6714-A1C; Mercedes-Benz 1031800610; Woodgate WGL9107  
**Thread:** 3/4 -16  
**O.D.:** 3 (76.2)  
**Height:** 3 27/32 (97.6)  
**I.Gskt:** [1] Included

**P7268**



Wire Mesh Supported Lube Element

**Replaces:** Fairey-Arlon TXW5CC10; Woodgate WGTW5CC-10  
**O.D.:** 4 3/16 (106.4)  
**I.D.:** 1 3/32 (10.3) & 2 27/32 (72.2)  
**Height:** 10 3/16 (258.8)  
**O-Ring:** [1] Attached

**B7276**



Lube Spin-on

**Contains:** Anti-Drainback Valve  
14 PSID By-Pass Valve  
**Fits:** Lombardini Engines  
**Replaces:** Lombardini 105.2175.136, 115.2175.136; Woodgate WGL9130  
**Thread:** M20 x 1.5  
**O.D.:** 3 (76.2)  
**Height:** 2 5/16 (58.7)  
**I.Gskt:** [1] Included

**P7269**



Lube Element with Bail Handle

**Replaces:** Woodgate WGL3605N  
**O.D.:** 3 7/32 (81.8)  
**I.D.:** 7/8 (22.2)  
**Height:** 5 3/16 (131.8)  
**O-Ring:** [2] Included, [1] Copper O-Ring  
**Grommets:** [2] Attached

**B7277**



Lube Spin-on

**Contains:** By-Pass Valve  
**Replaces:** Fiat-Iveco 5495622; Mercedes-Benz 1031840201; Woodgate WGL9132  
**Thread:** M20 x 1.5  
**O.D.:** 3 3/32 (78.6)  
**Height:** 3 27/32 (97.6)  
**I.Gskt:** [1] Included

**B7280**



Lube Spin-on

**Replaces:** GMC 93156631; Woodgate WGL9160  
**Thread:** M20 x 1.5  
**O.D.:** 4 9/32 (108.7)  
**Height:** 4 (101.6)  
**I.Gskt:** [1] Included

Measurements Are Shown In Inches And (Millimeters)

**WARNING:** These products can expose you to chemicals, including Diisononyl Phthalate, Carbon black extracts, Nickel, 1,3 Butadiene, Ethylene Oxide, Epichlorohydrin, which are known to the State of California to cause cancer, and Bisphenol, Ethylene Glycol, Ethylene Oxide, 1,3 Butadiene, Epichlorohydrin, which are known to the State of California to cause birth defects or other reproductive harm.

<p><b>B7281</b> Lube Spin-on  <b>Contains:</b> Anti-Drainback Valve            14 PSID By-Pass Valve  <b>Replaces:</b> Yanmar 119100-35100; Woodgate WGL3536  <b>Thread:</b> M20 x 1.5  <b>O.D.:</b> 3 7/32 (81.8)  <b>Height:</b> 3 7/8 (98.4)  <b>I.Gskt:</b> [1] Included</p> 	<p><b>B7291</b> Lube Spin-on  <b>Contains:</b> Anti-Drainback Valve            17 PSID By-Pass Valve  <b>Replaces:</b> Leyland ADU3553; Fleetguard LF3643; Woodgate WGL3643  <b>Thread:</b> 13/16 -16  <b>O.D.:</b> 3 5/8 (92.1)  <b>Height:</b> 3 7/8 (98.4)  <b>I.Gskt:</b> [1] Included</p> 
<p><b>B7283</b> Lube Spin-on  <b>Contains:</b> Anti-Drainback Valve            By-Pass Valve  <b>Replaces:</b> Renault 7701727480; Woodgate WGL9180  <b>Thread:</b> M20 x 1.5  <b>O.D.:</b> 3 1/2 (88.9)  <b>Height:</b> 2 11/32 (59.5)  <b>I.Gskt:</b> [1] Included</p> 	<p><b>B7292</b> Lube Spin-on  <b>Contains:</b> 8-12 PSID By-Pass Valve  <b>Fits:</b> Ducati Motorcycles  <b>Replaces:</b> GMC 7984608; Woodgate WGL9032  <b>Thread:</b> M16 x 1.5  <b>O.D.:</b> 3 (76.2)  <b>Height:</b> 2 31/32 (75.4)  <b>I.Gskt:</b> [1] Included</p> 
<p><b>B7285</b> Lube Spin-on  <b>Contains:</b> Anti-Drainback Valve            20 PSID By-Pass Valve  <b>Fits:</b> Kubota Engines, Equipment  <b>Replaces:</b> Kubota 15853-32430; Woodgate WGL9187  <b>Thread:</b> M20 x 1.5  <b>O.D.:</b> 2 9/16 (65.1)  <b>Height:</b> 2 5/8 (66.7)  <b>I.Gskt:</b> [1] Included</p> 	<p><b>B7293</b> Lube Spin-on  <b>Contains:</b> Anti-Drainback Valve            By-Pass Valve  <b>Replaces:</b> Lister 601-32950; Woodgate WGL9131  <b>Thread:</b> M16 x 1.5  <b>O.D.:</b> 3 3/32 (78.6)  <b>Height:</b> 2 1/2 (63.5)  <b>I.Gskt:</b> [1] Included</p> 
<p><b>B7286</b> Lube Spin-on  <b>Contains:</b> Anti-Drainback Valve            By-Pass Valve  <b>Replaces:</b> Iseki 621324000210; Woodgate WGL9200  <b>Thread:</b> 3/4 -16  <b>O.D.:</b> 2 11/16 (68.3)  <b>Height:</b> 3 (76.2)  <b>I.Gskt:</b> [1] Included</p> 	<p><b>B7294</b> Lube Spin-on  <b>Contains:</b> Anti-Drainback Valve            32 PSID By-Pass Valve  <b>Fits:</b> Bomag Rollers with Deutz Engines  <b>Replaces:</b> Deutz 1180815; Woodgate WGL9060  <b>Thread:</b> 3/4 -16  <b>O.D.:</b> 3 (76.2)  <b>Height:</b> 2 9/32 (57.9)  <b>I.Gskt:</b> [1] Included</p> 
<p><b>B7287</b> Lube Spin-on  <b>Replaces:</b> Iseki 621324000510; Woodgate WGL9201  <b>Thread:</b> 3/4 -16  <b>O.D.:</b> 3 1/32 (77.0)  <b>Height:</b> 3 3/16 (81.0)  <b>I.Gskt:</b> [1] Included</p> 	<p><b>B7295</b> Lube Spin-on  <b>Fits:</b> Claas Combines  <b>Replaces:</b> Woodgate WGL3310  <b>Thread:</b> 3/4 -16  <b>O.D.:</b> 3 (76.2)  <b>Height:</b> 3 1/8 (79.4)  <b>I.Gskt:</b> [1] Included</p> 
<p><b>B7289</b> Lube Spin-on  <b>Contains:</b> Anti-Drainback Valve            By-Pass Valve  <b>Fits:</b> Toro Groundsmaster, Reelmaster Tractors  <b>Replaces:</b> Toro 74-7970; Woodgate WGL9109  <b>Thread:</b> M20 x 1.5  <b>O.D.:</b> 3 (76.2)  <b>Height:</b> 3 11/32 (84.9)  <b>I.Gskt:</b> [1] Included</p> 	<p><b>B7298</b> Lube Spin-on  <b>Contains:</b> Anti-Drainback Valve            14 PSID By-Pass Valve  <b>Fits:</b> Kubota Equipment  <b>Replaces:</b> Kubota 1C020-32430; Woodgate WGL9202  <b>Thread:</b> 3/4 -16  <b>O.D.:</b> 3 23/32 (94.5)  <b>Height:</b> 3 31/32 (100.8)  <b>I.Gskt:</b> [1] Included</p> 
<p><b>B7290</b> Lube Spin-on  <b>Contains:</b> Anti-Drainback Valve            14 PSID By-Pass Valve  <b>Fits:</b> Caterpillar, Lombardini, Ruggerini Engines  <b>Replaces:</b> Lombardini 500.217.536; Woodgate WGL3338  <b>Thread:</b> 3/4 -16  <b>O.D.:</b> 3 (76.2)  <b>Height:</b> 3 7/8 (98.4)  <b>I.Gskt:</b> [1] Included</p> 	<p><b>B7299</b> High Efficiency Lube Spin-on  <b>Fits:</b> Caterpillar Engines  <b>Replaces:</b> Caterpillar 1R1808, 275-2604  <b>Thread:</b> 1 1/2 -16  <b>O.D.:</b> 5 3/8 (136.5)  <b>Height:</b> 12 3/32 (307.2)  <b>I.Gskt:</b> [1] Included  <b>Related To:</b> B99, B99-MPG, B99-SS (Standard Versions)            B7507 (w/3 O-Rings)</p> 

Measurements Are Shown In Inches And (Millimeters)

**WARNING:** These products can expose you to chemicals, including Diisononyl Phthalate, Carbon black extracts, Nickel, 1,3 Butadiene, Ethylene Oxide, Epichlorohydrin, which are known to the State of California to cause cancer, and Bisphenol, Ethylene Glycol, Ethylene Oxide, 1,3 Butadiene, Epichlorohydrin, which are known to the State of California to cause birth defects or other reproductive harm.

**P7303**



Lube Element with Bail Handle  
**Contains:** By-Pass Valve  
**Fits:** Lombardini Engines  
**Replaces:** Lombardini 710.275.138; Woodgate WGL9157  
**O.D.:** 1 17/32 (38.9)  
**I.D.:** 15/32 (11.9)  
**Height:** 2 17/32 (64.3)  
**A. Gskt:** [1] Attached

**B7311-MPG**



Maximum Performance Glass Lube Spin-on  
**Contains:** Anti-Drainback Valve  
 8 PSID By-Pass Valve  
**Fits:** Carrier Refrigeration Units  
**Replaces:** Carrier 30-00450-00; Fleetguard LF3947  
**Thread:** 3/4 -16  
**O.D.:** 3 11/16 (93.7)  
**Height:** 7 1/8 (181.0)  
**I.Gskt:** G381-A

**P7305**



Lube Element  
**Fits:** M.A.N. Trucks  
**Replaces:** Mann & Hummel HU947/1n; Mercedes-Benz 3661801009, 3661801025, 3661840125  
**O.D.:** 3 9/32 (83.3)  
**I.D.:** 15/16 (23.8)  
**Height:** 7 19/32 (192.9)  
**F. Gskt:** [1] Metal Washer  
**O-Ring:** [2] Included

**P7312**



Lube Element  
**Notes:** Inside-Out Flow Direction  
**Replaces:** Wartsila 5611F185, 5611F216  
**O.D.:** 4 31/32 (126.2)  
**I.D.:** 9/16 (14.3) & 3 5/8 (92.1)  
**Height:** 11 7/16 (290.5)  
**F. Gskt:** [1] Included  
**O-Ring:** [2] Included

**B7306**



Lube Spin-on  
**Contains:** 30 PSID By-Pass Valve  
**Fits:** John Deere Engines, Tractors  
**Replaces:** John Deere RE518977  
**Thread:** M24 x 1.5  
**O.D.:** 3 11/16 (93.7)  
**Height:** 5 13/32 (137.3)  
**I.Gskt:** G401

**P7313**



Lube Element  
**Fits:** Ford, Mazda Automotive  
**Replaces:** Ford 3M4Z-6744-AC; Mazda L321-14-302  
**O.D.:** 2 9/16 (65.1)  
**I.D.:** 31/32 (24.6)  
**Height:** 2 7/8 (73.0)  
**O-Ring:** [2] Included

**P7308**



Lube Element  
**Fits:** Volkswagen Automotive  
**Replaces:** Volkswagen 74115562  
**O.D.:** 2 17/32 (64.3)  
**I.D.:** 21/32 (16.7)  
**Height:** 6 1/32 (153.2)  
**A. Gskt:** [2] Attached  
**O-Ring:** [2] Included

**B7314**



Lube Spin-on  
**Contains:** 35 PSID By-Pass Valve  
**Fits:** International 4400 DuraStar  
**Replaces:** International 1842816-C2  
**Thread:** M45 x 1.5  
**O.D.:** 5 3/8 (136.5)  
**Height:** 9 5/8 (244.5)  
**I.Gskt:** [1] Included

**BD7309**



High Velocity Dual-Flow Lube Spin-on  
**Contains:** Venturi-Type Cone  
**Fits:** Cummins Engines  
**Replaces:** Cummins 3401544  
**Thread:** 2 1/4 -12  
**O.D.:** 4 21/32 (118.3)  
**Height:** 11 13/32 (289.7)  
**I.Gskt:** [1] Included  
**Related To:** BD103 (Standard Version)

**BT7316**



Lube Spin-on  
**Contains:** Anti-Drainback Valve  
 30 PSID By-Pass Valve  
 Standpipe  
**Fits:** Case-International Tractors  
**Replaces:** Case 47128196  
**Thread:** 3/4 -16  
**O.D.:** 4 1/4 (108.0)  
**Height:** 5 13/16 (147.6)  
**I.Gskt:** G381-A

**BD7310**



High Velocity Dual-Flow Lube Spin-on  
**Contains:** Venturi-Type Cone  
**Fits:** John Deere Equipment  
**Replaces:** John Deere RE58935  
**Thread:** M52 x 1.5  
**O.D.:** 4 21/32 (118.3)  
**Height:** 11 13/32 (289.7)  
**I.Gskt:** G293-B

**BD7317**



Dual-Flow Lube Spin-on  
**Contains:** Venturi-Type Cone  
**Fits:** Carrier Refrigeration Units  
**Replaces:** Carrier 30-00463-00; Fleetguard LF9028  
**Thread:** 1 -16  
**O.D.:** 3 11/16 (93.7)  
**Height:** 7 1/8 (181.0)  
**I.Gskt:** [1] Included

Measurements Are Shown In Inches And (Millimeters)

**WARNING:** These products can expose you to chemicals, including Diisononyl Phthalate, Carbon black extracts, Nickel, 1,3 Butadiene, Ethylene Oxide, Epichlorohydrin, which are known to the State of California to cause cancer, and Bisphenol, Ethylene Glycol, Ethylene Oxide, 1,3 Butadiene, Epichlorohydrin, which are known to the State of California to cause birth defects or other reproductive harm.

**B7318**

Lube Spin-on



**Contains:** Anti-Drainback Valve  
20 PSID By-Pass Valve  
**Fits:** Volvo Excavators  
**Replaces:** Volvo 7410062  
**Thread:** M20 x 1.5  
**O.D.:** 2 9/16 (65.1)  
**Height:** 3 1/2 (88.9)  
**I.Gskt:** [1] Included

**P7319**

Lube Element



**Fits:** Scania Generator Sets, Trucks  
**Replaces:** Scania 1439036; Fleetguard LF3895  
**O.D.:** 4 1/32 (102.4)  
**I.D.:** 1 25/32 (45.2) One End  
**Height:** 10 (254.0)  
**O-Ring:** [1] Included

**B7320**

Lube Spin-on



**Contains:** Anti-Drainback Valve  
40 PSID By-Pass Valve  
**Fits:** Demag Compressors; Volvo Loaders  
**Replaces:** Volvo 11700375; Mann & Hummel  
W940/18  
**Thread:** 1 -12  
**O.D.:** 3 11/16 (93.7)  
**Height:** 5 3/8 (136.5)  
**I.Gskt:** G381-A

**P7321**

Lube Element



**Notes:** Inside-Out Flow Direction  
**Replaces:** Perkins 996452, CH10929  
**O.D.:** 4 29/32 (124.6)  
**I.D.:** 1 11/16 (42.9) One End  
**Height:** 10 21/32 (270.7)  
**O-Ring:** [1] Included

**B7322**

Lube Spin-on



**Fits:** John Deere Equipment  
**Replaces:** John Deere RE504836  
**Thread:** M92 x 2.5  
**O.D.:** 3 29/32 (99.2)  
**Height:** 5 15/16 (150.8)  
**I.Gskt:** [1] Included

**B7324**

Lube Spin-on



**Contains:** 14 PSID By-Pass Valve  
**Fits:** J.C. Bamford Equipment with Isuzu  
Engines  
**Replaces:** Isuzu 87610-006, 1-87610-006-0;  
J.C. Bamford 02/801481, 581/18096  
**Thread:** 1 1/2 -12  
**O.D.:** 4 21/32 (118.3)  
**Height:** 8 3/32 (205.6)  
**I.Gskt:** [1] Included

**BD7325**

Dual-Flow Lube Spin-on



**Fits:** Hino, Nissan UD Trucks  
**Replaces:** Hino 15607-2190  
**Thread:** 1 1/2 -16  
**O.D.:** 4 21/32 (118.3)  
**Height:** 8 1/8 (206.4)  
**I.Gskt:** [1] Included

**BC7326**

Centrifugal Lube Element



**Fits:** Freightliner, Kenworth, Peterbilt, Sterling  
Trucks; Mercedes-Benz, Paccar Engines  
**Replaces:** Mercedes-Benz A9061810086;  
Fleetguard CS41008  
**O.D.:** 3 11/16 (93.7)  
**I.D.:** 1/4 (6.4) One End  
**Height:** 5 13/16 (147.6)  
**O-Ring:** [1] Included  
**Related To:** BC7485 (Different O-Ring)

**B7327**

Lube Spin-on



**Contains:** Anti-Drainback Valve  
**Fits:** Case-International, New Holland Tractors  
**Replaces:** Case 2854750, 87803206  
**Thread:** M27 x 2.0  
**O.D.:** 3 11/16 (93.7)  
**Height:** 6 5/8 (168.3)  
**I.Gskt:** G381-A

**B7328**

Lube Spin-on



**Fits:** New Holland Equipment  
**Replaces:** New Holland 87803201  
**Thread:** M27 x 2.0  
**O.D.:** 3 23/32 (94.5)  
**Height:** 3 7/8 (98.4)  
**I.Gskt:** G381-A

**P7329**

Lube Element



**Fits:** ERF Trucks; M.A.N. Engines, Trucks;  
R.V.I. Trucks; Volvo Engines, Trucks;  
Volvo-Penta Generators  
**Replaces:** M.A.N. 51.05504.0107, 51.05504.0108  
**O.D.:** 4 3/4 (120.7)  
**I.D.:** 9/16 (14.3) & 2 1/16 (52.4)  
**Height:** 7 7/8 (200.0)  
**A. Gskt:** [1] Included  
**O-Ring:** [1] Included

**P7330**

Lube Element



**Fits:** DAF Buses, Trucks  
**Replaces:** DAF 1397765; Hengst E43HD97;  
Mann & Hummel HU1297X  
**O.D.:** 4 7/16 (112.7)  
**I.D.:** 2 19/32 (65.9)  
**Height:** 8 17/32 (216.7)  
**A. Gskt:** [2] Attached  
**O-Ring:** [1] Included

Measurements Are Shown In Inches And (Millimeters)

**WARNING:** These products can expose you to chemicals, including Diisononyl Phthalate, Carbon black extracts, Nickel, 1,3 Butadiene, Ethylene Oxide, Epichlorohydrin, which are known to the State of California to cause cancer, and Bisphenol, Ethylene Glycol, Ethylene Oxide, 1,3 Butadiene, Epichlorohydrin, which are known to the State of California to cause birth defects or other reproductive harm.

**PT7332**



Full-Flow Lube or Hydraulic Element  
**Contains:** Reinforced Centertube  
**Fits:** American Hoist & Derrick, Caterpillar, Clark, Gardner Denver, Koehring, Komatsu LeRoi, Link-Belt Equipment  
**Replaces:** Caterpillar 1R0659; Deutz 1161212; Komatsu 611-4505-100  
**O.D.:** 3 15/16 (100.0)  
**I.D.:** 1 19/32 (40.5)  
**Height:** 9 9/32 (235.7)  
**F. Gskt:** G171, G214, [1] Included  
**O. Gskt:** G115-MSB, G342, G435  
**Related To:** PT670 (with Paper Wrapper)

**P7338**



Lube Element  
**Fits:** Volvo Automotive  
**Replaces:** Volvo 12758116  
**O.D.:** 2 7/8 (73.0)  
**I.D.:** 1 1/32 (26.2)  
**Height:** 3 5/32 (80.2)  
**O-Ring:** [1] Included

**B7333**



Lube Spin-on  
**Contains:** Anti-Drainback Valve By-Pass Valve  
**Fits:** Cushman Equipment  
**Replaces:** Jacobsen 2701908; Suzuki 16510-82703  
**Thread:** 3/4 -16  
**O.D.:** 2 25/32 (70.6)  
**Height:** 2 5/8 (66.7)  
**I.Gskt:** [1] Included

**BT7349**



Lube Spin-on  
**Notes:** BT7349 may be used in place of BT339. Do NOT substitute BT339 for BT7349. Can is fluted for improved installation.  
**Fits:** Dodge Light-Duty Trucks with 5.9L and 6.7L Turbo Diesel Engines  
**Replaces:** Chrysler 5083285AA  
**Thread:** 1 -16  
**O.D.:** 3 11/16 (93.7)  
**Height:** 7 1/8 (181.0)  
**I.Gskt:** G381-A

**B7334**



Lube Spin-on  
**Contains:** Anti-Drainback Valve 14 PSID By-Pass Valve  
**Fits:** Equipment with Cummins A1400, A1700, A2000, A2300 Engines  
**Replaces:** Kukje HRA11020F4A3; Fleetguard LF16034  
**Thread:** M22 x 1.5  
**O.D.:** 3 1/32 (77.0)  
**Height:** 3 7/16 (87.3)  
**I.Gskt:** [1] Included

**B7350**



Lube Spin-on  
**Contains:** Anti-Drainback Valve 35 PSID By-Pass Valve Check Valve  
**Fits:** Gillisons GVF5000 Lift Truck; J.C. Bamford Generators, Equipment  
**Replaces:** J.C. Bamford 320/04133; Alco SP-1294  
**Thread:** M22 x 1.5  
**O.D.:** 3 25/32 (96.0)  
**Height:** 6 11/16 (169.9)  
**I.Gskt:** [1] Included

**B7335-MPG**



Maximum Performance Glass Lube Spin-on  
**Fits:** John Deere Equipment  
**Replaces:** John Deere RE521420; Fleetguard LF16106  
**Thread:** 1 5/8 -12  
**O.D.:** 5 1/16 (128.6)  
**Height:** 6 31/32 (177.0)  
**F. Gskt:** G369-B  
**O-Ring:** G447

**B7351-MPG**



Maximum Performance Glass Lube Spin-on  
**Fits:** Komatsu Loaders  
**Replaces:** Komatsu 6731525130  
**Thread:** 1 -16  
**O.D.:** 3 11/16 (93.7)  
**Height:** 5 3/8 (136.5)  
**I.Gskt:** G381-A

**P7336 KIT**



Set of 2 Hydraulic Breather Elements  
**Fits:** Iveco EuroCargo Trucks  
**Replaces:** Iveco 2992447; Coopers AEM2940; Hengst EAS304MD152; Mann & Hummel C911X2  
**Each Element**  
**O.D.:** 2 3/32 (53.2) to 3 9/32 (83.3)  
**I.D.:** 21/32 (16.7) One End  
**Height:** 2 3/4 (69.9)  
**F. Gskt:** [1] Included  
**Grommets:** [1] Attached Each Element

**B7352**



Lube Spin-on  
**Contains:** Anti-Drainback Valve 11 PSID By-Pass Valve  
**Fits:** R.V.I. Trucks  
**Replaces:** Renault 7700720978, 7700734825, 7700856339, 7700867454, 7701349942  
**Thread:** M20 x 1.5  
**O.D.:** 3 1/8 (79.4)  
**Height:** 3 17/32 (89.7)  
**I.Gskt:** [1] Included

**P7337**



2-Section Hydraulic Element  
**Replaces:** Cummins 3420742; Fleetguard LF16031  
**O.D.:** 7 21/32 (194.5)  
**I.D.:** 4 21/32 (118.3)  
**Height:** 16 (406.4)  
**A. Gskt:** [2] Attached

**BD7355**



Dual-Flow Lube Spin-on  
**Fits:** Komatsu Equipment  
**Replaces:** Komatsu 600-211-1340; Fleetguard LF9018  
**Thread:** M95 x 2.5  
**O.D.:** 4 11/16 (119.1)  
**Height:** 11 25/32 (299.2)  
**I.Gskt:** [1] Included

Measurements Are Shown In Inches And (Millimeters)

**WARNING:** These products can expose you to chemicals, including Diisononyl Phthalate, Carbon black extracts, Nickel, 1,3 Butadiene, Ethylene Oxide, Epichlorohydrin, which are known to the State of California to cause cancer, and Bisphenol, Ethylene Glycol, Ethylene Oxide, 1,3 Butadiene, Epichlorohydrin, which are known to the State of California to cause birth defects or other reproductive harm.

**B7356** Lube Spin-on  
**Contains:** Anti-Drainback Valve  
 8 PSID By-Pass Valve  
**Fits:** Agco, Challenger, Massey Ferguson Tractors  
**Replaces:** Agco 72201898; Massey Ferguson 3609410-M1, 3710280-M2  
**Thread:** 3/4 -16  
**O.D.:** 2 9/16 (65.1)  
**Height:** 2 5/8 (66.7)  
**I.Gskt:** [1] Included



**B7363** Full-Flow Lube Spin-on  
**Contains:** 50 PSID By-Pass Valve  
 By-Pass Screen  
**Fits:** Agco, Challenger, Massey Ferguson Tractors  
**Replaces:** Agco V836862582; Sisu 836862582; Mann & Hummel W1374/7  
**Thread:** 1 1/2 -16  
**O.D.:** 5 3/8 (136.5)  
**Height:** 7 (177.8)  
**I.Gskt:** [1] Included



**B7357** Lube Spin-on  
**Contains:** 30 PSID By-Pass Valve  
**Fits:** Tata Engines  
**Replaces:** Tata Cummins 252518130139; Fleetguard LF16060  
**Thread:** 1 -14  
**O.D.:** 3 23/32 (94.5)  
**Height:** 8 1/8 (206.4)  
**I.Gskt:** G401



**P7364** Lube Element  
**Fits:** Hyundai Genesis, Sonata, Veracruz; Kia Sorento  
**Replaces:** Hyundai 26320-3C250  
**O.D.:** 2 9/16 (65.1)  
**I.D.:** 1 1/16 (27.0)  
**Height:** 4 7/32 (107.2)  
**I.Gskt:** [2] Included  
**F. Gskt:** [1] Metal Washer  
**O-Ring:** [2] Included



**B7359** Lube Spin-on  
**Contains:** 20 PSID By-Pass Valve  
**Fits:** Tata Engines  
**Replaces:** Tata Cummins 253418130165; Fleetguard LF16062  
**Thread:** 13/16 -16  
**O.D.:** 3 23/32 (94.5)  
**Height:** 5 15/32 (138.9)  
**I.Gskt:** G401



**P7365** Lube Element  
**Fits:** Nissan Light-Duty Trucks  
**Replaces:** Nissan 15209-00QAC, 15209-2W200; Opel 4415218; Renault 7701057828  
**O.D.:** 3 1/32 (77.0)  
**I.D.:** 7/8 (22.2)  
**Height:** 4 1/16 (103.2)  
**A. Gskt:** [2] Attached  
**O-Ring:** [1] Included



**B7360** Lube Spin-on  
**Contains:** Anti-Drainback Valve  
 40 PSID By-Pass Valve  
**Fits:** Tata Engines  
**Replaces:** Tata Cummins 253418130169; Fleetguard LF16056  
**Thread:** M24 x 1.5  
**O.D.:** 3 11/16 (93.7)  
**Height:** 5 11/16 (144.5)  
**I.Gskt:** G401



**B7367** Lube Spin-on  
**Contains:** Anti-Drainback Valve  
 30 PSID By-Pass Valve  
**Replaces:** CLARCOR Filtration (China) JX0818, WB236, Huafeng Power (Shandong Weichai Huafeng Power Co., Ltd.) 61000070005  
**Thread:** 1 -12  
**O.D.:** 3 19/32 (91.3)  
**Height:** 8 1/8 (206.4)  
**I.Gskt:** [1] Included



**B7361** Lube Spin-on  
**Contains:** Anti-Drainback Valve  
 14 PSID By-Pass Valve  
**Fits:** J.C. Bamford Equipment  
**Replaces:** J.C. Bamford 2/630935, 2/630935A  
**Thread:** 3/4 -16  
**O.D.:** 3 (76.2)  
**Height:** 3 17/32 (89.7)  
**I.Gskt:** G449-B



**P7368** By-Pass Lube Element  
**Fits:** Cummins Engines  
**Replaces:** Cummins 3873576; Fleetguard LF16029  
**O.D.:** 5 1/32 (127.8)  
**I.D.:** 1 1/2 (38.1) One End  
**Height:** 8 11/16 (220.7)  
**Grommets:** [1] Attached



**B7362** Lube Spin-on  
**Contains:** 30 PSID By-Pass Valve  
**Fits:** Tata Engines  
**Replaces:** Tata Cummins 252718130132; Fleetguard LF16061  
**Thread:** 1 -16  
**O.D.:** 3 11/16 (93.7)  
**Height:** 6 9/16 (166.7)  
**I.Gskt:** G381-A



**B7369** Lube Spin-on  
**Notes:** OBSOLETE. Availability Limited to Dealer Stock.  
**Contains:** Anti-Drainback Valve  
 20 PSID By-Pass Valve  
**Replaces:** Weichai Power 12272453; CLARCOR Filtration (China) WB202B  
**Thread:** 3/4 -16  
**O.D.:** 3 19/32 (91.3)  
**Height:** 5 1/8 (130.2)  
**I.Gskt:** [1] Included



Measurements Are Shown In Inches And (Millimeters)

**WARNING:** These products can expose you to chemicals, including Diisononyl Phthalate, Carbon black extracts, Nickel, 1,3 Butadiene, Ethylene Oxide, Epichlorohydrin, which are known to the State of California to cause cancer, and Bisphenol, Ethylene Glycol, Ethylene Oxide, 1,3 Butadiene, Epichlorohydrin, which are known to the State of California to cause birth defects or other reproductive harm.

**B7370** Lube Spin-on  
**Contains:** Anti-Drainback Valve  
 30 PSID By-Pass Valve  
**Fits:** Dongfeng DF304G2 Tractors  
**Replaces:** CLARCOR Filtration (China) JX0811A  
**Thread:** 1 -12  
**O.D.:** 3 19/32 (91.3)  
**Height:** 5 1/8 (130.2)  
**I.Gskt:** [1] Included



**B7378** Lube Spin-on  
**Contains:** Anti-Drainback Valve  
 20 PSID By-Pass Valve  
**Fits:** Caterpillar Equipment  
**Replaces:** Caterpillar 269-8325; Donaldson P550920  
**Thread:** M24 x 1.5  
**O.D.:** 3 11/16 (93.7)  
**Height:** 8 1/8 (206.4)  
**I.Gskt:** G381-A



**B7372** Lube Spin-on  
**Contains:** Anti-Drainback Valve  
**Fits:** Daewoo Excavators  
**Replaces:** Doosan 47100093, 65055105028A  
**Thread:** 1 -16  
**O.D.:** 3 11/16 (93.7)  
**Height:** 7 5/32 (181.8)  
**I.Gskt:** G381-A



**B7379** Lube Spin-on  
**Contains:** Anti-Drainback Valve  
 20 PSID By-Pass Valve  
**Fits:** Ford Super Duty Pickups with V8-406 (6.7L) Turbo Diesel Engine  
**Replaces:** Motorcraft FL2051  
**Thread:** 1 -16  
**O.D.:** 3 11/16 (93.7)  
**Height:** 6 7/16 (163.5)  
**I.Gskt:** G381-A



**B7373** Lube Spin-on  
**Contains:** Anti-Drainback Valve  
 40 PSID By-Pass Valve  
**Replaces:** Baudouin 1504168OC; Fleetguard LF3808; Mann & Hummel W1140/8  
**Thread:** 1 -12  
**O.D.:** 4 1/4 (108.0)  
**Height:** 4 3/4 (120.7)  
**I.Gskt:** [1] Included



**P7380** Lube Element  
**Replaces:** CLARCOR Filtration (China) 12VB1810B; Jinan Diesel Engine Co. 12VB1810B  
**O.D.:** 5 23/32 (145.3)  
**I.D.:** 2 7/16 (61.9)  
**Height:** 5 5/8 (142.9)



**B7375** Lube Spin-on  
**Fits:** Thermo King Refrigeration Units  
**Replaces:** Thermo King 11-9182; Donaldson P550835; Fleetguard LF9030, LF16164  
**Thread:** 1 1/8 -12  
**O.D.:** 3 11/16 (93.7)  
**Height:** 7 1/8 (181.0)  
**I.Gskt:** [1] Included



**P7381** Lube Element  
**Notes:** OBSOLETE. Availability Limited to Dealer Stock.  
**Replaces:** CLARCOR Filtration (China) 30121810A; Jinan Diesel Engine Co. 30121810  
**O.D.:** 5 3/4 (146.0)  
**I.D.:** 2 3/8 (60.3)  
**Height:** 11 7/16 (290.5)  
**A. Gskt:** [1] Attached



**B7376** Lube Spin-on  
**Contains:** Anti-Drainback Valve  
 40 PSID By-Pass Valve  
 Standpipe  
**Fits:** Iveco Daily Trucks  
**Replaces:** Iveco 2995561  
**Thread:** M22 x 1.5  
**O.D.:** 3 11/16 (93.7)  
**Height:** 6 5/8 (168.3)  
**I.Gskt:** G381-A



**B7383** Lube Spin-on  
**Contains:** 35 PSID By-Pass Valve  
**Replaces:** CLARCOR Filtration (China) JX1016; Sinotruk VG1246070031; Weichai Power 612630010239  
**Thread:** M30 x 2.0  
**O.D.:** 4 1/4 (108.0)  
**Height:** 7 11/16 (195.3)  
**I.Gskt:** [1] Included



**B7377** Lube Spin-on  
**Contains:** Anti-Drainback Valve  
 40 PSID By-Pass Valve  
**Fits:** Citroen, Fiat, Iveco Daily Vans  
**Replaces:** Citroen 1109Y6; Fiat 8093784; Iveco 2992188; Alco SP1269  
**Thread:** M22 x 1.5  
**O.D.:** 3 11/16 (93.7)  
**Height:** 5 3/8 (136.5)  
**I.Gskt:** G381-A



**B7384** Lube Spin-on  
**Contains:** 25 PSID By-Pass Valve  
**Replaces:** CLARCOR Filtration (China) WB202E; FAW-Xichai 1012015AB010000  
**Thread:** M20 x 1.5  
**O.D.:** 3 19/32 (91.3)  
**Height:** 4 13/16 (122.2)  
**I.Gskt:** [1] Included



Measurements Are Shown In Inches And (Millimeters)

**WARNING:** These products can expose you to chemicals, including Diisononyl Phthalate, Carbon black extracts, Nickel, 1,3 Butadiene, Ethylene Oxide, Epichlorohydrin, which are known to the State of California to cause cancer, and Bisphenol, Ethylene Glycol, Ethylene Oxide, 1,3 Butadiene, Epichlorohydrin, which are known to the State of California to cause birth defects or other reproductive harm.

**B7385**

Lube Spin-on



**Contains:** 20 PSID By-Pass Valve  
**Replaces:** CLARCOR Filtration (China) WB447S; FAW Xichai 1012101A020000A  
**Thread:** 1 -12  
**O.D.:** 4 1/4 (108.0)  
**Height:** 4 13/32 (111.9)  
**I.Gskt:** [1] Included

**B7386**

Lube Spin-on



**Contains:** 25 PSID By-Pass Valve  
**Replaces:** CLARCOR Filtration (China) WB447SX; FAW-Xichai 1012101A020000W  
**Thread:** 1 -12  
**O.D.:** 4 1/4 (108.0)  
**Height:** 4 13/32 (111.9)  
**I.Gskt:** [1] Included

**B7387**

Lube Spin-on



**Contains:** Anti-Drainback Valve  
 20 PSID By-Pass Valve  
**Replaces:** CLARCOR Filtration (China) JX0814, WB7031; DCD JX4102B  
**Thread:** 1 -12  
**O.D.:** 3 19/32 (91.3)  
**Height:** 6 5/8 (168.3)  
**I.Gskt:** [1] Included

**B7388**

Lube Spin-on



**Contains:** Anti-Drainback Valve  
 40 PSID By-Pass Valve  
 Standpipe  
**Fits:** Iveco Daily, Mitsubishi Trucks  
**Replaces:** Iveco 2995655; Mitsubishi MK666096, MK667378  
**Thread:** M22 x 1.5  
**O.D.:** 3 11/16 (93.7)  
**Height:** 5 3/8 (136.5)  
**A. Gskt:** G381-A

**B7389**

Lube Spin-on



**Notes:** OBSOLETE. Availability Limited to Dealer Stock.  
**Contains:** Anti-Drainback Valve  
 20 PSID By-Pass Valve  
**Replaces:** CLARCOR Filtration (China) WB7009; ShanDong HuaYuan Laidong Engine D495QB-092100  
**Thread:** 1 -12  
**O.D.:** 4 1/4 (108.0)  
**Height:** 5 7/8 (149.2)  
**I.Gskt:** [1] Included

**B7390**

Lube Spin-on



**Contains:** Anti-Drainback Valve  
 18-20 PSID By-Pass Valve  
**Replaces:** Faw-Xichai 1118105-051-0000; CLARCOR Filtration (China) WB178A  
**Thread:** M20 x 1.5  
**O.D.:** 3 3/32 (78.6)  
**Height:** 4 27/32 (123.0)  
**I.Gskt:** [1] Included

**B7392**

Lube Spin-on



**Notes:** OBSOLETE. Availability Limited to Dealer Stock.  
**Contains:** Anti-Drainback Valve  
 30-41 PSID By-Pass Valve  
**Replaces:** CLARCOR Filtration (China) JX0818B; Foton Lovol 392000001  
**Thread:** 1 -12  
**O.D.:** 3 19/32 (91.3)  
**Height:** 8 1/8 (206.4)  
**I.Gskt:** [1] Included

**B7393**

Lube Spin-on



**Contains:** Anti-Drainback Valve  
 20 PSID By-Pass Valve  
**Replaces:** CLARCOR Filtration (China) JX1012A; DCD (DongFeng Chaoyang Diesel) 4102AZL.14.40  
**Thread:** M30 x 1.5  
**O.D.:** 4 9/32 (108.7)  
**Height:** 6 1/4 (158.8)  
**I.Gskt:** [1] Included

**BC7394**

Centrifugal by-Pass Lube Element



**Fits:** International Engines, Trucks  
**Replaces:** International 1842825C91; Donaldson P552231  
**O.D.:** 3 27/32 (97.6)  
**I.D.:** 3/8 (9.5) & 1/2 (12.7)  
**Height:** 7 (177.8)  
**F. Gskt:** [1] Included  
**O-Ring:** [1] Included

**B7395**

Maximum Performance Glass Lube Spin-on



**Fits:** Quincy Compressors  
**Replaces:** Quincy 128381050  
**Thread:** 31/32 -20  
**O.D.:** 3 21/32 (92.9)  
**Height:** 5 3/8 (136.5)  
**A. Gskt:** G381-A

**B7396**

Lube Spin-on



**Notes:** Can be used with OB1368, OB1369 bases.  
**Contains:** Integral Post Seal  
**Fits:** Aksa, Belaz, Cummins, Demag, Euclid, Hitachi, Komatsu, Manitowoc, Unit Rig, WABCO Equipment  
**Replaces:** Cummins 3307885, 3310169, 3313282; Komatsu CU3307885, VS7692; Liebherr 7369715; Renault 5000822872  
**Thread:** 1 1/2 -12  
**O.D.:** 4 11/16 (119.1)  
**Height:** 11 9/32 (286.5)  
**I.Gskt:** [1] Included

**B7397**

Lube Spin-on



**Fits:** Case-International Tractors  
**Replaces:** Case 87300047; Fleetguard LF3593  
**Thread:** 1 1/8 -16  
**O.D.:** 4 1/4 (108.0)  
**Height:** 7 3/8 (187.3)  
**I.Gskt:** [1] Included

Measurements Are Shown In Inches And (Millimeters)

**WARNING:** These products can expose you to chemicals, including Diisononyl Phthalate, Carbon black extracts, Nickel, 1,3 Butadiene, Ethylene Oxide, Epichlorohydrin, which are known to the State of California to cause cancer, and Bisphenol, Ethylene Glycol, Ethylene Oxide, 1,3 Butadiene, Epichlorohydrin, which are known to the State of California to cause birth defects or other reproductive harm.



**P7398**

Lube Element



**Contains:** [1] Plastic Drain Plug  
**Fits:** Lexus, Toyota Automotive, Light-Duty Trucks  
**Replaces:** Toyota 4152-31090  
**O.D.:** 2 3/4 (69.9)  
**I.D.:** 1 3/32 (27.8)  
**Height:** 2 5/8 (66.7)  
**O-Ring:** [2] Included

**P7406**

Lube Element



**Contains:** [1] Plastic Drain Tube  
**Fits:** Toyota Light-Duty Trucks  
**Replaces:** Toyota 4152-YZZA4  
**O.D.:** 2 11/16 (68.3)  
**I.D.:** 1 1/8 (28.6)  
**Height:** 4 5/8 (117.5)  
**O-Ring:** [2] Included  
**Related To:** P40109 (w/o Drain Plug)

**P7399**

Lube Element



**Fits:** Audi, Volkswagen Automotive  
**Replaces:** Volkswagen 6D115466, 6D115562  
**O.D.:** 2 1/2 (63.5)  
**I.D.:** 1 7/32 (31.0)  
**Height:** 4 15/16 (125.4)  
**F. Gskt:** [1] Included

**B7407**

Lube Spin-on



**Contains:** Anti-Drainback Valve  
 20 PSID By-Pass Valve  
**Fits:** Hitachi, John Deere Excavators  
**Replaces:** Hitachi 4454526  
**Thread:** M20 x 1.5  
**O.D.:** 3 1/32 (77.0)  
**Height:** 2 25/32 (70.6)  
**I.Gskt:** [1] Included

**P7400**

Lube Element



**Fits:** Hyundai, Kia Automotive, Light-Duty Trucks  
**Replaces:** Hyundai 26320-3C100  
**O.D.:** 2 7/8 (73.0)  
**I.D.:** 1 3/8 (34.9)  
**Height:** 5 3/32 (129.4)  
**A. Gskt:** [2] Attached  
**O-Ring:** [2] Included

**P7408**

Lube Element



**Fits:** 2002-06 Mini Cooper, Cooper S  
**Replaces:** BMW 11427509208, 11427512466  
**O.D.:** 2 13/16 (71.4)  
**I.D.:** 23/32 (18.3) & 1 3/32 (27.8)  
**Height:** 3 3/16 (81.0)  
**A. Gskt:** [2] Attached  
**O-Ring:** [1] Included

**B7401**

Lube Spin-on



**Contains:** Anti-Drainback Valve  
 14 PSID By-Pass Valve  
**Fits:** Chrysler, Dodge, Jeep Automotive,  
 Light-Duty Trucks  
**Replaces:** Chrysler 4884900AB  
**Thread:** M22 x 1.5  
**O.D.:** 3 1/32 (77.0)  
**Height:** 2 25/32 (70.6)  
**I.Gskt:** [1] Included

**B7409**

By-Pass Lube Spin-on



**Fits:** Mack MP7, MP8, MP10 Engines, Trucks  
**Replaces:** Mack 20843764; Volvo 20843764  
**Thread:** 1 3/8 -16  
**O.D.:** 4 1/4 (108.0)  
**Height:** 10 1/16 (255.6)  
**I.Gskt:** [1] Included

**B7402**

Lube Spin-on



**Fits:** Freightliner, Kenworth, Peterbilt Trucks  
 all with Caterpillar C11, C13, C18 Engines  
**Replaces:** Caterpillar 249-2347  
**Thread:** 1 1/2 -16  
**O.D.:** 5 3/8 (136.5)  
**Height:** 8 19/32 (218.3)  
**I.Gskt:** [1] Included

**B7410**

Lube Spin-on



**Contains:** 40 PSID By-Pass Valve  
**Fits:** Case Compactors; Deutz Engines  
**Replaces:** Case ND103597; Deutz 1182236  
**Thread:** 3/4 -16  
**O.D.:** 3 1/32 (77.0)  
**Height:** 2 5/16 (58.7)  
**I.Gskt:** G449-B

**B7403**

Lube Spin-on



**Contains:** Anti-Drainback Valve  
 20 PSID By-Pass Valve  
**Fits:** Case, New Holland Wheel Loaders  
**Replaces:** Case 285451A1; Perkins 2654412  
**Thread:** 3/4 -16  
**O.D.:** 3 11/16 (93.7)  
**Height:** 4 3/8 (111.1)  
**I.Gskt:** G381-A

**P7411**

Lube Element



**Fits:** 2003-04 Cadillac CTS with V6-197 (3.2L)  
 Engine  
**Replaces:** GMC 24415388, 88894390  
**O.D.:** 2 1/16 (52.4)  
**I.D.:** 23/32 (18.3) One End  
**Height:** 4 (101.6)  
**A. Gskt:** [1] Attached  
**O-Ring:** [2] Included

Measurements Are Shown In Inches And (Millimeters)

**WARNING:** These products can expose you to chemicals, including Diisononyl Phthalate, Carbon black extracts, Nickel, 1,3 Butadiene, Ethylene Oxide, Epichlorohydrin, which are known to the State of California to cause cancer, and Bisphenol, Ethylene Glycol, Ethylene Oxide, 1,3 Butadiene, Epichlorohydrin, which are known to the State of California to cause birth defects or other reproductive harm.

**P7413** Lube Element  
**Fits:** Jeep, Mercedes-Benz Light-Duty Trucks, Dodge, Mercedes-Benz Sprinter Vans  
**Replaces:** Chrysler 5175571AA; Mercedes-Benz A6421800009; Fleetguard LF16231  
**O.D.:** 2 13/16 (71.4)  
**I.D.:** 1 7/32 (31.0)  
**Height:** 3 3/4 (95.3)  
**O-Ring:** [2] Included



**B7419** Lube Spin-on  
**Contains:** Anti-Drainback Valve  
 20 PSID By-Pass Valve  
**Fits:** Suzuki ATVs, Motorcycles  
**Replaces:** Suzuki 16510-03G00, 16510-06B01  
**Thread:** M20 x 1.0  
**O.D.:** 2 21/32 (67.5)  
**Height:** 2 5/8 (66.7)  
**I.Gskt:** [1] Included



**P7414** Lube Element  
**Contains:** [1] Circular Band Seal  
**Fits:** Audi Automotive  
**Replaces:** Audi 6E115562A; Wix 57204  
**O.D.:** 2 9/16 (65.1)  
**I.D.:** 1 1/4 (31.8)  
**Height:** 6 3/32 (154.8)  
**I.Gskt:** [2] Included  
**O-Ring:** [1] Included



**B7420** Lube Spin-on  
**Contains:** Anti-Drainback Valve  
**Fits:** Komatsu Excavators  
**Replaces:** Komatsu 6732-51-5141, 6732-51-5142; Fleetguard LF3915  
**Thread:** 1 -16  
**O.D.:** 3 11/16 (93.7)  
**Height:** 5 3/8 (136.5)  
**I.Gskt:** G381-A



**P7415** Lube Element  
**Fits:** Audi, Volkswagen Automotive, Light-Duty Trucks  
**Replaces:** Volkswagen 71115562, 71115562A, 71115562B; ACDelco PF1708  
**O.D.:** 2 25/32 (70.6)  
**I.D.:** 5/8 (15.9) One End  
**Height:** 5 9/16 (141.3)  
**O-Ring:** [1] Attached



**B7422** Lube Spin-on  
**Contains:** Anti-Drainback Valve  
 20 PSID By-Pass Valve  
**Fits:** General Motors, Suzuki Automotive  
**Replaces:** General Motors 12640445; Suzuki 16510-78J01  
**Thread:** M22 x 1.5  
**O.D.:** 3 (76.2)  
**Height:** 3 1/2 (88.9)  
**I.Gskt:** G449-B



**B7416** Lube Spin-on  
**Contains:** 14 PSID By-Pass Valve  
**Fits:** Case Excavators  
**Replaces:** Case 87327673; Isuzu 1-87610-006-1  
**Thread:** 1 1/2 -12  
**O.D.:** 4 21/32 (118.3)  
**Height:** 8 3/32 (205.6)  
**I.Gskt:** G498-D



**P7423** Lube Element  
**Fits:** International City Star Trucks; Workhorse Chassis all with IHC MaxxForce 5 (4.5L), VT275 (4.5L) Engines  
**Replaces:** International 1847174-C91  
**O.D.:** 3 5/16 (84.1)  
**I.D.:** 1 9/16 (39.7) One End  
**Height:** 5 15/16 (150.8)  
**O-Ring:** [1] Included



**P7417** Lube Element  
**Fits:** Volvo Automotive  
**Replaces:** Volvo 8642570  
**O.D.:** 2 1/2 (63.5)  
**I.D.:** 1 7/32 (31.0)  
**Height:** 4 15/16 (125.4)  
**O-Ring:** [1] Included



**B7424** Lube Spin-on  
**Contains:** Anti-Drainback Valve  
 20 PSID By-Pass Valve  
**Fits:** Jaguar Automotive  
**Replaces:** Jaguar EAC1467  
**Thread:** 1 -12  
**O.D.:** 3 11/16 (93.7)  
**Height:** 4 7/16 (112.7)  
**I.Gskt:** G401



**P7418** Lube Element  
**Contains:** [1] Plastic Drain Plug  
**Fits:** Lexus Automotive  
**Replaces:** Toyota 4152-31060, 4152-YZZA5  
**O.D.:** 2 3/4 (69.9)  
**I.D.:** 1 3/32 (27.8)  
**Height:** 3 7/32 (81.8)  
**O-Ring:** [2] Included



**P7426** Lube Element  
**Fits:** BMW Automotive  
**Replaces:** BMW 11421432097, 11421743398, 11421216192  
**O.D.:** 2 17/32 (64.3)  
**I.D.:** 31/32 (24.6)  
**Height:** 4 1/32 (102.4)  
**F. Gskt:** [1] Copper Washer  
**O-Ring:** [3] Included



Measurements Are Shown In Inches And (Millimeters)

**WARNING:** These products can expose you to chemicals, including Diisononyl Phthalate, Carbon black extracts, Nickel, 1,3 Butadiene, Ethylene Oxide, Epichlorohydrin, which are known to the State of California to cause cancer, and Bisphenol, Ethylene Glycol, Ethylene Oxide, 1,3 Butadiene, Epichlorohydrin, which are known to the State of California to cause birth defects or other reproductive harm.

<p><b>P7427</b></p>  <p>Lube Element  <b>Fits:</b> BMW Automotive  <b>Replaces:</b> BMW 11427506677, 11427511161  <b>O.D.:</b> 2 7/8 (73.0)  <b>I.D.:</b> 3/8 (9.5) &amp; 1 1/4 (31.8)  <b>Height:</b> 4 3/32 (104.0)  <b>A. Gskt:</b> [1] Attached  <b>F. Gskt:</b> [1] Metal Washer  <b>O-Ring:</b> [2] Included</p>	<p><b>B7434</b></p>  <p>Chrome Lube Spin-on  <b>Contains:</b> 17 PSID By-Pass Valve  <b>Fits:</b> Harley-Davidson Motorcycles  <b>Replaces:</b> Harley-Davidson 6379677A, 6373199A  <b>Thread:</b> 3/4 -16  <b>O.D.:</b> 3 1/8 (79.4)  <b>Height:</b> 3 21/32 (92.9)  <b>I.Gskt:</b> [1] Included</p>
<p><b>B7428</b></p>  <p>Lube Spin-on  <b>Contains:</b> Anti-Drainback Valve  25 PSID By-Pass Valve  <b>Fits:</b> Citroen, Fiat, Peugeot Automotive  <b>Replaces:</b> Peugeot 1109R0, 1109R1, 1109T0  <b>Thread:</b> M20 x 1.5  <b>O.D.:</b> 3 1/8 (79.4)  <b>Height:</b> 3 17/32 (89.7)  <b>I.Gskt:</b> [1] Included</p>	<p><b>B7435</b></p>  <p>By-Pass Lube Spin-on  <b>Contains:</b> Stud Thread: M16 x 1.5  <b>Replaces:</b> Fleetguard LF3882  <b>O.D.:</b> 5 1/16 (128.6)  <b>Height:</b> 6 31/32 (177.0)  <b>F. Gskt:</b> G372</p>
<p><b>B7429</b></p>  <p>Lube Spin-on  <b>Notes:</b> OBSOLETE. Availability Limited to Dealer Stock.  <b>Contains:</b> Anti-Drainback Valve  17 PSID By-Pass Valve  <b>Replaces:</b> Fiat 46808398, 71736159; Wix Europe WL7083  <b>Thread:</b> M20 x 1.5  <b>O.D.:</b> 3 1/8 (79.4)  <b>Height:</b> 2 7/8 (73.0)  <b>I.Gskt:</b> [1] Included</p>	<p><b>P7436</b></p>  <p>Lube Element with Lid  <b>Fits:</b> Ford, IHC Trucks and Buses  <b>Replaces:</b> Wix 57312  <b>O.D.:</b> 3 1/4 (82.6)  Lid 4 1/8 (104.8)  <b>I.D.:</b> 1 1/2 (38.1) One End  <b>Height:</b> 7 11/16 (195.3)  <b>Grommets:</b> [1] Attached  <b>Related To:</b> P7235 (without Lid)</p>
<p><b>B7430</b></p>  <p>Lube Spin-on  <b>Contains:</b> Anti-Drainback Valve  14 PSID By-Pass Valve  <b>Replaces:</b> Fiat 5984044, 71736157; Wix Europe WL7091  <b>Thread:</b> M20 x 1.5  <b>O.D.:</b> 3 1/8 (79.4)  <b>Height:</b> 4 1/32 (102.4)  <b>I.Gskt:</b> [1] Included</p>	<p><b>P7437</b></p>  <p>Lube Element with Lid  <b>Fits:</b> Ford E-Services Vans with 6.0L Diesel Engine  <b>Replaces:</b> Wix 57313, 57323  <b>O.D.:</b> 3 1/4 (82.6)  Lid 4 1/8 (104.8)  <b>I.D.:</b> 1 1/2 (38.1) One End  <b>Height:</b> 7 17/32 (191.3)  <b>Grommets:</b> [1] Attached  <b>Related To:</b> P7235 (without Lid)</p>
<p><b>B7431</b></p>  <p>Lube Spin-on  <b>Contains:</b> Anti-Drainback Valve  16 PSID By-Pass Valve  <b>Fits:</b> Nissan European Light-Duty Trucks  <b>Replaces:</b> Nissan 15208-BN30A, 15208-BN300  <b>Thread:</b> 3/4 -16  <b>O.D.:</b> 3 3/4 (95.3)  <b>Height:</b> 3 13/16 (96.8)  <b>I.Gskt:</b> [1] Included</p>	<p><b>P7438</b></p>  <p>Lube Element  <b>Fits:</b> BMW Automotive  <b>Replaces:</b> BMW 11427566327  <b>O.D.:</b> 2 7/8 (73.0)  <b>I.D.:</b> 1 5/8 (41.3)  <b>Height:</b> 3 1/8 (79.4)  <b>F. Gskt:</b> [1] Metal Washer  <b>O-Ring:</b> [2] Included</p>
<p><b>B7432</b></p>  <p>Lube Spin-on  <b>Contains:</b> Anti-Drainback Valve  18 PSID By-Pass Valve  <b>Fits:</b> Renault Master I European Light-Duty Trucks  <b>Replaces:</b> Renault 8200007832  <b>Thread:</b> M20 x 1.5  <b>O.D.:</b> 3 9/16 (90.5)  <b>Height:</b> 3 15/32 (88.1)  <b>I.Gskt:</b> [1] Included</p>	<p><b>B7440</b></p>  <p>Lube Spin-on  <b>Contains:</b> Anti-Drainback Valve  <b>Fits:</b> Komatsu Equipment  <b>Replaces:</b> Komatsu 6733-51-5142  <b>Thread:</b> 1 -16  <b>O.D.:</b> 3 11/16 (93.7)  <b>Height:</b> 5 3/8 (136.5)  <b>I.Gskt:</b> G381-A</p>
<p><b>B7433</b></p>  <p>Lube Spin-on  <b>Contains:</b> Anti-Drainback Valve  14 PSID By-Pass Valve  <b>Replaces:</b> Fiat 46805831, 71736160  <b>Thread:</b> 3/4 -16  <b>O.D.:</b> 3 1/8 (79.4)  <b>Height:</b> 4 1/32 (102.4)  <b>I.Gskt:</b> [1] Included</p>	<p><b>B7441</b></p>  <p>Lube Spin-on  <b>Contains:</b> Anti-Drainback Valve  14 PSID By-Pass Valve  <b>Replaces:</b> Fiat 46544820, 71736161; Wix Europe WL7134  <b>Thread:</b> M20 x 1.5  <b>O.D.:</b> 2 23/32 (69.1)  <b>Height:</b> 3 13/32 (86.5)  <b>I.Gskt:</b> [1] Included</p>

Measurements Are Shown In Inches And (Millimeters)

**WARNING:** These products can expose you to chemicals, including Diisononyl Phthalate, Carbon black extracts, Nickel, 1,3 Butadiene, Ethylene Oxide, Epichlorohydrin, which are known to the State of California to cause cancer, and Bisphenol, Ethylene Glycol, Ethylene Oxide, 1,3 Butadiene, Epichlorohydrin, which are known to the State of California to cause birth defects or other reproductive harm.

**P7442**

Lube Element



**Fits:** Chevrolet, Pontiac, Saturn Automotive  
**Replaces:** GM 12605566; ACDelco PF457G  
**O.D.:** 2 7/16 (61.9)  
**I.D.:** 1 3/8 (34.9) One End  
**Height:** 3 5/8 (92.1)  
**I.Gskt:** [1] Included  
**O-Ring:** [1] Included

**B7443**

Lube Spin-on



**Contains:** Anti-Drainback Valve  
 8 PSID By-Pass Valve  
**Fits:** Chrysler, Dodge, Jeep Automotive  
**Replaces:** Chrysler 4892339AA; Mopar MO-339  
**Thread:** M22 x 1.5  
**O.D.:** 3 (76.2)  
**Height:** 3 1/2 (88.9)  
**I.Gskt:** G449-B

**B7444**

Lube Spin-on



**Contains:** Anti-Drainback Valve  
 8 PSID By-Pass Valve  
**Fits:** Dodge, Jeep, Mitsubishi Light-Duty Trucks  
**Replaces:** Chrysler 5184231AA; Mopar MO231  
**Thread:** M22 x 1.5  
**O.D.:** 3 (76.2)  
**Height:** 4 27/32 (123.0)  
**I.Gskt:** G449-B

**B7445**

Lube Spin-on



**Contains:** Anti-Drainback Valve  
 17 PSID By-Pass Valve  
**Fits:** Antonio Carraro Equipment  
**Replaces:** Fiat 71736158, 46805832; Mann & Hummel W714/4  
**Thread:** M20 x 1.5  
**O.D.:** 3 1/8 (79.4)  
**Height:** 3 5/8 (92.1)  
**I.Gskt:** [1] Included

**B7446**

Lube Spin-on



**Replaces:** Hyster 1350036; Donaldson P550047  
**Thread:** M18 x 1.5  
**O.D.:** 2 29/32 (73.8)  
**Height:** 3 1/2 (88.9)  
**I.Gskt:** G449-B

**B7449**

Lube Spin-on



**Contains:** Anti-Drainback Valve  
 20 PSID By-Pass Valve  
**Fits:** Buick, Cadillac, Chevrolet, Ford, GMC, Lincoln, Mazda, Mercury Automotive, Light-Duty Trucks  
**Replaces:** Ford AA5Z-6714-A; Mazda ZC4-23-802  
**Thread:** M22 x 1.5  
**O.D.:** 3 (76.2)  
**Height:** 4 3/32 (104.0)  
**I.Gskt:** G449-B

**P7450**

Lube Element



**Fits:** Mini Cooper Automotive  
**Replaces:** BMW 11427557012  
**O.D.:** 2 9/16 (65.1)  
**I.D.:** 1 3/32 (27.8)  
**Height:** 2 23/32 (69.1)  
**F. Gskt:** [1] Brass Washer  
**O-Ring:** [1] Included

**B7451**

Lube Spin-on



**Contains:** 20 PSID By-Pass Valve  
 Integral Post Seal  
**Fits:** Foton FT404, FT504, Taishan TS554 Tractors  
**Replaces:** CLARCOR Filtration (China) CX85100C, JX85100C, WB202C  
**Thread:** M24 x 2.0  
**O.D.:** 3 21/32 (92.9)  
**Height:** 5 1/8 (130.2)  
**I.Gskt:** [1] Included

**B7452**

Lube Spin-on



**Contains:** Threaded Stud: M27 x 1.5  
 Front End Check Valve  
 35 PSID By-Pass Valve  
**Fits:** Audi, Volkswagen Automotive  
**Replaces:** Volkswagen 6J115403C, 6J115561B; Wix 57561  
**O.D.:** 3 1/16 (77.8)  
**Height:** 5 5/8 (142.9)  
**I.Gskt:** [1] Included

**B7453**

Lube Spin-on



**Contains:** 20 PSID By-Pass Valve  
 Integral Post Seal  
**Fits:** Kama, Taishan TS254C, TS354C Tractors  
**Replaces:** CLARCOR Filtration (China) JX0707, WB173-S  
**Thread:** M20 x 1.5  
**O.D.:** 3 11/16 (93.7)  
**Height:** 3 3/8 (85.7)  
**I.Gskt:** [1] Included

**P7454**

Lube Element



**Fits:** Scion, Toyota Automotive  
**Replaces:** Toyota 4152-YZZA6; Wix 57064  
**O.D.:** 2 3/8 (60.3)  
**I.D.:** 1 3/32 (27.8)  
**Height:** 2 1/4 (57.2)  
**O-Ring:** [1] Included

**P7455**

Lube Element



**Fits:** Nissan, Opel, Renault Light-Duty Trucks  
**Replaces:** Nissan 15209-00QAA; Opel 4415941, 4506039, 93184133; Renault 7700109402, 7701472321, 8200004835  
**O.D.:** 3 19/32 (91.3)  
**I.D.:** 1 15/32 (37.3)  
**Height:** 3 11/16 (93.7)  
**O-Ring:** [1] Included

Measurements Are Shown In Inches And (Millimeters)

**WARNING:** These products can expose you to chemicals, including Diisononyl Phthalate, Carbon black extracts, Nickel, 1,3 Butadiene, Ethylene Oxide, Epichlorohydrin, which are known to the State of California to cause cancer, and Bisphenol, Ethylene Glycol, Ethylene Oxide, 1,3 Butadiene, Epichlorohydrin, which are known to the State of California to cause birth defects or other reproductive harm.

### BC7456 KIT



#### Paper Insert

**Fits:** Mack Trucks  
**Replaces:** Spinner II 73165, 73187  
**O-Ring:** [2] Included

### B7462



#### Lube Spin-on

**Notes:** OBSOLETE. Availability Limited to Dealer Stock.  
**Contains:** 21-28 PSID By-Pass Valve  
**Replaces:** Huafeng Power WB202F; CLARCOR Filtration (China) WB202F  
**Thread:** 1 -12  
**O.D.:** 3 19/32 (91.3)  
**Height:** 5 5/8 (142.9)  
**I.Gskt:** [1] Included

### B7457



#### Lube Spin-on

**Contains:** Anti-Drainback Valve  
21-28 PSID By-Pass Valve  
**Replaces:** CLARCOR Filtration (China) WB202D; FAW-Xichai 1012010/4K  
**Thread:** 1 -12  
**O.D.:** 3 19/32 (91.3)  
**Height:** 5 5/8 (142.9)  
**I.Gskt:** [1] Included

### B7465



#### Lube Spin-on

**Notes:** OBSOLETE. Availability Limited to Dealer Stock.  
**Contains:** 21-28 PSID By-Pass Valve  
**Replaces:** FAW-Xichai 101201029D; CLARCOR Filtration (China) WB255  
**Thread:** 1 -12  
**O.D.:** 3 19/32 (91.3)  
**Height:** 5 7/16 (138.1)  
**I.Gskt:** [1] Included

### B7458



#### Lube Spin-on

**Contains:** 18-20 PSID By-Pass Valve  
**Replaces:** CLARCOR Filtration (China) WB178; Foton Lovol KM385T-09303  
**Thread:** 3/4 -16  
**O.D.:** 3 1/32 (77.0)  
**Height:** 4 13/16 (122.2)  
**I.Gskt:** [1] Included

### B7466



#### Lube Spin-on

**Notes:** OBSOLETE. Availability Limited to Dealer Stock.  
**Replaces:** Huafeng Power WB218A; CLARCOR Filtration (China) WB218A  
**Thread:** 1 1/8 -16  
**O.D.:** 4 11/32 (110.3)  
**Height:** 10 7/32 (259.6)  
**I.Gskt:** [1] Included

### B7459



#### Lube Spin-on

**Contains:** 30-42 PSID By-Pass Valve  
**Replaces:** CLARCOR Filtration (China) WB218; Sinotruk VG1540070007; Weichai Power 610800070015  
**Thread:** 1 1/8 -16  
**O.D.:** 4 11/32 (110.3)  
**Height:** 10 1/4 (260.3)  
**I.Gskt:** [1] Included

### B7467



#### Lube Spin-on

**Contains:** Anti-Drainback Valve  
8 PSID By-Pass Valve  
Standpipe  
**Fits:** J.C. Bamford Equipment  
**Replaces:** J.C. Bamford 2/100284, 2/100284A  
**Thread:** 3/4 -16  
**O.D.:** 3 11/16 (93.7)  
**Height:** 5 3/8 (136.5)

### B7460



#### Lube Spin-on

**Notes:** OBSOLETE. Availability Limited to Dealer Stock.  
**Contains:** 32-40 PSID By-Pass Valve  
**Replaces:** FAW-Xichai 10120104000000M; Mann & Hummel W11102/16  
**Thread:** 1 1/8 -16  
**O.D.:** 4 9/32 (108.7)  
**Height:** 10 7/16 (265.1)  
**I.Gskt:** [1] Included

### B7468



#### Lube Spin-on

**Contains:** By-Pass Valve  
**Replaces:** FAW-Xichai 1012015155YT50W; CLARCOR Filtration (China) JX1017  
**Thread:** 1 1/8 -16  
**O.D.:** 4 3/8 (111.1)  
**Height:** 8 11/32 (211.9)  
**I.Gskt:** [1] Included

### B7461



#### Lube Spin-on

**Contains:** 32-40 PSID By-Pass Valve  
**Replaces:** FAW-Xichai 101201036D; Mann & Hummel W950/31  
**Thread:** 1 -12  
**O.D.:** 3 19/32 (91.3)  
**Height:** 6 5/8 (168.3)  
**I.Gskt:** [1] Included

### B7469



#### Lube Spin-on

**Contains:** Anti-Drainback Valve  
20 PSID By-Pass Valve  
**Replaces:** Huafeng Power JX0810; ShanDong Huayuan Laidong Engine JX0810; CLARCOR Filtration (China) JX0810  
**Thread:** M20 x 1.5  
**O.D.:** 3 19/32 (91.3)  
**Height:** 5 1/8 (130.2)  
**I.Gskt:** [1] Included

Measurements Are Shown In Inches And (Millimeters)

**WARNING:** These products can expose you to chemicals, including Diisononyl Phthalate, Carbon black extracts, Nickel, 1,3 Butadiene, Ethylene Oxide, Epichlorohydrin, which are known to the State of California to cause cancer, and Bisphenol, Ethylene Glycol, Ethylene Oxide, 1,3 Butadiene, Epichlorohydrin, which are known to the State of California to cause birth defects or other reproductive harm.

**B7470** Lube Spin-on  
**Notes:** OBSOLETE. Availability Limited to Dealer Stock.  
**Contains:** Anti-Drainback Valve  
 14 PSID By-Pass Valve  
**Replaces:** DCD (DongFeng Chaoyang Diesel) 1520843G00; CLARCOR Filtration (China) JX0811B  
**Thread:** 3/4 -16  
**O.D.:** 3 19/32 (91.3)  
**Height:** 5 1/8 (130.2)  
**I.Gskt:** [1] Included



**B7477** Lube Spin-on  
**Contains:** 18-20 PSID By-Pass Valve  
**Replaces:** Weichai Power JX1010; CLARCOR Filtration (China) JX1010  
**Thread:** M24 x 2.0  
**O.D.:** 4 1/4 (108.0)  
**Height:** 5 9/32 (134.1)  
**I.Gskt:** [1] Included



**B7472** Lube Spin-on  
**Notes:** OBSOLETE. Availability Limited to Dealer Stock.  
**Contains:** Anti-Drainback Valve  
 18-20 PSID By-Pass Valve  
**Replaces:** Weichai Power JX0812; CLARCOR Filtration (China) JX0812  
**Thread:** M24 x 2.0  
**O.D.:** 3 19/32 (91.3)  
**Height:** 5 13/16 (147.6)  
**I.Gskt:** [1] Included



**B7478** Lube Spin-on  
**Notes:** OBSOLETE. Availability Limited to Dealer Stock.  
**Replaces:** Foton Lovol DC238B1504; CLARCOR Filtration (China) B76A  
**Thread:** 1 1/8 -16  
**O.D.:** 4 9/32 (108.7)  
**Height:** 7 3/32 (180.2)  
**I.Gskt:** [1] Included



**B7473** Lube Spin-on  
**Notes:** OBSOLETE. Availability Limited to Dealer Stock.  
**Contains:** Anti-Drainback Valve  
 11-17 PSID By-Pass Valve  
**Replaces:** Tianjin Lovol Engines T64101001, T741010016, T741010017, T74105021; CLARCOR Filtration (China) BT2161  
**Thread:** 3/4 -16  
**O.D.:** 3 19/32 (91.3)  
**Height:** 5 3/8 (136.5)  
**I.Gskt:** [1] Included



**B7481** Lube Spin-on  
**Notes:** OBSOLETE. Availability Limited to Dealer Stock.  
**Contains:** 30-42 PSID By-Pass Valve  
**Replaces:** Yuchai Watyuan J65F11012020  
**Thread:** 1 1/8 -16  
**O.D.:** 4 11/32 (110.3)  
**Height:** 8 11/32 (211.9)  
**I.Gskt:** [1] Included



**B7474** Lube Spin-on  
**Notes:** OBSOLETE. Availability Limited to Dealer Stock.  
**Contains:** 20 PSID By-Pass Valve  
**Replaces:** Yuchai Watyuan 1881012000  
**Thread:** 1 -12  
**O.D.:** 3 19/32 (91.3)  
**Height:** 7 9/16 (192.1)  
**I.Gskt:** [1] Included



**B7482** Lube Spin-on  
**Notes:** OBSOLETE. Availability Limited to Dealer Stock.  
**Contains:** 40 PSID By-Pass Valve  
**Replaces:** Yuchai Watyuan L30001012020, 4301012020A; CLARCOR Filtration (China) JX1023-1000  
**Thread:** 1 1/8 -16  
**O.D.:** 4 9/32 (108.7)  
**Height:** 10 7/16 (265.1)  
**I.Gskt:** [1] Included



**B7475** Lube Spin-on  
**Notes:** OBSOLETE. Availability Limited to Dealer Stock.  
**Contains:** 28-30 PSID By-Pass Valve  
**Replaces:** Yuchai Watyuan 6301012120A  
**Thread:** 1 -12  
**O.D.:** 3 19/32 (91.3)  
**Height:** 8 1/8 (206.4)  
**I.Gskt:** [1] Included



**B7483** Lube Spin-on  
**Contains:** 30-42 PSID By-Pass Valve  
**Replaces:** Yuchai Watyuan M30001012240A  
**Thread:** 1 1/8 -16  
**O.D.:** 4 9/32 (108.7)  
**Height:** 6 7/32 (158.0)  
**I.Gskt:** [1] Included



**B7476** Lube Spin-on  
**Notes:** OBSOLETE. Availability Limited to Dealer Stock.  
**Contains:** 18-20 PSID By-Pass Valve  
**Replaces:** Weichai Power JX0814G; CLARCOR Filtration (China) JX0814G  
**Thread:** M24 x 2.0  
**O.D.:** 3 19/32 (91.3)  
**Height:** 6 5/8 (168.3)  
**I.Gskt:** [1] Included



**P7484** Lube Element  
**Notes:** OBSOLETE. Availability Limited to Dealer Stock.  
**Replaces:** CLARCOR Filtration (China) J1018-1000; FAW-Xichai K1012001  
**O.D.:** 3 15/16 (100.0)  
**I.D.:** 1 3/4 (44.4)  
**Height:** 7 3/16 (182.6)



Measurements Are Shown In Inches And (Millimeters)

**WARNING:** These products can expose you to chemicals, including Diisononyl Phthalate, Carbon black extracts, Nickel, 1,3 Butadiene, Ethylene Oxide, Epichlorohydrin, which are known to the State of California to cause cancer, and Bisphenol, Ethylene Glycol, Ethylene Oxide, 1,3 Butadiene, Epichlorohydrin, which are known to the State of California to cause birth defects or other reproductive harm.

**BC7485** Centrifugal Lube Element  
**Fits:** IHC MaxxForce 9, MaxxForce 10, MaxxForce 11, MaxxForce 13 Engines, ProStar, 4400 DuraStar, 7400 WorkStar, 7500 WorkStar, 7600 WorkStar Trucks  
**Replaces:** International 2606467-C91  
**O.D.:** 3 11/16 (93.7)  
**I.D.:** 1/4 (6.4) One End  
**Height:** 5 13/16 (147.6)  
**O-Ring:** [1] Included  
**Related To:** BC7326 (Different O-Ring)



**B7491** Lube Spin-on  
**Contains:** 14 PSID By-Pass Valve  
**Fits:** Ford, Mercury Automotive, Light-Duty Trucks  
**Replaces:** Ford 1S7Z-6731-DA, BE8Z-6731-AB; Motorcraft EFL910, FL910, FL910S  
**Thread:** 3/4 -16  
**O.D.:** 3 (76.2)  
**Height:** 3 17/32 (89.7)  
**I.Gskt:** [1] Included



**B7486** Lube Spin-on  
**Contains:** Anti-Drainback Valve  
 30 PSID By-Pass Valve  
**Fits:** J.C. Bamford, Hitachi, John Deere, Kobelco, New Holland Excavators  
**Replaces:** Isuzu 8-98075-676-0; J.C. Bamford 32/926119; SF-Filter SP4959  
**Thread:** 3/4 -16  
**O.D.:** 3 13/16 (96.8)  
**Height:** 5 29/32 (150.0)  
**I.Gskt:** [1] Included



**P7492** Lube Element  
**Fits:** Chrysler, Dodge, Jeep, Ram Automotive, Light-Duty Trucks  
**Replaces:** Chrysler 68079744AA, 68079744AB; Mopar MO744  
**O.D.:** 2 1/16 (52.4)  
**I.D.:** 5/8 (15.9) & 7/8 (22.2)  
**Height:** 5 13/32 (137.3)  
**O-Ring:** [1] Included



**B7487** Lube Spin-on  
**Contains:** Anti-Drainback Valve  
 20 PSID By-Pass Valve  
**Fits:** Case, Komatsu, Takeuchi, Yanmar Engines, Equipment  
**Replaces:** Atlas Copco 2914920000; Isuzu 5864015150; Komatsu YM12915035153; Yanmar 12915035153  
**Thread:** M20 x 1.5  
**O.D.:** 3 1/32 (77.0)  
**Height:** 3 7/16 (87.3)  
**I.Gskt:** [1] Included



**P7493** Lube Element  
**Fits:** Mercedes-Benz Automotive  
**Replaces:** Mercedes-Benz 1803109, A0001802609; Mahle OX345DECO  
**O.D.:** 2 9/16 (65.1)  
**I.D.:** 1 7/32 (31.0)  
**Height:** 4 17/32 (115.1)  
**O-Ring:** [5] Included



**P7488** Lube Element  
**Fits:** 2008-on Land Rover LR2; 2007-on Volvo S80, XC90, 2008-10 V70, 2008-on XC70, 2009-on XC60, 2011-on S60  
**Replaces:** Land Rover LR001419; Volvo 3075001-3  
**O.D.:** 3 9/32 (83.3)  
**I.D.:** 1 11/16 (42.9)  
**Height:** 4 1/32 (102.4)  
**O-Ring:** [1] Included



**P7494** Lube Element  
**Fits:** Caterpillar, IHC Trucks with MaxxForce 11, MaxxForce 13 Engines  
**Replaces:** Caterpillar 3809364; International 3007498C92, 3007543C92, 3015784C1  
**O.D.:** 4 23/32 (119.9)  
**I.D.:** 1 3/4 (44.4) & 2 3/32 (53.2)  
**Height:** 7 5/8 (193.7)  
**O-Ring:** [1] Attached, [2] Included



**P7489** Lube Element  
**Fits:** Chevrolet Aveo; Pontiac G3; Saturn Astra  
**Replaces:** Fiat 71744410; General Motors 93185674; Opel 5650359  
**O.D.:** 2 1/4 (57.2)  
**I.D.:** 5/8 (15.9) & 13/16 (20.6)  
**Height:** 4 3/16 (106.4)  
**A. Gskt:** [1] Included  
**F. Gskt:** [1] Included



**P7495** Lube Element in Plastic Housing  
**Notes:** P40062 (Element only)  
**Fits:** Iveco Trucks; Case-International Steiger, New Holland Equipment  
**Replaces:** Iveco 2996416, 500054654, 504213801; New Holland 504213800, 87495056; Hengst H311W  
**Element**  
**O.D.:** 4 3/32 (104.0) to 4 3/8 (111.1)  
**I.D.:** 1 9/16 (39.7) One End  
**Height:** 12 21/32 (321.5)  
**O-Ring:** [1] Attached  
**Housing**  
**O.D.** 5 13/32 (111.9)  
**I.D. Thread:** S125x4  
**Height** 13 3/4 (349.3)



**P7490** Lube Element  
**Contains:** 30 PSID By-Pass Valve  
**Fits:** Suzuki ATVs  
**Replaces:** Suzuki 16510-24501, 16510-25000, 16510-25C00; Arctic Cat 3436-005  
**O.D.:** 1 23/32 (43.7)  
**I.D.:** 17/32 (13.5) One End  
**Height:** 2 3/16 (55.6)  
**O-Ring:** [2] Included

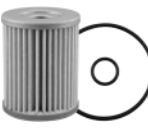

**B7496** Lube Spin-on  
**Contains:** Anti-Drainback Valve  
 40 PSID By-Pass Valve  
**Fits:** Iveco Trucks  
**Replaces:** Iveco 2995811, 504091563; Fiat 8094872  
**Thread:** M22 x 1.5  
**O.D.:** 3 11/16 (93.7)  
**Height:** 2 13/16 (71.4)  
**I.Gskt:** G381-A



Measurements Are Shown In Inches And (Millimeters)

**WARNING:** These products can expose you to chemicals, including Diisononyl Phthalate, Carbon black extracts, Nickel, 1,3 Butadiene, Ethylene Oxide, Epichlorohydrin, which are known to the State of California to cause cancer, and Bisphenol, Ethylene Glycol, Ethylene Oxide, 1,3 Butadiene, Epichlorohydrin, which are known to the State of California to cause birth defects or other reproductive harm.

**B7497** Lube Spin-on  
**Replaces:** DongFeng Cummins Engine Co. 1012BF11-025; CLARCOR Filtration (China) WPPA01102  
**Thread:** 1 1/8 -16  
**O.D.:** 3 5/8 (92.1)  
**Height:** 7 1/8 (181.0)  
**I.Gskt:** [1] Included



**B7503** Lube Spin-on  
**Fits:** International MaxxForce DT, MaxxForce 9, MaxxForce 10 Engines, DuraStar, WorkStar Trucks; Spartan ERV Series Fire Truck Chassis  
**Replaces:** International Harvester 1884508-C1, 1884508-C2, 1889124-C91  
**Thread:** 1 3/4 -12  
**O.D.:** 4 9/16 (115.9)  
**Height:** 11 13/32 (289.7)  
**I.Gskt:** [1] Included



**B7499** Lube Spin-on  
**Contains:** Anti-Drainback Valve  
 30 PSID By-Pass Valve  
 Standpipe  
**Fits:** Case Loaders; Case-International Tractors  
**Replaces:** Case 87679496; Iveco 504182581  
**Thread:** M27 x 2.0  
**O.D.:** 3 11/16 (93.7)  
**Height:** 3 7/8 (98.4)  
**I.Gskt:** G381-A



**BD7504** High Velocity Dual-Flow Lube Spin-on  
**Replaces:** Cummins 4906635; Fleetguard LF9039  
**Thread:** 2 1/4 -12  
**O.D.:** 4 21/32 (118.3)  
**Height:** 11 13/32 (289.7)  
**I.Gskt:** [1] Included



**F7500** Fuel Element with Bail Handle  
**Fits:** 750 Housings  
**O.D.:** 7 11/16 (195.3)  
**I.D.:** 7/8 (22.2)  
**Height:** 15 3/32 (383.4)  
**O. Gskt:** ES1067, ES1068, ES1376, ES1377, G155, G157, G238, G252, G309-B  
**Related To:** C750-E, C750-L, C750-L SINGLE (Depth-Pack or Vac-Cel By-Pass Lube Versions)



**P7505** Lube Element  
**Contains:** Offset By-Pass Valve  
**Fits:** Freightliner Cascadia, Century Class S/T, Columbia, Coronado, Business Class M2, Sterling L-Line, L-Line 9500, Western Star 4900EX, 4900FA, 4900SA Trucks all with Detroit Diesel DD13, DD15 or DD16 Eng  
**Replaces:** Detroit Diesel A4721800109, A4721800309; Mercedes-Benz A4721800309, A4721840525; Donaldson P551005  
**O.D.:** 4 3/4 (120.7)  
**I.D.:** 2 (50.8) One End  
**Height:** 10 7/16 (265.1)  
**A. Gskt:** [1] Attached  
**F. Gskt:** [1] Copper Washer  
**O-Ring:** [1] Included



**P7500** By-Pass Lube Element with Bail Handle  
**Fits:** 750 Housings  
**O.D.:** 7 11/16 (195.3)  
**I.D.:** 7/8 (22.2)  
**Height:** 15 3/32 (383.4)  
**O. Gskt:** ES1067, ES1068, ES1376, ES1377, G155, G157, G238, G252, G309-B  
**Related To:** C750-E, C750-L, C750-L SINGLE (Depth-Pack or Vac-Cel By-Pass Lube Versions)

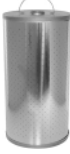

**B7506** Lube Spin-on  
**Fits:** International MaxxForce 7 Engines, DuraStar, TerraStar, TransStar Trucks  
**Replaces:** International 1899332-C91; 1893553-C2  
**Thread:** 1 -16  
**O.D.:** 4 9/32 (108.7)  
**Height:** 8 3/4 (222.3)  
**I.Gskt:** [1] Included



**B7501** Lube Spin-on  
**Contains:** 35 PSID By-Pass Valve  
**Fits:** Fendt Tractors  
**Replaces:** Agco F934201510320; Deutz 1182947; Fendt F934201510320; Mann & Hummel W1110228  
**Thread:** 1 1/8 -16  
**O.D.:** 4 1/4 (108.0)  
**Height:** 10 1/16 (255.6)  
**I.Gskt:** [1] Included



**B7507** High Efficiency Lube Spin-on  
**Fits:** IHC MaxxForce 15 Engine, ProStar Truck  
**Replaces:** Case-International 3014491C91  
**Thread:** 1 1/2 -16  
**O.D.:** 5 3/8 (136.5)  
**Height:** 12 3/32 (307.2)  
**I.Gskt:** [1] Included  
**O-Ring:** [3] Included  
**Related To:** B7299 (w/o O-Rings)



**P7502** Lube Element  
**Fits:** Scania Engines, Trucks  
**Replaces:** Scania 1742037, 2022275; Fleetguard LF17486; Hengst E123HD194; Mahle OX562DECO; Mann HU10771X  
**O.D.:** 3 9/16 (90.5)  
**I.D.:** 1 3/4 (44.4) One End  
**Height:** 11 1/8 (282.6)  
**O-Ring:** [1] Included



Measurements Are Shown In Inches And (Millimeters)

**WARNING:** These products can expose you to chemicals, including Diisononyl Phthalate, Carbon black extracts, Nickel, 1,3 Butadiene, Ethylene Oxide, Epichlorohydrin, which are known to the State of California to cause cancer, and Bisphenol, Ethylene Glycol, Ethylene Oxide, 1,3 Butadiene, Epichlorohydrin, which are known to the State of California to cause birth defects or other reproductive harm.



**P7508** Lube Element  
**Fits:** IHC MaxForce 11, MaxxForce 13 Engines; LoneStar, Prostar, 7600 WorkStar, 7700 WorkStar, 8600 WorkStar, 8600 TranStar Trucks  
**Replaces:** International 3006874C91  
**O.D.:** 4 3/4 (120.7)  
**I.D.:** 2 (50.8) One End  
**Height:** 8 3/32 (205.6)  
**A. Gskt:** [1] Attached  
**O-Ring:** [2] Included



**P7514** Lube Element  
**Fits:** Caterpillar C175-16, C175-20 Gen Set  
**Replaces:** Caterpillar 2492340, 3680066  
**O.D.:** 7 13/32 (188.1)  
**I.D.:** 3 13/32 (86.5)  
**Height:** 13 21/32 (346.9)  
**A. Gskt:** [2] Attached



**BD7509** High Velocity Dual-Flow Lube Spin-on  
**Contains:** Venturi-Type Cone  
**Fits:** Equipment with Various Cummins ISM11, QSX15 Series Engines  
**Replaces:** Cummins 4906633; Fleetguard LF9031  
**Thread:** M95 x 2.5  
**O.D.:** 4 11/16 (119.1)  
**Height:** 11 25/32 (299.2)  
**I.Gskt:** [1] Included  
**Related To:** BD7154 (Nitrile Gasket)



**P7515** Lube Element  
**Fits:** Hyundai, Kia Automotive  
**Replaces:** Hyundai 263203CAA0; Kia 263203CAA0  
**O.D.:** 2 19/32 (65.9)  
**I.D.:** 27/32 (21.4) & 1 3/32 (27.8)  
**Height:** 4 25/32 (121.4)  
**A. Gskt:** [1] Included  
**F. Gskt:** [1] Metal Washer  
**O-Ring:** [1] Included



**P7510** Lube Element  
**Fits:** Hino P11C Engine  
**Replaces:** Hino S156072430  
**O.D.:** 4 3/16 (106.4)  
**I.D.:** 19/32 (15.1) & 2 (50.8)  
**Height:** 7 3/8 (187.3)  
**A. Gskt:** [1] Attached  
**F. Gskt:** [1] Metal Washer  
**O-Ring:** [3] Included  
**Grommets:** [1] Attached



**B7516** Lube Spin-on  
**Contains:** 20 PSID By-Pass Valve  
**Fits:** John Deere Gen Set Power Units with PowerTech (4.5L) & (6.8L) Engine  
**Replaces:** John Deere RE506178; Fleetguard LF3941  
**Thread:** 1 1/2 -16  
**O.D.:** 3 3/4 (95.3)  
**Height:** 5 3/4 (146.0)  
**F. Gskt:** [1] Included



**B7511** Lube Spin-on  
**Contains:** Anti-Drainback Valve  
 14 PSID By-Pass Valve  
**Fits:** Bobcat, Ingersoll-Rand Compactors  
**Replaces:** Ingersoll-Rand 54477104  
**Thread:** 3/4 -16  
**O.D.:** 3 11/16 (93.7)  
**Height:** 3 1/4 (82.6)  
**I.Gskt:** [1] Included



**P7517** Lube Element  
**Fits:** Jeep Grand Cherokee; Ram 1500 Pickups  
**Replaces:** Chrysler 68109834AA  
**O.D.:** 2 19/32 (65.9)  
**I.D.:** 3/4 (19.0) One End  
**Height:** 4 7/8 (123.8)  
**O-Ring:** [1] Attached, [1] Included



**P7512** Lube Element  
**Replaces:** Hino S156072440  
**O.D.:** 4 25/32 (121.4)  
**I.D.:** 5/8 (15.9)  
**Height:** 8 21/32 (219.9)  
**F. Gskt:** [5] Included



**BF7519** Stainless Steel Screen In-Line Fuel Filter  
**Contains:** [2] Rubber Seals  
 [2] Brass Fittings  
**Fits:** Case-International, John Deere Tractors  
**Replaces:** Case A184963; John Deere AR103220  
**O.D.:** 1 29/32 (48.4)  
**Inlet:** 5/8-24  
**Outlet:** 5/8-24  
**Length:** 3 17/32 (89.7)



**B7513** Lube Spin-on  
**Fits:** Hino Engines, Trucks  
**Replaces:** Hino 15613E0030  
**Thread:** 1 1/2 -16  
**O.D.:** 4 21/32 (118.3)  
**Height:** 8 3/32 (205.6)  
**I.Gskt:** [1] Included



**BF7522** Fuel Element with Drain  
**Fits:** Ford (Europe) Trucks  
**Replaces:** Ford 6164913, 844F-9176-CAB  
**O.D.:** 3 1/2 (88.9)  
**I.D.:** 5/8 (15.9) One End  
**Height:** 6 11/32 (161.1)  
**A. Gskt:** [1] Attached



Measurements Are Shown In Inches And (Millimeters)

**WARNING:** These products can expose you to chemicals, including Diisononyl Phthalate, Carbon black extracts, Nickel, 1,3 Butadiene, Ethylene Oxide, Epichlorohydrin, which are known to the State of California to cause cancer, and Bisphenol, Ethylene Glycol, Ethylene Oxide, 1,3 Butadiene, Epichlorohydrin, which are known to the State of California to cause birth defects or other reproductive harm.

**BF7528**



Fuel Spin-on with Drain  
**Fits:** Kubota, Thomas Equipment  
**Replaces:** Kubota 70000-43170  
**Thread:** M20 x 1.5  
**O.D.:** 3 11/16 (93.7)  
**Height:** 4 11/16 (119.1)  
**I.Gskt:** G324-A

**BF7529**



Fuel Spin-on  
**Notes:** Can be used with FB46185 base.  
**Contains:** Integral Post Seal  
**Fits:** Mitsubishi Trucks  
**Replaces:** Mitsubishi ME035394  
**Thread:** 1 -14  
**O.D.:** 3 11/16 (93.7)  
**Height:** 6 11/16 (169.9)  
**I.Gskt:** G401

**BF7531**



Fuel Spin-on  
**Contains:** Integral Post Seal  
**Fits:** International Engines  
**Replaces:** International 1820479-C1  
**Thread:** 7/8 -14  
**O.D.:** 3 (76.2)  
**Height:** 5 7/8 (149.2)  
**I.Gskt:** G449-B

**BF7532**



Fuel/Water Separator Spin-on with Threaded Port  
**Notes:** Inside-Out Flow Direction  
**Contains:** Port Thread: M36 x 1.5  
**Fits:** Nissan Trucks  
**Replaces:** Nissan 16403-05E01, 16403-59E00, 16405-05E01  
**Thread:** 3/4 -16  
**O.D.:** 3 9/16 (90.5)  
**Height:** 5 7/16 (138.1)  
**I.Gskt:** G381-A  
**F. Gskt:** [1] Included

**BF7534**



Fuel/Water Separator Spin-on with Threaded Port  
**Notes:** Inside-Out Flow Direction  
**Contains:** Port Thread: M36 x 1.5  
**Fits:** Chevrolet, Dodge, GMC, Isuzu, Mitsubishi Automotive, Light-Duty Trucks; Toro Lawn & Garden Tractors  
**Replaces:** GMC 13240032; Isuzu 8-94483-850-0; Mitsubishi MB228988; Toro 60-5470  
**Thread:** M20 x 1.5  
**O.D.:** 3 9/16 (90.5)  
**Height:** 5 7/16 (138.1)  
**I.Gskt:** G381-A  
**F. Gskt:** [2] Included

**BF7535**



Fuel/Water Separator Spin-on with Threaded Port  
**Notes:** Inside-Out Flow Direction  
**Contains:** Port Thread: M36 x 1.5  
**Fits:** Nissan, Toyota Automotive; Toyota Lift Trucks  
**Replaces:** Nissan 16403-G9900; Toyota 23303-56040  
**Thread:** 3/4 -16  
**O.D.:** 3 9/16 (90.5)  
**Height:** 5 7/16 (138.1)  
**I.Gskt:** G381-A  
**O-Ring:** [1] Included

**BF7537**



Can-Type Fuel Filter  
**Replaces:** Mazda SL07-23-570  
**O.D.:** 3 7/16 (87.3)  
**I.D.:** 3/4 (19.0) & 1 1/8 (28.6)  
**Height:** 3 13/32 (86.5)  
**F. Gskt:** [2] Included  
**O-Ring:** [3] Included

**BF7538**



Fuel Spin-on  
**Contains:** Integral Post Seal  
**Fits:** Caterpillar Equipment  
**Replaces:** Caterpillar 5I7951  
**Thread:** M20 x 1.5  
**O.D.:** 3 11/16 (93.7)  
**Height:** 4 3/8 (111.1)  
**I.Gskt:** G324-A

**BF7541**



Fuel Spin-on  
**Fits:** Kobelco, MDI/Yutani Equipment  
**Replaces:** Kobelco 2451U309-2  
**Thread:** 3/4 -16  
**O.D.:** 3 11/16 (93.7)  
**Height:** 3 1/4 (82.6)  
**I.Gskt:** G324-A

**BF7544**



Fuel Spin-on  
**Fits:** Hino Engines; Kobelco Loaders  
**Replaces:** Hino 23401-1381  
**Thread:** M20 x 1.5  
**O.D.:** 3 1/32 (77.0)  
**Height:** 4 3/32 (104.0)  
**I.Gskt:** [1] Included

**PF7545**



Fuel Element  
**Fits:** Bolens, Case, Ford, International, New Holland, White Tractors  
**Replaces:** Bolens 1876440; Ford SBA360720020; International 1273082-C1  
**O.D.:** 1 1/8 (28.6)  
**I.D.:** 17/32 (13.5) One End  
**Height:** 2 9/32 (57.9)

Measurements Are Shown In Inches And (Millimeters)

**WARNING:** These products can expose you to chemicals, including Diisononyl Phthalate, Carbon black extracts, Nickel, 1,3 Butadiene, Ethylene Oxide, Epichlorohydrin, which are known to the State of California to cause cancer, and Bisphenol, Ethylene Glycol, Ethylene Oxide, 1,3 Butadiene, Epichlorohydrin, which are known to the State of California to cause birth defects or other reproductive harm.

**BF7546**



Fuel/Water Separator Spin-on with Drain

**Notes:** CAUTION: Furnished D-Ring must be installed on threaded bushing before installing filter on D60E-7, D65E-7 and D75S-3 machines with NH220 or NT855 engines. Do NOT use on other Komatsu engines. Can be used with FB46185 base.

**Contains:** Integral Post Seal  
**Fits:** Hitachi, Komatsu Equipment  
**Replaces:** Hitachi 4192631; Komatsu 600-311-8292  
**Thread:** 1 -14  
**O.D.:** 3 11/16 (93.7)  
**Height:** 6 31/32 (177.0)  
**I.Gskt:** G401  
**F. Gskt:** ES24-D

**PF7549**



Fuel Element

**Fits:** Isuzu Engines  
**Replaces:** Isuzu 5-87810-197-0  
**O.D.:** 1 11/16 (42.9)  
**I.D.:** 15/32 (11.9)  
**Height:** 1 25/32 (45.2)  
**F. Gskt:** [3] Included

**PF7550**

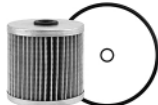

Fuel Element

**Fits:** Hino Buses, Trucks  
**Replaces:** Hino 23401-1060  
**O.D.:** 2 15/32 (62.7)  
**I.D.:** 13/32 (10.3)  
**Height:** 2 17/32 (64.3)  
**F. Gskt:** [2] Included  
**Grommets:** [2] Attached

**PF7551**



Fuel Element

**Fits:** Hino Equipment, Trucks; Hitachi Equipment  
**Replaces:** Hino 23401-1040; Hitachi 4020429  
**O.D.:** 2 7/8 (73.0)  
**I.D.:** 17/32 (13.5) & 19/32 (15.1)  
**Height:** 4 7/32 (107.2)  
**F. Gskt:** ES1049, [1] Included  
**End Seals:** [1] Attached  
**Grommets:** [1] Attached

**BF7552**



Fuel Spin-on

**Contains:** Integral Post Seal  
**Fits:** Caterpillar, Daewoo, Komatsu, Takeuchi, Yanmar Equipment; Mitsubishi Engines  
**Replaces:** Caterpillar 94-7073; Mitsubishi ME006066  
**Thread:** M20 x 1.5  
**O.D.:** 3 11/16 (93.7)  
**Height:** 2 27/32 (72.2)  
**A. Gskt:** [1] Included

**PF7553**



Fuel Element

**Fits:** Nissan Trucks  
**Replaces:** Nissan 16444-99026, 16444-99028  
**O.D.:** 4 3/8 (111.1)  
**I.D.:** 9/16 (14.3) & 1 (25.4)  
**Height:** 5 1/2 (139.7)  
**I.Gskt:** [2] Included  
**F. Gskt:** [1] Included, [1] Washer

**PF7554**



Fuel Element

**Fits:** Nissan Trucks  
**Replaces:** Nissan 16444-90027, 16444-99128  
**O.D.:** 3 19/32 (91.3)  
**I.D.:** 9/16 (14.3)  
**Height:** 5 19/32 (142.1)  
**F. Gskt:** [1] Included

**PF7556**



Fuel Element

**Replaces:** Nissan 16444-Z9027  
**O.D.:** 3 19/32 (91.3)  
**I.D.:** 9/16 (14.3)  
**Height:** 6 5/8 (168.3)  
**F. Gskt:** [1] Included  
**Grommets:** [1] Included

**BF7557**



Extended Life Fuel Spin-on

**Notes:** CAUTION: Furnished D-Ring must be installed on post for seal. Can be used with FB1311 base.  
**Fits:** Allis Chalmers, Taylor, Versatile Equipment; Cummins Engines  
**Replaces:** Cummins 3300901  
**Thread:** 1 -14  
**O.D.:** 3 11/16 (93.7)  
**Height:** 7 1/8 (181.0)  
**I.Gskt:** G381-A  
**F. Gskt:** ES24-D  
**Related To:** BF948, BF957 (Short, Standard Versions)  
 BF7558 (Long Version)

**BF7558**



Extended Life Fuel Spin-on

**Notes:** CAUTION: Furnished D-Ring must be installed on post for seal. Can be used with FB1311 base.  
**Thread:** 1 -14  
**O.D.:** 3 11/16 (93.7)  
**Height:** 8 23/32 (221.5)  
**I.Gskt:** G381-A  
**F. Gskt:** ES24-D  
**Related To:** BF948, BF957 (Short, Standard Versions)  
 BF7557 (Short Version)

**BF7559**



Fuel Spin-on

**Fits:** Isuzu Engines  
**Replaces:** Isuzu X13240-024  
**Thread:** 3/4 -16  
**O.D.:** 3 11/16 (93.7)  
**Height:** 4 3/8 (111.1)  
**I.Gskt:** G381-A

**BF7571**











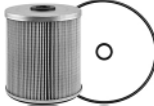



Fuel Spin-on

**Fits:** Fuel Dispensing Pumps  
**Replaces:** Cim-Tek 700-19, 800-10  
**Thread:** 1 1/2 -16  
**O.D.:** 5 1/16 (128.6)  
**Height:** 10 3/4 (273.1)  
**F. Gskt:** G369-B  
**O. Gskt:** G286-C, G369-V, G372, G447, G483, G704, G710

Measurements Are Shown In Inches And (Millimeters)

**WARNING:** These products can expose you to chemicals, including Diisononyl Phthalate, Carbon black extracts, Nickel, 1,3 Butadiene, Ethylene Oxide, Epichlorohydrin, which are known to the State of California to cause cancer, and Bisphenol, Ethylene Glycol, Ethylene Oxide, 1,3 Butadiene, Epichlorohydrin, which are known to the State of California to cause birth defects or other reproductive harm.

<p><b>PF7572</b></p>  <p><b>Fuel Element</b>  <b>Contains:</b> Reinforced Centertube  <b>Fits:</b> Hino Tractors, Trucks; Hitachi Equipment  <b>Replaces:</b> Hino 23401-1020; Hitachi 4143271  <b>O.D.:</b> 3 15/16 (100.0)  <b>I.D.:</b> 19/32 (15.1) &amp; 21/32 (16.7)  <b>Height:</b> 4 7/32 (107.2)  <b>F. Gskt:</b> [2] Included  <b>End Seals:</b> [1] Attached  <b>Grommets:</b> [1] Attached</p>	<p><b>B7585</b></p>  <p><b>Lube Spin-on</b>  <b>Contains:</b> Anti-Drainback Valve            14 PSID By-Pass Valve  <b>Fits:</b> Isuzu Engines  <b>Replaces:</b> Isuzu 8-97024-607-0, 8-97024-607-1  <b>Thread:</b> M20 x 1.5  <b>O.D.:</b> 4 1/4 (108.0)  <b>Height:</b> 5 27/32 (148.4)  <b>I.Gskt:</b> [1] Included  <b>F. Gskt:</b> [2] Included</p>
<p><b>BF7576</b></p>  <p><b>Box-Style Fuel Coalescer</b>  <b>Fits:</b> Thermo King Refrigeration Units  <b>Replaces:</b> Thermo King 11-6286  <b>Length:</b> 4 21/32 (118.3)  <b>Width:</b> 2 27/32 (72.2)  <b>Height:</b> 2 15/32 (62.7)</p>	<p><b>BF7586</b></p>  <p><b>Fuel Storage Tank Spin-on</b>  <b>Contains:</b> Water Absorbent Media  <b>Fits:</b> Various Fuel Islands  <b>Replaces:</b> Cim-Tek 400HS-10, 700-17  <b>Thread:</b> 1 1/2 -16  <b>O.D.:</b> 3 11/16 (93.7)  <b>Height:</b> 5 9/16 (141.3)  <b>I.Gskt:</b> [1] Included</p>
<p><b>B7577</b></p>  <p><b>By-Pass Lube Spin-on</b>  <b>Notes:</b> Can be used with OB1308 base.  <b>Fits:</b> Caterpillar, Cummins, GMC Engines  <b>Replaces:</b> Caterpillar 9Y4468; Cummins 3304232; Ford E3HZ-6731-A; GMC 25011187  <b>Thread:</b> 1 3/8 -16  <b>O.D.:</b> 4 11/16 (119.1)  <b>Height:</b> 9 15/16 (252.4)  <b>I.Gskt:</b> G498-D</p>	<p><b>BF7587</b></p>  <p><b>High Efficiency Fuel Spin-on</b>  <b>Notes:</b> Can be used with FB46185 base.  <b>Fits:</b> Caterpillar Engines, Equipment; Ford, Freightliner, International, Kenworth, Peterbilt, Sterling, Western Star Trucks  <b>Replaces:</b> Caterpillar 1R0749, 3089679  <b>Thread:</b> 1 -14  <b>O.D.:</b> 3 11/16 (93.7)  <b>Height:</b> 10 1/2 (266.7)  <b>I.Gskt:</b> G381-A  <b>Related To:</b> BF614 (Standard Version)            BF7633 (Short Version)</p>
<p><b>BF7579</b></p>  <p><b>Box-Style Fuel Filter</b>  <b>Fits:</b> Thermo King Refrigeration Units  <b>Replaces:</b> Thermo King 11-6285  <b>Length:</b> 4 21/32 (118.3)  <b>Width:</b> 2 27/32 (72.2)  <b>Height:</b> 2 15/32 (62.7)</p>	<p><b>PF7588</b></p>  <p><b>Fuel Element</b>  <b>Fits:</b> Hitachi, Komatsu Equipment  <b>Replaces:</b> Hitachi 4091472; Komatsu 600-311-8210  <b>O.D.:</b> 2 7/8 (73.0)  <b>I.D.:</b> 9/16 (14.3)  <b>Height:</b> 4 11/32 (110.3)  <b>A. Gskt:</b> [2] Attached  <b>F. Gskt:</b> [2] Included</p>
<p><b>BF7580</b></p>  <p><b>Box-Style Fuel Filter</b>  <b>Fits:</b> Thermo King Refrigeration Units  <b>Replaces:</b> Thermo King 11-7264  <b>Length:</b> 4 21/32 (118.3)  <b>Width:</b> 2 27/32 (72.2)  <b>Height:</b> 2 15/32 (62.7)</p>	<p><b>BF7591-D</b></p>  <p><b>Fuel/Water Separator Spin-on with Drain</b>  <b>Fits:</b> Case, Hanomag, International Equipment  <b>Replaces:</b> Hanomag 114924144; International 1967094-C1  <b>Thread:</b> M16 x 1.5  <b>O.D.:</b> 3 1/32 (77.0)  <b>Height:</b> 6 1/8 (155.6)  <b>A. Gskt:</b> G449-B</p>
<p><b>BF7584</b></p>  <p><b>Fuel/Water Separator Spin-on with Drain</b>  <b>Contains:</b> Integral Post Seal  <b>Fits:</b> International Engines  <b>Replaces:</b> International 1808623-C1  <b>Thread:</b> 7/8 -14  <b>O.D.:</b> 4 1/4 (108.0)  <b>Height:</b> 8 17/32 (216.7)  <b>I.Gskt:</b> G401  <b>Related To:</b> BF7629 (Fuel Version without Drain)</p>	<p><b>PF7592</b></p>  <p><b>Fuel Element</b>  <b>Fits:</b> Mitsubishi Equipment, Trucks  <b>Replaces:</b> Mitsubishi 30062-65101, ME971550  <b>O.D.:</b> 3 19/32 (91.3)  <b>I.D.:</b> 9/16 (14.3)  <b>Height:</b> 5 3/8 (136.5)  <b>F. Gskt:</b> [3] Included  <b>Grommets:</b> [2] Attached</p>

Measurements Are Shown In Inches And (Millimeters)

**WARNING:** These products can expose you to chemicals, including Diisononyl Phthalate, Carbon black extracts, Nickel, 1,3 Butadiene, Ethylene Oxide, Epichlorohydrin, which are known to the State of California to cause cancer, and Bisphenol, Ethylene Glycol, Ethylene Oxide, 1,3 Butadiene, Epichlorohydrin, which are known to the State of California to cause birth defects or other reproductive harm.

**BF7593**

Fuel Spin-on



**Contains:** Integral Post Seal  
**Fits:** Iveco Buses, Trucks  
**Replaces:** Iveco 1901607  
**Thread:** 3/4 -16  
**O.D.:** 4 1/4 (108.0)  
**Height:** 3 15/16 (100.0)  
**I.Gskt:** G381-A

**PF7594**

Fuel Element



**Fits:** Belarus Tractors  
**Replaces:** Belarus A6501100-10  
**O.D.:** 3 23/32 (94.5)  
**I.D.:** 13/32 (10.3) One End  
**Height:** 4 3/4 (120.7)  
**Grommets:** [1] Attached

**PF7595**

Fuel Element



**Fits:** Belarus Tractors  
**Replaces:** Belarus 501117030A  
**O.D.:** 2 1/16 (52.4)  
**I.D.:** 13/32 (10.3)  
**Height:** 4 7/8 (123.8)  
**Grommets:** [2] Attached

**PF7596**

Fuel Element



**Fits:** Iveco, M.A.N., R.V.I. Buses, Trucks;  
 Perkins Engines  
**Replaces:** M.A.N. A50.00241.676; Renault  
 854975700  
**O.D.:** 2 9/16 (65.1)  
**I.D.:** 9/16 (14.3)  
**Height:** 2 3/32 (53.2)  
**F. Gskt:** [1] Included

**PF7597**

Fuel/Water Separator Element



**Fits:** Luber-finer F170 Housings  
**Replaces:** Luber-finer 4666  
**O.D.:** 4 1/2 (114.3)  
**I.D.:** 7/8 (22.2)  
**Height:** 8 3/16 (208.0)  
**A. Gskt:** [2] Attached  
**F. Gskt:** [1] Included

**BF7598**

Fuel Spin-on with Threaded Sensor Port



**Contains:** Port Thread: M10 x 1.5  
**Fits:** Nissan Automotive, Light-Duty Trucks;  
 Komatsu, Nissan Lift Trucks  
**Replaces:** Komatsu 600-311-9620; Nissan  
 16405-34W25  
**Thread:** 3/4 -16  
**O.D.:** 3 5/16 (84.1)  
**Height:** 4 5/8 (117.5)  
**I.Gskt:** [1] Included

**B7600**

Full-Flow Lube Spin-on



**Fits:** Caterpillar Engines, Equipment  
**Replaces:** Caterpillar 1R0739  
**Thread:** 1 1/8 -16  
**O.D.:** 4 1/4 (108.0)  
**Height:** 10 1/16 (255.6)  
**I.Gskt:** [1] Included  
**Related To:** B76, B76-MPG, B76-SS (Long  
 Versions)  
 B7700 (High Efficiency Version)

**B7600-SS**

Severe Service Full-Flow Lube Spin-on



**Fits:** Caterpillar Engines, Equipment  
**Replaces:** Caterpillar 1R0739  
**Thread:** 1 1/8 -16  
**O.D.:** 4 1/4 (108.0)  
**Height:** 10 1/16 (255.6)  
**I.Gskt:** [1] Included  
**Related To:** B76, B76-MPG, B76-SS (Long  
 Versions)  
 B7700 (High Performance Version)

**BF7602**

Fuel Spin-on



**Contains:** Integral Post Seal  
**Fits:** Case, Hitachi, Kawasaki, Koehring,  
 Link-Belt Equipment; Chevrolet, GMC, Isuzu  
 Trucks  
**Replaces:** Hitachi 4206080; Isuzu  
 1-13240-079-1; Link-Belt 3H1750  
**Thread:** 3/4 -16  
**O.D.:** 3 11/16 (93.7)  
**Height:** 4 3/8 (111.1)  
**I.Gskt:** G324-A

**BF7606**

Fuel Spin-on



**Fits:** Volvo Equipment  
**Replaces:** Volvo 795210  
**Thread:** 1 -12  
**O.D.:** 3 11/16 (93.7)  
**Height:** 7 3/16 (182.6)  
**I.Gskt:** G401

**P7607**

Lube Element

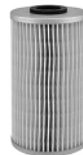

**Fits:** M.A.N. Trucks  
**Replaces:** M.A.N. 85.48386, 81.05504.0037  
**O.D.:** 3 7/32 (81.8)  
**I.D.:** 1 1/16 (27.0)  
**Height:** 5 31/32 (151.6)  
**A. Gskt:** [2] Attached

**BF7608**

Fuel Spin-on



**Notes:** CAUTION: Furnished O-Ring must be  
 installed on post for seal.  
**Fits:** Ford Buses, Trucks; New Holland  
 Equipment  
**Replaces:** Ford E7HZ-9365-B  
**Thread:** M16 x 1.5  
**O.D.:** 3 1/32 (77.0)  
**Height:** 4 3/32 (104.0)  
**I.Gskt:** [1] Included  
**O-Ring:** [1] Included

Measurements Are Shown In Inches And (Millimeters)

**WARNING:** These products can expose you to chemicals, including Diisononyl Phthalate, Carbon black extracts, Nickel, 1,3 Butadiene, Ethylene Oxide, Epichlorohydrin, which are known to the State of California to cause cancer, and Bisphenol, Ethylene Glycol, Ethylene Oxide, 1,3 Butadiene, Epichlorohydrin, which are known to the State of California to cause birth defects or other reproductive harm.

**BF7612** Fuel Spin-on  
**Contains:** Integral Post Seal  
**Fits:** Detroit Diesel Engines  
**Replaces:** Fleetguard FF5227  
**Thread:** 13/16 -12  
**O.D.:** 4 1/4 (108.0)  
**Height:** 7 5/8 (193.7)  
**I.Gskt:** G381-A  
**Related To:** BF7613 (Long Version)



**PF7618** Fuel Element  
**Fits:** Isuzu, Nissan Trucks  
**Replaces:** Nissan 16444-97001  
**O.D.:** 4 11/32 (110.3)  
**I.D.:** 19/32 (15.1) & 2 1/32 (51.6)  
**Height:** 8 9/32 (210.3)  
**A. Gskt:** [1] Attached  
**F. Gskt:** [3] Copper Washers, [1] Gasket  
**O-Ring:** [1] Included  
**Grommets:** [1] Attached



**BF7613** Fuel Spin-on  
**Contains:** Integral Post Seal  
**Fits:** Detroit Diesel Engines  
**Thread:** 13/16 -12  
**O.D.:** 4 1/4 (108.0)  
**Height:** 10 7/16 (265.1)  
**I.Gskt:** G381-A  
**Related To:** BF7612 (Short Version)



**BF7619** Fuel Spin-on  
**Contains:** Integral Post Seal  
**Fits:** Mercedes-Benz Automotive  
**Replaces:** Mercedes-Benz 10922201, 10922301  
**Thread:** M12 x 1.5  
**O.D.:** 3 3/8 (85.7)  
**Height:** 3 13/16 (96.8)  
**I.Gskt:** [2] Included  
**F. Gskt:** [2] Included



**BF7614** Fuel Spin-on  
**Notes:** Inside-Out Flow Direction  
**Fits:** Nissan Buses, Trucks  
**Replaces:** Nissan 16403-05D00, FL403-05D00  
**Thread:** 3/4 -16  
**O.D.:** 3 11/16 (93.7)  
**Height:** 5 3/8 (136.5)  
**I.Gskt:** [1] Included  
**F. Gskt:** [1] Included



**BF7623** Fuel Storage Tank Spin-on  
**Fits:** Fuel Dispensing Pumps  
**Replaces:** Cim-Tek 700-20, 800-30  
**Thread:** 1 1/2 -16  
**O.D.:** 5 1/16 (128.6)  
**Height:** 10 3/4 (273.1)  
**F. Gskt:** G369-B  
**O. Gskt:** G369-V, G704, G710



**P7615** Dual-Flow Lube Element with Bail Handle  
**Fits:** Mercedes-Benz Automotive, Light-Duty Trucks  
**Replaces:** Mercedes-Benz 6011800009, 6011800109, 6011800210  
**O.D.:** 3 9/16 (90.5)  
**I.D.:** 15/32 (11.9) & 31/32 (24.6)  
**Height:** 6 11/16 (169.9)  
**F. Gskt:** [3] Included  
**Grommets:** [2] Attached



**BF7624** Fuel Spin-on  
**Fits:** Scania Trucks  
**Replaces:** Scania 1361685, 1372444  
**Thread:** M24 x 1.5  
**O.D.:** 3 11/16 (93.7)  
**Height:** 5 9/16 (141.3)  
**I.Gskt:** G401



**PT7616** Hydraulic Element  
**Fits:** Caterpillar Excavators  
**Replaces:** Caterpillar 5W5803  
**O.D.:** 4 5/8 (117.5)  
**I.D.:** 2 5/16 (58.7)  
**Height:** 6 21/32 (169.1)  
**A. Gskt:** [2] Attached



**BF7625** In-Line Fuel Filter  
**Contains:** [2] 19/32 Inch Plastic Fittings  
**Fits:** Toyota Light-Duty Trucks  
**Replaces:** Toyota 23300-79535  
**O.D.:** 2 11/32 (59.5)  
**Inlet:** 1/4  
**Outlet:** 1/4  
**Length:** 2 31/32 (75.4)  
**F. Gskt:** [2] Included



**PT7617** Hydraulic Element  
**Replaces:** Hyster 376066  
**O.D.:** 4 (101.6)  
**I.D.:** 1 1/4 (31.8) & 1 9/16 (39.7)  
**Height:** 18 29/32 (480.2)  
**Grommets:** [1] Attached



**BF7626** In-Line Fuel Regulator Filter  
**Notes:** OBSOLETE. Availability Limited to Dealer Stock.  
**Contains:** [1] Hose Clamp  
**Fits:** Dodge Light-Duty Trucks  
**Replaces:** Chrysler 4864849  
**O.D.:** 3 (76.2)  
**Inlet:** 3/8  
**Outlet:** 1/4  
**Height:** 3 3/4 (95.3)



**PF7627** Fuel Element  
**Fits:** Dodge Light-Duty Trucks, Vans  
**Replaces:** Chrysler 4864307  
**O.D.:** 5 (127.0)  
**I.D.:** 3 9/32 (83.3) One End  
**Height:** 1 3/4 (44.4)



Measurements Are Shown In Inches And (Millimeters)

**WARNING:** These products can expose you to chemicals, including Diisononyl Phthalate, Carbon black extracts, Nickel, 1,3 Butadiene, Ethylene Oxide, Epichlorohydrin, which are known to the State of California to cause cancer, and Bisphenol, Ethylene Glycol, Ethylene Oxide, 1,3 Butadiene, Epichlorohydrin, which are known to the State of California to cause birth defects or other reproductive harm.

**BF7628** Fuel Spin-on  
**Contains:** Integral Post Seal  
**Fits:** Carrier Refrigeration Units  
**Replaces:** Carrier 30-01090-01  
**Thread:** 1 -14  
**O.D.:** 4 5/16 (109.5)  
**Height:** 5 29/32 (150.0)  
**I.Gskt:** [1] Included



**BF7629** Fuel Spin-on  
**Contains:** Integral Post Seal  
**Fits:** Terex Equipment; Detroit Diesel, International Engines  
**Replaces:** International 1822588-C1  
**Thread:** 7/8 -14  
**O.D.:** 4 1/4 (108.0)  
**Height:** 7 (177.8)  
**I.Gskt:** G401  
**Related To:** BF7584 (Fuel/Water Separator Version with Drain)



**BF7630** In-Line Fuel Filter  
**Contains:** [2] Nuts  
 [1] Plastic Retainer Clip  
**Fits:** Saturn Automotive  
**Replaces:** Saturn 21007437, 21007438  
**O.D.:** 2 5/32 (54.8)  
**Inlet:** 3/8  
**Outlet:** 3/8  
**Length:** 16 15/16 (430.2)



**BF7631** High Efficiency Fuel Spin-on  
**Contains:** Integral Post Seal  
**Fits:** Caterpillar Equipment  
**Replaces:** Caterpillar 1R0753  
**Thread:** 7/8 -14  
**O.D.:** 3 11/16 (93.7)  
**Height:** 10 1/2 (266.7)  
**I.Gskt:** G381-A



**BF7632** High Efficiency Fuel Spin-on  
**Contains:** Integral Post Seal  
**Fits:** Caterpillar Engines, Equipment  
**Replaces:** Caterpillar 1R0751  
**Thread:** 7/8 -14  
**O.D.:** 3 11/16 (93.7)  
**Height:** 7 1/8 (181.0)  
**I.Gskt:** G381-A



**BF7633** High Efficiency Fuel Spin-on  
**Fits:** Caterpillar Equipment  
**Replaces:** Caterpillar 1R0750  
**Thread:** 1 -14  
**O.D.:** 3 11/16 (93.7)  
**Height:** 7 1/8 (181.0)  
**I.Gskt:** G381-A  
**Related To:** BF7587 (Long Version)



**BF7634** High Efficiency Fuel Spin-on  
**Fits:** Caterpillar Engines  
**Replaces:** Caterpillar 1R0759  
**Thread:** 7/8 -14  
**O.D.:** 3 (76.2)  
**Height:** 7 1/8 (181.0)  
**I.Gskt:** [1] Included



**BF7635** High Efficiency Fuel/Water Separator Spin-on with Drain  
**Contains:** Integral Post Seal  
**Fits:** Mining Applications in Cold Weather  
**Thread:** 1 3/8 -16  
**O.D.:** 5 3/8 (136.5)  
**Height:** 10 9/16 (268.3)  
**I.Gskt:** [1] Included



**B7637** Lube Spin-on  
**Replaces:** Knecht OC246; Woodgate WGL3675  
**Thread:** 1 1/8 -16  
**O.D.:** 4 1/4 (108.0)  
**Height:** 10 9/32 (261.1)  
**I.Gskt:** [1] Included



**BF7637** High Performance Fuel Spin-on  
**Fits:** Caterpillar Equipment  
**Replaces:** Caterpillar 1R0750  
**Thread:** 1 -14  
**O.D.:** 3 1/32 (77.0)  
**Height:** 7 1/8 (181.0)  
**A. Gskt:** G449-B



**BF7639** High Efficiency Fuel Spin-on  
**Contains:** Integral Post Seal  
**Fits:** Caterpillar Equipment, Industrial and Marine Engines  
**Replaces:** Caterpillar 1R0755  
**Thread:** 1 3/8 -16  
**O.D.:** 5 3/8 (136.5)  
**Height:** 12 3/32 (307.2)  
**I.Gskt:** [1] Included



**BF7639-D** High Efficiency Fuel Spin-on with Drain  
**Contains:** Integral Post Seal  
**Fits:** Mining Applications Using Davco Mega Filter  
**Replaces:** GMC 23512631  
**Thread:** 1 3/8 -16  
**O.D.:** 5 3/8 (136.5)  
**Height:** 12 7/16 (315.9)  
**I.Gskt:** [1] Included



Measurements Are Shown In Inches And (Millimeters)

**WARNING:** These products can expose you to chemicals, including Diisononyl Phthalate, Carbon black extracts, Nickel, 1,3 Butadiene, Ethylene Oxide, Epichlorohydrin, which are known to the State of California to cause cancer, and Bisphenol, Ethylene Glycol, Ethylene Oxide, 1,3 Butadiene, Epichlorohydrin, which are known to the State of California to cause birth defects or other reproductive harm.

**BF7640** Fuel Spin-on  
**Contains:** Integral Post Seal  
**Fits:** John Deere Equipment  
**Replaces:** John Deere RE61552, RE501113  
**Thread:** 13/16 -12  
**O.D.:** 3 11/16 (93.7)  
**Height:** 6 5/8 (168.3)  
**I.Gskt:** [1] Included



**PF7655** Fuel Element  
**Contains:** Reinforced Centertube  
**Fits:** Caterpillar Engines  
**Replaces:** Caterpillar 1R0718, 1R0756  
**O.D.:** 3 15/16 (100.0)  
**I.D.:** 1 5/8 (41.3)  
**Height:** 9 7/32 (234.2)  
**A. Gskt:** [2] Attached



**BF7641** In-Line Fuel Filter  
**Notes:** OBSOLETE. Availability Limited to Dealer Stock.  
**Fits:** BMW Automotive  
**Replaces:** BMW 13321702632, 13321740985  
**O.D.:** 2 15/32 (62.7)  
**Inlet:** 5/16  
**Outlet:** 5/16  
**Length:** 11 13/16 (300.0)



**BF7656** Primary Fuel Spin-on  
**Contains:** Integral Post Seal  
**Fits:** Mack Engines, Trucks  
**Replaces:** Mack 483GB470M  
**Thread:** M22 x 1.5  
**O.D.:** 4 1/4 (108.0)  
**Height:** 7 19/32 (192.9)  
**I.Gskt:** [1] Included



**BF7644** Fuel Spin-on  
**Contains:** Integral Post Seal  
**Fits:** Volvo Engines  
**Replaces:** Volvo 420799  
**Thread:** M18 x 1.5  
**O.D.:** 3 11/16 (93.7)  
**Height:** 8 1/8 (206.4)  
**I.Gskt:** G381-A



**BF7657** Secondary Fuel Spin-on  
**Contains:** Integral Post Seal  
**Fits:** Mack Engines, Trucks  
**Replaces:** Mack 483GB471M  
**Thread:** M30 x 1.5  
**O.D.:** 4 1/4 (108.0)  
**Height:** 10 7/16 (265.1)  
**I.Gskt:** [1] Included



**BF7645** Fuel Storage Tank Spin-on  
**Fits:** Fuel Tanks  
**Replaces:** Cim-Tek 400-10, 700-15  
**Thread:** 1 1/2 -16  
**O.D.:** 3 3/4 (95.3)  
**Height:** 5 9/16 (141.3)  
**I.Gskt:** [1] Included



**BF7658** In-Line Fuel Filter  
**Contains:** [1] Plastic Retainer Clip  
**Fits:** GMC, Isuzu Light-Duty Trucks  
**Replaces:** GMC 25168594; Isuzu 8-25168-594-0  
**O.D.:** 2 9/32 (57.9)  
**Inlet:** M16 x 1.5  
**Outlet:** 3/8  
**Length:** 5 3/8 (136.5)



**BF7648** Fuel Spin-on  
**Fits:** GMC, Isuzu Trucks; Komatsu, Link-Belt Equipment  
**Replaces:** GMC 97718401; Isuzu 5-87310-335-0  
**Thread:** 3/4 -16  
**O.D.:** 3 1/32 (77.0)  
**Height:** 3 1/2 (88.9)  
**I.Gskt:** [1] Included



**BF7659** In-Line Fuel Filter  
**Fits:** Chrysler, Dodge, Eagle, Mitsubishi Automotive  
**Replaces:** GMC 25313814; Mitsubishi MR188221  
**O.D.:** 2 17/32 (64.3)  
**Inlet:** M12 x 1 1/4  
**Outlet:** M12 x 1 1/4  
**Length:** 3 31/32 (100.8)  
**F. Gskt:** [4] Metal Washers



**BF7653** Fuel Spin-on  
**Contains:** Integral Post Seal  
**Fits:** Volvo, WhiteGMC Trucks  
**Replaces:** Volvo 8193841  
**Thread:** M18 x 1.5  
**O.D.:** 3 11/16 (93.7)  
**Height:** 8 1/8 (206.4)  
**I.Gskt:** G381-A



**BF7661** In-Line Fuel Filter  
**Fits:** Lexus, Toyota Automotive  
**Replaces:** Toyota 23300-20040  
**O.D.:** 2 9/16 (65.1)  
**Inlet:** M14 x 1.5  
**Outlet:** 5/16  
**Length:** 4 3/16 (106.4)



Measurements Are Shown In Inches And (Millimeters)

**WARNING:** These products can expose you to chemicals, including Diisononyl Phthalate, Carbon black extracts, Nickel, 1,3 Butadiene, Ethylene Oxide, Epichlorohydrin, which are known to the State of California to cause cancer, and Bisphenol, Ethylene Glycol, Ethylene Oxide, 1,3 Butadiene, Epichlorohydrin, which are known to the State of California to cause birth defects or other reproductive harm.



**BF7662** In-Line Fuel Filter  
**Fits:** 1995-99 Toyota Paseo, Tercel  
**Replaces:** General Motors Corp. 25313812; Toyota 23300-11150, 23300-19385; Wix 33554, 533878, 33878  
**O.D.:** 2 9/16 (65.1)  
**Inlet:** M14 x 1.5  
**Outlet:** M12 x 1.25  
**Length:** 3 15/16 (100.0)  
**F. Gskt:** [4] Metal Washers



**BF7663** Fuel Spin-on  
**Fits:** Iveco EuroCargo, EuroStar, EuroTech, EuroTrakker Series Trucks  
**Replaces:** Iveco 1907640  
**Thread:** M16 x 1.5  
**O.D.:** 3 1/32 (77.0)  
**Height:** 5 27/32 (148.4)  
**I.Gskt:** G449-B



**BF7664** Fuel Spin-on  
**Fits:** DAF Trucks  
**Replaces:** DAF 1318695  
**Thread:** M16 x 1.5  
**O.D.:** 3 11/16 (93.7)  
**Height:** 5 3/8 (136.5)  
**I.Gskt:** G381-A



**BF7666** Fuel/Water Separator Spin-on  
**Fits:** Isuzu Engines; Link-Belt Backhoes  
**Replaces:** Isuzu 8-94453-738-1, 8-94453-738-2  
**Thread:** 3/4 -16  
**O.D.:** 3 11/16 (93.7)  
**Height:** 3 1/4 (82.6)  
**I.Gskt:** G324-A



**BF7667** In-Line Fuel Filter  
**Contains:** [1] Plastic Retainer Clip  
**Fits:** Cadillac Automotive  
**Replaces:** GMC 25163684  
**O.D.:** 2 5/32 (54.8)  
**Inlet:** 3/8  
**Outlet:** M14 x 1.5  
**Length:** 5 13/32 (137.3)



**BF7668** In-Line Fuel Filter  
**Contains:** [2] 3/8 Inch Clips  
**Fits:** Ford, Jaguar, Lincoln, Mazda, Mercury Automotive, Light-Duty Trucks  
**Replaces:** Ford F89Z-9155-A  
**O.D.:** 2 7/32 (56.4)  
**Inlet:** 5/16  
**Outlet:** 5/16  
**Length:** 7 3/32 (180.2)  
**Related To:** BF7768 (5/16 In. Clips)



**BF7669** In-Line Fuel Filter  
**Contains:** 5/16 Inch Return Line  
 Steel Braided Ground Wire  
**Fits:** Chrysler Vans  
**Replaces:** Chrysler 4682569, 4809117, 4809117-AB  
**O.D.:** 1 29/32 (48.4)  
**Inlet:** 3/8  
**Outlet:** 5/16  
**Length:** 30 (762.0)



**BF7670** In-Line Fuel Filter  
**Fits:** Audi, Volkswagen Automotive  
**Replaces:** Volkswagen 1J0201511A  
**O.D.:** 3 7/32 (81.8)  
**Inlet:** 5/16  
**Outlet:** 5/16  
**Length:** 6 15/16 (176.2)



**BF7671** In-Line Fuel Filter  
**Contains:** 5/16 Inch Return Line  
**Fits:** Chrysler Automotive  
**Replaces:** Chrysler 4764210  
**O.D.:** 2 11/32 (59.5)  
**Inlet:** 3/8  
**Outlet:** 5/16  
**Length:** 8 11/32 (211.9)



**BF7672-D** Primary Fuel/Water Coalescer Element with Drain  
**Notes:** Tab/Keys are not needed for installation.  
**Fits:** Caterpillar, John Deere Equipment  
**Use With:** BF7673-D, BF7674-D  
**Replaces:** Caterpillar 131-1812; John Deere RE53729, RE62421; Donaldson P550398; Fleetguard FS19554  
**O.D.:** 3 9/32 (83.3)  
**I.D.:** 2 1/32 (16.7) One End  
**Height:** 5 31/32 (151.6)  
**Grommets:** [1] Attached



**BF7673-D** Secondary Fuel/Water Coalescer Element with Drain  
**Notes:** Tab/Keys are not needed for installation.  
**Fits:** John Deere Engines, Equipment  
**Use With:** BF7672-D  
**Replaces:** John Deere RE50455, RE58367, RE62418; Donaldson P550351; Fleetguard FS19516  
**O.D.:** 3 9/32 (83.3)  
**I.D.:** 2 1/32 (16.7) One End  
**Height:** 5 7/32 (132.6)  
**F. Gskt:** [1] Included  
**Grommets:** [1] Attached



**BF7674-D** Secondary Fuel/Water Separator Element with Drain  
**Notes:** Tab/Keys are not needed for installation.  
**Fits:** Caterpillar, Perkins Engines; John Deere Equipment  
**Use With:** BF7672-D, BF7681-D  
**Replaces:** Caterpillar 100-5593, 138-3098, 159-6102; GMC 12554082; John Deere RE52987, RE53400, RE62419, RE509031  
**O.D.:** 3 9/32 (83.3)  
**I.D.:** 2 1/32 (16.7) One End  
**Height:** 5 31/32 (151.6)  
**F. Gskt:** [1] Included  
**Grommets:** [1] Attached



**BF7675-D** Secondary Fuel/Water Separator Element with Drain  
**Notes:** Tab/Keys are not needed for installation.  
**Fits:** John Deere Power Tech Engines  
**Replaces:** John Deere RE60021; Fleetguard FS19573  
**O.D.:** 3 9/32 (83.3)  
**I.D.:** 2 1/32 (16.7) One End  
**Height:** 4 15/32 (113.5)  
**Grommets:** [1] Attached



Measurements Are Shown In Inches And (Millimeters)

**WARNING:** These products can expose you to chemicals, including Diisononyl Phthalate, Carbon black extracts, Nickel, 1,3 Butadiene, Ethylene Oxide, Epichlorohydrin, which are known to the State of California to cause cancer, and Bisphenol, Ethylene Glycol, Ethylene Oxide, 1,3 Butadiene, Epichlorohydrin, which are known to the State of California to cause birth defects or other reproductive harm.

**BF7677-D**

Secondary Fuel/Water Separator Element with Drain



**Notes:** Tab/Keys are not needed for installation.  
**Fits:** Case-IH, Challenger, Massey Ferguson, New Holland Tractors; Caterpillar, John Deere Equipment  
**Replaces:** John Deere RE62420; Stanadyne 32179  
**O.D.:** 3 9/32 (83.3)  
**I.D.:** 21/32 (16.7) One End  
**Height:** 7 5/8 (193.7)  
**Grommets:** [1] Attached

**PF7678**

Fuel Element with Lid



**Notes:** Lid Accepts 1/2 In. Square Driver  
**Fits:** Ford Light-Duty Trucks, Vans  
**Replaces:** Ford F4TZ-9N184-A, F4TZ-9N184-B  
**O.D.:** 3 17/32 (89.7)  
 Lid 4 7/8 (123.8)  
**I.D.:** 9/16 (14.3) One End  
**Height:** 4 17/32 (115.1)  
**O-Ring:** [1] Attached  
**Grommets:** [1] Attached

**BF7679-D**

Primary Fuel/Water Coalescer Element with Drain



**Notes:** Tab/Keys are not needed for installation.  
**Fits:** Caterpillar, John Deere Equipment  
**Replaces:** Caterpillar 117-4089; John Deere RE62424  
**O.D.:** 3 9/32 (83.3)  
**I.D.:** 21/32 (16.7) One End  
**Height:** 5 31/32 (151.6)  
**Grommets:** [1] Attached

**PF7680**

Fuel/Water Separator Element



**Fits:** Caterpillar, Cummins, Detroit Diesel, Mack Engines with Davco Housing  
**Replaces:** Davco 380087; Detroit Diesel 23514049; Mack 301SD19A, 301SD19B  
**O.D.:** 3 3/4 (95.3)  
**I.D.:** 21/32 (16.7) One End  
**Height:** 7 1/32 (178.6)  
**O-Ring:** ES3012, G445  
**O. Gskt:** G717 (for Webb Housing)  
**Grommets:** [1] Attached

**BF7681-D**

Primary Fuel/Water Coalescer Element with Drain



**Notes:** Tab/Keys are not needed for installation.  
**Fits:** Caterpillar, Perkins Engines; New Holland Tractors  
**Use With:** BF7674-D  
**Replaces:** Caterpillar 100-6374, 138-3100; New Holland 87840591  
**O.D.:** 3 9/32 (83.3)  
**I.D.:** 21/32 (16.7) One End  
**Height:** 5 7/32 (132.6)  
**Grommets:** [1] Attached

**BF7682-D**

Primary Fuel/Water Coalescer Element with Drain



**Notes:** Tab/Keys are not needed for installation.  
**Fits:** John Deere, Timberjack Equipment  
**Replaces:** John Deere RE62423, RE65431; Timberjack 431892, F431892  
**O.D.:** 3 9/32 (83.3)  
**I.D.:** 21/32 (16.7) One End  
**Height:** 7 5/8 (193.7)  
**Grommets:** [1] Attached

**BF7683**

Fuel Spin-on



**Fits:** Kubota Engines, Equipment  
**Replaces:** Kubota 70000-43081  
**Thread:** M20 x 1.5  
**O.D.:** 3 (76.2)  
**Height:** 3 1/2 (88.9)  
**I.Gskt:** G449-B

**B7685**

By-Pass Lube Spin-on



**Fits:** R.V.I., Volvo Buses, Engines, Equipment, Trucks  
**Replaces:** V.M.E. 119962280; Volvo 477556, 477556-5  
**Thread:** 1 3/8 -16  
**O.D.:** 4 1/4 (108.0)  
**Height:** 10 1/16 (255.6)  
**I.Gskt:** [1] Included

**BF7686**

In-Line Fuel Filter



**Fits:** Kawasaki Motorcycles, Mules  
**Replaces:** Kawasaki 490191055  
**O.D.:** 1 7/16 (36.5)  
**Inlet:** 5/16  
**Outlet:** 5/16  
**Length:** 3 27/32 (97.6)

**PF7687**

Fuel Element



**Fits:** Late Model Detroit Diesel Engines Equipped with Davco Fuel Filters  
**Replaces:** Detroit Diesel 23519978, 23521527  
**O.D.:** 3 7/16 (87.3)  
**I.D.:** 21/32 (16.7) One End  
**Height:** 4 23/32 (119.9)  
**F. Gskt:** [4] Included  
**Grommets:** [1] Attached

**BF7690**

Steel Screen In-Line Fuel Strainer



**Fits:** John Deere Tractors  
**Replaces:** John Deere RE38818  
**O.D.:** 1 31/32 (50.0)  
**Inlet:** 9/16-18  
**Outlet:** 9/16-18  
**Length:** 3 23/32 (94.5)

**BF7691**

In-Line Fuel Filter



**Fits:** GMC Motor Homes with Portable Fuel Storage Tanks  
**Replaces:** GMC 25055347  
**O.D.:** 2 (50.8)  
**Inlet:** 1/2  
**Outlet:** 1/2  
**Length:** 4 7/16 (112.7)

Measurements Are Shown In Inches And (Millimeters)

**WARNING:** These products can expose you to chemicals, including Diisononyl Phthalate, Carbon black extracts, Nickel, 1,3 Butadiene, Ethylene Oxide, Epichlorohydrin, which are known to the State of California to cause cancer, and Bisphenol, Ethylene Glycol, Ethylene Oxide, 1,3 Butadiene, Epichlorohydrin, which are known to the State of California to cause birth defects or other reproductive harm.

**BF7693**



Steel Screen In-Line Fuel Strainer

**Fits:** Case-International, John Deere, Komatsu Equipment  
**Replaces:** Case 194199A1; Komatsu 20704-A1100  
**O.D.:** 1 29/32 (48.4)  
**Inlet:** 1/2  
**Outlet:** 1/2  
**Length:** 4 1/4 (108.0)

**B7700**



High Efficiency Lube Spin-on

**Fits:** Caterpillar Engines, Equipment  
**Replaces:** Caterpillar 1R1807  
**Thread:** 1 1/8 -16  
**O.D.:** 4 1/4 (108.0)  
**Height:** 10 1/16 (255.6)  
**I.Gskt:** [1] Included  
**Related To:** B76, B76-MPG, B76-SS (Long Versions)  
 B7600, B7600-SS (Standard Versions)

**BF7695**



Resin Ribbon Fuel Coalescer Spin-on with Drain

**Fits:** Cummins Natural Gas Engines  
**Replaces:** Cummins 3606712, 3607140  
**Thread:** 1 1/2 -16  
**O.D.:** 3 11/16 (93.7)  
**Height:** 7 3/16 (182.6)  
**I.Gskt:** [1] Included

**BF7711**



In-Line Fuel Filter

**Contains:** 3/8 Inch Quick Connect  
 [1] Plastic Clip  
**Fits:** Jeep Grand Cherokee  
**Replaces:** Chrysler 52100283AC  
**O.D.:** 2 5/32 (54.8)  
**Inlet:** 5/16  
**Outlet:** 3/8  
**Length:** 6 3/4 (171.5)

**BF7696**



Fuel Spin-on

**Fits:** Iveco EuroTech Trucks with Cursor Engine  
**Replaces:** Iveco 2991585  
**Thread:** M16 x 1.5  
**O.D.:** 3 11/16 (93.7)  
**Height:** 8 1/8 (206.4)  
**I.Gskt:** G381-A

**BF7713**



In-Line Fuel Filter

**Fits:** Dodge Light-Duty Trucks, Vans  
**Replaces:** Chrysler 4443452, 4443454, 4549712  
**O.D.:** 2 1/8 (54.0)  
**Inlet:** 5/16  
**Outlet:** 5/16  
**Length:** 4 13/16 (122.2)

**BF7697**



High Efficiency Fuel Spin-on

**Contains:** Integral Post Seal  
**Fits:** Detroit Diesel Engines  
**Replaces:** Detroit Diesel 23518529, 25013535  
**Thread:** 1 1/16 -16  
**O.D.:** 4 21/32 (118.3)  
**Height:** 9 1/2 (241.3)  
**I.Gskt:** [1] Included

**PF7715**



Fuel Element

**Fits:** Railroad Applications  
**Replaces:** Alco 1831113-2, 2321946; Clark FA1  
**O.D.:** 5 1/16 (128.6)  
**I.D.:** 11/16 (17.5) One End  
**Height:** 11 7/8 (301.6)  
**A. Gskt:** [1] Included  
**Spring:** [1] Attached

**PF7698**



Fuel Element with Lid

**Notes:** Lid Accepts 1/2 In. Square Driver  
**Fits:** Ford Light-Duty Trucks  
**Replaces:** Ford F81Z-9N184-AA  
**O.D.:** 3 27/32 (97.6)  
 Lid 4 7/8 (123.8)  
**I.D.:** 9/16 (14.3) One End  
**Height:** 3 9/16 (90.5)  
**I.Gskt:** [2] Included  
**Grommets:** [1] Attached

**PF7716**



Fuel Element

**Fits:** Railroad Applications  
**Replaces:** Alco 1831112-2; Clark FA2  
**O.D.:** 5 1/16 (128.6)  
**I.D.:** 11/16 (17.5) One End  
**Height:** 20 15/16 (531.8)  
**A. Gskt:** [1] Attached  
**Spring:** [1] Attached

**BF7699-D**



Primary Fuel/Water Coalescer Element with Drain

**Notes:** Reverse Flow  
 Tab/Keys are not needed for installation.  
**Fits:** Barber Greene, Caterpillar Equipment  
**Replaces:** Caterpillar 151-2409; Stanadyne 33748  
**O.D.:** 3 9/32 (83.3)  
**I.D.:** 21/32 (16.7) One End  
**Height:** 5 7/32 (132.6)  
**Grommets:** [1] Attached

**BF7717**

















Secondary Fuel Spin-on

**Fits:** John Deere Equipment  
**Replaces:** John Deere RE502204, RE506428  
**Thread:** 7/8 -14  
**O.D.:** 4 13/32 (111.9)  
**Height:** 5 29/32 (150.0)  
**I.Gskt:** [1] Included

Measurements Are Shown In Inches And (Millimeters)

**WARNING:** These products can expose you to chemicals, including Diisononyl Phthalate, Carbon black extracts, Nickel, 1,3 Butadiene, Ethylene Oxide, Epichlorohydrin, which are known to the State of California to cause cancer, and Bisphenol, Ethylene Glycol, Ethylene Oxide, 1,3 Butadiene, Epichlorohydrin, which are known to the State of California to cause birth defects or other reproductive harm.

<p><b>PF7718</b> Fuel Element</p>  <p><b>Replaces:</b> Fleetguard FS19559  <b>O.D.:</b> 4 11/32 (110.3)  <b>I.D.:</b> 21/32 (16.7) One End  <b>Height:</b> 6 1/2 (165.1)  <b>O-Ring:</b> [1] Included  <b>Grommets:</b> [1] Attached  <b>Related To:</b> PF7749 (Maximum Performance Glass Media Version)</p>	<p><b>PF7734</b> Maximum Performance Fuel/Water Separator Element</p>  <p><b>Replaces:</b> Fleetguard FS1020  <b>O.D.:</b> 4 11/32 (110.3)  <b>I.D.:</b> 21/32 (16.7)  <b>Height:</b> 6 1/2 (165.1)  <b>O-Ring:</b> [1] Included  <b>Grommets:</b> [1] Attached  <b>Related To:</b> PF7733 (Standard Media Version)</p>
<p><b>BF7719</b> In-Line Fuel Filter</p>  <p><b>Contains:</b> [1] Plastic Clip  <b>Fits:</b> Buick, Chevrolet, Oldsmobile, Pontiac Vans  <b>Replaces:</b> GMC 10290491  <b>O.D.:</b> 1 15/16 (49.2)  <b>Inlet:</b> 3/8  <b>Outlet:</b> 3/8  <b>Length:</b> 5 25/32 (146.8)</p>	<p><b>PF7735</b> Fuel Element</p>  <p><b>Fits:</b> Claas, Demag, Grove Equipment; Freightliner, Sterling Trucks; Mercedes-Benz Engines, Trucks  <b>Replaces:</b> Mercedes-Benz A0000901551, A9060920305  <b>O.D.:</b> 3 5/8 (92.1)  <b>I.D.:</b> 1 3/32 (27.8)  <b>Height:</b> 4 1/16 (103.2)  <b>O-Ring:</b> [1] Included</p>
<p><b>BF7720</b> In-Line Fuel Filter</p>  <p><b>Fits:</b> Geo, Suzuki Automotive  <b>Replaces:</b> Suzuki 15430-50G00  <b>O.D.:</b> 2 15/16 (74.6)  <b>Inlet:</b> 5/16  <b>Outlet:</b> 5/16  <b>Length:</b> 4 25/32 (121.4)</p>	<p><b>BF7736</b> In-Line Fuel Filter</p>  <p><b>Fits:</b> Bomag, Case, New Holland Equipment  <b>Replaces:</b> Wix 33002  <b>O.D.:</b> 2 1/8 (54.0)  <b>Inlet:</b> 5/16  <b>Outlet:</b> 5/16  <b>Length:</b> 3 21/32 (92.9)  <b>Related To:</b> BF840, BF840-K1 (Metal Versions)</p>
<p><b>BF7721</b> In-Line Fuel Filter</p>  <p><b>Fits:</b> Acura Automotive  <b>Replaces:</b> Honda 16900-SD4-671  <b>O.D.:</b> 3 13/32 (86.5)  <b>Inlet:</b> M14 x 1.5  <b>Outlet:</b> M12 x 1 1/4  <b>Length:</b> 4 1/4 (108.0)  <b>F. Gskt:</b> [2] Copper Washers</p>	<p><b>BF7736-K1</b> Fuel Element in Plastic Housing</p>  <p><b>Contains:</b> [4] Clips  [2] Hoses  <b>Replaces:</b> Fiaam FT4648B; Woodgate WGF149-PK  <b>O.D.:</b> 2 1/8 (54.0)  <b>Inlet:</b> 5/16  <b>Outlet:</b> 1/4  <b>Height:</b> 4 11/16 (119.1)</p>
<p><b>BF7725</b> Nylon Screen In-Line Fuel Filter</p>  <p><b>Fits:</b> Mercedes-Benz Automotive  <b>Replaces:</b> Atlas Copco 29148002; John Deere AL78988; Mercedes-Benz 14772101, 14776901  <b>O.D.:</b> 1 13/32 (35.7)  <b>Inlet:</b> 5/16  <b>Outlet:</b> 5/16  <b>Length:</b> 4 5/32 (105.6)</p>	<p><b>BF7742</b> In-Line Fuel Filter</p>  <p><b>Contains:</b> 5/16 Inch Return Line  <b>Fits:</b> Ford, Mercury Light-Duty Trucks  <b>Replaces:</b> Ford 2L2Z-9155-AB  <b>O.D.:</b> 2 1/4 (57.2)  <b>Inlet:</b> 3/8  <b>Outlet:</b> 3/8  <b>Length:</b> 7 (177.8)</p>
<p><b>BF7726</b> In-Line Fuel Filter</p>  <p><b>Contains:</b> [2] Bleeder Plugs  Reverse Flow Valve at Inlet  <b>Fits:</b> Allis Chalmers, Case, Continental, Hercules, Massey Ferguson, Oliver, Waukesha Equipment  <b>Replaces:</b> Case A57228; GMC 2449298  <b>O.D.:</b> 3 13/16 (96.8)  <b>Inlet:</b> 1/4-18  <b>Outlet:</b> 1/4-18  <b>Length:</b> 6 13/32 (162.7)</p>	<p><b>PF7744</b> Fuel/Water Separator Element</p>  <p><b>Fits:</b> Freightliner, International, Kenworth, Peterbilt, Sterling, Volvo Trucks  <b>Replaces:</b> Caterpillar 4176217; Detroit Diesel 23521528; General Motors 23521528; Fleetguard FF5369, FF5369W  <b>O.D.:</b> 3 3/4 (95.3)  <b>I.D.:</b> 21/32 (16.7) One End  <b>Height:</b> 6 29/32 (175.4)  <b>O-Ring:</b> G445  <b>O. Gskt:</b> G717  <b>End Seals:</b> ES3012  <b>Grommets:</b> [1] Attached</p>
<p><b>PF7733</b> Fuel/Water Separator Element</p>  <p><b>Replaces:</b> Fleetguard FS1011; Donaldson P550447  <b>O.D.:</b> 4 11/32 (110.3)  <b>I.D.:</b> 21/32 (16.7) One End  <b>Height:</b> 6 7/16 (163.5)  <b>O-Ring:</b> [1] Included  <b>Grommets:</b> [1] Attached  <b>Related To:</b> PF7734 (Maximum Performance Media Version)</p>	<p><b>BF7745-D</b> Secondary Fuel/Water Separator Element with Drain</p>  <p><b>Notes:</b> Reverse Flow  Tab/Keys are not needed for installation.  <b>Fits:</b> Ford, New Holland Equipment  <b>Replaces:</b> New Holland 87801434  <b>O.D.:</b> 3 9/32 (83.3)  <b>I.D.:</b> 21/32 (16.7) One End  <b>Height:</b> 4 15/32 (113.5)  <b>Grommets:</b> [1] Attached</p>

Measurements Are Shown In Inches And (Millimeters)

**WARNING:** These products can expose you to chemicals, including Diisononyl Phthalate, Carbon black extracts, Nickel, 1,3 Butadiene, Ethylene Oxide, Epichlorohydrin, which are known to the State of California to cause cancer, and Bisphenol, Ethylene Glycol, Ethylene Oxide, 1,3 Butadiene, Epichlorohydrin, which are known to the State of California to cause birth defects or other reproductive harm.

**BF7746-D** Secondary Fuel/Water Separator Element with Drain



**Notes:** Reverse Flow  
Tab/Keys are not needed for installation.  
**Fits:** Case, Caterpillar, New Holland Equipment  
**Replaces:** Ford YC15-9176-AA; Stanadyne 34470, 35332  
**O.D.:** 3 9/32 (83.3)  
**I.D.:** 2 1/32 (16.7) One End  
**Height:** 7 5/8 (193.7)  
**Grommets:** [1] Attached

**BF7753** High Efficiency Fuel Spin-on



**Fits:** Caterpillar Engines, Equipment, Trucks  
**Replaces:** Caterpillar 1R0762  
**Thread:** 1 -14  
**O.D.:** 3 11/16 (93.7)  
**Height:** 10 1/2 (266.7)  
**I.Gskt:** [1] Included

**BF7747** Fuel Spin-on



**Fits:** DAF Trucks  
**Replaces:** DAF 1345335; Fleetguard FF5366  
**Thread:** M22 x 1.5  
**O.D.:** 3 11/16 (93.7)  
**Height:** 5 5/8 (142.9)  
**I.Gskt:** G381-A

**PF7755** Fuel/Water Separator Element



**Contains:** Relief Valve  
**Fits:** Caterpillar, Cummins Engines; International, Kenworth, Peterbilt, Volvo Trucks  
**Replaces:** Davco 382116; Donaldson P550737; Fleetguard FS19729  
**O.D.:** 3 3/4 (95.3)  
**I.D.:** 2 1/32 (16.7) One End  
**Height:** 7 1/32 (178.6)  
**F. Gskt:** ES3012, G402, G445  
**Grommets:** [1] Attached

**PF7748** Fuel/Water Separator Element



**Contains:** Relief Valve  
**Fits:** Davco Fuel Pro  
**Replaces:** Detroit Diesel 23529168; Davco 382114  
**O.D.:** 3 3/4 (95.3)  
**I.D.:** 2 1/32 (16.7) One End  
**Height:** 7 1/32 (178.6)  
**O-Ring:** ES3012, G402, G445 Included  
**Grommets:** [1] Attached

**BF7756** In-Line Fuel Element



**Contains:** 13/32 Inch Return  
**Fits:** Mercedes-Benz Trucks  
**Replaces:** Mercedes-Benz 6110920201, A6110920201  
**O.D.:** 3 19/32 (91.3)  
**Inlet:** 3/8  
**Outlet:** 15/32  
**Height:** 5 (127.0)  
**O-Ring:** [1] Attached

**PF7749** Maximum Performance Fuel/Water Separator Element



**Fits:** Fleetguard FH23000, FH23001, FH23002, FH23003, FH23300, FH23301 Assemblies  
**Replaces:** Fleetguard FS1021, FS19557  
**O.D.:** 4 23/32 (119.9)  
**I.D.:** 2 1/32 (16.7) One End  
**Height:** 6 15/32 (164.3)  
**O-Ring:** [1] Included  
**Grommets:** [1] Attached  
**Related To:** PF7718 (Standard Media Version)

**PF7758** Fuel Element



**Fits:** Mitsubishi Engines  
**Replaces:** Mitsubishi ME036459, ME036478; Donaldson P550054  
**O.D.:** 3 5/8 (92.1)  
**I.D.:** 19/32 (15.1)  
**Height:** 4 11/32 (110.3)  
**F. Gskt:** [1] Included  
**Grommets:** [2] Attached

**BF7750** Fuel Spin-on



**Fits:** Various Fuel Pumps  
**Replaces:** Petro Clear 40510P  
**Thread:** 1 -12  
**O.D.:** 3 11/16 (93.7)  
**Height:** 5 5/8 (142.9)  
**I.Gskt:** G381-A

**BF7759** Stainless Steel Mesh Fuel Strainer with Drain



**Contains:** 200 Mesh Media  
**Fits:** GMC Trucks; Detroit Diesel Engines  
**Replaces:** GMC 15152281; Racor S6484  
**Thread:** 1 -12  
**O.D.:** 3 11/16 (93.7)  
**Height:** 7 13/32 (188.1)  
**I.Gskt:** [1] Included

**PF7751** Fuel/Water Separator Element with Lid



**Fits:** Dodge Light-Duty Trucks with 5.9L Turbo Diesel Engine  
**Replaces:** Chrysler 4883963AC; Cummins 3990130; Fleetguard FS19598  
**O.D.:** 3 19/32 (91.3)  
Lid 4 1/8 (104.8)  
**I.D.:** 1 1/8 (28.6)  
**Height:** 4 5/16 (109.5)  
**F. Gskt:** [2] Included  
**Grommets:** [1] Attached

**BF7760** Wire Mesh Fuel Spin-on



**Fits:** International, Kenworth, Peterbilt Trucks with ISX Engine  
**Replaces:** Cummins 4010476; Fleetguard FF2203  
**Thread:** 1 -14  
**O.D.:** 3 11/16 (93.7)  
**Height:** 5 11/16 (144.5)  
**I.Gskt:** G401  
**O-Ring:** [1] Included

Measurements Are Shown In Inches And (Millimeters)

**WARNING:** These products can expose you to chemicals, including Diisononyl Phthalate, Carbon black extracts, Nickel, 1,3 Butadiene, Ethylene Oxide, Epichlorohydrin, which are known to the State of California to cause cancer, and Bisphenol, Ethylene Glycol, Ethylene Oxide, 1,3 Butadiene, Epichlorohydrin, which are known to the State of California to cause birth defects or other reproductive harm.

**PF7761** Fuel Element  
**Fits:** Demag, Grove Equipment; Freightliner, Mercedes-Benz, Sterling, Western Star Trucks; Mercedes-Benz Engines  
**Replaces:** Mercedes-Benz 5410900151, A5410920305, A5410920805  
**O.D.:** 3 23/32 (94.5)  
**I.D.:** 1/2 (12.7) & 1 25/32 (45.2)  
**Height:** 8 (203.2)  
**I.Gskt:** [1] Included  
**A. Gskt:** [1] Attached  
**O-Ring:** [1] Included  
**Grommets:** [1] Included



**BF7762** In-Line Fuel Filter  
**Contains:** [2] Plastic Clips  
**Fits:** Chevrolet, GMC, Isuzu, Oldsmobile Light-Duty Trucks; Hummer H2  
**Replaces:** GMC 15015509  
**O.D.:** 2 5/32 (54.8)  
**Inlet:** 3/8  
**Outlet:** 3/8  
**Length:** 4 27/32 (123.0)



**BF7763** In-Line Fuel Filter  
**Contains:** 5/16 Inch Return Line Ground Wire  
**Fits:** Chrysler, Dodge Automotive  
**Replaces:** Chrysler 4809118AC, 4809118AD  
**O.D.:** 1 31/32 (50.0)  
**Inlet:** 3/8  
**Outlet:** 5/16  
**Length:** 24 (609.6)



**BF7765** In-Line Fuel Filter  
**Contains:** Mounting Bracket with M8 x 1 1/4 Threaded Stud  
 3/8 Inch Return Line  
**Fits:** Ford, Mazda Light-Duty Trucks  
**Replaces:** Ford 1L5E-9155-BA, 2L5Z-9155-AA  
**O.D.:** 3 5/8 (92.1)  
**Inlet:** 5/16  
**Outlet:** 5/16  
**Length:** 6 5/8 (168.3)



**BF7766** Fuel Spin-on  
**Fits:** Cummins ISX Series Engines; International, Kenworth, Mack, Peterbilt, Volvo Trucks  
**Replaces:** Cummins 4088272; Fleetguard FF2200  
**Thread:** M72 x 2.0  
**O.D.:** 3 23/32 (94.5)  
**Height:** 9 5/32 (232.6)  
**I.Gskt:** [1] Included



**PF7767** Fuel Element  
**Fits:** DAF Trucks  
**Replaces:** DAF 1397766  
**O.D.:** 3 31/32 (100.8)  
**I.D.:** 1/2 (12.7) & 1 3/4 (44.4)  
**Height:** 8 (203.2)  
**A. Gskt:** [1] Attached  
**O-Ring:** [1] Included  
**Grommets:** [2] Attached



**BF7768** In-Line Fuel Filter  
**Contains:** [2] 5/16 Inch Clips  
**Fits:** Ford Automotive  
**Replaces:** Motorcraft FG986B  
**O.D.:** 2 7/32 (56.4)  
**Inlet:** 5/16  
**Outlet:** 5/16  
**Length:** 7 1/32 (178.6)  
**Related To:** BF7668 (3/8 In. Clips)



**BF7769** In-Line Fuel Filter  
**Contains:** [2] Plastic Retainer Clips  
**Fits:** Buick, Chevrolet, Oldsmobile, Pontiac, Saturn Automotive, Light-Duty Trucks  
**Replaces:** GMC 10333072  
**O.D.:** 1 31/32 (50.0)  
**Inlet:** 3/8  
**Outlet:** 3/8  
**Length:** 6 27/32 (173.8)



**PF7770** Dual-Flow Fuel Element  
**Fits:** John Deere Engines, Equipment  
**Replaces:** John Deere RE507284  
**O.D.:** 4 5/8 (117.5)  
 Lid 5 3/8 (136.5)  
**I.D.:** 7/8 (22.2) One End  
**Height:** 8 3/8 (212.7)  
**A. Gskt:** [1] Attached  
**Grommets:** [1] Attached



**BF7771** In-Line Fuel Filter  
**Contains:** [2] Plastic Retainer Clips  
 5/16 Inch Return Line  
 Plastic Mounting Band  
 Screw and Washer  
**Fits:** Saturn Automotive  
**Replaces:** GMC 22633313, 22633314  
**O.D.:** 2 5/32 (54.8)  
**Inlet:** 3/8  
**Outlet:** 3/8  
**Length:** 6 7/8 (174.6)



**BF7772** Fuel/Water Separator Spin-on with Drain  
**Fits:** Case Equipment; Gehl Loaders  
**Replaces:** Gehl 132024  
**Thread:** M16 x 1.5  
**O.D.:** 3 1/32 (77.0)  
**Height:** 6 21/32 (169.1)  
**A. Gskt:** G449-B  
**F. Gskt:** [1] Included















**BF7773** Fuel Spin-on  
**Contains:** Integral Post Seal  
**Fits:** Mack Engines, Trucks  
**Replaces:** Mack 483GB476M  
**Thread:** M30 x 1.5  
**O.D.:** 4 1/4 (108.0)  
**Height:** 7 19/32 (192.9)  
**I.Gskt:** [1] Included



Measurements Are Shown In Inches And (Millimeters)

**WARNING:** These products can expose you to chemicals, including Diisononyl Phthalate, Carbon black extracts, Nickel, 1,3 Butadiene, Ethylene Oxide, Epichlorohydrin, which are known to the State of California to cause cancer, and Bisphenol, Ethylene Glycol, Ethylene Oxide, 1,3 Butadiene, Epichlorohydrin, which are known to the State of California to cause birth defects or other reproductive harm.

<p><b>BF7774</b> Fuel Spin-on  <b>Fits:</b> Detroit Diesel Engines  <b>Replaces:</b> Detroit Diesel 23530641  <b>Thread:</b> 1 -12  <b>O.D.:</b> 3 11/16 (93.7)  <b>Height:</b> 5 11/32 (135.7)  <b>I.Gskt:</b> [1] Included</p> 	<p><b>PF7782</b> Fuel/Water Separator Element with Relief Valve  <b>Fits:</b> Cummins ISX Engines; Davco Fuel Pro FH230 Series, 382 Series Housings  <b>Replaces:</b> Davco 382119; Fleetguard FS19728  <b>O.D.:</b> 3 27/32 (97.6)  <b>I.D.:</b> 2 1/32 (16.7) One End  <b>Height:</b> 7 1/32 (178.6)  <b>O-Ring:</b> [3] Included  <b>Grommets:</b> [1] Attached</p> 
<p><b>BF7775</b> In-Line Fuel Filter  <b>Contains:</b> 3/8 Inch Universal Return Line  <b>Fits:</b> Pontiac Automotive  <b>Replaces:</b> GMC 10337405; ACDelco GF872  <b>O.D.:</b> 2 1/8 (54.0)  <b>Inlet:</b> M16 x 1.5  <b>Outlet:</b> 3/8  <b>Length:</b> 6 9/16 (166.7)</p> 	<p><b>BF7783-D</b> Primary Fuel/Water Coalescer Element with Drain  <b>Notes:</b> Tab/Keys are not needed for installation.  <b>Fits:</b> Massey Ferguson Tractors  <b>Replaces:</b> Agco 3780931M1; J.C. Bamford 32/921001; Fleetguard FS19585  <b>O.D.:</b> 3 9/32 (83.3)  <b>I.D.:</b> 2 1/32 (16.7) One End  <b>Height:</b> 5 7/32 (132.6)  <b>Grommets:</b> [2] Attached</p> 
<p><b>BF7776</b> In-Line Fuel Filter  <b>Contains:</b> 5/16 Inch Universal Return Line  <b>Fits:</b> Cadillac Automotive  <b>Replaces:</b> GMC 25763176; ACDelco GF897  <b>O.D.:</b> 2 1/8 (54.0)  <b>Inlet:</b> M16 x 1.5  <b>Outlet:</b> 3/8  <b>Length:</b> 6 1/4 (158.8)</p> 	<p><b>BF7784-D</b> Primary Fuel/Water Separator Element with Drain  <b>Notes:</b> Reverse Flow            Tab/Keys are not needed for installation.  <b>Fits:</b> John Deere Equipment  <b>Replaces:</b> Case/New Holland 87802332; John Deere RE517181  <b>O.D.:</b> 3 9/32 (83.3)  <b>I.D.:</b> 2 1/32 (16.7) One End  <b>Height:</b> 5 31/32 (151.6)  <b>Grommets:</b> [1] Attached</p> 
<p><b>PF7777</b> Fuel/Water Separator Element  <b>Fits:</b> Cummins ISB Series Engines; Dodge Light-Duty Trucks; Ford, Freightliner, Kenworth, Peterbilt, Sterling Trucks  <b>Replaces:</b> Chrysler 5015581AA; Cummins 3942470; Fleetguard FS19579  <b>O.D.:</b> 3 3/8 (85.7)  <b>I.D.:</b> 13/16 (20.6) One End  <b>Height:</b> 4 3/32 (104.0)  <b>O-Ring:</b> [1] Included  <b>Grommets:</b> [1] Attached</p> 	<p><b>BF7785-D</b> Primary Fuel/Water Separator Element with Drain  <b>Notes:</b> Reverse Flow            Tab/Keys are not needed for installation.  <b>Fits:</b> John Deere Equipment  <b>Replaces:</b> John Deere RE509036, RE517180  <b>O.D.:</b> 3 9/32 (83.3)  <b>I.D.:</b> 2 1/32 (16.7) One End  <b>Height:</b> 7 5/8 (193.7)  <b>Grommets:</b> [1] Attached</p> 
<p><b>BF7778</b> Fuel/Water Separator Element with Drain  <b>Contains:</b> 1/2 Inch Universal Return Port Pressure Relief Screw  <b>Fits:</b> Dodge, Freightliner Sprinter Vans; Mercedes-Benz Engines  <b>Replaces:</b> Mercedes-Benz 6120920001, A6120920001  <b>O.D.:</b> 3 19/32 (91.3)  <b>Inlet:</b> 13/32  <b>Outlet:</b> 1/2  <b>Height:</b> 4 23/32 (119.9)</p> 	<p><b>BF7786-D</b> Secondary Fuel/Water Separator Element with Drain  <b>Notes:</b> Tab/Keys are not needed for installation.  <b>Fits:</b> John Deere Equipment  <b>Replaces:</b> John Deere RE509032  <b>O.D.:</b> 3 9/32 (83.3)  <b>I.D.:</b> 2 1/32 (16.7) One End  <b>Height:</b> 7 5/8 (193.7)  <b>Grommets:</b> [1] Attached</p> 
<p><b>PF7779</b> Fuel/Water Separator Element  <b>Fits:</b> International Engines, Trucks  <b>Replaces:</b> International 1842638-C91; Fleetguard FS19684  <b>O.D.:</b> 3 3/4 (95.3)  <b>I.D.:</b> 13/16 (20.6) One End  <b>Height:</b> 5 11/16 (144.5)  <b>O-Ring:</b> [2] Included  <b>Grommets:</b> [1] Attached</p> 	<p><b>PF7787</b> Primary Fuel Element  <b>Use With:</b> PF7788 (Secondary)  <b>Replaces:</b> Zetor 931207; Fleetguard FF5197; Woodgate WGF9001  <b>O.D.:</b> 2 27/32 (72.2)  <b>I.D.:</b> 27/32 (21.4)  <b>Height:</b> 5 5/32 (131.0)</p> 
<p><b>BF7780</b> In-Line Fuel Filter  <b>Contains:</b> 3/8 Inch Quick Connect  <b>Fits:</b> Jeep Grand Cherokee  <b>Replaces:</b> Chrysler 52100283AG  <b>O.D.:</b> 2 5/32 (54.8)  <b>Inlet:</b> 5/16  <b>Outlet:</b> 3/8  <b>Length:</b> 6 13/16 (173.0)</p> 	

Measurements Are Shown In Inches And (Millimeters)

**WARNING:** These products can expose you to chemicals, including Diisononyl Phthalate, Carbon black extracts, Nickel, 1,3 Butadiene, Ethylene Oxide, Epichlorohydrin, which are known to the State of California to cause cancer, and Bisphenol, Ethylene Glycol, Ethylene Oxide, 1,3 Butadiene, Epichlorohydrin, which are known to the State of California to cause birth defects or other reproductive harm.

**PF7788**



Secondary Fuel Element  
**Use With:** PF7787 (Primary)  
**Replaces:** Zetor 931209; Woodgate WGF9002  
**O.D.:** 2 27/32 (72.2)  
**I.D.:** 13/16 (20.6)  
**Height:** 5 3/16 (131.8)

**BF7798-O**



Fuel/Water Separator Spin-on with Open End for Bowl  
**Contains:** Bowl Thread 3 1/8 - 10 UN-1B  
**Fits:** Autocar, Ford, Freightliner, Peterbilt, Sterling, Western Star Trucks; Blue Bird, Thomas Buses  
**Replaces:** Alliance ABPN12232FRT03; Caterpillar 1986378; Racor S3201S  
**Thread:** 1 -14  
**O.D.:** 3 5/8 (92.2)  
**Height:** 7 13/32 (188.2)  
**F. Gskt:** [2] Included  
**O-Ring:** [1] Included

**BF7798-SP**



Fuel/Water Separator Spin-on with Drain and Sensor Port  
**Notes:** CAUTION: Furnished D-Ring must be installed on post for seal.  
 Can be used with FB1311 base.  
**Contains:** Sensor Port Thread: 1/2-20  
**Fits:** Caterpillar Engines  
**Replaces:** Caterpillar 198-6378  
**Thread:** 1 -14  
**O.D.:** 3 11/16 (93.7)  
**Height:** 9 17/32 (242.1)  
**I.Gskt:** G401  
**F. Gskt:** [1] Included  
**O-Ring:** [1] Included  
**Related To:** BF7798-O} (Open Port Version)

**PF7799**



Fuel Element  
**Fits:** Caterpillar Industrial, Marine Engines  
**Replaces:** Caterpillar 1R0725, 1R0766, 1W4056  
**O.D.:** 5 1/16 (128.6)  
**I.D.:** 2 3/32 (53.2)  
**Height:** 10 7/16 (265.1)  
**A. Gskt:** [2] Attached

**BF7800**



In-Line Fuel Filter  
**Fits:** Lincoln Light-Duty Trucks  
**Replaces:** Ford 2L7Z-9155-AA; Motorcraft FG1062  
**O.D.:** 2 1/4 (57.2)  
**Inlet:** 3/8  
**Outlet:** 3/8  
**Length:** 7 1/4 (184.2)

**BF7801**



In-Line Fuel Filter  
**Contains:** 3/8 Inch Return Line  
**Fits:** Ford Automotive, Light-Duty Trucks  
**Replaces:** Ford 1F1Z-9155-AD, 1F1Z-9155-CA  
**O.D.:** 2 9/32 (57.9)  
**Inlet:** 5/16  
**Outlet:** 5/16  
**Length:** 6 9/16 (166.7)

**BF7802**



In-Line Fuel Filter  
**Fits:** Ford, Lincoln, Mercury Automotive, Light-Duty Trucks  
**Replaces:** Ford 2C5Z-9155-AA  
**O.D.:** 2 9/32 (57.9)  
**Inlet:** 3/8  
**Outlet:** 3/8  
**Length:** 6 29/32 (175.4)

**BF7803**



In-Line Fuel Filter  
**Contains:** 3/8 Inch Vapor Diverter  
**Fits:** Ford, Mazda Light-Duty Trucks  
**Replaces:** Ford 1L2Z-9155-BA  
**O.D.:** 3 5/32 (80.2)  
**Inlet:** 5/16  
**Outlet:** 5/16  
**Length:** 6 11/16 (169.9)

**BF7804**



In-Line Fuel Filter  
**Contains:** 3/8 Inch Vapor Diverter  
**Fits:** Ford Light-Duty Trucks  
**Replaces:** Ford YF1Z-9155-BA  
**O.D.:** 3 5/32 (80.2)  
**Inlet:** 5/16  
**Outlet:** 5/16  
**Length:** 6 3/16 (157.2)

**BF7805**



In-Line Fuel Filter  
**Contains:** 5/16 Inch Vapor Diverter  
**Fits:** Ford Light-Duty Trucks  
**Replaces:** Ford 2L1Z-9155-AA  
**O.D.:** 2 1/4 (57.2)  
**Inlet:** 3/8  
**Outlet:** 3/8  
**Length:** 7 27/32 (199.2)

**BF7806**



Fuel/Water Separator Spin-on with Drain  
**Contains:** Front End Check Valve  
**Fits:** Caterpillar Engines; Ford Trucks  
**Replaces:** Ford YC35-9176-AA, YC3Z-9176-AA, YC3Z-9365-AA; Motorcraft FD4597, FG998  
**Thread:** 1 -14  
**O.D.:** 3 11/16 (93.7)  
**Height:** 6 7/32 (158.0)  
**I.Gskt:** [1] Included  
**Related To:** BF7806-O (Open Port Version)

**BF7806-O**



Fuel/Water Separator Spin-on with Open End for Bowl  
**Contains:** Bowl Thread 3 1/8 - 10 UN-1B  
**Fits:** Ford F750 with Cat 3126, Cummins ISB 200 Engine  
**Replaces:** Ford Motor Co. 5C4Z9N184AB; IHC (International Harvester) 2587803C1; Motorcraft FD4608; Parker PFF5527; Racor S6494  
**Thread:** 1 -14  
**O.D.:** 3 21/32 (92.7)  
**Height:** 4 1/32 (102.4)  
**F. Gskt:** [1] Included  
**O-Ring:** [1] Included  
**Related To:** BF7806 (with Drain)

**BF7807**



In-Line Fuel Filter  
**Notes:** OBSOLETE. Availability Limited to Dealer Stock.  
**Fits:** Chevrolet, Toyota Automotive; Toyota Light-Duty Trucks  
**Replaces:** Toyota 23300-15010  
**O.D.:** 2 1/4 (57.2)  
**Inlet:** 9/32  
**Outlet:** 9/32  
**Length:** 2 1/4 (57.2)

Measurements Are Shown In Inches And (Millimeters)

**WARNING:** These products can expose you to chemicals, including Diisononyl Phthalate, Carbon black extracts, Nickel, 1,3 Butadiene, Ethylene Oxide, Epichlorohydrin, which are known to the State of California to cause cancer, and Bisphenol, Ethylene Glycol, Ethylene Oxide, 1,3 Butadiene, Epichlorohydrin, which are known to the State of California to cause birth defects or other reproductive harm.



**BF7808**

In-Line Fuel Filter



**Fits:** Chevrolet, GMC Light-Duty Trucks  
**Replaces:** GMC 25164003  
**O.D.:** 2 5/16 (58.7)  
**Inlet:** M16 x 1.5  
**Outlet:** 3/8  
**Length:** 5 11/32 (135.7)

**BF7809**

In-Line Fuel Filter



**Contains:** [2] Plastic Clips  
**Fits:** Ford, Mercury Automotive  
**Replaces:** Ford YF1Z-9155-CA  
**O.D.:** 3 3/32 (78.6)  
**Inlet:** 5/16  
**Outlet:** 5/16  
**Length:** 5 23/32 (145.3)

**PF7812 KIT**

Set of 2 Fuel Elements



**Notes:** Filters not sold separately.  
**Contains:** [1] Primary Fuel Element  
 [1] Secondary Fuel Element  
**Fits:** Ford Light-Duty Trucks; International Engines  
**Replaces:** Ford 3C3Z-9N184-CA  
**Primary**  
**O.D.:** 3 5/16 (84.1)  
**I.D.:** 1 19/32 (40.5)  
**Height:** 4 3/16 (106.4)  
**O-Ring:** [2] Included  
**Secondary**  
**O.D.** 2 1/4  
**I.D.** 21/32  
**Height** 5 5/8

**BF7813**

Fuel Spin-on



**Fits:** Cummins Engines; DAF, Iveco Trucks  
**Replaces:** Cummins 4897833; DAF 1399760; Fleetguard FF5420, FF5485  
**Thread:** M20 x 1.5  
**O.D.:** 3 11/16 (93.7)  
**Height:** 7 1/8 (181.0)  
**A. Gskt:** G381-A

**BF7814**

Fuel Spin-on



**Fits:** Mack Engines, Trucks; R.V.I. Trucks; Volvo Buses, Engines, Trucks  
**Replaces:** Volvo 20430751; Donaldson P550739  
**Thread:** M32 x 1.5  
**O.D.:** 4 1/4 (108.0)  
**Height:** 10 15/32 (265.9)  
**I.Gskt:** [1] Included

**BF7815**

High Efficiency Fuel Spin-on



**Fits:** Cummins Engines; Kenworth, Mack, Peterbilt, Sterling Trucks  
**Replaces:** Cummins 3959612; Fleetguard FF5488  
**Thread:** 7/8 -14  
**O.D.:** 3 23/32 (94.5)  
**Height:** 7 5/32 (181.8)  
**I.Gskt:** G381-A  
**F. Gskt:** [1] Included

**PF7816**

Fuel Element with Threaded Lid



**Replaces:** Kubota 11420-43012; Woodgate WGF9327  
**O.D.:** 1 1/4 (31.8)  
**Lid** 2 9/32 (57.9)  
**I.D.:** 1/4 (6.4)  
**Height:** 4 5/8 (117.5)

**PF7817**

Fuel Element



**Fits:** Citroen Automotive  
**Replaces:** Peugeot 190629; Woodgate WGF9355  
**O.D.:** 2 19/32 (65.9)  
**Flange** 3 5/32 (80.2)  
**I.D.:** 3/4 (19.0)  
**Height:** 2 11/32 (59.5)  
**O-Ring:** [1] Attached

**PF7818**

Fuel Element



**Fits:** Hatz Engines  
**Replaces:** Hatz 50474300; Woodgate WGF9306  
**O.D.:** 1 1/8 (28.6)  
**I.D.:** 5/8 (15.9) One End  
**Height:** 2 7/32 (56.4)  
**Grommets:** [1] Attached

**PF7819**

Nylon Screen Fuel Element



**Replaces:** Mercedes-Benz 900150; Woodgate WGF9316  
**O.D.:** 7/8 (22.2)  
**I.D.:** 3/8 (9.5)  
**Height:** 1 13/16 (46.0)

**PF7820**

Fuel Element with Threaded Stud



**Fits:** Lister-Petter Engines  
**Replaces:** AP-Lockheed LK65300; Fleetguard FF5044; Woodgate WGF5044  
**O.D.:** 1 1/8 (28.6)  
**I.D.:** 3/16 (4.8)  
**Height:** 3 (76.2)  
**F. Gskt:** [1] Rubber Washer

**BF7821**













Fuel Element with Drain



**Fits:** Ford Light-Duty Trucks  
**Replaces:** Motorcraft EFG319; Fleetguard FF5483; Woodgate WGF850-2  
**O.D.:** 3 9/16 (90.5)  
**I.D.:** 1 15/32 (37.3)  
**Height:** 5 9/32 (134.1)

Measurements Are Shown In Inches And (Millimeters)

**WARNING:** These products can expose you to chemicals, including Diisononyl Phthalate, Carbon black extracts, Nickel, 1,3 Butadiene, Ethylene Oxide, Epichlorohydrin, which are known to the State of California to cause cancer, and Bisphenol, Ethylene Glycol, Ethylene Oxide, 1,3 Butadiene, Epichlorohydrin, which are known to the State of California to cause birth defects or other reproductive harm.

<p><b>PF7822</b></p>  <p>Fuel Element  <b>Replaces:</b> Robin 2286211008; Woodgate WGF9065  <b>O.D.:</b> 1 3/8 (34.9)  <b>I.D.:</b> 15/32 (11.9) One End  <b>Height:</b> 1 3/4 (44.4)  <b>O-Ring:</b> [1] Attached</p>	<p><b>PF7829</b></p>  <p>Fuel Element  <b>Replaces:</b> Coopers FEM4130; Woodgate WGF9311  <b>O.D.:</b> 2 23/32 (69.1)  <b>I.D.:</b> 1 5/32 (29.4)  <b>Height:</b> 3 3/4 (95.3)  <b>F. Gskt:</b> [2] Included  <b>Grommets:</b> [2] Attached</p>
<p><b>PF7823</b></p>  <p>Fuel Element  <b>Replaces:</b> Honda 17682-ZG5-003; Woodgate WGF9067  <b>O.D.:</b> 1 31/32 (50.0)  <b>I.D.:</b> 13/32 (10.3) One End  <b>Height:</b> 3 25/32 (96.0)  <b>O-Ring:</b> [1] Attached</p>	<p><b>PF7830</b></p>  <p>Nylon Screen Fuel Strainer  <b>Fits:</b> Komatsu Equipment; Yanmar Excavators  <b>Replaces:</b> Yanmar 121850-55710; Woodgate WGF9347  <b>O.D.:</b> 1 3/8 (34.9)  <b>I.D.:</b> 15/32 (11.9) One End  <b>Height:</b> 2 3/4 (69.9)  <b>O-Ring:</b> [1] Attached</p>
<p><b>PF7824</b></p>  <p>Fuel Element  <b>Fits:</b> Caterpillar, Mitsubishi Lift Trucks; Toro Lawn &amp; Garden Tractors  <b>Replaces:</b> Mitsubishi ME408992; Fleetguard FF5131; Woodgate WGF9103  <b>O.D.:</b> 1 19/32 (40.5)  <b>I.D.:</b> 31/32 (24.6)  <b>Height:</b> 1 13/32 (35.7)</p>	<p><b>PF7832</b></p>  <p>Fuel Element  <b>Fits:</b> Kubota Excavators  <b>Replaces:</b> Yanmar 10590G-55710; Woodgate WGF9369  <b>O.D.:</b> 1 31/32 (50.0)  <b>I.D.:</b> 25/32 (19.8) One End  <b>Height:</b> 3 1/8 (79.4)</p>
<p><b>PF7825</b></p>  <p>Fuel Element  <b>Fits:</b> Honda Engines  <b>Replaces:</b> Honda 17682-ZG3-003; Woodgate WGF9201  <b>O.D.:</b> 2 (50.8)  <b>I.D.:</b> 5/8 (15.9) &amp; 1 15/32 (37.3)  <b>Height:</b> 5 13/32 (137.3)  <b>O-Ring:</b> [1] Attached</p>	<p><b>PF7833</b></p>  <p>Fuel Element  <b>Replaces:</b> Renault 5000590728; Fleetguard FF5057; Woodgate WGF5057  <b>O.D.:</b> 2 1/32 (51.6)  <b>I.D.:</b> 1/2 (12.7)  <b>Height:</b> 2 21/32 (67.5)  <b>End Seals:</b> [2] Attached</p>
<p><b>PF7826</b></p>  <p>Fuel Element  <b>Contains:</b> [2] Threaded Bolts  <b>Fits:</b> Yanmar Engines  <b>Replaces:</b> Yanmar 114250-55120; Woodgate WGF9202  <b>O.D.:</b> 1 9/16 (39.7)  <b>I.D.:</b> 11/32 (8.7)  <b>Height:</b> 5 1/8 (130.2)  <b>A. Gskt:</b> [1] Included  <b>Related To:</b> PF7828, PF7876 (Long Versions)</p>	<p><b>PF7834</b></p>  <p>Oval Fuel Element  <b>Notes:</b> OBSOLETE. Availability limited to Dealer Stock.            Cap contains 10 tabs.  <b>Replaces:</b> Purflux C446; Woodgate WGF9312  <b>O.D.:</b> 2 25/32 (70.6)            Top 3 3/4 (95.3)  <b>I.D.:</b> 1 1/32 (26.2) One End  <b>Height:</b> 3 1/8 (79.4)  <b>O-Ring:</b> [1] Attached</p>
<p><b>PF7828</b></p>  <p>Fuel Element  <b>Contains:</b> [2] Threaded Bolts  <b>Fits:</b> Yanmar Carriers  <b>Replaces:</b> Yanmar 114650-55120; Woodgate WGF9203  <b>O.D.:</b> 1 9/16 (39.7)  <b>I.D.:</b> 5/8 (15.9) One End  <b>Height:</b> 7 13/16 (198.4)  <b>A. Gskt:</b> [1] Included  <b>Related To:</b> PF7826, PF7876 (Short Versions)</p>	<p><b>PF7836</b></p>  <p>Fuel Element  <b>Fits:</b> Lister-Petter Engines  <b>Replaces:</b> Lister 203-32470; Fleetguard FF5099; Woodgate WGF5099  <b>O.D.:</b> 2 5/32 (54.8)  <b>I.D.:</b> 5/8 (15.9) &amp; 15/16 (23.8)  <b>Height:</b> 2 15/32 (62.7)  <b>F. Gskt:</b> [3] Included</p>

Measurements Are Shown In Inches And (Millimeters)

**WARNING:** These products can expose you to chemicals, including Diisononyl Phthalate, Carbon black extracts, Nickel, 1,3 Butadiene, Ethylene Oxide, Epichlorohydrin, which are known to the State of California to cause cancer, and Bisphenol, Ethylene Glycol, Ethylene Oxide, 1,3 Butadiene, Epichlorohydrin, which are known to the State of California to cause birth defects or other reproductive harm.

**BF7837** Fuel Spin-on  
**Fits:** Kubota Engines  
**Replaces:** Woodgate WGF9071  
**Thread:** M20 x 1.5  
**O.D.:** 3 3/32 (78.6)  
**Height:** 2 21/32 (67.5)  
**I.Gskt:** [1] Included



**BF7838** Wound Fuel Spin-on with Threaded Port  
**Contains:** Port Thread: M22 x 1.5  
**Fits:** Hitachi Excavators; Komatsu Lift Trucks  
**Replaces:** Daihatsu 23303-87781; Fleetguard FF5229; Woodgate WGF9223  
**Thread:** M20 x 1.5  
**O.D.:** 3 7/32 (81.8)  
**Height:** 4 25/32 (121.4)  
**I.Gskt:** [1] Included  
**O-Ring:** [1] Included



**BF7839** Wound Fuel Spin-on with Threaded Port  
**Contains:** Port Thread: M36 x 1.5  
**Replaces:** Coopers FSM4135; Woodgate WGF9368  
**Thread:** 3/4 -16  
**O.D.:** 2 3/32 (53.2) to 2 27/32 (72.2)  
**Height:** 4 25/32 (121.4)  
**I.Gskt:** [1] Included



**BF7840** Fuel Spin-on  
**Replaces:** J.C. Bamford 8943254630; Woodgate WGF5114  
**Thread:** 3/4 -16  
**O.D.:** 3 1/8 (79.4)  
**Height:** 3 (76.2)  
**I.Gskt:** [1] Included



**BF7841** Fuel Spin-on  
**Fits:** Hitachi, Takeuchi Excavators  
**Replaces:** Nissan 16403-J6500; Woodgate WGF5141  
**Thread:** 3/4 -16  
**O.D.:** 3 1/8 (79.4)  
**Height:** 3 7/8 (98.4)  
**I.Gskt:** [1] Included



**BF7842** Wound Fuel Spin-on with Threaded Port  
**Contains:** Port Thread: M22 x 1.5  
**Fits:** Mitsubishi Trucks  
**Replaces:** Mitsubishi ME132525; Woodgate WGF9377  
**Thread:** M20 x 1.5  
**O.D.:** 3 27/32 (97.6)  
**Height:** 5 19/32 (142.1)  
**I.Gskt:** [1] Included  
**O-Ring:** [1] Attached



**BF7843** In-Line Fuel Filter in Plastic Housing  
**Replaces:** Mann & Hummel WK21; Woodgate WGF9304  
**O.D.:** 3/4 (19.0)  
**Inlet:** 3/16  
**Outlet:** 3/16  
**Length:** 2 3/8 (60.3)



**BF7844** In-Line Fuel Filter with Drain  
**Fits:** Kubota Excavators  
**Replaces:** Kubota 19099-11151; Woodgate WGF842-3  
**O.D.:** 3 3/8 (85.7)  
**Inlet:** 5/16  
**Outlet:** 5/16  
**Length:** 6 21/32 (169.1)



**BF7845** Plastic In-Line Fuel Filter  
**Contains:** [2] Bleed Screws  
**Fits:** Mitsubishi Engines  
**Replaces:** Mitsubishi MM304900; Woodgate WGF9060  
**O.D.:** 1 25/32 (45.2)  
**Inlet:** 5/16  
**Outlet:** 11/32  
**Length:** 3 27/32 (97.6)



**BF7847** Plastic In-Line Fuel Filter  
**Contains:** Inlet, Outlet and Return Lines Bleed Screw  
**Fits:** Robin Engines  
**Replaces:** Robin 2436210120; Woodgate WGF9341  
**O.D.:** 2 9/32 (57.9)  
**Length:** 4 1/32 (102.4)

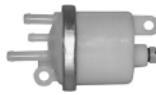

**BF7848** In-Line Fuel Filter  
**Fits:** Mercedes-Benz Automotive  
**Replaces:** Mercedes-Benz 14777901; Woodgate WGF31-5  
**O.D.:** 1 13/32 (35.7)  
**Inlet:** 5/16  
**Outlet:** 5/16  
**Length:** 4 3/32 (104.0)



**BF7849** Plastic In-Line Fuel Filter  
**Contains:** 9/32 Inch Return Line  
**Fits:** Lombardini Engines  
**Replaces:** Lombardini 196.3730.096; Woodgate WGF9229  
**O.D.:** 1 27/32 (46.8)  
**Inlet:** 9/32  
**Outlet:** 9/32  
**Length:** 3 3/8 (85.7)



**BF7850** Nylon In-Line Fuel Filter  
**Replaces:** Woodgate WGF9301  
**O.D.:** 2 (50.8)  
**Inlet:** 5/16 or 3/8 In. Universal  
**Outlet:** 5/16 or 3/8 In. Universal  
**Length:** 8 1/8 (206.4)



**BF7851** Wire Mesh In-Line Fuel Filter in Plastic Housing  
**Replaces:** Woodgate WGF9303  
**O.D.:** 1 15/32 (37.3)  
**Inlet:** 1/4 or 5/16 In. Universal  
**Outlet:** 1/4 or 5/16 In. Universal  
**Length:** 4 7/32 (107.2)



Measurements Are Shown In Inches And (Millimeters)

**WARNING:** These products can expose you to chemicals, including Diisononyl Phthalate, Carbon black extracts, Nickel, 1,3 Butadiene, Ethylene Oxide, Epichlorohydrin, which are known to the State of California to cause cancer, and Bisphenol, Ethylene Glycol, Ethylene Oxide, 1,3 Butadiene, Epichlorohydrin, which are known to the State of California to cause birth defects or other reproductive harm.

**PF7852 KIT**



Set of 2 Fuel Elements  
**Fits:** Ford Vans  
**Replaces:** Ford 4C2Z-9N184-BA; International 1845626-C91; Motorcraft FD4606  
**Primary**  
**O.D.:** 3 3/4 (95.3)  
**I.D.:** 1 1/2 (38.1) One End  
**Height:** 3 1/8 (79.4)  
**O-Ring:** [2] Included  
**Secondary**  
**O.D.:** 2 5/16  
**I.D.:** 15/16  
**Height:** 2 5/8

**BF7864**



Plastic In-Line Fuel Filter  
**Fits:** Ford Lawn & Garden Tractors  
**Replaces:** Briggs & Stratton 298090; Woodgate WGF9334  
**O.D.:** 1 5/16 (33.3)  
**Inlet:** 5/16  
**Outlet:** 5/16  
**Length:** 1 3/4 (44.4)

**BF7853**



Secondary Fuel Spin-on with Drain  
**Contains:** Integral Post Seal  
**Fits:** John Deere Engines, Equipment, Trucks  
**Replaces:** John Deere RE522688  
**Thread:** 7/8 -14  
**O.D.:** 4 1/4 (108.0)  
**Height:** 6 11/16 (169.9)  
**I.Gskt:** [1] Included

**BF7865**



Plastic In-Line Fuel Filter  
**Replaces:** M.A.N. 81.12503.0056; Woodgate WGF31-2  
**O.D.:** 1 3/16 (30.2) to 1 3/8 (34.9)  
**Inlet:** 5/16  
**Outlet:** 5/16  
**Length:** 4 7/32 (107.2)

**BF7855**



In-Line Fuel Filter  
**Replaces:** Stihl 3503500; Woodgate WGF9310  
**O.D.:** 13/16 (20.6)  
**Inlet:** 1/4  
**Outlet:** 1/4  
**Length:** 1 3/4 (44.4)

**BF7866**



Wire Mesh Fuel Strainer with Bail Handle  
**Fits:** Bobcat Excavators  
**Replaces:** Deutz 1319869; Fleetguard FF5584; Woodgate WGF9069  
**O.D.:** 3 5/16 (84.1)  
**I.D.:** 17/32 (13.5)  
**Height:** 4 21/32 (118.3)  
**Grommets:** [2] Attached

**BF7857**



In-Line Fuel Filter with Felt Wrap  
**Replaces:** Partner 506096001; Woodgate WGF9326  
**O.D.:** 27/32 (21.4)  
**Inlet:** 3/16  
**Outlet:** 3/16  
**Length:** 1 7/16 (36.5)

**BF7869**



Fuel Screen  
**Fits:** Kobelco, Takeuchi, Terex Excavators  
**Replaces:** Yanmar 171081-55910; Fleetguard FF5386; Woodgate WGF9302  
**O.D.:** 1 3/8 (34.9)  
**I.D.:** 15/32 (11.9) One End  
**Height:** 2 1/32 (51.6)  
**O-Ring:** [1] Attached

**BF7859**



In-Line Fuel/Water Separator with Drain  
**Contains:** 5/16 Inch Return Line  
**Replaces:** Honda 17670-ZG3-901; Woodgate WGF9373  
**O.D.:** 2 1/16 (52.4)  
**Inlet:** 5/16  
**Outlet:** 11/32  
**Length:** 4 17/32 (115.1)

**BF7870**



Can-Type Fuel Filter  
**Notes:** OBSOLETE. Availability Limited to Dealer Stock.  
**Replaces:** Renault 5000811111; Fleetguard FF5048; Woodgate WGF156  
**O.D.:** 3 15/32 (88.1)  
**I.D.:** 29/32 (23.0) & 1 9/32 (32.5)  
**Height:** 4 (101.6)  
**F. Gskt:** [2] Included  
**O-Ring:** [1] Included

**BF7860**



In-Line Fuel Filter with Felt Wrap  
**Replaces:** Woodgate WGF9383  
**O.D.:** 25/32 (19.8)  
**Inlet:** 5/32  
**Outlet:** 5/32  
**Length:** 1 5/8 (41.3)

**BF7871**



Can-Type Fuel Filter  
**Fits:** M.A.N. Trucks  
**Replaces:** Renault 5000043443; Woodgate WGF5049  
**O.D.:** 3 15/32 (88.1)  
**I.D.:** 29/32 (23.0) & 1 9/32 (32.5)  
**Height:** 2 25/32 (70.6)  
**F. Gskt:** [2] Included  
**O-Ring:** [1] Included

**BF7861**



In-Line Fuel Filter  
**Notes:** OBSOLETE. Availability Limited to Dealer Stock.  
**Replaces:** Woodgate WGF9384  
**O.D.:** 1 1/8 (28.6)  
**Inlet:** 5/16  
**Outlet:** 5/16  
**Length:** 3 3/32 (78.6)

**BF7863**



In-Line Mesh Fuel Filter  
**Fits:** Hatz Engines  
**Replaces:** Woodgate WGF9149  
**O.D.:** 2 1/16 (52.4)  
**Inlet:** 1/4 or 5/16 In. Universal  
**Outlet:** 1/4 or 5/16 In. Universal  
**Length:** 4 3/4 (120.7)

Measurements Are Shown In Inches And (Millimeters)

**WARNING:** These products can expose you to chemicals, including Diisononyl Phthalate, Carbon black extracts, Nickel, 1,3 Butadiene, Ethylene Oxide, Epichlorohydrin, which are known to the State of California to cause cancer, and Bisphenol, Ethylene Glycol, Ethylene Oxide, 1,3 Butadiene, Epichlorohydrin, which are known to the State of California to cause birth defects or other reproductive harm.

**PF7872**



Fuel Element

**Fits:** Hatz Engines; Wacker Equipment  
**Replaces:** Bomag 5723413; Woodgate WGF9300  
**O.D.:** 1 17/32 (38.9)  
**I.D.:** 9/16 (14.3)  
**Height:** 5 11/32 (135.7)  
**Grommets:** [2] Attached

**PF7878**



Fuel Element

**Fits:** M.A.N. Trucks  
**Replaces:** Mann & Hummel PU855X; Fleetguard FF5481  
**O.D.:** 3 (76.2)  
**I.D.:** 7/16 (11.1) & 1 1/32 (26.2)  
**Height:** 9 3/32 (231.0)  
**O-Ring:** [1] Included  
**Grommets:** [1] Attached

**PF7873**



Fuel Element

**Fits:** Yanmar Engines  
**Replaces:** Yanmar 104200-55710; Fleetguard FF5170; Woodgate WGF9062  
**O.D.:** 1 3/8 (34.9)  
**I.D.:** 1/2 (12.7) One End  
**Height:** 1 3/4 (44.4)  
**O-Ring:** [1] Attached

**BF7879**



Fuel Spin-on

**Notes:** CAUTION: Furnished O-Ring must be installed on post for seal.  
**Fits:** Cummins Marine Engines  
**Replaces:** Cummins 3890017; Fleetguard FF5285  
**Thread:** 13/16 -18  
**O.D.:** 3 11/16 (93.7)  
**Height:** 5 13/32 (137.3)  
**I.Gskt:** G401  
**O-Ring:** [1] Included  
**Related To:** BF1280 (with Drain)

**PF7874**



Fuel Element

**Fits:** Lombardini Engines  
**Replaces:** Lombardini 2175.112; Fleetguard FF5280; Woodgate WGF9321  
**O.D.:** 1 5/8 (41.3)  
**I.D.:** 3/8 (9.5) & 9/16 (14.3)  
**Height:** 2 1/16 (52.4)

**BF7880**



Fuel Spin-on

**Fits:** Ruggerini Engines  
**Replaces:** Ruggerini 17520; Woodgate WGF9362  
**Thread:** M16 x 1.5  
**O.D.:** 2 31/32 (75.4)  
**Height:** 2 31/32 (75.4)  
**I.Gskt:** [1] Included

**PF7875**



Fuel Element

**Fits:** Lombardini Engines  
**Replaces:** Lombardini 2175.108; Fleetguard FF5281; Woodgate WGF9322  
**O.D.:** 1 31/32 (50.0)  
**I.D.:** 3/8 (9.5) & 9/16 (14.3)  
**Height:** 2 1/16 (52.4)

**BF7881**



Box-Style Fuel Filter with Bail Handle

**Replaces:** Case 336430-A1; Separ 53050; Woodgate WGFS5305  
**Length:** 2 31/32 (75.4)  
**Width:** 2 31/32 (75.4)  
**Height:** 2 1/8 (54.0)

**PF7876**



Fuel Element

**Contains:** [2] Threaded Bolts  
**Fits:** Komatsu PC02-1 Excavators  
**Replaces:** Yanmar 114350-55120; Woodgate WGF9325  
**O.D.:** 1 9/16 (39.7)  
**I.D.:** 5/8 (15.9) One End  
**Height:** 6 5/32 (156.4)  
**A. Gskt:** [1] Included  
**Related To:** PF7826 (Short Version) PF7828 (Long Version)

**PF7882**



Nylon Mesh Fuel Screen with Lid

**Replaces:** M.A.N. 81.12106.0004; Woodgate WGF9370  
**O.D.:** 1 7/32 (31.0)  
**Lid 1 5/8 (41.3)**  
**I.D.:** 3/16 (4.8) & 1 1/16 (27.0)  
**Height:** 15/16 (23.8)  
**O-Ring:** [2] Included

**BF7883**



Fuel Spin-on

**Fits:** Volvo Excavators, Loaders, Motor Graders  
**Replaces:** Volvo 11708555  
**Thread:** M16 x 1.5  
**O.D.:** 3 11/16 (93.7)  
**Height:** 4 3/8 (111.1)  
**I.Gskt:** G381-A

**PF7877**



Fuel Element

**Fits:** Yanmar Engines, Generators  
**Replaces:** Yanmar 105370-55710; Woodgate WGF9374  
**O.D.:** 1 3/16 (30.2)  
**I.D.:** 5/8 (15.9) One End  
**Height:** 3 13/32 (86.5)  
**O-Ring:** [1] Attached

**BF7886**



Fuel Spin-on

**Notes:** External Post Seal Included.  
**Fits:** Renault Engines, Trucks  
**Replaces:** Mann WK940-20; Renault 5001853860, 5010412350  
**Thread:** M18 x 1.5  
**O.D.:** 3 11/16 (93.7)  
**Height:** 5 5/8 (142.9)  
**I.Gskt:** [1] Included  
**F. Gskt:** [1] Included

Measurements Are Shown In Inches And (Millimeters)

**WARNING:** These products can expose you to chemicals, including Diisononyl Phthalate, Carbon black extracts, Nickel, 1,3 Butadiene, Ethylene Oxide, Epichlorohydrin, which are known to the State of California to cause cancer, and Bisphenol, Ethylene Glycol, Ethylene Oxide, 1,3 Butadiene, Epichlorohydrin, which are known to the State of California to cause birth defects or other reproductive harm.

**BF7888**

Fuel Spin-on



**Fits:** Volvo Equipment  
**Replaces:** Volvo 11711074  
**Thread:** M16 x 1.5  
**O.D.:** 3 11/16 (93.7)  
**Height:** 5 13/32 (137.3)  
**I.Gskt:** G401

**PF7889**

Fuel Element with Bail Handle

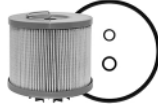

**Contains:** Emergency By-Pass Tab  
**Fits:** Racor 900 Series Housings  
**Replaces:** Racor 2040 Series  
**O.D.:** 4 5/16 (109.5)  
**I.D.:** 5/8 (15.9) & 13/16 (20.6)  
**Height:** 3 29/32 (99.2)  
**F. Gskt:** G240  
**O-Ring:** [1] Included  
**End Seals:** [1] Included  
**Related To:** PF7889-10, PF7889-30 (Media Difference)

**PF7889-10**

Fuel Element with Bail Handle



**Contains:** Emergency By-Pass Tab  
**Fits:** Racor 900 Series Housings  
**Replaces:** Racor 2040 Series  
**O.D.:** 4 5/16 (109.5)  
**I.D.:** 5/8 (15.9) & 13/16 (20.6)  
**Height:** 3 29/32 (99.2)  
**F. Gskt:** G240  
**O-Ring:** [1] Included  
**End Seals:** [1] Included  
**Related To:** PF7889, PF7889-30 (Media Difference)

**PF7889-30**

Fuel Element with Bail Handle

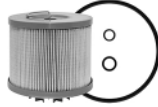

**Contains:** Emergency By-Pass Tab  
**Fits:** Racor 900 Series Housings  
**Replaces:** Racor 2040 Series  
**O.D.:** 4 5/16 (109.5)  
**I.D.:** 5/8 (15.9) & 13/16 (20.6)  
**Height:** 3 29/32 (99.2)  
**F. Gskt:** G240  
**O-Ring:** [1] Included  
**End Seals:** [1] Included  
**Related To:** PF7889, PF7889-10 (Media Difference)

**PF7890**

Fuel/Water Separator Element with Bail Handle



**Contains:** Emergency By-Pass Tab  
**Fits:** Racor 1000FH Series Housings  
**Replaces:** Racor 2020 Series  
**O.D.:** 4 5/16 (109.5)  
**I.D.:** 5/8 (15.9) & 13/16 (20.6)  
**Height:** 8 29/32 (226.2)  
**F. Gskt:** G240, [1] Included  
**O-Ring:** [1] Included  
**Related To:** PF7890-10, PF7890-30 (Media Difference)

**PF7890-10**

Fuel/Water Separator Element with Bail Handle



**Contains:** Emergency By-Pass Tab  
**Fits:** Racor 1000FH Series Housings  
**Replaces:** Racor 2020 Series  
**O.D.:** 4 5/16 (109.5)  
**I.D.:** 5/8 (15.9) & 13/16 (20.6)  
**Height:** 8 29/32 (226.2)  
**F. Gskt:** G240, [1] Included  
**O-Ring:** [1] Included  
**Related To:** PF7890, PF7890-30 (Media Difference)

**PF7890-30**

Fuel/Water Separator Element with Bail Handle

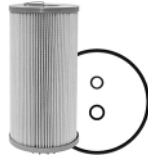

**Contains:** Emergency By-Pass Tab  
**Fits:** Racor 1000FH Series Housings  
**Replaces:** Racor 2020 Series  
**O.D.:** 4 5/16 (109.5)  
**I.D.:** 5/8 (15.9) & 13/16 (20.6)  
**Height:** 8 29/32 (226.2)  
**F. Gskt:** G240, [1] Included  
**O-Ring:** [1] Included  
**Related To:** PF7890, PF7890-10 (Media Difference)

**BF7892**

Fuel Spin-on



**Fits:** Komatsu Equipment  
**Replaces:** Komatsu 600-311-8222  
**Thread:** 3/4 -16  
**O.D.:** 3 1/32 (77.0)  
**Height:** 4 3/32 (104.0)  
**I.Gskt:** G449-B

**PF7894**

Fuel/Water Separator Element with Relief Valve



**Fits:** Davco FH230 Fuel Pro, 233 Series, FH233 Diesel Pro Series Housings, 382 Series Housings  
**Replaces:** Davco 102529; Fleetguard FS19761  
**O.D.:** 3 13/16 (96.8)  
**I.D.:** 21/32 (16.7) One End  
**Height:** 7 1/32 (178.6)  
**O-Ring:** [3] Included  
**Grommets:** [1] Attached

**PF7895**

Fuel/Water Separator Element



**Contains:** Relief Valve  
**Fits:** Davco FH230 Series, 233 Series, FH233 Series, 382 Series Housings  
**Replaces:** Fleetguard FS19727  
**O.D.:** 3 13/16 (96.8)  
**I.D.:** 21/32 (16.7) One End  
**Height:** 7 1/32 (178.6)  
**O-Ring:** [3] Included  
**Grommets:** [1] Attached

**PF7896**

Fuel Element



**Fits:** Scania Generator Sets, Trucks  
**Replaces:** Scania 1446432; Fleetguard FF5423  
**O.D.:** 3 5/16 (84.1)  
**I.D.:** 1 3/8 (34.9) One End  
**Height:** 7 7/32 (183.4)  
**O-Ring:** [1] Included

**BF7898-D**

Secondary Fuel/Water Separator Element with Drain



**Fits:** Caterpillar Skid Steer Loaders  
**Replaces:** Caterpillar 223-0702  
**O.D.:** 3 9/32 (83.3)  
**I.D.:** 21/32 (16.7) One End  
**Height:** 7 5/8 (193.7)  
**Grommets:** [1] Attached

Measurements Are Shown In Inches And (Millimeters)

**WARNING:** These products can expose you to chemicals, including Diisononyl Phthalate, Carbon black extracts, Nickel, 1,3 Butadiene, Ethylene Oxide, Epichlorohydrin, which are known to the State of California to cause cancer, and Bisphenol, Ethylene Glycol, Ethylene Oxide, 1,3 Butadiene, Epichlorohydrin, which are known to the State of California to cause birth defects or other reproductive harm.

**PF7899**

Fuel Element



**Contains:** Viton O-Ring for high heat applications.  
**Fits:** Perkins Engines  
**Replaces:** Perkins CH10930, 996453  
**O.D.:** 4 19/32 (116.7)  
**I.D.:** 2 5/32 (54.8) One End  
**Height:** 9 9/32 (235.7)  
**O-Ring:** [1] Viton Included

**PF7900**

Fuel Element



**Contains:** Viton O-Ring for high heat applications.  
**Fits:** Perkins Engines  
**Replaces:** Perkins CH10931, 996454  
**O.D.:** 4 29/32 (124.6)  
**I.D.:** 2 1/16 (52.4) One End  
**Height:** 10 5/16 (261.9)  
**O-Ring:** [1] Viton Included

**BF7903**

In-Line Fuel Filter



**Fits:** Aston Martin, BMW, Fiat, Peugeot Automotive; Poulan Lawn Tractors  
**Replaces:** Hastings GF95; Wix 33011  
**O.D.:** 1 13/32 (35.7)  
**Inlet:** 1/4  
**Outlet:** 1/4  
**Length:** 4 5/32 (105.6)

**BF7904-D**

Secondary Fuel/Water Separator Element with Drain



**Notes:** Reverse Flow  
Tab/Keys are not needed for installation.  
**Fits:** John Deere Engines, Equipment  
**Replaces:** John Deere RE508202  
**O.D.:** 3 3/8 (85.7)  
**I.D.:** 1 1/16 (17.5) One End  
**Height:** 6 1/32 (153.2)  
**Grommets:** [1] Attached

**BF7905-D**

Secondary Fuel/Water Separator Element with Drain



**Notes:** Tab/Keys are not needed for installation.  
**Fits:** Kubota Engines; Volvo Loaders  
**Replaces:** Omniquip 8320269; Volvo 11711183  
**O.D.:** 3 9/32 (83.3)  
**I.D.:** 2 1/32 (16.7) One End  
**Height:** 5 31/32 (151.6)  
**Grommets:** [1] Attached

**BF7906-D**

Secondary Fuel/Water Separator Element with Drain



**Notes:** Reverse Flow  
Tab/Keys are not needed for installation.  
**Fits:** Caterpillar Equipment  
**Replaces:** Caterpillar 233-9856  
**O.D.:** 3 9/32 (83.3)  
**I.D.:** 2 1/32 (16.7) One End  
**Height:** 5 31/32 (151.6)  
**Grommets:** [1] Attached

**BF7907**

Fuel Spin-on



**Contains:** Integral Post Seal  
**Fits:** Volvo Excavators  
**Replaces:** Volvo 11713240, 14520542, 14520578  
**Thread:** M20 x 1.5  
**O.D.:** 3 11/16 (93.7)  
**Height:** 5 5/8 (142.9)  
**I.Gskt:** G324-A

**BF7908**

Fuel Spin-on



**Fits:** Generator Sets with Scania DC12 Engine, Trucks  
**Replaces:** Scania 1411894; Fleetguard FF5424  
**Thread:** M24 x 1.5  
**O.D.:** 3 11/16 (93.7)  
**Height:** 5 21/32 (143.7)  
**I.Gskt:** [1] Included

**BF7909**

Fuel Spin-on



**Fits:** Deutz Engines; Volvo Loaders  
**Replaces:** KHD Deutz 1052175138; Volvo 2900777  
**Thread:** M16 x 1.5  
**O.D.:** 3 1/32 (77.0)  
**Height:** 2 27/32 (72.2)  
**I.Gskt:** G449-B

**PF7910**

Fuel Element with Bail Handle



**Fits:** Daewoo Excavators  
**Replaces:** Daewoo 65125035001; Donaldson P550860  
**O.D.:** 2 5/16 (58.7)  
**I.D.:** 1/2 (12.7)  
**Height:** 4 13/32 (111.9)  
**F. Gskt:** [1] Included  
**Grommets:** [1] Attached

**BF7911**

Wire Mesh Supported Maximum Performance Glass Fuel Spin-on



**Contains:** Integral Post Seal  
**Replaces:** Donaldson P550218; Fleetguard FF5347  
**Thread:** 7/8 -16  
**O.D.:** 4 1/4 (108.0)  
**Height:** 7 11/32 (186.5)  
**I.Gskt:** G381-A

**BF7912**

Box-Style Fuel Element with Bail Handle



**Fits:** M.A.N. Trucks; Volvo Excavators  
**Replaces:** Deutz 01319822; Volvo 14514238; Fleetguard FS19605  
**Length:** 3 15/32 (88.1)  
**Width:** 3 7/16 (87.3)  
**Height:** 2 1/8 (54.0)  
**A. Gskt:** [1] Attached

Measurements Are Shown In Inches And (Millimeters)

**WARNING:** These products can expose you to chemicals, including Diisononyl Phthalate, Carbon black extracts, Nickel, 1,3 Butadiene, Ethylene Oxide, Epichlorohydrin, which are known to the State of California to cause cancer, and Bisphenol, Ethylene Glycol, Ethylene Oxide, 1,3 Butadiene, Epichlorohydrin, which are known to the State of California to cause birth defects or other reproductive harm.

**BF7913**



High Efficiency Fuel Spin-on  
**Contains:** Integral Post Seal  
**Fits:** Komatsu Equipment  
**Replaces:** Komatsu 600-311-3310, 600-311-3510, 600-319-3510  
**Thread:** 1 1/4 -12  
**O.D.:** 4 21/32 (118.3)  
**Height:** 11 7/32 (285.0)  
**I.Gskt:** [1] Included

**BF7921**



Fuel/Water Separator Spin-on with Drain  
**Fits:** New Holland Loaders  
**Replaces:** New Holland 87803264  
**Thread:** M16 x 1.5  
**O.D.:** 3 1/32 (77.0)  
**Height:** 5 11/16 (144.5)  
**I.Gskt:** G449-B

**PF7914**



Water Absorbing Fuel Storage Tank Element  
**Fits:** Fuel Storage Tanks  
**Replaces:** Cim-Tek EHS10, 30033; Fleetguard FS19751; Wix 24841  
**O.D.:** 4 19/32 (116.7)  
**I.D.:** 9/16 (14.3) & 1 3/32 (27.8)  
**Height:** 9 5/16 (236.5)  
**F. Gskt:** [2] Included, [1] Metal Washer  
**Grommets:** [1] Attached

**BF7922**



Fuel Spin-on  
**Notes:** CAUTION: Furnished O-Ring must be installed on post for seal.  
**Fits:** Case; Case-International, New Holland Equipment  
**Replaces:** Case 87803200; Fleetguard FF5612  
**Thread:** M20 x 1.5  
**O.D.:** 3 11/16 (93.7)  
**Height:** 7 7/32 (183.4)  
**A. Gskt:** G401  
**F. Gskt:** [1] Included

**BF7915**



Fuel Spin-on  
**Fits:** Hatz Engines  
**Replaces:** Hatz 50251500; Donaldson P550345; Fleetguard FF5040  
**Thread:** M16 x 1.5  
**O.D.:** 3 1/32 (77.0)  
**Height:** 2 27/32 (72.2)  
**A. Gskt:** G449-B  
**Related To:** BF790 (Tall Version)

**BF7923**



Fuel Spin-on  
**Contains:** Integral Post Seal  
**Fits:** John Deere 600C LC Excavator  
**Replaces:** John Deere AT308578  
**Thread:** 1 -14  
**O.D.:** 3 11/16 (93.7)  
**Height:** 6 11/16 (169.9)  
**I.Gskt:** G401

**PF7916**



Fuel Element  
**Fits:** Volvo Excavators  
**Replaces:** Volvo 11708554, 11988962, VOE11988962  
**O.D.:** 2 7/8 (73.0)  
**I.D.:** 3/8 (9.5) & 1 7/16 (36.5)  
**Height:** 3 7/8 (98.4)  
**A. Gskt:** [2] Attached  
**O-Ring:** [1] Included

**BF7924**



Fuel Spin-on  
**Notes:** CAUTION: Furnished D-Ring must be installed on post for seal.  
**Contains:** Integral Post Seal  
**Fits:** Freightliner, Kenworth, Peterbilt Trucks  
**Replaces:** Cummins 4940647; Fleetguard FF5636  
**Thread:** 7/8 -14  
**O.D.:** 3 23/32 (94.5)  
**Height:** 7 5/32 (181.8)  
**I.Gskt:** G381-A  
**O-Ring:** [1] Included

**BF7917**



Fuel Spin-on  
**Notes:** CAUTION: Furnished O-Ring must be installed on post for seal.  
**Contains:** Integral Post Seal  
**Fits:** Cummins Engines; Hyundai Equipment  
**Replaces:** Cummins 3973232; Fleetguard FF5580  
**Thread:** 7/8 -14  
**O.D.:** 3 11/16 (93.7)  
**Height:** 7 1/8 (181.0)  
**I.Gskt:** G381-A  
**O-Ring:** [1] Included

**BF7925**



Fuel/Water Separator Spin-on with Drain  
**Notes:** Use with Conversion Adapter FD7926 on first installation only.  
 See Form 349 for installation instructions.  
**Fits:** Bobcat, Caterpillar, Gehl, J.C. Bamford, Manitou, Massey Ferguson, Terex Equipment  
**Replaces:** Caterpillar 1R1804; Gehl 184223, J.C. Bamford 32/925423; Massey Ferguson 4224811M1; Perkins 934181, 26560201  
**Thread:** M24 x 2.0  
**O.D.:** 3 11/16 (93.7)  
**Height:** 6 5/32 (156.4)  
**I.Gskt:** G381-A

**BF7919**



Fuel Spin-on  
**Fits:** John Deere Crawler Dozers, Crawler Loaders  
**Replaces:** John Deere AT279824  
**Thread:** M16 x 1.5  
**O.D.:** 3 11/16 (93.7)  
**Height:** 5 1/4 (133.4)  
**I.Gskt:** G381-A  
**F. Gskt:** [1] Included

Measurements Are Shown In Inches And (Millimeters)

**WARNING:** These products can expose you to chemicals, including Diisononyl Phthalate, Carbon black extracts, Nickel, 1,3 Butadiene, Ethylene Oxide, Epichlorohydrin, which are known to the State of California to cause cancer, and Bisphenol, Ethylene Glycol, Ethylene Oxide, 1,3 Butadiene, Epichlorohydrin, which are known to the State of California to cause birth defects or other reproductive harm.



**FD7926**

Fuel Filter Adapter



**Notes:** Converts base from element/housing to spin-on.  
**Contains:** [1] Tube Saf-T-Lok  
**Use With:** BF7925  
**Replaces:** Caterpillar 1R1804; Gehl 184223, J.C. Bamford 32/925423; Massey Ferguson 4224811M1; Perkins 934181, 26560201  
**Thread:** M24 x 2.0  
**O.D.:** 3 3/8 (85.7)  
**Height:** 1 1/2 (38.1)  
**O-Ring:** [1] Included

**BF7932**

Fuel Spin-on



**Fits:** Cummins QSK 19 (Tier 3) Engine  
**Replaces:** Cummins 4964100; Fleetguard FF5607, FF5634, FF5644  
**Thread:** 2 1/4 -12  
**O.D.:** 4 21/32 (118.3)  
**Height:** 10 5/16 (261.9)  
**I.Gskt:** [1] Included  
**Related To:** BF46002 (Upgrade)

**BF7927**

Fuel Spin-on



**Fits:** Case-International, New Holland Equipment; Iveco Trucks  
**Replaces:** Case 84818745; Iveco 500315480, 2994048; New Holland 1931108  
**Thread:** M16 x 1.5  
**O.D.:** 4 1/4 (108.0)  
**Height:** 7 (177.8)  
**I.Gskt:** G401

**PF7934 KIT**

Set of 2 Fuel Elements



**Notes:** Filters not sold separately.  
**Contains:** [1] Primary Fuel Element  
 [1] Secondary Fuel Element  
**Fits:** Ford Super Duty Pickups with V8-391 (6.4L) DI Turbo Diesel Engine  
**Replaces:** Ford 8C3Z-9N184-A; Motorcraft FD4609; Wix 33950  
**Primary**  
**O.D.:** 3 5/16 (84.1)  
**I.D.:** 1 19/32 (40.5)  
**Height:** 4 13/32 (111.9)  
**O-Ring:** [2] Included  
**Secondary**  
**O.D.** 3 9/16  
**I.D.** 3/4  
**Height** 4 23/32

**PF7928**

Fuel Element



**Contains:** Relief Valve  
**Fits:** Davco FH230, FH234, DI9100 Housings  
**Replaces:** Davco 102011, 102526, Fleetguard FS19763  
**O.D.:** 4 3/16 (106.4)  
**I.D.:** 21/32 (16.7) One End  
**Height:** 7 1/32 (178.6)  
**O-Ring:** [2] Included  
**Grommets:** [1] Attached

**PF7935**

Fuel Element



**Fits:** M.A.N. Trucks  
**Replaces:** M.A.N. 51.12503.0061, 51.12503.0063; Donaldson P785373; Fleetguard FF5629  
**O.D.:** 3 3/4 (95.3)  
**I.D.:** 9/16 (14.3) & 1 13/16 (46.0)  
**Height:** 6 27/32 (173.8)  
**A. Gskt:** [1] Attached  
**O-Ring:** [1] Included  
**Grommets:** [2] Attached

**BF7929 KIT**

Set of 2 Fuel Filters



**Notes:** Filters not sold separately.  
**Contains:** [1] Element  
 [1] Spin-on with Drain  
**Fits:** John Deere Equipment  
**Replaces:** John Deere RE520906, RE523236, RE525523, RE541747; SF-Filter SK3188-SET  
**Spin-on**  
**Thread:** 1 -14  
**O.D.:** 4 5/16 (109.5)  
**Height:** 6 25/32 (172.2)  
**I.Gskt:** [1] Included  
**Element**  
**O.D.** 3 23/32  
**I.D.** 1 19/32  
**Height** 6 9/32  
**O-Ring** [1] Included

**PF7936**

Fuel Element



**Fits:** Scania Trucks  
**Replaces:** Scania 1459762; Donaldson P550653; Fleetguard FF5463, FF5684  
**O.D.:** 3 13/32 (86.5)  
**I.D.:** 1 1/2 (38.1) One End  
**Height:** 7 7/32 (183.4)  
**O-Ring:** [1] Included  
**Grommets:** [1] Attached

**PF7930**

Fuel/Water Separator Element



**Contains:** Relief Valve  
**Fits:** Davco FH230 Series Fuel Pro, FH234 Series Industrial Pro  
**Replaces:** Davco 102528; Paccar 382951PAC25; Volvo 21737499, 85120233; Fleetguard FS19765  
**O.D.:** 4 3/16 (106.4)  
**I.D.:** 21/32 (16.7) One End  
**Height:** 6 15/16 (176.2)  
**O-Ring:** [2] Included  
**Grommets:** [1] Attached

**BF7937**

In-Line Fuel Filter



**Contains:** 5/16 Inch Return Line  
**Fits:** Chevrolet, GMC Light-Duty Trucks  
**Replaces:** GMC 15077584; Wix 33100  
**O.D.:** 2 11/32 (59.5)  
**Inlet:** 3/8  
**Outlet:** 3/8  
**Length:** 7 1/2 (190.5)

**BF7931**

Fuel Spin-on



**Fits:** Equipment and Trucks with Various Deutz Diesel Engines  
**Replaces:** Deutz 1174423  
**Thread:** M16 x 1.5  
**O.D.:** 3 1/32 (77.0)  
**Height:** 4 27/32 (123.0)  
**I.Gskt:** [1] Included

Measurements Are Shown In Inches And (Millimeters)

**WARNING:** These products can expose you to chemicals, including Diisononyl Phthalate, Carbon black extracts, Nickel, 1,3 Butadiene, Ethylene Oxide, Epichlorohydrin, which are known to the State of California to cause cancer, and Bisphenol, Ethylene Glycol, Ethylene Oxide, 1,3 Butadiene, Epichlorohydrin, which are known to the State of California to cause birth defects or other reproductive harm.

**PF7938**



Fuel Element

**Fits:** R.V.I., Volvo Trucks  
**Replaces:** Deutz 2931530, 4901031; Renault 2931711, 7420796772, 7420998806; Volvo 2931712, 20796775, 20998805  
**O.D.:** 3 23/32 (94.5)  
**I.D.:** 1 7/8 (47.6) One End  
**Height:** 6 3/8 (161.9)  
**O-Ring:** [1] Included

**BF7944**



In-Line Fuel Filter

**Contains:** [2] Plastic Caps  
**Fits:** Cushman Equipment  
**Replaces:** Jacobsen 2701898; Suzuki 15410-72F01  
**O.D.:** 2 3/4 (69.9)  
**Inlet:** 3/8  
**Outlet:** 3/8  
**Length:** 4 1/4 (108.0)

**PF7939**



Nylon Screen Fuel Element

**Fits:** Freightliner, M.A.N., Sterling Trucks  
**Replaces:** M.A.N. 51.12503.0062; Freightliner 902051; Mercedes-Benz 902051, A0000902051  
**O.D.:** 1 31/32 (50.0)  
**I.D.:** 29/32 (23.0) & 1 19/32 (40.5)  
**Height:** 1 5/8 (41.3)  
**O-Ring:** [1] Included  
**Related To:** PF7974 (Different O-Ring)

**BF7945**



In-Line Fuel Filter

**Fits:** Hyundai Automotive  
**Replaces:** GMC 25313807; Hyundai 31911-29000  
**O.D.:** 2 3/4 (69.9)  
**Inlet:** M14 x 1.5  
**Outlet:** 7/16  
**Length:** 4 1/8 (104.8)

**BF7940**



Fuel Spin-on

**Notes:** CAUTION: Furnished End Seal must be installed on post for seal.  
**Contains:** Integral Post Seal  
**Fits:** Ford, Freightliner, Kenworth, Peterbilt, Sterling Trucks; Cummins ISB Engine  
**Replaces:** Cummins 4934845; Fleetguard FF5632  
**Thread:** M20 x 1.5  
**O.D.:** 3 11/16 (93.7)  
**Height:** 7 7/32 (183.4)  
**A. Gskt:** G401  
**F. Gskt:** [1] Included

**PF7946**



Fuel Element

**Fits:** DAF Trucks  
**Replaces:** DAF 1450184  
**O.D.:** 3 9/16 (90.5)  
**I.D.:** 3/4 (19.0) & 1 7/8 (47.6)  
**Height:** 9 3/4 (247.7)  
**O-Ring:** [1] Included

**BF7941**



Fuel/Water Separator Spin-on with Sensor Port

**Contains:** Integral Post Seal  
 Sensor Port Thread: M10 x 1.5  
**Fits:** Cummins ISBE Engine; DAF Trucks  
**Replaces:** DAF 1437070; Fleetguard FS19584  
**Thread:** M20 x 1.5  
**O.D.:** 3 23/32 (94.5)  
**Height:** 7 9/32 (184.9)  
**I.Gskt:** G381-A

**PF7947**



Fuel Element

**Fits:** DAF Engines, Trucks  
**Replaces:** DAF 1616361, 1643080, 1699168  
**O.D.:** 3 9/16 (90.5)  
**I.D.:** 3/4 (19.0) & 1 3/4 (44.4)  
**Height:** 9 13/16 (249.2)  
**O-Ring:** [1] Included  
**Grommets:** [2] Attached

**BF7942**



Fuel/Water Separator Spin-on with Sensor Port

**Contains:** Integral Post Seal  
 Sensor Port Thread: M14 x 2.0  
**Fits:** Cummins ISBE Engine; DAF, Kenworth, Peterbilt Trucks  
**Replaces:** DAF 1618993; Fleetguard FS19689  
**Thread:** M20 x 1.5  
**O.D.:** 3 23/32 (94.5)  
**Height:** 7 5/16 (185.7)  
**I.Gskt:** G381-A

**BF7948**



Fuel Spin-on

**Contains:** Integral Post Seal  
**Fits:** Komatsu Equipment  
**Replaces:** Komatsu 600-319-3520, 600-319-3550  
**Thread:** 1 5/8 -12  
**O.D.:** 4 11/16 (119.1)  
**Height:** 11 9/32 (286.5)  
**I.Gskt:** [1] Included

**BF7943**



Fuel Spin-on

**Fits:** Mack, Volvo Trucks  
**Replaces:** Mack 20972295; Volvo 20972293  
**Thread:** M32 x 1.5  
**O.D.:** 4 1/4 (108.0)  
**Height:** 10 15/32 (265.9)  
**I.Gskt:** [1] Included

**BF7949-D**



Secondary Fuel/Water Separator Element with Removable Drain

**Fits:** John Deere Equipment  
**Replaces:** John Deere RE522878  
**O.D.:** 3 1/2 (88.9)  
**I.D.:** 1 5/32 (29.4) One End  
**Height:** 7 21/32 (194.5)  
**Grommets:** [1] Attached

Measurements Are Shown In Inches And (Millimeters)

**WARNING:** These products can expose you to chemicals, including Diisononyl Phthalate, Carbon black extracts, Nickel, 1,3 Butadiene, Ethylene Oxide, Epichlorohydrin, which are known to the State of California to cause cancer, and Bisphenol, Ethylene Glycol, Ethylene Oxide, 1,3 Butadiene, Epichlorohydrin, which are known to the State of California to cause birth defects or other reproductive harm.

**BF7949-DM**

Secondary Fuel Element with Drain Plug  
**Fits:** John Deere PowerTech 6068TFM (6.8L) Marine Engine  
**Replaces:** John Deere RE521538  
**O.D.:** 3 5/16 (84.1)  
**I.D.:** 1 5/32 (29.4) One End  
**Height:** 7 11/32 (186.5)  
**F. Gskt:** [1] Included  
**Grommets:** [1] Attached



**BF7956-D**

Primary Fuel/Water Separator Element with Removable Drain  
**Fits:** J.C. Bamford Equipment with 444 Diesel Max Engine  
**Replaces:** J.C. Bamford 32/925694  
**O.D.:** 3 1/2 (88.9)  
**I.D.:** 1 5/32 (29.4) One End  
**Height:** 5 (127.0)  
**Grommets:** [1] Attached



**BF7950-D**

Primary Fuel/Water Separator Element with Removable Drain  
**Fits:** John Deere Equipment  
**Replaces:** John Deere RE529643  
**O.D.:** 3 1/2 (88.9)  
**I.D.:** 1 5/32 (29.4) One End  
**Height:** 7 21/32 (194.5)  
**Grommets:** [1] Attached



**BF7957**

Fuel Spin-on  
**Contains:** Integral Post Seal  
**Fits:** Komatsu Equipment  
**Replaces:** Komatsu 6754-79-6130, 6754-79-6140  
**Thread:** M20 x 1.5  
**O.D.:** 3 11/16 (93.7)  
**Height:** 6 23/32 (170.7)  
**I.Gskt:** G401  
**F. Gskt:** [1] Included



**BF7951-D**

Secondary Fuel/Water Separator Element with Removable Drain  
**Fits:** Agco, Case-International, J.C. Bamford, Massey Ferguson, New Holland, Valtra Equipment; Iveco Engines  
**Replaces:** Iveco 504107584  
**O.D.:** 3 1/2 (88.9)  
**I.D.:** 1 5/32 (29.4) One End  
**Height:** 7 3/8 (187.3)  
**Grommets:** [1] Attached



**BF7958**

In-Line Fuel Filter with Drain  
**Fits:** Volkswagen Automotive  
**Replaces:** Volkswagen 1J0127401A, 1J0127401B; Wix 33619  
**O.D.:** 3 15/32 (88.1)  
**Inlet:** 5/16  
**Outlet:** 5/16  
**Length:** 7 13/16 (198.4)  
**O-Ring:** [2] Included



**BF7952-D**

Secondary Fuel/Water Separator Element with Removable Drain  
**Fits:** John Deere Tractors  
**Replaces:** John Deere RE522868; Wix 33739  
**O.D.:** 3 1/2 (88.9)  
**I.D.:** 5/8 (15.9) One End  
**Height:** 6 (152.4)  
**Grommets:** [1] Attached



**BF7959**

In-Line Fuel Filter  
**Contains:** 5/16 Inch Return Line  
**Fits:** Kia Automotive  
**Replaces:** Kia K2A1-20-490A, OK2A11-20-490A; Wix 33598  
**O.D.:** 2 23/32 (69.1)  
**Inlet:** 5/16  
**Outlet:** 5/16  
**Length:** 6 3/16 (157.2)



**BF7954-D**

Primary Fuel/Water Separator Element with Removable Drain  
**Fits:** Case, Case-International, John Deere, New Holland Equipment  
**Replaces:** Case 87803445; New Holland 87803444  
**O.D.:** 3 1/2 (88.9)  
**I.D.:** 1 5/32 (29.4) One End  
**Height:** 5 3/4 (146.0)  
**Grommets:** [1] Attached



**BF7960**

In-Line Fuel Filter  
**Fits:** Ford, Mazda Light-Duty Trucks  
**Replaces:** Ford XF5Z-9155-AA, XL5E-9155-AB; Mazda ZZP1-13-470, ZZR0-13-470  
**O.D.:** 2 7/32 (56.4)  
**Inlet:** 3/8  
**Outlet:** 5/16  
**Length:** 7 3/32 (180.2)



**BF7955**

Fuel Spin-on  
**Fits:** Liebherr Equipment  
**Replaces:** Liebherr 7382045; Fleetguard FF5427  
**Thread:** M16 x 1.5  
**O.D.:** 3 23/32 (94.5)  
**Height:** 5 3/8 (136.5)  
**I.Gskt:** G381-A  
**F. Gskt:** [1] Included



**BF7961**

In-Line Fuel Filter  
**Fits:** Toyota Light-Duty Trucks  
**Replaces:** Toyota 23030-62010; Wix 33236  
**O.D.:** 2 17/32 (64.3)  
**Inlet:** M14 x 1.5  
**Outlet:** M14 x 1.5  
**Length:** 3 3/4 (95.3)



**BF7962**

In-Line Fuel Filter  
**Contains:** 5/16 Inch Return Line  
**Fits:** Kia Automotive  
**Replaces:** Kia K32A-20-490; ACDelco GF782  
**O.D.:** 2 13/16 (71.4)  
**Inlet:** 5/16  
**Outlet:** 5/16  
**Length:** 7 1/16 (179.4)



Measurements Are Shown In Inches And (Millimeters)

**WARNING:** These products can expose you to chemicals, including Diisononyl Phthalate, Carbon black extracts, Nickel, 1,3 Butadiene, Ethylene Oxide, Epichlorohydrin, which are known to the State of California to cause cancer, and Bisphenol, Ethylene Glycol, Ethylene Oxide, 1,3 Butadiene, Epichlorohydrin, which are known to the State of California to cause birth defects or other reproductive harm.

**BF7963**

In-Line Fuel Filter



**Fits:** 1999-2004 Chevrolet Tracker  
**Replaces:** GMC 30020673; ACDelco GF826  
**O.D.:** 2 15/16 (74.6)  
**Inlet:** 5/16  
**Outlet:** 5/16  
**Length:** 5 1/4 (133.4)

**BF7964-D**

Secondary Fuel/Water Separator Element with Removable Drain



**Notes:** Reverse Flow  
 Tab/Keys are not needed for installation.  
**Replaces:** Ford 2C11-9176-AA, 4386518;  
 Motorcraft EFG331  
**O.D.:** 3 9/32 (83.3)  
**I.D.:** 21/32 (16.7) One End  
**Height:** 6 25/32 (172.2)  
**Grommets:** [1] Attached

**BF7965**

In-Line Fuel/Water Separator with Drain



**Fits:** J.C. Bamford Equipment  
**Replaces:** J.C. Bamford 320/07057, 320/07155;  
 Donaldson P765325  
**O.D.:** 3 3/8 (85.7)  
**Inlet:** 5/16  
**Outlet:** 3/8  
**Length:** 7 (177.8)

**BF7966**

Fuel Spin-on



**Notes:** CAUTION: Furnished O-Ring must be installed on post for seal.  
**Fits:** Freightliner S2 Bus Chassis; Kawasaki 70ZV Loader; Kenworth Trucks  
**Replaces:** Cummins 3978040, 4897897;  
 Fleetguard FF5421  
**Thread:** M20 x 1.5  
**O.D.:** 3 11/16 (93.7)  
**Height:** 7 7/32 (183.4)  
**I.Gskt:** G381-A  
**F. Gskt:** [1] Included

**BF7967**

Fuel Spin-on



**Fits:** Hino Trucks  
**Replaces:** Hino 23401-1510, S23401-1510  
**Thread:** 3/4 -16  
**O.D.:** 3 3/32 (78.6)  
**Height:** 3 31/32 (100.8)  
**I.Gskt:** [1] Included

**BF7968**

Fuel Spin-on



**Fits:** OMC Engines  
**Replaces:** Evinrude 502905, 174144; Johnson Marine 502905, 174144  
**Thread:** 1 -12  
**O.D.:** 3 11/16 (93.7)  
**Height:** 4 3/8 (111.1)  
**I.Gskt:** G381-A

**BF7968-O**

Fuel/Water Separator Spin-on with Open End for Bowl



**Contains:** Bowl Thread: 3 1/8-10 UN 1B  
**Fits:** Racor B32012, B32014 Marine Fuel Systems  
**Replaces:** Racor S3214  
**Thread:** 1 -12  
**O.D.:** 3 25/32 (96.0)  
**Height:** 4 1/32 (102.4)  
**F. Gskt:** [2] Included  
**O-Ring:** [1] Included  
**Related To:** BF7968

**BF7969**

Fuel Spin-on



**Contains:** Integral Post Seal  
**Fits:** Volvo-Penta Marine Engines  
**Replaces:** Volvo-Penta 38512182, 3852413, 3862228; Wix 33247  
**Thread:** 13/16 -18  
**O.D.:** 3 (76.2)  
**Height:** 3 15/32 (88.1)  
**I.Gskt:** G449-B

**BF7970**

Fuel Spin-on with Drain



**Fits:** Jeep Liberty; Iveco Light-Duty Trucks  
**Replaces:** Chrysler 52129238AA; Iveco 2992300, 504018807; Fleetguard FS19781  
**Thread:** M16 x 1.5  
**O.D.:** 3 3/8 (85.7)  
**Height:** 6 23/32 (170.7)  
**I.Gskt:** [1] Included  
**Grommets:** [1] Included

**BF7971-D**

Fuel Element with Removable Drain



**Notes:** Reverse Flow  
**Fits:** John Deere Equipment  
**Replaces:** John Deere RE522966  
**O.D.:** 3 5/16 (84.1)  
**I.D.:** 1 5/32 (29.4) One End  
**Height:** 7 5/8 (193.7)  
**Grommets:** [1] Attached

**BF7971-DM**

Primary Fuel Element with Removable Drain



**Notes:** Reverse Flow  
**Fits:** John Deere PowerTech 6068TFM (6.8L) Marine Engine  
**Replaces:** John Deere RE521540  
**O.D.:** 3 5/16 (84.1)  
**I.D.:** 1 5/32 (29.4) One End  
**Height:** 7 11/32 (186.5)  
**A. Gskt:** [1] Included  
**Grommets:** [1] Attached

**BF7972**

In-Line Fuel Filter with Sensor Port



**Notes:** Sensor must be removed from old filter and reinstalled on BF7972.  
**Contains:** 5/16 Inch Drainback Valve  
 Plastic Filter Collar  
**Fits:** Dodge, Freightliner, Mercedes-Benz Sprinter Vans; Jeep Grand Cherokee  
**Replaces:** Chrysler 5117494AA, 5170896AA, 5170896AB, 5175429AB; Mercedes-Benz A6420920101, A6460920701  
**O.D.:** 3 19/32 (91.3)  
**Inlet:** 3/8  
**Height:** 5 (127.0)  
**O-Ring:** [2] Included

**PF7973**

Fuel Element



**Contains:** Integral Housing Lid  
**Fits:** John Deere Engines, Equipment, Gen Sets  
**Replaces:** John Deere RE515345  
**O.D.:** 4 5/8 (117.5)  
 Lid 6 (152.4)  
**I.D.:** 13/16 (20.6) One End  
**Height:** 9 19/32 (243.7)  
**I.Gskt:** [1] Included  
**Grommets:** [1] Attached

Measurements Are Shown In Inches And (Millimeters)

**WARNING:** These products can expose you to chemicals, including Diisononyl Phthalate, Carbon black extracts, Nickel, 1,3 Butadiene, Ethylene Oxide, Epichlorohydrin, which are known to the State of California to cause cancer, and Bisphenol, Ethylene Glycol, Ethylene Oxide, 1,3 Butadiene, Epichlorohydrin, which are known to the State of California to cause birth defects or other reproductive harm.

**PF7974** Nylon Screen Fuel Element  
**Fits:** Freightliner, Sterling Trucks; Mercedes-Benz Engines  
**Replaces:** Mercedes-Benz 901351, A0000901351; Freightliner 901351  
**O.D.:** 1 31/32 (50.0)  
**I.D.:** 29/32 (23.0) & 1 19/32 (40.5)  
**Height:** 1 5/8 (41.3)  
**O-Ring:** [1] Included  
**Related To:** PF7939 (Different O-Ring)



**PF7980** Fuel/Water Separator Element  
**Replaces:** Cummins 4084133; Fleetguard FF5511  
**O.D.:** 5 27/32 (148.4)  
**I.D.:** 1 3/8 (34.9)  
**Height:** 9 7/8 (250.8)  
**Grommets:** [2] Attached



**PF7975** Nylon Fuel Element  
**Fits:** Volvo Excavators  
**Replaces:** Volvo 7412921  
**O.D.:** 1 3/8 (34.9)  
**I.D.:** 7/16 (11.1) One End  
**Height:** 1 15/16 (49.2)  
**O-Ring:** [1] Attached



**BF7981** Fuel Spin-on with Sensor Port  
**Notes:** CAUTION: Furnished O-Ring must be installed on post for seal.  
**Contains:** Sensor Port Thread: M14 x 2.0  
**Replaces:** Tata Cummins 278607989916; Fleetguard FS1275  
**Thread:** 13/16 -18  
**O.D.:** 3 11/16 (93.7)  
**Height:** 6 1/8 (155.6)  
**I.Gskt:** G401  
**O-Ring:** [2] Included



**BF7976** Fuel/Water Separator Spin-on with Drain  
**Fits:** Citroen, Fiat, Peugeot Vans  
**Replaces:** Citroen 190666, 190667; Fiat 46797378  
**Thread:** M16 x 1.5  
**O.D.:** 3 9/32 (83.3)  
**Height:** 6 3/16 (157.2)  
**I.Gskt:** [1] Included  
**Grommets:** [1] Attached



**PF7982** Fuel Element  
**Fits:** Case, Hitachi, J.C. Bamford, John Deere, Link-Belt Excavators; Mitsubishi Trucks  
**Replaces:** Hitachi 4642641; Isuzu 8-98008-840-0; S-F Filter SK3160  
**O.D.:** 3 23/32 (94.5)  
**I.D.:** 1 1/32 (26.2) One End  
**Height:** 5 15/32 (138.9)  
**O-Ring:** [3] Included  
**Grommets:** [1] Attached  
**Related To:** PF9803 (Short Version) PF7983, PF7984 (Long Versions)



**PF7977** Fuel/Water Separator Element  
**Fits:** Dodge Light-Duty Trucks with Cummins 5.9L Diesel Engine  
**Replaces:** Fleetguard FS19800  
**O.D.:** 3 3/8 (85.7)  
**I.D.:** 13/16 (20.6) One End  
**Height:** 4 3/32 (104.0)  
**O-Ring:** [1] Included  
**Grommets:** [1] Attached



**PF7983** Fuel Element  
**Fits:** Hitachi, John Deere Equipment  
**Replaces:** Hitachi 4649267, 4676385; Kobelco YN21P01068R100  
**O.D.:** 3 23/32 (94.5)  
**I.D.:** 1 1/32 (26.2) One End  
**Height:** 6 13/32 (162.7)  
**O-Ring:** [2] Included  
**Grommets:** [1] Attached  
**Related To:** PF7982, PF9803 (Short Versions) PF7984 (Long Version) PF9868 (With Furnished O-Rings)



**PF7978** Fuel/Water Separator Element  
**Fits:** International Engines, Trucks  
**Replaces:** International 1878042-C91; Donaldson P550824; Fleetguard FS19947  
**O.D.:** 3 9/32 (83.3)  
**I.D.:** 1/2 (12.7) One End  
**Height:** 5 7/16 (138.1)  
**O-Ring:** [2] Included  
**Grommets:** [1] Attached



**PF7984** Fuel Element  
**Fits:** John Deere Excavators  
**Replaces:** Hitachi 4679981; Isuzu 8-98074-288-0; S-F Filter SK3022  
**O.D.:** 3 23/32 (94.5)  
**I.D.:** 1 1/32 (26.2) One End  
**Height:** 7 15/16 (201.6)  
**F. Gskt:** [1] Included  
**O-Ring:** [1] Included  
**Grommets:** [1] Attached  
**Related To:** PF7982, PF7983, PF9803 (Short Versions)



**BF7979** Fuel/Water Separator Spin-on with Drain  
**Notes:** CAUTION: Furnished Post Seal must be installed on post for seal.  
**Replaces:** Ashok Leyland F8835100; Fleetguard FS19636  
**Thread:** M20 x 1.5  
**O.D.:** 3 23/32 (94.5)  
**Height:** 7 31/32 (202.4)  
**I.Gskt:** G401



Measurements Are Shown In Inches And (Millimeters)

**WARNING:** These products can expose you to chemicals, including Diisononyl Phthalate, Carbon black extracts, Nickel, 1,3 Butadiene, Ethylene Oxide, Epichlorohydrin, which are known to the State of California to cause cancer, and Bisphenol, Ethylene Glycol, Ethylene Oxide, 1,3 Butadiene, Epichlorohydrin, which are known to the State of California to cause birth defects or other reproductive harm.

**BF7985**

Fuel/Water Separator Spin-on with Sensor Port



**Notes:** CAUTION: Furnished O-Ring must be installed on post for seal.  
**Contains:** Sensor Port Thread: 1 1/4-12  
**Replaces:** Cummins 3890063; Tata Cummins 278609119903; Fleetguard FS1299  
**Thread:** 13/16 -18  
**O.D.:** 3 11/16 (93.7)  
**Height:** 5 5/16 (134.9)  
**I.Gskt:** G401  
**F. Gskt:** [1] Included  
**O-Ring:** [1] Included

**PF7986**

Fuel Element



**Fits:** International Engines, Trucks  
**Replaces:** International 3004473-C91; Donaldson P550821  
**O.D.:** 3 23/32 (94.5)  
**I.D.:** 1/2 (12.7) & 1 3/4 (44.4)  
**Height:** 6 27/32 (173.8)  
**O-Ring:** [1] G379 (Viton) Included, [1] Nitrile Included  
**Grommets:** [2] Attached

**BF7987**

Fuel Spin-on



**Contains:** Integral Post Seal  
**Fits:** M.T.U. 12V2000, 16V2000, 18V2000 Engines  
**Replaces:** M.T.U. 20920601; Fleetguard FF5641; Mahle KC231; Mann & Hummel WK940/17  
**Thread:** 1 -12  
**O.D.:** 3 23/32 (94.5)  
**Height:** 5 21/32 (143.7)  
**I.Gskt:** G401

**BF7988**

Fuel Spin-on



**Contains:** Integral Post Seal  
**Fits:** M.T.U. 12V2000, 12V4000 Engines  
**Replaces:** M.T.U. 20921901; Fleetguard FF5642; Mann & Hummel WK940/23; Wix 33821  
**Thread:** 1 -12  
**O.D.:** 3 23/32 (94.5)  
**Height:** 5 21/32 (143.7)  
**I.Gskt:** G401

**BF7989-D**

Fuel/Water Separator Element with Removable Drain



**Fits:** 11/2001-on R.V.I. Midlum Trucks all with dCi16 Engine  
**Replaces:** Renault 5001846015; Fleetguard FS19810  
**O.D.:** 3 9/32 (83.3)  
**I.D.:** 21/32 (16.7) One End  
**Height:** 6 25/32 (172.2)  
**Grommets:** [1] Attached

**BF7990**

Fuel Spin-on



**Contains:** Integral Post Seal  
**Fits:** Caterpillar Equipment  
**Replaces:** Agco 525517D1; Caterpillar 299-8229  
**Thread:** M12 x 1.5  
**O.D.:** 3 1/16 (77.8)  
**Height:** 5 1/2 (139.7)  
**I.Gskt:** [1] Included  
**O-Ring:** [1] Included

**BF7993**

Fuel Spin-on



**Contains:** Integral Post Seal  
**Fits:** Furukawa, Kato, Kobelco, Link-Belt, MDI/Yutani, Sumitomo, Tadano Equipment; Mitsubishi Engines, Trucks  
**Replaces:** Mitsubishi ME056670  
**Thread:** M24 x 1.5  
**O.D.:** 3 11/16 (93.7)  
**Height:** 6 9/16 (166.7)  
**I.Gskt:** [1] Included

**PF7994**

Nylon Mesh Fuel Strainer



**Fits:** International Trucks all with MaxxForce DT, MaxxForce 7, MaxxForce 9, MaxxForce 10 Engines  
**Replaces:** International 1873910-C91  
**O.D.:** 1 11/16 (42.9)  
**I.D.:** 1 13/32 (35.7) One End  
**Height:** 2 27/32 (72.2)  
**O-Ring:** [1] Included

**BF7995**

Fuel Storage Tank Spin-on



**Replaces:** Partmo A70015  
**Thread:** 1 1/2 -16  
**O.D.:** 3 3/4 (95.3)  
**Height:** 5 9/16 (141.3)  
**I.Gskt:** [1] Included

**BF7996**

Fuel Spin-on



**Contains:** Integral Post Seal  
**Fits:** M.T.U. 20V8000 Engine  
**Replaces:** M.T.U. 20922101; Donaldson P765199; Fleetguard FF5710  
**Thread:** M39 x 1.5  
**O.D.:** 5 3/8 (136.5)  
**Height:** 12 1/8 (308.0)  
**I.Gskt:** [1] Included

**BF7997**

Fuel Spin-on



**Fits:** Fendt Tractors; Volvo Equipment  
**Replaces:** Bomag 5717966; Deutz 1182672, 1182674; Fendt F934201060010; Volvo 20805349  
**Thread:** M18 x 1.5  
**O.D.:** 3 23/32 (94.5)  
**Height:** 8 5/32 (207.2)  
**I.Gskt:** [1] Included

**BF7998**

Fuel/Water Separator Spin-on with Sensor Port



**Notes:** CAUTION: Furnished post seal must be installed on post for seal.  
**Contains:** Post Seal  
**Sensor Port Thread:** M14 x 2.0  
**Fits:** Case-International, New Holland Tractors  
**Replaces:** Case 87803189; New Holland 87803187  
**Thread:** M16 x 1.5  
**O.D.:** 3 1/32 (77.0)  
**Height:** 6 1/2 (165.1)  
**I.Gskt:** G449-B

Measurements Are Shown In Inches And (Millimeters)

**WARNING:** These products can expose you to chemicals, including Diisononyl Phthalate, Carbon black extracts, Nickel, 1,3 Butadiene, Ethylene Oxide, Epichlorohydrin, which are known to the State of California to cause cancer, and Bisphenol, Ethylene Glycol, Ethylene Oxide, 1,3 Butadiene, Epichlorohydrin, which are known to the State of California to cause birth defects or other reproductive harm.

### BT8301

Hydraulic Spin-on



**Fits:** Bolens, Ford, Hitachi, Husky, John Deere Equipment  
**Replaces:** John Deere AM39653  
**Thread:** 3/4 -16  
**O.D.:** 3 3/4 (95.3)  
**Height:** 3 31/32 (100.8)  
**I.Gskt:** G381-A

### BT8302

Hydraulic Spin-on



**Contains:** Anti-Drainback Valve  
 30 PSID By-Pass Valve  
 Standpipe  
**Fits:** Fiat-Allis Equipment  
**Replaces:** Fiat 79026104  
**Thread:** 1 -12  
**O.D.:** 4 1/4 (108.0)  
**Height:** 9 3/16 (233.4)  
**I.Gskt:** G401

### BT8304

Hydraulic Spin-on



**Fits:** Joy Compressors  
**Replaces:** Joy 1228337-20  
**Thread:** M38 x 2.0  
**O.D.:** 3 11/16 (93.7)  
**Height:** 5 9/16 (141.3)  
**I.Gskt:** [1] Included

### PT8305

Hydraulic Element



**Fits:** Vickers Hydraulic Applications  
**Replaces:** Vickers 404211  
**O.D.:** 3 15/16 (100.0)  
**I.D.:** 2 9/32 (57.9) One End  
**Height:** 17 15/16 (455.6)

### PT8306-10

Hydraulic Element



**Fits:** Zinga Hydraulic Applications  
**Replaces:** Elgin 1032085; Zinga RE409-10  
**O.D.:** 3 15/16 (100.0)  
**I.D.:** 1 15/16 (49.2)  
**Height:** 9 1/4 (235.0)  
**End Seals:** [2] Attached  
**Related To:** PT8306-25 (Media Difference)

### PT8306-25

Hydraulic Element



**Fits:** Zinga Hydraulic Applications  
**Replaces:** Zinga RE409-25  
**O.D.:** 3 15/16 (100.0)  
**I.D.:** 1 15/16 (49.2)  
**Height:** 9 1/4 (235.0)  
**End Seals:** [2] Attached  
**Related To:** PT8306-10 (Media Difference)

### BT8307-MPG

Maximum Performance Glass Hydraulic Spin-on



**Notes:** Can be used with OB1314 and OB1316 bases (requires optional G286-C gasket).  
**Fits:** Gleaner, Swinger, Vermeer Equipment  
**Replaces:** Hycon MFE16010BN2; Pall HC7500SUN4H, HC7500SUS4H  
**Thread:** 1 1/2 -16  
**O.D.:** 5 1/16 (128.6)  
**Height:** 6 31/32 (177.0)  
**F. Gskt:** G369-B  
**O. Gskt:** G286-C, G369-V, G372, G447, G483, G704, G710  
**Related To:** BT8421-MPG (Micron Difference)

### BT8308-MPG

Maximum Performance Glass Hydraulic Spin-on



**Notes:** Can be used with OB1314 and OB1316 bases (requires optional G286-C gasket).  
**Fits:** Ag-Chem, Agco, Case, Volvo Equipment; Ingersoll-Rand Compressors  
**Replaces:** Case A177614, A177615; Gradall 91143144; Ingersoll-Rand 51608503; Pall HC7500SUN8H  
**Thread:** 1 1/2 -16  
**O.D.:** 5 1/16 (128.6)  
**Height:** 10 3/4 (273.1)  
**F. Gskt:** G369-B  
**O-Ring:** G447  
**O. Gskt:** G286-C, G369-V, G372, G483, G704, G710  
**Related To:** BT8422-MPG (High Efficiency Version)

### BT8308-MPG KIT

Set of 2 Maximum Performance Glass Hydraulic Spin-ons



**Notes:** Can be used with OB1314 and OB1316 bases (requires optional G286-C gasket).  
**Fits:** Ag-Chem, Agco, Case, Volvo Equipment; Ingersoll-Rand Compressors  
**Replaces:** Case A177614, A177615; Ingersoll-Rand 51608503; Pall HC7500SUN8H  
**Thread:** 1 1/2 -16  
**O.D.:** 5 1/16 (128.6)  
**Height:** 10 3/4 (273.1)  
**F. Gskt:** G369-B, G447  
**O. Gskt:** G286-C, G369-V, G372, G483, G704, G710  
**Related To:** BT8422-MPG (High Efficiency Version)

### BT8309-MPG

Maximum Performance Glass Hydraulic Spin-on



**Notes:** Can be used with OB1314 and OB1316 bases (requires optional G286-C gasket).  
**Fits:** John Deere Equipment  
**Replaces:** John Deere AT100973, RE45864  
**Thread:** 1 1/2 -16  
**O.D.:** 5 1/16 (128.6)  
**Height:** 6 31/32 (177.0)  
**F. Gskt:** G369-B, G447  
**O. Gskt:** G286-C, G369-V, G372, G483, G704, G710

### BT8310-MPG

Maximum Performance Glass Hydraulic Spin-on



**Notes:** Can be used with OB1314 and OB1316 bases (requires optional G286-C gasket).  
**Fits:** Champion Equipment  
**Replaces:** Pall HC7500SUT8H  
**Thread:** 1 1/2 -16  
**O.D.:** 5 1/16 (128.6)  
**Height:** 10 3/4 (273.1)  
**F. Gskt:** G369-B  
**O. Gskt:** G286-C, G369-V, G372, G447, G483, G704, G710

Measurements Are Shown In Inches And (Millimeters)

**WARNING:** These products can expose you to chemicals, including Diisononyl Phthalate, Carbon black extracts, Nickel, 1,3 Butadiene, Ethylene Oxide, Epichlorohydrin, which are known to the State of California to cause cancer, and Bisphenol, Ethylene Glycol, Ethylene Oxide, 1,3 Butadiene, Epichlorohydrin, which are known to the State of California to cause birth defects or other reproductive harm.

**BT8312** Hydraulic Spin-on  
**Fits:** Case Equipment  
**Use With:** OB8711, OB8712, OB8720, OB8721, OB8722, OB8724, OB8731, OB8732, OB8741, OB8742, OB8743, OB8744, OB8745, OB8746 filter bases.  
**Replaces:** Case L36242  
**Thread:** 1 3/8 -12  
**O.D.:** 3 3/4 (95.3)  
**Height:** 9 19/32 (243.7)  
**I.Gskt:** [1] Included



**BT8323** Hydraulic Spin-on  
**Contains:** 20 PSID By-Pass Valve  
**Fits:** Bush Hog Lawn Tractors; Zinga Hydraulic Systems  
**Replaces:** Zinga BE10-18  
**Thread:** 3/4 -16  
**O.D.:** 3 1/32 (77.0)  
**Height:** 3 1/2 (88.9)  
**I.Gskt:** [1] Included



**BT8314** Hydraulic Spin-on  
**Fits:** Caterpillar Equipment  
**Replaces:** Caterpillar 4T6915  
**Thread:** 1 1/8 -16  
**O.D.:** 3 11/16 (93.7)  
**Height:** 5 5/8 (142.9)  
**I.Gskt:** G381-A



**BT8328** Hydraulic Spin-on  
**Contains:** Anti-Drainback Valve  
 8 PSID By-Pass Valve  
**Fits:** Ford Light-Duty Trucks, Vans; Sellick Lift Trucks  
**Replaces:** Sellick 131559  
**Thread:** 3/4 -16  
**O.D.:** 3 11/16 (93.7)  
**Height:** 5 15/32 (138.9)  
**I.Gskt:** G401



**BT8316-MPG** Maximum Performance Glass Transmission Spin-on  
**Fits:** Allison Transmissions  
**Replaces:** Allison 23042062  
**Thread:** 1 1/2 -16  
**O.D.:** 3 11/16 (93.7)  
**Height:** 5 9/16 (141.3)  
**F. Gskt:** [1] Included



**PT8329** Hydraulic Element  
**Contains:** Spring Reinforced Centertube  
**Fits:** Tamrock Drills  
**Replaces:** Schroeder CC3  
**O.D.:** 2 7/8 (73.0)  
**I.D.:** 1 (25.4) One End  
**Height:** 9 5/8 (244.5)  
**O-Ring:** [1] Attached



**PT8318-MPG** Maximum Performance Glass Transmission Element  
**Fits:** John Deere Equipment  
**Replaces:** John Deere RE15472  
**O.D.:** 4 9/16 (115.9)  
**I.D.:** 2 7/32 (56.4)  
**Height:** 5 15/32 (138.9)  
**A. Gskt:** [2] Attached



**PT8330-MPG** Maximum Performance Glass Hydraulic Element  
**Fits:** Allison Transmissions  
**Replaces:** Allison 23040988  
**O.D.:** 3 7/32 (81.8)  
**I.D.:** 1 7/16 (36.5) One End  
**Height:** 8 1/8 (206.4)  
**O-Ring:** [1] Attached



**PT8319** Hydraulic Element  
**Fits:** Fiat, Fiat-Allis, Hitachi Equipment  
**Replaces:** Fiat 71402469; Hitachi 4207841, 4207841A  
**O.D.:** 1 31/32 (50.0)  
**I.D.:** 27/32 (21.4)  
**Height:** 5 29/32 (150.0)  
**O-Ring:** [1] Included  
**Grommets:** [1] Attached



**PT8331-MPG** Maximum Performance Glass Hydraulic Element  
**Contains:** Reinforced Centertube  
**Fits:** Case Equipment  
**Replaces:** Case L52029, R51643  
**O.D.:** 4 1/2 (114.3)  
**I.D.:** 15/32 (11.9) & 2 1/4 (57.2)  
**Height:** 9 (228.6)  
**F. Gskt:** [1] Included  
**Grommets:** [1] Attached Small End



**BT8320** Hydraulic Spin-on  
**Fits:** Case, John Deere, New Holland Equipment  
**Use With:** OB8711, OB8712, OB8720, OB8721, OB8722, OB8724, OB8731, OB8732, OB8741, OB8742, OB8743, OB8744, OB8745, OB8746 bases  
**Replaces:** Case D149921  
**Thread:** 1 3/8 -12  
**O.D.:** 4 23/32 (119.9)  
**Height:** 11 17/32 (292.9)  
**I.Gskt:** [1] Included



**BT8333** Hydraulic Spin-on  
**Notes:** Rated 2000 PSI minimum burst  
**Contains:** Integral Post Seal  
**Fits:** Caterpillar Equipment  
**Replaces:** Caterpillar 413948  
**Thread:** 2 -12  
**O.D.:** 3 1/8 (79.4)  
**Height:** 5 17/32 (140.5)



Measurements Are Shown In Inches And (Millimeters)

**WARNING:** These products can expose you to chemicals, including Diisononyl Phthalate, Carbon black extracts, Nickel, 1,3 Butadiene, Ethylene Oxide, Epichlorohydrin, which are known to the State of California to cause cancer, and Bisphenol, Ethylene Glycol, Ethylene Oxide, 1,3 Butadiene, Epichlorohydrin, which are known to the State of California to cause birth defects or other reproductive harm.



**PT8334** By-Pass Lube Element with Bail Handle  
**Contains:** Reinforced Centertube  
**Fits:** Hitachi Excavators  
**Replaces:** Hitachi 4208241  
**Thread:** M16 x 1.0  
**O.D.:** 6 1/2 (165.1)  
**Height:** 7 3/4 (196.9)  
**F. Gskt:** [1] Included  
**O-Ring:** [2] Included



**PT8345** Hydraulic Element  
**Fits:** Kobelco Loaders  
**Replaces:** Kobelco 2446U139-F1  
**O.D.:** 3 3/4 (95.3)  
**I.D.:** 19/32 (15.1) & 1 5/16 (33.3)  
**Height:** 6 1/8 (155.6)  
**F. Gskt:** [3] Included  
**End Seals:** [1] Attached  
**Grommets:** [1] Attached



**PT8335** Lube Element  
**Contains:** Bleed Hole  
**Fits:** Kobelco Loaders; Nissan Trucks  
**Replaces:** Kobelco 2451R131-1B; Nissan 15274-99027  
**O.D.:** 5 1/16 (128.6)  
**I.D.:** 19/32 (15.1)  
**Height:** 9 3/8 (238.1)  
**F. Gskt:** [3] Included  
**Grommets:** [2] Attached



**BT8347** Hydraulic Spin-on  
**Fits:** John Deere Tractors  
**Replaces:** John Deere AL56469  
**Thread:** 1 -12  
**O.D.:** 3 23/32 (94.5)  
**Height:** 7 7/32 (183.4)  
**I.Gskt:** G401



**PT8338** Transmission Element  
**Fits:** Kawasaki, Kobelco Equipment  
**Replaces:** Kawasaki KL49060-70010  
**O.D.:** 4 7/32 (107.2)  
**I.D.:** 1 13/16 (46.0)  
**Height:** 9 1/32 (229.4)  
**F. Gskt:** [3] Included  
**End Seals:** [2] Attached



**PT8350** Hydraulic Element  
**Fits:** Caterpillar Equipment  
**Replaces:** Caterpillar 1R0746  
**O.D.:** 2 7/8 (73.0)  
**I.D.:** 1 1/16 (27.0) One End  
**Height:** 5 5/8 (142.9)  
**End Seals:** [1] Attached



**PT8339** Hydraulic Element  
**Fits:** Caterpillar Excavators  
**Replaces:** Caterpillar 95-5481  
**O.D.:** 4 1/2 (114.3)  
**I.D.:** 2 9/32 (57.9) One End  
**Height:** 7 3/16 (182.6)  
**F. Gskt:** [1] Included  
**End Seals:** [1] Attached



**PT8351** Hydraulic Element  
**Fits:** Hitachi Equipment  
**Replaces:** Hitachi 3021593  
**O.D.:** 2 7/8 (73.0)  
**I.D.:** 1 11/32 (34.1)  
**Height:** 7 15/16 (201.6)  
**A. Gskt:** [2] Attached  
**F. Gskt:** [1] Included



**PT8341** Hydraulic Element  
**Fits:** Caterpillar Equipment  
**Replaces:** Caterpillar 96-6431, 99-7352  
**O.D.:** 1 31/32 (50.0)  
**I.D.:** 27/32 (21.4) One End  
**Height:** 3 3/32 (78.6)  
**O-Ring:** [1] Included  
**Grommets:** [1] Attached



**PT8352** Hydraulic Element  
**Fits:** Daewoo, Hitachi Equipment  
**Replaces:** Hitachi 4159320  
**O.D.:** 2 7/8 (73.0)  
**I.D.:** 1 11/32 (34.1) One End  
**Height:** 4 25/32 (121.4)  
**A. Gskt:** [2] Attached  
**F. Gskt:** G283, [1] Included



**PT8344** Hydraulic Element  
**Fits:** Belarus Tractors  
**Replaces:** Belarus 761000000  
**O.D.:** 3 21/32 (92.9)  
**I.D.:** 1 23/32 (43.7)  
**Height:** 7 7/8 (200.0)



**PT8353** Hydraulic Element  
**Notes:** Inside-Out Flow Direction  
**Fits:** Atlas-Weyhausen, Poclair, Volvo, Zettelmeyer Equipment  
**Replaces:** Poclair N0250574; Volvo 6638403; Zettelmeyer 2165400  
**O.D.:** 4 5/32 (105.6)  
**I.D.:** 13/32 (10.3) & 2 3/4 (69.9)  
**Height:** 10 1/4 (260.3)  
**Grommets:** [1] Attached



Measurements Are Shown In Inches And (Millimeters)

**WARNING:** These products can expose you to chemicals, including Diisononyl Phthalate, Carbon black extracts, Nickel, 1,3 Butadiene, Ethylene Oxide, Epichlorohydrin, which are known to the State of California to cause cancer, and Bisphenol, Ethylene Glycol, Ethylene Oxide, 1,3 Butadiene, Epichlorohydrin, which are known to the State of California to cause birth defects or other reproductive harm.

**PT8354**

Hydraulic Element



**Fits:** Kobelco Loaders  
**Replaces:** Kobelco 2446U126  
**O.D.:** 2 7/8 (73.0)  
**I.D.:** 1 11/32 (34.1) One End  
**Height:** 6 9/32 (159.5)  
**A. Gskt:** [1] Attached  
**F. Gskt:** [1] Included

**PT8355**

Hydraulic Element



**Fits:** Kobelco Equipment  
**Replaces:** Kobelco 2446R204-S3  
**O.D.:** 2 7/8 (73.0)  
**I.D.:** 1 11/32 (34.1) One End  
**Height:** 5 15/32 (138.9)  
**A. Gskt:** [1] Attached

**PT8356**

Hydraulic Element



**Fits:** Kobelco Equipment  
**Replaces:** Kobelco 2451R124-1  
**O.D.:** 3 19/32 (91.3)  
**I.D.:** 21/32 (16.7)  
**Height:** 6 5/8 (168.3)  
**F. Gskt:** [2] Included  
**Grommets:** [2] Attached

**BT8357**

Hydraulic Spin-on



**Contains:** 20 PSID By-Pass Valve  
**Fits:** Ford, New Holland Tractors  
**Replaces:** Ford F0NN-B486-AA  
**Thread:** 1 1/8 -16  
**O.D.:** 3 11/16 (93.7)  
**Height:** 6 5/8 (168.3)  
**I.Gskt:** G381-A

**PT8359**

Hydraulic Element

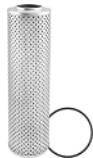

**Fits:** Daewoo, Hitachi Equipment  
**Replaces:** Hitachi 3502410N  
**O.D.:** 3 3/8 (85.7)  
**I.D.:** 1 7/8 (47.6)  
**Height:** 11 7/16 (290.5)  
**F. Gskt:** G162  
**O-Ring:** [2] Attached

**PT8361**

Hydraulic Element



**Fits:** Bantam, John Deere, Koehring, Lorain Equipment  
**Replaces:** Koehring 708-6449  
**O.D.:** 6 1/2 (165.1)  
**I.D.:** 3 15/32 (88.1)  
**Height:** 15 1/4 (387.4)  
**O-Ring:** [2] Attached

**PT8363**

Hydraulic Element

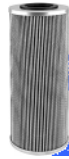

**Fits:** Caterpillar, Grove Equipment; Schroeder Hydraulic Systems  
**Replaces:** Caterpillar 837905; Grove 9437100641; Pall HC9700FDS9H; Schroeder KS7, KZ10  
**O.D.:** 3 15/16 (100.0)  
**I.D.:** 1 9/16 (39.7)  
**Height:** 9 5/32 (232.6)  
**Grommets:** [2] Attached

**PT8366**

Hydraulic Element



**Fits:** Caterpillar, Hitachi, Kobelco, Komatsu, MDI/Yutani, Mitsubishi Equipment  
**Replaces:** Caterpillar 94-4412; Hitachi 4219713; Komatsu 178-611-4160  
**O.D.:** 5 29/32 (150.0)  
**I.D.:** 4 11/32 (110.3)  
**Height:** 17 23/32 (450.1)  
**F. Gskt:** [1] Included  
**O. Gskt:** ES3231

**BT8368**

Stainless Steel Mesh Hydraulic Spin-on



**Fits:** Fiat-Allis Equipment  
**Use With:** OB1313, OB1314, OB1315, OB1316 bases (requires optional G286-C gasket).  
**Replaces:** Fiat 73133001; Zinga LE100  
**Thread:** 1 1/2 -16  
**O.D.:** 5 1/16 (128.6)  
**Height:** 10 3/4 (273.1)  
**F. Gskt:** G369-B  
**O. Gskt:** G286-C, G369-V, G372, G447, G483, G704, G710

**PT8370-MPG**

Maximum Performance Glass Hydraulic Element



**Fits:** Schroeder Hydraulic Systems  
**Replaces:** Pall HC9700FDP9H, HC9700FKP9H, HC9700FUP9H; Parker 925778; Schroeder KS1  
**O.D.:** 3 29/32 (99.2)  
**I.D.:** 1 13/16 (46.0)  
**Height:** 9 3/32 (231.0)  
**Grommets:** [2] Attached

**PT8371-MPG**

Maximum Performance Glass Hydraulic Element



**Fits:** Donaldson Assemblies  
**Replaces:** Donaldson P165628  
**O.D.:** 4 3/8 (111.1)  
**I.D.:** 2 7/16 (61.9)  
**Height:** 16 (406.4)  
**A. Gskt:** [1] Attached  
**Grommets:** [1] Attached

**PT8372**

Hydraulic Element



**Fits:** Kobelco, MDI/Yutani Equipment  
**Replaces:** Kobelco R36P0019  
**O.D.:** 1 21/32 (42.1)  
**I.D.:** 29/32 (23.0) One End  
**Height:** 3 15/32 (88.1)  
**O-Ring:** [1] Attached

Measurements Are Shown In Inches And (Millimeters)

**WARNING:** These products can expose you to chemicals, including Diisononyl Phthalate, Carbon black extracts, Nickel, 1,3 Butadiene, Ethylene Oxide, Epichlorohydrin, which are known to the State of California to cause cancer, and Bisphenol, Ethylene Glycol, Ethylene Oxide, 1,3 Butadiene, Epichlorohydrin, which are known to the State of California to cause birth defects or other reproductive harm.

**PT8375-MPG** Maximum Performance Glass Hydraulic Element



**Fits:** Timberjack Logging Equipment  
**Replaces:** Timberjack 411531  
**O.D.:** 4 3/8 (111.1)  
**I.D.:** 2 1/32 (51.6) One End  
**Height:** 8 (203.2)  
**O-Ring:** [1] Attached

**PT8383** Hydraulic Element

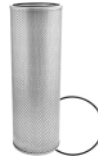

**Contains:** Reinforced Centertube  
**Fits:** Hitachi Excavators  
**Replaces:** Hitachi 4325820  
**O.D.:** 5 29/32 (150.0)  
**I.D.:** 4 11/32 (110.3)  
**Height:** 17 29/32 (454.8)  
**A. Gskt:** [2] Attached  
**F. Gskt:** [1] Included

**PT8376-MPG** Maximum Performance Glass Hydraulic Element



**Replaces:** Parker 908649  
**O.D.:** 5 11/16 (144.5)  
**I.D.:** 4 3/32 (104.0)  
**Height:** 12 1/8 (308.0)  
**A. Gskt:** [2] Attached

**BT8384** Hydraulic Spin-on



**Contains:** 50 PSID By-Pass Valve  
**Fits:** Liebherr, VogeLe Equipment  
**Replaces:** Case 45144600; Linde 983-06-13, 983-06-18, 983-06-23  
**Thread:** 3/4 -16  
**O.D.:** 3 1/32 (77.0)  
**Height:** 5 1/2 (139.7)  
**I.Gskt:** [1] Included

**PT8378-MPG** Maximum Performance Glass Hydraulic Element



**Fits:** Leach Packers  
**Replaces:** Leach 100815, 107408  
**O.D.:** 3 23/32 (94.5)  
**I.D.:** 1 23/32 (43.7) One End  
**Height:** 9 1/16 (230.2)  
**Grommets:** [1] Attached

**PT8385** Hydraulic Element



**Fits:** DAF, Iveco, M.A.N., R.V.I., Volvo Trucks  
**Replaces:** Volvo 1193281, 1193281-1  
**O.D.:** 2 23/32 (69.1)  
**I.D.:** 1 3/8 (34.9) One End  
**Height:** 4 1/16 (103.2)  
**F. Gskt:** [2] Included

**PT8380** Wire Mesh Supported Hydraulic Element

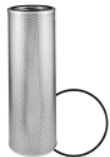

**Fits:** Hitachi, John Deere Equipment  
**Replaces:** John Deere AT127608, AT147343  
**O.D.:** 5 29/32 (150.0)  
**I.D.:** 4 11/32 (110.3)  
**Height:** 17 7/8 (454.0)  
**A. Gskt:** [2] Attached  
**F. Gskt:** [1] Included

**BT8386** Hydraulic Breather Element



**Fits:** Clark Lift Trucks  
**Replaces:** Clark 2370631  
**O.D.:** 3 1/8 (77.0)  
**I.D.:** 1 19/32 (40.5)  
**Height:** 2 7/32 (56.4)

**BT8381** Hydraulic Spin-on



**Fits:** Dresser Equipment  
**Replaces:** Dresser 1214275-H2  
**Thread:** 1 1/2 -16  
**O.D.:** 4 21/32 (118.3)  
**Height:** 11 3/4 (298.5)  
**I.Gskt:** [1] Included

**PT8387** Hydraulic Element



**Contains:** Reinforced Centertube  
**Fits:** Kobelco, MDI/Yutani Equipment  
**Replaces:** Kobelco 24046Z15  
**O.D.:** 4 13/32 (111.9)  
**I.D.:** 2 3/4 (69.9)  
**Height:** 17 11/16 (449.3)  
**F. Gskt:** [1] Included

**BT8382** Hydraulic Spin-on



**Contains:** 15 PSID By-Pass Valve  
**Fits:** Ford, New Holland Tractors  
**Replaces:** Ford F0NN-B486-BB; New Holland 82005016  
**Thread:** 1 3/4 -16  
**O.D.:** 5 3/8 (136.5)  
**Height:** 9 5/8 (244.5)  
**I.Gskt:** [1] Included

**PT8388** Hydraulic Element

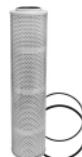

**Contains:** Reinforced Centertube  
**Fits:** Daewoo Equipment; Hitachi Excavators  
**Replaces:** Hitachi 4227353  
**O.D.:** 4 13/32 (111.9)  
**I.D.:** 2 9/16 (65.1)  
**Height:** 18 1/32 (458.0)  
**A. Gskt:** [2] Attached  
**F. Gskt:** [2] Included

Measurements Are Shown In Inches And (Millimeters)

**WARNING:** These products can expose you to chemicals, including Diisononyl Phthalate, Carbon black extracts, Nickel, 1,3 Butadiene, Ethylene Oxide, Epichlorohydrin, which are known to the State of California to cause cancer, and Bisphenol, Ethylene Glycol, Ethylene Oxide, 1,3 Butadiene, Epichlorohydrin, which are known to the State of California to cause birth defects or other reproductive harm.

**PT8389**

Hydraulic Element



**Notes:** OBSOLETE. Availability Limited to Dealer Stock.  
**Contains:** Reinforced Centertube  
**Fits:** Hitachi Equipment  
**Replaces:** Hitachi 4159319  
**O.D.:** 4 13/32 (111.9)  
**I.D.:** 2 9/16 (65.1)  
**Height:** 18 1/32 (458.0)  
**A. Gskt:** [2] Attached  
**F. Gskt:** [1] Included

**PT8396**

Hydraulic Element



**Fits:** V.M.E., Volvo Loaders  
**Replaces:** Volvo M2560232  
**O.D.:** 7 7/16 (188.9)  
**I.D.:** 4 13/16 (122.2)  
**Height:** 18 5/32 (461.2)  
**A. Gskt:** [2] Attached

**BT8391**

Hydraulic Spin-on



**Fits:** Ford, New Holland Tractors  
**Replaces:** Ford SBA340500610; New Holland 9846407  
**Thread:** 1 1/8 -16  
**O.D.:** 3 11/16 (93.7)  
**Height:** 5 21/32 (143.7)  
**I.Gskt:** G401

**BT8397-MPG**

Maximum Performance Glass Hydraulic Spin-on



**Fits:** John Deere Equipment  
**Replaces:** John Deere AT147496  
**Thread:** 1 1/2 -16  
**O.D.:** 3 15/16 (100.0)  
**Height:** 9 1/2 (241.3)  
**I.Gskt:** [1] Included

**PT8392**

Hydraulic Element



**Fits:** Bobcat, Case, Daewoo, Hitachi, Hyundai, Volvo Equipment  
**Replaces:** Case 153233A1; Clark 6655066; Hyundai 31E30018  
**O.D.:** 1 21/32 (42.1)  
**I.D.:** 27/32 (21.4) One End  
**Height:** 3 7/16 (87.3)  
**I.Gskt:** [1] Included  
**O-Ring:** [1] Included

**BT8398-MPG**

Maximum Performance Glass Hydraulic Spin-on



**Notes:** OBSOLETE. Availability Limited to Dealer Stock.  
**Replaces:** Pall MC7400SDN4Z  
**Thread:** 1 1/2 -16  
**O.D.:** 3 11/16 (93.7)  
**Height:** 5 9/16 (141.3)  
**I.Gskt:** [1] Included

**BT8393**

Hydraulic Spin-on



**Contains:** 15 PSID By-Pass Valve  
**Fits:** Ford, New Holland Tractors  
**Replaces:** Ford F0NN-3N976-AA; New Holland 81869132  
**Thread:** 1 1/8 -16  
**O.D.:** 3 11/16 (93.7)  
**Height:** 8 3/16 (208.0)  
**I.Gskt:** G401

**PT8400-MPG**

Maximum Performance Glass Hydraulic Element



**Fits:** J.C. Bamford Equipment  
**Replaces:** J.C. Bamford 581/05601, 581/06301  
**O.D.:** 2 27/32 (72.2)  
**I.D.:** 9/32 (7.1) & 1 25/32 (45.2)  
**Height:** 11 13/16 (300.0)

**PT8394-MPG**

Maximum Performance Glass Hydraulic Element



**Replaces:** Parker 924795  
**O.D.:** 3 21/32 (92.9)  
**I.D.:** 1 3/4 (44.4)  
**Height:** 18 1/2 (469.9)  
**Grommets:** [2] Attached

**BT8401-MPG**

Maximum Performance Glass Hydraulic Spin-on



**Fits:** Ingersoll-Rand Compressors  
**Use With:** OB8771, OB8772, OB8773 filter bases.  
**Replaces:** Ingersoll-Rand 39796982  
**Thread:** 1 3/4 -12  
**O.D.:** 4 23/32 (119.9)  
**Height:** 11 17/32 (292.9)  
**I.Gskt:** [1] Included

**PT8395**

Hydraulic Element



**Fits:** Dresser, Hough Loaders  
**Replaces:** International 940241-C2  
**O.D.:** 7 7/16 (188.9)  
**I.D.:** 4 13/16 (122.2)  
**Height:** 18 1/16 (458.8)  
**A. Gskt:** [2] Attached

**PT8402-MPG**

Maximum Performance Glass Hydraulic Element



**Notes:** OBSOLETE. Availability Limited to Dealer Stock.  
**Contains:** Reinforced Centertube  
**Fits:** Fiat-Allis Equipment  
**Replaces:** Fiat-Allis 73148371  
**O.D.:** 4 9/16 (115.9)  
**I.D.:** 2 7/32 (56.4)  
**Height:** 12 7/8 (327.0)  
**End Seals:** [2] Attached

Measurements Are Shown In Inches And (Millimeters)

**WARNING:** These products can expose you to chemicals, including Diisononyl Phthalate, Carbon black extracts, Nickel, 1,3 Butadiene, Ethylene Oxide, Epichlorohydrin, which are known to the State of California to cause cancer, and Bisphenol, Ethylene Glycol, Ethylene Oxide, 1,3 Butadiene, Epichlorohydrin, which are known to the State of California to cause birth defects or other reproductive harm.

**PT8403-MPG**

Maximum Performance Glass Hydraulic Element



**Contains:** Reinforced Centertube  
**Fits:** Caterpillar Equipment  
**Replaces:** Caterpillar 132-8875  
**O.D.:** 3 15/16 (100.0)  
**I.D.:** 2 9/32 (57.9)  
**Height:** 9 5/16 (236.5)  
**End Seals:** [2] Attached

**PT8411**

Hydraulic Element



**Contains:** Reinforced Centertube  
**Fits:** J.C. Bamford Equipment  
**Replaces:** J.C. Bamford 32/901200  
**O.D.:** 6 29/32 (175.4)  
**I.D.:** 2 1/32 (16.7) & 3 5/8 (92.1)  
**Height:** 9 13/32 (238.9)  
**A. Gskt:** [1] Attached

**PT8404-MPG**

Maximum Performance Glass Hydraulic Element



**Fits:** Kobelco, MDI/Yutani Equipment  
**Replaces:** Kobelco 2446U233-S2  
**O.D.:** 3 23/32 (94.5)  
**I.D.:** 1 15/16 (49.2) One End  
**Height:** 9 3/16 (233.4)  
**A. Gskt:** [1] Attached

**BT8412**

In-Line Hydraulic Filter



**Contains:** 15 PSID By-Pass Valve  
**Fits:** Toyota Lift Trucks  
**Replaces:** Toyota 67502-23000-71  
**O.D.:** 4 1/4 (108.0)  
**Inlet:** 1-14  
**Outlet:** 1 1/16  
**Length:** 5 11/32 (135.7)

**PT8407**

Power Steering Element



**Contains:** 8 PSID By-Pass Valve  
**Fits:** Freightliner, International Buses, Trucks  
**Replaces:** Ford F0HZ-3C602-A; International 1681202-C91  
**O.D.:** 4 1/32 (102.4)  
**I.D.:** 7/16 (11.1) & 2 7/16 (61.9)  
**Height:** 4 5/32 (105.6)  
**A. Gskt:** [1] Attached

**BT8413**

Transmission Spin-on



**Fits:** Saturn Automotive  
**Replaces:** Saturn 21002303, 21002496, 21003298  
**Thread:** 3/4 -20  
**O.D.:** 3 1/32 (77.0)  
**Height:** 3 1/2 (88.9)  
**I.Gskt:** [1] Included

**PT8408**

Hydraulic Element



**Contains:** Reinforced Centertube  
**Fits:** John Deere Equipment  
**Replaces:** John Deere TH103699, TH111010  
**O.D.:** 4 13/32 (111.9)  
**I.D.:** 2 19/32 (65.9)  
**Height:** 18 (457.2)  
**O-Ring:** [2] Included

**PT8414-MPG**

Maximum Performance Glass Hydraulic Element

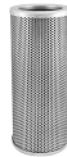

**Fits:** Broyt, V.M.E., Volvo Equipment  
**Replaces:** Volvo 6210359, 6635975, 11026934-7, 11996150-6  
**O.D.:** 4 31/32 (126.2)  
**I.D.:** 13/32 (10.3) & 3 5/8 (92.1)  
**Height:** 11 7/16 (290.5)  
**Related To:** PT722 (Standard Media Version)

**BT8409**

Lube or Transmission Spin-on



**Contains:** Anti-Drainback Valve  
 14 PSID By-Pass Valve  
**Fits:** 2011 Mazda Tribute; Case, Case-International, Komatsu, New Holland, Vermeer Equipment  
**Replaces:** Agco 700723604; Case 87409203; Komatsu 600-211-2110; New Holland 87415600  
**Thread:** 3/4 -16  
**O.D.:** 3 (76.2)  
**Height:** 3 17/32 (89.7)  
**I.Gskt:** [1] Included

**BT8415**

Transmission Spin-on



**Contains:** 30 PSID By-Pass Valve  
 Stud Thread: M24 x 1.5  
**Fits:** John Deere Equipment  
**Replaces:** John Deere AT179323  
**Thread:** 1 -12  
**O.D.:** 3 11/16 (93.7)  
**Height:** 6 1/16 (154.0)  
**I.Gskt:** G401

**PT8410**

Hydraulic Element



**Contains:** Reinforced Centertube  
**Fits:** J.C. Bamford Equipment  
**Replaces:** J.C. Bamford 581/01801  
**O.D.:** 6 7/8 (174.6)  
**I.D.:** 3 5/8 (92.1)  
**Height:** 14 3/16 (360.4)  
**A. Gskt:** [2] Attached

**BT8416**

Hydraulic Spin-on



**Fits:** John Deere, Toro Lawn & Garden Equipment; Bobcat Equipment  
**Use With:** OB8711, OB8712, OB8720, OB8721, OB8722, OB8724, OB8731, OB8732, OB8741, OB8742, OB8743, OB8744, OB8745, OB8746 bases.  
**Replaces:** John Deere AM102723; Stens 120842; Toro 75-1330  
**Thread:** 1 3/8 -12  
**O.D.:** 3 3/4 (95.3)  
**Height:** 4 17/32 (115.1)  
**I.Gskt:** [1] Included

Measurements Are Shown In Inches And (Millimeters)

**WARNING:** These products can expose you to chemicals, including Diisononyl Phthalate, Carbon black extracts, Nickel, 1,3 Butadiene, Ethylene Oxide, Epichlorohydrin, which are known to the State of California to cause cancer, and Bisphenol, Ethylene Glycol, Ethylene Oxide, 1,3 Butadiene, Epichlorohydrin, which are known to the State of California to cause birth defects or other reproductive harm.

**BT8417** Transmission Spin-on  
**Contains:** 30 PSID By-Pass Valve  
**Fits:** Caterpillar, Manitou, New Holland Equipment  
**Replaces:** Caterpillar 6E0924, 119-4740; New Holland 9968353, 9969450  
**Thread:** 13/16 -16  
**O.D.:** 3 1/32 (77.0)  
**Height:** 4 13/16 (122.2)  
**I.Gskt:** G449-B



**BT8418** Hydraulic Spin-on  
**Notes:** 2000 PSI minimum burst  
**Fits:** Caterpillar Equipment  
**Replaces:** Caterpillar 4I3950  
**Thread:** 2 -12  
**O.D.:** 3 1/8 (79.4)  
**Height:** 9 17/32 (242.1)  
**I.Gskt:** [1] Included



**PT8419** In-Tank Hydraulic Element  
**Notes:** Inside-Out Flow Direction. For use on return side.  
**Contains:** 21-24 PSID By-Pass Valve  
**Fits:** Komatsu Lift Trucks  
**Replaces:** Komatsu 3EB66-11711, 3EB66-11711L  
**O.D.:** 3 9/16 (90.5)  
**Inlet:** 3/4 In. NPT  
**Height:** 6 17/32 (165.9)



**BT8420** Wire Mesh Hydraulic Spin-on  
**Fits:** Barber-Greene Equipment  
**Use With:** OB1317, OB1318, OB1319, OB1320 bases.  
**Replaces:** Zinga AE100  
**Thread:** 1 -12  
**O.D.:** 3 11/16 (93.7)  
**Height:** 5 13/32 (137.3)  
**I.Gskt:** G401  
**Related To:** BT839, BT839-10 (Standard Versions)



**BT8421-MPG** Maximum Performance Glass Hydraulic Spin-on  
**Notes:** Can be used with OB1314 and OB1316 bases (requires optional G286-C gasket).  
**Fits:** Donaldson HBK05 Assembly  
**Replaces:** Hycon MFE16003BN2; Ingersoll-Rand 59700674; Pall HC7500SDP4H; Donaldson P169430  
**Thread:** 1 1/2 -16  
**O.D.:** 5 1/16 (128.6)  
**Height:** 6 31/32 (177.0)  
**F. Gskt:** G369-B  
**O. Gskt:** G286-C, G369-V, G372, G447, G483, G704, G710  
**Related To:** BT8307-MPG (Micron Difference)



**BT8422-MPG** High Efficiency Maximum Performance Glass Hydraulic Spin-on  
**Notes:** Can be used with OB1314 and OB1316 bases (requires optional G286-C gasket).  
**Fits:** Donaldson HBK05 Assembly  
**Replaces:** Hycon MFE160103BN2; Pall HC7500SUP8H; Donaldson P167832  
**Thread:** 1 1/2 -16  
**O.D.:** 5 1/16 (128.6)  
**Height:** 10 3/4 (273.1)  
**F. Gskt:** G369-B  
**O. Gskt:** G286-C, G369-V, G372, G447, G483, G704, G710  
**Related To:** BT8308-MPG (Standard Version)



**BT8423** Wire Mesh Hydraulic Spin-on  
**Fits:** Ingersoll-Rand Compressors  
**Use With:** OB1313, OB1314, OB1315, OB1316 bases (requires optional G286-C gasket).  
**Replaces:** Ingersoll-Rand 59879247; Zinga SE100  
**Thread:** 1 1/2 -16  
**O.D.:** 5 1/16 (128.6)  
**Height:** 6 31/32 (177.0)  
**F. Gskt:** G369-B  
**O. Gskt:** G286-C, G369-V, G372, G447, G483, G704, G710



**PT8425** Hydraulic Element  
**Fits:** John Deere, Takeuchi Loaders  
**Replaces:** John Deere AT204010; Takeuchi 1551101001  
**O.D.:** 2 (50.8)  
**I.D.:** 31/32 (24.6) One End  
**Height:** 8 7/32 (208.8)  
**I.Gskt:** [1] Included  
**O-Ring:** [1] Included



**BT8426-MPG** Maximum Performance Glass Hydraulic Spin-on  
**Contains:** 50 PSID By-Pass Valve  
**Fits:** Caterpillar, Grove Equipment  
**Replaces:** Clark 4202505; Gehl L99184  
**Thread:** 2 -16  
**O.D.:** 3 3/4 (95.3)  
**Height:** 6 3/32 (154.8)  
**I.Gskt:** [1] Included



**PT8427** Hydraulic Element  
**Fits:** Bros Compactors  
**Replaces:** GMC 25313910; Iowa Manufacturing 4517750903  
**O.D.:** 4 3/8 (111.1)  
**I.D.:** 1 7/8 (47.6)  
**Height:** 10 3/32 (256.4)  
**I.Gskt:** [2] Included

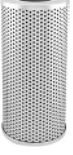

Measurements Are Shown In Inches And (Millimeters)

**WARNING:** These products can expose you to chemicals, including Diisononyl Phthalate, Carbon black extracts, Nickel, 1,3 Butadiene, Ethylene Oxide, Epichlorohydrin, which are known to the State of California to cause cancer, and Bisphenol, Ethylene Glycol, Ethylene Oxide, 1,3 Butadiene, Epichlorohydrin, which are known to the State of California to cause birth defects or other reproductive harm.

**BT8428-MPG** Maximum Performance Glass Hydraulic Spin-on  
**Notes:** Can be used with OB1318 and OB1320 bases.  
**Fits:** Various Hydraulic Applications  
**Replaces:** LHA SPE15BTA10  
**Thread:** 1 -12  
**O.D.:** 3 11/16 (93.7)  
**Height:** 5 15/32 (138.9)  
**I.Gskt:** G401  
**Related To:** BT839, BT839-10 (Standard Versions)



**BT8437** Hydraulic Spin-on  
**Contains:** 25 PSID By-Pass Valve  
**Fits:** Voith Transmissions  
**Replaces:** Voith 90.4399.10, 90.4399.11  
**Thread:** 1 1/2 -16  
**O.D.:** 5 1/2 (139.7)  
**Height:** 7 (177.8)  
**I.Gskt:** [1] Included



**BT8429** Air Breather Element  
**Fits:** Caterpillar Lift Trucks  
**Replaces:** Caterpillar 9Y5011  
**O.D.:** 3 1/32 (77.0)  
**I.D.:** 1 15/32 (37.3) One End  
**Height:** 2 7/32 (56.4)



**BT8439-MPG** Maximum Performance Glass Hydraulic or Transmission Spin-on  
**Fits:** Case, Komatsu, Volvo Loaders  
**Replaces:** Case 181167A1, 254686A1  
**Thread:** 13/16 -16  
**O.D.:** 3 3/4 (95.3)  
**Height:** 6 1/32 (153.2)  
**I.Gskt:** [1] Included



**BT8432-MPG** Maximum Performance Glass Hydraulic Spin-on  
**Fits:** Caterpillar Equipment  
**Use With:** OB8711, OB8712, OB8720, OB8721, OB8722, OB8724, OB8731, OB8732, OB8741, OB8742, OB8743, OB8744, OB8745, OB8746 bases.  
**Replaces:** Caterpillar 6E6408  
**Thread:** 1 3/8 -12  
**O.D.:** 4 23/32 (119.9)  
**Height:** 11 17/32 (292.9)  
**I.Gskt:** [1] Included



**BT8440-MPG** Maximum Performance Glass Hydraulic Spin-on  
**Contains:** 25 PSID By-Pass Valve  
**Fits:** Sullair Compressors  
**Replaces:** Sullair 250026-982, 250028-032  
**Thread:** 250026-982  
**O.D.:** 3 21/32 (92.9)  
**Height:** 5 5/8 (142.9)  
**I.Gskt:** [1] Included



**PT8433-MPG** Maximum Performance Glass Hydraulic Element  
**Fits:** V.M.E., Volvo Loaders  
**Replaces:** Volvo 11026936, 11026936-2  
**O.D.:** 4 31/32 (126.2)  
**I.D.:** 13/32 (10.3) & 3 5/8 (92.1)  
**Height:** 15 11/32 (389.7)  
**O-Ring:** [1] Attached



**PT8441** Hydraulic Element  
**Fits:** Caterpillar Compactors  
**Replaces:** Caterpillar 77-3092  
**O.D.:** 4 3/8 (111.1)  
**I.D.:** 1 7/8 (47.6)  
**Height:** 13 1/8 (333.4)  
**I.Gskt:** [2] Included

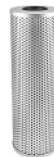

**PT8435-MPG** Maximum Performance Glass In-Line Hydraulic Filter  
**Contains:** 25 PSID By-Pass Valve  
**Fits:** Hyster Lift Trucks  
**Replaces:** Hyster 1337159  
**O.D.:** 4 1/32 (102.4)  
**Inlet:** 1  
**Outlet:** 1  
**Length:** 7 31/32 (202.4)  
**Related To:** PT716 (Standard Media Version with No By-Pass Valve)



**PT8442** Hydraulic Element  
**Fits:** Ingersoll-Rand Compressors  
**Replaces:** Ingersoll-Rand 39123229, 39123237  
**O.D.:** 4 3/8 (111.1)  
**I.D.:** 11/16 (17.5) & 2 7/16 (61.9)  
**Height:** 16 1/32 (407.2)  
**A. Gskt:** [1] Attached  
**Grommets:** [1] Attached



**PT8436** Hydraulic Element  
**Contains:** Reinforced Centertube  
**Fits:** Caterpillar Equipment  
**Replaces:** Caterpillar 126-2081  
**O.D.:** 5 19/32 (142.1)  
**I.D.:** 3 27/32 (97.6)  
**Height:** 16 23/32 (424.7)  
**I.Gskt:** [2] Included



**BT8443** Hydraulic or Lube Spin-on  
**Notes:** Can be used with OB1318 and OB1320 bases.  
**Fits:** Zinga Hydraulic Heads  
**Replaces:** LHA SPE25-10; Zinga AE10L  
**Thread:** 1 -12  
**O.D.:** 3 23/32 (94.5)  
**Height:** 8 3/16 (208.0)  
**I.Gskt:** G401



Measurements Are Shown In Inches And (Millimeters)

**WARNING:** These products can expose you to chemicals, including Diisononyl Phthalate, Carbon black extracts, Nickel, 1,3 Butadiene, Ethylene Oxide, Epichlorohydrin, which are known to the State of California to cause cancer, and Bisphenol, Ethylene Glycol, Ethylene Oxide, 1,3 Butadiene, Epichlorohydrin, which are known to the State of California to cause birth defects or other reproductive harm.

**BT8444**

Hydraulic Spin-on



**Fits:** Dynapac Rollers  
**Replaces:** Dynapac 499519; Gehl 34609074830; Voith 90.6103.10  
**Thread:** 1 -12  
**O.D.:** 3 23/32 (94.5)  
**Height:** 8 3/16 (208.0)  
**I.Gskt:** [1] Included

**BT8449-10**

Hydraulic Spin-on



**Fits:** Allis Chalmers, Barber-Greene, Case, Grove, John Deere, Steiger Equipment; Eaton Lift Trucks  
**Replaces:** Marvel 451217-1110, 451217-5110  
**Thread:** 1 5/16 -12  
**O.D.:** 3 7/8 (98.4)  
**Height:** 5 25/32 (146.8)  
**F. Gskt:** [1] Included  
**O-Ring:** G247

**BT8445**

Hydraulic Spin-on



**Fits:** Joy Compressors  
**Replaces:** Sullivan 190052012  
**Thread:** 1 -12  
**O.D.:** 3 11/16 (93.7)  
**Height:** 5 3/8 (136.5)  
**I.Gskt:** G381-A

**BT8450**

Hydraulic Spin-on



**Contains:** Anti-Drainback Valve  
 15 PSID By-Pass Valve  
**Fits:** New Holland Equipment  
**Replaces:** U.C.C. UC2418; Donaldson P550269  
**Thread:** 1 1/4 -11 BSP-PL  
**O.D.:** 5 (127.0)  
**Height:** 7 3/32 (180.2)  
**I.Gskt:** [1] Included  
**Related To:** BT351 (without Anti-Drainback, By-Pass Valve)  
 BT8475 (Micron Difference)  
 BT8476, BT8477 (Long Versions, Micron Difference)

**PT8446-MPG**

Maximum Performance Glass Hydraulic Element



**Fits:** Heil Garbage Packer  
**Replaces:** Schroeder 18LS7, 18LZ10  
**O.D.:** 3 7/8 (98.4)  
**I.D.:** 2 1/4 (57.2)  
**Height:** 18 1/2 (469.9)  
**I.Gskt:** [2] Included

**PT8451-MPG**

Wire Mesh Supported Maximum Performance Glass Hydraulic Element



**Fits:** Hitachi, John Deere Equipment  
**Replaces:** John Deere AT147821, AT186554  
**O.D.:** 1 31/32 (50.0)  
**I.D.:** 29/32 (23.0) One End  
**Height:** 6 (152.4)  
**I.Gskt:** [1] Included  
**O-Ring:** [2] Included

**PT8447-MPG**

Maximum Performance Glass Hydraulic Element



**Fits:** CMI Slip Form Paver, Rotomill  
**Replaces:** Pall HC8900FDN16H, HC8900FKN16H, HC8900FUN16H  
**O.D.:** 3 25/32 (96.0)  
**I.D.:** 2 7/32 (56.4) One End  
**Height:** 16 7/8 (428.6)  
**I.Gskt:** [1] Included

**PT8452**

Hydraulic Element



**Notes:** Inside-Out Flow Direction  
**Fits:** Barko Garbage Trucks  
**Replaces:** Parker 924450  
**O.D.:** 3 1/2 (88.9)  
**I.D.:** 1 9/16 (39.7)  
**Height:** 9 9/32 (235.7)  
**Grommets:** [2] Attached  
**Related To:** PT8489 (Double-Length Version)

**P8448**

Hydraulic Element



**Replaces:** Fleetguard HFKW800T  
**O.D.:** 5 (127.0)  
**I.D.:** 3/8 (9.5) & 7/8 (22.2)  
**Height:** 4 5/32 (105.6)  
**A. Gskt:** [1] Attached  
**F. Gskt:** [1] Included

**PT8453**

Hydraulic Element



**Fits:** John Deere Equipment  
**Replaces:** John Deere TH111011  
**O.D.:** 3 1/2 (88.9)  
**I.D.:** 1 27/32 (46.8)  
**Height:** 13 7/8 (352.4)  
**O-Ring:** [2] Included  
**Grommets:** [2] Attached

**BT8449**

Hydraulic Spin-on



**Fits:** Allis Chalmers, Barber-Greene, Case, Grove, John Deere, Steiger Equipment; Eaton Lift Trucks  
**Replaces:** Marvel 451217-5125  
**Thread:** 1 5/16 -12  
**O.D.:** 3 7/8 (98.4)  
**Height:** 5 25/32 (146.8)  
**F. Gskt:** [1] Included  
**O-Ring:** G247

**PT8455-MPG**

Maximum Performance Glass Hydraulic Element



**Notes:** Inside-Out Flow Direction  
**Fits:** J.C. Bamford 426 Series, 434S, 436 Series, 456 Series Loaders; John Deere 1063 Tree Harvester; F106, F106A Motor Graders  
**Replaces:** Heil 7571101  
**O.D.:** 4 5/32 (105.6)  
**I.D.:** 13/32 (10.3) & 2 27/32 (72.2)  
**Height:** 18 5/16 (465.1)  
**O-Ring:** [1] Attached

Measurements Are Shown In Inches And (Millimeters)

**WARNING:** These products can expose you to chemicals, including Diisononyl Phthalate, Carbon black extracts, Nickel, 1,3 Butadiene, Ethylene Oxide, Epichlorohydrin, which are known to the State of California to cause cancer, and Bisphenol, Ethylene Glycol, Ethylene Oxide, 1,3 Butadiene, Epichlorohydrin, which are known to the State of California to cause birth defects or other reproductive harm.



**PT8456-MPG** Wire Mesh Supported Maximum Performance Glass Hydraulic Element

**Notes:** Inside-Out Flow Direction  
**Fits:** Various Hydraulic Applications  
**Replaces:** Parker 924453; Donaldson P169557  
**O.D.:** 3 23/32 (94.5)  
**I.D.:** 1 23/32 (43.7)  
**Height:** 9 1/16 (230.2)  
**Grommets:** [2] Attached



**PT8462-MPG** Maximum Performance Glass Hydraulic Element

**Notes:** Inside-Out Flow Direction  
**Fits:** Donaldson HAK05, HDK06 Assemblies  
**Replaces:** Donaldson P163859  
**O.D.:** 4 3/8 (111.1)  
**I.D.:** 3/4 (19.0) & 2 7/16 (61.9)  
**Height:** 5 (127.0)  
**A. Gskt:** [1] Attached



**BT8457-MPG** Maximum Performance Glass Hydraulic Spin-on

**Fits:** John Deere Equipment  
**Replaces:** John Deere AT180249  
**Thread:** 1 1/2 -16  
**O.D.:** 4 13/16 (122.2)  
**Height:** 11 29/32 (302.4)  
**I.Gskt:** [1] Included



**BT8463-MPG** Maximum Performance Glass Hydraulic Spin-on

**Fits:** Various Hydraulic Applications  
**Use With:** OB8711, OB8712, OB8720, OB8721, OB8722, OB8724, OB8731, OB8732, OB8741, OB8742, OB8743, OB8744, OB8745, OB8746 bases.  
**Replaces:** Donaldson P165335; Fleetguard HF6556  
**Thread:** 1 3/8 -12  
**O.D.:** 3 3/4 (95.3)  
**Height:** 6 1/8 (155.6)  
**I.Gskt:** [1] Included



**PT8458-MPG** Wire Mesh Supported Maximum Performance Glass Hydraulic Element

**Contains:** Viton O-Ring for high heat applications.  
**Replaces:** Parker 925837; Heil 757051, 7559101  
**O.D.:** 2 3/8 (60.3)  
**I.D.:** 1 (25.4) One End  
**Height:** 9 21/32 (245.3)  
**O-Ring:** [1] Attached



**BT8464** Hydraulic Spin-on

**Fits:** Various Hydraulic Applications  
**Use With:** OB8711, OB8712, OB8720, OB8721, OB8722, OB8724, OB8731, OB8732, OB8741, OB8742, OB8743, OB8744, OB8745, OB8746 bases.  
**Replaces:** Donaldson P163405; Fleetguard HF6560  
**Thread:** 1 3/8 -12  
**O.D.:** 3 3/4 (95.3)  
**Height:** 6 1/8 (155.6)  
**I.Gskt:** [1] Included



**PT8459** Hydraulic Element

**Replaces:** Argo P2092301; Renault 6005019557  
**O.D.:** 3 9/32 (83.3)  
**I.D.:** 1 31/32 (50.0)  
**Height:** 8 15/16 (227.0)



**BT8465** Hydraulic Spin-on

**Fits:** Various Hydraulic Applications  
**Use With:** OB8711, OB8712, OB8720, OB8721, OB8722, OB8724, OB8731, OB8732, OB8741, OB8742, OB8743, OB8744, OB8745, OB8746 bases.  
**Replaces:** Donaldson P163558; Fleetguard HF6577  
**Thread:** 1 3/8 -12  
**O.D.:** 3 3/4 (95.3)  
**Height:** 9 19/32 (243.7)  
**I.Gskt:** [1] Included



**BT8460** Transmission Spin-on

**Contains:** 9 PSID By-Pass Valve  
**Fits:** Allison Transmissions; Ford, Freightliner, GMC, Hino, International, Kenworth, Mack, Nissan, Peterbilt Trucks  
**Replaces:** GMC 29537268, 29539579  
**Thread:** 3/4 -20  
**O.D.:** 2 7/8 (73.0)  
**Height:** 3 (76.2)  
**I.Gskt:** [1] Included



**BT8466-MPG** Maximum Performance Glass Hydraulic Spin-on

**Fits:** Various Hydraulic Applications  
**Use With:** OB8711, OB8712, OB8720, OB8721, OB8722, OB8724, OB8731, OB8732, OB8741, OB8742, OB8743, OB8744, OB8745, OB8746 bases.  
**Replaces:** Donaldson P163546; Fleetguard HF6578  
**Thread:** 1 3/8 -12  
**O.D.:** 3 15/16 (100.0)  
**Height:** 9 7/16 (239.7)  
**I.Gskt:** [1] Included



**PT8461** Hydraulic Element

**Notes:** Inside-Out Flow Direction  
**Fits:** Caterpillar Graders  
**Replaces:** Caterpillar 1R0774  
**O.D.:** 5 1/8 (130.2)  
**I.D.:** 3 11/32 (84.9)  
**Height:** 11 1/16 (281.0)  
**A. Gskt:** [2] Attached



Measurements Are Shown In Inches And (Millimeters)

**WARNING:** These products can expose you to chemicals, including Diisononyl Phthalate, Carbon black extracts, Nickel, 1,3 Butadiene, Ethylene Oxide, Epichlorohydrin, which are known to the State of California to cause cancer, and Bisphenol, Ethylene Glycol, Ethylene Oxide, 1,3 Butadiene, Epichlorohydrin, which are known to the State of California to cause birth defects or other reproductive harm.

**PT8467**



Hydraulic Element

**Fits:** Parker Hannifin Hydraulic Systems  
**Replaces:** Heil 7557201; Parker 926326  
**O.D.:** 4 7/16 (112.7)  
**I.D.:** 1 11/16 (42.9) One End  
**Height:** 9 1/2 (241.3)  
**F. Gskt:** [1] Included  
**O-Ring:** [1] Attached

**BT8474**



Hydraulic Spin-on

**Replaces:** MP Filtri CS070P25A  
**Thread:** 3/4 -14 BSP-PL  
**O.D.:** 3 11/16 (93.7)  
**Height:** 8 5/32 (207.2)  
**I.Gskt:** G381-A

**PT8468**



Hydraulic Element

**Replaces:** Parker 926566; Schroeder A3  
**O.D.:** 3 (76.2)  
**I.D.:** 1 1/16 (27.0)  
**Height:** 4 11/16 (119.1)  
**A. Gskt:** [2] Attached

**BT8475**



Hydraulic Spin-on

**Replaces:** MP Filtri CS100P25A; U.C.C. UCMX1591425; Zinga SE25G  
**Thread:** 1 1/4 -11 BSP-PL  
**O.D.:** 5 (127.0)  
**Height:** 7 3/32 (180.2)  
**I.Gskt:** [1] Included  
**Related To:** BT8450 (with Anti-Drainback Valve, 15 PSID By-Pass Valve)

**PT8470**



Hydraulic Element

**Replaces:** Parker 924451  
**O.D.:** 3 1/2 (88.9)  
**I.D.:** 1 9/16 (39.7)  
**Height:** 9 9/32 (235.7)  
**Grommets:** [2] Attached  
**Related To:** PT8511 (Double-Length Version)

**BT8475-MPG**



Wire Mesh Supported Maximum Performance Glass Hydraulic Spin-on

**Replaces:** MP Filtri CS100A25; Woodgate WGH9176  
**Thread:** 1 1/4 -11 BSP-PL  
**O.D.:** 5 1/16 (128.6)  
**Height:** 7 1/16 (179.4)

**BT8471-MPG**



Maximum Performance Glass Hydraulic Spin-on

**Fits:** Gradall Material Handlers  
**Replaces:** Gradall 91143144  
**Thread:** 1 1/2 -16  
**O.D.:** 5 1/16 (128.6)  
**Height:** 10 3/4 (273.1)  
**F. Gskt:** [1] Included  
**O. Gskt:** G369-V, G704, G710

**BT8476**



Hydraulic Spin-on

**Fits:** Belloli Trucks; Liebherr Loaders  
**Replaces:** Liebherr 7010930; MP Filtri CS150P10A  
**Thread:** 1 1/4 -11 BSP-PL  
**O.D.:** 5 1/8 (130.2)  
**Height:** 8 11/16 (220.7)  
**I.Gskt:** [1] Included

**BT8472**



Hydraulic Spin-on

**Fits:** Afron Manlift  
**Replaces:** MP Filtri CS050P25A  
**Thread:** 3/4 -14 BSP-PL  
**O.D.:** 3 11/16 (93.7)  
**Height:** 5 3/8 (136.5)  
**I.Gskt:** G381-A

**BT8476-MPG**



Maximum Performance Glass Hydraulic Spin-on

**Fits:** Belloli Trucks; Liebherr Loaders  
**Replaces:** MP Filtri CS150A10  
**Thread:** 1 1/4 -11 BSP-PL  
**O.D.:** 5 1/8 (130.2)  
**Height:** 8 11/16 (220.7)  
**I.Gskt:** [1] Included

**BT8473**



Hydraulic Spin-on

**Replaces:** MP Filtri CS070P10A  
**Thread:** 3/4 -14 BSP-PL  
**O.D.:** 3 11/16 (93.7)  
**Height:** 8 5/32 (207.2)  
**I.Gskt:** G381-A

**BT8477**



Hydraulic Spin-on

**Fits:** Case Tractors; Manitou Equipment; TCL Topper Hedgers  
**Replaces:** Manitou 485695; MP Filtri CS150P25A  
**Thread:** 1 1/4 -11 BSP-PL  
**O.D.:** 5 1/8 (130.2)  
**Height:** 8 11/16 (220.7)  
**I.Gskt:** [1] Included

Measurements Are Shown In Inches And (Millimeters)

**WARNING:** These products can expose you to chemicals, including Diisononyl Phthalate, Carbon black extracts, Nickel, 1,3 Butadiene, Ethylene Oxide, Epichlorohydrin, which are known to the State of California to cause cancer, and Bisphenol, Ethylene Glycol, Ethylene Oxide, 1,3 Butadiene, Epichlorohydrin, which are known to the State of California to cause birth defects or other reproductive harm.

**BT8477-MPG** Wire Mesh Supported Maximum Performance Glass Hydraulic Spin-on



**Fits:** Manitou Loaders; TCL Topper Hedgers  
**Replaces:** MP Filtri CS150A25; Woodgate WGH9182  
**Thread:** 1 1/4 -11 BSP-PL  
**O.D.:** 5 1/32 (127.8)  
**Height:** 8 15/16 (227.0)

**PT8485** Hydraulic Element



**Fits:** Schroeder Hydraulic Systems  
**Replaces:** Schroeder N10  
**O.D.:** 1 25/32 (45.2)  
**I.D.:** 23/32 (18.3) One End  
**Height:** 5 9/32 (134.1)

**PT8478** High Pressure Hydraulic Element



**Contains:** Reinforced Centertube  
**Fits:** Hitachi, John Deere, Komatsu Equipment  
**Replaces:** Hitachi 4333469; Komatsu 7063-01-383, 2086-06-1150; Fiat 4287634, 76580323  
**O.D.:** 7 (177.8)  
**I.D.:** 4 5/16 (109.5)  
**Height:** 17 3/4 (450.9)  
**O-Ring:** [1] Included

**BT8486** Transmission Spin-on



**Fits:** Cub Cadet Lawn & Garden Tractors  
**Replaces:** Cub Cadet 7233014, 9233014  
**Thread:** 3/4 -16  
**O.D.:** 3 3/4 (95.3)  
**Height:** 3 31/32 (100.8)  
**I.Gskt:** G381-A

**PT8479** Hydraulic Element



**Contains:** Reinforced Centertube  
**Fits:** Hitachi Excavators  
**Replaces:** Hitachi 3501404  
**O.D.:** 3 17/32 (89.7)  
**I.D.:** 1 29/32 (48.4)  
**Height:** 11 7/16 (290.5)  
**F. Gskt:** [1] Included  
**O-Ring:** [2] Attached

**PT8487** Power Steering Element



**Notes:** Inside-Out Flow Direction  
**Fits:** Freightliner, Peterbilt Trucks  
**Replaces:** Donaldson P550698; Nelson 83284D  
**O.D.:** 4 (101.6)  
**I.D.:** 1 3/32 (27.8) & 1 15/32 (37.3)  
**Height:** 5 7/32 (132.6)  
**A. Gskt:** [2] Attached

**PT8480** Depth-Pack 2-Section In-Line Hydraulic Element



**Fits:** Hitachi Excavators  
**Replaces:** Hitachi 4185299  
**O.D.:** 5 1/2 (139.7)  
**Inlet:** 7/8  
**Outlet:** 7/8  
**Length:** 11 15/16 (303.2)  
**O-Ring:** [2] Attached, [1] Included  
**Grommets:** [2] Attached

**BT8488** Hydraulic Spin-on



**Fits:** Case-International, Kubota, New Holland Tractors  
**Replaces:** Kubota 33960-82631  
**Thread:** 1 1/8 -16  
**O.D.:** 3 23/32 (94.5)  
**Height:** 7 1/32 (178.6)  
**I.Gskt:** [1] Included

**PT8481** Hydraulic Element



**Replaces:** Parker 924732, 924734  
**O.D.:** 2 3/4 (69.9)  
**I.D.:** 1 5/8 (41.3)  
**Height:** 8 27/32 (224.6)  
**End Seals:** [2] Attached

**PT8489** 2-Section Hydraulic Element



**Notes:** Inside-Out Flow Direction  
**Contains:** Grommet Seal Between Sections  
**Fits:** Various Equipment with Parker Hydraulic Systems  
**Replaces:** Parker 924792  
**O.D.:** 3 1/2 (88.9)  
**I.D.:** 1 9/16 (39.7)  
**Height:** 18 9/16 (471.5)  
**Grommets:** [3] Attached  
**Related To:** PT8452 (Single-Length Version)

**PT8484** Hydraulic Element with Bail Handle



**Contains:** 43.5 PSID By-Pass Valve  
**Fits:** J.C. Bamford Equipment  
**Replaces:** J.C. Bamford 32/910100, 32/913500  
**O.D.:** 2 9/16 (65.1)  
**I.D.:** 1 9/32 (32.5) One End  
**Height:** 8 31/32 (227.8)











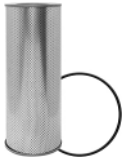

**PT8490-MPG** Maximum Performance Glass Hydraulic Element with Bail Handle



**Contains:** Nylon Mesh Media  
**Replaces:** Dresser AK3570  
**O.D.:** 4 1/8 (104.8)  
**I.D.:** 2 13/32 (61.1)  
**Height:** 12 5/16 (312.7)  
**O-Ring:** [2] Attached

Measurements Are Shown In Inches And (Millimeters)

**WARNING:** These products can expose you to chemicals, including Diisononyl Phthalate, Carbon black extracts, Nickel, 1,3 Butadiene, Ethylene Oxide, Epichlorohydrin, which are known to the State of California to cause cancer, and Bisphenol, Ethylene Glycol, Ethylene Oxide, 1,3 Butadiene, Epichlorohydrin, which are known to the State of California to cause birth defects or other reproductive harm.

<p><b>PT8491</b></p> 	<p>Hydraulic Element  <b>Notes:</b> Inside-Out Flow Direction  <b>Fits:</b> Donaldson HFK08 Housing; Wagner Mining Equipment  <b>Replaces:</b> Donaldson P161365; Fleetguard HF6489  <b>O.D.:</b> 6 (152.4)  <b>I.D.:</b> 23/32 (18.3) &amp; 3 17/32 (89.7)  <b>Height:</b> 18 1/32 (458.0)  <b>Grommets:</b> [1] Attached</p>	<p><b>BT8497-MPG</b> Wire Mesh Supported Maximum Performance Glass Hydraulic Spin-on  <b>Fits:</b> John Deere Skidders  <b>Replaces:</b> John Deere AT182209  <b>Thread:</b> 1 -12  <b>O.D.:</b> 3 23/32 (94.5)  <b>Height:</b> 8 1/8 (206.4)  <b>I.Gskt:</b> [1] Included</p> 
<p><b>PT8492</b></p> 	<p>High Pressure Hydraulic Element  <b>Contains:</b> Reinforced Centertube  <b>Fits:</b> John Deere Excavators; Samsung, Volvo Equipment  <b>Replaces:</b> John Deere AT201793  <b>O.D.:</b> 7 (177.8)  <b>I.D.:</b> 4 5/16 (109.5)  <b>Height:</b> 17 3/4 (450.9)  <b>O-Ring:</b> [1] Included</p>	<p><b>PT8498</b> Hydraulic Element  <b>Contains:</b> Viton O-Ring for high heat applications  <b>Fits:</b> Blue Bird Buses with Allison Transmissions  <b>Replaces:</b> Parker 925835  <b>O.D.:</b> 2 3/8 (60.3)  <b>I.D.:</b> 1 (25.4) One End  <b>Height:</b> 9 5/8 (244.5)  <b>O-Ring:</b> [1] Attached</p> 
<p><b>BT8493</b></p> 	<p>Hydraulic or Transmission Spin-on  <b>Contains:</b> Anti-Drainback Valve            14 PSID By-Pass Valve  <b>Fits:</b> Eaton Lift Trucks  <b>Replaces:</b> Hyster 8500023; Yale 518801624  <b>Thread:</b> 3/4 -16  <b>O.D.:</b> 3 11/16 (93.7)  <b>Height:</b> 2 29/32 (73.8)  <b>I.Gskt:</b> G401</p>	<p><b>BT8499</b> Hydraulic Spin-on  <b>Fits:</b> John Deere Lawn &amp; Garden Tractors  <b>Replaces:</b> John Deere AM116156  <b>Thread:</b> 1 -14  <b>O.D.:</b> 3 11/16 (93.7)  <b>Height:</b> 3 13/16 (96.8)  <b>I.Gskt:</b> G381-A</p> 
<p><b>PT8494</b></p> 	<p>Wire Mesh Supported Hydraulic Element  <b>Notes:</b> Inside-Out Flow Direction  <b>Fits:</b> Case Excavators; Donaldson HAK05 Assembly  <b>Replaces:</b> Case S104929; Donaldson P160516  <b>O.D.:</b> 4 3/8 (111.1)  <b>I.D.:</b> 23/32 (18.3) &amp; 2 13/32 (61.1)  <b>Height:</b> 16 1/16 (408.0)  <b>A. Gskt:</b> [1] Attached  <b>Grommets:</b> [1] Attached</p>	<p><b>BT8501-MPG</b> Maximum Performance Glass Hydraulic Spin-on  <b>Fits:</b> John Deere Equipment  <b>Replaces:</b> John Deere RE17380; Donaldson P551234  <b>Thread:</b> 1 -12  <b>O.D.:</b> 3 11/16 (93.7)  <b>Height:</b> 5 13/32 (137.3)  <b>I.Gskt:</b> G401</p> 
<p><b>PT8495-MPG</b></p> 	<p>Nylon Mesh Supported Maximum Performance Glass Hydraulic Element  <b>Fits:</b> Haulpak Trucks  <b>Replaces:</b> Dresser AK3572  <b>O.D.:</b> 3 1/8 (79.4)  <b>I.D.:</b> 1 15/16 (49.2) One End  <b>Height:</b> 16 17/32 (419.9)  <b>O-Ring:</b> [1] Attached</p>	<p><b>BT8502</b> Hydraulic Spin-on  <b>Replaces:</b> Parker 926543; Donaldson P551550; Fleetguard HF6500  <b>Thread:</b> 1 -12  <b>O.D.:</b> 3 11/16 (93.7)  <b>Height:</b> 5 13/32 (137.3)  <b>I.Gskt:</b> G401</p> 
<p><b>PT8496-MPG</b></p> 	<p>Maximum Performance Glass Hydraulic Element  <b>Contains:</b> Reinforced Centertube  <b>Fits:</b> Caterpillar Equipment  <b>Replaces:</b> Caterpillar 132-8876  <b>O.D.:</b> 5 1/8 (130.2)  <b>I.D.:</b> 3 3/8 (85.7)  <b>Height:</b> 9 1/16 (230.2)  <b>A. Gskt:</b> [2] Attached</p>	<p><b>BT8503-MPG</b> Maximum Performance Glass Hydraulic Spin-on  <b>Fits:</b> New Holland, Versatile Tractors  <b>Replaces:</b> New Holland 86016760; Fleetguard HF29000  <b>Thread:</b> M90 x 2.0  <b>O.D.:</b> 4 23/32 (119.9)  <b>Height:</b> 7 11/16 (195.3)  <b>I.Gskt:</b> [1] Included</p> 
	<p><b>BT8504</b> Transmission Spin-on  <b>Contains:</b> 8 PSID By-Pass Valve  <b>Fits:</b> Ford, New Holland Tractors  <b>Replaces:</b> Ford D8NN-B486-CA  <b>Thread:</b> 1 1/8 -16  <b>O.D.:</b> 3 11/16 (93.7)  <b>Height:</b> 6 5/8 (168.3)  <b>I.Gskt:</b> G381-A</p> 	

Measurements Are Shown In Inches And (Millimeters)

**WARNING:** These products can expose you to chemicals, including Diisononyl Phthalate, Carbon black extracts, Nickel, 1,3 Butadiene, Ethylene Oxide, Epichlorohydrin, which are known to the State of California to cause cancer, and Bisphenol, Ethylene Glycol, Ethylene Oxide, 1,3 Butadiene, Epichlorohydrin, which are known to the State of California to cause birth defects or other reproductive harm.

**BT8505** Hydraulic Spin-on  
**Fits:** Ford, New Holland Tractors  
**Replaces:** Ford SBA340500410, 83939935  
**Thread:** 1 1/8 -16  
**O.D.:** 3 11/16 (93.7)  
**Height:** 5 21/32 (143.7)  
**I.Gskt:** G401



**BT8512** Hydraulic Spin-on  
**Contains:** 40 PSID By-Pass Valve  
**Fits:** Claas, Hamm, Liebherr Equipment  
**Replaces:** Liebherr 5612546, 7004209; Rottne 480101; Fleetguard HF28989  
**Thread:** 1 -12  
**O.D.:** 3 23/32 (94.5)  
**Height:** 6 23/32 (170.7)  
**I.Gskt:** G401



**PT8506-MPG** Maximum Performance Glass Hydraulic Element  
**Contains:** Reinforced Centertube  
**Fits:** Komatsu Excavators  
**Replaces:** Komatsu 7063-51-100  
**O.D.:** 5 1/8 (130.2)  
**I.D.:** 3 3/8 (85.7)  
**Height:** 11 17/32 (292.9)



**PT8517-MPG** Wire Mesh Supported Maximum Performance Glass Hydraulic Element  
**Replaces:** Blount 31001609, 31004339; Donaldson P560402  
**O.D.:** 3 29/32 (99.2)  
**I.D.:** 1 5/8 (41.3) & 1 27/32 (46.8)  
**Height:** 18 1/2 (469.9)  
**A. Gskt:** G310  
**O-Ring:** [1] Included  
**End Seals:** ES1039 Attached



**PT8507-MPG** Maximum Performance Glass Hydraulic Element  
**Fits:** Komatsu Excavators  
**Replaces:** Komatsu 7063-51-054  
**O.D.:** 3 15/16 (100.0)  
**I.D.:** 2 11/32 (59.5)  
**Height:** 8 5/16 (211.1)



**PT8519-MPG** Wire Mesh Supported Maximum Performance Glass Hydraulic Element  
**Contains:** Viton O-Ring for high heat applications.  
**Replaces:** Pall HC8200FKS16H; Purolator Facet 8200EAL122N3; Donaldson P174547  
**O.D.:** 3 3/32 (78.6)  
**I.D.:** 1 1/2 (38.1) One End  
**Height:** 16 7/8 (428.6)  
**O-Ring:** [1] Attached



**BT8509-MPG** Maximum Performance Glass Hydraulic Spin-on  
**Replaces:** Pall HC7400SKN8H; PTI F4F040HCB; Donaldson P169392  
**Thread:** 1 1/2 -16  
**O.D.:** 3 11/16 (93.7)  
**Height:** 8 1/16 (204.8)  
**I.Gskt:** [1] Included



**OV8700** Heavy-Duty Hydraulic Indicator  
**Notes:** OBSOLETE. Availability Limited to Dealer Stock.  
**Contains:** Pop-Up Button  
**Use With:** By-Pass Valve Pressure of 25 PSID  
**Replaces:** Donaldson P162696



**OV8701** Heavy-Duty Hydraulic Indicator  
**Notes:** OBSOLETE. Availability Limited to Dealer Stock.  
**Contains:** Pop-up Button  
**Use With:** By-Pass Valve Pressure of 50 PSID  
**Replaces:** Donaldson P167580



**BT8510-MPG** Maximum Performance Glass Hydraulic Spin-on  
**Fits:** Hypac, Tigercat Equipment; Taylor Lift Trucks  
**Replaces:** Pall HC7500SKT8H  
**Thread:** 1 1/2 -16  
**O.D.:** 5 1/16 (128.6)  
**Height:** 10 3/4 (273.1)  
**F. Gskt:** [1] Included



**OS8703** Heavy-Duty Hydraulic Indicator  
**Notes:** OBSOLETE. Availability limited to Dealer Stock.  
**2-Wire AC/DC**  
**Use With:** By-Pass Valve Pressure of 50 PSID  
**Replaces:** Donaldson P171087



**PT8511** Hydraulic Element  
**Contains:** Grommet Seal Between Sections  
**Replaces:** Parker 924790; Donaldson P169558; Fleetguard HF7779  
**O.D.:** 3 1/2 (88.9)  
**I.D.:** 1 9/16 (39.7)  
**Height:** 18 9/16 (471.5)  
**Grommets:** [2] Attached  
**Related To:** PT8470 (Single-Length Version)



Measurements Are Shown In Inches And (Millimeters)

**WARNING:** These products can expose you to chemicals, including Diisononyl Phthalate, Carbon black extracts, Nickel, 1,3 Butadiene, Ethylene Oxide, Epichlorohydrin, which are known to the State of California to cause cancer, and Bisphenol, Ethylene Glycol, Ethylene Oxide, 1,3 Butadiene, Epichlorohydrin, which are known to the State of California to cause birth defects or other reproductive harm.

**OS8707**

Heavy-Duty Hydraulic Indicator



**Notes:** OBSOLETE. Availability limited to Dealer Stock.  
3-Wire AC/DC  
**Use With:** By-Pass Valve Pressure of 50 PSID  
**Replaces:** Donaldson P173893

**OP8709**

Hydraulic Plug



**Notes:** To be used with PureForce Hydraulic Bases where an indicator port plug is needed.  
**Replaces:** Donaldson P165983  
**Thread:** 9/16 -18  
**Length:** 1 3/16 (30.2)  
**O-Ring:** [2] Included

**OB8711**

Hydraulic Filter Base



**Contains:** 25 PSID By-Pass Valve  
Threaded Stud: 1 3/8-12  
[2] Indicator Ports with Plugs  
**Use With:** 4 Inch O.D. PureForce Filters  
**Replaces:** Donaldson P169317  
**O.D.:** 3 31/32 (100.8)  
**Inlet:** 3/4 In. NPT  
**Outlet:** 3/4 In. NPT  
**Height:** 4 (101.6)

**OB8712**

Hydraulic Filter Base with Indicator



**Contains:** 25 PSID By-Pass Valve  
Threaded Stud: 1 3/8-12  
[2] Indicator Ports  
Visual Indicator Mounted on Left Side  
**Use With:** 4 Inch O.D. PureForce Filters  
**Replaces:** Donaldson P169310  
**O.D.:** 3 31/32 (100.8)  
**Inlet:** 3/4 In. NPT  
**Outlet:** 3/4 In. NPT  
**Height:** 4 (101.6)

**OB8720**

Hydraulic Filter Base



**Contains:** Threaded Stud: 1 3/8-12  
**Use With:** 4 Inch O.D. PureForce Filters  
**Replaces:** Donaldson P165434  
**O.D.:** 3 31/32 (100.8)  
**Inlet:** 3/4 In. SAE O-Ring  
**Outlet:** 3/4 In. SAE O-Ring  
**Height:** 4 (101.6)

**OB8721**

Hydraulic Filter Base



**Contains:** 25 PSID By-Pass Valve  
Threaded Stud: 1 3/8-12  
[2] Indicator Ports with Plugs  
**Use With:** 4 Inch O.D. PureForce Filters  
**Replaces:** Donaldson P167473  
**O.D.:** 3 31/32 (100.8)  
**Inlet:** 3/4 In. SAE O-Ring  
**Outlet:** 3/4 In. SAE O-Ring  
**Height:** 4 (101.6)

**OB8722**

Hydraulic Filter Base with Indicator



**Contains:** 25 PSID By-Pass Valve  
Threaded Stud: 1 3/8-12  
[2] Indicator Ports  
Visual Indicator Mounted on Left Side  
**Use With:** 4 Inch O.D. PureForce Filters  
**Replaces:** Donaldson P166387  
**O.D.:** 3 31/32 (100.8)  
**Inlet:** 3/4 In. SAE O-Ring  
**Outlet:** 3/4 In. SAE O-Ring  
**Height:** 4 (101.6)

**OB8724**

Hydraulic Filter Base



**Contains:** 50 PSID By-Pass Valve  
Threaded Stud: 1 3/8-12  
[2] Indicator Ports  
**Use With:** 4 Inch O.D. PureForce Filters  
**O.D.:** 3 3/8 (85.7)  
**Inlet:** 3/4 In. SAE O-Ring  
**Outlet:** 3/4 In. SAE O-Ring  
**Height:** 4 (101.6)

**OV8728**

Heavy-Duty Hydraulic Indicator



**Notes:** OBSOLETE. Availability Limited to Dealer Stock.  
**Contains:** Auto Reset Pop-up Button  
Button Dust Cover  
**Use With:** By-Pass Valve Pressure of 50 PSID  
**Replaces:** Donaldson P167580

**OB8731**

Hydraulic Filter Base



**Contains:** 25 PSID By-Pass Valve  
Threaded Stud: 1 3/8-12  
[2] Indicator Ports with Plugs  
**Use With:** 4 Inch O.D. PureForce Filters  
**O.D.:** 3 31/32 (100.8)  
**Inlet:** 1 In. NPT  
**Outlet:** 1 In. NPT  
**Height:** 4 (101.6)

**OB8732**

Hydraulic Filter Base with Indicator



**Contains:** 25 PSID By-Pass Valve  
Threaded Stud: 1 3/8-12  
[2] Indicator Ports  
Visual Indicator Mounted on Left Side  
**Use With:** 4 Inch O.D. PureForce Filters  
**Replaces:** Donaldson P166416  
**O.D.:** 3 31/32 (100.8)  
**Inlet:** 1 In. NPT  
**Outlet:** 1 In. NPT  
**Height:** 4 (101.6)

**OB8741**

Hydraulic Filter Base



**Contains:** 25 PSID By-Pass Valve  
Threaded Stud: 1 3/8-12  
[2] Indicator Ports with Plugs  
**Use With:** 4 Inch O.D. PureForce Filters  
**Replaces:** Donaldson P163681  
**O.D.:** 3 31/32 (100.8)  
**Inlet:** 1 In. SAE O-Ring  
**Outlet:** 1 In. SAE O-Ring  
**Height:** 4 (101.6)

**OB8742**

Hydraulic Filter Base with Indicator



**Contains:** 25 PSID By-Pass Valve  
Threaded Stud: 1 3/8-12  
[2] Indicator Ports  
Visual Indicator Mounted on Left Side  
**Use With:** 4 Inch O.D. PureForce Filters  
**Replaces:** Donaldson P166417  
**O.D.:** 3 31/32 (100.8)  
**Inlet:** 1 In. SAE O-Ring  
**Outlet:** 1 In. SAE O-Ring  
**Height:** 4 (101.6)

Measurements Are Shown In Inches And (Millimeters)

**WARNING:** These products can expose you to chemicals, including Diisononyl Phthalate, Carbon black extracts, Nickel, 1,3 Butadiene, Ethylene Oxide, Epichlorohydrin, which are known to the State of California to cause cancer, and Bisphenol, Ethylene Glycol, Ethylene Oxide, 1,3 Butadiene, Epichlorohydrin, which are known to the State of California to cause birth defects or other reproductive harm.

**OB8743** Hydraulic Filter Base with Indicator  
**Notes:** Normally Open  
**Contains:** 25 PSID By-Pass Valve  
 Threaded Stud: 1 3/8-12  
 [2] Indicator Ports  
 Single Post Indicator Mounted on Left Side  
**Use With:** 4 Inch O.D. PureForce Filters  
**Replaces:** Donaldson P165537  
**O.D.:** 3 31/32 (100.8)  
**Inlet:** 1 In. SAE O-Ring  
**Outlet:** 1 In. SAE O-Ring  
**Height:** 4 (101.6)



**OP8753** Hex Head Plug  
**Notes:** Optional for BF1274-SP, BF1277-SP, BF1378-SPS  
**Thread:** M14 x 2.0  
**Length:** 11/16 (17.5)  
**O-Ring:** [1] Included



**OB8744** Hydraulic Filter Base  
**Contains:** 50 PSID By-Pass Valve  
 Threaded Stud: 1 3/8-12  
 [2] Indicator Ports with Plugs  
**Use With:** 4 Inch O.D. PureForce Filters  
**Replaces:** Donaldson P167201  
**O.D.:** 3 3/8 (85.7)  
**Inlet:** 1 In. SAE O-Ring  
**Outlet:** 1 In. SAE O-Ring  
**Height:** 4 (101.6)



**OB8771** Hydraulic Filter Base  
**Contains:** 25 PSID By-Pass Valve  
 Threaded Stud: 1 3/4-12  
 [2] Indicator Ports with Plugs  
**Use With:** 5 Inch O.D. PureForce Filters  
**O.D.:** 4 1/2 (114.3)  
**Inlet:** 1 1/4 In. NPT  
**Outlet:** 1 1/4 In. NPT  
**Height:** 5 (127.0)



**OB8745** Hydraulic Filter Base with Indicator  
**Contains:** 50 PSID By-Pass Valve  
 Threaded Stud: 1 3/8-12  
 [2] Indicator Ports  
 Visual Indicator Mounted on Left Side  
**Use With:** 4 Inch O.D. PureForce Filters  
**O.D.:** 3 31/32 (100.8)  
**Inlet:** 1 In. SAE O-Ring  
**Outlet:** 1 In. SAE O-Ring  
**Height:** 4 (101.6)



**OB8772** Hydraulic Filter Base  
**Contains:** 25 PSID By-Pass Valve  
 Threaded Stud: 1 3/4-12  
 [2] Indicator Ports  
 Visual Indicator Mounted on Left Side  
**Use With:** 5 Inch O.D. PureForce Filters  
**O.D.:** 4 1/2 (114.3)  
**Inlet:** 1 1/4 In. NPT  
**Outlet:** 1 1/4 In. NPT  
**Height:** 5 (127.0)



**OP8750** Hex Head Plug  
**Notes:** Optional for BF1223-SP, BF1329-SP.  
 Furnished with: BF1284-SP, BF1330-SP,  
 BF1351-SP, BF1358-SP, BF1374-SP,  
 BF1382-SP  
**Thread:** 9/16 -18  
**Length:** 11/16 (17.5)  
**O-Ring:** [1] Included



**OB8773** Hydraulic Filter Base with Indicator  
**Notes:** Normally Open  
**Contains:** 25 PSID By-Pass Valve  
 Threaded Stud: 1 3/4-12  
 [2] Indicator Ports  
 Single Post Indicator Mounted on Left Side  
**Use With:** 5 Inch O.D. PureForce Filters  
**Replaces:** Donaldson P167621  
**O.D.:** 4 1/2 (114.3)  
**Inlet:** 1 1/4 In. NPT  
**Outlet:** 1 1/4 In. NPT  
**Height:** 5 (127.0)



**OP8751** Hex Head Plug  
**Notes:** Optional for BF1222-SP, BF1345-SP  
**Thread:** 7/16 -20  
**Length:** 11/16 (17.5)  
**O-Ring:** [1] Included



**CFB8784** Dual Coolant Filter Base  
**Contains:** Threaded Stud: 11/16-16  
 [2] Brass Plugs  
**Fits:** All Coolant Spin-ons with 11/16-16  
 Thread  
**Inlet:** 3/8-18 NPT  
**Outlet:** 3/8-18 NPT  
**Length:** 8 3/16 (208.0)  
**Height:** 2 17/32 (64.3)



**OP8752** Hex Head Plug  
**Notes:** Optional for BF1204-SP, BF1205-SP,  
 BF1249-SP, BF1283-SP, BF1346-SP,  
 BF1348-SP, BF1355-SP  
**Thread:** 1/2 -20  
**Length:** 11/16 (17.5)  
**O-Ring:** [1] Included



**BT8800-MPG** Maximum Performance Glass Hydraulic Spin-on  
**Notes:** Uses 2 filters per application.  
**Fits:** John Deere Equipment  
**Replaces:** John Deere AT209204, AT210148  
**Thread:** 1 1/2 -16  
**O.D.:** 4 13/16 (122.2)  
**Height:** 11 9/16 (293.7)  
**I.Gskt:** [1] Included



Measurements Are Shown In Inches And (Millimeters)

**WARNING:** These products can expose you to chemicals, including Diisononyl Phthalate, Carbon black extracts, Nickel, 1,3 Butadiene, Ethylene Oxide, Epichlorohydrin, which are known to the State of California to cause cancer, and Bisphenol, Ethylene Glycol, Ethylene Oxide, 1,3 Butadiene, Epichlorohydrin, which are known to the State of California to cause birth defects or other reproductive harm.

**BT8801-MPG** Maximum Performance Glass Hydraulic Spin-on  
**Fits:** John Deere Equipment  
**Replaces:** John Deere AT184206; Komatsu 1233914-H1, 1233914-H2, 1233914-H4  
**Thread:** 1 1/2 -16  
**O.D.:** 4 13/16 (122.2)  
**Height:** 7 15/32 (189.7)  
**I.Gskt:** [1] Included



**BT8830** Transmission Spin-on  
**Contains:** 20 PSID By-Pass Valve  
**Fits:** Case, Clark, Fiat-Allis, Gradall, Volvo Equipment  
**Replaces:** Clark 247050; Fiat 73118171; Volvo 11993686, 119936862  
**Thread:** 2 -16  
**O.D.:** 3 11/16 (93.7)  
**Height:** 5 21/32 (143.7)  
**I.Gskt:** G401



**BT8802-MPG** Maximum Performance Glass Hydraulic Spin-on  
**Fits:** John Deere Equipment  
**Replaces:** John Deere AT103193  
**Thread:** 1 1/2 -16  
**O.D.:** 4 13/16 (122.2)  
**Height:** 7 15/32 (189.7)  
**I.Gskt:** [1] Included



**BT8831** Hydraulic Spin-on  
**Fits:** Clark Lift Trucks  
**Replaces:** Clark 2366807  
**Thread:** 2 -16  
**O.D.:** 3 11/16 (93.7)  
**Height:** 7 7/32 (183.4)  
**I.Gskt:** G401



**BT8803-MPG** Maximum Performance Glass Hydraulic Spin-on  
**Fits:** Hitachi Loaders  
**Replaces:** Hitachi 4230344  
**Thread:** 1 1/2 -16  
**O.D.:** 4 13/16 (122.2)  
**Height:** 11 9/16 (293.7)  
**I.Gskt:** [1] Included



**BT8832** Hydraulic Spin-on  
**Contains:** 20 PSID By-Pass Valve  
**Fits:** Hitachi Equipment; Hyster Lift Trucks  
**Replaces:** Hyster 1315621  
**Thread:** 2 -16  
**O.D.:** 3 11/16 (93.7)  
**Height:** 7 7/32 (183.4)  
**I.Gskt:** G401



**BT8805-MPG** Maximum Performance Glass Transmission Spin-on  
**Fits:** John Deere Equipment  
**Replaces:** John Deere AT167763, AT172912  
**Thread:** 1 1/2 -16  
**O.D.:** 4 13/16 (122.2)  
**Height:** 11 15/32 (291.3)  
**I.Gskt:** [1] Included



**BT8833** Hydraulic or Transmission Spin-on  
**Contains:** 35 PSID By-Pass Valve  
**Fits:** Hyundai Loaders  
**Replaces:** Clark 247052; Taylor 3939002  
**Thread:** 2 -16  
**O.D.:** 3 11/16 (93.7)  
**Height:** 7 7/32 (183.4)  
**I.Gskt:** G401



**BT8812-MPG** Maximum Performance Glass Hydraulic Spin-on  
**Fits:** John Deere Equipment  
**Replaces:** John Deere AT144879  
**Thread:** 1 1/2 -16  
**O.D.:** 4 13/16 (122.2)  
**Height:** 7 15/32 (189.7)  
**I.Gskt:** [1] Included



**BT8834-MPG** Maximum Performance Glass Hydraulic Spin-on  
**Contains:** Viton gasket for high heat applications  
**Fits:** Caterpillar Equipment; Freeman Hay Balers  
**Use With:** OB8711, OB8712, OB8720, OB8721, OB8722, OB8724, OB8731, OB8732, OB8741, OB8742, OB8743, OB8744, OB8745, OB8746 bases.  
**Replaces:** Ingersoll-Rand 39911615  
**Thread:** 1 3/8 -12  
**O.D.:** 3 13/16 (96.8)  
**Height:** 9 7/16 (239.7)  
**I.Gskt:** [1] Included



**BT8813-MPG** Maximum Performance Glass Hydraulic Spin-on  
**Fits:** John Deere Equipment  
**Replaces:** John Deere AT140315  
**Thread:** 1 1/2 -16  
**O.D.:** 4 13/16 (122.2)  
**Height:** 11 9/16 (293.7)  
**I.Gskt:** [1] Included



Measurements Are Shown In Inches And (Millimeters)

**WARNING:** These products can expose you to chemicals, including Diisononyl Phthalate, Carbon black extracts, Nickel, 1,3 Butadiene, Ethylene Oxide, Epichlorohydrin, which are known to the State of California to cause cancer, and Bisphenol, Ethylene Glycol, Ethylene Oxide, 1,3 Butadiene, Epichlorohydrin, which are known to the State of California to cause birth defects or other reproductive harm.



**BT8840-MPG** Maximum Performance Glass Hydraulic Spin-on  
**Notes:** Rated 1000 PSI minimum burst.  
**Fits:** Bobcat, Case, Caterpillar, Ingram, John Deere, Vermeer Equipment  
**Use With:** OB8711, OB8712, OB8720, OB8721, OB8722, OB8724, OB8731, OB8732, OB8741, OB8742, OB8743, OB8744, OB8745, OB8746 bases.  
**Replaces:** Case A165029; Clark 6630977; Melroe-Bobcat 6661248; Vermeer 81902001  
**Thread:** 1 3/8 -12  
**O.D.:** 3 3/4 (95.3)  
**Height:** 6 1/8 (155.6)  
**I.Gskt:** [1] Included



**BT8845** Hydraulic Spin-on  
**Notes:** Rated 1000 PSI minimum burst.  
**Fits:** Caterpillar, Dynapac Equipment  
**Use With:** OB8711, OB8712, OB8720, OB8721, OB8722, OB8724, OB8731, OB8732, OB8741, OB8742, OB8743, OB8744, OB8745, OB8746 bases.  
**Replaces:** Caterpillar 90-2900  
**Thread:** 1 3/8 -12  
**O.D.:** 3 3/4 (95.3)  
**Height:** 6 1/8 (155.6)  
**I.Gskt:** [1] Included



**BT8841-MPG** Maximum Performance Glass Hydraulic Spin-on  
**Notes:** Rated 1000 PSI minimum burst.  
**Fits:** J.C. Bamford, John Deere, Komatsu Equipment; Ingersoll-Rand Compressors  
**Use With:** OB8711, OB8712, OB8720, OB8721, OB8722, OB8724, OB8731, OB8732, OB8741, OB8742, OB8743, OB8744, OB8745, OB8746 bases.  
**Replaces:** Ingersoll-Rand 58887936; J.C. Bamford 32/905501; John Deere AL77061; New Holland 82003166  
**Thread:** 1 3/8 -12  
**O.D.:** 3 3/4 (95.3)  
**Height:** 6 3/32 (154.8)  
**I.Gskt:** [1] Included



**BT8846** Hydraulic Spin-on  
**Notes:** Rated 1000 PSI minimum burst.  
**Fits:** Case, Ditch Witch, Magnum, Vermeer Equipment  
**Use With:** OB8711, OB8712, OB8720, OB8721, OB8722, OB8724, OB8731, OB8732, OB8741, OB8742, OB8743, OB8744, OB8745, OB8746 bases.  
**Replaces:** Case D122562; Vermeer 67581001  
**Thread:** 1 3/8 -12  
**O.D.:** 3 3/4 (95.3)  
**Height:** 6 1/8 (155.6)  
**I.Gskt:** [1] Included



**BT8842-MPG** Maximum Performance Glass Hydraulic Spin-on  
**Notes:** Rated 1000 PSI minimum burst.  
**Fits:** Case, Caterpillar Equipment; Swinger Loaders; Thermo King Compressors  
**Use With:** OB8711, OB8712, OB8720, OB8721, OB8722, OB8724, OB8731, OB8732, OB8741, OB8742, OB8743, OB8744, OB8745, OB8746 bases.  
**Replaces:** Ford 3576-P165354; Thermo King 66-4917  
**Thread:** 1 3/8 -12  
**O.D.:** 3 3/4 (95.3)  
**Height:** 6 1/8 (155.6)  
**I.Gskt:** [1] Included



**BT8847** Hydraulic Spin-on  
**Notes:** Rated 1000 PSI minimum burst.  
**Fits:** Toro Equipment  
**Use With:** OB8711, OB8712, OB8720, OB8721, OB8722, OB8724, OB8731, OB8732, OB8741, OB8742, OB8743, OB8744, OB8745, OB8746 bases.  
**Replaces:** Ingersoll-Rand 39136650  
**Thread:** 1 3/8 -12  
**O.D.:** 3 3/4 (95.3)  
**Height:** 6 1/8 (155.6)  
**I.Gskt:** [1] Included



**BT8843-MPG** Maximum Performance Glass Hydraulic Spin-on  
**Contains:** 50 PSID Front-End By-Pass Valve By-Pass Screen  
**Replaces:** Clark 2792962  
**Thread:** 7/8 -14  
**O.D.:** 3 3/4 (95.3)  
**Height:** 6 1/32 (153.2)  
**I.Gskt:** [1] Included



**BT8848-MPG** Maximum Performance Glass Hydraulic Spin-on  
**Notes:** Rated 1000 PSI minimum burst.  
**Fits:** John Deere, New Holland Loaders  
**Use With:** OB8711, OB8712, OB8720, OB8721, OB8722, OB8724, OB8731, OB8732, OB8741, OB8742, OB8743, OB8744, OB8745, OB8746 bases.  
**Replaces:** John Deere M124541; New Holland 9800633, 9842392, 89842392  
**Thread:** 1 3/8 -12  
**O.D.:** 3 3/4 (95.3)  
**Height:** 8 1/32 (204.0)  
**I.Gskt:** [1] Included



**BT8844** Hydraulic Spin-on  
**Notes:** Rated 1000 PSI minimum burst.  
**Fits:** Bobcat, Michigan, TCM Loaders  
**Use With:** OB8711, OB8712, OB8720, OB8721, OB8722, OB8724, OB8731, OB8732, OB8741, OB8742, OB8743, OB8744, OB8745, OB8746 bases.  
**Replaces:** Clark 6599543  
**Thread:** 1 3/8 -12  
**O.D.:** 3 3/4 (95.3)  
**Height:** 6 1/8 (155.6)  
**I.Gskt:** [1] Included



**BT8849-MPG** Maximum Performance Glass Hydraulic Spin-on  
**Notes:** Rated 1000 PSI minimum burst.  
**Use With:** OB8711, OB8712, OB8720, OB8721, OB8722, OB8724, OB8731, OB8732, OB8741, OB8742, OB8743, OB8744, OB8745, OB8746 bases.  
**Thread:** 1 3/8 -12  
**O.D.:** 3 3/4 (95.3)  
**Height:** 6 3/32 (154.8)  
**I.Gskt:** [1] Included



Measurements Are Shown In Inches And (Millimeters)

**WARNING:** These products can expose you to chemicals, including Diisononyl Phthalate, Carbon black extracts, Nickel, 1,3 Butadiene, Ethylene Oxide, Epichlorohydrin, which are known to the State of California to cause cancer, and Bisphenol, Ethylene Glycol, Ethylene Oxide, 1,3 Butadiene, Epichlorohydrin, which are known to the State of California to cause birth defects or other reproductive harm.

**BT8850-MPG**



Maximum Performance Glass Hydraulic Spin-on  
**Notes:** Rated 1000 PSI minimum burst.  
 NOT interchangeable with BT8851-MPG.  
**Fits:** Case, Case-International, Caterpillar, Daewoo, Fiat-Allis, John Deere, Kawasaki, New Holland, Steiger, Thomas Equipment  
**Use With:** OB8711, OB8712, OB8720, OB8721, OB8722, OB8724, OB8731, OB8732, OB8741, OB8742, OB8743, OB8744, OB8745, OB8746 bases.  
**Replaces:** Case D94236; Caterpillar 9T5916; Fiat 73144499; John Deere RE34958  
**Thread:** 1 3/8 -12  
**O.D.:** 3 3/4 (95.3)  
**Height:** 9 17/32 (242.1)  
**I.Gskt:** [1] Included

**BT8851-MPG**



Maximum Performance Glass Hydraulic Spin-on  
**Notes:** Rated 1000 PSI minimum burst.  
 NOT interchangeable with BT8850-MPG.  
**Fits:** Agco, Caterpillar, Cedarapids, Ford, Gehl, John Deere, New Holland, Vermeer, V.M.E., Volvo Equipment  
**Use With:** OB8711, OB8712, OB8720, OB8721, OB8722, OB8724, OB8731, OB8732, OB8741, OB8742, OB8743, OB8744, OB8745, OB8746 bases.  
**Replaces:** Agco 303506819; Caterpillar 1G8878; Cedarapids 451750014101; John Deere RE47313; New Holland 89821387; Vermeer 73113001; V.M.E. 110366077  
**Thread:** 1 3/8 -12  
**O.D.:** 3 3/4 (95.3)  
**Height:** 9 19/32 (243.7)  
**I.Gskt:** [1] Included

**BT8852-MPG**



Maximum Performance Glass Hydraulic Spin-on  
**Notes:** Rated 1000 PSI minimum burst.  
**Fits:** John Deere Equipment  
**Use With:** OB8711, OB8712, OB8720, OB8721, OB8722, OB8724, OB8731, OB8732, OB8741, OB8742, OB8743, OB8744, OB8745, OB8746 bases.  
**Replaces:** John Deere AH128449  
**Thread:** 1 3/8 -12  
**O.D.:** 3 3/4 (95.3)  
**Height:** 9 19/32 (243.7)  
**I.Gskt:** [1] Included

**BT8853-MPG**



Maximum Performance Glass Hydraulic Spin-on  
**Notes:** Rated 1000 PSI minimum burst.  
**Fits:** Case, Caterpillar Equipment  
**Use With:** OB8711, OB8712, OB8720, OB8721, OB8722, OB8724, OB8731, OB8732, OB8741, OB8742, OB8743, OB8744, OB8745, OB8746 bases.  
**Replaces:** Case N14232; John Deere RE39390  
**Thread:** 1 3/8 -12  
**O.D.:** 3 3/4 (95.3)  
**Height:** 9 17/32 (242.1)  
**I.Gskt:** [1] Included

**BT8855-MPG**



Maximum Performance Glass Hydraulic Spin-on  
**Notes:** Rated 1000 PSI minimum burst.  
**Fits:** Various Hydraulic Applications  
**Use With:** OB8711, OB8712, OB8720, OB8721, OB8722, OB8724, OB8731, OB8732, OB8741, OB8742, OB8743, OB8744, OB8745, OB8746 bases.  
**Replaces:** Donaldson P167590  
**Thread:** 1 3/8 -12  
**O.D.:** 3 3/4 (95.3)  
**Height:** 9 19/32 (243.7)  
**I.Gskt:** [1] Included

**BT8856-MPG**



Maximum Performance Glass Hydraulic Spin-on  
**Notes:** Rated 1000 PSI minimum burst.  
**Fits:** Sakai Equipment  
**Use With:** OB8711, OB8712, OB8720, OB8721, OB8722, OB8724, OB8731, OB8732, OB8741, OB8742, OB8743, OB8744, OB8745, OB8746 bases.  
**Replaces:** Koehring 853531235, 8535301235  
**Thread:** 1 3/8 -12  
**O.D.:** 3 3/4 (95.3)  
**Height:** 9 19/32 (243.7)  
**I.Gskt:** [1] Included

**BT8861**



Hydraulic Spin-on  
**Notes:** Rated 1000 PSI minimum burst.  
**Fits:** Bobcat Loaders; Case Equipment  
**Use With:** OB8711, OB8712, OB8720, OB8721, OB8722, OB8724, OB8731, OB8732, OB8741, OB8742, OB8743, OB8744, OB8745, OB8746 bases.  
**Replaces:** Case D126922; Champion 44419; Timberjack 8428088; Versatile 79446  
**Thread:** 1 3/8 -12  
**O.D.:** 3 3/4 (95.3)  
**Height:** 9 19/32 (243.7)  
**I.Gskt:** [1] Included

**BT8862**



Hydraulic Spin-on  
**Notes:** Rated 1000 PSI minimum burst.  
**Fits:** Champion, Versatile Equipment  
**Use With:** OB8711, OB8712, OB8720, OB8721, OB8722, OB8724, OB8731, OB8732, OB8741, OB8742, OB8743, OB8744, OB8745, OB8746 bases.  
**Replaces:** Case N7332  
**Thread:** 1 3/8 -12  
**O.D.:** 3 3/4 (95.3)  
**Height:** 9 19/32 (243.7)  
**I.Gskt:** [1] Included

**BT8863**



Hydraulic Spin-on  
**Notes:** Rated 1000 PSI minimum burst.  
**Fits:** Timberjack Logging Equipment  
**Use With:** OB8711, OB8712, OB8720, OB8721, OB8722, OB8724, OB8731, OB8732, OB8741, OB8742, OB8743, OB8744, OB8745, OB8746 bases.  
**Replaces:** Case D89909  
**Thread:** 1 3/8 -12  
**O.D.:** 3 3/4 (95.3)  
**Height:** 9 19/32 (243.7)  
**I.Gskt:** [1] Included

Measurements Are Shown In Inches And (Millimeters)

**WARNING:** These products can expose you to chemicals, including Diisononyl Phthalate, Carbon black extracts, Nickel, 1,3 Butadiene, Ethylene Oxide, Epichlorohydrin, which are known to the State of California to cause cancer, and Bisphenol, Ethylene Glycol, Ethylene Oxide, 1,3 Butadiene, Epichlorohydrin, which are known to the State of California to cause birth defects or other reproductive harm.

**BT8870-MPG** Maximum Performance Glass Hydraulic Spin-on  
**Notes:** Can be used with OB8771, OB8772, OB8773 bases.  
**Fits:** Case-International, Caterpillar, John Deere Equipment  
**Replaces:** International 1971728-C1; John Deere RE51797  
**Thread:** 1 3/4 -12  
**O.D.:** 4 23/32 (119.9)  
**Height:** 14 1/8 (358.8)  
**I.Gskt:** [1] Included  
**Related To:** BT9560-MPG (Micron Difference)



**BT8878-MPG** Maximum Performance Glass Hydraulic Spin-on  
**Notes:** Can be used with OB8771, OB8772, OB8773 bases.  
**Fits:** Caterpillar, Champion Equipment  
**Replaces:** Champion 45543  
**Thread:** 1 3/4 -12  
**O.D.:** 4 23/32 (119.9)  
**Height:** 11 17/32 (292.9)  
**I.Gskt:** [1] Included



**BT8873** Hydraulic Spin-on  
**Notes:** Can be used with OB8771, OB8772, OB8773 bases.  
**Fits:** Champion, Clark, Daewoo, Link-Belt, V.M.E., Volvo Equipment  
**Replaces:** Champion 37104; Clark 243622, 965899  
**Thread:** 1 3/4 -12  
**O.D.:** 4 3/4 (120.7)  
**Height:** 11 17/32 (292.9)  
**I.Gskt:** [1] Included



**BT8879-MPG** Maximum Performance Glass Hydraulic Spin-on  
**Notes:** Can be used with OB8771, OB8772, OB8773 bases.  
**Fits:** Caterpillar, Timberjack, Volvo Equipment  
**Replaces:** Timberjack F434370  
**Thread:** 1 3/4 -12  
**O.D.:** 4 23/32 (119.9)  
**Height:** 11 17/32 (292.9)  
**I.Gskt:** [1] Included



**BT8874-MPG** Maximum Performance Glass Hydraulic Spin-on  
**Notes:** Can be used with OB8771, OB8772, OB8773 bases.  
**Fits:** Case, Ford, John Deere, New Holland, Versatile Equipment  
**Replaces:** Case N9086, A49386; John Deere AT112393; New Holland 9821388  
**Thread:** 1 3/4 -12  
**O.D.:** 4 23/32 (119.9)  
**Height:** 11 17/32 (292.9)  
**I.Gskt:** [1] Included



**BT8880-MPG** Maximum Performance Glass Hydraulic Spin-on  
**Notes:** Can be used with OB8771, OB8772, OB8773 bases.  
**Fits:** Ford, New Holland Equipment; Versatile Tractors  
**Replaces:** New Holland 9706161, 89706161  
**Thread:** 1 3/4 -12  
**O.D.:** 4 23/32 (119.9)  
**Height:** 7 3/4 (196.9)  
**I.Gskt:** [1] Included



**BT8875-MPG** Maximum Performance Glass Hydraulic Spin-on  
**Notes:** Can be used with OB8771, OB8772, OB8773 bases.  
**Fits:** Caterpillar Crawler Tractors  
**Replaces:** Caterpillar 9T6636  
**Thread:** 1 3/4 -12  
**O.D.:** 4 23/32 (119.9)  
**Height:** 7 3/4 (196.9)  
**I.Gskt:** [1] Included



**PT8883** Hydraulic Element  
**Fits:** Drott Equipment; Poclain Excavators  
**Replaces:** Case R1050586  
**O.D.:** 3 25/32 (96.0)  
**I.D.:** 13/32 (10.3) & 2 11/16 (68.3)  
**Height:** 6 23/32 (170.7)  
**A. Gskt:** [1] Attached



**BT8876-MPG** Maximum Performance Glass Hydraulic Spin-on  
**Notes:** Can be used with OB8771, OB8772, OB8773 bases.  
**Fits:** Caterpillar, Champion Equipment; Ingersoll-Rand Compressors; Volvo Motor Graders  
**Replaces:** Caterpillar 9T0973; Champion 49076; Ingersoll-Rand 51302214  
**Thread:** 1 3/4 -12  
**O.D.:** 4 3/4 (120.7)  
**Height:** 11 19/32 (294.5)  
**I.Gskt:** [1] Included



**PT8884-MPG** Wire Mesh Supported Maximum Performance Glass Hydraulic Element  
**Contains:** Viton O-Ring for high heat applications.  
**Replaces:** Parker 932636Q, 983061  
**O.D.:** 3 19/32 (91.3)  
**I.D.:** 1 29/32 (48.4) One End  
**Height:** 7 27/32 (199.2)  
**O-Ring:** [1] Included



**BT8877-MPG** Maximum Performance Glass Hydraulic Spin-on  
**Notes:** Can be used with OB8771, OB8772, OB8773 bases.  
**Fits:** Various Hydraulic Applications  
**Replaces:** Donaldson P170906  
**Thread:** 1 3/4 -12  
**O.D.:** 4 23/32 (119.9)  
**Height:** 11 17/32 (292.9)  
**I.Gskt:** [1] Included













**PT8885-MPG** Wire Mesh Supported Maximum Performance Glass Hydraulic Element  
**Replaces:** Schroeder KZ25  
**O.D.:** 3 29/32 (99.2)  
**I.D.:** 1 5/8 (41.3)  
**Height:** 9 1/8 (231.8)  
**Grommets:** [2] Attached



Measurements Are Shown In Inches And (Millimeters)

**WARNING:** These products can expose you to chemicals, including Diisononyl Phthalate, Carbon black extracts, Nickel, 1,3 Butadiene, Ethylene Oxide, Epichlorohydrin, which are known to the State of California to cause cancer, and Bisphenol, Ethylene Glycol, Ethylene Oxide, 1,3 Butadiene, Epichlorohydrin, which are known to the State of California to cause birth defects or other reproductive harm.

<p><b>BT8886-MPG</b></p> 	<p>Maximum Performance Glass Hydraulic Spin-on  <b>Fits:</b> Ag-Chem Ro-Gators; Caterpillar Equipment  <b>Replaces:</b> Ag-Chem 714122; Donaldson P173702  <b>Thread:</b> 2 -12  <b>O.D.:</b> 3 1/8 (79.4)  <b>Height:</b> 9 17/32 (242.1)</p>	<p><b>BT8892-MPG</b> Maximum Performance Glass Hydraulic Spin-on  <b>Fits:</b> Ingersoll-Rand Compressors  <b>Use With:</b> OB8771, OB8772, OB8773 bases.  <b>Replaces:</b> Ingersoll-Rand 36860336; Donaldson P165672  <b>Thread:</b> 1 3/4 -12  <b>O.D.:</b> 4 23/32 (119.9)  <b>Height:</b> 11 17/32 (292.9)  <b>I.Gskt:</b> [1] Included</p>
<p><b>PT8887</b></p> 	<p>Hydraulic Element  <b>Contains:</b> Viton O-Ring for high heat applications  <b>Fits:</b> Terex Equipment  <b>Replaces:</b> Parker 922625; Donaldson P164556; Fleetguard HF7739  <b>O.D.:</b> 2 3/8 (60.3)  <b>I.D.:</b> 1 (25.4) One End  <b>Height:</b> 5 5/16 (134.9)  <b>O-Ring:</b> [1] Attached</p>	<p><b>PT8893</b> Hydraulic Element  <b>Fits:</b> Caterpillar Excavators  <b>Replaces:</b> Caterpillar 93-5369  <b>O.D.:</b> 4 13/32 (111.9)  <b>I.D.:</b> 2 3/4 (69.9)  <b>Height:</b> 11 9/16 (293.7)</p> 
<p><b>PT8888</b></p> 	<p>Hydraulic Element  <b>Replaces:</b> Schroeder CC10; Donaldson P171315; Fleetguard HF7314  <b>O.D.:</b> 2 7/8 (73.0)  <b>I.D.:</b> 1 (25.4) One End  <b>Height:</b> 9 5/8 (244.5)  <b>I.Gskt:</b> [1] Included</p>	<p><b>PT8894-MPG</b> Wire Mesh Supported Maximum Performance Glass Hydraulic Element  <b>Fits:</b> Liebherr Excavators  <b>Replaces:</b> Liebherr 7363107  <b>O.D.:</b> 1 27/32 (46.8)  <b>I.D.:</b> 7/8 (22.2) One End  <b>Height:</b> 3 5/16 (84.1)  <b>O-Ring:</b> [1] Attached</p> 
<p><b>PT8889</b></p> 	<p>Hydraulic Element  <b>Fits:</b> Caterpillar Excavators  <b>Replaces:</b> Caterpillar 94-3229  <b>O.D.:</b> 5 29/32 (150.0)  <b>I.D.:</b> 4 11/32 (110.3)  <b>Height:</b> 11 13/16 (300.0)  <b>O-Ring:</b> [1] Included</p>	<p><b>PT8895-MPG</b> Wire Mesh Supported Maximum Performance Glass Hydraulic Element  <b>Fits:</b> Case-International, New Holland Tractors  <b>Replaces:</b> Case N3150506; Fleetguard HF30196  <b>O.D.:</b> 2 3/32 (53.2)  <b>I.D.:</b> 7/8 (22.2) One End  <b>Height:</b> 4 9/16 (115.9)  <b>O-Ring:</b> [1] Attached</p> 
<p><b>BT8890-MPG</b></p> 	<p>Maximum Performance Glass Hydraulic Spin-on  <b>Fits:</b> John Deere Compact Utility Tractors  <b>Replaces:</b> John Deere LVA11522  <b>Thread:</b> 1 1/2 -16  <b>O.D.:</b> 4 21/32 (118.3)  <b>Height:</b> 6 9/32 (159.5)  <b>I.Gskt:</b> [1] Included</p>	<p><b>PT8896</b> Hydraulic Element  <b>Fits:</b> Samsung, Volvo Excavators  <b>Replaces:</b> Volvo 104100130  <b>O.D.:</b> 5 29/32 (150.0)  <b>I.D.:</b> 4 11/32 (110.3)  <b>Height:</b> 17 23/32 (450.1)</p> 
<p><b>PT8891-MPG</b></p> 	<p>Maximum Performance Glass 2-Section Hydraulic Element  <b>Contains:</b> Grommet Seal Between Sections  <b>Fits:</b> Hood Forestry Equipment  <b>Replaces:</b> Parker 932410, 932694Q; Donaldson P174914; Fleetguard HF35000  <b>O.D.:</b> 3 11/16 (93.7)  <b>I.D.:</b> 1 9/16 (39.7) One End  <b>Height:</b> 18 15/16 (481.0)  <b>Grommets:</b> [1] Attached</p>	<p><b>PT8897-MPG</b> Wire Mesh Supported Maximum Performance Glass Hydraulic Element  <b>Contains:</b> 87 PSID By-Pass Valve  <b>Fits:</b> Case Excavators  <b>Replaces:</b> Case C2950511  <b>O.D.:</b> 2 7/8 (73.0)  <b>I.D.:</b> 1 11/32 (34.1) One End  <b>Height:</b> 15 5/32 (385.0)  <b>O-Ring:</b> [1] Attached</p> 

Measurements Are Shown In Inches And (Millimeters)

**WARNING:** These products can expose you to chemicals, including Diisononyl Phthalate, Carbon black extracts, Nickel, 1,3 Butadiene, Ethylene Oxide, Epichlorohydrin, which are known to the State of California to cause cancer, and Bisphenol, Ethylene Glycol, Ethylene Oxide, 1,3 Butadiene, Epichlorohydrin, which are known to the State of California to cause birth defects or other reproductive harm.

**BT8898** Hydraulic Spin-on  
**Fits:** Hitachi, Kubota Excavators, Loaders  
**Replaces:** Kubota 6813-16-2130  
**Thread:** 1 1/8 -16  
**O.D.:** 3 11/16 (93.7)  
**Height:** 5 21/32 (143.7)  
**I.Gskt:** G401



**BT8904-MPG** Maximum Performance Glass Hydraulic Spin-on  
**Notes:** Rated 1000 PSI minimum burst.  
 Dome end accepts 1/2 In. socket driver.  
**Fits:** John Deere Tractors  
**Replaces:** John Deere AL156625; Mann & Hummel WH945  
**Thread:** 1 3/8 -12  
**O.D.:** 3 3/4 (95.3)  
**Height:** 6 11/32 (161.1)  
**I.Gskt:** [1] Included



**BT8899** Hydraulic Spin-on  
**Contains:** 15 PSID By-Pass Valve By-Pass Screen  
**Fits:** New Holland Tractors  
**Replaces:** New Holland 5174044  
**Thread:** 1 3/4 -16  
**O.D.:** 5 3/8 (136.5)  
**Height:** 7 (177.8)  
**I.Gskt:** [1] Included



**BT8905** Hydraulic Spin-on  
**Fits:** Case-International, Ford, New Holland Mowers, Tractors  
**Replaces:** Ford SBA340500770, SBA340500890; New Holland 87300195, 87300196; Fleetguard HF35254  
**Thread:** 3/4 -16  
**O.D.:** 3 23/32 (94.5)  
**Height:** 3 7/8 (98.4)  
**I.Gskt:** G324-A



**BT8900** Stainless Steel Mesh Hydraulic Spin-on  
**Contains:** 100 Mesh Media  
**Fits:** Kubota Tractors  
**Replaces:** Kubota 35861-82630  
**Thread:** 1 -12  
**O.D.:** 3 11/16 (93.7)  
**Height:** 7 3/16 (182.6)  
**I.Gskt:** G401



**BT8906** Hydraulic Spin-on  
**Contains:** Retainer Ring  
**Fits:** Samsung, Volvo Excavators  
**Replaces:** Volvo 104207040; Fleetguard HF7935  
**Thread:** M48 x 2.0  
**O.D.:** 5 9/32 (134.1)  
**Height:** 6 27/32 (173.8)  
**I.Gskt:** [1] Included



**BT8901-MPG** Maximum Performance Glass Hydraulic Spin-on  
**Fits:** Case-International Tractors  
**Replaces:** Case 1976934C4, 1976934C5  
**Thread:** 1 1/2 -16  
**O.D.:** 5 1/32 (127.8)  
**Height:** 6 31/32 (177.0)  
**F. Gskt:** G369-B, G372, G447



**PT8907-MPG** Wire Mesh Supported Maximum Performance Glass Hydraulic Element  
**Fits:** Case-International Tractors  
**Replaces:** Case 93402-C1, 93413-C1  
**O.D.:** 5 3/32 (129.4)  
**I.D.:** 2 9/16 (65.1)  
**Height:** 3 (76.2)  
**A. Gskt:** [2] Attached  
**O-Ring:** [3] Included  
**Related To:** PT565 (Standard Media Version)



**BT8902** Hydraulic Spin-on  
**Fits:** Kubota Tractors  
**Replaces:** Kubota 67955-37710  
**Thread:** M20 x 1.5  
**O.D.:** 3 (76.2)  
**Height:** 4 13/16 (122.2)  
**I.Gskt:** [1] Included



**BT8908** Hydraulic Spin-on  
**Fits:** Kubota Excavators  
**Replaces:** Kubota 68051-62220; Yanmar 172638-73730  
**Thread:** 3/4 -16  
**O.D.:** 3 1/32 (77.0)  
**Height:** 4 3/32 (104.0)  
**I.Gskt:** [1] Included



**BT8903** Hydraulic Spin-on  
**Fits:** Industrial Applications  
**Replaces:** LHA SPE25-25; PTI F4E040DCB; Donaldson P550256  
**Thread:** 1 -12  
**O.D.:** 3 11/16 (93.7)  
**Height:** 8 25/32 (223.0)  
**I.Gskt:** G401



**PT8909** Hydraulic Element  
**Fits:** Link-Belt, Sumitomo Excavators  
**Replaces:** Case 159274A1; Link-Belt KRJ3836  
**O.D.:** 5 29/32 (150.0)  
**I.D.:** 4 11/32 (110.3)  
**Height:** 17 29/32 (454.8)  
**A. Gskt:** [2] Attached



Measurements Are Shown In Inches And (Millimeters)

**WARNING:** These products can expose you to chemicals, including Diisononyl Phthalate, Carbon black extracts, Nickel, 1,3 Butadiene, Ethylene Oxide, Epichlorohydrin, which are known to the State of California to cause cancer, and Bisphenol, Ethylene Glycol, Ethylene Oxide, 1,3 Butadiene, Epichlorohydrin, which are known to the State of California to cause birth defects or other reproductive harm.

**BT8910-MPG**

Maximum Performance Glass Hydraulic Spin-on



**Notes:** Can be used with OB8771, OB8772, OB8773 bases.  
**Fits:** John Deere Tractors  
**Replaces:** John Deere RE38965; Donaldson P173521  
**Thread:** 1 3/4 -12  
**O.D.:** 4 23/32 (119.9)  
**Height:** 11 17/32 (292.9)  
**I.Gskt:** [1] Included

**BT8911-MPG**

Maximum Performance Glass Hydraulic Spin-on



**Fits:** New Holland Loaders  
**Use With:** OB8771, OB8772, OB8773 bases.  
**Replaces:** New Holland 85802793; Donaldson P176779  
**Thread:** 1 3/4 -12  
**O.D.:** 4 23/32 (119.9)  
**Height:** 11 17/32 (292.9)  
**I.Gskt:** [1] Included

**PT8912**

Hydraulic Element



**Fits:** Fiat-Allis, New Holland Motor Graders  
**Replaces:** New Holland 73125853  
**O.D.:** 5 1/8 (130.2)  
**I.D.:** 3 3/8 (85.7)  
**Height:** 9 (228.6)

**BT8913-MPG**

Maximum Performance Glass Hydraulic Spin-on



**Replaces:** MP Filtri CS50A25; Woodgate WGH9166  
**Thread:** 3/4 -14 BSP-PL  
**O.D.:** 3 3/4 (95.3)  
**Height:** 5 23/32 (145.3)

**BT8914**

Hydraulic Spin-on



**Contains:** Threaded hex nut for removal.  
**Replaces:** Fairey-Arlon CXX3-10; Fleetguard HF35135; Woodgate WGCX3-10  
**Thread:** M60 x 1.5  
**O.D.:** 3 31/32 (100.8)  
**Height:** 7 1/4 (184.2)

**BT8915**

Hydraulic Spin-on



**Contains:** Water Absorbent Media  
**Replaces:** Filtrec A121CW10; Woodgate WGH1792  
**Thread:** 1 1/4 -11 BSP-PL  
**O.D.:** 5 1/8 (130.2)  
**Height:** 8 29/32 (226.2)  
**I.Gskt:** [1] Included

**BT8916**

Hydraulic Spin-on



**Replaces:** New Holland 87761096; Woodgate WGH1819  
**Thread:** 3/4 -16  
**O.D.:** 3 11/16 (93.7)  
**Height:** 4 1/16 (103.2)  
**I.Gskt:** [1] Included

**BT8917**

Hydraulic Spin-on



**Replaces:** Mitsubishi 4060100260; Woodgate WGH1825  
**Thread:** M20 x 1.5  
**O.D.:** 3 1/8 (79.4)  
**Height:** 3 (76.2)  
**I.Gskt:** [1] Included

**BT8918**

Hydraulic Spin-on



**Fits:** Toro Lawn & Garden Tractors  
**Replaces:** Toro 67-8110; Fleetguard HF6357; Woodgate WGH1835  
**Thread:** 1 -12  
**O.D.:** 3 21/32 (92.9)  
**Height:** 4 1/4 (108.0)  
**I.Gskt:** [1] Included

**BT8919**

Hydraulic Spin-on



**Fits:** Kato Excavators  
**Replaces:** Kato 68935703032; Woodgate WGH1844  
**Thread:** M22 x 1.5  
**O.D.:** 3 7/8 (98.4)  
**Height:** 5 7/32 (132.6)  
**I.Gskt:** [1] Included

**BT8920**

Hydraulic Spin-on



**Fits:** Case-International, New Holland Tractors  
**Replaces:** Fiat-Iveco 1930986; Fleetguard HF28833; Woodgate WGH1906  
**Thread:** M40 x 2.0  
**O.D.:** 4 3/16 (106.4)  
**Height:** 7 1/16 (179.4)  
**I.Gskt:** [1] Included

**BT8921**

Hydraulic Spin-on



**Contains:** 3 PSID By-Pass Valve  
**Fits:** Deutz Tractors  
**Replaces:** Deutz 4411047; Woodgate WGH1915  
**Thread:** 1 1/2 -16  
**O.D.:** 5 11/32 (135.7)  
**Height:** 7 1/32 (178.6)  
**I.Gskt:** [1] Included

**BT8922**

Hydraulic Spin-on



**Contains:** 36 PSID By-Pass Valve  
**Replaces:** Manitou 137658; Fleetguard HF6315; Woodgate WGH6315  
**Thread:** 3/4 -16  
**O.D.:** 3 3/4 (95.3)  
**Height:** 5 25/32 (146.8)  
**I.Gskt:** [1] Included

Measurements Are Shown In Inches And (Millimeters)

**WARNING:** These products can expose you to chemicals, including Diisononyl Phthalate, Carbon black extracts, Nickel, 1,3 Butadiene, Ethylene Oxide, Epichlorohydrin, which are known to the State of California to cause cancer, and Bisphenol, Ethylene Glycol, Ethylene Oxide, 1,3 Butadiene, Epichlorohydrin, which are known to the State of California to cause birth defects or other reproductive harm.

**BT8926** Hydraulic Spin-on  
**Contains:** 51 PSID By-Pass Valve  
**Fits:** Deutz Tractors  
**Replaces:** Deutz 4399525; Fleetguard HF28818; Woodgate WGH950-5  
**Thread:** 1 -12  
**O.D.:** 3 21/32 (92.9)  
**Height:** 6 25/32 (172.2)  
**I.Gskt:** [1] Included



**BT8937** Hydraulic Spin-on  
**Replaces:** Benford 17032; Fleetguard HF6327; Woodgate WGH9994  
**Thread:** 1 1/2 -11 BSP-PL  
**O.D.:** 5 1/32 (127.8)  
**Height:** 7 19/32 (192.9)



**BT8927** Hydraulic Spin-on  
**Fits:** Hitachi Equipment; Kubota Excavators  
**Replaces:** Woodgate WGH9996  
**Thread:** 1 7/8 -12  
**O.D.:** 5 7/32 (132.6)  
**Height:** 6 7/8 (174.6)  
**I.Gskt:** [1] Included



**PT8938-MPG** Wire Mesh Supported Maximum Performance Glass Hydraulic Element  
**Notes:** OBSOLETE. Availability Limited to Dealer Stock.  
**Replaces:** Fairey-Arlon FTXW10RCC10; Woodgate WGFW10RCC-10  
**O.D.:** 7 15/16 (201.6)  
**I.D.:** 5 7/8 (149.2)  
**Height:** 13 (330.2)



**BT8928** Hydraulic Spin-on  
**Replaces:** MP Filtri CS50M60; Woodgate WGH9168  
**Thread:** 3/4 -14 BSP-PL  
**O.D.:** 3 3/4 (95.3)  
**Height:** 5 3/4 (146.0)



**PT8939-MPG** Wire Mesh Supported Maximum Performance Glass Hydraulic Element  
**Fits:** Demag Cranes  
**Replaces:** Demag 69022273; Fleetguard HF35271; Woodgate WGH1736  
**O.D.:** 4 21/32 (118.3)  
**I.D.:** 2 11/32 (59.5)  
**Height:** 6 9/16 (166.7)  
**O-Ring:** [2] Attached



**BT8930** Wire Mesh Hydraulic Spin-on  
**Replaces:** MP Filtri CS100M125; Woodgate WGH9177  
**Thread:** 1 1/4 -11 BSP-PL  
**O.D.:** 5 1/16 (128.6)  
**Height:** 7 3/32 (180.2)  
**I.Gskt:** [1] Included



**PT8940-MPG** Wire Mesh Supported Maximum Performance Glass Hydraulic Element  
**Fits:** Manitou Equipment  
**Replaces:** Manitou 563483; Woodgate WGH1794  
**O.D.:** 2 23/32 (69.1)  
**I.D.:** 1 5/32 (29.4)  
**Height:** 6 29/32 (175.4)  
**O-Ring:** [1] Attached



**BT8931** Wire Mesh Hydraulic Spin-on  
**Replaces:** MP Filtri CS150M60; Woodgate WGH9184  
**Thread:** 1 1/4 -11 BSP-PL  
**O.D.:** 5 1/16 (128.6)  
**Height:** 9 (228.6)



**PT8941-MPG** Wire Mesh Supported Maximum Performance Glass Hydraulic Element  
**Replaces:** Finn FC1073F025BS; Woodgate WGH1818  
**O.D.:** 4 5/32 (105.6)  
**I.D.:** 1 1/4 (31.8) & 2 27/32 (72.2)  
**Height:** 19 7/16 (493.7)  
**O-Ring:** [1] Attached



**BT8935** Hydraulic Spin-on  
**Contains:** 25 PSID By-Pass Valve  
**Fits:** New Holland Equipment  
**Replaces:** U.C.C. UC2408; Fleetguard HF7901; Woodgate WGUC2408  
**Thread:** 3/4 -14 BSP-PL  
**O.D.:** 3 3/4 (95.3)  
**Height:** 5 3/4 (146.0)  
**I.Gskt:** [1] Included





**PT8943-MPG** Wire Mesh Supported Maximum Performance Glass Hydraulic Element  
**Replaces:** Demag 694400; Woodgate WGH1960  
**O.D.:** 9 (228.6)  
**I.D.:** 7 3/32 (180.2)  
**Height:** 21 1/2 (546.1)  
**A. Gskt:** [2] Attached



Measurements Are Shown In Inches And (Millimeters)

**WARNING:** These products can expose you to chemicals, including Diisononyl Phthalate, Carbon black extracts, Nickel, 1,3 Butadiene, Ethylene Oxide, Epichlorohydrin, which are known to the State of California to cause cancer, and Bisphenol, Ethylene Glycol, Ethylene Oxide, 1,3 Butadiene, Epichlorohydrin, which are known to the State of California to cause birth defects or other reproductive harm.

<p><b>PT8945-MPG</b> Wire Mesh Supported Maximum Performance Glass Hydraulic Element  <b>Replaces:</b> Argo V3092308; Woodgate WGH3208  <b>O.D.:</b> 3 17/32 (89.7)  <b>I.D.:</b> 1 9/16 (39.7) One End  <b>Height:</b> 9 5/32 (232.6)  <b>O-Ring:</b> [1] Attached</p> 	<p><b>PT8952-MPG</b> Wire Mesh Supported Maximum Performance Glass Hydraulic Element  <b>Replaces:</b> Stauff SL014E10B; Woodgate WGH9860  <b>O.D.:</b> 1 27/32 (46.8)  <b>I.D.:</b> 1 (25.4) One End  <b>Height:</b> 3 11/16 (93.7)</p> 
<p><b>PT8946-MPG</b> Wire Mesh Supported Maximum Performance Glass Hydraulic Element  <b>Contains:</b> 36 PSID By-Pass Valve  <b>Replaces:</b> Argo V3052056; Woodgate WGH3556  <b>O.D.:</b> 1 13/16 (46.0)  <b>I.D.:</b> 3/4 (19.0) One End  <b>Height:</b> 7 27/32 (199.2)  <b>O-Ring:</b> [1] Attached</p> 	<p><b>PT8954-MPG</b> Wire Mesh Supported Maximum Performance Glass Hydraulic Element  <b>Fits:</b> Liebherr Equipment  <b>Replaces:</b> Hydac 110D020BNHC; Woodgate WGH11020DB  <b>O.D.:</b> 1 27/32 (46.8)  <b>I.D.:</b> 13/16 (20.6) One End  <b>Height:</b> 6 1/32 (153.2)  <b>O-Ring:</b> [1] Attached</p> 
<p><b>PT8947-MPG</b> Wire Mesh Supported Maximum Performance Glass Hydraulic Element  <b>Fits:</b> Caterpillar Excavators  <b>Replaces:</b> Atlas Copco 8231-1018-04; Woodgate WGH9164  <b>O.D.:</b> 4 2 1/32 (118.3)  <b>I.D.:</b> 2 11/32 (59.5)  <b>Height:</b> 6 13/32 (162.7)  <b>O-Ring:</b> [2] Attached</p> 	<p><b>PT8955-MPG</b> Wire Mesh Supported Maximum Performance Glass Hydraulic Element  <b>Fits:</b> Roadtec Equipment  <b>Replaces:</b> Hydac 160D010BH; Woodgate WGH16010DH  <b>O.D.:</b> 2 23/32 (69.1)  <b>I.D.:</b> 1 11/32 (34.1) One End  <b>Height:</b> 4 17/32 (115.1)  <b>O-Ring:</b> [1] Attached</p> 
<p><b>PT8948-MPG</b> Maximum Performance Glass Hydraulic Element with Bail Handle  <b>Contains:</b> 25 PSID By-Pass Valve  <b>Replaces:</b> MP Filtri MF1003AA10HB; Woodgate WGH9528  <b>O.D.:</b> 2 3/4 (69.9)  <b>I.D.:</b> 1 5/8 (41.3) One End  <b>Height:</b> 8 1/16 (204.8)  <b>O-Ring:</b> [1] Attached, [1] Included</p> 	<p><b>PT8956-MPG</b> Wire Mesh Supported Maximum Performance Glass Hydraulic Element with Bail Handle  <b>Contains:</b> 43 PSID By-Pass Valve  <b>Replaces:</b> Hydac 160R010BNHC; Woodgate WGH16010RB  <b>O.D.:</b> 2 7/8 (73.0)  <b>I.D.:</b> 1 13/32 (35.7) One End  <b>Height:</b> 5 21/32 (143.7)</p> 
<p><b>PT8950-MPG</b> Wire Mesh Supported Maximum Performance Glass Hydraulic Element with Bail Handle  <b>Contains:</b> 72 PSID By-Pass Valve  <b>Replaces:</b> MP Filtri MF7501AA25HB; Fleetguard HF35220; Woodgate WGH9592  <b>O.D.:</b> 5 1/8 (130.2)  <b>I.D.:</b> 2 15/32 (62.7) One End  <b>Height:</b> 16 7/32 (412.0)  <b>Spring:</b> [1] Included  <b>Grommets:</b> [1] Attached</p> 	<p><b>PT8957-MPG</b> Wire Mesh Supported Maximum Performance Glass Hydraulic Element  <b>Replaces:</b> Hydac 160D020BNHC; Fleetguard HF30702; Woodgate WGH16020DB  <b>O.D.:</b> 2 23/32 (69.1)  <b>I.D.:</b> 1 5/16 (33.3) One End  <b>Height:</b> 4 9/16 (115.9)  <b>O-Ring:</b> [1] Attached</p> 
<p><b>PT8951-MPG</b> Wire Mesh Supported Maximum Performance Glass Hydraulic Element  <b>Replaces:</b> MP Filtri CU630A25NA; Woodgate WGH9651  <b>O.D.:</b> 5 1/8 (130.2)  <b>I.D.:</b> 2 29/32 (73.8)  <b>Height:</b> 9 13/16 (249.2)  <b>O-Ring:</b> [2] Attached</p> 	<p><b>PT8958-MPG</b> Wire Mesh Supported Maximum Performance Glass Hydraulic Element with Bail Handle  <b>Contains:</b> 43 PSID By-Pass Valve  <b>Replaces:</b> Hydac 165R020BN3HC; Woodgate WGH165020RB  <b>O.D.:</b> 2 3/8 (60.3)  <b>I.D.:</b> 1 13/32 (35.7) One End  <b>Height:</b> 9 (228.6)</p> 

Measurements Are Shown In Inches And (Millimeters)

**WARNING:** These products can expose you to chemicals, including Diisononyl Phthalate, Carbon black extracts, Nickel, 1,3 Butadiene, Ethylene Oxide, Epichlorohydrin, which are known to the State of California to cause cancer, and Bisphenol, Ethylene Glycol, Ethylene Oxide, 1,3 Butadiene, Epichlorohydrin, which are known to the State of California to cause birth defects or other reproductive harm.



**PT8959-MPG**

Wire Mesh Supported Maximum Performance  
Glass Hydraulic Element



**Replaces:** Hydac 240D005BNHC; Woodgate WGHH24005DB  
**O.D.:** 2 23/32 (69.1)  
**I.D.:** 1 9/32 (32.5) One End  
**Height:** 6 27/32 (173.8)  
**O-Ring:** [1] Attached

**PT8970-MPG**

Wire Mesh Supported Maximum Performance  
Glass Hydraulic Element



**Notes:** Inside-Out Flow Direction  
**Replaces:** Fairey-Arlon TXW8BCC10; Fleetguard HF7958; Woodgate WGTW8BCC-10  
**O.D.:** 4 31/32 (126.2)  
**I.D.:** 13/32 (10.3) & 3 5/8 (92.1)  
**Height:** 15 11/32 (389.7)

**PT8960-MPG**

Wire Mesh Supported Maximum Performance  
Glass Hydraulic Element



**Replaces:** Hydac 30D010BNHC; Fleetguard HF30348; Woodgate WGH30010DB  
**O.D.:** 1 3/8 (34.9)  
**I.D.:** 1/2 (12.7) One End  
**Height:** 3 21/32 (92.9)  
**O-Ring:** [1] Attached

**PT8971-MPG**

Wire Mesh Supported Maximum Performance  
Glass Hydraulic Element



**Notes:** Inside-Out Flow Direction  
**Replaces:** Fleetguard HF7964; Woodgate WGTW8CCC-10  
**O.D.:** 4 31/32 (126.2)  
**I.D.:** 13/32 (10.3) & 3 5/8 (92.1)  
**Height:** 18 29/32 (480.2)  
**O-Ring:** [1] Attached

**PT8962-MPG**

Wire Mesh Supported Maximum Performance  
Glass Hydraulic Element



**Fits:** Telesco Pelle Loaders  
**Replaces:** Hydac 60D010BNHC; Fleetguard HF30710; Woodgate WGH60010DB  
**O.D.:** 1 27/32 (46.8)  
**I.D.:** 7/8 (22.2) One End  
**Height:** 3 5/16 (84.1)  
**O-Ring:** [1] Attached

**PT8972-MPG**

Wire Mesh Supported Maximum Performance  
Glass Hydraulic Element



**Fits:** Caterpillar Equipment  
**Replaces:** Argo V3051008; Woodgate WGH1939  
**O.D.:** 1 25/32 (45.2)  
**I.D.:** 13/16 (20.6) One End  
**Height:** 4 3/32 (104.0)  
**O-Ring:** [1] Attached

**PT8963-MPG**

Wire Mesh Supported Maximum Performance  
Glass Hydraulic Element



**Notes:** OBSOLETE. Availability Limited to Dealer Stock.  
**Replaces:** Woodgate WGTW3CC-25  
**O.D.:** 2 27/32 (72.2)  
**I.D.:** 11/32 (8.7) & 2 1/32 (51.6)  
**Height:** 5 29/32 (150.0)  
**O-Ring:** [1] Attached

**PT8974-MPG**

Wire Mesh Supported Maximum Performance  
Glass Hydraulic Element



**Replaces:** Terex 15266831; Woodgate WGH1964  
**O.D.:** 2 3/8 (60.3)  
**I.D.:** 1 13/32 (35.7) One End  
**Height:** 5 11/32 (135.7)  
**O-Ring:** [1] Attached

**PT8967-MPG**

Wire Mesh Supported Maximum Performance  
Glass Hydraulic Element



**Notes:** Inside-Out Flow Direction  
**Replaces:** Fairey-Arlon TXW5CC25; Woodgate WGTW5CC-25  
**O.D.:** 4 3/16 (106.4)  
**I.D.:** 13/32 (10.3) & 2 27/32 (72.2)  
**Height:** 10 9/32 (261.1)  
**O-Ring:** [1] Attached

**PT8975-MPG**

Wire Mesh Supported Maximum Performance  
Glass Hydraulic Element



**Fits:** Caterpillar, Fiat-Hitachi Excavators; Volvo Dump Trucks  
**Replaces:** Argo V3060708; Woodgate WGH3708  
**O.D.:** 2 3/16 (55.6)  
**I.D.:** 1 1/8 (28.6) One End  
**Height:** 2 23/32 (69.1)  
**O-Ring:** [1] Attached

**PT8969-MPG**

Wire Mesh Supported Maximum Performance  
Glass Hydraulic Element



**Notes:** Inside-Out Flow Direction  
**Replaces:** Fairey-Arlon TXW8ACC25; Woodgate WGTW8ACC-25  
**O.D.:** 4 31/32 (126.2)  
**I.D.:** 13/32 (10.3) & 3 5/8 (92.1)  
**Height:** 11 7/16 (290.5)  
**O-Ring:** [1] Attached

**PT8978-MPG**











Wire Mesh Supported Maximum Performance  
Glass Hydraulic Element

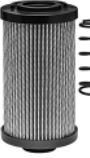

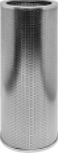
**Replaces:** MP Filtri HP1352A25NA; Woodgate WGH9268  
**O.D.:** 2 3/32 (53.2)  
**I.D.:** 1 1/32 (26.2) One End  
**Height:** 9 1/16 (230.2)  
**O-Ring:** [1] Attached

Measurements Are Shown In Inches And (Millimeters)

**WARNING:** These products can expose you to chemicals, including Diisononyl Phthalate, Carbon black extracts, Nickel, 1,3 Butadiene, Ethylene Oxide, Epichlorohydrin, which are known to the State of California to cause cancer, and Bisphenol, Ethylene Glycol, Ethylene Oxide, 1,3 Butadiene, Epichlorohydrin, which are known to the State of California to cause birth defects or other reproductive harm.

<p><b>PT8980-MPG</b></p> 	<p>Wire Mesh Supported Maximum Performance Glass Hydraulic Element  <b>Replaces:</b> MP Filtri HP3202A06NA; Woodgate WGH9336  <b>O.D.:</b> 3 1/16 (77.8)  <b>I.D.:</b> 1 17/32 (38.9) One End  <b>Height:</b> 9 1/4 (235.0)  <b>O-Ring:</b> [1] Attached</p>	<p><b>PT8987-MPG</b></p>  <p>Maximum Performance Glass Hydraulic Element  <b>Notes:</b> Inside-Out Flow Direction  <b>Replaces:</b> Fairey-Arlon TXW2CC10; Woodgate WGTW2CC-10  <b>O.D.:</b> 2 27/32 (72.2)  <b>I.D.:</b> 9/32 (7.1) &amp; 2 (50.8)  <b>Height:</b> 4 3/16 (106.4)  <b>O-Ring:</b> [1] Attached</p>
<p><b>PT8981-MPG</b></p> 	<p>Wire Mesh Supported Maximum Performance Glass Hydraulic Element with Bail Handle  <b>Contains:</b> 43 PSID By-Pass Valve  <b>Replaces:</b> Hydac 660R010BNHC; Donaldson P170619; Woodgate WGH66010RB  <b>O.D.:</b> 4 1/2 (114.3)  <b>I.D.:</b> 2 11/16 (68.3) One End  <b>Height:</b> 13 1/8 (333.4)</p>	<p><b>PT8989-MPG</b></p>  <p>Maximum Performance Glass Hydraulic Element with 2 Bail Handles  <b>Replaces:</b> J.C. Bamford 32/910801; Fleetguard HF35203; Woodgate WGH9520  <b>O.D.:</b> 2 3/4 (69.9)  <b>I.D.:</b> 1 3/32 (27.8) One End  <b>Height:</b> 5 7/32 (132.6)  <b>O-Ring:</b> [1] Attached</p>
<p><b>PT8982-MPG</b></p> 	<p>Wire Mesh Supported Maximum Performance Glass Hydraulic Element  <b>Notes:</b> Inside-Out Flow Direction  <b>Replaces:</b> Fairey-Arlon TXW4CC25; Woodgate WGTW4CC-25  <b>O.D.:</b> 4 5/32 (105.6)  <b>I.D.:</b> 5/8 (15.9) &amp; 2 27/32 (72.2)  <b>Height:</b> 7 7/16 (188.9)  <b>O-Ring:</b> [1] Attached</p>	<p><b>PT8990-MPG</b></p>  <p>Wire Mesh Supported Maximum Performance Glass Hydraulic Element  <b>Replaces:</b> Fairey-Arlon TXW12CC10; Fleetguard HF7966; Woodgate WGTW12CC-10  <b>O.D.:</b> 7 31/32 (202.4)  <b>I.D.:</b> 1/2 (12.7) &amp; 6 3/16 (157.2)  <b>Height:</b> 21 15/32 (545.3)  <b>O-Ring:</b> [1] Attached</p>
<p><b>PT8984-MPG</b></p> 	<p>Wire Mesh Supported Maximum Performance Glass Hydraulic Element  <b>Contains:</b> Viton gaskets for high heat applications  Spring Locator  <b>Replaces:</b> Fairey-Arlon 270Z105A; Woodgate WGAZ2715  <b>O.D.:</b> 2 29/32 (73.8)  <b>I.D.:</b> 1 1/4 (31.8) One End  <b>Height:</b> 4 1/8 (104.8)  <b>O-Ring:</b> [1] Viton Attached, [1] Viton Included</p>	<p><b>PT8991-MPG</b></p>  <p>Wire Mesh Supported Maximum Performance Glass Hydraulic Element  <b>Replaces:</b> Fairey-Arlon 170L210A; Woodgate WGAL1721  <b>O.D.:</b> 2 5/32 (54.8)  <b>I.D.:</b> 23/32 (18.3) One End  <b>Height:</b> 4 29/32 (124.6)  <b>O-Ring:</b> [1] Attached, [1] Included</p>
<p><b>PT8985-MPG</b></p> 	<p>Wire Mesh Supported Maximum Performance Glass Hydraulic Element  <b>Contains:</b> Viton gaskets for high heat applications  Spring Locator  <b>Replaces:</b> Fairey-Arlon 270Z215A; Woodgate WGAZ2721  <b>O.D.:</b> 2 29/32 (73.8)  <b>I.D.:</b> 1 1/4 (31.8) One End  <b>Height:</b> 9 11/32 (237.3)  <b>O-Ring:</b> [1] Viton Attached, [1] Viton Included</p>	<p><b>PT8992-MPG</b></p>  <p>Wire Mesh Supported Maximum Performance Glass Hydraulic Element  <b>Replaces:</b> Fairey-Arlon 370Z205A; Woodgate WGAZ3725  <b>O.D.:</b> 3 11/16 (93.7)  <b>I.D.:</b> 1 29/32 (48.4) One End  <b>Height:</b> 7 27/32 (199.2)  <b>O-Ring:</b> [1] Attached, [1] Included</p>
<p><b>PT8986-MPG</b></p> 	<p>Wire Mesh Supported Maximum Performance Glass Hydraulic Element  <b>Replaces:</b> Fairey-Arlon TXW3CC10; Woodgate WGTW3CC-10  <b>O.D.:</b> 2 27/32 (72.2)  <b>I.D.:</b> 5/8 (15.9) &amp; 1 25/32 (45.2)  <b>Height:</b> 5 29/32 (150.0)  <b>O-Ring:</b> [1] Attached</p>	<p><b>PT8993-MPG</b></p>  <p>Wire Mesh Supported Maximum Performance Glass Hydraulic Element  <b>Notes:</b> OBSOLETE. Availability Limited to Dealer Stock.  <b>Replaces:</b> Liebherr 7211191; Fleetguard HF6248; Woodgate WGH2504  <b>O.D.:</b> 3 15/16 (100.0)  <b>I.D.:</b> 1 7/8 (47.6) &amp; 3 1/8 (79.4)  <b>Height:</b> 13 5/8 (346.1)  <b>A. Gskt:</b> [2] Attached</p>

Measurements Are Shown In Inches And (Millimeters)

**WARNING:** These products can expose you to chemicals, including Diisononyl Phthalate, Carbon black extracts, Nickel, 1,3 Butadiene, Ethylene Oxide, Epichlorohydrin, which are known to the State of California to cause cancer, and Bisphenol, Ethylene Glycol, Ethylene Oxide, 1,3 Butadiene, Epichlorohydrin, which are known to the State of California to cause birth defects or other reproductive harm.

**PT8994-MPG**

Wire Mesh Supported Maximum Performance  
Glass Hydraulic Element



**Replaces:** Orenstein & Koppel 1771469;  
Fleetguard HF7560; Woodgate WGH4020  
**O.D.:** 5 3/8 (136.5)  
**Flange:** 5 15/16 (150.8)  
**I.D.:** 3 5/32 (80.2) One End  
**Height:** 14 3/32 (358.0)  
**A. Gskt:** [1] Attached

**H9001**

Wire Mesh Supported Hydraulic Element



**Contains:** Reinforced Centertube  
**Fits:** Terex Dump Trucks  
**Replaces:** Pall HC8300FKN8H, HC8300FUN8H;  
Terex 15265318  
**O.D.:** 5 31/32 (151.6)  
**I.D.:** 4 1/8 (104.8)  
**Height:** 8 3/16 (208.0)  
**I.Gskt:** [2] Included

**PT8995-MPG**

Wire Mesh Supported Maximum Performance  
Glass Hydraulic Element



**Replaces:** MP Filtri HP651A10NA; Woodgate  
WGH9191  
**O.D.:** 1 25/32 (45.2)  
**I.D.:** 1 1/32 (26.2) One End  
**Height:** 3 11/32 (84.9)  
**O-Ring:** [1] Attached

**H9007**

Wire Mesh Supported Hydraulic Element



**Contains:** Reinforced Centertube  
**Replaces:** Pall HC8300FKN16H,  
HC8300FUN16H  
**O.D.:** 5 31/32 (151.6)  
**I.D.:** 4 1/8 (104.8)  
**Height:** 16 27/32 (427.8)  
**I.Gskt:** [2] Included

**PT8996-MPG**

Wire Mesh Supported Maximum Performance  
Glass Hydraulic Element



**Replaces:** MP Filtri HP1351A25NA; Woodgate  
WGH9252  
**O.D.:** 2 3/32 (53.2)  
**I.D.:** 1 3/32 (27.8) One End  
**Height:** 4 11/16 (119.1)  
**O-Ring:** [1] Attached

**H9013**

Wire Mesh Supported Hydraulic Element



**Contains:** Reinforced Centertube  
**Replaces:** Pall HC8300FKN39H,  
HC8300FUN39H  
**O.D.:** 5 31/32 (151.6)  
**I.D.:** 4 1/8 (104.8)  
**Height:** 38 11/16 (982.7)  
**I.Gskt:** [2] Included

**PT8997-MPG**

Wire Mesh Supported Maximum Performance  
Glass Hydraulic Element with Bail Handle



**Contains:** By-Pass Valve  
**Replaces:** MP Filtri MF1801AA10HB; Woodgate  
WGH9533  
**O.D.:** 3 29/32 (99.2)  
**I.D.:** 1 9/16 (39.7) One End  
**Height:** 8 29/32 (226.2)  
**O-Ring:** [1] Included

**H9014**

Wire Mesh Supported Hydraulic Element



**Contains:** Reinforced Centertube  
**Replaces:** Pall HC8300FKS39H,  
HC8300FUS39H  
**O.D.:** 5 31/32 (151.6)  
**I.D.:** 4 5/32 (105.6)  
**Height:** 38 11/16 (982.7)  
**I.Gskt:** [2] Included

**PT8998-MPG**

Wire Mesh Supported Maximum Performance  
Glass Hydraulic Element



**Replaces:** Fairey-Arlon 170L110A; Fleetguard  
HF30668; Woodgate WGH1711  
**O.D.:** 2 5/32 (54.8)  
**I.D.:** 1 1/16 (17.5) One End  
**Height:** 2 23/32 (69.1)  
**O-Ring:** [1] Attached, [1] Included

**H9020**

Wire Mesh Supported Hydraulic Element



**Replaces:** Pall HC8400FKN16H,  
HC8400FUN16H  
**O.D.:** 6 (152.4)  
**I.D.:** 3 1/4 (82.6)  
**Height:** 16 7/8 (428.6)  
**I.Gskt:** [2] Included

**PT8999-MPG**

Wire Mesh Supported Maximum Performance  
Glass Hydraulic Element



**Replaces:** Fairey-Arlon TXW3DCC25;  
Woodgate WGTW3DCC-25  
**O.D.:** 2 27/32 (72.2)  
**I.D.:** 5/8 (15.9) & 1 25/32 (45.2)  
**Height:** 7 29/32 (200.8)  
**O-Ring:** [1] Attached

**H9021**













Wire Mesh Supported Hydraulic Element



**Contains:** Reinforced Centertube  
**Replaces:** Pall HC8400FKS16H,  
HC8400FUS16H  
**O.D.:** 6 (152.4)  
**I.D.:** 3 1/4 (82.6)  
**Height:** 16 7/8 (428.6)  
**I.Gskt:** [2] Included

Measurements Are Shown In Inches And (Millimeters)

**WARNING:** These products can expose you to chemicals, including Diisononyl Phthalate, Carbon black extracts, Nickel, 1,3 Butadiene, Ethylene Oxide, Epichlorohydrin, which are known to the State of California to cause cancer, and Bisphenol, Ethylene Glycol, Ethylene Oxide, 1,3 Butadiene, Epichlorohydrin, which are known to the State of California to cause birth defects or other reproductive harm.

<p><b>H9024</b></p> 	<p>Wire Mesh Supported Hydraulic Element  <b>Contains:</b> Reinforced Centertube  <b>Replaces:</b> Pall HC8400FKN26H, HC8400FUN26H  <b>O.D.:</b> 6 (152.4)  <b>I.D.:</b> 3 1/4 (82.6)  <b>Height:</b> 25 5/8 (650.9)  <b>I.Gskt:</b> [2] Included</p>	<p><b>H9043</b></p> 	<p>Wire Mesh Supported Hydraulic Element  <b>Replaces:</b> Pall HC9020FKS4H, HC9020FUS4H  <b>O.D.:</b> 1 3/4 (44.4)  <b>I.D.:</b> 1 1/32 (26.2) One End  <b>Height:</b> 4 15/32 (113.5)  <b>I.Gskt:</b> [1] Included</p>
<p><b>H9036</b></p> 	<p>Wire Mesh Supported Hydraulic Element  <b>Replaces:</b> Pall HC8500FKN13H, HC8500FUN13H  <b>O.D.:</b> 3 13/16 (96.8)  <b>I.D.:</b> 1 11/16 (42.9)  <b>Height:</b> 12 27/32 (326.2)  <b>I.Gskt:</b> [2] Included</p>	<p><b>H9043-V</b></p> 	<p>Wire Mesh Supported Hydraulic Element  <b>Contains:</b> Viton O-Ring for high heat applications.  <b>Fits:</b> Volvo Dump Trucks  <b>Replaces:</b> Volvo 11707525; Fleetguard HF30200  <b>O.D.:</b> 1 25/32 (45.2)  <b>I.D.:</b> 1 1/32 (26.2) One End  <b>Height:</b> 4 1/2 (114.3)  <b>O-Ring:</b> [1] Viton Attached</p>
<p><b>H9037</b></p> 	<p>Wire Mesh Supported Hydraulic Element  <b>Notes:</b> OBSOLETE. Availability Limited to Dealer Stock.  <b>Replaces:</b> Pall HC8500FKT13H, HC8500FUT13H  <b>O.D.:</b> 3 13/16 (96.8)  <b>I.D.:</b> 1 11/16 (42.9)  <b>Height:</b> 12 27/32 (326.2)  <b>I.Gskt:</b> [2] Included</p>	<p><b>H9044</b></p> 	<p>Wire Mesh Supported Hydraulic Element  <b>Fits:</b> Massey Ferguson Equipment  <b>Replaces:</b> Pall HC9020FKT4H, HC9020FUT4H  <b>O.D.:</b> 1 3/4 (44.4)  <b>I.D.:</b> 1 1/32 (26.2) One End  <b>Height:</b> 4 15/32 (113.5)  <b>I.Gskt:</b> [1] Included</p>
<p><b>H9039</b></p> 	<p>Wire Mesh Supported Hydraulic Element  <b>Notes:</b> OBSOLETE. Availability Limited to Dealer Stock.  <b>Fits:</b> Tamrock Drills  <b>Replaces:</b> Pall HC8500FKN26H, HC8500FUN26H  <b>O.D.:</b> 3 13/16 (96.8)  <b>I.D.:</b> 1 11/16 (42.9)  <b>Height:</b> 25 21/32 (651.7)  <b>I.Gskt:</b> [2] Included</p>	<p><b>H9045</b></p> 	<p>Wire Mesh Supported Hydraulic Element  <b>Replaces:</b> Pall HC9020FKP8H, HC9020FUP8H  <b>O.D.:</b> 1 3/4 (44.4)  <b>I.D.:</b> 1 1/32 (26.2) One End  <b>Height:</b> 8 7/32 (208.8)  <b>I.Gskt:</b> [1] Included</p>
<p><b>H9041</b></p> 	<p>Wire Mesh Supported Hydraulic Element  <b>Replaces:</b> Pall HC9020FKP4H, HC9020FUP4H  <b>O.D.:</b> 1 25/32 (45.2)  <b>I.D.:</b> 1 1/32 (26.2) One End  <b>Height:</b> 4 1/2 (114.3)  <b>I.Gskt:</b> [1] Included</p>	<p><b>H9046</b></p> 	<p>Wire Mesh Supported Hydraulic Element  <b>Replaces:</b> Pall HC9020FKN8H, HC9020FUN8H  <b>O.D.:</b> 1 3/4 (44.4)  <b>I.D.:</b> 1 1/32 (26.2) One End  <b>Height:</b> 8 7/32 (208.8)  <b>I.Gskt:</b> [1] Included</p>
<p><b>H9042</b></p> 	<p>Wire Mesh Supported Hydraulic Element  <b>Fits:</b> Caterpillar Off-Highway Trucks  <b>Replaces:</b> Pall HC9020FKN4H, HC9020FUN4H  <b>O.D.:</b> 1 3/4 (44.4)  <b>I.D.:</b> 1 1/32 (26.2) One End  <b>Height:</b> 4 15/32 (113.5)  <b>I.Gskt:</b> [1] Included</p>	<p><b>H9047</b></p> 	<p>Wire Mesh Supported Hydraulic Element  <b>Replaces:</b> Pall HC9020FKS8H, HC9020FUS8H  <b>O.D.:</b> 1 3/4 (44.4)  <b>I.D.:</b> 1 1/32 (26.2) One End  <b>Height:</b> 8 7/32 (208.8)  <b>I.Gskt:</b> [1] Included  <b>Related To:</b> H9052 (with Viton Gasket)</p>

Measurements Are Shown In Inches And (Millimeters)

 **WARNING:** These products can expose you to chemicals, including Diisononyl Phthalate, Carbon black extracts, Nickel, 1,3 Butadiene, Ethylene Oxide, Epichlorohydrin, which are known to the State of California to cause cancer, and Bisphenol, Ethylene Glycol, Ethylene Oxide, 1,3 Butadiene, Epichlorohydrin, which are known to the State of California to cause birth defects or other reproductive harm.

**H9048**



Wire Mesh Supported Hydraulic Element

**Replaces:** Pall HC9020FKT8H, HC9020FUT8H  
**O.D.:** 1 3/4 (44.4)  
**I.D.:** 1 1/32 (26.2) One End  
**Height:** 8 7/32 (208.8)  
**I.Gskt:** [1] Included

**H9055**



Wire Mesh Supported Hydraulic Element

**Replaces:** Pall HC9021FKT8H, HC9021FUT8H  
**O.D.:** 1 3/4 (44.4)  
**I.D.:** 1 (25.4) One End  
**Height:** 8 7/32 (208.8)  
**I.Gskt:** [1] Included  
**Related To:** H9056 (with Viton Seal)

**H9049**



Wire Mesh Supported Hydraulic Element

**Replaces:** Pall HC9021FKP4H, HC9021FUP4H  
**O.D.:** 1 3/4 (44.4)  
**I.D.:** 1 (25.4) One End  
**Height:** 4 1/2 (114.3)  
**I.Gskt:** [1] Included

**H9056**



Wire Mesh Supported Hydraulic Element

**Replaces:** Pall HC9021FKT8Z, HC9021FUT8Z  
**O.D.:** 1 25/32 (45.2)  
**I.D.:** 1 1/32 (26.2) One End  
**Height:** 8 5/32 (207.2)  
**I.Gskt:** [1] Included  
**Related To:** H9055 (with Nitrile Seal)

**H9050**



Wire Mesh Supported Hydraulic Element

**Replaces:** Pall HC9021FKP4Z, HC9021FUP4Z  
**O.D.:** 1 3/4 (44.4)  
**I.D.:** 1 (25.4) One End  
**Height:** 4 1/2 (114.3)  
**I.Gskt:** [1] Included

**H9058**



Wire Mesh Supported Hydraulic Element

**Replaces:** Pall HC9400FKN13H,  
HC9400FUN13H  
**O.D.:** 3 25/32 (96.0)  
**I.D.:** 2 3/16 (55.6)  
**Height:** 13 3/16 (335.0)  
**I.Gskt:** [2] Included

**H9051**



Wire Mesh Supported Hydraulic Element

**Replaces:** Pall HC9021FKP8H, HC9021FUP8H  
**O.D.:** 1 3/4 (44.4)  
**I.D.:** 1 (25.4) One End  
**Height:** 8 7/32 (208.8)  
**I.Gskt:** [1] Included

**H9060**



Wire Mesh Supported Hydraulic Element

**Replaces:** Pall HC9400FKT13H,  
HC9400FUT13H  
**O.D.:** 3 25/32 (96.0)  
**I.D.:** 2 3/16 (55.6)  
**Height:** 13 3/16 (335.0)  
**I.Gskt:** [2] Included

**H9052**



Wire Mesh Supported Hydraulic Element

**Contains:** Viton gasket for high heat applications  
**Replaces:** Parker 932618Q; Fleetguard HF30237  
**O.D.:** 1 25/32 (45.2)  
**I.D.:** 1 (25.4) One End  
**Height:** 8 7/32 (208.8)  
**I.Gskt:** [1] Included  
**Related To:** H9047 (with Buna N Gasket)

**H9062**



Wire Mesh Supported Hydraulic Element

**Replaces:** Pall HC9400FKN26H,  
HC9400FUN26H  
**O.D.:** 3 25/32 (96.0)  
**I.D.:** 2 3/16 (55.6)  
**Height:** 25 15/16 (658.8)  
**I.Gskt:** [2] Included

**H9054**



Wire Mesh Supported Hydraulic Element

**Replaces:** Pall HC9021FKT4Z, HC9021FUT4Z  
**O.D.:** 1 3/4 (44.4)  
**I.D.:** 1 (25.4) One End  
**Height:** 4 1/2 (114.3)  
**I.Gskt:** [1] Included

**H9069**















Wire Mesh Supported Hydraulic Element

**Replaces:** Pall HC9600FKP4H, HC9600FUP4H  
**O.D.:** 3 1/8 (79.4)  
**I.D.:** 1 11/16 (42.9) One End  
**Height:** 4 5/8 (117.5)  
**I.Gskt:** [1] Included

Measurements Are Shown In Inches And (Millimeters)

**WARNING:** These products can expose you to chemicals, including Diisononyl Phthalate, Carbon black extracts, Nickel, 1,3 Butadiene, Ethylene Oxide, Epichlorohydrin, which are known to the State of California to cause cancer, and Bisphenol, Ethylene Glycol, Ethylene Oxide, 1,3 Butadiene, Epichlorohydrin, which are known to the State of California to cause birth defects or other reproductive harm.

<p><b>H9070</b></p> 	<p>Wire Mesh Supported Hydraulic Element  <b>Replaces:</b> Pall HC9600FKN4H, HC9600FUN4H  <b>O.D.:</b> 3 1/8 (79.4)  <b>I.D.:</b> 1 11/16 (42.9) One End  <b>Height:</b> 4 5/8 (117.5)  <b>I.Gskt:</b> [1] Included</p>	<p><b>H9075</b></p>  <p>Wire Mesh Supported Hydraulic Element  <b>Fits:</b> Bomag, Caterpillar, John Deere, Massey Ferguson, Tamrock Equipment  <b>Replaces:</b> Pall HC9600FKS8H, HC9600FUS8H  <b>O.D.:</b> 3 1/8 (79.4)  <b>I.D.:</b> 1 11/16 (42.9) One End  <b>Height:</b> 8 1/4 (209.6)  <b>I.Gskt:</b> [1] Included</p>
<p><b>H9071</b></p> 	<p>Wire Mesh Supported Hydraulic Element  <b>Fits:</b> Bomag Paving Equipment; J.C. Bamford, V.M.E., Volvo Equipment  <b>Replaces:</b> Pall HC9600FKS4H, HC9600FUS4H; V.M.E. 4881701; Volvo 1191331  <b>O.D.:</b> 3 1/8 (79.4)  <b>I.D.:</b> 1 11/16 (42.9) One End  <b>Height:</b> 4 5/8 (117.5)  <b>I.Gskt:</b> [1] Included</p>	<p><b>H9075-V</b></p>  <p>Wire Mesh Supported Hydraulic Element  <b>Contains:</b> Viton gasket for high heat applications.  <b>Fits:</b> Volvo Motor Graders  <b>Replaces:</b> Volvo 12733419; Parker 932655Q; Donaldson P164365  <b>O.D.:</b> 3 1/8 (79.4)  <b>I.D.:</b> 1 11/16 (42.9) One End  <b>Height:</b> 8 1/4 (209.6)  <b>I.Gskt:</b> [1] Viton</p>
<p><b>H9072</b></p> 	<p>Wire Mesh Supported Hydraulic Element  <b>Fits:</b> Case, John Deere Tractors  <b>Replaces:</b> Case K946095; Pall HC9600FKT4H, HC9600FUT4H  <b>O.D.:</b> 3 1/8 (79.4)  <b>I.D.:</b> 1 11/16 (42.9) One End  <b>Height:</b> 4 5/8 (117.5)  <b>I.Gskt:</b> [1] Included</p>	<p><b>H9076</b></p>  <p>Wire Mesh Supported Hydraulic Element  <b>Replaces:</b> Pall HC9600FKT8H, HC9600FUT8H  <b>O.D.:</b> 3 1/8 (79.4)  <b>I.D.:</b> 1 11/16 (42.9) One End  <b>Height:</b> 8 1/4 (209.6)  <b>I.Gskt:</b> [1] Included</p>
<p><b>H9072-V</b></p> 	<p>Wire Mesh Supported Hydraulic Element  <b>Contains:</b> Viton gasket for high heat applications  <b>Fits:</b> Case Tractors  <b>Replaces:</b> Pall HC9600FUT4Z; Woodgate WGPT9604Z  <b>O.D.:</b> 3 3/32 (78.6)  <b>I.D.:</b> 1 11/16 (42.9) One End  <b>Height:</b> 4 19/32 (116.7)  <b>I.Gskt:</b> [1] Included</p>	<p><b>H9076-V</b></p>  <p>Wire Mesh Supported Hydraulic Element  <b>Contains:</b> Viton gasket for high heat applications  <b>Replaces:</b> Pall HC9600FUT8Z; WGPT9608Z  <b>O.D.:</b> 3 3/32 (78.6)  <b>I.D.:</b> 1 21/32 (42.1) One End  <b>Height:</b> 8 3/16 (208.0)  <b>I.Gskt:</b> [1] Included  <b>O-Ring:</b> [1] Included</p>
<p><b>H9073</b></p> 	<p>Wire Mesh Supported Hydraulic Element  <b>Fits:</b> Caterpillar, CMI Equipment  <b>Replaces:</b> Pall HC9600FKP8H, HC9600FUP8H  <b>O.D.:</b> 3 1/8 (79.4)  <b>I.D.:</b> 1 11/16 (42.9) One End  <b>Height:</b> 8 1/4 (209.6)  <b>I.Gskt:</b> [1] Included</p>	<p><b>H9077</b></p>  <p>Wire Mesh Supported Hydraulic Element  <b>Replaces:</b> Pall HC9600FKP13H, HC9600FUP13H  <b>O.D.:</b> 3 1/8 (79.4)  <b>I.D.:</b> 1 11/16 (42.9) One End  <b>Height:</b> 12 31/32 (329.4)  <b>I.Gskt:</b> [1] Included</p>
<p><b>H9074</b></p> 	<p>Wire Mesh Supported Hydraulic Element  <b>Fits:</b> Bomag, Massey Ferguson, White Equipment  <b>Replaces:</b> Bomag 7993014; Pall HC9600FKN8H, HC9600FUN8H  <b>O.D.:</b> 3 1/8 (79.4)  <b>I.D.:</b> 1 11/16 (42.9) One End  <b>Height:</b> 8 1/4 (209.6)  <b>I.Gskt:</b> [1] Included</p>	<p><b>H9078</b></p>  <p>Wire Mesh Supported Hydraulic Element  <b>Fits:</b> Wirtgen Milling Machines  <b>Replaces:</b> Pall HC9600FKN13H, HC9600FUN13H  <b>O.D.:</b> 3 1/8 (79.4)  <b>I.D.:</b> 1 11/16 (42.9) One End  <b>Height:</b> 12 31/32 (329.4)  <b>I.Gskt:</b> [1] Included</p>

Measurements Are Shown In Inches And (Millimeters)

**WARNING:** These products can expose you to chemicals, including Diisononyl Phthalate, Carbon black extracts, Nickel, 1,3 Butadiene, Ethylene Oxide, Epichlorohydrin, which are known to the State of California to cause cancer, and Bisphenol, Ethylene Glycol, Ethylene Oxide, 1,3 Butadiene, Epichlorohydrin, which are known to the State of California to cause birth defects or other reproductive harm.

**H9078-V**



Wire Mesh Supported Hydraulic Element  
**Contains:** Viton gasket for high heat applications  
**Replaces:** Case 78660C1; General Motors 23049373; International 78660-C1; Parker G01982; Schroeder SBG96001383  
**O.D.:** 3 5/32 (80.2)  
**I.D.:** 1 23/32 (43.7) One End  
**Height:** 12 15/16 (328.6)  
**I.Gskt:** [1] Included

**H9084**



Wire Mesh Supported Hydraulic Element  
**Replaces:** Pall HC9600FKN16H, HC9600FUN16H  
**O.D.:** 3 1/8 (79.4)  
**I.D.:** 1 11/16 (42.9) One End  
**Height:** 16 7/8 (428.6)  
**I.Gskt:** [1] Included

**H9079**



Wire Mesh Supported Hydraulic Element  
**Replaces:** Pall HC9600FKS13H, HC9600FUS13H  
**O.D.:** 3 1/8 (79.4)  
**I.D.:** 1 11/16 (42.9) One End  
**Height:** 12 31/32 (329.4)  
**I.Gskt:** [1] Included

**H9085**



Wire Mesh Supported Hydraulic Element  
**Replaces:** Pall HC9600FUS16H, HC9600KUS16H  
**O.D.:** 3 1/8 (79.4)  
**I.D.:** 1 11/16 (42.9) One End  
**Height:** 16 7/8 (428.6)  
**I.Gskt:** [1] Included

**H9080**



Wire Mesh Supported Hydraulic Element  
**Replaces:** Pall HC9600FKT13H, HC9600FUT13H  
**O.D.:** 3 1/8 (79.4)  
**I.D.:** 1 11/16 (42.9) One End  
**Height:** 12 31/32 (329.4)  
**I.Gskt:** [1] Included

**H9086**



Wire Mesh Supported Hydraulic Element  
**Replaces:** Pall HC9600FKT16H, HC9600FUT16H  
**O.D.:** 3 1/8 (79.4)  
**I.D.:** 1 11/16 (42.9) One End  
**Height:** 16 7/8 (428.6)  
**I.Gskt:** [1] Included  
**Related To:** H9087 (with Viton Gasket)

**H9081**



Wire Mesh Supported Hydraulic Element  
**Replaces:** Pall HC9600FKP13Z, HC9600FUP13Z  
**O.D.:** 3 1/8 (79.4)  
**I.D.:** 1 11/16 (42.9) One End  
**Height:** 12 31/32 (329.4)  
**I.Gskt:** [1] Included

**H9087**



Wire Mesh Supported Hydraulic Element  
**Contains:** Viton gasket for high heat applications  
**Replaces:** Pall HC9600FKT16Z, HC9600FUT16Z  
**O.D.:** 3 1/8 (79.4)  
**I.D.:** 1 11/16 (42.9) One End  
**Height:** 16 7/8 (428.6)  
**O-Ring:** [1] Attached  
**Related To:** H9086 (with Buna N Gasket)

**H9082**



Wire Mesh Supported Hydraulic Element  
**Replaces:** Pall HC9600FKS13Z, HC9600FUS13Z  
**O.D.:** 3 1/8 (79.4)  
**I.D.:** 1 11/16 (42.9) One End  
**Height:** 12 31/32 (329.4)  
**I.Gskt:** [1] Included

**H9092**



Wire Mesh Supported Hydraulic Element  
**Contains:** Reinforced Centertube  
**Replaces:** Pall HC9601FKT8H, HC9601FUT8H  
**O.D.:** 3 5/32 (80.2)  
**I.D.:** 1 11/16 (42.9) One End  
**Height:** 8 1/4 (209.6)  
**I.Gskt:** [1] Included

**H9083**



Wire Mesh Supported Hydraulic Element  
**Replaces:** Pall HC9600FKP16H, HC9600FUP16H  
**O.D.:** 3 1/8 (79.4)  
**I.D.:** 1 11/16 (42.9) One End  
**Height:** 16 7/8 (428.6)  
**I.Gskt:** [1] Included













**H9093**



Wire Mesh Supported Hydraulic Element  
**Contains:** Reinforced Centertube  
**Replaces:** Pall HC9601FKT13H, HC9601FUT13H  
**O.D.:** 3 5/32 (80.2)  
**I.D.:** 1 11/16 (42.9) One End  
**Height:** 12 29/32 (327.8)  
**I.Gskt:** [1] Included

Measurements Are Shown In Inches And (Millimeters)

**WARNING:** These products can expose you to chemicals, including Diisononyl Phthalate, Carbon black extracts, Nickel, 1,3 Butadiene, Ethylene Oxide, Epichlorohydrin, which are known to the State of California to cause cancer, and Bisphenol, Ethylene Glycol, Ethylene Oxide, 1,3 Butadiene, Epichlorohydrin, which are known to the State of California to cause birth defects or other reproductive harm.

<p><b>H9096</b></p> 	<p>Wire Mesh Supported Hydraulic Element  <b>Replaces:</b> Pall HC9650FKN8H, HC9650FUN8H  <b>O.D.:</b> 3 1/8 (79.4)  <b>I.D.:</b> 1 23/32 (43.7)  <b>Height:</b> 8 3/8 (212.7)  <b>I.Gskt:</b> [2] Included</p>	<p><b>H9111</b></p> 	<p>Wire Mesh Supported Hydraulic Element  <b>Replaces:</b> Pall HC9800FKP8H, HC9800FUP8H  <b>O.D.:</b> 2 (50.8)  <b>I.D.:</b> 15/16 (23.8) One End  <b>Height:</b> 8 7/32 (208.8)  <b>I.Gskt:</b> [1] Included</p>
<p><b>H9097</b></p> 	<p>Wire Mesh Supported Hydraulic Element  <b>Replaces:</b> Pall HC9650FKS8H, HC9650FUS8H  <b>O.D.:</b> 3 1/8 (79.4)  <b>I.D.:</b> 1 23/32 (43.7)  <b>Height:</b> 8 3/8 (212.7)  <b>I.Gskt:</b> [2] Included</p>	<p><b>H9112</b></p> 	<p>Wire Mesh Supported Hydraulic Element  <b>Fits:</b> Massey Ferguson, Renault Tractors  <b>Replaces:</b> Pall HC9800FKN8H, HC9800FUN8H  <b>O.D.:</b> 2 (50.8)  <b>I.D.:</b> 15/16 (23.8) One End  <b>Height:</b> 8 7/32 (208.8)  <b>I.Gskt:</b> [1] Included</p>
<p><b>H9103</b></p> 	<p>Wire Mesh Supported Hydraulic Element  <b>Contains:</b> Reinforced Centertube  <b>Replaces:</b> Pall HC9651FKP8H, HC9651FUP8H  <b>O.D.:</b> 3 5/32 (80.2)  <b>I.D.:</b> 1 11/16 (42.9)  <b>Height:</b> 8 3/16 (208.0)  <b>I.Gskt:</b> [2] Included</p>	<p><b>H9113</b></p> 	<p>Wire Mesh Supported Hydraulic Element  <b>Replaces:</b> Pall HC9800FKS8H, HC9800FUS8H  <b>O.D.:</b> 2 (50.8)  <b>I.D.:</b> 15/16 (23.8) One End  <b>Height:</b> 8 7/32 (208.8)  <b>I.Gskt:</b> [1] Included</p>
<p><b>H9107</b></p> 	<p>Wire Mesh Supported Hydraulic Element  <b>Replaces:</b> Pall HC9800FKP4H, HC9800FUP4H  <b>O.D.:</b> 2 (50.8)  <b>I.D.:</b> 15/16 (23.8) One End  <b>Height:</b> 4 1/2 (114.3)  <b>I.Gskt:</b> [1] Included</p>	<p><b>H9114</b></p> 	<p>Wire Mesh Supported Hydraulic Element  <b>Replaces:</b> Pall HC9800FKT8H, HC9800FUT8H  <b>O.D.:</b> 2 (50.8)  <b>I.D.:</b> 15/16 (23.8) One End  <b>Height:</b> 8 7/32 (208.8)  <b>I.Gskt:</b> [1] Included</p>
<p><b>H9108</b></p> 	<p>Wire Mesh Supported Hydraulic Element  <b>Replaces:</b> Pall HC9800FKN4H, HC9800FUN4H  <b>O.D.:</b> 2 (50.8)  <b>I.D.:</b> 15/16 (23.8) One End  <b>Height:</b> 4 1/2 (114.3)  <b>I.Gskt:</b> [1] Included</p>	<p><b>H9123</b></p> 	<p>Wire Mesh Supported Hydraulic Element  <b>Replaces:</b> Pall HC8800FDN16H, HC8800FKN16H  <b>O.D.:</b> 3 13/32 (86.5)  <b>I.D.:</b> 1 15/16 (49.2) One End  <b>Height:</b> 16 27/32 (427.8)  <b>I.Gskt:</b> [1] Included</p>
<p><b>H9110</b></p> 	<p>Wire Mesh Supported Hydraulic Element  <b>Fits:</b> Renault Engines  <b>Replaces:</b> Pall HC9800FKT4H, HC9800FUT4H  <b>O.D.:</b> 2 (50.8)  <b>I.D.:</b> 15/16 (23.8) One End  <b>Height:</b> 4 1/2 (114.3)  <b>I.Gskt:</b> [1] Included</p>	<p><b>PT9127</b></p> 	<p>Hydraulic Element  <b>Notes:</b> OBSOLETE. Availability Limited to Dealer Stock.  <b>Replaces:</b> Argo P2061302; Woodgate WGH1302  <b>O.D.:</b> 2 11/32 (59.5)  <b>I.D.:</b> 1 5/32 (29.4)  <b>Height:</b> 5 5/16 (134.9)  <b>A. Gskt:</b> [2] Attached</p>

Measurements Are Shown In Inches And (Millimeters)

 **WARNING:** These products can expose you to chemicals, including Diisononyl Phthalate, Carbon black extracts, Nickel, 1,3 Butadiene, Ethylene Oxide, Epichlorohydrin, which are known to the State of California to cause cancer, and Bisphenol, Ethylene Glycol, Ethylene Oxide, 1,3 Butadiene, Epichlorohydrin, which are known to the State of California to cause birth defects or other reproductive harm.



**PT9129**



Hydraulic Element with Lift Tab

**Contains:** By-Pass Valve  
**Replaces:** Argo K3102652; Woodgate WGH1937  
**O.D.:** 3 29/32 (99.2)  
 Flange 4 1/4 (108.0)  
**I.D.:** 13/32 (10.3) & 3/4 (19.0)  
**Height:** 10 31/32 (278.6)

**PT9137**



Hydraulic Element

**Replaces:** Orenstein & Koppel 1433860; Woodgate WGH1433  
**O.D.:** 1 25/32 (45.2)  
**I.D.:** 15/16 (23.8) One End  
**Height:** 4 15/32 (113.5)  
**O-Ring:** [1] Attached

**PT9131**



Hydraulic Element

**Contains:** Spring Locator  
**Fits:** Volvo Trucks  
**Replaces:** Volvo 15036627; Fleetguard HF6278; Woodgate WGH6278  
**O.D.:** 2 5/16 (58.7)  
**I.D.:** 1/2 (12.7)  
**Height:** 4 19/32 (116.7)  
**Grommets:** [2] Attached

**PT9139**



Hydraulic Element

**Contains:** Threaded hex nut for removal.  
**Fits:** Kubota Excavators  
**Replaces:** Kubota 6948162210; Woodgate WGH1788  
**Thread:** 1 1/2 -BSP-PL  
**O.D.:** 3 29/32 (99.2)  
**Height:** 5 5/32 (131.0)

**PT9132**



Hydraulic Element

**Replaces:** Fairey-Arlon FXX110; Fleetguard HF6273; Woodgate WGF1-10  
**O.D.:** 2 27/32 (72.2)  
**I.D.:** 2 1/32 (51.6)  
**Height:** 11 27/32 (300.8)

**PT9140**



Hydraulic Element

**Replaces:** U.C.C. EIL1115; Woodgate WGH1800  
**O.D.:** 2 11/32 (59.5)  
**I.D.:** 13/32 (10.3) & 1 1/2 (38.1)  
**Height:** 4 13/16 (122.2)

**PT9134**



Hydraulic Element

**Replaces:** Argo P3051005; Woodgate WGH1005  
**O.D.:** 1 25/32 (45.2)  
**I.D.:** 3/4 (19.0) One End  
**Height:** 4 1/16 (103.2)  
**O-Ring:** [1] Attached

**PT9142**



Hydraulic Element with Bail Handle

**Contains:** 25 PSID By-Pass Valve  
**Replaces:** J.C. Bamford PP1775, PPP17775; MP Filtri MF0301P25N, MF0301P25NB; Woodgate WGH1860  
**O.D.:** 2 1/16 (52.4)  
**I.D.:** 31/32 (24.6) One End  
**Height:** 2 7/8 (73.0)

**PT9135**



Hydraulic Element

**Replaces:** Argo P3071301; Fleetguard HF28802; Woodgate WGH1301  
**O.D.:** 2 3/4 (69.9)  
**I.D.:** 1 31/32 (50.0) One End  
**Height:** 5 9/32 (134.1)  
**O-Ring:** [1] Attached, [1] Included

**PT9143**



Hydraulic Element with Bail Handle

**Contains:** By-Pass Valve  
**Replaces:** MP Filtri MF0202P10NB; Woodgate WGH1882  
**O.D.:** 1 23/32 (43.7)  
**I.D.:** 27/32 (21.4)  
**Height:** 6 23/32 (170.7)  
**O-Ring:** [1] Attached

**PT9136**



Hydraulic Element

**Contains:** By-Pass Valve  
**Replaces:** Argo P3061352; Fleetguard HF35194; Woodgate WGH1352  
**O.D.:** 2 1/4 (57.2)  
**I.D.:** 1 1/16 (27.0) One End  
**Height:** 5 3/8 (136.5)  
**O-Ring:** [1] Attached

**PT9144**



Hydraulic Element with Bail Handle

**Contains:** By-Pass Valve  
**Replaces:** Schroeder 8Z10; Woodgate WGH1899  
**O.D.:** 3 3/32 (78.6)  
**I.D.:** 1 5/8 (41.3) One End  
**Height:** 8 1/8 (206.4)

Measurements Are Shown In Inches And (Millimeters)

**WARNING:** These products can expose you to chemicals, including Diisononyl Phthalate, Carbon black extracts, Nickel, 1,3 Butadiene, Ethylene Oxide, Epichlorohydrin, which are known to the State of California to cause cancer, and Bisphenol, Ethylene Glycol, Ethylene Oxide, 1,3 Butadiene, Epichlorohydrin, which are known to the State of California to cause birth defects or other reproductive harm.

<p><b>PT9145</b></p> 	<p>Wire Mesh Supported Hydraulic Element  <b>Replaces:</b> Finn FFP AVL1102825AB; Woodgate WGH1902  <b>O.D.:</b> 2 27/32 (72.2)  <b>I.D.:</b> 1 11/32 (8.7) &amp; 1 25/32 (45.2)  <b>Height:</b> 5 29/32 (150.0)</p>	<p><b>PT9153</b></p> 	<p>Hydraulic Element  <b>Contains:</b> By-Pass Valve  <b>Replaces:</b> Argo P3062051; Fleetguard HF28796; Woodgate WGH2051  <b>O.D.:</b> 2 5/16 (58.7)  <b>I.D.:</b> 1 1/16 (27.0)  <b>Height:</b> 7 27/32 (199.2)  <b>O-Ring:</b> [1] Attached</p>
<p><b>PT9147</b></p> 	<p>Hydraulic Element  <b>Notes:</b> OBSOLETE. Availability Limited to Dealer Stock.  <b>Contains:</b> By-Pass Valve  <b>Replaces:</b> U.C.C. Hydraulics MGR2143; Woodgate WGH1907  <b>O.D.:</b> 1 25/32 (45.2)  <b>I.D.:</b> 3/4 (19.0)  <b>Height:</b> 4 25/32 (121.4)  <b>O-Ring:</b> [1] Attached</p>	<p><b>PT9155</b></p> 	<p>Hydraulic Element  <b>Notes:</b> OBSOLETE. Availability Limited to Dealer Stock.  <b>Replaces:</b> Argo P2112311; Fleetguard HF35272; Woodgate WGH2311  <b>O.D.:</b> 4 11/32 (110.3)  <b>I.D.:</b> 1 13/16 (46.0)  <b>Height:</b> 8 29/32 (226.2)</p>
<p><b>PT9148</b></p> 	<p>Hydraulic Element  <b>Fits:</b> Manitou Equipment  <b>Replaces:</b> Manitou 46028; Woodgate WGH1934  <b>O.D.:</b> 3 9/16 (90.5)  <b>I.D.:</b> 1 5/8 (41.3) One End  <b>Height:</b> 11 13/16 (300.0)  <b>A. Gskt:</b> [1] Attached</p>	<p><b>PT9157</b></p> 	<p>Hydraulic Element  <b>Contains:</b> By-Pass Valve  <b>Replaces:</b> Argo P3072062; Woodgate WGH3062  <b>O.D.:</b> 2 3/4 (69.9)  <b>I.D.:</b> 1 1/4 (31.8) One End  <b>Height:</b> 7 27/32 (199.2)  <b>O-Ring:</b> [1] Attached</p>
<p><b>PT9149</b></p> 	<p>Hydraulic Element  <b>Fits:</b> Komatsu Excavators  <b>Replaces:</b> Demag 76184073; Woodgate WGH1958  <b>O.D.:</b> 2 23/32 (69.1)  <b>I.D.:</b> 1 9/32 (32.5) One End  <b>Height:</b> 4 9/16 (115.9)  <b>O-Ring:</b> [1] Attached</p>	<p><b>PT9158</b></p> 	<p>Wire Mesh Hydraulic Element  <b>Fits:</b> Vibromax Equipment  <b>Replaces:</b> Argo V3072308; Woodgate WGH3308  <b>O.D.:</b> 2 1/2 (63.5)  <b>I.D.:</b> 1 1/16 (27.0)  <b>Height:</b> 9 3/32 (231.0)  <b>O-Ring:</b> [1] Attached</p>
<p><b>PT9150</b></p> 	<p>Wire Mesh Supported Hydraulic Element  <b>Replaces:</b> Finn FC1260F025XS; Woodgate WGH1992  <b>O.D.:</b> 2 27/32 (72.2)  <b>I.D.:</b> 5/8 (15.9) &amp; 1 3/4 (44.4)  <b>Height:</b> 10 7/32 (259.6)</p>	<p><b>PT9159</b></p> 	<p>Hydraulic Element  <b>Notes:</b> OBSOLETE. Availability Limited to Dealer Stock.  <b>Replaces:</b> Argo P2123411; Woodgate WGH3411  <b>O.D.:</b> 4 21/32 (118.3)  <b>I.D.:</b> 2 3/8 (60.3)  <b>Height:</b> 13 (330.2)  <b>A. Gskt:</b> [2] Attached</p>
<p><b>PT9152</b></p> 	<p>Hydraulic Element  <b>Replaces:</b> Argo P2092022; Fleetguard HF35266; Woodgate WGH2022  <b>O.D.:</b> 3 9/32 (83.3)  <b>I.D.:</b> 1 9/16 (39.7)  <b>Height:</b> 7 25/32 (197.6)  <b>A. Gskt:</b> [2] Attached</p>	<p><b>PT9161</b></p> 	<p>Wire Mesh Supported Hydraulic Element  <b>Fits:</b> Bobcat, Komatsu, Krone, Terex Equipment  <b>Replaces:</b> Argo V3093308; Fleetguard HF28809; Woodgate WGH3908  <b>O.D.:</b> 3 17/32 (89.7)  <b>I.D.:</b> 1 17/32 (38.9) One End  <b>Height:</b> 13 3/32 (332.6)  <b>O-Ring:</b> [1] Attached</p>

Measurements Are Shown In Inches And (Millimeters)

**WARNING:** These products can expose you to chemicals, including Diisononyl Phthalate, Carbon black extracts, Nickel, 1,3 Butadiene, Ethylene Oxide, Epichlorohydrin, which are known to the State of California to cause cancer, and Bisphenol, Ethylene Glycol, Ethylene Oxide, 1,3 Butadiene, Epichlorohydrin, which are known to the State of California to cause birth defects or other reproductive harm.

**PT9162**



Hydraulic Element

**Fits:** Kato Excavators  
**Replaces:** Mitsubishi 68937001001; Fleetguard HF6305; Woodgate WGH6305  
**O.D.:** 4 15/32 (113.5)  
**I.D.:** 2 27/32 (72.2)  
**Height:** 14 7/8 (377.8)  
**A. Gskt:** [2] Attached

**PT9169**



Hydraulic Element

**Fits:** Takeuchi Excavators; Yanmar Carriers  
**Replaces:** Yanmar 155110-0700; Woodgate WGH9104  
**O.D.:** 4 13/32 (111.9)  
**I.D.:** 2 3/4 (69.9)  
**Height:** 8 13/16 (223.8)  
**A. Gskt:** [2] Attached  
**O-Ring:** [1] Included

**PT9163**



Hydraulic Element

**Notes:** OBSOLETE. Availability Limited to Dealer Stock.  
**Replaces:** Leyland 10871096; Fleetguard HF6527; Woodgate WGH6527  
**O.D.:** 2 19/32 (65.9)  
**I.D.:** 1 5/16 (33.3)  
**Height:** 5 17/32 (140.5)  
**Grommets:** [2] Attached

**PT9170**



Hydraulic Element

**Fits:** Link-Belt, Volvo, Yanmar Excavators  
**Replaces:** Yanmar 172112-74911; Woodgate WGH9108  
**O.D.:** 4 5/16 (109.5)  
**I.D.:** 2 3/4 (69.9)  
**Height:** 8 11/16 (220.7)

**BT9164**



Hydraulic Spin-on

**Fits:** Massey Ferguson Tractors  
**Replaces:** Massey Ferguson 3581032-M2; Fleetguard HF7541; Woodgate WGH7541  
**Thread:** M42 x 2.0  
**O.D.:** 5 13/32 (137.3)  
**Height:** 7 1/8 (181.0)  
**I.Gskt:** [1] Included

**PT9171**



Wire Mesh Supported Hydraulic Element

**Notes:** OBSOLETE. Availability Limited to Dealer Stock.  
**Fits:** Liebherr Equipment  
**Replaces:** Liebherr 7001636; Woodgate WGH9128  
**O.D.:** 4 19/32 (116.7)  
**I.D.:** 1 17/32 (38.9) & 2 5/16 (58.7)  
**Height:** 14 1/2 (368.3)  
**A. Gskt:** [2] Attached

**PT9165**



Hydraulic Element

**Replaces:** Massey Ferguson 2951149-M91; Woodgate WGH7552  
**O.D.:** 2 17/32 (64.3)  
**I.D.:** 1 1/16 (27.0) One End  
**Height:** 5 13/16 (147.6)  
**O-Ring:** [1] Attached

**PT9172**



Hydraulic Element

**Fits:** Hitachi, John Deere, Kubota Excavators, Loaders  
**Replaces:** Hitachi 4225846; Woodgate WGH9134  
**O.D.:** 3 17/32 (89.7)  
**I.D.:** 1 27/32 (46.8)  
**Height:** 14 1/8 (358.8)  
**O-Ring:** [2] Attached, [3] Included

**PT9167**



Hydraulic Element with Bail Handle

**Contains:** By-Pass Valve  
**Replaces:** MP Filtri MF1002AP25NB; Fleetguard HF7904; Woodgate WGH9100  
**O.D.:** 2 3/4 (69.9)  
**I.D.:** 1 3/32 (27.8) One End  
**Height:** 5 11/32 (135.7)  
**O-Ring:** [1] Attached  
**Spring:** [1] Included

**PT9174**



Hydraulic Element with Attached Spring

**Contains:** By-Pass Valve  
**Replaces:** MP Filtri MF1002AM60NB; Woodgate WGH9146  
**O.D.:** 2 3/4 (69.9)  
**I.D.:** 1 3/32 (27.8) One End  
**Height:** 5 11/32 (135.7)  
**Spring:** [1] Attached

**PT9168**



Hydraulic Element with Attached Spring

**Contains:** By-Pass Valve  
**Fits:** Liebherr Cranes  
**Replaces:** Liebherr 510670108; Fleetguard HF7911; Woodgate WGH9101  
**O.D.:** 5 1/8 (130.2)  
**I.D.:** 1 15/16 (49.2) One End  
**Height:** 8 3/16 (208.0)  
**O-Ring:** [1] Included  
**Spring:** [1] Attached

**PT9175**















Hydraulic Element with Bail Handle

**Contains:** By-Pass Valve  
**Replaces:** J.C. Bamford 32/925100; Fleetguard HF7906, HF35210; Woodgate WGH9147  
**O.D.:** 3 29/32 (99.2)  
**I.D.:** 1 9/16 (39.7) One End  
**Height:** 8 5/8 (219.1)  
**I.Gskt:** [1] Included

Measurements Are Shown In Inches And (Millimeters)

**WARNING:** These products can expose you to chemicals, including Diisononyl Phthalate, Carbon black extracts, Nickel, 1,3 Butadiene, Ethylene Oxide, Epichlorohydrin, which are known to the State of California to cause cancer, and Bisphenol, Ethylene Glycol, Ethylene Oxide, 1,3 Butadiene, Epichlorohydrin, which are known to the State of California to cause birth defects or other reproductive harm.

<p><b>PT9176</b></p> 	<p>Hydraulic Element with Bail Handle  <b>Contains:</b> By-Pass Valve  <b>Fits:</b> Manitou Equipment  <b>Replaces:</b> Komatsu 21D6011130; Fleetguard HF7909, HF35216; Woodgate WGH9150  <b>O.D.:</b> 5 5/32 (131.0)  <b>I.D.:</b> 2 15/32 (62.7) One End  <b>Height:</b> 8 9/32 (210.3)</p>	<p><b>PT9183</b></p>  <p>Hydraulic Element with Bail Handle  <b>Contains:</b> By-Pass Valve  <b>Replaces:</b> Liebherr 510665208; Woodgate WGH9554  <b>O.D.:</b> 5 11/32 (135.7)  <b>I.D.:</b> 2 9/16 (65.1) One End  <b>Height:</b> 7 7/8 (200.0)  <b>O-Ring:</b> [1] Attached</p>
<p><b>PT9178</b></p> 	<p>Hydraulic Element with Attached Spring  <b>Contains:</b> By-Pass Valve  <b>Fits:</b> Manitou Equipment  <b>Replaces:</b> Manitou 23091; Fleetguard HF7984; Woodgate WGH9160  <b>O.D.:</b> 2 3/4 (69.9)  <b>I.D.:</b> 1 5/8 (41.3) One End  <b>Height:</b> 3 31/32 (100.8)  <b>Spring:</b> [1] Attached</p>	<p><b>PT9185</b></p>  <p>Hydraulic Element  <b>Replaces:</b> Fairey-Arlon TXX2-10; Fleetguard HF35111; Woodgate WGTX2-10  <b>O.D.:</b> 2 27/32 (72.2)  <b>I.D.:</b> 1 1/32 (8.7) &amp; 1 25/32 (45.2)  <b>Height:</b> 4 5/32 (105.6)  <b>O-Ring:</b> [1] Attached</p>
<p><b>PT9179</b></p> 	<p>Hydraulic Element with Attached Spring  <b>Contains:</b> By-Pass Valve  <b>Replaces:</b> MP Filtri MF0301AP25NB; Woodgate WGH9500  <b>O.D.:</b> 1 31/32 (50.0)  <b>I.D.:</b> 15/16 (23.8) One End  <b>Height:</b> 3 (76.2)  <b>O-Ring:</b> [1] Attached  <b>Spring:</b> [1] Attached</p>	<p><b>PT9186</b></p>  <p>Hydraulic Element  <b>Replaces:</b> Fairey-Arlon TXX310; Fleetguard HF6306; Woodgate WGTX3-10  <b>O.D.:</b> 2 27/32 (72.2)  <b>I.D.:</b> 9/32 (7.1) &amp; 1 3/4 (44.4)  <b>Height:</b> 5 7/8 (149.2)  <b>O-Ring:</b> [1] Attached</p>
<p><b>PT9180</b></p> 	<p>Hydraulic Element with 2 Bail Handles  <b>Contains:</b> By-Pass Valve  <b>Replaces:</b> MP Filtri MF1001P10NB; Fleetguard HF35201; Woodgate WGH9505  <b>O.D.:</b> 2 3/4 (69.9)  <b>I.D.:</b> 1 3/32 (27.8) One End  <b>Height:</b> 3 5/8 (92.1)  <b>O-Ring:</b> [1] Attached</p>	<p><b>PT9187</b></p>  <p>Hydraulic Element  <b>Replaces:</b> J.C. Bamford 581/05702; Fleetguard HF6307; Woodgate WGTX3D-10  <b>O.D.:</b> 2 27/32 (72.2)  <b>I.D.:</b> 5/8 (15.9) &amp; 2 1/16 (52.4)  <b>Height:</b> 7 7/8 (200.0)  <b>O-Ring:</b> [1] Attached</p>
<p><b>PT9181</b></p> 	<p>Hydraulic Element  <b>Contains:</b> By-Pass Valve  <b>Fits:</b> Telesco Pelle Loaders  <b>Replaces:</b> MP Filtri MF1801AP10NB; Fleetguard HF35209; Woodgate WGH9532  <b>O.D.:</b> 3 29/32 (99.2)  <b>I.D.:</b> 1 25/32 (45.2) One End  <b>Height:</b> 8 5/8 (219.1)  <b>O-Ring:</b> [1] Attached</p>	<p><b>PT9188</b></p>  <p>Hydraulic Element  <b>Replaces:</b> Fairey-Arlon TXX410; Fleetguard HF6308; Woodgate WGTX4-10  <b>O.D.:</b> 4 5/32 (105.6)  <b>I.D.:</b> 13/32 (10.3) &amp; 2 27/32 (72.2)  <b>Height:</b> 7 9/16 (192.1)  <b>O-Ring:</b> [1] Attached</p>
<p><b>PT9182</b></p> 	<p>Hydraulic Element with Attached Spring  <b>Notes:</b> OBSOLETE. Availability Limited to Dealer Stock.  <b>Contains:</b> By-Pass Valve  <b>Replaces:</b> Liebherr 5106639; Woodgate WGH9550  <b>O.D.:</b> 5 1/8 (130.2)  <b>I.D.:</b> 1 31/32 (50.0) One End  <b>Height:</b> 8 3/16 (208.0)  <b>O-Ring:</b> [1] Included  <b>Spring:</b> [1] Attached</p>	<p><b>PT9189</b></p>  <p>Hydraulic Element  <b>Notes:</b> Inside-Out Flow Direction  <b>Replaces:</b> J.C. Bamford 32/100301; Fleetguard HF6309; Woodgate WGTX5A-10  <b>O.D.:</b> 4 5/32 (105.6)  <b>I.D.:</b> 13/32 (10.3) &amp; 2 27/32 (72.2)  <b>Height:</b> 18 9/32 (464.3)  <b>O-Ring:</b> [1] Attached</p>

Measurements Are Shown In Inches And (Millimeters)

**WARNING:** These products can expose you to chemicals, including Diisononyl Phthalate, Carbon black extracts, Nickel, 1,3 Butadiene, Ethylene Oxide, Epichlorohydrin, which are known to the State of California to cause cancer, and Bisphenol, Ethylene Glycol, Ethylene Oxide, 1,3 Butadiene, Epichlorohydrin, which are known to the State of California to cause birth defects or other reproductive harm.

**PT9190**



Hydraulic Element

**Notes:** OBSOLETE. Availability Limited to Dealer Stock.  
**Replaces:** Fairey-Arlon TXX8B10; Fleetguard HF6310; Woodgate WGTX8B-10  
**O.D.:** 4 31/32 (126.2)  
**I.D.:** 13/32 (10.3) & 3 5/8 (92.1)  
**Height:** 15 1/4 (387.3)  
**O-Ring:** [1] Attached

**PT9199**

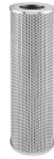

Hydraulic Element

**Replaces:** Argo P2093301; Woodgate WGH3301  
**O.D.:** 3 1/2 (88.9)  
**I.D.:** 1 31/32 (50.0)  
**Height:** 12 29/32 (327.8)

**PT9191**



Hydraulic Element

**Fits:** Case, Drott Equipment  
**Replaces:** Fairey-Arlon TXX8C10; Fleetguard HF6311; Woodgate WGTX8C-10  
**O.D.:** 4 15/16 (125.4)  
**I.D.:** 13/32 (10.3) & 3 5/8 (92.1)  
**Height:** 18 13/16 (477.8)  
**O-Ring:** [1] Attached

**PT9200**



Wire Mesh Supported Hydraulic Element

**Notes:** OBSOLETE. Availability Limited to Dealer Stock.  
**Replaces:** Mahle 9700066103; Woodgate WGH9724  
**O.D.:** 2 9/32 (57.9)  
**I.D.:** 31/32 (24.6) & 1 7/32 (31.0)  
**Height:** 7 1/8 (181.0)  
**O-Ring:** [1] Attached  
**End Seals:** [1] Attached

**PT9193**



Hydraulic Element

**Notes:** For suction side  
**Contains:** Threaded hex nut for removal.  
**Replaces:** J.C. Bamford 92/912004; Woodgate WGH1900  
**Thread:** 3/4 -BSP-PL  
**O.D.:** 2 3/4 (69.9)  
**Height:** 3 3/4 (95.3)

**PT9202**



Wire Mesh Supported Hydraulic Element

**Notes:** OBSOLETE. Availability Limited to Dealer Stock.  
**Fits:** Case Excavators  
**Replaces:** Fairey-Arlon TXX1110; Fleetguard HF6312; Woodgate WGTX11-10  
**O.D.:** 7 15/16 (201.6)  
**I.D.:** 9/16 (14.3) & 6 3/16 (157.2)  
**Height:** 17 5/16 (439.7)  
**O-Ring:** [1] Attached

**PT9195**



Hydraulic Element

**Contains:** 22 PSID By-Pass Valve  
**Replaces:** Argo P3051051; Fleetguard HF35267; Woodgate WGH1051  
**O.D.:** 1 25/32 (45.2)  
**I.D.:** 13/16 (20.6) One End  
**Height:** 4 3/32 (104.0)  
**O-Ring:** [1] Attached

**PT9203**



Wire Mesh Supported Hydraulic Element

**Replaces:** Parker GO1284; Fleetguard HF7738; Woodgate WGH1983  
**O.D.:** 1 15/32 (37.3)  
2 3/8 (60.3)  
**I.D.:** 1 (25.4) One End  
**Height:** 5 5/16 (134.9)  
**O-Ring:** [1] Attached

**PT9196**



Hydraulic Element

**Notes:** Inside-Out Flow Direction  
**Contains:** 2 PSID By-Pass Valve  
Threaded hex nut for removal.  
**Fits:** Caterpillar Lift Trucks; Kubota Excavators; Mitsubishi Equipment  
**Replaces:** Kubota 6978162120; Fleetguard HF7929; Woodgate WGH1965  
**Thread:** 3/4 NPT  
**O.D.:** 3 17/32 (89.7)  
**Height:** 6 9/16 (166.7)

**PT9205**



Wire Mesh Supported Hydraulic Element

**Notes:** OBSOLETE. Availability Limited to Dealer Stock.  
**Replaces:** Argo P3082301; Woodgate WGH8301  
**O.D.:** 3 1/16 (77.8)  
**I.D.:** 1 9/16 (39.7) One End  
**Height:** 9 1/8 (231.8)  
**O-Ring:** [1] Attached

**PT9197**



Hydraulic Element

**Contains:** 22 PSID By-Pass Valve  
**Replaces:** Argo P3062052; Fleetguard HF35263; Woodgate WGH2052  
**O.D.:** 2 5/16 (58.7)  
**I.D.:** 1 1/32 (26.2) One End  
**Height:** 7 7/8 (200.0)  
**O-Ring:** [1] Attached

**PT9206**















Wire Mesh Supported Hydraulic Element

**Notes:** OBSOLETE. Availability Limited to Dealer Stock.  
**Replaces:** MP Filtri HP651P25NA; Woodgate WGH9186  
**O.D.:** 1 25/32 (45.2)  
**I.D.:** 15/16 (23.8) One End  
**Height:** 3 3/8 (85.7)  
**O-Ring:** [1] Attached

Measurements Are Shown In Inches And (Millimeters)

**WARNING:** These products can expose you to chemicals, including Diisononyl Phthalate, Carbon black extracts, Nickel, 1,3 Butadiene, Ethylene Oxide, Epichlorohydrin, which are known to the State of California to cause cancer, and Bisphenol, Ethylene Glycol, Ethylene Oxide, 1,3 Butadiene, Epichlorohydrin, which are known to the State of California to cause birth defects or other reproductive harm.

<p><b>PT9207</b></p> 	<p>Wire Mesh Supported Hydraulic Element  <b>Notes:</b> OBSOLETE. Availability Limited to Dealer Stock.  <b>Replaces:</b> MP Filtri CH802CD11; Woodgate WGH9286  <b>O.D.:</b> 3 1/16 (77.8)  <b>I.D.:</b> 1 11/16 (42.9) One End  <b>Height:</b> 8 9/32 (210.3)  <b>O-Ring:</b> [1] Attached</p>	<p><b>PT9214</b></p>  <p>Wire Mesh Hydraulic Element with Bail Handle  <b>Replaces:</b> Tamrock 4701416; Woodgate WGH1954  <b>O.D.:</b> 3 5/16 (84.1)  <b>I.D.:</b> 9/16 (14.3)  <b>Height:</b> 4 23/32 (119.9)  <b>F. Gskt:</b> [1] Included, [1] Washer  <b>O-Ring:</b> [1] Included  <b>Grommets:</b> [2] Attached</p>
<p><b>PT9208</b></p> 	<p>Wire Mesh Supported Hydraulic Element  <b>Replaces:</b> MP Filtri HP0371P10AN; Woodgate WGH9410  <b>O.D.:</b> 1 5/8 (41.3)  <b>I.D.:</b> 27/32 (21.4) One End  <b>Height:</b> 3 17/32 (89.7)  <b>O-Ring:</b> [1] Attached</p>	<p><b>PT9215</b></p>  <p>Wire Mesh Hydraulic Element  <b>Fits:</b> Massey Ferguson Wheel Tractors  <b>Replaces:</b> Massey Ferguson 1674984M92; Woodgate WGH9139  <b>O.D.:</b> 2 7/8 (73.0)  <b>I.D.:</b> 13/32 (10.3) &amp; 1 13/32 (35.7)  <b>Height:</b> 6 7/32 (158.0)</p>
<p><b>PT9209</b></p> 	<p>Hydraulic Element  <b>Replaces:</b> MP Filtri HP0371P25; Woodgate WGH9411  <b>O.D.:</b> 1 5/8 (41.3)  <b>I.D.:</b> 29/32 (23.0) One End  <b>Height:</b> 3 19/32 (91.3)  <b>O-Ring:</b> [1] Attached</p>	<p><b>PT9217</b></p>  <p>Wire Mesh Hydraulic Element with Attached Spring  <b>Contains:</b> 25 PSID By-Pass Valve  <b>Replaces:</b> MP Filtri MF4002AM125NB; Woodgate WGH9561  <b>O.D.:</b> 5 1/8 (130.2)  <b>I.D.:</b> 2 9/16 (65.1) One End  <b>Height:</b> 7 7/8 (200.0)  <b>O-Ring:</b> [1] Included  <b>Spring:</b> [1] Attached</p>
<p><b>PT9210</b></p> 	<p>Hydraulic Element  <b>Replaces:</b> Argo P3052001; Woodgate WGH9434  <b>O.D.:</b> 1 25/32 (45.2)  <b>I.D.:</b> 3/4 (19.0) One End  <b>Height:</b> 7 27/32 (199.2)  <b>O-Ring:</b> [1] Attached</p>	<p><b>PT9221</b></p>  <p>Wire Mesh Hydraulic Element  <b>Notes:</b> OBSOLETE. Availability Limited to Dealer Stock.  <b>Replaces:</b> Hydac 30D025W; Woodgate WGHH30025DW  <b>O.D.:</b> 1 3/8 (34.9)  <b>I.D.:</b> 7/16 (11.1) One End  <b>Height:</b> 3 11/16 (93.7)  <b>O-Ring:</b> [1] Attached</p>
<p><b>PT9212</b></p> 	<p>Hydraulic Element  <b>Replaces:</b> Putzmeister 222895006; Woodgate WGH1901  <b>O.D.:</b> 4 (101.6)  <b>I.D.:</b> 2 7/16 (61.9)  <b>Height:</b> 13 3/16 (335.0)  <b>O-Ring:</b> [2] Attached</p>	<p><b>PT9222</b></p>  <p>Wire Mesh Hydraulic Element  <b>Notes:</b> For suction side  <b>Contains:</b> Threaded hex nut for removal.  <b>Replaces:</b> U.C.C. UCSE1319; Woodgate WGSE1319  <b>Thread:</b> 1/2 -14 BSP-PL  <b>O.D.:</b> 1 13/16 (46.0)  <b>Height:</b> 4 5/32 (105.6)</p>
<p><b>PT9213</b></p> 	<p>Hydraulic Element  <b>Notes:</b> OBSOLETE. Availability Limited to Dealer Stock.            For suction side  <b>Contains:</b> 2 PSID By-Pass Valve            Threaded hex nut for removal.  <b>Fits:</b> Kubota Excavators  <b>Replaces:</b> Kubota RB10162190; Woodgate WGH1918  <b>O.D.:</b> 3 17/32 (89.7)  <b>Height:</b> 3 27/32 (97.6)</p>	<p><b>PT9223</b></p>  <p>Wire Mesh Hydraulic Element  <b>Notes:</b> For suction side  <b>Contains:</b> Threaded hex nut for removal.  <b>Replaces:</b> U.C.C. UCSE1320; Fleetguard HF35159; Woodgate WGSE1320  <b>Thread:</b> 3/4 -14 BSP-PL  <b>O.D.:</b> 2 17/32 (64.3)  <b>Height:</b> 4 5/16 (109.5)</p>

Measurements Are Shown In Inches And (Millimeters)

**WARNING:** These products can expose you to chemicals, including Diisononyl Phthalate, Carbon black extracts, Nickel, 1,3 Butadiene, Ethylene Oxide, Epichlorohydrin, which are known to the State of California to cause cancer, and Bisphenol, Ethylene Glycol, Ethylene Oxide, 1,3 Butadiene, Epichlorohydrin, which are known to the State of California to cause birth defects or other reproductive harm.

**PT9224**



Wire Mesh Hydraulic Element  
**Contains:** Threaded hex nut for removal.  
**Replaces:** U.C.C. UCSE1324; Fleetguard HF6254; Woodgate WGSE1324  
**Thread:** 1 1/2 -11 BSP-PL  
**O.D.:** 3 5/16 (84.1)  
**Height:** 7 7/8 (200.0)

**PT9237**



Wire Mesh Supported Hydraulic Element with Bail Handle  
**Contains:** By-Pass Valve  
**Replaces:** MP Filtri MF1002AP10NB; Woodgate WGH9517  
**O.D.:** 2 3/4 (69.9)  
**I.D.:** 1 1/8 (28.6) One End  
**Height:** 5 7/32 (132.6)  
**I.Gskt:** [1] Included  
**O-Ring:** [1] Included

**PT9225**



Wire Mesh Hydraulic Element  
**Contains:** Threaded hex nut for removal.  
**Fits:** Kubota Excavators  
**Replaces:** U.C.C. UCSE1457; Fleetguard HF7444; Woodgate WGSE1457  
**Thread:** 1 -11 BSP-PL  
**O.D.:** 2 17/32 (64.3)  
**Height:** 5 7/16 (138.1)

**PT9238**



Hydraulic Element  
**Contains:** By-Pass Valve  
 Threaded hex nut for removal.  
**Fits:** Kubota, Takeuchi Excavators  
**Replaces:** Kubota 6865162120; Fleetguard HF28946; Woodgate WGH1982  
**Thread:** 1 NPT  
**O.D.:** 3 9/16 (90.5)  
**Height:** 7 7/8 (200.0)

**PT9227**



Wire Mesh Hydraulic Element with Bail Handle  
**Contains:** 25 PSID By-Pass Valve  
**Replaces:** MP Filtri MF1801AM60NB; Fleetguard HF28869; Woodgate WGH9144  
**O.D.:** 3 29/32 (99.2)  
**I.D.:** 1 9/16 (39.7) One End  
**Height:** 8 7/8 (225.4)  
**Spring:** [1] Included

**PT9239**



Wire Mesh Supported Hydraulic Element with 2 Bail Handles  
**Contains:** By-Pass Valve  
**Replaces:** MP Filtri MF1001P25NB; Woodgate WGH9507  
**O.D.:** 2 3/4 (69.9)  
**I.D.:** 1 3/32 (27.8) One End  
**Height:** 3 19/32 (91.3)  
**O-Ring:** [1] Attached

**PT9228**



Wire Mesh Hydraulic Element  
**Replaces:** MP Filtri MR1001M90; Woodgate WGST120  
**O.D.:** 2 27/32 (72.2)  
**I.D.:** 1 11/32 (8.7) & 1 25/32 (45.2)  
**Height:** 2 3/16 (55.6)  
**O-Ring:** [1] Attached

**PT9240**



Wire Mesh Supported Hydraulic Element with Attached Spring  
**Contains:** By-Pass Valve  
**Replaces:** MP Filtri MF0301AP10NB; Fleetguard HF35199; Woodgate WGH9499  
**O.D.:** 2 1/16 (52.4)  
**I.D.:** 29/32 (23.0) One End  
**Height:** 2 31/32 (75.4)  
**O-Ring:** [1] Included  
**Spring:** [1] Attached

**H9231**



Wire Mesh Supported Hydraulic Element  
**Contains:** Viton O-Ring for high heat applications  
**Replaces:** MP Filtri HP0653A06AN; Woodgate WGPN9208Z  
**O.D.:** 1 25/32 (45.2)  
**I.D.:** 15/16 (23.8) One End  
**Height:** 8 7/32 (208.8)  
**O-Ring:** [1] Viton Attached

**PT9242**



Wire Mesh Supported Hydraulic Element with Bail Handle  
**Contains:** By-Pass Valve  
**Replaces:** MP Filtri MF1002AM125NB; Woodgate WGH9524  
**O.D.:** 2 3/4 (69.9)  
**I.D.:** 1 1/8 (28.6) One End  
**Height:** 5 1/8 (130.2)  
**O-Ring:** [1] Included  
**Spring:** [1] Included

**PT9236-MPG**



Wire Mesh Supported Hydraulic Element with Attached Spring  
**Notes:** OBSOLETE. Availability Limited to Dealer Stock.  
**Contains:** By-Pass Valve  
**Replaces:** Woodgate WGH9502  
**O.D.:** 1 31/32 (50.0)  
**I.D.:** 1 1/32 (26.2) One End  
**Height:** 3 (76.2)  
**O-Ring:** [1] Included  
**Spring:** [1] Attached

**PT9244**



Hydraulic Element  
**Replaces:** Finn FC1073F010BS; Woodgate WGH1817  
**O.D.:** 4 5/32 (105.6)  
**I.D.:** 1 1/8 (28.6) & 2 27/32 (72.2)  
**Height:** 20 1/2 (520.7)  
**O-Ring:** [1] Attached

Measurements Are Shown In Inches And (Millimeters)

**WARNING:** These products can expose you to chemicals, including Diisononyl Phthalate, Carbon black extracts, Nickel, 1,3 Butadiene, Ethylene Oxide, Epichlorohydrin, which are known to the State of California to cause cancer, and Bisphenol, Ethylene Glycol, Ethylene Oxide, 1,3 Butadiene, Epichlorohydrin, which are known to the State of California to cause birth defects or other reproductive harm.

**PT9245**



Wire Mesh Hydraulic Element

**Fits:** Daewoo, Doosan Excavators, Loaders  
**Replaces:** Daewoo 24749016A; Woodgate WGH1864  
**O.D.:** 5 7/8 (149.2)  
**I.D.:** 2 15/16 (74.6) One End  
**Height:** 6 1/16 (154.0)  
**O-Ring:** [1] Attached

**PT9255**



Wire Mesh Supported Hydraulic Element

**Replaces:** Liebherr 5106622; Woodgate WGH9855  
**O.D.:** 1 27/32 (46.8)  
**I.D.:** 1 1/32 (26.2) One End  
**Height:** 3 11/16 (93.7)

**PT9247**



Wire Mesh Supported Hydraulic Element

**Fits:** Liebherr Excavators  
**Replaces:** Liebherr 7211188; Fleetguard HF6301; Woodgate WGH9130  
**O.D.:** 5 31/32 (151.6)  
**I.D.:** 1 25/32 (45.2) & 3 1/2 (88.9)  
**Height:** 24 1/2 (622.3)  
**A. Gskt:** [2] Attached

**PT9256-MPG**



Wire Mesh Supported Hydraulic Element with Attached Spring

**Contains:** By-Pass Valve  
**Replaces:** MP Filtri MF1002AA25HB; Fleetguard HF35204; Woodgate WGH9522  
**O.D.:** 2 25/32 (70.6)  
**I.D.:** 1 7/32 (31.0) One End  
**Height:** 5 7/32 (132.6)  
**Spring:** [1] Attached

**PT9248**



Hydraulic Element

**Contains:** By-Pass Valve  
**Fits:** Manitou Equipment  
**Replaces:** Manitou 21967; Fleetguard HF7981; Woodgate WGH9159  
**O.D.:** 2 3/4 (69.9)  
**I.D.:** 1 21/32 (42.1) One End  
**Height:** 7 15/16 (201.6)

**PT9257**



Hydraulic Element

**Notes:** OBSOLETE. Availability Limited to Dealer Stock.  
**Replaces:** Fairey-Arlon TX3B10; Woodgate WGTX3B-10  
**O.D.:** 4 1/8 (104.8)  
**I.D.:** 3/8 (9.5) & 3 11/32 (84.9)  
**Height:** 5 9/16 (141.3)

**PT9250**



Wire Mesh Supported Hydraulic Element with Bail Handle

**Contains:** By-Pass Valve  
**Replaces:** MP Filtri MF7501AP25NB; Woodgate WGH9590  
**O.D.:** 5 1/8 (130.2)  
**I.D.:** 2 17/32 (64.3) One End  
**Height:** 16 5/32 (410.4)  
**O-Ring:** [1] Included  
**Spring:** [1] Included

**PT9258**



Hydraulic Element

**Fits:** Hyundai Excavators  
**Replaces:** Hyundai 31EE01060; Woodgate WGH1808  
**O.D.:** 4 23/32 (119.9)  
**I.D.:** 2 15/16 (74.6)  
**Height:** 8 15/16 (227.0)  
**A. Gskt:** [2] Attached

**PT9251**



Hydraulic Element

**Contains:** Threaded hex nut for removal.  
**Replaces:** Woodgate WGSE1371  
**Thread:** 2 1/2 -11 BSP-PL  
**O.D.:** 5 1/8 (130.2)  
**Height:** 11 (279.4)

**PT9260**



Hydraulic Element

**Replaces:** Sumitomo CEJ1357; Woodgate WGH1832  
**O.D.:** 3 (76.2)  
**I.D.:** 1 13/16 (46.0)  
**Height:** 5 17/32 (140.5)  
**O-Ring:** [1] Attached

**PT9254**



Hydraulic Element

**Replaces:** Fairey-Arlon FXX310; Woodgate WGF3-10  
**O.D.:** 4 31/32 (126.2)  
**I.D.:** 3 5/8 (92.1)  
**Height:** 11 7/16 (290.5)

**PT9261-MPG**



Wire Mesh Supported Hydraulic Element

**Contains:** By-Pass Valve  
**Replaces:** MP Filtri MF4003AA10HB; Woodgate WGH9580  
**O.D.:** 5 1/8 (130.2)  
**I.D.:** 2 17/32 (64.3) One End  
**Height:** 10 3/16 (258.8)  
**O-Ring:** [1] Included

Measurements Are Shown In Inches And (Millimeters)

**WARNING:** These products can expose you to chemicals, including Diisononyl Phthalate, Carbon black extracts, Nickel, 1,3 Butadiene, Ethylene Oxide, Epichlorohydrin, which are known to the State of California to cause cancer, and Bisphenol, Ethylene Glycol, Ethylene Oxide, 1,3 Butadiene, Epichlorohydrin, which are known to the State of California to cause birth defects or other reproductive harm.



**PT9264** Wire Mesh Supported Hydraulic Element with Bail Handle  
**Contains:** By-Pass Valve  
**Replaces:** MP Filtri MF1003AP10NB; Woodgate WGH1991  
**O.D.:** 2 3/4 (69.9)  
**I.D.:** 1 19/32 (40.5) One End  
**Height:** 8 7/16 (214.3)  
**O-Ring:** [1] Included



**PT9278** Wire Mesh Hydraulic Element  
**Contains:** Threaded hex nut for removal.  
**Replaces:** U.C.C. UCSE1323  
**Thread:** 1 1/2 -11 BSP-PL  
**O.D.:** 3 3/8 (85.7)  
**Height:** 5 15/32 (138.9)



**PT9266** Hydraulic Element  
**Replaces:** Parker GO2836; Woodgate WGH9876  
**O.D.:** 1 27/32 (46.8)  
**I.D.:** 1 (25.4) One End  
**Height:** 6 25/32 (172.2)



**PT9279** Wire Mesh Hydraulic Element  
**Notes:** For suction side  
**Contains:** Threaded hex nut for removal.  
**Replaces:** Woodgate WGSE1360  
**Thread:** 1 1/2 -11 BSP-PL  
**O.D.:** 3 3/8 (85.7)  
**Height:** 7 7/8 (200.0)



**PT9267** Wire Mesh Supported Hydraulic Element  
**Replaces:** Stauff SL020D20B; Woodgate WGH9877  
**O.D.:** 1 27/32 (46.8)  
**I.D.:** 1 (25.4) One End  
**Height:** 6 3/4 (171.5)



**PT9282-MPG** Wire Mesh Supported Maximum Performance Glass Hydraulic Element  
**Contains:** 29 PSID By-Pass Valve  
**Replaces:** Internormen 300123VG10; Woodgate WGH1793  
**O.D.:** 2 3/16 (55.6)  
**I.D.:** 1 1/16 (27.0) One End  
**Height:** 6 27/32 (173.8)  
**O-Ring:** [1] Included



**PT9268** Wire Mesh Supported Hydraulic Element with Bail Handle  
**Contains:** By-Pass Valve  
**Replaces:** Hydac 330R010P; Woodgate WGHH33010RP  
**O.D.:** 3 23/32 (94.5)  
**I.D.:** 1 27/32 (46.8) One End  
**Height:** 7 5/8 (193.7)  
**O-Ring:** [1] Attached



**PT9283-MPG** Wire Mesh Supported Maximum Performance Glass Hydraulic Element  
**Fits:** Caterpillar Excavators  
**Replaces:** Caterpillar 1097287; Woodgate WGH1843  
**O.D.:** 4 21/32 (118.3)  
**I.D.:** 2 11/32 (59.5)  
**Height:** 23 5/8 (600.1)  
**O-Ring:** [2] Attached



**PT9272** Wire Mesh Hydraulic Element with Bail Handle  
**Contains:** 24 PSID By-Pass Valve  
**Replaces:** MP Filtri MF4002AM60NB; Fleetguard HF28874, HF35217; Woodgate WGH9145  
**O.D.:** 5 1/8 (130.2)  
**I.D.:** 2 9/16 (65.1) One End  
**Height:** 7 7/8 (200.0)  
**O-Ring:** [1] Included



**PT9284-MPG** Wire Mesh Supported Maximum Performance Glass Hydraulic Element  
**Replaces:** Argo V2092008; Woodgate WGH2008  
**O.D.:** 3 1/4 (82.6)  
**I.D.:** 1 19/32 (40.5)  
**Height:** 7 25/32 (197.6)  
**A. Gskt:** [2] Attached



**PT9277** Wire Mesh Hydraulic Element  
**Notes:** For suction side  
**Contains:** Threaded hex nut for removal.  
**Replaces:** U.C.C. UCSE1219; Woodgate WGSE1219  
**Thread:** 2 -11 BSP-PL  
**O.D.:** 5 29/32 (150.0)  
**Height:** 5 15/16 (150.8)











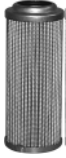

**PT9285-MPG** Wire Mesh Supported Maximum Performance Glass Hydraulic Element  
**Notes:** OBSOLETE. Availability Limited to Dealer Stock.  
**Contains:** 36 PSID By-Pass Valve  
**Replaces:** Demag 42211122; Woodgate WGH2056  
**O.D.:** 2 5/16 (58.7)  
**I.D.:** 1 1/32 (26.2) One End  
**Height:** 7 7/8 (200.0)  
**O-Ring:** [1] Attached



Measurements Are Shown In Inches And (Millimeters)

**WARNING:** These products can expose you to chemicals, including Diisononyl Phthalate, Carbon black extracts, Nickel, 1,3 Butadiene, Ethylene Oxide, Epichlorohydrin, which are known to the State of California to cause cancer, and Bisphenol, Ethylene Glycol, Ethylene Oxide, 1,3 Butadiene, Epichlorohydrin, which are known to the State of California to cause birth defects or other reproductive harm.

<p><b>PT9286-MPG</b> Wire Mesh Supported Maximum Performance Glass Hydraulic Element  <b>Contains:</b> 36 PSID By-Pass Valve  <b>Replaces:</b> Argo V3062058; Woodgate WGH2058  <b>O.D.:</b> 2 5/16 (58.7)  <b>I.D.:</b> 1 1/32 (26.2) One End  <b>Height:</b> 7 7/8 (200.0)  <b>O-Ring:</b> [1] Attached</p> 	<p><b>PT9293-MPG</b> Wire Mesh Supported Maximum Performance Glass Hydraulic Element  <b>Replaces:</b> Parker GO2005; Woodgate WGH9698  <b>O.D.:</b> 2 3/8 (60.3)  <b>I.D.:</b> 1 5/32 (29.4) &amp; 1 7/16 (36.5)  <b>Height:</b> 5 9/32 (134.1)  <b>O-Ring:</b> [2] Attached</p> 
<p><b>PT9287-MPG</b> Wire Mesh Supported Maximum Performance Glass Hydraulic Element  <b>Contains:</b> 36 PSID By-Pass Valve  <b>Fits:</b> Thwaites Dump Trucks  <b>Replaces:</b> Argo V3052058; Woodgate WGH3557  <b>O.D.:</b> 1 25/32 (45.2)  <b>I.D.:</b> 25/32 (19.8) One End  <b>Height:</b> 7 13/16 (198.4)  <b>O-Ring:</b> [1] Attached</p> 	<p><b>PT9295-MPG</b> Wire Mesh Supported Maximum Performance Glass Hydraulic Element  <b>Notes:</b> OBSOLETE. Availability Limited to Dealer Stock.  <b>Replaces:</b> Stauff SL010E20B; Woodgate WGH9839  <b>O.D.:</b> 1 13/16 (46.0)  <b>I.D.:</b> 15/16 (23.8) One End  <b>Height:</b> 4 15/32 (113.5)  <b>O-Ring:</b> [1] Attached</p> 
<p><b>PT9288-MPG</b> Wire Mesh Supported Maximum Performance Glass Hydraulic Element  <b>Contains:</b> Venturi-Type Cone  <b>Fits:</b> Liebherr Equipment  <b>Replaces:</b> Liebherr 7360470; Fleetguard HF6247; Woodgate WGH470  <b>O.D.:</b> 3 15/16 (100.0)  <b>I.D.:</b> 2 11/32 (59.5) &amp; 2 17/32 (64.3)  <b>Height:</b> 18 9/32 (464.3)  <b>A. Gskt:</b> [2] Attached</p> 	<p><b>PT9296-MPG</b> Wire Mesh Supported Maximum Performance Glass Hydraulic Element  <b>Replaces:</b> Stauff SL020E10B; Woodgate WGH9880  <b>O.D.:</b> 1 27/32 (46.8)  <b>I.D.:</b> 1 (25.4) One End  <b>Height:</b> 6 3/4 (171.5)</p> 
<p><b>PT9289-MPG</b> Maximum Performance Glass Hydraulic Element with 2 Bail Handles  <b>Contains:</b> 24 PSID By-Pass Valve  <b>Replaces:</b> MP Filtri MF1001AA25HB; Woodgate WGH9511  <b>O.D.:</b> 2 25/32 (70.6)  <b>I.D.:</b> 1 3/32 (27.8) One End  <b>Height:</b> 3 1/2 (88.9)  <b>O-Ring:</b> [1] Included  <b>Spring:</b> [1] Included</p> 	<p><b>PT9297-MPG</b> Wire Mesh Supported Maximum Performance Glass Hydraulic Element  <b>Replaces:</b> Stauff SL090E10B; Woodgate WGH9961  <b>O.D.:</b> 3 29/32 (99.2)  <b>I.D.:</b> 1 5/8 (41.3) One End  <b>Height:</b> 9 1/4 (235.0)</p> 
<p><b>PT9290-MPG</b> Wire Mesh Supported Maximum Performance Glass Hydraulic Element  <b>Contains:</b> 24 PSID By-Pass Valve  <b>Fits:</b> Fiat-Allis, Fiat-Hitachi Loaders  <b>Replaces:</b> MP Filtri MF4003AA25HB; Woodgate WGH9581  <b>O.D.:</b> 5 1/8 (130.2)  <b>I.D.:</b> 2 15/32 (62.7) One End  <b>Height:</b> 10 1/4 (260.3)  <b>O-Ring:</b> [1] Included</p> 	<p><b>PT9300-MPG</b> Wire Mesh Supported Maximum Performance Glass Hydraulic Element with Bail Handle  <b>Contains:</b> 43 PSID By-Pass Valve  <b>Replaces:</b> Hydac 240R020BNHC; Woodgate WGHH24020RB  <b>O.D.:</b> 2 29/32 (73.8)  <b>I.D.:</b> 1 13/32 (35.7) One End  <b>Height:</b> 8 (203.2)  <b>O-Ring:</b> [1] Attached</p> 
<p><b>PT9291-MPG</b> Wire Mesh Supported Maximum Performance Glass Hydraulic Element  <b>Replaces:</b> MP Filtri CU250A10NA; Woodgate WGH9633  <b>O.D.:</b> 3 29/32 (99.2)  <b>I.D.:</b> 2 1/16 (52.4)  <b>Height:</b> 8 5/16 (211.1)  <b>O-Ring:</b> [2] Included</p> 	<p><b>PT9302-MPG</b> Wire Mesh Supported Maximum Performance Glass Hydraulic Element  <b>Notes:</b> OBSOLETE. Availability Limited to Dealer Stock.  <b>Replaces:</b> Hydac 60D010BHHC; Woodgate WGHH60010DH  <b>O.D.:</b> 1 27/32 (46.8)  <b>I.D.:</b> 13/16 (20.6) One End  <b>Height:</b> 3 9/32 (83.3)  <b>O-Ring:</b> [1] Attached</p> 

Measurements Are Shown In Inches And (Millimeters)

**WARNING:** These products can expose you to chemicals, including Diisononyl Phthalate, Carbon black extracts, Nickel, 1,3 Butadiene, Ethylene Oxide, Epichlorohydrin, which are known to the State of California to cause cancer, and Bisphenol, Ethylene Glycol, Ethylene Oxide, 1,3 Butadiene, Epichlorohydrin, which are known to the State of California to cause birth defects or other reproductive harm.

**PT9303-MPG**

Wire Mesh Supported Maximum Performance Glass Hydraulic Element



**Replaces:** Hydac 60D010BNHC; Woodgate WGH66010DB  
**O.D.:** 3 9/16 (90.5)  
**I.D.:** 1 23/32 (43.7) One End  
**Height:** 12 15/16 (328.6)  
**O-Ring:** [1] Attached

**PT9310-MPG**

Wire Mesh Supported Maximum Performance Glass Hydraulic Element



**Replaces:** MP Filtri HP0651A25AN; Woodgate WGH9193  
**O.D.:** 1 25/32 (45.2)  
**I.D.:** 15/16 (23.8) One End  
**Height:** 3 13/32 (86.5)  
**O-Ring:** [1] Attached

**PT9304-MPG**

Wire Mesh Supported Maximum Performance Glass Hydraulic Element



**Replaces:** Genie 60857; Hydac 75D005BNHC; Woodgate WGH75005DB  
**O.D.:** 2 7/32 (56.4)  
**I.D.:** 15/16 (23.8) One End  
**Height:** 6 21/32 (169.1)  
**O-Ring:** [1] Attached

**PT9311-MPG**

Wire Mesh Supported Maximum Performance Glass Hydraulic Element



**Replaces:** MP Filtri HP1351P10AN; Woodgate WGH9250  
**O.D.:** 2 3/32 (53.2)  
**I.D.:** 1 (25.4) One End  
**Height:** 4 11/16 (119.1)  
**O-Ring:** [1] Attached

**PT9306-MPG**

Wire Mesh Supported Maximum Performance Glass Hydraulic Element



**Replaces:** Fairey-Arlon TXW8CCC25; Fleetguard HF7991; Woodgate WGTW8CCC-25  
**O.D.:** 4 31/32 (126.2)  
**I.D.:** 13/32 (10.3) & 3 5/8 (92.1)  
**Height:** 18 29/32 (480.2)  
**O-Ring:** [1] Attached

**PT9312-MPG**

Wire Mesh Supported Maximum Performance Glass Hydraulic Element



**Notes:** OBSOLETE. Availability Limited to Dealer Stock.  
**Replaces:** MP Filtri HP3201A10NA; Woodgate WGH9322  
**O.D.:** 3 1/16 (77.8)  
**I.D.:** 1 9/16 (39.7) One End  
**Height:** 4 19/32 (116.7)  
**O-Ring:** [1] Attached

**PT9307-MPG**

Wire Mesh Supported Maximum Performance Glass Hydraulic Element



**Replaces:** Demag 76204273; Woodgate WGH1708  
**O.D.:** 3 1/16 (77.8)  
**I.D.:** 1 9/16 (39.7) One End  
**Height:** 6 11/16 (169.9)  
**O-Ring:** [1] Attached

**PT9313-MPG**

Wire Mesh Supported Maximum Performance Glass Hydraulic Element



**Replaces:** MP Filtri HP3202A25NA; Woodgate WGH9340  
**O.D.:** 3 1/16 (77.8)  
**I.D.:** 1 9/16 (39.7) One End  
**Height:** 9 9/32 (235.7)  
**O-Ring:** [1] Attached

**PT9308-MPG**

Wire Mesh Supported Maximum Performance Glass Hydraulic Element



**Fits:** Daewoo Loaders; New Holland Equipment  
**Replaces:** Volvo 3114655; Fleetguard HF7658; Woodgate WGH1810  
**O.D.:** 2 7/32 (56.4)  
**I.D.:** 15/16 (23.8) One End  
**Height:** 4 1/8 (104.8)  
**O-Ring:** [1] Attached

**PT9315 KIT**

Set of 2 Hydraulic Elements



**Contains:** By-Pass Valve  
**Replaces:** Palfinger EA1412; Woodgate WGH1783  
**Larger Element**  
**O.D.:** 2 3/4 (69.9)  
**Height:** 5 11/32 (135.7)  
**O-Ring:** [1] Included  
**Spring:** [1] Included  
**Smaller Element**  
**O.D.:** 1 5/8  
**Height:** 1 11/32

**PT9309-MPG**

Wire Mesh Supported Maximum Performance Glass Hydraulic Element



**Fits:** Massey Ferguson Equipment  
**Replaces:** Massey Ferguson 3104387M1; Woodgate WGH1994  
**O.D.:** 2 3/8 (60.3)  
**I.D.:** 1 1/32 (26.2) One End  
**Height:** 5 5/16 (134.9)  
**O-Ring:** [1] Attached

**BT9316-MPG**

Maximum Performance Glass Hydraulic Spin-on



**Replaces:** MP Filtri CS70A10; Woodgate WGH9171  
**Thread:** 3/4 -14 BSP-PL  
**O.D.:** 3 25/32 (96.0)  
**Height:** 7 19/32 (192.9)  
**I.Gskt:** [1] Included

Measurements Are Shown In Inches And (Millimeters)

**WARNING:** These products can expose you to chemicals, including Diisononyl Phthalate, Carbon black extracts, Nickel, 1,3 Butadiene, Ethylene Oxide, Epichlorohydrin, which are known to the State of California to cause cancer, and Bisphenol, Ethylene Glycol, Ethylene Oxide, 1,3 Butadiene, Epichlorohydrin, which are known to the State of California to cause birth defects or other reproductive harm.

**BT9318**

Hydraulic Spin-on



**Contains:** Anti-Drainback Valve  
29 PSID By-Pass Valve  
**Fits:** Scania Trucks  
**Replaces:** Scania 1301696; Fleetguard HF7535;  
Woodgate WGH7535  
**Thread:** M23 x 1.5  
**O.D.:** 3 13/16 (96.8)  
**Height:** 4 5/16 (109.5)  
**I.Gskt:** G381-A

**BT9320**

Wire Mesh Supported Hydraulic Spin-on with  
Removal Nut



**Contains:** 14 PSID By-Pass Valve  
**Replaces:** CompAir 9826279; Fleetguard  
HF6329; Woodgate WGH6329  
**Thread:** 1 1/2 -11 BSP-PL  
**O.D.:** 4 15/16 (125.4)  
**Height:** 7 17/32 (191.3)  
**F. Gskt:** [1] Included

**BT9321**

Hydraulic Spin-on



**Fits:** Kobelco Excavators; Kubota Equipment  
**Replaces:** Kobelco S15510-35110; Yanmar  
155103-5110; 172179-7372  
**Thread:** 1 1/8 -16  
**O.D.:** 3 23/32 (94.5)  
**Height:** 6 13/16 (173.0)  
**I.Gskt:** [1] Included

**BT9324**

Stainless Steel Mesh Hydraulic Spin-on



**Replaces:** MP Filtri CS100M60; Woodgate  
WGH9178  
**Thread:** 1 1/4 -11 BSP-PL  
**O.D.:** 5 1/32 (127.8)  
**Height:** 7 7/32 (183.4)  
**I.Gskt:** [1] Included

**BT9326**

Air Breather Spin-on



**Replaces:** Woodgate WGUC4930  
**Thread:** 3/4 -14 BSP-PL  
**O.D.:** 3 3/4 (95.3)  
**Height:** 2 5/16 (58.7)  
**I.Gskt:** [1] Included

**H9327**

Wire Mesh Supported Hydraulic Element



**Fits:** Massey Ferguson Tractors  
**Replaces:** Massey Ferguson 3619594-M1;  
Fleetguard HF28811  
**O.D.:** 2 (50.8)  
**I.D.:** 15/16 (23.8) One End  
**Height:** 6 5/16 (160.3)  
**O-Ring:** [1] Attached

**PT9328-MPG**

Maximum Performance Glass Hydraulic  
Element



**Fits:** Liebherr R984 Li Excavator  
**Replaces:** Liebherr 7366869; Fleetguard  
HF28848; Woodgate WGH1921  
**O.D.:** 5 31/32 (151.6)  
**I.D.:** 1 5/8 (41.3) & 3 7/16 (87.3)  
**Height:** 32 11/16 (830.3)  
**A. Gskt:** [2] Attached

**PT9329**

Hydraulic Element with Attached Spring



**Fits:** Renault Tractors  
**Replaces:** Renault 7701015558; Fleetguard  
HF6186  
**O.D.:** 2 3/4 (69.9)  
**I.D.:** 1 (25.4) One End  
**Height:** 5 1/2 (139.7)  
**O-Ring:** [1] Included  
**Spring:** [1] Attached

**PT9330-MPG**

Wire Mesh Supported Maximum Performance  
Glass Hydraulic Element



**Fits:** Bomag Paving Equipment; JLG  
Equipment  
**Replaces:** Hydac 110D010BNHC; Woodgate  
WGH11010DB  
**O.D.:** 1 7/8 (47.6)  
**I.D.:** 13/16 (20.6) One End  
**Height:** 6 1/32 (153.2)  
**O-Ring:** [1] Attached

**PT9331**

Hydraulic Element



**Contains:** Threaded hex nut for removal.  
**Replaces:** U.C.C. UCSE1326; Woodgate  
WGSE1326  
**Thread:** 2 -11 BSP-PL  
**O.D.:** 3 5/16 (84.1)  
**Height:** 10 7/32 (259.6)

**PT9332**

Hydraulic Element



**Notes:** OBSOLETE. Availability Limited to  
Dealer Stock.  
**Replaces:** J.C. Bamford 581/05609; Woodgate  
WGTX3ER-10  
**O.D.:** 2 7/8 (73.0)  
**I.D.:** 5/8 (15.9) & 1 25/32 (45.2)  
**Height:** 11 27/32 (300.8)

**PT9335-MPG**

Maximum Performance Glass Hydraulic  
Element



**Notes:** OBSOLETE. Availability Limited to  
Dealer Stock.  
**Replaces:** Parker GO1098; Woodgate  
WGH1851  
**O.D.:** 3 19/32 (91.3)  
**I.D.:** 2 15/32 (62.7)  
**Height:** 12 15/32 (316.7)

Measurements Are Shown In Inches And (Millimeters)

**WARNING:** These products can expose you to chemicals, including Diisononyl Phthalate, Carbon black extracts, Nickel, 1,3 Butadiene, Ethylene Oxide, Epichlorohydrin, which are known to the State of California to cause cancer, and Bisphenol, Ethylene Glycol, Ethylene Oxide, 1,3 Butadiene, Epichlorohydrin, which are known to the State of California to cause birth defects or other reproductive harm.

**PT9337-MPG** Wire Mesh Supported Maximum Performance Glass Hydraulic Element  
**Fits:** Liebherr Equipment  
**Replaces:** Caterpillar 109-7293; Liebherr 7362910; Donaldson P173188; Fleetguard HF7834  
**O.D.:** 1 3/8 (34.9)  
**I.D.:** 1/2 (12.7) One End  
**Height:** 3 11/16 (93.7)  
**O-Ring:** [1] Attached



**PT9344** Hydraulic Element  
**Notes:** Inside-Out Flow Direction  
**Replaces:** Gillig 5322412002; Fleetguard HF8140  
**O.D.:** 4 (101.6)  
**I.D.:** 1 3/32 (27.8) & 1 15/32 (37.3)  
**Height:** 5 7/32 (132.6)  
**A. Gskt:** [2] Attached



**PT9338-MPG** Wire Mesh Supported Maximum Performance Glass Hydraulic Element  
**Fits:** John Deere Equipment  
**Replaces:** John Deere AT162766; Fleetguard HF7989  
**O.D.:** 5 29/32 (150.0)  
**I.D.:** 4 11/32 (110.3)  
**Height:** 17 23/32 (450.1)  
**A. Gskt:** [2] Attached  
**O-Ring:** [1] Included



**BT9345** Hydraulic Spin-on  
**Fits:** Ransomes Jacobsen HR6010 Mower  
**Replaces:** Ransomes Jacobsen 178025  
**Thread:** 1 1/2 -16  
**O.D.:** 5 1/16 (128.6)  
**Height:** 10 3/4 (273.1)  
**I.Gskt:** G369-B



**PT9340-MPG** Wire Mesh Supported Maximum Performance Glass Hydraulic Element  
**Notes:** Inside-Out Flow Direction  
**Fits:** Bomag Compactors; Case Excavators; Versatile Tractors  
**Replaces:** Donaldson P164699; Fleetguard HF35021  
**O.D.:** 4 3/8 (111.1)  
**I.D.:** 3/4 (19.0) & 2 7/16 (61.9)  
**Height:** 16 1/32 (407.2)  
**A. Gskt:** [1] Attached  
**Grommets:** [1] Attached



**BT9346-MPG** Wire Mesh Supported Maximum Performance Glass Hydraulic Spin-on  
**Contains:** 15 PSID By-Pass Valve  
**Fits:** John Deere Tractors  
**Replaces:** John Deere RE27284  
**Thread:** 1 1/2 -16  
**O.D.:** 3 11/16 (93.7)  
**Height:** 5 9/16 (141.3)  
**I.Gskt:** [1] Included



**PT9341** Hydraulic Element with Attached Spring  
**Fits:** Daewoo Equipment  
**Replaces:** Daewoo 65-05504-5021  
**O.D.:** 4 11/32 (110.3)  
**I.D.:** 2 3/16 (55.6) One End  
**Height:** 11 1/8 (282.6)  
**A. Gskt:** [1] Attached  
**O-Ring:** [2] Included



**BT9347-MPG** Maximum Performance Glass Hydraulic Spin-on  
**Fits:** Hitachi, John Deere Loaders  
**Replaces:** John Deere AT189924, AT195915, AT228474, AT310905  
**Thread:** M90 x 2.0  
**O.D.:** 4 23/32 (119.9)  
**Height:** 11 23/32 (297.7)  
**I.Gskt:** [1] Included



**PT9342-MPG** Wire Mesh Supported Maximum Performance Glass Hydraulic Element  
**Fits:** Skytrak Telehandlers  
**Replaces:** Koehring 8320265; Parker 932000  
**O.D.:** 3 11/16 (93.7)  
**I.D.:** 1 19/32 (40.5)  
**Height:** 8 1/4 (209.6)  
**Grommets:** [2] Attached



**PT9348-MPG** Wire Mesh Supported Maximum Performance Glass Hydraulic Element with Handle  
**Contains:** 25 PSID By-Pass Valve Bleed Hole Reinforced Centertube  
**Fits:** Hitachi Excavators  
**Replaces:** Hitachi 4448160, 4450003  
**O.D.:** 6 1/8 (155.6)  
**I.D.:** 3 15/16 (100.0) One End  
**Height:** 18 5/32 (461.2)  
**I.Gskt:** [1] Included  
**A. Gskt:** [1] Attached  
**O-Ring:** [1] Included



**BT9343-MPG** Maximum Performance Glass Hydraulic Spin-on  
**Fits:** John Deere Motor Graders  
**Replaces:** John Deere AT193883; Fleetguard HF6840  
**Thread:** 1 1/2 -16  
**O.D.:** 4 13/16 (122.2)  
**Height:** 7 15/32 (189.7)  
**I.Gskt:** [1] Included



**BT9349-MPG** Maximum Performance Glass Hydraulic Spin-on  
**Fits:** Caterpillar Equipment  
**Replaces:** Caterpillar 184-3931; Donaldson P170310  
**Thread:** 2 -12  
**O.D.:** 3 1/8 (79.4)  
**Height:** 5 17/32 (140.5)



Measurements Are Shown In Inches And (Millimeters)

**WARNING:** These products can expose you to chemicals, including Diisononyl Phthalate, Carbon black extracts, Nickel, 1,3 Butadiene, Ethylene Oxide, Epichlorohydrin, which are known to the State of California to cause cancer, and Bisphenol, Ethylene Glycol, Ethylene Oxide, 1,3 Butadiene, Epichlorohydrin, which are known to the State of California to cause birth defects or other reproductive harm.

**PT9350-MPG**

Wire Mesh Supported Maximum Performance Glass Hydraulic Element



**Replaces:** O&K 1717467; Donaldson P173081; Fleetguard HF7833; Woodgate WGH4060  
**O.D.:** 6 (152.4)  
**I.D.:** 3 15/16 (100.0) One End  
**Height:** 25 1/2 (647.7)

**BT9356**

Hydraulic Spin-on



**Fits:** Case-International, New Holland Equipment  
**Replaces:** New Holland 86632018, 87027973  
**Thread:** 1 1/2 -16  
**O.D.:** 5 1/16 (128.6)  
**Height:** 6 31/32 (177.0)  
**F. Gskt:** G369-B  
**O. Gskt:** G286-C, G369-V, G372, G447, G483, G704, G710

**PT9351-MPG**

Wire Mesh Supported Maximum Performance Glass Hydraulic Element



**Fits:** Komatsu Equipment  
**Replaces:** Komatsu 207-607-1180  
**O.D.:** 5 15/16 (150.8)  
**I.D.:** 3 19/32 (91.3)  
**Height:** 7 7/8 (200.0)  
**Related To:** PT9399-MPG (Long Version)

**PT9357**

Hydraulic Element



**Fits:** Volvo Excavators  
**Replaces:** Volvo 14509379  
**O.D.:** 5 29/32 (150.0)  
**I.D.:** 4 11/32 (110.3)  
**Height:** 17 23/32 (450.1)  
**O-Ring:** [1] Included

**PT9352**

Wire Mesh Hydraulic Element



**Notes:** Has M10 x 1.5 threaded bushing in closed end.  
**Fits:** Fiat-Hitachi, Hitachi Equipment  
**Replaces:** Hitachi 4210224, 4385915; John Deere TH110133  
**O.D.:** 5 29/32 (150.0)  
**I.D.:** 3 13/32 (86.5) One End  
**Height:** 5 5/16 (134.9)  
**O-Ring:** [1] Attached

**BT9358**

Transmission Spin-on



**Contains:** Reinforced Centertube  
**Fits:** Kubota Equipment  
**Replaces:** Kubota TA240-59900, TA240-59901  
**Thread:** 1 1/8 -16  
**O.D.:** 3 25/32 (96.0)  
**Height:** 6 15/32 (164.3)  
**I.Gskt:** [1] Included

**BT9353-MPG**

Maximum Performance Glass Hydraulic Spin-on



**Fits:** Caterpillar, John Deere Equipment  
**Use With:** OB8771, OB8772, OB8773 bases.  
**Replaces:** Caterpillar 225-4118  
**Thread:** 1 3/4 -12  
**O.D.:** 4 23/32 (119.9)  
**Height:** 11 17/32 (292.9)  
**I.Gskt:** [1] Included

**PT9359-MPG**

Wire Mesh Supported Maximum Performance Glass Hydraulic Element with Bail Handle



**Contains:** 43.5 PSID By-Pass Valve  
**Replaces:** McNeilus 1137725; Schroeder SBF0500RZ10B; Donaldson P173173  
**O.D.:** 3 23/32 (94.5)  
**I.D.:** 1 29/32 (48.4) One End  
**Height:** 10 7/8 (276.2)  
**O-Ring:** [1] Attached

**PT9354-MPG**

Wire Mesh Supported Maximum Performance Glass Hydraulic Element



**Fits:** Freightliner, International, Kenworth, Mack, Peterbilt, Sterling Trucks  
**Replaces:** International 1698964-C92; Nelson 87904M  
**O.D.:** 3 3/8 (85.7)  
**I.D.:** 1 1/8 (28.6)  
**Height:** 2 23/32 (69.1)  
**Grommets:** [2] Attached

**BT9360**

Hydraulic Spin-on



**Fits:** Komatsu Equipment  
**Replaces:** Komatsu 4196-03-5152  
**Thread:** M120 x 2.0  
**O.D.:** 5 3/32 (129.4)  
**Height:** 11 (279.4)  
**A. Gskt:** [1] Attached  
**O-Ring:** [1] Included

**PT9355-MPG**

2-Section Maximum Performance Glass Hydraulic Element with Bail Handle



**Contains:** Strainer Basket  
**Fits:** Liebherr Excavators  
**Replaces:** Liebherr 7373878; Fleetguard HF35109  
**O.D.:** 6 1/8 (155.6)  
**I.D.:** 3 5/32 (80.2) & 3 15/16 (100.0)  
**Height:** 20 1/2 (520.7)  
**I.Gskt:** [2] Included

**PT9361**

Hydraulic Element



**Notes:** Inside-Out Flow Direction  
**Replaces:** Zinga WE51810; Donaldson P550582  
**O.D.:** 5 7/32 (132.6)  
**I.D.:** 3 3/8 (85.7)  
**Height:** 18 7/16 (468.3)  
**Grommets:** [2] Attached

Measurements Are Shown In Inches And (Millimeters)

**WARNING:** These products can expose you to chemicals, including Diisononyl Phthalate, Carbon black extracts, Nickel, 1,3 Butadiene, Ethylene Oxide, Epichlorohydrin, which are known to the State of California to cause cancer, and Bisphenol, Ethylene Glycol, Ethylene Oxide, 1,3 Butadiene, Epichlorohydrin, which are known to the State of California to cause birth defects or other reproductive harm.

**BT9362-MPG** Maximum Performance Glass Hydraulic Spin-on  
**Fits:** Case, New Holland Dozers; Case-International Combines, Tractors  
**Use With:** OB8711, OB8712, OB8720, OB8721, OB8722, OB8724, OB8731, OB8732, OB8741, OB8742, OB8743, OB8744, OB8745, OB8746 bases.  
**Replaces:** Case 254353A1  
**Thread:** 1 3/8 -12  
**O.D.:** 4 23/32 (119.9)  
**Height:** 11 17/32 (292.9)  
**O-Ring:** [1] Included



**BT9367-MPG** Maximum Performance Glass Hydraulic Spin-on  
**Fits:** John Deere Equipment  
**Replaces:** John Deere AT308274; Fleetguard HF29033  
**Thread:** M90 x 2.0  
**O.D.:** 4 23/32 (119.9)  
**Height:** 11 29/32 (302.4)  
**I.Gskt:** [1] Included



**BT9363-MPG** Maximum Performance Glass Hydraulic Spin-on  
**Fits:** Volvo Excavators  
**Use With:** OB8711, OB8712, OB8720, OB8721, OB8722, OB8724, OB8731, OB8732, OB8741, OB8742, OB8743, OB8744, OB8745, OB8746 bases.  
**Replaces:** Volvo 11802677  
**Thread:** 1 3/8 -12  
**O.D.:** 3 3/4 (95.3)  
**Height:** 9 19/32 (243.7)  
**O-Ring:** [1] Included



**BT9368-MPG** Maximum Performance Glass Hydraulic Spin-on  
**Fits:** John Deere Motor Graders, Skidders  
**Replaces:** John Deere AT306605  
**Thread:** M72 x 2.0  
**O.D.:** 3 7/8 (98.4)  
**Height:** 9 3/16 (233.4)  
**I.Gskt:** [1] Included



**BT9364** Hydraulic Spin-on  
**Contains:** 50 PSID By-Pass Valve By-Pass Screen  
**Fits:** Bobcat Loaders with Kubota Engine  
**Use With:** OB8711, OB8712, OB8720, OB8721, OB8722, OB8724, OB8731, OB8732, OB8741, OB8742, OB8743, OB8744, OB8745, OB8746 bases.  
**Replaces:** Melroe-Bobcat 6677652  
**Thread:** 1 3/8 -12  
**O.D.:** 3 3/4 (95.3)  
**Height:** 6 1/8 (155.6)  
**O-Ring:** [1] Included



**BT9369-MPG** Maximum Performance Glass Hydraulic Spin-on  
**Fits:** John Deere Motor Graders  
**Replaces:** John Deere AT305049; Fleetguard HF29035  
**Thread:** M90 x 2.0  
**O.D.:** 4 23/32 (119.9)  
**Height:** 8 29/32 (226.2)  
**I.Gskt:** [1] Included



**BT9365-MPG** Maximum Performance Glass Hydraulic Spin-on  
**Fits:** Caterpillar Equipment  
**Use With:** OB8771, OB8772, OB8773 bases.  
**Replaces:** Caterpillar 134-3014  
**Thread:** 1 3/4 -12  
**O.D.:** 4 23/32 (119.9)  
**Height:** 11 1/2 (292.1)  
**I.Gskt:** [1] Included



**BT9370-MPG** Maximum Performance Glass Hydraulic Spin-on  
**Notes:** Rated 1000 PSI minimum burst. Dome end accepts 1/2 In. socket driver.  
**Fits:** John Deere Mowers, Tractors  
**Use With:** OB8711, OB8712, OB8720, OB8721, OB8722, OB8724, OB8726, OB8731, OB8732, OB8740, OB8741, OB8742, OB8743, OB8744, OB8745, OB8746 bases.  
**Replaces:** John Deere RE205726  
**Thread:** 1 3/8 -12  
**O.D.:** 3 3/4 (95.3)  
**Height:** 9 27/32 (250.0)  
**I.Gskt:** [1] Included



**BT9366-MPG** Maximum Performance Glass Hydraulic Spin-on  
**Fits:** Caterpillar Equipment, Trucks  
**Replaces:** Caterpillar 156-0214  
**Thread:** 1 3/8 -12  
**O.D.:** 3 11/16 (93.7)  
**Height:** 9 19/32 (243.7)  
**I.Gskt:** [1] Viton



**BT9371-MPG** Maximum Performance Glass Hydraulic Spin-on  
**Notes:** Can be used with OB1313, OB1314, OB1315, OB1316 bases (requires optional G286-C gasket).  
**Fits:** Caterpillar, Ditch Witch Equipment; Caterpillar Off-Highway Trucks  
**Replaces:** Caterpillar 144-0832; Donaldson P167162; Fleetguard HF6777  
**Thread:** 1 1/2 -16  
**O.D.:** 5 1/16 (128.6)  
**Height:** 6 31/32 (177.0)  
**F. Gskt:** G447











**PT9372** Wire Supported Hydraulic Element with Bail Handle  
**Contains:** 14.5 PSID By-Pass Valve  
**Fits:** Volvo Excavators  
**Replaces:** Volvo 14375005  
**O.D.:** 2 3/8 (60.3)  
**I.D.:** 25/32 (19.8) One End  
**Height:** 9 (228.6)  
**O-Ring:** [1] Attached  
**Spring:** [1] Included



Measurements Are Shown In Inches And (Millimeters)

**WARNING:** These products can expose you to chemicals, including Diisononyl Phthalate, Carbon black extracts, Nickel, 1,3 Butadiene, Ethylene Oxide, Epichlorohydrin, which are known to the State of California to cause cancer, and Bisphenol, Ethylene Glycol, Ethylene Oxide, 1,3 Butadiene, Epichlorohydrin, which are known to the State of California to cause birth defects or other reproductive harm.

<p><b>PT9373-MPG</b></p> 	<p>Wire Mesh Supported Maximum Performance Glass Hydraulic Element</p> <p><b>Contains:</b> 30 PSID By-Pass Valve</p> <p><b>Fits:</b> Bobcat Excavators; Terex Equipment</p> <p><b>Replaces:</b> Melroe-Bobcat 5380658088</p> <p><b>O.D.:</b> 3 9/32 (83.3)</p> <p><b>I.D.:</b> 1 3/4 (44.4) One End</p> <p><b>Height:</b> 12 5/16 (312.7)</p> <p><b>O-Ring:</b> [1] Included</p>	<p><b>PT9379</b></p> <p>Hydraulic Element</p> <p><b>Fits:</b> Komatsu Equipment</p> <p><b>Replaces:</b> Komatsu 7063-51-383</p> <p><b>O.D.:</b> 7 (177.8)</p> <p><b>I.D.:</b> 4 5/16 (109.5)</p> <p><b>Height:</b> 17 3/4 (450.9)</p> <p><b>O-Ring:</b> [1] Included</p> 
<p><b>PT9374</b></p> 	<p>Hydraulic Element</p> <p><b>Fits:</b> Scania Trucks</p> <p><b>Replaces:</b> Scania 1329876, 1381235; Donaldson P550220</p> <p><b>O.D.:</b> 3 7/16 (87.3)</p> <p><b>I.D.:</b> 23/32 (18.3) One End</p> <p><b>Height:</b> 4 3/16 (106.4)</p> <p><b>Grommets:</b> [1] Attached</p>	<p><b>PT9380-MPG</b></p> <p>Wire Mesh Supported Maximum Performance Glass Hydraulic Element</p> <p><b>Fits:</b> Caterpillar Equipment</p> <p><b>Replaces:</b> Caterpillar 139-1537</p> <p><b>O.D.:</b> 5 1/8 (130.2)</p> <p><b>I.D.:</b> 3 3/8 (85.7)</p> <p><b>Height:</b> 6 31/32 (177.0)</p> <p><b>A. Gskt:</b> [2] Attached</p> 
<p><b>PT9375</b></p> 	<p>Hydraulic Element</p> <p><b>Fits:</b> Hyundai Excavators</p> <p><b>Replaces:</b> Hyundai 31E-34527</p> <p><b>O.D.:</b> 5 29/32 (150.0)</p> <p><b>I.D.:</b> 3 5/16 (84.1)</p> <p><b>Height:</b> 11 13/16 (300.0)</p> <p><b>A. Gskt:</b> [2] Attached</p>	<p><b>PT9381-MPG</b></p> <p>Wire Supported Maximum Performance Glass Hydraulic Element with Bail Handle</p> <p><b>Fits:</b> Volvo Loaders</p> <p><b>Replaces:</b> Volvo 2906601, ZM2906601</p> <p><b>O.D.:</b> 3 1/16 (77.8)</p> <p><b>I.D.:</b> 1 23/32 (43.7) One End</p> <p><b>Height:</b> 12 5/16 (312.7)</p> <p><b>O-Ring:</b> [1] Attached</p> 
<p><b>PT9376</b></p> 	<p>Hydraulic Element</p> <p><b>Fits:</b> John Deere Excavators, Loaders</p> <p><b>Replaces:</b> Hitachi 4129280; John Deere AT308568</p> <p><b>O.D.:</b> 3 1/2 (88.9)</p> <p><b>I.D.:</b> 1 7/8 (47.6)</p> <p><b>Height:</b> 14 3/16 (360.4)</p> <p><b>O-Ring:</b> [2] Included</p> <p><b>Grommets:</b> [2] Attached</p>	<p><b>BT9382</b></p> <p>Hydraulic Spin-on</p> <p><b>Contains:</b> Hex nut for easy removal</p> <p><b>Fits:</b> Hitachi Excavators</p> <p><b>Replaces:</b> Hitachi 4252563; John Deere 4252563; Donaldson P550542; Fleetguard HF7553</p> <p><b>Thread:</b> 1 1/8 -16</p> <p><b>O.D.:</b> 3 11/16 (93.7)</p> <p><b>Height:</b> 5 7/8 (149.2)</p> <p><b>I.Gskt:</b> G381-A</p> 
<p><b>BT9377</b></p> 	<p>Hydraulic Spin-on</p> <p><b>Fits:</b> Komatsu Dozers, Excavators</p> <p><b>Replaces:</b> Komatsu 21N-60-12210; Fleetguard HF28894</p> <p><b>Thread:</b> M48 x 2.0</p> <p><b>O.D.:</b> 5 9/32 (134.1)</p> <p><b>Height:</b> 11 15/32 (291.3)</p> <p><b>I.Gskt:</b> [1] Included</p>	<p><b>PT9383-MPG</b></p> <p>Maximum Performance Glass Hydraulic Element with Spring and Bail Handle</p> <p><b>Contains:</b> 65 PSID By-Pass Valve</p> <p><b>Fits:</b> Volvo Excavators</p> <p><b>Replaces:</b> Volvo 14375006</p> <p><b>O.D.:</b> 4 1/2 (114.3)</p> <p><b>I.D.:</b> 2 1/2 (63.5) One End</p> <p><b>Height:</b> 16 7/32 (412.0)</p> <p><b>Spring:</b> [1] Included</p> 
<p><b>PT9378-MPG</b></p> 	<p>Wire Mesh Supported Maximum Performance Glass Hydraulic Element</p> <p><b>Fits:</b> Ransomes Jacobsen HR6010 Mower</p> <p><b>Replaces:</b> Ransomes Jacobsen 8089620; Woodgate WGH1774</p> <p><b>O.D.:</b> 2 3/32 (53.2)</p> <p><b>I.D.:</b> 1 3/32 (27.8)</p> <p><b>Height:</b> 6 3/32 (154.8)</p> <p><b>O-Ring:</b> [1] Attached</p>	<p><b>PT9384-MPG</b></p> <p>Wire Supported Maximum Performance Glass Hydraulic Element</p> <p><b>Contains:</b> 20 PSID By-Pass Valve</p> <p><b>Fits:</b> Volvo Loaders</p> <p><b>Replaces:</b> Volvo 2289977; Fleetguard HF28816</p> <p><b>O.D.:</b> 2 3/4 (69.9)</p> <p><b>I.D.:</b> 1 5/8 (41.3) One End</p> <p><b>Height:</b> 8 7/8 (225.4)</p> <p><b>O-Ring:</b> [1] Included</p> <p><b>Grommets:</b> [1] Attached</p> 

Measurements Are Shown In Inches And (Millimeters)

**WARNING:** These products can expose you to chemicals, including Diisononyl Phthalate, Carbon black extracts, Nickel, 1,3 Butadiene, Ethylene Oxide, Epichlorohydrin, which are known to the State of California to cause cancer, and Bisphenol, Ethylene Glycol, Ethylene Oxide, 1,3 Butadiene, Epichlorohydrin, which are known to the State of California to cause birth defects or other reproductive harm.



**PT9385-MPG**

Maximum Performance Glass Hydraulic Element



**Replaces:** Ingersoll-Rand 52263209; Donaldson P161571; Fleetguard HF6297  
**O.D.:** 4 3/8 (111.1)  
**I.D.:** 23/32 (18.3) & 2 13/32 (61.1)  
**Height:** 16 1/16 (408.0)  
**A. Gskt:** [1] Attached  
**Grommets:** [1] Attached

**BT9391-MPG**

Maximum Performance Glass Hydraulic Spin-on



**Fits:** Case-International, New Holland Tractors  
**Replaces:** New Holland 86018758  
**Thread:** 1 3/8 -12  
**O.D.:** 4 23/32 (119.9)  
**Height:** 11 17/32 (292.9)  
**I.Gskt:** [1] Included

**PT9386-MPG**

Wire Supported Maximum Performance Glass Hydraulic Element



**Notes:** Inside-Out Flow Direction  
**Fits:** Freightliner, Kenworth, Peterbilt Trucks  
**Replaces:** Nelson 87972A  
**O.D.:** 5 (127.0)  
**I.D.:** 7/8 (22.2) & 1 7/16 (36.5)  
**Height:** 4 1/16 (103.2)  
**A. Gskt:** [2] Attached

**BT9392-MPG**

Maximum Performance Glass Hydraulic Spin-on



**Fits:** Caterpillar Equipment, Off-Highway Trucks  
**Replaces:** Caterpillar 126-1814; Donaldson P170309; Wix 57397  
**Thread:** 2 -12  
**O.D.:** 3 1/8 (79.4)  
**Height:** 9 17/32 (242.1)  
**I.Gskt:** [2] Included

**BT9387**

Hydraulic Spin-on



**Contains:** 10 PSID By-Pass Valve By-Pass Screen  
**Fits:** Massey Ferguson Tractors  
**Replaces:** AGCO 3383386M92; Massey Ferguson 3383386-M92; Fleetguard HF7950  
**Thread:** M42 x 2.0  
**O.D.:** 5 3/8 (136.5)  
**Height:** 8 5/8 (219.1)  
**I.Gskt:** [1] Included

**BT9393-MPG**

Maximum Performance Glass Hydraulic Spin-on



**Fits:** Caterpillar Equipment, Off-Highway Trucks  
**Replaces:** Caterpillar 126-1813; Donaldson P170308  
**Thread:** 2 -12  
**O.D.:** 3 1/8 (79.4)  
**Height:** 5 17/32 (140.5)  
**I.Gskt:** [1] Included

**BT9388**

Power Steering Spin-on



**Contains:** 20 PSID By-Pass Valve  
**Fits:** International Thomas, Buses; Ford, Freightliner, International, Sterling, Western Star Trucks  
**Replaces:** Ford F8HZ-3C602-AA; Freightliner T1808D, VMLT1808D; International 2503221-C1  
**Thread:** 3/4 -16  
**O.D.:** 2 21/32 (67.5)  
**Height:** 3 1/2 (88.9)  
**I.Gskt:** [1] Included

**PT9394-MPG**

Wire Supported Maximum Performance Glass Power Steering Element



**Notes:** Inside-Out Flow Direction  
**Fits:** Kenworth, Mack Trucks  
**Replaces:** Mack 5839870678A; Nelson 870678A  
**O.D.:** 3 3/8 (85.7)  
**I.D.:** 13/16 (20.6)  
**Height:** 4 1/8 (104.8)  
**Grommets:** [2] Attached

**PT9389-MPG**

Wire Mesh Supported Maximum Performance Glass Hydraulic Element



**Fits:** John Deere Motor Graders  
**Replaces:** John Deere AT181127; Fleetguard HF28999  
**O.D.:** 2 7/8 (73.0)  
**I.D.:** 1 15/32 (37.3) One End  
**Height:** 9 17/32 (242.1)  
**O-Ring:** [1] Attached

**PT9395-MPG**

Maximum Performance Glass Hydraulic Element



**Fits:** Case-International, Fendt, J.C. Bamford, Massey Ferguson Tractors  
**Replaces:** Case 192200280705; Fleetguard HF35320  
**O.D.:** 2 3/4 (69.9)  
**I.D.:** 1 (25.4) One End  
**Height:** 7 29/32 (200.8)  
**I.Gskt:** [1] Included

**PT9390-MPG**

Wire Mesh Supported Maximum Performance Glass Hydraulic Element with Bail Handle



**Contains:** 43.5 PSID By-Pass Valve  
**Fits:** Caterpillar Equipment  
**Replaces:** Caterpillar 143-2849; Fleetguard ST1264  
**O.D.:** 3 23/32 (94.5)  
**I.D.:** 1 13/16 (46.0) One End  
**Height:** 7 5/8 (193.7)

**PT9396**

Hydraulic Element



**Fits:** Case, Kobelco, New Holland Excavators  
**Replaces:** Kobelco PA33H01040P1; New Holland PA33H01040P1  
**O.D.:** 2 3/4 (69.9)  
**I.D.:** 1 5/8 (41.3)  
**Height:** 4 29/32 (124.6)

Measurements Are Shown In Inches And (Millimeters)

**WARNING:** These products can expose you to chemicals, including Diisononyl Phthalate, Carbon black extracts, Nickel, 1,3 Butadiene, Ethylene Oxide, Epichlorohydrin, which are known to the State of California to cause cancer, and Bisphenol, Ethylene Glycol, Ethylene Oxide, 1,3 Butadiene, Epichlorohydrin, which are known to the State of California to cause birth defects or other reproductive harm.

**PT9397-MPG**

Wire Mesh Supported Maximum Performance Glass Hydraulic Element



**Fits:** Barber-Greene, Caterpillar Paving Equipment  
**Replaces:** Caterpillar 77-5479  
**O.D.:** 3 29/32 (99.2)  
**I.D.:** 1 5/8 (41.3)  
**Height:** 9 9/32 (235.7)  
**Grommets:** [2] Attached

**PT9403-MPG**

Wire Mesh Supported Maximum Performance Glass Hydraulic Element with Bail Handle



**Contains:** 22 PSID By-Pass Valve  
**Fits:** John Deere, Timberjack Equipment  
**Replaces:** John Deere F061786; Donaldson P173178  
**O.D.:** 4 1/2 (114.3)  
**I.D.:** 2 3/4 (69.9) One End  
**Height:** 16 3/16 (411.2)  
**O-Ring:** [1] Attached

**BT9398-MPG**

Maximum Performance Glass Hydraulic/Transmission Spin-on



**Fits:** John Deere Tractors  
**Replaces:** John Deere AL156624, RE55801; Donaldson P178619; Fleetguard HF35339  
**Thread:** 1 3/8 -12  
**O.D.:** 3 3/4 (95.3)  
**Height:** 4 25/32 (121.4)  
**I.Gskt:** [1] Included

**PT9404-MPG**

Maximum Performance Glass Hydraulic Element



**Fits:** Case Tractors  
**Replaces:** Case K210049; Fleetguard HF28939  
**O.D.:** 3 1/8 (79.4)  
**I.D.:** 1 11/16 (42.9) One End  
**Height:** 4 5/8 (117.5)  
**O-Ring:** [1] Attached

**PT9399-MPG**

Maximum Performance Glass Hydraulic Element



**Fits:** Komatsu Excavators, Loaders  
**Replaces:** Komatsu 209-60-77531  
**O.D.:** 5 15/16 (150.8)  
**I.D.:** 3 19/32 (91.3)  
**Height:** 15 3/4 (400.0)  
**Related To:** PT9351-MPG (Short Version)

**PT9405**

Hydraulic Element



**Fits:** Caterpillar Lift Trucks  
**Replaces:** Caterpillar 92-2568; Donaldson P161413; Fleetguard HF6465  
**O.D.:** 4 3/8 (111.1)  
**I.D.:** 2 7/16 (61.9)  
**Height:** 8 1/8 (206.4)  
**A. Gskt:** [2] Attached

**BT9400-MPG**

Maximum Performance Glass Hydraulic Spin-on



**Notes:** Rated 1000 PSI minimum burst.  
**Contains:** 50 PSID By-Pass Valve By-Pass Screen  
**Replaces:** Dana 4209440; Kalmar 9210280007  
**Thread:** 2 -16  
**O.D.:** 3 3/4 (95.3)  
**Height:** 7 7/32 (183.4)  
**O-Ring:** [2] Attached

**PT9406-MPG**

Maximum Performance Glass Hydraulic Element



**Fits:** Caterpillar Paving Equipment  
**Replaces:** Caterpillar 1G5459  
**O.D.:** 1 25/32 (45.2)  
**I.D.:** 1 (25.4) One End  
**Height:** 8 3/16 (208.0)  
**O-Ring:** [1] Attached

**PT9401**

Wire Mesh Supported Hydraulic Element



**Contains:** 3/8-16 Threaded Nut on Closed End  
**Fits:** Hitachi Excavators  
**Replaces:** Hitachi 4333464  
**O.D.:** 7 7/8 (200.0)  
**I.D.:** 4 15/32 (113.5) One End  
**Height:** 5 15/32 (138.9)  
**O-Ring:** [1] Attached

**PT9407-MPG**

Maximum Performance Glass Hydraulic Element



**Fits:** Caterpillar Equipment, Off-Highway Trucks  
**Replaces:** Caterpillar 1R1809  
**O.D.:** 4 29/32 (124.6)  
**I.D.:** 2 1/16 (52.4)  
**Height:** 10 15/32 (265.9)  
**I.Gskt:** [1] Viton  
**O-Ring:** [1] Included

**BT9402**

Transmission Spin-on



**Contains:** 50 PSID By-Pass Valve  
**Fits:** Case, New Holland Equipment  
**Replaces:** New Holland 85817004  
**Thread:** 13/16 -16  
**O.D.:** 3 1/32 (77.0)  
**Height:** 5 1/2 (139.7)  
**I.Gskt:** [1] Included

**BT9408**

Air Coalescer Spin-on



**Fits:** Iveco Trucks; Mack CHN613 Truck  
**Replaces:** Cummins 3682984; Mack 279GB43M; Donaldson P566130; Fleetguard AF26113  
**Thread:** M16 x 1.5  
**O.D.:** 3 1/32 (77.0)  
**Height:** 2 5/16 (58.7)  
**I.Gskt:** G449-B

Measurements Are Shown In Inches And (Millimeters)

**WARNING:** These products can expose you to chemicals, including Diisononyl Phthalate, Carbon black extracts, Nickel, 1,3 Butadiene, Ethylene Oxide, Epichlorohydrin, which are known to the State of California to cause cancer, and Bisphenol, Ethylene Glycol, Ethylene Oxide, 1,3 Butadiene, Epichlorohydrin, which are known to the State of California to cause birth defects or other reproductive harm.

**PT9409-MPG** Wire Supported Maximum Performance Glass Hydraulic Element



**Fits:** John Deere Tractors  
**Replaces:** John Deere AL160316, AL160771; Fleetguard HF35343  
**O.D.:** 3 3/32 (78.6)  
**I.D.:** 1 21/32 (42.1)  
**Height:** 10 1/4 (260.3)  
**O-Ring:** [2] Attached, [1] Included

**PT9410-MPG** Wire Supported Maximum Performance Glass Hydraulic Element



**Notes:** Inside-Out Flow Direction  
**Fits:** Lull Lift Trucks  
**Replaces:** Lull 10727810, P27810  
**O.D.:** 4 5/32 (105.6)  
**I.D.:** 13/32 (10.3) & 2 13/16 (71.4)  
**Height:** 7 15/32 (189.7)  
**Grommets:** [1] Attached

**PT9411-MPG** Maximum Performance Glass Hydraulic Element



**Fits:** Komatsu Dozers, Excavators  
**Replaces:** Komatsu 2076-07-1182  
**O.D.:** 5 15/16 (150.8)  
**I.D.:** 3 19/32 (91.3)  
**Height:** 7 7/8 (200.0)

**PT9413-MPG** Maximum Performance Glass Hydraulic Element



**Fits:** Komatsu Equipment  
**Replaces:** Komatsu 14X6031150  
**O.D.:** 4 3/8 (111.1)  
**I.D.:** 2 13/32 (61.1)  
**Height:** 7 27/32 (199.2)

**PT9414-MPG** Wire Supported Maximum Performance Glass Hydraulic Element



**Fits:** John Deere Forwarders, Wheeled Harvesters  
**Replaces:** John Deere F058437; Timberjack F058437; Fleetguard HF35198  
**O.D.:** 2 3/4 (69.9)  
**I.D.:** 1 5/16 (33.3) One End  
**Height:** 5 (127.0)  
**O-Ring:** [1] Attached

**PT9415-MPG KIT** Set of 2 Maximum Performance Glass Transmission Elements



**Notes:** High capacity filters.  
**Fits:** Allison World Transmissions with 4 Inch Sump  
**Replaces:** Allison 29545779; GMC 29506337; John Deere AT327883; Fleetguard HF28943  
**Each Element:**  
**O.D.:** 3 7/32 (81.8)  
**I.D.:** 1 17/32 (38.9) One End  
**Height:** 5 15/16 (150.8)  
**F. Gskt:** [2] Irregular, [2] Square Cut  
**O-Ring:** [6] Viton Included

**PT9416-MPG KIT** Set of 2 Maximum Performance Glass Transmission Elements



**Notes:** High capacity filters.  
**Fits:** Allison World Transmissions with 2 In. or 7 In. Sump  
**Replaces:** Allison 29545776, 29548987, 29558117, 29558328; Donaldson P179206, P560972; Fleetguard HF28944, HF35153  
**Each Element:**  
**O.D.:** 3 7/32 (81.8)  
**I.D.:** 1 17/32 (38.9) One End  
**Height:** 4 3/16 (106.4)  
**I.Gskt:** [1] Included Each Element  
**F. Gskt:** [2] Irregular, [2] Square Cut  
**O-Ring:** [6] Viton Included

**PT9417** Transmission Element



**Fits:** R.V.I., Volvo Trucks  
**Replaces:** Renault 7401521527, 7485105048, 7485108176; Volvo 1521527, 20776259, 85108176, 85105048  
**O.D.:** 2 17/32 (64.3)  
**I.D.:** 1 7/32 (31.0)  
**Height:** 5 7/8 (149.2)  
**A. Gskt:** [2] Attached

**PT9418** Hydraulic Element



**Contains:** Reinforced Centertube  
**Fits:** Caterpillar Equipment  
**Replaces:** Caterpillar 1R0778  
**O.D.:** 5 1/8 (130.2)  
**I.D.:** 3 3/8 (85.7)  
**Height:** 9 (228.6)

**PT9419-MPG** Maximum Performance Glass Hydraulic Element



**Notes:** Inside-Out Flow Direction  
**Fits:** IHC Trucks  
**Replaces:** International 1695528-C1; Nelson 87795A  
**O.D.:** 2 15/32 (62.7)  
**I.D.:** 11/32 (8.7) & 1 3/32 (27.8)  
**Height:** 5 1/32 (127.8)













**PT9420-MPG** Maximum Performance Glass Hydraulic Element



**Fits:** Komatsu CD110R-2 Crawler Carrier, D61EX-15EO, D61PX-15 Dozers, PC40MR-2, PC50MR-2, PC78MR-6, PC78US-6 Excavators  
**Replaces:** Komatsu 21W-60-41121  
**O.D.:** 4 3/8 (111.1)  
**I.D.:** 2 7/16 (61.9)  
**Height:** 3 31/32 (100.8)

Measurements Are Shown In Inches And (Millimeters)

**WARNING:** These products can expose you to chemicals, including Diisononyl Phthalate, Carbon black extracts, Nickel, 1,3 Butadiene, Ethylene Oxide, Epichlorohydrin, which are known to the State of California to cause cancer, and Bisphenol, Ethylene Glycol, Ethylene Oxide, 1,3 Butadiene, Epichlorohydrin, which are known to the State of California to cause birth defects or other reproductive harm.

<p><b>BT9421-MPG</b></p> 	<p>Maximum Performance Glass Hydraulic Spin-on  <b>Fits:</b> Case Dozers; Case-International Tractors  <b>Replaces:</b> Case 47131182, 87404986  <b>Thread:</b> 1 3/8 -12  <b>O.D.:</b> 4 23/32 (119.9)  <b>Height:</b> 11 17/32 (292.9)  <b>I.Gskt:</b> [1] Included</p>	<p><b>PT9427-MPG</b> Maximum Performance Glass Hydraulic Element  <b>Notes:</b> Inside-Out Flow Direction  <b>Fits:</b> Caterpillar D10T, D11T Crawler Tractors, 793D Off-Highway Truck, 587T Pipelayer, 657G Wheel Tractor  <b>Replaces:</b> Caterpillar 249-2337  <b>O.D.:</b> 6 25/32 (172.2)  <b>I.D.:</b> 4 1/4 (108.0)  <b>Height:</b> 9 (228.6)  <b>A. Gskt:</b> [2] Attached</p> 
<p><b>BT9422</b></p> 	<p>Hydraulic Spin-on  <b>Contains:</b> Stud Thread: M24 x 1.5  <b>Fits:</b> John Deere Equipment  <b>Replaces:</b> ZF 050132315401, 075013106101; Case/New Holland 332202A1, 8603535; John Deere AT336140  <b>O.D.:</b> 3 3/4 (95.3)  <b>Height:</b> 8 1/32 (204.0)  <b>I.Gskt:</b> [1] Included</p>	<p><b>PT9429-MPG</b> Maximum Performance Glass Hydraulic Element  <b>Fits:</b> Caterpillar Equipment, Off-Highway Trucks  <b>Replaces:</b> Caterpillar 328-3655  <b>O.D.:</b> 4 29/32 (124.6)  <b>I.D.:</b> 2 (50.8) One End  <b>Height:</b> 10 15/32 (265.9)  <b>O-Ring:</b> [1] Viton Attached</p> 
<p><b>PT9423</b></p> 	<p>Hydraulic Element  <b>Fits:</b> Mercedes-Benz Trucks, Vans  <b>Replaces:</b> Mercedes-Benz 2690321, A0002690321; Donaldson P550744  <b>O.D.:</b> 2 5/16 (58.7)  <b>I.D.:</b> 5/8 (15.9) One End  <b>Height:</b> 4 1/32 (102.4)  <b>A. Gskt:</b> [1] Attached</p>	<p><b>PT9430-MPG</b> Maximum Performance Glass Hydraulic Element  <b>Notes:</b> Inside-Out Flow Direction  <b>Fits:</b> Caterpillar Equipment  <b>Replaces:</b> Caterpillar 104-6931  <b>O.D.:</b> 5 1/8 (130.2)  <b>I.D.:</b> 3 3/8 (85.7)  <b>Height:</b> 7 (177.8)</p> 
<p><b>PT9424</b></p> 	<p>Hydraulic Element  <b>Fits:</b> Hitachi, John Deere Kubota Excavators  <b>Replaces:</b> Hitachi 4294130; John Deere 4294130  <b>O.D.:</b> 1 21/32 (42.1)  <b>I.D.:</b> 27/32 (21.4) One End  <b>Height:</b> 2 1/16 (52.4)  <b>O-Ring:</b> [1] Attached</p>	<p><b>PT9432-MPG</b> Maximum Performance Glass Hydraulic Element  <b>Replaces:</b> Euclid E12635052, E4099537; Hitachi 12635052, 4099537  <b>O.D.:</b> 3 25/32 (96.0)  <b>I.D.:</b> 2 1/8 (54.0) One End  <b>Height:</b> 12 15/16 (328.6)  <b>I.Gskt:</b> [1] Viton  <b>O-Ring:</b> [2] Included</p> 
<p><b>PT9425-MPG</b></p> 	<p>Maximum Performance Glass Hydraulic Element  <b>Fits:</b> Barber-Greene, Caterpillar Asphalt Pavers  <b>Replaces:</b> Caterpillar 123-2873  <b>O.D.:</b> 3 25/32 (96.0)  <b>I.D.:</b> 2 1/8 (54.0)  <b>Height:</b> 8 5/32 (207.2)  <b>O-Ring:</b> [1] Attached</p>	<p><b>BT9433</b> Hydraulic Spin-on  <b>Fits:</b> Caterpillar Dozers, Loaders  <b>Replaces:</b> Caterpillar 222-6713  <b>Thread:</b> 1 3/8 -12  <b>O.D.:</b> 3 3/4 (95.3)  <b>Height:</b> 9 17/32 (242.1)  <b>O-Ring:</b> [1] Attached</p> 
<p><b>PT9426</b></p> 	<p>Hydraulic Breather Element  <b>Fits:</b> Komatsu Compactors, Dump Trucks, Excavators, Loaders  <b>Replaces:</b> Komatsu 285-62-17320; Fleetguard HF28928  <b>O.D.:</b> 2 1/32 (51.6)  <b>I.D.:</b> 1 15/32 (37.3)  <b>Height:</b> 2 1/32 (51.6)</p>	<p><b>PT9434</b> Hydraulic Element  <b>Contains:</b> 35 PSID By-Pass Valve  <b>Fits:</b> Renault R212, R312, R322 Buses  <b>Replaces:</b> Renault 5000293901; Mann &amp; Hummel H616/1  <b>O.D.:</b> 2 11/32 (59.5)  <b>I.D.:</b> 1 3/16 (30.2) One End  <b>Height:</b> 7 3/8 (187.3)  <b>O-Ring:</b> [1] Attached</p> 

Measurements Are Shown In Inches And (Millimeters)

**WARNING:** These products can expose you to chemicals, including Diisononyl Phthalate, Carbon black extracts, Nickel, 1,3 Butadiene, Ethylene Oxide, Epichlorohydrin, which are known to the State of California to cause cancer, and Bisphenol, Ethylene Glycol, Ethylene Oxide, 1,3 Butadiene, Epichlorohydrin, which are known to the State of California to cause birth defects or other reproductive harm.

**PT9435-MPG**

Maximum Performance Glass Hydraulic Element



**Fits:** Volvo Dump Trucks, T450D Articulated Scraper Hauler  
**Replaces:** Volvo 11707544  
**O.D.:** 2 3/32 (53.2)  
**I.D.:** 29/32 (23.0) One End  
**Height:** 4 15/32 (113.5)  
**I.Gskt:** [1] Included  
**O-Ring:** [1] Included

**BT9442-MPG**

Maximum Performance Glass Hydraulic Spin-on



**Fits:** Volvo Excavators, Forestry Carriers  
**Replaces:** Volvo 14532687  
**Thread:** 1 1/8 -16  
**O.D.:** 3 11/16 (93.7)  
**Height:** 5 3/8 (136.5)  
**I.Gskt:** G381-A

**BT9436-MPG**

Maximum Performance Glass Hydraulic Spin-on



**Fits:** J.C. Bamford Equipment  
**Replaces:** J.C. Bamford 32/909000  
**Thread:** 1 3/8 -12  
**O.D.:** 3 3/4 (95.3)  
**Height:** 6 1/8 (155.6)  
**I.Gskt:** [1] Included

**PT9443**

Hydraulic Element with Lift Bar



**Fits:** Hitachi, John Deere Excavators  
**Replaces:** Hitachi 4443596, 4448401  
**O.D.:** 4 13/32 (111.9)  
**I.D.:** 2 1/8 (54.0) One End  
**Height:** 20 11/16 (525.5)  
**I.Gskt:** [1] Included  
**O-Ring:** [1] Included

**BT9437**

Hydraulic Spin-on



**Notes:** OBSOLETE. Availability Limited to Dealer Stock.  
**Contains:** By-Pass Valve  
**Replaces:** CLARCOR Filtration (China) B7158B; Foton Lovol B7158B  
**Thread:** M82 x 1.5  
**O.D.:** 4 1/4 (108.0)  
**Height:** 8 7/8 (225.4)  
**I.Gskt:** [1] Included

**PT9444-MPG**

Maximum Performance Glass Hydraulic Element



**Fits:** Caterpillar Equipment, Off-Highway Trucks  
**Replaces:** Caterpillar 1672009; Donaldson P550924  
**O.D.:** 6 25/32 (172.2)  
**I.D.:** 3 15/16 (100.0)  
**Height:** 9 1/16 (230.2)  
**A. Gskt:** [2] Attached

**BT9439**

Hydraulic Spin-on



**Contains:** 14 PSID By-Pass Valve  
**Fits:** Ford, New Holland Tractors  
**Replaces:** New Holland 82983474  
**Thread:** 1 3/4 -16  
**O.D.:** 4 21/32 (118.3)  
**Height:** 9 15/16 (252.4)  
**I.Gskt:** [1] Included

**PT9445-MPG**

Maximum Performance Glass Hydraulic Element



**Fits:** John Deere Dump Trucks  
**Replaces:** John Deere TT222389; Donaldson P763016  
**O.D.:** 4 31/32 (126.2)  
**I.D.:** 3/8 (9.5) & 3 5/8 (92.1)  
**Height:** 18 29/32 (480.2)  
**O-Ring:** [1] Attached

**BT9440**

Hydraulic Spin-on



**Contains:** Hex nut for removal  
**Fits:** Hitachi Excavators, John Deere Excavators, Forestry Swing Machines  
**Replaces:** Hitachi 4630525  
**Thread:** M68 x 2.0  
**O.D.:** 3 7/16 (87.3)  
**Height:** 6 13/32 (162.7)  
**O-Ring:** [2] Attached

**PT9446**

Hydraulic Element



**Notes:** Inside-Out Flow Direction  
**Contains:** By-Pass Valve  
**Fits:** Caterpillar, Mitsubishi Lift Trucks  
**Replaces:** Caterpillar 9257614100; Mitsubishi 9257614100  
**Thread:** 1 -11 BSP  
**O.D.:** 3 17/32 (89.7)  
**Height:** 11 11/16 (296.9)

**PT9441-MPG**

Maximum Performance Glass Hydraulic Element



**Fits:** Caterpillar Equipment, Off-Highway Trucks  
**Replaces:** Caterpillar 4T3133  
**O.D.:** 6 25/32 (172.2)  
**I.D.:** 3 15/16 (100.0)  
**Height:** 9 1/16 (230.2)  
**A. Gskt:** [2] Viton Attached

**PT9447**













Hydraulic Element



**Contains:** By-Pass Valve  
**Fits:** Caterpillar, Mitsubishi Lift Trucks  
**Replaces:** Caterpillar 9187505900, 9187511400; Mitsubishi 9187505900  
**Thread:** 1 -11.5 NPT  
**O.D.:** 3 3/32 (78.6)  
**Height:** 7 17/32 (191.3)

Measurements Are Shown In Inches And (Millimeters)

**WARNING:** These products can expose you to chemicals, including Diisononyl Phthalate, Carbon black extracts, Nickel, 1,3 Butadiene, Ethylene Oxide, Epichlorohydrin, which are known to the State of California to cause cancer, and Bisphenol, Ethylene Glycol, Ethylene Oxide, 1,3 Butadiene, Epichlorohydrin, which are known to the State of California to cause birth defects or other reproductive harm.

<p><b>PT9448</b></p> 	<p>Hydraulic Element  <b>Notes:</b> Inside-Out Flow Direction  <b>Contains:</b> By-Pass Valve  <b>Fits:</b> Caterpillar, Mitsubishi Lift Trucks  <b>Replaces:</b> Caterpillar 9137503800; Mitsubishi 9137503800  <b>Thread:</b> 1 -11 BSP  <b>O.D.:</b> 3 17/32 (89.7)  <b>Height:</b> 6 5/16 (160.3)</p>	<p><b>BT9454</b></p> 	<p>Hydraulic Spin-on with Removal Nut  <b>Fits:</b> Komatsu Equipment  <b>Replaces:</b> Komatsu 7140728711, 7140728712, 7140728713  <b>Thread:</b> M60 x 2.0  <b>O.D.:</b> 4 5/32 (105.6)  <b>Height:</b> 10 3/8 (263.5)  <b>I.Gskt:</b> [1] Included  <b>O-Ring:</b> [2] Attached</p>
<p><b>PT9449</b></p> 	<p>Power Steering Element  <b>Fits:</b> Mack CH612 Truck  <b>Replaces:</b> Mack 583983213F; Nelson 83213  <b>O.D.:</b> 3 3/8 (85.7)  <b>I.D.:</b> 2 (50.8)  <b>Height:</b> 2 23/32 (69.1)  <b>Grommets:</b> [2] Attached</p>	<p><b>BT9456</b></p> 	<p>Transmission Spin-on  <b>Contains:</b> Anti-Drainback Valve  30 PSID By-Pass Valve  <b>Fits:</b> J.C. Bamford Equipment  <b>Replaces:</b> ITL 58118062; J.C. Bamford 58118062  <b>Thread:</b> 1 -12  <b>O.D.:</b> 3 23/32 (94.5)  <b>Height:</b> 3 5/16 (84.1)  <b>I.Gskt:</b> G401</p>
<p><b>PT9450-MPG</b></p> 	<p>Maximum Performance Glass Hydraulic Element  <b>Fits:</b> Kalmar Lift Trucks  <b>Replaces:</b> Kalmar 9216890007  <b>O.D.:</b> 3 19/32 (91.3)  <b>I.D.:</b> 1 29/32 (48.4) One End  <b>Height:</b> 7 3/4 (196.9)  <b>I.Gskt:</b> [1] Included  <b>O-Ring:</b> [3] Included</p>	<p><b>PT9459-MPG</b></p> 	<p>2-Section Maximum Performance Glass Hydraulic Element with Bail Handle  <b>Fits:</b> Liebherr R984B, R984C Excavators  <b>Replaces:</b> Liebherr 7373884; Filtrec WG633; Fleetguard HF35367; Wix Industrial W01AG633  <b>O.D.:</b> 6 1/8 (155.6)  <b>I.D.:</b> 3 5/32 (80.2) &amp; 3 29/32 (99.2)  <b>Height:</b> 37 3/8 (949.3)  <b>O-Ring:</b> [2] Attached</p>
<p><b>PT9451-MPG</b></p> 	<p>Maximum Performance Glass Hydraulic Stacked Element with Bail Handle  <b>Contains:</b> Wire Mesh Strainer Basket  <b>Fits:</b> Liebherr Excavators  <b>Replaces:</b> Liebherr 7373881; Donaldson P784037  <b>O.D.:</b> 6 1/8 (155.6)  <b>I.D.:</b> 3 29/32 (99.2) One End  <b>Height:</b> 24 13/16 (630.2)  <b>I.Gskt:</b> [2] Included</p>	<p><b>PT9462</b></p> 	<p>Hydraulic Element  <b>Fits:</b> Agco, Challenger Tractors  <b>Replaces:</b> Agco 3792287M1  <b>O.D.:</b> 1 21/32 (42.1)  <b>I.D.:</b> 27/32 (21.4) One End  <b>Height:</b> 3 1/2 (88.9)  <b>O-Ring:</b> [1] Attached</p>
<p><b>PT9452</b></p> 	<p>Hydraulic Element  <b>Fits:</b> Hitachi Excavators, Loaders; John Deere Excavators, Forestry Swing Machines  <b>Replaces:</b> Hitachi 4656608; John Deere 4656608  <b>O.D.:</b> 6 1/16 (154.0)  <b>I.D.:</b> 3 3/4 (95.3)  <b>Height:</b> 17 1/4 (438.2)  <b>A. Gskt:</b> [2] Attached  <b>O-Ring:</b> [2] Included</p>	<p><b>PT9463</b></p> 	<p>Hydraulic Element  <b>Notes:</b> OBSOLETE. Availability Limited to Dealer Stock.  <b>Replaces:</b> Force America SRE40910AZ  <b>O.D.:</b> 3 1/2 (88.9)  <b>I.D.:</b> 1 9/16 (39.7)  <b>Height:</b> 9 9/32 (235.7)  <b>Grommets:</b> [2] Attached</p>
<p><b>PT9453-MPG</b></p> 	<p>Maximum Performance Glass Hydraulic Element  <b>Notes:</b> OBSOLETE. Availability Limited to Dealer Stock.  <b>Replaces:</b> Pall HC8900FKS16Z; Donaldson P167891, DT89001614UM; Fleetguard HF30317, Purolator-Facet 8900EAL122F3  <b>O.D.:</b> 3 25/32 (96.0)  <b>I.D.:</b> 2 3/16 (55.6) One End  <b>Height:</b> 16 7/8 (428.6)  <b>O-Ring:</b> [1] Attached</p>	<p><b>BT9464</b></p> 	<p>Hydraulic Spin-on  <b>Fits:</b> Caterpillar Equipment  <b>Replaces:</b> Caterpillar 518670, 518670X  <b>Thread:</b> M45 x 2.0  <b>O.D.:</b> 3 7/16 (87.3)  <b>Height:</b> 6 1/16 (154.0)  <b>I.Gskt:</b> [1] Included  <b>O-Ring:</b> [1] Included</p>

Measurements Are Shown In Inches And (Millimeters)

**WARNING:** These products can expose you to chemicals, including Diisononyl Phthalate, Carbon black extracts, Nickel, 1,3 Butadiene, Ethylene Oxide, Epichlorohydrin, which are known to the State of California to cause cancer, and Bisphenol, Ethylene Glycol, Ethylene Oxide, 1,3 Butadiene, Epichlorohydrin, which are known to the State of California to cause birth defects or other reproductive harm.

**BT9465** Hydraulic Spin-on  
**Replaces:** Raymond 52050901  
**Thread:** 1 -12  
**O.D.:** 3 11/16 (93.7)  
**Height:** 5 15/32 (138.9)  
**I.Gskt:** [1] Included



**PT9473** In-Line Hydraulic Element  
**Fits:** New Holland Combines  
**Replaces:** New Holland 86525899  
**Thread:** 1 3/16 -12  
**O.D.:** 2 11/32 (59.5)  
**Length:** 6 5/32 (156.4)  
**O-Ring:** [2] Included



**BT9466-MPG** Maximum Performance Glass Hydraulic Spin-on  
**Fits:** Caterpillar Equipment  
**Replaces:** Caterpillar 3416643; Donaldson P573360, P763535; Mann & Hummel WH9803  
**Thread:** 1 3/8 -12  
**O.D.:** 3 3/4 (95.3)  
**Height:** 9 17/32 (242.1)  
**I.Gskt:** [1] Included



**PT9474** In-Line Hydraulic Filter  
**Notes:** OBSOLETE. Availability Limited to Dealer Stock.  
**Fits:** John Deere Lawn & Garden Equipment  
**Replaces:** John Deere AM120916  
**O.D.:** 2 3/16 (55.6)  
**Inlet:** 11/16-16  
**Outlet:** 13/16-16  
**Length:** 3 11/16 (93.7)



**PT9468** In-Line Hydraulic Spin-on  
**Fits:** Bobcat Excavators, Loaders; John Deere Loaders  
**Replaces:** Bobcat 6661022; John Deere KV13414  
**Thread:** 9/16 -18  
**O.D.:** 1 1/2 (38.1) to 1 23/32 (43.7)  
**Length:** 3 3/16 (81.0)



**S9475** Set of 2 Foam Hydraulic Tank Breathers  
**Fits:** Komatsu Equipment  
**Replaces:** Komatsu 20Y6021470; Donaldson P502518  
**O.D.:** 2 7/16 (61.9)  
**I.D.:** 1 31/32 (50.0)  
**Height:** 15/16 (23.8)



**PT9469** In-Line Hydraulic Filter  
**Fits:** John Deere Loggers, Excavators; Hitachi Zaxis 350L Excavator  
**Replaces:** John Deere 4452326  
**O.D.:** 7/8 (22.2)  
**Inlet:** 5/16  
**Outlet:** 7/32  
**Length:** 1 15/32 (37.3)  
**O-Ring:** [1] Attached



**PT9476-MPG** Maximum Performance Glass Hydraulic Element  
**Fits:** Kobelco, New Holland Excavators  
**Replaces:** Case YN52V01020P1; Kobelco YN52V01020P1, YN52V01011P1, YN52V01011P2; New Holland YN52V01020P1  
**O.D.:** 5 23/32 (145.3)  
**I.D.:** 3 13/16 (96.8)  
**Height:** 5 1/4 (133.4)



**PT9470** In-Line Hydraulic Filter  
**Fits:** John Deere Equipment  
**Replaces:** John Deere AT183869  
**O.D.:** 1 1/2 (38.1)  
**Inlet:** 11/16-16  
**Outlet:** 13/16-16  
**Length:** 2 13/16 (71.4)  
**O-Ring:** [1] Attached



**PT9477** Stainless Steel Mesh Hydraulic Element  
**Fits:** Case, Fiat, Ford, New Holland Tractors  
**Replaces:** Case 1909143; New Holland 1909143  
**O.D.:** 1 3/4 (44.4)  
**I.D.:** 1 (25.4) One End  
**Height:** 3 15/16 (100.0)  
**A. Gskt:** [1] Attached



**BT9471** Hydraulic Spin-on  
**Contains:** 40 PSID By-Pass Valve  
**Fits:** Valtra Tractors  
**Replaces:** Agco 836536797, 836579590; Valmet 20410800; Valtra V836536797  
**Thread:** M24 x 1.5  
**O.D.:** 3 23/32 (94.5)  
**Height:** 4 3/16 (106.4)  
**I.Gskt:** [1] Included



**PT9478-MPG** Maximum Performance Glass Hydraulic Element  
**Fits:** Fiat-Allis, Fiat-Hitachi, New Holland Loaders  
**Replaces:** Case 76028203; New Holland 76028203; Donaldson P171733; Filtrec D132G25A  
**O.D.:** 2 3/32 (53.2)  
**I.D.:** 1 3/32 (27.8) One End  
**Height:** 3 11/32 (84.9)  
**O-Ring:** [1] Attached



**PT9472** Hydraulic Element  
**Fits:** Case, Link-Belt Excavators  
**Replaces:** Case 159282A1; Link-Belt KHJ0738  
**O.D.:** 6 13/32 (162.7)  
**I.D.:** 9/16 (14.3) One End  
**Height:** 9 7/16 (239.7)















**PT9479-MPG** Maximum Performance Glass Hydraulic Element  
**Fits:** J.C Bamford Loaders; MacDonald Johnston Trash Loaders  
**Replaces:** J.C. Bamford 58100012; Donaldson P171825; Filtrec R714G10  
**O.D.:** 2 27/32 (72.2)  
**I.D.:** 11/32 (8.7) & 1 25/32 (45.2)  
**Height:** 11 13/16 (300.0)



Measurements Are Shown In Inches And (Millimeters)

**WARNING:** These products can expose you to chemicals, including Diisononyl Phthalate, Carbon black extracts, Nickel, 1,3 Butadiene, Ethylene Oxide, Epichlorohydrin, which are known to the State of California to cause cancer, and Bisphenol, Ethylene Glycol, Ethylene Oxide, 1,3 Butadiene, Epichlorohydrin, which are known to the State of California to cause birth defects or other reproductive harm.

<p><b>PT9480-MPG</b> Maximum Performance Glass Hydraulic Element</p>  <p><b>Notes:</b> OBSOLETE. Availability Limited to Dealer Stock.  <b>Fits:</b> Liebherr Dozers, Excavators  <b>Replaces:</b> Liebherr 7211198; Donaldson P173483; Filtrec WG140  <b>O.D.:</b> 5 31/32 (151.6)  <b>I.D.:</b> 1 11/16 (42.9) &amp; 3 1/2 (88.9)  <b>Height:</b> 16 17/32 (419.9)  <b>A. Gskt:</b> [2] Attached</p>	<p><b>PT9486-MPG</b> Maximum Performance Glass Hydraulic Element</p>  <p><b>Replaces:</b> Donaldson P171742; Filtrec D154G25A  <b>O.D.:</b> 3 1/16 (77.8)  <b>I.D.:</b> 1 19/32 (40.5) One End  <b>Height:</b> 5 1/2 (139.7)  <b>O-Ring:</b> [1] Attached</p>
<p><b>PT9481-MPG</b> Maximum Performance Glass Hydraulic Element</p>  <p><b>Fits:</b> Komatsu Excavators, Loaders  <b>Replaces:</b> Komatsu 2076051410; Filtrec WG194  <b>O.D.:</b> 2 7/16 (61.9)            Flange 2 15/16 (74.6)  <b>I.D.:</b> 31/32 (24.6) &amp; 1 3/16 (30.2)  <b>Height:</b> 1 3/8 (34.9)</p>	<p><b>PT9487-MPG</b> Maximum Performance Glass Hydraulic Element</p>  <p><b>Replaces:</b> Schroeder KKS3; Donaldson P174247; Fleetguard HF30121  <b>O.D.:</b> 3 29/32 (99.2)  <b>I.D.:</b> 1 5/8 (41.3)  <b>Height:</b> 18 1/2 (469.9)</p>
<p><b>PT9482-MPG</b> Maximum Performance Glass Hydraulic Element</p>  <p><b>Fits:</b> Liebherr Excavators  <b>Replaces:</b> Liebherr 5618166; Filtrec WG426; Fleetguard HF35454  <b>O.D.:</b> 2 3/8 (60.3)  <b>I.D.:</b> 15/16 (23.8) One End  <b>Height:</b> 4 1/8 (104.8)  <b>O-Ring:</b> [1] Attached</p>	<p><b>PT9488-MPG</b> Maximum Performance Glass Hydraulic Element</p>  <p><b>Replaces:</b> Parker 931020Q; Donaldson P174260, P566277; Filtrec D651G25AV  <b>O.D.:</b> 3 29/32 (99.2)  <b>I.D.:</b> 1 5/8 (41.3)  <b>Height:</b> 18 1/2 (469.9)</p>
<p><b>PT9483-MPG</b> Maximum Performance Glass Hydraulic Element</p>  <p><b>Fits:</b> Caterpillar Equipment, Off-Highway Trucks  <b>Replaces:</b> Caterpillar 3434465; Donaldson P165239; Filtrec WG917  <b>O.D.:</b> 5 1/8 (130.2)  <b>I.D.:</b> 3 5/16 (84.1)  <b>Height:</b> 8 15/16 (227.0)  <b>A. Gskt:</b> [2] Viton Attached</p>	<p><b>PT9489-MPG</b> Maximum Performance Glass Hydraulic Element</p>  <p><b>Replaces:</b> Parker 929927Q; Donaldson P566498; Filtrec D761G25AV  <b>O.D.:</b> 3 25/32 (96.0)  <b>I.D.:</b> 2 7/32 (56.4) One End  <b>Height:</b> 12 31/32 (329.4)  <b>O-Ring:</b> [1] Viton Attached</p>
<p><b>PT9484-MPG</b> Maximum Performance Glass Hydraulic Element</p>  <p><b>Fits:</b> Case, New Holland Excavators  <b>Replaces:</b> Case 8914671; New Holland 8914671; Filtrec D120G25B  <b>O.D.:</b> 2 (50.8)  <b>I.D.:</b> 15/16 (23.8) One End  <b>Height:</b> 4 1/2 (114.3)  <b>O-Ring:</b> [1] Attached</p>	<p><b>PT9490-MPG</b> Maximum Performance Glass Hydraulic Element</p>  <p><b>Replaces:</b> Hydac 240D010BNHC; Donaldson P170608, P566672; Filtrec DHD240G10B  <b>O.D.:</b> 2 23/32 (69.1)  <b>I.D.:</b> 1 11/32 (34.1) One End  <b>Height:</b> 6 13/16 (173.0)  <b>O-Ring:</b> [1] Attached</p>
<p><b>PT9485-MPG</b> Maximum Performance Glass Hydraulic Element</p>  <p><b>Notes:</b> OBSOLETE. Availability Limited to Dealer Stock.  <b>Replaces:</b> Separation Technologies 3960SGHB04; Filtrec D140G10B  <b>O.D.:</b> 3 1/16 (77.8)  <b>I.D.:</b> 1 11/16 (42.9) One End  <b>Height:</b> 4 21/32 (118.3)  <b>O-Ring:</b> [1] Attached</p>	<p><b>PT9491-MPG</b> Maximum Performance Glass Hydraulic Element</p>  <p><b>Replaces:</b> Liebherr 7364597; Donaldson P177002, P566673  <b>O.D.:</b> 2 29/32 (73.8)  <b>I.D.:</b> 2 23/32 (69.1)  <b>Height:</b> 6 13/16 (173.0)  <b>O-Ring:</b> [1] Attached</p>

Measurements Are Shown In Inches And (Millimeters)

**WARNING:** These products can expose you to chemicals, including Diisononyl Phthalate, Carbon black extracts, Nickel, 1,3 Butadiene, Ethylene Oxide, Epichlorohydrin, which are known to the State of California to cause cancer, and Bisphenol, Ethylene Glycol, Ethylene Oxide, 1,3 Butadiene, Epichlorohydrin, which are known to the State of California to cause birth defects or other reproductive harm.



**PT9492-MPG**

Maximum Performance Glass Hydraulic Element



**Replaces:** Hydac 330D010BH3HC; Donaldson P170595, P566701; Filtrec DHD330H10B  
**O.D.:** 3 9/16 (90.5)  
**I.D.:** 1 29/32 (48.4) One End  
**Height:** 6 3/8 (161.9)  
**O-Ring:** [1] Attached

**PT9498-MPG**

Maximum Performance Glass Hydraulic Element



**Replaces:** Donaldson P165158; Filtrec R450G06; Fleetguard HF30073  
**O.D.:** 3 13/16 (96.8)  
**I.D.:** 1 11/16 (42.9) One End  
**Height:** 8 5/32 (207.2)  
**O-Ring:** [2] Attached

**PT9493-MPG**

Maximum Performance Glass Hydraulic Element



**Replaces:** Donaldson P564860; Filtrec DHD75G10B  
**O.D.:** 2 7/32 (56.4)  
**I.D.:** 1 (25.4) One End  
**Height:** 6 11/16 (169.9)  
**O-Ring:** [1] Attached

**PT9499-MPG**

Maximum Performance Glass Hydraulic Element with Bail Handle



**Fits:** Fendt Tractors  
**Replaces:** Fendt G716860060310; Filtrec R631G10  
**O.D.:** 2 1/2 (63.5)  
**I.D.:** 1 1/8 (28.6) One End  
**Height:** 12 3/16 (309.6)  
**O-Ring:** [1] Attached

**PT9494-MPG**

Maximum Performance Glass Hydraulic Element



**Replaces:** Donaldson P174297; Filtrec DMD0030E20B  
**O.D.:** 3 9/32 (83.3)  
**I.D.:** 1 7/8 (47.6) One End  
**Height:** 10 1/32 (254.8)

**PT9500-MPG**

Maximum Performance Glass Hydraulic Element with Bail Handle



**Replaces:** Hydac 950R010BNHC; Donaldson P170891; Filtrec RHR950G10B  
**O.D.:** 5 21/32 (143.7)  
**I.D.:** 3 3/4 (95.3) One End  
**Height:** 14 9/32 (362.7)

**PT9495-MPG**

Maximum Performance Glass Hydraulic Element



**Replaces:** Donaldson P174300; Filtrec DMD0045E10B; Mann & Hummel HD976  
**O.D.:** 3 9/32 (83.3)  
**I.D.:** 1 7/8 (47.6) One End  
**Height:** 14 11/16 (373.1)

**PT9501-MPG**

Maximum Performance Glass Hydraulic Element



**Fits:** Komatsu Excavators  
**Replaces:** Komatsu 2079705120; Filtrec WG239  
**O.D.:** 3 15/16 (100.0)  
**I.D.:** 1 29/32 (48.4) One End  
**Height:** 8 9/32 (210.3)  
**O-Ring:** [1] Attached

**PT9496-MPG**

Maximum Performance Glass Hydraulic Element



**Replaces:** Pall HC6400FDP26H; Filtrec R426G03  
**O.D.:** 3 3/8 (85.7)  
**I.D.:** 2 (50.8) One End  
**Height:** 25 21/32 (651.7)  
**O-Ring:** [1] Attached

**PT9502-MPG**

Maximum Performance Glass Hydraulic Element with Bail Handle



**Contains:** By-Pass Valve  
**Fits:** J.C. Bamford 520-50 Telescopic Handler  
**Replaces:** J.C. Bamford 32/918500; Filtrec WG326  
**O.D.:** 2 3/8 (60.3)  
**I.D.:** 1 11/32 (34.1) One End  
**Height:** 10 1/32 (254.8)  
**O-Ring:** [1] Attached

**PT9497-MPG**

Maximum Performance Glass Hydraulic Element



**Replaces:** Pall HC6400FDS26H; Donaldson P569622; Fleetguard HF30325  
**O.D.:** 3 3/8 (85.7)  
**I.D.:** 2 (50.8) One End  
**Height:** 25 21/32 (651.7)  
**O-Ring:** [1] Attached

**PT9503-MPG**













Maximum Performance Glass Hydraulic Element with Bail Handle



**Fits:** Terex Excavators  
**Replaces:** Terex 5368655680  
**O.D.:** 2 9/16 (65.1)  
**I.D.:** 1 5/16 (33.3) One End  
**Height:** 11 9/16 (293.7)  
**O-Ring:** [1] Attached

Measurements Are Shown In Inches And (Millimeters)

**WARNING:** These products can expose you to chemicals, including Diisononyl Phthalate, Carbon black extracts, Nickel, 1,3 Butadiene, Ethylene Oxide, Epichlorohydrin, which are known to the State of California to cause cancer, and Bisphenol, Ethylene Glycol, Ethylene Oxide, 1,3 Butadiene, Epichlorohydrin, which are known to the State of California to cause birth defects or other reproductive harm.

<p><b>PT9504-MPG</b></p> 	<p>Maximum Performance Glass Hydraulic Element  <b>Fits:</b> Kubota Excavators  <b>Replaces:</b> Kubota RG23862190  <b>O.D.:</b> 3 1/4 (82.6)  <b>I.D.:</b> 7/8 (22.2) One End  <b>Height:</b> 9 5/8 (244.5)  <b>O-Ring:</b> [1] Attached</p>	<p><b>PT9510</b></p> 	<p>Hydraulic Element  <b>Replaces:</b> Parker 925572; Filtrec D111T40AV  <b>O.D.:</b> 1 25/32 (45.2)  <b>I.D.:</b> 1 (25.4) One End  <b>Height:</b> 4 7/16 (112.7)  <b>O-Ring:</b> [1] Attached</p>
<p><b>PT9505-MPG</b></p> 	<p>Maximum Performance Glass Hydraulic Element  <b>Fits:</b> Case Excavators  <b>Replaces:</b> Case 159705A1; Filtrec WG544  <b>O.D.:</b> 3 7/32 (81.8)  <b>I.D.:</b> 1 25/32 (45.2) One End  <b>Height:</b> 8 (203.2)  <b>O-Ring:</b> [1] Attached</p>	<p><b>PT9511</b></p> 	<p>Hydraulic Element  <b>Replaces:</b> Donaldson P173781; Filtrec D650T60A  <b>O.D.:</b> 3 1/2 (88.9)  <b>I.D.:</b> 1 5/8 (41.3) One End  <b>Height:</b> 9 1/4 (235.0)  <b>O-Ring:</b> [2] Attached</p>
<p><b>PT9506</b></p> 	<p>Hydraulic Element  <b>Notes:</b> OBSOLETE. Availability Limited to Dealer Stock.  <b>Replaces:</b> Parker G01101; Filtrec D731C10A  <b>O.D.:</b> 3 19/32 (91.3)  <b>I.D.:</b> 2 1/2 (63.5) One End  <b>Height:</b> 12 5/8 (320.7)  <b>O-Ring:</b> [1] Attached</p>	<p><b>PT9512</b></p> 	<p>Hydraulic Element  <b>Notes:</b> OBSOLETE. Availability Limited to Dealer Stock.  <b>Replaces:</b> Hydac 110D050WHC; Filtrec DHD110S50B  <b>O.D.:</b> 1 27/32 (46.8)  <b>I.D.:</b> 7/8 (22.2) One End  <b>Height:</b> 6 1/32 (153.2)  <b>O-Ring:</b> [1] Attached</p>
<p><b>PT9507</b></p> 	<p>Hydraulic Element with Bail Handle  <b>Contains:</b> By-Pass Valve  <b>Replaces:</b> Donaldson P171557; Filtrec R151C10B  <b>O.D.:</b> 5 1/8 (130.2)  <b>I.D.:</b> 2 1/16 (52.4) One End  <b>Height:</b> 7 7/8 (200.0)  <b>Spring:</b> [1] Included</p>	<p><b>PT9513</b></p> 	<p>Hydraulic Element  <b>Replaces:</b> Parker 909299; Filtrec R590T149  <b>O.D.:</b> 4 1/4 (108.0)  <b>I.D.:</b> 3 1/8 (79.4) One End  <b>Height:</b> 9 3/4 (247.7)  <b>A. Gskt:</b> [2] Attached  <b>F. Gskt:</b> [1] Included</p>
<p><b>PT9508</b></p> 	<p>Hydraulic Element  <b>Replaces:</b> Donaldson P171310; Filtrec WP412  <b>O.D.:</b> 2 7/8 (73.0)  <b>I.D.:</b> 1 1/16 (27.0) One End  <b>Height:</b> 4 21/32 (118.3)  <b>O-Ring:</b> [1] Attached</p>	<p><b>PT9514</b></p> 	<p>Hydraulic Element  <b>Replaces:</b> Fairey-Arlon ST360; Donaldson P171795; Filtrec R712T60  <b>O.D.:</b> 2 27/32 (72.2)  <b>I.D.:</b> 1 1/32 (8.7) &amp; 1 25/32 (45.2)  <b>Height:</b> 5 29/32 (150.0)</p>
<p><b>PT9509</b></p> 	<p>Hydraulic Element  <b>Replaces:</b> U.C.C. UCSE1220; Donaldson P169019; Filtrec FS142B9T125; Fleetguard HF35164  <b>Thread:</b> 2 1/2 -11 BSP-PL  <b>O.D.:</b> 5 29/32 (150.0)  <b>Height:</b> 8 5/16 (211.1)</p>	<p><b>PT9515</b></p> 	<p>Hydraulic Element  <b>Replaces:</b> Parker 901755; Filtrec S440T149  <b>O.D.:</b> 5 31/32 (151.6)  <b>I.D.:</b> 3 5/8 (92.1)  <b>Height:</b> 9 7/8 (250.8)</p>

Measurements Are Shown In Inches And (Millimeters)

**WARNING:** These products can expose you to chemicals, including Diisononyl Phthalate, Carbon black extracts, Nickel, 1,3 Butadiene, Ethylene Oxide, Epichlorohydrin, which are known to the State of California to cause cancer, and Bisphenol, Ethylene Glycol, Ethylene Oxide, 1,3 Butadiene, Epichlorohydrin, which are known to the State of California to cause birth defects or other reproductive harm.

**PT9516**

Wire Mesh Hydraulic Element



**Fits:** Massey Ferguson Tractors  
**Replaces:** Massey Ferguson 1870199M92  
**O.D.:** 2 1/2 (63.5)  
**I.D.:** 7/16 (11.1) & 1 11/16 (42.9)  
**Height:** 3 1/2 (88.9)  
**A. Gskt:** [1] Attached  
**F. Gskt:** [1] Included

**PT9523-MPG**

Maximum Performance Glass Hydraulic Element with Bail Handle



**Fits:** Bobcat, Terex Excavators  
**Replaces:** Terex 5368632568  
**O.D.:** 3 5/16 (84.1)  
**I.D.:** 1 1/2 (38.1) One End  
**Height:** 16 1/8 (409.6)  
**O-Ring:** [1] Attached, [1] Included

**PT9517**

Wire Mesh Hydraulic Element



**Replaces:** Donaldson P173585; Filtrec WT1180; Wix W03AT1180  
**O.D.:** 5 1/2 (139.7)  
**I.D.:** 4 (101.6)  
**Height:** 8 5/8 (219.1)  
**O-Ring:** [2] Attached

**PT9524-MPG**

Maximum Performance Glass Hydraulic Element



**Fits:** Komatsu Excavators  
**Replaces:** Komatsu 76754473  
**O.D.:** 8 15/16 (227.0)  
**I.D.:** 7 1/16 (179.4)  
**Height:** 21 9/16 (547.7)  
**A. Gskt:** [1] Attached

**PT9518-MPG**

Maximum Performance Glass Hydraulic Element



**Fits:** Komatsu Equipment  
**Replaces:** Komatsu 2086071122, 2086071123  
**O.D.:** 7 (177.8)  
**I.D.:** 4 5/16 (109.5)  
**Height:** 7 7/8 (200.0)

**PT9525-MPG**

Maximum Performance Glass Hydraulic Element



**Fits:** John Deere Forwarders, Wheel Harvesters  
**Replaces:** John Deere F071978  
**O.D.:** 3 5/8 (92.1)  
**I.D.:** 1 13/16 (46.0) One End  
**Height:** 10 7/8 (276.2)  
**O-Ring:** [1] Attached

**PT9519-MPG**

Maximum Performance Glass Hydraulic Element



**Fits:** Volvo Excavators  
**Replaces:** Volvo 14510898  
**O.D.:** 2 7/8 (73.0)  
**I.D.:** 1 5/16 (33.3) One End  
**Height:** 12 1/2 (317.5)  
**O-Ring:** [1] Attached

**PT9526-MPG**

Maximum Performance Glass Hydraulic Element with Bail Handle



**Fits:** JLG Industries Aerial Work Platforms  
**Replaces:** JLG 7024375  
**O.D.:** 2 5/8 (66.7)  
**I.D.:** 1 1/4 (31.8) One End  
**Height:** 11 5/8 (295.3)  
**O-Ring:** [1] Attached

**PT9520-MPG**

Maximum Performance Glass Hydraulic Element



**Fits:** Case, New Holland Excavators  
**Replaces:** Case 72111326; New Holland 72111326  
**O.D.:** 4 15/16 (125.4)  
**I.D.:** 5/8 (15.9) & 3 1/4 (82.6)  
**Height:** 22 13/16 (579.4)

**PT9528**

Hydraulic Element



**Fits:** J.C. Bamford JS290, JS330 Excavators  
**Replaces:** J.C. Bamford JSJ0075  
**O.D.:** 7 (177.8)  
**I.D.:** 4 3/8 (111.1)  
**Height:** 13 1/8 (333.4)  
**A. Gskt:** [2] Attached

**PT9522-MPG**

Maximum Performance Glass Hydraulic Element with Bail Handle



**Fits:** J.C. Bamford 409ZX Loader, Telescopic Handlers  
**Replaces:** J.C. Bamford 32/925341  
**O.D.:** 2 9/16 (65.1)  
**I.D.:** 1 5/16 (33.3) One End  
**Height:** 9 1/8 (231.8)  
**O-Ring:** [1] Attached

**PT9529**

Hydraulic Element



**Fits:** Komatsu Excavators  
**Replaces:** Komatsu 21U6032210  
**O.D.:** 3 1/4 (82.6)  
**I.D.:** 1 5/8 (41.3)  
**Height:** 13 1/2 (342.9)

Measurements Are Shown In Inches And (Millimeters)

**WARNING:** These products can expose you to chemicals, including Diisononyl Phthalate, Carbon black extracts, Nickel, 1,3 Butadiene, Ethylene Oxide, Epichlorohydrin, which are known to the State of California to cause cancer, and Bisphenol, Ethylene Glycol, Ethylene Oxide, 1,3 Butadiene, Epichlorohydrin, which are known to the State of California to cause birth defects or other reproductive harm.

**PT9530** Hydraulic Element with Bail Handle  
**Fits:** Agco, Challenger, Fendt, Massey Ferguson Tractors  
**Replaces:** Massey Ferguson F916100490010  
**O.D.:** 3 1/4 (82.6)  
**I.D.:** 1 3/8 (34.9) One End  
**Height:** 15 3/8 (390.5)  
**O-Ring:** [1] Attached



**PT9537-MPG** Maximum Performance Glass Hydraulic Element  
**Fits:** Volvo Equipment  
**Replaces:** Volvo 14532686  
**O.D.:** 1 21/32 (42.1)  
**I.D.:** 27/32 (21.4) One End  
**Height:** 3 7/16 (87.3)  
**O-Ring:** [1] Attached



**PT9531** Hydraulic Element  
**Notes:** OBSOLETE. Availability Limited to Dealer Stock.  
**Contains:** Threaded End  
**Fits:** Case-IH, New Holland Tractors  
**Replaces:** Case 192310280014; New Holland 192310280014  
**O.D.:** 4 5/16 (109.5)  
**Height:** 5 1/8 (130.2)



**BT9553** Transmission Spin-on  
**Contains:** Anti-Drainback Valve  
 30 PSID By-Pass Valve  
**Fits:** J.C. Bamford Equipment  
**Replaces:** J.C. Bamford 581/18076  
**Thread:** 1 -12  
**O.D.:** 3 25/32 (96.0)  
**Height:** 4 27/32 (123.0)  
**I.Gskt:** [1] Included



**PT9532** Hydraulic Element  
**Fits:** Caterpillar Off-Highway Trucks  
**Replaces:** Caterpillar 6E1473; Fleetguard HF35501  
**O.D.:** 4 (101.6)  
**I.D.:** 2 5/16 (58.7)  
**Height:** 9 9/32 (235.7)



**PT9554-MPG** Wire Supported Maximum Performance Glass Hydraulic Element  
**Fits:** Link-Belt Hydraulic Truck Cranes  
**Replaces:** Link-Belt D7J0149  
**O.D.:** 5 (127.0)  
**I.D.:** 3 1/4 (82.6)  
**Height:** 18 5/16 (465.1)  
**End Seals:** [2] Attached



**BT9533** Hydraulic Spin-on  
**Fits:** Agco, Challenger, Massey Ferguson Tractors  
**Replaces:** Agco 4300400M1; Claas 6005028192; Massey Ferguson 3619712M1  
**Thread:** M45 x 2.0  
**O.D.:** 5 7/16 (138.1)  
**Height:** 6 15/16 (176.2)  
**I.Gskt:** [1] Included



**PT9555** Hydraulic Element  
**Contains:** Reinforced Centertube  
**Fits:** Caterpillar Equipment, Off-Highway Trucks  
**Replaces:** Caterpillar 1R0773; Donaldson P165238  
**O.D.:** 3 15/16 (100.0)  
**I.D.:** 2 9/32 (57.9)  
**Height:** 9 1/4 (235.0)  
**A. Gskt:** [2] Attached



**PT9535-MPG** Maximum Performance Glass Hydraulic Element  
**Fits:** Valmet Forestry Equipment; Valmet, Valtra Tractors  
**Replaces:** Agco 20639610; Donaldson P763757; Valmet 31549610  
**O.D.:** 2 15/16 (74.6)  
**I.D.:** 1 1/4 (31.8) One End  
**Height:** 7 3/32 (180.2)  
**O-Ring:** [1] Attached, [1] Included



**PT9556-MPG** Wire Supported Maximum Performance Glass Hydraulic Element  
**Fits:** Caterpillar Equipment  
**Replaces:** Caterpillar 179-9806, 179-9806X; Fleetguard HF35440  
**O.D.:** 5 19/32 (142.1)  
**I.D.:** 3 7/8 (98.4)  
**Height:** 16 11/16 (423.9)  
**O-Ring:** [2] Attached



**PT9536-MPG** Maximum Performance Glass Hydraulic Element  
**Fits:** Caterpillar Applications  
**Replaces:** Caterpillar 3481861  
**O.D.:** 3 1/4 (82.6)  
**I.D.:** 1 1/4 (31.8) & 1 7/8 (47.6)  
**Height:** 8 7/8 (225.4)  
**F. Gskt:** [1] Included  
**O-Ring:** [2] Attached



**PT9557** Hydraulic Element  
**Contains:** 20 PSID By-Pass Valve  
**Fits:** Hitachi Excavators; John Deere Excavators, Loaders  
**Replaces:** Hitachi 4448402, 4443773; Donaldson P502270; Fleetguard HF7691  
**O.D.:** 6 1/8 (155.6)  
**I.D.:** 4 13/16 (122.2) One End  
**Height:** 16 31/32 (431.0)  
**A. Gskt:** [1] Attached



Measurements Are Shown In Inches And (Millimeters)

**WARNING:** These products can expose you to chemicals, including Diisononyl Phthalate, Carbon black extracts, Nickel, 1,3 Butadiene, Ethylene Oxide, Epichlorohydrin, which are known to the State of California to cause cancer, and Bisphenol, Ethylene Glycol, Ethylene Oxide, 1,3 Butadiene, Epichlorohydrin, which are known to the State of California to cause birth defects or other reproductive harm.

**BT9558-MPG** Maximum Performance Glass Hydraulic Spin-on  
**Contains:** Integral Post Seal  
**Replaces:** Quincy 142136  
**Thread:** 1 1/4 -11 BSP-PL  
**O.D.:** 4 21/32 (118.3)  
**Height:** 8 3/32 (205.6)  
**I.Gskt:** G498-A



**PT9559-MPG** Wire Mesh Supported Maximum Performance Glass Hydraulic Element  
**Notes:** Inside-Out Flow Direction  
**Fits:** Euclid, Hitachi Dump Trucks  
**Replaces:** Euclid 4099538, E4099538; Hitachi E4099538; Donaldson P560404; Fleetguard HF30357  
**O.D.:** 3 5/32 (80.2)  
**I.D.:** 1 9/16 (39.7) One End  
**Height:** 12 15/16 (328.6)  
**O-Ring:** [1] Attached



**BT9560-MPG** Maximum Performance Glass Hydraulic Spin-on  
**Fits:** Caterpillar Equipment  
**Replaces:** Caterpillar 207-5035; Donaldson P179763  
**Thread:** 1 3/4 -12  
**O.D.:** 4 23/32 (119.9)  
**Height:** 14 3/32 (358.0)  
**I.Gskt:** [1] Included  
**Related To:** BT8870--MPG (Micron Difference)



**BT9561** Hydraulic Spin-on  
**Contains:** Anti-Drainback Valve  
 22 PSID By-Pass Valve  
**Fits:** J.C. Bamford Lift Trucks, Loaders  
**Replaces:** J.C. Bamford 581/18063  
**Thread:** 1 -12  
**O.D.:** 3 13/16 (96.8)  
**Height:** 3 13/16 (96.8)  
**I.Gskt:** [1] Included



**P9600** Lube Element  
**Fits:** Chrysler, Dodge, Ram Automotive, Jeep  
**Replaces:** Chrysler 68191349AA  
**O.D.:** 1 31/32 (50.0)  
**I.D.:** 7/8 (22.2)  
**Height:** 6 5/32 (156.4)  
**O-Ring:** [1] Attached, [1] Included



**B9601** Lube Spin-on  
**Contains:** 36 PSID By-Pass Valve  
**Fits:** Atlas, Deutz-Fahr, Ditch Witch, Mecalac, Voegel Equipment; Deutz Engines; Putzmeister Pumps  
**Replaces:** Claas 13022760; Deutz 1182552, 1183574, 1183575; Voegele 4912911424; Volvo 21640514  
**Thread:** 1 -12  
**O.D.:** 3 23/32 (94.5)  
**Height:** 8 9/32 (210.3)  
**I.Gskt:** [1] Included



**P9602** Lube Element  
**Fits:** Honda ATVs  
**Replaces:** Honda 15412KEA003  
**O.D.:** 2 11/16 (68.3)  
**I.D.:** 13/16 (20.6)  
**Height:** 1 27/32 (46.8)  
**O-Ring:** [2] Included  
**Grommets:** [2] Attached



**P9603** Lube Element  
**Contains:** 25 PSID By-Pass Valve  
**Fits:** Honda TRX450ER, TRX450R ATVs  
**Replaces:** Honda 15412-MEB-671, 15412-MEN-671  
**O.D.:** 1 9/16 (39.7)  
**I.D.:** 15/32 (11.9) One End  
**Height:** 1 7/16 (36.5)  
**O-Ring:** [1] Included  
**Grommets:** [1] Attached



**B9604** Lube Spin-on  
**Fits:** Ariel Compressors  
**Replaces:** Ariel A661, A-0661; Donaldson P554004  
**Thread:** 1 1/8 -16  
**O.D.:** 4 1/4 (108.0)  
**Height:** 10 15/32 (265.9)  
**I.Gskt:** [1] Included



**P9605** Lube Element  
**Fits:** Dodge Dart, Jeep Renegade; Fiat 500  
**Replaces:** Chrysler 68102241AA; Fiat 73500049; Ford 1565248; General Motors 93177787; Suzuki 1651185C00, 1651185E00  
**O.D.:** 2 9/16 (65.1)  
**I.D.:** 31/32 (24.6)  
**Height:** 3 9/32 (83.3)  
**O-Ring:** [1] Included



**B9606** Full-Flow Lube Spin-on  
**Fits:** Volvo-Penta Engines  
**Replaces:** Volvo 21632664  
**Thread:** 1 1/8 -16 UN-2B  
**O.D.:** 4 1/2 (114.3)  
**Height:** 7 5/16 (185.7)  
**I.Gskt:** [1] Included



**B9607** By-Pass Lube Spin-on  
**Fits:** Volvo-Penta Engines  
**Replaces:** Volvo 21632667  
**Thread:** 1 3/8 -16 UN-2B  
**O.D.:** 4 11/32 (110.3)  
**Height:** 7 5/16 (185.7)  
**I.Gskt:** [1] Included



Measurements Are Shown In Inches And (Millimeters)

**WARNING:** These products can expose you to chemicals, including Diisononyl Phthalate, Carbon black extracts, Nickel, 1,3 Butadiene, Ethylene Oxide, Epichlorohydrin, which are known to the State of California to cause cancer, and Bisphenol, Ethylene Glycol, Ethylene Oxide, 1,3 Butadiene, Epichlorohydrin, which are known to the State of California to cause birth defects or other reproductive harm.

**BF9800**

Fuel Spin-on



**Contains:** Integral Post Seal  
**Fits:** M.T.U. 12V4000, 16V4000, 20V4000 Diesel Engines  
**Replaces:** M.T.U. 20922801, X00012879  
**Thread:** M32 x 1.5  
**O.D.:** 4 1/4 (108.0)  
**Height:** 10 15/32 (265.9)  
**I.Gskt:** [1] Included

**PF9801**

Fuel Element



**Fits:** Nissan, Opel, Renault Trucks  
**Replaces:** Nissan 16405-00QAB; Opel 4411637; Renault 7701207667  
**O.D.:** 2 25/32 (70.6)  
**I.D.:** 25/32 (19.8)  
**Height:** 4 23/32 (119.9)  
**O-Ring:** [2] Included

**BF9802**

Fuel Spin-on



**Fits:** Equipment with M.T.U. 8V2000 M92, 8V2000 M93, 10V2000 M92, 10V2000 M93 (2004-on), 10V2000 M72 (2005-on) 16V4000R41 (2002-on), 20V4000 Engines with Common Rail Injection Systems  
**Replaces:** M.T.U. X00042421; Mann & Hummel WDK11102/10  
**Thread:** M32 x 1.5  
**O.D.:** 4 1/4 (108.0)  
**Height:** 10 15/32 (265.9)  
**I.Gskt:** [1] Included

**PF9803**

Fuel Element



**Fits:** Mitsubishi BE64D Bus, FE120, FE125, FD140, FG140, FD145, FD180 Trucks; Sterling 360 Truck all with Mitsubishi 4M50 Engine  
**Replaces:** Mitsubishi ME222133, ME222135; Nissan 16403-WK900  
**O.D.:** 3 23/32 (94.5)  
**I.D.:** 1 1/32 (26.2) One End  
**Height:** 3 11/16 (93.7)  
**F. Gskt:** [1] Included  
**O-Ring:** [1] Included  
**Grommets:** [1] Attached  
**Related To:** PF7982, PF7983, PF7984 (Long Versions)

**PF9804**

Fuel/Water Separator Element



**Fits:** Freightliner Cascadia, Columbia, Business Class M2 all with Detroit Diesel DD13, DD15 Engines  
**Replaces:** Alliance ABP/N10G-FS19915; Detroit Diesel FS19915WE, A0000903651, A4720921205  
**O.D.:** 5 27/32 (148.4)  
**I.D.:** 1 1/32 (26.2) One End  
**Height:** 7 19/32 (192.9)  
**O-Ring:** [2] Included  
**Grommets:** [1] Attached

**BF9805**

In-Line Fuel Filter



**Contains:** 1/4 Inch Vapor Line  
**Fits:** Audi, Volkswagen Automotive, Light-Duty Trucks  
**Replaces:** Volkswagen 6Q0201051C  
**O.D.:** 2 13/32 (61.1)  
**Inlet:** 1/4  
**Outlet:** 1/4  
**Length:** 6 15/32 (164.3)

**BF9807**

In-Line Fuel Filter



**Fits:** John Deere Tractors  
**Replaces:** John Deere AL153517  
**O.D.:** 2 1/8 (54.0)  
**Inlet:** 3/16  
**Outlet:** 3/16  
**Length:** 4 5/8 (117.5)

**BF9808-D**

Secondary Fuel Element with Drain



**Fits:** John Deere Forwarders, Tractors  
**Replaces:** John Deere RE526557; Stanadyne 37013; Fleetguard FS19978  
**O.D.:** 3 3/16 (81.0)  
**I.D.:** 1/2 (12.7) One End  
**Height:** 6 1/16 (154.0)  
**Grommets:** [1] Attached

**BF9809-D**

Secondary Fuel Element with Drain



**Notes:** Reverse Flow  
**Fits:** 7/2006-on Ford Transit  
**Replaces:** Ford 1370779, 6C11-9176-AA; Stanadyne 38034, 38640  
**O.D.:** 3 3/16 (81.0)  
**I.D.:** 13/16 (20.6) One End  
**Height:** 7 25/32 (197.6)  
**Grommets:** [1] Attached

**BF9810-D**

Secondary Fuel Element with Drain



**Notes:** Reverse Flow  
**Fits:** 11/2004-on Ford Transit 2.0 DI TDE, 3/2004-on Transit 2.4 TDE Van  
**Replaces:** Ford 4537952, 4669224, 3C11-9176-BB; Motorcraft EFC335; Stanadyne 36621, 36994  
**O.D.:** 3 3/16 (81.0)  
**I.D.:** 13/16 (20.6) One End  
**Height:** 7 25/32 (197.6)  
**Grommets:** [1] Attached

**BF9811-SP**

Fuel/Water Separator Spin-on with Drain and Sensor Port



**Notes:** CAUTION: Furnished O-Ring must be installed on post for seal.  
**Contains:** Sensor Port Thread: 9/16-18 Standpipe  
**Fits:** Caterpillar Equipment  
**Replaces:** Caterpillar 326-1642  
**Thread:** 1 -14  
**O.D.:** 4 1/4 (108.0)  
**Height:** 7 15/32 (189.7)  
**I.Gskt:** [1] Included  
**O-Ring:** [1] Included

**BF9812**

Fuel Spin-on with Drain



**Contains:** Integral Post Seal  
**Replaces:** CLARCOR Filtration (China) CX180, S1117040; Sinotruk VG1408739A  
**Thread:** M16 x 1.5  
**O.D.:** 3 5/32 (80.2)  
**Height:** 7 5/16 (185.7)  
**I.Gskt:** [1] Included

Measurements Are Shown In Inches And (Millimeters)

**WARNING:** These products can expose you to chemicals, including Diisononyl Phthalate, Carbon black extracts, Nickel, 1,3 Butadiene, Ethylene Oxide, Epichlorohydrin, which are known to the State of California to cause cancer, and Bisphenol, Ethylene Glycol, Ethylene Oxide, 1,3 Butadiene, Epichlorohydrin, which are known to the State of California to cause birth defects or other reproductive harm.

**BF9813**

Fuel Spin-on with Drain



**Contains:** Integral Post Seal  
**Replaces:** CLARCOR Filtration (China) CX180A; Sinotruk VG1408740A  
**Thread:** M16 x 1.5  
**O.D.:** 3 9/32 (83.3)  
**Height:** 7 15/32 (189.7)

**BF9819**

Fuel Spin-on



**Notes:** OBSOLETE. Availability Limited to Dealer Stock.  
**Replaces:** CLARCOR Filtration (China) WBF7608; FAW-Xichai 1117010B010000W  
**Thread:** M16 x 1.5  
**O.D.:** 3 1/32 (77.0)  
**Height:** 4 11/32 (110.3)  
**I.Gskt:** [1] Included

**PF9814**

Fuel/Water Separator Element



**Contains:** Relief Valve  
**Fits:** Freightliner, IHC, Kenworth, Peterbilt Trucks  
**Replaces:** Fleetguard FS19764; Davco 102527  
**O.D.:** 4 3/16 (106.4)  
**I.D.:** 2 1/32 (16.7) One End  
**Height:** 7 1/32 (178.6)  
**O-Ring:** [2] Included

**BF9820**

Fuel Spin-on



**Replaces:** CLARCOR Filtration (China) WBF7886  
**Thread:** M18 x 1.5  
**O.D.:** 3 11/16 (93.7)  
**Height:** 5 25/32 (146.8)  
**I.Gskt:** [1] Included

**BF9815**

Fuel Spin-on



**Replaces:** CLARCOR Filtration (China) CX0815; Weichai Power 612600081334  
**Thread:** M20 x 1.5  
**O.D.:** 3 19/32 (91.3)  
**Height:** 7 1/8 (181.0)  
**I.Gskt:** [1] Included

**BF9821**

Fuel Spin-on with Drain



**Replaces:** CLARCOR Filtration (China) CX0710B4  
**Thread:** M20 x 1.5  
**O.D.:** 3 1/32 (77.0)  
**Height:** 6 1/16 (154.0)  
**I.Gskt:** [1] Included

**BF9816**

Fuel Spin-on



**Contains:** Integral Post Seal  
**Replaces:** CLARCOR Filtration (China) CX1012; DCD 4102H1510  
**Thread:** 1 -14  
**O.D.:** 4 1/4 (108.0)  
**Height:** 5 11/16 (144.5)  
**I.Gskt:** [1] Included

**BF9822-D**

Fuel/Water Coalescer Element with Removable Drain



**Notes:** Reverse Flow  
**Fits:** J.C. Bamford Generators, Super Loaders  
**Replaces:** J.C. Bamford 32/925975; Stanadyne 38695  
**O.D.:** 3 7/32 (81.8)  
**I.D.:** 1/2 (12.7) One End  
**Height:** 5 9/32 (134.1)  
**Grommets:** [1] Attached

**BF9817**

Fuel Spin-on



**Replaces:** CLARCOR Filtration (China) WBF220; Weichai Power 612630080087  
**Thread:** M32 x 1.5  
**O.D.:** 4 9/32 (108.7)  
**Height:** 10 11/32 (262.7)  
**I.Gskt:** [1] Included

**PF9823**

Fuel Element with Bail Handle



**Replaces:** CLARCOR Filtration (China) C0607; Weichai Power 13022685  
**O.D.:** 2 17/32 (64.3)  
**I.D.:** 1/2 (12.7)  
**Height:** 3 (76.2)

**BF9818**

Fuel Spin-on with Drain



**Replaces:** CLARCOR Filtration (China) WBF1260A, WFB1260A  
**Thread:** 1 -14  
**O.D.:** 4 9/32 (108.7)  
**Height:** 10 25/32 (273.8)  
**I.Gskt:** [1] Included

**PF9824**

Fuel Element with Bail Handle



**Notes:** OBSOLETE. Availability Limited to Dealer Stock.  
**Replaces:** CLARCOR Filtration (China) C0913S; Sinotruk 614080295A  
**O.D.:** 3 17/32 (89.7)  
**I.D.:** 17/32 (13.5)  
**Height:** 5 7/16 (138.1)  
**Grommets:** [2] Attached

Measurements Are Shown In Inches And (Millimeters)

**WARNING:** These products can expose you to chemicals, including Diisononyl Phthalate, Carbon black extracts, Nickel, 1,3 Butadiene, Ethylene Oxide, Epichlorohydrin, which are known to the State of California to cause cancer, and Bisphenol, Ethylene Glycol, Ethylene Oxide, 1,3 Butadiene, Epichlorohydrin, which are known to the State of California to cause birth defects or other reproductive harm.

<p><b>PF9825</b></p>  <p>Fuel Element  <b>Replaces:</b> CLARCOR Filtration (China) 61021520; DCD 61021520  <b>O.D.:</b> 2 29/32 (73.8)  <b>I.D.:</b> 5/8 (15.9)  <b>Height:</b> 4 3/16 (106.4)</p>	<p><b>BF9831</b></p>  <p>Fuel/Water Separator Spin-on with Drain  <b>Contains:</b> Integral Post Seal  <b>Replaces:</b> CLARCOR Filtration (China) WBF1212; Foton Lovol 1106339100104; Weifang Hualing Diesel Power 1125AD-5705  <b>Thread:</b> 1 -14  <b>O.D.:</b> 3 19/32 (91.3)  <b>Height:</b> 7 7/8 (200.0)  <b>I.Gskt:</b> [1] Included</p>
<p><b>PF9826</b></p>  <p>Fuel Element  <b>Replaces:</b> CLARCOR Filtration (China) 12V1030A; Jicai 12VB1030A  <b>O.D.:</b> 4 3/8 (111.1)  <b>I.D.:</b> 31/32 (24.6)  <b>Height:</b> 7 1/8 (181.0)  <b>Grommets:</b> [2] Attached</p>	<p><b>BF9832</b></p>  <p>Fuel Spin-on  <b>Notes:</b> OBSOLETE. Availability Limited to Dealer Stock.  <b>Contains:</b> Integral Post Seal  <b>Replaces:</b> CLARCOR Filtration (China) CX1014B; Faw-Xichai 1117101-A34-0000W  <b>Thread:</b> 1 -14  <b>O.D.:</b> 4 9/32 (108.7)  <b>Height:</b> 7 3/32 (180.2)  <b>I.Gskt:</b> [1] Included</p>
<p><b>BF9827-D</b></p>  <p>Secondary Fuel/Water Separator Element with Drain  <b>Notes:</b> Reverse Flow  <b>Fits:</b> Ford Transit Vans  <b>Replaces:</b> Ford 3C11-9176-AA; 4537951; Stanadyne 36620, 36995  <b>O.D.:</b> 3 7/32 (81.8)  <b>I.D.:</b> 7/8 (22.2) One End  <b>Height:</b> 6 13/16 (173.0)  <b>Grommets:</b> [1] Attached</p>	<p><b>BF9833-D</b></p>  <p>Primary Fuel Element with Drain  <b>Fits:</b> J.C. Bamford Excavators  <b>Replaces:</b> J.C. Bamford 32/925760; Stanadyne 37932  <b>O.D.:</b> 3 7/32 (81.8)  <b>I.D.:</b> 7/8 (22.2) One End  <b>Height:</b> 6 1/16 (154.0)  <b>Grommets:</b> [1] Attached</p>
<p><b>BF9828-D</b></p>  <p>Primary Fuel/Water Separator Element with Removable Drain  <b>Notes:</b> Reverse Flow  <b>Fits:</b> JCB Loaders  <b>Replaces:</b> J.C. Bamford 32/925915; Stanadyne 38461  <b>O.D.:</b> 3 7/32 (81.8)  <b>I.D.:</b> 1/2 (12.7) One End  <b>Height:</b> 5 9/32 (134.1)  <b>Grommets:</b> [1] Attached</p>	<p><b>BF9834</b></p>  <p>Fuel Spin-on  <b>Fits:</b> E.M.D. Marine Engines  <b>Replaces:</b> Clark Filters FJ-33S; E.M.D. 40052587  <b>Thread:</b> 1 1/4 -12  <b>O.D.:</b> 3 11/16 (93.7)  <b>Height:</b> 8 23/32 (221.5)  <b>I.Gskt:</b> G381-A</p>
<p><b>PF9829 KIT</b></p>  <p>Set of 2 Fuel Elements  <b>Contains:</b> Primary and Secondary Elements - not sold separately  <b>Fits:</b> 10/07-on Scania P230, P280, P320, P360, P400, R400, R440, R480 Trucks all with Scania DC9, DC13 Series Engine  <b>Replaces:</b> Scania 1736248, 1736250, 1794863  <b>Primary</b>  <b>O.D.:</b> 3 5/16 (84.1)  <b>I.D.:</b> 1 1/2 (38.1)  <b>Height:</b> 8 15/16 (227.0)  <b>O-Ring:</b> [2] Included  <b>Secondary</b>  <b>O.D.:</b> 3 3/4 (95.3)  <b>I.D.:</b> 1 13/16 (46.0)  <b>Height:</b> 8 5/32 (207.2)</p>	<p><b>BF9835-D</b></p>  <p>Secondary Fuel Element with Drain  <b>Fits:</b> Magnum Light Towers  <b>Replaces:</b> Magnum Products 17647  <b>O.D.:</b> 3 3/16 (81.0)  <b>I.D.:</b> 5/8 (15.9) One End  <b>Height:</b> 5 9/32 (134.1)</p>
<p><b>BF9830-D</b></p>  <p>Fuel/Water Coalescer with Drain  <b>Fits:</b> J.C. Bamford Generators, Lift Trucks, Loaders all with Dieselmex (Tier2) 444 Engine  <b>Replaces:</b> J.C. Bamford 32/925705; Donaldson P551426  <b>O.D.:</b> 3 7/32 (81.8)  <b>I.D.:</b> 7/8 (22.2) One End  <b>Height:</b> 5 9/32 (134.1)  <b>Grommets:</b> [1] Attached</p>	<p><b>BF9836-D</b></p>  <p>Secondary Fuel Element with Drain  <b>Fits:</b> J.C. Bamford Excavators  <b>Replaces:</b> J.C. Bamford 32/925666; Mitsubishi D07-0015; Stanadyne 37130  <b>O.D.:</b> 3 7/32 (81.8)  <b>I.D.:</b> 1/2 (12.7) One End  <b>Height:</b> 4 17/32 (115.1)  <b>Grommets:</b> [1] Attached</p>

Measurements Are Shown In Inches And (Millimeters)

**WARNING:** These products can expose you to chemicals, including Diisononyl Phthalate, Carbon black extracts, Nickel, 1,3 Butadiene, Ethylene Oxide, Epichlorohydrin, which are known to the State of California to cause cancer, and Bisphenol, Ethylene Glycol, Ethylene Oxide, 1,3 Butadiene, Epichlorohydrin, which are known to the State of California to cause birth defects or other reproductive harm.



**BF9837-D**

Primary Fuel Element with Drain



**Notes:** Reverse Flow  
**Fits:** Agco, Challenger, Massey Ferguson, Valtra Tractors all with Sisu 4.4L, 6.6L, 7.4L, 8.4L Diesel Engines  
**Replaces:** Agco V836862600; Case 162000080882; Sisu 836862600; Valtra 20366575  
**O.D.:** 3 9/32 (83.3)  
**I.D.:** 21/32 (16.7) One End  
**Height:** 6 25/32 (172.2)  
**Grommets:** [1] Attached

**PF9838**

Fuel Element with Bail Handle



**Notes:** OBSOLETE. Availability Limited to Dealer Stock.  
**Replaces:** Sinotruk WG9725550002001; CLARCOR Filtration (China) 500FG-1000  
**O.D.:** 3 5/32 (80.2)  
**I.D.:** 21/32 (16.7)  
**Height:** 2 25/32 (70.6)  
**Grommets:** [2] Attached

**BF9839-D**

Primary Fuel Element with Drain



**Notes:** Reverse Flow  
**Fits:** Agco, Challenger, Massey Ferguson, Valtra Equipment all with Sisu 6.6L, 7.4L, 8.4L Engines  
**Replaces:** Agco V836867591; Sisu 836867591  
**O.D.:** 3 3/16 (81.0)  
**I.D.:** 3/4 (19.0) One End  
**Height:** 6 23/32 (170.7)  
**Grommets:** [1] Attached

**BF9840**

Fuel Spin-on with Drain



**Notes:** OBSOLETE. Availability Limited to Dealer Stock.  
**Replaces:** Foton Lovol T750010021, T750010022; CLARCOR Filtration (China) CX0710B3  
**Thread:** M16 x 1.5  
**O.D.:** 3 1/16 (77.8)  
**Height:** 6 1/16 (154.0)  
**I.Gskt:** [1] Included

**BF9841**

Fuel Spin-on



**Replaces:** CLARCOR Filtration (China) CX0710A; Faw-Xichai K1117001A; Weichai Power K1117001A  
**Thread:** M16 x 1.5  
**O.D.:** 3 1/32 (77.0)  
**Height:** 4 13/16 (122.2)  
**I.Gskt:** [1] Included

**BF9842**

Fuel Spin-on with Drain



**Fits:** Foton Trucks  
**Replaces:** Foton Lovol 1106611400005, T64101003; CLARCOR Filtration (China) WBF1235  
**Thread:** M16 x 1.5  
**O.D.:** 3 1/16 (77.8)  
**Height:** 5 25/32 (146.8)  
**I.Gskt:** [1] Included

**BF9843**

Fuel Spin-on



**Notes:** OBSOLETE. Availability Limited to Dealer Stock.  
**Replaces:** CLARCOR Filtration (China) CX0810; Foton Lovol 1103911500001  
**Thread:** 3/4 -16  
**O.D.:** 3 19/32 (91.3)  
**Height:** 5 1/8 (130.2)  
**I.Gskt:** [1] Included

**BF9844**

Fuel Spin-on



**Replaces:** Yuchai Watyuan G58001105140C  
**Thread:** 1 -14  
**O.D.:** 4 9/32 (108.7)  
**Height:** 8 1/32 (204.0)  
**I.Gskt:** [1] Included

**PF9845**

Fuel Element



**Notes:** OBSOLETE. Availability Limited to Dealer Stock.  
**Replaces:** Foton Lovol F500840, G20D5223; CLARCOR Filtration (China) C0810C-10110  
**O.D.:** 3 11/32 (84.9)  
**I.D.:** 1 9/16 (39.7)  
**Height:** 3 15/16 (100.0)

**BF9846**

In-Line Fuel Filter



**Fits:** Mercedes-Benz Automotive, Engines, Vans  
**Replaces:** Chrysler 5174056AA; Mercedes-Benz 6460920001, 6460920301, 6460920501  
**O.D.:** 3 5/8 (92.1)  
**Inlet:** 7/16  
**Outlet:** 3/8  
**Length:** 4 29/32 (124.6)

**BF9847-D**

Secondary Fuel Element with Drain



**Fits:** John Deere Equipment  
**Replaces:** John Deere RE533026; Donaldson P551432  
**O.D.:** 3 3/16 (81.0)  
**I.D.:** 1/2 (12.7) One End  
**Height:** 6 1/16 (154.0)  
**Grommets:** [1] Attached

**BF9848**

In-Line Fuel Filter



**Contains:** 3/8 Inch Return Line  
**Fits:** 2005-07 Chevrolet Cobalt; 2005-06 Pontiac Pursuit, 2010 G5; 2003-07 Saturn ION, 2004-07 ION Red Line  
**Replaces:** Saturn 22734980; ACDelco GF824  
**O.D.:** 2 5/32 (54.8)  
**Inlet:** 5/16  
**Outlet:** 5/16  
**Length:** 4 29/32 (124.6)

Measurements Are Shown In Inches And (Millimeters)

**WARNING:** These products can expose you to chemicals, including Diisononyl Phthalate, Carbon black extracts, Nickel, 1,3 Butadiene, Ethylene Oxide, Epichlorohydrin, which are known to the State of California to cause cancer, and Bisphenol, Ethylene Glycol, Ethylene Oxide, 1,3 Butadiene, Epichlorohydrin, which are known to the State of California to cause birth defects or other reproductive harm.

**BF9849**

Fuel/Water Separator Spin-on with Drain

**Notes:** OBSOLETE. Availability Limited to Dealer Stock.

**Replaces:** Foton Lovol 1104339100138, 1106911500012; CLARCOR Filtration (China) FT7535A

**Thread:** 3/4 -16  
**O.D.:** 3 19/32 (91.3)  
**Height:** 6 3/4 (171.5)  
**I.Gskt:** [1] Included



**BF9857**

In-Line Fuel Filter

**Fits:** John Deere Lawn and Garden Tractors, Utility Vehicles

**Replaces:** John Deere AM117584, AM118131  
**O.D.:** 3 5/16 (84.1)  
**Inlet:** 3/8  
**Outlet:** 3/8  
**Length:** 6 15/16 (176.2)



**BF9850**

Fuel Spin-on

**Contains:** Port for Drain/Sensor Bowl  
 Port Thread: M36 x 1.5

**Replaces:** Weichai Power CX0812; CLARCOR Filtration (China) CX0812

**Thread:** M20 x 1.5  
**O.D.:** 3 9/16 (90.5)  
**Height:** 7 (177.8)  
**I.Gskt:** [1] Included



**BF9858 KIT**

Set of 2 Fuel Filters

**Contains:** Port Thread: 3 3/4-10  
 [1] BF1390-O Spin-on with Open Port for Bowl  
 [1] Element  
 Not Sold Individually

**Fits:** IHC MaxxFORCE DT, MaxxFORCE 7 Engines, CD, RXT, 3200, 4300 DuraStar Trucks

**Replaces:** International 1848671-C1, 1876533-C93, 1877516-C1

**BF1390-O**  
**Thread:** 1 -14  
**O.D.:** 4 11/32 (110.3)  
**Height:** 6 3/16 (157.2)  
**I.Gskt:** [1] Included  
**O-Ring:** [1] Included  
**Element:**  
**O.D.** 3 9/16  
**I.D.** 17/32  
**Height** 4 25/32  
**O-Ring** [1] Included



**BF9851**

In-Line Fuel Filter

**Contains:** [2] 3/8 Inch Plastic Clips  
 [1] 5/16 Inch Plastic Clip  
 5/16 Inch Return Line

**Fits:** 1998-2001 Saturn SW1, SW2, 1998-2002 SC1, SL1, SC2, SL2, 2000-02 SL

**Replaces:** Saturn 21009427  
**O.D.:** 2 11/32 (59.5)  
**Inlet:** 3/8  
**Outlet:** 3/8  
**Length:** 8 15/32 (215.1)



**BF9860**

Fuel Spin-on

**Notes:** Fill Plug pre-installed in filter. Remove plug after pre-filling filter with fuel prior to installation on application.

**Fits:** Peterbilt 386 Truck; Cummins QSX15 Engine

**Replaces:** Cummins 3685306; Fleetguard FF5686

**Thread:** M90 x 2.0  
**O.D.:** 4 23/32 (119.9)  
**Height:** 11 9/16 (293.7)  
**I.Gskt:** [1] Included  
**Related To:** BF9885 (Short Version)  
 BF46179 (Upgrade)



**BF9852**

Fuel Spin-on with Drain

**Replaces:** Weichai Power 612600080934; CLARCOR Filtration (China) WBF1352

**Thread:** M20 x 1.5  
**O.D.:** 3 19/32 (91.3)  
**Height:** 7 7/8 (200.0)  
**I.Gskt:** [1] Included



**PF9861**

Fuel Element

**Fits:** Volkswagen Beetle, Golf, Jetta  
**Replaces:** Volkswagen 1K0127434B  
**O.D.:** 3 9/32 (83.3)  
**I.D.:** 3/4 (19.0) One End  
**Height:** 4 9/16 (115.9)  
**O-Ring:** [1] Included  
**Grommets:** [1] Attached



**BF9853**

Fuel Spin-on with Drain

**Notes:** OBSOLETE. Availability Limited to Dealer Stock.

**Replaces:** FAW-Xichai WBF1235B; CLARCOR Filtration (China) WBF1235B

**Thread:** M16 x 1.5  
**O.D.:** 3 1/32 (77.0)  
**Height:** 5 11/32 (135.7)  
**I.Gskt:** [1] Included



**PF9862**

Fuel/Water Separator Element

**Fits:** New Holland E70, E70SR, E80 Excavators

**Replaces:** Komatsu YM02P01039R100; New Holland YM02P01039R100, YM02P01039S002

**O.D.:** 1 7/8 (47.6)  
 Flange 2 9/16 (65.1)  
**I.D.:** 13/16 (20.6) One End  
**Height:** 2 19/32 (65.9)  
**O-Ring:** [1] Included  
**Grommets:** [1] Attached



**BF9854**

Fuel Spin-on with Drain

**Notes:** OBSOLETE. Availability Limited to Dealer Stock.

**Replaces:** Foton Lovol 1307211500006, DG2001464, F58201150003; CLARCOR Filtration (China) FT0810

**Thread:** 1 -14  
**O.D.:** 3 19/32 (91.3)  
**Height:** 6 23/32 (170.7)  
**I.Gskt:** [1] Included



Measurements Are Shown In Inches And (Millimeters)

**WARNING:** These products can expose you to chemicals, including Diisononyl Phthalate, Carbon black extracts, Nickel, 1,3 Butadiene, Ethylene Oxide, Epichlorohydrin, which are known to the State of California to cause cancer, and Bisphenol, Ethylene Glycol, Ethylene Oxide, 1,3 Butadiene, Epichlorohydrin, which are known to the State of California to cause birth defects or other reproductive harm.

**BF9863**

In-Line Fuel Filter



**Fits:** Volvo Excavators  
**Replaces:** Volvo 7410170  
**O.D.:** 3 7/16 (87.3)  
**Inlet:** 1/8  
**Outlet:** 3/16  
**Length:** 3 19/32 (91.3)

**BF9869**

Fuel Spin-on with Drain



**Replaces:** Yuchai Watyuan 1501105020A; Donaldson P502484  
**Thread:** 1 -14  
**O.D.:** 4 9/32 (108.7)  
**Height:** 7 1/8 (181.0)  
**I.Gskt:** [1] Included

**BF9864**

Fuel Spin-on



**Contains:** Integral Post Seal  
**Replaces:** Jinan Diesel B30121010; CLARCOR Filtration (China) BF596A  
**Thread:** 1 1/2 -12  
**O.D.:** 4 21/32 (118.3)  
**Height:** 11 5/16 (287.3)  
**I.Gskt:** [1] Included

**PF9870**

Fuel Element with Bail Handle



**Fits:** Dodge Pickups, 4500, 5500 Chassis Cabs; Ram Pickups, 4500HD, 5500HD Chassis Cabs all with 6-408 (6.7L) FI Turbo Diesel Engine  
**Replaces:** Chrysler 68065608AA; Cummins 4947561; Mopar MO608  
**O.D.:** 4 7/32 (107.2)  
**I.D.:** 1 9/16 (39.7) One End  
**Height:** 5 17/32 (140.5)  
**O-Ring:** [1] Included

**PF9865**

Fuel Element



**Fits:** Iveco Trucks  
**Replaces:** Iveco 504170771  
**O.D.:** 3 3/16 (81.0)  
**I.D.:** 1/2 (12.7) One End  
**Height:** 5 27/32 (148.4)  
**O-Ring:** [1] Included

**BF9871-O**

Fuel/Water Separator Spin-on with Open End for Bowl



**Contains:** Bowl Thread: 3 3/4-10 2B Buttress Integral Post Seal  
**Fits:** Freightliner, Sterling, Western Star Trucks  
**Replaces:** Alliance ABPN122BR90FRT10; Freightliner BR90FRT10, RAIBR90FRT10; Donaldson P551066  
**Thread:** 1 -14  
**O.D.:** 4 5/16 (109.5)  
**Height:** 6 5/16 (160.3)  
**I.Gskt:** [1] Included  
**F. Gskt:** [1] Included

**BF9866-O**

Fuel/Water Separator Spin-on with Open End for Bowl



**Contains:** Bowl Thread: M95 x 2.5 Integral Post Seal  
**Fits:** John Deere Equipment  
**Replaces:** John Deere RE532952, RE539465  
**Thread:** 7/8 -14  
**O.D.:** 4 3/8 (111.1)  
**Height:** 8 11/16 (220.7)  
**I.Gskt:** [1] Included  
**F. Gskt:** [1] Included

**PF9872**

Fuel Element



**Fits:** Volkswagen Jetta, Beetle, Golf  
**Replaces:** Volkswagen 1K0127434A  
**O.D.:** 3 1/4 (82.6)  
**I.D.:** 1 1/2 (38.1)  
**Height:** 5 19/32 (142.1)  
**F. Gskt:** [1] Aluminum Washer, [2] Included  
**O-Ring:** [2] Attached

**BF9867-O**

Fuel Spin-on with Open End for Bowl



**Contains:** Bowl Thread: M95 x 2.5 Integral Post Seal  
**Fits:** Evobus Citaro Buses; Mercedes-Benz, Renault Trucks; Bomag Paving Equipment  
**Replaces:** Bomag 05825015; Renault 7420754418; Racor R160TDMAX  
**Thread:** 1 -14  
**O.D.:** 4 13/32 (111.9)  
**Height:** 8 21/32 (219.9)  
**I.Gskt:** [1] Included  
**F. Gskt:** [1] Included

**PF9873**

Fuel Strainer



**Fits:** Doosan, Hitachi, John Deere, Kobelco, New Holland Excavators  
**Replaces:** Hitachi 8972133810; John Deere 8972133810  
**O.D.:** 1 7/16 (36.5)  
**I.D.:** 15/32 (11.9) One End  
**Height:** 1 15/16 (49.2)  
**O-Ring:** [1] Attached, [1] Included

**PF9868**

Fuel Element



**Fits:** Case, Link-Belt Excavators  
**Replaces:** New Holland KHH12030  
**O.D.:** 3 23/32 (94.5)  
**I.D.:** 1 1/32 (26.2) One End  
**Height:** 6 13/32 (162.7)  
**O-Ring:** [2] Included  
**Grommets:** [1] Attached  
**Related To:** PF7983 (Without Furnished O-Rings)

**BF9874-DM**

Primary Fuel/Water Separator Element



**Contains:** Drain Nut  
**Fits:** John Deere Power Tech 4045DFM, 4045TFM Marine Engines  
**Replaces:** John Deere RE521248; Stanadyne 36559  
**O.D.:** 3 5/32 (80.2)  
**I.D.:** 15/16 (23.8) One End  
**Height:** 5 5/16 (134.9)  
**F. Gskt:** [1] Included  
**Grommets:** [1] Attached

Measurements Are Shown In Inches And (Millimeters)

**WARNING:** These products can expose you to chemicals, including Diisononyl Phthalate, Carbon black extracts, Nickel, 1,3 Butadiene, Ethylene Oxide, Epichlorohydrin, which are known to the State of California to cause cancer, and Bisphenol, Ethylene Glycol, Ethylene Oxide, 1,3 Butadiene, Epichlorohydrin, which are known to the State of California to cause birth defects or other reproductive harm.

**BF9875-DM**

Secondary Fuel/Water Separator Element



**Contains:** Drain Nut  
**Fits:** John Deere Power Tech 4045DFM, 4045TFM Marine Engines  
**Replaces:** John Deere RE520842; Stanadyne 36503  
**O.D.:** 3 5/32 (80.2)  
**I.D.:** 15/16 (23.8) One End  
**Height:** 5 5/16 (134.9)  
**F. Gskt:** [1] Included  
**Grommets:** [1] Attached

**BF9876**

Fuel Spin-on with Drain



**Replaces:** Yuchai Watyuan A30001105020  
**Thread:** 1 -14  
**O.D.:** 3 1/4 (82.6)  
**Height:** 6 21/32 (169.1)  
**I.Gskt:** [1] Included

**BF9877**

Fuel Spin-on



**Fits:** J.C. Bamford Excavators with Isuzu 4GB1T, 6BG1T or J.C. Bamford Dieselmax 444 Engines  
**Replaces:** J.C. Bamford 32925856  
**Thread:** 3/4 -16  
**O.D.:** 3 11/16 (93.7)  
**Height:** 4 11/32 (110.3)  
**I.Gskt:** G381-A

**BF9878**

Fuel Spin-on with Drain



**Fits:** DongFeng Trucks  
**Replaces:** DongFeng-Cummins 1025BF11020; CLARCOR Filtration (China) WPPA01101  
**Thread:** M20 x 1.5  
**O.D.:** 3 5/8 (92.1)  
**Height:** 6 11/16 (169.9)  
**I.Gskt:** [1] Included  
**F. Gskt:** [1] Included

**PF9879**

Fuel Element



**Fits:** M.A.N. D28V V8-750, V10-900, V12-1100 Engines  
**Replaces:** M.A.N. 51125030069; Hengst E420KPD72  
**O.D.:** 3 9/32 (83.3)  
**I.D.:** 1/2 (12.7) One End  
**Height:** 10 15/32 (265.9)  
**O-Ring:** [1] Included

**BF9880**

Fuel Spin-on with Open Port



**Contains:** Port Thread: M36 x 1.5  
**Fits:** Yuchai Diesel YC6G240-30 Truck Engine  
**Replaces:** Yuchai Watyuan G58001105240C  
**Thread:** 1 -14  
**O.D.:** 4 11/32 (110.3)  
**Height:** 9 11/16 (246.1)  
**I.Gskt:** [1] Included  
**F. Gskt:** [1] Included

**BF9881**

In-Line Fuel Filter with Drain



**Fits:** J.C. Bamford Engines, Rollers, Telescopic Handlers  
**Replaces:** J.C. Bamford 32007138  
**O.D.:** 3 3/8 (85.7)  
**Inlet:** 3/8  
**Outlet:** 3/8  
**Length:** 7 5/32 (181.8)

**BF9883**

Fuel Spin-on with Drain



**Contains:** Integral Post Seal  
**Fits:** Case-IHC Farmall 65A, 65C, 75C, Workmaster 65 Tractors  
**Replaces:** Iveco 504287000  
**Thread:** M16 x 1.5  
**O.D.:** 3 9/32 (83.3)  
**Height:** 7 15/32 (189.7)  
**I.Gskt:** [1] Included

**BF9884**

Nylon In-Line Fuel Filter in Plastic Housing



**Fits:** John Deere Tractors  
**Replaces:** John Deere AL67975; Mann & Hummel WK3111  
**O.D.:** 1 17/32 (38.9)  
**Inlet:** 5/16  
**Outlet:** 5/16  
**Length:** 4 9/32 (108.7)

**BF9885**

Fuel Spin-on



**Notes:** Fill Plug pre-installed in filter. Remove after pre-filling filter with fuel prior to installation on application.  
**CAUTION:** Not to be used on X15 Engines.  
**Fits:** Kenworth, Peterbilt Trucks with Cummins ISX11.9, QSX11.9 Engines  
**Replaces:** Cummins 2864993, 2893612; Donaldson P555776; Fleetguard FF5776; Mann WK12003  
**Thread:** M90 x 2.0  
**O.D.:** 4 23/32 (119.9)  
**Height:** 8 27/32 (224.6)  
**I.Gskt:** [1] Included  
**Related To:** BF9860 (Long Version) BF46129 (Upgrade Version)

**BF9886**

In-Line Fuel Filter



**Fits:** John Deere Loaders, Tractors  
**Replaces:** John Deere RE176732  
**O.D.:** 1 29/32 (48.4)  
**Inlet:** 9/16-18  
**Outlet:** 9/16-18  
**Length:** 3 7/8 (98.4)

**BF9887**

Fuel Spin-on



**Contains:** Integral Post Seal  
**Fits:** John Deere Equipment  
**Replaces:** John Deere MIU800645; Yanmar 11980255800, 11980255801  
**Thread:** M20 x 1.5  
**O.D.:** 3 11/16 (93.7)  
**Height:** 3 1/4 (82.6)  
**I.Gskt:** [1] Included

Measurements Are Shown In Inches And (Millimeters)

**WARNING:** These products can expose you to chemicals, including Diisononyl Phthalate, Carbon black extracts, Nickel, 1,3 Butadiene, Ethylene Oxide, Epichlorohydrin, which are known to the State of California to cause cancer, and Bisphenol, Ethylene Glycol, Ethylene Oxide, 1,3 Butadiene, Epichlorohydrin, which are known to the State of California to cause birth defects or other reproductive harm.

**BF9888**

Fuel Spin-on



**Contains:** Integral Post Seal  
**Replaces:** Clark FL-3WS0  
**Thread:** 1 1/2 -12  
**O.D.:** 4 21/32 (118.3)  
**Height:** 9 15/16 (252.4)  
**I.Gskt:** [1] Included

**BF9894**

Fuel/Water Separator Spin-on



**Fits:** Thermo King Refrigeration Units  
**Replaces:** Thermo King 11-8047, 11-9342, 12-9342; ACDelco TP1362  
**Thread:** M22 x 1.5  
**O.D.:** 3 11/16 (93.7)  
**Height:** 4 3/8 (111.1)  
**A. Gskt:** G381-A

**PF9889**

Fuel Element



**Replaces:** Hino S234011790  
**O.D.:** 3 3/4 (95.3)  
**I.D.:** 1 1/16 (27.0) One End  
**Height:** 7 5/8 (193.7)  
**I.Gskt:** [1] Included  
**O-Ring:** [2] Included

**BF9895 KIT**

Set of 2 Fuel Elements



**Fits:** Ford Super Duty Trucks with V8-406 (6.7L) FI Turbo Diesel Engine  
**Replaces:** Ford BC3Z-9N184-B; Motorcraft FD4615  
**Element**  
**O.D.:** 4 (101.6)  
**I.D.:** 1 3/8 (34.9) One End  
**Height:** 5 1/4 (133.4)  
**A. Gskt:** [1] Attached  
**O-Ring:** [1] Included  
**In-Line**  
**O.D.** 3 15/16  
**I.D. Inlet:** 1/2 (12.7)  
**Height** 4 9/32

**PF9890**

Fuel Element



**Fits:** Mitsubishi Trucks  
**Replaces:** Mitsubishi ME300361; Donaldson P502226  
**O.D.:** 3 3/4 (95.3)  
**I.D.:** 1 1/16 (27.0) One End  
**Height:** 3 7/8 (98.4)  
**I.Gskt:** [1] Included  
**O-Ring:** [3] Included

**PF9897**

Fuel Element



**Fits:** Isuzu, Mitsubishi Trucks  
**Replaces:** General Motors 97726081; Isuzu 1132401940; Mitsubishi ME300647  
**O.D.:** 3 3/4 (95.3)  
**I.D.:** 1 3/32 (27.8) One End  
**Height:** 3 7/8 (98.4)  
**O-Ring:** [1] Attached, [3] Included

**BF9891-D**

Primary Fuel Element with Drain



**Notes:** Reverse Flow  
**Fits:** John Deere Engines, Equipment  
**Replaces:** John Deere RE541922  
**O.D.:** 3 3/16 (81.0)  
**I.D.:** 9/16 (14.3) One End  
**Height:** 7 11/16 (195.3)  
**Grommets:** [1] Attached

**BF9898-O**

Fuel/Water Separator Spin-on with Open End for Bowl



**Contains:** Bowl Thread: M95 x 2.5  
 Integral Post Seal  
**Fits:** Freightliner Cascadia, FLD, Business Class M2 Trucks  
**Replaces:** Alliance ABPN/122R-50418; Fleetguard FS19593  
**Thread:** 1 -14  
**O.D.:** 4 1/4 (108.0)  
**Height:** 6 5/16 (160.3)  
**I.Gskt:** [1] Included  
**F. Gskt:** [1] Included

**BF9892-D**

Secondary Fuel Element with Drain



**Fits:** John Deere Engines, Equipment  
**Replaces:** John Deere RE544394  
**O.D.:** 3 3/16 (81.0)  
**I.D.:** 9/16 (14.3) One End  
**Height:** 6 1/16 (154.0)

**PF9899**

Fuel Element



**Replaces:** Hino S234011800  
**O.D.:** 3 17/32 (89.7)  
**I.D.:** 3/4 (19.0)  
**Height:** 5 3/8 (136.5)  
**O-Ring:** [2] Included  
**Grommets:** [2] Attached

**BF9893**

Fuel Spin-on



**Replaces:** Thermo King 11-9954, 12-9954  
**Thread:** M22 x 1.5  
**O.D.:** 3 11/16 (93.7)  
**Height:** 6 5/32 (156.4)  
**A. Gskt:** G381-A

**PF9900**

Fuel Element

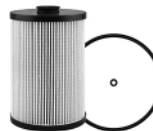

**Notes:** OBSOLETE. Availability Limited to Dealer Stock.  
**Fits:** Mitsubishi FV51JK Truck with 6M70 Engine  
**Replaces:** Mitsubishi ME165323; Donaldson P502371  
**O.D.:** 3 11/16 (93.7)  
**I.D.:** 19/32 (15.1) One End  
**Height:** 5 11/32 (135.7)  
**O-Ring:** [2] Included  
**Grommets:** [1] Attached

Measurements Are Shown In Inches And (Millimeters)

**WARNING:** These products can expose you to chemicals, including Diisononyl Phthalate, Carbon black extracts, Nickel, 1,3 Butadiene, Ethylene Oxide, Epichlorohydrin, which are known to the State of California to cause cancer, and Bisphenol, Ethylene Glycol, Ethylene Oxide, 1,3 Butadiene, Epichlorohydrin, which are known to the State of California to cause birth defects or other reproductive harm.

**PF9901 KIT** Fuel Filter Kit  
**Contains:** [1] Fuel Filter  
 [1] Strainer  
**Fits:** Freightliner Trucks  
**Replaces:** Freightliner A0000902751  
**Element**  
**O.D.:** 2 13/32 (61.1)  
**I.D.:** 17/32 (13.5) One End  
**Height:** 5 9/16 (141.3)  
**O-Ring:** [2] Included  
**Strainer**  
**O.D.** 2 (50.8)  
**I.D.** 17/32 (13.5)  
**Height** 2 15/16 (74.6)



**PF9907** In-Line Fuel Strainer with Housing  
**Fits:** International CD, 3600 Buses, I530E Engine  
**Replaces:** International 1817677C91; Fleetguard FF257  
**Strainer**  
**O.D.:** 23/32 (18.3)  
**I.D.:** 5/8 (15.9) One End  
**Height:** 3 1/8 (79.4)  
**O-Ring:** [1] Included  
**Housing**  
**O.D.** 1 5/8 (41.3)  
**I.D.** 1 1/32 (26.2)  
**Height** 2 27/32 (72.2)



**PF9902** Nylon Fuel Strainer  
**Fits:** Case, Kobelco, New Holland Excavators  
**Replaces:** Kobelco 2446R326; New Holland 2446R326  
**O.D.:** 3 1/16 (77.8)  
**I.D.:** 2 1/8 (54.0) One End  
**Height:** 5 3/16 (131.8)



**PF9908 KIT** Fuel Filter Kit  
**Contains:** [1] Fuel Filter  
 [1] Strainer  
 [1] Grease Tube  
**Fits:** Freightliner, Western Star Trucks with Detroit Diesel DD13, DD15, DD16 Engines  
**Replaces:** Detroit Diesel A4700903151, A4720900451, A4720900551  
**Element**  
**O.D.:** 4 19/32 (116.7)  
**I.D.:** 1 9/16 (39.7)  
**Height:** 10 (254.0)  
**O-Ring:** [2] Included  
**Strainer**  
**O.D.** 2 11/32 (59.5)  
**I.D.** 1 9/16 (39.7)  
**Height** 3 1/16 (77.8)



**BF9903-SP** Fuel/Water Separator Spin-on with Drain and Sensor Port  
**Notes:** CAUTION: Furnished O-Ring must be installed on Post for Seal  
**Contains:** Standpipe  
 Sensor Port Thread: 9/16-18  
**Fits:** Caterpillar Equipment; Kenworth, Western Star Trucks  
**Replaces:** Caterpillar 3261641; Fleetguard FS19968  
**Thread:** 1 -14  
**O.D.:** 4 1/4 (108.0)  
**Height:** 9 7/32 (234.2)  
**I.Gskt:** [1] Included  
**O-Ring:** [2] Included



**BF9910** Fuel Spin-on  
**Contains:** Integral Post Seal  
**Fits:** Cummins QSB3.3 (Tier 4) Engines; Dynapac Rollers; Komatsu Engines, Excavators; Skytrak Telehandlers  
**Replaces:** Cummins 4942437, 4946635; Komatsu 600-311-3530, 600-319-3530  
**Thread:** M22 x 1.5  
**O.D.:** 3 3/32 (78.6)  
**Height:** 5 1/2 (139.7)  
**I.Gskt:** [1] Included



**BF9904** Fuel Spin-on with Drain  
**Fits:** Nissan Trucks  
**Replaces:** Nissan 16400BN303, 164037F40a, 164037F400, 164037F401  
**Thread:** 3/4 -16  
**O.D.:** 3 3/4 (95.3)  
**Height:** 6 9/32 (159.5)  
**I.Gskt:** [1] Included



**PF9911** Fuel Element  
**Fits:** Kubota Tractors, Utility Vehicles  
**Replaces:** Kubota 6A32059930  
**O.D.:** 1 13/16 (46.0)  
**I.D.:** 1/32 (0.8) One End  
**Height:** 2 1/8 (54.0)  
**O-Ring:** [1] Included



**BF9905** In-Line Fuel Filter  
**Fits:** Case, New Holland Loaders  
**Replaces:** Case 87019604, 87548612; New Holland 87548612  
**O.D.:** 1 29/32 (48.4)  
**Inlet:** 3/8  
**Outlet:** 3/8  
**Length:** 5 5/8 (142.9)



**BF9912-O** Fuel/Water Separator Spin-on with Open End for Bowl  
**Contains:** Bowl Thread: 3 3/4-10 Buttress  
 Integral Post Seal  
**Replaces:** Atlas Copco 2914809200; Fleetguard FS19775  
**Thread:** 1 -14  
**O.D.:** 4 1/4 (108.0)  
**Height:** 3 15/32 (88.1)  
**I.Gskt:** [1] Included  
**F. Gskt:** [1] Included



**BF9906** In-Line Fuel Filter  
**Fits:** Kobelco, Komatsu, Yanmar Equipment  
**Replaces:** Kobelco VV12905255630; New Holland YJ21P01008P2; Yanmar 12905255630  
**O.D.:** 2 9/16 (65.1)  
**Inlet:** 11/32  
**Outlet:** 11/32  
**Length:** 3 7/32 (81.8)



Measurements Are Shown In Inches And (Millimeters)

**WARNING:** These products can expose you to chemicals, including Diisononyl Phthalate, Carbon black extracts, Nickel, 1,3 Butadiene, Ethylene Oxide, Epichlorohydrin, which are known to the State of California to cause cancer, and Bisphenol, Ethylene Glycol, Ethylene Oxide, 1,3 Butadiene, Epichlorohydrin, which are known to the State of California to cause birth defects or other reproductive harm.

**BF9913**

Fuel Spin-on



**Contains:** Water Absorbent Media  
**Replaces:** Cim-Tek 70067, CT70067; Fleetguard FS19748  
**Thread:** 1 -12  
**O.D.:** 3 11/16 (93.7)  
**Height:** 8 23/32 (221.5)  
**I.Gskt:** [1] Included

**BF9918 KIT**

Set of 2 Fuel Filters



**Notes:** Port Thread: M36 x 1.5  
**Contains:** [1] BF46062  
 [1] Element, not sold separately  
**Fits:** Chevrolet Express Vans, GMC Savana Vans, all with V8-400 (6.6L) Turbo Diesel Engine  
**Replaces:** General Motors 19149845; ACDelco TP3013, TP1537; Baldwin BF7933 KIT  
**BF46062**  
**Thread:** 3 3/8 -8 UN Buttress  
**O.D.:** 4 1/32 (102.4)  
**I.D.:** 1 5/8 (41.3)  
**Height:** 6 1/2 (165.1)  
**O-Ring:** [2] Included  
**Grommets:** [1] Attached  
**Element**  
**O.D.** 3 11/16 (93.7)  
**I.D.** 1 5/8 (41.3)  
**Height** 3 15/16 (100.0)

**PF9914 KIT**

Set of 2 Fuel Elements



**Fits:** International TerraStar, 4300 Trucks with MaxxForce 7 (6.4L) Engine  
**Replaces:** International 1884207C91, 1884207C92; Racor R33286  
**Primary**  
**O.D.:** 3 5/8 (92.1)  
**I.D.:** 1 11/16 (42.9) One End  
**Height:** 6 9/16 (166.7)  
**O-Ring:** [1] Attached, [1] Included  
**Secondary**  
**O.D.** 3 11/32  
**I.D.** 9/16  
**Height** 6 3/16  
**O-Ring** [1] Attached, [1] Included

**PF9919**

Fuel Element



**Fits:** Chevrolet, GMC, Isuzu Trucks  
**Replaces:** General Motors 98037011; Isuzu 8982035990, 8981628970, 8980370110  
**O.D.:** 3 25/32 (96.0)  
**I.D.:** 15/32 (11.9) One End  
**Height:** 4 9/16 (115.9)  
**A. Gskt:** [1] Attached  
**O-Ring:** [1] Included  
**Grommets:** [1] Attached

**BF9915**

Can-Type Fuel Element



**Fits:** Caterpillar, Gehl, Manitou, Massey Ferguson, Merlo Equipment  
**Replaces:** Caterpillar 2526338; Massey Ferguson 4225526M1; Perkins 26550005  
**O.D.:** 3 7/16 (87.3)  
**I.D.:** 3/4 (19.0) & 1 7/16 (36.5)  
**Height:** 2 13/16 (71.4)  
**F. Gskt:** [3] Included  
**O-Ring:** [2] Included

**BF9920**

Fuel/Water Separator Spin-on with Drain



**Fits:** Case-IH, New Holland Tractors; Wirtgen Paving Equipment  
**Replaces:** Case 84477362, 87366406, 87395356; New Holland 84477362, 87366406, 87395356  
**Thread:** M85 x 2.0  
**O.D.:** 4 11/16 (119.1)  
**Height:** 11 1/8 (282.6)  
**I.Gskt:** [1] Included

**BF9916**

Wire Mesh In-Line Fuel Strainer



**Fits:** John Deere Compact Track Loaders, Skid Steer Loaders  
**Replaces:** John Deere T257865  
**O.D.:** 1 29/32 (48.4)  
**Inlet:** 5/16  
**Outlet:** 5/16  
**Length:** 3 29/32 (99.2)

**BF9921-O**

Fuel/Water Separator Spin-on with Open End for Bowl



**Contains:** Pre-Fill Cup  
 Integral Post Seal  
 Bowl Thread: M95 x 2.5  
**Fits:** John Deere Industrial, Marine Engines  
**Replaces:** John Deere RE503676  
**Thread:** 1 -14  
**O.D.:** 4 1/4 (108.0)  
**Height:** 8 21/32 (219.9)  
**I.Gskt:** [1] Included  
**O-Ring:** [1] Included  
**Grommets:** [1] Attached

**BF9917**

High Efficiency Fuel Spin-on



**Contains:** Integral Post Seal  
**Fits:** John Deere Equipment  
**Replaces:** John Deere RE533910  
**Thread:** 1 -14  
**O.D.:** 4 11/32 (110.3)  
**Height:** 9 1/4 (235.0)  
**I.Gskt:** [1] Included

**BF9922-O**

Fuel/Water Separator Spin-on with Open End for Bowl



**Notes:** Inside-Out Flow Direction  
**Contains:** Bowl Thread: M80 x 2.5  
 Integral Post Seal  
**Fits:** Mercedes-Benz Latin America Buses, Trucks  
**Replaces:** Mercedes-Benz A3820927005; Racor R20P  
**Thread:** 1 -14  
**O.D.:** 3 21/32 (92.9)  
**Height:** 4 1/8 (104.8)  
**I.Gskt:** [1] Included  
**O-Ring:** [1] Included  
**Related To:** BF46021-O, BF46022-O (Micron Difference)

Measurements Are Shown In Inches And (Millimeters)

**WARNING:** These products can expose you to chemicals, including Diisononyl Phthalate, Carbon black extracts, Nickel, 1,3 Butadiene, Ethylene Oxide, Epichlorohydrin, which are known to the State of California to cause cancer, and Bisphenol, Ethylene Glycol, Ethylene Oxide, 1,3 Butadiene, Epichlorohydrin, which are known to the State of California to cause birth defects or other reproductive harm.

**BF9923-O**

Fuel Spin-on with Threaded Port



**Contains:** Port Thread: 1 1/4-10  
**Fits:** Atlas Copco, Bomag Equipment; Dynapac Rollers; Komatsu Excavators  
**Replaces:** Cummins 4941237; Komatsu 600-319-4110  
**Thread:** M24 x 1.5  
**O.D.:** 3 3/4 (95.3)  
**Height:** 5 1/4 (133.4)  
**I.Gskt:** [1] Included  
**O-Ring:** [1] Included

**PF9929**

Fuel/Water Separator Element



**Fits:** Kenworth, Peterbilt Trucks with Paccar MX-13 Engine  
**Replaces:** Paccar K371009  
**O.D.:** 4 1/8 (104.8)  
**Height:** 7 1/2 (190.5)  
**F. Gskt:** [1] Included  
**Grommets:** [1] Attached

**PF9924 KIT**

Fuel Filter Kit



**Notes:** Parts Not Sold Separately  
**Fits:** Detroit Diesel DD13 (12.8L), DD15 (14.8L), DD16 (15.6L) Engines; Freightliner, Sterling, Western Star Trucks  
**Replaces:** Detroit Diesel A0000904251  
**Coalescer**  
**O.D.:** 4 3/16 (106.4)  
**Height:** 9 11/32 (237.3)  
**O-Ring:** [3] Included  
**Final Filter**  
**O.D.:** 2 5/8 (66.7)  
**Height:** 7 5/32 (181.8)

**PA10000**

Panel Air Element



**Fits:** Mitsubishi Lancer, Outlander Sport  
**Replaces:** Mitsubishi 1500A513  
**Length:** 10 5/32 (258.0)  
**Width:** 8 3/16 (208.0)  
**Height:** 2 3/32 (53.2)

**PA10001**

Panel Air Element

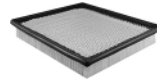

**Fits:** Cadillac XTS; Chevrolet Impala  
**Replaces:** General Motors 22753242  
**Length:** 11 5/16 (287.3)  
**Width:** 10 (254.0)  
**Height:** 1 25/32 (45.2)

**BF9925-O**

Fuel/Water Separator Spin-on with Open End for Bowl



**Contains:** Bowl Thread: M95 x 2.5  
**Replaces:** Racor S6464; Donaldson P551034; Fleetguard FS19538  
**Thread:** 1 -14  
**O.D.:** 4 1/4 (108.0)  
**Height:** 6 5/16 (160.3)  
**F. Gskt:** [2] Included

**PA10002**

Cabin Air Element

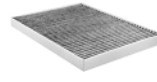

**Contains:** Charcoal Impregnated Media for Odor Control  
**Fits:** Buick, Chevrolet, GMC, Saturn Automotive, Light-Duty Trucks  
**Replaces:** ACDelco CF179C  
**Length:** 9 9/32 (235.7)  
**Width:** 6 25/32 (172.2)  
**Height:** 23/32 (18.3)

**BF9926-O**

Fuel/Water Separator Spin-on with Open End for Bowl



**Notes:** OBSOLETE. Availability Limited to Dealer Stock.  
**Contains:** Bowl Thread: M80 x 2.5 Integral Post Seal  
**Fits:** Yanmar Engines  
**Replaces:** Yanmar 12065055020  
**Thread:** 1 -14  
**O.D.:** 3 11/16 (93.7)  
**Height:** 4 1/8 (104.8)  
**I.Gskt:** [1] Included  
**O-Ring:** [1] Included

**PA10003**

Panel Air Element



**Fits:** Ford Fiesta  
**Replaces:** Ford CN1Z9601A; Motorcraft FA1914  
**Length:** 7 3/4 (196.9)  
**Width:** 6 5/16 (160.3)  
**Height:** 2 3/4 (69.9)

**PA10004**

Panel Air Element

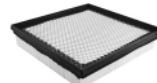

**Fits:** Chrysler 200, Dodge Avenger, Journey  
**Replaces:** Chrysler 68081249AC  
**Length:** 9 7/32 (234.2)  
**Width:** 8 15/16 (227.0)  
**Height:** 1 13/16 (46.0)

**BF9927**

High Efficiency Fuel Spin-on



**Fits:** Kenworth, Peterbilt Trucks with Paccar MX Engines  
**Replaces:** Paccar 1655115; Donaldson P551004; Fleetguard FF252  
**Thread:** 1 -14  
**O.D.:** 3 23/32 (94.5)  
**Height:** 8 7/32 (208.8)  
**I.Gskt:** G401

**RS10005**

Radial Seal Air Element



**Fits:** Dodge Caliber; Jeep Compass, Patriot  
**Replaces:** Chrysler 4593914AB  
**O.D.:** 5 11/32 (135.7)  
**I.D.:** 3 5/32 (80.2) One End  
**Height:** 6 15/16 (176.2)

**PF9928**

Fuel/Water Separator Element



**Fits:** Kenworth, Peterbilt Trucks with Cummins ISL, ISX, Paccar MX, MX-13 Engines  
**Replaces:** Paccar K371004  
**O.D.:** 4 1/8 (104.8)  
**Height:** 7 1/2 (190.5)  
**O-Ring:** [1] Included  
**Grommets:** [1] Attached

**PA10006**

Panel Air Element with Foam Pad

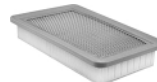

**Fits:** Chrysler 200 with V6-220 (3.6L) FI Engine  
**Replaces:** Chrysler 6824545AA  
**Length:** 11 15/16 (303.2)  
**Width:** 7 1/8 (181.0)  
**Height:** 1 7/8 (47.6)

Measurements Are Shown In Inches And (Millimeters)

**WARNING:** These products can expose you to chemicals, including Diisononyl Phthalate, Carbon black extracts, Nickel, 1,3 Butadiene, Ethylene Oxide, Epichlorohydrin, which are known to the State of California to cause cancer, and Bisphenol, Ethylene Glycol, Ethylene Oxide, 1,3 Butadiene, Epichlorohydrin, which are known to the State of California to cause birth defects or other reproductive harm.



**PA10007** Panel Air Element with Foam Pad  
**Fits:** Renault Kangoo Vans  
**Replaces:** Renault 7701477208  
**Length:** 14 31/32 (380.2)  
**Width:** 3 9/32 (83.3)  
**Height:** 2 5/16 (58.7)



**PA10008** Panel Air Element  
**Fits:** Nissan Rogue  
**Replaces:** Nissan 165464BA1A  
**Length:** 9 31/32 (253.2)  
**Width:** 6 25/32 (172.2)  
**Height:** 1 13/32 (35.7)  
**A. Gskt:** [1] Attached



**PA10009** Cabin Air Element  
**Fits:** Chrysler 200; Jeep Cherokee  
**Replaces:** Chrysler 68223044AA  
**Length:** 9 9/32 (235.7)  
**Width:** 8 19/32 (218.3)  
**Height:** 25/32 (19.8)  
**A. Gskt:** [2] Attached

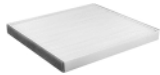

**PA10010** Panel Air Element  
**Fits:** 2010 Renault Megane with 4-1998cc (2.0L) Engine  
**Replaces:** Renault 820371661  
**Length:** 9 9/16 (242.9)  
**Width:** 5 9/32 (134.1)  
**to 7 15/32 (189.7)**  
**Height:** 2 3/16 (55.6)

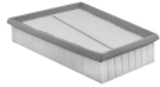

**PA10011** Foam Air Pre-Cleaner  
**Contains:** Flame Retardant Media  
**Fits:** Ford Super Duty Pickups with V8-406 (6.7L) FI Turbo Diesel Engine  
**Replaces:** Motorcraft FA1909  
**Length:** 7 3/8 (187.3)  
**Width:** 6 3/8 (161.9)  
**Height:** 3 1/4 (82.6)

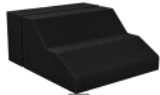

**PA10012** Panel Air Element with Foam Pad  
**Fits:** Opel Movano A 3.0 CDTI; Renault Master III 3.0 DCI European Light-Duty Vehicles  
**Replaces:** Renault 8200488878, 8200283082; Nissan 1654600Q0G, 1654600QAM; Opel 4415430, 4417325, 93190266, 93181231  
**Length:** 14 5/32 (359.6)  
**Width:** 10 3/8 (263.5)  
**Height:** 2 1/8 (54.0)

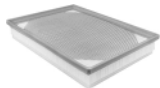

**PA10013** Air with Foam Pad  
**Notes:** OBSOLETE. Availability Limited to Dealer Stock.  
**Replaces:** Fiat 51925027  
**Length:** 14 1/32 (356.4)  
**Width:** 5 5/32 (131.0)  
**Height:** 2 (50.8)



**PA10014** Cabin Air Element  
**Fits:** Chevrolet Colorado; GMC Canyon  
**Replaces:** General Motors 23135671; ACDelco CF196  
**Length:** 9 7/16 (239.7)  
**Width:** 8 (203.2)  
**Height:** 1 3/16 (30.2)



**PA10015** Panel Air Element  
**Fits:** Chevrolet Colorado, GMC Canyon  
**Replaces:** General Motors 94775933; ACDelco A3195C  
**Length:** 10 11/16 (271.5)  
**Width:** 10 3/32 (256.4)  
**Height:** 1 9/16 (39.7)

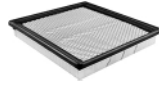

**PA10016** Cabin Air Element  
**Notes:** Single filter version of the PA4460 KIT Requires 2 filters per application.  
**Fits:** Jeep Wrangler  
**Replaces:** Chrysler 68233626AA  
**Length:** 5 27/32 (148.4)  
**Width:** 5 27/32 (148.4)  
**Height:** 25/32 (19.8)



**PA10017** Cabin Air Element  
**Fits:** Ram ProMaster 1500, ProMaster 2500, ProMaster 3500 Vans  
**Replaces:** Chrysler 68169308AA  
**Length:** 9 15/16 (252.4) to 11 31/32 (304.0)  
**Width:** 8 21/32 (219.9)  
**Height:** 1/2 (12.7)



**PA10018** Cabin Air Element  
**Contains:** Charcoal Impregnated Media for Odor Control  
**Fits:** Audi, Porsche, Volkswagen Automotive  
**Replaces:** Volkswagen 7HO819631A; Porsche 95557221910  
**Length:** 10 29/32 (277.0)  
**Width:** 8 5/8 (219.1)  
**Height:** 1 11/32 (34.1)  
**Related To:** PA10034 (without Charcoal)

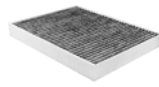

**PA10020** Cabin Air Element with Lift Tab  
**Fits:** 1996-2001 Volkswagen Eurovan  
**Replaces:** Volkswagen 7D0819989  
**O.D.:** 7 13/32 (188.1)  
**I.D.:** 4 11/32 (110.3) One End  
**Height:** 4 1/32 (102.4)



**RS10021** Radial Seal Air Element  
**Fits:** Ram ProMaster 1500, Promaster 2500, ProMaster 3500 Vans with V6-220 (3.6L) FI Engine  
**Replaces:** Ram 4861865AA, 52022424AA  
**O.D.:** 6 17/32 (165.9)  
**I.D.:** 4 1/2 (114.3) One End  
**Height:** 12 3/8 (314.3)



**PA10022** Panel Air Element  
**Fits:** Ram Light-Duty Trucks with V6-182 (3.0L) FI Turbo Diesel, V8-392 (6.4L) FI Engines  
**Replaces:** Chrysler 68190705AA  
**Length:** 13 7/8 (352.4)  
**Width:** 9 3/8 (238.1)  
**Height:** 2 9/32 (57.9)

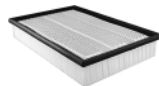

**PA10023** Panel Air Element  
**Fits:** Nissan Altima  
**Replaces:** Nissan 165463TA0A  
**Length:** 11 3/8 (288.9)  
**Width:** 11 3/8 (288.9)  
**Height:** 1 3/32 (27.8)  
**A. Gskt:** [1] Included



Measurements Are Shown In Inches And (Millimeters)

**WARNING:** These products can expose you to chemicals, including Diisononyl Phthalate, Carbon black extracts, Nickel, 1,3 Butadiene, Ethylene Oxide, Epichlorohydrin, which are known to the State of California to cause cancer, and Bisphenol, Ethylene Glycol, Ethylene Oxide, 1,3 Butadiene, Epichlorohydrin, which are known to the State of California to cause birth defects or other reproductive harm.

<p><b>PA10024</b> Panel Air Element  <b>Fits:</b> Acura TLX, Honda Accord with 4-2356cc (2.4L) Engine  <b>Replaces:</b> Honda 172205A2A00  <b>Length:</b> 12 1/16 (306.4)  <b>Width:</b> 7 5/8 (193.7)  <b>Height:</b> 2 9/32 (57.9)  <b>A. Gskt:</b> [1] Included</p> 	<p><b>PA10034</b> Cabin Air Element  <b>Fits:</b> Audi, Porsche, Volkswagen Automotive  <b>Replaces:</b> Volkswagen 7H0819631  <b>Length:</b> 10 29/32 (277.0)  <b>Width:</b> 8 5/8 (219.1)  <b>Height:</b> 1 11/32 (34.1)  <b>Related To:</b> PA10018 (Charcoal Version)</p> 
<p><b>PA10025</b> Panel Air Element  <b>Fits:</b> Mazda Automotive  <b>Replaces:</b> Mazda PE07133A0A  <b>Length:</b> 10 21/32 (270.7)  <b>Width:</b> 7 1/16 (179.4)  <b>Height:</b> 1 5/16 (33.3)  <b>A. Gskt:</b> [1] Included</p> 	<p><b>RS10035</b> Radial Seal Air Element  <b>Fits:</b> Ford Rangers; Mazda, Toyota Light-Duty Trucks  <b>Replaces:</b> Toyota 178010C010, 178010C01000, 178010C020; Donaldson P902609; Fleetguard AF26501  <b>O.D.:</b> 8 1/2 (215.9)  <b>I.D.:</b> 4 5/8 (117.5) One End  <b>Height:</b> 6 3/4 (171.5)</p> 
<p><b>PA10026</b> Panel Air Element  <b>Fits:</b> Honda Odyssey  <b>Replaces:</b> Honda 17220-RV0A00  <b>Length:</b> 11 29/32 (302.4)  <b>Width:</b> 6 23/32 (170.7)  <b>Height:</b> 2 3/32 (53.2)  <b>A. Gskt:</b> [1] Included</p> 	<p><b>PA10036</b> Cabin Air Element  <b>Contains:</b> Charcoal Impregnated Media for Odor Control  <b>Fits:</b> Mercedes-Benz Automotive  <b>Replaces:</b> Mercedes-Benz 2468300018, A2468300018  <b>Length:</b> 10 3/32 (256.4)  <b>Width:</b> 10 1/32 (254.8)  <b>Height:</b> 1 3/4 (44.4)</p> 
<p><b>PA10027</b> Panel Air Element  <b>Fits:</b> Hyundai Tucson; Kia Sportage  <b>Replaces:</b> Hyundai 28113-2S000; Kia 28113-2S000  <b>Length:</b> 10 5/32 (258.0)  <b>Width:</b> 6 13/32 (162.7)  <b>Height:</b> 1 7/8 (47.6)</p> 	<p><b>PA10038</b> Panel Air Element  <b>Fits:</b> Chevrolet Spark  <b>Replaces:</b> General Motors 96910360  <b>Length:</b> 11 13/32 (289.7)  <b>Width:</b> 6 1/8 (155.6)  <b>Height:</b> 1 1/8 (28.6)  <b>A. Gskt:</b> [1] Included</p> 
<p><b>PA10028</b> Panel Air Element  <b>Fits:</b> Lexus CT200h; Toyota Prius  <b>Replaces:</b> Toyota 17801-37020  <b>Length:</b> 8 3/4 (222.3)  <b>Width:</b> 7 3/8 (187.3)  <b>Height:</b> 1 13/32 (35.7)</p> 	<p><b>PA10039</b> Panel Air Element  <b>Fits:</b> Chevrolet Sonic  <b>Replaces:</b> General Motors 96950990  <b>Length:</b> 9 17/32 (242.1)  <b>Width:</b> 6 25/32 (172.2)  <b>Height:</b> 1 31/32 (50.0)</p> 
<p><b>PA10030</b> Cabin Air Element  <b>Fits:</b> Chrysler Town &amp; Country, Dodge Grand Caravan, Ram Cargo Vans  <b>Replaces:</b> Chrysler 68127809AA  <b>Length:</b> 8 15/16 (227.0)  <b>Width:</b> 7 7/8 (200.0)  <b>Height:</b> 1 3/16 (30.2)</p> 	<p><b>PA10040</b> Panel Air Element  <b>Fits:</b> Lexus, Toyota Automotive  <b>Replaces:</b> Toyota 17801-38010  <b>Length:</b> 10 5/8 (269.9)  <b>Width:</b> 7 3/32 (180.2)  <b>Height:</b> 1 3/8 (34.9)</p> 
<p><b>PA10031</b> Cabin Air Element  <b>Fits:</b> Infiniti JX35, QX60; Nissan Altima, Murano, Pathfinder  <b>Replaces:</b> Nissan 272773JC1A  <b>Length:</b> 11 1/16 (281.0)  <b>Width:</b> 9 21/32 (245.3)  <b>Height:</b> 3/4 (19.0)</p> 	<p><b>PA10041</b> Cabin Air Element  <b>Fits:</b> Subaru Impreza, Forester, Outback Sport, WRX, WRX Sti  <b>Replaces:</b> Subaru 72880FG000, 72880FG0009P  <b>Length:</b> 9 3/16 (233.4)  <b>Width:</b> 8 13/16 (223.8)  <b>Height:</b> 2 1/4 (57.2)  <b>A. Gskt:</b> [1] Included</p> 
<p><b>PA10032</b> Cabin Air Element  <b>Fits:</b> Mazda CX5, Mazda 3, Mazda 6  <b>Replaces:</b> Mazda KD4561J6X  <b>Length:</b> 8 7/8 (225.4)  <b>Width:</b> 7 3/4 (196.9)  <b>Height:</b> 13/16 (20.6)  <b>A. Gskt:</b> [1] Included</p> 	<p><b>PA10042</b> Cabin Air Element  <b>Fits:</b> Hyundai Santa Fe; Kia Sorento  <b>Replaces:</b> Hyundai 1UF79AQ000, 2BF79AQ000, 971331U000  <b>Length:</b> 10 5/16 (261.9)  <b>Width:</b> 8 7/32 (208.8)  <b>Height:</b> 1 3/16 (30.2)</p> 
<p><b>PA10033</b> Panel Air Element  <b>Contains:</b> Flame Retardant Media  <b>Fits:</b> Ford Mustang  <b>Replaces:</b> Ford FR3Z-9601-A; Motorcraft FA1918  <b>Length:</b> 11 3/16 (284.2)  <b>Width:</b> 10 3/16 (258.8)  <b>Height:</b> 2 9/32 (57.9)</p> 	<p><b>PA10043</b> Cabin Air Element  <b>Fits:</b> Chrysler 300, Dodge Challenger, Charger  <b>Replaces:</b> Chrysler 68071668AA  <b>Length:</b> 10 7/8 (276.2)  <b>Width:</b> 7 7/8 (200.0)  <b>Height:</b> 1 3/16 (30.2)</p> 

Measurements Are Shown In Inches And (Millimeters)

**WARNING:** These products can expose you to chemicals, including Diisononyl Phthalate, Carbon black extracts, Nickel, 1,3 Butadiene, Ethylene Oxide, Epichlorohydrin, which are known to the State of California to cause cancer, and Bisphenol, Ethylene Glycol, Ethylene Oxide, 1,3 Butadiene, Epichlorohydrin, which are known to the State of California to cause birth defects or other reproductive harm.

**PA10044** Panel Air Element with Pull Tabs  
**Fits:** Hyundai Sonata; Kia Optima  
**Replaces:** Hyundai 28113C1100, 28113D3300  
**Length:** 10 29/32 (277.0)  
**Width:** 7 27/32 (199.2)  
**Height:** 1 11/16 (42.9)

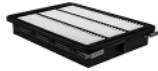

**PA10045** Panel Air Element with Foam Pad  
**Fits:** Toyota Sequoia, Tacoma, Tundra  
**Replaces:** Toyota 178010S020, 178010P100  
**Length:** 11 25/32 (299.2)  
**Width:** 10 7/32 (259.6)  
**Height:** 2 9/16 (65.1)



**PA10046** Panel Air Element with Foam Pad  
**Fits:** Jeep Renegade; Ram ProMaster City; Fiat 500X  
**Replaces:** Chrysler 68247339AA, K68247339AA; Fiat 51977574  
**Length:** 8 3/16 (208.0)  
**Width:** 7 13/32 (188.1)  
**Height:** 2 17/32 (64.3)

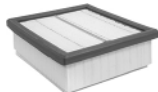

**PA10047** Panel Air Element  
**Fits:** Honda CRV with (2.4L) Engines  
**Replaces:** Honda 172205LAA00  
**Length:** 11 1/8 (282.6)  
**Width:** 7 1/2 (190.5)  
**Height:** 2 (50.8)  
**A. Gskt:** [1] Included



**PA10057** Panel Air Element  
**Fits:** Honda Civic, CR-V  
**Replaces:** Honda 172205AAA00  
**Length:** 9 11/16 (246.1)  
**Width:** 5 5/8 (142.9)  
**Height:** 2 5/16 (58.7)  
**A. Gskt:** [1] Included



**PA10058** Panel Air Element  
**Fits:** Acura, Honda Automotive, Light-Duty Trucks  
**Replaces:** Honda 172205J6A10  
**Length:** 11 9/16 (293.7)  
**Width:** 6 1/2 (165.1)  
**Height:** 1 7/8 (47.6)  
**A. Gskt:** [1] Included



**PA10059** Panel Air Element  
**Fits:** 2016-20 Honda Civic  
**Replaces:** Honda 172205BAA00; Wix WA10416  
**Length:** 9 1/4 (235.2)  
**Width:** 7 3/16 (182.6)  
**Height:** 1 13/16 (45.7)  
**A. Gskt:** [1] Included



**PA10060** Panel Air Element  
**Fits:** Chevrolet Caprice, SS; Pontiac G8  
**Replaces:** General Motors 92066873  
**Length:** 12 31/32 (329.4)  
**Width:** 6 (152.4) to 9 15/32 (240.5)  
**Height:** 2 1/32 (51.6)



**PA10061** Oval Air Element with Foam  
**Notes:** O.D. Includes Foam  
**Fits:** Ford Super-Duty Trucks with (6.7L) Engines  
**Replaces:** Ford HC3Z9601A; Motorcraft FA1927  
**O.D.:** 8 1/16 (204.8) to 11 1/32 (280.2)  
**I.D.:** 3 23/32 (94.5) & 6 11/16 (169.9) to  
**Height:** 9 9/16 (242.9)  
**Related To:** PA10068 (w/o attached foam)



**PA10062** Air Element with Foam Wrap  
**Contains:** Sensor Port  
**Fits:** Chevrolet Cruze  
**Replaces:** General Motors 39030321; ACDelco A3220C  
**O.D.:** 5 21/32 (143.7) to 6 7/32 (158.0)  
**Height:** 6 13/16 (173.0)



**PA10063** Panel Air Element with Foam Pad  
**Fits:** 2016-19 Chevrolet Colorado, 2016-19 GMC Canyon with 2.8L Turbo Diesel Engine  
**Replaces:** General Motors Corp. 23248945; ACDelco A3216C; Wix WA10427  
**Length:** 10 23/32 (272.0)  
**Width:** 10 1/32 (255.0)  
**Height:** 1 7/8 (48)

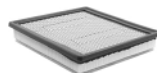

**PA10064** Panel Air Element  
**Fits:** Honda HR-V with (1.8L) Engine  
**Replaces:** Honda 1722051BH00  
**Length:** 9 (228.6)  
**Width:** 8 19/32 (218.3)  
**Height:** 1 15/16 (49.2)  
**A. Gskt:** [1] Included



**PA10066** Panel Air Element  
**Fits:** Kia Soul, Soul EV  
**Replaces:** Kia 97133B2000  
**Length:** 8 1/4 (209.6)  
**Width:** 6 15/32 (164.3)  
**Height:** 1 (25.4)



**PA10067** Cabin Air Element  
**Contains:** Charcoal Impregnated Media for Odor Control.  
**Fits:** Kia Sorento  
**Replaces:** Kia C6C79AC000  
**Length:** 10 9/32 (261.1)  
**Width:** 7 29/32 (200.8)  
**Height:** 1 3/16 (30.2)

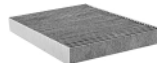

**PA10068** Oval Air Element  
**Fits:** Ford Super Duty Trucks with (6.2L), (6.8L) Engines  
**Replaces:** Ford HC3Z9601B; Motorcraft FA1928  
**O.D.:** 6 29/32 (175.4) to 9 7/8 (250.8)  
**I.D.:** 3 23/32 (94.5) & 6 11/16 (169.9) to  
**Height:** 9 9/16 (242.9)  
**Related To:** PA10061 (w/attached foam)



Measurements Are Shown In Inches And (Millimeters)

**WARNING:** These products can expose you to chemicals, including Diisononyl Phthalate, Carbon black extracts, Nickel, 1,3 Butadiene, Ethylene Oxide, Epichlorohydrin, which are known to the State of California to cause cancer, and Bisphenol, Ethylene Glycol, Ethylene Oxide, 1,3 Butadiene, Epichlorohydrin, which are known to the State of California to cause birth defects or other reproductive harm.

<p><b>PA10069</b> Panel Air Element  <b>Fits:</b> 2015-19 Acura TLX, 2013-17 Honda Accord  <b>Replaces:</b> Honda 172205J2A00, 172205G0A00  <b>Length:</b> 12 5/32 (308.6)  <b>Width:</b> 7 7/16 (189.0)  <b>Height:</b> 1 17/32 (38.6)  <b>A. Gskt:</b> [1] Included</p> 	<p><b>PA10078</b> Panel Air Element  <b>Fits:</b> 2016-19 Chevrolet Volt  <b>Replaces:</b> ACDelco A3217C  <b>Length:</b> 11 15/32 (291.1)  <b>Width:</b> 8 7/8 (225)  <b>Height:</b> 1 1/4 (32)</p> 
<p><b>PA10070</b> Panel Air Element  <b>Fits:</b> Ford C-Max, Fusion, Lincoln MKZ all with 4-122 (2.0L) FI Hybrid Engine  <b>Replaces:</b> Ford DG9Z-9601-A; Motorcraft FA1911  <b>Length:</b> 9 1/4 (235.0)  <b>Width:</b> 8 1/8 (206.4)  <b>Height:</b> 1 5/8 (41.3)</p> 	<p><b>PA10081</b> Cabin Air Element  <b>Fits:</b> 2017-18 Hyundai Elantra, 2018-19 Elantra GT; 2018-19 Kia Rio  <b>Replaces:</b> Hyundai 97133F2000  <b>Length:</b> 9 3/8 (238.0)  <b>Width:</b> 7 11/16 (195.1)  <b>Height:</b> 1 1/16 (26.9)</p> 
<p><b>PA10071</b> Panel Air Element  <b>Fits:</b> Infiniti M35, M37, Q70  <b>Replaces:</b> Nissan 16546EJ70A  <b>Length:</b> 8 3/16 (208.0)  <b>Width:</b> 6 31/32 (177.0)  <b>Height:</b> 1 3/4 (44.4)  <b>A. Gskt:</b> [1] Included</p> 	<p><b>PA10082</b> Cabin Air Element  <b>Fits:</b> 2014-18 Nissan Versa, 2015-18 Versa Note, 2016-18 Tiida, 2017-18 Micra, 2017-19 Note  <b>Replaces:</b> Nissan 272771KK0A, 272781KK0A  <b>Length:</b> 8 13/16 (223.5)  <b>Width:</b> 8 1/4 (210)  <b>Height:</b> 25/32 (20)</p> 
<p><b>PA10072</b> Panel Air Element  <b>Fits:</b> Acura RDX  <b>Replaces:</b> Honda 17220R8AA01  <b>Length:</b> 11 15/16 (303.2)  <b>Width:</b> 7 29/32 (200.8)  <b>Height:</b> 1 5/8 (41.3)  <b>A. Gskt:</b> [1] Included</p> 	<p><b>PA10083</b> Cabin Air Element  <b>Fits:</b> 2018 Fiat 500L, 2016-17 500X; 2015-17 Jeep Renegade  <b>Replaces:</b> Chrysler 68267921AA; Fram CF11810; Luber-finer CAF1919C  <b>Length:</b> 8 17/32 (217)  <b>Width:</b> 6 3/16 (157)  <b>Height:</b> 1 3/16 (30)  <b>Related To:</b> PA10154 (without Charcoal)</p> 
<p><b>PA10073</b> Panel Air Element  <b>Fits:</b> Acura MDX  <b>Replaces:</b> Acura 172205J6A00  <b>Length:</b> 11 5/8 (295.3)  <b>Width:</b> 6 7/8 (174.6)  <b>Height:</b> 1 5/8 (41.3)</p> 	<p><b>PA10084</b> Panel Air Element  <b>Fits:</b> 2017-19 Chrysler Pacifica with (3.6L) Engine  <b>Replaces:</b> Chrysler 68214516AA  <b>Length:</b> 9 3/4 (247.9)  <b>Width:</b> 9 3/8 (238.0)  <b>Height:</b> 1 9/16 (39.9)</p> 
<p><b>PA10075</b> Panel Air Element with Foam Pad  <b>Fits:</b> 2016-20 BMW X1, 2018-20 X2; 2015-19 Mini Cooper, 2016-19 Cooper Clubman, 2017-20 Cooper Countryman  <b>Replaces:</b> BMW (Bavarian Motor Works) 13718513944; Hastings Premium Filters AF1728; Wix WA9792  <b>Length:</b> 11 3/8 (289.1)  <b>Width:</b> 10 27/32 (275.1)  <b>Height:</b> 2 9/32 (57.9)</p> 	<p><b>PA10085</b> Cabin Air Element  <b>Fits:</b> 2015-18 RAM ProMaster City  <b>Replaces:</b> Chrysler 68103578AA; Citroen 6479-62; Fiat 77364561; Peugeot 6479-63  <b>Length:</b> 7 27/32 (199.5)  <b>Width:</b> 7 (178)  <b>Height:</b> 1 25/32 (45)</p> 
<p><b>PA10076</b> Panel Air Element  <b>Fits:</b> 2018-20 Buick Enclave; 2017-20 Cadillac XT5; 2019-20 Chevrolet Blazer, 2018-20 Traverse; 2017-20 GMC Acadia  <b>Replaces:</b> General Motors Corp. 23321606; Wix WA10718  <b>Length:</b> 14 1/8 (359.2)  <b>Width:</b> 10 7/32 (259.8)  <b>Height:</b> 1 23/32 (43.7)</p> 	<p><b>PA10086</b> Panel Air Element  <b>Fits:</b> 2017-19 Hyundai Elantra, 2018-19 Elantra GT, Kona, 2019 Veloster; 2019 Kia Forte  <b>Replaces:</b> Hyundai 28113F2000; Fram CA12057; Luber-finer AF5265; Wix WA10420  <b>Length:</b> 9 13/32 (239.0)  <b>Width:</b> 6 3/8 (162.1)  <b>Height:</b> 2 1/8 (53.6)</p> 
<p><b>PA10077</b> Panel Air Element with Foam Pad  <b>Fits:</b> 2016-19 Chevrolet Malibu; 2017-19 Buick LaCrosse  <b>Replaces:</b> General Motors 23430312; ACDelco A3208C  <b>Length:</b> 13 3/4 (349.3)  <b>Width:</b> 9 3/32 (231.0)  <b>Height:</b> 1 21/32 (42.1)</p> 	<p><b>PA10087</b> Panel Air Element  <b>Fits:</b> 2018-19 Nissan Titan  <b>Replaces:</b> Nissan 16546EZ31A  <b>Length:</b> 11 9/16 (293.8)  <b>Width:</b> 10 (254)  <b>Height:</b> 1 17/32 (38.5)  <b>A. Gskt:</b> [1] Included</p> 

Measurements Are Shown In Inches And (Millimeters)

**WARNING:** These products can expose you to chemicals, including Diisononyl Phthalate, Carbon black extracts, Nickel, 1,3 Butadiene, Ethylene Oxide, Epichlorohydrin, which are known to the State of California to cause cancer, and Bisphenol, Ethylene Glycol, Ethylene Oxide, 1,3 Butadiene, Epichlorohydrin, which are known to the State of California to cause birth defects or other reproductive harm.

**PA10089** Panel Air Element  
**Fits:** 2015-19 Audi A3 2015-18 Quattro, S3 2016 Audi TT 2016-19 Audi TT Quattro 2015 Volkswagen Golf 2015-17 Volkswagen Golf R 2015-16 Volkswagen GTI 2018 Volkswagen Tiguan Limited Volkswagen European Light-Duty Vehicles, Golf MK7 1.6, Golf MK7 2.0  
**Replaces:** Volkswagen 5Q0129620B, 5Q0129620D  
**Length:** 11 1/2 (292.1)  
**Width:** 6 31/32 (177.0)  
**Height:** 2 3/4 (70.1)



**PA10097** Cabin Air Element  
**Contains:** Charcoal Impregnated Media for Odor Control  
**Fits:** 2019 Lexus ES300h, 2019 ES350, 2016-19 RX350, 2018-19 RX350L, 2017-19 RX450h; 2019 Toyota Avalon, 2018-19 Camry, 2019 C-HR, 2017 Prius, 2017-18 Prius Prime  
**Replaces:** Toyota 871390E040, 8713958010, 871390K070  
**Length:** 8 15/32 (215)  
**Width:** 7 9/32 (185)  
**Height:** 1 5/32 (29)



**PA10090** Panel Air Element  
**Fits:** 2018-19 Honda Accord with 2.0L Turbo Engine  
**Replaces:** Honda 172206B2A00  
**Length:** 8 7/16 (463.3)  
**Width:** 8 1/8 (206.4)  
**Height:** 1 29/32 (48.4)  
**A. Gskt:** [1] Included



**PA10098** Cabin Air Element  
**Contains:** Charcoal Impregnated Media for Odor Control  
**Fits:** 2017-19 Volvo S90, 2019 V60, 2018-19 V90, 2017-19 V90 Cross Country, 2018-19 XC60, 2019-19 XC90  
**Replaces:** Alco MS6518C  
**Length:** 13 3/16 (335.0)  
**Width:** 9 3/8 (238)  
**Height:** 1 9/16 (39.9)

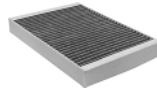

**PA10091** Panel Air Element with Foam and Pull Tab  
**Fits:** 2018-19 Chevrolet Equinox, GMC Terrain  
**Replaces:** ACDelco A3226C; General Motors Corp. 23279657  
**Length:** 10 11/16 (271)  
**Width:** 8 13/32 (213)  
**Height:** 1 5/8 (41)

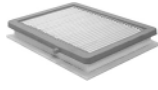

**PA10099** Cabin Air Element  
**Contains:** Charcoal Impregnated Media for Odor Control  
**Fits:** 2018-19 Infiniti QX60, Nissan Maxima, Murano, Pathfinder; 2018 Nissan Altima. (07/19/19)  
**Replaces:** Nissan 272779NM0A; Wix WP10009  
**Length:** 10 31/32 (278.9)  
**Width:** 9 9/16 (243.1)  
**Height:** 25/32 (19.6)



**PA10093** Panel Air Element with Foam Pad  
**Fits:** 2015-19 Ford Transit-150, Transit-250, Transit-350, Transit-350 HD  
**Replaces:** Motorcraft FA1916  
**Length:** 10 27/32 (275.1)  
**Width:** 9 13/32 (239.0)  
**Height:** 2 7/8 (72.9)



**SA10100** Foam Air Filter  
**Fits:** 2015-19 Ford Transit with 5-195 (3.2L) Engine  
**Replaces:** Ford Motor Co. CK4Z9601C; Motorcraft FA1921  
**Length:** 6 1/2 (165.1)  
**Width:** 2 1/4 (57.2)  
**Height:** 3 1/8 (79.5)



**PA10094** Panel Air Element  
**Fits:** 2017-19 Chevrolet Camaro  
**Replaces:** ACDelco A3223C; General Motors Corporation 23323508  
**Length:** 11 31/32 (304.0)  
**Width:** 10 7/16 (264.9)  
**Height:** 3 (51.1)



**PA10101** Panel Air Element with Foam Pad  
**Fits:** 2018-19 Volkswagen Atlas with 2.0L and 3.6L Engines  
**Replaces:** Volkswagen 3QF129620; Luber-finer AF3623; Wix WA10778  
**Length:** 12 5/8 (321.1)  
**Width:** 6 11/16 (169.9)  
**Height:** 2 15/32 (63)



**PA10095** Panel Air Element with Foam Pad  
**Fits:** 2017-19 Chevrolet Silverado 2500 HD, Silverado 3500 HD; GMC Sierra 2500 HD, Sierra 3500 HD  
**Replaces:** ACDelco A3231C, A3257C; GM General Motors 84262965; Wix WA10695  
**Length:** 11 1/32 (279.9)  
**Width:** 10 29/32 (277.1)  
**Height:** 2 27/32 (71.9)

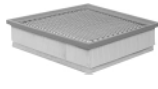

**PA10102** Panel Air Element  
**Fits:** 2016-18 Volkswagen Golf SportWagen, 2016-19 GTI, 2017-18 Volkswagen Golf, Golf Alltrack, 2018 Golf R  
**Replaces:** Volkswagen 5QM129620  
**Length:** 11 15/32 (291.1)  
**Width:** 6 15/16 (176.0)  
**Height:** 2 5/8 (67.1)

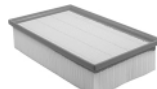

**PA10096** Panel Air Element  
**Fits:** 2016-19 Nissan Titan XD  
**Replaces:** Nissan 16546EZ40A  
**Length:** 12 19/32 (320.0)  
**Width:** 8 3/4 (222.0)  
**Height:** 2 9/32 (57.9)

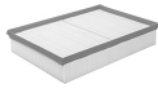

**PA10103** Cabin Air Element  
**Fits:** 2018-20 Ford Expedition; 2015-19 F-150; 2017-19 F-250 Super Duty, F-350 Super Duty, F-450 Super Duty, F-550 Super Duty; 2018-20 Lincoln Navigator  
**Replaces:** Ford Motor Co. FL3Z19N619A; Motorcraft FP79; Fram CF12150; Luber-finer CAF1953P; Wix WP10266  
**Length:** 10 5/32 (258.1)  
**Width:** 8 1/16 (205.0)  
**Height:** 1 9/16 (39.9)



Measurements Are Shown In Inches And (Millimeters)

**WARNING:** These products can expose you to chemicals, including Diisononyl Phthalate, Carbon black extracts, Nickel, 1,3 Butadiene, Ethylene Oxide, Epichlorohydrin, which are known to the State of California to cause cancer, and Bisphenol, Ethylene Glycol, Ethylene Oxide, 1,3 Butadiene, Epichlorohydrin, which are known to the State of California to cause birth defects or other reproductive harm.

**PA10104** Cabin Air Element  
**Fits:** 2013-14 Ford Mustang  
**Replaces:** Ford Motor Co. DR3Z19N619A; Motorcraft FP72  
**Length:** 8 1/32 (204.0)  
**Width:** 7 1/8 (181.1)  
**Height:** 15/16 (23.9)



**PA10106** Panel Air Element  
**Contains:** [4] Supports  
**Fits:** 2017-19 Kia Niro, Hyundai Ioniq  
**Replaces:** Hyundai 28113G2700; Kia 28113G2100; Wix WA10770  
**Length:** 13 19/32 (344.9)  
**Width:** 10 3/16 (259.1)  
**Height:** 2 9/16 (65)  
**A. Gskt:** [1] Included



**PA10108** Cabin Air Element  
**Fits:** 2019 Toyota Corolla, 2017-19 Prius, 2017-18 Prius Prime, 2019 Prius AWD-e, 2019 RAV 4  
**Replaces:** Toyota 8713928020; Fram CF12157; Luber-finer CAF1950P; Mann & Hummel CU22032; Wix WP10320  
**Length:** 8 1/2 (215.9)  
**Width:** 7 3/8 (186.9)  
**Height:** 1 1/8 (29)



**PA10109** Air Element  
**Contains:** [1] Tube of Lubricant  
**Fits:** Audi Automotive  
**Replaces:** Audi 8K0133843; Mann & Hummel C16114X; WIX 49143  
**O.D.:** 7 11/32 (186.5)  
**I.D.:** 4 (101.6) One End  
**Height:** 6 19/32 (167.5)  
**O-Ring:** [1] Included



**PA10110** Air Element  
**Contains:** [1] Tube of Lubricant  
**Fits:** Audi A6, A6 Quattro  
**Replaces:** Audi 4F0133843; Mann & Hummel C171371X; Wix 49846  
**O.D.:** 6 17/32 (165.9)  
**I.D.:** 1 1/8 (28.6) & 3 1/4 (82.6)  
**Height:** 6 3/16 (157.2)  
**I.Gskt:** [1] Included  
**O-Ring:** [1] Included



**PA10111** Air Element with Foam Wrap  
**Fits:** Audi Automotive  
**Replaces:** Volkswagen 4G0133843; Mann & Hummel C16005; WIX 49243  
**O.D.:** 3 11/32 (84.9)  
**I.D.:** 1 1/8 (28.6) & 3 17/32 (89.7)  
**Height:** 7 3/8 (187.3)



**PA10112** Air Element  
**Fits:** Mercedes-Benz Automotive  
**Replaces:** Mercedes-Benz 120943702; WIX 42194  
**O.D.:** 11 29/32 (302.4)  
**I.D.:** 8 19/32 (218.3)  
**Height:** 4 7/32 (107.2)



**PA10113** Air Element  
**Fits:** 2015 Audi A1; 2009-10 Seat Altea, Leon; 2015 Volkswagen Caddy, 2012-15 Jetta. (06/14/19)  
**Replaces:** VAG (Volkswagen/Audi Group) 3C0129620; Volkswagen 1F0129620; Wix 49013  
**O.D.:** 5 13/32 (137.3)  
**I.D.:** 2 5/8 (66.8) One End  
**Height:** 8 11/16 (220.7)



**PA10114** Air Element  
**Fits:** Mercedes-Benz E320  
**Replaces:** Mercedes-Benz 6460940104, A6460940104; WIX 49405  
**O.D.:** 4 23/32 (119.9)  
**I.D.:** 2 (50.8) One End  
**Height:** 17 1/16 (433.4)



**PA10115** Air Element  
**Fits:** Saab Automotive  
**Replaces:** Saab 7514722; Wix 46329, 42320  
**O.D.:** 5 31/32 (151.6)  
**I.D.:** 3 1/2 (88.9)  
**Height:** 9 9/32 (235.7)



**PA10116** Oblong Air Element  
**Fits:** Mercedes-Benz Automotive  
**Replaces:** Mercedes-Benz 10947804; WIX 46050  
**O.D.:** 15 3/8 (390.5)  
**I.D.:** 11 17/32 (292.9)  
**Height:** 3 5/32 (80.2)



**PA10117** Air Element with Foam Wrap  
**Fits:** Audi A6, A6 Quattro  
**Replaces:** Volkswagen 4G0133843K; WIX 49343  
**O.D.:** 6 5/32 (156.4)  
**I.D.:** 17/32 (13.5) & 3 3/32 (78.6)  
**Height:** 4 13/16 (122.2)



**PA10118** Conical-Shaped Air Element with Handle  
**Fits:** Honda S2000  
**Replaces:** Honda 17220-PCX-003; WIX 42726  
**O.D.:** 3 25/32 (96.0) to 7 5/16 (185.7)  
**Inlet:** 3 7/16  
**Height:** 10 11/32 (262.7)



Measurements Are Shown In Inches And (Millimeters)

**WARNING:** These products can expose you to chemicals, including Diisononyl Phthalate, Carbon black extracts, Nickel, 1,3 Butadiene, Ethylene Oxide, Epichlorohydrin, which are known to the State of California to cause cancer, and Bisphenol, Ethylene Glycol, Ethylene Oxide, 1,3 Butadiene, Epichlorohydrin, which are known to the State of California to cause birth defects or other reproductive harm.

**PA10119**

Air Element



**Fits:** Audi A8 Quattro  
**Replaces:** Audi 4E0129620; WIX 49620  
**O.D.:** 5 31/32 (151.6)  
**I.D.:** 3 13/32 (86.5)  
**Height:** 7 1/4 (184.2)

**PA10125**

Oval Air Element



**Contains:** Center Band  
**Fits:** Porsche Boxster, Cayman  
**Replaces:** Porsche 98711013300; WIX 49015  
**O.D.:** 3 9/32 (83.3)  
to 7 11/16 (195.3)  
**I.D.:** 6 1/16 (47.6) One End  
**Height:** 12 15/32 (316.7)

**PA10120**

Oblong Air Element



**Fits:** Mercedes-Benz 260, 300 Series  
**Replaces:** Mercedes-Benz 20948704; Wix 42174  
**O.D.:** 12 11/32 (313.5)  
to 15 27/32 (402.4)  
**I.D.:** 9 1/4 (235.0) & 12 3/4 (323.8) to  
**Height:** 3 9/32 (83.3)

**PA10126**

Air Element



**Fits:** Audi A8 Quattro, S8  
**Replaces:** Audi 4E0129620D; Volkswagen 4E0129620D; WIX 49241  
**O.D.:** 5 31/32 (151.6)  
**I.D.:** 3 13/32 (86.5)  
**Height:** 6 3/32 (154.8)

**PA10121**

Oval Air Element with Foam Wrap



**Fits:** Land Rover Range Rover  
**Replaces:** Land Rover PHE000050; Mann & Hummel C18161; Wix 42892  
**O.D.:** 5 11/32 (135.7)  
to 7 1/16 (179.4)  
**I.D.:** 4 13/32 (68.3) One End  
**Height:** 9 3/8 (238.1)

**SA10127**

Crankcase Breather Element



**Fits:** Ford Automotive, Light-Duty Trucks  
**Replaces:** Ford B2TZ-6A631-A; WIX 42841, CW6841  
**O.D.:** 2 7/32 (56.4)  
**I.D.:** 1 13/32 (35.7)  
**Height:** 1 13/16 (46)  
**F. Gskt:** [1] Included

**PA10122**

Air Element



**Fits:** Porsche 911  
**Replaces:** Porsche 99711013030, 99711013031; WIX 49330  
**O.D.:** 6 3/8 (161.9)  
4 5/8 (117.5)  
**I.D.:** 4 31/32 (126.2) & 3 1/4 (82.6)  
**Height:** 6 21/32 (169.1)

**PA10128**

Cabin Air Element



**Fits:** 2015-19 Hyundai Sonata  
**Replaces:** Hyundai C2H79AP000, 97133C2000; Wix WP10155  
**Length:** 8 29/32 (226.1)  
**Width:** 7 11/16 (195.1)  
**Height:** 1 3/16 (30)

**PA10123**

Air Element



**Fits:** 1999-2000 Saab 9-3, 1999-2009 9-5  
**Replaces:** Saab 4572491, 5173166, 55560911; Wix 42830  
**O.D.:** 6 29/32 (175.8)  
**I.D.:** 3 23/32 (94.5)  
**Height:** 5 15/32 (138.9)  
**A. Gskt:** [2] Included

**PA10129**

Cabin Air Element



**Fits:** 2019 Acura RDX; 2016-19 Honda Civic, HRV, 2017-19 CR-V, 2011-15 CR-Z, 2009-19 Fit, 2010-19 Insight, 2018-19 Odyssey  
**Replaces:** Honda 80292TBAA11, 80292-TF0-G01, 80291TF0G01, 80291TF0E01, 80291T5RA01  
**Length:** 8 7/32 (209.0)  
**Width:** 8 1/32 (204.0)  
**Height:** 1 3/16 (30)

**PA10124**

Oblong Cabin Air Element



**Contains:** Charcoal Impregnated Media for Odor Control  
**Fits:** Audi A8 Quattro, S8  
**Replaces:** Volkswagen 4E0819439A; WIX 49361  
**Length:** 15 31/32 (405.6)  
**Width:** 8 13/16 (223.8)  
**Height:** 2 19/32 (65.9)

**PA10130**

Cabin Air Element

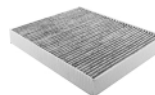

**Contains:** Charcoal Impregnated Media for Odor Control  
**Fits:** Buick, Cadillac, Chevrolet Automotive  
**Replaces:** General Motors Corp. 13271191; Wix 24590, 24191  
**Length:** 9 7/16 (239.7)  
**Width:** 7 15/16 (201.6)  
**Height:** 1 1/8 (28.6)

**PA10131**









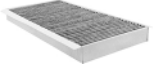

Cabin Air Element

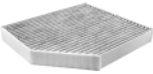

**Fits:** Hyundai Ioniq, Tucson  
**Replaces:** Hyundai 87902E250A, 971332E250; WIX 24761  
**Length:** 9 13/32 (238.9)  
**Width:** 7 7/16 (188.9)  
**Height:** 25/32 (19.8)

Measurements Are Shown In Inches And (Millimeters)

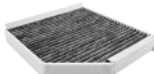
**WARNING:** These products can expose you to chemicals, including Diisononyl Phthalate, Carbon black extracts, Nickel, 1,3 Butadiene, Ethylene Oxide, Epichlorohydrin, which are known to the State of California to cause cancer, and Bisphenol, Ethylene Glycol, Ethylene Oxide, 1,3 Butadiene, Epichlorohydrin, which are known to the State of California to cause birth defects or other reproductive harm.

<p><b>PA10132</b> Cabin Air Element</p>  <p><b>Contains:</b> Charcoal Impregnated Media for Odor Control  <b>Fits:</b> 2016-19 Lexus GS F, 2017 GS Turbo, RC Turbo, 2016-17 GS200t, IS200t, RC200t, 2018 GS300, 2013-19 GS350, 2013-18 GS450h, 2017 IS Turbo, 2014-15 IS250, 2016-19 IS300, RC300, 2014-19 IS350, 2015-19 RC F, RC350  <b>Replaces:</b> Toyota 8713930100; Wix WP10099  <b>Length:</b> 8 3/4 (222.2)  <b>Width:</b> 8 (203.2)  <b>Height:</b> 1 5/32 (29.2)</p>	<p><b>PA10140</b> Cabin Air Element</p>  <p><b>Contains:</b> Charcoal Impregnated Media for Odor Control  <b>Fits:</b> Saab 9-3, 9-3X  <b>Replaces:</b> General Motors 93172129; Saab 93172129; WIX 24525  <b>Length:</b> 13 1/16 (331.8)  <b>Width:</b> 7 19/32 (192.9)  <b>Height:</b> 1 3/16 (30.2)</p>
<p><b>PA10133</b> Cabin Air Element</p>  <p><b>Fits:</b> Ford Fusion, Lincoln MKZ, Mercury Milan  <b>Replaces:</b> Ford AE5Z-19N619-A; Motorcraft FP67; Wix 24367  <b>Length:</b> 10 1/2 (266.7)  <b>Width:</b> 8 5/16 (211.1)  <b>Height:</b> 1 1/2 (38.1)</p>	<p><b>PA10141</b> Cabin Air Element</p>  <p><b>Contains:</b> Charcoal Impregnated Media for Odor Control  <b>Fits:</b> Lexus LS400; Toyota Highlander  <b>Replaces:</b> Toyota 87139-50010, 87139-YZZ02; Wix 24481  <b>Length:</b> 9 5/16 (236.5)  <b>Width:</b> 8 13/32 (213.5)  <b>Height:</b> 11/16 (17.5)  <b>A. Gskt:</b> [1] Included</p>
<p><b>PA10134</b> Cabin Air Element</p>  <p><b>Contains:</b> Charcoal Impregnated Media for Odor Control  <b>Fits:</b> BMW Automotive  <b>Replaces:</b> BMW (Bavarian Motor Works) 64119237554, 64119237555; Wix 24255  <b>Length:</b> 9 3/4 (247.7)  <b>Width:</b> 7 13/16 (198.4)  <b>Height:</b> 1 9/16 (39.7)  <b>A. Gskt:</b> [2] Included</p>	<p><b>PA10142</b> Cabin Air Element</p>  <p><b>Fits:</b> Ford Focus, Transit Connect, ZX2  <b>Replaces:</b> Ford XS4H-16N619-AB, XS4Z-19N619-AA, YS4Z-19N619-DB; Motorcraft FP32, FP38; WIX 24808, 524808  <b>Length:</b> 13 3/4 (349.3)  <b>Width:</b> 8 21/32 (219.9)  <b>Height:</b> 1 3/16 (30.2)</p>
<p><b>PA10135</b> Cabin Air Element</p>  <p><b>Fits:</b> 2015-19 Ford Mustang  <b>Replaces:</b> Motorcraft FP78; Wix WP10195  <b>Length:</b> 10 1/8 (257.0)  <b>Width:</b> 7 29/32 (200.7)  <b>Height:</b> 1 3/16 (30)</p>	<p><b>PA10143</b> Cabin Air Element</p>  <p><b>Notes:</b> Uses 2 filters per application.  <b>Contains:</b> Charcoal Impregnated Media for Odor Control  <b>Fits:</b> Audi Automotive; Porsche Macan  <b>Replaces:</b> Audi 8K0819439A; WIX 24227  <b>Length:</b> 11 1/32 (280.2)  <b>Width:</b> 10 (254.0)  <b>Height:</b> 1 3/8 (34.9)</p>
<p><b>PA10136</b> Cabin Air Element</p>  <p><b>Fits:</b> Mazda CX-7  <b>Replaces:</b> Mazda EG2-16-1P11; WIX 24579  <b>Length:</b> 8 1/2 (215.9)  <b>Width:</b> 7 3/4 (196.9)  <b>Height:</b> 31/32 (24.6)</p>	<p><b>PA10144</b> Cabin Air Element</p>  <p><b>Fits:</b> Ford GT, Mustang  <b>Replaces:</b> Ford 4R3Z-19N619-AA; Motorcraft FP53; WIX 24687  <b>Length:</b> 8 1/32 (204.0)  <b>Width:</b> 7 3/32 (180.2)  <b>Height:</b> 31/32 (24.6)</p>
<p><b>PA10137</b> Cabin Air Element</p>  <p><b>Fits:</b> Nissan Automotive  <b>Replaces:</b> Nissan 999M1VS007; WIX 49352  <b>Length:</b> 10 13/32 (264.3)  <b>Width:</b> 7 15/32 (189.7)  <b>Height:</b> 25/32 (19.8)</p>	<p><b>PA10145 KIT</b> Set of 2 Cabin Air Elements</p>  <p><b>Notes:</b> Uses 2 filters per application.  <b>Fits:</b> Nissan Armada, Pathfinder Armada, Titan  <b>Replaces:</b> Nissan 999M1VP055; WIX 24854  <b>Length:</b> 8 7/8 (225.4)  <b>Width:</b> 3 31/32 (100.8)  <b>Height:</b> 31/32 (24.6)</p>
<p><b>PA10138</b> Cabin Air Element</p>  <p><b>Contains:</b> Charcoal Impregnated Media for Odor Control  <b>Fits:</b> Audi A6 Quattro, A7 Quattro, A8 Quattro, S7, S8  <b>Replaces:</b> Volkswagen 4H0819439; WIX 24439  <b>Length:</b> 10 1/16 (255.6)  <b>Width:</b> 9 31/32 (253.2)  <b>Height:</b> 1 3/8 (34.9)</p>	<p><b>PA10146</b> Cabin Air Element</p>  <p><b>Fits:</b> Fiat 500  <b>Replaces:</b> Chrysler 68096453AA; WIX 24053  <b>Length:</b> 7 5/8 (193.7)  <b>Width:</b> 7 13/32 (188.1)  <b>Height:</b> 1 3/16 (30.2)</p>
<p><b>PA10139</b> Cabin Air Element</p>  <p><b>Fits:</b> Hyundai Veracruz  <b>Replaces:</b> Hyundai 87903J000A, 971333J00, 97133J000A, 97133J100; Mann &amp; Hummel CU26001; WIX 24753  <b>Length:</b> 9 7/8 (250.8)  <b>Width:</b> 7 7/8 (200.0)  <b>Height:</b> 1 3/16 (30.2)</p>	<p><b>PA10147</b> Cabin Air Element</p>  <p><b>Fits:</b> Ford Fiesta, Ecosport  <b>Replaces:</b> Ford BE8Z-19N-619A; WIX 24619  <b>Length:</b> 9 7/16 (239.7)  <b>Width:</b> 7 15/32 (189.7)  <b>Height:</b> 31/32 (24.6)  <b>A. Gskt:</b> [2] Included</p>

Measurements Are Shown In Inches And (Millimeters)

**WARNING:** These products can expose you to chemicals, including Diisononyl Phthalate, Carbon black extracts, Nickel, 1,3 Butadiene, Ethylene Oxide, Epichlorohydrin, which are known to the State of California to cause cancer, and Bisphenol, Ethylene Glycol, Ethylene Oxide, 1,3 Butadiene, Epichlorohydrin, which are known to the State of California to cause birth defects or other reproductive harm.



**PA10148** Cabin Air Element  
**Fits:** Hyundai Equus, Genesis  
**Replaces:** Hyundai 87903M000A, 971333M000; WIX 24300  
**Length:** 9 31/32 (253.2)  
**Width:** 8 3/4 (222.3)  
**Height:** 1 3/16 (30.2)  
**A. Gskt:** [2] Included

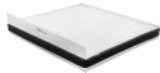

**PA10149** Cabin Air Element  
**Fits:** Mazda 6  
**Replaces:** Mazda GS3L61148; Wix 24148  
**Length:** 9 1/16 (230.2)  
**Width:** 7 25/32 (197.6)  
**Height:** 31/32 (24.6)



**PA10150** Cabin Air Element  
**Fits:** Chrysler PT Cruiser  
**Replaces:** Chrysler 5058040AA, 82206886; WIX 24725  
**Length:** 9 1/32 (229.4)  
**Width:** 4 17/32 (115.1)  
**Height:** 1 3/16 (30.2)



**PA10152 KIT** Set of 2 Cabin Air Elements  
**Notes:** Uses 2 filters per application.  
**Contains:** Charcoal Impregnated Media for Odor Control  
**Fits:** Mercedes-Benz Automotive  
**Replaces:** Mercedes-Benz 1648300218, A1648300218, A164830021864; WIX 49376  
**Each Filter:**  
**Length:** 9 29/32 (251.6)  
**Width:** 5 9/32 (134.1)  
**Height:** 1 17/32 (38.9)

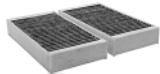

**PA10153** Cabin Air Element  
**Fits:** Volvo Automotive  
**Replaces:** Volvo 9204626; WIX 24818, 524818  
**Length:** 11 3/8 (288.9)  
**Width:** 10 1/4 (260.3)  
**Height:** 29/32 (23)  
**A. Gskt:** [1] Attached  
**Related To:** PA10200 (Charcoal Version)



**PA10154** Cabin Air Element  
**Fits:** Fiat 500L  
**Replaces:** Fiat 68212070AA; WIX WP10106  
**Length:** 8 5/8 (219.1)  
**Width:** 6 1/4 (158.8)  
**Height:** 1 3/16 (30.2)  
**Related To:** PA10083 (Charcoal Impregnated Media)



**PA10155** Cabin Air Element  
**Fits:** Kia Automotive  
**Replaces:** Kia 97133-2F000, 97133-2F010; WIX 49353  
**Length:** 9 7/16 (239.7)  
**Width:** 8 1/4 (209.6)  
**Height:** 21/32 (16.7)



**PA10156** Cabin Air Element  
**Contains:** Charcoal Impregnated Media for Odor Control  
**Fits:** Volvo Automotive  
**Replaces:** Volvo 30676484, 30780377; WIX 49354  
**Length:** 9 23/32 (246.9)  
**Width:** 8 9/32 (210.3)  
**Height:** 1 3/8 (34.9)  
**A. Gskt:** [2] Included



**PA10157** Cabin Air Element  
**Fits:** Scion FR-S  
**Replaces:** Scion SU003032112; WIX 24212  
**Length:** 7 1/4 (184.2)  
**Width:** 7 1/16 (179.4)  
**Height:** 1 5/32 (29.4)



**PA10158** Cabin Air Element  
**Contains:** Charcoal Impregnated Media for Odor Control  
**Fits:** Infiniti EX35, QX50, QX70  
**Replaces:** Nissan B72771CA0A, B72771CA1A; WIX 24007  
**Length:** 13 11/16 (347.7)  
**Width:** 10 1/16 (255.6)  
**Height:** 25/32 (19.8)



**PA10159** Cabin Air Element  
**Fits:** Kia Soul  
**Replaces:** Kia 97133-2K000; WIX 24600  
**Length:** 7 3/32 (180.2)  
**Width:** 6 5/16 (160.3)  
**Height:** 1 (25.4)



**PA10160** Cabin Air Element  
**Fits:** Suzuki Grand Vitara  
**Replaces:** Suzuki 9586164J01, 9586164J00; WIX 24200  
**Length:** 10 5/8 (269.9)  
**Width:** 7 13/16 (198.4)  
**Height:** 7/8 (22.2)  
**A. Gskt:** [1] Included



**PA10161** Cabin Air Element  
**Contains:** Charcoal Impregnated Media for Odor Control.  
**Fits:** Cadillac STS, XLR; Chevrolet Corvette  
**Replaces:** ACDelco CF131C; GM 10345066; Wix 24480  
**Length:** 11 1/2 (292.1)  
**Width:** 7 5/16 (185.7)  
**Height:** 1 3/32 (27.8)  
**A. Gskt:** [1] Attached

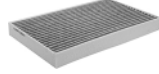

**PA10162** Cabin Air Element  
**Contains:** Charcoal Impregnated Media for Odor Control.  
**Fits:** Porsche Panamera  
**Replaces:** Porsche 97057362300; WIX 24110  
**Length:** 9 31/32 (253.2)  
**Width:** 8 1/2 (215.9)  
**Height:** 1 3/8 (34.9)



**PA10163** Cabin Air Element  
**Contains:** Charcoal Impregnated Media for Odor Control  
**Fits:** Nissan 370Z with (3.7L) Engine  
**Replaces:** Nissan B72771EA0B, B72771EA0A; WIX 24099  
**Length:** 8 17/32 (216.7)  
**Width:** 7 7/8 (200.0)  
**Height:** 25/32 (19.8)

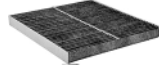









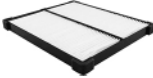



**PA10164** Cabin Air Element  
**Fits:** Cadillac CTS, SRX, STS  
**Replaces:** GMC 1562718, 25740404; WIX 24869, 524869  
**Length:** 10 7/16 (265.1)  
**Width:** 9 7/32 (234.2)  
**Height:** 15/16 (23.8)  
**Related To:** PA10201 (with Attached Gasket)

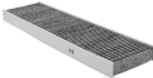

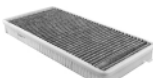
Measurements Are Shown In Inches And (Millimeters)

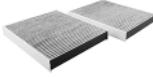
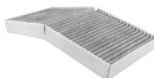
**WARNING:** These products can expose you to chemicals, including Diisononyl Phthalate, Carbon black extracts, Nickel, 1,3 Butadiene, Ethylene Oxide, Epichlorohydrin, which are known to the State of California to cause cancer, and Bisphenol, Ethylene Glycol, Ethylene Oxide, 1,3 Butadiene, Epichlorohydrin, which are known to the State of California to cause birth defects or other reproductive harm.

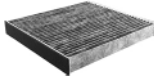
<p><b>PA10165</b> Cabin Air Element  <b>Fits:</b> Suzuki Kizashi  <b>Replaces:</b> Suzuki 9586157L00; WIX 24120  <b>Length:</b> 9 21/32 (245.3)  <b>Width:</b> 8 1/2 (215.9)  <b>Height:</b> 13/16 (20.6)</p> 	<p><b>PA10173</b> Cabin Air Element  <b>Fits:</b> Saturn L Series, LW Series  <b>Replaces:</b> Saturn 88997039, 90464424; WIX 24865, 524865  <b>Length:</b> 16 1/16 (408.0)  <b>Width:</b> 5 11/16 (144.5)  <b>Height:</b> 15/16 (23.8)</p> 
<p><b>PA10166</b> Cabin Air Element  <b>Fits:</b> Volvo Automotive  <b>Replaces:</b> Volvo 8687389; WIX 24688  <b>Length:</b> 9 1/4 (235.0)  <b>Width:</b> 8 9/32 (210.3)  <b>Height:</b> 1 3/8 (34.9)  <b>A. Gskt:</b> [2] Attached</p> 	<p><b>PA10174</b> Cabin Air Element  <b>Fits:</b> Volvo Automotive  <b>Replaces:</b> Volvo 91712968, 9184130; WIX 24821, 524821, WP6855  <b>Length:</b> 10 1/4 (260.3)  <b>Width:</b> 6 5/8 (168.3)  <b>Height:</b> 1 7/32 (31)</p> 
<p><b>PA10167</b> Cabin Air Element  <b>Fits:</b> Honda S2000  <b>Replaces:</b> Honda 79830S2A003; WIX 24803  <b>Length:</b> 6 9/16 (166.7)  <b>Width:</b> 6 3/8 (161.9)  <b>Height:</b> 9/16 (14.3)  <b>A. Gskt:</b> [4] Attached</p> 	<p><b>PA10175 KIT</b> Set of 2 Cabin Air Elements  <b>Notes:</b> Uses 2 filters per application.  <b>Contains:</b> Charcoal Impregnated Media for Odor Control  <b>Fits:</b> Mercedes-Benz Automotive  <b>Replaces:</b> Mercedes-Benz 2308300418; WIX 49356  <b>Each Filter</b>  <b>Length:</b> 8 13/16 (223.8)  <b>Width:</b> 7 27/32 (199.2)  <b>Height:</b> 1 9/16 (39.7)</p> 
<p><b>PA10168</b> Cabin Air Element  <b>Contains:</b> Charcoal Impregnated Media for Odor Control  <b>Fits:</b> Mini Cooper, Clubman  <b>Replaces:</b> BMW 64319127516; WIX 49367  <b>Length:</b> 17 13/32 (442.1)  <b>Width:</b> 4 23/32 (119.9)  <b>Height:</b> 1 3/16 (30.2)</p> 	<p><b>PA10176</b> Cabin Air Element  <b>Fits:</b> Kia Sorento  <b>Replaces:</b> Kia 97133-3E260, 97133-3E270; WIX 24794  <b>Length:</b> 8 9/32 (210.3)  <b>Width:</b> 4 15/32 (113.5)  <b>Height:</b> 23/32 (18.3)</p> 
<p><b>PA10169</b> Cabin Air Element  <b>Contains:</b> Charcoal Impregnated Media for Odor Control.  <b>Fits:</b> Porsche Automotive  <b>Replaces:</b> Porsche 99757121900, 99657121901; WIX 24202  <b>Length:</b> 12 5/16 (312.7)  <b>Width:</b> 6 1/32 (153.2)  <b>Height:</b> 1 11/32 (34.1)  <b>A. Gskt:</b> [1] Included</p> 	<p><b>PA10177</b> Cabin Air Element  <b>Notes:</b> Fold flaps out for installation.  <b>Fits:</b> Saab 9-3, 9-3X  <b>Replaces:</b> General Motors 93172299; Saab 9179905; WIX 24472  <b>Length:</b> 13 1/8 (333.4)  <b>Width:</b> 6 13/32 (162.7)  <b>Height:</b> 1 3/16 (30.2)</p> 
<p><b>PA10170 KIT</b> Set of 2 Cabin Air Elements  <b>Notes:</b> Uses 2 filters per application.  <b>Contains:</b> Charcoal Impregnated Media for Odor Control  <b>Fits:</b> BMW Automotive  <b>Replaces:</b> BMW 64119163328, 64119163329, 64119272642; WIX 24329  <b>Length:</b> 9 23/32 (246.9)  <b>Width:</b> 8 1/8 (206.4)  <b>Height:</b> 1 3/16 (30.2)</p> 	<p><b>PA10178</b> Cabin Air Element  <b>Contains:</b> Charcoal Impregnated Media for Odor Control  <b>Fits:</b> Mercedes-Benz Automotive  <b>Replaces:</b> Mercedes-Benz 1718300418, 1728350047, A1718300418, A1728350047; WIX 49373  <b>Length:</b> 14 9/32 (362.7)  <b>Width:</b> 7 (177.8)  <b>Height:</b> 1 3/8 (34.9)</p> 
<p><b>PA10171</b> Cabin Air Element with Pull Tab  <b>Fits:</b> Mazda 6  <b>Replaces:</b> Mazda GK3J61148; WIX 24907  <b>Length:</b> 8 15/16 (227.0)  <b>Width:</b> 8 5/16 (211.1)  <b>Height:</b> 31/32 (24.6)</p> 	<p><b>PA10179</b> Cabin Air Element  <b>Contains:</b> Charcoal Impregnated Media for Odor Control  <b>Fits:</b> Lexus Automotive  <b>Replaces:</b> Toyota 87139-50030, 87139-YZZ01; Wix 24893  <b>Length:</b> 9 1/16 (230.2)  <b>Width:</b> 8 1/2 (215.9)  <b>Height:</b> 1 1/8 (28.6)  <b>A. Gskt:</b> [2] Included</p> 
<p><b>PA10172</b> Cabin Air Element  <b>Contains:</b> Charcoal Impregnated Media for Odor Control  <b>Fits:</b> Volvo Automotive  <b>Replaces:</b> Volvo 30767024; WIX 49355  <b>Length:</b> 10 7/8 (276.2)  <b>Width:</b> 7 9/16 (192.1)  <b>Height:</b> 1 1/4 (31.8)  <b>A. Gskt:</b> [2] Included</p> 	

Measurements Are Shown In Inches And (Millimeters)

**WARNING:** These products can expose you to chemicals, including Diisononyl Phthalate, Carbon black extracts, Nickel, 1,3 Butadiene, Ethylene Oxide, Epichlorohydrin, which are known to the State of California to cause cancer, and Bisphenol, Ethylene Glycol, Ethylene Oxide, 1,3 Butadiene, Epichlorohydrin, which are known to the State of California to cause birth defects or other reproductive harm.

### PA10180 KIT

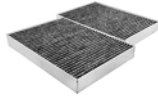

Set of 2 Cabin Air Elements  
**Notes:** Requires 2 filters per application.  
**Contains:** Charcoal Impregnated Media for Odor Control  
**Fits:** Mercedes-Benz Applications  
**Replaces:** Mercedes-Benz 2218300718, A2218300718; WIX 24218  
**Each Filter:**  
**Length:** 10 11/32 (262.7)  
**Width:** 7 1/4 (184.2)  
**Height:** 1 3/16 (30.2)

### PA10181



Cabin Air Element  
**Fits:** Pontiac G8; Chevrolet Caprice  
**Replaces:** ACDelco CF182; General Motors 92184248; WIX 49248  
**Length:** 10 5/8 (269.9)  
**Width:** 9 7/16 (239.7)  
**Height:** 25/32 (19.8)

### PA10182

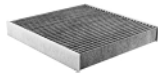

Cabin Air Element  
**Contains:** Charcoal Impregnated Media for Odor Control  
**Fits:** Infiniti Automotive  
**Replaces:** Nissan 272771ME0B; Wix 24021  
**Length:** 8 7/16 (214.3)  
**Width:** 8 3/8 (212.7)  
**Height:** 1 3/16 (30.2)

### PA10183



Cabin Air Element  
**Fits:** Mercedes-Benz Automotive  
**Replaces:** Mercedes-Benz 1638350047; Mann & Hummel CU2338; WIX 24867, 524867  
**Length:** 9 11/32 (237.3)  
**Width:** 8 1/2 (215.9)  
**Height:** 1 17/32 (38.9)  
**A. Gskt:** [1] Attached

### PA10184



Cabin Air Element  
**Contains:** Charcoal Impregnated Media for Odor Control  
**Fits:** Land Rover LR3, LR4, Range Rover Sport  
**Replaces:** Land Rover JKR500020; Mann & Hummel CUK2747; Wix 49369  
**Length:** 10 9/16 (268.3)  
**Width:** 6 7/32 (158.0)  
**Height:** 1 3/16 (30.2)

### PA10185

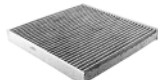

Cabin Air Element  
**Contains:** Charcoal Impregnated Media for Odor Control  
**Fits:** Smart Fortwo; Volkswagen Automotive  
**Replaces:** Mercedes-Benz 4518300018, A518300018; Wix 49351  
**Length:** 8 19/32 (218.3)  
**Width:** 8 15/32 (215.1)  
**Height:** 1 (25.4)

### PA10186 KIT



Set of 2 Cabin Air Elements  
**Notes:** Uses 2 filters per application.  
**Fits:** Maybach 57, 62; Mercedes-Benz Automotive  
**Replaces:** Mercedes-Benz 2108300018, 2108301018, A2108300018, A2108301018; Wix 24783, 524783  
**Each Filter:**  
**Length:** 10 1/32 (254.8)  
**Width:** 5 17/32 (140.5)  
**Height:** 1 19/32 (40.5)  
**A. Gskt:** [1] Attached Each Element

### PA10188

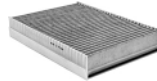

Cabin Air Element  
**Contains:** Charcoal Impregnated Media for Odor Control  
**Fits:** Jaguar S-Type, Super V8; Lincoln LS  
**Replaces:** Ford 2R8Z-19N619-BA; Motorcraft FP45; WIX 24757, 49378  
**Length:** 9 27/32 (250.0)  
**Width:** 7 5/32 (181.8)  
**Height:** 1 11/16 (42.9)  
**A. Gskt:** [2] Attached

### PA10189

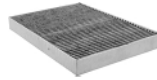

Cabin Air Element  
**Contains:** Charcoal Impregnated Media for Odor Control  
**Fits:** Audi Automotive  
**Replaces:** Volkswagen 4B0819439C; WIX 24765  
**Length:** 11 13/16 (300.0)  
**Width:** 8 1/16 (204.8)  
**Height:** 1 3/16 (30.2)

### PA10190

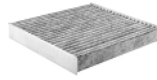

Cabin Air Element  
**Contains:** Charcoal Impregnated Media for Odor Control.  
**Fits:** Lexus LS460, LS600h  
**Replaces:** Toyota 8713950060; Wix 24160  
**Length:** 8 13/32 (213.5)  
**Width:** 7 5/8 (193.7)  
**Height:** 1 1/8 (28.6)

### PA10191 KIT

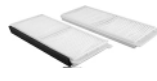

Set of 2 Cabin Air Elements  
**Fits:** Mazda 2  
**Replaces:** Mazda D65161J6X; Wix 24036  
**Larger Filter:**  
**Length:** 9 23/32 (246.9)  
**Width:** 3 29/32 (99.2)  
**Height:** 21/32 (16.7)  
**A. Gskt:** [1] Attached to Larger Filter  
**Smaller Filter:**  
**O.D. Length:** 9 23/32 (246.9)  
**I.D. Width:** 4 (101.6)  
**Height:** 21/32 (16.7)

### PA10192



Cabin Air Element  
**Fits:** BMW Automotive  
**Replaces:** BMW 64319142115; Wix 49371  
**Length:** 32 3/4 (831.9)  
**Width:** 4 13/16 (122.2)  
**Height:** 1 (25.4)  
**A. Gskt:** [2] Included

### PA10193 KIT



Set of 2 Cabin Air Elements  
**Notes:** Set consists of two different shaped elements.  
**Fits:** Subaru Forester with 4-2458cc (2.5L) FI Engine  
**Replaces:** Subaru G3210FC200; Wix 24010  
**Each Filter:**  
**Length:** 7 15/16 (201.6)  
**Width:** 4 7/16 (112.7)  
**Height:** 1 9/16 (39.7)

### PA10194









Cabin Air Element  
**Contains:** With Pull Tabs  
**Fits:** Mazda CX-3 with (2.0L) Engine  
**Replaces:** Mazda D09W-61-J6X, DB9L-61-J6X, 87139-WB001; Wix WP10267  
**Length:** 8 3/32 (205.6)  
**Width:** 7 27/32 (199.2)  
**Height:** 1 5/16 (33.3)  
**A. Gskt:** [1] Included

Measurements Are Shown In Inches And (Millimeters)

**WARNING:** These products can expose you to chemicals, including Diisononyl Phthalate, Carbon black extracts, Nickel, 1,3 Butadiene, Ethylene Oxide, Epichlorohydrin, which are known to the State of California to cause cancer, and Bisphenol, Ethylene Glycol, Ethylene Oxide, 1,3 Butadiene, Epichlorohydrin, which are known to the State of California to cause birth defects or other reproductive harm.

 <p><b>PA10195 KIT</b></p>	<p>Set of 2 Cabin Air Elements  <b>Notes:</b> Uses 2 filters per application.  <b>Fits:</b> Mazda Automotive  <b>Replaces:</b> Mazda BBM461J6X; Wix 24046  <b>Length:</b> 9 27/32 (250.0)  <b>Width:</b> 4 3/32 (104.0)  <b>Height:</b> 7/8 (22.2)  <b>A. Gskt:</b> [1] Attached to one filter</p>
 <p><b>PA10196 KIT</b></p>	<p>Set of 2 Cabin Air Elements  <b>Notes:</b> Uses 2 filters per application.  <b>Fits:</b> Audi A6, R8; Lamborghini Gallardo  <b>Replaces:</b> Audi 4F0898438A, 4F0819439A; Wix 49375  <b>Length:</b> 12 (304.8)  <b>Width:</b> 3 15/16 (100.0)  <b>Height:</b> 1 5/32 (29.4)  <b>A. Gskt:</b> [1] Attached Each Element</p>
 <p><b>PA10197</b></p>	<p>Cabin Air Element  <b>Contains:</b> Charcoal Impregnated Media for Odor Control  <b>Fits:</b> Mercedes-Benz Automotive  <b>Replaces:</b> Mercedes-Benz 2128300318; Mann &amp; Hummel CUK2551; Wix 49357  <b>Length:</b> 11 3/16 (284.2)  <b>Width:</b> 10 3/16 (258.8)  <b>Height:</b> 3 5/16 (84.1)  <b>A. Gskt:</b> [1] Included</p>
 <p><b>PA10198 KIT</b></p>	<p>Set of 2 Cabin Air Elements  <b>Notes:</b> Uses 2 filters per application.  <b>Contains:</b> Charcoal Impregnated Media for Odor Control  <b>Fits:</b> BMW Automotive  <b>Replaces:</b> BMW 64319171858, 64316935822, 64316935823; Wix 49374  <b>Each Filter</b>  <b>Length:</b> 12 11/16 (322.3)  <b>Width:</b> 6 15/16 (176.2)  <b>Height:</b> 1 3/16 (30.2)  <b>A. Gskt:</b> [1] Attached Each Filter</p>
 <p><b>PA10199 KIT</b></p>	<p>Set of 2 Cabin Air Elements  <b>Notes:</b> Uses 2 filters per application.  <b>Fits:</b> Hyundai Santa Fe, Sonata, XG350  <b>Replaces:</b> Hyundai 97619-3D000; Wix 24853  <b>Each Filter:</b>  <b>Length:</b> 10 1/8 (257.2)  <b>Width:</b> 3 7/8 (98.4)  <b>Height:</b> 1 1/2 (38.1)</p>
 <p><b>PA10200</b></p>	<p>Cabin Air Element  <b>Contains:</b> Charcoal Impregnated Media for Odor Control  <b>Fits:</b> Volvo Automotive  <b>Replaces:</b> Volvo 9171756  <b>Length:</b> 11 3/8 (288.9)  <b>Width:</b> 10 1/4 (260.3)  <b>Height:</b> 29/32 (23)  <b>A. Gskt:</b> [1] Attached  <b>Related To:</b> PA10153 (Non-Charcoal Version)</p>
 <p><b>PA10201</b></p>	<p>Cabin Air Element with Pull Tab  <b>Fits:</b> Hyundai Elantra, Entourage, Tiburon; Kia Sedona  <b>Replaces:</b> Hyundai 97133-2D000; Wix 24689  <b>Length:</b> 10 11/32 (262.7)  <b>Width:</b> 9 3/8 (238.1)  <b>Height:</b> 1 3/16 (30.2)  <b>A. Gskt:</b> [1] Attached  <b>Related To:</b> PA10164 (without Attached Gasket)</p>

 <p><b>PA10202</b></p>	<p>Cabin Air Element  <b>Fits:</b> Suzuki SX4  <b>Replaces:</b> Suzuki 9586080J00; Wix 49700  <b>Length:</b> 8 1/32 (204.0)  <b>Width:</b> 7 19/32 (192.9)  <b>Height:</b> 1 7/8 (47.6)  <b>A. Gskt:</b> [1] Included</p>
 <p><b>PA10203 KIT</b></p>	<p>Set of 3 Cabin Air Elements  <b>Notes:</b> Uses 3 filters per application.  <b>Fits:</b> Buick Park Avenue; Cadillac Seville  <b>Replaces:</b> GMC 52472175, 52482839; Wix 24874  <b>Each Filter:</b>  <b>Length:</b> 10 17/32 (267.5)  <b>Width:</b> 2 21/32 (67.5)  <b>Height:</b> 25/32 (19.8)</p>
 <p><b>PA10204 KIT</b></p>	<p>Set of 2 Cabin Air Elements  <b>Notes:</b> Uses 2 filters per application.  <b>Fits:</b> Mazda MPV Van, RX8  <b>Replaces:</b> Mazda LDY4-61-J6X; Wix 24826  <b>Length:</b> 9 1/8 (231.8)  <b>Width:</b> 4 3/32 (104.0)  <b>Height:</b> 27/32 (21.4)  <b>A. Gskt:</b> [1] Attached Each Filter</p>
 <p><b>PA10205 KIT</b></p>	<p>Set of 2 Cabin Air Elements  <b>Notes:</b> Uses 2 filters per application.  <b>Contains:</b> Charcoal Impregnated Media for Odor Control  <b>Fits:</b> Maybach 57, 62, 57S, 62S, Landulet; Mercedes-Benz Automotive  <b>Replaces:</b> Mercedes-Benz 2108300218; Wix 24778, 524778  <b>Larger Filter:</b>  <b>Length:</b> 9 7/32 (234.2)  <b>Width:</b> 8 7/16 (214.3)  <b>to 8 7/16 (214.3)</b>  <b>Height:</b> 1 23/32 (43.7)  <b>A. Gskt:</b> [2] Attached to Each Filter  <b>Smaller Filter:</b>  <b>O.D. Length:</b> 8 13/32 (223.8)  <b>I.D. Width:</b> 7 15/16 (201.6)  <b>Height:</b> 1 23/32 (43.7)</p>
 <p><b>PA10206 KIT</b></p>	<p>Set of 2 Cabin Air Elements  <b>Notes:</b> Uses 2 filters per application.  <b>Fits:</b> Land Rover Discovery, Range Rover  <b>Replaces:</b> Land Rover BTR8037; Wix 24898  <b>Each Filter:</b>  <b>Length:</b> 8 17/32 (216.7)  <b>Width:</b> 7 23/32 (196.1)  <b>Height:</b> 1 1/32 (26.2)</p>
 <p><b>PA10207</b></p>	<p>Cabin Air Element  <b>Contains:</b> Charcoal Impregnated Media for Odor Control.  <b>Fits:</b> Mercedes-Benz Automotive  <b>Replaces:</b> Mercedes-Benz 2118300018, A2118300018; Wix 24726  <b>Length:</b> 12 1/4 (311.2)  <b>Width:</b> 10 11/16 (271.5)  <b>Height:</b> 1 11/32 (34.1)  <b>A. Gskt:</b> [1] Attached</p>

Measurements Are Shown In Inches And (Millimeters)

**WARNING:** These products can expose you to chemicals, including Diisononyl Phthalate, Carbon black extracts, Nickel, 1,3 Butadiene, Ethylene Oxide, Epichlorohydrin, which are known to the State of California to cause cancer, and Bisphenol, Ethylene Glycol, Ethylene Oxide, 1,3 Butadiene, Epichlorohydrin, which are known to the State of California to cause birth defects or other reproductive harm.

**PA10208 KIT** Set of 2 Cabin Air Elements  
**Notes:** Uses 2 filters per application.  
**Contains:** Charcoal Impregnated Media for Odor Control  
**Fits:** BMW Automotive  
**Replaces:** BMW 64316945586; Wix 49585  
**Each Filter**  
**Length:** 11 27/32 (300.8)  
**Width:** 5 1/4 (133.4)  
**Height:** 1 9/16 (39.7)

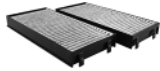

**PA10214** Cabin Air Element  
**Notes:** Uses 2 filters per application.  
**Fits:** Ford Thunderbird; Lincoln LS  
**Replaces:** Ford XW4Z-19N619-AC; Wix 24884  
**Length:** 11 3/8 (288.9)  
**Width:** 7 11/16 (195.3)  
**to 9 1/32 (229.4)**  
**Height:** 31/32 (24.6)  
**A. Gskt:** [1] Attached



**PA10209 KIT** Set of 2 Cabin Air Elements  
**Notes:** Uses 2 filters per application.  
**Contains:** [1] Metal Clip  
**Fits:** Nissan Frontier, Xterra  
**Replaces:** Nissan B7200-3S500; Wix 24856  
**Each Filter:**  
**Length:** 9 1/8 (231.8)  
**Width:** 8 9/32 (210.3)  
**Height:** 15/16 (23.8)  
**A. Gskt:** [1] Attached Each Filter



**PA10215 KIT** Set of 2 Cabin Air Elements  
**Notes:** Uses 2 filters per application.  
**Fits:** Lexus LX470; Toyota Landcruiser  
**Replaces:** Toyota 88568-60010; Wix 24908  
**Each Filter:**  
**Length:** 11 31/32 (304.0)  
**Width:** 5 1/8 (130.2)  
**Height:** 25/32 (19.8)

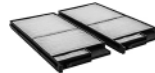

**PA10210 KIT** Set of 2 Cabin Air Elements  
**Notes:** Uses 2 filters per application.  
**Contains:** Charcoal Impregnated Media for Odor Control  
**Fits:** Lexus ES300  
**Replaces:** Toyota 88880-33020; Wix 24895  
**Top Filter:**  
**Length:** 10 9/32 (261.1)  
**Width:** 5 5/8 (142.9)  
**Height:** 25/32 (19.8)  
**A. Gskt:** [2] Attached on Top Filter  
**Bottom Filter:**  
**O.D. Length:** 10 9/32 (261.1)  
**I.D. Width:** 5 17/32 (140.5)  
**Height:** 25/32



**PA10216 KIT** Set of 2 Cabin Air Elements  
**Notes:** Uses 2 filters per application.  
**Fits:** Nissan Altima, Pathfinder, QX4  
**Replaces:** Nissan 27274-7J125, 999M1VP003; Wix 24863  
**Each Filter:**  
**Length:** 10 21/32 (270.7)  
**Width:** 4 1/4 (108.0)  
**Height:** 15/16 (23.8)  
**A. Gskt:** [1] Attached Each Filter



**PA10211 KIT** Set of 2 Cabin Air Elements  
**Notes:** Uses 2 filters per application.  
**Fits:** Chevrolet Tracker; Suzuki Grand Vitara, XL-7  
**Replaces:** GMC 91175923; Suzuki 9586165D00; Wix 24899  
**Each Filter:**  
**Length:** 8 3/4 (222.3)  
**Width:** 4 5/16 (109.5)  
**Height:** 11/16 (17.5)  
**A. Gskt:** [1] Attached Each Filter



**PA10217** Panel Air Element  
**Notes:** For Battery Pack  
**Fits:** Ford Escape Hybrid; Mercury Mariner Hybrid  
**Replaces:** Ford 5M6Z-19N619-AA, 5M6H-19N619-AD; Wix 24477  
**Length:** 4 13/16 (122.2)  
**Width:** 3 15/32 (88.1)  
**Height:** 25/32 (19.8)



**PA10212 KIT** Cabin Air Element  
**Contains:** Charcoal Impregnated Media for Odor Control  
**[1] Foam Strip**  
**Fits:** Saab 9-5  
**Replaces:** Saab 12758728; Wix 49370  
**Length:** 12 13/16 (325.4)  
**Width:** 7 7/8 (200.0)  
**Height:** 2 3/16 (55.6)

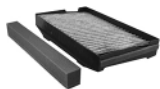

**PA10218** Panel Air Element  
**Fits:** Scion iQ  
**Replaces:** Toyota 1780140040; Mann & Hummel C34003; Wix 49740  
**Length:** 13 3/32 (332.6)  
**Width:** 5 3/8 (136.5)  
**Height:** 1 3/8 (34.9)



**PA10213** Cabin Air Element  
**Fits:** Chevrolet Camaro  
**Replaces:** ACDelco CF178; General Motors 92234714; Wix 24014  
**Length:** 9 29/32 (251.6)  
**Width:** 9 5/8 (244.5)  
**Height:** 25/32 (19.8)  
**A. Gskt:** [1] Included

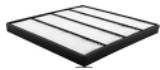

**PA10219** Panel Air Element  
**Fits:** Mazda 2 with 4-1498cc (1.5L) FI Engine  
**Replaces:** Mazda ZJ0113Z40; Wix 49640  
**Length:** 12 3/8 (314.3)  
**Width:** 7 29/32 (200.8)  
**Height:** 1 3/8 (34.9)



**PA10220** Panel Air Element  
**Fits:** Honda Fit with 4-1497cc (1.5L) FI Engine  
**Replaces:** Honda 172205R0008; Wix WA10212  
**Length:** 7 25/32 (197.6)  
**Width:** 5 9/16 (141.3)  
**Height:** 2 (50.8)  
**A. Gskt:** [1] Attached





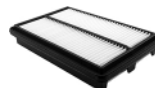









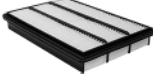

**PA10221** Panel Air Element  
**Fits:** 2010-13 Acura MDX, ZDX  
**Replaces:** Acura 17220-RYE-A10; Wix 49610  
**Length:** 10 31/32 (278.9)  
**Width:** 7 1/16 (179.1)  
**Height:** 1 3/4 (44.4)  
**A. Gskt:** [1] Included

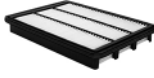

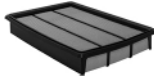
Measurements Are Shown In Inches And (Millimeters)

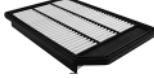
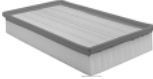
**WARNING:** These products can expose you to chemicals, including Diisononyl Phthalate, Carbon black extracts, Nickel, 1,3 Butadiene, Ethylene Oxide, Epichlorohydrin, which are known to the State of California to cause cancer, and Bisphenol, Ethylene Glycol, Ethylene Oxide, 1,3 Butadiene, Epichlorohydrin, which are known to the State of California to cause birth defects or other reproductive harm.

<p><b>PA10222</b> Panel Air Element  <b>Fits:</b> 2006-08 Infiniti M35  <b>Replaces:</b> Nissan 16546-EG000; Wix 49001  <b>Length:</b> 10 31/32 (278.4)  <b>Width:</b> 7 1/4 (183.9)  <b>Height:</b> 2 1/32 (51.6)  <b>A. Gskt:</b> [1] Included</p> 	<p><b>PA10230</b> Panel Air Element  <b>Fits:</b> Kia Sportage with 4-122 (2.0L) FI Turbo Engine  <b>Replaces:</b> Kia 281133W500; Wix 49047  <b>Length:</b> 11 9/32 (286.5)  <b>Width:</b> 6 15/32 (164.3)  <b>Height:</b> 2 3/32 (53.2)  <b>A. Gskt:</b> [1] Included</p> 
<p><b>PA10223</b> Panel Air Element  <b>Contains:</b> Locking tabs on both sides.  <b>Fits:</b> Hyundai Sonata; Kia Optima  <b>Replaces:</b> Hyundai 28113C1500; Wix WA10301  <b>Length:</b> 11 (279.4)  <b>Width:</b> 8 5/8 (219.1)  <b>Height:</b> 1 23/32 (43.7)  <b>A. Gskt:</b> [1] Attached</p> 	<p><b>PA10231</b> Panel Air Element  <b>Fits:</b> Mazda Miata  <b>Replaces:</b> Mazda F50-513-Z40; Wix 42486  <b>Length:</b> 10 5/32 (258.0)  <b>Width:</b> 6 1/2 (165.1)  <b>Height:</b> 1 9/16 (39.7)</p> 
<p><b>PA10224</b> Panel Air Element  <b>Fits:</b> Suzuki SX4  <b>Replaces:</b> Suzuki 13780-80J00; Wix 49005  <b>Length:</b> 11 3/32 (281.8)  <b>Width:</b> 5 3/8 (136.5)  <b>Height:</b> 1 11/16 (42.9)  <b>A. Gskt:</b> [1] Included</p> 	<p><b>PA10232</b> Panel Air Element  <b>Fits:</b> Hyundai Genesis, Equus  <b>Replaces:</b> Hyundai 28113-3M100; Wix 49004  <b>Length:</b> 10 21/32 (270.7)  <b>Width:</b> 7 3/4 (196.9)  <b>to 11 23/32 (297.7)</b>  <b>Height:</b> 2 1/8 (54)  <b>A. Gskt:</b> [1] Included</p> 
<p><b>PA10225</b> Panel Air Element  <b>Fits:</b> Mitsubishi Montero  <b>Replaces:</b> Mitsubishi MR404849, MR571476; Wix 42369  <b>Length:</b> 14 5/32 (359.6)  <b>Width:</b> 9 7/32 (234.2)  <b>Height:</b> 2 1/32 (51.6)  <b>A. Gskt:</b> [1] Attached</p> 	<p><b>PA10233</b> Panel Air Element  <b>Fits:</b> Lexus Automotive  <b>Replaces:</b> Toyota 17801-50060; Wix 46493  <b>Length:</b> 11 1/16 (281.0)  <b>Width:</b> 5 9/16 (141.3)  <b>to 9 7/32 (234.2)</b>  <b>Height:</b> 2 1/16 (52.4)  <b>A. Gskt:</b> [1] Attached</p> 
<p><b>PA10226</b> Panel Air Element  <b>Fits:</b> Jaguar Automotive  <b>Replaces:</b> Jaguar EAC1828, GFE1088, JLM9548; Wix 46004  <b>Length:</b> 16 5/8 (422.3)  <b>Width:</b> 5 3/8 (136.5)  <b>Height:</b> 1 9/32 (32.5)</p> 	<p><b>PA10234</b> Panel Air Element  <b>Fits:</b> Kia Borrego with V6-3778cc (3.8L), V8-282 (4.6L) Engines  <b>Replaces:</b> Kia 28113-2J000; Wix 49600  <b>Length:</b> 11 5/8 (295.3)  <b>Width:</b> 8 5/16 (211.1)  <b>Height:</b> 1 3/8 (34.9)  <b>A. Gskt:</b> [1] Included</p> 
<p><b>PA10227</b> Panel Air Element  <b>Fits:</b> Acura ILX, Honda Civic Hybrid with 4-1497cc (1.5L) FI Engine  <b>Replaces:</b> Honda 17220RW0A01; Wix 49091  <b>Length:</b> 7 13/32 (188.1)  <b>Width:</b> 7 1/16 (179.4)  <b>Height:</b> 1 27/32 (46.8)  <b>A. Gskt:</b> [1] Included</p> 	<p><b>PA10235</b> Panel Air Element  <b>Fits:</b> Infiniti FX45, Q45  <b>Replaces:</b> Nissan 16546-60U00; Wix 46053  <b>Length:</b> 10 31/32 (278.6)  <b>Width:</b> 7 3/8 (187.3)  <b>Height:</b> 1 23/32 (43.7)</p> 
<p><b>PA10228</b> Panel Air Element  <b>Fits:</b> Acura TL  <b>Replaces:</b> Honda 17220-RDA-A10; Wix 49224  <b>Length:</b> 12 15/16 (328.6)  <b>Width:</b> 5 7/8 (149.2)  <b>Height:</b> 1 31/32 (50)  <b>A. Gskt:</b> [1] Attached</p> 	<p><b>PA10236</b> Panel Air Element  <b>Fits:</b> Suzuki Kizashi  <b>Replaces:</b> Suzuki 1378057L00; Wix 49008  <b>Length:</b> 12 21/32 (321.5)  <b>Width:</b> 8 9/32 (210.3)  <b>Height:</b> 1 9/16 (39.7)  <b>A. Gskt:</b> [1] Included</p> 
<p><b>PA10229</b> Panel Air Element  <b>Fits:</b> Mercedes-Benz Automotive  <b>Replaces:</b> Mercedes-Benz 6040940504, 6040940604; Wix 42462  <b>Length:</b> 13 7/32 (335.8)  <b>Width:</b> 7 15/32 (189.7)  <b>Height:</b> 2 1/4 (57.2)</p> 	<p><b>PA10237</b> Panel Air Element  <b>Fits:</b> Hyundai Genesis Coupe  <b>Replaces:</b> Hyundai 281132M000; Wix 49110  <b>Length:</b> 10 9/16 (268.3)  <b>Width:</b> 8 3/4 (222.3)  <b>Height:</b> 2 1/8 (54)  <b>A. Gskt:</b> [1] Included</p> 
	<p><b>PA10238</b> Panel Air Element  <b>Fits:</b> Suzuki Grand Vitara  <b>Replaces:</b> Suzuki 13780-78K00; Wix 49800  <b>Length:</b> 9 7/16 (239.7)  <b>Width:</b> 8 17/32 (216.7)  <b>Height:</b> 2 (50.8)  <b>A. Gskt:</b> [1] Included</p> 

Measurements Are Shown In Inches And (Millimeters)

**WARNING:** These products can expose you to chemicals, including Diisononyl Phthalate, Carbon black extracts, Nickel, 1,3 Butadiene, Ethylene Oxide, Epichlorohydrin, which are known to the State of California to cause cancer, and Bisphenol, Ethylene Glycol, Ethylene Oxide, 1,3 Butadiene, Epichlorohydrin, which are known to the State of California to cause birth defects or other reproductive harm.

**PA10239** Panel Air Element  
**Fits:** Nissan Murano, Pathfinder; Infiniti QX60  
**Replaces:** Nissan 165463KY0A; Wix WA10267  
**Length:** 11 1/32 (280.2)  
**Width:** 9 1/2 (241.3)  
**Height:** 1 1/16 (27)  
**A. Gskt:** [1] Included

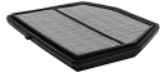

**PA10248** Panel Air Element  
**Fits:** Mazda MX-5 Miata  
**Replaces:** Mazda LFG1-13-Z40; Wix 42863  
**Length:** 11 7/8 (301.6)  
**Width:** 6 5/16 (160.3)  
**Height:** 1 23/32 (43.7)  
**A. Gskt:** [1] Included

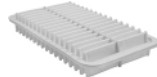

**PA10240** Panel Air Element  
**Fits:** Suzuki XL-7  
**Replaces:** Suzuki 13780-52D00; Wix 42737  
**Length:** 10 9/16 (268.3)  
**Width:** 8 29/32 (226.2)  
**Height:** 1 7/8 (47.6)  
**A. Gskt:** [1] Attached



**PA10249** Panel Air Element  
**Fits:** Pontiac Solstice, Saturn Sky all with 4-145 (2.4L) Engine  
**Replaces:** ACDelco A3076C; GMC 15287103; Wix 49066  
**Length:** 14 1/2 (368.3)  
**Width:** 9 7/16 (239.7)  
**Height:** 1 1/8 (28.6)  
**A. Gskt:** [1] Attached

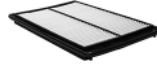

**PA10241** Panel Air Element  
**Fits:** Hyundai Genesis  
**Replaces:** Hyundai 28113-3M000; Wix 49100  
**Length:** 11 21/32 (296.1)  
**Width:** 8 15/16 (227.0)  
**Height:** 1 23/32 (43.7)  
**A. Gskt:** [1] Included



**PA10250** Panel Air Element  
**Fits:** Kia Amanti  
**Replaces:** Kia 28113-3F900; Wix 49900  
**Length:** 6 5/16 (160.3)  
**Width:** 6 (152.4)  
**to 8 15/32 (215.1)**  
**Height:** 1 25/32 (45.2)  
**A. Gskt:** [1] Included



**PA10242** Panel Air Element  
**Fits:** Dodge Viper; Mazda RX-8  
**Replaces:** Mazda N3H1-13-Z40; Wix 46835  
**Length:** 14 3/4 (374.7)  
**Width:** 8 31/32 (227.8)  
**Height:** 1 15/16 (49.2)  
**A. Gskt:** [1] Attached



**PA10251** Panel Air Element  
**Fits:** Kia Forte5, Forte Koup  
**Replaces:** Kia 28113A5800; Wix WA10059  
**Length:** 10 1/2 (266.7)  
**Width:** 5 3/4 (146.0)  
**Height:** 2 5/32 (54.8)



**PA10243** Oval Air Filter  
**Fits:** Mercedes-Benz Automotive  
**Replaces:** Mercedes-Benz A6510940104, 6510940104  
**Length:** 13 3/4 (349.3)  
**Width:** 6 29/32 (175.4)  
**Height:** 3 3/4 (95.3)  
**I.Gskt:** [1] Included



**PA10253** Panel Air Element  
**Fits:** Mitsubishi Diamante  
**Replaces:** Mitsubishi MR187912; Wix 546456, 46456  
**Length:** 9 7/8 (250.8)  
**Width:** 8 5/16 (211.1)  
**Height:** 2 3/32 (53.2)  
**A. Gskt:** [1] Attached



**PA10244** Panel Air Element  
**Fits:** Chevrolet Epica; Suzuki Verona  
**Replaces:** GMC 96328718; Suzuki 13780-86Z00; Wix 42838  
**Length:** 10 7/8 (276.2)  
**Width:** 9 23/32 (246.9)  
**Height:** 1 25/32 (45.2)  
**A. Gskt:** [1] Attached



**PA10254** Panel Air Element  
**Fits:** Hyundai Genesis Coupe  
**Replaces:** Hyundai 281132M200; Wix WA10022  
**Length:** 11 5/8 (295.3)  
**Width:** 6 7/16 (163.5)  
**Height:** 2 (50.8)



**PA10245** Panel Air Element  
**Fits:** Mitsubishi Montero, Montero Sport  
**Replaces:** Mitsubishi MD620837; Wix 46308  
**Length:** 9 3/4 (247.7)  
**Width:** 8 13/16 (223.8)  
**Height:** 1 15/16 (49.2)



**PA10255** Panel Air Element  
**Fits:** Infiniti M45, M56  
**Replaces:** ACDelco AF3939; Nissan 16546EH000; Wix 49290  
**Length:** 9 9/32 (235.7)  
**Width:** 9 1/8 (231.8)  
**Height:** 2 1/8 (54)  
**A. Gskt:** [1] Included



**PA10246** Set of 2 Air Elements  
**Notes:** For Right and Left Hand Sides  
**Fits:** Mercedes-Benz Automotive  
**Replaces:** Mercedes-Benz A6420942004, A6420941804, 6420942404, 6420942304, 6420942004, 6420941804  
**Length:** 12 1/32 (305.6)  
**Width:** 7 17/32 (191.3)  
**Height:** 4 (101.6)



**PA10256** Panel Air Element  
**Fits:** Honda Accord Hybrid  
**Replaces:** Honda 172205K0A00; Wix WA10124  
**Length:** 7 1/8 (181.0)  
**Width:** 5 19/32 (142.1)  
**Height:** 2 1/16 (52.4)













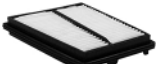
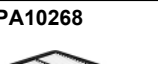

**PA10247** Panel Air Element  
**Fits:** Honda Insight  
**Replaces:** Honda 17220-PHM-000; Wix 46499  
**Length:** 10 5/8 (269.9)  
**Width:** 5 21/32 (143.7)  
**Height:** 1 7/32 (31)

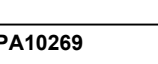

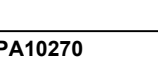
Measurements Are Shown In Inches And (Millimeters)

**WARNING:** These products can expose you to chemicals, including Diisononyl Phthalate, Carbon black extracts, Nickel, 1,3 Butadiene, Ethylene Oxide, Epichlorohydrin, which are known to the State of California to cause cancer, and Bisphenol, Ethylene Glycol, Ethylene Oxide, 1,3 Butadiene, Epichlorohydrin, which are known to the State of California to cause birth defects or other reproductive harm.

<p><b>PA10257</b> Air Element</p>  <p><b>Notes:</b> Left hand side. <b>Fits:</b> BMW Automotive <b>Replaces:</b> BMW 13717577458 <b>Length:</b> 14 31/32 (380.2) <b>Width:</b> 11 5/8 (295.3) <b>Height:</b> 4 11/32 (110.3) <b>A. Gskt:</b> [1] Included</p>	<p><b>PA10265</b> Panel Air Element</p>  <p><b>Fits:</b> Hyundai Genesis Coup with V6-3778cc (3.8L) Engine <b>Replaces:</b> Hyundai 281132M010; WIX 49006 <b>Length:</b> 10 9/16 (268.3) <b>Width:</b> 8 3/4 (222.3) <b>Height:</b> 2 1/8 (54) <b>A. Gskt:</b> [1] Included</p>
<p><b>PA10258</b> Panel Air Element</p>  <p><b>Fits:</b> Honda Accord, Prelude <b>Replaces:</b> Honda 17220-P13-000; Wix 46110 <b>Length:</b> 13 3/16 (335.0) <b>Width:</b> 6 1/16 (154.0) <b>Height:</b> 2 (50.8)</p>	<p><b>PA10266</b> Panel Air Element</p>  <p><b>Fits:</b> Honda CR-Z Hybrid <b>Replaces:</b> Honda 17220-RTW-000; WIX 49390 <b>Length:</b> 6 11/32 (161.1) <b>Width:</b> 5 31/32 (151.6) <b>Height:</b> 1 13/16 (46) <b>A. Gskt:</b> [1] Included</p>
<p><b>PA10259</b> Panel Air Element</p>  <p><b>Fits:</b> Jeep Liberty, TJ, Wrangler <b>Replaces:</b> Chrysler 5019443AA; Wix 42156 <b>Length:</b> 10 15/32 (265.9) <b>Width:</b> 6 15/32 (164.3) <b>Height:</b> 2 (50.8) <b>A. Gskt:</b> [1] Attached</p>	<p><b>PA10267</b> Panel Air Element</p>  <p><b>Fits:</b> 2007-11 Lexus GS350, 2006-07 GS430, 2006-13 IS250, 2006-13 IS350 <b>Replaces:</b> Toyota 17810-31110, Wix 49146 <b>Length:</b> 9 9/32 (235.5) <b>Width:</b> 9 9/32 (235.5) <b>Height:</b> 2 1/8 (54.1) <b>A. Gskt:</b> [1] Included</p>
<p><b>PA10260</b> Panel Air Element</p>  <p><b>Fits:</b> Acura Legend, TL <b>Replaces:</b> Acura 17220-PY3-000; Wix 46092 <b>Length:</b> 10 7/16 (265.1) <b>Width:</b> 8 21/32 (219.9) <b>Height:</b> 1 31/32 (50)</p>	<p><b>PA10268</b> Panel Air Element</p>  <p><b>Fits:</b> Suzuki SX4 <b>Replaces:</b> Suzuki 1378054L00; WIX 49340 <b>Length:</b> 11 23/32 (297.7) <b>Width:</b> 5 7/8 (149.2) <b>Height:</b> 1 23/32 (43.7) <b>A. Gskt:</b> [1] Included</p>
<p><b>PA10261</b> Panel Air Element</p>  <p><b>Fits:</b> Hyundai Genesis with V8-5038cc (5.0L) FI Engine <b>Replaces:</b> Hyundai 28113M500; WIX 49650 <b>Length:</b> 8 17/32 (216.7) <b>Width:</b> 3 1/16 (77.8) <b>Height:</b> 27/32 (21.4) <b>A. Gskt:</b> [1] Included</p>	<p><b>PA10269</b> Panel Air Element</p>  <p><b>Fits:</b> Honda Insight Hybrid with 4-1339cc (1.3L) Engine <b>Replaces:</b> Honda 17220-RBJ-000; WIX 49270 <b>Length:</b> 6 13/16 (173.0) <b>Width:</b> 6 1/32 (153.2) <b>Height:</b> 1 21/32 (42.1) <b>A. Gskt:</b> [1] Attached</p>
<p><b>PA10262</b> Air Element</p>  <p><b>Notes:</b> Right hand side. <b>Fits:</b> BMW Automotive <b>Replaces:</b> BMW (Bavarian Motor Works) 13717577457 <b>Length:</b> 14 31/32 (380.2) <b>Width:</b> 11 21/32 (296.1) <b>Height:</b> 4 31/32 (126.2) <b>A. Gskt:</b> [1] Included</p>	<p><b>PA10270</b> Panel Air Element</p>  <p><b>Fits:</b> Acura TSX <b>Replaces:</b> Acura 17220-RL5A00; WIX 49200 <b>Length:</b> 9 7/16 (239.7) <b>Width:</b> 8 9/32 (210.3) <b>Height:</b> 2 5/32 (54.8) <b>A. Gskt:</b> [1] Included</p>
<p><b>PA10263</b> Panel Air Element</p>  <p><b>Fits:</b> Acura TL <b>Replaces:</b> Honda 17220-PGE-A00; WIX 42023 <b>Length:</b> 12 11/16 (322.3) <b>Width:</b> 6 7/32 (158.0) <b>Height:</b> 1 19/32 (40.5) <b>A. Gskt:</b> [1] Attached</p>	<p><b>PA10271</b> Panel Air Element</p>  <p><b>Fits:</b> Hyundai Sonata Hybrid, Kia Optima <b>Replaces:</b> Kia 281133S100 <b>Length:</b> 10 29/32 (277.0) <b>Width:</b> 8 15/16 (227.0) <b>Height:</b> 1 21/32 (42.1) <b>A. Gskt:</b> [1] Included</p>
<p><b>PA10264</b> Panel Air Element</p>  <p><b>Fits:</b> Acura RL <b>Replaces:</b> Honda 17220-P5A-000; WIX 546245, 46245 <b>Length:</b> 10 15/32 (265.9) <b>Width:</b> 9 15/16 (252.4) <b>Height:</b> 1 9/16 (39.7)</p>	<p><b>PA10272</b> Panel Air Element</p>  <p><b>Fits:</b> Kia Soul <b>Replaces:</b> Kia 28113-2K000; Wix 49400 <b>Length:</b> 9 13/16 (249.2) <b>Width:</b> 5 1/8 (130.2) <b>Height:</b> 2 5/32 (54.8) <b>A. Gskt:</b> [1] Included</p>

Measurements Are Shown In Inches And (Millimeters)

 **WARNING:** These products can expose you to chemicals, including Diisononyl Phthalate, Carbon black extracts, Nickel, 1,3 Butadiene, Ethylene Oxide, Epichlorohydrin, which are known to the State of California to cause cancer, and Bisphenol, Ethylene Glycol, Ethylene Oxide, 1,3 Butadiene, Epichlorohydrin, which are known to the State of California to cause birth defects or other reproductive harm.



**PA10273** Panel Air Element  
**Fits:** Hyundai Genesis; 2017-18 Genesis G80 with (3.8L) Engines  
**Replaces:** Hyundai 28113B1000; WIX WA10163  
**Length:** 13 5/16 (338.1)  
**Width:** 9 1/4 (235.0)  
**Height:** 1 23/32 (43.7)  
**A. Gskt:** [1] Included



**PA10274** Air Element  
**Contains:** Sensor Port  
**Fits:** Cadillac ATS; Chevrolet Cruze  
**Replaces:** ACDelco A3202C; General Motors 13367308; WIX WA10646  
**O.D.:** 4 31/32 (126.2)  
to 5 1/2 (139.7)  
**I.D.:** 2 27/32 (72.2) & 2 7/8 (73.0) to  
**Height:** 6 13/16 (173)



**PA10275** Panel Air Element  
**Fits:** 2016-18 Toyota Prius, 2019 Prius AWD-e, 2012-19 Prius C, 2017-19 Prius Prime  
**Replaces:** Toyota 17801-21060; Wix WA10000  
**Length:** 6 31/32 (176.8)  
**Width:** 4 11/16 (119.1)  
**Height:** 1 7/16 (36.6)



**PA10276** Panel Air Element  
**Fits:** 2017 Lexus GS Turbo, IS Turbo, RC Turbo, 2016-17 GS200t, IS200t, RC200t, 2018-19 GS300, 2013-19 GS350, 2013-18 GS450h, 2014-15 IS250, 2016-19 IS300, RC300, 2014-19 IS350, 2015-19 RC350  
**Replaces:** Toyota 17801331170; Wix 49240  
**Length:** 9 1/8 (231.9)  
**Width:** 9 1/32 (229.1)  
**Height:** 2 1/8 (54.1)



**PA10277** Panel Air Element  
**Fits:** Various BMW automotive  
**Replaces:** BMW (Bavarian Motor Works) 13717571355, 13717605913; Wix 49555  
**Length:** 10 7/8 (276.1)  
**Width:** 10 9/32 (261.1)  
**Height:** 1 3/8 (34.8)

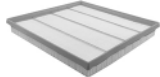

**PA10278** Panel Air Element  
**Fits:** BMW Automotive  
**Replaces:** BMW 13717542294; WIX 49056  
**Length:** 3 3/8 (85.7) to 10 17/32 (267.5)  
**Width:** 3 3/8 (85.7)  
to 10 7/16 (265.1)  
**Height:** 1 31/32 (50)



**PA10279** Panel Air Element  
**Fits:** Audi Q7; Land Rover Range Rover; Porsche Cayenne; Volkswagen Touareg  
**Replaces:** Volkswagen 7L0129620; WIX 42859  
**Length:** 15 7/16 (392.1)  
**Width:** 7 5/16 (185.7)  
**Height:** 2 9/32 (57.9)  
**Related To:** PA10340 (with Foam Pad)



**PA10280** Panel Air Element with Foam Pad  
**Fits:** Volvo Automotive  
**Replaces:** Volvo 30637444; Wix 46938  
**Length:** 9 7/32 (234.2)  
**Width:** 8 1/8 (206.4)  
**Height:** 2 5/8 (66.7)



**PA10281** Panel Air Element  
**Fits:** 2011-12 BMW Z4; 2007-16 MINI Cooper, 2012-17 Cooper Countryman, 2013-16 Cooper Paceman  
**Replaces:** BMW (Bavarian Motor Works) 13717568728; Wix 49728  
**Length:** 14 7/32 (361.4)  
**Width:** 5 23/32 (145.3)  
**Height:** 1 9/16 (39.9)

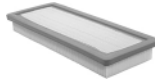

**PA10282** Panel Air Element  
**Fits:** 2016-18 Audi A3 Sportback e-tron; 2013-18 Volkswagen Jetta  
**Replaces:** Volkswagen 4E129620; Wix WA10072  
**Length:** 10 19/32 (269.0)  
**Width:** 7 1/2 (190.5)  
**Height:** 31/32 (24.6)

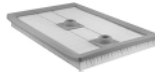

**PA10283** Panel Air Element  
**Fits:** Saab 9-3 Series  
**Replaces:** General Motors 55557597; Saab 12786800; WIX 46915  
**Length:** 11 5/8 (295.3)  
**Width:** 9 7/32 (234.2)  
**Height:** 1 7/8 (47.6)

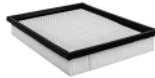

**PA10284** Panel Air Element  
**Fits:** Land Rover LR4, Range Rover, Range Rover Sport  
**Replaces:** Land Rover LR011593; Wix 49593  
**Length:** 13 5/8 (346.1)  
**Width:** 6 13/32 (162.7)  
**Height:** 1 15/16 (49.2)



**PA10285** Panel Air Element with Foam Pad  
**Fits:** Audi A4, A5, Allroad, Q5  
**Replaces:** Audi 8K0133843E; WIX 49043  
**Length:** 12 5/8 (320.7)  
**Width:** 5 (127.0)  
**Height:** 2 17/32 (64.3)



**PA10286** Panel Air Element  
**Fits:** 2008-15 Smart ForTwo  
**Replaces:** Mercedes-Benz A0010940301, 10940301; Luber-finer AF3914; Wix 49301  
**Length:** 10 17/32 (267.7)  
**Width:** 4 3/8 (111.5)  
**Height:** 1 13/32 (36.1)

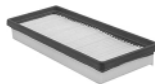

**PA10287** Panel Air Element  
**Fits:** Porsche Automotive  
**Replaces:** Porsche 99611013152; Mann & Hummel C54165  
**Length:** 20 15/16 (531.8)  
**Width:** 7 5/32 (181.8)  
**Height:** 1 21/32 (42.1)





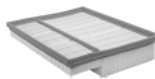



**PA10288** Panel Air Element  
**Fits:** Mercedes-Benz Automotive  
**Replaces:** Mercedes-Benz 6040940004, 6040940104, 6040941404; WIX 546321, 46321, 42525  
**Length:** 11 5/8 (295.3)  
**Width:** 8 29/32 (226.2)  
**Height:** 2 1/4 (57.2)

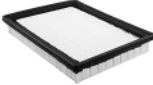
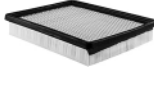

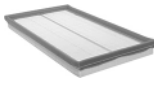
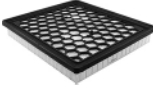
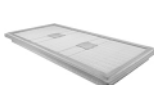

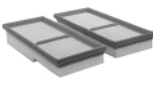

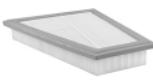
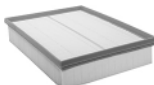
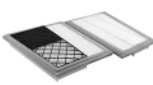
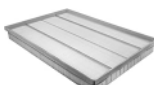
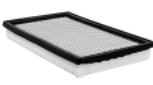
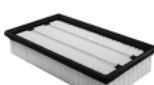
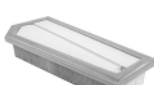





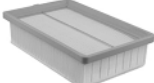

Measurements Are Shown In Inches And (Millimeters)

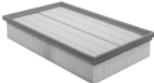
**WARNING:** These products can expose you to chemicals, including Diisononyl Phthalate, Carbon black extracts, Nickel, 1,3 Butadiene, Ethylene Oxide, Epichlorohydrin, which are known to the State of California to cause cancer, and Bisphenol, Ethylene Glycol, Ethylene Oxide, 1,3 Butadiene, Epichlorohydrin, which are known to the State of California to cause birth defects or other reproductive harm.

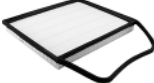
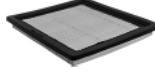
<p><b>PA10289</b> Panel Air Element  <b>Fits:</b> Mini Cooper  <b>Replaces:</b> BMW 13721477840; Mann &amp; Hummel C2237; WIX 42799  <b>Length:</b> 8 17/32 (216.7)  <b>Width:</b> 6 9/16 (166.7)  <b>Height:</b> 1 5/16 (33.3)</p> 	<p><b>PA10297</b> Panel Air Element  <b>Fits:</b> Cadillac XLR; Chevrolet Corvette  <b>Replaces:</b> ACDelco A2945C; General Motors Corp. 10342024; Wix 42821  <b>Length:</b> 9 3/8 (238.1)  <b>Width:</b> 7 1/8 (181.0)  <b>Height:</b> 1 5/8 (41.3)</p> 
<p><b>PA10290</b> Panel Air Element  <b>Fits:</b> Volkswagen Automotive  <b>Replaces:</b> Volkswagen 07K129620, 7K129620; Wix 49186  <b>Length:</b> 16 15/16 (430.2)  <b>Width:</b> 5 1/8 (130.2)  <b>Height:</b> 1 19/32 (40.5)</p> 	<p><b>PA10298</b> Panel Air Element  <b>Notes:</b> Uses 2 filters per application.  <b>Fits:</b> Mercedes-Benz CLK430  <b>Replaces:</b> Mercedes-Benz 40941604; WIX 542052, 42052  <b>Length:</b> 13 7/32 (335.8)  <b>Width:</b> 7 15/32 (189.7)  <b>Height:</b> 1 1/4 (31.8)</p> 
<p><b>PA10291</b> Panel Air Element  <b>Fits:</b> Buick, Chevrolet Automotive  <b>Replaces:</b> General Motors 55560894; WIX 49894  <b>Length:</b> 11 13/32 (289.7)  <b>Width:</b> 10 3/16 (258.8)  <b>Height:</b> 1 11/16 (42.9)</p> 	<p><b>PA10299</b> Panel Air Element  <b>Fits:</b> Mercedes-Benz Automotive  <b>Replaces:</b> Mercedes-Benz 2760940004, A2760940004; Wix 49034  <b>Length:</b> 16 11/16 (423.9)  <b>Width:</b> 7 29/32 (200.8)  <b>Height:</b> 1 3/8 (34.9)</p> 
<p><b>PA10292</b> Panel Air Element  <b>Fits:</b> 2003-06 Volvo XC90  <b>Replaces:</b> Volvo 30741594, 8638600; Wix 42823  <b>Length:</b> 12 15/16 (328.7)  <b>Width:</b> 8 15/32 (215.1)  <b>Height:</b> 2 1/4 (57.2)</p> 	<p><b>PA10300</b> Panel Air Element  <b>Fits:</b> Jaguar X-Type  <b>Replaces:</b> Jaguar 1X439601AA, C2S00002; WIX 42625  <b>Length:</b> 14 13/16 (376.2)  <b>Width:</b> 6 3/32 (154.8)  <b>Height:</b> 1 11/16 (42.9)</p> 
<p><b>PA10293</b> Set of 2 Panel Air Elements  <b>Notes:</b> Uses 2 filters per application.  <b>Fits:</b> Chrysler Crossfire; Mercedes-Benz SLK320  <b>Replaces:</b> Chrysler 5098424AA; Mercedes-Benz A1120940304; WIX 42822  <b>Length:</b> 10 9/16 (268.3)  <b>Width:</b> 4 11/16 (119.1)  <b>Height:</b> 1 15/16 (49.2)</p> 	<p><b>PA10301</b> Panel Air Element with Foam Pad  <b>Fits:</b> Volvo XC90  <b>Replaces:</b> Volvo 3068029-3; Wix 49293  <b>Length:</b> 8 31/32 (227.8)  <b>Width:</b> 8 5/8 (219.1)  <b>Height:</b> 2 5/8 (66.7)</p> 
<p><b>PA10294</b> Panel Air Element  <b>Fits:</b> BMW Automotive  <b>Replaces:</b> BMW 13717582908; WIX 49208  <b>Length:</b> 10 23/32 (272.3)  <b>Width:</b> 9 7/8 (250.8)  <b>Height:</b> 2 (50.8)</p> 	<p><b>PA10302</b> Panel Air Element  <b>Fits:</b> Land Rover LR3, Range Rover Sport  <b>Replaces:</b> Land Rover PHE000112; WIX 49112  <b>Length:</b> 11 29/32 (302.4)  <b>Width:</b> 8 7/8 (225.4)  <b>Height:</b> 2 5/16 (58.7)</p> 
<p><b>PA10295</b> Set of 2 Panel Air Elements  <b>Fits:</b> Mercedes-Benz Automotive  <b>Replaces:</b> Mercedes-Benz 6420940404; Wix 42468  <b>Larger Filter:</b>  <b>Length:</b> 10 3/4 (273.1)  <b>Width:</b> 7 19/32 (192.9)  <b>Height:</b> 1 11/32 (34.1)  <b>Smaller Filter:</b>  <b>O.D. Length:</b> 9 27/32 (250.0)  <b>I.D. Width:</b> 8 3/16 (208.0)  <b>Height:</b> 1 13/32 (35.7)</p> 	<p><b>PA10303</b> Panel Air Element  <b>Fits:</b> BMW X5  <b>Replaces:</b> BMW (Bavarian Motor Works) 13717548888; Wix 49888  <b>Length:</b> 14 (355.6)  <b>Width:</b> 9 9/16 (242.9)  <b>Height:</b> 1 1/2 (38.1)</p> 
<p><b>PA10296</b> Panel Air Element  <b>Fits:</b> Mini Cooper  <b>Replaces:</b> BMW 13721491749; WIX 42800  <b>Length:</b> 10 27/32 (275.4)  <b>Width:</b> 6 17/32 (165.9)  <b>Height:</b> 1 5/16 (33.3)</p> 	<p><b>PA10304</b> Panel Air Element  <b>Fits:</b> Jaguar Automotive  <b>Replaces:</b> Jaguar AJ82766, C2Z15037  <b>Length:</b> 11 21/32 (296.1)  <b>Width:</b> 6 23/32 (170.7)  <b>Height:</b> 2 7/32 (56.4)</p> 
	<p><b>PA10305</b> Panel Air Element  <b>Fits:</b> Mercedes-Benz C250, SLK250  <b>Replaces:</b> Mercedes-Benz 2710940304, A2710940304; WIX 49094  <b>Length:</b> 12 3/8 (314.3)  <b>Width:</b> 4 1/32 (102.4)  <b>to 5 3/4 (146.0)</b>  <b>Height:</b> 1 7/8 (47.6)</p> 

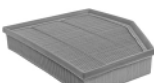
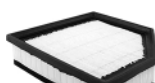

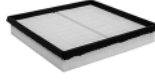
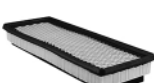
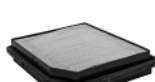
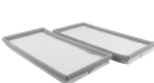







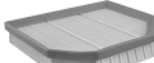

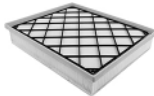
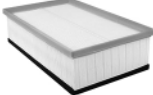
Measurements Are Shown In Inches And (Millimeters)

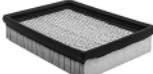
**WARNING:** These products can expose you to chemicals, including Diisononyl Phthalate, Carbon black extracts, Nickel, 1,3 Butadiene, Ethylene Oxide, Epichlorohydrin, which are known to the State of California to cause cancer, and Bisphenol, Ethylene Glycol, Ethylene Oxide, 1,3 Butadiene, Epichlorohydrin, which are known to the State of California to cause birth defects or other reproductive harm.

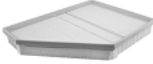
<p><b>PA10306</b> Panel Air Element  <b>Fits:</b> Mercedes-Benz Automotive  <b>Replaces:</b> Mercedes-Benz 6040940904; Wix 42620  <b>Length:</b> 9 1/4 (235.0)  <b>Width:</b> 7 29/32 (200.8)  <b>Height:</b> 1 13/16 (46)</p> 	<p><b>PA10315</b> Panel Air Element  <b>Fits:</b> Jaguar Vanden Plas, XJ8, XJR  <b>Replaces:</b> Jaguar NJA3558AA; WIX 42461  <b>Length:</b> 12 1/8 (308.0)  <b>Width:</b> 7 1/4 (184.2)  <b>Height:</b> 1 15/16 (49.2)</p> 
<p><b>PA10307</b> Panel Air Element with Foam Pad  <b>Fits:</b> Fiat 500L  <b>Replaces:</b> Fiat 68202151AA; WIX WA10084  <b>Length:</b> 9 3/16 (233.4)  <b>Width:</b> 5 9/16 (141.3)  <b>Height:</b> 2 1/4 (57.2)</p> 	<p><b>PA10316</b> Panel Air Element  <b>Fits:</b> Cadillac CTS-V; Land Rover LR2; Volkswagen Derby  <b>Replaces:</b> ACDelco A1623C; GMC 25750701; WIX 42827  <b>Length:</b> 11 (279.4)  <b>Width:</b> 7 1/4 (184.2)  <b>Height:</b> 2 11/32 (59.5)</p> 
<p><b>PA10308</b> Panel Air Element  <b>Fits:</b> Mercedes-Benz E320  <b>Replaces:</b> Mercedes-Benz 1120940104, 1120940204; WIX 42213  <b>Length:</b> 12 13/32 (315.1)  <b>Width:</b> 7 15/32 (189.7)  <b>Height:</b> 2 5/16 (58.7)</p> 	<p><b>PA10317</b> Panel Air Element  <b>Fits:</b> Volvo XC90 with V8-4414cc (4.4L) Engine  <b>Replaces:</b> Volvo 3063655-1; WIX 49242  <b>Length:</b> 12 (304.8)  <b>Width:</b> 9 1/16 (230.2)  <b>Height:</b> 2 9/32 (57.9)</p> 
<p><b>PA10309</b> Panel Air Element  <b>Fits:</b> BMW Automotive  <b>Replaces:</b> BMW (Bavarian Motor Works) 13717556961; Wix 49461  <b>Length:</b> 13 29/32 (353.2)  <b>Width:</b> 11 5/16 (287.3)  <b>Height:</b> 1 3/8 (34.9)  <b>A. Gskt:</b> [1] Included</p> 	<p><b>PA10318</b> Panel Air Element  <b>Fits:</b> Briggs &amp; Stratton Engines  <b>Replaces:</b> Briggs &amp; Stratton 805113; WIX 542442, 42442  <b>Length:</b> 7 1/16 (179.4)  <b>Width:</b> 6 9/32 (159.5)  <b>Height:</b> 5/8 (15.9)</p> 
<p><b>PA10310</b> Panel Air Element  <b>Fits:</b> Audi Automotive  <b>Replaces:</b> Volkswagen 6C133843; WIX 42972  <b>Length:</b> 10 13/32 (264.3)  <b>Width:</b> 8 11/32 (211.9)  <b>Height:</b> 2 11/16 (68.3)</p> 	<p><b>PA10319</b> Panel Air Element  <b>Fits:</b> BMW Automotive with 6-2979cc (3.0L) FI Turbo Engine  <b>Replaces:</b> BMW (Bavarian Motor Works) 13717599285; Wix 49285  <b>Length:</b> 11 3/16 (284.2)  <b>Width:</b> 10 5/16 (261.9)  <b>Height:</b> 1 9/32 (32.5)</p> 
<p><b>PA10311</b> Panel Air Element  <b>Fits:</b> BMW Automotive  <b>Replaces:</b> BMW 13717521033; WIX 42839  <b>Length:</b> 11 19/32 (294.5)  <b>Width:</b> 6 1/8 (155.6) to 9 3/32 (231.0)  <b>Height:</b> 1 13/16 (46)</p> 	<p><b>PA10320</b> Panel Air Element with Foam Pad  <b>Fits:</b> Volvo Automotive  <b>Replaces:</b> Volvo 30745344; Wix 49344  <b>Length:</b> 9 3/8 (238.1)  <b>Width:</b> 8 7/32 (208.8)  <b>Height:</b> 2 7/32 (56.4)</p> 
<p><b>PA10312</b> Panel Air Element  <b>Fits:</b> Volvo S80  <b>Replaces:</b> Volvo 9186361; WIX 42749  <b>Length:</b> 13 15/16 (354.0)  <b>Width:</b> 8 15/32 (215.1)  <b>Height:</b> 2 1/4 (57.2)</p> 	<p><b>PA10321</b> Panel Air Element  <b>Fits:</b> BMW Automotive  <b>Replaces:</b> BMW 13721247405; WIX 42168  <b>Length:</b> 9 5/16 (236.5)  <b>Width:</b> 9 3/16 (233.4)  <b>Height:</b> 1 21/32 (42.1)</p> 
<p><b>PA10313</b> Panel Air Element with Foam Pad  <b>Fits:</b> Fiat 500 with 4-1368cc (1.4L) FI Turbo Engine  <b>Replaces:</b> Mopar 52022346AA; WIX WA10006  <b>Length:</b> 11 7/8 (301.6)  <b>Width:</b> 4 7/16 (112.7)  <b>Height:</b> 1 5/8 (41.3)</p> 	<p><b>PA10323</b> Panel Air Element  <b>Fits:</b> Honda Civic, CRX  <b>Replaces:</b> Honda 17220-PM7-000; Wix 546158, 46158  <b>Length:</b> 7 13/16 (198.4)  <b>Width:</b> 6 13/16 (173.0)  <b>Height:</b> 1 15/32 (37.3)</p> 
<p><b>PA10314</b> Set of 2 Air Elements  <b>Notes:</b> Uses 2 filters per application.  <b>Fits:</b> Mercedes-Benz Automotive  <b>Replaces:</b> Mercedes-Benz 1560940504, A1560940404, A1560940504; WIX 49504  <b>Length:</b> 12 3/16 (309.6)  <b>Width:</b> 6 1/8 (155.6)  <b>Height:</b> 15/16 (23.8)</p> 	<p><b>PA10324</b> Panel Air Element  <b>Fits:</b> Mercedes-Benz Automotive  <b>Replaces:</b> Mercedes-Benz 2780940004; WIX 49704  <b>Length:</b> 12 21/32 (321.5)  <b>Width:</b> 5 5/16 (134.9)  <b>Height:</b> 1 7/8 (47.6)</p> 

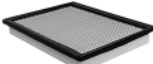
Measurements Are Shown In Inches And (Millimeters)

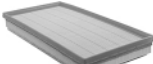
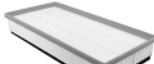
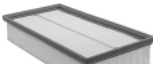
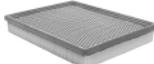
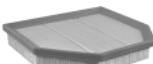
**WARNING:** These products can expose you to chemicals, including Diisononyl Phthalate, Carbon black extracts, Nickel, 1,3 Butadiene, Ethylene Oxide, Epichlorohydrin, which are known to the State of California to cause cancer, and Bisphenol, Ethylene Glycol, Ethylene Oxide, 1,3 Butadiene, Epichlorohydrin, which are known to the State of California to cause birth defects or other reproductive harm.

<p><b>PA10325</b> Panel Air Element  <b>Fits:</b> Fiat 500  <b>Replaces:</b> Chrysler 68073648AA; Wix 49048  <b>Length:</b> 15 5/32 (385.0)  <b>Width:</b> 5 1/4 (133.4)  <b>Height:</b> 1 5/8 (41.3)</p> 	<p><b>PA10334</b> Panel Air Element  <b>Notes:</b> For Right Side  <b>Fits:</b> BMW M3, M4, M5, M6  <b>Replaces:</b> BMW 13727843284; WIX WA10042  <b>Length:</b> 9 1/4 (235.0)  <b>Width:</b> 8 3/8 (212.7)  <b>Height:</b> 1 15/32 (37.3)</p> 
<p><b>PA10326</b> Panel Air Element  <b>Fits:</b> BMW X5  <b>Replaces:</b> BMW 13717548897; WIX 49897  <b>Length:</b> 11 5/8 (295.3)  <b>Width:</b> 9 1/32 (229.4)  <b>Height:</b> 1 1/2 (38.1)</p> 	<p><b>PA10335</b> Panel Air Element with Foam Pad  <b>Fits:</b> BMW X5 with 6-2993cc (3.0L) FI Turbo Diesel Engine  <b>Replaces:</b> BMW 13717798342; WIX 49342  <b>Length:</b> 12 3/4 (323.8)  <b>Width:</b> 10 1/16 (255.6)  <b>Height:</b> 1 31/32 (50)</p> 
<p><b>PA10327</b> Panel Air Element with Foam Precleaner  <b>Fits:</b> Volkswagen Golf, Golf SportWagen with 4-1968cc (2.0L) FI Turbo Diesel Engine  <b>Replaces:</b> Volkswagen 5QM129620A; WIX WA10317  <b>Length:</b> 11 1/2 (292.1)  <b>Width:</b> 6 31/32 (177.0)  <b>Height:</b> 3 5/32 (80.2)</p> 	<p><b>PA10336</b> Panel Air Element  <b>Fits:</b> Mini Cooper, Countryman  <b>Replaces:</b> ACDelco AF3604; BMW 13717534825; WIX 49825  <b>Length:</b> 19 7/16 (493.7)  <b>Width:</b> 3 5/16 (84.1)  <b>Height:</b> 2 1/4 (57.2)</p> 
<p><b>PA10328</b> Panel Air Element  <b>Fits:</b> Ford Automotive  <b>Replaces:</b> Ford E9BZ-9601-A; Motorcraft FA1064; Wix 546227, 46227  <b>Length:</b> 8 5/32 (207.2)  <b>Width:</b> 5 27/32 (148.4)  <b>Height:</b> 1 15/32 (37.3)</p> 	<p><b>PA10337</b> Panel Air Element  <b>Fits:</b> Jaguar Automotive  <b>Replaces:</b> Jaguar C2P16933, 0C2P16933; WIX 49033  <b>Length:</b> 9 3/4 (247.7)  <b>Width:</b> 6 9/32 (159.5)  <b>Height:</b> 2 11/32 (59.5)</p> 
<p><b>PA10329</b> Panel Air Element  <b>Fits:</b> BMW X5  <b>Replaces:</b> BMW 13717548898; WIX 49898  <b>Length:</b> 11 5/8 (295.3)  <b>Width:</b> 9 1/32 (229.4)  <b>Height:</b> 1 1/2 (38.1)</p> 	<p><b>PA10338</b> Panel Air Element  <b>Fits:</b> Porsche Panamera  <b>Replaces:</b> Porsche 97011022001; WIX 49055  <b>Length:</b> 26 31/32 (685.0)  <b>Width:</b> 4 27/32 (123.0)  <b>Height:</b> 2 9/32 (57.9)</p> 
<p><b>PA10330</b> Panel Air Element  <b>Fits:</b> Pontiac GTO  <b>Replaces:</b> General Motors Corp. 92082656; Wix 46913  <b>Length:</b> 11 1/4 (285.8)  <b>Width:</b> 8 29/32 (226.2)  <b>Height:</b> 1 17/32 (38.9)</p> 	<p><b>PA10339</b> Panel Air Element  <b>Fits:</b> Porsche 911  <b>Replaces:</b> Porsche 99611013171; WIX 49171  <b>Length:</b> 20 11/16 (525.5)  <b>Width:</b> 7 3/32 (180.2)  <b>Height:</b> 1 9/16 (39.7)</p> 
<p><b>PA10331</b> Panel Air Element with Foam  <b>Fits:</b> Volvo S40, V40  <b>Replaces:</b> Volvo 30850831; WIX 42897  <b>Length:</b> 13 1/2 (342.9)  <b>Width:</b> 6 21/32 (169.1)  <b>Height:</b> 1 11/16 (42.9)</p> 	<p><b>PA10340</b> Panel Air Element with Foam Pad  <b>Fits:</b> Porsche Cayenne; Volkswagen Touareg  <b>Replaces:</b> Volkswagen 7P0129620A; WIX 49920  <b>Length:</b> 15 (381.0)  <b>Width:</b> 7 5/16 (185.7)  <b>Height:</b> 2 3/8 (60.3)  <b>Related To:</b> PA10279 (without Foam Pad)</p> 
<p><b>PA10332</b> Panel Air Element  <b>Fits:</b> Saab 9-3  <b>Replaces:</b> Saab 4876074; WIX 49074  <b>Length:</b> 12 1/16 (306.4)  <b>Width:</b> 5 7/8 (149.2)  <b>Height:</b> 2 9/32 (57.9)</p> 	<p><b>PA10341</b> Panel Air Element  <b>Fits:</b> Volvo Automotive  <b>Replaces:</b> Volvo 1336397-3; WIX 546198, 46198  <b>Length:</b> 11 5/16 (287.3)  <b>Width:</b> 8 3/8 (212.7)  <b>Height:</b> 1 19/32 (40.5)</p> 
<p><b>PA10333</b> Panel Air Element  <b>Notes:</b> For Left Side  <b>Fits:</b> BMW M3, M4, M5, M6  <b>Replaces:</b> BMW 13727843283; WIX WA10041  <b>Length:</b> 9 1/4 (235.0)  <b>Width:</b> 8 3/8 (212.7)  <b>Height:</b> 1 15/32 (37.3)</p> 	<p><b>PA10342</b> Panel Air Element  <b>Fits:</b> BMW Mini Cooper  <b>Replaces:</b> BMW 13727529261; Mann &amp; Hummel C2245; WIX 49260  <b>Length:</b> 8 15/32 (215.1)  <b>Width:</b> 6 1/2 (165.1)  <b>Height:</b> 1 7/8 (47.6)</p> 

Measurements Are Shown In Inches And (Millimeters)

**WARNING:** These products can expose you to chemicals, including Diisononyl Phthalate, Carbon black extracts, Nickel, 1,3 Butadiene, Ethylene Oxide, Epichlorohydrin, which are known to the State of California to cause cancer, and Bisphenol, Ethylene Glycol, Ethylene Oxide, 1,3 Butadiene, Epichlorohydrin, which are known to the State of California to cause birth defects or other reproductive harm.

**PA10343** Panel Air Element with Foam Pad  
**Fits:** Toyota Highlander with 3.5L Hybrid Engine  
**Replaces:** Toyota 1780131141; WIX WA10313  
**Length:** 9 1/16 (230.2)  
**Width:** 8 17/32 (216.7)  
**Height:** 1 9/16 (39.7)



**PA10344** Panel Air Element  
**Fits:** Cadillac CTS with V6-217 (3.6L) FI Turbo  
**Replaces:** ACDelco A3185C; General Motors 22844634; WIX WA10400  
**Length:** 12 3/16 (309.6)  
**Width:** 9 1/4 (235.0)  
**Height:** 1 15/32 (37.3)

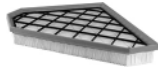

**PA10345** Panel Air Element with Foam Pad  
**Fits:** Buick Regal; Saab 9-5  
**Replaces:** ACDelco A3172C; GMC 13319421; WIX 49421  
**Length:** 11 7/16 (290.5)  
**Width:** 10 5/32 (258.0)  
**Height:** 2 1/16 (52.4)

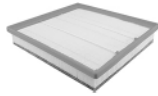

**PA10346** Panel Air Element  
**Fits:** Ford Mustang  
**Replaces:** Ford AR3Z-9601-B; Motorcraft FA1897; Wix 49201  
**Length:** 9 21/32 (245.3)  
**Width:** 8 19/32 (218.3)  
**Height:** 2 5/32 (54.8)

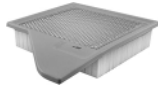

**RS10347** Radial Seal Air Element  
**Fits:** Mercedes-Benz Automotive  
**Replaces:** Mercedes-Benz 2710940204, A2710940204; WIX 49214  
**O.D.:** 5 1/4 (133.4)  
**I.D.:** 2 25/32 (70.6) One End  
**Height:** 9 7/8 (250.8)



**RS10348** Radial Seal Air Element  
**Fits:** Chevrolet HHR with 4-122 (2.0L) FI Turbo  
**Replaces:** ACDelco A3099C; General Motors 20774655; WIX 49459  
**O.D.:** 4 13/32 (111.9)  
**I.D.:** 2 23/32 (69.1) One End  
**Height:** 7 5/32 (181.8)



**RS10349** Radial Seal Air Element  
**Contains:** Mounting Band  
**Fits:** Ford Mustang V8-281 (4.6L) FI Engine  
**Replaces:** Motorcraft FA1895; WIX 49601  
**O.D.:** 6 3/32 (154.8)  
**I.D.:** 4 (101.6) One End  
**Height:** 10 3/8 (263.5)



**RS10350** Conical Air Element  
**Contains:** Mounting Band  
**Fits:** Ford Mustang with V8-330 (5.4L) FI Supercharged Engine  
**Replaces:** Motorcraft FA1896; WIX 49896  
**O.D.:** 5 21/32 (143.7)  
to 7 17/32 (191.3)  
**I.D.:** 5 3/8 (136.5) One End  
**Height:** 9 1/16 (230.2)



**RS10351** Air Element with Foam Wrap  
**Fits:** Volvo S60 R, V70 R  
**Replaces:** Volvo 8671488; WIX 42829  
**O.D.:** 4 5/8 (117.5)  
**I.D.:** 3 1/16 (77.8) One End  
**Height:** 12 5/16 (312.7)



**PA10352** Air Element  
**Fits:** Ford Automotive, Engines, Trucks  
**Replaces:** Ford C3AZ-9601-B, C4AZ-9601-A; Motorcraft FA6; Wix 542056, 42300, DT56, 42056  
**O.D.:** 9 3/4 (247.7)  
Top 10 3/8 (263.5)  
**I.D.:** 7 7/16 (188.9)  
**Height:** 2 1/2 (63.5)



**PA10353** Air Element  
**Fits:** Smart Fortwo with 3-799cc (0.8L) Engine  
**Replaces:** Mann & Hummel C1041; Wix 49068  
**O.D.:** 3 17/32 (89.7)  
**I.D.:** 1 15/16 (49.2)  
**Height:** 5 5/16 (134.9)



**PA10354** Air Element  
**Fits:** Cadillac Eldorado; Chevrolet Corvette; Dodge Charger  
**Replaces:** Chrysler 2402368; Ford ECJ-9601-B; Wix 542070, DT70, 42070  
**O.D.:** 12 13/16 (325.4)  
**I.D.:** 11 1/32 (280.2)  
**Height:** 2 5/32 (54.8)



**PA10355** Air Element  
**Fits:** Ford, Lincoln, Mercury Automotive  
**Replaces:** Ford C0AE-9601-B; Motorcraft FA5; Wix 542053, DT53, 42053  
**O.D.:** 13 1/8 (333.4)  
**I.D.:** 10 5/8 (269.9)  
**Height:** 2 11/32 (59.5)



**PA10356** Air Element  
**Fits:** Ford Mustang II  
**Replaces:** Ford D5ZF-9601-AA; Motorcraft FA605; Wix 542079, 42079  
**O.D.:** 13 9/16 (344.5)  
**I.D.:** 11 11/32 (288.1)  
**Height:** 1 7/8 (47.6)



Measurements Are Shown In Inches And (Millimeters)

**WARNING:** These products can expose you to chemicals, including Diisononyl Phthalate, Carbon black extracts, Nickel, 1,3 Butadiene, Ethylene Oxide, Epichlorohydrin, which are known to the State of California to cause cancer, and Bisphenol, Ethylene Glycol, Ethylene Oxide, 1,3 Butadiene, Epichlorohydrin, which are known to the State of California to cause birth defects or other reproductive harm.

<p><b>PA10357</b></p> 	<p><b>Air Element</b>  <b>Fits:</b> Nissan Automotive, Light-Duty Trucks  <b>Replaces:</b> Nissan 16546-U6710; Wix 42908  <b>O.D.:</b> 11 3/16 (284.2)  <b>I.D.:</b> 9 3/32 (231.0)  <b>Height:</b> 2 3/8 (60.3)</p>	<p><b>PA10365 KIT</b> Set of 2 Cabin Air Elements  <b>Fits:</b> Dodge Nitro; Jeep Liberty  <b>Replaces:</b> Chrysler 68033193AA; Wix 49093  <b>Length:</b> 7 1/8 (181.0)  <b>Width:</b> 3 19/32 (91.3)  <b>Height:</b> 25/32 (19.8)</p> 
<p><b>PA10358</b></p> 	<p><b>Panel Air Element</b>  <b>Fits:</b> Mercedes-Benz Automotive  <b>Replaces:</b> Mercedes-Benz 30946104; Wix 42365  <b>Length:</b> 13 1/16 (331.8)  <b>Width:</b> 6 5/32 (156.4)  <b>Height:</b> 1 21/32 (42.1)</p>	<p><b>PA10367</b> Cabin Air Element with Pull Tab  <b>Fits:</b> Nissan Sentra  <b>Replaces:</b> Nissan 278913DF0A  <b>Length:</b> 10 5/32 (258.0)  <b>Width:</b> 5 29/32 (150.0)  <b>Height:</b> 31/32 (24.6)</p> 
<p><b>SA10359</b></p> 	<p><b>Crankcase Breather Filter in Metal Housing</b>  <b>Fits:</b> Buick, Cadillac, Chevrolet, GMC, Pontiac Automotive, Light-Duty Trucks  <b>Replaces:</b> General Motors Corp. 557240, 6424244; Wix 46987, 42993  <b>Length:</b> 2 5/8 (66.7)  <b>Width:</b> 1 (25.4)  <b>Height:</b> 2 17/32 (64.3)</p>	<p><b>PA10368</b> Cabin Air Element  <b>Contains:</b> Charcoal Impregnated Media for Odor Control  <b>Fits:</b> Mercedes-Benz Automotive  <b>Replaces:</b> Mercedes-Benz 2038300118, 2038300918, 203830091864; Wix 24118  <b>Length:</b> 10 27/32 (275.4) to 13 (330.2)  <b>Width:</b> 7 11/32 (186.5)  <b>Height:</b> 1 11/32 (34.1)</p> 
<p><b>SA10360</b></p> 	<p><b>Crankcase Breather Filter in Plastic Housing</b>  <b>Contains:</b> 13/16 In. Fitting  <b>Fits:</b> Buick, Cadillac, Chevrolet, GMC, Pontiac Automotive, Light-Duty Trucks  <b>Replaces:</b> General Motors Corp. 8996724, 25096399; Wix 42994  <b>Length:</b> 1 31/32 (50.0)  <b>Width:</b> 1 13/16 (46.0)  <b>Height:</b> 1 19/32 (40.5)</p>	<p><b>PA10369</b> Cabin Air Element  <b>Contains:</b> Charcoal Impregnated Media for Odor Control  <b>Fits:</b> Buick LaCrosse, Regal, Verano; Cadillac ATS, XTS; Chevrolet Camaro, Cruze, Impala  <b>Replaces:</b> ACDelco CF184; General Motors Corp. 13356914, 13356916; Wix 24211  <b>Length:</b> 9 7/16 (239.7)  <b>Width:</b> 8 1/32 (204.0)  <b>Height:</b> 1 3/16 (30.2)</p> 
<p><b>SA10361</b></p> 	<p><b>Crankcase Breather Filter in Plastic Housing</b>  <b>Fits:</b> AMC Automotive, Jeep  <b>Replaces:</b> Chrysler 3236695, J3236695; Wix 46988  <b>Length:</b> 1 7/8 (47.6)  <b>Width:</b> 1 15/32 (37.3)  <b>Height:</b> 1 7/16 (36.5)</p>	<p><b>PA10370 KIT</b> Set of 2 Cabin Air Elements  <b>Notes:</b> Requires 2 filters per application.  <b>Contains:</b> Charcoal Impregnated Media for Odor Control  <b>Fits:</b> BMW X3, X4  <b>Replaces:</b> BMW (Bavarian Motor Works) 64319237157, 64319237158, 64319312318, 64319313316; Wix WP2076, SP2076  <b>Length:</b> 7 3/8 (187.3)  <b>Width:</b> 7 3/8 (187.3)  <b>Height:</b> 1 (25.4)</p> 
<p><b>PA10362</b></p> 	<p><b>Cabin Air Element</b>  <b>Fits:</b> Pontiac Vibe; Toyota Tacoma  <b>Replaces:</b> General Motors Corp. 88970273; Wix 49358, 24871, 524871  <b>Length:</b> 8 1/16 (204.8)  <b>Width:</b> 8 1/16 (204.8)  <b>Height:</b> 25/32 (19.8)</p>	<p><b>PA10371</b> Cabin Air Element  <b>Fits:</b> Hyundai Elantra  <b>Replaces:</b> Hyundai 87902L000A; Wix 24270  <b>Length:</b> 10 3/8 (263.5)  <b>Width:</b> 7 17/32 (191.3)  <b>Height:</b> 25/32 (19.8)  <b>A. Gskt:</b> [1] Attached</p> 
<p><b>PA10363</b></p> 	<p><b>Cabin Air Element</b>  <b>Contains:</b> Charcoal Impregnated Media for Odor Control  <b>Fits:</b> Lexus GX470, RX330; Toyota 4Runner, Avalon, Camry, FJ Cruiser  <b>Replaces:</b> Toyota 87139-33010, 87139-YZZ03; Wix 24905  <b>Length:</b> 8 1/2 (215.9)  <b>Width:</b> 8 7/16 (214.3)  <b>Height:</b> 29/32 (23)  <b>A. Gskt:</b> [2] Attached</p>	<p><b>PA10372</b> Cabin Air Element  <b>Fits:</b> Mitsubishi Mirage  <b>Replaces:</b> Mitsubishi 7850A002; Wix WP10125  <b>Length:</b> 6 31/32 (177.0)  <b>Width:</b> 6 31/32 (177.0)  <b>Height:</b> 3/4 (19)</p> 
<p><b>PA10364</b></p> 	<p><b>Cabin Air Element</b>  <b>Fits:</b> Hyundai Elantra  <b>Replaces:</b> Hyundai 87902-H000A  <b>Length:</b> 9 7/16 (239.7)  <b>Width:</b> 7 23/32 (196.1)  <b>Height:</b> 25/32 (19.8)  <b>A. Gskt:</b> [2] Included</p>	<p><b>PA10373</b> Cabin Air Element  <b>Fits:</b> Chevrolet Aveo, Aveo5; Pontiac G3, Wave  <b>Replaces:</b> General Motors Corp. 96435888, 96539649; Wix 24685  <b>Length:</b> 9 1/16 (230.2)  <b>Width:</b> 7 7/8 (200.0)  <b>Height:</b> 3/4 (19)  <b>A. Gskt:</b> [1] Attached</p> 

Measurements Are Shown In Inches And (Millimeters)

**WARNING:** These products can expose you to chemicals, including Diisononyl Phthalate, Carbon black extracts, Nickel, 1,3 Butadiene, Ethylene Oxide, Epichlorohydrin, which are known to the State of California to cause cancer, and Bisphenol, Ethylene Glycol, Ethylene Oxide, 1,3 Butadiene, Epichlorohydrin, which are known to the State of California to cause birth defects or other reproductive harm.

**PA10374** Cabin Air Element  
**Contains:** Charcoal Impregnated Media for Odor Control.  
**Fits:** BMW X5; Land Rover Range Rover  
**Replaces:** BMW (Bavarian Motor Works) 64318409044; Wix 24827  
**Length:** 21 9/32 (540.5)  
**Width:** 10 (254.0)  
**Height:** 1 9/32 (32.5)  
**A. Gskt:** [1] Attached

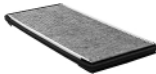

**PA10375** Cabin Air Element  
**Contains:** Charcoal Impregnated Media for Odor Control  
**Fits:** BMW Automotive  
**Replaces:** BMW (Bavarian Motor Works) 64319071935; Wix 24673, 24473  
**Length:** 26 19/32 (675.5)  
**Width:** 4 19/32 (116.7)  
**Height:** 1 3/32 (27.8)  
**A. Gskt:** [1] Included



**PA10376** Cabin Air Element  
**Fits:** Nissan Versa  
**Replaces:** Nissan 27891EL00A; Wix 24829  
**Length:** 9 3/8 (238.1)  
**Width:** 6 21/32 (169.1)  
**Height:** 1 13/32 (35.7)  
**A. Gskt:** [1] Included



**PA10378** Panel Air Element  
**Fits:** Honda Civic with 1.3L Hybrid Engine  
**Replaces:** Honda 17220-RMX-000; Wix 49157  
**Length:** 7 19/32 (192.9)  
**Width:** 7 1/32 (178.6)  
**Height:** 1 9/32 (32.5)  
**A. Gskt:** [1] Included



**PA10379** Panel Air Element  
**Fits:** Mitsubishi Lancer, Outlander  
**Replaces:** Mitsubishi 1500A023; Wix 49023  
**Length:** 10 9/16 (268.3)  
**Width:** 7 9/32 (184.9)  
**Height:** 2 1/8 (54)  
**A. Gskt:** [1] Attached



**PA10380** Panel Air Element  
**Fits:** Honda City, Fit  
**Replaces:** Honda 17220-RB0-000; Wix 49460  
**Length:** 6 13/16 (173.0)  
**Width:** 6 21/32 (169.1)  
**Height:** 1 13/16 (46)  
**A. Gskt:** [1] Included



**PA10381** Panel Air Element  
**Fits:** 2016-19 Acura ILX  
**Replaces:** Honda 17220R4HA00; Wix WA10334  
**Length:** 11 9/16 (293.9)  
**Width:** 9 21/32 (245.1)  
**Height:** 1 3/8 (35.1)



**PA10382** Panel Air Element  
**Fits:** Geo Prizm; Toyota Corolla, Celica  
**Replaces:** Toyota 17801-16040; Wix 546242, 46242  
**Length:** 9 27/32 (250.0)  
**Width:** 6 3/16 (157.2)  
**Height:** 1 11/16 (42.9)

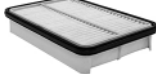

**PA10383** Panel Air Element  
**Fits:** BMW 750iL, X5  
**Replaces:** BMW (Bavarian Motor Works) 13721702907; Wix 49907  
**Length:** 11 5/16 (287.3)  
**Width:** 5 29/32 (150.0)  
**Height:** 2 7/32 (56.4)

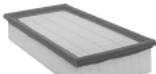

**PA10384** Panel Air Element  
**Fits:** Ford GT, F-150 Pickups  
**Replaces:** Ford XL3Z-9601-AA; Wix 42572  
**Length:** 12 7/8 (327.0)  
**Width:** 7 21/32 (194.5)  
**Height:** 1 7/8 (47.6)

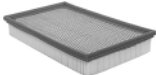

**PA10385** Panel Air Element with Foam Pad  
**Fits:** BMW 760Li, Apina B7; Rolls Royce Phantom  
**Replaces:** BMW (Bavarian Motor Works) 13717505007; Wix 46939  
**Length:** 11 5/8 (295.3)  
**Width:** 7 3/16 (182.6)  
**Height:** 2 7/16 (61.9)

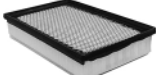

**PA10386** Panel Air Element  
**Fits:** Chevrolet Astra; Saturn Astra  
**Replaces:** General Motors Corp. 90531003, 93192885; Saturn 9117557; Wix 49522  
**Length:** 11 1/2 (292.1)  
**Width:** 9 1/4 (235.0)  
**Height:** 1 5/8 (41.3)

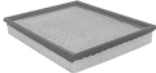

**PA10387** Panel Air Element  
**Fits:** Chevrolet Camaro  
**Replaces:** ACDelco A3137C; General Motors Corp. 92196275; Wix 49475  
**Length:** 11 3/16 (284.2)  
**Width:** 9 1/4 (235.0)  
**Height:** 2 5/32 (54.8)

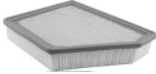

**PA10388** Panel Air Element  
**Fits:** 2019-20 Lexus UX200, ES300h; Toyota Avalon, Corolla, 2016-19 Mirai, 2018-20 Camry Hybrid, C-HR, 2019 RAV4  
**Replaces:** Toyota 17801F0020, 178010T060, 1780177050; Luber-finer AF5286; Wix WA10807  
**Length:** 10 11/16 (271.5)  
**Width:** 5 31/32 (151.4)  
**Height:** 1 15/32 (37.6)



**PA10389** Air Element  
**Fits:** Chevrolet Volt  
**Replaces:** ACDelco A3148C; General Motors Corp. 20871244; Wix 49244  
**Length:** 7 17/32 (191.3)  
**Width:** 7 1/8 (181.0)  
**Height:** 1 23/32 (43.7)

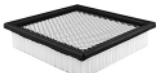



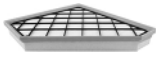





**PA10390** Panel Air Element  
**Fits:** Cadillac ATS, CTS; Chevrolet Camaro  
**Replaces:** ACDelco A3178C; General Motors Corp. 20857930; Wix 49830  
**Length:** 12 1/4 (311.2)  
**Width:** 2 3/4 (69.9)  
**to 11 (279.4)**  
**Height:** 1 1/8 (28.6)  
**A. Gskt:** [1] Included

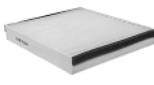
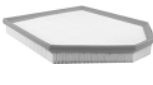
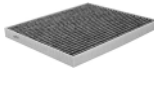
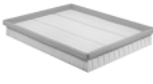

Measurements Are Shown In Inches And (Millimeters)

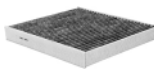
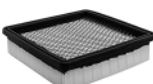
**WARNING:** These products can expose you to chemicals, including Diisononyl Phthalate, Carbon black extracts, Nickel, 1,3 Butadiene, Ethylene Oxide, Epichlorohydrin, which are known to the State of California to cause cancer, and Bisphenol, Ethylene Glycol, Ethylene Oxide, 1,3 Butadiene, Epichlorohydrin, which are known to the State of California to cause birth defects or other reproductive harm.

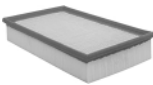
<p><b>PA10391</b> Panel Air Element  <b>Fits:</b> Chevrolet Trax  <b>Replaces:</b> General Motors Corp. 95021102; Wix WA10255  <b>Length:</b> 9 1/8 (231.8)  <b>Width:</b> 6 11/32 (161.1)  <b>Height:</b> 2 5/16 (58.7)</p> 	<p><b>PA10399</b> Air Element  <b>Replaces:</b> General Motors Corp. 6422468; Wix 42032  <b>O.D.:</b> 5 5/16 (134.9)  <b>I.D.:</b> 4 (101.6)  <b>Height:</b> 2 7/32 (56.4)</p> 
<p><b>PA10392</b> Panel Air Element  <b>Fits:</b> Land Rover Discovery Sport, Range Rover Evoque, LR2  <b>Replaces:</b> Land Rover LR029078; Wix WA10007  <b>Length:</b> 7 1/16 (179.4)  <b>Width:</b> 8 7/16 (214.3)  <b>to 11 7/16 (290.5)</b>  <b>Height:</b> 2 5/16 (58.7)</p> 	<p><b>PA10400</b> Cabin Air Element  <b>Fits:</b> Honda CR-V, Insight  <b>Replaces:</b> Honda 80291-ST3-505, 80291-ST3-E01; WIX 24877  <b>Length:</b> 8 29/32 (226.2)  <b>Width:</b> 7 27/32 (199.2)  <b>Height:</b> 1 1/8 (28.6)</p> 
<p><b>PA10393</b> Panel Air Element  <b>Fits:</b> BMW X3 with 4-1995cc (2.0) FI Turbo Diesel, 4-1997cc (2.0) Turbo Engines  <b>Replaces:</b> BMW (Bavarian Motor Works) 13717601868; Wix 49468  <b>Length:</b> 12 9/32 (311.9)  <b>Width:</b> 10 1/8 (257.2)  <b>Height:</b> 1 15/32 (37.3)</p> 	<p><b>PA10401</b> Cabin Air Element  <b>Contains:</b> Charcoal Impregnated Media for Odor Control.  <b>Fits:</b> 2017-20 Chrysler Pacifica  <b>Replaces:</b> Chrysler 68308950AB; Wix WP10316  <b>Length:</b> 9 7/8 (251.0)  <b>Width:</b> 8 7/32 (209.0)  <b>Height:</b> 25/32 (20.1)</p> 
<p><b>PA10394</b> Panel Air Element  <b>Fits:</b> BMW Automotive  <b>Replaces:</b> BMW (Bavarian Motor Works) 13717602643; Wix WA10403, WA10257  <b>Length:</b> 10 19/32 (269.1)  <b>Width:</b> 8 5/8 (219.1)  <b>Height:</b> 1 15/32 (37.3)</p> 	<p><b>PA10402</b> Cabin Air Element  <b>Fits:</b> 2015-20 Nissan Rogue, 2019-20 Rogue Sport  <b>Replaces:</b> Nissan 272774BU0A; Mann &amp; Hummel CU25003, FP25003; Wix WP10179  <b>Length:</b> 9 7/8 (251.0)  <b>Width:</b> 7 3/32 (180.1)  <b>Height:</b> 1 3/8 (35.1)</p> 
<p><b>PA10395</b> Panel Air Element  <b>Fits:</b> BMW Automotive  <b>Replaces:</b> BMW (Bavarian Motor Works) 13718507320; Wix WA10005  <b>Length:</b> 8 31/32 (227.8)  <b>Width:</b> 8 1/32 (204.0)  <b>Height:</b> 1 5/8 (41.3)</p> 	<p><b>PA10403</b> Panel Air Element  <b>Fits:</b> 2016-2020 Chevrolet Spark  <b>Replaces:</b> General Motors Corporation 95238310; Wix WA10415  <b>Length:</b> 8 1/16 (204.7)  <b>Width:</b> 6 3/32 (154.7)  <b>Height:</b> 1 15/32 (37.6)  <b>A. Gskt:</b> [1] Included</p> 
<p><b>PA10396</b> Cabin Air Element  <b>Fits:</b> 2018-20 Jeep Wrangler, 2020 Gladiator Diesel, 4-1997cc (2.0) Turbo Engines  <b>Replaces:</b> Chrysler 68301863AA; Luber-finer CAF10022P; Wix WP10371  <b>Length:</b> 9 7/16 (240.0)  <b>Width:</b> 7 7/8 (200.0)  <b>Height:</b> 21/32 (17)</p> 	<p><b>PA10404</b> Cabin Air Element  <b>Contains:</b> Charcoal Impregnated Media for Odor Control.  <b>Fits:</b> 2015-19 Audi A3, A3 Quattro; 2015-16 S3; 2016-17 A3 Sportback e-tron, TT Quattro; 2015 Volkswagen Golf SportWagen; 2015-17 Golf; 2015-18 e-Golf; 2015-19 Golf R, GTI; 2018-19 Atlas; Volkswagen European Light-Duty Vehicles  <b>Replaces:</b> Volkswagen 5Q0819653; Fram CF11643; Luber-finer CAF1945C; Mann &amp; Hummel CUK26009; Wix WP10159  <b>Length:</b> 10 (254.0)  <b>Width:</b> 9 1/4 (235.0)  <b>Height:</b> 1 1/4 (32)</p> 
<p><b>PA10397</b> Panel Air Element  <b>Fits:</b> Chevrolet Automotive  <b>Replaces:</b> General Motors Corp. 25043246; Wix 46140  <b>Length:</b> 6 21/32 (169.1)  <b>Width:</b> 6 21/32 (169.1)  <b>Height:</b> 1 9/16 (39.7)</p> 	<p><b>PA10405</b> Oval Air Element  <b>Fits:</b> 2014-19 Chevrolet Corvette  <b>Replaces:</b> General Motors Corp. 23107355; ACDelco A3191C; Fram CA12062; Luber-finer AF6191; Wix WA10171  <b>O.D.:</b> 5 1/8 (130.0)  <b>To 9 5/8 (244.1)</b>  <b>I.D.:</b> 2 13/32 (61.0) &amp; 6 7/8 (175.0)  <b>Height:</b> 8 13/32 (213.6)</p> 
<p><b>PA10398</b> Panel Air Element  <b>Fits:</b> Audi, Volkswagen Automotive  <b>Replaces:</b> Volkswagen 859129620; Wix 46240  <b>Length:</b> 12 1/4 (311.2)  <b>Width:</b> 7 1/4 (184.2)  <b>Height:</b> 2 7/32 (56.4)</p> 	

Measurements Are Shown In Inches And (Millimeters)

**WARNING:** These products can expose you to chemicals, including Diisononyl Phthalate, Carbon black extracts, Nickel, 1,3 Butadiene, Ethylene Oxide, Epichlorohydrin, which are known to the State of California to cause cancer, and Bisphenol, Ethylene Glycol, Ethylene Oxide, 1,3 Butadiene, Epichlorohydrin, which are known to the State of California to cause birth defects or other reproductive harm.



**PA10407** Panel Air Element  
**Fits:** 2017-20 Honda Civic with 2.0L Turbo Engine  
**Replaces:** Honda 172205BFA00; Wix WA10967  
**Length:** 9 11/16 (246.4)  
**Width:** 6 21/32 (168.9)  
**Height:** 1 25/32 (45)



**PA10409** Panel Air Element  
**Fits:** 2019-20 Jeep Cherokee with 2.4L & 3.2L Engines  
**Replaces:** Chrysler 68245310AA  
**Length:** 10 7/8 (276.6)  
**Width:** 6 15/16 (176.5)  
**Height:** 2 1/4 (57.4)

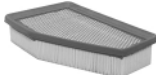

**PA10411** Cabin Air Element  
**Fits:** 2016-20 Hyundai Tucson, 2019 Veloster, 2019-20 Veloster N; 2017-19 Kia Sportage  
**Replaces:** Hyundai 97133D3000; Fram CF12160; Luber-finer CAF1948P; Mann & Hummel CU23019; Wix WP10265  
**Length:** 8 13/16 (224.0)  
**Width:** 7 7/8 (199.9)  
**Height:** 1 3/32 (27.9)



**PA10412** Cabin Air Element  
**Contains:** Charcoal Impregnated Media for Odor Control  
**Fits:** 2016-20 Toyota Tacoma  
**Replaces:** Toyota 8850804010  
**Length:** 8 3/32 (205.5)  
**Width:** 8 (202.9)  
**Height:** 25/32 (19.8)



**CV15000** Crankcase Breather  
**Fits:** Autocar, Cummins, Freightliner, IHC, Kenworth, Mack, Peterbilt, Volvo Trucks with Cummins ISM, ISX Engines  
**Replaces:** Cummins 3683918, 3685528, 391476, 4312011, 4312013; Fleetguard CV50031, CV50633, CV50634, CV50617, CV50601, CV50607  
**Length:** 11 1/8 (282.6)  
**Width:** 8 15/16 (227.0)  
**Height:** 2 21/32 (67.5)  
**A. Gskt:** [2] Attached



**CV15001** Crankcase Breather  
**Fits:** Mercedes-Benz Actros I Series, Actros II Series Trucks with Mercedes-Benz OM501LA, OM502LA Engines  
**Replaces:** Mercedes-Benz 5410100080  
**O.D.:** 2 1/4 (57.2)  
**I.D.:** 1 3/4 (44.4) One End  
**Height:** 4 13/16 (122.2)  
**O-Ring:** [1] Attached, [1] Included



**CV15002** Crankcase Breather  
**Fits:** Case Dump Trucks; Case-IH Steiger, Steiger Tractors; New Holland Combines  
**Replaces:** Iveco 504209107  
**Length:** 10 11/32 (262.7)  
**Width:** 5 15/32 (138.9)  
**Height:** 31/32 (24.6)  
**A. Gskt:** [2] Attached



**CV15003** Crankcase Breather  
**Fits:** Detroit Diesel Series 50, Series 60 Engines  
**Replaces:** Detroit Diesel 23522898; Racor CCV5524808  
**O.D.:** 3 25/32 (96.0)  
**I.D.:** 7/8 (22.2) One End  
**Height:** 5 31/32 (151.6)  
**O-Ring:** [2] Included



**CV15004** Crankcase Breather  
**Fits:** Spiracle Crankcase Ventilation Systems for Various Diesel Trucks and Equipment  
**Replaces:** Donaldson P607673  
**O.D.:** 5 3/32 (129.4)  
**I.D.:** 2 1/8 (54.0) One End  
**Height:** 7 19/32 (192.9)



**CV15005** Crankcase Breather  
**Fits:** Caterpillar, John Deere Marine Engines  
**Replaces:** John Deere RE530346; Fleetguard CV55018  
**O.D.:** 5 1/16 (128.6)  
**I.D.:** 1 1/4 (31.8) One End  
**Height:** 8 1/16 (204.8)  
**O-Ring:** [2] Included



**CV15006** Crankcase Breather  
**Contains:** Instruction Sheet  
 Foam  
 Tubing  
 Cap Replacement  
 Washers  
**Fits:** Case Dozers; Case-International Tractors; New Holland Dozers, Motor Graders; Steyr Tractors  
**Replaces:** Case 87304662; New Holland 87304662  
**O.D.:** 5 3/4 (146.0)  
**Height:** 3 5/16 (84.1)  
**O-Ring:** [2] Included



**CV15007** Crankcase Breather  
**Fits:** Caterpillar C13, C15 On-Highway Engines  
**Replaces:** Racor CV55603-02, CV55603-03; Caterpillar 3286272, 3805839; IHC (International Harvester) 3007357C1  
**O.D.:** 3 9/16 (90.5)  
**Lid:** 4 9/16 (115.9)  
**I.D.:** 1/2 (12.7) & 23/32 (18.3)  
**Height:** 9 31/32 (253.2)  
**O-Ring:** [2] Attached



**CV15008** Crankcase Breather  
**Fits:** Caterpillar C13, C15  
**Replaces:** Caterpillar 2968325, 3805840; Racor CV55603; Fleetguard CV50304  
**O.D.:** 3 11/16 (93.7)  
**Top:** 4 7/16 (112.5)  
**Height:** 8 1/2 (215.9)  
**O-Ring:** [2] Attached



Measurements Are Shown In Inches And (Millimeters)

**WARNING:** These products can expose you to chemicals, including Diisononyl Phthalate, Carbon black extracts, Nickel, 1,3 Butadiene, Ethylene Oxide, Epichlorohydrin, which are known to the State of California to cause cancer, and Bisphenol, Ethylene Glycol, Ethylene Oxide, 1,3 Butadiene, Epichlorohydrin, which are known to the State of California to cause birth defects or other reproductive harm.

**CV15010**

**Crankcase Breather**



**Fits:** Blue Bird, IC Corporation, New Flyer, Solaris, Thomas Buses; Autocar, Capacity of Texas, Ford, Freightliner, International, Kenworth, Mack Ottawa, Peterbilt, Rainier, RAM, Sterling Medium/Heavy-Duty Trucks; RAM Light-Duty Trucks  
**Replaces:** Chrysler 68002433AA, 68002433AB; Cummins 4936636; Dorman 904418; Dynapac 4812041782; Fleetguard CV52001  
**Length:** 16 3/8 (415.5)  
**Width:** 6 7/8 (174.8)  
**Height:** 2 31/32 (75.4)  
**O-Ring:** [3] Attached

**CV15011**

**Crankcase Breather**



**Fits:** Mitsubishi Trucks; Tadano Cranes  
**Replaces:** Isuzu 8976063180; Mitsubishi ME302763  
**O.D.:** 2 27/32 (71.9)  
**I.D.:** 1 1/16 (26.9)  
**Height:** 3 1/32 (77.0)  
**O-Ring:** [1] Included

**BA16000**

**Air Dryer Filter**



**Contains:** [4] Bolts and Nuts  
 [4] Locking Pins  
**Fits:** Volvo Dump Trucks, Excavators; European FH Serie Trucks  
**Replaces:** EvoBus 4294695; Haldex 78964, 83212, 92528, 93522; Iveco 42535061; Renault 5001826800; Volvo 20424148, 20546795, 20773824  
**O.D.:** 6 (152.4)  
**Height:** 6 3/8 (161.9)  
**O-Ring:** [1] Included

**PE17000**

**Diesel Exhaust Fluid Filter**



**Contains:** Plug and Filter Removal Tool  
**Fits:** Autocar, Blue Bird, DAF, Ford, Foton, Freightliner, Heuliez, Hino, International, Isuzu, Iveco, Kenworth, Mack, Peterbilt, R.V.I., Spartan, Solaris, Volvo, Western Star, and Off-Hwy Equipment using Diesel Exhaust Fluid  
**Replaces:** Bosch 1457436033; Caterpillar 3783187; Cummins 5303604; Daf 2014774; Fendt V837079423; Fiat 47364243; Fleetguard UF101; Isuzu 8981694030; Iveco 47364243; John Deere RE554498; Mack 21516231; New Holland 47364243; Volvo 21516229; Wix W74B191  
**O.D.:** 1 3/4 (44.3)  
**I.D.:** 29/32 (22.9) & 13/16 (20.3)  
**Height:** 3 23/32 (94.6)  
**O-Ring:** [2] Attached

**PE17001**

**Diesel Exhaust Fluid Strainer**



**Fits:** Mack, Nissan UD and Volvo Trucks  
**Replaces:** Mack 82269261; Nissan 5282269261  
**O.D.:** 15/16 (23.8)  
 1 13/16 (46.0)  
**I.D.:** 25/32 (19.8) One End  
**Height:** 7 17/32 (191.3)

**18002**

**Transmission Filter**



**Notes:** Pan gasket contains [14] bolt holes.  
**Fits:** 1992-99 Ford, 1991-95 Lincoln, 1992-95 Mercury Automotive with AOD-E, AODE-W Transmissions (2WD, RWD)  
**Replaces:** Ford F2VY-7A098-A; Wix 51877, 58877  
**Length:** 8 3/4 (222.3)  
**Width:** 7 1/8 (181.0)  
**Height:** 4 27/32 (123)  
**Pan Gasket:** [1] Included

**18003**

**Transmission Filter**



**Notes:** OBSOLETE. Availability Limited to Dealer Stock.  
 Pan gasket contains [13] bolt holes.  
**Fits:** Chrysler, Eagle Automotive with Torque-Flite 42LE (A606) Transmission (FWD, 4 Spd.)  
**Replaces:** Chrysler 4626449  
**Length:** 7 3/16 (182.6)  
**Width:** 6 7/8 (174.6)  
**O-Ring:** [1] Included  
**Pan Gasket:** [1] Included

**18004**

**Transmission Filter**



**Notes:** Pan gasket contains [14] bolt holes.  
**Fits:** Chrysler, Eagle, Mitsubishi Automotive, Vans with Torque-Flite 40TE, 41AE, 41TE, (A604) Transmissions (FWD, 4 Spd. with Overdrive)  
**Replaces:** Chrysler 4505048  
**Length:** 7 3/16 (182.6)  
**Width:** 6 29/32 (175.4)  
**O-Ring:** [1] Included  
**Pan Gasket:** [1] Included

**18007**

**Transmission Filter**



**Contains:** [1] Plastic Neck Seal  
 [1] Information Sheet  
**Fits:** 1991-96 Chevrolet, GMC Light-Duty Trucks, Vans, 1994-99 AM General, 1993-97 Jaguar Automotive with 4L80-E Electronic Transmission (RWD, 4 Spd.)  
**Replaces:** GMC 8684221  
**Length:** 8 17/32 (216.7)  
**Width:** 7 (177.8)

**18009**

**Transmission Filter**



**Notes:** Pan gasket contains [16] bolt holes.  
**Contains:** [2] Plastic Neck Seals  
 [2] Filters  
**Fits:** 2006-11 Buick Lucerne, 1993-2011 Cadillac, 1995-99, 2001-03 Oldsmobile Aurora, 2004-05 Pontiac Bonneville with 4T80-E Electronic Transmission (FWD, 4 Spd.)  
**Replaces:** General Motors Corp. 8684953; Wix 51895, 58895  
**Length:** 9 17/32 (242.1)  
**Width:** 5 1/2 (139.7)  
**Height:** 1 5/8 (41.3)  
**Pan Gasket:** [1] Included

Measurements Are Shown In Inches And (Millimeters)

**WARNING:** These products can expose you to chemicals, including Diisononyl Phthalate, Carbon black extracts, Nickel, 1,3 Butadiene, Ethylene Oxide, Epichlorohydrin, which are known to the State of California to cause cancer, and Bisphenol, Ethylene Glycol, Ethylene Oxide, 1,3 Butadiene, Epichlorohydrin, which are known to the State of California to cause birth defects or other reproductive harm.

**18010** Transmission Filter



**Notes:** Pan gasket contains [16] bolt holes.  
**Contains:** [1] Plastic Neck Seal  
 [1] Information Sheet  
**Fits:** 1994-96, 2004-07 Buick, 1994-2006 Cadillac, 1993-on Chevrolet, 1996-2000, 2003-08 Isuzu, 1993-2004 Oldsmobile, 1993-2002 Pontiac, 2006-09 Saab Automotive; 1993-on GMC Light-Duty Trucks, Vans, with 4L6  
**Replaces:** GMC 24200796  
**Length:** 9 1/2 (241.3)  
**Width:** 7 17/32 (191.3)  
**Height:** 3 3/4 (95.3)  
**Pan Gasket:** [1] Included

**18024** Transmission Filter



**Notes:** Pan gasket contains [18] bolt holes.  
**Contains:** [1] Mounting Bolt  
 [1] Rubber Seal  
**Fits:** 1989-on Ford Automotive, Light-Duty Trucks, 1991-2009 Mazda Light-Duty Trucks, 1998-2001 Mercury Mountaineer with A4LD Transmission (RWD, 4 Spd.)  
**Replaces:** Ford F9TZ-7A098-C; Mazda ZZL2-21-500  
**Length:** 11 1/2 (292.1)  
**Width:** 5 15/32 (138.9)  
**Height:** 1 1/16 (27.0)  
**O-Ring:** [2] Attached  
**Pan Gasket:** [1] Included

**18011** Transmission Filter

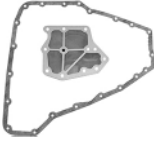

**Notes:** Pan gasket contains [21] bolt holes.  
**Fits:** 1996-99, 2002-04 Infiniti, 1993-2002 Mercury Villager, 1992-2002 Nissan Automotive with 4F20E Transmission (FWD)  
**Replaces:** Nissan 31728-80X03; Wix 58602  
**Length:** 6 7/32 (158.0)  
**Width:** 5 23/32 (145.3)  
**Height:** 1 5/32 (29.4)  
**Pan Gasket:** [1] Included

**18025** Transmission Filter



**Notes:** Pan gasket contains [18] bolt holes.  
**Contains:** [1] Mounting Bolt  
 [1] Rubber Seal  
**Fits:** Ford, Mazda Automotive, Light-Duty Trucks, Vans with A4LD Transmission (4WD, RWD, 4 Spd., Deep Pan)  
**Replaces:** Ford 85GT-7A098-AC; Mazda ZZL2-21-500  
**Length:** 11 1/2 (292.1)  
**Width:** 5 15/32 (138.9)  
**Height:** 2 9/32 (57.9)  
**Pan Gasket:** [1] Included

**18012** Transmission Filter



**Notes:** Pan gasket contains [14] bolt holes.  
**Fits:** 2001-2004 Chevrolet Tracker, 1986-87 Isuzu Light-Duty Trucks, 1995-2002 Kia Sportage, 1989-2005 Suzuki, 1982-86, 1991-97 Toyota Automotive  
**Replaces:** Toyota 35303-30060; Wix 51951, 58951  
**Length:** 5 3/4 (146.0)  
**Width:** 5 23/32 (145.3)  
**Height:** 3/8 (9.5)  
**F. Gskt:** [1] Included  
**Pan Gasket:** [1] Included

**18027** Transmission Filter



**Notes:** Reuse OEM gasket.  
**Contains:** [1] Plastic Neck Seal  
**Fits:** 2000-04 AM General, 2002-06 Cadillac Escalade, 1997-on Chevrolet, GMC Light-Duty Trucks, Vans with 4L80-E Electronic Transmission (RWD, 4 Spd.)  
**Replaces:** GMC 24208847  
**Length:** 8 17/32 (216.7)  
**Width:** 7 1/8 (181.0)  
**Height:** 1 1/8 (28.6)

**18013** Transmission Filter



**Notes:** Pan gasket contains [15] bolt holes.  
**Contains:** Clip for Solenoid Wire  
**Fits:** 1985-88 Chevrolet Spectrum; 1989-93 Geo; 1985-2001 Toyota Automotive with A140E, A140L Transmissions (FWD, 4 Spd.)  
**Replaces:** Toyota 35330-32022; Wix 58994, 51994  
**Length:** 7 5/8 (193.7)  
**Width:** 4 15/32 (113.5)  
**Height:** 21/32 (16.7)  
**Pan Gasket:** [1] Included

**18029** Transmission Filter



**Notes:** Pan gasket contains [14] bolt holes.  
**Fits:** 1994-on Ford, 1996-2011 Lincoln, Mercury Automotive with AOD-E Transmission (4WD, RWD)  
**Replaces:** Ford F4TZ-7A098-A, F6AZ-7A098-A  
**Length:** 9 9/16 (242.9)  
**Width:** 7 1/8 (181.0)  
**Height:** 2 3/4 (69.9)  
**Grommets:** [1] Attached  
**Pan Gasket:** [1] Included

**18022** Transmission Filter



**Notes:** Can only be used with 2 1/4 In. deep pan.  
**Contains:** [1] Plastic Neck Seal  
 Instruction Sheet  
**Fits:** 1991-2011 Buick, Chevrolet, 1991-95 Cadillac, 1991-2004 Oldsmobile, 1992-2009 Pontiac, 2005-09 Saturn Automotive with 4T60-E Electronic Transmissions (FWD, 4 Spd.)  
**Replaces:** GMC 24206433  
**Length:** 10 19/32 (269.1)  
**Width:** 6 13/16 (173.0)  
**Height:** 2 5/32 (54.8)  
**Related To:** 20014 (with Pan Gasket)

**18031** Transmission Filter



**Notes:** Pan gasket contains [13] bolt holes.  
**Fits:** 1975-83 Buick, Oldsmobile, Pontiac, 1980 Cadillac, 1976-83 Chevrolet Automotive, 1977-80, 1983 GMC Light-Duty Trucks with THM350, THM350C, THM375B Transmissions (RWD, 3 Spd., Buick Built)  
**Replaces:** GMC 8641910; WIX 51894, 58894  
**Length:** 7 15/32 (189.7)  
**Width:** 7 (177.8)  
**F. Gskt:** [1] Included  
**Pan Gasket:** [1] Included

Measurements Are Shown In Inches And (Millimeters)

**WARNING:** These products can expose you to chemicals, including Diisononyl Phthalate, Carbon black extracts, Nickel, 1,3 Butadiene, Ethylene Oxide, Epichlorohydrin, which are known to the State of California to cause cancer, and Bisphenol, Ethylene Glycol, Ethylene Oxide, 1,3 Butadiene, Epichlorohydrin, which are known to the State of California to cause birth defects or other reproductive harm.

**18032** Transmission Filter

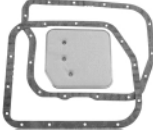

**Notes:** Both pan gaskets contain [14] bolt holes.  
**Fits:** AMC, Chrysler, Mitsubishi Automotive, Light-Duty Trucks, Vans, International Light-Duty Trucks, Jeep with Torque-Flite "6" (904), "6" (999), "8" (727) Transmissions (RWD)  
**Replaces:** Chrysler 3515966, 3515996; International 732931-C2; Jeep J8123042  
**Length:** 7 3/32 (180.2)  
**Width:** 6 5/8 (168.3)  
**Pan Gasket:** [2] Included

**18104** Transmission Filter



**Notes:** Can only be used with 2 1/4 In. deep pan.  
 Pan gasket contains [14] bolt holes.  
**Fits:** Chrysler Automotive, Vans with Torque-Flite 30TH A404 Transmissions (FWD, 3 Spd., Deep Pan)  
**Replaces:** Chrysler 4269649  
**Length:** 7 3/16 (182.6)  
**Width:** 6 1/16 (154.0)  
**Height:** 11/16 (17.5)  
**F. Gskt:** [1] Included  
**Pan Gasket:** [1] Included

**18033** Transmission Filter



**Notes:** [1] Pan gasket contains [17] bolt holes.  
 [1] Pan gasket contains [19] bolt holes.  
**Contains:** Mounting Bracket  
**Fits:** Ford Automotive with AX4N, AX4S Transmissions (FWD, 4 Spd., Deep Pan)  
**Replaces:** Ford F5DZ-7A098-A  
**Length:** 7 13/32 (188.1)  
**Width:** 7 1/16 (179.4)  
**Height:** 2 7/32 (56.4)  
**Pan Gasket:** [2] Included

**18139** Transmission Filter



**Notes:** Pan gasket contains [19] bolt holes.  
**Contains:** Plastic Neck Seal  
**Fits:** 1984-94 Buick, Oldsmobile, 1985-92 Cadillac, 1984-93 Chevrolet, 1985-91 Pontiac Automotive; 1983 GMC Light-Duty Trucks with 4T60-E (THM440) Transmission (FWD), 4 Spd.  
**Replaces:** General Motors Corp. 8682471; Wix 51942, 551942, 58942  
**Length:** 10 19/32 (269.1)  
**Width:** 6 13/16 (173.0)  
**Height:** 2 1/8 (54)  
**Pan Gasket:** [1] Included

**18034** Transmission Filter



**Notes:** Pan gasket contains [19] bolt holes.  
**Fits:** Ford, Mercury Automotive, Vans with AX4S, AX4N Transmissions (Shallow Pan)  
**Replaces:** Ford F6DZ-7A098-A  
**Length:** 7 13/32 (188.1)  
**Width:** 7 1/16 (179.4)  
**Pan Gasket:** [1] Included

**18155** Transmission Filter



**Notes:** Pan gasket contains [16] bolt holes.  
**Fits:** 1987-91 Avanti II; 1986-93 Buick, 1991-93 Cadillac, 1982-95 Chevrolet, 1988-93 Oldsmobile, 1983-93 Pontiac Automotive, 1982-93 GMC Light-Duty Trucks with 4L60 (THM700-R4) Transmission (RWD, 4 Spd. with Overdrive)  
**Replaces:** GMC 25011237  
**Length:** 8 1/16 (204.8)  
**Width:** 7 7/8 (200.0)  
**Height:** 4 1/4 (108.0)  
**Pan Gasket:** [1] Included

**18055** Transmission Filter



**Notes:** Both pan gaskets contain [14] bolt holes.  
**Fits:** Dodge Automotive, Light-Duty Trucks, Vans, Jeep Light-Duty Trucks with 42RE, 46RE, 47RE Transmissions  
**Replaces:** Chrysler 52118789  
**Length:** 7 3/16 (182.6)  
**Width:** 7 1/8 (181.0)  
**Height:** 31/32 (24.6)  
**Pan Gasket:** [2] Included

**18163** Transmission Filter



**Notes:** Pan gasket contains [15] bolt holes.  
**Fits:** 1985-88 Chevrolet Nova, 1999-2002 Chevrolet Prizm, 1989-97 Geo Prizm, 1983-2002 Toyota Automotive with A130L, A131L, A132L Transmissions (FWD, 3 Spd.)  
**Replaces:** Toyota 35330-20010; Wix 51960, 58960  
**Length:** 8 1/8 (206.4)  
**Width:** 4 1/2 (114.3)  
**Height:** 3/4 (19)  
**Pan Gasket:** [1] Included

**18056** Transmission Filter



**Notes:** Pan gasket contains [16] bolt holes.  
**Contains:** [1] Plastic Neck Seal  
**Fits:** 2004-07 Buick Rainier, 1999-2006 Cadillac Escalade, 1998-on Chevrolet, GMC Light-Duty Trucks, Vans, 2003-07 Hummer H2, 1998-2008 Isuzu, 1993-2004 Oldsmobile Bravada, 2004-06 Pontiac GTO, 2005-09 Saab  
**Replaces:** GMC 24208576  
**Length:** 9 7/16 (239.7)  
**Width:** 7 17/32 (191.3)  
**Height:** 4 23/32 (119.9)  
**Pan Gasket:** [1] Included

**18171** Transmission Filter



**Notes:** Pan gasket contains [17] bolt holes.  
**Contains:** [1] Metal Mounting Bracket  
**Fits:** Ford Automotive, Vans with AXOD, AX4N Transmissions (FWD, 4 Spd.)  
**Replaces:** Ford E6DZ-7A098-A  
**Length:** 7 11/32 (186.5)  
**Width:** 7 1/16 (179.4)  
**Height:** 2 11/16 (68.3)  
**Pan Gasket:** [1] Included

**18057** Transmission Filter



**Notes:** Pan gasket contains [12] bolt holes.  
**Contains:** [1] Plastic Neck Seal  
**Fits:** GMC, Saturn Automotive with 4T40E Transmission  
**Replaces:** GMC 8685185, 24203770  
**Length:** 13 3/8 (339.7)  
**Width:** 8 1/16 (204.8)  
**Height:** 1 25/32 (45.2)  
**Pan Gasket:** [1] Included

Measurements Are Shown In Inches And (Millimeters)

**WARNING:** These products can expose you to chemicals, including Diisononyl Phthalate, Carbon black extracts, Nickel, 1,3 Butadiene, Ethylene Oxide, Epichlorohydrin, which are known to the State of California to cause cancer, and Bisphenol, Ethylene Glycol, Ethylene Oxide, 1,3 Butadiene, Epichlorohydrin, which are known to the State of California to cause birth defects or other reproductive harm.

18198

Transmission Filter



**Notes:** Pan gasket contains [14] bolt holes.  
**Fits:** Ford Light-Duty Trucks, Vans with AOD, AOT Transmissions (4WD, RWD, 4 Spd.)  
**Replaces:** Ford E5TZ-7A098-C  
**Length:** 8 31/32 (227.8)  
**Width:** 6 15/16 (176.2)  
**Height:** 2 5/32 (54.8)  
**F. Gskt:** [1] Included  
**Pan Gasket:** [1] Included

18236

Transmission Filter



**Notes:** Pan gasket contains [21] bolt holes.  
**Fits:** Allison AT540 Series Transmissions (RWD)  
**Replaces:** GMC 6884270  
**Length:** 11 3/4 (298.5)  
**Width:** 6 1/2 (165.1)  
**O-Ring:** [1] Included  
**O. Gskt:** G1973  
**Pan Gasket:** G1972  
**Related To:** 19992 (Different Media)

18245

Transmission Filter



**Notes:** Pan gasket contains [19] bolt holes.  
**Fits:** Jeep with AW4 Transmission (RWD)  
**Replaces:** Chrysler 83504032  
**Length:** 9 11/16 (246.1)  
**Width:** 5 1/8 (130.2)  
**Height:** 25/32 (19.8)  
**Pan Gasket:** [1] Included

18264

Transmission Filter



**Notes:** Pan gasket contains [20] bolt holes.  
**Fits:** Ford Automotive, Light-Duty Trucks, Vans with E40D, 4R100 Transmissions (2WD, RWD, Shallow Pan)  
**Replaces:** Ford YC3Z-7A098-AA  
**Length:** 11 1/2 (292.1)  
**Width:** 6 29/32 (175.4)  
**Height:** 4 3/16 (106.4)  
**Pan Gasket:** [1] Included

18265

Transmission Filter



**Notes:** Pan gasket contains [20] bolt holes.  
**Contains:** [1] Rubber Neck Seal  
**Fits:** Ford Automotive, Light-Duty Trucks, Vans with E40D, 4R100 Transmissions (4WD, RWD, Deep Pan)  
**Replaces:** Ford YC3Z-7A098-BA  
**Length:** 11 15/32 (291.3)  
**Width:** 6 29/32 (175.4)  
**Height:** 4 3/16 (106.4)  
**Pan Gasket:** [1] Included

18267

Transmission Filter



**Notes:** Pan gasket contains [20] bolt holes.  
**Fits:** Ford, Mazda Automotive with 4F27E, J39A Transmissions (FWD, 4 Spd. with Overdrive)  
**Replaces:** Ford XS4Z-7A098-AB; Mazda FN01-21-500  
**Length:** 7 (177.8)  
**Width:** 4 29/32 (124.6)  
**Height:** 2 1/16 (52.4)  
**Pan Gasket:** [1] Included

18268

Transmission Filter



**Notes:** Pan gasket contains [19] bolt holes.  
**Fits:** 1991-2003 Ford Escort, 1991-99 Mercury Tracer with 4EAT-F Transmission (FWD, 4 Spd.); 1994-2001 Kia Sephia, 1991-98 Mazda 323, MX3, Protege with F4A-EL Transmission (FWD, 4 Spd.)  
**Replaces:** Ford F1CZ-7A098-A; Mazda FU61-21-500B; Wix 58995, 51995  
**Length:** 5 9/32 (134.1)  
**Width:** 5 1/32 (127.8)  
**Height:** 1 15/16 (49.2)  
**O-Ring:** [1] Included  
**Pan Gasket:** [1] Included

19593

Transmission Filter



**Notes:** Pan gasket contains [16] bolt holes.  
**Contains:** [1] Plastic Neck Seal  
**Fits:** 1980-96 Buick, Oldsmobile, 1982-88 Cadillac, 1980-2001 Chevrolet, Pontiac Automotive with 3T40 (TH125C) Transmissions (FWD, 3 Spd.)  
**Replaces:** GMC 8634223  
**Length:** 11 3/8 (288.9)  
**Width:** 5 13/16 (147.6)  
**Height:** 1 7/8 (47.6)  
**Pan Gasket:** [1] Included

19640

Transmission Filter



**Notes:** Pan gasket contains [14] bolt holes.  
**Fits:** Ford Automotive, Light-Duty Trucks, Vans with AOD, AOT Transmissions (2WD, RWD, 4 Spd.)  
**Replaces:** Ford E1AZ-7A098-A; WIX 51939, 58939  
**Length:** 8 15/16 (227.0)  
**Width:** 6 7/8 (174.6)  
**Height:** 13/16 (20.6)  
**F. Gskt:** [1] Included  
**Pan Gasket:** [1] Included

19739

Transmission Filter

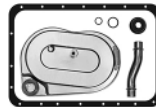

**Notes:** Pan gasket contains [21] bolt holes.  
**Contains:** [1] 7 Inch Outlet Tube  
**Fits:** Allison MT640, MT650 Series Transmissions (RWD, Deep Pan)  
**Replaces:** Allison 29502302; GMC 6834831  
**Length:** 12 5/8 (320.7)  
**Width:** 8 19/32 (218.3)  
**Height:** 1 1/4 (31.8)  
**O-Ring:** [2] Included  
**O. Gskt:** G1973 (Fiber Gasket)  
**Grommets:** [1] Attached  
**Pan Gasket:** G1972  
**Related To:** 19992 (Shallow Pan)

19828

Transmission Filter



**Notes:** Pan gasket contains [17] bolt holes.  
**Contains:** [1] Filter-to-Valve Metal Body Gasket  
**Fits:** Ford Automotive, Light-Duty Trucks, Vans with C-6 Transmission (Late, 2WD, RWD, Shallow Pan, Aluminum Case)  
**Replaces:** Ford D5AZ-7A098-BA  
**Length:** 9 3/16 (233.4)  
**Width:** 6 13/16 (173.0)  
**F. Gskt:** [1] Included  
**Pan Gasket:** [1] Included

Measurements Are Shown In Inches And (Millimeters)

**WARNING:** These products can expose you to chemicals, including Diisononyl Phthalate, Carbon black extracts, Nickel, 1,3 Butadiene, Ethylene Oxide, Epichlorohydrin, which are known to the State of California to cause cancer, and Bisphenol, Ethylene Glycol, Ethylene Oxide, 1,3 Butadiene, Epichlorohydrin, which are known to the State of California to cause birth defects or other reproductive harm.

**19992** Transmission Filter

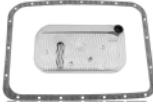

**Notes:** Pan gasket contains [21] bolt holes.  
**Fits:** Allison AT540 Series Transmissions (RWD, Mesh Screen, Shallow Pan)  
**Replaces:** Allison 29503617; GMC 6837428  
**Length:** 11 3/4 (298.5)  
**Width:** 6 1/2 (165.1)  
**O-Ring:** [1] Included  
**Pan Gasket:** G1972  
**Related To:** 18236 (Different Media) 19739 (Deep Pan)

**19996** Transmission Filter



**Notes:** Pan gasket contains [19] bolt holes.  
**Fits:** Lexus, Toyota Automotive, Light-Duty Trucks all with A343F Transmission  
**Replaces:** Toyota 35330-60030  
**Length:** 12 (304.8)  
**Width:** 5 5/16 (134.9)  
**Height:** 2 3/32 (53.2)  
**Pan Gasket:** [1] Included

**19999** Transmission Filter Kit



**Notes:** Pan gasket contains [15] bolt holes.  
**Contains:** [1] Transmission Filter [1] Spin-on  
 Spin-on has Anti-Drainback Valve  
**Fits:** 2007 Chrysler 300C SRT8, 2007-09 Aspen, 2000-11 Dodge Dakota, 2000-09 Durango, 2002-10 Jeep Grand Cherokee, Liberty, 2004 TJ, Wrangler, 2007 Mitsubishi Ranger with 45RFE, 55RFE Transmissions (2WD, RWD, Multi-Spd. with Overdrive)  
**Replaces:** Chrysler 4799662, 4800029AA  
**Spin-on**  
**Thread:** M20 x 1.5  
**O.D.:** 2 11/16 (68.3)  
**Height:** 4 (101.6)  
**I.Gskt:** [1] Included  
**Pan Gasket:** [1] Included  
**Pan-Type**  
**O.D. Length:** 11 11/16 (296.9)  
**I.D. Width:** 6 3/32 (154.8)  
**Height:** 4 7/32 (107.2)  
**O-Ring** [1] Grommet, [1] Pan Gasket

**20000** Transmission Filter Kit



**Notes:** Pan gasket contains [15] bolt holes.  
**Contains:** [1] Transmission Filter [1] Spin-on  
 Spin-on has Anti-Drainback Valve  
**Fits:** 2007 Chrysler 300C SRT8, 2007-09 Aspen, 2000-11 Dodge Dakota, 2000-09 Durango, 2001-10 Jeep Grand Cherokee, 2002-07 Liberty, 2004 TJ, Wrangler, 2006-07 Mitsubishi Raider with 45RFE, 55RFE Transmission  
**Replaces:** Chrysler 4799507, 4799662  
**Spin-on**  
**Thread:** M20 x 1.5  
**O.D.:** 2 11/16 (68.3)  
**Height:** 4 5/8 (117.5)  
**I.Gskt:** [1] Included  
**Pan Gasket:** [1] Included  
**Pan-Type**  
**O.D. Width:** 5 19/32 (142.1)  
**I.D. Length:** 11 11/16 (296.9)  
**Height:** 4 5/8 (117.5)  
**O-Ring** [1] Grommet, [1] Pan Gasket

**20002** Transmission Filter



**Fits:** Ford, Lincoln, Mercury Light-Duty Trucks all with 5R55W Transmission  
**Replaces:** Motorcraft FT140  
**Length:** 13 13/32 (340.5)  
**Width:** 6 21/32 (169.1)  
**Height:** 3 7/16 (87.3)

**20003** Transmission Filter

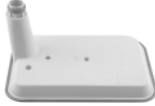

**Fits:** 2002-06 Chevrolet Avalanche, 2001-11 Silverado, GMC Sierra Series Light-Duty Trucks, 2001-06 Chevrolet Suburban, GMC Yukon, 2001, 2003 Chevrolet Tahoe, 2006 Hummer H1 with LCT 1000, 2000, 2400 Series  
**Replaces:** Allison 29537966  
**Length:** 9 7/16 (239.7)  
**Width:** 6 13/32 (162.7)  
**Height:** 5 1/8 (130.2)  
**Related To:** 20017 (with Pan Gasket)

**20004** Transmission Filter



**Fits:** 2002-06 Chevrolet Avalanche, 2001-11 Silverado, GMC Sierra Series Light-Duty Trucks, 2001-06 Chevrolet Suburban, GMC Yukon, 2001, 2003 Chevrolet Tahoe, 2006 Hummer H1 with LCT 1000, 2000, 2400 Series  
**Replaces:** Allison 29537965  
**Length:** 9 7/16 (239.7)  
**Width:** 6 13/32 (162.7)  
**Height:** 4 21/32 (118.3)  
**Related To:** 20016 (with Pan Gasket)

**20005** Transmission Filter



**Contains:** [1] Plastic Neck Seal  
**Fits:** Ford E Series Vans, F Series Super Duty Pickups  
**Replaces:** Ford 3C3P-7G186-AF, 3C3Z-7A098-AA; Motorcraft FT144  
**Length:** 11 7/16 (290.5)  
**Width:** 4 1/16 (103.2)  
**Height:** 6 3/32 (154.8)

**20006** Transmission Filter



**Contains:** [2] Rubber Neck Seals  
**Fits:** 2003-08 Ford Explorer, 2007 Explorer Sport Trac, 2004-05 Thunderbird, 2005-on Mustang, 2003-06 Lincoln LS, 2002-05 Mercury Mountaineer  
**Replaces:** Ford 3W4Z-7A098-AB; Motorcraft FT142; Wix 58844  
**Length:** 13 13/32 (340.5)  
**Width:** 6 21/32 (169.1)  
**Height:** 1 9/32 (32.5)

**20007** Transmission Filter



**Contains:** [2] Rubber Neck Seals  
**Fits:** 2002, 2004 Ford Thunderbird; 2003-04, 2006-08 Jaguar X-Type; 2000-02 Lincoln LS  
**Replaces:** Ford XW4Z-7A098-BB; Motorcraft FT117  
**Length:** 13 1/4 (336.5)  
**Width:** 6 1/8 (155.6)  
**Height:** 2 (50.8)

Measurements Are Shown In Inches And (Millimeters)

**WARNING:** These products can expose you to chemicals, including Diisononyl Phthalate, Carbon black extracts, Nickel, 1,3 Butadiene, Ethylene Oxide, Epichlorohydrin, which are known to the State of California to cause cancer, and Bisphenol, Ethylene Glycol, Ethylene Oxide, 1,3 Butadiene, Epichlorohydrin, which are known to the State of California to cause birth defects or other reproductive harm.

**20008** Transmission Filter  
**Notes:** Pan gasket contains [18] bolt holes.  
**Fits:** Lexus, Toyota Automotive  
**Replaces:** Toyota 35330-08010  
**Length:** 7 3/32 (180.2)  
**Width:** 6 19/32 (167.5)  
**Height:** 1 3/16 (30.2)  
**O-Ring:** [1] Included  
**Pan Gasket:** [1] Included



**20015** Transmission Filter  
**Notes:** Pan gasket contains [18] bolt holes.  
**Fits:** Lexus, Scion, Toyota Automotive, Light-Duty Trucks  
**Replaces:** Toyota 35330-06010; 35330-0W010  
**Length:** 7 19/32 (192.9)  
**Width:** 7 1/32 (178.6)  
**Height:** 1 5/8 (41.3)  
**O-Ring:** [1] Included  
**Pan Gasket:** [1] Included



**20010** Transmission Filter  
**Notes:** Pan gasket contains [13] bolt holes.  
**Fits:** Hyundai Elantra, Accent  
**Replaces:** Hyundai 46321-22731  
**Length:** 7 1/16 (179.4)  
**Width:** 6 15/16 (176.2)  
**Height:** 21/32 (16.7)  
**Pan Gasket:** [1] Included



**20016** Transmission Filter  
**Notes:** Pan gasket contains [12] bolt holes.  
**Contains:** Rubber Neck Seal  
**Fits:** 2002-06 Chevrolet Avalanche, 2001-on Silverado, GMC Sierra Light-Duty Trucks; 2001-06 Chevrolet Suburban, GMC Yukon; 2006 Hummer H1 with 2400 Series Transmissions (Shallow Pan)  
**Replaces:** Allison 29537965; General Motors 29537965  
**Length:** 9 7/16 (239.7)  
**Width:** 6 13/32 (162.7)  
**Height:** 4 21/32 (118.3)  
**Pan Gasket:** [1] Included  
**Related To:** 20004 (without Pan Gasket)



**20011** Transmission Filter  
**Notes:** Pan gasket contains [13] bolt holes.  
**Fits:** 2005 Chrysler 300C, 2005-10 300; 2004-11 Dodge Dakota, 2003-10 Jeep Liberty, 2004-06 TJ, 2004-09 Wrangler; 2011-on Dodge Pickups, 2006-10 Charger, 2006-09 Durango; 2006-on Mitsubishi Raider  
**Replaces:** Chrysler 52852913AB  
**Length:** 7 1/4 (184.2)  
**Width:** 6 7/8 (174.6)  
**Height:** 1 7/16 (36.5)  
**O-Ring:** [1] Included  
**Pan Gasket:** [1] Included



**20017** Transmission Filter  
**Notes:** Pan gasket contains [12] bolt holes.  
**Contains:** Rubber Neck Seal  
**Fits:** 2002-06 Chevrolet Avalanche, 2001-on Silverado, GMC Sierra Light-Duty Trucks; 2001-06 Chevrolet Suburban, GMC Yukon; 2006 Hummer H1 with 2400 Series Transmissions (Deep Pan)  
**Replaces:** Allison 29537966; General Motors 29537966  
**Length:** 9 7/16 (239.7)  
**Width:** 6 13/32 (162.7)  
**Height:** 4 29/32 (124.6)  
**Pan Gasket:** [1] Included  
**Related To:** 20003 (without Pan Gasket)



**20012** Transmission Filter  
**Notes:** Pan gasket contains [20] bolt holes.  
**Fits:** 1998-2001 Mitsubishi Montero, 1999-2002 Montero Sport with V5A517 Transmission (FWD, 5 Spd.)  
**Replaces:** Mitsubishi MR357710  
**Length:** 10 7/8 (276.2)  
**Width:** 5 15/16 (150.8)  
**Height:** 1 3/4 (44.4)  
**Pan Gasket:** [1] Included



**20018** Transmission Filter  
**Notes:** Pan gasket contains [21] bolt holes.  
**Contains:** Rubber Neck Seal  
**Fits:** 2006-07 Ford Explorer, 2009-on Explorer Sport Trac; 2006-on Mercury Mountaineer  
**Replaces:** Ford 6L2Z-7A098-AA; Motorcraft FT160  
**Length:** 9 1/8 (231.8)  
**Width:** 7 11/16 (195.3)  
**Height:** 3 5/8 (92.1)  
**Pan Gasket:** [1] Included



**20013** Transmission Filter  
**Notes:** Pan gasket contains [20] bolt holes.  
**Fits:** 2000-04, 2006 Mitsubishi Montero, 2003-04 Montero Sport with AW30-40LE Transmission (RWD, 4 Spd.)  
**Replaces:** Mitsubishi MR528836  
**Length:** 11 19/32 (294.5)  
**Width:** 5 15/16 (150.8)  
**Height:** 1 3/4 (44.4)  
**Pan Gasket:** [1] Included



**20014** Transmission Filter  
**Notes:** Pan gasket contains [20] bolt holes.  
**CAUTION:** Can only be used with 2 1/4 In. pan.  
**Fits:** 1991-2011 Buick, Chevrolet, 1991-95 Cadillac, 1991-2004 Oldsmobile, 1992-09 Pontiac, 2005-09 Saturn Automotive with 4T60-E Electronic Transmissions (FWD, 4 Spd.)  
**Replaces:** Wix 58837  
**Length:** 10 19/32 (269.1)  
**Width:** 6 13/16 (173.0)  
**Height:** 2 5/32 (54.8)  
**Pan Gasket:** [1] Included  
**Related To:** 18022 (without Pan Gasket)



**20019** Transmission Filter  
**Notes:** Pan gasket contains [21] bolt holes.  
**Contains:** Rubber Neck Seal  
**Fits:** 2008-on Ford Expedition, Expedition EL, 2008 Explorer, Mercury Mountaineer  
**Replaces:** Ford 7L1Z-7A098-A; Motorcraft FT171; Wix 58099  
**Length:** 9 7/8 (250.8)  
**Width:** 9 1/16 (230.2)  
**Height:** 3 3/4 (95.3)  
**Pan Gasket:** [1] Included

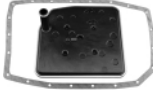

Measurements Are Shown In Inches And (Millimeters)

**WARNING:** These products can expose you to chemicals, including Diisononyl Phthalate, Carbon black extracts, Nickel, 1,3 Butadiene, Ethylene Oxide, Epichlorohydrin, which are known to the State of California to cause cancer, and Bisphenol, Ethylene Glycol, Ethylene Oxide, 1,3 Butadiene, Epichlorohydrin, which are known to the State of California to cause birth defects or other reproductive harm.

**20020** Transmission Filter



**Notes:** Pan gasket contains [16] bolt holes.  
**Contains:** Plastic Neck Seal  
**Fits:** 2004-12 Chevrolet Colorado, GMC Canyon, 2009 GMC Envoy, Envoy Denali; 2006-10 Hummer H3, H3 SUT; 2006-08 Isuzu 8-24225-323-6  
**Replaces:** General Motors 24225323; Isuzu 8-24225-323-6  
**Length:** 9 7/16 (239.7)  
**Width:** 6 3/8 (161.9)  
**Height:** 4 23/32 (119.9)  
**Pan Gasket:** [1] Included

**20021** Transmission Filter



**Contains:** [1] Rubber Neck Seal  
**Fits:** Blue Bird Micro Bird Buses, Collins Buses, Ford F53 Motorhome Chassis, Light-Duty Trucks and Vans, IHC City Star CF500, CF600 Trucks all with 5R110W-HI/Torque Transmission  
**Replaces:** Ford 8C3Z-7A098-D; Motorcraft FT180  
**Length:** 11 17/32 (292.9)  
**Width:** 4 11/32 (110.3)  
**Height:** 6 1/4 (158.8)  
**A. Gskt:** [1] Attached

**20022** Transmission Filter



**Notes:** Pan gasket contains [18] bolt holes.  
**Contains:** [1] Metal Neck Seal  
**Fits:** Cadillac; Chevrolet Light-Duty Trucks; GMC Sierra Series Light-Duty Trucks  
**Length:** 8 3/4 (222.3)  
**Width:** 6 1/2 (165.1)  
**Height:** 6 5/16 (160.3)  
**Pan Gasket:** [1] Included

**20023** Transmission Filter



**Notes:** Pan gasket contains [20] bolt holes.  
**Fits:** Lexus, Toyota Light-Duty Trucks  
**Replaces:** Toyota 35330-60050  
**Length:** 10 3/16 (258.8)  
**Width:** 6 3/16 (157.2)  
**Height:** 2 3/32 (53.2)  
**Pan Gasket:** [1] Included

**20024** Transmission Filter



**Notes:** Pan gasket contains [12] bolt holes.  
**Contains:** [1] Metal Neck Seal  
**Replaces:** Chrysler 5078555AA  
**Length:** 7 3/32 (180.2)  
**Width:** 6 3/16 (157.2)  
**Height:** 3 31/32 (100.8)  
**Pan Gasket:** [1] Included

**20025** Transmission Filter



**Fits:** 2008-10 Dodge Light-Duty Trucks; 2011-14 Ram Light-Duty Trucks, 4500HD, 5500HD Chassis Cab; 2008 Sterling Bullet all with 6-408 (6.7L ) FI Turbo Diesel Engine with 6 Speed 68 RFE Transmission  
**Replaces:** Chrysler 68019688AA  
**Length:** 9 9/16 (242.9)  
**Width:** 7 3/4 (196.9)  
**Height:** 2 23/32 (69.1)  
**Grommets:** [1] Attached

**20026** Transmission Filter



**Notes:** Pan gasket contains [20] bolt holes.  
**Fits:** 2007-12 Dodge Caliber, 2007-17 Jeep Compass, Patriot  
**Replaces:** Chrysler 5191890AA  
**Length:** 5 3/32 (129)  
**Width:** 4 11/32 (110)  
**Height:** 1 15/16 (49)  
**O-Ring:** [1] Attached  
**Pan Gasket:** [1] Included

**20027** Transmission Filter



**Notes:** Pan gasket contains [12] holes.  
**Contains:** [1] Metal Neck Seal  
**Fits:** 2011-17 Chrysler 200, 2013-17 300, 2007-08 & 2017 Pacifica, 2007-18 Sebring, 2008-16 Town & Country, 2011-2014 Dodge, 2013 Durango, 2008-19 Grand Caravan, 2009-18 Journey, 2012-15 RAM C/V Cargo Van, 2014-18, ProMaster 1500, ProMaster 2500, ProMaster 3500  
**Replaces:** Chrysler 68018555AA  
**Length:** 7 3/32 (180)  
**Width:** 6 3/16 (157)  
**Height:** 3 1/4 (82)  
**Pan Gasket:** [1] Included

**20028** Transmission Filter



**Notes:** Pan fasket contains [19] bolt holes.  
**Fits:** 2016-19 Ford E-350 Super Duty Vans, 2017-19 E-450 Super Duty Vans., 2011-19 F-250 Super Duty Pickups, 2011-19 F-350 Super Duty Pickups, 2011-19 F-450 Super Duty Trucks, 2011-19 F-550 Super Duty Trucks, 2012-19 F650 Trucks, 2016-19 F750 Trucks, 2017-19 F53  
**Replaces:** Ford Motor Corp. BC3Z7A098B, BC3P7G186BE; Motorcraft FT187  
**Length:** 11 1/16 (281)  
**Width:** 9 15/32 (240)  
**Height:** 2 1/4 (57)  
**O-Ring:** [1] Attached  
**Pan Gasket:** [1] Included

**20029** Transmission Filter



**Notes:** Pan gasket contains [21] bolt holes  
**Contains:** [1] Rubber Neck Seal  
**Fits:** 2012-18 Ford Expedition, 2011-19 F-150 Pickup, 2017-19 F-250 Super Duty Pickup, 2013 Ford Lobo, 2011-19 Mustang; 2015-18 Lincoln Navigator; 2015-17 Mobility Ventures MV-1; 2019 Ford F-450 Super Duty Pickup; 2019 Ford F-550 Super Duty Pickup  
**Replaces:** Ford Motor Co. BL3Z7A098A; Motorcraft FT188  
**Length:** 9 27/32 (249.9)  
**Width:** 9 3/32 (230.9)  
**Height:** 4 29/32 (125)  
**Pan Gasket:** [1] Included

**20030** Transmission Filter



**Notes:** Pan gasket contains [12] bolt holes.  
**Contains:** [1] Rubber Neck Seal  
**Fits:** 2013 Chevrolet Silverado 2500 HD, Silverado 3500 HD; 2013 GMC Sierra 2500 HD, Sierra 3500 HD  
**Replaces:** General Motors Corp. 29542824  
**Length:** 10 5/32 (258.1)  
**Width:** 7 3/32 (180.1)  
**Height:** 4 31/32 (126)  
**Pan Gasket:** [1] Included

Measurements Are Shown In Inches And (Millimeters)

**WARNING:** These products can expose you to chemicals, including Diisononyl Phthalate, Carbon black extracts, Nickel, 1,3 Butadiene, Ethylene Oxide, Epichlorohydrin, which are known to the State of California to cause cancer, and Bisphenol, Ethylene Glycol, Ethylene Oxide, 1,3 Butadiene, Epichlorohydrin, which are known to the State of California to cause birth defects or other reproductive harm.



**20031** Magnetic In-Line Universal Transmission Filter  
**Contains:** [2] Hoses  
 [4] Clamps  
**Replaces:** WIX 51964, 58964  
**O.D.:** 2 5/32 (54.8)  
**Inlet:** 5/16  
**Outlet:** 5/16  
**Length:** 4 15/32 (113.5)



**20033** Transmission Filter  
**Notes:** Pan gasket contains [18] bolt holes.  
**Contains:** Plastic Neck Seal  
**Fits:** 2007 BMW X3, X5, 2008 X6, all with L6 (3.0L) Engine  
**Replaces:** BMW (Bavarian Motor Works) 24236595  
**Length:** 8 3/4 (222.3)  
**Width:** 7 1/2 (190.5)  
**Height:** 5 1/8 (130.2)  
**Pan Gasket:** [1] Included



**20035** Transmission Filter  
**Notes:** Pan gasket contains [17] bolt holes.  
**Fits:** 1990-93 Lexus, 1988-93, 1996-2000 Toyota Automotive with A540E, A540H Transmissions (FWD)  
**Replaces:** Toyota 35330-32030; Wix 51888, 58888  
**Length:** 8 (203.2)  
**Width:** 5 1/32 (127.8)  
**Height:** 11/16 (17.5)  
**Pan Gasket:** [1] Included



**20037** Transmission Filter  
**Notes:** Pan gasket contains [21] bolt holes.  
**Fits:** 1991-96, 1999-2002 Infiniti G20, 1991-on Nissan Automotive with RL4F03A Transmission (4 Spd.)  
**Replaces:** Nissan 31728-31X01; Wix 51996, 58996  
**Length:** 6 1/4 (158.8)  
**Width:** 5 3/4 (146.0)  
**Height:** 3/8 (9.5)  
**Pan Gasket:** [1] Included



**20041** Transmission Filter  
**Notes:** Both pan gaskets contain [16] bolt holes.  
**Fits:** 1991-2000 BMW Automotive with 4L30-E Transmission (4 Spd.)  
**Replaces:** BMW (Bavarian Motor Works) 24111218899; Wix 51983, 58983  
**Length:** 9 5/8 (244.5)  
**Width:** 6 1/16 (154.0)  
**Height:** 1 3/4 (44.4)  
**Pan Gasket:** [2] Included



**20042** Transmission Filter  
**Notes:** Pan gasket contains [18] bolt holes.  
**Fits:** 1998-2002 Chevrolet Prizm, 1993-97 Geo Prizm, 1985-2002 Toyota Automotive with A245E Transmission (4 Spd.)  
**Replaces:** General Motors Corp. 94853372; Toyota 35330-12030; Wix 58605  
**Length:** 7 5/8 (193.7)  
**Width:** 5 (127.0)  
**Height:** 29/32 (23)  
**Pan Gasket:** [1] Included

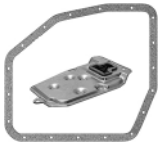

**20043** Transmission Filter  
**Notes:** Pan gasket contains [17] bolt holes.  
**Fits:** 1994-2001 Lexus, 1994-2004 Toyota Avalon, 2001-04 Camry, 1999-2001 Solara with A541E Transmission  
**Replaces:** Toyota 35330-33010; Wix 58614  
**Length:** 8 (203.2)  
**Width:** 5 1/32 (127.8)  
**Height:** 23/32 (18.3)  
**Pan Gasket:** [1] Included

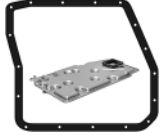

**20044** Transmission Filter  
**Notes:** Pan gasket contains [20] bolt holes.  
**Fits:** 1996-97 Lexus, 1995-2000 Toyota Light-Duty Trucks with A343F (4WD, 4 Spd.) Transmission  
**Replaces:** Toyota 35330-60020; Wix 58610  
**Length:** 12 3/8 (314.3)  
**Width:** 5 5/16 (134.9)  
**Height:** 1 27/32 (46.8)  
**Pan Gasket:** [1] Included



**20045** Transmission Filter  
**Notes:** Pan gasket contains [4] bolt holes.  
**Fits:** 1995-98 Audi Cabriolet, 1995-2008 Volkswagen Automotive with AG4 (097) Transmission (FWD, 4 Spd.)  
**Replaces:** Volkswagen 1M325429; Wix 58609  
**Length:** 7 11/16 (195.3)  
**Width:** 6 3/16 (157.2)  
**Height:** 1 5/16 (33.3)  
**Pan Gasket:** [1] Included



**20046** Transmission Filter  
**Notes:** Pan gasket contains [14] bolt holes.  
**Fits:** 1991-2005 Acura Automotive with MPYA Transmission (FWD, 4 Spd.)  
**Replaces:** Honda 25420-PY4-000; Wix 58615  
**Length:** 6 13/16 (173.0)  
**Width:** 3 27/32 (97.6)  
**Height:** 3 1/8 (79.4)  
**O-Ring:** [1] Included  
**Pan Gasket:** [1] Included



**20048** Transmission Filter  
**Fits:** 2004-on Chrysler, 2002-on Dodge, 2005-on Jeep, 1996-on Mercedes-Benz Automotive with 722.6 Transmission (RWD, 5 Spd. with Electronic Overdrive)  
**Replaces:** Mercedes-Benz 1402770095; Wix 58845  
**Length:** 7 3/8 (187.3)  
**Width:** 4 29/32 (124.6)  
**Height:** 2 (50.8)  
**O-Ring:** [1] Attached  
**Pan Gasket:** [1] Included



**20050** Transmission Filter  
**Notes:** Pan gasket contains [19] bolt holes.  
**Fits:** 1998-2000 Lexus GS300, 1998-2000 GS400  
**Replaces:** Toyota 35330-30050  
**Length:** 7 5/8 (193.7)  
**Width:** 6 9/16 (166.7)  
**Height:** 29/32 (23)  
**Pan Gasket:** [1] Included



Measurements Are Shown In Inches And (Millimeters)

**WARNING:** These products can expose you to chemicals, including Diisononyl Phthalate, Carbon black extracts, Nickel, 1,3 Butadiene, Ethylene Oxide, Epichlorohydrin, which are known to the State of California to cause cancer, and Bisphenol, Ethylene Glycol, Ethylene Oxide, 1,3 Butadiene, Epichlorohydrin, which are known to the State of California to cause birth defects or other reproductive harm.

**20051** Transmission Filter



**Notes:** Pan gasket contains [19] bolt holes.  
**Fits:** 2009-10 Pontiac Vibe; 2004-07 Scion xA, xB, 2008-on xD; 2000-on Toyota Automotive with U340E Transmission (FWD, 4 Spd.)  
**Replaces:** Toyota 35330-20020, 35330-0W020; Wix 58324  
**Length:** 7 7/32 (183.4)  
**Width:** 6 5/8 (168.3)  
**Height:** 1 3/8 (34.9)  
**O-Ring:** [1] Included  
**Pan Gasket:** [1] Included

**20052** Transmission Filter



**Notes:** Pan gasket contains [22] bolt holes.  
**Contains:** Rubber Neck Seal  
**Fits:** 2002 BMW Z3 with 5L40-E Transmission (Shallow Pan)  
**Replaces:** BMW (Bavarian Motor Works) 24722000  
**Length:** 11 3/8 (288.9)  
**Width:** 7 5/32 (181.8)  
**Height:** 4 7/8 (123.8)  
**Pan Gasket:** [1] Included

**20053** Transmission Filter



**Notes:** Pan gasket contains [11] bolt holes.  
**Fits:** 1965-69 Ford Automotive (Except Fairlane), 1965-69 Mercury with C4 Transmission (RWD, Aluminum Case)  
**Replaces:** Ford C5AZ-7A098-C; Motorcraft FT36, FT36-A; Wix 51923, 58923  
**Length:** 7 21/32 (194.5)  
**Width:** 4 1/8 (104.8)  
**Height:** 7/16 (11.1)  
**Pan Gasket:** [1] Included

**20054** Transmission Filter



**Notes:** Pan gasket contains [18] bolt holes.  
**Fits:** 2003-07 Pontiac Vibe; 2003-06 Toyota Matrix XR, 2007-08 Matrix, 2003-08 Corolla  
**Replaces:** Toyota 35330-12040; Wix 58040  
**Length:** 7 1/8 (181.0)  
**Width:** 5 (127.0)  
**Height:** 1 (25.4)  
**Pan Gasket:** [1] Included

**20055** Transmission Filter



**Notes:** Pan gasket contains [12] bolt holes.  
**Fits:** 1978-87 Chevrolet Chevette, 1972-74 LUV, 1998 Tracker, 1989-97 Geo Tracker, 1975-83 Fiat, 1987 GMC Light-Duty Trucks, 1983-93 Lada, 1969-75 Opel, 1980-87 Pontiac, 1989-98 Suzuki Sidekick with 3L30 Transmissions RWD, 3 Spd.)  
**Replaces:** General Motors Corp. 25010641; Wix 51889, 58889  
**Length:** 6 7/8 (174.6)  
**Width:** 4 5/8 (117.5)  
**F. Gskt:** [1] Included  
**Pan Gasket:** [1] Included

**20057** Transmission Filter



**Notes:** Pan gasket contains [13] bolt holes.  
**Fits:** 1981-94 Ford, Mercury, 2000 Volkswagen Automotive with ATX Transmission (FWD, 3 Spd.)  
**Replaces:** Ford E9FZ-7A098-A; Wix 51921, 58921  
**Length:** 6 13/16 (173.0)  
**Width:** 6 1/8 (155.6)  
**F. Gskt:** [1] Included  
**Pan Gasket:** [1] Included

**20058** Transmission Filter



**Notes:** Both pan gaskets contain [16] bolt holes.  
**Fits:** 1981-90 Buick, Cadillac, 1981-88, 1990 Chevrolet, Oldsmobile, 1981-89 Pontiac Automotive, 1982-85, 1987 GMC Light-Duty Trucks with THM200-4R Transmission (RWD, 4 Spd. with Overdrive)  
**Replaces:** General Motors Corp. 8634223; Wix 551896, 51896, 58896  
**Length:** 9 7/32 (234.2)  
**Width:** 6 (152.4)  
**Height:** 4 9/16 (115.9)  
**Pan Gasket:** [2] Included

**20060** Transmission Filter



**Notes:** Pan gasket contains [14] bolt holes.  
**Fits:** 1987-89 Dodge, 1987-89 Mitsubishi Light-Duty Trucks, 1980-97, 2001 Toyota Automotive, Light-Duty Trucks, Vans, 1983-85 Isuzu, 1980-97 Volvo Automotive  
**Replaces:** Toyota 35303-30050; Volvo 1239829-3; Wix 51945, 58945  
**Length:** 5 3/16 (131.8)  
**Width:** 3 27/326 (78.3)  
**Height:** 11/32 (8.7)  
**F. Gskt:** [1] Included  
**Pan Gasket:** [1] Included

**20061** Transmission Filter



**Notes:** Pan gasket contains [19] bolt holes.  
**Fits:** 1992-2000 Lexus, 1986-2002 Toyota Automotive with A340E Transmission (RWD)  
**Replaces:** Toyota 35330-30011; Wix 51805, 58805  
**Length:** 8 11/32 (211.9)  
**Width:** 5 1/8 (130.2)  
**Pan Gasket:** [1] Included

**20062** Transmission Filter



**Notes:** Pan gasket contains [19] bolt holes.  
**Fits:** 1989 Isuzu Trooper, Trooper II, 1985-97 Toyota, 1995-2002 Mitsubishi Automotive  
**Replaces:** Toyota 35330-35010; Wix 51884, 58884  
**Length:** 12 7/32 (310.4)  
**Width:** 3 15/16 (100.0)  
**Height:** 5/8 (15.9)  
**F. Gskt:** [1] Included  
**Pan Gasket:** [1] Included

**20063** Transmission Element

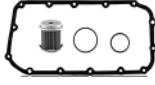

**Notes:** Pan gasket contains [14] bolt holes.  
**Fits:** 2008-11 Acura TL; 2007-2012 Honda Odyssey  
**Replaces:** Honda 25450P4V013; WIX 58732  
**O.D.:** 1 3/4 (44.4)  
**I.D.:** 11/32 (8.7) One End  
**Height:** 2 3/32 (53.2)  
**O-Ring:** [2] Included

**20064** Transmission Filter





**Notes:** Pan gasket contains [16] bolt holes.  
**Fits:** 1996-99 Acura SLX, 1994-2002 Honda Passport, 1989-2004 Isuzu Automotive with 4L30-E Transmission (4WD, RWD, 4 Spd.)  
**Replaces:** Isuzu 8-96015-062-0; Wix 51876, 58876  
**Length:** 9 1/8 (231.8)  
**Width:** 6 1/16 (154.0)  
**Height:** 1 7/32 (31)  
**Pan Gasket:** [1] Included

Measurements Are Shown In Inches And (Millimeters)

**WARNING:** These products can expose you to chemicals, including Diisononyl Phthalate, Carbon black extracts, Nickel, 1,3 Butadiene, Ethylene Oxide, Epichlorohydrin, which are known to the State of California to cause cancer, and Bisphenol, Ethylene Glycol, Ethylene Oxide, 1,3 Butadiene, Epichlorohydrin, which are known to the State of California to cause birth defects or other reproductive harm.

**20065** Transmission Filter  
  
**Notes:** Pan gasket contains [19] bolt holes.  
**Fits:** 1990-97 Lexus, 1993-98 Toyota Supra with A341E Transmission (RWD)  
**Replaces:** Toyota 35330-50010; Wix 58603  
**Length:** 8 3/32 (205.6)  
**Width:** 6 1/4 (158.8)  
**Height:** 31/32 (24.6)  
**Pan Gasket:** [1] Included

**BW21000** Coolant Spin-on without Chemicals  
  
**Fits:** Long Life Used with Extended Service Coolant.  
**Replaces:** Donaldson DBC4086; Fleetguard WF2130  
**Thread:** M16 x 1.5  
**O.D.:** 3 11/16 (93.7)  
**Height:** 5 7/16 (138.1)  
**I.Gskt:** [1] Included

**20066** Transmission Filter  
  
**Notes:** Pan gasket contains [20] bolt holes.  
**Fits:** 1990-99 Subaru Automotive with 4EAT Transmission (FWD, 4 Spd.)  
**Replaces:** Subaru 31728-AA011; Wix 51969, 58969  
**Length:** 8 27/32 (224.6)  
**Width:** 6 1/2 (165.1)  
**Height:** 1 3/32 (27.8)  
**O-Ring:** [2] Attached  
**Pan Gasket:** [1] Included

**PT23000** Hydraulic Element with Bail Handle  
  
**Fits:** FBO Hydraulic Systems  
**Replaces:** FBO CR6001; MP Filtri MF4003P25NB; Donaldson P171576  
**O.D.:** 5 1/8 (130.2)  
**I.D.:** 2 1/2 (63.5) One End  
**Height:** 10 3/16 (258.8)  
**I.Gskt:** [1] Included  
**Spring:** [1] Included

**20067** Transmission Filter  
  
**Notes:** Pan gasket contains [17] bolt holes.  
**Contains:** [1] Filter-to-Valve Metal Body Gasket  
**Fits:** 1965-74 Ford, 1962 Jeep, 1959-74 Lincoln, 1965-74 Mercury Automotive, Light-Duty Trucks, Vans with C6 Transmission (Early, RWD, Aluminum Case)  
**Replaces:** Ford C6AZ-7A098-A; Motorcraft FT37A, FT38A; Wix 51920, 58920  
**Length:** 9 3/16 (233.4)  
**Width:** 6 1/4 (158.8)  
**F. Gskt:** [1] Included  
**Pan Gasket:** [1] Included

**PT23001** Hydraulic Element with Bail Handle  
  
**Fits:** MP Filtri Hydraulic Systems  
**Replaces:** MP Filtri MF4003P10NB  
**O.D.:** 5 1/8 (130.2)  
**I.D.:** 2 9/16 (65.1) One End  
**Height:** 10 3/16 (258.8)  
**I.Gskt:** [1] Included

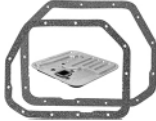
**20068** Transmission Filter  
  
**Notes:** Both pan gaskets contain [13] bolt holes.  
**Fits:** 1993-2001 Hyundai Automotive with F4A32 Transmission  
**Replaces:** Hyundai 46321-22050; Wix 58601  
**Length:** 6 15/16 (176.2)  
**Width:** 6 11/16 (169.9)  
**Height:** 21/32 (16.7)  
**A. Gskt:** [1] Attached  
**Pan Gasket:** [2] Included

**PT23002** Hydraulic Element  
  
**Fits:** Mahle Applications  
**Replaces:** Mahle P11015MIC25; Filtrec DMD0015D20B  
**O.D.:** 3 1/4 (82.6)  
**I.D.:** 1 7/8 (47.6) One End  
**Height:** 5 9/16 (141.3)

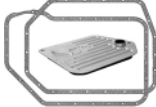
**20069** Transmission Filter  
  
**Notes:** One Pan gasket contains [22] bolt holes. One Pan gasket contains [27] bolt holes.  
**Fits:** 2002-03 Audi S6 Avant, 1997-2005 Jaguar S-Type, Vanden Plas, XJ8, XK8, 2004-06 Volkswagen with 5HP24 (01L) Transmission (5 Spd.)  
**Replaces:** Audi 1L325429; Jaguar JLM20216  
**Length:** 9 25/32 (248.4)  
**Width:** 7 7/8 (200.0)  
**Height:** 1 11/32 (34.1)  
**O-Ring:** [1] Included  
**Pan Gasket:** [2] Included











**PT23003** Hydraulic Element with Bail Handle  
  
**Fits:** FBO Hydraulic Systems  
**Replaces:** FBO CR2501  
**O.D.:** 5 1/8 (130.2)  
**I.D.:** 2 (50.8) One End  
**Height:** 6 (152.4)  
**I.Gskt:** [1] Included  
**Spring:** [1] Included

**20070** Transmission Filter  
  
**Notes:** Pan gasket contains [20] bolt holes.  
**Fits:** RAM 3500, 4500, 5500 with 6.4L & 6.7L Engines  
**Replaces:** Ram 68224232AA  
**Length:** 17 1/16 (433.1)  
**Width:** 12 13/16 (325.1)  
**Height:** 2 1/16 (52.1)  
**Pan Gasket:** [1] Included

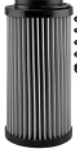
**PT23004** Hydraulic Element with Bail Handle  
  
**Fits:** Eppensteiner Hydraulic Systems  
**Replaces:** Eppensteiner 6300P10S0000  
**O.D.:** 3 9/16 (90.5)  
**I.D.:** 4 1/4 (108.0) One End  
**Height:** 15 3/8 (390.5)  
**I.Gskt:** [1] Included

Measurements Are Shown In Inches And (Millimeters)

**WARNING:** These products can expose you to chemicals, including Diisononyl Phthalate, Carbon black extracts, Nickel, 1,3 Butadiene, Ethylene Oxide, Epichlorohydrin, which are known to the State of California to cause cancer, and Bisphenol, Ethylene Glycol, Ethylene Oxide, 1,3 Butadiene, Epichlorohydrin, which are known to the State of California to cause birth defects or other reproductive harm.

<p><b>PT23005</b></p> 	<p>Hydraulic Element with Bail Handle  <b>Fits:</b> MP Filtri Hydraulic Systems  <b>Replaces:</b> MP Filtri MF1003P25NB  <b>O.D.:</b> 2 11/16 (68.3)  <b>I.D.:</b> 1 9/16 (39.7)  <b>Height:</b> 8 1/2 (215.9)  <b>I.Gskt:</b> [1] Included  <b>Spring:</b> [1] Included</p>	<p><b>PT23011</b></p>  <p>Hydraulic Element  <b>Contains:</b> 3-11 Inch BSP Threaded Stud  <b>Fits:</b> U.C.C. Hydraulic Systems  <b>Replaces:</b> U.C.C. UCSE1221  <b>O.D.:</b> 5 13/16 (147.6)  <b>I.D.:</b> 3 1/2 (88.9)  <b>Height:</b> 10 11/16 (271.5)  <b>I.Gskt:</b> [2] Included</p>
<p><b>PT23006</b></p> 	<p>Hydraulic Element  <b>Fits:</b> Argo Hydraulic Systems  <b>Replaces:</b> Argo P3052051  <b>O.D.:</b> 1 13/16 (46.0)  <b>I.D.:</b> 13/16 (20.6) One End  <b>Height:</b> 7 7/8 (200.0)  <b>I.Gskt:</b> [1] Included</p>	<p><b>PT23012</b></p>  <p>Hydraulic Element  <b>Fits:</b> MP Filtri Hydraulic Systems  <b>Replaces:</b> MP Filtri CU250M90N  <b>O.D.:</b> 3 29/32 (99.2)  <b>I.D.:</b> 2 1/16 (52.4)  <b>Height:</b> 8 3/16 (208.0)  <b>I.Gskt:</b> [2] Included</p>
<p><b>PT23007</b></p> 	<p>Hydraulic Element  <b>Fits:</b> Argo Hydraulic Systems  <b>Replaces:</b> Argo P3052052  <b>O.D.:</b> 1 13/16 (46.0)  <b>I.D.:</b> 13/16 (20.6) One End  <b>Height:</b> 7 7/8 (200.0)  <b>I.Gskt:</b> [1] Included</p>	<p><b>PT23013</b></p>  <p>Hydraulic Element with Bail Handle  <b>Contains:</b> By-Pass Valve  <b>Fits:</b> Donaldson FHK Assemblies  <b>Replaces:</b> Donaldson P171536  <b>O.D.:</b> 3 29/32 (99.2)  <b>I.D.:</b> 1 5/8 (41.3)  <b>Height:</b> 8 1/16 (204.8)  <b>I.Gskt:</b> [1] Included  <b>Spring:</b> [1] Included</p>
<p><b>PT23008</b></p> 	<p>Hydraulic Element  <b>Fits:</b> Eppensteiner Hydraulic Systems  <b>Replaces:</b> Eppensteiner 1063P10A000P  <b>O.D.:</b> 2 9/32 (57.9)  <b>I.D.:</b> 1 9/32 (32.5)  <b>Height:</b> 6 5/16 (160.3)  <b>I.Gskt:</b> [2] Included</p>	<p><b>PT23014</b></p>  <p>Hydraulic Element  <b>Fits:</b> Mahle Applications  <b>Replaces:</b> Mahle PI8530DRG100  <b>O.D.:</b> 3 3/16 (81.0)  <b>I.D.:</b> 1 7/8 (47.6) One End  <b>Height:</b> 10 1/16 (255.6)</p>
<p><b>PT23009</b></p> 	<p>Hydraulic Element  <b>Fits:</b> Mahle Hydraulic Systems  <b>Replaces:</b> Mahle PL13030RN  <b>O.D.:</b> 2 1/4 (57.2)  <b>I.D.:</b> 1 3/16 (30.2)  <b>Height:</b> 9 3/4 (247.7)  <b>I.Gskt:</b> [2] Included</p>	<p><b>PT23015</b></p>  <p>Hydraulic Element  <b>Contains:</b> Stud Thread: 1-11 BSP  <b>Fits:</b> OMT Hydraulic Systems  <b>Replaces:</b> OMT SP86A100GR125  <b>O.D.:</b> 3 29/32 (99.2)  <b>I.D.:</b> 1 5/8 (41.3)  <b>Height:</b> 8 1/16 (204.8)</p>
<p><b>PT23010</b></p> 	<p>Hydraulic Element  <b>Fits:</b> Liebherr Applications  <b>Replaces:</b> Liebherr 10044538  <b>O.D.:</b> 3 1/2 (88.9)  <b>I.D.:</b> 1 9/16 (39.7)  <b>Height:</b> 12 15/16 (328.6)  <b>O-Ring:</b> [2] Attached</p>	<p><b>PT23016</b></p>  <p>Hydraulic Element  <b>Contains:</b> Threaded Stud  <b>Fits:</b> OMT Hydraulic Systems  <b>Replaces:</b> OMT SP86A114GR125  <b>O.D.:</b> 3 1/4 (82.6)  <b>I.D.:</b> 1 5/8 (41.3)  <b>Height:</b> 5 1/2 (139.7)</p>

Measurements Are Shown In Inches And (Millimeters)

**WARNING:** These products can expose you to chemicals, including Diisononyl Phthalate, Carbon black extracts, Nickel, 1,3 Butadiene, Ethylene Oxide, Epichlorohydrin, which are known to the State of California to cause cancer, and Bisphenol, Ethylene Glycol, Ethylene Oxide, 1,3 Butadiene, Epichlorohydrin, which are known to the State of California to cause birth defects or other reproductive harm.

**PT23017** Hydraulic Element with Bail Handle  
**Fits:** Donaldson FHK/FSK Assemblies  
**Replaces:** Donaldson P171529  
**O.D.:** 2 3/4 (69.9)  
**I.D.:** 1 5/32 (29.4) One End  
**Height:** 3 5/32 (80.2)  
**I.Gskt:** [1] Included  
**Spring:** [1] Included



**PT23023** Hydraulic Element  
**Fits:** Mahle Applications  
**Replaces:** Mahle PI8445DRG60; Filtrec DMD0045B60B  
**O.D.:** 3 1/4 (82.6)  
**I.D.:** 1 7/8 (47.6) One End  
**Height:** 14 5/8 (371.5)



**PT23018** Hydraulic Element  
**Fits:** MP Filtri Hydraulic Assemblies  
**Replaces:** MP Filtri HP0652M60NA  
**O.D.:** 1 25/32 (45.2)  
**I.D.:** 1 (25.4)  
**Height:** 4 15/32 (113.5)  
**I.Gskt:** [1] Included



**PT23024** Hydraulic Element  
**Fits:** MP Filtri Hydraulic Assemblies  
**Replaces:** MP Filtri CU250M60N  
**O.D.:** 3 13/32 (86.5)  
**I.D.:** 2 1/8 (54.0)  
**Height:** 8 3/8 (212.7)  
**I.Gskt:** [2] Included



**PT23019** Hydraulic Element with Bail Handle  
**Contains:** By-Pass Valve  
**Fits:** MP Filtri Applications  
**Replaces:** MP Filtri MF4003M60NB; Filtrec R164T60B  
**O.D.:** 5 1/16 (128.6)  
**I.D.:** 2 1/2 (63.5) One End  
**Height:** 10 3/8 (263.5)  
**O-Ring:** [1] Attached  
**Spring:** [1] Included



**PT23025** Hydraulic Element  
**Fits:** Eppensteiner Applications  
**Replaces:** Eppensteiner 2225G25A000P; Filtrec DVD2225B25B  
**O.D.:** 2 7/8 (73.0)  
**I.D.:** 1 9/16 (39.7) One End  
**Height:** 8 13/16 (223.8)  
**O-Ring:** [1] Attached



**PT23020** Hydraulic Element  
**Fits:** Mahle Hydraulic Assemblies  
**Replaces:** Mahle PI8330DKG40  
**O.D.:** 3 3/16 (81.0)  
**I.D.:** 1 7/8 (47.6) One End  
**Height:** 10 1/32 (254.8)



**PT23026** Hydraulic Element  
**Fits:** MP Filtri Applications  
**Replaces:** MP Filtri HP3202M60NA; Filtrec D151T60A  
**O.D.:** 3 1/16 (77.8)  
**I.D.:** 1 1/2 (38.1) One End  
**Height:** 9 3/16 (233.4)  
**O-Ring:** [1] Attached



**PT23021** Hydraulic Element  
**Notes:** OBSOLETE. Availability Limited to Dealer Stock.  
**Fits:** Mahle Hydraulic Assemblies  
**Replaces:** Mahle PI8408DRG60  
**O.D.:** 1 27/32 (46.8)  
**I.D.:** 1 (25.4) One End  
**Height:** 6 25/32 (172.2)



**PT23027** Hydraulic Element with Bail Handle  
**Fits:** Parker Hydraulic Assemblies  
**Replaces:** Parker 939893Q  
**O.D.:** 9 1/8 (231.8)  
**I.D.:** 4 1/4 (108.0) One End  
**Height:** 11 (279.4)



**PT23022** Hydraulic Element  
**Fits:** Mahle Applications  
**Replaces:** Mahle PI8430DRG60; Filtrec DMD0030B60B  
**O.D.:** 3 3/16 (81.0)  
**I.D.:** 1 7/8 (47.6) One End  
**Height:** 10 1/16 (255.6)



**PT23028-MPG** Maximum Performance Glass Hydraulic Element  
**Fits:** Hydac Applications  
**Replaces:** Hydac 240D010BHHC  
**O.D.:** 2 11/16 (68.3)  
**I.D.:** 1 5/16 (33.3) One End  
**Height:** 6 13/16 (173.0)  
**O-Ring:** [1] Attached



Measurements Are Shown In Inches And (Millimeters)

**WARNING:** These products can expose you to chemicals, including Diisononyl Phthalate, Carbon black extracts, Nickel, 1,3 Butadiene, Ethylene Oxide, Epichlorohydrin, which are known to the State of California to cause cancer, and Bisphenol, Ethylene Glycol, Ethylene Oxide, 1,3 Butadiene, Epichlorohydrin, which are known to the State of California to cause birth defects or other reproductive harm.

<p><b>PT23029-MPG</b> Maximum Performance Glass Hydraulic Element</p>  <p><b>Fits:</b> MP Filtri Applications <b>Replaces:</b> MP Filtri HP3202A10NA <b>O.D.:</b> 3 1/16 (77.8) <b>I.D.:</b> 1 1/2 (38.1) One End <b>Height:</b> 9 1/4 (235.0) <b>O-Ring:</b> [1] Attached</p>	<p><b>PT23035-MPG</b> Maximum Performance Glass Hydraulic Element with Bail Handle</p>  <p><b>Fits:</b> MP Filtri Hydraulic Assemblies <b>Replaces:</b> MP Filtri 1003A25HB <b>O.D.:</b> 2 5/8 (66.7) <b>I.D.:</b> 1 3/8 (34.9) One End <b>Height:</b> 8 1/8 (206.4) <b>I.Gskt:</b> [1] Included</p>
<p><b>PT23030-MPG</b> Maximum Performance Glass Hydraulic Element</p>  <p><b>Fits:</b> Pall Applications <b>Replaces:</b> Pall HC8800FKS16H <b>O.D.:</b> 3 3/8 (85.7) <b>I.D.:</b> 1 15/16 (49.2) One End <b>Height:</b> 16 7/8 (428.6) <b>O-Ring:</b> [1] Attached</p>	<p><b>PT23036-MPG</b> Maximum Performance Glass Hydraulic Element</p>  <p><b>Fits:</b> MP Filtri Hydraulic Assemblies <b>Replaces:</b> MP Filtri HP0371A10A <b>O.D.:</b> 1 3/8 (34.9) <b>I.D.:</b> 1 1/4 (31.8) <b>Height:</b> 3 1/2 (88.9) <b>I.Gskt:</b> [1] Included</p>
<p><b>PT23031-MPG</b> Maximum Performance Glass Hydraulic Element</p>  <p><b>Fits:</b> Hydac Hydraulic Assemblies <b>Replaces:</b> Hydac 60103D10BN <b>O.D.:</b> 2 1/8 (54.0) <b>I.D.:</b> 25/32 (19.8) <b>Height:</b> 2 5/8 (66.7) <b>A. Gskt:</b> [1] Attached <b>F. Gskt:</b> [1] Included</p>	<p><b>PT23037-MPG</b> Maximum Performance Glass Hydraulic Element</p>  <p><b>Fits:</b> Hydac Hydraulic Assemblies <b>Replaces:</b> Hydac 60D005BNHC <b>O.D.:</b> 1 27/32 (46.8) <b>I.D.:</b> 7/8 (22.2) One End <b>Height:</b> 3 5/16 (84.1) <b>I.Gskt:</b> [1] Included</p>
<p><b>PT23032-MPG</b> Maximum Performance Glass Hydraulic Element</p>  <p><b>Fits:</b> Argo Equipment <b>Replaces:</b> Argo V3060706 <b>O.D.:</b> 2 1/8 (54.0) <b>I.D.:</b> 1 1/8 (28.6) One End <b>Height:</b> 2 23/32 (69.1) <b>I.Gskt:</b> [1] Included</p>	<p><b>PT23038-MPG</b> Maximum Performance Glass Hydraulic Element</p>  <p><b>Fits:</b> Hydac Hydraulic Assemblies <b>Replaces:</b> Hydac 110D005BNHC <b>O.D.:</b> 13/16 (20.6) <b>I.D.:</b> 1 13/16 (46.0) One End <b>Height:</b> 5 7/8 (149.2) <b>I.Gskt:</b> [1] Included</p>
<p><b>PT23033-MPG</b> Maximum Performance Glass Hydraulic Element</p>  <p><b>Fits:</b> VogeLe Hydraulic Assemblies <b>Replaces:</b> VogeLe 9624541001 <b>O.D.:</b> 4 1/2 (114.3) <b>I.D.:</b> 2 23/32 (69.1) <b>Height:</b> 15 23/32 (399.3) <b>I.Gskt:</b> [2] Included</p>	<p><b>PT23039-MPG</b> Maximum Performance Glass Hydraulic Element with Bail Handle</p>  <p><b>Contains:</b> By-Pass Valve <b>Fits:</b> Hydac Hydraulic Assemblies <b>Replaces:</b> Hydac 110R010BNHC <b>O.D.:</b> 2 (50.8) <b>I.D.:</b> 13/16 (20.6) One End <b>Height:</b> 6 3/8 (161.9) <b>I.Gskt:</b> [1] Included</p>
<p><b>PT23034-MPG</b> Maximum Performance Glass Hydraulic Element</p>  <p><b>Fits:</b> Parker Hydraulic Assemblies <b>Replaces:</b> Parker G01068 <b>O.D.:</b> 3 3/8 (85.7) <b>I.D.:</b> 2 1/8 (54.0) One End <b>Height:</b> 7 3/4 (196.9) <b>I.Gskt:</b> [1] Included</p>	<p><b>PT23040-MPG</b> Maximum Performance Glass Hydraulic Element</p>  <p><b>Fits:</b> Mahle Applications <b>Replaces:</b> Mahle PI3115SM10 <b>O.D.:</b> 3 3/16 (81.0) <b>I.D.:</b> 1 7/8 (47.6) One End <b>Height:</b> 5 5/8 (142.9)</p>

Measurements Are Shown In Inches And (Millimeters)

**WARNING:** These products can expose you to chemicals, including Diisononyl Phthalate, Carbon black extracts, Nickel, 1,3 Butadiene, Ethylene Oxide, Epichlorohydrin, which are known to the State of California to cause cancer, and Bisphenol, Ethylene Glycol, Ethylene Oxide, 1,3 Butadiene, Epichlorohydrin, which are known to the State of California to cause birth defects or other reproductive harm.

**PT23041-MPG** Maximum Performance Glass Hydraulic Element with Bail Handle  
**Fits:** MP Filtri Hydraulic Assemblies  
**Replaces:** MP Filtri MF180A25HB, Filtrec WG440  
**O.D.:** 4 (101.6)  
**I.D.:** 1 7/16 (36.5) One End  
**Height:** 8 1/2 (215.9)  
**I.Gskt:** [1] Included



**PT23047-MPG** Maximum Performance Glass Hydraulic Element  
**Fits:** MP Filtri Hydraulic Assemblies  
**Replaces:** MP Filtri HP1352A10NA  
**O.D.:** 2 1/8 (54.0)  
**I.D.:** 1 1/8 (28.6) One End  
**Height:** 9 1/8 (231.8)  
**I.Gskt:** [1] Included



**PT23042-MPG** Maximum Performance Glass Hydraulic Element  
**Fits:** Tamrock Equipment  
**Replaces:** Tamrock 4004080  
**O.D.:** 2 13/16 (71.4)  
**I.D.:** 1 13/16 (46.0) One End  
**Height:** 13 3/4 (349.3)



**PT23048-MPG** Maximum Performance Glass Hydraulic Element with Bail Handle  
**Fits:** Donaldson Housings  
**Replaces:** Donaldson P171561; Filtrec R160G10B  
**O.D.:** 5 1/8 (130.2)  
**I.D.:** 2 9/16 (65.1) One End  
**Height:** 7 7/8 (200.0)  
**O-Ring:** [1] Attached



**PT23043-MPG** Maximum Performance Glass Hydraulic Element  
**Fits:** Hydac Hydraulic Assemblies  
**Replaces:** Hydac 10D010BHHC  
**O.D.:** 1 13/16 (46.0)  
**I.D.:** 13/16 (20.6)  
**Height:** 6 (152.4)  
**I.Gskt:** [1] Included



**PT23049-MPG** Maximum Performance Glass Hydraulic Element  
**Fits:** Mahle Applications  
**Replaces:** Mahle PI4145SM25; Filtrec DMD0045E20B  
**O.D.:** 3 1/4 (82.6)  
**I.D.:** 1 7/8 (47.6) One End  
**Height:** 14 9/16 (369.9)



**PT23044-MPG** Maximum Performance Glass Hydraulic Element  
**Fits:** MP Filtri Hydraulic Assemblies  
**Replaces:** MP Filtri CU250A25N  
**O.D.:** 3 29/32 (99.2)  
**I.D.:** 2 1/16 (52.4)  
**Height:** 8 3/8 (212.7)  
**I.Gskt:** [2] Included



**PT23050-MPG** Maximum Performance Glass Hydraulic Element  
**Fits:** MP Filtri Applications  
**Replaces:** MP Filtri HP3203A10NA; Filtrec D152G10A  
**O.D.:** 3 1/16 (77.8)  
**I.D.:** 1 9/16 (39.7) One End  
**Height:** 14 13/16 (376.2)  
**O-Ring:** [1] Attached



**PT23045-MPG** Maximum Performance Glass Hydraulic Element  
**Fits:** Hydac Hydraulic Assemblies  
**Replaces:** Hydac 330D010BNHC  
**O.D.:** 3 1/2 (88.9)  
**I.D.:** 1 15/16 (49.2)  
**Height:** 6 5/16 (160.3)  
**I.Gskt:** [1] Included



**PT23051-MPG** Maximum Performance Glass Hydraulic Element  
**Fits:** Tamrock Equipment  
**Replaces:** Tamrock 400479  
**O.D.:** 7 7/8 (200.0)  
**I.D.:** 1/2 (12.7) & 6 5/8 (168.3)  
**Height:** 26 (660.4)



**PT23046-MPG** Maximum Performance Glass Hydraulic Element  
**Fits:** Hydac Hydraulic Assemblies  
**Replaces:** Hydac 330D020BNHC  
**O.D.:** 3 1/2 (88.9)  
**I.D.:** 1 15/16 (49.2)  
**Height:** 6 1/4 (158.8)  
**I.Gskt:** [1] Included















**PT23052-MPG** Maximum Performance Glass Hydraulic Element  
**Fits:** Hydac Hydraulic Assemblies  
**Replaces:** Hydac 660D010BHHC  
**O.D.:** 3 3/8 (85.7)  
**I.D.:** 1 7/8 (47.6)  
**Height:** 13 (330.2)  
**I.Gskt:** [1] Included



Measurements Are Shown In Inches And (Millimeters)

**WARNING:** These products can expose you to chemicals, including Diisononyl Phthalate, Carbon black extracts, Nickel, 1,3 Butadiene, Ethylene Oxide, Epichlorohydrin, which are known to the State of California to cause cancer, and Bisphenol, Ethylene Glycol, Ethylene Oxide, 1,3 Butadiene, Epichlorohydrin, which are known to the State of California to cause birth defects or other reproductive harm.

<p><b>PT23053-MPG</b> Maximum Performance Glass Hydraulic Element</p>  <p><b>Fits:</b> Eppensteiner Hydraulic Assemblies <b>Replaces:</b> Eppensteiner 2460H10SLC00P <b>O.D.:</b> 3 1/8 (79.4) <b>I.D.:</b> 1 1/2 (38.1) <b>Height:</b> 15 (381.0) <b>I.Gskt:</b> [1] Included</p>	<p><b>PT23059-MPG</b> Maximum Performance Glass Hydraulic Element</p>  <p><b>Fits:</b> Kalmer Applications <b>Replaces:</b> Kalmer 9239440053 <b>O.D.:</b> 2 5/8 (66.7) <b>I.D.:</b> 1 1/8 (28.6) <b>Height:</b> 9 5/8 (244.5) <b>I.Gskt:</b> [1] Included <b>F. Gskt:</b> [1] Backup Ring, [1] Included</p>
<p><b>PT23054-MPG</b> Maximum Performance Glass Hydraulic Element</p>  <p><b>Fits:</b> Eppensteiner Applications <b>Replaces:</b> Eppensteiner 2460H10SLA000P <b>O.D.:</b> 2 7/8 (73.0) <b>I.D.:</b> 1 9/16 (39.7) One End <b>Height:</b> 14 3/4 (374.7) <b>O-Ring:</b> [1] Attached</p>	<p><b>PT23060-MPG</b> Maximum Performance Glass Hydraulic Element with Bail Handle</p>  <p><b>Fits:</b> Hydac Applications <b>Replaces:</b> Hydac 240R010BNHC <b>O.D.:</b> 2 3/4 (69.9) <b>I.D.:</b> 1 5/8 (41.3) One End <b>Height:</b> 7 11/16 (195.3) <b>O-Ring:</b> [1] Attached</p>
<p><b>PT23055-MPG</b> Maximum Performance Glass Hydraulic Element</p>  <p><b>Fits:</b> Eppensteiner Applications <b>Replaces:</b> Eppensteiner 232H10XLA00P <b>O.D.:</b> 1 5/8 (41.3) <b>I.D.:</b> 5/8 (15.9) One End <b>Height:</b> 3 1/8 (79.4) <b>O-Ring:</b> [1] Attached</p>	<p><b>PT23061-MPG</b> Maximum Performance Glass Hydraulic Element with Bail Handle</p>  <p><b>Fits:</b> Hydac Applications <b>Replaces:</b> Hydac 330R010BNHC <b>O.D.:</b> 3 3/8 (85.7) <b>I.D.:</b> 1 7/8 (47.6) One End <b>Height:</b> 7 7/8 (200.0)</p>
<p><b>PT23056-MPG</b> Maximum Performance Glass Hydraulic Element</p>  <p><b>Fits:</b> Eppensteiner Applications <b>Replaces:</b> Eppensteiner 225H10XLC000P <b>O.D.:</b> 3 (76.2) <b>I.D.:</b> 1 9/16 (39.7) One End <b>Height:</b> 9 1/8 (231.8) <b>O-Ring:</b> [1] Attached</p>	<p><b>PT23062-MPG</b> Maximum Performance Glass Hydraulic Element with Bail Handle</p>  <p><b>Fits:</b> Hydac Applications <b>Replaces:</b> Hydac 1300R010BNHC; Filtrac RHR1300610B <b>O.D.:</b> 5 5/16 (134.9) <b>I.D.:</b> 3 3/4 (95.3) One End <b>Height:</b> 19 7/16 (493.7) <b>I.Gskt:</b> [1] Included</p>
<p><b>PT23057-MPG</b> Maximum Performance Glass Hydraulic Element</p>  <p><b>Fits:</b> Eppensteiner Applications <b>Replaces:</b> Eppensteiner 2460H20LLH000P <b>O.D.:</b> 3 (76.2) <b>I.D.:</b> 1 9/16 (39.7) One End <b>Height:</b> 14 3/4 (374.7) <b>O-Ring:</b> [1] Attached</p>	<p><b>PT23063-MPG</b> Maximum Performance Glass Hydraulic Element with Bail Handle</p>  <p><b>Replaces:</b> Donaldson P171544 <b>O.D.:</b> 3 29/32 (99.2) <b>I.D.:</b> 1 5/8 (41.3) One End <b>Height:</b> 9 27/32 (250.0) <b>I.Gskt:</b> [1] Included <b>Spring:</b> [1] Included</p>
<p><b>PT23058-MPG</b> Maximum Performance Glass Hydraulic Element</p>  <p><b>Fits:</b> Parker Hydraulic Assemblies <b>Replaces:</b> Parker G02832 <b>O.D.:</b> 1 27/32 (46.8) <b>I.D.:</b> 1 (25.4) One End <b>Height:</b> 3 23/32 (94.5)</p>	<p><b>PT23064-MPG</b> Maximum Performance Glass Hydraulic Element</p>  <p><b>Fits:</b> MP Filtri Hydraulic Systems <b>Replaces:</b> MP Filtri HP0372A10A <b>O.D.:</b> 1 3/8 (34.9) <b>I.D.:</b> 13/16 (20.6) One End <b>Height:</b> 7 (177.8) <b>I.Gskt:</b> [1] Included</p>

Measurements Are Shown In Inches And (Millimeters)

**WARNING:** These products can expose you to chemicals, including Diisononyl Phthalate, Carbon black extracts, Nickel, 1,3 Butadiene, Ethylene Oxide, Epichlorohydrin, which are known to the State of California to cause cancer, and Bisphenol, Ethylene Glycol, Ethylene Oxide, 1,3 Butadiene, Epichlorohydrin, which are known to the State of California to cause birth defects or other reproductive harm.



**PT23065-MPG** Maximum Performance Glass Hydraulic Element with Bail Handle



**Fits:** Hydac Applications  
**Replaces:** Hydac 2600R010BNHC  
**O.D.:** 5 1/2 (139.7)  
**I.D.:** 3 3/4 (95.3)  
**Height:** 36 11/16 (931.9)  
**I.Gskt:** [1] Included

**PT23071-MPG** Maximum Performance Glass Hydraulic Element



**Fits:** Parker Hydraulic Systems  
**Replaces:** Parker 939905Q  
**O.D.:** 3 (76.2)  
**I.D.:** 1 (25.4)  
**Height:** 5 7/8 (149.2)  
**I.Gskt:** [1] Included

**PT23066-MPG** Maximum Performance Glass Hydraulic Element



**Fits:** Hydac Hydraulic Systems  
**Replaces:** Hydac 140D010BNHC  
**O.D.:** 1 13/16 (46.0)  
**I.D.:** 13/16 (20.6) One End  
**Height:** 7 3/8 (187.3)  
**I.Gskt:** [1] Included

**PT23072-MPG** Maximum Performance Glass Hydraulic Element



**Contains:** By-Pass Valve  
**Fits:** Eppensteiner Hydraulic Systems  
**Replaces:** Eppensteiner 20330H10SL.S004P  
**O.D.:** 4 (101.6)  
**I.D.:** 2 3/8 (60.3) One End  
**Height:** 10 7/8 (276.2)  
**End Seals:** [1] Attached

**PT23067-MPG** Maximum Performance Glass Hydraulic Element



**Fits:** Hydac Hydraulic Systems  
**Replaces:** Hydac 140D020BNHC  
**O.D.:** 1 13/16 (46.0)  
**I.D.:** 1 1/8 (28.6) One End  
**Height:** 7 3/8 (187.3)  
**I.Gskt:** [1] Included

**PT23073-MPG** Maximum Performance Glass Hydraulic Element



**Fits:** MP Filtri Hydraulic Systems  
**Replaces:** MP Filtri HP0201A10HA  
**O.D.:** 1 1/8 (34.9)  
**I.D.:** 21/32 (16.7)  
**Height:** 3 15/16 (100.0)  
**I.Gskt:** [1] Included

**PT23068-MPG** Maximum Performance Glass Hydraulic Element



**Fits:** Eppensteiner Applications  
**Replaces:** Eppensteiner 20045H10XLA000P, 20045H10SLA000P; Filtrec DVD20045E10B  
**O.D.:** 3 1/8 (79.4)  
**I.D.:** 1 5/8 (41.3) One End  
**Height:** 15 11/16 (398.5)  
**O-Ring:** [1] Attached

**PT23074-MPG** Maximum Performance Glass Hydraulic Element



**Fits:** Pall Hydraulic Systems  
**Replaces:** Pall HC9021FKS4H  
**O.D.:** 1 3/4 (44.4)  
**I.D.:** 1 1/8 (28.6)  
**Height:** 4 1/2 (114.3)  
**I.Gskt:** [1] Included

**PT23069-MPG** Maximum Performance Glass Hydraulic Element



**Fits:** Parker Applications  
**Replaces:** Parker 939903Q  
**O.D.:** 1 13/16 (46.0)  
**I.D.:** 5/8 (15.9) One End  
**Height:** 1 5/16 (33.3)  
**O-Ring:** [1] Attached

**PT23075-MPG** Maximum Performance Glass Hydraulic Element



**Fits:** MP Filtri Hydraulic Systems  
**Replaces:** MP Filtri HP1352A10HA  
**O.D.:** 2 (50.8)  
**I.D.:** 1 1/4 (31.8) One End  
**Height:** 9 1/4 (235.0)  
**I.Gskt:** [1] Included

**PT23070-MPG** Maximum Performance Glass Hydraulic Element



**Fits:** Pall Hydraulic Systems  
**Replaces:** Pall HC2252FKT19H  
**O.D.:** 3 5/8 (92.1)  
**I.D.:** 1 3/4 (44.4) & 2 1/8 (54.0)  
**Height:** 18 7/8 (479.4)  
**I.Gskt:** [1] Included













**PT23076-MPG** Maximum Performance Glass Hydraulic Element



**Fits:** Pall Hydraulic Systems  
**Replaces:** Pall HC9100FKS8Z  
**O.D.:** 2 3/4 (69.9)  
**I.D.:** 1 5/16 (33.3)  
**Height:** 8 1/4 (209.6)  
**I.Gskt:** [1] Included

Measurements Are Shown In Inches And (Millimeters)

**WARNING:** These products can expose you to chemicals, including Diisononyl Phthalate, Carbon black extracts, Nickel, 1,3 Butadiene, Ethylene Oxide, Epichlorohydrin, which are known to the State of California to cause cancer, and Bisphenol, Ethylene Glycol, Ethylene Oxide, 1,3 Butadiene, Epichlorohydrin, which are known to the State of California to cause birth defects or other reproductive harm.

<p><b>PT23077-MPG</b> Maximum Performance Glass Hydraulic Element</p>  <p><b>Fits:</b> MP Filtri Hydraulic Systems <b>Replaces:</b> MP Filtri HP0372A06A <b>O.D.:</b> 1 5/8 (41.3) <b>I.D.:</b> 13/16 (20.6) <b>Height:</b> 7 (177.8) <b>I.Gskt:</b> [1] Included</p>	<p><b>PT23083-MPG</b> Maximum Performance Glass Hydraulic Element</p>  <p><b>Fits:</b> Argo Hydraulic Systems <b>Replaces:</b> Argo V3052008 <b>O.D.:</b> 1 3/4 (44.4) <b>I.D.:</b> 3/4 (19.0) One End <b>Height:</b> 7 3/4 (196.9) <b>O-Ring:</b> [1] Attached</p>
<p><b>PT23078-MPG</b> Maximum Performance Glass Hydraulic Element</p>  <p><b>Fits:</b> Parker Hydraulic Systems <b>Replaces:</b> Parker G01938Q <b>O.D.:</b> 2 5/8 (66.7) <b>I.D.:</b> 1 1/8 (28.6) <b>Height:</b> 9 5/8 (244.5) <b>O-Ring:</b> [1] Attached</p>	<p><b>PT23084-MPG</b> Maximum Performance Glass Hydraulic Element</p>  <p><b>Fits:</b> Argo Hydraulic Systems <b>Replaces:</b> Argo V3062306 <b>O.D.:</b> 2 1/8 (54.0) <b>I.D.:</b> 1 1/8 (28.6) One End <b>Height:</b> 9 1/8 (231.8) <b>O-Ring:</b> [1] Attached</p>
<p><b>PT23079-MPG</b> Maximum Performance Glass Hydraulic Element</p>  <p><b>Fits:</b> Parker Applications <b>Replaces:</b> Parker G01946 <b>O.D.:</b> 3 9/16 (90.5) <b>I.D.:</b> 1 7/8 (47.6) One End <b>Height:</b> 7 7/8 (200.0) <b>O-Ring:</b> [1] Attached</p>	<p><b>PT23085-MPG</b> Maximum Performance Glass Hydraulic Element</p>  <p><b>Fits:</b> Argo Applications <b>Replaces:</b> Argo V308330; Filtrac D841G10A <b>O.D.:</b> 3 1/16 (77.8) <b>I.D.:</b> 1 1/2 (38.1) One End <b>Height:</b> 9 3/16 (233.4) <b>O-Ring:</b> [1] Attached</p>
<p><b>PT23080-MPG</b> Maximum Performance Glass Hydraulic Element</p>  <p><b>Fits:</b> Parker Applications <b>Replaces:</b> Parker G04276 <b>O.D.:</b> 3 11/16 (93.7) <b>I.D.:</b> 1 13/16 (46.0) <b>Height:</b> 7 15/16 (201.6) <b>F. Gskt:</b> [1] Backup Ring, [1] Included <b>O-Ring:</b> [2] Included</p>	<p><b>PT23086-MPG</b> Maximum Performance Glass Hydraulic Element</p>  <p><b>Fits:</b> Hydac Hydraulic Systems <b>Replaces:</b> Hydac 30D010BH3HC <b>O.D.:</b> 1 1/4 (31.8) <b>I.D.:</b> 3/8 (9.5) One End <b>Height:</b> 3 5/8 (92.1) <b>O-Ring:</b> [1] Attached</p>
<p><b>PT23081-MPG</b> Maximum Performance Glass Hydraulic Element</p>  <p><b>Fits:</b> Parker Applications <b>Replaces:</b> Parker G04284 <b>O.D.:</b> 3 11/16 (93.7) <b>I.D.:</b> 1 3/4 (44.4) <b>Height:</b> 12 9/16 (319.1) <b>F. Gskt:</b> [1] Backup Ring, [1] Included <b>O-Ring:</b> [2] Included</p>	<p><b>PT23087-MPG</b> Maximum Performance Glass Hydraulic Element</p>  <p><b>Fits:</b> Hydac Hydraulic Systems <b>Replaces:</b> Hydac 35D003BNHC <b>O.D.:</b> 2 1/4 (57.2) <b>I.D.:</b> 15/16 (23.8) One End <b>Height:</b> 2 13/16 (71.4) <b>O-Ring:</b> [1] Attached</p>
<p><b>PT23082-MPG</b> Maximum Performance Glass Hydraulic Element</p>  <p><b>Fits:</b> Argo Hydraulic Systems <b>Replaces:</b> Argo V3052006 <b>O.D.:</b> 1 3/4 (44.4) <b>I.D.:</b> 3/4 (19.0) One End <b>Height:</b> 7 13/16 (198.4) <b>O-Ring:</b> [1] Attached</p>	<p><b>PT23088-MPG</b> Maximum Performance Glass Hydraulic Element</p>  <p><b>Fits:</b> Hydac Hydraulic Systems <b>Replaces:</b> Hydac 35D010BNHC <b>O.D.:</b> 2 1/8 (54.0) <b>I.D.:</b> 15/16 (23.8) One End <b>Height:</b> 2 3/4 (69.9) <b>O-Ring:</b> [1] Attached</p>

Measurements Are Shown In Inches And (Millimeters)

**WARNING:** These products can expose you to chemicals, including Diisononyl Phthalate, Carbon black extracts, Nickel, 1,3 Butadiene, Ethylene Oxide, Epichlorohydrin, which are known to the State of California to cause cancer, and Bisphenol, Ethylene Glycol, Ethylene Oxide, 1,3 Butadiene, Epichlorohydrin, which are known to the State of California to cause birth defects or other reproductive harm.

**PT23089-MPG** Maximum Performance Glass Hydraulic Element



**Fits:** Hydac Hydraulic Systems  
**Replaces:** Hydac 500D010BNHC  
**O.D.:** 3 1/2 (88.9)  
**I.D.:** 1 7/8 (47.6) One End  
**Height:** 10 (254.0)  
**O-Ring:** [1] Attached

**PT23095-MPG** Maximum Performance Glass Hydraulic Element



**Fits:** Internormen Hydraulic Systems  
**Replaces:** Internormen 1E9010VG30EP  
**O.D.:** 1 3/4 (44.4)  
**I.D.:** 13/16 (20.6) One End  
**Height:** 6 3/4 (171.5)  
**O-Ring:** [1] Attached

**PT23090-MPG** Maximum Performance Glass Hydraulic Element



**Fits:** Hydac Hydraulic Systems  
**Replaces:** Hydac 55D010BNHC  
**O.D.:** 2 1/8 (54.0)  
**I.D.:** 15/16 (23.8) One End  
**Height:** 4 5/8 (117.5)  
**O-Ring:** [1] Attached

**PT23096-MPG** Maximum Performance Glass Hydraulic Element



**Fits:** Eppensteiner Hydraulic Systems  
**Replaces:** Eppensteiner 232H10XLC000P  
**O.D.:** 1 13/16 (46.0)  
**I.D.:** 15/16 (23.8) One End  
**Height:** 3 1/8 (79.4)  
**O-Ring:** [1] Attached

**PT23091-MPG** Maximum Performance Glass Hydraulic Element



**Fits:** Hydac Hydraulic Systems  
**Replaces:** Hydac 95D010BNHC  
**O.D.:** 2 1/8 (54.0)  
**I.D.:** 15/16 (23.8) One End  
**Height:** 8 1/8 (206.4)  
**O-Ring:** [1] Attached

**PT23097-MPG** Maximum Performance Glass Hydraulic Element with Bail Handle



**Fits:** MP Filtri Hydraulic Systems  
**Replaces:** MP Filtri MF0301A10NB  
**O.D.:** 2 (50.8)  
**I.D.:** 15/16 (23.8) One End  
**Height:** 3 (76.2)  
**I.Gskt:** [1] Included  
**Spring:** [1] Included

**PT23092-MPG** Maximum Performance Glass Hydraulic Element



**Fits:** Parker Hydraulic Systems  
**Replaces:** Parker 938309Q  
**O.D.:** 2 1/8 (54.0)  
**I.D.:** 15/16 (23.8) One End  
**Height:** 8 1/8 (206.4)  
**O-Ring:** [1] Attached

**PT23098-MPG** Maximum Performance Glass Hydraulic Element with Bail Handle



**Fits:** MP Filtri Hydraulic Systems  
**Replaces:** MP Filtri MF1802A10NB  
**O.D.:** 3 7/8 (98.4)  
**I.D.:** 1 1/2 (38.1) One End  
**Height:** 17 1/8 (435.0)  
**I.Gskt:** [1] Included  
**Spring:** [1] Included

**PT23093-MPG** Maximum Performance Glass Hydraulic Element



**Fits:** Internormen Applications  
**Replaces:** Internormen 1E24010VG30EP  
**O.D.:** 2 3/8 (60.3)  
**I.D.:** 1 5/16 (33.3)  
**Height:** 9 (228.6)  
**O-Ring:** [1] Attached

**PT23099-MPG** Maximum Performance Glass Hydraulic Element with Bail Handle



**Notes:** OBSOLETE. Availability Limited to Dealer Stock.  
**Fits:** MP Filtri Applications  
**Replaces:** MP Filtri MF4002A03NB  
**O.D.:** 5 1/16 (128.6)  
**I.D.:** 2 1/2 (63.5) One End  
**Height:** 8 5/16 (211.1)  
**O-Ring:** [1] Attached  
**Spring:** [1] Included

**PT23094-MPG** Maximum Performance Glass Hydraulic Element



**Fits:** Internormen Hydraulic Systems  
**Replaces:** Internormen 1E36010VG30EP  
**O.D.:** 2 5/8 (66.7)  
**I.D.:** 15/16 (23.8) One End  
**Height:** 12 1/8 (308.0)  
**O-Ring:** [1] Attached













**PT23100-MPG** Maximum Performance Glass Hydraulic Element



**Fits:** Argo Hydraulic Systems  
**Replaces:** Argo V3051056  
**O.D.:** 1 11/16 (42.9)  
**I.D.:** 3/4 (19.0) One End  
**Height:** 4 1/8 (104.8)  
**I.Gskt:** [1] Included

Measurements Are Shown In Inches And (Millimeters)

**WARNING:** These products can expose you to chemicals, including Diisononyl Phthalate, Carbon black extracts, Nickel, 1,3 Butadiene, Ethylene Oxide, Epichlorohydrin, which are known to the State of California to cause cancer, and Bisphenol, Ethylene Glycol, Ethylene Oxide, 1,3 Butadiene, Epichlorohydrin, which are known to the State of California to cause birth defects or other reproductive harm.

<p><b>PT23101-MPG</b> Maximum Performance Glass Hydraulic Element</p>  <p><b>Fits:</b> Parker Hydraulic Systems <b>Replaces:</b> Parker 1181289070 <b>O.D.:</b> 4 1/8 (104.8) <b>I.D.:</b> 1 1/8 (28.6) &amp; 2 13/16 (71.4) <b>Height:</b> 15 3/4 (400.0) <b>I.Gskt:</b> [1] Included</p>	<p><b>PT23107-MPG</b> Maximum Performance Glass Hydraulic Element</p>  <p><b>Fits:</b> Hydac Hydraulic Systems <b>Replaces:</b> Hydac 40DN010BNHC <b>O.D.:</b> 1 3/4 (44.4) <b>I.D.:</b> 3/4 (19.0) <b>Height:</b> 3 13/16 (96.8) <b>I.Gskt:</b> [1] Included</p>
<p><b>PT23102-MPG</b> Maximum Performance Glass Hydraulic Element with Bail Handle</p>  <p><b>Fits:</b> Hydac Hydraulic Systems <b>Replaces:</b> Hydac 160R020BNHC <b>O.D.:</b> 2 13/16 (71.4) <b>I.D.:</b> 1 5/16 (33.3) One End <b>Height:</b> 5 3/8 (136.5) <b>I.Gskt:</b> [1] Included</p>	<p><b>PT23108-MPG</b> Maximum Performance Glass Hydraulic Element</p>  <p><b>Fits:</b> Hydac Hydraulic Systems <b>Replaces:</b> Hydac 100DN010BNHC <b>O.D.:</b> 1 3/4 (44.4) <b>I.D.:</b> 13/16 (20.6) <b>Height:</b> 9 3/4 (247.7) <b>I.Gskt:</b> [1] Included</p>
<p><b>PT23103-MPG</b> Maximum Performance Glass Hydraulic Element with Bail Handle</p>  <p><b>Fits:</b> Hydac Hydraulic Systems <b>Replaces:</b> Hydac 165R010BN3HC <b>O.D.:</b> 2 1/4 (57.2) <b>I.D.:</b> 1 5/16 (33.3) One End <b>Height:</b> 9 (228.6) <b>I.Gskt:</b> [1] Included</p>	<p><b>PT23109-MPG</b> Maximum Performance Glass Hydraulic Element</p>  <p><b>Fits:</b> Hydac Hydraulic Systems <b>Replaces:</b> Hydac 100DN025BNHC <b>O.D.:</b> 1 3/4 (44.4) <b>I.D.:</b> 13/16 (20.6) <b>Height:</b> 9 3/4 (247.7) <b>I.Gskt:</b> [1] Included</p>
<p><b>PT23104-MPG</b> Maximum Performance Glass Hydraulic Element with Bail Handle</p>  <p><b>Contains:</b> By-Pass Valve <b>Fits:</b> Hydac Hydraulic Systems <b>Replaces:</b> Hydac 2600R005BNHC <b>O.D.:</b> 5 1/2 (139.7) <b>I.D.:</b> 3 13/16 (96.8) One End <b>Height:</b> 36 11/16 (931.9) <b>I.Gskt:</b> [1] Included</p>	<p><b>PT23110-MPG</b> Maximum Performance Glass Hydraulic Element</p>  <p><b>Fits:</b> Hydac Applications <b>Replaces:</b> Hydac 160DN010BNHC, 1268869; Eppensteiner 20160H10SLA000P, 20160H10XLA000P; Filtrec XD160G10A <b>O.D.:</b> 3 1/16 (77.8) <b>I.D.:</b> 1 19/32 (40.5) One End <b>Height:</b> 6 3/16 (157.2) <b>O-Ring:</b> [1] Attached</p>
<p><b>PT23105-MPG</b> Maximum Performance Glass Hydraulic Element with Bail Handle</p>  <p><b>Contains:</b> By-Pass Valve <b>Fits:</b> Hydac Hydraulic Assemblies <b>Replaces:</b> Hydac 60R010BNHC <b>O.D.:</b> 1 15/16 (49.2) <b>I.D.:</b> 13/16 (20.6) One End <b>Height:</b> 4 (101.6) <b>I.Gskt:</b> [1] Included</p>	<p><b>PT23111-MPG</b> Maximum Performance Glass Hydraulic Element</p>  <p><b>Fits:</b> Hydac Applications <b>Replaces:</b> Hydac 250DN010BNHC <b>O.D.:</b> 3 1/16 (77.8) <b>I.D.:</b> 1 9/16 (39.7) <b>Height:</b> 9 3/4 (247.7) <b>O-Ring:</b> [1] Attached</p>
<p><b>PT23106-MPG</b> Maximum Performance Glass Hydraulic Element with Bail Handle</p>  <p><b>Contains:</b> By-Pass Valve <b>Fits:</b> Hydac Hydraulic Systems <b>Replaces:</b> Hydac 660R020BNHC <b>O.D.:</b> 4 1/2 (114.3) <b>I.D.:</b> 2 11/16 (68.3) One End <b>Height:</b> 13 1/8 (333.4) <b>I.Gskt:</b> [1] Included</p>	<p><b>PT23112-MPG</b> Maximum Performance Glass Hydraulic Element</p>  <p><b>Fits:</b> Hydac Applications <b>Replaces:</b> Hydac 250DN025BNHC <b>O.D.:</b> 3 (76.2) <b>I.D.:</b> 1 9/16 (39.7) One End <b>Height:</b> 9 9/16 (242.9) <b>O-Ring:</b> [1] Attached</p>

Measurements Are Shown In Inches And (Millimeters)

**WARNING:** These products can expose you to chemicals, including Diisononyl Phthalate, Carbon black extracts, Nickel, 1,3 Butadiene, Ethylene Oxide, Epichlorohydrin, which are known to the State of California to cause cancer, and Bisphenol, Ethylene Glycol, Ethylene Oxide, 1,3 Butadiene, Epichlorohydrin, which are known to the State of California to cause birth defects or other reproductive harm.

**PT23113-MPG** Maximum Performance Glass Hydraulic Element



**Fits:** Hydac Applications  
**Replaces:** Hydac 400DN006BNHC  
**O.D.:** 3 1/16 (77.8)  
**I.D.:** 1 1/2 (38.1) One End  
**Height:** 15 11/16 (398.5)  
**O-Ring:** [1] Attached

**PT23119-MPG** Maximum Performance Glass Hydraulic Element



**Fits:** Hydac Applications  
**Replaces:** Hydac 400RN010BNHC  
**O.D.:** 5 1/16 (128.6)  
**I.D.:** 2 3/4 (69.9) One End  
**Height:** 9 3/4 (247.7)  
**O-Ring:** [2] Attached

**PT23114-MPG** Maximum Performance Glass Hydraulic Element



**Fits:** Hydac Hydraulic Systems  
**Replaces:** Hydac 400DN010BNHC  
**O.D.:** 3 1/8 (79.4)  
**I.D.:** 1 1/2 (38.1) One End  
**Height:** 15 11/16 (398.5)  
**I.Gskt:** [1] Included

**PT23120-MPG** Maximum Performance Glass Hydraulic Element



**Fits:** Hydac Hydraulic Systems  
**Replaces:** Hydac 630RN010BNHC  
**O.D.:** 5 1/8 (130.2)  
**I.D.:** 2 11/16 (68.3)  
**Height:** 15 3/4 (400.0)  
**I.Gskt:** [2] Included

**PT23115-MPG** Maximum Performance Glass Hydraulic Element



**Fits:** Hydac Hydraulic Systems  
**Replaces:** Hydac 63RN010BNHC  
**O.D.:** 2 1/8 (54.0)  
**I.D.:** 1 1/8 (28.6)  
**Height:** 6 1/4 (158.8)  
**I.Gskt:** [2] Included

**PT23122** Hydraulic Strainer  
**Contains:** 3 PSID By-Pass Valve  
Threaded Hex Nut  
**Replaces:** Schroeder SS150100  
**O.D.:** 3 7/32 (81.8)  
**Height:** 8 9/16 (217.5)



**PT23116-MPG** Maximum Performance Glass Hydraulic Element



**Fits:** Pall Hydraulic Systems  
**Replaces:** Pall HC0600FKS16H  
**O.D.:** 6 (152.4)  
**I.D.:** 3 1/2 (88.9)  
**Height:** 15 11/16 (398.5)  
**I.Gskt:** [2] Included

**PT23123** Hydraulic Strainer  
**Contains:** 3 PSID By-Pass Valve  
Threaded Hex Nut  
**Replaces:** Schroeder SS125100  
**O.D.:** 3 3/16 (81.0)  
**Height:** 6 9/16 (166.7)



**PT23117-MPG** Maximum Performance Glass Hydraulic Element



**Fits:** Hydac Hydraulic Systems  
**Replaces:** Hydac 100RN010BNHC  
**O.D.:** 2 1/4 (57.2)  
**I.D.:** 1 1/8 (28.6)  
**Height:** 9 13/16 (249.2)  
**I.Gskt:** [2] Included

**PT23124** Hydraulic Strainer  
**Contains:** 3 PSID By-Pass Valve  
Threaded Nut: 2 Inch NPT  
**Fits:** Schroeder Industries Hydraulic Systems  
**Replaces:** Schroeder SS2100; Fleetguard  
HF6264; Wix 57453  
**O.D.:** 4 3/16 (106.4)  
**Height:** 7 7/32 (183.4)



**PT23118-MPG** Maximum Performance Glass Hydraulic Element











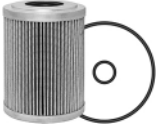

**Fits:** Hydac Hydraulic Systems  
**Replaces:** Hydac 160RN010BNHC  
**O.D.:** 3 15/16 (100.0)  
**I.D.:** 2 (50.8)  
**Height:** 6 1/4 (158.8)  
**I.Gskt:** [2] Included

**PT23125-MPG** Maximum Performance Glass Hydraulic Element  
**Fits:** Schroeder Industries Hydraulic Systems  
**Replaces:** Schroeder KSX3V; Donaldson  
P566412  
**O.D.:** 3 3/16 (81.0)  
**I.D.:** 1 19/32 (40.5)  
**Height:** 9 5/16 (236.5)  
**I.Gskt:** [2] Included

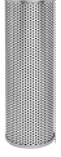

Measurements Are Shown In Inches And (Millimeters)

**WARNING:** These products can expose you to chemicals, including Diisononyl Phthalate, Carbon black extracts, Nickel, 1,3 Butadiene, Ethylene Oxide, Epichlorohydrin, which are known to the State of California to cause cancer, and Bisphenol, Ethylene Glycol, Ethylene Oxide, 1,3 Butadiene, Epichlorohydrin, which are known to the State of California to cause birth defects or other reproductive harm.

<p><b>PT23126-MPG</b> Maximum Glass Performance Hydraulic Element</p>  <p><b>Fits:</b> Pall Hydraulic Applications  <b>Replaces:</b> Pall HC9021FUS4H  <b>O.D.:</b> 1 25/32 (45.2)  <b>I.D.:</b> 1 (25.4) One End  <b>Height:</b> 4 1/2 (114.3)  <b>I.Gskt:</b> [1] Included</p>	<p><b>PT23133-MPG</b> Maximum Performance Glass Hydraulic Element</p>  <p><b>Fits:</b> Various Pall Hydraulic Applications  <b>Replaces:</b> Pall HC2618FKP18H; Parker 934179Q; Donaldson P566705  <b>O.D.:</b> 6 (152.4)  <b>I.D.:</b> 2 5/8 (66.7)  <b>Height:</b> 17 13/16 (452.4)</p>
<p><b>PT23127-MPG</b> Maximum Performance Glass Hydraulic Element</p>  <p><b>Fits:</b> Allison EV40, EV50 Transmission  <b>Replaces:</b> General Motors Corp. 29545785  <b>O.D.:</b> 3 7/32 (81.8)  <b>I.D.:</b> 1 17/32 (38.9) One End  <b>Height:</b> 4 3/16 (106.4)  <b>O-Ring:</b> [2] Included</p>	<p><b>PT23135-MPG</b> Maximum Performance Glass Hydraulic Element</p>  <p><b>Fits:</b> Parker Hydraulic Systems  <b>Replaces:</b> Parker 932633Q  <b>O.D.:</b> 2 3/8 (60.3)  <b>I.D.:</b> 31/32 (24.6) One End  <b>Height:</b> 9 23/32 (246.9)  <b>O-Ring:</b> [1] Attached</p>
<p><b>PT23128-MPG</b> Maximum Performance Glass Hydraulic Element</p>  <p><b>Fits:</b> Hydac Applications  <b>O.D.:</b> 1 27/32 (46.8)  <b>I.D.:</b> 7/8 (22.2) One End  <b>Height:</b> 6 1/32 (153.2)  <b>O-Ring:</b> [1] Attached</p>	<p><b>PT23136</b> Hydraulic Element</p>  <p><b>Contains:</b> Threaded Nut: 7/8-14  <b>Fits:</b> Ford Tractors  <b>Replaces:</b> Ford C5NN7B155A  <b>O.D.:</b> 3 15/32 (88.1)  <b>I.D.:</b> 5/8 (15.9)  <b>Height:</b> 4 31/32 (126.2)  <b>A. Gskt:</b> [1] Included  <b>F. Gskt:</b> [1] Included</p>
<p><b>PT23129-MPG</b> Maximum Performance Glass Hydraulic Element</p>  <p><b>Fits:</b> Hydac Hydraulic Applications  <b>Replaces:</b> Hydac 24D020BN3HCV  <b>O.D.:</b> 2 3/4 (69.9)  <b>I.D.:</b> 1 11/32 (34.1) One End  <b>Height:</b> 6 13/16 (173.0)  <b>I.Gskt:</b> [1] Included</p>	<p><b>PT23137</b> Hydraulic Element</p>  <p><b>Fits:</b> Driltech Equipment  <b>Replaces:</b> Driltech 318553; ACDelco PF1770; Donaldson P161917  <b>O.D.:</b> 4 3/8 (111.1)  <b>I.D.:</b> 23/32 (18.3) &amp; 2 7/16 (61.9)  <b>Height:</b> 13 1/32 (331.0)  <b>A. Gskt:</b> [1] Included  <b>Grommets:</b> [1] Attached</p>
<p><b>PT23131-MPG</b> Maximum Performance Glass Hydraulic Element</p>  <p><b>Fits:</b> Schroeder Hydraulic Applications  <b>Replaces:</b> Schroeder 8TSX7  <b>O.D.:</b> 3 1/16 (77.8)  <b>I.D.:</b> 1 11/16 (42.9) One End  <b>Height:</b> 8 9/32 (210.3)  <b>I.Gskt:</b> [1] Included</p>	<p><b>PT23138</b> Hydraulic Element</p>  <p><b>Fits:</b> Deutz-Fahr Tractors  <b>Replaces:</b> SDF 4417454; Hengst E84H; Mann &amp; Hummel H10592  <b>O.D.:</b> 3 7/8 (98.4)  <b>I.D.:</b> 2 5/16 (58.7)  <b>Height:</b> 9 (228.6)</p>
<p><b>PT23132-MPG</b> Maximum Performance Glass Hydraulic Element</p>  <p><b>Fits:</b> Hydac Applications  <b>Replaces:</b> Hydac 110D003BH3HC; Fleetguard ST1038  <b>O.D.:</b> 1 27/32 (46.8)  <b>I.D.:</b> 7/8 (22.2) One End  <b>Height:</b> 6 1/32 (153.2)  <b>I.Gskt:</b> [1] Included</p>	<p><b>PT23139-MPG</b> Maximum Performance Glass Hydraulic Element</p>  <p><b>Fits:</b> Heil Hydraulic Systems  <b>Replaces:</b> Heil 750912030  <b>O.D.:</b> 4 7/8 (123.8)  <b>I.D.:</b> 2 3/4 (69.9) One End  <b>Height:</b> 19 7/8 (504.8)  <b>F. Gskt:</b> [1] Included  <b>O-Ring:</b> [2] Attached</p>

Measurements Are Shown In Inches And (Millimeters)

**WARNING:** These products can expose you to chemicals, including Diisononyl Phthalate, Carbon black extracts, Nickel, 1,3 Butadiene, Ethylene Oxide, Epichlorohydrin, which are known to the State of California to cause cancer, and Bisphenol, Ethylene Glycol, Ethylene Oxide, 1,3 Butadiene, Epichlorohydrin, which are known to the State of California to cause birth defects or other reproductive harm.

**BT23140-MPG** Maximum Performance Glass Hydraulic Spin-on  
**Fits:** Ditchwitch, Genie, Pall, Vickers Hydraulic Systems  
**Replaces:** Pall HC7500SUP4Z  
**Thread:** 1 1/2 -16  
**O.D.:** 5 3/32 (129.4)  
**Height:** 6 21/32 (169.1)  
**F. Gskt:** [2] Included



**PT23141** Hydraulic Element with Bail Handle  
**Contains:** By-Pass Valve  
**Fits:** Purolator Applications  
**Replaces:** Purolator LI2692; Filtrec R142C25BG  
**O.D.:** 3 7/8 (98.4)  
**I.D.:** 1 1/2 (38.1) One End  
**Height:** 7 3/16 (182.6)  
**O-Ring:** [1] Attached  
**Spring:** [1] Included



**PT23142** Hydraulic Element  
**Fits:** Schroeder Applications  
**Replaces:** Schroeder C10; Filtrec WP603  
**O.D.:** 2 15/16 (74.6)  
**I.D.:** 1 (25.4) One End  
**Height:** 4 15/16 (125.4)  
**O-Ring:** [1] Attached



**PT23143** Hydraulic Element  
**Fits:** Schroeder Applications  
**Replaces:** Schroeder N3  
**O.D.:** 1 13/16 (46.0)  
**I.D.:** 13/16 (20.6) One End  
**Height:** 5 5/16 (134.9)  
**O-Ring:** [1] Attached



**PT23144** Hydraulic Element  
**Fits:** Domange Applications  
**Replaces:** Domange FD45P10  
**O.D.:** 3 5/8 (92.1)  
**I.D.:** 3/8 (9.5) & 2 1/2 (63.5)  
**Height:** 8 7/8 (225.4)  
**Grommets:** [1] Attached



**PT23145** Hydraulic Element  
**Fits:** Parker Applications  
**Replaces:** Parker HPR1619  
**O.D.:** 1 7/16 (36.5)  
**I.D.:** 1/2 (12.7)  
**Height:** 1 9/16 (39.7)



**PT23146** Hydraulic Element  
**Contains:** By-Pass Valve  
**Fits:** Argo Applications  
**Replaces:** Argo K3092062; Filtrec WP457  
**O.D.:** 3 1/4 (82.6)  
**I.D.:** 1 1/2 (38.1) One End  
**Height:** 7 13/16 (198.4)  
**O-Ring:** [1] Attached



**PT23147** Hydraulic Element with Bail Handle  
**Contains:** 22 PSID By-Pass Valve  
**Fits:** Manitou Applications  
**Replaces:** Mahle 7686470, 852369MIC25; MP Filtri MF4001P25NB  
**O.D.:** 5 1/2 (139.7)  
**I.D.:** 2 1/16 (52.4)  
**Height:** 5 11/32 (135.7)  
**O-Ring:** [1] Included  
**Spring:** [1] Included



**PT23148** Hydraulic Element  
**Fits:** Fairey-Arlon Applications  
**Replaces:** Fairey-Arlon TXX3B10; Parker PR4392  
**O.D.:** 4 3/16 (106.4)  
**I.D.:** 2 7/8 (73.0) One End  
**Height:** 5 1/2 (139.7)



**PT23149** Hydraulic Element  
**Fits:** Liebherr Applications  
**Replaces:** Liebherr 7367204  
**O.D.:** 3 5/16 (84.1)  
**I.D.:** 1 11/16 (42.9)  
**Height:** 7 1/2 (190.5)  
**End Seals:** [2] Attached



**PT23150** Hydraulic Element  
**Fits:** Parker Applications  
**Replaces:** Caterpillar 3I1536; Parker 924449  
**O.D.:** 3 5/8 (92.1)  
**I.D.:** 1 3/4 (44.4)  
**Height:** 9 5/16 (236.5)  
**Grommets:** [2] Attached



**PT23151** Hydraulic Element  
**Fits:** Argo Applications  
**Replaces:** Arco K3134062  
**O.D.:** 5 (127.0)  
**I.D.:** 3 1/2 (88.9) One End  
**Height:** 18 (457.2)  
**O-Ring:** [1] Attached  
**Spring:** [1] Attached



Measurements Are Shown In Inches And (Millimeters)

**WARNING:** These products can expose you to chemicals, including Diisononyl Phthalate, Carbon black extracts, Nickel, 1,3 Butadiene, Ethylene Oxide, Epichlorohydrin, which are known to the State of California to cause cancer, and Bisphenol, Ethylene Glycol, Ethylene Oxide, 1,3 Butadiene, Epichlorohydrin, which are known to the State of California to cause birth defects or other reproductive harm.

<p><b>PT23152</b></p>  <p>Hydraulic Element with Bail Handle  <b>Contains:</b> By-Pass Valve  <b>Fits:</b> MP Filtri Applications  <b>Replaces:</b> MP Filtri MF7501P10NB; Donaldson P171581  <b>O.D.:</b> 5 5/16 (134.9)  <b>I.D.:</b> 2 1/2 (63.5)  <b>Height:</b> 16 (406.4)  <b>Spring:</b> [1] Included</p>	<p><b>PT23159</b></p>  <p>Hydraulic Element  <b>Fits:</b> Voegelé Applications  <b>Replaces:</b> Voegelé 9606671002  <b>O.D.:</b> 4 1/32 (102.4)  <b>I.D.:</b> 1/4 (6.4)  <b>Height:</b> 12 11/16 (322.3)</p>
<p><b>PT23154</b></p>  <p>Hydraulic Element  <b>Fits:</b> Parker Applications  <b>Replaces:</b> Parker 908642  <b>O.D.:</b> 3 15/16 (100.0)  <b>I.D.:</b> 2 3/8 (60.3)  <b>Height:</b> 13 1/16 (331.8)  <b>A. Gskt:</b> [2] Attached  <b>F. Gskt:</b> [1] Included</p>	<p><b>PT23160</b></p>  <p>Hydraulic Element  <b>Fits:</b> PTI Applications  <b>Replaces:</b> Bosch 1457431909, 1457431109, 1457431914; PTI PG050CH; Donaldson P174293  <b>O.D.:</b> 3 1/4 (82.6)  <b>I.D.:</b> 1 7/8 (47.6) One End  <b>Height:</b> 5 5/8 (142.9)</p>
<p><b>PT23155</b></p>  <p>Hydraulic Element  <b>Fits:</b> PTI Applications  <b>Replaces:</b> PTI PG120DH; Donaldson P174298; Eppensteiner 18.1045P25E000P  <b>O.D.:</b> 3 5/16 (84.1)  <b>I.D.:</b> 2 (50.8) One End  <b>Height:</b> 14 11/16 (373.1)</p>	<p><b>PT23161</b></p>  <p>Hydraulic Element  <b>Fits:</b> Parker Applications  <b>Replaces:</b> Parker 907233, G01070; Donaldson P170095  <b>O.D.:</b> 3 1/2 (88.9)  <b>I.D.:</b> 2 3/16 (55.6) One End  <b>Height:</b> 8 1/16 (204.8)  <b>O-Ring:</b> [1] Attached</p>
<p><b>PT23156</b></p>  <p>Hydraulic Element  <b>Fits:</b> Caterpillar Applications  <b>Replaces:</b> Caterpillar 311714; Fleetguard HF7728  <b>O.D.:</b> 5 5/8 (142.9)  <b>I.D.:</b> 4 (101.6)  <b>Height:</b> 12 3/16 (309.6)  <b>A. Gskt:</b> [2] Attached  <b>F. Gskt:</b> [1] Included (Adhesive Backed)</p>	<p><b>PT23162</b></p>  <p>Hydraulic Element  <b>Fits:</b> Argo Applications  <b>Replaces:</b> Argo P2072301  <b>O.D.:</b> 2 1/2 (63.5)  <b>I.D.:</b> 1 3/16 (30.2)  <b>Height:</b> 9 (228.6)</p>
<p><b>PT23157</b></p>  <p>Hydraulic Stacked Element  <b>Fits:</b> Parker Applications  <b>Replaces:</b> Parker 937733, PR4434, TXX1410B  <b>O.D.:</b> 8 9/32 (210.3)  <b>I.D.:</b> 6 5/32 (156.4) One End  <b>Height:</b> 32 15/32 (824.7)</p>	<p><b>PT23163</b></p>  <p>Hydraulic Element  <b>Fits:</b> Fairey-Arlon Applications  <b>Replaces:</b> Fairey-Arlon TXX3ER10  <b>O.D.:</b> 2 13/16 (71.4)  <b>I.D.:</b> 1/4 (6.4) &amp; 1 3/4 (44.4)  <b>Height:</b> 11 13/16 (300.0)</p>
<p><b>PT23158</b></p>  <p>Hydraulic Element  <b>Fits:</b> Domange Applications  <b>Replaces:</b> Domange FD66P10  <b>O.D.:</b> 4 31/32 (126.2)  <b>I.D.:</b> 1/2 (12.7) &amp; 3 5/8 (92.1)  <b>Height:</b> 13 13/16 (350.8)  <b>Grommets:</b> [1] Attached</p>	<p><b>PT23164</b></p>  <p>Hydraulic Element  <b>Fits:</b> Argo Applications  <b>Replaces:</b> Argo P3051052  <b>O.D.:</b> 1 13/16 (46.0)  <b>I.D.:</b> 13/16 (20.6) One End  <b>Height:</b> 4 3/16 (106.4)  <b>O-Ring:</b> [1] Attached</p>

Measurements Are Shown In Inches And (Millimeters)

**WARNING:** These products can expose you to chemicals, including Diisononyl Phthalate, Carbon black extracts, Nickel, 1,3 Butadiene, Ethylene Oxide, Epichlorohydrin, which are known to the State of California to cause cancer, and Bisphenol, Ethylene Glycol, Ethylene Oxide, 1,3 Butadiene, Epichlorohydrin, which are known to the State of California to cause birth defects or other reproductive harm.



**PT23165**



Hydraulic Element

**Contains:** By-Pass Valve  
**Fits:** Argo Applications  
**Replaces:** Argo K3092552  
**O.D.:** 3 9/16 (90.5)  
**I.D.:** 2 5/16 (58.7) One End  
**Height:** 11 1/8 (282.6)  
**O-Ring:** [1] Attached

**PT23171**



Hydraulic Element

**Notes:** OBSOLETE. Availability Limited to Dealer Stock.  
**Fits:** Argo Applications  
**Replaces:** Argo P3051011  
**O.D.:** 1 7/8 (47.6)  
**I.D.:** 3/4 (19.0) One End  
**Height:** 4 1/8 (104.8)  
**O-Ring:** [1] Attached

**PT23166**



Hydraulic Element

**Fits:** Parker Applications  
**Replaces:** Parker 907234, G01071; Donaldson P170096  
**O.D.:** 3 1/2 (88.9)  
**I.D.:** 2 3/16 (55.6) One End  
**Height:** 8 1/16 (204.8)  
**O-Ring:** [1] Attached

**PT23172**



Hydraulic Element

**Fits:** Parker Applications  
**Replaces:** Parker 924730  
**O.D.:** 2 3/4 (69.9)  
**I.D.:** 1 13/16 (46.0)  
**Height:** 9 (228.6)  
**A. Gskt:** [2] Attached

**PT23167**



Hydraulic Element

**Contains:** By-Pass Valve  
**Fits:** Argo Applications  
**Replaces:** Argo K9123752; Filtrec WP461  
**O.D.:** 4 1/4 (108.0)  
**I.D.:** 2 7/16 (61.9) One End  
**Height:** 14 1/2 (368.3)  
**O-Ring:** [1] Attached

**PT23173**



Hydraulic Element

**Fits:** Parker Applications  
**Replaces:** Parker 922787  
**O.D.:** 5 13/16 (147.6)  
**I.D.:** 4 1/16 (103.2)  
**Height:** 12 1/8 (308.0)  
**A. Gskt:** [2] Attached

**PT23168**



Hydraulic Element

**Fits:** PTI Applications  
**Replaces:** Bosch 1457431911; PTI PG120CH  
**O.D.:** 3 3/8 (85.7)  
**I.D.:** 1 7/8 (47.6) One End  
**Height:** 14 3/4 (374.7)

**PT23174**



Hydraulic Element with Bail Handle

**Fits:** Hydac Applications  
**Replaces:** Hydac 270R015MM  
**O.D.:** 3 1/2 (88.9)  
**I.D.:** 1 1/2 (38.1) One End  
**Height:** 16 1/4 (412.8)  
**O-Ring:** [1] Attached

**PT23169**



Hydraulic Element

**Fits:** Argo Applications  
**Replaces:** Argo K6123452  
**O.D.:** 4 1/2 (114.3)  
**I.D.:** 2 5/16 (58.7)  
**Height:** 13 1/4 (336.5)

**PT23175**



Hydraulic Element

**Contains:** By-Pass Valve Threaded End  
**Fits:** U.C.C. Applications  
**Replaces:** U.C.C. UCSE5102  
**O.D.:** 2 1/2 (63.5)  
**I.D.:** 1 3/8 (34.9) One End  
**Height:** 5 13/16 (147.6)

**PT23170**



Hydraulic Element

**Fits:** Parker Applications  
**Replaces:** Parker 924467  
**O.D.:** 5 9/16 (141.3)  
**I.D.:** 4 (101.6)  
**Height:** 12 1/8 (308.0)  
**A. Gskt:** [2] Attached  
**F. Gskt:** [1] Included (Adhesive Backed)

**PT23176**



Hydraulic Element with Bail Handle

**Contains:** By-Pass Valve  
**Fits:** MP Filtri Applications  
**Replaces:** MP Filtri MF1003M60NB  
**O.D.:** 2 13/16 (71.4)  
**I.D.:** 1 9/16 (39.7) One End  
**Height:** 8 7/8 (225.4)  
**O-Ring:** [1] Attached

Measurements Are Shown In Inches And (Millimeters)

**WARNING:** These products can expose you to chemicals, including Diisononyl Phthalate, Carbon black extracts, Nickel, 1,3 Butadiene, Ethylene Oxide, Epichlorohydrin, which are known to the State of California to cause cancer, and Bisphenol, Ethylene Glycol, Ethylene Oxide, 1,3 Butadiene, Epichlorohydrin, which are known to the State of California to cause birth defects or other reproductive harm.

**PT23178**

Wire Supported Hydraulic Element



**Contains:** By-Pass Valve  
Threaded Stud  
**Fits:** U.C.C. Applications  
**Replaces:** U.C.C. UCSE5104  
**O.D.:** 3 5/16 (84.1)  
**Height:** 8 1/16 (204.8)

**PT23184**

Hydraulic Element



**Fits:** Vickers Applications  
**Replaces:** Vickers 36192  
**O.D.:** 4 (101.6)  
**I.D.:** 2 15/16 (74.6)  
**Height:** 6 15/16 (176.2)  
**O-Ring:** [2] Attached, [1] Included

**PT23179**

Hydraulic Element



**Contains:** By-Pass Valve  
**Fits:** U.C.C. Applications  
**Replaces:** U.C.C. UCSE5105  
**O.D.:** 3 1/2 (88.9)  
**I.D.:** 2 1/2 (63.5) One End  
**Height:** 10 5/16 (261.9)

**PT23185**

Hydraulic Element



**Fits:** MP Filtri Applications  
**Replaces:** MP Filtri CU630M90N  
**O.D.:** 5 5/16 (134.9)  
**I.D.:** 3 (76.2)  
**Height:** 9 13/16 (249.2)  
**O-Ring:** [2] Attached

**PT23180**

Hydraulic Element



**Contains:** By-Pass Valve  
**Fits:** U.C.C. Applications  
**Replaces:** U.C.C. UCSE5107  
**O.D.:** 5 15/16 (150.8)  
**I.D.:** 3 (76.2) One End  
**Height:** 8 1/2 (215.9)

**PT23186**

Hydraulic Element



**Contains:** Stud Thread: 2-11 BSP  
**Fits:** MP Filtri Applications  
**Replaces:** MP Filtri MPA280G1M90,  
STR1403SG1M90; Donaldson FIOA500, P171897  
**O.D.:** 5 5/32 (131.0)  
**Height:** 10 15/16 (277.8)  
**O-Ring:** [1] Attached

**PT23181**

Hydraulic Element



**Fits:** Parker Applications  
**Replaces:** Parker 924455  
**O.D.:** 3 13/16 (96.8)  
**I.D.:** 2 (50.8)  
**Height:** 9 3/8 (238.1)  
**Grommets:** [2] Attached

**PT23187**

Hydraulic Element



**Fits:** Fairey-Arlon Applications  
**Replaces:** Fairey-Arlon ST560  
**O.D.:** 4 1/4 (108.0)  
**I.D.:** 3 (76.2) One End  
**Height:** 10 1/8 (257.2)

**PT23182**

Hydraulic Element



**Fits:** Parker Applications  
**Replaces:** Parker 924456  
**O.D.:** 3 13/16 (96.8)  
**I.D.:** 2 (50.8)  
**Height:** 9 3/8 (238.1)  
**Grommets:** [2] Attached

**PT23188**

Hydraulic Element with Bail Handle



**Contains:** By-Pass Valve  
**Fits:** MP Filtri Applications  
**Replaces:** MP Filtri MF4001M60NB  
**O.D.:** 5 3/16 (131.8)  
**I.D.:** 2 (50.8)  
**Height:** 6 (152.4)  
**O-Ring:** [1] Attached  
**Spring:** [1] Included

**PT23183**

Hydraulic Element



**Fits:** Vickers Applications  
**Replaces:** Vickers 941056  
**O.D.:** 4 (101.6)  
**I.D.:** 2 15/16 (74.6)  
**Height:** 6 15/16 (176.2)  
**O-Ring:** [2] Attached, [1] Included

**PT23189**

Hydraulic Element



**Fits:** Argo Applications  
**Replaces:** Argo S2092000  
**O.D.:** 3 5/16 (84.1)  
**I.D.:** 2 7/16 (61.9)  
**Height:** 7 11/16 (195.3)

Measurements Are Shown In Inches And (Millimeters)

**WARNING:** These products can expose you to chemicals, including Diisononyl Phthalate, Carbon black extracts, Nickel, 1,3 Butadiene, Ethylene Oxide, Epichlorohydrin, which are known to the State of California to cause cancer, and Bisphenol, Ethylene Glycol, Ethylene Oxide, 1,3 Butadiene, Epichlorohydrin, which are known to the State of California to cause birth defects or other reproductive harm.

**PT23190**

Hydraulic Element



**Fits:** Komatsu Applications  
**Replaces:** Komatsu 79560373  
**O.D.:** 2 13/16 (71.4)  
**I.D.:** 1 1/2 (38.1) One End  
**Height:** 4 1/16 (103.2)  
**O-Ring:** [1] Attached

**PT23200-MPG**

Maximum Performance Glass Hydraulic Element



**Fits:** Fairey-Arlon Applications  
**Replaces:** Fairey-Arlon MXW2GDL10; Filtrec D411G10  
**O.D.:** 2 5/16 (58.7)  
**I.D.:** 1 1/16 (27.0) One End  
**Height:** 9 3/4 (247.7)  
**O-Ring:** [1] Attached

**PT23193-MPG**

Maximum Performance Glass Hydraulic Element



**Contains:** By-Pass Valve Backup O-Ring  
**Fits:** International Applications  
**Replaces:** International 3224623-R1, 3405722-R1, 3405722-R2, 3405729-R1  
**O.D.:** 2 3/8 (60.3)  
**I.D.:** 15/16 (23.8) One End  
**Height:** 2 13/16 (71.4)  
**O-Ring:** [1] Attached, [1] Included

**PT23201-MPG**

Maximum Performance Glass Hydraulic Element



**Fits:** Fairey-Arlon Applications  
**Replaces:** Fairey-Arlon TXW3DCC10, TXW3DGDL10  
**O.D.:** 2 7/8 (73.0)  
**I.D.:** 3/8 (9.5) & 1 15/16 (49.2)  
**Height:** 7 7/8 (200.0)

**PT23195-MPG**

Maximum Performance Glass Hydraulic Element



**Fits:** Fairey-Arlon Applications  
**Replaces:** Fairey-Arlon MW1GDL20; Filtrec D410G25  
**O.D.:** 2 5/16 (58.7)  
**I.D.:** 1 1/16 (27.0) One End  
**Height:** 4 13/16 (122.2)  
**O-Ring:** [1] Attached

**PT23202-MPG**

Maximum Performance Glass Hydraulic Element



**Fits:** Schroeder Hydraulic Systems  
**Replaces:** Schroeder NS7, NZ10; Fleetguard HF7351  
**O.D.:** 1 3/4 (44.4)  
**I.D.:** 3/4 (19.0) One End  
**Height:** 5 3/8 (136.5)  
**O-Ring:** [1] Attached

**PT23196-MPG**

Maximum Performance Glass Hydraulic Element



**Fits:** Fairey-Arlon Applications  
**Replaces:** Fairey-Arlon TXW3CC25, TXW3GDL20  
**O.D.:** 2 13/16 (71.4)  
**I.D.:** 1 13/16 (46.0)  
**Height:** 5 7/8 (149.2)

**PT23203-MPG**

Maximum Performance Glass Hydraulic Element



**Fits:** Schroeder Applications  
**Replaces:** Schroeder CS7, CZ10; Donaldson P171311  
**O.D.:** 2 3/4 (69.9)  
**I.D.:** 1 (25.4) One End  
**Height:** 4 3/4 (120.7)  
**O-Ring:** [1] Attached

**PT23197-MPG**

Maximum Performance Glass Hydraulic Element



**Fits:** Fairey-Arlon Applications  
**Replaces:** Fairey-Arlon 370L122A  
**O.D.:** 3 11/16 (93.7)  
**I.D.:** 1 29/32 (48.4) One End  
**Height:** 3 29/32 (99.2)  
**O-Ring:** [1] Included

**PT23204-MPG**

Maximum Performance Glass Hydraulic Element



**Fits:** P.T.I. Applications  
**Replaces:** P.T.I. PG050JH; Donaldson P174293  
**O.D.:** 3 5/16 (84.1)  
**I.D.:** 2 (50.8) One End  
**Height:** 5 9/16 (141.3)  
**O-Ring:** [1] Attached

**PT23198-MPG**

Maximum Performance Glass Hydraulic Element



**Contains:** By-Pass Valve  
**Fits:** Fendt Applications  
**Replaces:** Argo V3062088; Fendt G178860060030  
**O.D.:** 2 1/2 (63.5)  
**I.D.:** 1 3/16 (30.2) One End  
**Height:** 9 1/4 (235.0)  
**O-Ring:** [1] Attached

**PT23205-MPG**

Maximum Performance Glass Hydraulic Element



**Fits:** Pall Applications  
**Replaces:** Pall HC9800FDS4Z, HC9800FKS4Z; Donaldson P566394  
**O.D.:** 2 (50.8)  
**I.D.:** 15/16 (23.8) One End  
**Height:** 4 1/2 (114.3)  
**O-Ring:** [1] Attached

Measurements Are Shown In Inches And (Millimeters)

**WARNING:** These products can expose you to chemicals, including Diisononyl Phthalate, Carbon black extracts, Nickel, 1,3 Butadiene, Ethylene Oxide, Epichlorohydrin, which are known to the State of California to cause cancer, and Bisphenol, Ethylene Glycol, Ethylene Oxide, 1,3 Butadiene, Epichlorohydrin, which are known to the State of California to cause birth defects or other reproductive harm.

**PT23206-MPG** Maximum Performance Glass Hydraulic Element



**Fits:** Hydac Applications  
**Replaces:** Hydac 160D010BNHC  
**O.D.:** 2 11/16 (68.3)  
**I.D.:** 1 1/4 (31.8) One End  
**Height:** 4 9/16 (115.9)  
**O-Ring:** [1] Attached

**PT23213-MPG** Maximum Performance Glass Hydraulic Element



**Fits:** Parker Applications  
**Replaces:** Parker 924452, 924452Q  
**O.D.:** 3 11/16 (93.7)  
**I.D.:** 2 (50.8)  
**Height:** 9 1/8 (231.8)  
**Grommets:** [2] Attached

**PT23207-MPG** Maximum Performance Glass Hydraulic Element



**Fits:** Hydac Applications  
**Replaces:** Hydac 160D005BNHC  
**O.D.:** 2 3/4 (69.9)  
**I.D.:** 1 7/16 (36.5) One End  
**Height:** 4 5/8 (117.5)  
**F. Gskt:** [1] Included  
**O-Ring:** [1] Attached, [1] Backup O-Ring

**PT23214-MPG** Maximum Performance Glass Hydraulic Element



**Fits:** Fairey-Arlon Applications  
**Replaces:** Fairey-Arlon TXW5GDL6;  
 Donaldson P763010  
**O.D.:** 4 1/8 (104.8)  
**I.D.:** 5/8 (15.9) & 2 13/16 (71.4)  
**Height:** 10 1/4 (260.3)

**PT23208-MPG** Maximum Performance Glass Hydraulic Element



**Notes:** OBSOLETE. Availability Limited to Dealer Stock.  
**Fits:** MP Filtri Applications  
**Replaces:** MP Filtri HP1351A06NA; Airfil AFKOV241A3  
**O.D.:** 2 1/8 (54.0)  
**I.D.:** 1 (25.4) One End  
**Height:** 4 5/8 (117.5)  
**O-Ring:** [1] Attached

**PT23215-MPG** Maximum Performance Glass Hydraulic Element



**Fits:** Fairey-Arlon Applications  
**Replaces:** Fairey-Arlon TXW4CC10,  
 TXW4GDL10; Donaldson P171826  
**O.D.:** 4 5/16 (109.5)  
**I.D.:** 3 (76.2) One End  
**Height:** 7 9/16 (192.1)

**PT23209-MPG** Maximum Performance Glass Hydraulic Element



**Fits:** Pall Applications  
**Replaces:** Pall HC2252FKS10H  
**O.D.:** 3 15/16 (100.0)  
**I.D.:** 1 7/8 (47.6) One End  
**Height:** 9 3/16 (233.4)  
**Grommets:** [1] Attached

**PT23216-MPG** Maximum Performance Glass Hydraulic Element



**Fits:** Fairey-Arlon Applications  
**Replaces:** Fairey-Arlon 370L222A  
**O.D.:** 3 11/16 (93.7)  
**I.D.:** 1 29/32 (48.4) One End  
**Height:** 7 27/32 (199.2)  
**F. Gskt:** [1] Included  
**O-Ring:** [1] Attached

**PT23211-MPG** Maximum Performance Glass Hydraulic Element



**Fits:** Schroeder Applications  
**Replaces:** Schroeder KKS1, KKZ3; Cim-Tek 30144  
**O.D.:** 3 7/8 (98.4)  
**I.D.:** 1 5/8 (41.3)  
**Height:** 18 1/2 (469.9)  
**F. Gskt:** [1] Included  
**O-Ring:** [2] Attached

**PT23217-MPG** Maximum Performance Glass Hydraulic Element



**Fits:** Pall Applications  
**Replaces:** Pall HC9604FKS8Z  
**O.D.:** 1 5/32 (29.4)  
**I.D.:** 2 (50.8) One End  
**Height:** 8 (203.2)  
**O-Ring:** [1] Attached

**PT23212-MPG** Maximum Performance Glass Hydraulic Element



**Fits:** Parker Applications  
**Replaces:** Parker 940054Q  
**O.D.:** 2 3/4 (69.9)  
**I.D.:** 1 3/8 (34.9) One End  
**Height:** 5 (127.0)  
**O-Ring:** [1] Attached

**PT23218-MPG** Maximum Performance Glass Hydraulic Element



**Fits:** Pall Applications  
**Replaces:** Pall HC9021FKS4Z  
**O.D.:** 1 5/8 (41.3)  
**I.D.:** 15/16 (23.8) One End  
**Height:** 4 1/2 (114.3)  
**O-Ring:** [1] Attached

Measurements Are Shown In Inches And (Millimeters)

**WARNING:** These products can expose you to chemicals, including Diisononyl Phthalate, Carbon black extracts, Nickel, 1,3 Butadiene, Ethylene Oxide, Epichlorohydrin, which are known to the State of California to cause cancer, and Bisphenol, Ethylene Glycol, Ethylene Oxide, 1,3 Butadiene, Epichlorohydrin, which are known to the State of California to cause birth defects or other reproductive harm.

**PT23219-MPG** Maximum Performance Glass Hydraulic Element



**Fits:** Pall Applications  
**Replaces:** Pall HC9600FDS4Z, HC9600FKS4Z, HC9600FUS4Z  
**O.D.:** 3 5/32 (80.2)  
**I.D.:** 1 1/8 (28.6) One End  
**Height:** 4 7/32 (107.2)

**PT23226-MPG** Maximum Performance Glass Hydraulic Element



**Fits:** Pall Applications  
**Replaces:** Pall HC9604FL516Z  
**O.D.:** 3 1/8 (79.4)  
**I.D.:** 2 (50.8)  
**Height:** 16 9/16 (420.7)  
**O-Ring:** [1] Attached

**PT23220-MPG** Maximum Performance Glass Hydraulic Element



**Fits:** Hydac Applications  
**Replaces:** Hydac 1262386, 280D010BNHC, 280D010BN3HC, Donaldson P560141  
**O.D.:** 2 3/4 (69.9)  
**I.D.:** 1 3/8 (34.9) One End  
**Height:** 14 (355.6)  
**O-Ring:** [1] Attached

**PT23227-MPG** Maximum Performance Glass Hydraulic Element



**Fits:** Schroeder Applications  
**Replaces:** Schroeder 27KS15, 27KZ25, KKK15, KKKZ25  
**O.D.:** 4 (101.6)  
**I.D.:** 1 15/16 (49.2)  
**Height:** 27 11/16 (703.3)  
**O-Ring:** [2] Attached

**PT23221-MPG** Maximum Performance Glass Hydraulic Element



**Fits:** Fairey-Arlon Applications  
**Replaces:** Fairey-Arlon 370L323A, 370P310, 370Z310A, 370Z323A, 820P325, 820P335, 870P310  
**O.D.:** 3 3/4 (95.3)  
**I.D.:** 1 7/8 (47.6) One End  
**Height:** 12 5/8 (320.7)  
**F. Gskt:** [1] Included  
**O-Ring:** [1] Attached

**PT23228-MPG** Maximum Performance Glass Hydraulic Element



**Fits:** Pall Applications  
**Replaces:** Pall HC8900FDP13H, HC8900FKP13H, HC8900FUP13H  
**O.D.:** 3 3/4 (95.3)  
**I.D.:** 2 1/8 (54.0) One End  
**Height:** 12 7/8 (327.0)  
**O-Ring:** [1] Attached

**PT23223-MPG** Maximum Performance Glass Hydraulic Element



**Fits:** Pall, Parker Applications  
**Replaces:** Pall HC8900FUS13H; Filtrec D612G10  
**O.D.:** 3 3/4 (95.3)  
**I.D.:** 2 1/4 (57.2) One End  
**Height:** 12 7/8 (327.0)  
**O-Ring:** [1] Attached

**PT23229-MPG** Maximum Performance Glass Hydraulic Element with Bail Handle



**Fits:** MP Filtri Applications  
**Replaces:** MP Filtri MF4002A25HB, MF4002A25NB  
**O.D.:** 5 5/16 (134.9)  
**I.D.:** 2 1/2 (63.5) One End  
**Height:** 8 5/16 (211.1)  
**O-Ring:** [1] Attached  
**Spring:** [1] Included

**PT23224-MPG** Maximum Performance Glass Hydraulic Element



**Fits:** Pall Applications  
**Replaces:** Pall HC8900FDT13H, HC8900FKT13H, HC8900FUT13H  
**O.D.:** 3 3/4 (95.3)  
**I.D.:** 2 1/8 (54.0) One End  
**Height:** 12 7/8 (327.0)  
**O-Ring:** [1] Attached

**PT23230-MPG** Maximum Performance Glass Hydraulic Element



**Fits:** Parker Applications  
**Replaces:** Parker 976191, G01069  
**O.D.:** 3 1/2 (88.9)  
**I.D.:** 2 1/4 (57.2) One End  
**Height:** 7 7/8 (200.0)  
**O-Ring:** [1] Attached

**PT23225-MPG** Maximum Performance Glass Hydraulic Element



**Notes:** OBSOLETE. Availability Limited to Dealer Stock.  
**Fits:** Pall Applications  
**Replaces:** Pall HC6400FDN8H, HC6400FKN8H, HC6400FUN8H  
**O.D.:** 3 3/8 (85.7)  
**I.D.:** 1 15/16 (49.2) One End  
**Height:** 8 1/16 (204.8)  
**O-Ring:** [1] Attached













**PT23231-MPG** Maximum Performance Glass Hydraulic Element



**Fits:** Pall Applications  
**Replaces:** Pall HC8900FDN13H, HC8900FKN13H, HC8900FUN13H  
**O.D.:** 3 3/4 (95.3)  
**I.D.:** 2 1/8 (54.0) One End  
**Height:** 12 7/8 (327.0)  
**O-Ring:** [1] Attached

Measurements Are Shown In Inches And (Millimeters)

**WARNING:** These products can expose you to chemicals, including Diisononyl Phthalate, Carbon black extracts, Nickel, 1,3 Butadiene, Ethylene Oxide, Epichlorohydrin, which are known to the State of California to cause cancer, and Bisphenol, Ethylene Glycol, Ethylene Oxide, 1,3 Butadiene, Epichlorohydrin, which are known to the State of California to cause birth defects or other reproductive harm.

<p><b>PT23232-MPG</b> Maximum Performance Glass Hydraulic Element</p>  <p><b>Fits:</b> Fairey-Arlon Applications <b>Replaces:</b> Fairey-Arlon TXW5AGDL6 <b>O.D.:</b> 4 1/8 (104.8) <b>I.D.:</b> 3/8 (9.5) &amp; 2 3/4 (69.9) <b>Height:</b> 18 1/4 (463.6)</p>	<p><b>PT23238-MPG</b> Maximum Performance Glass Hydraulic Element</p>  <p><b>Fits:</b> Pall Applications <b>Replaces:</b> Pall HC6400FDN13H, HC6400FKN13H, HC6400FUN13H <b>O.D.:</b> 3 7/16 (87.3) <b>I.D.:</b> 2 (50.8) One End <b>Height:</b> 12 7/8 (327.0) <b>O-Ring:</b> [1] Attached</p>
<p><b>PT23233-MPG</b> Maximum Performance Glass Hydraulic Element</p>  <p><b>Fits:</b> Parker Applications <b>Replaces:</b> Parker FTBE1B10Q, G02070 <b>O.D.:</b> 2 7/32 (56.4) <b>I.D.:</b> 1 3/32 (27.8) <b>Height:</b> 5 7/32 (132.6) <b>O-Ring:</b> [2] Attached</p>	<p><b>PT23239-MPG</b> Maximum Performance Glass Hydraulic Element</p>  <p><b>Fits:</b> Pall Applications <b>Replaces:</b> Pall HC8300FKT16H <b>O.D.:</b> 5 7/8 (149.2) <b>I.D.:</b> 4 1/2 (114.3) <b>Height:</b> 20 9/32 (515.1) <b>O-Ring:</b> [2] Attached</p>
<p><b>PT23234-MPG</b> Maximum Performance Glass Hydraulic Element</p>  <p><b>Fits:</b> Fairey-Arlon Applications <b>Replaces:</b> Fairey-Arlon TXW8CCC3, TXW8CGDL3; Donaldson P174573 <b>O.D.:</b> 5 (127.0) <b>I.D.:</b> 7/16 (11.1) &amp; 3 9/16 (90.5) <b>Height:</b> 18 7/8 (479.4)</p>	<p><b>PT23240-MPG</b> Maximum Performance Glass Hydraulic Element</p>  <p><b>Fits:</b> Pall Applications <b>Replaces:</b> Pall HC9801FDS8Z, HC9801FKS8Z, HC9801FUS8Z <b>O.D.:</b> 2 (50.8) <b>I.D.:</b> 1 (25.4) One End <b>Height:</b> 8 9/16 (217.5) <b>O-Ring:</b> [1] Attached</p>
<p><b>PT23235-MPG</b> Maximum Performance Glass Hydraulic Element with Bail Handle</p>  <p><b>Fits:</b> Pall Applications <b>Replaces:</b> Pall HF8904FKS16H <b>O.D.:</b> 3 27/32 (97.6) <b>I.D.:</b> 2 17/32 (64.3) One End <b>Height:</b> 16 11/32 (415.1) <b>O-Ring:</b> [1] Attached</p>	<p><b>PT23241-MPG</b> Maximum Performance Glass Hydraulic Element</p>  <p><b>Fits:</b> Hydac Applications <b>Replaces:</b> Hydac 2055748, 660D020BN3HC, 660D020BNHC2 <b>O.D.:</b> 3 3/4 (95.3) <b>I.D.:</b> 2 1/8 (54.0) One End <b>Height:</b> 12 7/8 (327.0) <b>O-Ring:</b> [1] Attached</p>
<p><b>PT23236-MPG</b> Maximum Performance Glass Hydraulic Element with Bail Handle</p>  <p><b>Fits:</b> Pall Applications <b>Replaces:</b> Pall HC8904FKS1Z <b>O.D.:</b> 3 27/32 (97.6) <b>I.D.:</b> 2 17/32 (64.3) One End <b>Height:</b> 16 11/32 (415.1) <b>O-Ring:</b> [1] Attached</p>	<p><b>PT23242-MPG</b> Maximum Performance Glass Hydraulic Element</p>  <p><b>Fits:</b> Pall Applications <b>Replaces:</b> Pall HC6400FDN16H, HC6400FKN16H, HC6400FUN16H <b>O.D.:</b> 3 3/8 (85.7) <b>I.D.:</b> 1 15/16 (49.2) One End <b>Height:</b> 16 13/16 (427.0) <b>O-Ring:</b> [1] Attached</p>
<p><b>PT23237-MPG</b> Maximum Performance Glass Hydraulic Element</p>  <p><b>Fits:</b> Pall Applications <b>Replaces:</b> Pall HC6400FDS16H, HC6400FKS16H, HC6400FUS16H <b>O.D.:</b> 3 3/8 (85.7) <b>I.D.:</b> 1 15/16 (49.2) <b>Height:</b> 16 13/16 (427.0) <b>O-Ring:</b> [1] Attached</p>	<p><b>PT23243-MPG</b> Maximum Performance Glass Hydraulic Element with Bail Handle</p>  <p><b>Fits:</b> Hydac Applications <b>Replaces:</b> Hydac 2066373, 500R020BN3HC, 500R020BNHC2 <b>O.D.:</b> 3 11/16 (93.7) <b>I.D.:</b> 1 7/8 (47.6) One End <b>Height:</b> 10 13/16 (274.6) <b>O-Ring:</b> [1] Attached</p>

Measurements Are Shown In Inches And (Millimeters)

**WARNING:** These products can expose you to chemicals, including Diisononyl Phthalate, Carbon black extracts, Nickel, 1,3 Butadiene, Ethylene Oxide, Epichlorohydrin, which are known to the State of California to cause cancer, and Bisphenol, Ethylene Glycol, Ethylene Oxide, 1,3 Butadiene, Epichlorohydrin, which are known to the State of California to cause birth defects or other reproductive harm.

**PT23244-MPG** Maximum Performance Glass Hydraulic Element



**Fits:** Hydac Applications  
**Replaces:** Hydac 1252802, 1260899, 2055746, 660D005BN3HC, 660D005BNHC  
**O.D.:** 3 9/16 (90.5)  
**I.D.:** 1 13/16 (46.0) One End  
**Height:** 12 7/8 (327.0)  
**O-Ring:** [1] Attached

**PT23250-MPG** Maximum Performance Glass Hydraulic Element



**Fits:** Pall Applications  
**Replaces:** Pall HC6400FDN26H, HC6400FKN26H, HC6400FUN26H  
**O.D.:** 3 7/16 (87.3)  
**I.D.:** 1 7/8 (47.6) One End  
**Height:** 25 11/16 (652.5)  
**O-Ring:** [1] Attached

**PT23245-MPG** Maximum Performance Glass Hydraulic Element



**Fits:** Argo Applications  
**Replaces:** Argo V5124006  
**O.D.:** 4 3/4 (120.7)  
 Flange 5 3/8 (136.5)  
**I.D.:** 2 5/16 (58.7) & 3 (76.2)  
**Height:** 18 (457.2)  
**O-Ring:** [2] Attached

**PT23251-MPG** Maximum Performance Glass Hydraulic Element



**Fits:** Parker Applications  
**Replaces:** Parker 933802Q, 987141, G00801  
**O.D.:** 5 9/16 (141.3)  
**I.D.:** 4 (101.6)  
**Height:** 12 1/8 (308.0)  
**A. Gskt:** [2] Attached  
**F. Gskt:** [1] Included (Adhesive Backed)

**PT23246-MPG** Maximum Performance Glass Hydraulic Element



**Fits:** Pall Applications  
**Replaces:** Pall HC9600FDN8Z, HC9600FKN8Z, HC9600FUN8Z  
**O.D.:** 3 1/2 (88.9)  
**I.D.:** 1 9/16 (39.7) One End  
**Height:** 8 3/8 (212.7)  
**O-Ring:** [1] Attached

**PT23252-MPG** Maximum Performance Glass Hydraulic Element with Bail Handle



**Fits:** Volvo EC160, EW160 Excavators  
**Replaces:** Volvo 11705962  
**O.D.:** 3 11/16 (93.7)  
**I.D.:** 1 13/16 (46.0) One End  
**Height:** 17 1/2 (444.5)  
**O-Ring:** [1] Attached

**PT23247-MPG** Maximum Performance Glass Hydraulic Element



**Fits:** Parker Applications  
**Replaces:** Parker G02088, FTCE2B10Q  
**O.D.:** 3 11/16 (93.7)  
**I.D.:** 1 13/16 (46.0) & 1 15/16 (49.2)  
**Height:** 12 3/4 (323.8)  
**O-Ring:** [2] Attached

**PT23253-MPG** Maximum Performance Glass Hydraulic Element with Bail Handle



**Fits:** Hydac Applications  
**Replaces:** Hydac 2059112, 1300R020BNHC, 1300R020BN3HC, 1300R020BNHC2  
**O.D.:** 5 5/8 (142.9)  
**I.D.:** 3 3/4 (95.3) One End  
**Height:** 18 7/8 (479.4)  
**O-Ring:** [1] Attached

**PT23248-MPG** Maximum Performance Glass Hydraulic Element



**Fits:** Pall Applications  
**Replaces:** Pall HC8300FDT39Z, HC8300FKT39Z, HF8300FUT39Z  
**O.D.:** 6 (152.4)  
**I.D.:** 4 1/2 (114.3)  
**Height:** 38 1/2 (977.9)  
**O-Ring:** [2] Attached

**PT23254-MPG** Maximum Performance Glass Hydraulic Element



**Fits:** Mahle Applications  
**Replaces:** Mahle PI2245SMXVST3, PI2245SMVST3  
**O.D.:** 3 1/4 (82.6)  
**I.D.:** 1 13/16 (46.0) One End  
**Height:** 14 11/16 (373.1)

**PT23249-MPG** Maximum Performance Glass Hydraulic Element



**Fits:** Pall Applications  
**Replaces:** Pall HC8300FDS16H, HC8300FKS16H, HC8300FUS16H  
**O.D.:** 6 (152.4)  
**I.D.:** 4 1/32 (102.4)  
**Height:** 16 7/8 (428.6)  
**O-Ring:** [2] Attached













**PT23255-MPG** Maximum Performance Glass Hydraulic Element



**Contains:** Reinforced Centertube  
**Fits:** Pall Applications  
**Replaces:** Pall HC8300FDP39Z, HC8300FKP39Z, HC8300FUP39Z  
**O.D.:** 6 (152.4)  
**I.D.:** 4 1/32 (102.4)  
**Height:** 38 5/8 (981.1)  
**O-Ring:** [2] Attached

Measurements Are Shown In Inches And (Millimeters)

**WARNING:** These products can expose you to chemicals, including Diisononyl Phthalate, Carbon black extracts, Nickel, 1,3 Butadiene, Ethylene Oxide, Epichlorohydrin, which are known to the State of California to cause cancer, and Bisphenol, Ethylene Glycol, Ethylene Oxide, 1,3 Butadiene, Epichlorohydrin, which are known to the State of California to cause birth defects or other reproductive harm.

<p><b>PT23256-MPG</b> Maximum Performance Glass Hydraulic Element</p>  <p><b>Notes:</b> OBSOLETE. Availability Limited to Dealer Stock. <b>Fits:</b> Fairey-Arlon Applications <b>Replaces:</b> Fairey-Arlon TXW13CC10, TXW13GDL10 <b>O.D.:</b> 8 (203.2) <b>I.D.:</b> 6 1/4 (158.8) One End <b>Height:</b> 32 1/2 (825.5) <b>O-Ring:</b> [1] Attached</p>	<p><b>PT23262-MPG</b> Maximum Performance Glass Hydraulic Element</p>  <p><b>Notes:</b> OBSOLETE. Availability Limited to Dealer Stock. <b>Fits:</b> Pall Applications <b>Replaces:</b> HC9650FDN16Z, HC9650FKN16Z, HC9650FUN16Z <b>O.D.:</b> 3 1/32 (77.0) <b>I.D.:</b> 2 1/32 (51.6) <b>Height:</b> 17 (431.8) <b>O-Ring:</b> [2] Attached</p>
<p><b>PT23257-MPG</b> Maximum Performance Glass Hydraulic Element</p>  <p><b>Fits:</b> Hydac Applications <b>Replaces:</b> Hydac 1277896, 3106934015M <b>O.D.:</b> 3 3/4 (95.3) <b>I.D.:</b> 2 1/4 (57.2) One End <b>Height:</b> 9 7/16 (239.7)</p>	<p><b>PT23263-MPG</b> Maximum Performance Glass Hydraulic Element</p>  <p><b>Fits:</b> Pall Applications <b>Replaces:</b> HC9801FDS4H, HC9801FKS4H <b>O.D.:</b> 2 (50.8) <b>I.D.:</b> 7/8 (22.2) One End <b>Height:</b> 4 1/2 (114.3) <b>O-Ring:</b> [1] Attached</p>
<p><b>PT23258-MPG</b> Maximum Performance Glass Hydraulic Element</p>  <p><b>Fits:</b> Mahle Applications <b>Replaces:</b> Mahle 852126SMVST25, 852126SMXVST25 <b>O.D.:</b> 1 3/4 (44.4) <b>I.D.:</b> 15/16 (23.8) One End <b>Height:</b> 4 1/2 (114.3) <b>O-Ring:</b> [1] Attached</p>	<p><b>PT23264-MPG</b> Maximum Performance Glass Hydraulic Element</p>  <p><b>Fits:</b> Hydac Applications <b>Replaces:</b> Hydac 1277952, 201RK015BN3HC <b>O.D.:</b> 3 15/32 (88.1) <b>I.D.:</b> 1 19/32 (40.5) <b>Height:</b> 12 29/32 (327.8) <b>O-Ring:</b> [2] Attached</p>
<p><b>PT23259-MPG</b> Maximum Performance Glass Hydraulic Element with Bail Handle</p>  <p><b>Fits:</b> Hydac Applications <b>Replaces:</b> Hydac 660R003BNHC <b>O.D.:</b> 4 3/8 (111.1) <b>I.D.:</b> 2 9/16 (65.1) One End <b>Height:</b> 13 (330.2) <b>O-Ring:</b> [1] Attached</p>	<p><b>PT23265-MPG</b> Maximum Performance Glass Hydraulic Element</p>  <p><b>Fits:</b> Hydac Applications <b>Replaces:</b> Hydac 1252797, 280D005BN3HC, 280D005BNHC, 280D005BNHC3 <b>O.D.:</b> 2 3/8 (60.3) <b>I.D.:</b> 1 1/32 (26.2) One End <b>Height:</b> 14 (355.6) <b>O-Ring:</b> [1] Attached</p>
<p><b>PT23260-MPG</b> Maximum Performance Glass Hydraulic Element</p>  <p><b>Fits:</b> Pall Applications <b>Replaces:</b> HC9020FDP4Z, HC9020FKP4Z, HC9020FUP4Z <b>O.D.:</b> 1 3/4 (44.4) <b>I.D.:</b> 15/16 (23.8) One End <b>Height:</b> 4 3/8 (111.1)</p>	<p><b>PT23266-MPG</b> Maximum Performance Glass Hydraulic Element</p>  <p><b>Fits:</b> Pall Applications <b>Replaces:</b> Pall HC9800FDP8Z, HF9800FKP8Z, HF9800FUP8Z <b>O.D.:</b> 2 1/16 (52.4) <b>I.D.:</b> 1 (25.4) One End <b>Height:</b> 8 1/8 (206.4) <b>O-Ring:</b> [1] Attached</p>
<p><b>PT23261-MPG</b> Maximum Performance Glass Hydraulic Element</p>  <p><b>Fits:</b> Fairey-Arlon Applications <b>Replaces:</b> Fairey-Arlon 270L201A, 270L221A, 270Z221A <b>O.D.:</b> 3 (76.2) <b>I.D.:</b> 1 7/16 (36.5) One End <b>Height:</b> 9 1/2 (241.3) <b>O-Ring:</b> [1] Attached, [1] Included</p>	<p><b>PT23267-MPG</b> Maximum Performance Glass Hydraulic Element</p>  <p><b>Fits:</b> Hydac Applications <b>Replaces:</b> Hydac 100RK015BN3HC <b>O.D.:</b> 2 7/16 (61.9) <b>I.D.:</b> 1 1/16 (27.0) <b>Height:</b> 8 3/8 (212.7) <b>O-Ring:</b> [2] Attached</p>

Measurements Are Shown In Inches And (Millimeters)

**WARNING:** These products can expose you to chemicals, including Diisononyl Phthalate, Carbon black extracts, Nickel, 1,3 Butadiene, Ethylene Oxide, Epichlorohydrin, which are known to the State of California to cause cancer, and Bisphenol, Ethylene Glycol, Ethylene Oxide, 1,3 Butadiene, Epichlorohydrin, which are known to the State of California to cause birth defects or other reproductive harm.



**PT23269-MPG** Maximum Performance Glass Hydraulic Element



**Fits:** Pall Applications  
**Replaces:** Pall HC9600FDN4Z, HC9600FKN4Z, HC9600FUN4Z  
**O.D.:** 3 1/8 (79.4)  
**I.D.:** 1 7/8 (47.6) One End  
**Height:** 4 11/32 (110.3)  
**O-Ring:** [1] Attached

**PT23275-MPG** Maximum Performance Glass Hydraulic Element



**Fits:** Schroeder Applications  
**Replaces:** Schroeder KSX7V  
**O.D.:** 3 1/8 (79.4)  
**I.D.:** 1 13/32 (35.7)  
**Height:** 9 5/16 (236.5)  
**O-Ring:** [2] Attached

**PT23270-MPG** Maximum Performance Glass Hydraulic Element



**Fits:** Pall Applications  
**Replaces:** Pall HC9020FDT4Z, HC9020FKT4Z, HC9020FUT4Z  
**O.D.:** 1 3/4 (44.4)  
**I.D.:** 15/16 (23.8) One End  
**Height:** 4 1/2 (114.3)  
**O-Ring:** [1] Attached

**PT23276-MPG** Maximum Performance Glass Hydraulic Element



**Fits:** Pall Applications  
**Replaces:** Pall HC2237FDT13H  
**O.D.:** 3 9/16 (90.5)  
**I.D.:** 1 9/16 (39.7) One End  
**Height:** 12 15/16 (328.6)  
**O-Ring:** [1] Attached

**PT23271-MPG** Maximum Performance Glass Hydraulic Element



**Fits:** Pall Applications  
**Replaces:** Pall HC9600FDS16Z, HC9600FKS16Z, HC9600FUS16Z  
**O.D.:** 3 (76.2)  
**I.D.:** 1 11/32 (34.1) One End  
**Height:** 16 15/32 (418.3)  
**O-Ring:** [1] Attached

**PT23277-MPG** Maximum Performance Glass Hydraulic Element



**Fits:** Pall Applications  
**Replaces:** Pall HC8900FDS13Z, HC8900FKS13Z, HC900FUS13Z  
**O.D.:** 3 13/16 (96.8)  
**I.D.:** 2 1/4 (57.2) One End  
**Height:** 13 (330.2)  
**O-Ring:** [1] Viton Attached  
**Related To:** PT23223-MPG (Standard Gasket)

**PT23272-MPG** Maximum Performance Glass Hydraulic Element



**Fits:** Hydac Applications  
**Replaces:** Hydac 2055758, 280D003BN3HC, 280D003BNHC  
**O.D.:** 2 3/4 (69.9)  
**I.D.:** 1 3/8 (34.9) One End  
**Height:** 14 (355.6)  
**O-Ring:** [1] Attached

**PT23278-MPG** Maximum Performance Glass Hydraulic Element



**Fits:** Pall Applications  
**Replaces:** Pall HC9100FKT13Z  
**O.D.:** 2 13/16 (71.4)  
**I.D.:** 1 15/16 (49.2) One End  
**Height:** 13 (330.2)  
**O-Ring:** [1] Attached

**PT23273-MPG** Maximum Performance Glass Hydraulic Element



**Fits:** Fairey-Arlon Applications  
**Replaces:** Fairey-Arlon 370L305A, 370L322A, 370P305, 370Z305A  
**O.D.:** 3 11/16 (93.7)  
**I.D.:** 1 7/8 (47.6) One End  
**Height:** 12 5/8 (320.7)  
**O-Ring:** [1] Attached

**PT23279-MPG** Maximum Performance Glass Hydraulic Element



**Fits:** Pall Applications  
**Replaces:** Pall HC9600FDN16Z, HC9600FKN16Z, HC9600FUN16Z  
**O.D.:** 3 1/8 (79.4)  
**I.D.:** 1 11/32 (34.1) One End  
**Height:** 16 15/32 (418.3)  
**O-Ring:** [1] Attached

**PT23274-MPG** Maximum Performance Glass Hydraulic Element



**Fits:** Pall Applications  
**Replaces:** Pall HC2237FDT6H; Parker G03183, PR3183  
**O.D.:** 3 1/2 (88.9)  
**I.D.:** 1 15/16 (49.2) One End  
**Height:** 8 1/2 (215.9)  
**O-Ring:** [1] Attached













**PT23280-MPG** Maximum Performance Glass Hydraulic Element



**Fits:** Pall Applications  
**Replaces:** Pall HC9800FDN4Z, HC9800FKN4Z, HC9800FUN4Z  
**O.D.:** 1 31/32 (50.0)  
**I.D.:** 7/8 (22.2) One End  
**Height:** 4 1/2 (114.3)  
**O-Ring:** [1] Attached

Measurements Are Shown In Inches And (Millimeters)

**WARNING:** These products can expose you to chemicals, including Diisononyl Phthalate, Carbon black extracts, Nickel, 1,3 Butadiene, Ethylene Oxide, Epichlorohydrin, which are known to the State of California to cause cancer, and Bisphenol, Ethylene Glycol, Ethylene Oxide, 1,3 Butadiene, Epichlorohydrin, which are known to the State of California to cause birth defects or other reproductive harm.

<p><b>PT23281-MPG</b> Maximum Performance Glass Hydraulic Element</p>  <p><b>Fits:</b> Fairey-Arlon Applications  <b>Replaces:</b> Fairey-Arlon 270L205A, 270L222A, 270Z205A, 270Z222A  <b>O.D.:</b> 3 7/8 (98.4)  <b>I.D.:</b> 1 9/32 (32.5) One End  <b>Height:</b> 9 9/16 (242.9)  <b>O-Ring:</b> [1] Attached, [1] Included</p>	<p><b>PT23287-MPG</b> Maximum Performance Glass Hydraulic Element</p>  <p><b>Fits:</b> Hydac Applications  <b>Replaces:</b> Hydac 2055761, 280D020BN3HC, 280D020BNHC, 280D020BNHC2  <b>O.D.:</b> 2 3/4 (69.9)  <b>I.D.:</b> 1 3/8 (34.9) One End  <b>Height:</b> 14 (355.6)  <b>O-Ring:</b> [1] Attached</p>
<p><b>PT23282-MPG</b> Maximum Performance Glass Hydraulic Element</p>  <p><b>Fits:</b> Schroeder Applications  <b>Replaces:</b> Schroeder 27KS1, 27KZ3, KKKZ3; Donaldson P174246, P566278, P566279  <b>O.D.:</b> 4 (101.6)  <b>I.D.:</b> 1 3/4 (44.4)  <b>Height:</b> 27 11/16 (703.3)  <b>O-Ring:</b> [2] Attached</p>	<p><b>PT23289-MPG</b> Maximum Performance Glass Hydraulic Element</p>  <p><b>Fits:</b> Pall Applications  <b>Replaces:</b> P.T.I. (PTI/textron) PG050HH  <b>O.D.:</b> 3 5/32 (80.2)  <b>I.D.:</b> 1 15/32 (37.3)  <b>Height:</b> 5 9/16 (141.3)</p>
<p><b>PT23283-MPG</b> Maximum Performance Glass Hydraulic Element</p>  <p><b>Fits:</b> Pall Applications  <b>Replaces:</b> Pall HC8900FDS8Z, HC8900FKS8Z, HC8900FUS8Z  <b>O.D.:</b> 3 3/4 (95.3)  <b>I.D.:</b> 2 1/8 (54.0) One End  <b>Height:</b> 8 1/16 (204.8)  <b>O-Ring:</b> [1] Attached</p>	<p><b>PT23290-MPG</b> Maximum Performance Glass Hydraulic Element</p>  <p><b>Fits:</b> Fairey-Arlon Applications  <b>Replaces:</b> Fairey-Arlon 170L205A, 170Z222A, 170Z205A  <b>O.D.:</b> 2 1/8 (54.0)  <b>I.D.:</b> 3/4 (19.0) One End  <b>Height:</b> 4 13/16 (122.2)  <b>O-Ring:</b> [1] Attached, [1] Included</p>
<p><b>PT23284-MPG</b> Maximum Performance Glass Hydraulic Element</p>  <p><b>Fits:</b> Parker Applications  <b>Replaces:</b> Parker 925838, G01316Q  <b>O.D.:</b> 2 3/16 (55.6)  <b>I.D.:</b> 1 1/32 (26.2)  <b>Height:</b> 9 11/16 (246.1)  <b>O-Ring:</b> [1] Attached</p>	<p><b>PT23291-MPG</b> Maximum Performance Glass Hydraulic Element</p>  <p><b>Fits:</b> Parker Applications  <b>Replaces:</b> Parker 929923, 929923Q  <b>O.D.:</b> 3 3/4 (95.3)  <b>I.D.:</b> 2 5/16 (58.7) One End  <b>Height:</b> 12 7/8 (327.0)  <b>O-Ring:</b> [1] Attached</p>
<p><b>PT23285-MPG</b> Maximum Performance Glass Hydraulic Element</p>  <p><b>Fits:</b> Pall Applications  <b>Replaces:</b> Pall HC9020FDT8Z, HC9020FKT8Z, HC9020FUT8Z  <b>O.D.:</b> 1 3/4 (44.4)  <b>I.D.:</b> 15/16 (23.8) One End  <b>Height:</b> 8 3/16 (208.0)  <b>O-Ring:</b> [1] Viton Attached</p>	<p><b>PT23292-MPG</b> Maximum Performance Glass Hydraulic Element</p>  <p><b>Fits:</b> International Applications  <b>Replaces:</b> Case 1328276C1  <b>O.D.:</b> 2 1/8 (54.0)  <b>I.D.:</b> 15/16 (23.8) One End  <b>Height:</b> 4 11/16 (119.1)  <b>O-Ring:</b> [1] Attached</p>
<p><b>PT23286-MPG</b> Maximum Performance Glass Hydraulic Element</p>  <p><b>Fits:</b> Pall Applications  <b>Replaces:</b> Pall HC9800FDT4Z, HC9800FKT4Z, HC9800FUT4Z  <b>O.D.:</b> 2 (50.8)  <b>I.D.:</b> 15/16 (23.8) One End  <b>Height:</b> 4 1/2 (114.3)  <b>O-Ring:</b> [1] Attached</p>	<p><b>PT23294-MPG</b> Maximum Performance Glass Hydraulic Element</p>  <p><b>Fits:</b> Pall Applications  <b>Replaces:</b> Pall HC9020FDS4Z, HC9020FKS4Z, HC9020FUS4Z  <b>O.D.:</b> 1 11/16 (42.9)  <b>I.D.:</b> 15/16 (23.8) One End  <b>Height:</b> 4 3/8 (111.1)  <b>O-Ring:</b> [1] Attached</p>

Measurements Are Shown In Inches And (Millimeters)

**WARNING:** These products can expose you to chemicals, including Diisononyl Phthalate, Carbon black extracts, Nickel, 1,3 Butadiene, Ethylene Oxide, Epichlorohydrin, which are known to the State of California to cause cancer, and Bisphenol, Ethylene Glycol, Ethylene Oxide, 1,3 Butadiene, Epichlorohydrin, which are known to the State of California to cause birth defects or other reproductive harm.

**PT23295-MPG** Maximum Performance Glass Hydraulic Element



**Fits:** Manitou Applications  
**Replaces:** Manitou 236094  
**O.D.:** 2 11/16 (68.3)  
**I.D.:** 1 1/8 (28.6) One End  
**Height:** 9 5/8 (244.5)  
**O-Ring:** [1] Attached

**PT23310** Hydraulic Element



**Contains:** By-Pass Valve  
**Fits:** Argo Applications  
**Replaces:** Argo K3092072  
**O.D.:** 3 9/32 (83.3)  
**I.D.:** 1 5/8 (41.3) One End  
**Height:** 8 (203.2)  
**O-Ring:** [1] Attached

**PT23296-MPG** Maximum Performance Glass Hydraulic Element



**Fits:** Pall Applications  
**Replaces:** Pall HC6300FDT8H, HC6300FKT8H, HC6300FUT8H  
**O.D.:** 3 1/16 (77.8)  
**I.D.:** 1 5/8 (41.3) One End  
**Height:** 8 (203.2)  
**O-Ring:** [1] Attached

**PT23311** Hydraulic Element



**Fits:** Eppensteiner Applications  
**Replaces:** Eppensteiner 290P10A000P  
**O.D.:** 2 3/32 (53.2)  
**I.D.:** 1/32 (0.8) & 1/16 (1.6)  
**Height:** 5 7/8 (149.2)  
**O-Ring:** [1] Attached

**PT23297** Hydraulic Element



**Fits:** Schroeder Applications  
**Replaces:** Schroeder KM150  
**O.D.:** 3 15/16 (100.0)  
**I.D.:** 1 11/16 (42.9)  
**Height:** 9 5/16 (236.5)  
**O-Ring:** [2] Attached

**PT23312** Hydraulic Element



**Fits:** Eppensteiner Applications  
**Replaces:** Eppensteiner 2225P25A00P  
**O.D.:** 2 15/16 (74.6)  
**I.D.:** 1 1/2 (38.1) One End  
**Height:** 8 15/16 (227.0)  
**O-Ring:** [1] Attached

**PT23306** Wire Mesh Media Hydraulic Strainer



**Contains:** Threaded End: 2 1/8-8 NPT  
**Fits:** Case, New Holland Loaders  
**Replaces:** New Holland L128515  
**O.D.:** 4 7/32 (107.2)  
**Height:** 9 1/4 (235.0)

**PT23313** Hydraulic Element



**Fits:** Fairey-Arlon Applications  
**Replaces:** Fairey-Arlon TXX7A10  
**O.D.:** 4 31/32 (126.2)  
**I.D.:** 3/8 (9.5) & 3 5/8 (92.1)  
**Height:** 9 27/32 (250.0)

**PT23308** Hydraulic Element



**Fits:** Argo Applications  
**Replaces:** Argo P3072000  
**O.D.:** 2 3/4 (69.9)  
**I.D.:** 1 1/32 (26.2) One End  
**Height:** 7 27/32 (199.2)  
**O-Ring:** [1] Attached

**PT23314** Hydraulic Element



**Fits:** Fairey-Arlon Applications  
**Replaces:** Fairey-Arlon TXX10  
**O.D.:** 2 27/32 (72.2)  
**I.D.:** 11/32 (8.7)  
**Height:** 2 5/32 (54.8)

**PT23309** Hydraulic Element



**Fits:** Argo Applications  
**Replaces:** Argo P3051002  
**O.D.:** 1 25/32 (45.2)  
**I.D.:** 13/16 (20.6) One End  
**Height:** 4 3/32 (104.0)  
**O-Ring:** [1] Attached













**PT23315** Hydraulic Element



**Fits:** Mahle Applications  
**Replaces:** Mahle 852436MIC10  
**O.D.:** 5 1/16 (128.6)  
**I.D.:** 2 21/32 (67.5) & 2 13/16 (71.4)  
**Height:** 12 9/16 (319.1)  
**O-Ring:** [1] Attached

Measurements Are Shown In Inches And (Millimeters)

**WARNING:** These products can expose you to chemicals, including Diisononyl Phthalate, Carbon black extracts, Nickel, 1,3 Butadiene, Ethylene Oxide, Epichlorohydrin, which are known to the State of California to cause cancer, and Bisphenol, Ethylene Glycol, Ethylene Oxide, 1,3 Butadiene, Epichlorohydrin, which are known to the State of California to cause birth defects or other reproductive harm.

<p><b>PT23316</b></p> 	<p>Hydraulic Element  <b>Fits:</b> Mahle Applications  <b>Replaces:</b> Mahle 852438MIC10  <b>O.D.:</b> 3 29/32 (99.2)  <b>I.D.:</b> 1 29/32 (48.4) &amp; 2 1/16 (52.4)  <b>Height:</b> 6 1/4 (158.8)  <b>O-Ring:</b> [1] Attached</p>	<p><b>PT23322</b></p>  <p>Hydraulic Element  <b>Fits:</b> Mahle Applications  <b>Replaces:</b> Mahle 852126MICVST10  <b>O.D.:</b> 1 3/4 (44.4)  <b>I.D.:</b> 1 (25.4) One End  <b>Height:</b> 4 15/32 (113.5)  <b>O-Ring:</b> [1] Attached</p>
<p><b>PT23317</b></p> 	<p>Hydraulic Element  <b>Fits:</b> Mahle Applications  <b>Replaces:</b> Mahle 852439MIC10  <b>O.D.:</b> 3 15/16 (100.0)  <b>I.D.:</b> 2 (50.8) &amp; 2 1/2 (63.5)  <b>Height:</b> 8 1/2 (215.9)  <b>O-Ring:</b> [1] Attached</p>	<p><b>PT23323</b></p>  <p>Hydraulic Element  <b>Fits:</b> Parker Applications  <b>Replaces:</b> Parker 908643; Donaldson P173617, P168481  <b>O.D.:</b> 4 1/4 (108.0)  <b>I.D.:</b> 3 1/16 (77.8)  <b>Height:</b> 9 13/16 (249.2)  <b>F. Gskt:</b> [1] Included  <b>End Seals:</b> [2] Attached</p>
<p><b>PT23318</b></p> 	<p>Hydraulic Element  <b>Fits:</b> Mahle Applications  <b>Replaces:</b> Mahle 852754MIC25  <b>O.D.:</b> 4 (101.6)  <b>I.D.:</b> 2 1/2 (63.5)  <b>Height:</b> 19 (482.6)  <b>O-Ring:</b> [2] Attached</p>	<p><b>PT23324</b></p>  <p>Hydraulic Element  <b>Fits:</b> Parker Applications  <b>Replaces:</b> Parker 924791; Donaldson P169559  <b>O.D.:</b> 3 21/32 (92.9)  <b>I.D.:</b> 1 3/4 (44.4)  <b>Height:</b> 18 1/2 (469.9)  <b>Grommets:</b> [2] Attached</p>
<p><b>PT23319</b></p> 	<p>Hydraulic Element  <b>Fits:</b> Mahle Applications  <b>Replaces:</b> Mahle 852493MIC10  <b>O.D.:</b> 1 21/32 (42.1)  <b>I.D.:</b> 29/32 (23.0)  <b>Height:</b> 3 5/8 (92.1)  <b>O-Ring:</b> [2] Attached</p>	<p><b>PT23325</b></p>  <p>Hydraulic Element  <b>Fits:</b> Eppensteiner Applications  <b>Replaces:</b> Eppensteiner 2360G252P, 2360G25C000P; Donaldson P561439  <b>O.D.:</b> 3 1/16 (77.8)  <b>I.D.:</b> 1 19/32 (40.5) One End  <b>Height:</b> 11 1/16 (281.0)  <b>O-Ring:</b> [1] Attached</p>
<p><b>PT23320</b></p> 	<p>Hydraulic Element  <b>Fits:</b> Mahle Applications  <b>Replaces:</b> Mahle 852443MIC25  <b>O.D.:</b> 2 5/16 (58.7)  <b>I.D.:</b> 15/16 (23.8) &amp; 1 5/16 (33.3)  <b>Height:</b> 4 1/16 (103.2)  <b>O-Ring:</b> [1] Attached</p>	<p><b>PT23326</b></p>  <p>Hydraulic Element  <b>Fits:</b> Eppensteiner Applications  <b>Replaces:</b> Eppensteiner 20015G25A000P  <b>O.D.:</b> 2 7/16 (61.9)  <b>I.D.:</b> 1 3/8 (34.9) One End  <b>Height:</b> 7 (177.8)  <b>O-Ring:</b> [1] Attached</p>
<p><b>PT23321</b></p> 	<p>Hydraulic Element  <b>Fits:</b> Mahle Applications  <b>Replaces:</b> Mahle 852444MIC25  <b>O.D.:</b> 2 9/32 (57.9)  <b>I.D.:</b> 13/16 (20.6) &amp; 1 9/32 (32.5)  <b>Height:</b> 7 3/32 (180.2)  <b>O-Ring:</b> [1] Attached</p>	<p><b>PT23327</b></p>  <p>Hydraulic Element  <b>Fits:</b> Fairey-Arlon Applications  <b>Replaces:</b> Fairey-Arlon ST3D60; Donaldson CRS120.6, P171796  <b>O.D.:</b> 2 13/16 (71.4)  <b>I.D.:</b> 5/8 (15.9) &amp; 1 3/4 (44.4)  <b>Height:</b> 7 7/8 (200.0)  <b>O-Ring:</b> [1] Attached</p>

Measurements Are Shown In Inches And (Millimeters)

**WARNING:** These products can expose you to chemicals, including Diisononyl Phthalate, Carbon black extracts, Nickel, 1,3 Butadiene, Ethylene Oxide, Epichlorohydrin, which are known to the State of California to cause cancer, and Bisphenol, Ethylene Glycol, Ethylene Oxide, 1,3 Butadiene, Epichlorohydrin, which are known to the State of California to cause birth defects or other reproductive harm.

**PT23328**



Hydraulic Element

**Contains:** 1 1/4 Inch NPT Threaded Stud  
**Fits:** Flow-Ezy Applications  
**Replaces:** Flow-Ezy P10114100, P20114100  
**O.D.:** 3 13/32 (86.5)  
**I.D.:** 2 9/16 (65.1) One End  
**Height:** 5 15/32 (138.9)

**PT23334**



Hydraulic Element

**Contains:** 1 1/2-11 Inch BSP Threaded Stud  
By-Pass Valve  
**Fits:** U.C.C. Hydraulics Applications  
**Replaces:** U.C.C. UCSE5103  
**O.D.:** 3 13/32 (86.5)  
**I.D.:** 2 9/16 (65.1) One End  
**Height:** 5 15/32 (138.9)

**PT23329**



Hydraulic Element

**Contains:** 1/2-14 Inch BSP Threaded Stud  
**Fits:** MP Filtri Applications  
**Replaces:** MP Filtri MPA025G1M90  
**O.D.:** 2 7/8 (73.0)  
**I.D.:** 1 11/32 (34.1) One End  
**Height:** 4 3/32 (104.0)

**PT23335**



Hydraulic Element

**Contains:** 3-11 Inch BSP Threaded Stud  
**Fits:** U.C.C. Hydraulics Applications  
**Replaces:** U.C.C. UCSE5108  
**O.D.:** 5 29/32 (150.0)  
**I.D.:** 4 5/16 (109.5) One End  
**Height:** 10 23/32 (272.3)

**PT23330**



Hydraulic Element

**Contains:** 1 1/4-11 Inch BSP Threaded Stud  
**Fits:** MP Filtri Applications  
**Replaces:** MP Filtri MPA095G1M90,  
STR1001SG1M90  
**O.D.:** 4 1/32 (102.4)  
**I.D.:** 2 11/32 (59.5) One End  
**Height:** 6 3/32 (154.8)

**PT23336**



Hydraulic Element

**Fits:** Vickers Applications  
**Replaces:** Vickers 361741; Donaldson  
P168446, P173584  
**O.D.:** 4 1/32 (102.4)  
**I.D.:** 2 29/32 (73.8)  
**Height:** 6 1/4 (158.8)  
**O-Ring:** [1] Attached, [1] Included

**PT23331**



Hydraulic Element

**Fits:** Parker Applications  
**Replaces:** Parker 909309  
**O.D.:** 5 1/2 (139.7)  
**I.D.:** 4 3/16 (106.4)  
**Height:** 12 3/16 (309.6)  
**F. Gskt:** [1] Included  
**End Seals:** [1] Attached

**PT23337**



Hydraulic Element

**Fits:** Vickers Applications  
**Replaces:** Vickers 361739  
**O.D.:** 2 7/16 (61.9)  
**I.D.:** 1 1/2 (38.1)  
**Height:** 3 3/4 (95.3)  
**O-Ring:** [1] Included

**PT23332**



Hydraulic Element

**Fits:** Parker Applications  
**Replaces:** Parker 922627, G01280, G01280Q  
**O.D.:** 2 11/32 (59.5)  
**I.D.:** 1 13/32 (35.7)  
**Height:** 5 5/16 (134.9)  
**O-Ring:** [1] Attached

**PT23338-MPG**



Maximum Performance Glass Hydraulic Element

**Fits:** Argo Applications  
**Replaces:** Argo V3051018  
**O.D.:** 1 13/16 (46.0)  
**I.D.:** 13/16 (20.6) One End  
**Height:** 4 1/16 (103.2)  
**O-Ring:** [1] Attached

**PT23333**



Hydraulic Element

**Contains:** 3/4-14 Inch BSP Threaded Stud  
By-Pass Valve  
**Fits:** U.C.C. Hydraulics Applications  
**Replaces:** U.C.C. UCSE5101  
**O.D.:** 2 1/2 (63.5)  
**I.D.:** 1 31/32 (50.0) One End  
**Height:** 4 9/32 (108.7)

**PT23339-MPG**



Maximum Performance Glass Hydraulic Element

**Fits:** Argo Applications  
**Replaces:** Argo V3082318  
**O.D.:** 3 1/16 (77.8)  
**I.D.:** 1 9/16 (39.7) One End  
**Height:** 9 5/32 (232.6)  
**O-Ring:** [1] Attached

Measurements Are Shown In Inches And (Millimeters)

**WARNING:** These products can expose you to chemicals, including Diisononyl Phthalate, Carbon black extracts, Nickel, 1,3 Butadiene, Ethylene Oxide, Epichlorohydrin, which are known to the State of California to cause cancer, and Bisphenol, Ethylene Glycol, Ethylene Oxide, 1,3 Butadiene, Epichlorohydrin, which are known to the State of California to cause birth defects or other reproductive harm.

**PT23340-MPG** Maximum Performance Glass Hydraulic Element



**Fits:** Eppensteiner Applications  
**Replaces:** Eppensteiner 2225H20SLC000P  
**O.D.:** 3 1/16 (77.8)  
**I.D.:** 1 19/32 (40.5) One End  
**Height:** 9 3/32 (231.0)  
**O-Ring:** [1] Attached

**PT23346-MPG** Maximum Performance Glass Hydraulic Element



**Fits:** Fairey-Arlon Applications  
**Replaces:** Fairey-Arlon 330X101, 370L1FFA, 370L120A, 370Z1FFA, 370Z120, 830X101  
**O.D.:** 3 3/4 (95.3)  
**I.D.:** 1 15/16 (49.2) & 1 29/32 (48.4)  
**Height:** 4 1/8 (104.8)  
**O-Ring:** [1] Attached, [1] Included

**PT23341-MPG** Maximum Performance Glass Hydraulic Element



**Fits:** Eppensteiner Applications  
**Replaces:** Eppensteiner 2460H20SLC000P; Donaldson P561451  
**O.D.:** 3 1/16 (77.8)  
**I.D.:** 1 19/32 (40.5) One End  
**Height:** 15 (381.0)  
**O-Ring:** [1] Attached

**PT23347-MPG** Maximum Performance Glass Hydraulic Element



**Fits:** Fairey-Arlon Applications  
**Replaces:** Fairey-Arlon MXW2CC25, MXW2GDL20  
**O.D.:** 2 11/32 (59.5)  
**I.D.:** 1 1/16 (27.0) One End  
**Height:** 9 25/32 (248.4)

**PT23342-MPG** Maximum Performance Glass Hydraulic Element



**Fits:** Eppensteiner Applications  
**Replaces:** Eppensteiner 1361H10SLA000P  
**O.D.:** 3 15/16 (100.0)  
**I.D.:** 2 7/16 (61.9)  
**Height:** 9 5/16 (236.5)  
**O-Ring:** [2] Attached

**PT23348-MPG** Maximum Performance Glass Hydraulic Element



**Fits:** Fairey-Arlon Applications  
**Replaces:** Fairey-Arlon 330X301, 370L3FFA, 370L320A, 370Z3FFA, 830X301  
**O.D.:** 3 11/16 (93.7)  
**I.D.:** 1 7/32 (31.0) & 1 29/32 (48.4)  
**Height:** 12 19/32 (319.9)  
**O-Ring:** [1] Attached, [1] Included

**PT23343-MPG** Maximum Performance Glass Hydraulic Element



**Fits:** Fairey-Arlon Applications  
**Replaces:** Fairey-Arlon TXW14CC10, TXW14GDL10; Fleetguard HF35134  
**O.D.:** 7 31/32 (202.4)  
**I.D.:** 9/16 (14.3) & 6 3/16 (157.2)  
**Height:** 42 29/32 (1089.8)  
**O-Ring:** [1] Attached

**PT23349-MPG** Maximum Performance Glass Stacked Hydraulic Element



**Fits:** Fairey-Arlon Applications  
**Replaces:** Fairey-Arlon TXW8DCC25, TXW8DGDL20  
**O.D.:** 5 29/32 (150.0)  
**I.D.:** 4 5/32 (105.6)  
**Height:** 16 13/16 (427.0)  
**O-Ring:** [1] Attached

**PT23344-MPG** Maximum Performance Glass Hydraulic Element



**Fits:** Fairey-Arlon Applications  
**Replaces:** Fairey-Arlon TXW3BCC10, TXW3BGDL10  
**O.D.:** 4 3/16 (106.4)  
**I.D.:** 13/32 (10.3) & 2 13/16 (71.4)  
**Height:** 5 1/2 (139.7)  
**O-Ring:** [1] Attached

**PT23350-MPG** Maximum Performance Glass Hydraulic Element



**Fits:** Fairey-Arlon Applications  
**Replaces:** Fairey-Arlon 270Z1FFA  
**O.D.:** 2 15/16 (74.6)  
**I.D.:** 1 1/4 (31.8) One End  
**Height:** 4 3/16 (106.4)  
**O-Ring:** [1] Included

**PT23345-MPG** Maximum Performance Glass Hydraulic Element



**Fits:** Fairey-Arlon Applications  
**Replaces:** Fairey-Arlon TXW5GDL3, TXW5CC3  
**O.D.:** 4 3/16 (106.4)  
**I.D.:** 13/32 (10.3) & 2 13/16 (71.4)  
**Height:** 10 1/4 (260.3)

**PT23351-MPG** Maximum Performance Glass Hydraulic Element



**Fits:** Fairey-Arlon Applications  
**Replaces:** Fairey-Arlon 370L101A  
**O.D.:** 3 11/16 (93.7)  
**I.D.:** 1 15/16 (49.2)  
**Height:** 4 1/16 (103.2)  
**O-Ring:** [1] Attached, [1] Included

Measurements Are Shown In Inches And (Millimeters)

**WARNING:** These products can expose you to chemicals, including Diisononyl Phthalate, Carbon black extracts, Nickel, 1,3 Butadiene, Ethylene Oxide, Epichlorohydrin, which are known to the State of California to cause cancer, and Bisphenol, Ethylene Glycol, Ethylene Oxide, 1,3 Butadiene, Epichlorohydrin, which are known to the State of California to cause birth defects or other reproductive harm.

**PT23352-MPG** Maximum Performance Glass Hydraulic Element  
**Fits:** Fairey-Arlon Applications  
**Replaces:** Fairey-Arlon 170L1FFA, 170Z1FFA, 170L120A  
**O.D.:** 3 23/32 (94.5)  
**I.D.:** 25/32 (19.8) & 1 29/32 (48.4)  
**Height:** 17 3/32 (434.2)  
**O-Ring:** [1] Attached, [1] Included



**PT23358-MPG** Maximum Performance Glass Hydraulic Element  
**Fits:** Hydac Applications  
**Replaces:** Hydac 1262051, 75D020BNHC, 75D020BN3HC, 75D020BNHC2  
**O.D.:** 2 7/32 (56.4)  
**I.D.:** 1 (25.4) One End  
**Height:** 6 11/16 (169.9)  
**O-Ring:** [1] Attached



**PT23353-MPG** Maximum Performance Glass Hydraulic Element  
**Fits:** FBO Applications  
**Replaces:** FBO 456.51; Donaldson P171746  
**O.D.:** 3 1/16 (77.8)  
**I.D.:** 1 19/32 (40.5) One End  
**Height:** 14 3/4 (374.7)  
**O-Ring:** [1] Attached



**PT23359-MPG** Maximum Performance Glass Hydraulic Element with Bail Handle  
**Fits:** Hydac Applications  
**Replaces:** Hydac 500R005BNHC  
**O.D.:** 3 3/4 (95.3)  
**I.D.:** 1 15/16 (49.2) One End  
**Height:** 11 (279.4)  
**O-Ring:** [1] Attached



**PT23354-MPG** Maximum Performance Glass Hydraulic Element  
**Fits:** FBO Applications  
**Replaces:** FBO 456.53; Donaldson P171748  
**O.D.:** 3 1/16 (77.8)  
**I.D.:** 1 19/32 (40.5) One End  
**Height:** 14 3/4 (374.7)  
**O-Ring:** [1] Attached



**PT23360-MPG** Maximum Performance Glass Hydraulic Element with Bail Handle  
**Contains:** By-Pass Valve  
**Fits:** Hydac Applications  
**Replaces:** Hydac 2059110, 1300R005BNHC, 1300R005BNHC2  
**O.D.:** 5 21/32 (143.7)  
**I.D.:** 3 3/4 (95.3) & 3 25/32 (96.0)  
**Height:** 19 1/32 (483.4)  
**O-Ring:** [1] Attached



**PT23355-MPG** Maximum Performance Glass Hydraulic Element  
**Fits:** Hycon Applications  
**Replaces:** Hycon HC8400FUP16H; Donaldson P169438  
**O.D.:** 5 31/32 (151.6)  
**I.D.:** 3 1/4 (82.6)  
**Height:** 16 13/16 (427.0)  
**O-Ring:** [2] Attached



**PT23361-MPG** Maximum Performance Glass Hydraulic Element  
**Fits:** Hydac Applications  
**Replaces:** Hydac 1260905, 2055754, 240D003BNHC, 240D003BNHC2, 240D003BN3HC  
**O.D.:** 2 23/32 (69.1)  
**I.D.:** 1 11/32 (34.1) One End  
**Height:** 6 13/16 (173.0)  
**O-Ring:** [1] Attached



**PT23356-MPG** Maximum Performance Glass Hydraulic Element  
**Fits:** Hydac Applications  
**Replaces:** Hydac 280D101BH3HC  
**O.D.:** 2 3/4 (69.9)  
**I.D.:** 1 5/16 (33.3) One End  
**Height:** 14 (355.6)  
**O-Ring:** [1] Attached



**PT23362-MPG** Maximum Performance Glass Hydraulic Element with Bail Handle  
**Contains:** By-Pass Valve  
**Fits:** Hydac Applications  
**Replaces:** Hydac 2060548, 850R020BNHC, 850F020BNHC2, 850R020BN3HC  
**O.D.:** 4 1/2 (114.3)  
**I.D.:** 2 9/16 (65.1) & 2 23/32 (69.1)  
**Height:** 15 1/2 (393.7)  
**O-Ring:** [1] Attached



**PT23357-MPG** Maximum Performance Glass Hydraulic Element  
**Fits:** Hydac Applications  
**Replaces:** Hydac 160D003BNHC  
**O.D.:** 2 3/4 (69.9)  
**I.D.:** 1 3/4 (44.4) One End  
**Height:** 4 1/2 (114.3)  
**O-Ring:** [1] Attached



**PT23363-MPG** Maximum Performance Glass Hydraulic Element  
**Fits:** Hydac Applications  
**Replaces:** Hydac 1260907, 2055736, 330D003BNHC, 330D003BNHC2, 330D003BN3HC  
**O.D.:** 3 9/16 (90.5)  
**I.D.:** 1 29/32 (48.4) One End  
**Height:** 6 3/8 (161.9)  
**O-Ring:** [1] Attached



Measurements Are Shown In Inches And (Millimeters)

**WARNING:** These products can expose you to chemicals, including Diisononyl Phthalate, Carbon black extracts, Nickel, 1,3 Butadiene, Ethylene Oxide, Epichlorohydrin, which are known to the State of California to cause cancer, and Bisphenol, Ethylene Glycol, Ethylene Oxide, 1,3 Butadiene, Epichlorohydrin, which are known to the State of California to cause birth defects or other reproductive harm.

**PT23364-MPG** Maximum Performance Glass Hydraulic Element with Bail Handle



**Contains:** By-Pass Valve  
**Fits:** Hydac Applications  
**Replaces:** Hydac 1263016, 2059104, 660R005BNHC, 660R005BNHC2  
**O.D.:** 4 1/2 (114.3)  
**I.D.:** 2 9/16 (65.1) & 2 23/32 (69.1)  
**Height:** 12 3/8 (314.3)  
**O-Ring:** [1] Attached

**PT23365-MPG** Maximum Performance Glass Hydraulic Element



**Fits:** Hydac Applications  
**Replaces:** Hydac 2055988, 240D003BHHC, 240D003BHHC2  
**O.D.:** 2 23/32 (69.1)  
**I.D.:** 1 11/32 (34.1) One End  
**Height:** 6 13/16 (173.0)  
**O-Ring:** [1] Attached

**PT23366-MPG** Maximum Performance Glass Hydraulic Element with Bail Handle



**Contains:** By-Pass Valve  
**Fits:** Hydac Applications  
**Replaces:** Hydac 2066035, 550R003BNHC, 500R003BNHC2  
**O.D.:** 2 23/32 (69.1)  
**I.D.:** 1 25/32 (45.2) & 1 29/32 (48.4)  
**Height:** 10 9/32 (261.1)  
**O-Ring:** [1] Attached

**PT23367-MPG** Maximum Performance Glass Hydraulic Element



**Fits:** Hydac Applications  
**Replaces:** Hydac 2056688, 30D003BH3HC  
**O.D.:** 1 3/8 (34.9)  
**I.D.:** 15/32 (11.9) One End  
**Height:** 3 21/32 (92.9)  
**O-Ring:** [1] Attached

**PT23368-MPG** Maximum Performance Glass Hydraulic Element



**Fits:** Hydac Applications  
**Replaces:** Hydac 2055745, 660D003BNHC, 660D003BNHC2  
**O.D.:** 3 9/16 (90.5)  
**I.D.:** 1 29/32 (48.4) One End  
**Height:** 12 29/32 (327.8)  
**O-Ring:** [1] Attached

**PT23369-MPG** Maximum Performance Glass Hydraulic Element



**Fits:** Hydac Applications  
**Replaces:** Hydac 2055973, 110D003BHHC, 110D003BHHC2  
**O.D.:** 1 27/32 (46.8)  
**I.D.:** 7/8 (22.2) One End  
**Height:** 6 1/32 (153.2)  
**O-Ring:** [1] Attached

**PT23370-MPG** Maximum Performance Glass Hydraulic Element



**Fits:** Hydac Applications  
**Replaces:** Hydac 2055737, 330D005BNHC, 330D005BNHC2  
**O.D.:** 3 9/16 (90.5)  
**I.D.:** 1 29/32 (48.4) One End  
**Height:** 6 3/8 (161.9)  
**O-Ring:** [1] Attached

**PT23371-MPG** Maximum Performance Glass Hydraulic Element



**Fits:** Hydac Applications  
**Replaces:** Hydac 2055906, 110D003BNHC, 110D003BN3HC  
**O.D.:** 1 27/32 (46.8)  
**I.D.:** 7/8 (22.2) One End  
**Height:** 6 1/32 (153.2)  
**O-Ring:** [1] Attached

**PT23372-MPG** Maximum Performance Glass Hydraulic Element



**Fits:** Hydac Applications  
**Replaces:** Hydac 2056437, 330D003BHHC, 330D003BHHC2  
**O.D.:** 3 17/32 (89.7)  
**I.D.:** 1 29/32 (48.4) One End  
**Height:** 6 3/8 (161.9)  
**O-Ring:** [1] Attached

**PT23373-MPG** Maximum Performance Glass Hydraulic Element



**Fits:** Hydac Applications  
**Replaces:** Hydac 2055929, 140D005BNHC, 140D005BNHC2  
**O.D.:** 1 27/32 (46.8)  
**I.D.:** 7/8 (22.2) One End  
**Height:** 7 19/32 (192.9)  
**O-Ring:** [1] Attached

**PT23374-MPG** Maximum Performance Glass Hydraulic Element



**Fits:** Hydac Applications  
**Replaces:** Hydac 2055958, 60D003BHHC, 60D003BHHC2  
**O.D.:** 1 27/32 (46.8)  
**I.D.:** 7/8 (22.2) One End  
**Height:** 3 5/16 (84.1)  
**O-Ring:** [1] Attached

**PT23375-MPG** Maximum Performance Glass Hydraulic Element with Bail Handle



**Contains:** By-Pass Valve  
**Fits:** Hydac Applications  
**Replaces:** Hydac 2059097, 110R020BNHC, 110R020BNHC2  
**O.D.:** 2 1/32 (51.6)  
**I.D.:** 7/8 (22.2) & 15/16 (23.8)  
**Height:** 6 9/32 (159.5)  
**O-Ring:** [1] Attached

Measurements Are Shown In Inches And (Millimeters)

**WARNING:** These products can expose you to chemicals, including Diisononyl Phthalate, Carbon black extracts, Nickel, 1,3 Butadiene, Ethylene Oxide, Epichlorohydrin, which are known to the State of California to cause cancer, and Bisphenol, Ethylene Glycol, Ethylene Oxide, 1,3 Butadiene, Epichlorohydrin, which are known to the State of California to cause birth defects or other reproductive harm.



**PT23376-MPG** Maximum Performance Glass Hydraulic Element



**Fits:** Hydac Applications  
**Replaces:** Hydac 2055984, 160D003BHHC, 160D003BHHC2  
**O.D.:** 2 23/32 (69.1)  
**I.D.:** 1 11/32 (34.1) One End  
**Height:** 4 17/32 (115.1)  
**O-Ring:** [1] Attached

**PT23382-MPG** Maximum Performance Glass Hydraulic Element



**Fits:** Mahle Applications  
**Replaces:** Mahle PI3211SMVST10, PI3211SMXVST10  
**O.D.:** 1 27/32 (46.8)  
**I.D.:** 1 (25.4) One End  
**Height:** 9 11/16 (246.1)  
**O-Ring:** [1] Attached

**PT23377-MPG** Maximum Performance Glass Hydraulic Element



**Fits:** Hydac Applications  
**Replaces:** Hydac 12556542, 2056542, 30D005BN3HC  
**O.D.:** 1 3/8 (34.9)  
**I.D.:** 1/2 (12.7) One End  
**Height:** 3 21/32 (92.9)  
**O-Ring:** [1] Attached

**PT23383-MPG** Maximum Performance Glass Hydraulic Element



**Fits:** Mahle Applications  
**Replaces:** Mahle PI5230SMVST6, PI5230SMXVST6  
**O.D.:** 3 9/32 (83.3)  
**I.D.:** 1 27/32 (46.8) One End  
**Height:** 10 1/32 (254.8)  
**O-Ring:** [1] Attached

**PT23378-MPG** Maximum Performance Glass Hydraulic Element



**Fits:** Hydac Applications  
**Replaces:** Hydac 2055928, 140D003BNHC, 140D003BNHC2  
**O.D.:** 1 27/32 (46.8)  
**I.D.:** 7/8 (22.2) One End  
**Height:** 7 19/32 (192.9)  
**O-Ring:** [1] Attached

**PT23384-MPG** Maximum Performance Glass Hydraulic Element



**Fits:** Mahle Applications  
**Replaces:** Mahle PI3205SMXVST10  
**O.D.:** 1 7/8 (47.6)  
**I.D.:** 1 (25.4) One End  
**Height:** 3 3/4 (95.3)  
**O-Ring:** [1] Attached

**PT23379-MPG** Maximum Performance Glass Hydraulic Element



**Fits:** Hydac Applications  
**Replaces:** Hydac 2022902, 60D003BNHC, 60D003BNHC2  
**O.D.:** 1 27/32 (46.8)  
**I.D.:** 7/8 (22.2) One End  
**Height:** 3 5/16 (84.1)  
**O-Ring:** [1] Attached

**PT23385-MPG** Maximum Performance Glass Hydraulic Element



**Fits:** Mahle Applications  
**Replaces:** Mahle PI2230SMVST3, PI2230SMXVST3  
**O.D.:** 3 1/4 (82.6)  
**I.D.:** 1 27/32 (46.8) One End  
**Height:** 10 1/32 (254.8)  
**O-Ring:** [1] Attached

**PT23380-MPG** Maximum Performance Glass Hydraulic Element



**Fits:** Pall Applications  
**Replaces:** Pall HC8900FDT8H, HC8900FKT8H, HC8900FUT8H  
**O.D.:** 3 25/32 (96.0)  
**I.D.:** 2 7/32 (56.4) One End  
**Height:** 8 3/32 (205.6)  
**O-Ring:** [1] Attached

**PT23386-MPG** Maximum Performance Glass Hydraulic Element



**Fits:** Mahle Applications  
**Replaces:** Mahle PI3230SMXVST10  
**O.D.:** 3 5/16 (84.1)  
**I.D.:** 1 7/8 (47.6)  
**Height:** 10 (254.0)

**PT23381-MPG** Maximum Performance Glass Hydraulic Element



**Fits:** Mahle Applications  
**Replaces:** Mahle PI3245SMVST10, PI3245SMXVST10  
**O.D.:** 3 9/32 (83.3)  
**I.D.:** 1 27/32 (46.8) One End  
**Height:** 14 11/16 (373.1)  
**O-Ring:** [1] Attached













**PT23387-MPG** Maximum Performance Glass Hydraulic Element



**Fits:** Mahle Applications  
**Replaces:** Mahle PI4205SMXVST25  
**O.D.:** 1 27/32 (46.8)  
**I.D.:** 1 (25.4) One End  
**Height:** 3 11/16 (93.7)  
**O-Ring:** [1] Attached

Measurements Are Shown In Inches And (Millimeters)

**WARNING:** These products can expose you to chemicals, including Diisononyl Phthalate, Carbon black extracts, Nickel, 1,3 Butadiene, Ethylene Oxide, Epichlorohydrin, which are known to the State of California to cause cancer, and Bisphenol, Ethylene Glycol, Ethylene Oxide, 1,3 Butadiene, Epichlorohydrin, which are known to the State of California to cause birth defects or other reproductive harm.

<p><b>PT23388-MPG</b> Maximum Performance Glass Hydraulic Element</p>  <p><b>Fits:</b> Mahle Applications <b>Replaces:</b> Mahle 852444SM10, 852444SMX10 <b>O.D.:</b> 2 9/32 (57.9) <b>I.D.:</b> 1 9/32 (32.5) One End <b>Height:</b> 7 3/32 (180.2) <b>O-Ring:</b> [1] Attached</p>	<p><b>PT23394-MPG</b> Maximum Performance Glass Hydraulic Element</p>  <p><b>Fits:</b> Pall Applications <b>Replaces:</b> Pall HC6500FKS16H <b>O.D.:</b> 3 25/32 (96.0) <b>I.D.:</b> 2 7/32 (56.4) One End <b>Height:</b> 16 13/16 (427.0) <b>O-Ring:</b> [1] Attached</p>
<p><b>PT23389-MPG</b> Maximum Performance Glass Hydraulic Element</p>  <p><b>Fits:</b> Pall Applications <b>Replaces:</b> Pall HC9801FDP8H, HC9801FUP8H, HC9801FKP8H <b>O.D.:</b> 2 (50.8) <b>I.D.:</b> 15/16 (23.8) One End <b>Height:</b> 8 3/16 (208.0) <b>O-Ring:</b> [1] Attached</p>	<p><b>PT23395-MPG</b> Maximum Performance Glass Hydraulic Element</p>  <p><b>Fits:</b> Pall Applications <b>Replaces:</b> Pall HC9600FKS8Z <b>O.D.:</b> 3 1/16 (77.8) <b>I.D.:</b> 1 23/32 (43.7) One End <b>Height:</b> 8 1/4 (209.6) <b>O-Ring:</b> [1] Attached</p>
<p><b>PT23390-MPG</b> Maximum Performance Glass Hydraulic Element</p>  <p><b>Fits:</b> Fairey-Arlon Applications <b>Replaces:</b> Fairey-Arlon TXW8AC CZ <b>O.D.:</b> 4 31/32 (126.2) <b>I.D.:</b> 13/32 (10.3) &amp; 3 5/8 (92.1) <b>Height:</b> 11 7/16 (290.5) <b>O-Ring:</b> [1] Attached</p>	<p><b>PT23396-MPG</b> Maximum Performance Glass Hydraulic Element</p>  <p><b>Fits:</b> Pall Applications <b>Replaces:</b> Pall HC9601FUP8H <b>O.D.:</b> 3 1/16 (77.8) <b>I.D.:</b> 1 11/16 (42.9) One End <b>Height:</b> 8 1/4 (209.6) <b>O-Ring:</b> [1] Attached</p>
<p><b>PT23391-MPG</b> Maximum Performance Glass Hydraulic Element</p>  <p><b>Fits:</b> Fairey-Arlon Applications <b>Replaces:</b> Fairey-Arlon TXW3DCC3 <b>O.D.:</b> 2 7/8 (73.0) <b>I.D.:</b> 5/8 (15.9) &amp; 1 7/8 (47.6) <b>Height:</b> 7 15/16 (201.6) <b>O-Ring:</b> [1] Attached</p>	<p><b>PT23397-MPG</b> Maximum Performance Glass Hydraulic Element</p>  <p><b>Fits:</b> Pall Applications <b>Replaces:</b> Pall HC9601FDT8Z <b>O.D.:</b> 3 (76.2) <b>I.D.:</b> 1 13/16 (46.0) One End <b>Height:</b> 8 5/16 (211.1) <b>O-Ring:</b> [1] Attached</p>
<p><b>PT23392-MPG</b> Maximum Performance Glass Hydraulic Element</p>  <p><b>Fits:</b> Fairey-Arlon Applications <b>Replaces:</b> Fairey-Arlon TXW5AC CZ <b>O.D.:</b> 4 3/16 (106.4) <b>I.D.:</b> 13/32 (10.3) &amp; 2 13/16 (71.4) <b>Height:</b> 18 5/16 (465.1) <b>O-Ring:</b> [1] Attached</p>	<p><b>PT23398-MPG</b> Maximum Performance Glass Hydraulic Element</p>  <p><b>Fits:</b> Pall Applications <b>Replaces:</b> Pall HC9601FKP8Z <b>O.D.:</b> 3 1/16 (77.8) <b>I.D.:</b> 1 11/16 (42.9) One End <b>Height:</b> 8 1/4 (209.6) <b>O-Ring:</b> [1] Attached</p>
<p><b>PT23393-MPG</b> Maximum Performance Glass Hydraulic Element</p>  <p><b>Fits:</b> Pall Applications <b>Replaces:</b> Pall HC8200FKT13Z <b>O.D.:</b> 3 (76.2) <b>I.D.:</b> 1 1/2 (38.1) One End <b>Height:</b> 13 (330.2) <b>O-Ring:</b> [2] Attached</p>	<p><b>PT23399-MPG</b> Maximum Performance Glass Hydraulic Element with Bail Handle</p>  <p><b>Fits:</b> Pall Applications <b>Replaces:</b> Pall HC8904FKT16Z <b>O.D.:</b> 3 27/32 (97.6) <b>I.D.:</b> 2 17/32 (64.3) One End <b>Height:</b> 6 11/32 (161.1) <b>O-Ring:</b> [1] Attached</p>

Measurements Are Shown In Inches And (Millimeters)

**WARNING:** These products can expose you to chemicals, including Diisononyl Phthalate, Carbon black extracts, Nickel, 1,3 Butadiene, Ethylene Oxide, Epichlorohydrin, which are known to the State of California to cause cancer, and Bisphenol, Ethylene Glycol, Ethylene Oxide, 1,3 Butadiene, Epichlorohydrin, which are known to the State of California to cause birth defects or other reproductive harm.

**PT23400-MPG** Maximum Performance Glass Hydraulic Element



**Fits:** Pall Applications  
**Replaces:** Pall HC9801FUP4H  
**O.D.:** 2 1/32 (51.6)  
**I.D.:** 15/16 (23.8) One End  
**Height:** 4 1/2 (114.3)  
**O-Ring:** [1] Attached

**PT23406-MPG** Maximum Performance Glass Hydraulic Element



**Fits:** Pall Applications  
**Replaces:** Pall HC8904FKS13H  
**O.D.:** 3 13/16 (96.8)  
**I.D.:** 2 1/2 (63.5) One End  
**Height:** 14 7/8 (377.8)  
**O-Ring:** [1] Attached

**PT23401-MPG** Maximum Performance Glass Hydraulic Element



**Fits:** Pall Applications  
**Replaces:** Pall HC8900FKN13Z  
**O.D.:** 3 25/32 (96.0)  
**I.D.:** 2 7/32 (56.4) One End  
**Height:** 12 29/32 (327.8)  
**O-Ring:** [1] Attached

**PT23407-MPG** Maximum Performance Glass Hydraulic Element



**Fits:** Pall Applications  
**Replaces:** Pall HC8904FKT8H, HC9604FKT8Z  
**O.D.:** 3 1/8 (79.4)  
**I.D.:** 1 15/16 (49.2)  
**Height:** 8 (203.2)  
**O-Ring:** [1] Attached

**PT23402-MPG** Maximum Performance Glass Hydraulic Element



**Fits:** Pall Applications  
**Replaces:** Pall HC8800FKP16Z  
**O.D.:** 3 13/32 (86.5)  
**I.D.:** 1 31/32 (50.0) One End  
**Height:** 16 13/16 (427.0)  
**O-Ring:** [1] Attached

**PT23408-MPG** Maximum Performance Glass Hydraulic Element



**Fits:** Pall Applications  
**Replaces:** Pall HC9601FKP4Z  
**O.D.:** 3 1/16 (77.8)  
**I.D.:** 1 11/16 (42.9) One End  
**Height:** 4 21/32 (118.3)  
**O-Ring:** [1] Attached

**PT23403-MPG** Maximum Performance Glass Hydraulic Element



**Fits:** Pall Applications  
**Replaces:** Pall HC8300FKT8H  
**O.D.:** 6 (152.4)  
**I.D.:** 4 5/32 (105.6)  
**Height:** 8 5/32 (207.2)  
**O-Ring:** [2] Attached

**PT23409-MPG** Maximum Performance Glass Hydraulic Element



**Fits:** Pall Applications  
**Replaces:** Pall HC8900FKT16Z  
**O.D.:** 3 25/32 (96.0)  
**I.D.:** 2 7/32 (56.4) One End  
**Height:** 16 29/32 (429.4)  
**O-Ring:** [1] Attached

**PT23404-MPG** Maximum Performance Glass Hydraulic Element



**Fits:** Pall Applications  
**Replaces:** Pall HC8300FKS8H  
**O.D.:** 6 (152.4)  
**I.D.:** 4 5/32 (105.6)  
**Height:** 8 5/32 (207.2)  
**O-Ring:** [2] Attached

**PT23410-MPG** Maximum Performance Glass Hydraulic Element



**Fits:** Pall Applications  
**Replaces:** Pall HC9800FKS13H  
**O.D.:** 1 31/32 (50.0)  
**I.D.:** 31/32 (24.6) One End  
**Height:** 12 31/32 (329.4)  
**O-Ring:** [1] Attached

**PT23405-MPG** Maximum Performance Glass Hydraulic Element



**Fits:** Pall Applications  
**Replaces:** Pall HC8300FKS8Z  
**O.D.:** 6 (152.4)  
**I.D.:** 4 1/2 (114.3)  
**Height:** 8 1/4 (209.6)  
**O-Ring:** [2] Attached













**PT23411-MPG** Maximum Performance Glass Hydraulic Element with Bail Handle



**Fits:** Pall Applications  
**Replaces:** Pall HC8314FKP39Z  
**O.D.:** 6 (152.4)  
**I.D.:** 3 25/32 (96.0) & 3 15/16 (100.0)  
**Height:** 36 1/2 (927.1)  
**O-Ring:** [2] Attached

Measurements Are Shown In Inches And (Millimeters)

**WARNING:** These products can expose you to chemicals, including Diisononyl Phthalate, Carbon black extracts, Nickel, 1,3 Butadiene, Ethylene Oxide, Epichlorohydrin, which are known to the State of California to cause cancer, and Bisphenol, Ethylene Glycol, Ethylene Oxide, 1,3 Butadiene, Epichlorohydrin, which are known to the State of California to cause birth defects or other reproductive harm.

<p><b>PT23412-MPG</b> Maximum Performance Glass Hydraulic Element</p>  <p><b>Fits:</b> Pall Applications <b>Replaces:</b> Pall HC8900FKT8Z <b>O.D.:</b> 3 25/32 (96.0) <b>I.D.:</b> 2 7/32 (56.4) One End <b>Height:</b> 8 3/32 (205.6) <b>O-Ring:</b> [1] Attached</p>	<p><b>PT23418-MPG</b> Maximum Performance Glass Hydraulic Element</p>  <p><b>Fits:</b> Pall Applications <b>Replaces:</b> Pall HC9801FKP4H <b>O.D.:</b> 2 (50.8) <b>I.D.:</b> 15/16 (23.8) <b>Height:</b> 4 1/2 (114.3) <b>O-Ring:</b> [1] Attached</p>
<p><b>PT23413-MPG</b> Maximum Performance Glass Hydraulic Element</p>  <p><b>Fits:</b> Pall Applications <b>Replaces:</b> Pall HC9901FKT26H <b>O.D.:</b> 3 3/4 (95.3) <b>I.D.:</b> 2 5/16 (58.7) <b>Height:</b> 25 7/8 (657.2) <b>O-Ring:</b> [1] Attached</p>	<p><b>PT23419-MPG</b> Maximum Performance Glass Hydraulic Element</p>  <p><b>Fits:</b> Pall Applications <b>Replaces:</b> Pall HC9100FKN8Z <b>O.D.:</b> 2 3/4 (69.9) <b>I.D.:</b> 1 5/16 (33.3) One End <b>Height:</b> 8 1/4 (209.6) <b>O-Ring:</b> [1] Attached</p>
<p><b>PT23414-MPG</b> Maximum Performance Glass Hydraulic Element</p>  <p><b>Fits:</b> Pall Applications <b>Replaces:</b> Pall HC9606FKS8H <b>O.D.:</b> 3 1/16 (77.8) <b>I.D.:</b> 1 23/32 (43.7) One End <b>Height:</b> 8 1/4 (209.6) <b>O-Ring:</b> [1] Attached</p>	<p><b>PT23420-MPG</b> Maximum Performance Glass Hydraulic Element</p>  <p><b>Fits:</b> Pall Applications <b>Replaces:</b> Pall HC9400FKP26H <b>O.D.:</b> 3 25/32 (96.0) <b>I.D.:</b> 2 7/32 (56.4) <b>Height:</b> 25 27/32 (656.4) <b>O-Ring:</b> [2] Attached</p>
<p><b>PT23415-MPG</b> Maximum Performance Glass Hydraulic Element</p>  <p><b>Fits:</b> Pall Applications <b>Replaces:</b> Pall HC6400FKT16H <b>O.D.:</b> 3 13/32 (86.5) <b>I.D.:</b> 1 31/32 (50.0) One End <b>Height:</b> 16 13/16 (427.0) <b>O-Ring:</b> [1] Attached</p>	<p><b>PT23421-MPG</b> Maximum Performance Glass Hydraulic Element</p>  <p><b>Fits:</b> Pall Applications <b>Replaces:</b> Pall HC9400FKS39Z <b>O.D.:</b> 3 25/32 (96.0) <b>I.D.:</b> 2 7/32 (56.4) <b>Height:</b> 38 13/16 (985.8) <b>O-Ring:</b> [2] Attached</p>
<p><b>PT23416-MPG</b> Maximum Performance Glass Hydraulic Element</p>  <p><b>Fits:</b> Pall Applications <b>Replaces:</b> Pall HC8200FKN13Z <b>O.D.:</b> 3 (76.2) <b>I.D.:</b> 1 1/2 (38.1) One End <b>Height:</b> 13 (330.2) <b>O-Ring:</b> [1] Attached</p>	<p><b>PT23422-MPG</b> Maximum Performance Glass Hydraulic Element</p>  <p><b>Fits:</b> Pall Applications <b>Replaces:</b> Pall HC9901FKP26H <b>O.D.:</b> 3 13/16 (96.8) <b>I.D.:</b> 2 3/16 (55.6) <b>Height:</b> 25 13/16 (655.6) <b>O-Ring:</b> [2] Attached</p>
<p><b>PT23417-MPG</b> Maximum Performance Glass Hydraulic Element</p>  <p><b>Fits:</b> Pall Applications <b>Replaces:</b> Pall HC9604FKN16Z <b>O.D.:</b> 3 3/32 (78.6) <b>I.D.:</b> 2 1/32 (51.6) One End <b>Height:</b> 16 9/16 (420.7) <b>O-Ring:</b> [1] Attached</p>	<p><b>PT23423-MPG</b> Maximum Performance Glass Hydraulic Element</p>  <p><b>Fits:</b> Pall Applications <b>Replaces:</b> Pall HC9601FUP16H <b>O.D.:</b> 3 1/16 (77.8) <b>I.D.:</b> 1 13/16 (46.0) One End <b>Height:</b> 17 (431.8) <b>O-Ring:</b> [1] Attached</p>

Measurements Are Shown In Inches And (Millimeters)

 **WARNING:** These products can expose you to chemicals, including Diisononyl Phthalate, Carbon black extracts, Nickel, 1,3 Butadiene, Ethylene Oxide, Epichlorohydrin, which are known to the State of California to cause cancer, and Bisphenol, Ethylene Glycol, Ethylene Oxide, 1,3 Butadiene, Epichlorohydrin, which are known to the State of California to cause birth defects or other reproductive harm.

**PT23424-MPG** Maximum Performance Glass Hydraulic Element with Bail Handle



**Fits:** Pall Applications  
**Replaces:** Pall HC8304FKP9Z  
**O.D.:** 5 13/32 (137.3)  
**I.D.:** 3 25/32 (96.0) & 3 15/16 (100.0)  
**Height:** 36 1/2 (927.1)  
**O-Ring:** [2] Attached

**PT23430-MPG** Maximum Performance Glass Hydraulic Element



**Fits:** Pall Applications  
**Replaces:** Pall HC2217FDT6H  
**O.D.:** 2 23/32 (69.1)  
**I.D.:** 1 11/32 (34.1) One End  
**Height:** 6 13/16 (173.0)  
**O-Ring:** [1] Attached

**PT23425-MPG** Maximum Performance Glass Hydraulic Element with Bail Handle



**Fits:** Pall Applications  
**Replaces:** Pall HC8304FKN39Z  
**O.D.:** 5 13/32 (137.3)  
**I.D.:** 3 25/32 (96.0) & 3 15/16 (100.0)  
**Height:** 36 1/2 (927.1)  
**O-Ring:** [2] Attached

**PT23431-MPG** Maximum Performance Glass Hydraulic Element with Bail Handle



**Fits:** Pall Applications  
**Replaces:** Pall HC8314FKN39H  
**O.D.:** 6 (152.4)  
**I.D.:** 3 25/32 (96.0) & 3 15/16 (100.0)  
**Height:** 36 1/2 (927.1)  
**O-Ring:** [2] Attached

**PT23426-MPG** Maximum Performance Glass Hydraulic Element with Bail Handle



**Fits:** Pall Applications  
**Replaces:** Pall HC2792628314FKN39Z  
**O.D.:** 6 (152.4)  
**I.D.:** 3 25/32 (96.0) & 3 15/16 (100.0)  
**Height:** 36 1/2 (927.1)  
**O-Ring:** [2] Attached

**PT23432-MPG** Maximum Performance Glass Hydraulic Element



**Fits:** Pall Applications  
**Replaces:** Pall HC9801FUT13Z  
**O.D.:** 2 1/32 (51.6)  
**I.D.:** 29/32 (23.0) One End  
**Height:** 13 (330.2)  
**O-Ring:** [1] Attached

**PT23427-MPG** Maximum Performance Glass Hydraulic Element with Bail Handle



**Fits:** Pall Applications  
**Replaces:** Pall HC8304FKN16Z  
**O.D.:** 5 13/32 (137.3)  
**I.D.:** 3 25/32 (96.0) & 3 15/16 (100.0)  
**Height:** 14 21/32 (372.3)  
**O-Ring:** [2] Attached

**PT23433-MPG** Maximum Performance Glass Hydraulic Element



**Fits:** Pall Applications  
**Replaces:** Pall HC8900FDN8H  
**O.D.:** 3 25/32 (96.0)  
**I.D.:** 2 7/32 (56.4) One End  
**Height:** 8 3/32 (205.6)  
**O-Ring:** [1] Attached

**PT23428-MPG** Maximum Performance Glass Hydraulic Element with Bail Handle



**Fits:** Pall Applications  
**Replaces:** Pall HC8304FKS39Z  
**O.D.:** 5 13/32 (137.3)  
**I.D.:** 3 25/32 (96.0) & 3 15/16 (100.0)  
**Height:** 36 1/2 (927.1)  
**O-Ring:** [2] Attached

**PT23434-MPG** Maximum Performance Glass Hydraulic Element



**Fits:** Pall Applications  
**Replaces:** Pall HC9400FKN39H  
**O.D.:** 3 25/32 (96.0)  
**I.D.:** 2 7/32 (56.4)  
**Height:** 38 13/16 (985.8)  
**O-Ring:** [2] Attached

**PT23429-MPG** Maximum Performance Glass Hydraulic Element



**Fits:** Pall Applications  
**Replaces:** Pall HC9601FKP13H  
**O.D.:** 3 1/16 (77.8)  
**I.D.:** 1 11/16 (42.9) One End  
**Height:** 13 (330.2)  
**O-Ring:** [1] Attached













**PT23435-MPG** Maximum Performance Glass Hydraulic Element



**Fits:** Pall Applications  
**Replaces:** Pall HC6500FKS26H  
**O.D.:** 3 13/16 (96.8)  
**I.D.:** 2 3/8 (60.3) One End  
**Height:** 25 11/16 (652.5)  
**O-Ring:** [1] Attached

Measurements Are Shown In Inches And (Millimeters)

**WARNING:** These products can expose you to chemicals, including Diisononyl Phthalate, Carbon black extracts, Nickel, 1,3 Butadiene, Ethylene Oxide, Epichlorohydrin, which are known to the State of California to cause cancer, and Bisphenol, Ethylene Glycol, Ethylene Oxide, 1,3 Butadiene, Epichlorohydrin, which are known to the State of California to cause birth defects or other reproductive harm.

<p><b>PT23436-MPG</b> Maximum Performance Glass Hydraulic Element</p>  <p><b>Fits:</b> Pall Applications  <b>Replaces:</b> Pall HC9601FUP4Z  <b>O.D.:</b> 3 1/16 (77.8)  <b>I.D.:</b> 1 11/16 (42.9) One End  <b>Height:</b> 4 21/32 (118.3)  <b>O-Ring:</b> [1] Attached</p>	<p><b>PT23442-MPG</b> Maximum Performance Glass Hydraulic Element</p>  <p><b>Fits:</b> Pall Applications  <b>Replaces:</b> Pall HC8700FKN8H  <b>O.D.:</b> 1 31/32 (50.0)  <b>I.D.:</b> 31/32 (24.6)  <b>Height:</b> 8 13/32 (213.5)  <b>O-Ring:</b> [2] Attached</p>
<p><b>PT23437-MPG</b> Maximum Performance Glass Hydraulic Element</p>  <p><b>Fits:</b> Pall Applications  <b>Replaces:</b> Pall HC9801FKP8H  <b>O.D.:</b> 2 (50.8)  <b>I.D.:</b> 15/16 (23.8) One End  <b>Height:</b> 8 1/4 (209.6)  <b>O-Ring:</b> [1] Attached</p>	<p><b>PT23443-MPG</b> Maximum Performance Glass Hydraulic Element</p>  <p><b>Fits:</b> Pall Applications  <b>Replaces:</b> Pall HC8700FKS8H  <b>O.D.:</b> 1 31/32 (50.0)  <b>I.D.:</b> 31/32 (24.6)  <b>Height:</b> 8 13/32 (213.5)  <b>O-Ring:</b> [2] Attached</p>
<p><b>PT23438-MPG</b> Maximum Performance Glass Hydraulic Element</p>  <p><b>Fits:</b> Pall Applications  <b>Replaces:</b> Pall HC9606FKS13Z  <b>O.D.:</b> 3 1/16 (77.8)  <b>I.D.:</b> 1 23/32 (43.7) One End  <b>Height:</b> 12 31/32 (329.4)  <b>O-Ring:</b> [1] Attached</p>	<p><b>PT23444-MPG</b> Maximum Performance Glass Hydraulic Element</p>  <p><b>Fits:</b> Parker Applications  <b>Replaces:</b> Parker 932629Q  <b>O.D.:</b> 2 11/32 (59.5)  <b>I.D.:</b> 1 13/32 (35.7) One End  <b>Height:</b> 9 19/32 (243.7)  <b>O-Ring:</b> [1] Attached</p>
<p><b>PT23439-MPG</b> Maximum Performance Glass Hydraulic Element with Bail Handle</p>  <p><b>Fits:</b> Pall Applications  <b>Replaces:</b> Pall HC8314FKT39H  <b>O.D.:</b> 6 (152.4)  <b>I.D.:</b> 3 25/32 (96.0) &amp; 3 15/16 (100.0)  <b>Height:</b> 36 1/2 (927.1)  <b>O-Ring:</b> [2] Attached</p>	<p><b>PT23445-MPG</b> Maximum Performance Glass Hydraulic Element</p>  <p><b>Fits:</b> Parker Applications  <b>Replaces:</b> Parker G02082  <b>O.D.:</b> 3 17/32 (89.7)  <b>I.D.:</b> 2 1/32 (51.6) &amp; 2 1/2 (63.5)  <b>Height:</b> 8 3/32 (205.6)  <b>O-Ring:</b> [2] Attached</p>
<p><b>PT23440-MPG</b> Maximum Performance Glass Hydraulic Element</p>  <p><b>Fits:</b> Pall Applications  <b>Replaces:</b> Pall HC8800FKN13H  <b>O.D.:</b> 3 13/32 (86.5)  <b>I.D.:</b> 1 31/32 (50.0) One End  <b>Height:</b> 12 29/32 (327.8)  <b>O-Ring:</b> [1] Attached</p>	<p><b>PT23446-MPG</b> Maximum Performance Glass Hydraulic Element</p>  <p><b>Fits:</b> Parker Applications  <b>Replaces:</b> Parker 924794  <b>O.D.:</b> 3 11/16 (93.7)  <b>I.D.:</b> 1 15/16 (49.2)  <b>Height:</b> 18 7/16 (468.3)  <b>Grommets:</b> [2] Attached</p>
<p><b>PT23441-MPG</b> Maximum Performance Glass Hydraulic Element</p>  <p><b>Fits:</b> Pall Applications  <b>Replaces:</b> Pall HC9604FKT13H  <b>O.D.:</b> 3 3/16 (81.0)  <b>I.D.:</b> 2 (50.8) One End  <b>Height:</b> 12 11/16 (322.3)  <b>O-Ring:</b> [1] Attached</p>	<p><b>PT23447-MPG</b> Maximum Performance Glass Hydraulic Element</p>  <p><b>Fits:</b> Parker Applications  <b>Replaces:</b> Parker G02058  <b>O.D.:</b> 1 3/4 (44.4)  <b>I.D.:</b> 1 (25.4)  <b>Height:</b> 4 11/16 (119.1)  <b>O-Ring:</b> [2] Attached</p>

Measurements Are Shown In Inches And (Millimeters)

**WARNING:** These products can expose you to chemicals, including Diisononyl Phthalate, Carbon black extracts, Nickel, 1,3 Butadiene, Ethylene Oxide, Epichlorohydrin, which are known to the State of California to cause cancer, and Bisphenol, Ethylene Glycol, Ethylene Oxide, 1,3 Butadiene, Epichlorohydrin, which are known to the State of California to cause birth defects or other reproductive harm.

**PT23448-MPG** Maximum Performance Glass Hydraulic Element



**Fits:** Parker Applications  
**Replaces:** Parker G02064  
**O.D.:** 1 13/16 (46.0)  
**I.D.:** 15/16 (23.8)  
**Height:** 8 7/16 (214.3)  
**O-Ring:** [2] Attached

**PT23454** Hydraulic Element



**Fits:** Finn Filter Applications  
**Replaces:** Finn Filter FFP1053015  
**O.D.:** 7 3/32 (180.2)  
**I.D.:** 4 5/32 (105.6)  
**Height:** 7 7/8 (200.0)  
**O-Ring:** [2] Attached

**PT23449-MPG** Maximum Performance Glass Hydraulic Element



**Fits:** Schroeder Applications  
**Replaces:** Schroeder KKKS3  
**O.D.:** 3 15/16 (100.0)  
**I.D.:** 1 11/16 (42.9)  
**Height:** 28 (711.2)  
**O-Ring:** [2] Attached

**PT23455** Hydraulic Element



**Fits:** Finn Filter Applications  
**Replaces:** Finn Filter FFP1053015  
**O.D.:** 5 29/32 (150.0)  
**I.D.:** 3 1/2 (88.9)  
**Height:** 6 7/16 (163.5)  
**O-Ring:** [2] Attached

**PT23450-MPG** Maximum Performance Glass Hydraulic Element with Bail Handle



**Fits:** Sennebogen Applications  
**Replaces:** Sennebogen 27417  
**O.D.:** 3 23/32 (94.5)  
**I.D.:** 1 25/32 (45.2) & 1 29/32 (48.4)  
**Height:** 24 3/32 (612.0)  
**O-Ring:** [1] Attached, [1] Included

**PT23456** Hydraulic Element



**Fits:** MP Filtri Applications  
**Replaces:** MP Filtri CU250P10N; Donaldson C2501, P171667  
**O.D.:** 3 29/32 (99.2)  
**I.D.:** 2 1/32 (51.6)  
**Height:** 8 1/4 (209.6)  
**A. Gskt:** [2] Attached

**PT23451** Hydraulic Element



**Fits:** Donaldson Applications  
**Replaces:** Cim-Tek R320C20P; Donaldson P550216  
**O.D.:** 6 1/16 (154.0)  
**I.D.:** 2 5/8 (66.7)  
**Height:** 17 13/16 (452.4)  
**A. Gskt:** [2] Attached

**PT23457** Hydraulic Element



**Fits:** MP Filtri Applications  
**Replaces:** MP Filtri CU630P10N; Donaldson C6301, P171674  
**O.D.:** 5 1/8 (130.2)  
**I.D.:** 3 (76.2)  
**Height:** 9 27/32 (250.0)  
**A. Gskt:** [2] Attached

**PT23452** Hydraulic Element



**Notes:** OBSOLETE. Availability Limited to Dealer Stock.  
**Fits:** Donaldson Housings  
**Replaces:** Cim-Tek 30410  
**O.D.:** 3 29/32 (99.2)  
**I.D.:** 1 21/32 (42.1)  
**Height:** 27 31/32 (710.4)  
**O-Ring:** [2] Attached

**PT23458** Hydraulic Element



**Fits:** MP Filtri Applications  
**Replaces:** MP Filtri CU630P25N; Donaldson C6303, P171675  
**O.D.:** 5 1/8 (130.2)  
**I.D.:** 3 (76.2)  
**Height:** 9 27/32 (250.0)  
**A. Gskt:** [2] Attached

**PT23453** Hydraulic Element



**Fits:** Fairey-Arlon Applications  
**Replaces:** Fairey-Arlon TXX1010; Liebherr 7000250; Fleetguard HF6272  
**O.D.:** 7 31/32 (202.4)  
**I.D.:** 9/16 (14.3) & 6 3/16 (157.2)  
**Height:** 13 (330.2)  
**A. Gskt:** [1] Attached











**PT23459** Hydraulic Element



**Fits:** MP Filtri Applications  
**Replaces:** Caterpillar 3I2087; MP Filtri MR1004P10A; Donaldson CRS1601  
**O.D.:** 2 13/16 (71.4)  
**I.D.:** 5/8 (15.9) & 1 3/4 (44.4)  
**Height:** 11 13/16 (300.0)  
**A. Gskt:** [1] Attached

Measurements Are Shown In Inches And (Millimeters)

**WARNING:** These products can expose you to chemicals, including Diisononyl Phthalate, Carbon black extracts, Nickel, 1,3 Butadiene, Ethylene Oxide, Epichlorohydrin, which are known to the State of California to cause cancer, and Bisphenol, Ethylene Glycol, Ethylene Oxide, 1,3 Butadiene, Epichlorohydrin, which are known to the State of California to cause birth defects or other reproductive harm.

<p><b>PT23460</b></p>  <p>Hydraulic Element  <b>Fits:</b> MP Filtri Applications  <b>Replaces:</b> MP Filtri MF0202P25NB; Donaldson P171839  <b>O.D.:</b> 1 21/32 (42.1)  <b>I.D.:</b> 29/32 (23.0) &amp; 1 1/32 (26.2)  <b>Height:</b> 6 11/16 (169.9)  <b>O-Ring:</b> [1] Attached</p>	<p><b>PT23467</b></p>  <p>Hydraulic Element with Bail Handle  <b>Contains:</b> By-Pass Valve  <b>Fits:</b> Donaldson Applications  <b>Replaces:</b> Donaldson CR8006, P171583  <b>O.D.:</b> 5 1/8 (130.2)  <b>I.D.:</b> 2 17/32 (64.3) One End  <b>Height:</b> 15 29/32 (404.0)  <b>O-Ring:</b> [1] Attached  <b>Spring:</b> [1] Included</p>
<p><b>PT23461</b></p>  <p>Hydraulic Element  <b>Fits:</b> Parker Applications  <b>Replaces:</b> Parker 937726  <b>O.D.:</b> 4 3/16 (106.4)  <b>I.D.:</b> 13/32 (10.3) &amp; 2 27/32 (72.2)  <b>Height:</b> 10 1/4 (260.3)  <b>A. Gskt:</b> [1] Attached</p>	<p><b>PT23468</b></p>  <p>Hydraulic Element with Bail Handle  <b>Contains:</b> By-Pass Valve  <b>Fits:</b> Donaldson Applications  <b>Replaces:</b> Donaldson CR1256, P171589  <b>O.D.:</b> 3 29/32 (99.2)  <b>I.D.:</b> 1 19/32 (40.5) One End  <b>Height:</b> 6 29/32 (175.4)  <b>O-Ring:</b> [1] Attached  <b>Spring:</b> [1] Included</p>
<p><b>PT23462</b></p>  <p>Hydraulic Element with Bail Handle  <b>Contains:</b> By-Pass Valve  <b>Fits:</b> Sofima Applications  <b>Replaces:</b> Sofima CRE055CV1; Donaldson CR2014, P171546  <b>O.D.:</b> 3 29/32 (99.2)  <b>I.D.:</b> 1 19/32 (40.5) One End  <b>Height:</b> 10 1/4 (260.3)  <b>O-Ring:</b> [1] Attached  <b>Spring:</b> [1] Included</p>	<p><b>PT23469</b></p>  <p>Hydraulic Element with Bail Handle  <b>Contains:</b> By-Pass Valve  <b>Fits:</b> Mahle Applications  <b>Replaces:</b> Mahle 852378DRG60; Donaldson CR2206, P171595  <b>O.D.:</b> 5 1/8 (130.2)  <b>I.D.:</b> 2 17/32 (64.3) One End  <b>Height:</b> 5 23/32 (145.3)  <b>O-Ring:</b> [1] Attached  <b>Spring:</b> [1] Included</p>
<p><b>PT23463</b></p>  <p>Hydraulic Element  <b>Fits:</b> Sofima Applications  <b>Replaces:</b> Sofima CCH152CD1, CH152CD11; Donaldson CM2501, P171722  <b>O.D.:</b> 1 25/32 (45.2)  <b>I.D.:</b> 1 (25.4) One End  <b>Height:</b> 4 15/32 (113.5)  <b>O-Ring:</b> [1] Attached</p>	<p><b>PT23470</b></p>  <p>Hydraulic Element  <b>Fits:</b> MP Filtri Applications  <b>Replaces:</b> MP Filtri CU100M90N; Donaldson C100, P171657  <b>O.D.:</b> 2 3/4 (69.9)  <b>I.D.:</b> 1 3/8 (34.9)  <b>Height:</b> 5 1/8 (130.2)  <b>O-Ring:</b> [2] Attached</p>
<p><b>PT23464</b></p>  <p>Hydraulic Element  <b>Contains:</b> [6] Bolts  <b>Fits:</b> U.C.C. Hydraulic Applications  <b>Replaces:</b> U.C.C. Hydraulic UCAB116310; Donaldson P171855, TCO501  <b>O.D.:</b> 1 1/2 (38.1)  <b>Cap</b> 2 31/32 (75.4)  <b>Height:</b> 5 29/32 (150.0)  <b>F. Gskt:</b> [1] Included</p>	<p><b>PT23471</b></p>  <p>Hydraulic Element  <b>Fits:</b> MP Filtri Applications  <b>Replaces:</b> MP Filtri CU630M60N; Donaldson C6306, P171677  <b>O.D.:</b> 5 1/8 (130.2)  <b>I.D.:</b> 3 (76.2)  <b>Height:</b> 9 27/32 (250.0)  <b>O-Ring:</b> [2] Attached</p>
<p><b>PT23465</b></p>  <p>Hydraulic Element with Bail Handle  <b>Contains:</b> By-Pass Valve  <b>Fits:</b> Venieri Applications  <b>Replaces:</b> Venieri 102028; Donaldson P173048, P180014  <b>O.D.:</b> 2 3/4 (69.9)  <b>I.D.:</b> 1 5/32 (29.4) One End  <b>Height:</b> 6 13/16 (173.0)  <b>O-Ring:</b> [1] Attached  <b>Spring:</b> [1] Included</p>	<p><b>PT23472</b></p>  <p>Hydraulic Element  <b>Fits:</b> MP Filtri Applications  <b>Replaces:</b> MP Filtri SF510M90  <b>O.D.:</b> 3 29/32 (99.2)  <b>I.D.:</b> 2 9/16 (65.1)  <b>Height:</b> 7 25/32 (197.6)</p>

Measurements Are Shown In Inches And (Millimeters)

**WARNING:** These products can expose you to chemicals, including Diisononyl Phthalate, Carbon black extracts, Nickel, 1,3 Butadiene, Ethylene Oxide, Epichlorohydrin, which are known to the State of California to cause cancer, and Bisphenol, Ethylene Glycol, Ethylene Oxide, 1,3 Butadiene, Epichlorohydrin, which are known to the State of California to cause birth defects or other reproductive harm.



**PT23473**



Hydraulic Element

**Fits:** MP Filtri Applications  
**Replaces:** MP Filtri SF503M90  
**O.D.:** 4 23/32 (119.9)  
**I.D.:** 3 1/32 (77.0)  
**Height:** 7 25/32 (197.6)

**PT23479**



Hydraulic Element with Bail Handle

**Contains:** By-Pass Valve  
**Fits:** Sofima Applications  
**Replaces:** Sofima CRE055MN1  
**O.D.:** 3 29/32 (99.2)  
**I.D.:** 1 19/32 (40.5)  
**Height:** 10 1/4 (260.3)  
**O-Ring:** [1] Attached  
**Spring:** [1] Included

**PT23474**



Hydraulic Element

**Contains:** Threaded End: 1-11 BSP  
**Fits:** MP Filtri Applications  
**Replaces:** MP Filtri STR0704SG1M90, MPA050G1M90; Donaldson FIOA90, P171877  
**O.D.:** 2 7/8 (73.0)  
**Height:** 5 27/32 (148.4)

**PT23480**



Hydraulic Element with Bail Handle

**Contains:** By-Pass Valve  
**Fits:** Sofima Applications  
**Replaces:** Sofima TE55MCV1; Donaldson CR125, P171584  
**O.D.:** 3 29/32 (99.2)  
**I.D.:** 1 19/32 (40.5)  
**Height:** 6 29/32 (175.4)  
**O-Ring:** [1] Attached  
**Spring:** [1] Included

**PT23475**



Hydraulic Element

**Contains:** Threaded Stud: 2-11 BSP  
**Fits:** MP Filtri Applications  
**Replaces:** MP Filtri STR1004SG1M90; Donaldson FIOA220, P760151  
**O.D.:** 4 1/32 (102.4)  
**Height:** 8 31/32 (227.8)

**PT23481**



Hydraulic Element

**Contains:** Threaded Stud: 1 1/4-11 BSP  
**Fits:** U.F.I. Applications  
**Replaces:** U.F.I. Filters ESA31B10WMF; Donaldson FIOA130, P171885  
**O.D.:** 4 1/32 (102.4)  
**Height:** 7 11/16 (195.3)

**PT23476**



Hydraulic Element

**Fits:** Parker Applications  
**Replaces:** Parker 924739; Donaldson P171248; Fleetguard HF7777, HF7778  
**O.D.:** 2 3/4 (69.9)  
**I.D.:** 1 11/16 (42.9)  
**Height:** 8 21/32 (219.9)  
**A. Gskt:** [2] Attached

**PT23482**



Hydraulic Element

**Contains:** Threaded Stud: 1 1/2-11 BSP  
**Fits:** U.F.I. Applications  
**Replaces:** U.F.I. Filters ESA31B12WMF; Donaldson FIOA180, P172452  
**O.D.:** 4 1/32 (102.4)  
**Height:** 7 11/16 (195.3)

**PT23477**



Hydraulic Element

**Fits:** Parker Applications  
**Replaces:** Parker 925774  
**O.D.:** 3 29/32 (99.2)  
**I.D.:** 1 21/32 (42.1)  
**Height:** 9 1/4 (235.0)  
**O-Ring:** [2] Attached

**PT23483-MPG**



Maximum Performance Glass Hydraulic Element

**Fits:** Atlas Applications  
**Replaces:** Atlas 4653961; Fairey-Arlon TXW11CC10, TXW11GDL10  
**O.D.:** 7 31/32 (202.4)  
**I.D.:** 9/16 (14.3) & 6 3/16 (157.2)  
**Height:** 17 5/16 (439.7)  
**O-Ring:** [1] Attached

**PT23478**



Hydraulic Element with 2 Bail Handles

**Contains:** By-Pass Valve  
**Fits:** Sofima Applications  
**Replaces:** Sofima 52808; Donaldson CR50, CR60, P171518, P171524  
**O.D.:** 2 3/4 (69.9)  
**I.D.:** 1 5/32 (29.4)  
**Height:** 3 11/32 (84.9)  
**O-Ring:** [1] Attached  
**Spring:** [1] Included

**PT23484-MPG**







Maximum Performance Glass Hydraulic Element

**Fits:** Caterpillar Applications  
**Replaces:** Caterpillar 9J6472; Komatsu 21T6012460; Fleetguard HF30479  
**O.D.:** 3 3/32 (78.6)  
**I.D.:** 1 11/16 (42.9) One End  
**Height:** 4 21/32 (118.3)  
**O-Ring:** [1] Attached

Measurements Are Shown In Inches And (Millimeters)

**WARNING:** These products can expose you to chemicals, including Diisononyl Phthalate, Carbon black extracts, Nickel, 1,3 Butadiene, Ethylene Oxide, Epichlorohydrin, which are known to the State of California to cause cancer, and Bisphenol, Ethylene Glycol, Ethylene Oxide, 1,3 Butadiene, Epichlorohydrin, which are known to the State of California to cause birth defects or other reproductive harm.

<p><b>PT23485-MPG</b> Maximum Performance Glass Hydraulic Element</p>  <p><b>Fits:</b> Dana Applications  <b>Replaces:</b> Dana 57727; Cim-Tek E130030167; Donaldson P170102  <b>O.D.:</b> 6 3/32 (154.8)  <b>I.D.:</b> 2 5/8 (66.7)  <b>Height:</b> 17 27/32 (453.2)  <b>O-Ring:</b> [2] Attached</p>	<p><b>PT23491-MPG</b> Maximum Performance Glass Hydraulic Element</p>  <p><b>Fits:</b> Genie Applications  <b>Replaces:</b> Cenie 20880; Donaldson CM29002  <b>O.D.:</b> 1 25/32 (45.2)  <b>I.D.:</b> 1 (25.4) One End  <b>Height:</b> 8 1/4 (209.6)  <b>O-Ring:</b> [1] Attached</p>
<p><b>PT23486-MPG</b> Maximum Performance Glass Hydraulic Element</p>  <p><b>Fits:</b> Donaldson Applications  <b>Replaces:</b> Donaldson P164707, P161927  <b>O.D.:</b> 7 7/16 (188.9)  <b>I.D.:</b> 4 27/32 (123.0) One End  <b>Height:</b> 22 1/32 (559.6)  <b>A. Gskt:</b> [1] Attached</p>	<p><b>PT23492-MPG</b> Maximum Performance Glass Hydraulic Element</p>  <p><b>Fits:</b> Hydac Applications  <b>Replaces:</b> Hydac 2060902, 1074D03BN  <b>O.D.:</b> 1 25/32 (45.2)  <b>I.D.:</b> 1 (25.4) One End  <b>Height:</b> 4 15/32 (113.5)  <b>O-Ring:</b> [1] Attached</p>
<p><b>PT23487-MPG</b> Maximum Performance Glass Hydraulic Element</p>  <p><b>Fits:</b> Fairey-Arlon Applications  <b>Replaces:</b> Fairey-Arlon TXW5AGDL20; Donaldson CRS28003, P171821; Fleetguard HF35127  <b>O.D.:</b> 4 3/16 (106.4)  <b>I.D.:</b> 13/32 (10.3) &amp; 2 13/16 (71.4)  <b>Height:</b> 18 5/16 (465.1)  <b>O-Ring:</b> [1] Attached</p>	<p><b>PT23493-MPG</b> Maximum Performance Glass Hydraulic Element with Bail Handle</p>  <p><b>Contains:</b> By-Pass Valve  <b>Fits:</b> Hydac Applications  <b>Replaces:</b> Hydac 330R020BN3HC; Donaldson HR33003, P173170  <b>O.D.:</b> 3 23/32 (94.5)  <b>I.D.:</b> 1 25/32 (45.2) &amp; 1 29/32 (48.4)  <b>Height:</b> 7 3/32 (180.2)  <b>O-Ring:</b> [1] Attached</p>
<p><b>PT23488-MPG</b> Maximum Performance Glass Hydraulic Element</p>  <p><b>Fits:</b> Fairey-Arlon Applications  <b>Replaces:</b> Fairey-Arlon TXW6ACC10; Donaldson CRS3002, P172461; Fleetguard HF7962  <b>O.D.:</b> 4 31/32 (126.2)  <b>I.D.:</b> 13/32 (10.3) &amp; 3 5/8 (92.1)  <b>Height:</b> 8 1/4 (209.6)  <b>O-Ring:</b> [1] Attached</p>	<p><b>PT23494-MPG</b> Maximum Performance Glass Hydraulic Element</p>  <p><b>Fits:</b> Hydac Applications  <b>Replaces:</b> Hydac 60D020BN3HCV; Donaldson DT0060D25UM, P566653  <b>O.D.:</b> 1 27/32 (46.8)  <b>I.D.:</b> 7/8 (22.2) One End  <b>Height:</b> 3 5/16 (84.1)  <b>O-Ring:</b> [1] Attached</p>
<p><b>PT23489-MPG</b> Maximum Performance Glass Hydraulic Element</p>  <p><b>Fits:</b> Fairey-Arlon Applications  <b>Replaces:</b> Caterpillar 311957; Fairey-Arlon 270L123A; Donaldson 40753, P173030; Fleetguard HF30714  <b>O.D.:</b> 2 29/32 (73.8)  <b>I.D.:</b> 1 1/4 (31.8) One End  <b>Height:</b> 3 29/32 (99.2)  <b>O-Ring:</b> [1] Attached, [1] Included</p>	<p><b>PT23495-MPG</b> Maximum Performance Glass Hydraulic Element</p>  <p><b>Fits:</b> J.C. Bamford Applications  <b>Replaces:</b> J.C. Bamford 32/925363  <b>O.D.:</b> 1 21/32 (42.1)  <b>I.D.:</b> 29/32 (23.0) &amp; 1 1/32 (26.2)  <b>Height:</b> 8 (203.2)  <b>O-Ring:</b> [1] Attached</p>
<p><b>PT23490-MPG</b> Maximum Performance Glass Hydraulic Element</p>  <p><b>Fits:</b> Fairey-Arlon Applications  <b>Replaces:</b> Caterpillar 311955; Fairey-Arlon 870P110  <b>O.D.:</b> 3 11/16 (93.7)  <b>I.D.:</b> 1 29/32 (48.4) One End  <b>Height:</b> 3 29/32 (99.2)  <b>F. Gskt:</b> [1] Included  <b>O-Ring:</b> [1] Attached</p>	<p><b>PT23496-MPG</b> Maximum Performance Glass Hydraulic Element with Bail Handle</p>  <p><b>Contains:</b> By-Pass Valve  <b>Fits:</b> Liebherr Applications  <b>Replaces:</b> Liebherr 510670408; Donaldson CR32502, P171555  <b>O.D.:</b> 5 1/8 (130.2)  <b>I.D.:</b> 2 1/32 (51.6) One End  <b>Height:</b> 8 1/32 (204.0)  <b>O-Ring:</b> [1] Attached  <b>Spring:</b> [1] Included</p>

Measurements Are Shown In Inches And (Millimeters)

**WARNING:** These products can expose you to chemicals, including Diisononyl Phthalate, Carbon black extracts, Nickel, 1,3 Butadiene, Ethylene Oxide, Epichlorohydrin, which are known to the State of California to cause cancer, and Bisphenol, Ethylene Glycol, Ethylene Oxide, 1,3 Butadiene, Epichlorohydrin, which are known to the State of California to cause birth defects or other reproductive harm.

**PT23497-MPG** Maximum Performance Glass Hydraulic Element with Bail Handle  
**Fits:** Liebherr Applications  
**Replaces:** Liebherr 7621306, 7624324; Fleetguard HF35330  
**O.D.:** 6 (152.4)  
**I.D.:** 3 11/32 (84.9)  
**Height:** 13 1/2 (342.9)  
**O-Ring:** [2] Attached



**PT23503-MPG** Maximum Performance Glass Hydraulic Element  
**Fits:** MP Filtri Applications  
**Replaces:** MP Filtri HP1352A03NA; Donaldson P171737  
**O.D.:** 2 3/32 (53.2)  
**I.D.:** 1 3/32 (27.8) One End  
**Height:** 9 1/16 (230.2)  
**O-Ring:** [1] Attached



**PT23498-MPG** Maximum Performance Glass Hydraulic Element  
**Fits:** Linde Applications  
**Replaces:** Linde 9831601; Donaldson P763004  
**O.D.:** 1 31/32 (50.0)  
**I.D.:** 31/32 (24.6) One End  
**Height:** 8 1/4 (209.6)  
**O-Ring:** [1] Attached



**PT23504-MPG** Maximum Performance Glass Hydraulic Element  
**Fits:** MP Filtri Applications  
**Replaces:** MP Filtri MR1004A25A; Donaldson CRS16003  
**O.D.:** 2 27/32 (72.2)  
**I.D.:** 11/32 (8.7) & 1 25/32 (45.2)  
**Height:** 11 13/16 (300.0)  
**O-Ring:** [1] Attached



**PT23499-MPG** Maximum Performance Glass Hydraulic Element  
**Fits:** Manitou Applications  
**Replaces:** Manitou 236095  
**O.D.:** 2 23/32 (69.1)  
**I.D.:** 1 3/16 (30.2) One End  
**Height:** 6 29/32 (175.4)  
**O-Ring:** [1] Attached



**PT23505-MPG** Maximum Performance Glass Hydraulic Element with Bail Handle  
**Contains:** By-Pass Valve  
**Fits:** MP Filtri Applications  
**Replaces:** MP Filtri MF7501A10HB; Donaldson CR80002, P171579  
**O.D.:** 5 1/8 (130.2)  
**I.D.:** 2 9/16 (65.1) One End  
**Height:** 15 29/32 (404.0)  
**O-Ring:** [1] Attached



**PT23500-MPG** Maximum Performance Glass Hydraulic Element with Bail Handle  
**Contains:** By-Pass Valve  
**Fits:** MP Filtri Applications  
**Replaces:** MP Filtri MF1001A10HB; Donaldson CR5002, CR6002, P171519, P171525  
**O.D.:** 2 3/4 (69.9)  
**I.D.:** 1 5/32 (29.4)  
**Height:** 3 11/32 (84.9)  
**O-Ring:** [1] Attached  
**Spring:** [1] Included



**PT23506-MPG** Maximum Performance Glass Hydraulic Element  
**Fits:** Pall Applications  
**Replaces:** Pall HC8500FDS13H; Fleetguard HF30287  
**O.D.:** 3 13/16 (96.8)  
**I.D.:** 1 11/16 (42.9)  
**Height:** 12 7/8 (327.0)  
**O-Ring:** [2] Attached



**PT23501-MPG** Maximum Performance Glass Hydraulic Element with 2 Bail Handles  
**Contains:** By-Pass Valve  
**Fits:** MP Filtri Applications  
**Replaces:** MP Filtri MF1002A25HB; Donaldson CR5003, P171532  
**O.D.:** 2 3/4 (69.9)  
**I.D.:** 1 5/32 (29.4)  
**Height:** 5 1/8 (130.2)  
**O-Ring:** [1] Attached  
**Spring:** [1] Included



**PT23507-MPG** Maximum Performance Glass Hydraulic Element  
**Fits:** Pall Applications  
**Replaces:** Pall HC9600FKN13Z  
**O.D.:** 3 1/16 (77.8)  
**I.D.:** 1 23/32 (43.7) One End  
**Height:** 12 31/32 (329.4)  
**O-Ring:** [1] Attached



**PT23502-MPG** Maximum Performance Glass Hydraulic Element  
**Fits:** MP Filtri Applications  
**Replaces:** MP Filtri CU630A10N; Donaldson C63002, P171672  
**O.D.:** 5 1/8 (130.2)  
**I.D.:** 3 (76.2)  
**Height:** 9 27/32 (250.0)  
**O-Ring:** [2] Attached









**PT23508-MPG** Maximum Performance Glass Hydraulic Element  
**Fits:** Pall Applications  
**Replaces:** Pall HC0101FDT18H, HC2618FKT18H; Donaldson P170103, P566708  
**O.D.:** 6 3/32 (154.8)  
**I.D.:** 2 5/8 (66.7)  
**Height:** 17 27/32 (453.2)  
**A. Gskt:** [2] Attached



Measurements Are Shown In Inches And (Millimeters)

**WARNING:** These products can expose you to chemicals, including Diisononyl Phthalate, Carbon black extracts, Nickel, 1,3 Butadiene, Ethylene Oxide, Epichlorohydrin, which are known to the State of California to cause cancer, and Bisphenol, Ethylene Glycol, Ethylene Oxide, 1,3 Butadiene, Epichlorohydrin, which are known to the State of California to cause birth defects or other reproductive harm.

<p><b>PT23509-MPG</b> Maximum Performance Glass Hydraulic Element</p>  <p><b>Fits:</b> Parker Applications  <b>Replaces:</b> Parker G04167Q  <b>O.D.:</b> 3 3/32 (78.6)  <b>I.D.:</b> 1 23/32 (43.7) One End  <b>Height:</b> 8 1/4 (209.6)  <b>O-Ring:</b> [1] Attached</p>	<p><b>PT23515-MPG</b> Maximum Performance Glass Hydraulic Element</p>  <p><b>Fits:</b> Parker Applications  <b>Replaces:</b> Parker 932678Q; Donaldson DTHF4188UM, P566275  <b>O.D.:</b> 3 29/32 (99.2)  <b>I.D.:</b> 1 21/32 (42.1)  <b>Height:</b> 18 1/2 (469.9)  <b>O-Ring:</b> [2] Attached</p>
<p><b>PT23510-MPG</b> Maximum Performance Glass Hydraulic Element</p>  <p><b>Fits:</b> Parker Applications  <b>Replaces:</b> Parker 930367Q  <b>O.D.:</b> 1 25/32 (45.2)  <b>I.D.:</b> 1 (25.4) One End  <b>Height:</b> 4 15/32 (113.5)  <b>O-Ring:</b> [1] Attached</p>	<p><b>PT23516-MPG</b> Maximum Performance Glass Hydraulic Element</p>  <p><b>Fits:</b> Parker Applications  <b>Replaces:</b> Parker FTBE2810Q, G02076; Fleetguard HF7704  <b>O.D.:</b> 2 3/8 (60.3)  <b>I.D.:</b> 1 5/32 (29.4) &amp; 1 7/16 (36.5)  <b>Height:</b> 9 9/16 (242.9)  <b>O-Ring:</b> [2] Attached</p>
<p><b>PT23511-MPG</b> Maximum Performance Glass Hydraulic Element</p>  <p><b>Fits:</b> Parker Applications  <b>Replaces:</b> Parker 933800Q; Donaldson P170063  <b>O.D.:</b> 5 5/8 (142.9)  <b>I.D.:</b> 4 (101.6)  <b>Height:</b> 11 29/32 (302.4)  <b>A. Gskt:</b> [2] Attached  <b>F. Gskt:</b> [1] Included</p>	<p><b>PT23517-MPG</b> Maximum Performance Glass Hydraulic Element</p>  <p><b>Contains:</b> [2] Stacked Elements  <b>Fits:</b> Sandvik Applications  <b>Replaces:</b> Sandvik 86727289; Fleetguard HF35130  <b>O.D.:</b> 4 31/32 (126.2)  <b>I.D.:</b> 13/32 (10.3) &amp; 3 5/8 (92.1)  <b>Height:</b> 22 27/32 (580.2)  <b>O-Ring:</b> [1] Attached</p>
<p><b>PT23512-MPG</b> Maximum Performance Glass Hydraulic Element</p>  <p><b>Fits:</b> Parker Applications  <b>Replaces:</b> Parker 933135Q  <b>O.D.:</b> 2 3/8 (60.3)  <b>I.D.:</b> 1 13/32 (35.7) One End  <b>Height:</b> 5 5/16 (134.9)  <b>O-Ring:</b> [1] Attached</p>	<p><b>PT23518-MPG</b> Maximum Performance Glass Hydraulic Element</p>  <p><b>Fits:</b> Schroeder Applications  <b>Replaces:</b> Schroeder CCS7, CCZ10  <b>O.D.:</b> 2 7/8 (73.0)  <b>I.D.:</b> 1 3/32 (27.8)  <b>Height:</b> 9 1/2 (241.3)  <b>O-Ring:</b> [1] Attached</p>
<p><b>PT23513-MPG</b> Maximum Performance Glass Hydraulic Element</p>  <p><b>Fits:</b> Parker Applications  <b>Replaces:</b> Caterpillar 311717; Parker 932624Q, G01301, G01301Q; Donaldson P170068  <b>O.D.:</b> 2 3/8 (60.3)  <b>I.D.:</b> 1 13/32 (35.7) One End  <b>Height:</b> 5 5/16 (134.9)  <b>O-Ring:</b> [1] Attached</p>	<p><b>PT23519-MPG</b> Maximum Performance Glass Hydraulic Element</p>  <p><b>Fits:</b> Schroeder Applications  <b>Replaces:</b> Schroeder KKS7, KKZ10; Cim-Tek 30142; Donaldson P174249  <b>O.D.:</b> 3 29/32 (99.2)  <b>I.D.:</b> 1 21/32 (42.1)  <b>Height:</b> 18 1/2 (469.9)  <b>O-Ring:</b> [2] Attached</p>
<p><b>PT23514-MPG</b> Maximum Performance Glass Hydraulic Element</p>  <p><b>Fits:</b> Parker Applications  <b>Replaces:</b> Parker 925789, 932670Q, 415VQ; Donaldson P174624, P566272  <b>O.D.:</b> 3 29/32 (99.2)  <b>I.D.:</b> 1 21/32 (42.1)  <b>Height:</b> 9 1/4 (235.0)  <b>O-Ring:</b> [2] Attached</p>	<p><b>PT23520-MPG</b> Maximum Performance Glass Hydraulic Element</p>  <p><b>Fits:</b> Schroeder Hydraulic Applications  <b>Replaces:</b> Schroeder BBS7, BBZ7; Donaldson P560400  <b>O.D.:</b> 4 31/32 (126.2)  <b>I.D.:</b> 3 5/16 (84.1)  <b>Height:</b> 18 5/16 (465.1)  <b>A. Gskt:</b> [2] Attached</p>

Measurements Are Shown In Inches And (Millimeters)

 **WARNING:** These products can expose you to chemicals, including Diisononyl Phthalate, Carbon black extracts, Nickel, 1,3 Butadiene, Ethylene Oxide, Epichlorohydrin, which are known to the State of California to cause cancer, and Bisphenol, Ethylene Glycol, Ethylene Oxide, 1,3 Butadiene, Epichlorohydrin, which are known to the State of California to cause birth defects or other reproductive harm.

**PT23521-MPG** Maximum Performance Glass Hydraulic Element with Bail Handle  
**Fits:** Schwing Applications  
**Replaces:** Schwing 10190588; Donaldson P564845, P566352  
**O.D.:** 3 27/32 (97.6)  
**I.D.:** 2 9/16 (65.1)  
**Height:** 15 9/32 (388.1)  
**O-Ring:** [2] Attached



**PT23527** Hydraulic Strainer  
**Fits:** Claas Tractors  
**Replaces:** Claas 7665380  
**O.D.:** 2 3/4 (69.9)  
**I.D.:** 31/32 (24.6)  
**Height:** 2 29/32 (73.8)



**PT23522-MPG** Maximum Performance Glass Hydraulic Element  
**Fits:** Sennebogen Applications  
**Replaces:** Sennebogen 3751027324; Donaldson P560403  
**O.D.:** 3 3/32 (78.6)  
**I.D.:** 1 5/8 (41.3) One End  
**Height:** 16 13/16 (427.0)  
**O-Ring:** [1] Attached



**PT23528-MPG** Maximum Performance Glass Power Steering Element  
**Fits:** Ponsse Forestry Machines  
**Replaces:** Ponsse 36673  
**O.D.:** 2 1/8 (54.0)  
**I.D.:** 7/8 (22.2) One End  
**Height:** 2 5/8 (66.7)  
**O-Ring:** [1] Attached, [2] Included



**PT23523-MPG** Maximum Performance Glass Hydraulic Element with Bail Handle  
**Contains:** By-Pass Valve  
**Fits:** Sofima Applications  
**Replaces:** Sofima CRE055FD1, RS55FD1  
**O.D.:** 3 29/32 (99.2)  
**I.D.:** 1 19/32 (40.5) One End  
**Height:** 10 1/4 (260.3)  
**O-Ring:** [1] Attached



**PT23530** Hydraulic Strainer Element  
**Contains:** Threaded End: 1 1/2 BSP/G  
**Fits:** Sennebogen 825M, 870 Material Handlers with Cummins QSB6.7 Engine  
**Replaces:** Sennebogen 27376; Donaldson P550825  
**O.D.:** 3 3/8 (85.7)  
**Height:** 12 3/16 (309.6)



**PT23524-MPG** Maximum Performance Glass Hydraulic Element  
**Fits:** U.F.I. Filter Applications  
**Replaces:** U.F.I. EPA12NFD; Donaldson FM18003, P171709  
**O.D.:** 1 21/32 (42.1)  
**I.D.:** 7/8 (22.2) One End  
**Height:** 7 1/32 (178.6)  
**O-Ring:** [1] Attached



**PT23531-MPG** Maximum Performance Glass Hydraulic Element  
**Fits:** John Deere Dump Trucks, Loaders  
**Replaces:** John Deere AT335977; Donaldson P574195  
**O.D.:** 3 11/16 (93.7)  
**I.D.:** 1 7/8 (47.6) One End  
**Height:** 21 23/32 (551.7)  
**O-Ring:** [2] Attached



**BT23525-MPG** Maximum Performance Glass Hydraulic Spin-on  
**Fits:** Case, Case-IH, John Deere, Kalmar, New Holland Equipment  
**Replaces:** Hydac 90MA020BN; Fleetguard HF30399  
**Thread:** 1 1/2 -16  
**O.D.:** 3 3/4 (95.3)  
**Height:** 5 9/16 (141.3)  
**F. Gskt:** [1] Included



**PT23532-MPG** Maximum Performance Glass Hydraulic Element  
**Fits:** John Deere Engines, Forestry and Logging Equipment  
**Replaces:** John Deere F058908; Timberjack T058908  
**O.D.:** 2 11/16 (68.3)  
**I.D.:** 1 5/16 (33.3)  
**Height:** 7 1/2 (190.5)  
**O-Ring:** [1] Attached



**PT23526** Hydraulic Element  
**Contains:** [2] 1/4 Inch Bolt Holes  
**Fits:** Fendt Tractors  
**Replaces:** Fendt F285102050010; Fleetguard HF35309  
**O.D.:** 6 7/32 (158.0)  
**I.D.:** 2 17/32 (64.3)  
**Height:** 3 9/16 (90.5)



**PT23533** Hydraulic Element  
**Contains:** Threaded End  
**Fits:** Komatsu PC800, PF850, PC1100, PC1250, PC2000 Series Excavators  
**Replaces:** Komatsu 21N6231221  
**O.D.:** 2 3/8 (60.3)  
**I.D.:** 1 1/2 (38.1) One End  
**Height:** 7 7/8 (200.0)



Measurements Are Shown In Inches And (Millimeters)

**WARNING:** These products can expose you to chemicals, including Diisononyl Phthalate, Carbon black extracts, Nickel, 1,3 Butadiene, Ethylene Oxide, Epichlorohydrin, which are known to the State of California to cause cancer, and Bisphenol, Ethylene Glycol, Ethylene Oxide, 1,3 Butadiene, Epichlorohydrin, which are known to the State of California to cause birth defects or other reproductive harm.

**PT23534**

Hydraulic Element



**Fits:** J.C. Bamford Excavators  
**Replaces:** J.C Bamford 32/925140  
**O.D.:** 7 15/32 (189.7)  
 to 7 13/16 (198.4)  
**I.D.:** 1 1/16 (27.0) One End  
**Height:** 4 11/32 (110.3)

**PT23535**

Hydraulic Strainer Spin-on



**Contains:** Threaded Stud: 1 Inch NPT  
**Fits:** Caterpillar, Mitsubishi Lift Trucks  
**Replaces:** Caterpillar 8137523600  
**O.D.:** 3 31/32 (100.8)  
**Height:** 3 19/32 (91.3)

**PT23536**

Wire Mesh Transmission Strainer



**Contains:** By-Pass Valve  
**Fits:** Case Dozers, Loaders, Cable Layers  
**Replaces:** Case D37035  
**O.D.:** 2 5/8 (66.7)  
**I.D.:** 1 7/32 (31.0) One End  
**Height:** 4 3/4 (120.7)  
**O-Ring:** [1] Attached

**BT23537**

Hydraulic Spin-on



**Fits:** Agco Tractors with Cummins Engines  
**Replaces:** Massey Ferguson 3616579M2,  
 3907580M2, 4303303M1, 6907580M1  
**Thread:** M42 x 2-6G  
**O.D.:** 5 7/16 (138.1)  
**Height:** 3 15/16 (100)  
**I.Gskt:** [1] Included

**BT23539**

Hydraulic Spin-on



**Contains:** Water Absorbing Media  
**Fits:** Tigercat Grapple Skidders; Feller  
 Bunchers with Cummins Engines  
**Replaces:** Tigercat AY052; Donaldson  
 P561183; Fleetguard HF35477  
**Thread:** 1 1/2 -16  
**O.D.:** 5 1/32 (127.8)  
**Height:** 10 11/16 (271.5)  
**F. Gskt:** [2] Included  
**O-Ring:** [1] Included

**BT23540**

Hydraulic Spin-on



**Fits:** John Deere Tractors  
**Replaces:** John Deere RE161181; Donaldson  
 P564042; Fleetguard HF35484  
**Thread:** 1 1/4 -12  
**O.D.:** 3 27/32 (97.6)  
**Height:** 9 23/32 (246.9)  
**A. Gskt:** [1] Included  
**O-Ring:** [1] Attached

**BT23542-MPG**

Maximum Performance Glass Hydraulic Spin-on



**Fits:** Case-International Tractors, Harvesters;  
 New Holland Tractors  
**Replaces:** Case 84487937, 87413809; New  
 Holland 84487937, 87413809  
**Thread:** 1 3/4 -12  
**O.D.:** 4 25/32 (121.4)  
**Height:** 14 1/4 (362.0)  
**I.Gskt:** [1] Attached

**PT23544-MPG**

Maximum Performance Glass Hydraulic Element



**Fits:** Hamm HD120, HD130, HD275, 3412, 3307  
 Rollers  
**Replaces:** Wirtgen 1285491; Hamm 1285491,  
 3001285491; Fleetguard HF29065  
**O.D.:** 3 3/32 (78.6)  
**I.D.:** 1 9/32 (32.5) One End  
**Height:** 9 1/2 (241.3)

**PT23545-MPG**

Maximum Performance Glass Hydraulic Element



**Fits:** Volvo Excavators, Pipelayers  
**Replaces:** Volvo 14569658, 14690316  
**O.D.:** 7 (177.8)  
**I.D.:** 4 5/16 (109.5)  
**Height:** 17 1/32 (432.6)  
**A. Gskt:** [1] Included

**PT23546-MPG**

Maximum Performance Glass Hydraulic Element with Blank Band



**Fits:** Volvo Excavators  
**Replaces:** Volvo 14539482, 14688861;  
 Donaldson P502494; Fleetguard HF3551  
**O.D.:** 5 29/32 (150.0)  
**I.D.:** 4 1/16 (103.2)  
**Height:** 17 1/32 (432.6)  
**A. Gskt:** [1] Attached

**BT23555-MPG**

Maximum Performance Glass Hydraulic Spin-on



**Contains:** 15 PSID Bypass Valve  
**Fits:** Case-International Tractors; New Holland  
 Tractors; Steyer Tractors  
**Replaces:** Case 84257511; Donaldson  
 P765662; Mann & Hummel W14005; Wix 57794  
**Thread:** 1 3/4 -16 UN  
**O.D.:** 5 3/8 (136.7)  
**Height:** 7 (177.8)  
**A. Gskt:** [1] Included  
**Grommets:** [1] Attached

**PT23556-MPG**

Maximum Performance Glass Hydraulic Element



**Fits:** Schroeder Hydraulic Applications  
**Replaces:** Schroeder 9V5Z10; Donaldson  
 P572998  
**O.D.:** 2 7/8 (73.0)  
**I.D.:** 1 1/2 (38.1) One End  
**Height:** 9 9/16 (242.9)  
**O-Ring:** [1] Attached

Measurements Are Shown In Inches And (Millimeters)

**WARNING:** These products can expose you to chemicals, including Diisononyl Phthalate, Carbon black extracts, Nickel, 1,3 Butadiene, Ethylene Oxide, Epichlorohydrin, which are known to the State of California to cause cancer, and Bisphenol, Ethylene Glycol, Ethylene Oxide, 1,3 Butadiene, Epichlorohydrin, which are known to the State of California to cause birth defects or other reproductive harm.

**PT23560**

Hydraulic Element



**Fits:** Hitachi Excavators  
**Replaces:** Hitachi 4688140  
**O.D.:** 3 5/16 (84.1)  
**I.D.:** 1 1/2 (38.1)  
**Height:** 6 13/32 (162.7)  
**A. Gskt:** [1] Included

**PT23569-MPG**

Maximum Performance Glass Hydraulic Element



**Fits:** Internormen Applications  
**Replaces:** Internormen 300209  
**O.D.:** 2 3/4 (69.9)  
**I.D.:** 1 5/8 (41.3) One End  
**Height:** 11 31/32 (304.0)  
**O-Ring:** [1] Included

**PT23561-MPG**

Maximum Performance Glass Hydraulic Element with Blank Band



**Fits:** Bobcat Loaders  
**Replaces:** Bobcat 7024037  
**O.D.:** 3 13/32 (86.5)  
**I.D.:** 1 3/8 (34.9) One End  
**Height:** 8 3/32 (205.6)

**PT23570-MPG**

Maximum Performance Glass Hydraulic Element



**Replaces:** Internormen 300093; Filtrec RLR70E20B5; Wix R64D20EV5  
**O.D.:** 1 25/32 (45.2)  
**I.D.:** 29/32 (23.0) One End  
**Height:** 6 9/16 (166.7)  
**O-Ring:** [1] Included

**PT23565-MPG**

Maximum Performance Glass Hydraulic Element with Handle



**Fits:** Claas Combines; Ingersoll-Rand Compressors; Terex Loaders  
**Replaces:** Argo V3093408; Filtrec WG966; Wix R01E15GA  
**O.D.:** 3 17/32 (89.7)  
Lid 4 5/32 (105.6)  
**I.D.:** 2 1/16 (52.4) One End  
**Height:** 15 (381.0)  
**O-Ring:** [1] Attached

**PT23571-MPG**

Maximum Performance Glass Hydraulic Element



**Contains:** Slotted Pan Screw M4x12 [fully threaded] UNI EN ISO mounted and secured by means of loctite  
**Fits:** JLG Industries Inc. M400AJP, M400AJPN Aerial Lifts  
**Replaces:** JLG Industries Inc. 7021616; Filtrec WG908  
**O.D.:** 1 3/32 (27.8)  
**I.D.:** 11/32 (8.7) One End  
**Height:** 3 5/32 (80.2)  
**O-Ring:** [1] Attached

**PT23566-MPG**

Maximum Performance Glass Hydraulic Element with Handle



**Replaces:** Argo V3094108; Filtrec WG967; Wix R21G15GA  
**O.D.:** 3 17/32 (89.7)  
Lid 4 3/16 (106.4)  
**I.D.:** 2 1/16 (52.4) One End  
**Height:** 17 17/32 (445.3)  
**O-Ring:** [1] Attached

**PT23572-MPG**

Maximum Performance Glass Hydraulic Element



**Contains:** [1] Backup O-Ring  
**Fits:** Kalmar Applications  
**Replaces:** Kalmar 9239440052  
**O.D.:** 2 3/32 (53.2)  
**I.D.:** 1 1/4 (31.8)  
**Height:** 8 21/32 (219.9)  
**O-Ring:** [2] Included

**PT23567-MPG**

Maximum Performance Glass Hydraulic Element



**Replaces:** Clark 251223; Filtrec WG846; Wix W01AG846  
**O.D.:** 2 13/16 (71.4)  
**I.D.:** 1 5/8 (41.3)  
**Height:** 7 15/16 (201.6)  
**O-Ring:** [2] Attached

**PT23573-MPG**

Maximum Performance Glass Hydraulic Element



**Fits:** Kalmar Applications  
**Replaces:** Kalmar 9238551184  
**O.D.:** 1 21/32 (42.1)  
**I.D.:** 5/8 (15.9) One End  
**Height:** 3 1/2 (88.9)  
**O-Ring:** [1] Included  
**Grommets:** [1] Attached

**PT23568-MPG**

Maximum Performance Glass Hydraulic Element



**Fits:** Hamm Rollers  
**Replaces:** Hamm 02038889, 2038889; Filtrec WG726  
**O.D.:** 1 3/4 (44.4)  
**I.D.:** 13/16 (20.6) One End  
**Height:** 6 21/32 (169.1)  
**O-Ring:** [1] Attached

**PT23574-MPG**

Maximum Performance Glass Hydraulic Element



**Fits:** Komatsu Dozers, Excavators  
**Replaces:** Komatsu 20Y6021410  
**O.D.:** 2 3/4 (69.9)  
**I.D.:** 1 25/32 (45.2) & 1 25/32 (45.2)  
**Height:** 1 1/4 (31.8)  
**A. Gskt:** [2] Included

Measurements Are Shown In Inches And (Millimeters)

**WARNING:** These products can expose you to chemicals, including Diisononyl Phthalate, Carbon black extracts, Nickel, 1,3 Butadiene, Ethylene Oxide, Epichlorohydrin, which are known to the State of California to cause cancer, and Bisphenol, Ethylene Glycol, Ethylene Oxide, 1,3 Butadiene, Epichlorohydrin, which are known to the State of California to cause birth defects or other reproductive harm.

<p><b>PT23575-MPG</b> Maximum Performance Glass Hydraulic Element</p>  <p><b>Replaces:</b> Linde 0009831645, 9831645; Filtrec DHD55G05V; Wix D44B05GV  <b>O.D.:</b> 2 7/32 (56.4)  <b>I.D.:</b> 1 (25.4) One End  <b>Height:</b> 4 21/32 (118.3)  <b>O-Ring:</b> [1] Viton Attached</p>	<p><b>PT23581-MPG</b> Maximum Performance Glass Hydraulic Element with Bail Handle</p>  <p><b>Contains:</b> 43.5 PSID By-Pass Valve  <b>Replaces:</b> Terex 8520065; Filtrec WG820  <b>O.D.:</b> 4 1/2 (114.3)  <b>Flange:</b> 4 5/8 (117.5)  <b>I.D.:</b> 2 19/32 (65.9) One End  <b>Height:</b> 16 7/32 (412.0)  <b>O-Ring:</b> [1] Attached</p>
<p><b>PT23576-MPG</b> Maximum Performance Glass Hydraulic Element</p>  <p><b>Fits:</b> Linde Applications  <b>Replaces:</b> Linde 0009831644, 9831644; Hydac 0095D005BN4HCV, 95D005BN4HCV  <b>O.D.:</b> 2 7/32 (56.4)  <b>I.D.:</b> 1 1/32 (26.2) One End  <b>Height:</b> 8 9/32 (210.3)  <b>O-Ring:</b> [1] Attached</p>	<p><b>PT23582-MPG</b> Maximum Performance Glass Hydraulic Element</p>  <p><b>Fits:</b> Vogele Applications  <b>Replaces:</b> Vogele 9624531001  <b>O.D.:</b> 4 1/32 (102.4)  <b>I.D.:</b> 2 7/16 (61.9)  <b>Height:</b> 13 1/16 (331.8)  <b>I.Gskt:</b> [2] Included</p>
<p><b>PT23577-MPG</b> Maximum Performance Glass Hydraulic Element</p>  <p><b>Contains:</b> 3 PSID By-Pass Valve  <b>Fits:</b> Linde Applications  <b>Replaces:</b> Linde 0009831643, 9831643  <b>O.D.:</b> 3 23/32 (94.5)  <b>I.D.:</b> 1 29/32 (48.4) One End  <b>Height:</b> 15 27/32 (402.4)  <b>I.Gskt:</b> [1] Included</p>	<p><b>PT23583-MPG</b> Maximum Performance Glass Hydraulic Element</p>  <p><b>Fits:</b> Wirtgen Equipment  <b>Replaces:</b> Wirtgen 90200; Argo V3094006; Wix W01AG572  <b>O.D.:</b> 3 17/32 (89.7)  <b>I.D.:</b> 1 19/32 (40.5) One End  <b>Height:</b> 15 11/16 (398.5)  <b>O-Ring:</b> [1] Attached</p>
<p><b>PT23578-MPG</b> Maximum Performance Glass Hydraulic Element</p>  <p><b>Fits:</b> Putzmeister Applications  <b>Replaces:</b> Putzmeister 273827007  <b>O.D.:</b> 1 27/32 (46.8)  <b>I.D.:</b> 1 (25.4) One End  <b>Height:</b> 15 3/4 (400.0)</p>	<p><b>PT23585</b> Hydraulic Element</p>  <p><b>Fits:</b> Hyster Applications  <b>Replaces:</b> Hyster 2037740  <b>O.D.:</b> 3 15/16 (100.0)  <b>I.D.:</b> 1 1/4 (31.8) &amp; 1 9/16 (39.7)  <b>Height:</b> 11 1/32 (280.2)  <b>Grommets:</b> [1] Attached</p>
<p><b>PT23579-MPG</b> Maximum Performance Glass Hydraulic Element</p>  <p><b>Replaces:</b> Sandvik 73833256; Filtrec R734G10; Parker PR4411; Wix R20D10GP  <b>O.D.:</b> 4 31/32 (126.2)  <b>I.D.:</b> 13/32 (10.3) &amp; 3 5/8 (92.1)  <b>Height:</b> 9 27/32 (250.0)</p>	<p><b>PT23586</b> Hydraulic Element</p>  <p><b>Contains:</b> 14.5 PSID By-Pass Valve  1 3/8-12 UNF-2B Thread  <b>Fits:</b> TMC Applications  <b>Replaces:</b> TMC 214A752081  <b>O.D.:</b> 3 17/32 (89.7)  <b>Height:</b> 6 9/16 (166.7)</p>
<p><b>PT23580-MPG</b> Maximum Performance Glass Hydraulic Element</p>  <p><b>Fits:</b> COE, Inc. Orchard Equipment  <b>Replaces:</b> Schroeder 9VZ10, 9VS7; Filtrec WG486; Wix W01AG486  <b>O.D.:</b> 2 7/8 (73.0)  <b>I.D.:</b> 1 17/32 (38.9) One End  <b>Height:</b> 9 1/2 (241.3)  <b>O-Ring:</b> [1] Attached</p>	<p><b>PT23587</b> Hydraulic Element</p>  <p><b>Fits:</b> Komatsu Excavators  <b>Replaces:</b> Komatsu 76233773, 79671973; Filtrec WX470  <b>O.D.:</b> 5 9/32 (134.1)  <b>I.D.:</b> 3 19/32 (91.3)  <b>Height:</b> 2 27/32 (72.2)  <b>A. Gskt:</b> [2] Attached</p>

Measurements Are Shown In Inches And (Millimeters)

**WARNING:** These products can expose you to chemicals, including Diisononyl Phthalate, Carbon black extracts, Nickel, 1,3 Butadiene, Ethylene Oxide, Epichlorohydrin, which are known to the State of California to cause cancer, and Bisphenol, Ethylene Glycol, Ethylene Oxide, 1,3 Butadiene, Epichlorohydrin, which are known to the State of California to cause birth defects or other reproductive harm.



**PT23588**

Hydraulic Element



**Contains:** M6 Thread  
**Fits:** Putzmeister Applications  
**Replaces:** Putzmeister 294073005  
**O.D.:** 3 31/32 (100.8)  
**I.D.:** 2 13/32 (61.1)  
**Height:** 19 (482.6)  
**O-Ring:** [2] Attached

**PT23597-MPG**

Maximum Performance Glass Hydraulic Element



**Fits:** Komatsu PC220LC-8 Excavators  
**Replaces:** Komatsu 20Y9701820, 706311046; Fleetguard HF35530; Wix W01AG515  
**O.D.:** 3 3/4 (95.5)  
**I.D.:** 1 31/32 (50.3)  
**Height:** 9 5/32 (232.4)  
**O-Ring:** [1] Attached

**PT23589**

Hydraulic Element



**Contains:** M8 Thread  
**Fits:** Putzmeister Applications  
**Replaces:** Putzmeister 416341  
**O.D.:** 6 (152.4)  
**I.D.:** 3 15/16 (100.0)  
**Height:** 20 5/16 (515.9)  
**O-Ring:** [2] Attached

**PT23598-MPG**

Maximum Performance Glass Hydraulic Element



**Contains:** Reinforced Centertube  
**Fits:** Takeuchi Loaders  
**Replaces:** Takeuchi 1551103900; Sakura H-79861; Wix R64F10N  
**O.D.:** 4 13/32 (111.9)  
**I.D.:** 2 3/4 (69.9)  
**Height:** 11 3/4 (298.5)  
**A. Gskt:** [2] Attached

**PT23590**

Hydraulic Element



**Fits:** Terex Applications  
**Replaces:** Terex 1409828  
**O.D.:** 3 1/16 (77.8)  
**I.D.:** 1 19/32 (40.5) One End  
**Height:** 11 1/16 (281.0)  
**O-Ring:** [1] Attached

**PT23600**

Hydraulic Element

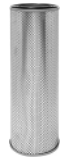

**Contains:** Guides  
**Fits:** Hyundai Excavators  
**Replaces:** Hyundai E1310212, E1310212A, E13102124  
**O.D.:** 5 15/16 (150.8)  
**I.D.:** 3 5/16 (84.1)  
**Height:** 17 15/16 (455.6)

**PT23591-MPG**

Maximum Performance Glass Hydraulic Element



**Fits:** Liebherr Dozers, Loaders  
**Replaces:** Liebherr 10324849; Filtrec WG1021; Uniflux XH1099  
**O.D.:** 5 31/32 (151.6)  
**I.D.:** 3 15/16 (100.0) One End  
**Height:** 14 7/32 (361.2)  
**O-Ring:** [1] Attached

**BT23603-MPG**

Maximum Performance Glass Hydraulic Spin-on



**Fits:** John Deere Tractors  
**Replaces:** John Deere LVA13038  
**Thread:** 1 1/2 -16 UN-2B  
**O.D.:** 4 21/32 (118.3)  
**Height:** 6 9/32 (159.5)  
**A. Gskt:** [1] Included

**PT23592**

Hydraulic Element



**Fits:** Case, Link-Belt Excavators  
**Replaces:** Case KRJ10590; New Holland KRJ10590  
**O.D.:** 5 29/32 (150.0)  
**I.D.:** 3 7/16 (87.3) One End  
**Height:** 7 23/32 (196.1)  
**I.Gskt:** [1] Included

**BT23604**

Hydraulic Spin-on



**Fits:** Komatsu Loaders  
**Replaces:** Komatsu 4181834160  
**Thread:** M45 x 1.5  
**O.D.:** 3 9/32 (83.1)  
**Height:** 6 1/8 (155.4)  
**O-Ring:** [1] Attached

**PT23595-MPG**

Maximum Performance Glass Hydraulic Element



**Fits:** Various Industrial Hydraulic Applications  
**Replaces:** Galbreath A4968, GBA4968; Killer Filter KF1059169; Main Filter MF0066085  
**O.D.:** 3 29/32 (99.2)  
**I.D.:** 2 1/4 (57.2)  
**Height:** 18 1/2 (469.9)  
**I.Gskt:** [2] Included

**BT23605-MPG**

Maximum Performance Glass Hydraulic Spin-on



**Contains:** 15 PSID Bypass Valve  
**Fits:** Case-International Tractors; New Holland Tractors; Steyr Tractors  
**Replaces:** Case 84248043; Donaldson P765704; Wix 57421  
**Thread:** 1 3/4 -16 UN  
**O.D.:** 5 3/8 (136.7)  
**Height:** 9 5/8 (244.3)  
**A. Gskt:** [1] Included  
**Grommets:** [1] Attached

Measurements Are Shown In Inches And (Millimeters)

**WARNING:** These products can expose you to chemicals, including Diisononyl Phthalate, Carbon black extracts, Nickel, 1,3 Butadiene, Ethylene Oxide, Epichlorohydrin, which are known to the State of California to cause cancer, and Bisphenol, Ethylene Glycol, Ethylene Oxide, 1,3 Butadiene, Epichlorohydrin, which are known to the State of California to cause birth defects or other reproductive harm.

**BT23607-MPG** Maximum Performance Glass Hydraulic Spin-on  
**Contains:** Threaded Hex-nut for removal.  
**Fits:** Case Excavators, Motor Graders;  
 Link-Belt Excavators all with Isuzu Engines  
**Replaces:** Case KHJ17730, 47635916  
**Thread:** M45 x 2.0-6H  
**O.D.:** 3 7/16 (87.3)  
**Height:** 6 17/32 (165.9)  
**O-Ring:** [1] Attached



**BT23628** Hydraulic Spin-on  
**Contains:** Threaded Stud: M24 x 1.5  
 35 PSID By-Pass Valve  
**Fits:** John Deere Loaders  
**Replaces:** John Deere AT466863  
**O.D.:** 3 23/32 (94.5)  
**Height:** 5 11/16 (169.9)  
**A. Gskt:** [1] Included



**BT23609-MPG** Maximum Performance Glass Hydraulic Spin-on  
**Replaces:** Donaldson P170546; Racor  
 944049Q; Fleetguard HF35438  
**Thread:** 1 3/4 -12 UN  
**O.D.:** 4 3/4 (120.7)  
**Height:** 14 1/4 (362.0)  
**I.Gskt:** [1] Included



**PT23629** Hydraulic Steering Element  
**Notes:** Inside-Out Flow Direction  
**Contains:** Bypass  
**Fits:** Freightliner 108SD, 114SD, 122SD,  
 Business Class M2 106, Business Class M2 112,  
 Business Class M2, Cascadia, Cascadia  
 Evolution, Coronado, Coronado SD, M2 106, M2  
 112, MT45, MT55; Western Star 4700, 4900EX,  
 4900FA, 4900SA, 5700XE, 6900XD Trucks  
**Replaces:** Freightliner 1417927000; Fleetguard  
 HF35387  
**O.D.:** 2 5/16 (58.9)  
**I.D.:** 23/32 (18.0) One End  
**Height:** 2 13/16 (71.4)  
**Grommets:** [1] Attached



**BT23611** Lube Spin-on  
**Contains:** Anti-Drainback Valve  
 50 PSID By-Pass Valve  
**Fits:** Hyster Applications  
**Replaces:** Hyster 4020588, 2075558  
**Thread:** 1 -12  
**O.D.:** 3 11/16 (93.7)  
**Height:** 5 15/32 (138.9)  
**A. Gskt:** G401



**BT23630** Spin-on Transmission Filter  
**Fits:** 1999-2004 Hyundai Sonata, 2001 XG300,  
 2002-05 XG350, 2001-09 Santa Fe, 2001-06  
 Elantra, 2004-08 Tiburon, 2006-09 Tucson,  
 2008-on Veracruz; 2003-on Kia Magentis,  
 Optima, 2005-09 Amanti, 2007-on Rondo,  
 2008-on Sedona  
**Replaces:** Hyundai 46322-39000; Kia  
 46322-39000  
**Thread:** M20 x 1.5  
**O.D.:** 3 1/32 (77.0)  
**Height:** 3 13/32 (86.5)  
**I.Gskt:** [1] Included



**PT23613-MPG** Maximum Performance Glass Hydraulic Stacked  
 Element with Bail Handle  
**Fits:** Liebherr R954C Litronic Excavator  
**Replaces:** Liebherr 11065673  
**O.D.:** 6 5/32 (156)  
**Height:** 21 (533.4)  
**O-Ring:** [2] Attached



**BT23631** Transmission Filter  
**Contains:** Anti-Drainback Valve  
 Wire Mesh By-Pass Screen  
**Fits:** 1999-on Subaru Forester, Impreza,  
 Legacy, Outback, Outback Sport, 2006-07 B9  
 Tribeca with R4AX-EL (ECB) Transmission  
 (4 Spd.)  
**Replaces:** Subaru 38325-AA032, 38325-KA000  
**Thread:** M20 x 1.5  
**O.D.:** 2 25/32 (70.6)  
**Height:** 2 5/8 (66.7)  
**I.Gskt:** [1] Included



**BT23617** Hydraulic Spin-on  
**Fits:** Komatsu Loaders  
**Replaces:** Komatsu 4171834130; Fleetguard  
 HF8144  
**Thread:** 1 1/8 -16  
**O.D.:** 3 23/32 (94.2)  
**Height:** 5 3/8 (136.4)  
**A. Gskt:** [1] Included



**BT23619-MPG** Maximum Performance Glass Hydraulic Spin-on  
**Fits:** John Deere Forestry Equipment, Loaders  
**Replaces:** John Deere AT367635; Wix  
 WL10185  
**Thread:** 1 3/8 -12  
**O.D.:** 3 3/4 (95.2)  
**Height:** 8 1/32  
**O-Ring:** [1] Attached



**PT23633** Oval Hydraulic Element  
**Notes:** Furnished gasket has 6 bolt holes.  
**Fits:** IHC Wheel Tractors  
**Replaces:** Motorcraft FH42; IHC (International  
 Harvester) 388081-R1, 3888081-R2, 388085-R1,  
 388085-R2, 403431-R92; Wix 51470, 551470  
**O.D.:** 4 5/8 (117.6)  
 to 7 1/4 (184.1)  
**I.D.:** 1 7/16 (36.6) & 2 7/8 (72.9)  
**Height:** 3 7/32 (81.8)  
**A. Gskt:** [2] Included  
**F. Gskt:** [1] Included



Measurements Are Shown In Inches And (Millimeters)

**WARNING:** These products can expose you to chemicals, including Diisononyl Phthalate, Carbon black extracts, Nickel, 1,3 Butadiene, Ethylene Oxide, Epichlorohydrin, which are known to the State of California to cause cancer, and Bisphenol, Ethylene Glycol, Ethylene Oxide, 1,3 Butadiene, Epichlorohydrin, which are known to the State of California to cause birth defects or other reproductive harm.

**PA30000** Cabin Air Element  
**Fits:** 1/2014-on Ford Transit 2.2 TDCI, 2012-on Transit Custom 2.2 Duratorq all with T22DDOP Engine  
**Replaces:** Ford 1812679  
**Length:** 10 15/16 (277.8)  
**Width:** 9 1/8 (231.8)  
**Height:** 31/32 (24.6)  
**A. Gskt:** [2] Attached



**PA30001** Cab Air Element  
**Fits:** Caterpillar Excavators  
**Replaces:** Caterpillar 3639402  
**Length:** 7 7/8 (200.0)  
**Width:** 7 1/8 (181.0)  
**Height:** 21/32 (16.7)  
**A. Gskt:** [1] Attached

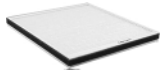

**PA30002** Cab Air Element with Pull Strap  
**Fits:** Caterpillar Equipment  
**Replaces:** Caterpillar 2902287  
**Length:** 14 3/32 (358.0)  
**Width:** 11 7/32 (285.0)  
**Height:** 2 3/16 (55.6)  
**A. Gskt:** [2] Attached

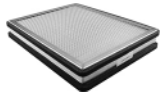

**PA30003** Cab Air Element  
**Fits:** Fiat-Allis/Fiat-Hitachi Loaders  
**Replaces:** New Holland 79109003  
**Length:** 19 9/32 (489.7)  
**Width:** 8 31/32 (227.8)  
**Height:** 2 23/32 (69.1)  
**A. Gskt:** [5] Attached



**PA30004** Cab Air Element with Pull Strap  
**Contains:** Charcoal Impregnated Media for Odor Control  
**Fits:** Caterpillar Dozers, Loaders  
**Replaces:** Caterpillar 1752834  
**Length:** 12 3/16 (309.6)  
**Width:** 9 17/32 (242.1)  
**Height:** 2 3/16 (55.6)  
**A. Gskt:** [1] Attached

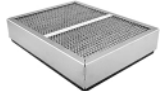

**PA30005** Cab Air Element  
**Contains:** Charcoal Impregnated Media for Odor Control.  
**Fits:** John Deere Sprayers, Tractors  
**Replaces:** John Deere RE199682  
**Length:** 12 19/32 (319.9)  
**Width:** 6 21/32 (169.1)  
**Height:** 1 15/16 (49.2)



**PA30006** Cab Air Element  
**Fits:** John Deere Combines, Forage Harvesters  
**Replaces:** John Deere H220870; Fleetguard AF27961  
**Length:** 12 19/32 (319.9)  
**Width:** 5 1/8 (130.2)  
**Height:** 1 7/8 (47.6)



**PA30007** Panel Air Element  
**Fits:** Yamaha Golf Carts  
**Replaces:** Yamaha JN6E445001, JN6E445000, JN6E44500100, JN0E445000  
**Length:** 12 29/32 (327.8)  
**Width:** 10 3/32 (256.4)  
**Height:** 1 17/32 (38.9)

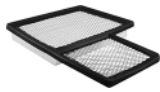

**RS30008** Radial Seal Outer Air Element  
**Fits:** John Deere Combines  
**Use With:** RS30009  
**Replaces:** John Deere HXE11090  
**O.D.:** 14 7/32 (361.2)  
**I.D.:** 8 (203.2)  
**Height:** 23 17/32 (597.7)



**RS30009** Radial Seal Inner Air Element  
**Fits Inside:** RS30008  
**Fits:** John Deere Combines  
**Replaces:** John Deere HXE11091  
**O.D.:** 8 1/8 (206.4)  
**I.D.:** 6 7/8 (174.6)  
**Height:** 20 31/32 (532.6)



**PA30010** Air Element  
**Replaces:** Donaldson B120439  
**O.D.:** 12 19/32 (319.9)  
**I.D.:** 7 27/32 (199.2) One End  
**Height:** 17 7/16 (442.9)



**PA30011** Air Element  
**Fits:** Generac Generators  
**Replaces:** Generac C8127  
**O.D.:** 6 21/32 (169.1)  
**I.D.:** 5 3/32 (129.4)  
**Height:** 3 3/16 (81.0)



**PA30012** Air Element  
**Fits:** Kohler Engines  
**Replaces:** Kohler 32063035  
**O.D.:** 5 11/16 (144.5)  
**I.D.:** 3 (76.2) & 3 7/8 (98.4) to  
**Height:** 1 23/32 (43.7)



**PA30013** Air Element  
**Fits:** Joy Compressors  
**Replaces:** Joy 360628319  
**O.D.:** 9 3/8 (238.1)  
**I.D.:** 7 9/16 (192.1)  
**Height:** 4 5/8 (117.5)



**PA30014** Oval Air Element  
**Fits:** Kawasaki, Mule Utility Vehicles with FC540V Engine  
**Replaces:** Kawasaki 110132143  
**O.D.:** 3 1/4 (82.6) to 7 7/16 (188.9)  
**I.D.:** 1 13/16 (22.2) & 5 15/16 (150.8)  
**Height:** 3 1/8 (79.4)  
**A. Gskt:** [2] Attached



Measurements Are Shown In Inches And (Millimeters)

**WARNING:** These products can expose you to chemicals, including Diisononyl Phthalate, Carbon black extracts, Nickel, 1,3 Butadiene, Ethylene Oxide, Epichlorohydrin, which are known to the State of California to cause cancer, and Bisphenol, Ethylene Glycol, Ethylene Oxide, 1,3 Butadiene, Epichlorohydrin, which are known to the State of California to cause birth defects or other reproductive harm.

**PA30015**

Air Element



**Fits:** Atlas Copco Compressors  
**Replaces:** Atlas Copco 1613872000  
**O.D.:** 4 5/8 (117.5)  
**I.D.:** 2 5/8 (66.7)  
**Height:** 5 5/16 (134.9)

**PA30016**

Oval Air Element



**Contains:** Two holes in metal end  
**Fits:** Tecumseh Engines  
**Replaces:** Briggs & Stratton 35403  
**O.D.:** 2 (50.8)  
to 8 (203.2)  
**I.D.:** 13/16 (20.6) & 6 3/4 (171.5)  
**Height:** 2 5/16 (58.7)

**PA30017**

Oval Air Element with Foam Wrap



**Fits:** John Deere LX178, LX188 Lawn Tractors  
**Replaces:** John Deere M115978  
**O.D.:** 4 (101.6)  
to 8 9/16 (217.5)  
**I.D.:** 1 13/16 (46.0) & 4 5/8 (117.5) to  
**Height:** 2 7/16 (61.9)

**PA30018**

Oval Air Element



**Contains:** Two holes in metal end  
**Fits:** Tecumseh Engines  
**Replaces:** Tecumseh 36356  
**O.D.:** 4 9/32 (108.7)  
to 7 5/32 (181.8)  
**I.D.:** 1 (25.4) & 6 (152.4)  
**Height:** 3 1/8 (79.4)

**PA30019**

Air Element



**Fits:** Homelite Concrete Saws  
**Replaces:** Homelite 46073  
**O.D.:** 4 9/32 (108.7)  
**I.D.:** 2 (50.8)  
**Height:** 2 17/32 (64.3)

**PA30020**

Air Element



**Fits:** Kohler Applications  
**Replaces:** Kohler 2808304  
**O.D.:** 4 1/2 (114.3)  
**I.D.:** 3 1/16 (77.8)  
**Height:** 4 5/16 (109.5)

**PA30021**

Air Element



**Contains:** Flame Retardant Media  
**Fits:** Daihatsu S-80 Trucks  
**Replaces:** Daihatsu 1780187508  
**O.D.:** 4 3/32 (104.0)  
**I.D.:** 2 1/4 (57.2)  
**Height:** 6 9/32 (159.5)  
**A. Gskt:** [2] Attached

**PA30022**

Oval Air Element



**Contains:** One hole in metal end  
**Fits:** Briggs & Stratton 196700 Engine; Cub  
Cadet 933E, 933R, 1027 Mowers  
**Replaces:** Briggs & Stratton 493910  
**O.D.:** 2 (50.8)  
to 7 1/4 (184.2)  
**I.D.:** 1 (25.4) & 6 (152.4)  
**Height:** 2 3/16 (55.6)

**PA30023**

Air Element



**Fits:** Vortex Housings  
**Replaces:** Vortex VF-100D  
**O.D.:** 7 3/8 (187.3)  
**I.D.:** 3 1/2 (88.9)  
**Height:** 10 (254.0)  
**A. Gskt:** [1] Included

**PA30024**

Air Element



**Fits:** Target Concrete Saws  
**Replaces:** Target 168323  
**O.D.:** 3 27/32 (97.6)  
**I.D.:** 2 3/8 (60.3)  
**Height:** 3 7/32 (81.8)

**PA30025**

Air Element



**Fits:** Joy Compressors  
**Replaces:** Joy 1663206  
**O.D.:** 7 3/8 (187.3)  
**I.D.:** 5 3/16 (131.8)  
**Height:** 3 5/16 (84.1)

**PA30026**

Inner Air Element



**Fits Inside:** PA1980-FN  
**Fits:** Ford Buses, Trucks  
**Replaces:** Donaldson P524815  
**O.D.:** 7 9/32 (184.9)  
Flange 8 15/32 (215.1)  
**I.D.:** 2 1/32 (16.7) & 6 3/16 (157.2)  
**Height:** 9 21/32 (245.3)  
**A. Gskt:** [1] Attached  
**F. Gskt:** [1] Included

**PA30027**

Air Element



**Fits:** Case Construction Equipment, Tractors  
**Replaces:** Air Refiner ARM5233  
**O.D.:** 8 1/16 (204.8)  
**I.D.:** 1/4 (6.4) & 5 25/32 (146.8)  
**Height:** 4 3/4 (120.7)  
**A. Gskt:** [2] Attached  
**Grommets:** [1] Attached

**PA30028**

Air Element



**Fits:** Nelson Housings  
**Replaces:** Nelson 89102A  
**O.D.:** 7 7/8 (200.0)  
**I.D.:** 4 5/8 (117.5)  
**Height:** 4 3/16 (106.4)

Measurements Are Shown In Inches And (Millimeters)

**WARNING:** These products can expose you to chemicals, including Diisononyl Phthalate, Carbon black extracts, Nickel, 1,3 Butadiene, Ethylene Oxide, Epichlorohydrin, which are known to the State of California to cause cancer, and Bisphenol, Ethylene Glycol, Ethylene Oxide, 1,3 Butadiene, Epichlorohydrin, which are known to the State of California to cause birth defects or other reproductive harm.

**PA30029** Oval Air Element  
**Fits:** Briggs & Stratton Engines; Cub Cadet 804 Lawn Tractor  
**Replaces:** Briggs & Stratton 393406  
**O.D.:** 3 5/16 (84.1) to 5 1/16 (128.6)  
**I.D.:** 2 1/4 (57.2) & 4 1/16 (103.2)  
**Height:** 2 1/8 (54.0)



**PA30030** Air Element  
**Fits:** Kohler Engines  
**Replaces:** Kohler 3208306  
**O.D.:** 4 3/16 (106.4) to 5 11/16 (144.5)  
**I.D.:** 2 9/16 (65.1) & 3 7/8 (98.4)  
**Height:** 3 1/16 (77.8)



**PA30031** Oval Air Element  
**Fits:** Cub Cadet, Toro Lawn & Garden Equipment; Kohler Engines  
**Replaces:** Kohler 1208305  
**O.D.:** 3 13/16 (96.8) to 4 1/2 (114.3)  
**I.D.:** 2 1/2 (63.5) & 3 1/8 (79.4)  
**Height:** 2 7/8 (73.0)  
**A. Gskt:** [1] Attached



**PA30032** Outer Air Element with Pull Tab  
**Fits:** Massey Ferguson Tractors, Loaders  
**Use With:** PA30033  
**Replaces:** Massey Ferguson 3824035M1  
**O.D.:** 5 1/4 (133.4)  
**I.D.:** 1/2 (12.7) & 3 1/4 (82.6)  
**Height:** 11 7/8 (301.6)  
**I.Gskt:** [2] Included  
**F. Gskt:** [1] Washer Included



**PA30033** Inner Air Element  
**Fits Inside:** PA30032  
**Fits:** Massey Ferguson Tractors, Loaders  
**Replaces:** Massey Ferguson 3824036M1  
**O.D.:** 2 15/16 (74.6)  
**I.D.:** 15/32 (11.9) & 2 15/32 (62.7)  
**Height:** 11 1/4 (285.8)  
**F. Gskt:** [1] Washer Included



**PA30034** Air Breather Element  
**Contains:** Flame Retardant Media  
**Fits:** Chevrolet, Dodge, Jeep Automotive, Light-Duty Trucks  
**Replaces:** General Motors 6421660  
**O.D.:** 3 1/4 (82.6)  
**I.D.:** 1 31/32 (50.0) One End  
**Height:** 3 21/32 (92.9)  
**F. Gskt:** [1] Included



**PA30035** Air Breather Element  
**Contains:** Flame Retardant Media  
**Fits:** Clark Lift Trucks  
**Replaces:** Clark 1618319  
**O.D.:** 3 1/4 (82.6)  
**I.D.:** 1 15/16 (49.2) One End  
**Height:** 2 1/16 (52.4)  
**F. Gskt:** [1] Included



**PA30036** Air Element in Disposable Housing  
**Fits:** John Deere Lawn Tractors  
**Replaces:** John Deere AM101283  
**O.D.:** 4 1/2 (114.3)  
**I.D.:** 1 1/2 (38.1) One End  
**Height:** 7 3/8 (187.3)



**PA30037** Air Element in Disposable Housing  
**Fits:** Railroad Applications; Fire Equipment  
**Replaces:** Farr 71338008  
**O.D.:** 9 3/4 (247.7)  
**I.D.:** 5 31/32 (151.6) One End  
**Height:** 19 3/4 (501.7)



**PA30038** Air Element in Disposable Housing  
**Fits:** Pierce Fire Trucks  
**Replaces:** Farr 400470002  
**O.D.:** 11 1/2 (292.1)  
**Inlet:** 7  
**Height:** 16 29/32 (429.4)



**PA30039** Air Element in Disposable Housing  
**Fits:** Pierce Arrow Fire Trucks  
**Replaces:** Farr 99842004  
**O.D.:** 13 1/2 (342.9)  
**Inlet:** 6 25/32  
**Outlet:** 6 25/32  
**Height:** 25 19/32 (650.1)



**PA30040** Air Element in Disposable Housing  
**Fits:** Pierce Arrow Fire Trucks  
**Replaces:** Farr 71338010  
**O.D.:** 10 29/32 (277.0)  
**I.D.:** 7 (177.8) One End  
**Height:** 19 11/16 (500.1)



**PA30041** Air Element in Disposable Housing  
**Fits:** Farr ECO-SM Medium Duty On-Road Vehicles High Inlet Configuration  
**Replaces:** Farr 99842010  
**O.D.:** 13 1/2 (342.9)  
**Inlet:** 7  
**Outlet:** 7  
**Height:** 16 19/32 (421.5)



Measurements Are Shown In Inches And (Millimeters)

**WARNING:** These products can expose you to chemicals, including Diisononyl Phthalate, Carbon black extracts, Nickel, 1,3 Butadiene, Ethylene Oxide, Epichlorohydrin, which are known to the State of California to cause cancer, and Bisphenol, Ethylene Glycol, Ethylene Oxide, 1,3 Butadiene, Epichlorohydrin, which are known to the State of California to cause birth defects or other reproductive harm.

**PA30042**



Air Element In Disposable Housing  
**Fits:** Alaska Marine Engines  
**Replaces:** Air Refiner ARM2842  
**O.D.:** 8 (203.2)  
**I.D.:** 4 (101.6) One End  
**Height:** 10 9/16 (268.3)

**PA30043**



Air Element in Disposable Housing  
**Fits:** Spartan Fire Trucks  
**Replaces:** Farr 62891004  
**O.D.:** 13 1/2 (342.9)  
**Inlet:** 6 15/16  
**Outlet:** 6 15/16  
**Height:** 19 13/16 (503.2)

**PA30044**



Cab Air Element  
**Fits:** Caterpillar Integrated Tool Carriers, Wheel Loaders  
**Replaces:** Caterpillar 1118738  
**Length:** 15 3/8 (390.5)  
**Width:** 3 5/8 (92.1)  
**Height:** 1/2 (12.7)

**PA30045**



Panel Air Element  
**Fits:** New Holland Harvesters Various Models  
**Replaces:** Case 86545652; Donaldson P783687; Wix 49129  
**Length:** 23 5/8 (600.1)  
**Width:** 4 9/32 (108.7)  
**Height:** 2 7/32 (56.4)

**PA30048**

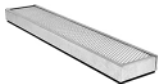

Cab Air Element  
**Fits:** Massey Ferguson Equipment  
**Replaces:** Massey Ferguson 3038997-M1  
**Length:** 30 (762.0)  
**Width:** 5 31/32 (151.6)  
**Height:** 2 1/8 (54.0)  
**A. Gskt:** [1] Attached

**PA30049**



Cab Air Element  
**Fits:** Massey Ferguson Tractors  
**Replaces:** Massey Ferguson 536836M1, 536836M2  
**Length:** 44 15/16 (1141.4)  
**Width:** 4 (101.6)  
**Height:** 2 3/16 (55.6)  
**A. Gskt:** [1] Attached

**PA30050**

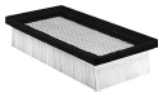

Panel Air Element  
**Fits:** Briggs & Stratton Engines  
**Replaces:** Briggs & Stratton 272218  
**Length:** 7 (177.8)  
**Width:** 3 1/2 (88.9)  
**Height:** 1 1/2 (38.1)

**PA30051**



Panel Air Element  
**Fits:** Briggs & Stratton Engines  
**Replaces:** Briggs & Stratton 710265  
**Length:** 6 11/32 (161.1)  
**Width:** 3 1/2 (88.9)  
**Height:** 15/16 (23.8)

**PA30052**

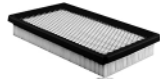

Panel Air Element  
**Fits:** 1991-96 E-Z-GO Marathon Golf Carts  
**Replaces:** E-Z-GO 26855G01  
**Length:** 8 9/16 (217.5)  
**Width:** 5 3/32 (129.4)  
**Height:** 1 11/32 (34.1)

**PA30053**



Panel Air Element  
**Fits:** Cub Cadet Chippers  
**Replaces:** Tecumseh 36046  
**Length:** 3 27/32 (97.6)  
**Width:** 3 7/16 (87.3)  
**Height:** 1 1/4 (31.8)

**PA30054**

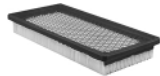

Panel Air Element  
**Fits:** Briggs & Stratton Engines  
**Replaces:** Briggs & Stratton 710266  
**Length:** 8 11/32 (211.9)  
**Width:** 3 31/32 (100.8)  
**Height:** 1 3/32 (27.8)

**PA30055**



Panel Air Element  
**Fits:** Honda Engines, Lawn Mowers  
**Replaces:** Honda 17211Z8B901  
**Length:** 5 1/8 (130.2)  
**Width:** 4 7/16 (112.7)  
**Height:** 7/8 (22.2)

**PA30056**



Panel Air Element  
**Fits:** Tecumseh Engines  
**Replaces:** Tecumseh 35500  
**Length:** 7 1/8 (181.0)  
**Width:** 2 3/16 (55.6)  
**Height:** 3/4 (19.0)

**RS30057**



Radial Seal Outer Air Element  
**Fits:** Donaldson FRG Housings  
**Use With:** RS30058  
**Replaces:** Donaldson P549523  
**O.D.:** 12 3/32 (307.2)  
**I.D.:** 6 25/32 (172.2) One End  
**Height:** 18 1/2 (469.9)

**RS30058**



Radial Seal Inner Air Element  
**Fits Inside:** RS30057  
**Fits:** Donaldson FRG Housings  
**Replaces:** Donaldson P549530  
**O.D.:** 6 7/8 (174.6)  
**I.D.:** 5 1/4 (133.4) One End  
**Height:** 17 27/32 (453.2)

**RS30059-FN**



Radial Seal Outer Air Element with Fins  
**Use With:** RS3885  
**Replaces:** Donaldson P601790  
**O.D.:** 8 3/16 (208.0)  
**Fins:** 9 11/32 (237.3)  
**I.D.:** 4 5/32 (105.6) One End  
**Height:** 16 1/2 (419.1)

Measurements Are Shown In Inches And (Millimeters)

**WARNING:** These products can expose you to chemicals, including Diisononyl Phthalate, Carbon black extracts, Nickel, 1,3 Butadiene, Ethylene Oxide, Epichlorohydrin, which are known to the State of California to cause cancer, and Bisphenol, Ethylene Glycol, Ethylene Oxide, 1,3 Butadiene, Epichlorohydrin, which are known to the State of California to cause birth defects or other reproductive harm.

**RS30060-FN** Radial Seal Outer Air Element with Fins



**Fits:** Donaldson FRG06 Air Cleaners  
**Use With:** RS30061  
**Replaces:** Donaldson P549271  
**O.D.:** 5 9/32 (134.1)  
**I.D.:** 3 13/32 (86.5) One End  
**Height:** 15 (381.0)

**RS30061** Radial Seal Inner Air Element



**Fits Inside:** RS30060-FN  
**Fits:** Donaldson FRG06 Air Cleaners  
**Replaces:** Donaldson P549271  
**O.D.:** 3 9/16 (90.5)  
**I.D.:** 2 13/16 (71.4) One End  
**Height:** 14 21/32 (372.3)

**RS30062** Radial Seal Air Element



**Fits:** Volvo Genset Engines  
**Replaces:** Volvo 21377913  
**O.D.:** 9 1/8 (231.8)  
**I.D.:** 5 29/32 (150.0) One End  
**Height:** 18 5/16 (465.1)

**PA30063** Air Element



**Fits:** Ford, New Holland Lawn & Garden Equipment  
**Replaces:** New Holland SBA408620002  
**O.D.:** 3 9/32 (83.3)  
 Flange 5 (127.0)  
**I.D.:** 1/4 (6.4) & 1 3/4 (44.4)  
**Height:** 7 11/32 (186.5)  
**A. Gskt:** [2] Attached

**PA30064** Cab Air Element

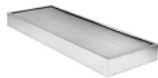

**Fits:** Challenger, Gleaner, Massey Ferguson Combines  
**Replaces:** Massey Ferguson 71393893  
**Length:** 23 11/16 (601.7)  
**Width:** 9 (228.6)  
**Height:** 2 3/16 (55.6)

**RS30065** Radial Seal Air Element



**Notes:** Must use RS30065 KIT (with Lid) on first installation only.  
 Use RS30065 (Element only) on subsequent applications.  
**Fits:** Applications previously using RS5362. Mercedes-Benz Trucks  
**Replaces:** Mercedes-Benz A0040942404; Baldwin RS5362  
**O.D.:** 15 7/8 (403.2)  
**I.D.:** 8 23/32 (221.5) One End  
**Height:** 12 11/16 (322.3)

**RS30065 KIT** Radial Seal Air Element with Lid



**Notes:** Must use RS30065 KIT (with Lid) on first installation only.  
 Use RS30065 (Element only) on subsequent applications.  
**Fits:** Applications previously using RS5362. Mercedes-Benz Trucks  
**Replaces:** Mercedes-Benz A0040942404; Baldwin RS5362; Donaldson P785542; Fleetguard AF26165  
**Element and Lid**  
**O.D.:** 15 7/8 (403.2)  
 Lid 20 15/32 (519.9)  
**I.D.:** 8 23/32 (221.5) One End  
**Height:** 13 5/16 (338.1)  
**F. Gskt:** [1] Included  
**Element Only**  
**O.D.** 15 7/8 (403.2)  
**I.D.** 8 23/32 (221.5)  
**Height** 12 11/16 (322.3)

**PA30066** Oval Air Element



**Fits:** Caterpillar CT660 Truck  
**Replaces:** Caterpillar 3903433  
**O.D.:** 16 3/8 (415.9)  
 to 21 3/4 (552.4)  
**I.D.:** 7 5/32 (181.8) & 12 7/16 (315.9)  
**Height:** 7 23/32 (196.1)

**PA30067** Air Element with Foam Wrap



**Fits:** Quincy Compressors  
**Replaces:** Quincy 127357E004  
**O.D.:** 8 1/4 (209.6)  
**I.D.:** 4 9/16 (115.9)  
**Height:** 9 5/8 (244.5)

**PA30068** Air Element



**Fits:** Cub Cadet Lawn Tractor  
**Replaces:** Donaldson P131321  
**O.D.:** 4 1/16 (103.2)  
 Flange 5 9/32 (134.1)  
**I.D.:** 1/4 (6.4) & 1 15/32 (37.3)  
**Height:** 6 1/32 (153.2)  
**A. Gskt:** [1] Included  
**F. Gskt:** [1] Wing Nut

**PA30069** Conical-Shaped Air Element



**Fits:** Caterpillar Marine Engines  
**Replaces:** Caterpillar 2076870  
**O.D.:** 7 1/4 (184.2)  
 to 12 1/4 (311.2)  
**I.D.:** 10 1/8 (257.2) One End  
**Height:** 15 (381.0)

Measurements Are Shown In Inches And (Millimeters)

**WARNING:** These products can expose you to chemicals, including Diisononyl Phthalate, Carbon black extracts, Nickel, 1,3 Butadiene, Ethylene Oxide, Epichlorohydrin, which are known to the State of California to cause cancer, and Bisphenol, Ethylene Glycol, Ethylene Oxide, 1,3 Butadiene, Epichlorohydrin, which are known to the State of California to cause birth defects or other reproductive harm.

<p><b>PA30070</b> Wire Mesh Supported Air Element  <b>Fits:</b> Caterpillar Marine Engines  <b>Replaces:</b> Caterpillar 1777375  <b>O.D.:</b> 8 25/32 (223.0)  <b>I.D.:</b> 7 7/16 (188.9) One End  <b>Height:</b> 10 11/32 (262.7)</p> 	<p><b>RS30077</b> Radial Seal Outer Air Element  <b>Fits:</b> Dynapac CC122, CC122C Rollers  <b>Use With:</b> RS30078  <b>Replaces:</b> Dynapac 380295; Donaldson P782299  <b>O.D.:</b> 5 1/32 (127.8)  <b>I.D.:</b> 3 5/32 (80.2) One End  <b>Height:</b> 9 23/32 (246.9)</p> 
<p><b>CA30071</b> Channel Flow Primary Air Element  <b>Fits:</b> Caterpillar, Claas Equipment  <b>Use With:</b> PA30072  <b>Replaces:</b> Caterpillar 2525001; Claas 1094005  <b>O.D.:</b> 9 1/16 (230.2) to 11 11/16 (296.9)  <b>Height:</b> 7 3/4 (196.9)  <b>A. Gskt:</b> [1] Attached</p> 	<p><b>RS30078</b> Radial Seal Inner Air Element  <b>Fits Inside:</b> RS30077  <b>Fits:</b> Dynapac CC122, CC122C Rollers  <b>Replaces:</b> Dynapac 380294; Donaldson P782300  <b>O.D.:</b> 3 5/16 (84.1)  <b>I.D.:</b> 2 3/8 (60.3) One End  <b>Height:</b> 9 3/32 (231.0)</p> 
<p><b>PA30072</b> Secondary Air Element  <b>Fits:</b> Caterpillar, Claas Equipment  <b>Use With:</b> CA30071  <b>Replaces:</b> Caterpillar 2525002  <b>O.D.:</b> 8 1/4 (209.6) to 10 7/8 (276.2)  <b>Height:</b> 1 11/16 (42.9)</p> 	<p><b>CA30079</b> Channel Flow Air Element  <b>Fits:</b> McCormick Tractors; New Holland Loaders; Skyjack Telehandlers  <b>Replaces:</b> Donaldson P608675  <b>O.D.:</b> 5 1/8 (130.2) to 12 7/8 (327.0)  <b>Height:</b> 11 5/16 (287.3)</p> 
<p><b>PA30073</b> Air Element in Disposable Housing  <b>Notes:</b> Inside-Out Flow Direction  <b>Contains:</b> Bleed Valve  <b>Fits:</b> Various Buses, Equipment and Trucks with Farr ECO-Style Air Filters  <b>Replaces:</b> Farr 94973007  <b>O.D.:</b> 11 (279.4)  <b>Inlet:</b> 6 7/8  <b>Height:</b> 19 3/4 (501.7)</p> 	<p><b>PA30080</b> Cab Air Element with Pull Ring  <b>Fits:</b> Caterpillar Equipment  <b>Replaces:</b> Caterpillar 1858154; Donaldson P616850  <b>Length:</b> 9 21/32 (245.3)  <b>Width:</b> 5 5/16 (134.9)  <b>Height:</b> 25/32 (19.8)</p> 
<p><b>PA30074</b> Dynacell Panel Air Element  <b>Fits:</b> Railroad and Marine Applications  <b>Length:</b> 29 1/2 (749.3)  <b>Width:</b> 19 (482.6)  <b>Height:</b> 5 (127.0)</p> 	<p><b>PA30081</b> Cab Air Element  <b>Notes:</b> Two filters hinged together.  <b>Fits:</b> Kobelco, New Holland Excavators  <b>Replaces:</b> New Holland YN50V01014P1P, YN50V01014P1  <b>Length:</b> 18 29/32 (480.2)  <b>Width:</b> 4 7/8 (123.8)  <b>Height:</b> 19/32 (15.1)  <b>A. Gskt:</b> [1] Attached Each Element</p> 
<p><b>PA30075</b> Wire Mesh Supported Air Element  <b>Fits:</b> Caterpillar Marine Engines  <b>Replaces:</b> Caterpillar 2436350  <b>O.D.:</b> 8 7/16 (214.3)  <b>I.D.:</b> 6 1/2 (165.1) One End  <b>Height:</b> 7 (177.8)</p> 	<p><b>PA30086</b> Panel Air Element  <b>Notes:</b> For air conditioning.  <b>Fits:</b> John Deere Equipment  <b>Replaces:</b> John Deere RE198488  <b>Length:</b> 15 1/4 (387.3)  <b>Width:</b> 4 29/32 (124.6)  <b>Height:</b> 1 7/32 (31.0)</p> 
<p><b>PA30076</b> Conical-Shaped Air Element  <b>Fits:</b> Caterpillar 3412, 3412B, 3412E Marine Engines  <b>Replaces:</b> Caterpillar 610384  <b>O.D.:</b> 7 (177.8) to 8 3/4 (222.3)  <b>I.D.:</b> 5 3/4 (146.0) &amp; 7 1/2 (190.5)  <b>Height:</b> 12 (304.8)</p> 	<p><b>RS30087</b> Radial Seal Outer Air Element  <b>Fits:</b> Hammel Red Giant Shredder with Caterpillar C18 Engine  <b>Use With:</b> RS30088  <b>Replaces:</b> Donaldson P785394, X770688  <b>O.D.:</b> 14 (355.6)  <b>I.D.:</b> 9 (228.6) One End  <b>Height:</b> 25 (635.0)</p> 

Measurements Are Shown In Inches And (Millimeters)

**WARNING:** These products can expose you to chemicals, including Diisononyl Phthalate, Carbon black extracts, Nickel, 1,3 Butadiene, Ethylene Oxide, Epichlorohydrin, which are known to the State of California to cause cancer, and Bisphenol, Ethylene Glycol, Ethylene Oxide, 1,3 Butadiene, Epichlorohydrin, which are known to the State of California to cause birth defects or other reproductive harm.



**RS30088**

Radial Seal Inner Air Element



**Fits Inside:** RS30087  
**Fits:** Hammel Red Giant Shredder with Caterpillar C18 Engine  
**Replaces:** Donaldson P785395, X770688  
**O.D.:** 8 23/32 (221.5)  
**I.D.:** 7 1/32 (178.6) One End  
**Height:** 22 31/32 (583.4)

**PA30095**

Oval Air Element



**Fits:** Challenger, Massey Ferguson Tractors  
**Replaces:** Massey Ferguson 4375638M1  
**O.D.:** 7 15/16 (201.6) to 11 1/4 (285.8)  
**I.D.:** 1 9/16 (39.7) & 4 3/8 (111.1) to  
**Height:** 8 1/16 (204.8)

**RS30090-FN**

Radial Seal Outer Air Element with Fins



**Fits:** International 4900 Series Trucks with HT570 Engine, 7400 WorkStar with DT466, MaxxForce DT, MaxxForce 9 Engines, 7500 WorkStar with HT530, MaxxForce 10 Engines  
**Replaces:** International 3532801C1  
**O.D.:** 10 1/4 (260.3)  
 Fins 12 (304.8)  
**I.D.:** 6 1/2 (165.1)  
**Height:** 15 7/8 (403.2)  
**Related To:** RS4636 (without Fins)

**PA30096**

Cab Air Element with Pull Tabs



**Fits:** Case, Link-Belt Excavators  
**Replaces:** Case KHR13330  
**Length:** 9 1/2 (241.3)  
**Width:** 7 (177.8)  
**Height:** 1 3/32 (27.8)  
**A. Gskt:** [1] Attached

**RS30091**

Radial Seal Outer Air Element



**Fits:** Fendt Tractors  
**Use With:** RS30092  
**Replaces:** Fendt H916201091050; Donaldson P783400; Fleetguard AF26205  
**O.D.:** 10 31/32 (278.6)  
**I.D.:** 5 13/16 (147.6) One End  
**Height:** 18 3/16 (462.0)

**PA30098**

Cab Air Element



**Fits:** Caterpillar Pipelayers  
**Replaces:** Caterpillar 2894225  
**Length:** 16 17/32 (419.9)  
**Width:** 5 (127.0)  
**Height:** 1 3/16 (30.2)  
**A. Gskt:** [1] Attached

**RS30099**

Radial Seal Oval Air Element



**Fits:** Kohler Engines  
**Replaces:** Kohler 6208304S  
**O.D.:** 5 9/16 (141.3)  
**I.D.:** 3 1/4 (82.6) One End  
**Height:** 8 5/8 (219.1)

**RS30092**

Radial Seal Inner Air Element



**Fits Inside:** RS30091  
**Fits:** Fendt Tractors  
**Replaces:** Fendt H916201091060; Donaldson P783401; Fleetguard AF26206  
**O.D.:** 5 29/32 (150.0)  
**I.D.:** 4 7/16 (112.7) One End  
**Height:** 17 1/8 (435.0)

**PA30100**

Inner Air Element



**Fits Inside:** PA30101  
**Fits:** Gehl Excavators; Wacker/Wacker Neuson Excavators, Wheel Dumpers  
**Replaces:** J.C. Bamford 16546LC50A; Kubota K3271-82240; Nissan 16546LC50A  
**O.D.:** 2 1/8 (54.0)  
**I.D.:** 1 11/16 (42.9) One End  
**Height:** 7 3/16 (182.6)

**PA30093**

Cab Air Element



**Fits:** Kenworth T680, Peterbilt 579 Truck  
**Replaces:** Peterbilt X1987001  
**Length:** 8 15/16 (227.0)  
**Width:** 7 7/8 (200.0)  
**Height:** 1 3/16 (30.2)

**PA30101**

Outer Air Element



**Fits:** Gehl Excavators; Wacker/Wacker Neuson Excavators, Wheel Dumpers  
**Use With:** PA30100  
**Replaces:** J.C. Bamford 32/925742; Kubota K3271-82240; Nissan 16546LC50A  
**O.D.:** 3 5/8 (92.1)  
**I.D.:** 2 5/16 (58.7) One End  
**Height:** 7 1/16 (179.4)

**PA30094**

Cab Air Element



**Fits:** Case, Link-Belt Excavators  
**Replaces:** Case KHR13340, MMR80030  
**Length:** 8 7/8 (225.4)  
**Width:** 6 27/32 (173.8)  
**Height:** 1 5/16 (33.3)  
**A. Gskt:** [1] Attached

**CA30102**

Channel Flow EXO Air Element



**Fits:** Kenworth Trucks  
**Replaces:** Paccar P611698  
**O.D.:** 11 3/8 (288.9) to 18 23/32 (475.5)  
**Height:** 6 1/2 (165.1)  
**A. Gskt:** [1] Attached

Measurements Are Shown In Inches And (Millimeters)

**WARNING:** These products can expose you to chemicals, including Diisononyl Phthalate, Carbon black extracts, Nickel, 1,3 Butadiene, Ethylene Oxide, Epichlorohydrin, which are known to the State of California to cause cancer, and Bisphenol, Ethylene Glycol, Ethylene Oxide, 1,3 Butadiene, Epichlorohydrin, which are known to the State of California to cause birth defects or other reproductive harm.

**CA30103**

Channel Flow EXO Air Element



**Fits:** Mercedes-Benz Actros II, Antos, Arocs European Trucks  
**Replaces:** Mercedes-Benz 40946904, A0040946904; Donaldson DBA3745  
**O.D.:** 7 3/8 (187.3)  
 to 18 7/16 (468.3)  
**Height:** 8 27/32 (224.6)  
**A. Gskt:** [1] Attached  
**O.D. Flange:** 8 7/32 to 19 3/8  
**Related To:** CA30104 (Tall Version)  
 CA30105 (Short Version)

**CA30104**

Channel Flow EXO Air Element



**Fits:** Mercedes-Benz Actros II, Antos, Arocs European Trucks  
**Replaces:** Mercedes-Benz 40946804, A0040946804; Donaldson DBA3746  
**O.D.:** 7 3/8 (187.3)  
 to 18 7/16 (468.3)  
**Height:** 10 1/4 (260.3)  
**A. Gskt:** [1] Attached  
**O.D. Flange:** 8 7/32 to 19 3/8  
**Related To:** CA30103  
 CA30105 (Short Versions)

**CA30105**

Channel Flow EXO Air Element



**Fits:** Mercedes-Benz Actros II, Antos, Arocs European Trucks  
**Replaces:** Mercedes-Benz A0040947204, 40947204; Mann & Hummel CP49001  
**O.D.:** 7 3/8 (187.3)  
 To 18 7/16 (468.3)  
**Height:** 7 5/8 (193.7)  
**A. Gskt:** [1] Included  
**O.D. Flange:** 8 7/32 to 19 3/8  
**Related To:** CA30104 (Tall Version)  
 CA30103 (Short Version)

**RS30106**

Radial Seal Cab Air Element



**Fits:** Fendt Tractors  
**Replaces:** Fendt H931812140600  
**O.D.:** 6 3/8 (161.9)  
**I.D.:** 3 23/32 (94.5) One End  
**Height:** 11 3/4 (298.5)

**PA30107**

Foam Cab Air Element



**Fits:** Peterbilt 579 Trucks with Cummins ISX, Paccar MX Series Engines  
**Replaces:** Peterbilt W2084001  
**Length:** 10 7/16 (265.1)  
**Width:** 6 1/2 (165.1)  
**Height:** 3/8 (9.5)

**PA30108**

Inner Air Element



**Fits Inside:** PA30109  
**Fits:** Daewoo, Terex Excavators; Doosan Loaders  
**Replaces:** Daewoo 24749057; Donaldson P902312  
**O.D.:** 6 3/8 (161.9)  
**I.D.:** 21/32 (16.7) & 5 9/32 (134.1)  
**Height:** 17 25/32 (451.6)  
**A. Gskt:** [1] Attached

**PA30109**

Outer Air Element



**Fits:** Daewoo, Terex Excavators; Doosan Loaders  
**Use With:** PA30108  
**Replaces:** Daewoo 24749051; Donaldson P902311  
**O.D.:** 10 27/32 (275.4)  
**I.D.:** 21/32 (16.7) & 6 17/32 (165.9)  
**Height:** 19 7/16 (493.7)  
**A. Gskt:** [1] Attached

**PA30110**

Cab Air Element

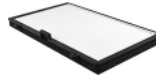

**Fits:** Case, Hyundai Loaders  
**Replaces:** Hyundai 71LB00290  
**Length:** 11 9/16 (293.7)  
**Width:** 6 31/32 (177.0)  
**Height:** 31/32 (24.6)  
**A. Gskt:** [1] Attached

**RS30112**

Radial Seal Air Element



**Fits:** Hino Trucks  
**Replaces:** Hino 17801E0130  
**O.D.:** 12 9/32 (311.9)  
**I.D.:** 6 31/32 (177.0) One End  
**Height:** 16 1/2 (419.1)

**PA30113**

Pre-Filter Cab Air Element



**Fits:** R.V.I., Volvo Trucks, Vans with Volvo D11K, D13C, D13K, D16G, D16K Engines  
**Replaces:** Renault 7482379897; Volvo 82354791  
**Length:** 10 23/32 (272.3)  
**Width:** 7 23/32 (196.1)  
**Height:** 25/32 (19.8)

**PA30114**

Cab Air Element



**Fits:** Volvo European Trucks, Vans  
**Replaces:** Renault 7482348995; Volvo 82348995  
**Length:** 11 7/8 (301.6)  
**Width:** 7 29/32 (200.8)  
**Height:** 1 1/4 (31.8)  
**O-Ring:** [1] Included

**PA30115**

Cab Air Element



**Fits:** Case Excavators  
**Replaces:** Case KHR27540  
**Length:** 7 29/32 (200.8)  
**Width:** 7 3/16 (182.6)  
**Height:** 21/32 (16.7)

**RS30116**

Radial Seal Outer Air Element



**Fits:** R.V.I. Trucks  
**Replaces:** Renault 5001865725; Donaldson P785530  
**O.D.:** 12 3/16 (309.6)  
**I.D.:** 6 31/32 (177.0) One End  
**Height:** 21 7/8 (555.6)

Measurements Are Shown In Inches And (Millimeters)

**WARNING:** These products can expose you to chemicals, including Diisononyl Phthalate, Carbon black extracts, Nickel, 1,3 Butadiene, Ethylene Oxide, Epichlorohydrin, which are known to the State of California to cause cancer, and Bisphenol, Ethylene Glycol, Ethylene Oxide, 1,3 Butadiene, Epichlorohydrin, which are known to the State of California to cause birth defects or other reproductive harm.

**PA30117** Set of 2 Cab Air Elements  
**Notes:** Requires 2 filters per application.  
**Fits:** John Deere Harvesters, Tractors  
**Replaces:** John Deere L155288  
**Each Filter:**  
**Length:** 8 7/32 (208.8)  
**Width:** 5 23/32 (145.3)  
**Height:** 7/8 (22.2)  
**A. Gskt:** [1] Attached Each Filter



**PA30118** Primary Air Element  
**Fits:** Wirtgen SP15, SP15i Slipform Pavers  
**Use With:** PA30119  
**Replaces:** Atlas-Weyhausen 8049126; Bomag 5821494; Sullair 274256; Wirtgen 2142670  
**O.D.:** 5 7/16 (138.1) to 10 1/4 (260.3)  
**I.D.:** 1 1/16 (27.0) & 4 13/16 (122.2) to  
**Height:** 6 11/16 (169.9)



**PA30119** Secondary Air Element  
**Fits:** Wirtgen SP15, SP15i Slipform Pavers  
**Use With:** PA30118  
**Replaces:** Atlas-Weyhausen 8049127; Bomag 5821495; Sullair 274381; Wirtgen 2142671  
**O.D.:** 5 5/8 (142.9) to 9 (228.6)  
**Height:** 1 9/16 (39.7)



**RS30120** Radial Seal Inner Air Element  
**Fits Inside:** RS30121  
**Fits:** Case, Case-International, New Holland Tractors  
**Replaces:** Case 87517153; J.C. Bamford 32/926032  
**O.D.:** 5 3/4 (146.0)  
**I.D.:** 4 7/8 (123.8) One End  
**Height:** 10 (254.0)



**RS30121** Radial Seal Outer Air Element  
**Fits:** Case, Case-International, New Holland Tractors  
**Use With:** RS30120  
**Replaces:** Case 87517154; J.C. Bamford 32/926031  
**O.D.:** 10 7/8 (276.2)  
**I.D.:** 5 3/4 (146.0) One End  
**Height:** 12 1/4 (311.2)



**PA30122** Panel Air Element  
**Fits:** Mercedes-Benz Trucks  
**Replaces:** Mercedes-Benz A9608300018  
**Length:** 12 5/16 (312.7)  
**Width:** 8 27/32 (224.6)  
**Height:** 1 7/16 (36.5)



**PA30123** Cab Air Element  
**Fits:** Mercedes-Benz Trucks  
**Replaces:** Mercedes-Benz A9608300118  
**Length:** 12 5/16 (312.7)  
**Width:** 8 27/32 (224.6)  
**Height:** 1 7/16 (36.5)



**PA30124** Panel Air Element  
**Fits:** Mercedes-Benz Trucks  
**Replaces:** Mercedes-Benz 9608300218, A9608300218  
**Length:** 12 5/16 (312.7)  
**Width:** 8 27/32 (224.6)  
**Height:** 1 7/16 (36.5)



**PA30125** Air Element  
**Fits:** Scania Stationary and Marine Engines  
**Replaces:** Scania 1332341; Donaldson B125011; Fleetguard AH8513  
**O.D.:** 12 19/32 (319.9)  
**I.D.:** 5 (127.0) One End  
**Height:** 10 5/16 (261.9)



**PA30126** Cab Air Element  
**Fits:** Case-International, New Holland Harvesters, Windrowers  
**Replaces:** Case 84058793  
**Length:** 20 5/32 (512.0)  
**Width:** 6 7/8 (174.6)  
**Height:** 1 15/32 (37.3)



**PA30127** Cab Air Element with Pull Tab  
**Fits:** Bobcat Utility Vehicles  
**Replaces:** Bobcat 6693221  
**Length:** 11 7/32 (285.0)  
**Width:** 7 (177.8)  
**Height:** 29/32 (23.0)  
**A. Gskt:** [2] Attached



**RS30128** Radial Seal Outer Air Element  
**Fits:** Donaldson Housings  
**Use With:** RS30129  
**Replaces:** Donaldson P786197, X770683; Atlas Copco 3222188161  
**O.D.:** 14 (355.6)  
**I.D.:** 9 (228.6) One End  
**Height:** 19 7/16 (493.7)



**RS30129** Radial Seal Inner Air Element  
**Fits Inside:** RS30128  
**Fits:** Donaldson Housings  
**Replaces:** Donaldson P786198, X770683  
**O.D.:** 9 1/32 (229.4)  
**I.D.:** 7 1/32 (178.6) One End  
**Height:** 17 7/16 (442.9)



**RS30130** Radial Seal Outer Air Element  
**Fits:** Mercedes-Benz Latin American Buses, South American Buses, Trucks, Vans  
**Use With:** RS5676  
**Replaces:** Agco 6211381M1; Mercedes-Benz 3760948204, A3760948204  
**O.D.:** 10 7/16 (265.1)  
**I.D.:** 5 5/8 (142.9) One End  
**Height:** 17 1/4 (438.2)



Measurements Are Shown In Inches And (Millimeters)

**WARNING:** These products can expose you to chemicals, including Diisononyl Phthalate, Carbon black extracts, Nickel, 1,3 Butadiene, Ethylene Oxide, Epichlorohydrin, which are known to the State of California to cause cancer, and Bisphenol, Ethylene Glycol, Ethylene Oxide, 1,3 Butadiene, Epichlorohydrin, which are known to the State of California to cause birth defects or other reproductive harm.

**CA30131** Channel Flow EXO Air Element  
**Contains:** Three Bolts Included  
**Fits:** Freightliner Trucks with Cummins Engines  
**Replaces:** Donaldson P621097; Freightliner P621097  
**O.D.:** 12 1/16 (306.4)  
**Flange:** 14 27/32 (377.0)  
**Height:** 8 3/32 (205.6)  
**A. Gskt:** [1] Included



**CA30132** Channel Flow EXO Air Element  
**Contains:** Four Bolts Included  
**Fits:** Freightliner 114SD; Western Star 4700 Trucks with Cummins and Detroit Diesel Engines  
**Replaces:** Freightliner P619498; Western Star Truck P619498; Donaldson P634517  
**O.D.:** 12 1/16 (306.4)  
**Flange:** 14 27/32 (377.0)  
**Height:** 10 (254.0)  
**A. Gskt:** [1] Included



**RS30133** Radial Seal Outer Air Element  
**Fits:** Blue Bird All American School Buses with Cummins ISB, ISC Engines  
**Use With:** RS30134  
**Replaces:** Blue Bird 10013632; Racor 500375001, 500375001BB  
**O.D.:** 12 3/8 (314.3)  
**I.D.:** 7 11/16 (195.3) One End  
**Height:** 20 5/8 (523.9)



**RS30134** Radial Seal Inner Air Element  
**Fits Inside:** RS30133  
**Fits:** Blue Bird All American School Buses with Cummins ISB, ISC Engines  
**Replaces:** Blue Bird 10013633; Farr 500443001  
**O.D.:** 7 3/16 (182.6)  
**I.D.:** 4 13/16 (122.2) One End  
**Height:** 20 1/2 (520.7)



**RS30135** Radial Seal Outer Air Element  
**Fits:** Atlas Copco Drilling Equipment  
**Use With:** RS30136  
**Replaces:** Atlas Copco 3222188151; Donaldson P785590  
**O.D.:** 12 1/8 (308.0)  
**I.D.:** 7 (177.8) One End  
**Height:** 20 5/8 (523.9)



**RS30136** Radial Seal Inner Air Element  
**Fits Inside:** RS30135  
**Fits:** Atlas Copco Drilling Equipment  
**Replaces:** Atlas Copco 3222188154  
**O.D.:** 7 1/16 (179.4)  
**I.D.:** 5 3/4 (146.0) One End  
**Height:** 18 13/32 (467.5)



**PA30137** Cab Air Element  
**Fits:** Caterpillar Excavators, Material Handlers  
**Replaces:** Caterpillar 2931184  
**Length:** 23 3/16 (589.0)  
**Width:** 4 1/2 (114.3)  
**Height:** 7/8 (22.2)



**PA30138** Panel Air Element  
**Fits:** Industrial Applications  
**Replaces:** Airguard DP40-217; Farr 49880008  
**Length:** 19 1/2 (495.3)  
**Width:** 9 1/2 (241.3)  
**Height:** 1 3/4 (44.4)

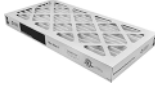

**PA30139** Panel Air Element  
**Fits:** Industrial Applications  
**Replaces:** CLC Air DP40-220; Farr 049880007, 49880007  
**Length:** 19 1/2 (495.3)  
**Width:** 11 1/2 (292.1)  
**Height:** 1 3/4 (44.4)



**PA30140** Cab Air Element with Pull Tab  
**Fits:** Peterbilt 388 with Cummins ISX (11.9L), (15.0L), Paccar MX Engines  
**Replaces:** Peterbilt 5S014010; Donaldson P629015  
**Length:** 10 1/32 (254.8)  
**Width:** 7 15/16 (201.6)  
**Height:** 1 7/32 (31.0)



**PA30141** Cab Air Element with Pull Tab  
**Fits:** Case Excavators  
**Replaces:** Case KHR27260; New Holland KRH27260  
**Length:** 9 1/4 (235.0)  
**Width:** 7 7/32 (183.4)  
**Height:** 1 13/32 (35.7)



**RS30142** Radial Seal Air Element  
**Notes:** Must use RS30142 KIT on first installation.  
**Fits:** Scania Trucks  
**Replaces:** Scania 1869993, 1869995  
**O.D.:** 11 15/16 (303.2)  
**I.D.:** 6 19/32 (167.5) One End  
**Height:** 18 1/8 (460.4)  
**Related To:** RS30142 KIT (with Lid)



**RS30142 KIT** Radial Seal Air Element with Lid  
**Notes:** Element only is RS30142  
**Fits:** Scania Trucks  
**Replaces:** Scania 1868883, 1869995; Baldwin RS5542  
**O.D.:** 11 15/16 (303.2)  
**Lid:** 14 3/8 (365.1)  
**I.D.:** 6 19/32 (167.5) One End  
**Height:** 18 1/8 (460.4)



**RS30143** Radial Seal Air Element  
**Notes:** Must use RS30143 KIT (with Lid) on first installation.  
**Contains:** Flame Retardant Media  
**Fits:** Scania Trucks  
**Replaces:** Scania 1728817, 1869992, 1869994; Baldwin RS5671; Donaldson P785519  
**O.D.:** 11 29/32 (302.4)  
**I.D.:** 6 5/8 (168.3) One End  
**Height:** 21 9/32 (540.5)



Measurements Are Shown In Inches And (Millimeters)

**WARNING:** These products can expose you to chemicals, including Diisononyl Phthalate, Carbon black extracts, Nickel, 1,3 Butadiene, Ethylene Oxide, Epichlorohydrin, which are known to the State of California to cause cancer, and Bisphenol, Ethylene Glycol, Ethylene Oxide, 1,3 Butadiene, Epichlorohydrin, which are known to the State of California to cause birth defects or other reproductive harm.

### RS30143 KIT



**Radial Seal Air Element with Lid**  
**Notes:** Element only is RS30143.  
**Contains:** Flame Retardant Media  
**Fits:** Scania Trucks  
**Replaces:** Scania 1728817, 1869992, 1869994;  
 Baldwin RS5671; Donaldson P785519  
**O.D.:** 11 29/32 (302.4)  
**Lid** 15 1/8 (384.2)  
**I.D.:** 6 5/8 (168.3) One End  
**Height:** 21 9/32 (540.5)

### PA30144



**Panel Air Element**  
**Fits:** Wacker Vibratory Rammers  
**Replaces:** Wacker 157193  
**Length:** 6 5/8 (168.3)  
**Width:** 3 3/4 (95.3)  
**Height:** 2 1/8 (54.0)

### PA30145



**Outer Air Element**  
**Fits:** Hyundai R360LC-7A, R450LC-7  
 Excavators, HL770, HL770-7 Loaders, all with  
 Cummins Engines  
**Use With:** PA30146  
**Replaces:** Hyundai 11NB20120, 11NB20120A,  
 14L101560; Fleetguard AF26664  
**O.D.:** 12 3/32 (307.2)  
**I.D.:** 15/16 (23.8) & 7 11/16 (195.3)  
**Height:** 21 25/32 (553.2)  
**A. Gskt:** [1] Attached

### PA30146



**Inner Air Element**  
**Fits Inside:** PA30145  
**Fits:** Hyundai R360LC-7A, R450LC-7  
 Excavators, HL770, HL770-7 Loaders, all with  
 Cummins Engines  
**Replaces:** Hyundai 11NB20130, 14L101570;  
 Fleetguard AF27843  
**O.D.:** 7 5/8 (193.7)  
**I.D.:** 5/8 (15.9) & 6 1/16 (154.0)  
**Height:** 21 (533.4)  
**A. Gskt:** [1] Attached

### RS30147



**Radial Seal Air Element**  
**Fits:** JLG 450AJ, 460SJ, 3394RT, 4394RT  
 Aerial Lifts with Deutz D2.9L4 Engine  
**Replaces:** JLG 70003937  
**O.D.:** 4 1/8 (104.8)  
**I.D.:** 2 5/16 (58.7) One End  
**Height:** 11 21/32 (296.1)  
**I.Gskt:** [1] Attached

### PA30148



**Cab Air Element with Pull Tab**  
**Fits:** Komatsu Graders  
**Replaces:** Komatsu 23B8099310  
**Length:** 8 3/16 (208.0)  
**Width:** 4 9/16 (115.9)  
**Height:** 19/32 (15.1)  
**A. Gskt:** [1] Attached

### PA30149

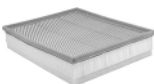

**Panel Air Element with Foam Pad**  
**Fits:** 10/2001-7/2004 Renault Mascott 110 DCI,  
 130 DCI, 150 DCI with DCI 2.8 Engine  
**Replaces:** Renault 5001847123, 5010317300,  
 7702295409  
**Length:** 12 15/32 (316.7)  
**Width:** 10 9/32 (261.1)  
**Height:** 2 17/32 (64.3)

### PA30150



**Cab Air Element**  
**Fits:** Komatsu Excavators  
**Replaces:** Komatsu 2A59791551  
**Length:** 8 11/32 (211.9)  
**Width:** 7 5/8 (193.7)  
**Height:** 1 3/32 (27.8)  
**A. Gskt:** [1] Attached

### PA30151



**Cab Air Element with Pull Tab**  
**Fits:** Kobelco, New Holland Excavators  
**Replaces:** New Holland LQ50V01008P1  
**Length:** 9 7/16 (239.7)  
**Width:** 7 11/16 (195.3)  
**Height:** 1 17/32 (38.9)

### PA30152



**Cab Air Element**  
**Fits:** Komatsu Excavators  
**Replaces:** Komatsu 2089797740; Hifi/Jura  
 Filtration SC80012; Sakura CA56080  
**Length:** 7 25/32 (197.6)  
**Width:** 4 1/32 (102.4)  
**Height:** 3/4 (19.0)

### PA30153



**Breather Filter**  
**Fits:** Volvo Excavators, Loaders  
**Replaces:** Volvo 4361204  
**O.D.:** 3 5/32 (80.2)  
**Height:** 2 29/32 (73.8)

### PA30154



**Foam Cab Air Element**  
**Fits:** Caterpillar Backhoe/Loaders  
**Replaces:** Caterpillar 2067514; Fleetguard  
 AF55756  
**Length:** 8 15/16 (227.0)  
**Width:** 2 1/2 (63.5)  
**Height:** 3/4 (19.0)

### PA30155



**Foam Cab Air Element**  
**Fits:** Mercedes/Evobus Citaro  
**Replaces:** Mercedes-Benz 18353447; Mann &  
 Hummel CU481110  
**Length:** 18 11/32 (465.9)  
**Width:** 8 31/32 (227.8)  
**Height:** 25/32 (19.8)

### PA30156

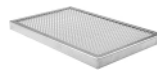

**Cab Air Element**  
**Fits:** Dressa, Komatsu Dozers  
**Replaces:** Komatsu 4270722130  
**Length:** 11 13/16 (300.0)  
**Width:** 7 17/32 (191.3)  
**Height:** 25/32 (19.8)













### PA30157

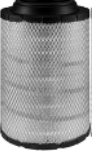

**Hydraulic Tank Breather**  
**Fits:** Komatsu Excavators, Loaders  
**Replaces:** Komatsu 4236035460  
**O.D.:** 1 31/32 (50.0)  
**I.D.:** 1 13/32 (35.7)  
**Height:** 19/32 (15.1)

Measurements Are Shown In Inches And (Millimeters)

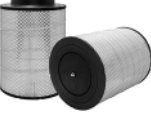
**WARNING:** These products can expose you to chemicals, including Diisononyl Phthalate, Carbon black extracts, Nickel, 1,3 Butadiene, Ethylene Oxide, Epichlorohydrin, which are known to the State of California to cause cancer, and Bisphenol, Ethylene Glycol, Ethylene Oxide, 1,3 Butadiene, Epichlorohydrin, which are known to the State of California to cause birth defects or other reproductive harm.

<p><b>PA30158</b></p> 	<p>Air Element <b>Fits:</b> Donaldson Housings <b>Replaces:</b> Donaldson B105002 <b>O.D.:</b> 10 1/2 (266.7) <b>I.D.:</b> 5 (127.0) One End <b>Height:</b> 15 (381.0)</p>	<p><b>PA30164</b> Panel Air Element with Pull Tabs <b>Fits:</b> Komatsu Dozers <b>Replaces:</b> Komatsu 12Y9791181 <b>Length:</b> 26 1/16 (662.0) <b>Width:</b> 2 1/2 (63.5) <b>Height:</b> 19/32 (15.1) <b>A. Gskt:</b> [1] Included</p> 
<p><b>RS30159</b></p> 	<p>Radial Seal Outer Air Element <b>Fits:</b> Hitachi, John Deere Equipment <b>Use With:</b> RS30160 <b>Replaces:</b> Hitachi 4700940; John Deere AXE42066; Donaldson P608116 <b>O.D.:</b> 9 9/16 (242.9) Flange 12 3/16 (309.6) <b>I.D.:</b> 7 1/4 (184.2) One End <b>Height:</b> 20 3/8 (517.5)</p>	<p><b>PA30165</b> Foam Cab Air Element <b>Fits:</b> Freightliner Cascadia Evolution <b>Replaces:</b> Freightliner VCCT1000906J; Donaldson P628394 <b>Length:</b> 9 1/32 (229.4) <b>Width:</b> 5 1/32 (127.8) <b>Height:</b> 1/4 (6.4)</p> 
<p><b>RS30160</b></p> 	<p>Radial Seal Inner Air Element <b>Fits Inside:</b> RS30159 <b>Fits:</b> Hitachi, John Deere Equipment <b>Replaces:</b> Donaldson P608391 <b>O.D.:</b> 5 15/16 (150.8) <b>I.D.:</b> 4 9/32 (108.7) One End <b>Height:</b> 19 21/32 (499.3)</p>	<p><b>PA30166</b> Foam Cab Air Element <b>Fits:</b> Freightliner Cascadia Evolution <b>Replaces:</b> Freightliner VCCT1000917R; Donaldson P628395 <b>Length:</b> 9 17/32 (242.1) <b>Width:</b> 6 23/32 (170.7) <b>Height:</b> 1/4 (6.4)</p> 
<p><b>RS30161</b></p> 	<p>Radial Seal Outer Air Element <b>Fits:</b> John Deere Equipment <b>Use With:</b> RS30162 <b>Replaces:</b> John Deere AN221846; Donaldson P611539 <b>O.D.:</b> 8 1/4 (209.6) Flange 9 31/32 (253.2) <b>I.D.:</b> 5 23/32 (145.3) One End <b>Height:</b> 18 7/8 (479.4)</p>	<p><b>RS30168</b> Radial Seal Outer Air Element <b>Fits:</b> Liebherr-Mobilkrane LTM 1130-5.1 Mobile Cranes <b>Use With:</b> RS30169 <b>Replaces:</b> Hitachi 59004010; Liebherr 10278553; Mann &amp; Hummel C23632/1; Tada 99707015285 <b>O.D.:</b> 8 7/8 (225.4) <b>I.D.:</b> 4 15/16 (125.4) One End <b>Height:</b> 14 (355.6)</p> 
<p><b>RS30162</b></p> 	<p>Radial Seal Inner Air Element <b>Fits Inside:</b> RS30161 <b>Replaces:</b> John Deere Equipment <b>O.D.:</b> 5 5/16 (134.9) <b>I.D.:</b> 3 11/16 (93.7) One End <b>Height:</b> 17 7/16 (442.9)</p>	<p><b>RS30169</b> Radial Seal Inner Air Element <b>Fits Inside:</b> RS30168 <b>Fits:</b> Liebherr-Mobilkrane LTM 1130-5.1 Mobile Cranes <b>Replaces:</b> Mann &amp; Hummel CF1250 <b>O.D.:</b> 4 1/4 (108.0) <b>I.D.:</b> 3 9/16 (90.5) One End <b>Height:</b> 13 1/4 (336.5)</p> 
<p><b>PA30163</b></p> 	<p>Conical-Shaped Inner Air Element <b>Fits Inside:</b> PA5584 <b>Fits:</b> Hyster, Yale Equipment <b>Replaces:</b> Donaldson P603729 <b>O.D.:</b> 1 5/16 (33.3) Flange 2 5/8 (66.7) <b>I.D.:</b> 1 3/4 (44.4) One End <b>Height:</b> 10 1/4 (260.3)</p>	<p><b>PA30170</b> Air Element <b>Contains:</b> Threaded Stud <b>Fits:</b> M.T.U. Diesel Engines <b>Replaces:</b> M.T.U. 180945802; Donaldson B120472; Fleetguard AH24332 <b>O.D.:</b> 12 19/32 (319.9) <b>I.D.:</b> 7 27/32 (199.2) One End <b>Height:</b> 17 15/16 (455.6)</p> 
<p><b>PA30171</b></p> 	<p>Conical-Shaped Inner Air Element <b>Fits Inside:</b> PA5584 <b>Fits:</b> Hyster, Yale Equipment <b>Replaces:</b> Donaldson P603729 <b>O.D.:</b> 1 5/16 (33.3) Flange 2 5/8 (66.7) <b>I.D.:</b> 1 3/4 (44.4) One End <b>Height:</b> 10 1/4 (260.3)</p>	<p><b>PA30171</b> Air Element <b>Contains:</b> Threaded Stud <b>Fits:</b> M.T.U. Applications <b>Replaces:</b> M.T.U. 170941202; Donaldson B105036; Hifi/Jura Filtration SAB105036; Mann &amp; Hummel C27040 <b>O.D.:</b> 10 9/16 (268.3) <b>I.D.:</b> 5 1/16 (128.6) One End <b>Height:</b> 16 15/16 (430.2)</p>
<p><b>PA30172</b></p> 	<p>Conical-Shaped Inner Air Element <b>Fits Inside:</b> PA5584 <b>Fits:</b> Hyster, Yale Equipment <b>Replaces:</b> Donaldson P603729 <b>O.D.:</b> 1 5/16 (33.3) Flange 2 5/8 (66.7) <b>I.D.:</b> 1 3/4 (44.4) One End <b>Height:</b> 10 1/4 (260.3)</p>	<p><b>PA30172</b> Foam Cab Air Element <b>Fits:</b> Liebherr Dozers, Loaders <b>Replaces:</b> Liebherr 7622972 <b>Length:</b> 14 31/32 (380.2) <b>Width:</b> 9 21/32 (245.3) <b>Height:</b> 1 3/16 (30.2)</p>

Measurements Are Shown In Inches And (Millimeters)

**WARNING:** These products can expose you to chemicals, including Diisononyl Phthalate, Carbon black extracts, Nickel, 1,3 Butadiene, Ethylene Oxide, Epichlorohydrin, which are known to the State of California to cause cancer, and Bisphenol, Ethylene Glycol, Ethylene Oxide, 1,3 Butadiene, Epichlorohydrin, which are known to the State of California to cause birth defects or other reproductive harm.

**PA30173** Cab Air Element  
**Fits:** Liebherr Dozers, Loaders  
**Replaces:** Liebherr 7622130  
**Length:** 9 27/32 (250.0)  
**Width:** 7 13/16 (198.4)  
**Height:** 25/32 (19.8)



**PA30174** Cab Air Element  
**Fits:** John Deere Excavators  
**Replaces:** John Deere FYA00001490  
**Length:** 9 19/32 (243.7)  
**Width:** 9 1/8 (231.8)  
**Height:** 1 5/16 (33.3)



**RS30175** Radial Seal Air Element  
**Fits:** MAN Buses  
**Replaces:** M.A.N. 81.08405-0030; Sullair 88291008-318; Donaldson P788716; Fleetguard AF27974  
**O.D.:** 11 3/32 (281.8)  
**I.D.:** 7 7/16 (188.9) One End  
**Height:** 22 5/32 (562.8)



**PA30177** Cab Air Element  
**Fits:** Case, New Holland Dozers, Motor Graders  
**Replaces:** Case 75326979; New Holland 75326979  
**Length:** 10 5/32 (258.0)  
**Width:** 6 17/32 (165.9)  
**Height:** 27/32 (21.4)



**PA30179** Foam Cab Air Element  
**Fits:** Caterpillar Loaders, Off-Highway Trucks  
**Replaces:** Caterpillar 1868228; Donaldson P505965  
**Length:** 15 5/32 (385.0)  
**Width:** 5 23/32 (145.3)  
**Height:** 13/32 (10.3)



**RS30180** Radial Seal Air Element  
**Fits:** M.A.N. Lions City C, L LE, GL LE Buses  
**Replaces:** M.A.N. 81083040093; Donaldson P782998  
**O.D.:** 9 11/16 (246.1)  
**I.D.:** 4 19/32 (116.7) One End  
**Height:** 19 5/32 (486.6)



**RS30181** Radial Seal Inner Air Element  
**Fits Inside:** RS30182  
**Fits:** Fendt Combines; Massey Ferguson, New Holland Harvesters  
**Replaces:** New Holland 84072430; Massey Ferguson D46485600; Donaldson P781203; Fleetguard AF26215  
**O.D.:** 5 29/32 (150.0)  
**I.D.:** 4 13/32 (111.9) One End  
**Height:** 22 3/32 (561.2)



**RS30182** Radial Seal Outer Air Element  
**Fits:** New Holland Harvesters  
**Use With:** RS30181  
**Replaces:** New Holland 84072431; Donaldson P789638; Fleetguard AF26214  
**O.D.:** 11 1/32 (280.2)  
**I.D.:** 5 13/16 (147.6) One End  
**Height:** 22 29/32 (581.8)



**PA30183** Cab Air Element  
**Contains:** Charcoal Impregnated Media for Odor Control  
**Fits:** Caterpillar Loaders  
**Replaces:** Caterpillar 3483432  
**Length:** 13 15/32 (342.1)  
**Width:** 10 19/32 (269.1)  
**Height:** 2 3/16 (55.6)  
**A. Gskt:** [2] Attached

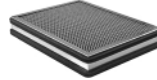

**PA30185** Cab Air Element  
**Fits:** Caterpillar Loaders  
**Replaces:** Caterpillar 3535058  
**Length:** 15 3/4 (400.0)  
**Width:** 6 3/8 (161.9)  
**Height:** 2 1/8 (54.0)



**RS30187XP** Extreme Performance Nano Radial Seal Outer Air Element  
**Contains:** Inlet Adapter  
**Fits:** Peterbilt 389 Trucks  
**Replaces:** Paccar X011623  
**O.D.:** 13 3/32 (332.6)  
**I.D.:** 4 5/8 (117.5) & 7 5/8 (193.7)  
**Height:** 24 13/16 (630.2)  
**F. Gskt:** [1] Included  
**Related To:** RS5287XP (Standard Housing Gasket)



**PA30188** Cab Air Element  
**Fits:** R.V.I., Volvo European Trucks  
**Replaces:** Renault 5001867491, 7421396525, 7485134455; Volvo 20559447, 21396525, 85134455  
**Length:** 8 (203.2)  
**Width:** 3 19/32 (91.3)  
**Height:** 3/4 (19.0)

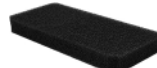

**PA30189** Air Element with Foam Wrap  
**Contains:** Bolt Hole  
**Fits:** Robin Engines  
**Replaces:** Subaru 26332610A1  
**O.D.:** 6 29/32 (175.4)  
**I.D.:** 1/4 (6.4) & 5 9/16 (141.3)  
**Height:** 2 15/32 (62.7)  
**Grommets:** [1] Attached



**PA30190** Cab Air Element  
**Fits:** Caterpillar Excavators, Forestry Equipment, Hydraulic Power Units, Material Handlers  
**Replaces:** Caterpillar 2931183  
**Length:** 23 5/8 (600.1)  
**Width:** 4 7/8 (123.8)  
**Height:** 1 1/32 (26.2)



Measurements Are Shown In Inches And (Millimeters)

**WARNING:** These products can expose you to chemicals, including Diisononyl Phthalate, Carbon black extracts, Nickel, 1,3 Butadiene, Ethylene Oxide, Epichlorohydrin, which are known to the State of California to cause cancer, and Bisphenol, Ethylene Glycol, Ethylene Oxide, 1,3 Butadiene, Epichlorohydrin, which are known to the State of California to cause birth defects or other reproductive harm.

**RS30191**



Radial Seal Inner Air Element  
**Fits Inside:** RS30192  
**Replaces:** Reytor IT3098S; Baldwin RS5295;  
 Donaldson P623172; Fleetguard AA2986  
**O.D.:** 6 23/32 (170.7)  
**I.D.:** 6 1/16 (154.0) One End  
**Height:** 15 11/16 (398.5)

**PA30207**



Conical-Shaped Outer Air Element  
**Fits:** John Deere Loaders, Tractors  
**Use With:** PA30208  
**Replaces:** Donaldson P609221; John Deere  
 RE282286  
**O.D.:** 5 1/8 (130.2)  
 Flange 6 3/16 (157.2)  
**I.D.:** 3 5/32 (80.2) One End  
**Height:** 13 3/16 (335.0)  
**A. Gskt:** [1] Included

**RS30192**



Radial Seal Outer Air Element  
**Use With:** RS30191  
**Replaces:** Reytor IT3098; Baldwin RS5296;  
 Donaldson P623166; Fleetguard AA2986  
**O.D.:** 11 (279.4)  
**I.D.:** 7 11/16 (195.3) One End  
**Height:** 16 15/16 (430.2)

**PA30208**



Conical-Shaped Inner Air Element  
**Fits Inside:** PA30207  
**Fits:** John Deere Loaders, Tractors  
**Replaces:** Donaldson P608599; John Deere  
 RE282287  
**O.D.:** 2 7/8 (73.0)  
 Flange 3 7/8 (98.4)  
**I.D.:** 2 3/8 (60.3) One End  
**Height:** 12 25/32 (324.6)

**PA30193-FN**



Outer Air Element with Fins  
**Fits:** Iveco Cursor 87 Engine; Winpower  
 DR250I4 Generator with Iveco Cursor 87 TE1D  
 Engine  
**Use With:** PA30194  
**Replaces:** Iveco 8019342  
**O.D.:** 9 7/32 (234.4)  
 Fins 11 11/32 (288.3)  
**I.D.:** 21/32 (16.5) & 4 27/32 (122.9)  
**Height:** 18 1/32 (458.0)  
**A. Gskt:** [1] Included  
**F. Gskt:** [1] Rubber Washer

**RS30209**



Radial Seal Outer Air Element  
**Fits:** Agco, Challenger, Massey Ferguson  
 Tractors  
**Replaces:** Agco 3607884M91, 3607884M92;  
 Hifi/Jura Filtration SA16370; Wix WA10404  
**O.D.:** 4 3/16 (106.4)  
**I.D.:** 2 (50.8)  
**Height:** 10 1/8 (257.2)

**PA30194**



Inner Air Element  
**Fits Inside:** PA30193-FN  
**Fits:** Iveco Cursor 87 Engine; Winpower  
 DR250I4 Generator with Iveco Cursor 87 TE1D  
 Engine  
**Replaces:** Iveco 8034304  
**O.D.:** 5 27/32 (148.1)  
**I.D.:** 5/8 (16) & 4 5/32 (105.2)  
**Height:** 17 11/16 (449.3)  
**A. Gskt:** [1] Included  
**F. Gskt:** [1] Rubber Washer

**PA30211**



Air Element  
**Fits:** Caterpillar, Mitsubishi Lift Trucks  
**Replaces:** Caterpillar 9206107410  
**O.D.:** 5 1/4 (133.4)  
**I.D.:** 21/32 (16.7) & 4 1/8 (104.8)  
**Height:** 11 31/32 (304.0)  
**A. Gskt:** [1] Included  
**F. Gskt:** [1] Included

**PA30204**



Crankcase Breather  
**Fits:** Volvo Marine Engines  
**Replaces:** Volvo 843736, 876069, 876069-6,  
 876069-9  
**O.D.:** 3 5/16 (84.1)  
**I.D.:** 1 5/8 (41.3) One End  
**Height:** 6 7/16 (163.5)  
**F. Gskt:** [1] Included

**RS30212**



Radial Seal Outer Air Element  
**Fits:** John Deere Tractors; Massey Ferguson  
 Wheel Tractors; New Holland Tractors  
**Use With:** RS30213  
**Replaces:** Agco 6223618M1; Massey Ferguson  
 6223618M1; John Deere DQ59138, SJ17532;  
 New Holland 87344135; Fleetguard AF25174  
**O.D.:** 6 7/8 (174.5)  
**I.D.:** 3 31/32 (101.1) One End  
**Height:** 13 31/32 (354.6)

**PA30206**



Conical-Shaped Air Element  
**Contains:** Flame Retardant Media  
**Fits:** Hyster Lift Trucks  
**Replaces:** Donaldson P616742; Hyster  
 1620142; Yale 580069337  
**O.D.:** 5 18 (127.0)  
 Flange 6 3/16 (157.2)  
**I.D.:** 3 5/32 (80.2) One End  
**Height:** 13 3/16 (335.0)  
**A. Gskt:** [1] Included

**RS30213**



Radial Seal Inner Air Element  
**Fits Inside:** RS30212  
**Fits:** John Deere Tractors; Massey Ferguson  
 Wheel Tractors; New Holland Tractors  
**Replaces:** Agco 6223619M1; John Deere  
 DQ59139; Massey Ferguson 6223619M1; New  
 Holland 87344136; Fleetguard AF25176  
**O.D.:** 4 1/8 (104.9)  
**I.D.:** 3 3/8 (85.9) One End  
**Height:** 13 7/32 (335.8)

Measurements Are Shown In Inches And (Millimeters)

**WARNING:** These products can expose you to chemicals, including Diisononyl Phthalate, Carbon black extracts, Nickel, 1,3 Butadiene, Ethylene Oxide, Epichlorohydrin, which are known to the State of California to cause cancer, and Bisphenol, Ethylene Glycol, Ethylene Oxide, 1,3 Butadiene, Epichlorohydrin, which are known to the State of California to cause birth defects or other reproductive harm.



**RS30216**



Radial Seal Outer Air Element

**Fits:** Dynapac Compactors, Rollers  
**Use With:** RS30217  
**Replaces:** Atlas Copco 4700394690, 3222188144; Dynapac 394690, 4700394690; Donaldson X770691, P785390  
**O.D.:** 11 (279.4)  
**I.D.:** 5 25/32 (146.8) One End  
**Height:** 20 11/16 (525.5)

**RS30224**



Radial Seal Inner Air Element

**Fits Inside:** RS30223  
**Fits:** Case, New Holland Motor Graders  
**Replaces:** Case 84286397; New Holland 84286397  
**O.D.:** 5 11/16 (144.5)  
**I.D.:** 5 5/32 (131.0) One End  
**Height:** 19 (482.6)

**RS30217**



Radial Seal Inner Air Element

**Fits Inside:** RS30216  
**Fits:** Dynapac Compactors, Rollers  
**Replaces:** Atlas Copco 4700394691, 32222188144; Dynapac 394691, 4700394691; Donaldson X770691  
**O.D.:** 5 29/32 (150.0)  
**I.D.:** 4 7/16 (112.7) One End  
**Height:** 18 5/16 (465.1)

**RS30225**



Radial Seal Outer Air Element

**Fits:** International, New Holland Tractors  
**Use With:** RS30226  
**Replaces:** New Holland 87741560; Fleetguard AF26345  
**O.D.:** 12 1/16 (306.4)  
**I.D.:** 7 3/4 (196.9) One End  
**Height:** 13 11/16 (347.7)

**RS30220**



Radial Seal Outer Air Element

**Fits:** JLG Industries Inc. 600S, 600SJ, 800A, 800AJ Aerial Lifts with Ford 2.5L Engine; Freeman Balers, John Deere Loaders, Swinger Loaders  
**Use With:** RS30221 (John Deere Applications)  
**Replaces:** JLG Industries Inc. 70005008; John Deere AT338105  
**O.D.:** 5 5/32 (131.3)  
**I.D.:** 3 19/32 (90.9) One End  
**Height:** 12 1/2 (317.5)

**RS30226**



Radial Seal Inner Air Element

**Fits Inside:** RS30225  
**Fits:** International, New Holland Tractors  
**Replaces:** New Holland 87741569; Fleetguard AF26346  
**O.D.:** 7 3/16 (182.6)  
**I.D.:** 5 27/32 (148.4) One End  
**Height:** 12 3/4 (323.8)

**RS30221**



Radial Seal Inner Air Element

**Fits Inside:** RS30220 (John Deere Applications)  
**Fits:** Freeman Balers, John Deere Loaders, Swinger Loaders  
**Replaces:** John Deere AT336803; Donaldson P629465; Wix WA10385  
**O.D.:** 2 13/32 (61.2) & 3 3/4 (95.2)  
**I.D.:** 2 1/8 (53.6) One End  
**Height:** 11 11/32 (288)

**PA30228**



Panel Air Element

**Fits:** Hyundai Excavators  
**Replaces:** Hyundai 11Q690510  
**Length:** 8 1/4 (209.6)  
**Width:** 4 5/8 (117.5)  
**Height:** 25/32 (19.8)

**PA30229**



Panel Air Element

**Fits:** Hyundai Excavators  
**Replaces:** Hyundai AM880002002, XJAU0153, 11N690760; Donaldson P753339; Fleetguard AF26474  
**Length:** 9 (228.6)  
**Width:** 4 5/32 (105.6)  
**Height:** 25/32 (19.8)

**RS30222XP**



Extreme Performance Nano Radial Seal Outer Air Element

**Fits:** Chevrolet, Ford, GMC, Nissan UD Medium-Duty Trucks  
**Use With:** RS3501  
**Replaces:** Nissan 16546NY108; Ford Motor Co. F3HZ-9601-A; General Motors Corp. 15619013; John Deere RE34962; Donaldson P812175; Wix 46433NP  
**O.D.:** 9 9/32 (236.0)  
**I.D.:** 5 5/32 (131.1) One End  
**Height:** 12 3/4 (324.1)  
**Related To:** RS2863 (Standard Media Version)

**RS30232**



Radial Seal Outer Air Element with Blank Band

**Fits:** Fendt Combines; Massey Ferguson Harvesters; Van Hool Astromega TD927, AG300 Buses  
**Replaces:** Massey Ferguson D46485500; DAF 1146384, 1525439; Van Hool 20276705; Volvo 1155727, 41155727; Donaldson P781199  
**O.D.:** 10 31/32 (278.6)  
**I.D.:** 5 13/16 (147.6) One End  
**Height:** 22 29/32 (581.8)

**RS30223**



Radial Seal Outer Air Element

**Fits:** Case, New Holland Motor Graders  
**Use With:** RS30224  
**Replaces:** Case 84286399  
**O.D.:** 9 21/32 (245.3)  
**I.D.:** 5 17/32 (140.5) One End  
**Height:** 19 13/32 (492.9)

**PA30233-FN**











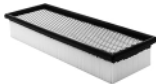

Air Element with Fins

**Fits:** Manitou Lift Trucks  
**Replaces:** Manitou 710467; Fiat 920007502; GPC FC280K; Donaldson P771511  
**O.D.:** 7 15/16 (201.6)  
**Fins:** 9 13/16 (249.2)  
**I.D.:** 21/32 (16.7) & 3 9/16 (90.5)  
**Height:** 13 5/8 (346.1)  
**A. Gskt:** [1] Included  
**F. Gskt:** [1] Included

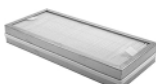
Measurements Are Shown In Inches And (Millimeters)

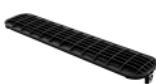
**WARNING:** These products can expose you to chemicals, including Diisononyl Phthalate, Carbon black extracts, Nickel, 1,3 Butadiene, Ethylene Oxide, Epichlorohydrin, which are known to the State of California to cause cancer, and Bisphenol, Ethylene Glycol, Ethylene Oxide, 1,3 Butadiene, Epichlorohydrin, which are known to the State of California to cause birth defects or other reproductive harm.

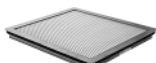
<p><b>RS30234</b></p> 	<p>Radial Seal Air Element  <b>Fits Inside:</b> PA5583  <b>Fits:</b> Bobcat 5600 Turbo, 5610 Utility Vehicles  <b>Replaces:</b> Bobcat 6983022; Donaldson P602427  <b>O.D.:</b> 3 1/16 (77.8)  <b>I.D.:</b> 2 1/16 (52.4) One End  <b>Height:</b> 12 21/32 (321.5)</p>	<p><b>PA30244</b></p>  <p>Inner Air Element  <b>Fits Inside:</b> PA30243  <b>Fits:</b> Hitachi Excavators; John Deere Excavators  <b>Replaces:</b> Hitachi 4642117; Donaldson P788912  <b>O.D.:</b> 5 5/32 (131.0)  <b>I.D.:</b> 2 1/32 (16.7) &amp; 3 15/16 (100.0)  <b>Height:</b> 11 1/16 (281.0)  <b>A. Gskt:</b> [1] Included  <b>F. Gskt:</b> [1] Included</p>
<p><b>PA30235</b></p> 	<p>Outer Air Element  <b>Contains:</b> Flame Retardant Media  <b>Fits:</b> Claas, Liebherr, V.M.E., Volvo Equipment; Iveco, M.A.N., Mercedes-Benz Trucks  <b>Use With:</b> PA3494, PA3857  <b>Replaces:</b> Iveco 2996154, 41272534; Mercedes-Benz A0040945004; Donaldson P786829  <b>O.D.:</b> 11 15/16 (303.2)  <b>I.D.:</b> 7/16 (11.1) &amp; 7 17/32 (191.3)  <b>Height:</b> 18 21/32 (473.9)  <b>A. Gskt:</b> [1] Included  <b>F. Gskt:</b> [1] Metal Included  <b>Related To:</b> PA2776 (Standard Media Version)</p>	<p><b>PA30249</b></p>  <p>Cab Air Element  <b>Fits:</b> Caterpillar Loaders, Lift Trucks  <b>Replaces:</b> Caterpillar 3657606; Wix WP10366  <b>Length:</b> 13 19/32 (344.9)  <b>Width:</b> 4 3/4 (120.9)  <b>Height:</b> 2 1/4 (56.9)</p> <p><b>PA30251</b></p>  <p>Cab Air Element  <b>Contains:</b> Charcoal Impregnated Media for Odor Control.  <b>Fits:</b> John Deere Tractors  <b>Replaces:</b> John Deere L156225, L209778  <b>Length:</b> 7 23/32 (196.1)  <b>Width:</b> 5 1/8 (130.2)  <b>Height:</b> 1 9/16 (39.7)</p>
<p><b>RS30236</b></p> 	<p>Radial Seal Air Element  <b>Contains:</b> Flame Retardant Media  <b>Fits:</b> R.V.I., Mack Truck  <b>Replaces:</b> Renault 5001865724; Volvo 20732730; Donaldson P786892  <b>O.D.:</b> 9 11/16 (246.1)  <b>I.D.:</b> 4 7/8 (123.8) One End  <b>Height:</b> 14 5/8 (371.5)  <b>Related To:</b> RS5301 (Standard Media Version)</p>	<p><b>PA30252</b></p>  <p>Cab Air Filter  <b>Fits:</b> Kubota Tractors  <b>Replaces:</b> Kubota T185571600  <b>Length:</b> 12 3/16 (309.6)  <b>Width:</b> 4 1/32 (102.4)  <b>Height:</b> 1 11/16 (42.9)  <b>A. Gskt:</b> [1] Included</p> <p><b>PA30253</b></p>  <p>Cab Air Element with Pull Tabs  <b>Fits:</b> Atlas Copco Equipment  <b>Replaces:</b> Atlas Copco 3222325376  <b>Length:</b> 15 1/8 (384.0)  <b>Width:</b> 6 11/16 (169.9)  <b>Height:</b> 2 1/8 (54.1)  <b>A. Gskt:</b> [1] Included</p>
<p><b>RS30237</b></p> 	<p>Radial Seal Inner Air Element  <b>Fits Inside:</b> RS5756  <b>Fits:</b> Blue Bird All-American Buses with Cummins ISB (5.9L) Engine  <b>Replaces:</b> Blue Bird 10004114; Parker 500455001  <b>O.D.:</b> 7 1/2 (190.5)  <b>I.D.:</b> 4 1/8 (104.8) One End  <b>Height:</b> 19 13/32 (492.9)</p>	<p><b>PA30255</b></p>  <p>Foam Cab Air Element in Plastic Housing  <b>Contains:</b> [3] Metal Clips  <b>Fits:</b> Bobcat Loaders  <b>Replaces:</b> Bobcat 7193354  <b>Length:</b> 12 3/4 (324.1)  <b>Width:</b> 2 5/8 (67.1)  <b>Height:</b> 1 3/16 (30.2)</p>
<p><b>RS30242</b></p> 	<p>Radial Seal Inner Air Element  <b>Replaces:</b> Ingersoll-Rand 35393651  <b>O.D.:</b> 3 15/32 (88.1)  <b>I.D.:</b> 2 1/2 (63.5) One End  <b>Height:</b> 12 9/16 (319.1)</p>	<p><b>RS30257</b></p>  <p>Radial Seal Outer Air Element  <b>Fits:</b> Bomag Compactors; Dina Linner, Dina Runner Buses; John Deere Excavators  <b>Use With:</b> RS5329  <b>Replaces:</b> Fleetguard AF26483  <b>O.D.:</b> 8 27/32 (224.5)  <b>I.D.:</b> 7 1/8 (180.8) One End  <b>Height:</b> 16 13/16 (427)</p>
<p><b>PA30243</b></p> 	<p>Outer Air Element  <b>Fits:</b> Hitachi Excavators; John Deere Excavators  <b>Use With:</b> PA30244  <b>Replaces:</b> Hitachi 4642122; Donaldson P789077; Hifi/Jura Filtration SA18087  <b>O.D.:</b> 9 7/32 (234.2)  <b>I.D.:</b> 5 3/16 (131.8) One End  <b>Height:</b> 14 1/4 (362.0)  <b>A. Gskt:</b> [1] Included</p>	<p><b>PA30258</b></p>  <p>Cab Air Element  <b>Fits:</b> Liebherr Equipment  <b>Replaces:</b> Liebherr 10097542  <b>Length:</b> 14 23/32 (373.9)  <b>Width:</b> 13 17/32 (343.9)  <b>Height:</b> 1 3/16 (30)  <b>A. Gskt:</b> [1] Included</p>

Measurements Are Shown In Inches And (Millimeters)

**WARNING:** These products can expose you to chemicals, including Diisononyl Phthalate, Carbon black extracts, Nickel, 1,3 Butadiene, Ethylene Oxide, Epichlorohydrin, which are known to the State of California to cause cancer, and Bisphenol, Ethylene Glycol, Ethylene Oxide, 1,3 Butadiene, Epichlorohydrin, which are known to the State of California to cause birth defects or other reproductive harm.

**PA30260** Felt Cabin Air Element with Foam Pad  
**Fits:** International 4300, 7300, 7400, 7500, 7500 WorkStar, 7600 WorkStar Trucks  
**Replaces:** IHC (International Harvester) CFFN6100  
**Length:** 15 21/32 (397.3)  
**Width:** 4 11/32 (110)  
**Height:** 1 1/32 (26.4)



**PA30270** Panel Air Element  
**Fits:** Caterpillar Loaders  
**Replaces:** Caterpillar 2902288  
**Length:** 14 21/32 (372.1)  
**Width:** 3 25/32 (96.0)  
**Height:** 1 3/8 (35.1)



**PA30261** Cab Air Element  
**Fits:** Kubota KX040-4, KX057-4, KX121-3S, KX121-3ST Super Series, U35-4, U45S, U45ST Excavators Kubota SVL75-2C, SV95-2SC Loaders Kubota M100GXDT, M110GXDT, M126GXDT, M135GXDT, M6040 Series, M6-141, M6-141DTC, M7-151, M7-171, M8540 Series, M9960 Series Tract  
**Replaces:** Kubota 6A67175090  
**Length:** 7 (177.8)  
**Width:** 4 3/4 (120.5)  
**Height:** 11/16 (17)



**PA30271** Cab Air Element  
**Fits:** New Holland, Versatile Tractors  
**Replaces:** Case 9707323  
**Length:** 40 25/32 (1036.1)  
**Width:** 8 1/2 (204.0)  
**Height:** 2 19/32 (66)  
**A. Gskt:** [1] Included

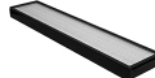

**PA30272** Cab Air Element  
**Fits:** Komatsu Loaders  
**Replaces:** Komatsu 4230752410  
**Length:** 14 7/32 (361.4)  
**Width:** 8 3/8 (212.3)  
**Height:** 1 3/16 (30)

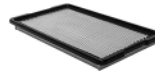

**PA30262** Nylon Mesh Screen Cab Air Filter  
**Fits:** Case 1221E, 1221EXR, 1221F Loaders; Hyundai R80-7, R80-7A, R110-7, R110-7A, R140LC-7, R140W-7, R140LC-7A, R140W-7A, R140LC-9, R140W-9, R160LC-7, R160LC-7A, R160LC-9, R170W-7, R170W-7A, R170W-9, R180LC-7, R180LC-7A, R180LC-9, R200W-7, R200W-7A, R210-7  
**Replaces:** Hyundai 11N690770  
**Length:** 7 25/32 (197.6)  
**Width:** 7 19/32 (192.9)  
**Height:** 13/32 (10.5)

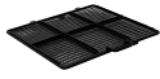

**PA30275** Primary Air Element  
**Fits:** Case-International, New Holland Tractors; Caterpillar Crawler Tractors, Excavators, Forestry Equipment, Loaders, Paving Equipment, Material Handlers; Tong Yang Mooslan Tractors  
**Use With:** PA30268  
**Replaces:** Case 73337834; Caterpillar 3466693; New Holland 73337834; Mann & Hummel C34540  
**Length:** 13 7/32 (336)  
**Width:** 8 1/32 (203.7)  
**Height:** 8 11/32 (211.6)



**PA30263** Panel Air Element  
**Fits:** Polaris Ranger 900 Crew, Ranger 900 XP, Ranger 1000 Diesel, Ranger 1000 Diesel Crew, Ranger Crew 1000 PS, Ranger Crew 1000XP 6P, Ranger Crew 1000XP MD, Ranger Crew 1000XP NB, Ranger Crew 1000XP PS, Ranger Crew 1000XP PS, RZR 570 Utility Vehicles  
**Replaces:** Polaris 7081706  
**Length:** 11 7/32 (285.2)  
**Width:** 8 3/16 (208)  
**Height:** 1 13/16 (46)

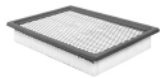

**PA30276** Foam Cab Air Element  
**Fits:** Case 521E, 521EXT, 521F Series, 621E, 621E XR, 621E XT, 721E, E21EXR, 721EXT, 821E, 821EXT, 821F, 821FXR, 821FXT, 921E, 921F, 1021F, 1121F Loaders; New Holland W130B, W130B TC, W170B, W170B LR, W170C, W190B, W190C, W230C, W270B Loaders  
**Replaces:** Case 76303499, 84389987; New Holland 76303499, 84389987  
**Length:** 16 5/16 (414)  
**Width:** 6 1/2 (165)  
**Height:** 3/4 (19)



**PA30264** Cab Air Element with Pull Tab  
**Contains:** Metal Bracket  
**Fits:** Caterpillar Loaders, Tractors  
**Replaces:** Caterpillar 1510914  
**Length:** 16 5/8 (421.9)  
**Width:** 5 9/16 (141.0)  
**Height:** 2 9/16 (65.3)  
**A. Gskt:** [1] Included



**PA30277** Foam Cab Air Element  
**Fits:** Mack Trucks  
**Replaces:** Mack 3543H9638  
**Length:** 10 (254.0)  
**Width:** 9 7/8 (251.0)  
**Height:** 25/32 (20.1)



**PA30268** Secondary Air Element  
**Fits:** Case-International, New Holland Tractors  
**Use With:** PA30275  
**Replaces:** Caterpillar 3466694; New Holland 73337833  
**Length:** 11 21/32 (295.9)  
**Width:** 6 5/8 (167.9)  
**Height:** 1 1/2 (38.1)



**PA30279** Panel Air Element  
**Fits:** Honda Small Engines  
**Replaces:** Honda 17210ZJ1841, 17210ZJ1842; Oregon 30436; Rotary Gas 10678, 10961; Stens 102164; Wix WA10562  
**Length:** 8 3/4 (222.5)  
**Width:** 6 17/32 (166.1)  
**Height:** 1 1/4 (32)  
**A. Gskt:** [1] Included



**PA30269** Cabin Air Element  
**Fits:** Kenworth Trucks T800, T880  
**Replaces:** Paccar F371018  
**Length:** 8 27/32 (225.0)  
**Width:** 7 27/32 (199.0)  
**Height:** 13/32 (10.0)

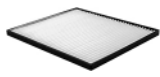

Measurements Are Shown In Inches And (Millimeters)

**WARNING:** These products can expose you to chemicals, including Diisononyl Phthalate, Carbon black extracts, Nickel, 1,3 Butadiene, Ethylene Oxide, Epichlorohydrin, which are known to the State of California to cause cancer, and Bisphenol, Ethylene Glycol, Ethylene Oxide, 1,3 Butadiene, Epichlorohydrin, which are known to the State of California to cause birth defects or other reproductive harm.

**PA30281**

Foam Cab Air Element



**Fits:** Kenworth K270 (2014-18), T170 (2019), T270 (2019), T300 (2018-19), T370 (2014-19), T400 (2013-19), T440 (2017-19), T470 (2019), T660 (2014-18) Trucks  
**Replaces:** Kenworth SR2000059  
**Length:** 12 3/32 (307)  
**Width:** 3 5/32 (80)  
**Height:** 31/32 (24.5)

**RS30285**

Radial Seal Outer Air Element



**Fits:** Perkins Generators  
**Use With:** RS5392  
**Replaces:** Perkins 2652C831  
**O.D.:** 10 31/32 (278.9)  
**I.D.:** 5 25/32 (147.1) One End  
**Height:** 16 7/16 (417.6)

**PA30287**

Foam Cab Air Element



**Fits:** Kenworth W900 Trucks  
**Replaces:** Kenworth R19501  
**Length:** 8 3/16 (208.0)  
**Width:** 6 1/32 (153.4)  
**Height:** 1 3/16 (30)

**RS30290**

Radial Seal Outer Air Element



**Fits:** Caterpillar 374F L, 390F L Excavators; MH3295 Material Handler; PM620, PM622, RM500B Paving Equipment  
**Replaces:** Caterpillar 3754301  
**O.D.:** 14 7/32 (360.9)  
**I.D.:** 8 29/32 (226.3) One End  
**Height:** 26 23/32 (678.9)

**PA30292**

Cab Air Element with Foam Pad and Pull Tabs



**Fits:** John Deere 450H Series, 450J, 550H, 550J, 550J Series, 550K, 650H, 650J, 650J Series, 650K, 700H LGP, 700J Series, 700K, 750J Series, 750K, 850J, 850J Series, 850JR, 850K, 1050K Dozers, Motor Graders; 605K, 655K, 755K Loaders  
**Replaces:** John Deere AT315957  
**Length:** 26 1/16 (661.9)  
**Width:** 2 15/32 (63.0)  
**Height:** 19/32 (15.2)  
**A. Gskt:** [1] Included

**PA30293**

Cab Air Element

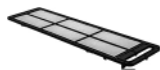

**Fits:** Komatsu PC78US-8, PC78UU-8, PC228US-8, PC228USLC-8 Excavators  
**Replaces:** Komatsu ND1455301210; Nippon 1455301210  
**Length:** 17 11/16 (449.6)  
**Width:** 4 13/16 (121.9)  
**Height:** 19/32 (15)

**PA30299**

Cab Air Element

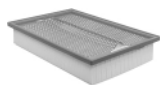

**Fits:** Caterpillar 1450, 1450AL, 1450CWS, 1450WTS, 1470, 1550 CWS, 1550 WTS. 1570, 2054, 2056, 2058, 2064, 2066, W330 Combines; 6610, 6650, 6710, 6750, 6810, 6850, 6910, 6950 Forage Harvesters  
**Replaces:** John Deere AZ43412  
**Length:** 14 3/4 (374.9)  
**Width:** 9 9/16 (243.1)  
**Height:** 2 27/32 (71.9)

**PA30301**

Air Element



**Fits:** Gardner Denver, Ingersoll-Rand, Schramm Air Compressors  
**Replaces:** Gardner Denver 2010945; Ingersoll-Rand W104069; Schramm OUH37810A; WIX 46063  
**O.D.:** 4 7/16 (112.7)  
**I.D.:** 2 13/16 (71.4)  
**Height:** 4 1/2 (114.3)

**PA30302**

Air Element



**Fits:** Tecumseh Engines  
**Replaces:** Lauson-Tecumseh 35066; Wix 542419, 42419  
**O.D.:** 1 25/32 (45.2)  
**I.D.:** 13/16 (20.6)  
**Height:** 2 7/8 (73)

**PA30303**

Oblong Air Element



**Fits:** Briggs & Stratton Engines  
**Replaces:** Briggs & Stratton 393292; Wix 46176  
**O.D.:** 3 27/32 (97.6) to 9 11/16 (246.1)  
**I.D.:** 2 11/32 (59.5) & 8 3/16 (208.0) to  
**Height:** 2 1/2 (63.5)

**PA30304**

Cab Air Element

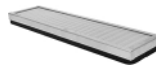

**Fits:** Case Loaders; New Holland Loaders, Telehandlers, Trenchers  
**Replaces:** Case 84376814; Wix WP10360  
**Length:** 16 15/16 (430.0)  
**Width:** 4 11/32 (110.0)  
**Height:** 1 3/16 (30)  
**A. Gskt:** [1] Included

**RS30305**

Radial Seal Outer Air Element



**Fits:** Claas Tractors; Iveco Buses; Tadano Cranes; Wirtgen Paving Equipment  
**Use With:** RS30306 (Radial Seal Inner Air)  
**Replaces:** Claas 05006151; GPC FC2247; Iveco 42553413; Mann+Hummel C301530; Mercedes-Benz A0040943704, 40943704; Power System 490031, 480031; Pozarli AJ159; Wirtgen 182496; Fleetguard AF4185; Wix 49159  
**O.D.:** 11 11/16 (297.2)  
**I.D.:** 7 27/32 (198.9) One End  
**Height:** 22 3/16 (563.6)

**RS30306**

Radial Seal Inner Air Element



**Fits Inside:** RS30305 (Radial Seal Outer Air)  
**Fits:** Claas Tractors; Neoplan Buses; Wirtgen Paving Equipment  
**Replaces:** Claas 005006161, 500616, 500616.1; Liebherr 11291030; Mann+Hummel CF1830; M.A.N. 81.08405-0028; Mercedes-Benz A0040943904, 40943904; Pozarli AJ159; Sullair 88291008-317; Wirtgen 182497; Fleetguard AF27973; Wix 49169  
**O.D.:** 7 3/32 (179.8)  
**I.D.:** 6 3/8 (161.8) One End  
**Height:** 20 1/16 (509.5)  
**O-Ring:** [1] Attached

Measurements Are Shown In Inches And (Millimeters)

**WARNING:** These products can expose you to chemicals, including Diisononyl Phthalate, Carbon black extracts, Nickel, 1,3 Butadiene, Ethylene Oxide, Epichlorohydrin, which are known to the State of California to cause cancer, and Bisphenol, Ethylene Glycol, Ethylene Oxide, 1,3 Butadiene, Epichlorohydrin, which are known to the State of California to cause birth defects or other reproductive harm.

**RS30307**



Radial Seal Outer Air Element  
**Fits:** Liebherr Dump Trucks, Excavators; Terex Loaders  
**Use With:** RS30308 (Radial Seal Inner Air)  
**Replaces:** Liebherr 10278562; Mann+Hummel C301330  
**O.D.:** 11 11/16 (297.2)  
**I.D.:** 7 27/32 (198.9) One End  
**Height:** 19 5/8 (498.6)

**PA30314**



Air Element in Disposable Housing  
**Fits:** Mobile and Stationary Gas and Diesel Engines  
**Replaces:** Farr 071338005, 71338005; Racor 071338005, 71338005; Fleetguard AH1195  
**O.D.:** 13 1/2 (343.2)  
**I.D.:** 7 1/16 (179.6) One End  
**Height:** 16 5/8 (421.9)

**RS30308**



Radial Seal Inner Air Element  
**Fits Inside:** RS30307 (Radial Seal Outer Air)  
**Replaces:** Kamaz CF1820; Mann+Hummel CF1820; Pozarli AV785  
**O.D.:** 7 3/32 (179.8)  
**I.D.:** 6 3/8 (161.8) One End  
**Height:** 17 1/2 (444.5)  
**O-Ring:** [1] Attached

**PA30315**



Air Element in Disposable Housing  
**Fits:** Mobile and Stationary Gas and Diesel Engines  
**Replaces:** Racor 71338007; Fleetguard AH19056  
**O.D.:** 11 1/32 (279.9)  
**I.D.:** 7 3/32 (179.8) One End  
**Height:** 25 11/16 (652.3)

**PA30309**



Replacement for Ecolite Air Element in Disposable Housing  
**Replaces:** Racor 400820020  
**O.D.:** 11 (279.4)  
**Inlet:** 7  
**Outlet:** 7 3/32  
**Height:** 16 5/8 (422.7)

**PA30316**



Air Element in Disposable Housing  
**Fits:** Custom Applications  
**Replaces:** Racor 071338013, 71338013  
**O.D.:** 13 1/2 (343.2)  
**I.D.:** 8 1/16 (204.7) One End  
**Height:** 25 29/32 (658.1)

**PA30310**



Cab Air Element with Pull Tabs  
**Fits:** Caterpillar Loaders, Crawler Tractors  
**Replaces:** Caterpillar 3293243; Wix WP10237  
**Length:** 9 21/32 (245.1)  
**Width:** 6 1/2 (165.1)  
**Height:** 1 (25.7)  
**A. Gskt:** [1] Included

**PA30317**



Air Element in Disposable Housing  
**Fits:** Mobile and Stationary Gas and Diesel Engines  
**Replaces:** Racor 062891010, 62891010  
**O.D.:** 13 1/2 (343.2)  
**Inlet:** 7  
**Outlet:** 7  
**Height:** 15 1/32 (381.8)

**RS30311**



Radial Seal Outer Air Element  
**Fits:** New Holland Harvesters  
**Replaces:** Case 84443964; New Holland 84443964; Donaldson P786106; Fleetguard AF27952; Wix WA10761  
**O.D.:** 12 9/32 (311.9)  
**I.D.:** 6 15/16 (176.5) One End  
**Height:** 28 1/32 (712)

**PA30318**



Air Element in Disposable Housing  
**Fits:** Custom Applications  
**Replaces:** Racor 062891012, 62891012  
**O.D.:** 11 (279.4)  
**Inlet:** 7.08  
**Outlet:** 7.00  
**Height:** 19 17/32 (496.1)

**RS30313**



Radial Seal Outer Air Element  
**Fits:** Blue Bird All-American Buses  
**Replaces:** Blue Bird 10004112; Racor 10004112; Fleetguard AF4335; Wix WA10653  
**O.D.:** 11 9/16 (293.9)  
**I.D.:** 5 13/16 (147.6) One End  
**Height:** 16 3/4 (425.2)

**PA30319**



Air Element in Disposable Housing  
**Fits:** Small Mobile and Stationary Engines for under the hood or outside, direct or remote applications  
**Replaces:** Racor 124923000  
**O.D.:** 11 1/32 (279.9)  
**Inlet:** 7  
**Outlet:** 7 3/32  
**Height:** 25 23/32 (653.5)

Measurements Are Shown In Inches And (Millimeters)

**WARNING:** These products can expose you to chemicals, including Diisononyl Phthalate, Carbon black extracts, Nickel, 1,3 Butadiene, Ethylene Oxide, Epichlorohydrin, which are known to the State of California to cause cancer, and Bisphenol, Ethylene Glycol, Ethylene Oxide, 1,3 Butadiene, Epichlorohydrin, which are known to the State of California to cause birth defects or other reproductive harm.

**PA30320** Air Element in Disposable Housing  
**Fits:** Custom Applications  
**Replaces:** Racor 400820021  
**O.D.:** 11 (279.4)  
**Inlet:** 6.09  
**Outlet:** 7.00  
**Height:** 16 7/8 (428.2)



**RS30328** Radial Seal Inner Air Element  
**Fits Inside:** RS30327  
**Fits:** Custom applications using Donaldson 15 inch ERB2 air housing  
**Replaces:** Donaldson P785427, X770687; Wix WA10669  
**O.D.:** 7 1/16 (179.3)  
**I.D.:** 5 11/16 (144.8) One End  
**Height:** 21 3/32 (535.7)



**PA30321** Air Element in Disposable Housing  
**Fits:** Mobile and Stationary Gas and Diesel Engines  
**Replaces:** Racor 400820026  
**O.D.:** 6 25/32 (172.5)  
**Inlet:** 6  
**Outlet:** 6  
**Height:** 20 (508)



**PA30329** Cab Air Element  
**Fits:** Komatsu Loaders  
**Replaces:** Komatsu 4230752440  
**Length:** 13 25/32 (350.0)  
**Width:** 8 3/8 (212.6)  
**Height:** 1 23/32 (43.9)

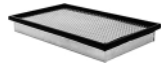

**PA30322** Air Element in Disposable Housing  
**Fits:** Blue Bird Wanderlodge buses with Detroit Diesel Series 60 Engine  
**Replaces:** Farr 99842007; Wix 49998  
**O.D.:** 13 1/2 (342.6)  
**Inlet:** 7  
**Outlet:** 7  
**Height:** 18 (457.5)



**PA30330** Cab Air Element  
**Fits:** Mack LR613 with MP7 Engine (To 2017)  
**Replaces:** Mack 82745222  
**Length:** 13 15/16 (354.1)  
**Width:** 6 1/8 (155.4)  
**Height:** 31/32 (24.9)



**PA30323** Air Element in Disposable Housing  
**Fits:** Mobile and Stationary Gas and Diesel Engines  
**Replaces:** Farr 76955000; Racor 076955000  
**O.D.:** 13 1/2 (343.2)  
**Inlet:** 8 1/16  
**Outlet:** 8 1/16  
**Height:** 25 7/8 (657.4)



**PA31000** Primary EnduraPanel Air  
**Fits:** Cummins QSB6.7 (Final Tier 4, Interim Tier 4), QSC, QSC9, QSL9 (Final Tier 4, Interim Tier 4) Engines  
**Use With:** PA31001 Secondary EnduraPanel  
**Replaces:** Cummins 5261250; Fleetguard AF55015  
**Length:** 11 23/32 (297.7)  
**Width:** 10 31/32 (278.6)  
**Height:** 14 1/16 (357.2)  
**A. Gskt:** [1] Included



**PA30324** Cab Air Element  
**Contains:** Charcoal Impregnated Media for Odor Control.  
**Fits:** Case Loaders; New Holland Loaders, Telehandlers, Trenchers  
**Replaces:** Case 84376815  
**Length:** 16 15/16 (430.0)  
**Width:** 4 11/32 (110.0)  
**Height:** 1 3/16 (30)  
**A. Gskt:** [1] Included



**PA31001** Secondary EnduraPanel Air with Pull Tabs  
**Fits:** Cummins QSB6.7 (Final Tier 4, Interim Tier 4), QSC, QSC9, QSL9 (Final Tier 4, Interim Tier 4) Engines  
**Use With:** PA31000 Primary EnduraPanel  
**Replaces:** Doosan 40050400030; Fleetguard AF55309  
**Length:** 11 5/16 (287.3)  
**Width:** 10 1/2 (266.7)  
**Height:** 1 1/2 (38.1)  
**A. Gskt:** [1] Included



**PA30325** Cab Air Element  
**Fits:** Mack Anthem, Granite Pinnacle Trucks  
**Replaces:** Mack 85151124, 85112361; Donaldson P636368; Wix WP10278  
**Length:** 9 7/8 (251.0)  
**Width:** 9 13/16 (249.5)  
**Height:** 1 (25.2)



**PA31002** Primary EnduraPanel Air  
**Notes:** Can be used with PA31003  
**Fits:** Cummins QSB6.7 (Tier 4 Interim & Final), QSL9 (Tier 4 Interim & Final), QSX11.9, QSX15 (Interim Tier 4) Engines  
**Replaces:** Cummins 5261249; Fleetguard AF55014; VogeLe 2216429; Wirtgen 2220358; Donaldson DBA5292  
**Length:** 15 31/32 (405.6)  
**Width:** 5 7/8 (149.2)  
**Height:** 14 (355.6)  
**A. Gskt:** [1] Included



**RS30327** Radial Seal Outer Air Element  
**Fits:** Custom applications using Donaldson 15 inch ERB2 air housing  
**Use With:** RS30328  
**Replaces:** Donaldson P785426, X770687; Fleetguard AF4271; Wix WA10668  
**O.D.:** 12 3/32 (306.8)  
**I.D.:** 7 (177.5) One End  
**Height:** 22 15/16 (582.4)



Measurements Are Shown In Inches And (Millimeters)

**WARNING:** These products can expose you to chemicals, including Diisononyl Phthalate, Carbon black extracts, Nickel, 1,3 Butadiene, Ethylene Oxide, Epichlorohydrin, which are known to the State of California to cause cancer, and Bisphenol, Ethylene Glycol, Ethylene Oxide, 1,3 Butadiene, Epichlorohydrin, which are known to the State of California to cause birth defects or other reproductive harm.

**PA31003** Secondary EnduraPanel Air with Pull Tabs  
**Fits:** Cummins QSB6.7 (Tier 4 Interim & Final), QSL9 (Tier 4 Interim & Final), QSX11.9, QSX15 (Interim Tier 4) Engines  
**Use With:** PA31002, PA31012  
**Replaces:** Cummins 5261251; Doosan 40050400048; Fleetguard AF55308; JCB 333E3686; Wirtgen 2220366; Voegel 2216432; Donaldson P633483, X011872  
**Length:** 15 1/4 (387.3)  
**Width:** 5 1/4 (133.4)  
**Height:** 1 15/32 (37.3)  
**A. Gskt:** [1] Included



**PA31008** Primary EnduraPanel Air  
**Fits:** Cummins QSM 12, QSM15 (Final Tier 4) Engines  
**Use With:** PA31009  
**Replaces:** Fleetguard AF55024; Wirtgen 2392907  
**Length:** 15 7/32 (386.3)  
**Width:** 6 5/32 (156.2)  
**Height:** 15 1/8 (384.6)  
**A. Gskt:** [1] Included



**PA31004** Primary EnduraPanel Air  
**Notes:** Can be used with PA31007 & PA31005  
**Fits:** Cummins QSF 3.8 (Final Tier 4), QSB4.5 (Final Tier 4), QSF2.8 Naturally Aspirated (Tier 4), QSF2.8 Turbo (Tier 3), QSF 2.8 (Final Tier 4) Engines  
**Replaces:** Fleetguard AF55020; JLG Industries Inc. 70024177; Doosan 46595499  
**Length:** 9 1/8 (231.8)  
**Width:** 7 19/32 (192.9)  
**Height:** 9 7/8 (250.8)  
**A. Gskt:** [1] Included



**PA31009** Secondary EnduraPanel Air with Pull Tabs  
**Fits:** Cummins Engines; John Deere Tractors  
**Use With:** PA31008  
**Replaces:** Fleetguard AF55318; John Deere R344420  
**Length:** 15 1/8 (383.8)  
**Width:** 5 25/32 (146.6)  
**Height:** 1 31/32 (50.3)  
**A. Gskt:** [1] Included



**PA31005** Secondary EnduraPanel Air  
**Contains:** Foam Media  
**Fits:** Cummins QSF 3.8 (Final Tier 4), QSB4.5 (Final Tier 4), QSF2.8 Naturally Aspirated (Tier 4), QSF2.8 Turbo (Tier 3), QSF 2.8 (Final Tier 4) Engines  
**Use With:** PA31004 and PA31006 w/ MAF Sensor.  
**Replaces:** Agco 700738184; Fleetguard AF55312; JLG Industries Inc. 70024176  
**Length:** 8 7/8 (225.4)  
**Width:** 6 31/32 (177.0)  
**Height:** 1 7/16 (36.5)  
**A. Gskt:** [1] Included



**PA31010** Primary EnduraPanel Air  
**Fits:** Bobcat Loaders Various Models, Telescopic Handlers with Doosan Engines  
**Use With:** PA31011  
**Replaces:** Bobcat 7286652, 7010030  
**Length:** 11 3/8 (288.9)  
**Width:** 10 7/16 (265.1)  
**Height:** 6 19/32 (167.5)  
**A. Gskt:** [1] Included



**PA31011** Secondary EnduraPanel Air  
**Fits:** Bobcat Loaders Various Models, Telescopic Handlers with Doosan Engines  
**Use With:** PA31010  
**Replaces:** Bobcat 7010031  
**Length:** 10 7/16 (265.1)  
**Width:** 5 15/32 (138.9)  
**Height:** 1 1/2 (38.1)  
**A. Gskt:** [1] Included



**PA31006** Primary EnduraPanel Air  
**Notes:** Can be used with PA31007 & PA31005  
**Fits:** Cummins QSF 3.8 (Final Tier 4), QSB4.5 (Final Tier 4), QSF2.8 Naturally Aspirated (Tier 4), QSF2.8 Turbo (Tier 3), QSF 2.8 (Final Tier 4) Engines  
**Replaces:** Fleetguard AF55021; Cummins 5288553; JLG Industries Inc. 70024175  
**Length:** 9 3/32 (231.0)  
**Width:** 7 19/32 (192.9)  
**Height:** 13 3/4 (349.3)  
**A. Gskt:** [1] Included



**PA31012** Primary EnduraPanel Air  
**Notes:** Can be used with PA31003 Secondary  
**Fits:** Cummins QSB6.7 (Final Tier 4, Interim Tier 4, Tier 4), QSL9 Engines  
**Replaces:** Cummins 5261248; Fleetguard AF55005  
**Length:** 16 1/8 (409.6)  
**Width:** 5 27/32 (148.4)  
**Height:** 10 1/32 (254.8)  
**A. Gskt:** [1] Included



**PA31007** Secondary EnduraPanel Air Element with Pull Tabs  
**Fits:** Cummins QSF 3.8 (Final Tier 4), QSB4.5 (Final Tier 4), QSF2.8 Naturally Aspirated (Tier 4), QSF2.8 Turbo (Tier 3), QSF 2.8 (Final Tier 4) Engines  
**Use With:** PA31004 & PA31006 w/o MAF Sensor  
**Replaces:** Fleetguard AF55320; Cummins 5310325  
**Length:** 9 (228.6)  
**Width:** 6 31/32 (177.0)  
**Height:** 1 7/16 (36.5)  
**A. Gskt:** [1] Included



**PA31013** Primary EnduraPanel Air Element  
**Fits:** Bobcat Loaders  
**Use With:** PA31014  
**Replaces:** Bobcat 7221933, 7286322  
**Length:** 6 5/32 (156.5)  
**Width:** 5 27/32 (148.6)  
**Height:** 9 9/32 (236)  
**A. Gskt:** [1] Included



**PA31014** Secondary EnduraPanel Air Element with Pull Tabs  
**Fits:** Bobcat Loaders  
**Use With:** PA31013  
**Replaces:** Bobcat 7221934  
**Length:** 5 11/16 (144.3)  
**Width:** 5 7/16 (138.4)  
**Height:** 1 7/16 (36.8)  
**A. Gskt:** [1] Included



Measurements Are Shown In Inches And (Millimeters)

**WARNING:** These products can expose you to chemicals, including Diisononyl Phthalate, Carbon black extracts, Nickel, 1,3 Butadiene, Ethylene Oxide, Epichlorohydrin, which are known to the State of California to cause cancer, and Bisphenol, Ethylene Glycol, Ethylene Oxide, 1,3 Butadiene, Epichlorohydrin, which are known to the State of California to cause birth defects or other reproductive harm.

**PA32000**

EnduraCube Air Element



**Fits:** Kenworth Trucks T680, T800, T880, Peterbilt Trucks 567, 579  
**Replaces:** Paccar P621725  
**Length:** 19 1/32 (483.1)  
**Width:** 8 13/32 (213.4)  
**Height:** 12 3/16 (309.4)  
**A. Gskt:** [1] Included

**PA32001**

Primary EnduraCube Air Element



**Notes:** Can be used with PA32004 Secondary EnduraCube  
**Fits:** International 4300, 4300LP, 4400, 4400 DuraStar, TerraStar Trucks with Cummins ISB (6.7L), ISL (8.9L), L9; MaxxForce 7 (6.4L), 9 (9.3L), DT (7.6L) Engines  
**Replaces:** IHC 2517298C1, 2602212C1  
**Length:** 10 13/16 (274.6)  
**Width:** 10 (254.0)  
**Height:** 8 3/32 (205.6)  
**A. Gskt:** [1] Included

**PA32002**

EnduraCube Air Element



**Fits:** Freightliner 122SD, Cascadia, Coronado, Coronado SD; Western Star 5700XE, 6900XD Trucks  
**Replaces:** Freightliner 336867002, 336867010; Donaldson P629641  
**Length:** 26 7/32 (665.7)  
**Width:** 9 5/8 (244.3)  
**Height:** 10 1/2 (267)  
**A. Gskt:** [1] Included

**PA32003**

EnduraCube Air Element



**Fits:** Kenworth T680, T800; Peterbilt 579 Trucks  
**Replaces:** Paccar P621730; Donaldson P637454  
**Length:** 19 1/32 (483.1)  
**Width:** 8 13/32 (213.4)  
**Height:** 7 9/32 (184.7)  
**A. Gskt:** [1] Included

**PA32004**

Secondary EnduraCube Air Element

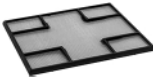

**Fits:** International 4300, 4300LP, 4400, 4400 DuraStar, TerraStar Trucks with Cummins ISB (6.7L), ISL (8.9L), L9; MaxxForce 7 (6.4L), 9 (9.3L), DT (7.6L) Engines  
**Use With:** PA32001 Primary EnduraCube  
**Replaces:** IHC 2602211C1  
**Length:** 8 21/32 (219.9)  
**Width:** 7 23/32 (196.1)  
**Height:** 11/32 (8.7)

**B40000**

Lube Spin-on



**Fits:** 2013-on Chevrolet Spark L4 with 1.2L Engine  
**Replaces:** General Motors 96985730  
**Thread:** M18 x 1.5  
**O.D.:** 2 25/32 (70.6)  
**Height:** 2 13/16 (71.4)  
**I.Gskt:** [1] Included

**P40001**

Lube Element



**Fits:** 2014-15 Freightliner Sprinter, Mercedes-Benz E250, GLK250 Sprinter, all with 4-2143cc (2.1L) FI Turbo Diesel Engine  
**Replaces:** Mercedes-Benz 6511800109  
**O.D.:** 2 9/16 (65.1)  
**I.D.:** 1 7/32 (31.0)  
**Height:** 4 17/32 (115.1)  
**A. Gskt:** [2] Attached  
**O-Ring:** [3] Included

**P40002**

Lube Element



**Contains:** By-Pass Valve  
**Fits:** Yamaha YZ250F, YZ450F, WR250R Motorcycles  
**Replaces:** Yamaha 5TA1344000  
**O.D.:** 1 1/2 (38.1)  
**I.D.:** 17/32 (13.5) One End  
**Height:** 1 27/32 (46.8)  
**End Seals:** [2] Attached

**P40003**

Lube Element



**Fits:** Mercedes-Benz European Light-Duty Trucks  
**Replaces:** Mercedes-Benz 9361800009, 9361840225, A9361800009, A9361840225  
**O.D.:** 3 1/2 (88.9)  
**I.D.:** 1/2 (12.7) & 1 5/8 (41.3)  
**Height:** 8 3/16 (208.0)  
**O-Ring:** [1] Included

**C40004**

By-Pass Lube Sock



**Fits:** Massey Ferguson Applications  
**Replaces:** Massey Ferguson 1013890M1  
**O.D.:** 3 1/8 (79.4)  
**I.D.:** 27/32 (21.4) & 15/16 (23.8)  
**Height:** 9 5/8 (244.5)  
**A. Gskt:** [1] Included  
**F. Gskt:** [1] Included  
**Related To:** Related to BF825 (Can-Type Version)

**C40005**

By-Pass Lube Sock



**Fits:** Massey Ferguson Applications  
**Replaces:** Massey Ferguson 1501049M91  
**O.D.:** 3 5/32 (80.2)  
**I.D.:** 5/8 (15.9) & 27/32 (21.4)  
**Height:** 6 7/8 (174.6)  
**A. Gskt:** [1] Included  
**F. Gskt:** [1] Included

**B40006**

Lube Spin-on



**Fits:** Blaw Knox Paving Equipment  
**Replaces:** Blaw Knox 11241400  
**Thread:** 3/4 -16  
**O.D.:** 3 1/16 (77.8)  
**Height:** 3 1/2 (88.9)  
**I.Gskt:** [1] Included

**BC40007**

Centrifugal By-Pass Lube Element



**Fits:** 10/07-on Ford Transit 3.2 TDCI European Light-Duty Vehicles  
**Replaces:** Ford 1372808  
**O.D.:** 3 1/4 (82.6)  
**I.D.:** 1/4 (6.4) & 5/16 (7.9)  
**Height:** 2 11/16 (68.3)  
**A. Gskt:** [2] Copper Washers  
**O-Ring:** [1] Included

Measurements Are Shown In Inches And (Millimeters)

**WARNING:** These products can expose you to chemicals, including Diisononyl Phthalate, Carbon black extracts, Nickel, 1,3 Butadiene, Ethylene Oxide, Epichlorohydrin, which are known to the State of California to cause cancer, and Bisphenol, Ethylene Glycol, Ethylene Oxide, 1,3 Butadiene, Epichlorohydrin, which are known to the State of California to cause birth defects or other reproductive harm.



**P40008**

Lube Element



**Contains:** Offset By-Pass Pin  
**Fits:** 2013-on DAF Trucks with Paccar MX 11 Euro 6 Engine  
**Replaces:** DAF 1928868  
**O.D.:** 4 1/4 (108.0)  
**I.D.:** 5/8 (15.9) & 1 11/16 (42.9)  
**Height:** 10 1/4 (260.3)  
**O-Ring:** [2] Included

**BC40009**

Centrifugal Lube Element



**Fits:** 2013-on DAF Trucks with Paccar MX11 Euro 6 Engine  
**Replaces:** DAF 1928869  
**O.D.:** 3 7/8 (98.4)  
**I.D.:** 3/8 (9.5) & 1 1/4 (31.8)  
**Height:** 5 3/8 (136.5)  
**O-Ring:** [2] Included

**P40010**

Lube Element



**Fits:** 2012-13 Audi A5, 2013 A4, 2015 A3, S3; 2014-15 Volkswagen Beetle, Jetta, Passat, 2015 Golf, GTI  
**Replaces:** Volkswagen 6K115562, 6L115562  
**O.D.:** 2 1/16 (52.4)  
**I.D.:** 15/16 (23.8)  
**Height:** 4 13/32 (111.9)  
**O-Ring:** [1] Included

**P40011**

Lube Element



**Fits:** Gehl, Schramm Compressors  
**Replaces:** Schramm COUB2295  
**O.D.:** 3 9/32 (83.3)  
**I.D.:** 1 1/16 (27.0)  
**Height:** 4 1/16 (103.2)  
**F. Gskt:** [1] Included  
**End Seals:** [2] Attached

**P40012**

By-Pass Lube Element with Lift Tab



**Fits:** Massey-Harris Tractors with Continental Engines  
**Replaces:** Massey Ferguson 760999M1  
**O.D.:** 3 15/16 (100.0)  
**I.D.:** 7/8 (22.2)  
**Height:** 6 3/32 (154.8)  
**A. Gskt:** [2] Attached  
**F. Gskt:** [1] Included

**B40013**

Lube Spin-on



**Replaces:** Alliance ABPN-10G-P550367  
**Thread:** M36 x 1.5  
**O.D.:** 5 11/32 (135.7)  
**Height:** 12 7/32 (310.4)  
**I.Gskt:** [1] Included

**P40014**

Lube Element



**Fits:** Volkswagen Fox, Polo MK4, MK5 Automotive, Light-Duty Trucks  
**Replaces:** Volkswagen 3D198819A  
**O.D.:** 2 1/2 (63.5)  
**I.D.:** 1 3/8 (34.9)  
**Height:** 2 9/16 (65.1)  
**O-Ring:** [1] Included

**BT40015**

Air Breather Spin-on



**Fits:** Caterpillar Excavators, Loaders, Off-Highway Trucks  
**Replaces:** Caterpillar 9C4937  
**Thread:** 3/8 -18 NPT  
**O.D.:** 3 (76.2)  
**Height:** 2 25/32 (70.6)

**P40017**

Lube Element



**Fits:** Mercedes-Benz European Trucks, Vans  
**Replaces:** Mercedes-Benz A9341800009, A9341840225, 9341800009  
**O.D.:** 3 1/2 (88.9)  
**I.D.:** 1/2 (12.7) & 1 5/8 (41.3)  
**Height:** 6 1/32 (153.2)  
**A. Gskt:** [1] Attached  
**O-Ring:** [1] Included

**P40019**

Lube Element



**Fits:** DAF, Kenworth, Peterbilt Trucks  
**Replaces:** DAF 1629393, 1643070; Coopers LEF5207; Donaldson P550812; Fleetguard LF16233  
**O.D.:** 4 7/16 (112.7)  
**I.D.:** 2 (50.8)  
**Height:** 8 11/16 (220.7)  
**A. Gskt:** [2] Attached  
**F. Gskt:** [1] Included

**P40020**

Lube Element



**Fits:** Fendt Tractors  
**Replaces:** Deutz 4505597; Fendt F836200510010  
**O.D.:** 3 9/32 (83.3)  
**I.D.:** 3/8 (9.5) & 1 3/8 (34.9)  
**Height:** 5 11/32 (135.7)  
**O-Ring:** [1] Included

**P40021**

Lube Element



**Fits:** Isuzu Engines, Trucks  
**Replaces:** Isuzu 8980188580  
**O.D.:** 2 19/32 (65.9)  
**I.D.:** 7/16 (11.1)  
**Height:** 6 3/16 (157.2)  
**F. Gskt:** [1] Included  
**O-Ring:** [2] Included

**B40022-MPG**













Maximum Performance Glass Lube Spin-on



**Contains:** 20 PSID By-Pass Valve  
**Fits:** John Deere Forestry Equipment, Loaders, Industrial Engines  
**Replaces:** John Deere RE67764  
**Thread:** 1 1/2 -16  
**O.D.:** 3 3/4 (95.3)  
**Height:** 8 1/4 (209.6)  
**F. Gskt:** [1] Included

Measurements Are Shown In Inches And (Millimeters)

**WARNING:** These products can expose you to chemicals, including Diisononyl Phthalate, Carbon black extracts, Nickel, 1,3 Butadiene, Ethylene Oxide, Epichlorohydrin, which are known to the State of California to cause cancer, and Bisphenol, Ethylene Glycol, Ethylene Oxide, 1,3 Butadiene, Epichlorohydrin, which are known to the State of California to cause birth defects or other reproductive harm.

<p><b>P40023</b></p>  <p>Lube Element  <b>Fits:</b> Mercedes-Benz Automotive  <b>Replaces:</b> Mercedes-Benz 2761800009  <b>O.D.:</b> 2 9/16 (65.1)  <b>I.D.:</b> 7/8 (22.2) &amp; 31/32 (24.6)  <b>Height:</b> 6 9/16 (166.7)  <b>O-Ring:</b> [1] Attached, [1] Included</p>	<p><b>P40030</b></p>  <p>Lube Element  <b>Fits:</b> M.T.U. Equipment  <b>Replaces:</b> M.T.U. X57518300024; Fleetguard LF17485  <b>O.D.:</b> 2 13/16 (71.4)            3 (76.2)  <b>I.D.:</b> 1 1/8 (28.6)  <b>Height:</b> 7 7/8 (200.0)  <b>O-Ring:</b> [1] Attached, [1] Included</p>
<p><b>P40024</b></p>  <p>Lube Element  <b>Fits:</b> Volkswagen Passat with 4-1968cc (2.0L) FI Turbo Diesel Engine  <b>Replaces:</b> Volkswagen 3L115562  <b>O.D.:</b> 2 9/16 (65.1)  <b>I.D.:</b> 1 3/32 (27.8)  <b>Height:</b> 3 31/32 (100.8)  <b>O-Ring:</b> [2] Attached, [3] Included</p>	<p><b>P40031-MPG</b></p>  <p>Maximum Performance Glass Lube Element  <b>Fits:</b> Case Harvesters, Loaders, Sprayers, Tractors; Iveco Trucks with Cursor 9, 11, 13 Engines.  <b>Replaces:</b> Case 2996570, 504179764, 84565867; Claas 11429540; Iveco 504179764; New Holland 2996570, 504179764, 84565867  <b>O.D.:</b> 4 13/32 (111.9)  <b>I.D.:</b> 1 1/8 (28.6) One End  <b>Height:</b> 8 13/16 (223.8)  <b>O-Ring:</b> [2] Attached, [1] Included</p>
<p><b>P40025</b></p>  <p>Lube Element  <b>Fits:</b> Jaguar; Land Rover LR4, Range Rover  <b>Replaces:</b> Land Rover LR011279  <b>O.D.:</b> 2 15/16 (74.6)  <b>I.D.:</b> 3/4 (19.0) &amp; 1 (25.4)  <b>Height:</b> 5 13/16 (147.6)  <b>A. Gskt:</b> [1] Included  <b>F. Gskt:</b> [1] Included</p>	<p><b>BT40032</b></p>  <p>Lube Spin-on  <b>Contains:</b> 40 PSID By-Pass Valve  <b>Fits:</b> Yanmar Engines  <b>Replaces:</b> Yanmar 12769535150  <b>Thread:</b> 1 -12  <b>O.D.:</b> 3 11/16 (93.7)  <b>Height:</b> 7 1/8 (181.0)  <b>I.Gskt:</b> G381-A</p>
<p><b>BD40027</b></p>  <p>Lube Spin-on  <b>Fits:</b> John Deere Dozers, Harvesters, Loaders, Tractors  <b>Replaces:</b> John Deere RE530107, RE557343, RE561823, RE572785; Hifi/Jura Filtration SO10014, SO10094; Mann &amp; Hummel W11011  <b>Thread:</b> M52 x 1.5-6H  <b>O.D.:</b> 4 11/16 (119.1)  <b>Height:</b> 11 25/32 (299.2)  <b>I.Gskt:</b> [1] Included  <b>A. Gskt:</b> [1] Included</p>	<p><b>P40033</b></p>  <p>Lube Element  <b>Fits:</b> Ford, Lincoln Automotive, Light-Duty Trucks  <b>Replaces:</b> Motorcraft FL2062  <b>O.D.:</b> 1 15/16 (49.2)  <b>I.D.:</b> 27/32 (21.4)  <b>Height:</b> 5 13/32 (137.3)  <b>A. Gskt:</b> [2] Included  <b>O-Ring:</b> [3] Included</p>
<p><b>BT40028</b></p>  <p>Lube Spin-on  <b>Contains:</b> 14 PSID By-Pass Valve  <b>Fits:</b> Ingersoll-Rand Air Source Plus 185 Compressor with 41RX3T Engine  <b>Replaces:</b> Ingersoll-Rand 22496905  <b>Thread:</b> 3/4 -16  <b>O.D.:</b> 3 11/16 (93.7)  <b>Height:</b> 3 1/4 (82.6)  <b>I.Gskt:</b> G381-A</p>	<p><b>BT40034</b></p>  <p>Lube Spin-on  <b>Contains:</b> Anti-Drainback Valve            14 PSID By-Pass Valve  <b>Fits:</b> NACCO Material Handling Equipment  <b>Replaces:</b> NACCO Materials Handling 8815414  <b>Thread:</b> M20 x 1.5  <b>O.D.:</b> 2 21/32 (67.5)  <b>Height:</b> 5 1/2 (139.7)  <b>I.Gskt:</b> [1] Included</p>
<p><b>BT40029</b></p>  <p>Lube or Hydraulic Spin-on  <b>Fits:</b> Atlas Copco XAS750 JD7 &amp; XATS1050 CD7 Compressors  <b>Replaces:</b> Atlas Copco 1626088200  <b>Thread:</b> M24 x 1.5-6H  <b>O.D.:</b> 3 23/32 (94.2)  <b>Height:</b> 8 3/16 (208.3)  <b>A. Gskt:</b> [1] Included</p>	<p><b>P40035</b></p>  <p>Lube Element  <b>Fits:</b> Porsche, Volkswagen Automotive  <b>Replaces:</b> Volkswagen 3H115562; Porsche 95810722210  <b>O.D.:</b> 3 3/16 (81.0)  <b>I.D.:</b> 5/8 (15.9) One End  <b>Height:</b> 4 11/16 (119.1)  <b>O-Ring:</b> [1] Attached, [1] Included</p>

Measurements Are Shown In Inches And (Millimeters)

**WARNING:** These products can expose you to chemicals, including Diisononyl Phthalate, Carbon black extracts, Nickel, 1,3 Butadiene, Ethylene Oxide, Epichlorohydrin, which are known to the State of California to cause cancer, and Bisphenol, Ethylene Glycol, Ethylene Oxide, 1,3 Butadiene, Epichlorohydrin, which are known to the State of California to cause birth defects or other reproductive harm.

**B40036** Lube Spin-on  
**Fits:** Mazda 5, 6, Tribute  
**Replaces:** Mazda LF0514302B  
**Thread:** 3/4 -16  
**O.D.:** 2 29/32 (73.8)  
**Height:** 3 1/2 (88.9)  
**I.Gskt:** [1] Included



**P40037** Lube Element  
**Notes:** [1] Bolt Furnished  
**Fits:** Mitsubishi Fuso Canter FE125, FE130, FE160, FE180, FG4x4 Trucks with (3.0L) Engines  
**Replaces:** Mitsubishi QC000001, QQC000001; Iveco 504385104; Nissan 15208-HJ00A; Donaldson P506077; Fleetguard LF16330  
**O.D.:** 2 3/4 (70.1)  
**I.D.:** 27/32 (21.1) One End  
**Height:** 5 3/16 (131.8)  
**O-Ring:** [1] Furnished



**BT40038** Lube Spin-on  
**Contains:** Anti-DrainBack Valve 11-17 PSID Bypass Valve  
**Fits:** Case Loaders, Compaction Equipment; New Holland Skid Steer Loaders  
**Replaces:** Case 84475542; New Holland 84475542; Donaldson P551132  
**Thread:** 3/4 -16  
**O.D.:** 3 (76.2)  
**Height:** 3 9/32 (83.3)  
**I.Gskt:** [1] Included



**P40042** Lube Element  
**Fits:** M.A.N. European Trucks  
**Replaces:** M.A.N. 51055010009, 51055010013, 51055040115  
**O.D.:** 4 23/32 (119.9)  
**I.D.:** 2 3/32 (53.1)  
**Height:** 6 31/32 (177)  
**O-Ring:** [1] Attached, [1] Included



**B40050** Lube Spin-on  
**Fits:** Cummins ISF3.8, QSF2.8 Naturally Aspirated (Tier 3), QSF2.8 Turbo (Tier 3), QSF2.8 (Tier 4 Final) Engines  
**Replaces:** Cummins 5262313; Fleetguard LF16352  
**Thread:** M27 x 2.0  
**O.D.:** 4 (101.6)  
**Height:** 6 7/8 (174.6)  
**A. Gskt:** [1] Included



**B40051** Lube Spin-on  
**Fits:** Cummins QSF 2.8 Engines  
**Replaces:** Cummins 5266016; Fleetguard LF17356; Donaldson P557356  
**Thread:** M67 x 4.0  
**O.D.:** 4 (101.6)  
**Height:** 6 7/32 (157.7)  
**A. Gskt:** [1] Included  
**O-Ring:** [1] Attached



**P40052** Fuel Element  
**Notes:** Superseded to PF40052  
**Fits:** Isuzu Trucks with 4HK1 (5.2L) Engine  
**Replaces:** General Motors Corp. 98165375; Isuzu 8981653750; Fleetguard FS20128  
**O.D.:** 2 9/16 (65.1)  
**I.D.:** 5/8 (15.9) One End  
**Height:** 4 1/16 (103.2)  
**O-Ring:** [1] Attached, [3] Included



**PF40052** Fuel Element  
**Fits:** Isuzu Trucks with 4HK1 (5.2L) Engine  
**Replaces:** General Motors Corp. 98165375; Isuzu 8981653750  
**O.D.:** 2 9/16 (65.1)  
**I.D.:** 5/8 (15.9) One End  
**Height:** 4 1/16 (103.2)  
**O-Ring:** [1] Attached, [3] Included



**B40053** Lube Spin-on  
**Fits:** International MaxxForce 9 and 10 Engines, DuraStar, TranStar, WorkStar Trucks  
**Replaces:** Navistar 1885920C2, 1885920C1  
**Thread:** 1 5/8 -12 UN  
**O.D.:** 4 5/8 (117.5)  
**Height:** 10 13/32 (264.3)  
**I.Gskt:** [1] Included



**B40054** Lube Spin-on  
**Contains:** Anti-Drain Back Valve 14 PSID By-Pass Valve  
**Fits:** Caterpillar, Mitsubishi Lift Trucks; Hyundai Excavators  
**Replaces:** Caterpillar 32B4020100; Donaldson P502476; Fleetguard LF17507  
**Thread:** 1 -12 UNS-2B  
**O.D.:** 4 1/4 (108.0)  
**Height:** 5 13/16 (147.6)  
**A. Gskt:** [1] Included



**B40056** Lube Spin-on  
**Contains:** 25 PSID By-Pass Valve  
**Fits:** Doosan Compressors  
**Replaces:** Ingersoll-Rand 23279078; Fleetguard LF17495  
**Thread:** M27 x 2.0  
**O.D.:** 3 23/32 (94.5)  
**Height:** 5 3/8 (136.5)  
**A. Gskt:** [1] Included



**P40058** Lube Element  
**Fits:** Fiat Doblo I 1.3 Multijet 16V JTD (119/223) w/with 75 HP, 85 HP Engines (11/05-on) European Light-Duty Vehicles  
**Replaces:** Fiat 55197218  
**O.D.:** 2 5/8 (66.7)  
**I.D.:** 1/2 (12.7) One End  
**Height:** 3 15/16 (100.0)  
**O-Ring:** [2] Attached, [1] Included



**P40061** Lube Element  
**Fits:** Volkswagen Beetle, Jetta, Passat, Golf  
**Replaces:** Volkswagen 3N115562  
**O.D.:** 2 9/16 (65.1)  
**I.D.:** 1 1/16 (27.0) One End  
**Height:** 4 3/32 (104.0)  
**O-Ring:** [2] Included



Measurements Are Shown In Inches And (Millimeters)

**WARNING:** These products can expose you to chemicals, including Diisononyl Phthalate, Carbon black extracts, Nickel, 1,3 Butadiene, Ethylene Oxide, Epichlorohydrin, which are known to the State of California to cause cancer, and Bisphenol, Ethylene Glycol, Ethylene Oxide, 1,3 Butadiene, Epichlorohydrin, which are known to the State of California to cause birth defects or other reproductive harm.

**P40062** Lube Element  
**Notes:** Element in Housing is P7495  
**Fits:** New Holland Combines, Forage Harvesters, Tractors  
**Replaces:** Case 5801592277; New Holland 5801592277; Iveco 50054654, 5801592277; Donaldson P954658; Fleetguard LF17546  
**O.D.:** 4 13/32 (111.9)  
**I.D.:** 1 9/16 (39.7) One End  
**Height:** 12 5/8 (320.7)  
**O-Ring:** [1] Attached, [1] Included

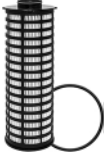

**P40074** Lube Element  
**Fits:** 2018-19 Chevrolet Colorado and GMC Canyon all with 2.8L Diesel Eng  
**Replaces:** ACDelco PF2262G; General Motors Corp.12670806,12679114  
**O.D.:** 2 21/32 (67.6)  
**I.D.:** 21/32 (16.5) & 15/16 (23.6)  
**Height:** 6 5/8 (168.7)  
**O-Ring:** [3] Attached, [1] Included



**B40063** Lube Spin-on  
**Fits:** Atlas Copco Compressors; John Deere Dozers, Excavators, Forestry Equipment, Generators, Harvesters, Industrial Engines, Loaders, Power Units, Sprayers, Tractors  
**Replaces:** John Deere RE539279; Donaldson P551910; Fram PH10220; Luber-finer LFP9279  
**Thread:** M92 x 2.5  
**O.D.:** 4 (101.6)  
**Height:** 5 7/8 (149.1)  
**O-Ring:** [1] Attached  
**Grommets:** [1] Attached



**P40076** Lube Element  
**Fits:** BMW Automobiles  
**Replaces:** BMW 11428583898  
**O.D.:** 2 7/32 (56.4)  
**I.D.:** 13/16 (20.6)  
**Height:** 6 1/16 (153.9)  
**F. Gskt:** [1] Copper Washer  
**O-Ring:** [3] Attached, [1] Included



**BT40065** Air Breather Spin-on  
**Fits:** McNeilus refuse systems  
**Replaces:** McNeilus 0604428, 604428  
**Thread:** 3/4 NPT  
**O.D.:** 3 11/16 (93.2)  
**Height:** 3 7/32 (81.6)



**OB40078** Replacement Filter Base  
**Notes:** Spin-on conversion for Chevrolet V8 engines.  
**Contains:** Threaded Stud: 13/16-16 [2] 1/4 In. Bolts [2] 5/16 In. Bolts  
**Use With:** B6, B7  
**Replaces:** ACDelco K157; GMC 6438357; Motorcraft FL774; WIX 24061  
**O.D.:** 4 (101.6)  
**A. Gskt:** [1] Attached  
**F. Gskt:** [1] Included



**BT40066-MPG** Maximum Performance Glass Hydraulic Spin-on  
**Fits:** Caterpillar Crawler Tractors, Off-Highway Trucks  
**Replaces:** Caterpillar 4656506  
**Thread:** 1 3/8 -12  
**O.D.:** 4 23/32 (119.6)  
**Height:** 10 (254)  
**A. Gskt:** [1] Included



**OB40079** Full-Flow Lube Filter Base for Remote Mount Filter  
**Contains:** Single Inlet/Outlet with Female 1/2-14 In. NPT Thread  
**Use With:** B34, B2, B253, B163, B132, B233, BT5, BT251, BT237, B1434, BT217, B74  
**Replaces:** Wix 24762  
**Thread:** 3/4 -16  
**O.D.:** 4 (101.6)  
**Height:** 2 1/2 (63.5)



**B40070** Lube Spin-on  
**Contains:** Anti-Drainback Valve  
 20 PSID By-Pass Valve  
**Fits:** Bobcat Excavators, Loaders, Telescopic Handlers, Utility Vehicles.  
**Replaces:** Bobcat 7012303  
**Thread:** 1 -12  
**O.D.:** 3 11/16 (93.7)  
**Height:** 3 31/32 (100.8)  
**A. Gskt:** G401



**OB40080** Replacement Filter Base for Remote Mount  
**Notes:** Cast Aluminum  
**Contains:** Dual Inlet/Outlet with Female 1/2 In. NPT  
 Threaded Stud: 3/4-16  
**Replaces:** Wix 24764, 524764



**S40071** Foam Fuel Element  
**Fits:** Master Portable Heaters; Heating-Fuel Storage Tanks  
**Replaces:** General 1A30; Kralinator F900; Fram C1250RO  
**O.D.:** 2 1/2 (63.5)  
**Height:** 3 25/32 (96.0)  
**F. Gskt:** [3] Included



**P40081** Lube Element  
**Fits:** 1991-95 BMW Automotive  
**Replaces:** BMW (Bavarian Motor Works) 11421727300; Wix 51185  
**O.D.:** 3 3/16 (81.0)  
**I.D.:** 1 31/32 (50.0)  
**Height:** 3 17/32 (89.7)  
**A. Gskt:** [2] Attached  
**F. Gskt:** [2] Metal Washers  
**O-Ring:** [2] Included



**B40073** Lube Spin-on  
**Fits:** Caterpillar Excavators, Loaders, Paving Equipment  
**Replaces:** Caterpillar 3776969  
**Thread:** 3/4 -16 UNF  
**O.D.:** 3 11/16 (94.0)  
**Height:** 3 7/8 (98.6)  
**A. Gskt:** [1] Included  
**Grommets:** [1] Attached



Measurements Are Shown In Inches And (Millimeters)

**WARNING:** These products can expose you to chemicals, including Diisononyl Phthalate, Carbon black extracts, Nickel, 1,3 Butadiene, Ethylene Oxide, Epichlorohydrin, which are known to the State of California to cause cancer, and Bisphenol, Ethylene Glycol, Ethylene Oxide, 1,3 Butadiene, Epichlorohydrin, which are known to the State of California to cause birth defects or other reproductive harm.

**P40083** Lube Element  
**Fits:** 1992-95 BMW 320i, 1991-95 325i, 325iC, 525i, 525iT, 1991 325iS, 325iX, 1995-2006 M3, 1998-2000 Z3, 2001-02 Z3 M  
**Replaces:** BMW (Bavarian Motor Works) 11421730389; Wix 51160  
**O.D.:** 3 3/16 (81.0)  
**I.D.:** 1 3/32 (27.8)  
**Height:** 4 15/32 (113.5)  
**A. Gskt:** [2] Attached  
**F. Gskt:** [4] Included



**P40093** Lube Element  
**Fits:** Honda Motorcycles  
**Replaces:** Honda 15410-426001-0; Wix 24940  
**O.D.:** 3 1/32 (77.0)  
**I.D.:** 25/32 (19.8)  
**Height:** 2 5/32 (54.8)  
**O-Ring:** [2] Included  
**Grommets:** [2] Attached



**P40085** Lube Element  
**Fits:** Yamaha Motorcycles  
**Replaces:** Yamaha 1L913440-91; Wix 24934, 51218  
**O.D.:** 3 (76.2)  
**I.D.:** 25/32 (19.8)  
**Height:** 1 19/32 (40.5)  
**O-Ring:** [2] Included  
**Grommets:** [2] Attached



**P40094** Lube Element  
**Fits:** 1999-on Porsche 911 Carrera, 2004-on 911 GT2, 2004-07 911 GT3, 911 Turbo S, 2000-05 911 Turbo, 1997-2009 Boxster, 2003-09 Cayenne, 2006-on Cayman S  
**Replaces:** Porsche 99610722552; Wix 57211  
**O.D.:** 2 9/16 (65.1)  
**I.D.:** 15/16 (23.8)  
**Height:** 4 1/2 (114.3)  
**O-Ring:** [2] Attached, [1] Included



**P40086** Lube Element  
**Fits:** Honda Motorcycles  
**Replaces:** Honda 15412-413-005, 154A1-413-005; Wix 24938, 51217  
**O.D.:** 2 5/8 (66.7)  
**I.D.:** 25/32 (19.8)  
**Height:** 1 25/32 (45.2)  
**F. Gskt:** [1] Included  
**O-Ring:** [1] Included  
**Grommets:** [2] Attached



**P40095** Lube Element  
**Fits:** 2005-07 Audi A6, 2006 A6 Avant, 2005 A6 Quattro, A8 Quattro, 2006-08 A8, A8 L, 2004-05 A8 L Quattro, 2004 Allroad Quattro, 2007 RS4, 2004-08 S4, S4 Avant, 2005-09 S4 Cabriolet; 2004-06 Volkswagen Phaeton  
**Replaces:** Volkswagen 79115561B, 79198405; WIX 57329, 557329  
**O.D.:** 2 7/8 (73.0)  
**I.D.:** 3/8 (9.5) & 1 1/4 (31.8)  
**Height:** 5 11/16 (144.5)  
**A. Gskt:** [1] Attached  
**F. Gskt:** [1] Washer  
**O-Ring:** [1] Included



**P40089** Lube Element  
**Contains:** 10 PSID By-Pass Valve  
**Fits:** Yamaha ATVs, Motorcycles  
**Replaces:** Yamaha 4X71344090; Wix 24935  
**O.D.:** 2 3/16 (55.6)  
**I.D.:** 21/32 (16.7) One End  
**Height:** 2 3/8 (60.3)  
**O-Ring:** [3] Included  
**Grommets:** [2] Attached



**P40096** Lube Element  
**Fits:** 2004-07 Volkswagen Touareg with 4.2L Gas Engine, 2005 Touareg with 4.9L Diesel Engine  
**Replaces:** Volkswagen 77115562; Wix 57563, 557563  
**O.D.:** 3 9/32 (83.3)  
**I.D.:** 13/16 (20.6) & 1 3/8 (34.9)  
**Height:** 4 5/16 (109.5)  
**A. Gskt:** [2] Attached  
**O-Ring:** [2] Included



**P40090** Lube Element  
**Fits:** Kawasaki KL250, KLR250, KL600, KL650, KLR650, KLX650, KLX650R Motorcycles  
**Replaces:** Kawasaki 16099004; Wix 24951  
**O.D.:** 2 5/32 (54.8)  
**I.D.:** 1/2 (12.7)  
**Height:** 2 9/32 (57.9)  
**O-Ring:** [2] Included  
**Grommets:** [2] Attached



**P40098** Lube Element  
**Fits:** 2003-on Maybach 57, 57S, 62; 2004-on Mercedes-Benz CL600, 2004-on S600, SL600, 2005-06 CL65 AMG, 2006 SL65 AMG all with V12 (5.5L), V12 (6.0L) Engines  
**Replaces:** Mercedes-Benz 2751800009, A2751800009; Wix 57198  
**O.D.:** 2 1/2 (63.5)  
**I.D.:** 1 7/32 (31.0)  
**Height:** 5 5/16 (134.9)  
**O-Ring:** [4] Included



**P40091** Lube Element  
**Fits:** Yamaha SR250, TT250, XT270, XV250 Series, BW350 Big Wheel, TT500, XT500, XV500 Virago, XV535 Virago, XT550, XV550 Vision, SRX600, TT600, XT600, XT600E, XVS650 Series, TDM850, TDM850E Motorcycles  
**Replaces:** Yamaha 4X71344090; Wix 24936  
**O.D.:** 2 3/16 (55.6)  
**I.D.:** 1/8 (3.2) One End  
**Height:** 2 3/8 (60.3)  
**O-Ring:** [2] Included  
**Grommets:** [2] Attached











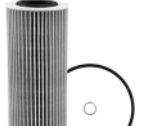

**P40099** Lube Element  
**Fits:** Mercedes-Benz Automotive  
**Replaces:** Mercedes-Benz 2711800009, 2711800109, 2711840125, A2711800009; Wix 57009  
**O.D.:** 1 13/16 (46.0)  
**I.D.:** 7/8 (22.2)  
**Height:** 6 5/32 (156.4)  
**O-Ring:** [3] Included  
**Grommets:** [2] Attached

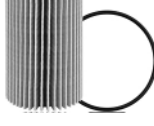

Measurements Are Shown In Inches And (Millimeters)

**WARNING:** These products can expose you to chemicals, including Diisononyl Phthalate, Carbon black extracts, Nickel, 1,3 Butadiene, Ethylene Oxide, Epichlorohydrin, which are known to the State of California to cause cancer, and Bisphenol, Ethylene Glycol, Ethylene Oxide, 1,3 Butadiene, Epichlorohydrin, which are known to the State of California to cause birth defects or other reproductive harm.

<p><b>P40100</b> Lube Element  <b>Fits:</b> BMW, Rolls Royce Automotive  <b>Replaces:</b> BMW 11427542021; WIX 57175  <b>O.D.:</b> 2 7/8 (73.0)  <b>I.D.:</b> 17/32 (13.5) &amp; 1 1/4 (31.8)  <b>Height:</b> 4 1/8 (104.8)  <b>A. Gskt:</b> [2] Attached  <b>F. Gskt:</b> [1] Metal Washer  <b>O-Ring:</b> [2] Included</p> 	<p><b>P40106</b> Lube Element  <b>Fits:</b> 2008-12 BMW M3  <b>Replaces:</b> BMW (Bavarian Motor Works) 11427837997; Wix 57997  <b>O.D.:</b> 3 9/32 (83.3)  <b>I.D.:</b> 1 5/32 (29.4)  <b>Height:</b> 4 1/4 (108)  <b>F. Gskt:</b> [2] Copper Washers  <b>O-Ring:</b> [2] Included</p> 
<p><b>P40101</b> Lube Element  <b>Fits:</b> 2007-09 Smart Fortwo with 3-799cc (0.8L) Turbo Diesel Engine, 2010 with 3-999 (1.0L) Engine  <b>Replaces:</b> Mercedes-Benz 1601840225, 19727V001, A1601840225  <b>O.D.:</b> 2 1/16 (52.3)  <b>I.D.:</b> 27/32 (21.4)  <b>Height:</b> 2 5/32 (54.8)  <b>O-Ring:</b> [1] Included</p> 	<p><b>P40107</b> Lube Element  <b>Fits:</b> BMW 335d, X5  <b>Replaces:</b> BMW 11427788454, 11427788460, 11427788461; Wix 57560  <b>O.D.:</b> 2 9/16 (65.1)  <b>I.D.:</b> 1 1/4 (31.8)  <b>Height:</b> 6 1/16 (154)  <b>F. Gskt:</b> [1] Metal Washer  <b>O-Ring:</b> [1] Included  <b>Grommets:</b> [2] Attached</p> 
<p><b>P40102</b> Lube Element  <b>Fits:</b> Hyundai Equus, Genesis; Kia Borrego, K900  <b>Replaces:</b> Hyundai 26320-3C30A, 26320-3C700; WIX 57042, 57029  <b>O.D.:</b> 2 19/32 (65.9)  <b>I.D.:</b> 3/4 (19.0)  <b>Height:</b> 4 (101.6)  <b>A. Gskt:</b> [2] Included  <b>F. Gskt:</b> [1] Metal Washer  <b>O-Ring:</b> [3] Included</p> 	<p><b>P40108</b> Lube Element  <b>Fits:</b> Mercedes-Benz Automotive  <b>Replaces:</b> Mercedes-Benz 1803009, A0001803009; Wix 57010  <b>O.D.:</b> 2 7/8 (73.0)  <b>I.D.:</b> 3/8 (9.5) &amp; 1 1/4 (31.8)  <b>Height:</b> 5 1/32 (127.8)  <b>A. Gskt:</b> [1] Attached  <b>F. Gskt:</b> [1] Included</p> 
<p><b>P40103</b> Lube Element  <b>Fits:</b> Audi Q7, R8; Volkswagen Touareg  <b>Replaces:</b> Audi 79198405B; Mann &amp; Hummel HU7005X; WIX 57330  <b>O.D.:</b> 2 11/16 (68.3)  <b>I.D.:</b> 3/4 (19.0) &amp; 1 1/16 (27.0)  <b>Height:</b> 5 1/16 (128.6)  <b>A. Gskt:</b> [1] Attached  <b>O-Ring:</b> [1] Included</p> 	<p><b>P40109</b> Lube Element  <b>Fits:</b> Lexus IS-F, LX570; Toyota Sequoia, Land Cruiser, Tundra  <b>Replaces:</b> Toyota 415251010; Wix 57310  <b>O.D.:</b> 2 3/4 (69.9)  <b>I.D.:</b> 1 3/32 (27.8)  <b>Height:</b> 4 9/16 (115.9)  <b>O-Ring:</b> [1] Included  <b>Related To:</b> P7406 (with Drain Plug)</p> 
<p><b>P40104</b> Lube Element  <b>Fits:</b> BMW, Rolls Royce Automotive  <b>Replaces:</b> BMW (Bavarian Motor Works) 11427583220; Wix 57189  <b>O.D.:</b> 2 31/32 (75.4)  <b>I.D.:</b> 1 1/8 (28.6) One End  <b>Height:</b> 4 11/32 (110.3)  <b>F. Gskt:</b> [1] Copper Washer  <b>O-Ring:</b> [2] Included</p> 	<p><b>P40110</b> Lube Element  <b>Fits:</b> Audi Q5, Q7; Volkswagen Touareg  <b>Replaces:</b> Volkswagen 57115561M; Mann &amp; Hummel HU8001X  <b>O.D.:</b> 3 (76.2)  <b>I.D.:</b> 1 1/8 (28.6)  <b>Height:</b> 7 7/8 (200)  <b>O-Ring:</b> [1] Included</p> 
<p><b>P40105</b> Lube Element  <b>Fits:</b> 2008-11 BMW M6, 2008-10 M5; 2008-12 Porsche Cayenne, 2009-12 911 Carrera, 911 Carrera 4, 911 Carrera 4S, 911 Carrera S, 911 Targa 4, 911 Targa 4S, 2010-12 Panamera, 2011-12 911 Carrera GTS, 911 Turbo  <b>Replaces:</b> BMW (Bavarian Motor Works) 11427840594, 11427834734; Porsche 94810722200; Wix 57694, 57594, WL10372, SL10372  <b>O.D.:</b> 3 9/32 (83.3)  <b>I.D.:</b> 1 5/32 (29.4)  <b>Height:</b> 4 1/4 (108)  <b>F. Gskt:</b> [2] Copper Washers  <b>O-Ring:</b> [2] Included</p> 	<p><b>P40111</b> Lube Element  <b>Contains:</b> By-Pass Boss/Plug  <b>Fits:</b> Audi A6 Quattro, A8 Quattro, Q5, Q7; Volkswagen Touareg  <b>Replaces:</b> Volkswagen 059198405, 59198405; Wix WL10008  <b>O.D.:</b> 2 13/16 (71.4)  <b>I.D.:</b> 1 1/8 (28.6)  <b>Height:</b> 5 1/32 (127.8)  <b>O-Ring:</b> [1] Attached, [1] Included</p> 

Measurements Are Shown In Inches And (Millimeters)

**WARNING:** These products can expose you to chemicals, including Diisononyl Phthalate, Carbon black extracts, Nickel, 1,3 Butadiene, Ethylene Oxide, Epichlorohydrin, which are known to the State of California to cause cancer, and Bisphenol, Ethylene Glycol, Ethylene Oxide, 1,3 Butadiene, Epichlorohydrin, which are known to the State of California to cause birth defects or other reproductive harm.

**P40112** Lube Element  
**Fits:** Mercedes-Benz C250, SLK250  
**Replaces:** Mercedes-Benz 2711800409, 2711800509, A2711800409, A2711800509; Wix WL10059  
**O.D.:** 1 13/16 (46.0)  
**I.D.:** 13/16 (20.6)  
**Height:** 6 5/32 (156.4)  
**O-Ring:** [3] Included

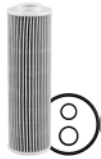

**P40119** Lube Element  
**Fits:** Mercedes-Benz Automotive  
**Replaces:** Mercedes-Benz A2701800009, A2701800109, A2701840025, A2701840125, 2701800009, 2701800109, 2701840025, 2701840125; Wix WL7515  
**O.D.:** 2 13/16 (71.4)  
**I.D.:** 1 7/32 (31.0)  
**Height:** 3 7/16 (87.3)  
**A. Gskt:** [1] Included  
**O-Ring:** [3] Included



**P40113** Lube Element  
**Contains:** [1] Plastic Plug  
**Fits:** BMW Automotive  
**Replaces:** BMW (Bavarian Motor Works) 11427640862  
**O.D.:** 2 7/8 (73.0)  
**I.D.:** 1 5/8 (41.3)  
**Height:** 3 1/8 (79.4)  
**O-Ring:** [2] Included



**B40120** Lube Spin-on  
**Contains:** Anti-Drainback Valve  
 20 PSID By-Pass Valve  
**Fits:** 1980-94 Jaguar  
**Replaces:** Jaguar C42797  
**Thread:** 1 -12  
**O.D.:** 3 11/16 (93.7)  
**Height:** 5 13/32 (137.3)  
**I.Gskt:** [1] Included



**P40114** Lube Element  
**Fits:** Chevrolet Cruze with 4-119 (2.0L) FI Turbo Diesel Engine  
**Replaces:** General Motors 55577033; Wix WL10021, SL10021  
**O.D.:** 2 19/32 (65.9)  
**I.D.:** 5/8 (15.9) & 1 1/4 (31.8)  
**Height:** 4 1/8 (104.8)  
**O-Ring:** [2] Attached



**B40122** Lube Spin-on  
**Contains:** 14 PSID By-Pass Valve  
**Fits:** Chevrolet 2500 HD, 3500 HD, 4500 HD, 5500 HD, 6500 HD Trucks with 6.6L Turbo Diesel; 2020 GMC Sierra 2500 HD, 3500HD Trucks  
**Replaces:** ACDelco PF26; General Motors Corp. 89017527; Wix 51372MP, 51372  
**Thread:** M22 x 1.5  
**O.D.:** 3 11/16 (93.7)  
**Height:** 4 3/8 (111.1)  
**I.Gskt:** [1] Included



**P40115** Lube Element  
**Fits:** Audi A8 Quattro; Bentley Continental; Volkswagen Phaeton, Touareg  
**Replaces:** Volkswagen 07C115562E, 7C115562E; Wix 57562  
**O.D.:** 2 7/8 (73.0)  
**I.D.:** 1 (25.4) & 1 5/8 (41.3)  
**Height:** 5 1/4 (133.4)  
**A. Gskt:** [2] Included  
**O-Ring:** [1] Included



**B40124** Lube Spin-on  
**Fits:** Chevrolet Astra, Volt  
**Replaces:** ACDelco PF65; General Motors Corp. 55352643, 93178952; Wix 57143  
**Thread:** M18 x 1.5  
**O.D.:** 3 1/32 (77.0)  
**Height:** 2 27/32 (72.2)  
**I.Gskt:** [1] Included



**P40116** Lube Element  
**Contains:** Plastic Drain Tube  
**Fits:** Scion iQ with 4-1329cc (1.3L) FI Engine  
**Replaces:** Toyota 415240060  
**O.D.:** 2 7/16 (61.9)  
**I.D.:** 1 3/32 (27.8)  
**Height:** 3 15/32 (88.1)  
**O-Ring:** [2] Included

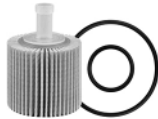

**B40125** Lube Spin-on  
**Contains:** Front-End By-Pass Valve  
**Fits:** 1978-95 Porsche 928, 1995-98 911  
**Replaces:** Porsche 92810720103; Wix 51285  
**Thread:** M20 x 1.5  
**O.D.:** 3 5/32 (80.2)  
**Height:** 6 3/4 (171.5)  
**I.Gskt:** [1] Included



**P40117** Lube Element  
**Fits:** 2005-08 Volkswagen Touareg with V10-4921cc (5.0L) Turbo Diesel Engine  
**Replaces:** Volkswagen 7Z15562; Wix 57162  
**O.D.:** 3 19/32 (91.3)  
**I.D.:** 1 1/4 (31.8) & 1 11/32 (34.1)  
**Height:** 5 9/16 (141.3)  
**O-Ring:** [1] Attached, [1] Included



**B40126** Lube Spin-on  
**Contains:** Anti-Drainback Valve  
 8 PSID By-Pass Valve  
**Fits:** 1993 Eagle, 1990-93 Geo, 1981-93 Isuzu Automotive  
**Replaces:** General Motors Corp. 25013451  
**Thread:** M20 x 1.5  
**O.D.:** 3 (76.2)  
**Height:** 3 1/2 (88.9)  
**I.Gskt:** [1] Included



**P40118** Lube Element  
**Fits:** Porsche Boxster, Cayman  
**Replaces:** Porsche 9A1.107.224.00; Wix 57070, 57070  
**O.D.:** 2 9/16 (65.1)  
**I.D.:** 1 1/4 (31.8)  
**Height:** 5 17/32 (140.5)  
**O-Ring:** [1] Included

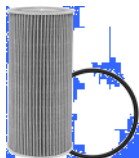

Measurements Are Shown In Inches And (Millimeters)

**WARNING:** These products can expose you to chemicals, including Diisononyl Phthalate, Carbon black extracts, Nickel, 1,3 Butadiene, Ethylene Oxide, Epichlorohydrin, which are known to the State of California to cause cancer, and Bisphenol, Ethylene Glycol, Ethylene Oxide, 1,3 Butadiene, Epichlorohydrin, which are known to the State of California to cause birth defects or other reproductive harm.

**B40127** Lube Spin-on  
**Contains:** Anti-Drainback Valve  
 36 PSID By-Pass Valve  
**Fits:** 2000-04 Audi A6 Series, 2002-03 S6 Series, all with V-8 4.2L Engine  
**Replaces:** Volkswagen 77115561G; WIX 57172  
**Thread:** M24 x 2.0  
**O.D.:** 2 31/32 (75.4)  
**Height:** 7 15/32 (189.7)  
**I.Gskt:** [1] Included



**B40133** Lube Spin-on  
**Fits:** Perkins 1104D-E44TA (4.4L), 1206F-E70TTA (7.0L) Engines  
**Replaces:** Perkins 4627133; Fleetguard LF16401  
**Thread:** M24 x 1.5  
**O.D.:** 3 11/16 (94.0)  
**Height:** 8 1/8 (206.8)  
**A. Gskt:** [1] Included



**B40128** Lube Spin-on  
**Contains:** Anti-Drainback Valve  
 30 PSID By-Pass Valve  
 Front End Check Valve  
**Fits:** 2005-06 Jeep Liberty with 2.8L Turbo Diesel Engine  
**Replaces:** Chrysler 5003558AA  
**Thread:** 3/4 -16  
**O.D.:** 2 29/32 (73.8)  
**Height:** 4 27/32 (123)  
**I.Gskt:** [1] Included



**B40136** Lube Spin-on  
**Contains:** Anti-Drainback Valve  
 20 PSID By-Pass Valve  
**Fits:** Cummins QSB3.3 Engine, B3.3 Generator Engine  
**Replaces:** Cummins 4982627; Fleetguard LF16097  
**Thread:** 3/4 -16 UNF  
**O.D.:** 3 1/32 (77.2)  
**Height:** 3 1/2 (88.9)  
**A. Gskt:** [1] Included



**B40129** Lube Spin-on  
**Contains:** 30 PSID By-Pass Valve  
 Front End Check Valve  
**Fits:** 1991-94 Porsche 911 Turbo, 1987-88 924, 1983-91 944, 1992-95 968  
**Replaces:** Porsche 94410720108; Wix 51287  
**Thread:** M20 x 1.5  
**O.D.:** 2 29/32 (73.8)  
**Height:** 4 27/32 (123)  
**I.Gskt:** [1] Included



**B40137** Lube Spin-on  
**Contains:** 35 PSID By-Pass Valve  
**Fits:** Isuzu FTR, NPR, NPR-HD, NPR-XD, NQR, NRR Trucks  
**Replaces:** Isuzu 2906544040, 2946542000; Fleetguard LF17537  
**Thread:** 1 1/2 -12  
**O.D.:** 4 21/32 (118.1)  
**Height:** 4 15/16 (125.2)  
**A. Gskt:** [1] Included



**P40130** Lube Element  
**Contains:** By-Pass Valve  
**Replaces:** Yamaha 1UY1344002  
**O.D.:** 1 1/2 (38.1)  
**I.D.:** 1/2 (12.7)  
**Height:** 1 13/16 (46.0)  
**A. Gskt:** [2] Attached  
**O-Ring:** [2] Included



**B40138** Lube Spin-on  
**Contains:** 20 PSID By-Pass Valve  
**Fits:** Isuzu NPR, NQR Trucks  
**Replaces:** Isuzu 2946541000, 2906542700; Fleetguard LF17538  
**Thread:** 1 1/2 -12  
**O.D.:** 4 21/32 (118.1)  
**Height:** 4 15/16 (125.2)  
**A. Gskt:** [1] Included



**P40131** Lube Element  
**Contains:** By-Pass Valve  
**Fits:** Yamaha Moto-4 200, Tri-Moto 200, Yamahauler 200, Moto-4 225, Tri-Moto 225; Pro Hauler 230, Bear Tracker 250, Moto-4 250, Timberwolf 250 ATVs, SRX, TW200 Series, XT200J, XT225, XT350 Series Motorcycles  
**Replaces:** Yamaha 5H01344009; WIX 57934  
**O.D.:** 1 1/2 (38.1)  
**I.D.:** 1/2 (12.7) One End  
**Height:** 1 7/8 (47.6)  
**O-Ring:** [2] Included



**BD40139** Dual-Flow Lube Spin-on  
**Fits:** Komatsu Dozers, Dump Trucks, Excavators, Tractors, Wheel Loaders  
**Replaces:** Komatsu 6002111341  
**Thread:** M95 x 2.5 -6H  
**O.D.:** 4 23/32 (119.6)  
**Height:** 11 25/32 (299.5)  
**A. Gskt:** [1] Included



**P40132** Lube Element  
**Fits:** Suzuki, Kawasaki ATVs, Motorcycles  
**Replaces:** Suzuki 1651029F00; WIX 57931  
**O.D.:** 1 3/4 (44.4)  
**I.D.:** 17/32 (13.5)  
**Height:** 1 23/32 (43.7)  
**F. Gskt:** [2] Included

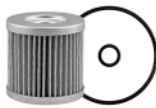

**B40140** Lube Spin-on  
**Contains:** Anti-Drainback Valve  
 30 PSID By-Pass Valve  
**Fits:** Bobcat 3400, 3400 XL, 3600, 3650 Utility Vehicles  
**Replaces:** Bobcat 7257441; Kohler 2175282  
**Thread:** M20 x 1.5 -6H  
**O.D.:** 3 1/32 (77.2)  
**Height:** 3 1/2 (88.9)  
**A. Gskt:** [1] Included



Measurements Are Shown In Inches And (Millimeters)

**WARNING:** These products can expose you to chemicals, including Diisononyl Phthalate, Carbon black extracts, Nickel, 1,3 Butadiene, Ethylene Oxide, Epichlorohydrin, which are known to the State of California to cause cancer, and Bisphenol, Ethylene Glycol, Ethylene Oxide, 1,3 Butadiene, Epichlorohydrin, which are known to the State of California to cause birth defects or other reproductive harm.



**B40142** Lube Spin-on  
**Fits:** Autocar, Dennis Eagle, Freightliner, International, Mack, Western Star Trucks; Blue Bird, IC Corporation, New Flyer, Thomas, Van Hool Buses  
**Replaces:** Cummins 5444774; Fleetguard LF14009NN; Donaldson DBL7300  
**Thread:** 2 1/4 -12  
**O.D.:** 4 21/32 (118.1)  
**Height:** 11 13/32 (289.6)  
**A. Gskt:** [1] Included  
**Grommets:** [1] Attached



**B40145** Lube Spin-on  
**Fits:** Cummins X12, X15 Engines  
**Replaces:** Cummins 5575298; Fleetguard LF14001NN  
**Thread:** M95 x 2.5 -6H  
**O.D.:** 4 11/16 (118.9)  
**Height:** 11 25/32 (299.5)  
**A. Gskt:** [1] Included  
**O-Ring:** [1] Attached  
**Related To:** BD50000 (High Efficiency Version where appropriate on use with 2020 Cummins X12, X15 Engines)



**B40150** Lube Spin-on  
**Contains:** Anti-Drainback Valve  
 25 PSID By-Pass Valve  
**Fits:** 2020 Chevrolet Silverado 2500 HD, Silverado 3500 HD, Silverado 4500 HD, Silverado 5500 HD, Silverado 6500 HD; GMC Sierra 2500 HD, Sierra 3500 HD.  
**Replaces:** ACDelco PF26; GM General Motors 12684038, 89017527  
**Thread:** M22 x 1.5  
**O.D.:** 3 11/16 (93.5)  
**Height:** 4 3/8 (111.3)  
**A. Gskt:** G381-A



**BF45000** In-Line Fuel Strainer  
**Fits:** Walker MD Series Mower  
**Replaces:** Walker 7020  
**O.D.:** 2 3/32 (53.2)  
**Inlet:** 1/4  
**Outlet:** 1/4  
**Length:** 3 7/16 (87.3)



**BF46000** In-Line Fuel Filter  
**Contains:** [1] Drain Screw  
**Fits:** Freightliner, Mercedes-Benz Sprinter Vans  
**Replaces:** Mercedes-Benz A6420920301  
**O.D.:** 3 5/8 (92.1)  
**Inlet:** 1/4  
**Outlet:** 1/4  
**Length:** 4 17/32 (115.1)  
**O-Ring:** [4] Included



**BF46001** In-Line Fuel Filter  
**Notes:** This filter used with detachable fuel heater.  
 Remove heater attachment from old filter and install on new filter.  
**Fits:** Mercedes-Benz Automotive  
**Replaces:** Mercedes-Benz 6420920201; Mann & Hummel WK820/2x  
**O.D.:** 3 9/16 (90.5)  
**Inlet:** 5/16  
**Outlet:** 3/8  
**Length:** 4 11/16 (119.1)  
**O-Ring:** [1] Included



**BF46002** High Efficiency Fuel Spin-on  
**Fits:** Cummins Engines, Marine Engines; Euclid, Hitachi, John Deere, Kawasaki, Komatsu, Terex Equipment, all with Cummins Engines  
**Replaces:** Cummins 2441458, 5417137  
**Thread:** 2 1/4 -12  
**O.D.:** 4 5/8 (117.5)  
**Height:** 10 (254.0)  
**I.Gskt:** [1] Included  
**Related To:** BF7932 (Standard Version)



**PF46003** Fuel Element  
**Fits:** Case, Case-International, New Holland Equipment  
**Replaces:** Case 5801439820  
**O.D.:** 4 1/4 (108.0)  
**I.D.:** 31/32 (24.6)  
**Height:** 6 11/32 (161.1)  
**O-Ring:** [1] Included



**PF46004** Fuel Element  
**Fits:** Ford Transit Vehicles  
**Replaces:** Ford 1837319, CC1Z-9354-A, CC119176BB; Motorcraft FD4621  
**O.D.:** 3 11/16 (93.7)  
 Flange 4 29/32 (124.6)  
**I.D.:** 5/8 (15.9) & 1 9/16 (39.7)  
**Height:** 5 9/32 (134.1)  
**O-Ring:** [2] Attached, [1] Included



**BF46005** In-Line Fuel Filter  
**Contains:** Mounting Bracket  
**Fits:** Caterpillar, Mitsubishi Lift Trucks  
**Replaces:** Caterpillar 9126406100  
**O.D.:** 1 13/16 (46.0)  
**Inlet:** M14 x 1.5  
**Outlet:** M14 x 1.5  
**Length:** 3 7/16 (87.3)



**BF46006** In-Line Diesel Fuel Filter  
**Fits:** Freightliner Trucks  
**Replaces:** Ford 4C4Z-9155-AA  
**O.D.:** 1 7/8 (47.6)  
**Length:** 4 31/32 (126.2)



**BF46007** In-Line Fuel Strainer  
**Fits:** 1992-2004 AM General, Chevrolet, GMC Trucks with V8-6.5L Engine  
**Replaces:** General Motors 12339208  
**O.D.:** 1 (25.4)  
**Inlet:** 1/4  
**Outlet:** 1/4  
**Length:** 3 (76.2)



Measurements Are Shown In Inches And (Millimeters)

**WARNING:** These products can expose you to chemicals, including Diisononyl Phthalate, Carbon black extracts, Nickel, 1,3 Butadiene, Ethylene Oxide, Epichlorohydrin, which are known to the State of California to cause cancer, and Bisphenol, Ethylene Glycol, Ethylene Oxide, 1,3 Butadiene, Epichlorohydrin, which are known to the State of California to cause birth defects or other reproductive harm.

**BF46008**

**In-Line Fuel Filter**



**Fits:** Kohler Generators  
**Replaces:** Kohler 267987  
**O.D.:** 1 7/32 (31.0)  
**Inlet:** 1/4-18 NPT  
**Outlet:** 1/8-27 NPT  
**Length:** 2 15/32 (62.7)

**PF46009**

**Fuel Element**



**Fits:** Kool-Gen Auxiliary Power Units  
**Replaces:** Racor R11T  
**O.D.:** 2 3/8 (60.3)  
**I.D.:** 5/8 (15.9) & 11/16 (17.5)  
**Height:** 2 5/8 (66.7)  
**F. Gskt:** [1] Included  
**O-Ring:** [1] Included

**PF46010 KIT**

**Set of 2 Fuel Elements**



**Notes:** NOTES: Larger filter is a coalescer smaller filter is a Fuel/Water Separator  
**Fits:** Marine Engines  
**Replaces:** Racor RK22610; Donaldson P551061, Carquest 96075; Fleetguard FS1107, Wix WF10075, HiFiJura YRK22610  
**Coalescer**  
**O.D.:** 4 (101.6)  
**I.D.:** 13/16 (20.6) & 1 3/16 (30.2)  
**Height:** 11 5/8 (295.3)  
**F. Gskt:** [1] Included  
**O-Ring:** [1] Included  
**Grommets:** [2] Attached to Each Filter  
**Fuel/Water Separator**  
**O.D.** 4  
**I.D.** 5/8 & 13/16  
**Height** 9 11/16

**BF46012**

**Fuel/Water Separator Spin-on**



**Fits:** Davco 210 Fuel Processor  
**Replaces:** Donaldson P550783; Wix 33998  
**Thread:** M16 x 1.5  
**O.D.:** 3 3/16 (81.0)  
**Height:** 6 15/16 (176.2)  
**I.Gskt:** [1] Included  
**F. Gskt:** [1] Included

**BF46013**

**Fuel Spin-on**



**Notes:** Fuel Dispensing Filter for Fuel Pumps (specifically for ethanol blended fuels up to E85)  
**Replaces:** CIM-TEK 70052, 70120  
**Thread:** 1 1/2 -16  
**O.D.:** 3 3/4 (95.3)  
**Height:** 4 13/32 (111.9)  
**I.Gskt:** [1] Included

**BF46014**

**Primary Fuel Spin-on**



**Notes:** CAUTION: Furnished O-Ring must be installed on post for seal.  
**Fits:** Davco 210 Fuel Processor  
**Replaces:** Donaldson P550782  
**Thread:** M16 x 1.5  
**O.D.:** 3 3/16 (81.0)  
**Height:** 6 15/16 (176.2)  
**I.Gskt:** [1] Included  
**F. Gskt:** [1] Included

**BF46015**

**Fuel/Water Separator Spin-on with Drain**



**Fits:** Eagle Tow Tractors with Yanmar 4TNV98 Engine  
**Replaces:** Fleetguard FS20000  
**Thread:** 1 1/8 -16  
**O.D.:** 3 11/16 (93.7)  
**Height:** 9 13/16 (249.2)  
**I.Gskt:** [1] Included  
**F. Gskt:** [1] Included

**BF46016-O**

**Fuel/Water Separator Spin-on with Open End for Bowl**



**Contains:** Bowl Thread: 3 3/4-10 Buttress Integral Post Seal  
**Fits:** Freightliner Trucks; Racor Fuel Systems  
**Replaces:** Freightliner ABPN122R50551  
**Thread:** 1 -14  
**O.D.:** 4 11/32 (110.3)  
**Height:** 6 1/8 (155.6)  
**F. Gskt:** [2] Included

**BF46017-O**

**Fuel/Water Separator Spin-on with Open End for Bowl**



**Contains:** Bowl Thread: 3 1/8-10 UN 1B  
**Fits:** Bobcat Compressors; Doosan G20 Portable Generators; Ingersoll-Rand Compressors  
**Replaces:** Ingersoll-Rand 54525530  
**Thread:** 1 -12  
**O.D.:** 3 25/32 (96.0)  
**Height:** 3 1/4 (82.6)  
**F. Gskt:** [1] Included  
**O-Ring:** [1] Included

**BF46018-O**

**Fuel/Water Separator Spin-on with Open End for Bowl**



**Contains:** Bowl Thread: 3 3/4-10UNS-2B Integral Post Seal  
**Fits:** International, Navistar Trucks with Maxxforce Engine  
**Replaces:** International 2602549C1  
**Thread:** 1 -14  
**O.D.:** 4 1/4 (108.0)  
**Height:** 8 17/32 (216.7)  
**F. Gskt:** [2] Included  
**Related To:** BF1281 (Drain Version)

**BF46019-O**

**Fuel/Water Separator Spin-on with Open End for Bowl**



**Contains:** Bowl Thread: 3 1/8-10 UN 1B  
**Fits:** Racor 215R Fuel Assembly  
**Replaces:** Racor R15S  
**Thread:** 1 -14  
**O.D.:** 3 13/16 (96.8)  
**Height:** 3 9/32 (83.3)  
**F. Gskt:** [1] Included  
**O-Ring:** [1] Included

**BF46020-O**

**Fuel/Water Separator Spin-on with Open End for Bowl**



**Contains:** Bowl Thread: 3 1/8-10 UN-1B  
**Fits:** Racor 215R Assemblies  
**Replaces:** Racor R15T  
**Thread:** 1 -14  
**O.D.:** 3 13/16 (96.8)  
**Height:** 3 9/32 (83.3)  
**F. Gskt:** [1] Included  
**O-Ring:** [1] Included

Measurements Are Shown In Inches And (Millimeters)

**WARNING:** These products can expose you to chemicals, including Diisononyl Phthalate, Carbon black extracts, Nickel, 1,3 Butadiene, Ethylene Oxide, Epichlorohydrin, which are known to the State of California to cause cancer, and Bisphenol, Ethylene Glycol, Ethylene Oxide, 1,3 Butadiene, Epichlorohydrin, which are known to the State of California to cause birth defects or other reproductive harm.

**BF46021-O** Fuel/Water Separator Spin-on with Open End for Bowl



**Contains:** Bowl Thread: 3 1/8-10 UN 1B  
**Fits:** Racor 230R Fuel Assembly Series  
**Replaces:** Racor R20S  
**Thread:** 1 -14  
**O.D.:** 3 11/16 (93.7)  
**Height:** 4 1/16 (103.2)  
**F. Gskt:** [1] Included  
**O-Ring:** [1] Included  
**Related To:** BF9922-O, BF46022-O (Micron Difference)

**BF46027-O** Fuel/Water Separator Spin-on with Open End for Bowl



**Contains:** Bowl Thread: 3 3/4-10 ANS Buttress Integral Post Seal  
**Fits:** Used in Racor 400, 600 Series Filter Assemblies  
**Replaces:** Racor R45S  
**Thread:** 1 -14  
**O.D.:** 4 3/8 (111.1)  
**Height:** 3 1/2 (88.9)  
**F. Gskt:** [2] Included

**BF46022-O** Fuel/Water Separator Spin-on with Open End for Bowl



**Contains:** Bowl Thread: 3 1/8-10 UN-1B  
**Fits:** Racor 230R Assembly  
**Replaces:** Racor R20T  
**Thread:** 1 -14  
**O.D.:** 3 11/16 (93.7)  
**Height:** 4 1/32 (102.4)  
**F. Gskt:** [1] Included  
**O-Ring:** [1] Included  
**Related To:** BF9922-O, BF46021-O (Micron Difference)

**BF46028-O** Fuel/Water Separator Spin-on with Open End for Bowl



**Contains:** Bowl Thread: 3 1/8-10UN-1B  
**Fits:** Racor 320R-RAC-02 Mounting Base; Marine Engines  
**Replaces:** Racor S3227  
**Thread:** 1 -14  
**O.D.:** 4 (101.6)  
**Height:** 4 1/16 (103.2)  
**F. Gskt:** [1] Included  
**O-Ring:** [1] Included

**BF46023-O** Fuel/Water Separator Spin-on with Open End for Bowl



**Contains:** Bowl Thread: 1 1/4-10  
**Fits:** Racor 220R Assemblies (Old Version)  
**Replaces:** Racor R24P  
**Thread:** 1 -14  
**O.D.:** 3 3/4 (95.3)  
**Height:** 3 9/16 (90.5)  
**F. Gskt:** [1] Included  
**O-Ring:** [1] Included

**BF46029-O** Fuel/Water Separator Spin-on with Open End for Bowl



**Contains:** Bowl Thread: 3 1/4-10  
 Integral Post Seal  
**Fits:** Racor Marine Applications  
**Replaces:** Racor S3228UL  
**Thread:** 1 -14  
**O.D.:** 3 25/32 (96.0)  
**Height:** 4 1/32 (102.4)  
**F. Gskt:** [1] Included  
**O-Ring:** [1] Included

**BF46024-O** Fuel/Water Separator Spin-on with Open End for Bowl



**Contains:** Bowl Thread: 1 1/4-10  
**Fits:** Used in Model 220RMAM Filter Assembly  
**Replaces:** Racor R24T  
**Thread:** 1 -14  
**O.D.:** 3 3/4 (95.3)  
**Height:** 3 9/16 (90.5)  
**F. Gskt:** [1] Included  
**O-Ring:** [1] Included

**BF46030-O** Fuel/Water Separator Spin-on with Open End for Bowl



**Contains:** Bowl Thread: 3 3/4-10 UN-1B  
**Fits:** Used in Racor 660R-RAC, 3120R-RAC Series Assemblies  
**Replaces:** Racor S3232  
**Thread:** 1 -14  
**O.D.:** 3 25/32 (96.0)  
**Height:** 5 1/2 (139.7)  
**F. Gskt:** [2] Included  
**O-Ring:** [1] Included  
**Related To:** BF1350-SP (Sensor Port Version)

**BF46025-O** Fuel/Water Separator Spin-on with Open End for Bowl



**Contains:** Bowl Thread: 3 1/8-10UN-1B  
**Fits:** Racor R245R Fuel Assembly  
**Replaces:** Racor R25T  
**Thread:** 1 -14  
**O.D.:** 3 3/4 (95.3)  
**Height:** 5 17/32 (140.5)  
**F. Gskt:** [1] Included  
**O-Ring:** [1] Included

**BF46031** Fuel/Water Separator Spin-on with Open Port



**Contains:** Port Thread: M36 x 1.5  
**Fits:** 2013 RAM Pickups with 6-408 (6.7L) FI Turbo Diesel Engine  
**Replaces:** Chrysler 68197867AA  
**Thread:** 1 -14  
**O.D.:** 4 1/4 (108.0)  
**Height:** 5 1/2 (139.7)  
**F. Gskt:** [1] Included  
**O-Ring:** [1] Included

**BF46026-O** Fuel/Water Separator Spin-on with Open End for Bowl



**Contains:** Bowl Thread: 1 1/4-10  
**Fits:** Racor 225 Series  
**Replaces:** Racor R26T; Donaldson P550088; Fleetguard FS1234  
**Thread:** 1 -14  
**O.D.:** 3 3/4 (95.3)  
**Height:** 4 21/32 (118.3)  
**F. Gskt:** [1] Included  
**O-Ring:** [1] Included

**BF46032** Fuel Spin-on



**Replaces:** Mann & Hummel WK962/7  
**Thread:** M18 x 1.5  
**O.D.:** 3 11/16 (93.7)  
**Height:** 8 9/32 (210.3)  
**I.Gskt:** [1] Included

Measurements Are Shown In Inches And (Millimeters)

**WARNING:** These products can expose you to chemicals, including Diisononyl Phthalate, Carbon black extracts, Nickel, 1,3 Butadiene, Ethylene Oxide, Epichlorohydrin, which are known to the State of California to cause cancer, and Bisphenol, Ethylene Glycol, Ethylene Oxide, 1,3 Butadiene, Epichlorohydrin, which are known to the State of California to cause birth defects or other reproductive harm.

**PF46033**

Fuel Element



**Fits:** Davco Fuel Systems  
**Replaces:** Davco 230029  
**O.D.:** 3 15/32 (88.1)  
**I.D.:** 21/32 (16.7) One End  
**Height:** 4 5/16 (109.5)  
**O-Ring:** [2] Included  
**Grommets:** [1] Attached

**BF46034**

Fuel Spin-on



**Fits:** Volvo Dump Trucks, Excavators, Loaders  
**Replaces:** Volvo 15126069; 21879886  
**Thread:** M32 x 1.5  
**O.D.:** 4 1/4 (108.0)  
**Height:** 10 15/32 (265.9)  
**I.Gskt:** [1] Included

**BF46037**

In-Line Fuel Filter with Plastic Connector



**Fits:** Mercedes-Benz Vito  
**Replaces:** Mercedes-Benz A6510903152  
**O.D.:** 3 17/32 (89.7)  
**Inlet:** 3/8  
**Outlet:** 5/16  
**Length:** 4 27/32 (123.0)

**BF46038-D**

Primary Fuel/Water Separator Element with Drain



**Fits:** Linde Lift Trucks  
**Replaces:** CEMS 42123; Linde 9839030  
**O.D.:** 3 9/32 (83.3)  
**Height:** 7 5/32 (181.8)  
**Grommets:** [1] Attached

**BF46039-D**

Primary Fuel/Water Separator Element with Drain



**Fits:** Caterpillar Loaders  
**Replaces:** Caterpillar 3619554  
**O.D.:** 3 15/32 (88.1)  
**I.D.:** 3/4 (19.0) One End  
**Height:** 7 3/4 (196.9)  
**Grommets:** [1] Attached

**BF46040-D**

Secondary Fuel/Water Separator Element with Drain



**Fits:** Ingersoll-Rand Air Source Plus 185 Compressor with IRX3T Engine  
**Replaces:** Ingersoll-Rand 22532378; Stanadyne 40232  
**O.D.:** 3 1/8 (79.4)  
**I.D.:** 3/4 (19.0)  
**Height:** 5 13/32 (137.3)  
**Grommets:** [1] Attached

**BF46041-D**

Primary Fuel/Water Separator Element with Drain



**Fits:** Allmand Brothers Generators, Equipment  
**Replaces:** CEMS 45658; Allmand Brothers 45658P  
**O.D.:** 3 15/32 (88.1)  
**I.D.:** 7/8 (22.2) One End  
**Height:** 7 13/16 (198.4)  
**Grommets:** [1] Attached

**BF46042-D**

Primary Fuel/Water Separator Element with Drain



**Fits:** Deutz-Fahr TTV7.260 Tractor with Deutz TCD (6.1L) Engine (Interim Tier 4)  
**Replaces:** Deutz 90005119, 243193000; Donaldson P564430; Doosan 46492252  
**O.D.:** 4 7/32 (107.2)  
**I.D.:** 1 1/4 (31.8) One End  
**Height:** 10 1/4 (260.3)  
**Grommets:** [1] Attached

**BF46043-D**

Primary Fuel/Water Separator Element with Drain



**Fits:** Volvo Industrial Engines  
**Replaces:** Volvo 22116209; Stanadyne 43592  
**O.D.:** 4 7/32 (107.2)  
**I.D.:** 1 1/4 (31.8) One End  
**Height:** 10 1/4 (260.3)  
**Grommets:** [1] Attached

**BF46044-D**

Primary Fuel/Water Separator Element with Drain



**Fits:** Deutz, Fahr, Same Tractors  
**Replaces:** SDF 90020434  
**O.D.:** 3 1/8 (79.4)  
**I.D.:** 15/16 (23.8) One End  
**Height:** 7 25/32 (197.6)  
**Grommets:** [1] Attached

**BF46045-D**

Primary Fuel/Water Separator Element with Drain



**Fits:** John Deere Tractors  
**Replaces:** John Deere RE536195, RE546336, RE548534  
**O.D.:** 3 1/8 (79.4)  
**I.D.:** 7/8 (22.2) One End  
**Height:** 6 1/8 (155.6)  
**Grommets:** [1] Attached

**PF46046**

Fuel Element



**Fits:** Deutz Engines  
**Replaces:** Deutz 2931748, 4291525; Fleetguard FF5769; Filtration SN70296  
**O.D.:** 3 3/4 (95.3)  
**I.D.:** 1 25/32 (45.2)  
**Height:** 6 7/16 (163.5)  
**O-Ring:** [1] Attached, [1] Included

Measurements Are Shown In Inches And (Millimeters)

**WARNING:** These products can expose you to chemicals, including Diisononyl Phthalate, Carbon black extracts, Nickel, 1,3 Butadiene, Ethylene Oxide, Epichlorohydrin, which are known to the State of California to cause cancer, and Bisphenol, Ethylene Glycol, Ethylene Oxide, 1,3 Butadiene, Epichlorohydrin, which are known to the State of California to cause birth defects or other reproductive harm.

**BF46048**

Fuel/Water Separator Spin-on with Drain, Sensor Port and Reusable Sensor



**Fits:** Hyster H50FT Lift Trucks with Cummins QSB 3.3L, Ammann AV85-2 Rollers with Cummins 4BT 3.3-C85 Diesel Engines  
**Replaces:** Cummins 4992119; Fleetguard FS19902  
**Thread:** M24 x 1.5  
**O.D.:** 3 11/16 (93.7)  
**Height:** 6 7/8 (174.6)  
**A. Gskt:** [1] Included

**PF46057**

Fuel Element



**Fits:** Multiquip generators and other equipment with Isuzu 4LE2T, 4LE2X Engines  
**Replaces:** Isuzu 8982402800; Wacker 5200017727  
**O.D.:** 3 (76.2)  
**I.D.:** 13/16 (20.6) One End  
**Height:** 4 5/16 (109.5)  
**O-Ring:** [2] Included  
**Grommets:** [1] Attached

**PF46049**

Fuel/Water Separator Element



**Fits:** Caterpillar Excavators, Generators, Loaders  
**Replaces:** Caterpillar 3635819  
**O.D.:** 2 27/32 (72.2)  
**I.D.:** 1 1/32 (26.2) One End  
**Height:** 5 1/2 (139.7)  
**F. Gskt:** [1] Included  
**O-Ring:** [1] Attached, [1] Included

**PF46059**

Fuel Element



**Fits:** Isuzu 4HK1 (5.2L), 4JJ1-TC- (3.0L) Engines Isuzu FTR, NPR, NPR-HD, NPR-XD, NQR, NRR Trucks  
**Replaces:** General Motors Corp. 94561104, 98147525; Isuzu 2945611040, 8981475250, 97780197, FE0040A  
**O.D.:** 2 5/8 (66.55)  
**I.D.:** 11/16 (17.27)  
**Height:** 4 17/32 (115.06)  
**F. Gskt:** [1] Included  
**O-Ring:** [3] Included

**BF46050**

Fuel Pre-Filter Spin-on with Sensor Port



**Fits:** Genie S-Boom, Scissors and Telehandlers  
**Replaces:** Genie 236260; Bomag 8820065; Caterpillar 4664177; Claas 19951210; Deutz 4130241, 4130650; JLG Industries 70025153  
**Thread:** M16 x 1.5  
**O.D.:** 3 23/32 (94.5)  
**Height:** 7 9/32 (184.9)  
**I.Gskt:** G381-A

**BF46062**

Fuel/Water Separator Spin-on with Open Port



**Contains:** Port Thread: M36 x 1.5  
**Fits:** 2012-16 Chevrolet Express Vans, GMC Savana Vans; 2001-16 Silverado Pickups, GMC Sierra Pickups; 2001-03 Chevrolet Suburban with V8 6.6L Turbo Diesel Engine  
**Replaces:** ACDelco TP3018  
**Thread:** 3 3/8 -8  
**O.D.:** 4 1/32 (102.4)  
**Height:** 6 3/8 (161.9)  
**O-Ring:** [2] Included  
**Grommets:** [1] Attached

**BF46051**

In-Line Fuel Filter



**Contains:** [2] Plastic Caps  
Plastic Drain  
**Fits:** Fiat Doblo II, Fiorino, Qubo, Strada Light-Duty Vehicles  
**Replaces:** Fiat 77363657; Hengst H340WK; Mahle KL567; Mann & Hummel WK853/21  
**O.D.:** 3 1/2 (88.9)  
**Length:** 8 1/16 (204.8)  
**F. Gskt:** [1] Included

**BF46064-D**

Fuel/Water Separator Element with Drain and Tab Keys



**Fits:** Mack Freedom MV with Renault E3 Engine  
**Replaces:** Mack 705836525; Wix 33444  
**O.D.:** 4 3/8 (111.3)  
**I.D.:** 1 1/16 (26.7) One End  
**Height:** 9 11/16 (246.1)  
**Grommets:** [1] Attached

**BF46052**

In-Line Fuel Filter



**Contains:** [2] Plastic Caps  
Plastic Drain  
**Fits:** Fiat, Ford Light-Duty Vehicles  
**Replaces:** Fiat 77363804; Ford 1578143, 1542785, 9S518N169BA; Hengst H303WK; Mahle KL566; Mann & Hummel WK853/20  
**O.D.:** 3 1/2 (88.9)  
**Length:** 8 1/16 (204.8)  
**F. Gskt:** [1] Included

**BF46065-SPS**

Fuel/Water Separator Spin-on with Drain, Sensor Port and Reusable Sensor



**Notes:** CAUTION:Furnished Gasket must be installed on post for seal.  
**Contains:** Sensor Port Thread M14 x 2 Integral Post Seal  
**Fits:** Volvo Compactors, Paving Equipment; Ingersoll-Rand PF6110 Paver  
**Replaces:** Volvo 43919935, 43802263; Fleetguard FS19732; Hifi/Jura Filtration SN909030; Napa Gold 3732; Wix 33732  
**Thread:** 1 -14 UNS-B  
**O.D.:** 3 21/32 (92.9)  
**Height:** 8 3/8 (212.7)  
**I.Gskt:** [1] Included  
**F. Gskt:** [1] Included

**PF46056**

Fuel Element



**Fits:** Multiquip generators and other equipment with Isuzu 4LE2T, 4LE2X Engines  
**Replaces:** Isuzu 8982402790; Wacker 5200017728  
**O.D.:** 3 (76.2)  
**I.D.:** 13/16 (20.6) One End  
**Height:** 5 19/32 (142.1)  
**O-Ring:** [2] Included  
**Grommets:** [1] Attached

Measurements Are Shown In Inches And (Millimeters)

**WARNING:** These products can expose you to chemicals, including Diisononyl Phthalate, Carbon black extracts, Nickel, 1,3 Butadiene, Ethylene Oxide, Epichlorohydrin, which are known to the State of California to cause cancer, and Bisphenol, Ethylene Glycol, Ethylene Oxide, 1,3 Butadiene, Epichlorohydrin, which are known to the State of California to cause birth defects or other reproductive harm.

**BF46069**



Fuel/Water Separator Spin-on with Drain  
**Notes:** Not to be used for applications using WIF sensor.  
**Fits:** Case-International, New Holland Tractors  
**Replaces:** New Holland 84526251; Fleetguard FS19927; Mann & Hummel WK9048X  
**Thread:** M16 x 1.5-6H  
**O.D.:** 3 23/32 (94)  
**Height:** 7 31/32 (202.2)  
**A. Gskt:** [1] Included  
**F. Gskt:** [1] Included

**BF46071**



Fuel/Water Separator with Bowl and Drain  
**Fits:** Mercedes-Benz Trucks  
**Replaces:** Mann & Hummel WK1060  
**Thread:** 1 -12  
**O.D.:** 4 1/32 (102.4)  
**Height:** 11 (279.4)  
**I.Gskt:** [1] Included

**BF46072**



Fuel/Water Separator with Bowl and Drain  
**Fits:** Volvo Construction Equipment  
**Replaces:** Mann & Hummel WK1060/1; Donaldson P502457, P551067, P551361  
**Thread:** 1 -14  
**O.D.:** 4 1/32 (102.4)  
**Height:** 11 (279.4)  
**I.Gskt:** [1] Included  
**Related To:** BF46083-O (Open End Version)  
 BF1339-SP (SP Thd. 1/2-20)  
 BF1329-SP (SP Thd. 9/16-18)  
 BF1329 (Drain Version)

**BF46073**



Fuel Water Separator Spin-On with Sensor Port  
**Contains:** Sensor Port Thread M12 x 1.5  
**Fits:** Leibherr A309 Litronic, A311 Litronic Excavators with Deutz TCD2012 L04 Engine, Paus Universa 50-3, 50-4 Utility Vehicle with Deutz Engine  
**Replaces:** Bomag 11110248; Deutz 02113831, 2113831, 02113837, 2113837, 02937814, 2937814; Liebherr 11110248  
**Thread:** 1 -14  
**O.D.:** 4 1/4 (107.7)  
**Height:** 10 19/32 (269)

**PF46076**



Fuel Element  
**Fits:** 2012-17 Mitsubishi Canter FE125, Canter FE130, Canter FE160, Canter FE180, Canter FG4x4 Trucks with 4P10 Engine  
**Replaces:** Fiat 500054702; Iveco 5801354114, 500054702; Mitsubishi MK667920  
**O.D.:** 2 21/32 (67.6)  
**I.D.:** 7/16 (11.4) One End  
**Height:** 6 13/32 (162.7)  
**O-Ring:** [1] Included

**PF46077**



Fuel Element  
**Fits:** Kubota Excavators, Tractors  
**Replaces:** Kubota 1583143380; Fleetguard FF5468  
**O.D.:** 1 3/8 (34.9)  
**I.D.:** 7/16 (11.1) One End  
**Height:** 2 25/32 (70.6)  
**O-Ring:** [1] Attached

**BF46078-D**



Primary Fuel Element with Drain and Tab Keys  
**Fits:** Ingersoll-Rand Compressors  
**Replaces:** Ingersoll-Rand 22926737  
**O.D.:** 3 1/8 (79.4)  
**Height:** 5 9/32 (134.1)  
**Grommets:** [1] Attached

**PF46079**



Stacked Fuel/Water Separator Element  
**Fits:** Cummins QSK 19, QSK 23, QSK 38, QSK 50, QSK 60, QST30 Engines (Final Tier 4)  
**Replaces:** Fleetguard FS53014; Davco 69001  
**O.D.:** 5 27/32 (148.3)  
**I.D.:** 1 5/32 (29.7)  
**Height:** 16 5/16 (414.3)  
**O-Ring:** [1] Attached, [2] Included  
**Grommets:** [1] Attached

**PF46080**



Fuel/Water Separator Element  
**Fits:** Terex TR60 Dump Truck with Cummins Engine  
**Replaces:** Fleetguard FS53015; Davco 68001  
**O.D.:** 5 27/32 (148.3)  
**I.D.:** 1 5/32 (29.7)  
**Height:** 7 15/32 (189.9)  
**O-Ring:** [1] Attached, [2] Included

**PF46081**



Fuel/Water Separator Element  
**Fits:** Kenworth, Peterbilt Trucks  
**Replaces:** Paccar K371011, K371029  
**O.D.:** 4 1/8 (104.6)  
**I.D.:** 13/16 (20.3) One End  
**Height:** 7 3/16 (182.6)  
**O-Ring:** [1] Included

**PF46082**



Fuel/Water Separator Element  
**Fits:** Kenworth, Peterbilt Trucks  
**Replaces:** Paccar K371012  
**O.D.:** 4 1/8 (104.6)  
**I.D.:** 13/16 (20.3) One End  
**Height:** 7 3/16 (182.6)

**BF46083-O**



Fuel/Water Separator with Open End for Bowl  
**Contains:** Bowl Thread: 3 3/4-10 Buttress Integral Post Seal  
**Fits:** Scania Trucks; Doosan Dump Trucks; JCB (J.C. Bamford) Generators  
**Replaces:** Scania 1393640  
**Thread:** 1 -14  
**O.D.:** 4 1/2 (114.3)  
**Height:** 6 3/16 (157.2)  
**F. Gskt:** [2] Included  
**Related To:** BF46072 (Bowl Version)  
 BF1329 (Drain Version)  
 BF1339-SP (SP Thd. 1/2-20)  
 BF1329-SP (SP Thd. 9/16-18)

Measurements Are Shown In Inches And (Millimeters)

**WARNING:** These products can expose you to chemicals, including Diisononyl Phthalate, Carbon black extracts, Nickel, 1,3 Butadiene, Ethylene Oxide, Epichlorohydrin, which are known to the State of California to cause cancer, and Bisphenol, Ethylene Glycol, Ethylene Oxide, 1,3 Butadiene, Epichlorohydrin, which are known to the State of California to cause birth defects or other reproductive harm.

**BF46084**

**In-Line Fuel Filter**



**Fits:** Caterpillar Equipment  
**Replaces:** Caterpillar 3848512; Perkins T412017  
**O.D.:** 2 5/32 (54.8)  
**Inlet:** 11/16  
**Outlet:** 9/32  
**Length:** 5 5/8 (142.9)

**BF46085**

**Fuel Spin-on**



**Fits:** John Deere Dozers; Liebherr Equipment  
**Replaces:** John Deere LW10429946; Liebherr 10044303; Yanmar 12065155020; Fleetguard FF5856  
**Thread:** 1 -14  
**O.D.:** 4 1/4 (108.0)  
**Height:** 5 25/32 (146.8)  
**I.Gskt:** [1] Included

**BF46087**

**Box-Style Fuel Element with Handle**



**Fits:** M.T.U. Engines  
**Replaces:** M.T.U. 0000925105, 925105; Separ 4030; Fleetguard FS19803  
**Length:** 7 7/32 (183.4)  
**Width:** 7 1/4 (184.2)  
**Height:** 2 5/32 (54.8)

**PF46088**

**Fuel Element**



**Fits:** Toyota, Isuzu Applications  
**Replaces:** Toyota 1860400021, 2330087317, 233900L010, 233900L020, 233900L030, 233900L041; Isuzu 8981596930  
**O.D.:** 3 5/16 (84.1)  
**I.D.:** 11/32 (8.7)  
**Height:** 3 1/32 (77.0)  
**A. Gskt:** [1] Included  
**O-Ring:** [1] Attached, [1] Included

**PF46091**

**Fuel/Water Separator Element**



**Fits:** International, Kenworth, Peterbilt, Volvo Trucks with Cummins ISX Engines  
**Replaces:** Fleetguard FS19764G  
**O.D.:** 4 7/32 (107.2)  
**I.D.:** 21/32 (16.7) One End  
**Height:** 7 1/32 (178.6)  
**O-Ring:** [2] Included

**PF46092**

**Fuel/Water Separator Element**



**Fits:** International LoneStar Trucks  
**Replaces:** Davco 382134; Fleetguard FS19905G  
**O.D.:** 4 7/32 (107.2)  
**I.D.:** 21/32 (16.7) One End  
**Height:** 7 1/32 (178.6)  
**O-Ring:** [2] Included

**PF46094**

**Fuel/Water Separator**



**Fits:** International 9900i Trucks; Kenworth T880 Trucks; Mack Pinnacle, CHU613, CXU613 Trucks; Peterbilt 389, 567, 587 Trucks  
**Replaces:** Fleetguard FS19765G  
**O.D.:** 4 7/32 (106.9)  
**I.D.:** 11/16 (0.7) One End  
**Height:** 7 1/8 (180.8)  
**O-Ring:** [2] Included  
**Grommets:** [1] Attached

**BF46098-O**

**Fuel/Water Separator Spin-on with Open End for Bowl**



**Contains:** Bowl Thread: 3 3/4-10 UNS B Integral Post Seal  
**Fits:** Freightliner Century Class, Cargo FC80, Cascadia Trucks  
**Replaces:** Alliance ABP/N122-R50419; ACDelco TP1348; Donaldson P551034, P551857; Fleetguard FS19798  
**Thread:** 1 -14  
**O.D.:** 4 1/4 (108.0)  
**Height:** 6 9/32 (159.5)  
**F. Gskt:** [2] Included  
**Grommets:** [1] Attached  
**Related To:** BF1373-SP (Sensor Port Version)

**BF46099-O**

**Fuel/Water Separator Spin-on with Open End for Bowl**



**Contains:** Bowl Thread: 3 3/4-10 UNS 2B Integral Post Seal  
**Fits:** John Deere Equipment  
**Replaces:** John Deere AT365869; Racor R51401; Donaldson P551858; Fleetguard FS19754; Wix 33986  
**Thread:** 1 -14  
**O.D.:** 4 1/4 (108.0)  
**Height:** 8 19/32 (218.3)  
**F. Gskt:** [2] Included  
**Grommets:** [1] Attached

**BF46100-O**

**Fuel/Water Separator with Open End for Bowl**



**Contains:** Bowl Thread: 3 3/4-10 UNS B Integral Post Seal  
**Fits:** John Deere Equipment  
**Replaces:** John Deere AT365870; Racor R51402; Donaldson P551034; Fleetguard FS19538  
**Thread:** 1 -14  
**O.D.:** 4 1/4 (108.0)  
**Height:** 6 7/32 (158.0)  
**F. Gskt:** [2] Included

**BF46101-O**

**Fuel/Water Separator Spin-on with Open End for Bowl**



**Contains:** Bowl Thread: 3 3/4  
**Fits:** Volvo-Penta Marine Diesel Engines  
**Replaces:** Volvo 3817517; Racor R120S-HD; Fleetguard FS19896  
**Thread:** 1 -12  
**O.D.:** 4 11/32 (110.3)  
**Height:** 8 1/2 (215.9)  
**F. Gskt:** [2] Included

**PF46103**

**Fuel Strainer**



**Fits:** John Deere Harvesters, Tractors  
**Replaces:** John Deere CQ29104; Hifi/Jura Filtration MO7013  
**O.D.:** 2 3/16 (55.6)  
**I.D.:** 1 25/32 (45.2) One End  
**Height:** 7 13/16 (198.4)

Measurements Are Shown In Inches And (Millimeters)

**WARNING:** These products can expose you to chemicals, including Diisononyl Phthalate, Carbon black extracts, Nickel, 1,3 Butadiene, Ethylene Oxide, Epichlorohydrin, which are known to the State of California to cause cancer, and Bisphenol, Ethylene Glycol, Ethylene Oxide, 1,3 Butadiene, Epichlorohydrin, which are known to the State of California to cause birth defects or other reproductive harm.

**BF46104**

Fuel Spin-on



**Fits:** Case Dozers, Loaders; New Holland Loaders, Tractors  
**Replaces:** New Holland 84534796  
**Thread:** M20 x 1.5  
**O.D.:** 3 23/32 (94.2)  
**Height:** 7 3/16 (182.9)  
**A. Gskt:** [1] Included

**BF46105-O**

Fuel/Water Separator with Open End for Bowl



**Contains:** Bowl Thread: 3 3/4  
**Fits:** Mercedes-Benz European, South American Trucks  
**Replaces:** Mercedes-Benz A0004771702, 4771702; Racor R160P, R90DMER03; Fleetguard FS19737  
**Thread:** 1 -14 UNS  
**O.D.:** 4 11/32 (110.3)  
**Height:** 8 1/2 (215.9)  
**F. Gskt:** [2] Included

**PF46106**

Fuel/Water Separator Element



**Fits:** Kenworth, Peterbilt Trucks  
**Replaces:** Paccar 1852006PE, 1852006, 2133096PE, 2133096  
**O.D.:** 3 15/16 (100.0)  
**I.D.:** 1 23/32 (43.7) One End  
**Height:** 11 3/32 (281.7)  
**O-Ring:** [1] Included  
**Grommets:** [1] Attached

**PF46108**

Fuel/Water Separator Element with Bail Handle



**Fits:** 2013-20 Dodge 2500, 3500; RAM 2500, 3500 Light-Duty Trucks with 6.7L Turbo Diesel Engine, 2013-19 RAM 4500, 5500 Medium Duty Trucks with 6.7L Engine  
**Replaces:** Chrysler 68157291AA; Cummins 5260529; Fleetguard FS53000; Mopar MO291  
**O.D.:** 4 7/32 (107.2)  
**I.D.:** 1 9/16 (39.7) One End  
**Height:** 5 17/32 (140.5)  
**O-Ring:** [1] Included

**BF46109-O**

Fuel Water Separator Spin-on with Open End for Bowl



**Contains:** Male Bowl Thread: 3 3/4  
**Fits:** Mercedes-Benz Latin America Buses, South America Trucks, Buses, & Vans  
**Replaces:** Mercedes-Benz A3844777015, A9794770015, A9794770015AZ, 3844777015, 9794770015, 9794770015AZ; Racor R120MB, R12030MB  
**Thread:** 1 -12  
**O.D.:** 4 17/32 (115.3)  
**Height:** 6 9/16 (166.9)  
**A. Gskt:** [1] Included  
**O-Ring:** [1] Included

**BF46111**

Fuel Spin-on



**Fits:** Bobcat, Doosan Compressors; Case Loaders; Hino Buses; Yanmar Marine Engines  
**Replaces:** Ingersoll-Rand 22226369; Donaldson P550127; Fleetguard FF253, FF5147  
**Thread:** M20 x 1.5  
**O.D.:** 3 11/16 (93.7)  
**Height:** 3 1/4 (82.6)  
**A. Gskt:** [1] Included

**PF46112**

Fuel Element



**Fits:** Nissan, Opel, Renault European Light-Duty Vehicles  
**Replaces:** Opel 4412830; Nissan 1640500QAC; Renault 7701475229  
**O.D.:** 2 3/4 (69.9)  
**I.D.:** 13/16 (20.6)  
**Height:** 3 3/8 (85.7)  
**F. Gskt:** [2] Included

**BF46113-D**

Fuel/Water Separator Element with Drain



**Fits:** Gehl Loaders  
**Replaces:** Bobcat 103761801CC; Atlas Copco1310072275; Case CLC103761801; Club Car 103761801; Gehl 245005; Wix SF10147, WF10147  
**O.D.:** 3 15/32 (88.1)  
**I.D.:** 23/32 (18.3)  
**Height:** 4 15/32 (113.5)

**BF46116 KIT**

Set of 2 Fuel Filters



**Contains:** [1] Spin-on [1] Element  
**Fits:** John Deere Combines, Crawler Dozers, Excavators, Feller Bunchers, Forestry Machines, Generators, Loaders, Motor Graders, Skidders, Sprayers, Tractors, Windrowers  
**Replaces:** John Deere RE556406; Racor PFF51572  
**Spin-on**  
**Thread:** 1 -14  
**O.D.:** 4 1/4 (108.0)  
**Height:** 6 1/2 (165.4)  
**F. Gskt:** [1] Included  
**Element**  
**O.D.** 3 3/4  
**I.D.** 1 19/32  
**Height** 6 1/4  
**O-Ring** [1] Included

**BF46117**

Fuel Spin-on



**Fits:** Mack, Volvo Trucks  
**Replaces:** Volvo 22474709, 22094967; Racor RS250RCR01  
**Thread:** M32 x 1.5  
**O.D.:** 4 11/32 (110.3)  
**Height:** 8 7/8 (225.4)  
**A. Gskt:** [1] Included

**PF46118**

Fuel Element



**Contains:** Front End Check Valve  
**Fits:** Volkswagen European Crafters; 2009-11 Mexico Crafters  
**Replaces:** Volkswagen 2E0127159, 2E0127177  
**O.D.:** 2 13/16 (71)  
**Height:** 5 3/16 (131.6)  
**O-Ring:** [2] Included

Measurements Are Shown In Inches And (Millimeters)

**WARNING:** These products can expose you to chemicals, including Diisononyl Phthalate, Carbon black extracts, Nickel, 1,3 Butadiene, Ethylene Oxide, Epichlorohydrin, which are known to the State of California to cause cancer, and Bisphenol, Ethylene Glycol, Ethylene Oxide, 1,3 Butadiene, Epichlorohydrin, which are known to the State of California to cause birth defects or other reproductive harm.



**PF46119**

Fuel Strainer



**Fits:** John Deere Harvesters, Tractors  
**Replaces:** John Deere AH165504  
**O.D.:** 7/8 (22.2)  
**I.D.:** 9/16 (14.3) One End  
**Height:** 5 19/32 (142.1)

**BF46127**

Fuel Spin-on



**Fits:** Bomag Paving Equipment; Kramer Loaders, Telehandlers; JLG Industries Equipment with Deutz Engines  
**Replaces:** Bomag 08820969, 8820969; Caterpillar 4406212; Deutz 214228, 4131531, 4131532, 4132775, 4132776; Genie 214228; JLG Industries 70025161; Wirtgen 2319002  
**Thread:** M18 x 1.5  
**O.D.:** 3 25/32 (96.0)  
**Height:** 5 13/16 (147.6)  
**A. Gskt:** [1] Included

**BF46122**

Fuel/Water Separator with Drain



**Fits:** Various Excavators, Sprayers, Telehandlers and Tractors with Deutz Engines  
**Replaces:** Deutz 4504438; Racor R60THB1; Fleetguard FS1095  
**Thread:** 1 -14  
**O.D.:** 4 13/32 (111.9)  
**Height:** 7 1/4 (184.2)  
**A. Gskt:** [1] Included

**BF46128-D**

Primary Fuel/Water Separator Element with Drain



**Notes:** Reverse Flow  
**Fits:** Doosan Engines  
**Replaces:** WIX WF10169, SF10169  
**O.D.:** 4 3/8 (111.3)  
**I.D.:** 21/32 (16.8) One End  
**Height:** 9 11/16 (246.1)  
**Grommets:** [1] Attached

**BF46123-O**

Fuel/Water Separator with Open End for Bowl



**Contains:** Male Bowl Thread: 3 3/4  
**Fits:** Mercedes-Benz Buses and Trucks  
**Replaces:** Ford BH0X9N074AA, T22VA, 9C459C340AB; Mercedes-Benz A9584770115, 9584770115; Racor R12010MBAQII  
**Thread:** 1 -12  
**O.D.:** 4 17/32 (115.3)  
**Height:** 7 5/32 (181.9)  
**A. Gskt:** [1] Included  
**O-Ring:** [1] Included

**BF46129**

Fuel Spin-on



**Notes:** Fill Plug pre-installed in filter. Remove after pre-filling filter with fuel prior to installation on application.  
**Fits:** Freightliner; Kenworth; Peterbilt; Volvo Trucks with Cummins ISX11.9, ISX15.0, QSX11.9, X15 Engines  
**Replaces:** Cummins 5365988; Fleetguard FF5825NN; Donaldson DBF6776  
**Thread:** M90 x 2.0  
**O.D.:** 4 23/32 (119.9)  
**Height:** 8 27/32 (224.6)  
**A. Gskt:** [1] Included  
**O-Ring:** [1] Attached  
**Related To:** BF9885 (Standard Version)

**BF46124-O**

Fuel/Water Separator Spin-on with Open End for Bowl



**Contains:** Bowl Thread: 3 3/4  
**Fits:** The Racor line of Spin-on Series fuel/water separator assemblies  
**Replaces:** Racor R90RDRCR01  
**Thread:** 1 -14  
**O.D.:** 4 5/16 (109.2)  
**Height:** 6 3/16 (157.5)  
**A. Gskt:** [1] Included  
**O-Ring:** [1] Included

**PF46130**

Fuel Element



**Fits:** RAM 1500 Pickups with V6-182 (3.0L) FI Turbo Diesel Engines  
**Replaces:** Chrysler 68235275AA  
**O.D.:** 2 21/32 (67.5)  
 2 29/32 (73.8)  
**I.D.:** 21/32 (16.7)  
**Height:** 5 11/32 (135.7)  
**O-Ring:** [1] Included

**BF46125**

Box-Style Fuel Element with Handle



**Fits:** Fendt Tractors  
**Replaces:** Fendt F916200060010; Fleetguard FS19733  
**Length:** 3 (76.2)  
**Width:** 3 (76.2)  
**Height:** 1 (25.4)

**BF46131**

Fuel Spin-on



**Fits:** R.V.I. Trucks with Volvo DTI 11 Engines  
**Replaces:** Racor RS175RCR01; Renault 7421764961; Volvo 22253547, 21764952, 21764961; Fleetguard FF5987  
**Thread:** M32 x 1.5  
**O.D.:** 4 11/32 (110.0)  
**Height:** 6 9/16 (166.9)  
**F. Gskt:** [1] Included

**PF46126**

Fuel Element



**Fits:** 2017-18 Chevrolet, GMC Light-Duty Trucks  
**Replaces:** ACDelco TP1014, TP1015; General Motors Corp. 22937279, 23149526, 23304095, 23304096, 23456595, 23459023  
**O.D.:** 3 7/16 (87.5)  
 3 5/8 (91.6)  
**I.D.:** 29/32 (23) & 7/16 (11.1)  
**Height:** 4 3/16 (106)  
**O-Ring:** [2] Attached, [2] Included

**PF46135**

Fuel/Water Separator Element



**Fits:** Compatible with GreenMAX fuel filter water separator housings (4400, 6600); Tigercat Feller Bunchers, Loaders, Skidders  
**Replaces:** Parker R61691T; Racor 6600R10; Tigercat 213473  
**O.D.:** 4 5/32 (105.4)  
**I.D.:** 1 23/32 (43.7)  
**Height:** 7 7/32 (183.6)  
**O-Ring:** [1] Included

Measurements Are Shown In Inches And (Millimeters)

**WARNING:** These products can expose you to chemicals, including Diisononyl Phthalate, Carbon black extracts, Nickel, 1,3 Butadiene, Ethylene Oxide, Epichlorohydrin, which are known to the State of California to cause cancer, and Bisphenol, Ethylene Glycol, Ethylene Oxide, 1,3 Butadiene, Epichlorohydrin, which are known to the State of California to cause birth defects or other reproductive harm.

**PF46137**

Fuel Element



**Notes:** Element in Housing is PF46137 KIT  
**Fits:** Bron Drainage Plow; Caterpillar Excavators; Prinoth Carrier Vehicles  
**Replaces:** Caterpillar 3608958  
**O.D.:** 2 15/16 (74.9)  
**I.D.:** 3/4 (19.0) One End  
**Height:** 6 7/32 (157.7)  
**F. Gskt:** [1] Included  
**O-Ring:** [1] Attached

**PF46137 KIT**

Fuel Element in Plastic Housing



**Notes:** Element only is PF46137  
**Fits:** Bron Drainage Plow; Caterpillar Excavators; Prinoth Carrier Vehicles  
**Replaces:** Caterpillar 3608958  
**PF46137**  
**O.D.:** 2 15/16 (74.9)  
**I.D.:** 3/4 (19.0)  
**Height:** 6 7/32 (157.7)  
**F. Gskt:** [1] Included  
**O-Ring:** [1] Attached  
**Housing**  
**O.D.** 3 5/8  
**Height** 8 13/32  
**O-Ring** [1] F. Gskt.

**PF46138**

Fuel Element



**Fits:** Kobelco SK230SR-3, SK260SR-3, New Holland E260C SR, E230CSR, E230CSR LC Excavators; Hino Trucks  
**Replaces:** Case VH23304EV040, VH23304EV041; New Holland VH23304EV040, VH23304EV041; Hino 23304EV360; Kobelco VH23304EV040, VH23304EV041J1L  
**O.D.:** 3 5/32 (80.3)  
**I.D.:** 9/16 (13.9)  
**Height:** 2 27/32 (72.1)  
**O-Ring:** [4] Included  
**Grommets:** [2] Attached

**PF46140**

Fuel Element



**Fits:** 2016-19 Nissan Titan XD  
**Replaces:** Cummins 4378483; Nissan 16403EZ41A  
**O.D.:** 3 9/32 (83.6)  
**I.D.:** 1 23/32 (43.4) One End  
**Height:** 4 13/32 (112.3)  
**A. Gskt:** [1] Included  
**O-Ring:** [1] Included

**BF46141**

Fuel Spin-on



**Fits:** Used on fuel dispensing pumps that have a 1 3/8 inch thread adapter (gasoline, diesel, biodiesel blends up to B20, and Ultra Low Sulfur Diesel)  
**Replaces:** Cim-tek 260AHS30, 70007, 70066; Petro Clear 40930WA  
**Thread:** 1 3/8 -12  
**O.D.:** 3 11/16 (93.7)  
**Height:** 8 3/4 (222.0)  
**A. Gskt:** G381-A

**PF46142**

Nylon Fuel Strainer



**Fits:** Hitachi, John Deere Excavators; John Deere Loaders  
**Replaces:** John Deere MIU801025  
**O.D.:** 2 3/32 (53.1)  
**I.D.:** 25/32 (20.1) One End  
**Height:** 2 9/16 (65.3)

**BF46143**

Fuel/Water Separator Spin-on with Drain



**Replaces:** Cimtek 70804; Fleetguard FS1023; Donaldson P550828  
**Thread:** 1 -14  
**O.D.:** 3 11/16 (93.7)  
**Height:** 7 31/32 (202.7)  
**A. Gskt:** [1] Included  
**O-Ring:** [1] Included

**PF46145**

Fuel/Water Separator Element



**Fits:** Freightliner 114SD, 112SD, Cascadia, Cascadia Evolution, Coronado, Coronado SD, M2 112; Western Star 4700, 4800, 4900EX, 4900FA, 4900SA, 5700XE, 6900XD  
**Replaces:** Detroit Diesel A0000905051; Freightliner A485007; Fleetguard FS20083  
**O.D.:** 6 (152.4)  
**I.D.:** 2 15/32 (63.0) One End  
**Height:** 7 17/32 (191.5)  
**O-Ring:** [1] Attached, [2] Included  
**Grommets:** [1] Attached

**BF46147-O**

Fuel/Water Separator with Open End for Bowl



**Contains:** Bowl Thread 3 3/4-10 ANS Buttress  
**Fits:** Freightliner FS-65 Buses; Ingersoll-Rand Equipment  
**Replaces:** Case 84211170; Racor R60P; Volvo 13224043, 13224043V; Ingersoll-Rand 13224043, 13224043IR  
**Thread:** 1 -14 UNS-2B  
**O.D.:** 4 1/4 (108.0)  
**Height:** 5 3/32 (129.4)  
**F. Gskt:** [2] Included  
**Related To:** BF1329 (Drain Version) BF1329-SP (SP Thd. 9/16-18) BF1339-SP (SP Thd. 1/2-20)

**BF46149-SP**

Fuel/Water Separator Spin-on



**Notes:** Remove preinstalled drain bolt before installation.  
**Contains:** Sensor Port/ Drain Thread: M8 x 1.25  
**Fits:** Kubota Engines  
**Replaces:** Kubota 1J43043060; Fleetguard FS1251; Mann+Hummel PL150  
**Thread:** M16 x 1.5  
**O.D.:** 3 1/32 (77.0)  
**Height:** 5 29/32 (149.9)  
**A. Gskt:** [1] Included

Measurements Are Shown In Inches And (Millimeters)

**WARNING:** These products can expose you to chemicals, including Diisononyl Phthalate, Carbon black extracts, Nickel, 1,3 Butadiene, Ethylene Oxide, Epichlorohydrin, which are known to the State of California to cause cancer, and Bisphenol, Ethylene Glycol, Ethylene Oxide, 1,3 Butadiene, Epichlorohydrin, which are known to the State of California to cause birth defects or other reproductive harm.

**BF46150-O**



Fuel/Water Separator with Open End for Bowl  
**Contains:** Bowl Thread 3 3/4 - 10  
**Fits:** Case-International, New Holland Harvesters, Tractors  
**Replaces:** Case 84423586; Racor S3207P  
**Thread:** 1 1/4 -12  
**O.D.:** 4 27/32 (122.9)  
**Height:** 9 29/32 (251.5)  
**F. Gskt:** [2] Included

**BF46164-O**



Fuel/Water Separator with Open End for Bowl  
**Notes:** Bowl Thread: 2 3/8-10 Whitworth  
**Fits:** Replacement element for Racor 120A and 120B assemblies  
**Replaces:** Racor R13P  
**Thread:** M18 x 1.5  
**O.D.:** 3 (75.9)  
**Height:** 3 31/32 (100.6)  
**A. Gskt:** [1] Included  
**F. Gskt:** [1] Included  
**O-Ring:** [1] Included

**PF46151**



Fuel Element  
**Fits:** John Deere Lawn & Garden Equipment, Loaders, Tractors; Gehl Loaders, Manitou Loaders, Mustang Loaders  
**Replaces:** Gehl 50352550; John Deere MIU802421; Takeuchi Y129A0055730; Yanmar 129A0055730; Wix WF10369  
**O.D.:** 3 3/8 (85.9)  
**I.D.:** 3/4 (19.3) One End  
**Height:** 4 17/32 (115.3)  
**Grommets:** [1] Attached

**BF46169-O**



Fuel/Water Separator with Open End for Bowl  
**Contains:** Bowl Thread 3 3/4-10 ANS Buttress  
**Fits:** Blue Bird All American, Vision School Buses; International 4300, 4300LP, 4400, 7400, 7500, HV507, HV607 Trucks  
**Replaces:** Blue Bird 10054676, R34000BB01; IHC (International Harvester) 4080114C1, 4080114C2  
**Thread:** 1 -14  
**O.D.:** 4 7/32 (107.4)  
**Height:** 6 1/8 (155.3)  
**F. Gskt:** [2] Included

**PF46152**



Fuel Element  
**Fits:** 2019-20 RAM 2500, 3500, 2019 4500, 5500 Trucks  
**Replaces:** Chrysler 68436631AA  
**O.D.:** 4 1/32 (102.4)  
**I.D.:** 1 3/16 (30.5) & 21/32 (16.8)  
**Height:** 4 7/32 (107.2)  
**O-Ring:** [2] Attached, [1] Furnished

**BF46170**



Fuel/Water Separator Spin-on with Drain  
**Contains:** Hose Barb  
**Fits:** Cummins S3.8-G7 Engines; C22 D5T, C44 D5, C55 D5, C66 D5 Power Generators  
**Replaces:** Fleetguard FS19652  
**Thread:** 13/16 -18  
**O.D.:** 3 11/16 (94.0)  
**Height:** 7 1/2 (190.2)  
**A. Gskt:** [1] Included  
**F. Gskt:** [1] Included

**BF46161**



Fuel Spin-on  
**Fits:** Volvo Buses, European Trucks & Vans, North America Trucks, Dump Trucks, Excavators, Loaders, Motor Graders; Winpower Generators  
**Replaces:** Volvo 22480372; Mann & Hummel WDK11102/28  
**Thread:** M32 x 1.5 -6H  
**O.D.:** 4 1/4 (108.0)  
**Height:** 10 15/32 (265.9)  
**A. Gskt:** [1] Included

**PF46171**



Fuel/Water Separator Element  
**Fits:** Autocar, Freightliner, Western Star Trucks  
**Replaces:** Detroit Diesel A0000904851; Freightliner A245007; Fleetguard FS20081  
**O.D.:** 3 31/32 (101.1)  
**I.D.:** 1 5/16 (33.0) One End  
**Height:** 7 7/8 (199.9)  
**O-Ring:** [1] Attached, [2] Furnished

**BF46162-O**



Fuel/Water Separator with Open End for Bowl  
**Fits:** Racor 215R Fuel Filter Assembly  
**Replaces:** Northern Lights/Lugger 2450014; Racor R15P  
**Thread:** 1-14  
**O.D.:** 3 5/16 (95.1)  
**Height:** 3 15/16 (83.6)  
**F. Gskt:** [1] Included  
**O-Ring:** [1] Included

**BF46173-O**



Fuel/Water Separator with Open End for Bowl  
**Contains:** Bowl Thread: 3-3/4-10 UNS-2B SPECIAL  
**Fits:** Volvo North America Trucks with Cummins ISX Engines  
**Replaces:** Racor S3238T; Volvo 85121709  
**Thread:** 1 1/4 -12  
**O.D.:** 4 27/32 (122.7)  
**Height:** 6 9/32 (159.7)  
**F. Gskt:** [2] Included

**BF46163-O**



Fuel/Water Separator Spin-on with Open Port  
**Contains:** Spin-on Drain and Hose Barb  
**Fits:** Western Star 4900, 4900E, 4900EX, 4900FA, 4900SA Trucks with Cat C15 (14.6L) Engine  
**Replaces:** Alliance ABPN122R50424; Donaldson P551856; Fleetguard FS20094  
**Thread:** 1 -14 UNS  
**O.D.:** 4 1/4 (108.0)  
**Height:** 6 1/8 (155.6)

**BF46175**



Fuel Spin-on  
**Fits:** Takeuchi TL6R, TL8, TL10, TL10V2, TL12, TL12V2, TL12R2 Loaders  
**Replaces:** Kubota AFK1J30143170, K1J30143170, 1J30143170; Takeuchi AFK1J30143170, K1J30143170, 1J30143170; Wix WF10456  
**Thread:** 1 -14  
**O.D.:** 3 23/32 (94.2)  
**Height:** 5 23/32 (145.5)  
**A. Gskt:** [1] Included

Measurements Are Shown In Inches And (Millimeters)

**WARNING:** These products can expose you to chemicals, including Diisononyl Phthalate, Carbon black extracts, Nickel, 1,3 Butadiene, Ethylene Oxide, Epichlorohydrin, which are known to the State of California to cause cancer, and Bisphenol, Ethylene Glycol, Ethylene Oxide, 1,3 Butadiene, Epichlorohydrin, which are known to the State of California to cause birth defects or other reproductive harm.

**BF46176**

Fuel Spin-on



**Fits:** AirDog I, AirDog II and AirDog II-4G Fuel Systems  
**Replaces:** AirDog FF100-2, FF803  
**Thread:** 7/8 -14  
**O.D.:** 3 1/16 (78.0)  
**Height:** 5 7/8 (149.1)  
**A. Gskt:** [1] Included

**FB46185**

Fuel Spin-on Replacement Base



**Notes:** Cast Aluminum  
**Contains:** Dual Inlet/Outlet with [2] Female 1/2-14 In. NPT  
**Use With:** BF1214, BF1218, BF1225, BF1240, BF1220, BF970, BF979, BF584, BF614, BF891, BF892, BF978, BF7529, BF7587, BF7546  
**Replaces:** Wix 24770, 524770  
**Thread:** 1 -14  
**O.D.:** 4 (101.6)  
**Height:** 2 7/8 (73)

**BF46179**

Fuel Spin-on



**Notes:** Fill Plug pre-installed in filter. Remove after pre-filling filter with fuel prior to installation on application.  
**Fits:** International, Kenworth, Peterbilt, Volvo, Western Star Trucks  
**Replaces:** Fleetguard FF5811  
**Thread:** M90 x 2.0  
**O.D.:** 4 23/32 (119.9)  
**Height:** 11 9/16 (293.9)  
**I.Gskt:** [1] Included  
**Related To:** BF9860 (Standard Version)

**PF46186**

Fuel Element with Bail Handle



**Fits:** Audi Q7  
**Replaces:** Bosch 1457070010; Volkswagen 7L6127434C; Wix 33434  
**O.D.:** 4 (101.6)  
**I.D.:** 1 5/8 (41.3)  
**Height:** 3 5/16 (84.1)  
**F. Gskt:** [2] Included, [1] Metal Washer  
**Grommets:** [2] Attached

**BF46181-O**

Fuel/Water Separator with Open End for Bowl



**Contains:** Bowl Thread: 3 3/4 - 10  
**Fits:** International, Mack Trucks  
**Replaces:** IHC (International Harvester) 2514003C1; Racor R33838  
**Thread:** 1 -14  
**O.D.:** 4 1/4 (108.0)  
**Height:** 5 21/32 (143.5)  
**F. Gskt:** [2] Included

**PF46187**

Fuel Element



**Fits:** Volkswagen Passat with V6-3597cc (3.6L) FI Engine  
**Replaces:** Volkswagen 7P6127177, 7P6127177A; Wix WF10120, SF10120  
**O.D.:** 3 1/32 (77.0)  
 3 11/16 (93.7)  
**I.D.:** 3/8 (9.5) One End  
**Height:** 4 13/16 (122.2)

**BF46182-O**

Fuel/Water Separator Spin-on with Open End for Bowl



**Contains:** Bowl Thread 3 1/8 - 10  
**Fits:** Mack, Volvo North America Trucks  
**Replaces:** Mack 22094987; Volvo 21764964  
**Thread:** 1 -14  
**O.D.:** 4 7/32 (106.9)  
**Height:** 5 1/32 (127.5)  
**F. Gskt:** [1] Included  
**O-Ring:** [1] Included

**PF46188**

Fuel Element



**Fits:** Audi, Volkswagen Automotive with (2.0L) Turbo Diesel Engine  
**Replaces:** Audi 3C0127434; Wix 33256  
**O.D.:** 3 1/8 (79.4)  
**I.D.:** 7/16 (11.1) One End  
**Height:** 5 3/8 (136.5)  
**F. Gskt:** [1] Included

**FB46183**

Fuel Storage Tank Filter Base



**Notes:** Cast Iron  
**Use With:** BF955, BF956  
**Replaces:** Wix GFB34  
**Thread:** 1 -12  
**Inlet:** 3/4-14  
**Outlet:** 3/4-14  
**Height:** 3 3/4 (95.3)

**PF46189**

Fuel Element



**Fits:** Volkswagen Passat with 4-1968cc (2.0L) FI Turbo Diesel Engine  
**Replaces:** Volkswagen 7N0127177B; Wix WF10114  
**O.D.:** 3 1/32 (77.0)  
 Flange 3 11/16 (93.7)  
**I.D.:** 3/8 (9.5) One End  
**Height:** 5 5/16 (134.9)

**FB46184**

Replacement Filter Base for Fuel/Water Separators



**Contains:** Inlet/Outlet with [2] 1/2-14 In. NPT Threaded Stud: 1-12  
**Use With:** BF1213, BF5813  
**Replaces:** Wix 24309  
**Thread:** 1 -12  
**O.D.:** 3 1/2 (88.9)  
**Height:** 3 1/4 (82.6)

**BF46192**

In-Line Fuel Filter



**Fits:** Volkswagen Automotive with (1.9L) Diesel Engine  
**Replaces:** Volkswagen 1H0127401E; Wix 33896  
**O.D.:** 3 9/16 (90.5)  
**Inlet:** 8 MM  
**Outlet:** 8 MM  
**Length:** 7 7/8 (200.0)  
**O-Ring:** [4] Included

Measurements Are Shown In Inches And (Millimeters)

**WARNING:** These products can expose you to chemicals, including Diisononyl Phthalate, Carbon black extracts, Nickel, 1,3 Butadiene, Ethylene Oxide, Epichlorohydrin, which are known to the State of California to cause cancer, and Bisphenol, Ethylene Glycol, Ethylene Oxide, 1,3 Butadiene, Epichlorohydrin, which are known to the State of California to cause birth defects or other reproductive harm.

**BF46193** In-Line Fuel Filter  
**Fits:** 1984 Chevrolet Corvette  
**Replaces:** General Motors Corp. 25055066; Wix 33482  
**O.D.:** 2 9/32 (57.9)  
**Inlet:** 3/8  
**Outlet:** 3/8  
**Length:** 5 1/4 (133.4)



**BF46194** In-Line Fuel Filter  
**Fits:** 1975-79 Volkswagen Beetle, 1977-81 Transporter, 1980-86 Vanagon  
**Replaces:** Volkswagen 133133511; Wix 33274  
**O.D.:** 2 3/32 (53.2)  
**Inlet:** 5/16  
**Outlet:** 1/2  
**Length:** 3 5/8 (92.1)



**BF46195** In-Line Fuel Filter  
**Fits:** 1984-98 Audi, 1981-2002 Ferrari, 1988-89 Merkur, 1982-87 Peugeot, 1985-2009 Saab, 1987-92 Volkswagen, 1981-98 Volvo Automotive  
**Replaces:** Volkswagen 447133511; Volvo 1389450-6; Wix 33291, 33279  
**O.D.:** 3 15/32 (88.1)  
**Inlet:** M14 x 1.5  
**Outlet:** M12 x 1.5  
**Length:** 5 31/32 (151.6)  
**F. Gskt:** [4] Washers Included



**BF46196** In-Line Fuel Filter  
**Fits:** 1984-87 Honda Civic CRX  
**Replaces:** Honda 16235-PE0-003; Wix 33206  
**O.D.:** 1 9/32 (32.5)  
**Inlet:** 1/4  
**Outlet:** 1/4  
**Length:** 3 5/16 (84.1)



**BF46197** In-Line Fuel Filter  
**Fits:** 1980-84 Nissan Light-Duty Trucks  
**Replaces:** Nissan 16400-06W00, 16400-Q0500; Wix 33214  
**O.D.:** 3 (76.2)  
**Inlet:** 11/32  
**Outlet:** 11/32  
**Length:** 2 17/32 (64.3)



**BF46198** In-Line Fuel Filter  
**Fits:** 1990-93 Dodge Ram 50; 1990-96 Mitsubishi Light-Duty Trucks; 1986-92 Toyota Supra  
**Replaces:** Mitsubishi MB504754; Toyota 23300-49155; Wix 33503, 33457, 533872, 33872  
**O.D.:** 2 13/16 (71.4)  
**Inlet:** M12 x 1.25  
**Outlet:** M14 x 1.5  
**Length:** 4 5/8 (117.5)  
**F. Gskt:** [2] Metal Washers



**BF46199** In-Line Fuel Filter with Drain  
**Fits:** 1986-88 Volkswagen Automotive with 1.6L Diesel Engine  
**Replaces:** Volkswagen 191127401; Wix 33467, 533467  
**O.D.:** 3 7/16 (87.3)  
**Inlet:** 11/32  
**Outlet:** 11/32  
**Length:** 6 3/32 (154.8)



**BF46200** In-Line Fuel Filter  
**Fits:** 1980-83 BMW, 1980-98 Porsche Automotive  
**Replaces:** BMW 13311269244; Porsche 92811014202; Wix 33276  
**O.D.:** 3 5/32 (80.2)  
**Inlet:** M14 x 1.5  
**Outlet:** M14 x 1.5  
**Length:** 5 1/8 (130.2)  
**F. Gskt:** [4] Washers



**BF46201** In-Line Fuel Filter  
**Fits:** 1990-93 Acura Integra  
**Replaces:** Honda 16900-SK7-A30; Wix 33555, 33292  
**O.D.:** 3 13/32 (86.5)  
**Inlet:** M12 x 1.25  
**Outlet:** M12 x 1.25  
**Length:** 3 13/16 (96.8)  
**F. Gskt:** [4] Copper Washers



**BF46202** In-Line Fuel Filter  
**Fits:** 1989-94 Mazda MPV Van, Light-Duty Trucks  
**Replaces:** Mazda G602-20-490, G607-20-490-A, G607-20-490-B; Wix 33298  
**O.D.:** 2 13/16 (71.4)  
**Inlet:** 5/16  
**Outlet:** 5/16  
**Length:** 5 3/4 (146.0)



**BF46203** In-Line Fuel Filter  
**Fits:** 1990-97 Mazda Miata, MX5  
**Replaces:** Mazda B61P-20-490; Wix 33289  
**O.D.:** 2 13/16 (71.4)  
**Inlet:** 5/16  
**Outlet:** 5/16  
**Length:** 6 1/32 (153.2)



**BF46204** In-Line Fuel Filter  
**Fits:** 1989-92 Geo, Toyota Automotive  
**Replaces:** Toyota 23300-19145; Wix 33294  
**O.D.:** 2 3/4 (69.9)  
**Inlet:** M14 x 1.5  
**Outlet:** M12 x 1.25  
**Length:** 4 3/16 (106.4)  
**F. Gskt:** [2] Copper Washers



**BF46205** In-Line Fuel Filter  
**Contains:** [1] Hose  
[2] Clamps  
**Fits:** 1966-66 Ford Automotive  
**Replaces:** Ford C5AZ-9155-A, C5AZ-9155-B; Motorcraft FG15; Wix 33045  
**O.D.:** 1 1/16 (17.5)  
**Inlet:** 3/8  
**Outlet:** 1/2-20  
**Length:** 2 27/32 (72.2)  
**F. Gskt:** [1] Included



**BF46206** In-Line Fuel Filter  
**Fits:** 1993-97 Toyota Land Cruiser; 1996-97 Lexus LX450  
**Replaces:** Toyota 23300-69045; Wix 33563, 533563  
**O.D.:** 2 13/16 (71.4)  
**Inlet:** M12 x 1.25  
**Outlet:** M12 x 1.25  
**Length:** 5 3/16 (131.8)  
**F. Gskt:** [4] Washers



Measurements Are Shown In Inches And (Millimeters)

**WARNING:** These products can expose you to chemicals, including Diisononyl Phthalate, Carbon black extracts, Nickel, 1,3 Butadiene, Ethylene Oxide, Epichlorohydrin, which are known to the State of California to cause cancer, and Bisphenol, Ethylene Glycol, Ethylene Oxide, 1,3 Butadiene, Epichlorohydrin, which are known to the State of California to cause birth defects or other reproductive harm.

**BF46207** In-Line Fuel Filter  
**Fits:** 1997-2004 Mitsubishi Montero Sport  
**Replaces:** Mitsubishi MR239580; Wix 33580, 533580, 33905  
**O.D.:** 2 9/16 (65.1)  
**Inlet:** 5/16  
**Outlet:** M14 x 1.5  
**Length:** 4 15/16 (125.4)  
**F. Gskt:** [3] Washers



**BF46208** In-Line Fuel Filter  
**Fits:** 1998-2002 Kia Sportage; 1992-95 Mazda Automotive  
**Replaces:** Kia K08A-20-490A; Mazda K801-20-490; Wix 33453, 533884, 533631, 533453, 33884, 33631  
**O.D.:** 2 3/4 (69.9)  
**Inlet:** 5/16  
**Outlet:** 5/16  
**Length:** 5 17/32 (140.5)



**BF46209** In-Line Fuel Filter  
**Fits:** 1998-2007 Lexus LX470, Toyota Land Cruiser  
**Replaces:** Toyota 23300-50090; Wix 33526, 533875, 533526, 33875  
**O.D.:** 2 23/32 (69.1)  
**Inlet:** M14 x 1.5  
**Outlet:** 5/16  
**Length:** 4 5/8 (117.5)



**BF46210** In-Line Fuel Filter  
**Fits:** 1999-2005 Mazda Miata, 1999-2001, 2005 MX5  
**Replaces:** Mazda BP4W-13-480, BP4W-20-490B; Wix 33538, 533538  
**O.D.:** 2 3/4 (69.9)  
**Inlet:** 5/16  
**Outlet:** 5/16  
**Length:** 6 1/32 (153.2)



**BF46211** In-Line Fuel Filter  
**Fits:** 2004 Chevrolet Tracker; 1999-2005 Suzuki Vitara, Grand Vitara  
**Replaces:** Suzuki 15410-65D00; Wix 533882, 533597, 33882, 33597  
**O.D.:** 2 23/32 (69.1)  
**Inlet:** 5/16  
**Outlet:** 5/16  
**Length:** 5 3/32 (129.4)



**BF46212** In-Line Fuel Filter  
**Contains:** Ground Connect  
**Fits:** 2001-06 Hyundai Accent  
**Replaces:** Hyundai 31911-25000; Wix 33235, 533235  
**O.D.:** 2 9/16 (65.1)  
**Inlet:** 5/16  
**Outlet:** 5/16  
**Length:** 5 (127.0)



**BF46213** In-Line Fuel Filter  
**Contains:** 5/16 In. Return Line Ground Wire  
**Fits:** 2002-04 Jeep Liberty  
**Replaces:** Chrysler 52100402AE  
**O.D.:** 2 1/16 (52.4)  
**Inlet:** 5/16  
**Outlet:** 5/16  
**Length:** 17 9/32 (438.9)



**BF46214** In-Line Fuel Filter  
**Contains:** 5/16 In. Return Line Pressure Regulator Clamp  
**Fits:** 2009 BMW 740i, 2002-05 745i, 745Li, 2006-09 750i, 2006-08 750Li  
**Replaces:** BMW (Bavarian Motor Works) 13327503413, 16126750475; Wix 33601, 533601  
**O.D.:** 2 3/16 (55.6)  
**Inlet:** 5/16  
**Outlet:** 5/16  
**Length:** 12 13/32 (315.0)



**BF46215** In-Line Fuel Filter  
**Contains:** Ground Plug  
**Fits:** 2001-04 Toyota Sequoia  
**Replaces:** Toyota 23030-50010; Wix 33410, 33924  
**O.D.:** 2 9/16 (65.1)  
**Inlet:** 5/16  
**Outlet:** M14 x 1.5  
**Length:** 4 9/32 (108.7)



**BF46216** In-Line Fuel Filter  
**Fits:** 2001-04 Toyota Avalon  
**Replaces:** Toyota 23300-20101; Wix 33923  
**O.D.:** 2 9/16 (65.1)  
**Inlet:** M14 x 1.5  
**Outlet:** 5/16  
**Length:** 4 1/32 (102.4)



**BF46217** In-Line Fuel Filter with Vapor Diverter  
**Contains:** 3/8 In. Return Line 1/4 In. Vapor Diverter  
**Fits:** 2004-08 Chrysler Crossfire; 1996-on Mercedes-Benz Automotive, Light-Duty Trucks, Vans  
**Replaces:** Chrysler 5097052AA; Mercedes-Benz A0024773001; Wix 33643  
**O.D.:** 2 15/16 (74.6)  
**Inlet:** 5/16  
**Outlet:** 5/16  
**Length:** 6 1/8 (155.6)



**BF46218** In-Line Fuel Filter  
**Fits:** 2004, 2006 Volvo C70, 2004 S40, V40, 2005-09 S60, S60 T5, 2003, 2005-07 XC70 Cross Country, 2004-on S60 R, 2006-on S80, 2003-04, 2007 V70, 2004, 2006 V70 R, 2003, 2005-08 XC90  
**Replaces:** Volvo 30620512; Wix 33605  
**O.D.:** 3 7/16 (87.3)  
**Inlet:** 7/16  
**Outlet:** 7/16  
**Length:** 6 1/2 (165.1)



**BF46219** In-Line Fuel Filter  
**Fits:** 1999-2004 Volvo S80, 2000-04 S80 T6, 2001-on S60, 2001-03 S40, V40, 2003, 2007 S60R, 2003-07 V70, 2004, 2007 S60 T5, XC70, 2005 V70 T5  
**Replaces:** Volvo 30817997; Wix 33603  
**O.D.:** 3 15/32 (88.1)  
**Inlet:** 7/16  
**Outlet:** 7/16  
**Length:** 8 1/4 (209.6)



Measurements Are Shown In Inches And (Millimeters)

**WARNING:** These products can expose you to chemicals, including Diisononyl Phthalate, Carbon black extracts, Nickel, 1,3 Butadiene, Ethylene Oxide, Epichlorohydrin, which are known to the State of California to cause cancer, and Bisphenol, Ethylene Glycol, Ethylene Oxide, 1,3 Butadiene, Epichlorohydrin, which are known to the State of California to cause birth defects or other reproductive harm.

**BF46220** In-Line Fuel Filter  
**Contains:** [2] Plastic Clips  
 Ground Prong  
**Fits:** 2004-06 Suzuki Verona  
**Replaces:** Suzuki 15410-86Z00; Wix 33850  
**O.D.:** 2 5/16 (58.7)  
**Inlet:** 1/4  
**Outlet:** 1/4  
**Length:** 6 9/16 (166.7)



**BF46228** Fuel Spin-on  
**Fits:** Kubota SVL75-2, SVL75-2C, SVL95-2S, SVL95-2SC Loaders  
**Replaces:** Kubota HHV0051640, V063151640; Wix WF10475  
**Thread:** 3/4 -16  
**O.D.:** 3 1/32 (77.0)  
**Height:** 4 3/32 (103.6)  
**A. Gskt:** [1] Included



**BF46221** In-Line Fuel Filter  
**Contains:** 3/16 Inch Return Line  
**Fits:** Audi, Volkswagen Automotive  
**Replaces:** Volkswagen 1K0201051C; Wix 33814  
**O.D.:** 2 13/32 (61.1)  
**Inlet:** 3/16  
**Outlet:** 3/16  
**Length:** 6 15/32 (164.3)



**BF46229** In-Line Fuel Filter  
**Fits:** Thermo King Tripac Auxiliary Power Unit  
**Replaces:** Thermo King 13864; Donaldson P553890; Fleetguard FF5864; Luber-finer G6635  
**O.D.:** 2 (51.1)  
**Inlet:** 1/8-27  
**Outlet:** 1/8-27  
**Length:** 3 (76.2)



**BF46222** In-Line Fuel Filter  
**Fits:** Fiat 500  
**Replaces:** Chrysler 68086606AA; Wix 33176  
**O.D.:** 1 31/32 (50.0)  
 Bracket 3 7/16 (87.3)  
**Inlet:** 3/8  
**Outlet:** 3/8  
**Length:** 6 7/8 (174.6)



**BF46233** Fuel Spin-on  
**Fits:** Volvo VAH200, VAH430, VAH630, VHD200, VNL300, VLN430, VNL630, VNL670, VNL730, VNL780, VNM200, VNX630 North America Trucks  
**Replaces:** Renault 7423044513; Volvo 22988765, 23044511  
**Thread:** M32x1.5 -6H  
**O.D.:** 4 1/4 (108.2)  
**Height:** 10 15/32 (265.9)  
**A. Gskt:** [1] Included



**BF46223** In-Line Fuel Filter  
**Fits:** 2010-on Cadillac SRX, 2011, 2014-on CTS  
**Replaces:** General Motors 25993215; Wix 33315  
**O.D.:** 2 5/32 (54.8)  
**Inlet:** 3/8  
**Outlet:** 3/8  
**Length:** 6 5/32 (156.4)



**PF46235** Fuel/Water Separator  
**Fits:** Freightliner Trucks  
**Replaces:** Detroit Diesel DDER61709; Racor R61709  
**O.D.:** 4 7/32 (107.2)  
**Height:** 7 7/32 (183.6)  
**O-Ring:** [2] Included



**BF46224** In-Line Fuel Filter  
**Fits:** 2004-06 Suzuki XL-7  
**Replaces:** Suzuki 1541052D20; Wix WF10009  
**O.D.:** 2 29/32 (73.8)  
**Inlet:** 5/16  
**Outlet:** 5/16  
**Length:** 5 5/16 (134.9)



**BF46225** In-Line Fuel Filter with Clamps and Hose  
**Contains:** [1] Hose  
 [2] Clamps  
**Fits:** 1968-78 Ford, Mercury, 1975-78 Lincoln Automotive, Light-Duty Trucks  
**Replaces:** Ford D32E-9155-A; Motorcraft FG19B, FG19C; Wix 33019  
**O.D.:** 3/4 (19.0)  
**Inlet:** 5/16  
**Outlet:** 7/8-20  
**Length:** 2 7/32 (56.4)  
**F. Gskt:** [1] Included



**PF46236** Fuel/Water Separator Element  
**Fits:** Kenworth, Peterbilt Trucks with Cummins Engine  
**Replaces:** Paccar K371021; Racor R6176XL10  
**O.D.:** 4 3/32 (104.1)  
**I.D.:** 13/16 (20.3) One End  
**Height:** 10 13/16 (274.3)  
**O-Ring:** [1] Included



**BF46227** Fuel Spin-on with Open Port  
**Fits:** Case Diesel Engines, Loaders; Case-International, New Holland, Steyer Tractors  
**Replaces:** New Holland 84278636  
**Thread:** M16 x 1.5-6H  
**O.D.:** 3 23/32 (94.2)  
**Height:** 7 5/32 (181.9)  
**A. Gskt:** [1] Included  
**F. Gskt:** [1] Included



**PF46237** Fuel/Water Separator Element  
**Fits:** Kenworth, Peterbilt Trucks with Paccar MX-13 Engine  
**Replaces:** Paccar K371022; Racor R61716XL30  
**O.D.:** 4 3/32 (104.1)  
**I.D.:** 13/16 (20.3) One End  
**Height:** 10 13/16 (274.3)  
**O-Ring:** [1] Included



Measurements Are Shown In Inches And (Millimeters)

**WARNING:** These products can expose you to chemicals, including Diisononyl Phthalate, Carbon black extracts, Nickel, 1,3 Butadiene, Ethylene Oxide, Epichlorohydrin, which are known to the State of California to cause cancer, and Bisphenol, Ethylene Glycol, Ethylene Oxide, 1,3 Butadiene, Epichlorohydrin, which are known to the State of California to cause birth defects or other reproductive harm.

**PF46238**

Fuel Element



**Fits:** Peterbilt 365, 520 Trucks  
**Replaces:** Paccar K371017, Racor R61716DCM  
**O.D.:** 4 1/32 (102.4)  
**I.D.:** 13/16 (20.4) & 7/32 (5.4)  
**Height:** 7 3/16 (182.6)  
**O-Ring:** [2] Included

**BD50000**

High Efficiency Dual-Flow Lube Spin-on



**Fits:** Cummins QST30 Engine; Cummins ISX15 Engines  
**Replaces:** Cummins 4367100; Donaldson P559000; Fleetguard LF14000NN  
**Thread:** M95 x 2.5-6H  
**O.D.:** 4 11/16 (119.1)  
**Height:** 11 25/32 (299.2)  
**I.Gskt:** [1] Included  
**Related To:** BD7154 (Standard Version) B40145 (Extended Life version for use on 2020 Cummins X15 Engine)

**BF63000**

Fuel Spin-on



**Fits:** Autocar, Dennis Eagle, Ford, Freightliner, International, Kenworth, Mack, Peterbilt, Western Star Trucks; Blue Bird Buses; Hyundai Excavators, Loaders; Skyjack Boom Lifts; Macdon Harvesters; VogeLe Paving Equipment (All with Cummins, Paccar Engines)  
**Replaces:** Atlas Copco 3222341179; Cummins 5289121, 5303743, 5304214; Doosan 40050800070, 46587383, 46645085; Fleetguard FF63004, FF63008, FF63009; Hyster 4103452; Hyundai 11Q771010; JCB 333E0268; JLG Industries Inc. 70024315; Sennebogen 169951; Wirtgen 2391354  
**Thread:** S102 x 4  
**O.D.:** 4 (101.6)  
**I.D.:** 1 3/32 (27.9)  
**Height:** 7 13/16 (198.1)  
**A. Gskt:** [2] Included

**OAS98000**

Oil/Air Separator Spin-on



**Fits:** DAF Trucks  
**Replaces:** Cummins 4931691; DAF 1686587  
**Thread:** M16 x 1.5  
**O.D.:** 3 (76.2)  
**Height:** 4 29/32 (124.6)  
**I.Gskt:** [1] Included

**OAS98001**

Oil/Air Separator Element



**Fits:** Ingersoll-Rand Compressors  
**Replaces:** Ingersoll-Rand 36845303  
**O.D.:** 5 3/4 (146.0)  
 Flange 7 3/16 (182.6)  
**I.D.:** 3 5/16 (84.1) One End  
**Height:** 11 11/16 (296.9)

**OAS98002**

Oil/Air Separator Element



**Notes:** OBSOLETE. Availability limited to Dealer Stock.  
**CAUTION:** Do not remove staples from gaskets. These staples provide electrical grounding continuity between defogger and tank.  
**Fits:** Sullair LS10-25L,H,HH,XH, LS10-30L,H,HH,XH, LS10B-25ACAC Compressors  
**Replaces:** Sullair 250034112, 250034143  
**O.D.:** 6 23/32 (170.7)  
 Flange 7 7/8 (200.0)  
**I.D.:** 3 3/8 (85.7) One End  
**Height:** 6 13/16 (173.0)  
**A. Gskt:** [2] Attached

**OAS98003**

Oil/Air Separator Element



**Notes:** OBSOLETE. Availability limited to Dealer Stock.  
**CAUTION:** Do not remove staples from gaskets. These staples provide electrical grounding continuity between defogger and tank.  
**Fits:** Sullair 260, DPQ260 with Cat C3.4 Engine  
**Replaces:** Sullair 2250078031, 410333, 250034155, 2250078029, 250034153  
**O.D.:** 6 23/32 (170.7)  
 Flange 7 7/8 (200.0)  
**I.D.:** 3 13/16 (96.8) One End  
**Height:** 8 11/32 (211.9)  
**A. Gskt:** [1] Attached

**OAS98004**

Oil/Air Separator Element



**Notes:** OBSOLETE. Availability Limited to Dealer Stock.  
**Fits:** Ingersoll-Rand SSR EP30U, SSR EP40U Compressors  
**Replaces:** Ingersoll-Rand 42361204, 39858691, 39627666  
**O.D.:** 6 23/32 (170.7)  
**I.D.:** 4 (101.6) One End  
**Height:** 11 5/16 (287.3)  
**A. Gskt:** [1] Attached  
**F. Gskt:** [2] Included

**OAS98005**

Oil/Air Separator Element



**Fits:** LeRoi Compressors  
**Replaces:** LeRoi 431103, 438891, 431022  
**O.D.:** 5 3/4 (146.0)  
 Flange 7 15/32 (189.7)  
**I.D.:** 3 5/16 (84.1) One End  
**Height:** 8 1/8 (206.4)  
**A. Gskt:** [2] Attached

**OAS98006**

Oil/Air Separator Spin-on



**Fits:** Gardner Denver Compressors  
**Replaces:** Gardner Denver 2116717, 55B57, 2118414  
**Thread:** 1 1/4 -11 BSP  
**O.D.:** 5 17/32 (140.5)  
**Height:** 10 7/8 (276.2)  
**I.Gskt:** [1] Included

Measurements Are Shown In Inches And (Millimeters)

**WARNING:** These products can expose you to chemicals, including Diisononyl Phthalate, Carbon black extracts, Nickel, 1,3 Butadiene, Ethylene Oxide, Epichlorohydrin, which are known to the State of California to cause cancer, and Bisphenol, Ethylene Glycol, Ethylene Oxide, 1,3 Butadiene, Epichlorohydrin, which are known to the State of California to cause birth defects or other reproductive harm.



**OAS98007**

Oil/Air Separator Element



**Fits:** Atlas Copco GA30 III, GA30 IV, GA37 III, GA37 IV, GA45 III Compressors, Chicago Pneumatic S-15/40H,HH,L,M, S-15/50H,HH,L,M, S15/60H,HH,L,M Compressors  
**Replaces:** Atlas Copco 2901056602, 16138397, 29010566  
**O.D.:** 6 5/8 (168.3)  
Flange 11 3/4 (298.5)  
**I.D.:** 4 7/32 (107.2) One End  
**Height:** 7 (177.8)  
**O-Ring:** [2] Included

**OAS98012**

Oil/Air Separator Element with Bail Handle



**Fits:** Tamrock Applications  
**Replaces:** Tamrock 3582228; Donaldson P782915  
**O.D.:** 3 15/16 (100.0)  
Flange 4 1/32 (102.4)  
**I.D.:** 1 15/16 (49.2) One End  
**Height:** 6 1/8 (155.6)  
**O-Ring:** [1] Attached, [1] Included

**OAS98008**

Oil/Air Separator Element



**Notes:** CAUTION: Do not remove staples from gaskets. These staples provide electrical grounding continuity between defogger and tank.  
**Fits:** Ingersoll-Rand SSR EP15SU, SSR HP15U Compressors  
**Replaces:** Ingersoll-Rand 39858683, 39760962, 42361196  
**O.D.:** 4 27/32 (123.0)  
**I.D.:** 2 15/32 (62.7) One End  
**Height:** 9 1/16 (230.2)  
**A. Gskt:** [2] Attached

**OAS98013**

Oil/Air Separator Element



**Notes:** CAUTION: Do not remove staples from gaskets. These staples provide electrical grounding continuity between defogger and tank.  
**Fits:** Ingersoll-Rand SSR EP250, SSR HP250, SSR XF250, SSR XP250, SSR EP300, SSR HP300, SSR XF300, SSR XF450 Compressors  
**Replaces:** Ingersoll-Rand 39760590, 39742861; Donaldson P530810  
**O.D.:** 14 7/8 (377.8)  
Flange 17 1/4 (438.2)  
**I.D.:** 11 13/32 (289.7) One End  
**Height:** 17 5/16 (439.7)  
**A. Gskt:** [2] Attached

**OAS98009**

Oil/Air Separator Element



**Fits:** Ingersoll-Rand SSR EP75, SSR EP100, SSR HP100, SSR XF100 Compressors  
**Replaces:** Ingersoll-Rand 39863857, 39831904  
**O.D.:** 8 5/16 (211.1)  
Flange 13 5/16 (338.1)  
**I.D.:** 5 3/32 (129.4) One End  
**Height:** 14 (355.6)  
**A. Gskt:** [2] Attached

**OAS98014**

Oil/Air Separator Element



**Notes:** CAUTION: Do not remove staples from gaskets. These staples provide electrical grounding continuity between defogger and tank.  
**Fits:** Ingersoll-Rand Compressors  
**Replaces:** Ingersoll-Rand 39831888  
**O.D.:** 6 23/32 (170.7)  
Flange 7 7/8 (200.0)  
**I.D.:** 3 13/16 (96.8) One End  
**Height:** 9 1/16 (230.2)  
**A. Gskt:** [2] Attached

**OAS98010**

Oil/Air Separator Element



**Notes:** OBSOLETE. Availability Limited to Dealer Stock.  
**Fits:** Sullair LS12-60, LS16E100, LS16-24KT-60, LS16-24KT-75, LS16-60,LS16-75,ACAC, LS16-75L,H,HH,XH, LS16B8-75WCAC, LS16SRF-60, LS16SRF-75, LS20-24KT-100, LS20S Compressors  
**Replaces:** Sullair 250034116, 408167005; Fleetguard AS2356  
**O.D.:** 8 3/8 (212.7)  
Flange 10 3/4 (273.1)  
**I.D.:** 5 1/4 (133.4) One End  
**Height:** 16 3/32 (408.8)  
**A. Gskt:** [1] Attached

**OAS98015**

Oil/Air Separator Element



**Notes:** CAUTION: Do not remove staples from gaskets. These staples provide electrical grounding continuity between defogger and tank.  
**Fits:** Ingersoll-Rand R90IU, R110IU, SSR EP125BR, SSR HP125BR,SSR XF125BR, SSR EP150BR, SSR HP150BR, SSR XF150BR, R160IU, SSR EP200BR, SSR HP200BR, SSR XF200BR Compressors  
**Replaces:** Ingersoll-Rand 54509427  
**O.D.:** 10 27/32 (275.4)  
Flange 14 3/4 (374.7)  
**I.D.:** 8 7/32 (208.8) One End  
**Height:** 9 1/16 (230.2)  
**A. Gskt:** [2] Attached

**OAS98011**

Oil/Air Separator Element



**Fits:** Atlas Copco GA11 III, GA11 IV, GA15 III, GA15 IV, GA18 III, GA18 IV, GA22 III, GA22 IV, GA30C III, GA30C IV Compressors  
**Replaces:** Atlas Copco 2901077900; Fleetguard AS2502  
**O.D.:** 5 3/16 (131.8)  
Flange 7 15/16 (201.6)  
**I.D.:** 2 27/32 (72.2) One End  
**Height:** 5 9/16 (141.3)  
**A. Gskt:** [1] Attached  
**F. Gskt:** [2] Included

**OAS98016**

Oil/Air Separator Element



**Fits:** Ingersoll-Rand SSR EP30SE, SSR XF30S, SSR EP40SE, SSR EP40SE-B, SSR HP40SE-B, SSR HXP40SE-B, SSR EP50, SSR EP50SE, SSR EP50SE-B, SSR HP50SE, SSR HXP50SE, SSR XF50SE, SSR XF50SF Compressors  
**Replaces:** Ingersoll-Rand 54595442  
**O.D.:** 6 21/32 (169.1)  
Flange 7 7/8 (200.0)  
**I.D.:** 3 29/32 (99.2) One End  
**Height:** 9 1/16 (230.2)  
**A. Gskt:** [1] Attached

Measurements Are Shown In Inches And (Millimeters)

**WARNING:** These products can expose you to chemicals, including Diisononyl Phthalate, Carbon black extracts, Nickel, 1,3 Butadiene, Ethylene Oxide, Epichlorohydrin, which are known to the State of California to cause cancer, and Bisphenol, Ethylene Glycol, Ethylene Oxide, 1,3 Butadiene, Epichlorohydrin, which are known to the State of California to cause birth defects or other reproductive harm.

**OAS98017**

Oil/Air Separator Element



**Notes:** CAUTION: Do not remove staples from gaskets. These staples provide electrical grounding continuity between defogger and tank.  
**Fits:** Sullair Compressors  
**Replaces:** Sullair 250034086  
**O.D.:** 10 7/8 (276.2)  
Flange 13 29/32 (353.2)  
**I.D.:** 7 15/32 (189.7) One End  
**Height:** 19 11/16 (500.1)  
**A. Gskt:** [2] Attached

**OAS98018**

Oil/Air Separator Element



**Notes:** Each gasket has 16 holes.  
**Fits:** Kaeser BS-44, BS-50, BS-51, BS-60, BS-61 Compressors  
**Replaces:** Kaeser 619600, 6.2012.0  
**O.D.:** 6 9/16 (166.7)  
Flange 7 7/8 (200.0)  
**I.D.:** 4 11/32 (110.3) One End  
**Height:** 17 1/2 (444.5)  
**F. Gskt:** [2] Included

**OAS98019**

Oil/Air Separator Element



**Fits:** Gardner Denver Compressors  
**Replaces:** Gardner Denver 202ECH6013, 200ECH035  
**O.D.:** 5 1/2 (139.7)  
**I.D.:** 2 5/8 (66.7) One End  
**Height:** 12 (304.8)

**OAS98020**

Oil/Air Separator Element with Lift Bars



**Fits:** Gardner Denver Compressors  
**Replaces:** Gardner Denver 208EAP6013, 200ECM035  
**O.D.:** 5 1/2 (139.7)  
**I.D.:** 2 13/32 (61.1) One End  
**Height:** 22 5/8 (574.7)  
**O-Ring:** [2] Attached

**OAS98021**

Oil/Air Separator Element



**Fits:** Sullair TS20-100, TS20-125, TS20-150, LS20SE-175, LS20SE-200, TS20-200, TS20-250, TS32-200, TS32-250, TS32-200, LS25/16 TANDEM 100 HP, LS25/16 TANDEM 125 HP, LS25/16 TANDEM 150 HP Compressors  
**Replaces:** Sullair 250034122, 250034121  
**O.D.:** 11 23/32 (297.7)  
Flange 13 29/32 (353.2)  
**I.D.:** 8 11/32 (211.9) One End  
**Height:** 26 1/16 (662.0)  
**A. Gskt:** [2] Attached

**OAS98022**

Oil/Air Separator Element



**Notes:** CAUTION: Do not remove staples from gaskets. These staples provide electrical grounding continuity between defogger and tank.  
**Contains:** Threaded Stud  
**Fits:** Atlas Copco GA11 I GEN 110.001-110.999, GA15 I GEN 150.001-150.999, GA18 I GEN 180.001-180.999, GA22 I GEN 220.001-220.999 Compressors; Chicago Pneumatic S-8, S-8/15, S-8/20, S-8/30H,HH,L,M, 180-Q Com  
**Replaces:** Atlas Copco 16123869, 1310250233; M.A.N. 4900152106; Donaldson P525529; Fleetguard AS2392  
**O.D.:** 5 9/32 (134.1)  
Flange 8 11/16 (220.7)  
**I.D.:** 3 7/16 (87.3) One End  
**Height:** 10 7/8 (276.2)  
**F. Gskt:** [2] Included  
**O-Ring:** [2] Included

**OAS98023**

Oil/Air Separator Element



**Notes:** OBSOLETE. Availability Limited to Dealer Stock.  
**Contains:** Bolt Hole in Flange  
**Fits:** Sullair Compressors  
**Replaces:** Sullair 250042862, 408167011; Fleetguard AS2388  
**O.D.:** 3 13/16 (96.8)  
Flange 10 3/4 (273.1)  
**I.D.:** 1 1/2 (38.1) One End  
**Height:** 14 1/16 (357.2)  
**A. Gskt:** [2] Attached

**OAS98024**

Oil/Air Separator Element

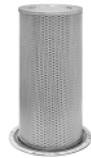

**Notes:** OBSOLETE. Availability Limited to Dealer Stock.  
**Fits:** Sullair LS20-125L,H,HH,XH,VSD, LS20E-125, LS20S-125, LS20-150L,H,HH,XH,VSD, LS20E-150, USA, LS20S-150, LS20-175L,H,HH,XH Compressors  
**Replaces:** Sullair 250034085  
**O.D.:** 10 5/8 (269.9)  
Flange 13 25/32 (350.0)  
**I.D.:** 7 7/16 (188.9) One End  
**Height:** 24 1/2 (622.3)  
**A. Gskt:** [2] Attached

**OAS98025**

Oil/Air Separator Element



**Notes:** CAUTION: Do not remove staples from gaskets. These staples provide electrical grounding continuity between defogger and tank.  
**Fits:** Ingersoll-Rand Compressors  
**Replaces:** Ingersoll-Rand 39737473; Donaldson P782921; Fleetguard AS2418  
**O.D.:** 8 21/32 (219.9)  
Flange 11 3/8 (288.9)  
**I.D.:** 5 25/32 (146.8) One End  
**Height:** 9 27/32 (250.0)  
**A. Gskt:** [2] Attached

Measurements Are Shown In Inches And (Millimeters)

**WARNING:** These products can expose you to chemicals, including Diisononyl Phthalate, Carbon black extracts, Nickel, 1,3 Butadiene, Ethylene Oxide, Epichlorohydrin, which are known to the State of California to cause cancer, and Bisphenol, Ethylene Glycol, Ethylene Oxide, 1,3 Butadiene, Epichlorohydrin, which are known to the State of California to cause birth defects or other reproductive harm.

**OAS98026**

Oil/Air Separator Element



**Notes:** CAUTION: Do not remove staples from gaskets. These staples provide electrical grounding continuity between defogger and tank.  
**Fits:** Ingersoll-Rand MHP825 Compressor  
**Replaces:** Ingersoll-Rand 89285761  
**O.D.:** 10 7/8 (276.2)  
**Flange** 14 1/8 (358.8)  
**I.D.:** 8 9/32 (210.3) One End  
**Height:** 19 11/16 (500.1)  
**A. Gskt:** [2] Attached

**OAS98031**

Oil/Air Separator Element



**Contains:** Bolt Hole plus [8] Holes in Flange  
**Fits:** Sullair LS12, LS12-60 Leak Free, LS16-24KT, LS16-24KT LEAK FREE-60, LS16-75, LS16SRF LEAK FREE-100, LS16SRF-60 LEAK FREE, LS16SRF-75 LEAK FREE, LS20T Compressors  
**Replaces:** Sullair 2250100756, 2250100754  
**O.D.:** 5 3/4 (146.0)  
**Flange** 14 (355.6)  
**I.D.:** 3 1/4 (82.6) One End  
**Height:** 9 11/16 (246.1)  
**A. Gskt:** [2] Attached

**OAS98027**

Oil/Air Separator Element



**Notes:** CAUTION: Do not remove staples from gaskets. These staples provide electrical grounding continuity between defogger and tank.  
**Contains:** Bolt Hole in Flange  
**Fits:** Sullair TS20-100, TS20-125, TS20-150, LS20SE-175, LS20SE-200, TS20-200, TS20-250 LS25/16 TANDEM 100 HP, LS25/16 TANDEM 150 HP Compressors  
**Replaces:** Sullair 250034134  
**O.D.:** 6 25/32 (172.2)  
**Flange** 13 29/32 (353.2)  
**I.D.:** 3 13/16 (96.8) One End  
**Height:** 18 7/16 (468.3)  
**A. Gskt:** [2] Attached

**OAS98032**

Oil/Air Separator Element



**Notes:** CAUTION: Do not remove staples from gaskets. These staples provide electrical grounding continuity between defogger and tank.  
**Fits:** Sullair LS10-40L,H,HH,XH Compressors  
**Replaces:** Sullair 2250137895  
**O.D.:** 6 23/32 (170.7)  
**Flange** 7 7/8 (200.0)  
**I.D.:** 3 13/16 (96.8) One End  
**Height:** 9 27/32 (250.0)  
**A. Gskt:** [2] Attached

**OAS98028**

Oil/Air Separator Element



**Fits:** To 12/2009 Shultz SRP2100, SRP2150, SRP3100, SRP3100SS GD, GDSRP3150E GD, SRP3200 GD, SRP3200FLEX Compressors  
**Replaces:** Tamrock 3340028; Fleetguard AS2458  
**O.D.:** 3 15/16 (100.0)  
**I.D.:** 2 5/32 (54.8) One End  
**Height:** 16 11/32 (415.1)

**OAS98033**

Oil/Air Separator Element



**Notes:** CAUTION: Do not remove staples from gaskets. These staples provide electrical grounding continuity between defogger and tank.  
**Contains:** [8] Holes in Flange  
**Fits:** Sullair LS12, LS12-60 Leak Free, LS16-24KT, LS16-24KT LEAK FREE-60, LS16-75, LS16SRF LEAK FREE-100, LS16SRF-60 LEAK FREE, LS16SRF-75 LEAK FREE, LS20T Compressors  
**Replaces:** Sullair 2250100755  
**O.D.:** 10 7/8 (276.2)  
**Flange** 14 (355.6)  
**I.D.:** 7 7/16 (188.9) One End  
**Height:** 10 29/32 (277.0)  
**A. Gskt:** [2] Attached

**OAS98029**

Oil/Air Separator Element with Bail Handle



**Fits:** Tamrock Applications  
**Replaces:** Tamrock 3498328; Gardner Denver 301EFC6013  
**O.D.:** 3 29/32 (99.2)  
**I.D.:** 2 7/32 (56.4) One End  
**Height:** 7 5/8 (193.7)

**OAS98034**

Oil/Air Separator Element with Lift Bars



**Notes:** CAUTION: Do not remove staples from gaskets. These staples provide electrical grounding continuity between defogger and tank.  
**Fits:** Kaeser DSD-125AIR COOLED+SIGMA, DS-141, DSD-150AIR COOLED+SIGMA, DS-171, DSD-172, DSD-172T, DSD-1725, DSD-200AIR COOLED+SIGMA, DS201, DS-241, M260, M270 Compressors  
**Replaces:** Kaeser 621320  
**O.D.:** 15 5/8 (396.9)  
**Flange** 17 1/16 (433.4)  
**I.D.:** 12 13/32 (315.1) One End  
**Height:** 15 11/16 (398.5)  
**F. Gskt:** [2] Included  
**O-Ring:** [2] Included

**OAS98030**

Oil/Air Separator Element



**Notes:** OBSOLETE. Availability Limited to Dealer Stock.  
**Fits:** Sullair Compressors  
**Replaces:** Sullair 40260, 11173; Fleetguard AS2349  
**O.D.:** 20 31/32 (532.6)  
**Flange** 26 1/2 (673.1)  
**I.D.:** 18 7/32 (462.8) One End  
**Height:** 32 9/16 (827.1)  
**A. Gskt:** [2] Attached

Measurements Are Shown In Inches And (Millimeters)

**WARNING:** These products can expose you to chemicals, including Diisononyl Phthalate, Carbon black extracts, Nickel, 1,3 Butadiene, Ethylene Oxide, Epichlorohydrin, which are known to the State of California to cause cancer, and Bisphenol, Ethylene Glycol, Ethylene Oxide, 1,3 Butadiene, Epichlorohydrin, which are known to the State of California to cause birth defects or other reproductive harm.

**OAS98035**

Oil/Air Separator Element



**Contains:** [6] Bolts  
[1] Mounting Plate  
**Fits:** Quincy Compressors  
**Replaces:** Quincy 127138002  
**O.D.:** 5 3/8 (136.5)  
**I.D.:** 2 1/4 (57.2) One End  
**Height:** 6 3/8 (161.9)  
**A. Gskt:** [1] Attached  
**F. Gskt:** [1] Included  
**Spring:** [1] Included

**OAS98040**

Oil/Air Separator Element



**Fits:** Ingersoll-Rand Compressors  
**Replaces:** Ingersoll-Rand 39739578;  
Donaldson P525712; Fleetguard AS2263  
**O.D.:** 11 7/8 (301.6)  
Flange 15 1/2 (393.7)  
**I.D.:** 8 7/16 (214.3) One End  
**Height:** 17 29/32 (454.8)  
**A. Gskt:** [2] Attached

**OAS98036**

Oil/Air Separator Element



**Fits:** Atlas Copco Compressors  
**Replaces:** Atlas Copco 2901000401;  
Fleetguard AS2471  
**O.D.:** 2 9/32 (57.9)  
Flange 8 21/32 (219.9)  
**I.D.:** 3 (76.2) One End  
**Height:** 6 3/4 (171.5)  
**O-Ring:** [2] Included

**OAS98041**

Oil/Air Separator Element



**Notes:** CAUTION: Do not remove staples from gaskets. These staples provide electrical grounding continuity between defogger and tank.  
**Fits:** Ingersoll-Rand R90IU, R110IU, SSR EP125, SSR EP125BR, SSR HP125BR, SSR XF125BR, SSR EP150BR, SSR HP150BR, SSR XF150BR, R160IU, SSR EP200BR, SSR HP200BR, SSR XF200BR Compressors  
**Replaces:** Ingersoll-Rand 39863865  
**O.D.:** 10 27/32 (275.4)  
Flange 14 3/4 (374.7)  
**I.D.:** 8 7/32 (208.8) One End  
**Height:** 17 (431.8)  
**A. Gskt:** [2] Attached

**OAS98037**

Oil/Air Separator Element



**Notes:** CAUTION: Do not remove staples from gaskets. These staples provide electrical grounding continuity between defogger and tank.  
**Fits:** Sullair 32/25-200, 32/25-300, TS32-200, TS32-250, TS32-300, TS32-350 Compressors  
**Replaces:** Sullair 250034124  
**O.D.:** 18 13/16 (477.8)  
Flange 23 25/32 (604.0)  
**I.D.:** 14 7/8 (377.8) One End  
**Height:** 22 1/4 (565.2)  
**A. Gskt:** [2] Attached

**OAS98042**

Oil/Air Separator Element with Lift Bars and Lift Tabs



**Contains:** Threaded Stud  
[2] Springs  
[1] Threaded Nut  
[12] Holes in Each Gasket  
**Fits:** Sullair Elgi TS750, DS900/100, DS900/200, DS900/300, DS-900/350, DT900/350, DS1100-300 Compressors  
**Replaces:** Sullair 2250044197  
**O.D.:** 11 1/2 (292.1)  
**I.D.:** 9 1/4 (235.0) One End  
**Height:** 29 27/32 (758.0)  
**F. Gskt:** [2] Included

**OAS98038**

Oil/Air Separator Element



**Notes:** CAUTION: Do not remove staples from gaskets. These staples provide electrical grounding continuity between defogger and tank.  
**Fits:** Sullair Compressors  
**Replaces:** Sullair 250005547; Curtis RN27518;  
Donaldson P530783; Fleetguard AS2368  
**O.D.:** 8 3/8 (212.7)  
Flange 10 3/4 (273.1)  
**I.D.:** 5 1/4 (133.4) One End  
**Height:** 11 (279.4)  
**A. Gskt:** [2] Attached

**OAS98043**

Oil/Air Separator Element



**Fits:** Sullair ES11 Compressor  
**Replaces:** Sullair 225016706  
**O.D.:** 5 7/16 (138.1)  
**I.D.:** 2 11/16 (68.3) One End  
**Height:** 13 11/16 (347.7)  
**O-Ring:** [1] Attached, [1] Included

**OAS98039**

Oil/Air Separator Element

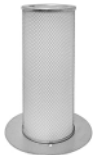

**Notes:** CAUTION: Do not remove staples from gaskets. These staples provide electrical grounding continuity between defogger and tank.  
**Contains:** Bolt Hole in Flange  
**Fits:** Sullair LS16-75L,H,HH,XHRA, LS16-100L,H,HH,RA,HH,USA, LS20-100L,H,HH,XHRA, LS20-125L,H,HH,XH, LS20-150L,H,HH,XH, LS20-175L,H,HH,XH, LS20-220L,H,HH,XH Compressors  
**Replaces:** Sullair 250034128  
**O.D.:** 8 3/8 (212.7)  
Flange 13 29/32 (353.2)  
**I.D.:** 5 25/32 (146.8) One End  
**Height:** 22 17/32 (572.3)  
**A. Gskt:** [2] Attached

**OAS98044**

Oil/Air Separator Element with Lift Tabs



**Fits:** Quincy Compressors  
**Replaces:** Quincy 129893  
**O.D.:** 5 3/4 (146.0)  
**I.D.:** 2 5/16 (58.7) One End  
**Height:** 11 7/16 (290.5)

Measurements Are Shown In Inches And (Millimeters)

**WARNING:** These products can expose you to chemicals, including Diisononyl Phthalate, Carbon black extracts, Nickel, 1,3 Butadiene, Ethylene Oxide, Epichlorohydrin, which are known to the State of California to cause cancer, and Bisphenol, Ethylene Glycol, Ethylene Oxide, 1,3 Butadiene, Epichlorohydrin, which are known to the State of California to cause birth defects or other reproductive harm.

**OAS98045**



Oil/Air Separator Element

**Fits:** Sullair ES8 Compressor  
**Replaces:** Sullair 2250106791  
**O.D.:** 3 7/32 (81.8)  
**I.D.:** 1 5/16 (33.3) One End  
**Height:** 11 25/32 (299.2)  
**A. Gskt:** [1] Attached  
**F. Gskt:** [1] Included  
**O-Ring:** [1] Included

**OAS98052**



Oil/Air Separator Element

**Contains:** Bolt Holes in Flange  
**Fits:** Compair 6180N084 Compressor  
**Replaces:** LeROI 431111  
**O.D.:** 11 7/8 (301.6)  
 Flange 13 25/32 (350.0)  
**I.D.:** 8 21/32 (219.9) One End  
**Height:** 19 13/16 (503.2)  
**A. Gskt:** [2] Attached

**OAS98046**



Oil/Air Separator Element with Lift Bars

**Notes:** CAUTION: Do not remove staples from gaskets. These staples provide electrical grounding continuity between defogger and tank.  
**Fits:** Gardner Denver Compressors  
**Replaces:** Gardner Denver 202EDP6013  
**O.D.:** 8 (203.2)  
**I.D.:** 5 21/32 (143.7) One End  
**Height:** 24 21/32 (626.3)  
**F. Gskt:** [1] Included

**OAS98053**



Oil/Air Separator Element

**Fits:** Atlas Copco GA110 ELEKTRONIKON MK I, GA110 ELEKTRONIKON MK III To 314.999, GA110 ELETROPNEUMATICO, GA160 ELEKTRONIKON MK I, GA160 ELEKTRONIKON MK III 314.999, GA160 ELETROPNEUMATICO Compressors; Chica  
**Replaces:** Atlas Copco 16146423  
**O.D.:** 13 25/32 (350.0)  
 Flange 19 11/16 (500.1)  
**I.D.:** 10 3/8 (263.5) One End  
**Height:** 17 9/16 (446.1)  
**O-Ring:** [2] Included

**OAS98047**



Oil/Air Separator Element

**Notes:** OBSOLETE. Availability Limited to Dealer Stock.  
**Fits:** Ingersoll-Rand Compressors  
**Replaces:** Ingersoll-Rand 39863899, 39831920  
**O.D.:** 14 7/8 (377.8)  
 Flange 17 (431.8)  
**I.D.:** 11 13/32 (289.7) One End  
**Height:** 16 15/32 (418.3)  
**A. Gskt:** [2] Attached

**OAS98054**

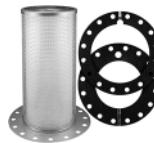

Oil/Air Separator Element

**Notes:** CAUTION: Do not remove staples from gaskets. These staples provide electrical grounding continuity between defogger and tank.  
**Fits:** Chicago Pneumatic 900-QH with Cummins NTA855C Engine, 950-DPH w/Mercedes-Benz Engine, 950-DUH with Scania DS11 Engine, 950-Q Compressors  
**Replaces:** Atlas Copco 16156038, 1615603801  
**O.D.:** 10 11/32 (262.7)  
 Flange 15 3/4 (400.0)  
**I.D.:** 6 1/4 (158.8) One End  
**Height:** 22 1/16 (560.4)  
**F. Gskt:** [2] Included

**OAS98049**



Oil/Air Separator Element

**Contains:** Bolt Hole in Flange  
**Fits:** Sullair LS20 Compressor  
**Replaces:** Sullair 225145897  
**O.D.:** 5 3/4 (146.0)  
 Flange 13 3/4 (349.3)  
**I.D.:** 3 9/32 (83.3) One End  
**Height:** 18 3/16 (462.0)  
**A. Gskt:** [2] Attached

**OAS98056**



Oil/Air Separator Element

**Contains:** [6] Holes in Flange  
**Fits:** Atlas Copco GA15 II GEN 151.001-151.999, GA18 II GEN 181.001-181.999, GA22 II GEN 221.001-221.999, GA30 BRP S/N 62855-up, GA30 VSD BRP S/N62855-up Compressors; Chicago Pneumatic S-8/15H,HH,L,M, S-8/20  
**Replaces:** Atlas Copco 16137502, 1613750200  
**O.D.:** 5 9/32 (134.1)  
 Flange 9 5/8 (244.5)  
**I.D.:** 3 (76.2) One End  
**Height:** 6 7/8 (174.6)  
**F. Gskt:** [2] Included

**OAS98050**



Oil/Air Separator Element

**Notes:** CAUTION: Do not remove staples from gaskets. These staples provide electrical grounding continuity between defogger and tank.  
**Fits:** Ingersoll-Rand SSR EP250BR, SSR HP250BR, SSR XF250BR, SSR XP250BR, SSR EP300BR, SSR EPE300, SSR HP300BR, SSR HP300I, SSR HPE300, SSR XFE300 Compressors  
**Replaces:** Ingersoll-Rand 54509500  
**O.D.:** 13 25/32 (350.0)  
 Flange 17 (431.8)  
**I.D.:** 10 7/16 (265.1) One End  
**Height:** 16 15/32 (418.3)  
**A. Gskt:** [2] Attached

**OAS98057**

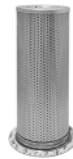

Oil/Air Separator Element

**Notes:** CAUTION: Do not remove staples from gaskets. These staples provide electrical grounding continuity between defogger and tank.  
**Fits:** Sullair S-16 BR Compressor  
**Replaces:** Sullair 250034118; Curtis RN27526; Fleetguard AS2357  
**O.D.:** 8 3/8 (212.7)  
 Flange 10 3/4 (273.1)  
**I.D.:** 5 1/4 (133.4) One End  
**Height:** 24 3/32 (612.0)  
**A. Gskt:** [2] Attached

Measurements Are Shown In Inches And (Millimeters)

**WARNING:** These products can expose you to chemicals, including Diisononyl Phthalate, Carbon black extracts, Nickel, 1,3 Butadiene, Ethylene Oxide, Epichlorohydrin, which are known to the State of California to cause cancer, and Bisphenol, Ethylene Glycol, Ethylene Oxide, 1,3 Butadiene, Epichlorohydrin, which are known to the State of California to cause birth defects or other reproductive harm.

**OAS98058**

Oil/Air Separator Element



**Notes:** CAUTION: Do not remove staples from gaskets. These staples provide electrical grounding continuity between defogger and tank.  
**Contains:** [8] Holes in Flange  
**Replaces:** Palatek 8000019  
**O.D.:** 5 3/4 (146.0)  
Flange 8 1/2 (215.9)  
**I.D.:** 5 19/32 (142.1) One End  
**Height:** 10 3/32 (256.4)  
**A. Gskt:** [2] Attached

**OAS98060**

Oil/Air Separator Spin-on



**Fits:** Various Air Compressors  
**Replaces:** Ingersoll-Rand 22388045, 24121212, 89259337; Doosan 89259337; Wix P26A734  
**Thread:** M23 x 1.5  
**O.D.:** 3 7/8 (98.4)  
**Height:** 8 1/4 (209.6)  
**I.Gskt:** [1] Included

**OAS98061**

Oil/Air Separator Spin-on



**Fits:** Ingersoll-Rand Compressors  
**Replaces:** Ingersoll-Rand 54749247; Hifi/Jura Filtration OV6077; Main Filter MF0534266; SF-Filter SPA50022/1; Wix P37A266  
**Thread:** 1 1/2 -16  
**O.D.:** 5 17/32 (140.5)  
**Height:** 11 7/8 (301.6)  
**O-Ring:** [1] Attached

**OAS99001**

Oil/Air Separator Element with Foam Wrap



**Replaces:** Atlas Copco 2911-0068-00; Woodgate WGOS1142  
**O.D.:** 4 15/16 (125.4)  
4 31/32 (126.2)  
**I.D.:** 1 3/32 (27.8)  
**Height:** 7 25/32 (197.6)  
**O-Ring:** [1] Included  
**Grommets:** [2] Attached

**OAS99002**

Oil/Air Separator Element with Foam Wrap



**Notes:** OBSOLETE. Availability Limited to Dealer Stock.  
**Replaces:** Ingersoll-Rand 92522135; Fleetguard AS2435; Woodgate WGOS135  
**O.D.:** 4 5/16 (109.5)  
Flange 6 15/32 (164.3)  
**I.D.:** 2 3/8 (60.3) One End  
**Height:** 9 27/32 (250.0)  
**A. Gskt:** [1] Attached  
**F. Gskt:** [1] Included

**OAS99003**

Oil/Air Separator Element

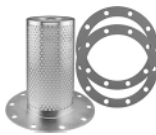

**Replaces:** Atlas Copco 2911-0028-00; Fleetguard AS2445; Woodgate WGOS1522  
**O.D.:** 5 9/32 (134.1)  
Flange 9 27/32 (250.0)  
**I.D.:** 2 15/16 (74.6) One End  
**Height:** 11 17/32 (292.9)  
**F. Gskt:** [2] Included

**OAS99004**

Oil/Air Separator Element



**Replaces:** Ingersoll-Rand 92699198; Woodgate WGOS198  
**O.D.:** 10 13/16 (274.6)  
Flange 12 (304.8)  
**I.D.:** 8 9/32 (210.3) One End  
**Height:** 9 21/32 (245.3)  
**F. Gskt:** [2] Furnished

**OAS99005**

Oil/Air Separator Element



**Replaces:** Demag 10012674; Woodgate WGOS2101  
**O.D.:** 3 11/16 (93.7)  
Flange 5 9/32 (134.1)  
**I.D.:** 2 31/32 (75.4) One End  
**Height:** 6 5/16 (160.3)  
**F. Gskt:** [2] Included

**OAS99006**

Oil/Air Separator Element



**Replaces:** Atlas Copco 2989-0051-00; Fleetguard AS2201; Woodgate WGOS2836  
**O.D.:** 6 5/8 (168.3)  
Flange 11 13/16 (300.0)  
**I.D.:** 4 13/16 (122.2) One End  
**Height:** 19 9/16 (496.9)  
**F. Gskt:** [2] Included

**OAS99008**

Oil/Air Separator Element



**Replaces:** Atlas Copco 4933-5210; Woodgate WGOS4656  
**O.D.:** 10 5/16 (261.9)  
Flange 15 3/4 (400.0)  
**I.D.:** 6 1/2 (165.1) One End  
**Height:** 13 31/32 (354.8)  
**F. Gskt:** [2] Included

**OAS99010**

Oil/Air Separator Element with Foam Wrap



**Replaces:** Ingersoll-Rand 92866508; Woodgate WGOS508  
**O.D.:** 5 9/32 (134.1)  
Flange 6 31/32 (177.0)  
**I.D.:** 3 15/32 (88.1) One End  
**Height:** 11 7/8 (301.6)  
**A. Gskt:** [1] Attached  
**F. Gskt:** [1] Included

**OAS99014**

Oil/Air Separator Element

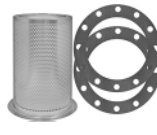

**Replaces:** Quincy 227052; Fleetguard AS2424; Woodgate WGOS5321  
**O.D.:** 10 3/4 (273.1)  
Flange 12 3/4 (323.8)  
**I.D.:** 8 5/8 (219.1) One End  
**Height:** 18 1/16 (458.8)  
**F. Gskt:** [2] Included

**OAS99015**

Oil/Air Separator Element



**Replaces:** Atlas Copco 1619-5498-00; Fleetguard AS2203; Woodgate WGOS5498  
**O.D.:** 6 5/8 (168.3)  
Flange 8 21/32 (219.9)  
**I.D.:** 4 13/16 (122.2) One End  
**Height:** 9 17/32 (242.1)  
**F. Gskt:** [2] Included

Measurements Are Shown In Inches And (Millimeters)

**WARNING:** These products can expose you to chemicals, including Diisononyl Phthalate, Carbon black extracts, Nickel, 1,3 Butadiene, Ethylene Oxide, Epichlorohydrin, which are known to the State of California to cause cancer, and Bisphenol, Ethylene Glycol, Ethylene Oxide, 1,3 Butadiene, Epichlorohydrin, which are known to the State of California to cause birth defects or other reproductive harm.

**OAS99017** Oil/Air Separator Element  
**Fits:** Ingersoll-Rand Compressors  
**Replaces:** Ingersoll-Rand 92077601; Fleetguard AS2437; Woodgate WGOS601  
**O.D.:** 5 5/16 (134.9)  
**Flange** 6 31/32 (177.0)  
**I.D.:** 3 15/32 (88.1) One End  
**Height:** 11 7/8 (301.6)  
**F. Gskt:** [2] Included



**OAS99025** Oil/Air Separator Element  
**Replaces:** Atlas Copco 1202-8722; Fleetguard AS2391; Woodgate WGOS8722  
**O.D.:** 5 9/32 (134.1)  
**Flange** 8 21/32 (219.9)  
**I.D.:** 3 (76.2) One End  
**Height:** 6 23/32 (170.7)  
**F. Gskt:** [2] Included



**OAS99018** Oil/Air Separator Element  
**Replaces:** Atlas Copco 2252-6313; Fleetguard AS2202; Woodgate WGOS6313  
**O.D.:** 10 27/32 (275.4)  
**Flange** 15 3/4 (400.0)  
**I.D.:** 8 1/2 (215.9) One End  
**Height:** 32 9/32 (819.9)  
**F. Gskt:** [2] Included



**OAS99028** Oil/Air Separator Spin-on  
**Contains:** Integral Post Seal  
**Replaces:** Mann & Hummel LB11102/2; Fleetguard AS2453; Woodgate WGOS1112  
**Thread:** M32 x 1.5  
**O.D.:** 4 11/32 (110.3)  
**Height:** 10 3/8 (263.5)  
**I.Gskt:** [1] Included



**OAS99019** Oil/Air Separator Element  
**Notes:** OBSOLETE. Availability Limited to Dealer Stock.  
**Replaces:** Atlas Copco 2911-0040-00; Woodgate WGOS6366  
**O.D.:** 3 29/32 (99.2)  
**Flange** 6 7/8 (174.6)  
**I.D.:** 1 5/8 (41.3) One End  
**Height:** 4 3/4 (120.7)



**OAS99029** Oil/Air Separator Spin-on  
**Contains:** Integral Post Seal  
**Replaces:** Ingersoll-Rand 93525657; Fleetguard AS2452; Woodgate WGOS1374  
**Thread:** M39 x 1.5  
**O.D.:** 5 1/2 (139.7)  
**Height:** 7 3/32 (180.2)  
**I.Gskt:** [1] Included



**OAS99020** Oil/Air Separator Element  
**Replaces:** Ingersoll-Rand 92754688; Fleetguard AS2273; Woodgate WGOS688  
**O.D.:** 6 17/32 (165.9)  
**Flange** 7 11/16 (195.3)  
**I.D.:** 4 9/32 (108.7) One End  
**Height:** 9 1/32 (229.4)  
**F. Gskt:** [2] Included



**OAS99032** Oil/Air Separator Spin-on  
**Notes:** OBSOLETE. Availability Limited to Dealer Stock. Replaced by OAS99048.  
**Contains:** Integral Post Seal  
**Replaces:** CompAir 98262215; Fleetguard AS2451; Woodgate WGOS962  
**Thread:** M24 x 1.5  
**O.D.:** 3 27/32 (97.6)  
**Height:** 8 7/32 (208.8)  
**I.Gskt:** [1] Included



**OAS99021** Oil/Air Separator Element  
**Notes:** OBSOLETE. Availability Limited to Dealer Stock.  
**Replaces:** Atlas Copco 2901-0213-00; Fleetguard AS2446; Woodgate WGOS6880  
**O.D.:** 6 19/32 (167.5)  
**Flange** 11 13/16 (300.0)  
**I.D.:** 4 1/4 (108.0)  
**Height:** 9 1/16 (230.2)  
**O-Ring:** [4] Included



**OAS99034** Oil/Air Separator Element  
**Replaces:** Atlas Copco 2911-0015-00; Fleetguard AS2393; Woodgate WGOS4373  
**O.D.:** 8 21/32 (219.9)  
**Flange** 11 13/16 (300.0)  
**I.D.:** 6 9/16 (166.7) One End  
**Height:** 9 17/32 (242.1)  
**F. Gskt:** [2] Included



**OAS99023** Oil/Air Separator Element  
**Replaces:** CompAir 982628045; Woodgate WGOS8045  
**O.D.:** 6 19/32 (167.5)  
**Flange** 8 19/32 (218.3)  
**I.D.:** 4 11/32 (110.3) One End  
**Height:** 6 5/16 (160.3)  
**F. Gskt:** [2] Included



**OAS99035** Oil/Air Separator Element  
**Replaces:** Tamrock 3267728; Fleetguard AS2462; Woodgate WGOS7728  
**O.D.:** 3 1/16 (77.8)  
**I.D.:** 1 19/32 (40.5) One End  
**Height:** 9 31/32 (253.2)  
**O-Ring:** [1] Attached



**OAS99024** Oil/Air Separator Element with Foam Wrap  
**Replaces:** Ingersoll-Rand 92808286; Woodgate WGOS8286  
**O.D.:** 5 29/32 (150.0)  
**Flange** 8 1/2 (215.9)  
**I.D.:** 3 15/16 (100.0) One End  
**Height:** 7 7/8 (200.0)  
**A. Gskt:** [1] Attached  
**F. Gskt:** [1] Included



**OAS99038** Oil/Air Separator Element  
**Replaces:** Atlas Copco 2989-0045-00; Fleetguard AS2200; Woodgate WGOS2433  
**O.D.:** 6 5/8 (168.3)  
**Flange** 11 13/16 (300.0)  
**I.D.:** 4 25/32 (121.4) One End  
**Height:** 12 15/16 (328.6)  
**F. Gskt:** [2] Included



Measurements Are Shown In Inches And (Millimeters)

**WARNING:** These products can expose you to chemicals, including Diisononyl Phthalate, Carbon black extracts, Nickel, 1,3 Butadiene, Ethylene Oxide, Epichlorohydrin, which are known to the State of California to cause cancer, and Bisphenol, Ethylene Glycol, Ethylene Oxide, 1,3 Butadiene, Epichlorohydrin, which are known to the State of California to cause birth defects or other reproductive harm.

**OAS99040**

Oil/Air Separator Element



**Notes:** OBSOLETE. Availability Limited to Dealer Stock.  
**Replaces:** CompAir 982625133; Woodgate WGOS5133  
**O.D.:** 3 29/32 (99.2)  
Flange 7 (177.8)  
**I.D.:** 1 5/8 (41.3) One End  
**Height:** 5 29/32 (150.0)  
**F. Gskt:** [2] Included

**OAS99042**

Oil/Air Separator Element



**Notes:** OBSOLETE. Availability Limited to Dealer Stock.  
**Replaces:** Sullair 408167010; Woodgate WGOS5201  
**O.D.:** 6 5/8 (168.3)  
Flange 7 7/8 (200.0)  
**I.D.:** 4 13/16 (122.2) One End  
**Height:** 9 17/32 (242.1)  
**F. Gskt:** [2] Included

**OAS99043**

Oil/Air Separator Element



**Notes:** OBSOLETE. Availability Limited to Dealer Stock.  
**Replaces:** Ingersoll-Rand 92735547; Fleetguard AS2417; Woodgate WGOS883  
**O.D.:** 5 9/32 (134.1)  
Flange 6 1/2 (165.1)  
**I.D.:** 3 15/32 (88.1) One End  
**Height:** 9 3/4 (247.7)  
**F. Gskt:** [2] Included

**OAS99046**

Oil/Air Separator Element



**Notes:** OBSOLETE. Availability Limited to Dealer Stock.  
**Replaces:** Atlas Copco 1613-8007-00; Woodgate WGOS5225  
**O.D.:** 9 13/32 (238.9)  
Flange 15 3/4 (400.0)  
**I.D.:** 6 31/32 (177.0)  
**Height:** 12 (304.8)  
**F. Gskt:** [2] Included

**OAS99047**

Oil/Air Separator Spin-on



**Replaces:** Rotorcomp R12101; Donaldson P782909; Fleetguard AS2454  
**Thread:** M39 x 1.5  
**O.D.:** 5 1/2 (139.7)  
**Height:** 12 1/32 (305.6)  
**I.Gskt:** [1] Included

**OAS99048**

Oil/Air Separator Spin-on



**Replaces:** Rotorcomp R12476; Donaldson P783499; Fleetguard AS2451  
**Thread:** M24 x 1.5  
**O.D.:** 3 27/32 (97.6)  
**Height:** 8 5/16 (211.1)  
**I.Gskt:** [1] Included

Measurements Are Shown In Inches And (Millimeters)

 **WARNING:** These products can expose you to chemicals, including Diisononyl Phthalate, Carbon black extracts, Nickel, 1,3 Butadiene, Ethylene Oxide, Epichlorohydrin, which are known to the State of California to cause cancer, and Bisphenol, Ethylene Glycol, Ethylene Oxide, 1,3 Butadiene, Epichlorohydrin, which are known to the State of California to cause birth defects or other reproductive harm.



## STANADYNE FUEL ADDITIVES

Part Number	Label Language**	Name	Package Size		Quantity Treated		Case Qty. Bottles
			US Gallons	Liters	US Gallons	Liters	
38557	C, P, S	Gasoline Additive	8 oz.	237 ml	up to 18	68	24
38559	C, P	Lubricity Formula™	8 oz.	237 ml	up to 15	60	24
38560	C, P	Lubricity Formula™	16 oz. (Pint)	473 ml	125	470	12
38561	C, P	Lubricity Formula™	64 oz. (1/2 Gallon)	1.9 L	500	1,900	6
38562	C, P	Lubricity Formula™	5 Gallons	19 L	5,000	19,200	1
38563*	C, P	Lubricity Formula™	55 Gallons	208 L	55,000	208,000	1
38564	C, P, S	Performance Formula® All Season	8 oz.	237 ml	up to 30	120	24
38565	C, P, S	Performance Formula® All Season	16 oz. (Pint)	473 ml	60	227	12
38566	C, P, S	Performance Formula® All Season	64 oz. (1/2 Gallon)	1.9 L	240	909	6
38567	C, P, S	Performance Formula® All Season	5 Gallons	19 L	2,500	9,600	1
38568*	C, P, S	Performance Formula® All Season	55 Gallons	208 L	27,500	104,099	1
43562	C, P, S	Performance Formula® Injector Cleaner	8 oz.	237 ml	up to 25	95	24
43564	C, P, S	Performance Formula® Injector Cleaner	16 oz. (Pint)	473 ml	50	189	12
43566	C, P, S	Performance Formula® Injector Cleaner	32 oz. (Quart)	946 ml	100	379	12
43568	C, P, S	Performance Formula® Warm Weather Blend	8 oz.	237 ml	up to 30	114	24
43570	C, P, S	Performance Formula® Warm Weather Blend	16 oz. (Pint)	473 ml	60	227	12
43572	C, P, S	Performance Formula® Warm Weather Blend	64 oz. (1/2 Gallon)	1.9 L	240	909	6
43573*	C, P, S	Performance Formula® Warm Weather Blend	55 Gallons	208 L	27,000	104,099	1
43574	C, P, S	Performance Formula® Warm Weather Blend	5 Gallons	19 L	2,500	9,464	1
38574	C, P	Winter 1000®	16 oz. (Pint)	473 ml	125	470	12
38575	C, P	Winter 1000®	5 Gallons	19 L	5,000	19,200	1
38576*	C, P	Winter 1000®	55 Gallons	208 L	55,000	208,000	1

\* 55-Gallon Drums will be special ordered and may be subject to special freight charges. Please call Baldwin Filters Customer Service Department for details.

\*\*Label Language. Label printed in English (P), French (C) and Spanish (S).

**Injector Cleaner, Lubricity Formula, Warm Weather Formula**



**WARNING:** This product can expose you to chemicals including Naphthalene and Ethylene Oxide, which are known to the State of California to cause cancer, and Ethylene Oxide, which is known to the State of California to cause birth defects or other reproductive harm.

**Performance Formula, Winter 1000, Gasoline Additive+**



**WARNING:** This product can expose you to chemicals including Naphthalene, which is known to the State of California to cause cancer, and Toluene which is known to the State of California to cause birth defects or other reproductive harm.

<p><b>Gaskets</b></p> <p>Numbers with -AF Suffix (Normally on Air Filters)</p>	<p><b>G37-AF</b> <b>Sponge O-Ring</b></p> <p>O.D.: 12 (304.8) I.D.: 11 3/8 (288.9) Thick: 5/16 (7.9) Optional On: PA1625</p>	<p><b>G107</b> <b>Neoprene Groove Gasket</b></p> <p>O.D.: 3 57/64 (98.8) I.D.: 3 23/32 (94.5) Thick: 1/8 (3.2) Furnished With: PT62 Optional On: PT70, PT71</p>	<p><b>G140-A</b> <b>Neoprene Groove Gasket</b></p> <p>O.D.: 5 15/16 (150.8) I.D.: 5 23/32 (145.3) Thick: 1/8 (3.2) Furnished With: V24-A2, V1645-C, Optional On: PT12</p>
<p><b>G15-AF</b> <b>Buna N Post Seal</b></p> <p>O.D.: 1 3/16 (30.2) I.D.: 27/64 (10.7) Thick: 1/8 (3.2) Furnished With: PA2607, PA2773</p>	<p><b>G39-AF</b> <b>Buna N Post Seal</b></p> <p>O.D.: 1 1/8 (28.6) I.D.: 3/8 (9.5) Thick: 1/8 (3.2) Furnished With: Various Air Filters</p>	<p><b>G115-A</b> <b>Buna N Gasket</b></p> <p>O.D.: 5 1/8 (130.2) I.D.: 4 3/8 (111.1) Thick: 3/32 (2.4) Furnished With: Various Filters Optional On: P40 (Massey Ferguson Applications), PT207 Series, PT951</p>	<p><b>G141-AF</b> <b>Sponge Boot Gasket</b></p> <p>O.D.: 18 1/4 (463.6) I.D.: 17 1/4 (438.2) Thick: 2 1/8 (54.0) Furnished With: PA2363, PA2453, PA2507</p>
<p><b>G21-AF</b> <b>Sponge Gasket with 8 Bolt Holes</b></p> <p>O.D.: 12 3/4 (323.9) I.D.: 10 1/2 (266.7) Thick: 1/4 (6.4) Furnished With: Various Air Filters</p>	<p><b>G102-A</b> <b>Buna N Gasket</b></p> <p>O.D.: 6 9/16 (166.7) I.D.: 6 1/16 (154.0) Thick: 5/64 (2.0) Furnished With: P116, PF116, PF949 Optional On: PT117, PT117-25</p>	<p><b>G115-MSB</b> <b>Buna N Groove Gasket</b></p> <p>O.D.: 5 1/64 (127.4) I.D.: 4 25/32 (121.4) Thick: 1/8 (3.2) Furnished With: Various Filters Optional On: PT61-HD, PT72, PT154, PT203-HD, PT203-HD10, PF225, PT670, PT670-E Replaces: Cat 5B5973; IHC 260839-R1</p>	<p><b>G143</b> <b>Fiber Gasket</b></p> <p>O.D.: 5 1/8 (130.2) I.D.: 4 5/8 (117.5) Thick: 1/16 (1.6) Furnished With: PT137, PF846, OB1303 Optional On: P20-HD</p>
<p><b>ES24-B</b> <b>Buna N Post Seal</b></p> <p>O.D.: 1 3/16 (30.2) I.D.: 15/16 (23.8) Thick: 7/32 (5.6) Furnished With: BF582, BF591, BF597, BF862 Optional On: BF1102</p>	<p><b>G103</b> <b>Buna N Groove Gasket</b></p> <p>O.D.: 2 59/64 (74.2) I.D.: 2 19/32 (65.9) Thick: 3/32 (2.4) Furnished With: PF847 Optional On: P42</p>	<p><b>G120-A</b> <b>Buna N Gasket</b></p> <p>O.D.: 4 3/16 (106.4) I.D.: 3 11/16 (93.7) Thick: 1/16 (1.6) Optional On: PA1963 Attached On: PT568</p>	<p><b>G144</b> <b>Fiber Gasket</b></p> <p>O.D.: 6 3/64 (153.6) I.D.: 5 49/64 (146.5) Thick: 1/16 (1.6) Furnished With: V1656-O, V1656-T</p>
<p><b>ES24-D</b> <b>Buna N D-Ring Seal</b></p> <p>O.D.: 1 21/64 (33.7) I.D.: 61/64 (24.2) Thick: 11/64 (4.4) Furnished With: Various Spin-ons Optional On: BF5813</p>	<p><b>G103-N</b> <b>Steel and Rubber End Seal</b></p> <p>O.D.: 1 1/4 (31.8) I.D.: 9/16 (14.3) Thick: 1/8 (3.2) Furnished With: Various Air Filters</p>	<p><b>G123</b> <b>Buna N Gasket</b></p> <p>O.D.: 4 5/32 (105.6) I.D.: 3 55/64 (98.0) Thick: 1/16 (1.6) Furnished With: P54, PT151</p>	<p><b>G145-AF</b> <b>Sponge Gasket with 12 Bolt Holes</b></p> <p>O.D.: 15 3/4 (400.1) I.D.: 13 3/4 (349.3) Thick: 7/32 (5.6) Furnished With: Various Air Filters</p>
<p><b>G25-AF</b> <b>Sponge Gasket with 12 Bolt Holes</b></p> <p>O.D.: 15 (381.0) I.D.: 12 3/4 (323.9) Thick: 1/4 (6.4) Furnished With: Various Air Filters Optional On: LL2438, PA2438, LL2439, PA2439</p>	<p><b>G104</b> <b>Buna N Fiber Gasket</b></p> <p>O.D.: 4 47/64 (120.3) I.D.: 4 11/32 (110.3) Thick: 1/16 (1.6) Furnished With: P41, P42, PT46, PF809, PF821-S Optional On: F225-F, PF225</p>	<p><b>G127</b> <b>Buna N Gasket</b></p> <p>O.D.: 4 17/32 (115.1) I.D.: 4 1/64 (102.0) Thick: 1/16 (1.6) Furnished With: JC405, V738-O, VT842-O Optional On: CU406</p>	<p><b>G147-A</b> <b>Buna N Groove Gasket</b></p> <p>O.D.: 3 5/32 (80.2) I.D.: 2 29/32 (73.8) Thick: 1/8 (3.2) Furnished With: Various Filters Optional On: P177</p>
<p><b>G31-AF</b> <b>Sponge O-Ring</b></p> <p>O.D.: 11 3/8 (288.9) I.D.: 10 3/4 (273.1) Thick: 5/16 (7.9) Furnished With: PA2658 Optional On: PA639</p>	<p><b>G105</b> <b>Fiber Gasket</b></p> <p>O.D.: 4 3/16 (106.4) I.D.: 3 25/32 (96.0) Thick: 1/16 (1.6) Furnished With: P40, C59-C, S489, F813-F</p>	<p><b>G132</b> <b>Buna N Gasket</b></p> <p>O.D.: 4 15/16 (125.4) I.D.: 4 13/32 (111.9) Thick: 1/16 (1.6) Furnished With: P80, P80-HD, P184</p>	<p><b>G148</b> <b>Neoprene Fiber Gasket</b></p> <p>O.D.: 6 1/32 (153.2) I.D.: 5 17/32 (140.5) Thick: 3/32 (2.4) Furnished With: DF408</p>
<p><b>G34-AF</b> <b>Sponge O-Ring</b></p> <p>O.D.: 13 (330.2) I.D.: 12 3/8 (314.3) Thick: 5/16 (7.9) Optional On: PA645 Replaces: Cat 2M6449</p>	<p><b>G106</b> <b>Buna N Fiber Gasket</b></p> <p>O.D.: 4 11/16 (119.1) I.D.: 4 (101.6) Thick: 1/16 (1.6) Furnished With: Various Filters</p>	<p><b>G133</b> <b>Buna N Gasket</b></p> <p>O.D.: 4 1/16 (103.2) I.D.: 3 1/2 (88.9) Thick: 3/32 (2.4) Furnished With: Various Filters Optional On: PT265</p>	<p><b>G153</b> <b>Buna N Groove Gasket</b></p> <p>O.D.: 4 (101.6) I.D.: 3 49/64 (95.6) Thick: 1/8 (3.2) Furnished With: Various Filters</p> <p><b>G154</b> <b>Buna N Gasket</b></p> <p>O.D.: 4 3/4 (120.7) I.D.: 4 1/4 (108.0) Thick: 3/32 (2.4) Optional On: P82, PT82-HD, PT82-HD10</p>



**WARNING:** These products can expose you to chemicals, including Diisononyl Phthalate, Carbon black extracts, Nickel, 1,3 Butadiene, Ethylene Oxide, Epichlorohydrin, which are known to the State of California to cause cancer, and Bisphenol-A, Ethylene Glycol, Ethylene Oxide, 1,3 Butadiene, Epichlorohydrin, which are known to the State of California to cause birth defects or other reproductive harm.

**G155**  
**Fiber Cover Gasket with 12 Bolt Holes**



O.D.: 9 3/4 (247.7)  
 I.D.: 8 5/16 (211.1)  
 Thick: 1/32 (0.8)  
**Optional On:** C704-L, C750-E, C750-L, C750-L SINGLE, F7040, P7040, F7500, P7500, P7500 SINGLE  
**Fits:** Luber-finer 500-B, 750-B Housings

**G157**  
**Buna N O-Ring (Uniform Dash Number 446)**

O.D.: 9 (228.6)  
 I.D.: 8 15/32 (215.1)  
 Thick: 9/32 (7.1)  
**Optional On:** C704-L, P706-M, PV706-M, C750-E, C750-L, C750-L SINGLE, P7040, F7500, P7500, P7500 SINGLE  
**Fits:** B7040, B7500 Series Housings; Mack, WGB Dual-Flow Housing  
**Replaces:** Cummins 256981; WGB GA38

**G161**  
**Buna N Groove Gasket**

O.D.: 3 7/64 (79.0)  
 I.D.: 2 61/64 (75.0)  
 Thick: 3/32 (2.4)  
**Furnished With:** PT29, P171, P177, PF816, PF820-S  
**Optional On:** P174

**G162**  
**Buna N O-Ring (Uniform Dash Number 240)**

O.D.: 4 (101.6)  
 I.D.: 3 3/4 (95.3)  
 Thick: 9/64 (3.6)  
**Furnished With:** P60, PT8359  
**Optional On:** PT90, PT93, PT93-MPG  
**Replaces:** Cat 1H8128

**G164-A**  
**Buna N Cover Gasket**

O.D.: 5 63/64 (152.0)  
 I.D.: 5 25/64 (136.9)  
 Thick: 1/16 (1.6)  
**Furnished With:** P47, PT431  
**Optional On:** PT146, P996, P999, P999-HD, B1000-CD  
**Fits:** Nugent Remote Mount Housings  
**Replaces:** Cummins 69751

**G165**  
**Buna N Groove Gasket**

O.D.: 3 5/64 (78.2)  
 I.D.: 2 59/64 (74.2)  
 Thick: 11/64 (4.4)  
**Furnished With:** P172, P174

**G168-B**  
**Buna N Groove Gasket**

O.D.: 4 11/32 (110.3)  
 I.D.: 4 3/32 (104.0)  
 Thick: 1/8 (3.2)  
**Furnished With:** PT12, P15, P104, P190, P219

**G169**  
**Buna N Cover Gasket**

O.D.: 5 3/4 (146.1)  
 I.D.: 5 1/4 (133.4)  
 Thick: 1/16 (1.6)  
**Optional On:** PF155  
**Fits:** Luber-finer F155 Housings Made Before 9/53 with Flat Head Gasket  
**Replaces:** Luber-finer 1867

**G171**  
**Buna N Groove Gasket**

O.D.: 4 1/2 (114.3)  
 I.D.: 4 19/64 (109.1)  
 Thick: 1/8 (3.2)  
**Furnished With:** PT670, PT670-E  
**Optional On:** PT61-HD, PT66-HD, P80, P80-HD  
**Replaces:** Cat 5B5937

**G172-A**  
**Buna N Groove Gasket**

O.D.: 3 1/8 (79.4)  
 I.D.: 2 57/64 (73.4)  
 Thick: 1/8 (3.2)  
**Furnished With:** P172, P240, P271  
**Optional On:** P176

**G173-C**  
**Buna N O-Ring (Uniform Dash Number 229)**

O.D.: 2 41/64 (67.1)  
 I.D.: 2 23/64 (59.9)  
 Thick: 9/64 (3.6)  
**Optional On:** PT435

**G183**  
**Cork Gasket**

O.D.: 3 3/4 (95.3)  
 I.D.: 3 1/4 (82.6)  
 Thick: 1/8 (3.2)  
**Furnished With:** S16-1  
**Optional On:** P171

**G184-A**  
**Buna N Groove Gasket**

O.D.: 5 9/64 (130.6)  
 I.D.: 4 51/64 (121.8)  
 Thick: 3/32 (2.4)  
**Furnished With:** PT154, P203, P204  
**Optional On:** P203-HD, P203-HD10, P204-HD, P204-HD10  
**Replaces:** IHC 381627-R1

**G193**  
**Buna N Groove Gasket**

O.D.: 7 53/64 (198.8)  
 I.D.: 7 29/64 (189.3)  
 Thick: 9/32 (7.1)  
**Furnished With:** PT394-5, PT394-15  
**Optional On:** P194, P194-HD, P194-HD10, PF194  
**Replaces:** Koehring 9006388

**G196-B**  
**Buna N Groove Gasket**

O.D.: 5 11/16 (144.5)  
 I.D.: 5 15/32 (138.9)  
 Thick: 1/8 (3.2)  
**Furnished With:** PT88-HD  
**Optional On:** PT90-10  
**Replaces:** Cat 6F9163

**G202**  
**Buna N Groove Gasket**

O.D.: 4 11/64 (106.0)  
 I.D.: 3 15/16 (100.0)  
 Thick: 3/32 (2.4)  
**Furnished With:** PT213, P235  
**Optional On:** P198

**G203**  
**Buna N O-Ring (Uniform Dash Number 255)**

O.D.: 5 7/8 (149.2)  
 I.D.: 5 39/64 (142.5)  
 Thick: 9/64 (3.6)  
**Optional On:** PT85, PT90-10  
**Replaces:** Cat 2D8009; Hyster 15895

**G204-A**  
**Buna N Groove Gasket**

O.D.: 2 23/32 (69.1)  
 I.D.: 2 15/32 (62.7)  
 Thick: 5/32 (4.0)  
**Furnished With:** PF827  
**Optional On:** PF224

**G206**  
**Buna N O-Ring (Uniform Dash Number 444)**

O.D.: 8 9/32 (210.3)  
 I.D.: 7 23/32 (196.1)  
 Thick: 9/32 (7.1)  
**Furnished With:** PT729  
**Optional On:** V1874-T  
**Fits:** Winslow 2075-CE Housings  
**Replaces:** Winslow 296G

**G207-AF**  
**Sponge Gasket with 8 Bolt Holes**

O.D.: 11 (279.4)  
 I.D.: 9 (228.6)  
 Thick: 1/4 (6.4)  
**Optional On:** LL2503, PA2503

**G208-A**  
**Neoprene Gasket**

O.D.: 4 13/16 (122.2)  
 I.D.: 4 3/8 (111.1)  
 Thick: 1/16 (1.6)  
**Furnished With:** P80, P80-HD  
**Optional On:** P52

**G210**  
**Buna N Gasket**

O.D.: 7 1/8 (181.0)  
 I.D.: 6 7/16 (163.5)  
 Thick: 5/64 (2.0)  
**Furnished With:** PF949  
**Optional On:** PT119, PT119-5, PT119-HD, PT119-HD5, PT119-HD5DL

**G211**  
**Buna N O-Ring (Uniform Dash Number 429)**

O.D.: 5 17/32 (140.5)  
 I.D.: 4 31/32 (126.2)  
 Thick: 9/32 (7.1)  
**Furnished With:** PT385, PT8338  
**Optional On:** P204, P204-HD, P204-HD10, PT275, PT275-10, PT376, PT385-E  
**Replaces:** GMC 5577310; IHC 343912-R91

**G214**  
**Buna N Groove Gasket**

O.D.: 4 49/64 (121.1)  
 I.D.: 4 39/64 (117.1)  
 Thick: 1/8 (3.2)  
**Furnished With:** PT670  
**Optional On:** PT670-E  
**Replaces:** Cat 5M5999

**G219**  
**Buna N O-Ring (Uniform Dash Number 345)**

O.D.: 4 25/64 (111.5)  
 I.D.: 3 31/32 (100.8)  
 Thick: 13/64 (5.2)  
**Furnished With:** PF823(6)  
**Optional On:** P82, PT82-HD, PT82-HD10  
**Replaces:** Cat 4F7387

**G220**  
**Buna N Groove Gasket**

O.D.: 4 9/32 (108.7)  
 I.D.: 3 31/32 (100.8)  
 Thick: 1/8 (3.2)  
**Optional On:** PT63-1  
**Replaces:** John Deere A519R

**G222-B**  
**Buna N Groove Gasket**

O.D.: 4 19/32 (116.7)  
 I.D.: 4 3/16 (106.4)  
 Thick: 5/32 (4.0)  
**Optional On:** P82, PT82-HD, PT82-HD10

**WARNING:** These products can expose you to chemicals, including Diisononyl Phthalate, Carbon black extracts, Nickel, 1,3 Butadiene, Ethylene Oxide, Epichlorohydrin, which are known to the State of California to cause cancer, and Bisphenol-A, Ethylene Glycol, Ethylene Oxide, 1,3 Butadiene, Epichlorohydrin, which are known to the State of California to cause birth defects or other reproductive harm.

**G225-AF**  
**Sponge Gasket**  
 O.D.: 12 5/8 (320.7)  
 I.D.: 11 5/8 (295.3)  
 Thick: 2 1/8 (54.0)  
 Optional On: LL1886, PA1886

**G229**  
**Buna N O-Ring**  
**(Uniform Dash Number 239)**  
 O.D.: 3 57/64 (98.8)  
 I.D.: 3 39/64 (91.7)  
 Thick: 9/64 (3.6)  
 Furnished With: S16-1  
 Optional On: PF121, PT189, PT189-MPG  
 Replaces: Cat 8H7521

**G232**  
**Buna N O-Ring**  
**(Uniform Dash Number 338)**  
 O.D.: 3 33/64 (89.3)  
 I.D.: 3 7/64 (79.0)  
 Thick: 13/64 (5.2)  
 Optional On: P106, P106-HD, P107

**G233-A**  
**Buna N Small**  
**Head Groove Gasket**  
 O.D.: 3 11/32 (84.9)  
 I.D.: 3 1/16 (77.8)  
 Thick: 1/8 (3.2)  
 Furnished With: P497, BF812, BF825, BF874, BF884

**G233-B**  
**Buna N Groove Gasket**  
**Identified with 2 Stripes**  
 O.D.: 3 15/32 (88.1)  
 I.D.: 3 3/16 (81.0)  
 Thick: 1/8 (3.2)  
 Furnished With: BF812, BF825, BF874, BF884  
 Optional On: PF834

**G236-A**  
**Buna N O-Ring**  
**(Uniform Dash Number 348)**  
 O.D.: 4 49/64 (121.0)  
 I.D.: 4 23/64 (110.7)  
 Thick: 13/64 (5.2)  
 Furnished With: PT373  
 Optional On: PT207, PT207-10, PT207-HD, PT207-HD10, PT433, PT554  
 Replaces: Massey Ferguson 515115-M1

**G238**  
**Buna N O-Ring**  
**(Uniform Dash Number 445)**  
 O.D.: 8 17/32 (216.7)  
 I.D.: 7 31/32 (202.4)  
 Thick: 9/32 (7.1)  
 Optional On: C704-L, C750-E, C750-L, C750-L SINGLE, P7040, F7500, P7500, P7500 SINGLE  
 Fits: Early Model Cummins 500, 750 Housings  
 Replaces: Cummins 145641, 150004

**G239**  
**Buna N Groove Gasket**  
 O.D.: 3 9/64 (79.8)  
 I.D.: 2 31/32 (75.4)  
 Thick: 5/32 (4.0)  
 Furnished With: P176  
 Optional On: P174

**G240**  
**Buna N Groove Gasket**  
 O.D.: 5 (127.0)  
 I.D.: 4 23/32 (119.9)  
 Thick: 1/8 (3.2)  
 Furnished With: PF7890 Series  
 Optional On: PF225

**G241**  
**Buna N Groove Gasket**  
 O.D.: 3 7/8 (98.4)  
 I.D.: 3 11/16 (93.7)  
 Thick: 1/8 (3.2)  
 Optional On: PF226

**G243-A**  
**Buna N Fiber Cover Gasket**  
 O.D.: 4 5/16 (109.5)  
 I.D.: 3 15/16 (100.0)  
 Thick: 1/16 (1.6)  
 Furnished With: VT842-O

**G247**  
**Buna N O-Ring**  
**(Uniform Dash Number 236)**  
 O.D.: 3 33/64 (89.3)  
 I.D.: 3 15/64 (82.2)  
 Thick: 9/64 (3.6)  
 Furnished With: Various Filters  
 Optional On: PT83, PT83-MPG, PT382, PF883

**G251**  
**Buna N Groove Gasket**  
 O.D.: 4 23/32 (119.9)  
 I.D.: 4 7/16 (112.7)  
 Thick: 1/8 (3.2)  
 Optional On: PT63-1  
 Replaces: John Deere B3586R

**G252**  
**Buna N Square Cut**  
**Cover Gasket**  
 O.D.: 8 1/2 (215.9)  
 I.D.: 7 31/32 (202.4)  
 Thick: 17/64 (6.8)  
 Furnished With: BK6310  
 Optional On: PT475, P528, C704-L, C750-E, C750-L, C750-L SINGLE, P7040, F7500, P7500, P7500 SINGLE  
 Fits: Late Model Cummins 500, 750 Housings; Some Fram 750 Housings  
 Replaces: Cummins 164159; Fram 230820

**G253-A**  
**Fiber Gasket**  
 O.D.: 5 1/4 (133.4)  
 I.D.: 3 1/2 (88.9)  
 Thick: 1/16 (1.6)  
 Furnished With: PT193 KIT  
 Optional On: PT191, PT191-5, PT191-10

**G255**  
**Buna N Groove Gasket**  
 O.D.: 3 1/2 (88.9)  
 I.D.: 3 7/32 (81.8)  
 Thick: 3/32 (2.4)  
 Furnished With: PT849, PT849-10

**G257**  
**Neoprene Fiber**  
**Cover Gasket**  
 O.D.: 5 11/32 (135.7)  
 I.D.: 4 51/64 (121.8)  
 Thick: 1/16 (1.6)  
 Furnished With: PF899

**G260**  
**Buna N Groove Gasket**  
 O.D.: 5 13/32 (137.3)  
 I.D.: 5 7/32 (132.6)  
 Thick: 3/32 (2.4)  
 Furnished With: PT550-10  
 Optional On: PT268  
 Replaces: IHC 382247-R1

**G261**  
**Pear-Shape Fiber**  
**Cover Gasket**

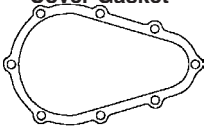

O.D.: 11 1/4 (285.8)  
 I.D.: 9 9/16 (242.9)  
 Thick: 1/32 (0.8)  
 Optional On: PT268  
 Replaces: IHC 382257-R1

**G263**  
**Buna N O-Ring**  
**(Uniform Dash Number 433)**  
 O.D.: 6 1/32 (153.2)  
 I.D.: 5 15/32 (138.9)  
 Thick: 9/64 (3.6)  
 Optional On: PT83, PT83-MPG, PT90, PT90-10, PT383, P996, P999, P999-HD, B1000-CD  
 Fits: Early Base-Mount Nugent & Cummins Full-Flow Lube Housings  
 Replaces: Cat 5H6733; Cummins 116024

**G264-A**  
**Buna N Groove Gasket**  
 O.D.: 3 41/64 (92.5)  
 I.D.: 3 3/8 (85.7)  
 Thick: 5/32 (4.0)  
 Furnished With: B10-AL, B10-AL BSP, PF10, PF10-CS, PF967

**G265**  
**Buna N O-Ring**  
**(Uniform Dash Number 257)**  
 O.D.: 6 9/64 (156.0)  
 I.D.: 5 55/64 (148.8)  
 Thick: 1/8 (3.2)  
 Optional On: PT89, PT90-10, PT90-MPG, PT94  
 Replaces: Cat 2K8257; Murphy MD8274

**G268**  
**Buna N Fiber Gasket**  
 O.D.: 3 49/64 (95.6)  
 I.D.: 3 13/32 (86.5)  
 Thick: 1/16 (1.6)  
 Furnished With: P184

**G269**  
**Fiber Cover Gasket**  
**with 6 Bolt Holes**

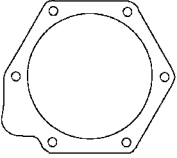

O.D.: 6 5/8 (168.3)  
 I.D.: 5 1/2 (139.7)  
 Thick: 1/32 (0.8)  
 Optional On: P996, P999, P999-HD, B1000-CD  
 Fits: Some Nugent & Cummins Upright Mount Full-Flow Lube Housings  
 Replaces: Cummins 154443

**G270**  
**Buna N O-Ring**  
**(Uniform Dash Number 233)**  
 O.D.: 3 9/64 (79.8)  
 I.D.: 2 55/64 (72.6)  
 Thick: 9/64 (3.6)  
 Furnished With: PT265, PT273  
 Optional On: PT66-HD  
 Replaces: Cat 6H3977

**G273**  
**Buna N Groove Gasket**  
 O.D.: 4 33/64 (114.7)  
 I.D.: 4 17/64 (108.4)  
 Thick: 3/32 (2.4)  
 Furnished With: PT185



**WARNING:** These products can expose you to chemicals, including Diisononyl Phthalate, Carbon black extracts, Nickel, 1,3 Butadiene, Ethylene Oxide, Epichlorohydrin, which are known to the State of California to cause cancer, and Bisphenol-A, Ethylene Glycol, Ethylene Oxide, 1,3 Butadiene, Epichlorohydrin, which are known to the State of California to cause birth defects or other reproductive harm.

**G274**  
**Cork Neoprene Cover Gasket**  
 O.D.: 3 1/2 (88.9)  
 I.D.: 3 1/8 (79.4)  
 Thick: 1/16 (1.6)  
 Furnished With: PT210

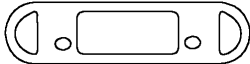
**G275**  
**Fiber Spool Gasket**  
  
 Size: 7 3/4 x 1 7/8 x 1/16 (196.9 x 47.6 x 1.6)  
 Fits: Later Model Nugent Spools using 2 Gaskets (Use G216 for Earlier Models)  
 Replaces: Cummins 158019

**G278**  
**Buna N Cover Gasket**  
 O.D.: 5 5/8 (142.9)  
 I.D.: 5 7/32 (132.6)  
 Thick: 13/64 (5.2)  
 Optional On: P999, P999-HD  
 Fits: OB1368, Late Cummins Base-Mounted Full-Flow Lube Element-Type Housings  
 Replaces: Cummins 153528, 254240

**G280**  
**Fiber Gasket**  
 O.D.: 5 1/64 (127.4)  
 I.D.: 4 51/64 (121.8)  
 Thick: 3/32 (2.4)  
 Optional On: Various Filters

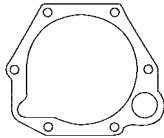
**G281**  
**Fiber Cover Gasket with 6 Bolt Holes**  
  
 O.D.: 6 5/8 (168.3)  
 I.D.: 5 1/2 (139.7)  
 Thick: 1/32 (0.8)  
 Optional On: P996  
 Fits: Some Nugent & Cummins Upright Mount Full-Flow Lube Housings  
 Replaces: Cummins 169797

**G283**  
**Buna N O-Ring (Uniform Dash Number 232)**  
 O.D.: 3 1/64 (76.6)  
 I.D.: 2 47/64 (69.5)  
 Thick: 9/64 (3.6)  
 Furnished With: PT542, PT8352  
 Optional On: PT66-HD  
 Replaces: Cat 5H8848

**G285-AF**  
**Sponge Boot**  
 O.D.: 14 3/8 (365.1)  
 I.D.: 13 3/8 (339.7)  
 Thick: 2 3/16 (55.6)  
 Furnished With: PA2749  
 Optional On: PA1975, PA2573, PA2574

**G286-C**  
**Buna N Molded Gasket**  
 O.D.: 5 1/32 (127.8)  
 I.D.: 4 1/2 (114.3)  
 Thick: 13/32 (10.3)  
 Furnished With: Various Filters  
 Optional On: Various Filters

**G288**  
**Cork Neoprene Cover Gasket with 6 Bolt Holes**  
 O.D.: 7 (177.8)  
 I.D.: 5 1/8 (130.2)  
 Thick: 1/16 (1.6)  
 Furnished With: PT193 KIT  
 Optional On: PT193, PT193-3

**G289**  
**Cork Neoprene Cover Gasket with 6 Bolt Holes**  
 O.D.: 9 5/8 (244.5)  
 I.D.: 7 3/4 (196.9)  
 Thick: 1/16 (1.6)  
 Furnished With: PT193 KIT  
 Optional On: PT193, PT193-3

**G291**  
**Buna N Molded Gasket**  
 O.D.: 5 1/64 (127.4)  
 I.D.: 4 35/64 (115.5)  
 Thick: 3/32 (2.4)  
 Furnished With: PT386, PT436, PT571

**G293-B**  
**Buna N Molded Gasket**  
 O.D.: 4 41/64 (117.9)  
 I.D.: 3 61/64 (100.4)  
 Thick: 19/32 (15.1)  
 Integral On: BD103, BD103-SS, BD324, B333, BD7309, BD7310

**G296**  
**Buna N Gasket**  
 O.D.: 5 13/32 (137.3)  
 I.D.: 4 3/4 (120.7)  
 Thick: 1/16 (1.6)  
 Furnished With: P446  
 Optional On: P450

**G298-AF**  
**Sponge Gasket**  
 O.D.: 11 49/64 (298.8)  
 I.D.: 11 (279.4)  
 Thick: 1/2 (12.7)  
 Furnished With: PA2703

**G299**  
**Buna N Gasket**  
 O.D.: 4 (101.6)  
 I.D.: 3 5/16 (84.1)  
 Thick: 3/32 (2.4)  
 Furnished With: PF967

**G302**  
**Buna N Groove Gasket**  
 O.D.: 4 41/64 (117.9)  
 I.D.: 4 13/32 (111.9)  
 Thick: 1/8 (3.2)  
 Optional On: PF225  
 Replaces: IHC 279781-R1

**G303**  
**Cork Buna N Cover Gasket with 2 Bolt Holes**  

O.D.: 3 3/8 x 2 7/8 (85.7 x 73.0)  
 I.D.: 1 13/16 (46.0)  
 Thick: 1/16 (1.6)  
 Optional On: PT88-HD  
 Replaces: Hyster 119934

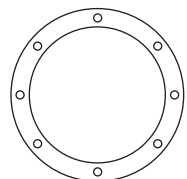
**G304**  
**Cork Buna N Cover Gasket with 8 Bolt Holes**  

O.D.: 7 1/4 (184.2)  
 I.D.: 5 11/16 (144.5)  
 Thick: 61/64 (24.2)  
 Optional On: Hyster Applications using PT88-HD  
 Replaces: Hyster 75670

**G305**  
**Buna N Fiber Gasket**  

O.D.: 14 13/16 x 7 1/2 (376.2 x 190.5)  
 I.D.: 12 15/16 (328.6)  
 Thick: 1/32 (0.8)  
 Optional On: PT380 KIT  
 Notes: Used on Housings with Two Elements Side by Side

**G306**  
**Cork Neoprene Cover Gasket with 12 Bolt Holes**  

O.D.: 8 x 16 (203.2 x 406.4)  
 I.D.: 6 1/2 (165.1)  
 Thick: 3/32 (2.4)  
 Optional On: PT88-HD  
 Replaces: Hyster 88106

**G307**  
**Buna N Groove Gasket**  
 O.D.: 5 33/64 (140.1)  
 I.D.: 5 7/32 (132.6)  
 Thick: 1/8 (3.2)  
 Optional On: PT87-S, PT268, PT288-HD, PT288-HD10, PT498, PT498-10  
 Replaces: Allis Chalmers 666244-9; John Deere R39596

**G309-B**  
**Buna N Molded Cover Gasket**  
 O.D.: 8 31/32 (227.8)  
 I.D.: 8 15/32 (215.1)  
 Thick: 15/64 (6.0)  
 Furnished With: BK6221  
 Optional On: P415 Series, C704-L, C750-E, C750-L, C750-L SINGLE, F7040, P7040, F7500, P7500, P7500 SINGLE  
 Fits: Luber-finer 500C, 750C, 750-2C, 750-3C, 970C, 1000 Housings  
 Replaces: Cummins 101853; Luber-finer 2788

**G310**  
**Buna N O-Ring (Uniform Dash Number 245)**  
 O.D.: 4 41/64 (117.9)  
 I.D.: 4 23/64 (110.7)  
 Thick: 9/32 (7.1)  
 Furnished With: PT437  
 Optional On: PT189, PT189-MPG, PT569-10  
 Replaces: Cat 4H9105

**G314**  
**Cork Neoprene Cover Gasket with 7 Bolt Holes**  

O.D.: 8 5/8 (219.1)  
 I.D.: 6 5/8 (168.3)  
 Thick: 1/16 (1.6)  
 Optional On: PT191, PT191-5, PT191-10, PT208  
 Replaces: Clark 746525

P R O D U C T G U I D E

**WARNING:** These products can expose you to chemicals, including Diisononyl Phthalate, Carbon black extracts, Nickel, 1,3 Butadiene, Ethylene Oxide, Epichlorohydrin, which are known to the State of California to cause cancer, and Bisphenol-A, Ethylene Glycol, Ethylene Oxide, 1,3 Butadiene, Epichlorohydrin, which are known to the State of California to cause birth defects or other reproductive harm.

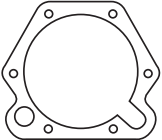
<p><b>G315</b> <b>Buna N O-Ring</b> <b>(Uniform Dash Number 249)</b> O.D.: 5 9/64 (130.6) I.D.: 4 55/64 (123.4) Thick: 9/64 (3.6) Optional On: PT189, PT189-MPG, PT293</p>	<p><b>G343-A</b> <b>Cork Neoprene</b> <b>Cover Gasket</b> <b>with 6 Bolt Holes</b></p>  <p>O.D.: 7 7/16 x 6 1/2 (188.9 x 165.1) I.D.: 5 1/2 (139.7) Thick: 1/16 (1.6) Optional On: P999, P999-HD Fits: Cummins Late Model Upright Mounted Full-Flow Lube Element-Type Housings Replaces: Cummins 175133, 194982, 216003</p>	<p><b>G359</b> <b>Buna N O-Ring</b> <b>(Uniform Dash Number 260)</b> O.D.: 6 49/64 (171.8) I.D.: 6 31/64 (164.7) Thick: 9/64 (3.6) Optional On: PT191, PT191-5, PT191-10</p>	<p><b>G369-B</b> <b>Buna N Groove Gasket</b> <b>(with Blue Stripe)</b> O.D.: 5 3/32 (129.4) I.D.: 4 45/64 (119.5) Thick: 3/16 (4.8) Furnished With: BT389-10, BT9356 Optional On: Various Filters Integral On: BT287-3</p>
<p><b>G323</b> <b>Buna N Groove Gasket</b> O.D.: 3 1/4 (82.6) I.D.: 3 3/32 (78.6) Thick: 1/8 (3.2) Optional On: PT93, PT93-MPG, PF935 Fits: Cat 8H4681 Replaces: Cat 8H2778</p>	<p><b>G344</b> <b>Buna N Groove Gasket</b> O.D.: 3 9/16 (90.5) I.D.: 3 5/16 (84.1) Thick: 1/8 (3.2) Furnished With: PF936, PF942, PF943 Optional On: PF810, PF906 Fits: Fram FCS1133PL, FSC1136M Housings Replaces: Fram 101489</p>	<p><b>G360</b> <b>Buna N O-Ring</b> <b>(Uniform Dash Number 259)</b> O.D.: 6 31/64 (164.7) I.D.: 6 15/64 (158.4) Thick: 9/64 (3.6) Optional On: PT89, PT90-10, PT90-MPG, PT94, PT268 Replaces: Cat 2K4472; IHC 343943-R1</p>	<p><b>G369-V</b> <b>Viton Gasket</b> O.D.: 5 3/32 (129.4) I.D.: 4 45/64 (119.5) Thick: 3/16 (4.8) Optional On: Various Filters</p>
<p><b>G332</b> <b>Buna N Gasket</b> O.D.: 3 63/64 (101.2) I.D.: 3 43/64 (93.3) Thick: 1/8 (3.2) Furnished With: PF950</p>	<p><b>G347</b> <b>Buna N O-Ring</b> <b>(Uniform Dash Number 252)</b> O.D.: 5 33/64 (140.1) I.D.: 5 15/64 (133.0) Thick: 9/64 (3.6) Optional On: PT90-10, PT90-MPG Replaces: Cat 2H9247</p>	<p><b>G362</b> <b>Buna N O-Ring</b> <b>(Uniform Dash Number 251)</b> O.D.: 5 25/64 (136.9) I.D.: 5 7/64 (129.8) Thick: 9/64 (3.6) Optional On: P204, P204-HD, P204-HD10, PT268 Replaces: IHC 138466-R1, 390610-R1</p>	<p><b>G372</b> <b>Buna N Groove Gasket</b> <b>(with Yellow Stripe)</b> O.D.: 5 5/32 (131.0) I.D.: 4 47/64 (120.3) Thick: 13/64 (5.2) Furnished With: BT287, BT389 Optional On: Various Filters Fits: Use ONLY on Case Applications</p>
<p><b>G333</b> <b>Buna N O-Ring</b> <b>(Uniform Dash Number 244)</b> O.D.: 4 33/64 (114.7) I.D.: 4 15/64 (107.6) Thick: 9/64 (3.6) Optional On: PT61-HD, PT189, PT189-MPG Replaces: Cat 2H3928</p>	<p><b>G348-AF</b> <b>Gasket</b> O.D.: 11 1/16 (281.0) I.D.: 10 3/16 (258.8) Thick: 7/16 (11.1) Furnished With: PA2732</p>	<p><b>G363</b> <b>Buna N Gasket</b> O.D.: 5 7/8 (149.2) I.D.: 5 3/8 (136.5) Thick: 1/16 (1.6) Optional On: V24-A2, PF155 Fits: Luber-finer F170, F170-2 Housings Replaces: Luber-finer 4041</p>	<p><b>G376</b> <b>Buna N O-Ring</b> <b>(Uniform Dash Number 242)</b> O.D.: 4 17/64 (108.3) I.D.: 3 63/64 (101.2) Thick: 9/64 (3.6) Furnished With: PT138-10, PT138-25 Optional On: PT66-HD, PT189, PT189-MPG Replaces: Cat 1H6227</p>
<p><b>G336</b> <b>Buna N Groove Gasket</b> O.D.: 6 15/64 (158.4) I.D.: 5 53/64 (148.0) Thick: 13/64 (5.2) Optional On: P20-HD, P999, P999-HD Fits: OB1369; Base Mounted Full-Flow Lube Element-Type Housing Using Square-Cut Gasket Replaces: Cummins 173368</p>	<p><b>G354</b> <b>Buna N O-Ring</b> <b>(Uniform Dash Number 253)</b> O.D.: 5 41/64 (143.3) I.D.: 5 23/64 (136.1) Thick: 9/64 (3.6) Optional On: PT88-HD, PT90-10, P998 Replaces: Cat 2H3935; Cummins 193302</p>	<p><b>G366</b> <b>Buna N O-Ring</b> <b>(Uniform Dash Number 238)</b> O.D.: 3 3/4 (95.3) I.D.: 3 1/2 (88.9) Thick: 1/8 (3.2) Furnished With: PT543 KIT Optional On: PT480, PT480-10, PT480-MPG Integral On: PT520, PT520-10, PT572-10</p>	<p><b>G379</b> <b>Fiber Gasket</b> O.D.: 3 13/32 (86.5) I.D.: 2 51/64 (71.0) Thick: 1/16 (1.6) Optional On: PT135</p>
<p><b>G340</b> <b>Copper Washer</b> O.D.: 63/64 (25.0) I.D.: 51/64 (20.2) Thick: 3/64 (1.2) Optional On: P20-HD</p>	<p><b>G356</b> <b>Buna N Gasket</b> O.D.: 7 3/64 (179.0) I.D.: 6 27/64 (163.1) Thick: 5/64 (2.0) Optional On: PF116, P528 Fits: Fleetguard Housings with Stamped Cover and Mounting Brackets</p>	<p><b>G368</b> <b>Buna N O-Ring</b> <b>(Uniform Dash Number 254)</b> O.D.: 5 3/4 (146.1) I.D.: 5 15/32 (138.9) Thick: 9/64 (3.6) Furnished With: PT379 KIT, PT487 KIT Optional On: PT268 Replaces: IHC 285253-R1</p>	<p><b>G380</b> <b>Buna N Groove Gasket</b> O.D.: 5 41/64 (143.3) I.D.: 5 5/64 (129.0) Thick: 3/16 (4.8) Optional On: PT152</p>
<p><b>G342</b> <b>Viton O-Ring</b> <b>(Uniform Dash Number 248)</b> O.D.: 5 1/64 (127.4) I.D.: 4 47/64 (120.3) Thick: 9/64 (3.6) Optional On: PT189, PT189-MPG, PT207 Series, PT385, PT385-E, PT670, PT670-E Replaces: Cat 5F3144</p>			<p><b>G381-A</b> <b>Buna N Groove Gasket</b> O.D.: 2 13/16 (71.4) I.D.: 2 15/32 (62.7) Thick: 13/64 (5.2) Integral On: Various Filters</p> <p><b>G382</b> <b>Buna N O-Ring</b> <b>(Uniform Dash Number 263)</b> O.D.: 7 33/64 (191.0) I.D.: 7 15/64 (183.8) Thick: 9/64 (3.6) Optional On: PT491, PT491-10</p>



**WARNING:** These products can expose you to chemicals, including Diisononyl Phthalate, Carbon black extracts, Nickel, 1,3 Butadiene, Ethylene Oxide, Epichlorohydrin, which are known to the State of California to cause cancer, and Bisphenol-A, Ethylene Glycol, Ethylene Oxide, 1,3 Butadiene, Epichlorohydrin, which are known to the State of California to cause birth defects or other reproductive harm.

<p><b>G382-V</b>  <b>Viton O-Ring</b>  <b>(Uniform Dash Number 263)</b>                      O.D.: 7 33/64 (190.9)                      I.D.: 7 15/64 (183.8)                      Thick: 9/64 (3.6)                      Replaces: Cat 6V3907</p>	<p><b>G401</b>  <b>Buna N Groove Gasket</b>                      O.D.: 2 13/16 (71.4)                      I.D.: 2 15/32 (62.7)                      Thick: 1/4 (6.4)                      Optional On: B378, B378-10                      Integral On: Various Filters</p>	<p><b>G412</b>  <b>Buna N O-Ring</b>  <b>(Uniform Dash Number 266)</b>                      O.D.: 8 17/64 (209.9)                      I.D.: 7 63/64 (202.8)                      Thick: 9/64 (3.6)                      Optional On: PT98-10, PT98-MPG                      Replaces: Cat 1J2176</p>	<p><b>G434</b>  <b>Buna N Gasket</b>                      O.D.: 4 1/16 (103.2)                      I.D.: 3 37/64 (90.9)                      Thick: 3/32 (2.4)                      Optional On: PT93, PT93-MPG                      Replaces: Cat 3J1991</p>
<p><b>G385</b>  <b>Buna N Groove Gasket</b>                      O.D.: 4 49/64 (121.1)                      I.D.: 4 11/32 (110.3)                      Thick: 1/4 (6.4)                      Furnished With: PT467-MPG                      Optional On: PT207, PT207-10, PT207-HD, PT207-HD10, PT433                      Fits: Gresen Line-Type Housings</p>	<p><b>G402</b>  <b>Buna N O-Ring</b>  <b>(Uniform Dash Number 243)</b>                      O.D.: 4 3/8 (111.1)                      I.D.: 4 1/8 (104.8)                      Thick: 1/8 (3.2)                      Furnished With: PT549                      Optional On: P40, P176                      Replaces: Cat 4M189</p>	<p><b>G416</b>  <b>Buna N O-Ring</b>  <b>(Uniform Dash Number 438)</b>                      O.D.: 6 25/64 (162.3)                      I.D.: 6 7/32 (158.0)                      Thick: 9/32 (7.1)                      Optional On: PT83, PT83-MPG, PT90-10, PT94                      Replaces: Cat 5L5032</p>	<p><b>G435</b>  <b>Buna N Gasket</b>                      O.D.: 4 1/8 (104.8)                      I.D.: 3 59/64 (99.6)                      Thick: 1/8 (3.2)                      Optional On: PT66-HD, PT670, PT670-E                      Replaces: Cat 5B5940</p>
<p><b>G386</b>  <b>Buna N Groove Gasket</b>                      O.D.: 4 55/64 (123.4)                      I.D.: 4 29/64 (113.1)                      Thick: 13/64 (5.2)                      Optional On: PT207, PT207-10, PT207-HD, PT207-HD10, PT433                      Fits: Gresen Line-Type Housings</p>	<p><b>G403</b>  <b>Buna N O-Ring</b>  <b>(Uniform Dash Number 231)</b>                      O.D.: 2 57/64 (73.4)                      I.D.: 2 39/64 (66.3)                      Thick: 9/64 (3.6)                      Furnished With: PT449                      Optional On: PT189, PT189-MPG                      Replaces: Cat 8F8882</p>	<p><b>G417</b>  <b>Buna N O-Ring</b>  <b>(Uniform Dash Number 427)</b>                      O.D.: 5 9/32 (134.1)                      I.D.: 4 23/32 (119.9)                      Thick: 9/32 (7.1)                      Furnished With: PT573                      Optional On: PT707-HD, PT707-HD3, PT707-HD10</p>	<p><b>G436</b>  <b>Buna N O-Ring</b>                      O.D.: 3 11/16 (93.7)                      I.D.: 3 5/16 (84.1)                      Thick: 3/16 (4.8)                      Optional On: PT66-HD                      Replaces: Cat 6F8509</p>
<p><b>G392</b>  <b>Buna N Groove Gasket</b>                      O.D.: 5 23/64 (136.1)                      I.D.: 4 61/64 (125.8)                      Thick: 13/64 (5.2)                      Furnished With: PT373                      Optional On: PT207, PT207-10, PT207-HD, PT207-HD10, PT401-MPG, PT433                      Fits: Massey Ferguson Hydraulic Filter Housings on 1100 Series Models                      Replaces: Massey Ferguson 366731X1; Dresser 932994-C2</p>	<p><b>G406</b>  <b>Buna N O-Ring</b>  <b>(Uniform Dash Number 340)</b>                      O.D.: 3 49/64 (95.6)                      I.D.: 3 11/32 (84.9)                      Thick: 13/64 (5.2)                      Optional On: PF814                      Replaces: John Deere R41721</p>	<p><b>G422-AF</b>  <b>Sponge Cover Gasket</b>                      O.D.: 15 (381.0)                      I.D.: 13 (330.2)                      Thick: 1/4 (6.4)                      Optional On: LL2438, PA2438, LL2439, PA2439</p>	<p><b>G438</b>  <b>Buna N O-Ring</b>  <b>(Uniform Dash Number 371)</b>                      O.D.: 8 57/64 (225.8)                      I.D.: 8 15/32 (215.1)                      Thick: 13/64 (5.2)                      Optional On: PT98-10, PT98-MPG</p>
<p><b>G394</b>  <b>Buna N Groove Gasket</b>                      O.D.: 5 27/32 (148.4)                      I.D.: 5 7/16 (138.1)                      Thick: 13/64 (5.2)                      Optional On: PT88-HD                      Replaces: Cat 8M4779</p>	<p><b>G409</b>  <b>Buna N Gasket</b>                      O.D.: 6 11/32 (161.1)                      I.D.: 5 7/8 (149.2)                      Thick: 1/8 (3.2)                      Optional On: PT90-10, PT94                      Replaces: Cat 4K1557</p>	<p><b>G431</b>  <b>Buna N Molded Gasket</b>                      O.D.: 2 19/32 (65.9)                      I.D.: 2 5/16 (58.7)                      Thick: 19/64 (7.5)                      Optional On: P540, P540-S</p>	<p><b>G439</b>  <b>Buna N O-Ring</b>  <b>(Uniform Dash Number 350)</b>                      O.D.: 5 1/64 (127.4)                      I.D.: 4 19/32 (116.7)                      Thick: 13/64 (5.2)                      Optional On: P507, PT760-10, PT760-25</p>
<p><b>G397</b>  <b>Buna N Groove Gasket</b>                      O.D.: 5 31/64 (139.3)                      I.D.: 5 15/64 (133.0)                      Thick: 1/8 (3.2)                      Furnished With: PT426                      Optional On: PT87-S, PT288-HD, PT288-HD10, PT390-MPG, PT391-MPG, PT498, PT498-10</p>	<p><b>G410</b>  <b>Buna N O-Ring</b>  <b>(Uniform Dash Number 241)</b>                      O.D.: 4 9/64 (105.2)                      I.D.: 3 55/64 (98.0)                      Thick: 9/64 (3.6)                      Optional On: PT12, PT66-HD                      Replaces: Cat 2H3934</p>	<p><b>G432</b>  <b>Buna N O-Ring</b>  <b>(Uniform Dash Number 237)</b>                      O.D.: 3 5/8 (92.1)                      I.D.: 3 11/32 (84.9)                      Thick: 1/8 (3.2)                      Optional On: PT66-HD, PT93, PT93-MPG</p>	<p><b>G441</b>  <b>Buna N O-Ring</b>  <b>(Uniform Dash Number 227)</b>                      O.D.: 2 25/64 (60.3)                      I.D.: 2 7/64 (53.6)                      Thick: 9/64 (3.6)                      Optional On: PT88-HD                      Replaces: Cat 7F8268</p>
<p><b>G400</b>  <b>Buna N Groove Gasket</b>                      O.D.: 6 31/32 (177.0)                      I.D.: 6 15/32 (164.3)                      Thick: 17/64 (6.7)                      Optional On: PT561                      Replaces: John Deere T26990</p>	<p><b>G411</b>  <b>Buna N Gasket</b>                      O.D.: 6 17/32 (165.9)                      I.D.: 6 3/64 (153.6)                      Thick: 1/8 (3.2)                      Optional On: PT90-10, PT94                      Replaces: Cat 5J3172</p>	<p><b>G433</b>  <b>Buna N O-Ring</b>  <b>(Uniform Dash Number 358)</b>                      O.D.: 6 1/64 (152.8)                      I.D.: 5 19/32 (142.1)                      Thick: 13/64 (5.2)                      Optional On: PT83, PT83-MPG, PT90-10, PT189, PT189-MPG                      Replaces: Cat 6D9157</p>	<p><b>G442</b>  <b>Buna N O-Ring</b>  <b>(Uniform Dash Number 235)</b>                      O.D.: 3 25/64 (86.1)                      I.D.: 3 7/64 (79.0)                      Thick: 9/64 (3.6)                      Optional On: PT66-HD                      Replaces: Cat 2H6184</p>
			<p><b>G443</b>  <b>Buna N O-Ring</b>  <b>(Uniform Dash Number 250)</b>                      O.D.: 5 17/64 (133.7)                      I.D.: 4 63/64 (126.6)                      Thick: 9/64 (3.6)                      Optional On: PT90-10, PT189, PT268                      Replaces: Cat 5F3106</p>



**WARNING:** These products can expose you to chemicals, including Diisononyl Phthalate, Carbon black extracts, Nickel, 1,3 Butadiene, Ethylene Oxide, Epichlorohydrin, which are known to the State of California to cause cancer, and Bisphenol-A, Ethylene Glycol, Ethylene Oxide, 1,3 Butadiene, Epichlorohydrin, which are known to the State of California to cause birth defects or other reproductive harm.

<p><b>G444</b> <b>Buna N O-Ring</b> <b>(Uniform Dash Number 258)</b> O.D.: 6 17/64 (159.1) I.D.: 5 63/64 (152.0) Thick: 9/64 (3.6) Optional On: PT88-HD, PT90-10 Replaces: Cat 8F8733</p>	<p><b>G472-AF</b> <b>Sponge Gasket</b> <b>with 6 Bolt Holes</b> O.D.: 11 (279.4) I.D.: 9 1/8 (231.8) Thick: 1/4 (6.4) Furnished With: PA2503 Optional On: LL2482, PA2482, PA2531, PA2532 Fits: United Air Housing</p>	<p><b>G704</b> <b>Buna N Gasket</b> O.D.: 4 63/64 (126.6) I.D.: 4 3/8 (111.1) Thick: 3/16 (4.8) Optional On: Various Filters</p>	<p><b>ES1030</b> <b>Steel Buna N Dyna-Seal</b> O.D.: 1 3/16 (30.2) I.D.: 5/8 (15.9) Thick: 5/64 (2.0) Furnished With: PT265, PT273, PF7592 Optional On: PF935 Replaces: Cat 2A1162</p>
<p><b>G445</b> <b>Buna N O-Ring</b> <b>(Uniform Dash Number 352)</b> O.D.: 5 17/64 (133.7) I.D.: 4 27/32 (123.0) Thick: 13/64 (5.2) Furnished With: PF7680, PF7744 Optional On: PT189, PT189-MPG Replaces: Cat 2S8439</p>	<p><b>G480</b> <b>Buna N Groove Gasket</b> O.D.: 4 25/64 (111.5) I.D.: 4 1/64 (102.0) Thick: 3/16 (4.8) Furnished With: PF312</p>	<p><b>G710</b> <b>Buna N Gasket</b> O.D.: 5 3/64 (128.2) I.D.: 4 45/64 (119.5) Thick: 3/16 (4.8) Optional On: Various Filters</p>	<p><b>ES1031</b> <b>Buna N Grommet</b> O.D.: 1 7/8 (47.6) I.D.: 1 3/64 (26.6) Thick: 27/64 (10.7)</p>
<p><b>G446</b> <b>Buna N O-Ring</b> <b>(Uniform Dash Number 432)</b> O.D.: 5 29/32 (150.0) I.D.: 5 11/32 (135.7) Thick: 9/32 (7.1) Optional On: PT88-HD Replaces: Cat 4F7507</p>	<p><b>G483</b> <b>Buna N Groove Gasket</b> O.D.: 4 63/64 (126.6) I.D.: 4 21/32 (118.3) Thick: 3/16 (4.8) Furnished With: BT345 KIT Optional On: Various Filters</p>	<p><b>G717</b> <b>Buna N Gasket</b> O.D.: 5 9/16 (141.3) I.D.: 5 7/32 (132.6) Thick: 9/32 (7.1) Optional On: PF7680 for use on Webb Housings</p>	<p><b>ES1032</b> <b>Fiber Washer</b> O.D.: 1 1/16 (27.0) I.D.: 3/4 (19.1) Thick: 3/64 (1.2) Furnished With: P20-HD Optional On: PF902, PF902-S, PF916</p>
<p><b>G447</b> <b>Buna N O-Ring</b> <b>(Uniform Dash Number 246)</b> O.D.: 4 49/64 (121.0) I.D.: 4 31/64 (113.9) Thick: 9/64 (3.6) Optional On: Various Filters Replaces: Cat 5H6734</p>	<p><b>G483</b> <b>Buna N Groove Gasket</b> O.D.: 4 63/64 (126.6) I.D.: 4 21/32 (118.3) Thick: 3/16 (4.8) Furnished With: BT345 KIT Optional On: Various Filters</p>	<p><b>G725</b> <b>Buna N Gasket</b> O.D.: 4 15/16 (125.4) I.D.: 4 19/32 (116.7) Thick: 13/64 (5.2) Optional On: BT389-10 When Replacing Parker 927736</p>	<p><b>ES1034</b> <b>Fiber Washer</b> O.D.: 3/4 (19.1) I.D.: 1/2 (12.7) Thick: 3/64 (1.2) Furnished With: F845-A, PF845, F916-C, PF916 Optional On: PF846</p>
<p><b>G449-B</b> <b>Buna N Groove Gasket</b> O.D.: 2 51/64 (71.0) I.D.: 2 15/32 (62.7) Thick: 1/4 (6.4) Integral On: Various Filters</p>	<p><b>G494</b> <b>Nitrile O-Ring</b> <b>(Uniform Dash Number 351)</b> O.D.: 4 15/16 (125.4) I.D.: 4 47/64 (120.3) Thick: 7/32 (5.6) Furnished With: PT777</p>	<p><b>ES1001</b> <b>Fiber Washer</b> O.D.: 7/8 (22.2) I.D.: 9/16 (14.3) Thick: 1/16 (1.6) Furnished With: B4, F844-A, BF938, BF939</p>	<p><b>ES1036</b> <b>Buna N O-Ring</b> <b>(Uniform Dash Number 112)</b> O.D.: 11/16 (17.5) I.D.: 31/64 (12.3) Thick: 7/64 (2.8) Furnished With: PF311, PF316, PT437, PF861 Optional On: P116, PF116 Replaces: Cat 8F9206</p>
<p><b>G458</b> <b>Buna N Groove Gasket</b> O.D.: 3 55/64 (98.0) I.D.: 3 19/32 (91.3) Thick: 9/64 (3.6) Furnished With: PT377, PT377-10, PF598, PF598-10, PF598-30</p>	<p><b>G498-A</b> <b>Buna N Groove Gasket</b> O.D.: 4 21/64 (109.9) I.D.: 3 27/32 (97.6) Thick: 3/8 (9.5) Integral On: Various Spin-ons</p>	<p><b>ES1023</b> <b>Buna N O-Ring</b> <b>(Uniform Dash Number 037)</b> O.D.: 2 5/8 (66.7) I.D.: 2 31/64 (63.5) Thick: 1/16 (1.6)</p>	<p><b>ES1039</b> <b>Nitrile Grommet</b> O.D.: 2 1/2 (63.5) I.D.: 1 39/64 (40.9) Thick: 7/16 (11.1) Attached To: PT8517-MPG</p>
<p><b>G467</b> <b>Buna N O-Ring</b> <b>(Uniform Dash Number 140)</b> O.D.: 2 7/16 (61.9) I.D.: 2 13/64 (56.0) Thick: 7/64 (2.8) Optional On: PF599, PF599-10, PF599-30</p>	<p><b>G499-AF</b> <b>Sponge Gasket</b> <b>with 7 Bolt Holes</b> O.D.: 12 7/8 (327.0) I.D.: 10 5/8 (269.9) Thick: 3/8 (9.5) Optional On: LL2312, PA2312, PA2425, PA2430</p>	<p><b>ES1026</b> <b>Steel Buna Dyna-Seal</b></p>	<p><b>ES1049</b> <b>Buna N O-Ring Post Seal</b> <b>(Uniform Dash Number 113)</b> O.D.: 3/4 (19.1) I.D.: 35/64 (16.4) Thick: 7/64 (2.8) Furnished With: Various Filters Optional On: PT90-10, PT189, PT189-MPG, PF589-30 Replaces: Cat 6F4855</p>
<p><b>G468</b> <b>Buna N O-Ring</b> <b>(Uniform Dash Number 156)</b> O.D.: 4 7/16 (112.7) I.D.: 4 15/64 (107.6) Thick: 7/64 (2.8) Optional On: PF599, PF599-10, PF599-30</p>	<p><b>G501-AF</b> <b>Sponge Gasket</b> O.D.: 13 41/64 (346.5) I.D.: 12 7/8 (327.0) Thick: 1/2 (12.7) Furnished With: PA2631, PA2632, PA2729, RS3539</p>	<p><b>ES1026</b> <b>Steel Buna Dyna-Seal</b></p>  <p>O.D.: 1 5/16 (33.3) I.D.: 3/4 (19.1) Thick: 3/32 (2.4) Furnished With: PT386, PT436, PT571, PT777 Optional On: P999, P999-HD Fits: Outer Center Bolt on Cummins Full-Flow Lube Housings Replaces: Cummins 208371</p>	



**WARNING:** These products can expose you to chemicals, including Diisononyl Phthalate, Carbon black extracts, Nickel, 1,3 Butadiene, Ethylene Oxide, Epichlorohydrin, which are known to the State of California to cause cancer, and Bisphenol-A, Ethylene Glycol, Ethylene Oxide, 1,3 Butadiene, Epichlorohydrin, which are known to the State of California to cause birth defects or other reproductive harm.



			NOTES
<p><b>ES1066</b> <b>Fiber Washer</b> O.D.: 57/64 (22.6) I.D.: 41/64 (16.3) Thick: 3/32 (2.4) Furnished With: F908-A Optional On: PF155 Fits: Head Screw Seal on Luber-finer F155C Housings Replaces: Luber-finer 2183</p>	<p><b>ES1092</b> <b>Buna N Post Seal</b> O.D.: 2 3/32 (53.2) I.D.: 1 23/32 (43.7) Thick: 1/4 (6.4) Furnished With: Various Filters</p>	<p><b>G1973</b> <b>Fiber Transmission Pan Gasket</b> Size: 12 5/8 x 8 5/8 (320.7 x 219.1) Optional On: 19739 Transmission Filters</p>	
<p><b>ES1067</b> <b>Buna N O-Ring (Uniform Dash Number 212)</b> O.D.: 1 9/64 (29.0) I.D.: 55/64 (21.8) Thick: 9/64 (3.6) Optional On: PT88-HD, P7040, F7500, P7500, P7500 SINGLE Fits: Caterpillar Housing Center Bolt; Cummins 500, 750 Model Housings T-Handle Replaces: Cat 3H107, 3H0107; Cummins 116029</p>	<p><b>ES1303-A</b> <b>Buna N Inner Adapter Seal</b> O.D.: 3 5/32 (80.2) I.D.: 2 25/64 (60.7) Thick: 1/8 (3.2) Furnished With: OB1303</p>	<p><b>ES3012</b> <b>Buna N O-Ring (Uniform Dash Number 222)</b> O.D.: 1 49/64 (44.8) I.D.: 1 31/64 (37.7) Thick: 9/64 (3.6) Furnished With: BC110, PF7680, PF7687, PF7744, DAHL 150 Series</p>	
<p><b>ES1068</b> <b>Buna N Post Seal</b> O.D.: 1 1/32 (26.2) I.D.: 39/64 (15.5) Thick: 3/16 (4.8) Furnished With: F7500, P7500, Optional On: C704-L, C750 Series, F7040, P7040, P7500 SINGLE Fits: Baldwin &amp; Luber-finer 500, 750 Model Housings T-Handle Replaces: Luber-finer 2145</p>	<p><b>ES1303-B</b> <b>Inner Adapter Seal</b> O.D.: 3 5/32 (80.2) I.D.: 2 25/64 (60.7) Thick: 1/16 (1.6) Furnished With: OB1303</p>	<p><b>ES3028</b> <b>Buna N O-Ring (Uniform Dash Number 214)</b> O.D.: 1 17/64 (32.1) I.D.: 63/64 (25.0) Thick: 9/64 (3.6) Optional On: BT367, BT367-S</p>	
<p><b>ES1071</b> <b>Copper Washer</b> O.D.: 1 1/16 (27.0) I.D.: 49/64 (19.4) Thick: 3/64 (1.2) Furnished With: PT385 Optional On: P52</p>	<p><b>ES1369-A</b> <b>Inner Seal</b> O.D.: 2 7/32 (56.4) I.D.: 1 11/16 (42.9) Thick: 13/64 (5.2) Furnished With: OB1369</p>	<p><b>ES3029</b> <b>Fiber Housing Flat Seal</b> O.D.: 3 3/4 (95.3) I.D.: 1 13/16 (46.0) Thick: 1/16 (1.6) Optional On: PT207, PT207-10, PT207-HD, PT207-HD10, PT373 Replaces: Gresen 1575</p>	
<p><b>ES1074</b> <b>Buna N O-Ring (Uniform Dash Number 110)</b> O.D.: 9/16 (14.3) I.D.: 23/64 (9.1) Thick: 7/64 (2.8) Optional On: PF155, PT189, PT189-MPG, P7053 Fits: Head Screw on Luber-finer F170 Housings Replaces: Cat 6F5559; Luber-finer 4190</p>	<p><b>ES1375</b> <b>Bleed Plug Washer</b> O.D.: 11/16 (17.5) I.D.: 17/32 (13.5) Thick: 1/16 (1.6) Furnished With: B7040A, B7500A Series Housings Optional On: C704-L, C750-E, C750-L, C750-L SINGLE, P7040, F7500, P7500, P7500 SINGLE</p>	<p><b>ES3063</b> <b>Fiber Washer</b> O.D.: 9/16 (14.3) I.D.: 21/64 (8.3) Thick: 3/64 (1.2) Furnished With: PF861 Optional On: BF825</p>	
<p><b>G1086-AF</b> <b>Buna N Seal</b> O.D.: 5 1/8 (130.2) I.D.: 3 9/16 (90.5) Thick: 1/32 (0.8) Optional On: PA669 Replaces: Purolator 56979</p>	<p><b>ES1376</b> <b>Bleed Plug Washer</b> O.D.: 7/8 (22.2) I.D.: 5/8 (15.9) Thick: 1/16 (1.6) Optional On: C704-L, C750-E, C750-L, C750-L SINGLE, P7040, F7500, P7500, P7500 SINGLE</p>	<p><b>ES3231</b> <b>Buna N O-Ring</b> O.D.: 7 29/32 (202.2) I.D.: 7 29/64 (189.3) Thick: 7/32 (5.6) Optional On: PT8366</p>	
<p><b>G1972</b> <b>Fiber Transmission Pan Gasket with 21 Bolt Holes</b> Size: 19 x 13 (482.6 x 330.2) Furnished With: 18236, 19739, 19992</p>	<p><b>ES1377</b> <b>Bleed Plug Washer</b> O.D.: 1 (25.4) I.D.: 11/16 (17.5) Thick: 1/16 (1.6) Optional On: C704-L, C750-E, C750-L, C750-L SINGLE, P7040, F7500, P7500, P7500 SINGLE</p>	<p><b>ES4007</b> <b>Buna N Fiber End Seal</b> O.D.: 3 15/16 (100.0) I.D.: 2 9/32 (57.9) Thick: 1/32 (0.8) Optional On: PT189, PT189-MPG Notes: Use with Stacked Elements</p>	
	<p><b>ES4008</b> <b>Buna N Fiber End Seal</b> O.D.: 4 15/16 (125.4) I.D.: 3 15/16 (100.0) Thick: 1/32 (0.8) Optional On: PT83, PT83-MPG, PT88-HD, PT90-10, PT90-MPG, PT98-10, PT98-MPG Notes: Use with Stacked Elements</p>	<p><b>ES4008</b> <b>Buna N Fiber End Seal</b> O.D.: 4 15/16 (125.4) I.D.: 3 15/16 (100.0) Thick: 1/32 (0.8) Optional On: PT83, PT83-MPG, PT88-HD, PT90-10, PT90-MPG, PT98-10, PT98-MPG Notes: Use with Stacked Elements</p>	

P  
R  
O  
D  
U  
C  
T  
G  
U  
I  
D  
E

 **WARNING:** These products can expose you to chemicals, including Diisononyl Phthalate, Carbon black extracts, Nickel, 1,3 Butadiene, Ethylene Oxide, Epichlorohydrin, which are known to the State of California to cause cancer, and Bisphenol-A, Ethylene Glycol, Ethylene Oxide, 1,3 Butadiene, Epichlorohydrin, which are known to the State of California to cause birth defects or other reproductive harm.

**Caterpillar Gaskets**

Irregular Shaped Gaskets for Cat Equipment

We use the Cat numbering system only for irregular-shaped gaskets which are used exclusively on Cat equipment.

**1S-9133**

**Buna N Fiber Cover Gasket with 8 Bolt Holes**

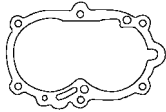

O.D.: 9 29/64 x 5 3/16  
(240.1 x 131.8)  
I.D.: 8 x 4 1/4 (203.2 x 108.0)  
Thick: 1/32 (0.8)  
Width: 29/64 (11.5)  
Optional On: PF824

**4L-8212-R**

**Buna N Fiber Cover Gasket with 4 Bolt Holes (Cat Number has No -R Suffix)**

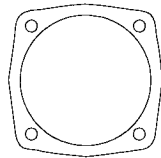

O.D.: 5 1/4 (133.4)  
I.D.: 4 1/2 (114.3)  
Thick: 1/16 (1.6)  
Furnished With: PF823(6)

**5H-5601**

**Buna N Fiber Cover Gasket with 6 Bolt Holes**

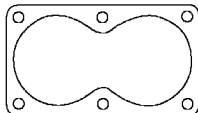

O.D.: 8 1/8 x 4 9/16  
(206.4 x 115.9)  
I.D.: 7 3/8 x 3 3/4  
(187.3 x 95.3)  
Thick: 1/32 (0.8)  
Width: 13/32 (10.3)  
Furnished With: PF823(2)

**5M-954**

**Buna N Fiber Cover Gasket with 4 Bolt Holes**

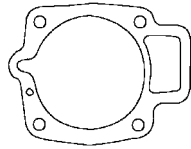

O.D.: 6 3/16 (157.2)  
I.D.: 3 3/4 (95.3)  
Thick: 1/16 (1.6)  
Furnished With: PF824

**6L-1540**

**Buna N Fiber Cover Gasket with 6 Bolt Holes**

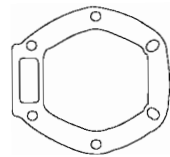

O.D.: 9 1/8 (231.8)  
I.D.: 6 1/16 (154.0)  
Thick: 1/32 (0.8)

**7B-7635**

**Buna N Fiber Cover Gasket with 5 Bolt Holes**

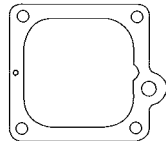

O.D.: 6 1/32 (153.2)  
I.D.: 4 9/32 (108.7)  
Thick: 1/32 (0.8)

**8M-7830**

**Buna N Fiber Cover Gasket with 7 Bolt Holes**

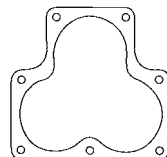

O.D.: 8 1/8 (206.4)  
Thick: 1/32 (0.8)  
Furnished With: PF823(3)

NOTES

NOTES



**WARNING:** These products can expose you to chemicals, including Diisononyl Phthalate, Carbon black extracts, Nickel, 1,3 Butadiene, Ethylene Oxide, Epichlorohydrin, which are known to the State of California to cause cancer, and Bisphenol-A, Ethylene Glycol, Ethylene Oxide, 1,3 Butadiene, Epichlorohydrin, which are known to the State of California to cause birth defects or other reproductive harm.

# DAHL DIESEL FUEL FILTER/WATER SEPARATORS REMOVE DIESEL FUEL SYSTEM PROBLEMS ALONG WITH WATER

Water and solid contaminants displace the diesel fuel's lubricative coating on high precision injection components. The loss of this protection results in wear, erosion, surface pitting and eventual pressure loss.

Many existing fuel filters aren't designed to remove significant amounts of water. They are designed to do their job in a single step. This means they must be porous enough to allow sufficient flow volume which, in turn, limits filtering ability to between 10 and 30 microns. Any tighter media would plug too quickly and result in frequent element changes.

The DAHL system takes care of those shortcomings. DAHL's functional dual-chamber 3-stage diesel fuel filter/water separators provide efficient suction side water separation and contaminant filtration. The key is the unique DAHL patented depressurizer cone which spreads the flow of the fuel. With more area to flow over, greater separation of water and dirt from the fuel is achieved.

DAHL diesel fuel filter/water separators have less mechanical flow resistance than other separators, because the fuel changes direction only twice. The DAHL unit removes virtually 100% of the water and most of the contaminants from the diesel fuel.

## Why DAHL Is Right For Your Diesel Equipment

1. The DAHL system eliminates water from fuel before reaching the fuel pump and injectors. This prevents the major cause of diesel fuel injection system failure.
  - a. It prolongs system life by eliminating pump and injector overhauls caused by water contaminated fuel. The cost of shop labor alone, just to repair the injection system on a 6-cylinder rig, exceeds the cost of the DAHL diesel fuel filter/water separator.
  - b. It reduces the need to repair the fuel pump and/or injectors that could easily tie up equipment for one or two days. The loss of income in just a few hours of equipment downtime again would pay for a DAHL diesel fuel filter/water separator.
2. The DAHL system separates solid contaminants from the fuel before reaching the fuel pump and injectors.
3. The DAHL system is easily installed.
  - a. Install it at any location before the fuel pump. (Complete installation instructions are included with each DAHL unit.)
  - b. This system can replace all other primary filters and water separators. It both filters and separates.
  - c. It takes minimal space to install. Clearance space for element removal is between 1 1/2 to 3 1/2 inches. Some models are installed with as few as two easily accessed bolts.
4. The DAHL system is easily serviced.
  - a. Models 150, 200 and 300 are serviced by loosening the T-Bolt handle. They also feature a self-ejecting element.
  - b. The transparent bowl (up to 24 ounce water capacity) makes constant draining unnecessary. The draincock is easy to use. An aluminum bowl is also available.
5. Most of the solid contaminants are separated by the patented depressurizer cone in the bowl BEFORE reaching the filter element. Another factor resulting in less frequent changes is the extra paper in the filter element. Under normal conditions, the element can last up to 40,000 miles.
6. The DAHL system includes a reverse flow valve. This holds the prime in the fuel system by not allowing flow back to the tank during shut-down. (Removable primer plug at top assists where complete priming is required.)
7. The DAHL system helps eliminate air entrapment because the inlet and outlet ports are at the top of the unit. The fuel changes directions only twice (see flow diagram), and so offers less mechanical resistance. Less resistance means longer pump and element life.

**PROVEN PERFORMANCE** in the laboratory and in millions of miles/hours of commercial and industrial operation. You can be sure that each DAHL unit is designed right, built right and does its job right.

**CLEAN FUEL** provided by a DAHL diesel fuel filter/water separator eliminates nearly all of the engine problems caused by water and solid contaminants in diesel fuel. In addition, you can expect:

- Longer Injection System Component Life
- Full Power Performance
- Lower Element Replacement Cost



**WARNING:** These products can expose you to chemicals, including Diisononyl Phthalate, Carbon black extracts, Nickel, 1,3 Butadiene, Ethylene Oxide, Epichlorohydrin, which are known to the State of California to cause cancer, and Bisphenol-A, Ethylene Glycol, Ethylene Oxide, 1,3 Butadiene, Epichlorohydrin, which are known to the State of California to cause birth defects or other reproductive harm.

# Here's How The DAHL System Works

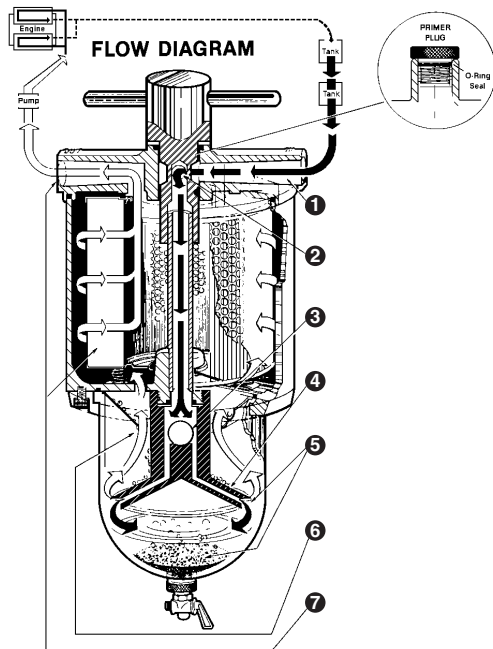

1. The contaminated fuel enters the inlet port.
2. The T-Bolt redirects the fuel downward through the centerpipe.
3. Fuel flows through the reverse flow valve.
4. Fuel flow is spread by the depressurizer cone.
5. As fuel is discharged from the depressurizer cone, 80% of contaminant separation takes place. Most of the solid particles and water settle into the quiet zone of the bowl.
6. As the fuel rises upward, any remaining minute water droplets coalesce on the cone, baffle and bowl surfaces. Droplet size and weight gradually increase, causing downward flow into the sump.
7. Fuel is filtered completely by the element, which contains HydroShield™ media. The clean fuel then continues upward through the outlet port and on to the pump and injection system.

## How To Select The Right DAHL Filter

Choose the size which can accommodate the flow rate recommended in the chart. (Maximum flow rate listed is for convenience in comparing with other systems only.) For most efficient separation and filtration, select from the recommended column.

### Flow Rates in Gallons Per Hour

The chart is for Fuel/Water Separators. Recyclers are limited by the pump. For example, a single 300 recycler unit has a flow rate limited to 180 GPH (U.S.), and a double 300 recycler unit has a flow rate limited to 360 GPH (U.S.).

## Flow Rates

### GPH (U.S.)

Model Series	Recommended	Maximum	Sump Capacity
65 & 75	20	30	4 oz.
100	40	65	8 oz.
100 Double	80	130	16 oz.
150	80	100	8 oz.
150 Double	160	200	16 oz.
200	120	200	24 oz.
200 Double	240	400	48 oz.
300	180	325	24 oz.
300 Double	360	650	48 oz.
300 Triple	540	975	72 oz.
500	1800	1920	11 Gallons
500 Double	3600	3840	22 Gallons
All Multiple Units	Multiply Flow Rate and Sump Capacity by Number of Units		

## Superior Engineering

- Die cast aluminum
- Impact-resistant large transparent bowl
- Element service life is several times longer than conventional
- Easy to install, service and clean
- Positive air elimination
- Advanced spring design assures positive element seal
- Less mechanical resistance because of streamlined flow path
- Baffle system is designed to stop emulsification and disperse trapped air
- Ball check valve to stop reverse flow
- Six series specifically designed to fit diesel engines of various capacities



**WARNING:** These products can expose you to chemicals, including Diisononyl Phthalate, Carbon black extracts, Nickel, 1,3 Butadiene, Ethylene Oxide, Epichlorohydrin, which are known to the State of California to cause cancer, and Bisphenol-A, Ethylene Glycol, Ethylene Oxide, 1,3 Butadiene, Epichlorohydrin, which are known to the State of California to cause birth defects or other reproductive harm.

# 65 & 75 Series Compact Fuel Filter/Water Separators



**MODEL 65**  
Diesel Fuel  
Filter/Water Separator



**MODEL 75**  
Gasoline or Diesel Fuel  
Filter/Water Separator with Aluminum Bowl

## Specifications

- **Flow Resistance:**.....0.75 In. Mercury
- **Maximum Working Pressure:**.....25 PSI (172 kPa)
- **Temperature Range:** .....-50° to +225°F (-45° to +107°C)
- **Port Thread:** .....9/16-18 w/O-Ring Boss
- **Height / 65:**.....6 3/8 In. (161.9 mm)
- **Height / 75:**.....6 1/8 In. (155.6 mm)
- **Width:** .....4 3/16 In. (106.4 mm)
- **Depth:** .....4 3/4 In. (120.6 mm)
- **Element Removal Clearance:**.....3 1/2 In. (88.9 mm)
- **Sump Capacity:** .....4 oz. (118 ml)

## Flow Rates

- **Model 65 & 75 Series:**  
Recommended:.....20 GPH (U.S.) (75.7 LPH)  
Maximum:.....30 GPH (U.S.) (113.5 LPH)

## Service Parts

- **Elements:**
  - 61 .....(For Use on Model 60)
  - 61-W ..... 4 Micron Nominal (20 Absolute) Element (For Use on Model 60)
  - 66\* ..... 5 Micron Nominal (25 Absolute) Element (For Use on Models 65 & 75)
  - 66-W ..... 4 Micron Nominal (20 Absolute) Element (For Use on Models 65 & 75)
  - 66-30 ..... 5 Micron Nominal (25 Absolute) Element (For Use on Models 65, 65-W30 & 75, 75-W30)
  - 66-30 ..... 9 Micron Nominal (40 Absolute) Element (For Use on Models 65, 65-W30 & 75, 75-W30)
- **Gaskets:**
  - 60-GK.....Complete Gasket Kit for 60, 65 & 75 (See Accessories Page)
- **Form 4060:**  
Installation, Operation, Parts & Service Information

## 65 & 75 Series Single Units

- 65** Diesel Fuel Filter/Water Separator
- 65-W30** Diesel Fuel Filter/Water Separator — 9 Micron Nominal (40 Absolute) Element
- 75** Gasoline or Diesel Fuel Filter/Water Separator with Aluminum Bowl
- 75-W30** Gasoline or Diesel Fuel Filter/Water Separator with Aluminum Bowl — 9 Micron Nominal (40 Absolute) Element

## Accessories

- **All Inlet & Outlet Fittings Require O-Ring Seals**
- **Fittings:**.....See DAHL Fittings Chart

## Used On

- 65 & 75 — Small Diesel Engines Where Space is Limited
- 75 — Small Gasoline Engines & Marine Applications
- Cars & Light-Duty Trucks

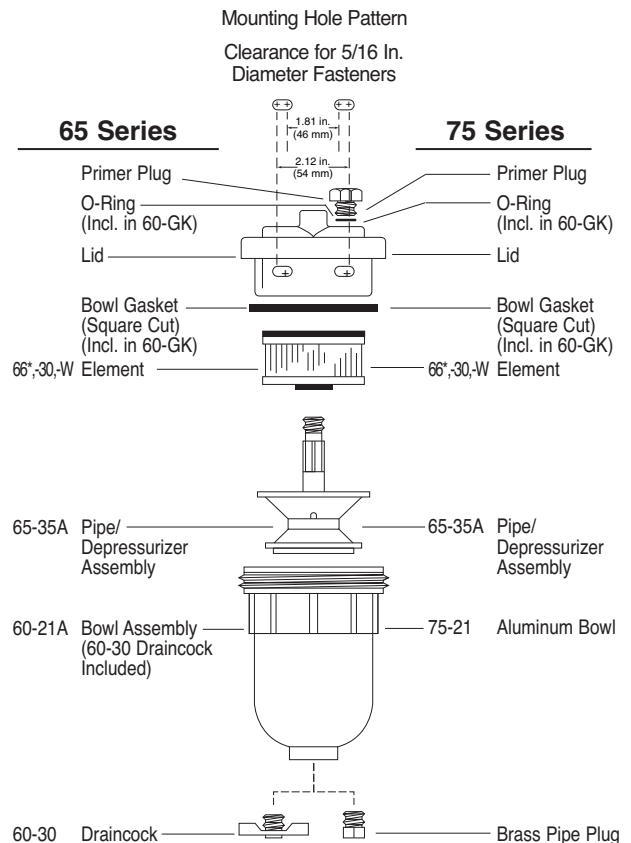

\* Standard with Unit Unless Stated.



**WARNING:** These products can expose you to chemicals, including Diisononyl Phthalate, Carbon black extracts, Nickel, 1,3 Butadiene, Ethylene Oxide, Epichlorohydrin, which are known to the State of California to cause cancer, and Bisphenol-A, Ethylene Glycol, Ethylene Oxide, 1,3 Butadiene, Epichlorohydrin, which are known to the State of California to cause birth defects or other reproductive harm.

# 100 Series Diesel Fuel Filter/Water Separators



**MODEL 100**  
Diesel Fuel Filter/Water Separator



**MODEL 100-M**  
Marine Diesel Fuel Filter/Water Separator



**MODEL 100-MFV**  
Double Manifold Diesel Fuel Filter/Water Separator  
with Shut-Off Valves for Continuous Operation



**MODEL 100-MMV**  
Double Marine Manifold Diesel Fuel Filter/Water Separator  
with Shut-Off Valves for Continuous Operation

## Specifications

- **Flow Resistance:** .....0.75 In. Mercury
- **Maximum Working Pressure:**.....25 PSI (172 kPa)
- **Temperature Range:** .....-50° to +225°F (-45° to +107°C)
- **Port Thread:**  
Single Units: .....9/16-18 w/O-Ring Boss  
Double Units:.....1/4-18 NPT
- **Height:**.....12 1/2 In. (317.5 mm)
- **Width:**.....5 1/2 In. (139.7 mm)
- **Depth:**.....6 1/2 In. (165.1 mm)
- **Element Removal Clearance:**.....1 1/2 In. (38.1 mm)
- **Sump Capacity:** .....8 oz. (236 ml)

## Flow Rates

- **Single Model 100 Series:**  
Recommended:.....40 GPH (U.S.) (151 LPH)  
Maximum: .....65 GPH (U.S.) (246 LPH)
- **Double Model 100 Series:**  
Recommended:.....80 GPH (U.S.) (302 LPH)  
Maximum: .....130 GPH (U.S.) (492 LPH)

## Service Parts

- **Elements:**  
101\* .....4 Micron Nominal (20 Absolute) Element  
101-W.....5 Micron Nominal (25 Absolute) Element  
101-30.....9 Micron Nominal (40 Absolute) Element
- **Gaskets:**  
100-GK.....Complete Gasket Kit (See Accessories Page)
- **Kits:**  
100-DEPR KIT.....Depressurizer Kit (See Accessories Page)  
100-MNTG KIT .....Mounting Bracket Kit  
(See Accessories Page)
- **Form 4100:**  
Installation, Operation, Parts & Service Information
- **Form 4123:**  
Marine Installation, Operation, Parts & Service Information

## Used On

- Small Diesel Engines Up to Approx. 200 HP (Except Cummins & Detroit Diesel Engines)
- Cars, Light-Duty Trucks & RV's
- Small Pleasure Crafts & Sailboats
- Caterpillar Engines Thru 3300 Series
- Small Generators & Farm Tractors
- Refrigeration Units
- 5.7L & 6.2L GMC Engines

\* Standard with Unit Unless Stated.



**WARNING:** These products can expose you to chemicals, including Diisononyl Phthalate, Carbon black extracts, Nickel, 1,3 Butadiene, Ethylene Oxide, Epichlorohydrin, which are known to the State of California to cause cancer, and Bisphenol-A, Ethylene Glycol, Ethylene Oxide, 1,3 Butadiene, Epichlorohydrin, which are known to the State of California to cause birth defects or other reproductive harm.

# 100 Series Diesel Fuel Filter/Water Separators (Cont'd.)

## Accessories

### All Inlet & Outlet Fittings Require O-Ring Seals

Aluminum Bowl .....	100-21AL
Clear Bowl w/Water Sensor Probes .....	100-21BP
Clear Bowl w/Heater Probes .....	100-21H
Clear Bowl w/Marine Collar for Marine Units .....	100-21M
Fittings.....	See DAHL Fittings Chart
Heat Deflector Shield for Marine Units.....	185-DS
Heater Kit...See Accessories Page (Heater Kits & Heater Parts)	
Shock Pad Mounting Kit .....	186-SK
Water Sensor Warning Light Kit (Use with 100-21BP)	
24 Volt DC .....	24-WLK

## 100 Series Single Units

<b>100</b>	Diesel Fuel Filter/Water Separator
<b>100-BP</b>	Diesel Fuel Filter/Water Separator with Water Sensor Bowl Probes — Order Warning Light Kit separately.
<b>100-H</b>	Diesel Fuel Filter/Water Separator with In-Filter Heater — Dash-Mounted Toggle Switch included. Operates on either 12 or 24 Volt systems. — 5 Micron Nominal (25 Absolute) Element
<b>100-M</b>	Marine Diesel Fuel Filter/Water Separator
<b>100-W</b>	Diesel Fuel Filter/Water Separator — 5 Micron Nominal (25 Absolute) Element
<b>100-W30</b>	Diesel Fuel Filter/Water Separator — 9 Micron Nominal (40 Absolute) Element

## 100 Series Double Manifold Units

- 100-MFV** Two Diesel Fuel Filter/Water Separators Manifolded with Shut-Off Valves — Allows continuous operation while servicing.
- 100-MMV** Two Marine Diesel Fuel Filter/Water Separators Manifolded with Shut-Off Valves — Allows continuous operation while servicing.

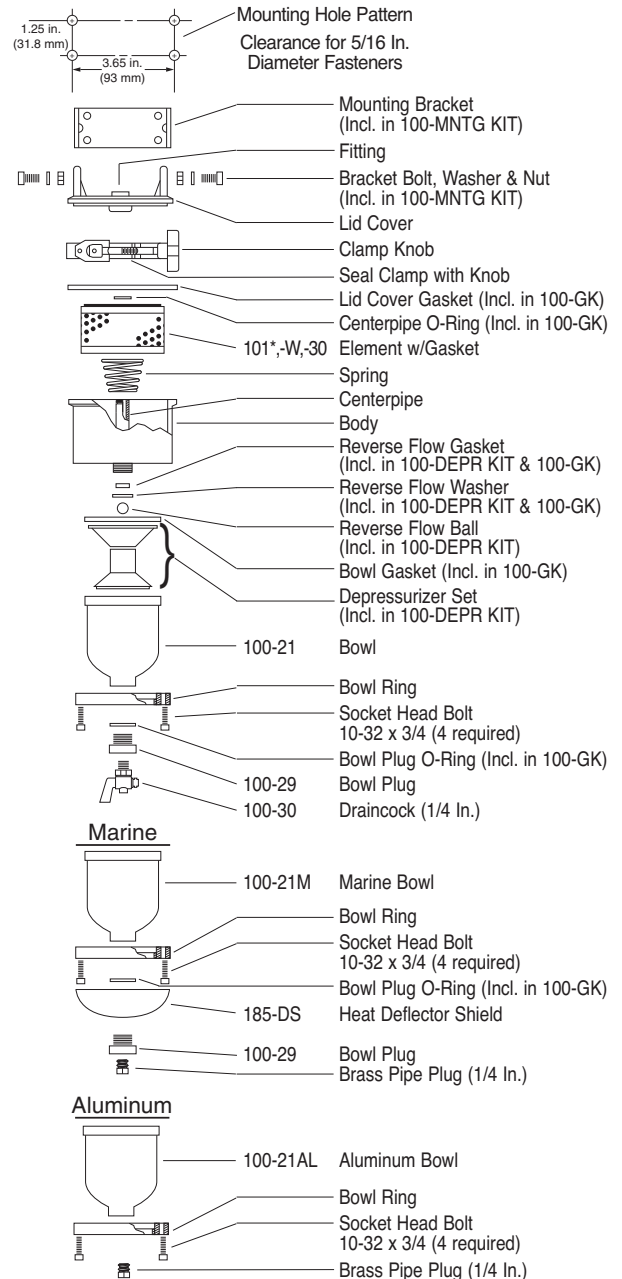

\* Standard with Unit Unless Stated.



**WARNING:** These products can expose you to chemicals, including Diisononyl Phthalate, Carbon black extracts, Nickel, 1,3 Butadiene, Ethylene Oxide, Epichlorohydrin, which are known to the State of California to cause cancer, and Bisphenol-A, Ethylene Glycol, Ethylene Oxide, 1,3 Butadiene, Epichlorohydrin, which are known to the State of California to cause birth defects or other reproductive harm.

# 150 Series Diesel Fuel Filter/Water Separators



**MODEL 150**  
Diesel Fuel Filter/Water Separator



**MODEL 150-M**  
Marine Diesel Fuel Filter/Water Separator

## Specifications

- **Flow Resistance:** .....0.75 In. Mercury
- **Maximum Working Pressure:**.....25 PSI (172 kPa)
- **Temperature Range:** .....-50° to +225°F (-45° to +107°C)
- **Port Thread:**  
Single Units: .....7/8-14 w/O-Ring Boss  
Double Units:.....3/4-14 NPT
- **Height:**.....14 1/4 In. (368.3 mm)
- **Width:** .....6 In. (152.4 mm)
- **Depth:** .....6 11/32 In. (161.1 mm)
- **Element Removal Clearance:**.....2 In. (50.8 mm)
- **Sump Capacity:** .....8 oz. (236 ml)

## Flow Rates

- **Single Model 150 Series:**  
Recommended:.....80 GPH (U.S.) (302 LPH)  
Maximum: .....100 GPH (U.S.) (378 LPH)
- **Double Model 150 Series:**  
Recommended:.....160 GPH (U.S.) (604 LPH)  
Maximum: .....200 GPH (U.S.) (757 LPH)

## Service Parts

- **Elements:**  
151\* .....4 Micron Nominal (20 Absolute) Element  
151-W.....5 Micron Nominal (25 Absolute) Element  
151-30 .....9 Micron Nominal (40 Absolute) Element
- **Gaskets:**  
150-GK.....Complete Gasket Kit (See Accessories Page)
- **Kits:**  
100-DEPR KIT .....Depressurizer Kit (See Accessories Page)
- **Form 4025:**..... Installation, Operation,  
Parts & Service Information
- **Form 4123:**.....Marine Installation, Operation,  
Parts & Service Information

\* Standard with Unit Unless Stated.



**WARNING:** These products can expose you to chemicals, including Diisononyl Phthalate, Carbon black extracts, Nickel, 1,3 Butadiene, Ethylene Oxide, Epichlorohydrin, which are known to the State of California to cause cancer, and Bisphenol-A, Ethylene Glycol, Ethylene Oxide, 1,3 Butadiene, Epichlorohydrin, which are known to the State of California to cause birth defects or other reproductive harm.



# 150 Series Diesel Fuel Filter/Water Separators (Cont'd.)

## Accessories

### All Inlet & Outlet Fittings Require O-Ring Seals

Aluminum Bowl .....	100-21AL
Clear Bowl w/Water Sensor Probes .....	100-21BP
Clear Bowl w/Heater Probes .....	100-21H
Clear Bowl w/Marine Collar for Marine Units .....	100-21M
Fittings.....	See DAHL Fittings Chart
Heat Deflector Shield for Marine Units.....	185-DS
Heater Kit...See Accessories Page (Heater Kits & Heater Parts)	
Shock Pad Mounting Kit.....	286-SK
Water Sensor Warning Light Kit (Use with 100-21BP)	
24 Volt DC .....	24-WLK

## 150 Series Units

<b>150</b>	Diesel Fuel Filter/Water Separator
<b>150-H</b>	Diesel Fuel Filter/Water Separator with In-Filter Heater—Dash-Mounted Toggle Switch included. Operates on either 12 or 14 Volt systems. — 5 Micron Nominal (25 Absolute) Element
<b>150-M</b>	Marine Diesel Fuel Filter/Water Separator
<b>150-W30</b>	Diesel Fuel Filter/Water Separator — 9 Micron Nominal (40 Absolute) Element

## Used On

- Small & Medium Size Heavy-Duty Diesel Engines (Up to Approx. 450 HP)
- Large Farm Tractors
- Detroit Diesel (53 & Small 71 Series)
- Some Cummins Six Cylinder Engines

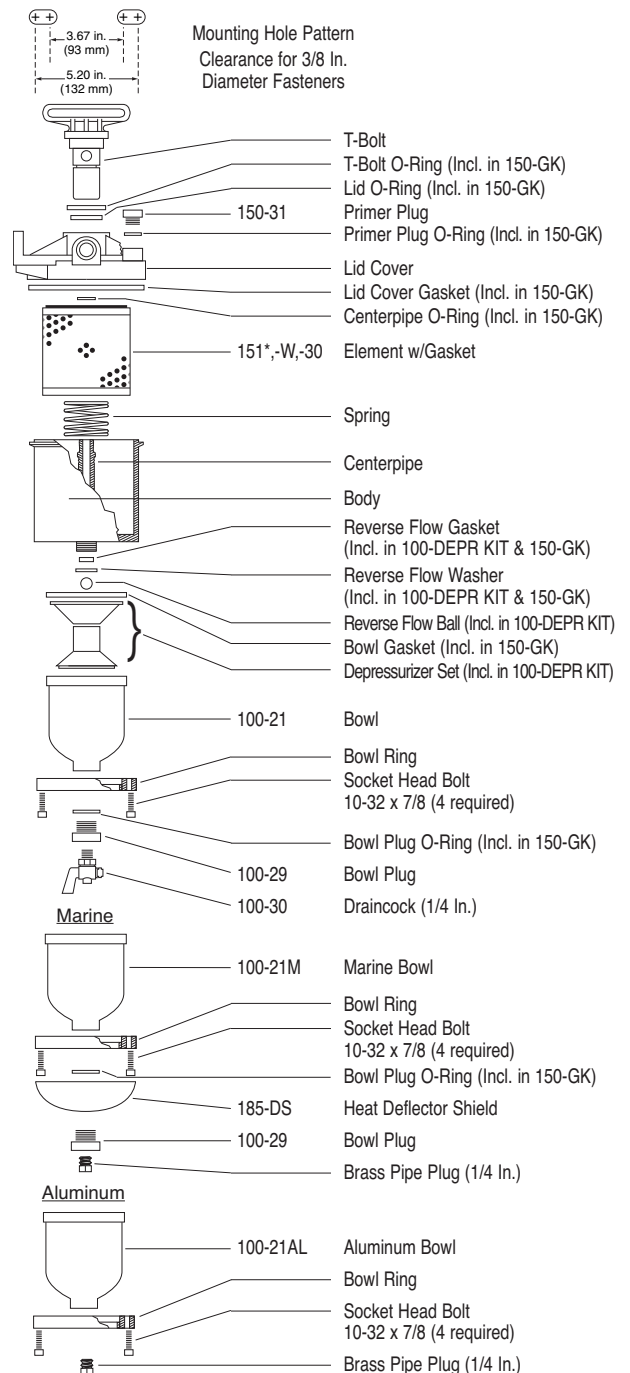

\* Standard with Unit Unless Stated.



**WARNING:** These products can expose you to chemicals, including Diisononyl Phthalate, Carbon black extracts, Nickel, 1,3 Butadiene, Ethylene Oxide, Epichlorohydrin, which are known to the State of California to cause cancer, and Bisphenol-A, Ethylene Glycol, Ethylene Oxide, 1,3 Butadiene, Epichlorohydrin, which are known to the State of California to cause birth defects or other reproductive harm.

# 200 Series Diesel Fuel Filter/Water Separators



**MODEL 200**  
Diesel Fuel Filter/Water Separator



**MODEL 200-M**  
Marine Diesel Fuel Filter/Water Separator



**MODEL 200-MFV**  
Double Manifold Diesel Fuel Filter/Water Separator  
with Shut-Off Valves for Continuous Operation



**MODEL 200-MMV**  
Double Marine Manifold Diesel Fuel Filter/Water Separator  
with Shut-Off Valves for Continuous Operation

## Specifications

- **Flow Resistance:** .....1.0 In. Mercury
- **Maximum Working Pressure:**.....25 PSI (172 kPa)
- **Temperature Range:** .....-50° to +225°F (-45° to +107°C)
- **Port Thread:**  
Single Units: .....7/8-14 w/O-Ring Boss  
Double Units:.....3/4-14 NPT
- **Height:**.....16 3/4 In. (425.5 mm)
- **Width:**.....7 1/2 In. (190.5 mm)
- **Depth:**.....7 3/4 In. (196.9 mm)
- **Element Removal Clearance:**.....2 1/2 In. (63.5 mm)
- **Sump Capacity:** .....24 oz. (708 ml)
- **Top to Inlet Clearance:** .....2 5/8 In. (66.7 mm)
- **Top to Outlet Clearance:** .....2 5/8 In. (66.7 mm)

## Flow Rates

- **Single Model 200 Series:**  
Recommended:.....120 GPH (U.S.) (454 LPH)  
Maximum: .....200 GPH (U.S.) (757 LPH)
- **Double Model 200 Series:**  
Recommended:.....240 GPH (U.S.) (908 LPH)  
Maximum: .....400 GPH (U.S.) (1,514 LPH)

## Service Parts

- **Elements:**  
201\* .....4 Micron Nominal (20 Absolute) Element  
201-W.....5 Micron Nominal (25 Absolute) Element  
201-30.....9 Micron Nominal (40 Absolute) Element
- **Gaskets:**  
200-GK.....Complete Gasket Kit (See Accessories Page)
- **Kits:**  
200-DEPR KIT.....Depressurizer Kit (See Accessories Page)
- **Form 4230:**  
Installation, Operation, Parts & Service Information
- **Form 4123:**  
Marine Installation, Operation, Parts & Service Information

\* Standard with Unit Unless Stated.



**WARNING:** These products can expose you to chemicals, including Diisononyl Phthalate, Carbon black extracts, Nickel, 1,3 Butadiene, Ethylene Oxide, Epichlorohydrin, which are known to the State of California to cause cancer, and Bisphenol-A, Ethylene Glycol, Ethylene Oxide, 1,3 Butadiene, Epichlorohydrin, which are known to the State of California to cause birth defects or other reproductive harm.

# 200 Series Diesel Fuel Filter/Water Separators (Cont'd.)

## Accessories

### All Inlet & Outlet Fittings Require O-Ring Seals

Aluminum Bowl .....	200-21AL
Clear Bowl w/Water Sensor Probes .....	200-21BP
Clear Bowl w/Heater Probes .....	200-21H
Clear Bowl w/Water Sensor & Heater Probes .....	200-21HBP
Clear Bowl w/Marine Collar for Marine Units .....	200-21M
Fittings.....	See DAHL Fittings Chart
Heat Deflector Shield for Marine Units.....	285-DS
Heater Kit...See Accessories Page (Heater Kits & Heater Parts)	
Shock Pad Mounting Kit.....	286-SK
Water Sensor Warning Light Kit (Use with 200-21BP)	
24 Volt DC .....	24-WLK

## 200 Series Single Units

<b>200</b>	Diesel Fuel Filter/Water Separator
<b>200-H</b>	Diesel Fuel Filter/Water Separator with In-Filter Heater — Operates on either 12 or 24 Volt systems — 5 Micron Nominal (25 Absolute) Element
<b>200-M</b>	Marine Diesel Fuel Filter/Water Separator
<b>200-W30</b>	Diesel Fuel Filter/Water Separator — 9 Micron Nominal (40 Absolute) Element

## 200 Series Double Manifold Units

<b>200-MFV</b>	Two Diesel Fuel Filter/Water Separators Manifoldd with Shut-Off Valves — Allows continuous operation while servicing.
<b>200-MMV</b>	Two Marine Diesel Fuel Filter/Water Separators Manifoldd with Shut-Off Valves — Allows continuous operation while servicing.

## Used On

- 8 Cylinder Cummins & Detroit Diesel Engines
- Caterpillar Engines up to Approximately 1,000 HP (Including 399)
- Most Other Medium Size Diesel Engines up to Approximately 1,000 HP
- Trucks & Buses
- Construction & Farm Equipment
- Medium Size Generators
- Smaller Commercial Boats

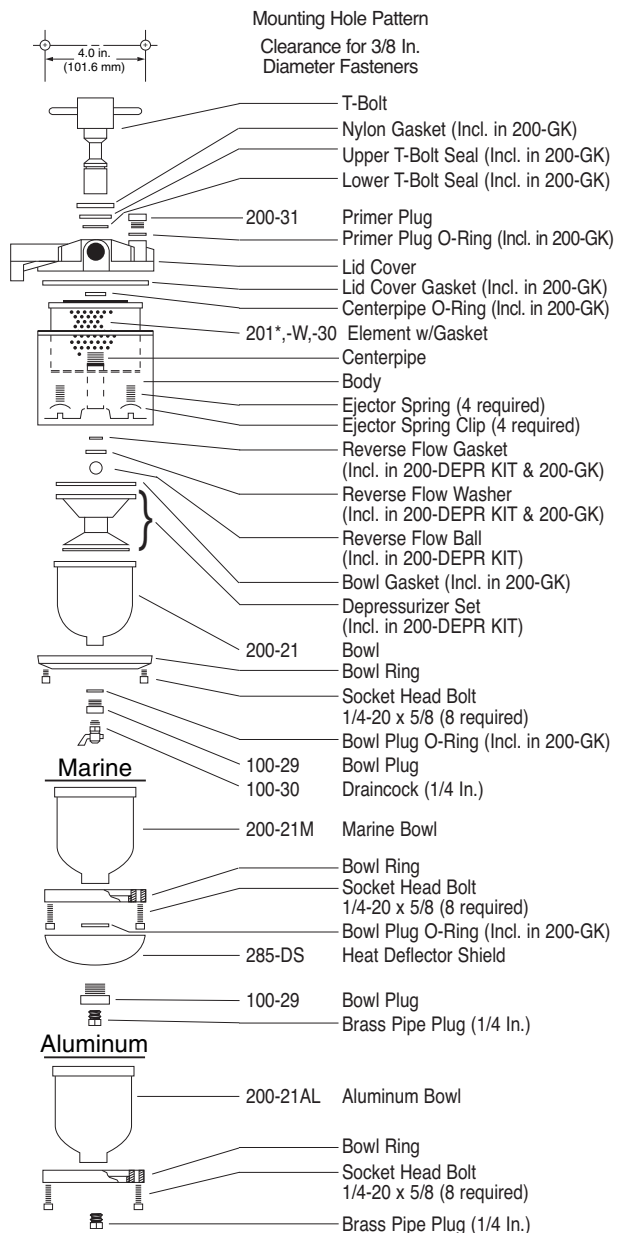

\* Standard with Unit Unless Stated.



**WARNING:** These products can expose you to chemicals, including Diisononyl Phthalate, Carbon black extracts, Nickel, 1,3 Butadiene, Ethylene Oxide, Epichlorohydrin, which are known to the State of California to cause cancer, and Bisphenol-A, Ethylene Glycol, Ethylene Oxide, 1,3 Butadiene, Epichlorohydrin, which are known to the State of California to cause birth defects or other reproductive harm.

# 300 Series Diesel Fuel Filter/Water Separators



**MODEL 300**  
Diesel Fuel  
Filter/Water Separator



**MODEL 300-M**  
Marine Diesel Fuel  
Filter/Water Separator



**MODEL 300-MMV3**  
Triple Marine Manifold Diesel Fuel Filter/Water Separator  
with Shut-Off Valves for Continuous Operation



**MODEL 300-MFV**  
Double Manifold Diesel Fuel Filter/Water Separator  
with Shut-Off Valves for Continuous Operation

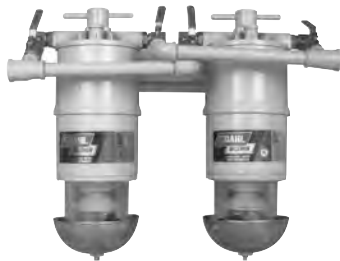

**MODEL 300-MMV**  
Double Marine Manifold Diesel Fuel Filter/Water Separator  
with Shut-Off Valves for Continuous Operation

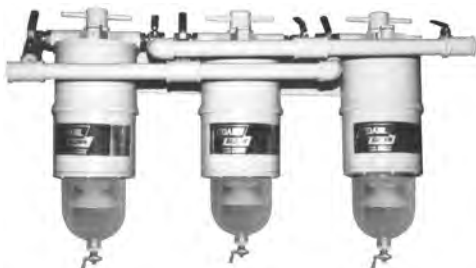

**MODEL 300-MFV3**  
Triple Manifold Diesel Fuel Filter/Water Separator  
with Shut-Off Valves for Continuous Operation

## Specifications

- **Flow Resistance:** .....1.5 In. Mercury
- **Maximum Working Pressure:**.....25 PSI (172 kPa)
- **Temperature Range:** .....-50° to +225°F (-45° to +107°C)
- **Port Thread:**  
Single Units: .....1 1/16-12 w/O-Ring Boss  
Double Units: .....1-11 1/2 NPT  
Triple Units:.....1-11 1/2 NPT
- **Height:**.....22 1/4 In. (565.2 mm)
- **Width:** .....7 1/2 In. (190.5 mm)
- **Depth:**.....7 3/4 In. (196.9 mm)
- **Element Removal Clearance:**.....2 1/2 In. (63.5 mm)
- **Sump Capacity:** .....24 oz. (708 ml)
- **Top to Inlet Clearance:** .....2 5/8 In. (66.7 mm)
- **Top to Outlet Clearance:** .....2 5/8 In. (66.7 mm)

## Flow Rates

- **Single Model 300 Series:**  
Recommended:.....180 GPH (U.S.) (681 LPH)  
Maximum: .....325 GPH (U.S.) (1,230 LPH)
- **Double Model 300 Series:**  
Recommended:.....360 GPH (U.S.) (1,363 LPH)  
Maximum: .....650 GPH (U.S.) (2,460 LPH)
- **Triple Model 300 Series:**  
Recommended:.....540 GPH (U.S.) (2,043 LPH)  
Maximum: .....975 GPH (U.S.) (3,690 LPH)

## Service Parts

- **Elements:**  
301\* .....4 Micron Absolute Element  
301-W.....3 Micron Nominal (9 Absolute) Element  
301-30.....9 Micron Nominal (40 Absolute) Element  
301-CS.....Element with Water Absorbing Media  
(for use with Hydraulic Recycler)  
301-MPG.....4 Micron Nominal (20 Absolute) Element  
(for use with Hydraulic Recycler)
- **Gaskets:**  
200-GK.....Complete Gasket Kit (See Accessories Page)
- **Kits:**  
200-DEPR KIT.....Depressurizer Kit (See Accessories Page)
- **Form 4230:**  
Installation, Operation, Parts & Service Information
- **Form 4123:**  
Marine Installation, Operation, Parts & Service Information

\* Standard with Unit Unless Stated.



**WARNING:** These products can expose you to chemicals, including Diisononyl Phthalate, Carbon black extracts, Nickel, 1,3 Butadiene, Ethylene Oxide, Epichlorohydrin, which are known to the State of California to cause cancer, and Bisphenol-A, Ethylene Glycol, Ethylene Oxide, 1,3 Butadiene, Epichlorohydrin, which are known to the State of California to cause birth defects or other reproductive harm.

# 300 Series Diesel Fuel Filter/Water Separators (Cont'd.)

## Accessories

### All Inlet & Outlet Fittings Require O-Ring Seals

Aluminum Bowl .....	200-21AL
Clear Bowl w/Water Sensor Probes .....	200-21BP
Clear Bowl w/Heater Probes .....	200-21H
Clear Bowl w/Water Sensor & Heater Probes .....	200-21HBP
Clear Bowl w/Marine Collar for Marine Units .....	200-21M
Fittings.....	See DAHL Fittings Chart
Heat Deflector Shield for Marine Units.....	285-DS
Heater Kit...See Accessories Page (Heater Kits & Heater Parts)	
Shock Pad Mounting Kit.....	286-SK
Water Sensor Warning Light Kit (Use with 200-21BP)	
24 Volt DC .....	24-WLK

## 300 Series Single Units

<b>300</b>	Diesel Fuel Filter/Water Separator
<b>300-H</b>	Diesel Fuel Filter/Water Separator with In-Filter Heater — Operates on either 12 or 24 Volt systems — 5 Micron Absolute Element
<b>300-M</b>	Marine Diesel Fuel Filter/Water Separator
<b>300-W30</b>	Diesel Fuel Filter/Water Separator — 9 Micron Nominal (40 Absolute) Element

## 300 Series Double Manifold Units

<b>300-MFV</b>	Two Diesel Fuel Filter/Water Separators Manifolded with Shut-Off Valves — Allows continuous operation while servicing.
<b>300-MMV</b>	Two Marine Diesel Fuel Filter/Water Separators Manifolded with Shut-Off Valves — Allows continuous operation while servicing.

## 300 Series Triple Manifold Units

<b>300-MFV3</b>	Three Diesel Fuel Filter/Water Separators Manifolded with Shut-Off Valves — Allows continuous operation while servicing.
<b>300-MMV3</b>	Three Marine Diesel Fuel Filter/Water Separators Manifolded with Shut-Off Valves — Allows continuous operation while servicing.

## Used On

- 12 & 16 Cylinder Cummins & Detroit Diesel Engines
- Caterpillar Engines (800 HP & Up)
- EMD & Alco Engines up to 2,000 HP
- Locomotives
- Large Stationary Engines
- Large Boats & Generators
- Applications Requiring a # 12 Fuel Hose

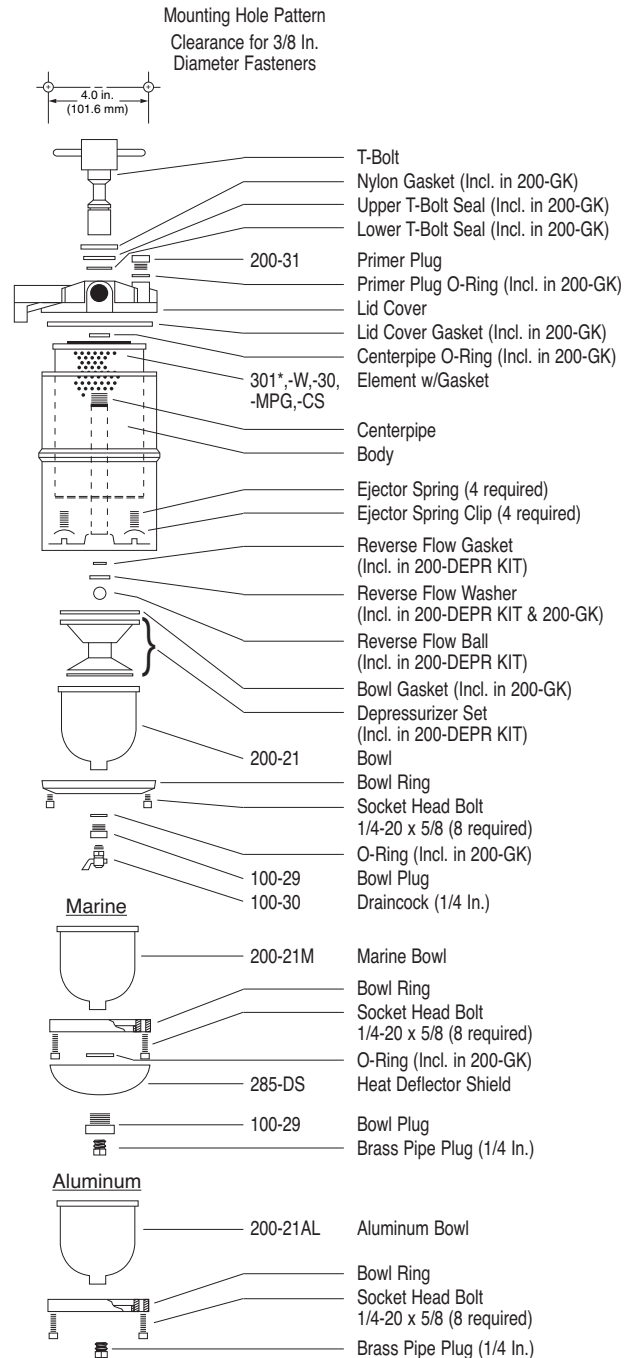

\* Standard with Unit Unless Stated.



**WARNING:** These products can expose you to chemicals, including Diisononyl Phthalate, Carbon black extracts, Nickel, 1,3 Butadiene, Ethylene Oxide, Epichlorohydrin, which are known to the State of California to cause cancer, and Bisphenol-A, Ethylene Glycol, Ethylene Oxide, 1,3 Butadiene, Epichlorohydrin, which are known to the State of California to cause birth defects or other reproductive harm.

# 500 Series Tank Diesel Fuel Filter/Water Separator



**MODEL 500-BP**  
Diesel Fuel Filter/Water Separator

Designed primarily for large marine engines, storage facilities, island fuel pumps and other permanent installations.

Nearly 17,000 square inches (11 square meters) of filtering surface is provided by seven giant DAHL 501-W (10 Micron) elements. Because of the effective separation of water and dirt, the elements will give long service.

## Specifications

- **Flow Resistance:** .....1.0 In. Mercury
- **Maximum Working Pressure:**.....15 PSI (103 kPa)
- **Temperature Range:**.....-60° to +250°F (-50° to +121°C)
- **Port Thread:** .....2 In. NPT
- **Height:** .....47 In. (1,194 mm)
- **Width:** .....28 1/2 In. (724 mm)
- **Depth:** .....22 In. (559 mm)
- **Element Removal Clearance:**.....10 In. (254 mm)
- **Sump Capacity:** .....11 U.S. Gallons (41.6 Liters)

## Flow Rates

- **Single Model 500 Series:**  
Recommended:.....1,800 GPH (U.S.) (6,813 LPH)  
Maximum: .....1,920 GPH (U.S.) (7,268 LPH)
- **Double Model 500 Series:**  
Recommended:.....3,600 GPH (U.S.) (13,626 LPH)  
Maximum: .....3,840 GPH (U.S.) (14,536 LPH)
- **Multiple Units:**  
Multiply Flow Rate and Sump Capacity by Number of Units

## Service Parts

- **Elements:**  
501 .....4 Micron Nominal (20 Absolute) Element  
501-W\* .....5 Micron Nominal (25 Absolute) Element  
501-30 .....9 Micron Nominal (40 Absolute) Element
- **Gaskets:** .....See Illustration
- **Form 4500:**  
Installation, Operation, Parts & Service Information

## 500 Series Single Units

- 500** Diesel Fuel Filter/Water Separator
- 500-BP** Diesel Fuel Filter/Water Separator with Water Sensor Warning Light Kit — Equipped with a 110 Volt Electrical Connector.
- 500-BP22** Diesel Fuel Filter/Water Separator with Water Sensor Warning Light Kit — Equipped with a 220 Volt Electrical Connector. (For Overseas Operation)

## 500 Series Double Manifold Units

- 500-MFVBP22** Double Manifold Diesel Fuel Filter/Water Separator with Shut-Off Valves — Allows for continuous operation and Water Sensor Warning Light Kit. — Equipped with a 220 Volt Electrical Connector. (For Overseas Operation)

## Used On

- Large Marine Diesel Engines
- Large Stationary Engines
- Storage Facilities
- Large Capacity Requirements
- Fuel Storage Tank Pumps

## Features of 500-BP Unit

- Easy draining with convenient bleed and drain valves.
- Easy to service - simply remove the 20 inch seal clamp to remove the top lid assembly for element replacement.
- Easy priming because primer plug is at the top.
- Easy to clean - handy four inch clean-out hole.
- Ruggedly built of high quality heavy-gauge steel.
- Hand welded and pressure tested.
- Minimum mechanical flow resistance because of the streamlined fuel flow through the seven large centertubes.
- Troubleshooting vacuum/pressure gauges monitor inlet and outlet ports.
- The water sensor kit on the 500-BP alerts the operator by a light when the unit should be drained.

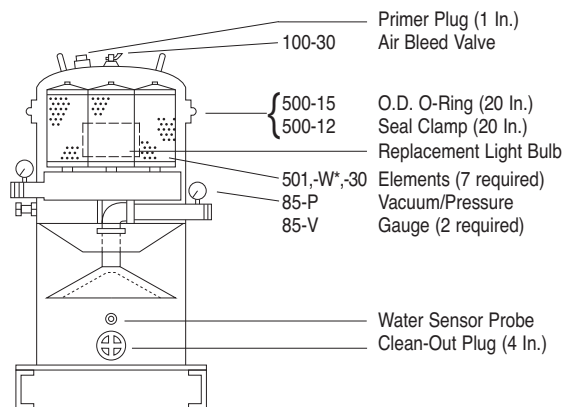

\* Standard with Unit Unless Stated.



**WARNING:** These products can expose you to chemicals, including Diisononyl Phthalate, Carbon black extracts, Nickel, 1,3 Butadiene, Ethylene Oxide, Epichlorohydrin, which are known to the State of California to cause cancer, and Bisphenol-A, Ethylene Glycol, Ethylene Oxide, 1,3 Butadiene, Epichlorohydrin, which are known to the State of California to cause birth defects or other reproductive harm.

# DAHL Hydraulic Recyclers

The DAHL Hydraulic Recyclers are specifically designed to remove emulsified water from hydraulic oils. Since water emulsified in hydraulic oil is not removed by the normal DAHL coalescing action, Hastings has designed a special filter element that absorbs water that has been emulsified in oil. The water remains in the filter element until the element is disposed. As the element absorbs water, the filtering media expands, increasing the restriction in the filter. By monitoring the pressure differential of the element, it is possible to determine when the element is saturated.

Two unique DAHL elements have been developed in conjunction with the hydraulic units. The first element is the 301-CS. The 301-CS contains a special polymer enhanced media that absorbs water regardless of emulsification. The element has the capacity to absorb over 1 1/2 quarts of water. (This is dependent upon oil viscosity, temperature and

other factors.) When the element becomes saturated, the water is disposed along with the element.

The second element is the 301-MPG. This has a synthetic grade media that is designed as a fine clean-up element. It has a Beta ratio of 2 at 3 micron and 100 at 12 micron, making this element an excellent choice for most hydraulic clean-up applications.

DAHL has designed two portable clean-up carts based on these hydraulic elements. The 300-DHRAP5 is designed for applications requiring larger quantities of water removal with less concern about contaminant removal. The 300-DHRAS5 is a two stage unit with one absorbing element and one clean-up element. To allow effective removal of emulsified water, these units are best used in multiple-pass applications.



**300-DHRAP5 Hydraulic Recycler**  
Portable Unit

**DAHL 300-DHRAP5:** Two DAHL 300 units mounted on a convenient dolly. The units are in a parallel arrangement using two of the special water absorbing elements (301-CS). A 5 GPM pump is furnished with the unit. The flow rate for this unit is dependent on the viscosity of the oil, but has been tested at about 200 gallons per hour initially with 20W SAE oil at room temperature. The flow rate will drop off as the element absorbs water. Included with the unit is a vacuum gauge that aids in monitoring the saturation of the filter. An automatic vacuum switch shuts the pump off at a predetermined vacuum setting to prevent pump and motor damage. Element water capacity is about 3 quarts.

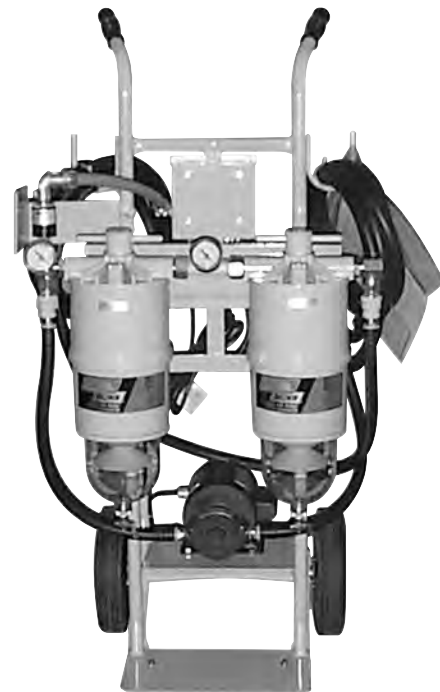

**300-DHRAS5 Hydraulic Recycler**  
Portable Unit

**DAHL 300-DHRAS5:** Two DAHL 300 units mounted on a convenient dolly. The units are connected in a series flow arrangement. The hydraulic oil flows through the first unit where Hastings' special water absorbing element (301-CS) absorbs the emulsified water. The hydraulic oil next flows to a second DAHL unit where the 301-MPG synthetic media element filters contaminants out of the oil. This unit is furnished with a 3 GPM pump. Two vacuum gauges monitor the pressure drop across both filters. An automatic vacuum switch shuts the pump off at a predetermined vacuum setting. Element water capacity is about 1 1/2 quarts.



**WARNING:** These products can expose you to chemicals, including Diisononyl Phthalate, Carbon black extracts, Nickel, 1,3 Butadiene, Ethylene Oxide, Epichlorohydrin, which are known to the State of California to cause cancer, and Bisphenol-A, Ethylene Glycol, Ethylene Oxide, 1,3 Butadiene, Epichlorohydrin, which are known to the State of California to cause birth defects or other reproductive harm.

# Accessories

## Heater Kits & Heater Parts

### In-Filter Heater Kits

Diesel fuel can become a problem in cold weather. Wax forms, plugging fuel lines and filters. DAHL has models 100-H and 150-H diesel fuel filter/water separators with the 55-EK Heater Kit included and models 200-H and 300-H with the 85-EK Heater Kit included. Or you can retrofit DAHL 100 and 150 series diesel fuel filter/water separators with the 55-EK Heater Kit. DAHL 200 and 300 series diesel fuel filter/water separators can be retrofitted with the 85-EK Heater Kit.

Both sizes feature an electric heating element between the body and the filter element. This simultaneously heats the filter element and the fuel around it.

An illuminated toggle switch conveniently located in the operator's area makes it easy to turn on and off. The unit is simple to install and operate. No seasonal adjustment or other maintenance is needed.

- Operates on 12 or 24 Volt Systems (Negative or Positive Ground)
- Low Amperage Requirements (Only 10 Amps at -40°F)
- Heats Fuel & Element



Use 55-EK for DAHL 100 or 150 Series and 85-EK (shown) for DAHL 200 or 300 Series

55-EK Numbers	Description & (Quantity)	85-EK Numbers
	Heater Element (1)	
100-21H	Heater Probes in Clear Bowl (1)	200-21H
	Bowl Gasket (1)	
	Toggle Switch & Connectors	
	Instructions	

55-EK has Replaced the 45-EK

## Sensors

**24-WLK** Dash-Mounted Water Sensor  
24 Volt Warning Light Kit

## DAHL Literature

All printed materials are listed here as individual items.

**Form 4005** DAHL Catalog  
**Form 4005-S** DAHL Catalog (Spanish)  
**Form 4011** DAHL 55-EK and 85-EK In-Filter Heater Kit Installation Instructions  
**Form 4012** Recycler, Recycler/Blender & Fuel Transfer Models - Installation, Operation, Parts & Service Information  
**Form 4013** DAHL 140-50 Hand Primer Kit  
**Form 4025** Model 150 - Installation, Operation, Parts & Service Information

**Form 4060** Model 65 & 75 - Installation, Operation, Parts & Service Information  
**Form 4100** Model 100 - Installation, Operation, Parts & Service Information  
**Form 4123** Marine - Installation, Operation, Parts & Service Information  
**Form 4230** Model 200 & 300 - Installation, Operation, Parts & Service Information  
**Form 4500** Model 500 - Installation, Operation, Parts & Service Information



**WARNING:** These products can expose you to chemicals, including Diisononyl Phthalate, Carbon black extracts, Nickel, 1,3 Butadiene, Ethylene Oxide, Epichlorohydrin, which are known to the State of California to cause cancer, and Bisphenol-A, Ethylene Glycol, Ethylene Oxide, 1,3 Butadiene, Epichlorohydrin, which are known to the State of California to cause birth defects or other reproductive harm.



# Accessories (Cont'd.)

## Vacuum Gauges

Vacuum gauges indicate the remaining life in filter elements. Replacement of the filter should be made when the gauge reading is 2-6 inches greater than the new element reading. (The exact reading depends on the characteristics of the fuel system, such as the engine, normal flow rate, component height, fuel line size, etc.)

To accurately determine when to replace the element, a reading of the gauge should be taken at the first noticeable power loss of the engine. Reduce this gauge reading by 1 inch of mercury for reference of future filter servicing.

The gauge is designed to be connected to the outlet side of the DAHL filter unit and can be mounted directly on the unit or dash-mounted.

- 85-V** Vacuum Gauge
- 85-P** Pressure Gauge

## Draincocks

- 60-30** 1/4 In. Draincock (See Model 65)
- 100-30** 1/4 In. Draincock
- 200-30U** 1/4 In. U.L. Approved Draincock

## Depressurizer Kits

- 100-DEPR KIT** Includes Depressurizer Set, Reverse Flow Gasket, Reverse Flow Washer and Reverse Flow Ball for 100 Series and 150 Series
- 200-DEPR KIT** Includes Depressurizer Set, Reverse Flow Gasket, Reverse Flow Washer and Reverse Flow Ball for 200 Series and 300 Series

## Mounting Bracket Kit

- 100-MNTG KIT** Includes Mounting Bracket, [2] Bracket Bolts, [2] Washers and [2] Nuts for 100 Series

## Gasket Kits

- 60-GK** Gaskets for 60, 65 & 75 Models includes Bowl Gasket, Bowl O-Ring, Hub Assembly Gasket and Primer Plug O-Ring
- 100-GK** Gaskets for 100 Series includes Bowl Gasket, [2] Bowl Plug Gaskets (older models), Centerpipe O-Ring, Lid Cover Gasket, Primer Plug O-Ring, Reverse Flow Gasket and Reverse Flow Washer
- 150-GK** Gaskets for 150 Series includes Bowl Gasket, [2] Bowl Plug Gaskets (older models), [2] Bowl Plug O-Rings, Centerpipe O-Ring, Lid Cover Gasket, Lid O-Ring, Primer Plug O-Ring, Reverse Flow Gasket, Reverse Flow Washer and T-Bolt O-Ring
- 200-GK** Gaskets for 200 & 300 Series includes Bowl Gasket, [2] Bowl Plug Gaskets (older models), Bowl Plug O-Ring, Centerpipe O-Ring, Lid Cover Gasket, Lower T-Bolt Seal, Nylon Gasket, [2] Primer Plug O-Rings, Reverse Flow Gasket, Reverse Flow Washer and T-Bolt O-Ring

## Hand Primers For DAHL Models 65, 75 & 100

- 140-50 KIT** 3/8 In. Fuel Hose

The DAHL primer is designed to make draining and/or element changing easy. Kits include primer bulb and 2 hose clamps.

## Marine Shield & Shock Pad Kits

- 185-DS** Aluminum Heat Deflector Shield for 100 & 150 Series
- 285-DS** Aluminum Heat Deflector Shield for 200 & 300 Series
- 186-SK** Mounting Bracket Shock Pad Kit for 100 Series
- 286-SK** Mounting Bracket Shock Pad Kit for 150, 200 & 300 Series



**WARNING:** These products can expose you to chemicals, including Diisononyl Phthalate, Carbon black extracts, Nickel, 1,3 Butadiene, Ethylene Oxide, Epichlorohydrin, which are known to the State of California to cause cancer, and Bisphenol-A, Ethylene Glycol, Ethylene Oxide, 1,3 Butadiene, Epichlorohydrin, which are known to the State of California to cause birth defects or other reproductive harm.

# DAHL Fittings Chart

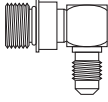
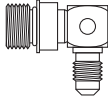
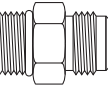
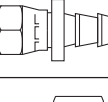
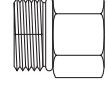
FITTING	FOR DAHL UNIT	THREAD 1	THREAD 2
<b>90° Elbow</b> Straight Thread with O-Ring/37° Male JIC 	65, 75 & 100 Series 65, 75 & 100 Series 150 & 200 Series 150 & 200 Series 300 Series 300 Series	9/16-18 UNF 9/16-18 UNF 7/8-14 UNF 7/8-14 UNF 1 1/16-12 UNF 1 1/16-12 UNF	7/16-20 9/16-18 3/4-16 7/8-14 7/8-14 1 1/16-12
<b>90° Elbow</b> Straight Thread with O-Ring/37° Male JIC Drilled & Tapped for #4 Vacuum Gauge Hose 	65, 75 & 100 Series 65, 75 & 100 Series 65, 75 & 100 Series 150 & 200 Series 150 & 200 Series 150 & 200 Series 150 & 200 Series 150 & 200 Series 300 Series 300 Series	9/16-18 UNF 9/16-18 UNF 9/16-18 UNF 7/8-14 UNF 7/8-14 UNF 7/8-14 UNF 7/8-14 UNF 7/8-14 UNF 1 1/16-12 UNF 1 1/16-12 UNF	7/16-20 9/16-18 9/16-18 3/4-16 3/4-16 3/4-16 3/4-16 7/8-14 7/8-14 1 1/16-12
<b>37° Male JIC</b> Straight Thread with O-Ring 	65, 75 & 100 Series 65, 75 & 100 Series 150 & 200 Series 150 & 200 Series 300 Series 300 Series	9/16-18 UNF 9/16-18 UNF 7/8-14 UNF 7/8-14 UNF 1 1/16-12 UNF 1 1/16-12 UNF	7/16-20 9/16-18 3/4-16 7/8-14 7/8-14 1 1/16-12
<b>37° Female JIC</b> Swivel-Push-On Hose Fitting 	65, 75 & 100 Series 150 & 200 Series 150, 200 & 300 Series 300 Series	7/16-20 3/4-16 7/8-14 1 1/16-12	1/4 Hose 1/2 Hose 5/8 Hose 3/4 Hose
<b>Female Pipe</b> Straight Thread with O-Ring 	65, 75 & 100 Series 65, 75 & 100 Series 150 & 200 Series 150 & 200 Series 150 & 200 Series 300 Series 300 Series	9/16-18 UNF 9/16-18 UNF 7/8-14 UNF 7/8-14 UNF 7/8-14 UNF 1 1/16-12 UNF 1 1/16-12 UNF	1/4-18 NPT 3/8-18 NPT 3/8-18 NPT 1/2-14 NPT 3/4-14 NPT 1/2-14 NPT 3/4-14 NPT
<b>90° Swivel Elbow</b> Straight Thread with O-Ring/37° Female JIC	300 Series	1 1/16-12 UNF	3/4-14
<b>90° Swivel Elbow</b> Straight Thread with O-Ring/37° Female JIC Drilled & Tapped for #4 Vacuum Gauge Hose	150 & 200 Series	7/8-14 UNF	1/2-14



**WARNING:** These products can expose you to chemicals, including Diisononyl Phthalate, Carbon black extracts, Nickel, 1,3 Butadiene, Ethylene Oxide, Epichlorohydrin, which are known to the State of California to cause cancer, and Bisphenol-A, Ethylene Glycol, Ethylene Oxide, 1,3 Butadiene, Epichlorohydrin, which are known to the State of California to cause birth defects or other reproductive harm.

# Replacement Parts

## Filter Bowls



- 60-21A** Amber Bowl for 60 & 65 Series — Draincock included
- 75-21** Aluminum Bowl for 75 Series
- 100-21** Clear Replacement Bowl for 100 & 150 Series
- 100-21AL** Aluminum Replacement Bowl for 100 & 150 Series
- 100-21BP** Clear Bowl w/Water Sensor Probes for 100 & 150 Series
- 100-21H** Clear Bowl w/Heater Probes for 100 & 150 Series (Part of 55-EK Heater Kit)
- 100-21M** Clear Bowl w/Marine Collar for 100 & 150 Series Marine Units
- 200-21** Clear Replacement Bowl for 200 & 300 Series
- 200-21AL** Aluminum Replacement Bowl for 200 & 300 Series
- 200-21BP** Clear Bowl w/Water Sensor Probes for 200 & 300 Series
- 200-21H** Clear Bowl w/Heater Probes for 200 & 300 Series (Part of 85-EK Heater Kit)
- 200-21HBP** Clear Bowl w/Water Sensor and Heater Probes for 200 & 300 Series (Upper Holes for Heater, Lower Holes for Bowl Probes)
- 200-21M** Clear Bowl w/Marine Collar for 200 & 300 Series Marine Units

## Filter Elements



As with all filter elements made by Hastings, you can be sure that DAHL filter elements are made just right. Not only do we make sure the paper conforms to our exacting requirements, but we also use more paper in a given size filter if this is needed to do the job. (The -W elements are designed for winter or severe conditions.)

- 61** 2 Micron Nominal (20 Absolute) Element for 60
- 61-W** 5 Micron Nominal (25 Absolute) Element for 60
- 66** 4 Micron Nominal (20 Absolute) Element for 65 & 75
- 66-W** 5 Micron Nominal (25 Absolute) Element for 65 & 75
- 66-30** 5 Micron Nominal (25 Absolute) Element for 65 & 75
- 101** 4 Micron Nominal (20 Absolute) Element for 100 Series
- 101-W** 5 Micron Nominal (25 Absolute) Element for 100 Series
- 101-30** 9 Micron Nominal (40 Absolute) Element for 100 Series
- 151** 4 Micron Nominal (20 Absolute) Element for 150 Series
- 151-W** 5 Micron Nominal (25 Absolute) Element for 150 Series
- 151-30** 9 Micron Nominal (40 Absolute) Element for 150 Series
- 201** 4 Micron Nominal (20 Absolute) Element for 200 Series
- 201-W** 5 Micron Nominal (25 Absolute) Element for 200 Series
- 201-30** 9 Micron Nominal (40 Absolute) Element for 200 Series
- 301** 5 Micron Absolute Element for 300 Series
- 301-W** 3 Micron Nominal (9 Absolute) Element for 300 Series
- 301-30** 9 Micron Nominal (40 Absolute) Element for 300 Series
- 301-CS** Water Absorbing Element for 300 Series
- 301-MPG** Maximum Performance Glass Element for 300 Series
- 501** 4 Micron Nominal (20 Absolute) Element for 500 Series
- 501-W** 5 Micron Nominal (25 Absolute) Element for 500 Series
- 501-30** 9 Micron Nominal (40 Absolute) Element for 500 Series

(See Product Guide for filter element specifications)

## DAHL Equivalents For Racor® Assemblies

Racor Assembly	Racor Flow (Max.)	DAHL Flow (Max.)	DAHL Assembly
200FG	15	30	65
200FGM	15	30	75
500FG	60	65	100
500MA	60	65	100-M
900FG	90	100	150
900MA	90	100	150-M
1000FG	180	200	200
1000MA	180	200	200-M
73/1000FG	360	400	200-MFV*
73/1000MA	360	400	200-MMV*
75/1000FG	360	400	200-MFV*
75/1000M	360	400	200-MMV*
79/1000FG	540	650	300-MFV3*
79/1000MA	540	650	300-MMV*

\* Unit includes shut-off valves.

## Replacements For Racor® Elements

Racor Element	Racor Housing	Hastings Element
<b>200 Series</b>		
2000SM-OR	.....	FF839
2000TM-OR	.....	
2000PM-OR	.....	
<b>500FG Series</b>		
2010SM-OR	.....	FF848
2010TM-OR	.....	FF1207
2010PM-OR	.....	FF1208
<b>900FG Series</b>		
2040SM-OR	.....	FF1232
2040TM-OR	.....	FF1233
2040PM-OR	.....	FF1234
<b>1000FG Series</b>		
2020SM-OR	.....	FF1235
2020TM-OR	.....	FF1236
2020PM-OR	.....	FF1237



**WARNING:** These products can expose you to chemicals, including Diisononyl Phthalate, Carbon black extracts, Nickel, 1,3 Butadiene, Ethylene Oxide, Epichlorohydrin, which are known to the State of California to cause cancer, and Bisphenol-A, Ethylene Glycol, Ethylene Oxide, 1,3 Butadiene, Epichlorohydrin, which are known to the State of California to cause birth defects or other reproductive harm.

## O-RING UNIFORM DASH NUMBERS

Uniform Dash Numbers represent specific sized O-Rings. The material used in the construction (or compound number) is added to the Dash Number to give a complete number, describing both size and material.

A filter will not filter if it does not seal, and it cannot seal without the right gasket. Order the gaskets you will need when you order your Baldwin filters.

### O-RING UNIFORM DASH NUMBERS TO BALDWIN NUMBERS

DASH NUMBER	BALDWIN NUMBER	DASH NUMBER	BALDWIN NUMBER	DASH NUMBER	BALDWIN NUMBER	DASH NUMBER	BALDWIN NUMBER	DASH NUMBER	BALDWIN NUMBER
014	100-17	162	G437	239	G229	254	G368	352	G445
017	150-17	212	ES1067	240	G162	255	G203	358	G433
018	200-17	213	ES3007	241	G410	257	G265	365	ES3020
037	ES1023	214	ES3028	242	G376	258	G444	371	G438
042	ES3009	222	ES3012	243	G402	259	G360	425	G290
110	ES1074	227	G441	244	G333	260	G359	427	G417
111	150-32	229	G173-C	245	G310	263	G382	429	G211
112	ES1036	231	G403	246	G447	263	G382-V	432	G446
113	ES1049	232	G283	248	G342	266	G412	433	G263
115	200-32	233	G270	249	G315	338	G232	438	G416
133	G328	235	G442	250	G443	340	G406	444	G206
140	G467	236	G247	251	G362	345	G219	445	G238
153	G387	237	G432	252	G347	348	G236-A	446	G157
156	G468	238	G366	253	G354	350	G439	906	ES3079

### BALDWIN NUMBERS TO O-RING UNIFORM DASH NUMBERS

BALDWIN NUMBER	DASH NUMBER	BALDWIN NUMBER	DASH NUMBER	BALDWIN NUMBER	DASH NUMBER	BALDWIN NUMBER	DASH NUMBER	BALDWIN NUMBER	DASH NUMBER
G157	446	G270	233	G368	254	G437	162	ES1049	113
G162	240	G283	232	G376	242	G438	371	ES1067	212
G173-C	229	G290	425	G382	263	G439	350	ES1074	110
G203	255	G310	245	G382-V	263	G441	227	ES3007	213
G206	444	G315	249	G387	153	G442	235	ES3009	042
G211	429	G328	133	G402	243	G443	250	ES3012	222
G219	345	G333	244	G403	231	G444	258	ES3020	365
G229	239	G342	248	G406	340	G445	352	ES3028	214
G232	338	G347	252	G410	241	G446	432	ES3079	906
G236-A	348	G354	253	G412	266	G447	246	100-17	014
G238	445	G359	260	G416	438	G467	140	150-17	017
G247	236	G360	259	G417	427	G468	156	150-32	111
G263	433	G362	251	G432	237	ES1023	037	200-17	018
G265	257	G366	238	G433	358	ES1036	112	200-32	115



**WARNING:** These products can expose you to chemicals, including Diisononyl Phthalate, Carbon black extracts, Nickel, 1,3 Butadiene, Ethylene Oxide, Epichlorohydrin, which are known to the State of California to cause cancer, and Bisphenol-A, Ethylene Glycol, Ethylene Oxide, 1,3 Butadiene, Epichlorohydrin, which are known to the State of California to cause birth defects or other reproductive harm.

## ROUND GASKETS ARRANGED BY O.D.

O.D. Inches	O.D. (mm)	I.D. Inches	I.D. (mm)	THICK Inches	THICK (mm)	CARQUEST NUMBER	O.D. Inches	O.D. (mm)	I.D. Inches	I.D. (mm)	THICK Inches	THICK (mm)	CARQUEST NUMBER
9/16	14.3	21/64	8.3	3/64	1.2	ES3063	3 3/4	95.3	3 1/2	88.9	1/8	3.2	G366
9/16	14.3	23/64	9.1	7/64	2.8	ES1074	3 49/64	95.6	3 11/32	84.9	13/64	5.2	G406
11/16	17.5	31/64	12.3	7/64	2.8	ES1036	3 49/64	95.6	3 13/32	86.5	1/16	1.6	G268
11/16	17.5	17/32	13.5	1/16	1.6	ES1375	3 55/64	98.0	3 19/32	91.3	9/64	3.6	G458
3/4	19.1	1/2	12.7	3/64	1.2	ES1034	3 7/8	98.4	3 11/16	93.7	1/8	3.2	G241
3/4	19.1	35/64	13.9	7/64	2.8	ES1049	3 57/64	98.8	3 39/64	91.7	9/64	3.6	G229
7/8	22.2	9/16	14.3	1/16	1.6	ES1001	3 57/64	98.8	3 23/32	94.5	1/8	3.2	G107
7/8	22.2	5/8	15.9	1/16	1.6	ES1376	3 15/16	100.0	2 9/32	57.9	1/32	0.8	ES4007
57/64	22.6	41/64	16.3	3/32	2.4	ES1066	3 63/64	101.2	3 43/64	93.3	1/8	3.2	G332
63/64	25.0	51/64	20.2	3/64	1.2	G340	4	101.6	3 5/16	84.1	3/32	2.4	G299
1	25.4	11/16	17.5	1/16	1.6	ES1377	4	101.6	3 3/4	95.3	9/64	3.6	G162
1 1/32	26.2	39/64	15.5	3/16	4.8	ES1068	4	101.6	3 49/64	95.6	1/8	3.2	G153
1 1/16	27.0	3/4	19.1	3/64	1.2	ES1032	4 1/16	103.2	3 1/2	88.9	3/32	2.4	G133
1 1/16	27.0	49/64	19.5	3/64	1.2	ES1071	4 1/16	103.2	3 37/64	90.9	3/32	2.4	G434
1 1/8	28.6	3/8	9.5	1/8	3.2	G39-AF	4 1/8	104.8	3 59/64	99.6	1/8	3.2	G435
1 9/64	29.0	55/64	21.8	9/64	3.6	ES1067	4 9/64	105.2	3 55/64	98.0	9/64	3.6	G410
1 3/16	30.2	27/64	10.7	1/8	3.2	G15-AF	4 5/32	105.6	3 55/64	98.0	1/16	1.6	G123
1 3/16	30.2	5/8	15.9	5/64	2.0	ES1030	4 11/64	106.0	3 15/16	100.0	3/32	2.4	G202
1 3/16	30.2	15/16	23.8	7/32	5.6	ES24-B	4 3/16	106.4	3 11/16	93.7	1/16	1.6	G120-A
1 1/4	31.8	9/16	14.3	1/8	3.2	G103-N	4 3/16	106.4	3 25/32	96.0	1/16	1.6	G105
1 17/64	32.1	63/64	25.0	9/64	3.6	ES3028	4 17/64	108.3	3 63/64	101.2	9/64	3.6	G376
1 5/16	33.3	3/4	19.1	3/32	2.4	ES1026	4 9/32	108.7	3 31/32	100.8	1/8	3.2	G220
1 21/64	33.7	61/64	24.2	11/64	4.4	ES24-D	4 5/16	109.5	3 15/16	100.0	1/16	1.6	G243-A
1 49/64	44.8	1 31/64	37.7	9/64	3.6	ES3012	4 21/64	109.9	3 27/32	97.6	3/8	9.5	G498-A
1 7/8	47.6	1 3/64	26.6	27/64	10.7	ES1031	4 11/32	110.3	4 3/32	104.0	1/8	3.2	G168-B
2 3/32	53.2	1 23/32	43.7	1/4	6.4	ES1092	4 3/8	111.1	4 1/8	104.8	1/8	3.2	G402
2 7/32	56.4	1 11/16	42.9	13/64	5.2	ES1369-A	4 25/64	111.5	3 31/32	100.8	13/64	5.2	G219
2 25/64	60.7	2 7/64	53.6	9/64	3.6	G441	4 25/64	111.5	4 1/64	102.0	3/16	4.8	G480
2 7/16	61.9	2 13/64	56.0	7/64	2.8	G467	4 7/16	112.7	4 15/64	107.6	7/64	2.8	G468
2 1/2	63.5	1 39/64	40.9	7/16	11.1	ES1039	4 1/2	114.3	4 19/64	109.1	1/8	3.2	G171
2 19/32	65.9	2 5/16	58.7	19/64	7.5	G431	4 33/64	114.7	4 15/64	107.6	9/64	3.6	G333
2 5/8	66.7	2 31/64	63.5	1/16	1.6	ES1023	4 33/64	114.7	4 17/64	108.3	3/32	2.4	G273
2 41/64	67.1	2 23/64	59.9	9/64	3.6	G173-C	4 17/32	115.1	4 1/64	102.0	1/16	1.6	G127
2 23/32	69.1	2 15/32	62.7	5/32	4.0	G204-A	4 19/32	116.7	4 3/16	106.4	5/32	4.0	G222-B
2 51/64	71.0	2 15/32	62.7	1/4	6.4	G449-B	4 5/8	117.5	4 17/32	115.1	1/8	3.2	G214
2 13/16	71.4	2 15/32	62.7	13/64	5.2	G381-A	4 41/64	117.9	3 61/64	100.4	19/32	15.1	G293-B
2 13/16	71.4	2 15/32	62.7	1/4	6.4	G401	4 41/64	117.9	4 23/64	110.7	9/32	7.1	G310
2 57/64	73.4	2 39/64	66.3	9/64	3.6	G403	4 41/64	117.9	4 13/32	111.9	1/8	3.2	G302
2 59/64	74.2	2 19/32	65.9	3/32	2.4	G103	4 11/16	119.1	4	101.6	1/16	1.6	G106
3 1/64	76.6	2 47/64	69.5	9/64	3.6	G283	4 23/32	119.9	4 7/16	112.7	1/8	3.2	G251
3 5/64	78.2	2 59/64	74.2	11/64	4.4	G165	4 47/64	120.3	4 11/32	110.3	1/16	1.6	G104
3 7/64	79.0	2 61/64	75.0	3/32	2.4	G161	4 49/64	121.0	4 11/32	110.3	1/4	6.4	G385
3 1/8	79.4	2 57/64	73.4	1/8	3.2	G172-A	4 49/64	121.0	4 23/64	110.7	13/64	5.2	G236-A
3 9/64	79.8	2 55/64	72.6	9/64	3.6	G270	4 49/64	121.0	4 31/64	113.9	9/64	3.6	G447
3 9/64	79.8	2 31/32	75.4	5/32	4.0	G239	4 13/16	122.2	4 3/8	111.1	1/16	1.6	G208-A
3 5/32	80.2	2 25/64	60.7	1/16	1.6	ES1303-B	4 55/64	123.4	4 29/64	113.1	13/64	5.2	G386
3 5/32	80.2	2 25/64	60.7	1/8	3.2	ES1303-A	4 15/16	125.4	3 15/16	100.0	1/32	0.8	ES4008
3 5/32	80.2	2 29/32	73.8	1/8	3.2	G147-A	4 15/16	125.4	4 13/32	111.9	1/16	1.6	G132
3 1/4	82.6	3 3/32	78.6	1/8	3.2	G323	4 15/16	125.4	4 19/32	116.7	13/64	5.2	G725
3 11/32	84.9	3 1/16	77.8	1/8	3.2	G233-A	4 63/64	126.6	4 47/64	120.3	7/32	5.6	G494
3 3/8	85.7	1 13/16	46.0	1/16	1.6	G303	4 63/64	126.6	4 3/8	111.1	3/16	4.8	G704
3 25/64	86.1	3 7/64	79.0	9/64	3.6	G442	4 21/32	118.3	4 21/32	118.3	3/16	4.8	G483
3 13/32	86.5	2 51/64	71.0	1/16	1.6	G379	5	127.0	4 23/32	119.9	1/8	3.2	G240
3 15/32	88.1	3 3/16	81.0	1/8	3.2	G233-B	5 1/64	127.4	4 35/64	115.5	3/32	2.4	G291
3 1/2	88.9	3 1/8	79.4	1/16	1.6	G274	5 1/64	127.4	4 19/32	116.7	13/64	5.2	G439
3 1/2	88.9	3 7/32	81.8	3/32	2.4	G255	5 1/64	127.4	4 47/64	120.3	9/64	3.6	G342
3 33/64	89.3	3 7/64	79.0	13/64	5.2	G232	5 1/64	127.4	4 25/32	121.4	1/8	3.2	G115-MSB
3 33/64	89.3	3 15/64	82.2	9/64	3.6	G247	5 1/64	127.4	4 25/32	121.4	1/8	3.2	G115-MSB
3 9/16	90.5	3 5/16	84.1	1/8	3.2	G344	5 1/32	127.8	4 51/64	121.8	3/32	2.4	G280
3 5/8	92.1	3 11/32	84.9	1/8	3.2	G432	5 3/64	128.2	4 1/2	114.3	13/32	10.3	G286-C
3 41/64	92.5	3 3/8	85.7	5/32	4.0	G264-A	5 3/32	129.4	4 45/64	119.5	3/16	4.8	G710
3 11/16	93.7	3 5/16	84.1	3/16	4.8	G436	5 3/32	129.4	4 45/64	119.5	3/16	4.8	G369-B
3 3/4	95.3	1 13/16	46.0	1/16	1.6	ES3029	5 1/8	130.2	4 45/64	119.5	3/16	4.8	G369-V
3 3/4	95.3	3 1/4	82.6	1/8	3.2	G183	5 1/8	130.2	3 9/16	90.5	1/32	0.8	G1086-AF
							5 1/8	130.2	4 3/8	111.1	3/32	2.4	G115-A
							5 1/8	130.2	4 5/8	117.5	1/16	1.6	G143



**WARNING:** These products can expose you to chemicals, including Diisononyl Phthalate, Carbon black extracts, Nickel, 1,3 Butadiene, Ethylene Oxide, Epichlorohydrin, which are known to the State of California to cause cancer, and Bisphenol-A, Ethylene Glycol, Ethylene Oxide, 1,3 Butadiene, Epichlorohydrin, which are known to the State of California to cause birth defects or other reproductive harm.

**ROUND GASKETS ARRANGED BY O.D.**

O.D. Inches	O.D. (mm)	I.D. Inches	I.D. (mm)	THICK Inches	THICK (mm)	CARQUEST NUMBER	O.D. Inches	O.D. (mm)	I.D. Inches	I.D. (mm)	THICK Inches	THICK (mm)	CARQUEST NUMBER
5 9/64	130.6	4 51/64	121.8	3/32	2.4	G184-A	7 3/64	179.0	6 27/64	163.1	5/64	2.0	G356
5 9/64	130.6	4 55/64	123.4	9/64	3.6	G315	7 1/8	181.0	6 7/16	163.5	5/64	2.0	G210
5 5/32	131.0	4 47/64	120.3	13/64	5.2	G372	7 1/4	184.2	5 11/16	144.5	61/64	24.2	G304
5 1/4	133.4	3 1/2	88.9	1/16	1.6	G253-A	7 7/16	188.9	5 1/2	139.7	1/16	1.6	G343-A
5 17/64	133.7	4 27/32	123.0	13/64	5.2	G445	7 33/64	190.9	7 15/64	183.8	9/64	3.6	G382
5 17/64	133.7	4 63/64	126.6	9/64	3.6	G443	7 33/64	190.9	7 15/64	183.8	9/64	3.6	G382-V
5 9/32	134.1	4 23/32	119.9	9/32	7.1	G417	7 53/64	198.8	7 29/64	189.3	9/32	7.1	G193
5 11/32	135.7	4 51/64	121.8	1/16	1.6	G257	7 29/32	202.2	7 29/64	189.3	7/32	5.6	ES3231
5 23/64	136.1	4 61/64	125.8	13/64	5.2	G392							
5 25/64	136.9	5 7/64	129.8	9/64	3.6	G362	8 17/64	209.9	7 63/64	202.8	9/64	3.6	G412
5 13/32	137.3	4 3/4	120.7	1/16	1.6	G296	8 9/32	210.3	7 23/32	196.1	9/32	7.1	G206
5 13/32	137.3	5 7/32	132.6	3/32	2.4	G260	8 1/2	215.9	7 31/32	202.4	17/64	6.7	G252
5 31/64	139.3	5 15/64	133.0	1/8	3.2	G397	8 17/32	216.7	7 31/32	202.4	9/32	7.1	G238
5 33/64	140.1	5 7/32	132.6	1/8	3.2	G307	8 5/8	219.1	6 5/8	168.3	1/16	1.6	G314
5 33/64	140.1	5 15/64	133.0	9/64	3.6	G347	8 57/64	225.8	8 15/32	215.1	13/64	5.2	G438
5 17/32	140.5	4 31/32	126.2	9/32	7.1	G211	8 31/32	227.8	8 15/32	215.1	15/64	6.0	G309-B
5 9/16	141.3	5 7/32	132.6	9/32	7.1	G717							
5 5/8	142.9	5 7/32	132.6	13/64	5.2	G278	9	228.6	8 15/32	215.1	9/32	7.1	G157
5 41/64	143.3	5 5/64	129.0	3/16	4.8	G380	9 5/8	244.5	7 3/4	196.9	1/16	1.6	G289
5 41/64	143.3	5 23/64	136.1	9/64	3.6	G354	9 3/4	247.7	8 5/16	211.1	1/32	0.8	G155
5 11/16	144.5	5 15/32	138.9	1/8	3.2	G196-B							
5 3/4	146.1	5 1/4	133.4	1/16	1.6	G169	11	279.4	9	228.6	1/4	6.4	G207-AF
5 3/4	146.1	5 15/32	138.9	9/64	3.6	G368	11	279.4	9 1/8	231.8	1/4	6.4	G472-AF
5 27/32	148.4	5 7/16	138.1	13/64	5.2	G394	11 1/16	281.0	10 3/16	258.8	7/16	11.1	G348-AF
5 7/8	149.2	5 3/8	136.5	1/16	1.6	G363	11 1/4	285.8	9 9/16	242.9	1/32	0.8	G261
5 7/8	149.2	5 39/64	142.5	9/64	3.6	G203	11 3/8	288.9	10 3/4	273.1	5/16	7.9	G31-AF
5 29/32	150.0	5 11/32	135.7	9/32	7.1	G446	11 49/64	298.8	11	279.4	1/2	12.7	G298-AF
5 15/16	150.8	5 23/32	145.3	1/8	3.2	G140-A							
5 63/64	152.0	5 25/64	136.9	1/16	1.6	G164-A	12	304.8	11 3/8	288.9	5/16	7.9	G37-AF
							12 5/8	320.7	11 5/8	295.3	2 1/8	54.0	G225-AF
6 1/64	152.8	5 19/32	142.1	13/64	5.2	G433	12 3/4	323.9	10 1/2	266.7	1/4	6.4	G21-AF
6 1/32	153.2	5 15/32	138.9	9/64	3.6	G263	12 7/8	327.0	10 5/8	269.9	3/8	9.5	G499-AF
6 1/32	153.2	5 17/32	140.5	3/32	2.4	G148							
6 3/64	153.6	5 49/64	146.5	1/16	1.6	G144	13	330.2	12 3/8	314.3	5/16	7.9	G34-AF
6 9/64	156.0	5 55/64	148.8	1/8	3.2	G265	13 11/32	338.9	13 3/16	335.0	5/64	2.0	G523-AF
6 15/64	158.4	5 53/64	148.0	13/64	5.2	G336	13 41/64	346.5	12 7/8	327.0	1/2	12.7	G501-AF
6 17/64	159.1	5 63/64	152.0	9/64	3.6	G444							
6 11/32	161.1	5 7/8	149.2	1/8	3.2	G409	14 3/8	365.1	13 3/8	339.7	2 3/16	55.6	G285-AF
6 25/64	162.3	6 7/32	158.0	9/32	7.1	G416	14 11/16	373.1	13	330.2	5/16	7.9	G534-AF
6 31/64	164.7	6 15/64	158.4	9/64	3.6	G360	14 13/16 x 7 1/2	376.2	12 15/16	328.6	1/32	0.8	G305
6 17/32	165.9	6 3/64	153.6	1/8	3.2	G411							
6 9/16	166.7	6 1/16	154.0	5/64	2.0	G102-A	15	381.0	12 3/4	323.9	1/4	6.4	G25-AF
6 5/8	168.3	5 1/2	139.7	1/32	0.8	G269	15	381.0	13	330.2	1/4	6.4	G422-AF
6 5/8	168.3	5 1/2	139.7	1/32	0.8	G281	15 3/4	400.1	13 3/4	349.3	7/32	5.6	G145-AF
6 49/64	171.8	6 31/64	164.7	9/64	3.6	G359							
6 31/32	177.0	6 15/32	164.3	17/64	6.7	G400	16	406.4	6 1/2	165.1	3/32	2.4	G306
7	177.8	5 1/8	130.2	1/16	1.6	G288	18 1/4	463.6	17 1/4	438.2	2 1/8	54.0	G141-AF



**WARNING:** These products can expose you to chemicals, including Diisononyl Phthalate, Carbon black extracts, Nickel, 1,3 Butadiene, Ethylene Oxide, Epichlorohydrin, which are known to the State of California to cause cancer, and Bisphenol-A, Ethylene Glycol, Ethylene Oxide, 1,3 Butadiene, Epichlorohydrin, which are known to the State of California to cause birth defects or other reproductive harm.

# SPIN-ON FILTERS BY TAP SIZE (U.S. THREAD)

THREAD I.D.	PER Inch	O.D. Inches	O.D. (mm)	LENGTH Inches	LENGTH (mm)	GASKET	FEATURES	BALDWIN NUMBER
3/8	18 NPT3	.....	76.2	2 25/32	.....			BT40015
3/8	24	3 7/16	.....	4 13/16	.....	D	[3] Included	BF939
7/16	20	3 7/16	.....	4 13/16	.....		ES1001, [1] Included	B4
7/16	20	3 7/16	.....	4 13/16	.....	D	[2] Included	BF938
5/8	11	3 11/16	.....	5 3/8	.....		G381-A	BF968
5/8	18	3 11/16	.....	3 7/8	.....	MO	G381-A	B296
5/8	18	3 11/16	.....	4 3/8	.....	MO	G381-A	BT341
5/8	18	3 11/16	.....	5 3/8	.....	MO	G381-A	B50
5/8	18	3 11/16	.....	5 3/8	.....	BP, MO	G381-A	BT541
5/8	18	3 11/16	.....	5 13/32	.....	AD, BP	G381-A	BT248
5/8	18	3 11/16	.....	6 5/8	.....	MO	G381-A	B164
5/8	18	4 1/4	.....	3 3/16	.....		[1] Included	B222
5/8	18	4 1/4	.....	3 3/16	.....	MO	[1] Included	B494
5/8	18	4 1/4	.....	5 7/8	.....		G401	B7124
11/16	16	3 11/16	.....	3 7/32	.....	BTE	G381-A	BW5182
11/16	16	3 11/16	.....	3 7/8	.....		G381-A	BF791
11/16	16	3 11/16	.....	4 3/8	.....	BTA PLUS	G381-A	BW5070
11/16	16	3 11/16	.....	4 3/8	.....	BTA PLUS	G381-A	BW5071
11/16	16	3 11/16	.....	4 3/8	.....	BTA PLUS	G381-A	BW5072
11/16	16	3 11/16	.....	4 3/8	.....		G381-A	B5088
11/16	16	3 11/16	.....	4 3/8	.....		G381-A	B5089
11/16	16	3 11/16	.....	4 3/8	.....	BTE	G381-A	BW5136
11/16	16	3 11/16	.....	4 13/32	.....	BTE	G381-A	BW5137
11/16	16	3 11/16	.....	5 11/32	.....	BTE	G381-A	BW5139
11/16	16	3 11/16	.....	5 3/8	.....	BTA PLUS	G381-A	BW5073
11/16	16	3 11/16	.....	5 3/8	.....	BTA PLUS	G381-A	BW5074
11/16	16	3 11/16	.....	5 3/8	.....	BTA PLUS	G381-A	BW5075
11/16	16	3 11/16	.....	5 3/8	.....	BTA PLUS	G381-A	BW5082
11/16	16	3 11/16	.....	5 3/8	.....		G381-A	B5090
11/16	16	3 11/16	.....	5 3/8	.....	BTE	G381-A	BW5138
11/16	16	3 11/16	.....	5 3/8	.....	BTE	G381-A	BW5143
11/16	16	3 11/16	.....	5 13/32	.....		G381-A	B5134
11/16	16	3 11/16	.....	5 13/32	.....	BTE, MO	G381-A	BW5200
11/16	16	3 11/16	.....	5 13/32	.....	BTA PLUS, MO	G381-A	BW5250
11/16	16	3 11/16	.....	7 5/32	.....	BTA PLUS	G381-A	BW5076
11/16	16	3 11/16	.....	7 5/32	.....	BTE	G381-A	BW5140
11/16	16	3 25/32	.....	4 1/32	.....		[3] Included	BF791-O
3/4	16	2 3/32	.....	4 25/32	.....		[1] Included	BF7839
3/4	16	2 9/16	.....	2 5/8	.....	AD, BP	[1] Included	B7356
3/4	16	2 9/16	.....	3 1/2	.....	AD, MBP	[1] Included	B37
3/4	16	2 9/16	.....	4 3/4	.....	AD, MBP	[1] Included	B7238
3/4	16	2 21/32	.....	3 1/2	.....	HBP	[1] Included	BT9388
3/4	16	2 11/16	.....	3	.....	AD, MBP	[1] Included	B33
3/4	16	2 11/16	.....	3	.....	AD, BPI	[1] Included	B7286
3/4	16	2 11/16	.....	3 1/2	.....	AD	[1] Included	B1406
3/4	16	2 25/32	.....	2 5/8	.....	AD, BPI	[1] Included	B7333
3/4	16	2 29/32	.....	3 1/2	.....	AD, BP	G449-B	BT223
3/4	16	2 29/32	.....	3 1/2	.....		[1] Included	B40036
3/4	16	2 29/32	.....	4 27/32	.....	AD, FECV, MBP	[1] Included	B1416
3/4	16	2 29/32	.....	4 27/32	.....	AD, FECV, SHBP	[1] Included	B40128
3/4	16	2 15/16	.....	4 27/32	.....	AD, SHBP	G449-B	B178
3/4	16	3	.....	2 9/32	.....	AD, SHBP	[1] Included	B7294
3/4	16	3	.....	2 27/32	.....	AD	[1] Included	B7049
3/4	16	3	.....	2 7/8	.....	AD, BP	G449-B	B1410
3/4	16	3	.....	3 1/8	.....		[1] Included	B7295
3/4	16	3	.....	3 1/2	.....	AD, SHBP	G449-B	B228
3/4	16	3	.....	3 1/2	.....	BP	G449-B	B1413
3/4	16	3	.....	3 17/32	.....	AD, MBP	G449-B	B7361
3/4	16	3	.....	3 17/32	.....	MBP	[1] Included	B7491
3/4	16	3	.....	3 17/32	.....	AD, MBP	[1] Included	BT8409
3/4	16	3	.....	3 27/32	.....	AD, BPI	[1] Included	B7275
3/4	16	3	.....	3 7/8	.....	AD, MBP	[1] Included	B7290
3/4	16	3	.....	4 1/16	.....	AD, BP	[1] Included	B159
3/4	16	3	.....	4 1/16	.....	AD, HBP	[1] Included	B1430
3/4	16	3	.....	4 3/32	.....	AD, MBP	[1] Included	B7020
3/4	16	3	.....	4 27/32	.....	AD, BP	G449-B	B243

## CAUTION!!!

### Read These Instructions Before Using Size Charts

The filter size charts on this and following pages are for filter experts. Careless use could lead to errors. When you have exhausted all other ways to determine a filter number, locate a suspect here, then check the Product Guide for confirmation.

Size alone does not assure you of the right filtering media, gasket or other features. What is being filtered, filter efficiency, flow rate and direction of flow all have to be considered.

Spin-on filters are listed by tap size rather than length. All other filters are listed on an overall basis. Check your Product Guide for other dimensions. Progression is from the smallest to the largest in each category.

### Do NOT Interchange Filters with Different Features

### Be Sure to Check Product Guide, Cross-References and Applications

### We Cannot be Responsible for Misapplications



**WARNING:** These products can expose you to chemicals, including Diisononyl Phthalate, Carbon black extracts, Nickel, 1,3 Butadiene, Ethylene Oxide, Epichlorohydrin, which are known to the State of California to cause cancer, and Bisphenol-A, Ethylene Glycol, Ethylene Oxide, 1,3 Butadiene, Epichlorohydrin, which are known to the State of California to cause birth defects or other reproductive harm.

# SPIN-ON FILTERS BY TAP SIZE (U.S. THREAD)

		THREAD I.D.	PER Inch	O.D. Inches	O.D. (mm)	LENGTH Inches	LENGTH (mm)	GASKET	FEATURES	BALDWIN NUMBER
<b>SPIN-ON FILTER FEATURES ARE CODED AS FOLLOWS</b>		3/4	16	3	76.2	5 3/32	129.4	AD	[1] Included	B143
		3/4	16	3	76.2	5 1/8	130.2	AD, ADP, BP	G449-B	BT215
		3/4	16	3 1/32	77.0	2 5/16	58.7	AD, BP	G449-B	BT765
		3/4	16	3 1/32	77.0	2 5/16	58.7	SHBP	G449-B	BT7410
		3/4	16	3 1/32	77.0	3 3/16	81.0		[1] Included	BT287
		3/4	16	3 1/32	77.0	3 7/16	87.3	AD, BP	[1] Included	B131
<b>AD</b>	Anti-Drainback Valve	3/4	16	3 1/32	77.0	3 1/2	88.9	AD, HBP	G449-B	B1405
<b>ADP</b>	Anti-Drainback Pipe	3/4	16	3 1/32	77.0	3 1/2	88.9	AD	G449-B	B1407
		3/4	16	3 1/32	77.0	3 1/2	88.9		[1] Included	BF7648
<b>BP</b>	8-10 PSID By-Pass Valve	3/4	16	3 1/32	77.0	3 1/2	88.9	HBP	[1] Included	BT8323
		3/4	16 UNF	3 1/32	77.0	3 1/2	88.9	AD, HBP	[1] Included	B40136
		3/4	16	3 1/32	77.0	4 1/16	103.2	AD	[1] Included	B113
<b>BPI</b>	By-Pass Included	3/4	16	3 1/32	77.0	4 3/32	103.6			BF46228
<b>BPS</b>	By-Pass Screen	3/4	16	3 1/32	77.0	4 3/32	104.0	AD, SHBP	[1] Included	BT139
		3/4	16	3 1/32	77.0	4 3/32	104.0	AD, HBP	[1] Included	BT7172
<b>BTA PLUS</b>		3/4	16	3 1/32	77.0	4 3/32	104.0		G449-B	BF7892
Balanced Treatment		3/4	16	3 1/32	77.0	4 3/32	104.0		[1] Included	BT8908
Additive Plus		3/4	16	3 1/32	77.0	4 13/16	122.2		[1] Included	BF13
<b>BTE</b>	Balanced Treatment for Ethylene Glycol Antifreeze	3/4	16	3 1/32	77.0	4 13/16	122.2	HBP	[1] Included	BT458
		3/4	16	3 1/32	77.0	5 1/2	139.7	XHBP	[1] Included	BF8384
		3/4	16	3 1/32	77.0	5 11/16	144.5	D, PS	G449-B	BF1275
		3/4	16	3 1/32	77.0	5 13/16	147.6		[1] Included	BF941
		3/4	16	3 1/32	77.0	5 13/16	147.6	AD, HBP	[1] Included	BT091
<b>D</b>	Drain	3/4	16	3 1/32	77.0	5 27/32	148.4	AD	[1] Included	B295
		3/4	16	3 1/32	77.0	5 27/32	148.4	AD, HBP	[1] Included	BT353
<b>FECV</b>	Front-End Check Valve	3/4	16	3 1/32	77.0	5 7/8	149.2		G449-B	BF330
		3/4	16	3 1/16	77.8	2 11/32	59.5	AD, HBP	G449-B	BT222
		3/4	16	3 1/16	77.8	3 7/16	87.3		[1] Included	BF954
<b>FP</b>	Fill Port	3/4	16	3 1/16	77.8	3 1/2	88.9			B40006
		3/4	16	3 3/32	78.6	3 31/32	100.8		[1] Included	BF7967
<b>HBP</b>	18-25 PSID High Pressure By-Pass Valve	3/4	16	3 1/8	79.4	3	76.2		[1] Included	BF7840
		3/4	16	3 1/8	79.4	3 21/32	92.9	MBP	[1] Included	BT434
		3/4	16	3 1/8	79.4	3 7/8	98.4		[1] Included	BF7841
<b>ISO</b>	Inside-Out Flow Direction	3/4	16	3 1/8	79.4	4 1/32	102.4	AD, MBP	[1] Included	BT433
		3/4	16	3 1/4	82.6	3 5/32	80.2	AD, MBP	[1] Included	BT119
<b>LBP</b>	2-7 PSID Low Pressure By-Pass Valve	3/4	16	3 5/16	84.1	4 5/8	117.5	SP	[1] Included	BF7598
		3/4	16	3 9/16	90.5	5 7/16	138.1	D, ISO, SP	[1] Included, G381-A	BF7532
		3/4	16	3 9/16	90.5	5 7/16	138.1	D, ISO, SP	[1] Included, G381-A	BF7535
		3/4	16	3 19/32	91.3	5 1/8	130.2	AD, HBP	[1] Included	BT369
		3/4	16	3 19/32	91.3	5 1/8	130.2	AD, MBP	[1] Included	BT470
<b>MBP</b>	11-17 PSID Medium Pressure By-Pass Valve	3/4	16	3 19/32	91.3	5 1/8	130.2		[1] Included	BF9843
		3/4	16	3 19/32	91.3	5 3/8	136.5	AD, MBP	[1] Included	BT473
		3/4	16	3 19/32	91.3	6 3/4	171.5	D	[1] Included	BF9849
<b>MO</b>	Metering Orifice	3/4	16	3 11/16	93.7	2 9/16	65.1	AD, BP	G381-A	BT221
<b>PS</b>	Integral Post Seal Gasket	3/4	16	3 11/16	93.7	2 29/32	73.8	AD, MBP	G401	BT8493
		3/4	16	3 11/16	93.7	3 1/4	82.6	AD, BP	G381-A	B132
		3/4	16	3 11/16	93.7	3 1/4	82.6	AD, HBP	G381-A	B1434
		3/4	16	3 11/16	93.7	3 1/4	82.6	AD, HBP	G381-A	BT152
		3/4	16	3 11/16	93.7	3 1/4	82.6	AD, MBP	G401	BT240
<b>PSR</b>	Post Seal Required; Must install loose O-Ring or D-Ring on Post for Seal	3/4	16	3 11/16	93.7	3 1/4	82.6	AD, MBP	[1] Included	BT511
		3/4	16	3 11/16	93.7	3 1/4	82.6		G324-A	BF7541
		3/4	16	3 11/16	93.7	3 1/4	82.6		G324-A	BF7666
		3/4	16	3 11/16	93.7	3 1/4	82.6		G381-A	BT40028
<b>RC</b>	Reinforced Centertube	3/4	16	3 11/16	93.7	3 7/8	98.4	AD, BP	G381-A	B34
<b>SHBP</b>	30-45 PSID Super High Pressure By-Pass Valve	3/4	16	3 11/16	93.7	3 7/8	98.4	AD, BP	G381-A	B120
		3/4	16 UNF	3 11/16	93.7	3 7/8	98.4		[1] Included	B163
		3/4	16	3 11/16	93.7	4 1/16	103.2		[1] Included	B40073
		3/4	16	3 11/16	93.7	4 11/32	110.3		G381-A	BT8916
<b>SP</b>	Sensor Port	3/4	16	3 11/16	93.7	4 3/8	111.1	AD, HBP	G381-A	B229
<b>XHBP</b>	50+ PSID Extra High Pressure By-Pass Valve	3/4	16	3 11/16	93.7	4 3/8	111.1	AD, BP	G381-A	B233
		3/4	16	3 11/16	93.7	4 3/8	111.1		G324-A	BF719
		3/4	16	3 11/16	93.7	4 3/8	111.1	AD, HBP	G381-A	BT7403
		3/4	16	3 11/16	93.7	4 3/8	111.1		G381-A	BF7559
		3/4	16	3 11/16	93.7	4 3/8	111.1	PS	G324-A	BF7602
		3/4	16	3 11/16	93.7	4 7/16	112.7	AD, SHBP	G401	B1429
		3/4	16	3 11/16	93.7	4 7/16	112.7	SHBP	G401	BT099
		3/4	16	3 11/16	93.7	4 7/16	112.7	AD, XHBP	G401	BT128
		3/4	16	3 11/16	93.7	4 15/32	113.5	AD, BP	G401	BT420
		3/4	16	3 11/16	93.7	4 1/2	114.3	AD, ADP, BP	[1] Included	BT7271



**WARNING:** These products can expose you to chemicals, including Diisononyl Phthalate, Carbon black extracts, Nickel, 1,3 Butadiene, Ethylene Oxide, Epichlorohydrin, which are known to the State of California to cause cancer, and Bisphenol-A, Ethylene Glycol, Ethylene Oxide, 1,3 Butadiene, Epichlorohydrin, which are known to the State of California to cause birth defects or other reproductive harm.



# SPIN-ON FILTERS BY TAP SIZE (U.S. THREAD)

THREAD I.D.	PER Inch	O.D. Inches	O.D. (mm)	LENGTH Inches	LENGTH (mm)	GASKET	FEATURES	BALDWIN NUMBER
3/4	16	3 11/16	93.7	5 3/8	136.5	HBP	G381-A	BT111
3/4	16	3 11/16	93.7	5 3/8	136.5	AD	G381-A	B118
3/4	16	3 11/16	93.7	5 3/8	136.5	AD, ADP, BP	G381-A	BT216
3/4	16	3 11/16	93.7	5 3/8	136.5	AD, HBP	G324-A	B244
3/4	16	3 11/16	93.7	5 3/8	136.5	AD, ADP, MBP	G381-A	B336
3/4	16	3 11/16	93.7	5 3/8	136.5		G381-A	BF797
3/4	16	3 11/16	93.7	5 3/8	136.5	AD, SHBP	G381-A	B7156
3/4	16	3 11/16	93.7	5 3/8	136.5	AD, ADP, BP	G381-A	B7467
3/4	16	3 11/16	93.7	5 3/8	136.5	ISO	[3] Included	BF7614
3/4	16	3 11/16	93.7	5 13/32	137.3	AD, BP, FECV	G381-A	B2
3/4	16	3 11/16	93.7	5 13/32	137.3	AD, BP, FECV	G381-A	B2-HPG
3/4	16	3 11/16	93.7	5 15/32	138.9	AD, HBP	G401	B252
3/4	16	3 11/16	93.7	5 15/32	138.9	AD, ADP, HBP	G401	B253
3/4	16	3 11/16	93.7	5 15/32	138.9	AD, BP	G401	BT8328
3/4	16	3 11/16	93.7	6 5/8	168.3	XHBP	G381-A	B481
3/4	16	3 11/16	93.7	7 1/8	181.0	AD, ADP, BP	G381-A	BT217
3/4	16	3 11/16	93.7	7 1/8	181.0	AD, ADP, BP	G381-A	BT237
3/4	16	3 11/16	93.7	7 1/8	181.0	AD, BP	G381-A	BT251
3/4	16	3 11/16	93.7	7 1/8	181.0		G381-A	B7231
3/4	16	3 11/16	93.7	7 1/8	181.0	AD, BP	G381-A	B7311-MPG
3/4	16	3 23/32	94.5	3 7/8	98.4		G324-A	BT8905
3/4	16	3 23/32	94.5	3 31/32	100.8	AD, BPI	[1] Included	B7298
3/4	16	3 23/32	94.5	4 15/32	113.5	AD	G401	B7047
3/4	16	3 3/4	95.3	3 13/16	96.8	AD, MBP	[1] Included	B7431
3/4	16	3 3/4	95.3	3 31/32	100.8	AD, HBP	G381-A	B74
3/4	16	3 3/4	95.3	3 31/32	100.8		G381-A	BT8301
3/4	16	3 3/4	95.3	3 31/32	100.8		G381-A	BT8486
3/4	16	3 3/4	95.3	5 9/32	134.1	AD, SHBP	G381-A	B114
3/4	16	3 3/4	95.3	5 9/32	134.1	AD	G381-A	B246
3/4	16	3 3/4	95.3	5 25/32	146.8	SHBP	[1] Included	BT8922
3/4	16	3 3/4	95.3	6 9/32	159.5	D	[1] Included	BF9904
3/4	16	3 25/32	96.0	5 9/32	134.1	AD	G381-A	B7022
3/4	16	3 13/16	96.8	5 29/32	150.0	SHBP	[1] Included	B7486
3/4	16	4 1/4	108.0	3 15/16	100.0	AD, BP	G381-A	BT5
3/4	16	4 1/4	108.0	3 15/16	100.0	PS	G381-A	BF7593
3/4	16	4 1/4	108.0	4 3/8	111.1	AD, FECV, SHBP	G381-A	B7219
3/4	16	4 1/4	108.0	5 11/16	144.5	ADP, SHBP	[1] Included	BD232
3/4	16	4 1/4	108.0	5 13/16	147.6	AD, HBP	G381-A	BT267
3/4	16	4 1/4	108.0	5 13/16	147.6	AD, ADP, SHBP	G381-A	BT348
3/4	16	4 1/4	108.0	5 13/16	147.6	AD, ADP, SHBP	G381-A	BT7316
3/4	16	4 1/4	108.0	5 7/8	149.2		G401	B7018
3/4	16	4 1/4	108.0	7 11/32	186.5	AD, HBP	G381-A	BT238
3/4	16	4 1/4	108.0	7 11/32	186.5	AD, ADP, SHBP	G381-A	BT347
3/4	16	4 1/4	108.0	7 11/32	186.5		G381-A	BF783
3/4	20	2 7/8	73.0	3	76.2	BP	[1] Included	BT8460
3/4	20	3 1/32	77.0	3 1/2	88.9		[1] Included	BT8413
3/4	20	3 11/16	93.7	4 3/8	111.1		G381-A	B369
3/4	20	3 11/16	93.7	5 3/8	136.5		G381-A	B5176
3/4	20	3 11/16	93.7	5 3/8	136.5	BTE	G381-A	BW5178
3/4	20	3 11/16	93.7	5 3/8	136.5	BTE, MO	G381-A	BW5201
3/4	20	3 11/16	93.7	5 3/8	136.5		G381-A	B7025
3/4	20	4 1/4	108.0	7 3/8	187.3		G401	B128
13/16	12	3 11/16	93.7	6 5/8	168.3	PS	[1] Included	BF7640
13/16	12	3 11/16	93.7	7 3/32	180.2	PS	[1] Included	BF5810
13/16	12	3 11/16	93.7	7 3/32	180.2	PS	[1] Included	BF5815
13/16	12	3 11/16	93.7	7 3/32	180.2	PS	[1] Included	BF5816
13/16	12	3 23/32	94.5	4 13/32	111.9	PS	[1] Included	BF593
13/16	12	4 1/4	108.0	7 5/8	193.7	PS	G381-A	BF7612
13/16	12	4 1/4	108.0	10 7/16	265.1	PS	G381-A	BF7613
13/16	16	3	76.2	3 1/2	88.9	AD	G449-B	B31
13/16	16	3	76.2	4 3/32	104.0	AD	G449-B	B1432
13/16	16	3	76.2	4 3/32	104.0		[1] Included	B7010
13/16	16	3	76.2	5 1/8	130.2		G449-B	B30
13/16	16	3 1/32	77.0	4 1/8	104.8	MBP	G449-B	B1447
13/16	16	3 1/32	77.0	4 13/16	122.2	SHBP	G449-B	BT8417
13/16	16	3 1/32	77.0	5 1/2	139.7	XHBP	[1] Included	BT9402
13/16	16	3 5/8	92.1	3 7/8	98.4	AD, MBP	[1] Included	B7291
13/16	16	3 11/16	93.7	2 29/32	73.8		G401	BT779
13/16	16	3 11/16	93.7	3 3/16	81.0	AD	[1] Included	B1438

## CAUTION!!! Read These Instructions Before Using Size Charts

The filter size charts on this and following pages are for filter experts. Careless use could lead to errors. When you have exhausted all other ways to determine a filter number, locate a suspect here, then check the Product Guide for confirmation.

Size alone does not assure you of the right filtering media, gasket or other features. What is being filtered, filter efficiency, flow rate and direction of flow all have to be considered.

Spin-on filters are listed by tap size rather than length. All other filters are listed on an overall basis. Check your Product Guide for other dimensions. Progression is from the smallest to the largest in each category.

## Do NOT Interchange Filters with Different Features

## Be Sure to Check Product Guide, Cross-References and Applications

## We Cannot be Responsible for Misapplications



**WARNING:** These products can expose you to chemicals, including Diisononyl Phthalate, Carbon black extracts, Nickel, 1,3 Butadiene, Ethylene Oxide, Epichlorohydrin, which are known to the State of California to cause cancer, and Bisphenol-A, Ethylene Glycol, Ethylene Oxide, 1,3 Butadiene, Epichlorohydrin, which are known to the State of California to cause birth defects or other reproductive harm.

# SPIN-ON FILTERS BY TAP SIZE (U.S. THREAD)

## A TYPICAL SPIN-ON

Spin-ons vary in size, media, fittings and other features. Let's look at the usual components.

### Spin-on Can



No housing to clean; faster to change.

### Baseplate and Seaming Cover Assembly



Size of mounting hole and gasket location determine if filter will seal. The baseplate is attached to the seaming cover and the seaming cover is attached to the can. (The gasket fits in the seaming cover.)

### Compression Spring



Holds element in place to maintain seal.

### Element End Caps

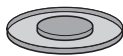

Closed End



Open End

End caps are bonded to the media.

### Filtering Media



Microlite® pleated paper comes in more than 60 types for exact filtering requirements.

### Centertube



Media is wrapped around the spiral perforated/louvered steel tube.

THREAD I.D.	PER Inch	O.D. Inches	O.D. (mm)	LENGTH Inches	LENGTH (mm)	GASKET	FEATURES	BALDWIN NUMBER
13/16	16	3 11/16	93.7	4 3/8	111.1	AD	G381-A	B39
13/16	16	3 11/16	93.7	4 3/8	111.1	LBP	G381-A	B358
13/16	16	3 11/16	93.7	5 5/16	134.9	AD, MBP	[1] Included	B1441
13/16	16	3 11/16	93.7	5 11/32	135.7		[1] Included	B6
13/16	16	3 11/16	93.7	5 11/32	135.7		[1] Included	B6-HPG
13/16	16	3 11/16	93.7	5 11/32	135.7	AD, HBP	[1] Included	B279
13/16	16	3 11/16	93.7	5 11/32	135.7	AD	[1] Included	B1428
13/16	16	3 11/16	93.7	5 3/8	136.5	AD	[1] Included	B9
13/16	16	3 11/16	93.7	5 3/8	136.5	BP	G381-A	BT112
13/16	16	3 11/16	93.7	5 13/32	137.3	HBP	G401	BT259
13/16	16	3 11/16	93.7	7 7/16	188.9	D	G381-A	BF974-D
13/16	16	3 11/16	93.7	8 11/16	220.7		[1] Included	B7
13/16	16	3 11/16	93.7	8 23/32	221.5	AD	G381-A	BT525
13/16	16	3 23/32	94.5	4 15/32	113.5	HBP	G401	BT344-S
13/16	16	3 23/32	94.5	5 15/32	138.9		G401	BT438
13/16	16	3 23/32	94.5	5 15/32	138.9	HBP	G401	B7359
13/16	16	3 3/4	95.3	6 1/32	153.2		[1] Included	BT8439-MPG
13/16	16	3 13/16	96.8	4 3/8	111.1		[1] Included	B27
13/16	16	3 13/16	96.8	4 3/8	111.1	AD, BP	[1] Included	BT241
13/16	16	3 13/16	96.8	4 3/8	111.1	AD	[1] Included	B360
13/16	16	4 1/4	108.0	7 11/32	186.5		G381-A	BT350
13/16	18	3	76.2	3 15/32	88.1	PS	G449-B	BF7969
13/16	18	3 11/16	93.7	4 11/16	119.1		G401	BF863
13/16	18	3 11/16	93.7	5 5/16	134.9	SP	G401, [2] Included	BF7985
13/16	18	3 11/16	93.7	5 13/32	137.3		G401, [1] O-Ring	BF7879
13/16	18	3 11/16	93.7	5 21/32	143.7	D	G401	BF896
13/16	18	3 11/16	93.7	6 1/8	155.6	PSR, SP	G401, [2] Included	BF7981
13/16	18	3 11/16	93.7	6 1/4	158.8	D, PSR	G401, [1] Included	BF1280
13/16	18	3 11/16	93.7	7 1/2	190.2	D	[2] Included	BF46170
13/16	18	4 1/4	108.0	7 11/32	186.5	PS	G381-A	BF877
13/16	18	4 1/4	108.0	8 1/8	206.4	D, PS	G381-A	BF1219
7/8	14	3	76.2	5 7/8	149.2	PS	G449-B	BF7531
7/8	14	3	76.2	7 1/8	181.0		[1] Included	BF7634
7/8	14	3 1/16	78.0	5 7/8	149.1			BF46176
7/8	14	3 11/16	93.7	4 3/8	111.1	AD, BP	G381-A	BT264
7/8	14	3 11/16	93.7	5 3/8	136.5	BP	G381-A	BT361
7/8	14	3 11/16	93.7	5 3/8	136.5	HBP	G381-A	BT395
7/8	14	3 11/16	93.7	5 3/8	136.5	PS	[1] Included	BF992
7/8	14	3 11/16	93.7	7 1/8	181.0	AD, BP	G381-A	BT126
7/8	14	3 11/16	93.7	7 1/8	181.0	PS	G381-A	BF7632
7/8	14	3 11/16	93.7	7 1/8	181.0	PS, PSR	G381-A	BF7917
							[1] O-Ring Included	
7/8	14	3 11/16	93.7	8 11/16	220.7	PS	G381-A	BF888
7/8	14	3 11/16	93.7	10 1/2	266.7	PS	G381-A	BF7631
7/8	14	3 23/32	94.5	7 5/32	181.8		G381-A, [1] Included	BF7815
7/8	14	3 23/32	94.5	7 5/32	181.8	PS, PSR	G381-A, [1] Included	BF7924
7/8	14	3 3/4	95.3	6 1/32	153.2	BPS, XHBP	[1] Included	BT8843-MPG
7/8	14	4 1/4	108.0	4 11/16	119.1	PS	G381-A	BF786
7/8	14	4 1/4	108.0	6 11/16	169.9	D, PS	[1] Included	BF7853
7/8	14	4 1/4	108.0	7	177.8	PS	G401	BF7629
7/8	14	4 1/4	108.0	7 11/32	186.5	PS	G381-A	BF588
7/8	14	4 1/4	108.0	8 17/32	216.7	D, PS	G401	BF7584
7/8	14	4 3/8	111.1	8 11/16	220.7	PS	[2] Included	BF9866-O
7/8	14	4 13/32	111.9	5 29/32	150.0		[1] Included	BF7717
7/8	16	4 1/4	108.0	7 11/32	186.5	AD, HBP	G381-A	BT124
7/8	16	4 1/4	108.0	7 11/32	186.5	AD	G381-A	BT521
7/8	16	4 1/4	108.0	7 11/32	186.5	PS	G381-A	BF876
7/8	16	4 1/4	108.0	7 11/32	186.5	PS	G381-A	BF7911
7/8	16	4 1/4	108.0	7 3/8	187.3	AD	G401	B326
15/16	16	3 11/16	93.7	4 23/32	119.9	PSR	ES24-B, G401	BF862
15/16	16	3 11/16	93.7	5 3/8	136.5	PS	G381-A	BF583
15/16	16	3 11/16	93.7	5 3/8	136.5	PSR	G381-A, [1] Included	BF962
15/16	16	3 11/16	93.7	5 13/32	137.3	PSR	ES24-B, G401	BF582
15/16	16	3 11/16	93.7	7 3/16	182.6	PS, PSR	ES24-B, G401	BF591
15/16	16	3 11/16	93.7	7 17/32	191.3	D, PSR	ES24-B, G401	BF597
15/16	16	4 1/4	108.0	8 17/32	216.7	D, ISO	G401	BF1211
15/16	16	4 1/4	108.0	11 11/32	288.1	D, ISO	G401	BF1210



**WARNING:** These products can expose you to chemicals, including Diisononyl Phthalate, Carbon black extracts, Nickel, 1,3 Butadiene, Ethylene Oxide, Epichlorohydrin, which are known to the State of California to cause cancer, and Bisphenol-A, Ethylene Glycol, Ethylene Oxide, 1,3 Butadiene, Epichlorohydrin, which are known to the State of California to cause birth defects or other reproductive harm.

# SPIN-ON FILTERS BY TAP SIZE (U.S. THREAD)

THREAD I.D.	PER Inch	O.D. Inches	O.D. (mm)	LENGTH Inches	LENGTH (mm)	GASKET	FEATURES	BALDWIN NUMBER
31/32	20	3 21/32	92.9	5 3/8	136.5		G381-A	B7395
31/32	20	3 21/32	92.9	5 5/8	142.9		G381-A	BT606-MPG
31/32	20	3 21/32	92.9	5 5/8	142.9	HBP	[1] Included	BT8440-MPG
1	12	3	76.2	4 27/32	123.0	AD, HBP	[1] Included	B1435
1	12	3 19/32	91.3	5 1/8	130.2	AD, SHBP	[1] Included	B7370
1	12	3 19/32	91.3	5 7/16	138.1	HBP	[1] Included	B7465
1	12	3 19/32	91.3	5 5/8	142.9	AD, HBP	[1] Included	B7457
1	12	3 19/32	91.3	5 5/8	142.9	SHBP	[1] Included	B7462
1	12	3 19/32	91.3	6 5/8	168.3	AD, HBP	[1] Included	B7387
1	12	3 19/32	91.3	6 5/8	168.3	SHBP	[1] Included	B7461
1	12	3 19/32	91.3	7 9/16	192.1	HBP	[1] Included	B7474
1	12	3 19/32	91.3	8 1/8	206.4	AD, SHBP	[1] Included	B7367
1	12	3 19/32	91.3	8 1/8	206.4	AD, SHBP	[1] Included	B7392
1	12	3 19/32	91.3	8 1/8	206.4	HBP	[1] Included	B7475
1	12	3 21/32	92.9	4 1/4	108.0		[1] Included	BT8918
1	12	3 21/32	92.9	6 25/32	172.2	XHBP	[1] Included	BT8926
1	12	3 11/16	93.7	3 1/4	82.6	BP	G381-A	BT346
1	12	3 11/16	93.7	3 1/4	82.6	LBP	G381-A	BT357
1	12	3 11/16	93.7	3 1/4	82.6	AD, SHBP	G381-A	BT220
1	12	3 11/16	93.7	3 31/32	100.8	AD, HBP		B40070
1	12	3 11/16	93.7	4 1/8	104.8	PS	[3] Included	BF1278-O
1	12	3 11/16	93.7	4 11/32	110.3		[1] Included	BF592
1	12	3 11/16	93.7	4 3/8	111.1	SHBP	G381-A	BT536
1	12	3 11/16	93.7	4 3/8	111.1	ADP, BPI	[1] Included	BT274
1	12	3 11/16	93.7	4 3/8	111.1		G381-A	BF7968
1	12	3 11/16	93.7	4 7/16	112.7	AD, HBP	G401	B7424
1	12	3 11/16	93.7	5 11/32	135.7		[1] Included	BF7774
1	12	3 11/16	93.7	5 3/8	136.5	BP	G381-A	BT274
1	12	3 11/16	93.7	5 3/8	136.5	AD, SHBP	G381-A	BT292
1	12	3 11/16	93.7	5 3/8	136.5	HBP	G381-A	BT364
1	12	3 11/16	93.7	5 3/8	136.5		G381-A	BF956
1	12	3 11/16	93.7	5 3/8	136.5		G381-A	BF955
1	12	3 11/16	93.7	5 3/8	136.5	AD, SHBP	G381-A	BT320
1	12	3 11/16	93.7	5 3/8	136.5		G381-A	BT8445
1	12	3 11/16	93.7	5 13/32	137.3	HBP	G401	BT452
1	12	3 11/16	93.7	5 13/32	137.3		G401	BT839
1	12	3 11/16	93.7	5 13/32	137.3		G401	BT839-10
1	12	3 11/16	93.7	5 13/32	137.3		G401	BT8420
1	12	3 11/16	93.7	5 13/32	137.3		G401	BT8501-MPG
1	12	3 11/16	93.7	5 13/32	137.3		G401	BT8502
1	12	3 11/16	93.7	5 13/32	137.3	AD, HBP	[1] Included	B40120
1	12	3 11/16	93.7	5 15/32	138.9		G401	B255
1	12	3 11/16	93.7	5 15/32	138.9		G401	BT8428-MPG
1	12	3 11/16	93.7	5 15/32	138.9		[1] Included	BT9465
1	12	3 11/16	93.7	5 15/32	138.9	AD, XHBP	[1] Included	BT23611
1	12	3 11/16	93.7	5 5/8	142.9		G381-A	BF7750
1	12	3 11/16	93.7	6 1/16	154.0	SHBP	G401	BT8415
1	12	3 11/16	93.7	6 1/8	155.6	D	[1] Included	BF781
1	12	3 11/16	93.7	6 5/32	156.4	D, PSR	ES24-D, [1] Included	BF1266
1	12	3 11/16	93.7	6 7/32	158.0	D	[1] Included	BF1278
1	12	3 11/16	93.7	6 5/8	168.3	HBP	G381-A	BT342
1	12	3 11/16	93.7	6 5/8	168.3	AD, SHBP	G381-A	B7031
1	12	3 11/16	93.7	6 5/8	168.3	SHBP	G381-A	B7089
1	12	3 11/16	93.7	6 5/8	168.3	HBP	G381-A	B7215
1	12	3 11/16	93.7	7 1/8	181.0	AD, BP	G381-A	B167
1	12	3 11/16	93.7	7 1/8	181.0	AD, ADP	G381-A	BT261
1	12	3 11/16	93.7	7 1/8	181.0		G381-A	BF971
1	12	3 11/16	93.7	7 1/8	181.0	AD, BP	G381-A	B975
1	12	3 11/16	93.7	7 1/8	181.0	SHBP	[1] Included	BT40032
1	12	3 11/16	93.7	7 5/32	181.8	AD, ADP	G401	B299
1	12	3 11/16	93.7	7 3/16	182.6		G401	BT365
1	12	3 11/16	93.7	7 3/16	182.6		G401	BT365-10
1	12	3 11/16	93.7	7 3/16	182.6		G401	BF7606
1	12	3 11/16	93.7	7 3/16	182.6		G401	BT8900
1	12	3 11/16	93.7	7 13/32	188.1	D	[1] Included	BF1213
1	12	3 11/16	93.7	7 13/32	188.1	D	[1] Included	BF7759
1	12	3 11/16	93.7	7 7/16	188.9	D	G381-A	BF915
1	12	3 11/16	93.7	8 1/8	206.4	AD, SHBP	G381-A	B236
1	12	3 11/16	93.7	8 1/8	206.4	AD, XHBP	G381-A	B403

## SPIN-ON FEATURES

Some spin-ons have no additional features while others have several. Here are some of the more important spin-on features:

### Anti-Drainback Valve



As the name implies, this valve keeps the oil from draining from a filter when the engine is shut off. (Some filters include an anti-drainback standpipe for the same function). The mounting direction determines the need for this feature.

### By-Pass Valve



Full-flow oil systems require a by-pass (relief) valve either in the system or in the filter. This valve opens at a predetermined setting to assure oil flow to the bearings at all times.

### Integral Post Seal



Seals threaded stud to prevent tiny particles from spiraling in via the threads.

**We Cannot be Responsible for Misapplications**



**WARNING:** These products can expose you to chemicals, including Diisononyl Phthalate, Carbon black extracts, Nickel, 1,3 Butadiene, Ethylene Oxide, Epichlorohydrin, which are known to the State of California to cause cancer, and Bisphenol-A, Ethylene Glycol, Ethylene Oxide, 1,3 Butadiene, Epichlorohydrin, which are known to the State of California to cause birth defects or other reproductive harm.

# SPIN-ON FILTERS BY TAP SIZE (U.S. THREAD)

		THREAD I.D.	PER Inch	O.D. Inches	O.D. (mm)	LENGTH Inches	LENGTH (mm)	GASKET	FEATURES	BALDWIN NUMBER
<b>SPIN-ON FILTER FEATURES ARE CODED AS FOLLOWS</b>		1	12	3 11/16	93.7	8	203.2		[1] Included	BF5800
		1	12	3 11/16	93.7	8 1/8	206.4	XHBP	G381-A	B7143
		1	12	3 11/16	93.7	8 1/8	206.4	AD, FECV, XHBP	G381-A	B7170
		1	12	3 11/16	93.7	8 23/32	221.5	SHBP	G381-A	B262
		1	12	3 11/16	93.7	8 23/32	221.5	FECV, SHBP	G381-A	BT778
		1	12	3 11/16	93.7	8 23/32	221.5		[1] Included	BF9913
<b>AD</b>	Anti-Drainback Valve	1	12	3 11/16	93.7	8 25/32	223.0		G401	BT8903
		1	12	3 11/16	93.7	8 13/16	223.8	D	[1] Included	BF5813
<b>ADP</b>	Anti-Drainback Pipe	1	12	3 23/32	94.5	3 5/16	84.1	AD, SHBP	G401	BT9456
<b>BP</b>	8-10 PSID By-Pass Valve	1	12	3 23/32	94.5	5 21/32	143.7	PS	G401	BF7987
		1	12	3 23/32	94.5	5 21/32	143.7	PS	G401	BF7988
		1	12	3 23/32	94.5	6 23/32	170.7	AD	G401	BT7044
<b>BPI</b>	By-Pass Included	1	12	3 23/32	94.5	6 23/32	170.7	SHBP	G401	BT8512
		1	12	3 23/32	94.5	7 7/32	183.4		G401	BT8347
<b>BPS</b>	By-Pass Screen	1	12	3 23/32	94.5	8 1/8	206.4		[1] Included	BT8497-MPG
<b>BTA PLUS</b>		1	12	3 23/32	94.5	8 3/16	208.0		G401	BT8443
	Balanced Treatment Additive Plus	1	12	3 23/32	94.5	8 3/16	208.0		[1] Included	BT8444
		1	12	3 23/32	94.5	8 7/32	208.8	SHBP	G401	BT735
		1	12	3 23/32	94.5	8 9/32	210.3	SHBP		B9601
<b>BTE</b>	Balanced Treatment for Ethylene Glycol Antifreeze	1	12	3 23/32	94.5	8 7/8	225.4	SHBP	G401	BT739
		1	12	UNF-2B 3 3/4	95.3	7 13/32	188.1		[3] Included	BF5813-O
		1	12	3 25/32	96.0	3 1/4	82.6		[2] Included	BF46017-O
<b>D</b>	Drain	1	12	3 25/32	96.0	4 1/32	102.4		[3] Included	BF7968-O
		1	12	3 25/32	96.0	4 27/32	123.0	AD, SHBP	[1] Included	BT9553
<b>FECV</b>	Front-End Check Valve	1	12	3 13/16	96.8	3 13/16	96.8	AD, HBP	[1] Included	BT9561
		1	12	4 1/32	102.4	11	279.4	D	[1] Included	BF46071
		1	12	4 7/32	107.2	5 1/8	130.2	AD, ADP, PS	[1] Included	BD142
<b>FP</b>	Fill Port	1	12	4 1/4	108.0	4 1/32	102.4	AD, SHBP	[1] Included	BT7131
		1	12	4 1/4	108.0	4 13/32	111.9	HBP	[1] Included	BT7385
<b>HBP</b>	18-25 PSID High Pressure By-Pass Valve	1	12	4 1/4	108.0	4 13/32	111.9	HBP	[1] Included	BT7386
		1	12	4 1/4	108.0	4 11/16	119.1	AD, HBP	G381-A	B447
		1	12	4 1/4	108.0	4 3/4	120.7	AD, SHBP	[1] Included	BT7373
<b>ISO</b>	Inside-Out Flow Direction	1	12	4 1/4	108.0	5 13/16	147.6	MBP	[1] Included	BT7130
		1	12	4 1/4	108.0	5 13/16	147.6	AD, MBP	[1] Attached	B40054
		1	12	UNF-2B 4 1/4	108.0	5 27/32	148.4	AD, MBP	[1] Included	BT7144
<b>LBP</b>	2-7 PSID Low Pressure By-Pass Valve	1	12	4 1/4	108.0	5 7/8	149.2	HBP	G401	BT355
		1	12	4 1/4	108.0	5 7/8	149.2	BP	G401	BT7009
		1	12	4 1/4	108.0	5 7/8	149.2	AD, HBP	[1] Included	BT7389
<b>MBP</b>	11-17 PSID Medium Pressure By-Pass Valve	1	12	4 1/4	108.0	7 3/8	187.3		G401	B129
		1	12	4 1/4	108.0	7 3/8	187.3	HBP	G401	B157
		1	12	4 1/4	108.0	7 3/8	187.3		G401	B309
		1	12	4 1/4	108.0	9 1/8	231.8		G401	B263
<b>MO</b>	Metering Orifice	1	12	4 1/4	108.0	9 1/8	231.8	AD, HBP	G401	BT349
		1	12	4 1/4	108.0	9 1/8	231.8	SHBP	G401	BT7151
<b>PS</b>	Integral Post Seal Gasket	1	12	4 1/4	108.0	9 3/16	233.4	AD, ADP, SHBP	G401	BT8302
		1	12	4 1/4	108.0	11 11/16	296.9	D, PS, SP	[1] Included	BF1353-SPS
<b>PSR</b>	Post Seal Required; Must install loose O-Ring or D-Ring on Post for Seal	1	12	4 9/32	108.7	11 7/32	285.0	D, PS, SP	[1] Included, [1] O-Ring	BF1285-SP
		1	12	4 11/32	110.3	8 1/2	215.9		[2] Included	BF46101-O
		1	12	4 17/32	115.3	6 9/16	166.9			BF46109-O
		1	12	4 17/32	115.3	7 5/32	181.9			BF46123-O
<b>RC</b>	Reinforced Centertube	1	14	3 1/32	77.0	7 1/8	181.0		G449-B	BF7637
		1	14	3 1/4	82.6	6 21/32	169.1		[1] Included	BF9876
<b>SHBP</b>	30-45 PSID Super High Pressure By-Pass Valve	1	14	3 19/32	91.3	6 23/32	170.7		[1] Included	BF9854
		1	14	3 19/32	91.3	7 7/8	200.0	D, PS	[1] Included	BF9831
		1	14	3 5/8	92.2	7 13/32	188.2		[3] Included	BF7798-O
		1	14	3 21/32	92.7	4 1/32	102.4		[1] Included, [1] O-Ring	BF7806-O
<b>SP</b>	Sensor Port	1	14	3 21/32	92.9	4 1/8	104.8	PS	[2] Included	BF9922-O
<b>XHBP</b>	50+ PSID Extra High Pressure By-Pass Valve	1	14	3 21/32	92.9	4 19/32	116.7		[3] Included	BF1282-O
		1	14	3 21/32	92.9	5 5/8	142.9	PS	[3] Included	BF1366-O
		1	14	3 21/32	92.9	5 5/8	142.9	ISO, PS	[2] Included	BF1398-O
		1	14	3 21/32	92.9	6 5/8	168.3	PS	[3] Included	BF1249-O
		1	14	3 21/32	92.9	8 3/8	212.7	SP, D, PSR	[2] Included	BF46065-SPS
	<b>Do NOT Interchange Filters with Different Features</b>	1	14	UNF-B 3 11/16	93.7	3 13/16	96.8		G381-A	BT8499
		1	14	3 11/16	93.7	4 1/32	102.4		[2] Included	BF46022-O
		1	14	3 11/16	93.7	4 1/16	103.2		[2] Included	BF46021-O



**WARNING:** These products can expose you to chemicals, including Diisononyl Phthalate, Carbon black extracts, Nickel, 1,3 Butadiene, Ethylene Oxide, Epichlorohydrin, which are known to the State of California to cause cancer, and Bisphenol-A, Ethylene Glycol, Ethylene Oxide, 1,3 Butadiene, Epichlorohydrin, which are known to the State of California to cause birth defects or other reproductive harm.

# SPIN-ON FILTERS BY TAP SIZE (U.S. THREAD)

THREAD I.D.	PER Inch	O.D. Inches	O.D. (mm)	LENGTH Inches	LENGTH (mm)	GASKET	FEATURES	BALDWIN NUMBER
1	14	3 11/16	93.7	4 1/8	104.8	PS	[2] Included	BF9926-O
1	14	3 11/16	93.7	4 3/8	111.1	PSR	ES24-D, G381-A	BF948
1	14	3 11/16	93.7	4 11/16	119.1	D, PSR	G381-A	BF948-JD
1	14	3 11/16	93.7	5 7/32	132.6	D, ISO	[1] Included	BF1253
1	14	3 11/16	93.7	5 5/16	134.9	PS	G381-A	BF984
1	14	3 11/16	93.7	5 11/32	135.7		[1] Included	BF585
1	14	3 11/16	93.7	5 7/16	138.1	PSR	ES24-D, G381-A	BF957
1	14	3 11/16	93.7	5 7/16	138.1	D, PSR	ES24-D, G381-A	BF957-D
1	14	3 11/16	93.7	5 5/8	142.9	D, PS, PSR	ES3028, G381-A	BF1248
1	14	3 11/16	93.7	5 11/16	144.5	D, PS	G381-A	BF891
1	14	3 11/16	93.7	5 11/16	144.5		G401, [1] Included	BF7760
1	14	3 11/16	93.7	6 1/16	154.0	D, ISO, PS	[1] Included	BF1204
1	14	3 11/16	93.7	6 1/16	154.0	D, ISO, PS, SP	[2] Included	BF1204-SP
1	14	3 11/16	93.7	6 1/16	154.0	D, ISO, PS	[1] Included	BF1205
1	14	3 11/16	93.7	6 1/16	154.0	D, ISO, PS, SP	[2] Included	BF1205-SP
1	14	3 11/16	93.7	6 1/16	154.0	D, PSR, SP	[1] Included, [1] O-Ring	BF1270-SP
1	14	3 11/16	93.7	6 5/32	156.4	D, PSR	ES24-D, G381-A	BF1282
1	14	3 11/16	93.7	6 3/16	157.2	D, PS, PSR	ES24-D, G381-A	BF1220
1	14	3 11/16	93.7	6 7/32	158.0	D, FECV	[1] Included	BF7806
1	14	3 11/16	93.7	6 11/16	169.9	PS	G401	BF7529
1	14	3 11/16	93.7	6 11/16	169.9	PS	G401	BF7923
1	14	3 11/16	93.7	6 31/32	177.0	D, PS, PSR	ES24-D, G401	BF7546
1	14	3 11/16	93.7	7 1/8	181.0	PS	G381-A	BF970
1	14	3 11/16	93.7	7 1/8	181.0	PS	G381-A	BF991
1	14	3 11/16	93.7	7 1/8	181.0	PSR	ES24-D, G381-A	BF7557
1	14	3 11/16	93.7	7 1/8	181.0	PS	G381-A	BF7633
1	14	3 11/16	93.7	7 3/8	187.3	D, PS	G381-A	BF1225
1	14	3 11/16	93.7	7 3/8	187.3	D, PS	G381-A	BF1268
1	14	3 11/16	93.7	7 3/8	187.3	D, SP	G381-A, [1] Included	BF1385-SPS
1	14	3 11/16	93.7	7 13/32	188.1	D, PS	G381-A	BF1214
1	14	3 11/16	93.7	7 13/32	188.1	D, PSR	ES24-D, G381-A	BF1252
1	14	3 11/16	93.7	7 13/32	188.1	D	G381-A, [1] O-Ring	BF1376
1	14	3 11/16	93.7	7 7/16	188.9	D, PSR	ES24-D, G381-A	BF1212
1	14	3 11/16	93.7	7 7/16	188.9	D, PSR	ES24-D, G381-A	BF1258
1	14	3 11/16	93.7	7 13/16	198.4	D, PSR, SP	[1] Included, [1] O-Ring	BF1350-SP
1	14	3 11/16	93.7	7 13/16	198.4	D, PSR, SP	[1] Included, [1] O-Ring	BF1384-SP
1	14	3 11/16	93.7	7 31/32	202.7			BF46143
1	14	3 11/16	93.7	8 1/32	204.0	PSR	ES24-D, G381-A	BF5801
1	14	3 11/16	93.7	8 23/32	221.5	PS	G381-A	BF978
1	14	3 11/16	93.7	8 23/32	221.5	PS	G381-A	BF979
1	14	3 11/16	93.7	8 23/32	221.5	PSR	ES24-D, G381-A	BF7558
1	14	3 11/16	93.7	8 25/32	223.0	PS	G401	BF577
1	14	3 11/16	93.7	8 13/16	223.8	D, PS, PSR, SP	G381-A, [2] Included	BF1393-SP
1	14	3 11/16	93.7	8 27/32	224.6	D, PSR	ES24-D, G381-A	BF5812
1	14	3 11/16	93.7	8 7/8	225.4	D, SP	G401	BF1394-SP
1	14	3 11/16	93.7	8 29/32	226.2	D, PSR	ES24-D, G381-A	BF1249
1	14	3 11/16	93.7	8 29/32	226.2	D, PSR, SP	ES24-D, G381-A	BF1249-SP
1	14	3 11/16	93.7	9 1/32	229.4	D, PS	G381-A	BF892
1	14	3 11/16	93.7	9 15/32	240.5	D, PSR, SP	ES24-D, G381-A	BF1272-SPS
1	14	3 11/16	93.7	9 17/32	242.1	D, PSR	ES24-D, G381-A	BF1259
1	14	3 11/16	93.7	9 17/32	242.1	PSR, SP	G401, [1] Included, [1] O-Ring	BF7798-SP
1	14	3 11/16	93.7	10 1/32	254.8	ADP, D, SP, SPR	G381-A	BF1293-SPS
1	14	3 11/16	93.7	10 1/2	266.7	PS	G381-A	BF614
1	14	3 11/16	93.7	10 1/2	266.7		G381-A	BF7587
1	14	3 11/16	93.7	10 1/2	266.7		[1] I. Gasket	BF7753
1	14	3 23/32	94.2	5 23/32	145.5			BF46175
1	14	3 23/32	94.5	7 15/16	201.6	D	G381-A, [1] O-Ring	BF1279
1	14	3 23/32	94.5	8 1/8	206.4	SHBP	G401	B7357
1	14	3 23/32	94.5	8 7/32	208.8		G401	BF9927
1	14	3 23/32	94.5	10 1/32	254.8	D, PSR, SP	G381-A, ES24-D	BF1378-SPS
1	14	3 5/16	95.1	3 15/16	83.6			BF46162-O
1	14	3 3/4	95.3	3 9/16	90.5		[2] Included	BF46023-O
1	14	3 3/4	95.3	3 9/16	90.5		[2] Included	BF46024-O
1	14	3 3/4	95.3	4 21/32	118.3		[2] Included	BF46026-O

## CAUTION!!! Read These Instructions Before Using Size Charts

The filter size charts on this and following pages are for filter experts. Careless use could lead to errors. When you have exhausted all other ways to determine a filter number, locate a suspect here, then check the Product Guide for confirmation.

Size alone does not assure you of the right filtering media, gasket or other features. What is being filtered, filter efficiency, flow rate and direction of flow all have to be considered.

Spin-on filters are listed by tap size rather than length. All other filters are listed on an overall basis. Check your Product Guide for other dimensions. Progression is from the smallest to the largest in each category.

**Do NOT Interchange Filters with Different Features**  
**Be Sure to Check Product Guide, Cross-References and Applications**

**We Cannot be Responsible for Misapplications**



**WARNING:** These products can expose you to chemicals, including Diisononyl Phthalate, Carbon black extracts, Nickel, 1,3 Butadiene, Ethylene Oxide, Epichlorohydrin, which are known to the State of California to cause cancer, and Bisphenol-A, Ethylene Glycol, Ethylene Oxide, 1,3 Butadiene, Epichlorohydrin, which are known to the State of California to cause birth defects or other reproductive harm.

# SPIN-ON FILTERS BY TAP SIZE (U.S. THREAD)

## A TYPICAL SPIN-ON

Spin-ons vary in size, media, fittings and other features. Let's look at the usual components.

### Spin-on Can



No housing to clean; faster to change.

### Baseplate and Seaming Cover Assembly



Size of mounting hole and gasket location determine if filter will seal. The baseplate is attached to the seaming cover and the seaming cover is attached to the can. (The gasket fits in the seaming cover.)

### Compression Spring



Holds element in place to maintain seal.

### Element End Caps



Closed End

Open End

End caps are bonded to the media.

### Filtering Media



Microlite® pleated paper comes in more than 60 types for exact filtering requirements.

### Centertube

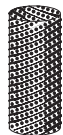

Media is wrapped around the spiral perforated/louvered steel tube.

THREAD I.D.	PER Inch	O.D. Inches	O.D. (mm)	LENGTH Inches	LENGTH (mm)	GASKET	FEATURES	BALDWIN NUMBER
1	14	3 3/4	95.3	4 11/16	119.1	PS	[2] Included	BF1204-O
1	14	3 3/4	95.3	5 17/32	140.5		[2] Included	BF46025-O
1	14	3 25/32	96.0	4 1/32	102.4	PS	[2] Included	BF46029-O
1	14	3 25/32	96.0	5 1/2	139.7		[3] Included	BF46030-O
1	14	3 13/16	96.8	3 9/32	83.3		[2] Included	BF46019-O
1	14	3 13/16	96.8	3 9/32	83.3		[1] Included,	BF46020-O
							[1] O-Ring	
1	14	4	101.6	4 1/16	103.2		[2] Included	BF46028-O
1	14	4 1/32	102.4	11	279.4	D	[1] Included	BF46072
1	14	4 5/32	105.6	6 5/16	160.3	PS	[2] Included	BF1292-O
1	14	4 7/32	106.9	5 1/32	127.5		[2] Included	BF46182-O
1	14	4 7/32	107.4	6 1/8	155.3		[2] Included	BF46169-O
1	14	4 1/4	108.0	3 15/32	88.1	PS	[2] Included	BF9912-O
1	14	4 1/4	108.0	3 17/32	89.7	PS	[2] Included	BF1389-O
1	14	4 1/4	108.0	4 1/8	104.8	PS	[2] Included	BF1222-O
1	14	4 1/4	108.0	5 1/32	127.8		[2] Included	BF1295-O
1	14	4 1/4	108.0	5 3/32	129.4		[2] Included	BF46147-O
		UNS-2B						
1	14	4 1/4	108.0	5 1/8	130.2	PS	[2] Included	BF1388-O
1	14	4 1/4	108.0	5 3/16	131.8	PS	[3] Included	BF1348-O
1	14	4 1/4	108.0	5 3/16	131.8	PS	[2] Included	BF1386-O
1	14	4 1/4	108.0	5 7/32	132.6	PS	[2] Included	BF1223-O
1	14	4 1/4	108.0	5 9/32	134.1	PS	[1] Included,	
							[1] O-Ring	BF1345-O
1	14	4 1/4	108.0	5 1/2	139.7		[2] Included	BF46031
1	14	4 1/4	108.0	5 21/32	143.5		[2] Included	BF46181-O
1	14	4 1/4	108.0	5 11/16	144.5	PS	[1] Included	BF9816
1	14	4 1/4	108.0	5 25/32	146.8		[1] Included	BF46085
1	14	4 1/4	108.0	5 29/32	150.0	PS	[1] Included	BF1224
1	14	4 1/4	108.0	6 1/8	155.6			BF46163-O
		UNS						
1	14	4 1/4	108.0	6 5/32	156.4	PS	[2] Included	BF1298-O
1	14	4 1/4	108.0	6 7/32	158.0	PS	[2] Included	BF46100-O
1	14	4 1/4	108.0	6 9/32	159.5	PS	[2] Included	BF46098-O
1	14	4 1/4	108.0	6 5/16	160.3	PS	[2] Included	BF1346-O
1	14	4 1/4	108.0	6 5/16	160.3	PS	[2] Included	BF1387-O
1	14	4 1/4	108.0	6 5/16	160.3	PS	[2] Included	BF9898-O
1	14	4 1/4	108.0	6 5/16	160.3		[2] Included	BF9925-O
1	14	4 1/4	108.0	6 13/32	162.7		[2] Included	BF1296-O
1	14	4 1/4	108.0	6 9/16	166.7	D, PS, PSR, SP	G401, [1] O-Ring	BF1273-SP
1	14	4 1/4	108.0	6 9/16	166.7	D, PS, SP	[1] Included	BF1345
1	14	4 1/4	108.0	6 9/16	166.7	D, PS, SP	[2] Included	BF1345-SP
1	14	4 1/4	108.0	6 25/32	172.2	D, PS	[1] Included	BF1223
1	14	4 1/4	108.0	6 25/32	172.2	D, PS, SP	[2] Included	BF1223-SP
1	14	4 1/4	108.0	6 25/32	172.2	D, PS	G401	BF1240
1	14	4 1/4	108.0	6 13/16	173.0	D	[1] Included	BF1362
1	14	4 1/4	108.0	7 5/32	181.8	PS	[2] Included	BF1294-O
1	14	4 1/4	108.0	7 15/32	189.7	ADP, D, PSR, SP	[1] Included,	
							[1] O-Ring	BF9811-SP
1	14	4 1/4	108.0	7 5/8	193.7	ADP, PSR, SP	[3] Included	BF1399-SP
1	14	4 1/4	108.0	7 13/16	198.4	PS	[2] Included	BF1299-O
1	14	4 1/4	108.0	7 29/32	200.8	FP, PS	[1] Included	BF880-FP
1	14	4 1/4	108.0	8 9/32	210.3	D, PS	[1] Included	BF1346
1	14	4 1/4	108.0	8 9/32	210.3	D, PSR, SP	[1] Included,	
							[1] O-Ring	BF1346-SP
1	14	4 1/4	108.0	8 9/32	210.3	D, PS	[1] Included	BF1347
1	14	4 1/4	108.0	8 17/32	216.7		[2] Included	BF46018-O
1	14	4 1/4	108.0	8 19/32	218.3	PS	[2] Included	BF46099-O
1	14	4 1/4	108.0	8 21/32	219.9	PS	[2] Included	BF1391-O
1	14	4 1/4	108.0	8 21/32	219.9	PS	[3] Included	BF9921-O
1	14	4 1/4	108.0	9 7/32	234.2	D, SP	[1] Included,	BF1374-SP
							[1] O-Ring	
1	14	4 1/4	108.0	9 7/32	234.2	ADP, D, SP	[3] Included	BF9903-SP
1	14	4 1/4	108.0	9 11/32	237.3	ADP, PSR, SP	[1] Included	BF1397-SP
1	14	4 1/4	108.0	9 3/8	238.1	D, PSR, SP	[1] Included,	BF1382-SP
							[1] O-Ring	
1	14	4 1/4	108.0	9 31/32	253.2	D	[1] Included	BF1377
1	14	4 1/4	108.0	10 7/16	265.1	PS	G381-A	BF584
1	14	4 1/4	108.0	10 7/16	265.1	PS	G381-A	BF584-B
1	14	4 1/4	108.0	10 19/32	269.0			BF46073



**WARNING:** These products can expose you to chemicals, including Diisononyl Phthalate, Carbon black extracts, Nickel, 1,3 Butadiene, Ethylene Oxide, Epichlorohydrin, which are known to the State of California to cause cancer, and Bisphenol-A, Ethylene Glycol, Ethylene Oxide, 1,3 Butadiene, Epichlorohydrin, which are known to the State of California to cause birth defects or other reproductive harm.

# SPIN-ON FILTERS BY TAP SIZE (U.S. THREAD)

THREAD I.D.	PER Inch	O.D. Inches	O.D. (mm)	LENGTH Inches	LENGTH (mm)	GASKET	FEATURES	BALDWIN NUMBER
1	14	4 1/4	108.0	11 1/8	282.6	D, PS, SP	[1] Included, [1] O-Ring	BF1359-SP
1	14	4 1/4	108.0	11 7/32	285.0	D	[1] Included	BF1363
1	14	4 1/4	108.0	11 5/16	287.3	D, PS	G401	BF1218
1	14	4 1/4	108.0	11 11/16	296.9	D, PS, SP	[1] Included	BF1354-SPS
1	14	4 9/32	108.7	5 1/4	133.4	D, PS	[1] Included	BF1222
1	14	4 9/32	108.7	5 1/4	133.4	D, PS, SP	[2] Included	BF1222-SP
1	14	4 9/32	108.7	5 21/32	143.7		[2] Included	BF1360-O
1	14	4 9/32	108.7	7 3/32	180.2	PS	[1] Included	BF9832
1	14	4 9/32	108.7	7 1/8	181.0	D	[1] Included	BF9869
1	14	4 9/32	108.7	8 1/32	204.0		[1] Included	BF9844
1	14	4 9/32	108.7	8 1/8	206.4	D, PS	[1] Included	BF1329
1	14	4 9/32	108.7	8 1/8	206.4	D, PS, SP	[2] Included	BF1329-SP
1	14	4 9/32	108.7	8 1/8	206.4	D, PS, PSR, SP	[1] Included, [1] O-Ring	BF1330-SP
1	14	4 9/32	108.7	8 1/8	206.4	D, PS, PSR, SP	[1] Included, [1] O-Ring	BF1339-SP
1	14	4 9/32	108.7	8 1/8	206.4	D, PS, PSR, SP	[2] Included	BF1360-SP
1	14	4 9/32	108.7	8 1/8	206.4	D, PS, SP	[1] Included, [1] O-Ring	BF1373-SP
1	14	4 9/32	108.7	8 7/32	208.8	D, PS	[1] Included	BF1349
1	14	4 9/32	108.7	8 7/32	208.8	D, PS	[1] Included	BF1360
1	14	4 9/32	108.7	9 3/32	231.0	PS	[2] Included	BF1297-O
1	14	4 9/32	108.7	9 3/32	231.0		[2] Included	BF1383-O
1	14	4 9/32	108.7	9 31/32	253.2	D, PS	[1] Included	BF1375
1	14	4 9/32	108.7	10 25/32	273.8	D	[1] Included	BF9818
1	14	4 9/32	108.7	11	279.4	D, PS, SP	[1] Included, [1] O-Ring	BF1358-SP
1	14	4 9/32	108.7	11 7/32	285.0	D, PS	[1] Included	BF1283
1	14	4 9/32	108.7	11 7/32	285.0	D, PS, PSR, SP	G579, [1] Included	BF1395-SP
1	14	4 9/32	108.7	11 5/16	287.3	D, PS	[1] Included	BF1265
1	14	4 9/32	108.7	11 5/16	287.3	D, PS	[1] Included	BF1281
1	14	4 9/32	108.7	11 5/16	287.3	D, PS, PSR, SP	[1] Included, [1] O-Ring	BF1283-SP
1	14	4 5/16	109.5	5 29/32	150.0	PS	[1] Included	BF7628
1	14	4 5/16	109.5	6 3/16	157.5		[2] Included	BF46124-O
1	14	4 5/16	109.5	6 5/16	160.3	PS	[2] Included	BF9871-O
1	14	4 5/16	109.5	6 25/32	172.2	D, PS	[1] Included	BF1231
1	14	4 5/16	109.5	6 25/32	172.2	D, PS	[1] Included	BF1348
1	14	4 5/16	109.5	6 25/32	172.2	D, PS, SP	[2] Included	BF1348-SP
1	14	4 5/16	109.5	6 25/32	172.2	D, PS	[1] Included	BF1370
1	14	4 11/32	110.3	6 1/8	155.6	PS	[2] Included	BF46016-O
1	14	4 11/32	110.3	6 3/16	157.2	PS	[2] Included	BF1390-O
1	14	4 11/32	110.3	6 13/32	162.7		[2] Included	BF1290-O
1	14	4 11/32	110.3	8 1/2	215.9		[2] Included	BF46105-O
UN5	14	4 11/32	110.3	9 1/4	235.0	PS	[1] Included	BF9917
1	14	4 11/32	110.3	9 11/16	246.1		[2] Included	BF9880
1	14	4 3/8	111.1	3 1/2	88.9	PS	[2] Included	BF46027-O
1	14	4 3/8	111.1	6 7/32	158.0	PS	[2] Included	BF1347-O
UN5-2B	14	4 13/32	111.9	7 1/4	184.2	D	[1] Included	BF46122
1	14	4 13/32	111.9	8 19/32	218.3	PS	[2] Included	BF1281-O
1	14	4 13/32	111.9	8 19/32	218.3	PS	[3] Included	BF1283-O
1	14	4 13/32	111.9	8 19/32	218.3	PS	[2] Included	BF1358-O
1	14	4 13/32	111.9	8 19/32	218.3	PS	[3] Included	BF1395-O
1	14	4 13/32	111.9	8 21/32	219.9	PS	[2] Included	BF9867-O
1	14	4 1/2	114.3	6 3/16	157.2	PS	[2] Included	BF46083-O
1	16	3 11/16	93.7	5 3/8	136.5		[1] Included	BT427
1	16	3 11/16	93.7	5 3/8	136.5	AD, MBP	G381-A	B7014
1	16	3 11/16	93.7	5 3/8	136.5		G381-A	B7117
1	16	3 11/16	93.7	5 3/8	136.5		G381-A	B7351-MPG
1	16	3 11/16	93.7	5 3/8	136.5	AD	G381-A	B7420
1	16	3 11/16	93.7	5 3/8	136.5	AD	G381-A	B7440
1	16	3 11/16	93.7	6 7/16	163.5	AD, HBP	G381-A	B7379
1	16	3 11/16	93.7	6 9/16	166.7	SHBP	G381-A	B7362
1	16	3 11/16	93.7	7 1/8	181.0		G381-A	BT339
1	16	3 11/16	93.7	7 1/8	181.0	AD	G381-A	B7181
1	16	3 11/16	93.7	7 1/8	181.0	Venturi-Type Cone	[1] Included	BD7317
1	16	3 11/16	93.7	7 1/8	181.0		G381-A	BT7349

## SPIN-ON FEATURES

Some spin-ons have no additional features while others have several. Here are some of the more important spin-on features:

### Anti-Drainback Valve



As the name implies, this valve keeps the oil from draining from a filter when the engine is shut off. (Some filters include an anti-drainback standpipe for the same function). The mounting direction determines the need for this feature.

### By-Pass Valve

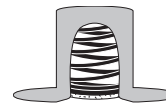

Full-flow oil systems require a by-pass (relief) valve either in the system or in the filter. This valve opens at a predetermined setting to assure oil flow to the bearings at all times.

### Integral Post Seal



Seals threaded stud to prevent tiny particles from spiraling in via the threads.

**We Cannot be Responsible for Misapplications**



**WARNING:** These products can expose you to chemicals, including Diisononyl Phthalate, Carbon black extracts, Nickel, 1,3 Butadiene, Ethylene Oxide, Epichlorohydrin, which are known to the State of California to cause cancer, and Bisphenol-A, Ethylene Glycol, Ethylene Oxide, 1,3 Butadiene, Epichlorohydrin, which are known to the State of California to cause birth defects or other reproductive harm.

# SPIN-ON FILTERS BY TAP SIZE (U.S. THREAD)

		THREAD I.D.	PER Inch	O.D. Inches	O.D. (mm)	LENGTH Inches	LENGTH (mm)	GASKET	FEATURES	BALDWIN NUMBER
<b>SPIN-ON FILTER FEATURES ARE CODED AS FOLLOWS</b>		1	16	3 11/16	93.7	7 5/32	181.8	AD	G381-A	B7372
		1	16	4 1/4	108.0	5 13/16	147.6	BTE	[1] Included	BW5179
		1	16	4 1/4	108.0	5 13/16	147.6		[1] Included	B5177
		1	16	4 1/4	108.0	5 13/16	147.6		G381-A	BT564
		1	16	4 1/4	108.0	7 11/32	186.5		G381-A	BT440
		1	16	4 9/32	108.7	8 3/4	222.3	HBP	[1] Included	B7506
<b>AD</b>	Anti-Drainback Valve									
<b>ADP</b>	Anti-Drainback Pipe	1 1/16	16	4 1/4	108.0	10 7/16	265.1	PS	[1] Included	BF976
		1 1/16	16	4 21/32	118.3	9 1/2	241.3	PS	[1] Included	BF785
<b>BP</b>	8-10 PSID By-Pass Valve	1 1/16	16	4 21/32	118.3	9 1/2	241.3	PS	[1] Included	BF7697
		1 1/8	12	3 11/16	93.7	7 1/8	181.0		[1] Included	B7375
<b>BPI</b>	By-Pass Included	1 1/8	16	3 5/8	92.1	7 1/8	181.0		[1] Included	B7497
		1 1/8	16	3 11/16	93.7	3 7/32	81.8			BT367-S
<b>BPS</b>	By-Pass Screen	1 1/8	16	3 11/16	93.7	4 5/16	109.5	PS		B7024
<b>BTA PLUS</b>		1 1/8	16	3 11/16	93.7	4 11/32	110.3			BT367
	Balanced Treatment Additive Plus	1 1/8	16	3 11/16	93.7	5 3/8	136.5		G381-A	BT230
		1 1/8	16	3 11/16	93.7	5 3/8	136.5		G381-A	BT260
		1 1/8	16	3 11/16	93.7	5 3/8	136.5		G381-A	BT260-10
<b>BTE</b>	Balanced Treatment for Ethylene Glycol Antifreeze	1 1/8	16	3 11/16	93.7	5 3/8	136.5		G381-A	BT334
		1 1/8	16	3 11/16	93.7	5 3/8	136.5	BP	G381-A	BT354
		1 1/8	16	3 11/16	93.7	5 3/8	136.5		G381-A	BT9442-MPG
		1 1/8	16	3 11/16	93.7	5 5/8	142.9		G381-A	BT8314
<b>D</b>	Drain	1 1/8	16	3 11/16	93.7	5 21/32	143.7		G401	BT8391
		1 1/8	16	3 11/16	93.7	5 21/32	143.7		G381-A	BT8505
<b>FECV</b>	Front-End Check Valve	1 1/8	16	3 11/16	93.7	5 21/32	143.7		G381-A	BT8898
		1 1/8	16	3 11/16	93.7	5 7/8	149.2		G381-A	BT9382
		1 1/8	16	3 11/16	93.7	6 5/8	168.3	HBP	G381-A	BT8357
<b>FP</b>	Fill Port	1 1/8	16	3 11/16	93.7	6 5/8	168.3	BP	G381-A	BT8504
<b>HBP</b>	18-25 PSID High Pressure By-Pass Valve	1 1/8	16	3 11/16	93.7	7 1/8	181.0		G381-A	BT305
		1 1/8	16	3 11/16	93.7	7 3/16	182.6		G401	BT595
		1 1/8	16	3 11/16	93.7	7 3/16	182.6		G401	BT177
		1 1/8	16	3 11/16	93.7	8 3/16	208.0	MBP	G401	BT8393
<b>ISO</b>	Inside-Out Flow Direction	1 1/8	16	3 11/16	93.7	9 13/16	249.2	D	[2] Included	BF46015
		1 1/8	16	3 23/32	94.5	6 13/16	173.0		[1] Included	BT9321
		1 1/8	16	3 23/32	94.5	7 1/32	178.6		[1] Included	BT8488
<b>LBP</b>	2-7 PSID Low Pressure By-Pass Valve	1 1/8	16	3 25/32	96.0	6 15/32	164.3	RC	[1] Included	BT9358
		1 1/8	16	4 1/4	108.0	5 27/32	148.4		[1] Included	B75
		1 1/8	16	4 1/4	108.0	5 27/32	148.4		[1] Included	B605
		1 1/8	16	4 1/4	108.0	5 27/32	148.4	AD, ADP, SHBP	[1] Included	B7051
<b>MBP</b>	11-17 PSID Medium Pressure By-Pass Valve	1 1/8	16	4 1/4	108.0	5 27/32	148.4	SHBP	[1] Included	B7223
		1 1/8	16	4 1/4	108.0	7 11/32	186.5	AD, SHBP	[1] Included	B7113
		1 1/8	16	4 1/4	108.0	7 3/8	187.3		[1] Included	BT470
		1 1/8	16	4 1/4	108.0	7 3/8	187.3		[1] Included	B7227
		1 1/8	16	4 1/4	108.0	7 3/8	187.3		[1] Included	B7397
<b>MO</b>	Metering Orifice	1 1/8	16	4 1/4	108.0	9 1/8	231.8		[1] Included	BT398
<b>PS</b>	Integral Post Seal Gasket	1 1/8	16	4 1/4	108.0	9 1/8	231.8	SHBP	[1] Included	BT402
		1 1/8	16	4 1/4	108.0	10 1/16	255.6	SHBP	[1] Included	B7501
		1 1/8	16	4 1/4	108.0	10 1/16	255.6		[1] Included	B7600
<b>PSR</b>	Post Seal Required; Must install loose O-Ring or D-Ring on Post for Seal	1 1/8	16	4 1/4	108.0	10 1/16	255.6		[1] Included	B7600-SS
		1 1/8	16	4 1/4	108.0	10 1/16	255.6		[1] Included	B7700
		1 1/8	16	4 1/4	108.0	10 9/32	261.1		[1] Included	B7637
		1 1/8	16	4 1/4	108.0	10 7/16	265.1		[1] Included	B76
<b>RC</b>	Reinforced Centertube	1 1/8	16	4 1/4	108.0	10 7/16	265.1		[1] Included	B76-MPG
		1 1/8	16	4 1/4	108.0	10 7/16	265.1		[1] Included	B76-SS
<b>SHBP</b>	30-45 PSID Super High Pressure By-Pass Valve	1 1/8	16	4 1/4	108.0	10 7/16	265.1	AD, SHBP	[1] Included	B218
		1 1/8	16	4 1/4	108.0	10 7/16	265.1		[1] Included	BT340
		1 1/8	16	4 1/4	108.0	10 7/16	265.1		[1] Included	BT556-10
		1 1/8	16	4 1/4	108.0	10 7/16	265.1	AD, ADP, SHBP	[1] Included	B7191
<b>SP</b>	Sensor Port	1 1/8	16	4 1/4	108.0	10 7/16	265.1		[1] Included	B7225
		1 1/8	16	4 1/4	108.0	10 15/32	265.9		[1] Included	B9604
<b>XHBP</b>	50+ PSID Extra High Pressure By-Pass Valve	1 1/8	16	4 9/32	108.7	6 7/32	158.0	SHBP	[1] Included	B7483
		1 1/8	16	4 9/32	108.7	7 3/32	180.2		[1] Included	B7478
		1 1/8	16	4 9/32	108.7	8 1/32	204.0		[1] Included	BT234
		1 1/8	16	4 9/32	108.7	10 7/16	265.1	SHBP	[1] Included	B7460
		1 1/8	16	4 9/32	108.7	10 7/16	265.1	SHBP	[1] Included	B7482
		1 1/8	16	4 5/16	109.5	9 5/32	232.6		[1] Included	B45
		1 1/8	16	4 11/32	110.3	8 11/32	211.9	SHBP	[1] Included	B7481
		1 1/8	16	4 11/32	110.3	10 7/32	259.6		[1] Included	B7466
		1 1/8	16	4 11/32	110.3	10 1/4	260.3	SHBP	[1] Included	B7459

**Do NOT Interchange Filters with Different Features**



**WARNING:** These products can expose you to chemicals, including Diisononyl Phthalate, Carbon black extracts, Nickel, 1,3 Butadiene, Ethylene Oxide, Epichlorohydrin, which are known to the State of California to cause cancer, and Bisphenol-A, Ethylene Glycol, Ethylene Oxide, 1,3 Butadiene, Epichlorohydrin, which are known to the State of California to cause birth defects or other reproductive harm.



# SPIN-ON FILTERS BY TAP SIZE (U.S. THREAD)

THREAD I.D.	PER Inch	O.D. Inches	O.D. (mm)	LENGTH Inches	LENGTH (mm)	GASKET	FEATURES	BALDWIN NUMBER
1 1/8	16	4 3/8	111.1	8 11/32	211.9	BPI	[1] Included	B7468
1 1/8	16	4 1/2	114.3	7 5/16	185.7		[1] Included	B9606
UN-2B								
1 1/8	16	5 3/8	136.5	6 1/32	153.2	AD, HBP	[1] Included	BT343
1 1/8	16	3 23/32	94.2	5 3/8	136.4			BT23617
1 1/4	12	3 11/16	93.7	5 3/8	136.5		G381-A	BT526
1 1/4	12	3 11/16	93.7	5 3/8	136.5		G381-A	BT526-10
1 1/4	12	3 11/16	93.7	5 3/8	136.5	MBP	G381-A	B7023
1 1/4	12	3 11/16	93.7	8 23/32	221.5		G381-A	B378
1 1/4	12	3 11/16	93.7	8 23/32	221.5		G381-A	B378-10
1 1/4	12	3 11/16	93.7	8 23/32	221.5		G381-A	BF9834
1 1/4	12	3 27/32	97.6	9 23/32	246.9		[2] Attached	BT23540
1 1/4	12	4 21/32	118.3	8 3/32	205.6	PS	[1] Included	BT443
1 1/4	12	4 21/32	118.3	9 1/2	241.3	PS	[1] Included	BF784
1 1/4	12	4 21/32	118.3	11 7/32	285.0	PS	G498-A	BF596
1 1/4	12	4 21/32	118.3	11 7/32	285.0	PS	[1] Included	BF7913
1 1/4	12	4 21/32	118.3	12 1/16	306.4	D, PS	[1] Included	BF1262
1 1/4	12	4 11/16	119.1	8 7/8	225.4	D, PS, PSR, SP	[1] Included	BF1355-SP
O-Ring								
1 1/4	12	4 11/16	119.1	8 29/32	226.2	D, PS	[1] Included	BF1355
1 1/4	12	4 11/16	119.1	12 3/32	307.2	D, PS	[1] Included	BF1216
1 1/4	12	4 11/16	119.1	12 3/32	307.2	D, PS	[1] Included	BF1357
1 1/4	12	4 27/32	122.7	6 9/32	159.7		[2] Included	BF46173-O
1 1/4	12	4 27/32	122.9	9 29/32	251.5		[2] Included	BF46150-O
1 1/4	12	4 7/8	123.8	6 5/16	160.3	PS	[2] Included	BF1355-O
1 1/4	12	4 7/8	123.8	9 29/32	251.6	PS	[3] Included	BF1287-O
1 1/4	12	4 7/8	123.8	9 29/32	251.6	PS	[2] Included	BF1288-O
1 1/4	17	7 9/32	184.9	7 17/32	191.3		[2] Included	BA5373
15/16	12	3 7/8	98.4	5 25/32	146.8		[1] Included, G247	BT8449
15/16	12	3 7/8	98.4	5 25/32	146.8		[1] Included, G247	BT8449-10
15/16	12	4 5/8	117.5	10 9/32	261.1		[1] Included	BT359
1 3/8	12	3 11/16	93.7	7 7/16	188.9	D	[1] Included	BF958
1 3/8	12	3 11/16	93.7	8 3/4	222.0			BF46141
1 3/8	12	3 11/16	93.7	9 19/32	243.7		[1] Viton Included	BT9366-MPG
1 3/8	12	3 3/4	95.3	4 17/32	115.1		[1] Included	BT8416
1 3/8	12	3 3/4	95.3	4 25/32	121.4		[1] Included	BT9398-MPG
1 3/8	12	3 3/4	95.3	6 3/32	154.8		[1] Included	BT8841-MPG
1 3/8	12	3 3/4	95.3	6 3/32	154.8		[1] Included	BT8849-MPG
1 3/8	12	3 3/4	95.3	6 1/8	155.6		[1] Included	BT732
1 3/8	12	3 3/4	95.3	6 1/8	155.6		[1] Included	BT8463-MPG
1 3/8	12	3 3/4	95.3	6 1/8	155.6		[1] Included	BT8464
1 3/8	12	3 3/4	95.3	6 1/8	155.6		[1] Included	BT8840-MPG
1 3/8	12	3 3/4	95.3	6 1/8	155.6		[1] Included	BT8842-MPG
1 3/8	12	3 3/4	95.3	6 1/8	155.6		[1] Included	BT8844
1 3/8	12	3 3/4	95.3	6 1/8	155.6		[1] Included	BT8845
1 3/8	12	3 3/4	95.3	6 1/8	155.6		[1] Included	BT8846
1 3/8	12	3 3/4	95.3	6 1/8	155.6		[1] Included	BT8847
1 3/8	12	3 3/4	95.3	6 1/8	155.6		[1] Included	BT9364
1 3/8	12	3 3/4	95.3	6 1/8	155.6	XHBP	[1] Included	BT9436-MPG
1 3/8	12	3 3/4	95.3	6 11/32	161.1		[1] I. Gskt.	BT8904-MPG
1 3/8	12	3 3/4	95.3	8 1/32	204.0		[1] Included	BT8848-MPG
1 3/8	12	3 3/4	95.3	9 17/32	242.1		[1] Included	BT8850-MPG
1 3/8	12	3 3/4	95.3	9 17/32	242.1		[1] Included	BT8853-MPG
1 3/8	12	3 3/4	95.3	9 17/32	242.1		[1] O-Ring	BT9433
1 3/8	12	3 3/4	95.3	9 17/32	242.1		[1] Included	BT9466-MPG
1 3/8	12	3 3/4	95.3	9 19/32	243.7		[1] Included	BT8312
1 3/8	12	3 3/4	95.3	9 19/32	243.7		[1] Included	BT8465
1 3/8	12	3 3/4	95.3	9 19/32	243.7		[1] Included	BT8851-MPG
1 3/8	12	3 3/4	95.3	9 19/32	243.7		[1] Included	BT8852-MPG
1 3/8	12	3 3/4	95.3	9 19/32	243.7		[1] Included	BT8855-MPG
1 3/8	12	3 3/4	95.3	9 19/32	243.7		[1] Included	BT8856-MPG
1 3/8	12	3 3/4	95.3	9 19/32	243.7		[1] Included	BT8861
1 3/8	12	3 3/4	95.3	9 19/32	243.7		[1] Included	BT8862
1 3/8	12	3 3/4	95.3	9 19/32	243.7		[1] Included	BT8863
1 3/8	12	3 3/4	95.3	9 19/32	243.7		[1] Included	BT9363-MPG
1 3/8	12	3 3/4	95.3	9 27/32	250.0		[1] Included	BT9370-MPG
1 3/8	12	3 13/16	96.8	9 7/16	239.7		[1] Included	BT8834-MPG

## CAUTION!!!

### Read These Instructions Before Using Size Charts

The filter size charts on this and following pages are for filter experts. Careless use could lead to errors. When you have exhausted all other ways to determine a filter number, locate a suspect here, then check the Product Guide for confirmation.

Size alone does not assure you of the right filtering media, gasket or other features. What is being filtered, filter efficiency, flow rate and direction of flow all have to be considered.

Spin-on filters are listed by tap size rather than length. All other filters are listed on an overall basis. Check your Product Guide for other dimensions. Progression is from the smallest to the largest in each category.

### Do NOT Interchange Filters with Different Features

### Be Sure to Check Product Guide, Cross-References and Applications

### We Cannot be Responsible for Misapplications



**WARNING:** These products can expose you to chemicals, including Diisononyl Phthalate, Carbon black extracts, Nickel, 1,3 Butadiene, Ethylene Oxide, Epichlorohydrin, which are known to the State of California to cause cancer, and Bisphenol-A, Ethylene Glycol, Ethylene Oxide, 1,3 Butadiene, Epichlorohydrin, which are known to the State of California to cause birth defects or other reproductive harm.

# SPIN-ON FILTERS BY TAP SIZE (U.S. THREAD)

## A TYPICAL SPIN-ON

Spin-ons vary in size, media, fittings and other features. Let's look at the usual components.

### Spin-on Can



No housing to clean; faster to change.

### Baseplate and Seaming Cover Assembly



Size of mounting hole and gasket location determine if filter will seal. The baseplate is attached to the seaming cover and the seaming cover is attached to the can. (The gasket fits in the seaming cover.)

### Compression Spring



Holds element in place to maintain seal.

### Element End Caps

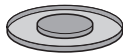

Closed End



Open End

End caps are bonded to the media.

### Filtering Media



MicroLite® pleated paper comes in more than 60 types for exact filtering requirements.

### Centertube

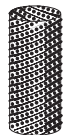

Media is wrapped around the spiral perforated/louvered steel tube.

THREAD I.D.	PER Inch	O.D. Inches	O.D. (mm)	LENGTH Inches	LENGTH (mm)	GASKET	FEATURES	BALDWIN NUMBER
1 3/8	12	3 15/16	100.0	9 7/16	239.7		[1] Included	BT8466-MPG
1 3/8	16	4 11/32	110.3	7 5/16	185.7		[1] Included	B9607
		UN-2B						
1 3/8	12	4 23/32	119.6	10	254.0			BT40066-MPG
1 3/8	12	4 23/32	119.9	11 17/32	292.9		[1] Included	BT8320
1 3/8	12	4 23/32	119.9	11 17/32	292.9		[1] Included	BT8432-MPG
1 3/8	12	4 23/32	119.9	11 17/32	292.9		[1] Included	BT9362-MPG
1 3/8	12	4 23/32	119.9	11 17/32	292.9		[1] Included	BT9391-MPG
1 3/8	12	4 23/32	119.9	11 17/32	292.9			BT9421-MPG
1 3/8	16	4 1/4	108.0	10 1/16	255.6		[1] Included	B7409
1 3/8	16	4 1/4	108.0	10 1/16	255.6		[1] Included	B7685
1 3/8	16	4 21/32	118.3	9 7/8	250.8		G498-A	B220
1 3/8	16	4 21/32	118.3	9 29/32	251.6	PS	[1] Included	B7019
1 3/8	16	4 11/16	119.1	9 15/16	252.4		G498-D	B7577
1 3/8	16	4 29/32	124.6	10 1/16	255.6		[1] Included	B7246
1 3/8	16	5 3/8	136.5	10 9/16	268.3	D, PS	[1] Included	BF7635
1 3/8	16	5 3/8	136.5	12 3/32	307.2	PS	[1] Included	BF799
1 3/8	16	5 3/8	136.5	12 3/32	307.2	PS	[1] Included	BF7639
1 3/8	16	5 3/8	136.5	12 7/16	315.9	D, PS	[1] Included	BF7639-D
1 1/2	12	4 21/32	118.3	4 15/16	125.4	SHBP	[1] Included	BD7159
1 1/2	12	4 21/32	118.3	4 15/16	125.4	HBP	[1] Included	BD7169
1 1/2	12	4 21/32	118.3	4 15/16	125.4	SHBP	[1] Included	B40137
1 1/2	12	4 21/32	118.3	4 15/16	125.4	HBP	[1] Included	B40138
1 1/2	12	4 21/32	118.3	6 1/4	158.8		G498-A	B404
1 1/2	12	4 21/32	118.3	6 9/32	159.5		[1] Included	B105
1 1/2	12	4 21/32	118.3	8 1/16	204.8	MBP	[1] Included	BD7166
1 1/2	12	4 21/32	118.3	8 3/32	205.6	PS	[1] Included	B205
1 1/2	12	4 21/32	118.3	8 3/32	205.6		[1] Included	B7004
1 1/2	12	4 21/32	118.3	8 3/32	205.6		[1] Included	B7005
1 1/2	12	4 21/32	118.3	8 3/32	205.6		[1] Included	BD7141
1 1/2	12	4 21/32	118.3	8 3/32	205.6	HBP	[1] Included	B7217
1 1/2	12	4 21/32	118.3	8 3/32	205.6	AD, PS	[1] Included	B7239
1 1/2	12	4 21/32	118.3	8 3/32	205.6	MBP	[1] Included	B7324
1 1/2	12	4 21/32	118.3	8 3/32	205.6	MBP	[1] Included	B7416
1 1/2	12	4 21/32	118.3	9 15/16	252.4	PS	[1] Included	B95
1 1/2	12	4 21/32	118.3	9 15/16	252.4	PS	[1] Included	B95-MPG
1 1/2	12	4 21/32	118.3	9 15/16	252.4	PS	[1] Included	B95-SS
1 1/2	12	4 21/32	118.3	9 15/16	252.4	PS	[1] Included	B196
1 1/2	12	4 21/32	118.3	9 15/16	252.4	AD	[1] Included	B7241
1 1/2	12	4 21/32	118.3	9 15/16	252.4			BF9888
1 1/2	12	4 21/32	118.3	11 5/16	287.3	PS	[1] Included	BF9864
1 1/2	12	4 11/16	119.1	11 9/32	286.5	PS	[1] Included	B96
1 1/2	12	4 11/16	119.1	11 9/32	286.5	PS	[1] Included	B96-MPG
1 1/2	12	4 11/16	119.1	11 9/32	286.5	PS	[1] Included	B96-SS
1 1/2	12	4 11/16	119.1	11 9/32	286.5	PS	[1] Included	B7396
1 1/2	12	5 1/16	128.6	6 31/32	177.0		[1] Included	BT486
1 1/2	16	3 11/16	93.7	5 9/16	141.3		[1] Included	BF7586
1 1/2	16	3 11/16	93.7	5 9/16	141.3		[1] Included	BT8316-MPG
1 1/2	16	3 11/16	93.7	5 9/16	141.3		[1] Included	BT8398-MPG
1 1/2	16	3 11/16	93.7	5 9/16	141.3	MBP	[1] Included	BT9346-MPG
1 1/2	16	3 11/16	93.7	5 3/4	146.0	HBP	[1] Included	B7125
1 1/2	16	3 11/16	93.7	7 3/16	182.6	D	[1] Included	BF7695
1 1/2	16	3 11/16	93.7	8 1/16	204.8		[1] Included	BT372-10
1 1/2	16	3 11/16	93.7	8 1/16	204.8		[1] Included	BT372-MPG
1 1/2	16	3 11/16	93.7	8 1/16	204.8		[1] Included	BT8509-MPG
1 1/2	16	3 3/4	95.3	4 13/32	111.9		[1] Included	BF46013
1 1/2	16	3 3/4	95.3	5 9/16	141.3		[1] Included	BF7645
1 1/2	16	3 3/4	95.3	5 9/16	141.3		[1] Included	BF7995
1 1/2	16	3 3/4	95.3	5 9/16	141.3			BT23525-MPG
1 1/2	16	3 3/4	95.3	5 3/4	146.0	HBP	[1] Included	B7516
1 1/2	16	3 3/4	95.3	8 1/4	209.6	HBP	[1] Included	B40022-MPG
1 1/2	16	3 25/32	96.0	5 23/32	145.3		[1] Included	BT371-5
1 1/2	16	3 13/16	96.8	5 13/32	137.3		[1] Included	BT371-10
1 1/2	16	3 13/16	96.8	5 13/32	137.3		[1] Included	BT371-MPG
1 1/2	16	3 15/16	100.0	9 1/2	241.3		[1] Included	BT8397-MPG
1 1/2	16	4 1/4	108.0	5 7/8	149.2		[1] Included	B134
1 1/2	16	4 1/4	108.0	7 3/8	187.3		[1] Included	B7039
1 1/2	16	4 7/16	112.7	8 11/32	211.9	ADP, D	[1] Included	BD7105
1 1/2	16	4 21/32	118.3	6 9/32	159.5		[1] Included	BT8890-MPG



**WARNING:** These products can expose you to chemicals, including Diisononyl Phthalate, Carbon black extracts, Nickel, 1,3 Butadiene, Ethylene Oxide, Epichlorohydrin, which are known to the State of California to cause cancer, and Bisphenol-A, Ethylene Glycol, Ethylene Oxide, 1,3 Butadiene, Epichlorohydrin, which are known to the State of California to cause birth defects or other reproductive harm.

# SPIN-ON FILTERS BY TAP SIZE (U.S. THREAD)

THREAD I.D.	PER Inch	O.D. Inches	O.D. (mm)	LENGTH Inches	LENGTH (mm)	GASKET	FEATURES	BALDWIN NUMBER
1 1/2	16	4 21/32	118.3	6 9/32	159.5		[1] Attached	BT23603-MPG
		UN-2B						
1 1/2	16	4 21/32	118.3	8 3/32	205.6		[1] Included	B7513
1 1/2	16	4 21/32	118.3	8 1/8	206.4		[1] Included	B7155
1 1/2	16	4 21/32	118.3	8 1/8	206.4		[1] Included	BD7325
1 1/2	16	4 21/32	118.3	9 29/32	251.6		G498-A	B97
1 1/2	16	4 21/32	118.3	11 1/4	285.8		G498-A	B49
1 1/2	16	4 21/32	118.3	11 3/4	298.5		[1] Included	BT8381
1 1/2	16	4 13/16	122.2	7 15/32	189.7		[1] Included	BT8801-MPG
1 1/2	16	4 13/16	122.2	7 15/32	189.7		[1] Included	BT8802-MPG
1 1/2	16	4 13/16	122.2	7 15/32	189.7		[1] Included	BT8812-MPG
1 1/2	16	4 13/16	122.2	7 15/32	189.7		[1] Included	BT9343-MPG
1 1/2	16	4 13/16	122.2	11 15/32	291.3		[1] Included	BT8805-MPG
1 1/2	16	4 13/16	122.2	11 9/16	293.7		[1] Included	BT8800-MPG
1 1/2	16	4 13/16	122.2	11 9/16	293.7		[1] Included	BT8803-MPG
1 1/2	16	4 13/16	122.2	11 9/16	293.7		[1] Included	BT8813-MPG
1 1/2	16	4 13/16	122.2	11 29/32	302.4		[1] Included	BT8457-MPG
1 1/2	16	5 1/32	127.8	6 31/32	177.0	BP, BPS	G369-B	BT424
1 1/2	16	5 1/32	127.8	6 31/32	177.0		G369-B, G372, G447	BT8901-MPG
1 1/2	16	5 1/32	127.8	7	177.8		G369-B (Blue), G372 (Yellow)	BT287
1 1/2	16	5 1/32	127.8	7	177.8		G369-B	BT287-10
1 1/2	16	5 1/32	127.8	7	177.8		G286-C	BT387
1 1/2	16	5 1/32	127.8	7	177.8		G286-C	BT387-10
1 1/2	16	5 1/32	127.8	10 11/16	271.5		[3] Included	BT23539
1 1/2	16	5 1/32	127.8	10 3/4	273.1		G286-C	BT388
1 1/2	16	5 1/32	127.8	10 3/4	273.1		G286-C	BT388-10
1 1/2	16	5 1/16	128.6	6 31/32	177.0		G369-B	BT8307-MPG
1 1/2	16	5 1/16	128.6	6 31/32	177.0		G369-B, G447	BT8309-MPG
1 1/2	16	5 1/16	128.6	6 31/32	177.0		G369-B	BT8421-MPG
1 1/2	16	5 1/16	128.6	6 31/32	177.0		G369-B	BT8423
1 1/2	16	5 1/16	128.6	6 31/32	177.0		G369-B	BT9356
1 1/2	16	5 1/16	128.6	6 31/32	177.0		G447	BT9371-MPG
1 1/2	16	5 1/16	128.6	7	177.8		G369-B	BT287-3
1 1/2	16	5 1/16	128.6	8 15/16	227.0	BP, BPS	[1] Included	BT425
1 1/2	16	5 1/16	128.6	10 3/4	273.1		G372	BT389
1 1/2	16	5 1/16	128.6	10 3/4	273.1		G369-B	BT389-10
1 1/2	16	5 1/16	128.6	10 3/4	273.1		G369-B	BF1239
1 1/2	16	5 1/16	128.6	10 3/4	273.1		G369-B	B7011
1 1/2	16	5 1/16	128.6	10 3/4	273.1		G369-B	BF7571
1 1/2	16	5 1/16	128.6	10 3/4	273.1		G369-B	BF7623
1 1/2	16	5 1/16	128.6	10 3/4	273.1		G369-B, G447	BT8308-MPG
1 1/2	16	5 1/16	128.6	10 3/4	273.1		G369-B, G447	BT8308-MPG KIT
1 1/2	16	5 1/16	128.6	10 3/4	273.1		G369-B	BT8310-MPG
1 1/2	16	5 1/16	128.6	10 3/4	273.1		G369-B	BT8368
1 1/2	16	5 1/16	128.6	10 3/4	273.1		G369-B	BT8422-MPG
1 1/2	16	5 1/16	128.6	10 3/4	273.1		[1] Included	BT8471-MPG
1 1/2	16	5 1/16	128.6	10 3/4	273.1		[1] Included	BT8510-MPG
1 1/2	16	5 1/16	128.6	10 3/4	273.1		G369-B	BT9345
1 1/2	16	5 1/16	128.6	10 25/32	273.8	HBP	[2] G483 (One Per Filter)	BT345 KIT
1 1/2	16	5 3/32	129.4	6 21/32	169.1			BT23140-MPG
1 1/2	16	5 11/32	135.7	7 1/32	178.6	LBP	[1] Included	BT8921
1 1/2	16	5 3/8	136.5	7	177.8	BPS, XHBP	[1] Included	B7363
1 1/2	16	5 3/8	136.5	8 19/32	218.3		[1] Included	B7402
1 1/2	16	5 3/8	136.5	8 7/8	225.4	SHBP	[1] Included	B7182
1 1/2	16	5 3/8	136.5	12 3/32	307.2		[1] Included	B99
1 1/2	16	5 3/8	136.5	12 3/32	307.2		[1] Included	B99-MPG
1 1/2	16	5 3/8	136.5	12 3/32	307.2		[1] Included	B99-SS
1 1/2	16	5 3/8	136.5	12 3/32	307.2	SHBP	[1] Included	B239
1 1/2	16	5 3/8	136.5	12 3/32	307.2	AD, SHBP	[1] Included	B7157
1 1/2	16	5 3/8	136.5	12 3/32	307.2	SHBP	[1] Included	B7180
1 1/2	16	5 3/8	136.5	12 3/32	307.2		[1] Included	B7245
1 1/2	16	5 3/8	136.5	12 3/32	307.2		[1] Included	B7249-MPG
1 1/2	16	5 3/8	136.5	12 3/32	307.2		[1] Included	B7299
1 1/2	16	5 3/8	136.5	12 3/32	307.2		[4] Included	B7507
1 1/2	16	5 3/8	136.5	12 3/8	314.3	SHBP	[1] Included	B7187

## SPIN-ON FEATURES

Some spin-ons have no additional features while others have several. Here are some of the more important spin-on features:

### Anti-Drainback Valve



As the name implies, this valve keeps the oil from draining from a filter when the engine is shut off. (Some filters include an anti-drainback standpipe for the same function). The mounting direction determines the need for this feature.

### By-Pass Valve

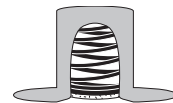

Full-flow oil systems require a by-pass (relief) valve either in the system or in the filter. This valve opens at a predetermined setting to assure oil flow to the bearings at all times.

### Integral Post Seal



Seals threaded stud to prevent tiny particles from spiraling in via the threads.

**We Cannot be Responsible for Misapplications**



**WARNING:** These products can expose you to chemicals, including Diisononyl Phthalate, Carbon black extracts, Nickel, 1,3 Butadiene, Ethylene Oxide, Epichlorohydrin, which are known to the State of California to cause cancer, and Bisphenol-A, Ethylene Glycol, Ethylene Oxide, 1,3 Butadiene, Epichlorohydrin, which are known to the State of California to cause birth defects or other reproductive harm.

# SPIN-ON FILTERS BY TAP SIZE (U.S. THREAD)

	THREAD I.D.	PER Inch	O.D. Inches	O.D. (mm)	LENGTH Inches	LENGTH (mm)	GASKET	FEATURES	BALDWIN NUMBER
<b>SPIN-ON FILTER FEATURES ARE CODED AS FOLLOWS</b>	1 1/2	16	5 1/2	139.7	7	177.8	HBP	[1] Included	BT8437
	1 5/8	12 UN	4 5/8	117.5	10 13/32	264.3		[1] Included	B40053
	1 5/8	12	4 21/32	118.3	9 15/16	252.4		[1] Included	B495
	1 5/8	12	4 21/32	118.3	9 15/16	252.4		[1] Included	B495-MPG
	1 5/8	12	4 21/32	118.3	9 15/16	252.4		[1] Included	B495-SS
	1 5/8	12	4 11/16	119.1	11 9/32	286.5	PS	[1] Included	BF7948
	1 5/8	12	5 1/16	128.6	6 31/32	177.0		G369-B, G447	B7335-MPG
	1 3/4	12	4 9/16	115.9	11 13/32	289.7			B7503
	1 3/4	12	4 23/32	119.9	7 3/4	196.9		[1] Included	BT8875-MPG
	1 3/4	12	4 23/32	119.9	7 3/4	196.9		[1] Included	BT8880-MPG
<b>AD</b> Anti-Drainback Valve	1 3/4	12	4 23/32	119.9	11 1/2	292.1		[1] Included	BT9365-MPG
<b>ADP</b> Anti-Drainback Pipe	1 3/4	12	4 23/32	119.9	11 17/32	292.9		[1] Included	BT8401-MPG
<b>BP</b> 8-10 PSID By-Pass Valve	1 3/4	12	4 23/32	119.9	11 17/32	292.9		[1] Included	BT8874-MPG
<b>BPI</b> By-Pass Included	1 3/4	12	4 23/32	119.9	11 17/32	292.9		[1] Included	BT8877-MPG
<b>BPS</b> By-Pass Screen	1 3/4	12	4 23/32	119.9	11 17/32	292.9		[1] Included	BT8878-MPG
<b>BTA PLUS</b> Balanced Treatment Additive Plus	1 3/4	12	4 23/32	119.9	11 17/32	292.9		[1] Included	BT8879-MPG
<b>BTE</b> Balanced Treatment for Ethylene Glycol Antifreeze	1 3/4	12	4 23/32	119.9	11 17/32	292.9		[1] Included	BT8892-MPG
<b>D</b> Drain	1 3/4	12	4 23/32	119.9	11 17/32	292.9		[1] Included	BT8910-MPG
<b>FECV</b> Front-End Check Valve	1 3/4	12	4 23/32	119.9	11 17/32	292.9		[1] Included	BT8911-MPG
<b>FP</b> Fill Port	1 3/4	12	4 23/32	119.9	14 3/32	358.0		[1] Included	BT9353-MPG
<b>HBP</b> 18-25 PSID High Pressure By-Pass Valve	1 3/4	12	4 23/32	119.9	14 3/32	358.0		[1] Included	BT9560-MPG
<b>ISO</b> Inside-Out Flow Direction	1 3/4	12	4 3/4	120.7	11 17/32	292.9		[1] Included	BT8870-MPG
<b>LBP</b> 2-7 PSID Low Pressure By-Pass Valve	1 3/4	12	4 3/4	120.7	11 19/32	294.5		[1] Included	BT8876-MPG
<b>MBP</b> 11-17 PSID Medium Pressure By-Pass Valve	1 3/4	12 UN	4 3/4	120.7	14 1/4	362.0		[1] Attached	BT23609-MPG
<b>MO</b> Metering Orifice	1 3/4	12	4 25/32	121.4	14 1/4	362.0			BT23542-MPG
<b>PS</b> Integral Post Seal Gasket	1 3/4	16	4 21/32	118.3	9 15/16	252.4	MBP	[1] Included	BT9439
<b>PSR</b> Post Seal Required; Must install loose O-Ring or D-Ring on Post for Seal	1 3/4	16	5 3/8	136.5	7	177.8	BPS, MBP	[1] Included	BT8899
<b>SHBP</b> 30-45 PSID Super High Pressure By-Pass Valve	1 3/4	16 UN	5 3/8	136.5	7	177.8	MBP	[1] Included	BT23555-MPG
<b>SP</b> Sensor Port	1 3/4	16	5 3/8	136.5	9 5/8	244.5	MBP	[1] Included	BT8382
<b>XHBP</b> 50+ PSID Extra High Pressure By-Pass Valve	1 3/4	16 UN	5 3/8	136.5	9 5/8	244.5	MBP	[1] Included	BT23605-MPG
<b>Do NOT Interchange Filters with Different Features</b>	1 7/8	12	5 7/32	132.6	6 7/8	174.6		[1] Included	BT8927
	2	12	3 1/8	79.4	5 17/32	140.5	PS		BT8333
	2	12	3 1/8	79.4	5 17/32	140.5			BT9349-MPG
	2	12	3 1/8	79.4	5 17/32	140.5		[1] Included	BT9393-MPG
	2	12	3 1/8	79.4	9 17/32	242.1		[1] Included	BT8418
	2	12	3 1/8	79.4	9 17/32	242.1			BT8886-MPG
	2	12	3 1/8	79.4	9 17/32	242.1		[2] Included	BT9392-MPG
	2	16	3 11/16	93.7	5 21/32	143.7	HBP	G401	BT8830
	2	16	3 11/16	93.7	7 7/32	183.4	HBP	G401	BT8832
	2	16	3 11/16	93.7	7 7/32	183.4	SHBP	G401	BT8833
	2	16	3 11/16	93.7	7 7/32	183.4		G401	BT8831
	2	16	3 3/4	95.3	6 3/32	154.8	XHBP	[1] Included	BT8426-MPG
	2	16	3 3/4	95.3	7 7/32	183.4	BPS, XHBP	[2] O-Rings	BT9400-MPG
	2 1/4	12	4 5/8	117.5	10	254.0			BF46002
	2 1/4	12	4 21/32	118.3	9 5/8	244.5		G293-B	BD324
	2 1/4	12	4 21/32	118.3	10 5/16	261.9		[1] Included	BF7932
	2 1/4	12	4 21/32	118.3	11 13/32	289.7		G293-B	BD103
	2 1/4	12	4 21/32	118.3	11 13/32	289.7		G293-B	BD103-SS
	2 1/4	12	4 21/32	118.3	11 13/32	289.7		G293-B	BD103-MPG
	2 1/4	12	4 21/32	118.3	11 13/32	289.7		G293-B	B333
	2 1/4	12	4 21/32	118.3	11 13/32	289.7		[1] Included	BD7309
	2 1/4	12	4 21/32	118.3	11 13/32	289.7			BD7504
	2 1/4	12	4 21/32	118.3	11 13/32	289.7			BA0142
	2 1/2	12	5 7/32	132.6	6 5/8	168.3		[1] Included	BA5371
	3	8	5	127.0	8 13/16	223.8			BT775
	3	8	5	127.0	12 1/4	311.2			BT774
	3 3/8	8	4 1/32	102.4	6 3/8	161.9		[2] O-Rings	BF46062



**WARNING:** These products can expose you to chemicals, including Diisononyl Phthalate, Carbon black extracts, Nickel, 1,3 Butadiene, Ethylene Oxide, Epichlorohydrin, which are known to the State of California to cause cancer, and Bisphenol-A, Ethylene Glycol, Ethylene Oxide, 1,3 Butadiene, Epichlorohydrin, which are known to the State of California to cause birth defects or other reproductive harm.

## SPIN-ON FILTERS BY TAP SIZE (BRITISH STANDARD PIPE THREAD)

THREAD I.D.	PER Inch	O.D. Inches	O.D. (mm)	LENGTH Inches	LENGTH (mm)	GASKET	FEATURES	BALDWIN NUMBER
3/4	14 BSP-PL	3 11/16	93.7	3 7/32	81.8			BT368
3/4	14 BSP-PL	3 11/16	93.7	5 3/8	136.5		G381-A	BT8472
3/4	14 BSP-PL	3 11/16	93.7	5 13/32	137.3		G401	BT366-10
3/4	14 BSP-PL	3 11/16	93.7	8 5/32	207.2		G381-A	BT8473
3/4	14 BSP-PL	3 11/16	93.7	8 5/32	207.2		G381-A	BT8474
3/4	14 BSP-PL	3 3/4	95.3	2 5/16	58.7		[1] Included	BT9326
3/4	14 BSP-PL	3 3/4	95.3	5 23/32	145.3			BT8913-MPG
3/4	14 BSP-PL	3 3/4	95.3	5 3/4	146.0	HBP	[1] Included	BT8935
3/4	14 BSP-PL	3 3/4	95.3	5 3/4	146.0			BT8928
3/4	14 BSP-PL	3 25/32	96.0	5 23/32	145.3		[1] Included	BT366-MPG
3/4	14 BSP-PL	3 25/32	96.0	7 19/32	192.9		[1] Included	BT9316-MPG
1	11 BSP-PL	3 13/16	96.8	5 1/4	133.4	D	[1] Included	BF553
1 1/4	11 BSP-PL	4 5/8	117.5	6 9/32	159.5	PS	G498-A	BT611-MPG
1 1/4	11 BSP-PL	4 5/8	117.5	11 9/32	286.5	PS	G498-A	BT610-MPG
1 1/4	11 BSP-PL	4 21/32	118.3	8 3/32	205.6	PS	G498-A	BT9558-MPG
1 1/4	11 BSP-PL	5	127.0	7	177.8		[1] Included	BT351-MPG
1 1/4	11 BSP-PL	5	127.0	7 3/32	180.2		[1] Included	BT351
1 1/4	11 BSP-PL	5	127.0	7 3/32	180.2	AD, MBP	[1] Included	BT8450
1 1/4	11 BSP-PL	5	127.0	7 3/32	180.2		[1] Included	BT8475
1 1/4	11 BSP-PL	5 1/32	127.8	7 7/32	183.4		[1] Included	BT9324
1 1/4	11 BSP-PL	5 1/32	127.8	8 15/16	227.0			BT8477-MPG
1 1/4	11 BSP-PL	5 1/16	128.6	7 1/16	179.4			BT8475-MPG
1 1/4	11 BSP-PL	5 1/16	128.6	7 3/32	180.2		[1] Included	BT8930
1 1/4	11 BSP-PL	5 1/16	128.6	9	228.6			BT8931
1 1/4	11 BSP-PL	5 1/8	130.2	8 11/16	220.7		[1] Included	BT8476
1 1/4	11 BSP-PL	5 1/8	130.2	8 11/16	220.7		[1] Included	BT8476-MPG
1 1/4	11 BSP-PL	5 1/8	130.2	8 11/16	220.7		[1] Included	BT8477
1 1/4	11 BSP-PL	5 1/8	130.2	8 29/32	226.2		[1] Included	BT8915
1 1/4	11 BSP-PL	5 11/32	135.7	7	177.8		[1] Included; [1] O-Ring	BA5378
1 1/4	11 BSP-PL	5 1/2	139.7	6 31/32	177.0		[1] Included; [1] O-Ring	BA5375
1 1/2	11 BSP-PL	4 15/16	125.4	7 17/32	191.3	MBP	[1] Included	BT9320
1 1/2	11 BSP-PL	5 1/32	127.8	7 19/32	192.9			BT8937

### CAUTION!!!

### Read These Instructions Before Using Size Charts

The filter size charts on this and following pages are for filter experts. Careless use could lead to errors. When you have exhausted all other ways to determine a filter number, locate a suspect here, then check the Product Guide for confirmation.

Size alone does not assure you of the right filtering media, gasket or other features. What is being filtered, filter efficiency, flow rate and direction of flow all have to be considered.

Spin-on filters are listed by tap size rather than length. All other filters are listed on an overall basis. Check your Product Guide for other dimensions. Progression is from the smallest to the largest in each category.

**Do NOT Interchange Filters with Different Features**

**Be Sure to Check Product Guide, Cross-References and Applications**

**We Cannot be Responsible for Misapplications**



**WARNING:** These products can expose you to chemicals, including Diisononyl Phthalate, Carbon black extracts, Nickel, 1,3 Butadiene, Ethylene Oxide, Epichlorohydrin, which are known to the State of California to cause cancer, and Bisphenol-A, Ethylene Glycol, Ethylene Oxide, 1,3 Butadiene, Epichlorohydrin, which are known to the State of California to cause birth defects or other reproductive harm.

# SPIN-ON FILTERS BY TAP SIZE (METRIC THREAD)

		THREAD I.D.	O.D. Inches	O.D. (mm)	LENGTH Inches	LENGTH (mm)	GASKET	FEATURES	BALDWIN NUMBER
<b>SPIN-ON FILTER FEATURES ARE CODED AS FOLLOWS</b>		Thread	OD1.....	OD1 mm	Height ...	Height (mm)	Size_Features.....	Size_Gasket.....	Part Number
	<b>AD</b> Anti-Drainback Valve	M12 x 1.5	3 1/16.....	77.8	5 1/2.....	139.7	PS.....	[2] Included.....	<b>BF7990</b>
	<b>ADP</b> Anti-Drainback Pipe	M12 x 1.5	3 3/8.....	85.7	3 13/16.....	96.8	PS.....	[2] Included.....	<b>BF7619</b>
	<b>BP</b> 8-10 PSID By-Pass Valve	M14 x 1.5	3 1/32.....	77.0	3 15/32.....	88.1		G449-B.....	<b>BF1056</b>
	<b>BPI</b> By-Pass Included	M14 x 1.5	3 11/16.....	93.7	4 11/16.....	119.1	D.....	G381-A.....	<b>BF1361</b>
	<b>BPS</b> By-Pass Screen	M14 x 1.5	3 11/16.....	93.7	7 11/32.....	186.5	D.....	[1] Included.....	<b>BF1217</b>
	<b>BTA PLUS</b> Balanced Treatment Additive Plus	M16 x 1.5	2 31/32.....	75.4	2 31/32.....	75.4		[1] Included.....	<b>BF7880</b>
	<b>BTE</b> Balanced Treatment for Ethylene Glycol Antifreeze	M16 x 1.5	3.....	76.2	2 31/32.....	75.4	MBP.....	[1] Included.....	<b>BF292</b>
	<b>D</b> Drain	M16 x 1.5	3.....	76.2	3 17/32.....	89.7	BP.....	G449-B.....	<b>B474</b>
	<b>FECV</b> Front-End Check Valve	M16 x 1.5	3.....	76.2	4 7/32.....	107.2	D, PS.....	G449-B.....	<b>BF1257</b>
	<b>FP</b> Fill Port	M16 x 1.5	3.....	76.2	4 7/32.....	107.2	D.....	[1] Included, G449-B.....	<b>BF1261</b>
	<b>HBP</b> 18-25 PSID High Pressure By-Pass Valve	M16 x 1.5	3.....	76.2	4 27/32.....	123.0	PS.....	G449-B.....	<b>BF782</b>
	<b>ISO</b> Inside-Out Flow Direction	M16 x 1.5	3 1/32.....	77.0	2 5/16.....	58.7		G449-B.....	<b>BT9408</b>
	<b>LBP</b> 2-7 PSID Low Pressure By-Pass Valve	M16 x 1.5	3 1/32.....	77.0	2 27/32.....	72.2		G449-B.....	<b>BF7909</b>
	<b>MBP</b> 11-17 PSID Medium Pressure By-Pass Valve	M16 x 1.5	3 1/32.....	77.0	2 27/32.....	72.2		G449-B.....	<b>BF7915</b>
	<b>MO</b> Metering Orifice	M16 x 1.5	3 1/32.....	77.0	3 1/8.....	79.4	D.....	[1] Included.....	<b>BF1267</b>
	<b>PS</b> Integral Post Seal Gasket	M16 x 1.5	3 1/32.....	77.0	3 15/32.....	88.1		G449-B.....	<b>BF790</b>
	<b>PSR</b> Post Seal Required; Must install loose O-Ring or D-Ring on Post for Seal	M16 x 1.5	3 1/32.....	77.0	4 3/32.....	104.0	PSR.....	[1] Included, [1] End Seal Included.....	<b>BF7608</b>
	<b>RC</b> Reinforced Centertube	M16 x 1.5	3 1/32.....	77.0	4 11/32.....	110.3		[1] Included.....	<b>BF9819</b>
	<b>SHBP</b> 30-45 PSID Super High Pressure By-Pass Valve	M16 x 1.5	3 1/32.....	77.0	4 11/16.....	119.1	PS, SP.....	[2] O-Rings, G449-B.....	<b>BF1232</b>
	<b>SP</b> Sensor Port	M16 x 1.5	3 1/32.....	77.0	4 13/16.....	122.2		[1] Included.....	<b>BF9841</b>
	<b>XHBP</b> 50+ PSID Extra High Pressure By-Pass Valve	M16 x 1.5	3 1/32.....	77.0	4 27/32.....	123.0	ADP, PSR.....	G449-B, [1] O-Ring.....	<b>BF788</b>
	<b>Do NOT Interchange Filters with Different Features</b>	M16 x 1.5	3 1/32.....	77.0	4 27/32.....	123.0		G449-B.....	<b>BF988</b>
		M16 x 1.5	3 1/32.....	77.0	5 7/32.....	132.6	D.....	G449-B.....	<b>BF1269</b>
		M16 x 1.5	3 1/32.....	77.0	5 11/32.....	135.7	D.....	[1] Included.....	<b>BF9853</b>
		M16 x 1.5	3 1/32.....	77.0	5 11/16.....	144.5	ADP, D, PSR.....	G449-B, [1] O-Ring.....	<b>BF1226</b>
		M16 x 1.5	3 1/32.....	77.0	5 11/16.....	144.5		G449-B.....	<b>BF7921</b>
		M16 x 1.5	3 1/32.....	77.0	5 27/32.....	148.4		G449-B.....	<b>BF586</b>
		M16 x 1.5	3 1/32.....	77.0	5 27/32.....	148.4	D.....	G449-B.....	<b>BF586-D</b>
		M16 x 1.5	3 1/32.....	77.0	5 27/32.....	148.4		G449-B.....	<b>BF7663</b>
		M16 x 1.5	3 1/32.....	77.0	5 29/32.....	149.9		G449-B.....	<b>BF46149-SP</b>
		M16 x 1.5	3 1/32.....	77.0	5 29/32.....	150.0	D, PS.....	[1] Included.....	<b>BF1372</b>
		M16 x 1.5	3 1/32.....	77.0	5 29/32.....	150.0	D.....	[1] Included.....	<b>BF1396</b>
		M16 x 1.5	3 1/32.....	77.0	6 1/8.....	155.6		G449-B.....	<b>BF587</b>
		M16 x 1.5	3 1/32.....	77.0	6 1/8.....	155.6	D.....	G449-B.....	<b>BF587-D</b>
		M16 x 1.5	3 1/32.....	77.0	6 1/8.....	155.6	D.....	G449-B.....	<b>BF7591-D</b>
		M16 x 1.5	3 1/32.....	77.0	6 1/2.....	165.1	PS, PSR, SP.....	G449-B.....	<b>BF7998</b>
		M16 x 1.5	3 1/32.....	77.0	6 21/32.....	169.1	ADP, D.....	G449-B.....	<b>BF1221</b>
		M16 x 1.5	3 1/32.....	77.0	6 21/32.....	169.1	D, PSR.....	[1] Included, G449-B.....	<b>BF1276</b>
		M16 x 1.5	3 1/32.....	77.0	6 21/32.....	169.1	D.....	G449-B.....	<b>BF1367</b>
		M16 x 1.5	3 1/32.....	77.0	6 21/32.....	169.1	D.....	G449-B, [1] Included.....	<b>BF7772</b>
		M16 x 1.5	3 1/16.....	77.8	5 25/32.....	146.8	D.....	[1] Included.....	<b>BF9842</b>
		M16 x 1.5	3 1/16.....	77.8	6 1/16.....	154.0	D.....	[1] Included.....	<b>BF9840</b>
		M16 x 1.5	3 3/32.....	78.6	2 1/2.....	63.5	AD, BPI.....	[1] Included.....	<b>BF293</b>
		M16 x 1.5	3 5/32.....	80.2	7 5/16.....	185.7	D, PS.....	[1] Included.....	<b>BF9812</b>
		M16 x 1.5	3 3/16.....	81.0	6 15/16.....	176.2		[2] Included.....	<b>BF46012</b>
		M16 x 1.5	3 3/16.....	81.0	6 15/16.....	176.2		[2] Included.....	<b>BF46014</b>
		M16 x 1.5	3 9/32.....	83.3	6 3/16.....	157.2		[1] Included.....	<b>BF7976</b>
		M16 x 1.5	3 9/32.....	83.3	7 15/32.....	189.7	D, PS.....	[1] Included.....	<b>BF9813</b>
		M16 x 1.5	3 9/32.....	83.3	7 15/32.....	189.7	D, PS.....	[1] Included.....	<b>BF9883</b>
		M16 x 1.5	3 3/8.....	85.7	6 23/32.....	170.7		[1] Included.....	<b>BF7970</b>
		M16 x 1.5	3 7/16.....	87.3	6 13/32.....	162.7	D.....	[1] Included, [1] O-Ring.....	<b>BF5587-D</b>
		M16 x 1.5	3 11/16.....	93.7	4 3/8.....	111.1		G381-A.....	<b>BF7883</b>
		M16 x 1.5	3 11/16.....	93.7	4 7/16.....	112.7		G401.....	<b>B5145</b>
		M16 x 1.5	3 11/16.....	93.7	4 7/16.....	112.7	BTE.....	G401.....	<b>BW5183</b>
		M16 x 1.5	3 11/16.....	93.7	5 1/4.....	133.4		G381-A, [1] Included.....	<b>BF7919</b>
		M16 x 1.5	3 11/16.....	93.7	5 3/8.....	136.5		G381-A.....	<b>BF900</b>
		M16 x 1.5	3 11/16.....	93.7	5 3/8.....	136.5		G381-A.....	<b>BF7664</b>
		M16 x 1.5	3 11/16.....	93.7	5 13/32.....	137.3		G401.....	<b>B5091</b>
		M16 x 1.5	3 11/16.....	93.7	5 13/32.....	137.3	BTE.....	G401.....	<b>BW5141</b>
		M16 x 1.5	3 11/16.....	93.7	5 13/32.....	137.3	BTE.....	G401.....	<b>BW5142</b>
		M16 x 1.5	3 11/16.....	93.7	5 13/32.....	137.3		G401.....	<b>BF7888</b>
		M16 x 1.5	3 11/16.....	93.7	5 7/16.....	138.1		G401.....	<b>B5144</b>
		M16 x 1.5	3 11/16.....	93.7	5 7/16.....	138.1		[1] Included.....	<b>BW21000</b>



**WARNING:** These products can expose you to chemicals, including Diisononyl Phthalate, Carbon black extracts, Nickel, 1,3 Butadiene, Ethylene Oxide, Epichlorohydrin, which are known to the State of California to cause cancer, and Bisphenol-A, Ethylene Glycol, Ethylene Oxide, 1,3 Butadiene, Epichlorohydrin, which are known to the State of California to cause birth defects or other reproductive harm.

# SPIN-ON FILTERS BY TAP SIZE (METRIC THREAD)

THREAD I.D.	O.D. Inches	O.D. (mm)	LENGTH Inches	LENGTH (mm)	GASKET	FEATURES	BALDWIN NUMBER
M16 x 1.5	3 11/16	93.7	7 13/32	188.1	D	G381-A	BF1365
M16 x 1.5	3 11/16	93.7	7 31/32	202.4	D, PSR, SP	G401, [1] O-Ring	BF1371
M16 x 1.5	3 11/16	93.7	8 1/8	206.4		G381-A	BF980
M16 x 1.5	3 11/16	93.7	8 1/8	206.4		G381-A	BF7696
M16 x 1.5	3 23/32	94.5	5 3/8	136.5		G381-A, [1] Included	BF7955
M16 x 1.5	3 23/32	94.5	7 9/32	184.9		G381-A	BF46050
M16 x 1.5	4 1/4	108.0	7	177.8		G401	BF7927
M16 x 1.5-6H	3 23/32	94.5	7 5/32	181.9		[1] Included	BF46227
M16 x 1.5-6H	3 23/32	94.5	7 31/32	202.2		[2] Included	BF46069
M18 x 1.5	2 25/32	70.6	2 13/16	71.4	AD, BP	[1] Included	B40000
M18 x 1.5	2 29/32	73.8	3 1/2	88.9	AD	G449-B	B43-S
M18 x 1.5	2 29/32	73.8	3 1/2	88.9		G449-B	B7446
M18 x 1.5	3	76.2	2 7/16	62.3	ISO	[2] Included	BF1380-O
M18 x 1.5	3	76.2	3 31/32	100.6		[2] Included, [1] O-Ring	BF46164-O
M18 x 1.5	3	76.2	4 27/32	123.0	AD	G449-B	B35-S
M18 x 1.5	3 1/32	77.0	2 3/8	60.2	ISO	[2] Included	BF1379-O
M18 x 1.5	3 1/32	77.0	2 27/32	72.2		[1] Included	B40124
M18 x 1.5	3 1/32	77.0	4 19/32	116.7	ISO, PS, SP	[1] Included	BF1379
M18 x 1.5	3 1/32	77.0	4 19/32	116.7	D, ISO, PS, SP	[1] Included	BF1380
M18 x 1.5	3 1/32	77.0	4 19/32	116.7	D, ISO, PS, SP	[1] Included	BF1381
M18 x 1.5	3 3/32	78.6	2 15/32	62.7		[1] Included, [1] O-Ring	BF1381-O
M18 x 1.5	3 1/8	79.4	3 1/2	88.9	AD	[1] Included	B195
M18 x 1.5	3 11/16	93.7	3 7/8	98.4	PS	G324-A	BT338
M18 x 1.5	3 11/16	93.7	5 5/8	142.9		[1] Included	BF7886
M18 x 1.5	3 11/16	93.7	5 25/32	146.8		[1] Included	BF9820
M18 x 1.5	3 11/16	93.7	8 1/8	206.4	PS	G381-A	BF7644
M18 x 1.5	3 11/16	93.7	8 1/8	206.4	PS	G381-A	BF7653
M18 x 1.5	3 11/16	93.7	8 9/32	210.3		[1] Included	BF46032
M18 x 1.5	3 23/32	94.5	8 5/32	207.2		[1] Included	BF7997
M18 x 1.5	3 25/32	96.0	5 13/16	147.6		[1] Included	BF46127
M20 x 1.0	2 21/32	67.5	2 5/8	66.7	AD, HBP	[1] Included	B7419
M20 x 1.5	2 9/16	65.1	2 5/8	66.7	AD, HBP	[1] Included	B7285
M20 x 1.5	2 9/16	65.1	3 1/2	88.9	AD, MBP	[1] Included	B1402
M20 x 1.5	2 9/16	65.1	3 1/2	88.9	AD, HBP	[1] Included	B7318
M20 x 1.5	2 21/32	67.5	2 5/8	66.7	AD, MBP	[1] Included	B1400
M20 x 1.5	2 21/32	67.5	4	101.6	AD, MBP	[1] Included	B1431
M20 x 1.5	2 21/32	67.5	5 1/2	139.7	AD, MBP	[1] Included	BT40034
M20 x 1.5	2 23/32	69.1	3 13/32	86.5	AD, MBP	[1] I. Gasket	B7441
M20 x 1.5	2 25/32	70.6	2 5/8	66.7	BD, BPS	[1] Included	BT23631
M20 x 1.5	2 29/32	73.8	4 27/32	123.0	FeCV, SHBP	I. Gasket	B40129
M20 x 1.5	3	76.2	2 5/16	58.7	AD, MBP	[1] Included	B7276
M20 x 1.5	3	76.2	2 27/32	72.2	AD, BP	[1] Included	B179
M20 x 1.5	3	76.2	2 27/32	72.2	AD, HBP	[1] Included	B227
M20 x 1.5	3	76.2	2 27/32	72.2	BP	[1] Included	B301
M20 x 1.5	3	76.2	2 27/32	72.2	AD, MBP	[1] Included	B421
M20 x 1.5	3	76.2	2 27/32	72.2		[1] Included	BF940
M20 x 1.5	3	76.2	2 27/32	72.2	BP	[1] Included	B1444
M20 x 1.5	3	76.2	2 27/32	72.2	AD, SHBP	[1] Included	B7216
M20 x 1.5	3	76.2	2 7/8	73.0	AD, BP	G449-B	B307
M20 x 1.5	3	76.2	3 11/32	84.9	AD, BPI	[1] Included	B7289
M20 x 1.5	3	76.2	3 1/2	88.9		G449-B	BF7683
M20 x 1.5	3	76.2	3 1/2	88.9	AD, BP	[1] Included	B40126
M20 x 1.5	3	76.2	3 17/32	89.7	AD, LBP	G449-B	BT310
M20 x 1.5	3	76.2	4 13/16	122.2	AD, BP	[1] Included	B247
M20 x 1.5	3	76.2	4 13/16	122.2		[1] Included	BT8902
M20 x 1.5	3	76.2	5 3/32	129.4	AD, BP	[1] Included	B168
M20 x 1.5	3	76.2	5 1/8	130.2	AD, BP	G449-B	B199
M20 x 1.5	3 1/32	77.0	2 25/32	70.6	AD, HBP	[1] Included	B7407
M20 x 1.5	3 1/32	77.0	3 13/32	86.5		[1] Included	BT23630
M20 x 1.5	3 1/32	77.0	3 7/16	87.3	AD, MBP	[1] Included	B1421
M20 x 1.5	3 1/32	77.0	3 7/16	87.3	AD, HBP	[1] Included	B1425
M20 x 1.5	3 1/32	77.0	3 7/16	87.3	AD, HBP	[1] Included	B7243
M20 x 1.5	3 1/32	77.0	3 7/16	87.3	AD, MBP	[1] Included	B7334
M20 x 1.5	3 1/32	77.0	3 7/16	87.3	AD, HBP	[1] Included	B7487
M20 x 1.5	3 1/32	77.0	3 1/2	88.9	AD, HBP	G449-B	B7167

## CAUTION!!! Read These Instructions Before Using Size Charts

The filter size charts on this and following pages are for filter experts. Careless use could lead to errors. When you have exhausted all other ways to determine a filter number, locate a suspect here, then check the Product Guide for confirmation.

Size alone does not assure you of the right filtering media, gasket or other features. What is being filtered, filter efficiency, flow rate and direction of flow all have to be considered.

Spin-on filters are listed by tap size rather than length. All other filters are listed on an overall basis. Check your Product Guide for other dimensions. Progression is from the smallest to the largest in each category.

## Do NOT Interchange Filters with Different Features

## Be Sure to Check Product Guide, Cross-References and Applications

## We Cannot be Responsible for Misapplications



**WARNING:** These products can expose you to chemicals, including Diisononyl Phthalate, Carbon black extracts, Nickel, 1,3 Butadiene, Ethylene Oxide, Epichlorohydrin, which are known to the State of California to cause cancer, and Bisphenol-A, Ethylene Glycol, Ethylene Oxide, 1,3 Butadiene, Epichlorohydrin, which are known to the State of California to cause birth defects or other reproductive harm.

# SPIN-ON FILTERS BY TAP SIZE (METRIC THREAD)

## A TYPICAL SPIN-ON

Spin-ons vary in size, media, fittings and other features. Let's look at the usual components.

### Spin-on Can



No housing to clean; faster to change.

### Baseplate and Seaming Cover Assembly



Size of mounting hole and gasket location determine if filter will seal. The baseplate is attached to the seaming cover and the seaming cover is attached to the can. (The gasket fits in the seaming cover.)

### Compression Spring



Holds element in place to maintain seal.

### Element End Caps

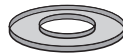

Closed End

Open End

End caps are bonded to the media.

### Filtering Media



Microlite® pleated paper comes in more than 60 types for exact filtering requirements.

### Centertube



Media is wrapped around the spiral perforated/louvered steel tube.

THREAD I.D.	O.D. Inches	O.D. (mm)	LENGTH Inches	LENGTH (mm)	GASKET	FEATURES	BALDWIN NUMBER
M20 x 1.5	3 1/32	77.0	4 1/16	103.2	AD, HBP	[1] Included	B161-S
M20 x 1.5	3 1/32	77.0	4 3/32	104.0	PS	[1] Included	BF1110
M20 x 1.5	3 1/32	77.0	4 3/32	104.0		[1] Included	BF7544
M20 x 1.5	3 1/32	77.0	6 1/16	154.0	D	[1] Included	BF9821
M20 x 1.5	3 3/32	78.6	2 21/32	67.5		[1] Included	BF7837
M20 x 1.5	3 3/32	78.6	3 27/32	97.6	BPI	[1] Included	B7277
M20 x 1.5	3 3/32	78.6	4 27/32	123.0	AD, HBP	[1] Included	B7390
M20 x 1.5	3 1/8	79.4	2 7/8	73.0	AD, MBP	[1] Included	B7429
M20 x 1.5	3 1/8	79.4	3	76.2		[1] Included	BT8917
M20 x 1.5	3 1/8	79.4	3 17/32	89.7	AD, MBP	[1] Included	B7352
M20 x 1.5	3 1/8	79.4	3 17/32	89.7	AD, HBP	[1] Included	B7428
M20 x 1.5	3 1/8	79.4	3 5/8	92.1	AD, MBP	[1] Included	B7445
M20 x 1.5	3 1/8	79.4	4 1/32	102.4	AD, MBP	[1] Included	B7430
M20 x 1.5	3 5/32	80.2	6 3/4	171.5	FECV	[1] Included	B40125
M20 x 1.5	3 7/32	81.8	3 7/8	98.4	AD, MBP	[1] Included	BF7281
M20 x 1.5	3 7/32	81.8	4 25/32	121.4		[1] Included, [1] O-Ring	BF7838
M20 x 1.5	3 1/2	88.9	2 11/32	59.5	AD, BPI	[1] Included	BF7283
M20 x 1.5	3 9/16	90.5	3 15/32	88.1	AD, HBP	[1] Included	B7432
M20 x 1.5	3 9/16	90.5	5 7/16	138.1	D, ISO, SP	[2] Included, G381-A	BF7534
M20 x 1.5	3 9/16	90.5	7	177.8		[1] Included	BF9850
M20 x 1.5	3 19/32	91.3	4 13/16	122.2	HBP	[1] Included	B7384
M20 x 1.5	3 19/32	91.3	5 1/8	130.2	AD, HBP	[1] Included	B7469
M20 x 1.5	3 19/32	91.3	7 1/8	181.0		[1] Included	BF9815
M20 x 1.5	3 19/32	91.3	7 7/8	200.0	D	[1] Included	BF9852
M20 x 1.5	3 5/8	92.1	5 1/16	128.6	AD, BPI	[1] Included	BF7273
M20 x 1.5	3 5/8	92.1	6 11/16	169.9		[2] Included	BF9878
M20 x 1.5	3 11/16	93.7	2 27/32	72.2	PS	[1] Included	BF7552
M20 x 1.5	3 11/16	93.7	3 1/4	82.6	AD, HBP	G381-A	B173-S
M20 x 1.5	3 11/16	93.7	3 1/4	82.6	AD, HBP	G324-A	B488
M20 x 1.5	3 11/16	93.7	3 1/4	82.6	PS	[1] Included	BF9887
M20 x 1.5	3 11/16	93.7	3 1/4	82.6		[1] Included	BF46111
M20 x 1.5	3 11/16	93.7	3 3/8	85.7	HBP, PS	[1] Included	B7453
M20 x 1.5	3 11/16	93.7	3 27/32	97.6	AD, MBP	[1] Included	BF7197
M20 x 1.5	3 11/16	93.7	3 7/8	98.4	AD, HBP	G381-A	B141
M20 x 1.5	3 11/16	93.7	3 7/8	98.4		G381-A	BF789
M20 x 1.5	3 11/16	93.7	4 3/8	111.1	PS	G324-A	BF720
M20 x 1.5	3 11/16	93.7	4 3/8	111.1	SP	[2] Included, G401	BF1233
M20 x 1.5	3 11/16	93.7	4 3/8	111.1	PS	G324-A	BF7538
M20 x 1.5	3 11/16	93.7	4 11/16	119.1	D	G324-A	BF7528
M20 x 1.5	3 11/16	93.7	5 3/32	129.4	AD, BP	[1] Included	B7082
M20 x 1.5	3 11/16	93.7	5 3/8	136.5	AD, HBP	G381-A	B202
M20 x 1.5	3 11/16	93.7	5 3/8	136.5	PS, SP	G401, [1] Included	BF1271
M20 x 1.5	3 11/16	93.7	5 3/8	136.5	AD, MBP	G381-A	B7042
M20 x 1.5	3 11/16	93.7	5 5/8	142.9	PS	G324-A	BF7907
M20 x 1.5	3 11/16	93.7	6 23/32	170.7	PS	G401, [1] Included	BF7957
M20 x 1.5	3 11/16	93.7	7 1/8	181.0		G381-A	BF7813
M20 x 1.5	3 11/16	93.7	7 7/32	183.4	PSR	G401, [1] Included	BF7922
M20 x 1.5	3 11/16	93.7	7 7/32	183.4	PS, PSR	G401, [1] Included	BF7940
M20 x 1.5	3 11/16	93.7	7 7/32	183.4		G381-A, [1] Included	BF7966
M20 x 1.5	3 11/16	93.7	7 3/8	187.3	D, PSR, SP	[1] Included	BF1352-SPS
M20 x 1.5	3 11/16	93.7	7 9/32	188.1		G381-A, [1] Included	BF1356
M20 x 1.5	3 23/32	94.5	3 27/32	97.6	HBP	[1] Included, [3] O-Rings	B1446
M20 x 1.5	3 23/32	94.5	3 7/8	98.4	PS	G324-A	BF792
M20 x 1.5	3 23/32	94.5	7 3/16	182.9		[1] Included	BF46104
M20 x 1.5	3 23/32	94.5	7 9/32	184.9	PS, SP	G381-A	BF7941
M20 x 1.5	3 23/32	94.5	7 5/16	185.7	PS, SP	G381-A	BF7942
M20 x 1.5	3 23/32	94.5	7 31/32	202.4		G401	BF7979
M20 x 1.5	3 23/32	94.5	8 3/32	205.6	SHBP	[1] Included	BF7163
M20 x 1.5	3 3/4	95.3	5 5/16	134.9	AD, HBP	[1] Included	B109
M20 x 1.5	3 25/32	96.0	3 1/4	82.6	AD, HBP	[1] Included	B166
M20 x 1.5	3 25/32	96.0	4 11/32	110.3		[1] Included	B7034
M20 x 1.5	3 27/32	97.6	5 19/32	142.1		[1] Included, [1] O-Ring	BF7842
M20 x 1.5	4 1/4	108.0	3 3/16	81.0		[1] Included	B201-S
M20 x 1.5	4 1/4	108.0	4 3/4	120.7	AD, HBP	[1] Included	BF7189
M20 x 1.5	4 1/4	108.0	5 27/32	148.4	HBP	[1] Included	B211
M20 x 1.5	4 1/4	108.0	5 27/32	148.4		[1] Included	B337
M20 x 1.5	4 1/4	108.0	5 27/32	148.4	AD, MBP	[3] Included	B7585
M20 x 1.5	4 1/4	108.0	7 5/8	193.7		[1] Included	B7164
M20 x 1.5 6H	3 1/32	77.2	3 1/2	88.9	AD, SHBP	[1] Included	B40140



**WARNING:** These products can expose you to chemicals, including Diisononyl Phthalate, Carbon black extracts, Nickel, 1,3 Butadiene, Ethylene Oxide, Epichlorohydrin, which are known to the State of California to cause cancer, and Bisphenol-A, Ethylene Glycol, Ethylene Oxide, 1,3 Butadiene, Epichlorohydrin, which are known to the State of California to cause birth defects or other reproductive harm.



# SPIN-ON FILTERS BY TAP SIZE (METRIC THREAD)

THREAD I.D.	O.D. Inches	O.D. (mm)	LENGTH Inches	LENGTH (mm)	GASKET	FEATURES	BALDWIN NUMBER
M20 x 1.5	4 9/32.....	108.7	4.....	101.6		[1] Included	B7280
M22 x 1.5	3.....	76.2	3 1/2.....	88.9	AD, HBP	G449-B	B160
M22 x 1.5	3.....	76.2	3 1/2.....	88.9	AD, HBP	G449-B	B7422
M22 x 1.5	3.....	76.2	3 1/2.....	88.9	AD, BP	G449-B	B7443
M22 x 1.5	3.....	76.2	4 3/32.....	104.0	AD, HBP	G449-B	B7449
M22 x 1.5	3.....	76.2	4 27/32.....	123.0	HBP	G449-B	B56
M22 x 1.5	3.....	76.2	4 27/32.....	123.0	AD, BP	G449-B	B7444
M22 x 1.5	3 1/32.....	77.0	2 25/32.....	70.6	AD, MBP	[1] Included	B7401
M22 x 1.5	3 1/32.....	77.0	3 1/2.....	88.9	AD, HBP	G449-B	B1422
M22 x 1.5	3 1/32.....	77.0	4 1/16.....	103.2	AD, MBP	[1] Included	B7033
M22 x 1.5	3 3/32.....	78.6	5 1/2.....	139.7	PS	[1] Included	BF9910
M22 x 1.5	3 11/16.....	93.7	2 13/16.....	71.4	AD, SHBP	G381-A	B7496
M22 x 1.5	3 11/16.....	93.7	3 1/4.....	82.6	AD, HBP	G324-A	B156
M22 x 1.5	3 11/16.....	93.7	3 3/4.....	95.3	AD, MBP	[1] Included	B7001
M22 x 1.5	3 11/16.....	93.7	3 7/8.....	98.4	AD, HBP	G381-A	B329
M22 x 1.5	3 11/16.....	93.7	4 3/8.....	111.1	D	G381-A	BF9894
M22 x 1.5	3 11/16.....	93.7	4 3/8.....	111.1	MBP	[1] Included	B40122
M22 x 1.5	3 11/16.....	93.7	4 3/8.....	111.3	AD, HBP	G381-A	B40150
M22 x 1.5	3 11/16.....	93.7	5 3/8.....	136.5	AD, HBP	G381-A	B281
M22 x 1.5	3 11/16.....	93.7	5 3/8.....	136.5	AD, SHBP	G381-A	B7377
M22 x 1.5	3 11/16.....	93.7	5 3/8.....	136.5	AD, ADP, SHBP	G381-A	B7388
M22 x 1.5	3 11/16.....	93.7	5 5/8.....	142.9		G381-A	BF7747
M22 x 1.5	3 11/16.....	93.7	6 5/32.....	156.4	D	G381-A	BF9893
M22 x 1.5	3 11/16.....	93.7	6 5/8.....	168.3	AD, ADP, SHBP	G381-A	B7376
M22 x 1.5	3 11/16.....	93.7	7 15/16.....	201.6	D, SP	[1] Included, [1] O-Ring	BF1289-SP
M22 x 1.5	3 25/32.....	96.0	6 11/16.....	169.9	AD, FECV, SHBP	[1] Included	B7350
M22 x 1.5	3 7/8.....	98.4	5 7/32.....	132.6		[1] Included	BT8919
M22 x 1.5	4 1/4.....	108.0	7 19/32.....	192.9	PS	[1] Included	BF7656
M22 x 1.5	4 1/4.....	108.0	9 15/16.....	252.4	D, PS	[1] Included	BF1256
M23 x 1.5	3 13/16.....	96.8	4 5/16.....	109.5	AD, HBP	[1] Included	BT9318
M24 x 1.5	3 11/16.....	93.7	5 13/32.....	137.3	SHBP	G401	B7306
M24 x 1.5	3 11/16.....	93.7	5 9/16.....	141.3		G401	BF7624
M24 x 1.5	3 11/16.....	93.7	5 21/32.....	143.7		[1] Included	BF7908
M24 x 1.5	3 11/16.....	93.7	5 11/16.....	144.5	AD, SHBP	G401	B7360
M24 x 1.5	3 11/16.....	93.7	6 9/16.....	166.7	PS	[1] Included	BF798
M24 x 1.5	3 11/16.....	93.7	6 9/16.....	166.7	PS	[1] Included	BF7993
M24 x 1.5	3 11/16.....	93.7	6 7/8.....	174.6	D, SP	[1] Included	BF46048
M24 x 1.5	3 11/16.....	93.7	7 3/16.....	182.6	AD, ADP	G401	BF1102
M24 x 1.5	3 11/16.....	93.7	8 1/8.....	206.4	AD, HBP	G381-A	B7378
M24 x 1.5	3 11/16.....	93.7	8 1/8.....	206.8			B40133
M24 x 1.5	3 23/32.....	94.5	4 3/16.....	106.4	SHBP	[1] Included	BT9471
M24 x 1.5-6H	3 23/32.....	94.5	8 3/16.....	208.3			BT40029
M24 x 1.5	3 3/4.....	95.3	5 1/4.....	133.4		[2] Included	BF9923-O
M24 x 1.5	3 31/32.....	100.8	4 27/32.....	123.0	AD, BP	[1] Included	BD7029
M24 x 1.5	4 1/4.....	108.0	5 27/32.....	148.4	AD, HBP	G401	B7179
M24 x 2.0	2 31/32.....	75.4	7 15/32.....	189.7		[1] Included	B40127
M24 x 2.0	3 19/32.....	91.3	5 13/16.....	147.6	AD, HBP	[1] Included	B7472
M24 x 2.0	3 19/32.....	91.3	6 5/8.....	168.3	HBP	[1] Included	B7476
M24 x 2.0	3 21/32.....	92.9	5 1/8.....	130.2	HBP, PS	[1] Included	B7451
M24 x 2.0	3 21/32.....	92.9	5 5/8.....	142.9		G381-A	B7026-MPG
M24 x 2.0	3 11/16.....	93.7	6 5/32.....	156.4	D	G381-A	BF7925
M24 x 2.0	4 1/4.....	108.0	5 9/32.....	134.1	HBP	[1] Included	B7477
M26 x 1.5	3 17/32.....	89.7	4 15/16.....	125.4	MBP	[1] Included, [3] O-Rings	BD7160
M26 x 1.5	3 11/16.....	93.7	5 3/8.....	136.5	AD, HBP	G381-A	BD28
M26 x 1.5	3 11/16.....	93.7	7 1/8.....	181.0	AD	G381-A	BD7095
M26 x 1.5	4 1/4.....	108.0	5 27/32.....	148.4	MBP	G401	B7045
M26 x 1.5	4 1/4.....	108.0	5 27/32.....	148.4	HBP	G401	BD7028
M26 x 1.5	4 1/4.....	108.0	7 11/32.....	186.5	ADP, MBP	[1] Included	B7121
M27 x 2.0	3 11/16.....	93.7	3 7/8.....	98.4	AD, ADP, SHBP	G381-A	B7499
M27 x 2.0	3 11/16.....	93.7	6 5/8.....	168.3		[1] Included	BT7237
M27 x 2.0	3 11/16.....	93.7	6 5/8.....	168.3	AD	G381-A	B7327
M27 x 2.0	3 23/32.....	94.5	3 7/8.....	98.4		G381-A	B7328

## SPIN-ON FEATURES

Some spin-ons have no additional features while others have several. Here are some of the more important spin-on features:

### Anti-Drainback Valve



As the name implies, this valve keeps the oil from draining from a filter when the engine is shut off. (Some filters include an anti-drainback standpipe for the same function). The mounting direction determines the need for this feature.

### By-Pass Valve



Full-flow oil systems require a by-pass (relief) valve either in the system or in the filter. This valve opens at a predetermined setting to assure oil flow to the bearings at all times.

### Integral Post Seal



Seals threaded stud to prevent tiny particles from spiraling in via the threads.

**We Cannot be Responsible for Misapplications**



**WARNING:** These products can expose you to chemicals, including Diisononyl Phthalate, Carbon black extracts, Nickel, 1,3 Butadiene, Ethylene Oxide, Epichlorohydrin, which are known to the State of California to cause cancer, and Bisphenol-A, Ethylene Glycol, Ethylene Oxide, 1,3 Butadiene, Epichlorohydrin, which are known to the State of California to cause birth defects or other reproductive harm.

**SPIN-ON FILTERS BY TAP SIZE (METRIC THREAD)**

	THREAD I.D.	O.D. Inches	O.D. (mm)	LENGTH Inches	LENGTH (mm)	GASKET	FEATURES	BALDWIN NUMBER
<b>SPIN-ON FILTER FEATURES ARE CODED AS FOLLOWS</b>	M27 x 2.0	3 23/32	94.5	5 3/8	136.5	HBP	[1] Included	B40056
	M27 x 2.0	4	101.6	6 7/8	174.6		[1] Included	B40050
<b>AD</b> Anti-Drainback Valve	M30 x 1.5	4 1/4	108.0	5 5/8	142.9	SHBP	[1] Included	BT221
	M30 x 1.5	4 1/4	108.0	7 9/16	192.1	HBP	[1] Included	B7142
	M30 x 1.5	4 1/4	108.0	7 19/32	192.9	PS	[1] Included	BF7773
	M30 x 1.5	4 1/4	108.0	8 11/32	211.9	D, PS	[1] Included	BF1286
	M30 x 1.5	4 1/4	108.0	10 7/16	265.1	PS	[1] Included	BF7657
	M30 x 1.5	4 9/32	108.7	6 1/4	158.8	AD, HBP	[1] Included	B7393
	M30 x 2.0	4 1/4	108.0	7 13/32	188.1	SHBP	[1] Included	B7116
	M30 x 2.0	4 1/4	108.0	7 11/16	195.3	SHBP	[1] Included	B7383
	M30 x 2.0	4 1/4	108.0	8 7/16	214.3	SHBP	[1] Included	BD325
	M30 x 2.0	4 1/4	108.0	9 1/8	231.8	AD, HBP	[1] Included	BT472
<b>ADP</b> Anti-Drainback Pipe	M30 x 2.0	4 1/4	108.0	9 1/8	231.8	AD, FECV, SHBP	[1] Included	B7171
	M30 x 2.0	4 1/4	108.0	9 1/8	231.8		[1] Included	B7174-MPG
<b>BP</b> 8-10 PSID By-Pass Valve	M30 x 2.0	4 5/16	109.5	10 3/8	263.5	AD, HBP	[2] Included	BD7168
	M32 x 1.5	4 1/4	108.0	8 25/32	223.0	HBP, PS	[1] Included	BD7158
<b>BPI</b> By-Pass Included	M32 x 1.5	4 1/4	108.0	10 15/32	265.9		[1] Included	BF7814
	M32 x 1.5	4 1/4	108.0	10 15/32	265.9		[1] Included	BF7943
	M32 x 1.5	4 1/4	108.0	10 15/32	265.9	PS	[1] Included	BF9800
	M32 x 1.5	4 1/4	108.0	10 15/32	265.9		[1] Included	BF9802
<b>BPS</b> By-Pass Screen	M32 x 1.5	4 1/4	108.0	10 15/32	265.9		[1] Included	BF46034
	M32 x 1.5-6H	4 1/4	108.2	10 15/32	265.9		[1] Included	BF46161
<b>BTA PLUS</b> Balanced Treatment Additive Plus	M32 x 1.5-6H	4 1/4	108.2	10 15/32	265.9		[1] Included	BF46233
	M32 x 1.5	4 9/32	108.7	10 11/32	262.7		[1] Included	BF9817
<b>BTE</b> Balanced Treatment for Ethylene Glycol Antifreeze	M32 x 1.5	4 11/32	110.0	6 9/16	166.9		[1] Included	BF46131
	M32 x 1.5	4 11/32	110.3	8 7/8	225.4		[1] Included	BF46117
<b>D</b> Drain	M36 x 1.5	5 1/8	130.2	8 21/32	219.9	PS	[1] Included	BD1403
	M36 x 1.5	5 11/32	135.7	12 7/32	310.4	SHBP	[1] Included	B40013
<b>FECV</b> Front-End Check Valve	M36 x 1.5	5 3/8	136.5	12 3/32	307.2	SHBP	[1] Included	B7030
	M36 x 1.5	5 3/8	136.5	12 3/32	307.2	BPS, SHBP	[1] Included	B7229
<b>FP</b> Fill Port	M36 x 2.0	3 3/4	95.3	5 13/32	137.3	BTA PLUS	[1] Included	BW5086
	M36 x 2.0	3 3/4	95.3	5 15/32	138.9		[1] Included	B5087
<b>HBP</b> 18-25 PSID High Pressure By-Pass Valve	M38 x 2.0	3 11/16	93.7	5 9/16	141.3		[1] Included	BT8304
	M39 x 1.5	5 3/8	136.5	6 9/16	166.7		[1] Included, [1] O-Ring	BA5379
<b>ISO</b> Inside-Out Flow Direction	M39 x 1.5 LH	5 3/8	136.5	6 9/16	166.7		[1] Included, [1] O-Ring	BA5566
	M39 x 1.5	5 3/8	136.5	12 1/8	308.0	PS	[1] Included	BF7996
	M39 x 1.5	5 1/2	139.7	6 9/16	166.7		[1] Included, [1] O-Ring	BA5374
	M39 x 1.5	5 1/2	139.7	6 9/16	166.7		[1] Included, [1] O-Ring	BA5592
<b>LBP</b> 2-7 PSID Low Pressure By-Pass Valve	M40 x 2.0	4 3/16	106.4	7 1/16	179.4		[1] Included	BT8920
	M41 x 1.5	5 7/16	138.1	6 9/16	166.7		[2] Included	BA5284
<b>MBP</b> 11-17 PSID Medium Pressure By-Pass Valve	M41 x 1.5	5 1/2	139.7	5 15/32	138.9		[1] Included, [1] O-Ring	BA5376
	M42 x 2.0	5 3/8	136.5	8 5/8	219.1	BP, BPS	[1] Included	BT9387
<b>MO</b> Metering Orifice	M42 x 2.0	5 3/8	136.5	8 7/8	225.4	SHBP	[1] Included	B7161
	M42 x 2.0	5 3/8	136.5	12 3/8	314.3	SHBP	[1] Included	B7162
	M42 x 2.0	5 3/8	136.5	12 3/8	314.3	SHBP	[1] Included	B7224
	M42 x 2.0	5 13/32	137.3	7 1/8	181.0		[1] Included	BT9164
<b>PS</b> Integral Post Seal Gasket	M42 x 2.0-6G	5 7/16	138.1	3 15/16	100.0		[1] Included	BT23537
	M45 x 1.5	3 9/32	83.1	6 1/8	155.4			BT23604
<b>PSR</b> Post Seal Required; Must install loose O-Ring or D-Ring on Post for Seal	M45 x 1.5	5 3/8	136.5	9 5/8	244.5	SHBP	[1] Included	B7314
	M45 x 1.5	5 3/8	136.5	12 3/32	307.2		[1] Included	B7135
<b>RC</b> Reinforced Centertube	M45 x 1.5	5 3/8	136.5	12 3/32	307.2		[1] Included	B7175
	M45 x 2.0	3 7/16	87.3	6 1/16	154.0		[2] Included	BT9464
<b>SHBP</b> 30-45 PSID Super High Pressure By-Pass Valve	M45 x 2.0-6H	3 7/16	87.3	6 17/32	165.9			BT23607-MPG
	M45 x 2.0	5 7/16	138.1	6 15/16	176.2			BT9533
<b>SP</b> Sensor Port	M48 x 2.0	5 9/32	134.1	6 27/32	173.8	Retainer Ring	[1] Included	BT8906
	M48 x 2.0	5 9/32	134.1	11 15/32	291.3		[1] Included	BT9377
<b>XHBP</b> 50+ PSID Extra High Pressure By-Pass Valve	M52 x 1.5	4 21/32	118.3	11 13/32	289.7		G293-B	BD7310
	M52 x 1.5-6H	4 11/16	119.1	11 25/32	299.2		[2] Attached	BD40027



**WARNING:** These products can expose you to chemicals, including Diisononyl Phthalate, Carbon black extracts, Nickel, 1,3 Butadiene, Ethylene Oxide, Epichlorohydrin, which are known to the State of California to cause cancer, and Bisphenol-A, Ethylene Glycol, Ethylene Oxide, 1,3 Butadiene, Epichlorohydrin, which are known to the State of California to cause birth defects or other reproductive harm.

# SPIN-ON FILTERS BY TAP SIZE (METRIC THREAD)

THREAD I.D.	O.D. Inches	O.D. (mm)	LENGTH Inches	LENGTH (mm)	GASKET	FEATURES	BALDWIN NUMBER
M60 x 1.5	3 31/32.....	100.8	7 1/4.....	184.2		[1] Included	BT8914
M60 x 2.0	4 5/32.....	105.6	10 3/8.....	263.5		[1] Included	BT9454
M60 x 3.0	5 15/32.....	138.9	6 3/4.....	171.5	MBP	[1] Included	B7097
M67 x 4	4.....	101.6	6 7/32.....	157.7			B40051
M68 x 2.0	3 7/16.....	87.3	6 13/32.....	162.7			BT9440
M72 x 2.0	3 23/32.....	94.5	9 5/32.....	232.6		[1] Included	BF7766
M72 x 2.0	3 7/8.....	98.4	9 3/16.....	233.4		[1] Included	BT9368-MPG
M82 x 1.5	4 1/4.....	108.0	8 7/8.....	225.4	BPI	[1] Included	BT9437
M85 x 2.0	4 21/32.....	118.3	11 5/8.....	295.3	D, PSR, SP	[2] Included	BF1274-SP
M85 x 2.0	4 21/32.....	118.3	11 5/8.....	295.3	D, PSR, SP	[1] Included	BF1274-SPS
M85 x 2.0	4 21/32.....	118.3	11 5/8.....	295.3	D, PSR, SP	[2] Included	BF1277-SP
M85 x 2.0	4 21/32.....	118.3	11 5/8.....	295.3	D, PSR, SP	[1] Included	BF1277-SPS
M85 x 2.0	4 11/16.....	119.1	11 1/8.....	282.6		[1] Included	BF9920
M90 x 2.0	4 23/32.....	119.9	7 11/16.....	195.3		[1] Included	BT8503-MPG
M90 x 2.0	4 23/32.....	119.9	8 27/32.....	224.6		[1] Included	BF9885
M90 x 2.0	4 23/32.....	119.9	8 27/32.....	224.6		[1] Included	BF46129
M90 x 2.0	4 23/32.....	119.9	8 29/32.....	226.2		[1] Included	BT9369-MPG
M90 x 2.0	4 23/32.....	119.9	11 9/16.....	293.7		[1] Included	BF9860
M90 x 2.0	4 23/32.....	119.9	11 9/16.....	293.7		[1] Included	BF46179
M90 x 2.0	4 23/32.....	119.9	11 5/8.....	295.3		[1] Included	BD7176
M90 x 2.0	4 23/32.....	119.9	11 23/32.....	297.7		[1] Included	BT9347-MPG
M90 x 2.0	4 23/32.....	119.9	11 29/32.....	302.4		[1] Included	BT9367-MPG
M90 x 2.0-7H	4 23/32.....	119.9	11 9/16.....	293.7		[2] Included	BT23543-MPG
M92 x 2.0	4 21/32.....	118.3	10 11/32.....	262.7		[1] Included, [2] O-Rings	BD7252
M92 x 2.5	3 29/32.....	99.2	5 15/16.....	150.8		[1] Included	B7322
M92 x 2.5	4.....	101.6	5 7/8.....	149.1			B40063
M95 x 2.0	4 21/32.....	118.3	14 7/32.....	361.2		[1] Included, [2] Viton O-Rings	BD7250
M95 x 2.5	4 21/32.....	118.3	11 25/32.....	299.2	Venturi-Type Cone	[1] Included	BD7154
M95 x 2.5	4 21/32.....	118.3	14 7/32.....	361.2	Venturi-Type Cone	[1] Included	BD7153
M95 x 2.5	4 11/16.....	119.1	11 25/32.....	299.2		[1] Included	BD7355
M95 x 2.5	4 11/16.....	119.1	11 25/32.....	299.2	VVenturi-Type Cone	[1] Varnac Included	BD7509
M95 x 2.5	4 11/16.....	119.1	11 25/32.....	299.2			B40145
M95 x 2.5-6H	4 11/16.....	119.1	11 25/32.....	299.2		[1] Included	BD50000
M95 x 2.5 6H	4 23/32.....	119.6	11 25/32.....	299.5			BD40139
M120 x 2.0	5 3/32.....	129.4	11.....	279.4		[1] Attached, [1] O-Ring	BT9360

## CAUTION!!!

### Read These Instructions Before Using Size Charts

The filter size charts on this and following pages are for filter experts. Careless use could lead to errors. When you have exhausted all other ways to determine a filter number, locate a suspect here, then check the Product Guide for confirmation.

Size alone does not assure you of the right filtering media, gasket or other features. What is being filtered, filter efficiency, flow rate and direction of flow all have to be considered.

Spin-on filters are listed by tap size rather than length. All other filters are listed on an overall basis. Check your Product Guide for other dimensions. Progression is from the smallest to the largest in each category.

### Do NOT Interchange Filters with Different Features

### Be Sure to Check Product Guide, Cross-References and Applications

### We Cannot be Responsible for Misapplications



**WARNING:** These products can expose you to chemicals, including Diisononyl Phthalate, Carbon black extracts, Nickel, 1,3 Butadiene, Ethylene Oxide, Epichlorohydrin, which are known to the State of California to cause cancer, and Bisphenol-A, Ethylene Glycol, Ethylene Oxide, 1,3 Butadiene, Epichlorohydrin, which are known to the State of California to cause birth defects or other reproductive harm.

# LIQUID ELEMENTS BY LENGTH

All Measurements in Inches and (Millimeters)

**NOTE:** All liquid element filters have been sorted by length and then outside diameter.  
The larger outside and inside diameters have been listed.

LENGTH Inches	LENGTH (mm)	O.D. Inches	O.D. (mm)	I.D. Inches	I.D. (mm)	BALDWIN NUMBER	LENGTH Inches	LENGTH (mm)	O.D. Inches	O.D. (mm)	I.D. Inches	I.D. (mm)	BALDWIN NUMBER
25/32	19.8	5/8	15.9	7/32	5.6	SF898	2 7/32	56.4	3 1/32	77.0	1 19/32	40.5	BT8386
15/16	23.8	1 5/8	41.3	1 1/16	27.0	PF7882	2 1/4	57.2	2 3/8	60.3	1 3/32	27.8	P7454
													P148
1 1/32	26.2	11/16	17.5	9/32	7.1	PF893	2 9/32	57.9	1 1/8	28.6	17/32	13.5	PF7545
1 1/32	26.2	11/16	17.5	9/32	7.1	PF893-RV	2 9/32	57.9	2 5/32	54.8	1/2	12.7	P40090
1 1/16	27.0	1 3/4	44.4	15/32	11.9	PF857	2 5/16	58.7	4 7/32	107.2	1 11/16	42.9	101
1 1/4	31.8	2	50.8	1 5/8	41.3	S423	2 5/16	58.7	4 7/32	107.2	1 11/16	42.9	101-30
1 1/4	31.8	2 3/4	69.9	1 25/32	45.2	PT23574-MPG	2 5/16	58.7	4 7/32	107.2	1 11/16	42.9	101-W
1 5/16	33.3	1 13/16	46.0	15/32	11.9	PF864	2 11/32	59.5	29/32	23.0	13/32	10.3	P7262
1 5/16	33.3	1 13/16	46.0	5/8	15.9	PT23069-MPG	2 11/32	59.5	1 13/32	35.7	5/8	15.9	P7261
1 3/8	34.9	1 1/2	38.1	1 1/8	28.6	S455	2 11/32	59.5	3 5/32	80.2	3/4	19.0	PF7817
1 3/8	34.9	2 15/16	74.6	1 3/16	30.2	PT9481-MPG	2 3/8	60.3	2 3/16	55.6	1/8	3.2	P40091
1 3/8	34.9	3 15/16	100.0	1 1/16	27.0	PT548	2 3/8	60.3	2 3/16	55.6	21/32	16.7	P40089
1 13/32	35.7	1 19/32	40.5	31/32	24.6	PF7824	2 7/16	61.9	3 9/16	90.5	1 11/32	34.1	P7255
1 7/16	36.5	1 9/16	39.7	15/32	11.9	P9603	2 15/32	62.7	1 7/8	47.6	23/32	18.3	PF224
1 7/16	36.5	1 31/32	50.0	15/32	11.9	P7132	2 15/32	62.7	2 5/32	54.8	15/16	23.8	PF7836
1 15/32	37.3	2 1/4	57.2	27/32	21.4	PF847	2 1/2	63.5	3 17/32	89.7	1 1/8	28.6	P186
1 1/2	38.1	2 3/4	69.9	9/16	14.3	PF314	2 17/32	64.3	1 17/32	38.9	15/32	11.9	P7303
1 17/32	38.9	2 7/8	73.0	1 1/16	27.0	PT214(2)	2 17/32	64.3	1 21/32	42.1	1/2	12.7	P7259
1 9/16	39.7	1 7/16	36.5	1/2	12.7	PT23145	2 17/32	64.3	2 15/32	62.7	13/32	10.3	PF7550
1 9/16	39.7	2 15/32	62.7	1 1/16	27.0	P450	2 17/32	64.3	2 9/16	65.1	15/32	11.9	P7260
1 9/16	39.7	3 3/16	81.0	1 1/16	27.0	P183	2 17/32	64.3	7 1/4	184.2	2 7/8	73.0	PT558
1 19/32	40.5	3	76.2	25/32	19.8	P40085	2 9/16	65.1	2 3/32	53.1	25/32	20.1	PF46142
1 5/8	41.3	1 31/32	50.0	1 19/32	40.5	PF7939	2 9/16	65.1	2 1/2	63.5	1 3/8	34.9	P40014
1 5/8	41.3	1 31/32	50.0	1 19/32	40.5	PF7974	2 9/16	65.1	2 3/4	69.9	9/16	14.3	PF506
1 23/32	43.7	1 3/4	44.4	17/32	13.5	P40132	2 9/16	65.1	2 7/8	73.0	21/32	16.7	PF945
1 23/32	43.7	2 29/32	73.8	23/32	18.3	61	2 9/16	65.1	3 3/16	81.0	1 1/16	27.0	P144
1 23/32	43.7	2 29/32	73.8	23/32	18.3	61-W	2 9/16	65.1	5	127.0	2 29/32	73.8	PT534
1 3/4	44.4	1 3/8	34.9	15/32	11.9	PF7822	2 19/32	65.9	2 9/16	65.1	13/16	20.6	PF9862
1 3/4	44.4	1 3/8	34.9	1/2	12.7	PF7873	2 5/8	66.7	2 1/8	54.0	25/32	19.8	PT23031-MPG
1 3/4	44.4	5	127.0	3 9/32	83.3	PF7627	2 5/8	66.7	2 1/8	54.0	7/8	22.2	PT23528-MPG
1 25/32	45.2	1 11/16	42.9	15/32	11.9	PF7549	2 5/8	66.7	2 3/8	60.3	11/16	17.5	PF46009
1 25/32	45.2	2 5/8	66.7	25/32	19.8	P40086	2 5/8	66.7	2 9/16	65.1	1/2	12.7	PF986
1 13/16	46.0	7/8	22.2	3/8	9.5	PF7819	2 5/8	66.7	2 3/4	69.9	1 3/32	27.8	PF7398
1 13/16	46.0	1 1/2	38.1	1/2	12.7	P40130	2 21/32	67.5	2 1/32	51.6	1/2	12.7	PF7833
1 13/16	46.0	2 1/4	57.2	1 7/8	47.6	S451	2 11/16	68.3	3 1/4	82.6	5/16	7.9	BC40007
1 13/16	46.0	2 15/16	74.6	1/2	12.7	66	2 23/32	69.1	1 3/8	34.9	1/2	12.7	PF937
1 13/16	46.0	2 15/16	74.6	1/2	12.7	66-30	2 23/32	69.1	2 1/8	54.0	1 1/8	28.6	PT23032-MPG
1 13/16	46.0	2 15/16	74.6	1/2	12.7	66-W	2 23/32	69.1	2 5/32	54.8	11/16	17.5	PT8998-MPG
1 27/32	46.8	1 1/2	38.1	17/32	13.5	P40002	2 23/32	69.1	2 3/16	55.6	1 1/8	28.6	PT8975-MPG
1 27/32	46.8	2 11/16	68.3	13/16	20.6	P9602	2 23/32	69.1	2 9/16	65.1	1 3/32	27.8	P7450
1 7/8	47.6	1 3/8	34.9	9/16	14.3	PF859	2 23/32	69.1	3 3/8	85.7	1 1/8	28.6	PT9354-MPG
1 7/8	47.6	1 1/2	38.1	1/2	12.7	P40131	2 23/32	69.1	3 3/8	85.7	2	50.8	PT9449
1 15/16	49.2	1 3/8	34.9	7/16	11.1	PF7975	2 3/4	69.9	1 3/8	34.9	15/32	11.9	PF7830
1 15/16	49.2	1 7/16	36.5	15/32	11.9	PF9873	2 3/4	69.9	2 1/8	54.0	15/16	23.8	PT23088-MPG
													P140
2 1/32	51.6	11/16	17.5	9/32	7.1	PF894	2 3/4	69.9	3 7/32	81.8	5/8	15.9	PF598
2 1/32	51.6	11/16	17.5	9/32	7.1	PF894-RV	2 3/4	69.9	3 7/32	81.8	5/8	15.9	PF598-10
2 1/32	51.6	1 3/8	34.9	15/32	11.9	PF7869	2 3/4	69.9	3 7/32	81.8	5/8	15.9	PF598-30
2 1/32	51.6	2 1/32	51.6	1 15/32	37.3	PT9426	2 3/4	69.9	3 5/16	84.1	13/16	20.6	PF838
2 1/16	52.4	1 5/8	41.3	9/16	14.3	PF7874	2 25/32	70.6	1 3/8	34.9	7/16	11.1	PF46077
2 1/16	52.4	1 21/32	42.1	27/32	21.4	PT9424	2 25/32	70.6	2 1/32	51.6	29/32	23.0	P7256
2 1/16	52.4	1 31/32	50.0	9/16	14.3	PF7875	2 25/32	70.6	3 5/32	80.2	21/32	16.7	PF9838
2 1/16	52.4	2 3/32	53.2	23/32	18.3	PT459	2 25/32	70.6	3 15/32	88.1	1 15/32	37.3	PT903
2 3/32	53.2	2 9/16	65.1	9/16	14.3	PF7596	2 25/32	70.6	3 15/32	88.1	1 15/32	37.3	PT951
2 1/8	54.0	1 13/16	46.0	1/32	0.8	PF9911	2 13/16	71.4	2 1/4	57.2	15/16	23.8	PT23087-MPG
2 1/8	54.0	1 31/32	50.0	29/32	23.0	P540	2 13/16	71.4	2 5/16	58.9	23/32	18.0	PT23629
2 1/8	54.0	2 7/8	73.0	17/32	13.5	PF860	2 13/16	71.4	2 3/8	60.3	15/16	23.8	PT23193-MPG
2 5/32	54.8	2 1/16	52.3	27/32	21.4	P40101	2 27/32	72.2	1 11/16	42.9	1 11/32	35.7	PF7994
2 5/32	54.8	2 27/32	72.2	11/32	8.7	PT23314	2 27/32	72.2	1 3/4	44.4	15/32	11.9	PF599
2 5/32	54.8	3 1/32	77.0	25/32	19.8	P40093	2 27/32	72.2	1 3/4	44.4	15/32	11.9	PF599-10
2 3/16	55.6	1 23/32	43.7	17/32	13.5	P7490	2 27/32	72.2	1 3/4	44.4	15/32	11.9	PF599-30
2 3/16	55.6	2 27/32	72.2	1 25/32	45.2	PT9228	2 27/32	72.2	3 5/32	80.3	9/16	13.9	PF46138
2 7/32	56.4	1 1/8	28.6	5/8	15.9	PF7818	2 27/32	72.2	5 9/32	134.1	3 19/32	91.3	PT23587
2 7/32	56.4	2 15/16	74.6	5/8	15.9	PF861	2 7/8	73.0	29/32	23.0	13/32	10.3	P7263



**WARNING:** These products can expose you to chemicals, including Diisononyl Phthalate, Carbon black extracts, Nickel, 1,3 Butadiene, Ethylene Oxide, Epichlorohydrin, which are known to the State of California to cause cancer, and Bisphenol-A, Ethylene Glycol, Ethylene Oxide, 1,3 Butadiene, Epichlorohydrin, which are known to the State of California to cause birth defects or other reproductive harm.

# LIQUID ELEMENTS BY LENGTH

LENGTH Inches	LENGTH (mm)	O.D. Inches	O.D. (mm)	I.D. Inches	I.D. (mm)	BALDWIN NUMBER	LENGTH Inches	LENGTH (mm)	O.D. Inches	O.D. (mm)	I.D. Inches	I.D. (mm)	BALDWIN NUMBER
2 7/8.....	73.0	2 1/16.....	52.4	31/32.....	24.6	PT9142	3 1/2.....	88.9	1 3/8.....	34.9	1/2.....	12.7	PF981
2 7/8.....	73.0	2 9/16.....	65.1	31/32.....	24.6	P7313	3 1/2.....	88.9	1 3/8.....	34.9	1 1/4.....	31.8	PT23036-MPG
2 7/8.....	73.0	3 3/4.....	95.3	1 5/16.....	33.3	P190	3 1/2.....	88.9	1 1/2.....	38.1	1 1/8.....	28.6	S485
2 31/32.....	75.4	2 1/16.....	52.4	29/32.....	23.0	PT9240	3 1/2.....	88.9	1 21/32.....	42.1	5/8.....	15.9	PT23573-MPG
2 31/32.....	75.4	2 9/16.....	65.1	11/16.....	17.5	PF866	3 1/2.....	88.9	1 21/32.....	42.1	27/32.....	21.4	PT9462
3.....	76.2	1 1/8.....	28.6	3/16.....	4.8	PF7820	3 1/2.....	88.9	1 21/32.....	42.1	7/8.....	22.2	PT257
3.....	76.2	1 31/32.....	50.0	15/16.....	23.8	PT9179	3 1/2.....	88.9	1 31/32.....	50.0	25/32.....	19.8	PF717
3.....	76.2	1 31/32.....	50.0	1 1/32.....	26.2	PT9236-MPG	3 1/2.....	88.9	2 1/2.....	63.5	1 11/16.....	42.9	PT9516
3.....	76.2	2.....	50.8	15/16.....	23.8	PT23097-MPG	3 1/2.....	88.9	2 25/32.....	70.6	1 3/32.....	27.8	PT9289-MPG
3.....	76.2	2 1/4.....	57.2	13/32.....	10.3	PF935	3 17/32.....	89.7	1 5/8.....	41.3	27/32.....	21.4	PT9208
3.....	76.2	2 17/32.....	64.3	1/2.....	12.7	PF9823	3 17/32.....	89.7	3 3/16.....	81.0	1 31/32.....	50.0	P40081
3.....	76.2	2 23/32.....	69.1	31/32.....	24.6	PE5270	3 9/16.....	90.5	2 15/32.....	62.7	1 1/16.....	27.0	P454
3.....	76.2	2 3/4.....	69.9	7/16.....	11.1	P7178	3 9/16.....	90.5	2 15/32.....	62.7	1 3/32.....	27.8	P446
3.....	76.2	2 7/8.....	73.0	1 1/16.....	27.0	P187	3 9/16.....	90.5	2 7/8.....	73.0	15/32.....	11.9	P7103
3.....	76.2	5.....	127.0	2 13/16.....	71.4	PT565	3 9/16.....	90.5	4 7/8.....	123.8	9/16.....	14.3	PF7698
3.....	76.2	5.....	127.0	2 15/16.....	74.6	PT379 KIT	3 9/16.....	90.5	6 7/32.....	158.0	2 17/32.....	64.3	PT23526
3.....	76.2	5 3/32.....	129.4	2 9/16.....	65.1	PT8907-MPG	3 19/32.....	91.3	1 5/8.....	41.3	29/32.....	23.0	PT9209
3 1/32.....	77.0	3 5/16.....	84.1	11/32.....	8.7	PF46088	3 19/32.....	91.3	2 5/32.....	54.8	29/32.....	23.0	PF997
3 1/16.....	77.8	2 7/8.....	73.0	15/16.....	23.8	PF816-S	3 19/32.....	91.3	2 3/4.....	69.9	1 3/32.....	27.8	PT9239
3 3/32.....	78.6	1 31/32.....	50.0	27/32.....	21.4	PT8341	3 5/8.....	92.1	1 1/4.....	31.8	3/8.....	9.5	PT23086-MPG
3 3/32.....	78.6	2 7/16.....	61.9	1 7/32.....	31.0	P1440	3 5/8.....	92.1	1 21/32.....	42.1	29/32.....	23.0	PT23319
3 1/8.....	79.4	23/32.....	18.3	5/8.....	15.9	PF9907	3 5/8.....	92.1	2 7/16.....	61.9	1 3/8.....	34.9	P7442
3 1/8.....	79.4	1 5/8.....	41.3	5/8.....	15.9	PT23055-MPG	3 5/8.....	92.1	2 3/4.....	69.9	1 3/32.....	27.8	PT9180
3 1/8.....	79.4	1 13/16.....	46.0	15/16.....	23.8	PT23096-MPG	3 5/8.....	92.1	2 7/8.....	73.0	1 1/8.....	28.6	PT728-MPG
3 1/8.....	79.4	1 31/32.....	50.0	25/32.....	19.8	PF7832	3 5/8.....	92.1	3.....	76.2	1 1/16.....	27.0	PF906
3 1/8.....	79.4	2 7/8.....	73.0	1 5/8.....	41.3	P7438	3 21/32.....	92.9	1 3/8.....	34.9	15/32.....	11.9	PT23367-MPG
3 1/8.....	79.4	2 7/8.....	73.0	1 5/8.....	41.3	P40113	3 21/32.....	92.9	1 3/8.....	34.9	1/2.....	12.7	PT8960-MPG
3 1/8.....	79.4	2 15/16.....	74.6	1 1/4.....	31.8	PF816	3 21/32.....	92.9	1 3/8.....	34.9	1/2.....	12.7	PT23377-MPG
3 1/8.....	79.4	3 3/4.....	95.3	1 1/32.....	26.2	PF7834	3 11/16.....	93.7	1 3/8.....	34.9	7/16.....	11.1	PT9221
3 1/8.....	79.4	3 3/4.....	95.3	1 1/2.....	38.1	PF7852 KIT	3 11/16.....	93.7	1 3/8.....	34.9	1/2.....	12.7	PT9337-MPG
3 5/32.....	80.2	1 1/16.....	27.0	5/8.....	15.9	PT283	3 11/16.....	93.7	1 27/32.....	46.8	1.....	25.4	PT8952-MPG
3 5/32.....	80.2	1 3/32.....	27.8	11/32.....	8.7	PT23571-MPG	3 11/16.....	93.7	1 27/32.....	46.8	1.....	25.4	PT23387-MPG
3 5/32.....	80.2	2 3/4.....	69.9	1 5/32.....	29.4	PT23017	3 11/16.....	93.7	1 27/32.....	46.8	1 1/32.....	26.2	PT9255
3 5/32.....	80.2	2 7/8.....	73.0	27/32.....	21.4	P240	3 11/16.....	93.7	3 19/32.....	91.3	1 15/32.....	37.3	P7455
3 5/32.....	80.2	2 7/8.....	73.0	1 1/32.....	26.2	P7338	3 11/16.....	93.7	3 23/32.....	94.5	1 1/32.....	26.2	PF9803
3 3/16.....	81.0	2 13/16.....	71.4	1 3/32.....	27.8	P7408	3 23/32.....	94.5	1 3/4.....	44.3	13/16.....	20.3	PE17000
3 7/32.....	81.8	2 3/4.....	69.9	1 3/32.....	27.8	P7418	3 23/32.....	94.5	1 27/32.....	46.8	1.....	25.4	PT23058-MPG
3 7/32.....	81.8	7 1/4.....	184.1	2 7/8.....	72.9	PT23633	3 3/4.....	95.3	1 7/8.....	47.6	1.....	25.4	PT23384-MPG
3 9/32.....	83.3	1 27/32.....	46.8	13/16.....	20.6	PT9302-MPG	3 3/4.....	95.3	2 7/16.....	61.9	1 1/2.....	38.1	PT23337
3 9/32.....	83.3	2 9/16.....	65.1	31/32.....	24.6	P9605	3 3/4.....	95.3	2 23/32.....	69.1	1 5/32.....	29.4	PF7829
3 9/32.....	83.3	3.....	76.2	—.....	—.....	BT40038	3 3/4.....	95.3	2 3/4.....	69.9	—.....	—.....	PT9193
3 5/16.....	84.1	1 27/32.....	46.8	7/8.....	22.2	PT8894-MPG	3 3/4.....	95.3	2 13/16.....	71.4	1 7/32.....	31.0	P7413
3 5/16.....	84.1	1 27/32.....	46.8	7/8.....	22.2	PT8962-MPG	3 3/4.....	95.3	4 17/32.....	115.1	2 1/4.....	57.2	P206
3 5/16.....	84.1	1 27/32.....	46.8	7/8.....	22.2	PT23037-MPG	3 25/32.....	96.0	1 31/32.....	50.0	13/32.....	10.3	PF7823
3 5/16.....	84.1	1 27/32.....	46.8	7/8.....	22.2	PT23374-MPG	3 25/32.....	96.0	2 1/2.....	63.5	—.....	—.....	S40071
3 5/16.....	84.1	1 27/32.....	46.8	7/8.....	22.2	PT23379-MPG	3 13/16.....	96.8	1 3/4.....	44.4	3/4.....	19.0	PT23107-MPG
3 5/16.....	84.1	1 27/32.....	46.8	7/8.....	22.2	PT23494-MPG	3 13/16.....	96.8	2 1/8.....	54.0	23/32.....	18.3	P1433
3 5/16.....	84.1	2 7/8.....	73.0	9/16.....	14.3	PF313	3 13/16.....	96.8	3 3/32.....	78.6	9/16.....	14.3	PF936
3 5/16.....	84.1	2 7/8.....	73.0	1 5/16.....	33.3	PF820-S	3 13/16.....	96.8	3 3/4.....	95.3	1 5/16.....	33.3	P15
3 5/16.....	84.1	4.....	101.6	1 5/8.....	41.3	PF46186	3 27/32.....	97.6	3 17/32.....	89.7	—.....	—.....	PT9213
3 11/32.....	84.9	1 25/32.....	45.2	1 1/32.....	26.2	PT8995-MPG	3 7/8.....	98.4	2 7/8.....	73.0	1 7/16.....	36.5	PF7916
3 11/32.....	84.9	2 3/32.....	53.2	1 3/32.....	27.8	PT9478-MPG	3 7/8.....	98.4	3 21/32.....	92.9	1 23/32.....	43.7	PF1587
3 11/32.....	84.9	2 3/4.....	69.9	1 5/32.....	29.4	PT23478	3 7/8.....	98.4	3 3/4.....	95.3	1 1/16.....	27.0	PF9890
3 11/32.....	84.9	2 3/4.....	69.9	1 5/32.....	29.4	PT23500-MPG	3 7/8.....	98.4	3 3/4.....	95.3	1 3/32.....	27.8	PF9897
3 3/8.....	85.7	1 11/16.....	42.9	1 1/32.....	26.2	PE5272	3 29/32.....	99.2	2 27/32.....	72.2	1 11/32.....	34.1	P1566
3 3/8.....	85.7	1 25/32.....	45.2	15/16.....	23.8	PT9206	3 29/32.....	99.2	2 29/32.....	73.8	1 1/4.....	31.8	PT23489-MPG
3 3/8.....	85.7	1 13/16.....	46.0	3/8.....	9.5	P7247	3 29/32.....	99.2	3 21/32.....	92.9	1 23/32.....	43.7	P1575
3 3/8.....	85.7	2 3/4.....	69.9	13/16.....	20.6	PF46112	3 29/32.....	99.2	3 11/16.....	93.7	1 29/32.....	48.4	PT23197-MPG
3 13/32.....	86.5	1 3/16.....	30.2	5/8.....	15.9	PF7877	3 29/32.....	99.2	3 11/16.....	93.7	1 29/32.....	48.4	PT23490-MPG
3 13/32.....	86.5	1 25/32.....	45.2	15/16.....	23.8	PT9310-MPG	3 29/32.....	99.2	4 5/16.....	109.5	13/16.....	20.6	PF7889
3 7/16.....	87.3	1 1/8.....	28.6	1/2.....	12.7	PF872	3 29/32.....	99.2	4 5/16.....	109.5	13/16.....	20.6	PF7889-10
3 7/16.....	87.3	1 21/32.....	42.1	27/32.....	21.4	PT8392	3 29/32.....	99.2	4 5/16.....	109.5	13/16.....	20.6	PF7889-30
3 7/16.....	87.3	1 21/32.....	42.1	27/32.....	21.4	PT9537-MPG	3 15/16.....	100.0	21/32.....	34.9	11/8.....	16.7	PT23073-MPG
3 7/16.....	87.3	2 13/16.....	71.4	1 7/32.....	31.0	P40119	3 15/16.....	100.0	1 3/4.....	44.4	1.....	25.4	PT9477
3 15/32.....	88.1	1 21/32.....	42.1	29/32.....	23.0	PT8372	3 15/16.....	100.0	2 19/32.....	65.9	7/16.....	11.1	PE5271
3 15/32.....	88.1	2 1/16.....	52.4	7/16.....	11.1	PF827	3 15/16.....	100.0	2 5/8.....	66.7	1/2.....	12.7	P40058
3 15/32.....	88.1	2 7/16.....	61.9	1 3/32.....	27.8	P40116	3 15/16.....	100.0	3 11/32.....	84.9	1 9/16.....	39.7	PF9845
3 15/32.....	88.1	2 7/8.....	73.0	1 5/16.....	33.3	P176	3 31/32.....	100.8	2 1/4.....	57.2	1 1/16.....	27.0	PF818



**WARNING:** These products can expose you to chemicals, including Diisononyl Phthalate, Carbon black extracts, Nickel, 1,3 Butadiene, Ethylene Oxide, Epichlorohydrin, which are known to the State of California to cause cancer, and Bisphenol-A, Ethylene Glycol, Ethylene Oxide, 1,3 Butadiene, Epichlorohydrin, which are known to the State of California to cause birth defects or other reproductive harm.

# LIQUID ELEMENTS BY LENGTH

LENGTH Inches	LENGTH (mm)	O.D. Inches	O.D. (mm)	I.D. Inches	I.D. (mm)	BALDWIN NUMBER	LENGTH Inches	LENGTH (mm)	O.D. Inches	O.D. (mm)	I.D. Inches	I.D. (mm)	BALDWIN NUMBER
3 31/32	100.8	2 5/16	58.7	1 1/16	17.5	P106	4 7/32	107.2	2 9/16	65.1	1 1/16	27.0	P7364
3 31/32	100.8	2 5/16	58.7	1 1/16	17.5	P106-HD	4 7/32	107.2	2 7/8	73.0	19/32	15.1	PF7551
3 31/32	100.8	2 9/16	65.1	1 3/32	27.8	P40024	4 7/32	107.2	2 7/8	73.0	1	25.4	PF802
3 31/32	100.8	2 3/4	69.9	1 5/8	41.3	PT9178	4 7/32	107.2	3 5/32	80.2	1 1/8	28.6	PT23219-MPG
3 31/32	100.8	2 7/8	73.0	13/16	20.6	PT48	4 7/32	107.2	3 15/16	100.0	21/32	16.7	PF7572
3 31/32	100.8	4 3/8	111.1	2 7/16	61.9	PT9420-MPG	4 7/32	107.2	4 1/32	102.4	21/32	16.8	PF46152
4	101.6	1 15/16	49.2	13/16	20.6	PT23105-MPG	4 1/4	108.0	2 7/8	73.0	9/16	14.3	P960
4	101.6	2 1/16	52.4	23/32	18.3	P7411	4 1/4	108.0	2 7/8	73.0	27/32	21.4	PF913
4	101.6	2 19/32	65.9	3/4	19.0	P40102	4 1/4	108.0	2 7/8	73.0	1 5/16	33.3	P171
4	101.6	2 7/8	73.0	1/2	12.7	PF947	4 1/4	108.0	3 9/32	83.3	1 5/32	29.4	P40105
4	101.6	3 1/32	77.0	23/32	18.3	PF807	4 1/4	108.0	3 9/32	83.3	1 5/32	29.4	P40106
4 1/32	102.4	1 3/8	34.9	7/8	22.2	PT284	4 9/32	108.7	2 1/2	63.5	1 31/32	50.0	PT23333
4 1/32	102.4	2 5/16	58.7	5/8	15.9	PT9423	4 9/32	108.7	2 9/16	65.1	1/2	12.7	PF834
4 1/32	102.4	2 17/32	64.3	31/32	24.6	P7426	4 9/32	108.7	4 7/32	107.2	1 11/16	42.9	151
4 1/32	102.4	3 9/32	83.3	1 11/16	42.9	P7488	4 9/32	108.7	4 7/32	107.2	1 11/16	42.9	151-W
4 1/16	103.2	1 25/32	45.2	3/4	19.0	PT9134	4 5/16	109.5	2 17/32	64.3	—	—	PT9223
4 1/16	103.2	1 13/16	46.0	13/16	20.6	PT23338-MPG	4 5/16	109.5	3	76.2	13/16	20.6	PF46057
4 1/16	103.2	2 5/16	58.7	1 5/16	33.3	PT23320	4 5/16	109.5	3 9/32	83.3	1 3/8	34.9	P40096
4 1/16	103.2	2 9/16	65.1	5/8	15.9	PF40052	4 5/16	109.5	3 15/32	88.1	21/32	16.7	PF46033
4 1/16	103.2	2 23/32	69.1	1 3/8	34.9	PT8385	4 5/16	109.5	4 1/8	104.8	1 1/8	28.6	PF7751
4 1/16	103.2	2 13/16	71.4	1 1/2	38.1	PT23190	4 11/32	110.3	2 7/8	73.0	9/16	14.3	PF311
4 1/16	103.2	2 7/8	73.0	13/16	20.6	PF946	4 11/32	110.3	2 7/8	73.0	9/16	14.3	PF7588
4 1/16	103.2	3 1/32	77.0	7/8	22.2	P7365	4 11/32	110.3	2 31/32	75.4	1 1/8	28.6	P40104
4 1/16	103.2	3 9/32	83.3	1 1/16	27.0	P40011	4 11/32	110.3	3 1/8	79.4	1 7/8	47.6	PT23269-MPG
4 1/16	103.2	3 5/16	84.1	15/16	23.8	P81	4 11/32	110.3	3 1/4	82.6	1 9/16	39.7	P7136
4 1/16	103.2	3 5/16	84.1	15/16	23.8	P84-2	4 11/32	110.3	3 5/8	92.1	19/32	15.1	PF7758
4 1/16	103.2	3 5/8	92.1	1 3/32	27.8	PF7735	4 11/32	110.3	7 13/16	198.4	1 1/16	27.0	PT23534
4 1/16	103.2	3 11/16	93.7	1 15/16	49.2	PT23351-MPG	4 3/8	111.1	1 11/16	42.9	15/16	23.8	PT23294-MPG
4 1/16	103.2	5	127.0	1 7/16	36.5	PT9386-MPG	4 3/8	111.1	1 3/4	44.4	15/16	23.8	PT23260-MPG
4 3/32	104.0	1 25/32	45.2	13/16	20.6	PT8972-MPG	4 3/8	111.1	2 7/8	73.0	21/32	16.7	P496
4 3/32	104.0	1 25/32	45.2	13/16	20.6	PT9195	4 3/8	111.1	2 7/8	73.0	1 3/16	30.2	PT849
4 3/32	104.0	1 25/32	45.2	13/16	20.6	PT23309	4 3/8	111.1	2 7/8	73.0	1 3/16	30.2	PT849-10
4 3/32	104.0	2 9/16	65.1	1 1/16	27.0	P40061	4 3/8	111.1	2 7/8	73.0	1 5/16	33.3	PT382
4 3/32	104.0	2 7/8	73.0	1 1/4	31.8	P7427	4 13/32	111.9	2 1/16	52.4	15/16	23.8	P40010
4 3/32	104.0	2 7/8	73.0	1 11/32	34.1	PT23329	4 13/32	111.9	2 5/16	58.7	1/2	12.7	PF7910
4 3/32	104.0	3 3/8	85.7	13/16	20.6	PF7777	4 13/32	111.9	3 9/32	83.6	1 23/32	43.4	PF46140
4 3/32	104.0	3 3/8	85.7	13/16	20.6	PF7977	4 13/32	111.9	3 5/16	84.1	1 19/32	40.5	PF7934 KIT
4 1/8	104.8	1 11/16	42.9	3/4	19.0	PT23100-MPG	4 13/32	111.9	3 23/32	94.5	9/16	14.3	PT151
4 1/8	104.8	1 7/8	47.6	3/4	19.0	PT23171	4 7/16	112.7	1 25/32	45.2	1	25.4	PT9510
4 1/8	104.8	2 7/32	56.4	15/16	23.8	PT9308-MPG	4 7/16	112.7	2 29/32	73.8	1 5/16	33.3	P172
4 1/8	104.8	2 3/8	60.3	15/16	23.8	PT9482-MPG	4 7/16	112.7	3 23/32	94.5	1/2	12.7	P40
4 1/8	104.8	2 19/32	65.9	1 1/4	31.8	P40114	4 15/32	113.5	1 3/4	44.4	1	25.4	PT23322
4 1/8	104.8	2 7/8	73.0	1 1/4	31.8	P40100	4 15/32	113.5	1 3/4	44.4	1 1/32	26.2	H9042
4 1/8	104.8	2 29/32	73.8	1 1/4	31.8	PT8984-MPG	4 15/32	113.5	1 3/4	44.4	1 1/32	26.2	H9043
4 1/8	104.8	3 1/4	82.6	1 9/16	39.7	P7138	4 15/32	113.5	1 3/4	44.4	1 1/32	26.2	H9044
4 1/8	104.8	3 5/16	84.1	1 1/8	28.6	PT62	4 15/32	113.5	1 25/32	45.2	15/16	23.8	PT9137
4 1/8	104.8	3 3/8	85.7	13/16	20.6	PT9394-MPG	4 15/32	113.5	1 25/32	45.2	1	25.4	PT23018
4 1/8	104.8	3 3/4	95.3	1 29/32	48.4	PT23346-MPG	4 15/32	113.5	1 25/32	45.2	1	25.4	PT23463
4 5/32	105.6	1 13/16	46.0	—	—	PT9222	4 15/32	113.5	1 25/32	45.2	1	25.4	PT23492-MPG
4 5/32	105.6	2 27/32	72.2	1 25/32	45.2	PT9185	4 15/32	113.5	1 25/32	45.2	1	25.4	PT23510-MPG
4 5/32	105.6	4 1/32	102.4	2 7/16	61.9	PT8407	4 15/32	113.5	1 13/16	46.0	15/16	23.8	PT9295-MPG
4 5/32	105.6	5	127.0	7/8	22.2	P8448	4 15/32	113.5	2 3/32	53.2	29/32	23.0	PT9435-MPG
4 3/16	106.4	1 11/16	42.9	1 1/32	26.2	PT461	4 15/32	113.5	3 3/16	81.0	1 3/32	27.8	P40083
4 3/16	106.4	1 13/16	46.0	13/16	20.6	PT23164	4 15/32	113.5	3 9/32	83.3	21/32	16.7	BF7675-D
4 3/16	106.4	2 1/4	57.2	13/16	20.6	PT489	4 15/32	113.5	3 9/32	83.3	21/32	16.7	BF7745-D
4 3/16	106.4	2 27/32	72.2	2	50.8	PT8987-MPG	4 15/32	113.5	3 15/32	88.1	23/32	18.3	BF46113-D
4 3/16	106.4	2 7/8	73.0	27/32	21.4	P271	4 1/2	114.3	1 5/8	41.3	15/16	23.8	PT23218-MPG
4 3/16	106.4	2 29/32	73.8	5/8	15.9	PF9825	4 1/2	114.3	1 3/4	44.4	15/16	23.8	PT23258-MPG
4 3/16	106.4	2 15/16	74.6	1 1/4	31.8	PT23350-MPG	4 1/2	114.3	1 3/4	44.4	15/16	23.8	PT23270-MPG
4 3/16	106.4	3 7/32	81.8	1 17/32	38.9	PT9416-MPG KIT	4 1/2	114.3	1 3/4	44.4	1	25.4	H9049
4 3/16	106.4	3 7/32	81.8	1 17/32	38.9	PT23127-MPG	4 1/2	114.3	1 3/4	44.4	1	25.4	H9050
4 3/16	106.4	3 5/16	84.1	1 19/32	40.5	PF7812 KIT	4 1/2	114.3	1 3/4	44.4	1	25.4	H9054
4 3/16	106.4	3 7/16	87.3	23/32	18.3	PF814	4 1/2	114.3	1 3/4	44.4	1 1/8	28.6	PT23074-MPG
4 3/16	106.4	3 7/16	87.3	23/32	18.3	PT9374	4 1/2	114.3	1 25/32	45.2	1	25.4	PT258
4 3/16	106.4	3 15/32	88.1	13/16	20.6	P73	4 1/2	114.3	1 25/32	45.2	1	25.4	PT23126-MPG
4 3/16	106.4	3 5/8	91.6	7/16	11.1	PF46126	4 1/2	114.3	1 25/32	45.2	1 1/32	26.2	H9041
4 3/16	106.4	4 3/4	120.7	1 9/16	39.7	P528	4 1/2	114.3	1 25/32	45.2	1 1/32	26.2	H9043-V
4 3/16	106.4	6	152.4	3 1/2	88.9	PT208	4 1/2	114.3	1 31/32	50.0	7/8	22.2	PT23280-MPG



**WARNING:** These products can expose you to chemicals, including Diisononyl Phthalate, Carbon black extracts, Nickel, 1,3 Butadiene, Ethylene Oxide, Epichlorohydrin, which are known to the State of California to cause cancer, and Bisphenol-A, Ethylene Glycol, Ethylene Oxide, 1,3 Butadiene, Epichlorohydrin, which are known to the State of California to cause birth defects or other reproductive harm.

# LIQUID ELEMENTS BY LENGTH

LENGTH Inches	LENGTH (mm)	O.D. Inches	O.D. (mm)	I.D. Inches	I.D. (mm)	BALDWIN NUMBER	LENGTH Inches	LENGTH (mm)	O.D. Inches	O.D. (mm)	I.D. Inches	I.D. (mm)	BALDWIN NUMBER
4 1/2	114.3	2	50.8	7/8	22.2	PT23263-MPG	4 11/16	119.1	3 1/4	82.6	3/4	19.0	S489
4 1/2	114.3	2	50.8	15/16	23.8	H9107	4 11/16	119.1	3 3/4	95.3	1 5/16	33.3	PT12
4 1/2	114.3	2	50.8	15/16	23.8	H9108	4 11/16	119.1	4 7/32	107.2	17/32	13.5	P26
4 1/2	114.3	2	50.8	15/16	23.8	H9110	4 23/32	119.9	2 25/32	70.6	25/32	19.8	PF9801
4 1/2	114.3	2	50.8	15/16	23.8	PT9484-MPG	4 23/32	119.9	3 5/16	84.1	9/16	14.3	PT9214
4 1/2	114.3	2	50.8	15/16	23.8	PT23205-MPG	4 23/32	119.9	3 7/16	87.3	21/32	16.7	PF7687
4 1/2	114.3	2	50.8	15/16	23.8	PT23286-MPG	4 23/32	119.9	3 15/32	88.1	1 11/32	34.1	PT374
4 1/2	114.3	2	50.8	15/16	23.8	PT23418-MPG	4 3/4	120.7	2 5/8	66.7	1 7/32	31.0	PT23536
4 1/2	114.3	2 1/32	51.6	15/16	23.8	PT23400-MPG	4 3/4	120.7	2 3/4	69.9	1	25.4	PT23203-MPG
4 1/2	114.3	2 9/16	65.1	15/16	23.8	P40094	4 3/4	120.7	3 1/4	82.6	1 13/32	35.7	P125
4 1/2	114.3	2 11/16	68.3	29/32	23.0	F834-F	4 3/4	120.7	3 23/32	94.5	13/32	10.3	PF7594
4 1/2	114.3	2 3/4	69.9	1 3/4	44.4	PT23357-MPG	4 25/32	121.4	1 25/32	45.2	3/4	19.0	PT9147
4 1/2	114.3	2 29/32	73.8	27/32	21.4	PT108	4 25/32	121.4	2 19/32	65.9	1 3/32	27.8	PT7515
4 1/2	114.3	2 29/32	73.8	27/32	21.4	PT108-HD	4 25/32	121.4	2 7/8	73.0	1 11/32	34.1	PT8352
4 1/2	114.3	3 3/16	81.0	1 1/16	27.0	PF828	4 13/16	122.2	2 1/8	54.0	3/4	19.0	PT23290-MPG
4 1/2	114.3	3 27/32	97.6	1/2	12.7	BC7173	4 13/16	122.2	2 5/16	58.7	1 1/16	27.0	PT23195-MPG
4 1/2	114.3	3 27/32	97.6	9/16	14.3	BC7194	4 13/16	122.2	2 11/32	59.5	1 1/2	38.1	PT9140
4 1/2	114.3	3 27/32	97.6	5/8	15.9	BC110	4 13/16	122.2	2 5/8	66.7	1 7/32	31.0	PT434
4 1/2	114.3	3 15/16	100.0	1 5/8	41.3	PF987	4 13/16	122.2	2 5/8	66.7	1 7/32	31.0	PT434-10
4 17/32	115.1	2 5/8	66.6	11/16	17.3	PF46059	4 13/16	122.2	2 5/8	66.7	1 7/32	31.0	PT477
4 17/32	115.1	2 9/16	65.1	1 7/32	31.0	P7493	4 13/16	122.2	2 7/8	73.0	1 1/16	27.0	PF943
4 17/32	115.1	2 9/16	65.1	1 7/32	31.0	P40001	4 13/16	122.2	3 11/16	93.7	3/8	9.5	PF46187
4 17/32	115.1	2 23/32	69.1	1 11/32	34.1	PT8955-MPG	4 13/16	122.2	3 15/16	100.0	23/32	18.3	P80
4 17/32	115.1	2 23/32	69.1	1 11/32	34.1	PT23376-MPG	4 13/16	122.2	3 15/16	100.0	23/32	18.3	P80-HD
4 17/32	115.1	2 3/4	69.9	7/16	11.1	F953-F	4 13/16	122.2	3 15/16	100.0	23/32	18.3	PF821-S
4 17/32	115.1	3 7/32	81.8	1/2	12.7	BF9836-D	4 13/16	122.2	5	127.0	2 13/16	71.4	PT578
4 17/32	115.1	4 7/8	123.8	9/16	14.3	PF7678	4 27/32	123.0	3 5/16	84.1	15/16	23.8	P184
4 17/32	115.3	3 3/8	85.9	3/4	19.3	PF46151	4 7/8	123.8	3	76.2	—	—	PF10
4 9/16	115.9	2 3/32	53.2	7/8	22.2	PT8895-MPG	4 7/8	123.8	3	76.2	—	—	PF10-CS
4 9/16	115.9	2 17/32	64.3	1 1/4	31.8	P1443	4 7/8	123.8	2 1/16	52.4	13/32	10.3	PF7595
4 9/16	115.9	2 11/16	68.3	1 1/4	31.8	PT23206-MPG	4 7/8	123.8	2 19/32	65.9	3/4	19.0	PT517
4 9/16	115.9	2 23/32	69.1	1 9/32	32.5	PT9149	4 7/8	123.8	3	76.2	1	25.4	PT727-HD
4 9/16	115.9	2 23/32	69.1	1 5/16	33.3	PT8957-MPG	4 7/8	123.8	3	76.2	1	25.4	PT727-HD10
4 9/16	115.9	2 3/4	69.9	1 3/32	27.8	P40109	4 7/8	123.8	4 7/32	107.2	1/2	12.7	P41
4 9/16	115.9	3 9/32	83.3	17/32	13.5	PT691	4 7/8	123.8	4 7/32	107.2	1/2	12.7	PF809
4 9/16	115.9	3 9/32	83.3	3/4	19.0	PF9861	4 29/32	124.6	2 5/32	54.8	23/32	18.3	PT8991-MPG
4 9/16	115.9	3 25/32	96.0	15/32	11.9	PF9919	4 29/32	124.6	2 3/4	69.9	1 5/8	41.3	PT9396
4 19/32	116.7	2 5/16	58.7	1/2	12.7	PT9131	4 15/16	125.4	2 1/2	63.5	1 7/32	31.0	PT399
4 19/32	116.7	3 1/16	77.8	1 9/16	39.7	PT9312-MPG	4 15/16	125.4	2 1/2	63.5	1 7/32	31.0	PT417
4 19/32	116.7	3 3/32	78.6	1 11/16	42.9	H9072-V	4 15/16	125.4	2 7/8	73.0	1 1/16	27.0	PT273
4 5/8	117.5	2 1/8	54.0	15/16	23.8	PT23090-MPG	4 15/16	125.4	2 15/16	74.6	1	25.4	PT23142
4 5/8	117.5	2 1/8	54.0	1	25.4	PT23208-MPG	4 15/16	125.4	4 1/2	114.3	13/16	20.6	P47
4 5/8	117.5	2 9/32	57.9	1/4	6.4	PF7816	4 31/32	126.2	3 15/32	88.1	5/8	15.9	PT23136
4 5/8	117.5	2 9/16	65.1	17/32	13.5	PT135	5	127.0	2	50.8	1 5/8	41.3	S456
4 5/8	117.5	2 11/16	68.3	1 1/8	28.6	P7406	5	127.0	2 5/8	66.7	1 7/32	31.0	PT492
4 5/8	117.5	2 3/4	69.9	1 7/16	36.5	PT23207-MPG	5	127.0	2 3/4	69.9	1 5/16	33.3	PT9414-MPG
4 5/8	117.5	3 1/8	79.4	1 11/16	42.9	H9069	5	127.0	2 3/4	69.9	1 3/8	34.9	PT23212-MPG
4 5/8	117.5	3 1/8	79.4	1 11/16	42.9	H9070	5	127.0	3 1/2	88.9	1 5/32	29.4	BF7956-D
4 5/8	117.5	3 1/8	79.4	1 11/16	42.9	H9071	5	127.0	3 3/4	95.3	1 1/8	28.6	PT468-MPG
4 5/8	117.5	3 1/8	79.4	1 11/16	42.9	H9072	5	127.0	4 7/32	107.2	1/2	12.7	P53
4 5/8	117.5	3 1/8	79.4	1 11/16	42.9	PT9404-MPG	5	127.0	4 3/8	111.1	2 13/32	61.1	PT764
4 5/8	117.5	3 5/16	84.1	15/16	23.8	PT269	5	127.0	4 3/8	111.1	2 13/32	61.1	PT765
4 5/8	117.5	6 1/16	154.0	3 9/32	83.3	201	5	127.0	4 3/8	111.1	2 7/16	61.9	PT8462-MPG
4 5/8	117.5	6 1/16	154.0	3 9/32	83.3	201-30	5 1/32	127.8	2 15/32	62.7	1 3/32	27.8	PT9419-MPG
4 5/8	117.5	6 1/16	154.0	3 9/32	83.3	201-W	5 1/32	127.8	2 13/16	71.4	1 1/8	28.6	P40111
4 21/32	118.3	2 7/32	56.4	1	25.4	PT23575-MPG	5 1/32	127.8	2 7/8	73.0	1 1/4	31.8	P40108
4 21/32	118.3	2 7/8	73.0	1 1/16	27.0	PT9508	5 1/32	127.8	3 31/32	100.8	1 5/8	41.3	P127
4 21/32	118.3	3 1/16	77.8	1 11/16	42.9	PT9485-MPG	5 1/16	128.6	2 11/16	68.3	1 1/16	27.0	P40103
4 21/32	118.3	3 1/16	77.8	1 11/16	42.9	PT23408-MPG	5 1/16	128.6	2 7/8	73.0	21/32	16.7	P497
4 21/32	118.3	3 1/16	77.8	1 11/16	42.9	PT23436-MPG	5 1/16	128.6	3 15/16	100.0	2 1/4	57.2	PT437
4 21/32	118.3	3 3/32	78.6	1 11/16	42.9	PT23484-MPG	5 1/16	128.6	4 17/32	115.1	2 9/32	57.9	P203
4 21/32	118.3	3 5/16	84.1	17/32	13.5	BF7866	5 1/16	128.6	4 17/32	115.1	2 9/32	57.9	P203-HD
4 11/16	119.1	1 5/32	29.4	5/8	15.9	PT256	5 1/16	128.6	4 17/32	115.1	2 9/32	57.9	P203-HD10
4 11/16	119.1	1 3/4	44.4	1	25.4	PT23447-MPG	5 1/16	128.6	4 17/32	115.1	2 9/32	57.9	P203-HD10
4 11/16	119.1	2 3/32	53.2	1	25.4	PT9311-MPG	5 3/32	129.4	2 7/8	73.0	1 3/8	34.9	P7400
4 11/16	119.1	2 3/32	53.2	1 3/32	27.8	PT8996-MPG	5 3/32	129.4	3 3/16	81.0	1 3/32	27.8	P7114
4 11/16	119.1	2 1/8	54.0	15/16	23.8	PT23292-MPG	5 3/32	129.4	6 1/2	165.1	—	—	P7102
4 11/16	119.1	3	76.2	1 1/16	27.0	PT8468	5 1/8	130.2	1 9/16	39.7	11/32	8.7	PF7826
4 11/16	119.1	3 3/16	81.0	5/8	15.9	P40035	5 1/8	130.2	2 3/4	69.9	1 1/8	28.6	PT9242



**WARNING:** These products can expose you to chemicals, including Diisononyl Phthalate, Carbon black extracts, Nickel, 1,3 Butadiene, Ethylene Oxide, Epichlorohydrin, which are known to the State of California to cause cancer, and Bisphenol-A, Ethylene Glycol, Ethylene Oxide, 1,3 Butadiene, Epichlorohydrin, which are known to the State of California to cause birth defects or other reproductive harm.

# LIQUID ELEMENTS BY LENGTH

LENGTH Inches	LENGTH (mm)	O.D. Inches	O.D. (mm)	I.D. Inches	I.D. (mm)	BALDWIN NUMBER	LENGTH Inches	LENGTH (mm)	O.D. Inches	O.D. (mm)	I.D. Inches	I.D. (mm)	BALDWIN NUMBER
5 1/8	130.2	2 3/4	69.9	1 5/32	29.4	PT23501-MPG	5 3/8	136.5	3 7/8	98.4	1 1/4	31.8	BC40009
5 1/8	130.2	2 3/4	69.9	1 3/8	34.9	PT23470	5 13/32	137.3	1 15/16	49.2	27/32	21.4	P40033
5 1/8	130.2	3 9/32	83.3	1 1/4	31.8	PF121	5 13/32	137.3	2	50.8	1 15/32	37.3	PF7825
5 1/8	130.2	3 15/16	100.0	1 1/8	28.6	P545	5 13/32	137.3	2 1/16	52.4	7/8	22.2	P7492
5 1/8	130.2	4 5/16	109.5	-	-	PT9531	5 13/32	137.3	2 13/16	71.4	1 5/16	33.3	P170
5 1/8	130.2	4 5/8	117.5	1 5/16	33.3	PT85	5 13/32	137.3	3 1/8	79.4	3/4	19.0	BF46040-D
5 5/32	131.0	2 27/32	72.2	27/32	21.4	PF7787	5 7/16	138.1	2 17/32	64.3	-	-	PT9225
5 5/32	131.0	3 29/32	99.2	-	-	PT9139	5 7/16	138.1	3 3/32	78.6	1 5/8	41.3	P7083
5 3/16	131.6	2 13/16	71.0	-	-	PF46118	5 7/16	138.1	3 9/32	83.3	1/2	12.7	PF7978
5 3/16	131.8	2 3/4	70.1	27/32	21.1	P40037	5 7/16	138.1	3 17/32	89.7	17/32	13.5	PF9824
5 3/16	131.8	2 27/32	72.2	13/16	20.6	PF7788	5 15/32	138.9	2 9/16	65.1	3/4	19.0	BF1201
5 3/16	131.8	3 1/16	77.8	2 1/8	54.0	PF9902	5 15/32	138.9	2 7/8	73.0	1 5/16	33.3	P280
5 3/16	131.8	3 7/32	81.8	7/8	22.2	P7269	5 15/32	138.9	2 7/8	73.0	1 11/32	34.1	PT8355
5 7/32	132.6	2 7/32	56.4	1 3/32	27.8	PT23233-MPG	5 15/32	138.9	3 3/8	85.7	-	-	PT9278
5 7/32	132.6	2 3/4	69.9	1 3/32	27.8	PT8989-MPG	5 15/32	138.9	3 13/32	86.5	2 9/16	65.1	PT23328
5 7/32	132.6	2 3/4	69.9	1 1/8	28.6	PT9237	5 15/32	138.9	3 13/32	86.5	2 9/16	65.1	PT23334
5 7/32	132.6	2 25/32	70.6	1 7/32	31.0	PT9256-MPG	5 15/32	138.9	3 5/8	92.1	23/32	18.3	P7081
5 7/32	132.6	3 9/32	83.3	21/32	16.7	BF7673-D	5 15/32	138.9	3 23/32	94.5	1 1/32	26.2	PF7982
5 7/32	132.6	3 9/32	83.3	21/32	16.7	BF7681-D	5 15/32	138.9	4 9/16	115.9	2 7/32	56.4	PT508-MPG
5 7/32	132.6	3 9/32	83.3	21/32	16.7	BF7699-D	5 15/32	138.9	4 9/16	115.9	2 7/32	56.4	PT8318-MPG
5 7/32	132.6	3 9/32	83.3	21/32	16.7	BF7783-D	5 15/32	138.9	7 7/8	200.0	4 15/32	113.5	PT9401
5 7/32	132.6	4	101.6	1 15/32	37.3	PT8487	5 1/2	139.7	2 3/4	69.9	1	25.4	PT9329
5 7/32	132.6	4	101.6	1 15/32	37.3	PT9344	5 1/2	139.7	2 27/32	72.2	1 1/32	26.2	PF46049
5 1/4	133.4	2 7/8	73.0	5/8	41.3	P40115	5 1/2	139.7	2 7/8	73.0	1 5/16	33.3	PF831
5 1/4	133.4	3 23/32	94.5	21/32	16.7	P67	5 1/2	139.7	3 1/16	77.8	1 19/32	40.5	PT9486-MPG
5 1/4	133.4	4	101.6	1 5/16	33.3	JC405	5 1/2	139.7	3 1/4	82.6	1 5/8	41.3	PT23016
5 1/4	133.4	4	101.6	1 3/8	34.9	BF9895 KIT	5 1/2	139.7	3 19/32	91.3	9/16	14.3	PF332
5 1/4	133.4	5 23/32	145.3	3 13/16	96.8	PT9476-MPG	5 1/2	139.7	4 1/8	104.8	1 13/16	46.0	CU406
5 9/32	134.1	1 25/32	45.2	23/32	18.3	PT8485	5 1/2	139.7	4 3/16	106.4	2 13/16	71.4	PT23344-MPG
5 9/32	134.1	2 3/8	60.3	1 7/16	36.5	PT9293-MPG	5 1/2	139.7	4 3/16	106.4	2 7/8	73.0	PT23148
5 9/32	134.1	2 3/4	69.9	1 31/32	50.0	PT9135	5 1/2	139.7	4 3/8	111.1	1	25.4	PF7553
5 9/32	134.1	3 1/8	79.4	-	-	BF46078-D	5 1/2	139.7	4 9/16	115.9	2 1/4	57.2	PT87-S
5 9/32	134.1	3 3/16	81.0	5/8	15.9	BF9835-D	5 17/32	140.5	2 9/16	65.1	1 1/4	31.8	P40118
5 9/32	134.1	3 7/32	81.8	1/2	12.7	BF9822-D	5 17/32	140.5	2 19/32	65.9	1 5/16	33.3	PT9163
5 9/32	134.1	3 7/32	81.8	1/2	12.7	BF9828-D	5 17/32	140.5	2 13/16	71.4	1 5/16	33.3	PT29
5 9/32	134.1	3 7/32	81.8	7/8	22.2	BF9830-D	5 17/32	140.5	3	76.2	1 13/16	46.0	PT9260
5 9/32	134.1	3 9/16	90.5	1 15/32	37.3	BF7821	5 17/32	140.5	4 7/32	107.2	1 9/16	39.7	PF9870
5 9/32	134.1	3 21/32	92.9	5/8	41.3	P5092	5 17/32	140.5	4 7/32	107.2	1 9/16	39.7	PF46108
5 9/32	134.1	4 29/32	124.6	1 9/16	39.7	PF46004	5 9/16	141.3	1 31/32	50.0	29/32	23.0	PT416
5 5/16	134.9	1 13/16	46.0	13/16	20.6	PT23143	5 9/16	141.3	2 25/32	70.6	5/8	15.9	P7415
5 5/16	134.9	2 11/32	59.5	1 5/32	29.4	PT9127	5 9/16	141.3	2 7/8	73.0	7/16	11.1	PF950
5 5/16	134.9	2 11/32	59.5	1 13/32	35.7	PT23332	5 9/16	141.3	2 7/8	73.0	1 5/16	33.3	P174
5 5/16	134.9	2 3/8	60.3	1	25.4	PT8887	5 9/16	141.3	3 5/32	80.2	1 15/32	37.3	PT23289-MPG
5 5/16	134.9	2 3/8	60.3	1	25.4	PT9203	5 9/16	141.3	3 1/4	82.6	1 7/8	47.6	PT23002
5 5/16	134.9	2 3/8	60.3	1 1/32	26.2	PT9309-MPG	5 9/16	141.3	3 5/16	84.1	2	50.8	PT23204-MPG
5 5/16	134.9	2 3/8	60.3	1 13/32	35.7	PT23512-MPG	5 9/16	141.3	3 19/32	91.3	1 11/32	34.1	P40117
5 5/16	134.9	2 3/8	60.3	1 13/32	35.7	PT23513-MPG	5 9/16	141.3	3 15/16	100.0	1 19/32	40.5	PT185
5 5/16	134.9	2 1/2	63.5	1 7/32	31.0	P40098	5 9/16	141.3	4 1/8	104.8	3 11/32	84.9	PT9257
5 5/16	134.9	3 5/32	80.2	15/16	23.8	BF9874-DM	5 19/32	142.1	7/8	22.2	9/16	14.3	PF46119
5 5/16	134.9	3 5/32	80.2	15/16	23.8	BF9875-DM	5 19/32	142.1	2 7/8	73.0	1 3/16	30.2	PT546
5 5/16	134.9	3 11/16	93.7	3/8	9.5	PF46189	5 19/32	142.1	3	76.2	13/16	20.6	PF46056
5 5/16	134.9	5 29/32	150.0	3 13/32	86.5	PT9352	5 19/32	142.1	3 1/4	82.6	1 1/2	38.1	PF9872
5 11/32	135.7	1 17/32	38.9	9/16	14.3	PF7872	5 19/32	142.1	3 19/32	91.3	9/16	14.3	PF7554
5 11/32	135.7	2 3/8	60.3	1 13/32	35.7	PT8974-MPG	5 5/8	142.9	2 9/16	65.1	1 3/32	27.8	PT396
5 11/32	135.7	2 3/4	69.9	-	-	PT9315 KIT	5 5/8	142.9	2 7/8	73.0	1 1/16	27.0	PT8350
5 11/32	135.7	2 3/4	69.9	1 3/32	27.8	PT9167	5 5/8	142.9	3	76.2	1 1/16	27.0	PF916
5 11/32	135.7	2 3/4	69.9	1 3/32	27.8	PT9174	5 5/8	142.9	3	76.2	1 1/16	27.0	PF967
5 11/32	135.7	2 29/32	73.8	21/32	16.7	PF46130	5 5/8	142.9	3 3/16	81.0	1/2	12.7	F950-F WO
5 11/32	135.7	3 9/32	83.3	1 3/8	34.9	P40020	5 5/8	142.9	3 3/16	81.0	1 7/8	47.6	PT23040-MPG
5 11/32	135.7	3 15/32	88.1	31/32	24.6	PT71	5 5/8	142.9	3 1/4	82.6	17/32	13.5	F950-F
5 11/32	135.7	3 11/16	93.7	19/32	15.1	PF9900	5 5/8	142.9	3 1/4	82.6	1 7/8	47.6	PT23160
5 11/32	135.7	5 1/2	139.7	2 1/16	52.4	PT23147	5 5/8	142.9	3 7/16	87.3	19/32	15.1	PF963
5 3/8	136.5	1 3/4	44.4	3/4	19.0	PT23202-MPG	5 5/8	142.9	5 23/32	145.3	2 7/16	61.9	P7380
5 3/8	136.5	2 1/4	57.2	1 1/16	27.0	PT9136	5 21/32	143.7	2 7/8	73.0	1 13/32	35.7	PT8956-MPG
5 3/8	136.5	2 13/16	71.4	1 5/16	33.3	PT23102-MPG	5 21/32	143.7	3	76.2	1 1/16	27.0	PT480
5 3/8	136.5	3 1/8	79.4	7/16	11.1	PF46188	5 21/32	143.7	3	76.2	1 1/16	27.0	PT480-10
5 3/8	136.5	3 9/32	83.3	13/16	20.6	P7017	5 21/32	143.7	3	76.2	1 1/16	27.0	PT480-MPG
5 3/8	136.5	3 17/32	89.7	3/4	19.0	PF9899	5 21/32	143.7	3 17/32	89.7	1 5/16	33.3	P18
5 3/8	136.5	3 19/32	91.3	9/16	14.3	PF7592	5 21/32	143.7	3 17/32	89.7	1 5/16	33.3	P18-HD
							5 11/16	144.5	2 7/8	73.0	1 1/4	31.8	P40095



**WARNING:** These products can expose you to chemicals, including Diisononyl Phthalate, Carbon black extracts, Nickel, 1,3 Butadiene, Ethylene Oxide, Epichlorohydrin, which are known to the State of California to cause cancer, and Bisphenol-A, Ethylene Glycol, Ethylene Oxide, 1,3 Butadiene, Epichlorohydrin, which are known to the State of California to cause birth defects or other reproductive harm.



# LIQUID ELEMENTS BY LENGTH

LENGTH Inches	LENGTH (mm)	O.D. Inches	O.D. (mm)	I.D. Inches	I.D. (mm)	BALDWIN NUMBER	LENGTH Inches	LENGTH (mm)	O.D. Inches	O.D. (mm)	I.D. Inches	I.D. (mm)	BALDWIN NUMBER
5 11/16	144.5	3 9/32	83.3	1 5/8	41.3	P266	6 1/32	153.2	1 27/32	46.8	7/8	22.2	PT23369-MPG
5 11/16	144.5	3 7/16	87.3	1 3/16	30.2	PT549	6 1/32	153.2	1 27/32	46.8	7/8	22.2	PT23371-MPG
5 11/16	144.5	3 3/4	95.3	13/16	20.6	PF7779	6 1/32	153.2	1 7/8	47.6	13/16	20.6	PT9330-MPG
5 23/32	145.3	3 7/16	87.3	1/2	12.7	PF804	6 1/32	153.2	2 17/32	64.3	21/32	16.7	P7308
5 23/32	145.3	3 15/16	100.0	1 15/32	37.3	P104	6 1/32	153.2	2 25/32	70.6	27/32	21.4	P1418
5 23/32	145.3	5 1/8	130.2	2 17/32	64.3	PT23469	6 1/32	153.2	3 3/8	85.7	11/16	17.5	BF7904-D
5 3/4	146.0	2 7/8	73.0	1	25.4	F916-C	6 1/32	153.2	3 1/2	88.9	1 5/8	41.3	P40017
5 3/4	146.0	3 1/2	88.9	1 5/32	29.4	BF7954-D	6 1/16	153.9	2 7/32	56.4	13/16	20.6	P40076
5 3/4	146.0	4 7/16	112.7	1 17/32	38.9	PT11	6 1/16	154.0	2 9/16	65.1	1 1/4	31.8	P40107
5 3/4	146.0	4 7/16	112.7	1 17/32	38.9	PT11-HD	6 1/16	154.0	3 3/16	81.0	1/2	12.7	BF9808-D
5 25/32	146.8	3 9/32	83.3	1 5/8	41.3	P7050	6 1/16	154.0	3 3/16	81.0	1/2	12.7	BF9847-D
5 25/32	146.8	4 3/4	120.7	2 1/16	52.4	P7233	6 1/16	154.0	3 3/16	81.0	9/16	14.3	BF9892-D
5 13/16	147.6	2 1/2	63.5	1 3/8	34.9	PT23175	6 1/16	154.0	3 7/32	81.8	7/8	22.2	BF9833-D
5 13/16	147.6	2 17/32	64.3	1 1/16	27.0	PT9165	6 1/16	154.0	3 25/32	96.0	1 23/32	43.7	P7104
5 13/16	147.6	2 15/16	74.6	1	25.4	P40025	6 1/16	154.0	3 15/16	100.0	1 1/16	27.0	PT138-10
5 13/16	147.6	3 11/16	93.7	1/4	6.4	BC7326	6 1/16	154.0	3 15/16	100.0	1 1/16	27.0	PT138-25
5 13/16	147.6	3 11/16	93.7	1/4	6.4	BC7485	6 1/16	154.0	5 7/8	149.2	2 15/16	74.6	PT9245
5 27/32	148.4	2 7/8	73.0	—	—	PT23474	6 3/32	154.8	2 3/32	53.2	1 3/32	27.8	PT9378-MPG
5 27/32	148.4	2 7/8	73.0	9/16	14.3	PF231	6 3/32	154.8	2 9/16	65.1	1 1/4	31.8	P7414
5 27/32	148.4	3 3/16	81.0	1/2	12.7	PF9865	6 3/32	154.8	3 15/16	100.0	7/8	22.2	P40012
5 27/32	148.4	4 3/4	120.7	2 7/32	56.4	P7190	6 3/32	154.8	4 1/32	102.4	2 11/32	59.5	PT23330
5 7/8	149.2	13/16	20.6	1 13/16	46.0	PT23038-MPG	6 1/8	155.6	1 1/8	27.9	7/8	22.2	BF46045-D
5 7/8	149.2	2 3/32	53.2	1/16	1.6	PT23311	6 1/8	155.6	3 3/4	95.3	1 5/16	33.3	PT8345
5 7/8	149.2	2 17/32	64.3	1 7/32	31.0	PT9417	6 1/8	155.6	5	127.0	2 13/16	71.4	PT268
5 7/8	149.2	2 13/16	71.4	1 13/16	46.0	PT23196-MPG	6 1/8	155.6	5	127.0	2 13/16	71.4	PT392
5 7/8	149.2	2 27/32	72.2	1 3/4	44.4	PT9186	6 1/8	155.6	5	127.0	2 13/16	71.4	PT514
5 7/8	149.2	3	76.2	1	25.4	PT23071-MPG	6 5/32	156.4	1 9/16	39.7	5/8	15.9	PF7876
5 7/8	149.2	3 23/32	94.5	25/32	19.8	P68	6 5/32	156.4	1 13/16	46.0	13/16	20.6	P40112
5 7/8	149.2	4 11/32	110.3	2 1/4	57.2	P7232	6 5/32	156.4	1 13/16	46.0	7/8	22.2	P40099
5 7/8	149.2	5 1/16	128.6	2 11/32	59.5	P7092	6 5/32	156.4	1 31/32	50.0	7/8	22.2	P9600
5 29/32	150.0	1 31/32	50.0	27/32	21.4	PT8319	6 5/32	156.4	2 13/16	71.4	1 5/16	33.3	P1565
5 29/32	150.0	2 27/32	72.2	1 25/32	45.2	PT8986-MPG	6 3/16	157.2	2 19/32	65.9	7/16	11.1	P40021
5 29/32	150.0	2 27/32	72.2	1 25/32	45.2	PT9145	6 3/16	157.2	3 1/16	77.8	1 19/32	40.5	PT23110-MPG
5 29/32	150.0	2 27/32	72.2	1 25/32	45.2	PT9514	6 3/16	157.2	5	127.0	2 13/16	71.4	PT383
5 29/32	150.0	2 27/32	72.2	2 1/32	51.6	PT8963-MPG	6 7/32	157.7	2 15/16	74.9	3/4	19.0	PF46137
5 29/32	150.0	2 31/32	75.4	—	—	PT23464	6 7/32	157.7	2 15/16	74.9	3/4	19.0	PF46137 KIT
5 29/32	150.0	3 1/2	88.9	1 15/32	37.3	PT61-HD	6 7/32	158.0	2 7/8	73.0	1 13/32	35.7	PT9215
5 29/32	150.0	3 27/32	97.6	1 3/16	30.2	PF1392	6 7/32	158.0	3 15/16	100.0	7/8	22.2	PF819
5 29/32	150.0	3 15/16	100.0	19/32	15.1	P7013	6 7/32	158.0	3 15/16	100.0	7/8	22.2	PF819-HD
5 15/16	150.8	3 7/32	81.8	1 17/32	38.9	PT9415-MPG KIT	6 7/32	158.0	3 15/16	100.0	7/8	22.2	PF899
5 15/16	150.8	3 9/32	83.3	1 9/16	39.7	P7199	6 1/4	158.8	2 1/8	54.0	1 1/8	28.6	PT23115-MPG
5 15/16	150.8	3 5/16	84.1	1 9/16	39.7	P7423	6 1/4	158.8	3 1/2	88.9	1 1/4	31.8	P19
5 15/16	150.8	3 15/16	100.0	1 1/16	27.0	P82	6 1/4	158.8	3 1/2	88.9	1 15/16	49.2	PT23046-MPG
5 15/16	150.8	3 15/16	100.0	1 1/16	27.0	PT82-HD	6 1/4	158.8	3 29/32	99.2	2 1/16	52.4	PT23316
5 15/16	150.8	3 15/16	100.0	1 1/16	27.0	PT82-HD10	6 1/4	158.8	3 15/16	100.0	1 1/16	27.0	P25
5 15/16	150.8	5 29/32	150.0	—	—	PT9277	6 1/4	158.8	3 15/16	100.0	1 1/16	27.0	PF826
5 31/32	151.6	3 7/32	81.8	1 1/16	27.0	P7607	6 1/4	158.8	3 15/16	100.0	2	50.8	PT23118-MPG
5 31/32	151.6	3 9/32	83.3	21/32	16.7	BF7672-D	6 1/4	158.8	4 1/32	102.4	2 29/32	73.8	PT23336
5 31/32	151.6	3 9/32	83.3	21/32	16.7	BF7674-D	6 1/4	158.8	4 17/32	115.1	7/8	22.2	PT152
5 31/32	151.6	3 9/32	83.3	21/32	16.7	BF7679-D	6 9/32	159.5	2 1/32	51.6	15/16	23.8	PT23375-MPG
5 31/32	151.6	3 9/32	83.3	21/32	16.7	BF7784-D	6 9/32	159.5	2 7/16	61.9	27/32	21.4	P1419
5 31/32	151.6	3 9/32	83.3	21/32	16.7	BF7905-D	6 9/32	159.5	2 7/8	73.0	1 11/32	34.1	PT8354
5 31/32	151.6	3 9/32	83.3	21/32	16.7	BF7906-D	6 5/16	160.3	2	50.8	15/16	23.8	H9327
5 31/32	151.6	3 15/16	100.0	1 1/16	27.0	PF822	6 5/16	160.3	2 9/32	57.9	1 9/32	32.5	PT23008
6	152.4	1 13/16	46.0	13/16	20.6	PT23043-MPG	6 5/16	160.3	3 1/2	88.9	1 15/16	49.2	PT23045-MPG
6	152.4	1 31/32	50.0	29/32	23.0	PT8451-MPG	6 5/16	160.3	3 17/32	89.7	—	—	PT9448
6	152.4	2 5/16	58.7	1 11/32	34.1	PT435	6 11/32	161.1	3 1/2	88.9	5/8	15.9	BF7522
6	152.4	2 7/8	73.0	1 5/16	33.3	P177	6 11/32	161.1	3 27/32	97.6	2 17/32	64.3	PT23399-MPG
6	152.4	3 1/32	77.0	23/32	18.3	PF883	6 11/32	161.1	4 1/4	108.0	31/32	24.6	PF46003
6	152.4	3 1/2	88.9	5/8	15.9	BF7952-D	6 3/8	161.9	2	50.8	13/16	20.6	PT23039-MPG
6	152.4	3 21/32	92.9	1 11/32	34.1	P356	6 3/8	161.9	3 1/4	82.6	1 9/16	39.7	PT137
6	152.4	5 1/8	130.2	2	50.8	PT23003	6 3/8	161.9	3 17/32	89.7	1 29/32	48.4	PT23372-MPG
6	152.4	5 1/8	130.2	3 3/8	85.7	PT89	6 3/8	161.9	3 9/16	90.5	1 29/32	48.4	PT9492-MPG
6	152.4	5 3/16	131.8	2	50.8	PT23188	6 3/8	161.9	3 9/16	90.5	1 29/32	48.4	PT23363-MPG
6	152.4	6 1/2	165.1	3 1/2	88.9	PT462	6 3/8	161.9	3 9/16	90.5	1 29/32	48.4	PT23370-MPG
6 1/32	153.2	1 27/32	46.8	13/16	20.6	PT8954-MPG	6 3/8	161.9	3 23/32	94.5	1 7/8	47.6	PF7938
6 1/32	153.2	1 27/32	46.8	7/8	22.2	PT9512	6 3/8	161.9	3 15/16	100.0	1 5/8	41.3	PT153
6 1/32	153.2	1 27/32	46.8	7/8	22.2	PT23128-MPG	6 13/32	162.7	2 21/32	67.6	7/16	11.4	PF46076
6 1/32	153.2	1 27/32	46.8	7/8	22.2	PT23132-MPG	6 13/32	162.7	3 5/16	84.1	1 1/2	38.1	PT23560
6 1/32	153.2	1 27/32	46.8	7/8	22.2	PT23132-MPG	6 13/32	162.7	3 23/32	94.5	1 1/32	26.2	PF7983



**WARNING:** These products can expose you to chemicals, including Diisononyl Phthalate, Carbon black extracts, Nickel, 1,3 Butadiene, Ethylene Oxide, Epichlorohydrin, which are known to the State of California to cause cancer, and Bisphenol-A, Ethylene Glycol, Ethylene Oxide, 1,3 Butadiene, Epichlorohydrin, which are known to the State of California to cause birth defects or other reproductive harm.

# LIQUID ELEMENTS BY LENGTH

LENGTH Inches	LENGTH (mm)	O.D. Inches	O.D. (mm)	I.D. Inches	I.D. (mm)	BALDWIN NUMBER	LENGTH Inches	LENGTH (mm)	O.D. Inches	O.D. (mm)	I.D. Inches	I.D. (mm)	BALDWIN NUMBER
6 13/32	162.7	3 23/32	94.5	1 1/32	26.2	PF9868	6 27/32	173.8	2 23/32	69.1	1 9/32	32.5	PT8959-MPG
6 13/32	162.7	4 21/32	118.3	2 11/32	59.5	PT8947-MPG	6 27/32	173.8	3 23/32	94.5	1 3/4	44.4	PF7986
6 7/16	163.5	3 3/4	95.3	1 25/32	45.2	PF46046	6 27/32	173.8	3 3/4	95.3	1 13/16	46.0	PF7935
6 7/16	163.5	4 11/32	110.3	21/32	16.7	PF7733	6 7/8	174.6	3 5/32	80.2	27/32	21.4	C40005
6 7/16	163.5	5 29/32	150.0	3 1/2	88.9	PT23455	6 7/8	174.6	5 29/32	150.0	2 13/16	71.4	P1563
6 15/32	164.3	3 1/32	77.0	1 1/4	31.8	PT377	6 29/32	175.4	2 23/32	69.1	1 5/32	29.4	PT8940-MPG
6 15/32	164.3	3 1/32	77.0	1 1/4	31.8	PT377-10	6 29/32	175.4	2 23/32	69.1	1 3/16	30.2	PT23499-MPG
6 15/32	164.3	4 23/32	119.9	21/32	16.7	PF7749	6 29/32	175.4	3 3/4	95.3	21/32	16.7	PF7744
6 15/32	164.3	5 1/32	127.8	2 15/32	62.7	P7059	6 29/32	175.4	3 29/32	99.2	1 19/32	40.5	PT23468
6 1/2	165.1	2	50.8	1 5/8	41.3	S479	6 29/32	175.4	3 29/32	99.2	1 19/32	40.5	PT23480
6 1/2	165.1	3 9/32	83.3	1 19/32	40.5	PT63-1	6 15/16	176.2	3 1/2	88.9	2	50.8	P198
6 1/2	165.1	3 5/16	84.1	1 1/16	27.0	PF823	6 15/16	176.2	4	101.6	2 15/16	74.6	PT23183
6 1/2	165.1	3 5/16	84.1	1 1/16	27.0	PF823-E	6 15/16	176.2	4	101.6	2 15/16	74.6	PT23184
6 1/2	165.1	3 5/16	84.1	1 1/16	27.0	PF824	6 15/16	176.2	4 3/16	106.4	21/32	16.7	PF7930
6 1/2	165.1	3 5/16	84.1	1 1/16	27.0	PF829(2)	6 31/32	177.0	3 1/4	82.6	1 7/16	36.5	P7196
6 1/2	165.1	3 15/16	100.0	2 1/4	57.2	P723	6 31/32	177.0	4 1/2	114.3	1 7/8	47.6	PT207
6 1/2	165.1	4 11/32	110.3	21/32	16.7	PF7718	6 31/32	177.0	4 1/2	114.3	1 7/8	47.6	PT207-10
6 1/2	165.1	4 11/32	110.3	21/32	16.7	PF7734	6 31/32	177.0	4 1/2	114.3	1 7/8	47.6	PT207-HD
6 17/32	165.9	3 9/16	90.5	-	-	PT8419	6 31/32	177.0	4 1/2	114.3	1 7/8	47.6	PT207-HD10
6 9/16	166.7	1 25/32	45.2	29/32	23.0	PT23570-MPG	6 31/32	177.0	4 1/2	114.3	1 7/8	47.6	PT467-MPG
6 9/16	166.7	2 9/16	65.1	31/32	24.6	P40023	6 31/32	177.0	4 23/32	119.9	2 3/32	53.1	P40042
6 9/16	166.7	3 3/16	81.0	-	-	PT23123	6 31/32	177.0	5 1/8	130.2	3 3/8	85.7	PT9380-MPG
6 9/16	166.7	3 17/32	89.7	-	-	PT9196							
6 9/16	166.7	3 17/32	89.7	-	-	PT23586	7	177.8	1 3/8	34.9	13/16	20.6	PT23064-MPG
6 9/16	166.7	3 5/8	92.1	1 11/16	42.9	PF9914 KIT	7	177.8	1 5/8	41.3	13/16	20.6	PT23077-MPG
6 9/16	166.7	4 21/32	118.3	2 11/32	59.5	PT8939-MPG	7	177.8	2 7/16	61.9	1 3/8	34.9	PT23326
6 5/8	168.3	2 7/8	73.0	9/16	14.3	P150	7	177.8	3 27/32	97.6	3/8	9.5	BC7242
6 5/8	168.3	3 19/32	91.3	9/16	14.3	PF7556	7	177.8	3 27/32	97.6	1/2	12.7	BC7394
6 5/8	168.3	3 19/32	91.3	21/32	16.7	PT8356	7	177.8	3 27/32	97.6	5/8	15.9	BC7228
6 5/8	168.3	3 15/16	100.0	23/32	18.3	PF594	7	177.8	4 7/16	112.7	1 1/2	38.1	PT137
6 5/8	168.3	4 1/2	114.3	1 1/16	27.0	P276	7	177.8	4 1/2	114.3	1 29/32	48.4	PT373
6 5/8	168.3	2 21/32	67.6	15/16	23.6	P40074	7	177.8	5 1/8	130.2	3 3/8	85.7	PT91
6 21/32	169.1	1 3/4	44.4	13/16	20.6	PT23568-MPG	7	177.8	5 1/8	130.2	3 3/8	85.7	PT9430-MPG
6 21/32	169.1	2 7/32	56.4	15/16	23.8	PT9304-MPG	7 1/32	178.6	1 21/32	42.1	7/8	22.2	PT23524-MPG
6 21/32	169.1	4 5/8	117.5	2 5/16	58.7	PT7616	7 1/32	178.6	3 3/4	95.3	21/32	16.7	PF7680
6 11/16	169.9	1 21/32	42.1	1 1/32	26.2	PT23460	7 1/32	178.6	3 3/4	95.3	21/32	16.7	PF7748
6 11/16	169.9	2 7/32	56.4	1	25.4	PT9493-MPG	7 1/32	178.6	3 3/4	95.3	21/32	16.7	PF7755
6 11/16	169.9	2 7/32	56.4	1	25.4	PT23358-MPG	7 1/32	178.6	3 13/16	96.8	21/32	16.7	PF7894
6 11/16	169.9	3 1/16	77.8	1 9/16	39.7	PT9307-MPG	7 1/32	178.6	3 13/16	96.8	21/32	16.7	PF7895
6 11/16	169.9	3 9/32	83.3	1 9/16	39.7	P7235	7 1/32	178.6	3 27/32	97.6	21/32	16.7	PF7782
6 11/16	169.9	3 9/16	90.5	31/32	24.6	P7615	7 1/32	178.6	4 3/16	106.4	21/32	16.7	PF7928
6 23/32	170.7	1 23/32	43.7	27/32	21.4	PT9143	7 1/32	178.6	4 3/16	106.4	21/32	16.7	PF9814
6 23/32	170.7	3 3/16	81.0	3/4	19.0	BF9839-D	7 1/32	178.6	4 7/32	107.2	21/32	16.7	PF46091
6 23/32	170.7	3 23/32	94.5	1/2	12.7	P54	7 1/32	178.6	4 7/32	107.2	21/32	16.7	PF46092
6 23/32	170.7	3 25/32	96.0	2 11/16	68.3	PT8883	7 1/16	179.4	2 1/32	51.6	1 7/32	31.0	PT463
6 23/32	170.7	4 5/32	105.6	3/4	19.0	F594-F	7 1/16	179.4	4 1/4	108.0	15/16	49.2	P7084
6 23/32	170.7	5 1/16	128.6	19/32	15.1	P7093	7 1/16	179.4	4 17/32	115.1	1 25/32	45.2	PT154
6 3/4	171.5	1 3/4	44.4	13/16	20.6	PT23095-MPG	7 1/16	179.4	4 17/32	115.1	2 9/32	57.9	P204
6 3/4	171.5	1 27/32	46.8	1	25.4	PT9296-MPG	7 1/16	179.4	4 17/32	115.1	2 9/32	57.9	P204-HD
6 3/4	171.5	1 27/32	46.8	1	25.4	PT9267	7 1/16	179.4	4 17/32	115.1	2 9/32	57.9	P204-HD10
6 3/4	171.5	3 5/16	84.1	1 1/4	31.8	P60	7 1/16	179.4	4 17/32	115.1	2 9/32	57.9	PT560 KIT
6 3/4	171.5	3 15/32	88.1	1	25.4	PF226	7 3/32	180.2	2 9/32	57.9	1 9/32	32.5	PT23321
6 3/4	171.5	4 5/32	105.6	1 7/8	47.6	P7106	7 3/32	180.2	2 9/32	57.9	1 9/32	32.5	PT23388-MPG
6 3/4	171.5	4 7/32	107.2	1	25.4	PF225	7 3/32	180.2	2 15/16	74.6	1 1/4	31.8	PT9535-MPG
6 25/32	172.2	1 27/32	46.8	1	25.4	PT9266	7 3/32	180.2	3 23/32	94.5	1 29/32	48.4	PT23493-MPG
6 25/32	172.2	1 27/32	46.8	1	25.4	PT23021	7 3/32	180.2	7 5/8	193.7	4 21/32	118.3	P7007
6 25/32	172.2	3 9/32	83.3	21/32	16.7	BF7964-D	7 1/8	180.8	4 7/32	106.9	11/16	0.7	PF46094
6 25/32	172.2	3 9/32	83.3	21/32	16.7	BF7989-D	7 1/8	181.0	2 9/32	57.9	1 7/32	31.0	PT9200
6 25/32	172.2	3 9/32	83.3	21/32	16.7	BF9837-D	7 1/8	181.0	4 3/8	111.1	31/32	24.6	PF9826
6 13/16	173.0	2 11/16	68.3	1 5/16	33.3	PT23028-MPG	7 1/8	181.0	4 1/2	114.3	1 25/32	45.2	PT433
6 13/16	173.0	2 23/32	69.1	1 11/32	34.1	PT9490-MPG	7 1/8	181.0	4 1/2	114.3	2 9/32	57.9	PT380 KIT
6 13/16	173.0	2 23/32	69.1	1 11/32	34.1	PT23361-MPG	7 5/32	181.8	3 9/32	83.3	-	-	BF46038-D
6 13/16	173.0	2 23/32	69.1	1 11/32	34.1	PT23365-MPG	7 5/32	181.8	4 1/2	114.3	2 1/4	57.2	PT509-MPG KIT
6 13/16	173.0	2 23/32	69.1	1 11/32	34.1	PT23430-MPG	7 3/16	182.6	3 5/8	92.1	1 1/16	27.0	V738-O
6 13/16	173.0	2 3/4	69.9	1 5/32	29.4	PT23465	7 3/16	182.6	3 7/8	98.4	1 1/2	38.1	PT23141
6 13/16	173.0	2 3/4	69.9	1 11/32	34.1	PT23129-MPG	7 3/16	182.6	3 15/16	100.0	1 3/4	44.4	P7484
6 13/16	173.0	2 7/8	73.0	27/32	21.4	PF882	7 3/16	182.6	4 1/32	102.4	7/32	5.4	PF46238
6 13/16	173.0	2 29/32	73.8	2 23/32	69.1	PT9491-MPG	7 3/16	182.6	4 1/8	104.6	13/16	20.3	PF46081
6 13/16	173.0	3 7/32	81.8	7/8	22.2	BF9827-D	7 3/16	182.6	4 1/8	104.6	13/16	20.3	PF46082
6 27/32	173.8	2 3/16	55.6	1 1/16	27.0	PT9282-MPG	7 3/16	182.6	4 1/2	114.3	2 9/32	57.9	PT8339



**WARNING:** These products can expose you to chemicals, including Diisononyl Phthalate, Carbon black extracts, Nickel, 1,3 Butadiene, Ethylene Oxide, Epichlorohydrin, which are known to the State of California to cause cancer, and Bisphenol-A, Ethylene Glycol, Ethylene Oxide, 1,3 Butadiene, Epichlorohydrin, which are known to the State of California to cause birth defects or other reproductive harm.

## LIQUID ELEMENTS BY LENGTH

LENGTH Inches	LENGTH (mm)	O.D. Inches	O.D. (mm)	I.D. Inches	I.D. (mm)	BALDWIN NUMBER	LENGTH Inches	LENGTH (mm)	O.D. Inches	O.D. (mm)	I.D. Inches	I.D. (mm)	BALDWIN NUMBER
7 7/32	183.4	3 5/16	84.1	1 3/8	34.9	PF7896	7 5/8	193.7	6 1/32	153.2	1 23/32	43.7	PT394-5
7 7/32	183.4	3 13/32	86.5	1 1/2	38.1	PF7936	7 5/8	193.7	6 1/32	153.2	1 23/32	43.7	PT394-15
7 7/32	183.4	4 5/32	105.4	1 23/32	43.7	PF46135	7 21/32	194.5	3 1/2	88.9	1 5/32	29.4	BF7949-D
7 7/32	183.4	4 3/16	106.4	—	—	PT23124	7 21/32	194.5	3 1/2	88.9	1 5/32	29.4	BF7950-D
7 7/32	183.4	4 7/32	107.2	—	—	PF46235	7 11/16	195.3	2 3/4	69.9	1 5/8	41.3	PT23060-MPG
7 1/4	184.2	3 15/16	100.0	27/32	21.4	PT72	7 11/16	195.3	3 3/16	81.0	9/16	14.3	BF9891-D
7 1/4	184.2	4 1/2	114.3	2 1/4	57.2	PT426	7 11/16	195.3	3 5/16	84.1	2 7/16	61.9	PT23189
7 1/4	184.2	4 1/2	114.3	2 1/4	57.2	PT498	7 11/16	195.3	4 1/32	102.4	—	—	PT23481
7 1/4	184.2	4 1/2	114.3	2 1/4	57.2	PT498-10	7 11/16	195.3	4 1/32	102.4	—	—	PT23482
7 9/32	184.9	3 1/16	77.8	1 11/16	42.9	C740-S	7 11/16	195.3	4 1/8	104.8	1 1/2	38.1	PT7436
7 9/32	184.9	3 15/16	100.0	1 15/16	49.2	P7053	7 11/16	195.3	4 1/2	114.3	2 1/4	57.2	P721
7 5/16	185.7	2 5/8	66.7	1 1/4	31.8	PT289	7 23/32	196.1	3	76.2	1 1/16	27.0	PT265
7 5/16	185.7	2 5/8	66.7	1 1/4	31.8	PT289-10	7 23/32	196.1	3	76.2	1 1/16	27.0	PF907
7 5/16	185.7	2 5/8	66.7	1 1/4	31.8	PT290	7 23/32	196.1	5 29/32	150.0	3 7/16	87.3	PT23592
7 11/32	186.5	3 5/16	84.1	1 5/32	29.4	BF7949-DM	7 3/4	196.9	1 3/4	44.4	3/4	19.0	PT23083-MPG
7 11/32	186.5	3 5/16	84.1	1 5/32	29.4	BF7971-DM	7 3/4	196.9	3 1/8	79.4	1 1/16	27.0	VT842-O
7 11/32	186.5	3 1/2	88.9	15/16	23.8	PT70	7 3/4	196.9	3 3/8	85.7	2 1/8	54.0	PT23034-MPG
7 3/8	187.3	1 13/16	46.0	13/16	20.6	PT23066-MPG	7 3/4	196.9	3 15/32	88.1	3/4	19.0	BF46039-D
7 3/8	187.3	1 13/16	46.0	1 1/8	28.6	PT23067-MPG	7 3/4	196.9	3 19/32	91.3	1 29/32	48.4	PT9450-MPG
7 3/8	187.3	2 11/32	59.5	1 3/16	30.2	PT9434	7 3/4	196.9	3 15/16	100.0	1 19/32	40.5	P7035
7 3/8	187.3	3 1/2	88.9	1 5/32	29.4	BF7951-D	7 3/4	196.9	4 7/32	107.2	1/2	12.7	P42
7 3/8	187.3	4 3/16	106.4	2	50.8	P7510	7 3/4	196.9	6 1/2	165.1	—	—	PT8334
7 3/8	187.3	4 1/2	114.3	2 1/4	57.2	PT298-10	7 25/32	197.6	2 15/32	62.7	1 1/16	27.0	PT210
7 13/32	188.1	4 25/32	121.4	2 5/32	54.8	P242	7 25/32	197.6	3 1/8	79.4	15/16	23.8	BF46044-D
7 7/16	188.9	2 29/32	73.8	1	25.4	PT513	7 25/32	197.6	3 3/16	81.0	13/16	20.6	BF9809-D
7 7/16	188.9	3 3/8	85.7	1 7/8	47.6	PT562-10	7 25/32	197.6	3 3/16	81.0	13/16	20.6	BF9810-D
7 7/16	188.9	4 5/32	105.6	2 27/32	72.2	PT8982-MPG	7 25/32	197.6	3 1/4	82.6	1 19/32	40.5	PT9284-MPG
7 7/16	188.9	4 1/2	114.3	2 7/32	56.4	PT288-HD	7 25/32	197.6	3 9/32	83.3	1 9/16	39.7	PT9152
7 7/16	188.9	4 1/2	114.3	2 7/32	56.4	PT288-HD10	7 25/32	197.6	3 29/32	99.2	2 9/16	65.1	PT23472
7 15/32	189.7	4 5/32	105.6	2 13/16	71.4	PT9410-MPG	7 25/32	197.6	4 23/32	119.9	3 1/32	77.0	PT23473
7 15/32	189.9	5 27/32	148.3	1 5/32	29.7	PF46080	7 25/32	197.6	6 1/2	165.1	1 19/32	40.5	P529
7 1/2	190.5	2 11/16	68.3	1 5/16	33.3	PT23532-MPG	7 13/16	198.4	1 9/16	39.7	5/8	15.9	PF7828
7 1/2	190.5	2 7/8	73.0	1 1/8	28.6	PT445-MPG	7 13/16	198.4	1 3/4	44.4	3/4	19.0	PT23082-MPG
7 1/2	190.5	3 5/16	84.1	1 11/16	42.9	PT23149	7 13/16	198.4	1 25/32	45.2	25/32	19.8	PT9287-MPG
7 1/2	190.5	3 15/16	100.0	2	50.8	PT277	7 13/16	198.4	2 3/16	55.6	1 25/32	45.2	PF46103
7 1/2	190.5	4 1/8	104.8	—	—	PF9928	7 13/16	198.4	3	76.2	1 1/16	27.0	PF810
7 1/2	190.5	4 1/8	104.8	—	—	PF9929	7 13/16	198.4	3	76.2	1 1/16	27.0	PF902
7 1/2	190.5	4 3/4	120.7	1 9/16	39.7	P998	7 13/16	198.4	3	76.2	1 1/16	27.0	PF902-S
7 1/2	190.5	6 1/2	165.1	3 15/32	88.1	PT520	7 13/16	198.4	3	76.2	1 1/16	27.0	PF910
7 17/32	191.3	1 13/16	46.0	25/32	19.8	PE17001	7 13/16	198.4	3 1/4	82.6	1 1/2	38.1	PT23146
7 17/32	191.3	3 3/32	78.6	—	—	PT9447	7 13/16	198.4	3 15/32	88.1	7/8	22.2	BF46041-D
7 17/32	191.3	3 23/32	94.5	1 1/32	26.2	PF312	7 13/16	198.4	3 17/32	89.7	1 5/16	33.3	P235
7 17/32	191.3	4 1/8	104.8	1 1/2	38.1	PT7437	7 13/16	198.4	3 3/4	95.3	1 31/32	50.0	PT567
7 17/32	191.5	6	152.4	2 15/32	63.0	PF46145	7 13/16	198.4	3 3/4	95.3	1 31/32	50.0	PT567-10
7 9/16	192.1	3 15/16	100.0	1 23/32	43.7	PT107	7 27/32	199.2	1 25/32	45.2	3/4	19.0	PT9210
7 9/16	192.1	4 5/32	105.6	2 27/32	72.2	PT9188	7 27/32	199.2	1 13/16	46.0	3/4	19.0	PT8946-MPG
7 9/16	192.1	4 5/16	109.5	3	76.2	PT23215-MPG	7 27/32	199.2	2 5/16	58.7	1 1/16	27.0	PT9153
7 19/32	192.9	1 27/32	46.8	7/8	22.2	PT23373-MPG	7 27/32	199.2	2 3/4	69.9	1 1/32	26.2	PT23308
7 19/32	192.9	1 27/32	46.8	7/8	22.2	PT23378-MPG	7 27/32	199.2	2 3/4	69.9	1 1/4	31.8	PT9157
7 19/32	192.9	2 7/8	73.0	1 1/16	27.0	PF942	7 27/32	199.2	3 9/32	83.3	13/16	20.6	P7016
7 19/32	192.9	3 9/32	83.3	15/16	23.8	P7305	7 27/32	199.2	3 5/16	84.1	29/32	23.0	P7015
7 19/32	192.9	5 27/32	148.4	1 1/32	26.2	PF9804	7 27/32	199.2	3 19/32	91.3	1 29/32	48.4	PT8884-MPG
7 5/8	193.7	3 9/32	83.3	21/32	16.7	BF7677-D	7 27/32	199.2	3 11/16	93.7	1 7/8	47.6	PT676
7 5/8	193.7	3 9/32	83.3	21/32	16.7	BF7682-D	7 27/32	199.2	3 11/16	93.7	1 29/32	48.4	PT8992-MPG
7 5/8	193.7	3 9/32	83.3	21/32	16.7	BF7746-D	7 27/32	199.2	3 11/16	93.7	1 29/32	48.4	PT23216-MPG
7 5/8	193.7	3 9/32	83.3	21/32	16.7	BF7785-D	7 27/32	199.2	3 15/16	100.0	1 1/8	28.6	P7021
7 5/8	193.7	3 9/32	83.3	21/32	16.7	BF7786-D	7 27/32	199.2	4 3/8	111.1	2 13/32	61.1	PT9413-MPG
7 5/8	193.7	3 9/32	83.3	21/32	16.7	BF7898-D	7 7/8	199.9	3 31/32	101.1	1 5/16	33.0	PF46171
7 5/8	193.7	3 5/16	84.1	1 5/32	29.4	BF7971-D	7 7/8	200.0	1 3/4	44.4	7/16	11.1	F919-C
7 5/8	193.7	3 15/32	88.1	31/32	24.6	P102	7 7/8	200.0	1 13/16	46.0	13/16	20.6	PT23006
7 5/8	193.7	3 23/32	94.5	1 13/16	46.0	PT9390-MPG	7 7/8	200.0	1 13/16	46.0	13/16	20.6	PT23007
7 5/8	193.7	3 23/32	94.5	1 27/32	46.8	PT9268	7 7/8	200.0	2 5/16	58.7	1 1/32	26.2	PT9197
7 5/8	193.7	3 3/4	95.3	1 1/16	27.0	PF9889	7 7/8	200.0	2 5/16	58.7	1 1/32	26.2	PT9285-MPG
7 5/8	193.7	4 11/32	110.3	3/4	19.0	P249	7 7/8	200.0	2 5/16	58.7	1 1/32	26.2	PT9286-MPG
7 5/8	193.7	4 23/32	119.9	2 3/32	53.2	P7494	7 7/8	200.0	2 3/8	60.3	1 1/2	38.1	PT23533
7 5/8	193.7	6 1/32	153.2	1 23/32	43.7	P194	7 7/8	200.0	2 13/16	71.4	1 3/4	44.4	PT23327
7 5/8	193.7	6 1/32	153.2	1 23/32	43.7	P194-HD	7 7/8	200.0	2 27/32	72.2	2 1/16	52.4	PT9187
7 5/8	193.7	6 1/32	153.2	1 23/32	43.7	P194-HD10	7 7/8	200.0	2 7/8	73.0	1 15/16	49.2	PT23201-MPG
7 5/8	193.7	6 1/32	153.2	1 23/32	43.7	PF194	7 7/8	200.0	3	76.2	1 1/8	28.6	P40030



**WARNING:** These products can expose you to chemicals, including Diisononyl Phthalate, Carbon black extracts, Nickel, 1,3 Butadiene, Ethylene Oxide, Epichlorohydrin, which are known to the State of California to cause cancer, and Bisphenol-A, Ethylene Glycol, Ethylene Oxide, 1,3 Butadiene, Epichlorohydrin, which are known to the State of California to cause birth defects or other reproductive harm.

# LIQUID ELEMENTS BY LENGTH

LENGTH Inches	LENGTH (mm)	O.D. Inches	O.D. (mm)	I.D. Inches	I.D. (mm)	BALDWIN NUMBER	LENGTH Inches	LENGTH (mm)	O.D. Inches	O.D. (mm)	I.D. Inches	I.D. (mm)	BALDWIN NUMBER
7 7/8	200.0	3	76.2	1 1/8	28.6	P40110	8 3/32	205.6	4 3/4	120.7	2	50.8	P7508
7 7/8	200.0	3 5/16	84.1	—	—	PT9224	8 1/8	206.4	2 1/16	52.4	1	25.4	PT23266-MPG
7 7/8	200.0	3 3/8	85.7	—	—	PT9279	8 1/8	206.4	2 1/8	54.0	15/16	23.8	PT23091-MPG
7 7/8	200.0	3 3/8	85.7	1 7/8	47.6	PT23061-MPG	8 1/8	206.4	2 1/8	54.0	15/16	23.8	PT23092-MPG
7 7/8	200.0	3 1/2	88.9	2 1/4	57.2	PT23230-MPG	8 1/8	206.4	2 5/8	66.7	1 3/8	34.9	PT23035-MPG
7 7/8	200.0	3 9/16	90.5	—	—	PT9238	8 1/8	206.4	3 3/32	78.6	1 5/8	41.3	PT9144
7 7/8	200.0	3 9/16	90.5	1 7/8	47.6	PT23079-MPG	8 1/8	206.4	3 7/32	81.8	1 7/16	36.5	PT8330-MPG
7 7/8	200.0	3 21/32	92.9	1 23/32	43.7	PT8344	8 1/8	206.4	4 3/8	111.1	2 7/16	61.9	PT9405
7 7/8	200.0	4 7/16	112.7	1 17/32	38.9	PT115	8 5/32	207.2	1 25/32	45.2	1 1/32	26.2	H9056
7 7/8	200.0	4 3/4	120.7	2 1/16	52.4	PT329	8 5/32	207.2	3 25/32	96.0	2 1/8	54.0	PT9425-MPG
7 7/8	200.0	4 13/16	122.2	—	—	PT716	8 5/32	207.2	3 13/16	96.8	1 11/16	42.9	PT9498-MPG
7 7/8	200.0	5 1/8	130.2	2 1/16	52.4	PT9507	8 5/32	207.2	6	152.4	4 5/32	105.6	PT23403-MPG
7 7/8	200.0	5 1/8	130.2	2 9/16	65.1	PT9217	8 5/32	207.2	6	152.4	4 5/32	105.6	PT23404-MPG
7 7/8	200.0	5 1/8	130.2	2 9/16	65.1	PT9272	8 3/16	208.0	1 3/4	44.4	15/16	23.8	PT23285-MPG
7 7/8	200.0	5 1/8	130.2	2 9/16	65.1	PT23048-MPG	8 3/16	208.0	1 25/32	45.2	1	25.4	PT9406-MPG
7 7/8	200.0	5 11/32	135.7	2 9/16	65.1	PT9183	8 3/16	208.0	2	50.8	15/16	23.8	PT23389-MPG
7 7/8	200.0	5 1/2	139.7	2 5/8	66.7	PT457-MPG	8 3/16	208.0	3	76.2	1 1/16	27.0	PT535
7 7/8	200.0	5 15/16	150.8	3 19/32	91.3	PT9351-MPG	8 3/16	208.0	3 3/32	78.6	1 21/32	42.1	H9076-V
7 7/8	200.0	5 15/16	150.8	3 19/32	91.3	PT9411-MPG	8 3/16	208.0	3 3/32	78.6	1 11/16	42.9	PT685-MPG
7 7/8	200.0	7	177.8	4 5/16	109.5	PT9518-MPG	8 3/16	208.0	3 5/32	80.2	1 11/16	42.9	H9103
7 7/8	200.0	7 3/32	180.2	4 5/32	105.6	PT23454	8 3/16	208.0	3 1/2	88.9	1 5/8	41.3	P40003
7 29/32	200.8	2 3/4	69.9	1	25.4	PT9395-MPG	8 3/16	208.0	3 29/32	99.2	2 1/16	52.4	PT23012
7 29/32	200.8	2 27/32	72.2	1 25/32	45.2	PT8999-MPG	8 3/16	208.0	4 1/2	114.3	7/8	22.2	PF155
7 15/16	201.6	2 3/4	69.9	1 21/32	42.1	PT9248	8 3/16	208.0	4 1/2	114.3	7/8	22.2	PF7597
7 15/16	201.6	2 13/16	71.4	1 5/8	41.3	PT23567-MPG	8 3/16	208.0	5 1/8	130.2	1 15/16	49.2	PT9168
7 15/16	201.6	2 7/8	73.0	1 11/32	34.1	PT8351	8 3/16	208.0	5 1/8	130.2	1 31/32	50.0	PT9182
7 15/16	201.6	2 7/8	73.0	1 7/8	47.6	PT23391-MPG	8 3/16	208.0	5 31/32	151.6	4 1/8	104.8	H9001
7 15/16	201.6	3 11/16	93.7	1 13/16	46.0	PT23080-MPG	8 7/32	208.8	1 3/4	44.4	1	25.4	H9051
7 15/16	201.6	3 23/32	94.5	1 1/32	26.2	PF7984	8 7/32	208.8	1 3/4	44.4	1	25.4	H9055
7 31/32	202.4	4 9/16	115.9	2 7/32	56.4	PT390-MPG	8 7/32	208.8	1 3/4	44.4	1 1/32	26.2	H9045
7 31/32	202.4	4 9/16	115.9	2 7/32	56.4	PT391-MPG	8 7/32	208.8	1 3/4	44.4	1 1/32	26.2	H9046
8	203.2	1 5/32	29.4	2	50.8	PT23217-MPG	8 7/32	208.8	1 3/4	44.4	1 1/32	26.2	H9047
8	203.2	1 21/32	42.1	1 1/32	26.2	PT23495-MPG	8 7/32	208.8	1 3/4	44.4	1 1/32	26.2	H9048
8	203.2	2 29/32	73.8	1 13/32	35.7	PT9300-MPG	8 7/32	208.8	1 25/32	45.2	15/16	23.8	H9231
8	203.2	3 1/16	77.8	1 5/8	41.3	PT23296-MPG	8 7/32	208.8	1 25/32	45.2	1	25.4	H9052
8	203.2	3 1/8	79.4	1 15/16	49.2	PT23407-MPG	8 7/32	208.8	2	50.8	15/16	23.8	H9111
8	203.2	3 7/32	81.8	1 25/32	45.2	PT9505-MPG	8 7/32	208.8	2	50.8	15/16	23.8	H9112
8	203.2	3 9/32	83.3	1 5/8	41.3	PT23310	8 7/32	208.8	2	50.8	15/16	23.8	H9113
8	203.2	3 23/32	94.5	1 25/32	45.2	PF7761	8 7/32	208.8	2	50.8	15/16	23.8	H9114
8	203.2	3 3/4	95.3	2 9/16	65.1	PT522	8 7/32	208.8	2	50.8	31/32	24.6	PT8425
8	203.2	3 31/32	100.8	1 3/4	44.4	PF7767	8 7/32	208.8	3 9/16	90.5	1 5/8	41.3	P7264
8	203.2	4 1/8	104.8	1 1/16	27.0	H852-O	8 1/4	209.6	1 25/32	45.2	1	25.4	PT23491-MPG
8	203.2	4 7/32	107.2	1/2	12.7	P52	8 1/4	209.6	1 31/32	50.0	31/32	24.6	PT23498-MPG
8	203.2	4 3/8	111.1	23/32	18.3	PT777	8 1/4	209.6	2	50.8	15/16	23.8	PT23437-MPG
8	203.2	4 3/8	111.1	2 1/32	51.6	PT8375-MPG	8 1/4	209.6	2 3/4	69.9	1 5/16	33.3	PT23076-MPG
8	203.2	4 3/8	111.1	2 7/16	61.9	PT760-10	8 1/4	209.6	2 3/4	69.9	1 5/16	33.3	PT23419-MPG
8	203.2	4 3/8	111.1	2 7/16	61.9	PT760-25	8 1/4	209.6	3 1/16	77.8	1 11/16	42.9	PT23396-MPG
8	203.2	6	152.4	3 17/32	89.7	PT191	8 1/4	209.6	3 1/16	77.8	1 11/16	42.9	PT23398-MPG
8	203.2	6	152.4	3 17/32	89.7	PT191-5	8 1/4	209.6	3 1/16	77.8	1 23/32	43.7	PT23395-MPG
8	203.2	6	152.4	3 17/32	89.7	PT191-10	8 1/4	209.6	3 1/16	77.8	1 23/32	43.7	PT23414-MPG
8 1/32	204.0	5 1/8	130.2	2 1/32	51.6	PT23496-MPG	8 1/4	209.6	3 3/32	78.6	1 23/32	43.7	PT23509-MPG
8 1/16	204.8	2 3/4	69.9	1 5/8	41.3	PT8948-MPG	8 1/4	209.6	3 1/8	79.4	1 11/16	42.9	H9073
8 1/16	204.8	3 5/16	84.1	—	—	PT23178	8 1/4	209.6	3 1/8	79.4	1 11/16	42.9	H9074
8 1/16	204.8	3 3/8	85.7	1 15/16	49.2	PT23225-MPG	8 1/4	209.6	3 1/8	79.4	1 11/16	42.9	H9075
8 1/16	204.8	3 1/2	88.9	2 3/16	55.6	PT23161	8 1/4	209.6	3 1/8	79.4	1 11/16	42.9	H9075-V
8 1/16	204.8	3 1/2	88.9	2 3/16	55.6	PT23166	8 1/4	209.6	3 1/8	79.4	1 11/16	42.9	H9076
8 1/16	204.8	3 3/4	95.3	2 1/8	54.0	PT23283-MPG	8 1/4	209.6	3 5/32	80.2	1 11/16	42.9	H9092
8 1/16	204.8	3 29/32	99.2	1 5/8	41.3	PT23013	8 1/4	209.6	3 11/16	93.7	1 19/32	40.5	PT9342-MPG
8 1/16	204.8	3 29/32	99.2	1 5/8	41.3	PT23015	8 1/4	209.6	3 29/32	99.2	2 1/32	51.6	PT23456
8 1/16	204.8	4 3/8	111.1	2 7/16	61.9	PT761	8 1/4	209.6	4 17/32	115.1	11/16	17.5	PF846
8 1/16	204.8	4 3/8	111.1	2 7/16	61.9	PT776-MPG	8 1/4	209.6	4 31/32	126.2	3 5/8	92.1	PT23488-MPG
8 1/16	204.8	4 1/2	114.3	2 1/4	57.2	PT561	8 1/4	209.6	6	152.4	4 1/2	114.3	PT23405-MPG
8 3/32	205.6	3 13/32	86.5	1 3/8	34.9	PT23561-MPG	8 9/32	210.3	2 7/32	56.4	1 1/32	26.2	PT23576-MPG
8 3/32	205.6	3 17/32	89.7	2 1/2	63.5	PT23445-MPG	8 9/32	210.3	3 1/16	77.8	1 11/16	42.9	PT9207
8 3/32	205.6	3 25/32	96.0	2 7/32	56.4	PT23380-MPG	8 9/32	210.3	3 1/16	77.8	1 11/16	42.9	PT23131-MPG
8 3/32	205.6	3 25/32	96.0	2 7/32	56.4	PT23412-MPG	8 9/32	210.3	3 15/16	100.0	1 29/32	48.4	PT9501-MPG
8 3/32	205.6	3 25/32	96.0	2 7/32	56.4	PT23433-MPG	8 9/32	210.3	4 11/32	110.3	2 1/32	51.6	PF7618
8 3/32	205.6	4 17/32	115.1	2 1/4	57.2	PT442-MPG	8 9/32	210.3	4 31/32	126.2	3 5/8	92.1	PT682
									5 5/32	131.0	2 15/32	62.7	PT9176



**WARNING:** These products can expose you to chemicals, including Diisononyl Phthalate, Carbon black extracts, Nickel, 1,3 Butadiene, Ethylene Oxide, Epichlorohydrin, which are known to the State of California to cause cancer, and Bisphenol-A, Ethylene Glycol, Ethylene Oxide, 1,3 Butadiene, Epichlorohydrin, which are known to the State of California to cause birth defects or other reproductive harm.

# LIQUID ELEMENTS BY LENGTH

LENGTH Inches	LENGTH (mm)	O.D. Inches	O.D. (mm)	I.D. Inches	I.D. (mm)	BALDWIN NUMBER	LENGTH Inches	LENGTH (mm)	O.D. Inches	O.D. (mm)	I.D. Inches	I.D. (mm)	BALDWIN NUMBER
8 5/16	211.1	2 7/8	73.0	1 3/16	30.2	PF845	8 15/16	227.0	4 1/2	114.3	1 23/32	43.7	PT475
8 5/16	211.1	3	76.2	1 13/16	46.0	PT23397-MPG	8 15/16	227.0	4 1/2	114.3	1 23/32	43.7	PT510
8 5/16	211.1	3 29/32	99.2	2 1/16	52.4	PT9291-MPG	8 15/16	227.0	4 1/2	114.3	1 25/32	45.2	PT86-HD
8 5/16	211.1	3 15/16	100.0	2 11/32	59.5	PT516	8 15/16	227.0	4 23/32	119.9	2 15/16	74.6	PT9258
8 5/16	211.1	3 15/16	100.0	2 11/32	59.5	PT8507-MPG	8 15/16	227.0	5 1/8	130.2	3 5/16	84.1	PT9483-MPG
8 5/16	211.1	5 1/16	128.6	2 1/2	63.5	PT23099-MPG	8 15/16	227.0	5 1/8	130.2	3 3/8	85.7	PT88-HD
8 5/16	211.1	5 5/16	134.9	2 1/2	63.5	PT23229-MPG	8 31/32	227.8	2 9/16	65.1	1 9/32	32.5	PT8484
8 5/16	211.1	5 29/32	150.0	—	—	PT9509	8 31/32	227.8	3 1/8	79.4	1 7/8	47.6	PT93
8 11/32	211.9	4 11/32	110.3	1 27/32	46.8	PT7058	8 31/32	227.8	3 1/8	79.4	1 7/8	47.6	PT93-MPG
8 3/8	212.7	2 7/16	61.9	1 1/16	27.0	PT23267-MPG	8 31/32	227.8	3 21/32	92.9	1 23/32	43.7	PT1577
8 3/8	212.7	3 1/8	79.4	1 23/32	43.7	H9096	8 31/32	227.8	3 21/32	92.9	2 5/32	54.8	PT1585
8 3/8	212.7	3 1/8	79.4	1 23/32	43.7	H9097	8 31/32	227.8	4 1/32	102.4	—	—	PT23475
8 3/8	212.7	3 9/32	83.3	1 9/16	39.7	PT188	8 31/32	227.8	4 3/4	120.7	2 1/4	57.2	P507
8 3/8	212.7	3 13/32	86.5	2 1/8	54.0	PT23024							
8 3/8	212.7	3 1/2	88.9	1 9/16	39.7	PT23246-MPG	9	228.6	2 1/4	57.2	1 5/16	33.3	PT23103-MPG
8 3/8	212.7	3 29/32	99.2	2 1/16	52.4	PT23044-MPG	9	228.6	2 3/8	60.3	25/32	19.8	PT9372
8 3/8	212.7	5 3/8	136.5	7/8	22.2	PT7770	9	228.6	2 3/8	60.3	1 5/16	33.3	PT23093-MPG
8 13/32	213.5	1 31/32	50.0	31/32	24.6	PT23442-MPG	9	228.6	2 3/8	60.3	1 13/32	35.7	PT8958-MPG
8 13/32	213.5	1 31/32	50.0	31/32	24.6	PT23443-MPG	9	228.6	2 1/2	63.5	1 3/16	30.2	PT23162
8 13/32	213.5	3 9/32	83.3	1 5/8	41.3	PT145	9	228.6	2 3/4	69.9	1 13/16	46.0	PT23172
8 7/16	214.3	1 13/16	46.0	15/16	23.8	PT23448-MPG	9	228.6	2 7/8	73.0	1 13/32	35.7	PT66-HD
8 7/16	214.3	2 3/4	69.9	1 19/32	40.5	PT9264	9	228.6	3 7/8	98.4	2 5/16	58.7	PT23138
8 7/16	214.3	2 7/8	73.0	1 3/16	30.2	S16-1	9	228.6	4	101.6	1 1/2	38.1	F844-A
8 7/16	214.3	2 7/8	73.0	1 1/4	31.8	F845-A	9	228.6	4 1/2	114.3	2 1/4	57.2	PT381
8 7/16	214.3	3 1/2	88.9	1 5/16	33.3	P476	9	228.6	4 1/2	114.3	2 1/4	57.2	PT8331-MPG
8 1/2	215.9	2 11/16	68.3	1 9/16	39.7	PT23005	9	228.6	4 9/16	115.9	1 11/16	42.9	PT79
8 1/2	215.9	3 1/2	88.9	1 15/16	49.2	PT23274-MPG	9	228.6	4 27/32	123.0	2 7/8	73.0	PT538
8 1/2	215.9	3 15/16	100.0	2 1/2	63.5	PT23317	9	228.6	5	127.0	2 13/16	71.4	PT563
8 1/2	215.9	4	101.6	1 7/16	36.5	PT23041-MPG	9	228.6	5	127.0	2 13/16	71.4	PT566
8 1/2	215.9	5 15/16	150.8	3	76.2	PT23180	9	228.6	5	127.0	2 15/16	74.6	PT393
8 17/32	216.7	4 7/16	112.7	2 19/32	65.9	PT330	9	228.6	5 1/8	130.2	3 3/8	85.7	PT90-10
8 17/32	216.7	6	152.4	3 17/32	89.7	PT193	9	228.6	5 1/8	130.2	3 3/8	85.7	PT90-MPG
8 17/32	216.7	6	152.4	3 17/32	89.7	PT193-3	9	228.6	5 1/8	130.2	3 3/8	85.7	PT8912
8 17/32	216.7	6	152.4	3 17/32	89.7	PT193 KIT	9	228.6	5 1/8	130.2	3 3/8	85.7	PT9418
8 9/16	217.5	2	50.8	1	25.4	PT23240-MPG	9	228.6	6	152.4	2 5/8	66.7	PT499-5
8 9/16	217.5	3 3/16	81.0	7/16	11.1	P352	9	228.6	6 25/32	172.2	3 15/16	100.0	PT98-10
8 9/16	217.5	3 7/32	81.8	—	—	PT23122	9	228.6	6 25/32	172.2	3 15/16	100.0	PT98-MPG
8 5/8	219.1	2 3/4	69.9	1 1/4	31.8	PT439	9	228.6	6 25/32	172.2	4 1/4	108.0	PT9427-MPG
8 5/8	219.1	3 29/32	99.2	1 9/16	39.7	PT9175	9	228.6	4 7/32	107.2	1 13/16	46.0	PT8338
8 5/8	219.1	3 29/32	99.2	1 25/32	45.2	PT9181	9 1/16	230.2	2 3/32	53.2	1 1/32	26.2	PT8978-MPG
8 5/8	219.1	5 1/2	139.7	4	101.6	PT9517	9 1/16	230.2	2 3/32	53.2	1 3/32	27.8	PT23503-MPG
8 21/32	219.9	2 3/32	53.2	1 1/4	31.8	PT23572-MPG	9 1/16	230.2	3 23/32	94.5	1 23/32	43.7	PT8378-MPG
8 21/32	219.9	2 3/4	69.9	1 11/16	42.9	PT23476	9 1/16	230.2	3 23/32	94.5	1 23/32	43.7	PT8456-MPG
8 21/32	219.9	4 25/32	121.4	5/8	15.9	PT7512	9 1/16	230.2	4 7/16	112.7	1 1/2	38.1	P20-HD
8 21/32	219.9	4 13/16	122.2	21/32	16.7	PT267	9 1/16	230.2	4 7/16	112.7	1 1/2	38.1	PT385
8 11/16	220.7	2 5/8	66.7	1 7/32	31.0	P162	9 1/16	230.2	4 7/16	112.7	1 1/2	38.1	PT385-E
8 11/16	220.7	4 5/16	109.5	2 3/4	69.9	PT9170	9 1/16	230.2	4 1/2	114.3	1 25/32	45.2	PT436
8 11/16	220.7	4 7/16	112.7	2	50.8	P40019	9 1/16	230.2	4 17/32	115.1	2 9/32	57.9	PT275
8 11/16	220.7	5 1/32	127.8	1 1/2	38.1	PT7368	9 1/16	230.2	4 17/32	115.1	2 9/32	57.9	PT275-10
8 3/4	222.3	5 27/32	148.4	31/32	24.6	PT316	9 1/16	230.2	4 31/32	126.2	1 9/16	39.7	PT431
8 13/16	223.8	2 7/8	73.0	1 9/16	39.7	PT23025	9 1/16	230.2	5 1/8	130.2	3 3/8	85.7	PT8496-MPG
8 13/16	223.8	4 13/32	111.9	1 1/8	28.6	P40031-MPG	9 1/16	230.2	6 25/32	172.2	3 15/16	100.0	PT9441-MPG
8 13/16	223.8	4 13/32	111.9	2 3/4	69.9	PT9169	9 1/16	230.2	6 25/32	172.2	3 15/16	100.0	PT9444-MPG
8 27/32	224.6	2 3/4	69.9	1 5/8	41.3	PT8481	9 3/32	231.0	2 1/2	63.5	1 1/16	27.0	PT9158
8 7/8	225.4	2 3/4	69.9	1 5/8	41.3	PT9384-MPG	9 3/32	231.0	3	76.2	1 1/32	26.2	PT7878
8 7/8	225.4	2 13/16	71.4	1 9/16	39.7	PT23176	9 3/32	231.0	3 1/16	77.8	1 19/32	40.5	PT23340-MPG
8 7/8	225.4	3 1/4	82.6	1 7/8	47.6	PT9536-MPG	9 3/32	231.0	3 29/32	99.2	1 13/16	46.0	PT8370-MPG
8 7/8	225.4	3 5/16	84.1	1 1/8	28.6	PT181 KIT	9 3/32	231.0	5 1/8	130.2	3 3/8	85.7	PT568
8 7/8	225.4	3 5/8	92.1	2 1/2	63.5	PT23144	9 1/8	231.8	2 1/8	54.0	1 1/8	28.6	PT23047-MPG
8 7/8	225.4	3 29/32	99.2	1 9/16	39.7	PT9227	9 1/8	231.8	2 1/8	54.0	1 1/8	28.6	PT23084-MPG
8 7/8	225.4	4 27/32	123.0	21/32	16.7	PT7127	9 1/8	231.8	2 9/16	65.1	1 5/16	33.3	PT9522-MPG
8 29/32	226.2	3 29/32	99.2	1 9/16	39.7	PT8997-MPG	9 1/8	231.8	3	76.2	1 9/16	39.7	PT23056-MPG
8 29/32	226.2	4 5/16	109.5	13/16	20.6	PT7890	9 1/8	231.8	3 1/16	77.8	1 9/16	39.7	PT9205
8 29/32	226.2	4 5/16	109.5	13/16	20.6	PT7890-10	9 1/8	231.8	3 11/16	93.7	2	50.8	PT23213-MPG
8 29/32	226.2	4 5/16	109.5	13/16	20.6	PT7890-30	9 1/8	231.8	3 29/32	99.2	1 5/8	41.3	PT8885-MPG
8 29/32	226.2	4 11/32	110.3	1 13/16	46.0	PT9155	9 1/8	231.8	4 1/2	114.3	1 25/32	45.2	PT401-MPG
8 15/16	227.0	2 15/16	74.6	1 1/2	38.1	PT23312	9 5/32	232.4	3 3/4	95.5	1 31/32	50.3	PT23597-MPG
8 15/16	227.0	3 9/32	83.3	1 31/32	50.0	PT8459	9 5/32	232.6	3 1/16	77.8	1 9/16	39.7	PT23339-MPG
8 15/16	227.0	3 5/16	84.1	1 1/2	38.1	PT9829 KIT	9 5/32	232.6	3 17/32	89.7	1 9/16	39.7	PT8945-MPG



**WARNING:** These products can expose you to chemicals, including Diisononyl Phthalate, Carbon black extracts, Nickel, 1,3 Butadiene, Ethylene Oxide, Epichlorohydrin, which are known to the State of California to cause cancer, and Bisphenol-A, Ethylene Glycol, Ethylene Oxide, 1,3 Butadiene, Epichlorohydrin, which are known to the State of California to cause birth defects or other reproductive harm.

# LIQUID ELEMENTS BY LENGTH

LENGTH Inches	LENGTH (mm)	O.D. Inches	O.D. (mm)	I.D. Inches	I.D. (mm)	BALDWIN NUMBER	LENGTH Inches	LENGTH (mm)	O.D. Inches	O.D. (mm)	I.D. Inches	I.D. (mm)	BALDWIN NUMBER
9 5/32.....	232.6	3 15/16.....	100.0	1 9/16.....	39.7	PT8363	9 19/32.....	243.7	6.....	152.4	13/16.....	20.6	PF7973
9 3/16.....	233.4	3 1/16.....	77.8	1 1/2.....	38.1	PT23026	9 5/8.....	244.5	2 3/8.....	60.3	1.....	25.4	PT8498
9 3/16.....	233.4	3 1/16.....	77.8	1 1/2.....	38.1	PT23085-MPG	9 5/8.....	244.5	2 5/8.....	66.7	1 1/8.....	28.6	PT23059-MPG
9 3/16.....	233.4	3 15/32.....	88.1	1 11/32.....	34.1	PT375	9 5/8.....	244.5	2 5/8.....	66.7	1 1/8.....	28.6	PT23078-MPG
9 3/16.....	233.4	3 23/32.....	94.5	1 15/16.....	49.2	PT8404-MPG	9 5/8.....	244.5	2 11/16.....	68.3	1 1/8.....	28.6	PT23295-MPG
9 3/16.....	233.4	3 15/16.....	100.0	1 7/8.....	47.6	PT23209-MPG	9 5/8.....	244.5	2 7/8.....	73.0	1.....	25.4	PT8329
9 3/16.....	233.4	3 15/16.....	100.0	2 9/32.....	57.9	PT189	9 5/8.....	244.5	2 7/8.....	73.0	1.....	25.4	PT8888
9 3/16.....	233.4	3 15/16.....	100.0	2 9/32.....	57.9	PT189-MPG	9 5/8.....	244.5	2 7/8.....	73.0	1 11/16.....	27.0	PT543 KIT
9 3/16.....	233.4	4 15/32.....	113.5	3/4.....	19.0	BF1392-SPS KIT	9 5/8.....	244.5	3 1/8.....	79.4	15/16.....	23.8	C40004
9 3/16.....	233.4	4 1/2.....	114.3	2 1/4.....	57.2	PT376	9 5/8.....	244.5	3 1/4.....	82.6	7/8.....	22.2	PT9504-MPG
9 3/16.....	233.4	4 17/32.....	115.1	1 3/32.....	27.8	PF1291	9 5/8.....	244.5	3 15/16.....	100.0	19/32.....	15.1	P7052
9 7/32.....	234.2	3 15/16.....	100.0	1 5/8.....	41.3	PF7655	9 21/32.....	245.3	2 3/8.....	60.3	1.....	25.4	PT8458-MPG
9 1/4.....	235.0	2.....	50.8	1 1/4.....	31.8	PT23075-MPG	9 11/16.....	246.1	1 27/32.....	46.8	1.....	25.4	PT23382-MPG
9 1/4.....	235.0	2 1/2.....	63.5	1 3/16.....	30.2	PT23198-MPG	9 11/16.....	246.1	2 3/16.....	55.6	1 1/32.....	26.2	PT23284-MPG
9 1/4.....	235.0	3 1/16.....	77.8	1 1/2.....	38.1	PT23029-MPG	9 11/16.....	246.1	4 3/8.....	111.3	21/32.....	16.8	BF46128-D
9 1/4.....	235.0	3 1/16.....	77.8	1 17/32.....	38.9	PT8980-MPG	9 11/16.....	246.1	4 3/8.....	111.3	1 1/16.....	26.7	BF46064-D
9 1/4.....	235.0	3 1/2.....	88.9	1 5/8.....	41.3	PT9511	9 11/16.....	246.1	4 1/2.....	114.3	2 1/4.....	57.2	PT725-MPG
9 1/4.....	235.0	3 17/32.....	89.7	1 5/8.....	41.3	PT737	9 11/16.....	246.1	4 31/32.....	126.2	1 9/16.....	39.7	P999-HD
9 1/4.....	235.0	3 17/32.....	89.7	1 5/8.....	41.3	PT737-10	9 11/16.....	246.1	6 1/16.....	154.0	3 1/4.....	82.6	301
9 1/4.....	235.0	3 29/32.....	99.2	1 5/8.....	41.3	PT9297-MPG	9 11/16.....	246.1	6 1/16.....	154.0	3 1/4.....	82.6	301-30
9 1/4.....	235.0	3 29/32.....	99.2	1 21/32.....	42.1	PT23477	9 11/16.....	246.1	6 1/16.....	154.0	3 1/4.....	82.6	301-CS
9 1/4.....	235.0	3 29/32.....	99.2	1 21/32.....	42.1	PT23514-MPG	9 11/16.....	246.1	6 1/16.....	154.0	3 1/4.....	82.6	301-MPG
9 1/4.....	235.0	3 15/16.....	100.0	1 5/8.....	41.3	PT487	9 11/16.....	246.1	6 1/16.....	154.0	3 1/4.....	82.6	301-W
9 1/4.....	235.0	3 15/16.....	100.0	1 5/8.....	41.3	PT708-HD	9 23/32.....	246.9	2 3/8.....	60.3	31/32.....	24.6	PT23135-MPG
9 1/4.....	235.0	3 15/16.....	100.0	1 15/16.....	49.2	PT8306-10	9 23/32.....	246.9	4 1/4.....	108.0	3 1/8.....	79.4	PT579
9 1/4.....	235.0	3 15/16.....	100.0	1 15/16.....	49.2	PT8306-25	9 23/32.....	246.9	6 1/16.....	154.0	1 15/32.....	37.3	501
9 1/4.....	235.0	3 15/16.....	100.0	2 9/32.....	57.9	PT9555	9 23/32.....	246.9	6 1/16.....	154.0	1 15/32.....	37.3	501-30
9 1/4.....	235.0	4 7/32.....	107.2	—	—	PT23306	9 23/32.....	246.9	6 1/16.....	154.0	1 15/32.....	37.3	501-W
9 1/4.....	235.0	5 1/8.....	130.2	3 3/8.....	85.7	P555	9 23/32.....	246.9	6 15/32.....	164.3	1 27/32.....	46.8	PT515
9 9/32.....	235.7	3 1/16.....	77.8	1 9/16.....	39.7	PT9313-MPG	9 3/4.....	247.7	1 3/4.....	44.4	13/16.....	20.6	PT23108-MPG
9 9/32.....	235.7	3 1/2.....	88.9	1 9/16.....	39.7	PT8452	9 3/4.....	247.7	1 3/4.....	44.4	13/16.....	20.6	PT23109-MPG
9 9/32.....	235.7	3 1/2.....	88.9	1 9/16.....	39.7	PT8470	9 3/4.....	247.7	2 1/4.....	57.2	13/16.....	30.2	PT23009
9 9/32.....	235.7	3 1/2.....	88.9	1 9/16.....	39.7	PT9463	9 3/4.....	247.7	2 5/16.....	58.7	1 1/16.....	27.0	PT23200-MPG
9 9/32.....	235.7	3 29/32.....	99.2	1 5/8.....	41.3	PT9397-MPG	9 3/4.....	247.7	2 9/16.....	65.1	1 1/16.....	27.0	PF926
9 9/32.....	235.7	3 15/16.....	100.0	1 19/32.....	40.5	PT670	9 3/4.....	247.7	3 1/16.....	77.8	1 9/16.....	39.7	PT23111-MPG
9 9/32.....	235.7	3 15/16.....	100.0	1 19/32.....	40.5	PT670-E	9 3/4.....	247.7	3 9/16.....	90.5	1 7/8.....	47.6	PF7946
9 9/32.....	235.7	3 15/16.....	100.0	1 19/32.....	40.5	PT707-HD	9 3/4.....	247.7	4 1/8.....	104.8	1 1/4.....	31.8	V1044-O
9 9/32.....	235.7	3 15/16.....	100.0	1 19/32.....	40.5	PT707-HD3	9 3/4.....	247.7	4 1/4.....	108.0	3 1/8.....	79.4	PT9513
9 9/32.....	235.7	3 15/16.....	100.0	1 19/32.....	40.5	PT707-HD10	9 3/4.....	247.7	4 1/2.....	114.3	2 1/4.....	57.2	PT139-10
9 9/32.....	235.7	3 15/16.....	100.0	1 19/32.....	40.5	PT7332	9 3/4.....	247.7	4 25/32.....	121.4	29/32.....	23.0	P7185
9 9/32.....	235.7	4.....	101.6	2 5/16.....	58.7	PT9532	9 3/4.....	247.7	5 1/16.....	128.6	2 3/4.....	69.9	PT23119-MPG
9 9/32.....	235.7	4 19/32.....	116.7	2 5/32.....	54.8	PF7899	9 25/32.....	248.4	2 11/32.....	59.5	1 1/16.....	27.0	PT23347-MPG
9 5/16.....	236.5	3 1/8.....	79.4	1 13/32.....	35.7	PT23275-MPG	9 13/16.....	249.2	2 1/4.....	57.2	1 1/8.....	28.6	PT23117-MPG
9 5/16.....	236.5	3 3/16.....	81.0	1 19/32.....	40.5	PT23125-MPG	9 13/16.....	249.2	3.....	76.2	1.....	25.4	PT727-DL
9 5/16.....	236.5	3 5/8.....	92.1	1 3/4.....	44.4	PT23150	9 13/16.....	249.2	3 9/16.....	90.5	1 3/4.....	44.4	PF7947
9 5/16.....	236.5	3 15/16.....	100.0	1 11/16.....	42.9	PT23297	9 13/16.....	249.2	4 1/4.....	108.0	3 1/16.....	77.8	PT23323
9 5/16.....	236.5	3 15/16.....	100.0	2 9/32.....	57.9	PT8403-MPG	9 13/16.....	249.2	5 1/8.....	130.2	2 29/32.....	73.8	PT8951-MPG
9 5/16.....	236.5	3 15/16.....	100.0	2 7/16.....	61.9	PT23342-MPG	9 13/16.....	249.2	5 5/16.....	134.9	3.....	76.2	PT23185
9 5/16.....	236.5	4 19/32.....	116.7	1 3/32.....	27.8	PF7914	9 13/16.....	249.2	5 27/32.....	148.4	31/32.....	24.6	P116
9 5/16.....	236.5	5.....	127.0	2 3/16.....	55.6	PT146	9 13/16.....	249.2	5 27/32.....	148.4	31/32.....	24.6	PF116
9 11/32.....	237.3	2 29/32.....	73.8	1 1/4.....	31.8	PT8985-MPG	9 27/32.....	250.0	3 29/32.....	99.2	1 5/8.....	41.3	PT23063-MPG
9 3/8.....	238.1	3 1/8.....	79.4	3/4.....	19.0	P254	9 27/32.....	250.0	4 31/32.....	126.2	3 5/8.....	92.1	PT23313
9 3/8.....	238.1	3 13/16.....	96.8	2.....	50.8	PT23181	9 27/32.....	250.0	4 31/32.....	126.2	3 5/8.....	92.1	PT23579-MPG
9 3/8.....	238.1	3 13/16.....	96.8	2.....	50.8	PT23182	9 27/32.....	250.0	5 1/8.....	130.2	3.....	76.2	PT23457
9 3/8.....	238.1	5 1/16.....	128.6	19/32.....	15.1	PT8335	9 27/32.....	250.0	5 1/8.....	130.2	3.....	76.2	PT23458
9 13/32.....	238.9	6 29/32.....	175.4	3 5/8.....	92.1	PT8411	9 27/32.....	250.0	5 1/8.....	130.2	3.....	76.2	PT23471
9 7/16.....	239.7	3 3/4.....	95.3	2 1/4.....	57.2	PT23257-MPG	9 27/32.....	250.0	5 1/8.....	130.2	3.....	76.2	PT23502-MPG
9 7/16.....	239.7	6 13/32.....	162.7	9/16.....	14.3	PT9472	9 7/8.....	250.8	5 27/32.....	148.4	1 3/8.....	34.9	PF7980
9 1/2.....	241.3	2 7/8.....	73.0	1 3/32.....	27.8	PT23518-MPG	9 7/8.....	250.8	5 31/32.....	151.6	3 5/8.....	92.1	PT9515
9 1/2.....	241.3	2 7/8.....	73.0	1 17/32.....	38.9	PT23580-MPG	9 15/16.....	252.4	4 1/4.....	108.0	1 15/16.....	49.2	PT466
9 1/2.....	241.3	3.....	76.2	1 7/16.....	36.5	PT23261-MPG	9 31/32.....	253.2	5.....	127.0	31/32.....	24.6	PF811
9 1/2.....	241.3	3 3/32.....	78.6	1 9/32.....	32.5	PT23544-MPG	10.....	254.0	2 7/8.....	73.0	1 13/32.....	35.7	PF924
9 1/2.....	241.3	4 7/16.....	112.7	1 11/16.....	42.9	PT8467	10.....	254.0	3 5/16.....	84.1	1 7/8.....	47.6	PT23386-MPG
9 17/32.....	242.1	2 7/8.....	73.0	1 15/32.....	37.3	PT9389-MPG	10.....	254.0	3 1/2.....	88.9	1 7/8.....	47.6	PT23089-MPG
9 9/16.....	242.9	2 3/8.....	60.3	1 7/16.....	36.5	PT23516-MPG	10.....	254.0	3 17/32.....	89.7	2 1/32.....	51.6	PT213
9 9/16.....	242.9	2 7/8.....	73.0	1 1/2.....	38.1	PT23556-MPG	10.....	254.0	4 1/32.....	102.4	1 25/32.....	45.2	PF319
9 9/16.....	242.9	3.....	76.2	1 9/16.....	39.7	PT23112-MPG	10.....	254.0	4 19/32.....	116.7	1 9/16.....	39.7	PF9908 KIT
9 9/16.....	242.9	3 7/8.....	98.4	1 9/32.....	32.5	PT23281-MPG	10.....	254.0	4 3/4.....	120.7	13/16.....	20.6	V1009-W
9 9/16.....	242.9	4 3/8.....	111.1	3 5/8.....	92.1	PT471	10.....	254.0	5 1/2.....	139.7	2 15/32.....	62.7	F908-A
9 19/32.....	243.7	2 11/32.....	59.5	1 13/32.....	35.7	PT23444-MPG	10.....	254.0	5 3/4.....	146.0	1 9/16.....	39.7	DF408



**WARNING:** These products can expose you to chemicals, including Diisononyl Phthalate, Carbon black extracts, Nickel, 1,3 Butadiene, Ethylene Oxide, Epichlorohydrin, which are known to the State of California to cause cancer, and Bisphenol-A, Ethylene Glycol, Ethylene Oxide, 1,3 Butadiene, Epichlorohydrin, which are known to the State of California to cause birth defects or other reproductive harm.

# LIQUID ELEMENTS BY LENGTH

LENGTH Inches	LENGTH (mm)	O.D. Inches	O.D. (mm)	I.D. Inches	I.D. (mm)	BALDWIN NUMBER	LENGTH Inches	LENGTH (mm)	O.D. Inches	O.D. (mm)	I.D. Inches	I.D. (mm)	BALDWIN NUMBER
10	254.0	7 11/16	195.3	7/8	22.2	C704-L	11 1/8	282.6	3 9/16	90.5	2 5/16	58.7	PT23165
10 1/32	254.8	2 3/8	60.3	1 11/32	34.1	PT9502-MPG	11 1/8	282.6	4 11/32	110.3	2 3/16	55.6	PT9341
10 1/32	254.8	3 3/16	81.0	1 7/8	47.6	PT23020	11 13/32	289.7	6 1/32	153.2	2	50.8	PT193
10 1/32	254.8	3 1/4	82.6	1 27/32	46.8	PT23385-MPG	11 7/16	290.5	3 3/8	85.7	1 7/8	47.6	PT8359
10 1/32	254.8	3 9/32	83.3	1 27/32	46.8	PT23383-MPG	11 7/16	290.5	3 17/32	89.7	1 29/32	48.4	PT8479
10 1/32	254.8	3 9/32	83.3	1 7/8	47.6	PT9494-MPG	11 7/16	290.5	4 31/32	126.2	3 5/8	92.1	PT722
10 1/16	255.6	3 3/16	81.0	1 7/8	47.6	PT23014	11 7/16	290.5	4 31/32	126.2	3 5/8	92.1	PT7312
10 1/16	255.6	3 3/16	81.0	1 7/8	47.6	PT23022	11 7/16	290.5	4 31/32	126.2	3 5/8	92.1	PT8414-MPG
10 3/32	256.4	4 3/8	111.1	1 7/8	47.6	PT8427	11 7/16	290.5	4 31/32	126.2	3 5/8	92.1	PT8969-MPG
10 1/8	257.2	4 1/4	108.0	3	76.2	PT23187	11 7/16	290.5	4 31/32	126.2	3 5/8	92.1	PT9254
10 3/16	258.8	4 3/16	106.4	2 27/32	72.2	PT268	11 7/16	290.5	4 31/32	126.2	3 5/8	92.1	PT23390-MPG
10 3/16	258.8	4 1/2	114.3	1 29/32	48.4	PT554	11 7/16	290.5	5 3/4	146.0	2 3/8	60.3	PT7381
10 3/16	258.8	5 1/8	130.2	2 1/2	63.5	PT23000	11 17/32	292.9	5 1/8	130.2	3 3/8	85.7	PT8506-MPG
10 3/16	258.8	5 1/8	130.2	2 17/32	64.3	PT9261-MPG	11 9/16	293.7	2 9/16	65.1	1 5/16	33.3	PT9503-MPG
10 3/16	258.8	5 1/8	130.2	2 9/16	65.1	PT23001	11 9/16	293.7	4 13/32	111.9	2 3/4	69.9	PT400
10 7/32	259.6	2 27/32	72.2	1 3/4	44.4	PT9150	11 9/16	293.7	4 13/32	111.9	2 3/4	69.9	PT8893
10 7/32	259.6	3 5/16	84.1	—	—	PT9331	11 9/16	293.7	5 1/8	130.2	3 3/8	85.7	PT539
10 1/4	260.3	3 3/32	78.6	1 21/32	42.1	PT9409-MPG	11 5/8	295.3	2 5/8	66.7	1 1/4	31.8	PT9526-MPG
10 1/4	260.3	3 29/32	99.2	1 19/32	40.5	PT23462	11 5/8	295.3	4	101.6	1 3/16	30.2	PF46010 KIT
10 1/4	260.3	3 29/32	99.2	1 19/32	40.5	PT23479	11 11/16	296.9	3 17/32	89.7	—	—	PT9446
10 1/4	260.3	3 29/32	99.2	1 19/32	40.5	PT23523-MPG	11 3/4	298.5	4 13/32	111.9	2 3/4	69.9	PT23598-MPG
10 1/4	260.3	4 1/8	104.8	2 13/16	71.4	PT23214-MPG	11 13/16	300.0	2 13/16	71.4	1 3/4	44.4	PT23163
10 1/4	260.3	4 5/32	105.6	2 3/4	69.9	PT8353	11 13/16	300.0	2 13/16	71.4	1 3/4	44.4	PT23459
10 1/4	260.3	4 3/16	106.4	2 13/16	71.4	PT23345-MPG	11 13/16	300.0	2 27/32	72.2	1 25/32	45.2	PT8400-MPG
10 1/4	260.3	4 3/16	106.4	2 27/32	72.2	PT23461	11 13/16	300.0	2 27/32	72.2	1 25/32	45.2	PT9479-MPG
10 1/4	260.3	4 7/32	107.2	1 1/4	31.8	BF46042-D	11 13/16	300.0	2 27/32	72.2	1 25/32	45.2	PT23504-MPG
10 1/4	260.3	4 7/32	107.2	1 1/4	31.8	BF46043-D	11 13/16	300.0	3 9/16	90.5	1 5/8	41.3	PT9148
10 1/4	260.3	4 1/4	108.0	1 11/16	42.9	PA0008	11 13/16	300.0	5 29/32	150.0	3 5/16	84.1	PT9375
10 1/4	260.3	5 1/8	130.2	2 15/32	62.7	PT9290-MPG	11 13/16	300.0	5 29/32	150.0	4 11/32	110.3	PT397
10 9/32	261.1	2 23/32	69.1	1 29/32	48.4	PT23366-MPG	11 13/16	300.0	5 29/32	150.0	4 11/32	110.3	PT8889
10 9/32	261.1	4 3/16	106.4	2 27/32	72.2	PT8967-MPG	11 27/32	300.8	2 27/32	72.2	2 1/32	51.6	PT9132
10 9/32	261.1	7 3/8	187.3	2 27/32	72.2	PT7003	11 27/32	300.8	2 7/8	73.0	1 25/32	45.2	PT9332
10 5/16	261.9	3 1/2	88.9	2 1/2	63.5	PT23179	11 7/8	301.6	5	127.0	2 1/2	63.5	PT469
10 5/16	261.9	4 29/32	124.6	2 1/16	52.4	PF7900	11 7/8	301.6	5 1/16	128.6	11/16	17.5	PF7715
10 3/8	263.5	5 1/16	128.6	2 1/2	63.5	PT23019	11 29/32	302.4	5 5/8	142.9	4	101.6	PT23511-MPG
10 13/32	264.3	4 25/32	121.4	2 5/32	54.8	P294	11 15/16	303.2	6 1/2	165.1	—	—	PT7126
10 7/16	265.1	4 3/4	120.7	2	50.8	P7505	11 31/32	304.0	2 3/4	69.9	1 5/8	41.3	PT23569-MPG
10 7/16	265.1	5 1/16	128.6	2 3/32	53.2	PF7799	12	304.8	4 1/8	104.8	1 1/16	27.0	V1240-C
10 15/32	265.9	3 9/32	83.3	1/2	12.7	PF9879	12 1/8	308.0	2 5/8	66.7	15/16	23.8	PT23094-MPG
10 15/32	265.9	4 3/4	120.7	2 1/16	52.4	PT7230	12 1/8	308.0	5 9/16	141.3	4	101.6	PT23170
10 15/32	265.9	4 29/32	124.6	2	50.8	PT9429-MPG	12 1/8	308.0	5 9/16	141.3	4	101.6	PT23251-MPG
10 15/32	265.9	4 29/32	124.6	2 1/16	52.4	PT9407-MPG	12 1/8	308.0	5 11/16	144.5	4 3/32	104.0	PT8376-MPG
10 21/32	270.7	4 29/32	124.6	1 11/16	42.9	PT7321	12 1/8	308.0	5 13/16	147.6	4 1/16	103.2	PT23173
10 11/16	271.5	5 13/16	147.6	3 1/2	88.9	PT23011	12 5/32	308.8	5 1/16	128.6	1 1/4	31.8	P996
10 23/32	272.3	5 29/32	150.0	4 5/16	109.5	PT23335	12 3/16	309.6	2 1/2	63.5	1 1/8	28.6	PT9499-MPG
10 13/16	274.3	4 3/32	104.1	13/16	20.3	PF46236	12 3/16	309.6	3 3/8	85.7	—	—	PT23530
10 13/16	274.3	4 3/32	104.1	13/16	20.3	PF46237	12 3/16	309.6	5 1/2	139.7	4 3/16	106.4	PT23331
10 13/16	274.6	3 11/16	93.7	1 7/8	47.6	PT23243-MPG	12 3/16	309.6	5 5/8	142.9	4	101.6	PT23156
10 7/8	276.2	3 5/8	92.1	1 13/16	46.0	PT9525-MPG	12 3/16	309.6	6 1/2	165.1	5 1/2	139.7	PT503
10 7/8	276.2	3 23/32	94.5	1 29/32	48.4	PT9359-MPG	12 1/4	311.2	3 15/16	100.0	1 21/32	42.1	PF869
10 7/8	276.2	4	101.6	2 3/8	60.3	PT23072-MPG	12 1/4	311.2	4 1/2	114.3	1 29/32	48.4	PT573
10 29/32	277.0	2 9/16	65.1	1 3/32	27.8	PT441	12 1/4	311.2	4 21/32	118.3	2 1/8	54.0	PT7192
10 15/16	277.8	5 5/32	131.0	—	—	PT23186	12 1/4	311.2	6	152.4	2 25/32	70.6	PT567
10 31/32	278.6	4 1/4	108.0	3/4	19.0	PT9129	12 5/16	312.7	3 1/16	77.8	1 23/32	43.7	PT9381-MPG
11	279.4	3 3/4	95.3	1 15/16	49.2	PT23359-MPG	12 5/16	312.7	3 9/32	83.3	1 3/4	44.4	PT9373-MPG
11	279.4	4 1/2	114.3	1 25/32	45.2	PT386	12 5/16	312.7	4 1/8	104.8	2 13/32	61.1	PT8490-MPG
11	279.4	5 1/16	128.6	3 11/32	84.9	PT83	12 3/8	314.3	4 1/2	114.3	2 23/32	69.1	PT23364-MPG
11	279.4	5 1/16	128.6	3 11/32	84.9	PT83-MPG	12 15/32	316.7	3 19/32	91.3	2 15/32	62.7	PT9335-MPG
11	279.4	5 1/8	130.2	—	—	PT9251	12 15/32	316.7	3 21/32	92.9	1 7/8	47.6	PT683
11	279.4	9 1/8	231.8	4 1/4	108.0	PT23027	12 1/2	317.5	2 7/8	73.0	1 5/16	33.3	PT9519-MPG
11 1/32	280.2	3 15/16	100.0	1 9/16	39.7	PT23585	12 9/16	319.1	3 11/16	93.7	1 3/4	44.4	PT23081-MPG
11 1/16	281.0	3 1/16	77.8	1 19/32	40.5	PT23325	12 9/16	319.1	5 1/16	128.6	2 13/16	71.4	PT23315
11 1/16	281.0	3 1/16	77.8	1 19/32	40.5	PT23590	12 19/32	319.9	3 11/16	93.7	1 29/32	48.4	PT23348-MPG
11 1/16	281.0	3 15/16	100.0	2 11/32	59.5	PT517	12 5/8	320.7	3 19/32	91.3	2 1/2	63.5	PT9506
11 1/16	281.0	5	127.0	2 13/16	71.4	PT285	12 5/8	320.7	3 11/16	93.7	1 7/8	47.6	PT23273-MPG
11 1/16	281.0	5 1/8	130.2	3 11/32	84.9	PT8461	12 5/8	320.7	3 3/4	95.3	1 7/8	47.6	PT23221-MPG
11 3/32	281.7	3 15/16	100.0	1 23/32	43.7	PF46106	12 5/8	320.7	4 13/32	111.9	1 9/16	39.7	PA0062
11 1/8	282.6	3 9/16	90.5	1 3/4	44.4	P7502	12 21/32	321.5	4 3/8	111.1	1 9/16	39.7	PT7495



**WARNING:** These products can expose you to chemicals, including Diisobutyl Phthalate, Carbon black extracts, Nickel, 1,3 Butadiene, Ethylene Oxide, Epichlorohydrin, which are known to the State of California to cause cancer, and Bisphenol-A, Ethylene Glycol, Ethylene Oxide, 1,3 Butadiene, Epichlorohydrin, which are known to the State of California to cause birth defects or other reproductive harm.

**LIQUID ELEMENTS BY LENGTH**

LENGTH Inches	LENGTH (mm)	O.D. Inches	O.D. (mm)	I.D. Inches	I.D. (mm)	BALDWIN NUMBER	LENGTH Inches	LENGTH (mm)	O.D. Inches	O.D. (mm)	I.D. Inches	I.D. (mm)	BALDWIN NUMBER
12 11/16	322.3	3 3/16	81.0	2	50.8	PT23441-MPG	13 1/2	342.9	6	152.4	3 11/32	84.9	PT23497-MPG
12 11/16	322.3	4 1/32	102.4	1/4	6.4	PT23159	13 19/32	345.3	7 5/16	185.7	3 13/32	86.5	PT7012
12 3/4	323.8	3 11/16	93.7	1 15/16	49.2	PT23247-MPG	13 5/8	346.1	3 15/16	100.0	3 1/8	79.4	PT8993-MPG
12 3/4	323.8	4 7/16	112.7	1 3/4	44.4	PT571	13 21/32	346.9	7 13/32	188.1	3 13/32	86.5	PT7514
12 27/32	326.2	3 13/16	96.8	1 11/16	42.9	H9036	13 3/4	349.3	2 13/16	71.4	1 13/16	46.0	PT23042-MPG
12 27/32	326.2	3 13/16	96.8	1 11/16	42.9	H9037	13 13/16	350.8	4 31/32	126.2	3 5/8	92.1	PT23158
12 7/8	327.0	3 3/32	78.6	1 11/16	42.9	PT317-MPG	13 7/8	352.4	3 1/2	88.9	1 27/32	46.8	PT8453
12 7/8	327.0	3 3/32	78.6	1 11/16	42.9	PT318-MPG							
12 7/8	327.0	3 7/16	87.3	2	50.8	PT23238-MPG	14	355.6	2 3/8	60.3	1 1/32	26.2	PT23265-MPG
12 7/8	327.0	3 9/16	90.5	1 13/16	46.0	PT23244-MPG	14	355.6	2 3/4	69.9	1 5/16	33.3	PT23356-MPG
12 7/8	327.0	3 3/4	95.3	2 1/8	54.0	PT23224-MPG	14	355.6	2 3/4	69.9	1 3/8	34.9	PT23220-MPG
12 7/8	327.0	3 3/4	95.3	2 1/8	54.0	PT23228-MPG	14	355.6	2 3/4	69.9	1 3/8	34.9	PT23272-MPG
12 7/8	327.0	3 3/4	95.3	2 1/8	54.0	PT23231-MPG	14	355.6	2 3/4	69.9	1 3/8	34.9	PT23287-MPG
12 7/8	327.0	3 3/4	95.3	2 1/8	54.0	PT23241-MPG	14 3/32	358.0	5 15/16	150.8	3 5/32	80.2	PT8994-MPG
12 7/8	327.0	3 3/4	95.3	2 1/4	57.2	PT23223-MPG	14 1/8	358.8	3 17/32	89.7	1 27/32	46.8	PT9172
12 7/8	327.0	3 3/4	95.3	2 5/16	58.7	PT23291-MPG	14 3/16	360.4	3 1/2	88.9	1 7/8	47.6	PT9376
12 7/8	327.0	3 13/16	96.8	1 11/16	42.9	PT23506-MPG	14 3/16	360.4	6 7/8	174.6	3 5/8	92.1	PT8410
12 7/8	327.0	4 9/16	115.9	2 7/32	56.4	PT8402-MPG	14 7/32	361.2	5 31/32	151.6	3 15/16	100.0	PT23591-MPG
12 29/32	327.8	3 5/32	80.2	1 11/16	42.9	H9093	14 9/32	362.7	5 21/32	143.7	3 3/4	95.3	PT9500-MPG
12 29/32	327.8	3 13/32	86.5	1 31/32	50.0	PT23440-MPG	14 7/16	366.7	4 9/32	108.7	2 3/32	53.2	P1578
12 29/32	327.8	3 15/32	88.1	1 19/32	40.5	PT23264-MPG	14 1/2	368.3	4 1/4	108.0	2 7/16	61.9	PT23167
12 29/32	327.8	3 1/2	88.9	1 31/32	50.0	PT9199	14 1/2	368.3	4 19/32	116.7	2 5/16	58.7	PT9171
12 29/32	327.8	3 9/16	90.5	1 29/32	48.4	PT23368-MPG	14 1/2	368.3	6	152.4	1 1/8	28.6	PT117
12 29/32	327.8	3 25/32	96.0	2 7/32	56.4	PT23401-MPG	14 1/2	368.3	6	152.4	1 1/8	28.6	PT117-25
12 15/16	328.6	3 5/32	80.2	1 9/16	39.7	PT9559-MPG	14 1/2	368.3	6	152.4	3 1/2	88.9	PT119
12 15/16	328.6	3 5/32	80.2	1 23/32	43.7	H9078-V	14 1/2	368.3	6	152.4	3 1/2	88.9	PT119-5
12 15/16	328.6	3 1/2	88.9	1 9/16	39.7	PT23010	14 1/2	368.3	6	152.4	3 1/2	88.9	PT119-HD
12 15/16	328.6	3 9/16	90.5	1 9/16	39.7	PT23276-MPG	14 1/2	368.3	6	152.4	3 1/2	88.9	PT119-HD5
12 15/16	328.6	3 9/16	90.5	1 23/32	43.7	PT9303-MPG	14 1/2	368.3	6 1/32	153.2	1	25.4	PF949
12 15/16	328.6	3 25/32	96.0	2 1/8	54.0	PT9432-MPG	14 9/16	369.9	3 1/4	82.6	1 7/8	47.6	PT23049-MPG
12 31/32	329.4	1 31/32	50.0	31/32	24.6	PT23410-MPG	14 5/8	371.5	3 1/4	82.6	1 7/8	47.6	PT23023
12 31/32	329.4	3 1/16	77.8	1 23/32	43.7	PT23438-MPG	14 21/32	372.3	5 13/32	137.3	3 15/16	100.0	PT23427-MPG
12 31/32	329.4	3 1/16	77.8	1 23/32	43.7	PT23507-MPG	14 11/16	373.1	3 1/4	82.6	1 13/16	46.0	PT23254-MPG
12 31/32	329.4	3 1/8	79.4	1 11/16	42.9	H9077	14 11/16	373.1	3 9/32	83.3	1 27/32	46.8	PT23381-MPG
12 31/32	329.4	3 1/8	79.4	1 11/16	42.9	H9078	14 11/16	373.1	3 9/32	83.3	1 7/8	47.6	PT9495-MPG
12 31/32	329.4	3 1/8	79.4	1 11/16	42.9	H9079	14 11/16	373.1	3 5/16	84.1	2	50.8	PT23155
12 31/32	329.4	3 1/8	79.4	1 11/16	42.9	H9080	14 3/4	374.7	2 7/8	73.0	1 9/16	39.7	PT23054-MPG
12 31/32	329.4	3 1/8	79.4	1 11/16	42.9	H9081	14 3/4	374.7	3	76.2	1 9/16	39.7	PT23057-MPG
12 31/32	329.4	3 1/8	79.4	1 11/16	42.9	H9082	14 3/4	374.7	3 1/16	77.8	1 19/32	40.5	PT23353-MPG
12 31/32	329.4	3 1/8	79.4	1 11/16	42.9	H9082	14 3/4	374.7	3 1/16	77.8	1 19/32	40.5	PT23354-MPG
12 31/32	329.4	3 25/32	96.0	2 7/32	56.4	PT9489-MPG	14 3/4	374.7	3 3/8	85.7	1 7/8	47.6	PT23168
13	330.2	2 1/32	51.6	29/32	23.0	PT23432-MPG	14 13/16	376.2	3 1/16	77.8	1 9/16	39.7	PT23050-MPG
13	330.2	2 13/16	71.4	1 15/16	49.2	PT23278-MPG	14 7/8	377.8	3 13/16	96.8	2 1/2	63.5	PT23406-MPG
13	330.2	3	76.2	1 1/2	38.1	PT23393-MPG	14 7/8	377.8	4	101.6	1 9/16	39.7	PT751
13	330.2	3	76.2	1 1/2	38.1	PT23416-MPG	14 7/8	377.8	4 15/32	113.5	2 27/32	72.2	PT9162
13	330.2	3 1/16	77.8	1 11/16	42.9	PT23429-MPG	14 15/16	379.4	7 1/2	190.5	23/32	18.3	PT706-M
13	330.2	3 3/8	85.7	1 7/8	47.6	PT23052-MPG							
13	330.2	3 13/16	96.8	2 1/4	57.2	PT23277-MPG	15	381.0	3 1/16	77.8	1 19/32	40.5	PT23341-MPG
13	330.2	4 3/8	111.1	2 9/16	65.1	PT23259-MPG	15	381.0	3 1/8	79.4	1 1/2	38.1	PT23053-MPG
13	330.2	4 21/32	118.3	2 3/8	60.3	PT9159	15	381.0	3 3/4	95.3	1 1/16	27.0	V1544-T
13	330.2	6	152.4	3 17/32	89.7	P537	15	381.0	4 5/32	105.6	2 1/16	52.4	PT23565-MPG
13	330.2	7 15/16	201.6	5 7/8	149.2	PT8938-MPG	15	381.0	4 1/2	114.3	2 1/4	57.2	PT550-10
13	330.2	7 31/32	202.4	6 3/16	157.2	PT23453	15	381.0	6 5/16	160.3	7/8	22.2	PT7195
13 1/32	331.0	4 3/8	111.1	2 13/32	61.1	PT766	15 3/32	383.4	6 1/2	165.1	5 1/2	139.7	PT418
13 1/32	331.0	4 3/8	111.1	2 13/32	61.1	PT772	15 3/32	383.4	7 11/16	195.3	7/8	22.2	F7500
13 1/32	331.0	4 3/8	111.1	2 7/16	61.9	PT23137	15 3/32	383.4	7 11/16	195.3	7/8	22.2	PT7500
13 1/16	331.8	3 15/16	100.0	2 3/8	60.3	PT23154	15 3/32	383.4	7 23/32	196.1	29/32	23.0	C750-E
13 1/16	331.8	4 1/32	102.4	2 7/16	61.9	PT23582-MPG	15 3/32	383.4	7 23/32	196.1	29/32	23.0	C750-L
13 3/32	332.6	3 17/32	89.7	1 17/32	38.9	PT9161	15 3/32	383.4	7 23/32	196.1	29/32	23.0	C750-L SINGLE
13 1/8	333.4	4 3/8	111.1	1 7/8	47.6	PT8441	15 5/32	385.0	2 7/8	73.0	1 11/32	34.1	PT8897-MPG
13 1/8	333.4	4 1/2	114.3	2 11/16	68.3	PT8981-MPG	15 1/4	387.3	4 31/32	126.2	3 5/8	92.1	PT9190
13 1/8	333.4	4 1/2	114.3	2 11/16	68.3	PT23106-MPG	15 1/4	387.4	6 1/2	165.1	3 15/32	88.1	PT8361
13 1/8	333.4	7	177.8	4 3/8	111.1	PT9528	15 9/32	388.1	3 27/32	97.6	2 9/16	65.1	PT23521-MPG
13 3/16	335.0	3 25/32	96.0	2 3/16	55.6	H9058	15 5/16	388.9	6 25/32	172.2	4 7/32	107.2	PT370
13 3/16	335.0	3 25/32	96.0	2 3/16	55.6	H9060	15 11/32	389.7	4 31/32	126.2	3 5/8	92.1	PT8433-MPG
13 3/16	335.0	4	101.6	2 7/16	61.9	PT9212	15 11/32	389.7	4 31/32	126.2	3 5/8	92.1	PT8970-MPG
13 7/32	335.8	8 13/16	223.8	4 1/16	103.2	P1568	15 3/8	390.5	3 1/4	82.6	1 3/8	34.9	PT9530
13 1/4	336.5	4 1/2	114.3	2 5/16	58.7	PT23169	15 3/8	390.5	3 9/16	90.5	4 1/4	108.0	PT23004
13 1/2	342.9	3 1/4	82.6	1 5/8	41.3	PT9529	15 1/2	393.7	3 3/4	95.3	-	-	V1542-C



**WARNING:** These products can expose you to chemicals, including Diisononyl Phthalate, Carbon black extracts, Nickel, 1,3 Butadiene, Ethylene Oxide, Epichlorohydrin, which are known to the State of California to cause cancer, and Bisphenol-A, Ethylene Glycol, Ethylene Oxide, 1,3 Butadiene, Epichlorohydrin, which are known to the State of California to cause birth defects or other reproductive harm.



# LIQUID ELEMENTS BY LENGTH

LENGTH Inches	LENGTH (mm)	O.D. Inches	O.D. (mm)	I.D. Inches	I.D. (mm)	BALDWIN NUMBER	LENGTH Inches	LENGTH (mm)	O.D. Inches	O.D. (mm)	I.D. Inches	I.D. (mm)	BALDWIN NUMBER
15 1/2	393.7	4 1/2	114.3	2 23/32	69.1	PT23362-MPG	16 7/8	428.6	3 1/8	79.4	1 11/16	42.9	H9086
15 1/2	393.7	6 3/16	157.2	2 7/32	56.4	V414-B	16 7/8	428.6	3 1/8	79.4	1 11/16	42.9	H9087
15 1/2	393.7	6 3/16	157.2	2 7/32	56.4	V414-FF	16 7/8	428.6	3 3/8	85.7	1 15/16	49.2	PT23030-MPG
15 11/16	398.5	3 1/16	77.8	1 1/2	38.1	PT23113-MPG	16 7/8	428.6	3 25/32	96.0	2 3/16	55.6	PT9453-MPG
15 11/16	398.5	3 1/8	79.4	1 1/2	38.1	PT23114-MPG	16 7/8	428.6	3 25/32	96.0	2 7/32	56.4	PT8447-MPG
15 11/16	398.5	3 1/8	79.4	1 5/8	41.3	PT23068-MPG	16 7/8	428.6	6	152.4	3 1/4	82.6	H9020
15 11/16	398.5	3 17/32	89.7	1 19/32	40.5	PT23583-MPG	16 7/8	428.6	6	152.4	3 1/4	82.6	H9021
15 11/16	398.5	6	152.4	3 1/2	88.9	PT23116-MPG	16 7/8	428.6	6	152.4	4 1/32	102.4	PT23249-MPG
15 23/32	399.3	4 1/2	114.3	2 23/32	69.1	PT23033-MPG	16 29/32	429.4	3 25/32	96.0	2 7/32	56.4	PT23409-MPG
15 3/4	400.0	1 27/32	46.8	1	25.4	PT23578-MPG	16 31/32	431.0	6 1/8	155.6	4 13/16	122.2	PT9557
15 3/4	400.0	4 1/8	104.8	2 13/16	71.4	PT23101-MPG	17	431.8	3 1/32	77.0	2 1/32	51.6	PT23262-MPG
15 3/4	400.0	5 1/8	130.2	2 11/16	68.3	PT23120-MPG	17	431.8	3 1/16	77.8	1 13/16	46.0	PT23423-MPG
15 3/4	400.0	5 15/16	150.8	3 19/32	91.3	PT9399-MPG	17	431.8	6 1/2	165.1	2 3/4	69.9	V1874-T
15 27/32	402.4	3 23/32	94.5	1 29/32	48.4	PT23577-MPG	17 1/32	432.6	5 29/32	150.0	4 1/16	103.2	PT23546-MPG
15 29/32	404.0	5 1/8	130.2	2 17/32	64.3	PT23467	17 1/32	432.6	7	177.8	4 5/16	109.5	PT23545-MPG
15 29/32	404.0	5 1/8	130.2	2 9/16	65.1	PT23505-MPG	17 3/32	434.2	3 23/32	94.5	1 29/32	48.4	PT23352-MPG
16	406.4	4 1/4	108.0	1 1/16	27.0	F1645-DS	17 3/32	434.2	6 5/8	168.3	3 13/32	86.5	PT1561
16	406.4	4 1/4	108.0	1 1/16	27.0	V1645-C	17 1/8	435.0	3 7/8	98.4	1 1/2	38.1	PT23098-MPG
16	406.4	4 3/8	111.1	2 7/16	61.9	PT694	17 5/32	435.8	6	152.4	2 5/32	54.8	PT729
16	406.4	4 3/8	111.1	2 7/16	61.9	PT8371-MPG	17 1/4	438.2	6 1/16	154.0	3 3/4	95.3	PT9452
16	406.4	4 1/2	114.3	1 1/16	27.0	V1656-O	17 5/16	439.7	7 15/16	201.6	6 3/16	157.2	PT9202
16	406.4	4 1/2	114.3	1 1/16	27.0	V1656-T	17 5/16	439.7	7 31/32	202.4	6 3/16	157.2	PT23483-MPG
16	406.4	5 5/16	134.9	2 1/2	63.5	PT23152	17 1/2	444.5	3 11/16	93.7	1 13/16	46.0	PT23252-MPG
16	406.4	6	152.4	2 5/8	66.7	PT718-5	17 17/32	445.3	4 3/16	106.4	2 1/16	52.4	PT23566-MPG
16	406.4	7 21/32	194.5	4 21/32	118.3	PT7337	17 11/16	449.3	4 13/32	111.9	2 3/4	69.9	PT8387
16 1/32	407.2	4 3/8	111.1	2 7/16	61.9	PT8442	17 23/32	450.1	5 29/32	150.0	4 11/32	110.3	PT483
16 1/32	407.2	4 3/8	111.1	2 7/16	61.9	PT9340-MPG	17 23/32	450.1	5 29/32	150.0	4 11/32	110.3	PT8366
16 1/16	408.0	4 3/8	111.1	2 13/32	61.1	PT752	17 23/32	450.1	5 29/32	150.0	4 11/32	110.3	PT8896
16 1/16	408.0	4 3/8	111.1	2 13/32	61.1	PT8494	17 23/32	450.1	5 29/32	150.0	4 11/32	110.3	PT9338-MPG
16 1/16	408.0	4 3/8	111.1	2 13/32	61.1	PT9385-MPG	17 3/4	450.9	5 29/32	150.0	4 11/32	110.3	PT9357
16 1/16	408.0	4 3/8	111.1	2 7/16	61.9	PT763	17 3/4	450.9	6	152.4	2 5/8	66.7	P415-5AN
16 1/16	408.0	4 3/8	111.1	2 7/16	61.9	PT767	17 3/4	450.9	7	177.8	4 5/16	109.5	PT8478
16 1/16	408.0	4 3/8	111.1	2 7/16	61.9	PT773-MPG	17 3/4	450.9	7	177.8	4 5/16	109.5	PT8492
16 1/16	408.0	4 13/32	111.9	2 7/16	61.9	PT768	17 3/4	450.9	7	177.8	4 5/16	109.5	PT9379
16 1/8	409.6	3 5/16	84.1	1 1/2	38.1	PT9523-MPG	17 13/16	452.4	6	152.4	2 5/8	66.7	PT23133-MPG
16 5/32	410.4	5 1/8	130.2	2 17/32	64.3	PT9250	17 13/16	452.4	6 1/16	154.0	2 5/8	66.7	PT23451
16 3/16	411.2	4 1/2	114.3	2 3/4	69.9	PT9403-MPG	17 27/32	453.2	6 3/32	154.8	2 5/8	66.7	PT23485-MPG
16 7/32	412.0	4 1/2	114.3	2 1/2	63.5	PT9383-MPG	17 27/32	453.2	6 3/32	154.8	2 5/8	66.7	PT23508-MPG
16 7/32	412.0	4 5/8	117.5	2 19/32	65.9	PT23581-MPG	17 7/8	454.0	5 29/32	150.0	4 11/32	110.3	PT8380
16 7/32	412.0	5 1/8	130.2	2 15/32	62.7	PT8950-MPG	17 29/32	454.8	5 29/32	150.0	4 11/32	110.3	PT8383
16 1/4	412.8	3 1/2	88.9	1 1/2	38.1	PT23174	17 29/32	454.8	5 29/32	150.0	4 11/32	110.3	PT8909
16 5/16	414.3	5 27/32	148.3	1 5/32	29.7	PF46079	17 15/16	455.6	3 21/32	92.9	1 23/32	43.7	PF1589
16 11/32	415.1	3 27/32	97.6	2 17/32	64.3	PT23235-MPG	17 15/16	455.6	3 15/16	100.0	2 9/32	57.9	PT8305
16 11/32	415.1	3 27/32	97.6	2 17/32	64.3	PT23236-MPG	17 15/16	455.6	5 15/16	150.8	3 5/16	84.1	PT23600
16 15/32	418.3	3	76.2	1 11/32	34.1	PT23271-MPG	18	457.2	4 13/32	111.9	2 19/32	65.9	PT8408
16 15/32	418.3	3 1/8	79.4	1 11/32	34.1	PT23279-MPG	18	457.2	4 15/16	125.4	1 17/32	38.9	PT490
16 17/32	419.9	3 1/8	79.4	1 15/16	49.2	PT8495-MPG	18	457.2	5	127.0	3 1/2	88.9	PT23151
16 17/32	419.9	5 31/32	151.6	3 1/2	88.9	PT9480-MPG	18	457.2	5 3/8	136.5	3	76.2	PT23245-MPG
16 9/16	420.7	3 3/32	78.6	2 1/32	51.6	PT23417-MPG	18	457.2	6	152.4	2 1/8	54.0	P415-5
16 9/16	420.7	3 1/8	79.4	2	50.8	PT23226-MPG	18	457.2	6	152.4	2 1/8	54.0	P415-10
16 11/16	423.9	5 19/32	142.1	3 7/8	98.4	PT9556-MPG	18	457.2	6	152.4	2 1/8	54.0	P415-25
16 23/32	424.7	5 19/32	142.1	3 27/32	97.6	PT8436	18	457.2	6	152.4	2 5/8	66.7	P415-5A
16 13/16	427.0	3 3/32	78.6	1 5/8	41.3	PT23522-MPG	18	457.2	6	152.4	2 5/8	66.7	P415-10A
16 13/16	427.0	3 3/8	85.7	1 15/16	49.2	PT23237-MPG	18	457.2	6	152.4	2 5/8	66.7	P415-25A
16 13/16	427.0	3 3/8	85.7	1 15/16	49.2	PT23242-MPG	18	457.2	6	152.4	2 23/32	69.1	PT491
16 13/16	427.0	3 13/32	86.5	1 31/32	50.0	PT23402-MPG	18	457.2	6	152.4	2 23/32	69.1	PT491-10
16 13/16	427.0	3 13/32	86.5	1 31/32	50.0	PT23415-MPG	18	457.2	6	152.4	3 1/2	88.9	PT122-5
16 13/16	427.0	3 25/32	96.0	2 3/16	55.6	PT319-MPG	18	457.2	6	152.4	6 3/16	157.2	F415-B
16 13/16	427.0	3 25/32	96.0	2 3/16	55.6	PT320-MPG	18	457.2	6 3/16	157.2	2 13/32	61.1	V415-B
16 13/16	427.0	3 25/32	96.0	2 7/32	56.4	PT23394-MPG	18	457.2	6 3/16	157.2	2 13/32	61.1	V415-FF
16 13/16	427.0	5 29/32	150.0	4 5/32	105.6	PT23349-MPG	18	457.2	6 17/32	165.9	2 17/32	64.3	P415-GM
16 13/16	427.0	5 31/32	151.6	3 1/4	82.6	PT23355-MPG	18 1/32	458.0	4 13/32	111.9	2 9/16	65.1	PT8388
16 27/32	427.8	3 13/32	86.5	1 15/16	49.2	H9123	18 1/32	458.0	4 13/32	111.9	2 9/16	65.1	PT8389
16 27/32	427.8	5 31/32	151.6	4 1/8	104.8	H9007	18 1/32	458.0	6	152.4	3 17/32	89.7	PT8491
16 7/8	428.6	3 3/32	78.6	1 1/2	38.1	PT8519-MPG	18 1/16	458.8	6	152.4	2 5/8	66.7	PT212-5
16 7/8	428.6	3 1/8	79.4	1 11/16	42.9	H9083	18 1/16	458.8	7 7/16	188.9	4 13/16	122.2	PT8395
16 7/8	428.6	3 1/8	79.4	1 11/16	42.9	H9084	18 1/8	460.4	4 1/2	114.3	1 25/32	45.2	PT430-FF
16 7/8	428.6	3 1/8	79.4	1 11/16	42.9	H9085							



**WARNING:** These products can expose you to chemicals, including Diisononyl Phthalate, Carbon black extracts, Nickel, 1,3 Butadiene, Ethylene Oxide, Epichlorohydrin, which are known to the State of California to cause cancer, and Bisphenol-A, Ethylene Glycol, Ethylene Oxide, 1,3 Butadiene, Epichlorohydrin, which are known to the State of California to cause birth defects or other reproductive harm.

# LIQUID ELEMENTS BY LENGTH

LENGTH Inches	LENGTH (mm)	O.D. Inches	O.D. (mm)	I.D. Inches	I.D. (mm)	BALDWIN NUMBER	LENGTH Inches	LENGTH (mm)	O.D. Inches	O.D. (mm)	I.D. Inches	I.D. (mm)	BALDWIN NUMBER
18 5/32	461.2	6 1/8	155.6	3 15/16	100.0	PT9348-MPG	22 1/32	559.6	7 7/16	188.9	4 27/32	123.0	PT23486-MPG
18 5/32	461.2	7 7/16	188.9	4 13/16	122.2	PT8396	22 13/16	579.4	4 15/16	125.4	3 1/4	82.6	PT9520-MPG
18 5/32	461.2	8 25/32	223.0	4 3/32	104.0	PF1584	22 27/32	580.2	4 31/32	126.2	3 5/8	92.1	PT23517-MPG
18 7/32	462.8	8 13/16	223.8	4 1/16	103.2	P1562							
18 1/4	463.6	4 1/8	104.8	2 3/4	69.9	PT23232-MPG	23 5/8	600.1	4 21/32	118.3	2 11/32	59.5	PT9283-MPG
18 9/32	464.3	3 15/16	100.0	2 17/32	64.3	PT9288-MPG							
18 9/32	464.3	4 5/32	105.6	2 27/32	72.2	PT9189	24 3/32	612.0	3 23/32	94.5	1 29/32	48.4	PT23450-MPG
18 5/16	465.1	4 5/32	105.6	2 27/32	72.2	PT8455-MPG	24 1/2	622.3	5 31/32	151.6	3 1/2	88.9	PT9247
18 5/16	465.1	4 3/16	106.4	2 13/16	71.4	PT23392-MPG	24 13/16	630.2	6 1/8	155.6	3 29/32	99.2	PT9451-MPG
18 5/16	465.1	4 3/16	106.4	2 13/16	71.4	PT23487-MPG							
18 5/16	465.1	4 31/32	126.2	3 5/16	84.1	PT23520-MPG	25 1/2	647.7	6	152.4	3 15/16	100.0	PT9350-MPG
18 5/16	465.1	5	127.0	3 1/4	82.6	PT551-10	25 5/8	650.9	6	152.4	3 1/4	82.6	H9024
18 5/16	465.1	5	127.0	3 1/4	82.6	PT9554-MPG	25 21/32	651.7	3 3/8	85.7	2	50.8	PT9496-MPG
18 7/16	468.3	3 11/16	93.7	1 15/16	49.2	PT23446-MPG	25 21/32	651.7	3 3/8	85.7	2	50.8	PT9497-MPG
18 7/16	468.3	5 7/32	132.6	3 3/8	85.7	PT9361	25 21/32	651.7	3 13/16	96.8	1 11/16	42.9	H9039
18 1/2	469.9	3 21/32	92.9	1 3/4	44.4	PT8394-MPG	25 11/16	652.5	3 7/16	87.3	1 7/8	47.6	PT23250-MPG
18 1/2	469.9	3 21/32	92.9	1 3/4	44.4	PT23324	25 11/16	652.5	3 13/16	96.8	2 3/8	60.3	PT23435-MPG
18 1/2	469.9	3 7/8	98.4	1 5/8	41.3	PT23211-MPG	25 13/16	655.6	3 13/16	96.8	2 3/16	55.6	PT23422-MPG
18 1/2	469.9	3 7/8	98.4	2 1/4	57.2	PT8446-MPG	25 27/32	656.4	3 25/32	96.0	2 7/32	56.4	PT23420-MPG
18 1/2	469.9	3 7/8	98.4	2 1/4	57.2	PT23616-MPG	25 7/8	657.2	3 3/4	95.3	2 5/16	58.7	PT23413-MPG
18 1/2	469.9	3 29/32	99.2	1 5/8	41.3	PT9487-MPG	25 15/16	658.8	3 25/32	96.0	2 3/16	55.6	H9062
18 1/2	469.9	3 29/32	99.2	1 5/8	41.3	PT9488-MPG							
18 1/2	469.9	3 29/32	99.2	1 21/32	42.1	PT23515-MPG	26	660.4	7 7/8	200.0	6 5/8	168.3	PT23051-MPG
18 1/2	469.9	3 29/32	99.2	1 21/32	42.1	PT23519-MPG							
18 1/2	469.9	3 29/32	99.2	1 27/32	46.8	PT8517-MPG	27 11/16	703.3	4	101.6	1 3/4	44.4	PT23282-MPG
18 1/2	469.9	3 29/32	99.2	2 1/4	57.2	PT23595-MPG	27 11/16	703.3	4	101.6	1 15/16	49.2	PT23227-MPG
18 1/2	469.9	3 15/16	100.0	1 19/32	40.5	PT757	27 31/32	710.4	3 29/32	99.2	1 21/32	42.1	PT23452
18 1/2	469.9	3 15/16	100.0	1 19/32	40.5	PT757-10							
18 9/16	471.5	3 1/2	88.9	1 9/16	39.7	PT8489	28	711.2	3 15/16	100.0	1 11/16	42.9	PT23449-MPG
18 9/16	471.5	3 1/2	88.9	1 9/16	39.7	PT8511							
18 5/8	473.1	4 31/32	126.2	1 3/16	30.2	PT493	29 1/4	742.9	6 3/16	157.2	2 1/2	63.5	V429-B
18 5/8	473.1	5 1/8	130.2	3 3/8	85.7	PT714	29 1/4	742.9	6 3/16	157.2	2 1/2	63.5	V429-FF
18 5/8	473.1	6 1/2	165.1	2 31/32	75.4	PT527	29 3/8	746.1	6 1/2	165.1	1 15/32	37.3	P1510
18 13/16	477.8	4 15/16	125.4	3 5/8	92.1	PT9191							
18 7/8	479.4	3 5/8	92.1	2 1/8	54.0	PT23070-MPG	30 3/32	764.4	6 13/32	162.7	1 15/32	37.3	P7183
18 7/8	479.4	5	127.0	3 9/16	90.5	PT23234-MPG	30 1/2	774.7	6 3/16	157.2	1 23/32	43.7	V1520-R
18 7/8	479.4	5 5/8	142.9	3 3/4	95.3	PT23253-MPG							
18 29/32	480.2	4	101.6	1 9/16	39.7	PT7617	31	787.4	4 3/8	111.1	1 5/8	41.3	C133-OW
18 29/32	480.2	4 31/32	126.2	3 5/8	92.1	PT8971-MPG	31	787.4	4 3/8	111.1	1 5/8	41.3	C133-W
18 29/32	480.2	4 31/32	126.2	3 5/8	92.1	PT9306-MPG	31 1/4	793.8	4 3/8	111.1	1 5/32	29.4	V7129-C
18 29/32	480.2	4 31/32	126.2	3 5/8	92.1	PT9445-MPG							
18 15/16	481.0	3 11/16	93.7	1 9/16	39.7	PT8891-MPG	32	812.8	6 1/2	165.1	3 3/4	95.3	V1560
							32 15/32	824.7	8 9/32	210.3	6 5/32	156.4	PT23157
							32 1/2	825.5	8	203.2	6 1/4	158.8	PT23256-MPG
							32 11/16	830.3	5 31/32	151.6	3 7/16	87.3	PT9328-MPG
19	482.6	3 31/32	100.8	2 13/32	61.1	PT23588	33 7/8	860.4	6 13/32	162.7	1 15/32	37.3	P1511
19	482.6	4	101.6	2 1/2	63.5	PT23318							
19 1/32	483.4	5 21/32	143.7	3 25/32	96.0	PT23360-MPG	36 1/2	927.1	5 13/32	137.3	3 15/16	100.0	PT23424-MPG
19 7/16	493.7	4 5/32	105.6	2 27/32	72.2	PT8941-MPG	36 1/2	927.1	5 13/32	137.3	3 15/16	100.0	PT23425-MPG
19 7/16	493.7	5 5/16	134.9	3 3/4	95.3	PT23062-MPG	36 1/2	927.1	5 13/32	137.3	3 15/16	100.0	PT23428-MPG
19 1/2	495.3	2 7/8	73.0	1 1/16	27.0	PF952	36 1/2	927.1	6	152.4	3 15/16	100.0	PT23411-MPG
19 1/2	495.3	3	76.2	1 11/16	42.9	TC413-CPE5	36 1/2	927.1	6	152.4	3 15/16	100.0	PT23426-MPG
19 7/8	504.8	4 7/8	123.8	2 3/4	69.9	PT23139-MPG	36 1/2	927.1	6	152.4	3 15/16	100.0	PT23431-MPG
							36 1/2	927.1	6	152.4	3 15/16	100.0	PT23439-MPG
20	508.0	4 1/2	114.3	1 23/32	43.7	PT512	36 1/2	927.1	6	152.4	3 15/16	100.0	PT23065-MPG
20 9/32	515.1	5 7/8	149.2	4 1/2	114.3	PT23239-MPG	36 11/16	931.9	5 1/2	139.7	3 3/4	95.3	PT23065-MPG
20 5/16	515.9	6	152.4	3 15/16	100.0	PT23589	36 11/16	931.9	5 1/2	139.7	3 13/16	96.8	PT23104-MPG
20 1/2	520.7	4 5/32	105.6	2 27/32	72.2	PT9244	36 3/4	933.5	2 3/8	60.3	-	-	F501-MD
20 1/2	520.7	6 1/8	155.6	3 15/16	100.0	PT9355-MPG							
20 11/16	525.5	4 13/32	111.9	2 1/8	54.0	PT9443	37 3/8	949.3	6 1/8	155.6	3 29/32	99.2	PT9459-MPG
20 15/16	531.8	5 1/16	128.6	11/16	17.5	PF7716							
21	533.4	6 5/32	156.0	-	-	PT23613-MPG	38 1/2	977.9	6	152.4	4 1/2	114.3	PT23248-MPG
21 15/32	545.3	7 31/32	202.4	6 3/16	157.2	PT8990-MPG	38 5/8	981.1	6	152.4	4 1/32	102.4	PT23255-MPG
21 1/2	546.1	8	203.2	6 3/16	157.2	PT753	38 11/16	982.7	5 31/32	151.6	4 1/8	104.8	H9013
21 1/2	546.1	9	228.6	7 3/32	180.2	PT8943-MPG	38 11/16	982.7	5 31/32	151.6	4 5/32	105.6	H9014
21 9/16	547.7	8 15/16	227.0	7 1/16	179.4	PT9524-MPG	38 13/16	985.8	3 25/32	96.0	2 7/32	56.4	PT23421-MPG
21 23/32	551.7	3 11/16	93.7	1 7/8	47.6	PT23531-MPG	38 13/16	985.8	3 25/32	96.0	2 7/32	56.4	PT23434-MPG
22	558.8	7 7/16	188.9	4 3/4	120.7	PT518	42 29/32	1089.8	7 31/32	202.4	6 3/16	157.2	PT23343-MPG
22	558.8	7 7/16	188.9	4 3/4	120.7	PT518-10							



**WARNING:** These products can expose you to chemicals, including Diisononyl Phthalate, Carbon black extracts, Nickel, 1,3 Butadiene, Ethylene Oxide, Epichlorohydrin, which are known to the State of California to cause cancer, and Bisphenol-A, Ethylene Glycol, Ethylene Oxide, 1,3 Butadiene, Epichlorohydrin, which are known to the State of California to cause birth defects or other reproductive harm.

# ROUND AIR FILTERS BY LENGTH

All Measurements in Inches and (Millimeters)

**NOTE:** All round air filters have been sorted by length and then outside diameter.  
The larger outside and inside diameters have been listed.

LENGTH Inches	LENGTH (mm)	O.D. Inches	O.D. (mm)	I.D. Inches	I.D. (mm)	BALDWIN NUMBER	LENGTH Inches	LENGTH (mm)	O.D. Inches	O.D. (mm)	I.D. Inches	I.D. (mm)	BALDWIN NUMBER
19/32.....	15.1	1 31/32.....	50.0	1 13/32.....	35.7	PA30157	2 3/8.....	60.3	4 1/4.....	108.0	2 1/4.....	57.2	PA4829
15/16.....	23.8	2 7/16.....	61.9	1 31/32.....	50.0	S9475	2 3/8.....	60.3	4 13/32.....	111.9	2 15/16.....	74.6	PA1712
31/32.....	24.6	9 13/32.....	238.9	—	—	PA4701	2 3/8.....	60.3	6 11/16.....	169.9	4 15/16.....	125.4	PA2036
1.....	25.4	2 13/16.....	71.4	1 5/16.....	33.3	PA1909	2 3/8.....	60.3	10 1/16.....	255.6	7 21/32.....	194.5	PA1735
1 9/32.....	32.5	2 5/32.....	54.8	1 1/32.....	26.2	PA5276	2 3/8.....	60.3	10 1/8.....	257.2	7 15/16.....	201.6	PA1657
1 5/16.....	33.3	5.....	127.0	2 5/8.....	66.7	PA1627	2 3/8.....	60.3	11 3/16.....	284.2	9 3/32.....	231.0	PA10357
1 3/8.....	34.9	3.....	76.2	1 5/8.....	41.3	PA1704	2 3/8.....	60.3	13 1/16.....	331.8	—	—	PA4070
1 3/8.....	34.9	4.....	101.6	1 11/32.....	34.1	PA2256	2 7/16.....	61.9	8 1/2.....	215.9	6 15/16.....	176.2	PA2109
1 13/32.....	35.7	5 5/32.....	131.0	3 3/8.....	85.7	PA2070	2 7/16.....	61.9	10 1/4.....	260.4	8.....	203.2	PA2117
1 1/2.....	38.1	2 5/32.....	54.8	1 7/32.....	31.0	PA5316	2 15/32.....	62.7	5 19/32.....	142.1	4.....	101.6	PA2096
1 1/2.....	38.1	4 1/4.....	108.0	3.....	76.2	PA677	2 15/32.....	62.7	7.....	177.8	5 9/16.....	141.3	PA2069
1 19/32.....	40.5	2 9/32.....	57.9	23/32.....	18.3	PA4978	2 15/32.....	62.7	9.....	228.6	7 1/2.....	190.5	PA691
1 19/32.....	40.5	11 17/32.....	292.9	8 3/4.....	222.3	PA2124	2 1/2.....	63.5	10 1/32.....	254.8	8 17/32.....	216.7	PA2113
1 5/8.....	41.3	3 7/8.....	98.4	2 1/2.....	63.5	PA633(2)	2 1/2.....	63.5	10 3/8.....	266.6	7 7/16.....	188.9	PA10352
1 5/8.....	41.3	9 5/8.....	244.5	—	—	PA2216	2 1/2.....	63.5	11 13/16.....	300.0	9 13/16.....	249.2	PA2006
1 21/32.....	42.1	2 29/32.....	73.8	1 19/32.....	40.5	PA4778	2 1/2.....	63.5	13.....	330.2	11 9/32.....	286.5	PA2024
1 23/32.....	43.7	10 3/8.....	263.5	7 13/16.....	198.4	PA2147	2 17/32.....	64.3	4 9/32.....	108.7	2.....	50.8	PA30019
1 25/32.....	45.2	4 1/8.....	104.8	2 1/8.....	54.0	PA4824	2 9/16.....	65.1	2 15/16.....	74.6	1 7/8.....	47.6	PA1603
1 25/32.....	45.2	7.....	177.8	5 9/16.....	141.3	PA2068	2 9/16.....	65.1	5 3/4.....	146.1	3 1/2.....	88.9	PA696
1 25/32.....	45.2	11 7/32.....	285.0	9 3/8.....	238.1	PA2074	2 9/16.....	65.1	10 3/4.....	273.1	8 5/8.....	219.1	PA2007
1 13/16.....	46.0	1 31/32.....	50.0	1 1/8.....	28.6	PA2933	2 19/32.....	65.9	4 3/8.....	111.1	1 31/32.....	50.0	PA2477
1 13/16.....	46.0	2 7/32.....	56.4	1 13/32.....	35.7	SA10127	2 19/32.....	65.9	5 3/16.....	131.8	1 1/2.....	38.1	PA2347
1 13/16.....	46.0	10 3/32.....	256.4	—	—	PA2207	2 5/8.....	66.7	4 13/16.....	122.2	2 5/16.....	58.7	PA4910
1 13/16.....	46.0	10 7/32.....	259.6	7 7/32.....	183.4	PA3697	2 5/8.....	66.7	12 5/16.....	312.7	10 13/16.....	274.6	PA2009
1 7/8.....	47.6	9 11/16.....	246.1	8 3/16.....	208.0	PA658	2 5/8.....	66.7	13 7/8.....	352.4	11 5/8.....	295.3	PA2110
1 7/8.....	47.6	13 9/16.....	344.5	11 11/32.....	288.1	PA10356	2 21/32.....	67.5	13.....	330.2	9 1/8.....	231.8	PA2188
1 15/16.....	49.2	5 5/32.....	131.0	3 3/8.....	85.7	PA2071	2 11/16.....	68.3	2 7/8.....	73.0	1 3/8.....	34.9	PA643
1 15/16.....	49.2	6 1/16.....	154.0	4 5/8.....	117.5	PA678	2 11/16.....	68.3	4 13/16.....	122.2	2 5/16.....	58.7	PA4694
1 15/16.....	49.2	9.....	228.6	6 7/8.....	174.6	PA2031	2 11/16.....	68.3	11 3/16.....	284.2	9 1/16.....	230.2	PA2051
1 31/32.....	50.0	4 23/32.....	119.9	1 31/32.....	50.0	PA3959	2 23/32.....	69.1	2 17/32.....	64.3	1 1/2.....	38.1	PA4705
1 31/32.....	50.0	7.....	177.8	6 3/4.....	171.5	PA4187	2 23/32.....	69.1	2 17/32.....	64.3	1 1/2.....	38.1	PA4891
2.....	50.8	3 17/32.....	89.7	2.....	50.8	PA1834	2 23/32.....	69.1	4 31/32.....	126.2	2 5/16.....	58.7	PA4737
2.....	50.8	6 7/8.....	174.6	5 1/8.....	130.2	PA1814	2 23/32.....	69.1	6 25/32.....	172.2	—	—	PA4026
2.....	50.8	12 7/16.....	315.9	9 3/8.....	238.1	PA2065	2 23/32.....	69.1	8 19/32.....	218.3	—	—	PA2171
2 1/32.....	51.6	4.....	101.6	2 3/4.....	69.9	PA1661(3)	2 3/4.....	69.9	8 19/32.....	218.3	—	—	PA2171
2 1/16.....	52.4	3 1/4.....	82.6	1 15/16.....	49.2	PA30035	2 3/4.....	69.9	2 3/4.....	69.9	1 1/4.....	31.8	PA2225
2 1/16.....	52.4	3 7/16.....	87.3	2 3/8.....	60.3	PA1757	2 3/4.....	69.9	3 7/8.....	98.4	2 11/32.....	59.5	PA697
2 1/16.....	52.4	6 5/8.....	168.3	5.....	127.0	PA2050	2 3/4.....	69.9	3 7/8.....	98.4	2 3/8.....	60.3	PA2862
2 3/32.....	53.2	3 15/16.....	100.0	2 23/32.....	69.0	PA4830	2 3/4.....	69.9	6 23/32.....	170.7	5 1/2.....	139.7	PA3628
2 3/32.....	53.2	9 11/16.....	246.1	7 15/16.....	201.6	PA2114	2 3/4.....	69.9	7 7/16.....	188.9	4 9/32.....	108.7	PA2037
2 1/8.....	54.0	3 3/4.....	95.3	2 1/32.....	51.6	PA1666	2 3/4.....	69.9	10 1/16.....	255.6	7 21/32.....	194.5	PA615
2 1/8.....	54.0	7 29/32.....	200.8	6 1/2.....	165.1	PA2063	2 3/4.....	69.9	12 3/4.....	323.9	11.....	279.4	PA2010
2 1/8.....	54.0	11 13/16.....	300.0	9 13/16.....	249.2	PA1802	2 25/32.....	70.6	2 3/4.....	69.9	1 1/4.....	31.8	PA4556
2 5/32.....	54.8	3 25/32.....	96.0	2 1/32.....	51.6	PA4873	2 25/32.....	70.6	5 31/32.....	151.6	3 15/32.....	88.1	PA2072
2 5/32.....	54.8	5 3/4.....	146.1	3 1/2.....	88.9	PA2053	2 25/32.....	70.6	13 9/32.....	337.3	11 9/32.....	286.5	PA2002
2 3/16.....	55.6	2 15/16.....	74.6	1 15/16.....	49.2	PA1915	2 13/16.....	71.4	3 5/16.....	84.1	2 3/8.....	60.3	PA4872
2 3/16.....	55.6	9 3/8.....	238.1	—	—	PA5418	2 13/16.....	71.4	3 15/32.....	88.1	1 9/16.....	39.7	PA3412
2 3/16.....	55.6	10 7/8.....	276.2	9.....	228.6	PA2005	2 13/16.....	71.4	9 11/16.....	246.1	8 3/16.....	208.0	PA2106
2 3/16.....	55.6	11 3/32.....	281.8	8 1/2.....	215.9	PA2075	2 27/32.....	72.2	3 5/8.....	92.1	1 31/32.....	50.0	PA2476
2 3/16.....	55.6	18 5/16.....	465.1	14 15/16.....	379.4	PA631	2 7/8.....	73.0	1 23/32.....	43.7	7/8.....	22.2	PA4777
2 7/32.....	56.4	3 1/32.....	77.0	1 15/32.....	37.3	BT8429	2 7/8.....	73.0	1 25/32.....	45.2	13/16.....	20.6	PA30302
2 7/32.....	56.4	5 5/16.....	134.9	4.....	101.6	PA10399	2 7/8.....	73.0	3 13/16.....	96.8	1 5/16.....	33.3	PA2224
2 7/32.....	56.4	13 9/32.....	337.3	11 9/32.....	286.5	PA1828	2 7/8.....	73.0	4 5/32.....	105.6	2 15/32.....	62.7	PA5311
2 1/4.....	57.2	6 29/32.....	175.4	5 9/16.....	141.3	PA2226	2 29/32.....	73.8	5 7/8.....	149.2	3 7/16.....	87.3	PA3419
2 1/4.....	57.2	8 11/16.....	220.7	5 29/32.....	150.0	PA4893	2 29/32.....	73.8	3 7/8.....	98.4	2 3/8.....	60.3	PA4708
2 1/4.....	57.2	9 11/16.....	246.1	7 15/16.....	201.6	PA642	2 29/32.....	73.8	12 15/16.....	328.6	9 9/16.....	242.9	PA5689
2 1/4.....	57.2	9 23/32.....	246.9	6 7/8.....	174.6	PA2125	2 15/16.....	74.6	4 11/32.....	110.3	2 7/16.....	61.9	PA4733
2 1/4.....	57.2	10 1/32.....	254.8	8 17/32.....	216.7	PA2077	2 15/16.....	74.6	6 15/16.....	176.2	5 9/16.....	141.3	PA5737 KIT
2 5/16.....	58.7	2 7/32.....	56.4	1 1/32.....	26.2	PA1763	2 15/16.....	74.6	9 11/16.....	246.1	7 1/2.....	190.5	PA2154
2 5/16.....	58.7	5 1/2.....	139.7	3 1/4.....	82.6	PA1832	3.....	76.2	3.....	76.2	1 5/8.....	41.3	PA1985
2 3/8.....	60.3	3 17/32.....	89.7	2 7/16.....	61.9	PA4727	3.....	76.2	6 5/8.....	168.3	5.....	127.0	PA634
							3.....	76.2	6 21/32.....	169.1	4 3/32.....	104.0	PA1648



**WARNING:** These products can expose you to chemicals, including Diisononyl Phthalate, Carbon black extracts, Nickel, 1,3 Butadiene, Ethylene Oxide, Epichlorohydrin, which are known to the State of California to cause cancer, and Bisphenol-A, Ethylene Glycol, Ethylene Oxide, 1,3 Butadiene, Epichlorohydrin, which are known to the State of California to cause birth defects or other reproductive harm.

**ROUND AIR FILTERS BY LENGTH**

LENGTH Inches	LENGTH (mm)	O.D. Inches	O.D. (mm)	I.D. Inches	I.D. (mm)	BALDWIN NUMBER	LENGTH Inches	LENGTH (mm)	O.D. Inches	O.D. (mm)	I.D. Inches	I.D. (mm)	BALDWIN NUMBER
3	76.2	6 31/32	177.0	5 19/32	142.1	PA3901	4	101.6	7 7/8	200.0	4 1/8	104.8	PA1949
3	76.2	7 7/8	200.0	4 1/8	104.8	PA1889	4	101.6	8 1/16	204.8	5 3/4	146.1	PA662
3	76.2	8 1/4	209.6	6 1/2	165.1	PA650	4	101.6	8 1/16	204.8	5 3/4	146.1	PA1698
3	76.2	9 3/4	247.7	7 15/16	201.6	PA648	4	101.6	8 7/32	208.8	5 15/16	150.8	PA4871
3	76.2	10 1/32	254.8	8 17/32	216.7	PA621	4	101.6	9 3/4	247.7	7 1/4	184.2	PA2095
3	76.2	12 15/16	328.6	10 7/16	265.1	PA1786	4	101.6	10 7/32	259.6	5 1/2	139.7	PA1618
3	76.2	13 7/8	352.4	11 5/8	295.3	PA1758	4	101.6	13 7/8	352.4	11 5/8	295.3	PA2073
3 1/32	77.0	2 27/32	71.9	1 1/16	26.9	CV15011	4	101.6	13 7/8	352.4	11 5/8	295.3	PA2079
3 1/32	77.0	6 7/32	158.0	4 27/32	123.0	PA2023	4 1/32	102.4	4 5/32	105.6	1 1/4	31.8	PA3983-FN
3 1/32	77.0	6 11/32	161.1	4 5/32	105.6	PA1805	4 1/32	102.4	7 13/32	188.1	4 11/32	110.3	PA10020
3 1/16	77.8	6 13/16	173.0	5 1/16	128.6	PA699	4 1/16	103.2	6	152.4	4 5/8	117.5	PA2064
3 1/16	77.8	11 5/16	287.3	8 9/16	217.5	PA625	4 1/16	103.2	7 3/16	182.6	3 15/16	100.0	PA3773
3 3/32	78.6	4 15/32	113.5	2	50.8	PA4902	4 1/16	103.2	9 23/32	246.9	7 5/16	185.7	PA4743
3 1/8	79.4	3 3/32	78.6	2 9/32	57.9	PA4883	4 3/32	104.0	3 7/8	98.4	2 3/8	60.3	PA4900
3 1/8	79.4	3 31/32	100.8	2 21/32	67.5	PA4758	4 1/8	104.8	3 11/16	93.7	2 3/16	55.6	PA1748
3 1/8	79.4	5 3/8	136.5	3 13/16	96.8	PA649	4 1/8	104.8	4 3/16	106.4	1 15/16	49.2	PA1858
3 1/8	79.4	5 23/32	145.3	3 1/16	77.8	PA1973	4 1/8	104.8	5 3/4	146.1	4 1/4	108.0	PA1857
3 1/8	79.4	6	152.4	4 5/8	117.5	PA2067	4 1/8	104.8	6 13/32	162.7	3 1/32	77.0	PA2182
3 1/8	79.4	10 1/8	257.2	7 1/2	190.5	PA1841	4 5/32	105.6	4 7/32	107.2	2 1/32	51.6	PA4764
3 5/32	80.2	2 23/32	69.1	1 5/16	33.3	PA4895	4 3/16	106.4	3 9/16	90.5	2 1/8	54.0	PA1859
3 5/32	80.2	4	101.6	2 3/4	69.9	PA4557	4 3/16	106.4	3 13/16	96.8	1 31/32	50.0	PA4732
3 3/16	81.0	6 21/32	169.1	5 3/32	129.4	PA30011	4 3/16	106.4	7 7/8	200.0	4 5/8	117.5	PA30028
3 7/32	81.8	4 5/32	105.6	2 13/16	71.4	PA4823	4 3/16	106.4	7 15/16	201.6	6 9/32	159.5	PA1860
3 1/4	82.6	5 11/16	144.5	2	50.8	PA1951	4 3/16	106.4	8 1/32	204.0	5 5/16	134.9	PA2100
3 1/4	82.6	8 13/32	213.5	6 19/32	167.5	PA657	4 3/16	106.4	13 23/32	348.5	11 5/8	295.3	PA4711
3 1/4	82.6	9	228.6	6 1/2	165.1	PA2107	4 7/32	107.2	11 29/32	302.4	8 19/32	218.3	PA10112
3 1/4	82.6	10 1/4	260.4	7 5/8	193.7	PA607	4 9/32	108.7	6 1/2	165.1	3 1/2	88.9	PA1852
3 9/32	83.3	4 21/32	118.3	2 3/4	69.9	PA4763	4 5/16	109.5	4 1/2	114.3	3 1/16	77.8	PA30020
3 9/32	83.3	5 1/2	139.7	3 1/4	82.6	PA4166	4 5/16	109.5	12 5/8	320.7	8 17/32	216.7	PA2878
3 9/32	83.3	7 27/32	199.2	4 27/32	123.0	PA5563	4 11/32	110.3	11 7/8	301.6	7 1/2	190.5	PA2337
3 5/16	84.1	4 1/4	108.0	3	76.2	PA675	4 3/8	111.1	8 1/2	215.9	3	76.2	PA2817
3 5/16	84.1	5 3/4	146.1	3 5/16	84.1	CV15006	4 13/32	111.9	7 9/32	184.9	4 21/32	118.3	PA2215
3 5/16	84.1	7 3/8	187.3	5 3/16	131.8	PA30025	4 13/32	111.9	12	304.8	8 19/32	218.3	PA4005
3 5/16	84.1	8 17/32	216.7	4 3/8	111.1	PA2479	4 7/16	112.7	5 1/32	127.8	2 27/32	72.2	PA4930
3 11/32	84.9	5 1/16	128.6	3 7/16	87.3	PA4810	4 7/16	112.7	7	177.8	4 7/8	123.8	PA680
3 3/8	85.7	11 5/16	287.3	8 9/16	217.5	PA2081	4 1/2	114.3	3 17/32	89.7	1 17/32	38.9	PA4158
3 15/32	88.1	3 15/32	88.1	31/32	24.6	PA2798	4 1/2	114.3	4 7/16	112.7	2 13/16	71.4	PA30301
3 15/32	88.1	9 1/2	241.3	6 11/32	161.1	PA4707	4 1/2	114.3	5 1/16	128.6	3 1/16	77.8	PA2044
3 15/32	88.1	11 13/16	300.0	9 13/16	249.2	PA2008	4 1/2	114.3	5 1/2	139.7	3 1/4	82.6	PA1718
3 1/2	88.9	3 7/16	87.3	2 3/8	60.3	PA1875	4 19/32	116.7	3	76.2	1 21/32	42.1	PA4878
3 1/2	88.9	7 3/8	187.3	4 5/16	109.5	PA2167	4 5/8	117.5	7	177.8	4 7/8	123.8	PA1891
3 1/2	88.9	8	203.2	5 3/4	146.1	PA612	4 5/8	117.5	9 3/8	238.1	7 9/16	192.1	PA30013
3 1/2	88.9	12 3/4	323.9	11	279.4	PA693	4 23/32	119.9	5 1/2	139.7	3 1/4	82.6	PA2001
7 3/8	89.7	3 11/32	161.1	3 17/32	89.7	PA10111	4 3/4	120.7	4 1/4	108.0	1 5/8	41.3	PA1633
3 17/32	89.7	10 7/8	276.2	9	228.6	PA2052	4 3/4	120.7	4 13/32	111.9	2 15/16	74.6	PA2335
3 9/16	90.5	9 21/32	245.3	8 1/4	209.6	PA1680	4 3/4	120.7	8 1/16	204.8	5 25/32	146.8	PA30027
3 5/8	92.1	3 1/16	77.8	1 9/16	39.7	PA644	4 3/4	120.7	9 15/32	240.5	4 11/32	110.3	PA4641
3 5/8	92.1	5 29/32	150.0	3 13/32	86.5	PA4741	4 25/32	121.4	4 13/32	111.9	3 1/32	77.0	PA2038
3 5/8	92.1	9 1/16	230.2	6 3/4	171.5	PA602	4 25/32	121.4	6 5/16	160.3	4 1/2	114.3	PA4713
3 21/32	92.9	3 1/4	82.6	1 31/32	50.0	PA30034	4 13/16	122.2	2 1/4	57.2	1 3/4	44.5	CV15001
3 21/32	92.9	6 1/2	165.1	3 15/32	88.1	PA3941	4 13/16	122.2	6 5/32	156.4	3 3/32	78.6	PA10117
3 21/32	92.9	6 1/2	165.1	3 1/2	88.9	PA3970	4 13/16	122.2	8 5/8	219.1	4 5/16	109.5	PA4649
3 11/16	93.7	4 5/16	109.5	2 7/8	73.0	PA1697	4 27/32	123.0	5 1/2	139.7	3 1/8	79.4	PA2978
3 11/16	93.7	5	127.0	3 9/16	90.5	PA1696	4 27/32	123.0	5 11/16	144.5	3 9/16	90.5	PA3457
3 11/16	93.7	9 3/4	247.7	6 1/16	154.0	PA1861	4 27/32	123.0	6 5/8	168.3	4 23/32	119.9	PA4389
3 3/4	95.3	3 1/8	79.4	1 1/2	38.1	PA1679	4 27/32	123.0	7 7/8	200.0	4 1/8	104.8	PA4072
3 3/4	95.3	4 1/4	108.0	2	50.8	PA2223	4 15/16	125.4	5	127.0	2 17/32	64.3	PA4706
3 3/4	95.3	9 9/16	242.9	7 1/4	184.2	PA2984	4 15/16	125.4	5 3/8	136.5	3 13/16	96.8	PA2162
3 13/16	96.8	7 15/16	201.6	4 31/32	126.2	PA4781	4 15/16	125.4	5 3/4	146.1	3 1/2	88.9	PA2134
3 13/16	96.8	8 1/4	209.6	6 13/32	162.7	PA3967	4 31/32	126.2	5 29/32	150.0	3 15/32	88.1	PA4715
3 7/8	98.4	6	152.4	4 5/8	117.5	PA652							
3 7/8	98.4	9 1/16	230.2	6 3/4	171.5	PA604	5	127.0	4 13/32	111.9	2 15/16	74.6	PA1639
3 15/16	100.0	3 1/4	82.6	2	50.8	PA1688	5	127.0	6 5/16	160.3	3 11/16	93.7	PA1963
3 15/16	100.0	7 31/32	202.4	3 27/32	97.6	PA5664	5	127.0	7	177.8	3 21/32	92.9	PA2858
3 15/16	100.0	8 1/4	209.6	5 7/8	149.2	PA1719	5	127.0	10 7/32	259.6	5 1/2	139.7	PA1619
3 31/32	100.8	5 3/4	146.1	3 1/2	88.9	PA2153	5	127.0	11 7/16	290.5	8 5/8	219.1	PA2092
4	101.6	5 15/16	150.8	3 1/4	82.6	PA669	5	127.0	11 7/16	290.5	8 5/8	219.1	PA2115
							5	127.0	12 5/8	320.7	9 3/4	247.7	PA2061



**WARNING:** These products can expose you to chemicals, including Diisononyl Phthalate, Carbon black extracts, Nickel, 1,3 Butadiene, Ethylene Oxide, Epichlorohydrin, which are known to the State of California to cause cancer, and Bisphenol-A, Ethylene Glycol, Ethylene Oxide, 1,3 Butadiene, Epichlorohydrin, which are known to the State of California to cause birth defects or other reproductive harm.

# ROUND AIR FILTERS BY LENGTH

LENGTH Inches	LENGTH (mm)	O.D. Inches	O.D. (mm)	I.D. Inches	I.D. (mm)	BALDWIN NUMBER	LENGTH Inches	LENGTH (mm)	O.D. Inches	O.D. (mm)	I.D. Inches	I.D. (mm)	BALDWIN NUMBER
5 1/32.....	127.8	10 27/32.....	275.4	6 1/2.....	165.1	PA2699	6 9/32.....	159.5	4 3/32.....	104.0	2 1/4.....	57.2	PA30021
5 1/8.....	130.2	6 11/16.....	169.9	2 5/8.....	66.7	PA2576	6 9/32.....	159.5	9 5/16.....	236.5	—.....	—	CA5352
5 1/8.....	130.2	9 3/8.....	238.1	4 21/32.....	118.3	PA3919	6 5/16.....	160.3	6 5/8.....	168.3	2 5/16.....	58.7	PA5326
5 3/16.....	131.8	3 7/16.....	87.3	31/32.....	24.6	PA3679	6 5/16.....	160.3	8 9/16.....	217.5	3 1/4.....	82.6	PA2827
5 3/16.....	131.8	4 3/32.....	104.0	1 13/32.....	35.7	PA4819	6 3/8.....	161.9	6.....	152.4	—.....	—	BA16000
5 3/16.....	131.8	5 21/32.....	143.7	3 1/2.....	88.9	PA4814	6 3/8.....	161.9	6 1/16.....	154.0	4.....	101.6	PA2884
5 3/16.....	131.8	7 13/16.....	198.4	3 5/8.....	92.1	PA3797	6 3/8.....	161.9	8 19/32.....	218.3	2 1/2.....	63.5	PA2828
5 3/16.....	131.8	7 7/8.....	200.0	6 1/8.....	155.6	PA1873	6 7/16.....	163.5	1 21/32.....	42.1	1 7/32.....	31.0	PA4633
5 3/16.....	131.8	12 1/4.....	311.2	9 7/16.....	239.7	PA654	6 15/32.....	164.3	8 1/16.....	204.8	5 23/32.....	145.3	PA4877
5 7/32.....	132.6	5 1/8.....	130.2	3 3/8.....	85.7	PA2139	6 1/2.....	165.1	7 5/16.....	185.7	5 5/16.....	134.9	PA1689
5 1/4.....	133.4	2 31/32.....	75.4	1 21/32.....	42.1	PA4939	6 9/16.....	166.7	9 5/8.....	244.5	5.....	127.0	PA1866
5 1/4.....	133.4	6 7/8.....	174.6	4 3/16.....	106.4	PA2404	6 19/32.....	167.5	5 5/8.....	142.9	2 13/32.....	61.1	PA4118
5 5/16.....	134.9	4 5/8.....	117.5	2 5/8.....	66.7	PA30015	6 19/32.....	167.5	7 11/32.....	186.5	4.....	101.6	PA10109
5 5/16.....	134.9	5.....	127.0	3 9/16.....	90.5	PA2140	6 5/8.....	168.3	1 11/16.....	42.9	1 3/16.....	30.2	RS3930
5 5/16.....	134.9	8 9/16.....	217.5	2 1/2.....	63.5	PA2825	6 5/8.....	168.3	4 3/32.....	104.0	2 15/32.....	62.7	PA5579
5 11/32.....	135.7	6 5/8.....	168.3	2.....	50.8	PA2823	6 5/8.....	168.3	8 5/32.....	207.2	4 3/16.....	106.4	RS3528
5 3/8.....	136.5	5 1/2.....	139.7	1 3/4.....	44.5	PA4619	6 5/8.....	168.3	9 1/8.....	231.8	6 7/8.....	174.6	PA638
5 13/32.....	137.3	6 11/16.....	169.9	2 11/32.....	59.5	PA2730	6 21/32.....	169.1	4 1/4.....	108.0	2 3/4.....	69.9	RS3537
5 13/32.....	137.3	9 3/4.....	247.7	6 1/16.....	154.0	PA1916	6 11/16.....	169.9	4 31/32.....	126.2	3 11/32.....	84.9	PA2099
5 7/16.....	138.1	6 5/8.....	168.3	4 1/4.....	108.0	PA2725	6 11/16.....	169.9	6 15/32.....	164.3	2 15/32.....	62.7	PA5444-FN
5 7/16.....	138.1	11 13/16.....	300.0	9 13/16.....	249.2	PA2091	6 23/32.....	170.7	5 1/4.....	133.4	2 27/32.....	72.2	PA2536
5 7/16.....	138.1	11 13/16.....	300.0	9 13/16.....	249.2	PA2148	6 3/4.....	171.5	8 1/2.....	215.9	4 5/8.....	117.5	RS10035
5 15/32.....	138.9	6 29/32.....	175.8	3 23/32.....	94.5	PA10123	6 25/32.....	172.2	3 11/16.....	93.7	1 11/16.....	42.9	PA3757
5 1/2.....	139.7	6 15/32.....	164.3	3.....	76.2	PA4897	6 25/32.....	172.2	5 3/16.....	131.8	2 5/8.....	66.7	PA2912
5 1/2.....	139.7	7 7/16.....	188.9	4 9/32.....	108.7	PA2156	6 13/16.....	173.0	5.....	127.0	3 9/16.....	90.5	PA2193
5 1/2.....	139.7	12 19/32.....	319.9	8 9/32.....	210.3	PA2483	6 27/32.....	173.8	5 7/16.....	138.1	3 5/32.....	80.2	RS4189
5 1/2.....	139.7	12 5/8.....	320.7	9 3/4.....	247.7	PA2472	6 7/8.....	174.6	5 3/8.....	136.5	3 15/16.....	100.0	PA3654
5 9/16.....	141.3	11 5/16.....	287.3	8 9/16.....	217.5	PA1798	6 29/32.....	175.4	13 7/8.....	352.4	7 7/16.....	188.9	PA2343
5 9/16.....	141.3	12.....	304.8	8 9/16.....	217.5	PA1800	6 15/16.....	176.2	3 17/32.....	89.7	1 25/32.....	45.2	PA4632
5 19/32.....	142.1	6 3/16.....	157.2	4 13/16.....	122.2	PA4813	6 15/16.....	176.2	3 3/4.....	95.3	1 21/32.....	42.1	RS4804
5 5/8.....	142.9	7 1/32.....	178.6	5 7/16.....	138.1	PA4848	6 15/16.....	176.2	5 11/32.....	135.7	3 5/32.....	80.2	RS10005
5 11/16.....	144.5	7 17/32.....	191.3	3 5/16.....	84.1	PA3863	6 31/32.....	177.0	2 3/4.....	69.9	1 31/32.....	50.0	PA3812
5 11/16.....	144.5	7 11/16.....	195.3	3 5/16.....	84.1	PA4615	6 31/32.....	177.0	3 17/32.....	89.7	2 13/32.....	61.1	PA3819
5 11/16.....	144.5	8 5/8.....	219.1	4 9/32.....	108.7	PA4648	6 31/32.....	177.0	6 5/16.....	160.3	3 29/32.....	99.2	PA3836
5 3/4.....	146.1	4 3/16.....	106.4	1 15/16.....	49.2	PA1946	7.....	177.8	3 17/32.....	89.7	1 17/32.....	38.9	RS5273
5 3/4.....	146.1	4 13/32.....	111.9	2 15/16.....	74.6	PA2083	7.....	177.8	3 17/32.....	89.7	1 3/4.....	44.5	RS3715
5 3/4.....	146.1	7 3/4.....	196.9	3 1/4.....	82.6	PA4647	7.....	177.8	6 7/8.....	174.6	5 1/8.....	130.2	PA1653
5 23/32.....	146.8	8 29/32.....	226.2	4 9/32.....	108.7	PA2042	7.....	177.8	8 7/16.....	214.3	6 1/2.....	165.1	PA30075
5 13/16.....	147.6	4 1/8.....	104.8	1 7/32.....	31.0	PA3880	7.....	177.8	8 19/32.....	218.3	7 19/32.....	192.9	PA3958
5 13/16.....	147.6	6 7/8.....	174.6	5 1/8.....	130.2	PA2102	7.....	177.8	11 7/16.....	290.5	8 5/8.....	219.1	PA2116
5 27/32.....	148.4	4 1/4.....	108.0	2 3/4.....	69.9	RS3529	7.....	177.8	11 11/16.....	296.9	7 25/32.....	197.6	PA2328
5 27/32.....	148.4	8 3/8.....	212.7	4.....	101.6	LL2575	7 1/32.....	178.6	3 7/8.....	98.4	3 3/16.....	81.0	PA3909
5 27/32.....	148.4	8 3/8.....	212.7	4.....	101.6	PA2575	7 1/32.....	178.6	4 13/32.....	111.9	2 15/16.....	74.6	PA640
5 7/8.....	149.2	4 1/2.....	114.3	1 1/2.....	38.1	PA2832	7 1/16.....	179.4	3 5/8.....	92.1	2 5/16.....	58.7	PA30101
5 7/8.....	149.2	4 19/32.....	116.7	1 5/8.....	41.3	PA3643	7 1/8.....	181.0	8 1/8.....	206.4	3 25/32.....	96.0	PA2763
5 29/32.....	150.0	6 23/32.....	170.7	3 1/32.....	77.0	PA4089	7 1/8.....	181.0	13.....	330.2	7 11/16.....	195.3	PA2403
5 31/32.....	151.6	3 25/32.....	96.0	7/8.....	22.2	CV15003	7 5/32.....	181.8	4 1/4.....	108.0	2 1/8.....	54.0	PA4665-FN
5 31/32.....	151.6	5 3/4.....	146.1	4 1/8.....	104.8	PA1721	7 5/32.....	181.8	4 13/32.....	111.9	2 23/32.....	69.1	RS10348
5 31/32.....	151.6	8 3/4.....	222.3	4 3/32.....	104.0	PA3890	7 3/16.....	182.6	2 1/8.....	54.0	1 11/16.....	42.9	PA30100
6.....	152.4	5 3/4.....	146.1	3 5/8.....	92.1	PA2136	7 3/16.....	182.6	4 1/2.....	114.3	2.....	50.8	PA3632
6.....	152.4	7.....	177.8	4 3/8.....	111.1	PA1888	7 7/32.....	183.4	9 1/8.....	231.8	6 7/8.....	174.6	PA651
6.....	152.4	9 23/32.....	246.9	7 9/32.....	184.9	PA5665	7 1/4.....	184.2	4 7/32.....	107.2	1 11/16.....	42.9	PA5324-FN
6.....	152.4	10 7/32.....	259.6	5 1/2.....	139.7	PA671	7 1/4.....	184.2	4 1/4.....	108.0	1 27/32.....	46.8	PA1865-FN
6.....	152.4	10 1/4.....	260.4	7 3/8.....	187.3	PA671-1	7 1/4.....	184.2	4 1/4.....	108.0	1 27/32.....	46.8	PA3895-FN
6 1/32.....	153.2	5 1/8.....	130.2	2 15/32.....	62.7	PA4834-FN	7 1/4.....	184.2	5.....	127.0	1 27/32.....	46.8	PA3664-FN
6 1/32.....	153.2	5 9/32.....	134.1	1 15/32.....	37.3	PA30068	7 1/4.....	184.2	5 31/32.....	151.6	3 13/32.....	86.5	PA10119
6 1/16.....	154.0	6 7/8.....	174.6	5 9/16.....	141.3	PA2340	7 1/4.....	184.2	6 27/32.....	173.8	3 3/4.....	95.3	RS5670
6 3/32.....	154.8	5.....	127.0	2 17/32.....	64.3	PA4716	7 1/4.....	184.2	15 1/16.....	382.6	7 7/16.....	188.9	PA1995
6 3/32.....	154.8	5 31/32.....	151.6	3 13/32.....	86.5	PA10126	7 9/32.....	184.9	6 3/32.....	154.8	3 15/32.....	88.1	PA2613
6 3/32.....	154.8	7 13/16.....	198.4	3 15/32.....	88.1	PA2589-FN	7 5/16.....	185.7	4 3/32.....	104.0	2 15/32.....	62.7	PA1921
6 1/8.....	155.6	4 3/16.....	106.4	1 15/16.....	49.2	PA1969	7 5/16.....	185.7	10 9/16.....	268.3	4 1/4.....	108.0	PA2830
6 1/8.....	155.6	6 3/32.....	154.8	3 15/32.....	88.1	PA2885	7 5/16.....	185.7	12 3/8.....	314.3	7 3/16.....	182.6	PA2339
6 3/16.....	157.2	6 7/8.....	174.6	4 3/16.....	106.4	PA1996	7 11/32.....	186.5	5.....	127.0	1 3/4.....	44.5	PA30063
6 7/32.....	158.0	6 1/8.....	155.6	3 3/8.....	85.7	PA4041	7 3/8.....	187.3	4 1/2.....	114.3	1 1/2.....	38.1	PA30036
6 1/4.....	158.8	2 5/32.....	54.8	1 17/32.....	38.9	PA4666	7 3/8.....	187.3	5 1/32.....	127.8	1 13/16.....	46.0	PA4833-FN
6 1/4.....	158.8	3 1/8.....	79.4	1 17/32.....	38.9	PA3565	7 3/8.....	187.3	9 31/32.....	253.2	4 31/32.....	126.2	PA3660-FN
6 1/4.....	158.8	5 1/32.....	127.8	3 5/32.....	80.2	RS4130	7 7/16.....	188.9	3 11/32.....	84.9	1 13/16.....	46.0	PA4934



**WARNING:** These products can expose you to chemicals, including Diisononyl Phthalate, Carbon black extracts, Nickel, 1,3 Butadiene, Ethylene Oxide, Epichlorohydrin, which are known to the State of California to cause cancer, and Bisphenol-A, Ethylene Glycol, Ethylene Oxide, 1,3 Butadiene, Epichlorohydrin, which are known to the State of California to cause birth defects or other reproductive harm.

# ROUND AIR FILTERS BY LENGTH

LENGTH Inches	LENGTH (mm)	O.D. Inches	O.D. (mm)	I.D. Inches	I.D. (mm)	BALDWIN NUMBER	LENGTH Inches	LENGTH (mm)	O.D. Inches	O.D. (mm)	I.D. Inches	I.D. (mm)	BALDWIN NUMBER
7 15/32	189.7	6 13/32	162.7	3 3/16	81.0	PA4071	8 1/2	215.9	4 7/16	112.7	—	—	CV15008
7 15/32	189.7	6 13/16	173.0	3 3/32	78.6	PA4088	8 1/2	215.9	6 7/8	174.6	2 25/32	70.6	PA4614
7 15/32	189.7	6 29/32	175.4	3 3/32	78.6	PA2240	8 1/2	215.9	12 1/32	305.6	7 11/16	195.3	PA2473
7 1/2	190.5	3 1/4	82.6	2 1/8	54.0	PA3472	8 1/2	215.9	13 3/4	349.3	6 23/32	170.7	PA1892-FN
7 1/2	190.5	4 1/4	108.0	2 1/8	54.0	PA3472-FN	8 9/16	217.5	6	152.4	4 5/8	117.5	PA653
7 1/2	190.5	8 5/32	207.2	4 3/16	106.4	RS3536	8 19/32	218.3	4 1/2	114.3	2 5/8	66.7	PA4388
7 1/2	190.5	8 27/32	224.6	5 15/32	138.9	PA2558	8 5/8	219.1	5 27/32	148.4	3 5/8	92.1	PA4173
7 1/2	190.5	10 7/32	259.6	7 7/8	200.0	PA1606	8 5/8	219.1	6	152.4	3 1/2	88.9	PA1901
7 1/2	190.5	10 27/32	275.4	6 1/2	165.1	PA2610	8 5/8	219.1	6 25/32	172.2	2 13/16	71.4	PA3818-FN
7 1/2	190.5	13 27/32	351.6	11 1/8	282.6	PA1641	8 5/8	219.1	12 5/8	320.7	8 13/32	213.5	PA2552
7 1/2	190.5	13 7/8	352.4	7 7/16	188.9	PA2789	8 11/16	220.7	5 13/32	137.3	2 5/8	66.8	PA10113
7 1/2	190.5	16 1/8	409.6	7 7/16	188.9	PA2406	8 11/16	220.7	9 29/32	251.6	4 1/16	103.2	PA3807
7 17/32	191.3	3 11/32	84.9	2 27/32	72.2	PA3684	8 25/32	223.0	10 1/4	260.4	6	152.4	PA1817
7 9/16	192.1	8 1/8	206.4	4 7/32	107.2	PA4075	8 13/16	223.8	3 7/8	98.4	3 7/32	81.8	PA3973
7 5/8	193.7	8 1/16	204.8	5 3/4	146.1	PA655	8 13/16	223.8	6 1/8	155.6	3 3/8	85.7	PA5555
7 21/32	194.5	4 5/32	105.6	2 29/32	73.8	PA3911	8 27/32	224.6	6 5/8	168.3	2	50.8	PA2824
7 11/16	195.3	6 1/8	155.6	3 3/8	85.7	PA5554	8 27/32	224.6	9 21/32	245.3	5 7/32	132.6	PA4610 KIT
7 11/16	195.3	10 1/16	255.6	7 9/16	192.1	PA3755	8 7/8	225.4	2 3/8	60.3	2	50.8	PA5437
7 23/32	196.1	5 1/8	130.2	2 15/32	62.7	PA2778-FN	8 7/8	225.4	6 3/32	154.8	2 31/32	75.4	PA1787
7 3/4	196.9	6	152.4	4	101.6	PA3908	8 7/8	225.4	13 13/16	350.8	9 1/2	241.3	PA1896
7 3/4	196.9	6 3/32	154.8	3 15/32	88.1	PA4328	8 15/16	227.0	5 3/8	136.5	1 31/32	50.0	PA3758
7 25/32	197.6	4 3/32	104.0	2 15/32	62.7	PA3795	8 31/32	227.8	4 3/8	111.1	1 15/16	49.2	PA3612
7 13/16	198.4	8 9/16	217.5	2 1/2	63.5	PA2826	9	228.6	6 5/8	168.3	4 1/4	108.0	LL1608
7 27/32	199.2	2 1/8	54.0	1 5/16	33.3	PA4896	9	228.6	6 5/8	168.3	4 1/4	108.0	PA1608
7 27/32	199.2	2 17/32	64.3	1 1/2	38.1	PA4720	9	228.6	6 27/32	173.8	4 3/16	106.4	PA2932
7 27/32	199.2	3 5/32	80.2	2 13/32	61.1	PA3682	9	228.6	7 1/2	190.5	5 1/4	133.4	PA1957
7 27/32	199.2	10 7/32	259.6	6 1/16	154.0	PA1620-S	9	228.6	8 1/4	209.6	5 3/4	146.1	PA1613
7 7/8	200.0	6 3/32	154.8	3 15/32	88.1	PA2904	9	228.6	8 1/4	209.6	5 3/4	146.1	PA1613-S
7 7/8	200.0	6 5/8	168.3	4 1/4	108.0	PA641	9	228.6	10 7/32	259.6	6 1/16	154.0	LL1621-2
7 7/8	200.0	6 5/8	168.3	4 1/4	108.0	PA1602	9	228.6	10 7/32	259.6	6 1/16	154.0	PA1621-2
7 7/8	200.0	7 13/16	198.4	3 15/32	88.1	PA3406-FN	9	228.6	10 7/32	259.6	7 7/8	200.0	PA1621
8	203.2	2 23/32	69.1	1 31/32	50.0	PA2889	9	228.6	10 7/32	259.6	7 7/8	200.0	PA1621-S
8	203.2	5 1/4	133.4	2 5/8	66.7	PA1635	9	228.6	12 3/4	323.9	8 11/32	211.9	PA2438
8	203.2	5 31/32	151.6	3 7/32	81.8	RS4161	9 1/32	229.4	2 3/4	69.9	2	50.8	PA4740
8	203.2	12 1/32	305.6	6 23/32	170.7	PA2599	9 1/32	229.4	3 5/32	80.2	2 5/32	54.8	PA4548
8	203.2	12 3/32	307.2	8 11/16	220.7	PA2596	9 1/32	229.4	3 25/32	96.0	2 7/8	73.0	PA3950
8 1/32	204.0	7 7/8	200.0	6 1/8	155.6	PA1934	9 1/32	229.4	5 29/32	150.0	2 13/16	71.4	PA3753
8 1/32	204.0	8 5/16	211.1	6 1/32	153.2	PA2958	9 1/32	229.4	6 1/16	154.0	3 1/2	88.9	PA2906
8 1/32	204.0	11 21/32	296.1	—	—	CA5420	9 1/32	229.4	9 5/16	236.5	4 27/32	123.0	PA2585
8 1/32	204.0	12 25/32	324.6	—	—	CA4700	9 1/32	229.4	13 5/32	334.2	5 1/4	133.4	PA4942
8 1/32	204.0	14 7/8	377.8	—	—	CA5368	9 1/16	230.2	4 5/32	105.6	2 7/8	73.0	PA2622
8 1/32	204.0	14 7/8	377.8	—	—	CA5419	9 1/16	230.2	7 17/32	191.3	5 3/8	136.5	RS10350
8 1/32	204.0	17 5/8	447.7	11 1/32	280.2	PA2399	9 3/32	231.0	3 5/16	84.1	2 3/8	60.3	RS30078
8 1/16	204.8	5 1/16	128.6	1 1/4	31.8	CV15005	9 3/32	231.0	3 17/32	89.7	2 7/16	61.9	PA3817
8 1/16	204.8	8 3/4	222.3	6 1/16	154.0	PA3653	9 3/32	231.0	3 5/8	92.1	2 13/32	61.1	PA2717
8 1/16	204.8	9 5/8	244.5	5	127.0	PA1867	9 3/32	231.0	6 3/32	154.8	2 5/16	58.7	PA3833
8 1/16	204.8	12	304.8	4 15/16	125.4	PA2548	9 1/8	231.8	2 7/16	61.9	1 15/16	49.2	PA2861
8 3/32	205.6	14 27/32	377.0	—	—	CA30131	9 1/8	231.8	5 7/8	149.2	3 7/32	81.8	PA5567
8 1/8	206.4	2 29/32	73.8	2 3/8	60.3	PA2748	9 1/8	231.8	5 31/32	151.6	2 7/32	56.4	PA3651-FN
8 3/16	208.0	10 7/32	259.6	5 1/2	139.7	PA1620	9 1/8	231.8	9 29/32	251.6	—	—	CA5417
8 3/16	208.0	12 1/32	305.6	—	—	CA5421	9 3/16	233.4	5 3/32	129.4	2 3/4	69.9	RS5748
8 1/4	209.6	2 15/16	74.6	1 7/8	47.6	PA2702	9 1/4	235.0	4 3/32	104.0	3	76.2	PA3601
8 1/4	209.6	6 15/32	164.3	3 11/32	84.9	PA2422	9 1/4	235.0	4 15/16	125.4	2 3/4	69.9	PA4903
8 9/32	210.3	7 7/8	200.0	3 15/32	88.1	PA3411-FN	9 1/4	235.0	7	177.8	4 3/8	111.1	PA1769
8 5/16	211.1	6 3/16	157.2	2 3/4	69.9	RS4450	9 9/32	235.7	6 5/8	168.3	4 1/4	108.0	PA2592
8 5/16	211.1	9 7/32	234.2	4 27/32	123.0	PA1922	9 5/16	236.5	5 1/8	130.2	2 15/32	62.7	PA1907-FN
8 5/16	211.1	11 5/8	295.3	4 27/32	123.0	PA1922-FN	9 5/16	236.5	6 3/8	161.9	3 15/16	100.0	PA3837
8 11/32	211.9	2 19/32	65.9	1 21/32	42.1	PA4867	9 5/16	236.5	8 3/8	212.7	3 15/32	88.1	PA3910-FN
8 3/8	212.7	5 1/8	130.2	2 15/32	62.7	PA3557-FN	9 5/16	236.5	9 1/16	230.2	4 15/16	125.4	PA1987
8 3/8	212.7	5 1/2	139.7	1 3/4	44.5	PA2807	9 11/32	237.3	4 19/32	116.7	2 15/32	62.7	PA2890
8 3/8	212.7	5 1/2	139.7	1 3/4	44.5	PA2822	9 11/32	237.3	5 3/4	146.1	3 1/32	77.0	PA2701
8 3/8	212.7	6 7/8	174.6	4 3/16	106.4	PA2446	9 11/32	237.3	6 3/8	161.9	3 11/16	93.7	PA4693
8 3/8	212.7	10 19/32	269.1	6	152.4	PA5491	9 3/8	238.1	4 3/32	104.0	2 15/32	62.7	PA1821
8 13/32	213.5	5 21/32	143.7	2 15/32	62.7	PA3811-FN	9 3/8	238.1	6 3/8	161.9	2 5/8	66.7	PA1752-FN
8 15/32	215.1	4 1/2	114.3	2	50.8	PA2535	9 3/8	238.1	6 15/32	164.3	3 11/32	84.9	PA2772
8 15/32	215.1	6 3/8	161.9	2 5/8	66.7	PA2860-FN	9 3/8	238.1	10 1/16	255.6	3 9/16	90.5	PA1919-FN
8 15/32	215.1	7 15/16	201.6	4 31/32	126.2	PA2895	9 3/8	238.1	13 3/4	349.3	6 3/4	171.5	PA1956-FN



**WARNING:** These products can expose you to chemicals, including Diisononyl Phthalate, Carbon black extracts, Nickel, 1,3 Butadiene, Ethylene Oxide, Epichlorohydrin, which are known to the State of California to cause cancer, and Bisphenol-A, Ethylene Glycol, Ethylene Oxide, 1,3 Butadiene, Epichlorohydrin, which are known to the State of California to cause birth defects or other reproductive harm.

# ROUND AIR FILTERS BY LENGTH

LENGTH Inches	LENGTH (mm)	O.D. Inches	O.D. (mm)	I.D. Inches	I.D. (mm)	BALDWIN NUMBER	LENGTH Inches	LENGTH (mm)	O.D. Inches	O.D. (mm)	I.D. Inches	I.D. (mm)	BALDWIN NUMBER
9 13/32	238.9	2 1/4	57.2	1 5/8	41.3	RS3991	10 1/4	260.4	6 3/8	161.9	2 5/8	66.7	PA1830-FN
9 13/32	238.9	5	127.0	2 11/16	68.3	PA4866	10 1/4	260.4	10 1/16	255.6	3 9/16	90.5	LL1636-FN
9 7/16	239.7	12	304.8	4 15/16	125.4	PA2379	10 1/4	260.4	10 1/16	255.6	3 9/16	90.5	PA1636-FN
9 7/16	239.7	12	304.8	4 15/16	125.4	PA2379-K	10 5/16	261.9	5 1/8	130.2	2 15/32	62.7	PA2944-FN
9 1/2	241.3	4 1/2	114.3	3 9/16	90.5	RS5550	10 5/16	261.9	5 13/16	147.6	2 1/2	63.5	PA3476
9 1/2	241.3	6 1/8	155.6	3 15/32	88.1	PA5752	10 5/16	261.9	9 1/16	230.2	4 15/16	125.4	PA1986
9 1/2	241.3	6 3/8	161.9	2 27/32	72.2	PA2949-FN	10 5/16	261.9	12 19/32	319.9	5	127.0	PA30125
9 1/2	241.3	6 7/8	174.6	4 3/16	106.4	PA2740	10 5/16	261.9	15 5/8	396.9	10 9/32	261.1	PA2848
9 1/2	241.3	10 3/8	263.5	6 1/32	153.2	LL2557	10 5/16	261.9	16 13/16	427.0	10	254.0	PA3838
9 1/2	241.3	10 3/8	263.5	6 1/32	153.2	PA2557	10 11/32	262.7	5 1/8	130.2	2 15/32	62.7	LL1690-FN
9 1/2	241.3	13 7/8	352.4	7 7/16	188.9	PA2445	10 11/32	262.7	5 1/8	130.2	2 15/32	62.7	PA1690-FN
9 17/32	242.1	3 1/4	82.6	2 1/8	54.0	PA3674	10 11/32	262.7	6 5/8	168.3	2	50.8	PA2803
9 9/16	242.9	5 3/16	131.8	3 31/32	100.8	PA3783	10 11/32	262.7	7 5/16	185.7	—	—	PA10118
9 9/16	242.9	7 15/16	201.6	4 5/8	117.5	PA2183	10 11/32	262.7	8 17/32	216.7	6 1/32	153.2	PA2869
9 19/32	243.7	4 7/32	107.2	2 5/32	54.8	RS4803	10 11/32	262.7	8 25/32	223.0	7 7/16	188.9	PA30070
9 19/32	243.7	6 3/32	154.8	3 15/32	88.1	PA2913	10 11/32	262.7	19 9/32	489.7	12 7/8	327.0	PA2653
9 5/8	244.5	5 15/16	150.8	4 27/32	123.0	PA2586	10 3/8	263.5	3 3/16	81.0	2 17/32	64.3	PA3672
9 5/8	244.5	6 3/32	154.8	4 3/32	104.0	PA3972	10 3/8	263.5	5 1/16	128.6	2 15/32	62.7	PA4604-FN
9 5/8	244.5	8 1/4	209.6	4 9/16	115.9	PA30067	10 3/8	263.5	5 1/8	130.2	2 1/2	63.5	PA5410-FN
9 21/32	245.3	8 15/32	215.1	6 3/16	157.2	PA30026	10 3/8	263.5	5 5/16	134.9	3 1/16	77.8	PA3969
9 11/16	246.1	8 11/32	211.9	3 7/8	98.4	PA1700	10 3/8	263.5	5 11/16	144.5	2 1/2	63.5	PA5436
9 23/32	246.9	5 1/32	127.8	3 5/32	80.2	RS30077	10 3/8	263.5	5 3/4	146.1	2 1/2	63.5	PA4651
9 23/32	246.9	5 27/32	148.4	—	—	BA5372	10 3/8	263.5	5 7/8	149.2	2 15/32	62.7	PA4795
9 13/16	249.2	6 5/8	168.3	4 1/4	108.0	PA1664	10 3/8	263.5	5 31/32	151.6	4 27/32	123.0	PA2372
9 13/16	249.2	14 17/32	369.1	8 11/32	211.9	PA1816	10 3/8	263.5	6 3/32	154.8	3 15/32	88.1	PA2716
9 7/8	250.8	2 11/32	59.5	1 7/8	47.6	PA1809	10 3/8	263.5	6 3/32	154.8	4	101.6	RS10349
9 7/8	250.8	4 9/16	115.9	2 5/8	66.7	RS3990	10 3/8	263.5	6 1/2	165.1	2 1/4	57.2	PA4918
9 7/8	250.8	5 1/4	133.4	2 25/32	70.6	RS10347	10 3/8	263.5	7 5/16	185.7	3 1/2	88.9	PA1851
9 29/32	251.6	5	127.0	2	50.8	RS5387 KIT	10 3/8	263.5	9 13/16	249.2	3 9/16	90.5	PA2954-FN
9 15/16	252.4	2 15/16	74.6	2 13/32	61.1	PA2514	10 3/8	263.5	10 3/8	263.5	5 1/2	139.7	PA1789
9 15/16	252.4	4 3/32	104.0	2 1/2	63.5	PA3792	10 3/8	263.5	11 5/8	295.3	4 27/32	123.0	PA1750-FN
9 31/32	253.2	2 15/16	74.6	1 7/8	47.6	PA2678	10 3/8	263.5	12 1/32	305.6	7 11/16	195.3	PA1705-2
9 31/32	253.2	4 9/16	116.1	23/32	18.3	CV15007	10 3/8	263.5	12 3/8	314.3	4 15/16	125.4	PA1986-K
10	254.0	3 11/16	93.7	2 9/16	65.1	PA2711	10 3/8	263.5	13 3/4	349.3	6 3/4	171.5	PA1977-FN
10	254.0	5 3/4	146.1	4 7/8	123.8	RS30120	10 3/8	263.5	15 3/4	400.1	7 11/16	195.3	PA1980-FN
10	254.0	5 13/16	147.6	3 7/16	87.3	PA3416	10 3/8	263.5	15 25/32	400.8	7 7/16	188.9	PA2349-FN
10	254.0	7 3/8	187.3	3 1/2	88.9	PA30023	10 13/32	264.3	2 13/32	61.1	1 3/4	44.5	RS3705
10	254.0	8 5/32	207.2	4 3/16	106.4	RS3550	10 13/32	264.3	7 13/16	198.4	3 15/32	88.1	PA1753-FN
10	254.0	8 7/8	225.4	4 11/32	110.3	PA656	10 7/16	265.1	9 5/16	236.5	4 27/32	123.0	PA2412
10	254.0	9	228.6	4 11/32	110.3	PA656	10 7/16	265.1	12 1/16	306.4	7 13/16	198.4	PA1663
10	254.0	12	304.8	6 5/8	168.3	PA617	10 15/32	265.9	3 5/32	80.2	2 7/16	61.9	RS4962
10	254.0	12 1/32	305.6	9 1/4	235.0	PA1626	10 1/2	266.7	5 29/32	150.0	2 1/2	63.5	PA3785-FN
10	254.0	12 1/8	308.0	7 11/16	195.3	LL1626-2	10 1/2	266.7	6 7/16	163.5	4 1/16	103.2	PA1868
10	254.0	12 1/8	308.0	7 11/16	195.3	PA1626-2	10 1/2	266.7	7 15/16	201.6	3 9/16	90.5	PA3627
10	254.0	13 5/16	338.1	5 1/4	133.4	PA2812	10 1/2	266.7	7 15/16	201.6	5 3/8	136.5	PA2712
10	254.0	14 27/32	377.0	—	—	CA30132	10 1/2	266.7	8 1/4	209.6	5 3/4	146.1	PA2909
10 1/32	254.8	7 13/16	198.4	4 1/16	103.2	PA3681	10 1/2	266.7	8 3/8	212.7	4	101.6	PA1673
10 1/16	255.6	6 1/4	158.8	3 9/16	90.5	RS5747	10 1/2	266.7	8 13/16	223.8	4 5/32	105.6	PA1794-FN
10 1/16	255.6	6 11/16	169.9	2 5/8	66.7	PA3471	10 1/2	266.7	9 7/32	234.2	4 27/32	123.0	PA1646
10 1/16	255.6	12 3/4	323.9	6 5/16	160.3	PA2942	10 1/2	266.7	10 3/8	263.5	6 1/32	153.2	PA2465
10 1/16	255.6	15 1/4	387.4	6 9/16	166.7	PA2838	10 1/2	266.7	10 3/8	263.5	6 1/32	153.2	PA2656
10 3/32	256.4	3 21/32	92.9	2 3/8	60.3	PA2700	10 1/2	266.7	10 3/8	263.5	6 1/32	153.2	PA2843
10 3/32	256.4	4 5/32	105.6	2 29/32	73.8	PA2689	10 1/2	266.7	10 1/2	266.7	7 3/4	196.9	PA639
10 3/32	256.4	6 11/16	169.9	2 5/8	66.7	PA1674	10 1/2	266.7	11 5/8	295.3	4 27/32	123.0	LL1646-FN
10 3/32	256.4	6 25/32	172.2	2 27/32	72.2	PA3816	10 1/2	266.7	11 5/8	295.3	4 27/32	123.0	PA1646-FN
10 3/32	256.4	9 7/32	234.2	4 27/32	123.0	PA1840	10 1/2	266.7	11 21/32	296.1	8 31/32	227.8	PA1625
10 1/8	257.2	3 3/32	78.6	2 5/32	54.8	PA2489	10 1/2	266.7	13 7/8	352.4	7 7/16	188.9	LL2642
10 1/8	257.2	4 3/16	106.4	2	50.8	RS30209	10 1/2	266.7	13 7/8	352.4	7 7/16	188.9	PA2642
10 1/8	257.2	5 31/32	151.6	3 1/32	77.0	RS4445	10 17/32	267.5	4 3/4	120.7	2 1/4	57.2	PA5584
10 1/8	257.2	8 7/8	225.4	5	127.0	PA1788	10 9/16	268.3	5 29/32	150.0	2 17/32	64.3	PA3820-FN
10 1/8	257.2	9 11/32	237.3	6 1/4	158.8	PA2598	10 9/16	268.3	8	203.2	4	101.6	PA30042
10 5/32	258.0	4 15/32	113.5	2 21/32	67.5	PA4802	10 9/16	268.3	8 1/8	206.4	6 1/8	155.6	RS4577
10 5/32	258.0	9 5/8	244.5	5	127.0	PA2566	10 11/16	271.5	5 11/32	135.7	2 7/32	56.4	PA2496
10 1/4	260.4	2 5/8	66.7	1 3/4	44.5	PA30163	10 23/32	272.3	4 5/32	105.6	3	76.2	RS5325
10 1/4	260.4	2 29/32	73.8	2 7/32	56.4	PA4881	10 23/32	272.3	5 27/32	148.4	—	—	BA5377
10 1/4	260.4	3 3/8	85.7	2 1/4	57.2	PA2413	10 3/4	273.1	4 1/8	104.8	2 7/16	61.9	RS5449
10 1/4	260.4	4 3/32	104.0	2 15/32	62.7	PA4766	10 3/4	273.1	4 1/2	114.3	2 1/4	57.2	PA1683
10 1/4	260.4	6 5/16	160.3	3 7/32	81.8	PA3650	10 3/4	273.1	4 19/32	116.7	3 11/32	84.9	PA2896



**WARNING:** These products can expose you to chemicals, including Diisononyl Phthalate, Carbon black extracts, Nickel, 1,3 Butadiene, Ethylene Oxide, Epichlorohydrin, which are known to the State of California to cause cancer, and Bisphenol-A, Ethylene Glycol, Ethylene Oxide, 1,3 Butadiene, Epichlorohydrin, which are known to the State of California to cause birth defects or other reproductive harm.

**ROUND AIR FILTERS BY LENGTH**

LENGTH Inches	LENGTH (mm)	O.D. Inches	O.D. (mm)	I.D. Inches	I.D. (mm)	BALDWIN NUMBER	LENGTH Inches	LENGTH (mm)	O.D. Inches	O.D. (mm)	I.D. Inches	I.D. (mm)	BALDWIN NUMBER
10 3/4.....	273.1	4 7/8.....	123.8	2 1/4.....	57.2	PA2331	11 15/32.....	291.3	4 7/16.....	112.7	3.....	76.2	PA3492
10 3/4.....	273.1	5 1/8.....	130.2	2 1/2.....	63.5	PA4645-FN	11 15/32.....	291.3	6 3/4.....	171.5	3 11/32.....	84.9	PA5407
10 3/4.....	273.1	6 3/32.....	154.8	3 25/32.....	96.0	PA2710	11 15/32.....	291.3	10 7/32.....	259.6	7 7/8.....	200.0	PA1607
10 3/4.....	273.1	19 9/32.....	489.7	12 7/16.....	315.9	PA5551	11 1/2.....	292.1	4 3/4.....	120.7	3 5/8.....	92.1	PA2736
10 25/32.....	273.8	4 1/4.....	108.0	2 3/4.....	69.9	RS3883	11 1/2.....	292.1	5 5/32.....	131.0	4 1/32.....	102.4	PA2646
10 25/32.....	273.8	5 9/16.....	141.3	4 7/32.....	107.2	PA2665	11 1/2.....	292.1	5 3/16.....	131.8	3 7/32.....	81.8	PA2662
10 13/16.....	274.6	4 1/8.....	104.8	2 5/16.....	58.7	RS3704	11 1/2.....	292.1	5 3/4.....	146.1	3 1/16.....	77.8	PA2513
10 13/16.....	274.6	4 1/8.....	104.8	2 5/16.....	58.7	RS3716	11 1/2.....	292.1	6 11/32.....	161.1	3 5/16.....	84.1	PA3801-FN
10 13/16.....	274.6	5 1/4.....	133.4	2 1/4.....	57.2	PA1945	11 1/2.....	292.1	6 3/8.....	161.9	2 5/8.....	66.7	LL1667-FN
10 13/16.....	274.6	8 9/16.....	217.5	2 1/2.....	63.5	PA2829	11 1/2.....	292.1	6 3/8.....	161.9	2 5/8.....	66.7	PA1667-FN
10 13/16.....	274.6	8 9/16.....	217.5	2 31/32.....	75.4	PA2805	11 1/2.....	292.1	6 3/8.....	161.9	2 5/8.....	66.7	PA3791-FN
10 7/8.....	276.2	6 3/8.....	161.9	2 27/32.....	72.2	PA2383	11 1/2.....	292.1	7.....	177.8	2 27/32.....	72.2	PA3979
10 7/8.....	276.2	6 7/8.....	174.6	5 5/16.....	134.9	RS4623	11 1/2.....	292.1	7 1/8.....	181.0	2 5/8.....	66.7	PA3875-FN
10 29/32.....	277.0	4 3/32.....	104.0	3 17/32.....	89.7	PA5468	11 1/2.....	292.1	7 13/16.....	198.4	3 15/32.....	88.1	PA2684-FN
10 29/32.....	277.0	6 1/4.....	158.8	2 3/4.....	69.9	RS5285	11 1/2.....	292.1	7 13/16.....	198.4	3 15/32.....	88.1	PA3466-FN
10 15/16.....	277.8	5 3/32.....	129.4	2 11/16.....	68.3	RS5742	11 1/2.....	292.1	7 29/32.....	200.8	4 3/32.....	104.0	PA3894
10 15/16.....	277.8	8 1/32.....	204.0	5 5/16.....	134.9	PA3956	11 1/2.....	292.1	8 9/32.....	210.3	4 7/16.....	112.7	PA1848
10 15/16.....	277.8	9 15/16.....	252.4	5 1/4.....	133.4	PA3479	11 1/2.....	292.1	8 3/8.....	212.7	3 15/32.....	88.1	PA2968-FN
11.....	279.4	3 9/16.....	90.5	2 1/32.....	51.6	PA1644	11 1/2.....	292.1	8 3/8.....	212.7	3 15/32.....	88.1	PA3924-FN
11.....	279.4	4 3/16.....	106.4	2 19/32.....	65.9	PA3985	11 1/2.....	292.1	8 5/8.....	219.1	7 1/16.....	179.4	PA2735
11.....	279.4	4 17/32.....	115.1	2 1/4.....	57.2	PA2636	11 1/2.....	292.1	9 7/32.....	234.2	4 27/32.....	123.0	PA1932
11.....	279.4	8 1/4.....	209.6	5 3/4.....	146.1	LL1614	11 1/2.....	292.1	9 7/32.....	234.2	4 27/32.....	123.0	PA3645
11.....	279.4	8 1/4.....	209.6	5 3/4.....	146.1	PA1614	11 23/32.....	292.7	6 13/16.....	173.0	2 27/32.....	72.2	PA5338-FN
11 1/32.....	280.2	5 3/16.....	131.8	2 17/32.....	64.3	PA4608	11 17/32.....	292.9	5.....	127.0	2 9/16.....	65.1	PA2792
11 1/32.....	280.2	5 13/32.....	137.3	3 3/16.....	81.0	RS3940	11 17/32.....	292.9	6 7/32.....	158.0	2 17/32.....	64.3	PA2905
11 1/32.....	280.2	6 1/2.....	165.1	3 9/16.....	90.5	RS3707	11 17/32.....	292.9	7 13/16.....	198.4	3 5/16.....	84.1	PA4674-FN
11 1/32.....	280.2	7 9/32.....	184.9	3 9/16.....	90.5	RS3735	11 17/32.....	292.9	12 13/16.....	325.4	8 11/32.....	211.9	PA645
11 1/32.....	280.2	8 5/16.....	211.1	3 7/16.....	87.3	PA5406-FN	11 9/16.....	293.7	2 15/16.....	74.6	1 7/8.....	47.6	PA2728
11 1/32.....	280.2	8 13/32.....	213.5	3 7/16.....	87.3	PA3790	11 9/16.....	293.7	4 1/8.....	104.8	3.....	76.2	PA2652
11 1/16.....	281.0	3 25/32.....	96.0	2 7/8.....	73.0	PA2321	11 9/16.....	293.7	6 7/16.....	163.5	3 5/8.....	92.1	PA5423-FN
11 1/16.....	281.0	4 1/8.....	104.8	2 29/32.....	73.8	PA4919	11 9/16.....	293.7	8 3/8.....	212.7	3 7/16.....	87.3	PA2970
11 1/16.....	281.0	5 5/32.....	131.0	3 15/16.....	100.0	PA30244	11 9/16.....	293.7	13 7/16.....	341.3	7 29/32.....	200.8	RS4576
11 1/16.....	281.0	6 3/8.....	161.9	2 5/8.....	66.7	PA3435-FN	11 19/32.....	294.5	3 7/8.....	98.4	3 3/16.....	81.0	PA4603
11 1/16.....	281.0	8 5/16.....	211.1	3 7/16.....	87.3	PA3853-FN	11 19/32.....	294.5	6 1/2.....	165.1	3 9/16.....	90.5	RS4597
11 3/32.....	281.8	4 5/32.....	105.6	2 29/32.....	73.8	PA2570	11 19/32.....	294.5	9 9/16.....	242.9	5 1/8.....	130.2	PA1701
11 3/32.....	281.8	7 11/32.....	186.5	3 19/32.....	91.3	RS3706	11 19/32.....	294.5	9 9/16.....	242.9	5 1/8.....	130.2	PA1701 ELE
11 1/8.....	282.6	3 21/32.....	92.9	2 7/16.....	61.9	PA2381	11 19/32.....	294.5	9 9/16.....	242.9	5 1/8.....	130.2	PA2627
11 3/16.....	284.2	2 3/4.....	69.9	2 1/16.....	52.4	PA3687	11 5/8.....	295.3	8 5/32.....	207.2	4 3/16.....	106.4	RS3882
11 7/32.....	285.0	4 3/16.....	106.4	2 15/16.....	74.6	PA4827	11 5/8.....	295.3	8 5/32.....	207.2	4 1/4.....	108.0	RS3882XP
11 7/32.....	285.0	9 1/8.....	231.8	4 23/32.....	119.9	RS4806	11 5/8.....	295.3	8 15/16.....	227.0	4 19/32.....	116.7	PA2891
11 1/4.....	285.8	2 15/16.....	74.6	2 15/32.....	62.7	PA30033	11 21/32.....	296.1	4 1/8.....	104.8	2 5/16.....	58.7	RS30147
11 1/4.....	285.8	4 9/16.....	115.9	3 7/16.....	87.3	PA1967	11 21/32.....	296.1	6 15/32.....	164.3	3 5/8.....	92.1	RS5761
11 1/4.....	285.8	4 3/4.....	120.7	2 1/8.....	54.0	PA3821	11 11/16.....	296.9	10 5/32.....	258.0	4 3/32.....	104.0	PA2865
11 1/4.....	285.8	5 1/4.....	133.4	4 1/8.....	104.8	PA1982	11 11/16.....	296.9	12 31/32.....	329.4	6 13/16.....	173.0	RS4622
11 1/4.....	285.8	6 3/32.....	154.8	3 15/32.....	88.1	PA1710	11 23/32.....	297.7	7 5/32.....	181.8	5 27/32.....	148.4	RS5355
11 1/4.....	285.8	6 3/8.....	161.9	2 5/8.....	66.7	PA2488-FN	11 23/32.....	297.7	9 9/16.....	242.9	5 3/16.....	131.8	PA3597
11 9/32.....	286.5	6 11/32.....	161.1	3 5/16.....	84.1	PA3671-FN	11 3/4.....	298.5	6 3/8.....	161.9	3 23/32.....	94.5	RS30106
11 9/32.....	286.5	6 3/8.....	161.9	2 5/8.....	66.7	PA3761-FN	11 3/4.....	298.5	8 5/16.....	211.1	6 1/32.....	153.2	RS3513
11 9/32.....	286.5	6 3/8.....	161.9	2 3/4.....	69.9	PA2657-FN	11 25/32.....	299.2	4 23/32.....	119.9	3 3/16.....	81.0	RS3503
11 5/16.....	287.3	5 1/4.....	133.4	4 1/8.....	104.8	PA2794	11 25/32.....	299.2	5 1/4.....	133.4	4 1/8.....	104.8	PA3417
11 5/16.....	287.3	6 3/8.....	161.9	2 5/8.....	66.7	PA3667-FN	11 13/16.....	300.0	10 9/16.....	268.3	4 1/4.....	108.0	PA2806
11 5/16.....	287.3	12 7/8.....	227.0	—.....	—.....	CA30079	11 27/32.....	300.8	4 1/8.....	104.8	2 5/16.....	58.7	RS3954
11 5/16.....	287.3	9 9/32.....	235.7	4 11/16.....	119.1	PA3415	11 27/32.....	300.8	6 1/2.....	165.1	3 9/16.....	90.5	RS5305
11 11/32.....	288.0	3 3/4.....	95.2	8 1/2.....	53.6	RS30221	11 27/32.....	300.8	7 1/16.....	179.4	2 27/32.....	72.2	PA3879-FN
11 11/32.....	288.1	6 5/8.....	168.3	1 13/32.....	35.7	PA2804	11 7/8.....	301.6	3 3/4.....	95.3	3 3/4.....	95.3	PA5572
11 11/32.....	288.1	6 11/16.....	169.9	3 3/4.....	95.3	PA2754	11 7/8.....	301.6	5 1/4.....	133.4	3 1/4.....	82.6	PA30032
11 11/32.....	288.1	9 5/8.....	244.5	4 7/8.....	123.8	RS5424	11 7/8.....	301.6	6 3/8.....	161.9	2 27/32.....	72.2	PA2391
11 3/8.....	288.9	5 15/16.....	150.8	4 27/32.....	123.0	PA2687	11 7/8.....	301.6	9.....	228.6	4 7/8.....	123.8	RS5536
11 3/8.....	288.9	6 3/8.....	161.9	3 1/4.....	82.6	PA2846-FN	11 7/8.....	301.6	9 31/32.....	253.2	3 13/16.....	96.8	PA2961-FN
11 3/8.....	288.9	6 3/8.....	161.9	3 5/16.....	84.1	PA4583-FN	11 7/8.....	301.6	10 1/2.....	266.7	4.....	101.6	PA2820
11 3/8.....	288.9	9 1/32.....	229.4	4 5/8.....	117.5	RS4807	11 15/16.....	303.2	6 1/8.....	155.6	3 3/8.....	85.7	PA5518
11 3/8.....	288.9	9 9/32.....	235.7	5 5/32.....	131.0	RS5434	11 15/16.....	303.2	6 5/8.....	168.3	3 13/16.....	96.8	PA4472
11 3/8.....	288.9	11 1/2.....	292.1	4 13/16.....	122.2	RS5458	11 15/16.....	303.2	9 7/32.....	234.2	5 5/16.....	134.9	PA3874
11 13/32.....	289.7	7 1/2.....	190.5	4 1/8.....	104.8	PA2948	11 31/32.....	304.0	5 3/16.....	84.1	2 15/32.....	62.7	RS3703
11 7/16.....	290.5	2 13/32.....	61.1	1 3/4.....	44.5	RS3547	11 31/32.....	304.0	5 1/4.....	133.4	4 1/8.....	104.8	PA30211
11 7/16.....	290.5	3 13/16.....	96.8	2 3/8.....	60.3	PA4594	12.....	304.8	4 5/32.....	105.6	2 5/16.....	58.7	PA4692
11 7/16.....	290.5	7 27/32.....	199.2	2 5/8.....	66.7	PA3608-FN	12.....	304.8	5 23/32.....	145.3	3 7/16.....	87.3	PA3657



**WARNING:** These products can expose you to chemicals, including Diisononyl Phthalate, Carbon black extracts, Nickel, 1,3 Butadiene, Ethylene Oxide, Epichlorohydrin, which are known to the State of California to cause cancer, and Bisphenol-A, Ethylene Glycol, Ethylene Oxide, 1,3 Butadiene, Epichlorohydrin, which are known to the State of California to cause birth defects or other reproductive harm.



# ROUND AIR FILTERS BY LENGTH

LENGTH Inches	LENGTH (mm)	O.D. Inches	O.D. (mm)	I.D. Inches	I.D. (mm)	BALDWIN NUMBER	LENGTH Inches	LENGTH (mm)	O.D. Inches	O.D. (mm)	I.D. Inches	I.D. (mm)	BALDWIN NUMBER
12	304.8	5 29/32	150.0	2 25/32	70.6	PA2888	12 3/8	314.3	8 13/32	213.5	5 25/32	146.8	PA2897
12	304.8	6 25/32	172.2	2 3/4	69.9	PA2976-FN	12 3/8	314.3	8 1/2	215.9	3	76.2	PA2815
12	304.8	7 1/8	181.0	2 27/32	72.2	PA3447	12 3/8	314.3	8 1/2	215.9	4	101.6	PA2818
12	304.8	7 5/16	185.7	3 5/8	92.1	PA1647	12 3/8	314.3	8 1/2	215.9	4	101.6	PA3867
12	304.8	8 1/32	204.0	6 1/16	154.0	PA2938	12 3/8	314.3	8 17/32	216.7	3	76.2	PA3868
12	304.8	8 3/4	222.3	7 1/2	190.5	PA30076	12 3/8	314.3	9 7/32	234.2	4 27/32	123.0	PA3474
12	304.8	8 29/32	226.2	4 21/32	118.3	RS5438	12 3/8	314.3	10	254.0	4 27/32	123.0	PA3902
12	304.8	9 1/8	231.8	6 7/8	174.6	PA1795	12 3/8	314.3	10 3/8	263.5	6 1/32	153.2	PA2520
12	304.8	9 15/16	252.4	5 1/2	139.7	PA1703	12 13/32	315.1	6 7/8	174.6	3 1/2	88.9	PA2666
12	304.8	10 7/32	259.6	5 1/2	139.7	PA618	12 13/32	315.1	6 7/8	174.6	3 1/2	88.9	PA4644
12	304.8	10 7/32	259.6	6 1/16	154.0	PA618-S	12 7/16	315.9	5 1/32	127.8	3 5/32	80.2	RS4595
12	304.8	10 7/32	259.6	7 7/8	200.0	PA616	12 7/16	315.9	13 3/4	349.3	5 11/16	144.5	PA2417-FN
12	304.8	10 3/8	263.5	7 13/16	198.4	PA1913	12 15/32	316.7	6 3/32	154.8	3 15/32	88.1	PA1882
12	304.8	10 13/32	264.3	6 15/16	176.2	PA2555	12 15/32	316.7	6 3/8	161.9	3 1/4	82.6	PA2380-FN
12	304.8	11 3/8	288.9	6 31/32	177.0	PA2647	12 1/2	317.5	5 5/32	131.3	3 19/32	90.0	RS30220
12	304.8	12 3/32	307.2	7 11/16	195.3	PA3598	12 1/2	317.5	5 1/4	133.4	3 1/4	82.6	PA3778
12 1/32	305.6	3 5/16	84.1	2 15/32	62.7	RS3747	12 1/2	317.5	5 9/16	141.3	4 1/2	114.3	PA2607
12 1/32	305.6	3 21/32	92.9	2 3/8	60.3	PA2791	12 1/2	317.5	5 15/16	150.8	4 27/32	123.0	PA1906
12 1/32	305.6	5 1/4	133.4	3 23/32	94.5	RS3501	12 1/2	317.5	7 5/8	193.7	6 1/16	154.0	PA2738
12 1/32	305.6	7 5/16	185.7	3 5/8	92.1	PA2719	12 1/2	317.5	7 13/16	198.4	3 7/8	98.4	PA3607-FN
12 1/16	306.4	2 3/4	69.9	2 11/16	68.3	RS3943	12 1/2	317.5	8 21/32	219.9	3 15/32	88.1	PA4640-FN
12 1/16	306.4	3 25/32	96.0	2 7/8	73.0	PA2670	12 1/2	317.5	9 5/32	232.6	4 5/8	117.5	RS3502
12 1/16	306.4	3 7/8	98.4	2 1/2	63.5	PA2512	12 1/2	317.5	9 7/32	234.2	4 27/32	123.0	PA2421
12 1/16	306.4	6 1/8	155.6	3 9/16	90.5	RS5741	12 1/2	317.5	9 1/4	235.0	4 27/32	123.0	LL1615
12 1/16	306.4	7 27/32	199.2	3 15/32	88.1	PA3848-FN	12 1/2	317.5	9 1/4	235.0	4 27/32	123.0	PA1615
12 3/32	307.2	3 21/32	92.9	2 7/8	73.0	RS4995	12 1/2	317.5	9 1/4	235.0	4 27/32	123.0	PA1615XP
12 3/32	307.2	5 3/4	146.1	4 7/32	107.2	PA22607	12 1/2	317.5	9 29/32	251.6	5 3/8	136.5	PA2304-FN
12 3/32	307.2	6 27/32	173.8	2 13/16	71.4	PA4870-FN	12 1/2	317.5	10 3/8	263.5	6 1/32	153.2	PA2371
12 3/32	307.2	7 25/32	197.6	4 11/32	110.3	PA5467	12 1/2	317.5	12 1/32	305.6	7 11/16	195.3	PA1877
12 3/32	307.2	11 7/8	301.6	7 1/4	184.2	PA2549	12 1/2	317.5	13 3/4	349.3	6 23/32	170.7	LL1637-FN
12 1/8	308.0	7 13/16	198.4	3 15/32	88.1	PA3989-FN	12 1/2	317.5	13 3/4	349.3	6 23/32	170.7	PA1637-FN
12 1/8	308.0	13 13/16	350.8	9 1/2	241.3	PA1629-S	12 1/2	317.5	15 3/4	400.1	7 7/16	188.9	PA2389-FN
12 5/32	308.8	8	203.2	6 1/8	155.6	PA3966	12 17/32	318.3	4 31/32	126.2	2 31/32	75.4	RS3942
12 3/16	309.6	7 13/16	198.4	4 5/32	105.6	PA5575	12 17/32	318.3	6 1/2	165.1	3 9/16	90.5	RS3746
12 3/16	309.6	9 5/8	244.5	5 3/8	136.5	PA1810	12 17/32	318.3	6 1/2	165.1	3 9/16	90.5	RS4994
12 7/32	310.4	3 5/16	84.1	2 15/32	62.7	RS5544	12 17/32	318.3	16 17/32	419.9	10	254.0	PA3844
12 7/32	310.4	11 7/32	285.0	4 21/32	118.2	PA3918	12 9/16	319.1	3 5/16	84.1	2 15/32	62.7	RS3543
12 1/4	311.2	4 1/8	104.8	3 1/16	77.8	PA1899	12 9/16	319.1	3 15/32	88.1	2 1/2	63.5	RS30242
12 1/4	311.2	4 9/16	115.9	3 17/32	89.7	PA3851	12 9/16	319.1	5 7/8	149.2	2 31/32	75.4	PA2727
12 1/4	311.2	5 1/8	130.2	3 9/16	90.5	PA4890	12 19/32	319.9	5 13/32	137.3	3 3/16	81.0	RS5543
12 1/4	311.2	5 1/4	133.4	4 1/8	104.8	PA2402	12 5/8	320.7	4 1/2	114.3	2 1/4	57.2	PA1684
12 1/4	311.2	5 29/32	150.0	3 31/32	100.8	PA3903	12 5/8	320.7	5 23/32	145.3	3	76.2	RS4680
12 1/4	311.2	7 15/16	201.6	3 17/32	89.7	PA5281	12 5/8	320.7	5 7/8	149.2	4 1/8	104.8	RS3505
12 1/4	311.2	9 9/32	235.7	3 19/32	91.3	PA3796	12 5/8	320.7	7	177.8	4 13/32	111.9	PA1849
12 1/4	311.2	10 1/16	255.6	3 9/16	90.5	PA1749-FN	12 5/8	320.7	7 25/32	197.6	6 15/16	176.2	PA2773
12 1/4	311.2	10 7/8	276.2	5 3/4	146.1	RS30121	12 5/8	320.7	7 13/16	198.4	6 17/32	165.9	PA2775
12 5/16	312.7	3 5/16	84.1	2 27/32	72.2	PA3685	12 5/8	320.7	8 3/8	212.7	4	101.6	PA2553
12 5/16	312.7	4 5/8	117.5	3 1/16	77.8	RS10351	12 5/8	320.7	9 1/8	231.8	5 1/4	133.4	PA2645
12 5/16	312.7	5 1/32	127.8	3 5/32	80.2	RS3549	12 21/32	321.5	13 13/16	350.8	9 1/2	241.3	PA4605
12 5/16	312.7	5 1/32	127.8	3 5/32	80.2	RS3988	12 21/32	321.5	6 7/8	174.6	3 31/32	100.8	RS30212
12 5/16	312.7	11 1/16	281.0	7 11/32	186.5	RS5693	12 11/16	322.3	12 3/32	307.2	7 13/16	198.4	RS5354
12 5/16	312.7	12 9/16	319.1	5	127.0	PA2831	12 11/16	322.3	15 7/8	403.2	8 23/32	221.5	RS30065
12 3/8	314.2	5 5/32	131.1	3 9/32	83.3	PA4101	12 23/32	323.1	5 1/4	133.4	3 23/32	94.5	RS3737
12 3/8	314.3	5 11/16	144.5	4 19/32	116.7	PA2545	12 3/4	323.9	7 3/16	182.6	5 27/32	148.4	RS30226
12 3/8	314.3	6 3/32	154.8	4 3/32	104.0	PA3636	12 3/4	323.9	8 1/2	215.9	5 3/8	136.5	PA2793
12 3/8	314.3	6 1/4	158.8	4 5/8	117.5	PA2737	12 3/4	323.9	8 21/32	219.9	4 5/8	117.5	PA4849
12 3/8	314.3	6 3/8	161.9	5 9/32	134.1	PA3915	12 3/4	323.9	9 9/32	235.7	5 5/32	131.0	RS2863
12 3/8	314.3	6 17/32	165.9	4 1/2	114.3	RS10021	12 3/4	323.9	9 9/32	235.7	5 5/32	131.0	RS2863XP
12 3/8	314.3	6 27/32	173.8	3 15/32	88.1	PA3698	12 3/4	323.9	9 9/32	235.7	5 5/32	131.0	RS30222XP
12 3/8	314.3	6 7/8	174.6	3 1/2	88.9	PA1926	12 25/32	324.6	3 7/8	98.4	2 3/8	60.3	PA30208
12 3/8	314.3	6 7/8	174.6	4 3/16	106.4	PA2498	12 25/32	324.6	3 7/8	98.4	3 5/8	92.1	PA5635
12 3/8	314.3	7 1/16	179.4	3 15/16	100.0	PA4593	12 25/32	324.6	4 23/32	119.9	3 1/4	82.6	RS5443
12 3/8	314.3	7 5/8	193.7	3 15/32	88.1	PA3670	12 13/16	325.4	3 17/32	89.7	2 3/4	69.9	PA3683
12 3/8	314.3	7 5/8	193.7	6 1/16	154.0	PA2415	12 27/32	326.2	3 5/32	80.2	21/32	16.7	PA3686
12 3/8	314.3	7 13/16	198.4	3 15/32	88.1	LL1681-FN	12 7/8	327.0	5 9/16	141.3	2 13/16	71.4	PA5583
12 3/8	314.3	7 13/16	198.4	3 15/32	88.1	PA1681-FN	12 29/32	327.0	6 1/8	155.6	3 3/8	85.7	PA5571
12 3/8	314.3	7 13/16	198.4	3 15/32	88.1	PA2877-FN	12 7/8	327.0	6 7/8	174.6	4 1/4	108.0	PA1900
12 3/8	314.3	7 31/32	202.4	5 3/8	136.5	PA2351	12 7/8	327.0	7 7/8	200.0	4 3/32	104.0	PA4602



**WARNING:** These products can expose you to chemicals, including Diisononyl Phthalate, Carbon black extracts, Nickel, 1,3 Butadiene, Ethylene Oxide, Epichlorohydrin, which are known to the State of California to cause cancer, and Bisphenol-A, Ethylene Glycol, Ethylene Oxide, 1,3 Butadiene, Epichlorohydrin, which are known to the State of California to cause birth defects or other reproductive harm.

**ROUND AIR FILTERS BY LENGTH**

LENGTH Inches	LENGTH (mm)	O.D. Inches	O.D. (mm)	I.D. Inches	I.D. (mm)	BALDWIN NUMBER	LENGTH Inches	LENGTH (mm)	O.D. Inches	O.D. (mm)	I.D. Inches	I.D. (mm)	BALDWIN NUMBER
12 7/8.....	327.0	8 1/2.....	215.9	5 3/8.....	136.5	PA2880	13 7/16.....	341.3	3 5/8.....	92.1	2 27/32.....	72.2	PA2837
12 29/32.....	327.8	5 9/16.....	141.3	4 7/16.....	112.7	PA4625	13 7/16.....	341.3	4 3/32.....	104.0	2 15/32.....	62.7	PA2303
12 29/32.....	327.8	6 1/8.....	155.6	3 9/32.....	83.3	PA5570	13 7/16.....	341.3	6 1/2.....	165.1	3 9/16.....	90.5	RS4678
12 15/16.....	328.6	4 3/32.....	104.0	3 1/8.....	79.4	PA2342	13 7/16.....	341.3	6 7/8.....	174.6	3 1/2.....	88.9	PA2527
12 15/16.....	328.6	7 3/4.....	196.9	4.....	101.6	PA3483	13 7/16.....	341.3	9 5/32.....	232.6	4 5/8.....	117.5	RS5442
12 15/16.....	328.6	8 1/4.....	209.6	4 3/16.....	106.4	PA2651	13 7/16.....	341.3	10 1/32.....	254.8	5 5/16.....	134.9	PA2859-FN
12 31/32.....	329.4	5 13/32.....	137.3	3 3/16.....	81.0	RS3542	13 15/32.....	342.1	9 7/32.....	234.2	4 27/32.....	123.0	PA2950
12 31/32.....	329.4	5 13/32.....	137.3	3 3/16.....	81.0	RS4578	13 15/32.....	342.1	10 1/4.....	260.4	6.....	152.4	PA1819
12 31/32.....	329.4	8 1/8.....	206.4	6.....	152.4	RS5456	13 1/2.....	342.9	3 21/32.....	92.9	2 7/8.....	73.0	RS3545
							13 1/2.....	342.9	5 15/16.....	150.8	4 27/32.....	123.0	PA3774
13.....	330.2	4 1/2.....	114.3	3 3/32.....	78.6	PA5786	13 1/2.....	342.9	7 3/32.....	180.2	3 7/8.....	98.4	PA5519
13.....	330.2	5 3/4.....	146.1	3 7/16.....	87.3	PA1911	13 1/2.....	342.9	7 13/16.....	198.4	3 15/32.....	88.1	PA2320-FN
13.....	330.2	5 15/16.....	150.8	3 1/4.....	82.6	PA5634	13 1/2.....	342.9	7 13/16.....	198.4	3 15/32.....	88.1	PA2669-FN
13.....	330.2	7 1/2.....	190.5	5 1/4.....	133.4	PA2871	13 1/2.....	342.9	8 3/8.....	212.7	3 15/32.....	88.1	PA5388
13.....	330.2	12 1/32.....	305.6	7 11/16.....	195.3	LL1642-2	13 1/2.....	342.9	8 27/32.....	224.6	5 13/16.....	147.6	PA2504
13.....	330.2	12 1/32.....	305.6	7 11/16.....	195.3	PA1642-2	13 1/2.....	342.9	9 1/8.....	231.8	5 13/16.....	147.6	LL2779
13 1/16.....	331.8	3 25/32.....	96.0	2 7/8.....	73.0	PA2644	13 1/2.....	342.9	9 1/8.....	231.8	5 13/16.....	147.6	PA2779
13 1/16.....	331.8	9 21/32.....	245.3	5 7/16.....	138.1	RS4968	13 1/2.....	342.9	9 7/32.....	234.2	4 27/32.....	123.0	LL1884
13 1/16.....	331.8	9 3/4.....	247.7	5 5/8.....	142.9	PA2664	13 1/2.....	342.9	9 7/32.....	234.2	4 27/32.....	123.0	PA1884
13 1/16.....	331.8	11 27/32.....	300.8	6 9/16.....	166.7	RS5483	13 1/2.....	342.9	9 7/32.....	234.2	4 27/32.....	123.0	PA1884XP
13 3/32.....	332.6	4 27/32.....	123.0	3 5/8.....	92.1	PA2634	13 1/2.....	342.9	9 9/32.....	235.7	4 11/16.....	119.1	PA3448
13 3/32.....	332.6	5 3/32.....	129.4	2 7/8.....	73.0	RS5746	13 1/2.....	342.9	9 9/32.....	235.7	5 5/32.....	131.0	RS3736
13 3/32.....	332.6	6 15/32.....	164.3	3 11/32.....	84.9	PA2423	13 1/2.....	342.9	10 1/4.....	260.4	6.....	152.4	PA2359
13 3/32.....	332.6	9 1/16.....	230.2	4 5/8.....	117.5	PA1675	13 1/2.....	342.9	10 3/8.....	263.5	5 11/32.....	135.7	PA2761
13 3/32.....	332.6	9 1/16.....	230.2	4 5/8.....	117.5	PA2310	13 1/2.....	342.9	11 1/8.....	282.6	6 23/32.....	170.7	LL1634
13 1/8.....	333.4	3 21/32.....	92.9	2 7/8.....	73.0	RS4679	13 1/2.....	342.9	11 1/8.....	282.6	6 23/32.....	170.7	PA1634
13 1/8.....	333.4	6 29/32.....	175.4	2 13/16.....	71.4	PA3793	13 1/2.....	342.9	11 1/8.....	282.6	6 23/32.....	170.7	PA1634XP
13 5/32.....	334.2	5 13/32.....	137.3	3 3/16.....	81.0	RS4131	13 1/2.....	342.9	11 15/32.....	291.3	7 1/8.....	181.0	RS3508
13 3/16.....	335.0	3 7/8.....	98.4	3 3/16.....	81.0	PA2370	13 1/2.....	342.9	11 15/32.....	291.3	7 1/8.....	181.0	RS3508XP
13 3/16.....	335.0	6 3/16.....	157.2	3 5/32.....	80.2	PA5582	13 1/2.....	342.9	11 1/2.....	292.1	8 1/16.....	204.8	LL2358
13 3/16.....	335.0	6 3/16.....	157.2	3 5/32.....	80.2	PA30206	13 1/2.....	342.9	11 1/2.....	292.1	8 1/16.....	204.8	PA2358
13 3/16.....	335.0	6 3/16.....	157.2	3 5/32.....	80.2	PA30207	13 1/2.....	342.9	11 5/8.....	295.3	4 27/32.....	123.0	PA1941-FN
13 3/16.....	335.0	7.....	177.8	2 13/16.....	71.4	PA3759	13 1/2.....	342.9	12 1/32.....	305.6	7 11/16.....	195.3	PA2414
13 3/16.....	335.0	7 1/4.....	184.2	5 9/32.....	134.1	RS3509	13 1/2.....	342.9	13 13/16.....	350.8	6 23/32.....	170.7	PA2870-FN
13 3/16.....	335.0	8 1/8.....	206.4	3 3/4.....	95.3	PA3491	13 1/2.....	342.9	13 7/8.....	352.4	7 7/16.....	188.9	PA3486
13 7/32.....	335.8	4 1/8.....	104.8	3 3/8.....	85.7	RS30213	13 1/2.....	342.9	13 7/8.....	352.4	9 1/2.....	241.3	PA4660
13 1/4.....	336.6	3 3/8.....	85.7	2 1/4.....	57.2	PA2305	13 17/32.....	343.7	6 3/32.....	154.8	3 5/32.....	80.2	PA3961
13 1/4.....	336.6	4 1/4.....	108.0	3 9/16.....	90.5	RS30169	13 17/32.....	343.7	16 1/8.....	409.6	7 7/16.....	188.9	PA2517
13 1/4.....	336.6	4 1/2.....	114.3	2.....	50.8	PA2602	13 9/16.....	344.5	4 17/32.....	115.1	3 7/16.....	87.3	PA2308
13 1/4.....	336.6	5 7/8.....	149.2	2 13/16.....	71.4	PA2767	13 9/16.....	344.5	10.....	254.0	5 11/16.....	144.5	PA2606
13 1/4.....	336.6	10 1/16.....	255.6	5 3/8.....	136.5	PA1989-FN	13 19/32.....	345.3	3 3/32.....	78.6	2 15/16.....	74.6	RS3921
13 1/4.....	336.6	11 29/32.....	302.4	7 17/32.....	191.3	PA3766	13 19/32.....	345.3	4 27/32.....	123.0	3 5/8.....	92.1	PA4628
13 9/32.....	337.3	4 5/8.....	117.5	3 1/32.....	77.0	PA4961	13 19/32.....	345.3	5 1/16.....	128.6	3 13/16.....	96.8	PA2668
13 9/32.....	337.3	7 13/16.....	198.4	3 15/32.....	88.1	PA3779-FN	13 19/32.....	345.3	11.....	279.4	4 27/32.....	123.0	PA3864
13 9/32.....	337.3	9 3/32.....	231.0	5 7/32.....	132.6	PA4145	13 19/32.....	345.3	11 13/32.....	289.7	4 29/32.....	124.6	PA4977-FN
13 5/16.....	338.1	6 3/32.....	154.8	3 15/32.....	88.1	PA2392	13 5/8.....	346.1	9 13/16.....	249.2	3 9/16.....	90.5	PA30233-FN
13 5/16.....	338.1	20 15/32.....	519.9	8 23/32.....	221.5	RS30065 KIT	13 21/32.....	346.9	3 5/16.....	84.1	2 1/4.....	57.2	PA2323
13 11/32.....	338.9	12 19/32.....	319.9	6.....	152.4	PA5762	13 21/32.....	346.9	6 1/8.....	155.6	2 1/2.....	63.5	RS5591XP
13 3/8.....	339.7	2 15/16.....	74.6	2 13/32.....	61.1	PA2588	13 21/32.....	346.9	6 13/32.....	162.7	3 17/32.....	89.7	RS5641
13 3/8.....	339.7	5 1/4.....	133.4	4 1/8.....	104.8	PA1836	13 11/16.....	347.7	4 31/32.....	126.2	4 3/16.....	106.4	RS5783
13 3/8.....	339.7	6 3/8.....	161.9	2 5/8.....	66.7	PA1883-FN	13 11/16.....	347.7	12 1/16.....	306.4	7 3/4.....	196.9	RS30225
13 3/8.....	339.7	7 11/32.....	186.5	3 31/32.....	100.8	PA2709	13 23/32.....	348.5	9 9/32.....	235.7	5 5/32.....	131.0	RS3733
13 3/8.....	339.7	7 15/16.....	201.6	3 9/16.....	90.5	PA2581	13 3/4.....	349.3	6 15/32.....	164.3	3 5/8.....	92.1	PA2845
13 3/8.....	339.7	7 31/32.....	202.4	3 5/16.....	84.1	PA2481	13 3/4.....	349.3	12 1/8.....	308.0	8 1/2.....	215.9	RS5455
13 3/8.....	339.7	8 1/4.....	209.6	7 3/32.....	180.2	PA4627	13 25/32.....	350.0	7 11/16.....	195.3	4 21/32.....	118.3	PA5787
13 3/8.....	339.7	8 13/32.....	213.5	4 29/32.....	124.6	RS5431	13 25/32.....	350.0	13 15/32.....	342.1	5 1/32.....	127.8	RS5342
13 3/8.....	339.7	8 7/8.....	225.4	4 1/8.....	104.8	PA3446	13 27/32.....	351.6	5 1/4.....	133.4	3 23/32.....	94.5	RS3535
13 3/8.....	339.7	9.....	228.6	5 3/8.....	136.5	PA2401	13 27/32.....	351.6	7 13/16.....	198.4	3 3/8.....	85.7	PA3752
13 3/8.....	339.7	10 1/16.....	255.6	3 9/16.....	90.5	PA1755-FN	13 27/32.....	351.6	19 9/32.....	489.7	12 7/8.....	327.0	PA3904
13 3/8.....	339.7	10 3/8.....	263.5	6 1/32.....	153.2	PA2616	13 7/8.....	352.4	3 5/8.....	92.1	2 15/16.....	74.6	PA2432
13 3/8.....	339.7	10 3/8.....	263.5	6 1/32.....	153.2	PA2616XP	13 7/8.....	352.4	5 15/16.....	150.8	4 27/32.....	123.0	PA2522
13 3/8.....	339.7	10 27/32.....	275.4	4 13/16.....	122.2	PA3850	13 7/8.....	352.4	7 11/32.....	186.5	5 3/8.....	136.5	PA3475
13 3/8.....	339.7	10 31/32.....	278.6	5 13/16.....	147.6	RS3504	13 7/8.....	352.4	7 11/16.....	195.3	4 21/32.....	118.3	PA5785
13 3/8.....	339.7	10 31/32.....	278.6	5 13/16.....	147.6	RS3504XP	13 29/32.....	353.2	7 1/8.....	181.0	2 27/32.....	72.2	PA3984
13 3/8.....	339.7	11 1/8.....	282.6	6 23/32.....	170.7	PA1881	13 29/32.....	353.2	9 3/4.....	247.7	5 1/4.....	133.4	PA1845
13 3/8.....	339.7	11 7/8.....	301.6	7 1/8.....	181.0	PA1790	13 15/16.....	354.0	4 15/16.....	125.4	3 31/32.....	100.8	RS3541
13 3/8.....	339.7	12 1/32.....	305.6	7 11/16.....	195.3	PA1920	13 15/16.....	354.0	5 5/16.....	134.9	4 1/4.....	108.0	RS5547
13 13/32.....	340.5	8 21/32.....	219.9	3 27/32.....	97.6	PA4683	13 15/16.....	354.0	7 1/16.....	179.4	2 13/16.....	71.4	PA3859



**WARNING:** These products can expose you to chemicals, including Diisononyl Phthalate, Carbon black extracts, Nickel, 1,3 Butadiene, Ethylene Oxide, Epichlorohydrin, which are known to the State of California to cause cancer, and Bisphenol-A, Ethylene Glycol, Ethylene Oxide, 1,3 Butadiene, Epichlorohydrin, which are known to the State of California to cause birth defects or other reproductive harm.

# ROUND AIR FILTERS BY LENGTH

LENGTH Inches	LENGTH (mm)	O.D. Inches	O.D. (mm)	I.D. Inches	I.D. (mm)	BALDWIN NUMBER	LENGTH Inches	LENGTH (mm)	O.D. Inches	O.D. (mm)	I.D. Inches	I.D. (mm)	BALDWIN NUMBER
13 15/16.....	354.0	8 13/32.....	213.5	3 15/32.....	88.1	PA3852-FN	14 7/16.....	366.7	7 23/32.....	196.1	5 3/32.....	129.4	PA2759
13 31/32.....	354.8	3 17/32.....	89.7	2 13/32.....	61.1	PA4753	14 7/16.....	366.7	11 3/32.....	281.8	6 3/4.....	171.5	PA4889
13 31/32.....	354.8	6 3/32.....	154.8	2 7/16.....	61.9	RS5685	14 15/32.....	367.5	6 1/4.....	158.8	4 7/8.....	123.8	PA5529
14.....	355.6	3 17/32.....	89.7	2 3/8.....	60.3	PA2306	14 15/32.....	367.5	7 13/16.....	198.4	3 15/32.....	88.1	PA1699-FN
14.....	355.6	4 15/32.....	113.5	3 7/16.....	87.3	PA2319	14 1/2.....	368.3	5 15/16.....	150.8	4 27/32.....	123.0	PA2539
14.....	355.6	6 1/2.....	165.1	3 3/4.....	95.3	RS5784	14 1/2.....	368.3	6 1/4.....	158.8	4 5/8.....	117.5	PA2739
14.....	355.6	7 23/32.....	196.1	4 11/16.....	119.1	RS5782	14 1/2.....	368.3	6 5/8.....	168.3	4 1/4.....	108.0	PA1726
14.....	355.6	8 7/8.....	225.4	4 15/16.....	125.4	RS30168	14 1/2.....	368.3	8 5/8.....	219.1	7 1/16.....	179.4	PA2625
14.....	355.6	13 13/16.....	350.8	9 1/2.....	241.3	LL1630-2	14 1/2.....	368.3	8 13/16.....	223.8	4 3/16.....	106.4	PA2633-FN
14.....	355.6	13 13/16.....	350.8	9 1/2.....	241.3	PA1630-2	14 1/2.....	368.3	10.....	254.0	4 5/8.....	117.5	PA2433
14.....	355.6	13 27/32.....	351.6	11 1/8.....	282.6	PA1630	14 1/2.....	368.3	10 7/32.....	259.6	6 1/16.....	154.0	LL1895
14.....	355.6	13 27/32.....	351.6	11 1/8.....	282.6	PA1643	14 1/2.....	368.3	10 7/32.....	259.6	6 1/16.....	154.0	PA1895
14.....	355.6	13 27/32.....	351.6	11 1/8.....	282.6	PA3604	14 1/2.....	368.3	10 27/32.....	275.4	6 1/2.....	165.1	PA3914
14 1/32.....	356.4	3 29/32.....	99.2	3 1/16.....	77.8	RS4599	14 1/2.....	368.3	12 1/32.....	305.6	7 11/16.....	195.3	PA1863
14 1/32.....	356.4	6 1/2.....	165.1	3 9/16.....	90.5	RS3544	14 1/2.....	368.3	12 1/32.....	305.6	7 7/8.....	200.0	PA2707
14 1/32.....	356.4	6 1/2.....	165.1	3 9/16.....	90.5	RS5517	14 1/2.....	368.3	13 25/32.....	350.0	9 7/16.....	239.7	PA1706
14 1/32.....	356.4	6 7/8.....	174.6	6 1/2.....	165.1	RS3711	14 1/2.....	368.3	13 25/32.....	350.0	9 7/16.....	239.7	PA1706XP
14 1/32.....	356.4	7 11/32.....	186.5	4 5/32.....	105.6	RS5422	14 1/2.....	368.3	13 13/16.....	350.8	8 9/32.....	210.3	PA2774
14 1/32.....	356.4	15 1/4.....	387.4	6 9/16.....	166.7	PA2955	14 1/2.....	368.3	14 17/32.....	369.1	8 3/8.....	212.7	PA1818
14 1/16.....	357.2	3 25/32.....	96.0	2 7/8.....	73.0	PA2332	14 1/2.....	368.3	15 3/4.....	400.1	7 11/16.....	195.3	LL1676-FN
14 1/16.....	357.2	6 1/4.....	158.8	3 9/16.....	90.5	RS5745	14 1/2.....	368.3	15 3/4.....	400.1	7 11/16.....	195.3	PA1676-FN
14 1/16.....	357.2	6 1/2.....	165.1	2 27/32.....	72.2	PA2790-FN	14 17/32.....	369.1	8 3/8.....	212.7	4 27/32.....	123.0	RS4864
14 1/16.....	357.2	8 1/2.....	215.9	4 1/16.....	103.2	PA2528	14 17/32.....	369.1	8 13/32.....	213.5	6 3/16.....	157.2	PA2834
14 1/16.....	357.2	9 1/2.....	241.3	3 9/16.....	90.5	PA4960-FN	14 9/16.....	369.9	4 7/32.....	107.2	4 1/16.....	103.2	PA5531
14 3/32.....	358.0	3 5/8.....	92.1	2 7/16.....	61.9	PA2487	14 19/32.....	370.7	4 21/32.....	118.3	3 15/16.....	100.0	PA2547
14 3/32.....	358.0	4 1/8.....	104.8	3 29/32.....	99.2	RS5684	14 19/32.....	370.7	8 5/32.....	207.2	4 27/32.....	123.0	RS3540
14 3/32.....	358.0	4 5/32.....	105.6	2 29/32.....	73.8	PA2419	14 19/32.....	370.7	9 9/32.....	235.7	5 5/32.....	131.0	RS3538
14 3/32.....	358.0	7 1/4.....	184.2	6 3/16.....	157.2	PA5702	14 5/8.....	371.5	4 1/8.....	104.8	3.....	76.2	PA1897
14 1/8.....	358.8	5 7/8.....	149.2	2 15/16.....	74.6	RS5750	14 5/8.....	371.5	4 13/32.....	111.9	3 5/16.....	84.1	PA2835
14 1/8.....	358.8	5 31/32.....	151.6	3 3/8.....	85.7	RS3920	14 5/8.....	371.5	6 1/2.....	165.1	3 11/16.....	93.7	RS4598
14 3/16.....	360.4	5 5/16.....	134.9	3 13/32.....	86.5	PA2322	14 5/8.....	371.5	7 7/16.....	188.9	4 3/16.....	106.4	PA2341
14 3/16.....	360.4	6.....	152.4	3 5/8.....	92.1	PA1609	14 5/8.....	371.5	8 3/8.....	212.7	3 15/32.....	88.1	PA2635-FN
14 3/16.....	360.4	6 3/8.....	161.9	5 9/32.....	134.1	PA3689	14 5/8.....	371.5	9 11/16.....	246.1	4 7/8.....	123.8	RS5301
14 3/16.....	360.4	7 1/8.....	181.0	3.....	76.2	PA3554	14 5/8.....	371.5	9 11/16.....	246.1	4 7/8.....	123.8	RS30236
14 7/32.....	361.2	3 17/32.....	88.7	3 13/32.....	86.5	RS3923	14 21/32.....	372.3	3 9/16.....	90.5	2 13/16.....	71.4	RS30061
14 7/32.....	361.2	5 1/4.....	133.4	3 13/32.....	86.5	RS3923	14 21/32.....	372.3	5 3/4.....	146.1	3 1/16.....	77.8	PA2587
14 1/4.....	362.0	4 1/8.....	104.8	3 23/32.....	94.5	RS3521	14 11/16.....	373.1	15 25/32.....	400.8	9 1/2.....	241.3	PA2867-FN
14 1/4.....	362.0	5 1/2.....	139.7	3.....	76.2	PA3430	14 23/32.....	373.9	4 13/16.....	122.2	3 5/8.....	92.1	PA2469
14 1/4.....	362.0	6 3/8.....	161.9	3 1/8.....	79.4	PA1682	14 23/32.....	373.9	5 23/32.....	145.3	3 7/16.....	87.3	PA2452
14 1/4.....	362.0	9 7/32.....	234.2	2 5/8.....	66.7	PA1707-FN	14 23/32.....	373.9	5 3/4.....	146.1	3 7/16.....	87.3	PA5486
14 1/4.....	362.0	12 1/16.....	306.4	5 3/16.....	131.8	PA30243	14 23/32.....	373.9	8 9/32.....	210.3	5 5/32.....	131.0	PA5503
14 1/4.....	362.0	15 5/8.....	396.9	6 3/32.....	154.8	PA2316	14 23/32.....	373.9	10 29/32.....	277.0	6 25/32.....	172.2	RS3710
14 9/32.....	362.7	7 21/32.....	194.5	10 9/32.....	261.1	PA3905	14 3/4.....	374.7	3 1/2.....	88.9	2 13/16.....	71.4	PA5764
14 9/32.....	362.7	19 9/32.....	489.7	6 31/32.....	177.0	RS5731	14 3/4.....	374.7	5 9/32.....	134.1	3 7/16.....	87.3	PA5557
14 5/16.....	363.5	5 1/8.....	130.2	12 7/16.....	315.9	PA5799	14 3/4.....	374.7	6 3/8.....	161.9	3 3/4.....	95.3	RS3922
14 5/16.....	363.5	5 1/8.....	130.2	2 15/32.....	62.7	LL2344-FN	14 3/4.....	374.7	7 11/32.....	186.5	4.....	101.6	PA2511
14 5/16.....	363.5	5 1/8.....	130.2	2 15/32.....	62.7	PA2344-FN	14 3/4.....	374.7	7 13/16.....	198.4	4 3/32.....	104.0	PA2405
14 5/16.....	363.5	5 3/4.....	146.1	2 15/32.....	62.7	PA3805-FN	14 3/4.....	374.7	9 7/32.....	234.2	5 27/32.....	148.4	PA4624
14 5/16.....	363.5	6 5/8.....	168.3	4 13/16.....	122.2	PA2301	14 3/4.....	374.7	11 1/4.....	285.8	4 3/4.....	120.7	PA3449
14 5/16.....	363.5	6 5/8.....	168.3	4 11/32.....	110.3	PA2637	14 25/32.....	375.4	6 1/4.....	158.8	5 11/16.....	144.5	PA4809
14 5/16.....	363.5	8 3/4.....	222.3	4 3/16.....	106.4	PA2302-FN	14 25/32.....	375.4	7 25/32.....	197.6	3 15/16.....	100.0	PA5473
14 5/16.....	363.5	10 1/16.....	255.6	5 3/8.....	136.5	PA1837-FN	14 13/16.....	376.2	7 1/2.....	190.5	5 11/16.....	144.5	RS5749
14 11/32.....	364.3	4 7/8.....	123.8	3 3/8.....	85.7	PA5504	14 13/16.....	376.2	9 3/4.....	247.7	4 1/16.....	103.2	PA2866
14 11/32.....	364.3	7 7/8.....	200.0	3 7/8.....	98.4	PA3405	14 27/32.....	377.0	4 5/8.....	117.5	3 11/16.....	93.7	PA1998
14 3/8.....	365.1	4 11/16.....	103.2	3 5/16.....	84.1	RS5490	14 27/32.....	377.0	5 1/4.....	133.4	3 23/32.....	94.5	RS3533
14 3/8.....	365.1	5 5/16.....	134.9	3 13/32.....	86.5	PA2486	14 27/32.....	377.0	9 17/32.....	242.1	5 3/16.....	131.8	PA3760
14 3/8.....	365.1	6 1/8.....	155.6	4 15/16.....	125.4	PA2460	14 7/8.....	377.8	3 5/16.....	84.1	2 15/32.....	62.7	RS3709
14 3/8.....	365.1	6 3/8.....	161.9	5 9/32.....	134.1	PA2578	14 7/8.....	377.8	7 1/2.....	190.5	5 1/4.....	133.4	PA3566
14 3/8.....	365.1	6 7/8.....	174.6	3 1/2.....	88.9	PA1940	14 7/8.....	377.8	11 29/32.....	302.4	7 17/32.....	191.3	PA2813
14 3/8.....	365.1	6 7/8.....	174.6	3 1/2.....	88.9	PA1972	14 15/16.....	379.4	4 25/32.....	121.4	3 11/16.....	93.7	PA2836
14 3/8.....	365.1	6 7/8.....	174.6	5 9/16.....	141.3	PA2605	15.....	381.0	4 1/4.....	108.0	2 3/4.....	69.9	RS3935
14 3/8.....	365.1	7 3/16.....	182.6	5 11/16.....	144.5	PA2579	15.....	381.0	4 1/4.....	108.0	3 3/8.....	85.7	RS5335
14 3/8.....	365.1	8 1/4.....	209.6	7 1/8.....	181.0	PA2960	15.....	381.0	5 1/8.....	130.2	4 3/8.....	111.1	RS5345
14 3/8.....	365.1	13 3/4.....	349.3	6 3/4.....	171.5	PA1978-FN	15.....	381.0	5 9/32.....	134.1	3 13/32.....	86.5	RS30060-FN
14 3/8.....	365.1	15 25/32.....	400.8	9 1/2.....	241.3	LL2447-FN	15.....	381.0	5 11/16.....	144.5	4 13/32.....	111.9	PA3470
14 3/8.....	365.1	15 25/32.....	400.8	9 1/2.....	241.3	PA2447-FN	15.....	381.0	5 29/32.....	150.0	4 13/32.....	111.9	RS3722
14 13/32.....	365.9	6 7/8.....	174.6	5 5/32.....	131.0	RS3519	15.....	381.0	5 15/16.....	150.8	4 27/32.....	123.0	PA3847
14 7/16.....	366.7	7.....	177.8	4 19/32.....	116.7	PA2307							



**WARNING:** These products can expose you to chemicals, including Diisononyl Phthalate, Carbon black extracts, Nickel, 1,3 Butadiene, Ethylene Oxide, Epichlorohydrin, which are known to the State of California to cause cancer, and Bisphenol-A, Ethylene Glycol, Ethylene Oxide, 1,3 Butadiene, Epichlorohydrin, which are known to the State of California to cause birth defects or other reproductive harm.

**ROUND AIR FILTERS BY LENGTH**

LENGTH Inches	LENGTH (mm)	O.D. Inches	O.D. (mm)	I.D. Inches	I.D. (mm)	BALDWIN NUMBER	LENGTH Inches	LENGTH (mm)	O.D. Inches	O.D. (mm)	I.D. Inches	I.D. (mm)	BALDWIN NUMBER
15	381.0	5 15/16	150.8	4 29/32	124.6	PA3656	15 15/32	392.9	5 13/32	137.3	3 3/16	81.0	RS3708
15	381.0	6 5/16	160.3	2 13/16	71.4	PA4865-FN	15 15/32	392.9	6 3/8	161.9	3 5/8	92.1	PA2541-FN
15	381.0	6 1/2	165.1	3 3/8	85.7	PA5763	15 15/32	392.9	9 5/32	232.6	4 7/8	123.8	PA2971
15	381.0	7	177.8	3 3/8	85.7	PA1826	15 15/32	392.9	12 3/32	307.2	6 3/32	154.8	PA3978
15	381.0	7 1/4	184.2	5 7/16	138.1	RS5292	15 1/2	393.7	5 1/4	133.4	4 1/8	104.8	PA2568
15	381.0	7 1/2	190.5	5 1/4	133.4	PA2455	15 1/2	393.7	5 3/4	146.1	4 7/8	123.8	RS5347
15	381.0	8 27/32	224.6	5 15/32	138.9	PA2550	15 1/2	393.7	6 1/16	154.0	3 15/32	88.1	PA1831
15	381.0	8 15/16	227.0	4 19/32	116.7	PA2474	15 1/2	393.7	7	177.8	3 5/8	92.1	PA2756
15	381.0	8 15/16	227.0	4 19/32	116.7	PA3605	15 1/2	393.7	7 5/16	185.7	6 5/32	156.4	PA3832
15	381.0	9 9/32	235.7	5 5/32	131.0	RS3520	15 1/2	393.7	7 15/16	201.6	4 5/8	117.5	PA4656
15	381.0	9 21/32	245.3	4 23/32	119.9	RS4775	15 1/2	393.7	8 3/8	212.7	3 15/32	88.1	PA2977-FN
15	381.0	10 3/8	263.5	6 1/32	153.2	PA2556	15 1/2	393.7	8 3/8	212.7	3 15/32	88.1	PA3669-FN
15	381.0	10 1/2	266.7	5	127.0	PA30158	15 1/2	393.7	9 7/32	234.2	4 27/32	123.0	PA2451
15	381.0	12 1/16	306.4	7 11/16	195.3	PA6666	15 1/2	393.7	9 9/32	235.7	4 11/16	119.1	PA2788
15	381.0	12 1/4	311.2	10 1/8	257.2	PA30069	15 1/2	393.7	9 9/32	235.7	4 11/16	119.1	PA3629
15	381.0	12 3/4	323.9	8 11/32	211.9	LL2439	15 1/2	393.7	9 7/16	239.7	4 17/32	115.1	LL2318
15	381.0	12 3/4	323.9	8 11/32	211.9	PA2439	15 1/2	393.7	9 7/16	239.7	4 17/32	115.1	PA2318
15	381.0	12 3/4	323.9	8 11/32	211.9	PA2494	15 1/2	393.7	9 5/8	244.5	5 7/32	132.6	LL2667
15 1/16	382.6	8 5/32	207.2	4 9/32	108.7	RS4972	15 1/2	393.7	9 5/8	244.5	5 7/32	132.6	PA2667
15 1/16	382.6	9 5/8	244.5	4 3/32	104.0	PA2374	15 1/2	393.7	9 29/32	251.6	5 3/8	136.5	PA2887-FN
15 1/16	382.6	8 31/32	277.8	4 7/16	112.7	PA5530	15 1/2	393.7	10	254.0	5 3/8	136.5	PA2338-FN
15 3/32	383.4	4 25/32	121.4	3 5/8	92.1	PA2427	15 1/2	393.7	10 27/32	275.4	6 1/2	165.1	PA2577
15 3/32	383.4	7 17/32	191.3	3 7/16	87.3	PA4697-FN	15 1/2	393.7	12 13/32	315.1	8 3/16	208.0	RS3510
15 3/32	383.4	10 15/16	277.8	4 9/16	115.9	PA2847	15 1/2	393.7	12 13/32	315.1	8 3/16	208.0	RS3510XP
15 5/32	385.0	4 1/4	108.0	3 3/8	85.7	RS5304	15 1/2	393.7	12 13/32	315.1	8 3/16	208.0	RS3512
15 5/32	385.0	4 11/32	110.3	3 9/16	90.5	RS3993	15 1/2	393.7	12 1/2	317.5	9 1/8	231.8	LL2384
15 5/32	385.0	6 1/4	158.8	5 1/4	133.4	RS5453	15 1/2	393.7	12 1/2	317.5	9 1/8	231.8	PA2384
15 5/32	385.0	7 11/32	186.5	3 31/32	100.8	PA2369	15 1/2	393.7	12 1/2	317.5	9 1/8	231.8	PA2384XP
15 5/32	385.0	10 29/32	277.0	6 3/4	171.5	RS3750XP	15 1/2	393.7	13 3/4	349.3	6 23/32	170.7	PA1864-FN
15 7/32	386.6	6 23/32	170.7	5 1/2	139.7	RS5295	15 1/2	393.7	14 15/32	367.5	6 15/32	164.3	PA2600
15 7/32	386.6	8 5/16	211.1	6 1/32	153.2	RS3511	15 1/2	393.7	14 1/2	368.3	9 1/2	241.3	PA2624
15 7/32	386.6	8 5/16	211.1	6 1/32	153.2	RS3515	15 1/2	393.7	15 25/32	400.8	9 1/2	241.3	PA2959-FN
15 7/32	386.6	9 3/32	231.0	6 29/32	175.4	RS3713	15 17/32	394.5	6 5/8	168.3	4 1/4	108.0	PA2946
15 1/4	387.4	4 1/8	104.8	3	76.2	PA3610	15 17/32	394.5	7 11/32	186.5	4 5/32	105.6	RS5334
15 1/4	387.4	4 23/32	119.9	4	101.6	RS3995	15 17/32	394.5	13 15/32	342.1	8 5/32	207.2	RS4988
15 1/4	387.4	8 11/16	204.8	5 3/4	146.1	PA1686	15 17/32	394.5	14 7/32	361.2	8 15/16	227.0	RS3712
15 1/4	387.4	8 1/2	215.9	5 3/8	136.5	PA3467	15 17/32	394.5	16 1/8	409.6	7 7/16	188.9	PA2648
15 1/4	387.4	11 3/8	288.9	6 31/32	177.0	PA2385	15 9/16	395.3	3 29/32	99.2	3 7/16	87.3	PA5527
15 1/4	387.4	12 1/8	308.0	7 11/16	195.3	PA2833	15 9/16	395.3	4 1/8	104.8	3 7/16	87.3	RS5479
15 1/4	387.4	12 31/32	329.4	6 13/16	173.0	RS3518	15 9/16	395.3	5 9/16	141.3	4 7/16	112.7	PA2674
15 1/4	387.4	12 31/32	329.4	6 13/16	173.0	RS3518XP	15 9/16	395.3	5 11/16	144.5	4 15/16	125.4	PA2743
15 5/16	388.9	6 3/32	154.8	3 15/32	88.1	PA2314	15 9/16	395.3	7 3/4	196.9	3 15/32	88.1	PA4631-FN
15 5/16	388.9	6 3/32	154.8	3 15/32	88.1	PA2420	15 9/16	395.3	7 27/32	199.2	5	127.0	PA5297
15 5/16	388.9	7 1/2	190.5	3 3/4	95.3	PA2431	15 9/16	395.3	9 13/16	249.2	5 3/16	131.8	PA2677
15 5/16	388.9	7 13/16	198.4	3 15/32	88.1	PA1822-FN	15 9/16	395.3	9 29/32	251.6	6 1/16	154.0	PA3775
15 5/16	388.9	7 13/16	198.4	3 15/32	88.1	LL2418-FN	15 9/16	395.3	10	254.0	4 27/32	123.0	PA3948
15 5/16	388.9	7 13/16	198.4	3 15/32	88.1	PA2418-FN	15 19/32	396.1	8 13/32	213.5	4 29/32	124.6	RS5435
15 5/16	388.9	8 3/4	222.3	4 3/16	106.4	PA3439-FN	15 19/32	396.1	10	254.0	4 27/32	123.0	PA5357
15 5/16	388.9	11 1/8	282.6	6 23/32	170.7	PA3699	15 5/8	396.9	6 15/32	164.3	2 27/32	72.2	PA4825
15 5/16	388.9	12 1/32	305.6	7 11/16	195.3	LL2330	15 5/8	396.9	8 5/32	207.2	4 3/16	106.4	RS3934
15 5/16	388.9	12 1/32	305.6	7 11/16	195.3	PA2330	15 5/8	396.9	9 9/32	235.7	5 5/32	131.0	RS3532
15 11/32	389.7	8 1/32	204.0	5 1/32	127.8	RS4637	15 5/8	396.9	10 31/32	278.6	5 13/16	147.6	RS3548
15 11/32	389.7	9 23/32	246.9	6 5/16	160.3	RS5692	15 5/8	396.9	10 31/32	278.6	5 13/16	147.6	RS3548XP
15 11/32	389.7	12	304.8	6 31/32	177.0	PA1797	15 21/32	397.7	5 9/16	141.3	4 13/32	111.9	PA2435
15 3/8	390.5	4 9/16	115.9	3 7/16	87.3	PA1981	15 21/32	397.7	5 3/4	146.1	3 7/16	87.3	PA1912
15 3/8	390.5	5 29/32	150.0	3 31/32	100.8	PA3949	15 21/32	397.7	7 11/32	186.5	4 5/32	105.6	RS3971
15 3/8	390.5	6 3/8	161.9	3 1/4	82.6	LL2360-FN	15 21/32	397.7	7 7/8	200.0	6 3/16	157.2	RS3741
15 3/8	390.5	6 3/8	161.9	3 1/4	82.6	PA2360-FN	15 21/32	397.7	8 3/16	208.0	3 11/16	93.7	PA4709
15 3/8	390.5	6 27/32	173.8	3 15/32	88.1	PA2551	15 21/32	397.7	10 29/32	277.0	6 25/32	172.2	RS3750
15 3/8	390.5	7 3/32	180.2	3 15/32	88.1	PA3487	15 11/16	398.5	5 9/16	141.3	4 13/32	111.9	RS3507
15 3/8	390.5	8 3/4	222.3	3 1/2	88.9	PA2524-FN	15 11/16	398.5	6 23/32	170.7	6 1/16	154.0	RS30191
15 3/8	390.5	9 7/32	234.2	4 27/32	123.0	PA2953	15 11/16	398.5	11 1/2	292.1	7 1/4	184.2	PA2611
15 13/32	391.3	7 5/8	193.7	6 1/16	154.0	PA1904	15 11/16	398.5	12 1/16	306.4	5 11/16	144.5	PA2429
15 13/32	391.3	8 3/8	212.7	3 1/8	79.4	RS5395-FN	15 11/16	398.5	12 1/16	306.4	7 11/16	195.3	PA3558
15 13/32	391.3	9 15/16	252.4	6 15/16	176.2	RS4863	15 23/32	399.3	5 1/4	133.4	3 23/32	94.5	RS3732
15 7/16	392.1	6 7/8	174.6	4 1/4	108.0	PA1898	15 23/32	399.3	5 29/32	150.0	4 3/8	111.1	RS5392
15 7/16	392.1	7 5/16	185.7	6 19/32	167.5	RS5539	15 23/32	399.3	7 11/16	195.3	4 17/32	115.1	RS3992
15 7/16	392.1	8 13/32	213.5	3 15/32	88.1	PA3690	15 3/4	400.1	5 1/2	139.7	3 3/4	95.3	RS5559



**WARNING:** These products can expose you to chemicals, including Diisononyl Phthalate, Carbon black extracts, Nickel, 1,3 Butadiene, Ethylene Oxide, Epichlorohydrin, which are known to the State of California to cause cancer, and Bisphenol-A, Ethylene Glycol, Ethylene Oxide, 1,3 Butadiene, Epichlorohydrin, which are known to the State of California to cause birth defects or other reproductive harm.

# ROUND AIR FILTERS BY LENGTH

LENGTH Inches	LENGTH (mm)	O.D. Inches	O.D. (mm)	I.D. Inches	I.D. (mm)	BALDWIN NUMBER	LENGTH Inches	LENGTH (mm)	O.D. Inches	O.D. (mm)	I.D. Inches	I.D. (mm)	BALDWIN NUMBER
15 3/4	400.1	10	254.0	4 31/32	126.2	PA5485-FN	16 11/32	415.1	9 15/32	240.5	5 9/16	141.3	RS5348
15 3/4	400.1	11	279.4	7 3/32	180.2	RS5291	16 11/32	415.1	13 25/32	350.0	7 15/16	201.6	RS4967
15 3/4	400.1	13 13/16	350.8	9 1/2	241.3	PA3602	16 11/32	415.1	14 19/32	370.7	5 5/16	134.9	PA3408
15 25/32	400.8	8 1/2	215.9	6 7/32	158.0	PA2883	16 3/8	415.9	5 23/32	145.3	4 19/32	116.7	PA2467
15 27/32	402.4	8 11/16	220.7	4 15/16	125.4	RS3994	16 3/8	415.9	5 15/16	150.8	4 27/32	123.0	PA2510
15 27/32	402.4	15 3/32	383.4	6 23/32	170.7	PA5425	16 3/8	415.9	8 1/4	209.6	7 1/8	181.0	PA2630
15 7/8	403.2	7 5/8	193.7	6 1/16	154.0	PA2526	16 3/8	415.9	8 5/8	219.1	4 1/4	108.0	PA1997
15 7/8	403.2	7 5/8	193.7	6 1/16	154.0	PA3480	16 3/8	415.9	8 3/4	222.3	4 3/16	106.4	LL2426-FN
15 7/8	403.2	10 3/8	263.5	5 3/4	146.1	RS5627	16 3/8	415.9	8 3/4	222.3	4 3/16	106.4	PA2426-FN
15 7/8	403.2	11 1/2	292.1	7 1/4	184.2	PA2604	16 3/8	415.9	9 7/32	234.2	4 27/32	123.0	PA1827
15 7/8	403.2	12	304.8	6 1/2	165.1	RS30090-FN	16 3/8	415.9	10	254.0	5 11/16	144.5	PA2569
15 29/32	404.0	5 5/16	134.9	4 3/8	111.1	RS5548	16 3/8	415.9	10 1/16	255.6	3 9/16	90.5	PA1650-FN
15 29/32	404.0	6 1/16	154.0	4 3/4	120.7	PA4607	16 3/8	415.9	11	279.4	4 27/32	123.0	PA3849
15 29/32	404.0	8 1/2	215.9	4 13/16	122.2	PA5556	16 3/8	415.9	12 1/32	305.6	7 11/16	195.3	LL1992
15 29/32	404.0	10 1/4	260.4	7 15/16	201.6	RS4636	16 3/8	415.9	12 1/2	317.5	6	152.4	PA2921
15 15/16	404.8	14 5/32	356.9	9 1/2	241.3	PA1687	16 3/8	415.9	13 3/4	349.3	6 3/4	171.5	PA1979-FN
15 15/16	404.8	16 1/16	408.0	8 21/32	219.9	PA2839	16 3/8	415.9	15 3/4	400.1	7 11/16	195.3	PA1992-FN
15 31/32	405.6	13 17/32	343.7	5 1/32	127.8	RS5343	16 13/32	416.7	5 1/4	133.4	3 3/4	95.3	RS4677
16	406.4	6 3/32	154.8	5 11/32	135.7	RS5361	16 7/16	417.5	4 21/32	118.3	3 15/16	100.0	PA2368
16	406.4	7 1/2	190.5	5 1/4	133.4	PA1893	16 7/16	417.5	6 11/16	169.9	2 27/32	72.2	PA4582
16	406.4	8 21/32	219.9	5 3/16	131.8	PA2540	16 7/16	417.5	8 3/8	212.7	4 11/16	119.1	RS4970
16	406.4	9 1/16	230.2	4 5/8	117.5	PA1670	16 7/16	417.5	8 1/2	215.9	4	101.6	RS5478-FN
16	406.4	9 29/32	251.6	6 1/16	154.0	PA3655	16 7/16	417.5	8 5/8	219.1	4 1/4	108.0	PA2495
16	406.4	10 3/8	263.5	6 1/32	153.2	LL2425	16 7/16	417.5	10 1/32	254.8	4 31/32	126.2	RS5344
16	406.4	10 3/8	263.5	6 1/32	153.2	PA2425	16 7/16	417.5	10 3/8	263.5	6 1/32	153.2	LL2521
16	406.4	12 1/32	305.6	6 23/32	170.7	PA2643	16 7/16	417.5	10 3/8	263.5	6 1/32	153.2	PA2521
16	406.4	12 1/16	306.4	7 11/16	195.3	LL2661	16 7/16	417.5	10 31/32	278.6	5 13/16	147.6	RS3506
16	406.4	12 1/16	306.4	7 11/16	195.3	PA2661	16 7/16	417.5	10 31/32	278.6	5 13/16	147.6	RS3506XP
16	406.4	12 15/32	316.7	7 7/8	200.0	PA1702	16 7/16	417.5	10 31/32	278.6	5 13/16	147.6	RS4561
16	406.4	13 13/16	350.8	9 1/2	241.3	LL1649	16 7/16	417.5	11	279.4	5 25/32	146.8	RS30285
16	406.4	13 13/16	350.8	9 1/2	241.3	PA1649	16 7/16	417.5	12 31/32	329.4	5 3/8	136.5	PA3854-FN
16	406.4	13 13/16	350.8	9 1/2	241.3	LL2685	16 15/32	418.3	9 3/16	233.4	4 13/16	122.2	PA4925
16	406.4	16 5/8	422.3	12	304.8	PA1632	16 15/32	418.3	9 17/32	242.1	4 13/16	122.2	RS4861
16 1/32	407.2	13 5/16	338.1	9 7/8	250.8	RS5389-FN	16 15/32	418.3	10 7/16	265.1	6 3/16	157.2	RS5360
16 1/32	407.2	16 1/8	409.6	7 7/16	188.9	PA2544	16 15/32	418.3	11	279.4	7 11/16	195.3	RS5296
16 1/16	408.0	4 1/4	108.0	3 3/8	85.7	RS3885	16 1/2	419.1	4 9/16	115.9	3 7/16	87.3	PA3809
16 3/32	408.8	5 1/4	133.4	4 1/8	104.8	PA2443	16 1/2	419.1	5 3/4	146.1	4 3/8	111.1	RS5628
16 3/32	408.8	12 1/16	306.4	9 7/8	250.8	RS4862	16 1/2	419.1	7 1/4	184.2	6 3/16	157.2	PA2967
16 1/8	409.6	7 1/4	184.2	3 5/8	92.1	RS5329	16 1/2	419.1	7 5/8	193.7	4 1/4	108.0	LL2783
16 1/8	409.6	12 13/16	325.4	5 15/16	150.8	PA9666	16 1/2	419.1	7 15/16	201.6	3 9/16	90.5	PA2484
16 1/8	409.6	13 3/32	332.6	8 9/32	210.3	RS5730	16 1/2	419.1	7 15/16	201.6	3 9/16	90.5	PA2856
16 5/32	410.4	5 5/32	131.0	4 1/32	102.4	PA2530	16 1/2	419.1	7 15/16	201.6	5 3/8	136.5	PA3460
16 5/32	410.4	9 1/8	231.8	5 13/16	147.6	RS5535	16 1/2	419.1	9 7/32	234.2	4 27/32	123.0	PA2523
16 5/32	410.4	9 25/32	248.4	5 21/32	143.7	RS5537	16 1/2	419.1	9 11/32	237.3	4 5/32	105.6	RS30059-FN
16 5/32	410.4	16 7/16	417.5	9 15/16	252.4	PA1815	16 1/2	419.1	9 29/32	251.6	6 1/16	154.0	PA2777
16 7/32	412.0	5 29/32	150.0	4 5/16	109.5	RS5676	16 1/2	419.1	10	254.0	5 3/8	136.5	PA4650-FN
16 7/32	412.0	9 1/16	230.2	4 5/8	117.5	PA2733	16 1/2	419.1	10 3/8	263.5	6 1/32	153.2	PA2538
16 1/4	412.8	5 21/32	143.7	4 7/16	112.7	RS5759	16 1/2	419.1	10 7/8	276.2	4 13/16	122.2	PA3675
16 1/4	412.8	6 3/32	154.8	3 15/32	88.1	PA1709	16 1/2	419.1	10 29/32	277.0	6 25/32	172.2	RS5452
16 1/4	412.8	7 1/16	179.4	5 29/32	150.0	RS5708	16 1/2	419.1	11	279.4	6 1/32	153.2	PA2300
16 1/4	412.8	7 13/16	198.4	3 15/32	88.1	PA1850-FN	16 1/2	419.1	11 1/8	282.6	6 23/32	170.7	LL1669
16 1/4	412.8	10 7/32	259.6	6 1/2	165.1	PA5528	16 1/2	419.1	11 1/8	282.6	6 23/32	170.7	PA1669
16 1/4	412.8	11 31/32	304.0	5 27/32	148.4	RS5507	16 1/2	419.1	11 1/8	282.6	6 23/32	170.7	LL1885
16 1/4	412.8	12 15/16	328.6	8 19/32	218.3	PA5701	16 1/2	419.1	11 1/8	282.6	6 23/32	170.7	PA1885
16 1/4	412.8	14	355.6	7 25/32	197.6	RS5776	16 1/2	419.1	11 1/8	282.6	6 23/32	170.7	PA1885XP
16 9/32	413.5	9 1/2	241.3	8 1/8	206.4	RS5758	16 1/2	419.1	11 1/8	282.6	6 23/32	170.7	PA2951
16 5/16	414.3	5 29/32	150.0	4 1/32	102.4	PA5497	16 1/2	419.1	11 7/16	290.5	6 3/16	157.2	PA3862-FN
16 5/16	414.3	9 3/32	231.0	5 7/16	138.1	RS5409	16 1/2	419.1	12 1/32	305.6	7 7/8	200.0	PA3453
16 5/16	414.3	9 3/32	231.0	5 7/16	138.1	RS5441	16 1/2	419.1	12 1/8	308.0	7 11/16	195.3	LL1886
16 5/16	414.3	9 19/32	243.7	5 7/16	138.1	RS4969	16 1/2	419.1	12 1/8	308.0	7 11/16	195.3	PA1886
16 5/16	414.3	9 5/8	244.5	6 3/16	157.2	PA2459	16 1/2	419.1	12 1/8	308.0	7 11/16	195.3	PA1886XP
16 5/16	414.3	10	254.0	5 3/8	136.5	LL1902-FN	16 1/2	419.1	12 9/32	311.9	6 31/32	177.0	RS30112
16 5/16	414.3	10	254.0	5 3/8	136.5	PA1902-FN	16 1/2	419.1	12 15/32	316.7	6 3/16	157.2	PA3855-FN
16 5/16	414.3	14 7/8	377.8	7 7/8	200.0	PA3768	16 1/2	419.1	12 1/2	317.5	6	152.4	PA3652
16 11/32	415.1	5 1/4	133.4	4 1/8	104.8	PA3578	16 1/2	419.1	12 1/2	317.5	6	152.4	PA3860
16 11/32	415.1	9 9/32	235.7	5 5/32	131.0	RS3731	16 1/2	419.1	14 3/16	360.4	6 23/32	170.7	PA2533



**WARNING:** These products can expose you to chemicals, including Diisononyl Phthalate, Carbon black extracts, Nickel, 1,3 Butadiene, Ethylene Oxide, Epichlorohydrin, which are known to the State of California to cause cancer, and Bisphenol-A, Ethylene Glycol, Ethylene Oxide, 1,3 Butadiene, Epichlorohydrin, which are known to the State of California to cause birth defects or other reproductive harm.

**ROUND AIR FILTERS BY LENGTH**

LENGTH Inches	LENGTH (mm)	O.D. Inches	O.D. (mm)	I.D. Inches	I.D. (mm)	BALDWIN NUMBER	LENGTH Inches	LENGTH (mm)	O.D. Inches	O.D. (mm)	I.D. Inches	I.D. (mm)	BALDWIN NUMBER
16 1/2.....	419.1	15 3/4.....	400.1	7 11/16.....	195.3	PA3786-FN	17 1/2.....	444.5	13 3/8.....	339.7	8 3/8.....	212.7	PA2326XP
16 17/32.....	419.9	8 13/32.....	213.5	4 11/16.....	119.1	RS5433	17 17/32.....	445.3	8 9/32.....	210.3	7 3/32.....	180.2	PA5446
16 9/16.....	420.7	8 5/32.....	207.2	4 3/16.....	106.4	RS3734	17 9/16.....	446.1	9 27/32.....	250.0	4 3/4.....	120.7	RS5411
16 9/16.....	420.7	8 5/32.....	207.2	4 3/16.....	106.4	RS3734XP	17 9/16.....	446.1	12 19/32.....	319.9	7 13/16.....	198.4	PA5505
16 9/16.....	420.7	8 5/32.....	207.2	4 3/16.....	106.4	RS3884	17 19/32.....	446.9	7 15/32.....	189.7	6 1/2.....	165.1	PA5275
16 9/16.....	420.7	8 7/8.....	225.4	4 1/8.....	104.8	PA2480	17 19/32.....	446.9	7 31/32.....	202.4	7.....	177.8	PA3925
16 9/16.....	420.7	10.....	254.0	5 11/16.....	144.5	PA2434	17 19/32.....	446.9	8 15/32.....	215.1	6 3/16.....	157.2	PA1880
16 19/32.....	421.5	5 15/32.....	138.9	4 1/2.....	114.3	RS5398	17 19/32.....	446.9	9 1/8.....	231.8	5 13/16.....	147.6	PA3906
16 19/32.....	421.5	14.....	355.6	7 25/32.....	197.6	PA3767	17 19/32.....	446.9	10.....	254.0	5 7/8.....	141.3	PA2742
16 5/8.....	421.9	13 1/2.....	343.2	7 1/16.....	179.6	PA30314	17 19/32.....	446.9	11 29/32.....	302.4	6 5/8.....	168.3	RS3724
16 5/8.....	422.3	5 23/32.....	145.3	4 19/32.....	116.7	PA5412	17 21/32.....	448.5	11 3/32.....	281.8	7 7/16.....	188.9	RS5538
16 21/32.....	423.1	4 29/32.....	124.6	3 31/32.....	100.8	PA5298	17 11/16.....	449.3	5 27/32.....	148.4	4 5/32.....	105.6	PA30194
16 21/32.....	423.1	8.....	203.2	4 3/8.....	111.1	RS5489	17 11/16.....	449.3	12 1/16.....	306.4	5 11/16.....	144.5	PA2428
16 21/32.....	423.1	12 3/4.....	323.9	8 11/32.....	211.9	PA2797	17 23/32.....	450.1	4 7/16.....	112.7	3 5/16.....	84.1	RS4673
16 11/16.....	423.9	12 1/32.....	305.6	7 11/16.....	195.3	LL2945	17 23/32.....	450.1	6 7/8.....	174.6	5 5/32.....	131.0	RS3531
16 11/16.....	423.9	12 1/32.....	305.6	7 11/16.....	195.3	PA2945	17 3/4.....	450.9	12 1/32.....	305.6	7 11/16.....	195.3	PA2612
16 23/32.....	424.7	8 13/16.....	223.8	5 17/32.....	140.5	RS5558	17 3/4.....	450.9	13 15/32.....	342.1	8 5/32.....	207.2	RS3738
16 23/32.....	424.7	8 27/32.....	224.6	7 1/8.....	181.0	RS4992	17 3/4.....	450.9	15 5/8.....	396.9	10 9/32.....	261.1	PA3933
16 3/4.....	425.2	11 9/16.....	293.9	5 13/16.....	147.6	RS30313	17 25/32.....	451.6	6 3/8.....	161.9	5 9/32.....	134.1	PA30108
16 3/4.....	425.5	8 13/32.....	213.5	6 3/16.....	157.2	PA5464	17 13/16.....	452.4	9 11/16.....	246.1	8 1/8.....	206.4	PA3551
16 3/4.....	425.5	8 1/2.....	215.9	4 5/32.....	105.6	PA3609	17 13/16.....	452.4	10 3/8.....	263.5	6 1/32.....	153.2	PA2382
16 3/4.....	425.5	8 1/2.....	215.9	4 5/32.....	105.6	PA4581	17 27/32.....	453.2	6 7/8.....	174.6	5 1/4.....	133.4	RS30058
16 13/16.....	427.0	8 5/16.....	211.1	6 1/32.....	153.2	RS3739	17 27/32.....	453.2	9 3/32.....	231.0	6 29/32.....	175.4	RS3701
16 13/16.....	427.0	8 27/32.....	224.5	7 1/8.....	181.0	RS30257	17 7/8.....	454.0	5 1/4.....	133.4	3 3/4.....	95.3	RS4621
16 7/8.....	428.6	8 13/16.....	223.8	5 5/32.....	131.0	RS5546	17 29/32.....	454.8	10 3/8.....	263.5	5 11/32.....	135.7	PA2784
16 7/8.....	428.6	9 7/32.....	234.2	5 5/16.....	134.9	PA5496	17 15/16.....	455.6	11.....	279.4	5 3/8.....	136.5	PA3808-FN
16 15/16.....	430.2	5 1/16.....	128.6	3 13/16.....	96.8	PA4611	17 15/16.....	455.6	12 19/32.....	319.9	7 27/32.....	199.2	PA30170
16 15/16.....	430.2	8 7/8.....	225.4	6 1/4.....	158.8	PA4626							
16 15/16.....	430.2	10 9/16.....	268.3	5 1/16.....	128.6	PA30171							
16 15/16.....	430.2	11.....	279.4	7 11/16.....	195.3	RS30192							
17.....	431.8	9 3/32.....	231.0	5 7/32.....	132.6	PA2546	18.....	457.2	7 1/2.....	190.5	5 1/4.....	133.4	PA2899
17.....	431.8	9 1/8.....	231.8	5 13/16.....	147.6	PA3469	18.....	457.2	10.....	254.0	5 1/32.....	127.8	RS5506
17.....	431.8	9 9/32.....	235.7	5 5/32.....	131.0	RS4676	18.....	457.2	12 3/4.....	323.9	8 11/32.....	211.9	PA2437
17.....	431.8	11 25/32.....	299.2	7 3/4.....	196.9	RS5707	18 1/32.....	458.0	11 11/32.....	122.9	4 27/32.....	123.0	PA30193-FN
17.....	431.8	12 3/4.....	323.9	8 11/32.....	211.9	PA2571	18 1/32.....	458.0	12 3/32.....	307.2	7 23/32.....	196.1	PA5751
17.....	431.8	13 7/8.....	352.4	9 13/32.....	238.9	PA3573	18 3/32.....	459.6	12 3/32.....	307.2	8 1/8.....	206.4	PA2782
17 1/32.....	432.6	7.....	177.8	3 3/8.....	85.7	PA1825	18 1/8.....	460.4	11 1/8.....	282.6	6 3/16.....	157.2	PA1768
17 1/32.....	432.6	8 5/8.....	219.1	7 1/32.....	178.6	PA1905	18 1/8.....	460.4	11 15/16.....	303.2	6 19/32.....	167.5	RS30142
17 1/16.....	433.4	4 23/32.....	119.9	2.....	50.8	PA10114	18 1/8.....	460.4	13 13/16.....	350.8	9 1/2.....	241.3	PA1631-S
17 1/8.....	435.0	5 29/32.....	150.0	4 7/16.....	112.7	RS30092	18 1/8.....	460.4	14 3/8.....	365.1	6 19/32.....	167.5	RS30142 KIT
17 1/8.....	435.0	8 1/4.....	209.6	7 1/8.....	181.0	PA2957	18 5/32.....	461.2	7 7/8.....	200.0	7 5/8.....	193.7	PA5365
17 5/32.....	435.8	12 3/32.....	307.2	7 23/32.....	196.1	PA3794	18 5/32.....	461.2	11 7/8.....	301.6	10 1/4.....	260.4	PA2508
17 3/16.....	436.6	6 19/32.....	167.5	3 21/32.....	92.9	PA2542	18 3/16.....	462.0	10 31/32.....	278.6	5 13/16.....	147.6	RS30091
17 3/16.....	436.6	7 5/16.....	185.7	6 5/16.....	160.3	RS5541	18 7/32.....	462.8	5 1/4.....	133.4	4 15/16.....	125.4	RS3717
17 3/16.....	436.6	8 1/8.....	206.4	4.....	101.6	PA3555	18 7/32.....	462.8	12 7/32.....	310.3	8 1/32.....	204.0	RS5356
17 3/16.....	436.6	9 7/8.....	250.8	5 5/16.....	134.9	RS5397	18 1/4.....	463.6	6 13/32.....	162.7	2 25/32.....	70.6	PA2800-FN
17 1/4.....	438.2	5 1/2.....	139.7	3 1/8.....	79.4	PA1692	18 1/4.....	463.6	7 1/8.....	181.0	5 13/16.....	147.6	PA2397
17 1/4.....	438.2	10 7/16.....	265.1	5 5/8.....	142.9	RS30130	18 5/16.....	465.1	5 29/32.....	150.0	4 7/16.....	112.7	RS30217
17 9/32.....	438.9	12 31/32.....	329.4	6 13/16.....	173.0	RS3749	18 5/16.....	465.1	6.....	152.4	3 5/8.....	92.1	PA1610
17 5/16.....	439.7	6 5/8.....	168.3	5.....	127.0	RS5408	18 5/16.....	465.1	6 1/8.....	155.6	4 15/16.....	125.4	PA2388
17 5/16.....	439.7	7 1/4.....	184.2	6 1/16.....	154.0	PA5521	18 5/16.....	465.1	9 1/8.....	231.8	5 29/32.....	150.0	RS30062
17 5/16.....	439.7	10.....	254.0	5 1/2.....	139.7	PA2442	18 5/16.....	465.1	9 15/32.....	240.5	5 15/32.....	138.9	RS5440
17 3/8.....	441.3	7 5/8.....	193.7	6 1/16.....	154.0	PA2410	18 5/16.....	465.1	12 3/16.....	309.6	7 1/32.....	178.6	RS4963
17 3/8.....	441.3	9 1/16.....	230.2	5 3/8.....	136.5	PA2567	18 5/16.....	465.1	19 9/32.....	489.7	12 7/8.....	327.0	PA3932
17 13/32.....	442.1	7 7/8.....	200.0	4 9/16.....	115.9	RS4859	18 11/32.....	465.9	18 11/32.....	465.9	6 31/32.....	177.0	RS3727
17 7/16.....	442.9	5 5/16.....	134.9	3 11/16.....	93.7	RS30162	18 11/32.....	465.9	12 9/32.....	311.9	6 31/32.....	177.0	RS5390
17 7/16.....	442.9	7 15/32.....	189.7	6 7/32.....	158.0	PA5589	18 11/32.....	465.9	12 7/8.....	327.0	8 1/2.....	215.9	PA5364
17 7/16.....	442.9	9 1/32.....	229.4	7 1/32.....	178.6	RS30129	18 11/32.....	465.9	14 7/32.....	361.2	8 15/16.....	227.0	RS3700XP
17 7/16.....	442.9	9 11/16.....	246.1	4 29/32.....	124.6	RS4562	18 3/8.....	466.7	5 15/16.....	150.8	4 27/32.....	123.0	PA2462
17 7/16.....	442.9	12 19/32.....	319.9	7 27/32.....	199.2	PA30010	18 3/8.....	466.7	7 5/8.....	193.7	6 1/16.....	154.0	PA2519
17 1/2.....	444.5	5 23/32.....	145.3	4 19/32.....	116.7	PA2621	18 3/8.....	466.7	7 5/8.....	193.7	6 1/16.....	154.0	PA2708
17 1/2.....	444.5	6 3/8.....	161.9	5 9/32.....	134.1	PA2853	18 3/8.....	466.7	9 7/32.....	234.2	4 27/32.....	123.0	PA1824
17 1/2.....	444.5	7 1/16.....	179.4	5 11/16.....	144.5	RS5351	18 3/8.....	466.7	9 7/32.....	234.2	5 27/32.....	148.4	PA2466
17 1/2.....	444.5	7 3/32.....	179.8	6 3/8.....	161.8	RS30308	18 3/8.....	466.7	10 3/8.....	263.5	6 1/32.....	153.2	PA2509
17 1/2.....	444.5	9 7/32.....	234.2	5 27/32.....	148.4	PA2673	18 3/8.....	466.7	10 31/32.....	278.6	5 17/32.....	140.5	RS5675
17 1/2.....	444.5	13 3/8.....	339.7	8 3/8.....	212.7	LL2326	18 13/32.....	467.5	11.....	279.4	6 1/32.....	153.2	PA2591
17 1/2.....	444.5	13 3/8.....	339.7	8 3/8.....	212.7	PA2326	18 13/32.....	467.5	7 1/16.....	179.4	5 3/4.....	146.1	RS30136
17 1/2.....	444.5	13 3/8.....	339.7	8 3/8.....	212.7	PA2326	18 13/32.....	467.5	15 25/32.....	400.8	9 1/2.....	241.3	PA2956-FN
							18 13/32.....	467.5	16 1/8.....	409.6	7 7/16.....	188.9	PA2595



**WARNING:** These products can expose you to chemicals, including Diisononyl Phthalate, Carbon black extracts, Nickel, 1,3 Butadiene, Ethylene Oxide, Epichlorohydrin, which are known to the State of California to cause cancer, and Bisphenol-A, Ethylene Glycol, Ethylene Oxide, 1,3 Butadiene, Epichlorohydrin, which are known to the State of California to cause birth defects or other reproductive harm.

# ROUND AIR FILTERS BY LENGTH

LENGTH Inches	LENGTH (mm)	O.D. Inches	O.D. (mm)	I.D. Inches	I.D. (mm)	BALDWIN NUMBER	LENGTH Inches	LENGTH (mm)	O.D. Inches	O.D. (mm)	I.D. Inches	I.D. (mm)	BALDWIN NUMBER
18 7/16	468.3	6 1/8	155.6	5 1/8	130.2	RS5549	19	482.6	12 1/2	317.5	9 1/8	231.8	LL2609
18 7/16	468.3	6 5/16	160.3	21/32	16.7	PA3857	19	482.6	12 1/2	317.5	9 1/8	231.8	PA2609
18 7/16	468.3	12 3/32	307.2	7 11/16	195.3	PA5487	19 1/32	483.4	12 13/32	315.1	8 3/16	208.0	RS3514
18 1/2	469.9	6 7/8	174.6	6 7/16	163.5	RS4549	19 1/32	483.4	12 13/32	315.1	8 3/16	208.0	RS3514XP
18 1/2	469.9	7 1/4	184.2	6 3/16	157.2	PA3668	19 1/16	484.2	6 7/8	174.6	5 13/32	137.3	PA2655
18 1/2	469.9	7 5/8	193.7	6 3/16	157.2	PA3893	19 1/16	484.2	7 5/32	181.8	5 1/2	139.7	RS5462
18 1/2	469.9	7 7/8	200.0	4 3/4	120.7	RS4672	19 3/32	485.0	9 3/32	231.0	6 29/32	175.4	RS4580
18 1/2	469.9	8 1/4	209.6	4 23/32	119.9	PA2750	19 3/32	485.0	11 29/32	302.4	6 5/8	168.3	RS3714
18 1/2	469.9	8 9/32	210.3	7 3/32	180.2	PA5562	19 1/8	485.8	6 7/8	174.6	5 13/32	137.3	PA4574
18 1/2	469.9	8 17/32	216.7	7 11/16	195.3	RS4643	19 1/8	485.8	11 31/32	304.0	7 3/8	187.3	RS5332
18 1/2	469.9	8 5/8	219.1	7 1/16	179.4	PA2574	19 5/32	486.6	7 1/16	179.4	6 15/32	164.3	RS5673
18 1/2	469.9	9 1/8	231.8	5 13/16	147.6	LL2688	19 5/32	486.6	8 15/32	215.1	6 5/32	156.4	PA3861
18 1/2	469.9	9 1/8	231.8	5 13/16	147.6	PA2688	19 5/32	486.6	9 11/16	246.1	4 19/32	116.7	RS30180
18 1/2	469.9	9 7/32	234.2	4 27/32	123.0	PA3600	19 1/4	489.0	11 9/16	293.7	9	228.6	RS5744
18 1/2	469.9	9 3/4	247.7	5 13/16	147.6	PA2620	19 9/32	489.7	9 3/8	238.1	8 1/16	204.8	PA5574
18 1/2	469.9	10 27/32	275.4	6 1/2	165.1	PA2852	19 9/32	489.7	15 1/32	381.8	10 9/16	268.3	PA5552
18 1/2	469.9	11 1/8	282.6	6 23/32	170.7	PA1823	19 5/16	490.5	4 15/16	122.2	3 5/8	92.1	PA3631
18 1/2	469.9	12 1/32	305.6	7 11/16	195.3	PA2409	19 3/8	492.1	11	279.4	5 13/16	147.6	RS3730
18 1/2	469.9	12 1/16	306.4	7 11/16	195.3	PA3688	19 3/8	492.1	12 1/4	311.2	5 5/32	131.0	PA3477
18 1/2	469.9	12 3/32	307.2	6 25/32	172.2	RS30057	19 3/8	492.1	14 7/32	361.2	8 15/16	227.0	RS4579
18 1/2	469.9	12 3/32	307.2	7 11/16	195.3	LL2525	19 13/32	492.9	7 1/2	190.5	4 1/8	104.8	RS30237
18 1/2	469.9	12 3/32	307.2	7 11/16	195.3	PA2525	19 13/32	492.9	9 21/32	245.3	5 17/32	140.5	RS30223
18 1/2	469.9	12 3/32	307.2	7 11/16	195.3	PA2952	19 13/32	492.9	11 3/32	281.8	7 7/16	188.9	RS5540
18 1/2	469.9	12 1/8	308.0	7 11/16	195.3	LL1846	19 13/32	492.9	12 7/8	327.0	8 11/32	211.9	PA5445
18 1/2	469.9	12 1/8	308.0	7 11/16	195.3	PA1846	19 7/16	493.7	5 5/32	131.0	4 1/32	102.4	PA4983
18 1/2	469.9	12 1/8	308.0	7 11/16	195.3	PA1846XP	19 7/16	493.7	5 1/4	133.4	4 1/8	104.8	PA2378
18 1/2	469.9	13 13/16	350.8	9 1/2	241.3	LL1894	19 7/16	493.7	10 27/32	275.4	6 17/32	165.9	PA30109
18 1/2	469.9	13 13/16	350.8	9 1/2	241.3	PA1894	19 1/2	495.3	6 3/8	161.9	5 9/32	134.1	PA2583
18 1/2	469.9	13 13/16	350.8	9 1/2	241.3	PA1894XP	19 1/2	495.3	7 3/8	187.3	6 1/8	155.6	PA2491
18 1/2	469.9	13 7/8	352.4	7 7/16	188.9	PA2468	19 1/2	495.3	9 1/2	241.3	4 7/8	123.8	RS5391
18 1/2	469.9	13 7/8	352.4	7 7/16	188.9	LL2618	19 1/2	495.3	9 17/32	242.1	5 5/32	131.0	PA3572
18 1/2	469.9	13 7/8	352.4	7 7/16	188.9	PA2618	19 1/2	495.3	9 27/32	250.0	6 1/4	158.8	PA2751
18 1/2	469.9	14 1/2	368.3	9 1/2	241.3	PA2749	19 1/2	495.3	11 17/32	292.9	6 17/32	165.9	PA3499
18 1/2	469.9	14 13/16	376.2	7 11/16	195.3	PA2478	19 1/2	495.3	12 1/32	305.6	7 11/16	195.3	PA2640
18 1/2	469.9	15 25/32	400.8	9 1/2	241.3	PA2663-FN	19 1/2	495.3	12 3/32	307.2	7 11/16	195.3	PA3916
18 1/2	469.9	16 1/4	412.8	9 1/2	241.3	PA4571	19 1/2	495.3	12 1/8	308.0	7 11/16	195.3	LL2676
18 17/32	470.7	11 27/32	300.8	6 9/16	166.7	RS5484	19 1/2	495.3	12 1/8	308.0	7 11/16	195.3	PA2676
18 9/16	471.5	6 3/8	161.9	5 19/32	142.1	PA3494	19 1/2	495.3	12 1/8	308.0	7 11/16	195.3	PA2676XP
18 9/16	471.5	15 3/4	400.1	7 11/16	195.3	PA1847-FN	19 1/2	495.3	13	330.2	9 1/8	231.8	RS4642
18 9/16	471.5	16 5/32	410.4	7 7/16	188.9	LL2333	19 1/2	495.3	13 23/32	348.5	9 1/4	235.0	PA3497
18 9/16	471.5	16 5/32	410.4	9 1/2	241.3	PA2333	19 1/2	495.3	16 5/32	410.4	7 7/16	188.9	LL2393
18 19/32	472.3	9 9/32	235.7	5 5/32	131.0	RS4620	19 1/2	495.3	16 5/32	410.4	7 7/16	188.9	PA2393
18 19/32	472.3	11 13/16	300.0	7 7/8	200.0	PA5588	19 17/32	496.1	8 1/32	204.0	5 3/16	131.8	RS5430
18 5/8	473.1	5 9/16	141.3	4 11/16	119.1	PA2814	19 17/32	496.1	16 1/8	409.6	8 11/32	211.9	PA2629
18 5/8	473.1	6 13/32	162.7	5 9/32	134.1	PA5565	19 17/32	496.1	18 5/16	465.1	12 1/8	308.0	LL2507
18 5/8	473.1	12 31/32	329.4	6 13/16	173.0	RS3530	19 17/32	496.1	18 5/16	465.1	12 1/8	308.0	PA2507
18 5/8	473.1	12 31/32	329.4	6 13/16	173.0	RS3530XP	19 9/16	496.9	9 17/32	242.1	5 5/32	131.0	PA2475
18 21/32	473.9	11 15/16	303.2	7 17/32	191.3	PA2776	19 9/16	496.9	9 17/32	242.1	5 1/4	133.4	PA5524
18 21/32	473.9	11 15/16	303.2	7 17/32	191.3	PA30235	19 19/32	497.7	5 29/32	150.0	4 13/32	111.9	RS3745
18 21/32	473.9	14 1/4	362.0	9 29/32	251.6	PA2781	19 5/8	498.5	9 1/16	230.2	5 3/8	136.5	PA2529
18 11/16	474.7	12	304.8	7 11/16	195.3	PA5469	19 5/8	498.6	11 11/16	297.2	7 27/32	198.9	RS30307
18 23/32	475.5	10 17/32	267.5	6 19/32	167.5	RS5534	19 7/16	498.7	14	355.6	9	228.6	RS30128
18 23/32	475.5	12 1/16	306.4	7 11/16	195.3	PA3780	19 21/32	499.3	5 15/16	150.8	4 9/32	108.7	RS30160
18 3/4	476.3	11 13/16	300.0	7 7/8	200.0	PA5274	19 21/32	499.3	7 5/32	181.8	5 27/32	148.4	RS5510
18 3/4	476.3	12 7/8	327.0	8 1/2	215.9	PA3754	19 21/32	499.3	9 27/32	250.0	7 13/32	188.1	RS5461
18 3/4	476.3	15 1/32	381.8	9 9/16	242.9	PA2801	19 11/16	500.1	10 29/32	277.0	7	177.8	PA30040
18 7/8	479.4	9 31/32	253.2	5 23/32	145.3	RS30161	19 11/16	500.1	11 3/8	288.9	6 3/8	161.9	RS5756
18 7/8	479.4	10 1/2	266.7	6 11/16	169.9	RS4959	19 23/32	500.9	6 7/8	174.6	5 5/32	131.0	RS5313
18 7/8	479.4	10 31/32	278.6	5 13/16	147.6	RS3888	19 23/32	500.9	7 13/16	198.4	4 27/32	123.0	RS5767
18 7/8	479.4	11 7/8	301.6	7 17/32	191.3	PA5687	19 3/4	501.7	9 3/4	247.7	5 31/32	151.6	PA30037
18 7/8	479.4	12 29/32	327.8	7 17/32	191.3	PA3765	19 13/16	503.2	9 13/16	249.2	5 3/8	136.5	PA4984-FN
18 29/32	480.2	9 29/32	251.6	6 3/16	157.2	RS5432	19 13/16	503.2	10 3/8	263.5	6 1/32	153.2	PA2441
18 15/16	481.0	9 9/32	235.7	5 5/32	131.0	RS3517	19 7/8	504.8	7 1/4	184.2	6 3/16	157.2	PA5578
18 15/16	481.0	9 9/32	235.7	5 5/32	131.0	RS3517XP	19 7/8	504.8	9 3/32	231.0	4 13/16	122.2	PA2367
19	482.6	5 11/16	144.5	5 5/32	131.0	RS30224	19 7/8	504.8	10 27/32	275.4	6 1/2	165.1	PA5564
19	482.6	6 1/8	155.6	5 7/32	132.6	PA5499	19 29/32	505.6	10 31/32	278.6	5 13/16	147.6	RS3952
19	482.6	6 3/8	161.9	5 7/16	138.1	PA3896	19 15/16	506.4	4 1/4	108.0	3 7/16	87.3	RS5448
							19 31/32	507.2	7 1/16	179.4	5 11/16	144.5	RS3871



**WARNING:** These products can expose you to chemicals, including Diisononyl Phthalate, Carbon black extracts, Nickel, 1,3 Butadiene, Ethylene Oxide, Epichlorohydrin, which are known to the State of California to cause cancer, and Bisphenol-A, Ethylene Glycol, Ethylene Oxide, 1,3 Butadiene, Epichlorohydrin, which are known to the State of California to cause birth defects or other reproductive harm.

**ROUND AIR FILTERS BY LENGTH**

LENGTH Inches	LENGTH (mm)	O.D. Inches	O.D. (mm)	I.D. Inches	I.D. (mm)	BALDWIN NUMBER	LENGTH Inches	LENGTH (mm)	O.D. Inches	O.D. (mm)	I.D. Inches	I.D. (mm)	BALDWIN NUMBER
19 31/32	507.2	7 1/16	179.4	5 11/16	144.5	RS4639	20 31/32	532.6	8 5/16	211.1	6 1/32	153.2	RS3721
19 31/32	507.2	12 1/32	305.6	7 11/16	195.3	PA2376	21	533.4	7 5/8	193.7	6 1/16	154.0	PA30146
20	508.0	7 1/2	190.5	5 1/4	133.4	PA2346	21	533.4	8 5/8	219.1	7 1/16	179.4	PA2672
20	508.0	10 11/16	271.5	6 11/16	169.9	RS4971	21	533.4	12	304.8	7 11/16	195.3	PA3559
20	508.0	11 25/32	299.2	7 3/4	196.9	RS5672	21	533.4	12 3/4	323.9	8 11/32	211.9	PA2398
20	508.0	12 3/4	323.9	8 3/8	212.7	PA5561	21 1/32	534.2	8 5/8	219.1	7 1/16	179.4	PA1976
20	508.0	13 7/8	345.2	7 7/16	188.9	PA2515	21 1/16	535.0	5 29/32	150.0	4 13/32	111.9	RS3719
20 1/32	508.8	10 31/32	278.6	5 13/16	147.6	RS5413	21 1/16	535.0	12 1/16	306.4	6 3/32	154.8	PA1952
20 1/16	509.5	7 3/32	179.8	6 3/8	161.8	RS30306	21 1/16	535.0	12 1/16	306.4	6 3/32	154.8	PA1953
20 1/8	511.2	9 5/8	244.5	5	127.0	PA3556	21 3/32	535.7	7 1/16	179.3	5 11/16	144.8	RS30328
20 5/32	512.0	13 19/32	345.3	5 25/32	146.8	RS5754	21 1/8	536.6	6 7/8	174.6	5 11/16	144.5	RS3729
20 3/16	512.8	11	279.4	6 1/2	165.1	PA5498	21 5/32	537.4	9 1/2	241.3	5 3/4	146.1	RS3996
20 3/16	512.8	12 29/32	327.8	8 5/8	219.1	PA3876	21 7/32	539.0	5 1/4	133.4	3 5/8	92.1	RS3975
20 1/4	514.4	7	177.8	4 13/32	111.9	PA1754	21 9/32	539.8	11 29/32	302.4	6 5/8	168.3	RS30143
20 1/4	514.4	7 15/16	201.6	3 9/16	90.5	PA3562	21 1/4	539.8	12 1/2	317.5	7 1/2	190.5	PA2490
20 9/32	515.1	12	304.8	7 11/16	195.3	PA5704	21 9/32	539.8	15 1/8	384.2	6 5/8	168.3	RS30143 KIT
20 11/32	516.7	9 3/32	231.0	6 29/32	175.4	RS4617	21 11/32	542.1	11 3/8	288.9	6 13/16	173.0	RS4564
20 3/8	517.5	7 5/8	193.7	6 1/16	154.0	PA2714	21 3/8	542.9	10 3/16	258.8	6 5/16	160.3	PA2786
20 3/8	517.5	7 15/16	201.6	4 5/8	117.5	PA2659	21 13/32	543.7	11 3/8	288.9	5 13/16	147.6	RS4618
20 3/8	517.5	10 3/8	263.5	6 1/32	153.2	PA2461	21 15/32	545.3	6 7/8	174.6	5 5/32	131.0	RS3927
20 3/8	517.5	12	304.8	6 7/8	174.6	PA2386	21 15/32	545.3	7 5/8	193.7	6 1/16	154.0	PA2362
20 3/8	517.5	12 3/16	309.6	7 1/4	184.2	RS30159	21 1/2	546.1	8 1/8	206.4	4 27/32	123.0	PA3898
20 3/8	517.5	12 13/16	325.4	7 11/16	195.3	LL2518	21 1/2	546.1	12 1/32	305.6	7 11/16	195.3	PA2713
20 3/8	517.5	12 13/16	325.4	7 11/16	195.3	PA2518	21 1/2	546.1	16 1/8	409.6	7 7/16	188.9	PA2394
20 3/8	517.5	12 13/16	325.4	7 11/16	195.3	PA2518XP	21 17/32	546.9	10 15/16	277.8	6 9/32	159.5	PA2982
20 3/8	517.5	14	355.6	7 11/16	195.3	PA2396	21 17/32	546.9	16 5/32	410.4	9 1/2	241.3	PA2734
20 13/32	518.3	5 3/4	146.1	3 7/16	87.3	PA3899	21 9/16	547.7	7 1/8	181.0	5 1/2	139.7	PA2964
20 7/16	519.1	10 1/4	260.4	8	203.2	RS5429	21 19/32	548.5	6 7/8	174.6	5 7/16	138.1	PA2915
20 7/16	519.1	11 1/2	292.1	6 3/16	157.2	PA2387	21 5/8	549.3	10 31/32	278.6	5 27/32	148.4	RS3718
20 15/32	519.9	10 27/32	275.4	6 1/2	165.1	PA3938	21 5/8	549.3	12 13/32	315.1	8 3/16	208.0	RS3720
20 15/32	519.9	11 3/32	281.8	8	203.2	RS4993	21 11/16	550.9	13 3/32	332.6	7 3/8	187.3	RS4572
20 1/2	520.7	6 1/8	155.6	4 15/16	125.4	PA2787	21 11/16	550.9	13 3/32	332.6	7 3/8	187.3	RS4613
20 1/2	520.7	7 3/16	182.6	4 13/16	122.2	RS30134	21 25/32	553.2	12 3/32	307.2	7 11/16	195.3	PA30145
20 1/2	520.7	8 3/4	222.3	4 3/16	106.4	PA3630-FN	21 13/16	554.0	8 13/32	213.5	6 3/16	157.2	PA3889
20 1/2	520.7	10 13/32	264.3	6 15/16	176.2	PA2851	21 7/8	555.6	9 9/32	235.7	5 5/32	131.0	RS3974
20 1/2	520.7	10 27/32	275.4	6 1/2	165.1	LL2582	21 7/8	555.6	12 3/16	309.6	6 31/32	177.0	RS30116
20 1/2	520.7	10 27/32	275.4	6 1/2	165.1	PA2582	21 7/8	555.6	12 9/32	311.9	6 31/32	177.0	RS3728
20 1/2	520.7	11 1/8	282.6	6 3/4	171.5	PA2345	21 15/16	557.2	7 3/32	180.2	2 15/32	62.7	RS5593XP
20 1/2	520.7	11 1/2	292.1	7 1/4	184.2	PA2654	22 3/32	561.2	5 29/32	150.0	4 13/32	111.9	RS30181
20 1/2	520.7	12 1/8	308.0	7 23/32	196.1	PA2840	22 3/32	561.2	7 1/16	179.4	5 11/16	144.5	RS3827
20 1/2	520.7	12 15/32	316.7	7 7/8	200.0	PA3892	22 3/32	561.2	9 3/32	231.0	6 7/8	174.6	RS5460
20 1/2	520.7	13 13/16	350.8	9 1/2	241.3	PA2573	22 5/32	562.8	11 3/32	281.8	7 7/16	188.9	RS30175
20 1/2	520.7	13 13/16	350.8	9 1/2	241.3	PA2573XP	22 3/16	563.6	10 13/32	264.3	5 27/32	148.4	RS4563
20 1/2	520.7	14 7/32	361.2	8 15/16	227.0	RS4616	22 3/16	563.6	10 29/32	277.0	8 5/32	207.2	PA2364
20 17/32	521.5	11 11/16	296.9	6 11/16	169.9	PA2704	22 3/16	563.6	11 11/16	297.2	7 27/32	198.9	RS30305
20 17/32	521.5	12 9/32	311.9	6 31/32	177.0	RS3870	22 3/16	563.6	12 23/32	323.1	9 9/32	235.7	PA5465
20 9/16	522.0	12 9/32	311.9	6 15/16	176.5	RS3870XP	22 1/4	565.2	8 9/32	210.3	7 3/32	180.2	PA5569
20 9/16	522.3	5 17/32	140.5	4 25/32	121.4	RS3997	22 1/4	565.2	12 1/2	317.5	7 1/2	190.5	PA2614
20 9/16	522.3	10 31/32	278.6	5 13/16	147.6	RS3744	22 9/32	565.9	12 31/32	329.4	6 13/16	173.0	RS3926
20 9/16	522.3	10 31/32	278.6	5 13/16	147.6	RS3744XP	22 3/8	568.3	8 1/4	209.6	7 3/32	180.2	PA2457
20 9/16	522.3	12 3/32	307.2	7 11/16	195.3	RS5509	22 7/16	569.9	14 7/32	361.2	8 15/16	227.0	RS5459
20 9/16	522.3	12 5/32	308.8	5 3/16	131.8	PA2981	22 7/16	569.9	15 1/32	381.8	10 9/16	268.3	PA5573
20 9/16	522.3	12 9/32	311.9	6 31/32	177.0	RS4638	22 15/32	570.7	11 11/16	296.9	6 23/32	170.7	PA2705
20 5/8	523.9	8 5/32	207.2	4 3/16	106.4	RS5447	22 15/32	570.7	11 11/16	296.9	6 23/32	170.7	PA4585
20 5/8	523.9	12 1/8	308.0	7	177.8	RS30135	22 1/2	571.5	7 1/16	179.4	6 13/32	162.7	RS5471
20 5/8	523.9	12 3/8	314.3	7 11/16	195.3	RS30133	22 1/2	571.5	7 15/16	201.6	3 9/16	90.5	PA3581
20 11/16	525.5	11	279.4	5 25/32	146.8	RS30216	22 1/2	571.5	10 1/4	260.4	9 1/8	231.8	PA2563
20 23/32	526.3	11 29/32	302.4	6 5/8	168.3	RS3726	22 1/2	571.5	10 13/32	264.3	6 15/16	176.2	PA2715
20 3/4	527.1	11 1/2	292.1	7 1/4	184.2	PA4573	22 1/2	571.5	11 7/8	301.6	10 1/4	260.4	PA2454
20 25/32	527.8	12	304.8	7 11/16	195.3	PA5577	22 1/2	571.5	12 3/32	307.2	7 11/16	195.3	PA3887
20 13/16	528.6	10 17/32	267.5	6 19/32	167.5	RS5358	22 1/2	571.5	12 1/2	317.5	7 1/2	190.5	PA3464
20 13/16	528.6	10 17/32	267.5	6 19/32	167.5	RS5508	22 1/2	571.5	12 3/4	323.9	8 11/32	211.9	PA2698
20 7/8	530.2	7 3/8	187.3	6 1/8	155.6	PA2615	22 1/2	571.5	12 3/4	323.9	8 11/32	211.9	PA3579
20 7/8	530.2	8 1/8	206.4	4 3/16	106.4	RS4794	22 1/2	571.5	13 13/16	350.8	9 1/2	241.3	PA1975
20 7/8	530.2	10	254.0	5 1/2	139.7	PA2377	22 1/2	571.5	13 13/16	350.8	9 1/2	241.3	PA3588
20 15/16	531.8	10 3/8	263.5	6 1/32	153.2	PA2430	22 1/2	571.5	13 7/8	352.4	9 1/2	241.3	PA5699
20 31/32	532.6	8 1/8	206.4	6 7/8	174.6	RS30009							



**WARNING:** These products can expose you to chemicals, including Diisononyl Phthalate, Carbon black extracts, Nickel, 1,3 Butadiene, Ethylene Oxide, Epichlorohydrin, which are known to the State of California to cause cancer, and Bisphenol-A, Ethylene Glycol, Ethylene Oxide, 1,3 Butadiene, Epichlorohydrin, which are known to the State of California to cause birth defects or other reproductive harm.



# ROUND AIR FILTERS BY LENGTH

LENGTH Inches	LENGTH (mm)	O.D. Inches	O.D. (mm)	I.D. Inches	I.D. (mm)	BALDWIN NUMBER	LENGTH Inches	LENGTH (mm)	O.D. Inches	O.D. (mm)	I.D. Inches	I.D. (mm)	BALDWIN NUMBER
22 1/2	571.5	14 1/2	368.3	9 1/2	241.3	PA2675	24 1/2	622.3	12 1/8	308.0	7 11/16	195.3	PA2902
22 17/32	572.3	16 5/32	410.4	7 7/16	188.9	PA2679	24 1/2	622.3	13 11/32	338.9	8 11/32	211.9	PA4566
22 9/16	573.1	6 7/8	174.6	5 7/16	138.1	RS5415	24 1/2	622.3	14 1/4	362.0	9 15/16	252.4	PA5480
22 19/32	573.9	7 15/16	201.6	4 5/8	117.5	PA3946	24 1/2	622.3	14 11/16	373.1	10 11/32	262.7	LL2562
22 19/32	573.9	9	228.6	5 11/16	144.5	PA2531	24 1/2	622.3	14 11/16	373.1	10 11/32	262.7	PA2562
22 5/8	574.7	7 29/32	200.8	7 9/16	192.1	RS3999	24 1/2	622.3	14 11/16	373.1	10 11/32	262.7	PA2562XP
22 5/8	574.7	15 31/32	405.6	8 5/16	211.1	PA2989	24 1/2	622.3	15 3/8	390.5	10 11/32	262.7	PA2849
22 11/16	576.3	10 5/8	269.9	6 1/4	158.8	PA2757	24 1/2	622.3	15 25/32	400.8	10	254.0	PA3496
22 13/16	579.4	10 3/8	263.5	6 1/32	153.2	LL2312	24 5/8	625.5	9 3/32	231.0	7	177.8	RS4629
22 13/16	579.4	10 3/8	263.5	6 1/32	153.2	PA2312	24 5/8	625.5	11 11/16	296.9	7 27/32	199.2	RS5470
22 13/16	579.4	10 5/8	269.9	7 1/4	184.2	PA2963	24 5/8	625.5	12 23/32	323.1	7 13/16	198.4	RS5472
22 27/32	580.2	6 25/32	172.2	5 3/8	136.5	PA3865	24 3/4	628.7	10 7/8	276.2	6 23/32	170.7	PA3644
22 27/32	580.2	10 5/8	269.9	7 1/4	184.2	PA2914	24 3/4	628.7	22	558.8	15 9/16	395.3	PA3633
22 29/32	581.8	10 31/32	278.6	5 13/16	147.6	RS30232	24 13/16	630.2	13 3/32	332.6	7 5/8	193.7	RS5287XP
22 29/32	581.8	11 1/32	280.2	5 13/16	147.6	RS30182	24 13/16	630.2	13 3/32	332.6	7 5/8	193.7	RS30187XP
22 29/32	581.8	11 13/32	289.7	7 5/8	193.7	RS5288XP	24 13/16	630.2	13 1/8	333.0	7 5/8	193.8	RS5287
22 29/32	581.8	12 9/32	311.9	6 31/32	177.0	RS3764	24 27/32	631.0	9 21/32	245.3	5 5/32	131.0	RS4646
22 29/32	581.8	12 9/32	311.9	6 31/32	177.0	RS3826	24 27/32	631.0	14 7/32	361.2	8 15/16	227.0	RS4989
22 15/16	582.4	11 13/32	289.6	7 5/8	193.5	RS5288	24 7/8	631.8	17 23/32	450.1	11 7/16	290.5	RS5743
22 15/16	582.4	12 3/32	306.8	7	177.5	RS30327	24 7/8	631.8	17 23/32	450.1	11 7/16	290.5	RS5743XP
22 31/32	583.4	8 23/32	221.5	7 1/32	178.6	RS30088	25	635.0	11 7/8	301.6	7 3/8	187.3	PA2729
23	584.2	8 21/32	219.9	5 3/16	131.8	PA2623	25	635.0	12 3/4	323.9	8 11/32	211.9	PA2631
23	584.2	8 27/32	224.6	5 15/32	138.9	LL2482	25	635.0	14	355.6	9	228.6	RS30087
23	584.2	8 27/32	224.6	5 15/32	138.9	PA2482	25	635.0	16 5/8	422.3	12	304.8	PA3584
23	584.2	10 13/32	264.3	6 15/16	176.2	PA2703	25 9/32	642.1	9 11/32	237.3	8 1/8	206.4	PA3810
23	584.2	12 3/4	323.9	8 11/32	211.9	LL2317	25 17/32	648.5	9 9/32	235.7	5 25/32	146.8	RS3936
23	584.2	12 3/4	323.9	8 11/32	211.9	PA2317	25 1/2	647.7	9 9/32	235.7	5 25/32	146.8	RS4634
23 7/32	589.8	11 13/16	300.0	6 5/16	160.3	PA3484	25 1/2	647.7	9 9/32	235.7	5 25/32	146.8	RS4634XP
23 1/4	590.6	8 1/8	206.4	4 11/16	119.1	PA2785	25 19/32	650.1	11 1/2	292.1	7	177.8	PA3800
23 9/32	591.3	12 31/32	329.4	6 13/16	173.0	RS5414	25 11/16	652.3	11 1/32	279.9	7 3/32	179.8	PA30315
23 5/16	592.1	11 23/32	297.7	8 1/32	204.0	RS3998	25 3/4	654.1	7 3/8	187.3	6 1/8	155.6	PA2745
23 5/16	592.1	11 23/32	297.7	8 1/32	204.0	RS3998XP	25 13/16	655.6	13 3/32	332.6	7 3/8	187.3	RS3534
23 7/16	595.3	9 9/32	235.7	5 25/32	146.8	RS3516	25 7/8	657.2	7 3/8	187.3	6 1/8	155.6	PA1937
23 15/32	595.9	9 5/16	236.5	5 3/4	146.1	RS3516XP	25 29/32	658.1	13 1/2	343.2	8 1/16	204.7	PA30316
23 1/2	596.9	7 1/4	184.2	6 3/16	157.2	PA2903	26	660.4	13 7/8	352.4	7 7/16	188.9	PA2516
23 1/2	596.9	7 11/32	186.5	5 5/16	134.9	PA2726	26 1/32	661.2	14 13/16	376.2	9 19/32	243.7	PA5463
23 1/2	596.9	9 29/32	251.6	8 11/16	204.8	PA3498	26 7/32	666.0	13 9/32	337.3	7 5/32	181.8	PA3772
23 1/2	596.9	12 3/32	307.2	7 23/32	196.1	PA2962	26 1/2	673.1	10 3/8	263.5	6 1/16	154.0	PA3452
23 1/2	596.9	12 3/4	323.9	7 23/32	196.1	LL2361	26 1/2	673.1	11 7/8	301.6	7 1/8	181.0	PA2900
23 1/2	596.9	12 3/4	323.9	7 23/32	196.1	PA2361	26 1/2	673.1	12 3/4	323.9	8 11/32	211.9	PA2799
23 1/2	596.9	12 3/4	323.9	7 23/32	196.1	PA2361XP	26 1/2	673.1	12 3/4	323.9	8 11/32	211.9	PA2855
23 1/2	596.9	12 3/4	323.9	8 11/32	211.9	PA2580	26 1/2	673.1	12 3/4	323.9	8 11/32	211.9	PA2857
23 17/32	597.7	9 21/32	245.3	5 5/32	131.0	RS3743	26 1/2	673.1	12 3/4	323.9	8 11/32	211.9	PA2973
23 17/32	597.7	14 7/32	361.2	8	203.2	RS30008	26 1/2	673.1	12 3/4	323.9	8 11/32	211.9	PA3458
23 17/32	597.7	17 5/8	447.7	11 1/32	280.2	PA3637	26 1/2	673.1	12 25/32	324.6	8 11/32	211.9	PA3404
23 17/32	597.7	18 5/16	465.1	11	279.4	LL2363	26 1/2	673.1	12 25/32	324.6	8 11/32	211.9	PA3563
23 17/32	597.7	18 5/16	465.1	11	279.4	PA2363	26 1/2	673.1	13 13/16	350.8	9 1/2	241.3	PA3461
23 17/32	597.7	18 5/16	465.1	11	279.4	PA2363XP	26 1/2	673.1	13 13/16	350.8	9 1/2	241.3	PA3463
23 17/32	597.7	18 5/16	465.1	12 1/8	308.0	LL2453	26 1/2	673.1	13 13/16	350.8	9 1/2	241.3	PA3614
23 17/32	597.7	18 5/16	465.1	12 1/8	308.0	PA2453	26 1/2	673.1	13 13/16	350.8	9 1/2	241.3	PA3614
23 17/32	597.7	18 5/16	465.1	12 1/8	308.0	PA2453XP	26 5/8	676.3	13 7/8	352.4	8 7/16	214.3	PA3560
23 5/8	600.1	4 23/32	119.9	2 15/16	74.6	PA4876	26 5/8	676.3	15 31/32	405.6	8 5/16	211.1	PA2988
23 23/32	602.5	11 13/32	289.7	6 23/32	170.7	RS3539	26 5/8	676.3	15 31/32	405.6	8 11/32	211.9	PA3580
23 23/32	602.5	11 13/32	289.7	6 23/32	170.7	RS3539XP	26 23/32	678.9	14 7/32	360.9	8 29/32	226.3	RS30290
23 3/4	603.3	16 1/4	412.8	7 23/32	194.5	PA5323	27	685.8	10 3/8	263.5	6 1/32	153.2	LL2493
23 31/32	608.8	8 5/16	211.1	7 11/32	186.5	PA3787	27	685.8	10 3/8	263.5	6 1/32	153.2	PA2493
24	609.6	13 7/8	352.4	7 7/16	188.9	LL2559	27	685.8	12 3/4	323.9	8 11/32	211.9	LL2608
24	609.6	13 7/8	352.4	7 7/16	188.9	PA2559	27	685.8	12 3/4	323.9	8 11/32	211.9	PA2608
24 1/32	610.4	12 25/32	324.6	8 3/8	212.7	LL2456	27	685.8	12 3/4	323.9	8 3/8	212.7	PA2357
24 1/32	610.4	12 25/32	324.6	8 3/8	212.7	PA2456	27	685.8	13 7/8	352.4	7 7/16	188.9	LL2458
24 1/32	610.4	12 25/32	324.6	8 3/8	212.7	PA2456XP	27	685.8	13 7/8	352.4	7 7/16	188.9	PA2458
24 1/8	612.8	7 15/16	201.6	4 5/8	117.5	PA2649	27	685.8	14 1/2	317.5	7 1/2	190.5	PA2744
24 1/4	616.0	12 29/32	327.8	8 1/2	215.9	PA3606	27 1/16	687.4	14 1/2	368.3	9 1/2	241.3	PA3806
24 3/8	619.1	11 9/16	293.7	9	228.6	RS5294	27 5/16	693.7	14 1/2	368.3	9 1/2	241.3	PA4606
24 7/16	620.7	12 31/32	329.4	8 3/8	212.7	PA5568	27 1/2	698.5	12 1/2	317.5	7 1/2	190.5	PA1936
24 1/2	622.3	9 1/4	235.0	6 3/4	171.5	PA3691	27 1/2	698.5	13 13/16	350.8	9 1/2	241.3	PA3587



**WARNING:** These products can expose you to chemicals, including Diisononyl Phthalate, Carbon black extracts, Nickel, 1,3 Butadiene, Ethylene Oxide, Epichlorohydrin, which are known to the State of California to cause cancer, and Bisphenol-A, Ethylene Glycol, Ethylene Oxide, 1,3 Butadiene, Epichlorohydrin, which are known to the State of California to cause birth defects or other reproductive harm.

## ROUND AIR FILTERS BY LENGTH

LENGTH Inches	LENGTH (mm)	O.D. Inches	O.D. (mm)	I.D. Inches	I.D. (mm)	BALDWIN NUMBER	LENGTH Inches	LENGTH (mm)	O.D. Inches	O.D. (mm)	I.D. Inches	I.D. (mm)	BALDWIN NUMBER
27 5/8.....	701.7	10 .....	254.0	4 23/32 .....	119.9	PA4887	29 .....	736.6	8 27/32 .....	224.6	5 13/16 .....	147.6	PA2503
28 1/32.....	712.0	12 9/32 .....	311.9	6 15/16 .....	176.5	RS30311	29 .....	736.6	10 13/32 .....	264.3	6 15/16 .....	176.2	PA2732
28 3/16.....	716.0	7 3/4 .....	196.9	4 .....	101.6	PA2771	29 .....	736.6	10 13/32 .....	264.3	6 15/16 .....	176.2	PA3951
28 1/4.....	717.6	9 29/32 .....	251.6	8 1/16 .....	204.8	PA2747	29 .....	736.6	12 3/4 .....	323.9	8 11/32 .....	211.9	PA2632
28 13/32.....	721.5	11 11/16.....	296.9	6 11/16 .....	169.9	PA2680	29 1/2.....	749.3	13 7/8 .....	352.4	10 .....	254.0	PA2746
28 7/16.....	722.3	9 1/2 .....	241.3	6 1/2 .....	165.1	PA2658	29 3/4.....	755.7	12 3/4 .....	323.9	8 3/8 .....	212.7	PA2796
28 1/2.....	723.9	8 21/32 .....	219.9	5 3/16 .....	131.8	PA3478	30 1/32.....	762.8	17 23/32.....	450.1	11 7/16 .....	290.5	RS5293
28 1/2.....	723.9	8 27/32 .....	224.6	5 13/16 .....	147.6	PA2755	30 1/32.....	762.8	17 23/32.....	450.1	11 7/16 .....	290.5	RS5293XP
28 1/2.....	723.9	9 .....	228.6	5 11/16 .....	144.5	PA2532	32 1/2.....	825.5	7 15/16 .....	201.6	3 9/16 .....	90.5	PA3640
28 1/2.....	723.9	9 1/2 .....	241.3	6 1/2 .....	165.1	PA2628	34 5/8.....	879.5	12 3/4 .....	323.9	8 3/8 .....	212.7	PA3595
28 1/2.....	723.9	9 11/16 .....	246.1	5 3/16 .....	131.8	PA2718	34 5/8.....	879.5	15 31/32.....	405.6	8 5/16 .....	211.1	PA3611
28 1/2.....	723.9	10 13/32 .....	264.3	6 15/16 .....	176.2	PA2660	36 1/2.....	927.1	12 25/32.....	324.6	8 11/32.....	211.9	PA3638
28 1/2.....	723.9	13 13/16.....	350.8	9 1/2 .....	241.3	PA3569	36 5/8.....	930.3	13 7/8 .....	352.4	8 3/8 .....	212.7	PA3576
29 .....	736.6	8 11/16 .....	220.7	2 3/16 .....	55.6	PA2500	36 5/8.....	930.3	16 1/2 .....	419.1	8 3/8 .....	212.7	PA3568
29 .....	736.6	8 27/32 .....	224.6	5 13/16 .....	147.6	LL2503							

### NOTES



**WARNING:** These products can expose you to chemicals, including Diisononyl Phthalate, Carbon black extracts, Nickel, 1,3 Butadiene, Ethylene Oxide, Epichlorohydrin, which are known to the State of California to cause cancer, and Bisphenol-A, Ethylene Glycol, Ethylene Oxide, 1,3 Butadiene, Epichlorohydrin, which are known to the State of California to cause birth defects or other reproductive harm.

# PANEL AIR FILTERS

LENGTH x WIDTH x THICK Inches	LENGTH x WIDTH x THICK (mm)	BALDWIN NUMBER	LENGTH x WIDTH x THICK Inches	LENGTH x WIDTH x THICK (mm)	BALDWIN NUMBER
1 3/16 x 6 31/32 x 2 5/8	30.2 x 177.0 x 66.7	PA5312 KIT	7 23/32 x 5 1/8 x 1 9/16	196.1 x 130.2 x 39.7	PA30251
2 1/2 x 1 3/4 x 1 3/8	63.5 x 44.4 x 34.9	PA1600	7 23/32 x 6 1/4 x 2 5/16	196.1 x 158.8 x 58.7	PA4455
3 7/16 x 2 23/32 x 1 1/32	87.3 x 69.1 x 26.2	PA4905	7 23/32 x 7 15/32 x 2 5/16	196.1 x 189.7 x 58.7	PA4473
3 15/32 x 3 15/32 x 13/32	88.1 x 88.1 x 10.3	PA4879	7 3/4 x 6 5/16 x 2 3/4	196.9 x 160.3 x 69.9	PA10003
3 15/32 x 10 7/8 x 1 1/4	88.1 x 276.2 x 31.8	PA4358	7 3/4 x 7 13/32 x 1 15/16	196.9 x 188.1 x 49.2	PA4401
3 9/16 x 2 9/16 x 21/32	90.5 x 65.1 x 16.7	PA4855	7 25/32 x 3 5/8 x 1 13/16	197.6 x 92.1 x 46.0	PA4941
3 27/32 x 3 7/16 x 1 1/4	97.6 x 87.3 x 31.8	PA30053	7 25/32 x 4 1/32 x 3/4	197.6 x 102.4 x 19.0	PA30152
3 27/32 x 3 19/32 x 23/32	97.6 x 91.3 x 18.3	PA4094	7 25/32 x 5 9/16 x 2	197.6 x 141.3 x 50.8	PA10220
3 7/8 x 3 3/32 x 15/16	98.4 x 78.6 x 23.8	PA4735	7 25/32 x 7 19/32 x 13/32	197.6 x 192.9 x 10.5	PA30262
4 1/8 x 3 5/32 x 2 5/16	104.8 x 80.2 x 58.7	PA4854	7 13/16 x 6 13/16 x 1 15/32	198.4 x 173.0 x 37.3	PA10323
4 9/32 x 3 29/32 x 1 3/8	108.7 x 99.2 x 34.9	PA4734	7 27/32 x 7 x 1 25/32	199.5 x 178.0 x 45.0	PA10085
4 5/8 x 2 11/16 x 1 5/32	117.5 x 68.3 x 29.4	PA4853	7 7/8 x 6 5/16 x 5/8	200.0 x 160.3 x 15.9	PA5494
4 5/8 x 4 5/8 x 25/32	117.5 x 117.5 x 19.8	PA4885	7 7/8 x 7 x 1 19/32	200.0 x 177.8 x 40.5	PA2127
4 11/16 x 3 9/32 x 15/16	119.1 x 83.3 x 23.8	PA5350	7 7/8 x 7 1/8 x 21/32	200.0 x 181.0 x 16.7	PA30001
4 13/16 x 3 15/32 x 25/32	122.2 x 88.1 x 19.8	PA10217	7 7/8 x 7 7/16 x 23/32	200.0 x 188.9 x 18.3	PA4365
4 31/32 x 3 27/32 x 1 19/32	126.2 x 97.6 x 40.5	PA4908	7 29/32 x 7 3/16 x 21/32	200.8 x 182.6 x 16.7	PA30115
5 1/8 x 4 7/16 x 7/8	130.2 x 112.7 x 22.2	PA30055	7 15/16 x 4 7/16 x 1 9/16	201.6 x 112.7 x 39.7	PA10193 KIT
5 5/32 x 4 7/16 x 25/32	131 x 112.7 x 19.8	PA2222	7 15/16 x 7 7/8 x 23/32	201.6 x 200.0 x 18.3	PA5638
5 5/32 x 4 1/2 x 29/32	131 x 114.3 x 23.0	PA4754	8 x 3 19/32 x 3/4	203.2 x 91.3 x 19.0	PA30188
5 13/32 x 3 3/8 x 1 13/16	137.3 x 85.7 x 46.0	PA4852	8 x 6 1/4 x 1 7/16	203.2 x 158.8 x 36.5	PA4570
5 5/8 x 4 1/32 x 1 7/8	142.9 x 102.4 x 47.6	PA5353	8 1/32 x 7 3/32 x 31/32	204.0 x 180.2 x 24.6	PA10144
5 11/16 x 5 7/16 x 1 7/16	144.3 x 138.4 x 36.8	PA31014	8 1/32 x 7 1/8 x 15/16	204.0 x 181.1 x 23.9	PA10104
5 27/32 x 4 17/32 x 1	148.4 x 115.1 x 25.4	PA5393	8 1/32 x 7 19/32 x 1 7/8	204.0 x 192.9 x 47.6	PA10202
5 27/32 x 5 27/32 x 25/32	148.4 x 148.4 x 19.8	PA10016	8 1/16 x 6 3/32 x 1 15/32	204.7 x 154.7 x 37.6	PA10403
5 29/32 x 4 7/32 x 1 17/32	150.0 x 107.2 x 38.9	PA5729	8 1/16 x 5 1/4 x 1 5/8	204.8 x 133.4 x 41.3	PA2104
6 1/16 x 2 15/16 x 25/32	154 x 74.6 x 19.8	PA4460 KIT	8 1/16 x 6 x 6	204.8 x 152.4 x 15.2	PA1771
6 5/32 x 5 27/32 x 9 9/32	156.5 x 148.6 x 236.0	PA31013	8 1/16 x 8 1/16 x 25/32	204.8 x 204.8 x 19.8	PA10362
6 9/32 x 6 5/32 x 1 17/32	159.5 x 156.4 x 38.9	PA4979	8 3/32 x 8 x 25/32	205.5 x 202.9 x 19.8	PA10412
6 9/32 x 6 3/16 x 1 17/32	159.5 x 157.2 x 38.9	PA4730	8 3/32 x 5 9/32 x 1 5/8	205.6 x 134.1 x 41.3	PA5333
6 5/16 x 4 7/16 x 13/16	160.3 x 112.7 x 20.6	PA4555	8 3/32 x 7 27/32 x 1 5/16	205.6 x 199.2 x 33.3	PA10194
6 5/16 x 8 15/32 x 1 25/32	160.3 x 215.1 x 45.2	PA10250	8 1/8 x 4 1/2 x 19/32	206.4 x 114.3 x 15.1	PA5651
6 11/32 x 3 1/2 x 15/16	161.1 x 88.9 x 23.8	PA30051	8 5/32 x 5 27/32 x 1 15/32	207.2 x 148.4 x 37.3	PA10328
6 11/32 x 5 31/32 x 1 13/16	161.1 x 151.6 x 46.0	PA10266	8 5/32 x 6 3/32 x 2 3/16	207.2 x 154.8 x 55.6	PA4470
6 1/2 x 2 1/4 x 3 1/8	165.1 x 57.2 x 79.5	SA10100	8 5/32 x 7 5/16 x 1 5/32	207.2 x 185.7 x 29.4	PA5620
6 9/16 x 6 3/8 x 9/16	166.7 x 161.9 x 14.3	PA10167	8 3/16 x 4 9/16 x 19/32	208.0 x 115.9 x 15.1	PA30148
6 5/8 x 3 3/4 x 2 1/8	168.3 x 95.3 x 54.0	PA30144	8 3/16 x 4 9/16 x 1 13/16	208.0 x 115.9 x 46.0	PA5403
6 21/32 x 5 13/16 x 2 7/32	169.1 x 147.6 x 56.4	PA4366	8 3/16 x 6 1/32 x 1 3/16	208.0 x 153.4 x 30.0	PA30287
6 21/32 x 6 21/32 x 1 9/16	169.1 x 169.1 x 39.7	PA10397	8 3/16 x 6 31/32 x 1 3/4	208.0 x 177.0 x 44.4	PA10071
6 13/16 x 6 1/32 x 1 21/32	173.0 x 153.2 x 42.1	PA10269	8 3/16 x 7 13/32 x 2 17/32	208.0 x 188.1 x 64.3	PA10046
6 13/16 x 6 21/32 x 1 13/16	173.0 x 169.1 x 46	PA10380	8 7/32 x 5 23/32 x 7/8	208.8 x 145.3 x 22.2	PA30117
6 31/32 x 4 11/16 x 1 7/16	176.8 x 119.1 x 36.6	PA10275	8 7/32 x 5 7/8 x 1 15/32	208.8 x 149.2 x 37.3	PA4045
6 31/32 x 3 15/32 x 1 9/32	177 x 88.1 x 32.5	PA4750	8 7/32 x 7 1/4 x 1 21/32	208.8 x 184.2 x 42.1	PA4050
6 31/32 x 6 31/32 x 3/4	177.0 x 177.0 x 19.0	PA10372	8 7/32 x 8 1/32 x 1 3/16	209.0 x 204.0 x 30.0	PA10129
7 x 3 1/2 x 1 1/16	177.8 x 88.9 x 27.0	PA4906	8 1/4 x 4 5/8 x 25/32	209.6 x 117.5 x 19.8	PA30228
7 x 3 1/2 x 1 1/2	177.8 x 88.9 x 38.1	PA30050	8 1/4 x 5 31/32 x 8 1/8	209.6 x 151.6 x 206.4	PA1772
7 x 4 3/4 x 11/16	177.8 x 120.5 x 17.0	PA30261	8 1/4 x 6 15/32 x 1	209.6 x 164.3 x 25.4	PA10066
7 x 5 15/32 x 1/2	177.8 x 138.9 x 12.7	PA5719	8 9/32 x 4 15/32 x 23/32	210.3 x 113.5 x 18.3	PA10176
7 1/16 x 6 9/32 x 5/8	179.4 x 159.5 x 15.9	PA10318	8 9/32 x 8 1/32 x 25/32	210.3 x 204.0 x 19.8	PA4987
7 1/16 x 11 7/16 x 2 5/16	179.4 x 290.5 x 58.7	PA10392	8 9/32 x 8 9/32 x 1 15/16	210.3 x 210.3 x 49.2	PA3839
7 3/32 x 6 5/16 x 1	180.2 x 160.3 x 25.4	PA10159	8 5/16 x 8 5/16 x 8 1/16	211.1 x 211.1 x 204.8	PA1773
7 1/8 x 2 3/16 x 3/4	181.0 x 55.6 x 19.0	PA30056	8 11/32 x 3 21/32 x 1 17/32	211.9 x 92.9 x 38.9	PA5738
7 1/8 x 3 19/32 x 25/32	181.0 x 91.3 x 19.8	PA10365 KIT	8 11/32 x 3 31/32 x 1 3/32	211.9 x 100.8 x 27.8	PA30054
7 1/8 x 5 19/32 x 2 1/16	181.0 x 142.1 x 52.4	PA10256	8 11/32 x 7 1/2 x 1 1/16	211.9 x 190.5 x 27.0	PA5753
7 1/8 x 6 5/8 x 1 5/16	181.0 x 168.3 x 33.3	PA4443	8 11/32 x 7 5/8 x 1 3/32	211.9 x 193.7 x 27.8	PA30150
7 3/16 x 7 1/16 x 1 1/8	182.6 x 179.4 x 28.6	PA4411	8 3/8 x 7 1/4 x 1 1/8	212.7 x 184.2 x 28.6	PA4408
7 1/4 x 7 1/16 x 1 5/32	184.2 x 179.4 x 29.4	PA10157	8 3/8 x 8 1/16 x 1 31/32	212.7 x 204.8 x 50.0	PA4103
7 5/16 x 6 23/32 x 1 1/16	185.7 x 170.7 x 27.0	PA4352	8 3/8 x 8 5/16 x 21/32	212.7 x 211.1 x 16.7	PA4194
7 3/8 x 7 3/8 x 1	187.3 x 187.3 x 25.4	PA10370 KIT	8 3/8 x 8 3/8 x 2 7/32	212.7 x 212.7 x 56.4	PA2208
7 13/32 x 7 1/16 x 1 27/32	188.1 x 179.4 x 46.8	PA10227	8 13/32 x 6 5/16 x 1 31/32	213.5 x 160.3 x 50.0	PA4176
7 7/16 x 6 1/16 x 2 1/16	188.9 x 154.0 x 52.4	PA4105	8 13/32 x 7 5/8 x 1 1/8	213.5 x 193.7 x 28.6	PA10190
7 17/32 x 7 1/8 x 1 23/32	191.3 x 181.0 x 43.7	PA10389	8 7/16 x 7 11/16 x 1 1/8	214.3 x 195.3 x 28.6	PA4327
7 19/32 x 7 1/32 x 1 9/32	192.9 x 178.6 x 32.5	PA10378	8 7/16 x 7 3/4 x 2 3/16	214.3 x 196.9 x 55.6	PA4419
7 19/32 x 7 7/8 x 1 7/8	192.9 x 200.0 x 47.6	PA4099	8 7/16 x 8 1/8 x 1 29/32	214.3 x 206.4 x 48.4	PA10090
7 5/8 x 6 1/32 x 1 17/32	193.7 x 153.2 x 38.9	PA2160	8 7/16 x 8 3/8 x 1 3/16	214.3 x 212.7 x 30.2	PA10182
7 5/8 x 6 1/16 x 1 3/32	193.7 x 154.0 x 27.8	PA3840	8 15/32 x 7 9/32 x 1 5/32	215.0 x 185.0 x 29.0	PA10097
7 5/8 x 7 13/32 x 1 3/16	193.7 x 188.1 x 30.2	PA10146	8 15/32 x 6 1/2 x 1 7/8	215.1 x 165.1 x 47.6	PA10342
			8 15/32 x 7 19/32 x 1 1/8	215.1 x 192.9 x 28.6	PA4393
			8 15/32 x 8 15/32 x 21/32	215.1 x 215.1 x 16.7	PA4188
			8 1/2 x 7 3/8 x 1 1/8	215.9 x 186.9 x 29.0	PA10108
			8 1/2 x 7 5/8 x 3/4	215.9 x 193.7 x 19.0	PA5495
			8 1/2 x 7 21/32 x 31/32	215.9 x 194.5 x 24.6	PA4373



**WARNING:** These products can expose you to chemicals, including Diisononyl Phthalate, Carbon black extracts, Nickel, 1,3 Butadiene, Ethylene Oxide, Epichlorohydrin, which are known to the State of California to cause cancer, and Bisphenol-A, Ethylene Glycol, Ethylene Oxide, 1,3 Butadiene, Epichlorohydrin, which are known to the State of California to cause birth defects or other reproductive harm.

**PANEL AIR FILTERS**

LENGTH x WIDTH x THICK Inches	LENGTH x WIDTH x THICK (mm)	BALDWIN NUMBER	LENGTH x WIDTH x THICK Inches	LENGTH x WIDTH x THICK (mm)	BALDWIN NUMBER
8 1/2 x 7 11/16 x 5/8	215.9 x 195.3 x 15.9	PA4372	9 x 9 x 2 9/16	228.6 x 228.6 x 65.1	PA3495
8 1/2 x 7 3/4 x 31/32	215.9 x 196.9 x 24.6	PA10136	9 x 9 x 2 9/16	228.6 x 228.6 x 65.1	PA3804
8 1/2 x 8 7/16 x 29/32	215.9 x 214.3 x 23.0	PA10363	9 1/32 x 4 17/32 x 1 3/16	229.4 x 115.1 x 30.2	PA10150
8 1/2 x 8 1/2 x 1 5/8	215.9 x 215.9 x 41.3	PA2221	9 1/32 x 4 9/16 x 2 7/32	229.4 x 115.9 x 56.4	PA4155 KIT
8 17/32 x 3 1/16 x 27/32	216.7 x 77.8 x 21.4	PA10261	9 1/32 x 5 1/32 x 1/4	229.4 x 127.8 x 6.4	PA30165
8 17/32 x 6 9/16 x 1 5/16	216.7 x 166.7 x 33.3	PA10289	9 1/32 x 6 5/8 x 1 7/32	229.4 x 168.3 x 31.0	PA4018
8 17/32 x 7 23/32 x 1 1/32	216.7 x 196.1 x 26.2	PA10206 KIT	9 1/32 x 7 3/16 x 1 5/8	229.4 x 182.6 x 41.3	PA3929
8 17/32 x 7 7/8 x 25/32	216.7 x 200.0 x 19.8	PA10163	9 1/32 x 7 9/32 x 2 1/16	229.4 x 184.9 x 52.4	PA4015
8 17/32 x 7 15/16 x 1 31/32	216.7 x 201.6 x 50.0	PA5629	9 1/16 x 5 5/16 x 1 11/32	230.2 x 134.9 x 34.1	PA4442
8 17/32 x 6 3/16 x 1 3/16	217.0 x 157.0 x 30.0	PA10083	9 1/16 x 6 1/8 x 1 3/16	230.2 x 155.6 x 30.2	PA5714
8 9/16 x 5 3/32 x 1 11/32	217.5 x 129.4 x 34.1	PA30052	9 1/16 x 7 7/16 x 2 9/32	230.2 x 188.9 x 57.9	PA4441
8 19/32 x 4 5/32 x 31/32	218.3 x 105.6 x 24.6	PA5683	9 1/16 x 7 25/32 x 31/32	230.2 x 197.6 x 24.6	PA10149
8 19/32 x 8 15/32 x 1	218.3 x 215.1 x 25.4	PA10185	9 1/16 x 7 7/8 x 3/4	230.2 x 200.0 x 19.0	PA10373
8 5/8 x 6 3/16 x 1 11/32	219.1 x 157.2 x 34.1	PA5337	9 1/16 x 7 7/8 x 2 5/32	230.2 x 200.0 x 54.8	PA4108
8 5/8 x 6 1/4 x 1 3/16	219.1 x 158.8 x 30.2	PA10154	9 1/16 x 8 1/2 x 1 1/8	230.2 x 215.9 x 28.6	PA10179
8 5/8 x 7 11/16 x 31/32	219.1 x 195.3 x 24.6	PA5722	9 1/16 x 8 17/32 x 1 9/16	230.2 x 216.7 x 39.7	PA10343
8 5/8 x 8 11/32 x 31/32	219.1 x 211.9 x 24.6	PA5359	9 3/32 x 6 7/8 x 2 23/32	231.0 x 174.6 x 69.1	PA4938
8 21/32 x 4 7/8 x 19/32	219.9 x 123.8 x 15.1	PA5723	9 3/32 x 7 19/32 x 13 3/4	231.0 x 192.9 x 349.3	PA31006
8 21/32 x 5 29/32 x 25/32	219.9 x 150.0 x 19.8	PA5585	9 1/8 x 4 3/32 x 27/32	231.8 x 104.0 x 21.4	PA10204 KIT
8 21/32 x 7 23/32 x 11/32	219.9 x 196.1 x 8.7	PA32004	9 1/8 x 4 9/16 x 1 11/32	231.8 x 115.9 x 34.1	PA4469
8 21/32 x 7 27/32 x 25/32	219.9 x 199.2 x 19.8	PA4332	9 1/8 x 6 11/32 x 2 5/16	231.8 x 161.1 x 58.7	PA10391
8 11/16 x 4 1/4 x 1 17/32	220.7 x 108.0 x 38.9	PA4156 KIT	9 1/8 x 7 15/32 x 2 9/32	231.8 x 189.7 x 57.9	PA4447
8 11/16 x 7 27/32 x 1 3/16	220.7 x 199.2 x 30.2	PA4199	9 1/8 x 7 19/32 x 9 7/8	231.8 x 192.9 x 250.8	PA31004
8 11/16 x 7 7/8 x 1 25/32	220.7 x 200.0 x 45.2	PA4424	9 1/8 x 8 9/32 x 15/16	231.8 x 210.3 x 23.8	PA10209 KIT
8 11/16 x 8 9/32 x 1 15/16	220.7 x 210.3 x 49.2	PA4483	9 1/8 x 8 17/32 x 1 31/32	231.8 x 216.7 x 50.0	PA4198
8 11/16 x 8 15/32 x 1 1/4	220.7 x 215.1 x 31.8	PA4197	9 1/8 x 8 21/32 x 5/16	231.8 x 219.9 x 7.9	PA4392
8 3/4 x 8 x 1 5/32	222.2 x 203.2 x 29.2	PA10132	9 1/8 x 9 1/32 x 2 1/8	231.9 x 229.1 x 54.1	PA10276
8 3/4 x 4 5/16 x 11/16	222.3 x 109.5 x 17.5	PA10211 KIT	9 5/32 x 7 29/32 x 15/16	232.6 x 200.8 x 23.8	PA5622
8 3/4 x 7 3/8 x 1 13/32	222.3 x 187.3 x 35.7	PA10028	9 5/32 x 8 15/32 x 1 27/32	232.6 x 215.1 x 46.8	PA4436
8 3/4 x 7 3/8 x 1 25/32	222.3 x 187.3 x 45.2	PA4344	9 3/16 x 5 9/16 x 2 1/4	233.4 x 141.3 x 57.2	PA10307
8 3/4 x 11 5/16 x 1 7/16	222.3 x 287.3 x 36.5	PA4368	9 3/16 x 8 13/16 x 2 1/4	233.4 x 223.8 x 57.2	PA10041
8 25/32 x 7 9/16 x 2 1/8	223 x 192.1 x 54.0	PA4102	9 7/32 x 8 1/8 x 2 5/8	234.2 x 206.4 x 66.7	PA10280
8 13/16 x 8 1/4 x 25/32	223.5 x 210.0 x 20.0	PA10082	9 7/32 x 8 7/16 x 23/32	234.2 x 214.3 x 18.3	PA4371
8 13/16 x 6 5/8 x 1 31/32	223.8 x 168.3 x 50.0	PA2169	9 7/32 x 8 7/16 x 1 23/32	234.2 x 214.3 x 43.7	PA10205 KIT
8 13/16 x 7 27/32 x 1 9/16	223.8 x 199.2 x 39.7	PA10175 KIT	9 7/32 x 8 21/32 x 1 1/8	234.2 x 219.9 x 28.6	PA4196
8 13/16 x 7 7/8 x 1 3/32	224.0 x 199.9 x 27.9	PA10411	9 7/32 x 8 15/16 x 1 13/16	234.2 x 227.0 x 46.0	PA10004
8 27/32 x 4 13/32 x 1 1/8	224.6 x 111.9 x 28.6	PA4195 KIT	9 1/4 x 7 7/32 x 1 13/32	235.0 x 183.4 x 35.7	PA30141
8 27/32 x 7 27/32 x 13/32	225.0 x 199.0 x 10.0	PA30269	9 1/4 x 7 29/32 x 1 13/16	235.0 x 200.8 x 46.0	PA10306
8 7/8 x 3 31/32 x 31/32	225.4 x 100.8 x 24.6	PA10145 KIT	9 1/4 x 8 1/8 x 1 5/8	235.0 x 206.4 x 41.3	PA10070
8 7/8 x 5 5/16 x 1 5/8	225.4 x 134.9 x 41.3	PA3953	9 1/4 x 8 9/32 x 1 3/8	235.0 x 210.3 x 34.9	PA10166
8 7/8 x 5 31/32 x 1 9/16	225.4 x 151.6 x 39.7	PA4381	9 1/4 x 8 3/8 x 1 15/32	235.0 x 212.7 x 37.3	PA10333
8 7/8 x 6 21/32 x 1 5/16	225.4 x 169.1 x 33.3	PA4100	9 1/4 x 8 3/8 x 1 15/32	235.0 x 212.7 x 37.3	PA10334
8 7/8 x 6 27/32 x 1 5/16	225.4 x 173.8 x 33.3	PA30094	9 1/4 x 7 3/16 x 1 13/16	235.2 x 182.6 x 45.7	PA10059
8 7/8 x 6 31/32 x 1 7/16	225.4 x 177.0 x 36.5	PA31005	9 9/32 x 9 9/32 x 2 1/8	235.5 x 235.5 x 54.1	PA10267
8 7/8 x 7 13/32 x 1 1/2	225.4 x 188.1 x 38.1	PA4085	9 9/32 x 6 25/32 x 23/32	235.7 x 172.2 x 18.3	PA10002
8 7/8 x 7 3/4 x 13/16	225.4 x 196.9 x 20.6	PA10032	9 9/32 x 7 15/16 x 1 9/16	235.7 x 201.6 x 39.7	PA2212
8 7/8 x 8 7/8 x 1 13/32	225.4 x 225.4 x 35.7	PA4016	9 9/32 x 8 7/16 x 1 17/32	235.7 x 214.3 x 38.9	PA4335
8 29/32 x 7 11/16 x 1 3/16	226.1 x 195.1 x 30.0	PA10128	9 9/32 x 8 19/32 x 25/32	235.7 x 218.3 x 19.8	PA10009
8 29/32 x 7 27/32 x 1 1/8	226.2 x 199.2 x 28.6	PA10400	9 9/32 x 8 13/16 x 2 5/16	235.7 x 223.8 x 58.7	PA4349
8 29/32 x 8 3/16 x 1 25/32	226.2 x 208.0 x 45.2	PA2228	9 9/32 x 9 1/8 x 2 1/8	235.7 x 231.8 x 54.0	PA10255
8 29/32 x 8 5/8 x 1 3/4	226.2 x 219.1 x 44.4	PA4184	9 5/16 x 6 11/32 x 2 9/32	236.5 x 161.1 x 57.9	PA5314
8 15/16 x 2 1/2 x 3/4	227.0 x 63.5 x 19.0	PA30154	9 5/16 x 7 3/32 x 1 19/32	236.5 x 180.2 x 40.5	PA2231
8 15/16 x 6 19/32 x 2 1/8	227.0 x 167.5 x 54.0	PA5328	9 5/16 x 8 13/32 x 11/16	236.5 x 213.5 x 17.5	PA10141
8 15/16 x 7 9/32 x 1 1/32	227.0 x 184.9 x 26.2	PA4461	9 5/16 x 9 3/16 x 1 21/32	236.5 x 233.4 x 42.1	PA10321
8 15/16 x 7 3/4 x 1 3/4	227.0 x 196.9 x 44.4	PA4320	9 11/32 x 5 7/16 x 29/32	237.3 x 138.1 x 23.0	PA4149 KIT
8 15/16 x 7 7/8 x 1 3/16	227.0 x 200.0 x 30.2	PA10030	9 11/32 x 8 7/16 x 1 3/8	237.3 x 214.3 x 34.9	PA4426
8 15/16 x 7 7/8 x 1 3/16	227.0 x 200.0 x 30.2	PA30093	9 11/32 x 8 7/16 x 1 21/32	237.3 x 214.3 x 42.1	PA4132
8 15/16 x 7 29/32 x 21/32	227.0 x 200.8 x 16.7	PA4391	9 11/32 x 8 1/2 x 1 17/32	237.3 x 215.9 x 38.9	PA10183
8 15/16 x 8 5/16 x 31/32	227.0 x 211.1 x 24.6	PA10171	9 3/8 x 7 11/16 x 1 1/16	238.0 x 195.1 x 26.9	PA10081
8 31/32 x 4 3/16 x 25/32	227.8 x 106.4 x 19.8	PA5330	9 3/8 x 6 21/32 x 1 13/32	238.1 x 169.1 x 35.7	PA10376
8 31/32 x 6 5/16 x 1 1/2	227.8 x 160.3 x 38.1	PA5661	9 3/8 x 7 1/8 x 1 5/8	238.1 x 181.0 x 41.3	PA10297
8 31/32 x 8 1/32 x 1 5/8	227.8 x 204.0 x 41.3	PA10395	9 3/8 x 7 1/2 x 1 9/16	238.1 x 190.5 x 39.7	PA4313
8 31/32 x 8 5/8 x 2 5/8	227.8 x 219.1 x 66.7	PA10301	9 3/8 x 8 7/32 x 2 7/32	238.1 x 208.8 x 56.4	PA10320
			9 3/8 x 8 3/8 x 1 25/32	238.1 x 212.7 x 45.2	PA4329
9 x 4 5/32 x 25/32	228.6 x 105.6 x 19.8	PA30229	9 3/8 x 8 27/32 x 1 31/32	238.1 x 224.6 x 50.0	PA4178
9 x 6 31/32 x 1 7/16	228.6 x 177.0 x 36.5	PA31007	9 13/32 x 7 7/16 x 25/32	238.9 x 188.9 x 19.8	PA10131
9 x 7 x 1 3/8	228.6 x 177.8 x 34.9	PA3777	9 13/32 x 6 3/8 x 2 1/8	239.0 x 162.1 x 53.6	PA10086
9 x 7 x 1 15/16	228.6 x 177.8 x 49.2	PA4421	9 7/16 x 6 31/32 x 2 3/32	239.7 x 177.0 x 53.2	PA4446
9 x 7 1/8 x 1 27/32	228.6 x 181.0 x 46.8	PA5631	9 7/16 x 7 15/32 x 31/32	239.7 x 189.7 x 24.6	PA10147
9 x 7 3/4 x 2 7/32	228.6 x 196.9 x 56.4	PA4160	9 7/16 x 7 11/16 x 1 17/32	239.7 x 195.3 x 38.9	PA30151
9 x 7 13/16 x 1 1/4	228.6 x 198.4 x 31.8	PA4405	9 7/16 x 7 23/32 x 25/32	239.7 x 196.1 x 19.8	PA10364
9 x 8 19/32 x 1 15/16	228.6 x 218.3 x 49.2	PA10064	9 7/16 x 7 15/16 x 1 1/8	239.7 x 201.6 x 28.6	PA10130



**WARNING:** These products can expose you to chemicals, including Diisononyl Phthalate, Carbon black extracts, Nickel, 1,3 Butadiene, Ethylene Oxide, Epichlorohydrin, which are known to the State of California to cause cancer, and Bisphenol-A, Ethylene Glycol, Ethylene Oxide, 1,3 Butadiene, Epichlorohydrin, which are known to the State of California to cause birth defects or other reproductive harm.

# PANEL AIR FILTERS

LENGTH x WIDTH x THICK Inches	LENGTH x WIDTH x THICK (mm)	BALDWIN NUMBER	LENGTH x WIDTH x THICK Inches	LENGTH x WIDTH x THICK (mm)	BALDWIN NUMBER
9 7/16 x 8 x 1 3/16	239.7 x 203.2 x 30.2	PA10014	9 31/32 x 6 13/16 x 1 23/32	253.2 x 173.0 x 43.7	PA4348
9 7/16 x 8 1/32 x 1 3/16	239.7 x 204.0 x 30.2	PA10369	9 31/32 x 8 1/2 x 1 3/8	253.2 x 215.9 x 34.9	PA10162
9 7/16 x 8 1/32 x 1 13/16	239.7 x 204.0 x 46.0	PA4386	9 31/32 x 8 3/4 x 1 3/16	253.2 x 222.3 x 30.2	PA10148
9 7/16 x 8 1/4 x 21/32	239.7 x 209.6 x 16.7	PA10155	9 31/32 x 9 3/16 x 1 23/32	253.2 x 233.4 x 43.7	PA4361
9 7/16 x 8 9/32 x 2 5/32	239.7 x 210.3 x 54.8	PA10270	10 x 5 5/8 x 25/32	254 x 142.9 x 19.8	PA5327
9 7/16 x 8 17/32 x 2	239.7 x 216.7 x 50.8	PA10238	10 x 6 x 2 3/16	254 x 152.4 x 55.6	PA3613
9 7/16 x 8 7/8 x 2 1/4	239.7 x 225.4 x 57.2	PA4790	10 x 6 7/8 x 1 5/8	254 x 174.6 x 41.3	PA4308
9 7/16 x 7 7/8 x 21/32	240.0 x 200.0 x 17.0	PA10396	10 x 9 1/4 x 1 1/4	254.0 x 235.0 x 32.0	PA10404
9 1/2 x 7 x 1 3/32	241.3 x 177.8 x 27.8	PA30096	10 x 9 3/8 x 2 1/4	254.0 x 238.1 x 57.2	PA4333
9 17/32 x 4 1/2 x 1 1/4	242.1 x 114.3 x 31.8	PA2138	10 x 9 7/8 x 25/32	254.0 x 251.0 x 20.1	PA30277
9 17/32 x 6 23/32 x 1/4	242.1 x 170.7 x 6.4	PA30166	10 x 10 x 2 9/16	254.0 x 254.0 x 65.1	PA3473
9 17/32 x 6 25/32 x 1 31/32	242.1 x 172.2 x 50.0	PA10039	10 1/32 x 5 17/32 x 1 19/32	254.8 x 140.5 x 40.5	PA10186 KIT
9 17/32 x 7 3/32 x 1 19/32	242.1 x 180.2 x 40.5	PA4109	10 1/32 x 7 7/16 x 1 15/32	254.8 x 188.9 x 37.3	PA4314
9 17/32 x 7 5/8 x 2 1/32	242.1 x 193.7 x 51.6	PA4375	10 1/32 x 7 15/16 x 1 7/32	254.8 x 201.6 x 31.0	PA30140
9 17/32 x 9 17/32 x 1 9/16	242.1 x 242.1 x 39.7	PA2191	10 1/32 x 8 3/16 x 2 13/32	254.8 x 208.0 x 61.1	PA4430
9 9/16 x 6 15/32 x 2 1/8	242.9 x 164.3 x 54.0	PA4382	10 1/16 x 7 5/32 x 1 9/16	255.6 x 181.8 x 39.7	PA4069
9 9/16 x 7 15/32 x 2 3/16	242.9 x 189.7 x 55.6	PA10010	10 1/16 x 8 3/4 x 1 1/16	255.6 x 222.3 x 17.5	PA4398
9 9/16 x 8 29/32 x 2 1/8	242.9 x 226.2 x 54.0	PA4449	10 1/16 x 9 31/32 x 1 3/8	255.6 x 253.2 x 34.9	PA10138
9 19/32 x 9 1/8 x 1 5/16	243.7 x 231.8 x 33.3	PA30174	10 3/32 x 7 x 1 5/16	256.4 x 177.8 x 33.3	PA2201
9 5/8 x 8 3/4 x 2 3/16	244.5 x 222.3 x 55.6	PA4438	10 3/32 x 7 15/16 x 1 23/32	256.4 x 201.6 x 43.7	PA4400
9 21/32 x 6 1/2 x 1	245.1 x 165.1 x 25.7	PA30310	10 3/32 x 9 13/16 x 1 21/32	256.4 x 249.2 x 42.1	PA4454
9 21/32 x 5 5/16 x 25/32	245.3 x 134.9 x 19.8	PA30080	10 3/32 x 10 1/32 x 1 3/4	256.4 x 254.8 x 44.4	PA10036
9 21/32 x 5 7/16 x 1 9/16	245.3 x 138.1 x 39.7	PA2204	10 1/8 x 7 29/32 x 1 3/16	257.0 x 200.7 x 30.0	PA10135
9 21/32 x 6 5/16 x 1 15/32	245.3 x 160.3 x 37.3	PA4043	10 1/8 x 3 7/8 x 1 1/2	257.2 x 98.4 x 38.1	PA10199 KIT
9 21/32 x 7 x 2 5/16	245.3 x 177.8 x 58.7	PA4048	10 1/8 x 5 1/32 x 3/16	257.2 x 127.8 x 4.8	PA5773
9 21/32 x 8 1/32 x 3/4	245.3 x 204.0 x 19.0	PA4404	10 1/8 x 7 3/4 x 1 11/16	257.2 x 196.9 x 42.9	PA4468
9 21/32 x 8 1/8 x 2 1/16	245.3 x 206.4 x 52.4	PA4060	10 1/8 x 8 9/32 x 1 11/16	257.2 x 210.3 x 42.9	PA4023
9 21/32 x 8 1/2 x 13/16	245.3 x 215.9 x 20.6	PA10165	10 1/8 x 8 7/16 x 2 3/16	257.2 x 214.3 x 55.6	PA4091
9 21/32 x 8 19/32 x 2 5/32	245.3 x 218.3 x 54.8	PA10346	10 5/32 x 3 31/32 x 31/32	258.0 x 100.8 x 24.6	PA4410 KIT
9 11/16 x 5 5/8 x 2 5/16	246.1 x 142.9 x 58.7	PA10057	10 5/32 x 5 3/4 x 1 7/8	258.0 x 146.0 x 47.6	PA4479
9 11/16 x 6 5/16 x 1 15/32	246.1 x 160.3 x 37.3	PA4084	10 5/32 x 5 29/32 x 31/32	258.0 x 150.0 x 24.6	PA10367
9 11/16 x 7 5/16 x 1 15/16	246.1 x 185.7 x 49.2	PA4452	10 5/32 x 6 13/32 x 1 7/8	258.0 x 162.7 x 47.6	PA10027
9 11/16 x 6 21/32 x 1 25/32	246.4 x 168.9 x 45.0	PA10407	10 5/32 x 6 13/32 x 2 1/16	258.0 x 162.7 x 52.4	PA4480
9 23/32 x 3 29/32 x 21/32	246.9 x 99.2 x 16.7	PA10191 KIT	10 5/32 x 6 1/2 x 1 9/16	258.0 x 165.1 x 39.7	PA10231
9 23/32 x 6 17/32 x 1 3/8	246.9 x 165.9 x 34.9	PA5633	10 5/32 x 6 1/2 x 1 11/16	258.0 x 165.1 x 42.9	PA4325
9 23/32 x 7 29/32 x 1 29/32	246.9 x 200.8 x 48.4	PA4471	10 5/32 x 6 17/32 x 27/32	258.0 x 165.9 x 21.4	PA30177
9 23/32 x 8 1/8 x 1 3/16	246.9 x 206.4 x 30.2	PA10170 KIT	10 5/32 x 8 3/16 x 2 3/32	258.0 x 208.0 x 53.2	PA10000
9 23/32 x 8 9/32 x 1 3/8	246.9 x 210.3 x 34.9	PA10156	10 5/32 x 8 1/16 x 1 9/16	258.1 x 205.0 x 39.9	PA10103
9 23/32 x 8 1/2 x 29/32	246.9 x 215.9 x 23.0	PA4317	10 3/16 x 5 7/8 x 2 7/32	258.8 x 149.2 x 56.4	PA4047
9 3/4 x 6 9/32 x 2 11/32	247.7 x 159.5 x 59.5	PA10337	10 3/16 x 7 x 1 31/32	258.8 x 177.8 x 50.0	PA4309
9 3/4 x 7 13/16 x 1 9/16	247.7 x 198.4 x 39.7	PA10134	10 7/32 x 6 15/32 x 2 13/32	259.6 x 164.3 x 61.1	PA4463
9 3/4 x 8 9/32 x 2 3/32	247.7 x 210.3 x 53.2	PA4354	10 1/4 x 6 17/32 x 1 13/32	260.3 x 165.9 x 35.7	PA5733
9 3/4 x 8 13/16 x 1 15/16	247.7 x 223.8 x 49.2	PA10245	10 1/4 x 6 5/8 x 1 7/32	260.3 x 168.3 x 31.0	PA10174
9 3/4 x 9 5/32 x 1 3/16	247.7 x 232.6 x 30.2	PA4486	10 1/4 x 6 3/4 x 2	260.3 x 171.5 x 50.8	PA2168
9 3/4 x 9 3/8 x 1 9/16	247.9 x 238.0 x 39.9	PA10084	10 1/4 x 7 3/32 x 1 17/32	260.3 x 180.2 x 38.9	PA4138
9 13/16 x 4 11/16 x 2	249.2 x 119.1 x 50.8	PA4031	10 1/4 x 8 x 2 1/4	260.3 x 203.2 x 57.2	PA4126
9 13/16 x 4 3/4 x 2 3/32	249.2 x 120.7 x 53.2	PA4305	10 9/32 x 5 5/8 x 25/32	261.1 x 142.9 x 19.8	PA10210 KIT
9 13/16 x 5 1/8 x 2 5/32	249.2 x 130.2 x 54.8	PA10272	10 9/32 x 7 29/32 x 1 3/16	261.1 x 200.8 x 30.2	PA10067
9 13/16 x 6 5/8 x 1 17/32	249.2 x 168.3 x 38.9	PA4311	10 5/16 x 5 21/32 x 1 1/2	261.9 x 143.7 x 38.1	PA4376
9 27/32 x 4 3/32 x 7/8	250.0 x 104.0 x 22.2	PA10195 KIT	10 5/16 x 6 15/16 x 2 9/32	261.9 x 176.2 x 57.9	PA10037
9 27/32 x 5 15/32 x 2 1/16	250.0 x 138.9 x 52.4	PA4049	10 5/16 x 8 3/32 x 1 3/4	261.9 x 205.6 x 44.4	PA4364
9 27/32 x 6 3/16 x 1 11/16	250.0 x 157.2 x 42.9	PA10382	10 5/16 x 8 7/32 x 1 3/16	261.9 x 208.8 x 30.2	PA10042
9 27/32 x 6 11/16 x 2	250.0 x 169.9 x 50.8	PA2214	10 11/32 x 5 9/32 x 2 3/16	262.7 x 134.1 x 55.6	PA4363
9 27/32 x 7 5/32 x 1 11/16	250.0 x 181.8 x 42.9	PA10188	10 11/32 x 5 15/32 x 31/32	262.7 x 138.9 x 24.6	CV15002
9 27/32 x 7 13/16 x 25/32	250.0 x 198.4 x 19.8	PA30173	10 11/32 x 6 13/32 x 1 19/32	262.7 x 162.7 x 40.5	PA2229
9 27/32 x 8 x 1 13/32	250.0 x 203.2 x 35.7	PA4474	10 11/32 x 6 1/2 x 1 9/16	262.7 x 165.1 x 39.7	PA5341
9 27/32 x 9 1/4 x 31/32	250.0 x 235.0 x 24.6	PA5798	10 11/32 x 6 23/32 x 1 13/32	262.7 x 170.7 x 35.7	PA4370
9 7/8 x 5 29/32 x 1 7/16	250.8 x 150.0 x 36.5	PA2220	10 11/32 x 7 1/4 x 1 3/16	262.7 x 184.2 x 30.2	PA10180 KIT
9 7/8 x 7 7/8 x 1 3/16	250.8 x 200.0 x 30.2	PA10139	10 11/32 x 9 3/8 x 1 3/16	262.7 x 238.1 x 30.2	PA10201
9 7/8 x 8 5/16 x 2 3/32	250.8 x 211.1 x 53.2	PA10253	10 3/8 x 7 x 1 13/32	263.5 x 177.8 x 35.7	PA5772
9 7/8 x 8 13/32 x 2 3/32	250.8 x 213.5 x 53.2	PA4380	10 3/8 x 7 17/32 x 25/32	263.5 x 191.3 x 19.8	PA10371
9 7/8 x 8 23/32 x 1 3/16	250.8 x 221.5 x 30.2	PA4334	10 3/8 x 9 19/32 x 1 3/16	263.5 x 243.7 x 30.2	PA4462
9 7/8 x 7 3/32 x 1 3/8	251.0 x 180.1 x 35.1	PA10402	10 13/32 x 5 5/8 x 11/16	264.3 x 142.9 x 17.5	PA4756
9 7/8 x 8 7/32 x 25/32	251.0 x 209.0 x 20.1	PA10401	10 13/32 x 7 15/32 x 25/32	264.3 x 189.7 x 19.8	PA10137
9 7/8 x 9 13/16 x 1	251.0 x 249.5 x 25.2	PA30325	10 13/32 x 7 1/2 x 2 3/32	264.3 x 190.5 x 53.2	PA4477
9 29/32 x 5 9/32 x 1 17/32	251.6 x 134.1 x 38.9	PA10152 KIT	10 13/32 x 8 11/32 x 2 11/16	264.3 x 211.9 x 68.3	PA10310
9 29/32 x 7 27/32 x 2 1/16	251.6 x 199.2 x 52.4	PA4144	10 13/32 x 8 3/8 x 1 25/32	264.3 x 212.7 x 45.2	PA4073
9 29/32 x 9 5/8 x 25/32	251.6 x 244.5 x 19.8	PA10213	10 7/16 x 5 15/32 x 1 1/2	265.1 x 138.9 x 38.1	PA31011
9 15/16 x 7 1/32 x 1 9/16	252.4 x 178.6 x 39.7	PA4044	10 7/16 x 5 3/4 x 1 7/8	265.1 x 146.0 x 47.6	PA4123
9 15/16 x 7 1/32 x 2 3/16	252.4 x 178.6 x 55.6	PA4163	10 7/16 x 6 1/2 x 3/8	265.1 x 165.1 x 9.5	PA30107
9 31/32 x 6 1/32 x 2 3/16	253.2 x 153.2 x 55.6	PA5663	10 7/16 x 6 19/32 x 1 5/16	265.1 x 167.5 x 33.3	PA4114
9 31/32 x 6 25/32 x 1 13/32	253.2 x 172.2 x 35.7	PA10008			



**WARNING:** These products can expose you to chemicals, including Diisononyl Phthalate, Carbon black extracts, Nickel, 1,3 Butadiene, Ethylene Oxide, Epichlorohydrin, which are known to the State of California to cause cancer, and Bisphenol-A, Ethylene Glycol, Ethylene Oxide, 1,3 Butadiene, Epichlorohydrin, which are known to the State of California to cause birth defects or other reproductive harm.

**PANEL AIR FILTERS**

LENGTH x WIDTH x THICK Inches	LENGTH x WIDTH x THICK (mm)	BALDWIN NUMBER	LENGTH x WIDTH x THICK Inches	LENGTH x WIDTH x THICK (mm)	BALDWIN NUMBER
10 7/16 x 7 1/8 x 1 7/16	265.1 x 181.0 x 36.5	PA4353	10 29/32 x 7 3/32 x 1 19/32	277.0 x 180.2 x 40.5	PA4076
10 7/16 x 8 21/32 x 1 31/32	265.1 x 219.9 x 50.0	PA10260	10 29/32 x 7 27/32 x 1 11/16	277.0 x 199.2 x 42.9	PA10044
10 7/16 x 9 7/32 x 1 15/16	265.1 x 234.2 x 23.8	PA10164	10 29/32 x 8 5/8 x 1 11/32	277.0 x 219.1 x 34.1	PA10018
10 7/16 x 10 13/32 x 1 23/32	265.1 x 264.3 x 43.7	PA4465	10 29/32 x 8 5/8 x 1 11/32	277.0 x 219.1 x 34.1	PA10034
10 15/32 x 6 15/32 x 2	265.9 x 164.3 x 50.8	PA10259	10 29/32 x 8 15/16 x 1 21/32	277.0 x 227.0 x 42.1	PA10271
10 15/32 x 9 29/32 x 1 7/8	265.9 x 251.6 x 47.6	PA4323	10 29/32 x 8 31/32 x 1 5/8	277.0 x 227.8 x 41.3	PA4476
10 15/32 x 9 15/16 x 1 9/16	265.9 x 252.4 x 39.7	PA10264	10 29/32 x 9 7/8 x 2 23/32	277.0 x 250.8 x 69.1	PA4162
10 15/32 x 10 3/16 x 1 15/32	265.9 x 258.8 x 37.3	PA4453	10 15/16 x 7 x 1 1/8	277.8 x 177.8 x 28.6	PA4112
10 1/2 x 5 3/4 x 2 5/32	266.7 x 146.0 x 54.8	PA10251	10 15/16 x 7 7/16 x 1 9/16	277.8 x 188.9 x 39.7	PA5720
10 1/2 x 6 23/32 x 1 21/32	266.7 x 170.7 x 42.1	PA2243	10 15/16 x 8 13/16 x 3/4	277.8 x 223.8 x 19.0	PA4475
10 1/2 x 7 7/8 x 1 9/16	266.7 x 200.0 x 39.7	PA4146	10 15/16 x 8 27/32 x 2 1/32	277.8 x 224.6 x 51.6	PA4431
10 1/2 x 8 5/16 x 1 1/2	266.7 x 211.1 x 38.1	PA10133	10 15/16 x 9 1/8 x 31/32	277.8 x 231.8 x 24.6	PA30000
10 17/32 x 2 21/32 x 25/32	267.5 x 67.5 x 19.8	PA10203 KIT	10 15/16 x 9 11/32 x 1 15/32	277.8 x 237.3 x 37.3	PA4157
10 17/32 x 6 23/32 x 1 15/16	267.5 x 170.7 x 49.2	PA4417	10 15/16 x 9 29/32 x 4 3/8	277.8 x 251.6 x 111.1	PA4318
10 17/32 x 10 7/16 x 1 31/32	267.5 x 265.1 x 50.0	PA10278	10 15/16 x 9 15/16 x 4 13/32	277.8 x 252.4 x 111.9	PA4458
10 17/32 x 4 3/8 x 1 13/32	267.7 x 111.5 x 36.1	PA10286	10 31/32 x 7 1/4 x 2 1/32	278.4 x 183.9 x 51.6	PA10222
10 9/16 x 4 11/16 x 1 15/16	268.3 x 119.1 x 49.2	PA10293	10 31/32 x 4 9/16 x 1/2	278.6 x 115.9 x 12.7	PA5643
10 9/16 x 6 7/32 x 1 3/16	268.3 x 158.0 x 30.2	PA10184	10 31/32 x 7 3/8 x 1 23/32	278.6 x 187.3 x 43.7	PA10235
10 9/16 x 6 5/16 x 1 31/32	268.3 x 160.3 x 50.0	PA4175	10 31/32 x 7 1/16 x 1 3/4	278.9 x 179.1 x 44.4	PA10221
10 9/16 x 6 7/8 x 2 3/8	268.3 x 174.6 x 60.3	PA4402	10 31/32 x 9 9/16 x 25/32	278.9 x 243.1 x 19.6	PA10099
10 9/16 x 7 9/32 x 2 1/8	268.3 x 184.9 x 54.0	PA10379			
10 9/16 x 8 1/4 x 8 1/16	268.3 x 209.6 x 204.8	PA1774	11 x 7 1/4 x 2 11/32	279.4 x 184.2 x 59.5	PA10316
10 9/16 x 8 21/32 x 2 1/32	268.3 x 219.9 x 51.6	PA4374	11 x 8 5/8 x 1 23/32	279.4 x 219.1 x 43.7	PA10223
10 9/16 x 8 3/4 x 2 1/8	268.3 x 222.3 x 54.0	PA10237	11 x 11 x 2 3/16	279.4 x 279.4 x 55.6	PA2497
10 9/16 x 8 3/4 x 2 1/8	268.3 x 222.3 x 54.0	PA10265	11 1/32 x 10 29/32 x 2 27/32	279.9 x 277.1 x 71.9	PA10095
10 9/16 x 8 29/32 x 1 7/8	268.3 x 226.2 x 47.6	PA10240	11 1/32 x 6 5/16 x 1 25/32	280.2 x 160.3 x 45.2	PA5666
10 9/16 x 9 31/32 x 1 7/32	268.3 x 253.2 x 31.0	PA4133	11 1/32 x 9 1/2 x 1 1/16	280.2 x 241.3 x 27.0	PA10239
10 9/16 x 10 9/16 x 8 1/8	268.3 x 268.3 x 206.4	PA1776	11 1/32 x 10 x 1 3/8	280.2 x 254.0 x 34.9	PA10143
10 19/32 x 7 1/2 x 31/32	269.1 x 190.5 x 24.6	PA10282	11 1/16 x 6 9/16 x 1 5/16	281.0 x 166.7 x 33.3	PA2135
10 19/32 x 3 9/16 x 1 3/32	269.1 x 90.5 x 27.8	PA5698	11 1/16 x 9 7/32 x 2 1/16	281.0 x 234.2 x 52.4	PA10233
10 19/32 x 7 9/32 x 1 21/32	269.1 x 184.9 x 42.1	PA4484	11 1/16 x 9 21/32 x 3/4	281.0 x 245.3 x 19.0	PA10031
10 19/32 x 7 7/8 x 1 21/32	269.1 x 200.0 x 42.1	PA2189	11 1/16 x 10 9/16 x 13/16	281.0 x 268.3 x 20.6	PA4444
10 19/32 x 8 5/8 x 1 15/32	269.1 x 219.1 x 37.3	PA10394	11 3/32 x 5 3/8 x 1 11/16	281.8 x 136.5 x 42.9	PA10224
10 19/32 x 10 19/32 x 3/4	269.1 x 269.1 x 19.0	PA5319	11 3/32 x 7 1/8 x 2 9/32	281.8 x 181.0 x 57.9	PA4793
10 5/8 x 4 3/4 x 2 7/32	269.9 x 120.7 x 56.4	PA5774	11 3/32 x 8 3/16 x 1 3/16	281.8 x 208.0 x 30.2	PA4331
10 5/8 x 5 21/32 x 1 7/32	269.9 x 143.7 x 31.0	PA10247	11 1/8 x 6 25/32 x 25/32	282.6 x 172.2 x 19.8	PA5321
10 5/8 x 6 3/32 x 1 3/8	269.9 x 154.8 x 34.9	PA2121	11 1/8 x 7 1/2 x 2	282.6 x 190.5 x 50.8	PA10047
10 5/8 x 7 3/32 x 1 3/8	269.9 x 180.2 x 34.9	PA10040	11 1/8 x 8 13/16 x 5 1/4	282.6 x 223.8 x 133.4	PA4397
10 5/8 x 7 13/32 x 1 25/32	269.9 x 188.1 x 45.2	PA3414	11 1/8 x 8 15/16 x 2 21/32	282.6 x 227.0 x 67.5	CV15000
10 5/8 x 7 17/32 x 1 31/32	269.9 x 191.3 x 50.0	PA4387	11 3/16 x 8 15/16 x 1 7/8	284.2 x 227.0 x 47.6	PA4451
10 5/8 x 7 13/16 x 7/8	269.9 x 198.4 x 22.2	PA10160	11 3/16 x 9 1/4 x 2 5/32	284.2 x 235.0 x 54.8	PA10387
10 5/8 x 9 1/16 x 1 3/16	269.9 x 230.2 x 30.2	PA5516	11 3/16 x 9 15/16 x 1 9/16	284.2 x 252.4 x 39.7	PA4485
10 5/8 x 9 7/16 x 25/32	269.9 x 239.7 x 19.8	PA10181	11 3/16 x 9 15/16 x 1 11/16	284.2 x 252.4 x 42.9	PA4487
10 5/8 x 9 7/16 x 1	269.9 x 239.7 x 25.4	PA4169	11 3/16 x 10 3/16 x 2 9/32	284.2 x 258.8 x 57.9	PA10033
10 5/8 x 10 5/8 x 31/32	269.9 x 269.9 x 24.6	PA4857	11 3/16 x 10 3/16 x 3 5/16	284.2 x 258.8 x 84.1	PA10197
10 21/32 x 4 1/4 x 15/16	270.7 x 108.0 x 23.8	PA10216 KIT	11 3/16 x 10 5/16 x 1 9/32	284.2 x 261.9 x 32.5	PA10319
10 21/32 x 7 1/16 x 1 5/16	270.7 x 179.4 x 33.3	PA10025	11 7/32 x 6 1/8 x 1 7/32	285.0 x 155.6 x 31.0	PA2150
10 21/32 x 11 23/32 x 2 1/8	270.7 x 297.7 x 54.0	PA10232	11 7/32 x 6 11/32 x 1 5/8	285.0 x 161.1 x 41.3	PA4303
10 11/16 x 8 13/32 x 1 5/8	271.5 x 213.0 x 41.0	PA10091	11 7/32 x 7 x 29/32	285.0 x 177.8 x 23.0	PA30127
10 11/16 x 5 31/32 x 1 15/32	271.5 x 151.4 x 37.6	PA10388	11 7/32 x 7 17/32 x 1 25/32	285.0 x 191.3 x 45.2	PA2152
10 11/16 x 10 3/32 x 1 9/16	271.5 x 256.4 x 39.7	PA10015	11 7/32 x 8 3/16 x 1 13/16	285.2 x 208.0 x 46.0	PA30263
10 23/32 x 10 1/32 x 1 7/8	272.3 x 255.0 x 48.0	PA10063	11 1/4 x 6 13/32 x 2 9/16	285.8 x 162.7 x 65.1	PA4129
10 23/32 x 4 3/32 x 1 3/32	272.3 x 104.0 x 27.8	PA5650	11 1/4 x 6 19/32 x 1 21/32	285.8 x 167.5 x 42.1	PA2237
10 23/32 x 7 23/32 x 25/32	272.3 x 196.1 x 19.8	PA30113	11 1/4 x 8 5/8 x 29/32	285.8 x 219.1 x 23.0	PA4330
10 23/32 x 9 11/16 x 1 17/32	272.3 x 246.1 x 38.9	PA4164	11 1/4 x 8 29/32 x 1 17/32	285.8 x 226.2 x 38.9	PA10330
10 23/32 x 9 7/8 x 2	272.3 x 250.8 x 50.8	PA10294	11 9/32 x 6 15/32 x 2 3/32	286.5 x 164.3 x 53.2	PA10230
10 3/4 x 5 1/4 x 1 19/32	273.1 x 133.4 x 40.5	PA2103	11 9/32 x 8 29/32 x 1 19/32	286.5 x 226.2 x 40.5	PA2149
10 3/4 x 6 1/2 x 1 21/32	273.1 x 165.1 x 42.1	PA4079	11 9/32 x 8 15/16 x 1 29/32	286.5 x 227.0 x 48.4	PA3822
10 3/4 x 7 19/32 x 1 11/32	273.1 x 192.9 x 34.1	PA10295	11 9/32 x 9 13/16 x 2 23/32	286.5 x 249.2 x 69.1	PA4467
10 3/4 x 9 13/16 x 1 27/32	273.1 x 249.2 x 46.8	PA4425	11 5/16 x 5 29/32 x 2 7/32	287.3 x 150.0 x 56.4	PA10383
10 25/32 x 6 5/8 x 1 21/32	273.8 x 168.3 x 42.1	PA4104	11 5/16 x 8 3/8 x 1 19/32	287.3 x 212.7 x 40.5	PA10341
10 13/16 x 8 1/8 x 25/32	274.6 x 206.4 x 19.8	PA5320	11 5/16 x 10 x 1 25/32	287.3 x 254.0 x 45.2	PA10001
10 13/16 x 10 x 8 3/32	274.6 x 254.0 x 205.6	PA32001	11 5/16 x 10 1/2 x 1 1/2	287.3 x 266.7 x 38.1	PA31001
10 27/32 x 9 13/32 x 2 7/8	275.1 x 239.0 x 72.9	PA10093	11 11/32 x 3 15/32 x 25/32	288.1 x 88.1 x 19.8	PA5405
10 27/32 x 6 17/32 x 1 5/16	275.4 x 165.9 x 33.3	PA10296	11 11/32 x 6 5/8 x 1 7/16	288.1 x 168.3 x 36.5	PA5624
10 27/32 x 7 3/8 x 2 3/32	275.4 x 187.3 x 53.2	PA4345	11 11/32 x 7 1/4 x 1 1/16	288.1 x 184.2 x 27.0	PA4192
10 7/8 x 10 9/32 x 1 3/8	276.1 x 261.1 x 34.8	PA10277	11 11/32 x 8 15/32 x 1 13/32	288.1 x 215.1 x 35.7	PA4167
10 7/8 x 6 11/32 x 2 1/8	276.2 x 161.1 x 54.0	PA4193	11 3/8 x 5 1/16 x 15/16	288.9 x 128.6 x 23.8	PA4152
10 7/8 x 6 15/16 x 2 1/4	276.2 x 176.5 x 57.4	PA10409	11 3/8 x 5 29/32 x 2	288.9 x 150.0 x 50.8	PA4180
10 7/8 x 7 9/16 x 1 1/4	276.2 x 192.1 x 31.8	PA10172	11 3/8 x 6 15/32 x 1 5/8	288.9 x 164.3 x 41.3	PA4190
10 7/8 x 7 7/8 x 1 3/16	276.2 x 200.0 x 30.2	PA10043	11 3/8 x 6 9/16 x 3/8	288.9 x 166.7 x 9.5	PA5662
10 7/8 x 9 23/32 x 1 25/32	276.2 x 246.9 x 45.2	PA10244	11 3/8 x 9 1/32 x 31/32	288.9 x 229.4 x 24.6	PA10214



**WARNING:** These products can expose you to chemicals, including Diisononyl Phthalate, Carbon black extracts, Nickel, 1,3 Butadiene, Ethylene Oxide, Epichlorohydrin, which are known to the State of California to cause cancer, and Bisphenol-A, Ethylene Glycol, Ethylene Oxide, 1,3 Butadiene, Epichlorohydrin, which are known to the State of California to cause birth defects or other reproductive harm.

# PANEL AIR FILTERS

LENGTH x WIDTH x THICK Inches	LENGTH x WIDTH x THICK (mm)	BALDWIN NUMBER	LENGTH x WIDTH x THICK Inches	LENGTH x WIDTH x THICK (mm)	BALDWIN NUMBER
11 3/8 x 9 3/8 x 2 3/32	288.9 x 238.1 x 53.2	PA4429	11 7/8 x 6 5/16 x 1 23/32	301.6 x 160.3 x 43.7	PA10248
11 3/8 x 9 3/4 x 1 15/32	288.9 x 247.7 x 37.3	PA4046	11 7/8 x 7 29/32 x 1 1/4	301.6 x 200.8 x 31.8	PA30114
11 3/8 x 10 1/4 x 29/32	288.9 x 260.3 x 23.0	PA10153	11 29/32 x 6 23/32 x 2 3/32	302.4 x 170.7 x 53.2	PA10026
11 3/8 x 10 1/4 x 29/32	288.9 x 260.3 x 23.0	PA10200	11 29/32 x 8 15/32 x 1 13/32	302.4 x 215.1 x 35.7	PA4312
11 3/8 x 10 7/16 x 6 19/32	288.9 x 265.1 x 167.5	PA31010	11 29/32 x 8 7/8 x 2 5/16	302.4 x 225.4 x 58.7	PA10302
11 3/8 x 11 3/8 x 1 3/32	288.9 x 288.9 x 27.8	PA10023	11 15/16 x 5 7/16 x 7/8	303.2 x 138.1 x 22.2	PA5318
11 3/8 x 11 3/8 x 1 3/4	288.9 x 288.9 x 44.4	PA4975	11 15/16 x 7 1/8 x 1 7/8	303.2 x 181.0 x 47.6	PA10006
11 3/8 x 10 27/32 x 2 9/32	289.1 x 275.1 x 57.9	PA10075	11 15/16 x 7 23/32 x 1 5/16	303.2 x 196.1 x 33.3	PA4423
11 13/32 x 4 23/32 x 1 23/32	289.7 x 119.9 x 43.7	PA3986	11 15/16 x 7 29/32 x 1 5/8	303.2 x 200.8 x 41.3	PA10072
11 13/32 x 6 1/8 x 1 1/8	289.7 x 155.6 x 28.6	PA10038	11 31/32 x 5 1/8 x 25/32	304 x 130.2 x 19.8	PA10215 KIT
11 13/32 x 6 5/16 x 1 3/16	289.7 x 160.3 x 30.2	PA4954	11 31/32 x 6 9/32 x 2 1/8	304 x 159.5 x 54.0	PA4413
11 13/32 x 7 19/32 x 1 31/32	289.7 x 192.9 x 50.0	PA4338	11 31/32 x 6 11/16 x 1 3/4	304 x 169.9 x 44.4	PA4321
11 13/32 x 10 3/16 x 1 11/16	289.7 x 258.8 x 42.9	PA10291	11 31/32 x 8 21/32 x 1/2	304 x 219.9 x 12.7	PA10017
11 7/16 x 10 5/32 x 2 1/16	290.5 x 258.0 x 52.4	PA10345	11 31/32 x 9 15/16 x 2 23/32	304 x 252.4 x 69.1	PA3897
11 15/32 x 6 15/16 x 2 5/8	291.1 x 176.0 x 67.1	PA10102	11 31/32 x 10 7/16 x 3	304 x 264.9 x 51.1	PA10094
11 15/32 x 8 7/8 x 1 1/4	291.1 x 225.0 x 32.0	PA10078			
11 15/32 x 5 3/32 x 1 13/16	291.3 x 129.4 x 46.0	PA4932	12 x 3 15/16 x 1 5/32	304.8 x 100.0 x 29.4	PA10196 KIT
11 15/32 x 7 11/32 x 1 5/32	291.3 x 186.5 x 29.4	PA4154	12 x 7 13/16 x 3/4	304.8 x 198.4 x 19.1	PA4986
11 15/32 x 8 5/16 x 1 19/32	291.3 x 211.1 x 40.5	PA4179	12 x 9 1/16 x 2 9/32	304.8 x 230.2 x 57.9	PA10317
11 15/32 x 8 11/32 x 1 1/2	291.3 x 211.9 x 38.1	PA4177	12 1/32 x 7 17/32 x 4	305.6 x 191.3 x 101.6	PA10246
11 15/32 x 9 1/16 x 2 5/16	291.3 x 230.2 x 58.7	PA4367	12 1/16 x 4 1/32 x 2 7/16	306.4 x 102.4 x 61.9	PA5739
11 1/2 x 6 31/32 x 2 3/4	292.1 x 177.0 x 70.1	PA10089	12 1/16 x 5 7/8 x 2 9/32	306.4 x 149.2 x 57.9	PA10332
11 1/2 x 6 31/32 x 3 5/32	292.1 x 177.0 x 80.2	PA10327	12 1/16 x 7 9/32 x 2 1/8	306.4 x 184.9 x 54.0	PA4077
11 1/2 x 7 1/32 x 1 21/32	292.1 x 178.6 x 42.1	PA2196	12 2/32 x 7 5/8 x 1 19/32	306.4 x 193.7 x 40.5	PA4107
11 1/2 x 7 3/32 x 2 1/4	292.1 x 180.2 x 57.2	PA4147	12 1/16 x 7 5/8 x 2 9/32	306.4 x 193.7 x 57.9	PA10024
11 1/2 x 7 5/16 x 1 3/32	292.1 x 185.7 x 27.8	PA10161	12 3/32 x 3 5/32 x 31/32	307.2 x 80.0 x 24.5	PA30281
11 1/2 x 8 3/16 x 1 23/32	292.1 x 208.0 x 43.7	PA4437	12 3/32 x 4 7/32 x 1 3/16	307.2 x 107.2 x 30.2	PA5768
11 1/2 x 9 1/4 x 1 5/8	292.1 x 235.0 x 41.3	PA10386	12 1/8 x 7 1/4 x 1 15/16	308.0 x 184.2 x 49.2	PA10315
11 17/32 x 6 1/32 x 1 5/8	292.9 x 153.2 x 41.3	PA2257	12 1/8 x 7 27/32 x 1 11/16	308.0 x 199.2 x 42.9	PA4081
11 17/32 x 7 9/16 x 1 3/16	292.9 x 192.1 x 30.2	PA5475	12 5/32 x 7 7/16 x 1 17/32	308.6 x 189.0 x 38.6	PA10069
11 17/32 x 7 7/8 x 1 11/16	292.9 x 200.0 x 42.9	PA4350	12 5/32 x 6 1/8 x 1 21/32	308.8 x 155.6 x 42.1	PA2041
11 9/16 x 6 1/2 x 1 7/8	293.7 x 165.1 x 47.6	PA10058	12 5/32 x 8 5/16 x 1 3/16	308.8 x 211.1 x 30.2	PA4174
11 9/16 x 6 31/32 x 31/32	293.7 x 177.0 x 24.6	PA30110	12 5/32 x 12 19/32 x 1 25/32	308.8 x 319.9 x 45.2	PA4170
11 9/16 x 10 x 1 17/32	293.8 x 254.0 x 38.5	PA10087	12 3/16 x 4 1/32 x 1 11/16	309.6 x 102.4 x 42.9	PA30252
11 9/16 x 9 21/32 x 1 3/8	293.9 x 245.1 x 35.1	PA10381	12 3/16 x 6 1/8 x 15/16	309.6 x 155.6 x 23.8	PA10314
11 19/32 x 3 3/4 x 1 3/16	294.5 x 95.3 x 30.2	PA4416 KIT	12 3/16 x 7 1/16 x 25/32	309.6 x 179.4 x 19.8	PA4394
11 19/32 x 9 3/32 x 1 13/16	294.5 x 231.0 x 46.0	PA10311	12 3/16 x 7 3/8 x 1 11/16	309.6 x 187.3 x 42.9	PA4028
11 5/8 x 5 9/32 x 2 3/32	295.3 x 134.1 x 53.2	PA4078	12 3/16 x 9 1/4 x 1 15/32	309.6 x 235.0 x 37.3	PA10344
11 5/8 x 6 7/16 x 2	295.3 x 163.5 x 50.8	PA10254	12 3/16 x 9 17/32 x 2 3/16	309.6 x 242.1 x 55.6	PA30004
11 5/8 x 6 1/2 x 31/32	295.3 x 165.1 x 24.6	PA4096	12 7/32 x 6 17/32 x 1 3/4	310.4 x 165.9 x 44.4	PA4181
11 5/8 x 6 7/8 x 1 5/8	295.3 x 174.6 x 41.3	PA10073	12 7/32 x 9 7/32 x 29/32	310.4 x 234.2 x 23.0	PA4159
11 5/8 x 7 3/32 x 1 23/32	295.3 x 180.2 x 43.7	PA4337	12 1/4 x 4 x 2 9/16	311.2 x 101.6 x 65.1	PA3828
11 5/8 x 7 3/16 x 2 7/16	295.3 x 182.6 x 61.9	PA10385	12 1/4 x 6 5/32 x 1 3/16	311.2 x 156.4 x 30.2	PA5679
11 5/8 x 8 5/16 x 1 3/8	295.3 x 211.1 x 34.9	PA10234	12 1/4 x 7 1/4 x 2 7/32	311.2 x 184.2 x 56.4	PA10398
11 5/8 x 8 29/32 x 2 1/4	295.3 x 226.2 x 57.2	PA10288	12 1/4 x 9 1/8 x 2 1/16	311.2 x 231.8 x 52.4	PA4127
11 5/8 x 9 1/32 x 1 1/2	295.3 x 229.4 x 38.1	PA10326	12 1/4 x 9 9/16 x 2 9/16	311.2 x 242.9 x 65.1	PA3781
11 5/8 x 9 1/32 x 1 1/2	295.3 x 229.4 x 38.1	PA10329	12 1/4 x 9 31/32 x 1 3/4	311.2 x 253.2 x 44.4	PA5766
11 5/8 x 9 7/32 x 1 7/8	295.3 x 234.2 x 47.6	PA10283	12 1/4 x 10 11/16 x 1 11/32	311.2 x 271.5 x 34.1	PA10207
11 5/8 x 10 3/8 x 25/32	295.3 x 263.5 x 19.8	PA4304	12 1/4 x 11 x 1 1/8	311.2 x 279.4 x 28.6	PA10390
11 21/32 x 6 5/8 x 1 1/2	295.9 x 167.9 x 38.1	PA30268	12 9/32 x 7 9/16 x 2 7/16	311.9 x 192.1 x 61.9	PA5331
11 21/32 x 6 23/32 x 2 7/32	296.1 x 170.7 x 56.4	PA10304	12 9/32 x 9 23/32 x 2 5/16	311.9 x 246.9 x 58.7	PA4113
11 21/32 x 8 13/16 x 7/8	296.1 x 223.8 x 22.2	PA4384	12 9/32 x 9 23/32 x 2 5/16	311.9 x 246.9 x 58.7	PA4134
11 21/32 x 8 15/16 x 1 23/32	296.1 x 227.0 x 43.7	PA10241	12 9/32 x 10 x 2	311.9 x 254.0 x 50.8	PA4412
11 21/32 x 9 3/8 x 1 5/16	296.1 x 238.1 x 33.3	PA4341	12 9/32 x 10 1/16 x 1 13/16	311.9 x 255.6 x 46.0	PA5482
11 11/16 x 5 1/8 x 3/8	296.9 x 130.2 x 9.5	PA5721	12 9/32 x 10 1/8 x 1 15/32	311.9 x 257.2 x 37.3	PA10393
11 23/32 x 5 11/32 x 1 27/32	297.7 x 135.7 x 46.8	PA4183	12 5/16 x 6 1/32 x 1 11/32	312.7 x 153.2 x 34.1	PA10169
11 23/32 x 5 7/8 x 1 23/32	297.7 x 149.2 x 43.7	PA10268	12 5/16 x 6 23/32 x 3 5/16	312.7 x 170.7 x 84.1	PA4171
11 23/32 x 10 31/32 x 14 1/16	297.7 x 278.6 x 357.2	PA31000	12 5/16 x 6 15/16 x 1 27/32	312.7 x 176.2 x 46.8	PA4360
11 25/32 x 10 7/32 x 2 9/16	299.2 x 259.6 x 65.1	PA10045	12 5/16 x 8 27/32 x 1 7/16	312.7 x 224.6 x 36.5	PA30122
11 13/16 x 6 7/8 x 1 19/32	300.0 x 174.6 x 40.5	PA4351	12 5/16 x 8 27/32 x 1 7/16	312.7 x 224.6 x 36.5	PA30123
11 13/16 x 7 3/16 x 2 29/32	300.0 x 182.6 x 73.8	PA4464	12 5/16 x 8 27/32 x 1 7/16	312.7 x 224.6 x 36.5	PA30124
11 13/16 x 7 15/32 x 1 25/32	300.0 x 189.7 x 45.2	PA5511	12 11/32 x 4 x 1 5/8	313.5 x 101.6 x 41.3	PA4319
11 13/16 x 7 17/32 x 25/32	300.0 x 191.3 x 19.8	PA30156	12 11/32 x 5 7/32 x 2 1/4	313.5 x 132.6 x 57.2	PA4399
11 13/16 x 8 1/16 x 1 3/16	300.0 x 204.8 x 30.2	PA10189	12 3/8 x 5 3/4 x 1 7/8	314.3 x 146.0 x 47.6	PA10305
11 13/16 x 9 13/16 x 1 1/16	300.0 x 249.2 x 27.0	PA4652	12 3/8 x 6 3/16 x 2 23/32	314.3 x 157.2 x 69.1	PA4090
11 13/16 x 10 3/4 x 2 3/16	300.0 x 273.1 x 55.6	PA3823	12 3/8 x 7 29/32 x 1 3/8	314.3 x 200.8 x 34.9	PA10219
11 13/16 x 10 25/32 x 2 11/16	300.0 x 273.8 x 68.3	PA3763	12 13/32 x 7 15/32 x 2 5/16	315.1 x 189.7 x 58.7	PA10308
11 13/16 x 11 7/32 x 17/32	300.0 x 285.0 x 13.5	PA5691	12 13/32 x 10 7/8 x 2 25/32	315.1 x 276.2 x 70.6	PA4600
11 27/32 x 5 1/4 x 1 9/16	300.8 x 133.4 x 39.7	PA10208 KIT	12 13/32 x 10 7/8 x 3 3/16	315.1 x 276.2 x 81.0	PA4601
11 27/32 x 6 7/8 x 1 27/32	300.8 x 174.6 x 46.8	PA4434	12 7/16 x 7 1/32 x 1 7/16	315.9 x 178.6 x 36.5	PA2230
11 27/32 x 9 x 1 15/32	300.8 x 228.6 x 37.3	PA4481	12 7/16 x 7 1/16 x 2 5/32	315.9 x 179.4 x 54.8	PA5632
11 7/8 x 4 7/16 x 1 5/8	301.6 x 112.7 x 41.3	PA10313	12 7/16 x 11 11/16 x 2	315.9 x 296.9 x 50.8	PA4322



**WARNING:** These products can expose you to chemicals, including Diisononyl Phthalate, Carbon black extracts, Nickel, 1,3 Butadiene, Ethylene Oxide, Epichlorohydrin, which are known to the State of California to cause cancer, and Bisphenol-A, Ethylene Glycol, Ethylene Oxide, 1,3 Butadiene, Epichlorohydrin, which are known to the State of California to cause birth defects or other reproductive harm.

**PANEL AIR FILTERS**

LENGTH x WIDTH x THICK Inches	LENGTH x WIDTH x THICK (mm)	BALDWIN NUMBER	LENGTH x WIDTH x THICK Inches	LENGTH x WIDTH x THICK (mm)	BALDWIN NUMBER
12 15/32 x 10 9/32 x 2 17/32	316.7 x 261.1 x 64.3	PA30149	13 5/16 x 6 23/32 x 1 17/32	338.1 x 170.7 x 38.9	PA4124
12 1/2 x 6 1/2 x 1 3/4	317.5 x 165.1 x 44.4	PA3900	13 5/16 x 9 1/4 x 1 23/32	338.1 x 235.0 x 43.7	PA10273
12 1/2 x 7 1/16 x 1 7/16	317.5 x 179.4 x 36.5	PA4659	13 11/32 x 9 3/32 x 5/8	338.9 x 231.0 x 15.9	PA5755
12 17/32 x 7 1/16 x 1 5/8	318.3 x 179.4 x 41.3	PA5669	13 3/8 x 7 1/4 x 2 5/16	339.7 x 184.2 x 58.7	PA4120
12 17/32 x 7 19/32 x 1 11/16	318.3 x 192.9 x 42.9	PA4150	13 3/8 x 7 5/16 x 3 13/32	339.7 x 185.7 x 86.5	PA4148
12 9/16 x 6 1/2 x 1 7/16	319.1 x 165.1 x 36.5	PA5652	13 3/8 x 12 13/16 x 25/32	339.7 x 325.4 x 19.8	PA5690
12 9/16 x 8 x 3 1/16	319.1 x 203.2 x 77.8	PA5656	13 7/16 x 5 15/16 x 1 25/32	341.3 x 150.8 x 45.2	PA4191
12 19/32 x 5 1/8 x 1 7/8	319.9 x 130.2 x 47.6	PA30006	13 7/16 x 8 3/8 x 25/32	341.3 x 212.7 x 19.8	PA4682
12 19/32 x 5 29/32 x 1 5/8	319.9 x 150.0 x 41.3	PA2200	13 15/32 x 10 19/32 x 2 3/16	342.1 x 269.1 x 55.6	PA30183
12 19/32 x 5 31/32 x 2 9/32	319.9 x 151.6 x 57.9	PA4888	13 1/2 x 6 1/4 x 1 5/16	342.9 x 158.8 x 33.3	PA4092
12 19/32 x 6 1/2 x 1 7/8	319.9 x 165.1 x 47.6	PA5580	13 1/2 x 6 21/32 x 1 11/16	342.9 x 169.1 x 42.9	PA10331
12 19/32 x 6 21/32 x 1 15/16	319.9 x 169.1 x 49.2	PA30005	13 17/32 x 6 21/32 x 1 19/32	343.7 x 169.1 x 40.5	PA2163
12 19/32 x 6 15/16 x 1 27/32	319.9 x 176.2 x 46.8	PA4310	13 9/16 x 5 11/32 x 2 25/32	344.5 x 135.7 x 70.6	PA4428
12 19/32 x 7 1/4 x 31/32	319.9 x 184.2 x 24.6	PA4985	13 19/32 x 4 3/4 x 2 1/4	344.9 x 120.9 x 56.9	PA30249
12 19/32 x 7 3/4 x 1 15/32	319.9 x 196.9 x 37.3	PA4182	13 19/32 x 10 3/16 x 2 9/16	344.9 x 259.1 x 65.0	PA10106
12 19/32 x 9 11/32 x 1 13/32	319.9 x 237.3 x 35.7	PA4121	13 5/8 x 6 13/32 x 1 15/16	346.1 x 162.7 x 49.2	PA10284
12 19/32 x 9 11/32 x 2 7/16	319.9 x 237.3 x 61.9	PA4435	13 21/32 x 10 1/32 x 19/32	346.9 x 254.8 x 15.1	PA5637
12 19/32 x 9 1/2 x 2 1/16	319.9 x 241.3 x 52.4	PA4356	13 11/16 x 5 11/16 x 9/16	347.7 x 144.5 x 14.3	PA5778
12 19/32 x 10 5/8 x 5/8	319.9 x 269.9 x 15.9	PA3825	13 11/16 x 10 1/32 x 25/32	347.7 x 254.8 x 19.8	PA5694
12 19/32 x 8 3/4 x 2 9/32	320 x 222.0 x 57.9	PA10096	13 11/16 x 10 1/16 x 25/32	347.7 x 255.6 x 19.8	PA10158
12 5/8 x 5 x 2 17/32	320.7 x 127 x 64.3	PA10285	13 3/4 x 4 5/32 x 1 19/32	349.3 x 105.6 x 40.5	PA2218
12 5/8 x 6 11/32 x 2 15/16	320.7 x 161.1 x 74.6	PA4106	13 3/4 x 5 3/16 x 2 5/16	349.3 x 131.8 x 58.7	PA2234
12 5/8 x 6 11/16 x 2 15/32	321.1 x 169.9 x 63.0	PA10101	13 3/4 x 8 21/32 x 1 3/16	349.3 x 219.0 x 30.2	PA10142
12 21/32 x 5 5/16 x 1 7/8	321.5 x 134.9 x 47.6	PA10324	13 3/4 x 9 3/32 x 1 21/32	349.3 x 231.0 x 42.1	PA10077
12 21/32 x 8 9/32 x 1 9/16	321.5 x 210.3 x 39.7	PA10236	13 3/4 x 9 11/32 x 1 15/16	349.3 x 237.3 x 49.2	PA4151
12 21/32 x 9 1/4 x 15/16	321.5 x 235.0 x 23.8	PA4612	13 3/4 x 11 3/4 x 1 23/32	349.3 x 298.5 x 43.7	PA4418
12 11/16 x 6 7/32 x 1 19/32	322.3 x 158.0 x 40.5	PA10263	13 25/32 x 8 3/8 x 1 23/32	350.0 x 212.6 x 43.9	PA30329
12 11/16 x 6 15/16 x 1 3/16	322.3 x 176.2 x 30.2	PA10198 KIT	13 13/16 x 7 9/32 x 2 3/16	350.8 x 184.9 x 55.6	PA2244
12 23/32 x 5 27/32 x 2 7/32	323.1 x 148.4 x 56.4	PA5770	13 7/8 x 4 29/32 x 2 9/32	352.4 x 124.6 x 57.9	PA4316
12 23/32 x 6 3/32 x 2 5/16	323.1 x 154.8 x 58.7	PA4785	13 7/8 x 9 x 1 1/4	352.4 x 228.6 x 31.8	PA4439
12 3/4 x 4 7/8 x 1 7/32	323.8 x 123.8 x 31.0	PA4714	13 7/8 x 9 3/8 x 2 9/32	352.4 x 238.1 x 57.9	PA10022
12 3/4 x 9 23/32 x 1 25/32	323.8 x 246.9 x 45.2	PA4456	13 7/8 x 10 3/32 x 7/8	352.4 x 256.4 x 22.2	PA5306
12 3/4 x 10 1/16 x 1 31/32	323.8 x 255.6 x 50.0	PA10335	13 29/32 x 5 1/4 x 1 3/4	353.2 x 133.4 x 44.4	PA4440 KIT
12 3/4 x 11 9/16 x 1 1/8	323.8 x 293.7 x 28.6	PA4681	13 29/32 x 10 7/16 x 2 1/4	353.2 x 265.1 x 57.2	PA4390
12 3/4 x 2 5/8 x 1 3/16	324.1 x 67.1 x 30.2	PA30255	13 29/32 x 11 5/16 x 1 3/8	353.2 x 287.3 x 34.9	PA10309
12 13/16 x 6 1/32 x 2 9/32	325.4 x 153.2 x 57.9	PA5317	13 15/16 x 6 x 2 9/16	354.1 x 152.4 x 65.1	PA4554
12 13/16 x 7 7/8 x 2 3/16	325.4 x 200.0 x 55.6	PA10212 KIT	13 15/16 x 8 15/32 x 2 1/4	354.1 x 215.1 x 57.2	PA10312
12 13/16 x 10 9/16 x 8 5/32	325.4 x 268.3 x 207.2	PA1778	13 15/16 x 6 1/8 x 31/32	354.1 x 155.4 x 24.9	PA30330
12 27/32 x 5 25/32 x 2 1/8	326.2 x 146.8 x 54.0	PA4355	13 31/32 x 6 3/16 x 1 19/32	354.8 x 157.2 x 40.5	PA5339
12 27/32 x 5 7/8 x 1 21/32	326.2 x 149.2 x 42.1	PA2164	13 31/32 x 6 17/32 x 2 7/16	354.8 x 165.9 x 61.9	PA4165
12 27/32 x 6 5/8 x 1 1/4	326.2 x 168.3 x 31.8	PA4362	13 31/32 x 9 7/32 x 1 3/8	354.8 x 234.2 x 34.9	PA4488
12 7/8 x 5 17/32 x 1 23/32	327.0 x 140.5 x 43.7	PA4385	14 x 9 9/16 x 1 1/2	355.6 x 242.9 x 38.1	PA10303
12 7/8 x 7 21/32 x 1 7/8	327.0 x 194.5 x 47.6	PA10384	14 1/32 x 5 5/32 x 2	356.4 x 131.0 x 50.8	PA10013
12 7/8 x 12 x 2 9/16	327.0 x 304.8 x 65.1	PA3803	14 1/16 x 6 11/16 x 4 9/32	357.2 x 169.9 x 108.7	PA4433
12 29/32 x 3 17/32 x 1/2	327.8 x 89.7 x 12.7	PA5727	14 3/32 x 11 7/32 x 2 3/16	358.0 x 285.0 x 55.6	PA30002
12 29/32 x 5 27/32 x 1 19/32	327.8 x 148.4 x 40.5	PA4306	14 1/8 x 7 1/8 x 2 9/16	358.8 x 181.0 x 65.1	PA4654 KIT
12 29/32 x 10 3/32 x 1 17/32	327.8 x 256.4 x 38.9	PA30007	14 1/8 x 10 7/32 x 1 23/32	359.2 x 259.8 x 43.7	PA10076
12 15/16 x 5 7/8 x 1 31/32	328.6 x 149.2 x 50.0	PA10228	14 5/32 x 9 7/32 x 2 1/32	359.6 x 234.2 x 51.6	PA10225
12 15/16 x 10 7/16 x 2 23/32	328.6 x 265.1 x 69.1	PA4723	14 5/32 x 10 3/8 x 2 1/8	359.6 x 263.5 x 54.0	PA10012
12 15/16 x 8 15/32 x 2 1/4	328.7 x 215.1 x 57.2	PA10292	14 7/32 x 5 23/32 x 1 9/16	361.4 x 145.3 x 39.9	PA10281
12 31/32 x 9 15/32 x 2 1/32	329.4 x 240.5 x 51.6	PA10060	14 7/32 x 8 3/8 x 1 3/16	361.4 x 212.3 x 30.0	PA30272
13 x 5 7/8 x 2 3/16	330.2 x 149.2 x 55.6	PA2235	14 1/4 x 5 3/32 x 1 31/32	362.0 x 129.4 x 50.0	PA4414
13 x 7 x 1/2	330.2 x 177.8 x 12.7	PA3931	14 1/4 x 9 1/8 x 1 15/32	362.0 x 231.8 x 37.3	PA4478
13 x 7 11/32 x 1 11/32	330.2 x 186.5 x 34.1	PA10368	14 1/4 x 10 23/32 x 1 13/32	362.0 x 272.3 x 35.7	PA5712
13 x 8 1/2 x 2 9/32	330.2 x 215.9 x 57.9	PA4359	14 9/32 x 7 x 1 3/8	362.7 x 177.8 x 34.9	PA10178
13 x 9 1/2 x 2 29/32	330.2 x 241.3 x 73.8	PA4466	14 5/16 x 6 3/16 x 1 29/32	363.5 x 157.2 x 48.4	PA4448
13 1/16 x 6 5/32 x 1 21/32	331.8 x 156.4 x 42.1	PA10358	14 5/16 x 7 1/4 x 1 31/32	363.5 x 184.2 x 50.0	PA4111
13 1/16 x 6 15/32 x 1 15/32	331.8 x 164.3 x 37.3	PA2181	14 7/16 x 6 1/32 x 2 9/32	366.7 x 153.2 x 57.9	PA5680
13 1/16 x 7 19/32 x 1 3/16	331.8 x 192.9 x 30.2	PA10140	14 1/2 x 4 9/32 x 15/16	368.3 x 108.7 x 23.8	PA5660
13 3/32 x 5 3/8 x 1 3/8	332.6 x 136.5 x 34.9	PA10218	14 1/2 x 6 11/32 x 15/16	368.3 x 161.1 x 23.8	PA5725
13 1/8 x 6 13/32 x 1 3/16	333.4 x 162.7 x 30.2	PA10177	14 1/2 x 9 7/16 x 1 1/8	368.3 x 239.7 x 28.6	PA10249
13 1/8 x 6 15/16 x 1 25/32	333.4 x 176.2 x 45.2	PA4377	14 9/16 x 6 7/16 x 31/32	369.9 x 163.5 x 24.6	PA4489
13 3/16 x 5 11/32 x 1 21/32	335.0 x 135.7 x 42.1	PA21014	14 9/16 x 9 9/16 x 1 5/32	369.9 x 242.9 x 29.4	PA4324
13 3/16 x 6 1/16 x 2	335.0 x 154.0 x 50.8	PA10258	14 9/16 x 11 5/32 x 1 3/8	369.9 x 283.4 x 34.9	PA4336
13 3/16 x 9 3/8 x 1 9/16	335.0 x 238.0 x 39.9	PA10098	14 5/8 x 4 5/8 x 1 3/16	371.5 x 117.5 x 30.2	PA5625
13 7/32 x 6 17/32 x 2 1/8	335.8 x 165.9 x 24.0	PA4369	14 5/8 x 4 7/8 x 2 9/16	371.5 x 123.8 x 65.1	PA4567
13 7/32 x 7 15/32 x 1 1/4	335.8 x 189.7 x 31.8	PA10298	14 21/32 x 3 25/32 x 1 3/8	372.1 x 96.0 x 35.1	PA30270
13 7/32 x 7 15/32 x 2 1/4	335.8 x 189.7 x 57.2	PA10229	14 21/32 x 5 1/4 x 2 7/16	372.3 x 133.4 x 61.9	PA3886
13 1/4 x 7 1/16 x 2 19/32	336.5 x 179.4 x 65.9	PA4110	14 21/32 x 6 7/16 x 1 9/32	372.3 x 163.5 x 32.5	PA4128
13 1/4 x 11 15/16 x 13/16	336.5 x 303.2 x 20.6	PA3482	14 23/32 x 5 5/16 x 25/32	373.9 x 134.9 x 19.8	PA5493
13 9/32 x 8 21/32 x 2 13/16	337.3 x 219.9 x 71.4	PA5621	14 23/32 x 6 13/16 x 2 3/4	373.9 x 173.0 x 69.9	PA4172



**WARNING:** These products can expose you to chemicals, including Diisononyl Phthalate, Carbon black extracts, Nickel, 1,3 Butadiene, Ethylene Oxide, Epichlorohydrin, which are known to the State of California to cause cancer, and Bisphenol-A, Ethylene Glycol, Ethylene Oxide, 1,3 Butadiene, Epichlorohydrin, which are known to the State of California to cause birth defects or other reproductive harm.



# PANEL AIR FILTERS

LENGTH x WIDTH x THICK Inches	LENGTH x WIDTH x THICK (mm)	BALDWIN NUMBER	LENGTH x WIDTH x THICK Inches	LENGTH x WIDTH x THICK (mm)	BALDWIN NUMBER
14 23/32 x 13 17/32 x 1 3/16	373.9 x 343.9 x 30.0	PA30258	16 7/16 x 5 x 1 7/16	417.5 x 127.0 x 36.5	PA2706
14 3/4 x 5 11/32 x 2 1/8	374.7 x 135.7 x 54.0	PA4307	16 7/16 x 5 9/16 x 2 9/16	417.5 x 141.3 x 65.1	PA3937
14 3/4 x 6 7/8 x 2 7/16	374.7 x 174.6 x 61.9	PA4635	16 7/16 x 6 5/32 x 2 9/32	417.5 x 156.4 x 23.0	PA4928
14 3/4 x 8 31/32 x 1 15/16	374.7 x 227.8 x 49.2	PA10242	16 17/32 x 5 x 1 3/16	419.9 x 127.0 x 30.2	PA30098
14 3/4 x 9 9/16 x 2 27/32	374.9 x 243.1 x 71.9	PA30299	16 5/8 x 5 9/16 x 2 9/16	421.9 x 141.0 x 65.3	PA30264
14 13/16 x 4 x 2 11/16	376.2 x 101.6 x 68.3	PA3829	16 5/8 x 5 3/8 x 1 9/32	422.3 x 136.5 x 32.5	PA10226
14 13/16 x 6 3/32 x 1 11/16	376.2 x 154.8 x 42.9	PA10300	16 11/16 x 7 29/32 x 1 3/8	423.9 x 200.8 x 34.9	PA10299
14 13/16 x 6 5/8 x 1 3/32	376.2 x 168.3 x 27.8	PA4409	16 11/16 x 8 7/8 x 2 1/4	423.9 x 225.4 x 57.2	PA5428
14 7/8 x 5 1/2 x 1 9/16	377.8 x 139.7 x 39.7	PA5492	16 3/4 x 4 13/32 x 1 1/8	425.5 x 111.9 x 28.6	PA4340
14 15/16 x 5 5/16 x 1 17/32	379.4 x 134.9 x 38.9	PA4956	16 13/16 x 11 11/16 x 2 9/16	427.0 x 296.9 x 65.1	PA5300
14 31/32 x 5 9/32 x 2 5/16	380.2 x 83.3 x 58.7	PA10007	16 15/16 x 4 11/32 x 1 3/16	430.0 x 110.0 x 30.0	PA30304
14 31/32 x 5 1/8 x 1 31/32	380.2 x 130.2 x 50.0	PA5399	16 15/16 x 4 11/32 x 1 3/16	430.0 x 110.0 x 30.0	PA30324
14 31/32 x 5 1/8 x 2 1/8	380.2 x 130.2 x 54.0	PA5400	16 15/16 x 5 1/8 x 1 19/32	430.2 x 130.2 x 40.5	PA10290
14 31/32 x 5 27/32 x 2 3/32	380.2 x 148.4 x 53.2	PA5740			
14 31/32 x 9 21/32 x 1 3/16	380.2 x 245.3 x 30.2	PA30172			
14 31/32 x 11 5/8 x 4 11/32	380.2 x 295.3 x 110.3	PA10257			
14 31/32 x 11 21/32 x 4 31/32	380.2 x 296.1 x 126.2	PA10262			
15 x 7 x 2 3/16	381.0 x 177.8 x 55.6	PA2936	17 x 6 x 2 3/16	431.8 x 152.4 x 55.6	PA4592
15 x 7 5/16 x 2 3/8	381.0 x 185.7 x 60.3	PA10340	17 x 8 x 2 3/16	431.8 x 203.2 x 55.6	PA3420
15 x 11 1/2 x 5 1/2	381.0 x 292.1 x 139.7	PA2450	17 x 10 x 2 3/16	431.8 x 254.0 x 55.6	PA2534
15 x 15 x 2 3/16	381.0 x 381.0 x 55.6	PA1961	17 x 10 1/32 x 2 3/16	431.8 x 254.8 x 55.6	PA5653
15 x 15 x 2 9/16	381.0 x 381.0 x 65.1	PA1960	17 1/32 x 2 7/8 x 1 7/8	432.6 x 73.0 x 47.6	PA5401
15 x 15 x 5 1/2	381.0 x 381.0 x 139.7	PA2554	17 1/8 x 4 13/16 x 1 3/4	435.0 x 122.2 x 44.4	PA5310
15 1/32 x 5 3/16 x 1 19/32	381.8 x 131.8 x 40.5	PA4912	17 1/8 x 8 7/16 x 2 11/16	435.0 x 214.3 x 68.3	PA3945
15 1/16 x 7 9/32 x 1 5/16	382.6 x 184.9 x 33.3	PA4422	17 9/32 x 5 21/32 x 2 1/32	438.9 x 143.7 x 16.7	PA5779
15 1/8 x 5 25/32 x 1 31/32	383.8 x 146.6 x 50.3	PA31009	17 5/16 x 3 29/32 x 1 1/2	439.7 x 99.2 x 38.1	PA4947
15 1/8 x 6 11/16 x 2 1/8	384.0 x 169.9 x 54.1	PA30253	17 5/16 x 10 19/32 x 1 17/32	439.7 x 269.1 x 38.9	PA2241
15 5/32 x 5 1/4 x 1 5/8	385.0 x 133.4 x 41.3	PA10325	17 13/32 x 4 23/32 x 1 3/16	442.1 x 119.9 x 30.2	PA10168
15 5/32 x 5 23/32 x 13/32	385.0 x 145.3 x 10.3	PA30179	17 15/32 x 8 1/2 x 5/8	443.7 x 215.9 x 15.9	PA3917
15 5/32 x 8 1/16 x 1 9/32	385.0 x 204.8 x 32.5	PA4185	17 1/2 x 4 1/4 x 3/16	444.5 x 108.0 x 4.8	PA5630
15 3/16 x 5 15/16 x 8 5/32	385.8 x 150.8 x 207.2	PA1775	17 1/2 x 6 x 2 9/16	444.5 x 152.4 x 65.1	PA3782
15 3/16 x 8 1/4 x 8 1/8	385.8 x 209.6 x 206.4	PA1806	17 21/32 x 8 1/8 x 1	448.5 x 206.4 x 25.4	PA5336
15 3/16 x 10 9/16 x 8 5/32	385.8 x 268.3 x 207.2	PA1779	17 21/32 x 8 1/8 x 1	448.5 x 206.4 x 25.4	PA5476
15 7/32 x 6 5/32 x 15 1/8	386.3 x 156.2 x 384.6	PA31008	17 11/16 x 4 13/16 x 19/32	449.6 x 121.9 x 15.0	PA30293
15 1/4 x 4 29/32 x 1 7/32	387.3 x 124.6 x 31.0	PA30086	17 3/4 x 7 13/32 x 1 7/32	450.9 x 188.1 x 31.0	PA4945
15 1/4 x 5 1/4 x 1 15/32	387.3 x 133.4 x 37.3	PA31003	17 29/32 x 5 27/32 x 1 3/16	454.8 x 148.4 x 30.2	PA5645
15 1/4 x 7 5/16 x 2 3/16	387.3 x 185.7 x 55.6	PA3881	17 29/32 x 5 15/16 x 15/32	454.8 x 150.8 x 11.9	PA5597
15 11/32 x 4 29/32 x 1 7/16	389.7 x 124.6 x 36.5	PA5282			
15 3/8 x 3 5/8 x 1/2	390.5 x 92.1 x 12.7	PA30044	18 x 10 x 2 15/16	457.2 x 254.0 x 74.6	PA3878
15 3/8 x 5 19/32 x 23/32	390.5 x 142.1 x 18.3	PA5599	18 1/8 x 9 7/16 x 1 3/16	460.4 x 239.7 x 30.2	PA5532
15 7/16 x 6 3/32 x 21/32	392.1 x 154.8 x 16.7	PA5594	18 5/32 x 15 9/16 x 19/32	461.2 x 395.3 x 15.1	PA4559
15 7/16 x 7 5/16 x 2 9/32	392.1 x 185.7 x 57.9	PA10279	18 1/4 x 3 7/8 x 3 3/16	463.6 x 98.4 x 81.0	PA3798
15 9/16 x 8 9/32 x 3/16	395.3 x 210.3 x 4.8	PA5732	18 5/16 x 3 1/16 x 1 5/8	465.1 x 77.8 x 41.3	PA4168
15 19/32 x 12 27/32 x 2 3/4	396.1 x 326.2 x 69.9	PA4560	18 5/16 x 5 5/16 x 2 5/32	465.1 x 134.9 x 54.8	PA5667
15 5/8 x 10 1/32 x 1 1/32	396.9 x 254.8 x 26.2	PA5363	18 11/32 x 7 x 2 5/32	465.9 x 177.8 x 54.8	PA5777
15 21/32 x 4 11/32 x 1 1/32	397.3 x 110.0 x 26.4	PA30260	18 11/32 x 8 31/32 x 25/32	465.9 x 227.8 x 19.8	PA30155
15 21/32 x 6 7/16 x 1 17/32	397.7 x 163.5 x 38.9	PA5697	18 3/8 x 7 9/32 x 2 13/16	466.7 x 184.9 x 71.4	PA4955
15 23/32 x 7 3/32 x 1 9/16	399.3 x 180.2 x 39.7	PA3980	18 7/16 x 5 1/4 x 2 3/16	468.3 x 133.4 x 55.6	PA3481
15 3/4 x 5 3/16 x 25/32	400.0 x 131.8 x 19.8	PA5586	18 1/2 x 4 9/16 x 2 1/4	469.9 x 115.9 x 57.2	PA5649
15 3/4 x 6 3/8 x 2 1/8	400.0 x 161.9 x 54.0	PA30185	18 17/32 x 3 17/32 x 1/2	470.7 x 89.7 x 12.7	PA5718 KIT
15 13/16 x 7 3/32 x 1 5/8	401.6 x 180.2 x 41.3	PA4042	18 19/32 x 7 7/16 x 2 13/16	472.3 x 188.9 x 71.4	PA5477
15 7/8 x 7 27/32 x 1 19/32	403.2 x 199.2 x 40.5	PA2178	18 19/32 x 7 7/8 x 2 19/32	472.3 x 200.0 x 65.9	PA5736
15 29/32 x 6 25/32 x 1 13/32	404.0 x 172.2 x 35.7	PA4383	18 5/8 x 4 23/32 x 1 3/8	473.1 x 119.9 x 34.9	PA4415
15 29/32 x 7 7/8 x 2 3/16	404.0 x 200.0 x 55.6	PA5655	18 13/16 x 4 1/8 x 1/2	477.8 x 104.8 x 12.7	PA5716
15 31/32 x 5 7/8 x 14	405.6 x 149.2 x 355.6	PA31002	18 29/32 x 3 15/32 x 1/2	480.2 x 88.1 x 12.7	PA5715
15 31/32 x 7 1/16 x 1 3/16	405.6 x 179.4 x 30.2	PA5797	18 29/32 x 4 7/8 x 19/32	480.2 x 123.8 x 15.1	PA30081
15 31/32 x 7 29/32 x 2 5/32	405.6 x 200.8 x 54.8	PA2232			
15 31/32 x 8 13/16 x 2 19/32	405.6 x 223.8 x 65.9	PA10124			
16 x 7 1/16 x 1 3/16	406.4 x 179.4 x 30.2	PA5512	19 x 19 x 5 3/8	482.6 x 482.6 x 136.5	PA2350
16 x 8 x 2 3/16	406.4 x 203.2 x 55.6	PA3756	19 x 19 x 5 3/8	482.6 x 482.6 x 136.5	PA2375
16 x 11 31/32 x 2 3/16	406.4 x 304.0 x 55.6	PA5681	19 1/32 x 8 13/32 x 7 9/32	483.1 x 213.4 x 184.7	PA32003
16 1/16 x 4 23/32 x 2 5/16	408.0 x 119.9 x 58.7	PA5695	19 1/32 x 8 13/32 x 12 3/16	483.1 x 213.4 x 309.4	PA32000
16 1/16 x 5 11/16 x 15/16	408.0 x 144.5 x 23.8	PA10173	19 1/16 x 6 15/16 x 2 1/8	484.2 x 176.2 x 54.0	PA5796
16 3/32 x 11 23/32 x 1 3/16	408.8 x 297.7 x 30.2	PA5623	19 1/8 x 11 1/4 x 2 7/16	485.8 x 285.8 x 61.9	PA4991
16 1/8 x 5 27/32 x 10 1/32	409.6 x 148.4 x 254.8	PA31012	19 9/32 x 8 31/32 x 2 23/32	489.7 x 227.8 x 69.1	PA30003
16 1/8 x 5 31/32 x 2 19/32	409.6 x 151.6 x 65.9	PA5654	19 3/8 x 5 3/4 x 3/8	492.1 x 146.0 x 9.5	PA5545
16 5/16 x 6 1/2 x 3/4	414.0 x 165.0 x 19.0	PA30276	19 13/32 x 5 27/32 x 1 3/16	492.9 x 148.4 x 30.2	PA5644
16 3/8 x 6 7/8 x 2 31/32	415.5 x 174.8 x 75.4	CV15010	19 7/16 x 3 5/16 x 2 1/4	493.7 x 84.1 x 57.2	PA10336
16 3/8 x 8 9/16 x 1 9/16	415.9 x 217.5 x 39.7	PA4858	19 7/16 x 19 7/16 x 5 5/16	493.7 x 493.7 x 134.9	PA2690
16 3/8 x 9 27/32 x 27/32	415.9 x 250.0 x 21.4	PA5734	19 7/16 x 19 7/16 x 8 1/16	493.7 x 493.7 x 204.8	PA2694
			19 1/2 x 9 1/2 x 1 3/4	495.3 x 241.3 x 44.4	PA30138
			19 1/2 x 11 1/2 x 1 3/4	495.3 x 292.1 x 44.4	PA30139
			19 1/2 x 15 1/2 x 1 3/4	495.3 x 393.7 x 44.4	PA4664
			19 1/2 x 19 1/2 x 1 3/4	495.3 x 495.3 x 44.4	PA4661
			19 1/2 x 19 1/2 x 1 25/32	495.3 x 495.3 x 45.2	PA4874
			19 1/2 x 19 1/2 x 2 19/32	495.3 x 495.3 x 65.9	PA2692



**WARNING:** These products can expose you to chemicals, including Diisononyl Phthalate, Carbon black extracts, Nickel, 1,3 Butadiene, Ethylene Oxide, Epichlorohydrin, which are known to the State of California to cause cancer, and Bisphenol-A, Ethylene Glycol, Ethylene Oxide, 1,3 Butadiene, Epichlorohydrin, which are known to the State of California to cause birth defects or other reproductive harm.

**PANEL AIR FILTERS**

LENGTH x WIDTH x THICK Inches	LENGTH x WIDTH x THICK (mm)	BALDWIN NUMBER	LENGTH x WIDTH x THICK Inches	LENGTH x WIDTH x THICK (mm)	BALDWIN NUMBER
19 1/2 x 19 1/2 x 5 1/4	495.3 x 495.3 x 133.4	PA3814	25 1/4 x 19 1/4 x 3 3/4	641.3 x 489.0 x 95.3	PA5454
19 1/2 x 19 1/2 x 5 1/4	495.3 x 495.3 x 133.4	PA3815	25 7/16 x 19 7/16 x 5 5/8	646.1 x 493.7 x 142.9	PA2691
19 1/2 x 19 1/2 x 5 9/16	495.3 x 495.3 x 141.3	PA2593	25 1/2 x 6 1/16 x 2 3/16	647.7 x 154.0 x 55.6	PA2572
19 1/2 x 19 1/2 x 5 11/16	495.3 x 495.3 x 144.5	PA2696	25 1/2 x 19 1/2 x 2 5/32	647.7 x 495.3 x 54.8	PA2693
19 21/32 x 5 9/32 x 2 19/32	499.3 x 134.1 x 65.9	PA5686	25 9/16 x 13 7/8 x 1 1/2	649.3 x 352.4 x 38.1	PA5688
19 11/16 x 3 15/16 x 3 9/16	500.1 x 100.0 x 90.5	PA3802	25 31/32 x 5 15/16 x 1 21/32	659.6 x 150.8 x 42.1	PA5781
19 11/16 x 7 7/8 x 2 5/32	500.1 x 200.0 x 54.8	PA5682	26 7 x 2 9/16	660.4 x 177.8 x 65.1	PA2753
19 13/16 x 19 13/16 x 8 1/8	503.2 x 503.2 x 206.4	PA1784	26 x 11 x 2 3/16	660.4 x 279.4 x 55.6	PA2935
19 27/32 x 5 31/32 x 8 5/32	504.0 x 151.6 x 207.2	PA1777	26 1/16 x 2 15/32 x 19/32	661.9 x 63.0 x 15.2	PA30292
19 27/32 x 8 7/8 x 1 3/16	504.0 x 225.4 x 30.2	PA5648	26 1/16 x 2 1/2 x 19/32	662.0 x 63.5 x 15.1	PA30164
19 7/8 x 8 1/4 x 8 5/32	504.8 x 209.6 x 207.2	PA1780	26 1/8 x 5 1/4 x 9 9/32	663.6 x 133.4 x 235.7	CA5790
19 7/8 x 10 9/16 x 8 5/32	504.8 x 268.3 x 207.2	PA1781	26 1/8 x 5 7/16 x 2 9/16	663.6 x 138.1 x 65.1	PA2844
19 7/8 x 15 7/32 x 8 5/32	504.8 x 386.6 x 207.2	PA1783	26 7/32 x 9 5/8 x 10 1/2	665.7 x 244.3 x 267.0	PA32002
19 29/32 x 12 25/32 x 8 5/32	505.6 x 324.6 x 207.2	PA1782	26 7/32 x 6 1/2 x 2 7/32	666.0 x 165.1 x 56.4	PA5771
19 31/32 x 9 1/16 x 2 19/32	507.2 x 230.2 x 65.9	PA5711	26 19/32 x 4 19/32 x 1 3/32	675.5 x 116.7 x 27.8	PA10375
20 x 3 15/16 x 3 9/16	508.0 x 100.0 x 90.5	PA5757	26 3/4 x 7 3/4 x 2 3/16	679.4 x 196.9 x 55.6	PA2448
20 x 7 1/2 x 2 3/16	508.0 x 190.5 x 55.6	PA2354	26 15/16 x 5 15/16 x 2 19/32	684.2 x 150.8 x 65.9	PA3877
20 x 7 1/2 x 2 3/16	508.0 x 190.5 x 55.6	PA5315	26 15/16 x 6 1/4 x 2 9/16	684.2 x 158.8 x 65.1	PA3824
20 x 9 x 2 9/16	508.0 x 228.6 x 65.1	PA3869	26 31/32 x 4 27/32 x 2 9/32	685 x 123.0 x 57.9	PA10338
20 x 14 19/32 x 2 3/16	508.0 x 370.7 x 55.6	PA5636	28 x 6 3/4 x 2 3/16	711.2 x 171.5 x 55.6	PA2463
20 x 15 x 2 3/16	508.0 x 381.0 x 55.6	PA3944	28 x 7 1/2 x 2 3/16	711.2 x 190.5 x 55.6	PA2353
20 5/32 x 6 7/8 x 1 15/32	512.0 x 174.6 x 37.3	PA30126	28 x 7 1/2 x 2 9/16	711.2 x 190.5 x 65.1	PA2352
20 5/32 x 9 7/32 x 1 7/8	512.0 x 234.2 x 47.6	PA5642	28 1/2 x 19 x 5 3/8	723.9 x 482.6 x 136.5	PA2444
20 11/32 x 4 1/8 x 1 1/8	516.7 x 104.8 x 28.6	PA4153	28 1/2 x 19 x 5 3/8	723.9 x 482.6 x 136.5	PA2564
20 7/16 x 4 1/8 x 1 31/32	519.1 x 104.8 x 50.0	PA5710	29 x 9 1/4 x 2 3/16	736.6 x 235.0 x 55.6	PA2329
20 15/32 x 4 3/32 x 2	519.9 x 104.0 x 50.8	PA5404	29 3/32 x 5 9/16 x 2 3/16	739.0 x 141.3 x 55.6	PA5668
20 11/16 x 7 3/32 x 1 9/16	525.5 x 180.2 x 39.7	PA10339	29 1/2 x 5 x 2 9/16	749.3 x 127.0 x 65.1	PA2752
20 25/32 x 3 31/32 x 3 5/8	527.8 x 100.8 x 92.1	PA5755	29 1/2 x 19 x 5	749.3 x 482.6 x 127.0	PA30074
20 13/16 x 5 11/32 x 2 9/32	528.6 x 135.7 x 57.9	PA5581	29 17/32 x 4 1/8 x 31/32	750.1 x 104.8 x 24.6	PA5713
20 15/16 x 7 5/32 x 1 21/32	531.8 x 181.8 x 42.1	PA10287	29 29/32 x 4 5/32 x 1/2	759.6 x 105.6 x 12.7	PA5726
21 1/4 x 5 29/32 x 2 11/16	539.8 x 150.0 x 68.3	PA3440	29 29/32 x 9 17/32 x 2 3/16	759.6 x 242.1 x 55.6	PA5657
21 9/32 x 10 x 1 9/32	540.5 x 254.0 x 32.5	PA10374	29 15/16 x 6 x 2 9/16	760.4 x 152.4 x 65.1	PA3438
21 21/32 x 3 15/16 x 2 1/2	550.1 x 100.0 x 63.5	PA5396	30 x 5 31/32 x 2 1/8	762 x 151.6 x 54.0	PA30048
22 23/32 x 6 7/16 x 1 15/32	577.1 x 163.5 x 37.3	PA5340	30 x 20 x 3 9/16	762.0 x 508 x 90.5	PA2854
22 3/4 x 4 x 2 9/32	577.9 x 101.6 x 57.9	PA4801	31 x 5 x 2 3/16	787.4 x 127.0 x 55.6	PA3442
22 3/4 x 20 1/4 x 4 1/4	577.9 x 514.4 x 108.0	PA2313	32 x 6 3/4 x 2 3/16	812.8 x 171.5 x 55.6	PA2436
22 15/16 x 14 x 6 7/32	582.6 x 355.6 x 158.0	PA2315	32 x 9 x 2 9/16	812.8 x 228.6 x 65.1	PA3421
23 3/16 x 4 1/2 x 7/8	589.0 x 114.3 x 22.2	PA30137	32 3/16 x 9 13/32 x 3 1/2	817.6 x 238.9 x 88.9	PA4973
23 5/16 x 5 3/8 x 3 11/32	592.1 x 136.5 x 84.9	PA3928	32 3/4 x 4 13/16 x 1	831.9 x 122.2 x 25.4	PA10192
23 3/8 x 4 9/16 x 15/32	593.7 x 115.9 x 11.9	PA5598	33 x 4 x 2 7/32	838.2 x 101.6 x 56.4	PA5299
23 3/8 x 10 3/8 x 3 3/4	593.7 x 263.5 x 95.3	PA4668	33 x 6 1/2 x 2 3/16	838.2 x 165.1 x 55.6	PA2440
23 3/8 x 11 3/8 x 1 3/4	593.7 x 288.9 x 44.4	PA4663	33 5/16 x 9 23/32 x 27/32	846.1 x 246.9 x 21.4	PA5533
23 3/8 x 19 3/8 x 1 3/4	593.7 x 492.1 x 44.4	PA3873	33 31/32 x 5 15/16 x 1 21/32	862.8 x 150.8 x 42.1	PA5780
23 3/8 x 23 3/8 x 1 3/4	593.7 x 593.7 x 44.4	PA3872	34 17/32 x 5 5/16 x 2 13/32	877.1 x 134.9 x 61.1	PA5626
23 1/2 x 6 x 2 3/16	596.9 x 152.4 x 55.6	PA2626	36 x 6 1/2 x 2 3/16	914.4 x 165.1 x 55.6	PA2638
23 1/2 x 6 x 2 9/16	596.9 x 152.4 x 65.1	PA3658	36 7/16 x 14 x 6 3/16	925.5 x 355.6 x 157.2	PA2395
23 1/2 x 6 1/2 x 2 3/16	596.9 x 165.1 x 55.6	PA2502	37 x 6 x 2 3/16	939.8 x 152.4 x 55.6	PA2408
23 1/2 x 7 x 2 3/16	596.9 x 177.8 x 55.6	PA2356	38 x 5 x 2 3/16	965.2 x 127.0 x 55.6	PA2411
23 1/2 x 7 1/8 x 15/16	596.9 x 181 x 23.8	PA2499	38 x 6 x 2 3/16	965.2 x 152.4 x 55.6	PA2407
23 17/32 x 6 23/32 x 2 13/32	597.7 x 170.7 x 61.1	PA3842	38 x 6 x 2 9/16	965.2 x 152.4 x 65.1	PA2619
23 17/32 x 6 23/32 x 3 3/16	597.7 x 170.7 x 81.0	PA3843	38 x 7 x 2 3/16	965.2 x 177.8 x 55.6	PA2617
23 5/8 x 4 9/32 x 2 7/32	600.1 x 108.7 x 56.4	PA30045	40 25/32 x 8 1/32 x 2 19/32	1036.1 x 204.0 x 66.0	PA30271
23 5/8 x 4 7/8 x 1 1/32	600.1 x 123.8 x 26.2	PA30190	44 x 4 x 2 9/16	1117.6 x 101.6 x 65.1	PA2601
23 5/8 x 4 7/8 x 1 1/16	600.1 x 123.8 x 27.0	PA3939	44 15/16 x 4 x 2 3/16	1141.4 x 101.6 x 55.6	PA30049
23 11/16 x 9 x 2 3/16	601.7 x 228.6 x 55.6	PA30064	45 3/8 x 14 x 6 3/16	1152.5 x 355.6 x 157.2	PA2390
23 29/32 x 9 x 2 1/4	607.2 x 228.6 x 57.2	PA5283	47 x 6 x 2 9/16	1193.8 x 152.4 x 65.1	PA2464
24 x 5 x 2 3/16	609.6 x 127.0 x 55.6	PA3676	47 x 7 x 2 3/16	1193.8 x 177.8 x 55.6	PA2485
24 x 19 11/16 x 2 9/16	609.6 x 500.1 x 65.1	PA2947			
24 x 24 x 2 9/16	609.6 x 609.6 x 65.1	PA1765			
24 1/32 x 4 1/16 x 3 7/16	610.4 x 103.2 x 87.3	PA5696			
24 9/32 x 4 11/32 x 31/32	616.7 x 110.3 x 24.6	PA5678			
24 13/32 x 4 3/16 x 1 3/32	619.9 x 106.4 x 27.8	PA5618			
24 1/2 x 15 1/2 x 3/4	622.3 x 393.7 x 19.0	PA4669			
24 1/2 x 15 1/2 x 1 3/4	622.3 x 393.7 x 44.4	PA4662			
24 1/2 x 19 1/2 x 1 3/4	622.3 x 495.3 x 44.4	PA5457			
24 29/32 x 22 1/2 x 3 3/32	632.6 x 571.5 x 78.6	PA5426			



**WARNING:** These products can expose you to chemicals, including Diisononyl Phthalate, Carbon black extracts, Nickel, 1,3 Butadiene, Ethylene Oxide, Epichlorohydrin, which are known to the State of California to cause cancer, and Bisphenol-A, Ethylene Glycol, Ethylene Oxide, 1,3 Butadiene, Epichlorohydrin, which are known to the State of California to cause birth defects or other reproductive harm.

# OVAL, OBLONG & MISCELLANEOUS AIR FILTERS

## All Measurements in Inches and (Millimeters)

**NOTE:** All air filters have been sorted by length, outside diameter and inside diameter.  
The larger outside and inside diameters have been listed.

LENGTH Inches	LENGTH (mm)	O.D. Inches	O.D. (mm)	I.D. Inches	I.D. (mm)	BALDWIN NUMBER	LENGTH Inches	LENGTH (mm)	O.D. Inches	O.D. (mm)	I.D. Inches	I.D. (mm)	BALDWIN NUMBER
1 7/32.....	31.0	4 25/32.....	121.4	3 15/16.....	100.0	PA4731	6 11/16.....	169.9	10 1/4.....	260.3	4 13/16.....	122.2	PA30118
1 1/4.....	31.8	4 23/32.....	119.9	—	—	PA4738	6 13/16.....	173.0	5 1/2.....	139.7	2 7/8.....	73.0	PA10274
1 1/2.....	38.1	10 5/16.....	261.9	—	—	PA5290	6 13/16.....	173.0	6 7/32.....	158.0	—	—	PA10062
1 9/16.....	39.7	9.....	228.6	—	—	PA30119	6 7/8.....	174.6	8 1/16.....	204.8	4 3/8.....	111.1	PA2194
1 19/32.....	40.5	8 7/32.....	208.8	—	—	PA4997	6 7/8.....	174.6	9 1/8.....	231.8	—	—	CA4996
1 11/16.....	42.9	10 11/16.....	271.5	1 31/32.....	50.0	PA4729	—	—	—	—	—	—	—
1 11/16.....	42.9	10 7/8.....	276.2	—	—	PA30072	7 1/8.....	181.0	9 13/16.....	249.2	—	—	CA5450
1 23/32.....	43.7	5 11/16.....	144.5	3 7/8.....	98.4	PA30012	7 7/32.....	183.4	10 29/32.....	277.0	—	—	CA5416
1 3/4.....	44.4	20 23/32.....	526.3	18 5/16.....	465.1	PA632	7 5/16.....	185.7	12 13/16.....	325.4	—	—	CA5278
1 13/16.....	46.0	11 25/32.....	299.2	—	—	PA4704	7 11/32.....	186.5	12 7/32.....	310.4	—	—	CA4702
1 15/16.....	49.2	7 17/32.....	191.3	6 1/32.....	153.2	PA4698	7 7/16.....	188.9	13 3/8.....	339.7	—	—	CA5514
1 31/32.....	50.0	6 11/16.....	169.9	5.....	127.0	93010	7 5/8.....	193.7	18 7/16.....	468.3	—	—	CA30105
—	—	—	—	—	—	—	7 23/32.....	196.1	21 3/4.....	552.4	12 7/16.....	315.9	PA30066
2 1/16.....	52.4	4.....	101.6	1 5/16.....	33.3	PA4551	7 3/4.....	196.9	11 11/16.....	296.9	—	—	CA30071
2 1/8.....	54.0	5 1/16.....	128.6	4 1/16.....	103.2	PA30029	—	—	—	—	—	—	—
2 1/8.....	54.0	10 9/16.....	268.3	9 1/16.....	230.2	PA2076	8 1/16.....	204.8	11 1/4.....	285.8	4 3/8.....	111.1	PA30095
2 1/8.....	54.0	14 9/16.....	369.9	13 1/4.....	336.5	PA2094	8 11/32.....	211.6	13 7/32.....	336.0	—	—	PA30275
2 3/16.....	55.6	7 1/4.....	184.2	6.....	152.4	PA30022	8 5/8.....	212.7	11 1/4.....	285.8	6.....	152.4	PA5289
2 7/32.....	56.4	8 27/32.....	224.6	7 9/32.....	184.9	PA2158	8 13/32.....	213.6	9 5/8.....	244.1	6 7/8.....	175.0	PA10405
2 5/16.....	58.7	4 15/32.....	113.5	3 7/32.....	81.8	PA2258	8 5/8.....	219.1	5 9/16.....	141.3	3 1/4.....	82.6	RS30099
2 5/16.....	58.7	8.....	203.2	6 3/4.....	171.5	PA30016	8 23/32.....	221.5	11 7/8.....	301.6	—	—	CA5369
2 5/16.....	58.7	12 13/16.....	325.4	—	—	PA5515	8 27/32.....	224.6	18 7/16.....	468.3	—	—	CA30103
2 5/16.....	58.7	14 3/4.....	374.7	—	—	PA5792	—	—	—	—	—	—	—
2 11/32.....	59.5	13 1/8.....	333.4	10 5/8.....	269.9	PA10355	9 3/16.....	233.4	11 7/16.....	290.5	—	—	CA5366
2 7/16.....	61.9	6.....	152.4	3 27/32.....	97.6	PA4935	9 5/16.....	236.5	12 3/32.....	307.2	—	—	CA4999
2 7/16.....	61.9	8 9/16.....	217.5	4 5/8.....	117.5	PA30017	9 5/16.....	236.5	15 1/16.....	382.6	—	—	CA5791
2 1/2.....	63.5	9 11/16.....	246.1	8 3/16.....	208.0	PA30303	9 3/8.....	238.1	7 1/16.....	179.4	4 15/32.....	111.9	PA10121
2 9/16.....	65.1	7.....	177.8	5 9/16.....	141.3	93023	9 9/16.....	242.9	9 7/8.....	250.8	6 11/16.....	169.9	PA10068
2 9/16.....	65.1	7 7/8.....	200.0	5 7/8.....	149.2	PA4553	9 9/16.....	242.9	11 1/32.....	280.2	6 11/16.....	169.9	PA10061
2 9/16.....	65.1	8 1/4.....	209.6	—	—	PA5451	9 27/32.....	250.0	17 11/32.....	440.5	—	—	CA5500
2 9/16.....	65.1	24 1/4.....	615.9	22 27/32.....	580.2	PA2093	—	—	—	—	—	—	—
2 19/32.....	65.9	6 3/32.....	154.8	4 1/16.....	103.2	PA4755	10 1/4.....	260.3	18 7/16.....	468.3	—	—	CA30104
2 11/16.....	68.3	3 31/32.....	100.8	1 1/4.....	31.8	PA4820	—	—	—	—	—	—	—
2 7/8.....	73.0	4 1/2.....	114.3	3 1/8.....	79.4	PA30031	11 3/16.....	284.2	12 7/32.....	310.4	—	—	CA4703
2 7/8.....	73.0	5 19/32.....	142.1	3 11/16.....	93.7	PA4886	11 7/32.....	285.0	13 13/32.....	340.5	—	—	CA5788
2 7/8.....	73.0	14 9/16.....	369.9	11 13/16.....	300.0	PA2881	—	—	—	—	—	—	—
2 29/32.....	73.8	8 5/8.....	219.1	6 27/32.....	173.8	PA5619	12 15/32.....	316.7	7 11/16.....	195.3	6 1/16.....	154.0	PA10125
—	—	—	—	—	—	—	12 21/32.....	321.5	3 1/16.....	77.8	2 1/16.....	52.4	RS30234
3 1/32.....	77.0	7 1/4.....	184.2	3 29/32.....	99.2	PA4773	13 3/16.....	335.0	5 18.....	127.0	3 5/32.....	80.2	PA30206
3 1/16.....	77.8	5 11/16.....	144.5	3 7/8.....	98.4	PA30030	13 1/4.....	336.5	15 5/8.....	396.9	—	—	CA5789
3 1/16.....	77.8	5 3/4.....	146.0	4 1/16.....	103.2	PA4907	—	—	—	—	—	—	—
3 3/32.....	78.6	3 31/32.....	100.8	1 5/8.....	41.3	PA4552	24 13/16.....	630.2	13 3/32.....	332.6	7 5/8.....	193.7	RS30187XP
3 1/8.....	79.4	5 3/32.....	129.4	3 9/16.....	90.5	PA4695	28 1/2.....	723.9	8 21/32.....	219.9	5 3/16.....	131.8	PA3478XP
3 1/8.....	79.4	7 5/32.....	181.8	6.....	152.4	PA30018	—	—	—	—	—	—	—
3 1/8.....	79.4	7 7/16.....	188.9	5 15/16.....	150.8	PA30014	—	—	—	—	—	—	—
3 5/32.....	80.2	15 3/8.....	390.5	11 17/32.....	292.9	PA10116	—	—	—	—	—	—	—
3 3/16.....	81.0	6 5/32.....	156.4	4 23/32.....	119.9	PA4769	—	—	—	—	—	—	—
3 3/16.....	81.0	12 15/16.....	328.6	9 13/16.....	249.2	PA2192	—	—	—	—	—	—	—
3 7/32.....	81.8	5 25/32.....	146.8	4 5/32.....	105.6	PA4689	—	—	—	—	—	—	—
3 1/4.....	82.6	7 5/16.....	185.7	5 7/16.....	138.1	PA5728	—	—	—	—	—	—	—
3 9/32.....	83.3	15 27/32.....	402.4	12 3/4.....	323.8	PA10120	—	—	—	—	—	—	—
3 7/16.....	87.3	5 9/32.....	134.1	3 1/2.....	88.9	PA4760	—	—	—	—	—	—	—
3 1/2.....	88.9	11 1/8.....	282.6	8 7/8.....	225.4	PA613	—	—	—	—	—	—	—
3 5/8.....	92.1	4 13/32.....	111.9	1 5/8.....	41.3	PA3957	—	—	—	—	—	—	—
3 5/8.....	92.1	9 3/4.....	247.7	5 1/2.....	139.7	PA4093	—	—	—	—	—	—	—
4 1/16.....	103.2	6 19/32.....	167.5	5 1/32.....	127.8	PA5658	—	—	—	—	—	—	—
6.....	152.4	12 7/8.....	327.0	—	—	CA5793	—	—	—	—	—	—	—
6 1/32.....	153.2	12 31/32.....	329.4	9 7/8.....	250.8	PA2233	—	—	—	—	—	—	—
6 9/32.....	159.5	10 29/32.....	277.0	—	—	CA5370	—	—	—	—	—	—	—
6 1/2.....	165.1	18 23/32.....	475.5	—	—	CA30102	—	—	—	—	—	—	—
6 21/32.....	169.1	4 5/8.....	117.5	3 1/4.....	82.6	PA10122	—	—	—	—	—	—	—



**WARNING:** These products can expose you to chemicals, including Diisononyl Phthalate, Carbon black extracts, Nickel, 1,3 Butadiene, Ethylene Oxide, Epichlorohydrin, which are known to the State of California to cause cancer, and Bisphenol-A, Ethylene Glycol, Ethylene Oxide, 1,3 Butadiene, Epichlorohydrin, which are known to the State of California to cause birth defects or other reproductive harm.

**BOXSTYLE FUEL FILTERS**

**CANTYPE FUEL FILTERS**

LENGTH x WIDTH x HEIGHT Inches	LENGTH x WIDTH x HEIGHT (mm)	BALDWIN NUMBER	LENGTH Inches	LENGTH (mm)	O.D. Inches	O.D. (mm)	I.D. Inches	I.D. (mm)	BALDWIN NUMBER
2 31/32 x 2 31/32 x 2 1/8.....	75.4 x 75.4 x 54.0 .....	<b>BF7881</b>	25/32.....	70.6	3 15/32.....	88.1	1 9/32.....	32.5 .....	<b>BF7871</b>
3 x 3 x 1.....	76.2 x 76.2 x 25.4 .....	<b>BF46125</b>	2 13/16.....	71.4	3 7/16.....	87.3	3/4.....	19.0 .....	<b>BF825</b>
3 15/32 x 3 7/16 x 2 1/8.....	88.1 x 87.3 x 54.0 .....	<b>BF7912</b>	2 13/16.....	71.4	3 7/16.....	87.3	3/4.....	19.0 .....	<b>BF838-F2</b>
4 3/8 x 2 17/32 x 2 5/8.....	111.1 x 64.3 x 66.7 .....	<b>BF806</b>	2 13/16.....	71.4	3 7/16.....	87.3	1 7/16.....	36.5 .....	<b>BF9915</b>
4 5/8 x 2 27/32 x 2 15/32.....	117.5 x 72.2 x 62.7 .....	<b>BF855</b>	3 13/32.....	86.5	3 7/16.....	87.3	1 1/8.....	28.6 .....	<b>BF7537</b>
4 21/32 x 2 27/32 x 2 15/32.....	118.3 x 72.2 x 62.7 .....	<b>BF7576</b>	3 13/16.....	96.8	3 15/32.....	88.1	3/4.....	19.0 .....	<b>BF874</b>
4 21/32 x 2 27/32 x 2 15/32.....	118.3 x 72.2 x 62.7 .....	<b>BF7579</b>	4.....	101.6	3 15/32.....	88.1	1 9/32.....	32.5 .....	<b>BF7870</b>
4 21/32 x 2 27/32 x 2 15/32.....	118.3 x 72.2 x 62.7 .....	<b>BF7580</b>	4 7/16.....	112.7	3 15/32.....	88.1	3/4.....	19.0 .....	<b>BF884</b>
4 15/16 x 3 11/16 x 3 11/32.....	125.4 x 93.7 x 84.9 .....	<b>BF909</b>	5 13/32.....	137.3	3 15/32.....	88.1	3/4.....	19.0 .....	<b>BF812</b>
4 15/16 x 3 11/16 x 3 11/32.....	125.4 x 93.7 x 84.9 .....	<b>BF912</b>							
5 1/8 x 3 11/16 x 3 7/32.....	130.2 x 93.7 x 81.8 .....	<b>BF959</b>							
6 11/32 x 3 9/32 x 2 21/32.....	161.1 x 83.3 x 67.5 .....	<b>BF856</b>							
7 1/4 x 7 7/32 x 2 5/32.....	184.2 x 183.4 x 54.8 .....	<b>BF46087</b>							

**NOTES**



**WARNING:** These products can expose you to chemicals, including Diisononyl Phthalate, Carbon black extracts, Nickel, 1,3 Butadiene, Ethylene Oxide, Epichlorohydrin, which are known to the State of California to cause cancer, and Bisphenol-A, Ethylene Glycol, Ethylene Oxide, 1,3 Butadiene, Epichlorohydrin, which are known to the State of California to cause birth defects or other reproductive harm.

# OIL/AIR SEPARATOR ELEMENTS BY LENGTH

All Measurements in Inches and (Millimeters)

**NOTE:** All oil/air separator element filters have been sorted by length and then outside diameter.  
The larger outside and inside diameters have been listed.

LENGTH Inches	LENGTH (mm)	O.D. Inches	O.D. (mm)	I.D. Inches	I.D. (mm)	BALDWIN NUMBER	LENGTH Inches	LENGTH (mm)	O.D. Inches	O.D. (mm)	I.D. Inches	I.D. (mm)	BALDWIN NUMBER
4 3/4.....	120.7	6 7/8.....	174.6	1 5/8.....	41.3	OAS99019	12.....	304.8	5 1/2.....	139.7	2 5/8.....	66.7	OAS98019
5 9/16.....	141.3	7 15/16.....	201.6	2 27/32.....	72.2	OAS98011	12.....	304.8	15 3/4.....	400.0	6 31/32.....	177.0	OAS99046
5 29/32.....	150.0	7.....	177.8	1 5/8.....	41.3	OAS99040	12 15/16.....	328.6	11 13/16.....	300.0	4 25/32.....	121.4	OAS99038
6 1/8.....	155.6	4 1/32.....	102.4	1 15/16.....	49.2	OAS98012	13 11/16.....	347.7	5 7/16.....	138.1	2 11/16.....	68.3	OAS98043
6 5/16.....	160.3	5 9/32.....	134.1	2 31/32.....	75.4	OAS99005	13 31/32.....	354.8	15 3/4.....	400.0	6 1/2.....	165.1	OAS99008
6 5/16.....	160.3	8 19/32.....	218.3	4 11/32.....	110.3	OAS99023	14.....	355.6	13 5/16.....	338.1	5 3/32.....	129.4	OAS98009
6 3/8.....	161.9	5 3/8.....	136.5	2 1/4.....	57.2	OAS98035	14 1/16.....	357.2	10 3/4.....	273.1	1 1/2.....	38.1	OAS98023
6 23/32.....	170.7	8 21/32.....	219.9	3.....	76.2	OAS99025	15 11/16.....	398.5	17 1/16.....	433.4	12 13/32.....	315.1	OAS98034
6 3/4.....	171.5	8 21/32.....	219.9	3.....	76.2	OAS98036	16 3/32.....	408.8	10 3/4.....	273.1	5 1/4.....	133.4	OAS98010
6 13/16.....	173.0	7 7/8.....	200.0	3 3/8.....	85.7	OAS98002	16 11/32.....	415.1	3 15/16.....	100.0	2 5/32.....	54.8	OAS98028
6 7/8.....	174.6	9 5/8.....	244.5	3.....	76.2	OAS98056	16 15/32.....	418.3	17.....	431.8	10 7/16.....	265.1	OAS98050
7.....	177.8	11 3/4.....	298.5	4 7/32.....	107.2	OAS98007	16 15/32.....	418.3	17.....	431.8	11 13/32.....	289.7	OAS98047
7 5/8.....	193.7	3 29/32.....	99.2	2 7/32.....	56.4	OAS98029	17.....	431.8	17.....	431.8	11 13/32.....	289.7	OAS98047
7 25/32.....	197.6	4 31/32.....	126.2	1 3/32.....	27.8	OAS99001	17.....	431.8	17.....	431.8	11 13/32.....	289.7	OAS98047
7 7/8.....	200.0	8 1/2.....	215.9	3 15/16.....	100.0	OAS99024	17.....	431.8	14 3/4.....	374.7	8 7/32.....	208.8	OAS98041
8 1/8.....	206.4	7 15/32.....	189.7	3 5/16.....	84.1	OAS98005	17 5/16.....	439.7	17 1/4.....	438.2	11 13/32.....	289.7	OAS98013
8 11/32.....	211.9	7 7/8.....	200.0	3 13/16.....	96.8	OAS98003	17 1/2.....	444.5	7 7/8.....	200.0	4 11/32.....	110.3	OAS98018
9 1/32.....	229.4	7 11/16.....	195.3	4 9/32.....	108.7	OAS99020	17 9/16.....	446.1	19 11/16.....	500.1	10 3/8.....	263.5	OAS98053
9 1/16.....	230.2	4 27/32.....	123.0	2 15/32.....	62.7	OAS98008	17 29/32.....	454.8	15 1/2.....	393.7	8 7/16.....	214.3	OAS98040
9 1/16.....	230.2	7 7/8.....	200.0	3 13/16.....	96.8	OAS98014	18 1/16.....	458.8	12 3/4.....	323.8	8 5/8.....	219.1	OAS99014
9 1/16.....	230.2	7 7/8.....	200.0	3 29/32.....	99.2	OAS98016	18 3/16.....	462.0	13 3/4.....	349.3	3 9/32.....	83.3	OAS98049
9 1/16.....	230.2	11 13/16.....	300.0	4 1/4.....	108.0	OAS99021	18 7/16.....	468.3	13 29/32.....	353.2	3 13/16.....	96.8	OAS98027
9 1/16.....	230.2	14 3/4.....	374.7	8 7/32.....	208.8	OAS98015	19 9/16.....	496.9	11 13/16.....	300.0	4 13/16.....	122.2	OAS99006
9 17/32.....	242.1	7 7/8.....	200.0	4 13/16.....	122.2	OAS99042	19 11/16.....	500.1	13 29/32.....	353.2	7 15/32.....	189.7	OAS98017
9 17/32.....	242.1	8 21/32.....	219.9	4 13/16.....	122.2	OAS99015	19 11/16.....	500.1	14 1/8.....	358.8	8 9/32.....	210.3	OAS98026
9 17/32.....	242.1	11 13/16.....	300.0	6 9/16.....	166.7	OAS99034	19 13/16.....	503.2	13 25/32.....	350.0	8 21/32.....	219.9	OAS98052
9 21/32.....	245.3	12.....	304.8	8 9/32.....	210.3	OAS99004	22 1/16.....	560.4	15 3/4.....	400.0	6 1/4.....	158.8	OAS98054
9 11/16.....	246.1	14.....	355.6	3 1/4.....	82.6	OAS98031	22 1/4.....	565.2	23 25/32.....	604.0	14 7/8.....	377.8	OAS98037
9 3/4.....	247.7	6 1/2.....	165.1	3 15/32.....	88.1	OAS99043	22 17/32.....	572.3	13 29/32.....	353.2	5 25/32.....	146.8	OAS98039
9 27/32.....	250.0	6 15/32.....	164.3	2 3/8.....	60.3	OAS99002	22 5/8.....	574.7	5 1/2.....	139.7	2 13/32.....	61.1	OAS98020
9 27/32.....	250.0	7 7/8.....	200.0	3 13/16.....	96.8	OAS98032	24 3/32.....	612.0	10 3/4.....	273.1	5 1/4.....	133.4	OAS98057
9 27/32.....	250.0	11 3/8.....	288.9	5 25/32.....	146.8	OAS98025	24 1/2.....	622.3	13 25/32.....	350.0	7 7/16.....	188.9	OAS98024
9 31/32.....	253.2	3 1/16.....	77.8	1 19/32.....	40.5	OAS99035	24 21/32.....	626.3	8.....	203.2	5 21/32.....	143.7	OAS98046
10 3/32.....	256.4	8 1/2.....	215.9	5 19/32.....	142.1	OAS98058	26 1/16.....	662.0	13 29/32.....	353.2	8 11/32.....	211.9	OAS98021
10 7/8.....	276.2	8 11/16.....	220.7	3 7/16.....	87.3	OAS98022	29 27/32.....	758.0	11 1/2.....	292.1	9 1/4.....	235.0	OAS98042
10 29/32.....	277.0	14.....	355.6	7 7/16.....	188.9	OAS98033	32 9/32.....	819.9	15 3/4.....	400.0	8 1/2.....	215.9	OAS99018
11.....	279.4	10 3/4.....	273.1	5 1/4.....	133.4	OAS98038	32 9/16.....	827.1	26 1/2.....	673.1	18 7/32.....	462.8	OAS98030
11 5/16.....	287.3	6 23/32.....	170.7	4.....	101.6	OAS98004							
11 7/16.....	290.5	5 3/4.....	146.0	2 5/16.....	58.7	OAS98044							
11 17/32.....	292.9	9 27/32.....	250.0	2 15/16.....	74.6	OAS99003							
11 11/16.....	296.9	7 3/16.....	182.6	3 5/16.....	84.1	OAS98001							
11 25/32.....	299.2	3 7/32.....	81.8	1 5/16.....	33.3	OAS98045							
11 7/8.....	301.6	6 31/32.....	177.0	3 15/32.....	88.1	OAS99010							
11 7/8.....	301.6	6 31/32.....	177.0	3 15/32.....	88.1	OAS99017							



**WARNING:** These products can expose you to chemicals, including Diisononyl Phthalate, Carbon black extracts, Nickel, 1,3 Butadiene, Ethylene Oxide, Epichlorohydrin, which are known to the State of California to cause cancer, and Bisphenol-A, Ethylene Glycol, Ethylene Oxide, 1,3 Butadiene, Epichlorohydrin, which are known to the State of California to cause birth defects or other reproductive harm.

## OIL/AIR SEPARATOR SPIN-ON FILTERS BY TAP SIZE (METRIC THREAD)

	THREAD I.D.	O.D. Inches	O.D. (mm)	LENGTH Inches	LENGTH (mm)	GASKET	FEATURES	BALDWIN NUMBER
	1 1/4-11 BSP	5 17/32.....	140.5	10 7/8.....	276.2	[1] Included .....		OAS98006
	M16 x 1.5	3.....	76.2	4 29/32.....	124.6	[1] Included .....		OAS98000
	M24 x 1.5	3 27/32.....	97.6	8 7/32.....	208.8	[1] Included .....	PS.....	OAS99032
	M24 x 1.5	3 27/32.....	97.6	8 5/16.....	211.1	[1] Included .....		OAS99048
	M32 x 1.5	4 11/32.....	110.3	10 3/8.....	263.5	[1] Included .....	PS.....	OAS99028
	M39 x 1.5	5 13/32.....	137.3	11 31/32.....	304.0	[1] Included .....		OAS99031
	M39 x 1.5	5 1/2.....	139.7	7 3/32.....	180.2	[1] Included .....	PS.....	OAS99029
	M39 x 1.5	5 1/2.....	139.7	12 1/32.....	305.6	[1] Included .....		OAS99047

### NOTES



**WARNING:** These products can expose you to chemicals, including Diisononyl Phthalate, Carbon black extracts, Nickel, 1,3 Butadiene, Ethylene Oxide, Epichlorohydrin, which are known to the State of California to cause cancer, and Bisphenol-A, Ethylene Glycol, Ethylene Oxide, 1,3 Butadiene, Epichlorohydrin, which are known to the State of California to cause birth defects or other reproductive harm.

## IN-LINE FILTERS BY INLET SIZE

INLET	OUTLET	O.D. Inches	O.D. (mm)	LENGTH Inches	LENGTH (mm)	BALDWIN NUMBER	INLET	OUTLET	O.D. Inches	O.D. (mm)	LENGTH Inches	LENGTH (mm)	BALDWIN NUMBER
1/8	3/16	3/16	87.3	3 19/32	91.3	BF9863	5/16	5/16	2 7/32	56.4	7 1/32	178.6	BF7768
1/8-27	1/8-27	2	50.8	3	76.2	BF46229	5/16	5/16	2 7/32	56.4	7 3/32	180.2	BF7668
1/8-27	1/2-20	2	50.8	3 7/16	87.3	BF843	5/16	5/16	2 1/4	57.2	6	152.4	BF1184
5/32	5/32	25/32	19.8	1 5/8	41.3	BF7860	5/16	5/16	2 9/32	57.9	6 9/16	166.7	BF7801
3/16	3/16	3/4	19.0	2 3/8	60.3	BF7843	5/16	5/16	2 5/16	58.7	4 11/32	110.3	BF795
3/16	3/16	27/32	21.4	1 7/16	36.5	BF7857	5/16	5/16	2 5/16	58.7	5 15/32	138.9	BF1049
3/16	3/16	2 1/8	54.0	4 5/8	117.5	BF9807	5/16	5/16	2 7/16	61.9	4 13/16	122.2	BF1123
3/16	3/16	2 13/32	61.1	6 15/32	164.3	BF46221	5/16	5/16	2 15/32	62.7	11 13/16	300.0	BF7641
1/4-18 NPT	1/8-27 NPT	1 7/32	31.0	2 15/32	62.7	BF46008	5/16	5/16	2 17/32	64.3	4 11/16	119.1	BF1104
1/4	1/4	13/16	20.6	1 3/4	44.4	BF7855	5/16	5/16	2 17/32	64.3	5	127.0	BF1163
1/4	1/4	1	25.4	3	76.2	BF46007	5/16	5/16	2 9/16	65.1	5	127.0	BF46212
1/4	1/4	19/32	32.5	3 5/16	84.1	BF46196	5/16	5/16	2 23/32	69.1	5 3/32	129.4	BF46211
1/4	1/4	1 13/32	35.7	4 5/32	105.6	BF7903	5/16	5/16	2 23/32	69.1	6 3/16	157.2	BF7959
1/4 or 5/16	1/4 or 5/16	1 15/32	37.3	4 7/32	107.2	BF7851	5/16	5/16	2 3/4	69.9	5 17/32	140.5	BF46208
Universal	Universal						5/16	5/16	2 3/4	69.9	5 3/4	146.0	BF1190
1/4	1/4	1 29/32	48.4	4 1/16	103.2	BF833	5/16	5/16	2 3/4	69.9	6 1/32	153.2	BF46210
1/4	1/4	1 29/32	48.4	4 1/16	103.2	BF833-K2	5/16	5/16	2 25/32	70.6	2 19/32	65.9	BF1160
1/4 or 5/16	1/4 or 5/16	2 1/16	52.4	4 3/4	120.7	BF7863	5/16	5/16	2 13/16	71.4	5 3/4	146.0	BF46202
1/4	1/4	2 3/32	53.2	3 7/16	87.3	BF45000	5/16	5/16	2 13/16	71.4	6 1/32	153.2	BF46203
1/4	1/4	2 5/16	58.7	6 9/16	166.7	BF46220	5/16	5/16	2 13/16	71.4	6 17/32	165.9	BF929
1/4	1/4	2 11/32	59.5	2 31/32	75.4	BF7625	5/16	5/16	2 13/16	71.4	7 1/16	179.4	BF7962
1/4	1/4	2 13/32	61.1	6 15/32	164.3	BF9805	5/16	5/16	2 29/32	73.8	5 5/16	134.9	BF46224
1/4	1/4	3 5/8	92.1	4 17/32	115.1	BF46000	5/16	5/16	2 15/16	74.6	4 25/32	121.4	BF7720
1/4-18	1/4-18	3 13/16	96.8	6 13/32	162.7	BF7726	5/16	5/16	2 15/16	74.6	5 1/4	133.4	BF7963
9/32	9/32	1 27/32	46.8	3 3/8	85.7	BF7849	5/16	5/16	2 15/16	74.6	6 1/8	155.6	BF46217
9/32	9/32	1 7/8	47.6	3 17/32	89.7	BF932	5/16	5/16	3 3/32	78.6	5 23/32	145.3	BF7809
9/32	9/32	2 1/4	57.2	2 1/4	57.2	BF7807	5/16	5/16	3 1/8	79.4	2 1/4	57.2	BF805
9/32	9/32	3 1/8	79.4	2 9/32	57.9	BF873	5/16	5/16	3 1/8	79.4	5 3/8	136.5	BF1105
9/32	9/32	4 1/16	103.2	2 1/4	57.2	BF933	5/16	5/16	3 1/8	79.4	5 13/16	147.6	BF966
5/16	1/8-27	31/32	24.6	2 5/16	58.7	BF995	5/16	5/16	3 1/8	79.4	5 31/32	151.6	BF1194
5/16	7/32	7/8	22.2	1 15/32	37.3	PT9469	5/16	5/16	3 1/8	79.4	6 25/32	172.2	BF1166
5/16	1/4	2 1/8	54.0	4 11/16	119.1	BF7736-K1	5/16	5/16	3 1/8	79.4	2 9/32	57.9	BF1140
5/16	5/16	15/16	23.8	3 1/32	77.0	BF989	5/16	5/16	3 1/8	79.4	3 1/16	57.2	BF7804
5/16	5/16	1 1/8	28.6	3 3/32	78.6	BF7861	5/16	5/16	3 1/8	79.4	3 1/16	57.2	BF7800
5/16	5/16	1 1/4	31.8	3 15/32	88.1	BF930	5/16	5/16	3 5/32	80.2	6 11/16	169.9	BF7803
5/16	5/16	1 5/16	33.3	1 3/4	44.4	BF7864	5/16	5/16	3 5/32	80.2	5 1/8	130.2	BF830
5/16	5/16	1 3/8	34.9	4 7/32	107.2	BF7865	5/16	5/16	3 5/32	80.2	6 1/4	158.8	BF1195
5/16	5/16	1 13/32	35.7	4 5/32	105.6	BF7725	5/16	5/16	3 5/32	80.2	6 15/16	176.2	BF7670
5/16	5/16	1 13/32	35.7	4 3/32	104.0	BF7848	5/16	5/16	3 5/32	80.2	2 15/16	74.6	BF1150
5/16	5/16	1 7/16	36.5	3 15/32	88.1	BF881	5/16	5/16	3 5/8	81.0	7 17/32	191.3	BF1047
5/16	5/16	1 7/16	36.5	3 27/32	97.6	BF7686	5/16	5/16	3 5/8	81.0	4 7/8	123.8	BF1048
5/16 or 1/4	5/16 or 1/4	1 15/32	37.3	4 7/32	107.2	BF7851	5/16	5/16	3 5/8	81.0	6 5/8	168.3	BF1215
Universal	Universal						5/16	5/16	4 1/16	103.2	6 21/32	169.3	BF7844
5/16	5/16	1 1/2	38.1	3 7/16	87.3	BF918-K	5/16	5/16	3 15/32	88.1	7 13/16	198.4	BF7958
5/16	5/16	1 17/32	38.9	4 9/32	108.7	BF9884	5/16	5/16	3 5/8	92.1	6 5/8	168.3	BF7765
5/16	5/16	1 29/32	48.4	3 29/32	99.2	BF9916	5/16	5/16	4 1/16	103.2	2 5/16	58.7	BF837
5/16	5/16	1 29/32	48.4	4 5/32	105.6	BF840	5/16	5/16	1 25/32	45.2	3 27/32	97.6	BF7845
5/16	5/16	1 29/32	48.4	4 5/32	105.6	BF840-K1	5/16	5/16	2 11/16	52.4	4 17/32	115.1	BF7859
5/16	5/16	1 15/16	49.2	3 1/32	77.0	BF964	5/16	5/16	2 5/32	54.8	6 3/4	171.5	BF7711
5/16	5/16	1 31/32	50.0	3 15/16	100.0	BF865	5/16	5/16	2 5/32	54.8	6 13/16	173.0	BF7780
5/16	5/16	1 31/32	50.0	3 15/16	100.0	BF865-K	5/16	5/16	2 7/32	56.4	6 3/8	161.9	BF1170
5/16	5/16	1 31/32	50.0	3 15/16	100.0	BF886	5/16	5/16	3 3/8	85.7	7	177.8	BF7965
5/16 or 3/8	5/16 or 3/8	2	50.8	8 1/8	206.4	BF7850	5/16	5/16	3 9/16	90.5	4 11/16	119.1	BF46001
Universal	Universal						5/16	5/16	2 3/32	53.2	3 5/8	92.1	BF46194
5/16 or 1/4	5/16 or 1/4	2 1/16	52.4	4 3/4	120.7	BF7863	5/16	5/16	2 7/32	56.4	2 7/32	56.4	BF46225
Universal	Universal						5/16	5/16	3 4	19.0	5 3/16	131.8	BF925
5/16	5/16	2 1/16	52.4	17 9/32	438.9	BF46213	5/16	M12 x 1 1/4	2 9/16	65.1	4 9/32	108.7	BF46215
5/16	5/16	2 1/8	54.0	2 15/16	74.6	BF1178	5/16	M14 x 1.5	2 9/16	65.1	4 15/16	125.4	BF46207
5/16	5/16	2 1/8	54.0	3 21/32	92.9	BF7736	11/32	11/32	2 9/16	65.1	3 7/32	81.8	BF9906
5/16	5/16	2 1/8	54.0	4 13/16	122.2	BF7713	11/32	11/32	2 3/4	69.9	3 19/32	91.3	BF928
5/16	5/16	2 5/32	54.8	4	101.6	BF794	11/32	11/32	3	76.2	2 17/32	64.3	BF46197
5/16	5/16	2 5/32	54.8	4 5/16	109.5	BF1057	11/32	11/32	3 7/16	87.3	6 3/32	154.8	BF46199
5/16	5/16	2 5/32	54.8	4 29/32	124.6	BF9848	3/8	1/8-27	1	25.4	2 5/8	66.7	BF879
5/16	5/16	2 5/32	54.8	6 1/4	158.8	BF1182	3/8	1/4	3	76.2	3 3/4	95.3	BF7626
5/16	5/16	2 5/32	54.8	6 3/8	161.9	BF1008	3/8	5/16	1 29/32	48.4	30	762.0	BF7669
5/16	5/16	2 3/16	55.6	6 5/16	160.3	BF1185	3/8	5/16	1 29/32	48.4	36	914.4	BF1053
5/16	5/16	2 3/16	55.6	12 13/32	315.0	BF46214	3/8	5/16	1 31/32	50.0	24	609.6	BF7763
							3/8 or 5/16	3/8 or 5/16	2	50.8	8 1/8	206.4	BF7850
							Universal	Universal					
							3/8	5/16	2 5/32	54.8	6 13/32	162.7	BF1181



**WARNING:** These products can expose you to chemicals, including Diisononyl Phthalate, Carbon black extracts, Nickel, 1,3 Butadiene, Ethylene Oxide, Epichlorohydrin, which are known to the State of California to cause cancer, and Bisphenol-A, Ethylene Glycol, Ethylene Oxide, 1,3 Butadiene, Epichlorohydrin, which are known to the State of California to cause birth defects or other reproductive harm.

# IN-LINE FILTERS BY INLET SIZE

INLET	OUTLET	O.D. Inches	O.D. (mm)	LENGTH Inches	LENGTH (mm)	BALDWIN NUMBER	INLET	OUTLET	O.D. Inches	O.D. (mm)	LENGTH Inches	LENGTH (mm)	BALDWIN NUMBER
3/8	5/16	2 5/32	54.8	9 1/2	241.3	BF1054	5/8-18	3/8	2 9/32	57.9	4 3/4	120.7	BF858
3/8	[2] 5/16	2 5/32	54.8	9 17/32	242.1	BF1058	5/8-24	5/8-24	1 29/32	48.4	3 17/32	89.7	BF7519
3/8	5/16	2 7/32	56.4	7 3/32	180.2	BF7960							
3/8	5/16	2 11/32	59.5	8 11/32	211.9	BF7671	11/16	9/32	2 5/32	54.8	5 5/8	142.9	BF46084
3/8	5/16	2 5/8	66.7	6 9/16	166.7	BF1199	11/16-16	13/16-16	1 1/2	38.1	2 13/16	71.4	PT9470
3/8	5/16	3 1/16	77.8	6 1/16	154.0	BF890	11/16-16	13/16-16	2 3/16	55.6	3 11/16	93.7	PT9474
3/8	5/16	3 17/32	89.7	4 27/32	123.0	BF46037							
3/8	3/8	1 29/32	48.4	3 13/16	96.8	BF1052	7/8	7/8	5 1/2	139.7	11 15/16	303.2	PT8480
3/8	3/8	1 29/32	48.4	3 13/16	96.8	BF1173							
3/8	3/8	1 29/32	48.4	3 7/8	98.4	BF836	1	1	4 1/32	102.4	7 31/32	202.4	PT8435-MPG
3/8	3/8	1 29/32	48.4	3 7/8	98.4	BF836-K3	1-14	1 1/16	4 1/4	108.0	5 11/32	135.7	BT8412
3/8	3/8	1 29/32	48.4	3 7/8	98.4	BF836-K4							
3/8	3/8	1 29/32	48.4	5 5/8	142.9	BF9905	8 MM	8 MM	3 9/16	90.5	7 7/8	200.0	BF46192
3/8	3/8	1 15/16	49.2	5 25/32	146.8	BF7719							
3/8	3/8	1 31/32	50.0	6 27/32	173.8	BF7769	M12 x 1 1/4	M12 x 1.25	2 17/32	64.3	3 31/32	100.8	BF7659
3/8	3/8	1 31/32	50.0	6 7/8	174.6	BF46222	M12 x 1 1/4	M12 x 1.25	2 3/4	69.9	4 13/32	111.9	BF1191
3/8	3/8	2 5/32	54.8	4 27/32	123.0	BF7762	M12 x 1 1/4	M12 x 1.25	2 3/4	69.9	4 29/32	124.6	BF1100
3/8	3/8	2 5/32	54.8	6 5/32	156.4	BF46223	M12 x 1.25	M12 x 1.25	2 13/16	71.4	5 3/16	131.8	BF46206
3/8	3/8	2 5/32	54.8	6 5/16	160.3	BF1174	M12 x 1.25	M12 x 1.25	3 13/32	86.5	3 13/16	96.8	BF46201
3/8	3/8	2 5/32	54.8	6 15/32	164.3	BF1172	M12 x 1.25	M12 x 1.25	3 13/32	86.5	3 7/8	98.4	BF1120
3/8	3/8	2 5/32	54.8	6 7/8	174.6	BF7771	M12 x 1.25	M14 x 1.5	2 13/16	71.4	4 5/8	117.5	BF46198
3/8	3/8	2 5/32	54.8	16 15/16	430.2	BF7630	M12 x 1.5	M14 x 1.5	3 13/32	86.5	5 23/32	145.3	BF1177
3/8	3/8	2 1/4	57.2	7	177.8	BF7742							
3/8	3/8	2 1/4	57.2	7 1/4	184.2	BF7800	M14 x 1.5	5/16	2 9/16	65.1	4 1/32	102.4	BF46216
3/8	3/8	2 1/4	57.2	7 27/32	199.2	BF7805	M14 x 1.5	5/16	2 9/16	65.1	4 3/16	106.4	BF7661
3/8	3/8	2 9/32	57.9	5 1/4	133.4	BF46193	M14 x 1.5	5/16	2 23/32	69.1	4 5/8	117.5	BF46209
3/8	3/8	2 9/32	57.9	6 13/32	162.7	BF1046	M14 x 1.5	7/16	2 3/4	69.9	4 1/8	104.8	BF7945
3/8	3/8	2 9/32	57.9	6 15/32	164.3	BF1045	M14 x 1.5	M12 x 1.25	2 9/16	65.1	3 15/16	100.0	BF7662
3/8	3/8	2 9/32	57.9	6 29/32	175.4	BF7802	M14 x 1.5	M12 x 1.25	2 9/16	65.1	3 31/32	100.8	BF1112
3/8	3/8	2 11/32	59.5	7 1/2	190.5	BF7937	M14 x 1.5	M12 x 1.25	2 9/16	65.1	4	101.6	BF1059
3/8	3/8	2 11/32	59.5	8 15/32	215.1	BF9851	M14 x 1.5	M12 x 1.25	2 9/16	65.1	4 1/32	102.4	BF1061
3/8	3/8	2 3/4	69.9	4 1/4	108.0	BF7944	M14 x 1.5	M12 x 1.25	2 3/4	69.9	4 3/16	106.4	BF46204
3/8	3/8	3 5/16	84.1	6 15/16	176.2	BF9857	M14 x 1.5	M12 x 1.25	2 3/4	69.9	4 9/32	108.7	BF1050
3/8	3/8	3 3/8	85.7	7 5/32	181.8	BF9881	M14 x 1.5	M12 x 1.25	2 3/4	69.9	4 3/8	111.1	BF1179
3/8	15/32	3 19/32	91.3	5	127.0	BF7756	M14 x 1.5	M12 x 1.25	2 15/16	74.6	4 7/16	112.7	BF1193
3/8	1/2-20	11/16	17.5	2 27/32	72.2	BF46205	M14 x 1.5	M12 x 1.25	3 3/8	85.7	3 21/32	92.9	BF1188
3/8	M14 x 1.5	2 5/32	54.8	5 13/32	137.3	BF7667	M14 x 1.5	M12 x 1.25	3 13/32	86.5	4 1/4	108.0	BF7721
3/8	M16 x 1.5	2 5/32	54.8	4 7/8	123.8	BF868	M14 x 1.5	M12 x 1.5	3 1/8	79.4	5 11/32	135.7	BF885
3/8	M16 x 1.5	2 5/32	54.8	5 3/8	136.5	BF1171	M14 x 1.5	M12 x 1.5	3 15/32	88.1	5 31/32	151.6	BF46195
							M14 x 1.5	M14 x 1.5	1 13/16	46.0	3 7/16	87.3	BF46005
13/32	1/2	3 19/32	91.3	4 23/32	119.9	BF7778	M14 x 1.5	M14 x 1.5	2 5/32	54.8	4 7/16	112.7	BF1186
							M14 x 1.5	M14 x 1.5	2 17/32	64.3	3 3/4	95.3	BF7961
7/16	3/8	3 5/8	92.1	4 29/32	124.6	BF9846	M14 x 1.5	M14 x 1.5	2 3/4	69.9	4 9/32	108.7	BF1148
7/16	7/16	3 7/16	87.3	6 1/2	165.1	BF46218	M14 x 1.5	M14 x 1.5	3 5/32	80.2	5 1/8	130.2	BF46200
7/16	7/16	3 15/32	88.1	8 1/4	209.6	BF46219							
1/2-20	1/8-27	1 11/32	34.1	1 15/16	49.2	BF920	M16 x 1.5	3/8	2 1/8	54.0	6 1/4	158.8	BF7776
1/2	1/2	1 29/32	48.4	4 1/4	108.0	BF7693	M16 x 1.5	3/8	2 1/8	54.0	6 9/16	166.7	BF7775
1/2	1/2	2	50.8	4 7/16	112.7	BF7691	M16 x 1.5	3/8	2 9/32	57.9	5 3/8	136.5	BF7658
							M16 x 1.5	3/8	2 5/16	58.7	5 11/32	135.7	BF7808
9/16-18	9/16-18	1 29/32	48.4	3 7/8	98.4	BF9886	M16 x 1.5	M16 x 1.5	2 5/16	58.7	4 7/16	112.7	BF853
9/16-18	9/16-18	1 31/32	50.0	3 23/32	94.5	BF7690							

## NOTES



**WARNING:** These products can expose you to chemicals, including Diisononyl Phthalate, Carbon black extracts, Nickel, 1,3 Butadiene, Ethylene Oxide, Epichlorohydrin, which are known to the State of California to cause cancer, and Bisphenol-A, Ethylene Glycol, Ethylene Oxide, 1,3 Butadiene, Epichlorohydrin, which are known to the State of California to cause birth defects or other reproductive harm.



**DECIMAL EQUIVALENTS CHART**

	1/64 →	.015625		33/64 →	.515625
	1/32	.03125		17/32	.53125
	3/64	.046875		35/64	.546875
1/16		.0625	9/16		.5625
	5/64	.078125		37/64	.578125
	3/32	.09375		19/32	.59375
	7/64	.109375		39/64	.609375
<b>1/8</b>	→	<b>.125</b>	<b>5/8</b>	→	<b>.625</b>
	9/64	.140625		41/64	.640625
	5/32	.15625		21/32	.65625
	11/64	.171875		43/64	.671875
3/16		.1875	11/16		.6875
	13/64	.203125		45/64	.703125
	7/32	.21875		23/32	.71875
	15/64	.234375		47/64	.734375
<b>1/4</b>	→	<b>.25</b>	<b>3/4</b>	→	<b>.75</b>
	17/64	.265625		49/64	.765625
	9/32	.28125		25/32	.78125
	19/64	.296875		51/64	.796875
5/16		.3125	13/16		.8125
	21/64	.328125		53/64	.828125
	11/32	.34375		27/32	.84375
	23/64	.359375		55/64	.859375
<b>3/8</b>	→	<b>.375</b>	<b>7/8</b>	→	<b>.875</b>
	25/64	.390625		57/64	.890625
	13/32	.40625		29/32	.90625
	27/64	.421875		59/64	.921875
7/16		.4375	15/16		.9375
	29/64	.453125		61/64	.953125
	15/32	.46875		31/32	.96875
	31/64	.484375		63/64	.984375
<b>1/2</b>	→	<b>.5</b>	<b>1</b>	→	<b>1</b>

# BALDWIN TO UPC (INDIVIDUAL PARTS)

BALDWIN NUMBER	UPC NUMBER	BALDWIN NUMBER	UPC NUMBER	BALDWIN NUMBER	UPC NUMBER	BALDWIN NUMBER	UPC NUMBER	BALDWIN NUMBER	UPC NUMBER
BDW#	UPCCode	PT83	791440001053	P148	791440001923	BT223	791440002821	PT304	791440003682
B2	791440000018	PT83-MPG	791440001060	P150	791440001947	PF224	791440002838	BT305	7914400038059
B2-HPG	791440000025	P84-2	791440001084	PT151	791440001954	PF225	791440002852	B307	791440003705
B4	791440000049	PT85	791440001091	PT152	791440001961	PF226	791440002876	T308-M	791440003712
BT5	791440000056	PT86-HD	791440001107	PT153	791440001978	B227	791440002883	B309	791440003729
B6	791440000063	PT87-S	791440001114	PT154	791440001985	B228	791440002890	BT310	7914400038462
B6-HPG	791440000070	PT88-HD	791440001121	PF155	791440001992	B229	791440002906	PF311	791440003736
B7	791440000087	PT89	791440001138	B156	791440002005	BT230	791440002913	PF312	791440003743
B9	791440000094	PT90-10	791440001145	B157	791440002012	PF231	791440002920	PF313	791440003750
B10-AL	791440000100	PT90-MPG	791440001152	B159	791440002036	BD232	7914400038455	PF314	791440003767
B10-AL BOWL	791440000117	PT91	791440001169	B160	791440002043	B233	791440002937	PF316	791440003774
B10-AL BSP	7914400065482	PT93	791440001183	B161-S	791440002050	BT234	791440002951	PT317-MPG	791440003811
B10-AL BSPCS	7914400088658	PT93-MPG	791440001190	P162	791440002067	P235	791440002968	PT318-MPG	791440003798
B10-AL CAP	791440000124	B95	791440001213	B163	791440002074	B236	791440002975	PT319-MPG	791440003804
PF10	791440000131	B95-MPG	791440001244	B164	791440002081	BT237	791440002982	PT320-MPG	791440003811
PF10-CS	791440000148	B95-SS	7914400050396	B166	791440002104	BT238	791440002999	BD324	791440003859
PT11	791440000155	B96	791440001251	B167	791440002111	B239	791440003002	BD325	7914400047518
PT11-HD	791440000162	B96-MPG	791440001282	B168	791440002128	P240	791440003019	B326	791440003866
PT12	791440000179	B96-SS	7914400050389	P170	791440002142	BT241	791440003026	B329	791440003880
BF13	791440000186	B97	791440001299	P171	791440002159	P242	791440003033	BF330	791440003897
P15	791440000193	PT98-10	791440001305	P172	791440002166	B243	791440003040	PF332	791440003903
S16-1	791440000209	PT98-MPG	791440001312	B173-S	791440002173	B244	791440003057	B333	791440003910
P18	791440000230	B99	791440001329	P174	791440002180	B246	791440003071	BT334	791440003927
P18-HD	791440000247	B99-B	791440001336	P176	791440002203	B247	791440003088	B336	791440003941
P19	791440000254	B99-MPG	791440001350	P177	791440002210	BT248	791440003095	B337	791440003958
P20-HD	791440000261	B99-SS	7914400050419	B178	791440002227	P249	791440003101	BT338	791440003965
P25	791440000339	P102	791440001381	B179	791440002234	BT251	791440003118	BT339	791440003972
P26	791440000346	BD103	791440001398	PT181 KIT	791440002258	B252	791440003125	BT340	791440003989
B27	791440000353	BD103-MPG	7914400042674	P183	791440002272	B253	791440003132	BT341	791440003996
BD28	791440000360	BD103-SS	7914400050402	P184	791440002296	P254	791440003149	BT342	791440004009
PT29	791440000377	P104	791440001404	PT185	791440002302	B255	791440003156	BT343	791440004016
AFG30	791440000384	B105	791440001411	P186	791440002319	PT256	791440003163	BT344-S	791440004023
B30	791440000391	P106	791440001428	P187	791440002326	PT257	791440003170	BT345 KIT	791440004030
B31	791440000407	P106-HD	791440001435	PT189	791440002340	PT258	791440003187	BT346	791440004047
B33	791440000421	PT108	791440001459	PT189-MPG	791440002357	BT259	791440003194	BT347	791440004054
B34	791440000438	PT108-HD	791440001466	P190	791440002364	BT260	791440003200	BT348	791440004061
B35-S	791440000445	B109	791440001473	PT191	791440002371	BT260-10	791440003217	BT349	791440004078
AFG37R	791440000469	BC110	791440001480	PT191-10	791440002388	B261	791440003224	BT350	791440004085
B37	791440000476	BT111	791440001497	PT191-5	791440002395	B262	791440003231	BT351	791440004092
AFG38D	791440000483	BT112	791440001503	PT193	791440002418	B263	791440003248	BT351-MPG	791440006970
B39	791440000506	B113	791440001510	PT193 KIT	791440002425	BT264	791440003255	P352	791440004108
P40	791440000513	B114	791440001527	PT193-3	791440002432	PT265	791440003262	BT353	791440004115
P41	791440000520	PT115	791440001534	P194	791440002449	P266	791440003279	BT354	791440004122
P42	791440000537	P116	791440001541	P194-HD	791440002456	BT267	791440003286	BT355	791440004139
B43-S	791440000544	PF116	791440001558	PF194-HD10	791440002463	PT268	791440003293	P356	791440004146
B45	791440000568	PT117	791440001565	PF194	791440002470	PT269	791440003309	BT357	791440004153
P47	791440000582	PT117-25	791440001572	B195	791440002487	P271	791440003323	B358	791440004160
PT48	791440000599	B118	791440001589	B196	791440002494	PT273	791440003347	BT359	791440004177
B49	791440000605	PT119	791440001596	P198	791440002517	BT274	791440003354	B360	791440004184
B50	791440000612	PT119-5	791440001602	B199	791440002524	PT275	791440003361	BT361	791440004191
P52	791440000636	PT119-HD	791440001619	B201-S	791440002548	PT275-10	791440003378	BT364	791440004214
P53	791440000643	PT119-HD5	791440001626	B202	791440002555	P276	791440003385	BT365	791440004221
P54	791440000650	B120	791440001640	P203	791440002562	PT277	791440003408	BT365-10	791440004238
B56	791440000674	PF121	791440001657	P203-HD	791440002579	B279	791440003415	BT366-10	791440004245
P60	791440000711	PT122-5	791440001664	P203-HD10	791440002586	P280	791440003422	BT366-MPG	7914400069695
PT61-HD	791440000728	BT124	791440001688	P204	791440002593	B281	791440003439	BT367	791440004252
PT62	791440000735	P125	791440001695	P204-HD	791440002609	PT283	791440003450	BT367-S	791440004269
PT63-1	791440000742	BT126	791440001701	P204-HD10	791440002616	PT284	791440003477	BT368	791440004276
PT66-HD	791440000773	P127	7914400052918	B205	791440002623	PT285	791440003484	B369	791440004283
P67	791440000780	B128	791440001718	P206	791440002630	BT287	791440003491	PT370	791440004290
P68	791440000797	B129	791440001725	PT207	791440002647	BT287-3	7914400058231	BT371-5	7914400069718
PT70	791440000810	B131	791440001749	PT207-10	791440002654	BT287-10	791440003507	BT371-10	791440004306
PT71	791440000834	B132	791440001756	PT207-HD	791440002661	PT288-HD	791440003514	BT371-MPG	791440004313
PT72	791440000858	C133-OW	791440001763	PT207-HD10	791440002678	PT288-HD10	791440003521	BT372-10	791440004320
P73	791440000872	C133-W	791440001770	PT208	791440002685	PT289	791440003538	BT372-MPG	7914400038127
B74	791440000889	B134	791440001787	PT210	791440002692	PT289-10	791440003545	PT373	791440004337
B75	791440000896	PT135	791440001794	B211	791440002708	PT290	791440003552	PT374	791440004344
B76	791440000902	PT137	791440001817	PT212-5	791440002715	B292	791440003576	PT375	791440004351
B76-MPG	791440000933	PT138-10	791440001824	PT213	791440002722	P294	791440003590	PT376	791440004368
B76-SS	7914400050426	PT138-25	791440001831	PT214(2)	791440002739	B295	791440003606	PT377	791440004375
PT79	791440000964	PT139-10	791440001848	BT215	791440002746	B296	791440003613	PT377-10	791440004382
P80	791440000988	P140	791440001855	BT216	791440002753	PT298-10	791440003620	B378	791440004399
P80-HD	791440000995	B141	791440001862	BT217	791440002760	B299	791440003637	B378-10	791440004405
P81	791440001015	BD142	791440001879	B218	791440002777	T300-M	791440003644	PT379 KIT	791440004412
P82	791440001022	B143	791440001886	B220	791440002791	B301	791440003651	PT380 KIT	791440004429
PT82-HD	791440001039	P144	791440001893	BT221	791440002807	PT302	791440003668	PT381	791440004436
PT82-HD10	791440001046	PT146	791440001909	B222	791440002814	T303-M	791440003675	PT382	791440004443



**WARNING:** These products can expose you to chemicals, including Diisononyl Phthalate, Carbon black extracts, Nickel, 1,3 Butadiene, Ethylene Oxide, Epichlorohydrin, which are known to the State of California to cause cancer, and Bisphenol-A, Ethylene Glycol, Ethylene Oxide, 1,3 Butadiene, Epichlorohydrin, which are known to the State of California to cause birth defects or other reproductive harm.

# BALDWIN TO UPC (INDIVIDUAL PARTS)

BALDWIN NUMBER	UPC NUMBER	BALDWIN NUMBER	UPC NUMBER	BALDWIN NUMBER	UPC NUMBER	BALDWIN NUMBER	UPC NUMBER	BALDWIN NUMBER	UPC NUMBER
PT383	791440004450	PT461	791440005402	PT551-10	791440006355	PA651	791440007369	BT774	791440008397
PT385	791440004467	PT462	791440005419	PT554	791440006379	PA652	791440007376	BT775	791440008403
PT385-E	791440004474	PT463	791440005426	P555	791440006386	PA653	791440007383	PT776-MPG	791440008410
PT386	791440004481	PT466	791440005457	BT556-10	791440006393	PA654	791440007390	PT777	791440008427
BT387	791440004498	PT467-MPG	791440005464	PT558	791440006416	PA655	791440007406	BT778	791440008434
BT387-10	791440004504	PT468-MPG	791440005471	PT560 KIT	791440006423	PA656	791440007413	BT779	791440008441
BT388	791440004511	PT469	791440005488	PT561	791440006430	PA657	791440007420	BF781	791440008458
BT388-10	791440004528	BT470	791440005495	PT562-10	791440006454	PA658	791440007437	BF782	791440008465
BT389	791440004535	PT471	791440005501	PT563	791440006461	PA662	791440007475	BF783	791440008472
BT389-10	791440004542	BT472	791440005518	BT564	791440006478	PA666	791440007505	BF784	791440008489
PT390-MPG	791440004559	B474	791440005525	PT565	791440006485	PA669	791440007512	BF785	791440008496
PT391-MPG	791440004566	PT475	791440005532	PT566	791440006492	PT670	791440007529	BF786	791440008502
PT392	791440004573	P476	791440005549	PT567	791440006508	PT670-E	791440007536	BF788	791440008526
PT393	791440004580	PT477	791440005556	PT567-10	791440006515	PA671	791440007543	BF789	791440008533
PT394-15	791440004597	S479	791440005570	PT568	791440006522	PA671-1	791440007550	BF790	791440008540
BT395	791440004603	PT480	791440005587	PT571	791440006553	PA675	791440007567	BF791	791440008557
PT396	791440004610	PT480-10	791440005594	PT573	791440006577	PT676	791440007574	BF791-O	791440009712
PT397	791440004627	PT480-MPG	791440005600	BF577	791440006607	PA677	791440007581	BF792	791440008564
BT398	791440004634	B481	791440005617	PT578	791440006614	PA678	791440007598	BF794	791440008588
PT400	791440004641	PT483	791440005631	PT579	791440006621	PA680	791440007604	BF795	791440008595
PT401-MPG	791440004658	S485	791440005655	BF582	791440006676	PT682	7914400052970	BF797	791440008618
BT402	791440004665	BT486	791440005662	BF583	791440006683	PT683	7914400052987	BF798	791440008625
B403	791440004672	PT487	791440005679	BF584	791440006690	PT685-MPG	791440007617	BF799	791440008632
B404	791440004689	B488	791440005693	BF584-B	791440006706	PA691	791440007628	PF802	791440008670
JC405	791440004696	S489	791440005709	BF585	791440006713	PT691	791440007634	PF804	791440008694
CU406	791440004702	PT490	791440005716	BF586	791440006720	PA693	791440007645	BF805	791440008700
DF408	791440004719	PT491	791440005723	BF586-D	791440006737	PT694	791440007642	BF806	791440008717
TC413-CPE5	791440004849	PT491-10	791440005747	BF587	791440006744	PA696	791440007666	PF807	791440008724
V414-B	791440004863	PT492	791440005754	BF587-D	791440006751	PA697	791440007673	PF809	791440008748
V414-FF	791440004870	PT493	791440005761	BF588	791440006768	PA699	791440007680	PF810	791440008755
F415-B	791440004887	B494	791440005778	BF591	791440006874	C704-L	791440007727	PF811	791440008762
P415-10	791440004894	B495	791440005785	BF592	791440006881	PT706-M	791440007741	BF812	791440008779
P415-10A	791440004900	B495-MPG	7914400062474	BF593	791440006898	PT707-HD	791440007765	PF814	791440008793
P415-25	791440004917	B495-SS	7914400050341	F594-F	7914400052949	PT707-HD10	791440007772	PF816	791440008816
P415-25A	791440004924	P496	791440005815	PF594	791440006904	PT707-HD3	791440007789	PF816-S	791440008823
P415-5	791440004931	P497	791440005822	BT595	791440006911	PT708-HD	791440007796	PF818	791440008847
P415-5A	791440004948	PT498	791440005839	BF596	791440006928	PT714	791440007802	PF819	791440008854
P415-5AN	791440004955	PT498-10	791440005846	BF597	791440006935	PT716	7914400050938	PF819-HD	791440008861
P415-GM	791440004962	PT499-5	791440005853	PF598	791440006942	PF717	791440007819	PF820-S	791440008878
V415-B	791440004979	F501-MD	791440005884	PF598-10	791440006959	PT718-5	791440007857	PF821-S	791440008885
V415-FF	791440004986	PT503	791440005907	PF598-30	791440006966	BF719	791440007840	PF822	791440008892
PT416	791440004993	PF506	791440005921	PF599	791440006973	BF720	791440007857	PF823	791440008908
PT418	791440005013	P507	791440005938	PF599-10	791440006980	P721	791440007864	PF823-E	791440008953
BT420	791440005037	PT508-MPG	791440005945	PF599-30	791440006997	PT722	791440007871	PF824	791440008960
B421	791440005044	PT509-MPG KIT	791440005952	PA602	791440007000	P723	791440007888	BF825	791440008984
S423	791440005051	PT510	791440005969	PA604	791440007017	PT725-MPG	791440007895	BF826	791440008991
BT424	791440005068	PT512	791440005976	B605	791440007024	PT727-DL	791440007901	PF827	791440009004
BT425	791440005075	PT513	791440005983	BT606-MPG	7914400046467	PT727-HD	791440007918	PF828	791440009028
PT426	791440005082	PT514	791440005990	PA607	791440007048	PT727-HD10	791440007925	PF829(2)	791440009035
BT427	791440005099	PT515	791440006003	BT610-MPG	791440045927	PT728-MPG	791440007932	BF830	791440009042
V429-B	791440005112	PT516	791440006010	BT611-MPG	791440045958	PT729	791440007949	PF831	791440009059
V429-FF	791440005129	PT517	791440006027	PA612	791440007086	BT732	791440007970	BF833	791440009073
PT430-FF	791440005136	PT518	791440006034	PA613	791440007093	BT735	791440007994	BF833-K2	791440009080
PT431	791440005143	PT518-10	791440006041	BF614	791440007109	PT737	791440008014	F834-F	791440009097
PT433	791440005150	PT520	791440006058	PA615	791440007116	PT737-10	791440008021	BF834	791440009103
PT434	791440005167	BT521	791440006072	PA616	791440007123	V738-O	791440008038	BF836	791440009127
PT434-10	791440005174	PT522	791440006089	PA617	791440007130	BT739	791440008045	BF836-K3	791440009134
PT435	791440005181	BT525	791440006096	PA618	791440007147	C740-S	791440008052	BF836-K4	791440009141
PT436	791440005198	BT526	791440006102	PA618 FOAM	791440007154	C750-E	791440008144	BF837	791440009158
PT437	791440005204	BT526-10	791440006119	PA618-S	791440007161	C750-L	791440008151	BF838-F2	791440009165
BT438	791440005211	PT527	791440006126	PA621	791440007185	C750-L SINGLE	791440008168	PF838	791440009172
PT439	791440005228	P528	791440006133	PA625	791440007192	PT751	791440008175	BT839	791440009189
BT440	791440005235	P529	791440006140	PA631	791440007208	PT752	791440008182	BT839-10	791440009196
PT441	791440005242	PT534	791440006188	PA632	791440007215	PT753	791440008199	BF840	791440009202
PT442-MPG	791440005259	PT535	791440006195	PA633(2)	791440007222	PT757	791440008212	BF840-K1	791440009219
BT443	791440005266	BT536	791440006201	PA634	791440007239	PT757-10	791440008229	VT842-O	791440009233
PT445-MPG	791440005273	P537	791440006218	PA638	791440007246	PT760-10	791440008243	BF843	791440009240
P446	791440005280	PT538	791440006225	PA639	791440007253	PT760-25	791440008250	BF844-A	791440009257
B447	791440005297	PT539	791440006232	PA640	791440007260	PT761	791440008267	F845-A	791440009264
P450	791440005310	P540	791440006249	PA641	791440007277	PT763	791440008281	PF845	791440009271
S451	791440005327	BT541	791440006263	PA642	791440007284	PT764	791440008298	PF846	791440009288
BT452	791440005334	PT543 KIT	791440006287	PA643	791440007291	PT765	791440008304	PF847	791440009295
P454	791440005358	P545	791440006300	PA644	791440007307	PT766	791440008311	PT849	791440009318
S455	791440005365	PT546	791440006317	PA645	791440007314	PT767	791440008328	PT849-10	791440009325
S456	791440005372	PT548	791440006324	PA648	791440007338	PT768	791440008335	BF852-O	791440009356
PT457-MPG	791440005389	PT549	791440006331	PA649	791440007345	PT772	791440008373	BF853	791440009363
PT459	791440005396	PT550-10	791440006348	PA650	791440007352	PT773-MPG	791440008380	BF855	791440009387



**WARNING:** These products can expose you to chemicals, including Diisononyl Phthalate, Carbon black extracts, Nickel, 1,3 Butadiene, Ethylene Oxide, Epichlorohydrin, which are known to the State of California to cause cancer, and Bisphenol-A, Ethylene Glycol, Ethylene Oxide, 1,3 Butadiene, Epichlorohydrin, which are known to the State of California to cause birth defects or other reproductive harm.

# BALDWIN TO UPC (INDIVIDUAL PARTS)

BALDWIN NUMBER	UPC NUMBER	BALDWIN NUMBER	UPC NUMBER	BALDWIN NUMBER	UPC NUMBER	BALDWIN NUMBER	UPC NUMBER	BALDWIN NUMBER	UPC NUMBER
BF856	79144009394	BF948	791440010482	BF1177	791440049024	BF1279	791440064089	BF1365	791440078758
PF857	79144009400	BF948-JD	791440010512	BF1178	791440049031	BF1280	791440011717	BF1366-O	791440085855
BF858	79144009417	PF949	791440010529	BF1179	791440049048	BF1281	791440063297	BF1367	791440078994
PF859	79144009424	F950-F	791440010536	BF1181	791440049086	BF1281-O	791440093492	OB1368	791440012011
PF860	79144009431	F950-F WO	791440053007	BF1182	791440049119	BF1282	791440057906	OB1369	791440012028
PF861	79144009448	PF950	791440010543	BF1184	791440049123	BF1282-O	791440094529	BF1370	791440079014
BF862	79144009455	PT951	791440010550	BF1185	791440049130	BF1283	791440063280	BF1371	791440079038
BF863	79144009462	PF952	791440010567	BF1186	791440049147	BF1283-O	791440093515	BF1372	791440079342
PF864	79144009479	F953-F	791440053014	BF1188	791440049215	BF1283-SP	791440078482	BF1373-SP	791440079199
BF865	79144009486	BF954	791440010574	BF1190	791440049413	BF1285-SP	791440064805	BF1374-SP	791440079267
BF865-K	79144009493	BF955	791440010581	BF1191	791440049420	BF1286	791440066052	BF1375	791440079274
PF866	79144009509	BF955 KIT	791440112490	BF1193	791440049444	BF1287-O	791440086395	BF1376	791440079304
BF868	79144009523	BF956	791440010598	BF1195	791440049468	BF1288-O	791440086401	BF1377	791440079359
PF869	79144009530	BF957	791440010604	BF1199	791440049529	BF1289-SP	791440086852	BF1378-SPS	791440079502
PF872	79144009554	BF957-D	791440010628	BF1201	791440011441	BF1290-O	791440087439	BF1379	791440079618
BF873	79144009561	BF958	791440010635	BF1204	791440045828	PF1291	791440062511	BF1379-O	791440111226
BF874	79144009578	BF959	791440010642	BF1204-O	791440097605	BF1292-O	791440087446	BF1380	791440079625
BF876	79144009592	P960	791440010659	BF1204-SP	791440045910	BF1293-SPS	791440078048	BF1380-O	791440110816
BF877	79144009615	BF962	791440010673	BF1205	791440045811	BF1294-O	791440087453	BF1381	791440079632
BF879	79144009646	PF963	791440010680	BF1205-SP	791440045835	BF1296-O	791440087613	BF1381-O	791440109537
BF880-FP	791440037991	BF966	791440010710	BF1210	791440011472	BF1297-O	791440087620	BF1382-SP	791440079656
BF881	79144009660	PF967	791440010727	BF1211	791440011489	BF1298-O	791440088672	BF1383-O	791440087125
PF882	79144009677	BF968	791440010734	BF1212	791440011496	BF1299-O	791440089112	BF1384-SP	791440080249
PF883	79144009684	BF970	791440010741	BF1212 FOAM	791440011502	FB1301	791440011731	BF1385-SPS	791440080843
BF884	79144009691	BF971	791440010758	BF1213	791440011526	FB1302	791440011748	BF1386-O	791440081253
BF885	79144009707	BF974-D	791440010772	BF1214	791440011533	OB1303	791440011755	BF1387-O	791440081345
BF886	79144009714	B975	791440010789	BF1215	791440049383	OB1305	791440011779	BF1388-O	791440081352
BF888	79144009721	BF976	791440010796	BF1216	791440011540	FB1306	791440077447	BF1389-O	791440081567
BF890	79144009745	BF978	791440010819	BF1217	791440051089	BF1307	791440011786	BF1390-O	791440082205
BF891	79144009752	BF979	791440010826	BF1218	791440011557	OB1308	791440011793	BF1391-O	791440082250
BF892	79144009769	BF980	791440010833	BF1219	791440011564	FB1309	791440011809	PF1392	791440086562
PF893	79144009776	PF981	791440010840	BF1220	791440011571	BF1310	791440011816	BF1392-SPS KIT	791440082748
PF893-RV	79144009783	BF984	791440010864	BF1221	791440011588	FB1311	791440011823	BF1393-SP	791440082922
PF894	79144009790	PF986	791440010871	BF1222	791440045675	OB1313	791440011830	BF1394-SP	791440083042
PF894-RV	79144009806	PF987	791440010888	BF1222-O	791440087217	OB1314	791440011847	BF1395-O	791440090521
BF896	79144009820	BF988	791440010895	BF1222-SP	791440045668	OB1315	791440011854	BF1395-SP	791440083080
BF897 KIT	79144009837	BF989	791440010901	BF1223	791440011595	OB1316	791440011861	BF1396	791440083226
BF898	79144009844	BF991	791440010925	BF1223-O	791440087354	OB1317	791440011878	BF1397-SP	791440084001
PF899	79144009851	BF992	791440010932	BF1223-SP	791440046115	OB1318	791440011885	BF1398-O	791440083288
BF900	79144009868	BF995	791440010956	BF1224	791440045033	OB1319	791440011892	BF1399-SP	791440084094
PF902	79144009899	P996	791440010963	BF1225	791440011601	OB1320	791440011908	B1400	791440012035
PF902-S	79144009905	PF997	791440053021	BF1226	791440011618	VG1325	791440011933	B1402	791440012059
PT903	79144009912	P998	791440010970	BF1231	791440043343	PG1326	791440011960	BD1403	791440054899
PF906	79144009950	P999-HD	791440010994	BF1232	791440011632	BF1329	791440045705	B1405	791440043442
PF907	79144009967	BF1008	791440049871	BF1233	791440011649	BF1329-SP	791440045644	B1406	791440012080
PF908-A	79144009974	V1009-W	791440011038	BF1239	791440042520	BF1330-SP	791440058033	B1407	791440012097
BF909	79144009981	V1044-O	791440011069	BF1240	791440050327	BF1339-SP	791440065437	B1410	791440043558
PF910	79144009998	BF1045	791440049574	V1240-C	791440011670	BF1345	791440037892	B1413	791440045545
BF912	791440010024	BF1046	791440049581	BF1248	791440050488	BF1345-O	791440087262	B1416	791440054691
PF913	791440010031	BF1047	791440049598	BF1249	791440050983	BF1345-SP	791440045804	P1418	791440050136
BF914	791440010048	BF1048	791440049604	BF1249-O	791440093423	BF1346	791440038356	P1419	791440050143
BF915	791440010055	BF1049	791440049611	BF1249-SP	791440052666	BF1346-O	791440088467	B1421	791440050587
F916-C	791440010062	BF1050	791440049628	BF1252	791440051041	BF1346-SP	791440066014	B1422	791440050846
PF916	791440010079	BF1052	791440050549	BF1253	791440051515	BF1347	791440045781	B1425	791440051782
BF918-K	791440010109	BF1053	791440050563	BF1256	791440054530	BF1347-O	791440104662	B1428	791440012127
F919-C	791440010147	BF1056	791440050822	BF1257	791440053366	BF1348	791440045903	B1429	791440038219
BF920	791440010192	BF1057	791440051171	BF1258	791440047174	BF1348-O	791440088474	B1430	791440043077
PF924	791440010239	BF1058	791440051188	BF1259	791440011694	BF1348-SP	791440051898	B1431	791440055865
BF925	791440010246	BF1061	791440051201	BF1261	791440054875	BF1349	791440050624	B1432	791440055919
PF926	791440010253	BF1100	791440047723	BF1262	791440056817	BF1350-SP	791440065062	P1433	791440056589
BF928	791440010277	BF1102	791440011076	BF1265	791440058286	BF1352-SPS	791440078161	B1434	791440058477
BF929	791440010284	BF1104	791440011090	BF1266	791440058729	BF1353-SPS	791440067462	B1435	791440058910
BF930	791440010291	BF1105	791440011106	BF1267	791440058781	BF1354-SPS	791440080645	B1438	791440058743
BF932	791440010321	BF1110	791440011144	BF1268	791440059023	BF1355	791440078604	P1440	791440058996
BF933	791440010338	BF1120	791440011175	BF1269	791440059290	BF1355-O	791440090460	B1441	791440060654
PF935	791440010352	BF1123	791440011182	BF1270-SP	791440059375	BF1355-SP	791440076419	P1443	791440060678
PF936	791440010369	BF1140	791440011250	BF1271	791440059856	BF1356	791440076754	B1444	791440061651
PF937	791440010376	BF1148	791440011281	BF1272-SPS	791440078055	BF1357	791440076853	B1446	791440062559
BF938	791440010383	BF1150	791440011298	BF1273-SP	791440056749	BF1358-O	791440091313	B1447	791440064928
BF939	791440010390	BF1160	791440011342	BF1274-SP	791440059733	BF1358-SP	791440076877	P1510	791440012172
BF940	791440010406	BF1163	791440011366	BF1274-SPS	791440059740	BF1359-SP	791440077775	P1511	791440012189
BF941	791440010413	BF1166	791440011380	BF1275	791440063785	BF1360	791440077973	V152-C	791440012219
PF942	791440010420	BF1170	791440011427	BF1276	791440011700	BF1360-O	791440104655	V1544-T	791440012226
PF943	791440010437	BF1171	791440011434	BF1277-SP	791440056732	BF1360-SP	791440083325	V1560	791440062580
PF945	791440010451	BF1172	791440059337	BF1277-SPS	791440059337	BF1361	791440078185	P1561	791440075351
PF946	791440010468	BF1173	791440041493	BF1278	791440060472	BF1362	791440078499	P1562	791440075368
PF947	791440010475	BF1174	791440048898	BF1278-O	791440095120	BF1363	791440078611		



**WARNING:** These products can expose you to chemicals, including Diisononyl Phthalate, Carbon black extracts, Nickel, 1,3 Butadiene, Ethylene Oxide, Epichlorohydrin, which are known to the State of California to cause cancer, and Bisphenol-A, Ethylene Glycol, Ethylene Oxide, 1,3 Butadiene, Epichlorohydrin, which are known to the State of California to cause birth defects or other reproductive harm.

# BALDWIN TO UPC (INDIVIDUAL PARTS)

BALDWIN NUMBER	UPC NUMBER	BALDWIN NUMBER	UPC NUMBER	BALDWIN NUMBER	UPC NUMBER	BALDWIN NUMBER	UPC NUMBER	BALDWIN NUMBER	UPC NUMBER
P1563	791440075375	PA1663	791440012905	PA1783	791440013735	PA1888	791440014565	PA2005	791440015456
P1565	791440075399	PA1664	791440012912	PA1784	791440013742	PA1889	791440014572	PA2006	791440015463
P1566	791440075405	PA1666	791440012929	PA1786	791440013759	PA1891	791440014589	PA2007	791440015470
P1567	791440075436	LL1667-FN	791440012936	PA1787	791440013766	PA1892-FN	791440014596	PA2008	791440015487
P1568	791440075443	PA1667-FN	791440012943	PA1788	791440013773	PA1893	791440014602	PA2009	791440015494
P1575	791440075559	LL1669	791440012950	PA1789	791440013780	LL1894	791440014619	PA2010	791440015500
P1577	791440075573	PA1669	791440012967	PA1790	791440013797	PA1894	791440014626	PA2023	791440015531
PF1578	791440075634	PA1670	791440012974	PA1794-FN	791440013803	PA1894XP	791440090576	PA2024	791440015548
PF1584	791440075528	PA1673	791440012981	PA1795	791440013810	LL1895	791440014633	SA2027	791440015562
PF1585	791440075535	PA1674	791440012998	PA1797	791440013827	PA1895	791440014640	PA2031	791440015579
PF1587	791440075597	PA1675	791440013001	PA1798	791440013834	PA1896	791440014657	PA2036	791440015609
PF1589	791440075610	LL1676-FN	791440013018	PA1800	791440013841	PA1897	791440014664	PA2037	791440015616
PA1600	791440012233	PA1676-FN	791440013025	PA1802	791440013865	PA1898	791440014671	PA2038	791440015623
PA1602	791440012240	PA1679	791440013032	PA1805	791440013889	PA1899	791440014688	SA2039	791440015630
PA1603	791440012257	PA1680	791440013049	PA1806	791440013896	PA1900	791440014695	PA2041	791440015647
PA1606	791440012264	LL1681-FN	791440013056	PA1809	791440013919	PA1901	791440014701	PA2042	791440015654
PA1607	791440012271	PA1681-FN	791440013063	PA1810	791440013926	LL1902-FN	791440014718	PA2044	791440015661
LL1608	791440012288	PA1682	791440013070	PA1814	791440013940	PA1902-FN	791440014725	SA2047	791440015678
PA1608	791440012295	PA1683	791440013087	PA1815	791440013957	PA1904	791440014732	PA2050	791440015692
PA1609	791440012301	PA1684	791440013094	PA1816	791440013964	PA1905	791440014749	PA2051	791440015708
PA1610	791440012318	PA1686	791440013100	PA1817	791440013971	PA1906	791440014756	PA2052	791440015715
PA1613	791440012325	PA1687	791440013117	PA1818	791440013988	PA1907-FN	791440014763	PA2053	791440015722
PA1613-S	791440012332	PA1688	791440013124	PA1819	791440013995	PA1909	791440014770	PA2061	791440015777
LL1614	791440012349	PA1689	791440013131	PA1821	791440014008	PA1911	791440014787	PA2063	791440015791
PA1614	791440012356	LL1690-FN	791440013148	PA1822-FN	791440014015	PA1912	791440014794	PA2064	791440015807
LL1615	791440012363	PA1690-FN	791440013155	PA1823	791440014022	PA1913	791440014800	PA2065	791440015814
PA1615	791440012370	PA1692	791440013162	PA1824	791440014039	PA1915	791440014817	PA2067	791440015838
PA1615XP	791440090613	PA1696	791440013179	PA1825	791440014046	PA1916	791440014824	PA2067 FOAM	791440073432
PA1618	791440012394	PA1697	791440013186	PA1826	791440014053	PA1919-FN	791440014831	PA2068	791440015845
PA1619	791440012400	PA1698	791440013193	PA1827	791440014060	PA1920	791440014848	PA2068 FOAM	791440067646
PA1620	791440012417	PA1699-FN	791440013209	PA1828	791440014077	PA1921	791440014855	PA2069	791440015852
PA1620-S	791440012424	PA1700	791440013216	PA1830-FN	791440014084	PA1922	791440014879	PA2069 FOAM	791440073425
LL1621-2	791440012431	PA1701	791440013230	PA1831	791440014091	PA1922-FN	791440014886	PA2070	791440015869
PA1621	791440012448	PA1701 ELE	791440013247	PA1832	791440014107	PA1926	791440014912	PA2071	791440015876
PA1621-2	791440012455	PA1701 FOAM	791440013254	PA1834	791440014114	PA1932	791440014923	PA2072	791440015883
PA1621-S	791440012462	PA1702	791440013261	PA1836	791440014121	PA1934	791440014930	PA2073	791440015890
PA1625	791440012486	PA1702 FOAM	791440013285	PA1837-FN	791440014138	PA1936	791440014947	PA2074	791440015906
LL1626-2	791440012493	PA1703	791440013292	PA1840	791440014152	PA1937	791440014954	PA2075	791440015913
PA1626	791440012509	PA1704	791440013315	PA1841	791440014169	PA1940	791440014961	PA2076	791440015920
PA1626-2	791440012516	PA1705-2	791440013322	PA1845	791440014176	PA1941-FN	791440014978	PA2077	791440015937
PA1627	791440012523	PA1706	791440013339	LL1846	791440014183	PA1945	791440015005	PA2079	791440015951
PA1629-S	791440012530	PA1706XP	791440090637	PA1846	791440014190	PA1946	791440015012	PA2081	791440015968
LL1630-2	791440012547	PA1707-FN	791440013346	PA1846XP	791440090774	PA1949	791440015029	PA2083	791440015982
PA1630	791440012554	PA1709	791440013353	PA1847-FN	791440014213	PA1951	791440015043	SA2084	791440015999
PA1630-2	791440012561	PA1710	791440013360	PA1848	791440014220	PA1952	791440015050	SA2085	791440016002
PA1631-S	791440012578	PA1712	791440013377	PA1849	791440014237	PA1953	791440015067	PA2091	791440016057
PA1632	791440012585	PA1718	791440013391	PA1850-FN	791440014244	PA1956-FN	791440015081	PA2092	791440016064
PA1633	791440012608	PA1719	791440013407	PA1851	791440014251	PA1957	791440015098	PA2093	791440016071
LL1634	791440012615	PA1721	791440013414	PA1852	791440014268	PA1960	791440015104	PA2094	791440016088
PA1634	791440012622	PA1726	791440013421	PA1857	791440014299	PA1961	791440015111	PA2095	791440016095
PA1634XP	791440090743	PA1735	791440013445	PA1858	791440014305	PA1963	791440015128	PA2096	791440016101
PA1635	791440012639	PA1748	791440013469	PA1859	791440014312	PA1967	791440015135	PA2099	791440016118
LL1636-FN	791440012646	PA1749-FN	791440013476	PA1860	791440014329	PA1969	791440015142	PA2100	791440016125
PA1636-FN	791440012653	PA1750-FN	791440013483	PA1861	791440014336	PA1972	791440015166	PA2101A	791440016132
LL1637-FN	791440012660	PA1752-FN	791440013490	PA1863	791440014343	PA1973	791440015173	PA2102	791440016149
PA1637-FN	791440012677	PA1753-FN	791440013506	PA1864-FN	791440014367	PA1975	791440015197	PA2103	791440016156
PA1639	791440012684	PA1754	791440013513	PA1865-FN	791440014374	PA1976	791440015203	PA2104	791440016163
PA1641	791440012691	PA1755-FN	791440013520	PA1866	791440014381	PA1977-FN	791440015210	PA2106	791440016187
LL1642-2	791440012707	PA1757	791440013537	PA1867	791440014398	PA1978-FN	791440015227	PA2107	791440016194
PA1642-2	791440012714	PA1758	791440013544	PA1868	791440014404	PA1979-FN	791440015241	PA2109	791440016217
PA1643	791440012721	PA1763	791440013551	PA1873	791440014411	PA1980-FN	791440015265	PA2110	791440016224
PA1644	791440012738	PA1765	791440013568	V1874-T	791440014428	PA1981	791440015272	PA2113	791440016255
F1645-DS	791440012745	PA1765 FOAM	791440013575	PA1875	791440014435	PA1982	791440015289	PA2114	791440016262
V1645-C	791440012752	PA1768	791440013582	PA1877	791440014442	PA1985	791440015296	PA2115	791440016279
LL1646-FN	791440012769	PA1769	791440013599	PA1880	791440014459	PA1986	791440015302	PA2116	791440016286
PA1646	791440012786	PA1771	791440013612	PA1881	791440014466	PA1986-K	791440015319	PA2117	791440016293
PA1646-FN	791440012783	PA1772	791440013629	PA1882	791440014473	PA1987	791440015326	PA2121	791440016323
PA1647	791440012790	PA1773	791440013636	PA1883-FN	791440014480	PA1989-FN	791440015333	PA2124	791440016354
PA1648	791440012806	PA1774	791440013643	LL1884	791440014497	LL1992	791440015340	PA2125	791440016361
LL1649	791440012813	PA1775	791440013650	PA1884	791440014503	PA1992-FN	791440015371	PA2127	791440016385
PA1649	791440012820	PA1776	791440013667	PA1884XP	791440090620	PA1995	791440015388	PA2134	791440016453
PA1650-FN	791440012837	PA1777	791440013674	LL1885	791440014510	PA1996	791440015395	PA2135	791440016460
PA1653	791440012851	PA1778	791440013681	PA1885	791440014527	PA1997	791440015401	PA2136	791440016477
V1656-O	791440012868	PA1779	791440013698	PA1885XP	791440090545	PA1998	791440015418	PA2138	791440016491
V1656-T	791440012875	PA1780	791440013704	LL1886	791440014534	PA2001	791440015425	PA2139	791440016507
PA1657	791440012882	PA1781	791440013711	PA1886	791440014541	PA2001 FOAM	791440042643	PA2139 FOAM	791440038585
PA1661(3)	791440012899	PA1782	791440013728	PA1886XP	791440090736	PA2002	791440015432	PA2140	791440016514



**WARNING:** These products can expose you to chemicals, including Diisononyl Phthalate, Carbon black extracts, Nickel, 1,3 Butadiene, Ethylene Oxide, Epichlorohydrin, which are known to the State of California to cause cancer, and Bisphenol-A, Ethylene Glycol, Ethylene Oxide, 1,3 Butadiene, Epichlorohydrin, which are known to the State of California to cause birth defects or other reproductive harm.

# BALDWIN TO UPC (INDIVIDUAL PARTS)

BALDWIN NUMBER	UPC NUMBER	BALDWIN NUMBER	UPC NUMBER	BALDWIN NUMBER	UPC NUMBER	BALDWIN NUMBER	UPC NUMBER	BALDWIN NUMBER	UPC NUMBER
PA2147	791440016576	PA2317	791440017559	PA2389-FN	791440018358	PA2459	791440019133	PA2534	791440019997
PA2148	791440016583	LL2318	791440017566	PA2390	791440018365	PA2460	791440019140	PA2535	791440020009
PA2149	791440016590	PA2318	791440017573	PA2391	791440018372	PA2461	791440019164	PA2536	791440020016
PA2150	791440016606	PA2319	791440017580	PA2392	791440018389	PA2462	791440019171	PA2538	791440020023
PA2152	791440016620	PA2320-FN	791440017597	LL2393	791440018396	PA2463	791440019188	PA2539	791440020030
PA2153	791440016637	PA2321	791440017603	PA2393	791440018402	PA2464	791440019195	PA2540	791440020047
PA2154	791440016644	PA2322	791440017610	PA2394	791440018419	PA2465	791440019218	PA2541-FN	791440020054
PA2156	791440016668	PA2323	791440017627	PA2395	791440018426	PA2466	791440019225	PA2542	791440020061
PA2158	791440016682	LL2326	791440017641	PA2396	791440018433	PA2467	791440019232	PA2544	791440020085
SA2159	791440016699	PA2326	791440017658	PA2397	791440018440	PA2468	791440019249	PA2545	791440020092
PA2160	791440016705	PA2326XP	791440090767	PA2398	791440018457	PA2469	791440019256	PA2546	791440020108
PA2162	791440016729	PA2328	791440017672	PA2399	791440018464	PA2472	791440019263	PA2547	791440020115
PA2163	791440016736	PA2329	791440017689	PA2401	791440018488	PA2473	791440019270	PA2548	791440020122
PA2164	791440016743	LL2330	791440017696	PA2402	791440018495	PA2474	791440019287	PA2550	791440020146
PA2167	791440016774	PA2330	791440017702	PA2403	791440018501	PA2475	791440019294	PA2551	791440020153
PA2168	791440016781	PA2331	791440017719	PA2404	791440018518	PA2476	791440019300	PA2552	791440020160
PA2169	791440016798	PA2332	791440017726	PA2405	791440018525	PA2477	791440019317	PA2553	791440020177
PA2171	791440016811	LL2333	791440017733	PA2406	791440018532	PA2478	791440019324	PA2554	791440020184
PA2178	791440016880	PA2333	791440017740	PA2407	791440018549	PA2479	791440019331	PA2554 FOAM	791440038615
PA2181	791440016890	PA2335	791440017757	PA2408	791440018556	PA2480	791440038608	PA2555	791440020207
PA2182	791440016927	PA2337	791440017764	PA2409	791440018563	PA2481	791440019348	PA2556	791440020221
PA2183	791440016934	PA2338-FN	791440017771	PA2410	791440018570	LL2482	791440019355	LL2557	791440020238
PA2188	791440016965	PA2339	791440017788	PA2411	791440018587	PA2482	791440019362	PA2557	791440020245
PA2189	791440016972	PA2340	791440017795	PA2412	791440018594	PA2483	791440019379	PA2558	791440020269
PA2191	791440016996	PA2341	791440017801	PA2413	791440018600	PA2484	791440019386	LL2559	791440020276
PA2193	791440017016	PA2342	791440017818	PA2414	791440018617	PA2485	791440019393	PA2559	791440020283
PA2194	791440017023	PA2343	791440017825	PA2415	791440018624	PA2486	791440019409	LL2562	791440020313
PA2196	791440017047	LL2344-FN	791440017832	PA2417-FN	791440018631	PA2487	791440019416	PA2562	791440020320
PA2200	791440043459	PA2344-FN	791440017849	LL2418-FN	791440018648	PA2488-FN	791440019423	PA2562XP	791440090569
PA2204	791440017115	PA2345	791440017856	PA2418-FN	791440018655	PA2489	791440019430	PA2563	791440020337
PA2207	791440017146	PA2346	791440017863	PA2419	791440018662	PA2490	791440019447	PA2564	791440020344
PA2208	791440017153	PA2347	791440017870	PA2420	791440018679	PA2491	791440019454	PA2566	791440020368
PA2212	791440017191	PA2349-FN	791440017894	PA2421	791440018686	LL2493	791440019478	PA2567	791440020375
PA2214	791440017214	PA2350	791440017900	PA2422	791440018693	PA2493	791440019485	PA2568	791440020382
PA2215	791440017221	PA2351	791440017917	PA2423	791440018709	PA2494	791440019508	PA2569	791440020399
PA2216	791440017238	PA2352	791440017924	LL2425	791440018716	PA2495	791440019515	PA2570	791440020405
PA2218	791440017252	PA2353	791440017931	PA2425	791440018723	PA2496	791440019522	PA2571	791440020412
PA2221	791440017283	PA2354	791440017948	LL2426-FN	791440018730	PA2497	791440019539	PA2572	791440020429
PA2222	791440017290	PA2356	791440017955	PA2426-FN	791440018747	PA2498	791440019546	PA2573	791440020436
PA2223	791440017306	PA2357	791440017979	PA2427	791440018754	PA2499	791440019553	PA2573XP	791440090552
PA2223 FOAM	791440067653	LL2358	791440017986	PA2428	791440018761	PA2500	791440019560	PA2574	791440020443
PA2224	791440017313	PA2358	791440017993	PA2429	791440018778	PA2502	791440019584	LL2575	791440020450
PA2225	791440017320	PA2359	791440018006	PA2430	791440018785	LL2503	791440019591	PA2575	791440020467
PA2226	791440017337	LL2360-FN	791440018013	PA2431	791440018792	PA2503	791440019607	PA2576	791440020474
PA2228	791440043473	PA2360-FN	791440018020	PA2432	791440018808	PA2504	791440019614	PA2577	791440020481
PA2230	791440043497	LL2361	791440018037	PA2433	791440018815	LL2507	791440019621	PA2578	791440020498
PA2231	791440045118	PA2361	791440018044	PA2434	791440018822	PA2507	791440019638	PA2579	791440020504
PA2232	791440045484	PA2361XP	791440103481	PA2435	791440018839	PA2508	791440019645	PA2580	791440020511
PA2233	791440045699	PA2362	791440018051	PA2436	791440018846	PA2509	791440019652	PA2581	791440020528
PA2234	791440046078	LL2363	791440018068	PA2437	791440018853	PA2510	791440019669	LL2582	791440020535
PA2235	791440048881	PA2363	791440018075	PA2438	791440018877	PA2511	791440019676	PA2582	791440020542
PA2237	791440049093	PA2363XP	791440090606	LL2439	791440018884	PA2512	791440019683	PA2583	791440020559
PA2240	791440049734	PA2364	791440018082	PA2439	791440018891	PA2513	791440019690	PA2585	791440020573
PA2241	791440049741	PA2367	791440018099	PA2440	791440018907	PA2514	791440019706	PA2586	791440020580
PA2243	791440049765	PA2368	791440018105	PA2441	791440018914	PA2515	791440019720	PA2587	791440020597
PA2244	791440049772	PA2369	791440018112	PA2442	791440018921	PA2516	791440019744	PA2588	791440020603
PA2256	791440017344	PA2370	791440018129	PA2443	791440018938	PA2517	791440019751	PA2589-FN	791440020610
PA2257	791440017351	PA2371	791440018136	PA2444	791440018945	LL2518	791440019768	PA2591	791440020634
PA2258	791440038592	PA2372	791440018143	PA2445	791440018952	PA2518	791440019775	PA2592	791440020641
PA2260	791440037601	PA2374	791440018167	PA2446	791440018969	PA2518XP	791440090729	PA2593	791440020658
PA2300	791440017368	PA2375	791440018174	LL2447-FN	791440018976	PA2519	791440019782	PA2595	791440020672
PA2301	791440017375	PA2376	791440018181	PA2447-FN	791440018983	PA2520	791440019805	PA2596	791440020689
PA2302-FN	791440017382	PA2377	791440018198	PA2448	791440018990	LL2521	791440019812	PA2598	791440020719
PA2303	791440017399	PA2378	791440018204	PA2450	791440019010	PA2521	791440019829	PA2599	791440020726
PA2304-FN	791440017405	PA2379	791440018211	PA2451	791440019027	PA2522	791440019836	PA2600	791440020733
PA2305	791440017412	PA2379-K	791440018228	PA2452	791440019034	PA2523	791440019843	PA2601	791440020740
PA2306	791440017429	PA2380-FN	791440018235	LL2453	791440019041	PA2524-FN	791440019850	PA2602	791440020757
PA2307	791440017436	PA2381	791440018242	PA2453	791440019058	LL2525	791440019867	PA2604	791440020771
PA2308	791440017443	PA2382	791440018266	PA2453XP	791440090583	PA2525	791440019874	PA2605	791440020788
PA2310	791440017467	PA2383	791440018273	PA2454	791440019065	PA2526	791440019881	PA2606	791440020795
LL2312	791440017474	LL2384	791440018280	PA2455	791440019072	PA2527	791440019898	PA2607	791440020801
PA2312	791440017481	PA2384	791440018297	LL2456	791440019089	PA2528	791440019904	LL2608	791440020818
PA2313	791440017498	PA2384XP	791440090590	PA2456	791440019096	PA2529	791440019911	PA2608	791440020825
PA2314	791440017504	PA2385	791440018303	PA2456XP	791440091375	PA2530	791440019928	LL2609	791440020832
PA2315	791440017511	PA2386	791440018310	PA2457	791440019102	PA2531	791440019942	PA2609	791440020849
PA2316	791440017535	PA2387	791440018327	LL2458	791440019119	PA2532	791440019966	PA2610	791440020856
LL2317	791440017542	PA2388	791440018334	PA2458	791440019126	PA2533	791440019980	PA2611	791440020863



**WARNING:** These products can expose you to chemicals, including Diisononyl Phthalate, Carbon black extracts, Nickel, 1,3 Butadiene, Ethylene Oxide, Epichlorohydrin, which are known to the State of California to cause cancer, and Bisphenol-A, Ethylene Glycol, Ethylene Oxide, 1,3 Butadiene, Epichlorohydrin, which are known to the State of California to cause birth defects or other reproductive harm.

# BALDWIN TO UPC (INDIVIDUAL PARTS)

BALDWIN NUMBER	UPC NUMBER	BALDWIN NUMBER	UPC NUMBER	BALDWIN NUMBER	UPC NUMBER	BALDWIN NUMBER	UPC NUMBER	BALDWIN NUMBER	UPC NUMBER
PA2612	791440020870	PA2687	791440021730	PA2776	791440022546	PA2862	791440045385	PA2982	791440054097
PA2613	791440020887	LL2688	791440021747	PA2777	791440022553	PA2862 FOAM	791440053595	PA2984	791440023536
PA2614	791440020894	PA2688	791440021754	PA2778-FN	791440022560	RS2863	791440023291	PA2988	791440023543
PA2615	791440020900	PA2689	791440021761	LL2779	791440022577	RS2863XP	791440090873	PA2989	791440023550
PA2616	791440020917	PA2690	791440021778	PA2779	791440022584	PA2865	791440023307	HSG3077	791440082847
PA2616XP	791440090750	PA2691	791440021785	PA2781	791440022607	PA2866	791440053601	HSG3078	791440085558
PA2617	791440020924	PA2692	791440021792	PA2782	791440022614	PA2867-FN	791440053618	AB3349	791440085565
LL2618	791440020931	PA2693	791440021808	PA2783	791440022638	PA2869	791440045392	PA3404	791440025523
PA2618	791440020948	PA2694	791440021815	PA2784	791440022645	PA2870-FN	791440053625	PA3405	791440054141
PA2619	791440020955	PA2696	791440021839	PA2785	791440022652	PA2871	791440052536	PA3406-FN	791440025530
PA2620	791440020962	PA2698	791440021846	PA2786	791440022669	PA2874	791440023321	PA3408	791440025554
PA2621	791440020979	PA2699	791440021860	PA2787	791440022676	PA2875	791440023328	PA3411-FN	791440054158
PA2622	791440020986	PA2700	791440021877	PA2788	791440022683	PA2876	791440023345	PA3412	791440054851
PA2623	791440020993	PA2701	791440021884	PA2789	791440022690	PA2877-FN	791440052680	PA3414	791440054165
PA2624	791440021006	PA2702	791440021891	PA2790-FN	791440022706	PA2878	791440054400	PA3415	791440054172
PA2625	791440021013	PA2703	791440021907	PA2791	791440022713	PA2880	791440053656	PA3416	791440054189
PA2626	791440021020	PA2704	791440021914	PA2792	791440022720	PA2881	791440053663	PA3417	791440054196
PA2627	791440021037	PA2705	791440021921	PA2793	791440022737	PA2883	791440053670	PA3419	791440052215
PA2628	791440021044	PA2706	791440021938	PA2794	791440022744	PA2884	791440053677	PA3420	791440025592
PA2629	791440021051	PA2707	791440021945	PA2796	791440022768	PA2885	791440053700	PA3421	791440025608
PA2630	791440021068	PA2708	791440021952	PA2797	791440022775	PA2887-FN	791440053717	PA3430	791440038028
PA2631	791440021075	PA2709	791440021969	PA2798	791440022782	PA2888	791440053724	PA3435-FN	791440061934
PA2632	791440021082	PA2710	791440021976	PA2799	791440022799	PA2889	791440053731	PA3438	791440025615
PA2633-FN	791440021099	PA2711	791440021983	PA2800-FN	791440053496	PA2890	791440053748	PA3439-FN	791440025622
PA2634	791440021105	PA2712	791440021990	PA2801	791440022805	PA2891	791440054511	PA3440	791440025639
PA2635-FN	791440021112	PA2713	791440022003	PA2803	791440022812	PA2895	791440053762	PA3442	791440025653
PA2636	791440021129	PA2714	791440022010	PA2804	791440046924	PA2896	791440061330	PA3446	791440038646
PA2637	791440021136	PA2715	791440022027	PA2805	791440022836	PA2897	791440053779	PA3447	791440025677
PA2638	791440021143	PA2716	791440022034	PA2806	791440022843	PA2900	791440023352	PA3448	791440025684
PA2640	791440021150	PA2717	791440022041	PA2807	791440022850	PA2902	791440023369	PA3449	791440038172
PA2641	791440021174	PA2718	791440022058	PA2812	791440022867	PA2903	791440041141	PA3452	791440038653
LL2642	791440021181	PA2719	791440022065	PA2813	791440051317	PA2904	791440053809	PA3453	791440025714
PA2642	791440021198	PA2721	791440022089	PA2814	791440022874	PA2905	791440053816	PA3457	791440025738
PA2643	791440021204	PA2722	791440022096	PA2815	791440022881	PA2906	791440053823	PA3458	791440025745
PA2644	791440021211	PA2723	791440022102	PA2816	791440022898	PA2909	791440053847	PA3460	791440025769
PA2645	791440021228	PA2724	791440022119	PA2817	791440022904	PA2912	791440053878	PA3461	791440025776
PA2646	791440021235	PA2725	791440022126	PA2818	791440022911	PA2913	791440053885	PA3463	791440025790
PA2647	791440021242	PA2726	791440022133	PA2819	791440022928	PA2914	791440053892	PA3464	791440025806
PA2648	791440021259	PA2727	791440022140	PA2820	791440022935	PA2915	791440053908	PA3466-FN	791440025820
PA2649	791440021266	PA2728	791440022157	PA2821	791440022942	PA2932	791440023376	PA3467	791440025837
PA2650	791440021273	PA2729	791440022164	PA2822	791440022959	PA2933	791440023383	PA3469	791440025851
PA2651	791440021280	PA2730	791440022171	PA2823	791440022966	PA2935	791440023390	PA3470	791440025868
PA2652	791440021297	PA2731	791440022188	PA2824	791440022973	PA2936	791440023406	PA3471	791440025885
PA2653	791440021303	PA2732	791440022195	PA2825	791440022980	PA2938	791440023413	PA3472	791440067691
PA2653 FOAM	791440021310	PA2733	791440022201	PA2826	791440022997	PA2942	791440051645	PA3472-FN	791440025882
PA2654	791440021327	PA2734	791440022225	PA2827	791440023000	PA2944-FN	791440023444	PA3473	791440025899
PA2655	791440021334	PA2735	791440022232	PA2828	791440023017	LL2945	791440023451	PA3474	791440025905
PA2656	791440021358	PA2736	791440022249	PA2829	791440023024	PA2945	791440023468	PA3475	791440025912
PA2657-FN	791440021365	PA2737	791440022256	PA2830	791440023031	PA2946	791440023475	PA3476	791440025929
PA2658	791440021372	PA2738	791440022263	PA2831	791440023048	PA2947	791440023482	PA3477	791440025936
PA2659	791440021396	PA2739	791440022270	PA2832	791440023055	PA2948	791440053939	PA3478	791440025943
PA2660	791440021402	PA2740	791440022287	PA2833	791440023062	PA2949-FN	791440023499	PA3478XP	791440103931
LL2661	791440021419	PA2742	791440022300	PA2834	791440023079	PA2950	791440053946	PA3479	791440025950
PA2661	791440021426	PA2743	791440022317	PA2835	791440023086	PA2951	791440048836	PA3480	791440030459
PA2662	791440021433	PA2744	791440022324	PA2836	791440023093	PA2952	791440048850	PA3481	791440025967
PA2663-FN	791440021457	PA2745	791440022331	PA2837	791440023109	PA2953	791440053953	PA3482	791440025974
PA2664	791440021464	PA2746	791440022348	PA2838	791440045361	PA2954-FN	791440053960	PA3483	791440049284
PA2665	791440021471	PA2747	791440022355	PA2839	791440023116	PA2955	791440045446	PA3484	791440049277
PA2666	791440021488	PA2748	791440022362	PA2840	791440053557	PA2956-FN	791440052721	PA3486	791440025981
LL2667	791440021495	PA2749	791440022386	PA2843	791440023123	PA2957	791440052727	PA3487	791440025998
PA2667	791440021501	PA2750	791440022393	PA2844	791440023130	PA2958	791440053977	PA3491	791440038660
PA2668	791440021518	PA2751	791440022409	PA2845	791440023147	PA2959-FN	791440052697	PA3492	791440026001
PA2669-FN	791440021525	PA2752	791440022416	PA2846-FN	791440023154	PA2960	791440052703	PA3493	791440030527
PA2670	791440021532	PA2753	791440022423	PA2847	791440053571	PA2961-FN	791440052673	PA3494	791440047150
PA2672	791440021556	PA2754	791440022430	PA2848	791440023161	PA2962	791440053984	PA3495	791440026018
PA2673	791440021563	PA2755	791440022447	PA2849	791440023178	PA2963	791440045453	PA3496	791440026025
PA2674	791440021570	PA2756	791440022454	PA2851	791440023192	PA2964	791440053991	PA3497	791440026032
PA2675	791440021584	PA2757	791440022461	PA2852	791440023208	PA2967	791440054004	PA3498	791440026049
LL2676	791440021600	PA2759	791440053458	PA2853	791440023215	PA2968-FN	791440056701	PA3499	791440041325
PA2676	791440021617	PA2761	791440022478	PA2854	791440023222	PA2970	791440054028	RS3501	791440026056
PA2676XP	791440090781	PA2763	791440022485	PA2855	791440023239	PA2971	791440054035	RS3502	791440026063
PA2677	791440021624	PA2767	791440022492	PA2856	791440023246	PA2973	791440023505	RS3503	791440026070
PA2678	791440021631	PA2771	791440053489	PA2857	791440023253	PA2976-FN	791440054066	RS3504	791440026087
PA2679	791440021655	PA2772	791440022508	PA2858	791440023260	PA2977-FN	791440050273	RS3504XP	791440090941
PA2680	791440021662	PA2773	791440022515	PA2859-FN	791440053588	PA2978	791440023529	RS3505	791440026094
PA2684-FN	791440021693	PA2774	791440022522	PA2860-FN	791440045378	PA2980	791440054073	RS3506	791440026100
LL2685	791440021709	PA2775	791440022539	PA2861	791440023277	PA2981	791440054080	RS3506XP	791440090927



**WARNING:** These products can expose you to chemicals, including Diisononyl Phthalate, Carbon black extracts, Nickel, 1,3 Butadiene, Ethylene Oxide, Epichlorohydrin, which are known to the State of California to cause cancer, and Bisphenol-A, Ethylene Glycol, Ethylene Oxide, 1,3 Butadiene, Epichlorohydrin, which are known to the State of California to cause birth defects or other reproductive harm.

# BALDWIN TO UPC (INDIVIDUAL PARTS)

BALDWIN NUMBER	UPC NUMBER	BALDWIN NUMBER	UPC NUMBER	BALDWIN NUMBER	UPC NUMBER	BALDWIN NUMBER	UPC NUMBER	BALDWIN NUMBER	UPC NUMBER
RS3507	791440026117	PA3605	791440037755	RS3716	791440049666	PA3804	791440052505	RS3888	791440056237
RS3508	791440026124	PA3606	791440037762	RS3717	791440049321	PA3805-FN	791440052543	PA3889	791440056244
RS3508XP	791440090835	PA3607-FN	791440037779	RS3718	791440049307	PA3806	791440053052	PA3890	791440056282
RS3509	791440026131	PA3608-FN	791440037786	RS3719	791440049314	PA3807	791440054738	PA3891	791440056343
RS3510	791440026148	PA3609	791440037793	RS3720	791440049703	PA3808-FN	791440053038	PA3892	791440056756
RS3510XP	791440090811	PA3610	791440037809	RS3721	791440052468	PA3809	791440053045	PA3893	791440056763
RS3511	791440026155	PA3611	791440037816	RS3722	791440050990	PA3810	791440053106	PA3894	791440056909
RS3512	791440026162	PA3612	791440038264	RS3723	791440051294	PA3811-FN	791440053267	PA3895-FN	791440056923
RS3513	791440026179	PA3613	791440038271	RS3724	791440052208	PA3812	791440053274	PA3896	791440056954
RS3514	791440026186	PA3614	791440038332	RS3727	791440052239	PA3814	791440053311	PA3897	791440057005
RS3514XP	791440090842	PA3627	791440042469	RS3728	791440052246	PA3815	791440053328	PA3898	791440056961
RS3515	791440026193	PA3628	791440042476	RS3729	791440052253	PA3816	791440058620	PA3899	791440056978
RS3516	791440026209	PA3629	791440042483	RS3730	791440051881	PA3817	791440058224	PA3900	791440057418
RS3516XP	791440110502	PA3630-FN	791440042575	RS3731	791440052314	PA3818-FN	791440058217	PA3901	791440057432
RS3517	791440043039	PA3631	791440042582	RS3732	791440056824	PA3819	791440058590	PA3901 FOAM	791440067660
RS3517XP	791440090880	PA3632	791440042599	RS3733	791440051980	PA3820-FN	791440058613	PA3902	791440057548
RS3518	791440038431	PA3633	791440042605	RS3734	791440052734	PA3821	791440058200	PA3903	791440057555
RS3518XP	791440108905	PA3633 FOAM	791440055803	RS3734XP	791440090934	PA3822	791440054394	PA3904	791440057562
RS3519	791440047501	PA3636	791440042667	RS3735	791440052598	PA3823	791440054400	PA3905	791440057579
RS3520	791440038677	PA3637	791440042704	RS3736	791440052550	PA3824	791440054417	PA3906	791440057586
RS3521	791440050570	PA3638	791440042711	RS3737	791440052567	PA3825	791440058071	PA3907	791440057791
RS3522	791440038424	PA3640	791440042735	RS3738	791440052857	RS3826	791440057463	PA3908	791440057661
RS3528	791440042827	PA3643	791440042810	RS3739	791440052864	RS3827	791440057470	PA3909	791440057678
RS3530	791440038363	PA3644	791440042858	RS3740	791440053175	PA3828	791440058088	PA3910-FN	791440057777
RS3530XP	791440090910	PA3645	791440042889	RS3741	791440053182	PA3829	791440058095	PA3911	791440057784
RS3531	791440048768	PA3650	791440043244	RS3743	791440054370	PA3832	791440054523	PA3914	791440057838
RS3532	791440039377	PA3651-FN	791440043251	RS3744	791440054707	PA3833	791440054561	PA3915	791440057845
RS3533	791440039384	PA3652	791440043268	RS3744XP	791440090804	PA3834	791440054585	PA3916	791440057944
RS3534	791440045170	PA3653	791440043299	RS3745	791440054714	PA3835	791440054592	PA3917	791440058118
RS3535	791440039391	PA3654	791440043428	RS3746	791440055209	PA3836	791440055049	PA3918	791440058293
RS3536	791440045132	PA3655	791440043589	RS3747	791440055148	PA3837	791440055063	PA3919	791440058309
RS3537	791440042834	PA3656	791440043602	RS3749	791440055193	PA3838	791440056350	RS3920	791440058354
RS3538	791440038370	PA3657	791440043596	RS3750	791440056657	PA3839	791440055070	RS3921	791440058361
RS3539	791440045187	PA3658	791440043619	RS3750XP	791440109827	PA3840	791440055087	RS3922	791440058378
RS3539XP	791440093188	PA3660-FN	791440043800	PA3752	791440048485	PA3842	791440054806	RS3923	791440058385
RS3540	791440038042	PA3664-FN	791440045590	PA3753	791440048492	PA3843	791440054813	PA3924-FN	791440058415
RS3541	791440043848	PA3667-FN	791440043831	PA3754	791440048508	PA3844	791440056367	PA3925	791440058651
RS3542	791440041233	PA3668	791440045620	PA3755	791440048614	PA3847	791440056381	RS3926	791440058422
RS3543	791440041240	PA3669-FN	791440045637	PA3756	791440048621	PA3848-FN	791440056398	RS3927	791440058439
RS3544	791440041257	PA3670	791440045767	PA3757	791440048638	PA3849	791440056404	PA3928	791440058491
RS3545	791440041264	PA3671-FN	791440045996	PA3758	791440048645	PA3850	791440056411	PA3929	791440058545
RS3547	791440041288	PA3672	791440045989	PA3759	791440048652	PA3851	791440056428	RS3930	791440058675
RS3548	791440043060	PA3674	791440046016	PA3760	791440048669	PA3852-FN	791440056435	PA3931	791440058736
RS3548XP	791440090897	PA3675	791440046085	PA3761-FN	791440048683	PA3853-FN	791440056442	PA3932	791440058705
RS3549	791440045729	PA3676	791440046092	PA3763	791440048737	PA3854-FN	791440056459	PA3933	791440058712
RS3550	791440038448	PA3679	791440046528	RS3764	791440057456	PA3855-FN	791440056466	RS3934	791440058873
PA3551	791440026278	PA3680	791440046795	PA3765	791440048805	PA3857	791440056480	RS3935	791440058880
PA3554	791440026285	PA3681	791440046818	PA3766	791440048812	PA3859	791440056503	RS3936	791440058903
PA3555	791440026292	PA3682	791440046825	PA3767	791440049642	PA3860	791440056510	PA3937	791440059047
PA3556	791440026308	PA3683	791440046832	PA3768	791440049659	PA3861	791440056527	PA3938	791440059078
PA3557-FN	791440026315	PA3684	791440046849	PA3772	791440049390	PA3862-FN	791440056534	PA3939	791440059351
PA3558	791440026322	PA3685	791440046856	PA3773	791440049567	PA3863	791440056541	RS3940	791440059368
PA3559	791440026339	PA3686	791440046863	PA3774	791440050051	PA3864	791440056558	PA3941	791440059399
PA3560	791440026346	PA3687	791440046870	PA3775	791440050068	PA3865	791440056565	RS3942	791440059429
PA3562	791440026353	PA3688	791440047228	PA3777	791440050235	PA3867	791440055155	RS3943	791440059436
PA3563	791440026360	PA3689	791440047549	PA3778	791440050252	PA3868	791440055162	PA3944	791440059443
PA3565	791440026377	PA3690	791440047525	PA3779-FN	791440050310	PA3869	791440055064	PA3945	791440059450
PA3566	791440026384	PA3691	791440048089	PA3780	791440050365	RS3870	791440055179	PA3946	791440059467
PA3568	791440037915	PA3697	791440047860	PA3781	791440050495	RS3870XP	791440090828	PA3948	791440059474
PA3569	791440026391	PA3698	791440048171	PA3782	791440050662	RS3871	791440055186	PA3949	791440060760
PA3572	791440026438	PA3699	791440048201	PA3783	791440050679	PA3872	791440055926	PA3950	791440059511
PA3573	791440026445	RS3700	791440043510	PA3785-FN	791440051416	PA3873	791440055933	PA3951	791440059016
PA3576	791440026469	RS3700XP	791440090859	PA3786-FN	791440050952	PA3874	791440055230	RS3952	791440059597
PA3578	791440038035	RS3701	791440043527	PA3787	791440050921	PA3875-FN	791440056022	PA3953	791440059498
PA3579	791440038738	RS3703	791440045736	PA3790	791440051546	PA3876	791440056770	RS3954	791440059603
PA3580	791440026483	RS3704	791440045743	PA3791-FN	791440051560	PA3877	791440055827	PA3956	791440059801
PA3581	791440026490	RS3705	791440045750	PA3792	791440051577	PA3878	791440055834	PA3957	791440059863
PA3584	791440038745	RS3706	791440046344	PA3793	791440051584	PA3879-FN	791440055841	PA3957 FOAM	791440073418
PA3587	791440037908	RS3707	791440046351	PA3794	791440051607	PA3880	791440056039	PA3958	791440059948
PA3588	791440037946	RS3708	791440046375	PA3795	791440051751	PA3881	791440056091	PA3959	791440060029
PA3595	791440038097	RS3709	791440046382	PA3796	791440051713	RS3882	791440056046	PA3961	791440059955
PA3597	791440037533	RS3710	791440046771	RS3711	791440051720	RS3882XP	791440098985	BA3964(4)	791440060074
PA3598	791440037540	RS3711	791440046788	PA3798	791440051874	RS3883	791440056053	BA3965(4)	791440060081
PA3600	791440037595	RS3712	791440047563	PA3800	791440052345	RS3884	791440056060	PA3966	791440060098
PA3601	791440037649	RS3713	791440050358	PA3801-FN	791440052772	RS3885	791440056077	PA3967	791440060111
PA3602	791440037700	RS3714	791440048188	PA3802	791440052482	PA3886	791440056107	PA3969	791440060166
PA3604	791440037724	RS3715	791440048232	PA3803	791440052499	PA3887	791440056220	PA3970	791440060173



**WARNING:** These products can expose you to chemicals, including Diisononyl Phthalate, Carbon black extracts, Nickel, 1,3 Butadiene, Ethylene Oxide, Epichlorohydrin, which are known to the State of California to cause cancer, and Bisphenol-A, Ethylene Glycol, Ethylene Oxide, 1,3 Butadiene, Epichlorohydrin, which are known to the State of California to cause birth defects or other reproductive harm.



# BALDWIN TO UPC (INDIVIDUAL PARTS)

BALDWIN NUMBER	UPC NUMBER	BALDWIN NUMBER	UPC NUMBER	BALDWIN NUMBER	UPC NUMBER	BALDWIN NUMBER	UPC NUMBER	BALDWIN NUMBER	UPC NUMBER
RS3971	791440061095	PA4112	791440057425	PA4307	791440080522	PA4394	791440082861	PA4480	791440093706
PA3972	791440060197	PA4113	791440057890	PA4308	791440080539	PA4397	791440082984	PA4481	791440094390
PA3973	791440060203	PA4114	791440058101	PA4309	791440080546	PA4398	791440082991	PA4483	791440094536
RS3974	791440060227	PA4118	791440059160	PA4310	791440080560	PA4399	791440083004	PA4484	791440094666
RS3975	791440060234	PA4120	791440059085	PA4311	791440080577	PA4400	791440083011	PA4485	791440094703
PA3978	791440060265	PA4121	791440059320	PA4312	791440080584	PA4401	791440083097	PA4486	791440095113
PA3979	791440060272	PA4123	791440059559	PA4313	791440080591	PA4402	791440083103	PA4487	791440095137
PA3980	791440060357	PA4124	791440059566	PA4314	791440080607	PA4403	791440083134	PA4488	791440095144
PA3983-FN	791440060623	PA4126	791440059849	SA4315	791440080553	PA4404	791440083141	PA4489	791440095151
PA3984	791440060791	PA4127	791440059924	PA4316	791440080652	PA4405	791440083158	PA4548	791440063341
PA3985	791440060777	PA4128	791440060319	PA4317	791440080669	PA4408	791440083189	RS4549	791440063334
PA3986	791440060920	PA4129	791440060326	PA4318	791440080744	PA4409	791440083240	PA4551	791440061231
PA3987	791440060937	RS4130	791440060333	PA4319	791440080751	PA4410 KIT	791440083516	PA4552	791440061248
RS3988	791440060944	RS4131	791440060336	PA4320	791440080775	PA4411	791440083578	PA4553	791440061354
PA3989-FN	791440061033	PA4132	791440060449	PA4321	791440080881	PA4412	791440083592	PA4554	791440061361
RS3990	791440060968	PA4133	791440060487	PA4322	791440080898	PA4413	791440083608	PA4555	791440061378
RS3991	791440061026	PA4134	791440060689	PA4323	791440081048	PA4414	791440083615	PA4557	791440061392
RS3992	791440060975	PA4138	791440061125	PA4324	791440081062	PA4415	791440083622	PA4559	791440061880
RS3993	791440061279	SA4141	791440061194	PA4325	791440081109	PA4416 KIT	791440083677	PA4560	791440061910
RS3994	791440060982	PA4144	791440061965	PA4327	791440081086	PA4417	791440083776	RS4561	791440061958
RS3995	791440061286	PA4145	791440062238	PA4328	791440081093	PA4418	791440083868	RS4562	791440061989
RS3996	791440060993	PA4146	791440062528	PA4329	791440081215	PA4419	791440083731	RS4563	791440062016
RS3997	791440061299	PA4147	791440062535	PA4330	791440081376	PA4421	791440084155	RS4564	791440062023
RS3998	791440061002	PA4148	791440062542	PA4331	791440081383	PA4422	791440085985	PA4566	791440062153
RS3998XP	791440090866	PA4149 KIT	791440063082	PA4332	791440081390	PA4423	791440085992	PA4567	791440062177
RS3999	791440061040	PA4150	791440063464	PA4333	791440081574	PA4424	791440086142	PA4570	791440062382
PA4005	791440043435	PA4151	791440064317	PA4334	791440081505	PA4425	791440086418	PA4571	791440062924
PA4015	791440038691	PA4152	791440064492	PA4335	791440081512	PA4426	791440086425	RS4572	791440062597
PA4016	791440026551	PA4153	791440064508	PA4336	791440081581	PA4428	791440086685	PA4573	791440062832
PA4018	791440026568	PA4154	791440064515	PA4337	791440081604	PA4429	791440087026	PA4574	791440062849
PA4023	791440026582	PA4156 KIT	791440065048	PA4338	791440081796	PA4430	791440087057	RS4576	791440062870
PA4026	791440026599	PA4157	791440065055	PA4340	791440081802	PA4431	791440087231	RS4577	791440062887
PA4028	791440026605	PA4158	791440065253	PA4341	791440081819	PA4433	791440087675	RS4578	791440062900
PA4041	791440043565	PA4159	791440065406	PA4344	791440081826	PA4434	791440087965	RS4579	791440063129
PA4042	791440048959	PA4160	791440065444	PA4345	791440081833	PA4435	791440088108	RS4580	791440063136
PA4043	791440048966	RS4161	791440065451	PA4348	791440081840	PA4436	791440088160	PA4581	791440063143
PA4044	791440049222	PA4162	791440065536	PA4349	791440081857	PA4437	791440088177	PA4582	791440063150
PA4045	791440049239	PA4163	791440065888	PA4350	791440081864	PA4438	791440088443	PA4583-FN	791440063181
PA4046	791440049246	PA4164	791440066083	PA4351	791440081871	PA4439	791440089167	PA4585	791440063327
PA4047	791440049338	PA4165	791440066090	PA4352	791440081887	PA4440 KIT	791440089174	PA4592	791440063457
PA4048	791440049345	PA4166	791440066656	PA4353	791440081994	PA4441	791440089181	PA4593	791440063471
PA4049	791440049406	PA4167	791440066762	PA4354	791440082007	PA4442	791440089297	PA4594	791440063488
PA4050	791440026600	PA4168	791440067073	PA4355	791440082014	PA4443	791440089303	RS4595	791440063587
PA4060	791440026681	PA4169	791440067134	PA4356	791440082021	PA4444	791440089310	RS4597	791440063792
PA4069	791440043626	PA4170	791440072602	PA4358	791440082045	RS4445	791440089419	RS4598	791440063648
PA4070	791440043633	PA4171	791440074927	PA4359	791440082052	PA4446	791440089426	RS4599	791440063655
PA4071	791440043640	PA4172	791440076761	PA4360	791440082069	PA4447	791440089433	PA4600	791440063709
PA4072	791440043794	PA4173	791440077188	PA4361	791440082076	PA4448	791440089440	PA4601	791440063716
PA4073	791440043817	PA4174	791440077195	PA4362	791440082083	PA4449	791440089574	PA4602	791440063747
PA4075	791440047068	PA4175	791440077997	PA4363	791440082212	RS4450	791440089815	PA4603	791440064898
PA4077	791440047532	PA4176	791440078000	PA4364	791440082229	PA4451	791440089891	PA4604-FN	791440063808
PA4078	791440047679	PA4177	791440078123	PA4365	791440082236	PA4452	791440089907	PA4605	791440063815
PA4079	791440047877	PA4178	791440078666	PA4366	791440082267	PA4453	791440089914	PA4606	791440063822
PA4081	791440049536	PA4179	791440078673	PA4367	791440082335	PA4454	791440089949	PA4608	791440063853
PA4084	791440050044	PA4180	791440078680	PA4368	791440082342	PA4455	791440089969	PA4610 KIT	791440063921
PA4085	791440050303	PA4181	791440078697	PA4369	791440082359	PA4456	791440089983	PA4611	791440063991
PA4088	791440051140	PA4182	791440078703	PA4370	791440082366	PA4458	791440090019	PA4612	791440063938
PA4089	791440051157	PA4183	791440078710	PA4371	791440082373	PA4460 KIT	791440090101	RS4613	791440064393
PA4090	791440051164	PA4184	791440079090	PA4372	791440082380	PA4461	791440090125	PA4614	791440063952
PA4091	791440051218	PA4185	791440079366	PA4373	791440082397	PA4462	791440090132	RS4616	791440064041
PA4092	791440051409	PA4187	791440079649	PA4374	791440082458	PA4463	791440090163	RS4617	791440064058
PA4093	791440051737	PA4188	791440080270	PA4376	791440082489	PA4464	791440090309	RS4618	791440064386
PA4094	791440051744	RS4189	791440080294	PA4377	791440082496	PA4465	791440090422	PA4619	791440064690
PA4096	791440052017	PA4190	791440080300	PA4380	791440082502	PA4466	791440091016	RS4620	791440064409
PA4099	791440052307	PA4191	791440080317	PA4381	791440082519	PA4467	791440091252	RS4621	791440064416
PA4100	791440052444	PA4192	791440080409	PA4382	791440082526	PA4468	791440091528	RS4622	791440064423
PA4101	791440053090	PA4193	791440080416	PA4383	791440082533	PA4469	791440091535	RS4623	791440065246
PA4102	791440053137	PA4194	791440080423	PA4384	791440082540	PA4470	791440092297	PA4624	791440064652
PA4103	791440054516	PA4195 KIT	791440080430	PA4385	791440082557	PA4471	791440092310	PA4625	791440064669
PA4104	791440054639	PA4196	791440080447	PA4386	791440082564	PA4472	791440092365	PA4627	791440064966
PA4105	791440054646	PA4197	791440080454	PA4387	791440082571	PA4473	791440092440	PA4628	791440065178
PA4106	791440054653	PA4198	791440080461	PA4388	791440082649	PA4474	791440092522	RS4629	791440065215
PA4107	791440054660	PA4199	791440080478	PA4389	791440082656	PA4475	791440092853	PA4630	791440065550
PA4108	791440054950	PA4303	791440080485	PA4390	791440082670	PA4476	791440093669	PA4631-FN	791440065284
PA4109	791440054967	PA4304	791440080492	PA4391	791440082762	PA4477	791440093676	PA4632	791440065338
PA4110	791440055131	PA4305	791440080508	PA4392	791440082786	PA4478	791440093683	PA4633	791440065345
PA4111	791440056084	PA4306	791440080515	PA4393	791440082793	PA4479	791440093690	RS4634	791440065321



**WARNING:** These products can expose you to chemicals, including Diisononyl Phthalate, Carbon black extracts, Nickel, 1,3 Butadiene, Ethylene Oxide, Epichlorohydrin, which are known to the State of California to cause cancer, and Bisphenol-A, Ethylene Glycol, Ethylene Oxide, 1,3 Butadiene, Epichlorohydrin, which are known to the State of California to cause birth defects or other reproductive harm.

# BALDWIN TO UPC (INDIVIDUAL PARTS)

BALDWIN NUMBER	UPC NUMBER	BALDWIN NUMBER	UPC NUMBER	BALDWIN NUMBER	UPC NUMBER	BALDWIN NUMBER	UPC NUMBER	BALDWIN NUMBER	UPC NUMBER
RS4634XP	791440104266	PA4737	791440068148	PA4891	791440072763	CTK5029-4	791440050211	PA5312 KIT	791440077348
PA4635	791440065413	PA4738	791440068155	PA4893	791440072787	CS5057	791440026889	RS5313	791440077352
RS4636	791440065369	PA4740	791440068179	PA4895	791440072800	CS5058	791440026896	PA5314	791440077365
RS4637	791440065376	PA4741	791440068186	PA4896	791440072817	OTK5060	791440026902	PA5315	791440077454
RS4638	791440065390	PA4743	791440068209	PA4897	791440072824	OTK5061	791440026919	PA5316	791440077461
RS4639	791440065512	PA4750	791440068278	PA4900	791440072848	OTK5063	791440026933	PA5317	791440077478
PA4640-FN	791440077300	PA4753	791440068308	PA4902	791440072862	BW5070	791440026940	PA5318	791440077492
PA4641	791440065574	PA4754	791440068315	PA4903	791440072879	BW5071	791440026957	PA5319	791440077508
RS4642	791440065581	PA4755	791440068322	PA4905	791440072893	BW5072	791440026964	PA5320	791440077515
RS4643	791440065598	PA4756	791440068339	PA4906	791440072909	BW5073	791440026971	PA5321	791440077522
PA4644	791440065611	PA4758	791440068353	PA4907	791440072916	BW5074	791440026988	PA5323	791440077669
PA4645-FN	791440065628	PA4760	791440068377	PA4908	791440072923	BW5075	791440026995	PA5324-FN	791440077706
RS4646	791440065635	PA4763	791440068407	PA4910	791440072947	BW5076	791440027008	RS5325	791440077713
PA4647	791440065642	PA4764	791440068414	PA4911	791440072954	BW5082	791440043107	PA5326	791440077720
PA4648	791440065659	PA4766	791440068438	PA4912	791440075092	BW5086	791440057593	PA5327	791440077867
PA4649	791440065666	PA4769	791440068469	PA4918	791440073029	B5087	791440058262	PA5328	791440077874
PA4650-FN	791440065727	PA4773	791440068506	PA4919	791440073036	B5088	791440058279	RS5329	791440077881
PA4651	791440065758	RS4775	791440068520	PA4925	791440073098	B5089	791440063440	PA5330	791440078178
PA4652	791440065895	PA4778	791440068568	PA4928	791440073128	B5090	791440065673	PA5331	791440078192
PA4653	791440066106	PA4781	791440068599	PA4929	791440073135	B5091	791440082830	RS5332	791440078376
PA4654 KIT	791440066151	PA4790	791440068681	PA4930	791440073142	P5092	791440091542	PA5333	791440078444
PA4655	791440066182	PA4793	791440068711	PA4931	791440073159	B5134	791440027046	RS5334	791440078741
PA4656	791440066267	RS4794	791440068728	PA4932	791440073166	BW5136	791440027053	RS5335	791440078475
PA4657	791440066281	PA4795	791440068735	PA4934	791440073180	BW5137	791440027060	PA5336	791440078543
PA4659	791440066328	PA4801	791440068797	PA4935	791440073197	BW5138	791440027077	PA5337	791440078635
PA4660	791440066335	PA4802	791440068803	PA4938	791440073227	BW5139	791440027084	PA5338-FN	791440078642
PA4661	791440066847	RS4803	791440068810	PA4939	791440073234	BW5140	791440027091	PA5339	791440078871
PA4662	791440066854	RS4804	791440068827	PA4941	791440073258	BW5141	791440027107	PA5340	791440078895
PA4663	791440066861	RS4806	791440068841	PA4942	791440073265	BW5142	791440052581	PA5341	791440078918
PA4664	791440066878	RS4807	791440068858	PA4945	791440075108	BW5143	791440057029	RS5342	791440078970
PA4665-FN	791440066901	PA4809	791440068872	PA4947	791440075122	B5144	791440060645	RS5343	791440078987
PA4666	791440066918	PA4810	791440068889	PA4955	791440075207	B5145	791440066922	RS5344	791440081291
PA4668	791440066885	PA4813	791440068919	PA4956	791440075214	B5176	791440027121	RS5345	791440081307
RS4672	791440067042	PA4814	791440068926	RS4959	791440075252	B5177	791440027138	RS5347	791440081321
RS4673	791440067059	PA4819	791440068971	PA4960-FN	791440075054	BW5178	791440027145	RS5348	791440081338
PA4674-FN	791440067066	PA4820	791440068988	PA4961	791440075078	BW5179	791440027152	PA5350	791440079045
RS4676	791440067264	PA4823	791440069015	RS4962	791440075269	BW5182	791440066298	RS5351	791440079120
RS4677	791440067271	PA4824	791440069022	RS4963	791440075276	BW5183	791440079021	CA5352	791440079137
RS4678	791440067288	PA4825	791440069039	RS4966	791440075283	BW5200	791440053281	PA5353	791440079403
RS4679	791440067295	PA4827	791440069053	RS4967	791440075290	BW5201	791440057401	RS5354	791440079236
RS4680	791440067325	PA4829	791440069077	RS4968	791440075306	BW5250	791440060050	RS5355	791440079243
PA4681	791440067363	PA4830	791440069084	RS4969	791440075313	PE5270	791440091894	RS5356	791440079427
PA4682	791440067424	PA4833-FN	791440069107	RS4970	791440075320	PE5271	791440091900	PA5357	791440079434
PA4683	791440067523	PA4834-FN	791440069114	RS4971	791440075337	PE5272	791440094925	RS5358	791440079465
PA4689	791440067639	PA4848	791440069251	RS4972	791440075344	RS5273	791440094949	PA5359	791440079526
PA4692	791440067745	PA4849	791440069268	PA4973	791440076013	PA5274	791440094970	RS5360	791440079557
PA4693	791440067752	PA4852	791440067547	PA4975	791440075993	PA5275	791440094987	RS5361	791440079564
PA4694	791440067769	PA4852 FOAM	791440067554	PA4977-FN	791440075979	PA5276	791440094994	PA5363	791440079601
PA4695	791440067776	PA4853	791440067561	PA4978	791440075982	CA5278	791440095045	PA5364	791440079786
PA4696 FOAM	791440067783	PA4854	791440067578	PA4979	791440075955	PA5281	791440095076	PA5365	791440079793
PA4697-FN	791440067790	PA4855	791440067592	PA4983	791440076310	PA5282	791440095083	CA5366	791440079861
PA4698	791440067806	PA4857	791440072503	PA4984-FN	791440076303	PA5283	791440095090	CA5368	791440079885
CA4700	791440066571	PA4858	791440072527	PA4985	791440076372	BA5284	791440095106	CA5369	791440079892
PA4701	791440066588	RS4859	791440072541	PA4986	791440076389	RS5285	791440095168	CA5370	791440079908
CA4702	791440066724	PA4860	791440072558	PA4987	791440076396	RS5287	791440109803	BA5371	791440081956
CA4703	791440066731	RS4861	791440073470	RS4988	791440076518	RS5287XP	791440095212	BA5373	791440085619
PA4704	791440066717	RS4862	791440072565	RS4989	791440076563	RS5288	791440109810	BA5374	791440078840
PA4705	791440067820	RS4863	791440072572	PA4991	791440076594	RS5288XP	791440096608	BA5375	791440078857
PA4706	791440067837	RS4864	791440073463	RS4992	791440076679	PA5289	791440095236	BA5376	791440078864
PA4707	791440067844	PA4865-FN	791440073333	RS4993	791440076785	PA5290	791440095229	BA5377	791440085626
PA4708	791440067851	PA4870-FN	791440073340	RS4994	791440076686	RS5291	791440095250	BA5378	791440085718
PA4709	791440067868	PA4871	791440073357	RS4995	791440076693	RS5292	791440095267	BA5379	791440085725
PA4711	791440067882	PA4872	791440073364	CA4996	791440094796	RS5293	791440096516	RS5387 KIT	791440079977
PA4713	791440067905	PA4873	791440073371	PA4997	791440094802	RS5293XP	791440103597	PA5388	791440079984
PA4714	791440067912	PA4874	791440073388	CA4999	791440076808	RS5294	791440096523	RS5389-FN	791440080010
PA4715	791440067929	PA4876	791440073401	CFB5000	791440026704	PA5297	791440096554	RS5390	791440080034
PA4716	791440067936	PA4877	791440072626	CS5007	791440026742	PA5298	791440096561	RS5391	791440080089
PA4720	791440067974	PA4878	791440072633	CS5008	791440026759	PA5299	791440096592	RS5392	791440080171
PA4723	791440068001	PA4879	791440072640	CS5009	791440026766	PA5300	791440076907	PA5393	791440080225
PA4727	791440068049	PA4881	791440072664	CS5010	791440026773	RS5301	791440076990	RS5395-FN	791440080928
PA4730	791440068070	PA4883	791440072688	CS5011	791440026780	PA5302	791440077058	PA5396	791440080935
PA4731	791440068087	PA4885	791440072701	CSC5012	791440026797	PA5303	791440077072	RS5397	791440080942
PA4732	791440068094	PA4886	791440072718	CSC5013	791440026803	RS5304	791440077102	RS5398	791440080959
PA4733	791440068100	PA4887	791440072725	CTK5028	791440026865	RS5305	791440077126	PA5399	791440080966
PA4734	791440068117	PA4888	791440072732	CTK5029	791440043237	PA5306	791440077133	PA5400	791440080973
PA4735	791440068124	PA4889	791440072749	CTK5029-M	791440079144	PA5310	791440077256	PA5401	791440080980
PA4736 FOAM	791440068131	PA4890	791440072756	CTK5029-1	791440059528	PA5311	791440077331	PA5403	791440081000



**WARNING:** These products can expose you to chemicals, including Diisononyl Phthalate, Carbon black extracts, Nickel, 1,3 Butadiene, Ethylene Oxide, Epichlorohydrin, which are known to the State of California to cause cancer, and Bisphenol-A, Ethylene Glycol, Ethylene Oxide, 1,3 Butadiene, Epichlorohydrin, which are known to the State of California to cause birth defects or other reproductive harm.

# BALDWIN TO UPC (INDIVIDUAL PARTS)

BALDWIN NUMBER	UPC NUMBER	BALDWIN NUMBER	UPC NUMBER	BALDWIN NUMBER	UPC NUMBER	BALDWIN NUMBER	UPC NUMBER	BALDWIN NUMBER	UPC NUMBER
PA5404	791440081017	RS5490	791440094659	PA5621	791440090224	PA5719	791440092792	BF5813	791440027220
PA5405	791440081024	PA5491	791440086753	PA5622	791440090231	PA5720	791440092815	BF5813-O	791440097599
PA5406-FN	791440081031	PA5492	791440086760	PA5623	791440090248	PA5721	791440092822	BF5815	791440060036
PA5407	791440081079	PA5493	791440086777	PA5624	791440090255	PA5722	791440092839	BF5816	791440066977
RS5408	791440081123	PA5494	791440086791	PA5625	791440090279	PA5723	791440092846	6017	791440027282
RS5409	791440081166	PA5495	791440086807	PA5626	791440090293	PA5725	791440092884	6020	791440027305
PA5410-FN	791440081130	PA5496	791440086838	RS5627	791440090316	PA5727	791440092914	6021	791440027312
RS5411	791440081147	PA5497	791440086845	RS5628	791440090323	PA5728	791440092921	BK6022	791440084049
PA5412	791440081161	PA5498	791440086890	PA5629	791440090330	PA5728 FOAM	791440092938	BK6023	791440084056
RS5413	791440081178	PA5499	791440086906	PA5630	791440090347	PA5729	791440092952	BK6024	791440084063
RS5414	791440081239	CA5500	791440086913	PA5631	791440090354	RS5730	791440092969	BK6025	791440084070
RS5415	791440081246	PA5503	791440086975	PA5632	791440090392	RS5731	791440092976	BK6026	791440084087
CA5416	791440081420	PA5504	791440086982	PA5633	791440090477	PA5732	791440092983	BK6027	791440084124
CA5417	791440081437	PA5505	791440087071	PA5636	791440090514	PA5733	791440093157	BK6028	791440085640
PA5418	791440081444	RS5506	791440087460	PA5637	791440090699	PA5734	791440093195	BK6029	791440085749
CA5419	791440081468	RS5507	791440087132	PA5638	791440090705	PA5735	791440093218	BK6030	791440085923
CA5420	791440081475	RS5508	791440087156	RS5641	791440091009	PA5736	791440093225	BK6031	791440085961
CA5421	791440081451	RS5509	791440087194	PA5642	791440091085	PA5738	791440093294	BK6032	791440085978
RS5422	791440081895	RS5510	791440087200	PA5644	791440091108	PA5739	791440093300	BK6033	791440086524
PA5423-FN	791440081963	PA5511	791440087248	PA5645	791440091115	RS5741	791440093324	BK6034	791440088061
RS5424	791440082151	PA5512	791440087255	PA5646	791440091122	RS5742	791440093331	BK6035	791440088078
PA5425	791440082663	CA5514	791440087293	PA5648	791440091146	RS5743	791440093348	BK6041	791440086012
PA5426	791440082887	PA5515	791440087309	PA5649	791440091245	RS5743XP	791440093355	BK6043	791440086029
PA5428	791440082878	PA5516	791440087347	PA5650	791440091276	RS5744	791440093362	BK6044	791440088412
RS5429	791440082939	RS5517	791440087491	PA5651	791440091283	RS5745	791440093379	BK6045	791440086036
RS5430	791440082946	PA5528	791440087835	PA5652	791440091290	RS5746	791440093585	BK6046	791440086043
RS5431	791440082960	PA5529	791440087842	PA5653	791440091306	RS5747	791440093386	BK6047	791440088405
RS5432	791440083035	PA5530	791440087859	PA5654	791440091320	RS5748	791440093393	BK6048	791440086050
RS5433	791440083059	PA5532	791440087934	PA5655	791440091337	RS5749	791440093409	BK6049	791440089457
RS5434	791440083493	PA5533	791440087941	PA5656	791440091399	RS5750	791440093416	BK6050	791440089464
RS5435	791440083633	RS5534	791440090361	PA5657	791440091405	PA5751	791440093430	BK6051	791440094888
PA5436	791440083639	RS5535	791440090453	PA5658	791440091412	PA5752	791440093454	BK6052	791440089471
PA5437	791440084100	RS5536	791440088757	PA5661	791440091443	PA5753	791440093522	BK6053	791440089495
RS5438	791440083370	RS5537	791440090439	PA5662	791440091450	RS5754	791440093539	BK6054	791440089501
RS5440	791440083646	RS5538	791440087996	PA5663	791440091467	PA5755	791440093546	BK6055	791440089976
RS5441	791440083653	RS5539	791440088009	PA5664	791440091474	RS5756	791440093553	BK6056	791440090095
RS5442	791440083834	RS5540	791440088016	PA5665	791440091481	PA5757	791440093591	BK6057	791440108844
RS5443	791440083851	RS5541	791440088023	PA5666	791440091498	RS5758	791440093607	BK6058	791440090651
PA5445	791440083714	RS5543	791440089730	PA5667	791440091504	RS5759	791440093614	BK6059	791440090675
PA5446	791440083721	RS5544	791440089747	PA5668	791440091511	RS5761	791440093638	BK6060	791440091269
RS5447	791440083738	PA5545	791440088085	PA5669	791440091566	PA5762	791440093645	BK6061	791440091344
RS5448	791440083745	RS5546	791440088139	RS5670	791440091573	PA5763	791440093713	BK6062	791440091351
RS5449	791440085909	RS5547	791440088771	RS5672	791440091610	PA5764	791440093720	BK6063	791440091368
CA5450	791440094772	RS5548	791440088788	RS5673	791440091627	PA5765	791440093751	BK6064	791440091597
PA5451	791440089402	RS5549	791440088795	PA5674	791440091634	PA5766	791440093805	BK6065	791440091726
RS5452	791440085732	RS5550	791440088764	RS5675	791440091641	RS5767	791440093812	BK6066	791440091733
RS5453	791440085756	PA5552	791440088344	RS5676	791440091658	PA5768	791440093836	BK6067	791440091955
PA5454	791440085664	PA5554	791440088368	PA5678	791440091719	PA5770	791440094451	BK6068	791440109445
RS5455	791440085671	PA5556	791440088382	PA5679	791440091749	PA5771	791440094468	BK6069	791440109490
RS5456	791440085688	PA5557	791440088399	PA5680	791440091775	PA5772	791440094475	BK6070	791440090860
PA5457	791440085787	RS5558	791440088450	PA5681	791440091791	PA5773	791440094482	BK6071	791440092044
RS5458	791440085831	RS5559	791440088641	PA5682	791440091832	PA5774	791440094505	BK6072	791440093119
RS5459	791440085930	PA5561	791440088566	PA5683	791440091924	RS5776	791440094550	BK6073	791440093126
RS5460	791440085947	PA5562	791440088573	RS5684	791440092136	PA5777	791440094574	BK6074	791440093133
RS5461	791440086111	PA5563	791440088597	RS5685	791440092143	PA5778	791440094581	BK6075	791440093140
RS5462	791440086128	BA5566	791440088665	PA5686	791440092150	PA5779	791440094598	BK6076	791440092464
PA5463	791440087958	PA5573	791440089013	PA5687	791440092167	PA5780	791440094628	BK6077	791440092471
PA5464	791440086116	PA5574	791440089020	PA5688	791440092174	PA5781	791440094635	BK6078	791440092488
PA5465	791440086227	PA5580	791440089761	PA5689	791440092181	RS5782	791440094673	BK6079	791440092495
PA5467	791440086258	PA5581	791440089778	PA5690	791440092198	RS5783	791440094680	BK6080	791440092501
PA5468	791440092129	PA5583	791440089792	PA5691	791440092204	RS5784	791440094741	BK6081	791440093782
RS5470	791440086340	PA5584	791440089808	RS5692	791440092211	PA5785	791440094717	BK6082	791440109506
RS5471	791440086357	PA5585	791440089821	RS5693	791440092228	PA5786	791440094722	BK6083	791440109315
RS5472	791440086364	PA5586	791440089938	PA5694	791440092235	PA5787	791440094734	BK6085	791440109313
PA5473	791440086302	BF5587-D	791440076488	PA5695	791440092242	CA5788	791440094789	BK6086	791440104280
PA5475	791440086319	PA5588	791440089822	PA5696	791440092259	CA5789	791440094819	BK6087	791440104297
PA5476	791440086326	PA5589	791440089839	PA5697	791440092266	CA5790	791440094826	BK6088	791440109322
PA5477	791440086333	RS5591XP	791440098336	PA5698	791440092327	CA5791	791440094833	BK6089	791440108646
RS5478-FN	791440086630	BA5592	791440090002	PA5699	791440092334	PA5792	791440094840	BK6090	791440108127
RS5479	791440086647	RS5593XP	791440098343	PA5700	791440092426	CA5793	791440094857	BK6092	791440108677
PA5482	791440086449	PA5594	791440090033	RS5707	791440092617	PA5796	791440094895	BK6093	791440108943
RS5483	791440086500	PA5597	791440090057	RS5708	791440092624	PA5797	791440094901	BK6094	791440109124
RS5484	791440086517	PA5598	791440090064	PA5710	791440092693	PA5798	791440094918	BK6095	791440111271
PA5485-FN	791440086531	PA5599	791440090071	PA5711	791440092709	BF5800	791440027190	BK6096	791440111288
PA5486	791440086579	PA5618	791440090194	PA5712	791440092716	BF5801	791440027183	BK6097	791440111295
PA5487	791440086548	PA5619	791440090200	PA5713	791440092723	BF5810	791440027206	BK6098	791440111301
RS5489	791440094642	PA5620	791440090217	PA5716	791440092761	BF5812	791440027213	BK6099	791440111318



**WARNING:** These products can expose you to chemicals, including Diisononyl Phthalate, Carbon black extracts, Nickel, 1,3 Butadiene, Ethylene Oxide, Epichlorohydrin, which are known to the State of California to cause cancer, and Bisphenol-A, Ethylene Glycol, Ethylene Oxide, 1,3 Butadiene, Epichlorohydrin, which are known to the State of California to cause birth defects or other reproductive harm.

# BALDWIN TO UPC (INDIVIDUAL PARTS)

BALDWIN NUMBER	UPC NUMBER	BALDWIN NUMBER	UPC NUMBER	BALDWIN NUMBER	UPC NUMBER	BALDWIN NUMBER	UPC NUMBER	BALDWIN NUMBER	UPC NUMBER
BK6102	791440116221	BK6685	791440063990	B7031	791440038851	BD7169	791440058668	B7281	791440071995
BK6103	791440116238	BK6686	791440063020	B7033	791440054233	B7170	791440058750	B7283	791440072015
BK6104	791440116245	BK6691	791440067196	B7034	791440054240	B7171	791440058767	B7285	791440072039
BK6105	791440116269	BK6693	791440066045	P7035	791440038110	B7172	791440059641	B7286	791440072046
BK6106	791440116276	BK6694	791440062566	B7039	791440037854	BC7173	791440059412	B7287	791440072053
BK6107	791440116283	BK6696	791440061057	B7042	791440038875	B7174-MPG	791440061262	B7289	791440072077
BK6108	791440116252	BK6700	791440028241	B7044	791440038387	B7175	791440058408	B7290	791440072084
BK6110	791440109735	BK6702	791440045972	B7045	791440043671	BD7176	791440060142	B7291	791440072091
BK6112	791440109858	BK6704	791440056138	B7047	791440038066	B7177	791440060210	B7292	791440072107
BK6114	791440116160	BK6705	791440056145	B7049	791440044999	P7178	791440060289	B7293	791440072114
BK6115	791440116290	BK6710	791440028265	P7050	791440043718	B7179	791440060296	B7294	791440072121
BK6116	791440116030	BK6720	791440028296	B7051	791440037625	B7180	791440058552	B7295	791440072138
BK6117	791440110533	BK6721	791440028302	P7052	791440045712	B7181	791440060739	B7298	791440074705
BK6118	791440110649	BK6723	791440028326	P7053	791440037588	B7182	791440060845	B7299	791440066755
BK6120	791440116306	BK6764	791440042254	P7058	791440038226	P7183	791440061064	P7303	791440074743
BK6121	791440115958	BK6780	791440028333	P7059	791440038233	P7185	791440061477	P7305	791440075030
BK6124	791440116771	BK6799	791440046955	P7081	791440043145	BC7186 KIT	791440061613	B7306	791440076297
BK6138	791440105447	BK6903	791440064225	B7082	791440043282	B7187	791440061736	P7308	791440076464
BK6140	791440106789	BK6923	791440078369	P7083	791440043329	P7188	791440061941	BD7309	791440058941
BK6161	791440086661	BK6930	791440080157	B7084	791440043350	B7189	791440060852	BD7310	791440060685
BK6167	791440087699	BK6931	791440080164	B7089	791440045019	P7190	791440061972	B7311-MPG	791440076532
BK6181	791440079335	BK6933	791440080201	B7091	791440045217	B7191	791440062047	P7312	791440076549
BK6183	791440072510	BK6934	791440066502	P7092	791440045552	P7192	791440062078	P7313	791440076570
BK6184	791440067455	BK6942	791440083295	P7093	791440045569	P7193	791440062092	B7314	791440076747
BK6185	791440076952	BK6943	791440083387	BD7095	791440046061	BC7194	791440062146	BT7316	791440076914
BK6186	791440077164	BK6944	791440083394	B7097	791440046610	P7195	791440062214	BD7317	791440076969
BK6187	791440078208	BK6945	791440083400	B7099	791440047020	P7196	791440062399	B7318	791440077041
BK6189	791440065918	BK6946	791440083417	P7102	791440047082	B7197	791440064034	P7319	791440077089
BK6195	791440056633	BK6947	791440083424	P7103	791440047556	P7199	791440062603	B7320	791440077171
BK6196	791440056640	BK6948	791440083431	P7104	791440047587	B7215	791440062993	P7321	791440077263
BK6215	791440062030	BK6949	791440083448	BD7105	791440047594	B7216	791440063105	B7322	791440077324
BK6287	791440052338	BK6950	791440083455	P7106	791440047600	B7217	791440063112	B7324	791440077676
BK6299	791440079205	BK6951	791440083462	P7107	791440047617	B7219	791440063761	BD7325	791440077744
BK6341	791440062979	BK6952	791440084025	B7113	791440047846	B7220	791440063877	BC7326	791440078529
BK6375	791440046450	BK6953	791440083806	P7114	791440048263	B7221	791440063907	B7327	791440078567
BK6376	791440046542	BK6954	791440083813	B7116	791440048720	B7222	791440063914	B7328	791440078659
BK6380	791440027725	BK6955	791440083820	B7117	791440048829	B7223	791440064164	P7329	791440078963
BK6426	791440077843	BK6956	791440085800	B7119	791440050297	B7224	791440064430	P7330	791440079069
BK6429	791440079410	BK6980	791440081529	B7121	791440050525	B7225	791440064478	PT7332	791440079113
BK6438	791440086654	BK6981	791440081536	B7124	791440051300	B7227	791440064621	B7333	791440079830
BK6440	791440066120	BK6982	791440081543	B7125	791440051393	BC7228	791440064645	B7334	791440080058
BK6444	791440077928	BK6983	791440081734	P7126	791440051324	B7229	791440064683	B7335-MPG	791440080041
BK6451	791440077935	BK6984	791440081550	P7127	791440051478	P7230	791440064850	P7336 KIT	791440080102
BK6452	791440077942	BK6985	791440083783	B7128	791440052086	B7231	791440064881	P7337	791440080263
BK6457	791440087224	BK6986	791440083790	V7129-C	791440052529	P7232	791440064942	P7338	791440080287
BK6463	791440078147	BK6987	791440083998	B7130	791440052604	P7233	791440065017	BT7349	791440076266
BK6464	791440078598	BK6988	791440086173	B7131	791440052611	P7235	791440065086	B7350	791440084018
BK6467	791440064355	BK6993	791440080324	P7132	791440053120	BT7237	791440087064	B7351-MPG	791440085510
BK6561	791440028081	BK6996	791440087095	BK6996	791440054325	B7238	791440065383	B7352	791440085596
BK6562	791440028098	BK6997	791440084117	B7135	791440054363	B7239	791440065475	BD7355	791440085794
BK6579	791440046252	P7000 KIT	791440038134	P7136	791440054608	B7240	791440065499	B7356	791440085848
BK6583	791440047211	B7001	791440048195	P7137	791440054615	B7241	791440065680	B7357	791440085886
BK6595	791440054752	P7003	791440028487	P7138	791440054622	BC7242	791440066229	B7359	791440085916
BK6600	791440028128	B7004	791440028494	B7139	791440054677	B7243	791440066636	B7360	791440086135
BK6601	791440028135	B7005	791440028500	BD7141	791440055094	B7245	791440066779	B7361	791440086180
BK6610	791440028203	P7007	791440038813	B7142	791440055124	B7246	791440067035	B7362	791440086234
BK6613	791440077119	B7009	791440028531	B7143	791440055810	P7247	791440067165	B7363	791440086371
BK6619	791440045538	B7010	791440028548	B7144	791440055957	B7249-MPG	791440067219	P7364	791440086388
BK6634	791440053236	B7011	791440028555	P7145	791440056619	BD7250	791440067387	P7365	791440086456
BK6649	791440079779	P7012	791440038820	B7151	791440056848	BD7252	791440067394	B7367	791440086555
BK6650	791440085657	P7013	791440042568	B7152	791440056855	P7255	791440071735	P7368	791440086623
BK6652	791440082175	B7014	791440028562	BD7153	791440056886	P7256	791440071742	B7370	791440086920
BK6653	791440083110	P7015	791440046627	BD7154	791440056893	P7259	791440071773	B7372	791440087187
BK6654	791440077966	P7016	791440046726	B7155	791440056930	P7260	791440071780	B7373	791440087316
BK6656	791440082953	P7017	791440046733	B7156	791440057494	P7261	791440071797	B7375	791440087385
BK6657	791440083127	B7018	791440028579	B7157	791440057760	P7263	791440071810	B7376	791440087392
BK6658	791440076495	B7019	791440028586	BD7158	791440057852	P7264	791440071827	B7377	791440087408
BK6659	791440076501	B7020	791440028593	BD7159	791440057951	P7267	791440071858	B7378	791440087422
BK6661	791440076365	P7021	791440046474	BD7160	791440057968	P7268	791440071865	B7379	791440087444
BK6662	791440076099	B7022	791440028609	B7161	791440058125	P7269	791440071872	P7380	791440087729
BK6663	791440076037	B7023	791440028616	B7162	791440058002	B7271	791440071896	B7383	791440087538
BK6665	791440072596	B7024	791440028623	B7163	791440058019	B7273	791440071919	B7384	791440087545
BK6666	791440077904	B7025	791440028630	B7164	791440058026	B7274	791440071926	B7385	791440087552
BK6670	791440067103	BD7026-MPG	791440048706	B7165	791440058057	B7275	791440071933	B7386	791440087569
BK6675	791440065956	B7028	791440037618	BD7166	791440058149	B7276	791440071940	B7387	791440087576
BK6676	791440065963	BD7029	791440051225	B7167	791440058446	B7277	791440071957	B7388	791440088146
BK6683	791440063884	B7030	791440040243	BD7168	791440058644	B7280	791440071988	B7389	791440088207



**WARNING:** These products can expose you to chemicals, including Diisononyl Phthalate, Carbon black extracts, Nickel, 1,3 Butadiene, Ethylene Oxide, Epichlorohydrin, which are known to the State of California to cause cancer, and Bisphenol-A, Ethylene Glycol, Ethylene Oxide, 1,3 Butadiene, Epichlorohydrin, which are known to the State of California to cause birth defects or other reproductive harm.

# BALDWIN TO UPC (INDIVIDUAL PARTS)

BALDWIN NUMBER	UPC NUMBER	BALDWIN NUMBER	UPC NUMBER	BALDWIN NUMBER	UPC NUMBER	BALDWIN NUMBER	UPC NUMBER	BALDWIN NUMBER	UPC NUMBER
B7390	791440088238	P7493	791440089952	P7615	791440050518	PF7734	791440061866	PF7832	791440069466
B7393	791440088252	P7494	791440090088	PT7616	791440050600	PF7735	791440061927	PF7833	791440069473
BC7394	791440092419	P7495	791440090415	PT7617	791440050617	BF7736	791440062276	PF7834	791440069480
B7395	791440092549	B7496	791440090538	PF7618	791440050907	BF7736-K1	791440069664	PF7836	791440069503
B7396	791440077393	B7497	791440090965	BF7619	791440050969	BF7742	791440062658	BF7837	791440069510
B7397	791440079466	B7499	791440091689	BF7623	791440051492	PF7744	791440062801	BF7838	791440069527
P7398	791440080348	F7500	791440028715	BF7624	791440051669	BF7745-D	791440066472	BF7839	791440069534
P7399	791440080355	P7500	791440028722	BF7625	791440051775	BF7746-D	791440066465	BF7840	791440069541
P7400	791440080362	B7501	791440091887	BF7626	791440052031	BF7747	791440063204	BF7841	791440069558
B7401	791440080379	P7502	791440091993	PF7627	791440052048	PF7748	791440063211	BF7842	791440069565
B7402	791440080614	B7503	791440092112	BF7628	791440052222	PF7749	791440063228	BF7843	791440069572
B7403	791440080621	BD7504	791440092273	BF7629	791440052277	BF7750	791440063273	BF7844	791440069589
P7406	791440080911	P7505	791440088290	BF7630	791440052291	PF7751	791440062955	BF7845	791440069596
B7407	791440081055	B7506	791440092280	BF7631	791440052321	BF7753	791440063679	BF7847	791440069619
P7408	791440081185	B7507	791440092402	BF7632	791440052352	PF7755	791440063270	BF7848	791440069626
B7409	791440081192	P7508	791440092587	BF7633	791440053113	BF7756	791440063730	BF7849	791440069633
B7410	791440081208	BD7509	791440092686	BF7634	791440053298	PF7758	791440063829	BF7850	791440069640
P7411	791440081222	BF7635	791440093232	BF7635	791440053373	BF7759	791440064037	BF7851	791440069657
P7413	791440081277	B7511	791440093263	B7637	791440074699	BF7760	791440063969	PF7852 KIT	791440072497
P7414	791440081284	P7512	791440093737	BF7637	791440086159	BF7761	791440064843	BF7853	791440072534
P7415	791440081369	BF7513	791440093744	BF7639	791440054431	BF7762	791440064157	BF7855	791440074576
B7416	791440081413	P7514	791440093768	BF7639-D	791440054827	BF7763	791440064287	BF7857	791440074590
P7417	791440081987	BF7515	791440093829	BF7640	791440056251	BF7765	791440064485	BF7859	791440074613
P7418	791440081611	B7516	791440094413	BF7641	791440052437	BF7766	791440065154	BF7860	791440074620
B7419	791440081789	P7517	791440094437	BF7644	791440052741	PF7767	791440065543	BF7861	791440074637
B7420	791440081918	BF7519	791440028760	BF7645	791440052628	BF7768	791440065871	BF7863	791440074644
B7422	791440081925	BF7522	791440048911	BF7648	791440053069	BF7769	791440066144	BF7864	791440074651
P7423	791440081949	BF7528	791440028821	BF7653	791440056268	PF7770	791440066168	BF7865	791440074668
B7424	791440082090	BF7529	791440028838	PF7655	791440057487	BF7771	791440066274	BF7866	791440074675
P7426	791440082106	BF7531	791440038882	BF7656	791440054462	BF7772	791440066595	PF7869	791440074484
P7427	791440082113	BF7532	791440046559	BF7657	791440055032	BF7773	791440066694	BF7870	791440074491
B7428	791440082168	BF7534	791440041530	BF7658	791440054905	BF7774	791440066704	BF7871	791440074507
B7429	791440082281	BF7535	791440045248	BF7659	791440054912	BF7775	791440066853	PF7872	791440074514
B7430	791440082274	BF7537	791440054264	BF7661	791440054936	BF7776	791440066960	PF7873	791440074521
B7431	791440082304	BF7538	791440028852	BF7663	791440055497	PF7777	791440067004	PF7874	791440074538
B7432	791440082311	BF7541	791440037984	BF7664	791440054981	BF7778	791440067011	PF7875	791440074545
B7433	791440082328	BF7544	791440037960	BF7666	791440055056	PF7779	791440067081	PF7876	791440074552
B7434	791440082441	PF7545	791440043664	BF7667	791440055117	BF7780	791440067140	PF7877	791440074569
B7435	791440082625	BF7546	791440037885	BF7668	791440057500	PF7782	791440067486	PF7878	791440075047
P7436	791440082717	PF7549	791440037632	BF7669	791440055858	BF7783-D	791440067493	BF7879	791440075665
P7437	791440082724	PF7550	791440037687	BF7670	791440055940	BF7784-D	791440067509	BF7880	791440071889
P7438	791440083769	PF7551	791440037694	BF7671	791440056121	BF7785-D	791440067516	BF7881	791440075924
B7440	791440083819	BF7552	791440037748	BF7672-D	791440066403	BF7786-D	791440067530	PF7882	791440075917
B7441	791440083854	PF7553	791440038240	BF7673-D	791440066434	PF7787	791440069299	BF7883	791440076280
P7442	791440083028	PF7554	791440038257	BF7674-D	791440066441	PF7788	791440069305	BF7886	791440076433
B7443	791440083202	PF7556	791440038325	BF7675-D	791440066427	BF7798-O	791440110410	BF7888	791440076860
B7444	791440083219	BF7557	791440028869	BF7677-D	791440066458	BF7798-SP	791440076723	PF7889	791440076600
B7445	791440083233	BF7558	791440028883	PF7678	791440054578	PF7799	791440064768	PF7889-10	791440076617
B7446	791440083264	BF7559	791440038349	BF7679-D	791440063937	BF7800	791440064775	PF7889-30	791440076624
B7449	791440083950	BF7571	791440041295	PF7680	791440057036	BF7801	791440064782	PF7890	791440076631
P7450	791440083301	PF7572	791440042537	BF7681-D	791440066380	BF7802	791440064799	PF7890-10	791440076648
B7451	791440083318	BF7576	791440042766	BF7682-D	791440066410	BF7803	791440064793	PF7890-30	791440076655
B7452	791440083363	B7577	791440028906	BF7683	791440059658	BF7804	791440064980	BF7892	791440076884
B7453	791440083486	BF7579	791440042773	B7685	791440058392	BF7805	791440064997	PF7894	791440077027
P7454	791440083585	BF7580	791440042780	BF7686	791440058507	BF7806	791440065000	PF7895	791440077034
P7455	791440083660	BF7584	791440043138	PF7687	791440058521	BF7806-O	791440110397	PF7896	791440077096
BC7456 KIT	791440083837	B7585	791440043275	BF7690	791440058576	BF7807	791440065024	BF7898-D	791440077157
B7457	791440083806	BF7586	791440043305	BF7691	791440058666	BF7808	791440065031	PF7899	791440077270
B7458	791440083813	BF7587	791440043312	BF7693	791440058897	BF7809	791440065079	PF7900	791440077287
B7459	791440083820	PF7588	791440043336	BF7695	791440059283	PF7812 KIT	791440065130	BF7903	791440077379
B7461	791440083849	BF7591-D	791440045521	BF7696	791440059665	BF7813	791440065314	BF7904-D	791440077386
B7462	791440083852	PF7592	791440045583	BF7697	791440059917	BF7814	791440065352	BF7905-D	791440077416
B7466	791440083868	BF7593	791440046122	PF7698	791440059900	BF7815	791440067233	BF7906-D	791440077423
B7467	791440083870	PF7594	791440046283	BF7699-D	791440066489	PF7816	791440069312	BF7907	791440077430
B7468	791440083879	PF7595	791440046290	B7700	791440066830	PF7817	791440069329	BF7908	791440077553
B7469	791440083876	PF7596	791440046412	BF7711	791440060715	BF7818	791440069336	BF7909	791440077560
B7474	791440083832	PF7597	791440046535	BF7713	791440060470	PF7819	791440069343	PF7910	791440077584
B7477	791440083863	BF7598	791440047570	PF7715	791440060494	PF7820	791440069350	BF7911	791440077980
B7483	791440083931	B7600	791440060500	BF7716	791440060650	BF7821	791440069367	BF7912	791440078130
BC7485	791440089051	B7600-SS	791440050433	BF7717	791440060517	PF7822	791440069374	BF7913	791440078154
B7486	791440089143	BF7602	791440047662	PF7718	791440060647	PF7823	791440069381	PF7914	791440078406
B7487	791440089150	BF7606	791440047822	BF7719	791440061088	BF7824	791440069398	BF7915	791440078413
P7488	791440089204	P7607	791440051676	BF7720	791440061101	PF7825	791440069404	PF7916	791440078536
P7489	791440089211	BF7608	791440048942	BF7721	791440061132	PF7826	791440069411	PF7917	791440078550
P7490	791440089334	BF7612	791440050457	BF7725	791440061163	PF7828	791440069428	BF7919	791440078819
B7491	791440089341	BF7613	791440050464	BF7726	791440061408	PF7829	791440069435	BF7921	791440078901
P7492	791440089860	BF7614	791440050501	PF7733	791440061859	PF7830	791440069442	BF7922	791440079007



**WARNING:** These products can expose you to chemicals, including Diisononyl Phthalate, Carbon black extracts, Nickel, 1,3 Butadiene, Ethylene Glycol, Epichlorohydrin, which are known to the State of California to cause cancer, and Bisphenol-A, Ethylene Glycol, Ethylene Oxide, 1,3 Butadiene, Epichlorohydrin, which are known to the State of California to cause birth defects or other reproductive harm.

# BALDWIN TO UPC (INDIVIDUAL PARTS)

BALDWIN NUMBER	UPC NUMBER	BALDWIN NUMBER	UPC NUMBER	BALDWIN NUMBER	UPC NUMBER	BALDWIN NUMBER	UPC NUMBER
BF7923	791440079052	BT8304	791440029095	PT8414-MPG	791440055001	PT8496-MPG	791440062788
BF7924	791440079250	PT8305	791440029101	BT8415	791440055889	BT8497-MPG	791440062856
BF7925	791440079397	PT8306-10	791440029118	BT8416	791440055100	PT8498	791440062917
FD7926	791440079380	PT8306-25	791440029125	BT8417	791440055872	BT8499	791440063006
BF7927	791440079151	BT8307-MPG	791440030466	BT8418	791440055614	BT8501-MPG	791440063051
PF7928	791440079533	BT8308-MPG	791440030473	PT8419	7914400556190	BT8502	791440063099
BF7929 KIT	791440079540	BT8308-MPG KIT	791440051096	BT8420	7914400556985	BT8503-MPG	791440063167
PF7930	791440079687	BT8309-MPG	791440030480	BT8421-MPG	791440055717	BT8504	791440063174
BF7931	791440079847	BT8310-MPG	791440030497	BT8422-MPG	7914400557524	BT8505	791440063617
BF7932	791440079854	BT8312	791440029132	BT8423	7914400557531	PT8506-MPG	791440063525
PF7934 KIT	791440080133	BT8314	791440029149	BT8425	7914400557869	PT8507-MPG	791440063532
PF7935	791440080218	BT8316-MPG	791440038905	BT8426-MPG	7914400557937	BT8509-MPG	791440063600
PF7936	791440080331	PT8318-MPG	791440029156	PT8427	7914400558170	BT8510-MPG	791440063662
BF7937	791440080393	PT8319	791440043152	BT8428-MPG	7914400558248	PT8511	791440065529
PF7938	791440080638	BT8320	791440029163	BT8429	7914400558316	PT8512	791440064836
PF7939	791440080850	BT8323	791440038912	BT8432-MPG	7914400558569	PT8517-MPG	791440066250
BF7940	791440080867	BT8328	791440038080	PT8433-MPG	7914400558583	PT8519-MPG	791440065147
BF7941	791440080874	PT8329	791440042926	PT8435-MPG	7914400558798	OV8700	791440057326
BF7942	791440080904	PT8330-MPG	791440038943	PT8436	7914400558804	OV8701	791440057333
BF7943	791440081154	PT8331-MPG	791440038141	BT8437	7914400558811	OS8703	791440057357
BF7944	791440081260	BT8333	791440038950	BT8439-MPG	7914400559061	OS8704	791440057364
BF7945	791440081406	PT8334	791440043725	BT8440-MPG	7914400559030	OS8707	791440066359
PF7946	791440081499	PT8335	791440043176	PT8441	7914400559177	OS8709	791440057388
PF7947	791440081598	PT8338	791440043657	PT8442	7914400559382	OB8711	791440055353
BF7948	791440081635	PT8339	791440045897	BT8443	7914400559504	OB8712	791440055360
BF7949-D	791440081659	PT8341	791440043169	BT8444	7914400559610	OB8720	791440055445
BF7949-DM	791440083332	PT8344	791440037571	BT8445	7914400559788	OB8721	791440055452
BF7950-D	791440081666	PT8345	791440038073	PT8446-MPG	7914400559795	OB8722	791440055469
BF7951-D	791440081741	BT8347	791440038295	PT8447-MPG	7914400559870	OB8724	791440055483
BF7952-D	791440081758	PT8350	791440039353	P8448	7914400559887	OV8728	791440081642
BF7954-D	791440081772	PT8351	791440041196	BT8449	7914400600005	OB8731	791440057067
BF7955	791440081901	PT8352	791440041189	BT8449-10	791440060012	OB8732	791440057074
BF7956-D	791440081932	PT8353	791440041202	BT8450	791440060104	OB8741	791440057135
BF7957	791440082182	PT8354	791440042490	PT8451-MPG	791440060135	OB8742	791440057142
BF7958	791440082403	PT8355	791440042506	BT8452	791440060159	OB8743	791440057128
BF7959	791440082410	PT8356	791440043091	PT8453	791440060340	OB8744	791440057173
BF7960	791440082427	BT8357	791440043206	PT8455-MPG	791440060616	OB8745	791440057180
BF7961	791440082434	PT8359	791440043374	PT8456-MPG	791440060692	OP8750	791440083530
BF7962	791440082588	PT8361	791440044968	BT8457-MPG	791440060753	OP8751	791440083547
BF7963	791440082595	PT8363	791440045095	PT8458-MPG	791440060784	OP8752	791440083554
BF7964-D	791440082601	PT8366	791440045231	BT8459	791440060883	OP8753	791440083561
BF7965	791440082755	BT8368	791440045491	BT8460	791440062931	OB8771	791440057197
BF7966	791440082823	PT8370-MPG	791440047112	PT8461	791440063976	OB8772	791440057203
BF7967	791440082915	PT8371-MPG	791440047129	PT8462-MPG	791440061415	OB8773	791440057395
BF7968	791440083257	PT8372	791440047655	BT8463-MPG	791440061552	CFB8784	791440092945
BF7968-O	791440097629	PT8375-MPG	791440048140	BT8464	791440061569	BT8800-MPG	791440060548
BF7969	791440083684	PT8376-MPG	791440048157	BT8465	791440061576	BT8801-MPG	791440060555
BF7970	791440085862	PT8378-MPG	791440048676	BT8466-MPG	791440061583	BT8802-MPG	791440029194
BF7971-D	791440085349	PT8380	791440051805	PT8467	791440061590	BT8803-MPG	791440029200
BF7971-DM	791440083356	BT8381	791440049680	PT8468	791440061439	BT8805-MPG	791440057913
BF7972	791440083752	PT8382	791440050105	PT8470	791440061460	BT8812-MPG	791440029231
PF7973	791440083981	PT8383	791440050129	BT8471-MPG	791440061484	BT8813-MPG	791440029248
PF7974	791440085503	BT8384	791440050334	BT8472	791440061491	BT8830	791440042995
PF7975	791440085589	PT8385	791440050532	BT8473	791440061507	BT8831	791440043015
BF7976	791440085695	BT8386	791440050594	BT8474	791440061514	BT8832	791440043008
PF7977	791440077690	PT8387	791440050686	BT8475	791440061521	BT8833	791440058163
PF7978	791440085763	PT8388	791440050693	BT8475-MPG	791440073548	BT8834-MPG	791440062320
BF7979	791440085879	BT8391	791440050945	BT8476	791440061538	BT8840-MPG	791440038394
PF7980	791440085954	PT8392	791440051003	BT8476-MPG	791440061596	BT8841-MPG	791440046917
BF7981	791440086005	BT8393	791440051454	BT8477	791440061545	BT8842-MPG	791440051973
PF7982	791440086210	PT8394-MPG	791440051553	BT8477-MPG	791440073555	BT8843-MPG	791440052000
PF7983	791440086074	PT8395	791440051621	PT8478	791440061606	BT8844	791440042636
PF7984	791440086081	PT8396	791440051638	PT8479	791440061637	BT8845	791440042629
BF7985	791440086104	BT8397-MPG	791440051850	PT8480	791440061644	BT8846	791440045934
PF7986	791440086203	BT8398-MPG	791440051904	PT8481	791440062634	BT8847	791440059634
BF7987	791440086241	PT8400-MPG	791440052079	PT8484	791440061897	BT8848-MPG	791440051652
BF7988	791440086265	BT8401-MPG	791440052123	PT8485	791440062054	BT8849-MPG	791440055735
BF7989-D	791440086289	PT8402-MPG	791440052178	PT8486	791440062108	BT8850-MPG	791440038967
BF7990	791440086432	BT8403-MPG	791440052192	BT8487	791440062122	BT8851-MPG	791440039322
BF7993	791440086487	PT8404-MPG	791440052284	BT8488	791440062139	BT8852-MPG	791440045941
PF7994	791440086609	PT8407	791440053076	PT8489	791440062160	BT8853-MPG	791440053304
BF7995	791440086616	PT8408	791440053083	PT8490-MPG	791440062221	BT8855-MPG	791440055742
BF7996	791440086678	BT8409	791440053199	PT8491	791440062283	BT8856-MPG	791440059573
BF7997	791440086784	PT8410	791440053817	PT8492	791440062290	BT8861	791440038981
BF7998	791440086821	PT8411	7914400538194	BT8493	791440062375	BT8862	791440038400
BT8301	791440029071	BT8412	791440054424	PT8494	791440062504	BT8863	791440038417
BT8302	791440038899	BT8413	791440055896	PT8495-MPG	791440062665	BT8870-MPG	791440046429
BT8873	791440046511						
BT8874-MPG	791440046443						
BT8875-MPG	791440046566						
BT8876-MPG	791440048775						
BT8877-MPG	791440055759						
BT8878-MPG	791440055766						
BT8879-MPG	791440055773						
BT8880-MPG	791440056183						
PT8883	791440064935						
PT8884-MPG	791440065093						
PT8885-MPG	791440065162						
PT8886-MPG	791440065191						
PT8887	791440065468						
PT8888	791440065505						
PT8889	791440065604						
BT8890-MPG	791440065697						
PT8891-MPG	791440065734						
PT8892-MPG	791440065741						
PT8893	791440065864						
PT8894-MPG	791440066069						
PT8895-MPG	791440066076						
PT8896	791440066113						
PT8897-MPG	791440066212						
BT8898	791440066236						
BT8899	791440066243						
BT8900	791440066304						
BT8901-MPG	791440066496						
BT8902	791440066649						
BT8903	791440066663						
BT8904-MPG	791440066670						
BT8905	791440067028						
BT8906	791440067127						
PT8907-MPG	791440067158						
BT8908	791440067226						
PT8909	791440067240						
BT8910-MPG	791440067318						
BT8911-MPG	791440067301						
PT8912	791440067400						
BT8913-MPG	791440069671						
BT8914	791440069725						
BT8915	791440069732						
BT8916	791440069749						
BT8917	791440069756						
BT8918	791440069763						
BT8919	791440069770						
BT8920	791440069787						
BT8921	791440069794						
BT8922	791440069800						
BT8926	791440069848						
BT8927	791440069855						
BT8928	791440069862						
BT8930	791440069886						
BT8931	791440069893						
BT8935	791440069930						
BT8937	791440069954						
PT8938-MPG	791440069961						
PT8939-MPG	791440069978						
PT							

# BALDWIN TO UPC (INDIVIDUAL PARTS)

BALDWIN NUMBER	UPC NUMBER	BALDWIN NUMBER	UPC NUMBER	BALDWIN NUMBER	UPC NUMBER	BALDWIN NUMBER	UPC NUMBER	BALDWIN NUMBER	UPC NUMBER
PT8970-MPG	791440070295	H9097	791440029811	PT9222	791440071599	BT9346-MPG	791440076815	PT9424	791440086968
PT8971-MPG	791440070301	H9103	791440029828	PT9223	791440071605	BT9347-MPG	791440076822	PT9425-MPG	791440087019
PT8972-MPG	791440070318	H9107	791440029835	PT9224	791440071612	PT9348-MPG	791440076839	PT9426	791440087033
PT8974-MPG	791440070332	H9108	791440029842	PT9225	791440071629	BT9349-MPG	791440076846	PT9427-MPG	791440087101
PT8975-MPG	791440070349	H9110	791440029859	PT9227	791440071643	PT9350-MPG	791440076976	PT9429-MPG	791440087118
PT8978-MPG	791440070370	H9111	791440029866	PT9228	791440071650	PT9351-MPG	791440076983	PT9430-MPG	791440087477
PT8980-MPG	791440070394	H9112	791440029873	H9231	791440071681	PT9352	791440077317	PT9432-MPG	791440087910
PT8981-MPG	791440070400	H9113	791440029880	PT9237	791440074019	BT9353-MPG	791440077409	BT9433	791440087972
PT8982-MPG	791440070417	H9114	791440029897	PT9238	791440074026	PT9354-MPG	791440077485	PT9434	791440088092
PT8984-MPG	791440070431	H9123	791440029903	PT9239	791440074033	PT9355-MPG	791440077577	PT9435-MPG	791440088184
PT8985-MPG	791440070448	PT9127	791440070646	PT9240	791440074040	BT9356	791440077652	BT9436-MPG	791440089136
PT8986-MPG	791440070455	PT9129	791440070660	PT9242	791440074064	PT9357	791440077852	PT9437	791440089504
PT8987-MPG	791440070462	PT9131	791440070684	PT9244	791440074088	BT9358	791440077911	BT9439	791440089716
PT8989-MPG	791440070486	PT9132	791440070691	PT9245	791440074095	PT9359-MPG	791440078017	BT9440	791440090378
PT8990-MPG	791440070493	PT9134	791440070714	PT9247	791440074118	BT9360	791440078024	PT9441-MPG	791440090668
PT8991-MPG	791440070509	PT9135	791440070721	PT9248	791440074125	PT9361	791440078031	PT9442-MPG	791440091023
PT8992-MPG	791440070516	PT9136	791440070738	PT9250	791440074149	BT9362-MPG	791440078109	PT9443	791440091054
PT8993-MPG	791440070523	PT9137	791440070745	PT9251	791440074156	BT9363-MPG	791440078116	PT9444-MPG	791440091061
PT8994-MPG	791440070530	PT9139	791440070769	PT9254	791440074187	BT9364	791440078390	PT9445-MPG	791440091153
PT8995-MPG	791440070547	PT9140	791440070776	PT9255	791440074194	BT9365-MPG	791440078420	PT9446	791440091160
PT8996-MPG	791440070554	PT9142	791440070790	PT9256-MPG	791440074200	BT9366-MPG	791440078437	PT9447	791440091177
PT8997-MPG	791440070561	PT9143	791440070806	PT9257	791440074217	BT9367-MPG	791440078451	PT9448	791440091184
PT8998-MPG	791440070578	PT9144	791440070813	PT9258	791440074224	BT9368-MPG	791440078505	PT9449	791440091191
PT8999-MPG	791440070585	PT9145	791440070820	PT9260	791440074248	BT9369-MPG	791440078512	PT9450-MPG	791440091207
H9001	791440029255	PT9147	791440070844	PT9261-MPG	791440074255	BT9370-MPG	791440078574	PT9451-MPG	791440091214
H9007	791440029279	PT9148	791440070851	PT9264	791440074286	BT9371-MPG	791440078727	PT9452	791440091221
H9013	791440029293	PT9149	791440070868	PT9266	791440074309	PT9372	791440078796	PT9453-MPG	791440084490
H9014	791440029309	PT9150	791440070875	PT9267	791440074316	PT9373-MPG	791440079106	BT9454	791440091238
H9020	791440029323	PT9152	791440070899	PT9268	791440074323	PT9374	791440078888	BT9456	791440091702
H9021	791440029330	PT9153	791440070905	PT9272	791440074361	PT9375	791440078932	PT9459-MPG	791440091788
H9024	791440029347	PT9155	791440070929	PT9277	791440074415	PT9376	791440078949	PT9462	791440091825
H9036	791440029361	PT9157	791440070943	PT9278	791440074422	BT9377	791440078956	PT9463	791440091856
H9041	791440029408	PT9158	791440070950	PT9279	791440074439	PT9378-MPG	791440079083	BT9464	791440091849
H9042	791440029415	PT9161	791440070981	PT9282-MPG	791440073647	PT9379	791440079168	BT9465	791440091917
H9043	791440029422	PT9162	791440070998	PT9283-MPG	791440073654	PT9380-MPG	791440079182	PT9466-MPG	791440091962
H9043-V	791440077621	PT9163	791440071001	PT9284-MPG	791440073661	PT9381-MPG	791440079281	PT9468	791440092457
H9044	791440029439	BT9164	791440071018	PT9286-MPG	791440073685	BT9382	791440079298	PT9469	791440092662
H9045	791440029446	PT9165	791440071025	PT9287-MPG	791440073692	PT9383-MPG	791440079441	PT9470	791440092679
H9046	791440029453	PT9167	791440071049	PT9288-MPG	791440073708	PT9384-MPG	791440079458	BT9471	791440092808
H9047	791440029460	PT9168	791440071056	PT9289-MPG	791440073715	PT9385-MPG	791440079472	PT9472	791440093256
H9048	791440029477	PT9169	791440071063	PT9290-MPG	791440073722	PT9386-MPG	791440079489	PT9473	791440093287
H9049	791440029484	PT9170	791440071070	PT9291-MPG	791440073739	BT9387	791440079515	S9475	791440093461
H9050	791440029491	PT9171	791440071087	PT9293-MPG	791440073760	BT9388	791440079531	PT9476-MPG	791440093485
H9051	791440029507	PT9172	791440071094	PT9296-MPG	791440073791	PT9389-MPG	791440079991	PT9477	791440093843
H9052	791440063631	PT9174	791440071117	PT9297-MPG	791440073807	PT9390-MPG	791440080027	PT9478-MPG	791440093850
H9054	791440029521	PT9175	791440071124	PT9300-MPG	791440073838	BT9391-MPG	791440080065	PT9479-MPG	791440093867
H9055	791440029538	PT9176	791440071131	PT9303-MPG	791440073869	BT9392-MPG	791440080119	PT9480-MPG	791440093874
H9056	791440029545	PT9178	791440071155	PT9304-MPG	791440073876	PT9393-MPG	791440080126	PT9481-MPG	791440093881
H9058	791440029569	PT9179	791440071162	PT9306-MPG	791440073890	PT9394-MPG	791440080270	PT9482-MPG	791440093898
H9060	791440029576	PT9180	791440071179	PT9307-MPG	791440073906	PT9395-MPG	791440080768	PT9483-MPG	791440093904
H9062	791440029583	PT9181	791440071186	PT9308-MPG	791440073913	PT9396	791440080829	PT9484-MPG	791440093911
H9069	791440029590	PT9182	791440071193	PT9309-MPG	791440073920	PT9397-MPG	791440080836	PT9485-MPG	791440093928
H9070	791440029606	PT9183	791440071209	PT9310-MPG	791440073937	BT9398-MPG	791440081482	PT9486-MPG	791440093935
H9071	791440029613	PT9185	791440071223	PT9311-MPG	791440073944	PT9399-MPG	791440081970	PT9487-MPG	791440093942
H9072	791440029620	PT9186	791440071230	PT9313-MPG	791440073968	BT9400-MPG	791440082120	PT9488-MPG	791440093959
H9072-V	791440075757	PT9187	791440071247	PT9315 KIT	791440073982	PT9401	791440082137	PT9489-MPG	791440093966
H9073	791440029637	PT9188	791440071254	BT9316-MPG	791440073531	BT9402	791440082144	PT9490-MPG	791440093973
H9074	791440029644	PT9189	791440071261	BT9318	791440075009	PT9403-MPG	791440082199	PT9491-MPG	791440093980
H9075	791440029651	PT9190	791440071278	BT9320	791440073579	PT9404-MPG	791440082243	PT9492-MPG	791440093997
H9075-V	791440077539	PT9191	791440071285	BT9321	791440073586	PT9405	791440082298	PT9493-MPG	791440094000
H9076	791440029668	PT9193	791440071308	BT9324	791440073616	PT9406-MPG	791440082465	PT9494-MPG	791440094017
H9076-V	791440075764	PT9195	791440071322	BT9326	791440073630	PT9407-MPG	791440082618	PT9495-MPG	791440094024
H9077	791440029675	PT9196	791440071339	H9327	791440075016	BT9408	791440082632	PT9496-MPG	791440094031
H9078	791440029682	PT9197	791440071346	PT9328-MPG	791440075023	PT9409-MPG	791440082809	PT9497-MPG	791440094048
H9078-V	791440075771	PT9199	791440071360	PT9329	791440075245	PT9410-MPG	791440083066	PT9498-MPG	791440094055
H9079	791440029699	PT9200	791440071377	PT9330-MPG	791440075733	PT9411-MPG	791440083073	PT9499-MPG	791440094062
H9080	791440029705	PT9203	791440071407	PT9331	791440075887	PT9413-MPG	791440083271	PT9500-MPG	791440094079
H9081	791440029712	PT9205	791440071421	PT9332	791440075870	PT9414-MPG	791440083691	PT9501-MPG	791440094086
H9082	791440029729	PT9208	791440071452	PT9335-MPG	791440075849	PT9415-MPG KIT	791440079212	PT9502-MPG	791440094093
H9083	791440029736	PT9209	791440071469	PT9337-MPG	791440076112	PT9416-MPG KIT	791440079229	PT9503-MPG	791440094109
H9084	791440029743	PT9210	791440071476	PT9338-MPG	791440076259	PT9417	791440083943	PT9504-MPG	791440094116
H9085	791440029750	PT9212	791440071490	PT9340-MPG	791440076341	PT9418	791440083974	PT9505-MPG	791440094123
H9086	791440029767	PT9213	791440071506	PT9341	791440076525	PT9419-MPG	791440084148	PT9506	791440094130
H9087	791440062252	PT9214	791440071513	PT9342-MPG	791440076587	PT9420-MPG	791440086272	PT9507	791440094147
H9092	791440029774	PT9215	791440071520	BT9343-MPG	791440076662	BT9421-MPG	791440086692	PT9508	791440094154
H9093	791440029781	PT9217	791440071544	PT9344	791440076730	BT9422	791440086814	PT9509	791440094161
H9096	791440029804	PT9221	791440071582	BT9345	791440076792	PT9423	791440086883	PT9510	791440094178



**WARNING:** These products can expose you to chemicals, including Diisononyl Phthalate, Carbon black extracts, Nickel, 1,3 Butadiene, Ethylene Oxide, Epichlorohydrin, which are known to the State of California to cause cancer, and Bisphenol-A, Ethylene Glycol, Ethylene Oxide, 1,3 Butadiene, Epichlorohydrin, which are known to the State of California to cause birth defects or other reproductive harm.

# BALDWIN TO UPC (INDIVIDUAL PARTS)

BALDWIN NUMBER	UPC NUMBER	BALDWIN NUMBER	UPC NUMBER	BALDWIN NUMBER	UPC NUMBER	BALDWIN NUMBER	UPC NUMBER	BALDWIN NUMBER	UPC NUMBER
PT9511	791440094185	BF9841	791440088733	PA10000	791440096677	PA10093	791440110069	PA10173	791440115262
PT9512	791440094192	BF9842	791440088801	PA10001	791440096684	PA10094	791440110076	PA10174	791440115453
PT9513	791440094208	BF9844	791440088900	PA10002	791440096691	PA10095	791440110083	PA10175 KIT	791440115378
PT9514	791440094215	BF9846	791440089099	PA10003	791440096813	PA10096	791440110366	PA10176	791440115385
PT9515	791440094222	BF9847-D	791440089105	PA10004	791440096868	PA10097	791440110687	PA10177	791440115477
PT9516	791440094239	BF9848	791440089198	RS10005	791440096875	PA10098	791440110700	PA10178	791440115330
PT9517	791440094246	BF9850	791440089235	PA10006	791440096905	PA10099	791440110717	PA10179	791440113602
PT9518-MPG	791440094260	BF9851	791440089327	PA10007	791440096929	SA10100	791440110793	PA10180 KIT	791440115125
PT9519-MPG	791440094277	BF9852	791440089358	PA10008	791440097995	PA10101	791440110915	PA10181	791440112025
PT9520-MPG	791440094284	BF9857	791440089488	PA10009	791440098312	PA10102	791440110922	PA10182	791440115019
PT9522-MPG	791440094291	BF9858 KIT	791440089518	PA10010	791440098930	PA10103	791440110991	PA10183	791440114692
PT9523-MPG	791440094307	BF9860	791440090118	PA10011	791440098947	PA10104	791440111004	PA10184	791440114517
PT9524-MPG	791440094314	PF9861	791440090149	PA10012	791440098982	PA10106	791440111028	PA10185	791440115170
PT9525-MPG	791440094321	PF9862	791440090170	PA10013	791440100589	PA10108	791440111158	PA10186 KIT	791440113855
PT9526-MPG	791440094338	BF9863	791440090187	BF9863	791440100619	PA10109	791440112469	PA10188	791440114838
PT9528	791440094345	BF9864	791440090262	PA10015	791440100787	PA10110	791440112223	PA10189	791440114777
PT9529	791440094352	PF9865	791440090286	PA10016	791440100893	PA10111	791440112636	PA10190	791440114920
PT9530	791440094369	BF9866-O	791440090385	PA10017	791440100909	PA10112	791440112834	PA10191 KIT	791440113534
PT9531	791440094376	BF9867-O	791440090446	PA10018	791440101005	PA10113	791440112568	PA10192	791440112018
PT9532	791440094383	PF9868	791440090507	PA10020	791440102484	PA10114	791440114210	PA10193 KIT	791440113923
BT9533	791440094420	BF9869	791440090644	RS10021	791440102606	PA10115	791440112421	PA10194	791440113701
PT9535-MPG	791440094611	PF9870	791440090682	PA10022	791440103412	PA10116	791440112902	PA10195 KIT	791440112193
PT9536-MPG	791440094765	BF9871-O	791440090798	PA10023	791440103610	PA10117	791440113480	PA10196 KIT	791440114227
PT9537-MPG	791440095021	PF9872	791440090958	PA10024	791440103627	PA10118	791440113503	PA10197	791440111929
BT9553	791440085497	PF9873	791440090996	PA10025	791440103634	PA10119	791440113237	PA10198 KIT	791440112681
PT9554-MPG	791440085527	BF9874-DM	791440091030	PA10026	791440103641	PA10120	791440114548	PA10199 KIT	791440112841
PT9555	791440085534	BF9875-DM	791440091047	PA10027	791440103658	PA10121	791440114166	PA10200	791440114395
PT9556-MPG	791440085541	BF9876	791440091078	PA10028	791440103665	PA10122	791440114883	PA10201	791440113022
PT9557	791440085572	BF9877	791440091382	PA10030	791440103689	PA10123	791440114579	PA10202	791440114081
BT9558-MPG	791440085817	BF9878	791440091559	PA10031	791440103696	PA10124	791440115316	PA10203 KIT	791440114722
PT9559-MPG	791440085824	PF9879	791440091757	PA10032	791440103702	PA10125	791440114975	PA10204 KIT	791440113510
BT9560-MPG	791440086067	BF9880	791440091764	PA10033	791440103924	PA10126	791440115446	PA10205 KIT	791440114326
BT9561	791440086197	BF9881	791440091801	PA10034	791440103993	SA10127	791440112124	PA10206 KIT	791440115088
P9600	791440094444	BF9883	791440091863	RS10035	791440104235	PA10128	791440111424	PA10207	791440114364
B9601	791440094567	BF9884	791440091931	PA10036	791440104372	PA10129	791440111554	PA10208 KIT	791440114371
P9602	791440095007	BF9885	791440091948	PA10037	791440104501	PA10130	791440111615	PA10209 KIT	791440113404
P9603	791440095014	BF9886	791440091986	PA10038	791440105638	PA10131	791440113046	PA10210 KIT	791440114821
B9604	791440096509	PF9887	791440092020	PA10039	791440105645	PA10132	791440111998	PA10211 KIT	791440114852
P9605	791440096578	BF9888	791440092037	PA10040	791440105652	PA10133	791440111639	PA10212 KIT	791440115484
B9606	791440096615	PF9889	791440092051	PA10041	791440105669	PA10134	791440112872	PA10213	791440113985
B9607	791440096622	PF9890	791440092068	PA10042	791440105676	PA10135	791440112506	PA10214	791440114876
BF9800	791440086999	BF9891-D	791440092075	PA10043	791440105683	PA10136	791440112377	PA10215 KIT	791440115217
BF9801	791440087002	BF9892-D	791440092082	PA10044	791440105744	PA10137	791440111868	PA10216 KIT	791440114111
BF9802	791440087040	BF9893	791440092099	PA10045	791440105751	PA10138	791440113381	PA10217	791440112209
PF9803	791440087088	BF9894	791440092105	PA10046	791440105768	PA10139	791440112933	PA10218	791440113770
PF9804	791440087149	BF9895 KIT	791440092303	PA10047	791440107298	PA10140	791440113640	PA10219	791440112407
BF9805	791440087170	PF9897	791440092358	PA10057	791440107885	PA10141	791440113282	PA10220	791440111547
BF9807	791440087323	BF9898-O	791440092372	PA10058	791440108356	PA10142	791440112261	PA10221	791440111550
BF9808-D	791440087330	PF9899	791440092389	PA10059	791440108363	PA10143	791440112087	PA10222	791440111851
BF9809-D	791440087361	PF9900	791440092396	PA10060	791440108455	PA10144	791440113244	PA10223	791440112186
BF9810-D	791440087378	PF9901 KIT	791440092433	PA10061	791440108547	PA10145 KIT	791440112216	PA10224	791440112148
BF9811-SP	791440087415	PF9902	791440092518	PA10062	791440108622	PA10146	791440113060	PA10225	791440112698
BF9812	791440087507	BF9903-SP	791440092525	PA10063	791440111325	PA10147	791440113435	PA10226	791440112865
BF9813	791440087514	BF9904	791440092570	PA10064	791440108714	PA10148	791440113015	PA10227	791440112780
PF9814	791440087521	BF9905	791440092747	PA10066	791440108936	PA10149	791440112919	PA10228	791440111967
BF9815	791440087583	BF9906	791440092891	PA10067	791440108950	PA10150	791440114005	PA10229	791440112964
BF9816	791440087606	PF9907	791440092990	PA10068	791440109001	PA10152 KIT	791440112759	PA10230	791440113299
BF9817	791440087637	PF9908 KIT	791440093164	PA10069	791440109032	PA10153	791440112711	PA10231	791440112995
BF9818	791440087644	BF9910	791440093201	PA10070	791440109049	PA10154	791440113824	PA10232	791440112247
BF9820	791440087668	PF9911	791440093249	PA10071	791440109056	PA10155	791440114357	PA10233	791440112360
BF9821	791440087682	BF9912-O	791440093478	PA10072	791440109063	PA10156	791440114494	PA10234	791440113305
BF9822-D	791440087705	BF9913	791440093508	PA10073	791440109070	PA10157	791440115255	PA10235	791440113039
PF9823	791440087712	PF9914 KIT	791440093577	PA10075	791440109285	PA10158	791440115293	PA10236	791440113589
PF9824	791440087736	BF9915	791440093584	PA10076	791440109308	PA10159	791440112384	PA10237	791440113527
PF9825	791440087743	BF9916	791440093652	PA10077	791440109339	PA10160	791440113725	PA10238	791440113183
PF9826	791440087750	BF9917	791440093775	PA10078	791440109346	PA10161	791440113565	PA10239	791440113466
BF9827-D	791440087927	BF9918 KIT	791440093799	PA10081	791440109520	PA10162	791440114531	PA10240	791440113657
BF9828-D	791440087989	PF9919	791440094499	PA10082	791440109599	PA10163	791440114036	PA10241	791440113138
PF9829 KIT	791440088153	BF9920	791440094604	PA10083	791440109988	PA10164	791440112667	PA10242	791440114470
BF9830-D	791440088191	BF9921-O	791440094697	PA10084	791440109636	PA10165	791440114845	PA10243	791440114296
BF9831	791440088214	BF9922-O	791440094758	PA10085	791440109650	PA10166	791440113992	PA10244	791440114937
BF9833-D	791440088269	BF9923-O	791440094956	PA10086	791440110304	PA10167	791440114999	PA10245	791440114418
BF9834	791440088276	PF9924 KIT	791440095175	PA10087	791440110359	PA10168	791440114425	PA10246	791440113572
BF9835-D	791440088283	BF9925-O	791440095199	PA10088	791440109889	PA10169	791440115002	PA10247	791440115460
BF9836-D	791440088436	PF9927	791440095274	PA10089	791440109902	PA10170 KIT	791440114753	PA10248	791440112575
BF9837-D	791440088511	PF9928	791440096639	PA10090	791440109919	PA10171	791440112643	PA10249	791440113879
BF9839-D	791440088627	PF9929	791440096646	PA10091	791440109995	PA10172	791440114012	PA10250	791440114487



**WARNING:** These products can expose you to chemicals, including Diisononyl Phthalate, Carbon black extracts, Nickel, 1,3 Butadiene, Ethylene Oxide, Epichlorohydrin, which are known to the State of California to cause cancer, and Bisphenol-A, Ethylene Glycol, Ethylene Oxide, 1,3 Butadiene, Epichlorohydrin, which are known to the State of California to cause birth defects or other reproductive harm.



# BALDWIN TO UPC (INDIVIDUAL PARTS)

BALDWIN NUMBER	UPC NUMBER	BALDWIN NUMBER	UPC NUMBER	BALDWIN NUMBER	UPC NUMBER	BALDWIN NUMBER	UPC NUMBER	BALDWIN NUMBER	UPC NUMBER
PA10251	791440115071	PA10330	791440115415	PA10412	791440116337	20029	791440110472	PT23045-MPG	791440095731
PA10253	791440115095	PA10331	791440114500	PA10414	791440116412	20030	791440110779	PT23046-MPG	791440095748
PA10254	791440113695	PA10332	791440115347	CV15000	791440084032	20031	791440113398	PT23047-MPG	791440095755
PA10255	791440114043	PA10333	791440115392	CV15001	791440089853	20033	791440114029	PT23048-MPG	791440095762
PA10256	791440113053	PA10334	791440115408	CV15002	791440090156	20035	791440113367	PT23049-MPG	791440095779
PA10257	791440114319	PA10335	791440114128	CV15003	791440093560	20037	791440112414	PT23050-MPG	791440095786
PA10258	791440114791	PA10336	791440115064	CV15004	791440096943	20041	791440114265	PT23051-MPG	791440095793
PA10259	791440114708	PA10337	791440115132	CV15005	791440104693	20042	791440112599	PT23052-MPG	791440095809
PA10260	791440115101	PA10338	791440115231	CV15006	791440105546	20043	791440111820	PT23053-MPG	791440095816
PA10261	791440115279	PA10339	791440115361	CV15007	791440109018	20044	791440113794	PT23054-MPG	791440095823
PA10262	791440114340	PA10340	791440115422	CV15008	791440109025	20045	791440112322	PT23055-MPG	791440095830
PA10263	791440114401	PA10341	791440114258	CV15010	791440109674	20046	791440114562	PT23056-MPG	791440095847
PA10264	791440113350	PA10342	791440115491	CV15011	791440110335	20048	791440111417	PT23057-MPG	791440095854
PA10265	791440114333	PA10343	791440114647	BA16000	791440104204	20050	791440114586	PT23058-MPG	791440095861
PA10266	791440114678	PA10344	791440114913	PE17000	791440105515	20051	791440114067	PT23059-MPG	791440095878
PA10267	791440111882	PA10345	791440114142	PE17001	791440106918	20052	791440112100	PT23060-MPG	791440095885
PA10268	791440113473	PA10346	791440112346	18002	791440047884	20053	791440113411	PT23061-MPG	791440095892
PA10269	791440112742	RS10347	791440114272	18004	791440047970	20054	791440111684	PT23062-MPG	791440095908
PA10270	791440111806	RS10348	791440115118	18007	791440047938	20055	791440114135	PT23063-MPG	791440095915
PA10271	791440114289	RS10349	791440115026	18009	791440047952	20057	791440115439	PT23064-MPG	791440095922
PA10272	791440113619	RS10350	791440115309	18010	791440047969	20058	791440112988	PT23065-MPG	791440095939
PA10273	791440113732	RS10351	791440114661	18013	791440047990	20060	791440113756	PT23066-MPG	791440095946
PA10274	791440111752	PA10352	791440112889	18022	791440051355	20061	791440113762	PT23067-MPG	791440095953
PA10275	791440111721	PA10353	791440115163	18024	791440051348	20062	791440113763	PT23068-MPG	791440095960
PA10276	791440111776	PA10354	791440113145	18025	791440051331	20063	791440112827	PT23069-MPG	791440095977
PA10277	791440112049	PA10355	791440112537	18027	791440051379	20064	791440113626	PT23070-MPG	791440095984
PA10278	791440111516	PA10356	791440114098	18029	791440052758	20065	791440113916	PT23071-MPG	791440095991
PA10279	791440111769	PA10357	791440114890	18032	791440055228	20066	791440114241	PT23072-MPG	791440096004
PA10280	791440111790	PA10358	791440113268	18033	791440056206	20067	791440112773	PT23073-MPG	791440096011
PA10281	791440111936	SA10359	791440113596	18034	791440056213	20068	791440115224	PT23074-MPG	791440096028
PA10282	791440112315	SA10360	791440114654	18055	791440059757	20069	791440114074	PT23075-MPG	791440096035
PA10283	791440111899	SA10361	791440113084	18056	791440059764	20070	791440116092	PT23076-MPG	791440096042
PA10284	791440112179	PA10362	791440111448	18057	791440059771	BW21000	791440097483	PT23077-MPG	791440096059
PA10285	791440111981	PA10363	791440111462	18104	791440029989	PT23000	791440095928	PT23078-MPG	791440096066
PA10286	791440112278	PA10364	791440111486	18139	791440030015	PT23001	791440095281	PT23079-MPG	791440096073
PA10287	791440112957	PA10365 KIT	791440112520	18155	791440030039	PT23002	791440095304	PT23080-MPG	791440096080
PA10288	791440112094	PA10367	791440111653	18171	791440030053	PT23003	791440095311	PT23081-MPG	791440096097
PA10289	791440112438	PA10368	791440113213	18198	791440030077	PT23004	791440095328	PT23082-MPG	791440096103
PA10290	791440111660	PA10369	791440111783	18236	791440030114	PT23005	791440095335	PT23083-MPG	791440096110
PA10291	791440111837	PA10370 KIT	791440114463	18245	791440030121	PT23006	791440095342	PT23084-MPG	791440096127
PA10292	791440112001	PA10371	791440112339	18264	791440060371	PT23007	791440095359	PT23085-MPG	791440096134
PA10293	791440112766	PA10372	791440113886	18265	791440060388	PT23008	791440095366	PT23086-MPG	791440096141
PA10294	791440112476	PA10373	791440113206	18267	791440060456	PT23009	791440095373	PT23087-MPG	791440096158
PA10295	791440112612	PA10374	791440112797	18268	791440039148	PT23010	791440095380	PT23088-MPG	791440096165
PA10296	791440112445	PA10375	791440112971	19593	791440030244	PT23011	791440095397	PT23089-MPG	791440096172
PA10297	791440113251	PA10376	791440112162	19739	791440030329	PT23012	791440095403	PT23090-MPG	791440096189
PA10298	791440113497	PA10378	791440112063	19828	791440030343	PT23013	791440095410	PT23091-MPG	791440096196
PA10299	791440111738	PA10379	791440111707	19992	791440030442	PT23014	791440095427	PT23092-MPG	791440096202
PA10300	791440112582	PA10380	791440111950	19996	791440064553	PT23015	791440095434	PT23093-MPG	791440096219
PA10301	791440112650	PA10381	791440115507	19999	791440064584	PT23016	791440095441	PT23094-MPG	791440096226
PA10302	791440113442	PA10382	791440113909	20000	791440064591	PT23017	791440095458	PT23095-MPG	791440096233
PA10303	791440113169	PA10383	791440112544	20002	791440064614	PT23018	791440095465	PT23096-MPG	791440096240
PA10304	791440112551	PA10384	791440114630	20003	791440065765	PT23019	791440095472	PT23097-MPG	791440096257
PA10305	791440113329	PA10385	791440113107	20004	791440065796	PT23020	791440095489	PT23098-MPG	791440096264
PA10306	791440113633	PA10386	791440113817	20005	791440067370	PT23022	791440095502	PT23100-MPG	791440096288
PA10307	791440113343	PA10387	791440112605	20006	791440077782	PT23023	791440095519	PT23101-MPG	791440096295
PA10308	791440113374	PA10388	791440115972	20007	791440077799	PT23024	791440095526	PT23102-MPG	791440096301
PA10309	791440112810	PA10389	791440113008	20008	791440077805	PT23025	791440095533	PT23103-MPG	791440096318
PA10310	791440112353	PA10390	791440112230	20010	791440077829	PT23026	791440095540	PT23104-MPG	791440096325
PA10311	791440112728	PA10391	791440111646	20011	791440077836	PT23027	791440095557	PT23105-MPG	791440096332
PA10312	791440113336	PA10392	791440112483	20012	791440077850	PT23028-MPG	791440095564	PT23106-MPG	791440096349
PA10313	791440113541	PA10393	791440113671	20013	791440078062	PT23029-MPG	791440095571	PT23107-MPG	791440096356
PA10314	791440113930	PA10394	791440114203	20014	791440080386	PT23030-MPG	791440095588	PT23108-MPG	791440096363
PA10315	791440113831	PA10395	791440112155	20015	791440081673	PT23031-MPG	791440095595	PT23109-MPG	791440096370
PA10316	791440113077	PA10396	791440115989	20016	791440081680	PT23032-MPG	791440095601	PT23110-MPG	791440096387
PA10317	791440113893	PA10397	791440113800	20017	791440081697	PT23033-MPG	791440095618	PT23111-MPG	791440096394
PA10318	791440114616	PA10398	791440115156	20018	791440081703	PT23034-MPG	791440095625	PT23112-MPG	791440096400
PA10319	791440114814	PA10399	791440113848	20019	791440081710	PT23035-MPG	791440095632	PT23113-MPG	791440096417
PA10320	791440112131	PA10400	791440115514	20020	791440081727	PT23036-MPG	791440095649	PT23114-MPG	791440096424
PA10321	791440114968	PA10401	791440115590	20021	791440086708	PT23037-MPG	791440095656	PT23115-MPG	791440096431
PA10323	791440114609	PA10402	791440115613	20022	791440086715	PT23038-MPG	791440095663	PT23116-MPG	791440096448
PA10324	791440112858	PA10403	791440115682	20023	791440086722	PT23039-MPG	791440095670	PT23117-MPG	791440096455
PA10325	791440112926	PA10404	791440115910	20024	791440086739	PT23040-MPG	791440095687	PT23118-MPG	791440096462
PA10326	791440114159	PA10405	791440115927	20025	791440100848	PT23041-MPG	791440095694	PT23119-MPG	791440096479
PA10327	791440114555	PA10407	791440116078	20026	791440110113	PT23042-MPG	791440095701	PT23120-MPG	791440096486
PA10328	791440115194	PA10409	791440116153	20027	791440110120	PT23043-MPG	791440095717	PT23122	791440097803
PA10329	791440114593	PA10411	791440116320	20028	791440110038	PT23044-MPG	791440095724	PT23123	791440097810



**WARNING:** These products can expose you to chemicals, including Diisononyl Phthalate, Carbon black extracts, Nickel, 1,3 Butadiene, Ethylene Oxide, Epichlorohydrin, which are known to the State of California to cause cancer, and Bisphenol-A, Ethylene Glycol, Ethylene Oxide, 1,3 Butadiene, Epichlorohydrin, which are known to the State of California to cause birth defects or other reproductive harm.



**BALDWIN TO UPC (INDIVIDUAL PARTS)**

BALDWIN NUMBER	UPC NUMBER	BALDWIN NUMBER	UPC NUMBER	BALDWIN NUMBER	UPC NUMBER	BALDWIN NUMBER	UPC NUMBER	BALDWIN NUMBER	UPC NUMBER
PT23536	791440104334	PA30018	791440097025	CA30102	791440103504	RS30181	791440105157	PA30310	791440115705
BT23537	791440104532	PA30019	791440097032	CA30103	791440103498	RS30182	791440105164	RS30311	791440115743
BT23539	791440104570	PA30020	791440097049	CA30104	791440103528	PA30183	791440105171	RS30313	791440115767
BT23540	791440104587	PA30021	791440097056	CA30105	791440103511	PA30185	791440105478	PA30314	791440115774
BT23542-MPG	791440104686	PA30022	791440097063	RS30106	791440102545	RS30187XP	791440105492	PA30315	791440115781
BT23543-MPG	791440104785	PA30023	791440097070	PA30107	791440102552	PA30188	791440105539	PA30316	791440115798
PT23544-MPG	791440104792	PA30024	791440097087	PA30108	791440102576	PA30189	791440105560	PA30317	791440115804
PT23545-MPG	791440104808	PA30025	791440097094	PA30109	791440102569	PA30190	791440105577	PA30318	791440115811
PT23546-MPG	791440104815	PA30026	791440097100	PA30110	791440102583	RS30191	791440105584	PA30319	791440115828
BT23555-MPG	791440105225	PA30027	791440097117	RS30112	791440102590	RS30192	791440105591	PA30320	791440115835
PT23556-MPG	791440105256	PA30028	791440097124	PA30113	791440103382	PA30193-FN	791440105608	PA30321	791440115842
PT23560	791440105621	PA30029	791440097131	PA30114	791440103399	PA30194	791440105812	PA30322	791440115859
PT23561-MPG	791440106796	PA30030	791440097148	PA30115	791440103405	PA30204	791440108608	PA30323	791440115866
PT23565-MPG	791440106925	PA30031	791440097155	RS30116	791440103436	PA30206	791440108370	PA30324	791440115897
PT23566-MPG	791440106932	PA30032	791440097179	PA30117	791440103467	PA30207	791440108387	PA30325	791440115903
PT23567-MPG	791440106949	PA30033	791440097186	PA30118	791440103542	PA30208	791440108394	RS30327	791440116016
PT23568-MPG	791440106956	PA30034	791440097193	PA30119	791440103559	RS30209	791440107908	RS30328	791440116023
PT23569-MPG	791440106963	PA30035	791440097209	RS30120	791440103573	PA30211	791440107922	PA30329	791440116054
PT23570-MPG	791440106970	PA30036	791440097216	RS30121	791440103580	RS30212	791440107946	PA30330	791440116085
PT23571-MPG	791440106987	PA30037	791440097223	PA30122	791440103801	RS30213	791440107953	PA30331	791440116375
PT23572-MPG	791440106994	PA30038	791440097230	PA30123	791440103818	RS30216	791440107984	PA30332	791440116399
PT23573-MPG	791440107007	PA30039	791440097247	PA30124	791440103825	RS30217	791440107991	PA31000	791440105317
PT23574-MPG	791440107014	PA30040	791440097254	PA30125	791440103832	RS30220	791440108035	PA31001	791440105348
PT23575-MPG	791440107021	PA30041	791440097261	PA30126	791440103948	RS30221	791440108042	PA31002	791440105324
PT23576-MPG	791440107038	PA30042	791440097278	PA30127	791440103955	RS30222XP	791440108059	PA31003	791440105355
PT23577-MPG	791440107045	PA30043	791440097285	RS30128	791440103979	RS30223	791440108066	PA31004	791440105393
PT23578-MPG	791440107052	PA30044	791440097292	RS30129	791440103986	RS30224	791440108073	PA31005	791440105423
PT23579-MPG	791440107069	PA30045	791440097308	RS30130	791440104228	RS30225	791440108080	PA31006	791440105409
PT23580-MPG	791440107076	PA30048	791440097339	CA30131	791440107267	RS30226	791440108097	PA31007	791440105430
PT23581-MPG	791440107083	PA30049	791440097346	CA30132	791440107274	PA30228	791440108196	PA31008	791440105881
PT23582-MPG	791440107090	PA30050	791440097353	RS30133	791440104105	PA30229	791440108202	PA31009	791440105898
PT23583-MPG	791440107106	PA30051	791440097360	RS30134	791440104112	RS30232	791440108288	PA31010	791440105331
PT23585	791440107120	PA30052	791440097377	RS30135	791440104181	PA30233-FN	791440108301	PA31011	791440105362
PT23586	791440107137	PA30053	791440097384	RS30136	791440104198	RS30234	791440108332	PA31012	791440105416
PT23587	791440107144	PA30054	791440097391	PA30137	791440104129	PA30235	791440107939	PA31013	791440105867
PT23588	791440107151	PA30055	791440097407	PA30138	791440104136	RS30236	791440108004	PA31014	791440105874
PT23589	791440107168	PA30056	791440097414	PA30139	791440104143	RS30237	791440108561	PA32000	791440106833
PT23590	791440107175	RS30057	791440097421	PA30140	791440104150	RS30242	791440108448	PA32001	791440106819
PT23591-MPG	791440107199	RS30058	791440097438	PA30141	791440104167	PA30243	791440108660	PA32002	791440106864
PT23592	791440107304	RS30059-FN	791440097445	RS30142	791440104976	PA30244	791440108653	PA32003	791440106840
PT23595-MPG	791440107717	RS30060-FN	791440097452	RS30142 KIT	791440104983	PA30249	791440111332	PA32004	791440106826
PT23597-MPG	791440107779	RS30061	791440097469	RS30143	791440104990	PA30251	791440108668	B40000	791440096721
PT23598-MPG	791440107793	RS30062	791440097476	RS30143 KIT	791440105003	PA30252	791440108912	PA0001	791440096738
PT23600	791440107830	PA30063	791440097162	PA30144	791440104174	PA30253	791440108981	PA0002	791440097957
BT23603-MPG	791440107762	PA30064	791440098008	PA30145	791440104426	PA30255	791440110106	PA0003	791440096912
BT23604	791440107786	RS30065	791440098039	PA30146	791440104433	RS30257	791440109261	CA0004	791440097971
BT23605-MPG	791440107816	RS30065 KIT	791440098046	RS30147	791440104419	PA30258	791440109421	CA0005	791440097989
BT23607-MPG	791440107878	PA30066	791440098114	PA30148	791440104427	PA30260	791440109544	B40006	791440097964
BT23609-MPG	791440108325	PA30067	791440098121	PA30149	791440104358	PA30261	791440109551	BC40007	791440098022
BT23611	791440108509	PA30068	791440098138	PA30150	791440104365	PA30262	791440109568	PA0008	791440098077
PT23613-MPG	791440108783	PA30069	791440098145	PA30151	791440104389	PA30263	791440110373	BC40009	791440098084
PT23616-MPG	791440109179	PA30070	791440098152	PA30152	791440105720	PA30264	791440110694	PA0010	791440098091
BT23617	791440109575	CA30071	791440098169	PA30153	791440104440	PA30268	791440109926	PA0011	791440098237
BT23619-MPG	791440110670	PA30072	791440098176	PA30154	791440104457	PA30269	791440109971	PA0012	791440098244
BT23628	791440111240	PA30073	791440098183	PA30155	791440104464	PA30270	791440109964	B40013	791440098251
PT23629	791440111264	PA30074	791440098190	PA30156	791440104471	PA30271	791440110137	PA0014	791440098329
BT23630	791440111622	PA30075	791440098282	PA30157	791440104488	PA30272	791440110458	BT40015	791440107063
BT23631	791440111455	PA30076	791440098305	PA30158	791440104594	PA30275	791440109933	PA0017	791440104044
PT23633	791440114869	RS30077	791440098954	RS30159	791440104600	PA30276	791440109940	PA0019	791440102491
PA30000	791440096653	RS30078	791440098961	RS30160	791440104617	PA30277	791440110021	PA0020	791440103450
PA30001	791440096660	CA30079	791440099005	RS30161	791440104624	PA30279	791440110151	PA0021	791440103603
PA30002	791440096752	PA30080	791440100596	RS30162	791440104631	RS30281	791440110465	B40022-MPG	791440103566
PA30003	791440096769	PA30081	791440100602	PA30163	791440104679	RS30285	791440110755	PA0023	791440103719
PA30004	791440096776	PA30086	791440100770	PA30164	791440104761	PA30287	791440110786	PA0024	791440103726
PA30005	791440096783	RS30087	791440103764	PA30165	791440105270	RS30290	791440110960	PA0025	791440103733
PA30006	791440096790	RS30088	791440103771	PA30166	791440105263	PA30292	791440111073	BD40027	791440104556
PA30007	791440096806	RS30090-FN	791440100831	RS30168	791440104877	PA30293	791440111080	BT40028	791440105027
RS30008	791440096820	RS30091	791440100855	RS30169	791440104884	PA30299	791440111141	BT40029	791440105218
RS30009	791440096837	RS30092	791440100862	PA30170	791440104822	PA30301	791440113664	PA0030	791440105034
PA30010	791440096882	PA30093	791440100886	PA30171	791440104846	PA30302	791440114234	PA0031-MPG	791440105072
PA30011	791440096950	PA30094	791440100916	PA30172	791440104907	PA30303	791440114951	BT40032	791440105287
PA30012	791440096967	PA30095	791440100930	PA30173	791440104914	PA30304	791440111363	PA0033	791440105386
PA30013	791440096974	PA30096	791440100954	PA30174	791440105041	RS30305	791440111370	BT40034	791440105461
PA30014	791440096981	PA30098	791440101012	RS30175	791440105058	RS30306	791440111387	PA0035	791440105690
PA30015	791440096998	RS30099	791440102507	PA30177	791440105089	RS30307	791440115521	B40036	791440105706
PA30016	791440097001	PA30100	791440102514	PA30179	791440105126	RS30308	791440115538	PA0037	791440105775
PA30017	791440097018	PA30101	791440102521	RS30180	791440105140	PA30309	791440115583	BT40038	791440105782



**WARNING:** These products can expose you to chemicals, including Diisononyl Phthalate, Carbon black extracts, Nickel, 1,3 Butadiene, Ethylene Oxide, Epichlorohydrin, which are known to the State of California to cause cancer, and Bisphenol-A, Ethylene Glycol, Ethylene Oxide, 1,3 Butadiene, Epichlorohydrin, which are known to the State of California to cause birth defects or other reproductive harm.

# BALDWIN TO UPC (INDIVIDUAL PARTS)

BALDWIN NUMBER	UPC NUMBER	BALDWIN NUMBER	UPC NUMBER	BALDWIN NUMBER	UPC NUMBER	BALDWIN NUMBER	UPC NUMBER	BALDWIN NUMBER	UPC NUMBER
P40042	791440107205	BF46002	791440096745	BF46104	791440108110	BF46213	791440111912	OAS98060	791440103740
B40050	791440107458	PF46003	791440096844	BF46105-O	791440108134	BF46214	791440115057	OAS98061	791440105737
B40051	791440107465	PF46004	791440096851	PF46106	791440108141	BF46215	791440112513	OAS99001	791440072169
P40052	791440107687	BF46005	791440096899	PF46108	791440108165	BF46216	791440113114	OAS99002	791440072176
B40053	791440107731	BF46006	791440097490	BF46109-O	791440108189	BF46217	791440111875	OAS99003	791440072183
B40054	791440107748	BF46007	791440097506	BF46111	791440108257	BF46218	791440111745	OAS99004	791440072190
B40056	791440107847	BF46008	791440097513	PF46112	791440104495	BF46219	791440114180	OAS99005	791440072206
P40058	791440108226	PF46009	791440097520	BF46113-D	791440108318	BF46220	791440114807	OAS99006	791440072213
P40061	791440108578	PF46010 KIT	791440097537	BF46116 KIT	791440108585	BF46221	791440113954	OAS99008	791440072237
P40062	791440108615	BF46012	791440097551	BF46117	791440108462	BF46222	791440115286	OAS99010	791440072251
B40063	791440110496	BF46013	791440097568	PF46118	791440108479	BF46223	791440114449	OAS99014	791440072299
BT40065	791440108882	BF46014	791440097575	PF46119	791440108486	BF46224	791440113121	OAS99015	791440072305
BT40066-MPG	791440109377	BF46015	791440097582	BF46122	791440109605	BF46225	791440113428	OAS99017	791440072329
B40070	791440109742	BF46016-O	791440097636	BF46123-O	791440108691	BF46227	791440115569	OAS99018	791440072336
S40071	791440109773	BF46017-O	791440097643	BF46124-O	791440108707	BF46228	791440115736	OAS99020	791440072350
B40073	791440110571	BF46018-O	791440097650	BF46125	791440108721	BF46229	791440115873	OAS99023	791440072381
P40074	791440110946	BF46019-O	791440097667	PF46126	791440108745	BF46233	791440116047	OAS99024	791440072398
P40076	791440111059	BF46020-O	791440097674	BF46127	791440108820	PF46235	791440116108	OAS99025	791440072404
OB40078	791440112940	BF46021-O	791440097681	BF46128-D	791440108967	PF46236	791440116115	OAS99028	791440072435
OB40079	791440112056	BF46022-O	791440097698	BF46129	791440108998	PF46237	791440116122	OAS99029	791440072442
OB40080	791440113961	BF46023-O	791440097704	PF46130	791440109155	PF46238	791440116139	OAS99032	791440072473
P40081	791440113220	BF46024-O	791440097711	BF46131	791440109193	BD50000	791440105096	OAS99034	791440074771
P40083	791440111844	BF46025-O	791440097728	PF46135	791440109292	BF63000	791440104839	OAS99035	791440074784
P40085	791440115187	BF46026-O	791440097735	PF46137	791440109391	OAS98000	791440096963	OAS99038	791440074811
P40086	791440113190	BF46027-O	791440097742	PF46137 KIT	791440110229	OAS98001	791440098350	OAS99043	791440074866
P40089	791440112629	BF46028-O	791440097759	PF46138	791440109414	OAS98002	791440098367	OAS99047	791440107663
P40090	791440112803	BF46029-O	791440097766	PF46140	791440110441	OAS98003	791440098374	OAS99048	791440107670
P40091	791440114104	BF46030-O	791440097773	BF46141	791440109582	OAS98004	791440098381	G15-AF	791440033764
P40093	791440113459	BF46031	791440098053	PF46142	791440109612	OAS98005	791440098398	G21-AF	791440033801
P40094	791440111523	BF46032	791440098107	BF46143	791440109629	OAS98006	791440098404	ES24-B	791440030558
P40095	791440111813	PF46033	791440098206	PF46145	791440109728	OAS98007	791440098411	ES24-D	791440054271
P40096	791440114739	BF46034	791440098978	BF46147-O	791440109780	OAS98008	791440098428	G25-AF	791440033818
P40098	791440114432	BF46037	791440100923	BF46149-SP	791440109841	OAS98009	791440098435	G31-AF	791440034129
P40099	791440112032	BF46038-D	791440100985	BF46150-O	791440109896	OAS98010	791440098442	G34-AF	791440034150
P40100	791440111493	BF46039-D	791440100992	PF46151	791440109957	OAS98011	791440098459	G37-AF	791440034167
P40101	791440114388	BF46040-D	791440102460	PF46152	791440116405	OAS98012	791440098466	G39-AF	791440034174
P40102	791440111943	BF46041-D	791440103351	BF46161	791440110212	OAS98013	791440098473	G102-A	791440030619
P40103	791440111561	BF46042-D	791440103368	BF46162-O	791440110403	OAS98014	791440098480	G103	791440030626
P40104	791440111431	BF46043-D	791440103375	BF46163-O	791440110427	OAS98015	791440098497	G103-N	791440054288
P40105	791440111400	BF46044-D	791440103443	BF46164-O	791440110434	OAS98016	791440098503	G104	791440030633
P40106	791440112070	BF46045-D	791440103849	BF46169-O	791440110656	OAS98017	791440098510	G105	791440030640
P40107	791440111585	PF46046	791440103962	BF46170	791440110663	OAS98018	791440098527	G106	791440030657
P40108	791440112117	BF46048	791440104037	PF46171	791440110748	OAS98019	791440098534	G107	791440030664
P40109	791440111974	PF46049	791440104549	BF46173-O	791440110892	OAS98020	791440098541	G115-A	791440030718
P40110	791440112292	BF46050	791440104303	BF46175	791440110984	OAS98021	791440098558	G115-MSB	791440030725
P40111	791440111578	BF46051	791440104341	BF46176	791440111165	OAS98022	791440098565	G120-A	791440030756
P40112	791440111677	BF46052	791440104396	BF46179	791440111196	OAS98023	791440098572	G123	791440030787
P40113	791440111479	PF46056	791440104709	BF46181-O	791440111257	OAS98024	791440098589	G127	791440030817
P40114	791440111592	PF46057	791440104719	BF46182-O	791440111356	OAS98025	791440098596	G132	791440030855
P40115	791440112452	PF46059	791440104730	FB46183	791440111905	OAS98026	791440098602	G133	791440030862
P40116	791440112254	BF46062	791440104778	FB46184	791440112308	OAS98027	791440098619	G140-A	791440030923
P40117	791440114623	BF46064-D	791440110878	BF46185	791440111394	OAS98028	791440098626	G141-AF	791440034396
P40118	791440114173	BF46065-SPS	791440105607	PF46186	791440115323	OAS98029	791440098633	G143	791440030954
P40119	791440111509	BF46069	791440105195	PF46187	791440114050	OAS98031	791440098657	G144	791440030961
B40120	791440112704	BF46071	791440105232	PF46188	791440115248	OAS98032	791440098664	G145-AF	791440034419
B40122	791440111691	BF46072	791440105249	PF46189	791440113275	OAS98033	791440098671	G147-A	791440030978
B40124	791440111714	BF46073	791440105294	BF46192	791440114760	OAS98034	791440098688	G148	791440030985
B40125	791440114715	PF46076	791440105614	BF46193	791440113312	OAS98035	791440098695	G153	791440031005
B40126	791440112285	PF46077	791440105713	BF46194	791440111608	OAS98036	791440098701	G154	791440031012
B40127	791440113176	BF46078-D	791440105799	BF46195	791440112896	OAS98037	791440098718	G155	791440031029
B40128	791440113091	PF46079	791440105829	BF46196	791440114982	OAS98038	791440098725	G157	791440031036
B40129	791440112674	PF46080	791440105836	BF46197	791440115149	OAS98039	791440098732	G161	791440031074
P40130	791440113787	PF46081	791440105843	BF46198	791440114197	OAS98040	791440098749	G162	791440031081
P40131	791440114784	PF46082	791440105850	BF46199	791440115033	OAS98041	791440098756	G164-A	791440031098
P40132	791440114685	BF46083-O	791440106758	BF46200	791440114456	OAS98042	791440098763	G165	791440031104
B40133	791440115576	BF46084	791440106871	BF46201	791440114524	OAS98043	791440098770	G168-B	791440031128
B40136	791440115699	BF46085	791440107182	BF46202	791440115040	OAS98044	791440098787	G169	791440031135
B40137	791440115712	BF46087	791440107281	BF46203	791440113688	OAS98045	791440098794	G171	791440031159
B40138	791440115729	PF46088	791440107311	BF46204	791440114906	OAS98046	791440098800	G172-A	791440031173
BD40139	791440115965	PF46091	791440107359	BF46205	791440113152	OAS98049	791440098831	G183	791440002265
B40140	791440116184	PF46092	791440108493	BF46206	791440113978	OAS98050	791440098848	G184-A	791440031227
B40142	791440116351	PF46094	791440107397	BF46207	791440112735	OAS98052	791440098862	G193	791440031265
B40145	791440116689	BF46098-O	791440107366	BF46208	791440113718	OAS98053	791440098879	G196-B	791440031289
B40150	791440116924	BF46099-O	791440107380	BF46209	791440112391	OAS98054	791440098886	G202	791440031319
BF45000	791440098299	BF46100-O	791440107373	BF46210	791440113749	OAS98056	791440098909	G203	791440031326
BF46000	791440096707	BF46101-O	791440107403	BF46211	791440113947	OAS98057	791440098916	G204-A	791440031333
BF46001	791440096714	PF46103	791440107700	BF46212	791440113558	OAS98058	791440098923	G206	791440031357



**WARNING:** These products can expose you to chemicals, including Diisononyl Phthalate, Carbon black extracts, Nickel, 1,3 Butadiene, Ethylene Oxide, Epichlorohydrin, which are known to the State of California to cause cancer, and Bisphenol-A, Ethylene Glycol, Ethylene Oxide, 1,3 Butadiene, Epichlorohydrin, which are known to the State of California to cause birth defects or other reproductive harm.

# BALDWIN TO UPC (INDIVIDUAL PARTS)

BALDWIN NUMBER	UPC NUMBER	BALDWIN NUMBER	UPC NUMBER	BALDWIN NUMBER	UPC NUMBER	BALDWIN NUMBER	UPC NUMBER	BALDWIN NUMBER	UPC NUMBER
G207-AF	791440034440	G369-B	791440060913	ES1092	791440033382	186-SK	791440035997	43564P	857123005142
G208-A	791440031364	G369-V	791440066007	ES1303-A	791440033399	200	791440036000	43566P	857123005159
G210	791440031388	G372	791440032446	ES1303-B	791440033405	200-15	791440036079	43568P	857123005166
G211	791440031395	G376	791440032484	ES1369-A	791440033412	200-21	791440036130	43570P	857123005173
G214	791440031401	G379	791440032507	ES1376	791440051256	200-21AL	791440060425	43572P	857123005180
G219	791440031425	G380	791440032514	ES1377	791440045651	200-21BP	791440036147	43573P	857123005203
G220	791440031432	G381-A	791440032521	G1972	791440076235	200-21H	791440036154	43574P	857123005197
G222-B	791440031449	G382	791440032538	G1973	791440033177	200-21HBP	791440036161	38557C	857123005654
G225-AF	791440059146	G382-V	791440032545	ES3012	791440033474	200-21M	791440036178	38559C	857123005418
G229	791440031487	G385	791440032576	ES3028	791440033481	200-30U	791440036239	38560C	857123005425
G232	791440031500	G386	791440032583	ES3029	791440033498	200-31	791440036246	38561C	857123005432
G233-A	791440031517	G392	791440032613	ES3063	791440033528	200-DEPR KIT	791440080799	38562C	857123005449
G233-B	791440031524	G394	791440032637	ES3231	791440066748	200-GK	791440036321	38563C	857123005456
G236-A	791440031555	G397	791440032668	ES4007	791440039773	200-H	791440036338	38564C	857123005302
G238	791440031579	G400	791440032682	ES4008	791440039766	200-M	791440036369	38565C	857123005319
G239	791440031586	G401	791440032699	1S-9133	791440033559	200-MFV	791440036390	38566C	857123005326
G240	791440031593	G402	791440032705	4L-8212-R	791440033603	200-MMV	791440036406	38567C	857123005333
G241	791440031609	G403	791440032712	5H-5601	791440033627	200-W30	791440036451	38568C	857123005340
G243-A	791440031616	G406	791440032743	5M-954	791440033634	201	791440036468	38574C	857123005463
G247	791440031630	G409	791440032774	6L-1540	791440033658	201-30	791440036475	38575C	857123005470
G251	791440031661	G410	791440032781	7B-7635	791440033665	201-W	791440036499	38576C	857123005487
G252	791440031678	G411	791440032798	8M-7830	791440033740	285-DS	791440036505	43562C	857123005494
G253-A	791440031685	G412	791440032804	24-WLK	791440034778	286-SK	791440036512	43564C	857123005500
G255	791440031692	G416	791440032835	55-EK	791440034792	300	791440036529	43566C	857123005517
G257	791440031715	G417	791440032842	60-21	791440034822	300-DHRAP5	791440036659	43568C	857123005555
G260	791440031722	G422-AF	791440034587	60-21A	791440034939	300-DHRAS5	791440036666	43570C	857123005562
G261	791440031739	G431	791440032880	60-30	791440034877	300-H	791440036741	43572C	857123005579
G263	791440031753	G432	791440032897	60-35A	791440034914	300-M	791440036758	43573C	857123005593
G264-A	791440031760	G433	791440032903	60-GK	791440034921	300-MFV	791440036796	43574C	857123005586
G265	791440031777	G434	791440032910	61	791440034938	300-MFV3	791440036802	38557S	857123005561
G268	791440031791	G435	791440032927	61-W	791440034945	300-MMV	791440036833	38564S	857123005357
G269	791440031807	G436	791440032934	65	791440034952	300-MMV3	791440036840	38565S	857123005364
G270	791440031814	G438	791440032958	65-35A	791440034976	300-W30	791440065840	38566S	857123005371
G273	791440031821	G439	791440032965	65-W30	791440065802	301	791440036956	38567S	857123005388
G274	791440031838	G441	791440032972	66	791440034983	301-30	791440036963	38568S	857123005395
G275	791440031845	G442	791440032989	66-30	791440065857	301-CS	791440036970	43562S	857123005524
G278	791440031852	G443	791440032996	66-W	791440034990	301-MPG	791440034624	43564S	857123005531
G280	791440031876	G444	791440033009	75	791440035003	301-W	791440036987	43566S	857123005548
G281	791440031883	G445	791440033016	75-21	791440035027	500	791440036994	43568S	857123005609
G283	791440031906	G446	791440033023	75-W30	791440065819	500-12	791440037007	43570S	857123005516
G285-AF	791440033471	G447	791440033030	85-EK	791440035034	500-15	791440037014	43572S	857123005623
G286-C	791440047167	G449-B	791440033047	85-P	791440035041	500-BP	791440037021	43573S	857123005647
G288	791440031913	G458	791440033061	85-V	791440035058	500-BP22	791440037038	43574S	857123005630
G289	791440031920	G467	791440033108	100	791440035126	500-MFVBP22	791440088122		
G291	791440031944	G468	791440033115	100-12	791440035157	501	791440037052		
G293-B	791440059092	G472-AF	791440059153	100-21	791440035232	501-30	791440037069		
G296	791440031951	G480	791440033139	100-21AL	791440060418	501-W	791440037076		
G298-AF	791440034501	G483	791440040106	100-21BP	791440035249	PKG50	791440046399		
G299	791440031968	G494	791440076198	100-21M	791440035270	PKG400	791440040496		
G302	791440031982	G498-A	791440040052	100-28	791440035324	PKG401	791440040502		
G303	791440031999	G499-AF	791440039650	100-29	791440035331	PKG402	791440040517		
G304	791440032002	G501-AF	791440033832	100-30	791440035348	PKG406	791440040559		
G305	791440032019	AF521-WN	791440049352	100-BP	791440035416	PKG406-W	791440040564		
G306	791440032026	G523-AF	791440076204	100-DEPR KIT	791440080805	PKG411	791440058842		
G307	791440032033	AF525-WN	791440049369	100-GK	791440035454	PKG412	791440058859		
G309-B	791440032040	G534-AF	791440079519	100-H	791440035461	PKG470	791440063549		
G310	791440032057	G704	791440065987	100-M	791440035485	PKG470-DVD	791440063556		
G314	791440032071	G710	791440065994	100-MFV	791440035508	PKG470-S	791440063570		
G315	791440032088	G717	791440066253	100-MMV	791440035515	PKG475	791440067431		
G323	791440032149	G725	791440066303	100-MNTG KIT	791440080812	PKG475-R	791440076440		
G332	791440032187	ES1001	791440033184	100-W	791440035546	PKG475-S	791440067448		
G333	791440032194	ES1023	791440033207	100-W30	791440065826	PKG490-BANK	791440065949		
G336	791440032217	ES1026	791440033214	101	791440035577	38557P	857123005210		
G340	791440032248	ES1030	791440033238	101-30	791440001374	38559P	857123005050		
G342	791440032255	ES1031	791440059122	101-W	791440035591	38560P	857123005067		
G343-A	791440032262	ES1032	791440033245	140-10	791440035614	38561P	857123005074		
G344	791440032279	ES1034	791440033252	140-50 KIT	791440035652	38562P	857123005081		
G347	791440032293	ES1036	791440033276	150	791440035737	38563P	857123005098		
G348-AF	791440039667	ES1039	791440076211	150-31	791440035812	38564P	857123005005		
G354	791440032316	ES1041	791440033283	150-GK	791440035850	38565P	857123005012		
G356	791440032330	ES1049	791440033306	150-H	791440035867	38566P	857123005029		
G359	791440032354	ES1066	791440033337	150-M	791440035881	38567P	857123005036		
G360	791440032361	ES1067	791440033344	150-W30	791440065833	38568P	857123005043		
G362	791440032378	ES1068	791440033351	151	791440035911	38574P	857123005104		
G363	791440032385	ES1071	791440033368	151-30	791440035928	38575P	857123005111		
G366	791440032408	ES1074	791440033375	151-W	791440035935	38576P	857123005128		
G368	791440032415	G1086-AF	791440033825	185-DS	791440035942	43562P	857123005135		



**WARNING:** These products can expose you to chemicals, including Diisononyl Phthalate, Carbon black extracts, Nickel, 1,3 Butadiene, Ethylene Oxide, Epichlorohydrin, which are known to the State of California to cause cancer, and Bisphenol-A, Ethylene Glycol, Ethylene Oxide, 1,3 Butadiene, Epichlorohydrin, which are known to the State of California to cause birth defects or other reproductive harm.

# UPC TO BALDWIN (INDIVIDUAL PARTS)

UPC NUMBER	BALDWIN NUMBER	UPC NUMBER	BALDWIN NUMBER	UPC NUMBER	BALDWIN NUMBER	UPC NUMBER	BALDWIN NUMBER	UPC NUMBER	BALDWIN NUMBER
UPCCode	BDW#	791440001091	PT85	791440002012	B157	791440002913	BT230	791440003781	PT317-MPG
791440000018	B2	791440001107	PT86-HD	791440002036	B159	791440002920	PF231	791440003798	PT318-MPG
791440000025	B2-HPG	791440001114	PT87-S	791440002043	B160	791440002937	B233	791440003804	PT319-MPG
791440000049	B4	791440001121	PT88-HD	791440002050	B161-S	791440002951	BT234	791440003811	PT320-MPG
791440000056	BT5	791440001138	PT89	791440002067	P162	791440002968	P235	791440003859	BD324
791440000063	B6	791440001145	PT90-10	791440002074	B163	791440002975	B236	791440003866	B326
791440000070	B6-HPG	791440001152	PT90-MPG	791440002081	B164	791440002982	BT237	791440003880	B329
791440000087	B7	791440001169	PT91	791440002104	B166	791440002999	BT238	791440003897	BF330
791440000094	B9	791440001183	PT93	791440002111	B167	791440003002	B239	791440003903	PF332
791440000100	B10-AL	791440001190	PT93-MPG	791440002128	B168	791440003019	P240	791440003910	B333
791440000117	B10-AL BOWL	791440001213	B95	791440002142	P170	791440003026	BT241	791440003927	BT334
791440000124	B10-AL CAP	791440001244	B95-MPG	791440002159	P171	791440003033	P242	791440003941	B336
791440000131	PF10	791440001251	B96	791440002166	P172	791440003040	B243	791440003958	B337
791440000148	PF10-CS	791440001282	B96-MPG	791440002173	B173-S	791440003057	B244	791440003965	BT338
791440000155	PT11	791440001299	B97	791440002180	P174	791440003071	B246	791440003972	BT339
791440000162	PT11-HD	791440001305	PT98-10	791440002203	P176	791440003088	B247	791440003989	BT340
791440000179	PT12	791440001312	PT98-MPG	791440002210	P177	791440003095	BT248	791440003996	BT341
791440000186	BF13	791440001329	B99	791440002227	B178	791440003101	P249	791440004009	BT342
791440000193	P15	791440001336	B99-B	791440002234	B179	791440003118	BT251	791440004016	BT343
791440000209	S16-1	791440001350	B99-MPG	791440002258	PT181 KIT	791440003125	B252	791440004023	BT344-S
791440000230	P18	791440001374	101-30	791440002265	G183	791440003132	B253	791440004030	BT345 KIT
791440000247	PT18-HD	791440001381	P102	791440002272	P183	791440003149	P254	791440004047	BT346
791440000254	P19	791440001398	BD103	791440002296	P184	791440003156	B255	791440004054	BT347
791440000261	P20-HD	791440001404	P104	791440002302	PT185	791440003163	PT256	791440004061	BT348
791440000339	P25	791440001411	B105	791440002319	P186	791440003170	PT257	791440004078	BT349
791440000346	P26	791440001428	P106	791440002326	P187	791440003187	PT258	791440004085	BT350
791440000353	B27	791440001435	P106-HD	791440002340	PT189	791440003194	BT259	791440004092	BT351
791440000360	BD28	791440001459	PT108	791440002357	PT189-MPG	791440003200	BT260	791440004108	P352
791440000377	PT29	791440001466	PT108-HD	791440002364	P190	791440003217	BT260-10	791440004115	BT353
791440000384	AFG30	791440001473	B109	791440002371	PT191	791440003224	BT261	791440004122	BT354
791440000391	B30	791440001480	BC110	791440002388	PT191-10	791440003231	B262	791440004139	BT355
791440000407	B31	791440001497	BT111	791440002395	PT191-5	791440003248	B263	791440004146	P356
791440000421	B33	791440001503	BT112	791440002418	PT193	791440003255	BT264	791440004153	BT357
791440000438	B34	791440001510	B113	791440002425	PT193 KIT	791440003262	PT265	791440004160	B358
791440000445	B35-S	791440001527	B114	791440002432	PT193-3	791440003279	P266	791440004177	BT359
791440000469	AFG37R	791440001534	PT115	791440002449	P194	791440003286	BT267	791440004184	B360
791440000476	B37	791440001541	P116	791440002456	P194-HD	791440003293	PT268	791440004191	BT361
791440000483	AFG38D	791440001558	PF116	791440002463	P194-HD10	791440003309	PT269	791440004214	BT364
791440000506	B39	791440001565	PT117	791440002470	PF194	791440003323	P271	791440004221	BT365
791440000513	P40	791440001572	PT117-25	791440002487	B195	791440003347	PT273	791440004238	BT365-10
791440000520	P41	791440001589	B118	791440002494	B196	791440003354	BT274	791440004245	BT366-10
791440000537	P42	791440001596	PT119	791440002517	P198	791440003361	PT275	791440004252	BT367
791440000544	B43-S	791440001602	PT119-5	791440002524	B199	791440003378	PT275-10	791440004269	BT367-S
791440000568	B45	791440001619	PT119-HD	791440002548	B201-S	791440003385	P276	791440004276	BT368
791440000582	P47	791440001626	PT119-HD05	791440002555	B202	791440003408	PT277	791440004283	B369
791440000599	PT48	791440001640	B120	791440002562	P203	791440003415	B279	791440004290	PT370
791440000605	B49	791440001657	PF121	791440002579	P203-HD	791440003422	P280	791440004306	BT371-10
791440000612	B50	791440001664	PT122-5	791440002586	P203-HD10	791440003439	B281	791440004313	BT371-MPG
791440000636	P52	791440001688	BT124	791440002593	P204	791440003460	PT283	791440004320	BT372-10
791440000643	P53	791440001695	P125	791440002609	P204-HD	791440003477	PT284	791440004337	PT373
791440000650	P54	791440001701	BT126	791440002616	P204-HD10	791440003484	PT285	791440004344	PT374
791440000674	B56	791440001718	B128	791440002623	B205	791440003491	BT287	791440004351	PT375
791440000711	P60	791440001725	B129	791440002630	P206	791440003507	BT287-10	791440004368	PT376
791440000728	PT61-HD	791440001749	B131	791440002647	PT207	791440003514	PT288-HD	791440004375	PT377
791440000735	PT62	791440001756	B132	791440002654	PT207-10	791440003521	PT288-HD10	791440004382	PT377-10
791440000742	PT63-1	791440001763	C133-OW	791440002661	PT207-HD	791440003538	PT289	791440004399	B378
791440000773	PT66-HD	791440001770	C133-W	791440002678	PT207-HD10	791440003545	PT289-10	791440004405	B378-10
791440000780	P67	791440001787	B134	791440002685	PT208	791440003552	PT290	791440004412	PT379 KIT
791440000797	P68	791440001794	PT135	791440002692	PT210	791440003576	BT292	791440004429	PT380 KIT
791440000810	PT70	791440001817	PT137	791440002708	B211	791440003590	P294	791440004436	PT381
791440000834	PT71	791440001824	PT138-10	791440002715	PT212-5	791440003606	B295	791440004443	PT382
791440000858	PT72	791440001831	PT138-25	791440002722	PT213	791440003613	B296	791440004450	PT383
791440000872	P73	791440001848	PT139-10	791440002739	PT214(2)	791440003620	PT298-10	791440004467	PT385
791440000889	B74	791440001855	P140	791440002746	BT215	791440003637	B299	791440004474	PT385-E
791440000896	B75	791440001862	B141	791440002753	BT216	791440003644	T300-M	791440004481	PT386
791440000902	B76	791440001879	BD142	791440002760	BT217	791440003651	B301	791440004498	BT387
791440000933	B76-MPG	791440001886	B143	791440002777	B218	791440003668	PT302	791440004504	BT387-10
791440000964	PT79	791440001893	P144	791440002791	B220	791440003675	T303-M	791440004511	BT388
791440000988	P80	791440001909	PT146	791440002807	BT221	791440003682	PT304	791440004528	BT388-10
791440000995	P80-HD	791440001923	P148	791440002814	B222	791440003705	B307	791440004535	BT389
791440001015	P81	791440001947	P150	791440002821	BT223	791440003712	T308-M	791440004542	BT389-10
791440001022	P82	791440001954	PT151	791440002838	PF224	791440003729	B309	791440004559	PT390-MPG
791440001039	PT82-HD	791440001961	PT152	791440002852	PF225	791440003736	PF311	791440004566	PT391-MPG
791440001046	PT82-HD10	791440001978	PT153	791440002876	PF226	791440003743	PF312	791440004573	PT392
791440001053	PT83	791440001985	PT154	791440002883	B227	791440003750	PF313	791440004580	PT393
791440001060	PT83-MPG	791440001992	PF155	791440002890	B228	791440003767	PF314	791440004597	PT394-15
791440001084	P84-2	791440002005	B156	791440002906	B229	791440003774	PF316	791440004603	BT395



**WARNING:** These products can expose you to chemicals, including Diisononyl Phthalate, Carbon black extracts, Nickel, 1,3 Butadiene, Ethylene Oxide, Epichlorohydrin, which are known to the State of California to cause cancer, and Bisphenol-A, Ethylene Glycol, Ethylene Oxide, 1,3 Butadiene, Epichlorohydrin, which are known to the State of California to cause birth defects or other reproductive harm.

# UPC TO BALDWIN (INDIVIDUAL PARTS)

UPC NUMBER	BALDWIN NUMBER	UPC NUMBER	BALDWIN NUMBER	UPC NUMBER	BALDWIN NUMBER	UPC NUMBER	BALDWIN NUMBER	UPC NUMBER	BALDWIN NUMBER
791440004610	PT396	791440005594	PT480-10	791440006614	PT578	791440007635	PA693	791440008724	PF807
791440004627	PT397	791440005600	PT480-MPG	791440006621	PT579	791440007642	PT694	791440008748	PF809
791440004634	BT398	791440005617	B481	791440006676	BF582	791440007666	PA696	791440008755	PF810
791440004641	PT400	791440005631	PT483	791440006683	BF583	791440007673	PA697	791440008762	PF811
791440004658	PT401-MPG	791440005655	S485	791440006690	BF584	791440007680	PA699	791440008779	BF812
791440004665	BT402	791440005662	BT486	791440006706	BF584-B	791440007727	C704-L	791440008793	PF814
791440004672	B403	791440005679	PT487	791440006713	BF585	791440007741	P706-M	791440008816	PF816
791440004689	B404	791440005693	B488	791440006720	BF586	791440007765	PT707-HD	791440008823	PF816-S
791440004696	JC405	791440005709	S489	791440006737	BF586-D	791440007772	PT707-HD10	791440008847	PF818
791440004702	CU406	791440005716	PT490	791440006744	BF587	791440007789	PT707-HD3	791440008854	PF819
791440004719	DF408	791440005723	PT491	791440006751	BF587-D	791440007796	PT708-HD	791440008861	PF819-HD
791440004849	TC413-CPE5	791440005747	PT491-10	791440006768	BF588	791440007802	PT714	791440008878	PF820-S
791440004863	V414-B	791440005754	PT492	791440006874	BF591	791440007819	PF717	791440008885	PF821-S
791440004870	V414-FF	791440005761	PT493	791440006881	BF592	791440007833	P718-5	791440008892	PF822
791440004887	F415-B	791440005778	B494	791440006898	BF593	791440007840	BF719	791440008908	PF823
791440004894	P415-10	791440005785	B495	791440006904	PF594	791440007857	BF720	791440008953	PF823-E
791440004900	P415-10A	791440005815	P496	791440006911	BT595	791440007864	P721	791440008960	PF824
791440004917	P415-25	791440005822	PA97	791440006928	BF596	791440007871	PT722	791440008984	BF825
791440004924	P415-25A	791440005839	PT498	791440006935	BF597	791440007888	PT23	791440008991	PF826
791440004931	P415-5	791440005846	PT498-10	791440006942	PF598	791440007895	PT725-MPG	791440009004	PF827
791440004948	P415-5A	791440005853	PT499-5	791440006959	PF598-10	791440007901	PT727-DL	791440009028	PF828
791440004955	P415-5AN	791440005884	F501-MD	791440006966	PF598-30	791440007918	PT727-HD	791440009035	PF829(2)
791440004962	P415-GM	791440005907	PT503	791440006973	PF599	791440007925	PT727-HD10	791440009042	BF830
791440004979	V415-B	791440005921	PF506	791440006980	PF599-10	791440007932	PT728-MPG	791440009059	PF831
791440004986	V415-FF	791440005938	P507	791440006997	PF599-30	791440007949	PT729	791440009073	BF833
791440004993	PT416	791440005945	PT508-MPG	791440007000	PA602	791440007970	BT732	791440009080	BF833-K2
791440005013	PT418	791440005952	PT509-MPG KIT	791440007017	PA604	791440007994	BT735	791440009097	BF834-F
791440005037	BT420	791440005969	PT510	791440007024	B605	791440008014	PT737	791440009103	PF834
791440005044	B421	791440005976	PT512	791440007048	PA607	791440008021	PT737-10	791440009127	BF836
791440005051	S423	791440005983	PT513	791440007086	PA612	791440008038	V738-O	791440009134	BF836-K3
791440005068	BT424	791440005990	PT514	791440007093	PA613	791440008045	BT739	791440009141	BF836-K4
791440005075	BT425	791440006003	PT515	791440007109	BF614	791440008052	C740-S	791440009158	BF837
791440005082	PT426	791440006010	PT516	791440007116	PA615	791440008144	C750-E	791440009165	BF838-F2
791440005099	BT427	791440006027	PT517	791440007123	PA616	791440008151	C750-L	791440009172	PF838
791440005112	V429-B	791440006034	PT518	791440007130	PA617	791440008168	C750-L SINGLE	791440009189	BT839
791440005129	V429-FF	791440006041	PT518-10	791440007147	PA618	791440008175	PT751	791440009196	BT839-10
791440005136	PT430-FF	791440006058	PT520	791440007154	PA618 FOAM	791440008182	PT752	791440009202	BF840
791440005143	PT431	791440006072	BT521	791440007161	PA618-S	791440008199	PT753	791440009219	BF840-K1
791440005150	PT433	791440006089	PT522	791440007185	PA621	791440008212	PT757	791440009233	V7842-O
791440005167	PT434	791440006096	BT525	791440007192	PA625	791440008229	PT757-10	791440009240	BF843
791440005174	PT434-10	791440006102	BT526	791440007208	PA631	791440008243	PT760-10	791440009257	F844-A
791440005181	PT435	791440006119	BT526-10	791440007215	PA632	791440008250	PT760-25	791440009264	F845-A
791440005198	PT436	791440006126	PT527	791440007222	PA633(2)	791440008267	PT761	791440009271	PF845
791440005204	PT437	791440006133	P528	791440007239	PA634	791440008281	PT763	791440009288	PF846
791440005211	BT438	791440006140	P529	791440007246	PA638	791440008298	PT764	791440009295	PF847
791440005228	PT439	791440006188	PT534	791440007253	PA639	791440008304	PT765	791440009318	PT849
791440005235	BT440	791440006195	PT535	791440007260	PA640	791440008311	PT766	791440009325	PT849-10
791440005242	PT441	791440006201	BT536	791440007277	PA641	791440008328	PT767	791440009356	V852-O
791440005259	PT442-MPG	791440006218	P537	791440007284	PA642	791440008335	PT768	791440009363	BF853
791440005266	BT443	791440006225	PT538	791440007291	PA643	791440008373	PT772	791440009387	BF855
791440005273	PT445-MPG	791440006232	PT539	791440007307	PA644	791440008380	PT773-MPG	791440009394	BF856
791440005280	PA446	791440006249	P540	791440007314	PA645	791440008397	PT774	791440009400	PF857
791440005297	B447	791440006263	BT541	791440007338	PA648	791440008403	BT775	791440009417	BF858
791440005310	P450	791440006287	PT543 KIT	791440007345	PA649	791440008410	PT776-MPG	791440009424	PF859
791440005327	S451	791440006300	P545	791440007352	PA650	791440008427	PT777	791440009431	PF860
791440005334	BT452	791440006317	PT546	791440007369	PA651	791440008434	BT778	791440009448	PF861
791440005358	P454	791440006324	PT548	791440007376	PA652	791440008441	BT779	791440009455	BF862
791440005365	S455	791440006331	PT549	791440007383	PA653	791440008458	BF781	791440009462	BF863
791440005372	S456	791440006348	PT550-10	791440007390	PA654	791440008465	BF782	791440009479	PF864
791440005389	PT457-MPG	791440006355	PT551-10	791440007406	PA655	791440008472	BF783	791440009486	BF865
791440005396	PT459	791440006379	PT554	791440007413	PA656	791440008489	BF784	791440009493	BF865-K
791440005402	PT461	791440006386	P555	791440007420	PA657	791440008496	BF785	791440009509	PF866
791440005419	PT462	791440006393	BT556-10	791440007437	PA658	791440008502	BF786	791440009523	BF868
791440005426	PT463	791440006416	PT558	791440007475	PA662	791440008526	BF788	791440009530	PF869
791440005457	PT466	791440006423	PT560 KIT	791440007505	PA666	791440008533	BF789	791440009554	PF872
791440005464	PT467-MPG	791440006430	PT561	791440007512	PA669	791440008540	BF790	791440009561	BF873
791440005471	PT468-MPG	791440006454	PT562-10	791440007529	PT670	791440008557	BF791	791440009578	BF874
791440005488	PT469	791440006461	PT563	791440007536	PT670-E	791440008564	BF792	791440009592	BF876
791440005495	BT470	791440006478	BT564	791440007543	PA671	791440008588	BF794	791440009615	BF877
791440005501	PT471	791440006485	PT565	791440007550	PA671-1	791440008595	BF795	791440009646	BF879
791440005518	BT472	791440006492	PT566	791440007567	PA675	791440008618	BF797	791440009660	BF881
791440005525	B474	791440006508	PT567	791440007574	PT676	791440008625	BF798	791440009677	PF882
791440005532	PT475	791440006515	PT567-10	791440007581	PA677	791440008632	BF799	791440009684	PF883
791440005549	PA776	791440006522	PT568	791440007598	PA678	791440008670	PF802	791440009691	BF884
791440005556	PT477	791440006553	PT571	791440007604	PA680	791440008694	PF804	791440009707	BF885
791440005570	S479	791440006577	PT573	791440007611	PT685-MPG	791440008700	BF805	791440009714	BF886
791440005587	PT480	791440006607	BF577	791440007628	PA691	791440008717	BF806	791440009721	BF888



**WARNING:** These products can expose you to chemicals, including Diisononyl Phthalate, Carbon black extracts, Nickel, 1,3 Butadiene, Ethylene Oxide, Epichlorohydrin, which are known to the State of California to cause cancer, and Bisphenol-A, Ethylene Glycol, Ethylene Oxide, 1,3 Butadiene, Epichlorohydrin, which are known to the State of California to cause birth defects or other reproductive harm.

# UPC TO BALDWIN (INDIVIDUAL PARTS)

UPC NUMBER	BALDWIN NUMBER	UPC NUMBER	BALDWIN NUMBER	UPC NUMBER	BALDWIN NUMBER	UPC NUMBER	BALDWIN NUMBER	UPC NUMBER	BALDWIN NUMBER
791440009745	BF890	791440010840	PF981	791440012196	V1520-R	791440013018	LL1676-FN	791440013865	PA1802
791440009752	BF891	791440010864	BF984	791440012219	V1542-C	791440013025	PA1676-FN	791440013889	PA1805
791440009769	BF892	791440010871	PF986	791440012226	V1544-T	791440013032	PA1679	791440013896	PA1806
791440009776	PF893	791440010888	PF987	791440012233	PA1600	791440013049	PA1680	791440013919	PA1809
791440009783	PF893-RV	791440010895	BF988	791440012240	PA1602	791440013056	LL1681-FN	791440013926	PA1810
791440009790	PF894	791440010901	BF989	791440012257	PA1603	791440013063	PA1681-FN	791440013940	PA1814
791440009806	PF894-RV	791440010925	BF991	791440012264	PA1606	791440013070	PA1682	791440013957	PA1815
791440009820	BF896	791440010932	BF992	791440012271	PA1607	791440013087	PA1683	791440013964	PA1816
791440009837	BF897 KIT	791440010956	BF995	791440012288	LL1608	791440013094	PA1684	791440013971	PA1817
791440009844	SF898	791440010963	P996	791440012295	PA1608	791440013100	PA1686	791440013988	PA1818
791440009851	PF899	791440010970	P998	791440012301	PA1609	791440013117	PA1687	791440013995	PA1819
791440009868	BF900	791440010994	P999-HD	791440012318	PA1610	791440013124	PA1688	791440014008	PA1821
791440009899	PF902	791440011038	V1009-W	791440012325	PA1613	791440013131	PA1689	791440014015	PA1822-FN
791440009905	PF902-S	791440011069	V1044-O	791440012332	PA1613-S	791440013148	LL1690-FN	791440014022	PA1823
791440009912	PT903	791440011076	BF1102	791440012349	LL1614	791440013155	PA1690-FN	791440014039	PA1824
791440009950	PF906	791440011090	BF1104	791440012356	PA1614	791440013162	PA1692	791440014046	PA1825
791440009967	PF907	791440011106	BF1105	791440012363	LL1615	791440013179	PA1696	791440014053	PA1826
791440009974	PF908-A	791440011144	BF1110	791440012370	PA1615	791440013186	PA1697	791440014060	PA1827
791440009981	BF909	791440011175	BF1120	791440012394	PA1618	791440013193	PA1698	791440014077	PA1828
791440009998	PF910	791440011182	BF1123	791440012400	PA1619	791440013209	PA1699-FN	791440014084	PA1830-FN
791440010024	BF912	791440011250	BF1140	791440012417	PA1620	791440013216	PA1700	791440014091	PA1831
791440010031	PF913	791440011281	BF1148	791440012424	PA1620-S	791440013230	PA1701	791440014107	PA1832
791440010048	BF914	791440011298	BF1150	791440012431	LL1621-2	791440013247	PA1701 ELE	791440014114	PA1834
791440010055	BF915	791440011342	BF1160	791440012448	PA1621	791440013254	PA1701 FOAM	791440014121	PA1836
791440010062	PF916-C	791440011366	BF1163	791440012455	PA1621-2	791440013261	PA1702	791440014138	PA1837-FN
791440010079	PF916	791440011380	BF1166	791440012462	PA1621-S	791440013285	PA1702 FOAM	791440014152	PA1840
791440010109	BF918-K	791440011427	BF1170	791440012486	PA1625	791440013292	PA1703	791440014169	PA1841
791440010147	PF919-C	791440011434	BF1171	791440012493	LL1626-2	791440013315	PA1704	791440014176	PA1845
791440010192	BF920	791440011441	BF1201	791440012509	PA1626	791440013322	PA1705-2	791440014183	LL1846
791440010239	PF924	791440011472	BF1210	791440012516	PA1626-2	791440013339	PA1706	791440014190	PA1846
791440010246	BF925	791440011489	BF1211	791440012523	PA1627	791440013346	PA1707-FN	791440014213	PA1847-FN
791440010253	PF926	791440011496	BF1212	791440012530	PA1629-S	791440013353	PA1709	791440014220	PA1848
791440010277	BF928	791440011502	BF1212 FOAM	791440012547	LL1630-2	791440013360	PA1710	791440014237	PA1849
791440010284	BF929	791440011526	BF1213	791440012554	PA1630	791440013377	PA1712	791440014244	PA1850-FN
791440010291	BF930	791440011533	BF1214	791440012561	PA1630-2	791440013391	PA1718	791440014251	PA1851
791440010321	BF932	791440011540	BF1216	791440012578	PA1631-S	791440013407	PA1719	791440014268	PA1852
791440010338	BF933	791440011557	BF1218	791440012585	PA1632	791440013414	PA1721	791440014299	PA1857
791440010352	PF935	791440011564	BF1219	791440012608	PA1633	791440013421	PA1726	791440014305	PA1858
791440010369	PF936	791440011571	BF1220	791440012615	LL1634	791440013445	PA1735	791440014312	PA1859
791440010376	PF937	791440011588	BF1221	791440012622	PA1634	791440013469	PA1748	791440014329	PA1860
791440010383	BF938	791440011595	BF1223	791440012639	PA1635	791440013476	PA1749-FN	791440014336	PA1861
791440010390	BF939	791440011601	BF1225	791440012646	LL1636-FN	791440013483	PA1750-FN	791440014343	PA1863
791440010406	BF940	791440011618	BF1226	791440012653	LL1636-FN	791440013490	PA1752-FN	791440014367	PA1864-FN
791440010413	BF941	791440011632	BF1232	791440012660	LL1637-FN	791440013506	PA1753-FN	791440014374	PA1865-FN
791440010420	PF942	791440011649	BF1233	791440012677	PA1637-FN	791440013513	PA1754	791440014381	PA1866
791440010437	PF943	791440011670	V1240-C	791440012684	PA1639	791440013520	PA1755-FN	791440014398	PA1867
791440010451	PF945	791440011694	BF1259	791440012691	PA1641	791440013537	PA1757	791440014404	PA1868
791440010468	PF946	791440011700	BF1276	791440012707	LL1642-2	791440013544	PA1758	791440014411	PA1873
791440010475	PF947	791440011717	BF1280	791440012714	PA1642-2	791440013551	PA1763	791440014428	V1874-T
791440010482	BF948	791440011731	FB1301	791440012721	PA1643	791440013568	PA1765	791440014435	PA1875
791440010512	BF949-JD	791440011748	FB1302	791440012738	PA1644	791440013575	PA1765 FOAM	791440014442	PA1877
791440010529	PF949	791440011755	OB1303	791440012745	F1645-DS	791440013582	PA1768	791440014459	PA1880
791440010536	PF950-F	791440011779	OB1305	791440012752	V1645-C	791440013599	PA1769	791440014466	PA1881
791440010543	PF950	791440011786	FB1307	791440012769	LL1646-FN	791440013612	PA1771	791440014473	PA1882
791440010550	PT951	791440011793	OB1308	791440012776	PA1646	791440013629	PA1772	791440014480	PA1883-FN
791440010567	PF952	791440011809	FB1309	791440012783	PA1646-FN	791440013636	PA1773	791440014497	LL1884
791440010574	BF954	791440011816	FB1310	791440012790	PA1647	791440013643	PA1774	791440014503	PA1884
791440010581	BF955	791440011823	FB1311	791440012806	PA1648	791440013650	PA1775	791440014510	LL1885
791440010598	BF956	791440011830	OB1313	791440012813	LL1649	791440013667	PA1776	791440014527	PA1885
791440010604	BF957	791440011847	OB1314	791440012820	PA1649	791440013674	PA1777	791440014534	LL1886
791440010628	BF957-D	791440011854	OB1315	791440012837	PA1650-FN	791440013681	PA1778	791440014541	PA1886
791440010635	BF958	791440011861	OB1316	791440012851	PA1653	791440013698	PA1779	791440014565	PA1888
791440010642	BF959	791440011878	OB1317	791440012868	V1656-O	791440013704	PA1780	791440014572	PA1889
791440010659	P960	791440011885	OB1318	791440012875	V1656-T	791440013711	PA1781	791440014589	PA1891
791440010673	BF962	791440011892	OB1319	791440012882	PA1657	791440013728	PA1782	791440014596	PA1892-FN
791440010680	PF963	791440011908	OB1320	791440012899	PA1661(3)	791440013735	PA1783	791440014602	PA1893
791440010710	BF966	791440011953	VG1325	791440012905	PA1663	791440013742	PA1784	791440014619	LL1894
791440010727	PF967	791440011960	PG1326	791440012912	PA1664	791440013759	PA1786	791440014626	PA1894
791440010734	BF968	791440012011	OB1368	791440012929	PA1666	791440013766	PA1787	791440014633	LL1895
791440010741	BF970	791440012028	OB1369	791440012936	LL1667-FN	791440013773	PA1788	791440014640	PA1895
791440010758	BF971	791440012035	B1400	791440012943	PA1667-FN	791440013780	PA1789	791440014657	PA1896
791440010772	BF974-D	791440012059	B1402	791440012950	LL1669	791440013797	PA1790	791440014664	PA1897
791440010789	B975	791440012080	B1406	791440012967	PA1669	791440013803	PA1794-FN	791440014671	PA1898
791440010796	BF976	791440012097	B1407	791440012974	PA1670	791440013810	PA1795	791440014688	PA1899
791440010819	BF978	791440012127	B1428	791440012981	PA1673	791440013827	PA1797	791440014695	PA1900
791440010826	BF979	791440012172	P1510	791440012998	PA1674	791440013834	PA1798	791440014701	PA1901
791440010833	BF980	791440012189	P1511	791440013001	PA1675	791440013841	PA1800	791440014718	LL1902-FN



**WARNING:** These products can expose you to chemicals, including Diisononyl Phthalate, Carbon black extracts, Nickel, 1,3 Butadiene, Ethylene Oxide, Epichlorohydrin, which are known to the State of California to cause cancer, and Bisphenol-A, Ethylene Glycol, Ethylene Oxide, 1,3 Butadiene, Epichlorohydrin, which are known to the State of California to cause birth defects or other reproductive harm.



## UPC TO BALDWIN (INDIVIDUAL PARTS)

UPC NUMBER	BALDWIN NUMBER	UPC NUMBER	BALDWIN NUMBER	UPC NUMBER	BALDWIN NUMBER	UPC NUMBER	BALDWIN NUMBER	UPC NUMBER	BALDWIN NUMBER
791440014725	PA1902-FN	791440015708	PA2051	791440016972	PA2189	791440017986	LL2358	791440018792	PA2431
791440014732	PA1904	791440015715	PA2052	791440016996	PA2191	791440017993	PA2358	791440018808	PA2432
791440014749	PA1905	791440015722	PA2053	791440017016	PA2193	791440018006	PA2359	791440018815	PA2433
791440014756	PA1906	791440015777	PA2061	791440017023	PA2194	791440018013	LL2360-FN	791440018822	PA2434
791440014763	PA1907-FN	791440015791	PA2063	791440017047	PA2196	791440018020	PA2360-FN	791440018839	PA2435
791440014770	PA1909	791440015807	PA2064	791440017115	PA2204	791440018037	LL2361	791440018846	PA2436
791440014787	PA1911	791440015814	PA2065	791440017146	PA2207	791440018044	PA2361	791440018853	PA2437
791440014794	PA1912	791440015838	PA2067	791440017153	PA2208	791440018051	PA2362	791440018877	PA2438
791440014800	PA1913	791440015845	PA2068	791440017191	PA2212	791440018068	LL2363	791440018884	LL2439
791440014817	PA1915	791440015852	PA2069	791440017214	PA2214	791440018075	PA2363	791440018891	PA2439
791440014824	PA1916	791440015869	PA2070	791440017221	PA2215	791440018082	PA2364	791440018907	PA2440
791440014831	PA1919-FN	791440015876	PA2071	791440017238	PA2216	791440018099	PA2367	791440018914	PA2441
791440014848	PA1920	791440015883	PA2072	791440017252	PA2218	791440018105	PA2368	791440018921	PA2442
791440014855	PA1921	791440015890	PA2073	791440017283	PA2221	791440018112	PA2369	791440018938	PA2443
791440014879	PA1922	791440015906	PA2074	791440017290	PA2222	791440018129	PA2370	791440018945	PA2444
791440014886	PA1922-FN	791440015913	PA2075	791440017306	PA2223	791440018136	PA2371	791440018952	PA2445
791440014916	PA1926	791440015920	PA2076	791440017313	PA2224	791440018143	PA2372	791440018969	PA2446
791440014923	PA1932	791440015937	PA2077	791440017320	PA2225	791440018167	PA2374	791440018976	LL2447-FN
791440014930	PA1934	791440015951	PA2079	791440017337	PA2226	791440018174	PA2375	791440018983	PA2447-FN
791440014947	PA1936	791440015968	PA2081	791440017344	PA2256	791440018181	PA2376	791440018990	PA2448
791440014954	PA1937	791440015982	PA2083	791440017351	PA2257	791440018198	PA2377	791440019010	PA2450
791440014961	PA1940	791440015999	SA2084	791440017368	PA2300	791440018204	PA2378	791440019027	PA2451
791440014978	PA1941-FN	791440016002	SA2085	791440017375	PA2301	791440018211	PA2379	791440019034	PA2452
791440015005	PA1945	791440016057	PA2091	791440017382	PA2302-FN	791440018228	PA2379-K	791440019041	LL2453
791440015012	PA1946	791440016064	PA2092	791440017399	PA2303	791440018235	PA2380-FN	791440019058	PA2453
791440015029	PA1949	791440016071	PA2093	791440017405	PA2304-FN	791440018242	PA2381	791440019065	PA2454
791440015043	PA1951	791440016088	PA2094	791440017412	PA2305	791440018266	PA2382	791440019072	PA2455
791440015050	PA1952	791440016095	PA2095	791440017429	PA2306	791440018273	PA2383	791440019089	LL2456
791440015067	PA1953	791440016101	PA2096	791440017436	PA2307	791440018280	LL2384	791440019096	PA2456
791440015081	PA1956-FN	791440016118	PA2099	791440017443	PA2308	791440018297	PA2384	791440019102	PA2457
791440015098	PA1957	791440016125	PA2100	791440017467	PA2310	791440018303	PA2385	791440019119	LL2458
791440015104	PA1960	791440016132	PA2101A	791440017474	LL2312	791440018310	PA2386	791440019126	PA2458
791440015111	PA1961	791440016149	PA2102	791440017481	PA2312	791440018327	PA2387	791440019133	PA2459
791440015128	PA1963	791440016156	PA2103	791440017498	PA2313	791440018334	PA2388	791440019140	PA2460
791440015135	PA1967	791440016163	PA2104	791440017504	PA2314	791440018358	PA2389-FN	791440019164	PA2461
791440015142	PA1969	791440016187	PA2106	791440017511	PA2315	791440018365	PA2390	791440019171	PA2462
791440015166	PA1972	791440016194	PA2107	791440017535	PA2316	791440018372	PA2391	791440019188	PA2463
791440015173	PA1973	791440016217	PA2109	791440017542	LL2317	791440018389	PA2392	791440019195	PA2464
791440015197	PA1975	791440016224	PA2110	791440017559	PA2317	791440018396	LL2393	791440019218	PA2465
791440015203	PA1976	791440016255	PA2113	791440017566	LL2318	791440018402	PA2393	791440019225	PA2466
791440015210	PA1977-FN	791440016262	PA2114	791440017573	PA2318	791440018419	PA2394	791440019232	PA2467
791440015227	PA1978-FN	791440016279	PA2115	791440017580	PA2319	791440018426	PA2395	791440019249	PA2468
791440015241	PA1979-FN	791440016286	PA2116	791440017597	PA2320-FN	791440018433	PA2396	791440019256	PA2469
791440015265	PA1980-FN	791440016293	PA2117	791440017603	PA2321	791440018440	PA2397	791440019263	PA2472
791440015272	PA1981	791440016323	PA2121	791440017610	PA2322	791440018457	PA2398	791440019270	PA2473
791440015289	PA1982	791440016354	PA2124	791440017627	PA2323	791440018464	PA2399	791440019287	PA2474
791440015296	PA1985	791440016361	PA2125	791440017641	LL2326	791440018488	PA2401	791440019294	PA2475
791440015302	PA1986	791440016385	PA2127	791440017658	PA2326	791440018495	PA2402	791440019300	PA2476
791440015319	PA1986-K	791440016453	PA2134	791440017672	PA2328	791440018501	PA2403	791440019317	PA2477
791440015326	PA1987	791440016460	PA2135	791440017689	PA2329	791440018518	PA2404	791440019324	PA2478
791440015333	PA1989-FN	791440016477	PA2136	791440017696	LL2330	791440018525	PA2405	791440019331	PA2479
791440015340	LL1992	791440016491	PA2138	791440017702	PA2330	791440018532	PA2406	791440019348	PA2481
791440015371	PA1992-FN	791440016507	PA2139	791440017719	PA2331	791440018549	PA2407	791440019355	LL2482
791440015388	PA1995	791440016514	PA2140	791440017726	PA2332	791440018556	PA2408	791440019362	PA2482
791440015395	PA1996	791440016576	PA2147	791440017733	LL2333	791440018563	PA2409	791440019379	PA2483
791440015401	PA1997	791440016583	PA2148	791440017740	PA2333	791440018570	PA2410	791440019386	PA2484
791440015418	PA1998	791440016590	PA2149	791440017757	PA2335	791440018587	PA2411	791440019393	PA2485
791440015425	PA2001	791440016606	PA2150	791440017764	PA2337	791440018594	PA2412	791440019409	PA2486
791440015432	PA2002	791440016620	PA2152	791440017771	PA2338-FN	791440018600	PA2413	791440019416	PA2487
791440015456	PA2005	791440016637	PA2153	791440017788	PA2339	791440018617	PA2414	791440019423	PA2488-FN
791440015463	PA2006	791440016644	PA2154	791440017795	PA2340	791440018624	PA2415	791440019430	PA2489
791440015470	PA2007	791440016668	PA2156	791440017801	PA2341	791440018631	PA2417-FN	791440019447	PA2490
791440015487	PA2008	791440016682	PA2158	791440017818	PA2342	791440018648	LL2418-FN	791440019454	PA2491
791440015494	PA2009	791440016699	SA2159	791440017825	PA2343	791440018655	PA2418-FN	791440019478	LL2493
791440015500	PA2010	791440016705	PA2160	791440017832	LL2344-FN	791440018662	PA2419	791440019485	PA2493
791440015531	PA2023	791440016729	PA2162	791440017849	PA2344-FN	791440018679	PA2420	791440019508	PA2494
791440015548	PA2024	791440016736	PA2163	791440017856	PA2345	791440018686	PA2421	791440019515	PA2495
791440015562	SA2027	791440016743	PA2164	791440017863	PA2346	791440018693	PA2422	791440019522	PA2496
791440015579	PA2031	791440016774	PA2167	791440017870	PA2347	791440018709	PA2423	791440019539	PA2497
791440015609	PA2036	791440016781	PA2168	791440017894	PA2349-FN	791440018716	LL2425	791440019546	PA2498
791440015616	PA2037	791440016798	PA2169	791440017900	PA2350	791440018723	PA2425	791440019553	PA2499
791440015623	PA2038	791440016811	PA2171	791440017917	PA2351	791440018730	LL2426-FN	791440019560	PA2500
791440015630	SA2039	791440016880	PA2178	791440017924	PA2352	791440018747	PA2426-FN	791440019584	PA2502
791440015647	PA2041	791440016910	PA2181	791440017931	PA2353	791440018754	PA2427	791440019591	LL2503
791440015654	PA2042	791440016927	PA2182	791440017948	PA2354	791440018761	PA2428	791440019607	PA2503
791440015661	PA2044	791440016934	PA2183	791440017955	PA2356	791440018778	PA2429	791440019614	PA2504
791440015692	PA2050	791440016965	PA2188	791440017979	PA2357	791440018785	PA2430	791440019621	LL2507



**WARNING:** These products can expose you to chemicals, including Diisononyl Phthalate, Carbon black extracts, Nickel, 1,3 Butadiene, Ethylene Oxide, Epichlorohydrin, which are known to the State of California to cause cancer, and Bisphenol-A, Ethylene Glycol, Ethylene Oxide, 1,3 Butadiene, Epichlorohydrin, which are known to the State of California to cause birth defects or other reproductive harm.

# UPC TO BALDWIN (INDIVIDUAL PARTS)

UPC NUMBER	BALDWIN NUMBER	UPC NUMBER	BALDWIN NUMBER	UPC NUMBER	BALDWIN NUMBER	UPC NUMBER	BALDWIN NUMBER	UPC NUMBER	BALDWIN NUMBER
791440019638	PA2507	791440020542	PA2582	791440021402	PA2660	791440022300	PA2742	791440023123	PA2843
791440019645	PA2508	791440020559	PA2583	791440021419	LL2661	791440022317	PA2743	791440023130	PA2844
791440019652	PA2509	791440020573	PA2585	791440021426	PA2661	791440022324	PA2744	791440023147	PA2845
791440019669	PA2510	791440020580	PA2586	791440021433	PA2662	791440022331	PA2745	791440023154	PA2846-FN
791440019676	PA2511	791440020597	PA2587	791440021457	PA2663-FN	791440022348	PA2746	791440023161	PA2848
791440019683	PA2512	791440020603	PA2588	791440021464	PA2664	791440022355	PA2747	791440023178	PA2849
791440019690	PA2513	791440020610	PA2589-FN	791440021471	PA2665	791440022362	PA2748	791440023192	PA2851
791440019706	PA2514	791440020634	PA2591	791440021488	PA2666	791440022386	PA2749	791440023208	PA2852
791440019720	PA2515	791440020641	PA2592	791440021495	LL2667	791440022393	PA2750	791440023215	PA2853
791440019744	PA2516	791440020658	PA2593	791440021501	PA2667	791440022409	PA2751	791440023222	PA2854
791440019751	PA2517	791440020672	PA2595	791440021518	PA2668	791440022416	PA2752	791440023239	PA2855
791440019768	LL2518	791440020696	PA2596	791440021525	PA2669-FN	791440022423	PA2753	791440023246	PA2856
791440019775	PA2518	791440020719	PA2598	791440021532	PA2670	791440022430	PA2754	791440023253	PA2857
791440019782	PA2519	791440020726	PA2599	791440021556	PA2672	791440022447	PA2755	791440023260	PA2858
791440019805	PA2520	791440020733	PA2600	791440021563	PA2673	791440022454	PA2756	791440023277	PA2861
791440019812	LL2521	791440020740	PA2601	791440021570	PA2674	791440022461	PA2757	791440023291	RS2863
791440019829	PA2521	791440020757	PA2602	791440021594	PA2675	791440022478	PA2761	791440023307	PA2865
791440019836	PA2522	791440020771	PA2604	791440021600	LL2676	791440022485	PA2763	791440023321	PA2874
791440019843	PA2523	791440020788	PA2605	791440021617	PA2676	791440022492	PA2767	791440023338	PA2875
791440019850	PA2524-FN	791440020795	PA2606	791440021624	PA2677	791440022508	PA2772	791440023345	PA2876
791440019867	LL2525	791440020801	PA2607	791440021631	PA2678	791440022515	PA2773	791440023352	PA2900
791440019874	PA2525	791440020818	LL2608	791440021655	PA2679	791440022522	PA2774	791440023369	PA2902
791440019881	PA2526	791440020825	PA2608	791440021662	PA2680	791440022539	PA2775	791440023376	PA2932
791440019898	PA2527	791440020832	LL2609	791440021693	PA2684-FN	791440022546	PA2776	791440023383	PA2933
791440019904	PA2528	791440020849	PA2609	791440021709	LL2685	791440022553	PA2777	791440023390	PA2935
791440019911	PA2529	791440020856	PA2610	791440021730	PA2687	791440022560	PA2778-FN	791440023406	PA2936
791440019928	PA2530	791440020863	PA2611	791440021747	LL2688	791440022577	LL2779	791440023413	PA2938
791440019942	PA2531	791440020870	PA2612	791440021754	PA2688	791440022584	PA2779	791440023444	PA2944-FN
791440019966	PA2532	791440020887	PA2613	791440021761	PA2689	791440022607	PA2781	791440023451	LL2945
791440019980	PA2533	791440020894	PA2614	791440021778	PA2690	791440022614	PA2782	791440023468	PA2945
791440019997	PA2534	791440020900	PA2615	791440021785	PA2691	791440022638	PA2783	791440023475	PA2946
791440020009	PA2535	791440020917	PA2616	791440021792	PA2692	791440022645	PA2784	791440023482	PA2947
791440020016	PA2536	791440020924	PA2617	791440021808	PA2693	791440022652	PA2785	791440023499	PA2949-FN
791440020023	PA2538	791440020931	LL2618	791440021815	PA2694	791440022669	PA2786	791440023505	PA2973
791440020030	PA2539	791440020948	PA2618	791440021839	PA2696	791440022676	PA2787	791440023529	PA2978
791440020047	PA2540	791440020955	PA2619	791440021846	PA2698	791440022683	PA2788	791440023536	PA2984
791440020054	PA2541-FN	791440020962	PA2620	791440021860	PA2699	791440022690	PA2789	791440023543	PA2988
791440020061	PA2542	791440020979	PA2621	791440021877	PA2700	791440022706	PA2790-FN	791440023550	PA2989
791440020085	PA2544	791440020986	PA2622	791440021884	PA2701	791440022713	PA2791	791440023557	PA3404
791440020092	PA2545	791440020993	PA2623	791440021891	PA2702	791440022720	PA2792	791440023564	PA3406-FN
791440020108	PA2546	791440021006	PA2624	791440021907	PA2703	791440022737	PA2793	791440023571	PA3408
791440020115	PA2547	791440021013	PA2625	791440021914	PA2704	791440022744	PA2794	791440023578	PA3420
791440020122	PA2548	791440021020	PA2626	791440021921	PA2705	791440022751	PA2796	791440023585	PA3421
791440020146	PA2550	791440021037	PA2627	791440021938	PA2706	791440022758	PA2797	791440023592	PA3438
791440020153	PA2551	791440021044	PA2628	791440021945	PA2707	791440022765	PA2798	791440023599	PA3439-FN
791440020160	PA2552	791440021051	PA2629	791440021952	PA2708	791440022772	PA2799	791440023606	PA3440
791440020177	PA2553	791440021068	PA2630	791440021969	PA2709	791440022779	PA2800	791440023613	PA3442
791440020184	PA2554	791440021075	PA2631	791440021976	PA2710	791440022786	PA2801	791440023620	PA3444
791440020207	PA2555	791440021082	PA2632	791440021983	PA2711	791440022793	PA2802	791440023627	PA3448
791440020221	PA2556	791440021099	PA2633-FN	791440021990	PA2712	791440022800	PA2803	791440023634	PA3448
791440020238	LL2557	791440021105	PA2634	791440022003	PA2713	791440022807	PA2804	791440023641	PA3453
791440020245	PA2557	791440021112	PA2635-FN	791440022010	PA2714	791440022814	PA2805	791440023648	PA3457
791440020269	PA2558	791440021129	PA2636	791440022027	PA2715	791440022821	PA2806	791440023655	PA3458
791440020276	LL2559	791440021136	PA2637	791440022034	PA2716	791440022828	PA2807	791440023662	PA3460
791440020283	PA2559	791440021143	PA2638	791440022041	PA2717	791440022835	PA2808	791440023669	PA3461
791440020313	LL2562	791440021150	PA2640	791440022058	PA2718	791440022842	PA2809	791440023676	PA3463
791440020320	PA2562	791440021174	PA2641	791440022065	PA2719	791440022849	PA2810	791440023683	PA3464
791440020337	PA2563	791440021181	LL2642	791440022089	PA2721	791440022856	PA2811	791440023690	PA3466-FN
791440020344	PA2564	791440021198	PA2642	791440022096	PA2722	791440022863	PA2812	791440023697	PA3467
791440020368	PA2566	791440021204	PA2643	791440022102	PA2723	791440022870	PA2813	791440023704	PA3469
791440020375	PA2567	791440021211	PA2644	791440022119	PA2724	791440022877	PA2814	791440023711	PA3470
791440020382	PA2568	791440021228	PA2645	791440022126	PA2725	791440022884	PA2815	791440023718	PA3471
791440020399	PA2569	791440021235	PA2646	791440022133	PA2726	791440022891	PA2816	791440023725	PA3472-FN
791440020405	PA2570	791440021242	PA2647	791440022140	PA2727	791440022898	PA2817	791440023732	PA3473
791440020412	PA2571	791440021259	PA2648	791440022157	PA2728	791440022905	PA2818	791440023739	PA3474
791440020429	PA2572	791440021266	PA2649	791440022164	PA2729	791440022912	PA2819	791440023746	PA3475
791440020436	PA2573	791440021273	PA2650	791440022171	PA2730	791440022919	PA2820	791440023753	PA3476
791440020443	PA2574	791440021280	PA2651	791440022188	PA2731	791440022926	PA2821	791440023760	PA3477
791440020450	LL2575	791440021297	PA2652	791440022195	PA2732	791440022933	PA2822	791440023767	PA3478
791440020467	PA2575	791440021303	PA2653	791440022201	PA2733	791440022940	PA2823	791440023774	PA3479
791440020474	PA2576	791440021310	PA2653 FOAM	791440022208	PA2734	791440022947	PA2824	791440023781	PA3480
791440020481	PA2577	791440021327	PA2654	791440022215	PA2735	791440022954	PA2825	791440023788	PA3481
791440020498	PA2578	791440021334	PA2655	791440022222	PA2736	791440022961	PA2826	791440023795	PA3482
791440020504	PA2579	791440021358	PA2656	791440022229	PA2737	791440022968	PA2827	791440023802	PA3483
791440020511	PA2580	791440021365	PA2657-FN	791440022236	PA2738	791440022975	PA2828	791440023809	PA3484
791440020528	PA2581	791440021372	PA2658	791440022243	PA2739	791440022982	PA2829	791440023816	PA3485
791440020535	LL2582	791440021396	PA2659	791440022250	PA2740	791440022989	PA2830	791440023823	PA3486



**WARNING:** These products can expose you to chemicals, including Diisononyl Phthalate, Carbon black extracts, Nickel, 1,3 Butadiene, Ethylene Oxide, Epichlorohydrin, which are known to the State of California to cause cancer, and Bisphenol-A, Ethylene Glycol, Ethylene Oxide, 1,3 Butadiene, Epichlorohydrin, which are known to the State of California to cause birth defects or other reproductive harm.

**UPC TO BALDWIN (INDIVIDUAL PARTS)**

UPC NUMBER	BALDWIN NUMBER	UPC NUMBER	BALDWIN NUMBER	UPC NUMBER	BALDWIN NUMBER	UPC NUMBER	BALDWIN NUMBER	UPC NUMBER	BALDWIN NUMBER
791440026049	PA3498	791440027213	BF5812	791440029576	H9060	791440031128	G168-B	791440032378	G362
791440026056	RS3501	791440027220	BF5813	791440029583	H9062	791440031135	G169	791440032385	G363
791440026063	RS3502	791440027282	.6017	791440029590	H9069	791440031159	G171	791440032408	G366
791440026070	RS3503	791440027305	.6020	791440029606	H9070	791440031173	G172-A	791440032415	G368
791440026087	RS3504	791440027312	.6021	791440029613	H9071	791440031227	G184-A	791440032446	G372
791440026094	RS3505	791440027725	BK6380	791440029620	H9072	791440031265	G193	791440032484	G376
791440026100	RS3506	791440028081	BK6561	791440029637	H9073	791440031289	G196-B	791440032507	G379
791440026117	RS3507	791440028098	BK6562	791440029644	H9074	791440031319	G202	791440032514	G380
791440026124	RS3508	791440028128	BK6600	791440029651	H9075	791440031326	G203	791440032521	G381-A
791440026131	RS3509	791440028135	BK6601	791440029668	H9076	791440031333	G204-A	791440032538	G382
791440026148	RS3510	791440028203	BK6610	791440029675	H9077	791440031357	G206	791440032545	G382-V
791440026155	RS3511	791440028241	BK6700	791440029682	H9078	791440031364	G208-A	791440032576	G385
791440026162	RS3512	791440028265	BK6710	791440029689	H9079	791440031388	G210	791440032583	G386
791440026179	RS3513	791440028296	BK6720	791440029705	H9080	791440031395	G211	791440032613	G392
791440026186	RS3514	791440028302	BK6721	791440029712	H9081	791440031401	G214	791440032637	G394
791440026193	RS3515	791440028326	BK6723	791440029729	H9082	791440031425	G219	791440032668	G397
791440026209	RS3516	791440028333	BK6780	791440029736	H9083	791440031432	G220	791440032682	G400
791440026278	PA3551	791440028487	P7003	791440029743	H9084	791440031449	G222-B	791440032699	G401
791440026285	PA3554	791440028494	B7004	791440029750	H9085	791440031487	G229	791440032705	G402
791440026292	PA3555	791440028500	B7005	791440029767	H9086	791440031500	G232	791440032712	G403
791440026308	PA3556	791440028531	B7009	791440029774	H9092	791440031517	G233-A	791440032743	G406
791440026315	PA3557-FN	791440028548	B7010	791440029781	H9093	791440031524	G233-B	791440032774	G409
791440026322	PA3558	791440028555	B7011	791440029804	H9096	791440031555	G236-A	791440032781	G410
791440026339	PA3559	791440028562	B7014	791440029811	H9097	791440031579	G238	791440032798	G411
791440026346	PA3560	791440028579	B7018	791440029828	H9103	791440031586	G239	791440032804	G412
791440026353	PA3562	791440028586	B7019	791440029835	H9107	791440031593	G240	791440032835	G416
791440026360	PA3563	791440028593	B7020	791440029842	H9108	791440031609	G241	791440032842	G417
791440026377	PA3565	791440028609	B7022	791440029859	H9110	791440031616	G243-A	791440032880	G431
791440026384	PA3566	791440028616	B7023	791440029866	H9111	791440031630	G247	791440032897	G432
791440026391	PA3569	791440028623	B7024	791440029873	H9112	791440031661	G251	791440032903	G433
791440026438	PA3572	791440028630	B7025	791440029880	H9113	791440031678	G252	791440032910	G434
791440026445	PA3573	791440028715	F7500	791440029887	H9114	791440031685	G253-A	791440032927	G435
791440026469	PA3576	791440028722	P7500	791440029903	H9123	791440031692	G255	791440032934	G436
791440026483	PA3580	791440028760	BF7519	791440029989	18104	791440031715	G257	791440032958	G438
791440026490	PA3581	791440028821	BF7528	791440030015	18139	791440031722	G260	791440032965	G439
791440026551	PA4016	791440028838	BF7529	791440030039	18155	791440031739	G261	791440032972	G441
791440026568	PA4018	791440028852	BF7538	791440030053	18171	791440031753	G263	791440032989	G442
791440026582	PA4023	791440028869	BF7557	791440030077	18198	791440031760	G264-A	791440032996	G443
791440026599	PA4026	791440028883	BF7558	791440030114	18236	791440031777	G265	791440033009	G444
791440026605	PA4028	791440028906	B7577	791440030121	18245	791440031791	G268	791440033016	G445
791440026650	PA4050	791440028937	B7600	791440030244	19593	791440031807	G269	791440033023	G446
791440026681	PA4060	791440029071	BT8301	791440030329	19739	791440031814	G270	791440033030	G447
791440026704	CFB5000	791440029095	BT8304	791440030343	19828	791440031821	G273	791440033047	G449-B
791440026742	CS5007	791440029101	PT8305	791440030442	19992	791440031838	G274	791440033061	G458
791440026759	CS5008	791440029118	PT8306-10	791440030459	PA3480	791440031845	G275	791440033108	G467
791440026766	CS5009	791440029125	PT8306-25	791440030466	BT8307-MPG	791440031852	G278	791440033115	G468
791440026773	CS5010	791440029132	BT8312	791440030473	BT8308-MPG	791440031876	G280	791440033139	G480
791440026780	CS5011	791440029149	BT8314	791440030480	BT8309-MPG	791440031883	G281	791440033177	G1973
791440026797	CSC5012	791440029156	PT8318-MPG	791440030497	BT8310-MPG	791440031906	G283	791440033184	ES1001
791440026803	CSC5013	791440029163	BT8320	791440030527	PA3493	791440031913	G288	791440033207	ES1023
791440026865	CTK5028	791440029194	BT8802-MPG	791440030558	ES24-B	791440031920	G289	791440033214	ES1026
791440026889	CS5057	791440029200	BT8803-MPG	791440030619	G102-A	791440031944	G291	791440033238	ES1030
791440026896	CS5058	791440029231	BT8812-MPG	791440030626	G103	791440031951	G296	791440033245	ES1032
791440026902	OTK5060	791440029248	BT8813-MPG	791440030633	G104	791440031968	G299	791440033252	ES1034
791440026919	OTK5061	791440029255	H9001	791440030640	G105	791440031982	G302	791440033276	ES1036
791440026933	OTK5063	791440029279	H9007	791440030657	G106	791440031999	G303	791440033283	ES1041
791440026940	BW5070	791440029293	H9013	791440030664	G107	791440032002	G304	791440033306	ES1049
791440026957	BW5071	791440029309	H9014	791440030718	G115-A	791440032019	G305	791440033337	ES1066
791440026964	BW5072	791440029323	H9020	791440030725	G115-MSB	791440032026	G306	791440033344	ES1067
791440026971	BW5073	791440029330	H9021	791440030756	G120-A	791440032033	G307	791440033351	ES1068
791440026988	BW5074	791440029347	H9024	791440030787	G123	791440032040	G309-B	791440033368	ES1071
791440026995	BW5075	791440029361	H9036	791440030817	G127	791440032057	G310	791440033375	ES1074
791440027008	BW5076	791440029408	H9041	791440030855	G132	791440032071	G314	791440033382	ES1092
791440027046	B5134	791440029415	H9042	791440030862	G133	791440032088	G315	791440033399	ES1303-A
791440027053	BW5136	791440029422	H9043	791440030923	G140-A	791440032149	G323	791440033405	ES1303-B
791440027060	BW5137	791440029439	H9044	791440030954	G143	791440032187	G332	791440033412	ES1369-A
791440027077	BW5138	791440029446	H9045	791440030961	G144	791440032194	G333	791440033474	ES3012
791440027084	BW5139	791440029453	H9046	791440030978	G147-A	791440032217	G336	791440033481	ES3028
791440027091	BW5140	791440029460	H9047	791440030985	G148	791440032248	G340	791440033498	ES3029
791440027107	BW5141	791440029477	H9048	791440031005	G153	791440032255	G342	791440033528	ES3063
791440027121	B5176	791440029484	H9049	791440031012	G154	791440032262	G343-A	791440033559	1S-9133
791440027138	B5177	791440029491	H9050	791440031029	G155	791440032279	G344	791440033603	4L-8212-R
791440027145	BW5178	791440029507	H9051	791440031036	G157	791440032293	G347	791440033627	5H-5601
791440027152	BW5179	791440029521	H9054	791440031074	G162	791440032316	G354	791440033634	5M-954
791440027183	BF5801	791440029538	H9055	791440031081	G161	791440032330	G356	791440033658	6L-1540
791440027190	BF5800	791440029545	H9056	791440031098	G164-A	791440032354	G359	791440033665	7B-7635
791440027206	BF5810	791440029569	H9058	791440031104	G165	791440032361	G360	791440033740	8M-7830



**WARNING:** These products can expose you to chemicals, including Diisononyl Phthalate, Carbon black extracts, Nickel, 1,3 Butadiene, Ethylene Oxide, Epichlorohydrin, which are known to the State of California to cause cancer, and Bisphenol-A, Ethylene Glycol, Ethylene Oxide, 1,3 Butadiene, Epichlorohydrin, which are known to the State of California to cause birth defects or other reproductive harm.

# UPC TO BALDWIN (INDIVIDUAL PARTS)

UPC NUMBER	BALDWIN NUMBER	UPC NUMBER	BALDWIN NUMBER	UPC NUMBER	BALDWIN NUMBER	UPC NUMBER	BALDWIN NUMBER	UPC NUMBER	BALDWIN NUMBER
791440033764	G15-AF	791440036451	200-W30	791440038271	PA3613	791440042520	BF1239	791440043831	PA3667-FN
791440033801	G21-AF	791440036468	201	791440038295	BT8347	791440042537	PF7572	791440043848	RS3541
791440033818	G25-AF	791440036475	201-30	791440038325	PF7556	791440042568	P7013	791440044968	PT8361
791440033825	G1086-AF	791440036499	201-W	791440038332	PA3614	791440042575	PA3630-FN	791440044999	B7049
791440033832	G501-AF	791440036505	285-DS	791440038349	BF7559	791440042582	PA3631	791440045019	B7089
791440034129	G31-AF	791440036512	286-SK	791440038356	BF1346	791440042599	PA3632	791440045033	BF1224
791440034150	G34-AF	791440036529	300	791440038363	RS3530	791440042605	PA3633	791440045095	PT8363
791440034167	G37-AF	791440036659	300-DHRAP5	791440038370	RS3538	791440042629	BT8845	791440045118	PA2231
791440034174	G39-AF	791440036666	300-DHRAS5	791440038387	B7044	791440042636	BT8844	791440045132	RS3536
791440034396	G141-AF	791440036741	300-H	791440038394	BT8840-MPG	791440042643	PA2001 FOAM	791440045170	RS3534
791440034419	G145-AF	791440036758	300-M	791440038400	BT8862	791440042667	PA3636	791440045187	RS3539
791440034440	G207-AF	791440036796	300-MFV	791440038417	BT8863	791440042674	BD103-MPG	791440045217	B7091
791440034471	G285-AF	791440036802	300-MFV3	791440038424	RS3528	791440042704	PA3637	791440045231	PT8366
791440034501	G298-AF	791440036833	300-MMV	791440038431	RS3518	791440042711	PA3638	791440045248	BF7535
791440034587	G422-AF	791440036840	300-MMV3	791440038448	RS3550	791440042735	PA3640	791440045361	PA2838
791440034624	301-MPG	791440036956	301	791440038455	BD232	791440042766	BF7576	791440045378	PA2860-FN
791440034778	24-WLK	791440036963	301-30	791440038462	BT310	791440042773	BF7579	791440045385	PA2862
791440034792	55-EK	791440036970	301-CS	791440038585	PA2139 FOAM	791440042780	BF7580	791440045392	PA2869
791440034822	60-21	791440036987	301-W	791440038592	PA2258	791440042810	PA3643	791440045408	PA2878
791440034839	60-21A	791440036994	500	791440038608	PA2480	791440042827	RS3529	791440045415	PA2891
791440034877	60-30	791440037007	500-12	791440038615	PA2554 FOAM	791440042834	RS3537	791440045446	PA2955
791440034914	60-35A	791440037014	500-15	791440038646	PA3446	791440042858	PA3644	791440045453	PA2963
791440034921	60-GK	791440037021	500-BP	791440038653	PA3452	791440042889	PA3645	791440045484	PA2232
791440034938	61	791440037038	500-BP22	791440038660	PA3491	791440042926	PT8329	791440045491	BT8368
791440034945	61-W	791440037052	501	791440038677	RS3520	791440042995	BT8830	791440045521	BF7591-D
791440034952	65	791440037069	501-30	791440038691	PA4015	791440043008	BT8832	791440045538	BK6619
791440034976	65-35A	791440037076	501-W	791440038738	PA3579	791440043015	BT8831	791440045545	B1413
791440034983	66	791440037533	PA3597	791440038745	PA3584	791440043039	RS3517	791440045552	P7092
791440034990	66-W	791440037540	PA3598	791440038813	P7007	791440043060	RS3548	791440045569	P7093
791440035003	75	791440037571	PT8344	791440038820	P7012	791440043077	B1430	791440045583	PF7592
791440035027	75-21	791440037588	P7053	791440038851	B7031	791440043091	PT8356	791440045590	PA3664-FN
791440035034	85-EK	791440037595	PA3600	791440038875	B7042	791440043107	BW5082	791440045620	PA3668
791440035041	85-P	791440037601	PA2260	791440038882	BF7531	791440043138	BF7584	791440045637	PA3669-FN
791440035058	85-V	791440037618	BD7028	791440038899	BT8302	791440043145	P7081	791440045644	BF1329-SP
791440035126	100	791440037625	B7051	791440038905	BT8316-MPG	791440043152	PT8319	791440045651	ES1377
791440035157	100-12	791440037632	PF7549	791440038912	BT8323	791440043169	PT8341	791440045668	BF1222-SP
791440035232	100-21	791440037649	PA3601	791440038943	PT8330-MPG	791440043176	PT8335	791440045675	BF1222
791440035249	100-21BP	791440037687	PF7550	791440038950	BT8333	791440043206	BT8357	791440045699	PA2233
791440035270	100-21M	791440037694	PF7551	791440038967	BT8850-MPG	791440043237	CTK5029	791440045705	BF1239
791440035324	100-28	791440037700	PA3602	791440038981	BT8861	791440043244	PA3650	791440045712	P7052
791440035331	100-29	791440037724	PA3604	791440039148	18268	791440043251	PA3651-FN	791440045729	RS3549
791440035348	100-30	791440037748	BF7552	791440039322	BT8851-MPG	791440043268	PA3652	791440045736	RS3703
791440035416	100-BP	791440037755	PA3605	791440039353	PT8350	791440043275	B7585	791440045743	RS3704
791440035454	100-GK	791440037762	PA3606	791440039377	RS3532	791440043282	B7082	791440045750	RS3705
791440035461	100-H	791440037779	PA3607-FN	791440039384	RS3533	791440043299	PA3653	791440045767	PA3670
791440035485	100-M	791440037786	PA3608-FN	791440039391	RS3535	791440043305	BF7586	791440045781	BF1347
791440035508	100-MFV	791440037793	PA3609	791440039650	G499-AF	791440043312	BF7587	791440045804	BF1345-SP
791440035515	100-MMV	791440037809	PA3610	791440039667	G348-AF	791440043329	P7083	791440045811	BF1205
791440035546	100-W	791440037816	PA3611	791440039766	ES4008	791440043336	PF7588	791440045828	BF1204
791440035577	101	791440037854	B7039	791440039773	ES4007	791440043343	BF1231	791440045835	BF1205-SP
791440035591	101-W	791440037885	BF7546	791440040052	G498-A	791440043350	P7084	791440045897	PT8339
791440035614	140-10	791440037892	BF1345	791440040106	G483	791440043374	PT8359	791440045903	BF1348
791440035652	140-50 KIT	791440037908	PA3587	791440040243	B7030	791440043428	PA3654	791440045910	BF1204-SP
791440035737	150	791440037915	PA3588	791440040496	PKG400	791440043435	PA4005	791440045927	BT610-MPG
791440035812	150-31	791440037946	PA3588	791440040502	PKG401	791440043442	B1405	791440045934	BT8846
791440035850	150-GK	791440037960	BF7544	791440040519	PKG402	791440043459	PA2200	791440045941	BT8852-MPG
791440035867	150-H	791440037984	BF7541	791440040557	PKG406	791440043473	PA2228	791440045958	BT611-MPG
791440035881	150-M	791440037991	BF880-FP	791440040564	PKG406-W	791440043497	PA2230	791440045972	BK6702
791440035911	151	791440038028	PA3430	791440041141	PA2903	791440043510	RS3700	791440045989	PA3672
791440035928	151-30	791440038035	PA3578	791440041189	PT8352	791440043527	RS3701	791440045996	PA3671-FN
791440035935	151-W	791440038042	RS3540	791440041196	PT8351	791440043558	B1410	791440046016	PA3674
791440035942	185-DS	791440038059	BT305	791440041202	PT8353	791440043565	PA4041	791440046061	BD7095
791440035997	186-SK	791440038066	B7047	791440041233	RS3542	791440043589	PA3655	791440046078	PA2234
791440036000	200	791440038073	PT8345	791440041240	RS3543	791440043596	PA3657	791440046085	PA3675
791440036079	200-15	791440038080	BT8328	791440041257	RS3544	791440043602	PA3656	791440046092	PA3676
791440036130	200-21	791440038097	PA3595	791440041264	RS3545	791440043619	PA3658	791440046115	BF1223-SP
791440036147	200-21BP	791440038110	P7035	791440041288	RS3547	791440043626	PA4069	791440046122	BF7593
791440036154	200-21H	791440038127	BT372-MPG	791440041295	BF7571	791440043633	PA4070	791440046252	BK6579
791440036161	200-21HBP	791440038134	P7000 KIT	791440041325	PA3499	791440043640	PA4071	791440046283	PF7594
791440036178	200-21M	791440038141	PT8331-MPG	791440041493	BF1173	791440043657	PT8338	791440046290	PF7595
791440036239	200-30U	791440038172	PA3449	791440041530	BF7534	791440043664	PF7545	791440046344	RS3706
791440036246	200-31	791440038219	B1429	791440042254	BK6764	791440043671	B7045	791440046351	RS3707
791440036321	200-GK	791440038226	P7058	791440042469	PA3627	791440043718	P7050	791440046375	RS3708
791440036338	200-H	791440038233	P7059	791440042476	PA3628	791440043725	PT8334	791440046382	RS3709
791440036369	200-M	791440038240	PF7553	791440042483	PA3629	791440043794	PA4072	791440046399	PK650
791440036390	200-MFV	791440038257	PF7554	791440042490	PT8354	791440043800	PA3660-FN	791440046412	PF7596
791440036406	200-MMV	791440038264	PA3612	791440042506	PT8355	791440043817	PA4073	791440046429	BT8870-MPG



**WARNING:** These products can expose you to chemicals, including Diisononyl Phthalate, Carbon black extracts, Nickel, 1,3 Butadiene, Ethylene Oxide, Epichlorohydrin, which are known to the State of California to cause cancer, and Bisphenol-A, Ethylene Glycol, Ethylene Oxide, 1,3 Butadiene, Epichlorohydrin, which are known to the State of California to cause birth defects or other reproductive harm.

# UPC TO BALDWIN (INDIVIDUAL PARTS)

UPC NUMBER	BALDWIN NUMBER	UPC NUMBER	BALDWIN NUMBER	UPC NUMBER	BALDWIN NUMBER	UPC NUMBER	BALDWIN NUMBER	UPC NUMBER	BALDWIN NUMBER
791440046443	BT8874-MPG	791440048638	PA3757	791440050211	CTK5029-4	791440051515	BF1253	791440052758	18029
791440046450	BK6375	791440048645	PA3758	791440050235	PA3777	791440051546	PA3790	791440052772	PA3801-FN
791440046467	BT606-MPG	791440048652	PA3759	791440050259	PA3778	791440051553	PT8394-MPG	791440052857	RS3738
791440046474	P7021	791440048669	PA3760	791440050266	BF1172	791440051560	PA3791-FN	791440052864	RS3739
791440046511	BT8873	791440048676	PT8378-MPG	791440050273	PA2977-FN	791440051577	PA3792	791440052918	P127
791440046528	PA3679	791440048683	PA3761-FN	791440050297	BT1119	791440051584	PA3793	791440052949	F594-F
791440046535	PF7597	791440048706	B7026-MPG	791440050303	PA4085	791440051607	PA3794	791440052970	PT682
791440046542	BK6376	791440048720	B7116	791440050310	PA3779-FN	791440051621	PT8395	791440052987	PT683
791440046559	BF7532	791440048737	PA3763	791440050327	BF1240	791440051638	PT8396	791440053007	F950-F WO
791440046566	BT8875-MPG	791440048768	RS3531	791440050334	BT8384	791440051645	PA2942	791440053014	F953-F
791440046610	B7097	791440048775	BT8876-MPG	791440050341	B495-SS	791440051652	BT8848-MPG	791440053021	PF997
791440046627	P7015	791440048805	PA3765	791440050358	BF7624	791440051669	BF7624	791440053038	PA3808-FN
791440046726	P7016	791440048812	PA3766	791440050365	PA3780	791440051676	P7607	791440053045	PA3809
791440046733	P7017	791440048829	B7117	791440050389	B96-SS	791440051713	PA3796	791440053052	PA3806
791440046771	RS3710	791440048836	PA2951	791440050396	B95-SS	791440051720	PA3797	791440053069	BF7648
791440046788	RS3711	791440048850	PA2952	791440050402	BD103-SS	791440051737	PA4093	791440053076	PT8407
791440046795	PA3680	791440048881	PA2235	791440050419	B99-SS	791440051744	PA4094	791440053083	PT8408
791440046818	PA3681	791440048898	BF1174	791440050426	BF6-SS	791440051751	PA3795	791440053090	PA4101
791440046825	PA3682	791440048911	BF7522	791440050433	B7600-SS	791440051775	BF7625	791440053106	PA3810
791440046832	PA3683	791440048942	BF7608	791440050457	BF7612	791440051782	BT1425	791440053113	BF7633
791440046849	PA3684	791440048959	PA4042	791440050464	BF7613	791440051805	PT8380	791440053120	P7132
791440046856	PA3685	791440048966	PA4043	791440050488	BF1248	791440051850	BT8397-MPG	791440053137	PA4102
791440046863	PA3686	791440049024	BF1177	791440050495	PA3781	791440051874	PA3798	791440053175	RS3740
791440046870	PA3687	791440049031	BF1178	791440050501	BF7614	791440051881	RS3730	791440053182	RS3741
791440046917	BT8841-MPG	791440049048	BF1179	791440050518	P7615	791440051898	BF1348-SP	791440053199	BT8409
791440046924	PA2804	791440049086	BF1181	791440050525	BT121	791440051904	BT8398-MPG	791440053236	BK6634
791440046955	BK6799	791440049093	PA2237	791440050532	PT8385	791440051973	BT8842-MPG	791440053267	PA3811-FN
791440047020	B7099	791440049116	BF1182	791440050549	BF1052	791440051980	RS3733	791440053274	PA3812
791440047068	PA4075	791440049123	BF1184	791440050563	BF1053	791440052000	BT8843-MPG	791440053281	BW5200
791440047082	P7102	791440049130	BF1185	791440050570	RS3521	791440052017	PA4096	791440053298	BF7634
791440047112	PT8370-MPG	791440049147	BF1186	791440050587	B1422	791440052031	BF7626	791440053304	BT8853-MPG
791440047129	PT8371-MPG	791440049215	BF1188	791440050594	BT8386	791440052048	PF7627	791440053311	PA3814
791440047150	PA3494	791440049222	PA4044	791440050600	PT7616	791440052079	PT8400-MPG	791440053328	PA3815
791440047167	G286-C	791440049239	PA4045	791440050617	PT7617	791440052086	B7128	791440053366	BF1257
791440047174	BF1258	791440049246	PA4046	791440050624	BF1349	791440052123	BT8401-MPG	791440053373	BF7635
791440047211	BK6583	791440049277	PA3484	791440050662	PA3782	791440052178	PT8402-MPG	791440053458	PA2759
791440047228	PA3688	791440049284	PA3483	791440050679	PA3783	791440052192	PT8403-MPG	791440053489	PA2771
791440047501	RS3519	791440049307	RS3718	791440050686	PT8387	791440052208	RS3726	791440053496	PA2800-FN
791440047518	BD325	791440049314	RS3719	791440050693	PT8388	791440052215	PA3419	791440053557	PA2840
791440047525	PA3690	791440049321	RS3717	791440050822	BF1056	791440052222	BF7628	791440053571	PA2847
791440047532	PA4077	791440049338	PA4047	791440050846	B1422	791440052239	RS3727	791440053588	PA2859-FN
791440047549	PA3689	791440049345	PA4048	791440050907	PF7618	791440052246	RS3728	791440053595	PA2862 FOAM
791440047556	P7103	791440049352	AF521-WN	791440050921	PA3787	791440052253	RS3729	791440053601	PA2866
791440047563	RS3712	791440049369	AF525-WN	791440050938	PT716	791440052277	BF7629	791440053618	PA2867-FN
791440047570	BF7598	791440049383	BF1215	791440050945	BT8391	791440052284	PT8404-MPG	791440053625	PA2870-FN
791440047587	P7104	791440049390	PA3772	791440050952	PA3786-FN	791440052291	BF7630	791440053656	PA2880
791440047594	BD7105	791440049406	PA4049	791440050969	BF7619	791440052307	PA4099	791440053663	PA2881
791440047600	P7106	791440049413	BF1190	791440050983	BF1249	791440052314	RS3731	791440053687	PA2883
791440047617	P7107	791440049420	BF1191	791440050990	RS3722	791440052321	BF7631	791440053694	PA2884
791440047655	PT8372	791440049444	BF1193	791440051003	PT8392	791440052338	BK6287	791440053700	PA2885
791440047662	BF7602	791440049468	BF1195	791440051041	BF1252	791440052345	PA3800	791440053717	PA2887-FN
791440047679	PA4078	791440049529	BF1199	791440051089	BF1217	791440052352	BF7632	791440053724	PA2888
791440047723	BF1100	791440049536	PA4081	791440051096	BT8308-MPG KIT	791440052437	BF7641	791440053731	PA2889
791440047822	BF7606	791440049567	PA3773	791440051140	PA4088	791440052444	PA4100	791440053748	PA2890
791440047846	B7113	791440049574	BF1045	791440051157	PA4089	791440052468	RS3721	791440053762	PA2895
791440047860	PA3697	791440049581	BF1046	791440051164	PA4090	791440052482	PA3802	791440053779	PA2897
791440047877	PA4079	791440049598	BF1047	791440051171	BF1057	791440052499	PA3803	791440053809	PA2904
791440047884	18002	791440049604	BF1048	791440051188	BF1058	791440052505	PA3804	791440053816	PA2905
791440047907	18004	791440049611	BF1049	791440051201	BF1061	791440052529	V7129-C	791440053823	PA2906
791440047938	18007	791440049628	BF1050	791440051218	PA4091	791440052536	PA2871	791440053847	PA2909
791440047952	18009	791440049642	PA3767	791440051225	BD7029	791440052543	PA3805-FN	791440053878	PA2912
791440047969	18010	791440049659	PA3768	791440051256	ES1376	791440052550	RS3736	791440053885	PA2913
791440047990	18013	791440049666	RS3716	791440051294	RS3724	791440052567	RS3737	791440053892	PA2914
791440048089	PA3691	791440049680	BT8381	791440051300	B7124	791440052581	BW5142	791440053908	PA2915
791440048140	PT8375-MPG	791440049703	RS3720	791440051317	PA2813	791440052598	RS3735	791440053939	PA2948
791440048157	PT8376-MPG	791440049734	PA2240	791440051324	P7126	791440052604	BT130	791440053946	PA2950
791440048171	PA3698	791440049741	PA2241	791440051331	18025	791440052611	B7131	791440053953	PA2953
791440048188	RS3714	791440049765	PA2243	791440051348	18024	791440052628	BF7645	791440053960	PA2954-FN
791440048195	B7001	791440049772	PA2244	791440051355	18022	791440052666	BF1249-SP	791440053977	PA2958
791440048201	PA3699	791440049871	BF1008	791440051379	18027	791440052673	PA2961-FN	791440053984	PA2962
791440048232	RS3715	791440050044	PA4084	791440051393	B7125	791440052680	PA2877-FN	791440053991	PA2964
791440048263	P7114	791440050051	PA3774	791440051409	PA4092	791440052697	PA2959-FN	791440054004	PA2967
791440048485	PA3752	791440050068	PA3775	791440051416	PA3785-FN	791440052703	PA2960	791440054028	PA2970
791440048492	PA3753	791440050105	BT8382	791440051454	BT8393	791440052710	PA2957	791440054035	PA2971
791440048508	PA3754	791440050129	PT8383	791440051478	PT127	791440052727	PA2956-FN	791440054066	PA2976-FN
791440048614	PA3755	791440050136	P1418	791440051492	BF7623	791440052734	RS3734	791440054073	PA2980
791440048621	PA3756	791440050143	P1419	791440051508	SA2047	791440052741	BF7644	791440054080	PA2981



**WARNING:** These products can expose you to chemicals, including Diisononyl Phthalate, Carbon black extracts, Nickel, 1,3 Butadiene, Ethylene Oxide, Epichlorohydrin, which are known to the State of California to cause cancer, and Bisphenol-A, Ethylene Glycol, Ethylene Oxide, 1,3 Butadiene, Epichlorohydrin, which are known to the State of California to cause birth defects or other reproductive harm.

# UPC TO BALDWIN (INDIVIDUAL PARTS)

UPC NUMBER	BALDWIN NUMBER	UPC NUMBER	BALDWIN NUMBER	UPC NUMBER	BALDWIN NUMBER	UPC NUMBER	BALDWIN NUMBER	UPC NUMBER	BALDWIN NUMBER
791440054097	PA2982	791440055445	OB8720	791440056763	PA3893	791440058095	PA3829	791440059153	G472-AF
791440054141	PA3405	791440055452	OB8721	791440056770	PA3876	791440058101	PA4114	791440059160	PA4118
791440054158	PA3411-FN	791440055469	OB8722	791440056817	BF1262	791440058118	PA3917	791440059177	PT8441
791440054165	PA3414	791440055483	OB8724	791440056824	RS3732	791440058125	B7161	791440059283	BF7695
791440054172	PA3415	791440055528	18032	791440056848	B7151	791440058149	BD7166	791440059290	BF1269
791440054189	PA3416	791440055735	BT8849-MPG	791440056855	B7152	791440058163	BT8833	791440059320	PA4121
791440054196	PA3417	791440055742	BT8855-MPG	791440056886	BD7153	791440058170	PT8427	791440059337	BF1277-SPS
791440054233	B7033	791440055759	BT8877-MPG	791440056893	BD7154	791440058187	PT8410	791440059351	PA3939
791440054240	B7034	791440055766	BT8878-MPG	791440056909	PA3894	791440058194	PT8411	791440059368	RS3940
791440054264	BF7537	791440055773	BT8879-MPG	791440056923	PA3895-FN	791440058200	PA3821	791440059375	BF1270-SP
791440054271	ES24-D	791440055803	PA3633 FOAM	791440056930	B7155	791440058217	PA3818-FN	791440059382	PT8442
791440054288	G103-N	791440055810	B7143	791440056954	PA3896	791440058224	PA3817	791440059399	PA3941
791440054325	P7134	791440055827	PA3877	791440056961	PA3898	791440058231	BT287-3	791440059412	BC7173
791440054363	B7135	791440055834	PA3878	791440056978	PA3899	791440058248	BT8428-MPG	791440059429	RS3942
791440054370	RS3743	791440055841	PA3879-FN	791440056985	BT8420	791440058262	B5087	791440059436	RS3943
791440054394	PA3822	791440055858	BF7669	791440057005	PA3897	791440058279	B5088	791440059443	PA3944
791440054400	PA3823	791440055865	B1431	791440057029	BW5143	791440058286	BF1265	791440059450	PA3945
791440054417	PA3824	791440055872	BT8417	791440057036	PF7680	791440058293	PA3918	791440059467	PA3946
791440054424	BT8412	791440055889	BT8415	791440057067	OB8731	791440058309	PA3919	791440059474	PA3948
791440054431	BF7639	791440055896	BT8413	791440057074	OB8732	791440058316	BT8429	791440059498	PA3953
791440054462	BF7656	791440055919	B1432	791440057128	OB8743	791440058354	RS3920	791440059504	BT8443
791440054516	PA4103	791440055926	PA3872	791440057135	OB8741	791440058361	RS3921	791440059511	PA3950
791440054523	PA3832	791440055933	PA3873	791440057142	OB8742	791440058378	RS3922	791440059528	CTK5029-1
791440054530	BF1256	791440055940	BF7670	791440057173	OB8744	791440058385	RS3923	791440059559	PA4123
791440054561	PA3833	791440055957	B7144	791440057180	OB8745	791440058392	B7685	791440059566	PA4124
791440054578	PF7678	791440056022	PA3875-FN	791440057197	OB8771	791440058408	B7175	791440059573	BT8856-MPG
791440054585	PA3834	791440056039	PA3880	791440057203	OB8772	791440058415	PA3924-FN	791440059597	RS3952
791440054592	PA3835	791440056046	RS3882	791440057326	OV8700	791440058422	RS3926	791440059603	RS3954
791440054608	P7136	791440056053	RS3883	791440057333	OV8701	791440058439	RS3927	791440059610	BT8444
791440054615	P7137	791440056060	RS3884	791440057357	OS8703	791440058446	B7167	791440059634	BT8847
791440054622	P7138	791440056077	RS3885	791440057364	OS8704	791440058477	B1434	791440059641	BT7172
791440054639	PA4104	791440056084	PA4111	791440057388	OP8709	791440058491	PA3928	791440059658	BF7683
791440054646	PA4105	791440056091	PA3881	791440057395	OB8773	791440058507	BF7686	791440059665	BF7696
791440054653	PA4106	791440056107	PA3886	791440057401	BW5201	791440058521	PF7687	791440059733	BF1274-SP
791440054660	PA4107	791440056114	BT8418	791440057418	PA3900	791440058545	PA3929	791440059740	BF1274-SPS
791440054677	B7139	791440056121	BF7671	791440057425	PA4112	791440058552	B7180	791440059757	18055
791440054691	B1416	791440056138	BK6704	791440057432	PA3901	791440058569	BT8432-MPG	791440059764	18056
791440054707	RS3744	791440056145	BK6705	791440057456	RS3764	791440058576	BF7690	791440059771	18057
791440054714	RS3745	791440056183	BT8880-MPG	791440057463	RS3826	791440058583	PT8433-MPG	791440059788	BT8445
791440054738	PA3807	791440056190	PT8419	791440057470	RS3827	791440058590	PA3819	791440059795	PT8446-MPG
791440054752	BK6595	791440056206	18033	791440057487	PF7655	791440058613	PA3820-FN	791440059801	PA3956
791440054806	PA3842	791440056213	18034	791440057494	B7156	791440058620	PA3816	791440059849	PA4126
791440054813	PA3843	791440056220	PA3887	791440057500	BF7668	791440058644	BD7168	791440059856	BF1271
791440054837	BF7639-D	791440056237	RS3888	791440057517	BT8421-MPG	791440058651	PA3925	791440059863	PA3957
791440054844	PT691	791440056244	PA3889	791440057524	BT8422-MPG	791440058668	BD7169	791440059870	PT8447-MPG
791440054851	PA3412	791440056251	BF7640	791440057531	BT8423	791440058675	RS3930	791440059887	PA4128
791440054875	BF1261	791440056268	BF7653	791440057548	PA3902	791440058705	PA3932	791440059900	PF7698
791440054899	BD1403	791440056282	PA3890	791440057555	PA3903	791440058712	PA3933	791440059917	BF7697
791440054905	BF7658	791440056343	PA3891	791440057562	PA3904	791440058729	BF1266	791440059924	PA4127
791440054912	BF7659	791440056350	PA3838	791440057579	PA3905	791440058736	PA3931	791440059948	PA3958
791440054936	BF7661	791440056367	PA3844	791440057586	PA3906	791440058743	B1438	791440059955	PA3961
791440054950	PA4108	791440056381	PA3847	791440057593	BW5086	791440058750	B7170	791440060005	BT8449
791440054967	PA4109	791440056398	PA3848-FN	791440057661	PA3908	791440058767	B7171	791440060012	BT8449-10
791440054974	BF7663	791440056404	PA3849	791440057678	PA3909	791440058781	BF1267	791440060029	PA3959
791440054981	BF7664	791440056411	PA3850	791440057760	B7157	791440058798	PT8435-MPG	791440060036	BF5815
791440055001	PT8414-MPG	791440056428	PA3851	791440057777	PA3910-FN	791440058804	PT8436	791440060050	BW5250
791440055032	BF7657	791440056435	PA3852-FN	791440057784	PA3911	791440058811	BT8437	791440060074	BA3964(4)
791440055049	PA3836	791440056442	PA3853-FN	791440057791	PA3907	791440058842	PKG411	791440060081	BA3965(4)
791440055056	BF7666	791440056459	PA3854-FN	791440057838	PA3914	791440058859	PKG412	791440060098	PA3966
791440055063	PA3837	791440056466	PA3855-FN	791440057845	PA3915	791440058866	BF7691	791440060104	BT8450
791440055070	PA3839	791440056480	PA3857	791440057852	BD7158	791440058873	RS3934	791440060111	PA3967
791440055087	PA3840	791440056503	PA3859	791440057869	PT8425	791440058880	RS3935	791440060135	PT8451-MPG
791440055094	BD7141	791440056510	PA3860	791440057890	PA4113	791440058897	BF7693	791440060142	BD7176
791440055100	BT8416	791440056527	PA3861	791440057906	BF1282	791440058903	RS3936	791440060159	PT8452
791440055117	BF7667	791440056534	PA3862-FN	791440057913	BT8805-MPG	791440058910	B1435	791440060166	PA3969
791440055124	B7142	791440056541	PA3863	791440057937	BT8426-MPG	791440058941	BD7309	791440060173	PA3970
791440055131	PA4110	791440056558	PA3864	791440057944	PA3916	791440058996	P1440	791440060197	PA3972
791440055148	RS3747	791440056565	PA3865	791440057951	BD7159	791440059016	PA3951	791440060203	PA3973
791440055155	PA3867	791440056589	P1433	791440057968	BD7160	791440059023	BF1268	791440060210	B7177
791440055162	PA3868	791440056619	P7145	791440058002	B7162	791440059030	BT8440-MPG	791440060227	RS3974
791440055179	RS3870	791440056633	BK6195	791440058019	B7163	791440059047	PA3937	791440060234	RS3975
791440055186	RS3871	791440056640	BK6196	791440058026	B7164	791440059061	BT8439-MPG	791440060265	PA3978
791440055193	RS3749	791440056657	RS3750	791440058033	BF1330-SP	791440059078	PA3938	791440060272	PA3979
791440055209	RS3746	791440056670	PA2968-FN	791440058057	B7165	791440059085	PA4120	791440060289	P7179
791440055230	PA3874	791440056732	BF1277-SP	791440058064	PA3869	791440059092	G293-B	791440060296	BT7179
791440055353	OB8711	791440056749	BF1273-SP	791440058071	PA3825	791440059122	ES1031	791440060319	PA4128
791440055360	OB8712	791440056756	PA3892	791440058088	PA3828	791440059146	G225-AF	791440060326	PA4129



**WARNING:** These products can expose you to chemicals, including Diisononyl Phthalate, Carbon black extracts, Nickel, 1,3 Butadiene, Ethylene Oxide, Epichlorohydrin, which are known to the State of California to cause cancer, and Bisphenol-A, Ethylene Glycol, Ethylene Oxide, 1,3 Butadiene, Epichlorohydrin, which are known to the State of California to cause birth defects or other reproductive harm.

# UPC TO BALDWIN (INDIVIDUAL PARTS)

UPC NUMBER	BALDWIN NUMBER	UPC NUMBER	BALDWIN NUMBER	UPC NUMBER	BALDWIN NUMBER	UPC NUMBER	BALDWIN NUMBER	UPC NUMBER	BALDWIN NUMBER
791440060333	RS4130	791440061538	BT8476	791440062979	BK6341	791440064287	BF7763	791440065475	B7239
791440060340	PT8453	791440061545	BT8477	791440062993	B7215	791440064317	PA4151	791440065482	B10-AL BSP
791440060357	PA3980	791440061552	BT8463-MPG	791440063006	BT8499	791440064355	BK6467	791440065499	B7240
791440060364	RS4131	791440061569	BT8464	791440063020	BK6686	791440064386	RS4618	791440065505	PT8888
791440060371	18264	791440061576	BT8465	791440063051	BT8501-MPG	791440064393	RS4613	791440065512	RS4639
791440060388	18265	791440061583	BT8466-MPG	791440063082	PA4149 KIT	791440064409	RS4620	791440065529	PT8511
791440060418	100-21AL	791440061590	PT8467	791440063099	BT8502	791440064416	RS4621	791440065536	PA4162
791440060425	200-21AL	791440061606	PT8478	791440063105	B7216	791440064423	RS4622	791440065543	PF7767
791440060449	PA4132	791440061613	BC7186 KIT	791440063112	B7217	791440064430	BT8424	791440065550	PA4630
791440060456	18267	791440061637	PT8479	791440063129	RS4579	791440064478	B7225	791440065574	PA4641
791440060470	BF7713	791440061644	PT8480	791440063136	RS4580	791440064485	BF7765	791440065581	RS4642
791440060487	PA4133	791440061651	B1444	791440063143	PA4581	791440064492	PA4152	791440065598	RS4643
791440060494	PF7715	791440061736	B7187	791440063150	PA4582	791440064508	PA4153	791440065604	PT8889
791440060500	PF7716	791440061859	PF7733	791440063167	BT8503-MPG	791440064515	PA4154	791440065611	PA4644
791440060517	BF7717	791440061866	PF7734	791440063174	BT8504	791440064553	19996	791440065628	PA4645-FN
791440060548	BT8800-MPG	791440061880	PA4559	791440063181	PA4583-FN	791440064584	19999	791440065635	RS4646
791440060555	BT8801-MPG	791440061897	PT8484	791440063204	BF7747	791440064591	20000	791440065642	PA4647
791440060616	PT8455-MPG	791440061910	PA4560	791440063211	PF7748	791440064614	20002	791440065659	PA4648
791440060623	PA3983-FN	791440061927	PF7735	791440063228	PF7749	791440064621	B7227	791440065666	PA4649
791440060647	PF7718	791440061934	PA3435-FN	791440063273	BF7750	791440064645	BC7228	791440065673	B5090
791440060654	B1441	791440061941	P7188	791440063280	BF1283	791440064652	PA4624	791440065680	B7241
791440060678	P1443	791440061958	RS4561	791440063297	BF1281	791440064669	PA4625	791440065697	BT8890-MPG
791440060685	BD7310	791440061965	PA4144	791440063303	G725	791440064683	BT7229	791440065727	PA4650-FN
791440060692	PT8456-MPG	791440061972	P7190	791440063327	PA4585	791440064690	PA4619	791440065734	PT8891-MPG
791440060715	BF7711	791440061989	RS4562	791440063334	RS4549	791440064768	PF7799	791440065741	BT8892-MPG
791440060739	B7181	791440062016	RS4563	791440063341	PA4548	791440064775	BF7800	791440065758	PA4651
791440060753	BT8457-MPG	791440062023	RS4564	791440063440	B5089	791440064782	BF7801	791440065765	20003
791440060760	PA3949	791440062030	BK6215	791440063457	PA4592	791440064799	BF7802	791440065796	20004
791440060777	PA3985	791440062047	B7191	791440063464	PA4150	791440064805	BF1285-SP	791440065802	65-W30
791440060784	PT8458-MPG	791440062054	PT8485	791440063471	PA4593	791440064836	BT8512	791440065819	75-W30
791440060791	PA3984	791440062078	P7192	791440063488	PA4594	791440064843	PF7761	791440065826	100-W30
791440060845	B7182	791440062092	P7193	791440063525	PT8506-MPG	791440064850	BT7230	791440065833	150-W30
791440060852	B7189	791440062108	BT8486	791440063532	PT8507-MPG	791440064881	B7231	791440065840	300-W30
791440060869	PA4134	791440062122	PT8487	791440063549	PKG470	791440064898	PA4603	791440065857	66-30
791440060883	PT8459	791440062139	BT8488	791440063556	PKG470-DVD	791440064928	B1447	791440065864	PT8893
791440060913	G369-B	791440062146	BC7194	791440063570	PKG470-S	791440064935	PT8883	791440065871	BF7768
791440060920	PA3986	791440062153	PA4566	791440063587	RS4595	791440064942	P7232	791440065888	PA4163
791440060937	PA3987	791440062160	PT8489	791440063600	BT8509-MPG	791440064966	PA4627	791440065895	PA4652
791440060944	RS3988	791440062177	PA4567	791440063617	BT8505	791440064973	BF7803	791440065918	BK6189
791440060968	RS3990	791440062214	P7195	791440063631	H9052	791440064980	BF7804	791440065949	PKG490-BANK
791440060975	RS3992	791440062221	PT8490-MPG	791440063648	RS4598	791440064997	BF7805	791440065956	BK6675
791440060982	RS3994	791440062238	PA4145	791440063655	RS4599	791440065000	BF7806	791440065963	BK6676
791440060999	RS3996	791440062252	H9087	791440063662	BT8510-MPG	791440065017	P7233	791440065987	G704
791440061002	RS3998	791440062276	BF7736	791440063679	BF7753	791440065024	BF7807	791440065994	G710
791440061026	RS3991	791440062283	PT8491	791440063709	PA4600	791440065031	BF7808	791440066007	G369-V
791440061033	PA3989-FN	791440062290	PT8492	791440063716	PA4601	791440065048	PA4156 KIT	791440066014	BF1346-SP
791440061040	RS3999	791440062320	BT8834-MPG	791440063730	BF7756	791440065055	PA4157	791440066045	BK6693
791440061057	BK6696	791440062375	BT8493	791440063747	PA4602	791440065062	BF1350-SP	791440066052	BF1286
791440061064	P7183	791440062382	PA4570	791440063761	B7219	791440065079	BF7809	791440066069	PT8894-MPG
791440061088	BF7719	791440062399	P7196	791440063785	BF1275	791440065086	P7235	791440066076	PT8895-MPG
791440061095	RS3971	791440062474	B495-MPG	791440063792	RS4597	791440065093	PT8884-MPG	791440066083	PA4164
791440061101	BF7720	791440062504	PT8494	791440063808	PA4604-FN	791440065130	PF7812 KIT	791440066090	PA4165
791440061125	PA4138	791440062511	PF1291	791440063815	PA4605	791440065147	PT8519-MPG	791440066106	PA4653
791440061132	BF7721	791440062528	PA4146	791440063822	PA4606	791440065154	BF7766	791440066113	PT8896
791440061163	BF7725	791440062535	PA4147	791440063839	PF7758	791440065161	PT8885-MPG	791440066120	BK6440
791440061194	SA4141	791440062542	PA4148	791440063853	PA4608	791440065178	PA4628	791440066144	BF7769
791440061231	PA4551	791440062559	B1446	791440063877	B7220	791440065192	BT8886-MPG	791440066151	PA4654 KIT
791440061248	PA4552	791440062566	BK6694	791440063884	BK6683	791440065215	RS4629	791440066168	PF7770
791440061262	B7174-MPG	791440062573	G717	791440063891	PA4611	791440065246	RS4623	791440066182	PA4655
791440061279	RS3993	791440062580	V1560	791440063907	B7221	791440065253	PA4158	791440066212	PT8897-MPG
791440061286	RS3995	791440062597	RS4572	791440063914	B7222	791440065284	PA4631-FN	791440066229	BC7242
791440061293	RS3997	791440062603	P7199	791440063921	PA4610 KIT	791440065314	BF7813	791440066236	BT8898
791440061330	PA2896	791440062634	PT8481	791440063938	PA4612	791440065321	RS4634	791440066243	BT8899
791440061354	PA4553	791440062658	BF7742	791440063952	PA4614	791440065338	PA4632	791440066250	PT8517-MPG
791440061361	PA4554	791440062665	PT8495-MPG	791440063969	BF7760	791440065345	PA4633	791440066267	PA4656
791440061378	PA4555	791440062788	PT8496-MPG	791440063976	PT8461	791440065352	BF7814	791440066274	BF7771
791440061392	PA4557	791440062801	PF7744	791440063990	BK6685	791440065369	RS4636	791440066281	PA4657
791440061408	BF7726	791440062832	PA4573	791440064027	BF7759	791440065376	RS4637	791440066298	BW5182
791440061415	PT8462-MPG	791440062849	PA4574	791440064034	B7197	791440065383	BT7238	791440066304	BT8900
791440061439	PT8468	791440062856	BT8497-MPG	791440064041	RS4616	791440065390	RS4638	791440066328	PA4659
791440061460	PT8470	791440062870	RS4576	791440064058	RS4617	791440065406	PA4159	791440066335	PA4660
791440061477	P7185	791440062887	RS4577	791440064065	B5144	791440065413	PA4635	791440066359	OS8707
791440061484	BT8471-MPG	791440062900	RS4578	791440064072	BF1278	791440065420	PF7755	791440066366	B7243
791440061491	BT8472	791440062917	PT8498	791440064089	BF1279	791440065437	BF1339-SP	791440066380	BF7681-D
791440061507	BT8473	791440062924	PA4571	791440064157	BF7762	791440065444	PA4160	791440066397	BF7679-D
791440061514	BT8474	791440062931	BT8460	791440064164	B7223	791440065451	RS4161	791440066403	BF7672-D
791440061521	BT8475	791440062955	PF7751	791440064225	BK6903	791440065468	PT8887	791440066410	BF7682-D



**WARNING:** These products can expose you to chemicals, including Diisononyl Phthalate, Carbon black extracts, Nickel, 1,3 Butadiene, Ethylene Oxide, Epichlorohydrin, which are known to the State of California to cause cancer, and Bisphenol-A, Ethylene Glycol, Ethylene Oxide, 1,3 Butadiene, Epichlorohydrin, which are known to the State of California to cause birth defects or other reproductive harm.

# UPC TO BALDWIN (INDIVIDUAL PARTS)

UPC NUMBER	BALDWIN NUMBER	UPC NUMBER	BALDWIN NUMBER	UPC NUMBER	BALDWIN NUMBER	UPC NUMBER	BALDWIN NUMBER	UPC NUMBER	BALDWIN NUMBER
791440066427	BF7675-D	791440067516	BF7785-D	791440069022	PA4824	791440070127	PT8954-MPG	791440071223	PT9185
791440066434	BF7673-D	791440067523	PA4683	791440069039	PA4825	791440070134	PT8955-MPG	791440071230	PT9186
791440066441	BF7674-D	791440067530	BF7786-D	791440069053	PA4827	791440070141	PT8956-MPG	791440071247	PT9187
791440066458	BF7677-D	791440067547	PA4852	791440069077	PA4829	791440070158	PT8957-MPG	791440071254	PT9188
791440066465	BF7746-D	791440067554	PA4852 FOAM	791440069084	PA4830	791440070165	PT8958-MPG	791440071261	PT9189
791440066472	BF7745-D	791440067561	PA4853	791440069107	PA4833-FN	791440070172	PT8959-MPG	791440071278	PT9190
791440066489	BF7699-D	791440067578	PA4854	791440069114	PA4834-FN	791440070189	PT8960-MPG	791440071285	PT9191
791440066496	BT8901-MPG	791440067592	PA4855	791440069251	PA4848	791440070219	PT8962-MPG	791440071308	PT9193
791440066502	BK6934	791440067639	PA4689	791440069268	PA4849	791440070264	PT8967-MPG	791440071322	PT9195
791440066571	CA4700	791440067646	PA2068 FOAM	791440069299	PF7787	791440070288	PT8969-MPG	791440071339	PT9196
791440066588	PA4701	791440067653	PA2223 FOAM	791440069305	PF7788	791440070295	PT8970-MPG	791440071346	PT9197
791440066595	BF7772	791440067660	PA3901 FOAM	791440069312	PF7816	791440070301	PT8971-MPG	791440071360	PT9199
791440066601	PA4665-FN	791440067691	PA3472	791440069329	PF7817	791440070318	PT8972-MPG	791440071377	PT9200
791440066618	PA4666	791440067745	PA4692	791440069336	PF7818	791440070332	PT8974-MPG	791440071407	PT9203
791440066649	BT8902	791440067752	PA4693	791440069343	PF7819	791440070349	PT8975-MPG	791440071421	PT9205
791440066656	PA4166	791440067769	PA4694	791440069350	PF7820	791440070370	PT8978-MPG	791440071452	PT9208
791440066663	BT8903	791440067776	PA4695	791440069367	BF7821	791440070394	PT8980-MPG	791440071469	PT9209
791440066670	BT8904-MPG	791440067783	PA4696 FOAM	791440069374	PF7822	791440070400	PT8981-MPG	791440071476	PT9210
791440066694	BF7773	791440067790	PA4697-FN	791440069381	PF7823	791440070417	PT8982-MPG	791440071490	PT9212
791440066700	BF7774	791440067806	PA4698	791440069398	PF7824	791440070431	PT8984-MPG	791440071506	PT9213
791440066717	PA4704	791440067820	PA4705	791440069404	PF7825	791440070448	PT8985-MPG	791440071513	PT9214
791440066724	CA4702	791440067837	PA4706	791440069411	PF7826	791440070455	PT8986-MPG	791440071520	PT9215
791440066731	CA4703	791440067844	PA4707	791440069428	PF7828	791440070462	PT8987-MPG	791440071544	PT9217
791440066748	ES3231	791440067851	PA4708	791440069435	PF7829	791440070486	PT8989-MPG	791440071582	PT9221
791440066755	B7299	791440067868	PA4709	791440069442	PF7830	791440070493	PT8990-MPG	791440071599	PT9222
791440066762	PA4167	791440067882	PA4711	791440069466	PF7832	791440070509	PT8991-MPG	791440071605	PT9223
791440066779	B7245	791440067905	PA4713	791440069473	PF7833	791440070516	PT8992-MPG	791440071612	PT9224
791440066830	B7700	791440067912	PA4714	791440069480	PF7834	791440070523	PT8993-MPG	791440071629	PT9225
791440066847	PA4661	791440067929	PA4715	791440069503	PF7836	791440070530	PT8994-MPG	791440071643	PT9227
791440066854	PA4662	791440067936	PA4716	791440069510	BF7837	791440070547	PT8995-MPG	791440071650	PT9228
791440066861	PA4663	791440067974	PA4720	791440069527	BF7838	791440070554	PT8996-MPG	791440071681	H9231
791440066878	PA4664	791440068001	PA4723	791440069534	BF7839	791440070561	PT8997-MPG	791440071735	P7255
791440066885	PA4668	791440068049	PA4727	791440069541	BF7840	791440070578	PT8998-MPG	791440071742	P7256
791440066922	B5145	791440068070	PA4730	791440069558	BF7841	791440070585	PT8999-MPG	791440071773	P7259
791440066953	BF7775	791440068087	PA4731	791440069565	BF7842	791440070646	PT9127	791440071780	P7260
791440066960	BF7776	791440068094	PA4732	791440069572	BF7843	791440070660	PT9129	791440071797	P7261
791440066977	BF5816	791440068100	PA4733	791440069589	BF7844	791440070684	PT9131	791440071810	P7263
791440067004	PF7777	791440068117	PA4734	791440069596	BF7845	791440070691	PT9132	791440071827	P7264
791440067011	BF7778	791440068124	PA4735	791440069619	BF7847	791440070714	PT9134	791440071858	P7267
791440067028	BT8905	791440068131	PA4736 FOAM	791440069626	BF7848	791440070721	PT9135	791440071865	P7268
791440067035	B7246	791440068148	PA4737	791440069633	BF7849	791440070738	PT9136	791440071872	P7269
791440067042	RS4672	791440068155	PA4738	791440069640	BF7850	791440070745	PT9137	791440071889	BF7880
791440067059	RS4673	791440068179	PA4740	791440069657	BF7851	791440070769	PT9139	791440071896	B7271
791440067066	PA4674-FN	791440068186	PA4741	791440069664	BF7736-K1	791440070776	PT9140	791440071919	B7273
791440067073	PA4168	791440068209	PA4743	791440069671	BT8913-MPG	791440070790	PT9142	791440071926	B7274
791440067080	PF7779	791440068278	PA4750	791440069688	BT8476-MPG	791440070806	PT9143	791440071933	B7275
791440067103	BK6670	791440068308	PA4753	791440069695	BT366-MPG	791440070813	PT9144	791440071940	B7276
791440067127	BT8906	791440068315	PA4754	791440069701	BT351-MPG	791440070820	PT9145	791440071957	B7277
791440067134	PA4169	791440068322	PA4755	791440069718	BT371-5	791440070844	PT9147	791440071988	B7280
791440067141	BF7780	791440068339	PA4756	791440069725	BT8914	791440070851	PT9148	791440071995	B7281
791440067158	PT8907-MPG	791440068353	PA4758	791440069732	BT8915	791440070868	PT9149	791440072015	B7283
791440067165	P7247	791440068377	PA4760	791440069749	BT8916	791440070875	PT9150	791440072039	B7285
791440067196	BK6691	791440068407	PA4763	791440069756	BT8917	791440070899	PT9152	791440072046	B7286
791440067219	B7249-MPG	791440068414	PA4764	791440069763	BT8918	791440070905	PT9153	791440072053	B7287
791440067226	BT8908	791440068438	PA4766	791440069770	BT8919	791440070929	PT9155	791440072077	B7289
791440067233	BF7815	791440068469	PA4769	791440069787	BT8920	791440070943	PT9157	791440072084	B7290
791440067240	PT8909	791440068506	PA4773	791440069794	BT8921	791440070950	PT9158	791440072091	B7291
791440067264	RS4676	791440068520	RS4775	791440069800	BT8922	791440070981	PT9161	791440072107	B7292
791440067271	RS4677	791440068568	PA4778	791440069848	BT8926	791440070998	PT9162	791440072114	B7293
791440067288	RS4678	791440068599	PA4781	791440069855	BT8927	791440071001	PT9163	791440072121	B7294
791440067295	RS4679	791440068681	PA4790	791440069862	BT8928	791440071018	BT9164	791440072138	B7295
791440067301	BT8910-MPG	791440068711	PA4793	791440069886	BT8930	791440071025	PT9165	791440072169	OAS99001
791440067318	BT8911-MPG	791440068728	RS4794	791440069893	BT8931	791440071049	PT9167	791440072176	OAS99002
791440067325	RS4680	791440068735	PA4795	791440069930	BT8935	791440071056	PT9168	791440072183	OAS99003
791440067363	PA4681	791440068797	PA4801	791440069954	BT8937	791440071063	PT9169	791440072190	OAS99004
791440067370	20005	791440068803	PA4802	791440069961	PT8938-MPG	791440071070	PT9170	791440072206	OAS99005
791440067387	BD7250	791440068810	RS4803	791440069978	PT8939-MPG	791440071087	PT9171	791440072213	OAS99006
791440067394	BD7252	791440068827	RS4804	791440069985	PT8940-MPG	791440071094	PT9172	791440072237	OAS99008
791440067400	PT8912	791440068841	RS4806	791440069992	PT8941-MPG	791440071117	PT9174	791440072251	OAS99010
791440067424	PA4682	791440068858	RS4807	791440070011	PT8943-MPG	791440071124	PT9175	791440072299	OAS99014
791440067431	PKG475	791440068872	PA4809	791440070035	PT8945-MPG	791440071131	PT9176	791440072305	OAS99015
791440067448	PKG475-S	791440068889	PA4810	791440070042	PT8946-MPG	791440071155	PT9178	791440072329	OAS99017
791440067455	BK6184	791440068919	PA4813	791440070059	PT8947-MPG	791440071162	PT9179	791440072336	OAS99018
791440067462	BF1353-SPS	791440068926	PA4814	791440070066	PT8948-MPG	791440071179	PT9180	791440072350	OAS99020
791440067486	PF7782	791440068971	PA4819	791440070080	PT8950-MPG	791440071186	PT9181	791440072381	OAS99023
791440067493	BF7783-D	791440068988	PA4820	791440070097	PT8951-MPG	791440071193	PT9182	791440072398	OAS99024
791440067509	BF7784-D	791440069015	PA4823	791440070103	PT8952-MPG	791440071209	PT9183	791440072404	OAS99025



**WARNING:** These products can expose you to chemicals, including Diisononyl Phthalate, Carbon black extracts, Nickel, 1,3 Butadiene, Ethylene Oxide, Epichlorohydrin, which are known to the State of California to cause cancer, and Bisphenol-A, Ethylene Glycol, Ethylene Oxide, 1,3 Butadiene, Epichlorohydrin, which are known to the State of California to cause birth defects or other reproductive harm.



## UPC TO BALDWIN (INDIVIDUAL PARTS)

UPC NUMBER	BALDWIN NUMBER	UPC NUMBER	BALDWIN NUMBER	UPC NUMBER	BALDWIN NUMBER	UPC NUMBER	BALDWIN NUMBER	UPC NUMBER	BALDWIN NUMBER
791440072435	OAS99028	791440073708	PT9288-MPG	791440075092	PA4912	791440076594	PA4991	791440077539	H9075-V
791440072442	OAS99029	791440073715	PT9289-MPG	791440075108	PA4945	791440076600	PF7889	791440077553	BF7908
791440072473	OAS99032	791440073722	PT9290-MPG	791440075122	PA4947	791440076617	PF7889-10	791440077560	BF7909
791440072497	PF7852 KIT	791440073739	PT9291-MPG	791440075207	PA4955	791440076624	PF7889-30	791440077577	PT9355-MPG
791440072503	PA4857	791440073760	PT9293-MPG	791440075214	PA4956	791440076631	PF7890	791440077584	PF7910
791440072510	BK6183	791440073791	PT9296-MPG	791440075245	PT9329	791440076648	PF7890-10	791440077621	H9043-V
791440072527	PA4858	791440073807	PT9297-MPG	791440075252	RS4959	791440076655	PF7890-30	791440077652	BT9356
791440072534	BF7853	791440073838	PT9300-MPG	791440075269	RS4962	791440076662	BT9343-MPG	791440077669	PA5323
791440072541	RS4859	791440073869	PT9303-MPG	791440075276	RS4963	791440076679	RS4992	791440077676	BF7324
791440072558	PA4860	791440073876	PT9304-MPG	791440075283	RS4966	791440076686	RS4994	791440077683	PT9357
791440072565	RS4862	791440073890	PT9306-MPG	791440075290	RS4967	791440076693	RS4995	791440077690	PF7977
791440072572	RS4863	791440073906	PT9307-MPG	791440075306	RS4968	791440076723	BF7798-SP	791440077706	PA5324-FN
791440072596	BK6665	791440073913	PT9308-MPG	791440075313	RS4969	791440076730	PT9344	791440077713	RS5325
791440072602	PA4170	791440073920	PT9309-MPG	791440075320	RS4970	791440076747	BF7314	791440077720	PA5326
791440072626	PA4877	791440073937	PT9310-MPG	791440075337	RS4971	791440076754	BT1356	791440077744	BD7325
791440072633	PA4878	791440073944	PT9311-MPG	791440075344	RS4972	791440076761	PA4172	791440077775	BF1359-SP
791440072640	PA4879	791440073968	PT9313-MPG	791440075351	P1561	791440076785	RS4993	791440077782	20006
791440072664	PA4881	791440073982	PT9315 KIT	791440075368	P1562	791440076792	BT9345	791440077799	20007
791440072688	PA4883	791440074019	PT9237	791440075375	P1563	791440076808	CA4999	791440077805	20008
791440072701	PA4885	791440074026	PT9238	791440075399	P1565	791440076815	BT9346-MPG	791440077829	20010
791440072718	PA4886	791440074033	PT9239	791440075405	P1566	791440076822	BT9347-MPG	791440077836	20011
791440072725	PA4887	791440074040	PT9240	791440075436	P1567	791440076839	PT9348-MPG	791440077843	BK6426
791440072732	PA4888	791440074064	PT9242	791440075443	P1568	791440076846	BT9349-MPG	791440077850	20012
791440072749	PA4889	791440074088	PT9244	791440075528	PF1584	791440076853	BF1357	791440077867	PA5327
791440072756	PA4890	791440074095	PT9245	791440075535	PF1585	791440076860	BF7888	791440077874	PA5328
791440072763	PA4891	791440074118	PT9247	791440075559	P1575	791440076877	BF1358-SP	791440077881	RS5329
791440072787	PA4893	791440074125	PT9248	791440075573	P1577	791440076884	BF7892	791440077904	BK6666
791440072800	PA4895	791440074149	PT9250	791440075597	PF1587	791440076907	PA5300	791440077911	BT9358
791440072817	PA4896	791440074156	PT9251	791440075610	PF1589	791440076914	BT7316	791440077928	BK6444
791440072824	PA4897	791440074187	PT9254	791440075634	P1578	791440076952	BK6185	791440077935	BK6451
791440072848	PA4900	791440074194	PT9255	791440075665	BF7879	791440076969	BD7317	791440077942	BK6452
791440072862	PA4902	791440074200	PT9256-MPG	791440075733	PT9330-MPG	791440076976	PT9350-MPG	791440077966	BK6654
791440072879	PA4903	791440074217	PT9257	791440075757	H9072-V	791440076983	PT9351-MPG	791440077973	BF1360
791440072893	PA4905	791440074224	PT9258	791440075764	H9076-V	791440076990	RS5301	791440077980	BF7911
791440072909	PA4906	791440074248	PT9260	791440075771	H9078-V	791440077027	PF7894	791440077997	PA4175
791440072916	PA4907	791440074255	PT9261-MPG	791440075849	PT9335-MPG	791440077034	PF7895	791440078000	PA4176
791440072923	PA4908	791440074286	PT9264	791440075870	PT9332	791440077041	BF7318	791440078017	PT9359-MPG
791440072947	PA4910	791440074309	PT9266	791440075887	PT9331	791440077058	PA5302	791440078024	BT9360
791440072954	PA4911	791440074316	PT9267	791440075917	PF7882	791440077072	PA5303	791440078031	PT9361
791440073029	PA4918	791440074323	PT9268	791440075924	BF7881	791440077089	P7319	791440078048	BF1293-SPS
791440073036	PA4919	791440074361	PT9272	791440075955	PA4979	791440077096	PF7896	791440078055	BF1272-SPS
791440073098	PA4925	791440074415	PT9277	791440075962	PA4978	791440077102	RS5304	791440078062	20013
791440073128	PA4928	791440074422	PT9278	791440075979	PA4977-FN	791440077119	BK6613	791440078109	BT9362-MPG
791440073135	PA4929	791440074439	PT9279	791440075993	PA4975	791440077126	RS5305	791440078116	BT9363-MPG
791440073142	PA4930	791440074484	PF7879	791440076013	PA4973	791440077133	PA5306	791440078123	PA4177
791440073159	PA4931	791440074491	BF7860	791440076037	BK6663	791440077157	BF7898-D	791440078130	BF7912
791440073166	PA4932	791440074507	BF7871	791440076099	BK6662	791440077164	BK6186	791440078147	BK6463
791440073180	PA4934	791440074514	PF7872	791440076112	PT9337-MPG	791440077171	B7320	791440078154	BF7913
791440073197	PA4935	791440074521	PF7873	791440076198	G494	791440077188	PA4178	791440078161	BF1352-SPS
791440073227	PA4938	791440074538	PF7874	791440076204	G523-AF	791440077195	PA4174	791440078178	PA5330
791440073234	PA4939	791440074545	PF7875	791440076211	ES1039	791440077256	PA5310	791440078185	BF1361
791440073258	PA4941	791440074552	PF7876	791440076235	G1972	791440077263	P7321	791440078192	PA5331
791440073265	PA4942	791440074569	PF7877	791440076259	PT9338-MPG	791440077270	PF7899	791440078208	BK6187
791440073333	PA4865-FN	791440074576	BF7855	791440076266	BT7349	791440077287	PF7900	791440078369	BK6923
791440073340	PA4870-FN	791440074590	BF7857	791440076280	BF7883	791440077300	PA4640-FN	791440078376	RS5332
791440073357	PA4871	791440074613	BF7859	791440076297	B7306	791440077317	PT9352	791440078390	BT9364
791440073364	PA4872	791440074620	BF7860	791440076303	PA4984-FN	791440077324	BF7322	791440078406	PF7914
791440073371	PA4873	791440074637	BF7861	791440076310	PA4983	791440077331	PA5311	791440078413	BF7915
791440073388	PA4874	791440074644	BF7863	791440076341	PT9340-MPG	791440077348	PA5312 KIT	791440078420	BT9365-MPG
791440073401	PA4876	791440074651	BF7864	791440076365	BK6661	791440077355	RS5313	791440078437	BT9366-MPG
791440073418	PA3957 FOAM	791440074668	BF7865	791440076372	PA4985	791440077362	PA5314	791440078444	PA5333
791440073425	PA2069 FOAM	791440074675	BF7866	791440076389	PA4986	791440077379	BF7903	791440078451	BT9367-MPG
791440073432	PA2067 FOAM	791440074699	B7637	791440076396	PA4987	791440077386	BF7904-D	791440078475	RS5335
791440073463	RS4864	791440074705	B7298	791440076419	BF1355-SP	791440077393	B7396	791440078482	BF1283-SP
791440073470	RS4861	791440074743	P7303	791440076433	BF7886	791440077409	BT9353-MPG	791440078499	BF1362
791440073531	BT9316-MPG	791440074774	OAS99034	791440076440	PKG475-R	791440077416	BF7905-D	791440078505	BT9368-MPG
791440073548	BT8475-MPG	791440074781	OAS99035	791440076464	P7308	791440077423	BF7906-D	791440078512	BT9369-MPG
791440073555	BT8477-MPG	791440074811	OAS99038	791440076488	BF5587-D	791440077430	BF7907	791440078529	BC7326
791440073579	BT9320	791440074866	OAS99043	791440076495	BK6658	791440077447	FB1306	791440078536	PF7916
791440073586	BT9321	791440074927	PA4171	791440076501	BK6659	791440077454	PA5315	791440078543	PA5336
791440073616	BT9324	791440075009	BT9318	791440076518	RS4988	791440077461	PA5316	791440078550	BF7917
791440073630	BT9326	791440075016	H9327	791440076525	PT9341	791440077478	PA5317	791440078567	BF7327
791440073647	PT9282-MPG	791440075023	PT9328-MPG	791440076532	B7311-MPG	791440077485	PT9354-MPG	791440078574	BT9370-MPG
791440073654	PT9283-MPG	791440075030	P7305	791440076549	P7312	791440077492	PA5318	791440078598	BK6464
791440073661	PT9284-MPG	791440075047	PF7878	791440076563	RS4989	791440077508	PA5319	791440078604	BF1355
791440073685	PT9286-MPG	791440075054	PA4960-FN	791440076570	P7313	791440077515	PA5320	791440078611	BF1363
791440073692	PT9287-MPG	791440075078	PA4961	791440076587	PT9342-MPG	791440077522	PA5321	791440078635	PA5337



**WARNING:** These products can expose you to chemicals, including Diisononyl Phthalate, Carbon black extracts, Nickel, 1,3 Butadiene, Ethylene Oxide, Epichlorohydrin, which are known to the State of California to cause cancer, and Bisphenol-A, Ethylene Glycol, Ethylene Oxide, 1,3 Butadiene, Epichlorohydrin, which are known to the State of California to cause birth defects or other reproductive harm.

# UPC TO BALDWIN (INDIVIDUAL PARTS)

UPC NUMBER	BALDWIN NUMBER	UPC NUMBER	BALDWIN NUMBER	UPC NUMBER	BALDWIN NUMBER	UPC NUMBER	BALDWIN NUMBER	UPC NUMBER	BALDWIN NUMBER
791440078642	PA5338-FN	791440079557	RS5360	791440080607	PA4314	791440081468	CA5419	791440082267	PA4366
791440078659	B7328	791440079564	RS5361	791440080614	B7402	791440081475	CA5420	791440082274	B7430
791440078666	PA4178	791440079601	PA5363	791440080621	B7403	791440081482	BT9398-MPG	791440082281	B7429
791440078673	PA4179	791440079618	BF1379	791440080638	PF7938	791440081499	PF7946	791440082298	PT9405
791440078680	PA4180	791440079625	BF1380	791440080645	BF1354-SPS	791440081505	PA4334	791440082304	B7431
791440078697	PA4181	791440079632	BF1381	791440080652	PA4316	791440081512	PA4335	791440082311	B7432
791440078703	PA4182	791440079649	PA4187	791440080669	PA4317	791440081529	BK6980	791440082328	B7433
791440078710	PA4183	791440079656	BF1382-SP	791440080720	PT9394-MPG	791440081536	BK6981	791440082335	PA4367
791440078727	BT9371-MPG	791440079687	PF7930	791440080744	PA4318	791440081543	BK6982	791440082342	PA4368
791440078741	RS5334	791440079779	BK6649	791440080751	PA4319	791440081550	BK6984	791440082359	PA4369
791440078758	BF1365	791440079786	PA5364	791440080768	PT9395-MPG	791440081567	BF1389-O	791440082366	PA4370
791440078796	PT9372	791440079793	PA5365	791440080775	PA4320	791440081574	PA4333	791440082373	PA4371
791440078819	BF7919	791440079830	B7333	791440080799	200-DEPR KIT	791440081581	PA4336	791440082380	PA4372
791440078840	BA5374	791440079847	BF7931	791440080805	100-DEPR KIT	791440081598	PF7947	791440082397	PA4373
791440078857	BA5375	791440079854	BF7932	791440080812	100-MNTG KIT	791440081604	PA4347	791440082403	BF7958
791440078864	BA5376	791440079861	CA5366	791440080829	PT9396	791440081611	P7418	791440082410	BF7959
791440078871	PA5339	791440079885	CA5368	791440080836	PT9397-MPG	791440081635	BF7948	791440082427	BF7960
791440078888	PT9374	791440079892	CA5369	791440080843	BF1385-SPS	791440081642	OV8728	791440082434	BF7961
791440078895	PA5340	791440079908	CA5370	791440080850	PF7939	791440081659	BF7949-D	791440082441	B7434
791440078901	BF7921	791440079915	BT9387	791440080867	BF7940	791440081666	BF7950-D	791440082458	PA4374
791440078918	PA5341	791440079946	B7397	791440080874	BF7941	791440081673	20015	791440082465	PT9406-MPG
791440078932	PT9375	791440079953	BT9388	791440080881	PA4321	791440081680	20016	791440082489	PA4376
791440078949	PT9376	791440079977	RS5387 KIT	791440080898	PA4322	791440081697	20017	791440082496	PA4377
791440078956	BT9377	791440079984	PA5388	791440080904	BF7942	791440081703	20018	791440082502	PA4380
791440078963	P7329	791440079991	PT9389-MPG	791440080911	P7406	791440081710	20019	791440082519	PA4381
791440078970	RS5342	791440080010	RS5389-FN	791440080928	RS5395-FN	791440081727	20020	791440082526	PA4382
791440078987	RS5343	791440080027	PT9390-MPG	791440080935	PA5396	791440081734	BK6983	791440082533	PA4383
791440078994	BF1367	791440080034	RS5390	791440080942	RS5397	791440081741	BF7951-D	791440082540	PA4384
791440079007	BF7922	791440080041	B7335-MPG	791440080959	RS5398	791440081758	BF7952-D	791440082557	PA4385
791440079014	BF1370	791440080058	B7334	791440080966	PA5399	791440081772	BF7954-D	791440082564	PA4386
791440079021	BW5183	791440080065	BT9391-MPG	791440080973	PA5400	791440081789	B7419	791440082571	PA4387
791440079038	BF1371	791440080089	RS5391	791440080980	PA5401	791440081796	PA4338	791440082588	BF7962
791440079045	PA5350	791440080102	P7336 KIT	791440081000	PA5403	791440081802	PA4340	791440082595	BF7963
791440079052	BF7923	791440080119	BT9392-MPG	791440081017	PA5404	791440081819	PA4341	791440082601	BF7964-D
791440079069	P7330	791440080126	BT9393-MPG	791440081024	PA5405	791440081826	PA4344	791440082618	PT9407-MPG
791440079083	PT9378-MPG	791440080133	PF7934 KIT	791440081031	PA5406-FN	791440081833	PA4345	791440082625	B7435
791440079090	PA4184	791440080157	BK6930	791440081048	PA4323	791440081840	PA4348	791440082632	BT9408
791440079106	PT9373-MPG	791440080164	BK6931	791440081055	B7407	791440081857	PA4349	791440082649	PA4388
791440079113	PT7332	791440080171	RS5392	791440081062	PA4324	791440081864	PA4350	791440082656	PA4389
791440079120	RS5351	791440080201	BK6933	791440081079	PA5407	791440081871	PA4351	791440082663	PA5425
791440079137	CA5352	791440080218	PF7935	791440081086	PA4327	791440081888	PA4352	791440082670	PA4390
791440079144	CTK5029-M	791440080225	PA5393	791440081093	PA4328	791440081895	RS5422	791440082687	PA5426
791440079151	BF7927	791440080249	BF1384-SP	791440081109	PA4325	791440081901	BF7955	791440082717	P7436
791440079168	PT9379	791440080263	P7337	791440081116	RS5409	791440081918	B7420	791440082724	P7437
791440079182	PT9380-MPG	791440080270	PA4188	791440081123	RS5408	791440081925	B7422	791440082748	BF1392-SPS KIT
791440079199	BF1373-SP	791440080287	P7338	791440081130	PA5410-FN	791440081932	BF7956-D	791440082755	BF7965
791440079205	BK6299	791440080294	RS4189	791440081147	RS5411	791440081949	P7423	791440082762	PA4391
791440079212	PT9415-MPG KIT	791440080300	PA4190	791440081154	BF7943	791440081956	BA5371	791440082786	PA4392
791440079229	PT9416-MPG KIT	791440080317	PA4191	791440081161	PA5412	791440081963	PA5423-FN	791440082793	PA4393
791440079236	RS5354	791440080324	BK6993	791440081178	RS5413	791440081970	PT9399-MPG	791440082809	PT9409-MPG
791440079243	RS5355	791440080331	PF7936	791440081185	P7408	791440081987	P7417	791440082816	B7440
791440079250	BF7924	791440080348	P7398	791440081192	B7409	791440081994	PA4353	791440082823	BF7966
791440079267	BF1374-SP	791440080355	P7399	791440081208	B7410	791440082007	PA4354	791440082830	B5091
791440079274	BF1375	791440080362	P7400	791440081215	PA4329	791440082014	PA4355	791440082847	HSG3077
791440079281	PT9381-MPG	791440080379	B7401	791440081222	P7411	791440082021	PA4356	791440082854	B7441
791440079298	BT9382	791440080386	20014	791440081239	RS5414	791440082045	PA4358	791440082861	PA4394
791440079304	BF1376	791440080393	BF7937	791440081246	RS5415	791440082052	PA4359	791440082878	PA5428
791440079335	BK6181	791440080409	PA4192	791440081253	BF1386-O	791440082069	PA4360	791440082915	BF7967
791440079342	BF1372	791440080416	PA4193	791440081260	BF7944	791440082076	PA4361	791440082922	BF1393-SP
791440079359	BF1377	791440080423	PA4194	791440081277	P7413	791440082083	PA4362	791440082939	RS5429
791440079366	PA4185	791440080430	PA4195 KIT	791440081284	P7414	791440082090	B7424	791440082946	RS5430
791440079380	FD7926	791440080447	PA4196	791440081291	RS5344	791440082106	P7426	791440082953	BK6656
791440079397	BF7925	791440080454	PA4197	791440081307	RS5345	791440082113	P7427	791440082960	RS5431
791440079403	PA5353	791440080461	PA4198	791440081321	RS5347	791440082120	BT9400-MPG	791440082984	PA4397
791440079410	BK6429	791440080478	PA4199	791440081338	RS5348	791440082137	PT9401	791440082991	PA4398
791440079427	RS5356	791440080485	PA4303	791440081345	BF1387-O	791440082144	BT9402	791440083004	PA4399
791440079434	PA5357	791440080492	PA4304	791440081352	BF1388-O	791440082151	RS5424	791440083011	PA4400
791440079441	PT9383-MPG	791440080508	PA4305	791440081369	P7415	791440082168	B7428	791440083028	P7442
791440079458	PT9384-MPG	791440080515	PA4306	791440081376	PA4330	791440082175	BK6652	791440083035	RS5432
791440079465	RS5358	791440080522	PA4307	791440081383	PA4331	791440082182	BF7957	791440083042	BF1394-SP
791440079472	PT9385-MPG	791440080539	PA4308	791440081390	PA4332	791440082199	PT9403-MPG	791440083059	RS5433
791440079489	PT9386-MPG	791440080546	PA4309	791440081406	BF7945	791440082205	BF1390-O	791440083066	PT9410-MPG
791440079502	BF1378-SPS	791440080553	SA4315	791440081413	B7416	791440082212	PA4363	791440083073	PT9411-MPG
791440079519	G534-AF	791440080560	PA4310	791440081420	CA5416	791440082229	PA4364	791440083080	BF1395-SP
791440079526	PA5359	791440080577	PA4311	791440081437	CA5417	791440082236	PA4365	791440083097	PA4401
791440079533	PF7928	791440080584	PA4312	791440081444	PA5418	791440082243	PT9404-MPG	791440083103	PA4402
791440079540	BF7929 KIT	791440080591	PA4313	791440081451	CA5421	791440082250	BF1391-O	791440083110	BK6653



**WARNING:** These products can expose you to chemicals, including Diisononyl Phthalate, Carbon black extracts, Nickel, 1,3 Butadiene, Ethylene Oxide, Epichlorohydrin, which are known to the State of California to cause cancer, and Bisphenol-A, Ethylene Glycol, Ethylene Oxide, 1,3 Butadiene, Epichlorohydrin, which are known to the State of California to cause birth defects or other reproductive harm.

**UPC TO BALDWIN (INDIVIDUAL PARTS)**

UPC NUMBER	BALDWIN NUMBER	UPC NUMBER	BALDWIN NUMBER	UPC NUMBER	BALDWIN NUMBER	UPC NUMBER	BALDWIN NUMBER	UPC NUMBER	BALDWIN NUMBER
791440083127	BK6657	791440084032	CV15000	791440086180	B7361	791440087071	PA5505	791440088016	RS5540
791440083134	PA4403	791440084049	BK6022	791440086197	BT9561	791440087088	PF9803	791440088023	RS5541
791440083141	PA4404	791440084056	BK6023	791440086203	PF7986	791440087095	BK6996	791440088061	BK6034
791440083158	PA4405	791440084063	BK6024	791440086210	PF7982	791440087101	PT9427-MPG	791440088078	BK6035
791440083189	PA4408	791440084070	BK6025	791440086227	PA5465	791440087118	PT9429-MPG	791440088085	PA5545
791440083202	B7443	791440084087	BK6026	791440086234	B7362	791440087125	BF1383-O	791440088092	PT9434
791440083219	B7444	791440084094	BF1399-SP	791440086241	BF7987	791440087132	RS5507	791440088108	PA4435
791440083226	BF1396	791440084100	PA5437	791440086258	PA5467	791440087149	PF9804	791440088122	500-MFVBP22
791440083233	B7445	791440084117	BK6997	791440086265	BF7988	791440087156	RS5508	791440088139	RS5546
791440083240	PA4409	791440084124	BK6027	791440086272	PT9420-MPG	791440087170	BF9805	791440088146	B7388
791440083257	BF7986	791440084148	PT9419-MPG	791440086289	BF7989-D	791440087187	B7372	791440088153	PF9829 KIT
791440083264	B7446	791440084155	PA4421	791440086302	PA5473	791440087194	RS5509	791440088160	PA4436
791440083271	PT9413-MPG	791440084490	PT9453-MPG	791440086319	PA5475	791440087200	RS5510	791440088177	PA4437
791440083288	BF1398-O	791440085497	BT9553	791440086326	PA5476	791440087217	BF1222-O	791440088184	PT9435-MPG
791440083295	BK6942	791440085503	PF7974	791440086333	PA5477	791440087224	BK6457	791440088191	BF9830-D
791440083301	P7450	791440085510	B7351-MPG	791440086340	RS5470	791440087231	PA4431	791440088207	B7389
791440083318	B7451	791440085527	PT9554-MPG	791440086357	RS5471	791440087248	PA5511	791440088214	BF9831
791440083325	BF1360-SP	791440085534	PT9555	791440086364	RS5472	791440087255	PA5512	791440088238	BF7930
791440083332	BF7949-DM	791440085541	PT9556-MPG	791440086371	B7363	791440087262	BF1345-O	791440088252	BF7933
791440083349	BF7971-D	791440085558	HSG3078	791440086388	P7364	791440087293	CA5514	791440088269	BF9833-D
791440083356	BF7971-DM	791440085565	AB3349	791440086395	BF1287-O	791440087309	PA5515	791440088276	BF9834
791440083363	B7452	791440085572	PT9557	791440086401	BF1288-O	791440087316	B7373	791440088283	BF9835-D
791440083370	RS5438	791440085589	PF7975	791440086418	PA4425	791440087323	BF9807	791440088290	PT7505
791440083387	BK6943	791440085596	B7352	791440086425	PA4426	791440087330	BF9808-D	791440088306	B7457
791440083394	BK6944	791440085619	BA5373	791440086432	BF7990	791440087347	PA5516	791440088313	B7458
791440083400	BK6945	791440085626	BA5377	791440086449	PA5480	791440087354	BF1223-O	791440088320	B7459
791440083417	BK6946	791440085633	RS5435	791440086456	P7365	791440087361	BF9809-D	791440088344	PA5552
791440083424	BK6947	791440085640	BK6028	791440086487	BF7993	791440087378	BF9810-D	791440088368	PA5554
791440083431	BK6948	791440085657	BK6650	791440086500	RS5483	791440087385	B7375	791440088382	PA5556
791440083448	BK6949	791440085664	PA5454	791440086517	RS5484	791440087392	B7376	791440088399	PA5557
791440083455	BK6950	791440085671	RS5455	791440086524	BK6033	791440087408	BF7377	791440088405	BK6047
791440083462	BK6951	791440085688	RS5456	791440086531	PA5485-FN	791440087415	BF9811-SP	791440088412	BK6044
791440083486	B7453	791440085695	BF7976	791440086548	PA5487	791440087422	BF7378	791440088436	BF9836-D
791440083493	RS5434	791440085718	BA5378	791440086555	B7367	791440087439	BF1290-O	791440088443	PA4438
791440083516	PA4410 KIT	791440085725	BA5379	791440086562	PF1392	791440087446	BF1292-O	791440088450	RS5558
791440083530	OP8750	791440085732	RS5452	791440086579	PA5486	791440087453	BF1294-O	791440088467	BF1346-O
791440083547	OP8751	791440085749	BK6029	791440086609	PF7994	791440087460	RS5506	791440088474	BF1348-O
791440083554	OP8752	791440085756	RS5453	791440086616	BF7995	791440087477	PT9430-MPG	791440088498	B7461
791440083561	OP8753	791440085763	PF7978	791440086623	P7368	791440087484	B7379	791440088504	BT9437
791440083578	PA4411	791440085787	PA5457	791440086630	RS5478-FN	791440087491	RS5517	791440088511	BF9837-D
791440083585	P7454	791440085794	BD7355	791440086647	RS5479	791440087507	BF9812	791440088528	B7462
791440083592	PA4412	791440085800	BK6956	791440086654	BK6438	791440087514	BF9813	791440088566	PA5561
791440083608	PA4413	791440085817	BT9558-MPG	791440086661	BK6161	791440087521	PF9814	791440088573	PA5562
791440083615	PA4414	791440085824	PT9559-MPG	791440086678	BF7996	791440087538	B7383	791440088597	PA5563
791440083622	PA4415	791440085831	RS5458	791440086685	PA4428	791440087545	B7384	791440088627	BF9839-D
791440083639	PA5436	791440085848	B7356	791440086692	BT9421-MPG	791440087552	B7385	791440088641	RS5559
791440083646	RS5440	791440085855	BF1366-O	791440086708	20021	791440087569	B7386	791440088658	B10-AL BSPCS
791440083653	RS5441	791440085862	BF7970	791440086715	20022	791440087576	B7387	791440088665	BA5566
791440083660	P7455	791440085879	BF7979	791440086722	20023	791440087583	BF9815	791440088672	BF1298-O
791440083677	PA4416 KIT	791440085886	B7357	791440086739	20024	791440087606	BF9816	791440088689	B7466
791440083684	BF7969	791440085909	RS5449	791440086753	PA5491	791440087613	BF1296-O	791440088702	B7467
791440083691	PT9414-MPG	791440085916	B7359	791440086760	PA5492	791440087620	BF1297-O	791440088719	B7468
791440083714	PA5445	791440085923	BK6030	791440086777	PA5493	791440087637	BF9817	791440088726	B7469
791440083721	PA5446	791440085930	RS5459	791440086784	BF7997	791440087644	BF9818	791440088733	BF9841
791440083738	RS5447	791440085947	RS5460	791440086791	PA5494	791440087668	BF9820	791440088757	RS5536
791440083745	RS5448	791440085954	PF7980	791440086807	PA5495	791440087675	PA4433	791440088764	RS5550
791440083752	BF7972	791440085961	BK6031	791440086814	BT9422	791440087682	BF9821	791440088771	RS5547
791440083769	P7438	791440085978	BK6032	791440086821	BF7998	791440087699	BK6167	791440088788	RS5548
791440083776	PA4417	791440085985	PA4422	791440086838	PA5496	791440087705	BF9822-D	791440088795	RS5549
791440083783	BK6985	791440085992	PA4423	791440086845	PA5497	791440087712	PF9823	791440088801	BF9842
791440083790	BK6986	791440086005	BF7981	791440086852	BF1289-SP	791440087729	P7380	791440088832	B7474
791440083806	BK6953	791440086012	BK6041	791440086869	PT9423	791440087736	PF9824	791440088863	B7477
791440083813	BK6954	791440086029	BK6043	791440086883	PA5498	791440087743	PF9825	791440088900	BF9844
791440083820	BK6955	791440086036	BK6045	791440086890	PA5499	791440087750	PF9826	791440088931	B7483
791440083837	BC7456 KIT	791440086043	BK6046	791440086897	CA5500	791440087835	PA5528	791440088913	PA5573
791440083844	RS5442	791440086050	BK6048	791440086920	B7370	791440087842	PA5529	791440088920	PA5574
791440083851	RS5443	791440086067	BT9560-MPG	791440086968	PT9424	791440087859	PA5530	791440088951	BC7485
791440083868	PA4418	791440086074	PF7983	791440086975	PA5503	791440087910	PT9432-MPG	791440089039	BF9846
791440083875	PA4419	791440086081	PF7984	791440086982	PA5504	791440087927	BF9827-D	791440089105	BF9847-D
791440083943	PT9417	791440086104	BF7985	791440086999	BF9800	791440087934	PA5532	791440089112	BF1299-O
791440083950	B7449	791440086111	RS5461	791440087002	PF9801	791440087941	PA5533	791440089136	BT9436-MPG
791440083974	PT9418	791440086128	RS5462	791440087019	PT9425-MPG	791440087958	PA5463	791440089143	B7486
791440083981	PF7973	791440086135	B7360	791440087026	PA4429	791440087965	PA4434	791440089150	B7487
791440083998	BK6987	791440086142	PA4424	791440087033	PT9426	791440087972	BT9433	791440089167	PA4439
791440084001	BF1397-SP	791440086159	BF7637	791440087040	BF9802	791440087989	BF9828-D	791440089174	PA4440 KIT
791440084018	B7350	791440086166	PA5464	791440087057	PA4430	791440087996	RS5538	791440089181	PA4441
791440084025	BK6952	791440086173	BK6988	791440087064	BT7237	791440088009	RS5539	791440089198	BF9848



**WARNING:** These products can expose you to chemicals, including Diisononyl Phthalate, Carbon black extracts, Nickel, 1,3 Butadiene, Ethylene Oxide, Epichlorohydrin, which are known to the State of California to cause cancer, and Bisphenol-A, Ethylene Glycol, Ethylene Oxide, 1,3 Butadiene, Epichlorohydrin, which are known to the State of California to cause birth defects or other reproductive harm.

# UPC TO BALDWIN (INDIVIDUAL PARTS)

UPC NUMBER	BALDWIN NUMBER	UPC NUMBER	BALDWIN NUMBER	UPC NUMBER	BALDWIN NUMBER	UPC NUMBER	BALDWIN NUMBER	UPC NUMBER	BALDWIN NUMBER
791440089204	P7488	791440090347	PA5630	791440091207	PT9450-MPG	791440092099	BF9893	791440093126	BK6073
791440089211	P7489	791440090354	PA5631	791440091214	PT9451-MPG	791440092105	BF9894	791440093133	BK6074
791440089235	BF9850	791440090361	RS5534	791440091221	PT9452	791440092112	B7503	791440093140	BK6075
791440089297	PA4442	791440090378	BT9440	791440091238	BT9454	791440092129	PA5468	791440093157	PA5733
791440089303	PA4443	791440090385	BF9866-O	791440091245	PA5649	791440092136	RS5684	791440093164	PF9908 KIT
791440089310	PA4444	791440090392	PA5632	791440091252	PA4467	791440092143	RS5685	791440093188	RS3539XP
791440089327	BF9851	791440090415	P7495	791440091269	BK6060	791440092150	PA5686	791440093195	PA5734
791440089334	P7490	791440090422	PA4465	791440091276	PA5650	791440092167	PA5687	791440093201	BF9910
791440089341	B7491	791440090439	RS5537	791440091283	PA5651	791440092174	PA5688	791440093218	PA5735
791440089358	BF9852	791440090446	BF9867-O	791440091290	PA5652	791440092181	PA5689	791440093225	PA5736
791440089402	PA5451	791440090453	RS5535	791440091306	PA5653	791440092198	PA5690	791440093232	PF9910
791440089419	RS4445	791440090460	BF1355-O	791440091313	BF1358-O	791440092204	PA5691	791440093249	BF9911
791440089426	PA4446	791440090477	PA5633	791440091320	PA5654	791440092211	RS5692	791440093256	PT9472
791440089433	PA4447	791440090507	PF9868	791440091337	PA5655	791440092228	RS5693	791440093263	B7511
791440089440	PA4448	791440090514	PA5636	791440091344	BK6061	791440092235	PA5694	791440093287	PT9473
791440089457	BK6049	791440090521	BF1395-O	791440091351	BK6062	791440092242	PA5695	791440093294	PA5738
791440089464	BK6050	791440090538	B7496	791440091368	BK6063	791440092259	PA5696	791440093300	PA5739
791440089471	BK6052	791440090545	PA1885XP	791440091375	PA2456XP	791440092266	PA5697	791440093324	RS5741
791440089488	BF9857	791440090552	PA2573XP	791440091382	BF9877	791440092273	BD7504	791440093331	RS5742
791440089495	BK6053	791440090569	PA2562XP	791440091399	PA5656	791440092280	B7506	791440093348	RS5743
791440089501	BK6054	791440090576	PA1894XP	791440091405	PA5657	791440092297	PA4470	791440093355	RS5743XP
791440089518	BF9858 KIT	791440090583	PA2453XP	791440091412	PA5658	791440092303	BF9895 KIT	791440093362	RS5744
791440089716	BT9439	791440090590	PA2384XP	791440091443	PA5661	791440092310	PA4471	791440093379	RS5745
791440089730	RS5543	791440090606	PA2363XP	791440091450	PA5662	791440092327	PA5698	791440093386	RS5747
791440089747	RS5544	791440090613	PA1615XP	791440091467	PA5663	791440092334	PA5699	791440093393	RS5748
791440089754	PA4449	791440090620	PA1884XP	791440091474	PA5664	791440092358	PF9897	791440093409	RS5749
791440089761	PA5580	791440090637	PA1706XP	791440091481	PA5665	791440092365	PA4472	791440093416	RS5750
791440089778	PA5581	791440090644	BF9869	791440091498	PA5666	791440092372	BF9898-O	791440093423	BF1249-O
791440089792	PA5583	791440090651	BK6058	791440091504	PA5667	791440092389	PF9899	791440093430	PA5751
791440089808	PA5584	791440090668	PT9441-MPG	791440091511	PA5668	791440092396	PF9900	791440093454	PA5752
791440089815	RS4450	791440090675	BK6059	791440091528	PA4468	791440092402	B7507	791440093461	S9475
791440089822	PA5588	791440090682	PF9870	791440091535	PA4469	791440092419	BC7394	791440093478	BF9912-O
791440089839	PA5589	791440090699	PA5637	791440091542	P5092	791440092426	PA5700	791440093485	PT9476-MPG
791440089853	CV15001	791440090705	PA5638	791440091559	BF9878	791440092433	PF9901 KIT	791440093492	BF1281-O
791440089860	P7492	791440090729	PA2518XP	791440091566	PA5669	791440092440	PA4473	791440093508	BF9913
791440089891	PA4451	791440090736	PA1886XP	791440091573	RS5670	791440092457	PT9468	791440093515	BF1283-O
791440089907	PA4452	791440090743	PA1634XP	791440091597	BK6064	791440092464	BK6066	791440093522	PA5753
791440089914	PA4453	791440090750	PA2616XP	791440091610	RS5672	791440092471	BK6077	791440093539	RS5754
791440089921	PA5585	791440090767	PA2326XP	791440091627	RS5673	791440092488	BK6078	791440093546	PA5755
791440089938	PA5586	791440090774	PA1846XP	791440091634	PA5674	791440092495	BK6079	791440093553	RS5756
791440089945	PA4454	791440090781	PA2676XP	791440091641	RS5675	791440092501	BK6080	791440093560	CV15003
791440089952	P7493	791440090798	BF9871-O	791440091658	RS5676	791440092518	PF9902	791440093577	PF9914 KIT
791440089969	PA4455	791440090804	RS3744XP	791440091689	B7499	791440092525	BF9903-SP	791440093584	BF9915
791440089976	BK6055	791440090811	RS3510XP	791440091702	BT9456	791440092532	PA4474	791440093591	PA5757
791440089983	PA4456	791440090828	RS3870XP	791440091719	PA5678	791440092549	B7395	791440093607	RS5758
791440090002	BA5592	791440090835	RS3508XP	791440091726	BK6065	791440092570	BF9904	791440093614	RS5759
791440090019	PA4458	791440090842	RS3514XP	791440091733	BK6066	791440092587	P7508	791440093638	RS5761
791440090033	PA5594	791440090859	RS3700XP	791440091740	PA5679	791440092617	RS5707	791440093645	PA5762
791440090057	PA5597	791440090866	RS3998XP	791440091757	PF9879	791440092624	RS5708	791440093652	BF9916
791440090064	PA5598	791440090873	RS2863XP	791440091764	BF9880	791440092662	PT9469	791440093669	PA4476
791440090071	PA5599	791440090880	RS3517XP	791440091771	PA5680	791440092679	PT9470	791440093676	PA4477
791440090088	P7494	791440090897	RS3548XP	791440091788	PT9459-MPG	791440092686	BD7509	791440093683	PA4478
791440090095	BK6056	791440090910	RS3530XP	791440091795	PA5681	791440092693	PA5710	791440093690	PA4479
791440090101	PA4460 KIT	791440090927	RS3506XP	791440091801	BF9881	791440092709	PA5711	791440093706	PA4480
791440090118	BF9860	791440090934	RS3734XP	791440091825	PT9462	791440092716	PA5712	791440093713	PA5763
791440090125	PA4461	791440090941	RS3504XP	791440091832	PA5682	791440092723	PA5713	791440093720	PA5764
791440090132	PA4462	791440090958	PF9872	791440091849	BT9464	791440092747	BF9905	791440093737	P7512
791440090149	PF9861	791440090965	B7497	791440091856	PT9463	791440092761	PA5716	791440093744	B7513
791440090156	CV15002	791440090996	PF9873	791440091863	BF9883	791440092792	PA5719	791440093751	PA5765
791440090163	PA4463	791440091009	RS5641	791440091887	B7501	791440092808	BT9471	791440093768	P7514
791440090170	PF9862	791440091016	PA4466	791440091894	PE5270	791440092815	PA5720	791440093775	BF9917
791440090187	BF9863	791440091023	BT9442-MPG	791440091900	PE5271	791440092822	PA5721	791440093782	BK6081
791440090194	PA5618	791440091030	BF9874-DM	791440091917	BT9465	791440092839	PA5722	791440093799	BF9918 KIT
791440090200	PA5619	791440091047	BF9875-DM	791440091924	PA5683	791440092846	PA5723	791440093805	PA5766
791440090217	PA5620	791440091054	PT9443	791440091931	BF9884	791440092853	PA4475	791440093812	RS5767
791440090224	PA5621	791440091061	PT9444-MPG	791440091948	BF9885	791440092884	PA5725	791440093829	P7515
791440090231	PA5622	791440091078	BF9876	791440091955	BK6067	791440092891	BF9906	791440093836	PA5768
791440090248	PA5623	791440091085	PA5642	791440091962	BT9466-MPG	791440092914	PA5727	791440093843	PT9477
791440090255	PA5624	791440091108	PA5644	791440091986	BF9886	791440092921	PA5728	791440093850	PT9478-MPG
791440090262	BF9864	791440091115	PA5645	791440091993	P7502	791440092938	PA5728 FOAM	791440093867	PT9479-MPG
791440090279	PA5625	791440091122	PA5646	791440092020	BF9887	791440092945	CFB8784	791440093874	PT9480-MPG
791440090286	PF9865	791440091146	PA5648	791440092037	BF9888	791440092952	PA5729	791440093881	PT9481-MPG
791440090293	PA5626	791440091153	PT9445-MPG	791440092044	BK6071	791440092969	RS5730	791440093898	PT9482-MPG
791440090309	PA4464	791440091160	PT9446	791440092051	PF9889	791440092976	RS5731	791440093904	PT9483-MPG
791440090316	RS5627	791440091177	PT9447	791440092068	PF9890	791440092983	PA5732	791440093911	PT9484-MPG
791440090323	RS5628	791440091184	PT9448	791440092075	BF9891-D	791440092990	PF9907	791440093928	PT9485-MPG
791440090330	PA5629	791440091191	PT9449	791440092082	BF9892-D	791440093119	BK6072	791440093935	PT9486-MPG



**WARNING:** These products can expose you to chemicals, including Diisononyl Phthalate, Carbon black extracts, Nickel, 1,3 Butadiene, Ethylene Oxide, Epichlorohydrin, which are known to the State of California to cause cancer, and Bisphenol-A, Ethylene Glycol, Ethylene Oxide, 1,3 Butadiene, Epichlorohydrin, which are known to the State of California to cause birth defects or other reproductive harm.

**UPC TO BALDWIN (INDIVIDUAL PARTS)**

UPC NUMBER	BALDWIN NUMBER	UPC NUMBER	BALDWIN NUMBER	UPC NUMBER	BALDWIN NUMBER	UPC NUMBER	BALDWIN NUMBER	UPC NUMBER	BALDWIN NUMBER
791440093942	PT9487-MPG	791440094758	BF9922-O	791440095632	PT23035-MPG	791440096417	PT23113-MPG	791440097216	PA30036
791440093959	PT9488-MPG	791440094765	PT9536-MPG	791440095649	PT23036-MPG	791440096424	PT23114-MPG	791440097223	PA30037
791440093966	PT9489-MPG	791440094772	CA5450	791440095656	PT23037-MPG	791440096431	PT23115-MPG	791440097230	PA30038
791440093973	PT9490-MPG	791440094789	CA5788	791440095663	PT23038-MPG	791440096448	PT23116-MPG	791440097247	PA30039
791440093980	PT9491-MPG	791440094796	CA4996	791440095670	PT23039-MPG	791440096455	PT23117-MPG	791440097254	PA30040
791440093997	PT9492-MPG	791440094802	PA4997	791440095687	PT23040-MPG	791440096462	PT23118-MPG	791440097261	PA30041
791440094000	PT9493-MPG	791440094819	CA5789	791440095694	PT23041-MPG	791440096479	PT23119-MPG	791440097278	PA30042
791440094017	PT9494-MPG	791440094826	CA5790	791440095700	PT23042-MPG	791440096486	PT23120-MPG	791440097285	PA30043
791440094024	PT9495-MPG	791440094833	CA5791	791440095717	PT23043-MPG	791440096509	B9604	791440097292	PA30044
791440094031	PT9496-MPG	791440094840	PA5792	791440095724	PT23044-MPG	791440096516	RS5293	791440097308	PA30045
791440094048	PT9497-MPG	791440094857	CA5793	791440095731	PT23045-MPG	791440096523	RS5294	791440097339	PA30048
791440094055	PT9498-MPG	791440094888	BK6051	791440095748	PT23046-MPG	791440096554	PA5297	791440097346	PA30049
791440094062	PT9499-MPG	791440094895	PA5796	791440095755	PT23047-MPG	791440096561	PA5298	791440097353	PA30050
791440094079	PT9500-MPG	791440094901	PA5797	791440095762	PT23048-MPG	791440096578	P9605	791440097360	PA30051
791440094086	PT9501-MPG	791440094918	PA5798	791440095779	PT23049-MPG	791440096585	RS5746	791440097377	PA30052
791440094093	PT9502-MPG	791440094925	PE5272	791440095786	PT23050-MPG	791440096592	PA5299	791440097384	PA30053
791440094109	PT9503-MPG	791440094949	RS5273	791440095793	PT23051-MPG	791440096608	RS5288XP	791440097391	PA30054
791440094116	PT9504-MPG	791440094956	BF9923-O	791440095809	PT23052-MPG	791440096615	B9606	791440097407	PA30055
791440094123	PT9505-MPG	791440094970	PA5274	791440095816	PT23053-MPG	791440096622	B9607	791440097414	PA30056
791440094130	PT9506	791440094987	PA5275	791440095823	PT23054-MPG	791440096639	PF9928	791440097421	RS30057
791440094147	PT9507	791440094994	PA5276	791440095830	PT23055-MPG	791440096646	PF9929	791440097438	RS30058
791440094154	PT9508	791440095007	P9602	791440095847	PT23056-MPG	791440096653	PA30000	791440097445	RS30059-FN
791440094161	PT9509	791440095014	P9603	791440095854	PT23057-MPG	791440096660	PA30001	791440097452	RS30060-FN
791440094178	PT9510	791440095021	PT9537-MPG	791440095861	PT23058-MPG	791440096677	PA10000	791440097469	RS30061
791440094185	PT9511	791440095045	CA5278	791440095878	PT23059-MPG	791440096684	PA10001	791440097476	RS30062
791440094192	PT9512	791440095076	PA5281	791440095885	PT23060-MPG	791440096691	PA10002	791440097483	BW21000
791440094208	PT9513	791440095083	PA5282	791440095892	PT23061-MPG	791440096707	BF46000	791440097490	BF46006
791440094215	PT9514	791440095090	PA5283	791440095908	PT23062-MPG	791440096714	BF46001	791440097506	BF46007
791440094222	PT9515	791440095106	BA5284	791440095915	PT23063-MPG	791440096721	B40000	791440097513	BF46008
791440094239	PT9516	791440095113	PA4486	791440095922	PT23064-MPG	791440096738	P40001	791440097520	PF46009
791440094246	PT9517	791440095120	BF1278-O	791440095939	PT23065-MPG	791440096745	BF46002	791440097537	PF46010 KIT
791440094260	PT9518-MPG	791440095137	PA4487	791440095946	PT23066-MPG	791440096752	PA30002	791440097551	BF46012
791440094277	PT9519-MPG	791440095144	PA4488	791440095953	PT23067-MPG	791440096769	PA30003	791440097568	BF46013
791440094284	PT9520-MPG	791440095151	PA4489	791440095960	PT23068-MPG	791440096776	PA30004	791440097575	BF46014
791440094291	PT9521-MPG	791440095168	RS5285	791440095977	PT23069-MPG	791440096783	PA30005	791440097582	BF46015
791440094307	PT9523-MPG	791440095175	PF9924 KIT	791440095984	PT23070-MPG	791440096790	PA30006	791440097599	BF5813-O
791440094314	PT9524-MPG	791440095199	BF9925-O	791440095991	PT23071-MPG	791440096806	PA30007	791440097605	BF1204-O
791440094321	PT9525-MPG	791440095212	RS5287XP	791440096004	PT23072-MPG	791440096813	PA10003	791440097612	BF791-O
791440094338	PT9526-MPG	791440095229	PA5290	791440096011	PT23073-MPG	791440096820	RS30008	791440097629	BF7968-O
791440094345	PT9528	791440095236	PA5289	791440096028	PT23074-MPG	791440096837	RS30009	791440097636	BF46016-O
791440094352	PT9529	791440095250	RS5291	791440096035	PT23075-MPG	791440096844	PF46003	791440097643	BF46017-O
791440094369	PT9530	791440095267	RS5292	791440096042	PT23076-MPG	791440096851	PF46004	791440097650	BF46018-O
791440094376	PT9531	791440095274	BF9927	791440096059	PT23077-MPG	791440096868	PA10004	791440097667	BF46019-O
791440094383	PT9532	791440095281	PT23001	791440096066	PT23078-MPG	791440096875	RS10005	791440097674	BF46020-O
791440094390	PA4481	791440095298	PT23000	791440096073	PT23079-MPG	791440096882	PA30010	791440097681	BF46021-O
791440094413	B7516	791440095304	PT23002	791440096080	PT23080-MPG	791440096889	BF46005	791440097698	BF46022-O
791440094420	BT9533	791440095311	PT23003	791440096097	PT23081-MPG	791440096905	PA10006	791440097704	BF46023-O
791440094437	P7517	791440095328	PT23004	791440096103	PT23082-MPG	791440096912	P40003	791440097711	BF46024-O
791440094444	P9600	791440095335	PT23005	791440096110	PT23083-MPG	791440096929	PA10007	791440097728	BF46025-O
791440094451	PA5770	791440095342	PT23006	791440096127	PT23084-MPG	791440096943	CV15004	791440097735	BF46026-O
791440094468	PA5771	791440095359	PT23007	791440096134	PT23085-MPG	791440096950	PA30011	791440097742	BF46027-O
791440094475	PA5772	791440095366	PT23008	791440096141	PT23086-MPG	791440096963	OAS98000	791440097759	BF46028-O
791440094482	PA5773	791440095373	PT23009	791440096158	PT23087-MPG	791440096967	PA30012	791440097766	BF46029-O
791440094499	PF9919	791440095380	PT23010	791440096165	PT23088-MPG	791440096974	PA30013	791440097773	BF46030-O
791440094505	PA5774	791440095397	PT23011	791440096172	PT23089-MPG	791440096981	PA30014	791440097780	PT23136
791440094529	BF1282-O	791440095403	PT23012	791440096189	PT23090-MPG	791440096998	PA30015	791440097803	PT23122
791440094536	PA4483	791440095410	PT23013	791440096196	PT23091-MPG	791440097001	PA30016	791440097810	PT23123
791440094550	RS5776	791440095427	PT23014	791440096202	PT23092-MPG	791440097018	PA30017	791440097827	PT23137
791440094567	B9601	791440095434	PT23015	791440096219	PT23093-MPG	791440097025	PA30018	791440097834	PT23124
791440094574	PA5777	791440095441	PT23016	791440096226	PT23094-MPG	791440097032	PA30019	791440097841	PT23125-MPG
791440094581	PA5778	791440095458	PT23017	791440096233	PT23095-MPG	791440097049	PA30020	791440097858	PT23126-MPG
791440094598	PA5779	791440095465	PT23018	791440096240	PT23096-MPG	791440097056	PA30021	791440097865	PT23127-MPG
791440094604	BF9920	791440095472	PT23019	791440096257	PT23097-MPG	791440097063	PA30022	791440097872	PT23128-MPG
791440094611	PT9535-MPG	791440095489	PT23020	791440096264	PT23098-MPG	791440097070	PA30023	791440097889	PT23129-MPG
791440094628	PA5780	791440095502	PT23021	791440096288	PT23100-MPG	791440097087	PA30024	791440097902	PT23131-MPG
791440094635	PA5781	791440095519	PT23022	791440096295	PT23101-MPG	791440097094	PA30025	791440097919	PT23132-MPG
791440094642	RS5489	791440095526	PT23024	791440096301	PT23102-MPG	791440097100	PA30026	791440097926	PT23133-MPG
791440094659	RS5490	791440095533	PT23025	791440096318	PT23103-MPG	791440097117	PA30027	791440097940	PT23135-MPG
791440094666	PA4484	791440095540	PT23026	791440096325	PT23104-MPG	791440097124	PA30028	791440097957	P40002
791440094673	RS5782	791440095557	PT23027	791440096332	PT23105-MPG	791440097131	PA30029	791440097964	B40006
791440094680	RS5783	791440095564	PT23028-MPG	791440096349	PT23106-MPG	791440097148	PA30030	791440097971	C40004
791440094697	BF9921-O	791440095571	PT23029-MPG	791440096356	PT23107-MPG	791440097155	PA30031	791440097989	C40005
791440094703	PA4485	791440095588	PT23030-MPG	791440096363	PT23108-MPG	791440097162	PA30032	791440097995	PA10008
791440094710	PA5785	791440095595	PT23031-MPG	791440096370	PT23109-MPG	791440097179	PA30033	791440098008	PA30064
791440094727	PA5786	791440095601	PT23032-MPG	791440096387	PT23110-MPG	791440097186	PA30033	791440098015	PT23138
791440094734	PA5787	791440095618	PT23033-MPG	791440096394	PT23111-MPG	791440097193	PA30034	791440098022	BC40007
791440094741	RS5784	791440095625	PT23034-MPG	791440096400	PT23112-MPG	791440097209	PA30035	791440098039	RS30065



**WARNING:** These products can expose you to chemicals, including Diisononyl Phthalate, Carbon black extracts, Nickel, 1,3 Butadiene, Ethylene Oxide, Epichlorohydrin, which are known to the State of California to cause cancer, and Bisphenol-A, Ethylene Glycol, Ethylene Oxide, 1,3 Butadiene, Epichlorohydrin, which are known to the State of California to cause birth defects or other reproductive harm.

# UPC TO BALDWIN (INDIVIDUAL PARTS)

UPC NUMBER	BALDWIN NUMBER	UPC NUMBER	BALDWIN NUMBER	UPC NUMBER	BALDWIN NUMBER	UPC NUMBER	BALDWIN NUMBER	UPC NUMBER	BALDWIN NUMBER
791440098046	RS30065 KIT	791440098886	OAS98054	791440099753	PT23215-MPG	791440100589	PA10013	791440101555	PT23361-MPG
791440098053	BF46031	791440098909	OAS98056	791440099760	PT23216-MPG	791440100596	PA30080	791440101562	PT23362-MPG
791440098060	BK6070	791440098916	OAS98057	791440099777	PT23217-MPG	791440100602	PA30081	791440101579	PT23363-MPG
791440098077	PA0008	791440098923	OAS98058	791440099784	PT23218-MPG	791440100619	PA10014	791440101586	PT23364-MPG
791440098084	BC40009	791440098930	PA10010	791440099791	PT23219-MPG	791440100763	BT40015	791440101593	PT23365-MPG
791440098091	PA0010	791440098947	PA10011	791440099807	PT23220-MPG	791440100770	PA30086	791440101609	PT23366-MPG
791440098107	BF46032	791440098954	RS30077	791440099814	PT23221-MPG	791440100787	PA10015	791440101616	PT23367-MPG
791440098114	PA30066	791440098961	RS30078	791440099838	PT23223-MPG	791440100831	RS30090-FN	791440101623	PT23368-MPG
791440098121	PA30067	791440098978	BF46034	791440099845	PT23224-MPG	791440100848	20025	791440101630	PT23369-MPG
791440098138	PA30068	791440098985	RS3882XP	791440099869	PT23226-MPG	791440100855	RS30091	791440101647	PT23370-MPG
791440098145	PA30069	791440098992	PA10012	791440099876	PT23227-MPG	791440100862	RS30092	791440101654	PT23371-MPG
791440098152	PA30070	791440099005	CA30079	791440099883	PT23228-MPG	791440100886	CA30093	791440101661	PT23372-MPG
791440098169	CA30071	791440099012	PT23141	791440099890	PT23229-MPG	791440100893	PA10016	791440101678	PT23373-MPG
791440098176	PA30072	791440099029	PT23142	791440099906	PT23230-MPG	791440100909	PA10017	791440101685	PT23374-MPG
791440098183	PA30073	791440099036	PT23143	791440099913	PT23231-MPG	791440100916	PA30094	791440101692	PT23375-MPG
791440098190	PA30074	791440099043	PT23144	791440099920	PT23232-MPG	791440100923	BF46037	791440101708	PT23376-MPG
791440098206	PF46033	791440099050	PT23145	791440099937	PT23233-MPG	791440100930	PA30095	791440101715	PT23377-MPG
791440098237	PA0011	791440099067	PT23146	791440099944	PT23234-MPG	791440100947	PT23306	791440101722	PT23378-MPG
791440098244	PA0012	791440099074	PT23147	791440099951	PT23235-MPG	791440100954	PA30096	791440101739	PT23379-MPG
791440098251	B40013	791440099081	PT23148	791440099968	PT23236-MPG	791440100985	BF46038-D	791440101746	PT23380-MPG
791440098268	PT23139-MPG	791440099098	PT23149	791440099975	PT23237-MPG	791440100992	BF46039-D	791440101753	PT23381-MPG
791440098282	PA30075	791440099104	PT23150	791440099982	PT23238-MPG	791440101005	PA10018	791440101760	PT23382-MPG
791440098299	BF45000	791440099111	PT23151	791440099989	PT23239-MPG	791440101012	PA30098	791440101777	PT23383-MPG
791440098305	PA30076	791440099128	PT23152	791440100008	PT23240-MPG	791440101029	PT23308	791440101784	PT23384-MPG
791440098312	PA10009	791440099142	PT23154	791440100015	PT23241-MPG	791440101036	PT23309	791440101791	PT23385-MPG
791440098329	PA0014	791440099159	PT23155	791440100022	PT23242-MPG	791440101043	PT23310	791440101794	PT23355-MPG
791440098336	RS5591XP	791440099166	PT23156	791440100039	PT23243-MPG	791440101050	PT23311	791440101807	PT23386-MPG
791440098343	RS5593XP	791440099173	PT23157	791440100046	PT23244-MPG	791440101067	PT23312	791440101814	PT23387-MPG
791440098350	OAS98001	791440099180	PT23158	791440100053	PT23245-MPG	791440101074	PT23313	791440101821	PT23388-MPG
791440098367	OAS98002	791440099197	PT23159	791440100060	PT23246-MPG	791440101081	PT23314	791440101838	PT23389-MPG
791440098374	OAS98003	791440099203	PT23160	791440100077	PT23247-MPG	791440101098	PT23315	791440101845	PT23390-MPG
791440098381	OAS98004	791440099210	PT23161	791440100084	PT23248-MPG	791440101104	PT23316	791440101852	PT23391-MPG
791440098398	OAS98005	791440099227	PT23162	791440100091	PT23249-MPG	791440101111	PT23317	791440101869	PT23392-MPG
791440098404	OAS98006	791440099234	PT23163	791440100107	PT23250-MPG	791440101128	PT23318	791440101876	PT23393-MPG
791440098411	OAS98007	791440099241	PT23164	791440100114	PT23251-MPG	791440101135	PT23319	791440101883	PT23394-MPG
791440098428	OAS98008	791440099258	PT23165	791440100121	PT23252-MPG	791440101142	PT23320	791440101890	PT23395-MPG
791440098435	OAS98009	791440099265	PT23166	791440100138	PT23253-MPG	791440101159	PT23321	791440101906	PT23396-MPG
791440098442	OAS98010	791440099272	PT23167	791440100145	PT23254-MPG	791440101166	PT23322	791440101913	PT23397-MPG
791440098459	OAS98011	791440099289	PT23168	791440100152	PT23255-MPG	791440101173	PT23323	791440101920	PT23398-MPG
791440098466	OAS98012	791440099296	PT23169	791440100176	PT23257-MPG	791440101180	PT23324	791440101937	PT23399-MPG
791440098473	OAS98013	791440099302	PT23170	791440100183	PT23258-MPG	791440101197	PT23325	791440101944	PT23400-MPG
791440098480	OAS98014	791440099326	PT23172	791440100190	PT23259-MPG	791440101203	PT23326	791440101951	PT23401-MPG
791440098497	OAS98015	791440099333	PT23173	791440100206	PT23260-MPG	791440101210	PT23327	791440101968	PT23402-MPG
791440098503	OAS98016	791440099340	PT23174	791440100213	PT23261-MPG	791440101227	PT23328	791440101975	PT23403-MPG
791440098510	OAS98017	791440099357	PT23175	791440100220	PT23262-MPG	791440101234	PT23329	791440101982	PT23404-MPG
791440098527	OAS98018	791440099364	PT23176	791440100237	PT23263-MPG	791440101241	PT23330	791440101989	PT23405-MPG
791440098534	OAS98019	791440099388	PT23178	791440100244	PT23264-MPG	791440101258	PT23331	791440102002	PT23406-MPG
791440098541	OAS98020	791440099395	PT23179	791440100251	PT23265-MPG	791440101265	PT23332	791440102019	PT23407-MPG
791440098558	OAS98021	791440099401	PT23180	791440100268	PT23266-MPG	791440101272	PT23333	791440102026	PT23408-MPG
791440098565	OAS98022	791440099418	PT23181	791440100275	PT23267-MPG	791440101289	PT23334	791440102033	PT23409-MPG
791440098572	OAS98023	791440099425	PT23182	791440100299	PT23269-MPG	791440101296	PT23335	791440102040	PT23410-MPG
791440098589	OAS98024	791440099432	PT23183	791440100305	PT23270-MPG	791440101302	PT23336	791440102057	PT23411-MPG
791440098596	OAS98025	791440099449	PT23184	791440100312	PT23271-MPG	791440101319	PT23337	791440102064	PT23412-MPG
791440098602	OAS98026	791440099456	PT23185	791440100329	PT23272-MPG	791440101326	PT23338-MPG	791440102071	PT23413-MPG
791440098619	OAS98027	791440099463	PT23186	791440100336	PT23273-MPG	791440101333	PT23339-MPG	791440102088	PT23415-MPG
791440098626	OAS98028	791440099470	PT23187	791440100343	PT23274-MPG	791440101340	PT23340-MPG	791440102095	PT23414-MPG
791440098633	OAS98029	791440099487	PT23188	791440100350	PT23275-MPG	791440101357	PT23341-MPG	791440102101	PT23416-MPG
791440098657	OAS98031	791440099494	PT23189	791440100367	PT23276-MPG	791440101364	PT23342-MPG	791440102118	PT23417-MPG
791440098664	OAS98032	791440099500	PT23190	791440100374	PT23277-MPG	791440101371	PT23343-MPG	791440102125	PT23418-MPG
791440098671	OAS98033	791440099531	PT23193-MPG	791440100381	PT23278-MPG	791440101388	PT23344-MPG	791440102132	PT23419-MPG
791440098688	OAS98034	791440099555	PT23195-MPG	791440100398	PT23279-MPG	791440101395	PT23345-MPG	791440102149	PT23420-MPG
791440098695	OAS98035	791440099562	PT23196-MPG	791440100404	PT23280-MPG	791440101401	PT23346-MPG	791440102156	PT23421-MPG
791440098701	OAS98036	791440099579	PT23197-MPG	791440100411	PT23281-MPG	791440101408	PT23347-MPG	791440102163	PT23422-MPG
791440098718	OAS98037	791440099586	PT23198-MPG	791440100428	PT23282-MPG	791440101418	PT23348-MPG	791440102170	PT23423-MPG
791440098725	OAS98038	791440099609	PT23200-MPG	791440100435	PT23283-MPG	791440101422	PT23349-MPG	791440102187	PT23424-MPG
791440098732	OAS98039	791440099616	PT23201-MPG	791440100442	PT23284-MPG	791440101425	PT23350-MPG	791440102194	PT23425-MPG
791440098749	OAS98040	791440099623	PT23202-MPG	791440100459	PT23285-MPG	791440101432	PT23351-MPG	791440102200	PT23426-MPG
791440098756	OAS98041	791440099630	PT23203-MPG	791440100466	PT23286-MPG	791440101449	PT23352-MPG	791440102217	PT23427-MPG
791440098763	OAS98042	791440099647	PT23204-MPG	791440100473	PT23287-MPG	791440101456	PT23353-MPG	791440102224	PT23428-MPG
791440098770	OAS98043	791440099654	PT23205-MPG	791440100497	PT23289-MPG	791440101463	PT23354-MPG	791440102231	PT23429-MPG
791440098787	OAS98044	791440099661	PT23206-MPG	791440100503	PT23290-MPG	791440101470	PT23355-MPG	791440102248	PT23430-MPG
791440098794	OAS98045	791440099678	PT23207-MPG	791440100510	PT23291-MPG	791440101487	PT23356-MPG	791440102255	PT23431-MPG
791440098800	OAS98046	791440099692	PT23209-MPG	791440100527	PT23292-MPG	791440101500	PT23357-MPG	791440102262	PT23432-MPG
791440098831	OAS98049	791440099715	PT23211-MPG	791440100541	PT23294-MPG	791440101517	PT23358-MPG	791440102279	PT23433-MPG
791440098848	OAS98050	791440099722	PT23212-MPG	791440100558	PT23295-MPG	791440101524	PT23359-MPG	791440102286	PT23434-MPG
791440098862	OAS98052	791440099739	PT23213-MPG	791440100565	PT23296-MPG	791440101531	PT23360-MPG	791440102293	PT23435-MPG
791440098879	OAS98053	791440099746	PT23214-MPG	791440100572	PT23297	791440101548	PT23361-MPG	791440102309	PT23436-MPG



**WARNING:** These products can expose you to chemicals, including Diisononyl Phthalate, Carbon black extracts, Nickel, 1,3 Butadiene, Ethylene Oxide, Epichlorohydrin, which are known to the State of California to cause cancer, and Bisphenol-A, Ethylene Glycol, Ethylene Oxide, 1,3 Butadiene, Epichlorohydrin, which are known to the State of California to cause birth defects or other reproductive harm.

## UPC TO BALDWIN (INDIVIDUAL PARTS)

UPC NUMBER	BALDWIN NUMBER	UPC NUMBER	BALDWIN NUMBER	UPC NUMBER	BALDWIN NUMBER	UPC NUMBER	BALDWIN NUMBER	UPC NUMBER	BALDWIN NUMBER
791440102316	PT23437-MPG	791440103139	PT23503-MPG	791440104020	PT23531-MPG	791440105003	RS30143 KIT	791440106789	BK6140
791440102323	PT23438-MPG	791440103146	PT23504-MPG	791440104037	BF46048	791440105027	BT40028	791440106796	PT23561-MPG
791440102330	PT23439-MPG	791440103153	PT23505-MPG	791440104044	P40017	791440105034	P40030	791440106819	PA32001
791440102347	PT23440-MPG	791440103160	PT23506-MPG	791440104105	RS30133	791440105041	PA30174	791440106826	PA32004
791440102354	PT23441-MPG	791440103177	PT23507-MPG	791440104112	RS30134	791440105058	RS30175	791440106833	PA32000
791440102361	PT23442-MPG	791440103184	PT23508-MPG	791440104129	PA30137	791440105072	P40031-MPG	791440106840	PA32003
791440102378	PT23443-MPG	791440103191	PT23509-MPG	791440104136	PA30138	791440105089	PA30177	791440106864	PA32002
791440102385	PT23444-MPG	791440103207	PT23510-MPG	791440104143	PA30139	791440105096	BD50000	791440106871	BF46084
791440102392	PT23445-MPG	791440103214	PT23511-MPG	791440104150	PA30140	791440105126	PA30179	791440106918	PE17001
791440102408	PT23446-MPG	791440103221	PT23512-MPG	791440104167	PA30141	791440105140	RS30180	791440106925	PT23565-MPG
791440102415	PT23447-MPG	791440103238	PT23513-MPG	791440104174	PA30144	791440105157	RS30181	791440106932	PT23566-MPG
791440102439	PT23449-MPG	791440103245	PT23514-MPG	791440104181	RS30135	791440105164	RS30182	791440106949	PT23567-MPG
791440102446	PT23450-MPG	791440103252	PT23515-MPG	791440104198	RS30136	791440105171	PA30183	791440106956	PT23568-MPG
791440102460	BF46040-D	791440103269	PT23516-MPG	791440104204	BA16000	791440105195	BF46069	791440106963	PT23569-MPG
791440102484	PA10020	791440103276	PT23517-MPG	791440104211	PT23532-MPG	791440105218	BT40029	791440106970	PT23570-MPG
791440102491	P40019	791440103283	PT23518-MPG	791440104228	RS30130	791440105225	BT23555-MPG	791440106987	PT23571-MPG
791440102507	RS30099	791440103290	PT23519-MPG	791440104235	RS10035	791440105232	BF46071	791440106994	PT23572-MPG
791440102514	PA30100	791440103306	PT23520-MPG	791440104242	PT23530	791440105249	BF46072	791440107007	PT23573-MPG
791440102521	PA30101	791440103313	PT23521-MPG	791440104259	PT23533	791440105256	PT23556-MPG	791440107014	PT23574-MPG
791440102545	RS30106	791440103320	PT23522-MPG	791440104266	RS4634XP	791440105263	PA30166	791440107021	PT23575-MPG
791440102552	PA30107	791440103337	PT23523-MPG	791440104273	PA30148	791440105270	PA30165	791440107038	PT23576-MPG
791440102569	PA30109	791440103344	PT23524-MPG	791440104280	BK6086	791440105287	BT40032	791440107045	PT23577-MPG
791440102576	PA30108	791440103351	BF46041-D	791440104297	BK6087	791440105294	BF46073	791440107052	PT23578-MPG
791440102583	PA30110	791440103368	BF46042-D	791440104303	BF46050	791440105317	PA31000	791440107069	PT23579-MPG
791440102590	RS30112	791440103375	BF46043-D	791440104310	PT23534	791440105324	PA31002	791440107076	PT23580-MPG
791440102606	RS10021	791440103382	PA30113	791440104327	PT23535	791440105331	PA31010	791440107083	PT23581-MPG
791440102613	PT23451	791440103399	PA30114	791440104334	PT23536	791440105348	PA31001	791440107090	PT23582-MPG
791440102620	PT23452	791440103405	PA30115	791440104341	BF46051	791440105355	PA31003	791440107106	PT23583-MPG
791440102637	PT23453	791440103412	PA10022	791440104358	PA30149	791440105362	PA31011	791440107120	PT23585
791440102644	PT23454	791440103429	BT23525-MPG	791440104365	PA30150	791440105386	P40033	791440107137	PT23586
791440102651	PT23455	791440103436	RS30116	791440104372	PA10036	791440105393	PA31004	791440107144	PT23587
791440102668	PT23456	791440103443	BF46044-D	791440104389	PA30151	791440105409	PA31006	791440107151	PT23588
791440102675	PT23457	791440103450	P40020	791440104396	BF46052	791440105416	PA31012	791440107168	PT23589
791440102682	PT23458	791440103467	PA30117	791440104419	RS30147	791440105423	PA31005	791440107175	PT23590
791440102699	PT23459	791440103474	PT23526	791440104426	PA30145	791440105430	PA31007	791440107182	BF46085
791440102705	PT23460	791440103481	PA2361XP	791440104433	PA30146	791440105447	BK6138	791440107199	PT23591-MPG
791440102712	PT23461	791440103498	CA30103	791440104440	PA30153	791440105461	BT40034	791440107205	P40042
791440102729	PT23462	791440103504	CA30102	791440104457	PA30154	791440105478	PA30185	791440107267	CA30131
791440102736	PT23463	791440103511	CA30105	791440104464	PA30155	791440105492	RS30187XP	791440107274	CA30132
791440102743	PT23464	791440103528	CA30104	791440104471	PA30156	791440105515	PE17000	791440107281	BF46087
791440102750	PT23465	791440103535	PT23527	791440104488	PA30157	791440105539	PA30188	791440107298	PA10047
791440102774	PT23467	791440103542	PA30118	791440104495	PF46112	791440105546	CV15006	791440107304	PT23592
791440102781	PT23468	791440103559	PA30119	791440104501	PA10037	791440105560	PA30189	791440107311	PF46088
791440102798	PT23469	791440103566	B40022-MPG	791440104532	BT23537	791440105577	PA30190	791440107359	PF46091
791440102804	PT23470	791440103573	RS30120	791440104549	PF46049	791440105584	RS30191	791440107366	BF46098-O
791440102811	PT23471	791440103580	RS30121	791440104556	BD40027	791440105591	RS30192	791440107373	BF46100-O
791440102828	PT23472	791440103597	RS5293XP	791440104570	BT23539	791440105607	BF46065-SPS	791440107380	BF46099-O
791440102835	PT23473	791440103603	P40021	791440104587	BT23540	791440105614	PF46076	791440107397	PF46094
791440102842	PT23474	791440103610	PA10023	791440104594	PA30158	791440105621	PT23576	791440107403	BF46101-O
791440102859	PT23475	791440103627	PA10024	791440104600	RS30159	791440105638	PA10038	791440107458	B40050
791440102866	PT23476	791440103634	PA10025	791440104617	RS30160	791440105645	PA10039	791440107465	B40051
791440102873	PT23477	791440103641	PA10026	791440104624	RS30161	791440105652	PA10040	791440107463	OAS99047
791440102880	PT23478	791440103658	PA10027	791440104631	RS30162	791440105669	PA10041	791440107670	OAS99048
791440102897	PT23479	791440103665	PA10028	791440104655	BF1360-O	791440105676	PA10042	791440107687	P40052
791440102903	PT23480	791440103689	PA10030	791440104662	BF1347-O	791440105683	PA10043	791440107700	PF46103
791440102910	PT23481	791440103696	PA10031	791440104679	PA30163	791440105690	P40035	791440107717	PT23595-MPG
791440102927	PT23482	791440103702	PA10032	791440104686	BT23542-MPG	791440105706	B40036	791440107731	B40053
791440102934	PT23483-MPG	791440103719	P40023	791440104693	CV15005	791440105713	PF46077	791440107748	B40054
791440102941	PT23484-MPG	791440103726	P40024	791440104709	PF46056	791440105720	PA30152	791440107762	BT23603-MPG
791440102958	PT23485-MPG	791440103733	P40025	791440104719	PF46057	791440105737	OAS98661	791440107779	PT23597-MPG
791440102965	PT23486-MPG	791440103740	OAS98060	791440104730	PF46059	791440105744	PA10044	791440107786	BT23604
791440102972	PT23487-MPG	791440103757	PT23528-MPG	791440104761	PA30164	791440105751	PA10045	791440107793	PT23598-MPG
791440102989	PT23488-MPG	791440103764	RS30087	791440104778	BF46062	791440105768	PA10046	791440107816	BT23605-MPG
791440102996	PT23489-MPG	791440103771	RS30088	791440104785	BT23543-MPG	791440105775	P40037	791440107830	PT23600
791440103009	PT23490-MPG	791440103780	PA30122	791440104792	PT23544-MPG	791440105782	BT40038	791440107847	B40056
791440103016	PT23491-MPG	791440103818	PA30123	791440104808	PT23545-MPG	791440105799	BF46078-D	791440107878	BT23607-MPG
791440103023	PT23492-MPG	791440103825	PA30124	791440104815	PT23546-MPG	791440105805	PA30193-FN	791440107885	PA10057
791440103030	PT23493-MPG	791440103832	PA30125	791440104822	PA30170	791440105812	PA30194	791440107908	RS30209
791440103047	PT23494-MPG	791440103849	BF46045-D	791440104839	BF63000	791440105829	PF46079	791440107922	PA30211
791440103054	PT23495-MPG	791440103924	PA10033	791440104846	PA30171	791440105836	PF46080	791440107939	PA30235
791440103061	PT23496-MPG	791440103931	PA3478XP	791440104877	RS30168	791440105843	PF46081	791440107946	RS30212
791440103078	PT23497-MPG	791440103948	PA30126	791440104884	RS30169	791440105850	PF46082	791440107953	RS30213
791440103085	PT23498-MPG	791440103955	PA30127	791440104907	PA30172	791440105867	PA31013	791440107984	RS30216
791440103092	PT23499-MPG	791440103962	PF46046	791440104914	PA30173	791440105874	PA31014	791440107991	RS30217
791440103108	PT23500-MPG	791440103979	RS30128	791440104976	RS30142	791440105881	PA31008	791440108004	RS30236
791440103115	PT23501-MPG	791440103986	RS30129	791440104983	RS30142 KIT	791440105898	PA31009	791440108035	RS30220
791440103122	PT23502-MPG	791440103993	PA10034	791440104990	RS30143	791440106758	BF46083-O	791440108042	RS30221



**WARNING:** These products can expose you to chemicals, including Diisononyl Phthalate, Carbon black extracts, Nickel, 1,3 Butadiene, Ethylene Oxide, Epichlorohydrin, which are known to the State of California to cause cancer, and Bisphenol-A, Ethylene Glycol, Ethylene Oxide, 1,3 Butadiene, Epichlorohydrin, which are known to the State of California to cause birth defects or other reproductive harm.

# UPC TO BALDWIN (INDIVIDUAL PARTS)

UPC NUMBER	BALDWIN NUMBER	UPC NUMBER	BALDWIN NUMBER	UPC NUMBER	BALDWIN NUMBER	UPC NUMBER	BALDWIN NUMBER	UPC NUMBER	BALDWIN NUMBER
791440108059	RS30222XP	791440109315	BK6083	791440110571	B40073	791440111691	B40122	791440112469	PA10109
791440108066	RS30223	791440109322	BK6088	791440110649	BK6118	791440111707	PA10379	791440112476	PA10294
791440108073	RS30224	791440109339	PA10077	791440110656	BF46169-O	791440111714	B40124	791440112483	PA10392
791440108080	RS30225	791440109346	PA10078	791440110663	BF46170	791440111721	PA10275	791440112490	BF955 KIT
791440108097	RS30226	791440109377	BT40066-MPG	791440110670	BT23619-MPG	791440111738	PA10299	791440112506	PA10135
791440108110	BF46104	791440109391	PF46137	791440110687	PA10097	791440111745	BF46218	791440112513	BF46215
791440108127	BK6090	791440109414	PF46138	791440110694	PA30264	791440111752	PA10274	791440112520	PA10365 KIT
791440108134	BF46105-O	791440109421	PA30258	791440110700	PA10098	791440111769	PA10279	791440112537	PA10355
791440108141	PF46106	791440109445	BK6068	791440110717	PA10099	791440111776	PA10276	791440112544	PA10383
791440108165	PF46108	791440109490	BK6069	791440110748	PF46171	791440111783	PA10369	791440112551	PA10304
791440108189	BF46109-O	791440109506	BK6082	791440110755	RS30285	791440111790	PA10280	791440112568	PA10113
791440108196	PA30228	791440109513	BK6085	791440110779	20030	791440111806	PA10270	791440112575	PA10248
791440108202	PA30229	791440109520	PA10081	791440110786	PA30287	791440111813	P40095	791440112582	PA10300
791440108226	P40058	791440109537	BF1381-O	791440110793	SA10100	791440111820	20043	791440112599	20042
791440108257	BF46111	791440109544	PA30260	791440110816	BF1380-O	791440111837	PA10291	791440112605	PA10387
791440108288	RS30232	791440109551	PA30261	791440110878	BF46064-D	791440111844	P40083	791440112612	PA10295
791440108301	PA30233-FN	791440109568	PA30262	791440110892	BF46173-O	791440111851	PA10222	791440112629	P40089
791440108318	BF46113-D	791440109575	BT23617	791440110915	PA10101	791440111868	PA10137	791440112636	PA10111
791440108325	BT23609-MPG	791440109582	BF46141	791440110922	PA10102	791440111875	BF46217	791440112643	PA10171
791440108332	RS30234	791440109599	PA10082	791440110946	P40074	791440111882	PA10267	791440112650	PA10301
791440108356	PA10058	791440109605	BF46122	791440110960	RS30290	791440111899	PA10283	791440112667	PA10164
791440108363	PA10059	791440109612	PF46142	791440110984	BF46175	791440111905	FB46183	791440112674	B40129
791440108370	PA30206	791440109629	BF46143	791440110991	PA10103	791440111912	BF46213	791440112681	PA10198 KIT
791440108387	PA30207	791440109636	PA10084	791440111004	PA10104	791440111929	PA10197	791440112698	PA10225
791440108394	PA30208	791440109650	PA10085	791440111028	PA10106	791440111936	PA10281	791440112704	B40120
791440108448	RS30242	791440109674	CV15010	791440111059	P40076	791440111943	P40102	791440112711	PA10153
791440108455	PA10060	791440109728	PF46145	791440111073	PA30292	791440111950	PA10380	791440112728	PA10311
791440108462	BF46117	791440109735	BK6110	791440111080	PA30293	791440111967	PA10228	791440112735	BF46207
791440108479	PF46118	791440109742	B40070	791440111141	PA30299	791440111974	P40109	791440112742	PA10269
791440108486	PF46119	791440109773	S40071	791440111158	PA10108	791440111981	PA10285	791440112759	PA10152 KIT
791440108493	BF46092	791440109780	BF46147-O	791440111165	BF46176	791440111998	PA10132	791440112766	PA10293
791440108509	PT23611	791440109803	RS5287	791440111196	BF46179	791440112001	PA10292	791440112773	20067
791440108547	PA10061	791440109810	RS5288	791440111226	BF1379-O	791440112018	PA10192	791440112780	PA10227
791440108561	RS30237	791440109827	RS3750XP	791440111240	BT23628	791440112025	PA10181	791440112797	PA10374
791440108578	P40061	791440109841	BF46149-SP	791440111257	BF46181-O	791440112032	P40099	791440112803	P40090
791440108585	BF46116 KIT	791440109858	BK6112	791440111264	PT23629	791440112049	PA10277	791440112810	PA10309
791440108608	PA30204	791440109889	PA10088	791440111271	BK6095	791440112056	OB40079	791440112827	20063
791440108615	PA0062	791440109896	BF46150-O	791440111288	BK6096	791440112063	PA10378	791440112834	PA10112
791440108622	PA10062	791440109902	PA10089	791440111295	BK6097	791440112070	P40106	791440112841	PA10199 KIT
791440108646	BK6089	791440109919	PA10090	791440111301	BK6098	791440112087	PA10143	791440112858	PA10324
791440108653	PA30244	791440109926	PA30268	791440111318	BK6099	791440112094	PA10288	791440112865	PA10226
791440108660	PA30243	791440109933	PA30275	791440111325	PA10063	791440112100	20052	791440112872	PA10134
791440108677	BK6092	791440109940	PA30276	791440111332	PA30249	791440112117	P40108	791440112889	PA10352
791440108691	BF46123-O	791440109957	PF46151	791440111356	BF46182-O	791440112124	SA10127	791440112896	BF46195
791440108707	BF46124-O	791440109964	PA30270	791440111363	PA30304	791440112131	PA10320	791440112902	PA10116
791440108714	PA10064	791440109971	PA30269	791440111370	RS30305	791440112148	PA10224	791440112919	PA10149
791440108721	BF46125	791440109988	PA10083	791440111387	RS30306	791440112155	PA10395	791440112926	PA10325
791440108745	PF46126	791440109995	PA10091	791440111394	FB46185	791440112162	PA10376	791440112933	PA10139
791440108783	PT23613-MPG	791440110021	PA30277	791440111400	PA40105	791440112179	PA10284	791440112940	OB40078
791440108820	BF46127	791440110038	20028	791440111417	20048	791440112186	PA10223	791440112957	PA10287
791440108844	BK6057	791440110069	PA10093	791440111424	PA10128	791440112193	PA10195 KIT	791440112964	PA10229
791440108868	PA30251	791440110076	PA10094	791440111431	PA10104	791440112209	PA10217	791440112971	PA10375
791440108882	BT40065	791440110083	PA10095	791440111448	PA10362	791440112216	PA10145 KIT	791440112988	20058
791440108905	RS3518XP	791440110106	PA30255	791440111455	BT23631	791440112223	PA10110	791440112995	PA10231
791440108912	PA30252	791440110113	20026	791440111462	PA10363	791440112230	PA10390	791440113008	PA10389
791440108936	PA10066	791440110120	20027	791440111479	PA40113	791440112247	PA10232	791440113015	PA10148
791440108943	BK6093	791440110137	PA30271	791440111486	PA10364	791440112254	P40116	791440113022	PA10201
791440108950	PA10067	791440110151	PA30279	791440111493	PA40100	791440112261	PA10142	791440113039	PA10235
791440108967	BF46128-D	791440110212	BF46161	791440111509	PA40119	791440112278	PA10286	791440113046	PA10131
791440108981	PA30253	791440110229	PF46137 KIT	791440111516	PA10278	791440112285	B40126	791440113053	PA10256
791440108998	BF46129	791440110304	PA10086	791440111523	P40094	791440112292	P40110	791440113060	PA10146
791440109001	PA10068	791440110335	CV15011	791440111530	PA10221	791440112308	FB46184	791440113077	PA10316
791440109018	CV15007	791440110359	PA10087	791440111547	PA10220	791440112315	PA10282	791440113084	SA10361
791440109025	CV15008	791440110366	PA10096	791440111554	PA10129	791440112322	20045	791440113091	B40128
791440109032	PA10069	791440110373	PA30263	791440111561	PA40103	791440112339	PA10371	791440113107	PA10385
791440109049	PA10070	791440110397	BF7806-O	791440111578	P40111	791440112346	PA10346	791440113114	BF46216
791440109056	PA10071	791440110403	BF46162-O	791440111585	P40107	791440112353	PA10310	791440113121	BF46224
791440109063	PA10072	791440110410	BF7798-O	791440111592	PA40114	791440112360	PA10233	791440113138	PA10241
791440109070	PA10073	791440110427	BF46163-O	791440111608	BF46194	791440112377	PA10136	791440113145	PA10354
791440109124	BK6094	791440110434	BF46164-O	791440111615	PA10130	791440112384	PA10159	791440113152	BF46205
791440109155	PF46130	791440110441	PF46140	791440111622	BT23630	791440112391	BF46209	791440113169	PA10303
791440109179	PT23616-MPG	791440110458	PA30272	791440111639	PA10133	791440112407	PA10219	791440113176	B40127
791440109193	BF46131	791440110465	PA30281	791440111646	PA10391	791440112414	20037	791440113183	PA10238
791440109261	RS30257	791440110472	20029	791440111653	PA10367	791440112421	PA10115	791440113190	P40086
791440109285	PA10075	791440110496	B40063	791440111660	PA10290	791440112438	PA10289	791440113206	PA10373
791440109292	PF46135	791440110502	RS3516XP	791440111677	P40112	791440112445	PA10296	791440113213	PA10368
791440109308	PA10076	791440110533	BK6117	791440111684	20054	791440112452	P40115	791440113220	P40081



**WARNING:** These products can expose you to chemicals, including Diisononyl Phthalate, Carbon black extracts, Nickel, 1,3 Butadiene, Ethylene Oxide, Epichlorohydrin, which are known to the State of California to cause cancer, and Bisphenol-A, Ethylene Glycol, Ethylene Oxide, 1,3 Butadiene, Epichlorohydrin, which are known to the State of California to cause birth defects or other reproductive harm.



**UPC TO BALDWIN (INDIVIDUAL PARTS)**

UPC NUMBER	BALDWIN NUMBER	UPC NUMBER	BALDWIN NUMBER	UPC NUMBER	BALDWIN NUMBER	UPC NUMBER	BALDWIN NUMBER	UPC NUMBER	BALDWIN NUMBER
791440113237	PA10119	791440114005	PA10150	791440114791	PA10258	791440115682	PA10403	857123005159	43566P
791440113244	PA10144	791440114012	PA10172	791440114807	BF46220	791440115699	B40136	857123005166	43568P
791440113251	PA10297	791440114029	20033	791440114814	PA10319	791440115705	PA30310	857123005173	43570P
791440113268	PA10358	791440114036	PA10163	791440114821	PA10210 KIT	791440115712	B40137	857123005180	43572P
791440113275	PF46189	791440114043	PA10255	791440114838	PA10188	791440115729	B40138	857123005197	43574P
791440113282	PA10141	791440114050	PF46187	791440114845	PA10165	791440115736	BF46228	857123005203	43573P
791440113299	PA10230	791440114067	20051	791440114852	PA10211 KIT	791440115743	RS30311	857123005210	38557P
791440113305	PA10234	791440114074	20069	791440114869	PT23633	791440115767	RS30313	857123005217	38564C
791440113312	BF46193	791440114081	PA10202	791440114876	PA10214	791440115774	PA30314	857123005319	38565C
791440113329	PA10305	791440114098	PA10356	791440114883	PA10122	791440115781	PA30315	857123005326	38566C
791440113336	PA10312	791440114104	P40091	791440114890	PA10357	791440115798	PA30316	857123005333	38567C
791440113343	PA10307	791440114111	PA10216 KIT	791440114906	BF46204	791440115804	PA30317	857123005340	38568C
791440113350	PA10264	791440114128	PA10335	791440114913	PA10344	791440115811	PA30318	857123005357	38564S
791440113367	20035	791440114135	20055	791440114920	PA10190	791440115828	PA30319	857123005364	38565S
791440113374	PA10308	791440114142	PA10345	791440114937	PA10244	791440115835	PA30320	857123005371	38566S
791440113381	PA10138	791440114159	PA10326	791440114951	PA30303	791440115842	PA30321	857123005388	38567S
791440113398	20031	791440114166	PA10121	791440114968	PA10321	791440115859	PA30322	857123005395	38568S
791440113404	PA10209 KIT	791440114173	P40118	791440114975	PA10125	791440115866	PA30323	857123005418	38559C
791440113411	20053	791440114180	BF46219	791440114982	BF46196	791440115873	BF46229	857123005425	38560C
791440113428	BF46225	791440114197	BF46198	791440114999	PA10167	791440115897	PA30324	857123005432	38561C
791440113435	PA10147	791440114203	PA10394	791440115002	PA10169	791440115903	PA30325	857123005449	38562C
791440113442	PA10302	791440114210	PA10114	791440115019	PA10182	791440115910	PA10404	857123005456	38563C
791440113459	P40093	791440114227	PA10196 KIT	791440115026	RS10349	791440115927	PA10405	857123005463	38574C
791440113466	PA10239	791440114234	PA30302	791440115033	BF46199	791440115958	BK6121	857123005470	38575C
791440113473	PA10268	791440114241	20066	791440115040	BF46202	791440115965	BD40139	857123005487	38576C
791440113480	PA10117	791440114258	PA10341	791440115057	BF46214	791440115972	PA10388	857123005494	43562C
791440113497	PA10298	791440114265	20041	791440115064	PA10336	791440115989	PA10396	857123005500	43564C
791440113503	PA10118	791440114272	RS10347	791440115071	PA10251	791440116016	RS30327	857123005517	43566C
791440113510	PA10204 KIT	791440114289	PA10271	791440115088	PA10206 KIT	791440116023	RS30328	857123005524	43562S
791440113527	PA10237	791440114296	PA10243	791440115095	PA10253	791440116030	BK6116	857123005531	43564S
791440113534	PA10191 KIT	791440114319	PA10257	791440115101	PA10260	791440116047	BF46233	857123005548	43566S
791440113541	PA10313	791440114326	PA10205 KIT	791440115118	RS10348	791440116054	PA30329	857123005555	43568C
791440113558	BF46212	791440114333	PA10265	791440115125	PA10180 KIT	791440116078	PA10407	857123005562	43570C
791440113565	PA10161	791440114340	PA10262	791440115132	PA10337	791440116085	PA30330	857123005579	43572C
791440113572	PA10246	791440114357	PA10155	791440115149	BF46197	791440116092	20070	857123005586	43574C
791440113589	PA10236	791440114364	PA10207	791440115156	PA10398	791440116108	PF46235	857123005593	43573C
791440113596	SA10359	791440114371	PA10208 KIT	791440115163	PA10353	791440116115	PF46236	857123005609	43568S
791440113602	PA10179	791440114388	P40101	791440115170	PA10185	791440116122	PF46237	857123005616	43570S
791440113619	PA10272	791440114395	PA10200	791440115187	P40085	791440116139	PF46238	857123005623	43572S
791440113626	20064	791440114401	PA10263	791440115194	PA10328	791440116153	PA10409	857123005630	43574S
791440113633	PA10306	791440114418	PA10245	791440115217	PA10215 KIT	791440116160	BK6114	857123005647	43573S
791440113640	PA10140	791440114425	PA10168	791440115224	20068	791440116184	B40140	857123005654	38557C
791440113657	PA10240	791440114432	P40098	791440115231	PA10338	791440116221	BK6102	857123005661	38557S
791440113664	PA30301	791440114449	BF46223	791440115248	PF46188	791440116238	BK6103		
791440113671	PA10393	791440114456	BF46200	791440115255	PA10157	791440116245	BK6104		
791440113688	BF46203	791440114463	PA10370 KIT	791440115262	PA10173	791440116252	BK6108		
791440113695	PA10254	791440114470	PA10242	791440115279	PA10261	791440116269	BK6105		
791440113701	PA10194	791440114487	PA10250	791440115286	BF46242	791440116276	BK6106		
791440113718	BF46208	791440114494	PA10156	791440115293	PA10158	791440116283	BK6107		
791440113725	PA10160	791440114500	PA10331	791440115309	RS10350	791440116290	BK6115		
791440113732	PA10273	791440114517	PA10184	791440115316	PA10124	791440116306	BK6120		
791440113749	BF46210	791440114524	BF46201	791440115323	PF46186	791440116320	PA10411		
791440113756	20061	791440114531	PA10162	791440115330	PA10178	791440116337	PA10412		
791440113763	20062	791440114548	PA10120	791440115347	PA10332	791440116351	B40142		
791440113770	PA10218	791440114555	PA10327	791440115361	PA10339	791440116375	PA30331		
791440113787	P40130	791440114562	20046	791440115378	PA10175 KIT	791440116399	PA30332		
791440113794	20044	791440114579	PA10123	791440115385	PA10176	791440116405	PF46152		
791440113800	PA10397	791440114586	20050	791440115392	PA10333	791440116412	PA10414		
791440113817	PA10386	791440114593	PA10329	791440115408	PA10334	791440116689	B40145		
791440113824	PA10154	791440114609	PA10323	791440115415	PA10330	791440116771	BK6124		
791440113831	PA10315	791440114616	PA10318	791440115422	PA10340	791440116924	B40150		
791440113848	PA10399	791440114623	P40117	791440115439	20057	791770098275	BT23140-MPG		
791440113855	PA10186 KIT	791440114630	PA10384	791440115446	PA10126	857123005005	38564P		
791440113862	20060	791440114647	PA10343	791440115453	PA10174	857123005012	38565P		
791440113879	PA10249	791440114654	SA10360	791440115460	PA10247	857123005029	38566P		
791440113886	PA10372	791440114661	RS10351	791440115477	PA10177	857123005036	38567P		
791440113893	PA10317	791440114678	PA10266	791440115484	PA10212 KIT	857123005043	38568P		
791440113909	PA10382	791440114685	P40132	791440115491	PA10342	857123005050	38559P		
791440113916	20065	791440114692	PA10183	791440115507	PA10381	857123005057	38560P		
791440113923	PA10193 KIT	791440114708	PA10259	791440115514	PA10400	857123005074	38561P		
791440113930	PA10314	791440114715	B40125	791440115521	RS30307	857123005081	38562P		
791440113947	BF46211	791440114722	PA10203 KIT	791440115538	RS30308	857123005098	38563P		
791440113954	BF46221	791440114739	P40096	791440115569	BF46227	857123005104	38574P		
791440113961	OB40080	791440114753	PA10170 KIT	791440115576	B40133	857123005111	38575P		
791440113978	BF46206	791440114760	BF46192	791440115583	PA30309	857123005128	38576P		
791440113985	PA10213	791440114777	PA10189	791440115590	PA10401	857123005135	43562P		
791440113992	PA10166	791440114784	P40131	791440115613	PA10402	857123005142	43564P		



**WARNING:** These products can expose you to chemicals, including Diisononyl Phthalate, Carbon black extracts, Nickel, 1,3 Butadiene, Ethylene Oxide, Epichlorohydrin, which are known to the State of California to cause cancer, and Bisphenol-A, Ethylene Glycol, Ethylene Oxide, 1,3 Butadiene, Epichlorohydrin, which are known to the State of California to cause birth defects or other reproductive harm.

# BALDWIN CASE TO I 2/5 (SHIPPING CASES)

BALDWIN CASE NUMBER	CASE QTY.	I 2/5 NUMBER	BALDWIN CASE NUMBER	CASE QTY.	I 2/5 NUMBER	BALDWIN CASE NUMBER	CASE QTY.	I 2/5 NUMBER	BALDWIN CASE NUMBER	CASE QTY.	I 2/5 NUMBER	BALDWIN CASE NUMBER	CASE QTY.	I 2/5 NUMBER
BDW# ...CaseQty		ITFCode	PT85	12	10791440001098	B161-S	12	10791440002057	B243	12	10791440003047	BT340	12	10791440003986
B2	12	10791440000015	PT86-HD	12	10791440001104	P162	12	10791440002064	B244	12	10791440003054	BT341	12	10791440003993
B2-HPG	12	10791440000022	PT87-S	12	10791440001111	B163	12	10791440002071	B246	12	10791440003078	BT342	12	10791440004006
B4	12	10791440000046	PT88-HD	12	10791440001128	B164	12	10791440002088	B247	12	10791440003085	BT343	6	10791440004013
BT5	12	10791440000053	PT89	12	10791440001135	B166	12	10791440002101	BT248	12	10791440003092	BT344-S	12	10791440004020
B6	12	10791440000060	PT90-10	12	10791440001142	B167	12	10791440002118	P249	12	10791440003108	BT346	12	10791440004044
B6-HPG	12	10791440000077	PT90-MPG	12	10791440001159	B168	12	10791440002125	BT251	12	10791440003115	BT347	12	10791440004051
B7	12	10791440000084	PT91	12	10791440001166	P170	12	10791440002149	B252	12	10791440003122	BT348	12	10791440004068
B9	12	10791440000091	PT93	12	10791440001180	P171	12	10791440002156	B253	12	10791440003139	BT349	12	10791440004075
B10-AL	6	10791440000107	PT93-MPG	12	10791440001197	P172	12	10791440002163	B255	12	10791440003153	BT350	12	10791440004082
B10-AL BOWL	6	10791440000114	B95	6	10791440001210	B173-S	12	10791440002170	PT256	12	10791440003160	BT351	12	10791440004099
B10-AL BSP	6	10791440006548	B95-MPG	6	10791440001241	P174	12	10791440002187	PT257	12	10791440003177	BT351-MPG	6	10791440006970
B10-AL BSPCS	6	10791440008855	B95-SS	6	10791440001258	P176	12	10791440002200	PT258	12	10791440003184	P352	6	10791440004105
B10-AL CAP	6	10791440000121	B96	6	10791440001289	P177	12	10791440002217	BT259	12	10791440003197	BT353	12	10791440004112
PF10	12	10791440000138	B96-MPG	6	10791440001296	B178	12	10791440002224	BT260	12	10791440003201	BT354	12	10791440004129
PF10-CS	12	10791440000145	B96-SS	6	10791440001302	B179	12	10791440002231	BT260-10	12	10791440003214	BT355	12	10791440004136
PT11	12	10791440000152	B97	6	10791440001319	P183	12	10791440002279	BT261	12	10791440003221	P356	12	10791440004143
PT11-HD	12	10791440000169	PT98-10	6	10791440001326	P184	12	10791440002293	B262	12	10791440003238	BT357	12	10791440004150
PT12	12	10791440000176	PT98-MPG	6	10791440001332	PT185	12	10791440002309	B263	12	10791440003245	B358	12	10791440004167
BF13	12	10791440000183	B99	6	10791440001357	P186	12	10791440002316	BT264	12	10791440003252	BT359	6	10791440004174
P15	12	10791440000190	B99-B	6	10791440001364	P187	12	10791440002323	PT265	12	10791440003269	B360	12	10791440004181
S16-1	12	10791440000206	B99-MPG	6	10791440001371	PT189	12	10791440002347	P266	12	10791440003276	BT361	12	10791440004198
P18	12	10791440000237	B99-SS	6	10791440001388	PT189-MPG	12	10791440002354	BT267	12	10791440003283	BT364	12	10791440004211
P18-HD	12	10791440000244	P102	12	10791440001395	P190	12	10791440002361	PT268	12	10791440003290	BT365	12	10791440004228
P19	12	10791440000251	BD103	6	10791440001401	PT191-10	6	10791440002385	PT269	12	10791440003306	BT365-10	12	10791440004235
P20-HD	12	10791440000268	BD103-MPG	6	10791440001418	P194	6	10791440002446	P271	12	10791440003320	BT366-10	12	10791440004242
P25	12	10791440000336	BD103-SS	6	10791440001425	P194-HD	6	10791440002453	PT273	12	10791440003341	BT366-MPG	12	10791440006962
P26	12	10791440000343	P104	12	10791440001432	P194-HD10	6	10791440002460	BT274	12	10791440003354	BT367	12	10791440004259
B27	12	10791440000350	B105	6	10791440001449	PF194	6	10791440002477	PT275	12	10791440003368	BT367-S	12	10791440004266
BD28	12	10791440000367	P106	12	10791440001456	B195	12	10791440002484	PT275-10	12	10791440003375	BT368	12	10791440004273
PT29	12	10791440000374	P106-HD	12	10791440001463	B196	6	10791440002491	P276	12	10791440003382	B369	12	10791440004280
B30	12	10791440000398	PT108	12	10791440001470	P198	12	10791440002514	PT277	12	10791440003405	PT370	4	10791440004297
B31	12	10791440000404	PT108-HD	12	10791440001487	B199	12	10791440002521	B279	12	10791440003412	BT371-5	12	107914400069715
B33	12	10791440000428	B109	12	10791440001494	B201-S	12	10791440002545	P280	12	10791440003429	BT371-10	12	10791440004303
B34	12	10791440000435	BC110	12	10791440001500	B202	12	10791440002552	B281	12	10791440003436	BT371-MPG	12	10791440004310
B35-S	12	10791440000442	BT111	12	10791440001517	P203	12	10791440002569	PT283	12	10791440003447	BT372-10	12	10791440004327
AFG37R	6	10791440000466	BT112	12	10791440001524	P203-HD	12	10791440002576	PT284	12	10791440003474	BT372-MPG	12	107914400038124
B37	12	10791440000473	B113	12	10791440001531	P203-HD10	12	10791440002583	PT285	6	10791440003481	PT373	12	10791440004334
AFG38D	6	10791440000480	B114	12	10791440001548	P204	12	10791440002590	BT287	6	10791440003498	PT374	12	10791440004341
B39	12	10791440000503	PT115	12	10791440001555	P204-HD	12	10791440002606	BT287-3	6	10791440003528	PT375	12	10791440004358
P40	12	10791440000510	PF116	6	10791440001562	P204-HD10	12	10791440002613	BT287-10	6	10791440003504	PT376	12	10791440004365
P41	12	10791440000527	PT117	6	10791440001579	B205	6	10791440002620	PT288-HD	12	10791440003511	PT377	12	10791440004372
P42	12	10791440000534	PT117-25	6	10791440001586	P206	12	10791440002627	PT288-HD10	12	10791440003528	PT377-10	12	10791440004389
B43-S	12	10791440000541	B118	12	10791440001593	PT207	12	10791440002644	PT289	12	10791440003535	B378	12	10791440004396
B45	12	10791440000565	B120	12	10791440001600	PT207-10	12	10791440002651	PT289-10	12	10791440003542	B378-10	12	10791440004402
P47	12	10791440000589	PF121	12	10791440001617	PT207-HD	12	10791440002668	PT290	12	10791440003559	PT379 KIT	6	10791440004419
PT48	12	10791440000596	BT124	12	10791440001624	PT207-HD10	12	10791440002675	BT292	12	10791440003573	PT381	12	10791440004433
B49	6	10791440000602	P125	12	10791440001631	P208	12	10791440002682	P294	12	10791440003587	PT382	12	10791440004440
B50	12	10791440000619	BT126	12	10791440001648	PT210	12	10791440002699	B295	12	10791440003603	PT383	12	10791440004447
P51	12	10791440000633	P127	12	10791440001655	B211	12	10791440002705	B296	12	10791440003610	PT385	12	10791440004464
P53	12	10791440000640	B128	12	10791440001662	PT213	12	10791440002729	PT298-10	12	10791440003627	PT385-E	12	10791440004471
B54	12	10791440000657	B129	12	10791440001679	PT214(2)	12	10791440002736	B299	12	10791440003634	PT386	12	10791440004488
P56	12	10791440000671	B131	12	10791440001686	BT215	12	10791440002743	T300-M	12	10791440003641	BT387	6	10791440004495
P60	12	10791440000718	B132	12	10791440001693	BT216	12	10791440002750	B301	12	10791440003658	BT387-10	6	10791440004501
PT61-HD	12	10791440000725	C133-OW	7	10791440001700	BT217	12	10791440002757	PT302	12	10791440003665	BT388	6	10791440004518
PT62	12	10791440000732	C133-W	7	10791440001707	B218	12	10791440002774	T303-M	12	10791440003672	BT388-10	6	10791440004525
PT63-1	12	10791440000749	B134	12	10791440001714	B220	6	10791440002798	PT304	12	10791440003689	BT389	6	10791440004532
PT66-HD	12	10791440000770	PT135	12	10791440001721	BT221	12	10791440002804	BT305	12	10791440003702	BT389-10	6	10791440004549
P67	12	10791440000787	PT137	12	10791440001728	B222	12	10791440002811	B307	12	10791440003719	PT390-MPG	12	10791440004556
P68	12	10791440000794	PT138-10	12	10791440001735	BT223	12	10791440002828	T308-M	12	10791440003726	PT391-MPG	12	10791440004563
PT70	12	10791440000817	PT138-25	12	10791440001742	PF224	12	10791440002835	B309	12	10791440003733	PT392	12	10791440004570
PT71	12	10791440000831	PT139-10	12	10791440001749	PF225	12	10791440002842	BT310	12	10791440003740	PT393	12	10791440004587
PT72	12	10791440000855	P140	12	10791440001756	PF226	12	10791440002849	PF311	12	10791440003747	PT394-15	6	10791440004594
P73	12	10791440000879	B141	12	10791440001763	B227	12	10791440002856	PF312	12	10791440003754	BT395	12	10791440004600
B74	12	10791440000886	BD142	12	10791440001770	B228	12	10791440002863	PF313	12	10791440003761	PT396	12	10791440004617
B75	12	10791440000893	B143	12	10791440001777	B229	12	10791440002870	PF314	12	10791440003768	PT397	4	10791440004624
B76	12	10791440000909	P144	12	10791440001784	BT230	12	10791440002877	PF316	6	10791440003775	BT398	12	10791440004631
B76-MPG	12	10791440000930	PT146	12	10791440001791	PF231	12	10791440002884	BD324	6	1			

**BALDWIN CASE TO I 2/5 (SHIPPING CASES)**

BALDWIN CASE NUMBER	CASE QTY.	I 2/5 NUMBER	BALDWIN CASE NUMBER	CASE QTY.	I 2/5 NUMBER	BALDWIN CASE NUMBER	CASE QTY.	I 2/5 NUMBER	BALDWIN CASE NUMBER	CASE QTY.	I 2/5 NUMBER	BALDWIN CASE NUMBER	CASE QTY.	I 2/5 NUMBER
P415-10	4	10791440004891	F501-MD	4	10791440005881	PA612	6	10791440007083	PT772	6	10791440008370	PF857	12	10791440009407
P415-10A	4	10791440004907	PF506	12	10791440005928	PA613	6	10791440007090	PT773-MPG	6	10791440008387	BF858	12	10791440009414
P415-25	4	10791440004914	P507	12	10791440005935	BF614	12	10791440007106	BT775	6	10791440008400	PF859	12	10791440009421
P415-25A	4	10791440004921	PT508-MPG	12	10791440005942	PA615	6	10791440007113	PT776-MPG	12	10791440008417	PF860	12	10791440009438
P415-5	4	10791440004938	PT510	12	10791440005966	PA618 FOAM	6	10791440007151	PT777	12	10791440008424	PF861	12	10791440009445
P415-5A	4	10791440004945	PT512	4	10791440005973	PA621	6	10791440007189	BT778	12	10791440008431	BF862	12	10791440009452
P415-5AN	4	10791440004952	PT513	12	10791440005980	PA625	6	10791440007192	BT779	12	10791440008448	BF863	12	10791440009469
P415-GM	4	10791440004969	PT514	12	10791440005997	PA631	6	10791440007205	BF781	12	10791440008455	PF864	12	10791440009476
V415-B	4	10791440004976	PT515	4	10791440006000	PA632	6	10791440007212	BF782	12	10791440008462	BF865	12	10791440009483
V415-FF	4	10791440004983	PT516	12	10791440006017	PA633(2)	12	10791440007229	BF783	12	10791440008479	BF865-K	12	10791440009490
PT416	12	10791440004990	PT517	12	10791440006024	PA634	6	10791440007236	BF784	6	10791440008486	PF866	12	10791440009506
PT418	4	10791440005010	PT520	6	10791440006055	PA638	4	10791440007243	BF785	6	10791440008493	BF868	12	10791440009520
BT420	12	10791440005034	BT521	12	10791440006079	PA640	6	10791440007267	BF786	12	10791440008509	PF869	12	10791440009537
B421	12	10791440005041	PT522	12	10791440006086	PA642	6	10791440007281	BF788	12	10791440008523	PF872	12	10791440009551
S423	12	10791440005058	BT525	12	10791440006093	PA643	12	10791440007298	BF789	12	10791440008530	BF873	12	10791440009568
BT424	6	10791440005065	BT526	12	10791440006109	PA644	12	10791440007304	BF790	12	10791440008547	BF874	12	10791440009575
BT425	6	10791440005072	BT526-10	12	10791440006116	PA648	6	10791440007335	BF791	12	10791440008554	BF876	12	10791440009599
PT426	12	10791440005089	P528	12	10791440006130	PA649	6	10791440007342	BF791-O	12	107914400097619	BF877	12	10791440009612
BT427	12	10791440005096	P529	6	10791440006147	PA650	6	10791440007359	BF792	12	10791440008569	BF879	12	10791440009631
V429-B	4	10791440005119	PT534	6	10791440006185	PA651	4	10791440007366	BF794	12	10791440008585	BF880-FP	12	10791440037998
V429-FF	4	10791440005126	PT535	12	10791440006192	PA652	6	10791440007373	BF795	12	10791440008592	BF881	12	10791440009667
PT430-FF	6	10791440005133	BT536	12	10791440006208	PA657	6	10791440007427	BF797	12	10791440008615	PF882	12	10791440009674
PT431	12	10791440005140	P537	6	10791440006215	PA658	6	10791440007434	BF798	12	10791440008622	PF883	12	10791440009681
PT433	12	10791440005157	PT538	12	10791440006222	PA662	6	10791440007472	BF799	6	10791440008639	BF884	12	10791440009698
PT434	12	10791440005164	P540	12	10791440006246	PA669	6	10791440007519	PF802	12	10791440008677	BF885	12	10791440009704
PT434-10	12	10791440005171	BT541	12	10791440006260	PT670	12	10791440007526	PF804	12	10791440008691	BF886	12	10791440009711
PT435	12	10791440005188	PT543 KIT	6	10791440006284	PT670-E	12	10791440007533	BF805	12	10791440008707	BF888	12	10791440009728
PT436	12	10791440005195	P545	12	10791440006307	PA675	6	10791440007564	BF806	12	10791440008714	BF890	12	10791440009742
PT437	12	10791440005201	PT546	12	10791440006314	PA677	6	10791440007588	PF807	12	10791440008721	BF891	12	10791440009759
BT438	12	10791440005218	PT548	6	10791440006321	PA678	6	10791440007595	PF809	12	10791440008745	BF892	12	10791440009766
PT439	12	10791440005225	PT549	12	10791440006338	PA680	6	10791440007601	BF810	12	10791440008752	BF893	12	10791440009773
BT440	12	10791440005232	PT550-10	6	10791440006345	PT685-MPG	12	10791440007618	PF811	12	10791440008769	PF893-RV	12	10791440009780
PT441	12	10791440005249	PT554	12	10791440006376	PA691	6	10791440007625	BF812	12	10791440008776	PF894	12	10791440009797
PT442-MPG	12	10791440005256	P555	12	10791440006383	PA693	6	10791440007632	BF814	12	10791440008790	BF894-RV	12	10791440009803
BT443	6	10791440005263	BT556-10	12	10791440006390	PA696	6	10791440007663	PF816	12	10791440008813	BF896	12	10791440009827
PT445-MPG	12	10791440005270	PT558	6	10791440006413	PA697	6	10791440007670	PF816-S	12	10791440008820	SF898	12	10791440009841
P446	12	10791440005287	PT561	12	10791440006437	PA699	6	10791440007687	PF818	12	10791440008844	PF899	12	10791440009858
B447	12	10791440005294	PT562-10	12	10791440006451	C704-L	4	10791440007724	PF819	12	10791440008851	BF900	12	10791440009865
P450	12	10791440005317	PT563	12	10791440006468	P706-M	4	10791440007748	PF819-HD	12	10791440008868	PF902	12	10791440009896
S451	12	10791440005324	BT564	12	10791440006475	PT707-HD	12	10791440007762	PF820-S	12	10791440008875	PF902-S	12	10791440009902
BT452	12	10791440005331	PT565	6	10791440006482	PT707-HD10	12	10791440007779	PF821-S	12	10791440008882	PT903	12	10791440009919
P454	12	10791440005355	PT566	12	10791440006499	PT707-HD3	12	10791440007786	PF822	12	10791440008899	PF906	12	10791440009957
S455	12	10791440005362	PT567	12	10791440006505	PT708-HD	12	10791440007793	PF823	12	10791440008905	PF907	12	10791440009964
S456	12	10791440005379	PT567-10	12	10791440006512	PT714	6	10791440007809	PF823-E	12	10791440008950	PF908-A	6	10791440009971
PT457-MPG	6	10791440005386	PT568	12	10791440006529	PF717	12	10791440007816	PF824	12	10791440008967	BF909	12	10791440009988
PT459	12	10791440005393	BF577	12	10791440006604	P718-5	4	10791440007830	BF825	12	10791440008981	PF910	12	10791440009995
PT461	12	10791440005409	PT578	12	10791440006611	BF719	12	10791440007847	PF826	12	10791440008998	BF912	12	10791440010021
PT462	6	10791440005416	PT579	12	10791440006628	BF720	12	10791440007854	PF827	12	10791440009001	PF913	12	10791440010038
PT463	12	10791440005423	BF582	12	10791440006673	P721	12	10791440007861	PF828	12	10791440009025	BF914	6	10791440010045
PT466	12	10791440005454	BF583	12	10791440006680	PT722	6	10791440007878	BF829(2)	6	10791440009032	BF915	12	10791440010052
PT467-MPG	6	10791440005461	BF584	12	10791440006697	P723	12	10791440007885	BF830	12	10791440009049	F916-C	12	10791440010069
PT468-MPG	12	10791440005478	BF584-B	12	10791440006703	PT725-MPG	6	10791440007892	PF831	12	10791440009056	PF916	12	10791440010076
BT470	12	10791440005492	BF585	12	10791440006710	PT727-DL	24	10791440007908	BF833	12	10791440009070	BF918-K	12	10791440010106
PT471	12	10791440005508	BF586	12	10791440006727	PT727-HD	12	10791440007915	BF833-K2	12	10791440009087	F919-C	60	10791440010144
BT472	12	10791440005515	BF586-D	12	10791440006734	PT727-HD10	12	10791440007922	F834-F	12	10791440009104	BF920	12	10791440010199
B474	12	10791440005522	BF587	12	10791440006741	PT728-MPG	12	10791440007939	BF834	12	10791440009119	PF924	12	10791440010236
PT475	12	10791440005539	BF587-D	12	10791440006758	PT729	4	10791440007946	BF836	12	10791440009124	BF925	12	10791440010243
P476	12	10791440005546	BF588	12	10791440006765	BT732	6	10791440007977	BF836-K3	12	10791440009131	PF926	12	10791440010250
PT477	12	10791440005553	BF591	12	10791440006871	BT735	12	10791440007997	BF836-K4	12	10791440009148	BF928	12	10791440010274
S479	12	10791440005577	BF592	12	10791440006888	PT737	12	10791440008011	BF837	12	10791440009155	BF929	12	10791440010281
PT480	12	10791440005584	BF593	12	10791440006895	PT737-10	12	10791440008028	BF838-F2	12	10791440009162	BF930	12	10791440010298
PT480-10	12	10791440005591	F594-F	12	107914400052946	V738-O	12	10791440008035	PF838	12	10791440009179	BF932	12	10791440010328
PT480-MPG	12	10791440005607	PF594	12	10791440006901	BT739	12	10791440008042	BT839	12	10791440009186	BF933	12	10791440010335
B481	12	10791440005614	BT595	12	10791440006918	C740-S	4	10791440008059	BF839-10	12	10791440009193	PF935	12	10791440010359
S485	12	10791440005652	BF596	6	10791440006925	C750-E	4	10791440008141	BF840	12	10791440009200	PF936	12	10791440010366
BT486	6	10791440005669	BF597	12	10791440006932	C750-L	4	10791440008158	BF840-K1	12	10791440009216	PF937	12	10791440010373
PT487	12	10791440005676	PF598	12	10791440006949	PT751	6	10791440008172	VT842-O	12</				

# BALDWIN CASE TO I 2/5 (SHIPPING CASES)

BALDWIN CASE NUMBER	CASE QTY.	I 2/5 NUMBER	BALDWIN CASE NUMBER	CASE QTY.	I 2/5 NUMBER	BALDWIN CASE NUMBER	CASE QTY.	I 2/5 NUMBER	BALDWIN CASE NUMBER	CASE QTY.	I 2/5 NUMBER	BALDWIN CASE NUMBER	CASE QTY.	I 2/5 NUMBER
PF950	12	10791440010540	BF1190	12	10791440049410	BF1287-O	12	10791440086392	BF1395-SP	12	10791440083087	PA1832	6	10791440014104
PT951	12	10791440010557	BF1191	12	10791440049427	BF1288-O	12	10791440086408	BF1396	12	10791440083223	PA1834	6	10791440014111
PF952	12	10791440010564	BF1193	12	10791440049441	BF1289-SP	12	10791440086859	BF1397-SP	12	10791440084008	PA1841	6	10791440014166
F953-F	12	10791440053011	BF1195	12	10791440049465	BF1290-O	12	10791440087436	BF1398-O	12	10791440083285	PA1852	6	10791440014265
BF954	12	10791440010571	BF1199	12	10791440049526	PF1291	12	107914400862518	BF1399-SP	12	10791440084091	PA1857	6	10791440014296
BF955	12	10791440010588	BF1201	12	10791440011448	BF1292-O	12	10791440087443	B1400	12	10791440012032	PA1858	6	10791440014302
BF955 KIT	6	10791440012497	BF1204	12	10791440045825	BF1293-SPS	12	10791440078045	B1402	12	10791440012056	PA1859	6	10791440014319
BF956	12	10791440010595	BF1204-O	12	10791440097602	BF1294-O	12	10791440087450	BD1403	6	10791440054896	PA1860	6	10791440014326
BF957	12	10791440010601	BF1204-SP	12	10791440045917	BF1296-O	12	10791440087610	B1405	12	10791440043449	PA1861	6	10791440014333
BF957-D	12	10791440010625	BF1205	12	10791440045818	BF1297-O	12	10791440087627	B1406	12	10791440012087	PA1873	4	10791440014418
BF958	12	10791440010632	BF1205-SP	12	10791440045832	BF1298-O	12	10791440088679	B1407	12	10791440012094	V1874-T	4	10791440014425
BF959	12	10791440010649	BF1210	12	10791440011479	BF1299-O	12	10791440089119	B1410	12	10791440043555	PA1875	12	10791440014432
P960	12	10791440010656	BF1211	12	10791440011486	BF1329	12	10791440045702	B1413	12	10791440045542	PA1878	6	10791440014462
BF962	12	10791440010670	BF1212	12	10791440011493	BF1329-SP	12	10791440045641	B1416	12	10791440054698	PA1889	6	10791440014579
PF963	12	10791440010687	BF1212 FOAM	12	10791440011509	BF1330-SP	12	10791440058030	PA1418	12	10791440050133	PA1891	6	10791440014586
BF966	12	10791440010717	BF1213	12	10791440011523	BF1339-SP	12	10791440065434	PA1419	12	10791440050140	PA1909	12	10791440014777
PF967	12	10791440010724	BF1214	12	10791440011530	BF1345	12	10791440037899	B1421	12	10791440050584	PA1915	12	10791440014814
BF968	12	10791440010731	BF1215	12	10791440049380	BF1345-O	12	10791440087269	B1422	12	10791440050843	PA1934	4	10791440014937
BF970	12	10791440010748	BF1216	6	10791440011547	BF1345-SP	12	10791440045801	B1425	12	10791440051789	PA1946	6	10791440015019
BF971	12	10791440010755	BF1217	12	10791440051086	BF1346	12	10791440038353	B1428	12	10791440012124	PA1949	6	10791440015026
BF974-D	12	10791440010779	BF1218	12	10791440011554	BF1346-O	12	10791440088464	B1429	12	10791440038216	PA1951	6	10791440015040
B975	12	10791440010786	BF1219	12	10791440011561	BF1346-SP	12	10791440066011	B1430	12	10791440043074	PA1963	6	10791440015125
BF976	12	10791440010793	BF1220	12	10791440011578	BF1347	12	10791440045788	B1431	12	10791440055862	PA1969	6	10791440015149
BF978	12	10791440010816	BF1221	12	10791440011585	BF1347-O	6	107914400104669	B1432	12	10791440055916	PA1973	6	10791440015170
BF979	12	10791440010823	BF1222	12	10791440045672	BF1348	12	10791440045900	PA1433	12	10791440056586	PA1985	12	10791440015293
BF980	12	10791440010830	BF1222-O	12	10791440087214	BF1348-O	12	10791440088471	B1434	12	10791440058474	PA2001	6	10791440015422
PF981	12	10791440010847	BF1222-SP	12	10791440045665	BF1348-SP	12	10791440051895	B1435	12	10791440058917	PA2001 FOAM	12	10791440042640
BF984	12	10791440010861	BF1223	12	10791440011592	BF1349	12	10791440050621	B1438	12	10791440058740	PA2002	6	10791440015439
PF986	12	10791440010878	BF1223-O	12	10791440087351	BF1350-SP	12	10791440065069	P1440	12	10791440058993	PA2005	6	10791440015453
PF987	12	10791440010885	BF1223-SP	12	10791440046112	BF1352-SPS	12	10791440078168	B1441	12	10791440060651	PA2006	6	10791440015460
BF988	12	10791440010892	BF1224	12	10791440045030	BF1353-SPS	12	10791440067469	B1443	12	10791440060675	PA2007	6	10791440015477
BF989	12	10791440010908	BF1225	12	10791440011608	BF1354-SPS	12	10791440080642	B1444	12	10791440061658	PA2008	6	10791440015484
BF991	12	10791440010922	BF1226	12	10791440011615	BF1355	6	10791440078601	B1446	12	10791440062556	PA2009	6	10791440015491
BF992	12	10791440010939	BF1231	12	10791440043340	BF1355-O	12	10791440090467	B1447	12	10791440064925	PA2010	6	10791440015507
BF995	12	10791440010953	BF1232	12	10791440011639	BF1355-SP	6	10791440076416	P1510	12	10791440012179	PA2023	6	10791440015538
P996	12	10791440010960	BF1233	12	10791440011646	BF1356	12	10791440076751	P1511	4	10791440012186	PA2024	6	10791440015545
PF997	12	10791440053028	BF1239	6	10791440042527	BF1357	6	10791440076850	V1520-R	4	10791440012193	SA2027	12	10791440015569
P998	12	10791440010977	BF1240	12	10791440050324	BF1358-O	12	10791440093130	V1542-C	6	10791440012216	PA2031	6	10791440015576
P999-HD	12	10791440010991	V1240-C	8	10791440011677	BF1358-SP	12	10791440076874	V1544-T	16	10791440012223	PA2036	6	10791440015606
BF1008	12	10791440049878	BF1248	12	10791440050485	BF1359-SP	12	10791440077772	V1560	4	10791440062587	PA2037	6	10791440015613
V1009-W	12	10791440011035	BF1249	12	10791440050980	BF1360	12	10791440077970	PA1600	12	10791440012230	SA2039	12	10791440015637
V1044-O	12	10791440011066	BF1249-O	12	10791440093420	BF1360-O	6	107914400104652	PA1603	12	10791440012254	PA2041	6	10791440015644
BF1045	12	10791440049571	BF1249-SP	12	10791440052663	BF1360-SP	12	10791440083322	PA1627	6	10791440012520	PA2042	4	10791440015651
BF1046	12	10791440049588	BF1252	12	10791440051048	BF1361	12	10791440078182	PA1633	6	10791440012605	PA2044	6	10791440015668
BF1047	12	10791440049595	BF1253	12	10791440051512	BF1362	12	10791440078496	PA1639	6	10791440012681	SA2047	12	10791440051505
BF1048	12	10791440049601	BF1256	12	10791440054537	BF1363	12	10791440078618	F1645-DS	12	10791440012742	PA2050	6	10791440015699
BF1049	12	10791440049618	BF1257	12	10791440053363	BF1365	12	10791440078755	V1645-C	7	10791440012759	PA2051	6	10791440015705
BF1050	12	10791440049625	BF1258	12	10791440047171	BF1366-O	12	10791440085852	PA1648	6	10791440012803	PA2052	6	10791440015712
BF1052	12	10791440050546	BF1259	12	10791440011691	BF1367	12	10791440078991	V1656-O	6	10791440012865	PA2053	6	10791440015729
BF1056	12	10791440050829	BF1261	12	10791440054872	BF1370	12	10791440079011	V1656-T	6	10791440012872	PA2061	6	10791440015774
BF1057	12	10791440051178	BF1262	6	10791440056814	BF1371	12	10791440079035	PA1657	6	10791440012889	PA2063	6	10791440015798
BF1061	12	10791440051208	BF1265	12	10791440058283	BF1372	12	10791440079349	PA1661(3)	6	10791440012896	PA2064	6	10791440015804
BF1100	12	10791440047720	BF1266	12	10791440058726	BF1373-SP	12	10791440079196	PA1666	12	10791440012926	PA2065	6	10791440015811
BF1102	12	10791440011073	BF1267	12	10791440058788	BF1374-SP	12	10791440079264	PA1679	12	10791440013039	PA2067	6	10791440015835
BF1104	12	10791440011097	BF1268	12	10791440059020	BF1375	12	10791440079271	PA1680	6	10791440013046	PA2067 FOAM	12	10791440073439
BF1105	12	10791440011103	BF1269	12	10791440059297	BF1376	12	10791440079301	PA1688	12	10791440013121	PA2068	6	10791440015842
BF1110	12	10791440011141	BF1270-SP	12	10791440059372	BF1377	12	10791440079356	PA1696	6	10791440013176	PA2068 FOAM	12	10791440067643
BF1120	12	10791440011172	BF1271	12	10791440059853	BF1378-SPS	12	10791440079509	PA1697	6	10791440013183	PA2069	6	10791440015859
BF1123	12	10791440011189	BF1272-SPS	12	10791440078052	BF1379	12	10791440079615	PA1701 FOAM	6	10791440013251	PA2069 FOAM	12	10791440073422
BF1140	12	10791440011257	BF1273-SP	12	10791440056746	BF1379-O	12	10791440111223	PA1702 FOAM	6	10791440013282	PA2070	6	10791440015866
BF1148	12	10791440011288	BF1274-SP	6	10791440059730	BF1380	12	10791440079622	PA1704	12	10791440013312	PA2071	6	10791440015873
BF1150	12	10791440011295	BF1274-SPS	6	10791440059747	BF1380-O	12	10791440110813	PA1712	6	10791440013374	PA2072	6	10791440015880
BF1160	12	10791440011349	BF1275	12	10791440063782	BF1381	12	10791440079639	PA1718	6	10791440013398	PA2073	6	10791440015897
BF1163	12	10791440011363	BF1276	12	10791440011707	BF1381-O	12	10791440109534	PA1719	6	10791440013404	PA2074	6	10791440015903
BF1166	12	10791440011387	BF1277-SP	6	10791440056739	BF1382-SP	12	10791440079653	PA1721	6	10791440013411	PA2075	6	10791440015910
BF1170	12	10791440011424	BF1277-SPS	6	10791440059334									

**BALDWIN CASE TO I 2/5 (SHIPPING CASES)**

BALDWIN CASE NUMBER	CASE QTY.	I 2/5 NUMBER	BALDWIN CASE NUMBER	CASE QTY.	I 2/5 NUMBER	BALDWIN CASE NUMBER	CASE QTY.	I 2/5 NUMBER	BALDWIN CASE NUMBER	CASE QTY.	I 2/5 NUMBER	BALDWIN CASE NUMBER	CASE QTY.	I 2/5 NUMBER
PA2101A	6	10791440016139	PA2306	4	10791440017426	PA4093	6	10791440051734	PA4305	6	10791440080505	PA4399	6	10791440083001
PA2102	6	10791440016146	PA2308	4	10791440017440	PA4094	6	10791440051741	PA4306	6	10791440080512	PA4400	6	10791440083018
PA2103	6	10791440016153	PA2335	6	10791440017754	PA4096	6	10791440052014	PA4307	6	10791440080529	PA4401	6	10791440083039
PA2104	6	10791440016160	PA2337	6	10791440017761	PA4099	6	10791440052304	PA4308	6	10791440080536	PA4402	6	10791440083100
PA2106	6	10791440016184	PA2347	6	10791440017877	PA4100	6	10791440052441	PA4309	6	10791440080543	PA4403	6	10791440083131
PA2107	6	10791440016191	PA2472	6	10791440019260	PA4102	6	10791440053134	PA4310	6	10791440080567	PA4404	6	10791440083148
PA2109	6	10791440016214	PA2476	6	10791440019307	PA4103	6	10791440054513	PA4311	6	10791440080574	PA4405	6	10791440083155
PA2110	6	10791440016221	PA2477	6	10791440019314	PA4104	6	10791440054636	PA4312	6	10791440080581	PA4408	6	10791440083186
PA2113	6	10791440016252	PA2483	6	10791440019376	PA4105	6	10791440054643	PA4313	6	10791440080598	PA4409	6	10791440083247
PA2114	6	10791440016269	PA2554 FOAM	6	10791440038612	PA4106	6	10791440054650	PA4314	6	10791440080604	PA4410 KIT	6	10791440083513
PA2115	6	10791440016276	PA2653 FOAM	6	10791440021317	PA4107	6	10791440054667	SA4315	12	10791440080550	PA4411	6	10791440083575
PA2116	4	10791440016283	PA2798	12	10791440022789	PA4108	6	10791440054957	PA4316	6	10791440080659	PA4412	6	10791440083599
PA2117	6	10791440016290	PA2862 FOAM	12	10791440053592	PA4109	6	10791440059564	PA4317	6	10791440080666	PA4413	6	10791440083605
PA2121	6	10791440016320	PA2884	12	10791440053691	PA4110	6	10791440055138	PA4319	6	10791440080758	PA4414	6	10791440083612
PA2124	6	10791440016351	PA3414	6	10791440054162	PA4111	6	10791440056081	PA4320	6	10791440080772	PA4415	6	10791440083629
PA2125	6	10791440016368	PA3419	6	10791440052212	PA4112	6	10791440057422	PA4321	6	10791440080888	PA4416 KIT	6	10791440083674
PA2127	6	10791440016382	PA3697	6	10791440047867	PA4113	6	10791440057897	PA4322	6	10791440080895	PA4417	6	10791440083773
PA2134	6	10791440016450	PA3763	6	10791440048734	PA4114	6	10791440058108	PA4323	6	10791440081045	PA4418	6	10791440083865
PA2135	6	10791440016467	PA3773	6	10791440049564	PA4118	6	10791440059167	PA4324	6	10791440081069	PA4419	6	10791440083872
PA2136	6	10791440016474	PA3822	6	10791440054391	PA4120	6	10791440059082	PA4325	6	10791440081106	PA4421	6	10791440084152
PA2138	6	10791440016498	PA3823	6	10791440054407	PA4121	6	10791440059327	PA4327	6	10791440081083	PA4422	6	10791440085982
PA2139	6	10791440016504	PA3825	6	10791440058078	PA4123	6	10791440059556	PA4329	6	10791440081212	PA4423	6	10791440085999
PA2139 FOAM	12	10791440038582	PA3834	6	10791440054582	PA4124	6	10791440059563	PA4330	6	10791440081373	PA4424	6	10791440086149
PA2140	6	10791440016511	PA3835	6	10791440054599	PA4126	6	10791440059846	PA4331	6	10791440081380	PA4425	6	10791440086415
PA2147	6	10791440016573	PA3836	6	10791440055046	PA4127	6	10791440059921	PA4332	6	10791440081397	PA4426	6	10791440086422
PA2148	6	10791440016580	PA3839	6	10791440055077	PA4128	6	10791440060316	PA4333	6	10791440081571	PA4428	6	10791440086682
PA2149	6	10791440016597	PA3840	6	10791440055084	PA4129	6	10791440060323	PA4334	6	10791440081502	PA4429	6	10791440087023
PA2150	6	10791440016603	PA3872	12	10791440055923	PA4132	6	10791440060446	PA4335	6	10791440081519	PA4430	6	10791440087054
PA2152	6	10791440016627	PA3873	12	10791440055930	PA4133	6	10791440060484	PA4336	6	10791440081588	PA4431	6	10791440087238
PA2153	6	10791440016634	PA3880	6	10791440056036	PA4134	6	10791440060826	PA4337	6	10791440081619	PA4433	6	10791440087672
PA2154	6	10791440016641	PA3890	6	10791440056289	PA4138	6	10791440061186	PA4338	6	10791440081793	PA4434	6	10791440087962
PA2156	6	10791440016665	PA3901	6	10791440057439	SA4141	12	10791440061191	PA4340	6	10791440081809	PA4435	6	10791440088105
PA2158	6	10791440016689	PA3901 FOAM	12	10791440067667	PA4144	6	10791440061962	PA4341	6	10791440081816	PA4436	6	10791440088167
SA2159	12	10791440016696	PA3929	6	10791440058542	PA4146	6	10791440062525	PA4344	6	10791440081823	PA4437	6	10791440088174
PA2160	6	10791440016702	PA3931	6	10791440058733	PA4147	6	10791440062532	PA4345	6	10791440081830	PA4438	6	10791440088440
PA2162	6	10791440016726	PA3941	6	10791440059396	PA4148	6	10791440062549	PA4348	6	10791440081847	PA4439	6	10791440089164
PA2163	6	10791440016733	PA3953	6	10791440059495	PA4149 KIT	6	10791440063089	PA4349	6	10791440081854	PA4440 KIT	6	10791440089171
PA2164	6	10791440016740	PA3957	6	10791440059860	PA4150	6	10791440063461	PA4350	6	10791440081861	PA4441	6	10791440089188
PA2167	6	10791440016771	PA3957 FOAM	12	10791440073415	PA4151	6	10791440064314	PA4351	6	10791440081878	PA4442	6	10791440089294
PA2168	6	10791440016788	PA3958	6	10791440059945	PA4152	6	10791440064499	PA4352	6	10791440081885	PA4443	6	10791440089300
PA2169	6	10791440016795	PA3967	6	10791440060118	PA4154	6	10791440064512	PA4353	6	10791440081991	PA4444	6	10791440089317
PA2171	6	10791440016818	PA3970	6	10791440060170	PA4157	6	10791440065052	PA4354	6	10791440082004	PA4446	6	10791440089423
PA2178	6	10791440016887	PA3980	6	10791440060354	PA4158	6	10791440065250	PA4355	6	10791440082011	PA4447	6	10791440089430
PA2181	6	10791440016917	PA3983-FN	6	10791440060620	PA4159	6	10791440065403	PA4356	6	10791440082028	PA4448	6	10791440089447
PA2188	6	10791440016962	PA3986	6	10791440060927	PA4160	6	10791440065441	PA4358	6	10791440082042	PA4449	6	10791440089751
PA2189	6	10791440016979	PA4005	6	10791440043432	PA4162	6	10791440065533	PA4359	6	10791440082056	PA4452	6	10791440089904
PA2191	6	10791440016993	PA4015	6	10791440038698	PA4163	6	10791440065585	PA4360	6	10791440082069	PA4453	6	10791440089911
PA2193	6	10791440017013	PA4016	6	10791440026558	PA4164	6	10791440066080	PA4361	6	10791440082073	PA4454	6	10791440089942
PA2194	6	10791440017020	PA4018	6	10791440026565	PA4166	6	10791440066653	PA4362	6	10791440082080	PA4455	6	10791440089966
PA2196	6	10791440017044	PA4023	6	10791440026589	PA4167	6	10791440066769	PA4363	6	10791440082219	PA4456	6	10791440089980
PA2200	6	10791440043456	PA4026	6	10791440026596	PA4169	6	10791440067131	PA4364	6	10791440082226	PA4460 KIT	12	10791440090108
PA2204	6	10791440017112	PA4028	6	10791440026602	PA4170	6	10791440072609	PA4365	6	10791440082233	PA4461	6	10791440090122
PA2207	6	10791440017143	PA4042	6	10791440048956	PA4172	6	10791440076768	PA4366	6	10791440082284	PA4462	6	10791440090139
PA2208	6	10791440017150	PA4043	6	10791440048963	PA4174	6	10791440077192	PA4367	6	10791440082332	PA4463	6	10791440090160
PA2212	6	10791440017198	PA4044	6	10791440049229	PA4175	6	10791440077994	PA4368	6	10791440082349	PA4464	6	10791440090306
PA2214	6	10791440017211	PA4045	6	10791440049236	PA4176	6	10791440078007	PA4369	6	10791440082356	PA4465	6	10791440090429
PA2216	6	10791440017235	PA4046	6	10791440049243	PA4177	6	10791440078120	PA4370	6	10791440082363	PA4466	6	10791440090103
PA2218	6	10791440017259	PA4047	6	10791440049335	PA4178	6	10791440078663	PA4371	6	10791440082370	PA4467	6	10791440091259
PA2221	6	10791440017280	PA4048	6	10791440049342	PA4179	6	10791440078670	PA4372	6	10791440082387	PA4468	6	10791440091525
PA2222	6	10791440017297	PA4049	6	10791440049403	PA4180	6	10791440078687	PA4373	6	10791440082394	PA4469	6	10791440091532
PA2223	6	10791440017303	PA4050	6	10791440026657	PA4181	6	10791440078694	PA4374	6	10791440082455	PA4470	6	10791440092294
PA2223 FOAM	12	10791440067650	PA4060	6	10791440026688	PA4182	6	10791440078700	PA4376	6	10791440082486	PA4471	6	10791440092317
PA2224	6	10791440017310	PA4069	6	10791440043623	PA4183	6	10791440078717	PA4377	6	10791440082493	PA4473	6	10791440092447
PA2225	6	10791440017327	PA4070	6	10791440043630	PA4184	6	10791440079097	PA4380	6	10791440082509	PA4475	6	10791440092850
PA2226	6	10791440017334	PA4071	6	10791440043647	PA4185	6	10791440079363	PA4381	6	10791440082516	PA4476	6	10791440093666
PA2228	6	10791440043470	PA4072	6	10791440043791	PA4187	12	10791440079646	PA4382	6	10791440082523	PA4477	6	10791440093673
PA2230	6	10791440043494	PA4073	6	10791440043814	PA4188	6	10791440080277	PA					

# BALDWIN CASE TO I 2/5 (SHIPPING CASES)

BALDWIN CASE NUMBER	QTY.	I 2/5 NUMBER	BALDWIN CASE NUMBER	QTY.	I 2/5 NUMBER	BALDWIN CASE NUMBER	QTY.	I 2/5 NUMBER	BALDWIN CASE NUMBER	QTY.	I 2/5 NUMBER	BALDWIN CASE NUMBER	QTY.	I 2/5 NUMBER
PA4600	6	10791440063706	PA4932	6	10791440073163	PA5341	6	10791440078915	B7009	12	10791440028538	B7156	12	10791440057491
PA4601	6	10791440063713	PA4934	12	10791440073187	PA5353	12	10791440079400	B7010	12	10791440028545	B7157	6	10791440057767
PA4612	6	10791440063935	PA4935	12	10791440073194	PA5359	6	10791440079523	B7011	6	10791440028552	BD7159	6	10791440057958
PA4632	6	10791440065335	PA4938	4	10791440073224	BA5374	4	10791440078847	P7012	4	10791440038827	B7161	6	10791440058122
PA4633	12	10791440065342	PA4939	12	10791440073231	BA5375	4	10791440078854	P7013	12	10791440042565	B7162	6	10791440058009
PA4661	12	10791440066844	PA4941	4	10791440073255	BA5376	4	10791440078861	B7014	12	10791440028569	B7163	12	10791440058016
PA4662	12	10791440066851	PA4975	12	10791440075990	BA5378	4	10791440085715	P7015	12	10791440046624	B7164	12	10791440058023
PA4663	12	10791440066868	PA4979	12	10791440075952	BA5379	4	10791440085722	P7016	12	10791440046723	B7165	12	10791440058054
PA4664	12	10791440066875	PA4985	6	10791440076379	PA5393	6	10791440080222	P7017	12	10791440046730	BD7166	6	10791440058146
PA4668	6	10791440066882	PA4986	6	10791440076386	PA5428	6	10791440082875	B7018	12	10791440028576	B7167	12	10791440058443
PA4681	6	10791440067360	PA4987	6	10791440076393	PA5457	12	10791440085784	B7019	6	10791440028583	BD7169	6	10791440058665
PA4682	6	10791440067421	PA4997	6	10791440094809	PA5482	6	10791440086446	B7020	12	10791440028590	B7170	12	10791440058757
PA4689	12	10791440067636	CS5007	12	10791440026749	PA5494	6	10791440086798	P7021	12	10791440046471	B7171	12	10791440058764
PA4694	12	10791440067766	CS5008	12	10791440026756	PA5495	6	10791440086804	B7022	12	10791440028606	B7172	12	10791440059648
PA4695	12	10791440067773	CS5009	6	10791440026763	BA5566	4	10791440086862	B7023	12	10791440028613	BC7173	12	10791440059419
PA4696 FOAM	12	10791440067780	CSC5012	4	10791440026794	PA5580	6	10791440089768	B7024	12	10791440028620	B7174-MPG	12	10791440061269
PA4698	6	10791440067803	CTK5029	24	10791440043234	BF5587-D	12	10791440076485	B7025	12	10791440028637	B7175	6	10791440058405
PA4701	6	10791440066858	CTK5029-M	24	10791440079141	BA5592	4	10791440090009	BD7026-MPG	12	10791440048703	BD7176	6	10791440060149
PA4707	6	10791440067841	CS5058	6	10791440026893	PA5619	6	10791440090207	BD7028	12	10791440037615	B7177	12	10791440062027
PA4711	4	10791440067889	OTK5060	10	10791440026909	PA5620	6	10791440090214	BD7029	12	10791440051222	P7178	12	10791440060286
PA4714	6	10791440067919	OTK5061	12	10791440026916	PA5622	6	10791440090238	B7030	6	10791440040240	B7179	12	10791440060293
PA4720	12	10791440067971	OTK5063	10	10791440026930	PA5623	6	10791440090245	B7031	12	10791440038858	B7180	6	10791440058559
PA4723	2	10791440068008	BW5070	12	10791440026947	PA5624	6	10791440090252	B7033	12	10791440054230	B7181	12	10791440060736
PA4727	12	10791440068046	BW5071	12	10791440026954	PA5629	6	10791440090337	B7034	12	10791440054247	B7182	6	10791440060842
PA4730	6	10791440068077	BW5072	12	10791440026961	PA5631	6	10791440090351	P7035	12	10791440038117	P7183	4	10791440061061
PA4731	6	10791440068084	BW5073	12	10791440026978	PA5632	6	10791440090399	B7039	12	10791440037851	P7185	12	10791440061474
PA4732	12	10791440068091	BW5074	12	10791440026985	PA5633	6	10791440090474	B7042	12	10791440038872	BC7186 KIT	12	10791440061610
PA4733	6	10791440068107	BW5075	12	10791440026992	PA5637	6	10791440090696	B7044	12	10791440038938	B7187	6	10791440061733
PA4734	6	10791440068114	BW5076	12	10791440027005	PA5638	6	10791440090702	B7045	12	10791440043678	P7188	12	10791440061948
PA4735	12	10791440068121	BW5082	12	10791440043104	PA5658	6	10791440091914	B7047	12	10791440038063	B7189	12	10791440060859
PA4736 FOAM	12	10791440068138	BW5086	12	10791440057590	PA5661	6	10791440091440	B7049	12	10791440044996	B7191	12	10791440062044
PA4737	6	10791440068145	B5087	12	10791440058269	PA5662	6	10791440091457	P7050	12	10791440043715	BC7194	12	10791440062103
PA4738	6	10791440068152	B5088	12	10791440058276	PA5666	6	10791440091495	B7051	12	10791440037622	P7196	12	10791440062396
PA4750	6	10791440068275	B5089	12	10791440063447	PA5669	6	10791440091563	P7052	12	10791440045719	B7197	12	10791440064031
PA4754	6	10791440068312	B5090	12	10791440065670	PA5679	6	10791440091747	P7053	12	10791440037585	P7199	12	10791440062600
PA4755	10	10791440068329	B5091	12	10791440082837	PA5683	6	10791440091921	P7081	12	10791440043142	B7215	12	10791440062990
PA4756	6	10791440068336	P5092	12	10791440091549	PA5689	6	10791440092188	B7082	12	10791440043289	B7216	12	10791440063102
PA4758	12	10791440068350	B5134	12	10791440027043	PA5690	6	10791440092195	P7083	12	10791440043326	B7217	6	10791440063119
PA4760	12	10791440068374	BW5136	12	10791440027050	PA5691	6	10791440092201	P7084	12	10791440043357	B7219	12	10791440063768
PA4763	12	10791440068404	BW5137	12	10791440027067	PA5694	6	10791440092232	B7089	12	10791440045016	B7220	12	10791440063874
PA4764	6	10791440068411	BW5138	12	10791440027074	PA5698	6	10791440092324	B7091	12	10791440045214	B7221	12	10791440063904
PA4769	12	10791440068466	BW5139	12	10791440027081	PA5700	12	10791440092423	P7092	12	10791440045559	B7222	12	10791440063911
PA4773	12	10791440068503	BW5140	12	10791440027098	PA5720	6	10791440092812	B7093	12	10791440045566	B7223	12	10791440064161
PA4778	12	10791440068565	BW5141	12	10791440027104	PA5721	6	10791440092829	BD7095	12	10791440046068	B7224	6	10791440064437
PA4793	6	10791440068718	BW5142	12	10791440052588	PA5722	6	10791440092836	B7099	12	10791440047027	B7225	12	10791440064475
PA4814	2	10791440068923	BW5143	12	10791440057026	PA5723	6	10791440092843	P7103	12	10791440047553	B7227	12	10791440064628
PA4819	12	10791440068978	B5144	12	10791440064062	PA5725	6	10791440092881	P7104	12	10791440047584	BC7228	12	10791440064642
PA4820	12	10791440068985	B5145	12	10791440066929	PA5727	6	10791440092931	BD7105	6	10791440047591	B7229	6	10791440064680
PA4823	6	10791440069012	B5176	12	10791440027128	PA5728	6	10791440092928	P7106	12	10791440047607	P7230	6	10791440064687
PA4824	12	10791440069029	B5177	12	10791440027135	PA5728 FOAM	6	10791440092935	P7107	12	10791440047614	B7231	12	10791440064688
PA4829	6	10791440069074	BW5178	12	10791440027142	PA5729	6	10791440092959	B7113	12	10791440047843	P7232	12	10791440064949
PA4830	12	10791440069081	BW5179	12	10791440027159	PA5732	6	10791440092980	P7114	12	10791440048260	P7233	12	10791440065014
PA4848	2	10791440069258	BW5182	12	10791440066295	PA5733	6	10791440093154	B7116	12	10791440048727	P7235	12	10791440065083
PA4852	12	10791440067544	BW5183	12	10791440079028	PA5738	6	10791440093291	B7117	12	10791440048826	BT7237	12	10791440087061
PA4852 FOAM	12	10791440067551	BW5200	12	10791440053288	PA5753	6	10791440093529	B7119	12	10791440050294	B7238	12	10791440065380
PA4853	12	10791440067568	BW5201	12	10791440057408	PA5765	6	10791440093758	B7121	12	10791440050522	B7239	6	10791440065472
PA4854	6	10791440067575	BW5250	12	10791440060057	PA5766	6	10791440093802	B7124	12	10791440051307	B7240	12	10791440065496
PA4855	12	10791440067599	PE5270	12	10791440091891	PA5768	6	10791440093833	B7125	12	10791440051390	B7241	6	10791440065687
PA4857	6	10791440072530	PE5271	12	10791440091907	PA5770	6	10791440094458	B7128	12	10791440052083	BC7242	12	10791440066226
PA4872	12	10791440073361	PE5272	12	10791440094922	PA5772	6	10791440094472	V7129-C	7	10791440052526	B7243	12	10791440066363
PA4873	12	10791440073378	PA5276	12	10791440094991	PA5773	6	10791440094489	B7130	12	10791440052601	B7245	6	10791440066776
PA4874	12	10791440073385	PA5282	6	10791440095080	PA5774	6	10791440094502	B7131	12	10791440052618	B7246	6	10791440067032
PA4878	12	10791440072630	BA5284	4	10791440095103	BF5800	12	10791440027197	P7132	12	10791440053127	P7247	12	10791440067162
PA4879	12	10791440072647	PA5306	6	10791440077130	BF5801	12	10791440027210	P7134	12	10791440053432	BD7249-MPG	6	10791440067214
PA4883	12	10791440072685	PA5311	12	10791440077338	BF5810	12	10791440027203	B7135	6	10791440053436	BD7250	6	10791440067386
PA4885	4	10791440072708	PA5312 KIT	6	10791440077345	BF5812	12	10791440027210	P7136	12	10791440053465	BD7252	6	10791440067391
PA4886	12	10791440072715	PA5314	6	10791440077369	BF5813	12	107						

**BALDWIN CASE TO I 2/5 (SHIPPING CASES)**

BALDWIN CASE NUMBER	CASE QTY.	I 2/5 NUMBER	BALDWIN CASE NUMBER	CASE QTY.	I 2/5 NUMBER	BALDWIN CASE NUMBER	CASE QTY.	I 2/5 NUMBER	BALDWIN CASE NUMBER	CASE QTY.	I 2/5 NUMBER	BALDWIN CASE NUMBER	CASE QTY.	I 2/5 NUMBER
B7277	12	10791440071954	B7396	6	10791440077390	B7501	12	10791440091884	BF7634	12	10791440053295	PF7767	12	10791440065540
B7280	12	10791440071985	B7397	12	10791440079943	P7502	6	10791440091990	BF7635	6	10791440053370	BF7768	12	10791440065878
B7281	12	10791440071992	P7398	12	10791440080345	B7503	6	10791440092110	BF7637	12	10791440086156	BF7769	12	10791440066141
B7283	12	10791440072012	P7399	12	10791440080352	BD7504	6	10791440092270	BF7639	6	10791440054438	PF7770	12	10791440066165
B7285	12	10791440072036	P7400	12	10791440080369	P7505	6	10791440088297	BF7639-D	6	10791440054834	BF7771	12	10791440066271
B7286	12	10791440072043	B7401	12	10791440080376	B7506	12	10791440092287	BF7640	12	10791440056258	BF7772	12	10791440066592
B7287	12	10791440072050	B7402	6	10791440080611	B7507	12	10791440092409	BF7644	12	10791440052748	BF7773	12	10791440066691
B7289	12	10791440072074	B7403	12	10791440080628	P7508	6	10791440092584	BF7645	12	10791440052625	BF7774	12	10791440066707
B7290	12	10791440072081	P7406	12	10791440080918	BD7509	6	10791440092683	BF7648	12	10791440053066	BF7775	12	10791440066950
B7291	12	10791440072098	B7407	12	10791440081052	P7510	12	10791440093239	BF7653	12	10791440052685	BF7776	12	10791440066967
B7292	12	10791440072104	P7408	12	10791440081182	B7511	12	10791440093260	PF7655	12	10791440057484	PF7777	12	10791440067001
B7293	12	10791440072111	B7409	12	10791440081199	P7512	12	10791440093734	BF7656	12	10791440054469	BF7778	12	10791440067018
B7294	12	10791440072128	B7410	12	10791440081205	B7513	6	10791440093741	BF7657	12	10791440055399	PF7779	12	10791440067087
B7298	12	10791440074702	P7411	12	10791440081229	P7515	12	10791440093826	BF7658	12	10791440054902	BF7780	12	10791440067148
B7299	6	10791440066752	P7413	12	10791440081274	B7516	12	10791440094410	BF7659	12	10791440054931	PF7782	6	10791440067483
P7303	12	10791440076470	P7414	12	10791440081281	P7517	12	10791440094434	BF7661	12	10791440054993	BF7783-D	12	10791440067490
P7305	12	10791440075037	P7415	12	10791440081366	BF7519	12	10791440028767	BF7663	12	10791440054971	BF7784-D	12	10791440067506
B7306	12	10791440076294	B7416	6	10791440081410	BF7528	12	10791440028828	BF7664	12	10791440054988	BF7785-D	12	10791440067513
P7308	12	10791440076461	P7417	12	10791440081984	BF7529	12	10791440028835	BF7666	12	10791440055053	BF7786-D	12	10791440067537
BD7309	6	10791440058948	P7418	12	10791440081618	BF7531	12	10791440038889	BF7667	12	10791440055114	PF7787	12	10791440069296
BD7310	6	10791440060868	B7419	12	10791440081786	BF7532	12	10791440046556	BF7668	12	10791440057507	PF7788	12	10791440069302
B7311-MPG	12	10791440076539	B7420	12	10791440081915	BF7534	12	10791440041377	BF7670	12	10791440055947	BF7798-O	12	10791440110417
P7312	6	10791440076546	B7422	12	10791440081922	BF7535	12	10791440045245	BF7672-D	12	10791440066400	BF7798-SP	12	10791440076720
P7313	12	10791440076577	P7423	12	10791440081946	BF7537	12	10791440054261	BF7673-D	12	10791440066431	PF7799	12	10791440064765
B7314	6	10791440076744	B7424	12	10791440082097	BF7538	12	10791440028859	BF7674-D	12	10791440066448	BF7800	12	10791440064772
BT7316	12	10791440076911	P7426	12	10791440082103	BF7541	12	10791440037981	BF7675-D	12	10791440066424	BF7801	12	10791440064789
BD7317	12	10791440076966	P7427	12	10791440082110	BF7544	12	10791440037967	BF7677-D	12	10791440066455	BF7802	12	10791440064796
B7318	12	10791440077048	B7428	12	10791440082165	PF7545	12	10791440037661	PF7678	12	10791440054575	BF7803	12	10791440064970
P7319	12	10791440077086	B7429	12	10791440082288	BF7546	12	10791440037882	BF7679-D	12	10791440066394	BF7804	12	10791440064987
B7320	12	10791440077178	B7430	12	10791440082271	PF7549	12	10791440037639	PF7680	12	10791440057033	BF7805	12	10791440064994
B7322	6	10791440077321	B7431	12	10791440082301	PF7550	12	10791440037684	BF7681-D	12	10791440066387	BF7806	12	10791440065007
B7324	6	10791440077673	B7432	12	10791440082318	PF7551	12	10791440037691	BF7682-D	12	10791440066417	BF7806-O	12	10791440110394
BD7325	6	10791440077741	B7433	12	10791440082325	BF7552	12	10791440037745	BF7683	12	10791440059655	BF7807	12	10791440065021
BC7326	12	10791440078526	B7434	12	10791440082448	PF7553	12	10791440038247	B7685	12	10791440058399	BF7808	12	10791440065038
B7327	12	10791440078564	P7436	6	10791440082714	PF7554	12	10791440038254	BF7686	12	10791440058504	BF7809	12	10791440065076
B7328	12	10791440078656	P7437	12	10791440082721	BF7557	12	10791440028866	PF7687	12	10791440058528	PF7812 KIT	12	10791440065137
P7329	6	10791440078960	P7438	12	10791440083766	BF7558	12	10791440028880	BF7690	12	10791440058573	BF7813	12	10791440065311
P7330	6	10791440079066	B7440	12	10791440082813	BF7559	12	10791440038346	BF7691	12	10791440058663	BF7814	12	10791440065359
B7333	12	10791440079837	B7441	12	10791440082851	BF7571	6	10791440041292	BF7693	12	10791440058894	BF7815	12	10791440067230
B7334	12	10791440080055	P7442	12	10791440083025	BF7572	12	10791440042534	BF7695	6	10791440059280	PF7816	12	10791440069319
B7335-MPG	6	10791440080048	B7443	12	10791440083209	BF7576	12	10791440042763	BF7696	12	10791440059662	PF7817	12	10791440069326
P7336 KIT	12	10791440080109	B7444	12	10791440083216	B7577	6	10791440028903	BF7697	6	10791440059914	PF7818	24	10791440069333
P7338	12	10791440080284	B7445	12	10791440083230	BF7579	12	10791440042770	PF7698	12	10791440059907	PF7819	12	10791440069340
BT7349	12	10791440076263	B7446	12	10791440083261	BF7580	12	10791440042787	BF7699-D	12	10791440066486	PF7820	12	10791440069357
B7350	12	10791440080415	B7449	12	10791440083957	BF7584	12	10791440043135	B7700	12	10791440066837	BF7821	12	10791440069364
B7351-MPG	12	10791440085517	P7450	12	10791440083308	B7585	12	10791440043272	BF7711	12	10791440060712	PF7822	30	10791440069371
B7352	12	10791440085593	B7451	12	10791440083315	BF7586	12	10791440043302	BF7713	12	10791440060477	PF7823	12	10791440069388
BD7355	6	10791440085791	B7452	12	10791440083360	BF7587	12	10791440043319	PF7715	6	10791440060491	PF7824	30	10791440069395
B7356	12	10791440085845	B7453	12	10791440083483	PF7588	12	10791440043333	BF7717	12	10791440060514	PF7825	12	10791440069401
B7357	12	10791440085883	P7454	12	10791440083582	BF7591-D	12	10791440045258	PF7718	12	10791440060644	PF7826	12	10791440069418
B7359	12	10791440085913	P7455	12	10791440083667	PF7592	12	10791440045580	BF7719	12	10791440061085	PF7828	6	10791440069425
B7360	12	10791440086132	BC7456 KIT	12	10791440083834	BF7593	12	10791440046129	BF7720	12	10791440061108	PF7829	12	10791440069432
B7361	12	10791440086187	B7457	12	10791440083803	PF7594	12	10791440046280	BF7721	12	10791440061139	PF7830	12	10791440069449
B7362	12	10791440086231	B7458	12	10791440083810	PF7595	12	10791440046297	BF7725	12	10791440061160	PF7832	12	10791440069463
B7363	6	10791440086378	B7459	12	10791440083827	PF7596	12	10791440046419	BF7726	12	10791440061185	PF7833	12	10791440069470
P7364	12	10791440086385	B7461	12	10791440083849	PF7597	12	10791440046532	PF7733	12	10791440061856	PF7834	12	10791440069487
P7365	12	10791440086453	B7462	12	10791440083852	BF7598	12	10791440047577	PF7734	12	10791440061863	PF7836	12	10791440069500
B7367	12	10791440086552	B7466	12	10791440083868	B7600	12	10791440028934	PF7735	12	10791440061924	BF7837	12	10791440069517
P7368	12	10791440086620	B7467	12	10791440083879	B7600-SS	12	10791440050430	BF7736	12	10791440062273	BF7838	12	10791440069524
B7370	12	10791440086927	B7468	12	10791440083876	BF7602	12	10791440047669	BF7736-K1	12	10791440069661	BF7839	20	10791440069531
B7372	12	10791440087184	B7469	12	10791440083873	BF7606	12	10791440047829	BF7742	12	10791440062655	BF7840	12	10791440069548
B7373	12	10791440087313	B7474	12	10791440083839	BF7608	12	10791440048499	PF7744	12	10791440062808	BF7841	12	10791440069555
B7375	12	10791440087382	B7477	12	10791440083886	BF7612	12	10791440050454	BF7745-D	12	10791440066479	BF7842	12	10791440069562
B7376	12	10791440087399	B7483	12	10791440083893	BF7613	12	10791440050461	BF7746-D	12	10791440066420	BF7843	12	10791440069579
B7377	12	10791440087405	BC7485	12	10791440083905	BF7614	12	10791440050508	BF7747	12	10791440063201	BF7844	12	10791440069586
B7378	12	10791440087429	B7486	12	10791440083914	P7615	12	10791440050515	PF7748	12	10791440063218</			

# BALDWIN CASE TO I 2/5 (SHIPPING CASES)

BALDWIN CASE NUMBER	CASE QTY.	I 2/5 NUMBER	BALDWIN CASE NUMBER	CASE QTY.	I 2/5 NUMBER	BALDWIN CASE NUMBER	CASE QTY.	I 2/5 NUMBER	BALDWIN CASE NUMBER	CASE QTY.	I 2/5 NUMBER	BALDWIN CASE NUMBER	CASE QTY.	I 2/5 NUMBER
BF7864	12	10791440074658	BF7957	12	10791440082189	PT8372	12	10791440047652	OP8750	12	10791440083537	PT9134	12	10791440070711
BF7865	12	10791440074665	BF7958	12	10791440082400	PT8375-MPG	6	10791440048147	OP8751	12	10791440083544	PT9135	12	10791440070728
BF7866	12	10791440074672	BF7959	12	10791440082417	PT8376-MPG	6	10791440048154	OP8752	12	10791440083551	PT9136	12	10791440070735
PF7869	12	10791440074481	BF7960	12	10791440082424	BT8381	6	10791440049687	OP8753	12	10791440083558	PT9142	12	10791440070797
BF7870	12	10791440074498	BF7961	12	10791440082431	BT8382	6	10791440050102	BT8801-MPG	6	10791440080552	PT9143	12	10791440070803
BF7871	12	10791440074504	BF7962	12	10791440082585	BT8384	12	10791440050331	BT8802-MPG	6	10791440029191	PT9144	12	10791440070810
PF7872	12	10791440074511	BF7963	12	10791440082592	PT8385	12	10791440050539	BT8803-MPG	6	10791440029207	PT9147	12	10791440070841
PF7873	12	10791440074528	BF7964-D	12	10791440082608	BT8386	12	10791440050591	BT8812-MPG	6	10791440029233	PT9167	12	10791440071046
PF7874	12	10791440074535	BF7965	12	10791440082752	BT8391	12	10791440050942	BT8830	6	10791440042992	PT9169	10	10791440071060
PF7875	12	10791440074542	BF7966	12	10791440082820	PT8392	12	10791440051000	BT8832	6	10791440043005	PT9174	12	10791440071114
PF7876	12	10791440074559	BF7967	12	10791440082912	BT8393	12	10791440051451	BT8833	6	10791440058160	PT9180	12	10791440071176
PF7877	12	10791440074566	BF7968	12	10791440083254	BT8398-MPG	12	10791440051901	BT8840-MPG	6	10791440038391	PT9181	12	10791440071183
PF7887	12	10791440075044	BF7969-O	12	10791440097626	BT8401-MPG	6	10791440052120	BT8841-MPG	6	10791440046914	PT9185	12	10791440071220
BF7879	12	10791440075662	BF7969	12	10791440083681	PT8403-MPG	12	10791440052199	BT8842-MPG	6	10791440051907	PT9214	12	10791440071510
BF7880	12	10791440071886	BF7970	12	10791440085869	PT8404-MPG	12	10791440052281	BT8843-MPG	6	10791440052007	PT9238	12	10791440074023
BF7881	12	10791440075921	BF7971-D	12	10791440083346	BT8407	12	10791440053073	BT8844	6	10791440042633	PT9239	12	10791440074030
PF7882	12	10791440075914	BF7971-DM	12	10791440083353	BT8409	12	10791440053196	BT8845	6	10791440042626	PT9260	12	10791440074245
BF7883	12	10791440076287	BF7972	12	10791440083759	BT8412	12	10791440054421	BT8846	6	10791440045931	BT9318	12	10791440075006
BF7886	12	10791440076430	PF7974	12	10791440085500	BT8413	12	10791440055893	BT8847	6	10791440059631	BT9321	12	10791440073583
BF7888	12	10791440076867	PF7975	12	10791440085586	BT8415	12	10791440055886	BT8848-MPG	6	10791440051659	BT9324	6	10791440073613
PF7889	12	10791440076607	BF7976	12	10791440085692	BT8416	6	10791440055107	BT8849-MPG	6	10791440055732	PT9329	12	10791440075242
PF7889-10	12	10791440076614	PF7977	12	10791440077697	BT8417	12	10791440055879	BT8850-MPG	6	10791440038964	PT9337-MPG	12	10791440076119
PF7889-30	12	10791440076621	PF7978	12	10791440085760	BT8418	6	10791440056111	BT8851-MPG	6	10791440039329	PT9342-MPG	12	10791440076584
PF7890	12	10791440076638	BF7979	12	10791440085876	PT8419	12	10791440056197	BT8852-MPG	6	10791440045948	BT9343-MPG	6	10791440076669
PF7890-10	12	10791440076645	BF7981	12	10791440086002	BT8420	12	10791440056982	BT8853-MPG	6	10791440053301	PT9344	12	10791440076737
PF7890-30	12	10791440076652	PF7982	12	10791440086217	BT8422-MPG	6	10791440057521	BT8855-MPG	6	10791440055749	BT9345	6	10791440076799
BF7892	12	10791440076881	PF7983	12	10791440086071	BT8426-MPG	6	10791440057934	BT8856-MPG	6	10791440059570	BT9346-MPG	12	10791440076812
PF7894	6	10791440077024	PF7984	12	10791440086088	BT8428-MPG	12	10791440058245	BT8861	6	10791440038988	BT9347-MPG	6	10791440076829
PF7895	6	10791440077031	BF7985	12	10791440086101	BT8429	12	10791440058313	BT8862	6	10791440038407	BT9349-MPG	6	10791440076843
PF7896	12	10791440077039	PF7986	12	10791440086200	BT8432-MPG	6	10791440058566	BT8863	6	10791440038414	BT9353-MPG	6	10791440077406
BF7896-D	12	10791440077154	BF7987	12	10791440086248	BT8437	6	10791440058818	BT8870-MPG	6	10791440046426	PT9354-MPG	12	10791440077482
BF7903	12	10791440077376	BF7988	12	10791440086262	BT8439-MPG	6	10791440059068	BT8873	6	10791440046518	BT9356	6	10791440077659
BF7904-D	12	10791440077383	BF7989-D	12	10791440086266	BT8440-MPG	12	10791440059073	BT8874-MPG	6	10791440046440	BT9362-MPG	6	10791440078106
BF7905-D	12	10791440077413	BF7990	12	10791440086439	BT8443	12	10791440059501	BT8875-MPG	6	10791440046563	PT9363-MPG	12	10791440078113
BF7906-D	12	10791440077420	BF7993	12	10791440086484	BT8444	12	10791440059617	BT8876-MPG	6	10791440048772	BT9364	6	10791440078397
BF7907	12	10791440077437	PF7994	12	10791440086606	BT8445	12	10791440059785	BT8877-MPG	6	10791440055756	BT9365-MPG	6	10791440078427
BF7908	12	10791440077550	BF7995	12	10791440086613	P8448	12	10791440059884	BT8878-MPG	6	10791440055763	BT9366-MPG	6	10791440078434
BF7909	12	10791440077567	BF7996	6	10791440086675	BT8449	12	10791440060002	BT8879-MPG	6	10791440055770	BT9367-MPG	6	10791440078458
PF7910	12	10791440077581	BF7997	12	10791440086678	BT8449-10	12	10791440060019	BT8880-MPG	6	10791440056180	BT9368-MPG	6	10791440078502
BF7911	12	10791440077987	BF7998	12	10791440086682	BT8450	12	10791440060101	PT8883	12	10791440064932	BT9369-MPG	6	10791440078519
BF7912	12	10791440078137	BT8301	12	10791440029078	BT8452	12	10791440060156	PT8884-MPG	12	10791440065090	BT9370-MPG	6	10791440078571
BF7913	6	10791440078151	BT8302	12	10791440038896	PT8453	4	10791440060347	PT8885-MPG	12	10791440065168	BT9371-MPG	6	10791440078724
BF7915	12	10791440078410	BT8304	12	10791440029092	BT8457-MPG	6	10791440060750	BT8886-MPG	6	10791440065199	PT9374	12	10791440078885
PF7916	12	10791440078533	BT8305	4	10791440029108	BT8459	12	10791440060880	PT8888	12	10791440065502	PT9375	4	10791440078939
BF7917	12	10791440078557	PT8306-10	12	10791440029115	BT8460	12	10791440062938	PT8889	4	10791440065601	PT9380-MPG	12	10791440079189
BF7919	12	10791440078816	PT8306-25	12	10791440029122	PT8461	6	10791440063973	BT8890-MPG	6	10791440065694	BT9382	12	10791440079295
BF7921	12	10791440078908	BT8307-MPG	6	10791440030463	PT8462-MPG	12	10791440061412	BT8892-MPG	6	10791440065748	PT9386-MPG	12	10791440079486
BF7922	12	10791440079004	BT8308-MPG	6	10791440030470	BT8463-MPG	6	10791440061559	PT8893	6	10791440065863	BT9387	6	10791440079912
BF7923	12	10791440079059	BT8312	6	10791440029139	BT8464	6	10791440061566	BT8898	12	10791440066231	BT9388	12	10791440079950
BF7924	12	10791440079257	BT8314	6	10791440029146	BT8465	6	10791440061573	BT8899	6	10791440066240	BT9391-MPG	6	10791440080062
BF7925	12	10791440079394	BT8316-MPG	12	10791440038902	PT8468	12	10791440061436	BT8900	12	10791440066301	BT9392-MPG	6	10791440080116
BF7927	12	10791440079158	PT8318-MPG	12	10791440029153	PT8470	12	10791440061467	BT8901-MPG	6	10791440066493	BT9393-MPG	6	10791440080123
PF7928	12	10791440079530	BT8319	12	10791440043159	BT8472	12	10791440061498	BT8902	12	10791440066646	PT9394-MPG	12	10791440080777
PF7930	6	10791440079684	BT8320	6	10791440029160	BT8473	12	10791440061504	BT8903	12	10791440066660	PT9395-MPG	6	10791440080765
BF7931	12	10791440079844	BT8323	12	10791440038919	BT8474	12	10791440061511	BT8904-MPG	6	10791440066677	PT9396	12	10791440080826
BF7932	6	10791440079851	BT8328	12	10791440038087	BT8475	12	10791440061528	BT8905	12	10791440067025	BT9398-MPG	6	10791440081489
PF7934 KIT	12	10791440080130	PT8329	12	10791440042923	BT8475-MPG	6	10791440073545	BT8906	6	10791440067124	BT9400-MPG	6	10791440082127
PF7935	12	10791440080215	PT8330-MPG	6	10791440038940	BT8476	6	10791440061535	PT8907-MPG	12	10791440067155	BT9402	12	10791440082141
PF7936	12	10791440080338	BT8333	6	10791440038957	BT8476-MPG	6	10791440069685	BT8908	12	10791440067223	PT9405	12	10791440082295
BF7937	12	10791440080390	PT8334	6	10791440043722	BT8477	6	10791440061542	BT8910-MPG	6	10791440067308	BT9408	12	10791440082639
PF7938	6	10791440080635	PT8335	6	10791440043173	BT8477-MPG	6	10791440073552	BT8911-MPG	6	10791440067315	PT9413-MPG	12	10791440083278
PF7939	12	10791440080857	PT8338	12	10791440043654	PT8481	12	10791440062631	PT8912	12	10791440067407	PT9414-MPG	12	10791440083698
BF7940	12	10791440080864	PT8339	12	10791440045894	PT8484	12	10791440061894	BT8913-MPG	12	10791440069678	PT9417	12	10791440083940
BF7941	12	10791440080871	PT8341	12	10791440043166	PT8485	12	10791440062051	BT8914	12	10791440069722	PT9418	12	10791440083971
BF7942	12	10791440080901	PT8344	12	10791440037578	BT8486	12	10791440062105	BT8916	12	1079			



**BALDWIN CASE TO I 2/5 (SHIPPING CASES)**

BALDWIN CASE NUMBER	CASE QTY.	I 2/5 NUMBER	BALDWIN CASE NUMBER	CASE QTY.	I 2/5 NUMBER	BALDWIN CASE NUMBER	CASE QTY.	I 2/5 NUMBER	BALDWIN CASE NUMBER	CASE QTY.	I 2/5 NUMBER	BALDWIN CASE NUMBER	CASE QTY.	I 2/5 NUMBER
BT9440	.....6	10791440090375	BF9851	.....12	10791440089324	PA10015	.....6	10791440100784	PA10135	.....6	10791440112503	PA10220	.....6	10791440111544
PT9441-MPG	.....6	10791440090665	BF9852	.....12	10791440089355	PA10016	.....6	10791440100890	PA10136	.....6	10791440112374	PA10221	.....6	10791440111537
BT9442-MPG	.....12	10791440091020	BF9857	.....12	10791440089485	PA10017	.....6	10791440100906	PA10137	.....6	10791440111865	PA10222	.....6	10791440111858
PT9444-MPG	.....6	10791440091068	BF9860	.....6	10791440090115	PA10018	.....6	10791440101002	PA10138	.....6	10791440113388	PA10223	.....6	10791440112183
PT9446	.....12	10791440091167	PF9861	.....12	10791440090146	PA10022	.....6	10791440103419	PA10139	.....6	10791440112930	PA10224	.....6	10791440112145
PT9447	.....12	10791440091174	PF9862	.....12	10791440090177	PA10023	.....6	10791440103617	PA10140	.....6	10791440113647	PA10227	.....6	10791440112787
PT9448	.....12	10791440091181	PF9863	.....12	10791440090184	PA10024	.....6	10791440103624	PA10141	.....6	10791440113289	PA10228	.....6	10791440111964
PT9449	.....12	10791440091198	BF9864	.....6	10791440090269	PA10025	.....6	10791440103631	PA10142	.....6	10791440112268	PA10229	.....6	10791440112961
PT9450-MPG	.....12	10791440091204	PF9865	.....12	10791440090283	PA10026	.....6	10791440103648	PA10143	.....6	10791440112084	PA10230	.....6	10791440113296
PT9453-MPG	.....4	10791440084497	BF9866-O	.....12	10791440090382	PA10027	.....6	10791440103655	PA10144	.....6	10791440113241	PA10231	.....6	10791440112992
BT9456	.....12	10791440091709	BF9867-O	.....12	10791440090443	PA10028	.....6	10791440103662	PA10145 KIT	.....6	10791440112213	PA10232	.....6	10791440112244
PT9462	.....12	10791440091822	PF9868	.....12	10791440090504	PA10030	.....6	10791440103686	PA10146	.....6	10791440113067	PA10233	.....6	10791440112367
PT9463	.....12	10791440091853	BF9869	.....12	10791440090641	PA10031	.....6	10791440103693	PA10147	.....6	10791440113432	PA10234	.....6	10791440113302
BT9464	.....12	10791440091846	PF9870	.....12	10791440090689	PA10032	.....6	10791440103709	PA10148	.....6	10791440113012	PA10235	.....6	10791440113036
BT9465	.....12	10791440091914	BF9871-O	.....12	10791440090795	PA10033	.....6	10791440103921	PA10149	.....6	10791440112916	PA10236	.....6	10791440113586
BT9466-MPG	.....6	10791440091969	PF9872	.....12	10791440091037	PA10036	.....6	10791440104379	PA10150	.....6	10791440114202	PA10237	.....6	10791440113524
PT9469	.....12	10791440092669	PF9873	.....12	10791440090993	PA10037	.....6	10791440104508	PA10152 KIT	.....6	10791440112756	PA10238	.....6	10791440113180
PT9470	.....12	10791440092676	BF9874-DM	.....12	10791440091034	PA10039	.....6	10791440105642	PA10153	.....6	10791440112718	PA10239	.....6	10791440113463
BT9471	.....12	10791440092805	BF9875-DM	.....12	10791440091047	PA10040	.....6	10791440105659	PA10154	.....6	10791440113281	PA10240	.....6	10791440113654
PT9473	.....6	10791440093284	BF9876	.....12	10791440091075	PA10041	.....6	10791440105666	PA10155	.....6	10791440114354	PA10241	.....6	10791440113135
S9475	.....12	10791440093468	BF9877	.....12	10791440091389	PA10042	.....6	10791440105673	PA10156	.....6	10791440114491	PA10242	.....6	10791440114477
PT9476-MPG	.....6	10791440093482	BF9878	.....12	10791440091556	PA10043	.....6	10791440105680	PA10157	.....6	10791440115252	PA10244	.....6	10791440114934
PT9532	.....6	10791440094380	PF9879	.....6	10791440091754	PA10044	.....6	10791440105741	PA10158	.....6	10791440115290	PA10245	.....6	10791440114415
PT9537-MPG	.....12	10791440095028	BF9880	.....12	10791440091761	PA10045	.....6	10791440105758	PA10159	.....6	10791440113281	PA10247	.....6	10791440115467
BT9553	.....12	10791440085494	BF9881	.....12	10791440091808	PA10046	.....6	10791440105765	PA10160	.....6	10791440112722	PA10248	.....6	10791440112572
PT9555	.....12	10791440085531	BF9883	.....12	10791440091860	PA10047	.....6	10791440107295	PA10161	.....6	10791440113562	PA10249	.....6	10791440113876
PT9558-MPG	.....6	10791440085814	BF9884	.....12	10791440091938	PA10057	.....6	10791440107882	PA10162	.....6	10791440114538	PA10250	.....6	10791440114484
BT9560-MPG	.....6	10791440086064	BF9885	.....6	10791440091945	PA10058	.....6	10791440108353	PA10163	.....6	10791440114033	PA10251	.....6	10791440115078
BT9561	.....12	10791440086194	BF9886	.....12	10791440091983	PA10059	.....6	10791440108360	PA10164	.....6	10791440112664	PA10253	.....6	10791440115092
P9600	.....12	10791440094441	BF9887	.....12	10791440092027	PA10060	.....6	10791440108452	PA10165	.....6	10791440114842	PA10254	.....6	10791440113692
P9601	.....12	10791440094564	BF9888	.....6	10791440092034	PA10062	.....6	10791440108629	PA10166	.....6	10791440113999	PA10255	.....6	10791440114040
P9602	.....12	10791440095004	PF9889	.....12	10791440092058	PA10063	.....6	10791440111322	PA10167	.....6	10791440114996	PA10256	.....6	10791440113050
P9603	.....12	10791440095011	PF9890	.....12	10791440092065	PA10064	.....6	10791440108711	PA10169	.....6	10791440115009	PA10258	.....6	10791440114798
P9604	.....12	10791440095066	BF9891-D	.....12	10791440092072	PA10066	.....6	10791440108933	PA10170 KIT	.....6	10791440114750	PA10259	.....6	10791440114705
P9605	.....12	10791440096575	BF9892-D	.....12	10791440092089	PA10067	.....6	10791440108957	PA10171	.....6	10791440112640	PA10260	.....6	10791440115108
P9606	.....12	10791440096612	BF9893	.....12	10791440092106	PA10069	.....6	10791440109039	PA10172	.....6	10791440114019	PA10261	.....6	10791440115276
P9607	.....12	10791440096629	BF9894	.....12	10791440092102	PA10070	.....6	10791440109046	PA10173	.....6	10791440115269	PA10263	.....6	10791440114408
BF9800	.....12	10791440086996	BF9895 KIT	.....6	10791440092300	PA10071	.....6	10791440109053	PA10174	.....6	10791440115450	PA10264	.....6	10791440113357
PF9801	.....12	10791440087009	PF9897	.....12	10791440092355	PA10072	.....6	10791440109060	PA10175 KIT	.....6	10791440115375	PA10265	.....6	10791440114330
BF9802	.....12	10791440087047	BF9898-O	.....12	10791440092379	PA10073	.....6	10791440109077	PA10176	.....6	10791440115382	PA10266	.....6	10791440114675
PF9803	.....12	10791440087085	PF9899	.....12	10791440092386	PA10075	.....6	10791440109282	PA10177	.....6	10791440115474	PA10267	.....6	10791440111889
PF9804	.....6	10791440087146	PF9900	.....12	10791440092393	PA10076	.....6	10791440109305	PA10178	.....6	10791440115337	PA10268	.....6	10791440113470
BF9805	.....12	10791440087177	PF9901 KIT	.....12	10791440092430	PA10077	.....6	10791440109336	PA10179	.....6	10791440113609	PA10269	.....6	10791440112749
BF9807	.....12	10791440087320	PF9902	.....12	10791440092515	PA10078	.....6	10791440109343	PA10180 KIT	.....6	10791440115122	PA10270	.....6	10791440111803
BF9808-D	.....12	10791440087337	BF9903-SP	.....12	10791440092522	PA10081	.....6	10791440109527	PA10181	.....6	10791440112022	PA10271	.....6	10791440114286
BF9809-D	.....12	10791440087368	BF9904	.....12	10791440092577	PA10082	.....6	10791440109596	PA10182	.....6	10791440115016	PA10272	.....6	10791440113616
BF9810-D	.....12	10791440087375	BF9905	.....12	10791440092744	PA10083	.....6	10791440109598	PA10183	.....6	10791440114699	PA10273	.....6	10791440113739
BF9811-SP	.....12	10791440087412	BF9906	.....12	10791440092898	PA10084	.....6	10791440109633	PA10185	.....6	10791440115177	PA10275	.....6	10791440111728
BF9812	.....12	10791440087504	PF9907	.....12	10791440092997	PA10085	.....6	10791440109657	PA10186 KIT	.....6	10791440113852	PA10276	.....6	10791440111773
BF9813	.....12	10791440087511	BF9910	.....12	10791440093208	PA10086	.....6	10791440110301	PA10188	.....6	10791440114835	PA10277	.....6	10791440112046
PF9814	.....12	10791440087528	PF9911	.....12	10791440093246	PA10087	.....6	10791440110356	PA10189	.....6	10791440114774	PA10278	.....6	10791440111513
BF9815	.....12	10791440087580	BF9912-O	.....12	10791440093475	PA10088	.....6	10791440109886	PA10190	.....6	10791440114927	PA10279	.....6	10791440111766
BF9816	.....12	10791440087603	BF9913	.....12	10791440093505	PA10089	.....6	10791440109909	PA10191 KIT	.....6	10791440113531	PA10280	.....6	10791440111797
BF9817	.....12	10791440087634	PF9914 KIT	.....6	10791440093574	PA10090	.....6	10791440109916	PA10193 KIT	.....6	10791440113920	PA10281	.....6	10791440111933
BF9818	.....12	10791440087641	BF9915	.....12	10791440093581	PA10091	.....6	10791440109992	PA10194	.....6	10791440113708	PA10282	.....6	10791440112312
BF9820	.....12	10791440087665	PF9916	.....12	10791440093659	PA10093	.....6	10791440110066	PA10195 KIT	.....6	10791440112190	PA10283	.....6	10791440111896
BF9821	.....12	10791440087689	BF9917	.....12	10791440093772	PA10094	.....6	10791440110073	PA10196 KIT	.....6	10791440114224	PA10284	.....6	10791440112176
BF9822-D	.....12	10791440087702	BF9918 KIT	.....6	10791440093796	PA10095	.....6	10791440110080	PA10197	.....6	10791440111268	PA10285	.....6	10791440111988
PF9823	.....12	10791440087719	PF9919	.....12	10791440094496	PA10096	.....6	10791440110363	PA10198 KIT	.....6	10791440112628	PA10286	.....6	10791440112275
PF9824	.....12	10791440087733	BF9920	.....6	10791440094601	PA10097	.....6	10791440110684	PA10199 KIT	.....6	10791440112848	PA10288	.....6	10791440112091
PF9825	.....12	10791440087740	BF9921-O	.....12	10791440094694	PA10098	.....6	10791440110707	PA10200	.....6	10791440114392	PA10289	.....6	10791440112435
PF9826	.....12	10791440087757	BF9922-O	.....12	10791440094755	PA10099	.....6	10791440110714	PA10201	.....6	10791440113029	PA10291	.....6	10791440111834
BF9827-D	.....12	10791440087924	BF9923-O	.....12	10791440094953	SA10100	.....12	10791440110790	PA10202	.....6	10791440114088	PA10292	.....6	10791440112008
BF9828-D	.....12	10												

# BALDWIN CASE TO I 2/5 (SHIPPING CASES)

BALDWIN NUMBER	CASE QTY.	I 2/5 NUMBER	BALDWIN NUMBER	CASE QTY.	I 2/5 NUMBER	BALDWIN NUMBER	CASE QTY.	I 2/5 NUMBER	BALDWIN NUMBER	CASE QTY.	I 2/5 NUMBER	BALDWIN NUMBER	CASE QTY.	I 2/5 NUMBER
PA10309	6	10791440112817	PA10401	6	10791440115597	20037	6	10791440112411	PA30052	6	10791440097374	P40025	12	10791440103730
PA10310	6	10791440112350	PA10402	6	10791440115610	20041	6	10791440114262	PA30053	6	10791440097381	BD40027	6	10791440104553
PA10311	6	10791440112725	PA10403	6	10791440115689	20042	6	10791440112596	PA30054	6	10791440097398	BT40028	12	10791440105024
PA10312	6	10791440113333	PA10404	6	10791440115917	20043	6	10791440111827	PA30055	6	10791440097404	BT40029	12	10791440105215
PA10313	6	10791440113548	PA10407	6	10791440116075	20044	6	10791440113791	PA30056	6	10791440097411	P40030	12	10791440105031
PA10314	6	10791440113937	PA10409	6	10791440116150	20045	6	10791440112329	PA30072	6	10791440098173	P40031-MPG	6	10791440105079
PA10315	6	10791440113838	PA10411	6	10791440116327	20046	6	10791440114569	PA30080	6	10791440100593	BT40032	12	10791440105284
PA10316	6	10791440113074	PA10412	6	10791440116334	20048	6	10791440111414	PA30086	6	10791440100777	P40033	12	10791440105383
PA10317	6	10791440113890	PA10414	6	10791440116419	20050	6	10791440114583	PA30093	6	10791440100883	BT40034	12	10791440105468
PA10318	6	10791440114613	CV15000	4	10791440084039	20051	6	10791440114064	PA30115	6	10791440103402	P40035	12	10791440105697
PA10319	6	10791440114811	CV15001	12	10791440089850	20052	6	10791440112107	PA30126	6	10791440103945	B40036	12	10791440105703
PA10320	6	10791440112138	CV15003	12	10791440093567	20053	6	10791440113418	PA30138	12	10791440104133	P40037	12	10791440105772
PA10321	6	10791440114965	CV15005	6	10791440104690	20054	6	10791440111681	PA30139	12	10791440104140	BT40038	12	10791440105789
PA10323	6	10791440114606	CV15007	6	10791440109015	20055	6	10791440114132	PA30140	6	10791440104157	P40042	6	10791440107202
PA10324	6	10791440112855	CV15008	6	10791440109022	20057	6	10791440115436	PA30141	6	10791440104163	B40050	12	10791440107455
PA10325	6	10791440112923	CV15011	6	10791440110332	20058	6	10791440112985	RS30142	6	10791440104973	B40051	12	10791440107462
PA10326	6	10791440114156	PE17000	12	10791440105512	20060	6	10791440113869	PA30144	6	10791440104171	P40052	12	10791440107684
PA10327	6	10791440114552	PE17001	12	10791440106915	20061	6	10791440113753	PA30151	6	10791440104386	B40053	6	10791440107738
PA10328	6	10791440115191	18002	6	10791440047881	20062	6	10791440113760	PA30152	6	10791440105727	B40054	12	10791440107745
PA10329	6	10791440114590	18004	6	10791440047904	20063	12	10791440112824	PA30153	12	10791440104447	B40056	12	10791440107844
PA10330	6	10791440115412	18007	6	10791440047935	20064	6	10791440113623	PA30154	6	10791440104453	P40058	12	10791440108223
PA10331	6	10791440114507	18009	6	10791440047959	20065	6	10791440113913	PA30157	12	10791440104485	PA0061	12	10791440108575
PA10332	6	10791440115344	18010	6	10791440047966	20066	6	10791440114248	PA30174	6	10791440105048	B40063	6	10791440110493
PA10333	6	10791440115399	18013	6	10791440047997	20067	6	10791440112770	PA30177	6	10791440105086	BT40065	12	10791440108889
PA10334	6	10791440115405	18022	6	10791440051352	20068	6	10791440115221	PA30179	6	10791440105123	BT40066-MPG	6	10791440109374
PA10335	6	10791440114125	18024	6	10791440051345	20069	6	10791440114071	PA30185	6	10791440105475	B40070	12	10791440109749
PA10337	6	10791440115139	18025	6	10791440051338	20070	6	10791440116099	PA30188	6	10791440105536	SA0071	12	10791440109770
PA10340	6	10791440115429	18027	6	10791440051376	BW21000	12	10791440097480	PA30189	6	10791440105567	B40073	12	10791440110578
PA10341	6	10791440114255	18029	6	10791440052755	PT23122	12	10791440097800	PA30190	6	10791440105574	P40074	6	10791440110943
PA10342	6	10791440115498	18032	6	10791440055725	PT23123	12	10791440097816	PA30204	12	10791440108605	PA0076	12	10791440111056
PA10343	6	10791440114644	18033	6	10791440056203	PT23124	12	10791440097831	PA30249	6	10791440111339	OB40078	12	10791440112947
PA10344	6	10791440114910	18034	6	10791440056210	PT23125-MPG	12	10791440097848	PA30251	6	10791440108865	OB40079	12	10791440112053
PA10345	6	10791440114149	18055	6	10791440059754	PT23126-MPG	12	10791440097855	PA30252	6	10791440108919	PA0081	12	10791440113227
PA10346	6	10791440112343	18056	6	10791440059761	PT23127-MPG	12	10791440097862	PA30255	6	10791440110103	P40083	12	10791440111841
PA10352	6	10791440112886	18057	6	10791440059778	PT23128-MPG	12	10791440097879	PA30260	6	10791440109541	PA0085	12	10791440115184
PA10353	6	10791440115160	18104	6	10791440029986	PT23129-MPG	12	10791440097886	PA30261	6	10791440109558	PA0086	12	10791440113197
PA10354	6	10791440113142	18139	6	10791440030012	PT23132-MPG	12	10791440097916	PA30262	6	10791440109565	PA0089	12	10791440112626
PA10355	6	10791440112534	18155	6	10791440030036	PT23136	12	10791440097787	PA30263	6	10791440110370	PA0090	12	10791440112800
PA10356	6	10791440114095	18171	6	10791440030050	PT23137	6	10791440097824	PA30269	12	10791440109978	PA0091	12	10791440114101
PA10357	6	10791440114897	18198	6	10791440030074	BT23525-MPG	12	10791440103426	PA30270	6	10791440109961	PA0093	12	10791440113456
PA10358	6	10791440113265	18236	6	10791440030111	PT23527	12	10791440103532	PA30272	6	10791440110455	PA0094	12	10791440111520
SA10359	12	10791440113593	18245	6	10791440030128	PT23536	12	10791440104331	PA30276	6	10791440109947	PA0095	12	10791440111810
SA10360	12	10791440114651	18264	6	10791440060378	BT23543-MPG	6	10791440104782	PA30277	6	10791440110028	PA0096	12	10791440114736
SA10361	12	10791440113081	18265	6	10791440060385	PT23544-MPG	12	10791440104799	PA30279	6	107914401110158	PA0098	12	10791440114439
PA10362	6	10791440111445	18267	6	10791440060453	BT23555-MPG	6	10791440105222	PA30281	6	10791440110462	PA0099	12	10791440112039
PA10363	6	10791440111469	18268	6	10791440039145	PT23560	6	10791440105628	PA30287	6	10791440110783	PA0100	12	10791440111490
PA10364	6	10791440111483	19593	6	10791440030241	PT23561-MPG	12	10791440106793	PA30299	6	10791440111148	PA0101	12	10791440114385
PA10365 KIT	6	10791440112527	19828	6	10791440030340	PT23592	6	10791440107301	PA30301	6	10791440113661	PA0102	12	10791440111940
PA10367	6	10791440111650	19992	6	10791440030449	PT23597-MPG	12	10791440107776	PA30302	12	10791440114231	PA0103	12	10791440111568
PA10368	6	10791440113210	19996	6	10791440064550	BT23603-MPG	6	10791440107769	PA30303	6	10791440114958	PA0104	12	10791440111438
PA10369	6	10791440111780	19999	6	10791440064581	BT23604	12	10791440107783	PA30304	6	10791440111360	PA0105	12	10791440111407
PA10370 KIT	6	10791440114460	20000	6	10791440064598	BT23605-MPG	6	10791440107813	PA30310	6	107914401115702	PA0106	12	10791440112077
PA10372	6	10791440113883	20002	6	10791440064611	BT23607-MPG	6	10791440107875	PA30324	6	10791440115894	PA0107	12	10791440111582
PA10373	6	10791440113203	20003	6	10791440065762	BT23611	12	10791440108506	PA30325	6	10791440115900	PA0108	12	10791440112114
PA10375	6	10791440112978	20004	6	10791440065793	BT23617	12	10791440109572	PA30329	6	10791440116051	PA0109	12	10791440111971
PA10376	6	10791440112169	20005	6	10791440067377	BT23619-MPG	6	10791440110677	PA30330	6	10791440116082	PA0110	12	10791440112299
PA10378	6	10791440112060	20006	6	10791440077789	BT23628	12	10791440111247	PA30331	6	10791440116372	PA0111	12	10791440111575
PA10379	6	10791440111704	20007	6	10791440077796	PT23629	12	10791440111261	PA30332	6	10791440116396	PA0112	12	10791440111674
PA10380	6	10791440111957	20008	6	10791440077802	BT23630	12	10791440111629	B40000	12	10791440096728	PA0113	12	10791440114746
PA10381	6	10791440115504	20010	6	10791440077826	BT23631	12	10791440111452	P40001	12	10791440096735	PA0114	12	10791440111599
PA10382	6	10791440113906	20011	6	10791440077833	PT23633	6	10791440114866	PA0002	12	10791440097954	PA0115	12	10791440112459
PA10383	6	10791440112541	20012	6	10791440077857	PA30007	6	10791440096803	PA0003	12	10791440098619	PA0116	12	10791440111506
PA10384	6	10791440114637	20013	6	10791440078069	PA30011	6	10791440096957	C40005	12	10791440097986	PA0117	12	10791440114620
PA10385	6	10791440113104	20014	6	10791440080383	PA30012	6	10791440096964	B40006	12	10791440098961	PA0118	12	10791440114170
PA10386	6	10791440113814	20015	6	10791440081670	PA30014	12	10791440096988	BC40007	12	10791440098209	PA0119	12	10791440111569
PA10387	6	10791440112602												

**BALDWIN CASE TO I 2/5 (SHIPPING CASES)**

BALDWIN CASE NUMBER	CASE QTY.	I 2/5 NUMBER	BALDWIN CASE NUMBER	CASE QTY.	I 2/5 NUMBER	BALDWIN CASE NUMBER	CASE QTY.	I 2/5 NUMBER	BALDWIN CASE NUMBER	CASE QTY.	I 2/5 NUMBER	BALDWIN CASE NUMBER	CASE QTY.	I 2/5 NUMBER	BALDWIN CASE NUMBER	CASE QTY.	I 2/5 NUMBER
B40138	.....6	10791440115726	BF46048	.....12	10791440104034	BF46125	.....12	10791440108728	BF46203	.....12	10791440113685	301-30	.....4	10791440036960			
BD40139	.....6	10791440115962	PF46049	.....12	10791440104546	PF46126	.....12	10791440108742	BF46204	.....12	10791440114903	301-CS	.....4	10791440036977			
B40140	.....12	10791440116181	BF46050	.....12	10791440104300	BF46127	.....12	10791440108827	BF46205	.....12	10791440113159	301-W	.....4	10791440036984			
B40142	.....6	10791440116358	BF46051	.....12	10791440104348	BF46128-D	.....6	10791440108964	BF46206	.....12	10791440113975	501	.....4	10791440037059			
B40145	.....6	10791440116686	BF46052	.....12	10791440104393	BF46129	.....6	10791440108995	BF46207	.....12	10791440112732	501-30	.....4	10791440037066			
B40150	.....12	10791440116921	PF46056	.....12	10791440104706	PF46130	.....12	10791440109152	BF46208	.....12	10791440113715	501-W	.....4	10791440037073			
BF45000	.....12	10791440098298	PF46057	.....12	10791440104716	BF46131	.....6	10791440109190	BF46209	.....12	10791440112398	PKG490-BANK	12	10791440065946			
BF46000	.....12	10791440096704	PF46059	.....12	10791440104737	PF46135	.....6	10791440109299	BF46210	.....12	10791440113746	38557P	.....24	10857123005217			
BF46001	.....12	10791440096711	BF46062	.....6	10791440104775	PF46137	.....12	10791440109398	BF46211	.....12	10791440113944	38559P	.....24	10857123005057			
PF46003	.....12	10791440096841	BF46064-D	.....6	10791440110875	PF46138	.....12	10791440109411	BF46212	.....12	10791440113555	38560P	.....12	20857123005061			
PF46004	.....12	10791440096858	BF46065-SPS	.....12	10791440105604	PF46140	.....12	10791440110448	BF46215	.....12	10791440112510	38561P	.....6	30857123005075			
BF46005	.....12	10791440096896	BF46069	.....12	10791440105192	BF46141	.....12	10791440109589	BF46216	.....12	10791440113111	38564P	.....24	10857123005002			
BF46006	.....12	10791440097497	PF46071	.....12	10791440105239	PF46142	.....6	10791440109619	BF46217	.....12	10791440111872	38565P	.....12	20857123005016			
BF46007	.....12	10791440097503	BF46072	.....12	10791440105246	BF46143	.....12	10791440109626	BF46218	.....12	10791440111742	38566P	.....6	30857123005020			
BF46008	.....12	10791440097510	BF46073	.....12	10791440105291	PF46145	.....6	10791440109725	BF46219	.....12	10791440114187	38574P	.....12	20857123005108			
PF46009	.....12	10791440097527	PF46076	.....12	10791440105611	BF46147-O	.....12	10791440109787	BF46220	.....12	10791440114804	43562P	.....24	10857123005132			
BF46012	.....12	10791440097558	PF46077	.....12	10791440105710	BF46149-SP	.....12	10791440109848	BF46221	.....12	10791440113951	43564P	.....12	20857123005146			
BF46013	.....12	10791440097565	BF46078-D	.....12	10791440105796	BF46150-O	.....6	10791440109893	BF46222	.....12	10791440115283	43566P	.....12	40857123005157			
BF46014	.....12	10791440097640	PF46080	.....6	10791440105833	PF46151	.....12	10791440109954	BF46223	.....12	10791440114446	43568P	.....24	10857123005163			
BF46015	.....12	10791440097589	PF46081	.....12	10791440105840	PF46152	.....12	10791440116402	BF46224	.....12	10791440113128	43570P	.....12	20857123005177			
BF46016-O	.....12	10791440097633	PF46082	.....12	10791440105857	BF46161	.....12	10791440110219	BF46225	.....12	10791440113425	43572P	.....6	30857123005181			
BF46017-O	.....12	10791440097640	BF46083-O	.....6	10791440106755	BF46162-O	.....12	10791440110400	BF46227	.....12	10791440115566	38557C	.....24	10857123005196			
BF46018-O	.....12	10791440097657	BF46084	.....12	10791440106878	BF46163-O	.....12	10791440110424	BF46228	.....12	10791440115733	38559C	.....24	10857123005416			
BF46019-O	.....12	10791440097664	BF46085	.....12	10791440107189	BF46164-O	.....12	10791440110431	BF46229	.....12	10791440115870	38560C	.....12	20857123005429			
BF46020-O	.....12	10791440097671	PF46087	.....12	10791440107288	BF46169-O	.....12	10791440110653	BF46233	.....12	10791440116044	38561C	.....6	30857123005433			
BF46021-O	.....12	10791440097688	PF46088	.....12	10791440107318	BF46170	.....12	10791440110660	PF46235	.....12	10791440116105	38564C	.....24	10857123005309			
BF46022-O	.....12	10791440097695	PF46091	.....6	10791440107356	PF46171	.....6	10791440110745	PF46236	.....6	10791440116112	38565C	.....12	20857123005313			
BF46023-O	.....12	10791440097701	PF46092	.....6	10791440108490	BF46173-O	.....6	10791440110899	PF46237	.....6	10791440116129	38566C	.....6	30857123005327			
BF46024-O	.....12	10791440097718	PF46094	.....6	10791440107394	BF46175	.....12	10791440110981	PF46238	.....12	10791440116136	38574C	.....12	20857123005467			
BF46025-O	.....12	10791440097725	BF46098-O	.....6	10791440107363	BF46176	.....6	10791440111162	BD50000	.....6	10791440105093	43562C	.....24	10857123005491			
BF46026-O	.....12	10791440097732	BF46099-O	.....6	10791440107387	BF46179	.....6	10791440111193	BF63000	.....12	10791440104836	43564C	.....12	20857123005504			
BF46027-O	.....12	10791440097749	BF46100-O	.....6	10791440107370	BF46181-O	.....6	10791440111254	OAS98000	.....12	10791440096960	43566C	.....12	40857123005515			
BF46028-O	.....12	10791440097756	BF46101-O	.....6	10791440107400	BF46182-O	.....12	10791440111353	OAS99035	.....12	10791440074788	43568C	.....24	10857123005552			
BF46029-O	.....12	10791440097763	PF46103	.....12	10791440107707	FB46183	.....12	10791440111902	G183	.....10	10791440002262	43570C	.....12	20857123005566			
BF46030-O	.....12	10791440097770	BF46104	.....12	10791440108117	PF46186	.....12	10791440115320	61	.....12	10791440034935	43572C	.....6	30857123005570			
BF46031	.....12	10791440098050	BF46105-O	.....6	10791440108131	PF46187	.....12	10791440114057	61-W	.....12	10791440034942	38557S	.....24	10857123005668			
BF46032	.....12	10791440098104	PF46106	.....6	10791440108148	PF46188	.....12	10791440115245	66	.....12	10791440034980	38564S	.....24	10857123005354			
PF46033	.....12	10791440098203	PF46108	.....12	10791440108162	PF46189	.....12	10791440113272	66-30	.....12	10791440065854	38565S	.....12	20857123005368			
BF46034	.....12	10791440098975	BF46109-O	.....6	10791440108186	BF46192	.....12	10791440114767	66-W	.....12	10791440034997	38566S	.....6	30857123005372			
BF46037	.....12	10791440100920	BF46111	.....12	10791440108254	BF46193	.....12	10791440113319	101	.....18	10791440035574	43562S	.....24	10857123005501			
BF46038-D	.....12	10791440100982	PF46112	.....12	10791440104492	BF46194	.....12	10791440111605	101-30	.....18	10791440001371	43564S	.....12	20857123005535			
BF46039-D	.....12	10791440100999	BF46113-D	.....12	10791440108315	BF46195	.....12	10791440112893	101-W	.....18	10791440035598	43566S	.....12	40857123005546			
BF46040-D	.....12	10791440102467	BF46116 KIT	.....6	10791440108582	BF46196	.....12	10791440114989	151	.....18	10791440035918	43568S	.....24	10857123005606			
BF46041-D	.....12	10791440103358	BF46117	.....6	10791440108469	BF46197	.....12	10791440115146	151-30	.....18	10791440035925	43570S	.....12	20857123005610			
BF46042-D	.....6	10791440103365	PF46118	.....12	10791440108476	BF46198	.....12	10791440114194	151-W	.....18	10791440035932	43572S	.....6	30857123005624			
BF46043-D	.....6	10791440103372	PF46119	.....12	10791440108483	BF46199	.....12	10791440115030	201	.....8	10791440036465						
BF46044-D	.....12	10791440103440	BF46122	.....12	10791440109602	BF46200	.....12	10791440114453	201-30	.....8	10791440036472						
BF46045-D	.....12	10791440103846	BF46123-O	.....6	10791440108698	BF46201	.....12	10791440114521	201-W	.....8	10791440036496						
PF46046	.....12	10791440103969	BF46124-O	.....6	10791440108704	BF46202	.....12	10791440115047	301	.....4	10791440036953						

NOTES

# I 2/5 TO BALDWIN CASE (SHIPPING CASES)

I 2/5 NUMBER	CASE QTY.	BALDWIN NUMBER	I 2/5 NUMBER	CASE QTY.	BALDWIN NUMBER	I 2/5 NUMBER	CASE QTY.	BALDWIN NUMBER	I 2/5 NUMBER	CASE QTY.	BALDWIN NUMBER	I 2/5 NUMBER	CASE QTY.	BALDWIN NUMBER
ITFCODE	CaseQty	BDW#	10791440001128	12	PT88-HD	10791440002156	12	P171	10791440003139	12	B253	10791440004112	12	BT353
10791440000015	12	B2	10791440001135	12	PT89	10791440002163	12	P172	10791440003153	12	B255	10791440004129	12	BT354
10791440000022	12	B2-HPG	10791440001142	12	PT90-10	10791440002170	12	B173-S	10791440003160	12	PT256	10791440004136	12	BT355
10791440000046	12	B4	10791440001159	12	PT90-MPG	10791440002187	12	P174	10791440003177	12	PT257	10791440004143	12	P356
10791440000053	12	B5	10791440001166	12	PT91	10791440002200	12	P176	10791440003184	12	PT258	10791440004150	12	BT357
10791440000060	12	B6	10791440001180	12	PT93	10791440002217	12	P177	10791440003191	12	BT259	10791440004167	12	B358
10791440000077	12	B6-HPG	10791440001197	12	PT93-MPG	10791440002224	12	B178	10791440003207	12	BT260	10791440004174	6	BT359
10791440000084	12	B7	10791440001210	6	B95	10791440002231	12	B179	10791440003214	12	BT260-10	10791440004181	12	B360
10791440000091	12	B9	10791440001241	6	B95-MPG	10791440002262	10	G183	10791440003221	12	BT261	10791440004198	12	BT361
10791440000107	6	B10-AL	10791440001258	6	B96	10791440002279	12	P183	10791440003238	12	B262	10791440004211	12	BT364
10791440000114	6	B10-AL BOWL	10791440001289	6	B96-MPG	10791440002293	12	P184	10791440003245	12	B263	10791440004228	12	BT365
10791440000121	6	B10-AL CAP	10791440001296	6	B97	10791440002309	12	PT185	10791440003252	12	BT264	10791440004235	12	BT365-10
10791440000138	12	PF10	10791440001302	6	PT98-10	10791440002316	12	P186	10791440003269	12	PT265	10791440004242	12	BT366-10
10791440000145	12	PF10-CS	10791440001319	6	PT98-MPG	10791440002323	12	P187	10791440003276	12	P266	10791440004259	12	BT367
10791440000152	12	PT11	10791440001326	6	B99	10791440002347	12	PT189	10791440003283	12	BT267	10791440004266	12	BT367-S
10791440000169	12	PT11-HD	10791440001333	6	B99-B	10791440002354	12	PT189-MPG	10791440003290	12	PT268	10791440004273	12	BT368
10791440000176	12	PT12	10791440001357	6	B99-MPG	10791440002361	12	P190	10791440003306	12	PT269	10791440004280	12	B369
10791440000183	12	BF13	10791440001371	18	101-30	10791440002385	6	PT191-10	10791440003320	12	P271	10791440004297	4	PT370
10791440000190	12	P15	10791440001388	12	P102	10791440002446	6	P194	10791440003344	12	PT273	10791440004303	12	BT371-10
10791440000206	12	S16-1	10791440001395	6	BD103	10791440002453	6	P194-HD	10791440003351	12	BT274	10791440004310	12	BT371-MPG
10791440000237	12	P18	10791440001401	12	P104	10791440002460	6	P194-HD10	10791440003368	12	PT275	10791440004327	12	BT372-10
10791440000244	12	P18-HD	10791440001418	6	B105	10791440002477	6	PF194	10791440003375	12	PT275-10	10791440004334	12	PT373
10791440000251	12	P19	10791440001425	12	P106	10791440002484	12	B195	10791440003382	12	P276	10791440004341	12	PT374
10791440000268	12	P20-HD	10791440001432	12	PT106-HD	10791440002491	6	P196	10791440003405	12	PT277	10791440004358	12	PT375
10791440000336	12	P25	10791440001456	12	PT108	10791440002514	12	P198	10791440003412	12	B279	10791440004365	12	PT376
10791440000343	12	P26	10791440001463	12	PT108-HD	10791440002521	12	B199	10791440003429	12	P280	10791440004372	12	PT377
10791440000350	12	B27	10791440001470	12	B109	10791440002545	12	B201-S	10791440003436	12	B281	10791440004389	12	PT377-10
10791440000367	12	BD28	10791440001487	12	BC110	10791440002552	12	B202	10791440003467	12	PT283	10791440004396	12	B378
10791440000374	12	PT29	10791440001494	12	BT111	10791440002569	12	P203	10791440003474	12	PT284	10791440004402	12	B378-10
10791440000398	12	B30	10791440001500	12	BT112	10791440002576	12	PT203-HD	10791440003481	6	PT285	10791440004419	6	PT379 KIT
10791440000404	12	B31	10791440001517	12	B113	10791440002583	12	P203-HD10	10791440003498	6	BT287	10791440004433	12	PT381
10791440000428	12	B33	10791440001524	12	B114	10791440002590	12	P204	10791440003504	6	BT287-10	10791440004440	12	PT382
10791440000435	12	B34	10791440001531	12	PT115	10791440002606	12	P204-HD	10791440003511	12	PT288-HD	10791440004457	12	PT383
10791440000442	12	B35-S	10791440001555	6	PF116	10791440002613	12	P204-HD10	10791440003528	12	PT288-HD10	10791440004464	12	PT385
10791440000466	6	AFG37R	10791440001562	6	PT117	10791440002620	6	B205	10791440003535	12	PT289	10791440004471	12	PT385-E
10791440000473	12	B37	10791440001579	6	PT117-25	10791440002637	12	P206	10791440003542	12	PT289-10	10791440004488	12	PT386
10791440000480	6	AFG38D	10791440001586	12	B118	10791440002644	12	PT207	10791440003559	12	PT290	10791440004495	6	BT387
10791440000503	12	B39	10791440001647	12	B120	10791440002651	12	PT207-10	10791440003573	12	BT292	10791440004501	6	BT387-10
10791440000510	12	P40	10791440001654	12	PF121	10791440002668	12	PT207-HD	10791440003597	12	P294	10791440004518	6	BT388
10791440000527	12	P41	10791440001685	12	BT124	10791440002675	12	PT207-HD10	10791440003603	12	B295	10791440004525	6	BT388-10
10791440000534	12	P42	10791440001692	12	P125	10791440002682	6	PT208	10791440003610	12	B296	10791440004532	6	BT389
10791440000541	12	B43-S	10791440001708	12	BT126	10791440002699	12	PT210	10791440003627	12	PT298-10	10791440004549	6	BT389-10
10791440000555	12	B45	10791440001715	12	B128	10791440002705	12	B211	10791440003634	12	B299	10791440004556	12	PT390-MPG
10791440000589	12	P47	10791440001722	12	B129	10791440002729	12	PT213	10791440003641	12	T300-M	10791440004563	12	PT391-MPG
10791440000596	12	PT48	10791440001746	12	B131	10791440002736	12	PT214(2)	10791440003658	12	B301	10791440004570	12	PT392
10791440000602	6	B49	10791440001753	12	B132	10791440002743	12	BT125	10791440003665	12	PT302	10791440004587	12	PT393
10791440000619	12	B50	10791440001760	7	C133-OW	10791440002750	12	BT216	10791440003672	12	T303-M	10791440004594	6	PT394-15
10791440000633	12	P52	10791440001777	7	C133-W	10791440002767	12	BT217	10791440003689	12	PT304	10791440004600	12	BT395
10791440000640	12	P53	10791440001784	12	B134	10791440002774	12	B218	10791440003702	12	B307	10791440004617	12	PT396
10791440000657	12	P54	10791440001791	12	PT135	10791440002798	6	B220	10791440003719	12	T308-M	10791440004624	4	PT397
10791440000671	12	B56	10791440001814	12	PT137	10791440002804	12	BT221	10791440003726	12	B309	10791440004631	12	BT398
10791440000718	12	P60	10791440001821	12	PT138-10	10791440002811	12	B222	10791440003733	12	PF311	10791440004648	6	PT400
10791440000725	12	PT61-HD	10791440001838	12	PT138-25	10791440002828	12	BT223	10791440003740	12	PF312	10791440004655	6	PT401-MPG
10791440000732	12	PT62	10791440001845	12	PT139-10	10791440002835	12	PF224	10791440003757	12	PF313	10791440004662	12	BT402
10791440000749	12	PT63-1	10791440001852	12	P140	10791440002859	12	PF225	10791440003764	12	PF314	10791440004679	12	B403
10791440000770	12	PT66-HD	10791440001869	12	B141	10791440002873	12	PF226	10791440003771	6	PF316	10791440004686	6	B404
10791440000787	12	P67	10791440001876	12	BD142	10791440002880	12	B227	10791440003856	6	BD324	10791440004693	12	JC405
10791440000794	12	P68	10791440001883	12	B143	10791440002897	12	B228	10791440003863	12	B326	10791440004709	12	CU406
10791440000817	12	PT70	10791440001890	12	P144	10791440002903	12	B229	10791440003887	12	B329	10791440004716	6	DF408
10791440000831	12	PT71	10791440001906	12	PT146	10791440002910	12	BT230	10791440003894	12	BF330	10791440004846	12	TC413-CPE5
10791440000855	12	PT72	10791440001920	12	P148	10791440002927	12	PF231	10791440003900	12	PF332	10791440004860	4	V414-B
10791440000879	12	PT73	10791440001944	12	P150	10791440002934	12	B233	107914400					

## I 2/5 TO BALDWIN CASE (SHIPPING CASES)

UPC NUMBER	CASE QTY.	BALDWIN NUMBER	UPC NUMBER	CASE QTY.	BALDWIN NUMBER	UPC NUMBER	CASE QTY.	BALDWIN NUMBER	UPC NUMBER	CASE QTY.	BALDWIN NUMBER	UPC NUMBER	CASE QTY.	BALDWIN NUMBER
10791440005072	6	BT425	10791440006147	6	P529	10791440007434	6	PA658	10791440008639	6	BF799	10791440009704	12	BF885
10791440005089	12	PT426	10791440006185	6	PT534	10791440007472	6	PA662	10791440008677	12	PF802	10791440009711	12	BF886
10791440005096	12	BT427	10791440006192	12	PT535	10791440007519	6	PA669	10791440008691	12	PF804	10791440009728	12	BF888
10791440005119	4	V429-B	10791440006208	12	BT536	10791440007526	12	PT670	10791440008707	12	BF805	10791440009742	12	BF890
10791440005126	4	V429-FF	10791440006215	6	P537	10791440007533	12	PT670-E	10791440008714	12	BF806	10791440009759	12	BF891
10791440005133	6	PT430-FF	10791440006222	12	PT538	10791440007564	6	PA675	10791440008721	12	PF807	10791440009766	12	BF892
10791440005140	12	PT431	10791440006246	12	P540	10791440007588	6	PA677	10791440008745	12	PF809	10791440009773	12	PF893
10791440005157	12	PT433	10791440006260	12	BT541	10791440007595	6	PA678	10791440008752	12	PF810	10791440009780	12	PF893-RV
10791440005164	12	PT434	10791440006284	6	PT543 KIT	10791440007601	6	PA680	10791440008769	12	PF811	10791440009797	12	PF894
10791440005171	12	PT434-10	10791440006307	12	P545	10791440007618	12	PT685-MPG	10791440008776	12	BF812	10791440009803	12	PF894-RV
10791440005188	12	PT435	10791440006314	12	PT546	10791440007625	6	PA691	10791440008790	12	PF814	10791440009827	12	BF896
10791440005195	12	PT436	10791440006321	6	PT548	10791440007632	6	PA693	10791440008813	12	PF816	10791440009841	12	SF898
10791440005201	12	PT437	10791440006338	12	PT549	10791440007663	6	PA696	10791440008820	12	PF816-S	10791440009858	12	PF899
10791440005218	12	BT438	10791440006345	6	PT550-10	10791440007670	6	PA697	10791440008844	12	PF818	10791440009865	12	BF900
10791440005225	12	PT439	10791440006376	12	PT554	10791440007687	6	PA699	10791440008851	12	PF819	10791440009892	12	PF902
10791440005232	12	BT440	10791440006383	12	P555	10791440007724	4	C704-L	10791440008868	12	PF819-HD	10791440009902	12	PF902-S
10791440005249	12	PT441	10791440006390	12	BT556-10	10791440007748	4	P706-M	10791440008875	12	PF820-S	10791440009919	12	PT903
10791440005256	12	PT442-MPG	10791440006413	6	PT558	10791440007762	12	PT707-HD	10791440008882	12	PF821-S	10791440009957	12	PF906
10791440005263	6	BT443	10791440006437	12	PT561	10791440007779	12	PT707-HD10	10791440008899	12	PF822	10791440009964	12	PF907
10791440005270	12	PT445-MPG	10791440006451	12	PT562-10	10791440007786	12	PT707-HD3	10791440008905	12	PF823	10791440009971	6	F908-A
10791440005287	12	P446	10791440006468	12	PT563	10791440007793	12	PT708-HD	10791440008950	12	PF823-E	10791440009988	12	BF909
10791440005294	12	B447	10791440006475	12	BT564	10791440007809	6	PT714	10791440008967	12	PF824	10791440009995	12	PF910
10791440005317	12	P450	10791440006482	6	PT565	10791440007816	12	PF717	10791440008981	12	BF825	10791440010021	12	BF912
10791440005324	12	S451	10791440006499	12	PT566	10791440007830	4	P718-5	10791440008998	12	PF826	10791440010038	12	PF913
10791440005331	12	BT452	10791440006505	12	PT567	10791440007847	12	BF719	10791440009001	12	PF827	10791440010045	6	BF914
10791440005355	12	P454	10791440006512	12	PT567-10	10791440007854	12	BF720	10791440009025	12	PF828	10791440010052	12	BF915
10791440005362	12	S455	10791440006529	12	PT568	10791440007861	12	PT721	10791440009032	6	PF829(2)	10791440010069	12	F916-C
10791440005379	12	S456	10791440006604	12	BF577	10791440007878	6	PT722	10791440009049	12	PF830	10791440010076	12	PF916
10791440005386	6	PT457-MPG	10791440006611	12	PT578	10791440007885	12	P723	10791440009056	12	PF831	10791440010106	12	BF918-K
10791440005393	12	PT459	10791440006628	12	PT579	10791440007892	6	PT725-MPG	10791440009070	12	BF833	10791440010144	60	F919-C
10791440005409	12	PT461	10791440006673	12	BF579	10791440007908	24	PT727-DL	10791440009087	12	BF833-K2	10791440010199	12	BF920
10791440005416	6	PT462	10791440006680	12	BF583	10791440007915	12	PT727-HD	10791440009094	12	F834-F	10791440010236	12	PF924
10791440005423	12	PT463	10791440006697	12	BF584	10791440007922	12	PT727-HD10	10791440009100	12	PF834	10791440010243	12	BF925
10791440005454	12	PT466	10791440006703	12	BF584-B	10791440007939	12	PT728-MPG	10791440009124	12	BF836	10791440010250	12	PF926
10791440005461	6	PT467-MPG	10791440006710	12	BF585	10791440007946	4	PT729	10791440009131	12	BF836-K3	10791440010274	12	BF928
10791440005478	12	PT468-MPG	10791440006727	12	BF586	10791440007977	6	BT732	10791440009148	12	BF836-K4	10791440010281	12	BF929
10791440005492	12	BT470	10791440006734	12	BF586-D	10791440007991	12	BT735	10791440009155	12	BF837	10791440010298	12	BF930
10791440005508	12	PT471	10791440006741	12	BF587	10791440008011	12	PT737	10791440009162	12	BF838-F2	10791440010328	12	BF932
10791440005515	12	BT472	10791440006758	12	BF587-D	10791440008028	12	PT737-10	10791440009179	12	PF838	10791440010335	12	BF933
10791440005522	12	B474	10791440006765	12	BF588	10791440008035	12	V738-0	10791440009186	12	BT839	10791440010359	12	PF935
10791440005539	12	PT475	10791440006871	12	BF591	10791440008042	12	BT739	10791440009193	12	BT839-10	10791440010366	12	PF936
10791440005546	12	P476	10791440006888	12	BF592	10791440008059	12	C740-S	10791440009209	12	BF840	10791440010373	12	PF937
10791440005553	12	PT477	10791440006895	12	BF593	107914400080814	4	C750-E	10791440009216	12	BF840-K1	10791440010380	12	BF938
10791440005577	12	S479	10791440006901	12	PF594	10791440008158	4	C750-L	10791440009230	12	VT842-0	10791440010397	12	BF939
10791440005584	12	PT480	10791440006918	12	BT595	10791440008172	6	PT751	10791440009247	12	BF843	10791440010403	12	BF940
10791440005591	12	PT480-10	10791440006925	6	BF596	10791440008189	6	PT752	10791440009254	12	F844-A	10791440010410	12	BF941
10791440005607	12	PT480-MPG	10791440006932	12	BF597	10791440008219	12	PT757	10791440009261	12	BF845-A	10791440010427	12	PF942
10791440005614	12	B481	10791440006949	12	PF598	10791440008226	6	PT757-10	10791440009278	12	PF845	10791440010434	12	PF943
10791440005652	12	S485	10791440006956	12	PF598-10	10791440008240	12	PT760-10	10791440009285	12	PF846	10791440010458	12	PF945
10791440005669	6	BT486	10791440006963	12	PF598-30	10791440008257	12	PT760-25	10791440009292	12	PF847	10791440010465	12	PF946
10791440005676	12	PT487	10791440006970	12	PF599	10791440008264	12	PT761	10791440009315	12	PT849	10791440010472	12	PF947
10791440005690	12	B488	10791440006987	12	PF599-10	10791440008288	6	PT763	10791440009322	12	PT849-10	10791440010489	12	BF948
10791440005706	12	S489	10791440006994	12	PF599-30	10791440008295	12	PT764	10791440009353	12	V852-0	10791440010519	12	BF948-JD
10791440005751	12	PT492	10791440007007	6	PA602	10791440008301	12	PT765	10791440009360	12	BF853	10791440010533	12	F950-F
10791440005768	6	PT493	10791440007014	6	PA604	10791440008318	6	PT766	10791440009384	12	BF855	10791440010540	12	PF950
10791440005775	12	B494	10791440007021	12	B605	10791440008325	6	PT767	10791440009391	12	BF856	10791440010557	12	PT951
10791440005782	6	B495	10791440007045	6	PA607	10791440008332	6	PT768	10791440009407	12	PF857	10791440010564	12	PF952
10791440005812	12	P496	10791440007083	6	PA612	10791440008370	6	PT772	10791440009414	12	BF858	10791440010571	12	BF954
10791440005829	12	P497	10791440007090	6	PA613	10791440008387	6	PT773-MPG	10791440009421	12	PF859	10791440010588	12	BF955
10791440005836	12	PT498	10791440007106	12	BF614	10791440008400	6	BT775	10791440009438	12	PF860	10791440010595	12	BF956
10791440005843	12	PT498-10	10791440007113	6	PA615	10791440008417	12	PT776-MPG	10791440009445	12	PF861	10791440010601	12	BF957
10791440005881	4	F501-MD	10791440007151	6	PA618 FOAM	10791440008424	12	PT777	10791440009452	12	BF862	10791440010625	12	BF957-D
10791440005928	12	PF506	10791440007182	6	PA621	10791440008431	12	BT778	10791440009469	12	BF863	10791440010632	12	BF958
10791440005935	12	P507	10791440007199	6	PA625	10791440008448	12	BT779	10791440009476	12	PF864	10791440010649	12	BF959
10791440005942	12	PT508-MPG	10791440007205	6	PA631	10791440008455	12	BF781	10791440009483	12	PF865	10791440010656	12	P960
10791440005966	12	PT510	10791440007212	6	PA632	10791440008462	12	BF782	10791440009490	12	BF865-K	10791440010670	12	BF962
10791440005973	4	PT512	10791440007229	12	PA633(2)	10791440008479	12	BF783	10791440009					

## I 2/5 TO BALDWIN CASE (SHIPPING CASES)

I 2/5 NUMBER	CASE QTY.	BALDWIN NUMBER	I 2/5 NUMBER	CASE QTY.	BALDWIN NUMBER	I 2/5 NUMBER	CASE QTY.	BALDWIN NUMBER	I 2/5 NUMBER	CASE QTY.	BALDWIN NUMBER	I 2/5 NUMBER	CASE QTY.	BALDWIN NUMBER
10791440010861	12	BF984	10791440013374	6	PA1712	10791440015934	6	PA2077	10791440017754	6	PA2335	10791440029139	6	BT8312
10791440010878	12	PF986	10791440013398	6	PA1718	10791440015958	6	PA2079	10791440017761	6	PA2337	10791440029146	12	BT8314
10791440010885	12	PF987	10791440013404	6	PA1719	10791440015965	6	PA2081	10791440017877	6	PA2347	10791440029153	12	PT8318-MPG
10791440010892	12	BF988	10791440013411	6	PA1721	10791440015989	6	PA2083	10791440019260	6	PA2472	10791440029160	6	BT8320
10791440010908	12	BF989	10791440013442	6	PA1735	10791440015996	12	SA2084	10791440019307	6	PA2476	10791440029191	6	BT8802-MPG
10791440010922	12	BF991	10791440013466	12	PA1748	10791440016009	12	SA2085	10791440019314	6	PA2477	10791440029207	6	BT8803-MPG
10791440010939	12	BF992	10791440013534	12	PA1757	10791440016054	6	PA2091	10791440019376	6	PA2483	10791440029238	6	BT8812-MPG
10791440010953	12	BF995	10791440013541	6	PA1758	10791440016061	6	PA2092	10791440021317	6	PA2653 FOAM	10791440029986	6	18104
10791440010960	12	P996	10791440013558	12	PA1763	10791440016085	6	PA2094	10791440022789	12	PA2798	10791440030012	6	18139
10791440010977	12	P998	10791440013572	12	PA1765 FOAM	10791440016092	4	PA2095	10791440026558	6	PA4016	10791440030036	6	18155
10791440010991	12	P999-HD	10791440013756	6	PA1786	10791440016108	6	PA2096	10791440026565	6	PA4018	10791440030050	6	18171
10791440011035	12	V1009-W	10791440013831	6	PA1798	10791440016115	6	PA2099	10791440026589	6	PA4023	10791440030074	6	18198
10791440011066	12	V1044-O	10791440013848	6	PA1800	10791440016122	6	PA2100	10791440026596	6	PA4026	10791440030111	6	18236
10791440011073	12	BF1102	10791440013862	6	PA1802	10791440016139	6	PA2101A	10791440026602	6	PA4028	10791440030128	6	18245
10791440011097	12	BF1104	10791440013886	6	PA1805	10791440016146	6	PA2102	10791440026657	6	PA4050	10791440030241	6	19593
10791440011103	12	BF1105	10791440013916	4	PA1809	10791440016153	6	PA2103	10791440026688	6	PA4060	10791440030304	6	19828
10791440011141	12	BF1110	10791440013947	6	PA1814	10791440016160	6	PA2104	10791440026749	12	CS5007	10791440030349	6	19992
10791440011172	12	BF1120	10791440014074	6	PA1828	10791440016184	6	PA2106	10791440026756	12	CS5008	10791440030463	6	BT8307-MPG
10791440011189	12	BF1123	10791440014104	6	PA1832	10791440016191	6	PA2107	10791440026763	6	CS5009	10791440030470	6	BT8308-MPG
10791440011257	12	BF1140	10791440014111	6	PA1834	10791440016214	6	PA2109	10791440026794	4	CSC5012	10791440034935	12	61
10791440011288	12	BF1148	10791440014166	6	PA1841	10791440016221	6	PA2110	10791440026893	6	CS5058	10791440034942	12	61-W
10791440011295	12	BF1150	10791440014265	6	PA1852	10791440016252	6	PA2113	10791440026909	10	OTK5060	10791440030490	12	66
10791440011349	12	BF1160	10791440014296	6	PA1857	10791440016269	6	PA2114	10791440026916	12	OTK5061	10791440034997	12	66-W
10791440011363	12	BF1163	10791440014302	6	PA1858	10791440016276	6	PA2115	10791440026930	10	OTK5063	10791440035574	18	101
10791440011387	12	BF1166	10791440014319	6	PA1859	10791440016283	4	PA2116	10791440026947	12	BW5070	10791440035598	18	101-W
10791440011424	12	BF1170	10791440014326	6	PA1860	10791440016290	6	PA2117	10791440026954	12	BW5071	10791440035918	18	151
10791440011431	12	BF1171	10791440014333	6	PA1861	10791440016320	6	PA2121	10791440026961	12	BW5072	10791440035925	18	151-30
10791440011448	12	BF1201	10791440014418	4	PA1873	10791440016351	6	PA2124	10791440026978	12	BW5073	10791440035932	18	151-W
10791440011479	12	BF1210	10791440014425	4	V1874-T	10791440016368	6	PA2125	10791440026985	12	BW5074	10791440036465	8	201
10791440011486	12	BF1211	10791440014432	12	PA1875	10791440016382	6	PA2127	10791440026992	12	BW5075	10791440036472	8	201-30
10791440011493	12	BF1212	10791440014456	6	PA1888	10791440016450	6	PA2134	10791440027005	12	BW5076	10791440036496	8	201-W
10791440011509	12	BF1212 FOAM	10791440014579	6	PA1889	10791440016467	6	PA2135	10791440027043	12	B5134	10791440036953	4	301
10791440011523	12	BF1213	10791440014586	6	PA1891	10791440016474	6	PA2136	10791440027050	12	BW5136	10791440036960	4	301-30
10791440011530	12	BF1214	10791440014777	12	PA1909	10791440016498	6	PA2138	10791440027067	12	BW5137	10791440036977	4	301-CS
10791440011547	6	BF1216	10791440014814	12	PA1915	10791440016504	6	PA2139	10791440027074	12	BW5138	10791440036984	4	301-W
10791440011554	12	BF1218	10791440014937	4	PA1934	10791440016511	6	PA2140	10791440027081	12	BW5139	10791440037059	4	501
10791440011561	12	BF1219	10791440015019	6	PA1946	10791440016573	6	PA2147	10791440027098	12	BW5140	10791440037066	4	501-30
10791440011578	12	BF1220	10791440015026	6	PA1949	10791440016580	6	PA2148	10791440027104	12	BW5141	10791440037073	4	501-W
10791440011585	12	BF1221	10791440015040	6	PA1951	10791440016597	6	PA2149	10791440027128	12	B5176	10791440037578	12	PT8344
10791440011592	12	BF1223	10791440015125	6	PA1963	10791440016603	6	PA2150	10791440027135	12	B5177	10791440037585	12	P7303
10791440011608	12	BF1225	10791440015149	6	PA1969	10791440016627	6	PA2152	10791440027142	12	BW5178	10791440037615	12	BD7028
10791440011615	12	BF1226	10791440015170	6	PA1973	10791440016634	6	PA2153	10791440027159	12	BW5179	10791440037622	12	B7051
10791440011639	12	BF1232	10791440015293	12	PA1985	10791440016641	6	PA2154	10791440027180	12	BF5801	10791440037639	12	PF7549
10791440011646	12	BF1233	10791440015422	6	PA2001	10791440016665	6	PA2156	10791440027197	12	BF5800	10791440037684	12	PF7550
10791440011677	8	V1240-C	10791440015439	6	PA2002	10791440016689	6	PA2158	10791440027203	12	BF5810	10791440037691	12	PF7551
10791440011691	12	BF1259	10791440015453	6	PA2005	10791440016696	12	SA2159	10791440027210	12	BF5812	10791440037745	12	BF7552
10791440011707	12	BF1276	10791440015460	6	PA2006	10791440016702	6	PA2160	10791440027227	12	BF5813	10791440037851	12	B7039
10791440011714	12	BF1280	10791440015477	6	PA2007	10791440016726	6	PA2162	10791440027289	6	6017	10791440037882	12	BF7546
10791440012032	12	B1400	10791440015484	6	PA2008	10791440016733	6	PA2163	10791440027302	6	6020	10791440037899	12	BF1345
10791440012056	12	B1402	10791440015491	6	PA2009	10791440016740	6	PA2164	10791440027319	6	6021	10791440037967	12	BF7544
10791440012087	12	B1406	10791440015507	6	PA2010	10791440016771	6	PA2167	10791440028484	3	P7003	10791440037981	12	BF7541
10791440012094	12	B1407	10791440015538	6	PA2023	10791440016788	6	PA2168	10791440028491	6	B7004	10791440037998	12	BF880-FP
10791440012124	12	B1428	10791440015545	6	PA2024	10791440016795	6	PA2169	10791440028507	6	B7005	10791440038056	12	BT305
10791440012179	4	P1510	10791440015569	12	SA2027	10791440016818	6	PA2171	10791440028538	12	B7009	10791440038063	12	B7047
10791440012186	4	P1511	10791440015576	6	PA2031	10791440016887	6	PA2178	10791440028545	12	B7010	10791440038070	12	PT8345
10791440012193	4	V1520-R	10791440015606	6	PA2036	10791440016917	6	PA2181	10791440028552	6	B7011	10791440038087	12	BT8328
10791440012216	6	V1542-C	10791440015613	6	PA2037	10791440016962	6	PA2188	10791440028569	12	B7014	10791440038117	12	P7035
10791440012223	16	V1544-T	10791440015637	12	SA2039	10791440016979	6	PA2189	10791440028576	12	B7018	10791440038124	12	BT372-KIT
10791440012230	12	PA1600	10791440015644	6	PA2041	10791440016993	6	PA2191	10791440028583	6	B7019	10791440038131	6	P7000 KIT
10791440012254	12	PA1603	10791440015651	4	PA2042	10791440017013	6	PA2193	10791440028590	12	B7020	10791440038216	12	B1429
10791440012520	6	PA1627	10791440015668	6	PA2044	10791440017020	6	PA2194	10791440028606	12	B7022	10791440038247	12	PF7553
10791440012605	6	PA1633	10791440015699	6	PA2050	10791440017044	6	PA2196	10791440028613	12	B7023	10791440038254	12	PF7554
10791440012681	6	PA1639	10791440015705	6	PA2051	10791440017112	6	PA2204	10791440028620	12	B7024	10791440038292	6	BT8347
10791440012742	12	F1645-DS	10791440015712	6	PA2052	10791440017143	6	PA2207	10791440028637	12	B7025	10791440038346	6	BT8804-MPG
10791440012759	7	V1645-C	10791440015729	6	PA2053	10791440017150	6	PA2208	10791440028712	4	F7500	10791440038353	12	BF1346
10791440012803	6	PA1648	10791440015774	6	PA2061	10791440017198	6	PA2212	10791440028729	4	P7500	10791440038384	12	B7044
10791440012865	6	V1656-O	10791440015780	6										

## I 2/5 TO BALDWIN CASE (SHIPPING CASES)

I 2/5 NUMBER	CASE BALDWIN QTY. NUMBER	I 2/5 NUMBER	CASE BALDWIN QTY. NUMBER	I 2/5 NUMBER	CASE BALDWIN QTY. NUMBER	I 2/5 NUMBER	CASE BALDWIN QTY. NUMBER	I 2/5 NUMBER	CASE BALDWIN QTY. NUMBER
10791440038889	12.....BF7531	10791440045566	12.....P7093	10791440048963	6.....PA4043	10791440051222	12.....BD7029	10791440054612	12.....P7137
10791440038896	12.....BT8302	10791440045580	12.....PF7592	10791440049021	12.....BF1177	10791440051307	12.....B7124	10791440054629	12.....P7138
10791440038902	12.....BT8316-MPG	10791440045641	12.....BF1329-SP	10791440049038	12.....BF1178	10791440051338	6.....18025	10791440054636	6.....PA4104
10791440038919	12.....BT8323	10791440045665	12.....BF1222-SP	10791440049045	12.....BF1179	10791440051345	6.....18024	10791440054643	6.....PA4105
10791440038940	6.....PT8330-MPG	10791440045672	12.....BF1222	10791440049083	12.....BF1181	10791440051352	6.....18022	10791440054650	6.....PA4106
10791440038957	6.....BT8333	10791440045696	6.....PA2233	10791440049090	6.....PA2237	10791440051376	6.....18027	10791440054667	6.....PA4107
10791440038964	6.....BT8850-MPG	10791440045702	12.....BF1329	10791440049113	12.....BF1182	10791440051390	12.....B7125	10791440054674	12.....B7139
10791440038988	6.....BT8861	10791440045719	12.....P7052	10791440049120	12.....BF1184	10791440051406	6.....PA4092	10791440054698	12.....B1416
10791440039145	6.....18268	10791440045788	12.....BF1347	10791440049137	12.....BF1185	10791440051451	12.....BT8393	10791440054834	6.....BF7639-D
10791440039329	6.....BT8851-MPG	10791440045801	12.....BF1345-SP	10791440049144	12.....BF1186	10791440051499	6.....BF7623	10791440054872	12.....BF1261
10791440039350	12.....PT8350	10791440045818	12.....BF1205	10791440049212	12.....BF1188	10791440051505	12.....SA2047	10791440054896	6.....BD1403
10791440040240	6.....B7030	10791440045825	12.....BF1204	10791440049229	6.....PA4044	10791440051512	12.....BF1253	10791440054902	12.....BF7658
10791440041186	12.....BT8352	10791440045832	12.....BF1205-SP	10791440049236	6.....PA4045	10791440051659	6.....BT8848-MPG	10791440054919	12.....BF7659
10791440041193	12.....PT8351	10791440045894	12.....PT8339	10791440049243	6.....PA4046	10791440051666	12.....BF7624	10791440054933	12.....BF7661
10791440041209	6.....PT8353	10791440045900	12.....BF1348	10791440049335	6.....PA4047	10791440051734	6.....PA4093	10791440054957	6.....PA4108
10791440041292	6.....BF7571	10791440045917	12.....BF1204-SP	10791440049342	6.....PA4048	10791440051741	6.....PA4094	10791440054964	6.....PA4109
10791440041490	12.....BF1173	10791440045924	6.....BT610-MPG	10791440049380	12.....BF1215	10791440051772	12.....BF7625	10791440054971	12.....BF7663
10791440041537	12.....BF7534	10791440045931	6.....BT8846	10791440049403	6.....PA4049	10791440051789	12.....B1425	10791440054988	12.....BF7664
10791440042497	12.....PT8354	10791440045948	6.....BT8852-MPG	10791440049410	12.....BF1190	10791440051895	12.....BF1348-SP	10791440055039	12.....BF7657
10791440042503	12.....PT8355	10791440045955	6.....BT611-MPG	10791440049427	12.....BF1191	10791440051901	12.....BT8398-MPG	10791440055046	6.....PA3836
10791440042527	6.....BF1239	10791440046068	12.....BD7095	10791440049441	12.....BF1193	10791440051970	6.....BT8842-MPG	10791440055053	12.....BF7666
10791440042534	12.....PF7572	10791440046075	6.....PA2234	10791440049465	12.....BF1195	10791440052007	6.....BT8843-MPG	10791440055077	6.....PA3839
10791440042565	12.....P7013	10791440046112	12.....BF1223-SP	10791440049526	12.....BF1199	10791440052014	6.....PA4096	10791440055084	6.....PA3840
10791440042626	6.....BT8845	10791440046129	12.....BF7593	10791440049533	6.....PA4071	10791440052038	12.....BF7626	10791440055091	6.....BD7141
10791440042633	6.....BT8844	10791440046280	12.....PF7594	10791440049564	6.....PA3783	10791440052045	6.....PF7627	10791440055107	6.....BT8416
10791440042640	12.....PA2001 FOAM	10791440046297	12.....PF7595	10791440049571	12.....BF1045	10791440052083	12.....B7128	10791440055114	12.....BF7667
10791440042671	6.....BD103-MPG	10791440046419	12.....PF7596	10791440049588	12.....BF1046	10791440052120	6.....BT8401-MPG	10791440055121	12.....B7142
10791440042763	12.....BF7576	10791440046426	6.....BT8870-MPG	10791440049595	12.....BF1047	10791440052199	12.....PT8403-MPG	10791440055138	6.....PA4110
10791440042770	12.....BF7579	10791440046440	6.....BT8874-MPG	10791440049601	12.....BF1048	10791440052212	6.....PA3419	10791440055175	6.....18032
10791440042787	12.....BF7580	10791440046464	12.....BT606-MPG	10791440049618	12.....BF1049	10791440052229	12.....BF7628	10791440055193	6.....BT8849-MPG
10791440042923	12.....PT8329	10791440046471	12.....P7021	10791440049625	12.....BF1050	10791440052274	12.....BF7629	10791440055199	6.....BT8855-MPG
10791440042992	6.....BT8830	10791440046518	6.....BT8873	10791440049687	6.....BT8381	10791440052281	12.....PT8404-MPG	10791440055199	6.....BT8877-MPG
10791440043005	6.....BT8832	10791440046532	12.....PF7597	10791440049731	6.....PA2240	10791440052304	6.....PA4099	10791440055263	6.....BT8878-MPG
10791440043074	12.....B1430	10791440046556	12.....BF7532	10791440049762	6.....PA2243	10791440052328	12.....BF7631	10791440055270	6.....BT8879-MPG
10791440043098	12.....PT8356	10791440046563	6.....BT8875-MPG	10791440049779	6.....PA2244	10791440052359	12.....BF7632	10791440055281	12.....B7143
10791440043104	12.....BW5082	10791440046624	12.....P7015	10791440049878	12.....BF1008	10791440052441	6.....PA1100	10791440055282	12.....B1431
10791440043135	12.....BF7584	10791440046723	12.....P7016	10791440050041	6.....PA4084	10791440052526	7.....V7129-C	10791440055289	12.....BT8417
10791440043142	12.....P7081	10791440046730	12.....P7017	10791440050102	6.....BT8382	10791440052588	12.....BW5142	10791440055296	12.....BT8415
10791440043159	12.....PT8319	10791440046914	6.....BT8841-MPG	10791440050133	12.....P1418	10791440052601	12.....B7130	10791440055299	12.....BT8413
10791440043166	12.....PT8341	10791440047027	12.....B7099	10791440050140	12.....P1419	10791440052618	12.....B7131	10791440055316	12.....B1432
10791440043173	6.....PT8335	10791440047065	6.....PA4075	10791440050263	12.....BF1172	10791440052625	12.....BF7645	10791440055323	12.....PA3872
10791440043203	12.....BT8357	10791440047119	12.....PT8370-MPG	10791440050294	12.....B7119	10791440052663	12.....BF1249-SP	10791440055330	12.....PA3873
10791440043234	6.....CTK5029	10791440047126	6.....PT8371-MPG	10791440050300	6.....PA4085	10791440052748	12.....BF7644	10791440055347	12.....BF7670
10791440043272	12.....BF7585	10791440047171	12.....BF1258	10791440050324	12.....BF1240	10791440052755	6.....18029	10791440055354	12.....B7144
10791440043289	12.....B7082	10791440047515	12.....BD325	10791440050331	12.....BT8384	10791440052915	12.....P127	10791440055361	6.....PA3880
10791440043302	12.....BF7586	10791440047539	6.....PA4077	10791440050348	6.....B495-SS	10791440052946	12.....F594-F	10791440055368	6.....PA4111
10791440043319	12.....BF7587	10791440047553	12.....P7103	10791440050386	6.....B96-SS	10791440053004	12.....F950-F WO	10791440055375	6.....BT8418
10791440043326	12.....P7083	10791440047577	12.....BF7598	10791440050393	6.....B95-SS	10791440053011	12.....F953-F	10791440055382	6.....BT8880-MPG
10791440043333	12.....PF7588	10791440047584	12.....P7104	10791440050409	6.....BD103-SS	10791440053028	12.....PF997	10791440055399	12.....PT8419
10791440043340	12.....BF1231	10791440047591	6.....BD7105	10791440050416	6.....B99-SS	10791440053066	12.....BF7648	10791440055406	6.....18033
10791440043357	12.....P7084	10791440047607	12.....P7106	10791440050423	12.....B76-SS	10791440053073	12.....PT8407	10791440055413	6.....18034
10791440043432	6.....PA4005	10791440047614	12.....P7107	10791440050430	12.....B7600-SS	10791440053110	12.....BF7633	10791440055420	12.....BF7640
10791440043449	12.....B1405	10791440047652	12.....PT8372	10791440050454	12.....BF7612	10791440053127	12.....P7132	10791440055427	12.....BF7653
10791440043456	6.....PA2200	10791440047669	12.....BF7602	10791440050461	12.....BF7613	10791440053134	6.....PA4102	10791440055434	6.....PA3890
10791440043470	6.....PA2228	10791440047676	6.....PA4078	10791440050485	12.....BF1248	10791440053196	12.....B78409	10791440055441	12.....P1433
10791440043494	6.....PA2230	10791440047720	6.....BF1100	10791440050508	12.....BF7614	10791440053288	12.....BW5200	10791440055448	12.....P7145
10791440043555	12.....B1410	10791440047829	12.....BF7606	10791440050515	12.....P7615	10791440053295	12.....BF7634	10791440055455	6.....BF1277-SP
10791440043623	6.....PA4069	10791440047843	12.....B7113	10791440050522	12.....BF1212	10791440053303	6.....BT8853-MPG	10791440055462	12.....BF1273-SP
10791440043630	6.....PA4070	10791440047867	6.....PA3697	10791440050539	12.....PT8385	10791440053363	12.....BF1257	10791440055469	6.....BF1262
10791440043647	6.....PA4071	10791440047874	6.....PA4079	10791440050546	12.....BF1052	10791440053370	6.....BF7635	10791440055476	12.....B7151
10791440043654	12.....PT8338	10791440047881	12.....18002	10791440050584	12.....B1421	10791440053592	12.....PA2862 FOAM	10791440055483	12.....B7152
10791440043661	12.....PF7545	10791440047904	6.....18004	10791440050591	12.....BT8386	10791440053691	12.....PA2884	10791440055490	6.....BD7153
10791440043678	12.....B7045	10791440047935	6.....18007	10791440050614	12.....PT7617	10791440054162	6.....PA3414	10791440055497	6.....BD7154
10791440043715	12.....P7050	10791440047959	6.....18009	10791440050621	12.....BF1349	10791440054230	12.....B7033	10791440055504	6.....B7155
10791440043722	6.....PT8334	10791440047966	6.....18010	10791440050629	12.....BF1056	10791440054247	12.....B7034	10791440055511	12.....BT8420
10791440043791	6.....PA4072	10791440047997	6.....18013	10791440050843	12.....B1422	10791440054261	12.....BF7537	10791440055518	12.....BW5143
10791440043814	6.....PA4073	10791440048147	6.....PT8375-MPG	10791440050904	12.....PF7165	10791440054322	12.....P7134	10791440055525	12.....PF7680
10791440044996	12.....B7049	10791440048154	6.....PT8376-MPG	10791440050942	12.....BT8391	10791440054360	6.....B7135	10791440055532	12.....BW5201
10791440045016	12.....B7089	10791440048192	12.....B7001	10791440050966	12.....BF7619	10791440054391	6.....PA3822	10791440055539	6.....PA4112
10791440045030	12.....BF1224	10791440048260	12.....P7114	10791440050980	12.....BF1249	10791440054407	6.....PA3823	10791440055546	6.....PA3901
10791440045092	12.....PT8363	10791440048703	12.....B7026-MPG	10791440051000	12.....PT8392	10791440054421	12.....BT8412	10791440055553	12.....PF7655
10791440045115	6.....PA2231	10791440048727	12.....B7116	10791440051048	12.....BF1252	10791440054438	6.....BF7639	10791440055560	12.....B7156
10791440045214	6.....BF7091	10791440048734	6.....PA3763	10791440051086	12.....BF1217	10791440054469	12.....BF7656	10791440055567	12.....BF7668
10791440045245	12.....B7535	10791440048772	6.....BT8876-MPG</						

# I 2/5 TO BALDWIN CASE (SHIPPING CASES)

I 2/5 NUMBER	CASE QTY.	BALDWIN NUMBER	I 2/5 NUMBER	CASE QTY.	BALDWIN NUMBER	I 2/5 NUMBER	CASE QTY.	BALDWIN NUMBER	I 2/5 NUMBER	CASE QTY.	BALDWIN NUMBER	I 2/5 NUMBER	CASE QTY.	BALDWIN NUMBER
10791440057958	6	BD7159	10791440060057	12	BW5250	10791440062471	6	B495-MPG	10791440064949	12	P7232	10791440066776	6	B7245
10791440058009	6	B7162	10791440060101	12	BT8450	10791440062518	12	PF1291	10791440064970	12	BF7803	10791440066837	12	BT700
10791440058016	12	B7163	10791440060118	6	PA3967	10791440062525	6	PA4146	10791440064987	12	BF7804	10791440066844	12	PA4661
10791440058023	12	B7164	10791440060149	6	BD7176	10791440062532	6	PA4147	10791440064994	12	BF7805	10791440066851	12	PA4662
10791440058030	12	BF1330-SP	10791440060156	12	PT8452	10791440062549	6	PA4148	10791440065007	12	BF7806	10791440066868	12	PA4663
10791440058054	12	B7165	10791440060170	6	PA3970	10791440062556	12	B1446	10791440065014	12	P7233	10791440066875	12	PA4664
10791440058078	6	PA3825	10791440060217	12	B7177	10791440062587	4	V1560	10791440065021	12	BF7807	10791440066882	6	PA4668
10791440058108	6	PA4114	10791440060286	12	P7178	10791440062600	12	P7199	10791440065038	12	BF7808	10791440066899	12	B5145
10791440058122	6	B7161	10791440060293	12	B7179	10791440062631	12	PT8481	10791440065052	6	PA4157	10791440066950	12	BF7775
10791440058146	6	BD7166	10791440060316	6	PA4128	10791440062655	12	BF7742	10791440065069	12	BF1350-SP	10791440066967	12	BF7776
10791440058160	6	BT8833	10791440060323	6	PA4129	10791440062785	12	PT8496-MPG	10791440065076	12	BF7809	10791440066974	12	BF5816
10791440058238	6	BT287-3	10791440060347	4	PT8453	10791440062808	12	PF7744	10791440065083	12	P7235	10791440067001	12	PF7777
10791440058245	12	BT8428-MPG	10791440060354	6	PA3980	10791440062853	12	BT8497-MPG	10791440065090	12	PT8884-MPG	10791440067018	12	BF7778
10791440058269	12	B5087	10791440060378	6	18264	10791440062938	12	BT8460	10791440065137	12	PF7812 KIT	10791440067025	12	BT8905
10791440058276	12	B5088	10791440060385	6	18265	10791440062952	12	PF7751	10791440065151	12	BF7766	10791440067032	6	BF7246
10791440058283	12	BF1265	10791440060446	6	PA4132	10791440062990	12	B7215	10791440065168	12	PT8885-MPG	10791440067087	12	PF7779
10791440058313	12	BT8429	10791440060453	6	18267	10791440063003	12	BT8499	10791440065199	6	BT8886-MPG	10791440067124	6	BT8906
10791440058399	12	B7685	10791440060477	12	BF7713	10791440063058	12	BT8501-MPG	10791440065250	6	PA4158	10791440067131	6	PA4669
10791440058405	6	B7175	10791440060484	6	PA4133	10791440063089	6	PA4149 KIT	10791440065311	12	BF7813	10791440067148	12	BF7780
10791440058443	12	B7167	10791440060491	6	PF7715	10791440063096	12	BT8502	10791440065335	6	PA4632	10791440067155	12	PT8907-MPG
10791440058474	12	B1434	10791440060514	12	BF7717	10791440063102	12	B7216	10791440065342	12	PA4633	10791440067162	12	P7247
10791440058504	12	BF7686	10791440060552	6	BT8801-MPG	10791440063119	6	B7217	10791440065359	12	BF7814	10791440067216	6	B7249-MPG
10791440058528	12	PF7687	10791440060620	6	PA3983-FN	10791440063164	6	BT8503-MPG	10791440065380	12	B7238	10791440067223	12	BT8908
10791440058542	6	PA3929	10791440060644	12	PF7718	10791440063171	12	BT8504	10791440065403	6	PA4159	10791440067230	12	BF7815
10791440058559	6	B7180	10791440060651	12	B1441	10791440063201	12	BF7747	10791440065427	12	PF7755	10791440067308	6	BT8910-MPG
10791440058566	6	BT8432-MPG	10791440060675	12	P1443	10791440063218	12	PF7748	10791440065434	12	BF1339-SP	10791440067315	6	BT8911-MPG
10791440058573	12	BF7690	10791440060682	6	BD7310	10791440063225	12	PF7749	10791440065441	6	PA4160	10791440067360	6	PA4681
10791440058665	6	BD7169	10791440060712	12	BF7711	10791440063270	12	BF7750	10791440065472	6	B7239	10791440067377	6	20005
10791440058726	12	BF1266	10791440060736	12	B7181	10791440063287	12	BF1283	10791440065489	6	B10-AL BSP	10791440067384	6	BD7250
10791440058733	6	PA3931	10791440060750	6	BT8457-MPG	10791440063294	12	BF1281	10791440065496	12	B7240	10791440067391	6	BD7252
10791440058740	12	B1438	10791440060842	6	B7182	10791440063447	12	B5089	10791440065502	12	PT8888	10791440067407	12	PT8912
10791440058757	12	B7170	10791440060859	12	B7189	10791440063461	6	PA4150	10791440065533	6	PA4162	10791440067421	6	PA4682
10791440058764	12	B7171	10791440060866	6	PA4134	10791440063539	12	PT8507-MPG	10791440065540	12	PF7767	10791440067469	12	BF1353-SPS
10791440058788	12	BF1267	10791440060880	12	PT8459	10791440063607	12	BT8509-MPG	10791440065601	4	PT8889	10791440067483	6	PF7782
10791440058818	6	BT8437	10791440060927	6	PA3986	10791440063614	12	BT8505	10791440065670	12	B5090	10791440067490	12	BF7783-D
10791440058863	12	BF7691	10791440061061	4	P7183	10791440063676	12	BF7753	10791440065687	6	B7241	10791440067506	12	BF7784-D
10791440058894	12	BF7693	10791440061085	12	BF7719	10791440063706	6	PA4600	10791440065694	6	BT8890-MPG	10791440067513	12	BF7785-D
10791440058917	12	B1435	10791440061108	12	BF7720	10791440063713	6	PA4601	10791440065748	6	BT8892-MPG	10791440067537	12	BF7786-D
10791440058948	6	BD7309	10791440061122	6	PA4138	10791440063737	12	BF7756	10791440065762	6	20003	10791440067544	12	PA4852
10791440058993	12	P1440	10791440061139	12	BF7721	10791440063768	12	B7219	10791440065793	6	20004	10791440067551	12	PA4852 FOAM
10791440059020	12	BF1268	10791440061160	12	BF7725	10791440063782	12	BF1275	10791440065854	12	66-30	10791440067568	12	PA4853
10791440059037	12	BT8440-MPG	10791440061191	12	SA4141	10791440063836	12	PF7758	10791440065861	6	PT8893	10791440067575	6	PA4854
10791440059068	6	BT8439-MPG	10791440061238	12	PA4551	10791440063874	12	B7220	10791440065878	12	BF7768	10791440067599	12	PA4855
10791440059082	6	PA4120	10791440061245	12	PA4552	10791440063904	12	B7221	10791440065885	6	PA4163	10791440067636	12	PA4689
10791440059167	6	PA4118	10791440061269	12	B7174-MPG	10791440063911	12	B7222	10791440065946	12	PKG490-BANK	10791440067643	12	PA2068 FOAM
10791440059280	6	BF7695	10791440061375	6	PA4555	10791440063935	6	PA4612	10791440066011	12	BF1346-SP	10791440067650	12	PA2223 FOAM
10791440059297	12	BF7169	10791440061399	6	PA4557	10791440063966	12	BF7760	10791440066059	12	BF1286	10791440067667	12	PA3901 FOAM
10791440059327	6	PA4121	10791440061405	12	BF7726	10791440063973	6	PT8461	10791440066080	6	PA4164	10791440067766	12	PA4694
10791440059334	6	BF1277-SPS	10791440061412	12	PT8462-MPG	10791440064024	12	BF7759	10791440066141	12	BF7769	10791440067773	12	PA4695
10791440059372	12	BF1270-SP	10791440061436	12	PT8468	10791440064031	12	B7197	10791440066165	12	PF7770	10791440067780	12	PA4696 FOAM
10791440059396	6	PA3941	10791440061467	12	PT8470	10791440064062	12	B5144	10791440066226	12	BC7242	10791440067803	6	PA4698
10791440059419	12	BC7173	10791440061474	12	P7185	10791440064079	12	BF1278	10791440066233	12	BT8898	10791440067814	6	PA4707
10791440059495	6	PA3953	10791440061498	12	BT8472	10791440064086	12	BF1279	10791440066240	6	BT8899	10791440067889	4	PA4711
10791440059501	12	BT8443	10791440061504	12	BT8473	10791440064154	12	BF7762	10791440066271	12	BF7771	10791440067919	6	PA4714
10791440059556	6	PA4123	10791440061511	12	BT8474	10791440064161	12	B7223	10791440066295	12	BW1582	10791440067971	12	PA4720
10791440059563	6	PA4124	10791440061528	12	BT8475	10791440064314	6	PA4151	10791440066301	12	BT8900	10791440068008	2	PA4723
10791440059570	6	BT8856-MPG	10791440061535	6	BT8476	10791440064437	6	B7224	10791440066363	12	B7243	10791440068046	12	PA4727
10791440059617	12	BT8444	10791440061542	6	BT8477	10791440064475	12	B7225	10791440066387	12	BF7681-D	10791440068077	6	PA4730
10791440059631	6	BT8847	10791440061559	6	BT8463-MPG	10791440064482	12	BF7765	10791440066394	12	BF7679-D	10791440068084	6	PA4731
10791440059648	12	B7172	10791440061566	6	BT8464	10791440064499	6	PA4152	10791440066400	12	BF7672-D	10791440068091	12	PA4732
10791440059655	12	BF7683	10791440061573	6	BT8465	10791440064512	6	PA4154	10791440066417	12	BF7682-D	10791440068107	6	PA4733
10791440059662	12	BF7696	10791440061610	12	BC7186 KIT	10791440064550	6	19996	10791440066424	12	BF7675-D	10791440068114	6	PA4734
10791440059730	6	BF1274-SP	10791440061658	12	B1444	10791440064581	6	19999	10791440066431	12	BF7673-D	10791440068121	12	PA4735
10791440059747	6	BF1274-SPS	10791440061733	6	B7187	10791440064598	6	20000	10791440066448	12	BF7674-D	10791440068138	12	PA4736 FOAM
10791440059754	6	18055	10791440061856	12	PF7733	10791440064611	6	20002	10791440066455	12	BF7677-D	10791440068145	6	PA4737
10791440059761	6	18056	10791440061863	12	PF7734	10791440064628	12	B7227	10791440066462	12				



**I 2/5 TO BALDWIN CASE (SHIPPING CASES)**

I 2/5 NUMBER	CASE QTY.	BALDWIN NUMBER	I 2/5 NUMBER	CASE QTY.	BALDWIN NUMBER	I 2/5 NUMBER	CASE QTY.	BALDWIN NUMBER	I 2/5 NUMBER	CASE QTY.	BALDWIN NUMBER	I 2/5 NUMBER	CASE QTY.	BALDWIN NUMBER
10791440068978	12	PA4819	10791440071770	12	P7259	10791440074641	12	BF7863	10791440077529	6	PA5321	10791440079189	12	PT9380-MPG
10791440068985	12	PA4820	10791440071787	12	P7260	10791440074658	12	BF7864	10791440077550	12	BF7908	10791440079196	12	BF1373-SP
10791440069012	6	PA4823	10791440071794	12	P7261	10791440074665	12	BF7865	10791440077567	12	BF7909	10791440079257	12	BF7924
10791440069029	12	PA4824	10791440071817	12	P7263	10791440074672	12	BF7866	10791440077581	12	PF7910	10791440079264	12	BF1374-SP
10791440069074	6	PA4829	10791440071824	12	P7264	10791440074702	12	B7298	10791440077659	6	BT9356	10791440079271	12	BF1375
10791440069081	12	PA4830	10791440071879	12	P7269	10791440074740	12	P7303	10791440077673	6	BT9356	10791440079295	12	BF9382
10791440069258	2	PA4848	10791440071886	12	BF7880	10791440074788	12	OAS99035	10791440077697	12	PF7924	10791440079301	12	BF1376
10791440069296	12	PF7787	10791440071893	12	B7271	10791440075006	12	BT9318	10791440077741	6	BD7325	10791440079349	12	BF1372
10791440069302	12	PF7788	10791440071916	12	B7273	10791440075037	12	P7305	10791440077772	12	BF1359-SP	10791440079356	12	BF1377
10791440069319	12	PF7816	10791440071923	12	B7274	10791440075044	12	PF7870	10791440077789	6	20006	10791440079363	6	PA4185
10791440069326	12	PF7817	10791440071930	12	B7275	10791440075242	12	PT9329	10791440077796	6	20007	10791440079394	12	BF7925
10791440069333	24	PF7818	10791440071947	12	B7276	10791440075662	12	BF7879	10791440077802	6	20008	10791440079400	12	PA5353
10791440069340	12	PF7819	10791440071954	12	B7277	10791440075914	12	PF7882	10791440077826	6	20010	10791440079462	12	PT9386-MPG
10791440069357	12	PF7820	10791440071985	12	B7280	10791440075921	12	BF7881	10791440077833	6	20011	10791440079509	12	BF1378-SPS
10791440069364	12	BF7821	10791440071992	12	B7281	10791440075952	12	PA4975	10791440077857	6	20012	10791440079523	12	PA5359
10791440069371	30	PF7822	10791440072012	12	B7283	10791440075990	12	PA4979	10791440077864	6	PA5327	10791440079530	12	PF7928
10791440069388	12	PF7823	10791440072036	12	B7285	10791440076119	12	PT9337-MPG	10791440077871	6	PA5328	10791440079615	12	BF1379
10791440069395	30	PF7824	10791440072043	12	B7286	10791440076263	12	BT7349	10791440077970	12	BF1360	10791440079622	12	BF1380
10791440069401	12	PF7825	10791440072050	12	B7287	10791440076287	12	BF7883	10791440077987	12	PF7911	10791440079639	12	BF1381
10791440069418	12	PF7826	10791440072074	12	B7289	10791440076294	12	B7306	10791440077994	6	PA4175	10791440079646	12	PA4187
10791440069425	6	PF7828	10791440072081	12	B7290	10791440076379	6	PA4985	10791440078007	6	PA4176	10791440079653	12	BF1382-SP
10791440069432	12	PF7829	10791440072098	12	B7291	10791440076386	6	PA4986	10791440078045	12	BF1293-SPS	10791440079660	6	PF7930
10791440069449	12	PF7830	10791440072104	12	B7292	10791440076393	6	PA4987	10791440078052	12	BF1272-SPS	10791440079837	12	B7333
10791440069463	12	PF7832	10791440072111	12	B7293	10791440076416	6	BF1355-SP	10791440078069	6	20013	10791440079844	12	BF7931
10791440069470	12	PF7833	10791440072128	12	B7294	10791440076430	12	BF7886	10791440078106	6	BT9362-MPG	10791440079851	6	BF7932
10791440069487	12	PF7834	10791440072494	12	PF7852 KIT	10791440076461	12	P7308	10791440078113	6	BT9363-MPG	10791440079912	6	BT9387
10791440069500	12	PF7836	10791440072500	6	PA4857	10791440076485	12	BF5587-D	10791440078120	6	PA4177	10791440079943	12	B7397
10791440069517	12	BF7837	10791440072531	12	BF7853	10791440076539	12	B7311-MPG	10791440078137	12	BF7912	10791440079950	12	BT9388
10791440069524	12	BF7838	10791440072609	6	PA4170	10791440076546	6	P7312	10791440078151	6	BF7913	10791440080048	6	B7335-MPG
10791440069531	20	BF7839	10791440072630	12	PA4878	10791440076577	12	P7313	10791440078168	12	BF1352-SPS	10791440080055	12	B7334
10791440069548	12	BF7840	10791440072647	12	PA4879	10791440076584	12	PT9342-MPG	10791440078175	12	PA5330	10791440080062	6	BT9391-MPG
10791440069555	12	BF7841	10791440072685	12	PA4883	10791440076607	12	PF7889	10791440078182	12	BF1361	10791440080109	12	P7336 KIT
10791440069562	12	BF7842	10791440072708	4	PA4885	10791440076614	12	PF7889-10	10791440078397	6	BT9364	10791440080116	6	BT9392-MPG
10791440069579	12	BF7843	10791440072715	12	PA4886	10791440076621	12	PF7889-30	10791440078410	12	BF7915	10791440080123	6	BT9393-MPG
10791440069586	12	BF7844	10791440072739	6	PA4888	10791440076638	12	PF7890	10791440078427	6	BT9365-MPG	10791440080130	12	PF7934 KIT
10791440069593	12	BF7845	10791440072753	6	PA4890	10791440076645	12	PF7890-10	10791440078434	6	BT9366-MPG	10791440080215	12	PF7935
10791440069616	12	BF7847	10791440072760	12	PA4891	10791440076652	12	PF7890-30	10791440078441	6	PA5333	10791440080222	6	PA5393
10791440069623	12	BF7848	10791440072807	12	PA4895	10791440076669	6	BT9343-MPG	10791440078458	6	BT9367-MPG	10791440080246	12	BF1384-SP
10791440069630	12	BF7849	10791440072869	12	PA4902	10791440076720	12	BF7798-SP	10791440078489	12	BF1283-SP	10791440080277	6	PA4188
10791440069647	12	BF7850	10791440072890	12	PA4905	10791440076737	12	PT9344	10791440078496	12	BF1362	10791440080284	12	P7338
10791440069654	12	BF7851	10791440072906	6	PA4906	10791440076744	6	B7314	10791440078502	6	BT9368-MPG	10791440080307	6	PA4190
10791440069661	12	BF7736-K1	10791440072913	12	PA4907	10791440076751	12	BF1356	10791440078519	6	BT9369-MPG	10791440080314	6	PA4191
10791440069678	12	BT8913-MPG	10791440072920	12	PA4908	10791440076768	6	PA4172	10791440078526	12	BC7326	10791440080338	12	PF7936
10791440069685	6	BT8476-MPG	10791440072944	6	PA4910	10791440076799	6	BT9345	10791440078533	12	PF7916	10791440080345	12	P7398
10791440069692	12	BT366-MPG	10791440072951	12	PA4911	10791440076812	12	BT9346-MPG	10791440078557	12	BF7917	10791440080352	12	P7399
10791440069708	6	BT351-MPG	10791440073156	12	PA4931	10791440076829	6	BT9347-MPG	10791440078564	12	B7327	10791440080369	12	P7400
10791440069715	12	BT371-5	10791440073163	6	PA4932	10791440076843	6	BT9348-MPG	10791440078571	6	BT9370-MPG	10791440080376	12	BT7401
10791440069722	12	BT8914	10791440073187	12	PA4934	10791440076850	6	BF1357	10791440078601	6	BF1355	10791440080383	6	20014
10791440069746	12	BT8916	10791440073194	12	PA4935	10791440076867	12	BF7888	10791440078618	6	BF1363	10791440080390	12	BF7937
10791440069753	12	BT8917	10791440073224	4	PA4938	10791440076874	12	BF1358-SP	10791440078632	6	PA5337	10791440080406	6	PA4192
10791440069760	12	BT8918	10791440073231	12	PA4939	10791440076881	12	BF7892	10791440078656	12	B7328	10791440080413	6	PA4193
10791440069777	12	BT8919	10791440073255	4	PA4941	10791440076911	12	BT7316	10791440078663	6	PA4178	10791440080420	6	PA4194
10791440069784	12	BT8920	10791440073361	12	PA4872	10791440076966	12	BD7317	10791440078670	6	PA4179	10791440080437	6	PA4195 KIT
10791440069807	12	BT8922	10791440073378	12	PA4873	10791440077024	6	PF7894	10791440078687	6	PA4180	10791440080444	6	PA4196
10791440069845	12	BT8926	10791440073385	12	PA4874	10791440077031	6	PF7895	10791440078694	6	PA4181	10791440080451	6	PA4197
10791440069852	6	BT8927	10791440073415	12	PA3957 FOAM	10791440077048	6	B7318	10791440078700	6	PA4182	10791440080468	6	PA4198
10791440069869	12	BT8928	10791440073422	12	PA2069 FOAM	10791440077086	12	P7319	10791440078717	6	PA4183	10791440080475	6	PA4199
10791440069883	6	BT8930	10791440073439	12	PA2067 FOAM	10791440077093	12	PF7896	10791440078724	12	BT9371-MPG	10791440080482	6	PA4303
10791440069890	6	BT8931	10791440073545	6	BT8475-MPG	10791440077130	6	PA5306	10791440078755	6	BF1365	10791440080499	6	PA4304
10791440069937	12	BT8935	10791440073552	6	BT8477-MPG	10791440077154	12	BF7898-D	10791440078816	12	BF7919	10791440080505	6	PA4305
10791440069951	6	BT8937	10791440073583	12	BT9321	10791440077178	12	B7320	10791440078847	4	BA5374	10791440080512	6	PA4306
10791440070643	12	PT9127	10791440073613	6	BT9324	10791440077192	6	PA4174	10791440078854	4	BA5375	10791440080529	6	PA4307
10791440070681	12	PT9131	10791440074023	12	PT9238	10791440077321	6	B7322	10791440078861	4	BA5376	10791440080536	6	PA4308
10791440070711	12	PT9134	10791440074030	12	PT9239	10791440077338	12	PA5311	10791440078878	6	PA5339	10791440080543	6	PA4309
10791440070728	12	PT9135	10791440074245	12	PT9260	10791440077345	6	PA5312 KIT	10791440078885	12	PT9374	10791440080550	12	SA4315
10791440070735	12	PT9136	1079144007448											

# I 2/5 TO BALDWIN CASE (SHIPPING CASES)

I 2/5 NUMBER	CASE QTY.	BALDWIN NUMBER	I 2/5 NUMBER	CASE QTY.	BALDWIN NUMBER	I 2/5 NUMBER	CASE QTY.	BALDWIN NUMBER	I 2/5 NUMBER	CASE QTY.	BALDWIN NUMBER	I 2/5 NUMBER	CASE QTY.	BALDWIN NUMBER
10791440080772	6	PA4320	10791440082080	6	PA4362	10791440083223	12	BF1396	10791440086231	12	B7362	10791440087641	12	BF9818
10791440080826	12	PT9396	10791440082097	12	B7424	10791440083230	12	B7445	10791440086242	12	BF7987	10791440087665	12	BF9820
10791440080840	12	BF1385-SPS	10791440082103	12	P7426	10791440083247	6	PA4409	10791440086262	12	BF7988	10791440087672	6	PA4433
10791440080857	12	PF7939	10791440082110	12	P7427	10791440083254	12	BF7968	10791440086286	12	BF7989-D	10791440087689	12	BF9821
10791440080864	12	BF7940	10791440082127	6	BT9400-MPG	10791440083261	12	B7446	10791440086378	6	B7363	10791440087702	12	BF9822-D
10791440080871	12	BF7941	10791440082141	12	BT9402	10791440083278	12	PT9413-MPG	10791440086385	12	P7364	10791440087719	12	PF9823
10791440080888	6	PA4321	10791440082165	12	B7428	10791440083285	12	BF1398-O	10791440086392	12	BF1287-O	10791440087726	12	P7380
10791440080895	6	PA4322	10791440082189	12	BF7957	10791440083308	12	P7450	10791440086408	12	BF1288-O	10791440087733	12	PF9824
10791440080901	12	BF7942	10791440082202	12	BF1390-O	10791440083315	12	B7451	10791440086415	6	PA4425	10791440087740	12	PF9825
10791440080918	12	P7406	10791440082219	6	PA4363	10791440083322	12	BF1360-SP	10791440086422	6	PA4426	10791440087757	12	PF9826
10791440081045	6	PA4323	10791440082226	6	PA4364	10791440083339	12	BF7949-D	10791440086439	12	BF7990	10791440087924	12	BF9827-D
10791440081052	12	B7407	10791440082233	6	PA4365	10791440083346	12	BF7971-D	10791440086446	6	PA5482	10791440087962	6	PA4434
10791440081069	6	PA4324	10791440082249	12	BF1391-O	10791440083352	12	BF7971-D	10791440086453	12	P7365	10791440087979	6	BF9433
10791440081083	6	PA4327	10791440082264	6	PA4366	10791440083360	12	B7452	10791440086484	12	BF7993	10791440087986	12	BF9828-D
10791440081106	6	PA4325	10791440082271	12	B7430	10791440083383	12	B7453	10791440086552	12	BF7997	10791440088099	12	PT9434
10791440081151	12	BF7943	10791440082288	12	B7429	10791440083513	6	PA4410 KIT	10791440086569	12	PT1392	10791440088105	6	PA4435
10791440081182	12	P7408	10791440082295	12	PT9405	10791440083537	12	OP8750	10791440086606	12	PF7994	10791440088143	12	B7388
10791440081199	12	B7409	10791440082301	12	B7431	10791440083544	12	OP8751	10791440086613	12	BF7995	10791440088167	6	PA4436
10791440081205	12	BF7410	10791440082318	12	B7432	10791440083551	12	OP8752	10791440086620	12	P7368	10791440088174	6	PA4437
10791440081212	6	PA4329	10791440082325	12	B7433	10791440083568	12	OP8753	10791440086675	6	BF7996	10791440088181	12	PT9435-MPG
10791440081229	12	P7411	10791440082332	6	PA4367	10791440083575	6	PA4411	10791440086682	6	PA4428	10791440088198	12	BF9830-D
10791440081250	12	BF1386-O	10791440082349	6	PA4368	10791440083582	12	P7454	10791440086699	6	BT9421-MPG	10791440088204	12	B7389
10791440081267	12	BF7944	10791440082356	6	PA4369	10791440083599	6	PA4412	10791440086705	6	20021	10791440088211	12	BF9831
10791440081274	12	P7413	10791440082363	6	PA4370	10791440083605	6	PA4413	10791440086729	6	20023	10791440088235	12	B7390
10791440081281	12	P7414	10791440082370	6	PA4371	10791440083612	6	PA4414	10791440086781	12	BF7997	10791440088259	12	B7393
10791440081342	12	BF1387-O	10791440082387	6	PA4372	10791440083629	6	PA4415	10791440086798	6	PA5494	10791440088266	12	BF9833-D
10791440081359	12	BF1388-O	10791440082394	6	PA4373	10791440083667	12	P7455	10791440086804	6	PA5495	10791440088273	12	BF9834
10791440081366	12	P7415	10791440082400	12	BF7958	10791440083674	6	PA4416 KIT	10791440086811	6	BT9422	10791440088280	12	BF9835-D
10791440081373	6	PA4330	10791440082417	12	BF7959	10791440083681	12	BF7969	10791440086828	12	BF7998	10791440088297	6	P7505
10791440081380	6	PA4331	10791440082424	12	BF7960	10791440083698	12	PT9414-MPG	10791440086859	12	BF1289-SP	10791440088303	12	B7457
10791440081397	6	PA4332	10791440082431	12	BF7961	10791440083759	12	BF7972	10791440086880	12	PT9423	10791440088310	12	B7458
10791440081403	12	BF7945	10791440082448	12	B7434	10791440083766	12	P7438	10791440086927	12	B7370	10791440088327	12	B7459
10791440081410	6	B7416	10791440082455	6	PA4374	10791440083773	6	PA4417	10791440086965	12	PT9424	10791440088433	12	BF9836-D
10791440081489	6	BT9398-MPG	10791440082486	6	PA4376	10791440083834	12	BC7456 KIT	10791440086996	12	BF9800	10791440088440	6	PA4438
10791440081496	6	PF7946	10791440082493	6	PA4377	10791440083865	6	PA4418	10791440087009	12	PF9801	10791440088464	12	BF1346-O
10791440081502	6	PA4334	10791440082509	6	PA4380	10791440083872	6	PA4419	10791440087016	6	PT9425-MPG	10791440088471	12	BF1348-O
10791440081519	6	PA4335	10791440082516	6	PA4381	10791440083940	12	PT9417	10791440087023	6	PA4429	10791440088495	12	B7461
10791440081564	12	BF1389-O	10791440082523	6	PA4382	10791440083957	12	B7449	10791440087030	12	PT9426	10791440088501	12	BF9437
10791440081571	6	PA4333	10791440082530	6	PA4383	10791440083971	12	PT9418	10791440087047	12	BF9802	10791440088518	12	BF9837-D
10791440081588	6	PA4336	10791440082547	6	PA4384	10791440084008	12	BF1397-SP	10791440087054	6	PA4430	10791440088525	12	B7462
10791440081595	12	PF7947	10791440082554	6	PA4385	10791440084015	12	B7350	10791440087061	12	BT7237	10791440088624	12	BF9839-D
10791440081601	6	PA4337	10791440082561	6	PA4386	10791440084039	4	CV15000	10791440087085	12	PF9803	10791440088655	6	6 B10-AL BSPCS
10791440081618	12	P7418	10791440082578	6	PA4387	10791440084091	12	BF1399-SP	10791440087108	6	PT9427-MPG	10791440088662	4	BA5566
10791440081632	6	BF7948	10791440082585	12	BF7962	10791440084145	12	PT9419-MPG	10791440087122	12	BF1383-O	10791440088679	12	BF1298-O
10791440081656	12	BF7949-D	10791440082592	12	BF7963	10791440084152	6	PA4421	10791440087146	6	PF9804	10791440088686	12	B7466
10791440081663	12	BF7950-D	10791440082608	12	BF7964-D	10791440084497	4	PT9453-MPG	10791440087177	12	BF9805	10791440088709	12	B7467
10791440081670	6	20015	10791440082639	12	BT9408	10791440085494	12	B7953	10791440087184	12	B7372	10791440088716	12	B7468
10791440081687	6	20016	10791440082646	6	PA4388	10791440085500	12	PF7974	10791440087214	12	BF1222-O	10791440088723	12	B7469
10791440081694	6	20017	10791440082677	6	PA4390	10791440085517	12	B7351-MPG	10791440087238	6	PA4431	10791440088730	12	BF9841
10791440081700	6	20018	10791440082714	6	P7436	10791440085531	12	PT9555	10791440087269	12	BF1345-O	10791440088808	12	BF9842
10791440081724	6	20020	10791440082721	12	P7437	10791440085586	12	PF7975	10791440087313	12	B7373	10791440088839	12	B7474
10791440081748	12	BF7951-D	10791440082745	6	BF1392-SPS KIT	10791440085593	12	B7352	10791440087320	12	BF9807	10791440088860	12	B7477
10791440081755	12	BF7952-D	10791440082752	12	BF7965-D	10791440085692	12	BF7976	10791440087337	12	BF9808-D	10791440088907	12	BF9844
10791440081779	12	BF7954-D	10791440082769	6	PA4391	10791440085715	4	BA5378	10791440087351	12	BF1223-O	10791440088938	12	B7483
10791440081786	12	B7419	10791440082783	6	PA4392	10791440085722	12	BA5379	10791440087368	12	BF9809-D	10791440088950	12	BC7485
10791440081793	6	PA4338	10791440082790	6	PA4393	10791440085760	12	PF7978	10791440087375	12	BF9810-D	10791440088996	12	BF9846
10791440081809	6	PA4340	10791440082813	12	B7440	10791440085784	12	PA5457	10791440087382	12	B7375	107914400889102	12	BF9847-D
10791440081816	6	PA4341	10791440082820	12	BF7966	10791440085791	6	BD7355	10791440087399	12	B7376	107914400889119	12	BF1299-O
10791440081823	6	PA4344	10791440082837	12	B5091	10791440085814	6	BT9558-MPG	10791440087405	12	B7377	107914400889133	6	BT9436-MPG
10791440081830	6	PA4345	10791440082851	12	B7441	10791440085845	12	B7356	10791440087412	12	BF9811-SP	107914400889140	12	B7486
10791440081847	6	PA4348	10791440082868	6	PA4394	10791440085852	12	BF1366-O	10791440087429	12	B7378	107914400889157	12	B7487
10791440081854	6	PA4349	10791440082875	6	PA5428	10791440085869	12	BF7970	10791440087436	12	BF1290-O	107914400889164	6	PA4439
10791440081861	6	PA4350	10791440082912	12	BF7967	10791440085876	12	BF7979	10791440087443	12	BF1292-O	107914400889171	6	PA4440 KIT
10791440081878	6	PA4351	10791440082929	12	BF1393-SP	10791440085883	12	B7357	10791440087450	12	BF1294-O	107914400889188	6	PA4441
10791440081885	6	PA4352	10791440082981	6	PA4397	10791440085913	12	B7359	10791440087474	12	PT9430-MPG	107914400889195	12	BF9848
10791440081908	12	BF7955	10791440082998	6	PA4398	10791440085982								

# I 2/5 TO BALDWIN CASE (SHIPPING CASES)

I 2/5 NUMBER	CASE QTY.	BALDWIN NUMBER	I 2/5 NUMBER	CASE QTY.	BALDWIN NUMBER	I 2/5 NUMBER	CASE QTY.	BALDWIN NUMBER	I 2/5 NUMBER	CASE QTY.	BALDWIN NUMBER	I 2/5 NUMBER	CASE QTY.	BALDWIN NUMBER
10791440089713	6	BT9439	10791440091808	12	BF9881	10791440093505	12	BF9913	10791440096988	12	PA30014	10791440100593	6	PA30080
10791440089751	6	PA4449	10791440091822	12	PT9462	10791440093512	12	BF1283-O	10791440097008	12	PA30016	10791440100616	6	PA10014
10791440089768	6	PA5580	10791440091846	12	BT9464	10791440093529	6	PA5753	10791440097015	12	PA30017	10791440100760	12	BT40015
10791440089850	12	CV15001	10791440091853	12	PT9463	10791440093567	12	CV15003	10791440097022	12	PA30018	10791440100777	6	PA30086
10791440089867	12	P7492	10791440091860	12	BF9883	10791440093574	6	PF9914 KIT	10791440097039	12	PA30019	10791440100784	6	PA10015
10791440089904	6	PA4452	10791440091884	12	B7501	10791440093581	12	BF9915	10791440097060	12	PA30022	10791440100845	6	20025
10791440089911	6	PA4453	10791440091891	12	PE5270	10791440093659	12	BF9916	10791440097084	12	PA30024	10791440100883	6	PA30093
10791440089942	6	PA4454	10791440091907	12	PE5271	10791440093666	6	PA4476	10791440097138	12	PA30029	10791440100890	6	PA10016
10791440089959	12	P7493	10791440091914	12	BT9465	10791440093673	6	PA4477	10791440097145	6	PA30030	10791440100906	6	PA10017
10791440089966	6	PA4455	10791440091921	6	PA5683	10791440093680	6	PA4478	10791440097152	12	PA30031	10791440100920	12	BF46037
10791440089980	6	PA4456	10791440091938	12	BF9884	10791440093697	6	PA4479	10791440097190	12	PA30034	10791440100982	12	BF46038-D
10791440090009	4	BA5592	10791440091945	6	BF9885	10791440093703	6	PA4480	10791440097206	12	PA30035	10791440100999	12	BF46039-D
10791440090085	6	P7494	10791440091969	6	BT9466-MPG	10791440093734	12	P7512	10791440097299	6	PA30044	10791440101002	6	PA10018
10791440090108	12	PA4460 KIT	10791440091983	12	BF9886	10791440093741	6	B7513	10791440097350	6	PA30050	10791440102467	12	BF46040-D
10791440090115	6	BF9860	10791440091990	12	P7502	10791440093758	6	PA5765	10791440097367	6	PA30051	10791440102498	12	P40019
10791440090122	6	PA4461	10791440092027	6	BF9887	10791440093772	12	BF9917	10791440097374	6	PA30052	10791440103358	12	BF46041-D
10791440090139	6	PA4462	10791440092034	6	BF9888	10791440093796	6	BF9918 KIT	10791440097381	6	PA30053	10791440103365	6	BF46042-D
10791440090146	12	PF9861	10791440092058	12	PF9889	10791440093802	6	PA5766	10791440097398	6	PA30054	10791440103372	6	BF46043-D
10791440090160	6	PA4463	10791440092065	12	PF9890	10791440093826	12	P7515	10791440097404	6	PA30055	10791440103402	6	PA30115
10791440090177	12	PF9862	10791440092072	12	BF9891-D	10791440093833	6	PA5768	10791440097411	6	PA30056	10791440103419	6	PA10022
10791440090184	12	BF9863	10791440092089	12	BF9892-D	10791440094380	6	PT9532	10791440097480	12	BW21000	10791440103426	12	BT3525-MPG
10791440090207	6	PA5619	10791440092096	12	BF9893	10791440094397	6	PA4481	10791440097497	12	BF6006	10791440103440	12	BF46044-D
10791440090214	6	PA5620	10791440092102	12	BF9894	10791440094410	12	B7516	10791440097503	12	BF6007	10791440103457	12	P40020
10791440090238	6	PA5622	10791440092119	6	B7503	10791440094434	12	P7517	10791440097510	12	BF6008	10791440103532	12	PT23527
10791440090245	6	PA5623	10791440092188	6	PA5689	10791440094441	12	P9600	10791440097527	12	PF6009	10791440103563	12	B40022-MPG
10791440090252	6	PA5624	10791440092195	6	PA5690	10791440094458	6	PA5770	10791440097558	12	BF6012	10791440103600	12	P40021
10791440090269	6	BF9864	10791440092201	6	PA5691	10791440094472	6	PA5772	10791440097565	12	BF6013	10791440103617	6	PA10023
10791440090283	12	PF9865	10791440092232	6	PA5694	10791440094489	6	PA5773	10791440097572	12	BF6014	10791440103624	6	PA10024
10791440090306	6	PA4464	10791440092270	6	BD7504	10791440094496	12	PF9919	10791440097589	12	BF6015	10791440103631	6	PA10025
10791440090337	6	PA5629	10791440092287	12	B7506	10791440094502	6	PA5774	10791440097596	12	BF5813-O	10791440103648	6	PA10026
10791440090351	6	PA5631	10791440092294	6	PA4470	10791440094526	12	BF1282-O	10791440097602	12	BF1204-O	10791440103655	6	PA10027
10791440090375	6	BT9440	10791440092300	6	BF9895 KIT	10791440094536	6	PA4483	10791440097619	12	BF791-O	10791440103662	6	PA10028
10791440090382	12	BF9866-O	10791440092317	6	PA4471	10791440094564	12	B9601	10791440097626	12	BF7968-O	10791440103686	6	PA10030
10791440090399	6	PA5632	10791440092324	6	PA5698	10791440094601	6	BF9920	10791440097633	12	BF6016-O	10791440103693	6	PA10031
10791440090429	6	PA4465	10791440092355	12	PF9897	10791440094663	6	PA4484	10791440097640	12	BF6017-O	10791440103709	6	PA10032
10791440090443	12	BF9867-O	10791440092379	12	BF9898-O	10791440094694	12	BF9921-O	10791440097657	12	BF6018-O	10791440103716	12	P40023
10791440090467	12	BF1355-O	10791440092386	12	PF9899	10791440094700	6	PA4485	10791440097664	12	BF6019-O	10791440103723	12	P40024
10791440090474	6	PA5633	10791440092393	12	PF9900	10791440094755	12	BF9922-O	10791440097671	12	BF6020-O	10791440103730	12	P40025
10791440090504	12	PF9868	10791440092409	6	B7507	10791440094809	6	PA4997	10791440097688	12	BF6021-O	10791440103846	12	BF46045-D
10791440090528	12	BF1355-O	10791440092416	12	BC7394	10791440094922	12	PE5272	10791440097695	12	BF6022-O	10791440103921	6	PA10033
10791440090535	12	B7496	10791440092423	12	PA5700	10791440094953	12	BF9923-O	10791440097701	12	BF6023-O	10791440103945	6	PA30126
10791440090641	12	BF9869	10791440092430	12	PF9901 KIT	10791440094991	12	PA5276	10791440097718	12	BF6024-O	10791440103969	12	PF46046
10791440090665	6	PT9441-MPG	10791440092447	6	PA4473	10791440095004	12	P9602	10791440097725	12	BF6025-O	10791440104034	12	BF46048
10791440090689	12	PF9870	10791440092515	12	PF9902	10791440095011	12	P9603	10791440097732	12	BF6026-O	10791440104041	12	P40017
10791440090696	6	PA5637	10791440092522	12	BF9903-SP	10791440095028	12	PT9537-MPG	10791440097749	12	BF6027-O	10791440104133	12	PA30138
10791440090702	6	PA5638	10791440092546	12	BF9904	10791440095050	6	PA5282	10791440097756	12	BF6028-O	10791440104140	12	PA30139
10791440090795	12	BF9871-O	10791440092577	12	BF9905	10791440095103	4	BA5284	10791440097763	12	BF6029-O	10791440104157	6	PA30140
10791440090955	12	PF9872	10791440092584	6	P7508	10791440095110	6	PA4486	10791440097770	12	BF6030-O	10791440104163	6	PA30141
10791440090962	12	B7497	10791440092669	12	PT9469	10791440095127	12	BF1278-O	10791440097787	12	PT23136	10791440104171	6	PA30144
10791440090993	12	PF9873	10791440092676	12	PT9470	10791440095134	6	PA4487	10791440097800	12	PT23122	10791440104300	12	BF46050
10791440091013	6	PA4466	10791440092683	6	BD7509	10791440095172	6	PF9924 KIT	10791440097817	12	PT23123	10791440104331	12	PT23536
10791440091020	12	BT9442-MPG	10791440092744	12	BF9905	10791440095196	12	BF9925-O	10791440097824	6	PT23137	10791440104348	12	BF46051
10791440091037	12	BF9874-DM	10791440092805	12	BT9471	10791440095271	12	BF9927	10791440097831	12	PT23124	10791440104379	6	PA10036
10791440091044	12	BF9875-DM	10791440092812	6	PA5720	10791440096506	12	B9604	10791440097848	12	PT23125-MPG	10791440104386	6	PA30151
10791440091068	6	PT9444-MPG	10791440092829	6	PA5721	10791440096575	12	P9605	10791440097855	12	PT23126-MPG	10791440104393	12	BF46052
10791440091075	12	BF9876	10791440092836	6	PA5722	10791440096612	12	B9606	10791440097862	12	PT23127-MPG	10791440104447	12	PA30153
10791440091167	12	PT9446	10791440092843	6	PA5723	10791440096629	12	B9607	10791440097879	12	PT23128-MPG	10791440104453	6	PA30154
10791440091174	12	PT9447	10791440092850	6	PA4475	10791440096636	12	PF9928	10791440097886	12	PT23129-MPG	10791440104485	12	PA30157
10791440091181	12	PT9448	10791440092881	6	PA5725	10791440096643	12	PF9929	10791440097916	12	PT23132-MPG	10791440104492	12	PF46112
10791440091198	12	PT9449	10791440092898	12	BF9906	10791440096644	6	PA10000	10791440097954	12	P40002	10791440104508	6	PA10037
10791440091204	12	PT9450-MPG	10791440092911	6	PA5727	10791440096681	6	PA10001	10791440097961	12	B40006	10791440104546	12	PF46049
10791440091259	6	PA4467	10791440092928	6	PA5728	10791440096698	6	PA10002	10791440097986	12	C40005	10791440104553	6	BD40027
10791440091310	12	BF1358-O	10791440092935	6	PA5728 FOAM	10791440096704	12	BF46000	10791440097992	6	PA10008	10791440104652	6	BF1360-O
10791440091389	12	BF9877	10791440092959	6	PA5729	10791440096711	12	BF46001	10791440098029	12	BC40007	10791440104669	6	BF1347-O
10791440091419	6	PA5658	10791440092980	6	PA5732	10791440096728	12	B40000	10791440098050	12	BF46031	10791440104690	6	CV15005

## I 2/5 TO BALDWIN CASE (SHIPPING CASES)

I 2/5 NUMBER	CASE QTY.	BALDWIN NUMBER	I 2/5 NUMBER	CASE QTY.	BALDWIN NUMBER	I 2/5 NUMBER	CASE QTY.	BALDWIN NUMBER	I 2/5 NUMBER	CASE QTY.	BALDWIN NUMBER	I 2/5 NUMBER	CASE QTY.	BALDWIN NUMBER
10791440105093	6	BD50000	10791440108483	12	PF46119	10791440110370	6	PA30263	10791440111766	6	PA10279	10791440112626	12	PA40089
10791440105123	6	PA30179	10791440108490	6	PF46092	10791440110394	12	BF7806-O	10791440111773	6	PA10276	10791440112640	6	PA10171
10791440105192	12	BF46069	10791440108506	12	BT23611	10791440110400	12	BF46162-O	10791440111780	6	PA10369	10791440112657	6	PA10301
10791440105215	12	BT40029	10791440108575	12	P40061	10791440110417	12	BF7798-O	10791440111797	6	PA10280	10791440112664	6	PA10164
10791440105222	6	BT23555-MPG	10791440108582	6	BF46116 KIT	10791440110424	12	BF46163-O	10791440111803	6	PA10270	10791440112671	12	B40129
10791440105239	12	BF46071	10791440108605	12	PA30204	10791440110431	12	BF46164-O	10791440111810	12	P40095	10791440112688	6	PA10198 KIT
10791440105246	12	BF46072	10791440108629	6	PA10062	10791440110448	6	PF46140	10791440111827	6	20043	10791440112701	12	PA10210
10791440105284	12	BT40032	10791440108698	6	BF46123-O	10791440110455	6	PA30272	10791440111834	6	PA10291	10791440112718	6	PA10153
10791440105291	12	BF46073	10791440108704	6	BF46124-O	10791440110462	6	PA30281	10791440111841	12	PA40083	10791440112725	6	PA10311
10791440105383	12	PA30033	10791440108711	6	PA10064	10791440110479	6	20029	10791440111858	6	PA10222	10791440112732	12	BF46207
10791440105468	12	BT40034	10791440108728	12	BF46125	10791440110493	6	B40063	10791440111865	6	PA10137	10791440112749	6	PA10269
10791440105475	6	PA30185	10791440108742	12	PF46126	10791440110578	12	B40073	10791440111872	12	BF46217	10791440112756	6	PA10152 KIT
10791440105512	12	PE17000	10791440108827	12	BF46127	10791440110653	12	BF46169-O	10791440111889	6	PA10267	10791440112763	6	PA10293
10791440105536	6	PA30188	10791440108865	6	PA30251	10791440110660	12	BF46170	10791440111896	6	PA10283	10791440112770	6	20067
10791440105567	6	PA30189	10791440108889	12	BT40065	10791440110677	6	BT23619-MPG	10791440111902	12	FB46183	10791440112787	6	PA10227
10791440105574	6	PA30190	10791440108919	6	PA30252	10791440110684	6	PA10097	10791440111926	6	PA10197	10791440112800	12	PA00290
10791440105604	12	BF46065-SPS	10791440108933	6	PA10066	10791440110707	6	PA10098	10791440111933	6	PA10281	10791440112817	6	PA10309
10791440105611	12	PF46076	10791440108957	6	PA10067	10791440110714	6	PA10099	10791440111940	12	PA40102	10791440112824	12	20063
10791440105628	6	BT23560	10791440108964	6	BF46128-D	10791440110745	6	PF46171	10791440111957	6	PA10380	10791440112848	6	PA10199 KIT
10791440105642	6	PA10039	10791440108995	6	BF46129	10791440110776	6	20030	10791440111964	6	PA10228	10791440112855	6	PA10324
10791440105659	6	PA10040	10791440109015	6	CV15007	10791440110783	6	PA30287	10791440111971	12	PA40109	10791440112879	6	PA10134
10791440105666	6	PA10041	10791440109022	6	CV15008	10791440110790	12	SA10100	10791440111988	6	PA10285	10791440112886	6	PA10352
10791440105673	6	PA10042	10791440109039	6	PA10069	10791440110813	12	BF1380-O	10791440111995	6	PA10132	10791440112893	12	BF46195
10791440105680	6	PA10043	10791440109046	6	PA10070	10791440110875	6	BF46064-D	10791440112008	6	PA10292	10791440112916	6	PA10149
10791440105697	12	PA00335	10791440109053	6	PA10071	10791440110899	6	BF46173-O	10791440112022	6	PA10181	10791440112923	6	PA10325
10791440105703	12	B40036	10791440109060	6	PA10072	10791440110912	6	PA10101	10791440112039	12	PA40099	10791440112930	6	PA10139
10791440105710	12	PF46077	10791440109077	6	PA10073	10791440110929	6	PA10102	10791440112046	6	PA10277	10791440112947	12	OB40078
10791440105727	6	PA30152	10791440109152	12	PF46130	10791440110943	6	PA40074	10791440112053	12	OB40079	10791440112961	6	PA10229
10791440105741	6	PA10044	10791440109190	6	BF46131	10791440110981	12	BF46175	10791440112060	6	PA10378	10791440112978	6	PA10375
10791440105758	6	PA10045	10791440109282	6	PA10075	10791440110988	6	PA10103	10791440112077	12	PA40106	10791440112985	6	20058
10791440105765	6	PA10046	10791440109299	6	PF46135	10791440111001	6	PA10104	10791440112084	6	PA10143	10791440112992	6	PA10231
10791440105772	12	PA00337	10791440109305	6	PA10076	10791440111025	6	PA10106	10791440112091	6	PA10288	10791440113005	6	PA10389
10791440105789	12	BT40038	10791440109336	6	PA10077	10791440111056	12	PA40076	10791440112107	6	20052	10791440113012	6	PA10148
10791440105796	12	BF46078-D	10791440109343	6	PA10078	10791440111148	6	PA30299	10791440112114	12	PA40108	10791440113029	6	PA10201
10791440105833	6	PF46080	10791440109374	6	BT40066-MPG	10791440111155	6	PA10108	10791440112121	12	SA10127	10791440113036	6	PA10235
10791440105840	12	PF46081	10791440109398	12	PF46137	10791440111162	12	BF46176	10791440112138	6	PA10320	10791440113043	6	PA10131
10791440105857	12	PF46082	10791440109411	12	PF46138	10791440111193	6	BF46179	10791440112145	6	PA10224	10791440113050	6	PA10256
10791440106755	6	BF46083-O	10791440109527	6	PA10081	10791440111223	12	BF1379-O	10791440112152	6	PA10395	10791440113067	6	PA10146
10791440106793	12	BT23561-MPG	10791440109534	12	BF1381-O	10791440111247	12	BT23628	10791440112169	6	PA10376	10791440113074	6	PA10316
10791440106878	12	BF46084	10791440109541	6	PA30260	10791440111254	6	BF46181-O	10791440112176	6	PA10284	10791440113081	12	SA10361
10791440106915	12	PE17001	10791440109558	6	PA30261	10791440111261	12	PT23629	10791440112183	6	PA10223	10791440113098	12	PA40128
10791440107189	12	BF46085	10791440109565	6	PA30262	10791440111322	6	PA10063	10791440112190	6	PA10195 KIT	10791440113104	6	PA10385
10791440107202	6	PA0042	10791440109572	12	BT23612	10791440111339	6	PA30249	10791440112206	6	PA10217	10791440113111	12	BF46216
10791440107288	12	BF46087	10791440109589	12	BF46141	10791440111353	12	BF46182-O	10791440112213	6	PA10145 KIT	10791440113128	12	BF46224
10791440107295	6	PA10047	10791440109596	6	PA10082	10791440111360	6	PA30304	10791440112237	6	PA10390	10791440113135	6	PA10241
10791440107301	6	PT23592	10791440109602	12	BF46122	10791440111407	12	PA40105	10791440112244	6	PA10232	10791440113142	6	PA10354
10791440107318	12	PF46088	10791440109619	6	PF46142	10791440111414	6	20048	10791440112251	12	PA40116	10791440113159	12	BF46205
10791440107356	6	PF46091	10791440109626	12	BF46143	10791440111421	6	PA10128	10791440112268	6	PA10142	10791440113166	6	PA10303
10791440107363	6	BF46098-O	10791440109633	6	PA10084	10791440111438	12	PA40104	10791440112275	6	PA10286	10791440113173	12	B40127
10791440107370	6	BF46100-O	10791440109657	6	PA10085	10791440111445	6	PA10362	10791440112282	12	B40126	10791440113180	6	PA10238
10791440107387	6	BF46099-O	10791440109725	6	PF46145	10791440111452	12	BT23631	10791440112299	12	PA40110	10791440113197	12	PA40086
10791440107394	6	PF46094	10791440109749	12	B40070	10791440111469	6	PA10363	10791440112312	6	PA10282	10791440113203	6	PA10373
10791440107400	6	BF46101-O	10791440109770	12	S40071	10791440111476	12	PA40113	10791440112329	6	20045	10791440113210	6	PA10368
10791440107455	12	B40050	10791440109787	12	BF46147-O	10791440111483	6	PA10364	10791440112343	6	PA10346	10791440113227	12	PA40081
10791440107462	12	B40051	10791440109848	12	BF46149-SP	10791440111490	12	PA40100	10791440112350	6	PA10310	10791440113241	6	PA10144
10791440107684	12	PA0052	10791440109886	6	PA10088	10791440111506	12	PA40119	10791440112367	6	PA10233	10791440113258	6	PA10297
10791440107707	12	PF46103	10791440109893	6	BF46150-O	10791440111513	6	PA10278	10791440112374	6	PA10136	10791440113265	6	PA10358
10791440107738	6	B40053	10791440109909	6	PA10089	10791440111520	12	PA40094	10791440112381	6	PA10159	10791440113272	12	PF46189
10791440107745	12	B40054	10791440109916	6	PA10090	10791440111537	6	PA10221	10791440112398	12	BF46209	10791440113289	6	PA10141
10791440107769	6	BT23603-MPG	10791440109947	6	PA30276	10791440111544	6	PA10220	10791440112404	6	PA10219	10791440113296	6	PA10230
10791440107776	12	PT23597-MPG	10791440109954	12	PF46151	10791440111551	6	PA10129	10791440112411	6	20037	10791440113302	6	PA10234
10791440107783	12	BT23604	10791440109961	6	PA30270	10791440111568	12	PA40103	10791440112435	6	PA10289	10791440113319	12	BF46193
10791440107813	6	BT23605-MPG	10791440109978	12	PA30269	10791440111575	12	PA40111	10791440112442	6	PA10296	10791440113326	6	PA10305
10791440107844	12	B40056	10791440109985	6	PA10083	10791440111582	12	PA40107	10791440112459	12	PA40115	10791440113333	6	PA10312
10791440107875	6	BT23607-MPG	10791440109992	6										

**I 2/5 TO BALDWIN CASE (SHIPPING CASES)**

I 2/5 NUMBER	CASE QTY.	BALDWIN NUMBER	I 2/5 NUMBER	CASE QTY.	BALDWIN NUMBER	I 2/5 NUMBER	CASE QTY.	BALDWIN NUMBER	I 2/5 NUMBER	CASE QTY.	BALDWIN NUMBER	I 2/5 NUMBER	CASE QTY.	BALDWIN NUMBER
10791440113517	6	PA10204 KIT	10791440114040	6	PA10255	10791440114651	12	SA10360	10791440115269	6	PA10173	10791440116334	6	PA10412
10791440113524	6	PA10237	10791440114057	12	PF46187	10791440114675	6	PA10266	10791440115276	6	PA10261	10791440116358	6	B40142
10791440113531	6	PA10191 KIT	10791440114064	6	20051	10791440114682	12	PA0132	10791440115283	12	BF46221	10791440116372	6	PA30331
10791440113548	6	PA10313	10791440114071	6	20069	10791440114699	6	PA10183	10791440115290	6	PA10158	10791440116396	6	PA30332
10791440113555	12	BF46212	10791440114088	6	PA10202	10791440114705	6	PA10259	10791440115320	12	PF46186	10791440116402	12	PF46152
10791440113562	6	PA10161	10791440114095	6	PA10356	10791440114712	12	B40125	10791440115337	6	PA10178	10791440116419	6	PA10414
10791440113586	6	PA10236	10791440114101	12	P40091	10791440114729	6	PA10203 KIT	10791440115344	6	PA10332	10791440116686	6	B40145
10791440113593	12	SA10359	10791440114118	6	PA10216 KIT	10791440114736	12	P40096	10791440115375	6	PA10175 KIT	10791440116921	12	B40150
10791440113609	6	PA10179	10791440114125	6	PA10335	10791440114750	6	PA10170 KIT	10791440115382	6	PA10176	10857123005002	24	38564P
10791440113616	6	PA10272	10791440114132	6	20055	10791440114767	12	BF46192	10791440115399	6	PA10333	10857123005057	24	38559P
10791440113623	6	20064	10791440114149	6	PA10345	10791440114774	6	PA10189	10791440115405	6	PA10334	10857123005132	24	43562P
10791440113630	6	PA10306	10791440114156	6	PA10326	10791440114781	12	PA0131	10791440115412	6	PA10330	10857123005163	24	43568P
10791440113647	6	PA10140	10791440114170	12	P40118	10791440114798	6	PA10258	10791440115429	6	PA10340	10857123005217	24	38557P
10791440113654	6	PA10240	10791440114187	12	BF46219	10791440114804	12	BF46220	10791440115436	6	20057	10857123005309	24	38564C
10791440113661	6	PA30301	10791440114194	12	BF46198	10791440114811	6	PA10319	10791440115450	6	PA10174	10857123005354	24	385654S
10791440113678	6	PA10393	10791440114200	6	PA10394	10791440114828	6	PA10211 KIT	10791440115467	6	PA10247	10857123005416	24	38559C
10791440113685	12	BF46203	10791440114217	6	PA10114	10791440114835	6	PA10188	10791440115474	6	PA10177	10857123005491	24	43562C
10791440113692	6	PA10254	10791440114224	6	PA10196 KIT	10791440114842	6	PA10165	10791440115481	6	PA10212 KIT	10857123005521	24	43562S
10791440113708	6	PA10194	10791440114231	12	PA30302	10791440114859	6	PA10211 KIT	10791440115498	6	PA10342	10857123005552	24	43568C
10791440113715	12	BF46208	10791440114248	6	20066	10791440114866	6	PT23633	10791440115504	6	PA10381	10857123005606	24	43568S
10791440113722	6	PA10160	10791440114255	6	PA10341	10791440114873	6	PA10214	10791440115511	6	PA10400	10857123005651	24	38557C
10791440113739	6	PA10273	10791440114262	6	20041	10791440114897	6	PA10357	10791440115566	12	BF46227	10857123005688	24	38557S
10791440113746	12	BF46210	10791440114286	6	PA10271	10791440114903	12	BF46204	10791440115573	12	B40133	20857123005016	12	38565P
10791440113753	6	20061	10791440114300	6	PA10265	10791440114910	6	PA10344	10791440115597	6	PA10401	20857123005061	12	38560P
10791440113760	6	20062	10791440114354	6	PA10155	10791440114927	6	PA10190	10791440115610	6	PA10402	20857123005108	12	38574P
10791440113777	6	PA10218	10791440114361	6	PA10207	10791440114934	6	PA10244	10791440115689	6	PA10403	20857123005146	12	43564P
10791440113784	12	PA0130	10791440114378	6	PA10208 KIT	10791440114958	6	PA30303	10791440115696	12	B40136	20857123005177	12	43570P
10791440113791	6	20044	10791440114385	12	P40101	10791440114965	6	PA10321	10791440115702	6	PA30310	20857123005313	12	38565C
10791440113807	6	PA10397	10791440114392	6	PA10200	10791440114989	12	BF46196	10791440115719	6	B40137	20857123005368	12	38565S
10791440113814	6	PA10386	10791440114408	6	PA10263	10791440114996	6	PA10167	10791440115726	6	B40138	20857123005429	12	38560C
10791440113821	6	PA10154	10791440114415	6	PA10245	10791440115009	6	PA10169	10791440115733	12	BF46228	20857123005467	12	38574C
10791440113838	6	PA10315	10791440114439	12	P40098	10791440115016	6	PA10182	10791440115870	12	BF46229	20857123005504	12	43564C
10791440113845	6	PA10399	10791440114446	12	BF46223	10791440115030	12	BF46199	10791440115894	6	PA30324	20857123005535	12	43564S
10791440113852	6	PA10186 KIT	10791440114453	12	BF46200	10791440115047	12	BF46202	10791440115900	6	PA30325	20857123005566	12	43570C
10791440113869	6	20060	10791440114460	6	PA10370 KIT	10791440115078	6	PA10251	10791440115917	6	PA10404	20857123005610	12	43570S
10791440113876	6	PA10249	10791440114477	6	PA10242	10791440115085	6	PA10206 KIT	10791440115962	6	BD40139	30857123005020	6	38566P
10791440113883	6	PA10372	10791440114484	6	PA10250	10791440115092	6	PA10253	10791440115979	6	PA10388	30857123005075	6	38561P
10791440113890	6	PA10317	10791440114491	6	PA10156	10791440115108	6	PA10260	10791440115986	6	PA10396	30857123005181	6	43572P
10791440113906	6	PA10382	10791440114507	6	PA10331	10791440115122	6	PA10180 KIT	10791440116044	12	BF46233	30857123005327	6	38566C
10791440113913	6	20065	10791440114521	12	BF46201	10791440115139	6	PA10337	10791440116051	6	PA30329	30857123005372	6	38566S
10791440113920	6	PA10193 KIT	10791440114538	6	PA10162	10791440115146	12	BF46197	10791440116075	6	PA10407	30857123005433	6	38561C
10791440113937	6	PA10314	10791440114552	6	PA10327	10791440115153	6	PA10398	10791440116082	6	PA30330	30857123005570	6	43572C
10791440113944	12	BF46211	10791440114569	6	20046	10791440115160	6	PA10353	10791440116099	6	20070	30857123005624	6	43572S
10791440113951	12	BF46221	10791440114583	6	20050	10791440115177	6	PA10185	10791440116105	12	PF46235	40857123005157	12	43566P
10791440113975	12	BF46206	10791440114590	6	PA10329	10791440115184	12	P40085	10791440116112	6	PF46236	40857123005515	12	43566C
10791440113982	6	PA10213	10791440114606	6	PA10323	10791440115191	6	PA10328	10791440116129	6	PF46237	40857123005546	12	43566S
10791440113999	6	PA10166	10791440114613	6	PA10318	10791440115214	6	PA10215 KIT	10791440116136	12	PF46238			
10791440114002	6	PA10150	10791440114620	12	P40117	10791440115221	6	20068	10791440116150	6	PA10409			
10791440114019	6	PA10172	10791440114637	6	PA10384	10791440115245	12	PF46188	10791440116181	12	B40140			
10791440114033	6	PA10163	10791440114644	6	PA10343	10791440115252	6	PA10157	10791440116327	6	PA10411			

NOTES

# BALDWIN WEIGHTS AND VOLUMES

BALDWIN NUMBER	CASE QTY.	WEIGHT (ea.) lbs.	WEIGHT (ea.) kgs.	Volume (ea.) ft <sup>3</sup>	Volume (ea.) m <sup>3</sup>	BALDWIN NUMBER	CASE QTY.	WEIGHT (ea.) lbs.	WEIGHT (ea.) kgs.	Volume (ea.) ft <sup>3</sup>	Volume (ea.) m <sup>3</sup>	BALDWIN NUMBER	CASE QTY.	WEIGHT (ea.) lbs.	WEIGHT (ea.) kgs.	Volume (ea.) ft <sup>3</sup>	Volume (ea.) m <sup>3</sup>
Baldwin Number...QtyWeight (lbs)Weight (kgs)Volume (ft)Volume (m)																	
B2	12	1.213	0.550	.061	0.002	B76-SS	12	2.492	1.130	.122	0.003	C133-W	7	2.679	1.215	.388	0.011
B2-HPG	12	1.162	0.527	.050	0.001	PT79	12	1.237	0.561	.132	0.004	B134	12	1.621	0.735	.069	0.002
B4	12	.954	0.433	.044	0.001	P80	12	.704	0.319	.063	0.002	PT135	12	.342	0.155	.034	0.001
B5	12	1.304	0.591	.049	0.001	P80-HD	12	.817	0.371	.063	0.002	PT137	12	1.075	0.488	.106	0.003
B6	12	1.221	0.554	.061	0.002	P81	12	.517	0.235	.046	0.001	PT138-10	12	.862	0.391	.080	0.002
B6-HPG	12	1.108	0.503	.052	0.001	P82	12	.725	0.329	.079	0.002	PT138-25	12	.842	0.382	.080	0.002
B7	12	1.600	0.726	.082	0.002	PT82-HD	12	.950	0.431	.105	0.003	PT139-10	12	1.208	0.548	.186	0.005
B9	12	1.142	0.518	.061	0.002	PT82-HD10	12	.958	0.435	.108	0.003	P140	12	.317	0.144	.033	0.001
B10-AL	6	2.525	1.145	.154	0.004	PT83	6	2.384	1.081	.270	0.008	B141	12	1.038	0.471	.051	0.001
B10-AL BSP	6	2.483	1.126	.156	0.004	PT83-MPG	6	3.200	1.452	.273	0.008	BD142	12	2.100	0.953	.070	0.002
B10-AL BSPCS	6	2.530	1.148	.160	0.005	P84-2	12	.558	0.253	.040	0.001	B143	12	.760	0.345	.040	0.001
B10-AL CAP	6	1.625	0.737	.043	0.001	PT85	12	.763	0.346	.079	0.002	P144	12	.337	0.153	.040	0.001
B10-AL BOWL	6	.658	0.298	.144	0.004	PT86-HD	12	1.204	0.546	.189	0.005	PT146	12	1.304	0.591	.189	0.005
PF10	12	.392	0.178	.037	0.001	PT87-S	12	1.146	0.520	.088	0.002	P148	12	.279	0.127	.033	0.001
PF10-CS	12	.408	0.185	.037	0.001	PT88-HD	12	1.283	0.582	.190	0.005	P150	12	.475	0.215	.046	0.001
PT11	12	.917	0.416	.089	0.003	PT89	12	1.175	0.533	.129	0.004	151	18	.550	0.249	.068	0.002
PT11-HD	12	1.079	0.489	.090	0.003	PT90-10	12	1.700	0.771	.186	0.005	151-30	18	.533	0.242	.068	0.002
PT12	12	.575	0.261	.061	0.002	PT90-MPG	12	2.175	0.987	.187	0.005	151-W	18	.600	0.272	.070	0.002
BF13	12	.950	0.431	.043	0.001	PT91	12	1.838	0.834	.130	0.004	PT151	12	.612	0.278	.051	0.001
P15	12	.483	0.219	.051	0.001	PT93	12	.958	0.435	.099	0.003	PT152	12	1.088	0.494	.106	0.003
S16-1	12	.563	0.255	.063	0.002	PT93-MPG	12	1.192	0.541	.109	0.003	PT153	12	.779	0.353	.080	0.002
P18	12	.571	0.259	.065	0.002	B95	6	2.792	1.266	.142	0.004	PT154	12	.971	0.440	.105	0.003
P18-HD	12	.717	0.325	.065	0.002	B95-MPG	6	3.008	1.364	.143	0.004	PF155	12	1.142	0.518	.134	0.004
P19	12	.783	0.355	.081	0.002	B95-SS	6	2.767	1.255	.143	0.004	B156	12	.963	0.437	.045	0.001
P20-HD	12	1.188	0.539	.133	0.004	B96	6	2.942	1.334	.163	0.005	B157	12	1.779	0.807	.087	0.002
P25	12	.754	0.342	.080	0.002	B96-MPG	6	3.317	1.505	.163	0.005	B159	12	.708	0.321	.037	0.001
P26	12	.808	0.367	.078	0.002	B96-SS	6	2.992	1.357	.160	0.005	B160	12	.650	0.295	.028	0.001
B27	12	1.092	0.495	.051	0.001	B97	6	2.658	1.206	.148	0.004	B161-S	12	.700	0.318	.032	0.001
BD28	12	1.304	0.591	.057	0.002	PT98-10	6	3.075	1.395	.327	0.009	P162	12	.529	0.240	.063	0.002
PT29	12	.425	0.193	.048	0.001	PT98-MPG	6	3.567	1.618	.328	0.009	B163	12	1.042	0.473	.051	0.001
AFG30	1	.300	0.136	.014	**	B99	6	4.183	1.897	.236	0.007	B164	12	1.400	0.635	.062	0.002
B30	12	.754	0.342	.037	0.001	B99-B	6	4.492	2.038	.269	0.008	B166	12	1.033	0.469	.050	0.001
B31	12	.642	0.291	.031	0.001	B99-MPG	6	4.542	2.060	.225	0.006	B167	12	1.279	0.580	.068	0.002
B33	12	.529	0.240	.028	0.001	B99-SS	6	4.333	1.965	.225	0.006	B168	12	.796	0.361	.047	0.001
B34	12	1.046	0.474	.049	0.001	101	18	.364	0.165	.032	0.001	P170	12	.438	0.199	.049	0.001
B35-S	12	.717	0.325	.035	0.001	101-30	18	.375	0.170	.034	0.001	P171	12	.396	0.180	.032	0.001
AFG37R	6	.450	0.204	.040	0.001	101-W	18	.400	0.181	.034	0.001	P172	12	.392	0.178	.034	0.001
B37	12	.571	0.259	.028	0.001	P102	12	1.167	0.529	.100	0.003	B173-S	12	.954	0.433	.052	0.001
AFG38D	6	.208	0.094	.030	0.001	BD103	6	3.533	1.603	.165	0.005	P174	12	.458	0.208	.048	0.001
B39	12	1.025	0.465	.052	0.001	BD103-MPG	6	3.667	1.663	.164	0.005	P176	12	.321	0.146	.034	0.001
P40	12	.658	0.298	.051	0.001	BD103-SS	6	3.559	1.614	.161	0.005	P177	12	.442	0.200	.047	0.001
P41	12	.817	0.371	.080	0.002	P104	12	.675	0.306	.065	0.002	B178	12	.725	0.329	.036	0.001
P42	12	1.021	0.463	.133	0.004	B105	6	2.092	0.949	.094	0.003	B179	12	.621	0.282	.028	0.001
B43-S	12	.625	0.284	.028	0.001	P106	12	.150	0.068	.016	**	PT181 KIT	1	1.750	0.794	.239	0.007
B45	12	2.250	1.021	.107	0.003	P106-HD	12	.250	0.113	.022	0.001	P183	12	.267	0.121	.040	0.001
P47	12	.904	0.410	.079	0.002	PT108	12	.383	0.174	.038	0.001	P184	12	.617	0.280	.055	0.002
PT48	12	.438	0.199	.034	0.001	PT108-HD	12	.475	0.215	.037	0.001	PT185	12	.658	0.298	.097	0.003
B49	6	2.825	1.281	.161	0.005	B109	12	1.271	0.577	.060	0.002	P186	12	.358	0.162	.041	0.001
B50	12	1.167	0.529	.052	0.001	BC110	12	.883	0.401	.062	0.002	PT187	12	.296	0.134	.032	0.001
P52	12	1.121	0.508	.132	0.004	BT111	12	1.167	0.529	.061	0.002	PT189	12	1.192	0.541	.099	0.003
P53	12	.837	0.380	.081	0.002	BT112	12	1.175	0.533	.061	0.002	PT189-MPG	12	1.275	0.578	.107	0.003
P54	12	.987	0.448	.079	0.002	B113	12	.712	0.323	.036	0.001	P190	12	.463	0.210	.050	0.001
B56	12	.746	0.338	.036	0.001	B114	12	1.208	0.548	.061	0.002	PT191	1	1.750	0.794	.211	0.006
P60	12	.725	0.329	.066	0.002	PT115	12	1.125	0.510	.134	0.004	PT191-5	1	1.800	0.816	.208	0.006
61	12	.238	0.108	.016	**	P116	1	2.600	1.179	.233	0.007	PT191-10	6	2.117	0.960	.255	0.007
61-W	12	.233	0.106	.016	**	PF116	6	2.334	1.059	.272	0.008	PT193	1	2.150	0.975	.209	0.006
PT61-HD	12	.754	0.342	.080	0.002	PT117	6	3.267	1.482	.458	0.013	PT193-3	1	2.250	1.021	.209	0.006
PT62	12	.525	0.238	.040	0.001	PT117-25	6	3.325	1.508	.454	0.013	PT193 KIT	1	2.400	1.089	.289	0.008
PT63-1	12	.633	0.287	.081	0.002	B118	12	1.196	0.543	.061	0.002	P194	6	2.025	0.919	.258	0.007
66	12	.229	0.104	.016	**	PT119	1	2.950	1.338	.395	0.011	P194-HD	6	2.292	1.040	.255	0.007
66-30	12	.217	0.098	.016	**	PT119-5	1	2.950	1.338	.395	0.011	P194-HD10	6	2.375	1.077	.255	0.007
66-W	12	.229	0.104	.016	**	PT119-HD	1	3.500	1.588	.395	0.011	PF194	6	2.100	0.953	.258	0.007
PT66-HD	12	.771	0.350	.063	0.002	PT119-HD5	1	3.550	1.610	.395	0.011	B195	12	.650	0.295	.027	0.001
P67	12	.742	0.337	.061	0.002	B120	12	.996	0.452	.051	0.001	B196	6	2.758	1.251	.144	0.004
P68	12	.871	0.395	.082	0.002	PF121	12	.525	0.238	.047	0.001	P198	12	.708	0.321	.079	0.002
PT70	12	.671	0.304	.066	0.002	PT122-5	1	4.400	1.996	.464	0.013	B199	12	.788	0.357	.038	0.001
PT71	12	.530	0.240	.056	0.002	BT124	12	1.883	0.854	.087	0.002	201	8	.894	0.406	.128	0.004
PT72	12	.712	0.323	.081	0.002	P125	12	.450	0.204	.046	0.001	201-30	8	1.143	0.518	.129	0.004
P73	12	.529	0.240	.040	0.001	BT126	12	1.388	0.630	.079	0.002	201-W	8	.950	0.431	.129	0.004
B74	12	1.025	0.465	.052	0.001	P127	12	.788	0.357	.082	0.002	B201-S	12	1.475	0.669	.056	0.002
B75	12	1.612	0.731	.070	0.002	B128	12	1.971	0.894	.086	0.002	B202	12	1.175	0.533	.060	0.002
B76	12	2.375	1.077	.120	0.003	B129	12	1.787	0.811	.088	0.0						

**BALDWIN WEIGHTS AND VOLUMES**

BALDWIN NUMBER	CASE QTY.	WEIGHT (ea.)		Volume (ea.)	BALDWIN NUMBER	CASE QTY.	WEIGHT (ea.)		Volume (ea.)	BALDWIN NUMBER	CASE QTY.	WEIGHT (ea.)		Volume (ea.)			
		lbs.	kgs.	ft <sup>3</sup>			lbs.	kgs.	ft <sup>3</sup>			lbs.	kgs.	ft <sup>3</sup>			
P204-HD	12	1.179	0.535	.107	0.003	P280	12	400	0.181	.049	0.001	B358	12	1.071	0.486	.048	0.001
P204-HD10	12	1.167	0.529	.107	0.003	B281	12	1.142	0.518	.051	0.001	BT359	6	3.200	1.452	.145	0.004
B205	6	2.392	1.085	.121	0.003	PT283	12	217	0.098	.036	0.001	B360	12	1.104	0.501	.051	0.001
P206	12	1.700	0.318	.081	0.002	PT284	12	238	0.108	.037	0.001	BT361	12	1.042	0.473	.052	0.001
PT207	12	.908	0.412	.107	0.003	PT285	6	1.833	0.831	.275	0.008	BT364	12	1.175	0.533	.052	0.001
PT207-10	12	.896	0.406	.108	0.003	BT287	6	2.558	1.160	.124	0.004	BT365	12	1.275	0.578	.068	0.002
PT207-HD	12	1.142	0.518	.106	0.003	BT287-10	6	2.592	1.176	.126	0.004	BT365-10	12	1.362	0.618	.080	0.002
PT207-HD10	12	1.138	0.516	.107	0.003	BT287-3	6	2.608	1.183	.127	0.004	BT366-10	12	1.112	0.504	.052	0.001
PT208	6	1.533	0.695	.160	0.005	PT288-HD	12	1.308	0.593	.133	0.004	BT366-MPG	12	1.863	0.845	.059	0.002
PT210	12	.700	0.284	.062	0.002	PT288-HD10	12	1.338	0.607	.134	0.004	BT367	12	.958	0.435	.043	0.001
B211	12	1.596	0.724	.070	0.002	PT289	12	.483	0.219	.061	0.002	BT367-S	12	.896	0.406	.051	0.001
PT212-5	1	4.600	2.087	.464	0.013	PT289-10	12	.475	0.215	.063	0.002	BT368	12	.904	0.410	.050	0.001
PT213	12	1.009	0.458	.126	0.004	PT290	12	.471	0.214	.062	0.002	B369	12	1.025	0.465	.051	0.001
PT214(2)	12	.563	0.255	.097	0.003	BT292	12	1.125	0.510	.053	0.001	PT370	4	6.163	2.796	.719	0.020
BT215	12	.717	0.325	.035	0.001	P294	12	1.867	0.847	.158	0.004	BT371-10	12	1.292	0.586	.061	0.002
BT216	12	1.183	0.537	.052	0.001	B295	12	.837	0.380	.048	0.001	BT371-MPG	12	1.404	0.637	.060	0.002
BT217	12	1.342	0.609	.068	0.002	B296	12	.904	0.410	.045	0.001	BT372-10	12	1.804	0.818	.096	0.003
B218	12	2.508	1.138	.122	0.003	PT298-10	12	1.075	0.488	.119	0.003	BT372-MPG	12	1.917	0.870	.096	0.003
B220	6	2.658	1.206	.145	0.004	B299	12	1.379	0.626	.067	0.002	PT373	12	1.225	0.556	.105	0.003
BT221	12	1.996	0.905	.080	0.002	T300-M	12	.729	0.331	.053	0.001	PT374	12	.612	0.278	.064	0.002
B222	12	1.475	0.669	.057	0.002	301	4	1.600	0.726	.254	0.007	PT375	12	.950	0.431	.099	0.003
BT223	12	.700	0.318	.029	0.001	301-30	4	1.425	0.646	.260	0.007	PT376	12	1.433	0.650	.135	0.004
PF224	12	.179	0.081	.020	0.001	301-CS	4	2.338	1.061	.251	0.007	PT377	12	.646	0.293	.047	0.001
PF225	12	.904	0.410	.107	0.003	301-MPG	1	2.550	1.157	.319	0.009	PT377-10	12	.646	0.293	.048	0.001
PF226	12	.546	0.248	.065	0.002	301-W	4	1.563	0.709	.258	0.007	B378	12	1.554	0.705	.084	0.002
B227	12	.625	0.284	.028	0.001	B301	12	.625	0.284	.031	0.001	B378-10	12	1.521	0.690	.083	0.002
B228	12	.667	0.303	.028	0.001	PT302	12	1.267	0.575	.074	0.002	PT379 KIT	6	1.383	0.627	.157	0.004
B229	12	1.004	0.455	.043	0.001	T303-M	12	1.204	0.546	.071	0.002	PT380 KIT	1	2.350	1.066	.221	0.006
BT230	12	1.088	0.494	.051	0.001	PT304	12	1.333	0.605	.095	0.003	PT381	12	1.821	0.826	.134	0.004
PF231	12	.429	0.195	.056	0.002	BT305	12	1.379	0.626	.065	0.002	PT382	12	.471	0.214	.035	0.001
BD232	12	2.196	0.996	.078	0.002	B307	12	.633	0.287	.032	0.001	PT383	12	1.088	0.494	.132	0.004
B233	12	1.071	0.486	.051	0.001	T308-M	12	.725	0.329	.054	0.002	PT385	12	1.517	0.688	.134	0.004
BT234	6	2.325	1.055	.095	0.003	B309	12	1.754	0.796	.086	0.002	PT385-E	12	1.546	0.701	.132	0.004
P235	12	.725	0.329	.100	0.003	BT310	12	.663	0.301	.032	0.001	PT386	12	1.355	0.615	.231	0.007
B236	12	1.475	0.669	.079	0.002	PF311	12	.354	0.161	.033	0.001	BT387	6	2.592	1.176	.124	0.004
BT237	12	1.350	0.612	.066	0.002	PF312	12	1.071	0.486	.100	0.003	BT387-10	6	2.625	1.191	.125	0.004
BT238	12	1.787	0.811	.088	0.002	PF313	12	.325	0.147	.034	0.001	BT388	6	3.300	1.497	.264	0.007
B239	6	4.208	1.909	.225	0.006	PF314	12	.250	0.113	.034	0.001	BT388-10	6	3.325	1.508	.265	0.007
P240	12	.342	0.155	.034	0.001	PF316	6	2.617	1.187	.277	0.008	BT389	6	3.342	1.516	.263	0.007
BT241	12	1.108	0.503	.051	0.001	PT317-MPG	1	1.550	0.703	.096	0.003	BT389-10	6	3.392	1.539	.262	0.007
P242	12	1.492	0.677	.115	0.003	PT318-MPG	1	1.650	0.748	.090	0.003	PT390-MPG	12	1.796	0.815	.135	0.004
B243	12	.767	0.348	.037	0.001	PT319-MPG	1	3.550	1.610	.366	0.010	PT391-MPG	12	1.675	0.760	.130	0.004
B244	12	1.125	0.510	.052	0.001	PT320-MPG	1	2.950	1.338	.226	0.006	PT392	12	1.096	0.497	.131	0.004
B246	12	1.155	0.524	.059	0.002	BD324	6	3.100	1.406	.140	0.004	PT393	12	1.859	0.843	.185	0.005
B247	12	.750	0.340	.036	0.001	BD325	12	2.946	1.336	.115	0.003	PT394-5	6	2.509	1.138	.254	0.007
BT248	12	1.183	0.537	.052	0.001	B326	12	1.783	0.809	.086	0.002	PT394-15	6	2.600	1.179	.255	0.007
P249	12	1.471	0.667	.120	0.003	B329	12	1.017	0.461	.051	0.001	BT395	12	1.083	0.491	.047	0.001
BT251	12	1.296	0.588	.066	0.002	BF330	12	.862	0.391	.042	0.001	PT396	12	.417	0.189	.034	0.001
B252	12	1.425	0.646	.053	0.001	PF332	12	.604	0.274	.065	0.002	PT397	4	3.025	1.372	.378	0.011
B253	12	1.438	0.652	.051	0.001	B333	6	3.250	1.474	.164	0.005	BT398	12	2.308	1.047	.107	0.003
B255	12	1.396	0.633	.049	0.001	BT334	12	1.217	0.552	.060	0.002	PT400	6	1.983	0.899	.205	0.006
PT256	12	.150	0.068	.036	0.001	B336	12	1.188	0.539	.062	0.002	PT401-MPG	6	1.517	0.688	.148	0.004
PT257	12	.183	0.083	.035	0.001	B337	12	1.625	0.737	.072	0.002	BT402	12	2.333	1.058	.108	0.003
PT258	12	.350	0.159	.030	0.001	BT338	12	1.042	0.473	.046	0.001	B403	12	1.563	0.709	.079	0.002
BT259	12	1.213	0.550	.060	0.002	BT339	12	1.208	0.548	.066	0.002	B404	6	2.083	0.945	.093	0.003
BT260	12	1.063	0.482	.052	0.001	BT340	12	2.584	1.172	.120	0.003	JC405	12	.767	0.348	.070	0.002
BT260-10	12	1.112	0.504	.051	0.001	BT341	12	1.042	0.473	.040	0.001	CU406	12	.775	0.352	.072	0.002
BT261	12	1.313	0.596	.068	0.002	BT342	12	1.458	0.661	.077	0.002	DF408	6	2.175	0.987	.236	0.007
B262	12	1.546	0.701	.084	0.002	BT343	6	3.175	1.440	.143	0.004	TC413-CPE5	12	1.404	0.637	.122	0.003
B263	12	2.108	0.956	.107	0.003	BT344-S	12	1.371	0.622	.041	0.001	V414-B	4	3.313	1.503	.541	0.015
BT264	12	1.075	0.488	.049	0.001	BT345 KIT	1	6.250	2.835	.546	0.015	V414-FF	4	2.963	1.344	.535	0.015
PT265	12	.675	0.306	.061	0.002	BT346	12	.950	0.431	.050	0.001	F415-B	4	3.338	1.514	.546	0.015
P266	12	.558	0.253	.055	0.002	BT347	12	1.821	0.826	.086	0.002	P415-5	4	4.438	2.013	.534	0.015
BT267	12	1.496	0.679	.070	0.002	BT348	12	1.575	0.714	.073	0.002	P415-10	4	4.725	2.143	.532	0.015
PT268	12	1.033	0.469	.132	0.004	BT349	12	2.063	0.936	.109	0.003	P415-25	4	4.313	1.956	.539	0.015
PT269	12	.558	0.253	.055	0.002	BT350	12	1.775	0.805	.089	0.003	P415-5A	4	4.163	1.888	.532	0.015
P271	12	.392	0.178	.033	0.001	BT351	12	2.625	1.191	.115	0.003	P415-10A	4	4.288	1.945	.532	0.015
PT273	12	.538	0.244	.047	0.001	BT351-MPG	6	2.967	1.346	.148	0.004	P415-25A	4	4.013	1.820	.532	0.015
BT274	12	1.204	0.546	.062	0.002	P352	6	1.475	0.669	.201	0.006	P415-5AN	4	4.113	1.866	.532	0.015
PT275	12	1.213	0.550	.134	0.004	BT353	12	.854	0.387	.047	0.001	P415-GM	4	3.787	1.718	.585	0.017
PT275-10	12	1.150	0.522	.134	0.004	BT354	12	1.117	0.507	.052	0.001	V415-B	4	3.475	1.576	.516	0.015
P276	12	1.029	0.467	.108	0.003	BT355	12	1.504	0.682	.072	0.002	V415-FF	4	3.063	1.389	.539	0.015
PT277	1																

# BALDWIN WEIGHTS AND VOLUMES

BALDWIN NUMBER	CASE QTY.	WEIGHT (ea.) lbs.	WEIGHT (ea.) kgs.	Volume (ea.) ft <sup>3</sup>	Volume (ea.) m <sup>3</sup>	BALDWIN NUMBER	CASE QTY.	WEIGHT (ea.) lbs.	WEIGHT (ea.) kgs.	Volume (ea.) ft <sup>3</sup>	Volume (ea.) m <sup>3</sup>	BALDWIN NUMBER	CASE QTY.	WEIGHT (ea.) lbs.	WEIGHT (ea.) kgs.	Volume (ea.) ft <sup>3</sup>	Volume (ea.) m <sup>3</sup>
BT420	12	1.338	0.607	.041	0.001	PT503	1	3.250	1.474	.486	0.014	PF598	12	.371	0.168	.039	0.001
B421	12	.638	0.289	.032	0.001	PF506	12	.296	0.134	.034	0.001	PF598-10	12	.350	0.159	.040	0.001
S423	12	.067	0.030	.011	0.001	P507	12	1.188	0.539	.187	0.005	PF598-30	12	.392	0.178	.040	0.001
BT424	6	2.550	1.157	.129	0.004	PT508-MPG	12	1.321	0.599	.097	0.003	PF599	12	.100	0.045	.016	0.001
BT425	6	2.725	1.236	.178	0.005	PT509-MPG KIT	1	3.450	1.565	.236	0.007	PF599-10	12	.163	0.074	.015	0.001
PT426	12	1.287	0.584	.107	0.003	PT510	12	1.433	0.650	.133	0.004	PA602	6	1.312	0.595	.258	0.007
BT427	12	1.046	0.474	.054	0.002	PT512	4	1.787	0.811	.280	0.008	PA604	6	1.509	0.684	.230	0.007
V429-B	4	4.750	2.155	.914	0.026	PT513	12	.387	0.176	.055	0.002	B605	12	1.742	0.790	.070	0.002
V429-FF	4	4.387	1.990	.777	0.022	PT514	12	1.108	0.503	.131	0.004	BT606-MPG	12	1.325	0.601	.054	0.002
PT430-FF	6	2.417	1.096	.251	0.007	PT515	4	3.788	1.718	.584	0.017	PA607	6	1.825	0.828	.282	0.008
PT431	12	1.700	0.771	.188	0.005	PT516	12	1.167	0.529	.100	0.003	BT610-MPG	6	3.883	1.761	.162	0.005
PT433	12	1.129	0.512	.109	0.003	PT517	12	1.521	0.690	.231	0.007	BT611-MPG	6	2.575	1.168	.095	0.003
PT434	12	.429	0.195	.038	0.001	PT518	1	8.050	3.651	1.288	0.036	PA612	6	1.217	0.552	.214	0.006
PT434-10	12	.433	0.196	.037	0.001	PT518-10	1	7.950	3.606	1.288	0.036	PA613	6	1.417	0.643	.281	0.008
PT435	12	.513	0.233	.033	0.001	PT520	6	2.792	1.266	.327	0.009	BF614	12	2.017	0.915	.098	0.003
PT436	12	1.525	0.692	.134	0.004	BT521	12	1.921	0.871	.088	0.002	PA615	6	1.350	0.612	.247	0.007
PT437	12	.858	0.389	.083	0.002	PT522	12	.600	0.272	.100	0.003	PA616	1	4.500	2.041	.891	0.025
BT438	12	1.421	0.645	.057	0.002	BT525	12	1.608	0.729	.096	0.003	PA617	1	3.450	1.565	.574	0.016
PT439	12	.587	0.266	.062	0.002	BT526	12	1.167	0.529	.050	0.001	PA618	1	5.450	2.472	.884	0.025
BT440	12	1.733	0.786	.086	0.002	BT526-10	12	1.208	0.548	.050	0.001	PA618-S	1	5.150	2.336	.869	0.025
PT441	12	.983	0.446	.054	0.002	PT527	1	5.100	2.313	.853	0.024	PA618 FOAM	6	.242	0.110	.153	0.004
PT442-MPG	12	2.375	1.077	.139	0.004	P528	12	1.013	0.459	.097	0.003	PA621	6	1.067	0.484	.234	0.007
BT443	6	2.334	1.059	.119	0.003	P529	6	2.625	1.191	.326	0.009	PA625	6	1.717	0.779	.342	0.010
PT445-MPG	12	.829	0.376	.062	0.002	PT534	6	.892	0.405	.157	0.004	PA631	6	3.908	1.773	.959	0.027
P446	12	.346	0.157	.034	0.001	PT535	12	.779	0.353	.063	0.002	PA632	6	2.490	1.129	.410	0.012
B447	12	1.375	0.624	.059	0.002	BT536	12	1.029	0.467	.052	0.001	PA633(2)	12	.808	0.367	.052	0.001
P450	12	.150	0.068	.008	0.001	P537	6	3.292	1.493	.454	0.013	PA634	6	.700	0.318	.102	0.003
S451	12	.060	0.027	.010	0.001	PT538	12	1.529	0.694	.189	0.005	PA638	4	2.000	0.907	.502	0.014
BT452	12	1.196	0.543	.062	0.002	PT539	1	1.950	0.885	.230	0.007	PA639	1	5.200	2.359	.780	0.022
P454	12	.346	0.157	.014	0.001	P540	12	.100	0.045	.016	0.001	PA640	6	.625	0.284	.106	0.003
S455	12	.067	0.030	.011	0.001	BT541	12	1.112	0.504	.051	0.001	PA641	1	2.100	0.953	.288	0.008
S456	12	.192	0.087	.034	0.001	PT543 KIT	6	1.642	0.745	.212	0.006	PA642	6	1.217	0.552	.250	0.007
PT457-MPG	6	2.917	1.323	.255	0.007	P545	12	.755	0.342	.059	0.002	PA643	12	.346	0.157	.081	0.002
PT459	12	.162	0.073	.011	0.001	PT546	12	.542	0.246	.048	0.001	PA644	12	.367	0.166	.082	0.002
PT461	12	.238	0.108	.033	0.001	PT548	6	.400	0.181	.034	0.001	PA645	1	7.850	3.561	1.230	0.035
PT462	6	2.225	1.009	.279	0.008	PT549	12	.600	0.272	.056	0.002	PA648	6	1.042	0.473	.233	0.007
PT463	12	.380	0.172	.021	0.001	PT550-10	6	2.284	1.036	.250	0.007	PA649	6	.584	0.265	.097	0.003
PT466	12	1.505	0.683	.126	0.004	PT551-10	1	3.050	1.383	.318	0.009	PA650	6	1.666	0.756	.214	0.006
PT467-MPG	6	1.575	0.714	.110	0.003	PT554	12	1.642	0.745	.233	0.007	PA651	4	2.125	0.964	.518	0.015
PT468-MPG	12	1.167	0.529	.089	0.003	P555	12	1.600	0.726	.186	0.005	PA652	6	.892	0.405	.148	0.004
PT469	1	2.200	0.998	.233	0.007	BT556-10	12	2.471	1.121	.120	0.003	PA653	1	1.200	0.544	.223	0.006
BT470	12	1.838	0.834	.086	0.003	PT558	6	.867	0.393	.104	0.003	PA654	1	3.992	1.811	.589	0.017
PT471	12	.884	0.401	.185	0.005	PT560 KIT	1	2.550	1.157	.221	0.006	PA655	1	2.650	1.202	.361	0.010
BT472	12	2.563	1.163	.108	0.003	PT561	12	1.542	0.699	.131	0.004	PA656	1	4.100	1.860	.554	0.016
B474	12	.675	0.306	.031	0.001	PT562-10	12	.658	0.298	.066	0.002	PA657	6	1.009	0.458	.185	0.005
PT475	12	1.317	0.597	.136	0.004	PT563	12	1.596	0.724	.189	0.005	PA658	6	.925	0.420	.148	0.004
P476	12	.833	0.378	.102	0.003	BT564	12	1.454	0.660	.070	0.002	PA662	6	2.050	0.930	.185	0.005
PT477	12	.342	0.155	.037	0.001	PT565	6	.842	0.382	.159	0.004	PA666	1	7.400	3.357	1.519	0.043
PT480	12	.629	0.285	.049	0.001	PT566	12	1.379	0.626	.189	0.005	PA669	6	1.334	0.605	.109	0.003
PT480-10	12	.629	0.285	.047	0.001	PT567	12	.942	0.427	.101	0.003	PT670	12	.929	0.421	.108	0.003
PT480-MPG	12	.763	0.346	.048	0.001	PT567-10	12	.892	0.405	.099	0.003	PT670-E	12	.888	0.403	.109	0.003
B481	12	1.338	0.607	.063	0.002	PT568	12	2.137	0.969	.187	0.005	PA671	1	4.200	1.905	.652	0.018
PT483	1	4.100	1.860	.464	0.013	PT571	1	1.800	0.816	.177	0.005	PA671-1	1	3.550	1.610	.652	0.018
S485	12	.010	0.005	.016	0.001	PT573	1	1.900	0.862	.179	0.005	PA675	6	.450	0.204	.081	0.002
BT486	6	2.667	1.210	.148	0.004	BF577	12	1.488	0.675	.083	0.002	PT676	1	1.450	0.658	.117	0.003
PT487	12	1.208	0.548	.098	0.003	PT578	12	1.033	0.469	.133	0.004	PA677	6	.317	0.144	.034	0.001
B488	12	.967	0.439	.050	0.001	PT579	12	1.071	0.486	.189	0.005	PA678	6	.592	0.269	.100	0.003
PT490	1	3.200	1.452	.318	0.009	BF582	12	1.221	0.554	.060	0.002	PA680	6	1.092	0.495	.194	0.005
PT491	1	5.700	2.586	.464	0.013	BF583	12	1.138	0.516	.054	0.002	PT682	1	2.100	0.953	.234	0.007
PT491-10	1	5.050	2.291	.464	0.013	BF584	12	2.383	1.081	.124	0.004	PT683	1	2.950	1.338	.167	0.005
PT492	12	.329	0.149	.037	0.001	BF584-B	12	2.558	1.160	.128	0.004	PT685-MPG	12	1.146	0.520	.091	0.003
PT493	6	2.984	1.354	.372	0.011	BF585	12	1.071	0.486	.052	0.001	PA691	6	1.075	0.488	.214	0.006
B494	12	1.463	0.664	.054	0.002	BF586	12	.904	0.410	.046	0.001	PT691	1	.500	0.227	.072	0.002
B495	6	2.817	1.278	.147	0.004	BF586-D	12	.925	0.420	.046	0.001	PA693	6	2.034	0.923	.591	0.017
B495-MPG	6	3.008	1.364	.144	0.004	BF587	12	.933	0.423	.046	0.001	PT694	1	3.000	1.361	.231	0.007
B495-SS	6	2.800	1.270	.143	0.004	BF587-D	12	.962	0.436	.046	0.001	PA696	6	.742	0.337	.105	0.003
P496	12	.342	0.155	.034	0.001	BF588	12	1.904	0.864	.086	0.002	PA697	6	.558	0.253	.052	0.001
P497	12	.413	0.187	.048	0.001	BF591	12	1.458	0.661	.081	0.002	PA699	6	.858	0.389	.120	0.003
PT498	12	1.058	0.480	.105	0.003	BF592	12	.983	0.446	.045	0.001	C704-L	4	4.575	2.075	.388	0.011
PT498-10	12	1.071	0.486	.107	0.003	BF593	12	.983	0.446	.042	0.001	P706-M	4	3.675	1.667	.583	0.016
PT499-5	1	2.650	1.202	.289	0.008	F594-F	12	1.104	0.501	.106	0.003	PT707-HD	12	1.321	0.599	.100	0.003
501	4	1.475	0.669	.251	0.007	PF594	12	.942	0.427	.107	0.003	PT707-HD3	12	1.350	0.612	.101	0.003
501-30	4	1.438	0.652	.252	0.007	BT595	12	1.237	0.561	.066	0.002	PT707-HD10	12				



**BALDWIN WEIGHTS AND VOLUMES**

BALDWIN NUMBER	CASE QTY.	WEIGHT (ea.) lbs.	WEIGHT (ea.) kgs.	Volume (ea.) ft <sup>3</sup>	Volume (ea.) m <sup>3</sup>	BALDWIN NUMBER	CASE QTY.	WEIGHT (ea.) lbs.	WEIGHT (ea.) kgs.	Volume (ea.) ft <sup>3</sup>	Volume (ea.) m <sup>3</sup>	BALDWIN NUMBER	CASE QTY.	WEIGHT (ea.) lbs.	WEIGHT (ea.) kgs.	Volume (ea.) ft <sup>3</sup>	Volume (ea.) m <sup>3</sup>
PF717	12	.196	0.089	.020	0.001	PF818	12	200	0.091	.015	**	PF894	12	.001	**	.010	**
P718-5	4	4.025	1.826	.532	0.015	PF819	12	.725	0.329	.081	0.002	PF894-RV	12	.006	0.003	.015	**
BF719	12	1.088	0.494	.045	0.001	PF820-S	12	.308	0.140	.033	0.001	BF896	12	1.133	0.514	.055	0.002
BF720	12	.979	0.444	.042	0.001	PF821-S	12	.712	0.323	.062	0.002	BF897 KIT	1	2.400	1.089	.234	0.007
PT721	12	1.013	0.459	.134	0.004	PF822	12	.733	0.332	.079	0.002	SF898	12	.030	0.014	.004	**
PT722	6	2.817	1.278	.275	0.008	PF823	12	.729	0.331	.065	0.002	PF899	12	.738	0.335	.077	0.002
P723	12	.763	0.346	.107	0.003	PF823-E	12	.692	0.314	.080	0.002	BF900	12	1.125	0.510	.052	0.001
PT725-MPG	6	1.892	0.858	.152	0.004	PF824	12	.717	0.325	.066	0.002	PF902	12	.583	0.264	.061	0.002
PT727-HD	12	.600	0.272	.048	0.001	BF825	12	.420	0.191	.030	0.001	PF902-S	12	.521	0.236	.063	0.002
PT727-HD10	12	.612	0.278	.048	0.001	PF826	12	.742	0.337	.082	0.002	PT903	12	.467	0.212	.042	0.001
PT727-DL	24	.848	0.385	.061	0.002	PF827	12	.158	0.072	.024	0.001	PF906	12	.358	0.162	.034	0.001
PT728-MPG	12	.513	0.233	.050	0.001	PF828	12	.408	0.185	.047	0.001	PF907	12	.533	0.242	.063	0.002
PT729	4	4.438	2.013	.532	0.015	PF829(2)	6	1.550	0.703	.185	0.005	F908-A	6	2.033	0.922	.254	0.007
BT732	6	2.375	1.077	.090	0.003	BF830	12	.633	0.287	.059	0.002	BF909	12	1.700	0.771	.048	0.001
BT735	12	1.975	0.896	.075	0.002	PF831	12	.421	0.191	.049	0.001	PF910	12	.508	0.230	.062	0.002
PT737	12	1.121	0.508	.101	0.003	BF833	12	.204	0.093	.020	0.001	BF912	12	1.420	0.644	.047	0.001
PT737-10	12	1.121	0.508	.101	0.003	BF833-K2	12	.250	0.113	.020	0.001	PF913	12	.308	0.140	.034	0.001
V738-O	12	.667	0.303	.087	0.002	F834-F	12	.379	0.172	.027	0.001	BF914	6	2.192	0.994	.142	0.004
BT739	12	2.229	1.011	.096	0.003	PF834	12	.337	0.153	.034	0.001	BF915	12	1.350	0.612	.070	0.002
C740-S	12	.450	0.204	.059	0.002	BF836	12	.204	0.093	.020	0.001	F916-C	12	.396	0.180	.062	0.002
C750-E	4	6.138	2.784	.678	0.019	BF836-K3	12	.258	0.117	.020	0.001	PF916	12	.492	0.223	.047	0.001
C750-L	4	7.913	3.589	.653	0.018	BF836-K4	12	.100	0.045	.016	**	BF918-K	12	.250	0.113	.016	**
C750-L SINGLE	1	8.150	3.697	.704	0.020	BF837	12	.100	0.045	.016	**	F919-C	60	.283	0.128	.025	0.001
PT751	6	2.233	1.013	.248	0.007	BF838-F2	12	.513	0.233	.040	0.001	BF920	12	.184	0.083	.018	0.001
PT752	6	2.700	1.225	.375	0.011	PF838	12	.462	0.210	.040	0.001	PF924	12	.529	0.240	.066	0.002
PT753	1	8.250	3.742	1.288	0.036	BT839	12	1.092	0.495	.053	0.001	PF926	12	.425	0.193	.066	0.002
PT757	6	2.242	1.017	.250	0.007	BT839-10	12	1.104	0.501	.051	0.001	BF928	12	.125	0.057	.022	0.001
PT757-10	6	2.384	1.081	.250	0.007	BF840	12	.188	0.085	.020	0.001	BF929	12	.558	0.253	.065	0.002
PT760-10	12	1.446	0.656	.133	0.004	BF840-K1	12	.250	0.113	.016	**	BF930	12	.254	0.115	.023	0.001
PT760-25	12	1.417	0.643	.134	0.004	VT842-O	12	.558	0.253	.070	0.002	BF932	12	.121	0.055	.022	0.001
PT761	12	1.429	0.648	.135	0.004	BF843	12	.275	0.125	.020	0.001	BF933	12	.100	0.045	.020	0.001
PT763	6	3.067	1.391	.371	0.010	F844-A	12	1.071	0.486	.128	0.004	PF935	12	.208	0.094	.022	0.001
PT764	12	1.104	0.501	.083	0.002	F845-A	12	.488	0.221	.059	0.002	PF936	12	.542	0.246	.034	0.001
PT765	12	1.171	0.531	.081	0.002	PF845	12	.542	0.246	.061	0.002	PF937	12	.125	0.057	.014	**
PT766	6	2.609	1.183	.454	0.013	PF846	12	1.329	0.603	.132	0.004	BF938	12	.946	0.429	.042	0.001
PT767	6	3.183	1.444	.370	0.010	PF847	12	.166	0.075	.013	**	BF939	12	.975	0.442	.043	0.001
PT768	6	3.009	1.365	.371	0.010	PT849	12	.450	0.204	.033	0.001	BF940	12	.604	0.274	.028	0.001
PT772	6	2.442	1.108	.371	0.010	PT849-10	12	.471	0.214	.034	0.001	BF941	12	.875	0.397	.042	0.001
PT773-MPG	6	3.892	1.765	.244	0.007	V852-O	12	.992	0.450	.125	0.004	PF942	12	.529	0.240	.062	0.002
BT774	1	5.400	2.449	.210	0.006	BF853	12	.375	0.170	.021	0.001	PF943	12	.383	0.174	.038	0.001
BT775	6	4.317	1.958	.205	0.006	BF855	12	.558	0.253	.029	0.001	PF945	12	.288	0.131	.033	0.001
PT776-MPG	12	2.246	1.019	.135	0.004	BF856	12	.950	0.431	.035	0.001	PF946	12	.379	0.172	.034	0.001
PT777	12	1.508	0.684	.130	0.004	PF857	12	.071	0.032	.011	**	PF947	12	.367	0.166	.034	0.001
BT778	12	1.663	0.754	.084	0.002	BF858	12	.367	0.166	.037	0.001	BF948	12	.950	0.431	.043	0.001
BT779	12	1.183	0.537	.045	0.001	PF859	12	.088	0.040	.011	**	BF948-JD	12	1.067	0.484	.061	0.002
BF781	12	1.317	0.597	.079	0.002	PF860	12	.288	0.131	.033	0.001	PF949	1	3.600	1.633	.407	0.012
BF782	12	.692	0.314	.033	0.001	PF861	12	.308	0.140	.033	0.001	F950-F	12	.646	0.293	.056	0.002
BF783	12	1.688	0.766	.087	0.002	BF862	12	1.092	0.495	.061	0.002	PF950	12	.467	0.212	.056	0.002
BF784	6	2.692	1.221	.139	0.004	BF863	12	1.104	0.501	.060	0.002	PT951	12	.442	0.200	.039	0.001
BF785	6	2.625	1.191	.139	0.004	PF864	12	.030	0.014	.124	0.004	PF952	12	1.430	0.649	.115	0.003
BF786	12	1.563	0.709	.058	0.002	BF865	12	.213	0.097	.020	0.001	F953-F	12	.313	0.142	.037	0.001
BF788	12	.917	0.416	.032	0.001	BF865-K	12	.275	0.125	.021	0.001	BF954	12	.720	0.327	.028	0.001
BF789	12	.950	0.431	.044	0.001	PF866	12	.292	0.132	.034	0.001	BF955	12	1.096	0.497	.052	0.001
BF790	12	.688	0.312	.029	0.001	BF868	12	.367	0.166	.038	0.001	BF955 KIT	6	1.933	0.877	.143	0.004
BF791	12	1.063	0.482	.044	0.001	PF869	12	1.280	0.581	.231	0.007	BF956	12	1.150	0.522	.051	0.001
BF791-O	12	1.095	0.497	.051	0.001	PF872	12	.088	0.040	.015	**	BF957	12	1.063	0.482	.055	0.002
BF792	12	1.092	0.495	.046	0.001	BF873	12	.175	0.079	.045	0.001	BF957-D	12	1.075	0.488	.052	0.001
BF794	12	.383	0.174	.038	0.001	BF874	12	.621	0.282	.040	0.001	BF958	12	1.475	0.669	.077	0.002
BF795	12	.488	0.221	.076	0.002	BF876	12	1.813	0.822	.086	0.002	BF959	12	1.075	0.488	.049	0.001
BF797	12	1.071	0.486	.052	0.001	BF877	12	1.858	0.843	.087	0.002	P960	12	.404	0.183	.051	0.001
BF798	12	1.321	0.599	.064	0.002	BF879	12	.154	0.070	.019	0.001	BF962	12	1.171	0.531	.062	0.002
BF799	6	4.258	1.931	.247	0.007	BF880-FP	12	2.121	0.962	.095	0.003	PF963	12	.629	0.285	.063	0.002
PF802	12	.375	0.170	.034	0.001	BF881	12	.150	0.068	.023	0.001	BF966	12	.483	0.219	.046	0.001
PF804	12	.621	0.282	.064	0.002	PF882	12	.396	0.180	.061	0.002	PF967	12	.492	0.223	.046	0.001
BF805	12	.001	**	.011	**	PF883	12	.417	0.189	.048	0.001	BF968	12	1.209	0.548	.055	0.002
BF806	12	.871	0.395	.031	0.001	BF884	12	.708	0.321	.048	0.001	BF970	12	1.217	0.552	.066	0.002
PF807	12	.350	0.159	.034	0.001	BF885	12	.788	0.357	.064	0.002	BF971	12	1.263	0.573	.069	0.002
PF809	12	.742	0.337	.082	0.002	BF886	12	.321	0.146	.037	0.001	BF974-D	12	1.375	0.624	.070	0.002
PF810	12	.563	0.255	.063	0.002	BF888	12	1.625	0.737	.084	0.002	B975	12	1.292	0.586	.067	0.002
PF811	12	1.692	0.767	.188	0.005	BF890	12	.629	0.285	.047	0.001	BF976	12	2.463	1.117	.123	0.003
BF812	12	.733	0.332	.054	0.002	BF891	12	1.175	0.533	.063	0.002	BF978	12	1.550	0.703	.084	0.002
PF814	12	.508	0.230	.045	0.001	BF892	12	1.542	0.699	.084	0.002	BF979	12	1.554	0.705	.084	0.002
PF816	12	.275	0.125	.034	0.001	PF893	12	.071	0.032	.023	0.001	BF980	12	1.529	0.694	.076	0.002
PF816-S	12	.233	0.106	.033	0.001	PF893-RV	12										

# BALDWIN WEIGHTS AND VOLUMES

BALDWIN NUMBER	CASE QTY.	WEIGHT (ea.) lbs.	WEIGHT (ea.) kgs.	Volume (ea.) ft <sup>3</sup>	Volume (ea.) m <sup>3</sup>	BALDWIN NUMBER	CASE QTY.	WEIGHT (ea.) lbs.	WEIGHT (ea.) kgs.	Volume (ea.) ft <sup>3</sup>	Volume (ea.) m <sup>3</sup>	BALDWIN NUMBER	CASE QTY.	WEIGHT (ea.) lbs.	WEIGHT (ea.) kgs.	Volume (ea.) ft <sup>3</sup>	Volume (ea.) m <sup>3</sup>
BF984	12	1.142	0.518	.060	0.002	BF1222	12	1.704	0.773	.076	0.002	FB1311	1	.781	0.354	.043	0.001
PF986	12	.262	0.119	.020	0.001	BF1222-SP	12	1.863	0.845	.072	0.002	OB1313	1	2.000	0.907	.091	0.003
PF987	12	.758	0.344	.081	0.002	BF1222-O	12	1.708	0.775	.062	0.002	OB1314	1	1.900	0.862	.093	0.003
BF988	12	.917	0.416	.033	0.001	BF1223	12	1.950	0.885	.086	0.002	OB1315	1	1.950	0.885	.091	0.003
BF989	12	.100	0.045	.016	**	BF1223-SP	12	2.092	0.949	.087	0.002	OB1316	1	2.000	0.907	.095	0.003
BF991	12	1.304	0.591	.067	0.002	BF1223-O	12	1.846	0.837	.081	0.002	OB1317	1	.850	0.386	.027	0.001
BF992	12	1.188	0.539	.060	0.002	BF1224	12	1.838	0.834	.069	0.002	OB1318	1	.800	0.363	.030	0.001
BF995	12	.129	0.059	.010	**	BF1225	12	1.362	0.618	.074	0.002	OB1319	1	.700	0.318	.027	0.001
P996	12	2.279	1.034	.234	0.007	BF1226	12	1.040	0.472	.039	0.001	OB1320	1	.700	0.318	.027	0.001
PF997	12	.167	0.076	.020	0.001	BF1231	12	1.992	0.902	.088	0.002	VG1325	1	.250	0.113	.029	0.001
P998	12	1.234	0.560	.185	0.005	BF1232	12	1.029	0.467	.035	0.001	PG1326	1	.200	0.091	.030	0.001
P999-HD	12	1.592	0.722	.186	0.005	BF1233	12	1.179	0.535	.043	0.001	BF1329	12	2.046	0.928	.110	0.003
BF1008	12	.550	0.249	.062	0.002	BF1239	6	3.492	1.584	.270	0.008	BF1329-SP	12	2.196	0.996	.106	0.003
V1044-O	12	1.067	0.484	.127	0.004	BF1240	12	1.862	0.845	.088	0.002	BF1330-SP	12	2.233	1.013	.109	0.003
BF1045	12	.529	0.240	.061	0.002	V1240-C	8	1.581	0.717	.167	0.005	BF1339-SP	12	2.167	0.983	.108	0.003
BF1046	12	.321	0.146	.048	0.001	BF1248	12	1.183	0.537	.063	0.002	BF1345	12	1.875	0.851	.088	0.002
BF1047	12	.750	0.340	.078	0.002	BF1249	12	1.558	0.707	.091	0.003	BF1345-SP	12	2.033	0.922	.087	0.002
BF1048	12	.746	0.338	.062	0.002	BF1249-O	12	1.442	0.654	.083	0.002	BF1345-O	12	1.870	0.848	.080	0.002
BF1049	12	.329	0.149	.037	0.001	BF1249-SP	12	1.813	0.822	.088	0.002	BF1346	12	1.963	0.890	.103	0.003
BF1050	12	.788	0.357	.059	0.002	BF1252	12	1.317	0.597	.078	0.002	BF1346-SP	12	2.258	1.024	.107	0.003
BF1052	12	.217	0.098	.037	0.001	BF1253	12	1.237	0.561	.054	0.002	BF1346-O	12	1.975	0.896	.092	0.003
BF1053	1	1.050	0.476	.819	0.023	BF1256	12	2.358	1.070	.121	0.003	BF1347	12	2.063	0.936	.106	0.003
BF1056	12	.646	0.293	.032	0.001	BF1257	12	.850	0.386	.031	0.001	BF1347-O	6	1.567	0.711	.087	0.002
BF1057	12	.400	0.181	.037	0.001	BF1258	12	1.525	0.692	.077	0.002	BF1348	12	1.942	0.881	.088	0.002
BF1058	1	.700	0.318	.228	0.006	BF1259	12	1.667	0.756	.098	0.003	BF1348-SP	12	2.096	0.951	.088	0.002
BF1061	12	.504	0.229	.038	0.001	BF1261	12	.833	0.378	.032	0.001	BF1348-O	12	1.783	0.809	.079	0.002
BF1100	12	.579	0.263	.038	0.001	BF1262	6	3.183	1.444	.183	0.005	BF1349	12	2.080	0.943	.106	0.003
BF1102	12	1.321	0.599	.067	0.002	BF1265	12	2.504	1.136	.141	0.004	BF1350-SP	12	1.754	0.796	.079	0.002
BF1104	12	.333	0.151	.037	0.001	BF1266	12	1.363	0.618	.069	0.002	BF1352-SPS	12	1.929	0.875	.074	0.002
BF1105	12	.504	0.229	.047	0.001	BF1267	12	.671	0.304	.028	0.001	BF1353-SPS	12	2.917	1.323	.137	0.004
BF1110	12	.754	0.342	.032	0.001	BF1268	12	1.333	0.605	.077	0.002	BF1354-SPS	12	2.858	1.296	.137	0.004
BF1120	12	.658	0.298	.060	0.002	BF1269	12	.958	0.435	.033	0.001	BF1355-O	12	2.325	1.055	.121	0.003
BF1123	12	.308	0.140	.032	0.001	BF1270-SP	12	1.675	0.760	.064	0.002	BF1355	6	2.550	1.157	.139	0.004
BF1140	12	.146	0.066	.022	0.001	BF1271	12	1.296	0.588	.057	0.002	BF1355-SP	6	2.725	1.236	.136	0.004
BF1148	12	.600	0.272	.038	0.001	BF1272-SPS	12	1.942	0.881	.094	0.003	BF1356	12	1.475	0.669	.075	0.002
BF1150	12	.146	0.066	.022	0.001	BF1273-SP	12	2.017	0.915	.090	0.003	BF1357	6	3.200	1.452	.183	0.005
BF1160	12	.175	0.079	.042	0.001	BF1274-SP	6	3.400	1.542	.169	0.005	BF1358-SP	12	2.854	1.295	.140	0.004
BF1163	12	.421	0.191	.044	0.001	BF1274-SPS	6	3.525	1.599	.168	0.005	BF1358-O	12	2.475	1.123	.123	0.003
BF1166	12	.521	0.236	.060	0.002	BF1275	12	1.037	0.470	.040	0.001	BF1359-SP	12	2.787	1.264	.140	0.004
BF1170	12	.383	0.174	.047	0.001	BF1276	12	1.046	0.474	.047	0.001	BF1360	12	2.075	0.941	.108	0.003
BF1171	12	.354	0.161	.037	0.001	BF1277-SP	6	3.392	1.539	.168	0.005	BF1360-O	6	1.590	0.721	.079	0.002
BF1172	12	.609	0.276	.228	0.006	BF1277-SPS	6	3.675	1.667	.172	0.005	BF1360-SP	12	2.313	1.049	.109	0.003
BF1173	12	.225	0.102	.038	0.001	BF1278	12	1.346	0.611	.065	0.002	BF1361	12	1.054	0.478	.046	0.001
BF1174	12	.433	0.196	.058	0.002	BF1278-O	12	1.213	0.550	.057	0.002	BF1362	12	1.917	0.870	.087	0.002
BF1177	12	.958	0.435	.065	0.002	BF1279	12	1.508	0.684	.077	0.002	BF1363	12	2.742	1.244	.137	0.004
BF1178	12	.146	0.066	.022	0.001	BF1280	12	1.342	0.609	.070	0.002	BF1365	12	1.646	0.747	.076	0.002
BF1179	12	.563	0.255	.039	0.001	BF1281-O	12	2.450	1.111	.130	0.004	BF1366-O	12	1.338	0.607	.060	0.002
BF1181	12	.346	0.157	.046	0.001	BF1281	12	2.517	1.142	.139	0.004	BF1367	12	1.079	0.489	.046	0.001
BF1182	12	.538	0.244	.062	0.002	BF1282	12	1.321	0.599	.065	0.002	OB1368	1	3.650	1.656	.142	0.004
BF1184	12	.363	0.165	.038	0.001	BF1282-O	12	1.230	0.558	.061	0.002	BF1370	12	1.917	0.870	.089	0.003
BF1185	12	.340	0.154	.050	0.001	BF1283-O	12	2.408	1.092	.123	0.003	BF1371	12	1.383	0.627	.076	0.002
BF1186	12	.483	0.219	.063	0.002	BF1283	12	2.617	1.187	.141	0.004	BF1372	12	1.200	0.544	.046	0.001
BF1191	12	.775	0.352	.061	0.002	BF1283-SP	12	2.909	1.320	.136	0.004	BF1373-SP	12	2.321	1.053	.108	0.003
BF1193	12	.642	0.291	.037	0.001	BF1285-SP	12	3.033	1.376	.139	0.004	BF1374-SP	12	2.517	1.142	.125	0.004
BF1195	12	.688	0.312	.047	0.001	BF1286	12	2.192	0.994	.106	0.003	BF1375	12	2.413	1.095	.120	0.003
BF1199	12	.454	0.206	.060	0.002	BF1287-O	6	3.050	1.383	.227	0.006	BF1376	12	1.263	0.573	.079	0.002
BF1201	12	.563	0.255	.065	0.002	BF1288-O	6	2.875	1.304	.183	0.005	BF1377	12	2.392	1.085	.121	0.003
BF1204	12	1.354	0.614	.099	0.002	BF1289-SP	12	1.992	0.904	.081	0.002	BF1378-SPS	12	2.250	1.021	.091	0.003
BF1204-O	12	1.237	0.561	.099	0.003	PF1291	12	1.392	0.631	.133	0.004	BF1379	12	1.238	0.562	.038	0.001
BF1204-SP	12	1.621	0.735	.063	0.002	BF1292-O	12	2.021	0.917	.091	0.003	BF1379-O	12	.595	0.270	.028	0.001
BF1205	12	1.346	0.611	.066	0.002	BF1293-SPS	12	2.092	0.949	.091	0.003	BF1380	12	1.225	0.556	.037	0.001
BF1205-SP	12	1.596	0.724	.066	0.002	BF1294-O	12	2.096	0.951	.109	0.003	BF1380-O	12	.587	0.266	.027	0.001
BF1210	12	2.871	1.302	.138	0.004	BF1296-O	12	2.292	1.040	.093	0.003	BF1381	12	1.225	0.556	.039	0.001
BF1211	12	2.367	1.074	.108	0.003	BF1297-O	12	2.692	1.221	.135	0.004	BF1381-O	12	.583	0.264	.028	0.001
BF1212	12	1.438	0.652	.077	0.002	BF1298-O	12	1.967	0.892	.089	0.003	BF1382-SP	12	2.463	1.117	.128	0.004
BF1212 FOAM	12	.246	0.112	.102	0.003	BF1299-O	12	2.208	1.002	.110	0.003	BF1383-O	12	2.660	1.207	.130	0.004
BF1213	12	1.383	0.627	.077	0.002	FB1301	1	1.700	0.771	.087	0.002	BF1384-SP	12	1.713	0.777	.079	0.002
BF1214	12	1.329	0.603	.077	0.002	FB1302	1	1.700	0.771	.092	0.003	BF1385-SPS	12	1.983	0.899	.074	0.002
BF1215	12	.954	0.433	.064	0.002	OB1303	1	2.100	0.953	.092	0.003	BF1386-O	12	1.537	0.697	.077	0.002
BF1216	6	2.917	1.323	.182	0.005	OB1305	1	1.250	0.567	.078	0.002	BF1387-O	12	1.996	0.905	.091	0.003
BF1217	12	1.354	0.614	.075	0.002	FB1306	1	2.050	0.930	.107	0.003	BF1388-O	12	1.838			

**BALDWIN WEIGHTS AND VOLUMES**

BALDWIN NUMBER	CASE QTY.	WEIGHT (ea.) lbs.	WEIGHT (ea.) kgs.	Volume (ea.) ft <sup>3</sup>	Volume (ea.) m <sup>3</sup>	BALDWIN NUMBER	CASE QTY.	WEIGHT (ea.) lbs.	WEIGHT (ea.) kgs.	Volume (ea.) ft <sup>3</sup>	Volume (ea.) m <sup>3</sup>	BALDWIN NUMBER	CASE QTY.	WEIGHT (ea.) lbs.	WEIGHT (ea.) kgs.	Volume (ea.) ft <sup>3</sup>	Volume (ea.) m <sup>3</sup>
BF1392-SPS KIT	6	1.287	0.584	.131	0.004	PA1620	1	4.350	1.973	.652	0.018	PA1697	6	442	0.200	.059	0.002
BF1393-SP	12	1.896	0.860	.089	0.003	PA1620-S	1	4.350	1.973	.656	0.019	PA1698	1	1.600	0.726	.215	0.006
BF1394-SP	12	2.058	0.934	.091	0.003	PA1621	1	4.100	1.860	.652	0.018	PA1699-FN	1	3.100	1.406	.617	0.017
BF1395-SP	12	2.940	1.334	.146	0.004	LL1621-2	1	5.300	2.404	.652	0.018	PA1700	1	3.500	1.588	.554	0.016
BF1395-O	12	2.371	1.075	.123	0.003	PA1621-2	1	4.650	2.109	.652	0.018	PA1701	1	4.850	2.200	.869	0.025
BF1396	12	1.290	0.585	.043	0.001	PA1625	1	5.800	2.631	.916	0.026	PA1701 ELE	1	4.050	1.837	.869	0.025
BF1397-SP	12	2.629	1.193	.124	0.004	PA1626	1	5.450	2.472	.987	0.028	PA1701 FOAM	6	292	0.132	.230	0.007
BF1398-O	12	1.430	0.649	.067	0.002	LL1626-2	1	7.100	3.221	.987	0.028	PA1702	1	8.100	3.674	1.640	0.046
BF1399-SP	12	2.296	1.041	.101	0.003	PA1626-2	1	6.300	2.858	1.091	0.031	PA1702 FOAM	6	408	0.185	.268	0.008
B1400	12	513	0.233	.028	0.001	PA1627	6	542	0.246	.106	0.003	PA1703	1	4.900	2.223	.869	0.025
B1402	12	563	0.255	.027	0.001	PA1629-S	1	8.250	3.742	1.527	0.043	PA1704	12	179	0.081	.012	**
BD1403	6	3.450	1.565	.151	0.004	PA1630	1	8.200	3.720	1.939	0.055	PA1705-2	1	5.400	2.449	1.082	0.031
B1405	12	679	0.308	.027	0.001	LL1630-2	1	9.550	4.332	1.939	0.055	PA1706	1	9.400	4.264	1.939	0.055
B1406	12	546	0.248	.033	0.001	PA1630-2	1	9.350	4.241	1.939	0.055	PA1707-FN	1	2.300	1.043	.395	0.011
B1407	12	725	0.329	.032	0.001	PA1631-S	1	10.050	4.559	2.352	0.067	PA1709	1	3.250	1.474	.421	0.012
B1410	12	629	0.285	.032	0.001	PA1632	1	12.400	5.625	2.854	0.081	PA1710	1	2.650	1.202	.321	0.009
B1413	12	663	0.301	.033	0.001	PA1633	6	1.125	0.510	.156	0.004	PA1712	6	442	0.200	.039	0.001
B1416	12	779	0.353	.036	0.001	LL1634	1	7.150	3.243	1.163	0.033	PA1718	6	850	0.386	.116	0.003
P1418	12	467	0.212	.047	0.001	PA1634	1	5.260	2.386	1.152	0.033	PA1719	6	1.275	0.578	.185	0.005
P1419	12	283	0.128	.049	0.001	PA1634XP	1	5.260	2.386	1.076	0.030	PA1721	6	1.258	0.571	.151	0.004
B1421	12	679	0.308	.027	0.001	PA1635	1	1.600	0.726	.289	0.008	PA1726	1	2.800	1.270	.456	0.013
B1422	12	679	0.304	.026	0.001	LL1636-FN	1	4.200	1.905	.780	0.022	PA1735	6	1.408	0.639	.247	0.007
B1425	12	679	0.308	.027	0.001	PA1636-FN	1	3.900	1.769	.784	0.022	PA1748	12	463	0.210	.082	0.002
B1428	12	1.250	0.567	.059	0.002	LL1637-FN	1	7.550	3.425	1.686	0.048	PA1749-FN	1	4.250	1.928	.869	0.025
B1429	12	1.150	0.522	.040	0.001	PA1637-FN	1	7.000	3.175	1.686	0.048	PA1750-FN	1	4.700	2.132	.916	0.026
B1430	12	712	0.323	.037	0.001	PA1639	6	575	0.261	.092	0.003	PA1752-FN	1	1.950	0.885	.349	0.010
B1431	12	575	0.261	.032	0.001	PA1641	1	6.100	2.767	1.127	0.032	PA1753-FN	1	2.600	1.179	.520	0.015
B1432	12	704	0.319	.034	0.001	LL1642-2	1	8.050	3.651	1.315	0.037	PA1754	1	4.200	1.905	.683	0.019
P1433	12	142	0.064	.019	0.001	PA1642-2	1	7.350	3.334	1.314	0.037	PA1755-FN	1	4.300	1.950	.976	0.028
B1434	12	1.033	0.469	.051	0.001	PA1643	1	8.350	3.788	1.939	0.055	PA1757	12	338	0.153	.038	0.001
B1435	12	958	0.435	.035	0.001	PA1644	1	1.050	0.476	.129	0.004	PA1758	6	2.125	0.964	.531	0.015
B1438	12	1.004	0.455	.051	0.001	F1645-DS	12	1.963	0.890	.229	0.006	PA1763	12	167	0.076	.021	0.001
P1440	12	179	0.081	.034	0.001	V1645-C	7	1.630	0.739	.211	0.006	PA1765	1	8.400	3.810	1.003	0.028
B1441	12	1.379	0.626	.060	0.002	PA1646	1	4.500	2.064	.784	0.022	PA1765 FOAM	12	288	0.131	.257	0.007
P1443	12	233	0.106	.048	0.001	LL1646-FN	1	4.950	2.245	.916	0.026	PA1768	1	8.450	3.833	1.477	0.042
B1444	12	608	0.276	.028	0.001	PA1646-FN	1	4.500	2.041	.916	0.026	PA1769	1	2.700	1.225	.520	0.015
B1446	12	1.179	0.535	.050	0.001	PA1647	1	2.950	1.338	.487	0.014	PA1771	1	1.400	0.635	.220	0.006
B1447	12	708	0.321	.028	0.001	PA1648	6	883	0.401	.113	0.003	PA1772	1	2.100	0.953	.303	0.009
P1510	4	4.525	2.053	.809	0.023	LL1649	1	11.250	5.103	2.153	0.061	PA1773	1	2.700	1.225	.417	0.012
P1511	4	4.938	2.240	.916	0.026	PA1649	1	10.300	4.672	2.156	0.061	PA1774	1	3.550	1.610	.493	0.014
V1520-R	4	5.038	2.285	.908	0.026	PA1650-FN	1	5.250	2.381	1.214	0.034	PA1775	1	3.600	1.633	.537	0.015
V1542-C	6	1.350	0.612	.219	0.006	PA1653	1	1.500	0.680	.261	0.007	PA1776	1	4.850	2.200	.612	0.017
V1544-T	16	1.275	0.578	.163	0.005	V1656-O	6	1.667	0.756	.218	0.006	PA1777	1	4.950	2.245	.713	0.020
V1560	4	5.012	2.273	.908	0.026	V1656-T	6	1.825	0.828	.221	0.006	PA1778	1	5.600	2.540	.759	0.021
P1561	1	7.950	3.606	.496	0.014	PA1657	6	1.267	0.575	.243	0.007	PA1779	1	6.500	2.948	.899	0.025
P1562	1	14.750	6.691	.906	0.026	PA1661(3)	6	.942	0.427	.139	0.004	PA1780	1	6.300	2.858	.910	0.026
P1563	1	2.500	1.134	.178	0.005	PA1663	1	6.350	2.880	1.050	0.030	PA1781	1	8.800	3.992	1.145	0.032
P1565	1	450	0.204	.050	0.001	PA1664	1	2.100	0.953	.291	0.008	PA1782	1	11.150	5.058	1.441	0.041
P1566	1	450	0.204	.044	0.001	PA1666	12	338	0.153	.039	0.001	PA1783	1	12.850	5.829	1.631	0.046
P1567	1	6.100	2.767	.477	0.013	LL1667-FN	1	2.150	0.975	.349	0.010	PA1784	1	17.300	7.847	2.143	0.061
P1568	1	11.250	5.103	.726	0.021	PA1667-FN	1	2.050	0.930	.349	0.010	PA1786	6	2.108	0.956	.525	0.015
P1575	1	800	0.363	.050	0.001	LL1669	1	8.350	3.788	1.408	0.040	PA1787	1	2.050	0.930	.282	0.008
P1577	1	1.300	0.590	.095	0.003	PA1669	1	7.950	3.606	1.408	0.040	PA1788	1	3.950	1.792	.557	0.016
PF1584	1	12.650	5.738	.987	0.028	PA1670	1	4.900	2.223	.910	0.026	PA1789	1	5.450	2.472	.736	0.021
PF1585	1	2.100	0.953	.164	0.005	PA1673	1	4.050	1.837	.520	0.015	PA1790	1	7.200	3.266	1.315	0.037
PF1587	1	1.100	0.499	.057	0.002	PA1674	1	2.500	1.134	.352	0.010	PA1794-FN	1	2.800	1.270	.554	0.016
PA1600	12	.050	0.023	.012	**	PA1675	1	4.600	2.087	.839	0.024	PA1795	1	3.250	1.474	.779	0.022
PA1602	1	2.000	0.907	.288	0.008	LL1676-FN	1	9.250	4.196	2.499	0.071	PA1797	1	5.400	2.449	1.560	0.044
PA1603	12	.279	0.127	.039	0.001	PA1676-FN	1	8.400	3.810	2.499	0.071	PA1798	6	2.642	1.198	.753	0.021
PA1606	1	3.250	1.474	.652	0.018	PA1679	12	479	0.217	.052	0.001	PA1800	6	2.667	1.210	.762	0.022
PA1607	1	4.200	1.905	.869	0.025	PA1680	6	1.034	0.469	.230	0.007	PA1802	6	1.400	0.635	.257	0.007
LL1608	1	2.550	1.157	.291	0.008	LL1681-FN	1	3.050	1.383	.512	0.014	PA1805	6	.758	0.344	.104	0.003
PA1608	1	2.300	1.043	.288	0.008	PA1681-FN	1	2.850	1.293	.512	0.014	PA1806	1	5.450	2.472	.740	0.021
PA1609	1	3.000	1.361	.395	0.011	PA1682	1	2.500	1.134	.288	0.008	PA1809	4	.575	0.261	.087	0.002
PA1610	1	3.900	1.769	.464	0.013	PA1683	1	1.650	0.748	.233	0.007	PA1810	1	4.950	2.245	.869	0.025
PA1613	1	3.200	1.452	.429	0.012	PA1684	1	1.850	0.839	.239	0.007	PA1814	6	.775	0.352	.117	0.003
PA1613-S	1	3.150	1.429	.429	0.012	PA1686	1	3.750	1.701	.650	0.018	PA1815	1	12.700	5.761	2.854	0.081
LL1614	1	3.800	1.724	.520	0.015	PA1687	1	10.600	4.808	2.156	0.061	PA1816	1	8.550	3.878	1.432	0.041
PA1614	1	3.300	1.497	.527	0.015	PA1688	12	413	0.187	.065	0.002	PA1817	1	3.350	1.520	.652	0.018
LL1615	1	5.050	2.291	.736	0.021	PA1689	1	2.000	0.907	.361	0.010	PA1818	1	10.200	4.627	1.939	0.055
PA1615	1	4.700	2.132	.737	0.021	LL1690-FN	1	1.350	0.612	.209	0.006	PA1819	1	4.100	1.860	1.163	0.033
PA1615XP</																	

**BALDWIN WEIGHTS AND VOLUMES**

BALDWIN NUMBER	CASE QTY.	WEIGHT (ea.) lbs.	WEIGHT (ea.) kgs.	Volume (ea.) ft <sup>3</sup>	Volume (ea.) m <sup>3</sup>	BALDWIN NUMBER	CASE QTY.	WEIGHT (ea.) lbs.	WEIGHT (ea.) kgs.	Volume (ea.) ft <sup>3</sup>	Volume (ea.) m <sup>3</sup>	BALDWIN NUMBER	CASE QTY.	WEIGHT (ea.) lbs.	WEIGHT (ea.) kgs.	Volume (ea.) ft <sup>3</sup>	Volume (ea.) m <sup>3</sup>
PA1824	1	6.100	2.767	1.045	0.030	PA1912	1	2.050	0.930	462	0.013	PA2061	6	2.750	1.247	.732	0.021
PA1825	1	3.100	1.406	.853	0.024	PA1913	1	5.250	2.381	.869	0.025	PA2063	6	.908	0.412	.222	0.006
PA1826	1	2.850	1.293	.650	0.018	PA1915	12	.213	0.097	.034	0.001	PA2064	6	.850	0.386	.157	0.004
PA1827	1	5.500	2.495	.949	0.027	PA1916	1	2.550	1.157	.432	0.012	PA2065	6	2.225	1.009	.529	0.015
PA1828	6	1.792	0.813	.286	0.008	PA1919-FN	1	3.750	1.701	.780	0.022	PA2067	6	.659	0.299	.097	0.003
PA1830-FN	1	1.900	0.862	.347	0.010	PA1920	1	7.350	3.334	1.315	0.037	PA2067 FOAM	12	.020	0.009	.016	0.000
PA1831	1	3.700	1.678	.421	0.012	PA1921	1	1.000	0.454	.092	0.003	PA2068	6	.725	0.329	.148	0.004
PA1832	6	.692	0.314	.102	0.003	PA1922	1	4.150	1.882	.652	0.018	PA2068 FOAM	12	.020	0.009	.016	0.000
PA1834	6	.333	0.151	.051	0.001	PA1922-FN	1	4.250	1.928	.750	0.021	PA2069	6	.750	0.340	.117	0.003
PA1836	1	1.800	0.816	.288	0.008	PA1926	1	3.100	1.406	.486	0.014	PA2069 FOAM	12	.001	0.000	.016	0.000
PA1837-FN	1	4.500	2.041	1.308	0.037	PA1932	1	4.750	2.155	.736	0.021	PA2070	6	.383	0.174	.036	0.001
PA1840	1	4.450	2.019	.554	0.016	PA1934	4	2.638	1.197	.647	0.018	PA2071	6	.533	0.242	.106	0.003
PA1841	6	1.517	0.688	.342	0.010	PA1936	1	14.300	6.486	2.897	0.082	PA2072	6	.750	0.340	.097	0.003
PA1845	1	5.900	2.676	.942	0.027	PA1937	1	4.600	2.087	.935	0.026	PA2073	6	2.433	1.104	.527	0.015
LL1846	1	10.600	4.808	1.830	0.052	PA1940	1	3.500	1.588	.456	0.013	PA2074	6	1.292	0.586	.257	0.007
PA1846	1	9.200	4.173	1.830	0.052	PA1941-FN	1	5.400	2.449	1.163	0.033	PA2075	6	2.067	0.938	.257	0.007
PA1846XP	1	7.900	3.583	1.922	0.054	PA1945	1	2.000	0.907	.235	0.007	PA2076	6	1.375	0.624	.353	0.010
PA1847-FN	1	9.950	4.513	3.137	0.089	PA1946	6	.667	0.303	.103	0.003	PA2077	6	.984	0.446	.230	0.007
PA1848	1	4.100	1.860	.736	0.021	PA1949	6	2.125	0.964	.435	0.012	PA2079	6	2.325	1.055	.527	0.015
PA1849	1	3.150	1.429	.487	0.014	PA1951	6	.967	0.439	.113	0.003	PA2081	6	1.858	0.843	.358	0.010
PA1850-FN	1	3.400	1.542	.853	0.024	PA1952	1	14.050	6.373	2.447	0.069	PA2083	6	.592	0.269	.103	0.003
PA1851	1	3.500	1.588	.520	0.015	PA1953	1	12.600	5.715	2.039	0.058	SA2084	12	.121	0.055	.038	0.001
PA1852	6	1.034	0.469	.217	0.006	PA1956-FN	1	6.300	2.858	1.527	0.043	SA2085	12	.179	0.081	.038	0.001
PA1857	6	.975	0.442	.146	0.004	PA1957	1	2.150	0.975	.429	0.012	PA2091	6	2.550	1.157	.524	0.015
PA1858	6	.558	0.253	.080	0.002	PA1960	1	3.600	1.633	.461	0.013	PA2092	6	2.392	1.085	.547	0.015
PA1859	6	.408	0.185	.053	0.001	PA1961	1	4.050	1.837	.462	0.013	PA2093	1	1.950	0.885	.780	0.022
PA1860	6	1.683	0.763	.440	0.012	PA1963	6	1.633	0.741	.209	0.006	PA2094	6	2.450	1.111	.613	0.017
PA1861	6	2.175	0.987	.267	0.008	PA1967	1	1.500	0.680	.233	0.007	PA2095	4	1.638	0.743	.320	0.009
PA1863	1	8.000	3.629	1.521	0.043	PA1969	6	.725	0.329	.137	0.004	PA2096	6	.625	0.284	.106	0.003
PA1864-FN	1	7.850	3.561	2.156	0.061	PA1972	1	4.050	1.837	.456	0.013	PA2099	6	1.158	0.525	.137	0.004
PA1865-FN	1	.800	0.363	.100	0.003	PA1973	6	.933	0.423	.103	0.003	PA2100	6	1.392	0.631	.295	0.008
PA1866	1	3.900	1.769	.652	0.018	PA1975	1	12.000	5.443	2.722	0.077	PA2101A	6	.550	0.249	.113	0.003
PA1867	1	4.300	1.950	.652	0.018	PA1976	1	5.050	2.291	1.071	0.030	PA2102	6	1.350	0.612	.325	0.009
PA1868	1	2.250	1.021	.344	0.010	PA1977-FN	1	6.550	2.971	1.432	0.041	PA2103	6	.475	0.215	.069	0.002
PA1873	4	1.700	0.771	.386	0.011	PA1978-FN	1	7.600	3.447	1.939	0.055	PA2104	6	.483	0.219	.061	0.002
V1874-T	4	3.475	1.576	.540	0.015	PA1979-FN	1	7.850	3.561	2.178	0.062	PA2106	6	1.117	0.507	.230	0.007
PA1875	12	.375	0.170	.060	0.002	PA1980-FN	1	7.400	3.357	1.737	0.049	PA2107	6	1.025	0.465	.185	0.005
PA1877	1	7.500	3.402	1.315	0.037	PA1981	1	1.850	0.839	.339	0.010	PA2109	6	.983	0.446	.236	0.007
PA1880	1	3.700	1.678	.853	0.024	PA1982	1	1.650	0.748	.235	0.007	PA2110	6	2.325	1.055	.425	0.012
PA1881	1	6.500	2.948	1.163	0.033	PA1985	12	.346	0.157	.034	0.001	PA2113	6	1.092	0.495	.230	0.007
PA1882	1	2.500	1.134	.321	0.009	PA1986	1	4.150	1.882	.554	0.016	PA2114	6	1.075	0.488	.148	0.004
PA1883-FN	1	2.400	1.089	.486	0.014	PA1986-K	1	8.300	3.765	1.050	0.030	PA2115	6	2.808	1.274	.666	0.019
LL1884	1	5.400	2.449	.842	0.024	PA1987	1	3.950	1.792	.554	0.016	PA2116	4	3.100	1.406	.667	0.019
PA1884	1	5.100	2.313	.839	0.024	PA1989-FN	1	4.200	1.905	1.164	0.033	PA2117	6	1.400	0.635	.230	0.007
PA1884XP	1	5.600	2.540	.868	0.025	LL1992	1	9.150	4.150	1.640	0.046	PA2121	6	1.075	0.488	.124	0.004
LL1885	1	8.100	3.674	1.409	0.040	PA1992-FN	1	9.350	4.241	3.136	0.089	PA2124	6	1.792	0.813	.353	0.010
PA1885	1	7.400	3.357	1.408	0.040	PA1995	1	8.550	3.878	1.126	0.032	PA2125	6	1.250	0.567	.210	0.006
PA1885XP	1	8.200	3.720	1.442	0.041	PA1996	1	1.950	0.885	.213	0.006	PA2127	6	.592	0.269	.095	0.003
LL1886	1	9.450	4.287	1.640	0.046	PA1997	1	5.800	2.631	.910	0.026	PA2134	6	.992	0.450	.158	0.004
PA1886	1	8.300	3.765	1.640	0.046	PA1998	1	1.450	0.658	.316	0.009	PA2135	6	.583	0.264	.100	0.003
PA1886XP	1	8.300	3.765	1.519	0.043	PA2001	6	1.025	0.465	.154	0.004	PA2136	6	1.108	0.503	.258	0.007
PA1888	6	1.833	0.831	.437	0.012	PA2001 FOAM	12	.067	0.030	.041	0.001	PA2138	6	.583	0.264	.135	0.004
PA1889	6	1.625	0.737	.212	0.006	PA2002	6	1.967	0.892	.542	0.015	PA2139	6	.992	0.450	.152	0.004
PA1891	6	1.167	0.529	.194	0.005	PA2005	6	1.492	0.677	.257	0.007	PA2139 FOAM	12	.067	0.030	.042	0.001
PA1892-FN	1	5.900	2.676	1.432	0.041	PA2006	6	1.858	0.843	.365	0.010	PA2140	6	.908	0.412	.149	0.004
PA1893	1	3.100	1.406	.856	0.024	PA2007	6	1.459	0.662	.257	0.007	PA2147	6	1.850	0.839	.230	0.007
LL1894	1	12.000	5.443	2.232	0.063	PA2008	6	1.792	0.813	.357	0.010	PA2148	6	2.392	1.085	.749	0.021
PA1894	1	10.800	4.899	2.232	0.063	PA2009	6	1.667	0.756	.529	0.015	PA2149	6	1.000	0.454	.151	0.004
PA1894XP	1	11.500	5.216	2.292	0.065	PA2010	6	1.758	0.797	.531	0.015	PA2150	6	.617	0.280	.073	0.002
LL1895	1	6.450	2.926	1.214	0.034	PA2023	6	.700	0.318	.105	0.003	PA2152	6	.917	0.416	.124	0.004
PA1895	1	6.000	2.722	1.214	0.034	PA2024	6	1.858	0.843	.430	0.012	PA2153	6	.767	0.348	.109	0.003
PA1896	1	7.500	3.402	1.432	0.041	SA2027	12	.125	0.057	.038	0.001	PA2154	6	1.392	0.631	.246	0.007
PA1897	1	1.500	0.680	.315	0.009	PA2031	6	1.367	0.620	.211	0.006	PA2156	6	1.783	0.809	.438	0.012
PA1898	1	3.650	1.656	.617	0.017	PA2036	6	.642	0.291	.097	0.003	PA2158	6	.867	0.393	.153	0.004
PA1899	1	1.550	0.703	.239	0.007	PA2037	6	1.159	0.526	.185	0.005	SA2159	12	.154	0.070	.038	0.001
PA1900	1	3.250	1.474	.487	0.014	PA2038	1	.800	0.363	.081	0.002	PA2160	6	.592	0.269	.072	0.002
PA1901	1	1.300	0.590	.233	0.007	SA2039	12	.137	0.062	.038	0.001	PA2162	6	.867	0.393	.153	0.004
LL1902-FN	1	4.850	2.200	1.133	0.032	PA2041	6	.950	0.431	.218	0.006	PA2163	6	.967	0.439	.125	0.004
PA1902-FN	1	4.650	2.109	1.048	0.030	PA2042	4	2.625	1.191	.553	0.016	PA2164	6	.867	0.393	.116	0.003
PA1904	1	3.400	1.542	.617	0.017	PA2044	6	.908	0.412	.159	0.004	PA2167	6	1.692	0.767	.207	0.006
PA1905	1	4.400	1.996	.856	0.024	SA2047	12	.167	0.076	.037	0.001	PA2168	6	1.017	0.461	.107	0.003
PA1906	1	2.050	0.930	.321	0.009												

**BALDWIN WEIGHTS AND VOLUMES**

BALDWIN NUMBER	CASE QTY.	WEIGHT (ea.) lbs.	WEIGHT (ea.) kgs.	Volume (ea.) ft <sup>3</sup>	Volume (ea.) m <sup>3</sup>	BALDWIN NUMBER	CASE QTY.	WEIGHT (ea.) lbs.	WEIGHT (ea.) kgs.	Volume (ea.) ft <sup>3</sup>	Volume (ea.) m <sup>3</sup>	BALDWIN NUMBER	CASE QTY.	WEIGHT (ea.) lbs.	WEIGHT (ea.) kgs.	Volume (ea.) ft <sup>3</sup>	Volume (ea.) m <sup>3</sup>
PA2182	1	1.150	0.522	.174	0.005	LL2333	1	16.450	7.462	3.136	0.089	PA2403	1	7.000	3.175	1.126	0.032
PA2183	1	3.500	1.588	.520	0.015	PA2333	1	13.100	5.942	3.136	0.089	PA2404	1	1.800	0.816	.213	0.006
PA2188	6	1.742	0.790	.342	0.010	PA2335	6	.583	0.264	.087	0.002	PA2405	1	4.400	1.996	.615	0.017
PA2189	6	.983	0.446	.122	0.003	PA2337	6	3.217	1.459	.527	0.015	PA2407	1	3.950	1.792	.446	0.013
PA2191	6	.958	0.435	.142	0.004	PA2338-FN	1	4.750	2.155	1.052	0.030	PA2408	1	4.100	1.860	.437	0.012
PA2193	6	.742	0.337	.140	0.004	PA2339	1	5.700	2.586	1.019	0.029	PA2409	1	9.000	4.082	1.820	0.052
PA2194	1	1.500	0.680	.372	0.011	PA2340	1	1.650	0.748	.213	0.006	PA2410	1	3.700	1.678	.853	0.024
PA2196	6	1.133	0.514	.137	0.004	PA2341	1	3.700	1.678	.650	0.018	PA2411	1	3.800	1.724	.352	0.010
PA2200	6	.767	0.348	.097	0.003	PA2342	1	1.300	0.590	.170	0.005	PA2412	1	5.150	2.336	.780	0.022
PA2204	6	.590	0.268	.090	0.003	PA2343	1	8.500	3.856	1.126	0.032	PA2413	1	.950	0.431	.171	0.005
PA2208	6	.658	0.298	.151	0.004	LL2344-FN	1	1.800	0.816	.315	0.009	PA2414	1	7.500	3.402	1.315	0.037
PA2212	6	.833	0.378	.131	0.004	PA2344-FN	1	1.700	0.771	.317	0.009	PA2415	1	2.900	1.315	.512	0.014
PA2214	6	.892	0.405	.127	0.004	PA2345	1	9.000	4.082	2.039	0.058	PA2417-FN	1	9.050	4.105	1.686	0.048
PA2215	1	1.100	0.499	.212	0.006	PA2346	1	3.450	1.565	.824	0.023	LL2418-FN	1	3.500	1.588	.650	0.018
PA2216	6	.558	0.253	.152	0.004	PA2347	6	.892	0.405	.100	0.003	PA2418-FN	1	3.150	1.429	.654	0.019
PA2218	6	.950	0.431	.082	0.002	PA2349-FN	1	8.750	3.969	1.737	0.049	PA2419	1	.900	0.408	.277	0.008
PA2220	6	.892	0.405	.202	0.006	PA2350	1	11.250	5.103	1.396	0.040	PA2420	1	2.850	1.293	.421	0.012
PA2221	6	.700	0.318	.127	0.004	PA2351	1	3.450	1.565	.512	0.014	PA2421	1	4.850	2.200	.736	0.021
PA2222	6	.217	0.098	.038	0.001	PA2352	1	3.950	1.792	.392	0.011	PA2422	1	2.350	1.066	.292	0.008
PA2223	6	.517	0.235	.075	0.002	PA2353	1	3.800	1.724	.407	0.012	PA2423	1	3.300	1.497	.395	0.011
PA2223 FOAM	12	.020	0.009	.017	0.001	PA2354	1	2.750	1.247	.455	0.013	LL2425	1	7.250	3.289	1.214	0.034
PA2224	6	.425	0.193	.049	0.001	PA2356	1	3.050	1.383	.419	0.012	PA2425	1	6.850	3.107	1.214	0.034
PA2225	6	.292	0.132	.040	0.001	PA2357	1	12.700	5.761	2.897	0.082	LL2426-FN	1	4.250	1.928	.949	0.027
PA2226	6	.625	0.284	.093	0.003	LL2358	1	7.450	3.379	1.163	0.033	PA2426-FN	1	3.900	1.769	.949	0.027
PA2228	6	.725	0.329	.179	0.005	PA2358	1	7.000	3.175	1.163	0.033	PA2427	1	1.500	0.680	.294	0.008
PA2230	6	.717	0.325	.125	0.004	PA2359	1	4.150	1.882	1.163	0.033	PA2428	1	11.500	5.216	1.830	0.052
PA2231	6	.650	0.295	.089	0.003	LL2360-FN	1	2.650	1.202	.460	0.013	PA2429	1	10.550	4.785	1.640	0.046
PA2232	6	1.470	0.667	.213	0.006	PA2360-FN	1	2.500	1.134	.460	0.013	PA2430	1	8.050	3.651	1.540	0.044
PA2233	6	3.058	1.387	.568	0.016	LL2361	1	12.100	5.489	2.610	0.074	PA2431	1	3.650	1.656	.617	0.017
PA2234	6	1.175	0.533	.162	0.005	PA2361	1	10.600	4.808	2.610	0.074	PA2432	1	1.150	0.522	.175	0.005
PA2235	6	1.100	0.499	.219	0.006	PA2361XP	1	10.850	4.922	2.561	0.072	PA2433	1	5.250	2.381	1.640	0.046
PA2237	6	.758	0.344	.105	0.003	PA2362	1	4.200	1.905	.824	0.023	PA2434	1	6.000	2.722	1.214	0.034
PA2240	6	.792	0.359	.304	0.009	LL2363	1	25.950	11.771	5.278	0.149	PA2435	1	2.400	1.089	.421	0.012
PA2241	1	1.850	0.839	.695	0.020	PA2363	1	23.850	10.818	5.285	0.150	PA2436	1	3.900	1.769	.473	0.013
PA2243	6	.850	0.386	.106	0.003	PA2363XP	1	25.750	11.680	5.160	0.146	PA2437	1	10.000	4.536	2.232	0.063
PA2244	6	1.033	0.469	.216	0.006	PA2364	1	8.050	3.651	1.937	0.055	PA2438	1	6.050	2.744	.990	0.028
PA2256	6	.408	0.185	.025	0.001	PA2367	1	6.450	2.926	1.269	0.036	LL2439	1	9.950	4.513	1.617	0.046
PA2257	6	.808	0.367	.093	0.003	PA2368	1	2.100	0.953	.407	0.012	PA2439	1	9.000	4.082	1.617	0.046
PA2258	6	.317	0.144	.062	0.002	PA2369	1	4.300	1.950	.615	0.017	PA2440	1	4.100	1.860	.484	0.014
PA2260	1	1.750	0.794	.321	0.009	PA2370	1	1.150	0.522	.146	0.004	PA2442	1	7.350	3.334	1.473	0.042
PA2300	1	7.000	3.175	1.408	0.040	PA2371	1	5.900	2.676	.869	0.025	PA2443	1	2.150	0.975	.342	0.010
PA2301	1	2.400	1.089	.395	0.011	PA2372	1	1.950	0.885	.344	0.010	PA2444	1	15.520	7.040	1.994	0.056
PA2302-FN	1	3.700	1.678	.839	0.024	PA2374	1	6.850	3.107	.942	0.027	PA2445	1	9.150	4.150	1.432	0.041
PA2303	1	1.600	0.726	.239	0.007	PA2375	1	11.600	5.262	1.457	0.041	PA2446	1	2.300	1.043	.434	0.012
PA2304-FN	1	4.300	1.950	.869	0.025	PA2376	1	8.650	3.924	2.007	0.057	LL2447-FN	1	10.500	4.763	2.499	0.071
PA2305	1	1.200	0.544	.239	0.007	PA2377	1	8.000	3.629	1.540	0.044	PA2447-FN	1	9.750	4.423	2.499	0.071
PA2306	4	1.412	0.640	.201	0.006	PA2378	1	2.450	1.111	.527	0.015	PA2448	1	3.400	1.542	.417	0.012
PA2307	1	3.500	1.588	.617	0.017	PA2379	1	5.000	2.268	.780	0.022	PA2450	1	6.000	2.722	.658	0.019
PA2308	4	1.838	0.834	.324	0.009	PA2379-K	1	6.850	3.107	.987	0.028	PA2451	1	5.550	2.517	.949	0.027
PA2310	1	4.000	1.814	.767	0.022	PA2380-FN	1	2.300	1.043	.486	0.014	PA2452	1	2.100	0.953	.421	0.012
LL2312	1	9.350	4.241	1.614	0.046	PA2381	1	.800	0.363	.146	0.004	LL2453	1	25.700	11.658	4.991	0.141
PA2312	1	8.800	3.992	1.614	0.046	PA2382	1	7.400	3.357	1.473	0.042	PA2453	1	25.000	11.340	4.991	0.141
PA2313	1	8.150	3.697	2.017	0.057	PA2383	1	2.100	0.953	.320	0.009	PA2453XP	1	25.350	11.499	5.085	0.144
PA2314	1	3.350	1.520	.460	0.013	LL2384	1	8.600	3.901	1.521	0.043	PA2454	1	8.200	3.720	2.447	0.069
PA2315	1	7.650	3.470	1.492	0.042	PA2384	1	7.750	3.515	1.553	0.044	PA2455	1	2.850	1.293	.617	0.017
PA2316	1	9.100	4.128	1.521	0.043	PA2384XP	1	8.150	3.697	1.424	0.040	LL2456	1	12.050	5.466	2.717	0.077
LL2317	1	12.850	5.829	2.447	0.069	PA2385	1	6.700	3.039	1.299	0.037	PA2456	1	11.000	4.990	2.881	0.082
PA2317	1	11.200	5.080	2.447	0.069	PA2386	1	8.400	3.810	2.039	0.058	PA2456XP	1	11.850	5.375	2.788	0.079
LL2318	1	5.300	2.404	.949	0.027	PA2387	1	7.600	3.447	2.039	0.058	PA2457	1	4.650	2.109	1.288	0.036
PA2318	1	5.200	2.359	.949	0.027	PA2388	1	2.850	1.293	.532	0.015	LL2458	1	21.450	9.730	3.406	0.096
PA2319	1	1.550	0.703	.239	0.007	PA2389-FN	1	11.100	5.035	2.269	0.064	PA2458	1	18.150	8.233	3.406	0.096
PA2320-FN	1	2.950	1.338	.617	0.017	PA2390	1	25.500	11.567	4.817	0.136	PA2459	1	6.200	2.812	1.214	0.034
PA2321	1	.900	0.408	.142	0.004	PA2391	1	2.250	1.021	.321	0.009	PA2460	1	2.300	1.043	.395	0.011
PA2322	1	2.250	1.021	.288	0.008	PA2392	1	3.150	1.429	.486	0.014	PA2461	1	8.750	3.969	1.540	0.044
PA2323	1	1.250	0.567	.135	0.004	LL2393	1	15.150	6.872	4.491	0.127	PA2462	1	2.750	1.247	.532	0.015
LL2326	1	9.500	4.309	2.292	0.065	PA2393	1	14.550	6.600	4.559	0.129	PA2463	1	3.650	1.656	.421	0.012
PA2326	1	8.250	3.742	2.260	0.064	PA2394	1	17.500	7.938	3.773	0.107	PA2464	1	5.350	2.427	.602	0.017
PA2326XP	1	9.100	4.128	2.276	0.064	PA2395	1	20.900	9.480	3.908	0.111	PA2465	1	5.350	2.427	.780	0.022
PA2328	1	3.550	1.610	1.050	0.030	PA2396	1	10.200	4.627	2.722	0.077	PA2466	1	6.300	2.858	1.045	0.030
PA2329	1	4.450	2.019	.509	0.014	PA2397	1	3.550	1.610	.853	0.024	PA2467	1	2.450	1.111	.421	0.012
LL2330	1	8.450	3.833	1.606	0.045	PA2398	1	10.650									

**BALDWIN WEIGHTS AND VOLUMES**

BALDWIN NUMBER	CASE QTY.	WEIGHT (ea.) lbs.	WEIGHT (ea.) kgs.	Volume (ea.) ft <sup>3</sup>	Volume (ea.) m <sup>3</sup>	BALDWIN NUMBER	CASE QTY.	WEIGHT (ea.) lbs.	WEIGHT (ea.) kgs.	Volume (ea.) ft <sup>3</sup>	Volume (ea.) m <sup>3</sup>	BALDWIN NUMBER	CASE QTY.	WEIGHT (ea.) lbs.	WEIGHT (ea.) kgs.	Volume (ea.) ft <sup>3</sup>	Volume (ea.) m <sup>3</sup>
PA2474	1	5.350	2.427	.949	0.027	PA2550	1	5.200	2.359	.796	0.023	PA2623	1	5.850	2.654	1.288	0.036
PA2475	1	7.550	3.425	1.244	0.035	PA2551	1	4.100	1.860	.650	0.018	PA2624	1	10.100	4.581	2.156	0.061
PA2476	6	.375	0.170	.060	0.002	PA2552	1	5.500	2.495	.990	0.028	PA2625	1	4.050	1.837	.796	0.023
PA2477	6	.683	0.310	.101	0.003	PA2554	1	7.350	3.334	.845	0.024	PA2626	1	2.750	1.247	.303	0.009
PA2478	1	11.950	5.421	3.136	0.089	PA2554 FOAM	6	.258	0.117	.148	0.004	PA2627	1	4.800	2.177	.869	0.025
PA2479	1	2.150	0.975	.229	0.006	PA2555	1	5.200	2.359	.869	0.025	PA2628	1	9.650	4.377	2.092	0.059
LL2482	1	7.500	3.402	1.288	0.036	PA2556	1	6.300	2.858	1.214	0.034	PA2629	1	14.050	6.373	3.773	0.107
PA2482	1	6.900	3.130	1.288	0.036	LL2557	1	5.450	2.472	.780	0.022	PA2630	1	3.650	1.656	.856	0.024
PA2483	6	3.430	1.556	.739	0.021	PA2557	1	5.000	2.268	.784	0.022	PA2631	1	12.200	5.534	2.532	0.072
PA2484	1	4.950	2.245	.853	0.024	PA2558	1	3.400	1.542	.652	0.018	PA2632	1	13.200	5.988	2.940	0.083
PA2485	1	6.300	2.858	.574	0.016	LL2559	1	18.600	8.437	3.362	0.095	PA2633-FN	1	3.600	1.633	.839	0.024
PA2486	1	2.050	0.930	.288	0.008	PA2559	1	15.700	7.122	3.362	0.095	PA2634	1	1.300	0.590	.227	0.006
PA2487	1	.600	0.272	.162	0.005	LL2562	1	15.550	7.053	3.362	0.095	PA2635-FN	1	3.950	1.792	.796	0.023
PA2488-FN	1	2.200	0.998	.344	0.010	PA2562	1	13.750	6.237	3.362	0.095	PA2636	1	1.350	0.612	.262	0.007
PA2489	1	.650	0.295	.087	0.002	PA2562XP	1	15.500	7.031	3.372	0.095	PA2637	1	3.150	1.429	.456	0.013
PA2490	1	11.900	5.398	2.532	0.072	PA2563	1	6.050	2.744	1.614	0.046	PA2638	1	4.650	2.109	.438	0.012
PA2491	1	3.850	1.746	.827	0.023	PA2564	1	15.700	7.122	2.059	0.058	PA2640	1	9.150	4.150	2.039	0.058
LL2493	1	11.200	5.080	2.092	0.059	PA2566	1	5.000	2.268	.780	0.022	PA2641	1	5.750	2.608	.949	0.027
PA2493	1	10.200	4.627	2.092	0.059	PA2567	1	5.600	2.540	.910	0.026	LL2642	1	10.350	4.695	1.432	0.041
PA2494	1	8.700	3.946	1.617	0.046	PA2568	1	2.100	0.953	.339	0.010	PA2642	1	9.500	4.309	1.432	0.041
PA2495	1	5.050	2.291	.910	0.026	PA2569	1	6.200	2.812	1.640	0.046	PA2643	1	9.350	4.241	1.640	0.046
PA2496	1	2.200	0.998	.235	0.007	PA2570	1	.950	0.431	.140	0.004	PA2644	1	1.000	0.454	.182	0.005
PA2497	1	1.950	0.885	.235	0.007	PA2571	1	9.400	4.264	2.232	0.063	PA2645	1	4.200	1.905	.767	0.022
PA2498	1	5.800	2.631	.486	0.014	PA2572	1	3.500	1.588	.402	0.011	PA2646	1	1.600	0.726	.233	0.007
PA2499	1	1.750	0.794	.175	0.005	PA2573	1	10.750	4.876	2.748	0.078	PA2647	1	6.000	2.722	1.163	0.033
PA2500	1	6.800	3.084	1.382	0.039	PA2573XP	1	12.050	5.466	2.710	0.077	PA2648	1	14.100	6.396	2.854	0.081
PA2502	1	3.100	1.406	.433	0.012	PA2574	1	4.900	2.223	1.244	0.035	PA2650	1	17.650	8.006	2.250	0.064
LL2503	1	9.500	4.309	2.092	0.059	LL2575	1	3.050	1.383	.288	0.008	PA2651	1	4.350	1.973	.693	0.020
PA2503	1	8.800	3.992	2.092	0.059	PA2575	1	3.000	1.361	.288	0.008	PA2652	1	1.250	0.567	.183	0.005
PA2504	1	4.450	2.019	.765	0.022	PA2576	1	2.200	0.998	.234	0.007	PA2653	1	12.520	5.679	2.564	0.073
LL2507	1	25.150	11.408	4.173	0.118	PA2577	1	6.900	3.130	1.408	0.040	PA2653 FOAM	6	.350	0.159	.424	0.012
PA2507	1	23.450	10.637	4.173	0.118	PA2578	1	2.500	1.134	.456	0.013	PA2654	1	9.650	4.377	2.039	0.058
PA2508	1	6.450	2.926	1.674	0.047	PA2579	1	3.050	1.383	.617	0.017	PA2655	1	3.300	1.497	.683	0.019
PA2509	1	7.650	3.470	1.473	0.042	PA2580	1	13.650	6.192	2.532	0.072	PA2656	1	5.250	2.381	.780	0.022
PA2510	1	2.550	1.157	.421	0.012	PA2581	1	4.900	2.223	.693	0.020	PA2657-FN	1	2.200	0.998	.352	0.010
PA2511	1	4.100	1.860	.617	0.017	LL2582	1	9.250	4.196	1.623	0.046	PA2658	1	9.250	4.196	2.092	0.059
PA2512	1	1.400	0.635	.241	0.007	PA2582	1	7.900	3.583	1.552	0.044	PA2659	1	5.550	2.517	.827	0.023
PA2513	1	2.050	0.930	.321	0.009	PA2583	1	3.050	1.383	.532	0.015	PA2660	1	8.850	4.014	2.092	0.059
PA2514	1	.700	0.318	.080	0.002	PA2585	1	4.500	2.041	.688	0.019	LL2661	1	7.100	3.221	1.679	0.048
PA2515	1	13.950	6.328	2.555	0.072	PA2586	1	1.850	0.839	.234	0.007	PA2661	1	6.100	2.767	1.640	0.046
PA2516	1	17.150	7.779	3.201	0.091	PA2587	1	2.500	1.134	.460	0.013	PA2662	1	1.900	0.862	.229	0.006
PA2517	1	12.800	5.806	2.499	0.071	PA2588	1	.850	0.386	.090	0.003	PA2663-FN	1	11.750	5.330	3.136	0.089
LL2518	1	11.150	5.058	2.039	0.058	PA2589-FN	1	2.100	0.953	.361	0.010	PA2664	1	5.350	2.427	1.071	0.030
PA2518	1	9.900	4.491	2.178	0.062	PA2591	1	7.700	3.493	1.473	0.042	PA2665	1	1.950	0.885	.349	0.010
PA2518XP	1	9.450	4.287	2.151	0.061	PA2592	1	2.100	0.953	.288	0.008	PA2666	1	3.250	1.474	.486	0.014
PA2519	1	4.000	1.814	.853	0.024	PA2593	1	9.150	4.150	1.412	0.040	LL2667	1	6.550	2.971	1.212	0.034
PA2520	1	5.650	2.563	.869	0.025	PA2595	1	13.650	6.192	3.136	0.089	PA2667	1	6.200	2.812	1.214	0.034
LL2521	1	7.450	3.379	1.214	0.034	PA2596	1	4.650	2.109	.987	0.028	PA2668	1	1.850	0.839	.239	0.007
PA2521	1	7.050	3.198	1.219	0.034	PA2598	1	4.750	2.155	.736	0.021	PA2669-FN	1	3.000	1.361	.617	0.017
PA2522	1	2.350	1.066	.395	0.011	PA2599	1	6.150	2.790	1.011	0.029	PA2670	1	1.000	0.454	.156	0.004
PA2523	1	4.350	1.973	.853	0.024	PA2601	1	4.450	2.019	.666	0.019	PA2672	1	5.000	2.268	1.071	0.030
PA2524-FN	1	4.250	1.928	.949	0.027	PA2602	1	.950	0.431	.204	0.006	PA2673	1	6.050	2.744	1.045	0.030
LL2525	1	9.150	4.150	1.902	0.054	PA2604	1	7.900	3.583	1.408	0.040	PA2674	1	2.350	1.066	.421	0.012
PA2525	1	8.250	3.742	1.844	0.052	PA2605	1	2.700	1.225	.456	0.013	PA2675	1	12.250	5.557	2.722	0.077
PA2526	1	3.400	1.542	.650	0.018	PA2606	1	5.200	2.359	1.163	0.033	LL2676	1	10.400	4.717	2.039	0.058
PA2527	1	3.150	1.429	.486	0.014	PA2607	1	2.100	0.953	.368	0.010	PA2676	1	9.050	4.105	2.039	0.058
PA2528	1	5.400	2.449	.693	0.020	LL2608	1	14.950	6.781	2.897	0.082	PA2676XP	1	9.050	4.105	1.899	0.054
PA2529	1	6.650	3.016	1.275	0.036	PA2608	1	13.050	5.919	2.897	0.082	PA2677	1	5.950	2.699	1.214	0.034
PA2530	1	2.150	0.975	.339	0.010	LL2609	1	9.650	4.377	2.129	0.060	PA2678	1	.750	0.340	.068	0.002
PA2531	1	6.400	2.903	1.288	0.036	PA2609	1	8.500	3.856	2.129	0.060	PA2679	1	18.500	8.392	3.773	0.107
PA2532	1	8.100	3.674	1.492	0.042	PA2610	1	4.800	2.177	.771	0.022	PA2680	1	11.900	5.398	2.572	0.073
PA2533	1	10.650	4.831	2.156	0.061	PA2611	1	8.250	3.742	1.408	0.040	PA2684-FN	1	2.750	1.247	.512	0.014
PA2534	1	2.900	1.315	.373	0.011	PA2612	1	9.350	4.241	1.674	0.047	LL2685	1	11.500	5.216	2.047	0.058
PA2535	1	.750	0.340	.192	0.005	PA2613	1	1.650	0.748	.201	0.006	PA2687	1	2.050	0.930	.351	0.010
PA2536	1	1.450	0.658	.211	0.006	PA2614	1	12.400	5.625	2.532	0.072	LL2688	1	5.900	2.676	1.045	0.030
PA2538	1	7.150	3.243	1.214	0.034	PA2615	1	3.800	1.724	.824	0.023	PA2688	1	5.750	2.608	1.045	0.030
PA2539	1	2.400	1.089	.395	0.011	PA2616	1	6.550	2.971	1.163	0.033	PA2689	1	.900	0.408	.143	0.004
PA2540	1	4.500	2.041	.949	0.027	PA2616XP	1	6.550	2.971	1.076	0.030	PA2690	1	10.450	4.740	1.450	0.041
PA2541-FN	1	2.450	1.111	.461	0.013	PA2617	1	4.700	2.132	.595	0.017	PA2691	1	12.550	5.693	2.048	0.058
PA2542	1	3.700	1.678	.683	0.019	LL2618	1	13.600	6.169	2.446	0.069	PA2692	1	5.950	2.699	.996	0.028
PA2544	1	1															

**BALDWIN WEIGHTS AND VOLUMES**

BALDWIN NUMBER	CASE QTY.	WEIGHT (ea.) lbs.	WEIGHT (ea.) kgs.	Volume (ea.) ft <sup>3</sup>	Volume (ea.) m <sup>3</sup>	BALDWIN NUMBER	CASE QTY.	WEIGHT (ea.) lbs.	WEIGHT (ea.) kgs.	Volume (ea.) ft <sup>3</sup>	Volume (ea.) m <sup>3</sup>	BALDWIN NUMBER	CASE QTY.	WEIGHT (ea.) lbs.	WEIGHT (ea.) kgs.	Volume (ea.) ft <sup>3</sup>	Volume (ea.) m <sup>3</sup>
PA2701	1	1.850	0.839	.234	0.007	PA2787	1	3.200	1.452	.824	0.023	PA2871	1	2.650	1.202	.486	0.014
PA2702	1	.700	0.318	.111	0.003	PA2788	1	4.500	2.041	.949	0.027	PA2874	1	19.050	8.641	2.651	0.075
PA2703	1	7.650	3.470	1.678	0.047	PA2789	1	8.300	3.765	1.126	0.032	PA2875	1	17.250	7.825	2.555	0.072
PA2704	1	9.300	4.218	2.039	0.058	PA2790-FN	1	2.750	1.247	.456	0.013	PA2876	1	14.000	6.350	1.785	0.051
PA2705	1	8.850	4.014	1.950	0.055	PA2791	1	.800	0.363	.158	0.004	PA2877-FN	1	2.950	1.338	.512	0.014
PA2706	1	1.650	0.748	.345	0.010	PA2792	1	1.750	0.794	.233	0.007	PA2878	1	2.250	1.021	.656	0.019
PA2707	1	7.800	3.538	1.550	0.044	PA2793	1	4.550	2.064	.693	0.020	PA2880	1	4.600	2.087	.695	0.020
PA2708	1	3.900	1.769	.853	0.024	PA2794	1	1.600	0.726	.227	0.006	PA2881	1	2.250	1.021	.461	0.013
PA2709	1	3.850	1.746	.654	0.019	PA2796	1	14.000	6.350	3.031	0.086	PA2883	1	3.800	1.724	.805	0.023
PA2710	1	2.200	0.998	.323	0.009	PA2797	1	10.050	4.559	1.822	0.052	PA2884	12	1.963	0.890	.205	0.006
PA2711	1	1.050	0.476	.180	0.005	PA2798	12	.525	0.238	.033	0.001	PA2885	1	1.600	0.726	.184	0.005
PA2712	1	3.150	1.429	.512	0.014	PA2799	1	14.150	6.418	2.805	0.079	PA2887-FN	1	4.550	2.064	1.245	0.035
PA2713	1	10.150	4.604	2.447	0.069	PA2801	1	11.950	5.421	3.136	0.089	PA2888	1	2.650	1.202	.320	0.009
PA2714	1	4.050	1.837	.827	0.023	PA2803	1	3.250	1.474	.347	0.010	PA2889	1	.250	0.113	.056	0.002
PA2715	1	7.400	3.357	1.678	0.047	PA2804	1	3.350	1.520	.349	0.010	PA2890	1	1.150	0.522	.149	0.004
PA2717	1	.800	0.363	.100	0.003	PA2805	1	4.700	2.132	.520	0.015	PA2891	1	4.750	2.155	.724	0.020
PA2718	1	9.000	4.082	2.096	0.059	PA2806	1	5.600	2.540	.969	0.027	PA2895	1	2.500	1.134	.429	0.012
PA2719	1	2.750	1.247	.512	0.014	PA2807	1	1.250	0.567	.267	0.008	PA2896	1	1.400	0.635	.214	0.006
PA2721	1	13.800	6.260	2.258	0.064	PA2812	1	9.500	4.309	1.432	0.041	PA2897	1	4.200	1.905	.767	0.022
PA2722	1	19.200	8.709	2.805	0.079	PA2813	1	7.850	3.561	1.550	0.044	PA2900	1	11.250	5.103	2.805	0.079
PA2723	1	20.150	9.140	3.591	0.102	PA2814	1	2.050	0.930	.385	0.011	PA2902	1	11.600	5.262	2.532	0.072
PA2724	1	22.200	10.070	2.955	0.084	PA2815	1	3.400	1.542	.708	0.020	PA2903	1	4.250	1.928	.838	0.024
PA2725	1	1.800	0.816	.213	0.006	PA2816	1	4.450	2.019	.520	0.015	PA2904	1	2.050	0.930	.288	0.008
PA2726	1	5.200	2.359	.838	0.024	PA2817	1	1.750	0.794	.427	0.012	PA2905	1	2.500	1.134	.352	0.010
PA2727	1	2.500	1.134	.321	0.009	PA2818	1	3.500	1.588	.769	0.022	PA2906	1	1.350	0.612	.289	0.008
PA2728	1	.950	0.431	.180	0.005	PA2819	1	7.100	3.221	.963	0.027	PA2909	1	3.600	1.633	.520	0.015
PA2729	1	12.150	5.511	2.532	0.072	PA2820	1	4.800	2.177	.978	0.028	PA2912	1	1.450	0.658	.166	0.005
PA2730	1	1.900	0.862	.213	0.006	PA2821	1	7.800	3.538	1.432	0.041	PA2913	1	2.350	1.066	.319	0.009
PA2731	1	27.150	12.315	4.196	0.119	PA2822	1	1.250	0.567	.256	0.007	PA2914	1	12.700	5.761	2.532	0.072
PA2732	1	8.650	3.924	2.168	0.061	PA2823	1	2.200	0.998	.213	0.006	PA2915	1	5.400	2.449	.824	0.023
PA2733	1	4.550	2.064	.910	0.026	PA2824	1	2.900	1.315	.288	0.008	PA2932	1	2.250	1.021	.324	0.009
PA2734	1	15.350	6.963	3.773	0.107	PA2825	1	3.000	1.361	.404	0.011	PA2936	1	2.250	1.021	.420	0.012
PA2735	1	3.600	1.633	.736	0.021	PA2826	1	2.850	1.293	.445	0.013	PA2938	1	3.000	1.361	.736	0.021
PA2736	1	1.650	0.703	.239	0.007	PA2827	1	3.600	1.633	.402	0.011	PA2942	1	7.850	3.561	1.154	0.033
PA2737	1	2.350	1.066	.321	0.009	PA2828	1	3.500	1.588	.402	0.011	PA2944-FN	1	1.350	0.612	.231	0.007
PA2738	1	2.950	1.338	.512	0.014	PA2829	1	4.750	2.155	.520	0.015	LL2945	1	8.350	3.788	1.676	0.047
PA2739	1	2.600	1.179	.421	0.012	PA2830	1	5.600	2.540	.630	0.018	PA2945	1	7.200	3.266	1.702	0.048
PA2740	1	2.100	0.953	.319	0.009	PA2831	1	9.400	4.264	1.465	0.041	PA2946	1	3.100	1.406	.460	0.013
PA2742	1	7.050	3.198	1.473	0.042	PA2832	1	.600	0.272	.090	0.003	PA2947	1	6.900	3.130	1.183	0.033
PA2743	1	2.100	0.953	.387	0.011	PA2833	1	10.100	4.581	1.640	0.046	PA2948	1	3.700	1.678	.512	0.014
PA2744	1	14.700	6.668	2.897	0.082	PA2834	1	3.300	1.497	.693	0.020	PA2949-FN	1	1.900	0.862	.348	0.010
PA2745	1	4.600	2.087	.938	0.027	PA2835	1	1.300	0.590	.200	0.006	PA2950	1	5.200	2.359	.773	0.022
PA2746	1	15.550	7.053	3.787	0.107	PA2836	1	1.100	0.499	.265	0.007	PA2951	1	8.650	3.924	1.408	0.040
PA2747	1	7.350	3.334	2.070	0.059	PA2837	1	1.050	0.476	.183	0.005	PA2952	1	10.650	4.831	1.830	0.052
PA2748	1	.300	0.136	.111	0.003	PA2838	1	11.900	5.398	1.737	0.049	PA2953	1	6.100	2.767	.949	0.027
PA2749	1	11.600	5.262	2.446	0.069	PA2839	1	14.400	6.532	2.826	0.080	PA2954-FN	1	4.350	1.973	.798	0.023
PA2750	1	.950	0.431	.853	0.024	PA2840	1	12.400	5.625	2.039	0.058	PA2955	1	16.100	7.303	2.202	0.062
PA2751	1	6.750	3.062	1.552	0.044	PA2843	1	5.200	2.359	.777	0.022	PA2956-FN	1	13.250	6.010	3.136	0.089
PA2752	1	3.150	1.429	.363	0.010	PA2844	1	3.400	1.542	.396	0.011	PA2957	1	3.750	1.701	.856	0.024
PA2753	1	3.600	1.633	.429	0.012	PA2845	1	2.950	1.338	.410	0.012	PA2958	1	1.850	0.839	.517	0.015
PA2754	1	3.050	1.383	.512	0.014	PA2846-FN	1	2.100	0.953	.347	0.010	PA2959-FN	1	12.050	5.466	3.136	0.089
PA2755	1	7.900	3.583	1.492	0.042	PA2847	1	7.500	3.402	1.473	0.042	PA2960	1	3.400	1.542	.692	0.020
PA2756	1	3.800	1.724	.650	0.018	PA2848	1	9.100	4.128	1.737	0.049	PA2961-FN	1	4.600	2.087	.869	0.025
PA2757	1	9.600	4.355	1.614	0.046	PA2849	1	16.850	7.643	4.599	0.130	PA2962	1	11.700	5.307	2.380	0.067
PA2759	1	3.650	1.656	.607	0.017	PA2851	1	7.150	3.243	1.540	0.044	PA2963	1	9.200	4.173	1.614	0.046
PA2761	1	5.150	2.336	.963	0.027	PA2852	1	7.950	3.606	1.830	0.052	PA2964	1	4.300	1.950	.824	0.023
PA2763	1	1.750	0.794	.402	0.011	PA2853	1	2.850	1.293	.533	0.015	PA2967	1	3.300	1.497	.856	0.024
PA2767	1	2.400	1.089	.317	0.009	PA2854	1	10.700	4.854	1.985	0.056	PA2968-FN	1	3.350	1.520	.555	0.016
PA2771	1	10.550	4.785	1.113	0.031	PA2855	1	12.500	5.670	2.774	0.079	PA2970	1	3.550	1.610	.572	0.016
PA2772	1	2.700	1.225	.348	0.010	PA2856	1	5.100	2.313	.856	0.024	PA2971	1	5.750	2.608	1.335	0.038
PA2773	1	8.800	1.270	.650	0.018	PA2857	1	13.000	5.897	2.879	0.081	PA2973	1	14.000	6.350	2.805	0.079
PA2774	1	11.300	5.126	1.939	0.055	PA2858	1	1.850	0.839	.179	0.005	PA2976-FN	1	2.350	1.066	.512	0.014
PA2775	1	3.000	1.361	.650	0.018	PA2859-FN	1	4.650	2.109	1.163	0.033	PA2977-FN	1	4.000	1.814	.750	0.021
PA2776	1	9.300	4.218	1.830	0.052	PA2860-FN	1	1.750	0.794	.236	0.007	PA2978	1	.950	0.431	.144	0.004
PA2777	1	6.350	2.880	1.052	0.030	PA2861	1	.500	0.227	.051	0.001	PA2980	1	2.400	1.089	.584	0.017
PA2778-FN	1	1.100	0.499	.151	0.004	PA2862	1	.550	0.249	.065	0.002	PA2982	1	9.850	4.468	1.840	0.052
LL2779	1	5.000	2.268	.767	0.022	PA2862 FOAM	12	.020	0.009	.022	0.001	PA2984	1	1.200	0.544	.305	0.009
PA2779	1	4.650	2.109	.767	0.022	RS2863	1	3.800	1.724	.750	0.021	PA2988	1	17.300	7.847	4.111	0.116
PA2781	1	12.750	5.783	2.446	0.069	RS2863XP	1	3.750	1.701	.750	0.021	PA2989	1	14.700	6.668	4.285	0.121
PA2782	1	6.850	3.107	1.674	0.047	PA2865	1	5.600	2.540	.869	0.025	HSG3077	1	1.850	0.839	.347	0.010
PA2783	1	4.450	2.019	.901	0.025	PA2866											

**BALDWIN WEIGHTS AND VOLUMES**

BALDWIN NUMBER	CASE QTY.	WEIGHT (ea.) lbs.	WEIGHT (ea.) kgs.	Volume (ea.) ft <sup>3</sup>	Volume (ea.) m <sup>3</sup>	BALDWIN NUMBER	CASE QTY.	WEIGHT (ea.) lbs.	WEIGHT (ea.) kgs.	Volume (ea.) ft <sup>3</sup>	Volume (ea.) m <sup>3</sup>	BALDWIN NUMBER	CASE QTY.	WEIGHT (ea.) lbs.	WEIGHT (ea.) kgs.	Volume (ea.) ft <sup>3</sup>	Volume (ea.) m <sup>3</sup>
PA3406-FN	1	2.400	1.089	.361	0.010	RS3515	1	3.050	1.383	.856	0.024	PA3629	1	5.050	2.291	.949	0.027
PA3411-FN	1	2.400	1.089	.429	0.012	RS3516	1	5.950	2.699	1.343	0.038	PA3630-FN	1	4.850	2.200	1.244	0.035
PA3414	6	.775	0.352	.125	0.004	RS3516XP	1	6.250	2.835	1.676	0.047	PA3631	1	1.750	0.794	.288	0.008
PA3415	1	4.300	1.950	.741	0.021	RS3517	1	5.300	2.404	1.250	0.035	PA3632	1	.600	0.272	.105	0.003
PA3416	1	1.500	0.680	.322	0.009	RS3517XP	1	5.200	2.359	1.233	0.035	PA3633	1	34.200	15.513	7.671	0.217
PA3417	1	1.700	0.771	.337	0.010	RS3518	1	7.300	3.311	1.615	0.046	PA3633 FOAM	1	1.250	0.567	1.004	0.028
PA3419	6	.475	0.215	.078	0.002	RS3518XP	1	7.400	3.357	1.628	0.046	PA3636	1	2.750	1.247	.321	0.009
PA3420	1	2.950	1.338	.402	0.011	RS3519	1	2.400	1.089	.456	0.013	PA3637	1	24.700	11.204	4.991	0.141
PA3421	1	4.750	2.155	.537	0.015	RS3520	1	4.300	1.950	.964	0.027	PA3638	1	15.500	7.031	4.526	0.128
PA3430	1	1.550	0.703	.315	0.009	RS3521	1	1.600	0.726	.314	0.009	PA3640	1	8.250	3.742	1.535	0.043
PA3435-FN	1	2.000	0.907	.324	0.009	RS3528	1	1.950	0.885	.402	0.011	PA3643	1	.550	0.249	.094	0.003
PA3438	1	3.600	1.633	.467	0.013	RS3529	1	.650	0.295	.125	0.004	PA3644	1	8.750	3.969	1.903	0.054
PA3439-FN	1	4.350	1.973	.949	0.027	RS3530	1	9.150	4.150	2.182	0.062	PA3645	1	4.850	2.200	.736	0.021
PA3440	1	2.400	1.089	.274	0.008	RS3530XP	1	9.250	4.196	2.182	0.062	PA3650	1	2.400	1.089	.348	0.010
PA3442	1	3.200	1.452	.369	0.010	RS3531	1	2.900	1.315	.853	0.024	PA3651-FN	1	2.050	0.930	2.234	0.007
PA3446	1	3.800	1.724	.767	0.022	RS3532	1	4.700	2.132	.947	0.027	PA3652	1	9.150	4.150	2.156	0.061
PA3447	1	2.600	1.179	.486	0.014	RS3533	1	1.700	0.771	.344	0.010	PA3653	1	3.400	1.542	.433	0.012
PA3448	1	4.450	2.019	.768	0.022	RS3534	1	13.550	6.146	2.847	0.081	PA3654	1	1.300	0.590	.201	0.006
PA3452	1	9.050	4.105	1.785	0.051	RS3535	1	1.550	0.703	.293	0.008	PA3655	1	6.600	2.994	1.048	0.030
PA3453	1	9.050	4.105	1.640	0.046	RS3536	1	2.050	0.930	.402	0.011	PA3656	1	2.600	1.179	.460	0.013
PA3457	1	1.350	0.612	.144	0.004	RS3537	1	.650	0.295	.127	0.004	PA3657	1	1.850	0.839	.321	0.009
PA3458	1	13.100	5.942	2.805	0.079	RS3538	1	3.850	1.746	.833	0.024	PA3658	1	2.600	1.179	.289	0.008
PA3460	1	4.850	2.200	.856	0.024	RS3539	1	8.350	3.788	1.974	0.056	PA3660-FN	1	3.400	1.542	.652	0.018
PA3461	1	15.200	6.895	3.407	0.096	RS3539XP	1	8.250	3.742	1.990	0.056	PA3664-FN	1	1.150	0.522	.211	0.006
PA3463	1	16.800	7.620	3.406	0.096	RS3540	1	3.600	1.633	.796	0.023	PA3667-FN	1	2.150	0.975	.348	0.010
PA3464	1	11.150	5.058	2.532	0.072	RS3541	1	.900	0.408	.236	0.007	PA3668	1	3.850	1.746	.853	0.024
PA3466-FN	1	2.800	1.270	.512	0.014	RS3542	1	1.750	0.794	.288	0.008	PA3669-FN	1	4.300	1.950	.856	0.024
PA3467	1	4.700	2.132	.856	0.024	RS3543	1	.500	0.227	.125	0.004	PA3670	1	3.600	1.633	.512	0.014
PA3469	1	5.650	2.563	.910	0.026	RS3544	1	2.450	1.111	.398	0.011	PA3671-FN	1	2.250	1.021	.352	0.010
PA3470	1	2.350	1.066	.421	0.012	RS3545	1	.600	0.272	.129	0.004	PA3672	1	.800	0.363	.140	0.004
PA3471	1	2.100	0.953	.349	0.010	RS3547	1	.300	0.136	.051	0.001	PA3674	1	.850	0.386	.124	0.004
PA3472	1	.800	0.363	.090	0.003	RS3548	1	5.950	2.699	1.277	0.036	PA3675	1	8.050	3.651	1.408	0.040
PA3472-FN	1	.800	0.363	.127	0.004	RS3548XP	1	5.950	2.699	1.277	0.036	PA3676	1	2.600	1.179	.299	0.008
PA3473	1	2.100	0.953	.237	0.007	RS3549	1	1.750	0.794	.321	0.009	PA3679	1	.800	0.363	.072	0.002
PA3474	1	5.200	2.359	.736	0.021	RS3550	1	2.750	1.247	.554	0.016	PA3680	1	.400	0.181	.227	0.006
PA3475	1	3.700	1.678	.617	0.017	PA3551	1	5.250	2.381	1.473	0.042	PA3681	1	3.750	1.701	.520	0.015
PA3476	1	1.550	0.703	.352	0.010	PA3554	1	4.400	1.996	.450	0.013	PA3682	1	.700	0.318	.112	0.003
PA3477	1	9.850	4.468	2.039	0.058	PA3555	1	6.450	2.926	.734	0.021	PA3683	1	1.050	0.476	.167	0.005
PA3478	1	6.650	3.016	1.383	0.039	PA3556	1	11.950	5.421	1.276	0.036	PA3684	1	.750	0.340	.094	0.003
PA3478XP	1	5.700	2.586	1.367	0.039	PA3557-FN	1	1.350	0.612	.234	0.007	PA3685	1	.900	0.408	.128	0.004
PA3479	1	4.650	2.109	.869	0.025	PA3558	1	8.050	3.651	1.639	0.046	PA3686	1	.900	0.408	.125	0.004
PA3480	1	3.400	1.542	.650	0.018	PA3560	1	14.100	6.396	3.406	0.096	PA3687	1	.650	0.295	.174	0.005
PA3481	1	2.350	1.066	.299	0.008	PA3562	1	6.100	2.767	.827	0.023	PA3688	1	10.050	4.559	1.830	0.052
PA3482	1	1.500	0.680	.153	0.004	PA3563	1	14.100	6.396	2.805	0.079	PA3689	1	2.650	1.202	.456	0.013
PA3483	1	5.300	2.404	.538	0.015	PA3565	1	.400	0.181	.051	0.001	PA3690	1	4.200	1.905	.709	0.020
PA3484	1	13.800	6.260	2.532	0.072	PA3566	1	2.900	1.315	.617	0.017	PA3691	1	7.150	3.243	1.678	0.047
PA3486	1	11.400	5.171	1.950	0.055	PA3568	1	22.400	10.161	6.272	0.177	PA3697	6	1.783	0.809	.234	0.007
PA3487	1	3.800	1.724	.617	0.017	PA3569	1	16.400	7.439	3.787	0.107	PA3698	1	3.350	1.520	.486	0.014
PA3491	1	4.350	1.973	.694	0.020	PA3572	1	7.850	3.561	1.244	0.035	PA3699	1	8.250	3.742	1.408	0.040
PA3492	1	1.100	0.499	.221	0.006	PA3573	1	11.700	5.307	2.232	0.063	RS3700	1	9.750	4.423	2.426	0.069
PA3493	1	13.700	6.214	1.453	0.041	PA3576	1	17.500	7.938	5.766	0.163	RS3700XP	1	10.000	4.536	2.324	0.066
PA3494	1	1.950	0.885	.612	0.017	PA3578	1	2.150	0.975	.342	0.010	RS3701	1	4.150	1.882	1.045	0.030
PA3495	1	1.900	0.862	.237	0.007	PA3579	1	13.050	5.919	2.532	0.072	RS3703	1	.500	0.227	.125	0.004
PA3496	1	17.450	7.915	4.529	0.128	PA3581	1	6.100	2.767	1.288	0.036	RS3704	1	.900	0.408	.122	0.003
PA3498	1	6.450	2.926	1.698	0.048	PA3584	1	17.950	8.142	4.599	0.130	RS3705	1	.350	0.159	.051	0.001
PA3499	1	9.350	4.241	2.039	0.058	PA3587	1	16.000	7.258	3.406	0.096	RS3706	1	2.100	0.953	.538	0.015
RS3501	1	1.250	0.567	.229	0.006	PA3588	1	14.600	6.623	3.549	0.100	RS3707	1	1.900	0.862	.346	0.010
RS3502	1	3.800	1.724	.741	0.021	PA3595	1	18.250	8.278	3.839	0.109	RS3708	1	2.200	0.998	.421	0.012
RS3503	1	1.250	0.567	.231	0.007	PA3597	1	6.550	2.971	.869	0.025	RS3709	1	.750	0.340	.316	0.009
RS3504	1	5.400	2.449	1.180	0.033	PA3598	1	8.050	3.651	1.315	0.037	RS3710	1	5.050	2.291	1.299	0.037
RS3504XP	1	5.400	2.449	1.180	0.033	PA3600	1	6.150	2.790	1.045	0.030	RS3711	1	2.100	0.953	.456	0.013
RS3505	1	1.400	0.635	.413	0.012	PA3601	1	.650	0.295	.127	0.004	RS3712	1	8.450	3.833	1.995	0.056
RS3506	1	6.450	2.926	1.426	0.040	PA3602	1	9.800	4.445	2.156	0.061	RS3713	1	3.600	1.633	.949	0.027
RS3506XP	1	6.400	2.903	1.426	0.040	PA3604	1	8.150	3.697	1.939	0.055	RS3714	1	8.750	3.969	2.039	0.058
RS3507	1	2.000	0.907	.421	0.012	PA3605	1	5.500	2.495	.949	0.027	RS3715	1	.600	0.272	.092	0.003
RS3508	1	5.500	2.495	1.192	0.034	PA3606	1	14.500	6.577	2.600	0.074	RS3716	1	.900	0.408	.134	0.004
RS3508XP	1	5.300	2.404	1.192	0.034	PA3607-FN	1	2.900	1.315	.512	0.014	RS3717	1	2.100	0.953	.532	0.015
RS3509	1	2.400	1.089	.486	0.014	PA3608-FN	1	3.250	1.474	.512	0.014	RS3718	1	9.150	4.150	1.937	0.055
RS3510	1	6.800	3.084	1.639	0.046	PA3609	1	5.250	2.381	.856	0.024	RS3719	1	2.800	1.270	.838	0.024
RS3510XP	1	7.000	3.175	1.614	0.046	PA3611	1	20.900	9.480	5.623	0.159	RS3720	1	8.700	3.946	2.321	0.066
RS3511	1	3.200	1.452	.856	0.024	PA3612	1	1.350	0.61								



**BALDWIN WEIGHTS AND VOLUMES**

BALDWIN NUMBER	CASE QTY.	WEIGHT (ea.) lbs.	kgs.	Volume (ea.) ft <sup>3</sup>	m <sup>3</sup>	BALDWIN NUMBER	CASE QTY.	WEIGHT (ea.) lbs.	kgs.	Volume (ea.) ft <sup>3</sup>	m <sup>3</sup>	BALDWIN NUMBER	CASE QTY.	WEIGHT (ea.) lbs.	kgs.	Volume (ea.) ft <sup>3</sup>	m <sup>3</sup>
RS3728	1	9.200	4.173	2.355	0.067	PA3815	1	12.500	5.670	1.403	0.040	PA3899	1	2.600	1.179	.819	0.023
RS3729	1	3.300	1.497	.824	0.023	PA3816	1	2.150	0.975	.358	0.010	PA3900	1	1.900	0.862	.381	0.011
RS3730	1	7.250	3.289	1.909	0.054	PA3817	1	.700	0.318	.135	0.004	PA3901	6	.767	0.348	.125	0.004
RS3731	1	4.250	1.928	1.076	0.030	PA3818-FN	1	1.800	0.816	.319	0.009	PA3901 FOAM	12	.083	0.038	.029	0.001
RS3732	1	1.800	0.816	.339	0.010	PA3819	1	.300	0.136	.085	0.002	PA3902	1	5.700	2.586	1.315	0.037
RS3733	1	3.850	1.746	.868	0.025	PA3820-FN	1	1.700	0.771	.298	0.008	PA3903	1	1.800	0.816	.372	0.011
RS3734	1	4.050	1.837	.882	0.025	PA3821	1	1.550	0.703	.246	0.007	PA3904	1	14.950	6.781	3.664	0.104
RS3734XP	1	4.100	1.860	.858	0.024	PA3822	6	1.192	0.541	.171	0.005	PA3905	1	10.650	4.831	3.448	0.098
RS3735	1	4.000	1.814	.512	0.014	PA3823	6	1.483	0.673	.248	0.007	PA3906	1	6.100	2.767	1.045	0.030
RS3736	1	4.150	1.892	.767	0.022	PA3824	1	3.250	1.474	.455	0.013	PA3907	1	10.700	4.854	1.676	0.047
RS3737	1	1.450	0.658	.288	0.008	PA3825	6	.842	0.382	.135	0.004	PA3908	1	1.900	0.862	.291	0.008
RS3738	1	9.400	4.264	2.232	0.063	RS3826	1	9.450	4.287	2.410	0.068	PA3909	1	.800	0.363	.095	0.003
RS3739	1	3.700	1.678	.856	0.024	RS3827	1	3.400	1.542	.838	0.024	PA3910-FN	1	3.350	1.520	.554	0.016
RS3740	1	8.250	3.742	1.997	0.057	PA3828	1	1.600	0.726	.207	0.006	PA3911	1	.800	0.363	.142	0.004
RS3741	1	2.700	1.225	.858	0.024	PA3829	1	1.800	0.816	.209	0.006	PA3914	1	7.650	3.470	1.299	0.037
RS3743	1	6.900	3.130	1.678	0.047	PA3832	1	3.150	1.429	.617	0.017	PA3915	1	2.450	1.111	.395	0.011
RS3744	1	7.650	3.470	1.609	0.046	PA3833	1	1.850	0.839	.282	0.008	PA3916	1	10.600	4.808	2.039	0.058
RS3744XP	1	7.700	3.493	1.609	0.046	PA3834	6	.200	0.091	.076	0.002	PA3917	1	.700	0.318	.116	0.003
RS3745	1	2.300	1.043	.532	0.015	PA3835	6	1.83	0.083	.081	0.002	PA3918	1	6.650	3.016	1.074	0.030
RS3746	1	2.350	1.066	.398	0.011	PA3836	6	1.283	0.582	.285	0.008	PA3919	1	2.100	0.953	.404	0.011
RS3747	1	.550	0.249	.121	0.003	PA3838	1	12.200	5.534	2.274	0.064	RS3920	1	2.000	0.907	.395	0.011
RS3749	1	9.400	4.264	2.232	0.063	PA3839	6	.675	0.306	.125	0.004	RS3921	1	.500	0.227	.095	0.003
RS3750	1	5.650	2.563	1.223	0.035	PA3840	6	.442	0.200	.028	0.001	RS3922	1	2.250	1.021	.460	0.013
RS3750XP	1	5.300	2.404	1.247	0.035	PA3843	1	2.650	1.202	.938	0.027	RS3923	1	.700	0.318	.241	0.007
PA3752	1	4.000	1.814	.607	0.017	PA3844	1	17.450	7.915	2.269	0.064	PA3924-FN	1	3.800	1.724	.736	0.021
PA3753	1	2.250	1.021	.292	0.008	PA3847	1	2.600	1.179	.460	0.013	PA3925	1	4.650	2.109	.725	0.021
PA3754	1	13.650	6.192	2.129	0.060	PA3848-FN	1	2.300	1.043	.535	0.015	RS3926	1	11.100	5.035	2.701	0.076
PA3755	1	3.750	1.701	.630	0.018	PA3849	1	6.000	2.722	1.351	0.038	RS3927	1	3.300	1.497	.838	0.024
PA3756	1	2.200	0.998	.417	0.012	PA3850	1	6.650	3.016	1.192	0.034	PA3928	1	4.500	2.041	.652	0.018
PA3757	1	.900	0.408	.093	0.003	PA3851	1	1.750	0.794	.213	0.006	RS3929	6	.692	0.314	.104	0.003
PA3758	1	1.550	0.703	.237	0.007	PA3852-FN	1	3.450	1.565	.717	0.020	RS3930	1	.200	0.091	.020	0.001
PA3760	1	6.350	2.880	.952	0.027	PA3853-FN	1	3.000	1.361	.622	0.018	PA3931	6	.275	0.125	.108	0.003
PA3761-FN	1	2.200	0.998	.346	0.010	PA3854-FN	1	5.350	2.427	1.408	0.040	PA3932	1	18.650	8.460	4.489	0.127
PA3763	6	1.400	0.635	.242	0.007	PA3855-FN	1	7.700	3.493	1.640	0.046	PA3933	1	11.200	5.080	3.240	0.092
RS3764	1	9.550	4.332	2.418	0.068	PA3859	1	3.550	1.610	.547	0.015	RS3934	1	3.850	1.746	.853	0.024
PA3765	1	12.150	5.511	2.365	0.067	PA3860	1	7.950	3.606	1.890	0.053	RS3935	1	1.300	0.590	.317	0.009
PA3766	1	8.250	3.742	1.326	0.038	PA3861	1	4.150	1.882	1.001	0.028	RS3936	1	6.900	3.130	1.805	0.051
PA3767	1	11.500	5.216	2.300	0.065	PA3862-FN	1	6.800	3.084	1.408	0.040	PA3937	1	2.100	0.953	.263	0.007
PA3768	1	15.550	7.053	2.793	0.079	PA3863	1	1.550	0.703	.288	0.008	PA3938	1	9.150	4.150	1.616	0.046
PA3773	6	.867	0.393	.201	0.006	PA3864	1	5.850	2.654	1.163	0.033	PA3939	1	1.250	0.567	.168	0.005
PA3774	1	2.350	1.066	.395	0.011	PA3865	1	3.600	1.633	.938	0.027	RS3940	1	1.750	0.794	.321	0.009
PA3775	1	6.450	2.926	1.048	0.030	PA3867	1	3.500	1.588	.591	0.017	PA3941	6	.775	0.352	.123	0.003
PA3777	1	1.050	0.476	.231	0.007	PA3868	1	3.500	1.588	.781	0.022	RS3942	1	1.300	0.590	.211	0.006
PA3778	1	2.000	0.907	.321	0.009	PA3869	1	3.500	1.588	.506	0.014	RS3943	1	.400	0.181	.090	0.003
PA3779-FN	1	3.400	1.542	.693	0.020	RS3870	1	8.650	3.924	2.038	0.058	PA3944	1	3.900	1.769	.848	0.024
PA3780	1	10.250	4.649	1.830	0.052	RS3870XP	1	8.800	3.992	2.039	0.058	PA3945	1	2.500	1.134	.370	0.010
PA3781	1	2.100	0.953	.240	0.007	RS3871	1	3.000	1.361	.681	0.019	PA3946	1	6.700	3.039	1.288	0.036
PA3782	1	2.250	1.021	.371	0.010	PA3872	12	1.470	0.667	.631	0.018	PA3948	1	6.500	2.948	1.640	0.046
PA3783	1	1.550	0.703	.199	0.006	PA3873	12	1.121	0.508	.525	0.015	PA3949	1	1.850	0.839	.367	0.010
PA3785-FN	1	1.750	0.794	.325	0.009	PA3874	1	5.000	2.268	.758	0.021	PA3950	1	.650	0.295	.097	0.003
PA3786-FN	1	10.300	4.672	3.136	0.089	PA3875-FN	1	2.450	1.111	.422	0.012	PA3951	1	9.050	4.105	2.092	0.059
PA3787	1	4.600	2.087	1.141	0.032	PA3877	1	3.250	1.474	.457	0.013	RS3952	1	8.500	3.856	1.938	0.055
PA3790	1	3.400	1.542	.572	0.016	PA3878	1	2.900	1.315	.395	0.011	PA3953	6	.500	0.227	.083	0.002
PA3791-FN	1	2.250	1.021	.352	0.010	PA3879-FN	1	3.000	1.361	.486	0.014	RS3954	1	1.100	0.499	.175	0.005
PA3792	1	1.100	0.499	.123	0.003	PA3880	6	.725	0.329	.107	0.003	PA3956	1	2.600	1.179	.775	0.022
PA3794	1	10.000	4.536	1.674	0.047	PA3881	1	2.600	1.179	.427	0.012	PA3957	6	.550	0.249	.071	0.002
PA3795	1	1.050	0.476	.127	0.004	RS3882	1	3.200	1.452	.693	0.020	PA3957 FOAM	12	.020	0.009	.017	**
PA3796	1	5.000	2.268	.750	0.021	RS3882XP	1	2.950	1.338	.637	0.018	PA3958	6	.500	0.227	.137	0.004
PA3797	1	1.450	0.658	.288	0.008	RS3883	1	.950	0.431	.179	0.005	PA3959	1	.500	0.227	.065	0.002
PA3798	1	2.350	1.066	.215	0.006	RS3884	1	4.100	1.860	.856	0.024	BA3964(4)	1	14.650	6.645	4.370	0.124
PA3800	1	14.850	6.736	2.153	0.061	RS3885	1	1.300	0.590	.219	0.006	BA3965(4)	1	23.180	10.514	8.233	0.233
PA3801-FN	1	2.000	0.907	.352	0.010	PA3886	1	1.550	0.703	.289	0.008	PA3966	1	2.150	0.975	.512	0.014
PA3802	1	2.700	1.225	.210	0.006	PA3887	1	12.300	5.579	2.532	0.072	PA3967	6	1.209	0.548	.230	0.007
PA3803	1	2.850	1.293	.433	0.012	RS3888	1	8.250	3.742	1.937	0.055	PA3969	1	1.850	0.839	.231	0.007
PA3804	1	1.450	0.658	.226	0.006	PA3889	1	4.550	2.064	1.288	0.036	PA3970	6	1.308	0.593	.232	0.007
PA3805-FN	1	1.800	0.816	.317	0.009	PA3890	6	2.233	1.013	.381	0.011	RS3971	1	3.300	1.497	.650	0.018
PA3806	1	16.900	7.666	3.406	0.096	PA3891	1	12.700	5.761	2.039	0.058	PA3972	1	2.200	0.998	.319	0.009
PA3807	1	5.000	2.268	.652	0.018	PA3892	1	11.800	5.352	2.201	0.062	PA3973	1	.800	0.363	.093	0.003
PA3808-FN	1	6.250	2.835	1.473	0.042	PA3893	1	3.900	1.769	.853	0.024	RS3974	1	6.200	2.812	1.277	0.036
PA3809	1	2.000	0.907	.339	0.010	PA3894	1	2.800	1.270	.527	0.015	RS3975	1	2.450	1.111	.838	0.024
PA3810	1	6.000	2.722	1.785	0.051	PA3895-FN	1	.700	0.318	.090	0.003	PA3978	1	11.300	5.126	1.640</	

# BALDWIN WEIGHTS AND VOLUMES

BALDWIN NUMBER	CASE QTY.	WEIGHT (ea.) lbs.	WEIGHT (ea.) kgs.	Volume (ea.) ft <sup>3</sup>	Volume (ea.) m <sup>3</sup>	BALDWIN NUMBER	CASE QTY.	WEIGHT (ea.) lbs.	WEIGHT (ea.) kgs.	Volume (ea.) ft <sup>3</sup>	Volume (ea.) m <sup>3</sup>	BALDWIN NUMBER	CASE QTY.	WEIGHT (ea.) lbs.	WEIGHT (ea.) kgs.	Volume (ea.) ft <sup>3</sup>	Volume (ea.) m <sup>3</sup>
PA3984	1	3.100	1.406	.617	.017	PA4126	6	.975	.442	.160	.005	PA4310	6	1.267	.575	.226	.006
PA3985	1	.900	.408	.143	.004	PA4127	6	1.617	.733	.207	.006	PA4311	6	.642	.291	.105	.003
PA3986	6	.333	.151	.093	.003	PA4128	6	.817	.371	.104	.003	PA4312	6	.767	.348	.122	.003
PA3987	1	15.600	7.076	2.293	.065	PA4129	6	1.267	.575	.223	.006	PA4313	6	.667	.303	.105	.003
RS3988	1	1.600	.726	.321	.009	RS4130	1	.900	.408	.210	.006	PA4314	6	.590	.268	.140	.004
PA3989-FN	1	3.100	1.406	.512	.014	RS4131	1	1.800	.816	.288	.008	SA4315	12	.137	.062	.039	.001
RS3990	1	.750	.340	.176	.005	PA4132	6	.842	.382	.101	.003	PA4316	6	1.067	.484	.160	.005
RS3991	1	.300	.136	.072	.002	PA4133	6	.725	.329	.236	.007	PA4317	6	.542	.246	.235	.007
RS3992	1	3.150	1.429	.654	.019	PA4134	6	1.560	.708	.204	.006	PA4318	1	2.150	.975	.402	.011
RS3993	1	.850	.386	.319	.009	SA4137	12	.104	.047	.020	.001	PA4319	6	.530	.240	.079	.002
RS3994	1	3.950	1.792	.856	.024	PA4138	6	.617	.280	.085	.002	PA4320	6	.817	.371	.084	.002
RS3995	1	1.000	.454	.326	.009	SA4141	12	.267	.121	.037	.001	PA4321	6	.692	.314	.115	.003
RS3996	1	6.000	2.722	1.614	.046	SA4142	12	.067	.030	.021	.001	PA4322	6	1.775	.805	.233	.007
RS3997	1	1.550	.703	.786	.022	PA4144	6	1.042	.473	.131	.004	PA4323	6	1.200	.544	.210	.006
RS3998	1	8.600	3.901	2.430	.069	PA4145	1	6.000	2.722	.767	.022	PA4324	6	1.775	.805	.591	.017
RS3998XP	1	8.650	3.924	2.430	.069	PA4146	6	.758	.344	.109	.003	PA4325	6	.792	.359	.104	.003
RS3999	1	2.300	1.043	1.285	.036	PA4147	6	.975	.442	.132	.004	PA4327	6	.342	.155	.062	.002
PA4005	6	2.933	1.330	.752	.021	PA4148	6	1.550	.703	.245	.007	PA4328	1	1.750	.794	.267	.008
PA4015	6	.925	.420	.104	.003	PA4149 KIT	6	.659	.299	.124	.004	PA4329	6	.667	.303	.152	.004
PA4016	6	.642	.291	.092	.003	PA4150	6	.717	.325	.121	.003	PA4330	6	.758	.344	.265	.007
PA4018	6	.591	.268	.090	.003	PA4151	6	1.158	.525	.211	.006	PA4331	6	1.050	.476	.271	.008
PA4023	6	1.167	.529	.160	.005	PA4152	6	.333	.151	.057	.002	PA4332	6	.442	.200	.148	.004
PA4026	6	.533	.242	.097	.003	PA4153	1	.600	.272	.383	.011	PA4333	6	.925	.420	.230	.007
PA4028	6	1.133	.514	.132	.004	PA4154	6	.568	.258	.084	.002	PA4334	6	.609	.276	.230	.007
PA4041	1	1.600	.726	.187	.005	PA4155 KIT	1	.750	.340	.197	.006	PA4335	6	.767	.348	.104	.003
PA4042	6	1.240	.562	.163	.005	PA4156 KIT	1	.600	.272	.169	.005	PA4336	6	1.342	.609	.176	.005
PA4043	6	.492	.223	.073	.002	PA4157	6	.834	.378	.208	.006	PA4337	6	.680	.308	.130	.004
PA4044	6	.658	.298	.089	.003	PA4158	6	.433	.196	.066	.002	PA4338	6	.942	.427	.160	.005
PA4045	6	.667	.303	.132	.004	PA4159	6	.817	.371	.208	.006	PA4340	6	.500	.227	.084	.002
PA4046	6	.983	.446	.126	.004	PA4160	6	.683	.310	.123	.003	PA4341	6	1.067	.484	.208	.006
PA4047	6	.717	.325	.126	.004	RS4161	1	1.200	.544	.201	.006	PA4344	6	.934	.424	.148	.004
PA4048	6	.725	.329	.199	.006	PA4162	6	1.467	.665	.228	.006	PA4345	6	.900	.408	.130	.004
PA4049	6	.758	.344	.087	.002	PA4163	6	.983	.446	.133	.004	PA4348	6	.925	.420	.124	.004
PA4050	6	.775	.352	.081	.002	PA4164	6	1.200	.544	.208	.006	PA4349	6	1.450	.658	.234	.007
PA4060	6	.917	.416	.127	.004	PA4165	1	1.300	.590	.193	.005	PA4350	6	.858	.389	.208	.006
PA4061	6	1.100	.499	.238	.007	PA4166	6	.834	.378	.109	.003	PA4351	6	1.167	.529	.133	.004
PA4069	6	.942	.427	.196	.006	PA4167	6	.700	.318	.107	.003	PA4352	6	.575	.261	.148	.004
PA4070	6	1.533	.695	.445	.013	PA4168	1	.550	.249	.271	.008	PA4354	6	.883	.401	.133	.004
PA4071	6	.925	.420	.309	.009	PA4169	6	.808	.367	.210	.006	PA4355	6	1.209	.548	.160	.005
PA4072	6	2.350	1.066	.439	.012	PA4170	6	1.042	.473	.244	.007	PA4356	6	.917	.416	.208	.006
PA4073	6	1.400	.635	.298	.008	PA4171	1	1.550	.703	.314	.009	PA4358	6	1.217	.552	.177	.005
PA4075	6	1.067	.484	.392	.011	PA4172	6	1.192	.541	.207	.006	PA4359	6	1.167	.529	.246	.007
PA4077	6	1.117	.507	.238	.007	PA4173	1	1.000	.454	.235	.007	PA4360	6	1.067	.484	.138	.004
PA4078	6	1.117	.507	.160	.005	PA4174	6	.875	.397	.208	.006	PA4361	6	.725	.329	.124	.004
PA4079	6	.992	.450	.126	.004	PA4175	6	.725	.329	.124	.004	PA4362	6	.675	.306	.111	.003
PA4081	6	1.033	.469	.124	.004	PA4176	6	.675	.306	.129	.004	PA4363	6	.525	.238	.127	.004
PA4084	6	.717	.325	.075	.002	PA4177	6	.833	.378	.112	.003	PA4364	6	1.000	.454	.154	.004
PA4085	6	.650	.295	.144	.004	PA4178	6	.925	.420	.134	.004	PA4365	6	.283	.128	.129	.004
PA4088	6	.733	.332	.275	.008	PA4179	6	.933	.423	.143	.004	PA4366	6	.650	.295	.097	.003
PA4089	6	.842	.382	.260	.007	PA4180	6	.625	.284	.160	.005	PA4367	6	1.125	.510	.203	.006
PA4090	6	1.175	.533	.228	.006	PA4181	6	.508	.230	.122	.003	PA4368	6	1.083	.491	.126	.004
PA4091	6	.867	.393	.198	.006	PA4182	6	.908	.412	.153	.004	PA4369	6	1.292	.586	.160	.005
PA4092	6	.708	.321	.151	.004	PA4183	6	.800	.363	.134	.004	PA4370	6	.459	.208	.124	.004
PA4093	6	1.925	.873	.230	.007	PA4184	6	.750	.340	.114	.003	PA4371	6	.417	.189	.148	.004
PA4099	6	.567	.257	.094	.003	PA4185	6	.933	.423	.153	.004	PA4372	6	.258	.117	.051	.001
PA4100	6	.533	.242	.066	.002	PA4187	12	.076	.034	.009	.001	PA4373	6	.508	.230	.079	.002
PA4101	1	1.200	.544	.325	.009	PA4188	6	.434	.197	.148	.004	PA4374	6	1.108	.503	.230	.007
PA4102	6	.867	.393	.122	.003	RS4189	1	.850	.386	.212	.006	PA4376	6	.675	.306	.125	.004
PA4103	6	.975	.442	.095	.003	PA4190	6	1.025	.465	.160	.005	PA4377	6	1.350	.612	.175	.005
PA4104	6	.867	.393	.131	.004	PA4191	6	1.034	.469	.160	.005	PA4381	6	.758	.344	.125	.004
PA4105	6	.825	.374	.153	.004	PA4192	6	.742	.337	.163	.005	PA4383	6	1.008	.457	.176	.005
PA4106	6	1.308	.593	.223	.006	PA4193	6	1.150	.522	.160	.005	PA4384	6	1.050	.476	.208	.006
PA4107	6	.883	.401	.122	.003	PA4194	6	.450	.204	.148	.004	PA4385	6	.675	.306	.129	.004
PA4108	6	.950	.431	.113	.003	PA4195 KIT	6	.634	.288	.148	.004	PA4386	6	.767	.348	.108	.003
PA4109	6	.600	.272	.086	.002	PA4196	6	.525	.238	.148	.004	PA4388	6	.883	.401	.384	.011
PA4110	6	1.558	.707	.256	.007	PA4197	6	.683	.310	.085	.002	PA4389	1	.800	.363	.245	.007
PA4111	6	1.158	.525	.240	.007	PA4198	6	.617	.280	.148	.004	PA4390	6	1.633	.741	.242	.007
PA4112	6	.475	.215	.124	.004	PA4199	6	.509	.231	.148	.004	PA4391	6	.459	.208	.148	.004
PA4113	6	1.625	.737	.216	.006	PA4303	6	1.034	.469	.160	.005	PA4393	6	.500	.227	.148	.004
PA4114	6	.725	.329	.129	.004	PA4304	6	.892	.405	.257	.007	PA4394	6	.442	.200	.075	.002
PA4118	6	1.050	.476	.200	.006	PA4305	6	.517	.235	.124	.004	PA4397	6	1.084	.492	.160	.005
PA4120	6	1.017	.461	.162	.005	PA4306	6	1.042	.473	.160	.005	PA4398	6	.525	.238	.169	.005
PA4121	6	.775	.352	.133	.004	PA4307	6	.784	.356	.160	.005	PA4399	6	.717	.325	.134	.004
PA4123	6	.700	.318	.094	.003	PA4308	6	.784	.356	.230	.007	PA4400	6	.683	.310	.118	.003
PA4124	6	.767	.348	.110	.003	PA4309	6	.942	.427	.123	.003	PA4401	6	.908	.412	.134	.004

\* Sold in Full Cases Only.      TBD To be Determined.      \*\* Measurement is less than 0.001.



**WARNING:** These products can expose you to chemicals, including Diisononyl Phthalate, Carbon black extracts, Nickel, 1,3 Butadiene, Ethylene Oxide, Epichlorohydrin, which are known to the State of California to cause cancer, and Bisphenol-A, Ethylene Glycol, Ethylene Oxide, 1,3 Butadiene, Epichlorohydrin, which are known to the State of California to cause birth defects or other reproductive harm.

**BALDWIN WEIGHTS AND VOLUMES**

BALDWIN NUMBER	CASE QTY.	WEIGHT (ea.) lbs.	WEIGHT (ea.) kgs.	Volume (ea.) ft <sup>3</sup>	Volume (ea.) m <sup>3</sup>	BALDWIN NUMBER	CASE QTY.	WEIGHT (ea.) lbs.	WEIGHT (ea.) kgs.	Volume (ea.) ft <sup>3</sup>	Volume (ea.) m <sup>3</sup>	BALDWIN NUMBER	CASE QTY.	WEIGHT (ea.) lbs.	WEIGHT (ea.) kgs.	Volume (ea.) ft <sup>3</sup>	Volume (ea.) m <sup>3</sup>
PA4402	6	1.292	0.586	.194	0.005	PA4487	6	1.100	0.499	.185	0.005	PA4640-FN	1	3.550	1.610	.767	0.022
PA4404	6	.492	0.223	.148	0.004	PA4488	1	.500	0.227	.140	0.004	PA4641	1	2.700	1.225	.306	0.009
PA4405	6	.458	0.208	.105	0.003	PA4489	1	.350	0.159	.116	0.003	RS4642	1	8.600	3.901	2.123	0.060
PA4408	6	.380	0.172	.137	0.004	PA4548	1	.750	0.340	.112	0.003	RS4643	1	2.600	1.179	1.244	0.035
PA4409	6	.908	0.412	.118	0.003	RS4549	1	2.600	1.179	.681	0.019	PA4644	1	2.750	1.247	.486	0.014
PA4410 KIT	6	.458	0.208	.096	0.003	PA4551	12	413	0.187	.056	0.002	RS4646	1	6.950	3.153	1.762	0.050
PA4411	6	.367	0.166	.136	0.004	PA4552	12	513	0.233	.057	0.002	PA4647	1	2.000	0.907	.300	0.008
PA4412	6	1.233	0.559	.208	0.006	PA4553	1	.700	0.318	.165	0.005	PA4648	1	2.850	1.293	.293	0.008
PA4413	6	1.233	0.559	.167	0.005	PA4554	1	1.750	0.794	.273	0.008	PA4649	1	1.900	0.862	.313	0.009
PA4415	6	.933	0.423	.399	0.011	PA4555	6	300	0.136	.025	0.001	PA4650-FN	1	4.850	2.200	1.144	0.032
PA4416 KIT	6	.684	0.310	.208	0.006	PA4557	6	.333	0.151	.064	0.002	PA4651	1	1.550	0.703	.349	0.010
PA4417	6	1.042	0.473	.109	0.003	PA4559	1	.850	0.386	.605	0.017	PA4652	1	1.750	0.794	.211	0.006
PA4418	6	1.617	0.733	.229	0.006	PA4560	1	2.200	0.998	.692	0.020	PA4653	1	17.050	7.734	1.885	0.053
PA4419	6	.617	0.280	.129	0.004	RS4561	1	7.650	3.470	1.408	0.040	PA4654 KIT	1	5.000	2.268	.406	0.011
PA4421	6	.866	0.393	.148	0.004	RS4562	1	5.250	2.381	1.473	0.042	PA4655	1	7.050	3.198	.917	0.026
PA4422	6	.900	0.408	.170	0.005	RS4563	1	7.050	3.198	1.614	0.046	PA4656	1	4.500	2.041	.650	0.018
PA4423	6	.840	0.381	.130	0.004	RS4564	1	8.400	3.810	1.937	0.055	PA4657	1	19.950	9.049	3.584	0.101
PA4424	6	.533	0.242	.115	0.003	PA4566	1	14.550	6.600	2.788	0.079	PA4659	1	1.000	0.454	.240	0.007
PA4425	6	.950	0.431	.230	0.007	PA4567	1	1.800	0.816	.299	0.008	PA4660	1	10.050	4.559	2.168	0.061
PA4426	6	.560	0.254	.112	0.003	PA4570	1	.550	0.249	.225	0.006	PA4661	12	1.183	0.537	.442	0.013
PA4428	6	1.017	0.461	.187	0.005	PA4571	1	15.000	6.804	3.136	0.089	PA4662	12	1.125	0.510	.441	0.012
PA4429	6	1.130	0.513	.220	0.006	RS4572	1	8.200	3.720	2.355	0.067	PA4663	12	.892	0.405	.327	0.009
PA4430	6	.783	0.355	.149	0.004	PA4573	1	10.650	4.831	2.039	0.058	PA4664	12	1.100	0.499	.470	0.013
PA4431	6	1.008	0.457	.173	0.005	PA4574	1	3.500	1.588	.683	0.019	PA4665-FN	1	.850	0.386	.130	0.004
PA4433	6	1.600	0.726	.315	0.009	RS4576	1	6.600	2.994	1.539	0.044	PA4666	1	350	0.159	.047	0.001
PA4434	6	1.258	0.571	.267	0.008	RS4577	1	2.250	1.021	.538	0.015	RS4672	1	4.150	1.882	.879	0.025
PA4435	6	1.350	0.612	.219	0.006	RS4578	1	1.950	0.885	.288	0.008	RS4673	1	1.500	0.680	.269	0.008
PA4436	6	.942	0.427	.152	0.004	RS4579	1	9.550	4.332	2.700	0.076	PA4674-FN	1	2.750	1.247	.512	0.014
PA4437	6	.708	0.321	.150	0.004	RS4580	1	4.450	2.019	1.244	0.035	RS4676	1	4.800	2.177	1.094	0.031
PA4438	6	1.017	0.461	.173	0.005	PA4581	1	5.400	2.449	.856	0.024	RS4677	1	1.800	0.816	.339	0.010
PA4439	6	1.308	0.593	.296	0.008	PA4582	1	3.050	1.383	.683	0.019	RS4678	1	2.400	1.089	.395	0.011
PA4440 KIT	6	1.175	0.533	.200	0.006	PA4583-FN	1	2.200	0.998	.395	0.011	RS4679	1	.600	0.272	.128	0.004
PA4441	6	.842	0.382	.157	0.004	PA4585	1	9.900	4.491	1.937	0.055	RS4680	1	2.000	0.907	.392	0.011
PA4442	6	.433	0.196	.078	0.002	PA4592	1	2.000	0.907	.294	0.008	PA4681	6	.525	0.238	.130	0.004
PA4443	6	.433	0.196	.086	0.002	PA4593	1	3.300	1.497	.512	0.014	PA4682	6	.375	0.170	.087	0.002
PA4444	6	.700	0.318	.269	0.008	PA4594	1	1.150	0.522	.178	0.005	PA4683	1	4.250	1.928	.870	0.025
RS4445	1	.950	0.431	.290	0.008	RS4595	1	1.600	0.726	.321	0.009	PA4689	12	.750	0.340	.063	0.002
PA4446	6	.558	0.253	.115	0.003	RS4597	1	2.050	0.930	.346	0.010	PA4693	1	1.450	0.658	.303	0.009
PA4447	6	.883	0.401	.155	0.004	RS4598	1	2.600	1.179	.460	0.013	PA4694	12	.910	0.413	.080	0.002
PA4448	6	.733	0.332	.169	0.005	RS4599	1	800	0.363	.167	0.005	PA4695	12	.529	0.240	.071	0.002
PA4449	6	1.000	0.454	.168	0.005	PA4600	6	1.942	0.881	.386	0.011	PA4696 FOAM	12	.010	0.005	.024	0.001
RS4450	1	.950	0.431	.293	0.008	PA4601	6	1.983	0.899	.430	0.012	PA4697-FN	1	2.900	1.315	.673	0.019
PA4451	1	.942	0.427	.170	0.005	PA4602	1	3.500	1.588	.693	0.020	PA4698	6	.400	0.181	.025	0.001
PA4452	6	.875	0.397	.133	0.004	PA4603	1	1.100	0.499	.156	0.004	CA4700	1	5.400	2.449	1.047	0.030
PA4453	6	.975	0.442	.131	0.004	PA4604-FN	1	1.450	0.658	.233	0.007	PA4701	6	.608	0.276	.134	0.004
PA4454	6	1.117	0.507	.238	0.007	PA4605	1	9.200	4.173	1.686	0.048	CA4702	1	2.900	1.315	.314	0.009
PA4455	6	.658	0.298	.133	0.004	PA4606	1	17.550	7.961	3.770	0.107	CA4703	1	3.600	1.633	.477	0.013
PA4456	6	1.142	0.518	.220	0.006	PA4608	1	2.250	1.021	.265	0.007	PA4704	1	.700	0.318	.099	0.003
PA4458	1	2.050	0.930	.395	0.011	RS4613	1	10.050	4.559	2.348	0.066	PA4705	1	300	0.136	.020	0.001
PA4460 KIT	12	.179	0.081	.048	0.001	PA4614	1	2.150	0.975	.276	0.008	PA4706	1	1.350	0.612	.123	0.003
PA4461	6	.341	0.155	.078	0.002	RS4616	1	10.700	4.854	2.573	0.073	PA4707	1	1.300	0.590	.237	0.007
PA4462	6	.542	0.246	.137	0.004	RS4617	1	3.900	1.769	1.263	0.036	PA4708	1	.400	0.181	.047	0.001
PA4463	6	1.067	0.484	.222	0.006	RS4618	1	9.200	4.173	1.937	0.055	PA4709	1	3.600	1.633	.783	0.022
PA4464	6	1.200	0.544	.227	0.006	PA4619	1	1.000	0.454	.156	0.004	PA4711	4	1.537	0.697	.589	0.017
PA4465	6	.992	0.450	.239	0.007	RS4620	1	5.050	2.291	1.288	0.036	PA4713	1	.900	0.408	.151	0.004
PA4466	6	1.533	0.695	.265	0.007	RS4621	1	2.100	0.953	.464	0.013	PA4714	6	.950	0.431	.122	0.003
PA4468	6	1.250	0.567	.128	0.004	RS4622	1	7.350	3.334	1.466	0.041	PA4715	1	1.450	0.658	.200	0.006
PA4469	6	.508	0.230	.081	0.002	RS4623	1	1.800	0.816	.533	0.015	PA4716	1	1.400	0.635	.146	0.004
PA4470	6	.658	0.298	.097	0.003	PA4624	1	5.650	2.563	.942	0.027	PA4720	12	.479	0.217	.082	0.002
PA4471	6	.950	0.431	.151	0.004	PA4625	1	2.050	0.930	.395	0.011	PA4727	12	.296	0.134	.044	0.001
PA4472	6	1.925	0.873	.497	0.014	PA4627	1	3.250	1.474	.693	0.020	PA4730	6	.433	0.196	.075	0.002
PA4473	6	.600	0.272	.132	0.004	PA4628	1	1.350	0.612	.241	0.007	PA4731	6	.200	0.091	.014	**
PA4474	6	.483	0.219	.102	0.003	RS4629	1	5.200	2.359	1.753	0.050	PA4732	12	.363	0.165	.061	0.002
PA4475	6	.442	0.200	.093	0.003	PA4630	1	18.200	8.256	2.242	0.063	PA4733	6	.533	0.242	.074	0.002
PA4476	6	1.050	0.476	.131	0.004	PA4631-FN	1	3.050	1.383	.617	0.017	PA4734	6	.100	0.045	.027	0.001
PA4477	6	1.058	0.480	.135	0.004	PA4632	6	.742	0.337	.076	0.002	PA4735	12	.001	**	.007	**
PA4478	6	1.233	0.559	.170	0.005	PA4633	12	.150	0.068	.012	**	PA4736 FOAM	12	.020	0.009	.017	**
PA4479	6	.725	0.329	.115	0.003	RS4634	1	6.450	2.926	1.812	0.051	PA4737	6	.942	0.427	.075	0.002
PA4480	6	.917	0.416	.134	0.004	RS4634XP	1	6.450	2.926	1.805	0.051	PA4740	1	.400	0.181	.111	0.003
PA4481	6	1.000	0.454	.138	0.004	PA4635	1	2.350	1.066	.400	0.011	PA4741	1	5.650	2.563	1.179	0.033
PA4483	6	.833	0.378	.110	0.003	RS4636	1	5.900	2.676	1.214	0.034	PA4750	6	.200	0.091	.031	0.001
PA4484	6	.650	0.295	.100	0.003	RS4637	1	2.000	0.907	.743	0.021	PA4753	1	.600	0.272	.171	0.005
PA4485																	

# BALDWIN WEIGHTS AND VOLUMES

BALDWIN NUMBER	CASE QTY.	WEIGHT (ea.) lbs.	WEIGHT (ea.) kgs.	Volume (ea.) ft <sup>3</sup>	Volume (ea.) m <sup>3</sup>	BALDWIN NUMBER	CASE QTY.	WEIGHT (ea.) lbs.	WEIGHT (ea.) kgs.	Volume (ea.) ft <sup>3</sup>	Volume (ea.) m <sup>3</sup>	BALDWIN NUMBER	CASE QTY.	WEIGHT (ea.) lbs.	WEIGHT (ea.) kgs.	Volume (ea.) ft <sup>3</sup>	Volume (ea.) m <sup>3</sup>
PA4756	6	.020	0.009	.019	0.001	PA4928	1	.400	0.181	.158	0.004	B5091	12	1.096	0.497	.051	0.001
PA4758	12	.254	0.115	.051	0.001	PA4929	1	10.750	4.876	2.204	0.062	P5092	10	.687	0.312	.060	0.002
PA4760	12	.429	0.195	.064	0.002	PA4930	1	.800	0.363	.113	0.003	B5134	12	1.150	0.522	.050	0.001
PA4763	12	.417	0.189	.076	0.002	PA4931	12	.020	0.009	.043	0.001	BW5136	12	1.046	0.474	.042	0.001
PA4764	6	.525	0.238	.074	0.002	PA4932	6	.650	0.295	.125	0.004	BW5137	12	1.071	0.486	.042	0.001
PA4766	1	1.150	0.522	.195	0.006	PA4934	12	.554	0.251	.081	0.002	BW5138	12	1.150	0.522	.049	0.001
PA4769	12	.358	0.162	.062	0.002	PA4935	12	.413	0.187	.063	0.002	BW5139	12	1.325	0.601	.049	0.001
PA4773	12	.530	0.240	.070	0.002	PA4938	4	.850	0.386	.213	0.006	BW5140	12	1.558	0.707	.065	0.002
RS4775	1	5.450	2.472	.935	0.026	PA4939	12	.321	0.146	.052	0.001	BW5141	12	1.196	0.543	.050	0.001
PA4778	12	.254	0.115	.029	0.001	PA4942	1	6.820	3.094	1.018	0.029	BW5142	12	1.292	0.586	.051	0.001
PA4781	1	1.300	0.590	.307	0.009	PA4945	1	.800	0.363	.433	0.012	BW5143	12	1.475	0.669	.050	0.001
PA4793	6	1.025	0.465	.259	0.007	PA4955	1	.850	0.386	.433	0.012	B5144	12	.712	0.323	.051	0.001
RS4794	1	5.250	2.381	1.037	0.029	PA4956	1	.400	0.181	.118	0.003	B5145	12	1.071	0.486	.041	0.001
PA4795	1	1.150	0.522	.292	0.008	RS4959	1	7.800	3.538	1.602	0.045	B5176	12	1.146	0.520	.049	0.001
PA4802	1	.950	0.431	.179	0.005	PA4960-FN	1	4.650	2.109	.865	0.024	B5177	12	1.558	0.707	.069	0.002
RS4803	1	.950	0.431	.140	0.004	PA4961	1	1.000	0.454	.227	0.006	BW5178	12	1.279	0.580	.052	0.001
RS4804	1	.550	0.249	.090	0.003	RS4962	1	.450	0.204	.127	0.004	BW5179	12	1.883	0.854	.070	0.002
RS4806	1	3.350	1.520	.781	0.022	RS4963	1	7.550	3.425	.164	0.005	BW5182	12	1.254	0.569	.046	0.001
PA4809	1	2.050	0.930	.444	0.013	RS4966	1	8.550	3.878	1.808	0.051	BW5183	12	1.330	0.603	.050	0.001
PA4813	1	1.050	0.476	.158	0.004	RS4967	1	9.700	4.400	2.251	0.064	BW5200	12	1.904	0.864	.049	0.001
PA4819	12	.496	0.225	.064	0.002	RS4968	1	5.350	2.427	.945	0.027	BW5201	12	1.883	0.854	.051	0.001
PA4820	12	.346	0.157	.031	0.001	RS4969	1	6.450	2.926	1.062	0.030	BW5250	12	1.890	0.857	.049	0.001
PA4823	6	.450	0.204	.075	0.002	RS4970	1	5.350	2.427	.792	0.022	PE5270	12	.333	0.151	.033	0.001
PA4824	12	.387	0.176	.029	0.001	RS4971	1	8.100	3.674	1.587	0.045	PE5271	12	.404	0.183	.051	0.001
PA4825	1	2.550	1.157	.465	0.013	RS4972	1	3.750	1.701	.645	0.018	PE5272	12	.446	0.202	.027	0.001
PA4827	1	.650	0.295	.150	0.004	PA4973	1	4.950	2.245	.740	0.021	RS5273	1	.600	0.272	.089	0.003
PA4829	6	.400	0.181	.076	0.002	PA4977-FN	1	6.650	3.016	1.672	0.047	PA5274	1	8.950	4.060	1.786	0.051
PA4830	12	.408	0.185	.051	0.001	PA4978	1	.050	0.023	.018	0.001	PA5275	1	3.200	1.452	.681	0.019
PA4833-FN	1	.950	0.431	.174	0.005	PA4979	12	.508	0.230	.125	0.004	PA5276	1	.088	0.040	.011	**
PA4834-FN	1	.950	0.431	.140	0.004	PA4983	1	2.400	1.089	.538	0.015	CA5278	1	2.550	1.157	.389	0.011
PA4848	2	.750	0.340	.243	0.007	PA4984-FN	1	6.250	2.835	1.277	0.036	PA5281	1	4.650	2.109	.522	0.015
PA4852	12	.275	0.125	.039	0.001	PA4985	6	.367	0.166	.093	0.003	PA5282	6	.850	0.386	.116	0.003
PA4852 FOAM	12	.400	0.181	.130	0.004	PA4986	6	.758	0.344	.082	0.002	PA5283	1	3.550	1.610	.329	0.009
PA4853	12	.125	0.057	.029	0.001	PA4987	6	.408	0.185	.059	0.002	BA5284	4	5.687	2.580	.203	0.006
PA4854	6	.150	0.068	.029	0.001	RS4988	1	9.600	4.355	2.288	0.065	RS5285	1	1.800	0.816	.346	0.010
PA4855	12	.100	0.045	.024	0.001	RS4989	1	13.450	6.101	3.115	0.088	RS5287	1	14.200	6.441	3.064	0.087
PA4857	6	.417	0.189	.112	0.003	PA4991	1	2.400	1.089	.366	0.010	RS5287XP	1	13.100	5.942	2.942	0.083
PA4858	1	1.500	0.680	.372	0.011	RS4992	1	4.450	2.019	.915	0.026	RS5288	1	10.100	4.581	2.250	0.064
RS4859	1	4.350	1.973	.853	0.024	RS4993	1	8.450	3.833	1.966	0.056	RS5288XP	1	9.350	4.241	2.287	0.065
PA4860	1	17.350	7.870	1.885	0.053	RS4994	1	2.250	1.021	.395	0.011	PA5289	1	2.900	1.315	.516	0.015
RS4861	1	5.800	2.631	1.192	0.034	RS4995	1	.600	0.272	.124	0.004	PA5290	1	.400	0.181	.060	0.002
RS4862	1	7.300	3.311	1.640	0.046	CA4996	1	1.300	0.590	.282	0.008	RS5291	1	6.100	2.767	1.458	0.041
RS4863	1	2.650	1.202	1.318	0.037	PA4997	6	.625	0.284	.079	0.002	RS5292	1	2.400	1.089	.638	0.018
RS4864	1	4.050	1.837	.820	0.023	CA4999	1	5.850	2.654	.814	0.023	RS5293	1	24.400	11.068	6.233	0.176
PA4870-FN	1	2.400	1.089	.475	0.013	CFB5000	1	1.600	0.726	.090	0.003	RS5293XP	1	27.150	12.315	6.368	0.180
PA4871	1	1.250	0.567	.240	0.007	CS5007	12	1.308	0.593	.035	0.001	RS5294	1	7.850	3.561	2.344	0.066
PA4872	12	.333	0.151	.030	0.001	CS5008	12	1.200	0.544	.037	0.001	PA5297	1	4.250	1.928	.589	0.017
PA4874	12	1.109	0.503	.713	0.020	CS5009	6	4.725	2.143	1.48	0.004	PA5298	1	1.450	0.658	.260	0.007
PA4876	1	2.400	1.089	.440	0.012	CS5010	1	49.420	22.417	1.356	0.038	PA5299	1	4.600	2.087	.413	0.012
PA4877	1	1.550	0.703	.266	0.008	CS5011	1	524.000	237.686	10.623	0.301	PA5300	1	3.300	1.497	.371	0.010
PA4878	12	.267	0.121	.037	0.001	CSC5012	4	9.862	4.473	.308	0.009	RS5301	1	4.700	2.132	.979	0.028
PA4879	12	.010	0.005	.002	**	CSC5013	1	48.850	22.158	1.242	0.035	PA5302	1	11.900	5.398	2.663	0.075
PA4881	1	.600	0.272	.078	0.002	CTK5028	1	.500	0.227	.033	0.001	PA5303	1	18.000	8.165	3.876	0.110
PA4883	12	.300	0.136	.023	0.001	CTK5029	24	.190	0.086	.023	0.001	RS5304	1	.850	0.386	.314	0.009
PA4885	4	.100	0.045	.028	0.001	CTK5029-M	24	.180	0.082	.026	0.001	RS5305	1	2.100	0.953	.349	0.010
PA4886	12	.638	0.289	.075	0.002	CTK5029-1	1	.001	**	.001	**	PA5306	6	.850	0.386	.128	0.004
PA4887	1	15.650	7.099	1.777	0.050	CTK5029-4	1	.001	**	.010	**	PA5310	1	.600	0.272	.097	0.003
PA4889	1	7.350	3.334	1.434	0.041	CS5057	1	51.280	23.261	1.338	0.038	PA5311	12	.383	0.174	.058	0.002
PA4890	6	1.467	0.665	.234	0.007	CS5058	6	5.050	2.291	.149	0.004	PA5312 KIT	6	1.283	0.582	.199	0.006
PA4891	12	.271	0.123	.018	0.001	OTK5060	10	.050	0.023	.023	0.001	RS5313	1	2.900	1.315	.683	0.019
PA4893	1	.917	0.416	.189	0.005	OTK5061	12	.020	0.009	.008	**	PA5314	6	.750	0.340	.127	0.004
PA4895	12	.304	0.138	.037	0.001	OTK5063	10	.020	0.009	.011	**	PA5315	1	2.900	1.315	.396	0.011
PA4896	1	.300	0.136	.050	0.001	BW5070	12	.979	0.444	.041	0.001	PA5316	12	.096	0.044	.013	**
PA4897	1	.900	0.408	.210	0.006	BW5071	12	1.104	0.501	.041	0.001	PA5317	6	.658	0.298	.165	0.005
PA4900	1	.200	0.091	.042	0.001	BW5072	12	1.133	0.514	.041	0.001	PA5318	6	.742	0.337	.141	0.004
PA4902	12	.421	0.191	.059	0.002	BW5073	12	1.292	0.586	.050	0.001	PA5319	6	.758	0.344	.101	0.003
PA4903	1	1.300	0.590	.176	0.005	BW5074	12	1.454	0.660	.053	0.001	PA5320	6	.600	0.272	.118	0.003
PA4905	12	.129	0.059	.029	0.001	BW5075	12	1.521	0.690	.049	0.001	PA5321	6	.517	0.235	.128	0.004
PA4907	12	.533	0.242	.078	0.002	BW5076	12	2.075	0.941	.066	0.002	PA5323	1	15.500	7.031	4.002	0.113
PA4908	12	.188	0.085	.062	0.002	BW5082	12	1.217	0.552	.048	0.001	RS5325	1	1.100	0.499	.176	0.005
PA4911	12	.020	0.009	.016	**	BW5086	12	1.500	0.680	.059	0.002	PA5326	1	2.300	1.043	.231	0.007
PA4912	1	.800	0.363	.111	0.003	B5087	12	1.204	0.546	.062	0.002	PA5327	6	.383	0.174	.045	

**BALDWIN WEIGHTS AND VOLUMES**

BALDWIN NUMBER	CASE QTY.	WEIGHT (ea.) lbs.	WEIGHT (ea.) kgs.	Volume (ea.) ft <sup>3</sup>	Volume (ea.) m <sup>3</sup>	BALDWIN NUMBER	CASE QTY.	WEIGHT (ea.) lbs.	WEIGHT (ea.) kgs.	Volume (ea.) ft <sup>3</sup>	Volume (ea.) m <sup>3</sup>	BALDWIN NUMBER	CASE QTY.	WEIGHT (ea.) lbs.	WEIGHT (ea.) kgs.	Volume (ea.) ft <sup>3</sup>	Volume (ea.) m <sup>3</sup>
RS5332	1	8.400	3.810	2.039	0.058	RS5422	1	3.200	1.452	.616	0.017	RS5508	1	7.300	3.311	1.533	0.043
PA5333	6	.425	0.193	.064	0.002	PA5423-FN	1	2.039	0.925	.326	0.009	RS5509	1	9.000	4.082	2.070	0.059
RS5334	1	3.150	1.429	.638	0.018	RS5424	1	3.600	1.633	.839	0.024	RS5510	1	2.750	1.247	.702	0.020
RS5335	1	.800	0.363	.315	0.009	PA5425	1	10.850	4.922	2.588	0.073	PA5511	1	.500	0.227	.173	0.005
PA5336	1	.850	0.386	.532	0.015	PA5426	1	8.980	4.073	1.216	0.034	PA5512	1	.450	0.204	.112	0.003
PA5337	6	.483	0.219	.080	0.002	PA5428	6	1.742	0.790	.297	0.008	CA5514	1	3.900	1.769	.617	0.017
PA5338-FN	1	2.400	1.089	.486	0.014	RS5429	1	7.050	3.198	1.595	0.045	PA5515	1	1.050	0.476	.277	0.008
PA5339	6	.734	0.333	.160	0.005	RS5430	1	2.850	1.293	1.163	0.033	PA5516	1	.450	0.204	.165	0.005
PA5340	1	.700	0.318	.425	0.012	RS5431	1	3.650	1.656	.773	0.022	RS5517	1	2.450	1.111	.404	0.011
PA5341	6	.542	0.246	.124	0.004	RS5432	1	6.050	2.744	1.626	0.046	PA5528	1	6.300	2.858	1.319	0.037
RS5342	1	8.500	3.856	1.779	0.050	RS5433	1	4.550	2.064	.929	0.026	PA5529	1	2.450	1.111	.404	0.011
RS5343	1	9.500	4.309	2.284	0.065	RS5434	1	3.450	1.565	.736	0.021	RS5534	1	6.850	3.107	1.724	0.049
RS5344	1	5.250	2.381	1.215	0.034	RS5435	1	4.250	1.928	.947	0.027	RS5535	1	5.050	2.291	.919	0.026
RS5345	1	.980	0.445	.312	0.009	PA5436	1	1.600	0.726	.578	0.016	RS5536	1	3.600	1.633	.768	0.022
RS5347	1	1.150	0.522	.475	0.013	PA5437	1	.500	0.227	.042	0.001	RS5537	1	5.450	2.472	1.019	0.029
RS5348	1	4.600	2.087	1.173	0.033	RS5438	1	4.500	2.041	.752	0.021	RS5538	1	6.000	2.722	1.486	0.042
PA5350	1	.020	0.009	.067	0.002	RS5440	1	6.350	2.880	1.745	0.049	RS5539	1	2.150	0.975	.646	0.018
RS5351	1	2.800	1.270	.683	0.019	RS5441	1	4.950	2.245	.956	0.027	RS5540	1	7.400	3.357	1.686	0.048
CA5352	1	3.050	1.383	.385	0.011	RS5442	1	3.700	1.678	.779	0.022	RS5541	1	2.300	1.043	.696	0.020
PA5353	12	.262	0.119	.051	0.001	RS5443	1	1.250	0.567	.236	0.007	RS5543	1	1.700	0.771	.303	0.009
RS5354	1	5.900	2.676	1.289	0.036	PA5445	1	13.400	6.078	1.586	0.045	RS5544	1	.500	0.227	.129	0.004
RS5355	1	2.050	0.930	.486	0.014	PA5446	1	3.900	1.769	.901	0.025	RS5546	1	4.500	2.041	.886	0.025
RS5356	1	8.150	3.697	1.887	0.053	RS5447	1	5.000	2.268	1.071	0.030	RS5547	1	1.350	0.612	.334	0.009
PA5357	1	5.850	2.654	1.640	0.046	RS5448	1	1.000	0.454	.272	0.008	RS5548	1	1.500	0.680	.402	0.011
RS5358	1	8.300	3.765	1.597	0.045	RS5449	1	.850	0.386	.137	0.004	RS5549	1	1.750	0.794	.563	0.016
PA5359	6	.400	0.181	.094	0.003	CA5450	1	1.750	0.794	.257	0.007	RS5550	1	.800	0.363	.172	0.005
RS5360	1	7.000	3.175	1.301	0.037	PA5451	1	.550	0.249	.088	0.002	PA5554	1	1.800	0.816	.220	0.006
RS5361	1	1.800	0.816	.448	0.013	RS5452	1	5.700	2.586	1.438	0.041	PA5557	1	1.800	0.816	.331	0.009
PA5363	1	1.450	0.658	.136	0.004	RS5453	1	1.350	0.612	.403	0.011	PA5556	1	4.800	2.177	.953	0.027
PA5364	1	12.100	5.489	2.177	0.062	PA5454	1	11.400	5.171	1.301	0.037	RS5558	1	4.350	1.973	1.035	0.029
PA5365	1	3.650	1.656	.787	0.022	RS5455	1	5.450	2.472	1.392	0.039	RS5559	1	1.750	0.794	.439	0.012
CA5366	1	3.850	1.746	.521	0.015	RS5456	1	2.550	1.157	.611	0.017	PA5563	1	1.300	0.590	.163	0.005
CA5368	1	7.250	3.289	1.221	0.035	PA5457	12	1.479	0.671	.554	0.016	BA5566	4	5.750	2.608	1.162	0.005
CA5369	1	3.300	1.497	.494	0.014	RS5458	1	5.800	2.631	1.278	0.036	PA5580	6	.567	0.257	.147	0.004
CA5370	1	2.850	1.293	.335	0.009	RS5459	1	12.600	5.715	2.835	0.080	PA5581	1	1.450	0.658	.202	0.006
BA5371	1	6.200	2.812	.129	0.004	RS5460	1	4.650	2.109	1.320	0.037	PA5583	1	1.150	0.522	.386	0.011
BA5373	1	16.100	7.303	.398	0.011	RS5461	1	5.350	2.427	1.312	0.037	PA5584	1	.800	0.363	.203	0.006
BA5374	4	6.160	2.794	.156	0.004	RS5462	1	2.200	0.998	.692	0.020	PA5585	1	.050	0.023	.065	0.002
BA5375	4	6.150	2.790	.175	0.005	PA5463	1	17.400	7.893	4.616	0.131	PA5586	1	1.150	0.068	.112	0.003
BA5376	4	5.530	2.508	.137	0.004	PA5464	1	3.400	1.542	.853	0.024	BF5587-D	12	1.154	0.523	.060	0.002
BA5377	1	9.200	4.173	.220	0.006	PA5465	1	10.450	4.740	2.465	0.070	PA5588	1	7.390	3.352	1.730	0.049
BA5378	4	5.850	2.654	.179	0.005	PA5467	1	3.850	1.746	.552	0.016	PA5589	1	3.250	1.474	.677	0.019
BA5379	4	5.888	2.671	.161	0.005	PA5468	1	8.000	3.633	.185	0.005	RS5591XP	1	2.150	0.975	.419	0.012
RS5387 KIT	1	2.550	1.157	.727	0.021	RS5470	1	9.600	4.355	2.610	0.074	BA5592	4	5.750	2.608	.161	0.005
PA5388	1	4.350	1.973	.693	0.020	RS5471	1	2.178	0.988	.703	0.020	RS5593XP	1	3.850	1.746	.755	0.021
RS5389-FN	1	8.200	3.720	2.210	0.063	RS5472	1	10.800	4.899	2.620	0.074	PA5597	1	.400	0.181	.112	0.003
RS5390	1	8.800	3.992	1.859	0.053	PA5475	1	.400	0.181	.132	0.004	PA5618	1	.550	0.249	.115	0.003
RS5391	1	6.300	2.858	1.308	0.037	PA5476	1	1.000	0.454	.158	0.004	PA5619	1	.600	0.271	.134	0.004
RS5392	1	2.050	0.930	.421	0.012	PA5477	1	1.400	0.635	.260	0.007	PA5620	6	.358	0.162	.102	0.003
PA5393	6	.125	0.057	.033	0.001	RS5478-FN	1	3.600	1.633	1.018	0.029	PA5621	1	1.200	0.544	.238	0.007
RS5395-FN	1	2.650	1.202	.615	0.017	RS5479	1	.750	0.340	.220	0.006	PA5622	6	.375	0.170	.104	0.003
PA5396	1	.850	0.386	.183	0.005	PA5482	6	1.317	0.597	.198	0.006	PA5623	6	1.267	0.575	.224	0.006
RS5397	1	5.950	2.699	1.174	0.033	RS5483	1	6.100	2.767	1.247	0.035	PA5624	6	.250	0.113	.154	0.004
RS5398	1	1.900	0.862	.387	0.011	RS5484	1	7.800	3.538	1.662	0.047	PA5625	1	.500	0.227	.060	0.002
PA5399	1	.700	0.318	.163	0.005	PA5485-FN	1	5.050	2.291	1.089	0.031	PA5626	1	1.750	0.794	.309	0.009
PA5400	1	.750	0.340	.161	0.005	PA5486	1	1.900	0.862	.469	0.013	RS5627	1	5.450	2.472	1.363	0.039
PA5401	1	.400	0.181	.095	0.003	RS5488	1	6.880	3.121	1.843	0.052	RS5628	1	1.450	0.658	.630	0.018
PA5403	1	.350	0.159	.072	0.002	RS5489	1	4.200	1.905	.867	0.025	PA5629	6	.542	0.246	.136	0.004
PA5404	1	.750	0.340	.223	0.006	RS5490	1	.750	0.340	.241	0.007	PA5630	1	.150	0.068	.050	0.001
PA5405	1	.200	0.091	.044	0.001	PA5491	1	4.350	1.973	.668	0.019	PA5631	6	.750	0.340	.153	0.004
RS5408	1	3.250	1.474	.518	0.015	PA5492	1	.750	0.340	.118	0.003	PA5632	6	1.192	0.541	.177	0.005
RS5409	1	5.250	2.381	.962	0.027	PA5493	1	.350	0.159	.109	0.003	PA5633	6	.717	0.325	.083	0.002
PA5410-FN	1	1.400	0.635	.229	0.006	PA5494	6	.150	0.068	.037	0.001	PA5636	1	4.250	1.928	.489	0.014
RS5411	1	5.600	2.540	1.140	0.032	PA5495	6	.280	0.127	.138	0.004	PA5637	6	.500	0.227	.106	0.003
PA5412	1	2.400	1.089	.527	0.015	PA5496	1	6.350	2.880	.999	0.028	PA5638	6	.242	0.110	.065	0.002
RS5413	1	8.500	3.856	2.016	0.057	PA5497	1	2.440	1.107	.395	0.011	RS5641	1	2.350	1.066	.463	0.013
RS5414	1	11.350	5.148	2.447	0.069	PA5498	1	9.350	4.241	1.565	0.044	PA5642	1	.750	0.340	.307	0.009
RS5415	1	3.400	1.542	.838	0.024	PA5499	1	3.750	1.701	.543	0.015	PA5649	1	.700	0.318	.146	0.004
CA5416	1	2.900	1.315	.386	0.011	CA5500	1	10.700	4.854	1.639	0.046	PA5650	1	.500	0.227	.064	0.002
CA5417	1	4.200	1.905	.675	0.019	PA5503	1	5.350	2.427	.715	0.020	PA5651	1	.300	0.136	.048	0.001
PA5418	1	.850	0.386	.183	0.005	PA5504	1	1.950	0.885	.266	0.008	PA5652	1	1.100	0.499	.233	0.007
CA5419	1	8.100	3.674	1.177	0.033	PA5505											

**BALDWIN WEIGHTS AND VOLUMES**

BALDWIN NUMBER	CASE QTY.	WEIGHT (ea.) lbs.	WEIGHT (ea.) kgs.	Volume (ea.) ft <sup>3</sup>	Volume (ea.) m <sup>3</sup>	BALDWIN NUMBER	CASE QTY.	WEIGHT (ea.) lbs.	WEIGHT (ea.) kgs.	Volume (ea.) ft <sup>3</sup>	Volume (ea.) m <sup>3</sup>	BALDWIN NUMBER	CASE QTY.	WEIGHT (ea.) lbs.	WEIGHT (ea.) kgs.	Volume (ea.) ft <sup>3</sup>	Volume (ea.) m <sup>3</sup>
PA5656	1	1.250	0.567	.247	0.007	PA5751	1	8.200	3.720	1.825	0.052	BK6064	1	10.650	4.831	.758	0.021
PA5657	1	5.150	2.336	.541	0.015	PA5752	1	2.000	0.907	.292	0.008	BK6065	1	3.300	1.497	.367	0.010
PA5658	6	.500	0.227	.104	0.003	PA5753	6	.500	0.227	.107	0.003	BK6067	1	2.800	1.270	.447	0.013
PA5661	6	.342	0.155	.047	0.001	RS5754	1	10.750	4.876	2.845	0.081	BK6068	1	11.100	5.035	.752	0.021
PA5662	6	.200	0.091	.063	0.002	PA5755	1	3.150	1.429	.249	0.007	BK6069	1	12.350	5.602	.747	0.021
PA5663	1	1.550	0.703	.119	0.003	RS5756	1	6.650	3.016	1.694	0.048	BK6070	1	9.650	4.377	.539	0.015
PA5664	1	1.150	0.522	.208	0.006	PA5757	1	3.000	1.361	.218	0.006	BK6071	1	8.050	3.651	.541	0.015
PA5665	1	1.850	0.839	.456	0.013	RS5758	1	5.450	2.472	.987	0.028	BK6073	1	12.500	5.670	.774	0.022
PA5666	6	.783	0.355	.121	0.003	RS5759	1	1.750	0.794	.414	0.012	BK6075	1	11.500	5.216	.790	0.022
PA5667	1	9.000	4.048	.157	0.004	RS5761	1	2.350	1.066	.362	0.010	BK6076	1	8.150	3.697	.766	0.022
PA5668	1	3.300	1.497	.329	0.009	PA5762	1	7.250	3.289	1.949	0.055	BK6080	1	5.950	2.699	.446	0.013
PA5669	6	.942	0.427	.125	0.004	PA5763	1	3.800	1.724	.392	0.011	BK6081	1	9.800	4.445	.752	0.021
RS5670	1	1.450	0.658	.304	0.009	PA5764	1	.900	0.408	.106	0.003	BK6082	1	9.750	4.423	.536	0.015
RS5672	1	8.200	3.720	1.874	0.053	PA5765	6	.617	0.280	.106	0.003	BK6083	1	10.850	4.922	.775	0.022
RS5673	1	3.350	1.520	.876	0.025	PA5766	6	1.558	0.707	.170	0.005	BK6085	1	9.500	4.309	.724	0.020
PA5674	1	15.850	7.190	2.773	0.078	RS5767	1	4.550	2.064	1.116	0.032	BK6086	1	9.550	4.332	.748	0.021
RS5675	1	6.950	3.153	1.473	0.042	PA5768	6	.433	0.196	.081	0.002	BK6087	1	2.850	1.293	.439	0.012
RS5676	1	1.000	0.454	.422	0.012	PA5770	6	.942	0.427	.165	0.005	BK6088	1	4.950	2.245	.730	0.021
PA5678	1	.001	**	.064	0.002	PA5771	1	4.050	1.837	.274	0.008	BK6089	1	6.150	2.790	1.541	0.044
PA5679	6	.483	0.219	.106	0.003	PA5772	6	.733	0.332	.111	0.003	BK6090	1	11.600	5.262	.779	0.022
PA5680	1	8.000	3.363	.133	0.004	PA5773	6	.067	0.030	.019	0.001	BK6092	1	9.650	4.377	.743	0.021
PA5681	1	3.000	1.361	.317	0.009	PA5774	6	.692	0.314	.117	0.003	BK6093	1	12.750	5.783	.775	0.022
PA5682	1	1.350	0.612	.235	0.007	RS5776	1	10.800	4.899	2.225	0.063	BK6094	1	12.500	5.670	.760	0.022
PA5683	6	.417	0.189	.078	0.002	PA5780	1	2.700	1.225	.225	0.006	BK6095	1	9.600	4.355	.524	0.015
RS5684	1	6.500	2.925	.176	0.005	PA5781	1	2.400	1.089	.209	0.006	BK6096	1	4.100	1.860	.538	0.015
RS5685	1	2.650	1.202	.382	0.011	RS5782	1	2.900	1.315	.642	0.018	BK6097	1	5.100	2.313	.439	0.012
PA5686	1	2.850	1.293	.213	0.006	RS5783	1	.850	0.386	.305	0.009	BK6098	1	4.500	2.041	.751	0.021
PA5689	6	1.708	0.775	.408	0.012	RS5784	1	2.250	1.021	.395	0.011	BK6099	1	9.850	4.468	.538	0.015
PA5690	6	.350	0.159	.121	0.003	PA5785	1	3.850	1.746	.533	0.015	BK6102	1	8.300	3.765	.538	0.015
PA5691	6	.250	0.113	.095	0.003	PA5786	1	1.400	0.635	.257	0.007	BK6103	1	6.800	3.084	.524	0.015
RS5692	1	4.850	2.200	1.133	0.032	PA5787	1	3.900	1.769	.536	0.015	BK6104	1	10.600	4.808	.756	0.021
RS5693	1	5.450	2.472	1.309	0.037	CA5788	1	5.430	2.463	1.036	0.029	BK6105	1	9.100	4.128	.750	0.021
PA5694	6	.275	0.125	.099	0.003	CA5789	1	7.600	3.447	1.530	0.043	BK6106	1	6.800	3.084	.524	0.015
PA5695	1	.850	0.386	.134	0.004	CA5790	1	5.300	2.404	.903	0.026	BK6107	1	8.150	3.697	.748	0.021
PA5696	1	1.450	0.658	.235	0.007	CA5791	1	5.900	2.676	1.109	0.031	BK6108	1	6.700	3.039	1.252	0.035
PA5697	1	.650	0.295	.116	0.003	PA5792	1	1.350	0.612	.246	0.007	BK6110	1	6.150	2.790	1.462	0.041
PA5698	6	.392	0.178	.052	0.001	CA5793	1	2.650	1.202	.548	0.016	BK6112	1	4.550	2.064	1.101	0.031
PA5699	1	15.500	7.031	3.541	0.100	PA5796	1	1.550	0.703	.430	0.012	BK6114	1	9.700	4.400	.747	0.021
PA5700	12	.646	0.293	.035	0.001	PA5797	1	.400	0.181	.158	0.004	BK6115	1	9.000	4.082	.750	0.021
RS5707	1	7.100	3.221	1.611	0.046	PA5798	1	.300	0.136	.096	0.003	BK6116	1	10.800	4.899	.766	0.022
RS5708	1	2.600	1.179	.771	0.022	BF5800	12	1.425	0.646	.074	0.002	BK6117	1	12.400	5.625	.833	0.024
PA5710	1	1.650	0.748	.122	0.003	BF5801	12	1.400	0.635	.074	0.002	BK6118	1	9.950	4.513	.748	0.021
PA5711	1	3.750	1.701	.391	0.011	BF5810	12	1.296	0.588	.067	0.002	BK6120	1	9.000	4.082	.743	0.021
PA5712	1	2.100	0.953	.173	0.005	BF5812	12	1.513	0.686	.091	0.003	BK6121	1	10.700	4.854	.768	0.022
PA5713	1	.010	0.005	.070	0.002	BF5813	12	1.542	0.699	.088	0.002	BK6124	1	11.300	5.126	.787	0.022
PA5716	1	.001	**	.022	0.001	BF5813-O	12	1.388	0.630	.080	0.002	BK6138	1	11.850	5.375	.760	0.022
PA5719	1	.001	**	.010	**	BF5815	12	1.325	0.601	.067	0.002	BK6140	1	9.700	4.400	.752	0.021
PA5720	6	.866	0.393	.159	0.004	BF5816	12	1.367	0.620	.065	0.002	BK6161	1	2.450	1.111	.454	0.013
PA5722	6	.392	0.178	.081	0.002	6017	6	.558	0.253	.057	0.002	BK6167	1	5.650	2.563	.452	0.013
PA5723	6	.208	0.094	.042	0.001	6020	6	1.342	0.609	.140	0.004	BK6183	1	8.550	3.878	.736	0.021
PA5725	6	.675	0.306	.122	0.003	6021	6	.508	0.230	.059	0.002	BK6184	1	6.600	2.994	.598	0.017
PA5727	6	.050	0.023	.013	**	BK6022	1	7.850	3.561	.520	0.015	BK6185	1	12.050	5.466	.749	0.021
PA5728	6	.658	0.298	.073	0.002	BK6023	1	8.950	4.060	.839	0.024	BK6187	1	9.550	4.332	.736	0.021
PA5728 FOAM	6	.067	0.030	.031	0.001	BK6024	1	5.500	2.495	.423	0.012	BK6195	1	6.600	2.994	.423	0.012
PA5729	6	.550	0.249	.121	0.003	BK6025	1	7.050	3.198	.473	0.013	BK6196	1	7.900	3.583	.736	0.021
RS5730	1	8.500	3.856	1.967	0.056	BK6026	1	3.850	1.746	.747	0.021	BK6215	1	8.750	3.969	.736	0.021
RS5731	1	2.400	1.089	.585	0.017	BK6027	1	10.450	4.740	.831	0.024	BK6287	1	4.300	1.950	.423	0.012
PA5732	6	.117	0.053	.045	0.001	BK6028	1	18.690	8.478	1.167	0.033	BK6341	1	6.100	2.767	.530	0.015
PA5733	6	.483	0.219	.079	0.002	BK6029	1	10.650	4.831	.773	0.022	BK6375	1	6.750	3.062	.520	0.015
PA5734	1	1.200	0.544	.154	0.004	BK6031	1	5.550	2.517	.558	0.016	BK6376	1	5.700	2.586	.423	0.012
PA5735	1	10.450	4.740	1.459	0.041	BK6032	1	7.700	3.493	.559	0.016	BK6380	1	6.600	2.994	.423	0.012
PA5736	1	2.600	1.179	.257	0.007	BK6035	1	5.350	2.427	.453	0.013	BK6426	1	9.950	4.513	.720	0.020
PA5738	6	.667	0.303	.053	0.001	BK6045	1	6.950	3.153	.449	0.013	BK6429	1	7.650	3.470	.520	0.015
PA5739	1	1.500	0.680	.087	0.002	BK6049	1	5.650	2.563	.468	0.013	BK6438	1	7.300	3.311	.766	0.022
RS5741	1	2.200	0.998	.369	0.010	BK6050	1	21.850	9.911	1.683	0.048	BK6440	1	7.900	3.583	.530	0.015
RS5742	1	.650	0.295	.230	0.007	BK6051	1	11.500	5.216	.789	0.022	BK6457	1	12.750	5.783	.770	0.022
RS5743	1	21.400	9.707	5.055	0.143	BK6053	1	10.300	4.672	.775	0.022	BK6464	1	7.500	3.402	.735	0.021
RS5743XP	1	24.100	10.932	5.558	0.157	BK6054	1	10.600	4.808	.783	0.022	BK6467	1	6.000	2.722	.423	0.012
RS5744	1	6.550	2.971	1.675	0.047	BK6055	1	8.600	3.901	.728	0.021	BK6561	1	9.650	4.377	.520	0.015
RS5745	1	2.500	1.134	.419	0.012	BK6057	1	12.850	5.829	.764	0.022	BK6562	1	8.600	3.901	.554	0.016
RS5746	1	.800	0.363	.311	0.009	BK6058	1	10.400	4.717	.830	0.023	BK6579	1	9.550	4.332	.520	0.015
RS5747	1	1.800	0.816	.302	0.009	BK6059	1	9.850	4.468	.817	0.023	BK					

**BALDWIN WEIGHTS AND VOLUMES**

BALDWIN NUMBER	CASE QTY.	WEIGHT (ea.) lbs.	WEIGHT (ea.) kgs.	Volume (ea.) ft <sup>3</sup>	Volume (ea.) m <sup>3</sup>	BALDWIN NUMBER	CASE QTY.	WEIGHT (ea.) lbs.	WEIGHT (ea.) kgs.	Volume (ea.) ft <sup>3</sup>	Volume (ea.) m <sup>3</sup>	BALDWIN NUMBER	CASE QTY.	WEIGHT (ea.) lbs.	WEIGHT (ea.) kgs.	Volume (ea.) ft <sup>3</sup>	Volume (ea.) m <sup>3</sup>
BK6610	1	6.600	2.994	.429	0.012	B7026-MPG	12	1.188	0.539	.054	0.002	B7162	6	4.358	1.977	.231	0.007
BK6613	1	10.850	4.922	.749	0.021	BD7028	12	1.917	0.870	.069	0.002	B7163	12	2.150	0.975	.076	0.002
BK6619	1	7.750	3.515	.551	0.016	BD7029	12	1.783	0.809	.064	0.002	B7164	12	2.121	0.962	.095	0.003
BK6634	1	7.650	3.470	.423	0.012	B7030	6	4.333	1.965	.239	0.007	B7165	12	6.29	0.285	.025	0.001
BK6650	1	10.270	4.658	.521	0.015	B7031	12	1.304	0.591	.062	0.002	BD7166	6	2.700	1.225	.119	0.003
BK6652	1	5.400	2.449	.611	0.017	B7033	12	.713	0.323	.033	0.001	B7167	12	.688	0.312	.027	0.001
BK6653	1	11.700	5.307	.854	0.024	B7034	12	1.246	0.565	.047	0.001	BD7168	1	3.350	1.520	.171	0.005
BK6656	1	13.000	5.897	.849	0.024	P7035	12	1.000	0.454	.120	0.003	BD7169	6	2.117	0.960	.076	0.002
BK6657	1	12.200	5.534	.749	0.021	B7039	12	1.833	0.831	.087	0.002	B7170	12	1.592	0.722	.078	0.002
BK6658	1	11.250	5.103	.846	0.024	B7042	12	1.183	0.537	.053	0.001	B7171	12	2.542	1.153	.107	0.003
BK6659	1	11.000	4.990	.749	0.021	B7044	12	1.508	0.684	.063	0.002	B7172	12	.737	0.334	.030	0.001
BK6661	1	1.300	0.590	.296	0.008	B7045	12	1.717	0.779	.071	0.002	BC7173	12	.892	0.405	.062	0.002
BK6662	1	10.700	4.854	.739	0.021	B7047	12	1.246	0.565	.044	0.001	B7174-MPG	12	2.692	1.221	.108	0.003
BK6663	1	10.150	4.604	.520	0.015	B7049	12	.621	0.282	.032	0.001	B7175	6	4.392	1.992	.223	0.006
BK6665	1	10.400	4.717	.520	0.015	P7050	12	.567	0.257	.057	0.002	BD7176	6	4.867	2.208	.167	0.005
BK6666	1	11.400	5.171	.753	0.021	B7051	12	1.787	0.811	.070	0.002	B7177	12	1.221	0.554	.067	0.002
BK6670	1	11.050	5.012	.749	0.021	P7052	12	1.204	0.546	.127	0.004	P7178	12	.404	0.183	.034	0.001
BK6675	1	2.250	1.021	.640	0.018	P7053	12	.983	0.446	.119	0.003	B7179	12	1.679	0.762	.071	0.002
BK6676	1	3.650	1.656	.779	0.022	P7058	1	1.000	0.454	.116	0.003	B7180	6	4.392	1.992	.189	0.005
BK6683	1	9.200	4.173	.520	0.015	P7059	1	1.550	0.703	.189	0.005	B7181	12	1.204	0.546	.066	0.002
BK6686	1	7.800	3.538	.736	0.021	P7081	12	.563	0.255	.065	0.002	B7182	6	3.683	1.671	.171	0.005
BK6693	1	11.100	5.035	.749	0.021	B7082	12	1.167	0.529	.052	0.001	P7183	4	4.200	1.905	.810	0.023
BK6694	1	11.850	5.375	.749	0.021	P7083	12	.517	0.235	.057	0.002	P7185	12	2.158	0.979	.222	0.006
BK6696	1	10.600	4.808	.749	0.021	P7084	12	1.183	0.537	.107	0.003	BC7186 KIT	12	.158	0.072	.051	0.001
BK6700	1	10.250	4.649	.749	0.021	B7089	12	1.304	0.591	.062	0.002	B7187	6	4.358	1.977	.231	0.007
BK6702	1	9.450	4.287	.520	0.015	B7091	12	.913	0.414	.042	0.001	P7188	12	.500	0.227	.101	0.003
BK6704	1	11.950	5.421	.749	0.021	P7092	12	1.308	0.593	.132	0.004	B7189	12	1.521	0.690	.059	0.002
BK6705	1	10.500	4.763	.736	0.021	P7093	12	1.787	0.811	.131	0.004	P7190	1	1.000	0.454	.127	0.004
BK6710	1	13.750	6.237	.749	0.021	BD7095	12	1.438	0.652	.069	0.002	B7191	12	2.592	1.176	.123	0.003
BK6720	1	12.250	5.557	.749	0.021	B7097	1	3.650	1.656	.215	0.006	P7192	1	.950	0.431	.241	0.007
BK6721	1	10.400	4.717	.749	0.021	B7099	12	1.104	0.501	.043	0.001	P7193	1	2.950	1.338	.321	0.009
BK6723	1	11.700	5.307	.749	0.021	P7102	1	2.800	1.270	.234	0.007	BC7194	12	.904	0.410	.062	0.002
BK6764	1	6.700	3.039	.551	0.016	P7103	12	.325	0.147	.034	0.001	P7195	1	4.950	2.245	.460	0.013
BK6780	1	15.300	6.940	2.532	0.072	P7104	12	.804	0.365	.080	0.002	P7196	12	.467	0.212	.066	0.002
BK6799	1	2.800	1.270	.221	0.006	BD7105	6	3.200	1.452	.136	0.004	B7197	12	1.121	0.508	.050	0.001
BK6903	1	6.800	3.084	.598	0.017	P7106	12	1.517	0.688	.085	0.002	P7199	12	.458	0.208	.056	0.002
BK6923	1	7.350	3.334	.520	0.015	P7107	12	.875	0.397	.120	0.003	B7215	12	1.325	0.601	.064	0.002
BK6930	1	13.350	6.056	.749	0.021	B7113	12	1.875	0.851	.089	0.003	B7216	12	.642	0.291	.033	0.001
BK6934	1	6.750	3.062	.520	0.015	P7114	12	.504	0.229	.062	0.002	B7217	6	2.408	1.092	.119	0.003
BK6942	1	12.100	5.489	.749	0.021	B7116	12	1.950	0.885	.087	0.002	B7219	12	1.454	0.660	.061	0.002
BK6954	1	8.300	3.765	.809	0.023	B7117	12	1.067	0.484	.053	0.001	B7220	12	1.042	0.473	.050	0.001
BK6955	1	7.950	3.606	.750	0.021	B7119	12	.788	0.357	.032	0.001	B7221	12	.913	0.414	.052	0.001
BK6956	1	11.700	5.307	.783	0.022	B7121	12	2.021	0.917	.086	0.002	B7222	12	.671	0.304	.030	0.001
BK6980	1	8.750	3.969	.578	0.016	B7124	12	1.646	0.747	.071	0.002	B7223	12	1.746	0.792	.070	0.002
BK6982	1	7.800	3.538	.736	0.021	B7125	12	1.296	0.588	.062	0.002	B7224	6	4.992	2.264	.230	0.007
BK6983	1	9.600	4.355	.854	0.024	P7126	1	4.050	1.837	.353	0.010	B7225	12	2.425	1.100	.121	0.003
BK6984	1	24.850	11.272	2.921	0.083	P7127	1	2.750	1.247	.132	0.004	B7227	12	1.813	0.822	.086	0.002
BK6985	1	6.500	2.948	.591	0.017	B7128	12	1.088	0.494	.045	0.001	BC7228	12	1.142	0.518	.079	0.002
BK6986	1	6.500	2.948	.520	0.015	V7129-C	7	5.021	2.278	.416	0.012	B7229	6	4.358	1.977	.222	0.006
BK6987	1	3.750	1.701	.489	0.014	B7130	12	1.662	0.754	.072	0.002	P7230	6	1.242	0.563	.208	0.006
BK6997	1	2.850	1.293	.423	0.012	B7131	12	1.529	0.694	.049	0.001	B7231	12	1.321	0.599	.069	0.002
P7000 KIT	6	3.350	1.520	.454	0.013	P7132	12	.140	0.064	.013	0.001	P7232	12	.575	0.261	.109	0.003
B7001	12	1.167	0.529	.051	0.001	P7134	12	.358	0.162	.038	0.001	P7233	12	.917	0.416	.133	0.004
P7003	3	3.933	1.784	.394	0.011	B7135	6	4.317	1.958	.225	0.006	P7235	12	.450	0.204	.081	0.002
B7004	6	2.358	1.070	.123	0.003	P7136	12	.275	0.125	.040	0.001	BT7237	12	1.330	0.603	.060	0.002
B7005	6	2.375	1.077	.122	0.003	P7137	12	.371	0.168	.049	0.001	B7238	12	.654	0.297	.035	0.001
P7007	4	3.863	1.752	.508	0.014	P7138	12	.267	0.121	.039	0.001	B7239	6	2.367	1.074	.121	0.003
B7009	12	1.479	0.671	.071	0.002	B7139	12	.788	0.357	.036	0.001	B7240	12	1.038	0.471	.050	0.001
B7010	12	.704	0.319	.036	0.001	BD7141	6	2.725	1.236	.120	0.003	B7241	6	2.667	1.210	.146	0.004
B7011	6	3.458	1.569	.268	0.008	B7142	12	1.900	0.862	.095	0.003	BC7242	12	1.179	0.535	.081	0.002
P7012	4	4.838	2.195	.723	0.020	B7143	12	1.475	0.669	.078	0.002	B7243	12	.725	0.329	.032	0.001
P7013	12	.638	0.289	.090	0.003	B7144	12	1.671	0.758	.072	0.002	B7245	6	4.367	1.981	.224	0.006
B7014	12	1.096	0.497	.051	0.001	P7145	12	.475	0.215	.101	0.003	B7246	6	3.450	1.565	.176	0.005
P7015	12	.563	0.255	.079	0.002	B7151	12	2.167	0.983	.106	0.003	P7247	12	.158	0.072	.020	0.001
P7016	12	.546	0.248	.099	0.003	B7152	12	.967	0.439	.051	0.001	B7249-MPG	6	4.500	2.041	.227	0.006
P7017	12	.387	0.176	.056	0.002	BD7153	6	4.350	1.973	.203	0.006	BD7250	6	4.300	1.950	.210	0.006
B7018	12	1.754	0.796	.073	0.002	BD7154	6	4.083	1.852	.171	0.005	BD7252	6	3.475	1.576	.149	0.004
B7019	6	2.650	1.202	.146	0.004	B7155	6	2.442	1.108	.119	0.003	P7255	12	.304	0.138	.051	0.001
B7020	12	.717	0.325	.035	0.001	B7156	12	1.154	0.523	.054	0.002	P7256	12	.100	0.045	.014	0.001
P7021	12	1.004	0.455	.119	0.003	B7157	6	4.292	1.947	.225	0.006	P7259	12	.150	0.068	.008	0.001
B7022	12	1.179	0.535	.060	0.002	BD7158	1	2.900	1.315	.133	0.004	P7260	12	.150	0.068	.023	0.001
B7023	12	1.229	0.557	.049	0.001	BD7159	6	2.117	0.960	.077	0.002	P7263	12	.092	0.042	.011	0.001
B7024	12	.954															

# BALDWIN WEIGHTS AND VOLUMES

BALDWIN NUMBER	CASE QTY.	WEIGHT (ea.) lbs.	WEIGHT (ea.) kgs.	Volume (ea.) ft <sup>3</sup>	Volume (ea.) m <sup>3</sup>	BALDWIN NUMBER	CASE QTY.	WEIGHT (ea.) lbs.	WEIGHT (ea.) kgs.	Volume (ea.) ft <sup>3</sup>	Volume (ea.) m <sup>3</sup>	BALDWIN NUMBER	CASE QTY.	WEIGHT (ea.) lbs.	WEIGHT (ea.) kgs.	Volume (ea.) ft <sup>3</sup>	Volume (ea.) m <sup>3</sup>
P7268	1	2.000	0.907	.149	0.004	B7378	12	1.621	0.735	.078	0.002	B7486	12	1.588	0.720	.064	0.002
P7269	12	.508	0.230	.063	0.002	B7379	12	1.446	0.656	.066	0.002	B7487	12	.767	0.348	.028	0.001
B7271	12	1.163	0.528	.061	0.002	P7380	12	1.800	0.816	.199	0.006	P7488	12	.263	0.119	.041	0.001
B7273	12	1.163	0.528	.063	0.002	B7383	12	2.710	1.229	.101	0.003	P7489	12	.163	0.074	.034	0.001
B7274	12	1.090	0.494	.044	0.001	B7384	12	1.250	0.567	.050	0.001	P7490	12	.142	0.064	.011	**
B7275	12	.779	0.353	.037	0.001	B7385	12	1.571	0.713	.066	0.002	B7491	12	.658	0.298	.026	0.001
B7276	12	.592	0.269	.031	0.001	B7386	12	1.613	0.732	.064	0.002	P7492	12	.221	0.100	.032	0.001
B7277	12	.758	0.344	.037	0.001	B7387	12	1.409	0.639	.065	0.002	P7493	12	.108	0.049	.035	0.001
B7280	12	1.417	0.643	.056	0.002	B7388	12	1.258	0.571	.056	0.002	P7494	6	1.108	0.503	.165	0.005
B7281	12	.792	0.359	.036	0.001	B7390	12	.938	0.425	.035	0.001	P7495	1	3.150	1.429	.282	0.008
B7283	12	.783	0.355	.044	0.001	B7393	12	2.188	0.992	.093	0.003	B7496	12	1.092	0.495	.045	0.001
B7285	12	.525	0.238	.026	0.001	B7394	12	1.179	0.535	.078	0.002	B7497	12	1.533	0.695	.074	0.002
B7286	12	.546	0.248	.031	0.001	B7395	12	1.404	0.637	.053	0.001	B7499	12	1.155	0.524	.045	0.001
B7287	12	.629	0.285	.029	0.001	B7396	6	2.908	1.319	.165	0.005	F7500	4	5.438	2.467	.585	0.017
B7289	12	.725	0.329	.028	0.001	B7397	12	1.871	0.849	.086	0.002	P7500	4	5.425	2.461	.582	0.016
B7290	12	.780	0.354	.030	0.001	P7398	12	.154	0.070	.023	0.001	B7501	12	2.454	1.113	.120	0.003
B7291	12	1.079	0.489	.050	0.001	P7399	12	.225	0.102	.039	0.001	P7502	6	.875	0.397	.210	0.006
B7292	12	.650	0.295	.020	0.001	P7400	12	.275	0.125	.275	0.008	B7503	6	3.433	1.557	.178	0.005
B7293	12	.617	0.280	.030	0.001	B7401	12	.679	0.308	.033	0.001	BD7504	6	3.450	1.565	.162	0.005
B7294	12	.679	0.308	.028	0.001	B7402	6	3.583	1.625	.171	0.005	P7505	6	1.858	0.843	.206	0.006
B7295	1	.646	0.293	.028	0.001	B7403	12	1.133	0.514	.046	0.001	B7506	12	2.404	1.090	.122	0.003
B7298	12	1.129	0.512	.051	0.001	P7406	12	.250	0.113	.040	0.001	B7507	6	4.275	1.939	.238	0.007
B7299	6	4.283	1.943	.225	0.006	B7407	12	.750	0.340	.033	0.001	P7508	6	1.200	0.544	.162	0.005
P7303	12	.125	0.057	.021	0.001	P7408	12	.192	0.087	.034	0.001	BD7509	6	4.067	1.845	.170	0.005
P7305	12	.633	0.287	.101	0.003	B7409	12	2.279	1.034	.122	0.003	P7510	12	1.254	0.569	.097	0.003
B7306	12	1.150	0.522	.050	0.001	B7410	12	.608	0.276	.034	0.001	B7511	12	1.050	0.476	.050	0.001
P7308	12	.333	0.151	.050	0.001	P7411	12	.150	0.068	.017	**	P7512	12	1.833	0.831	.143	0.004
BD7309	6	3.508	1.591	.162	0.005	P7413	12	.221	0.100	.034	0.001	B7513	6	2.583	1.172	.120	0.003
BD7310	6	3.517	1.595	.160	0.005	P7414	12	.254	0.115	.048	0.001	P7514	1	10.100	4.581	.587	0.017
B7311-MPG	12	1.467	0.665	.067	0.002	P7415	12	.313	0.142	.049	0.001	P7515	12	.250	0.113	.037	0.001
P7312	6	2.234	1.013	.270	0.008	B7416	6	2.575	1.168	.123	0.003	B7516	12	1.354	0.614	.063	0.002
P7313	12	.142	0.064	.024	0.001	P7417	12	.217	0.098	.038	0.001	P7517	12	.254	0.115	.037	0.001
B7314	6	4.092	1.856	.222	0.006	P7418	12	.225	0.102	.048	0.001	BF7519	12	.379	0.172	.037	0.001
BT7316	12	1.617	0.733	.071	0.002	B7419	12	.521	0.236	.033	0.001	BF7522	1	.900	0.408	.077	0.002
BD7317	12	1.558	0.707	.069	0.002	B7420	12	1.317	0.597	.051	0.001	BF7528	12	1.108	0.503	.046	0.001
B7318	12	.567	0.257	.031	0.001	B7422	12	.667	0.303	.032	0.001	BF7529	12	1.379	0.626	.063	0.002
P7319	12	.746	0.338	.129	0.004	P7423	12	.430	0.195	.060	0.002	BF7531	12	.917	0.416	.040	0.001
B7320	12	1.150	0.522	.052	0.001	B7424	12	1.046	0.474	.052	0.001	BF7532	12	1.504	0.682	.057	0.002
P7321	1	2.250	1.021	.182	0.005	P7426	12	.225	0.102	.033	0.001	BF7534	12	1.496	0.679	.056	0.002
B7322	6	2.067	0.938	.071	0.002	P7427	12	.217	0.098	.033	0.001	BF7535	12	1.496	0.679	.056	0.002
B7324	6	2.417	1.096	.124	0.004	B7428	12	.700	0.318	.030	0.001	BF7537	12	.624	0.283	.050	0.001
BD7325	6	2.717	1.232	.119	0.003	B7430	12	.792	0.359	.032	0.001	BF7538	12	1.083	0.491	.044	0.001
BC7326	12	.779	0.353	.091	0.003	B7431	12	1.120	0.508	.050	0.001	BF7541	12	.904	0.410	.046	0.001
B7327	12	1.492	0.677	.063	0.002	B7432	12	.916	0.415	.040	0.001	BF7544	12	.704	0.319	.030	0.001
B7328	12	1.150	0.522	.052	0.001	B7433	12	.788	0.357	.036	0.001	PF7545	12	.075	0.034	.011	**
P7329	6	1.042	0.473	.173	0.005	B7434	12	.725	0.329	.033	0.001	BF7546	12	1.321	0.599	.069	0.002
P7330	6	.475	0.215	.142	0.004	B7435	1	3.050	1.383	.125	0.004	PF7549	12	.117	0.053	.011	**
PT7332	1	1.142	0.518	.109	0.003	P7436	6	.950	0.431	.118	0.003	PF7550	12	.213	0.097	.020	0.001
B7333	12	.508	0.230	.029	0.001	P7437	12	1.146	0.520	.122	0.003	PF7551	12	.371	0.168	.034	0.001
B7334	12	.692	0.314	.031	0.001	P7438	12	.196	0.089	.034	0.001	BF7552	12	1.008	0.457	.051	0.001
B7335-MPG	6	2.925	1.327	.132	0.004	B7440	12	1.408	0.639	.049	0.001	PF7553	12	.892	0.405	.090	0.003
P7336 KIT	12	.392	0.178	.067	0.002	B7441	12	.590	0.268	.022	0.001	PF7554	12	.633	0.287	.081	0.002
P7337	1	7.850	3.561	.678	0.019	P7442	12	.163	0.074	.023	0.001	PF7556	1	.550	0.249	.089	0.003
P7338	12	.204	0.093	.033	0.001	B7443	12	.679	0.308	.033	0.001	BF7557	12	1.208	0.548	.067	0.002
BT7349	12	1.442	0.654	.065	0.002	B7444	12	.758	0.344	.036	0.001	BF7558	12	1.513	0.686	.083	0.002
B7350	12	1.671	0.758	.062	0.002	B7445	12	.763	0.346	.028	0.001	BF7559	12	1.079	0.489	.044	0.001
B7351-MPG	12	1.304	0.591	.051	0.001	B7446	12	.584	0.265	.025	0.001	BF7571	6	3.400	1.542	.266	0.008
B7352	12	.770	0.349	.028	0.001	B7449	12	.729	0.331	.033	0.001	PF7572	12	.746	0.338	.081	0.002
B7356	12	.525	0.238	.034	0.001	P7450	12	.213	0.097	.033	0.001	BF7576	12	.500	0.227	.029	0.001
B7357	12	1.670	0.758	.076	0.002	B7451	12	1.310	0.594	.054	0.002	B7577	6	2.992	1.357	.144	0.004
B7359	12	1.342	0.609	.052	0.001	B7452	12	1.133	0.514	.055	0.002	BF7579	12	.542	0.246	.030	0.001
B7360	12	1.196	0.543	.053	0.001	B7453	12	1.042	0.473	.042	0.001	BF7580	12	.467	0.212	.030	0.001
B7361	12	.675	0.306	.031	0.001	P7454	12	.129	0.059	.021	0.001	BF7584	12	2.158	0.979	.109	0.003
B7362	12	1.654	0.750	.062	0.002	P7455	12	.383	0.174	.054	0.002	B7585	12	1.721	0.781	.082	0.002
B7363	6	3.550	1.610	.260	0.007	BC7456 KIT	12	.167	0.076	.052	0.001	BF7586	12	1.304	0.591	.061	0.002
P7364	12	.246	0.112	.034	0.001	B7457	12	1.317	0.597	.055	0.002	BF7587	12	1.992	0.904	.097	0.003
P7365	12	.288	0.131	.037	0.001	B7458	12	.950	0.431	.035	0.001	PF7588	12	.387	0.176	.032	0.001
B7367	12	1.695	0.769	.080	0.002	B7459	12	3.288	1.491	.142	0.004	BF7591-D	12	.933	0.423	.041	0.001
P7368	12	1.846	0.837	.191	0.005	B7461	12	1.483	0.673	.067	0.002	PF7592	12	.621	0.282	.064	0.002
B7370	12	1.320	0.599	.054	0.002	B7467	12	1.204	0.546	.053	0.001	BF7593	12	1.371	0.622	.050	0.001
B7372	12	1.442	0.654	.066	0.002	B7468	12	2.954	1.340	.126	0.004	PF7594	12	.725	0.329	.062	0.002
B7373	12	1.517	0.688	.059	0.002	B7469	12	1.271	0.577	.054	0.002	PF7595	12	.271	0.123	.037	0.001
B7375	12	1.375	0.624	.067	0.002	B7477	12	1.717	0.779	.080	0.002	PF7596	12	.258	0.117	.033</	



**BALDWIN WEIGHTS AND VOLUMES**

BALDWIN NUMBER	CASE QTY.	WEIGHT (ea.) lbs.	WEIGHT (ea.) kgs.	Volume (ea.) ft <sup>3</sup>	Volume (ea.) m <sup>3</sup>	BALDWIN NUMBER	CASE QTY.	WEIGHT (ea.) lbs.	WEIGHT (ea.) kgs.	Volume (ea.) ft <sup>3</sup>	Volume (ea.) m <sup>3</sup>	BALDWIN NUMBER	CASE QTY.	WEIGHT (ea.) lbs.	WEIGHT (ea.) kgs.	Volume (ea.) ft <sup>3</sup>	Volume (ea.) m <sup>3</sup>
B7600	12	2.292	1.040	.118	0.003	PF7715	6	2.058	0.934	.271	0.008	PF7818	24	.056	0.025	.011	**
B7600-SS	12	2.396	1.087	.120	0.003	PF7716	1	2.450	1.111	.396	0.011	PF7819	12	.050	0.023	.015	**
BF7602	12	1.017	0.461	.044	0.001	BF7717	12	1.933	0.877	.076	0.002	PF7820	12	.050	0.023	.015	**
BF7606	12	1.287	0.584	.067	0.002	PF7718	12	1.204	0.546	.107	0.003	BF7821	12	.783	0.355	.063	0.002
PF7607	1	.500	0.227	.077	0.002	BF7719	12	.379	0.172	.046	0.001	PF7822	30	.070	0.032	.008	**
BF7608	12	.771	0.350	.032	0.001	BF7720	12	.450	0.204	.038	0.001	PF7823	12	.167	0.076	.022	0.001
BF7612	12	2.004	0.909	.095	0.003	BF7721	12	.879	0.399	.060	0.002	PF7824	30	.065	0.029	.005	**
BF7613	12	2.479	1.124	.121	0.003	BF7725	12	.067	0.030	.013	**	PF7825	12	.146	0.066	.034	0.001
BF7614	12	1.417	0.643	.050	0.001	BF7726	12	1.125	0.510	.065	0.002	PF7826	12	.221	0.100	.033	0.001
P7615	12	.921	0.418	.078	0.002	PF7733	12	1.204	0.546	.107	0.003	PF7828	6	.100	0.045	.025	0.001
PT7616	1	1.550	0.703	.140	0.004	PF7734	12	1.258	0.571	.108	0.003	PF7830	12	.020	0.009	.016	**
PT7617	12	3.446	1.563	.277	0.008	PF7735	12	.538	0.244	.052	0.001	PF7832	12	.171	0.078	.020	0.001
PF7618	12	1.354	0.614	.135	0.004	BF7736	12	.090	0.041	.010	**	PF7833	12	.221	0.100	.028	0.001
BF7619	12	1.008	0.457	.039	0.001	BF7736-K1	12	.229	0.104	.027	0.001	PF7836	12	.179	0.081	.028	0.001
BF7623	6	3.383	1.535	.265	0.007	BF7742	12	.467	0.212	.046	0.001	BF7837	12	.688	0.312	.028	0.001
BF7624	12	1.450	0.658	.057	0.002	PF7744	12	.821	0.372	.080	0.002	BF7838	12	.917	0.416	.046	0.001
BF7625	12	.196	0.089	.034	0.001	BF7745-D	12	.654	0.297	.045	0.001	BF7839	20	.600	0.272	.029	0.001
PF7627	6	.608	0.276	.092	0.003	BF7746-D	12	.888	0.403	.064	0.002	BF7840	12	.683	0.310	.029	0.001
BF7628	12	1.858	0.843	.074	0.002	BF7747	12	1.242	0.563	.053	0.001	BF7841	12	.792	0.359	.036	0.001
BF7629	12	1.846	0.837	.087	0.002	PF7748	12	.904	0.410	.080	0.002	BF7842	12	1.221	0.554	.060	0.002
BF7630	1	1.000	0.454	.399	0.011	PF7749	12	1.479	0.671	.130	0.004	BF7843	12	.001	**	.004	**
BF7631	12	1.975	0.896	.096	0.003	BF7750	12	1.146	0.520	.053	0.001	BF7844	12	.892	0.405	.078	0.002
BF7632	12	1.383	0.627	.066	0.002	PF7751	12	.508	0.230	.071	0.002	BF7845	12	.188	0.085	.020	0.001
BF7633	12	1.338	0.607	.065	0.002	BF7753	12	2.046	0.928	.099	0.003	BF7847	12	.179	0.081	.021	0.001
BF7634	12	1.200	0.544	.046	0.001	PF7755	12	.842	0.382	.081	0.002	BF7848	12	.100	0.045	.025	0.001
BF7635	6	3.992	1.811	.227	0.006	BF7756	12	.900	0.408	.062	0.002	BF7849	12	.175	0.079	.021	0.001
BF7637	12	1.104	0.501	.045	0.001	PF7758	12	.642	0.291	.056	0.002	BF7850	12	.250	0.113	.080	0.002
BF7639	6	4.433	2.011	.228	0.006	BF7759	12	1.371	0.622	.077	0.002	BF7851	12	.050	0.023	.013	**
BF7639-D	6	4.392	1.992	.229	0.006	BF7760	12	1.260	0.572	.057	0.002	PF7852 KIT	12	.471	0.214	.081	0.002
BF7640	12	1.508	0.684	.065	0.002	PF7761	12	.575	0.261	.092	0.003	BF7853	12	1.862	0.845	.088	0.002
BF7644	12	1.533	0.695	.079	0.002	BF7762	12	.321	0.146	.038	0.001	BF7855	12	.067	0.030	.011	**
BF7645	12	1.296	0.588	.062	0.002	BF7763	1	1.050	0.476	.825	0.023	BF7857	12	.010	0.005	.008	**
BF7648	12	.817	0.371	.032	0.001	BF7765	12	.604	0.274	.046	0.001	BF7859	6	.150	0.068	.017	**
BF7653	12	1.571	0.713	.075	0.002	BF7766	12	2.292	1.040	.086	0.002	BF7860	12	.010	0.005	.007	**
PF7655	12	1.125	0.510	.128	0.004	PF7767	12	.610	0.277	.100	0.003	BF7863	12	.138	0.063	.022	0.001
BF7656	12	1.933	0.877	.095	0.003	BF7768	12	.367	0.166	.047	0.001	BF7864	12	.079	0.036	.019	0.001
BF7657	12	2.517	1.142	.121	0.003	BF7769	12	.375	0.170	.046	0.001	BF7865	12	.050	0.023	.015	**
BF7658	12	.346	0.157	.037	0.001	PF7770	12	2.150	0.975	.227	0.006	BF7866	12	.746	0.338	.060	0.002
BF7659	12	.504	0.229	.038	0.001	BF7771	12	.400	0.181	.046	0.001	PF7869	12	.001	**	.008	**
BF7661	12	.408	0.185	.036	0.001	BF7772	12	1.096	0.497	.045	0.001	BF7871	12	.571	0.259	.050	0.001
BF7662	12	.441	0.200	.031	0.001	BF7773	12	2.100	0.953	.095	0.003	PF7872	12	.200	0.091	.019	0.001
BF7663	12	.929	0.421	.046	0.001	BF7774	12	1.100	0.499	.051	0.001	PF7873	12	.079	0.036	.012	**
BF7664	12	1.271	0.577	.051	0.001	BF7775	12	.413	0.187	.047	0.001	PF7874	12	.100	0.045	.007	**
BF7666	12	.946	0.429	.046	0.001	BF7776	12	.413	0.187	.047	0.001	PF7875	12	.040	0.018	.007	**
BF7667	12	.379	0.172	.038	0.001	PF7777	12	.392	0.178	.039	0.001	PF7876	12	.355	0.161	.046	0.001
BF7668	12	.379	0.172	.045	0.001	BF7778	12	1.146	0.520	.061	0.002	PF7877	12	.096	0.044	.016	**
BF7669	1	.950	0.431	.752	0.021	PF7779	12	.712	0.323	.062	0.002	PF7878	12	.640	0.290	.070	0.002
BF7670	12	.667	0.303	.080	0.002	BF7780	12	.813	0.369	.126	0.004	BF7879	12	1.175	0.533	.051	0.001
BF7671	1	.750	0.340	.233	0.007	PF7782	6	.850	0.386	.116	0.003	BF7880	12	.683	0.310	.028	0.001
BF7672-D	12	.683	0.310	.054	0.002	BF7783-D	12	.629	0.285	.048	0.001	BF7881	12	.400	0.181	.029	0.001
BF7673-D	12	.650	0.295	.050	0.001	BF7784-D	12	.775	0.352	.053	0.001	PF7882	12	.104	0.047	.029	0.001
BF7674-D	12	.733	0.332	.052	0.001	BF7785-D	12	.875	0.397	.064	0.002	BF7883	12	1.171	0.531	.045	0.001
BF7675-D	12	.592	0.269	.041	0.001	BF7786-D	12	.829	0.376	.064	0.002	BF7886	12	1.713	0.777	.056	0.002
BF7677-D	12	.854	0.387	.063	0.002	PF7787	12	.425	0.193	.050	0.001	BF7888	12	1.250	0.567	.050	0.001
PF7678	12	.933	0.423	.100	0.003	PF7788	12	.438	0.199	.050	0.001	PF7889	12	.638	0.289	.080	0.002
BF7679-D	12	.688	0.312	.052	0.001	BF7798-O	12	1.504	0.682	.116	0.003	PF7889-10	12	.638	0.289	.081	0.002
PF7680	12	.875	0.397	.079	0.002	BF7798-SP	12	2.034	0.923	.091	0.003	PF7889-30	12	.596	0.270	.080	0.002
BF7681-D	12	.612	0.278	.047	0.001	PF7799	12	1.929	0.875	.236	0.007	PF7890	12	1.067	0.484	.131	0.004
BF7682-D	12	.771	0.350	.064	0.002	BF7800	12	.413	0.187	.046	0.001	PF7890-10	12	.996	0.452	.131	0.004
BF7683	12	.638	0.289	.032	0.001	BF7801	12	.675	0.306	.062	0.002	PF7890-30	12	1.025	0.465	.134	0.004
B7685	12	2.258	1.024	.124	0.004	BF7802	12	.383	0.174	.046	0.001	BF7892	12	.779	0.353	.036	0.001
BF7686	12	.108	0.049	.020	0.001	BF7803	12	.638	0.289	.061	0.002	PF7894	6	.925	0.420	.106	0.003
PF7687	12	.596	0.270	.047	0.001	BF7804	12	.621	0.282	.060	0.002	PF7895	6	.891	0.404	.079	0.002
BF7690	12	.313	0.142	.039	0.001	BF7805	12	.521	0.236	.077	0.002	PF7896	12	.479	0.217	.066	0.002
BF7691	12	.238	0.108	.020	0.001	BF7806	12	1.342	0.609	.065	0.002	BF7898-D	12	.779	0.353	.064	0.002
BF7693	12	.246	0.112	.038	0.001	BF7806-O	12	1.088	0.494	.050	0.001	PF7899	1	1.250	0.567	.158	0.004
BF7695	6	1.133	0.514	.104	0.003	BF7808	12	.375	0.170	.038	0.001	PF7900	1	1.700	0.771	.180	0.005
BF7696	12	1.538	0.698	.078	0.002	BF7809	12	.438	0.199	.047	0.001	BF7903	12	.050	0.023	.013	**
BF7697	6	2.708	1.228	.141	0.004	PF7812 KIT	12	.529	0.240	.079	0.002	BF7904-D	12	.550	0.249	.041	0.001
PF7698	12	.996	0.452	.079	0.002	BF7813	12	1.354	0.614	.066	0.002	BF7905-D	12	.654	0.297	.053	0.001
BF7699-D	12	.683	0.310	.047	0.001	BF7814	12	2.521	1.144	.122	0.003	BF7906-D	12	.771	0.350	.053	0.001
B7700	12	2.421	1.098	.121	0.003	BF7815	12	1.446	0.656	.069	0.002	BF7907	12	1.183	0.537	.053	0.001
BF7711	12	.696	0.316	.130	0.004	PF7816	12	.175	0.079	.034							

**BALDWIN WEIGHTS AND VOLUMES**

BALDWIN NUMBER	CASE QTY.	WEIGHT (ea.) lbs.	WEIGHT (ea.) kgs.	Volume (ea.) ft <sup>3</sup>	Volume (ea.) m <sup>3</sup>	BALDWIN NUMBER	CASE QTY.	WEIGHT (ea.) lbs.	WEIGHT (ea.) kgs.	Volume (ea.) ft <sup>3</sup>	Volume (ea.) m <sup>3</sup>	BALDWIN NUMBER	CASE QTY.	WEIGHT (ea.) lbs.	WEIGHT (ea.) kgs.	Volume (ea.) ft <sup>3</sup>	Volume (ea.) m <sup>3</sup>
PF7910	12	275	0.125	.032	0.001	PF7986	12	.558	0.253	.080	0.002	PT8396	1	9.950	4.513	.646	0.018
BF7911	12	1.942	0.881	.087	0.002	BF7987	12	1.671	0.758	.052	0.001	BT8397-MPG	1	3.400	1.542	.118	0.003
BF7912	12	.300	0.136	.035	0.001	BF7988	12	1.646	0.747	.052	0.001	PT8400-MPG	1	1.000	0.454	.091	0.003
BF7913	6	3.433	1.557	.163	0.005	BF7989-D	12	.690	0.313	.060	0.002	BT8401-MPG	6	4.820	2.186	.226	0.006
PF7914	1	1.700	0.771	.193	0.005	BF7990	12	1.220	0.553	.043	0.001	PT8403-MPG	12	1.300	0.590	.111	0.003
BF7915	12	.642	0.291	.031	0.001	BF7993	12	1.288	0.584	.066	0.002	PT8404-MPG	12	2.525	1.145	.122	0.003
PF7916	12	.254	0.115	.034	0.001	PF7994	12	.100	0.045	.023	0.001	PT8407	12	.563	0.255	.081	0.002
BF7917	12	1.417	0.643	.081	0.002	BF7995	12	1.288	0.584	.062	0.002	PT8408	1	3.100	1.406	.342	0.010
BF7919	12	1.229	0.557	.057	0.002	BF7996	6	4.280	1.941	.239	0.007	BT8409	12	.667	0.303	.029	0.001
BF7921	12	1.063	0.482	.040	0.001	BF7997	12	2.070	0.939	.074	0.002	PT8410	1	3.500	1.588	.626	0.018
BF7922	12	1.596	0.724	.070	0.002	BF7998	12	1.050	0.476	.045	0.001	PT8411	1	2.850	1.293	.319	0.009
BF7923	12	1.379	0.626	.063	0.002	BT8301	12	.933	0.423	.045	0.001	BT8412	12	1.396	0.633	.090	0.003
BF7924	12	1.454	0.660	.072	0.002	BT8302	12	2.083	0.945	.109	0.003	BT8413	12	.904	0.410	.028	0.001
BF7925	12	1.288	0.584	.065	0.002	BT8304	12	1.496	0.679	.062	0.002	PT8414-MPG	1	2.600	1.179	.198	0.006
FD7926	1	.300	0.136	.062	0.002	PT8305	4	2.825	1.281	.532	0.015	BT8415	12	1.658	0.752	.080	0.002
BF7927	12	1.967	0.892	.086	0.002	PT8306-10	12	1.325	0.601	.100	0.003	BT8416	6	1.900	0.862	.088	0.002
PF7928	12	1.154	0.523	.107	0.003	PT8306-25	12	1.287	0.584	.098	0.003	BT8417	12	1.088	0.494	.032	0.001
BF7929 KIT	1	2.650	1.202	.185	0.005	BT8307-MPG	6	2.750	1.247	.156	0.004	BT8418	6	2.375	1.077	.129	0.004
PF7930	6	1.075	0.488	.108	0.003	BT8308-MPG	6	3.650	1.656	.263	0.007	PT8419	12	1.075	0.488	.080	0.002
BF7931	12	.990	0.449	.030	0.001	BT8308-MPG KIT	1	7.050	3.198	.924	0.026	BT8420	12	1.213	0.550	.051	0.001
BF7932	6	4.159	1.887	.147	0.004	BT8309-MPG	1	2.650	1.202	.148	0.004	BT8421-MPG	1	2.650	1.202	.136	0.004
PF7934 KIT	12	1.004	0.455	.128	0.004	BT8310-MPG	1	3.550	1.610	.230	0.007	BT8422-MPG	6	3.575	1.622	.264	0.007
PF7935	12	.717	0.325	.104	0.003	BT8312	6	2.900	1.315	.132	0.004	BT8423	1	2.650	1.202	.162	0.005
PF7936	12	.567	0.257	.067	0.002	BT8314	12	1.050	0.476	.053	0.001	PT8425	1	.600	0.272	.112	0.003
BF7937	12	.671	0.304	.079	0.002	BT8316-MPG	12	1.350	0.612	.061	0.002	BT8426-MPG	6	2.450	1.111	.091	0.003
PF7938	6	.650	0.295	.074	0.002	PT8318-MPG	12	1.575	0.714	.096	0.003	PT8427	1	1.450	0.658	.138	0.004
PF7939	12	.058	0.026	.013	**	PT8319	12	.433	0.196	.034	0.001	BT8428-MPG	12	1.412	0.640	.050	0.001
BF7940	12	1.583	0.718	.069	0.002	BT8320	6	4.950	2.245	.224	0.006	BT8429	12	.425	0.193	.031	0.001
BF7941	12	1.600	0.726	.074	0.002	BT8323	12	.679	0.308	.025	0.001	BT8432-MPG	6	4.717	2.140	.232	0.007
BF7942	12	1.704	0.773	.075	0.002	BT8328	12	1.421	0.645	.052	0.001	PT8433-MPG	1	3.200	1.452	.314	0.009
BF7943	12	2.671	1.212	.121	0.003	PT8329	12	1.229	0.557	.129	0.004	PT8435-MPG	1	1.950	0.885	.140	0.004
BF7944	12	.409	0.186	.031	0.001	PT8330-MPG	6	1.242	0.563	.143	0.004	PT8436	1	4.300	1.950	.464	0.013
BF7945	12	.583	0.264	.037	0.001	PT8331-MPG	1	2.650	1.202	.146	0.004	BT8437	6	3.542	1.607	.151	0.004
PF7946	6	.783	0.355	.159	0.004	BT8333	6	1.617	0.733	.085	0.002	BT8439-MPG	6	2.375	1.077	.091	0.003
PF7947	12	.808	0.367	.132	0.004	PT8334	6	3.250	1.474	.327	0.009	BT8440-MPG	12	1.471	0.667	.064	0.002
BF7948	6	3.017	1.369	.161	0.005	PT8335	6	2.292	1.040	.225	0.006	PT8441	1	2.000	0.907	.238	0.007
BF7949-D	12	.770	0.349	.060	0.002	PT8338	12	1.233	0.559	.134	0.004	PT8442	1	3.050	1.383	.232	0.007
BF7949-DM	12	.750	0.340	.063	0.002	PT8339	12	1.108	0.503	.106	0.003	BT8443	12	1.696	0.769	.076	0.002
BF7950-D	12	.650	0.295	.045	0.001	PT8341	12	.238	0.108	.020	0.001	BT8444	12	2.158	0.979	.076	0.002
BF7951-D	12	.750	0.340	.062	0.002	PT8344	12	.833	0.378	.101	0.003	BT8445	12	1.117	0.507	.053	0.001
BF7952-D	12	.617	0.280	.051	0.001	PT8345	12	.725	0.329	.081	0.002	PT8446-MPG	1	3.550	1.610	.214	0.006
BF7954-D	12	.629	0.285	.051	0.001	BT8347	6	1.733	0.786	.104	0.003	PT8447-MPG	1	3.250	1.474	.231	0.007
BF7955-D	12	1.425	0.646	.055	0.002	PT8350	12	.579	0.263	.048	0.001	P8448	12	1.375	0.624	.088	0.002
BF7956-D	12	.583	0.264	.061	0.002	PT8351	12	.533	0.242	.063	0.002	BT8449	12	1.388	0.630	.060	0.002
BF7957	12	1.758	0.797	.064	0.002	PT8352	12	.387	0.176	.037	0.001	BT8449-10	12	1.433	0.650	.062	0.002
BF7958	12	1.038	0.471	.085	0.002	PT8353	6	1.792	0.813	.208	0.006	BT8450	12	2.713	1.231	.124	0.004
BF7959	12	.588	0.267	.047	0.001	PT8354	12	.454	0.206	.047	0.001	PT8451-MPG	1	.450	0.204	.020	0.001
BF7960	12	.383	0.174	.047	0.001	PT8355	12	.408	0.185	.048	0.001	PT8452	12	.996	0.452	.101	0.003
BF7961	12	.488	0.221	.037	0.001	PT8356	12	.638	0.289	.080	0.002	PT8453	4	2.000	0.907	.197	0.006
BF7962	12	.567	0.257	.064	0.002	BT8357	12	1.304	0.591	.063	0.002	PT8455-MPG	1	3.650	1.656	.321	0.009
BF7963	12	.542	0.246	.037	0.001	PT8359	1	1.700	0.771	.176	0.005	PT8456-MPG	1	1.700	0.771	.116	0.003
BF7964-D	12	.834	0.378	.068	0.002	PT8361	1	4.950	2.245	.650	0.018	BT8457-MPG	6	5.617	2.548	.243	0.007
BF7965	12	.938	0.425	.080	0.002	PT8363	12	1.450	0.658	.111	0.003	PT8458-MPG	1	.950	0.431	.048	0.001
BF7966	12	1.721	0.781	.065	0.002	PT8366	1	4.100	1.860	.464	0.013	PT8459	12	.921	0.418	.099	0.003
BF7967	12	.858	0.389	.030	0.001	BT8368	6	3.783	1.716	.267	0.008	BT8460	12	.950	0.431	.031	0.001
BF7968	12	1.079	0.489	.044	0.001	PT8370-MPG	12	1.938	0.879	.132	0.004	PT8461	6	2.433	1.104	.268	0.008
BF7968-O	12	1.075	0.488	.052	0.001	PT8371-MPG	6	3.358	1.523	.269	0.008	PT8462-MPG	12	1.188	0.539	.089	0.003
BF7969	12	.710	0.322	.026	0.001	PT8372	12	.150	0.068	.016	**	BT8463-MPG	6	2.442	1.108	.090	0.003
BF7970	12	1.330	0.603	.060	0.002	PT8375-MPG	6	1.725	0.782	.144	0.004	BT8464	6	2.208	1.002	.089	0.003
BF7971-D	12	.729	0.331	.063	0.002	PT8376-MPG	6	3.934	1.784	.454	0.013	BT8465	6	3.490	1.583	.138	0.004
BF7971-DM	12	.742	0.337	.063	0.002	PT8378-MPG	1	1.800	0.816	.111	0.003	BT8466-MPG	1	3.400	1.542	.113	0.003
BF7972	12	.929	0.421	.062	0.002	PT8380	1	5.450	2.472	.465	0.013	PT8467	1	2.300	1.043	.170	0.005
PF7973	1	1.850	0.839	.239	0.007	BT8381	6	5.010	2.273	.264	0.007	PT8468	12	.587	0.266	.037	0.001
PF7974	12	.071	0.032	.011	**	BT8382	6	3.925	1.780	.227	0.006	PT8470	12	.971	0.440	.100	0.003
PF7975	12	.050	0.023	.003	**	PT8383	1	4.400	1.996	.464	0.013	BT8471-MPG	1	3.800	1.724	.230	0.007
BF7976	12	1.108	0.503	.060	0.002	BT8384	12	1.133	0.514	.040	0.001	BT8472	12	1.221	0.554	.052	0.001
PF7977	12	.438	0.199	.040	0.001	PT8385	12	.696	0.316	.040	0.001	BT8473	12	1.608	0.729	.078	0.002
PF7978	12	.583	0.264	.065	0.002	BT8386	12	.396	0.180	.032	0.001	BT8474	12	1.542	0.699	.080	0.002
BF7979	12	1.808	0.820	.081	0.002	PT8387	1	3.000	1.361	.245	0.007	BT8475	12	2.488	1.129	.115	0.003
PF7980	1	2.200	0.998	.334	0.009	PT8388	1	3.300	1.497	.258	0.007	BT8475-MPG	6	3.170	1.438	.130	0.004
BF7981	12	1.458	0.661	.063	0.002	BT8391	12	1.088	0.494	.053	0.001	BT8476	6	2.892	1.312	.146	0.004
PF7982	1																

# BALDWIN WEIGHTS AND VOLUMES

BALDWIN NUMBER	CASE QTY.	WEIGHT (ea.)		Volume (ea.)		BALDWIN NUMBER	CASE QTY.	WEIGHT (ea.)		Volume (ea.)		BALDWIN NUMBER	CASE QTY.	WEIGHT (ea.)		Volume (ea.)	
		lbs.	kgs.	ft <sup>3</sup>	m <sup>3</sup>			lbs.	kgs.	ft <sup>3</sup>	m <sup>3</sup>			lbs.	kgs.	ft <sup>3</sup>	m <sup>3</sup>
PT8479	1	1.450	0.658	.198	0.006	BT8848-MPG	6	2.700	1.225	.130	0.004	PT8950-MPG	1	4.800	2.177	.363	0.010
PT8480	1	5.000	2.268	.325	0.009	BT8849-MPG	6	2.333	1.058	.091	0.003	PT8951-MPG	1	2.550	1.157	.201	0.006
PT8481	12	.750	0.340	.063	0.002	BT8850-MPG	6	3.133	1.421	.130	0.004	PT8952-MPG	1	400	0.181	.015	0.001
PT8484	12	1.046	0.474	.059	0.002	BT8851-MPG	6	3.017	1.369	.129	0.004	PT8954-MPG	1	500	0.227	.022	0.001
PT8485	12	.317	0.144	.049	0.001	BT8852-MPG	6	3.375	1.531	.133	0.004	PT8955-MPG	1	1.300	0.590	.033	0.001
BT8486	12	.983	0.446	.051	0.001	BT8853-MPG	6	3.075	1.395	.130	0.004	PT8956-MPG	1	700	0.318	.042	0.001
PT8487	12	.712	0.323	.083	0.002	BT8855-MPG	6	3.067	1.391	.130	0.004	PT8957-MPG	1	350	0.159	.026	0.001
BT8488	12	1.704	0.773	.076	0.002	BT8856-MPG	6	3.275	1.486	.127	0.004	PT8958-MPG	1	1.100	0.499	.125	0.004
PT8489	1	1.700	0.771	.276	0.008	BT8861	6	2.983	1.353	.128	0.004	PT8959-MPG	1	1.000	0.454	.054	0.002
PT8490-MPG	1	1.950	0.885	.304	0.009	BT8862	6	2.900	1.315	.132	0.004	PT8960-MPG	1	200	0.091	.009	0.001
PT8491	1	6.250	2.835	.464	0.013	BT8863	6	3.008	1.364	.132	0.004	PT8962-MPG	1	250	0.113	.013	0.001
PT8492	1	6.200	2.812	.683	0.019	BT8870-MPG	6	5.617	2.548	.276	0.008	PT8967-MPG	1	2.000	0.907	.154	0.004
BT8493	12	1.229	0.557	.187	0.005	BT8873	6	4.550	2.064	.221	0.006	PT8969-MPG	1	2.500	1.134	.211	0.006
PT8494	1	3.050	1.383	.340	0.010	BT8874-MPG	6	4.658	2.113	.224	0.006	PT8970-MPG	1	3.100	1.406	.314	0.009
PT8495-MPG	1	1.750	0.794	.295	0.008	BT8875-MPG	6	3.692	1.675	.157	0.004	PT8971-MPG	1	3.550	1.610	.396	0.011
PT8496-MPG	12	2.121	0.962	.187	0.005	BT8876-MPG	6	4.950	2.245	.221	0.006	PT8972-MPG	1	250	0.113	.015	0.001
BT8497-MPG	12	1.987	0.901	.086	0.002	BT8877-MPG	6	4.725	2.143	.223	0.006	PT8974-MPG	1	550	0.249	.033	0.001
PT8498	1	1.000	0.454	.050	0.001	BT8878-MPG	6	4.733	2.147	.222	0.006	PT8975-MPG	1	300	0.136	.013	0.001
BT8499	12	.929	0.421	.051	0.001	BT8879-MPG	6	5.142	2.332	.225	0.006	PT8978-MPG	1	650	0.295	.037	0.001
BT8501-MPG	12	1.608	0.729	.049	0.001	BT8880-MPG	6	3.658	1.659	.156	0.004	PT8980-MPG	1	1.500	0.680	.067	0.002
BT8502	12	1.162	0.527	.050	0.001	PT8883	12	.992	0.450	.079	0.002	PT8981-MPG	1	3.750	1.701	.194	0.005
BT8503-MPG	6	3.958	1.795	.127	0.004	PT8884-MPG	12	1.783	0.809	.109	0.003	PT8982-MPG	1	1.600	0.726	.131	0.004
BT8504	12	1.275	0.578	.062	0.002	PT8885-MPG	12	1.933	0.877	.130	0.004	PT8984-MPG	1	700	0.318	.032	0.001
BT8505	12	1.125	0.510	.053	0.001	PT8886-MPG	6	2.530	1.148	.130	0.004	PT8985-MPG	1	1.400	0.635	.072	0.002
PT8506-MPG	1	2.850	1.293	.229	0.006	PT8887	1	550	0.249	.037	0.001	PT8986-MPG	1	550	0.249	.034	0.001
PT8507-MPG	12	1.458	0.661	.111	0.003	PT8888	12	.946	0.429	.130	0.004	PT8987-MPG	1	500	0.227	.030	0.001
BT8509-MPG	12	2.267	1.028	.094	0.003	PT8889	4	3.113	1.412	.366	0.010	PT8989-MPG	1	600	0.272	.043	0.001
BT8510-MPG	1	3.600	1.633	.227	0.006	BT8890-MPG	6	2.242	1.017	.096	0.003	PT8990-MPG	1	8.800	3.992	.898	0.025
PT8511	1	1.900	0.862	.272	0.008	PT8891-MPG	1	3.350	1.520	.276	0.008	PT8991-MPG	1	500	0.227	.016	0.001
BT8512	12	1.875	0.851	.062	0.002	BT8892-MPG	6	4.708	2.136	.225	0.006	PT8992-MPG	1	1.800	0.816	.118	0.003
PT8517-MPG	1	3.100	1.406	.318	0.009	PT8893	6	2.084	0.945	.204	0.006	PT8994-MPG	1	4.450	2.019	.397	0.011
PT8519-MPG	1	1.800	0.816	.188	0.005	PT8894-MPG	1	400	0.181	.015	0.001	PT8995-MPG	1	250	0.113	.014	0.001
OB8709	1	.030	0.014	.001	0.000	PT8895-MPG	1	400	0.181	.018	0.001	PT8996-MPG	1	350	0.159	.016	0.001
OB8711	1	1.700	0.771	.071	0.002	PT8896	1	4.500	2.041	.464	0.013	PT8997-MPG	1	1.550	0.703	.110	0.003
OB8712	1	1.850	0.839	.072	0.002	PT8897-MPG	1	2.250	1.021	.117	0.003	PT8998-MPG	1	200	0.091	.012	0.001
OB8720	1	1.600	0.726	.072	0.002	BT8898	12	1.100	0.499	.054	0.002	PT8999-MPG	1	750	0.340	.053	0.001
OB8721	1	1.700	0.771	.075	0.002	BT8899	6	3.383	1.535	.241	0.007	H9001	1	3.100	1.406	.228	0.006
OB8722	1	1.700	0.771	.072	0.002	BT8900	12	1.463	0.664	.067	0.002	H9007	1	5.950	2.699	.430	0.012
OB8724	1	1.650	0.748	.073	0.002	BT8901-MPG	6	2.740	1.243	.130	0.004	H9013	1	13.700	6.214	.966	0.027
OB8731	1	1.650	0.748	.072	0.002	BT8902	12	.750	0.340	.036	0.001	H9014	1	12.150	5.511	.936	0.026
OB8732	1	1.700	0.771	.074	0.002	BT8903	12	1.500	0.680	.084	0.002	H9020	1	6.650	3.016	.494	0.014
OB8741	1	1.600	0.726	.072	0.002	BT8904-MPG	6	2.367	1.074	.089	0.003	H9021	1	6.950	3.153	.501	0.014
OB8742	1	1.600	0.726	.072	0.002	BT8905	12	1.088	0.494	.050	0.001	H9024	1	9.500	4.309	.970	0.027
OB8743	1	1.600	0.726	.072	0.002	BT8906	6	3.342	1.516	.137	0.004	H9036	1	1.700	0.771	.144	0.004
OB8744	1	1.600	0.726	.073	0.002	PT8907-MPG	12	1.042	0.473	.070	0.002	H9041	1	300	0.136	.017	0.001
OB8745	1	1.600	0.726	.074	0.002	BT8908	12	.700	0.318	.029	0.001	H9042	1	300	0.136	.023	0.001
OP8750	12	.058	0.026	.065	0.002	PT8909	1	4.400	1.996	.464	0.013	H9043	1	350	0.159	.023	0.001
OP8751	12	.040	0.018	.065	0.002	BT8910-MPG	6	5.092	2.310	.222	0.006	H9043-V	1	350	0.159	.023	0.001
OP8752	12	.010	0.005	.003	0.000	BT8911-MPG	6	4.950	2.245	.222	0.006	H9044	1	300	0.136	.019	0.001
OP8753	12	.010	0.005	.004	0.000	PT8912	12	1.671	0.758	.188	0.005	H9045	1	550	0.249	.041	0.001
OB8771	1	2.600	1.179	.103	0.003	BT8913-MPG	12	1.671	0.758	.062	0.002	H9046	1	500	0.227	.037	0.001
OB8772	1	2.700	1.225	.102	0.003	BT8914	12	1.612	0.731	.081	0.002	H9047	1	500	0.227	.035	0.001
OB8773	1	2.250	1.021	.106	0.003	BT8915	1	3.450	1.565	.197	0.006	H9048	1	500	0.227	.035	0.001
CFB8784	1	1.750	0.794	.071	0.002	BT8916	12	.800	0.363	.037	0.001	H9049	1	450	0.204	.021	0.001
BT8800-MPG	1	4.600	2.087	.227	0.006	BT8917	12	.708	0.321	.029	0.001	H9050	1	200	0.091	.014	0.001
BT8801-MPG	6	3.658	1.659	.148	0.004	BT8918	12	1.104	0.501	.049	0.001	H9051	1	950	0.431	.032	0.001
BT8802-MPG	6	3.517	1.595	.148	0.004	BT8919	12	1.338	0.607	.063	0.002	H9052	1	500	0.227	.038	0.001
BT8803-MPG	6	3.667	1.663	.264	0.007	BT8920	12	2.296	1.041	.112	0.003	H9054	1	600	0.272	.020	0.001
BT8805-MPG	1	5.050	2.291	.231	0.007	BT8922	12	1.779	0.807	.059	0.002	H9055	1	900	0.408	.019	0.001
BT8812-MPG	6	3.508	1.591	.147	0.004	BT8926	12	1.900	0.862	.079	0.002	H9056	1	950	0.431	.020	0.001
BT8813-MPG	1	4.250	1.928	.231	0.007	BT8927	6	2.858	1.296	.124	0.004	H9058	1	2.550	1.157	.178	0.005
BT8830	6	1.817	0.824	.083	0.002	BT8928	12	1.683	0.763	.061	0.002	H9060	1	2.750	1.247	.173	0.005
BT8831	1	1.900	0.862	.090	0.003	BT8930	6	2.825	1.281	.125	0.004	H9062	1	4.150	1.882	.281	0.008
BT8832	6	2.067	0.938	.115	0.003	BT8931	6	3.158	1.432	.154	0.004	H9069	1	800	0.363	.044	0.001
BT8833	6	2.092	0.949	.115	0.003	BT8935	12	1.483	0.673	.059	0.002	H9070	1	700	0.318	.036	0.001
BT8834-MPG	1	3.250	1.474	.098	0.003	BT8937	6	3.033	1.376	.128	0.004	H9071	1	750	0.340	.034	0.001
BT8840-MPG	6	2.258	1.024	.091	0.003	PT8939-MPG	1	1.700	0.771	.138	0.004	H9072	1	750	0.340	.037	0.001
BT8841-MPG	6	2.292	1.040	.091	0.003	PT8940-MPG	1	1.250	0.567	.040	0.001	H9072-V	1	700	0.318	.033	0.001
BT8842-MPG	6	2.233	1.013	.091	0.003	PT8941-MPG	1	4.400	1.996	.338	0.010	H9073	1	1.150	0.522	.058	0.002
BT8843-MPG	6	2.358	1.070	.092	0.003	PT8943-MPG	1	15.950	7.235	1.161	0.033	H9074	1	1.100	0.499	.059	0.002
BT8844	6	2.208	1.002	.089	0.003	PT8945-MPG	1	1.550	0.703	.097	0.003	H9075					

# BALDWIN WEIGHTS AND VOLUMES

BALDWIN NUMBER	CASE QTY.	WEIGHT (ea.) lbs.	WEIGHT (ea.) kgs.	Volume (ea.) ft <sup>3</sup>	Volume (ea.) m <sup>3</sup>	BALDWIN NUMBER	CASE QTY.	WEIGHT (ea.) lbs.	WEIGHT (ea.) kgs.	Volume (ea.) ft <sup>3</sup>	Volume (ea.) m <sup>3</sup>	BALDWIN NUMBER	CASE QTY.	WEIGHT (ea.) lbs.	WEIGHT (ea.) kgs.	Volume (ea.) ft <sup>3</sup>	Volume (ea.) m <sup>3</sup>
H9077	1	1.850	0.839	.149	0.004	PT9209	1	.300	0.136	.013	**	PT9341	1	1.700	0.771	.143	0.004
H9078	1	1.600	0.726	.090	0.003	PT9210	1	.350	0.159	.030	0.001	PT9342-MPG	12	1.517	0.688	.100	0.003
H9078-V	1	1.750	0.794	.160	0.005	PT9212	1	1.900	0.862	.184	0.005	BT9343-MPG	6	3.900	1.769	.149	0.004
H9079	1	1.650	0.748	.090	0.003	PT9214	12	.650	0.295	.056	0.002	PT9344	12	.725	0.329	.082	0.002
H9080	1	1.650	0.748	.090	0.003	PT9215	1	.600	0.272	.057	0.002	BT9345	6	3.367	1.527	.264	0.007
H9081	1	1.600	0.726	.090	0.003	PT9217	1	2.600	1.179	.247	0.007	BT9346-MPG	12	1.450	0.658	.061	0.002
H9082	1	1.700	0.771	.093	0.003	PT9222	1	.100	0.045	.022	0.001	BT9347-MPG	6	5.345	2.424	.168	0.005
H9083	1	2.300	1.043	.177	0.005	PT9223	1	.400	0.181	.026	0.001	PT9348-MPG	1	7.500	3.402	.464	0.013
H9084	1	2.100	0.953	.117	0.003	PT9224	1	.900	0.408	.081	0.002	BT9349-MPG	6	1.658	0.752	.084	0.002
H9085	1	2.150	0.975	.117	0.003	PT9225	1	.550	0.249	.034	0.001	PT9350-MPG	1	10.300	4.672	1.250	0.035
H9086	1	2.200	0.998	.118	0.003	PT9227	1	1.550	0.703	.015	**	PT9351-MPG	1	2.650	1.202	.213	0.006
H9087	1	2.000	0.907	.117	0.003	PT9228	1	.400	0.181	.031	0.001	PT9352	1	2.050	0.930	.189	0.005
H9092	1	2.600	1.179	.095	0.003	H9231	1	.600	0.272	.030	0.001	BT9353-MPG	6	5.183	2.351	.224	0.006
H9093	1	4.300	1.950	.146	0.004	PT9237	1	.450	0.204	.040	0.001	PT9354-MPG	12	.688	0.312	.040	0.001
H9096	1	1.150	0.522	.059	0.002	PT9238	12	1.104	0.501	.080	0.002	PT9355-MPG	1	10.900	4.944	.639	0.018
H9097	1	1.050	0.476	.068	0.002	PT9239	12	.505	0.229	.030	0.001	BT9356	6	2.575	1.168	.127	0.004
H9103	1	2.500	1.134	.068	0.002	PT9240	1	.250	0.113	.015	**	PT9357	1	4.850	2.200	.464	0.013
H9107	1	.500	0.227	.017	**	PT9242	1	.600	0.272	.040	0.001	BT9358	1	3.000	1.361	.076	0.002
H9108	1	.500	0.227	.018	0.001	PT9244	1	4.650	2.109	.338	0.010	PT9359-MPG	1	2.400	1.089	.138	0.004
H9110	1	.500	0.227	.017	**	PT9245	1	1.550	0.703	.131	0.004	BT9360	1	6.350	2.880	.182	0.005
H9111	1	.550	0.249	.066	0.002	PT9247	1	7.350	3.334	.614	0.017	PT9361	1	4.400	1.996	.464	0.013
H9112	1	.700	0.318	.039	0.001	PT9248	1	.700	0.318	.051	0.001	BT9362-MPG	6	4.708	2.136	.222	0.006
H9113	1	.800	0.363	.041	0.001	PT9250	1	3.500	1.588	.397	0.011	BT9363-MPG	6	3.183	1.444	.130	0.004
H9114	1	.700	0.318	.040	0.001	PT9251	1	3.000	1.361	.236	0.007	BT9364	6	2.242	1.017	.089	0.003
H9123	1	2.400	1.089	.190	0.005	PT9254	1	2.150	0.975	.195	0.006	PT9365-MPG	6	4.950	2.245	.227	0.006
PT9129	1	1.350	0.612	.166	0.005	PT9255	1	.350	0.159	.015	**	BT9366-MPG	6	3.325	1.508	.131	0.004
PT9131	12	.387	0.176	.034	0.001	PT9256-MPG	1	.550	0.249	.040	0.001	BT9367-MPG	6	5.467	2.480	.169	0.005
PT9132	1	.800	0.363	.069	0.002	PT9258	1	2.100	0.953	.203	0.006	PT9368-MPG	6	3.450	1.565	.110	0.003
PT9134	12	.267	0.121	.020	0.001	PT9260	12	.538	0.244	.061	0.002	BT9369-MPG	6	4.410	2.000	.149	0.004
PT9135	12	.587	0.266	.033	0.001	PT9261-MPG	1	3.250	1.474	.293	0.008	BT9370-MPG	6	3.433	1.557	.129	0.004
PT9136	12	.350	0.159	.026	0.001	PT9264	1	.650	0.295	.056	0.002	BT9371-MPG	6	2.775	1.259	.160	0.005
PT9137	1	.350	0.159	.016	**	PT9266	1	.400	0.181	.024	0.001	PT9372	1	1.300	0.590	.109	0.003
PT9139	1	1.150	0.522	.133	0.004	PT9267	1	.400	0.181	.024	0.001	PT9373-MPG	1	2.400	1.089	.114	0.003
PT9140	1	.375	0.170	.026	0.001	PT9268	1	1.800	0.816	.082	0.002	PT9374	12	.521	0.236	.052	0.002
PT9142	12	.150	0.068	.016	**	PT9272	1	2.500	1.134	.238	0.007	PT9375	4	3.600	1.633	.366	0.010
PT9143	12	.408	0.185	.082	0.002	PT9277	1	1.700	0.771	.161	0.005	PT9376	1	2.150	0.975	.171	0.005
PT9144	12	.996	0.452	.101	0.003	PT9278	1	.700	0.318	.056	0.002	BT9377	1	3.950	1.792	.229	0.006
PT9145	1	.700	0.318	.033	0.001	PT9279	1	1.050	0.476	.090	0.003	PT9378-MPG	1	.500	0.227	.024	0.001
PT9148	1	1.450	0.658	.141	0.004	PT9282-MPG	1	.650	0.295	.024	0.001	PT9379	1	6.150	2.790	.683	0.019
PT9149	1	1.150	0.522	.053	0.001	PT9283-MPG	1	5.100	2.313	.332	0.009	PT9380-MPG	12	2.575	1.168	.139	0.004
PT9150	1	1.100	0.499	.053	0.001	PT9284-MPG	1	1.250	0.567	.082	0.002	PT9381-MPG	1	1.450	0.658	.114	0.003
PT9152	1	1.350	0.612	.060	0.002	PT9286-MPG	1	.800	0.363	.038	0.001	BT9382	12	1.271	0.577	.055	0.002
PT9153	1	.850	0.386	.040	0.001	PT9287-MPG	1	.500	0.227	.030	0.001	PT9383-MPG	1	6.000	2.722	.551	0.016
PT9157	1	.800	0.363	.039	0.001	PT9288-MPG	1	2.850	1.293	.249	0.007	PT9384-MPG	1	1.350	0.612	.049	0.001
PT9158	1	1.100	0.499	.054	0.002	PT9289-MPG	1	.450	0.204	.024	0.001	PT9385-MPG	1	3.400	1.542	.322	0.009
PT9161	1	2.200	0.998	.134	0.004	PT9290-MPG	1	3.350	1.520	.253	0.007	PT9386-MPG	12	1.333	0.605	.140	0.004
PT9162	1	3.450	1.565	.211	0.006	PT9291-MPG	1	1.300	0.590	.095	0.003	BT9387	6	3.892	1.765	.165	0.005
BT9164	1	4.750	2.155	.211	0.006	PT9293-MPG	1	.650	0.295	.033	0.001	BT9388	12	.571	0.259	.028	0.001
PT9165	1	.600	0.272	.031	0.001	PT9296-MPG	1	.450	0.204	.024	0.001	PT9389-MPG	1	1.400	0.635	.114	0.003
PT9167	1	.500	0.227	.038	0.001	PT9297-MPG	1	1.850	0.839	.103	0.003	PT9390-MPG	1	1.800	0.816	.091	0.003
PT9168	1	2.150	0.975	.212	0.006	PT9300-MPG	1	1.150	0.522	.059	0.002	BT9391-MPG	6	4.800	2.177	.221	0.006
PT9169	10	1.830	0.830	.127	0.004	PT9303-MPG	1	2.800	1.270	.139	0.004	BT9392-MPG	6	2.533	1.149	.131	0.004
PT9170	1	1.600	0.726	.123	0.003	PT9304-MPG	1	.750	0.340	.022	0.001	BT9393-MPG	6	1.500	0.680	.085	0.002
PT9172	1	2.050	0.930	.139	0.004	PT9306-MPG	1	3.800	1.724	.396	0.011	PT9394-MPG	12	.863	0.391	.051	0.001
PT9174	12	.600	0.272	.042	0.001	PT9307-MPG	1	1.050	0.476	.056	0.002	PT9395-MPG	6	1.100	0.499	.141	0.004
PT9175	1	1.267	0.575	.090	0.003	PT9308-MPG	1	.300	0.136	.015	**	PT9396	12	.467	0.212	.038	0.001
PT9176	1	2.100	0.953	.239	0.007	PT9309-MPG	1	.650	0.295	.031	0.001	PT9397-MPG	1	1.950	0.885	.113	0.003
PT9178	1	.500	0.227	.032	0.001	PT9310-MPG	1	.250	0.113	.014	**	BT9398-MPG	6	1.975	0.896	.085	0.002
PT9179	1	.300	0.136	.018	0.001	PT9311-MPG	1	.400	0.181	.016	**	PT9399-MPG	1	5.050	2.291	.474	0.013
PT9180	12	.400	0.181	.023	0.001	PT9313-MPG	1	1.550	0.703	.067	0.002	BT9400-MPG	6	2.558	1.160	.105	0.003
PT9181	1	1.300	0.590	.110	0.003	PT9315 KIT	1	.700	0.318	.043	0.001	PT9401	1	2.700	1.225	.300	0.008
PT9183	1	2.150	0.975	.205	0.006	BT9316-MPG	1	2.100	0.953	.088	0.002	BT9402	12	1.113	0.505	.039	0.001
PT9185	12	.429	0.195	.037	0.001	BT9318	12	1.467	0.665	.044	0.001	PT9504-MPG	1	1.700	0.771	.111	0.003
PT9186	1	.750	0.340	.044	0.001	BT9320	1	3.217	1.459	.128	0.004	PT9403-MPG	1	5.200	2.359	.244	0.007
PT9187	1	.500	0.227	.040	0.001	BT9321	12	1.517	0.688	.069	0.002	PT9404-MPG	1	.700	0.318	.036	0.001
PT9188	1	1.500	0.680	.131	0.004	BT9324	6	2.958	1.342	.124	0.004	PT9405	12	1.479	0.671	.121	0.003
PT9189	1	2.900	1.315	.252	0.007	BT9326	1	1.000	0.454	.021	0.001	PT9406-MPG	1	.950	0.431	.033	0.001
PT9191	1	2.950	1.338	.387	0.011	H9327	1	.400	0.181	.020	0.001	PT9407-MPG	1	2.400	1.089	.231	0.007
PT9193	1	.500	0.227	.025	0.001	PT9328-MPG	1	9.150	4.150	.968	0.027	BT9408	12	.725	0.329	.031	0.001
PT9195	1	.350	0.159	.017	**	PT9329	12	.521	0.236	.035	0.001	PT9409-MPG	1	1.400	0.635	.072	0.002
PT9196	1	.900	0.408	.072	0.002	PT9330-MPG	1	.550	0.249	.024	0.001	PT9410-MPG	1	1.850	0.839	.093	0.003
PT9197	1	.550	0.249	.040	0.001	PT9331	1	1.250	0.567	.115	0.003	PT9411-MPG	1	2.650	1.202	.210	0.0

**BALDWIN WEIGHTS AND VOLUMES**

BALDWIN NUMBER	CASE QTY.	WEIGHT (ea.) lbs.	kgs.	Volume (ea.) ft <sup>3</sup>	m <sup>3</sup>	BALDWIN NUMBER	CASE QTY.	WEIGHT (ea.) lbs.	kgs.	Volume (ea.) ft <sup>3</sup>	m <sup>3</sup>	BALDWIN NUMBER	CASE QTY.	WEIGHT (ea.) lbs.	kgs.	Volume (ea.) ft <sup>3</sup>	m <sup>3</sup>
PT9416-MPG KIT...	1	1.900	0.862	.128	0.004	PT9508	1	.700	0.318	.030	0.001	BF9836-D	12	.521	0.236	.051	0.001
PT9417	12	.242	0.110	.035	0.001	PT9509	1	2.350	1.066	.218	0.006	BF9837-D	12	.780	0.354	.058	0.002
PT9418	12	1.746	0.792	.189	0.005	PT9510	1	.250	0.113	.016	0.001	BF9839-D	12	.667	0.303	.063	0.002
PT9419-MPG	12	.542	0.246	.038	0.001	PT9511	1	1.500	0.680	.110	0.003	BF9841	12	.867	0.393	.035	0.001
PT9420-MPG	1	1.250	0.567	.088	0.002	PT9513	1	1.650	0.748	.172	0.005	BF9842	12	.750	0.340	.041	0.001
BT9421-MPG	6	5.633	2.555	.224	0.006	PT9514	1	.800	0.363	.042	0.001	BF9844	12	2.550	1.157	.115	0.003
BT9422	6	3.080	1.397	.140	0.004	PT9515	1	3.250	1.474	.281	0.008	BF9846	12	.763	0.346	.062	0.002
PT9423	12	.325	0.147	.022	0.001	PT9516	1	.400	0.181	.025	0.001	BF9847-D	12	.621	0.282	.051	0.001
PT9424	12	.129	0.059	.011	0.001	PT9517	1	2.150	0.975	.203	0.006	BF9848	12	.483	0.219	.060	0.002
PT9425-MPG	6	2.100	0.953	.176	0.005	PT9518-MPG	1	5.100	2.313	.431	0.012	BF9850	12	1.663	0.754	.073	0.002
PT9426	12	.133	0.060	.009	0.001	PT9519-MPG	1	1.900	0.862	.105	0.003	BF9851	12	.675	0.306	.078	0.002
PT9427-MPG	6	5.183	2.351	.337	0.010	PT9520-MPG	1	5.300	2.404	.642	0.018	BF9852	12	1.546	0.701	.085	0.002
PT9429-MPG	1	2.850	1.293	.182	0.005	PT9522-MPG	1	1.000	0.454	.053	0.001	BF9857	12	.363	0.165	.063	0.002
PT9430-MPG	12	2.083	0.945	.140	0.004	PT9523-MPG	1	3.250	1.474	.238	0.007	BF9858 KIT	1	2.550	1.157	.188	0.005
PT9432-MPG	1	2.450	1.111	.201	0.006	PT9524-MPG	1	14.950	6.781	1.550	0.044	BF9860	6	5.142	2.332	.172	0.005
BT9433	6	3.250	1.474	.129	0.004	PT9525-MPG	1	2.300	1.043	.118	0.003	PF9861	12	.379	0.172	.047	0.001
PT9434	12	.683	0.310	.063	0.002	PT9526-MPG	1	1.300	0.590	.083	0.002	PF9862	12	.183	0.083	.018	0.001
PT9435-MPG	12	.375	0.170	.037	0.001	PT9528	1	5.500	2.495	.601	0.017	BF9863	12	.179	0.081	.019	0.001
BT9436-MPG	6	2.433	1.104	.091	0.003	PT9529	1	3.000	1.361	.137	0.004	BF9864	6	3.208	1.455	.171	0.005
BT9439	6	2.900	1.315	.154	0.004	PT9530	1	1.750	0.794	.232	0.007	PF9865	12	.442	0.200	.056	0.002
BT9440	6	1.833	0.831	.066	0.002	PT9532	6	2.892	1.312	.151	0.004	BF9866-O	12	2.460	1.116	.130	0.004
PT9441-MPG	6	3.742	1.697	.329	0.009	BT9533	1	3.650	1.656	.165	0.005	BF9867-O	12	2.317	1.051	.127	0.004
BT9442-MPG	12	1.217	0.552	.051	0.001	PT9535-MPG	1	.950	0.431	.058	0.002	PF9868	12	.729	0.331	.086	0.002
PT9443	1	4.450	2.019	.263	0.007	PT9536-MPG	1	.750	0.340	.105	0.003	BF9869	12	2.213	1.004	.100	0.003
PT9444-MPG	6	3.925	1.780	.328	0.009	PT9537-MPG	12	.225	0.102	.020	0.001	PF9870	12	.650	0.295	.087	0.002
PT9445-MPG	1	4.300	1.950	.375	0.011	BT9553	12	1.360	0.617	.050	0.001	BF9871-O	12	1.846	0.837	.107	0.003
PT9446	12	1.642	0.745	.123	0.003	PT9554-MPG	1	4.350	1.973	.328	0.009	PF9872	12	.554	0.251	.056	0.002
PT9447	12	1.038	0.471	.071	0.002	PT9555	1	1.300	0.590	.134	0.004	PF9873	12	.050	0.023	.005	0.001
PT9448	12	1.067	0.484	.078	0.002	PT9556-MPG	1	5.750	2.608	.452	0.013	BF9874-DM	12	.613	0.278	.052	0.001
PT9449	12	.546	0.248	.041	0.001	PT9557	1	6.000	2.722	.481	0.014	BF9875-DM	12	.650	0.295	.053	0.001
PT9450-MPG	12	1.633	0.741	.093	0.003	BT9558-MPG	6	2.850	1.293	.123	0.003	BF9876	12	1.267	0.575	.059	0.002
PT9451-MPG	1	10.950	4.967	.709	0.020	PT9559-MPG	1	1.950	0.885	.093	0.003	BF9877	12	1.075	0.488	.041	0.001
PT9452	1	5.000	2.268	.500	0.014	BT9560-MPG	6	5.516	2.502	.280	0.008	BF9878	12	1.442	0.654	.068	0.002
BT9454	1	4.150	1.882	.124	0.004	BT9561	12	1.250	0.567	.047	0.001	PF9879	6	1.042	0.473	.162	0.005
BT9456	12	1.200	0.544	.046	0.001	P9600	12	.175	0.079	.022	0.001	BF9880	12	2.790	1.266	.144	0.004
PT9459-MPG	1	15.500	7.031	1.015	0.029	B9601	12	1.908	0.865	.092	0.003	BF9881	12	1.029	0.467	.075	0.002
PT9462	12	.363	0.165	.020	0.001	P9602	12	.258	0.117	.029	0.001	BF9883	12	1.383	0.627	.067	0.002
BT9464	12	1.917	0.870	.099	0.003	P9603	12	.104	0.047	.012	0.001	BF9884	12	.071	0.032	.010	0.001
BT9465	12	1.092	0.495	.054	0.002	B9604	12	2.330	1.057	.121	0.003	BF9885	6	4.217	1.913	.140	0.004
BT9466-MPG	6	3.350	1.520	.138	0.004	P9605	12	.183	0.083	.029	0.001	BF9886	12	.300	0.136	.018	0.001
PT9468	1	.450	0.204	.015	0.001	B9606	12	2.440	1.107	.134	0.004	BF9887	12	.975	0.442	.046	0.001
PT9469	12	.100	0.045	.007	0.001	B9607	12	2.320	1.052	.134	0.004	BF9888	6	2.533	1.149	.147	0.004
PT9470	12	1.075	0.488	.019	0.001	BF9800	12	2.654	1.204	.122	0.003	PF9889	12	.833	0.378	.085	0.002
BT9471	12	1.117	0.507	.041	0.001	PF9801	12	.388	0.176	.040	0.001	PF9890	12	.592	0.269	.050	0.001
PT9472	1	3.050	1.383	.295	0.008	BF9802	12	2.660	1.207	.123	0.003	BF9891-D	12	.850	0.386	.063	0.002
S9475	12	.013	0.006	.005	0.001	PF9803	12	.538	0.244	.051	0.001	BF9892-D	12	.642	0.291	.048	0.001
PT9476-MPG	6	1.250	0.567	.159	0.004	PF9804	6	2.408	1.092	.259	0.007	BF9893	12	1.333	0.605	.068	0.002
PT9477	1	.250	0.113	.016	0.001	BF9805	12	.510	0.231	.048	0.001	BF9894	12	1.279	0.580	.068	0.002
PT9478-MPG	1	.300	0.136	.013	0.001	BF9807	12	.313	0.142	.037	0.001	BF9895 KIT	6	1.342	0.609	.173	0.005
PT9479-MPG	1	1.450	0.658	.081	0.002	BF9808-D	12	.617	0.280	.047	0.001	PF9897	12	.671	0.304	.061	0.002
PT9481-MPG	1	.250	0.113	.025	0.001	BF9809-D	12	.925	0.420	.088	0.002	BF9898-O	12	1.642	0.745	.108	0.003
PT9482-MPG	1	.550	0.249	.024	0.001	BF9810-D	12	.767	0.348	.064	0.002	PF9899	12	.675	0.306	.057	0.002
PT9483-MPG	1	2.950	1.338	.197	0.006	BF9811-SP	12	2.308	1.047	.101	0.003	PF9901 KIT	12	.729	0.331	.102	0.003
PT9484-MPG	1	.900	0.408	.016	0.001	BF9812	12	1.208	0.548	.067	0.002	PF9902	12	.183	0.083	.055	0.002
PT9486-MPG	1	1.000	0.454	.043	0.001	BF9813	12	1.325	0.601	.069	0.002	BF9903-SP	12	2.562	1.162	.123	0.003
PT9487-MPG	1	4.250	1.928	.285	0.008	PF9814	12	1.117	0.507	.106	0.003	BF9904	12	1.079	0.489	.086	0.002
PT9488-MPG	1	4.300	1.950	.291	0.008	BF9815	12	1.492	0.677	.072	0.002	BF9905	12	2.46	0.112	.029	0.001
PT9489-MPG	1	2.850	1.293	.141	0.004	BF9816	12	1.921	0.871	.080	0.002	BF9906	12	.125	0.057	.014	0.001
PT9490-MPG	1	1.050	0.476	.041	0.001	BF9817	12	3.021	1.370	.135	0.004	PF9907	12	.121	0.055	.013	0.001
PT9491-MPG	1	1.050	0.476	.040	0.001	BF9818	12	2.841	1.289	.160	0.005	PF9908 KIT	1	1.900	0.862	.191	0.005
PT9492-MPG	1	2.600	1.179	.074	0.002	BF9820	12	1.704	0.773	.063	0.002	BF9910	12	1.042	0.473	.040	0.001
PT9493-MPG	1	.550	0.249	.023	0.001	BF9821	12	.996	0.452	.047	0.001	PF9911	12	.079	0.036	.007	0.001
PT9494-MPG	1	1.900	0.862	.109	0.003	BF9822-D	12	.604	0.274	.064	0.002	BF9912-O	12	1.550	0.703	.061	0.002
PT9495-MPG	1	2.700	1.225	.104	0.003	PF9823	12	.321	0.146	.035	0.001	BF9913	12	.750	0.340	.079	0.002
PT9496-MPG	1	3.900	1.769	.268	0.008	PF9825	12	.200	0.091	.036	0.001	PF9914 KIT	6	1.292	0.586	.183	0.005
PT9497-MPG	1	4.050	1.837	.268	0.008	PF9826	12	1.238	0.562	.108	0.003	BF9915	12	.592	0.269	.035	0.001
PT9498-MPG	1	2.000	0.907	.092	0.003	BF9827-D	12	.692	0.314	.064	0.002	BF9916	12	.196	0.089	.017	0.001
PT9499-MPG	1	1.050	0.476	.082	0.002	BF9828-D	12	.596	0.270	.051	0.001	BF9917	12	2.950	1.338	.130	0.004
PT9500-MPG	1	6.900	3.130	.421	0.012	PF9829 KIT	1	1.500	0.680	.403	0.011	BF9918 KIT	6	2.075	0.941	.156	0.004
PT9501-MPG	1	2.050	0.930	.128	0.004	BF9830-D	12	.463	0.210	.053	0.001	PF9919	12	.600	0.272	.061	0.002
PT9502-MPG	1	1.100	0.499	.057	0.002	BF9831	12	1.521	0.690	.081	0.002	BF9920	6	3.567	1.618	.173	0.005
PT9503-MPG	1	1.25															

# BALDWIN WEIGHTS AND VOLUMES

BALDWIN NUMBER	CASE QTY.	WEIGHT (ea.) lbs.	WEIGHT (ea.) kgs.	Volume (ea.) ft <sup>3</sup>	Volume (ea.) m <sup>3</sup>	BALDWIN NUMBER	CASE QTY.	WEIGHT (ea.) lbs.	WEIGHT (ea.) kgs.	Volume (ea.) ft <sup>3</sup>	Volume (ea.) m <sup>3</sup>	BALDWIN NUMBER	CASE QTY.	WEIGHT (ea.) lbs.	WEIGHT (ea.) kgs.	Volume (ea.) ft <sup>3</sup>	Volume (ea.) m <sup>3</sup>
PF9924 KIT	6	2.350	1.066	.226	.006	PA10086	6	.866	.393	.107	.003	PA10165	6	.400	.181	.061	.002
BF9925-O	12	1.650	.748	.108	.003	PA10087	6	1.083	.491	.163	.005	PA10166	6	.550	.249	.160	.005
BF9927	12	1.833	.831	.077	.002	PA10088	6	.817	.371	.136	.004	PA10167	6	.358	.162	.097	.003
PF9928	12	1.080	.490	.124	.004	PA10089	6	1.150	.522	.213	.006	PA10168	1	.750	.340	.445	.013
PF9929	12	1.033	.469	.107	.003	PA10090	6	.916	.415	.127	.004	PA10169	6	.967	.439	.141	.004
PA10000	6	.700	.318	.147	.004	PA10091	6	.758	.344	.127	.004	PA10170 KIT	6	1.092	.495	.158	.004
PA10001	6	1.358	.616	.211	.006	PA10093	6	1.216	.552	.257	.007	PA10171	6	.350	.159	.152	.004
PA10002	6	.400	.181	.062	.002	PA10094	6	1.342	.609	.252	.007	PA10172	6	.710	.322	.170	.005
PA10003	6	.808	.367	.194	.005	PA10095	6	1.725	.782	.266	.008	PA10173	6	.458	.208	.121	.003
PA10004	6	.916	.415	.129	.004	PA10096	6	1.291	.586	.228	.006	PA10174	6	.591	.268	.251	.007
RS10005	1	.900	.408	.151	.004	PA10097	6	.541	.245	.096	.003	PA10175 KIT	6	1.600	.726	.297	.008
PA10006	6	1.033	.469	.147	.004	PA10098	6	.958	.435	.183	.005	PA10176	6	.325	.147	.134	.004
PA10007	6	.716	.325	.211	.006	PA10099	6	.741	.336	.123	.003	PA10177	6	.567	.257	.134	.004
PA10008	6	.825	.374	.104	.003	SA10100	12	.195	.088	.066	.002	PA10178	6	1.092	.495	.119	.003
PA10009	1	.300	.136	.063	.002	PA10101	6	1.050	.476	.170	.005	PA10179	6	.533	.242	.154	.004
PA10010	6	.767	.348	.136	.004	PA10102	6	1.150	.522	.200	.006	PA10180 KIT	6	1.590	.721	.181	.005
PA10011	6	.500	.227	.196	.006	PA10103	6	.617	.280	.189	.005	PA10181	6	.392	.178	.089	.003
PA10012	6	1.550	.703	.370	.010	PA10104	6	.358	.162	.081	.002	PA10182	6	.400	.181	.065	.002
PA10014	6	.450	.204	.091	.003	PA10106	6	1.125	.510	.277	.008	PA10183	6	.520	.236	.170	.005
PA10015	6	1.091	.495	.154	.004	PA10108	6	.350	.159	.107	.003	PA10184	1	.550	.249	.083	.002
PA10016	6	.200	.091	.042	.001	PA10109	1	1.100	.499	.414	.012	PA10185	6	.433	.196	.134	.004
PA10017	6	.458	.208	.103	.003	PA10110	1	.900	.408	.289	.008	PA10186 KIT	6	.570	.259	.214	.006
PA10018	6	.900	.408	.103	.003	PA10111	1	1.350	.612	.381	.011	PA10188	6	1.000	.454	.140	.004
PA10020	1	.700	.318	.309	.009	PA10112	1	2.300	1.043	.783	.022	PA10189	6	1.025	.465	.218	.006
RS10021	1	1.650	.748	.358	.010	PA10113	6	1.083	.491	.266	.008	PA10190	6	.433	.196	.052	.001
PA10022	6	1.666	.756	.218	.006	PA10114	6	1.375	.624	.372	.011	PA10191 KIT	6	.467	.212	.075	.002
PA10023	6	1.150	.522	.179	.005	PA10115	1	.950	.431	.236	.007	PA10192	1	1.050	.476	.353	.010
PA10024	6	1.375	.624	.255	.007	PA10116	1	1.950	.885	.684	.019	PA10193 KIT	6	.775	.352	.104	.003
PA10025	6	.808	.367	.117	.003	PA10117	1	.800	.363	.151	.004	PA10194	6	.442	.200	.087	.002
PA10026	6	1.083	.491	.133	.004	PA10118	1	1.700	.771	.560	.016	PA10195 KIT	6	.575	.261	.093	.003
PA10027	6	.975	.442	.134	.004	PA10119	1	.750	.340	.212	.006	PA10196 KIT	6	.775	.352	.220	.006
PA10028	6	.625	.284	.087	.002	PA10120	1	1.850	.839	.646	.018	PA10197	6	1.192	.541	.302	.009
PA10030	6	.383	.174	.077	.002	PA10121	1	1.850	.839	.542	.015	PA10198 KIT	6	1.133	.514	.216	.006
PA10031	6	.458	.208	.092	.003	PA10122	1	.850	.386	.240	.007	PA10199 KIT	6	.767	.348	.110	.003
PA10032	6	.442	.200	.131	.004	PA10123	1	.950	.431	.247	.007	PA10200	6	1.190	.540	.214	.006
PA10033	6	1.625	.737	.410	.012	PA10124	1	1.600	.726	.504	.014	PA10201	6	.758	.344	.208	.006
PA10034	1	.350	.159	.096	.003	PA10125	1	1.150	.522	.343	.010	PA10202	6	.558	.253	.117	.003
RS10035	1	2.000	.907	.415	.012	PA10126	1	.850	.386	.198	.006	PA10203 KIT	6	.730	.331	.169	.005
PA10036	6	1.267	.575	.165	.005	SA10127	12	.125	.057	.036	.001	PA10204 KIT	6	.558	.253	.154	.004
PA10037	6	1.833	.837	.160	.005	PA10128	6	.375	.170	.075	.002	PA10205 KIT	1	2.800	1.270	.416	.012
PA10038	1	.692	.314	.098	.003	PA10129	6	.375	.170	.076	.002	PA10206 KIT	6	.500	.227	.134	.004
PA10039	6	.742	.337	.110	.003	PA10130	6	.758	.344	.104	.003	PA10207	6	1.140	.517	.300	.008
PA10040	6	.725	.329	.101	.003	PA10131	6	.300	.136	.062	.002	PA10208 KIT	6	1.208	.548	.218	.006
PA10041	6	.625	.284	.303	.009	PA10132	6	.525	.238	.080	.002	PA10209 KIT	6	.425	.193	.090	.003
PA10042	6	.450	.204	.090	.003	PA10133	6	.200	.091	.160	.005	PA10210 KIT	6	.742	.337	.133	.004
PA10043	6	.408	.185	.079	.002	PA10134	6	.650	.295	.103	.003	PA10211 KIT	6	.425	.193	.066	.002
PA10044	6	1.208	.548	.117	.003	PA10135	6	.517	.235	.092	.003	PA10212 KIT	6	.967	.439	.210	.006
PA10045	6	1.642	.745	.255	.007	PA10136	6	.470	.213	.155	.004	PA10213	6	.625	.284	.152	.004
PA10046	6	1.050	.476	.206	.006	PA10137	6	.450	.204	.167	.005	PA10214	6	.667	.303	.218	.006
PA10047	6	1.058	.480	.145	.004	PA10138	6	.808	.367	.127	.004	PA10215 KIT	6	.600	.272	.160	.005
PA10057	6	.800	.363	.122	.003	PA10139	6	.458	.208	.090	.003	PA10216 KIT	6	.550	.249	.106	.003
PA10058	6	.883	.401	.135	.004	PA10140	6	.900	.408	.137	.004	PA10217	6	.125	.057	.021	.001
PA10059	6	.758	.344	.113	.003	PA10141	6	.508	.230	.156	.004	PA10218	6	.583	.264	.125	.004
PA10060	6	1.050	.476	.210	.006	PA10142	6	.600	.272	.168	.005	PA10219	6	.743	.337	.129	.004
PA10061	1	2.350	1.066	.776	.022	PA10143	6	1.017	.461	.201	.006	PA10220	6	.700	.318	.100	.003
PA10062	6	.975	.442	.296	.008	PA10144	6	.417	.189	.138	.004	PA10221	6	1.108	.503	.163	.005
PA10063	6	1.058	.480	.192	.005	PA10145 KIT	6	.383	.174	.166	.005	PA10222	6	1.108	.503	.168	.005
PA10064	6	.841	.381	.149	.004	PA10146	6	.350	.159	.063	.002	PA10223	6	1.258	.571	.131	.004
PA10066	6	.283	.128	.064	.002	PA10147	6	.317	.144	.061	.002	PA10224	6	.975	.442	.168	.005
PA10067	6	.583	.264	.089	.003	PA10148	6	.592	.269	.166	.005	PA10225	1	1.600	.726	.355	.010
PA10068	1	1.900	.862	.507	.014	PA10149	6	.425	.193	.163	.005	PA10226	1	1.100	.499	.200	.006
PA10069	6	1.091	.495	.130	.004	PA10150	6	.275	.125	.058	.002	PA10227	6	.667	.303	.134	.004
PA10070	6	.717	.325	.102	.003	PA10152 KIT	6	1.283	.582	.209	.006	PA10228	6	1.170	.531	.150	.004
PA10071	6	.792	.359	.097	.003	PA10153	6	.608	.276	.116	.003	PA10229	6	1.208	.548	.177	.005
PA10072	6	1.267	.575	.204	.006	PA10154	6	.380	.172	.059	.002	PA10230	6	1.083	.491	.146	.004
PA10073	6	.883	.401	.110	.003	PA10155	6	.383	.174	.151	.004	PA10231	6	.820	.372	.140	.004
PA10075	6	1.025	.465	.290	.008	PA10156	6	.742	.337	.101	.003	PA10232	6	1.342	.609	.207	.006
PA10076	6	1.200	.544	.291	.008	PA10157	6	.292	.132	.064	.002	PA10233	6	.883	.401	.210	.006
PA10077	6	1.258	.571	.233	.007	PA10158	6	.958	.435	.182	.005	PA10234	6	1.225	.556	.218	.006
PA10078	6	.925	.420	.162	.005	PA10159	6	.300	.136	.131	.004	PA10235	6	1.125	.510	.135	.004
PA10081	6	.366	.166	.078	.002	PA10160	6	.433	.196	.092	.003	PA10236	6	1.158	.525	.170	.005
PA10082	6	.308	.140	.056	.002	PA10161	6	.590	.268	.140	.004	PA10237	6	1.158	.525	.176	.005
PA10083	6	.633	.287	.098	.003	PA10162	6	1.075	.488	.101	.003	PA10238	6	1.042	.473	.162	.005
PA10084	6	.950	.431	.129	.004	PA10163	6	.467	.212	.056	.002	PA10239	6	1.010	.458	.133	.004
PA10085	6	.366	.166	.095	.003	PA10164	6	.533	.242	.217	.006	PA10240	6	1.158	.525	.170	.005

\* Sold in Full Cases Only.      TBD To be Determined.      \*\* Measurement is less than 0.001.



**WARNING:** These products can expose you to chemicals, including Diisononyl Phthalate, Carbon black extracts, Nickel, 1,3 Butadiene, Ethylene Oxide, Epichlorohydrin, which are known to the State of California to cause cancer, and Bisphenol-A, Ethylene Glycol, Ethylene Oxide, 1,3 Butadiene, Epichlorohydrin, which are known to the State of California to cause birth defects or other reproductive harm.

**BALDWIN WEIGHTS AND VOLUMES**

BALDWIN NUMBER	CASE QTY.	WEIGHT (ea.) lbs.	WEIGHT (ea.) kgs.	Volume (ea.) ft <sup>3</sup>	Volume (ea.) m <sup>3</sup>	BALDWIN NUMBER	CASE QTY.	WEIGHT (ea.) lbs.	WEIGHT (ea.) kgs.	Volume (ea.) ft <sup>3</sup>	Volume (ea.) m <sup>3</sup>	BALDWIN NUMBER	CASE QTY.	WEIGHT (ea.) lbs.	WEIGHT (ea.) kgs.	Volume (ea.) ft <sup>3</sup>	Volume (ea.) m <sup>3</sup>
PA10241	6	1.333	0.605	.222	0.006	PA10316	6	1.017	0.461	.180	0.005	PA10393	6	1.158	0.525	.231	0.007
PA10242	6	1.467	0.665	.187	0.005	PA10317	6	1.367	0.620	.280	0.008	PA10394	6	.775	0.352	.165	0.005
PA10243	1	1.650	0.748	.463	0.013	PA10318	6	.492	0.223	.137	0.004	PA10395	6	.600	0.272	.091	0.003
PA10244	6	1.392	0.631	.192	0.005	PA10319	6	.858	0.389	.134	0.004	PA10396	6	.316	0.143	.105	0.003
PA10245	6	1.175	0.533	.212	0.006	PA10320	6	.816	0.370	.155	0.004	PA10397	6	.775	0.352	.124	0.004
PA10246	1	3.250	1.474	.558	0.016	PA10321	6	.625	0.284	.109	0.003	PA10398	6	.842	0.382	.162	0.005
PA10247	6	.734	0.333	.124	0.004	PA10323	6	.675	0.306	.124	0.004	PA10399	6	.475	0.215	.097	0.003
PA10248	6	.808	0.367	.140	0.004	PA10324	6	.867	0.393	.144	0.004	PA10400	6	.300	0.136	.150	0.004
PA10249	6	1.225	0.556	.177	0.005	PA10325	6	.917	0.416	.146	0.004	PA10401	6	.416	0.189	.065	0.002
PA10250	6	1.317	0.597	.168	0.005	PA10326	6	.817	0.371	.152	0.004	PA10402	6	.366	0.166	.080	0.002
PA10251	6	.842	0.382	.116	0.003	PA10327	6	1.233	0.559	.223	0.006	PA10403	6	.533	0.242	.088	0.002
PA10253	6	1.058	0.480	.131	0.004	PA10328	6	.458	0.208	.060	0.002	PA10404	6	.917	0.416	.125	0.004
PA10254	6	1.075	0.488	.208	0.006	PA10329	6	.817	0.371	.154	0.004	PA10405	1	1.400	0.635	.348	0.010
PA10255	6	1.242	0.563	.173	0.005	PA10330	6	.908	0.412	.125	0.004	PA10407	6	.983	0.446	.108	0.003
PA10256	6	.692	0.314	.099	0.003	PA10331	6	.892	0.405	.174	0.005	PA10409	6	.833	0.378	.135	0.004
PA10257	1	1.580	0.717	.592	0.017	PA10332	6	.992	0.450	.167	0.005	PA10411	6	.308	0.140	.067	0.002
PA10258	6	.950	0.431	.121	0.003	PA10333	6	.708	0.321	.104	0.003	PA10412	6	.475	0.215	.056	0.002
PA10259	6	.908	0.412	.107	0.003	PA10334	6	.733	0.332	.103	0.003	PA10414	6	TBD	TBD	TBD	TBD
PA10260	6	1.000	0.454	.135	0.004	PA10335	6	1.683	0.763	.252	0.007	CV15000	4	1.637	0.743	.240	0.007
PA10261	6	.317	0.144	.046	0.001	PA10336	1	.800	0.363	.211	0.006	CV15001	12	.338	0.153	.033	0.001
PA10262	1	1.640	0.744	.756	0.021	PA10337	6	.933	0.423	.138	0.004	CV15002	1	.700	0.318	.075	0.002
PA10263	6	.925	0.420	.127	0.004	PA10338	1	1.450	0.658	.413	0.012	CV15003	12	.496	0.225	.106	0.003
PA10264	6	1.317	0.597	.153	0.004	PA10339	1	1.250	0.567	.408	0.012	CV15004	1	1.050	0.476	.173	0.005
PA10265	6	1.217	0.552	.166	0.005	PA10340	6	1.475	0.669	.256	0.007	CV15005	6	1.033	0.469	.211	0.006
PA10266	6	.650	0.295	.098	0.003	PA10341	6	.808	0.367	.113	0.003	CV15006	1	.800	0.363	.086	0.002
PA10267	6	1.030	0.467	.163	0.005	PA10342	6	.558	0.253	.141	0.004	CV15007	6	1.158	0.525	.215	0.006
PA10268	6	.858	0.389	.103	0.003	PA10343	6	.800	0.363	.132	0.004	CV15008	6	.966	0.438	.211	0.006
PA10269	6	.708	0.321	.156	0.004	PA10344	6	1.175	0.533	.192	0.005	CV15010	1	2.350	1.066	.262	0.007
PA10270	6	.883	0.401	.154	0.004	PA10345	6	1.258	0.571	.217	0.006	CV15011	6	.241	0.109	.027	0.001
PA10271	6	1.067	0.484	.168	0.005	PA10346	6	1.300	0.590	.215	0.006	BA16000	1	4.700	2.132	.234	0.007
PA10272	6	.725	0.329	.128	0.004	RS10347	1	.950	0.431	.192	0.005	PE17000	12	.279	0.127	.037	0.001
PA10273	6	1.408	0.639	.234	0.007	RS10348	1	.600	0.272	.127	0.004	PE17001	12	.225	0.102	.020	0.001
PA10274	1	.700	0.318	.192	0.005	RS10349	1	1.350	0.612	.309	0.009	18002	6	1.025	0.465	.151	0.004
PA10275	6	.425	0.193	.064	0.002	RS10350	1	2.400	1.089	.444	0.013	18004	6	.833	0.378	.096	0.003
PA10276	6	1.017	0.461	.169	0.005	RS10351	1	1.000	0.454	.288	0.008	18007	6	1.030	0.467	.225	0.006
PA10277	6	.942	0.427	.199	0.006	PA10352	6	1.142	0.518	.230	0.007	18009	6	.700	0.318	.135	0.004
PA10278	6	1.020	0.463	.235	0.007	PA10353	6	.391	0.177	.079	0.002	18010	6	1.375	0.624	.293	0.008
PA10279	6	1.425	0.646	.218	0.006	PA10354	6	2.250	1.021	.550	0.016	18011	6	.775	0.352	.143	0.004
PA10280	6	1.092	0.495	.207	0.006	PA10355	6	1.867	0.847	.526	0.015	18012	6	.433	0.196	.056	0.002
PA10281	6	.900	0.408	.173	0.005	PA10356	6	1.484	0.673	.386	0.011	18013	6	.775	0.352	.100	0.003
PA10282	6	.617	0.280	.080	0.002	PA10357	6	1.209	0.548	.238	0.007	18022	6	1.250	0.567	.146	0.004
PA10283	6	1.350	0.612	.216	0.006	PA10358	6	1.267	0.575	.160	0.005	18024	6	1.000	0.454	.145	0.004
PA10284	6	1.133	0.514	.174	0.005	SA10359	12	.117	0.053	.020	0.001	18025	6	1.017	0.461	.142	0.004
PA10285	6	1.017	0.461	.178	0.005	SA10360	12	.133	0.060	.038	0.001	18027	6	1.108	0.503	.292	0.008
PA10286	6	.417	0.189	.080	0.002	SA10361	12	.058	0.026	.013	**	18029	6	1.042	0.473	.147	0.004
PA10287	1	1.450	0.658	.796	0.023	PA10362	6	.225	0.102	.052	0.001	18031	6	.800	0.363	.043	0.001
PA10288	6	1.230	0.558	.230	0.007	PA10363	6	.383	0.174	.059	0.002	18032	6	.675	0.306	.059	0.002
PA10289	6	.390	0.177	.060	0.002	PA10364	6	.342	0.155	.080	0.002	18033	6	1.010	0.458	.144	0.004
PA10290	1	.900	0.408	.208	0.006	PA10365 KIT	6	.233	0.106	.050	0.001	18034	6	.966	0.438	.143	0.004
PA10291	6	1.092	0.495	.151	0.004	PA10367	6	.333	0.151	.073	0.002	18055	6	.858	0.389	.074	0.002
PA10292	6	1.417	0.643	.214	0.006	PA10368	6	.750	0.340	.142	0.004	18056	6	1.100	0.499	.230	0.007
PA10293	6	1.217	0.552	.208	0.006	PA10369	6	.767	0.348	.109	0.003	18057	6	1.400	0.635	.212	0.006
PA10294	6	1.142	0.518	.213	0.006	PA10370 KIT	6	.567	0.257	.132	0.004	18104	6	.633	0.287	.059	0.002
PA10295	6	1.017	0.461	.217	0.006	PA10371	1	.200	0.091	.070	0.002	18139	6	1.308	0.593	.139	0.004
PA10296	6	.550	0.249	.082	0.002	PA10372	6	.217	0.098	.053	0.001	18155	6	1.150	0.522	.229	0.006
PA10297	6	.725	0.329	.104	0.003	PA10373	6	.533	0.242	.169	0.005	18163	6	.717	0.325	.073	0.002
PA10298	6	.925	0.420	.175	0.005	PA10374	1	1.350	0.612	.226	0.006	18171	6	.933	0.423	.145	0.004
PA10299	6	1.367	0.620	.275	0.008	PA10375	6	.650	0.295	.167	0.005	18198	6	1.217	0.552	.146	0.004
PA10300	6	1.000	0.454	.175	0.005	PA10376	6	.450	0.204	.104	0.003	18236	6	1.330	0.603	.137	0.004
PA10301	6	.970	0.440	.188	0.005	PA10378	6	.700	0.318	.149	0.004	18245	6	1.016	0.461	.146	0.004
PA10302	6	1.392	0.631	.216	0.006	PA10379	6	1.258	0.571	.129	0.004	18264	6	1.425	0.646	.295	0.008
PA10303	6	1.250	0.567	.229	0.006	PA10380	6	.683	0.310	.113	0.003	18265	6	1.450	0.658	.290	0.008
PA10304	6	1.058	0.480	.218	0.006	PA10381	6	1.170	0.531	.209	0.006	18267	6	.742	0.337	.143	0.004
PA10305	6	.908	0.412	.133	0.004	PA10382	6	.750	0.340	.085	0.002	18268	6	.742	0.337	.059	0.002
PA10306	6	.825	0.374	.160	0.005	PA10383	6	.700	0.318	.130	0.004	19739	1	2.400	1.089	.194	0.005
PA10307	6	.683	0.310	.112	0.003	PA10384	6	.850	0.386	.181	0.005	19828	6	.525	0.238	.074	0.002
PA10308	6	1.200	0.544	.172	0.005	PA10385	6	.933	0.423	.239	0.007	19992	6	1.267	0.575	.122	0.003
PA10309	6	1.360	0.617	.440	0.012	PA10386	6	.875	0.397	.163	0.005	19996	6	1.700	0.771	.289	0.008
PA10310	6	1.267	0.575	.211	0.006	PA10387	6	1.308	0.593	.256	0.007	19999	6	1.620	0.735	.292	0.008
PA10311	6	1.167	0.529	.205	0.006	PA10388	6	.667	0.303	.128	0.004	20000	6	1.750	0.794	.287	0.008
PA10312	6	1.417	0.643	.252	0.007	PA10389	6	.617	0.280	.095	0.003	20002	6	1.267	0.575	.303	0.009
PA10313	6	.660	0.299	.110	0.003	PA10390	6	1.067	0.484	.203	0.006	20003	6	1.375	0.624	.293	0.008

**BALDWIN WEIGHTS AND VOLUMES**

BALDWIN NUMBER	CASE QTY.	WEIGHT (ea.) lbs.	WEIGHT (ea.) kgs.	Volume (ea.) ft <sup>3</sup>	Volume (ea.) m <sup>3</sup>	BALDWIN NUMBER	CASE QTY.	WEIGHT (ea.) lbs.	WEIGHT (ea.) kgs.	Volume (ea.) ft <sup>3</sup>	Volume (ea.) m <sup>3</sup>	BALDWIN NUMBER	CASE QTY.	WEIGHT (ea.) lbs.	WEIGHT (ea.) kgs.	Volume (ea.) ft <sup>3</sup>	Volume (ea.) m <sup>3</sup>
20006	6	1.350	0.612	.298	0.008	PT23020	1	2.000	0.907	.110	0.003	PT23098-MPG	1	2.900	1.315	.302	0.009
20007	6	1.283	0.582	.292	0.008	PT23023	1	2.954	1.340	.146	0.004	PT23100-MPG	1	.300	0.136	.017	**
20008	6	.725	0.329	.073	0.002	PT23024	1	1.250	0.567	.098	0.003	PT23101-MPG	1	3.350	1.520	.231	0.007
20010	6	.692	0.314	.059	0.002	PT23025	1	1.455	0.660	.060	0.002	PT23102-MPG	1	.900	0.408	.044	0.001
20011	6	1.142	0.518	.288	0.008	PT23026	1	1.499	0.680	.060	0.002	PT23103-MPG	1	1.050	0.476	.053	0.001
20012	6	1.042	0.473	.142	0.004	PT23027	1	2.400	1.089	.158	0.004	PT23104-MPG	1	15.350	6.963	.951	0.027
20013	6	1.058	0.480	.143	0.004	PT23028-MPG	1	1.720	0.780	.038	0.001	PT23105-MPG	1	.400	0.181	.017	**
20014	6	1.333	0.605	.197	0.006	PT23029-MPG	1	1.455	0.660	.060	0.002	PT23106-MPG	1	3.900	1.769	.198	0.006
20015	6	.942	0.427	.100	0.003	PT23030-MPG	1	2.910	1.320	.146	0.004	PT23107-MPG	1	.400	0.181	.017	**
20016	6	1.442	0.654	.290	0.008	PT23031-MPG	1	.250	0.113	.014	**	PT23108-MPG	1	.750	0.340	.037	0.001
20017	6	1.433	0.650	.292	0.008	PT23032-MPG	1	.300	0.136	.014	**	PT23109-MPG	1	.750	0.340	.037	0.001
20018	6	1.250	0.567	.229	0.006	PT23033-MPG	1	4.250	1.928	.232	0.007	PT23110-MPG	1	1.150	0.522	.044	0.001
20019	1	1.600	0.726	.435	0.012	PT23034-MPG	1	1.750	0.794	.081	0.002	PT23111-MPG	1	1.700	0.771	.072	0.002
20020	6	1.158	0.525	.225	0.006	PT23035-MPG	1	.850	0.386	.053	0.001	PT23112-MPG	1	1.700	0.771	.072	0.002
20021	6	1.667	0.756	.291	0.008	PT23036-MPG	1	.350	0.159	.014	**	PT23113-MPG	1	2.650	1.202	.164	0.005
20022	1	1.050	0.476	.433	0.012	PT23037-MPG	1	.353	0.160	.010	**	PT23114-MPG	1	2.600	1.179	.189	0.005
20023	6	1.342	0.609	.147	0.004	PT23038-MPG	1	.550	0.249	.021	0.001	PT23115-MPG	1	.600	0.272	.043	0.001
20024	1	.850	0.386	.225	0.006	PT23039-MPG	1	.550	0.249	.022	0.001	PT23116-MPG	1	6.350	2.880	.413	0.012
20025	6	1.000	0.454	.275	0.008	PT23040-MPG	1	1.300	0.590	.058	0.002	PT23117-MPG	1	.850	0.386	.053	0.001
20026	6	.642	0.291	.101	0.003	PT23041-MPG	1	1.650	0.748	.115	0.003	PT23118-MPG	1	1.700	0.771	.072	0.002
20027	6	.858	0.389	.143	0.004	PT23042-MPG	1	1.400	0.635	.104	0.003	PT23119-MPG	1	3.350	1.520	.206	0.006
20028	6	1.966	0.892	.232	0.007	PT23043-MPG	1	.750	0.340	.021	0.001	PT23120-MPG	1	4.750	2.155	.310	0.009
20029	6	1.808	0.820	.348	0.010	PT23044-MPG	1	1.300	0.590	.096	0.003	PT23122	12	.846	0.384	.101	0.003
20030	6	1.816	0.824	.339	0.010	PT23045-MPG	1	1.700	0.771	.078	0.002	PT23123	12	.650	0.295	.069	0.002
20031	12	.533	0.242	.048	0.001	PT23046-MPG	1	1.650	0.748	.070	0.002	PT23124	12	1.310	0.594	.109	0.003
20033	1	.950	0.431	.399	0.011	PT23047-MPG	1	.600	0.272	.034	0.001	PT23125-MPG	12	3.270	1.483	.100	0.003
20035	6	.925	0.420	.101	0.003	PT23048-MPG	1	2.900	1.315	.243	0.007	PT23126-MPG	12	.775	0.352	.031	0.001
20037	6	.627	0.282	.059	0.002	PT23049-MPG	1	2.800	1.270	.105	0.003	PT23127-MPG	12	.816	0.370	.040	0.001
20041	6	.933	0.423	.142	0.004	PT23051-MPG	1	15.100	6.849	1.423	0.040	PT23128-MPG	12	.617	0.280	.030	0.001
20042	6	.692	0.314	.074	0.002	PT23052-MPG	1	4.300	1.950	.151	0.004	PT23129-MPG	12	1.150	0.522	.062	0.002
20043	6	.808	0.367	.072	0.002	PT23053-MPG	1	3.950	1.792	.111	0.003	PT23131-MPG	1	3.071	1.393	.083	0.002
20044	6	1.750	0.794	.284	0.008	PT23054-MPG	1	2.350	1.066	.105	0.003	PT23132-MPG	12	.875	0.397	.032	0.001
20045	6	.900	0.408	.075	0.002	PT23055-MPG	1	.300	0.136	.014	**	PT23133-MPG	1	6.250	2.835	.496	0.014
20046	6	1.000	0.454	.220	0.006	PT23056-MPG	1	2.750	1.247	.072	0.002	PT23135-MPG	1	1.800	0.816	.074	0.002
20048	6	.817	0.371	.101	0.003	PT23057-MPG	1	2.300	1.043	.119	0.003	PT23136	12	.700	0.318	.070	0.002
20050	6	1.042	0.473	.069	0.002	PT23058-MPG	1	.300	0.136	.017	**	PT23137	6	2.630	1.193	.275	0.008
20051	6	.758	0.344	.071	0.002	PT23059-MPG	1	1.000	0.454	.053	0.001	PT23138	1	1.100	0.499	.097	0.003
20052	6	1.650	0.748	.373	0.011	PT23060-MPG	1	1.150	0.522	.058	0.002	PT23139-MPG	1	5.350	2.427	.389	0.011
20053	6	.458	0.208	.058	0.002	PT23061-MPG	1	1.750	0.794	.086	0.002	BT23140-MPG	1	2.750	1.247	.145	0.004
20054	6	.730	0.331	.070	0.002	PT23062-MPG	1	8.800	3.992	.540	0.015	PT23141	1	1.115	0.506	.092	0.003
20055	6	.775	0.352	.056	0.002	PT23063-MPG	1	1.800	0.816	.141	0.004	PT23142	1	.750	0.340	.029	0.001
20057	6	.642	0.291	.058	0.002	PT23064-MPG	1	.550	0.249	.023	0.001	PT23143	1	.350	0.159	.022	0.001
20058	6	1.242	0.563	.228	0.006	PT23065-MPG	1	15.500	7.031	.953	0.027	PT23144	1	1.250	0.567	.097	0.003
20060	6	.383	0.174	.058	0.002	PT23066-MPG	1	.650	0.295	.033	0.001	PT23145	1	.050	0.023	.005	**
20061	6	.833	0.378	.074	0.002	PT23067-MPG	1	.700	0.318	.033	0.001	PT23146	1	1.100	0.499	.082	0.002
20062	6	1.008	0.457	.224	0.006	PT23068-MPG	1	2.650	1.202	.167	0.005	PT23147	1	1.750	0.794	.199	0.006
20063	12	.241	0.109	.051	0.001	PT23069-MPG	1	.350	0.159	.014	**	PT23148	1	1.250	0.567	.082	0.002
20064	6	.875	0.397	.103	0.003	PT23070-MPG	1	3.350	1.520	.336	0.010	PT23149	1	1.400	0.635	.085	0.002
20065	6	1.000	0.454	.076	0.002	PT23071-MPG	1	1.150	0.522	.042	0.001	PT23150	1	1.200	0.544	.116	0.003
20066	6	1.092	0.495	.139	0.004	PT23072-MPG	1	2.750	1.247	.157	0.004	PT23151	1	3.150	1.429	.522	0.015
20067	6	.583	0.264	.072	0.002	PT23073-MPG	1	.300	0.136	.015	**	PT23152	1	3.400	1.542	.378	0.011
20068	6	.817	0.371	.071	0.002	PT23074-MPG	1	.650	0.295	.016	**	PT23154	1	1.600	0.726	.157	0.004
20069	6	1.300	0.590	.224	0.006	PT23075-MPG	1	1.350	0.612	.038	0.001	PT23155	1	2.500	1.134	.104	0.003
20070	6	1.408	0.639	.233	0.007	PT23076-MPG	1	1.200	0.544	.055	0.002	PT23156	1	2.800	1.270	.241	0.007
BW21000	12	1.504	0.682	.064	0.002	PT23077-MPG	1	.550	0.249	.023	0.001	PT23157	1	14.400	6.532	1.972	0.056
PT23000	1	2.350	1.066	.247	0.007	PT23078-MPG	1	.850	0.386	.055	0.002	PT23158	1	2.600	1.179	.301	0.009
PT23001	1	2.550	1.157	.251	0.007	PT23079-MPG	1	1.700	0.771	.093	0.003	PT23159	1	2.150	0.975	.192	0.005
PT23002	1	1.059	0.480	.037	0.001	PT23080-MPG	1	1.800	0.816	.082	0.002	PT23160	1	1.200	0.544	.059	0.002
PT23003	1	1.900	0.862	.212	0.006	PT23081-MPG	1	2.750	1.247	.137	0.004	PT23161	1	1.550	0.703	.085	0.002
PT23004	1	2.600	1.179	.233	0.007	PT23082-MPG	1	.450	0.204	.032	0.001	PT23162	1	.850	0.386	.053	0.001
PT23005	1	.650	0.295	.054	0.002	PT23083-MPG	1	.450	0.204	.033	0.001	PT23163	1	1.500	0.680	.081	0.002
PT23006	1	.500	0.227	.031	0.001	PT23084-MPG	1	.750	0.340	.037	0.001	PT23164	1	.300	0.136	.015	**
PT23007	1	.500	0.227	.031	0.001	PT23085-MPG	1	1.550	0.703	.072	0.002	PT23165	1	1.250	0.567	.152	0.004
PT23008	1	.550	0.249	.039	0.001	PT23086-MPG	1	.300	0.136	.016	**	PT23166	1	1.550	0.703	.082	0.002
PT23009	1	.750	0.340	.053	0.001	PT23087-MPG	1	.300	0.136	.013	**	PT23167	1	2.250	1.021	.237	0.007
PT23010	1	2.050	0.930	.124	0.004	PT23088-MPG	1	.300	0.136	.013	**	PT23168	1	2.600	1.179	.104	0.003
PT23011	1	2.600	1.179	.277	0.008	PT23089-MPG	1	2.250	1.021	.121	0.003	PT23169	1	2.200	0.998	.188	0.005
PT23012	1	1.250	0.567	.098	0.003	PT23090-MPG	1	.450	0.204	.015	**	PT23170	1	2.700	1.225	.241	0.007
PT23013	1	1.550	0.703	.114	0.003	PT23091-MPG	1	.700	0.318	.033	0.001	PT23172	1	.800	0.363	.053	0.001
PT23014	1	2.601	1.180	.099	0.003	PT23092-MPG	1	.700	0.318	.032	0.001	PT23173	1	2.450	1.111	.241	0.007
PT23015	1	.900	0.408	.057	0.002	PT23093-MPG	1	1.150	0.522	.053	0.001	PT23174	1	3.350	1.520		



**BALDWIN WEIGHTS AND VOLUMES**

BALDWIN NUMBER	CASE QTY.	WEIGHT (ea.) lbs.	WEIGHT (ea.) kgs.	Volume (ea.) ft <sup>3</sup>	Volume (ea.) m <sup>3</sup>	BALDWIN NUMBER	CASE QTY.	WEIGHT (ea.) lbs.	WEIGHT (ea.) kgs.	Volume (ea.) ft <sup>3</sup>	Volume (ea.) m <sup>3</sup>	BALDWIN NUMBER	CASE QTY.	WEIGHT (ea.) lbs.	WEIGHT (ea.) kgs.	Volume (ea.) ft <sup>3</sup>	Volume (ea.) m <sup>3</sup>
PT23180	1	2.400	1.089	.229	0.006	PT23264-MPG	1	2.350	1.066	.136	0.004	PT23350-MPG	1	.700	0.318	.031	0.001
PT23181	1	1.750	0.794	.113	0.003	PT23265-MPG	1	2.050	0.930	.099	0.003	PT23351-MPG	1	1.150	0.522	.059	0.002
PT23182	1	1.800	0.816	.110	0.003	PT23266-MPG	1	.750	0.340	.025	0.001	PT23352-MPG	1	.300	0.136	.014	0.001
PT23183	1	1.000	0.454	.099	0.003	PT23267-MPG	1	1.050	0.476	.053	0.001	PT23353-MPG	1	2.400	1.089	.098	0.003
PT23184	1	1.200	0.544	.099	0.003	PT23269-MPG	1	.850	0.386	.030	0.001	PT23354-MPG	1	2.400	1.089	.104	0.003
PT23185	1	2.350	1.066	.214	0.006	PT23270-MPG	1	.300	0.136	.016	0.001	PT23355-MPG	1	7.450	3.379	.511	0.014
PT23186	1	2.500	1.134	.247	0.007	PT23271-MPG	1	2.700	1.225	.170	0.005	PT23356-MPG	1	2.950	1.338	.102	0.003
PT23187	1	1.950	0.885	.156	0.004	PT23272-MPG	1	2.050	0.930	.101	0.003	PT23357-MPG	1	.850	0.386	.024	0.001
PT23188	1	2.200	0.998	.201	0.006	PT23273-MPG	1	2.650	1.202	.135	0.004	PT23358-MPG	1	.550	0.249	.022	0.001
PT23189	1	.800	0.363	.084	0.002	PT23274-MPG	1	2.650	1.202	.073	0.002	PT23359-MPG	1	2.400	1.089	.116	0.003
PT23190	1	.850	0.386	.025	0.001	PT23275-MPG	1	3.100	1.406	.070	0.002	PT23360-MPG	1	8.550	3.878	.538	0.015
PT23193-MPG	1	.350	0.159	.013	0.001	PT23276-MPG	1	4.250	1.928	.136	0.004	PT23361-MPG	1	1.150	0.522	.042	0.001
PT23195-MPG	1	.550	0.249	.032	0.001	PT23277-MPG	1	2.850	1.293	.143	0.004	PT23362-MPG	1	4.800	2.177	.233	0.007
PT23196-MPG	1	.800	0.363	.043	0.001	PT23278-MPG	1	1.950	0.885	.104	0.003	PT23363-MPG	1	1.650	0.748	.074	0.002
PT23197-MPG	1	1.150	0.522	.056	0.002	PT23279-MPG	1	2.650	1.202	.170	0.005	PT23364-MPG	1	3.950	1.792	.200	0.006
PT23198-MPG	1	.700	0.318	.053	0.001	PT23280-MPG	1	4.500	2.024	.017	0.001	PT23365-MPG	1	1.700	0.771	.040	0.001
PT23200-MPG	1	.950	0.431	.050	0.001	PT23281-MPG	1	1.450	0.658	.072	0.002	PT23366-MPG	1	2.400	1.089	.111	0.003
PT23201-MPG	1	1.050	0.476	.057	0.002	PT23282-MPG	1	6.200	2.812	.403	0.011	PT23367-MPG	1	.300	0.136	.016	0.001
PT23202-MPG	1	.350	0.159	.024	0.001	PT23283-MPG	1	1.900	0.862	.094	0.003	PT23368-MPG	1	2.950	1.338	.140	0.004
PT23203-MPG	1	.700	0.318	.029	0.001	PT23284-MPG	1	.850	0.386	.053	0.001	PT23369-MPG	1	.750	0.340	.020	0.001
PT23204-MPG	1	1.300	0.590	.058	0.002	PT23285-MPG	1	.450	0.204	.032	0.001	PT23370-MPG	1	1.650	0.748	.074	0.002
PT23205-MPG	1	.450	0.204	.016	0.001	PT23286-MPG	1	4.500	2.024	.017	0.001	PT23371-MPG	1	.600	0.272	.022	0.001
PT23206-MPG	1	.800	0.363	.024	0.001	PT23287-MPG	1	1.950	0.885	.101	0.003	PT23372-MPG	1	2.650	1.202	.072	0.002
PT23207-MPG	1	.850	0.386	.024	0.001	PT23289-MPG	1	1.300	0.590	.058	0.002	PT23373-MPG	1	.700	0.318	.030	0.001
PT23209-MPG	1	1.800	0.816	.110	0.003	PT23290-MPG	1	4.000	1.811	.016	0.001	PT23374-MPG	1	.500	0.227	.014	0.001
PT23211-MPG	1	4.200	1.905	.279	0.008	PT23291-MPG	1	2.850	1.293	.137	0.004	PT23375-MPG	1	.600	0.272	.022	0.001
PT23212-MPG	1	.950	0.431	.032	0.001	PT23292-MPG	1	.450	0.204	.024	0.001	PT23376-MPG	1	1.300	0.590	.024	0.001
PT23213-MPG	1	1.750	0.794	.113	0.003	PT23294-MPG	1	.300	0.136	.017	0.001	PT23377-MPG	1	.200	0.091	.016	0.001
PT23214-MPG	1	2.050	0.930	.157	0.004	PT23295-MPG	1	1.550	0.703	.055	0.002	PT23378-MPG	1	.700	0.318	.030	0.001
PT23215-MPG	1	1.700	0.771	.131	0.004	PT23296-MPG	1	1.200	0.544	.057	0.002	PT23379-MPG	1	.353	0.160	.010	0.001
PT23216-MPG	1	1.750	0.794	.082	0.002	PT23297	1	1.350	0.612	.114	0.003	PT23380-MPG	1	1.950	0.885	.093	0.003
PT23217-MPG	1	.500	0.227	.055	0.002	PT23306	1	1.700	0.771	.221	0.006	PT23381-MPG	1	1.650	0.748	.086	0.002
PT23218-MPG	1	.650	0.295	.017	0.001	PT23308	1	1.150	0.522	.041	0.001	PT23382-MPG	1	1.000	0.454	.035	0.001
PT23219-MPG	1	.900	0.408	.029	0.001	PT23309	1	.250	0.113	.017	0.001	PT23383-MPG	1	3.150	1.429	.115	0.003
PT23220-MPG	1	2.050	0.930	.102	0.003	PT23310	1	.750	0.340	.091	0.003	PT23384-MPG	1	.450	0.204	.016	0.001
PT23221-MPG	1	2.700	1.225	.143	0.004	PT23311	1	.400	0.181	.024	0.001	PT23385-MPG	1	3.150	1.429	.115	0.003
PT23223-MPG	1	2.800	1.270	.143	0.004	PT23312	1	1.350	0.612	.072	0.002	PT23386-MPG	1	3.250	1.474	.132	0.004
PT23224-MPG	1	2.850	1.293	.137	0.004	PT23313	1	2.250	1.021	.199	0.006	PT23387-MPG	1	.400	0.181	.017	0.001
PT23226-MPG	1	1.150	0.522	.347	0.010	PT23314	1	.450	0.204	.030	0.001	PT23388-MPG	1	.700	0.318	.040	0.001
PT23227-MPG	1	6.150	2.790	.384	0.011	PT23315	1	3.360	1.524	.243	0.007	PT23389-MPG	1	1.300	0.590	.031	0.001
PT23228-MPG	1	2.800	1.270	.153	0.004	PT23316	1	1.450	0.658	.074	0.002	PT23390-MPG	1	2.700	1.225	.243	0.007
PT23229-MPG	1	2.700	1.225	.247	0.007	PT23317	1	1.800	0.816	.091	0.003	PT23391-MPG	1	1.000	0.454	.056	0.002
PT23230-MPG	1	1.750	0.794	.085	0.002	PT23318	1	2.400	1.089	.330	0.009	PT23392-MPG	1	3.400	1.542	.283	0.008
PT23231-MPG	1	2.800	1.270	.139	0.004	PT23319	1	.200	0.091	.017	0.001	PT23393-MPG	1	2.200	0.998	.140	0.004
PT23232-MPG	1	3.150	1.429	.276	0.008	PT23320	1	.350	0.159	.023	0.001	PT23394-MPG	1	3.300	1.497	.292	0.008
PT23233-MPG	1	.550	0.249	.034	0.001	PT23321	1	.550	0.249	.043	0.001	PT23395-MPG	1	1.450	0.658	.055	0.002
PT23234-MPG	1	4.050	1.837	.380	0.011	PT23322	1	.550	0.249	.016	0.001	PT23396-MPG	1	2.750	1.247	.056	0.002
PT23235-MPG	1	1.500	0.680	.279	0.008	PT23323	1	1.550	0.703	.159	0.004	PT23397-MPG	1	2.750	1.247	.055	0.002
PT23236-MPG	1	1.500	0.680	.283	0.008	PT23324	1	2.200	0.998	.282	0.008	PT23398-MPG	1	2.750	1.247	.060	0.002
PT23237-MPG	1	2.700	1.225	.166	0.005	PT23325	1	3.150	1.429	.084	0.002	PT23399-MPG	1	1.450	0.658	.294	0.008
PT23238-MPG	1	2.150	0.975	.143	0.004	PT23326	1	.900	0.408	.042	0.001	PT23400-MPG	1	.900	0.408	.016	0.001
PT23239-MPG	1	7.550	3.425	.519	0.015	PT23327	1	.950	0.431	.055	0.002	PT23401-MPG	1	2.800	1.270	.103	0.004
PT23240-MPG	1	1.300	0.590	.030	0.001	PT23328	1	.850	0.386	.057	0.002	PT23402-MPG	1	3.400	1.542	.165	0.005
PT23241-MPG	1	2.800	1.270	.137	0.004	PT23329	1	.550	0.249	.029	0.001	PT23403-MPG	1	4.250	1.928	.212	0.006
PT23242-MPG	1	2.650	1.202	.175	0.005	PT23330	1	1.150	0.522	.100	0.003	PT23404-MPG	1	4.250	1.928	.210	0.006
PT23243-MPG	1	2.450	1.111	.110	0.003	PT23331	1	3.250	1.474	.251	0.007	PT23405-MPG	1	4.300	1.950	.212	0.006
PT23244-MPG	1	2.850	1.293	.137	0.004	PT23332	1	.700	0.318	.033	0.001	PT23406-MPG	1	1.100	0.499	.204	0.006
PT23245-MPG	1	4.850	2.200	.312	0.009	PT23333	1	.500	0.227	.024	0.001	PT23407-MPG	1	.500	0.227	.055	0.002
PT23246-MPG	1	1.450	0.658	.057	0.002	PT23334	1	.800	0.363	.059	0.002	PT23408-MPG	1	1.950	0.885	.029	0.001
PT23247-MPG	1	2.500	1.134	.137	0.004	PT23335	1	2.650	1.202	.284	0.008	PT23409-MPG	1	3.850	1.746	.299	0.008
PT23248-MPG	1	16.250	7.371	1.039	0.029	PT23336	1	1.100	0.499	.075	0.002	PT23410-MPG	1	1.150	0.522	.058	0.002
PT23249-MPG	1	7.600	3.447	.517	0.015	PT23337	1	.400	0.181	.024	0.001	PT23411-MPG	1	5.550	2.517	1.026	0.029
PT23250-MPG	1	3.900	1.769	.280	0.008	PT23338-MPG	1	.400	0.181	.016	0.001	PT23412-MPG	1	1.950	0.885	.091	0.003
PT23251-MPG	1	4.000	1.814	.253	0.007	PT23339-MPG	1	3.300	1.497	.070	0.002	PT23413-MPG	1	8.900	4.037	.266	0.008
PT23252-MPG	1	4.050	1.837	.271	0.008	PT23340-MPG	1	2.800	1.270	.114	0.003	PT23414-MPG	1	1.400	0.635	.059	0.002
PT23253-MPG	1	8.850	4.014	.522	0.015	PT23341-MPG	1	4.000	1.814	.104	0.003	PT23415-MPG	1	2.700	1.225	.174	0.005
PT23254-MPG	1	4.300	1.950	.104	0.003	PT23342-MPG	1	2.250	1.021	.123	0.003	PT23416-MPG	1	2.200	0.998	.141	0.004
PT23255-MPG	1	15.800	7.167	1.026	0.029	PT23343-MPG	1	18.700	8.482	1.972	0.056	PT23417-MPG	1	.900	0.408	.170	0.005
PT23257-MPG	1	2.200	0.998	.115	0.003	PT23344-MPG	1	1.350	0.612	.085	0.002	PT23418-MPG	1	.900	0.408	.016	0.001
PT23258-M																	

**BALDWIN WEIGHTS AND VOLUMES**

BALDWIN NUMBER	CASE QTY.	WEIGHT (ea.) lbs.	WEIGHT (ea.) kgs.	Volume (ea.) ft <sup>3</sup>	Volume (ea.) m <sup>3</sup>	BALDWIN NUMBER	CASE QTY.	WEIGHT (ea.) lbs.	WEIGHT (ea.) kgs.	Volume (ea.) ft <sup>3</sup>	Volume (ea.) m <sup>3</sup>	BALDWIN NUMBER	CASE QTY.	WEIGHT (ea.) lbs.	WEIGHT (ea.) kgs.	Volume (ea.) ft <sup>3</sup>	Volume (ea.) m <sup>3</sup>
PT23424-MPG	1	4.750	2.155	1.026	0.029	PT23501-MPG	1	.600	0.272	.042	0.001	PT23598-MPG	1	2.250	1.021	.200	0.006
PT23425-MPG	1	4.700	2.132	1.003	0.028	PT23502-MPG	1	2.600	1.179	.197	0.006	PT23600	1	4.700	2.132	.477	0.013
PT23426-MPG	1	5.650	2.563	.996	0.028	PT23503-MPG	1	.650	0.295	.037	0.001	BT23603-MPG	6	2.542	1.153	.094	0.003
PT23427-MPG	1	2.150	0.975	.449	0.013	PT23504-MPG	1	1.450	0.658	.081	0.002	BT23604	12	1.895	0.860	.053	0.001
PT23428-MPG	1	4.900	2.223	.996	0.028	PT23505-MPG	1	4.600	2.087	.378	0.011	BT23605-MPG	6	4.291	1.946	.237	0.007
PT23429-MPG	1	3.750	1.701	.101	0.003	PT23506-MPG	1	2.900	1.315	.141	0.004	BT23607-MPG	6	2.100	0.953	.102	0.003
PT23430-MPG	1	1.700	0.771	.040	0.001	PT23507-MPG	1	2.200	0.998	.105	0.003	BT23609-MPG	1	4.800	2.177	.226	0.006
PT23431-MPG	1	5.750	2.608	1.041	0.029	PT23508-MPG	1	8.150	3.697	.527	0.015	BT23611	12	1.563	0.709	.051	0.001
PT23432-MPG	1	1.800	0.816	.061	0.002	PT23509-MPG	1	1.450	0.658	.060	0.002	PT23613-MPG	1	9.800	4.445	.594	0.017
PT23433-MPG	1	1.950	0.885	.090	0.003	PT23510-MPG	1	.200	0.091	.017	**	PT23616-MPG	1	3.400	1.542	.228	0.006
PT23434-MPG	1	7.750	3.515	.395	0.011	PT23511-MPG	1	3.850	1.746	.245	0.007	BT23617	12	1.291	0.586	.049	0.001
PT23435-MPG	1	4.400	1.996	.267	0.008	PT23512-MPG	1	.500	0.227	.033	0.001	BT23619-MPG	12	2.733	1.240	.106	0.003
PT23436-MPG	1	2.050	0.930	.041	0.001	PT23513-MPG	1	.500	0.227	.032	0.001	BT23628	12	1.971	0.894	.078	0.002
PT23437-MPG	1	1.250	0.567	.031	0.001	PT23514-MPG	1	1.650	0.748	.113	0.003	PT23629	12	.317	0.144	.024	0.001
PT23438-MPG	1	2.200	0.998	.101	0.003	PT23515-MPG	1	4.200	1.905	.287	0.008	BT23630	12	.717	0.325	.029	0.001
PT23439-MPG	1	5.800	2.631	1.040	0.029	PT23516-MPG	1	.750	0.340	.053	0.001	BT23631	12	.567	0.257	.034	0.001
PT23440-MPG	1	2.550	1.157	.141	0.004	PT23517-MPG	1	5.300	2.404	.382	0.011	PT23633	6	1.017	0.461	.152	0.004
PT23441-MPG	1	.750	0.340	.104	0.003	PT23518-MPG	1	1.250	0.567	.115	0.003	PA30000	1	.350	0.159	.089	0.003
PT23442-MPG	1	.750	0.340	.025	0.001	PT23519-MPG	1	4.250	1.928	.282	0.008	PA30001	1	.200	0.091	.076	0.002
PT23443-MPG	1	.750	0.340	.031	0.001	PT23520-MPG	1	6.400	2.903	.380	0.011	PA30002	1	2.100	0.953	.280	0.008
PT23444-MPG	1	.800	0.363	.054	0.002	PT23521-MPG	1	1.300	0.590	.245	0.007	PA30003	1	2.800	1.270	.581	0.016
PT23445-MPG	1	1.700	0.771	.079	0.002	PT23522-MPG	1	2.350	1.066	.170	0.005	PA30004	1	2.400	1.089	.306	0.009
PT23446-MPG	1	3.300	1.497	.287	0.008	PT23523-MPG	1	1.900	0.862	.135	0.004	PA30005	1	1.400	0.635	.189	0.005
PT23447-MPG	1	.350	0.159	.017	**	PT23524-MPG	1	.550	0.249	.022	0.001	PA30006	1	.550	0.249	.178	0.005
PT23448-MPG	1	.550	0.249	.030	0.001	BT23525-MPG	12	1.429	0.648	.063	0.002	PA30007	6	1.041	0.472	.214	0.006
PT23449-MPG	1	6.050	2.744	.390	0.011	PT23526	1	2.150	0.975	.106	0.003	RS30008	1	14.050	6.373	3.351	0.095
PT23450-MPG	1	5.650	2.563	.280	0.008	PT23527	12	.350	0.159	.030	0.001	RS30009	1	3.600	1.633	1.078	0.031
PT23451	1	4.700	2.132	.519	0.015	PT23528-MPG	1	.350	0.159	.014	**	PA30010	1	9.000	4.082	1.898	0.054
PT23453	1	6.050	2.744	.598	0.017	PT23530	1	1.750	0.794	.140	0.004	PA30011	6	.808	0.367	.125	0.004
PT23454	1	3.400	1.542	.426	0.012	PT23531-MPG	1	4.600	2.087	.281	0.008	PA30012	6	.666	0.302	.076	0.002
PT23455	1	2.000	0.907	.218	0.006	PT23532-MPG	1	1.250	0.567	.041	0.001	PA30013	1	1.900	0.862	.408	0.012
PT23456	1	1.000	0.454	.092	0.003	PT23533	1	2.550	1.157	.035	0.001	PA30014	12	.445	0.202	.086	0.002
PT23457	1	1.950	0.885	.192	0.005	PT23536	12	.642	0.291	.060	0.002	PA30015	1	.450	0.204	.118	0.003
PT23458	1	1.900	0.862	.196	0.006	PT23535	1	.662	0.300	.064	0.002	PA30016	12	.529	0.240	.062	0.002
PT23459	1	1.250	0.567	.079	0.002	BT23537	1	2.750	1.247	.113	0.003	PA30017	12	.508	0.230	.082	0.002
PT23460	1	.250	0.113	.022	0.001	BT23539	1	3.250	1.474	.184	0.005	PA30018	12	.562	0.255	.065	0.002
PT23461	1	1.900	0.862	.160	0.005	BT23540	1	2.700	1.225	.117	0.003	PA30019	12	.475	0.215	.058	0.002
PT23462	1	1.400	0.635	.136	0.004	BT23542-MPG	1	4.800	2.177	.226	0.006	PA30020	1	.400	0.181	.084	0.002
PT23463	1	.200	0.091	.016	**	BT23543-MPG	6	5.475	2.483	.161	0.005	PA30021	1	.850	0.386	.081	0.002
PT23464	1	.650	0.295	.041	0.001	PT23544-MPG	12	.929	0.421	.126	0.004	PA30022	12	.500	0.227	.066	0.002
PT23465	1	.700	0.318	.051	0.001	PT23545-MPG	1	9.100	4.128	.614	0.017	PA30023	1	3.050	1.383	.587	0.017
PT23467	1	4.150	1.882	.378	0.011	PT23546-MPG	1	5.600	2.540	.479	0.014	PA30024	12	.554	0.251	.056	0.002
PT23468	1	1.450	0.658	.089	0.003	BT23555-MPG	6	3.633	1.648	.204	0.006	PA30025	1	.850	0.386	.296	0.008
PT23469	1	2.100	0.953	.201	0.006	PT23556-MPG	1	1.050	0.476	.100	0.003	PA30026	1	2.650	1.202	.597	0.017
PT23470	1	.450	0.204	.032	0.001	PT23560	6	4.650	2.109	.065	0.002	PA30028	1	1.450	0.658	.208	0.006
PT23471	1	2.400	1.089	.201	0.006	PT23561-MPG	12	1.438	0.652	.118	0.003	PA30029	12	.308	0.140	.055	0.002
PT23472	1	1.050	0.476	.082	0.002	PT23565-MPG	1	2.350	1.066	.238	0.007	PA30030	6	.791	0.359	.125	0.004
PT23473	1	1.400	0.635	.165	0.005	PT23566-MPG	1	2.950	1.338	.286	0.008	PA30031	12	.437	0.198	.061	0.002
PT23474	1	.650	0.295	.034	0.001	PT23567-MPG	1	.400	0.181	.040	0.001	PA30032	1	2.400	1.089	.282	0.008
PT23475	1	1.450	0.658	.095	0.003	PT23568-MPG	1	.650	0.295	.021	0.001	PA30033	1	.500	0.227	.092	0.003
PT23476	1	1.000	0.454	.053	0.001	PT23569-MPG	1	1.000	0.454	.065	0.002	PA30034	12	.475	0.215	.040	0.001
PT23477	1	1.700	0.771	.115	0.003	PT23570-MPG	1	.550	0.249	.023	0.001	PA30035	12	.370	0.168	.043	0.001
PT23478	1	.450	0.204	.025	0.001	PT23571-MPG	1	.200	0.091	.013	**	PA30036	1	.800	0.363	.127	0.004
PT23479	1	1.700	0.771	.141	0.004	PT23572-MPG	1	.550	0.249	.030	0.001	PA30037	1	11.700	5.307	1.378	0.039
PT23480	1	1.450	0.658	.089	0.003	PT23573-MPG	1	.300	0.136	.016	**	PA30038	1	10.500	4.763	1.515	0.043
PT23481	1	1.250	0.567	.083	0.002	PT23574-MPG	1	.200	0.091	.024	0.001	PA30039	1	21.750	9.866	3.666	0.104
PT23482	1	1.200	0.544	.082	0.002	PT23575-MPG	1	.450	0.204	.016	**	PA30040	1	12.600	5.715	1.672	0.047
PT23483-MPG	1	8.250	3.742	.937	0.027	PT23576-MPG	1	.700	0.318	.030	0.001	PA30041	1	17.600	7.983	2.805	0.079
PT23484-MPG	1	2.000	0.907	.030	0.001	PT23577-MPG	1	1.650	0.748	.243	0.007	PA30042	1	3.350	1.520	.533	0.015
PT23485-MPG	1	8.000	3.629	.519	0.015	PT23578-MPG	1	1.300	0.590	.059	0.002	PA30043	1	19.100	8.664	2.824	0.080
PT23486-MPG	1	14.100	6.396	1.147	0.032	PT23579-MPG	1	2.450	1.111	.196	0.006	PA30044	6	.233	0.106	.064	0.002
PT23487-MPG	1	3.450	1.565	.282	0.008	PT23580-MPG	1	1.600	0.726	.069	0.002	PA30045	1	.900	0.408	.197	0.006
PT23488-MPG	1	2.200	0.998	.160	0.005	PT23581-MPG	1	5.000	2.268	.331	0.009	PA30048	1	4.200	1.905	.380	0.011
PT23489-MPG	1	.700	0.318	.030	0.001	PT23582-MPG	1	2.700	1.225	.194	0.005	PA30049	1	6.100	2.767	.376	0.011
PT23490-MPG	1	1.150	0.522	.057	0.002	PT23583-MPG	1	2.450	1.111	.244	0.007	PA30050	6	.408	0.185	.066	0.002
PT23491-MPG	1	.500	0.227	.030	0.001	PT23585	1	2.500	1.134	.137	0.004	PA30051	6	.283	0.128	.046	0.001
PT23492-MPG	1	.200	0.091	.017	**	PT23586	1	.800	0.363	.082	0.002	PA30052	6	.516	0.234	.085	0.002
PT23493-MPG	1	1.850	0.839	.083	0.002	PT23587	1	1.350	0.612	.121	0.003	PA30053	6	.183	0.083	.022	0.001
PT23494-MPG	1	.300	0.136	.014	**	PT23588	1	2.650	1.202	.333	0.009	PA30054	6	.375	0.170	.064	0.002
PT23495-MPG	1	.450	0.204	.031	0.001	PT23589	1	5.950	2.699	.516	0.015	PA30055	6	.283	0.128	.046	

**BALDWIN WEIGHTS AND VOLUMES**

BALDWIN NUMBER	CASE QTY.	WEIGHT (ea.) lbs.	WEIGHT (ea.) kgs.	Volume (ea.) ft <sup>3</sup>	Volume (ea.) m <sup>3</sup>	BALDWIN NUMBER	CASE QTY.	WEIGHT (ea.) lbs.	WEIGHT (ea.) kgs.	Volume (ea.) ft <sup>3</sup>	Volume (ea.) m <sup>3</sup>	BALDWIN NUMBER	CASE QTY.	WEIGHT (ea.) lbs.	WEIGHT (ea.) kgs.	Volume (ea.) ft <sup>3</sup>	Volume (ea.) m <sup>3</sup>
RS30061	1	.650	0.295	.220	0.006	PA30141	6	.641	0.291	.141	0.004	RS30236	1	5.400	2.449	.967	0.027
RS30062	1	5.550	2.517	1.283	0.036	RS30142	1	8.300	3.765	1.677	0.047	RS30237	1	3.100	1.406	.881	0.025
PA30063	1	.850	0.386	.133	0.004	RS30142 KIT	1	10.900	4.944	3.146	0.089	RS30242	1	.500	0.227	.129	0.004
PA30064	1	2.200	0.998	.372	0.011	RS30143	1	9.900	4.491	2.012	0.057	PA30243	1	5.250	2.381	.891	0.025
RS30065	1	11.650	5.284	2.340	0.066	RS30143 KIT	1	12.750	5.783	4.084	0.116	PA30244	1	1.700	0.771	.217	0.006
RS30065 KIT	1	15.400	6.985	4.117	0.117	PA30144	6	.441	0.200	.095	0.003	PA30249	6	.792	0.359	.114	0.003
PA30066	1	13.150	5.965	2.260	0.064	PA30145	1	10.800	4.899	2.457	0.070	PA30251	6	.441	0.200	.091	0.003
PA30067	1	4.600	2.087	.604	0.017	PA30146	1	4.000	1.814	.847	0.024	PA30252	6	.675	0.306	.079	0.002
PA30068	1	1.350	0.612	.122	0.003	RS30147	1	1.050	0.476	.175	0.005	PA30253	1	1.400	0.635	.268	0.008
PA30069	1	4.300	1.950	1.529	0.043	PA30148	1	1.529	0.068	.030	0.001	PA30255	6	.517	0.235	.078	0.002
PA30070	1	3.950	1.792	.581	0.016	PA30149	1	1.625	0.737	.392	0.011	RS30257	1	4.550	2.064	.911	0.026
CA30071	1	3.450	1.565	.784	0.022	PA30150	1	300	0.136	.065	0.002	PA30258	1	2.350	1.066	.292	0.008
PA30072	6	1.158	0.525	.158	0.004	PA30151	6	.675	0.306	.104	0.003	PA30260	6	.516	0.234	.120	0.003
PA30073	1	15.100	6.849	1.981	0.056	PA30152	6	.300	0.136	.053	0.001	PA30261	6	.158	0.072	.036	0.001
PA30074	1	16.150	7.326	1.941	0.055	PA30153	12	.329	0.149	.038	0.001	PA30262	6	.241	0.109	.052	0.001
PA30075	1	2.350	1.066	.410	0.012	PA30154	6	.216	0.098	.066	0.002	PA30263	6	1.275	0.578	.227	0.006
PA30076	1	2.950	1.338	.896	0.025	PA30155	1	.250	0.113	.103	0.003	PA30264	1	2.350	1.066	.174	0.005
RS30077	1	1.200	0.544	.197	0.006	PA30156	1	.850	0.386	.090	0.003	PA30268	1	.600	0.272	.100	0.003
RS30078	1	.450	0.204	.106	0.003	PA30157	12	.010	0.005	.001	**	PA30269	12	.296	0.134	.066	0.002
CA30079	1	3.350	1.520	.581	0.016	PA30158	1	7.650	3.470	1.154	0.033	PA30270	6	.558	0.253	.083	0.002
PA30080	6	.716	0.325	.045	0.001	RS30159	1	8.400	3.810	2.174	0.062	PA30271	1	7.500	3.402	.566	0.016
PA30081	1	.450	0.204	.082	0.002	RS30160	1	2.450	1.111	.691	0.020	PA30272	6	1.050	0.476	.146	0.004
PA30086	6	.591	0.268	.112	0.003	RS30161	1	8.450	3.833	1.662	0.047	PA30275	1	4.500	2.041	.759	0.021
RS30087	1	14.600	6.623	3.431	0.097	RS30162	1	6.200	2.812	.366	0.010	PA30276	6	.341	0.155	.089	0.003
RS30088	1	4.950	2.245	1.339	0.038	PA30163	1	.300	0.136	.165	0.005	PA30277	6	.408	0.185	.089	0.003
RS30090-FN	1	6.000	2.722	1.650	0.047	PA30164	1	.350	0.159	.071	0.002	PA30279	6	.508	0.230	.061	0.002
RS30091	1	6.750	3.062	1.630	0.046	PA30165	1	100	0.045	.071	0.002	PA30281	6	.141	0.064	.047	0.001
RS30092	1	1.950	0.885	.481	0.014	PA30166	1	.015	0.007	.017	**	RS30285	1	6.800	3.084	1.495	0.042
PA30093	6	.425	0.193	.098	0.003	RS30168	1	4.300	1.950	.856	0.024	PA30287	6	.166	0.075	.085	0.002
PA30094	1	.300	0.136	.147	0.004	RS30169	1	1.000	0.454	.238	0.007	RS30290	1	14.850	6.736	3.407	0.096
PA30095	1	2.650	1.202	.464	0.013	PA30170	1	9.450	4.287	2.087	0.059	PA30292	1	.200	0.091	.054	0.002
PA30096	1	.350	0.159	.097	0.003	PA30171	1	6.000	2.722	1.456	0.041	PA30293	1	.350	0.159	.070	0.002
PA30098	1	.900	0.408	.114	0.003	PA30172	1	.842	0.382	.285	0.008	PA30299	6	1.766	0.801	.353	0.010
RS30099	1	1.300	0.590	.144	0.004	PA30173	1	.250	0.113	.060	0.002	PA30301	6	.550	0.249	.105	0.003
PA30100	1	.150	0.068	.024	0.001	PA30174	6	.858	0.389	.181	0.005	PA30302	12	.112	0.051	.020	0.001
PA30101	1	.350	0.159	.067	0.002	RS30175	1	7.950	3.606	1.901	0.054	PA30303	6	.775	0.352	.124	0.004
CA30102	1	8.150	3.697	1.002	0.028	PA30177	6	.533	0.242	.103	0.003	PA30304	6	.733	0.332	.101	0.003
CA30103	1	9.250	4.196	1.617	0.046	PA30179	6	.400	0.181	.124	0.004	RS30305	1	8.750	3.969	1.974	0.056
CA30104	1	9.750	4.423	1.765	0.050	RS30180	1	5.800	2.631	1.544	0.044	RS30306	1	2.300	1.043	.705	0.020
CA30105	1	7.550	3.425	1.371	0.039	RS30181	1	2.500	1.134	.768	0.021	RS30307	1	8.100	3.674	2.048	0.058
RS30106	1	1.750	0.794	.358	0.010	RS30182	1	8.400	3.810	1.974	0.056	RS30308	1	2.150	0.975	.610	0.017
PA30107	1	.020	0.009	.021	0.001	PA30183	1	2.950	1.338	.231	0.007	PA30309	1	12.225	5.545	1.626	0.046
PA30108	1	2.900	1.315	.592	0.017	PA30185	6	1.500	0.680	.259	0.007	PA30310	6	.650	0.295	.113	0.003
PA30109	1	9.000	4.082	1.566	0.044	RS30187XP	1	13.600	6.169	2.943	0.083	RS30311	1	12.550	5.693	3.050	0.086
PA30110	1	.500	0.227	.077	0.002	PA30188	6	.105	0.048	.026	0.001	RS30313	1	7.450	3.379	1.446	0.041
RS30112	1	7.400	3.357	1.933	0.055	PA30189	6	.950	0.431	.133	0.004	PA30314	1	13.650	6.192	2.061	0.058
PA30113	1	.300	0.136	.089	0.003	PA30190	6	1.525	0.692	.165	0.005	PA30315	1	15.600	7.076	2.267	0.064
PA30114	1	.450	0.204	.177	0.005	RS30191	1	1.500	0.680	.517	0.015	PA30316	1	18.500	8.392	2.952	0.084
PA30115	6	.383	0.174	.063	0.002	RS30192	1	6.250	2.835	1.328	0.038	PA30317	1	17.100	7.757	2.488	0.070
RS30116	1	9.950	4.513	2.143	0.061	PA30193-FN	1	6.900	3.130	1.650	0.047	PA30318	1	15.600	7.076	2.026	0.057
PA30117	1	.550	0.249	.140	0.004	PA30194	1	1.400	0.635	.612	0.017	PA30319	1	17.950	8.142	2.753	0.078
PA30118	1	1.800	0.816	.361	0.010	PA30204	12	.783	0.355	.066	0.002	PA30320	1	12.350	5.602	1.593	0.045
PA30119	1	.550	0.249	.077	0.002	PA30206	1	2.550	1.157	.416	0.012	PA30321	1	12.050	5.466	1.595	0.045
RS30120	1	1.200	0.544	.302	0.009	PA30207	1	2.550	1.157	.387	0.011	PA30322	1	19.100	8.664	2.822	0.080
RS30121	1	5.100	2.313	1.170	0.033	PA30208	1	.500	0.227	.178	0.005	PA30323	1	22.650	10.274	3.452	0.098
PA30122	1	.750	0.340	.178	0.005	RS30209	1	1.000	0.454	.159	0.004	PA30324	6	.766	0.347	.108	0.003
PA30123	1	1.000	0.454	.186	0.005	PA30211	1	1.600	0.726	.334	0.009	PA30325	6	.483	0.219	.115	0.003
PA30124	1	.850	0.386	.172	0.005	RS30212	1	2.750	1.247	.495	0.014	RS30327	1	10.100	4.581	2.610	0.074
PA30125	1	5.600	2.540	1.287	0.036	RS30213	1	.750	0.340	.241	0.007	RS30328	1	3.100	1.406	.824	0.023
PA30126	6	1.117	0.507	.194	0.005	RS30216	1	8.050	3.651	1.966	0.056	PA30329	6	1.600	0.726	.185	0.005
PA30127	1	.600	0.272	.090	0.003	RS30217	1	2.000	0.907	.489	0.014	PA30330	6	.533	0.242	.135	0.004
RS30128	1	11.550	5.239	2.567	0.073	RS30220	1	1.800	0.816	.293	0.008	PA30331	6	.250	0.113	.035	0.001
RS30129	1	4.050	1.837	1.056	0.030	RS30221	1	.450	0.204	.124	0.004	PA30332	6	.858	0.389	.127	0.004
RS30130	1	6.300	2.858	1.511	0.043	RS30222XP	1	3.750	1.701	.748	0.021	PA31000	1	9.850	4.468	1.213	0.034
CA30131	1	8.250	3.742	1.195	0.034	RS30223	1	7.050	3.198	1.332	0.038	PA31001	1	1.400	0.635	.145	0.004
CA30132	1	8.650	3.924	1.400	0.040	RS30224	1	2.250	1.021	.555	0.016	PA31002	1	6.600	2.994	.873	0.025
RS30133	1	9.150	4.150	2.048	0.058	RS30225	1	2.250	2.835	1.402	0.040	PA31003	1	1.250	0.567	.076	0.002
RS30134	1	2.950	1.338	.805	0.023	RS30226	1	2.050	0.930	.513	0.015	PA31004	1	5.200	2.359	.474	0.013
RS30135	1	8.850	4.014	2.090	0.059	PA30228	1	.250	0.113	.070	0.002	PA31005	1	.850	0.386	.056	0.002
RS30136	1	2.550	1.157	.676	0.019	PA30229	1	.150	0.068	.029	0.001	PA31006	1	7.000	3.175	.647	0.018
PA30137	1	.450	0.204	.098	0.003												

# BALDWIN WEIGHTS AND VOLUMES

BALDWIN NUMBER	CASE QTY.	WEIGHT (ea.) lbs.	WEIGHT (ea.) kgs.	Volume (ea.) ft <sup>3</sup>	Volume (ea.) m <sup>3</sup>	BALDWIN NUMBER	CASE QTY.	WEIGHT (ea.) lbs.	WEIGHT (ea.) kgs.	Volume (ea.) ft <sup>3</sup>	Volume (ea.) m <sup>3</sup>	BALDWIN NUMBER	CASE QTY.	WEIGHT (ea.) lbs.	WEIGHT (ea.) kgs.	Volume (ea.) ft <sup>3</sup>	Volume (ea.) m <sup>3</sup>
PA31011	1	.900	0.408	.061	0.002	P40095	12	283	0.128	.048	0.001	BF46031	12	1.508	0.684	.091	0.003
PA31012	1	5.300	2.404	.672	0.019	P40096	12	288	0.131	.047	0.001	BF46032	12	2.116	0.960	.087	0.002
PA31013	1	2.700	1.225	.241	0.007	P40098	12	246	0.112	.047	0.001	PF46033	12	.570	0.259	.064	0.002
PA31014	1	.600	0.272	.038	0.001	P40099	12	233	0.106	.048	0.001	BF46034	12	2.595	1.177	.128	0.004
PA32000	1	9.000	4.082	1.294	0.037	P40100	12	263	0.119	.036	0.001	BF46037	12	1.025	0.465	.060	0.002
PA32001	1	4.950	2.245	.654	0.019	P40101	12	.110	0.050	.020	0.001	BF46038-D	12	.800	0.363	.064	0.002
PA32002	1	12.750	5.783	1.855	0.052	P40102	12	238	0.108	.034	0.001	BF46039-D	12	.721	0.327	.065	0.002
PA32003	1	6.400	2.903	.786	0.022	P40103	12	283	0.128	.038	0.001	BF46040-D	12	.562	0.255	.049	0.001
PA32004	1	.400	0.181	.029	0.001	P40104	12	.292	0.132	.033	0.001	BF46041-D	12	.792	0.359	.065	0.002
B40000	12	.500	0.227	.027	0.001	P40105	12	313	0.142	.041	0.001	BF46042-D	6	1.833	0.831	.166	0.005
P40001	12	.229	0.104	.037	0.001	P40106	12	296	0.134	.041	0.001	BF46043-D	6	1.883	0.854	.164	0.005
P40002	12	.100	0.045	.008	0.001	P40107	12	250	0.113	.050	0.001	BF46044-D	12	.800	0.363	.063	0.002
P40003	12	.492	0.223	.089	0.003	P40108	12	242	0.110	.039	0.001	BF46045-D	12	.708	0.321	.051	0.001
C40004	1	1.000	0.454	.073	0.002	P40109	12	.196	0.089	.038	0.001	PF46046	12	.650	0.295	.081	0.002
C40005	12	.804	0.365	.064	0.002	P40110	12	.417	0.189	.061	0.002	BF46048	12	1.692	0.767	.066	0.002
B40006	12	.758	0.344	.028	0.001	P40111	12	279	0.127	.038	0.001	PF46049	12	.500	0.227	.058	0.002
BC40007	12	.400	0.181	.022	0.001	P40112	12	213	0.097	.049	0.001	BF46050	12	1.650	0.748	.074	0.002
P40008	6	1.100	0.499	.194	0.005	P40113	12	208	0.094	.029	0.001	BF46051	12	1.367	0.620	.079	0.002
BC40009	6	.800	0.363	.099	0.003	P40114	12	258	0.117	.033	0.001	BF46052	12	1.300	0.590	.066	0.002
P40010	12	.129	0.059	.020	0.001	P40115	12	258	0.117	.049	0.001	PF46056	12	.567	0.257	.055	0.002
P40011	12	.400	0.181	.034	0.001	P40116	12	.146	0.066	.025	0.001	PF46057	12	.446	0.202	.033	0.001
P40012	12	.833	0.378	.107	0.003	P40117	12	429	0.195	.065	0.002	PF46059	12	.358	0.162	.037	0.001
B40013	1	5.700	2.586	.246	0.007	P40118	12	312	0.142	.061	0.002	BF46062	12	1.150	0.522	.077	0.002
P40014	12	.171	0.078	.029	0.001	P40119	12	200	0.091	.029	0.001	BF46064-D	6	1.591	0.722	.170	0.005
BT40015	12	.595	0.270	.027	0.001	B40120	12	1.179	0.535	.060	0.002	BF46065-SPS	12	1.825	0.828	.079	0.002
P40017	12	.400	0.181	.067	0.002	B40122	12	TBD	TBD	TBD	TBD	BF46069	12	1.725	0.782	.077	0.002
P40019	12	.800	0.363	.127	0.004	B40124	12	.663	0.301	.029	0.001	BF46071	12	2.650	1.202	.158	0.004
P40020	12	.354	0.161	.053	0.001	B40125	12	.908	0.412	.048	0.001	BF46072	12	2.608	1.183	.153	0.004
P40021	12	.304	0.138	.049	0.001	B40126	12	.667	0.303	.031	0.001	BF46073	12	2.921	1.325	.131	0.004
B40022-MPG	12	2.017	0.915	.099	0.003	B40127	12	1.254	0.569	.063	0.002	PF46076	12	.408	0.185	.048	0.001
P40023	12	.317	0.144	.049	0.001	B40128	12	.783	0.355	.036	0.001	PF46077	12	.158	0.072	.020	0.001
P40024	12	.238	0.108	.032	0.001	B40129	12	.775	0.352	.038	0.001	BF46078-D	12	.567	0.257	.051	0.001
P40025	12	.329	0.149	.046	0.001	P40130	12	.154	0.070	.030	0.001	PF46079	12	4.100	1.860	.441	0.012
BD40027	6	4.167	1.890	.168	0.005	P40131	12	.154	0.070	.032	0.001	PF46080	6	2.233	1.013	.258	0.007
BT40028	12	1.033	0.469	.049	0.001	P40132	12	.138	0.063	.011	0.001	PF46081	12	.858	0.389	.105	0.003
BT40029	12	1.996	0.905	.076	0.002	B40133	12	1.646	0.747	.074	0.002	PF46082	12	.821	0.372	.104	0.003
P40030	12	.463	0.210	.088	0.002	B40136	12	.695	0.315	.024	0.001	BF46083-O	6	1.558	0.707	.083	0.002
P40031-MPG	6	1.383	0.627	.188	0.005	B40137	6	1.966	0.892	.075	0.002	BF46084	12	.358	0.162	.048	0.001
BT40032	12	1.346	0.611	.065	0.002	B40138	6	1.950	0.885	.074	0.002	BF46085	12	2.463	1.117	.098	0.003
P40033	12	.196	0.089	.028	0.001	BD40139	6	5.050	2.291	.167	0.005	BF46087	12	.858	0.389	.095	0.003
BT40034	12	.725	0.329	.046	0.001	B40140	12	.700	0.318	.024	0.001	PF46088	12	.304	0.138	.041	0.001
P40035	12	.317	0.144	.044	0.001	B40142	6	3.691	1.674	.163	0.005	PF46091	6	1.667	0.756	.163	0.005
B40036	12	.670	0.304	.023	0.001	B40145	6	4.342	1.970	.172	0.005	PF46092	6	.967	0.439	.112	0.003
P40037	12	.338	0.153	.033	0.001	B40150	12	1.083	0.491	.050	0.001	PF46094	6	.983	0.446	.108	0.003
BT40038	12	.729	0.331	.022	0.001	BF45000	12	.129	0.059	.020	0.001	BF46098-O	6	1.533	0.695	.080	0.002
P40042	6	1.075	0.488	.163	0.005	BF46000	12	.962	0.436	.063	0.002	BF46099-O	6	1.975	0.896	.146	0.004
B40050	12	1.037	0.470	.119	0.003	BF46001	12	.900	0.408	.064	0.002	BF46100-O	6	1.550	0.703	.092	0.003
B40051	12	.758	0.344	.028	0.001	BF46002	6	3.883	1.761	.149	0.004	BF46101-O	6	2.142	0.972	.105	0.003
PF40052	12	.258	0.117	.034	0.001	PF46003	12	.792	0.359	.108	0.003	PF46103	12	.300	0.136	.035	0.001
B40053	6	3.067	1.391	.152	0.004	PF46004	12	.750	0.340	.105	0.003	BF46104	12	1.883	0.854	.065	0.002
B40054	12	1.804	0.818	.074	0.002	BF46005	12	.413	0.187	.030	0.001	BF46105-O	6	2.042	0.926	.104	0.003
B40056	12	1.342	0.609	.050	0.001	BF46006	12	.658	0.298	.034	0.001	PF46106	6	1.900	0.862	.204	0.006
P40058	12	.150	0.068	.017	0.001	BF46007	12	.100	0.045	.019	0.001	PF46108	12	.795	0.361	.089	0.003
P40061	12	.204	0.093	.036	0.001	BF46008	12	.170	0.077	.011	0.001	BF46109-O	6	1.990	0.903	.096	0.003
P40062	1	1.200	0.544	.217	0.006	PF46009	12	2.00	0.091	.019	0.001	BF46111	12	.929	0.421	.048	0.001
B40063	6	2.175	0.987	.074	0.002	PF46010 KIT	1	2.550	1.157	.474	0.013	PF46112	12	.358	0.162	.037	0.001
BT40065	12	.912	0.414	.046	0.001	BF46012	12	1.212	0.550	.066	0.002	BF46113-D	12	.575	0.261	.050	0.001
BT40066-MPG	6	4.675	2.121	.200	0.006	BF46013	12	1.290	0.585	.061	0.002	BF46116 KIT	6	3.000	1.361	.181	0.005
B40070	12	1.317	0.597	.041	0.001	BF46014	12	1.180	0.535	.065	0.002	BF46117	12	2.529	1.147	.120	0.003
S40071	12	.200	0.091	.033	0.001	BF46015	12	2.350	1.066	.144	0.004	PF46118	12	.342	0.155	.049	0.001
B40073	12	1.175	0.533	.046	0.001	BF46016-O	12	1.862	0.845	.107	0.003	PF46119	12	.038	0.017	.004	0.001
P40074	6	.320	0.145	.060	0.002	BF46017-O	12	1.037	0.470	.052	0.001	BF46122	12	2.238	1.015	.101	0.003
OB40078	12	.754	0.342	.051	0.001	BF46018-O	6	1.842	0.836	.124	0.004	BF46123-O	6	2.358	1.070	.130	0.004
P40076	12	.246	0.112	.034	0.001	BF46019-O	12	1.033	0.469	.051	0.001	BF46125	12	.150	0.068	.012	0.001
OB40079	12	.704	0.319	.057	0.002	BF46020-O	12	1.041	0.472	.051	0.001	PF46126	12	.492	0.223	.062	0.002
OB40080	1	.800	0.363	.030	0.001	BF46021-O	12	1.112	0.504	.051	0.001	BF46127	12	1.608	0.729	.063	0.002
P40081	12	.425	0.193	.042	0.001	BF46022-O	12	1.116	0.506	.051	0.001	BF46128-D	6	1.866	0.846	.167	0.005
P40083	12	.492	0.223	.063	0.002	BF46023-O	12	1.045	0.474	.052	0.001	BF46129	6	4.200	1.905	.131	0.004
P40085	12	.279	0.127	.034	0.001	BF46024-O	12	1.050	0.476	.052	0.001	PF46130	12	.396	0.180	.065	0.002
P40086	12	.292	0.132	.033	0.001	BF46025-O	12	1.300	0.590	.065	0.002	BF46131	6	1.858	0.843	.082	0.002
P40089	12	.188	0.085	.021	0.001	BF46026-O	12	1.175	0.533	.063	0.002	PF46135	6	.783	0.355	.107	0.003
P40090	12	.179	0.081	.020	0.00												

**BALDWIN WEIGHTS AND VOLUMES**

BALDWIN NUMBER	CASE QTY.	WEIGHT (ea.) lbs.	WEIGHT (ea.) kgs.	Volume (ea.) ft <sup>3</sup>	Volume (ea.) m <sup>3</sup>	BALDWIN NUMBER	CASE QTY.	WEIGHT (ea.) lbs.	WEIGHT (ea.) kgs.	Volume (ea.) ft <sup>3</sup>	Volume (ea.) m <sup>3</sup>	BALDWIN NUMBER	CASE QTY.	WEIGHT (ea.) lbs.	WEIGHT (ea.) kgs.	Volume (ea.) ft <sup>3</sup>	Volume (ea.) m <sup>3</sup>
BF46141	12	1.608	0.729	.079	0.002	OAS98001	1	5.850	2.654	.662	0.019	7B-7635	1	.010	0.005	.002	**
PF46142	6	350	0.159	.070	0.002	OAS98002	1	6.100	2.767	.605	0.017	8M-7830	1	.020	0.009	.004	**
BF46143	12	1.725	0.782	.098	0.003	OAS98003	1	6.550	2.971	.569	0.016	G15-AF	1	.160	0.073	.001	**
PF46145	6	2.667	1.210	.278	0.008	OAS98004	1	6.600	2.994	.569	0.016	G21-AF	1	.020	0.009	.019	0.001
BF46147-O	12	1.404	0.637	.074	0.002	OAS98005	1	4.950	2.245	.595	0.017	100	1	4.850	2.200	.273	0.008
BF46149-SP	12	1.275	0.578	.045	0.001	OAS98006	1	7.400	3.357	.241	0.007	100-12	1	.300	0.136	.042	0.001
BF46150-O	6	3.041	1.379	.240	0.007	OAS98007	1	7.400	3.357	1.443	0.041	100-21	1	.250	0.113	.040	0.001
PF46151	12	.595	0.270	.059	0.002	OAS98008	1	3.900	1.769	.569	0.016	100-21AL	1	.650	0.295	.040	0.001
PF46152	12	.583	0.264	.081	0.002	OAS98009	1	13.150	5.965	2.356	0.067	100-21BP	1	.300	0.136	.040	0.001
BF46161	12	2.658	1.206	.122	0.003	OAS98010	1	12.950	5.874	2.189	0.062	100-21M	1	.300	0.136	.040	0.001
BF46162-O	12	1.022	0.464	.048	0.001	OAS98011	1	3.750	1.701	.538	0.015	100-28	1	.010	0.005	.001	**
BF46163-O	12	1.725	0.782	.106	0.003	OAS98012	1	2.050	0.930	.281	0.008	100-29	1	.050	0.023	.001	**
BF46164-O	12	.754	0.342	.032	0.001	OAS98013	1	34.300	15.558	6.493	0.184	100-30	1	.100	0.045	.001	**
BF46169-O	12	1.516	0.688	.100	0.003	OAS98015	1	19.650	8.913	3.062	0.087	100-BP	1	4.900	2.223	.269	0.008
BF46170	12	1.841	0.835	.087	0.002	OAS98016	1	5.000	2.268	.651	0.018	100-DEPR KIT	1	.250	0.113	.064	0.002
PF46171	6	1.183	0.537	.107	0.003	OAS98017	1	22.600	10.251	3.844	0.109	100-GK	1	.001	**	.001	**
BF46173-O	6	2.383	1.081	.096	0.003	OAS98018	1	9.450	4.287	1.735	0.049	100-M	1	5.850	2.654	.267	0.008
BF46175	12	.775	0.352	.062	0.002	OAS98019	1	6.050	2.744	.939	0.027	100-MFV	1	17.500	7.938	1.606	0.045
BF46176	12	1.070	0.485	.053	0.001	OAS98020	1	8.500	3.856	1.590	0.045	100-MMV	1	19.650	8.913	1.603	0.045
BF46179	6	5.016	2.275	.166	0.005	OAS98021	1	33.650	15.264	4.768	0.135	100-MNTG KIT	1	.900	0.408	.023	0.001
BF46181-O	6	1.625	0.737	.105	0.003	OAS98022	1	5.850	2.654	1.027	0.029	100-W	1	5.000	2.268	.264	0.007
BF46182-O	12	1.579	0.716	.076	0.002	OAS98023	1	6.200	2.812	1.777	0.050	100-W30	1	4.850	2.200	.235	0.007
FB46183	12	1.746	0.792	.051	0.001	OAS98024	1	25.500	11.567	3.476	0.098	140-50 KIT	1	.150	0.068	.014	**
FB46184	1	1.300	0.590	.065	0.002	OAS98025	1	9.700	4.400	1.519	0.043	150	1	6.150	2.790	.368	0.010
BF46185	1	1.050	0.476	.065	0.002	OAS98026	1	22.950	10.410	3.843	0.109	150-31	1	.100	0.045	.001	**
PF46186	12	.613	0.278	.057	0.002	OAS98027	1	14.400	6.532	3.970	0.112	150-GK	1	.010	0.005	.007	**
PF46187	12	.420	0.191	.060	0.002	OAS98028	1	4.400	1.996	.250	0.007	150-H	1	6.400	2.903	.387	0.011
PF46188	12	.463	0.210	.056	0.002	OAS98029	1	2.150	0.975	.309	0.009	150-M	1	7.250	3.289	.379	0.011
PF46189	12	.440	0.200	.060	0.002	OAS98031	1	8.750	3.969	1.463	0.041	150-W30	1	6.200	2.812	.379	0.011
BF46192	12	1.060	0.481	.101	0.003	OAS98032	1	7.050	3.198	.613	0.017	185-DS	1	.300	0.136	.042	0.001
BF46193	12	.325	0.147	.037	0.001	OAS98033	1	15.700	7.122	2.194	0.062	186-SK	1	.650	0.295	.015	**
BF46194	12	.192	0.087	.021	0.001	OAS98034	1	30.850	13.994	3.804	0.108	200	1	12.100	5.489	.641	0.018
BF46195	12	.879	0.399	.077	0.002	OAS98035	1	2.850	1.293	.582	0.016	200-15	1	.010	0.005	.003	**
BF46196	12	.158	0.072	.020	0.001	OAS98036	1	4.300	1.950	.534	0.015	200-21	1	.400	0.181	.122	0.003
BF46197	12	.125	0.057	.020	0.001	OAS98037	1	70.200	31.843	9.176	0.260	200-21BP	1	.450	0.204	.117	0.003
BF46198	12	.658	0.298	.047	0.001	OAS98038	1	11.350	5.148	1.575	0.045	200-21H	1	.550	0.249	.117	0.003
BF46199	12	.896	0.406	.067	0.002	OAS98040	1	29.350	13.313	6.309	0.179	200-21HBP	1	.650	0.295	.111	0.003
BF46200	12	.792	0.359	.061	0.002	OAS98041	1	24.100	10.932	4.019	0.114	200-21M	1	.550	0.249	.118	0.003
BF46201	12	.763	0.346	.051	0.001	OAS98042	1	21.800	9.888	3.450	0.098	200-30U	1	.300	0.136	.002	**
BF46202	12	.546	0.248	.047	0.001	OAS98043	1	3.000	1.361	.270	0.008	200-31	1	.100	0.045	.001	**
BF46203	12	.600	0.272	.064	0.002	OAS98044	1	5.250	2.381	.678	0.019	200-DEPR KIT	1	.400	0.181	.106	0.003
BF46204	12	.667	0.303	.058	0.002	OAS98045	1	1.000	0.454	.104	0.003	200-GK	1	.020	0.009	.012	**
BF46205	12	.158	0.072	.021	0.001	OAS98046	1	13.900	6.305	2.662	0.075	200-M	1	13.300	6.033	.630	0.018
BF46206	12	.879	0.399	.081	0.002	OAS98050	1	28.050	12.723	3.724	0.105	200-MFV	1	36.100	16.375	2.821	0.080
BF46207	12	.471	0.214	.043	0.001	OAS98052	1	24.400	11.068	3.851	0.109	200-MMV	1	39.200	17.781	2.821	0.080
BF46208	12	.563	0.255	.046	0.001	OAS98053	1	32.850	14.901	6.309	0.179	200-W30	1	11.900	5.398	.547	0.015
BF46209	12	.621	0.282	.037	0.001	OAS98054	1	25.350	11.499	5.715	0.162	24-WLK	1	.300	0.136	.023	0.001
BF46210	12	.608	0.276	.060	0.002	OAS98056	1	4.600	2.087	.639	0.018	285-DS	1	.200	0.091	.082	0.002
BF46211	12	.525	0.238	.037	0.001	OAS98057	1	19.200	8.709	3.476	0.098	286-SK	1	.800	0.363	.013	**
BF46212	12	.375	0.170	.038	0.001	OAS98058	1	7.450	3.379	1.609	0.046	300	1	15.750	7.144	.863	0.024
BF46213	1	.750	0.340	.434	0.012	OAS98060	1	2.950	1.338	.094	0.003	300-DHRAP5	1	120.000	54.432	37.875	1.072
BF46214	1	1.000	0.454	.167	0.005	OAS98061	1	7.500	3.402	.253	0.007	300-DHRAS5	1	143.000	64.865	41.427	1.172
BF46215	12	.400	0.181	.037	0.001	OAS99001	1	2.800	1.270	.141	0.004	300-H	1	15.800	7.167	.871	0.025
BF46216	12	.454	0.206	.040	0.001	OAS99005	1	3.700	1.678	.269	0.008	300-W30	1	15.550	7.053	.871	0.025
BF46217	12	.837	0.380	.048	0.001	OAS99006	1	13.900	6.305	1.966	0.056	500	1	248.000	112.493	34.050	0.964
BF46218	12	.750	0.340	.080	0.002	OAS99008	1	20.500	9.299	2.695	0.076	500-12	1	4.800	2.177	.237	0.007
BF46219	12	.850	0.386	.098	0.003	OAS99014	1	20.000	9.072	2.260	0.064	500-15	1	.500	0.227	.029	0.001
BF46220	12	.358	0.162	.048	0.001	OAS99015	1	6.200	2.812	.616	0.017	500-BP22	1	289.500	131.317	38.250	1.082
BF46221	12	.525	0.238	.047	0.001	OAS99017	1	5.700	2.586	.669	0.019	500-MFVBP22	1	780.000	353.808	72.575	2.054
BF46222	12	.250	0.113	.078	0.002	OAS99018	1	36.420	16.520	5.278	0.149	55-EK	1	.550	0.249	.125	0.004
BF46223	12	.454	0.206	.049	0.001	OAS99020	1	6.100	2.767	.408	0.012	60-21	1	.250	0.113	.037	0.001
BF46224	12	.580	0.263	.050	0.001	OAS99025	1	4.500	2.041	.422	0.012	60-21A	1	.150	0.068	.041	0.001
BF46225	12	.167	0.076	.019	0.001	OAS99028	1	3.800	1.724	.210	0.006	60-30	1	.100	0.045	.001	**
BF46227	12	1.713	0.777	.075	0.002	OAS99029	1	5.150	2.336	.145	0.004	60-GK	1	.100	0.045	.005	**
BF46228	12	.742	0.337	.033	0.001	OAS99034	1	10.000	4.536	1.280	0.036	65	1	1.550	0.703	.111	0.003
BF46229	12	.362	0.164	.035	0.001	OAS99035	12	1.700	0.771	.140	0.004	65-35A	1	.050	0.023	.018	0.001
BF46233	12	2.779	1.261	.122	0.003	OAS99038	1	9.550	4.332	1.493	0.042	65-W30	1	1.550	0.703	.108	0.003
PF46235	12	.796	0.361	.103	0.003	OAS99047	1	6.450	2.926	.282	0.008	75	1	2.050	0.930	.107	0.003
PF46236	6	1.150	0.522	.167	0.005	OAS99048	1	2.750	1.247	.080	0.002	75-21	1	.600	0.272	.036	0.001
PF46237	6	1.150	0.522	.167	0.005	1S-9133	1	.020	0.009	.003	**	75-W30	1	2.050	0.930	.110	0.003
PF46238	12	.763	0.346	.104	0.003	4L-8212-R	1	.020	0.009	.002	**	85-EK	1	1.100			

# BALDWIN WEIGHTS AND VOLUMES

BALDWIN NUMBER	CASE QTY.	WEIGHT (ea.)		Volume (ea.)		BALDWIN NUMBER	CASE QTY.	WEIGHT (ea.)		Volume (ea.)		BALDWIN NUMBER	CASE QTY.	WEIGHT (ea.)		Volume (ea.)	
		lbs.	kgs.	ft <sup>3</sup>	m <sup>3</sup>			lbs.	kgs.	ft <sup>3</sup>	m <sup>3</sup>			lbs.	kgs.	ft <sup>3</sup>	m <sup>3</sup>
AF525-WN	1	.001	**	.001	**	G207-AF	1	.100	.045	.014	**	G359	1	.016	.007	.003	**
ES1001	1	.001	**	.001	**	G208-A	1	.010	.005	.001	**	G360	1	.014	.006	.002	**
ES1023	1	.001	**	.001	**	G210	1	.020	.009	.003	**	G362	1	.020	.009	.002	**
ES1026	1	.020	.009	.001	**	G211	1	.001	**	.003	**	G363	1	.014	.006	.002	**
ES1030	1	.020	.009	.001	**	G214	1	.001	**	.001	**	G366	1	.008	.004	.001	**
ES1031	1	.018	.008	.001	**	G219	1	.020	.009	.002	**	G368	1	.020	.009	.002	**
ES1032	1	.010	.005	.001	**	G220	1	.020	.009	.001	**	G369-B	1	.001	**	.001	**
ES1034	1	.001	**	.001	**	G222-B	1	.020	.009	.001	**	G369-V	1	.010	.005	.002	**
ES1036	1	.001	**	.001	**	G225-AF	1	.180	.082	.193	.005	G372	1	.032	.015	.002	**
ES1039	1	.020	.009	.001	**	G229	1	.001	**	.001	**	G376	1	.013	.006	.001	**
ES1049	1	.001	**	.001	**	G232	1	.020	.009	.001	**	G379	1	.006	.003	.001	**
ES1066	1	.001	**	.001	**	G233-A	1	.001	**	.001	**	G37-AF	1	.060	.027	.025	.001
ES1067	1	.001	**	.001	**	G233-B	1	.001	**	.001	**	G380	1	.044	.020	.002	**
ES1068	1	.001	**	.001	**	G236-A	1	.020	.009	.003	**	G381-A	1	.013	.006	.001	**
ES1071	1	.001	**	.001	**	G238	1	.001	**	.007	**	G382	1	.016	.007	.003	**
ES1074	1	.001	**	.001	**	G239	1	.020	.009	.001	**	G382-V	1	.024	.011	.003	**
ES1092	1	.020	.009	**	**	G240	1	.020	.009	.001	**	G385	1	.001	**	.003	**
ES1303-A	1	.020	.009	.001	**	G241	1	.001	**	.001	**	G386	1	.024	.011	.003	**
ES1303-B	1	.001	**	.001	**	G243-A	1	.010	.005	.001	**	G392	1	.032	.015	.003	**
ES1369-A	1	.020	.009	.001	**	G247	1	.001	**	.001	**	G394	1	.034	.015	.004	**
ES1376	1	.001	**	.001	**	G251	1	.001	**	.001	**	G397	1	.001	**	.002	**
ES1377	1	.001	**	.001	**	G252	1	.001	**	.008	**	G39-AF	1	.006	.003	.001	**
ES24-B	1	.001	**	.001	**	G253-A	1	.020	.009	.002	**	G400	1	.064	.029	.005	**
ES24-D	1	.001	**	.001	**	G255	1	.001	**	.001	**	G401	1	.001	**	.001	**
ES3012	1	.001	**	.001	**	G257	1	.010	.005	.002	**	G402	1	.010	.005	.001	**
ES3028	1	.001	**	.001	**	G25-AF	1	.160	.073	.026	.001	G403	1	.006	.003	.001	**
ES3029	1	.001	**	.001	**	G260	1	.001	**	.002	**	G406	1	.018	.008	.002	**
ES3063	1	.001	**	.001	**	G261	1	.001	**	.004	**	G409	1	.026	.012	.002	**
ES3231	1	.040	.018	.007	**	G263	1	.030	.014	.004	**	G410	1	.010	.005	.001	**
ES4007	1	.010	.005	.001	**	G264-A	1	.001	**	.001	**	G411	1	.028	.013	.002	**
ES4008	1	.001	**	.001	**	G265	1	.020	.009	.002	**	G412	1	.020	.009	.004	**
G102-A	1	.020	.009	.002	**	G268	1	.001	**	.001	**	G416	1	.056	.025	.005	**
G103	1	.001	**	.001	**	G269	1	.020	.009	.002	**	G417	1	.042	.019	.003	**
G103-N	1	.001	**	**	**	G270	1	.001	**	.001	**	G422-AF	1	.220	.100	.026	.001
G104	1	.020	.009	.001	**	G273	1	.010	.005	.001	**	G431	1	.012	.005	.001	**
G105	1	.001	**	.001	**	G274	1	.019	.009	.001	**	G432	1	.001	**	.001	**
G106	1	.010	.005	.001	**	G275	1	.020	.009	.001	**	G433	1	.030	.014	.004	**
G107	1	.001	**	.001	**	G278	1	.040	.018	.004	**	G434	1	.014	.006	.001	**
G1086-AF	1	.080	.036	.002	**	G280	1	.001	**	.002	**	G435	1	.008	.004	.001	**
G115-A	1	.001	**	.001	**	G281	1	.020	.009	.002	**	G436	1	.016	.007	.001	**
G115-MSB	1	.001	**	.001	**	G283	1	.001	**	**	**	G438	1	.044	.020	.009	**
G120-A	1	.025	.011	.001	**	G285-AF	1	.150	.068	.039	.001	G439	1	.024	.011	.003	**
G123	1	.010	.005	.001	**	G286-C	1	.001	**	.006	**	G441	1	.006	.003	.001	**
G127	1	.020	.009	.001	**	G288	1	.040	.018	.001	**	G442	1	.007	.003	.001	**
G132	1	.020	.009	.001	**	G289	1	.020	.009	.005	**	G443	1	.012	.005	.002	**
G133	1	.001	**	.001	**	G291	1	.020	.009	.001	**	G444	1	.001	**	.002	**
G140-A	1	.016	.007	.002	**	G293-B	1	.060	.027	.006	**	G445	1	.026	.012	.003	**
G141-AF	1	.267	.121	.402	.011	G296	1	.020	.009	.002	**	G446	1	.048	.022	.004	**
G143	1	.001	**	.002	**	G298-AF	1	.100	.045	.040	.001	G447	1	.011	.005	.001	**
G144	1	.020	.009	.002	**	G299	1	.020	.009	.001	**	G449-B	1	.001	**	.001	**
G145-AF	1	.140	.064	.028	.001	G302	1	.010	.005	.001	**	G458	1	.001	**	.001	**
G147-A	1	.001	**	**	**	G303	1	.020	.009	**	**	G467	1	.003	.001	.001	**
G148	1	.020	.009	.002	**	G304	1	.020	.009	.027	.001	G468	1	.006	.003	.001	**
G153	1	.001	**	.001	**	G305	1	.001	**	.006	**	G472-AF	1	.160	.073	.014	**
G155	1	.001	**	.006	**	G306	1	.080	.036	.007	**	G480	1	.020	.009	.001	**
G157	1	.001	**	.008	**	G307	1	.001	**	.002	**	G483	1	.020	.009	.001	**
G161	1	.001	**	.001	**	G309-B	1	.001	**	.009	**	G494	1	.026	.012	.003	**
G162	1	.001	**	.001	**	G310	1	.001	**	.002	**	G498-A	1	.044	.020	.003	**
G164-A	1	.020	.009	.002	**	G314	1	.020	.009	.004	**	G499-AF	1	.240	.109	.028	.001
G165	1	.001	**	**	**	G315	1	.001	**	.002	**	G501-AF	1	.107	.049	.053	.001
G168-B	1	.020	.009	.001	**	G31-AF	1	.040	.018	.022	.001	G523-AF	1	.290	.132	.010	**
G169	1	.001	**	.002	**	G323	1	.001	**	.001	**	G534-AF	1	.020	.009	.024	.001
G171	1	.001	**	.001	**	G332	1	.010	.005	.001	**	G704	1	.040	.018	.001	**
G172-A	1	.001	**	.001	**	G333	1	.020	.009	.001	**	G710	1	.022	.010	.001	**
G183	1	.010	.005	.001	**	G336	1	.001	**	.003	**	G717	1	.038	.017	.004	**
G184-A	1	.010	.005	.002	**	G340	1	.001	**	.001	**	G725	1	.001	**	.003	**
G193	1	.001	**	.007	**	G342	1	.001	**	.001	**						
G196-B	1	.001	**	.002	**	G343-A	1	.022	.010	.003	**						
G1972	1	.060	.027	.014	**	G344	1	.008	.004	.001	**						
G1973	1	.800	.363	.684	.019	G347	1	.012	.005	.002	**						
G202	1	.001	**	.001	**	G348-AF	1	.120	.054	.028	.001						
G203	1	.020	.009	.002	**	G34-AF	1	.020	.009	.010	**						
G204-A	1	.001	**	.001	**	G354	1	.014	.006	.003	**						
G206	1	.080	.036	.008	**	G356	1	.028	.013	.003	**						

\* Sold in Full Cases Only.    TBD To be Determined.    \*\* Measurement is less than 0.001.



**WARNING:** These products can expose you to chemicals, including Diisononyl Phthalate, Carbon black extracts, Nickel, 1,3 Butadiene, Ethylene Oxide, Epichlorohydrin, which are known to the State of California to cause cancer, and Bisphenol-A, Ethylene Glycol, Ethylene Oxide, 1,3 Butadiene, Epichlorohydrin, which are known to the State of California to cause birth defects or other reproductive harm.

**FILTER WRENCHES**

**PKG400 4 1/8" - 5" O.D.  
(104.8 - 127.0)**



PART#	BT564	BF1347	BD7169
BT5	BF584	BF1347-O	B7171
B45	BF584-B	BF1348	B7174-MPG
B49	BF588	BF1348-O	BD7176
B75	BF596	BF1348-SP	B7179
B76	B605	BF1349	B7189
B76-MPG	BT610-MPG	BF1353-SPS	B7191
B76-SS	BT611-MPG	BF1354-SPS	B7217
B95	BT774	BF1355	B7219
B95-MPG	BT775	BF1355-O	B7223
B95-SS	BF783	BF1355-SP	B7225
B96	BF784	BF1357	B7227
B96-MPG	BF785	BF1358-O	B7239
B96-SS	BF786	BF1358-SP	B7241
B97	BF876	BF1359-SP	B7246
BD103	BF877	BF1360	BD7250
BD103-MPG	BF880-FP	BF1360-O	BD7252
BD103-SS	BF976	BF1360-SP	B7280
B105	BF1210	BF1362	BD7309
BT124	BF1211	BF1363	BD7310
B128	BF1216	BF1370	BT7316
B129	BF1218	BF1373-SP	B7324
B134	BF1219	BF1374-SP	BD7325
BD142	BF1222	BF1375	BD7355
B157	BF1222-O	BF1377	B7373
B196	BF1222-SP	BF1382-SP	B7383
B201-S	BF1223	BF1383-O	B7385
B205	BF1223-O	BF1386-O	B7386
B211	BF1223-SP	BF1387-O	B7389
B218	BF1224	BF1388-O	B7393
B220	BF1231	BF1389-O	B7396
BT221	BF1240	BF1390-O	B7397
B222	BF1256	BF1391-O	B7409
BD232	BF1262	BF1395-O	B7416
BT234	BF1265	BF1395-SP	B7459
BT238	BF1273-SP	BF1397-SP	B7460
B263	BF1274-SP	BF1399-SP	B7466
BT267	BF1274-SPS	B5177	B7468
B309	BF1277-SP	BW5179	B7477
BD324	BF1277-SPS	B7004	B7478
BD325	BF1281	B7005	B7481
B326	BF1281-O	B7009	B7482
B333	BF1283	B7018	B7483
B337	BF1283-O	B7019	B7501
BT340	BF1283-SP	BD7028	B7503
BT347	BF1285-SP	B7039	BD7504
BT348	BF1286	B7045	B7506
BT349	BF1287-O	B7051	BD7509
BT350	BF1288-O	BD7105	B7513
BT351	BF1290-O	B7113	B7577
BT351-MPG	BF1292-O	B7116	BF7584
BT355	BF1294-O	B7121	B7585
BT359	BF1295-O	B7124	BF7593
BT398	BF1296-O	B7130	B7600
BT402	BF1297-O	B7131	B7600-SS
B404	BF1298-O	BD7141	BF7612
BT440	BF1299-O	B7142	BF7613
BT443	BF1329	B7144	BF7628
B447	BF1329-SP	B7151	BF7629
BT470	BF1330-SP	BD7153	B7637
BT472	BF1339-SP	BD7154	BF7656
B494	BF1345	B7155	BF7657
B495	BF1345-O	BD7158	B7685
B495-MPG	BF1345-SP	BD7159	BF7697
B495-SS	BF1346	B7164	B7700
BT521	BF1346-O	BD7166	BF7717
BT556-10	BF1346-SP	BD7168	BF7773

**PKG400 4 1/8" - 5" O.D. (Cont'd.)  
(104.8 - 127.0)**

BF7814	BT8880-MPG	BF9860	BF46027-O
BF7853	BT8890-MPG	BF9864	BF46031
BF7911	BT8892-MPG	BF9866-O	BF46034
BF7913	BT8910-MPG	BF9867-O	BF46073
BF7927	BT8911-MPG	BF9869	BF46083-O
BF7932	BT8920	BF9871-O	BF46085
BF7943	BT9320	BF9880	BF46098-O
BF7948	BT9343-MPG	BF9885	BF46099-O
BT8302	BT9347-MPG	BF9888	BF46100-O
BT8320	BT9353-MPG	BF9898-O	BF46101-O
BT8381	BT9362-MPG	BF9903-SP	BF46105-O
BT8401-MPG	BT9365-MPG	BF9912-O	BF46109-O
BT8432-MPG	BT9367-MPG	BF9917	BF46117
BT8450	BT9369-MPG	BF9920	BF46122
BT8457-MPG	BT9391-MPG	BF9921-O	BF46123-O
BD7475	BT9421-MPG	BF9925-O	BF46124-O
BT8503-MPG	BT9437	BT23542-MPG	BF46129
BT8800-MPG	BT9439	BT23543-MPG	BF46131
BT8801-MPG	BT9454	BT23603-MPG	BF46147-O
BT8802-MPG	BT9558-MPG	BT23609-MPG	BF46150-O
BT8803-MPG	BT9560-MPG	BD40027	BF46161
BT8805-MPG	B9604	B40053	BF46163-O
BT8812-MPG	B9606	B40054	BF46169-O
BT8813-MPG	B9607	BT40066-MPG	BF46173-O
BT8870-MPG	BF9800	B40137	BF46179
BT8873	BF9802	B40138	BF46181-O
BT8874-MPG	BF9811-SP	BD40139	BF46182-O
BT8875-MPG	BF9816	B40142	BF46233
BT8876-MPG	BF9817	B40145	BD50000
BT8877-MPG	BF9818	BF46002	OAS99028
BT8878-MPG	BF9832	BF46016-O	
BT8879-MPG	BF9844	BF46018-O	

**PKG401 4 3/8" - 5 1/4" O.D.  
(111.1 - 133.4)**



Part	BT388	BF1283-O	B7241
B49	BT388-10	BF1287-O	B7246
B95	BT389	BF1288-O	BD7250
B95-MPG	BT389-10	BF1347-O	BD7252
B95-SS	B404	BF1355	BD7309
B96	BT424	BF1355-O	BD7310
B96-MPG	BT425	BF1355-SP	B7324
B96-SS	BT443	BF1357	BD7325
B97	BT486	BF1358-O	B7335-MPG
BD103	B495	BF1395-O	BD7355
BD103-MPG	B495-MPG	BD1403	B7396
BD103-SS	B495-SS	BA5371	B7416
B105	BF596	B7004	B7468
B196	BT610-MPG	B7005	B7503
B205	BT611-MPG	B7011	BD7504
B220	BT774	B7019	BD7509
BT287	BT775	BD7105	B7513
BT287-10	BF784	BD7141	BF7571
BT287-3	BF785	BD7153	B7577
BD324	BF1216	BD7154	BF7623
B333	BF1239	B7155	BF7697
BT345 KIT	BF1262	BD7159	BF7717
BT351	BF1274-SP	BD7166	BF7913
BT351-MPG	BF1274-SPS	BD7169	BF7932
BT359	BF1277-SP	BD7176	BF7948
BT387	BF1277-SPS	B7217	BT8307-MPG
BT387-10	BF1281-O	B7239	BT8308-MPG



**WARNING:** These products can expose you to chemicals, including Diisononyl Phthalate, Carbon black extracts, Nickel, 1,3 Butadiene, Ethylene Oxide, Epichlorohydrin, which are known to the State of California to cause cancer, and Bisphenol-A, Ethylene Glycol, Ethylene Oxide, 1,3 Butadiene, Epichlorohydrin, which are known to the State of California to cause birth defects or other reproductive harm.

# FILTER WRENCHES



**PKG401 4 3/8" - 5 1/4" O.D. (Cont'd.) (111.1 - 133.4)**

**PKG411 2 9/16" - 3 11/16" O.D. (65.1 - 93.7)**

BT8308-MPG	BT8802-MPG	BT9324	BT23140-MPG
KIT	BT8803-MPG	BT9343-MPG	BT23539
BT8309-MPG	BT8805-MPG	BT9345	BT23542-MPG
BT8310-MPG	BT8812-MPG	BT9347-MPG	BT23543-MPG
BT8320	BT8813-MPG	BT9353-MPG	BT23603-MPG
BT8368	BT8870-MPG	BT9356	BT23609-MPG
BT8381	BT8873	BT9360	BD40027
BT8401-MPG	BT8874-MPG	BT9362-MPG	B40053
BT8421-MPG	BT8875-MPG	BT9365-MPG	BT40066-MPG
BT8422-MPG	BT8876-MPG	BT9367-MPG	B40137
BT8423	BT8877-MPG	BT9369-MPG	B40138
BT8432-MPG	BT8878-MPG	BT9371-MPG	BD40139
BT8450	BT8879-MPG	BT9391-MPG	B40142
BT8457-MPG	BT8880-MPG	BT9421-MPG	B40145
BT8471-MPG	BT8890-MPG	BT9439	BF46002
BT8475	BT8892-MPG	BT9558-MPG	BF46027-O
BT8475-MPG	BT8901-MPG	BT9560-MPG	BF46083-O
BT8476	BT8910-MPG	B9606	BF46109-O
BT8476-MPG	BT8911-MPG	BF9860	BF46122
BT8477	BT8915	BF9864	BF46123-O
BT8477-MPG	BT8927	BF9866-O	BF46129
BT8503-MPG	BT8930	BF9867-O	BF46150-O
BT8510-MPG	BT8931	BF9885	BF46173-O
BT8800-MPG	BT8937	BF9888	BF46179
BT8801-MPG	BT9320	BF9920	BD50000

Part	BT260-10	BT595	BF1226
B2	BT261	BF597	BF1232
B2-HPG	B262	BT606-MPG	BF1233
B4	BT264	BF614	BF1248
B6	BT274	BF719	BF1249
B6-HPG	B279	BF720	BF1249-O
B7	B281	BT778	BF1249-SP
B9	BT292	BT779	BF1252
BF13	B295	BF781	BF1253
BD28	B296	BF782	BF1257
B30	B299	BF788	BF1258
B31	B301	BF789	BF1259
B33	BT305	BF790	BF1261
B34	B307	BF791	BF1266
B35-S	BT310	BF797	BF1267
B37	B329	BF798	BF1268
B39	BF330	BT839	BF1269
B43-S	BT334	BT839-10	BF1270-SP
B50	B336	BF862	BF1271
B56	BT338	BF863	BF1272-SPS
BT111	BT339	BF888	BF1275
BT112	BT341	BF891	BF1276
B113	BT342	BF892	BF1278
B118	BT346	BF896	BF1278-O
B120	BT353	BF900	BF1280
BT126	BT354	BF915	BF1282
B131	BT357	BF938	BF1282-O
B132	B358	BF939	BF1289-SP
B141	BT361	BF940	BF1293-SPS
B143	BT364	BF941	BF1350-SP
B156	BT365	BF948	BF1352-SPS
B159	BT365-10	BF948-JD	BF1356
B160	BT366-10	BF954	BF1361
B161-S	BT367	BF955	BF1365
B163	BT367-S	BF956	BF1366-O
B164	BT368	BF957	BF1367
B167	B369	BF957-D	BF1371
B168	BT372-10	BF958	BF1372
B173-S	BT372-MPG	BF962	BF1376
B178	B378	BF968	BF1379
B179	B378-10	BF970	BF1379-O
B195	BT395	BF971	BF1380
B199	B403	BF974-D	BF1380-O
B202	BT420	B975	BF1381
BT215	B421	BF978	BF1381-O
BT216	BT427	BF979	BF1384-SP
BT217	BT452	BF980	BF1385-SPS
BT223	B474	BF984	BF1393-SP
B227	B481	BF988	BF1394-SP
B228	B488	BF991	BF1396
B229	BT525	BF992	BF1398-O
BT230	BT526	BF1056	B1400
B233	BT526-10	BF1102	B1402
B236	BT536	BF1110	B1405
BT237	BT541	BF1204	B1406
B243	BF577	BF1204-SP	B1407
B244	BF582	BF1205	B1410
B247	BF583	BF1205-SP	B1413
BT248	BF585	BF1212	B1416
BT251	BF586	BF1213	B1421
B252	BF586-D	BF1214	B1422
B253	BF587	BF1217	B1425
B255	BF587-D	BF1220	B1428
BT259	BF591	BF1221	B1429
BT260	BF592	BF1225	B1430

**PKG402 4 3/4" - 5 1/2" O.D. (120.7 - 139.7)**



Part	BA5376	BT8307-MPG	BT8906
B99	BA5378	BT8308-MPG	BT8915
B99-MPG	BA5379	BT8308-MPG	BT8921
B99-SS	BA5566	KIT	BT8927
B239	BA5592	BT8309-MPG	BT8930
BT287	B7011	BT8310-MPG	BT8931
BT287-10	B7030	BT8368	BT8937
BT287-3	B7097	BT8382	BT9164
BT343	B7135	BT8421-MPG	BT9320
BT345 KIT	B7157	BT8422-MPG	BT9324
BT351	B7161	BT8423	BT9343-MPG
BT351-MPG	B7162	BT8437	BT9345
BT387	B7175	BT8450	BT9356
BT387-10	B7180	BT8457-MPG	BT9360
BT388	B7182	BT8471-MPG	BT9371-MPG
BT388-10	B7187	BT8475	BT9377
BT389	B7224	BT8475-MPG	BT9387
BT389-10	B7229	BT8476	BT9533
BT424	B7245	BT8476-MPG	BT23140-MPG
BT425	B7246	BT8477	BT23537
BT486	B7249-MPG	BT8477-MPG	BT23539
BT774	B7299	BT8510-MPG	BT23542-MPG
BT775	B7314	BT8800-MPG	BT23555-MPG
BF799	B7335-MPG	BT8801-MPG	BT23605-MPG
BF1239	B7363	BT8802-MPG	BT23609-MPG
BF1287-O	B7402	BT8803-MPG	B40013
BF1288-O	B7507	BT8805-MPG	BF46150-O
BF1355-O	BF7571	BT8812-MPG	BF46173-O
BD1403	BF7623	BT8813-MPG	OAS99029
BA5284	BF7635	BT8873	OAS99047
BA5371	BF7639	BT8876-MPG	
BA5374	BF7639-D	BT8899	
BA5375	BF7996	BT8901-MPG	



**WARNING:** These products can expose you to chemicals, including Diisononyl Phthalate, Carbon black extracts, Nickel, 1,3 Butadiene, Ethylene Oxide, Epichlorohydrin, which are known to the State of California to cause cancer, and Bisphenol-A, Ethylene Glycol, Ethylene Oxide, 1,3 Butadiene, Epichlorohydrin, which are known to the State of California to cause birth defects or other reproductive harm.



# FILTER WRENCHES

**PKG411 2 9/16" - 3 11/16" O.D. (Cont'd.)  
(65.1 - 93.7)**

B1431	B7125	B7379	BF7591-D
B1432	B7128	B7384	BF7598
B1434	B7139	B7387	BF7602
B1435	B7143	B7388	BF7606
B1438	B7152	B7390	BF7608
B1441	B7156	B7392	BF7614
B1444	BD7160	B7395	BF7619
B1447	B7165	B7401	BF7624
BW5070	B7167	B7403	BF7631
BW5071	B7170	B7407	BF7632
BW5072	B7172	B7410	BF7633
BW5073	B7177	B7419	BF7634
BW5074	B7181	B7420	BF7637
BW5075	B7197	B7422	BF7640
BW5076	B7215	B7424	BF7644
BW5082	B7216	B7428	BF7648
B5088	B7220	B7429	BF7653
B5089	B7221	B7430	BF7663
B5090	B7222	B7432	BF7664
B5091	B7231	B7433	BF7666
B5134	BT7237	B7434	BF7683
BW5136	B7238	B7440	BF7695
BW5137	B7240	B7441	BF7696
BW5138	B7243	B7443	BF7747
BW5139	B7271	B7444	BF7750
BW5140	B7273	B7445	BF7753
BW5141	B7274	B7446	BF7759
BW5142	B7275	B7449	BF7760
BW5143	B7276	B7451	BF7772
B5144	B7277	B7453	BF7774
B5145	B7281	B7457	BF7798-O
B5176	B7283	B7458	BF7798-SP
BW5178	B7285	B7461	BF7806
BW5182	B7286	B7462	BF7806-O
BW5183	B7287	B7465	BF7813
BW5200	B7289	B7467	BF7837
BW5201	B7290	B7469	BF7838
BW5250	B7291	B7470	BF7840
BF5587-D	B7292	B7472	BF7841
BF5800	B7293	B7473	BF7879
BF5801	B7294	B7474	BF7880
BF5810	B7295	B7475	BF7883
BF5812	B7306	B7476	BF7886
BF5813	B7311-MPG	B7487	BF7888
BF5815	BD7317	B7491	BF7892
BF5816	B7318	B7496	BF7907
B7001	B7320	B7497	BF7908
B7010	B7327	B7499	BF7909
B7014	B7333	B7511	BF7915
B7020	B7334	BF7528	BF7917
B7023	BT7349	BF7529	BF7919
B7024	B7351-MPG	BF7531	BF7921
B7025	B7352	BF7532	BF7922
B7026-MPG	B7356	BF7534	BF7923
B7031	B7360	BF7535	BF7925
B7033	B7361	BF7538	BF7931
B7042	B7362	BF7541	BF7940
B7049	B7367	BF7544	BF7957
B7082	B7369	BF7546	BF7966
B7089	B7370	BF7552	BF7967
B7091	B7372	BF7557	BF7968
BD7095	B7375	BF7558	BF7969
B7099	B7376	BF7559	BF7970
B7117	B7377	BF7586	BF7976
B7119	B7378	BF7587	BF7981

**PKG411 2 9/16" - 3 11/16" O.D. (Cont'd.)  
(65.1 - 93.7)**

BF7985	BT8509-MPG	BF9831	B40036
BF7990	BT8830	BF9834	B40070
BF7993	BT8831	BF9840	B40073
BF7998	BT8832	BF9841	B40120
BT8304	BT8833	BF9842	B40122
BT8314	BT8886-MPG	BF9843	B40124
BT8316-MPG	BT8898	BF9849	B40125
BT8323	BT8900	BF9850	B40126
BT8328	BT8902	BF9852	B40127
BT8333	BT8903	BF9853	B40128
BT8357	BT8908	BF9854	B40129
BT8384	BT8916	BF9876	B40133
BT8391	BT8917	BF9877	B40136
BT8393	BT8918	BF9878	B40140
BT8398-MPG	BT8926	BF9883	B40150
BT8409	BT9346-MPG	BF9887	BF46012
BT8413	BT9349-MPG	BF9893	BF46014
BT8415	BT9366-MPG	BF9894	BF46015
BT8417	BT9382	BF9910	BF46021-O
BT8418	BT9388	BF9913	BF46022-O
BT8420	BT9392-MPG	BF9922-O	BF46032
BT8428-MPG	BT9393-MPG	BF9926-O	BF46048
BT8440-MPG	BT9402	BW21000	BF46065-SPS
BT8445	BT9408	BT23604	BF46111
BT8460	BT9440	BT23607-MPG	BF46141
BT8472	BT9442-MPG	BT23611	BF46143
BT8473	BT9464	BT23630	BF46149-SP
BT8474	BT9465	BT23631	BF46164-O
BT8493	BF9812	B40000	BF46170
BT8499	BF9813	B40006	BF46176
BT8501-MPG	BF9815	BT40015	BF46228
BT8502	BF9819	BT40028	OAS98000
BT8504	BF9820	BT40032	
BT8505	BF9821	BT40034	

**PKG412 3 5/8" - 4" O.D.  
(92.1 - 101.6)**



B2	B164	BT261	BT357
B2-HPG	B166	B262	B358
B6	B167	BT264	B360
B6-HPG	B173-S	BT274	BT361
B7	B202	B279	BT364
B9	BT216	B281	BT365
B27	BT217	BT292	BT365-10
BD28	B229	B296	BT366-10
B34	BT230	B299	BT366-MPG
B39	B233	PT302	BT367
B50	B236	T303-M	BT367-S
B74	BT237	PT304	BT368
B109	BT241	BT305	B369
BT111	B244	B329	BT371-10
BT112	B246	BT334	BT371-5
B114	BT248	B336	BT371-MPG
B118	BT251	BT338	BT372-10
B120	B252	BT339	BT372-MPG
BT126	B253	BT341	B378
B132	B255	BT342	B378-10
B141	BT259	BT344-S	BT395
B156	BT260	BT346	B403
B163	BT260-10	BT354	BT420



**WARNING:** These products can expose you to chemicals, including Diisononyl Phthalate, Carbon black extracts, Nickel, 1,3 Butadiene, Ethylene Oxide, Epichlorohydrin, which are known to the State of California to cause cancer, and Bisphenol-A, Ethylene Glycol, Ethylene Oxide, 1,3 Butadiene, Epichlorohydrin, which are known to the State of California to cause birth defects or other reproductive harm.

**FILTER WRENCHES****PKG412 3 5/8" - 4" O.D. (Cont'd.)  
(92.1 - 101.6)**

BT427	BF992	B5088	B7271
BT438	BF1102	B5089	B7273
BT452	BF1204	B5090	B7274
B481	BF1204-O	B5091	B7291
B488	BF1204-SP	B5134	B7298
BT525	BF1205	BW5136	B7306
BT526	BF1205-SP	BW5137	B7311-MPG
BT526-10	BF1212	BW5138	BD7317
BT536	BF1213	BW5139	B7320
BT541	BF1214	BW5140	B7322
BF553	BF1217	BW5141	B7327
BF577	BF1220	BW5142	B7328
BF582	BF1225	BW5143	BT7349
BF583	BF1233	B5144	B7350
BF585	BF1248	B5145	B7351-MPG
BF591	BF1249	B5176	B7357
BF592	BF1249-O	BW5178	B7359
BF593	BF1249-SP	BW5182	B7360
BT595	BF1252	BW5183	B7362
BF597	BF1253	BW5200	B7372
BT606-MPG	BF1258	BW5201	B7375
BF614	BF1259	BW5250	B7376
BF719	BF1266	BF5800	B7377
BF720	BF1268	BF5801	B7378
BT732	BF1270-SP	BF5810	B7379
BT735	BF1271	BF5812	B7388
BT739	BF1272-SPS	BF5813	B7395
BT778	BF1278	BF5813-O	B7403
BT779	BF1278-O	BF5815	B7420
BF781	BF1279	BF5816	B7424
BF789	BF1280	B7001	B7431
BF791	BF1282	B7014	B7440
BF791-O	BF1282-O	B7022	B7451
BF792	BF1289-SP	B7023	B7453
BF797	BF1293-SPS	B7024	B7467
BF798	BF1350-SP	B7025	B7486
BT839	BF1352-SPS	B7026-MPG	B7496
BT839-10	BF1356	BD7029	B7497
BT841	BF1361	B7031	B7499
BF862	BF1365	B7034	B7511
BF863	BF1366-O	B7042	BF7528
BF888	BF1371	B7044	BF7529
BF891	BF1376	B7047	BF7538
BF892	BF1378-SPS	B7082	BF7541
BF896	BF1384-SP	B7089	BF7546
BF900	BF1385-SPS	BD7095	BF7552
BF915	BF1393-SP	B7099	BF7557
BF948	BF1394-SP	B7117	BF7558
BF948-JD	BF1398-O	BD7120	BF7559
BF955	B1428	B7125	BF7586
BF956	B1429	B7128	BF7587
BF957	B1434	B7143	BF7602
BF957-D	B1438	B7152	BF7606
BF958	B1441	B7156	BF7614
BF962	B1446	B7163	BF7624
BF968	BW5070	B7170	BF7631
BF970	BW5071	B7177	BF7632
BF971	BW5072	B7181	BF7633
BF974-D	BW5073	B7197	BF7640
B975	BW5074	B7215	BF7644
BF978	BW5075	B7220	BF7645
BF979	BW5076	B7221	BF7653
BF980	BW5082	B7231	BF7664
BF984	BW5086	BT7237	BF7666
BF991	B5087	B7240	BF7695

**PKG412 3 5/8" - 4" O.D. (Cont'd.)  
(92.1 - 101.6)**

BF7696	BT8347	BT8846	BT9466-MPG
BF7747	BT8357	BT8847	BT9471
BF7750	BT8391	BT8848-MPG	BT9553
BF7753	BT8393	BT8849-MPG	BT9561
BF7759	BT8397-MPG	BT8850-MPG	B9601
BF7760	BT8398-MPG	BT8851-MPG	BF9820
BF7766	BT8415	BT8852-MPG	BF9834
BF7774	BT8416	BT8853-MPG	BF9877
BF7798-SP	BT8420	BT8855-MPG	BF9878
BF7806	BT8426-MPG	BT8856-MPG	BF9887
BF7813	BT8428-MPG	BT8861	BF9893
BF7815	BT8439-MPG	BT8862	BF9894
BF7842	BT8440-MPG	BT8863	BF9904
BF7879	BT8443	BT8898	BF9913
BF7883	BT8444	BT8900	BF9922-O
BF7886	BT8445	BT8903	BF9923-O
BF7888	BT8449	BT8904-MPG	BF9926-O
BF7907	BT8449-10	BT8905	BF9927
BF7908	BT8463-MPG	BT8913-MPG	BW21000
BF7917	BT8464	BT8916	BT23525-MPG
BF7919	BT8465	BT8918	BT23540
BF7922	BT8466-MPG	BT8919	BT23611
BF7923	BT8472	BT8922	B40022-MPG
BF7924	BT8473	BT8926	BT40028
BF7925	BT8474	BT8928	BT40032
BF7940	BT8486	BT8935	B40056
BF7941	BT8488	BT9211	BF46015
BF7942	BT8493	BT9316-MPG	BF46017-O
BF7955	BT8497-MPG	BT9318	BF46019-O
BF7957	BT8499	BT9321	BF46020-O
BF7966	BT8501-MPG	BT9325	BF46021-O
BF7968	BT8502	BT9326	BF46022-O
BF7968-O	BT8504	BT9346-MPG	BF46023-O
BF7979	BT8505	BT9358	BF46024-O
BF7981	BT8509-MPG	BT9363-MPG	BF46026-O
BF7985	BT8512	BT9364	BF46029-O
BF7987	BT8830	BT9366-MPG	BF46030-O
BF7988	BT8831	BT9368-MPG	BF46032
BF7993	BT8832	BT9370-MPG	BF46048
BF7995	BT8833	BT9382	BF46050
BF7997	BT8834-MPG	BT9398-MPG	BF46055-SPS
BT8301	BT8840-MPG	BT9400-MPG	BF46111
BT8304	BT8841-MPG	BT9433	BF46127
BT8312	BT8842-MPG	BT9436-MPG	OAS98060
BT8314	BT8843-MPG	BT9442-MPG	
BT8316-MPG	BT8844	BT9456	
BT8328	BT8845	BT9465	



**WARNING:** These products can expose you to chemicals, including Diisononyl Phthalate, Carbon black extracts, Nickel, 1,3 Butadiene, Ethylene Oxide, Epichlorohydrin, which are known to the State of California to cause cancer, and Bisphenol-A, Ethylene Glycol, Ethylene Oxide, 1,3 Butadiene, Epichlorohydrin, which are known to the State of California to cause birth defects or other reproductive harm.

---

## BALDWIN FILTER DATE CODING METHODS

---

You will find several different date coding methods used on Baldwin products and packaging. Please look for one of these coding methods whenever you are trying to find the date of manufacture for a Baldwin product.

■ **Six (6) Digit Numeric Code - e.g. 010320**

**Introduced November 8, 2002** (Replaces (3) Digit Numeric Code)

1st Two Digits	- 01 -	indicate month (January)
2nd Two Digits	- 03 -	indicate day of month (3rd)
Last Two Digits	- 20 -	indicate year (2020)

■ **Eleven (11) Digit Numeric Code - e.g. 08291314301**

**Introduced November 8, 2002** (Replaces (10) Digit Numeric Code)

1st Two Digits	- 08 -	indicate month (August)
2nd Two Digits	- 29 -	indicate day of month (29th)
5th and 6th Digits	- 20 -	indicate year (2020)
Next 4 Digits	- 1430 -	indicate time of day (Military) (2:30 p.m.)
Last Digit	- 1 -	indicates filter line

### Date Coding Methods Used Prior to 2003

■ **Three (3) Digit Numeric Code - e.g. 082**

1st Two Digits	- 08 -	indicate month (August)
Last Digit	- 2 -	indicates year (2002)

■ **Ten (10) Digit Numeric Code - e.g. 0829214303**

1st Two Digits	- 08 -	indicate month (August)
2nd Two Digits	- 29 -	indicate day of month (29th)
5th Digit	- 2 -	indicates year (2002)
Next 4 Digits	- 1430 -	indicate time of day (Military) (2:30 p.m.)
Last Digit	- 3 -	for internal control purposes

■ **Numeric Digits and Diamonds - e.g. 234 ◆◆◆◆◆**

1st Digit	- 2 -	indicates last digit of the year (2002)
Diamonds	- ◆◆◆◆◆ -	indicate month (August) Number of diamonds subtracted from 13 equals the month (13 - 5 = 8 = August)

# BALDWIN HEAVY-DUTY FILTERS

QUALITY. COVERAGE. SERVICE. AVAILABILITY.

---

## FIND THE COVERAGE YOU'RE LOOKING FOR

### FILTERS FOR ALL OF YOUR NEEDS

Baldwin's high quality filters are designed for on and off-road vehicles with diesel engines.

- service shops
- farmers
- trucking companies
- contractors
- municipalities
- fleets or anyone who operates diesel equipment

No matter what the industry or operating conditions, you can be confident that Baldwin's heavy-duty filters provide protection that matches or exceeds the original equipment.

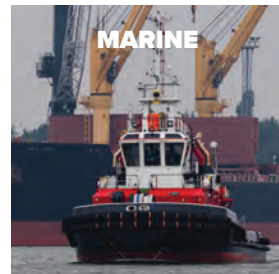
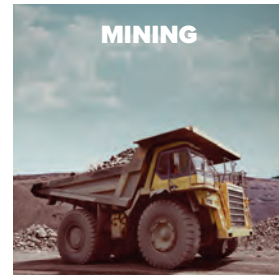
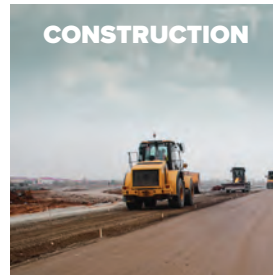
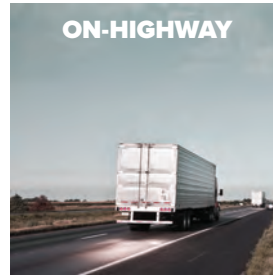

TS 16949  
ISO 9001



QUALITY SYSTEM  
CERTIFIED

Discover other replacement A/C and heating parts on our website.