

FITTING INSTRUCTIONS

**ARB WINCH/NON WINCH BUMPER TO SUIT MITSUBISHI PAJERO NM
FLARED. EXCLUDING EXCEED MODEL**

**PRODUCT No. 3934020 Sahara Bar
3034020 Sahara Bumper
FITTING KIT No. 6171383, 6171762, 6171363**

WARNING

FOR VEHICLES EQUIPPED WITH SRS AIRBAG

**WHEN INSTALLED IN ACCORDANCE WITH THESE INSTRUCTIONS, THE FRONT
PROTECTION BAR DOES NOT AFFECT OPERATION OF THE SRS AIRBAG.**

TAKE NOTE OF THE FOLLOWING:

- **THIS PRODUCT MUST BE INSTALLED EXACTLY AS PER THESE INSTRUCTIONS USING ONLY THE HARDWARE SUPPLIED.**
- **IN THE EVENT OF DAMAGE TO ANY BULL BAR COMPONENT, CONTACT YOUR NEAREST AUTHORISED ARB STOCKIST. REPAIRS OR MODIFICATIONS TO THE IMPACT ABSORPTION SYSTEM MUST NOT BE ATTEMPTED.**
- **DO NOT USE THIS PRODUCT FOR ANY VEHICLE MAKE OR MODEL, OTHER THAN THOSE SPECIFIED BY ARB.**
- **DO NOT REMOVE LABELS FROM THIS BULL BAR.**
- **THIS PRODUCT OR ITS FIXING MUST NOT BE MODIFIED IN ANY WAY.**

Note:

- 1 If fitting optional fog lights, fitting kit no. 9381FCK is required.**
- 2 This winch bumper is suitable for Warn 8,000lb & 9,000lb winch only.**

Tools Required

10mm, 18mm, 19mm, 21mm Spanners and Sockets. Phillips head screwdriver, 12mm and 13mm drill bit and drill.

USE	PART No	QTY	DESCRIPTION
BUFFER FITTMENT	6151128	17	NUT FLANGE M6
	3162158	1	BUFFER LOWER
	3162153	1	BUFFER LHS SAHARA BAR
	3162154	1	BUFFER RHS SAHARA BAR
	3162471L	1	BUFFER LHS SAHARA BUMPER
	3162471R	1	BUFFER RHS SAHARA BUMPER
LIGHT SURROUNDS TO BAR	3162156	1	LIGHT SURROUND LHS
	3162157	1	LIGHT SURROUND RHS
CHROME TUBE FITTMENT (SAHARA BAR ONLY)	6151255	2	BOLT M12 X 40mm
	4581049	2	WASHER FLAT M12
	4581050	2	WASHER SPRING M12
	6131174	1	CHROME TUBE
MOUNT ASSY TO VEHICLE	3756190L	1	BRACKET IMPACT ABSORBER LHS
	3756190R	1	BRACKET IMPACT ABSORBER RHS
	3756194L	1	BRACKET FRONT MOUNT LHS
	3756194R	1	BRACKET FRONT MOUNT RHS
	3756189L	1	BRACKET CHASSIS SUPPORT LHS
	3756189R	1	BRACKET CHASSIS SUPPORT RHS
	6151246	6	BOLT M12 X 25mm
	6151204	8	BOLT M10 X 35mm
	4581010	4	WASHER Ø14 ID, Ø35 OD
	4581041	12	WASHER FLAT M10
	4581048	8	WASHER M10 SPRING
	6151026	4	NUT M10
	3193659	2	PLATE CAPTIVE NUT
	6151255	6	BOLT M12 X 40mm
	4581049	8	WASHER FLAT M12
	PT003-12B	6	CAP RUBBER
	6151026	4	NUT M10
	4581050	12	WASHER SPRING M12
	6151268	6	NUT CAPTIVE
WING BRACE TO BAR/VEHICLE	4681081	2	BRACE WING
	6151256	2	BOLT M6 BUTTON HEAD S/STEEL
	4581072	2	WASHER M6 x 19mm
	6151017	2	BOLT M6 X 16mm HEX HEAD
	6151128	4	NUT M6 FLANGE
WINCH	4581044	4	WASHER 3/8"
CONTROL BOX FITTMENT	3756220	1	CONTROL BOX BRACKET
	6151017	2	BOLT M6 X 16MM
	6151128	4	NUT FLANGE M6
WINCH COVER FITTMENT	6151128	2	NUT FLANGE M6
	6151256	2	SCREW M6 S/STEEL BUTTON HEAD
	6191001	1	WINCH COVER EXTRUSION
	6521031	1	WINCH COVER
	6151046	2	WASHER M6

USE	PART No	QTY	DESCRIPTION
CAP WING COVER FITTMENT	6151267	6	CLIP CHRISTMAS TREE
	3162164	1	CAP WING COVER LHS
	3162165	1	CAP WING COVER RHS
	6151180	4	BOLT M6 X 20mm
	6151162	4	NUT M6 NYLOC
	4581072	8	WASHER M6 X 19mm
BAR TO MOUNT ASSEMBLY	6151255	6	BOLT M12 X 40mm
	4581050	6	WASHER SPRING M12
	4581007	6	WASHER FLAT M12 LARGE
	4581048	2	WASHER SPRING M10
	6151026	2	NUT M10
	6151045	2	BOLT M10 X 25mm
	4581041	12	WASHER FLAT M10
CB	3162152	2	PLASTIC PLUG DIA16
ROLLER FAIRLEAD FITTMENT	4581049	4	WASHER FLAT M12
NUMBER PLATE FITTMENT	6151017	2	BOLT M6 X 16mm
	6151128	2	NUT FLANGE M6
	6781408	1	TAPE DOUBLE SIDED
WIRING	180302	10	CABLE TIE

ASSEMBLY SEQUENCE.

1.

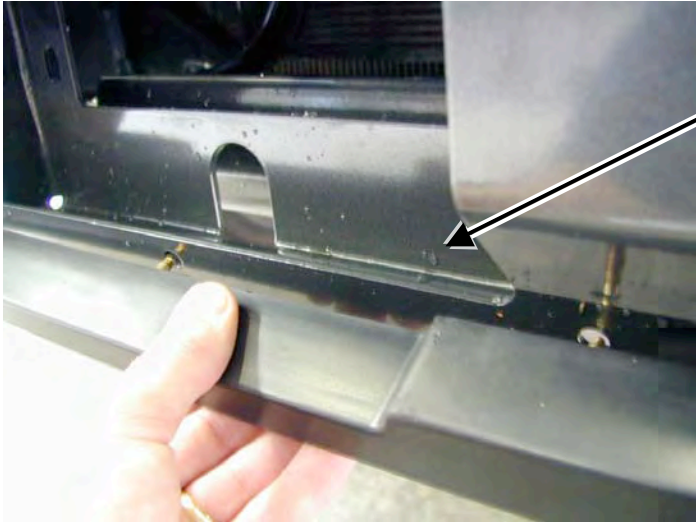

1. Position the lower buffer on the winch bumper and assemble using the M6 flange nuts.

2.



1. Insert the side buffers through the holes and fix using the M6 flange nuts.

NOTE

Sahara bumper buffer has no large top hole.

5.



1. Glue the light surrounds to the bar using a silicone based rubber adhesive. Run the bead along the cavity on the rear side of the part. Position the surround to align the inside edge with the buffer and concentric to the light.
2. Wipe off any adhesive on the front face of the bar. Allow adhesive to cure before continuing.
3. **If fitting optional fog lights, do so at this stage.**
4. **If fitting Sahara Bumper go to step 7**

6.



1. Push the top chrome tube through the hole in the bumper and fasten using the M12 x 40mm bolts, washers and spring washers.

NOTE

This step for Sahara bar only

7.

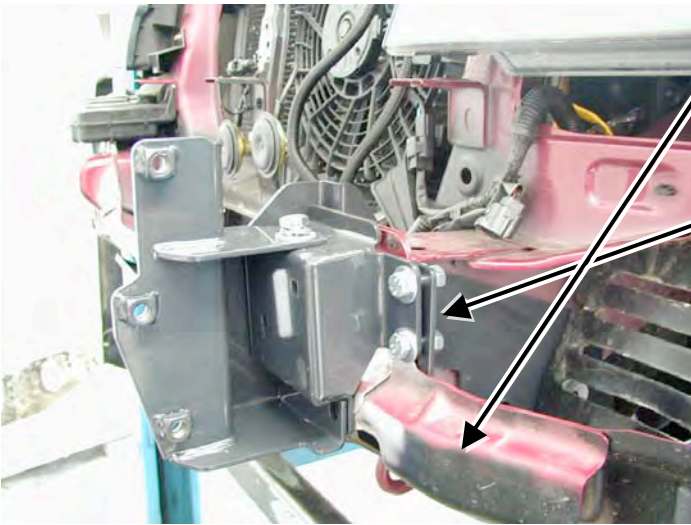

1. Remove the bumper bar and grill.
2. Spray paint the vehicles cross member with matt black spray paint on both sides.
3. Assemble the mounts to the vehicle as shown in the pictures 7 & 8. Fasten bolts finger tight only.

M10 x 35mm bolts, flat washers, spring washers and nuts.

8.

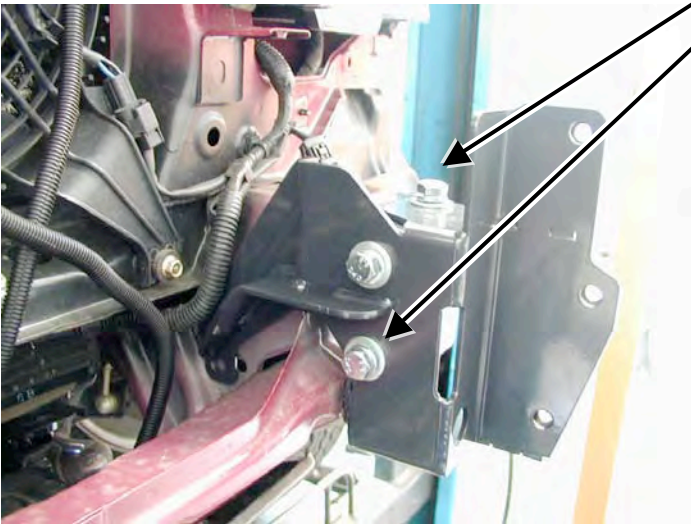

M12 x 25mm bolts, flat washers and spring washers.

9.



1. Using a 12mm drill bit, drill through the two slot holes at the front into the chassis cross member.

10.

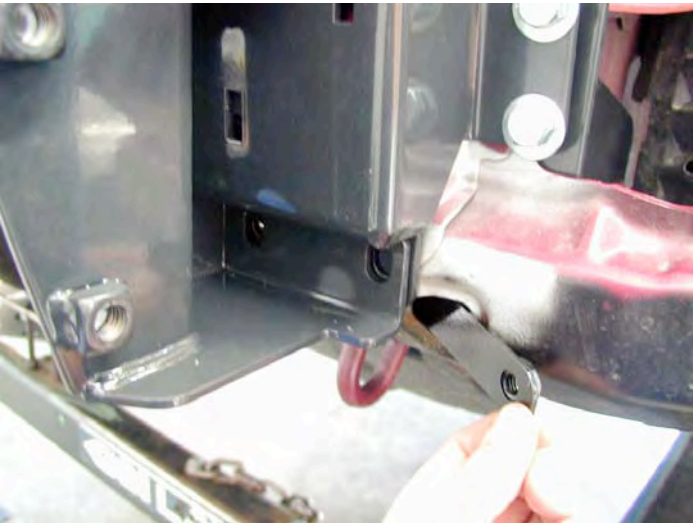

1. Feed the captive nut plate through the hole in the cross member and fasten using M10 bolts, flat washers and spring washers.

11.

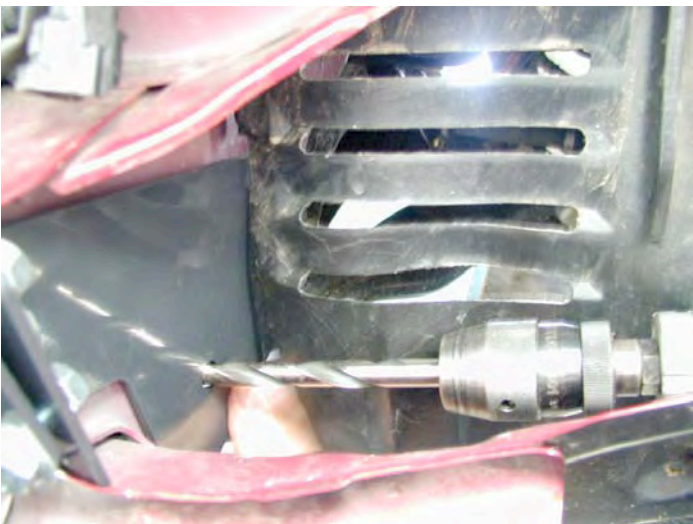

1. Using a 13mm drill bit, drill through the holes in the outside bracket and into the chassis rail.

12.

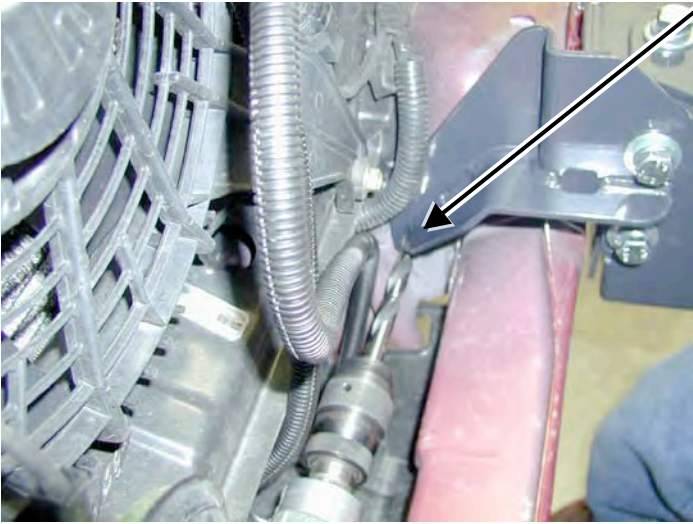

1. Using a 13mm drill bit, drill through the hole in the main bracket and into the chassis rail.

13.

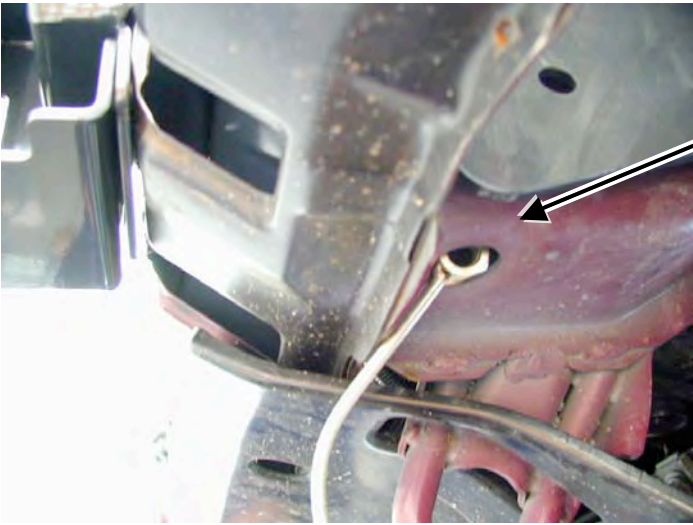

1. The mounting bolts for the drilled holes are fastened using the captive nuts with extension arms. Feed these through the hole underneath the chassis rail. The wire can be manipulated to shape for easier installation.

14.

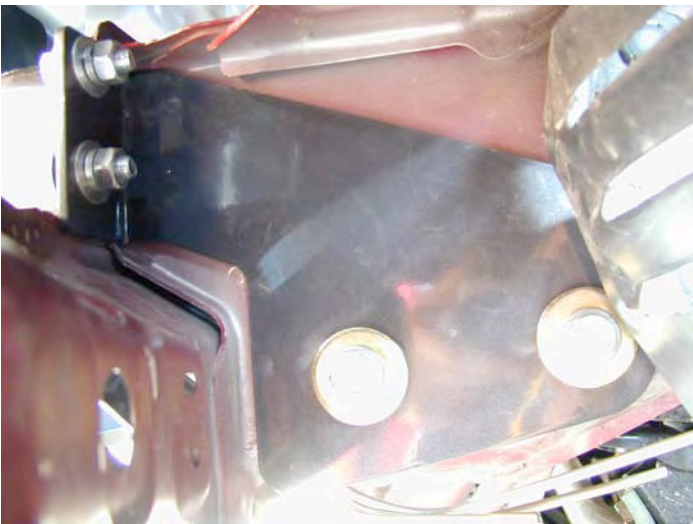

1. Fasten the brackets using the M12 x 40mm bolts, Large washers and spring washers.
Note: The inside bolt uses a small M12 washer.

15.

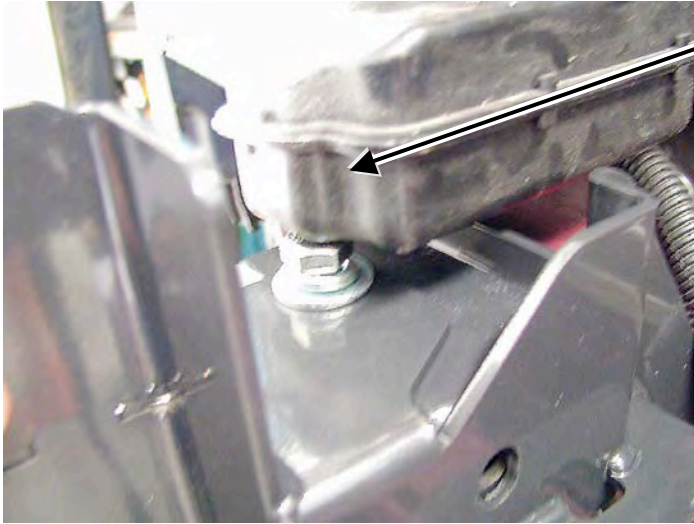

Note: The washer bottle on the drivers side must be removed to gain access to the top bolt.

1. Tighten all bolts.

16.



1. Fasten the wing braces to the vehicle using M6 bolts flange nuts and washers.

17.

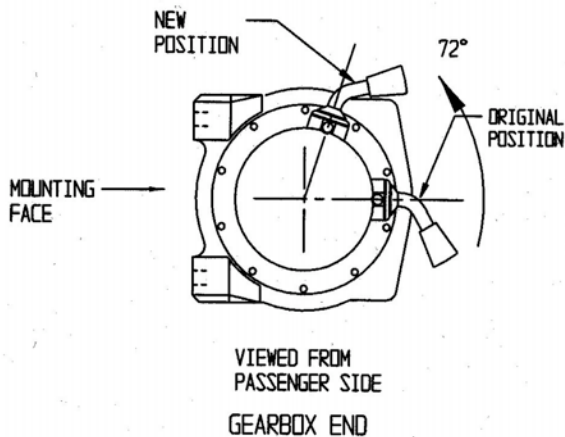

(If fitting the winch.)

1. To place the winch clutch handle in a convenient location the winch gearbox must be rotated 2 hole spacings, 72 degrees, in an anti-clockwise direction when viewed from the gearbox end. Place the winch on its end and remove all gearbox bolts. Gently raise the gearbox just enough to rotate it. Do not completely remove the gearbox and avoid damaging the gasket. Refit all bolts and tighten.

NOTE: Take care not to lift the assembly more than a couple of millimetres while rotating to the desired position to avoid unmeshing the gears.

18.

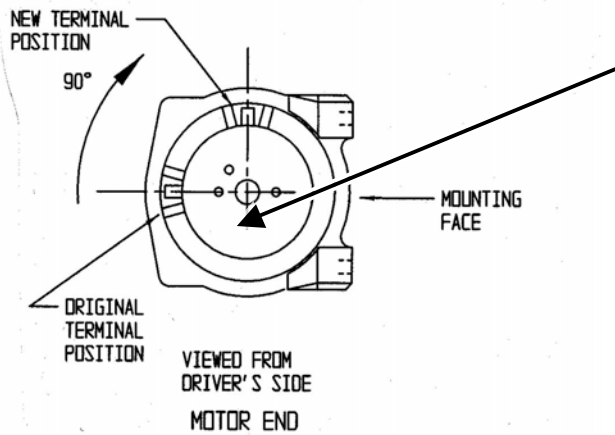

1. To place the winch motor in the correct location the winch motor must be rotated 90 degrees, in a clockwise direction when viewed from the motor end. Place the winch on its end and remove the 2 motor retaining bolts. Gently raise the motor just enough to rotate it. Do not completely remove the motor and avoid damaging the gasket. Refit all bolts and tighten.

NOTE: Take care not to lift the assembly more than a couple of millimetres while rotating to the desired position to avoid unmeshing the gears.

19.



1. Bolt the winch and roller fair lead to the bar using the bolts supplied. The longer bolts are used for the two bottom holes through the roller fair lead.

20.

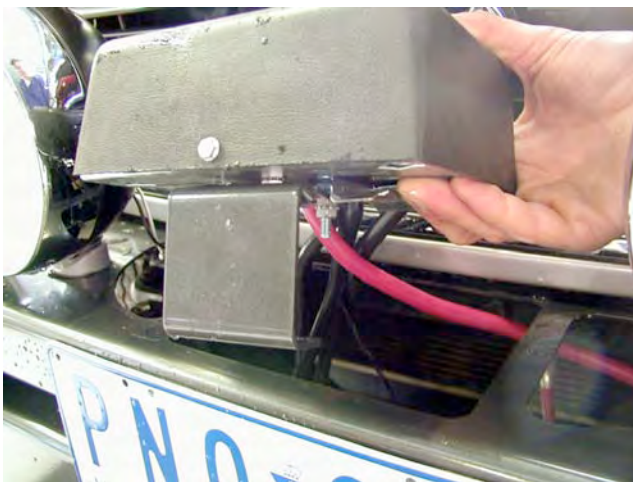

1. Install the winch and roller fairlead using bolts, nuts and spring washers supplied by Warn, and the 4 x 3/8" flat washers supplied in the bolt kit. Refer to Warn installation instructions for correct procedure. Adjust winch in slots until the winch is centralised in the bull bar.
2. Assemble the control box bracket to the control box using M6 flange nuts.
3. Mount the control box to the bar using M6 X 16 bolts and M6 flange nuts.

NOTE: The gearbox is on the passenger side for the 8,000lb and 9,000lb. The cable spools from the bottom for the two winches mentioned.

21.



(If not fitting winch)

1. Wrap rubber extrusion around winch cover.
2. Place washers over the winch cover fixing holes located on the top middle face of the winch bumper.
3. Place the winch cover on top of the winch bumper inline with the mount holes.
4. Bolt together using the M6 button head stainless steel screws and M6 nuts.

22.



1. Fasten the Cap Wing Cover to the bar using the christmas tree clips, M6 x 20mm bolts, washers and nyloc nuts.

Three christmas tree clips are used on the inside holes.

The bolts are for the two end holes.

23.



With winch



Without winch

(If fitting with winch.)

1. Peel off one side of the double sided tape and adhere to the top rear side of the number plate. Note: Clean the adhering surfaces before applying tape with an alcohol solvent.
2. Peel off the other side of the tape and bolt to the winch bumper with the M6 X 16mm bolts and M6 flange nuts through the lower holes of the number plate.
3. Press firmly to the top of the number plate so the tape can properly adhere.

(If not fitting with winch.)

1. Bolt the number plate through the top holes using M6 X 16mm bolts and M6 flange nuts.
If desired the double sided tape can be used down the sides of the number plate.

24.

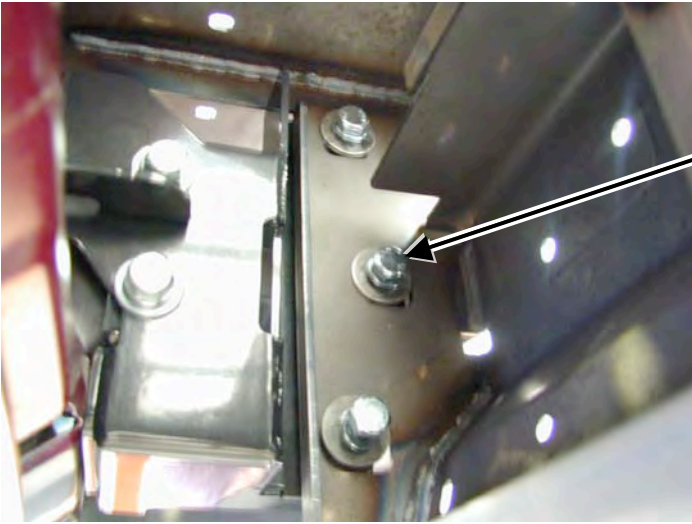

1. With the aid of another person place the bar on the mounts. Line the bar to the vehicle and fasten using six M12 x 40mm bolts six large washers and six spring washers. Tighten all bolts so the large washer deforms inside the rectangular cutout. Note: when aligning the bar to the vehicle the plastic wing trims can be adjusted along the side of the wheel arches by undoing the two bolts and repositioning. Note: if car is fitted with headlight covers, remove them before fitting the bar. Leave approximately a 2-3mm gap between the plastic trim and headlight when tightening the bolts. Fit the headlight covers after bar is fitted.

25.



1. Bolt the wing brace to the back of the wing using the button head M6 bolt and flange nut. Note: The brace has adjustment so the wing can be pushed up to the vehicle then tightened.

26.

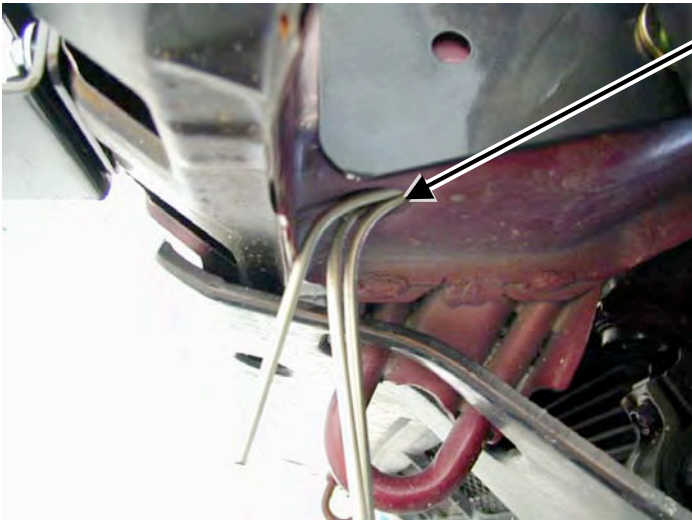

1. Cut the excess wires from under the vehicle so they don't protrude past the chassis rail.

27.



1. Place the rubber caps over the cut ends of the wires.

28.



1. Next step is to lock pin the bar so there is no movement by drilling a 10mm hole on both sides of vehicle, and fasten with 10mm x 25mm bolts plus 10mm hardware.

29.



(If fitting with winch)

1. Feed the winch cable through the roller fair lead. Mount the hook to the end of the cable.

30.

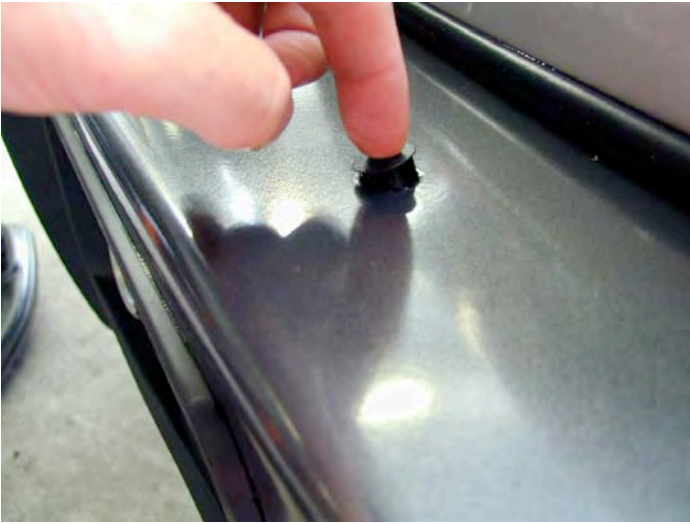

1. There are two dia 16 hole located on the top face of the bar. If no CB arials are fitted the holes can be covered with the plastic plugs provided in the fitting kit.
2. Place the ARB logo on the front face of the bar in the indentation.

31. If fitting fog lights, wire the fog lights as described in the fog light fitting instructions

The fog lights can be adjusted to desired angles by the adjustment bolts located at the back of the light insert. When adjustment is finalised be sure to retighten the fog light bolts.

(If fitting with winch)

32. Connect the winch control box cables to the winch motor. Refer to the Warn handbook for additional information. Connect the long winch + & - cables to the vehicle after the bar is installed.

Refer to the Warn winch manual for vehicle wiring instructions.

Ensure that these cables are installed well clear of sharp, hot or moving objects. Secure the winch cables to the vehicle and winch bumper with the supplied cable ties.