



DESIGNER AND MANUFACTURER  
OF CARGO RESTRAINT SYSTEMS





# EVERYTHING YOU NEED FROM A TO Z TO MOVE ANYTHING FROM A TO B.



**ANKRA'S TIE-DOWN-CALCULATOR APP HELPS KEEP YOU IN COMPLIANCE WITH THE LAW**  
SEE PAGE 60

## WELCOME TO OUR CATALOG.

From anchor points to zinc coated winches and everything in-between, Ankra's world class cargo restraint systems equip you to take to the road with a stable, secure load. Whether your cargo calls for standard or heavy-duty restraint, in this comprehensive catalog you'll find dependable flatbed, interior van solutions, lifting slings, auto transport products, hardware, and utility tie downs to meet all your load securement requirements and ensure your compliance with CSA.

### THIS CATALOG IS ORGANIZED TO SAVE YOU TIME AND EFFORT.

There are seven major product sections:

- Flatbed
- Interior Van
- Auto Transport
- Lifting Slings
- Utility Tie Downs
- General Hardware & Webbing
- General Information

**Color-coded pages** in each section help you find the desired category quickly. All products are presented with photos and complete descriptions, capacities and sizes. **Drawings** and **sidebar how-tos** give you additional details, as well as **web links** and **Quick Response (QR) Codes** that connect you to dynamic online information.

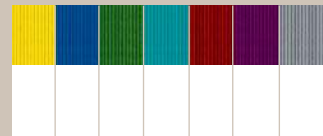

### Trucker-Friendly Pages

If you're looking for a specific product, it's easy to find in our Index listings. Whether you're searching by part number or product name, you can find what you're looking for in our Numerical Index starting on page 98, or our Alphabetical Index on page 109.

## Product pages offer comprehensive product information and more:

### Trucker Tips:

Handy, helpful tips in boxes framed in black and yellow stripes.

### Part Numbers:

Listed in boldfaced type followed by technical specifications.

### Warnings:

Vital Information regarding product use or hazards on the road highlighted in color boxes.



### Did you know?:

Facts and figures, historical industry notes stand out with their blue background.



#### PAYMENT OPTIONS

AUTHORIZED DISTRIBUTORS CAN PAY BY CHECK, MONEY ORDER, OR WIRE OR BANK TRANSFER. YOU CAN OPEN A LINE OF CREDIT BY REQUESTING A CREDIT APPLICATION FROM OUR CUSTOMER SERVICE DEPARTMENT. AFTER THE SHORT APPROVAL PROCESS, YOU WILL BE READY TO PLACE YOUR ORDER.

## SAFETY IN NUMBERS TIMES 3

### Solid parent organization

Ancra International has continuous access to professional services, financial and insurance partners and best practices policies, plus the further advantage of a solid parent organization, the Heico Companies, with annual sales approaching \$3-billion.

### Safety factors

It doesn't take a numbers person to appreciate the built-in safety factor of reputable products. At Ancra, we use our own in-house testing facilities as well as independent sources to test and retest our securement products. It's a process that begins with initial design concepts and continues through the final manufacturing.

It doesn't end there. We constantly spot test finished products to make sure they meet quality cargo control standards day after day. We even test and evaluate products that have been in service for signs of corrosion and fatigue. When you see the working load limits permanently marked on Ancra winches, you can be sure those numbers will be met, and more.

### In-service record

There's a third way we ensure safety in numbers. Serving the trucking industry for decades we have hundreds of thousands of reliable products working hard everyday. Truckers know what's good.

## OUR SAFETY TESTING PROCESS



### ABRASION TESTER CONFIRMS THE STRENGTH OF ANCRA STRAPS.

Random webbing samples are abrasion tested per ASTM D6770-097 then load tested for its ability to withstand accelerated wear.



TENSILE TEST EQUIPMENT CHECKS ANCRA WEBBING AND HARDWARE FOR LOAD CAPACITY USING UP TO 50,000 LBS. OF FORCE. If a product doesn't meet the minimum required capacity, the lot is rejected.



**TOLERANCES.** During the process of first article inspection, Ancra measures crucial tolerances with a granite table and height stand. This assures the product is built to design specs.



**HIGH DEFINITION COMPARATOR** verifies dimensions. Ancra products are inspected for accuracy and proper fit with mating parts that will assure trouble-free performance.

# TABLE OF CONTENTS

## COLOR-CODED PRODUCT SECTION

### Flatbed Solutions

Web Winches	.2, 3, 4, 5
Combination Winches	.6
Cable Winches	.6
Lashing Winches	.7
PortaWinch™ & Porta Anchor™	.8
Winch Dimension Chart	.9
Winch Track	.10
SilverCap™ OverDrive™ Ratcheting Cap	.11
Cable & Chain Anchors	.11
Winch Bars	.12
Forged D-Rings	.13
Hooks & Web Winders	.13
Safety Products, Banners, Flags	.14
GlideLock®	.15
Coil Rack	.15
Corner Protectors	.16, 17
Tarp Protector	.16
Web Protector	.16
Rubber Rope & Hooks	.17
Tarp Ties	.18
Transport Chain & Hardware	.19, 20, 21, 22, 23
Chain Load Binder & Accessories	.24, 25
Floor Chain Tie Downs	.25
Winch Strap Assemblies, X-TREME	.26, 27, 28
Winch Strap Assemblies, Standard	.29, 30, 31
Roll On/Off Container Straps	.31
Ratchet Strap Assemblies, X-TREME	.32, 33
Ratchet Strap Assemblies, Standard	.34, 35, 36
Ratchet Strap Replacements	.37, 38

### Interior Van Solutions

Lift-A-Deck® II	.40, 41, 42, 43, 44, 45
Poly Board Deck	.46
Retract-A-Roll® II	.47
Logistic Track	.48, 49
Beams, Bars & Hoops	.50, 51
Shoring Bars	.50
Garment Beams	.51
Beam Sockets	.51
Cargo Sta®	.52
Hoop Set for Cargo Sta®	.52
Heavy-Duty Jack Bars	.52
Cargo Bar Holder	.53
Tie Offs	.54
Trailer Fittings	.54
Door Pull Straps	.54
Transmat®	.54
Tension Limiting Ratchet Assemblies	.55
Cam Buckle Strap Assemblies	.56, 57
Plate Trailer Straps	.57
Ratchet Buckle Straps	.58
Custom Nets	.59

### Auto Transport Solutions

Car Hauler Straps	.62
Car Tie Downs	.62, 63
Dolly Straps	.63
Transit Straps	.63
Tire Bonnets	.64
Lashing Winches	.64

### Lifting Solutions

Round Slings	.66
Eye to Eye Web Slings	.67, 68

### Utility Tie Downs

Ratchet Strap Assemblies	.70
Cam Strap Assemblies	.70
Packaged Straps	.71
Trackstar Motorcycle Wheelchock	.71
Pickup Truck Cargo Nets	.72

### General Hardware & Webbing

Ratchet Buckles	.74, 75, 76
Overcenter Buckles	.76
Cam Buckles	.77
Roller Buckle	.77
3-Bar Slide Adjuster	.77
Wire Hooks	.78
Flat Hooks	.79
Snap Hooks	.80
Rings	.80
Bolt Plates	.81
Track Fittings	.82, 83
Chain Attachments	.83
Clevis Hooks	.84
RTJ Cluster Hook	.84
Chain Hardware	.85, 86
Webbing	.87
Heavy Duty Aircraft Style Track	.88
Heavy Duty Beveled Aircraft Style Track	.88
Bottle Jacks	.89
Merchandising	.90

### General Information

Specifications/Warranty	.92
Industry Standards	.93, 94
Replacement Criteria	.95
Glossary	.96
Trade Association, Resources	.97
Index by Product Number	.98
Index by Product Name	.109



# FLATBED SOLUTIONS

Ankra's trusted straps and high performance winches, tie downs, and chain assemblies are engineered to meet the challenges of today's highways. If it wears the Ankra name, it can be trusted.

- Long wearing heavy-duty components in every assembly
- Weather resistant, performance proven products
- Specially engineered construction for maximum durability
- Quick and easy operation
- Products to meet your most demanding applications
- Custom products available to meet your unique needs





# FLATBED SOLUTIONS

## STRONGEST IN THE INDUSTRY

Ankra winches comply with DOT, WSTDA-T3 and Canadian Standard 905 regulations. Available in different base configurations to suit a variety of needs and load requirements.

*All winches shown are right hand models. Left hand models may be available on special orders.*

Black powder coat is the standard finish for all winches.

Smooth ground web slots prevent web wear.

Seamless solid steel mandrel.

Powder coating withstands 250 hours of standard salt spray testing to ensure years of service.

Stamped working load limit and Ankra name certify quality.

High-strength alloy pawl pins.



## WEB WINCHES

### Bottom Mount



#### 43563-10

Standard  
Weight: 8.6 lbs./3.9 kg.  
WLL: 5,500 lbs./2,500 kg.



#### 43563-10-RW

Standard Weld-on Ratcheting  
Weight: 10.1 lbs./4.58 kg.  
WLL: 5,500 lbs./2,500 kg.



#### 43573-10

Standard Storable  
Weight: 9.1 lbs./4.1 kg.  
WLL: 5,500 lbs./2,500 kg.



#### 43564-12

Standard Storable  
Portable w/ 2SS  
Weight: 11.1 lbs./5.0 kg.  
WLL: 5,500 lbs./2,500 kg.



#### 43564-147

Standard Portable w/ 2SS  
Lighter 7mm heat treated frame  
Weight: 7.7 lbs./3.5 kg.  
WLL: 5,500 lbs./2,500 kg.



#### 43564-147-RW

Standard Portable Ratcheting  
Lighter 7mm heat treated frame  
Weight: 9.2 lbs./4.17 kg.  
WLL: 5,500 lbs./2,500 kg.



#### 43564-16

Low Profile Portable w/ 2SS  
Weight: 10.1 lbs./4.58 kg.  
WLL: 5,500 lbs./2,500 kg.



#### 43573-11

Standard Storable 2" Spool  
Weight: 10.4 lbs./4.7 kg.  
WLL: 5,500 lbs./2,500 kg.



#### 43573-13

Standard Storable 4" Spool  
Weight: 12.4 lbs./5.6 kg.  
WLL: 5,500 lbs./2,500 kg.



#### 48783-10

Standard Double Cap  
Weight: 9.0 lbs./4.1 kg.  
WLL: 5,500 lbs./2,500 kg.



## WEB WINCHES

### Side Mount



**43579-20**  
Low Profile  
Weight: 7.3 lbs./3.3 kg.  
WLL: 5,500 lbs./2,500 kg.



**41691-10**  
Leg Bracket  
Weight: 7.1 lbs./3.2 kg.  
WLL: 5,500 lbs./2,500 kg.

### DID YOU KNOW? About Winches

- 3-BAR:** Designed for easy strap insertion during snow and ice conditions. Prevents the mandrel from freezing up.
- PORTABLE:** Versatile and meant for temporary installation, and can be placed along the trailer side frame.
- SPOOL:** Designed to reduce strap wear, spool discs guide and store the webbing into a single roll up to 30°.
- STANDARD DOUBLE CAP:** Incremental adjustment from both sides of the winch allows for clearance applications.
- SLIDERS:** Allow for easy positioning in the track, but lock into place when tension is applied to the strap. For use with Ancra track 42357-11, 42357-21, 49242-10-120 or equivalent.

### Sliders



**43565-127**  
Storable Bottom Mount  
C Track Slider.  
Lighter 7mm heat treated frame  
Weight: 8.2 lbs./3.7 kg.  
WLL: 6,000 lbs./2,730 kg.



**43565-127-RW**  
Storable Web  
C Track Slider  
Lighter 7mm heat treated frame  
Weight: 9.7 lbs./4.4 kg.  
WLL: 6,000 lbs./2,730 kg.



**43565-127-XZ**  
Storable Bottom Mount  
X-Treme Zinc Finish  
C Track Slider  
Lighter 7mm heat treated frame  
Weight: 8.2 lbs./3.7 kg.  
WLL: 6,000 lbs./2,730 kg.



**43565-137**  
Standard Double Cap  
C Track Slider. Lighter 7mm  
heat treated frame  
Weight: 8.3 lbs./3.8 kg.  
WLL: 6,000 lbs./2,730 kg.



**43565-147**  
Storable w/ Side Washers  
C Track Slider. Lighter 7mm  
heat treated frame  
Weight: 8.6 lbs./3.9 kg.  
WLL: 6,000 lbs./2,730 kg.



**43565-157**  
Standard Bottom Mount  
C Track Slider. Lighter 7mm  
heat treated frame  
Weight: 7.6 lbs./3.5 kg.  
WLL: 6,000 lbs./2,730 kg.



**43565-157-RW**  
Slider Ratcheting  
Lighter 7mm heat  
treated frame  
Weight: 9.1 lbs./4.1 kg.  
WLL: 6,000 lbs./2,730 kg.

## 7MM

*Reduces Weight per Winch by 2 lbs. on Average.  
Lighter weight reduces fuel expenses and  
allows for a greater pay load. Heat treated  
material maintains strength.*



**43565-157-XZ**  
Standard Bottom Mount  
X-Treme Zinc Finish  
C Track Slider  
Lighter 7mm heat treated frame  
Weight: 7.6 lbs./3.5 kg.  
WLL: 6,000 lbs./2,730 kg.



# FLATBED SOLUTIONS

## WEB WINCHES

### Sliders



**49207-127**  
Storable  
Double L Track Slider  
Lighter 7mm heat treated frame  
Weight: 6.8 lbs./3.09 kg.  
WLL: 5,500 lbs./2,500 kg.



**49207-127-RW**  
Storable Web Ratcheting  
Double L Track Slider  
Lighter 7mm heat treated frame  
Weight: 8.3 lbs./3.8 kg.  
WLL: 5,500 lbs./2,500 kg.



**49207-127-XZ**  
Storable  
Double L Track Slider  
X-Treme Zinc Finish  
Lighter 7mm heat treated frame  
Weight: 6.8 lbs./3.1 kg.  
WLL: 5,500 lbs./2,500 kg.



**49207-137**  
Standard  
Double L Track Slider  
Lighter 7mm heat treated frame  
Weight: 6.5 lbs./2.95 kg.  
WLL: 5,500 lbs./2,500 kg.



**49207-137-RW**  
Standard Ratcheting  
Double L Track Slider  
Lighter 7mm heat treated frame  
Weight: 8.0 lbs./3.6 kg.  
WLL: 5,500 lbs./2,500 kg.



**49207-137-XZ**  
Standard  
Double L Track Slider  
X-Treme Zinc Finish  
Lighter 7mm heat treated frame  
Weight: 6.5 lbs./2.3 kg.  
WLL: 5,500 lbs./2,500 kg.



**49207-187**  
Low Profile  
Double L Track Slider  
Lighter 7mm heat treated frame  
Weight: 6.2 lbs./2.8 kg.  
WLL: 5,500 lbs./2,500 kg.



**49207-187-XZ**  
Low Profile  
Double L Track Slider  
X-Treme Zinc Finish  
Lighter 7mm heat treated frame  
Weight: 6.2 lbs./2.8 kg.  
WLL: 5,500 lbs./2,500 kg.



**49207-187-RW**  
Low Profile Ratcheting  
Double L Track Slider  
Lighter 7mm heat treated frame  
Weight: 7.7 lbs./3.5 kg.  
WLL: 5,500 lbs./2,500 kg.

## RATCHETING WINCHES

*Faster and more convenient than traditional winches. Reduces the tensioning time by 33%. Also, reduces risk of winch bar rollover.*



**49246-10-BP**  
Standard  
Utility Trailer Track Slider  
Weight: 13 lbs./5.9 kg.  
WLL: 5,500 lbs./2,500 kg.

## LOOSE TIE DOWNS?

Even with enough tie downs in place, if any are loose or defective, you could get a citation.



## WEB WINCHES

### Sliders



**49706-10**  
Standard  
Wilson Track Slider  
Weight: 12.5 lbs./5.7 kg.  
WLL: 5,500 lbs./2,500 kg.



**49706-11**  
Low Profile  
Wilson Track Slider  
Weight: 11.5 lbs./5.2 kg.  
WLL: 5,500 lbs./2,500 kg.

**DID YOU KNOW?**  
Portable and slider winches are engineered to be placed anywhere along side the trailer as needed to best secure the load.

### 3-Bar

Weld-on and 3-Bar winches are available in various finishes, including X-Treme Zinc.



**48101-103**  
3-Bar Weld-on  
Side Mount  
Weight: 9.5 lbs./4.3 kg.  
WLL: 6,000 lbs./2,730 kg.



**48101-103-XZ**  
3-Bar Weld-on  
Side Mount  
X-Treme Zinc Finish  
Weight: 9.5 lbs./4.3 kg.  
WLL: 6,000 lbs./2,730 kg.



**48101-133**  
3-Bar Low Profile Weld-on  
Bottom Mount  
Weight: 9.6 lbs./4.4 kg.  
WLL: 6,000 lbs./2,730 kg.



**48101-143**  
3-Bar Weld-on  
Bottom Mount  
Weight: 11.3 lbs./5.1 kg.  
WLL: 6,000 lbs./2,730 kg.



**48101-163-XZ**  
3-Bar Standard Portable  
w/ 2 Set Screws  
X-Treme Zinc Finish  
Weight: 11.2 lbs./5.1 kg.  
WLL: 6,000 lbs./2,730 kg.



**48101-173**  
3-Bar Standard  
C Track Slider  
Weight: 10.4 lbs./4.7 kg.  
WLL: 6,000 lbs./2,730 kg.



**49207-273**  
3-Bar Standard  
Double L Track Slider  
Weight: 8.7 lbs./3.9 kg.  
WLL: 5,500 lbs./2,500 kg.



**49207-273-XZ**  
3-Bar Standard  
Double L Track Slider  
X-Treme Zinc Finish  
Weight: 8.7 lbs./3.9 kg.  
WLL: 5,500 lbs./2,500 kg.

**X-TREME  
ZINC™**

*To give your winches a longer working life, specify X-Treme Zinc for better corrosion protection than zinc-plated, paint or powder coated finishes.*



**49207-283-XZ**  
3-Bar Low Profile  
Double L Track Slider  
X-Treme Zinc Finish  
Weight: 9.2 lbs./4.2 kg.  
WLL: 5,500 lbs./2,500 kg.



# FLATBED SOLUTIONS

## COMBINATION WINCHES

Ankra winches are made in a variety of configurations to fit any application that requires cable or up to a 4" wide strap. These winches are lighter than traditional models to help reduce fuel costs and increase net cargo capacity.



**41681-10**  
Standard Bottom Mount  
Weight: 10.6 lbs./4.8 kg.  
WLL: 5,500 lbs./2,500 kg.



**43488-20**  
Low Profile Side Mount  
Weight: 10.9 lbs./4.9 kg.  
WLL: 5,500 lbs./2,500 kg.



**43908-10**  
Recessed Box  
Weight: 12.9 lbs./5.9 kg.  
WLL: 5,500 lbs./2,500 kg.



**43997-10**  
Low Profile Leg Bracket  
Weight: 8.7 lbs./3.9 kg.  
WLL: 5,500 lbs./2,500 kg.

## CABLE WINCH

For cable applications, Ankra offers these popular models. Your cable selection must be consistent with your cable manufacturer's safe working load ratings.



**END MOUNT**

**41696-10**  
End Mount RH  
Weight: 15.4 lbs./7.0 kg.  
WLL: 5,500 lbs./2,500 kg.

**41696-11**  
End Mount LH  
Weight: 15.4 lbs./7.0 kg.  
WLL: 5,500 lbs./2,500 kg.



## LASHING WINCHES

The lashing winch with double hex drive can be bolted or welded to the trailer like a standard winch, yet offers the quick release and easy operation of a ratchet buckle.



### 47640-31

With double hex drive and three mounting holes.  
Weight: 3.8 lbs./1.7 kg.  
WLL: 3,333 lbs./1,515 kg.

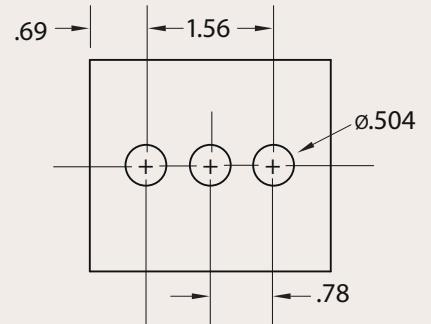

### 48496-11

With double hex drive, release latch, and single mounting hole.  
Weight: 2.2 lbs./1 kg.  
WLL: 2,500 lbs./1,135 kg.



## WINCH MAINTENANCE

Though winches don't actually come in contact with the load, their function of tightening and anchoring the webbing or cable is critical to the security of over-the-road cargo hauling.

### INSPECTION

To insure winches will perform, a quick inspection before each use will assure they are undamaged and working properly. Damaged or non-operational winches should be replaced immediately.

### CARE

For optimum performance, winches should be cleaned to remove dirt, mud, road salt, and ice. Lubrication ensures that gravity will allow the winch pawl to drop freely into the sprocket teeth, and the sprocket will rotate freely. When not in use, portable winches should be cleaned and stored in a dry location. With a little care, your winches will go a long way.



# FLATBED SOLUTIONS

## PORTAWINCH™ AND PORTANCHOR™

PATENTED

### Turn stake pockets into strap anchor points.

Ancra has created a way you can turn standard stake pockets into solid anchor points for securement straps. Our DOT and FMCSA compliant 3-Bar PortaWinch and PortaAnchor offer a versatile system that allows you to position the tie down straps anywhere along either side, front or back of the trailer, using stake pockets that best accommodate your load.

- ▶ Fasten straps securely and legally.
- ▶ Working Load Limit (WLL) 5,500 lbs./ 2,495 kg.
- ▶ For use with standard winch straps and tensions with standard winch bar.
- ▶ Fits all standard stake pockets. Will not fit tapered stake pockets.
- ▶ Installs easily without tools.
- ▶ Works over tires and toolboxes.
- ▶ Removable when not in use.



Installs easily with patented spring-loaded front hook design that distributes the load evenly across the stake pocket. Cap has four holes and accommodates standard winch bars.



PortaAnchor accepts straps with flat hooks and straps with chain anchors.

### PORTAWINCH™ Patented No 6,626,621



**49716-10**  
Standard outward off-set.  
Weight: 11.5 lbs./5.2 kg. WLL: 5,500 lbs.



**49716-10-RW**  
Ratcheting PortaWinch  
Standard outward off-set.  
Weight: 13.2 lbs./5.9 kg. WLL: 5,500 lbs.

**49716-11**  
Inward off-set to allow for track-mounted tarp clearance.  
Weight: 11.5 lbs./5.2 kg. WLL: 5,500 lbs.

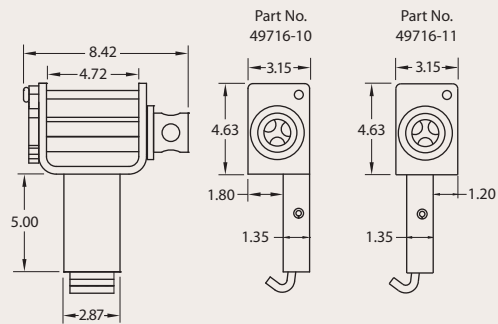

### PORTANCHOR™ Patented No 6,939,095 & 7,090,449



**49717-10**  
Standard outward off-set.  
Weight: 9.5 lbs./4.3 kg.  
WLL: 5,500 lbs.

**49717-11**  
Inward off-set to allow for track-mounted tarp clearance.  
Weight: 9.5 lbs./4.3 kg.  
WLL: 5,500 lbs.

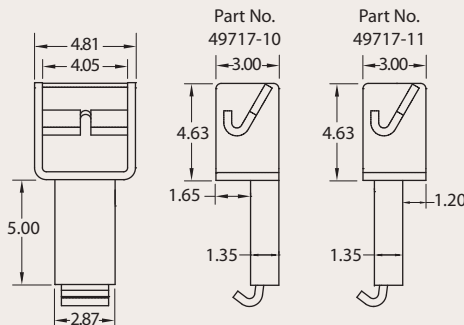

Flat Hook Application



Chain Anchor Application

## WINCH DIMENSIONS (inches)

Ancra Part No.	A Overall Width	B Inside Frame Width	C Frame Height	D Frame Depth	Ancra Part No.	A Overall Width	B Inside Frame Width	C Frame Height	D Frame Depth
<b>41681-10</b>	9.75	6.8	5.4	3.5	<b>48101-103</b>	8.6	4.8	4.3	4.0
<b>41691-10</b>	7.6	4.8	5.0	3.9	<b>48101-103-XZ</b>	8.6	4.8	4.3	4.0
<b>41696-10</b>	7.1	4.2	10.0	3.9	<b>48101-133</b>	8.6	4.8	4.3	4.3
<b>41696-11</b>	7.1	4.2	10.0	3.9	<b>48101-143</b>	8.6	4.8	5.5	4.0
<b>43488-20</b>	9.4	6.5	4.1	4.0	<b>48101-163-XZ</b>	8.6	4.8	6.5	4.0
<b>43563-10</b>	7.6	4.6	5.4	3.5	<b>48101-173</b>	8.5	5.6	6.1	4.0
<b>43563-10-RW</b>	8.6	4.6	6.6	4.0	<b>48496-11</b>	4.4	2.1	2.5	4.9
<b>43564-12</b>	7.6	4.6	6.2	3.5	<b>48783-10</b>	9.2	4.6	5.4	3.5
<b>43564-147</b>	7.3	4.6	5.5	3.5	<b>49207-127</b>	7.5	4.6	6.6	4.0
<b>43564-147-RW</b>	8.0	4.6	5.5	3.5	<b>49207-127-RW</b>	8.0	4.6	6.5	4.0
<b>43564-16</b>	7.6	4.7	4.1	4.0	<b>49207-127-XZ</b>	7.5	4.6	6.6	4.0
<b>43565-127</b>	7.6	4.6	7.5	4.0	<b>49207-137</b>	7.5	4.6	6.0	4.0
<b>43565-127-RW</b>	10.0	4.6	7.5	4.0	<b>49207-137-RW</b>	8.0	4.6	6.0	4.0
<b>43565-127-XZ</b>	7.6	4.6	7.5	4.0	<b>49207-137-XZ</b>	7.5	4.6	6.0	4.0
<b>43565-137</b>	9.2	4.6	6.5	4.0	<b>49207-187</b>	7.5	4.6	5.3	4.0
<b>43565-147</b>	7.6	4.2	7.5	4.0	<b>49207-187-RW</b>	8.0	4.6	5.3	4.0
<b>43565-157</b>	7.6	4.6	6.5	4.0	<b>49207-187-XZ</b>	7.3	4.6	5.3	4.0
<b>43565-157-RW</b>	8.0	4.6	6.5	4.0	<b>49207-273</b>	8.6	4.9	5.7	4.0
<b>43565-157-XZ</b>	7.6	4.6	6.5	4.0	<b>49207-273-XZ</b>	8.6	4.9	5.7	4.0
<b>43573-10</b>	7.6	4.6	6.2	3.5	<b>49207-283-XZ</b>	8.6	4.9	4.7	4.0
<b>43573-11</b>	7.6	2.2	6.2	3.5	<b>49246-10-BP</b>	7.6	4.6	6.5	3.5
<b>43579-20</b>	7.4	4.8	4.1	4.0	<b>49706-10</b>	7.9	4.9	6.5	4.0
<b>43908-10</b>	10.3	9.5	5.5	4.0	<b>49706-11</b>	7.9	4.9	5.1	4.0
<b>43997-10</b>	10.3	7.2	5.0	3.9					
<b>47640-31</b>	5.9	2.1	4.0	3.0					

Winch dimensions are subject to change.

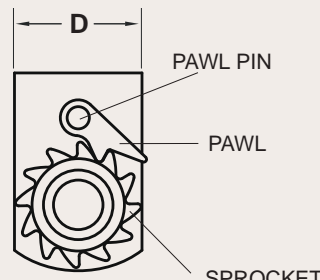
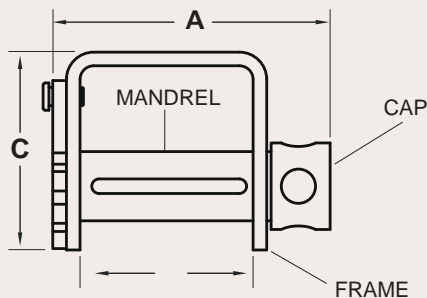

Winches are labeled with installation, maintenance and proper use instructions.



# FLATBED SOLUTIONS

## WINCH TRACK

### Ankra winch track comes in two distinct styles:

- ▶ Standard C track, designed for use with standard slider winches (43565-127 and 43565-157), is available in roll-formed ¼" plate steel (42357-11), or aluminum (42357-21) for aluminum trailers.
- ▶ Double L aluminum track (49242-10-120) is designed for 49207 Double L slider winches.

Custom lengths are available upon request. Winch track should be installed to meet the testing requirements of TTMA RP No. 47-03.



#### 42357-11

Steel C Track  
Weight: 39.0 lbs./17.73 kg. Length: 6'

#### 42357-12

Steel C Track  
Weight: 78.0 lbs./35.4 kg. Length 12'

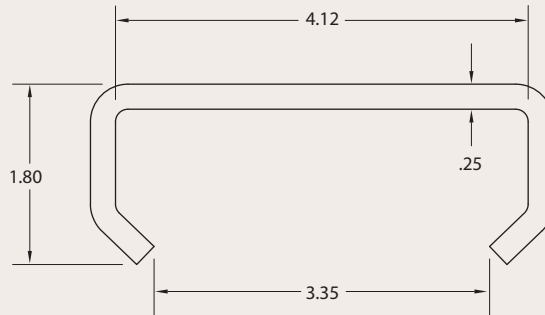

#### 42357-21

Aluminum C Track  
Weight: 19.0 lbs./8.64 kg. Length: 6'

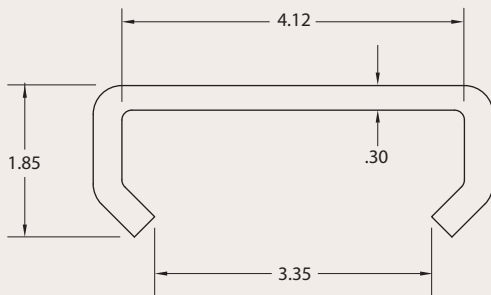

#### 49242-10-120

Aluminum Double L Track  
Weight: 20.9 lbs./9.5 kg. Length: 10'

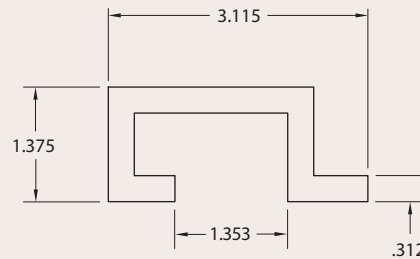

#### 49789-10-120.00

Low Profile Aluminum Double L Track  
Weight: 16.83 lbs./7.64 kg. Length: 10'

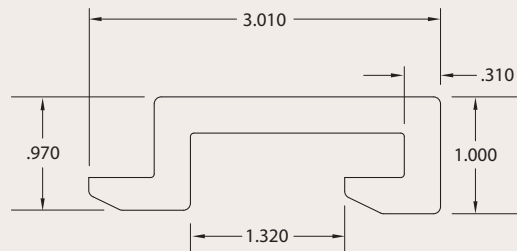

## SILVERCAP OVERDRIVE® RATCHETING CAP

PATENTED

Convert any winch into a ratcheting winch by adding Ancra's OverDrive Ratcheting Cap. The lubricated cap with a Grime Guard Weather-Tight Seal fits over the existing winch cap without having to remove the winch from the trailer, making it faster than conventional winches. Your winch bar stays in the winch until your straps are tight.

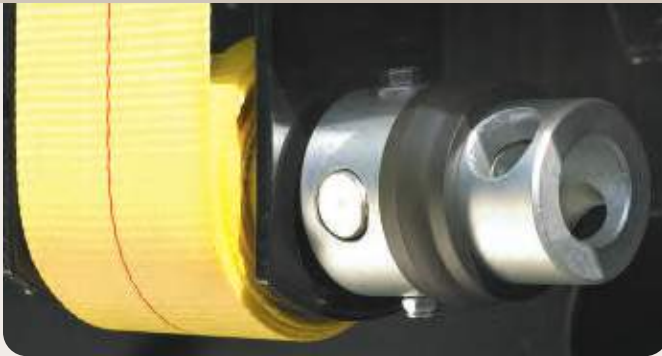

**SilverCap  
OverDrive**  
Patent Number 7,618,021



**49723-10**

Weight: 3.45 lbs./1.56 kg.



Ancra's OverDrive® is the easy upgrade for winches. With a ratcheting winch, you work faster because the winch bar stays in the winch until the strap is tight.

To install on any existing winch:

1. Simply slide the OverDrive unit over the cap of the old winch.
2. Spin it in place.
3. Secure it with the bolt.

It's that simple. All necessary parts are included.

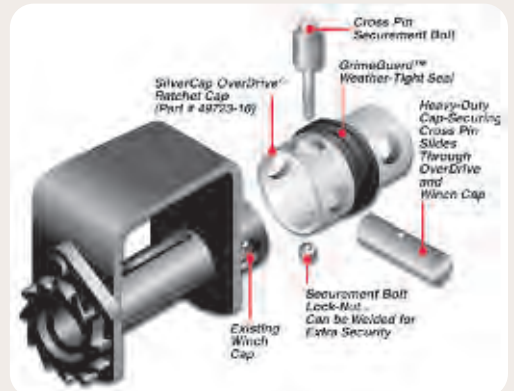

## FLATBED ACCESSORIES

### Cable Assemblies with Chain Anchor



Ancra's heavy-duty cable assemblies with zinc-plated gold chromate chain anchor can be used on cable, combination winches, or web winches with side washers to prevent binding. Constructed of galvanized aircraft cable with grade 70 NACM-compliant chain anchor. The cable assemblies are available in 7/32", 1/4" and 5/16" diameter cable in 30' and 32' lengths. The chain anchors are 19" in length.

**49828-12-30**

7/32" x 30' Weight: 4.9 lbs./2.2 kg. WLL: 1,867 lbs./848 kg.

**49828-12-32**

7/32" x 32' Weight: 5.1 lbs./2.3 kg. WLL: 1,867 lbs./848 kg.

**49828-10-30**

1/4" x 30' Weight: 5.4 lbs./2.45 kg. WLL: 2,300 lbs./1,050 kg.

**49828-10-32**

1/4" x 32' Weight: 5.8 lbs./2.6 kg. WLL: 2,300 lbs./1,050 kg.

**49828-11-30**

5/16" x 30' Weight: 7.9 lbs./3.6 kg. WLL: 3,300 lbs./1,500 kg.

**49828-11-32**

5/16" x 32' Weight: 8.4 lbs./3.8 kg. WLL: 3,300 lbs./1,500 kg.



# FLATBED SOLUTIONS

## FLATBED ACCESSORIES

### ERGO 360° Winch Bars

PATENTED

No. 7,740,232

FIRST ANGRA RAISED THE BAR. THEN WE BENT IT.



End collar prevents hand slipping off end.

Knurled handle for good grip.

Can be rotated 360° for leverage to tension a strap, accommodating various clearance requirements.

Offset design eliminates need to use bar at extreme upward or downward angles.

Mushroom tip helps keep the bar from slipping from the winch cap.



#### See what a difference a bend in the bar makes.

The Ergo 360° Bar takes Ancra's winch bars to the next level. The patented ergonomic design maintains

parallel alignment of handle and tip, so you can rotate the bar for optimum leverage without removing it, and keep it secured in the winch cap through the mushroom tip. Easy to carry, easy to handle, the Ergo 360° Bar is the most efficient and economical new tool you'll use. Available in standard, combination and combination box end models. Combination winch bars can be used to release tension on chain binders. Use caution to avoid injury. Not to be used as a cheater bar.



#### 50015-10

Standard Painted. Weight: 5.0 lbs./2.27 kg.

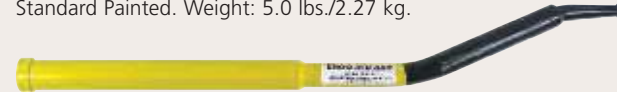

#### 50015-20

Combination Painted. Weight: 6.5 lbs./2.95 kg.

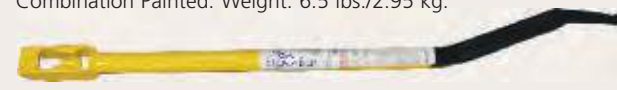

#### 50015-21

Combination Box End Painted. Weight: 6.0 lbs./2.72 kg.

### Standard Winch Bars

Tapered and angled at the end for easy operation, Ancra's winch bar handles are knurled at two sections, and the mushroom tip helps keep the bar from slipping from the winch cap. They are heat-treated for extra strength and cycle tested to simulate years of heavy use. Combination winch bars can be used to release tension on chain binders. Use caution to avoid injury. Not to be used as a cheater bar.

Flanged mushroom tip helps keep the bar from slipping from the winch cap.



#### 42313-10

Standard Painted. Weight: 5.0 lbs./2.27 kg.



#### 42313-17

Standard Chrome. Weight: 5.0 lbs./2.27 kg.



#### 42313-19

Combination Chrome. Weight: 6.5 lbs./2.95 kg.



#### 42313-12

Combination Box End Painted Silver and Yellow. Weight: 6.5 lbs./2.95 kg.

## FLATBED ACCESSORIES

### Heavy Duty D-Rings



Rugged forged steel D-Rings add versatility for securing complex loads. Utility trailers typically use 1/2 and 5/8 inch models, while heavy-duty applications rely on the 3/4 and 1-inch sizes. Individually polybagged.

#### 49896-10

1/2-inch forged steel w/  
Bolt-on clip  
Weight: 1.0 lbs./.50 kg.  
WLL: 4,000 lbs.

#### 49896-11

1/2-inch forged steel w/  
Weld-on clip  
Weight: 1.0 lbs./.50 kg.  
WLL: 4,000 lbs.

#### 49897-10

5/8-inch forged steel w/  
Weld-on clip  
Weight: 1.9 lbs./.86 kg.  
WLL: 6,300 lbs.

#### 49898-10

3/4-inch forged steel w/  
Weld-on clip  
Weight: 2.2 lbs./1.0 kg.  
WLL: 9,000 lbs.

#### 49899-10

1-inch forged steel w/  
Weld-on clip  
Weight: 4.4 lbs./2.0 kg.  
WLL: 15,600 lbs.

### Hooks & Web Winders

#### 44102-11

H-2 Hook. Flame-cut from 5/8-in. material and can be welded on vehicles. Accepts web loops, D-Rings, cable or rope. Meets anchorage requirements when properly secured. Hook opening .81" Weight: .61 lb./ .28 kg. WLL: 5,400 lbs./2,450 kg.

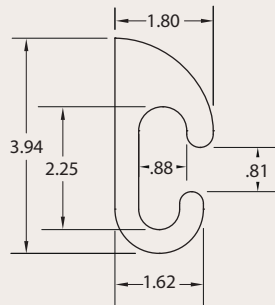

#### 44122-10

Corner Iron Hook  
Constructed with no sharp corners to reduce abrasion to rope or cable.  
Weight: .63 lb./ .29 kg.



#### 50024-10

Tarp Hook. For securing tarp straps to trailers. 1/2-in. steel wire. Unfinished light oil. Weight: .39 lb./ .18 kg.

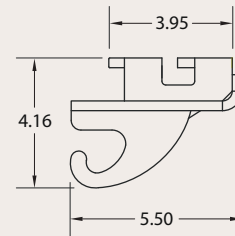

#### 49768-10

Double L Track Slider Hook  
Black powder coat finish. Hook opening .71"  
Weight: 5.65 lb./2.57 kg.  
WLL: 5,500 lbs./2,500 kg.



#### 50092-10

EZ Winder Strap Winder quickly and easily winds webbing onto your winch for storage.



#### 45801-10

Web Winder. Constructed of all steel, the Ankra Web Winder winds 2-in., 3-in. and 4-in. winch straps for compact storage. Easy to attach to vehicle rails, easy to remove with tapered forks, and easy to disassemble for storage. Weight: 3.25 lbs./1.48 kg.

#### 50391-10

Premium Cargo Strap Winder  
Constructed of zinc-plated steel for maximum durability, the new Strap Winder quickly assists in winding winch straps into rolls for storage. Designed to clip into trailer stake pocket or side rail. Weight: 2.7 lb./1.2 kg.





# FLATBED SOLUTIONS

## FLATBED ACCESSORIES

### Safety Related Products

Meet FMCSA 393.87 standards.



**49893-10**  
Fluorescent Red Heavy-Duty Mesh Flag w/ wooden dowel. 18" x 18"



**49893-11**  
Red Cotton Flag w/ steel wire rod. 18" x 18"



**49893-12**  
Fluorescent Red Mesh Flag w/ 2 brass grommets. 18" x 18"



**49893-13**  
Fluorescent Orange Mesh Flag w/ wooden dowel. 18" x 18"



**49893-14**  
Fluorescent Orange Mesh Flag w/ 2 brass grommets.



**49894-10**  
Double-sided banner reads WIDE LOAD and OVERSIZED LOAD. Made of durable vinyl fabric and comes with four grommets and four 44" attachment ropes. 84" x 18" Tri-lingual package.



**49894-11**  
Double-sided banner reads WIDE LOAD and OVERSIZED LOAD. Made of durable vinyl fabric and comes with sewn-in ropes top and bottom, plus four grommets. 84" x 18" Tri-lingual package.



**49894-12**  
Double-sided banner reads WIDE LOAD and OVERSIZED LOAD. Made of durable vinyl fabric and comes with four grommets and four 44" attachment ropes. 72" x 14" Tri-lingual package.



**49894-13**  
Mesh OVERSIZED LOAD banner. Made of woven polyester mesh with 4 grommets and four 44" attachment ropes. 84" x 18" Tri-lingual package.



**49894-14**  
Mesh WIDE LOAD banner. Made of woven polyester mesh with 4 grommets and four 44" attachment ropes. 84" x 18" Tri-lingual package.

### Reflective Signs



**49895-10**  
Canadian D sign is made of durable vinyl fabric. Comes with 10 grommet attachment points. 96" x 12"

**49895-11**  
Reflective Canadian D Sign with 8 grommets. 96" x 12"

**49895-12**  
Reflective Canadian D Sign with 8 grommets. 96" x 18"

**49895-13**  
Reflective Canadian D Sign with 8 grommets, reverse side: Oversize Load. 96" x 18"

## FLATBED ACCESSORIES

### GlideLock® Sliding Load-Securement Bracket

**GLIDELOCK®**  
Sliding Load-Securement Bracket

#### Lock and load with GlideLock® movable securement bracket

GlideLock Sliding Load-Securement Bracket offers versatility and positioning of tie down anchor point.

1. GlideLock positions exactly where it's needed, no matter what type of load or the location of cargo on the vehicle.
2. Once the flat hook is engaged, the unit locks the hook in position. It cannot shift or come undone, it remains secure until you unlock it.

With a Working Load Limit of 5,400 lbs., GlideLock glides into any position along the trailer rail or winch track to ensure the correct pull-angle for securing cargo. The compact unit keeps the strap inboard of the rub rail and works with any standard flat-hook strap.



#### 49527-10

GlideLock for Double L Track  
WLL: 5,400 lbs./2,450 kg.  
Weight 4.50 lbs./2.04 kg



#### How GlideLock Works

1. Slide the unit onto the Double L Track.
2. Glide to correct position to ensure a correct pull-angle.
3. Release the keeper to allow the flat hook to engage GlideLock.
4. Secure the keeper to lock the flat hook into position. Once in place, the hook can't shift or come undone. Ideal for trailers with double L winch track and slider winches. Meets Federal Motor Safety Administration (FMCSA) standards.

### Coil Racks

Our coil racks are designed to aid in supporting steel coils on flatbed trailers. Available for both light and heavy duty applications. Used with lumber blocks which provide extra cradling of the coils. Both have a black lacquer finish. New D.O.T. standards specifically address securement of metal coils. If chocks are used, they must be held in place by coil bunks or racks to prevent them from coming loose.



#### 49344-10

Standard Duty  
Metal Gauge: 10  
Weight: 5.7 lbs./2.60 kg.

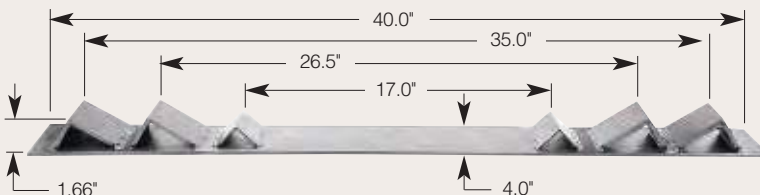
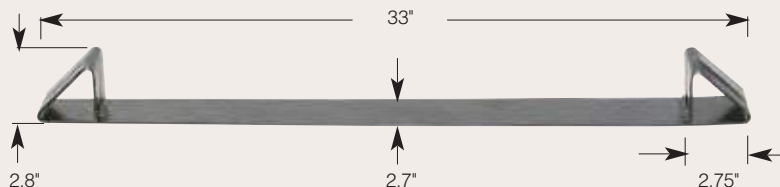

#### 49344-12

Heavy-Duty 1/4" steel sheet per  
ASTM A36  
Weight: 16.75 lbs./7.6 kg.



# FLATBED SOLUTIONS

## FLATBED ACCESSORIES

### Corner Protectors

Along with our standard rugged flatbed products, Ancra web accessories offer high performance and durability. Sturdy corner and web protectors prevent abrasion of cargo and cargo-securing straps. **Corner Protectors not to be used as sling protection for overhead lifting.**



#### 43986-10

High Density Polymer  
Suitable for webbing up to 4".  
5.25" wide and extends approx.  
3.5" to protect the load. **Has excellent low temperature performance, down to -20°F.**  
Weight: .06 lb./03 kg.



#### 49377-10

Steel (Zinc Plated)  
For use with chain and extends  
4" to protect the load.  
Weight: 1.10 lbs./50 kg.



#### 49377-11

Rubber coated Steel  
For use with chain and extends  
4" to protect load.  
Weight: 1.9 lbs./86 kg.



#### 49577-10

Steel (Galvanized)  
For use with chain. 4" wide  
and extends 3" on top and  
3.5" to protect the load.  
Weight: .90 lb./41 kg.



#### 49756-10

Steel Corner Protector for chain and up to  
4" winch straps and extends 3-5/8" to  
protect the load. Weight: 1.26 lbs./57 kg.



#### 41516-11

Aluminum 6061-T6  
Suitable for 2" webbing.  
Weight: .63 lbs./29 kg.



#### 49584-10

12" Long Plastic. Extends approx. 3" to protect  
the load. Suitable for webbing up to 4" in width.  
**Has excellent low temperature performance, down to -20°F.** Weight: .47 lb./21 kg.



#### 42098-11

Fiber Reinforced Rubber. Extends approx  
5" to protect the load for webbing up to  
3" in width. Weight: .63 lb./29 kg.

#### 42098-12

Extends approx 5" to protect the load for webbing up to 4" in width.  
Weight: .75 lb./34 kg.



#### 49913-10

Tarp Protector. Yellow plastic.  
Weight: .21 lb./09 kg.

### Web Protector



#### 40985-05-12

12-in. Cordura® Nylon sleeve for 2-in.  
webbing. Weight: .13 lb./06 kg.

#### 40985-05-RL

100-yd. bulk roll Cordura Nylon sleeve  
for 2-in. webbing. Weight: .39 lb./yd./  
.18 kg./meter. Cordura® is a registered  
trademark of Dupont.

**TRUCKER TIP**  
**BE SURE YOU'RE SECURED**  
If any part of the load securement system is loose — even if the required number of straps are used per regulation but are not tensioned properly — the load is considered unsecured.  
**It is your responsibility to ensure the cargo is secure.**

## FLATBED ACCESSORIES

### X-TREME GUARD™ PROTECTS YOUR LOAD AND YOUR STRAPS



Ankra's new high-density polyethylene X-TREME GUARD™ Corner Protector distributes strap tension over the length of the guard to prevent your cargo from being crushed by the straps and protects your webbing from abrasion. Made in lengths of 12-, 24-, 36- and 48-inches, this durable guard is strong yet lightweight, and crack/weather resistant to -30°. **Corner Protectors not to be used as sling protection for overhead lifting.**

Made in the USA



<b>50089-12</b>	8" x 1' long — Weight: .8 lbs./,36 kg.
<b>50089-24</b>	8" x 2' long — Weight: 1.7 lbs./,78 kg.
<b>50089-36</b>	8" x 3' long — Weight: 2.7 lbs./,1.23 kg.
<b>50089-48</b>	8" x 4' long — Weight: 3.6 lbs./,1.63 kg.

### Rubber Rope & Hooks



- Standard 150-ft. coils
- Easily assembled to desired length for application.

**49454-11**  
3/8" Solid Core Rubber Rope  
Weight: 10.7 lbs./4.86 kg.

**49454-13**  
7/16" Solid Core Rubber Rope  
Weight: 7.4 lbs./3.35 kg.



**49211-10**  
Rubber Rope Hook  
100 per pack  
Weight: 5.2 lbs./2.37 kg.

#### HOW TO ATTACH HOOK TO RUBBER ROPE

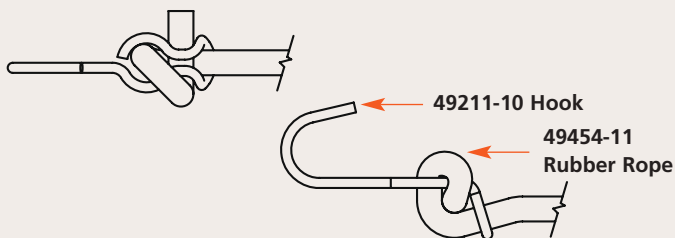

**41572-10**  
Replacement Hooks for  
Tarp Ties  
Bag of 100  
Weight: 3.7 lbs./1.7 kg.



# FLATBED SOLUTIONS

## FLATBED ACCESSORIES

### Top Premium Brand Tarp Ties



**In the heavy duty trucking industry, Goldline® Heavy Duty EPDM Tarp Ties have been a favorite with fleets and independent owners for 40 years.**

Made in the USA and known for quality, durability, and resistance to the elements, these tarp ties offer good stretch recovery and maintain their strength over the entire life of the tarp ties. The two lines include the longest lasting, larger cross section Goldline® Heavy Duty EPDM tarp ties best recognized by truckers, and the standard cross section Silverline Elite® EPDM. Our natural rubber tarp ties are

best suited for colder climates and are our most economical offering. Ancra's tarp tie offering provides you the customer with product options that can be chosen and suited to your application.



- Quantity 50 per box
- Designed to hold tarp covers on trucks and trailers
- Not to be used to restrain or secure cargo
- Molded EPDM construction for high Ozone resistance and strength resiliency or molded natural rubber for good cold weather stretch properties
- Wear safety glasses and use caution when using tarp ties
- WARNING: SUDDEN RUPTURE OR DISCONNECT WHILE IN STRETCHED POSITION CAN CAUSE SERIOUS INJURY

Made in  the USA

# GOLDLINE®

#### 52210GL

Goldline HD EPDM made in the USA-10"

#### 52215GL

Goldline HD EPDM made in the USA-15"

#### 52221GL

Goldline HD EPDM made in the USA-21"

#### 52231GL

Goldline HD EPDM made in the USA-31"

#### 52241GL

Goldline HD EPDM made in the USA-41"

Made in  the USA

# SILVERLINE®

ELITE  
EPDM

#### 52210SE

Silverline Elite EPDM made in the USA-10"

#### 52215SE

Silverline Elite EPDM made in the USA-15"

#### 52221SE

Silverline Elite EPDM made in the USA-21"

#### 52231SE

Silverline Elite EPDM made in the USA-31"

#### 52241SE

Silverline Elite EPDM made in the USA-41"

# NATURAL RUBBER

#### 52210C

Natural Rubber Tarp Tie-10"

#### 52215C

Natural Rubber Tarp Tie-15"

#### 52221C

Natural Rubber Tarp Tie-21"

#### 52231C

Natural Rubber Tarp Tie-31"

#### 52241C

Natural Rubber Tarp Tie-41"

## GRADE 70 'TRANSPORT' CHAIN

Grade 70 chain was designed specifically to provide a strong chain for tie downs. Made from carbon steel and zinc plated gold chromate for corrosion resistance. Heat treated and 100% proof tested to 2X WLL rating. Made to NACM standards per specifications of the Department of Transportation & CCMTA for tie down use. All clevis hooks are made of heat treated alloy steel.



**BROWN BARREL**  
1/4-in. Chain



**ORANGE BARREL**  
5/16-in. Chain



**GREEN BARREL**  
3/8-in. Chain



**RED BARREL**  
1/2-in. Chain

### Grade 70 Chain Assemblies with Clevis Hooks



- 45881-10-16** 5/16-in. x 16-ft. WLL: 4,700 lbs./2,130 kg. Weight: 17.4 lbs./7.89 kg.  
10 Assemblies per Orange Barrel
- 45881-10-20** 5/16-in. x 20-ft. WLL: 4,700 lbs./2,130 kg. Weight: 21.7 lbs./9.90 kg.  
10 Assemblies per Orange Barrel
- 45881-10-25** 5/16-in. x 25-ft. WLL: 4,700 lbs./2,130 kg. Weight: 26.7 lbs./12.10 kg.  
10 Assemblies per Orange Barrel
- 45881-11-16** 3/8-in x 16-ft. WLL: 6,600 lbs./2,990 kg. Weight: 24.4 lbs./11.08 kg.  
10 Assemblies per Green Barrel
- 45881-11-20** 3/8-in. x 20-ft. WLL: 6,600 lbs./2,990 kg. Weight: 30.4 lbs./13.80 kg.  
10 assemblies per Green Barrel
- 45881-11-25** 3/8-in. x 25-ft. WLL: 6,600 lbs./2,990 kg.. Weight: 39.0 lbs./17.71 kg.  
10 Assemblies per Green Barrel
- 45881-13-20** 1/2-in x 20-ft. WLL: 11,300 lbs./5,130 kg. Weight: 53.6 lbs./24.33 kg.  
5 Assemblies per Red Barrel
- 45881-13-25** 1/2-in. x 25-ft. WLL: 11,300 lbs./5,130 kg. Weight: 66.2 lbs./30.05 kg.  
5 Assemblies per Red Barrel

### Grade 70 Bulk Chain



- 45880-12** 1/4-in. x 400-ft. WLL: 3,150 lbs./1,430 kg. Weight: 262 lbs./118.9 kg.  
Brown Barrel
- 45880-10** 5/16-in x 400-ft. WLL: 4,700 lbs./2,130 kg. Weight: 408 lbs./185 kg.  
Orange Barrel
- 45880-11** 3/8-in. x 200-ft. WLL: 6,600 lbs./2,990 kg. Weight: 296 lbs./134.4 kg.  
Green Barrel
- 45880-13** 1/2-in x 100-ft. WLL: 11,300 lbs./5,130 kg. Weight: 251 lbs./114 kg.  
Red Barrel



## GRADE 70 'TRANSPORT' CHAIN

### XHD™ 3/8" Chain Assemblies

**LIGHTER BUT STRONGER.** Lighter weight performance of G70 chain with the added strength and size of our G80 clevis hooks. Each part is heat treated and proof tested to twice the Working Load Limit. All chain assemblies are made to NACM standards and comply with the specifications of the FMCSA and CCMTA for tie down use.

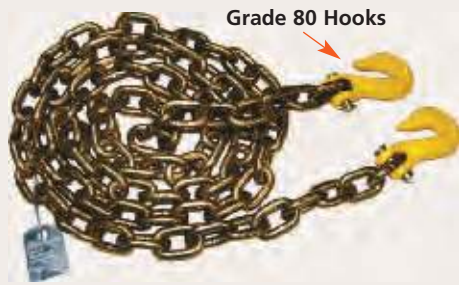

- ▶ Available in 10' and 20' lengths
- ▶ G70 carbon steel, zinc plated, alloy chain with gold chromate finish
- ▶ G80 forged alloy hooks with 19% more material in the neck of the hook
- ▶ Individually packaged for resale inside color coded barrels

#### 50364-38-10

Length: 10-ft./3.0m  
WLL: 6,600 lbs./3,000 kg.  
Weight: 17 lbs./7.7 kg.

#### 50364-38-20

Length: 20-ft./6.0m  
WLL: 6,600 lbs./3,000 kg.  
Weight: 31 lbs./14.5 kg.

### Packaged Transport Chain In A Pail

Packaged Grade 70 transport chain assemblies are offered in a convenient storage pail to keep organized in your tool box or vehicle. Grade 70 chain is specifically designed to provide a light, yet strong chain for tie downs. Made from carbon steel, heat treated for strength and zinc plated gold chromate for corrosion resistance. Made to NACM standards to meet the specifications of the DOT & CCMTA for tie down use. All clevis hooks are made of heat-treated alloy steel.



**45881-10-16-SP** 5/16-in x 16-ft. WLL: 4,700 lbs./2,130 kg. Weight: 18.8 lbs./8.52 kg.

**45881-10-20-SP** 5/16-in x 20-ft. WLL: 4,700 lbs./2,130 kg. Weight: 23.4 lbs./10.61 kg.

**45881-10-25-SP** 5/16-in x 25-ft. WLL: 4,700 lbs./2,130 kg. Weight: 28.3 lbs./12.83 kg.

**45881-11-16-SP** 3/8-in x 16-ft. WLL: 6,600 lbs./2,990 kg. Weight: 25.8 lbs./11.71 kg.

**45881-11-20-SP** 3/8-in x 20-ft. WLL: 6,600 lbs./2,990 kg. Weight: 31.9 lbs./14.48 kg.

**45881-11-25-SP** 3/8-in x 25-ft. WLL: 6,600 lbs./2,990 kg. Weight; 40.5 lbs./18.39 kg.

### Grade 70 Agricultural Safety Chain

For use as a safety chain to prevent the separation of the towed vehicle and the towing vehicle in the event the primary attachment becomes disengaged. The safety chain allows for the two vehicles to come to a controlled stop. Conforms to the specifications of the ASABE as a Safety Chain for towed field equipment for agriculture. Has a zinc plated gold chromate finish and complies with NACM Standards for grade 70 transport chain.



**50090-31** 5/16-in x 67.5-in. WLL: 4,700 lbs./2,133 kg. For towed machines not exceeding 16,100 lbs./7,309 kg. gross weight. Weight: 6.8 lbs./3.08 kg.  
20 per Black Barrel, Weight in barrel: 148 lbs./67.19 kg.

**50090-38** 3/8-in x 69-in. WLL: 6,600 lbs./2,996 kg. For towed machines not exceeding 20,200 lbs./9,170 kg. gross weight. Weight: 11.6 lbs./5.26 kg.  
10 per Black Barrel, Weight in barrel: 120 lbs./54.48 kg.

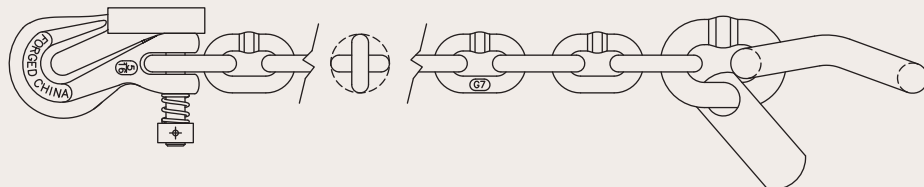

## GRADE 70 CLEVIS HOOKS

Forged from high strength alloy steel, Ankra clevis hooks are made for Grade 70 chain. Sized from 1/4" to 1/2", the chain hooks are strength tested and heat treated for strength and durability. Meets Department of Transportation requirements.

Forged steel hook, zinc plated gold chromate finish. Individually polybagged.

- 45946-12** 1/4-in. Clevis Hook WLL: 3,150 lbs./1,430 kg. Weight: .40 lbs./.18 kg.
- 45946-10** 5/16-in. Clevis Hook WLL: 4,700 lbs./2,130 kg. Weight: .85 lbs./.39 kg.
- 45946-11** 3/8-in. Clevis Hook WLL: 6,600 lbs./2,990 kg. Weight: 1.10 lbs./.5 kg.
- 45946-13** 1/2-in. Clevis Hook WLL: 11,300 lbs./5,130 kg. Weight: 2.10 lbs./1.04 kg.

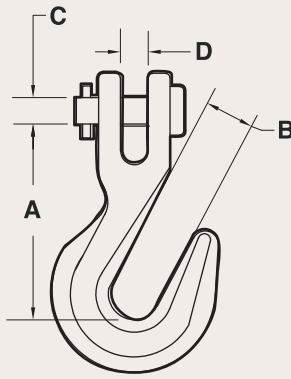

DIMENSION TABLE				
	A	B	C	D
45946-12	2.00	.40	.38	.36
45946-10	2.30	.43	.38	.38
45946-11	2.70	.50	.48	.44
45946-13	3.20	.66	.63	.75

## Grade 70 Clevis Hooks with Keeper

Forged steel hook with Keeper, zinc plated gold chromate. Individually polybagged, 30 per box.

- 50091-31** 5/16-in. Clevis Hook w/ Keeper WLL: 4,700 lbs./2,130 kg. Weight: .9 lbs./.41 kg.
- 50091-38** 3/8-in. Clevis Hook w/ Keeper WLL: 6,600 lbs./2,990 kg. Weight: 1.3 lbs./.59 kg.
- 50091-50** 1/2-in. Clevis Hook w/ Keeper WLL: 11,300 lbs./5,130 kg. Weight: 2.2 lbs./1.00

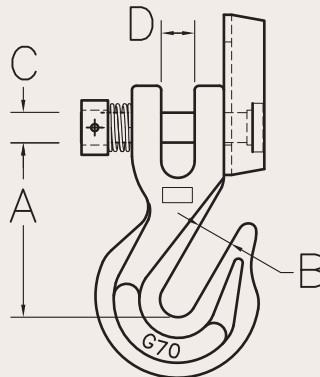

DIMENSION TABLE				
	A	B	C	D
50091-31	2.3	.43	.38	.42
50091-38	2.7	.56	.48	.48
50091-50	3.0	.61	.63	.57

**WARNING:** Never exceed the Working Load Limit. Not to be used for overhead lifting.



# FLATBED SOLUTIONS

## CHAIN HARDWARE

We offer a wide selection of chain hardware for popular applications — from zinc plated clear chromate anchor shackles in screw pins and clevis pin models to Quick Links in various sizes. Corrosion resistant, zinc plated gold chromate Grade 70 Twin Clevis and Slip Hooks come in a wide range of sizes, with and without safety latches.

### Screw Pin Anchor Shackle — Galvanized and individually polybagged

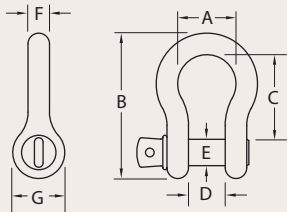

PART NUMBER	SIZE	WEIGHT	WLL				
<b>50013-31</b>	5/16-in.	.18 lbs./08 kg.	1,500 lbs./681 kg.				
<b>50013-38</b>	3/8-in.	.30 lbs./14 kg.	2,000 lbs./900 kg.				
<b>50013-44</b>	7/16-in.	.49 lbs./22 kg.	3,000 lbs./1,362 kg.				
<b>50013-50</b>	1/2-in.	.74 lbs./34 kg.	4,000 lbs./1,816 kg.				
<b>50013-63</b>	5/8-in.	1.44 lbs./65 kg.	6,500 lbs./2,951 kg.				
<b>50013-75</b>	3/4-in.	2.16 lbs./98 kg.	9,500 lbs./4,313 kg.				
	A	B	C	D	E	F	G
<b>50013-31</b>	.81	2.25	1.25	.53	Ø3/8	Ø.31	1.00
<b>50013-38</b>	.94	2.61	1.44	.66	Ø7/16	Ø.38	1.13
<b>50013-44</b>	1.06	3.01	1.69	.72	Ø1/2	Ø.44	1.25
<b>50013-50</b>	1.19	3.34	1.88	.81	Ø5/8	Ø.50	1.38
<b>50013-63</b>	1.50	4.04	2.41	1.06	Ø3/4	Ø.63	1.88
<b>50013-75</b>	1.75	5.04	2.84	1.25	Ø7/8	Ø.75	2.13

### Clevis Pin Anchor Shackle — Galvanized and individually polybagged

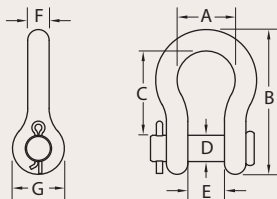

PART NUMBER	SIZE	WEIGHT	WLL				
<b>50014-50</b>	1/2-in.	.74 lbs./34 kg.	4,000 lbs./1,816 kg.				
<b>50014-63</b>	5/8-in.	1.44 lbs./65 kg.	6,500 lbs./2,951 kg.				
	A	B	C	D	E	F	G
<b>50014-50</b>	1.19	3.39	1.88	Ø5/8	.81	Ø.50	1.38
<b>50014-63</b>	1.50	4.17	2.41	Ø3/4	1.06	Ø.63	1.88

### Quick Links — Zinc plated clear chromate and individually polybagged

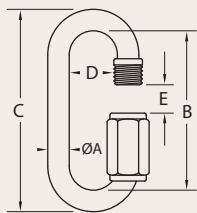

PART NUMBER	SIZE	WEIGHT	WLL		
<b>50016-25</b>	1/4-in.	.062 lbs./028 kg.	880 lbs./399 kg.		
<b>50016-31</b>	5/16-in.	.154 lbs./07 kg.	1,760 lbs./799 kg.		
<b>50016-38</b>	3/8-in.	.198 lbs./90kg.	2,200 lbs./998 kg.		
	A	B	C	D	E
<b>50016-25</b>	.235	1.85	2.31	.51	.32
<b>50016-31</b>	.313	2.32	2.95	.65	.41
<b>50016-38</b>	.350	2.54	3.22	.67	.43

## CHAIN HARDWARE

### Twin Clevis G70

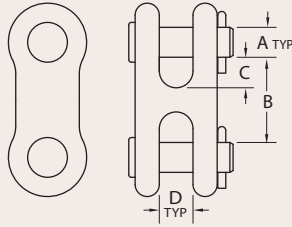

Forged steel with zinc plated gold chromate and individually polybagged

PART NUMBER	SIZE	WEIGHT	WLL	
<b>50017-10</b>	1/4-in. – 5/16-in.	.30 lbs./14 kg.	4,700 lbs./2,130 kg.	
<b>50017-11</b>	3/8-in.	.40 lbs./18 kg.	6,600 lbs./2,990 kg.	
<b>50017-12</b>	7/16-in – 1/2-in.	.98 lbs./44 kg.	11,300 lbs./5,130 kg.	
	A	B	C	D
<b>50017-10</b>	.38	1.18	.43	.47
<b>50017-11</b>	.47	1.34	.48	.53
<b>50017-12</b>	.56	1.75	.63	.65

### Slip Hooks G70 without Safety Latch

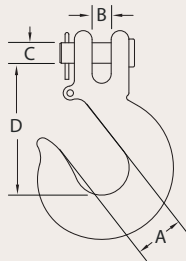

Forged steel with zinc plated gold chromate and individually polybagged

PART NUMBER	SIZE	WEIGHT	WLL	
<b>50019-10</b>	1/4-in.	.44 lbs./20 kg.	3,150 lbs./1,430 kg.	
<b>50019-11</b>	5/16-in.	.75 lbs./34 kg.	4,700 lbs./2,130 kg.	
<b>50019-12</b>	3/8-in.	1.13 lbs./51 kg.	6,600 lbs./2,990 kg.	
<b>50019-13</b>	1/2-in.	2.75 lbs./1.25 kg.	11,300 lbs./5,130 kg.	
	A	B	C	D
<b>50019-10</b>	.94	.44	.38	2.44
<b>50019-11</b>	1.06	.41	.44	2.72
<b>50019-12</b>	1.31	.59	.47	3.25
<b>50019-13</b>	1.75	.75	.63	4.00

### Slip Hooks G70 with Safety Latch

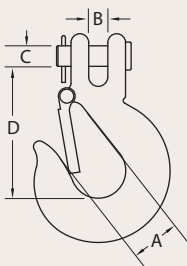

Forged steel with zinc plated gold chromate and individually polybagged

PART NUMBER	SIZE	WEIGHT	WLL	
<b>50019-20</b>	1/4-in.	.59 lbs./27 kg.	3,150 lbs./1,430 kg.	
<b>50019-21</b>	5/16-in.	.92 lbs./42 kg.	4,700 lbs./2,130 kg.	
<b>50019-22</b>	3/8-in.	1.32 lbs./60 kg.	6,600 lbs./2,990 kg.	
<b>50019-23</b>	1/2-in.	2.90 lbs./1.32 kg.	11,300 lbs./5,130 kg.	
	A	B	C	D
<b>50019-20</b>	.94	.44	.38	2.44
<b>50019-21</b>	1.06	.41	.44	2.72
<b>50019-22</b>	1.31	.59	.47	3.25
<b>50019-23</b>	1.75	.75	.63	4.00



# FLATBED SOLUTIONS

## EZ BINDER



### 50140-10

EZ Binder  
WLL: 5,400 lbs./2,450 kg.  
Weight: 11.5 lbs./5.22 kg.



- ▶ Ratchet design is easy to tension and release
- ▶ Extra long handle provides mechanical advantage
- ▶ Durable contoured handle grip for comfortable operation
- ▶ Heavy gauge steel construction with electro zinc plating
- ▶ Dual solid gears distribute tensioning forces evenly
- ▶ Free wheel function for quick take up
- ▶ Quality grade 100 load chain is used in binder
- ▶ Use with 5/16-in grade 70 or 3/8-in grade 43 binder chains
- ▶ Swiveling grab hooks for ease of use
- ▶ Will take up 12-in of chain during tensioning

## CHAIN LOAD BINDERS

All traditional chain load binders are constructed of drop forged steel for strength and durability and were designed to be used with transport chain. They are available in traditional Lever, Recoilless and Ratcheting models, and are finished in a red E-coat paint. They meet or exceed WSTDA T-6 standards.

**WARNING:** Failure to follow all instructions may result in serious personal injury, property damage and loss of life. Observe the working load limits as noted below and on tags to determine the number of tie downs and hardware required under federal D.O.T. FMCSA 40 CFR Parts 392-393. Use extreme caution when tensioning load binders to ensure chain links are seated securely in the hook before release tension on the load binder.

### Lever Chain Load Binders



- 45943-12** 1/4-in. Lever Load Binder. Accepts chain from 1/4-in. G70 up to 5/16-in. G43. WLL: 2,600 lbs./1,180 kg. Weight: 3.5 lbs./1.59 kg.
- 45943-10** 5/16-in. Lever Load Binder. Accepts chain from 5/16-in. G70 up to 3/8-in. G43. WLL: 5,400 lbs./2,450 kg. Weight: 7.9 lbs./3.59 kg.
- 45943-10HD** 5/16-in, Heavy-Duty Lever Load Binder. Accepts chain from 5/16-in G70 up to 3/8-in G70. WLL: 6,600 lbs./2,990 kg. Weight: 9.4 lbs./4.3 kg.
- 45943-11** 3/8-in Lever Load Binder. Accepts chain from 3/8-in. G70 up to 1/2-in. G43. WLL: 9,200 lbs./4,170 kg. Weight: 11.9 lbs./5.4 kg.
- 45943-13** 1/2-in Lever Load Binder. Accepts chain from 1/2-in. G70 up to 5/8-in. G43. WLL: 13,000 lbs./5,910 kg. Weight: 20.8 lbs./9.44 kg.

### Recoilless Lever Chain Load Binders



- 45943-14** 5/16-in. Lever Load Binder. Accepts chain from 5/16-in. G70 up to 3/8-in. G43. WLL: 5,400 lbs./2,450 kg. Weight: 9.0 lbs./4.09 kg.

## CHAIN LOAD BINDERS

### Ratcheting Chain Load Binders



**45943-20**

5/16-in Ratchet Load Binder accepts chain from 5/16-in. G70 up to 3/8-in. G43. WLL: 5,400 lbs./2,450 kg. Weight: 10.4 lbs./4.72 kg.

**45943-20HD**

5/16-in, Heavy-Duty Ratchet Load Binder. Accepts chain from 5/16-in G70 up to 3/8-in G70. WLL: 6,600 lbs./2,990 kg. Weight: 10.5 lbs./4.8 kg.

**45943-21**

3/8-in Ratchet Load Binder accepts chain from 3/8-in. G70 up to 1/2-in. G43. WLL: 9,200 lbs./4,170 kg. Weight: 11.8 lbs./5.36 kg.

**45943-23**

1/2-in Ratchet Load Binder accepts chain from 1/2-in. G70 up to 5/8-in. G43. WLL: 13,000 lbs./5,910 kg. Weight: 15.7 lbs./7.13 kg.

### XHD™ Chain Binders



**EXTRA STRENGTH AND SECURITY.** Constructed of drop forged steel and designed for added strength, durability and superior performance, XHD binders exceed WSTDA T-6 standards. The high visibility yellow E-coat finish protects against harsh elements and extreme road conditions. Available in 2 sizes: 5/16-in – 3/8-in x 6,600 lbs. and 3/8-in – 1/2-in x 9,200 lbs.

- ▶ Forged alloy steel
- ▶ Stronger two-piece handle design with compression spring assembly
- ▶ Welded gear assembly to barrel
- ▶ Pre-lubricated Acme threaded screws
- ▶ Internal thread stops to prevent over-extension and loss of capacity
- ▶ 6-in take-up

**50360-20**

Chain size: 5/16-in. – 3/8-in. WLL: 6,600 lbs./3,000 kg. Weight: 12 lbs./5.4 kg.

**50360-21**

Chain size: 3/8-in. – 1/2-in. WLL: 9,200 lbs./4,200 kg. Weight: 13 lbs./5.9 kg.

## LEVER BINDER LOCKING CLIP



**50117-10**

Locking clip secures the handle on lever load binders to prevent the handle from opening and releasing chain tension. Yellow powder coated for corrosion protection and visibility. Weight: .40 lbs./0.18 kg.

## FLOOR CHAIN TIE DOWNS

Floor chain tie down anchors are available in either weld-on or bolt-on models to meet your specific needs. Each with a working load limit of 6,000 lbs./2,724 kg. Each are made with 3/8-in grade 70 transport chain for strength and durability.

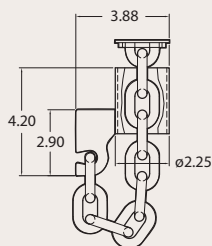

**49345-10**

Weld-on Black E-coat. Weight: 5.6 lbs./2.54 kg.

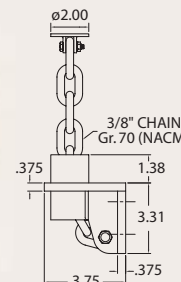

**49583-10**

Bolt-on Plated. Weight: 5.25 lbs./2.38 kg.



# FLATBED SOLUTIONS

## ANCRA X-TREME: WEBBING PERFORMANCE LEADER

As the name implies, Ancra's X-TREME webbing offers our greatest performance, durability, strength and abrasion resistance. Because of its special weave construction and coating process, X-TREME realizes an impressive 80% retained strength after abrasion testing, as opposed to 40% for standard webbing.

X-TREME's coating is durable and permanent, and reduces water absorption and freezing. Ancra X-TREME is available in popular winch and ratchet strap models that meet or exceed WSTDA T-1 standards. Custom lengths and end hardware quoted upon request.



## ANCRA X-TREME WINCH STRAP ASSEMBLIES

Custom lengths and webbing configurations available.

**2" WINCH STRAPS** — WLL: 3,333 lbs./1,515 kg. using 41632-37 X-TREME Webbing



### 41659-90-27

2-in. x 27-ft. ANCRA X-TREME Strap w/ 40891-18 Flat Hook

### 41659-90-30

2-in x 30-ft. ANCRA X-TREME Strap w/ 40891-18 Flat Hook



### 41659-92-30

2-in x 30-ft. ANCRA X-TREME Strap w/ 43120-13 Wire Hook



### 41659-93-30

2-in x 30-ft. ANCRA X-TREME Strap w/ 43366-21 Chain Anchor



### 41659-94-30

2-in x 30-ft. ANCRA X-TREME Strap w/o hardware. For winch to winch applications. Custom lengths available.

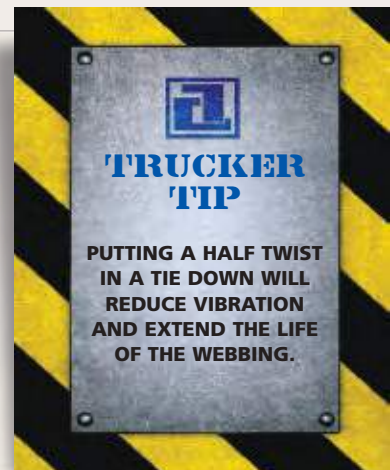

## ANCRA X-TREME WINCH STRAP ASSEMBLIES

**3" WINCH STRAPS** — WLL: 5,400 lbs./2,450 kg. using 41632-38 X-TREME Webbing



### 41660-90-30

3-in. x 30-ft. ANCRA X-TREME Strap w/ 41766-18 Flat Hook



### 41660-93-30

3-in. x 30-ft. ANCRA X-TREME Strap w/ 43366-14 Chain Anchor



### 41660-95-30

3-in. x 30-ft. ANCRA X-TREME Strap w/o hardware. For winch to winch applications. Custom lengths available.

## ANATOMY OF A WINCH STRAP

### Overall Length

The overall distance from the tip of the attachment hardware (flat hook pictured) to the end of the webbing. Standard lengths are 27' and 30', with the most popular being 30'.



Hardware End

Webbing

Width

Determined by the width of the webbing used, 2", 3" or 4"



### Label

Sewn near the hook end is our new extremely durable, yellow reinforced label with proper warnings, usage and working load limits in pounds and kilos.



## ANCRA X-TREME WINCH STRAP ASSEMBLIES

4" WINCH STRAPS — WLL: 5,400 lbs./2,450 kg. using 43797-37 X-TREME Webbing



### 43795-90-27

4-in. x 27-ft. ANCRA X-TREME Strap w/ 41766-18 Flat Hook

### 43795-90-30

4-in. x 30-ft. ANCRA X-TREME Strap w/ 41766-18 Flat Hook

### 43795-90-40

4-in. x 40-ft. ANCRA X-TREME Strap w/ 41766-18 Flat Hook



### 43795-91-27

4-in. x 27-ft. ANCRA X-TREME Strap w/ 41631-12 Delta Ring

### 43795-91-30

4-in. x 30-ft. ANCRA X-TREME Strap w/ 41631-12 Delta Ring

### 43795-91-40

4-in. x 40-ft. ANCRA X-TREME Strap w/ 41631-12 Delta Ring



### 43795-93-30

4-in. x 30-ft. ANCRA X-TREME Strap w/ Half Twisted Loop



### 43795-95-30

4-in. x 30-ft. ANCRA X-TREME Strap w/ 43366-14 Chain Anchor



### 43795-92-30

4-in. x 30-ft. ANCRA X-TREME Strap w/o hardware. For winch to winch applications. Custom lengths available.

## MILE AFTER MILE, YOUR DEPENDABLE CLASSIC.

Ancra Winch Strap Assemblies combine heavy-duty, wear and weather resistant latex treated polyester webbing with strong, dependable hardware to meet the demanding conditions of flatbed operations. Ancra straps meet DOT specifications and are tested for strength and durability. Meets or exceeds WSTDA T-1 Recommended Standard Specifications for synthetic web tie downs.



### WINCH STRAP ASSEMBLIES

**2" WINCH STRAPS** — WLL: 3,333 lbs./1,515 kg. using 41632-46 Webbing



**41659-10-27**

2-in. x 27-ft. Winch Strap w/  
40891-18 Flat Hook

**41659-10-30**

2-in. x 30-ft. Winch Strap w/  
40891-18 Flat Hook



**41659-11-27**

2-in. x 27-ft. Winch Strap w/  
40978-11 Delta Ring

**41659-11-30**

2-in. x 30-ft. Winch Strap w/  
40978-11 Delta Ring



**41659-13-27**

2-in. x 27-ft. Winch Strap w/  
43120-13 Wire Hook

**41659-13-30**

2-in. x 30-ft. Winch Strap w/  
43120-13 Wire Hook



**41659-15-27**

2-in. x 27-ft. Winch Strap w/  
43366-21 Chain Anchor

**41659-15-30**

2-in. x 30-ft. Winch Strap w/  
43366-21 Chain Anchor



**41659-16-30**

2-in. x 30-ft. Winch Strap w/o hardware for winch to winch application.  
Custom lengths available.



# FLATBED SOLUTIONS

## WINCH STRAP ASSEMBLIES

**3" WINCH STRAPS** — WLL: 5,400 lbs./2,450 kg. using 41632-14 Webbing



**41660-10-27**

3-in. x 27-ft. Winch Strap w/  
41766-18 Flat Hook

**41660-10-30**

3-in. x 30-ft. Winch Strap w/  
41766-18 Flat Hook



**41660-14-27**

3-in. x 27-ft. Winch Strap w/  
43366-14 Chain Anchor

**41660-14-30**

3-in. x 30-ft. Winch Strap w/  
43366-14 Chain Anchor



**41660-18-27**

3-in. x 27-ft. Winch Strap w/  
43120-20 Wire Hook

**41660-18-30**

3-in. x 30-ft. Winch Strap w/  
43120-20 Wire Hook



**41660-17-30**

3-in. x 30-ft. strap w/o hardware for winch to winch application.  
Custom lengths available.

**4" WINCH STRAPS** — WLL: 5,400 lbs./2,450 kg. using 43797-12 Webbing



**43795-10-27**

4-in. x 27-ft. Winch Strap w/  
41766-18 Flat Hook

**43795-10-40**

4-in. x 40-ft. Winch Strap w/  
41766-18 Flat Hook



**43795-11-27**

4-in. x 27-ft. Winch Strap w/  
41631-12 Delta Ring

**43795-11-40**

4-in. x 40-ft. Winch Strap w/  
41631-12 Delta Ring

**43795-10-30**

4-in. x 30-ft. Winch Strap w/  
41766-18 Flat Hook

**43795-10-50**

4-in. x 50-ft. Winch Strap w/  
41766-18 Flat Hook

**43795-11-30**

4-in. x 30-ft. Winch Strap w/  
41631-12 Delta Ring

**43795-11-50**

4-in. x 50-ft. Winch Strap w/  
41631-12 Delta Ring

**43795-10-35**

4-in. x 35-ft. Winch Strap w/  
41766-18 Flat Hook

**43795-11-35**

4-in. x 35-ft. Winch Strap w/  
41631-12 Delta Ring



**43795-13-30**

4-in. x 30-ft. Winch Strap w/  
Half Twisted Loop

**43795-13-65**

4-in. x 65-ft. Winch Strap w/  
Half Twisted Loop



**43795-14-27**

4-in. x 27-ft. Winch Strap w/  
43365-12 Grab Hook

**43795-14-30**

4-in. x 30-ft. Winch Strap w/  
43365-12 Grab Hook

**43795-13-45**

4-in. x 45-ft. Winch Strap w/  
Half Twisted Loop

**43795-13-75**

4-in. x 75-ft. Winch Strap w/  
Half Twisted Loop

**43795-13-50**

4-in. x 50-ft. Winch Strap w/  
Half Twisted Loop

## WINCH STRAP ASSEMBLIES

**4" WINCH STRAPS** — WLL: 5,400 lbs./2,450 kg. using 43797-12 Webbing



**43795-15-27**

4-in. x 27-ft. Winch Strap w/  
43366-14 Chain Anchor

**43795-15-30**

4-in. x 30-ft. Winch Strap w/  
43366-14 Chain Anchor



**43795-19-30**

4-in. x 30-ft. Winch Strap w/o hardware for winch to winch  
application. Custom lengths available.



**43795-40-30**

4-in. x 30-ft. Winch Strap w/ 41766-18 Flat Hook.  
using 43797-19 Blue Webbing.



**43795-60-30**

4-in. x 30-ft. Winch Strap w/ 41766-18 Flat Hook.  
using 43797-23 Crimson Red Webbing.

## ROLL-ON/ROLL-OFF CONTAINER STRAPS

### STANDARD



**49526-10**

4-in. x 5-ft. Strap w/ 48968-11 Container Hook.  
WLL: 5,400 lbs./2,450 kg.



**49526-11**

4-in. x 5-ft. Strap w/ 48968-11 Container Hook and Sewn Loop  
end. WLL: 5,400 lbs./2,450 kg.

### ANCRA X-TREME



**49526-90**

4-in. x 5-ft. Ancra X-TREME Strap w/ 48968-11 Container Hook.  
WLL: 5,400 lbs./2,450 kg.



**49526-91**

4-in. x 5-ft. Ancra X-TREME Strap w/ 48968-11 Container Hook and  
Sewn loop end. WLL: 5,400 lbs./2,450 kg.



# FLATBED SOLUTIONS

## ENGINEERED FOR STRENGTH AND DURABILITY

Ancra Ratchet Buckle Strap Assemblies have redefined the industry standard. Now with the tested and proven 80% retained strength of Ancra X-TREME webbing and the integrity of our ratchet buckles, these assemblies surpass the others. A complete line of Ancra's standard and heavy-duty assemblies and accessories can meet all your specific requirements.

- ▶ Custom lengths and a wide range of end hardware are available.
- ▶ Complies with WSTDA T-1 Standards
- ▶ Webbing meets or exceeds WSTDA T-4 Standards
- ▶ Standard fixed end length is 18-in., unless otherwise specified.



## ANCRA X-TREME RATCHET STRAP ASSEMBLIES

**2" ANCRA X-TREME RATCHET STRAPS USING 41632-37 WEBBING WITH LONG-WIDE HANDLE RATCHET BUCKLE 44587-10 — WLL: 3,333 lbs./1,515 kg.**



### **45982-90-27**

2-in. x 27-ft. ANCRA X-TREME Ratchet Strap w/ 40891-18 Flat Hooks.

### **45982-90-30**

2-in. x 30-ft. ANCRA X-TREME Ratchet Strap w/ 40891-18 Flat Hooks.



### **45982-93-30**

2-in. x 30-ft. ANCRA X-TREME Ratchet Strap w/ 43366-21 Chain Anchors. Fixed End 33-in.



### **45982-95-27**

2-in. x 27-ft. ANCRA X-TREME Ratchet Strap w/ 43120-13 Wire Hooks.

### **45982-95-30**

2-in. x 30-ft. ANCRA X-TREME Ratchet Strap w/ 43120-13 Wire Hooks.

**3" ANCRA X-TREME RATCHET STRAPS USING 41632-38 WEBBING WITH RATCHET BUCKLE 48965-10 — WLL: 5,400 lbs./2,450 kg.**



### **48987-90-27**

3-in. x 27-ft. ANCRA X-TREME Ratchet Strap w/ 41766-18 Flat Hooks. Fixed End 22-in.

### **48987-90-30**

3-in. x 30-ft. ANCRA X-TREME Ratchet Strap w/ 41766-18 Flat Hooks. Fixed End 22-in.



### **48987-92-27**

3-in. x 27-ft. ANCRA X-TREME Ratchet Strap w/ 43366-14 Chain Anchors. Fixed End 37-in.

### **48987-92-30**

3-in. x 30-ft. ANCRA X-TREME Ratchet Strap w/ 43366-14 Chain Anchors. Fixed End 37-in.

## ANCRA X-TREME RATCHET STRAP ASSEMBLIES

**4" ANCRA X-TREME RATCHET STRAPS USING 43797-37 WEBBING WITH RATCHET BUCKLE**  
**49349-10** — WLL: 5,400 lbs./2,450 kg.



**49346-90-27**

4-in. x 27-ft. ANCRA X-TREME Ratchet Strap w/ 41766-18 Flat Hooks. Fixed End 20-in.

**49346-90-30**

4-in. x 30-ft. ANCRA X-TREME Ratchet Strap w/ 41766-18 Flat Hooks. Fixed End 20-in.



**49346-91-27**

4-in. x 27-ft. ANCRA X-TREME Ratchet Strap w/ 43366-14 Chain Anchors. Fixed End 35-in.

**49346-91-30**

4-in. x 30-ft. ANCRA X-TREME Ratchet Strap w/ 43366-14 Chain Anchors. Fixed End 35-in.



**49346-93-27**

4-in. x 27-ft. ANCRA X-TREME Ratchet Strap w/ 43120-20 Wire Hooks. Fixed End 20-in.

**49346-93-30**

4-in. x 30-ft. ANCRA X-TREME Ratchet Strap w/ 43120-20 Wire Hooks. Fixed End 20-in.

## ANATOMY OF A RATCHET STRAP

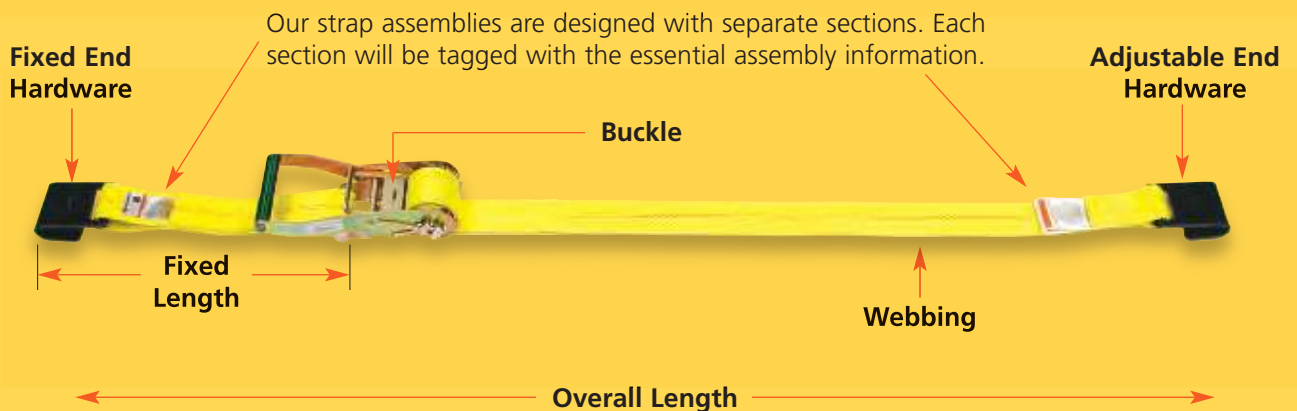

The distance between extreme end bearing points of the web tie down assembly, including the fittings. Standard fixed end length is 18" (33" for chain anchor straps). This puts the ratchet in the optimum position on the side of the trailer.

# FLATBED SOLUTIONS

## RATCHET STRAP ASSEMBLIES

The strength of Ancra Ratchet Strap Assemblies reflects the strength of Ancra's reputation in the Transportation Industry. Our heavy-duty, weather resistant straps and solid, reliable hardware have met the demands of the road for more than 40 years. Our straps are stringently tested for strength and durability in order to bear the Ancra name.

### 2" RATCHET BUCKLE STRAPS USING 41632-46 WEBBING WITH LONG-WIDE HANDLE RATCHET BUCKLE 44587-10 — WLL: 3,333 lbs./1,515 kg.



#### 45982-10

2-in. x 27-ft. Ratchet Strap w/  
40891-18 Flat Hooks.

#### 45982-11

2-in. x 30-ft. Ratchet Strap w/  
40891-18 Flat Hooks.



#### 45982-15

2-in. x 27-ft. Ratchet Strap w/  
43366-21 Chain Anchors.  
Fixed End 33-in.

#### 45982-34

2-in. x 30-ft. Ratchet Strap w/  
43366-21 Chain Anchors.  
Fixed End 33-in.



#### 45982-19

2-in. x 27-ft. Ratchet Strap w/  
40758-11 Twisted Snap Hooks.

#### 45982-36

2-in. x 30-ft. Ratchet Strap w/  
40758-11 Twisted Snap Hooks.



#### 45982-42

2-in. x 27-ft. Ratchet Strap w/  
43120-13 Wire Hooks.

#### 45982-43

2-in. x 30-ft. Ratchet Strap w/  
43120-13 Wire Hooks.

### 2" RATCHET BUCKLE STRAPS USING 41632-46 WEBBING WITH SHORT-WIDE HANDLE RATCHET BUCKLE 47105-11 — WLL: 3,333 lbs./1,515 kg.



#### 47970-10

2-in. x 27-ft. Ratchet Strap w/  
40891-18 Flat Hooks.

#### 47970-11

2-in. x 30-ft. Ratchet Strap w/  
40891-18 Flat Hooks.

### 2" RATCHET BUCKLE STRAPS USING 41632-46 WEBBING WITH STANDARD HANDLE RATCHET BUCKLE 44627-11 — WLL: 3,333 lbs./1,515 kg.



#### 47971-10

2-in. x 27-ft. Ratchet Strap w/  
40891-18 Flat Hooks.

#### 47971-11

2-in. x 30-ft. Ratchet Strap w/  
40891-18 Flat Hooks.



## RATCHET STRAP ASSEMBLIES

**3" RATCHET BUCKLE STRAPS USING 41632-14 WEBBING WITH RATCHET BUCKLE 48965-10 —**  
WLL: 5,400 lbs./2,450 kg.



**48987-20**

3-in. x 27-ft. Ratchet Strap w/ 41766-18 Flat Hooks.

**48987-21**

3-in. x 30-ft. Ratchet Strap w/ 41766-18 Flat Hooks.



**48987-24**

3-in. x 27-ft. Ratchet Strap w/ 43366-14 Chain Anchors. Fixed End 33-in.

**48987-25**

3-in. x 30-ft. Ratchet Strap w/ 43366-14 Chain Anchors. Fixed End 33-in.



**48987-28**

3-in. x 27-ft. Ratchet Strap w/ 43120-20 Wire Hook.

**48987-29**

3-in. x 30-ft. Ratchet Strap w/ 43120-20 Wire Hook.

**4" RATCHET BUCKLE STRAPS USING 43797-12 WEBBING WITH RATCHET BUCKLE 49349-10 —**  
WLL: 5,400 lbs./2,450 kg.



**49346-10**

4-in. x 27-ft. Ratchet Strap w/ 41766-18 Flat Hooks.

**49346-11**

4-in. x 30-ft. Ratchet Strap w/ 41766-18 Flat Hooks.

WLL: 5,400 lbs./2,450 kg.



**49346-14**

4-in. x 27-ft. Ratchet Strap w/ 43366-14 Chain Anchors. Fixed End 33-in.

**49346-15**

4-in. x 30-ft. Ratchet Strap w/ 43366-14 Chain Anchors. Fixed End 33-in.

**4" RATCHET BUCKLE STRAPS USING 41632-15 WEBBING WITH RATCHET BUCKLE 49349-10 —**  
WLL: 6,600 lbs./3,000 kg.



**49346-12**

4-in. x 27-ft. Ratchet Strap w/ 43120-20 Narrow Wire Hooks.

**49346-13**

4-in. x 30-ft. Ratchet Strap w/ 43120-20 Narrow Wire Hooks.

# FLATBED SOLUTIONS

## WEB KEEPER RATCHET STRAP ASSEMBLIES



Keep your excess webbing neat and secure with our new patented Web Keeper Ratchet Buckle Straps.

PATENTED

Tension your strap, roll up excess webbing and store it under the lever. Straps are available in 27' and 30' lengths in flat hook or wire hook models in standard or X-TREME webbing. These straps have a fixed end length of 18" and meet or exceed WSTDA T-1 Standard Specification for synthetic web tie downs.

**2" WEB KEEPER RATCHET BUCKLE STRAPS USING 41632-46 WEBBING WITH LONG-WIDE HANDLE WEB KEEPER RATCHET BUCKLE 50037-10 — WLL: 3,333 lbs./1,515 kg.**



**45982-10-27-WK**

2-in. x 27-ft. Web Keeper Ratchet Strap w/ 40891-18 Flat Hooks.

**45982-11-30-WK**

2-in. x 30-ft. Web Keeper Ratchet Strap w/ 40891-18 Flat Hooks.



**45982-42-27-WK**

2-in. x 27-ft. Web Keeper Ratchet Strap w/ 43120-13 Wire Hooks.

**45982-43-30-WK**

2-in. x 30-ft. Web Keeper Ratchet Strap w/ 43120-13 Wire Hooks.

**2" WEB KEEPER RATCHET BUCKLE STRAPS USING 41632-37 X-TREME WEBBING WITH LONG-WIDE HANDLE WEB KEEPER RATCHET BUCKLE 50037-10 — WLL: 3,333 lbs./1,515 kg.**



**45982-90-27-WK**

2-in. x 27-ft. X-TREME Web Keeper Ratchet Strap w/ 40891-18

**45982-90-30-WK**

2-in. x 30-ft. X-TREME Web Keeper Ratchet Strap w/ 40891-18 Flat Hooks.



**45982-95-27-WK**

2-in. x 27-ft. X-TREME Web Keeper Ratchet Strap w/ 43120-13 Wire Hooks.

**45982-95-30-WK**

2-in. x 30-ft. X-TREME Web Keeper Ratchet Strap w/ 43120-13 Wire Hooks.

## RATCHET STRAP ASSEMBLIES



### FOR ANCRA X-TREME 2" RATCHET STRAP ASSEMBLIES

Replacement for:	Part No.	Description
45982-90-27 & -30	<b>10632-90</b>	2" x 18" Fixed end strap w/ 44587-10 Buckle and 40891-18 Flat hook
45982-90-27 & -30, 45982-90-27-WK, 45982-90-30-WK	<b>10632-90-28</b>	2" x 28' Adjustable end strap w/ 40891-18 Flat hook
45982-93-30	<b>10632-93</b>	2" x 33" Fixed end strap w/ 44587-10 Buckle and 43366-21 Chain Anchor
45982-93-30	<b>10632-93-28</b>	2" x 28' Adjustable end strap w/ 43366-21 Chain Anchor
45982-95-27 & -30	<b>10632-95</b>	2" x 18" Fixed end strap w/ 44587-10 Buckle and 43120-13 Wire hook
45982-95-27 & -30, 45982-95-27-WK, 45982-95-30-WK	<b>10632-95-28</b>	2" x 28' Adjustable end strap w/ 43120-13 Wire hook

### FOR ANCRA X-TREME 3" RATCHET STRAP ASSEMBLIES

48987-90-27 & -30	<b>10633-90</b>	3" x 22" Fixed end strap w/ 48965-10 Buckle and 41766-18 Flat hook
48987-90-27 & -30	<b>10633-90-28</b>	3" x 28' Adjustable end strap w/ 41766-18 Flat hook
48987-92-27 & -30	<b>10633-92</b>	3" x 37" Fixed end strap w/ 48965-10 Buckle and 43366-14 Chain Anchor
48987-92-27 & -30	<b>10633-92-28</b>	3" x 28' Adjustable end strap w/ 43366-14 Chain Anchor

### FOR ANCRA X-TREME 4" RATCHET STRAP ASSEMBLIES

49346-90-27 & -30	<b>10634-90</b>	4" x 18" +/- 2" Fixed end strap w/ 49349-10 Buckle and 41766-18 Flat hook
49346-90-27 & -30	<b>10634-90-28</b>	4" x 28' Adjustable end strap w/ 41766-18 Flat hook
49346-91-27 & -30	<b>10634-91</b>	4" x 33" +/- 2" Fixed end strap w/ 49349-10 Buckle and 43366-14 Chain Anchor
49346-91-27 & -30	<b>10634-91-28</b>	4" x 28' Adjustable end strap w/ 43366-14 Chain Anchor
49346-93-27 & -30	<b>10634-93</b>	4" x 18" +/- 2" Fixed end strap w/ 49349-10 Buckle and 43120-20 Wire hook
49346-93-27 & -30	<b>10634-93-28</b>	4" x 28' Adjustable end strap w/ 43120-20 Wire hook

### FOR STANDARD 2" RATCHET STRAP ASSEMBLIES

Replacement for:	Part No.	Description
45982-10 & -11, 47970-10 & -11, 47971-10 & -11, 45982-10-27-WK, 45982-11-30-WK	<b>48922-10</b>	2" x 18" Fixed end strap w/ 40891-18 Flat hook & loop end
45982-42 & -43	<b>48922-13</b>	2" x 18" Fixed end strap w/ 43120-13 Wire hook & loop end
445982-15 & -34, 45982-42-27-WK, 45982-43-30-WK	<b>48922-16</b>	2" x 33" Fixed end strap w/ 43366-21 Chain Anchor & loop end
45982-10 & -11	<b>49347-10</b>	2" x 18" Fixed end strap w/ 40891-18 Flat hook & 44587-10 Buckle
45982-42 & -43	<b>49347-19</b>	2" x 18" Fixed end strap w/ 43120-13 Wire hook & 44587-10 Buckle
45982-15 & -34	<b>49347-28</b>	2" x 33" Fixed end strap w/ 43366-21 Chain Anchor & 44587-10 Buckle
45982-10, 47970-10, 47971-10	<b>49347-11</b>	2" x 25' Adjustable end strap w/ 40891-18 Flat hook
45982-42	<b>49347-20</b>	2" x 25' Adjustable end strap w/ 43120-13 Wire hook
45982-15	<b>49347-29</b>	2" x 25' Adjustable end strap w/ 43366-21 Chain Anchor
45982-11, 47970-11, 47971-11	<b>49347-12</b>	2" x 28' Adjustable end strap w/ 40891-18 Flat hook
45982-43	<b>49347-21</b>	2" x 28' Adjustable end strap w/ 43120-13 Wire hook
45982-34	<b>49347-30</b>	2" x 28' Adjustable end strap w/ 43366-21 Chain Anchor



## RATCHET STRAP ASSEMBLIES

### FOR STANDARD 3" RATCHET STRAP ASSEMBLIES

Replacement for:	Part No.	Description
48987-20 & -21	<b>48922-11</b>	3" x 18" Fixed end strap w/ 41766-18 Flat hook & loop end
48987-24 & -25	<b>48922-17</b>	3" x 33" Fixed end strap w/ 43366-14 Chain Anchor & loop end
48987-22 & -23	<b>48922-20</b>	3" x 18" Fixed end strap w/ 43365-12 Grab hook & loop end
48987-20 & -21	<b>49347-13</b>	3" x 18" Fixed end strap w/ 41766-18 Flat hook & 48965-10 Buckle
48987-24 & -25	<b>49347-31</b>	3" x 33" Fixed end strap w/ 43366-14 Chain Anchor & 48965-10 Buckle
48987-22 & -23	<b>49347-40</b>	3" x 18" Fixed end strap w/ 43365-12 Grab hook & 48965-10 Buckle
48987-20	<b>49347-14</b>	3" x 25' Adjustable end strap w/ 41766-18 Flat hook
48987-24	<b>49347-32</b>	3" x 25' Adjustable end strap w/ 43366-14 Chain Anchor
48987-22	<b>49347-41</b>	3" x 25' Adjustable end strap w/ 43365-12 Grab hook
48987-21	<b>49347-15</b>	3" x 28' Adjustable end strap w/ 41766-18 Flat hook
48987-25	<b>49347-33</b>	3" x 28' Adjustable end strap w/ 43366-14 Chain Anchor
48987-23	<b>49347-42</b>	3" x 28' Adjustable end strap w/ 43365-12 Grab hook

### FOR STANDARD 4" RATCHET STRAP ASSEMBLIES

49346-10 & -11	<b>48922-12</b>	4" x 18" Fixed end strap w/ 41766-18 Flat hook & loop end
49346-12 & -13	<b>48922-15</b>	4" x 18" Fixed end strap w/ 43120-20 Wire hook & loop end
49346-14 & -15	<b>48922-18</b>	4" x 33" Fixed end strap w/ 43366-14 Chain Anchor & loop end
49346-10 & -11	<b>49347-16</b>	4" x 18" Fixed end strap w/ 41766-18 Flat hook & 49349-10 Buckle
49346-12 & -13	<b>49347-25</b>	4" x 18" Fixed end strap w/ 43120-20 Wire hook & 49349-10 Buckle
49346-14 & -15	<b>49347-34</b>	4" x 33" Fixed end strap w/ 43366-14 Chain Anchor & 49349-10 Buckle
49346-10	<b>49347-17</b>	4" x 25' Adjustable end strap w/ 41766-18 Flat hook
49346-12	<b>49347-26</b>	4" x 25' Adjustable end strap w/ 43120-20 Wire hook
49346-14	<b>49347-35</b>	4" x 25' Adjustable end strap w/ 43366-14 Chain Anchor
49346-11	<b>49347-18</b>	4" x 28' Adjustable end strap w/ 41766-18 Flat hook
49346-13	<b>49347-27</b>	4" x 28' Adjustable end strap w/ 43120-20 Wire hook
49346-15	<b>49347-36</b>	4" x 28' Adjustable end strap w/ 43366-14 Chain Anchor



## TIE DOWN TIPS

### From the Web Sling and Tie Down Association

- ▶ The angle from the horizontal (tie down to trailer deck) has an enormous influence on load securement.
- ▶ If the angle is 90 degrees, the effective downward pressure is 100% of the tie down tension.
- ▶ If the angle is 60 degrees, the effective downward pressure is reduced to 87% of the tie down tension.
- ▶ If the angle is 45 degrees, the effective downward pressure is reduced to 71% of the tie down tension.
- ▶ If the angle is 30 degrees, the effective downward pressure is reduced to 50% of the tie down tension.
- ▶ For more information about the Recommended Standard for Tie Downs, contact WSTDA.

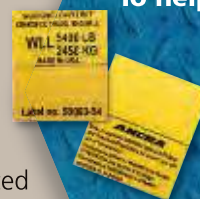

To help prevent unrated straps, Ancra uses high-quality, tear and fade-resistant, reinforced vinyl WLL labels on all flatbed tie downs.

# INTERIOR VAN SOLUTIONS

From decking systems, track, beams and bars, to strap assemblies and custom nets, Ancra's Interior Van Solutions are made of quality components to secure your loads. Whether your application is standard or heavy-duty, your solution is here.

- Loading systems match your application
- Track treated with high quality finishes for corrosion resistance
- Versatile beams and bars with the best possible strength-to-weight ratio
- Replacement parts for added life and efficiency
- Strength tested and highway proven



# INTERIOR VAN SOLUTIONS

## LIFT-A-DECK® II

### The most popular patented solution for decking loads in trailer and van bodies.

With Ancra's patented adjustable second deck in your trailer, you can carry double the amount of palletized freight, or you can mix loads with only part of the vehicle double decked. Either way, you can increase your payload capacity and your profits. For the loads where you need full height, you simply push the adjustable beams to the roof for convenient and safe storage. There will be no more beams left on the loading dock. The Ancra Lift-A-Deck® II system is the most versatile you can install. With many track styles to choose from, installations can be made on any type of vehicle construction, including sheet and post. Lift-A-Deck II track can also be used with a wide range of Ancra accessories for cargo containment.

#### Convenient storage.

When not in use, beams are easily pushed to the roof for secure storage. No more lost beams.

#### Easy operation.

Beams are easily moved by one operator.

#### Super strength.

Ancra Wide Top Beams have the highest rating in the industry – 4,000 lbs./1,816 kg.

#### Wide range of accessories.

Lift-A-Deck II track can be used for securing loads with cargo straps, tie-offs, and decking/shoring beams.



#### Fits all trailers.

Available for 96 or 102 inch trailer widths and height can be specified. Track also can be made as an integral part of sidewall structure.

#### Versatile.

Beams can be adjusted in one-inch increments to accommodate various loads within a trailer. Only Ancra offers this much adjustability.

#### Snag resistant.

Low profile track design with sloping shoulders helps protect against forklift damage and allows for surface mounting. Standard track length is 72-inches. Custom lengths are available.

#### Simple, yet secure.

Double engagement lock on the aluminum beam features a simplified trigger release mechanism. Internal locking design helps protect against forklift damage.



## LIFT-A-DECK® II

### Only Ancra gives you so many decking options.

Cargo beams and Lift-A-Deck beams are rated at Working Load Limits (WLL) that are 1/3 of the breaking strength or failure load capacity of the beams. In order to account for dynamics and vibrations that are experienced during transit and avoid overloading the beams beyond the WLL rating, the actual weight of cargo supported by the beams should be reduced below the rated WLL value of the beam. The allowable weight of cargo supported by the beams should be factored down based on anticipated dynamic G forces expected during transit. Below are typical examples of de-rated weight carrying values for beams based on a range of expected levels of transport dynamics.

Recommended Maximum Cargo Weight per Beam	24" Centers (lbs)		16" Centers (lbs)		
	BEAM TYPE	S-S-S	D-S-D	S-S-S-S	D-S-S-D
	Standard	1100	1650	1650	2200
	Heavy Duty	1500	2250	2250	3000
	Reinforced Wide	2000	3000	3000	4000

- ▶ Beams can be positioned in one-inch increments for most efficient utilization of space
- ▶ Beams easily moved by just one operator
- ▶ Low Profile locking mechanism to help protect against forklift damage.

### STANDARD AND LOW PROFILE BEAMS W/ LOW PROFILE FOOT AND CHANNEL ASSEMBLY



**PATENTED**  
No. 6,074,143

**49414-15**  
Standard LAD Beam  
Adjustment range: 95.1" – 105.6"  
Weight: 18.1 lbs./8.2 kg.  
Decking WLL: 2,200 lbs./999 kg.\*  
Shoring WLL: 2,200 lbs./999 kg.



**PATENTED**  
No. 6,074,143

**49414-19**  
Heavy Duty LAD Beam  
Adjustment range: 95.1" – 105.6"  
Weight: 19.7 lbs./8.9 kg.  
Decking WLL: 3,000 lbs./1,360 kg.\*  
Shoring WLL: 2,500 lbs./1,135 kg.

### WIDE TOP BEAM W/ LOW PROFILE FOOT AND CHANNEL ASSEMBLY

The textured Beam top surface is 4-1/2" wide to increase the contact area for cargo on the beam deck.



**PATENTED**  
No. 6,074,143

**PATENT PENDING**

**50080-11**  
Wide Top LAD Beam Assembly  
Adjustment range 95.1" – 105.6"  
Weight: 24.9 lbs./11.3 kg.  
Decking WLL: 4,000 lbs./1,816 kg.\*  
Not recommended for shoring.



**PATENT PENDING**  
No. 6,074,143

**50312-10**  
Wide Top LAD Beam  
w/ Reinforced 1-in. Sides  
Adjustment range: 95.2" – 105.7"  
Weight: 26.7 lbs./12.1 kg.  
Decking WLL: 4,000 lbs./1,814 kg.\*  
Shoring WLL: 2,500 lbs./1,135 kg.

**50312-10-RT** Replacement tube for 50312-10. Length 90.71 inches.

\* Note: Also consult trailer or truck body manufacturer for their recommended load capacity of secondary deck.

# INTERIOR VAN SOLUTIONS

## LIFT-A-DECK® II

**BEAM ACCESSORIES AND COMPONENTS** — RT Beams have all the required labels.



### 49414-15-RT

Replacement Tube for 49414-15 Standard LAD Beam. Length 90.71 inches. Weight: 11.2 lbs./5.1 kg.

### 49414-19-RT

Replacement Tube for 49414-19 Heavy-Duty LAD Beam. Length 90.71 inches. Weight: 14.3 lbs./6.5 kg.

### 50080-11-RT

Replacement Tube for 50080-11 Wide Top LAD Beam. Length 90.71 inches. Weight: 19.5 lbs./8.8 kg.



**49445-12** Beam Release Bar  
Length: 52 inches. Weight: 2.5 lbs./1.14 kg.



## PRODUCT FEATURES

WITH MORE THAN 45,000 SYSTEMS OPERATING YEAR AFTER YEAR WITH LOW MAINTENANCE COSTS, LIFT-A-DECK IS THE DECK SYSTEM MOST REQUESTED BY MAJOR FLEETS.

- + NO TRACK LUBRICATION REQUIRED.
- + SYSTEM TRACK AND FOOT ASSEMBLIES ARE PRECISION MACHINED RESULTING IN SMOOTH SLIDING BEAMS.
- + EVALUATION, TESTING, TRAINING AND INSTALLATION BY CERTIFIED DECK SPECIALISTS WILL HELP DETERMINE THE BEST LAD II SYSTEM FOR YOUR APPLICATION AND ENSURE MAXIMUM EFFICIENCY AND ROI.



### 49446-10 Lift-A-Deck Kit

Lift-A-Deck Kit includes the 49445-12 Beam Release Bar and 49438-13 Warning, Operations and Maintenance placard. Weight: 2.5 lbs. / 1.14 kg.



**50055-10** Beam Release Bar Holder  
Weight: .44 lbs./2 kg.



**49384-12** Track Stop  
Weight: .04 lb./02 kg.



### 50187-30

Low Profile Foot and Channel Assembly  
Machined Guide Shoe allows for inspection of the locking elements while foot is installed in track.  
Coil spring increases the service life.  
Weight: 3.1 lbs./1.41 kg.



### 50187-31

Lift-A-Deck II Foot Assembly  
Machined guide shoe allows for inspection of both locking lugs while beam remains installed in the track. Features a coil spring and spring limiter for increased service life.  
Weight: 0.6 lbs./ .27 kg.



### 50194-100

Low Profile Allen Sleeve Nut and Bolt Kit  
Low profile allen head bolt and sleeve nut with a semi-flush head height of .10". Used for attaching channel assemblies to beams. The bolt has a self locking patch to prevent loosening due to vibration. For 43638, 49039, 49360, 49414, 50080, 50158, 50186 and 50191 beams. Weight: .10 lb./5 kg.

\* Note: Also consult trailer or truck body manufacturer for their recommended load capacity of secondary deck.

## AFTERMARKET DECKING SYSTEM BEAMS

### AFTERMARKET DECKING BEAMS — OLDER STYLE CAPTIVE BEAM SYSTEMS



#### 49414-21

Standard Aftermarket Beam  
 Adjustment range 97.3" – 108.8"  
 Weight: 23.7 lbs./10.76 kg.  
 Decking WLL: 2,200 lbs./1,000 kg.  
 Shoring WLL: 1,500 lbs./680 kg.



#### 50191-10

Heavy-Duty Aftermarket Beam  
 Adjustment range 97.3" – 108.8"  
 Weight: 25.3 lbs./11.49 kg.  
 Decking WLL: 2,200 lbs./1,000 kg.  
 Shoring WLL: 1,500 lbs./680 kg.



#### 50186-10

Wide Top Aftermarket Beam  
 Adjustment range 97.3" – 108.8"  
 Weight: 30.5 lbs./13.85 kg.  
 Decking WLL: 2,500 lbs./1,135 kg.  
 Not recommended for shoring.

*\* Note: Also consult trailer or truck body manufacturer for their recommended load capacity of secondary deck.*

### AFTERMARKET BEAM ACCESSORIES AND COMPONENTS — RT Beams have all the required labels.



**49414-21-RT** (shown above)  
 Replacement Tube for 49414-21 Standard Aftermarket Beam. Length 90.71 inches. Weight: 11.2 lbs./5.1 kg.

**50191-10-RT**  
 Replacement Tube for 50191-10 Heavy-Duty Aftermarket Beam. Length 90.71 inches. Weight: 14.3 lbs./6.5 kg.

**50186-10-RT**  
 Replacement Tube for 50186-10 Wide Top Aftermarket Beam. Length 90.71 inches. Weight: 19.5 lbs./8.8 kg.

**50188-10**  
 Foot and Channel Assembly for 49414-22, 50186-10 and 50191-10 Aftermarket Beams. Weight: 5.9 lbs./2.68 kg.



#### 50194-100

Low Profile Allen Sleeve Nut and Bolt Kit  
 Kit consists of (1) 50194-10 Bolt and (1) 50194-11 Sleeve Nut. Low profile allen head bolt and sleeve nut with a semi-flush head height of .10". Used for attaching channel assemblies to beams. The bolt has a self locking patch to prevent loosening due to vibration. For 43638, 49039, 49360, 49414, 50080, 50158, 50186 and 50191 beams. Weight: .10 lb./5 kg.





## LIFT-A-DECK® II

### Lift-A-Deck® II Track Options

- ▶ Widest choice of track types to meet every application.
- ▶ No track lubrication is required.
- ▶ Beam access slot is provided as standard for all track for easy beam removal and replacement. Standard track length is 72 inches (61 inch loadable). Custom lengths and an installation manual are available upon request.



**50192-14-72.00**  
Standard Single Track

*Various Track Configurations Available*  
*Diagram shows Single Track System on 24 In. Centers (Single-Single-Single)*

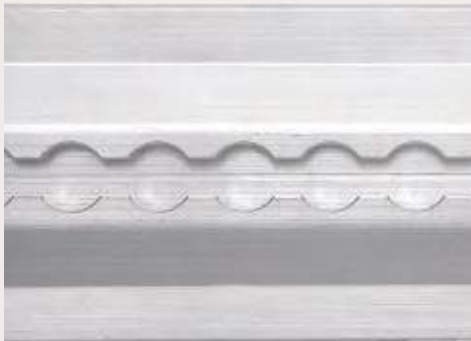
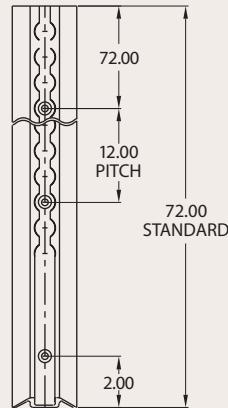

**50058-18-72.00**  
Flanged Single Track. Beveled, Weight: 4.2 lbs./ 1.9 kg.

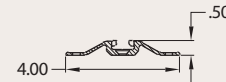
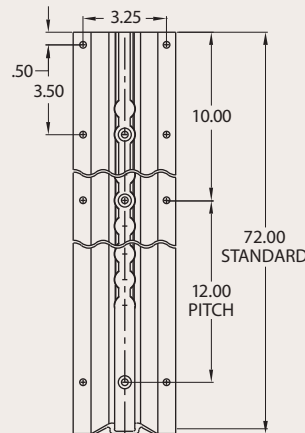

**49562-17-72.00**  
Narrow Single Track

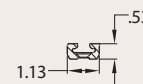
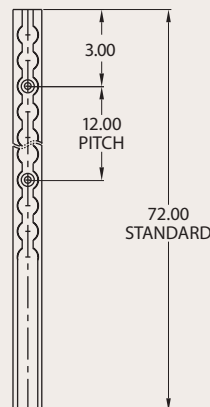

## LIFT-A-DECK® II

### LIFT-A-DECK® II TRACK OPTIONS

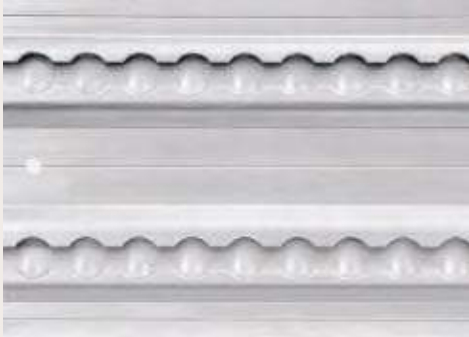

#### 50072-14-72.00

Flanged Double Track  
Beveled, Weight: 6.8 lbs./ 3.1 kg.

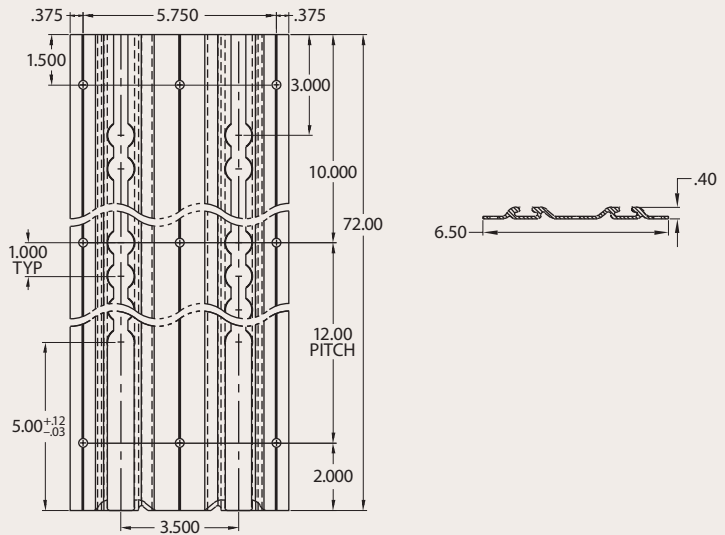

### LIFT-A-DECK® II LOGISTIC STRAPS



6,000 lb. Polyester Webbing (47200) with Cam Buckle (40880-15) and (50112-10) Single Stud Fitting. Fixed End: 48-in. Working Load Limit: 833 lbs./378 kg.

Part No.	Length	Weight
<b>40602-100</b>	12 ft.	1.40 lbs.
<b>40602-101</b>	16 ft.	1.55 lbs.
<b>40602-102</b>	20 ft.	1.70 lbs.



6,000 lb. Polyester Webbing (47200) with Ratchet Buckle (44258-13) and (50362-11) Double Stud Fitting. Fixed End: 48-in. Working Load Limit: 1,500 lbs./680 kg.

Part No.	Length	Weight
<b>48672-16</b>	12 ft.	2.50 lbs.
<b>48672-17</b>	16 ft.	2.65 lbs.
<b>48672-18</b>	20 ft.	2.80 lbs.



#### 49988-10 Pallet Deck

Add another deck to double your freight and your profits, and reduce damage claims. Pallet Deck is stackable, durable, recyclable high density polyethylene. 2-inch x 2-foot square tube with zinc flo-coat finish 46-inch deep x 92-inch wide x 56-inch high. WLL: 5,500 lbs. / 2,495 kg.



## POLY DECK BOARD



### Poly Deck Board for LAD System

- ▶ Lighter than plywood - Increase trailer capacity
- ▶ Ergonomic - Convenient hand slot
- ▶ Splinter Proof - Reduces labor to clean out trailers and docks - longer life than plywood
- ▶ Stackable - Nests for storage
- ▶ Durable - Reduces purchase frequency
- ▶ Recyclable - Energy savings
- ▶ Tough high density polyethylene has excellent low temperature performance down to -40°F
- ▶ Tested to demonstrate durability under load and vibration at -40°F



### 50105-11

Poly Deck Board for LAD System  
For beams set at 24" on center.  
48" x 48" x 2.7"H  
Weight: 21 lbs./9.53 kg.

## 414-10KIT

**Versatile Security Divider & Deck Board.** High density polyethylene panels with hand slots for easy positioning are ideal for moving household items, keeping your freight separate and secure. Used with lockable beams to provide a secure load divider for missed loads. When used as a decking board, the cargo carrying capacity is determined by the beam supporting it.

- ▶ Kit includes 2 lockable E Beams and 2 Panels
- ▶ For use with Standard and Heavy Duty E Beams
- ▶ Splinter proof
- ▶ 3-year Warranty

### 414-10

Panel size: 96" h x 48" w x 3" d.  
Weight: 56 lbs./25.4 kg.

### 414-10KIT

(2) Panel size: 96" h x 96" w x 3" d.  
Weight: 157 lbs./71.2 kg.







Assembled in USA from  
US & Foreign Components

## THE NEWEST TECHNOLOGY IN PNEUMATIC ROLLER TRACK SYSTEMS

# Retract-A-Roll<sup>3</sup>

ANCRA PUTS AIRCRAFT  
CARGO LOADING CONVENIENCE  
IN YOUR TRAILER.

Your trailers can benefit from the same  
high speed loading that moves thousands  
of tons of air cargo everyday.



**Move 1,000 pound  
loads with one finger.**

Ancra's next generation  
heavy cargo system  
uses retractable rollers  
to lift and slide  
containers to speed  
turnarounds. Loading

and unloading is  
quicker, reducing

handling time and lowering labor costs.

Available for air freight or palletized  
freight, both systems instantly convert  
back to a flat floor for general freight.

ENGINEERED FOR LIGHT WEIGHT,  
HEAVY DURABILITY.

Steel top cap and rollers fend off  
forklifts. Lower sections are aluminum to  
reduce weight. All parts are easily accessed for  
inspection or repair. System is powered by  
pneumatics off the truck's existing air supply.



**Light, strong  
and rugged.**

Extruded aluminum  
channel saves weight  
and adds strength.

**Centralized controls.**  
Easy to use controls are housed  
in a weatherproof container.

**Smaller roller opening.**

Helps prevent debris collection  
in roller cradle and reduces  
clean out requirement.

**Simple roller  
replacement.**

Rollers can be easily  
replaced by removing a  
spring clip.

**Exclusive safety interlock.**

If rollers are not lowered by the operator,  
a control valve automatically lowers rollers  
when the vehicles brakes are released.

**Industry-standard  
connectors.**

Standard DOT fittings  
and 3/8" air line used  
throughout for reliability,  
serviceability and for  
reduced cycle times.

**Fast operation.**

Unit takes less than  
1 minute to raise rollers.

**Heavy-duty top plate.**

Hi-tensile, 11-gauge folded  
steel top plate with reinforcing  
ribs takes the abuse of forklifts.  
Galvanized finish fights corrosion.

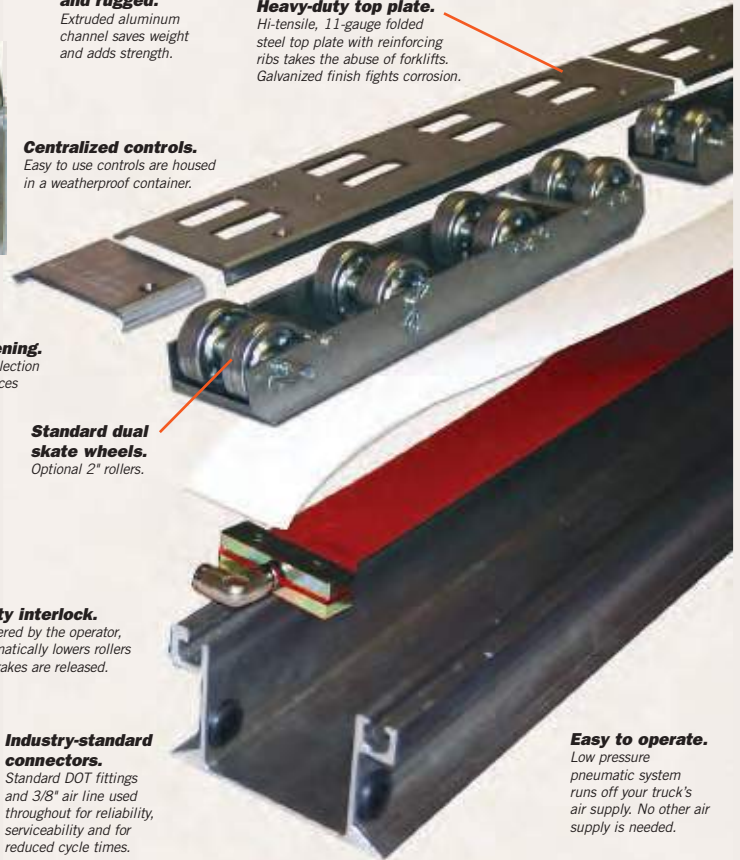

**Standard dual  
skate wheels.**  
Optional 2" rollers.

**Easy to operate.**

Low pressure  
pneumatic system  
runs off your truck's  
air supply. No other air  
supply is needed.



## FREIGHT GLIDES ON GLIDES OFF



### RETRACT-A-ROLL III SPECIFICATIONS

Track width:	4.5 inches / 114 mm
Track height:	2.63 inches / 67 mm
Track weight:	4" (85.5 lbs / 38.8 kg) Dual (82.5 lbs / 37.4 kg) 6" (79 lbs / 35.8 kg)
Inflated height:	3.13 inches / 79.5 mm
Rollers:	Dual sealed skate wheels 2" rollers – optional
Roller spacing:	4", 6" or combination pitch
Track lengths:	8', 10' and 13' (standard) 2.4 m, 3 m, 4 m (standard)
Lifting capacity:	375 lbs/ft / 671 kg/m
Bearing capacity:	Dual skate wheels - 300 lbs / 136 kg 2" roller – 250 lbs / 113 kg
Operating air pressure:	33 +/- 2 psi / 2 bar
Control box:	Weatherproof with centralized controls

# INTERIOR VAN SOLUTIONS

## THE RIGHT TRACK

Ankra Series E, A and F Track were designed to team with Ankra end fittings, Beam Sockets, and Decking/Shoring Beams for the strongest, most reliable support. Steel constructed and tested for strength, Ankra Track comes in 10 ft. (3 m) lengths for a wide range of cargo restraint applications. To withstand corrosion, Ankra galvanized track has a G-90 hot dip finish with a surface chemical treatment. Painted track is finished with either high-quality, powder coat or semi-gloss enamel. Custom lengths and special finishes available, contact Customer Service Department.

**WARNING:** Reference TTMA RP No. 47 for installation. Attach track using screws, rivets or by welding. Contact vehicle manufacturer or qualified installer to determine fastener size and mounting method. Welding of galvanized material may emit toxic fumes. Please use caution and proper ventilation.

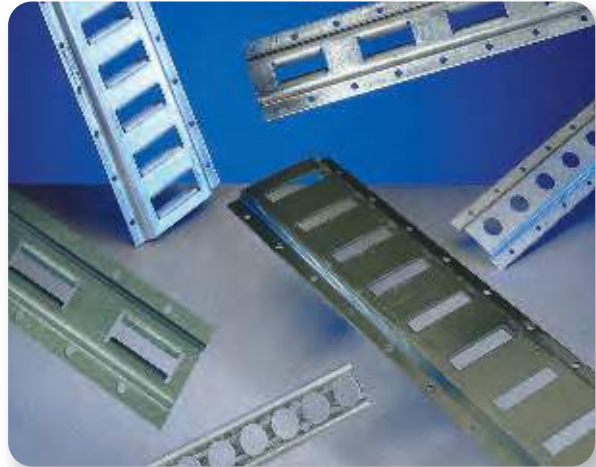

## LOGISTIC TRACK

### Series E

Series E track is made of high strength 12-gauge steel for Series E end fittings, Beam Sockets and Decking/Shoring Beams. (See products on page 50 and 51.) This track may be attached with screws, rivets, or by welding.\*

#### HORIZONTAL

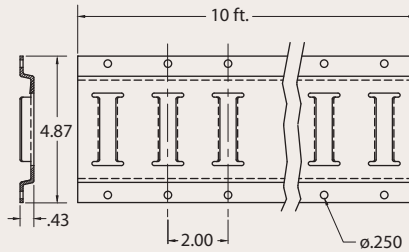
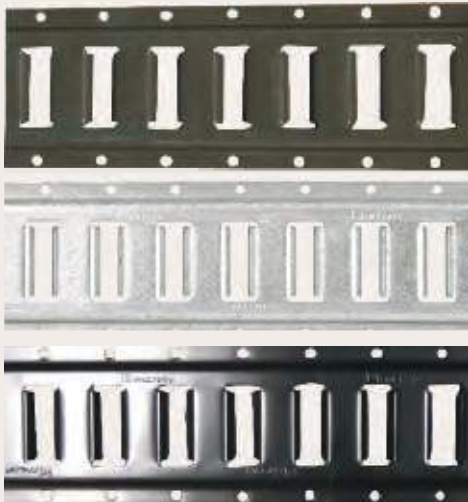

#### 48117-25-120.00

Gray Powdercoat. Weight/Length: 16.6 lbs./10 ft. 7.5 kg./3 m

#### 48117-25-60.00

Gray Powdercoat. Weight/Length: 8.3 lbs./5 ft. 3.77 kg./1.5 m

#### 48117-21-120.00

Galvanized. Weight/Length: 17.2 lb./10 ft., 7.80 kg./3 m

#### 48117-21-60.00

Galvanized. Weight/Length: 8.6 lbs./5 ft. 3.90 kg./1.5 m

#### 48117-32-120.00

Black Powdercoat Weight/Length: 16.6 lbs./10 ft., 7.5 kg./3 m

#### VERTICAL

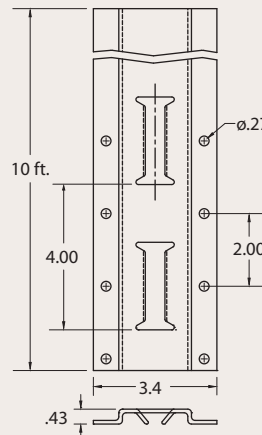

#### 40838-10

Gray Powdercoat.  
Weight/Length: 13.5 lbs./10 ft.  
6.1 kg./3 m

#### 40838-11

Galvanized.  
Weight/Length: 14 lbs./10 ft.  
6.4 kg./3 m

\*Caution: Welding of galvanized track should be done only in well ventilated areas. Welding fumes may be toxic.

## LOGISTIC TRACK

### Series A

Series A track, made of high strength steel or 6061 T6 aluminum, is designed for Series E end fittings, Beam Sockets and Decking/Shoring Beams. (See products on page 50 and 51.) This track may be attached with screws, rivets, or by welding.\*

#### HORIZONTAL

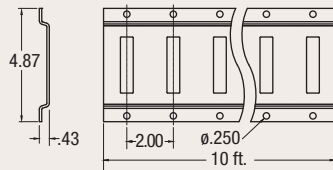

#### 42948-10

Gray Powdercoat. Weight/Length: 15.0 lbs./10 ft. 6.8 kg./3 m. 12-gauge.

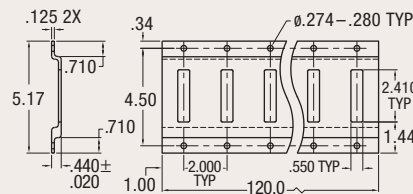

#### 49359-10

Aluminum. Weight/Length: 8 lbs./10 ft. 3.6 kg./3 m.

### Series F

Series F track is made of high strength steel for F end fittings and Shoring Beams. (See products on page 50.) This track may be attached with screws, rivets, or by welding.\*

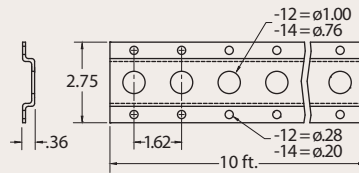

#### 40849-14

Galvanized. 1.62 in. hole spacing & 3/4" hole dia. Weight/length: 6.0 lbs./10 ft., 2.7 kg./3 m. 15-gauge.

#### 40849-12

Galvanized. 1.62 in. hole spacing & 1" hole dia. Weight/length: 6.0 lbs./10 ft., 2.7 kg./3 m. 14-gauge.

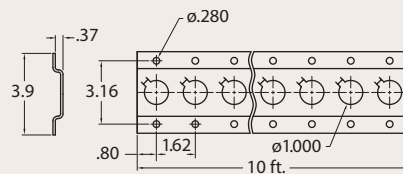

#### 49313-13

Galvanized. 1.62 in. hole spacing. Weight/length: 12.2 lbs./10 ft., 5.53 kg./3 m. 12-gauge.

### Series F Channel



**47235-10** Galvanized. 1.62 in. hole spacing.  
Weight: 9.0 lbs./10 ft.  
Length: 4.05 kg./3 m.

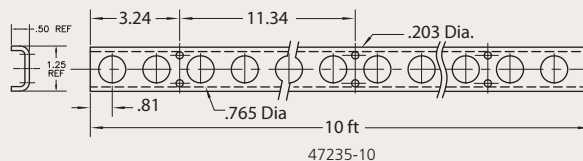

\* Caution: Welding of galvanized track should be done only in well ventilated areas. Welding fumes may be toxic.



# INTERIOR VAN SOLUTIONS

## BEAMS, BARS & HOOPS

All the innovation and selection you'll ever need. Ancra gives you a choice of shoring beams with steel, aluminum, or heavy-duty aluminum models. Aluminum beams feature a patented flat latch mechanism that eliminates the age old problem of damaged trigger mechanisms. It's easier to release, even while wearing gloves. There is even a replacement flat latch channel assembly that can be used to update your existing beams. Extend beam life and keep your costs low.

**ANCR A BEAMS ARE PROUDLY MADE IN USA**

### STANDARD-DUTY ALUMINUM SERIES E AND A DECKING/SHORING BEAM WITH PATENTED FLAT LATCH

Decking and Shoring WLL: 2,200 lbs./999 kg.\*



#### 43638-50

Adjustable Range/Weight:  
85.7 – 96.6 in./16.0 lbs./7.3 kg.

#### 43638-51

Adjustable Range/Weight:  
92.9 – 103.8/18.8 lbs./8.5 kg.



#### 50158-10

Wide Top Decking Beam with textured, 4-1/2" top surface to increase contact area for cargo on the beam deck. Adjustable Range/Weight: 92.9-103.8 in./26.4 lbs./12.0 kg. Decking WLL: 3000 lbs. not recommended for shoring. Patented Flat Latch.

### HEAVY-DUTY ALUMINUM SERIES E AND A BEAM ASSEMBLY WITH PATENTED FLAT LATCH

Decking WLL: 3,000 lbs./1,363 kg.\* Shoring WLL: 2,500 lbs./1,136 kg.\*



#### 49039-50

Adjustable Range/Weight:  
84.7 – 95.6/20.5 lbs./  
9.3 kg.

#### 49039-51

Adjustable Range/Weight:  
Weight: 92.9 – 103.8/  
22.5 lbs./10.2 kg.

#### 49039-52

Adjustable Range/Weight:  
Weight: 93.8 – 106.9 /24.5 lbs./  
11.0 kg.

### SERIES E AND A STEEL DECKING/SHORING BEAM WITH TRIGGER LATCH

Decking WLL: 2,000 lbs./900 kg. Shoring WLL: 1,100 lbs./499 kg.\*



#### 49360-13

Adjustable Range/Weight: 92.1 – 102.9 in./27 lbs./12.3 kg. 14 gauge steel.  
Decking WLL: 2,000 lbs./907 kg.

### DECKING BEAM HOOPS

#### 47670-10

Designed to help restrain the movement of packages of cargo within your truck or trailer. Two hoops and attachment hardware are included providing easy mounting. For 43638, 49039 and 49360 series E and A Decking/Shoring Beams. Weight: 13.25 lbs./6.01 kg.

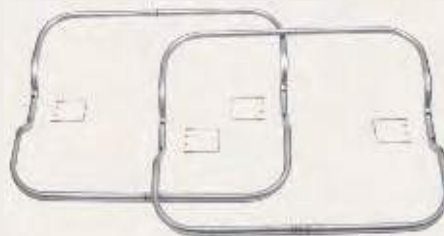

\*Working Load Capacity is 1/3 of Breaking Strength Capacity, and based on evenly distributed loads.

## BEAMS, BARS & HOOPS

### REPLACEMENT PARTS

**PATENTED**

No. 6,895,867



#### 43627-13

Replacement Channel Assembly with patented flat latch. 11 Gauge. Weight: 3.8 lbs./1.73 kg. For aluminum beams 43638, 49039 and 50158. Can be retrofitted into conventional trigger style beams.



**50194-100** Low Profile Allen Sleeve Nut and Bolt Kit. Low profile allen head bolt and sleeve nut with a semi-flush head height of .10". Used for attaching channel assemblies to beams. The bolt has a self locking patch to prevent loosening due to vibration. For 43638, 49039, 49360, 49414, 50080, 50158, 50186 and 50191 beams. Weight: .10 lb./5 kg.

**PATENTED**

No. 6,895,867



#### 45951-12

Flat Latch Repair Kit Includes latch, screw, nut, springs and instructions. Weight: .14 lb./06 kg. For Part No. 43627-13 channel assembly.

### GARMENT BEAMS — WLL: 1,500 lbs./681 kg.\*



Specially designed for transporting hanging garments suspended from rope loops in closed trailers. Features a curved top beam to reduce wear on ropes, and is made of high strength extruded aluminum for durability. Assembled with Ankra Beam Socket 40921-10.

#### 45867-12

Length/Weight: 96 in./14.0 lbs./6.36 kg.

#### 45867-13

Length/Weight: 102 in./15.0 lbs./6.82 kg.



#### 10751-10

Garment Rope 1/4" x 8' Yellow braided Polypropylene. 12" loop end w/ knots approx. every 9". NOTE: Contact Ankra Customer Service for minimum order quantities.

### BEAM SOCKETS — For use with standard commercial grade Douglas Fir 2-in. x 6-in. lumber.

PLEASE NOTE: The working load limit of lumber varies widely.



#### 40921-10

Standard Beam Socket. Weight: .70 lb./32 kg.



#### 40921-11

Heavy-Duty Beam Socket. Internally welded plate for added strength. Weight: .85 lb./39 kg.

### SHORING BARS – F SERIES WITH NEW EASY PUSH BUTTON DESIGN



#### 49439-10

Round Shoring Bar. Steel. Adjustable in 2" increments to 117". Weight: 20.0 lbs./9.1 kg. Shoring WLL: 500 lbs./227 kg. Recommended installed length: 81" – 117". Outer tube diameter: 1.66" Inner tube diameter: .72"

#### 49439-11

Round Shoring Bar for 1" hole diameter track (Canada). Steel. Adjustable in 2" increments to 117". Weight: 20.0 lbs./9.1 kg. Shoring WLL: 500 lbs./227 kg. Recommended installed length: 81" – 117". Outer tube diameter: 1.66" Inner tube diameter: .945"



#### 49439-20

Square Shoring Bar. Steel. Adjustable in 2" increments to 117". Weight: 28.0 lbs./12.71 kg. Shoring WLL: 1,000 lbs./454 kg. Recommended installed length: 81" – 117". Tube size 2" square. Inner tube diameter: .72"

#### 49439-21

Square Shoring Bar for 1" hole diameter track (Canada). Steel. Adjustable in 2" increments to 117". Weight: 28.0 lbs./12.71 kg. Shoring WLL: 1,000 lbs./454 kg. Recommended installed length: 81" – 117". Tube size 2" square. Inner tube diameter: .945" for Canadian application.

\*Working Load Capacity is 1/3 of Breaking Strength Capacity, and based on evenly distributed loads.

# INTERIOR VAN SOLUTIONS

## CARGO STA® BARS & HOOP SET

### ALUMINUM STANDARD CARGO STA®



**43782-15** 6061 T6 Aluminum  
Length/Weight: 89.75 – 104.5 in. 8.95 lbs./4.07 kg.  
Long Tube Diameter: 1.50 in.

**CAUTION:** Due to the wall construction of a trailer, Cargo Sta® and Jack Bars do not have a working load limit.

### ECONOMY STEEL CARGO STA® W/ BOLT-ON FEET



**48407-10** Galvanized Steel Tubing  
Length/Weight: 89.75 – 104.5 in. 11.72 lbs./5.33 kg.  
Long Tube Diameter: 1.50 in.

### HOOP SET FOR CARGO STA®

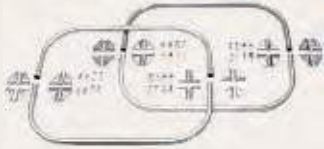

**43991-10**  
Designed to help restrain the movement of small packages of cargo within your truck or trailer. Two hoops and attachment hardware are included providing easy mounting. For 43782, 48407 round tube bars. Tube Diameter: 1.5 in. Weight: 10.0 lbs./4.5 kg.

### CARGO STA® AND JACK BAR REPLACEMENTS



Foot, Adjustable End (short)

**43781-15S**

2 in. x 4 in. Bolt-on.  
Weight: .78 lb./.36 kg.  
For 43782-15, 48407-10.

**43781-17**

4 in. x 4 in. Bolt-on.  
Weight: 1.35 lbs./.61 kg.  
For 49205-25, 49205-26, 49205-27, 49205-28, 49205-31.



Foot, Fixed End (long)

**43781-14S**

2 in. x 4 in. Bolt-on.  
Weight: .62 lb./.29 kg.  
For 43782-15, 48407-10.

**43781-16**

4 in. x 4 in. Bolt-on.  
Weight: 1.1 lbs./.5 kg.  
For 49205-25, 49205-26, 49205-27, 49205-28, 49205-31.



**49443-10** Housing, Rack and Lever Assembly  
For Cargo Sta 43782-15, 48407-10.  
Complete with necessary hardware.  
Weight: 2.12 lbs./.97 kg.



49400-10 38" Red Handle Assembly

49400-11 28" Black Handle Assembly

**Jack Bar Component Kits**

Complete kit consisting of a Jack Assembly Housing, 4" x 4" adjustable end foot, 4" x 4" fixed end foot and all necessary hardware.

**49400-10** Red Handle for 49205-26, 49205-27 & 49205-31 Jack Bars.

**49400-11** Black Handle for 49205-25 & 49205-28 Jack Bars.



## HEAVY-DUTY JACK BARS

Jack Bars feature 4" x 4" bolt-on feet assemblies and are designed for use in light to medium duty cargo applications. They feature 1-1/2" square heavy-gauge, galvanized steel tubing with a cycle tested, heavy duty automotive jack assembly. For ease of recognition, bars with the longest adjustment range have red handles.

### HEAVY-DUTY ONE-PIECE GALVANIZED



**PATENTED**  
No. 6,736,371



**49205-25** Weight: 16.2 lbs./7.35 kg. Adjustment range: 85.0" – 104.0" Black Handle

**49205-26** Weight: 16.6 lbs./7.54 kg. Adjustment range: 85.0" – 114.0" Red Handle

### HEAVY-DUTY ONE-PIECE GALVANIZED WITH HOOPS

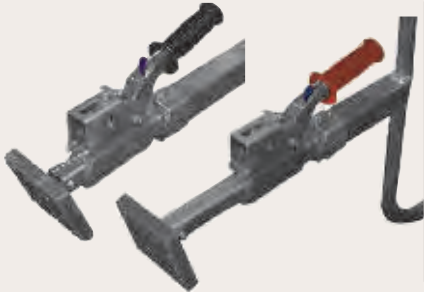

**49205-27** Weight: 20.0 lbs./9.08 kg. Adjustment range: 85.0" – 114.0" Red Handle

**49205-28** Weight: 19.6 lbs./9.0 kg. Adjustment range: 85.0" – 104.0" Black Handle

### UNIVERSAL JACK BAR



**PATENTED**  
No. 6,736,371

#### 49205-31

Weight: 18.2 lbs./8.26 kg.

- 51" size used to restrain half loads; compact to fit in locked tool box
- Useful in various load configurations through the universal design
- Patented Safety Snap Pin



Fully Retracted

Adjustment Range: 51" – 80"



Mid Extension

Adjustment Range: 70" – 99"



Full Extension

Adjustment Range: 85" – 114"

## CAUTION:

Due to the wall construction of a trailer, Cargo Sta® and Jack Bars do not have a working load limit. The Jack mechanism has a quick release feature that allows the bar to be retracted for easy removal. Read and follow instructions to prevent damage or injury.

# INTERIOR VAN SOLUTIONS

## ACCESSORIES

### BAR KEEP™ CARGO BAR HOLDER

Constructed of high quality steel and finished with black powder coating for corrosion resistance. Holds two standard or heavy-duty cargo bars. A built in gasket reduces vibration and rattle while protecting the bars. Accommodates both 2" x 4" or 4" x 4" feet.



**49348-11** Weight: 6.68 lbs./3.03 kg.

### DOOR PULL STRAPS

For pulling overhead, and side doors and wheel carts. Rust protected galvanized steel clip is pre-punched for easy installation.



**49015-18**

18-in. Door Pull Strap. Weight: .20 lb./0.09 kg.

**49015-24**

24-in. Door Pull Strap. Weight: .30 lb./0.14 kg.

**49015-36**

36-in. Door Pull Strap. Weight: .40 lb./0.18 kg.

**10788-10** Door Pull Strap. WLL: 500 lbs./227 kg Weight: 1.6 lbs./0.72 kg



Allows the driver to close the roll-up door while standing on the ground.

- ▶ Black wear sleeve protects the elastic section
- ▶ Easily installs into existing logistics post or E track of the sidewall and the inside of the rear roll up door.

**TIE OFFS** A convenient way to attach rope or web to trailer side wall.



**40386-10**

Series E and A Rope Tie Off 3-piece end fitting for use with Series E or A Track. WLL: 1,000 lbs./454 kg. Weight: .30 lb./0.14 kg.



**40386-12**

Series F Rope Tie Off. For use with Series F Track. WLL: 500 lbs./225 kg. Weight: .30 lb./0.14 kg.

**40386-13**

For use with Series F Track Canada. WLL: 500 lbs./ 225 kg. Weight: .30 lb./0.14 kg.



**40386-11**

Series E and A Rope Tie Off Spring actuated fitting for use with Series E or Series A Track. WLL: 1,333 lbs./605 kg. Weight: .40 lbs./0.18 kg.



**49542-10**

Series E and A Fitting w/ D-Ring. WLL: 1,000 lbs./454 kg. Weight: .34 lb./0.15 kg.



**47772-12**

Series E and A Track Fitting w/ Round Ring. WLL: 1,000 lbs./454 kg. Weight: .45 lb./0.20 kg.



**50115-10**

Heavy-Duty Series E and A Track Fitting w/ Round Ring. Heat treated. WLL: 2,000 lbs./908 kg. Weight: .40 lbs./0.18 kg.



**50115-11**

Heavy-Duty Series E and A Track Fitting w/ D-Ring. Heat treated. WLL: 2,000 lbs./908 kg. Weight: .40 lbs./0.18 kg.

### TRUCK & TRAILER FITTINGS

Designed for low-profile mounting in trucks and trailers, the Recessed Pan Fitting is tensioned to reduce ring movement, but allows easy lifting. The Stake Pocket Anchor can be surface or flush mounted and accepts roll cart lock pins.



**45545-15**

With black trim collar. WLL: 530 lbs./240 kg. Weight: .30 lb./0.14 kg.



**45849-15**

Recessed Pan Fitting WLL: 1,666 lbs./757 kg. Weight: 1.20 lbs./0.55 kg.



**49371-10**

Stake Pocket Anchor. Conforms to USPS drawing B-13956. Black Lacquer Finish. Weight: 0.98 lb./0.44 kg.

## ACCESSORIES

### 5TH WHEEL RELEASE HOOK

**50354-10** With a 5-inch tee-handled grip, the hook end releases the locking pin on a 5th wheel connection. The short angled bar releases the secondary lock found on some models.

- ▶ Chrome plated finish
- ▶ Welded steel construction
- ▶ Total product length: 34.5 inches
- ▶ Weight: 1.89 lb./ .86kg.

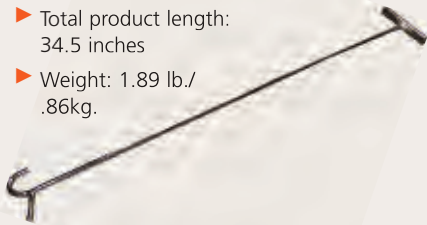

### TRANSMAT® FRICTION MAT

**49382-10** Durable 2mm-thick, 30" x 42" rubber mats offer stability to any load and reduce risk of load shifting in box cars or intermodal transport.

- ▶ Coefficient of friction of 1.2 min
- ▶ Shore A hardness of 35-55 points
- ▶ Meets new minimum 1g loading regulations



### TRAILER DOOR LIMIT STRAP

**10924-10** Designed to be used when opening swing doors.

- ▶ If cargo has shifted against the doors during transit, they may swing open suddenly when the lock bar is released, dumping cargo out of the trailer
- ▶ The hooks are inserted into the lock tabs on each door to limit the opening of the door
- ▶ 800 lbs./363 kg. WLL hook with keeper
- ▶ 32-inch length from hook to hook



### DRIVER ASSIST STRAP

**10902-11** Driver Assist Strap



**Helping Hand.** Ancra's Driver Assist Strap lends a hand to drivers and dock workers climbing into and out of trailers. The 36" strap with reinforced handle connects to existing E or A track, offering a convenient additional hand grip for a more secure entry and exit. Assembled with high strength components for a rated user weight limit of 320 lbs. Patent pending.



## TENSION-LIMITING RATCHET ASSEMBLIES

### No more overtightening

You can prevent damage caused by over tightened ratchet buckles with the Tension-Limiting Ratchet Buckle. Ancra's innovative buckle will tighten to no more than 300 pounds of tension. It's enough force to secure the cargo, but not enough to damage your vehicle. Not even your strongest driver can apply too much force.

### How it works

Once the strap is installed in the track, ratchet the strap normally. When proper tension is reached, the handle releases and no more tension can be applied. Even if you try, you can never go too tight. Assemblies are available with Low Profile (49715-10, patented) or Heavy-Duty (49410-13, patented) long handle buckles. There are six Torque-Limiting Ratchet Straps available in lengths from 12 to 20 feet.



Series E Heavy-Duty Buckle Strap w/ Spring E Fitting  
Heavy-duty 12,000 lbs. yellow latex treated polyester webbing.  
WLL: 1,333 lbs./605 kg. Fixed End: 48-in.

Part No.	Strap Length	Weight
<b>49021-30</b>	12 ft.	4.00 lbs.
<b>49021-31</b>	16 ft.	4.25 lbs.
<b>49021-32</b>	20 ft.	4.50 lbs.



Series E Low Profile Buckle Strap w/ Spring E Fitting  
Strong 6,000 lbs. polyester webbing.  
WLL: 1,333 lbs./605 kg. Fixed End: 48-in.

Part No.	Strap Length	Weight
<b>48672-33</b>	12 ft.	2.50 lbs.
<b>48672-34</b>	16 ft.	2.65 lbs.
<b>48672-35</b>	20 ft.	2.80 lbs.



# INTERIOR VAN SOLUTIONS

## LOGISTIC STRAPS & ASSEMBLIES

Ancra logistic straps are available in cam buckle and ratchet buckle models with end hardware to suit your specific application. Made with strong polyester webbing, they are color coded to easily identify the length. The standard fixed end length for all straps is 48". Built on a reputation for dependability and strength, these strap assemblies promise the quality that comes with every product that bears the Ancra name.



## CAM BUCKLE STRAP ASSEMBLIES

6,000 lb. Polyester Webbing (47200) with a Cam Buckle (40880-15). The adjustable end of the straps are captivated to prevent them from pulling out of the buckle and separating.

**SERIES E STRAP ASSEMBLY** Working Load Limit: 833 lbs./378 kg.



Series E Assembly with spring actuated end fitting



Part No.	Strap Length	Weight
<b>40602-17</b>	12 ft.	1.65 lbs.
<b>40602-18</b>	16 ft.	1.80 lbs.
<b>40602-19</b>	20 ft.	1.95 lbs.



Series E Assembly with 3-piece end fitting

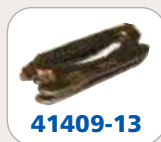

Part No.	Strap Length	Weight
<b>40602-10</b>	12 ft.	1.55 lbs.
<b>40602-11</b>	16 ft.	1.70 lbs.
<b>40602-12</b>	20 ft.	1.85 lbs.

**SERIES F STRAP ASSEMBLY** Working Load Limit: 500 lbs./225 kg.



Part No.	Strap Length	Weight
<b>40602-20</b>	12 ft.	2.40 lbs.
<b>40602-21</b>	16 ft.	2.55 lbs.
<b>40602-22</b>	20 ft.	2.70 lbs.

**SERIES F STRAP ASSEMBLY (CANADA)** Working Load Limit: 500 lbs./225 kg.



For Canada



Part No.	Strap Length	Weight
<b>40602-103</b>	12 ft.	2.40 lbs.
<b>40602-104</b>	16 ft.	2.55 lbs.
<b>40602-105</b>	20 ft.	2.70 lbs.

Please note: Ancra logistics straps come in three webbing colors, coded according to lengths. 12 ft. webbing is yellow, 16 ft. webbing is gray, 20 ft. webbing is blue. End fitting part numbers are shown for reference only.

### WARNING:

Interior van straps should be inserted in track behind the front edge of the load and cinched tight.

## CAM BUCKLE STRAP ASSEMBLIES

**ELECTRONIC STRAP ASSEMBLY** Working Load Limit: 833 lbs./378 kg. Fixed Ends: 7-in. & 48-in. 6,000 lbs. polyester webbing 47200 and cam buckle 40880-19. Fixed End: 48-in.



Part No.	Strap Length	Weight
<b>49025-20</b>	12 ft.	1.90 lbs.
<b>49025-21</b>	16 ft.	2.05 lbs.
<b>49025-22</b>	20 ft.	2.20 lbs.

An additional E fitting allows for increased adjustability for various applications.

**PLATE TRAILER STRAPS** 6,000 lbs. polyester webbing 47200 and cam buckle 40880-19.



Part No.	Strap Length	Weight
<b>48253-19</b>	12 ft.	1.85 lbs.
<b>48253-20</b>	16 ft.	2.00 lbs.
<b>48253-21</b>	20 ft.	2.15 lbs.

Cam Buckle Strap w/ Wire Hook & Spring E Fitting  
WLL: 833 lbs./378 kg.

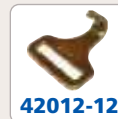

Part No.	Strap Length	Weight
<b>48253-22</b>	12ft.	2.00 lbs.
<b>48253-23</b>	16 ft.	2.15 lbs.
<b>48253-24</b>	20 ft.	2.30 lbs.

Cam Buckle Strap w/ F Hook & Spring E Fitting. Fixed End: 48-in.  
WLL: 800 lbs./360 kg.



Part No.	Strap Length	Weight
<b>40602-97</b>	12ft.	1.50 lbs.
<b>40602-98</b>	16 ft.	1.65 lbs.
<b>40602-99</b>	20 ft.	1.80 lbs.

Cam Buckle Strap w/ Wire Hooks. Fixed End: 48-in.  
WLL: 500 lbs./225 kg.

### WARNING:

Interior van straps should be inserted in track behind the front edge of the load and cinched tight.

# INTERIOR VAN SOLUTIONS

## RATCHET BUCKLE STRAP ASSEMBLIES

**RATCHET BUCKLE STRAPS** Working Load Limit: 1,333 lbs./605 kg. Fixed End: 48-in.



Series E Ratchet Buckle Strap w/ 47608-21 Spring End Fitting

6,000 lb. polyester webbing 47200 and low profile ratchet buckle 44258-13 for durability and wear.

Part No.	Strap Length	Weight
<b>48672-13</b>	12 ft.	2.25 lbs.
<b>48672-14</b>	16 ft.	2.40 lbs.
<b>48672-15</b>	20 ft.	2.55 lbs.



Series E Heavy-Duty Ratchet Buckle Strap w/ 47608-21 Spring End Fitting  
WLL: 1,333 lbs./605 kg. Fixed End: 48-in.

Heavy-duty 12,000 lb. yellow polyester webbing 41632-13 and standard handle ratchet buckle 44627-11 for durability and wear. All yellow straps.

Part No.	Strap Length	Weight
<b>49021-20</b>	12 ft.	3.50 lbs.
<b>49021-21</b>	16 ft.	3.75 lbs.
<b>49021-22</b>	20 ft.	4.00 lbs.

**PLATE TRAILER STRAPS** 6,000 lbs. polyester webbing 47200 and low profile ratchet buckle 44258-13.  
Fixed End: 48-in.



Ratchet Buckle Strap w/ Wire Hook & Spring E Fitting  
WLL: 833 lbs./378 kg.

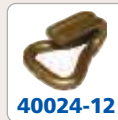

Part No.	Strap Length	Weight
<b>48253-13</b>	12 ft.	2.50 lbs.
<b>48253-14</b>	16 ft.	2.65 lbs.
<b>48253-15</b>	20 ft.	2.80 lbs.



Ratchet Buckle Strap w/ F Hook & Spring E Fitting  
WLL: 800 lbs./360 kg.



Part No.	Strap Length	Weight
<b>48253-16</b>	12 ft.	2.70 lbs.
<b>48253-17</b>	16 ft.	2.85 lbs.
<b>48253-18</b>	20 ft.	3.00 lbs.



Ratchet Buckle Strap w/ Wire Hooks  
WLL: 500 lbs./225 kg.

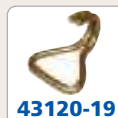

Part No.	Strap Length	Weight
<b>48672-22</b>	12 ft.	2.00 lbs.
<b>48672-23</b>	16 ft.	2.15 lbs.
<b>48672-24</b>	20 ft.	2.30 lbs.

### WARNING:

Interior van straps should be inserted in track behind the front edge of the load and cinched tight.



## TIE DOWN STRAPS & ASSEMBLIES

### CUSTOM NETS



### Ankra custom solutions promise quality and performance.

Designed for your particular application, Ankra custom nets offer retention support for various sized and shaped packages. Using strong 1" or 2" webbing, they're individually tailored to fit your loading condition, assuring maximum effectiveness in transporting a load securely.

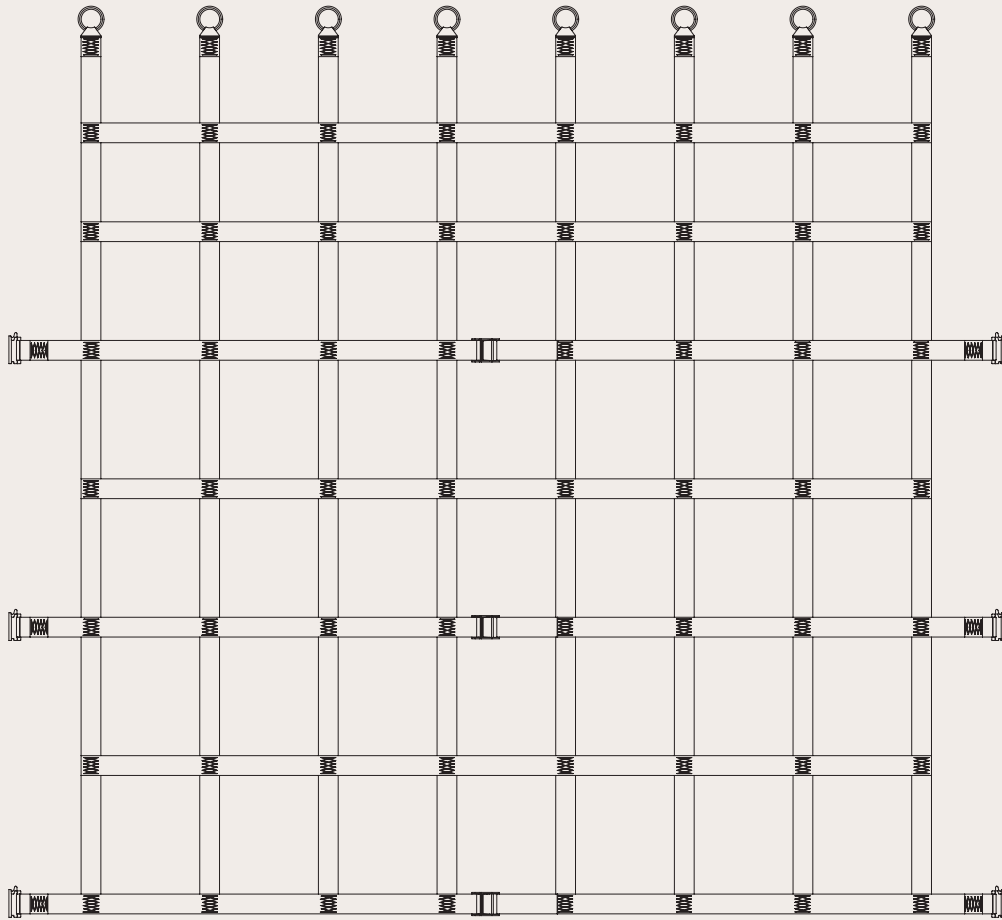

#### **10865-11** 100" Wide x 90.5" Tall Cargo Net

Installed inside the rear door of the trailer and protects drivers/operators from falling cargo that could have shifted during transport from location to location. Permanently installed in the trailer, the net moves forward and aft in the trailer using a roller system and the sides clip into E/A logistics track to position as close to the cargo as possible. When not in use, the net can be stowed in the rear of the trailer.

## MOBILE APP

### Ancra Helps Keep You In Compliance with the Law



**Ancra's mobile tie-down-calculator app is available at no cost.**

Better safe than sorry. Ancra's free mobile app helps you determine the minimum strap requirements to comply with FMCSA and CCMTA.

Our app lets you work in standard or metric measurements and gives you the option to enter custom article lengths and weights. It will also store Working Load Limits of straps for future use and links to the FMCSA website for more information.

Works with IOS and Android mobile devices

Available on the App Store and on Google Play.



It's free.

# AUTO 'TRANSPORT' SOLUTIONS

Whether transporting a load of cars or someone's pride and joy, you depend on proven quality restraint products. Ancra designs and manufactures auto transport products, strap assemblies, harnesses and hardware to meet your most demanding requirements. We're committed to offering you the quality you demand.





# AUTO 'TRANSPORT' SOLUTIONS

## TIE DOWNS & ACCESSORIES

**CAR HAULER RATCHET STRAPS** WLL: 3,333 lbs./1,515 kg. using 41632-46 yellow latex treated polyester webbing and 47105-11 Short Wide Handle Ratchet Buckle. Available with 43120-13 Wire Hooks or 49914-11 Low Profile Swivel J Hooks.



### 50179-10

2" x 102" Ratchet Strap w/ Wire Hooks. Weight 5 lbs./2.3 kg.



### 50179-11

2" x 102" Ratchet Strap w/ Low Profile Swivel J Hook. Weight 6.1 lbs./2.8 kg.

## AUTO HAULER WINCH STRAP



### 48487-24

2" x 140" Winch Strap w/ cleats  
The auto tie down strap goes over the tire and utilizes three cleated rubber pads that mesh with the tread to keep the strap centered and secured.  
Weight 1.9 lbs./.86 kg.

## SINGLE CLEAT

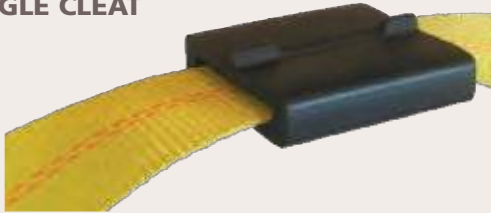

### 48485-11

Rubber tread cleat for Auto Hauler Winch Strap.  
Used with 2-inch webbing to secure vehicle tire.  
Length: 3.0-in. Width: 2.8-in.  
Weight: .20 lbs./0.09 kg.

**TIE DOWN W/ SNAP HOOKS** Working Load Limit: 1,666 lbs./757 kg. using 41632-13 yellow latex treated polyester webbing, a 47105-11 Short Wide Handle Ratchet Buckle and 40084-14 Snap Hooks.



Ankra's tie downs feature yellow latex treated polyester webbing (41632-13) with Ratchet Buckle (47105-11) and Snap Hook (40084-14).

Part No.	Strap Length	Weight	Fixed End
49020-20	6 ft.	3.80 lbs./1.73 kg.	6 in.
49020-21	8 ft.	4.44 lbs./2.02 kg.	8 in.
49020-22	12 ft.	4.84 lbs./2.20 kg.	12 in.

## 'TIE DOWNS & 'TRANSIT' STRAPS

### ANTIQUE & RACE CAR TIE DOWNS



#### 30AS33-BK

2" x 33" Black Axle Strap w/ sleeve. Individually display packaged. WLL: 3,300 lbs./1,498 kg. Weight .5 lbs./23 kg.



#### 500-C8-RD

2" x 8' Red Ratchet Strap w/ Twisted Snap Hooks. WLL: 3,300 lbs. Weight 5 lbs./2.3 kg.

**DOLLY STRAPS** Ancra designs and manufactures a complete line of wheel straps for automobile-towing dollies. Three of the more popular designs are shown here. Call us about your specific requirements.



#### BASKET STRAP

##### 45143-20

for tires 7"W x 20"H  
Weight: 2.25 lbs./1.02 kg.  
WLL: 1,666 lbs./755 kg.

##### 45143-22

for tires 8"W x 24"H  
Weight: 2.5 lbs./1.14 kg.  
WLL: 1,666 lbs./755 kg.



#### WHEEL DOLLY STRAP

##### 47934-11

2" x 86" with Round Ring  
for tires 8"W x 22"H  
Weight: 1.0 lbs./46 kg.  
WLL: 900 lbs./410 kg.



#### WHEEL DOLLY STRAP

##### 47935-11

with 5 Hooks  
for tires 10"W x 24"H  
Weight: 1.5 lbs./46 kg.  
WLL: 800 lbs./360 kg.

##### 47935-12

with Spring E Fittings  
for tires 10"W x 24" H  
Weight: 1.5 lbs./46 kg.  
WLL: 1,300 lbs./590 kg.

### SERIES E TRANSIT STRAP W/ RTJ HOOKS



#### 49023-20

6-foot Strap

#### 49023-21

8-foot Strap

#### 49023-22

12-foot Strap

Working Load Limit: 1,000 lbs./454 kg. Fixed End: 14"

Assembled with durable latex treated polyester webbing (41632-13) and Ratchet Buckle (47105-11). Fixed end features a heavy-duty Series E & A Track Fitting (47772-12), and the adjustable end features a Cluster Hook (45515-10) with R,T, and J Hooks.

# AUTO 'TRANSPORT' SOLUTIONS

## 'TIE DOWNS & 'TRANSIT' STRAPS

### ADJUSTABLE TIRE BONNETS



#### **30ATB Adjustable Tire Bonnet**

for 13" – 17" OEM Tires.  
WLL: 1,000 lbs./454 kg.  
Weight 3 lbs./1.4 kg.



#### **30RT Double Adjustable Tire Bonnet**

for 10" – 22" Wide Tires.  
WLL: 3,333 lbs./1,515 kg.  
Weight 6 lbs./2.7 kg.

## LASHING WINCHES

The lashing winch with double hex drive can be bolted or welded to the trailer like a standard winch, yet offers the quick release and easy operation of a ratchet buckle.

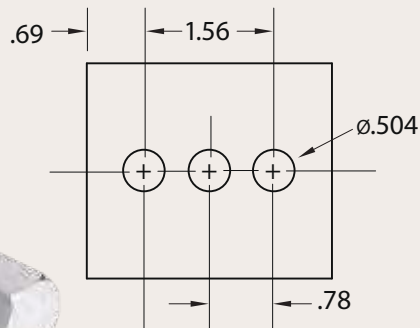

#### **47640-31**

With double hex drive and three mounting holes.  
WLL: 3,333 lbs./ 1,515 kg.  
Weight: 3.8 lbs./1.7 kg.



#### **48496-11**

With double hex drive, release latch, and single mounting hole.  
WLL: 2,500 lbs./ 1,135 kg.  
Weight: 2.2 lbs./1 kg.



# LIFTING SOLUTIONS

Trust Ancra's slings for your lifting and rigging needs. Our durable polyester round slings and eye to eye web slings come in a full range of lengths and widths for your application.





# LIFTING SOLUTIONS

## GET A LIFT FROM ANCRA'S SLINGS

Flexible and resistant to abrasion, Ancra's line of durable polyester round slings and polyester twisted eye to eye slings are built for strength and durability. Round slings are color-coded by width from 1" to 7". Eye to eye web slings are available in 1", 2", 3" and 4" web widths in single- and double-ply models. Custom sizes and models may be available.

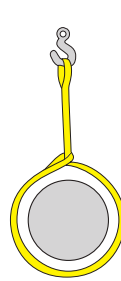

CHOKER



VERTICAL

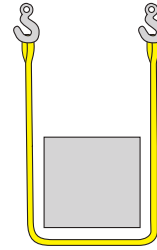

BASKET

## ROUND SLINGS



### LIFTING SLINGS — ROUND

Part No.	Description	Choker	Vertical	Basket
<b>20-ENR1X3</b>	1" x 3' Purple Endless Round Sling	2,100	2,600	5,200
<b>20-ENR1X4</b>	1" x 4' Purple Endless Round Sling	2,100	2,600	5,200
<b>20-ENR1X6</b>	1" x 6' Purple Endless Round Sling	2,100	2,600	5,200
<b>20-ENR1X8</b>	1" x 8' Purple Endless Round Sling	2,100	2,600	5,200
<b>20-ENR1X12</b>	1" x 12' Purple Endless Round Sling	2,100	2,600	5,200
<b>20-ENR2X3</b>	2" x 3' Green Endless Round Sling	4,200	5,300	10,600
<b>20-ENR2X4</b>	2" x 4' Green Endless Round Sling	4,200	5,300	10,600
<b>20-ENR2X8</b>	2" x 8' Green Endless Round Sling	4,200	5,300	10,600
<b>20-ENR2X12</b>	2" x 12' Green Endless Round Sling	4,200	5,300	10,600
<b>20-ENR2X20</b>	2" x 20' Green Endless Round Sling	4,200	5,300	10,600
<b>20-ENR3X3</b>	3" x 3' Yellow Endless Round Sling	6,700	8,400	16,800
<b>20-ENR3X4</b>	3" x 4' Yellow Endless Round Sling	6,700	8,400	16,800
<b>20-ENR3X8</b>	3" x 8' Yellow Endless Round Sling	6,700	8,400	16,800
<b>20-ENR3X12</b>	3" x 12' Yellow Endless Round Sling	6,700	8,400	16,800
<b>20-ENR3X20</b>	3" x 20' Yellow Endless Round Sling	6,700	8,400	16,800
<b>20-ENR4X10</b>	4" x 10' Tan Endless Round Sling	8,500	10,600	21,200
<b>20-ENR4X16</b>	4" x 16' Tan Endless Round Sling	8,500	10,600	21,200
<b>20-ENR5X4</b>	5" x 4' Red Endless Round Sling	10,600	13,200	24,400
<b>20-ENR5X6</b>	5" x 6' Red Endless Round Sling	10,600	13,200	24,400
<b>20-ENR5X12</b>	5" x 12' Red Endless Round Sling	10,600	13,200	24,400
<b>20-ENR5X20</b>	5" x 20' Red Endless Round Sling	10,600	13,200	24,400
<b>20-ENR7X6</b>	7" x 6' Blue Endless Round Sling	17,000	21,200	42,400

## POLYESTER TWISTED EYE TO EYE WEB SLINGS

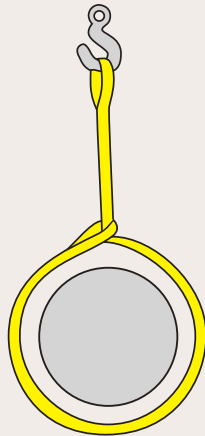

CHOKER



VERTICAL

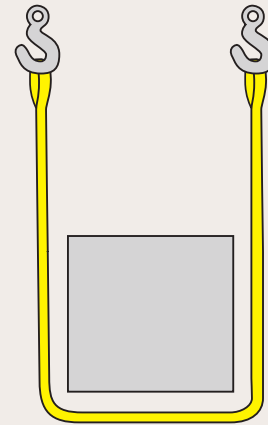

BASKET



- ▶ Light Weight & Economical
- ▶ 9,800 lbs. Polyester Webbing
- ▶ Single-Ply & Double-Ply Styles
- ▶ Industry Compliant Sewn In Warning Tags
- ▶ Reinforced Eyes
- ▶ Tapered Eyes on 2", 3", & 4" Widths
- ▶ Complies with WSTDA — WS-1-Type IV CL7 Web Slings

### SINGLE-PLY 9,800 LB. TWISTED EYE TO EYE SLING

Part No.	Size	Choker	Vertical	Basket
20-EE1-9801X3	1" x 3'	1,250	1,600	3,200
20-EE1-9801X4	1" x 4'	1,250	1,600	3,200
20-EE1-9801X6	1" x 6'	1,250	1,600	3,200
20-EE1-9801X10	1" x 10'	1,250	1,600	3,200
20-EE1-9802X3	2" x 3'	2,450	3,100	6,200
20-EE1-9802X4	2" x 4'	2,450	3,100	6,200
20-EE1-9802X6	2" x 6'	2,450	3,100	6,200
20-EE1-9802X10	2" x 10'	2,450	3,100	6,200
20-EE1-9802X12	2" x 12'	2,450	3,100	6,200
20-EE1-9802X14	2" x 14'	2,450	3,100	6,200



## POLYESTER TWISTED EYE TO EYE WEB SLINGS

### DOUBLE-PLY 9,800 LB. TWISTED EYE TO EYE SLING

Part No.	Size	Choker	Vertical	Basket
20-EE2-9801X4	1" x 4'	2,450	3,100	6,200
20-EE2-9801X8	1" x 8'	2,450	3,100	6,200
20-EE2-9802X3	2" x 3'	4,950	6,200	12,400
20-EE2-9802X4	2" x 4'	4,950	6,200	12,400
20-EE2-9802X6	2" x 6'	4,950	6,200	12,400
20-EE2-9802X8	2" x 8'	4,950	6,200	12,400
20-EE2-9802X10	2" x 10'	4,950	6,200	12,400
20-EE2-9802X12	2" x 12'	4,950	6,200	12,400
20-EE2-9802X16	2" x 16'	4,950	6,400	12,400
20-EE2-9802X20	2" x 20'	4,950	6,200	12,400
20-EE2-9802X30	2" x 30'	4,950	6,200	12,400
20-EE2-9803X10	3" x 10'	7,040	8,800	17,600
20-EE2-9803X12	3" x 12'	7,040	8,800	17,600
20-EE2-9803X16	3" x 16'	7,040	8,800	17,600
20-EE2-9803X20	3" x 20'	7,040	8,800	17,600
20-EE2-9804X6	4" x 6'	8,800	11,000	22,000
20-EE2-9804X8	4" x 8'	8,800	11,000	22,000
20-EE2-9804X10	4" x 10'	8,800	11,000	22,000
20-EE2-9804X12	4" x 12'	8,800	11,000	22,000
20-EE2-9804X16	4" x 16'	8,800	11,000	22,000
20-EE2-9804X20	4" x 20'	8,800	11,000	22,000

### WARNING:

Please read and comply with all warnings on labels and packaging. Failure to do so may result in loss of load, serious property damage, and/or personal injury!

DO NOT exceed the rated capacity shown on the package and label attached to the sling. For examples of out-of-service criteria, please see page 74.

For Operating and Inspection Manuals for synthetic Web Slings, see the Web Sling and Tie Down Association Publication WSTDA-WS-2.

For Operating and Inspection Manuals for polyester Round Slings, see the Web Slings and Tie Down Association Publication WSTDA-RS-2.

# UTILITY TIE DOWNS

Ankra offers high quality restraint products for both commercial truckers and consumers. For transporting motorcycles, ATVs, household furnishings or equipment, our utility strap assemblies are made of high strength steel components and durable materials. Look to Ancra for years of trouble free use.



# UTILITY TIE DOWNS

## UTILITY TIE DOWNS

Ancra Utility Tie Downs are versatile and reliable for securing a wide range of light to medium duty cargo. Made of high-strength steel and abrasion-resistant webbing, they're quick and easy to use for secure performance in recreational, light industrial, and agricultural applications.

### MINI RATCHET STRAP



Ratchet strap with Wire Hooks and floating D-Ring for use together or separately. Fixed End: 23" Individually display packaged.

- 43887-10** 1" x 16' Weight: 1.56 lbs./71 kg.
- 43887-11** 1" x 20' Weight: 1.69 lbs./77 kg.
- 43887-15** 1" x 9' Weight: 1.33 lbs./60 kg.  
WLL: 1,000 lbs./454 kg.

### ANCRALASH WITH RATCHET BUCKLE STRAP

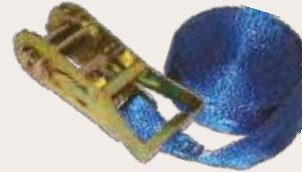

- 44557-10**  
15' long endless multipurpose Ratchet strap.  
WLL: 400 lbs./181 kg.  
Weight: .84 lb./38 kg.

### HEAVY-DUTY RATCHET STRAP ASSEMBLY



- 44340-11**  
1" x 10' Ratchet strap with Wire Hooks for multipurpose use.  
WLL: 1,000 lbs./454 kg.  
Weight: 1.60 lbs./73 kg.

### ANCRALASH RED UTILITY STRAP



- 41048-10**  
1" x 5.5' Cam buckle strap with vinyl-coated S Hooks.  
Fixed End: 6-in.  
WLL: 400 lbs./181 kg.  
Weight: 1.60 lbs./73 kg.
- 41048-23**  
1" x 13' Cam buckle strap with vinyl-coated S Hooks.  
Fixed End: 30-in.  
WLL: 400 lbs./181 kg.  
Weight: 1.78 lbs./81 kg.

### RATCHETING TIE DOWNS



- 49368-10** 1" x 15' 4-pack  
1" red Ratchet strap with vinyl-coated S Hooks secures cargo, equipment and household furnishings.  
Weight: 4.7 lbs./2.14 kg.  
WLL: 266 lbs./121 kg.

### CAM BUCKLE TIE DOWNS



- 49368-11** 1" x 6' 4-pack  
1" black Cam strap with scratch-resistant vinyl-coated S Hooks. A simple way to secure your possessions.  
Weight: 3.7 lbs./1.69 kg.  
WLL: 266 lbs./121 kg.

### RATCHETING & CAM BUCKLE TIE DOWNS



- 49368-12** Combo Pack  
Contains two each 1" multipurpose Ratchet and Cam Buckle tie downs with scratch-resistant vinyl coating.  
Weight: 4.2 lbs./1.91 kg.  
WLL: 266 lbs./121 kg.

### CAM BUCKLE TIE DOWNS



- 95001** 1" x 8' 2-pack  
1" Cam strap with vinyl-coated S Hooks. Packaged in an interactive package.  
Weight: 1.85 lbs./84 kg.  
WLL: 400 lbs./181 kg.



## MULTI-PACK CONSUMER TIE DOWNS

### RATCHETING TIE DOWNS



**95002** 1" x 10' 2-pack  
1" black Ratchet straps with vinyl-coated S Hooks in an interactive package.  
Weight: 2.25 lbs./1.0 kg.  
WLL: 550 lbs./250 kg.

### RETRACTABLE RATCHETING TIE DOWNS



**95003** 1" x 6' 2-pack  
1" black Retractable Ratchet straps with scratch-resistant vinyl-coated S Hooks in an interactive package.  
Weight: 3.20 lbs./1.45 kg.  
WLL: 500 lbs./227 kg.

### CAM BUCKLE TIE DOWNS



**95004** 1" x 8' 4-pack  
1" red Cam straps with scratch-resistant vinyl-coated S Hooks in an interactive package.  
Weight: 3.8 lbs./1.72 kg.  
WLL: 400 lbs./181 kg.

### RATCHETING TIE DOWNS



**95005** 1" x 10' 4-pack  
1" black Ratchet straps with vinyl-coated S Hooks in an interactive package.  
Weight: 4.6 lbs./2.1 kg.  
WLL: 550 lbs./250 kg.

### RATCHETING & CAM BUCKLE TIE DOWNS



**95006** Combo Pack  
Contains two each 1" multipurpose 10' Ratchet straps and 8' Cam Buckle tie downs. All have scratch-resistant vinyl-coated S Hooks and are in an interactive package.  
Weight: 5.20 lbs./1.90 kg.  
Ratchet Strap WLL: 550 lbs./250 kg.  
Cam Strap WLL: 400 lbs./181 kg.

### RATCHETING TIE DOWNS



**95007** 1" x 12' Endless Loop, 2-pack, 1" Ratchet straps in an interactive package.  
Weight: 1.75 lbs./.79 kg.  
WLL: 550 lbs./250 kg.

### TRACKSTAR MOTORCYCLE WHEELCHOCK



**49603-10**  
Quick Connect to aircraft style L track. Fits tire widths from 3.5" to 5.5". Comes complete with mounting kit.  
Weight: 7.0 lbs./3.18 kg.

### TRACKSTAR ACCESSORY MOUNTING KIT



**49288-10**  
TrackStar Accessory Mounting Kit (8" L track & hardware) for installation in a second vehicle.

# UTILITY TIE DOWNS

## PICKUP TRUCK CARGO NETS



### SHORT BED PICKUPS

**50199-10**

For short beds - 72" W x 80" L

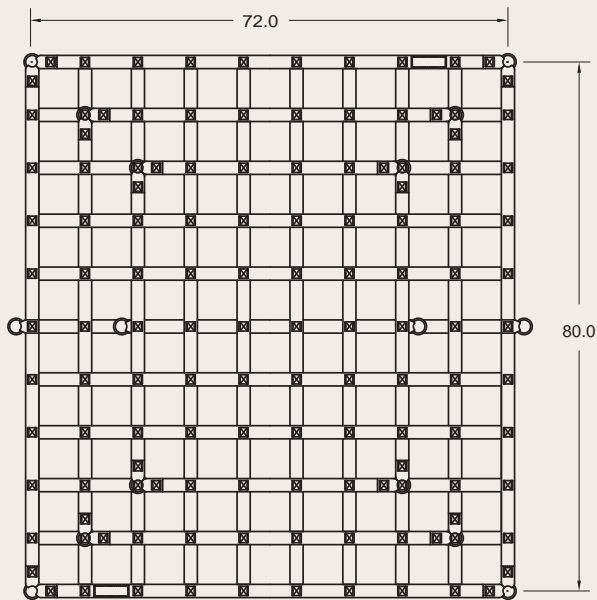

### LONG BED PICKUPS

**50199-11**

For standard beds - 72" W x 96" L

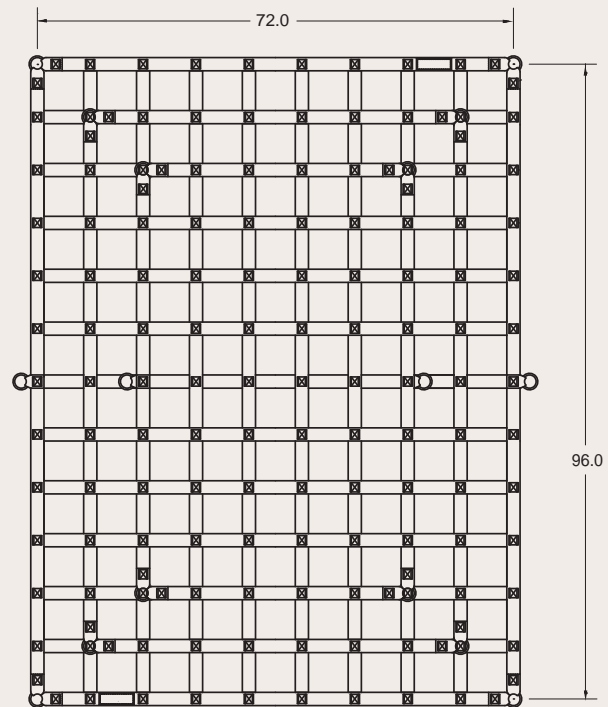

D-Rings and Connectors are spaced to accommodate various heights of loads. Each net comes with six (6), 1-1/4" x 5' long straps with a die cast cam buckle. Each strap has vinyl-coated S hooks with wire keepers to prevent them from disengaging.

Net openings: 6.0"  
WLL: 1,200 lbs./540 kg.



# GENERAL HARDWARE & WEBBING

We make them tough. Buckles, hooks, rings, track fittings and attachment hardware are made from high-strength steel. Webbing is abrasion-resistant, a trademark of Ancra quality. Standard or custom, these products are the core of Ancra's first-rate reputation.

- Quality materials and solid steel construction ensures long life
- Positive locking feature on tensioning hardware for security
- Wide assortment of hardware and webbing to suit your application
- Protective coatings for improved corrosion resistance





# GENERAL HARDWARE & WEBBING

## ANCR A BUCKLE QUALITY –

The standard of the industry, Ancra's durable buckles are designed with a unique latch and fast release cam that reduces sprocket wear. Our broad line of steel Ratchet, Cam and Overcenter Buckles meets your wide ranging load requirements, offering quick and easy release and secure locking tension. The popular and often copied long, wide-handle ratchet is a classic example of Ancra innovation. Our locking mechanism guards against vibration release, the 1.5-inch longer handle increases leverage by 20%, and the wider frame and latch design allows more hand room for easier operation. What began as innovation, is now the standard of the industry.



## RATCHET BUCKLES

Ancra Ratchet Buckles are available in a wide range of models for 1-inch to 4-inch webbing widths. The buckles have a locking latch that engages when the handle is closed and prevents the inadvertent release of tension when under load. The handle cross pin interlocks with the frame, maintaining a low profile design. A removable rear bolt on most models allows for in field conversion or repair.

### 1-INCH

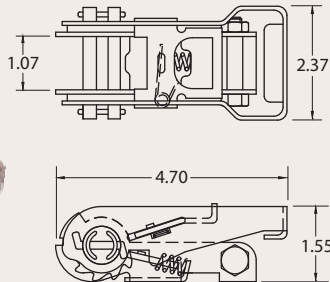
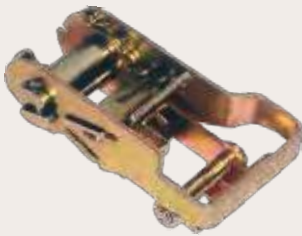

#### 43320-32

WLL: 1,466 lbs./666 kg.  
Weight: .76 lb./34 kg.

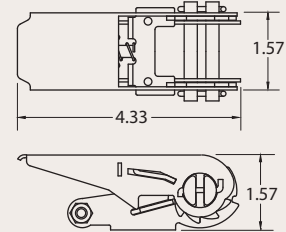

#### 48770-10

Low profile, black powder coat  
WLL: 500 lbs./227 kg.  
Weight: .50 lb./22 kg.

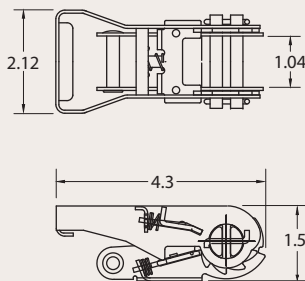

#### 44232-10

WLL: 400 lbs./181 kg.  
Weight: .50 lb./22 kg.

### 1-3/4 INCH

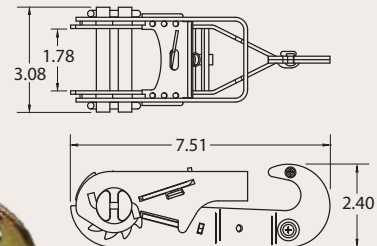

#### 41808-14

1-3/4 in. Hook End  
WLL: 2,000 lbs./908 kg.  
Weight: 1.65 lbs./75 kg.

## RATCHET BUCKLES

### 2-INCH

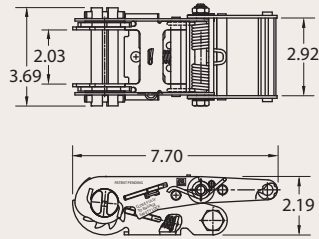

#### 49410-13

Long Wide Handle Torque Limiting. Reduces trailer damage by limiting overzealous tensioning. See page 55.  
WLL: 3,666 lbs./1,663 kg.  
Weight: 2.7 lbs./1.23 kg.

PATENT PENDING

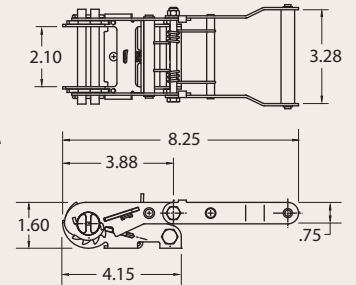

#### 49715-10

Low Profile Torque Limiting. Reduces trailer damage by limiting overzealous tensioning. See page 55.  
WLL: 1,500 lbs./680 kg.  
Weight: 1.56 lbs./.71 kg.

PATENTED

No. 10/821,987

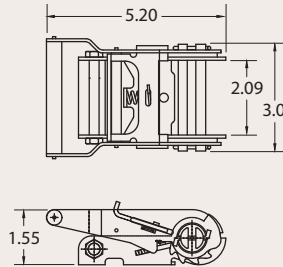

#### 44258-13

Low Profile. Nut & bolt packaged separately.  
WLL: 1,500 lbs./680 kg.  
Weight: 1.30 lbs./.59 kg.

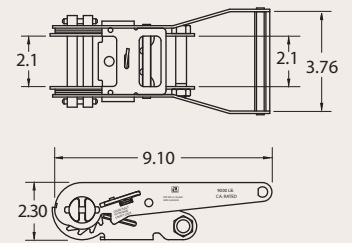

#### 44587-10

Long Wide Handle  
WLL: 3,666 lbs./1,666 kg.  
Weight: 2.3 lbs./1.05 kg.

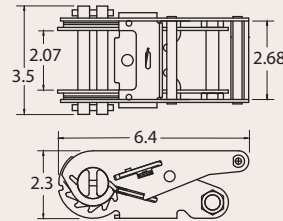

#### 44627-11

Standard Handle  
WLL: 3,333 lbs./1,515 kg.  
Weight: 2.10 lbs./.95 kg.

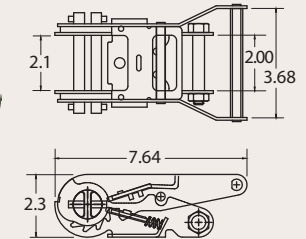

#### 47105-11

Short Wide Handle  
WLL: 3,666 lbs./1,666 kg.  
Weight: 2.20 lbs./1.0 kg.



#### 50037-10

Long Wide Handle Web Keeper Ratchet Buckle  
WLL: 3,666 lbs./1,666 kg.  
Weight: 2.35 lbs./1.07 kg.

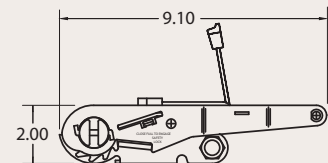
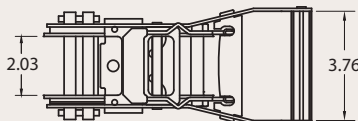

# GENERAL HARDWARE & WEBBING

## RATCHET BUCKLES

### 3-INCH

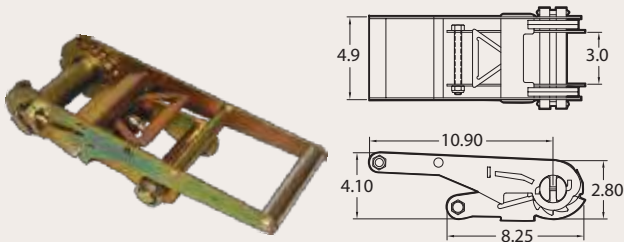

**48965-10**

WLL: 7,333 lbs./3,333 kg.

Weight: 7.0 lbs./3.18 kg.

### 4-INCH

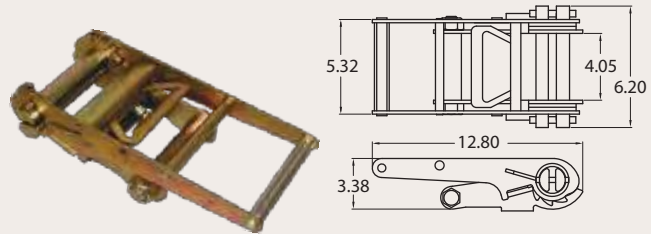

**49349-10**

WLL: 8,000 lbs./3,636 kg.

Weight: 8.0 lbs./3.63 kg.

## OVERCENTER BUCKLES

Ankra Overcenter Buckles have one-piece steel frame construction. Designed for simple and easy operation. When attached to the strap, the webbing provides a pad between the buckle and the cargo.

### 1-INCH

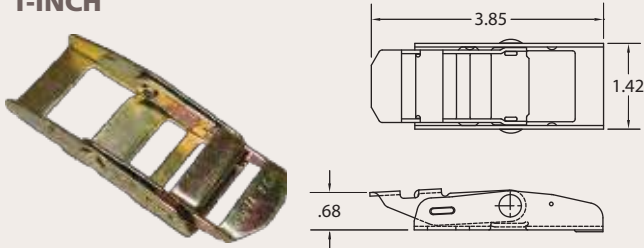

**42816-18**

WLL: 600 lbs./272 kg.

Weight: .15 lb./0.06 kg.

### 2-INCH

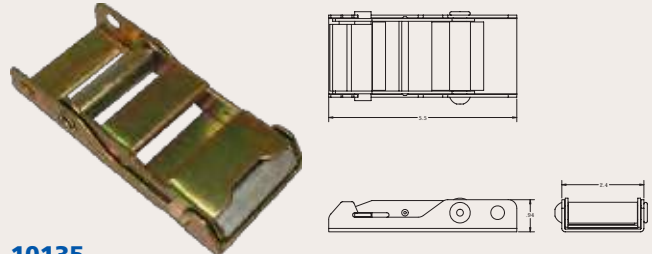

**10135**

WLL: 3,000 lbs./1,361 kg.

Weight: .8 lbs./0.36 kg.

### 1 3/4-INCH

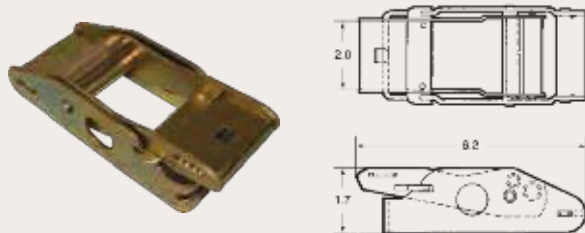

**44639-12**

WLL: 1,666 lbs./757 kg.

Weight: 1.20 lbs./0.54 kg.

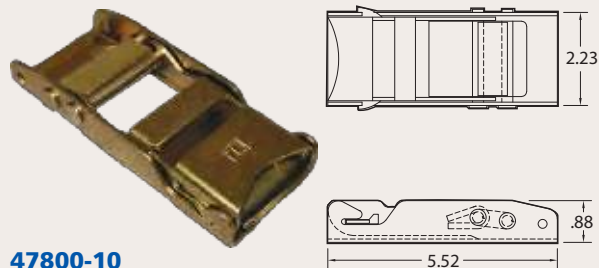

**47800-10**

WLL: 1,666 lbs./757 kg.

Weight: .70 lb./0.31 kg.

## DID YOU KNOW?

In addition to the trucking industry, Ankra buckles are used in specialty markets that include aircraft, marine, automotive, material handling and military applications.

In each case, material specifications have been modified to give optimum performance for their specific use.



## CAM BUCKLES

A one-piece frame design lengthens the service life of Ankra Cam Buckles. Quick and easy operation consists of simply pulling the handhold to tension and depressing the cam lever to release.

### 1-INCH

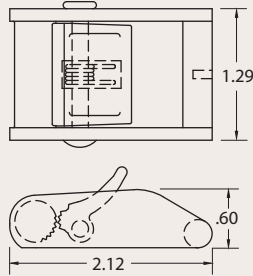

#### 41030-12

WLL: 166 lbs./75 kg.  
Weight: .13 lb./0.06 kg.

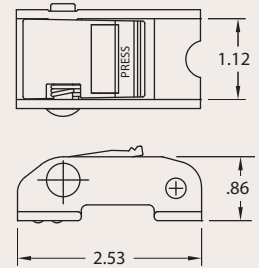

#### 42195-11

WLL: 500 lbs./227 kg.  
Weight: .25 lb./0.11 kg.

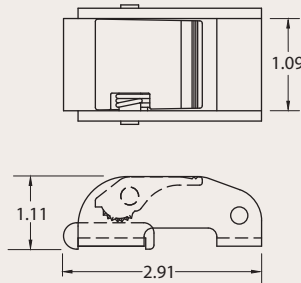

#### 40880-22

WLL: 600 lbs./272 kg.  
Weight: .40 lb./0.18 kg.

### 2-INCH

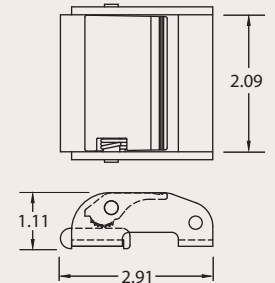

#### 40880-15

WLL: 833 lbs./378 kg.  
Weight: .69 lb./0.31 kg.

## ROLLER BUCKLE

A simple slide bar adjuster buckle for light duty applications.

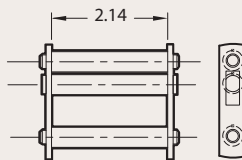

#### 41645-10 Roller Buckle

WLL: 500 lbs./227 kg.  
Weight: .20 lb./0.10 kg.

## 3-BAR SLIDE ADJUSTER

This adjuster is designed to be used for adjustment of strap lengths only, not for tensioning.

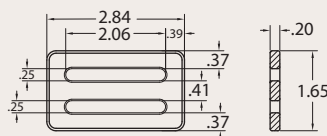
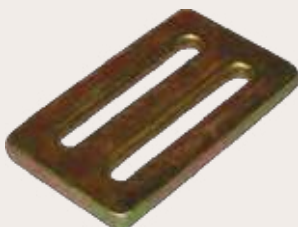

#### 49834-10 3-Bar Slide Adjuster

WLL: 1,000 lbs./454 kg.  
Weight: .30 lb./0.14 kg.

# GENERAL HARDWARE & WEBBING

## ATTACHMENT HARDWARE

Ankra hooks, rings and fittings are made to last. With heat treating and corrosion resistant plating or vinyl-coating, this quality line of attachment hardware is strong and durable.

### WIRE HOOKS

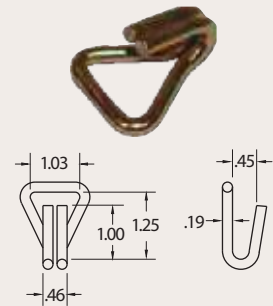

#### 40316-12

1-inch Narrow Hook  
WLL: 166 lbs./75 kg.  
Weight: .10 lb./05 kg.

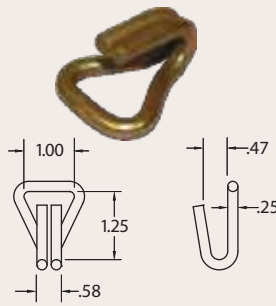

#### 40024-10

1-inch Narrow Hook  
WLL: 1,000 lbs./454 kg.  
Weight: .10 lb./05 kg.

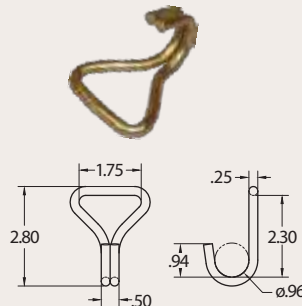

#### 43120-19

1 3/4-inch Narrow Hook  
WLL: 500 lbs./227 kg.  
Weight: .17 lb./08 kg.

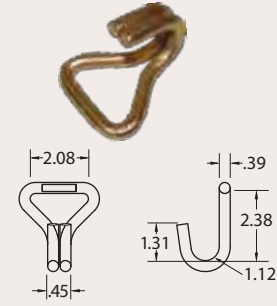

#### 43120-11

2-inch Narrow Hook  
WLL: 1,666 lbs./757 kg.  
Weight: .39 lb./18 kg.

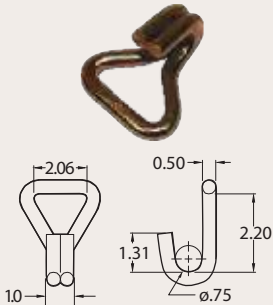

#### 43120-13

2-inch Narrow Hook  
WLL: 3,333 lbs./1,515 kg.  
Weight: .62 lb./28 kg.

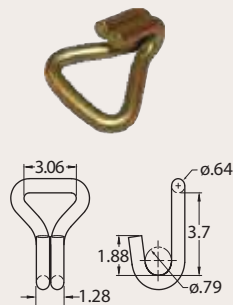

#### 43120-20

3-inch Narrow Hook  
WLL: 7,333 lbs./3,333 kg.  
Weight: 1.39 lbs./63 kg.

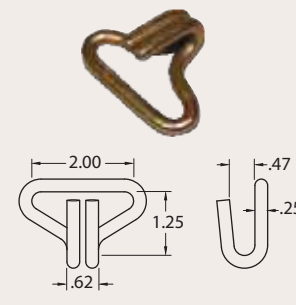

#### 40024-12

2-inch Narrow Hook  
WLL: 833 lbs./378 kg.  
Weight: .10 lb./05 kg.

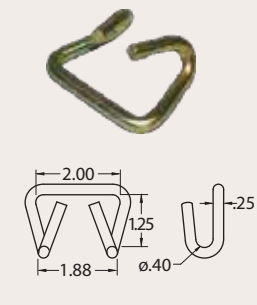

#### 40023-12

2-inch Wide Hook  
WLL: 833 lbs./378 kg.  
Weight: .12 lb./06 kg.

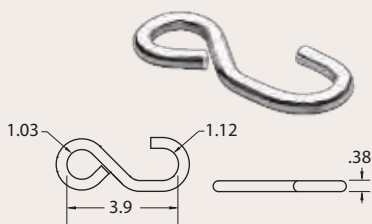

#### 41313-12

Zinc-plated S Hook  
WLL: 400 lbs./181 kg.  
Weight: .28 lbs./13 kg.

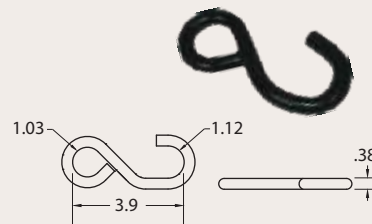

#### 41313-13

1-inch Vinyl S Hook  
WLL: 400 lbs./181 kg.  
Weight: .29 lb./13 kg.

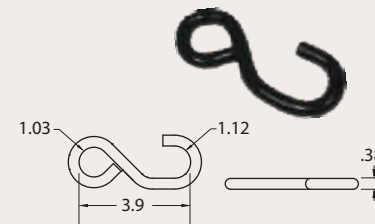

#### 41313-19

1-inch Vinyl S Hook Heat Treated  
WLL: 600 lbs./272 kg.  
Weight: .30 lb./14 kg.

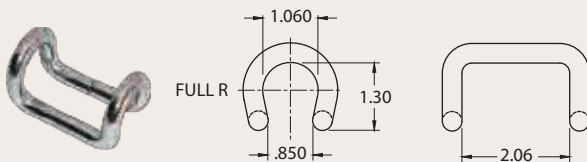

#### 45228-10

Rave Hook  
WLL: 1,167 lb./530 kg.  
Weight: .29 lb./13 kg.

## ATTACHMENT HARDWARE

### FLAT HOOKS

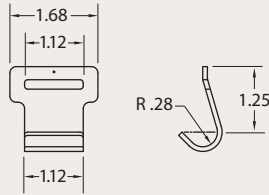

**43546-10**  
1-inch Gutter Hook  
WLL: 250 lbs./113 kg.  
Weight: .05 lb./02 kg.

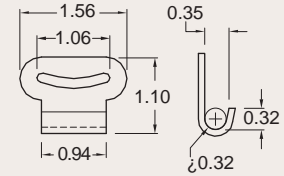

**40065-10**  
1-inch Plated Flat Hook  
WLL: 333 lbs./151 kg.  
Weight: .04 lb./02 kg.

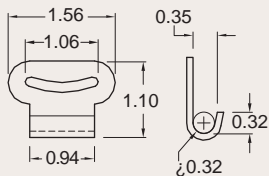

**40065-12**  
1-inch Vinyl Flat Hook  
WLL: 333 lbs./151 kg.  
Weight: .05 lb./02 kg.

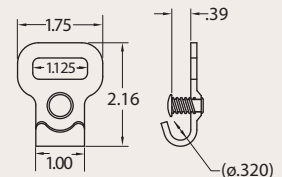

**40044-10**  
1-inch Flat Hook with Keeper  
WLL: 1,166 lbs./530 kg.  
Weight: .68 lb./31 kg.

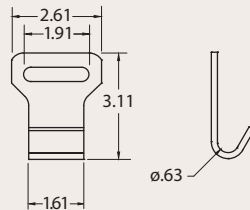

**43099-10**  
2-inch Flat Hook  
WLL: 1,666 lbs./757 kg.  
Weight: .40 lb./18 kg.

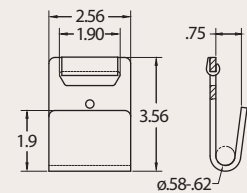

**40891-18**  
2-inch Flat Hook  
WLL: 3,333 lbs./1,515 kg.  
Weight: .68 lb./31 kg.

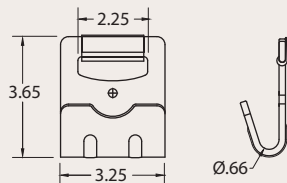

**41766-18**  
3-inch Flat Hook  
WLL: 5,400 lbs./2,450 kg.  
Weight: .98 lb./45 kg.

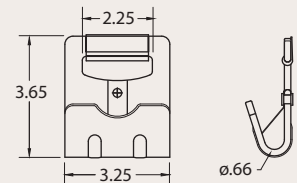

**41766-19**  
3-inch Flat Hook with Keeper  
WLL: 5,400 lbs./2,450 kg.  
Weight: 1.03/47 kg.

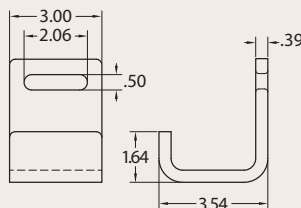

**48968-11**  
2-inch Container Hook  
WLL: 5,400 lbs./2,450 kg.  
Weight: 2.0 lbs./91 kg.

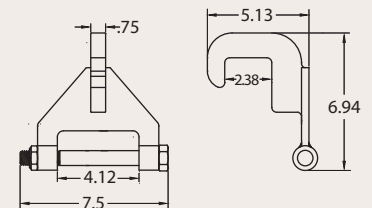

**49770-10**  
4-inch Heavy-Duty Waste Hook  
WLL: 5,400 lbs./2,450 kg.  
Weight: 5.0 lbs./2.27 kg.



# GENERAL HARDWARE & WEBBING

## ATTACHMENT HARDWARE

### SNAP HOOKS

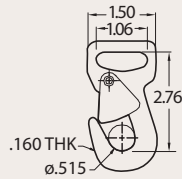

#### 43044-10

1-inch Snap Hook  
WLL: 1,666 lbs./757 kg.  
Weight: .20 lb./.09 kg.

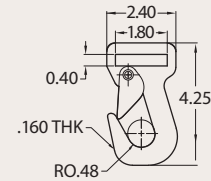

#### 40084-14

2-inch Snap Hook  
WLL: 2,100 lbs./953 kg.  
Weight: .34 lb./.15 kg.

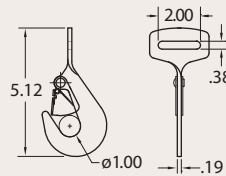

#### 40758-11

2-inch Snap Hook w/ Satin Black Finish. Twisted Version  
WLL: 3,333 lbs./1,515 kg.  
Weight: .59 lb./.27 kg.

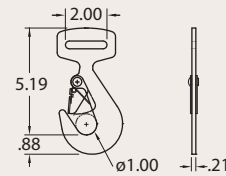

#### 40758-13

2-inch Snap Hook w/ Satin Black Finish  
WLL: 3,333 lbs./1,515 kg.  
Weight: .59 lb./.27 kg.

### RINGS



#### 47944-10

Round Ring  
WLL: 900 lbs./409 kg.  
Weight: .25 lbs./.11 kg.

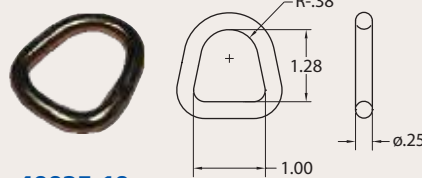

#### 40025-10

1-inch D-Ring  
WLL: 1,666 lbs./757 kg.  
Weight: .05 lb./.02 kg.

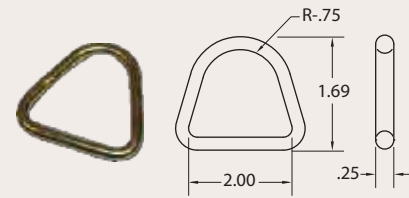

#### 40025-12

2-inch D-Ring  
WLL: 1,666 lbs./757 kg.  
Weight: .09 lb./.04 kg.

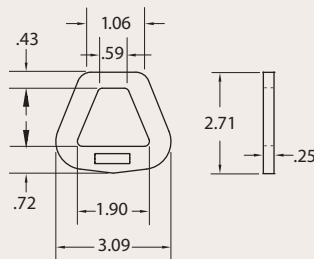

#### 40978-11

2-inch Delta Ring  
WLL: 3,333 lbs./1,515 kg.  
Weight: .28 lb./.13 kg.

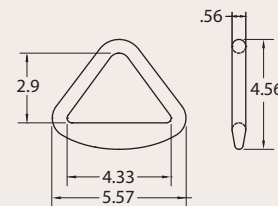

#### 41631-12

4-inch Delta Ring  
WLL: 6,666 lbs./3,030 kg.  
Weight: 1.30 lbs./.59 kg.

## PRODUCT FEATURES

- + ANCRAs RUST-RESISTANT, HIGH QUALITY ATTACHMENT HARDWARE IS MADE TO LAST.
- + OUR PRODUCTS AND COMPONENTS ARE FULLY TESTED TO MEET OUR EXACTING STANDARDS.

## ATTACHMENT HARDWARE

### BOLT PLATES

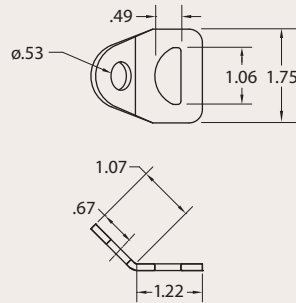

**49917-10** 1", 45 degree  
Heat treated, Zinc Plated Gold Chromate Finish.  
WLL: 1,000 lbs./450 kg.  
Weight: .10 lbs./05 kg.

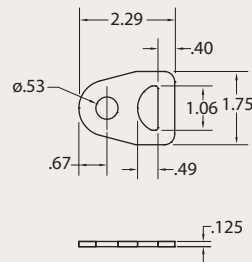

**49917-11** 1", Flat  
Heat treated, Zinc Plated Gold Chromate Finish.  
WLL: 1,000 lbs./450 kg.  
Weight: .10 lbs./05 kg.

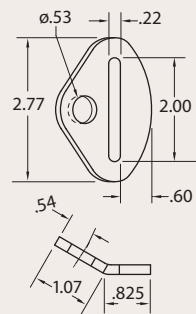

**48904-10** 2", 30 degree  
Heat treated, Zinc Plated Clear Chromate Finish.  
WLL: 1,000 lbs./450 kg.  
Weight: .14 lbs./07 kg.

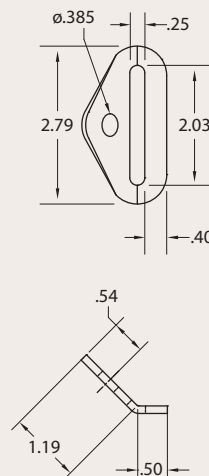

**49968-10** 2", 45 degree  
Heat treated, Chrome Plated Finish.  
WLL: 1,000 lbs./450 kg.  
Weight: .10 lbs./05 kg.

OUR COMMITMENT TO  
QUALITY IS NEVER ENDING



*All Ankra products and components are fully tested to meet our exacting standards.*

# GENERAL HARDWARE & WEBBING

## ATTACHMENT HARDWARE

Designed to fit securely into Ankra Track, sturdy Ankra Track Fittings are easy to use and long wearing.

### TRACK FITTINGS

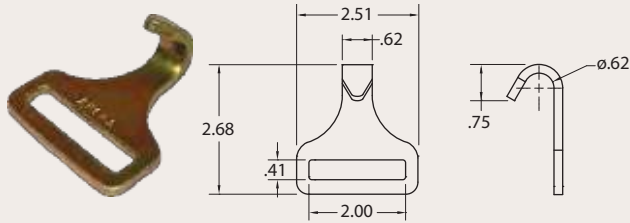

#### 42012-12

Series F Heavy-Duty Track Hook  
WLL: 800 lbs./363 kg.  
Weight: .20 lb./.09 kg.

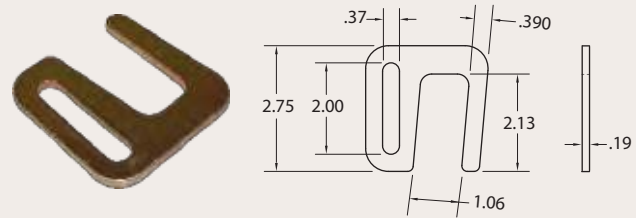

#### 41325-10

Slat Hook. For use with Attachment Rails (Wooden Slats).  
WLL: 1,000 lbs./454 kg.  
Weight: .23 lb./.10 kg.

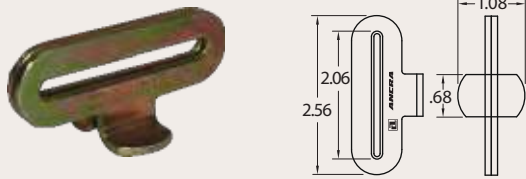

#### 40980-11

Series F Track Fitting  
WLL: 500 lbs./225 kg.  
Weight: .60 lb./.27 kg.

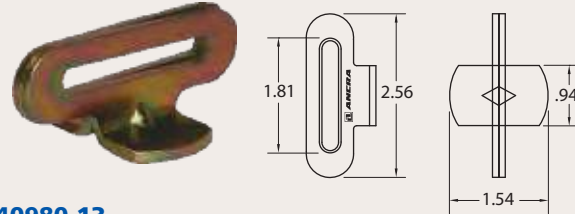

#### 40980-13

For 1" hole diameter track (Canada).  
WLL: 500 lbs./225 kg.  
Weight: .60 lb./.27 kg.



#### 41409-13

Series E & A 3-Piece Track Fitting  
WLL: 1,000 lbs./454 kg.  
Weight: .20 lb./.09 kg.

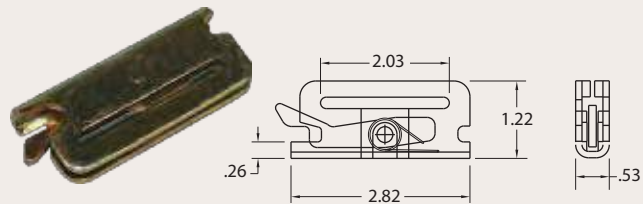

#### 47608-21

Series E & A Track Spring Fitting  
WLL: 1,333 lbs./605 kg. in 12-ga. track,  
WLL: 1,500 lbs./680 kg. in 11-ga. track.  
Weight: .22 lb./.10 kg.

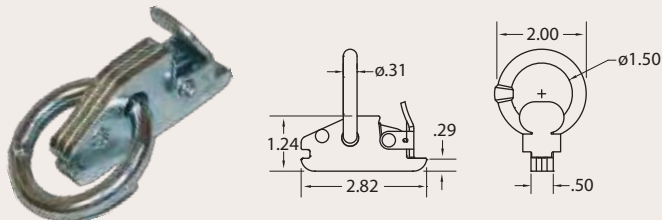

#### 50115-10

Heavy-Duty Series E and A Track Fitting w/ Round Ring. Heat treated.  
WLL: 2,000 lbs./900 kg.  
Weight: .40 lbs./.18 kg.

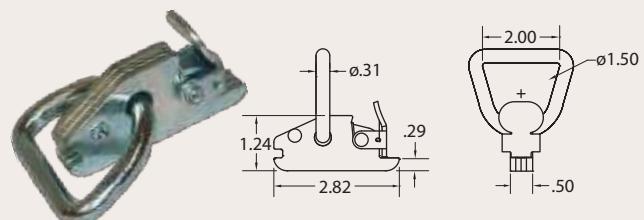

#### 50115-11

Heavy-Duty Series E and A Track Fitting w/ D-Ring. Heat treated.  
WLL: 2,000 lbs./900 kg.  
Weight: .40 lbs./.18 kg.



## ATTACHMENT HARDWARE

### TRACK FITTINGS

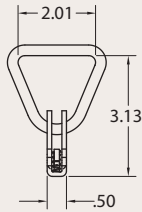
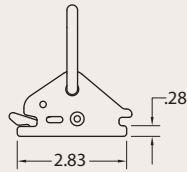

#### 49542-10

Series E & A Fitting w/ D-Ring  
WLL: 1,000 lbs./454 kg.  
Weight: .32 lb./15 kg.

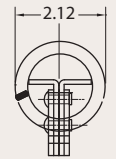
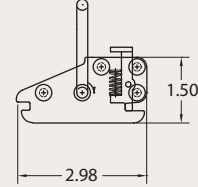

#### 47772-12

Series E & A Track Fitting  
WLL: 1,000 lbs./454 kg.  
Weight: .45 lb./20 kg.

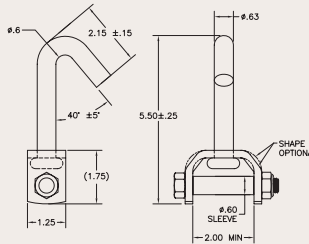

#### 49914-10

Swivel J Idler Hook  
Heat treated w/ gold zinc finish.  
WLL: 3,333 lbs./1,515 kg.  
Weight: 1.12 lbs./51 kg.

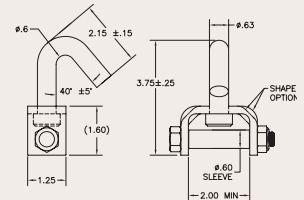

#### 49914-11

Low Profile Swivel J Idler Hook  
Heat treated w/ gold zinc finish.  
WLL: 3,333 lbs./1,515 kg.  
Weight: .87 lb./40 kg.

### CHAIN ATTACHMENTS

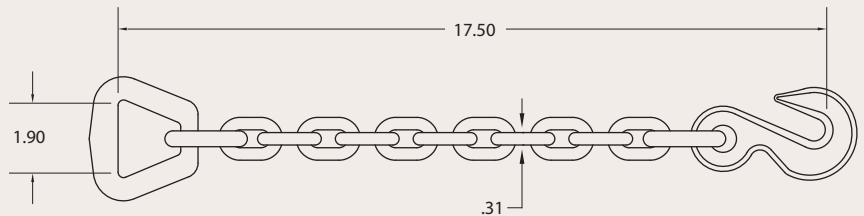

#### 43366-21

Chain Anchor with Delta Ring for 2" Strap Assemblies. 5/16", G43 Chain and Grab Hook, gold zinc plated.  
WLL: 3,330 lbs./1,510 kg.  
Weight: 2.55 lbs./1.16 kg.

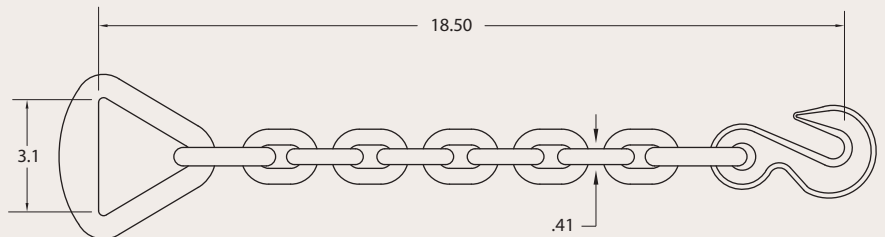

#### 43366-14

Chain Anchor with Delta Ring for 3" & 4" Strap Assemblies. 3/8", G43 Chain and 3/8" G70 Grab Hook, gold zinc plated.  
WLL: 5,400 lbs./2,450 kg.  
Weight: 3.4 lbs./1.54 kg.

# GENERAL HARDWARE & WEBBING

## ATTACHMENT HARDWARE

Forged from high strength alloy steel, Ankra clevis hooks are made for Grade 70 chain. Sized from 1/4" to 1/2", the chain hooks are strength tested and heat treated for safety and durability. Meets Department of Transportation requirements.

Forged steel hook, Zinc Plated Gold Chromate finish. Individually polybagged.

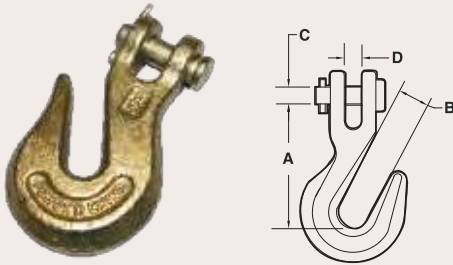

**45946-12**

1/4-in. Clevis Hook WLL: 3,150 lbs./1,430 kg.  
Weight: .40 lbs./.18 kg.

**45946-10**

5/16-in. Clevis Hook WLL: 4,700 lbs./2,130 kg.  
Weight: .85 lbs./.39 kg.

**45946-11**

3/8-in. Clevis Hook WLL: 6,600 lbs./2,990 kg.  
Weight: 1.10 lbs./.5 kg.

**45946-13**

1/2-in. Clevis Hook WLL: 11,300 lbs./5,130 kg.  
Weight: 2.10 lbs./1.04 kg.

DIMENSION TABLE

	A	B	C	D
45946-12	2.00	.40	.38	.36
45946-10	2.30	.43	.38	.38
45946-11	2.70	.50	.48	.44
45946-13	3.20	.66	.63	.75

### Grade 70 Clevis Hooks with Keeper

Forged steel hook with Keeper, Zinc Plated Gold Chromate finish. Individually polybagged, 30 per box.

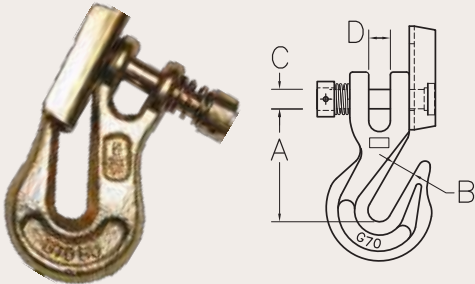

**50091-31**

5/16-in. Clevis Hook w/ Keeper WLL: 4,700 lbs./2,130 kg.  
Weight: .9 lbs./.41 kg.

**50091-38**

3/8-in. Clevis Hook w/ Keeper WLL: 6,600 lbs./2,990 kg.  
Weight: 1.3 lbs./.59 kg.

**50091-50**

1/2-in. Clevis Hook w/ Keeper WLL: 11,300 lbs./5,130 kg.  
Weight: 2.2 lbs./1.00 kg.

DIMENSION TABLE

	A	B	C	D
50091-31	2.3	.43	.38	.42
50091-38	2.7	.56	.48	.48
50091-50	3.0	.61	.63	.57

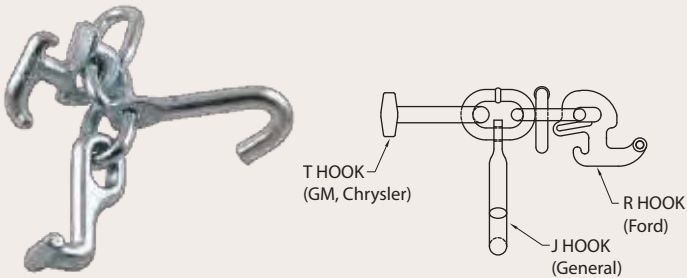

**45515-10**

RTJ Cluster Hook  
WLL: 3,900 lbs./1,770 kg.  
Weight: 2.65 lbs./1.20 kg.

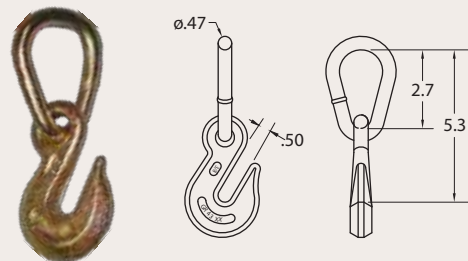

**43365-12**

Grab Hook Assembly  
Heat Treated, Gold Zinc plated finish.  
WLL: 5,400 lbs./2,450 kg.  
Weight: 1.60 lbs./.73 kg.

## CHAIN HARDWARE

We offer a wide selection of chain hardware for popular applications — from anchor shackles with screw pins and clevis pin models to Quick Links in various sizes. Corrosion resistant, gold zinc plated Grade 70 Twin Clevis and Slip Hooks come in a wide range of sizes, with and without safety latches. All are individually packaged.

### Screw Pin Anchor Shackle — Galvanized and individually polybagged

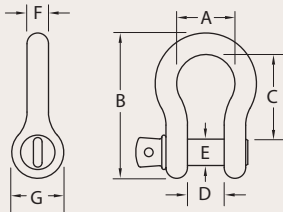

PART NUMBER	SIZE	WEIGHT	WLL				
<b>50013-31</b>	5/16-in.	.18 lbs./ .08 kg.	1,500 lbs./681 kg.				
<b>50013-38</b>	3/8-in.	.30 lbs./ .14 kg.	2,000 lbs./900 kg.				
<b>50013-44</b>	7/16-in.	.49 lbs./ .22 kg.	3,000 lbs./1,362 kg.				
<b>50013-50</b>	1/2-in.	.74 lbs./ .34 kg.	4,000 lbs./1,816 kg.				
<b>50013-63</b>	5/8-in.	1.44 lbs./ .65 kg.	6,500 lbs./2,951 kg.				
<b>50013-75</b>	3/4-in.	2.16 lbs./ .98 kg.	9,500 lbs./4,313 kg.				
	A	B	C	D	E	F	G
<b>50013-31</b>	.81	2.25	1.25	.53	Ø3/8	Ø.31	1.00
<b>50013-38</b>	.94	2.61	1.44	.66	Ø7/16	Ø.38	1.13
<b>50013-44</b>	1.06	3.01	1.69	.72	Ø1/2	Ø.44	1.25
<b>50013-50</b>	1.19	3.34	1.88	.81	Ø5/8	Ø.50	1.38
<b>50013-63</b>	1.50	4.04	2.41	1.06	Ø3/4	Ø.63	1.88
<b>50013-75</b>	1.75	5.04	2.84	1.25	Ø7/8	Ø.75	2.13

### Clevis Pin Anchor Shackle — Galvanized and individually polybagged

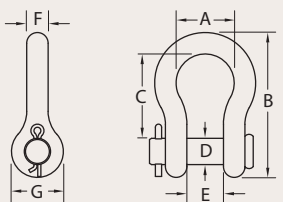

PART NUMBER	SIZE	WEIGHT	WLL				
<b>50014-50</b>	1/2-in.	.74 lbs./ .34 kg.	4,000 lbs./1,816 kg.				
<b>50014-63</b>	5/8-in.	1.44 lbs./ .65 kg.	6,500 lbs./2,951 kg.				
	A	B	C	D	E	F	G
<b>50014-50</b>	1.19	3.39	1.88	Ø5/8	.81	Ø.50	1.38
<b>50014-63</b>	1.50	4.17	2.41	Ø3/4	1.06	Ø.63	1.88

### Quick Links — Zinc Plated Clear Chromate finish and individually polybagged

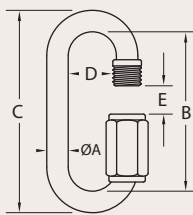

PART NUMBER	SIZE	WEIGHT	WLL		
<b>50016-25</b>	1/4-in.	.062 lbs./ .028 kg.	880 lbs./399 kg.		
<b>50016-31</b>	5/16-in.	.154 lbs./ .07 kg.	1,760 lbs./799 kg.		
<b>50016-38</b>	3/8-in.	.198 lbs./ .90kg.	2,200 lbs./998 kg.		
	A	B	C	D	E
<b>50016-25</b>	.235	1.85	2.31	.51	.32
<b>50016-31</b>	.313	2.32	2.95	.65	.41
<b>50016-38</b>	.350	2.54	3.22	.67	.43



## CHAIN HARDWARE

**Twin Clevis G70** — Forged steel with Zinc Plated Gold Chromate finish and individually polybagged.

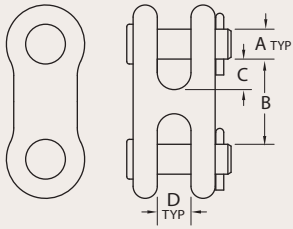

PART NUMBER	SIZE	WEIGHT	WLL	
<b>50017-10</b>	1/4-in. – 5/16-in.	.30 lbs./14 kg.	4,700 lbs./2,130 kg.	
<b>50017-11</b>	3/8-in.	.40 lbs./18 kg.	6,600 lbs./2,990 kg.	
<b>50017-12</b>	7/16-in – 1/2-in.	.98 lbs./44 kg.	11,300 lbs./5,130 kg.	
	A	B	C	D
<b>50017-10</b>	.38	1.18	.43	.47
<b>50017-11</b>	.47	1.34	.48	.53
<b>50017-12</b>	.56	1.75	.63	.65

**Slip Hooks G70 without Safety Latch** — Forged steel with Zinc Plated Gold Chromate finish and individually polybagged.

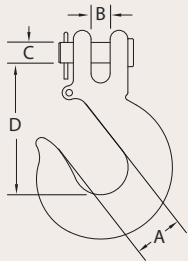

PART NUMBER	SIZE	WEIGHT	WLL	
<b>50019-10</b>	1/4-in.	.44 lbs./20 kg.	3,150 lbs./1,430 kg.	
<b>50019-11</b>	5/16-in.	.75 lbs./34 kg.	4,700 lbs./2,130 kg.	
<b>50019-12</b>	3/8-in.	1.13 lbs./51 kg.	6,600 lbs./2,990 kg.	
<b>50019-13</b>	1/2-in.	2.75 lbs./1.25 kg.	11,300 lbs./5,130 kg.	
	A	B	C	D
<b>50019-10</b>	.94	.44	.38	2.44
<b>50019-11</b>	1.06	.41	.44	2.72
<b>50019-12</b>	1.31	.59	.47	3.25
<b>50019-13</b>	1.75	.75	.63	4.00

**Slip Hooks G70 with Safety Latch** — Forged steel with Zinc Plated Gold Chromate finish and individually polybagged.

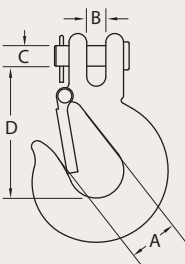

PART NUMBER	SIZE	WEIGHT	WLL	
<b>50019-20</b>	1/4-in.	.59 lbs./27 kg.	3,150 lbs./1,430 kg.	
<b>50019-21</b>	5/16-in.	.92 lbs./42 kg.	4,700 lbs./2,130 kg.	
<b>50019-22</b>	3/8-in.	1.32 lbs./60 kg.	6,600 lbs./2,990 kg.	
<b>50019-23</b>	1/2-in.	2.90 lbs./1.32 kg.	11,300 lbs./5,130 kg.	
	A	B	C	D
<b>50019-20</b>	.94	.44	.38	2.44
<b>50019-21</b>	1.06	.41	.44	2.72
<b>50019-22</b>	1.31	.59	.47	3.25
<b>50019-23</b>	1.75	.75	.63	4.00

## WEBBING

Along with exceptional quality, Ancra's broad line of webbing gives you a range of choices to match your application. Custom made according to our strict specifications, Ancra webbing is treated for extra strength and durability, offering additional flexibility and ease of use.



Width in./mm.		Breaking Strength Capacity		Type	Standard Color	Part No.
in.	mm.	lbs.	kg.			
1.00	25	4,500	2,045	Nylon	<span style="color: red;">■</span> Red <span style="color: blue;">■</span> Blue <span style="color: black;">■</span> Black	<b>41820-10-RL</b> <b>41820-14-RL</b> <b>41820-15-RL</b>
2.00	50	6,000	2,727	Polyester	<span style="color: yellow;">■</span> Yellow	<b>47200-61-BULK-CUT</b>
2.00	50	6,000	2,727	Polyester	<span style="color: gray;">■</span> Gray	<b>47200-60-BULK-CUT</b>
2.00	50	6,000	2,727	Polyester	<span style="color: blue;">■</span> Blue <span style="color: red;">■</span> Red	<b>47200-62-BULK-CUT</b> <b>47200-64-BULK-CUT</b>
2.00	50	12,000	5,454	Polyester, Latex Treated	<span style="color: blue;">■</span> Blue <span style="color: yellow;">■</span> Yellow <span style="color: red;">■</span> Red	<b>41632-26-BULK-CUT</b> <b>41632-31-BULK-CUT</b> <b>41632-19-BULK-CUT</b>
3.00	75	18,000	8,181	Polyester, Latex Treated	<span style="color: yellow;">■</span> Yellow <span style="color: blue;">■</span> Blue	<b>41632-17-BULK-CUT</b> <b>41632-24-BULK-CUT</b>
4.00	100	20,000	9,090	Polyester, Latex Treated	<span style="color: gray;">■</span> Gray <span style="color: blue;">■</span> Blue <span style="color: red;">■</span> Red <span style="color: yellow;">■</span> Yellow <span style="color: green;">■</span> Green	<b>43797-18-BULK-CUT</b> <b>43797-19-BULK-CUT</b> <b>43797-23-BULK-CUT</b> <b>43797-36-RL</b> <b>43797-34-BULK-CUT</b>

*Webbing will have a longer life if stored in a dry, dark location. Continuous exposure to ultra-violet light can degrade the strength of synthetic webbing.*

## WEBBING CHARACTERISTICS



Nylon's elongation characteristics make it suitable for slings and tow straps, but less desirable for heavy-duty tie downs. It displays good UV, abrasion, alkaline resistance and color fast properties. Polyester is well suited for webbing because of its low cost, high-strength, and resistance to abrasion. It also withstands acid environments and resists elongation in high moisture applications. Its durability and abrasion resistance can be increased even further with coatings of latex or other materials.

## SPECIALTY PRODUCTS

### AIRCRAFT STYLE SEAT / LOGISTIC TRACK

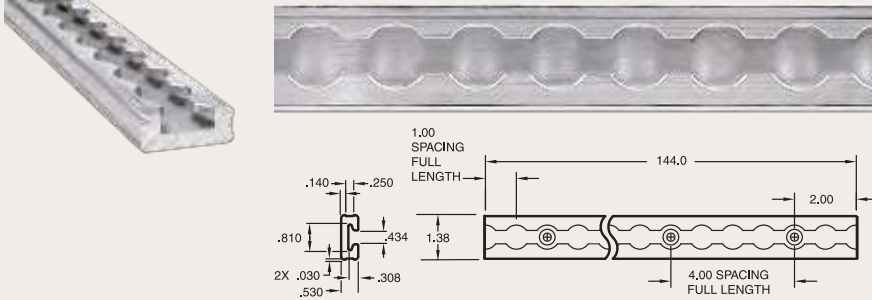

**40467-33-144**

12' long. Weight: 7.0 lbs./3.2 kg.

### HEAVY-DUTY BEVELED AIRCRAFT STYLE TRACK

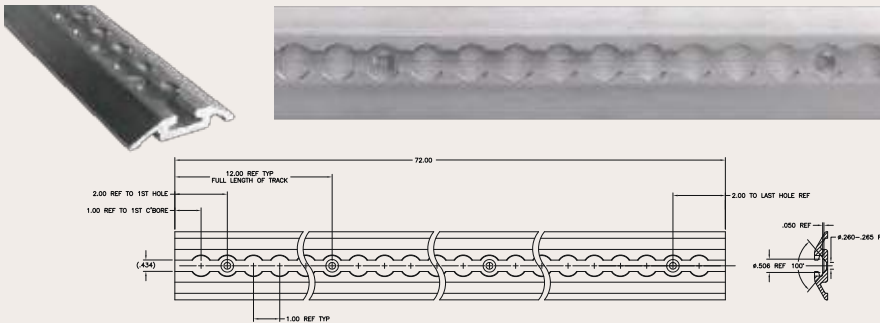

**50193-30-72.00**

72" long. Weight: 4.30 lbs./1.95 kg.

### SINGLE STUD TRACK FITTING

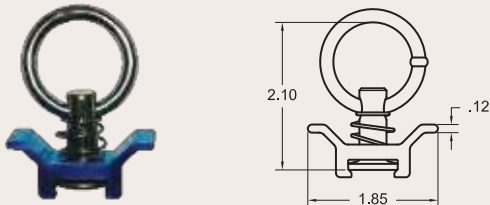

**50112-10** Single Stud Track Fitting  
Steel Retainer. WLL: 4,000 lbs./1,814 kg. Vertical.  
Weight: .12 lb./0.05 kg.

\*Load rating varies with the angle of pull.

### DOUBLE STUD TRACK FITTING WITH ROUND RING

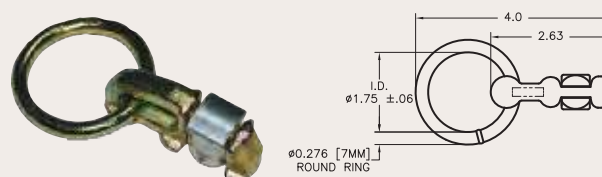

**50362-11** Double Stud Track Fitting with Round Ring  
WLL: 1,666lbs./756 kg. Vertical.  
Weight: .32 lb./0.14 kg.

## Dedicated to You

Ankra designs and manufactures a full spectrum of restraints and hardware to meet your wide ranging needs. Our specialty items represent our ongoing mission to provide the right solutions for a changing industry. If you can't find a specific product in this catalog, or if you have a particular requirement that calls for a unique solution, give us a call. Our customization capabilities can be your assurance that you have Ankra quality for all your cargo restraint applications.





## SPECIALTY PRODUCTS

### 12 & 20 TON BOTTLE JACKS

#### 49880-12

12 Ton Bottle Jack w/ 3-Pc. Handle  
Weight: 16.7 lb./7.58 kg.

- 24,000 lb./10,900 kg. rated capacity
- Compact 7.5-inch height
- Lifts 4.1 inches
- Adjustable to screw height of 2.6 inches
- Extends to 14 inches
- Complies with ASME PALD-2005 standard



#### 49880-20

20 Ton Bottle Jack w/ 3-Pc. Handle  
Weight: 24.9 lb./11.30 kg.

- 40,000 lb./18,180 kg. rated capacity
- Compact 7.5-inch height
- Lifts 3.9 inches
- Adjustable screw height of 2.6 inches
- Extends to 14 inches
- Complies with ASME PALD-2005 standard



### EASIER ACCESS FOR FORK LIFT MAINTENANCE AND REPAIR

#### LR0401-01 Fork Lift Stand

Designed to comply with ASME PASE 2014 Standard for Portable Automotive Service Equipment, Ancra's American-made Fork Lift Stand offers a stable platform to raise your fork lift 20 inches for easier access from all sides. Dimensions: 48" w x 20" h x 180" d  
Weight: 1,260 lb./571 kg.

- For lifts up to 10,000 lbs. with 62" maximum wheelbase and 30-40" track width
- 20,000 lbs. evenly distributed load capacity rating for properly installed assembly
- Includes removable approach ramps
- Protective lip lets operator know when to stop fork lift



### SHOWCASE ANCRA PRODUCTS WITH CARGO CONTROL DISPLAYS

Display your cargo bars, beams, straps, coil racks and other Ancra products with display racks that break down and take less space in transportation and warehousing. Available in two sizes — free standing and wall mounted, the secure displays come with hooks and offer flexibility in customizing your featured products.



#### 50398-10

Cargo Control Display  
Wall mounted.  
Dimensions: 24" x 20" x 71"  
Weight: 78 lb./35.4 kg.  
14 Hooks provided.  
Shipping size: 75" x 13" x 14"



#### 50398-20

Cargo Control Display  
Freestanding.  
Dimensions: 24" x 20" x 71"  
Weight: 100 lb./45.5 kg.  
28 Hooks provided.  
Shipping size: 75" x 13" x 24"

# GENERAL HARDWARE & WEBBING

## MERCHANDISING AIDS

Contact our Customer Service Department to obtain.



Floor\_Stickers

Sold\_Here\_Sticker



Outdoor\_Banner



X-TREME\_CC



Ergo\_Bar\_CC

Product\_CC

Goldline\_CC



Wall\_Chart



PortaWinch  
49714-10

Catalog-220-LAM



Cargo Bar Display  
49458-10

**Part No.**

**Description**

BANNERS  
OUTDOOR\_BANNER  
SOLD\_HERE\_STICKER  
FLOOR\_STICKERS

INDOOR BANNER, 4' x 18" w/ 4 grommets  
OUTDOOR BANNER, 6' x 3' w/ 4 grommets  
SOLD HERE WINDOW STICKER, 5" x 9-1/2"  
TIE DOWN ZONE FLOOR GRAPHICS, 11" x 17"

CATALOG-220-LAM  
49458-10  
49714-10  
WALL\_CHART

CATALOG 220 LAMINATED  
CARGO BAR DISPLAY  
PORTA WINCH / PORTA ANCHOR IN STORE DISPLAY  
CARGO CONTROL WALL CHART - 18" x 24"

ERGO\_BAR\_CC  
X-TREME\_CC  
PRODUCT\_CC  
GOLDLINE\_CC

ERGO BAR COUNTER CARD, 8-1/2" x 11"  
X-TREME PRODUCT COUNTER CARD, 8-1/2" x 11"  
CARGO CONTROL COUNTER CARD, 8-1/2" x 11"  
GOLDLINE TARP TIES COUNTER CARD, 8-1/2" x 11"

LAD\_TRAINING\_DVD  
LAD\_SALES\_DVD  
GLIDELOCK\_DVD

LFT A DECK II TRAINING VIDEO (DVD)  
LFT A DECK II SALES VIDEO (DVD)  
GLIDELOCK VIDEO (DVD)



# GENERAL INFORMATION

Ancra's cargo restraint products are backed by outstanding service:

**Customer Assistance:**

- Bar coding on standard products
- Technical training manuals
- CD ROM marketing material assistance
- Point of purchase selling aids

**Engineering and Technical Services:**

- Product development
- Design and drawing check – 3D solids
- Product testing and evaluation

**Quality Assurance:**

- Product inspection
- Vendor qualifications
- Internal and supplier audits
- Product and lot testing





## SPECIFICATIONS

### Working Load Limit (WLL)

The maximum load a component or assembly should be subjected to during routine use.

### Rated Load Capacity

Ratings are generally established and/or regulated by industry or legislative standards and may vary from industry to industry. The working load limit rating (WLL) is established by Federal DOT Standards at 1/3 of the Breaking Strength of the assembly.

Note: All strengths referenced in this brochure unless noted, are based on a straight pull application.

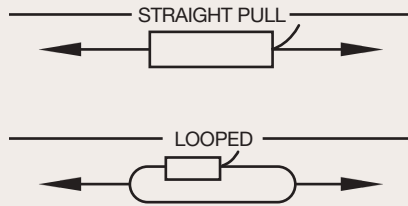

### IMPORTANT NOTE:

It is the owner's and user's responsibility to determine suitability of a product for any particular use. Check all applicable industry, trade association, federal, state and local regulations. Read all operating instructions and warnings carefully.

All ratings shown in this catalog are based on the product being new, and used in normal environmental conditions. Special consideration must be given to item selection when unusual conditions can be expected. Particular caution should be exercised to avoid exposing the product to sharp edges, acids, alkalis and temperatures above 194°F.

Products are subjected to age, wear, and deterioration, all of which cause a reduction in the product's working load limit. We recommend that all products be regularly inspected. Any worn, deformed, misused or overloaded products should be replaced.

CAUTION! The component with the lowest working load capacity in the entire restraint system will determine its strength. Each component of the entire system plays an important part in restraining cargo. It is important that tie downs be attached to anchorage that are of sufficient strength to properly secure the load. For example, if one anchors a standard web binder assembly with a rated WLL of 5,000 lbs. to a device with a WLL of 1,000 lbs., then that system is only as good as the anchorage and would be limited to a 1,000 lbs. capacity WLL.

The purpose of this catalog is to assist our customers in the selection of cargo restraint products suitable for their specific applications. Because we continuously strive to offer new and improved products, part numbers and specifications are subject to change without notice. Please contact your Ancra Representative or our Customer Service Department for any new information.

## WARRANTY

All Ancra International LLC products, unless otherwise indicated are warranted to be free from defect in material or workmanship for a period of six (6) months from date of shipment. During this period, Ancra International LLC will, at its option repair or replace without charge any products or part thereof found to be defective in material or workmanship. This warranty does not extend to any product which has been subject to misuse, abuse, negligence, accident, alteration or repair.

All Ancra International LLC SilverCap OverDrive product, unless otherwise indicated are warranted to be free from defect in material or workmanship for a period of twelve (12) months from date of shipment. During this period, Ancra International LLC will, at its option repair or replace without charge any product or part thereof found to be defective in material or workmanship. This warranty does not extend to any product which has been subject to misuse, abuse, negligence, accident, alteration or repair.

Ancra International LLC LAD II & or RAR systems, unless otherwise indicated are warranted to be free from defect in material or workmanship for a period of twenty (24) months from date of shipment. During this period, Ancra International LLC will, at its option repair or replace without charge any product or part thereof found to be defective in material or workmanship. This warranty does not extend to any product which has been subject to misuse, abuse, negligence, accident, alteration or repair.

Defective products must be returned to Ancra International LLC within the above period, transportation prepaid. Ancra will bear the cost of return transportation. Contact Customer Service for details.

THIS WARRANTY IS IN LIEU OF ALL OTHER WARRANTIES EXPRESSED OR IMPLIED INCLUDING BUT NOT LIMITED TO ANY IMPLIED WARRANTY OF MERCHANTABILITY OR FITNESS FOR ANY PARTICULAR PURPOSE. IN NO EVENT WILL ANCRA INTERNATIONAL LLC BE LIABLE FOR SPECIAL, INDIRECT OR CONSEQUENTIAL DAMAGES OR LOSS OF VEHICLE, CARGO OR PROFITS.

## INDUSTRY STANDARDS

**Ankra has provided the following information as a service to our customers. This information is intended to promote the safe and informed sales and use of our products.**

ALL CARGO RESTRAINTS, INCLUDING SYNTHETIC WEB TIE DOWNS SHALL BE USED IN ACCORDANCE WITH ALL STATE, FEDERAL, PROVINCIAL, LOCAL AND INDUSTRY REGULATIONS, AS APPLICABLE.

U.S. Department of Transportation regulations subchapter B-Motor Carrier Safety Regulations, 49 CFR, Part 393, Paragraph 393.102(b) requires that: "The aggregate working load limit of the tie down assemblies used to secure an article against movement in any direction must be at least 1/2 times the weight of that article."

It is the owner's and user's responsibility to determine suitability of a product for any particular use. All strap assemblies or systems are as strong as their weakest component, including the point of attachment.

### An example using this regulation follows:

- Determine the number of synthetic web tie downs required when using the Working Load Limit (WLL) value marked on the synthetic web tie down assembly.
- Weight of article being secured is 24,000 LB (10,910 KG).
- Working Load Limit of the 3-inch synthetic web tie down is 4,000 LB (1,820 kg) as marked on the label.
- Required Aggregate WLL  
 $1/2 \times 24,000 \text{ LB (Article Weight)} = 12,000 \text{ LB (5,455 KG)}$
- Minimum number of tie downs  
 $12,000 \text{ LB} \div 4,000 \text{ LB (WLL of tie down)} = 3 \text{ tie downs}$

In this example, a minimum of 3 synthetic web tie downs are required to secure the article, based only on the weight of the article.

Some factors to be considered when determining the number and location of synthetic web tie downs, as specified by applicable regulations are:

- Article weight
- Configuration of load to be secured (pipe, coil, equipment, stacking, etc.)
- Number of tiers
- Length of load to be secured
- WLL of synthetic web tie downs
- Stakes, blocking and bracing
- Tension in the synthetic tie down shall never exceed the WLL strength rating of anchorage.
- Any other factors that may affect safe securement of the load during normal and emergency conditions.

### Operating Guidelines

This section provides recommended guidelines for the use, care, and inspection of synthetic web tie downs.

#### Use

- Inspect tie downs before each use, see Out-Of-Service Criteria.
- Synthetic web tie down assemblies shall not be loaded in excess of their Working Load Limit (WLL).

- Synthetic web tie downs shall be attached to provide control of load and positioned in accordance with applicable regulations.
- Synthetic web tie down assemblies shall not be dragged on floor, ground, or over an abrasive surface.
- Synthetic web tie downs shall not be tied in knots, or joined by knotting.
- Synthetic web tie downs shall not be pulled from under loads if the load is resting on the tie down.
- Synthetic web tie downs shall always be protected from being cut by sharp corners, sharp edges, protrusions or abrasive surfaces.
- The opening in fittings shall have the required shape and size to insure that the fitting will sit properly in the vehicle anchorage or other attachments. If the anchorage is inadequate to support the rating of the synthetic web tie down assembly, then the load rating will be limited to the strength of the anchorage.
- Synthetic web tie downs shall not be used for lifting or towing. This includes raising, lowering and suspending.
- Before operating any tie down assembly, the user shall secure his footing to prevent slipping or falling.
- In freezing temperatures caution shall be exercised when operating frozen tie down assemblies.
- A minimum of two (2) wraps of webbing shall be on the winch or ratchet buckle mandrel. Caution: Excessive wraps of webbing on the mandrel will reduce the working load limit of the winch or ratchet buckle.

When tightening or loosening winches, always maintain a firm grip on the winch bar. Never release a winch bar without checking the pawl to ensure that it is fully engaged between ratchet teeth. Releasing a winch bar without the pawl being properly engaged can cause serious injury to the user or bystanders. The use of a slip resistant handle winch bar specifically designed to tighten or loosen winches is recommended. Only winch bars designed to be used with winches shall be used to tension and release the tie down.

"Cheater Bars" ("extenders") shall not be used with winch bars.

The user shall stand clear (to one side) of the winch bar handle during operation, in case the winch bar slips. The tip of the winch bar shall be inserted through both holes in the end cap to prevent the winch bar from "slipping out" and overloading the tip and end cap.

Synthetic web tie downs shall be used, checked and adjusted during the transportation of cargo per applicable federal, state, provincial, local and industry regulations.

#### Care

Environments in which synthetic web tie downs are continuously exposed to ultra-violet sunlight can affect the strength in varying degrees, ranging from slight to total degradation.

- Store in a clean, dry location out of direct sunlight.
- Avoid exposure to acids, alkalis or temperatures in excess of 194°F.

#### Inspection

Inspect equipment before each use. Do not use synthetic web tie downs that have excessive wear, cuts, abrasion or which have any other defect that should cause it to be pulled from service.

## INDUSTRY STANDARDS

**IT IS ULTIMATELY THE DRIVER'S RESPONSIBILITY TO INSURE THAT THE CARGO BEING HAULED IS PROPERLY SECURED.** The U.S. Department of Transportation, Federal Motor Carrier Safety Administration regulation 49CFR Part 392.9(a) states: "A driver may not operate a commercial motor vehicle, and a motor carrier may not require or permit a driver to operate a commercial motor vehicle unless the commercial motor vehicle's cargo is properly distributed and adequately secured as specified in sections 393.100 through 393.142 of this subchapter." In addition, 49CFR Part 392.9(b) states: "Drivers of truck and truck tractors ..... must assure himself/herself that the provisions of paragraph (a) of this section have been complied with before he/she drives that commercial motor vehicle; inspect the cargo and the devices used to secure the cargo within the first 50 miles after beginning a trip and cause any adjustments to be made to the cargo or load securement devices as necessary, including adding more securement devices, to ensure that cargo cannot shift on or within, or fall from the commercial motor vehicle; and reexamine the commercial motor vehicle's cargo and its load securement devices during the course of transportation and make any necessary adjustments to the cargo or load securement devices, including adding more securement devices, to ensure that the cargo cannot shift on or within, or fall from, the commercial motor vehicle."

### CARE AND USE

**INSPECT BEFORE USE** – Do not use synthetic web tie downs if the webbing has excessive wear, is damaged, abraded or cut. Do not use if the hardware is damaged or defective. Do not use if there are knots in the webbing. Do not use if the WLL markings are not visible.

**PROTECT FROM SHARP EDGES** – Always use corner protectors or edge protectors to protect the straps when they are exposed to corners or abrasive or hot surfaces.

**STORAGE** – Store synthetic web tie downs in a clean dry place out of direct sunlight when not in use. Avoid exposure to acids, alkalis or temperatures in excess of 194 degrees F.

**NOT FOR LIFTING OR TOWING** – Do not use synthetic web tie down straps for lifting, lowering, suspending, recovery or towing. Use only properly marked and rated lifting slings for lifting, lowering or suspending applications and properly marked and rated recovery or tow straps for recovery or towing applications.

**MODIFICATION OR MISUSE** – Any modification or misuse of Ancra products will result in voiding of warranty and liability responsibility of Ancra International.

**WINCHES** – Ancra cargo securement winches shall be installed, used and maintained in accordance with the information sheet provided with each winch. Ancra winches are designed to be used with Ancra winch bars inserted fully through the hole in the mandrel cap end. Do not use cheater bars or extenders on the Ancra winch bars.

**WEBBING WRAPS** – When using winch or ratchet straps, a minimum of two (2) and maximum of four (4) wraps of webbing shall be on the winch mandrel. Excessive wraps of webbing on the mandrel may reduce the working load limit (WLL) of the synthetic web tie down and may interfere with proper operation.

**SECURE FOOTING** – Before operating any synthetic web tie down assembly the user shall secure his footing to prevent slipping or falling. In adverse weather conditions, including freezing temperatures, additional caution should be exercised.

**CAUTIONS AND WARNINGS** – For the benefit of the user and the motoring public, each Ancra product is provided with instructions including cautions and warnings associated with its use. Failure to comply may result in personal injury, property damage or death.

### RECOMMENDED OPERATING PRACTICES for SYNTHETIC WEB TIE DOWNS

These guidelines are not intended to replace proper training, experience and learned knowledge regarding proper tie down procedures.

**SELECTION** – Select a synthetic web tie down having suitable characteristics for the type of load, environment and attachment to vehicle anchor point. Fittings shall have the required shape and size to attach properly to the vehicle anchor points.

**WORKING LOAD LIMIT** – Identify the working load limit (WLL) marked on the synthetic web tie down by the manufacturer. If the required markings are illegible or missing, remove from service. Read all warnings and/or instructions provided by the manufacturer.

**ANCHOR POINTS** – Identify the working load limit (WLL) of the vehicle anchor points. If no rating is visible, contact the vehicle manufacturer for tie down instructions. The lesser-rated WLL, whether the anchor point or the synthetic web tie down, shall determine the WLL of the securement system.

**NUMBER OF TIE DOWNS** – Determine the proper number of synthetic web tie downs required based on the weight of the cargo, the type of commodity, the aggregate working load limit of the securement system and the length/weight ratio of the cargo being secured. Additionally, end users and enforcement personnel are required to know commodity-specific rules governing proper tie down determination as published by the Federal Motor Carrier Safety Administration Standard for Protection Against Shifting and Falling Cargo; Final Rule effective December 26, 2002.



## OUT-OF-SERVICE CRITERIA (REPLACEMENT)

Synthetic web tie downs shall be removed from service if any of the following are visible:



*Excessive abrasive wear*



*Melting or charring of the tie down, or weld splatter on the tie down*

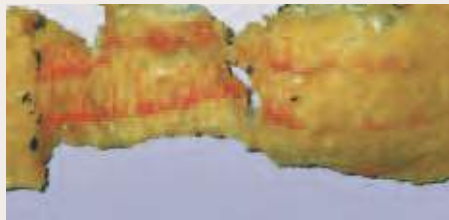

*Chemical burns*



*Holes, tears, cuts, snags*

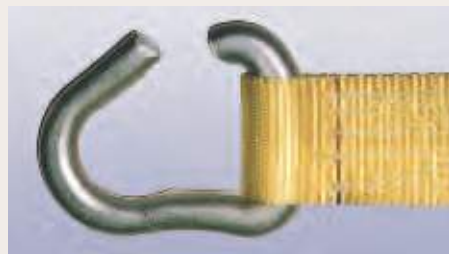

*Tear in webbing or fitting*

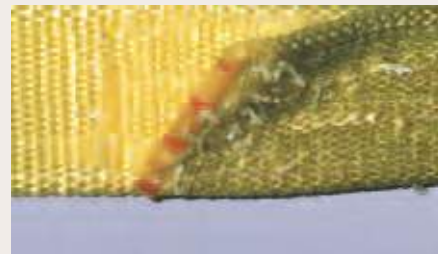

*Broken or worn stitching in load bearing sew patterns*

## GLOSSARY

<b>Abrasion</b>	The mechanical wearing of a surface from contact with other object.
<b>Aggregate Working Load Limit</b>	The summation of the Working Load Limit (WLL) of all tie downs used to secure an article of cargo.
<b>Anchor Point</b>	The location to which a tie down is attached to a vehicle or article of cargo. If the anchor point is inadequate to support the force of the tie down system, then the load rating of the tie down will be limited to the strength of the anchor point.
<b>Breaking Strength</b>	The tensile load in pounds or kilograms at which any part of the securement assembly fails.
<b>Cargo</b>	All articles or material carried by a vehicle, including those used in operation of the vehicle.
<b>Design Factor</b>	The ratio of the breaking strength to the Working Load Limit (WLL).
<b>Direct Tie Down</b>	A tie down that is attached directly to the cargo.
<b>Elongation</b>	The measurement of stretch at a specifically applied load, expressed as a percentage of the original length.
<b>Fabrication Efficiency</b>	The synthetic web tie down assembly break strength, as a percentage of the webbing strength prior to fabrication.
<b>Indirect Tie Down</b>	A tie down which passes over the cargo and is secured to the vehicle at both ends. Tension in the tie down increases the pressure of an article or stack of articles on the deck of the vehicle.
<b>Keeper</b>	A device used on a hook to prevent the hook from inadvertently releasing.
<b>Length</b>	The distance between extreme end bearing points of the synthetic web tie down assembly, including the fittings.
<b>Lever Load Binder</b>	A chain binder incorporating an overcenter locking action.
<b>Proof Load Test</b>	A non-destructive load test to some multiple of the working load limit.
<b>Selvage</b>	The woven or knitted edge of synthetic webbing.
<b>Sew/Stitch Pattern</b>	The pattern of the stitches used to sew the webbing together.
<b>Shoring Bar</b>	A structural bar placed transversely between the walls of a vehicle to prevent cargo from tipping or shifting.
<b>Ultimate Test</b>	A load test of a securement assembly tested to failure.
<b>Warp</b>	A longitudinal load bearing yarn in webbing.
<b>Winch</b>	A device for tensioning a webbing or wire rope tie down that is fitted with means to lock the initial tension.
<b>Working Load Limit (WLL)</b>	The maximum load a component or assembly should be subjected to during routine use.

## INNOVATIVE TEAMWORK SOLUTIONS

- ▶ **When we start a project with you, we develop shared objectives based on your specific goals.** We view your requirements from all angles. With over decades of industry experience, we don't automatically reach for the easy answers. The innovative solutions we've developed are a result of looking at each new project from a fresh perspective.
- ▶ We envision the global picture, and we sweat the details. Each part is tested and tested again against the highest standards of quality, reliability and durability.
- ▶ Through every step of the process, we work as a team with you. We continue to provide technical support after our products have been installed.

### TRADE ASSOCIATIONS

	Web Sling & Tie Down Association (WSTDA)		Associated Wire Rope Fabricators (AWRF)
	British Columbia Trucking Association (BCTA)		Commercial Vehicle Safety Alliance (CVSA)
	Technology & Maintenance Council (TMC)		Association of American Railroads (AAR)
	Truck Trailer Manufacturers Association (TTMA)		National Trailer Dealers Association (NTDA)
	Canadian Transportation Equipment Association (CTEA/AETC)		National Association of Trailer Manufacturers (NATM)
	Commercial Vehicle Safety Network (CVSN)		Heavy Duty Distributor Council (HDDC)
	Air Forwarders Association (AFA)		American Moving & Storage Association (AMSA)
			National Private Truck Council (NPTC)

### STATE TRUCKING ASSOCIATIONS

- ▶ Arkansas Trucking Association
- ▶ Alabama Trucking Association
- ▶ Indiana Motor Truck Association
- ▶ Minnesota Trucking Association
- ▶ New Jersey Motor Truck Association
- ▶ Ohio Trucking Association
- ▶ Pennsylvania Motor Truck Association
- ▶ Texas Motor Transportation Association
- ▶ Tennessee Trucking Association
- ▶ Washington Trucking Association
- ▶ Wisconsin Motor Carrier Association

### LITERATURE AVAILABLE BY REQUEST



#### Angra International Aircraft Interiors & Cargo Fittings

This catalog provides a full selection of the very best aircraft fittings and components, all made in the U.S.A. by Angra for over 25 years.

**Request Catalog 402**



#### Angra International Cargo Restraint Catalog

Angra showcases the most popular solutions for flatbed and interior van cargo restraints. A mini catalog of winches, straps, tie-offs, beams and bars.

**Request Brochure 221**

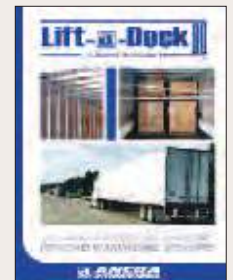

#### Angra International Lift-A-Deck II

Angra's proprietary Lift-A-Deck decking systems enables optimum utilization of cargo space in vans and trailers.

**Request Brochure B-254**



# GENERAL INFORMATION

## INDEX BY PRODUCT NUMBER

10135	Overcenter Buckle - 2" - 3,00 lb. WLL.....	76	20-EE1-9802X14	2" x 14' Eye/Eye 1 Ply Sling .....	67
10632-90	2" x 18" Fixed End Strap w/ 44587-10 Buckle & 40891-18 Flat Hook .....	37	20-EE2-9801X4	1" x 4' Eye/Eye 2 Ply Sling .....	68
10632-90-28	2" x 28' Adjustable End Strap w/ 40891-18 Flat Hook .....	37	20-EE2-9801X8	1" x 8' Eye/Eye 2 Ply Sling .....	68
10632-93	2" x 33" Fixed End Strap w/ 44587-10 Buckle & 43366-21 Chain Anchor.....	37	20-EE2-9802X3	2" x 3' Eye/Eye 2 Ply Sling .....	68
10632-93-28	2" x 28' Adjustable End Strap w/ 43366-21 Chain Anchor.....	37	20-EE2-9802X4	2" x 4' Eye/Eye 2 Ply Sling .....	68
10632-95	2" x 18" Fixed End Strap w/ 44587-10 Buckle & 43120-13 Wire Hook .....	37	20-EE2-9802X6	2" x 6' Eye/Eye 2 Ply Sling .....	68
10632-95-28	2" x 28' Adjustable End Strap w/ 43120-13 Wire Hook .....	37	20-EE2-9802X8	2" x 8' Eye/Eye 2 Ply Sling .....	68
10633-90	3" x 18" Fixed End Strap w/ 48965-10 Buckle & 41766-18 Flat Hook .....	37	20-EE2-9802X10	2" x 10' Eye/Eye 2 Ply Sling .....	68
10633-90-28	3" x 28' Adjustable End Strap w/ 41766-18 Flat Hook .....	37	20-EE2-9802X12	2" x 12' Eye/Eye 2 Ply Sling .....	68
10633-92	3" x 33" Fixed End Strap w/ 48965-10 Buckle & 43366-14 Chain Anchor.....	37	20-EE2-9802X16	2" x 16' Eye/Eye 2 Ply Sling .....	68
10633-92-28	3" x 28' Adjustable End Strap w/ 43366-14 Chain Anchor.....	37	20-EE2-9802X20	2" x 20' Eye/Eye 2 Ply Sling .....	68
10634-90	4" x 18" Fixed End Strap w/ 49349-10 Buckle & 41766-18 Flat Hook .....	37	20-EE2-9802X30	2" x 30' Eye/Eye 2 Ply Sling .....	68
10634-90-28	4" x 28' Adjustable End Strap w/ 41766-18 Flat Hook .....	37	20-EE2-9803X10	3" x 10' Eye/Eye 2 Ply Sling .....	68
10634-91	4" x 33" Fixed End Strap w/ 49349-10 Buckle & 43366-14 Chain Anchor.....	37	20-EE2-9803X12	3" x 12' Eye/Eye 2 Ply Sling .....	68
10634-91-28	4" x 28' Adjustable End Strap w/ 43366-14 Chain Anchor.....	37	20-EE2-9803X16	3" x 16' Eye/Eye 2 Ply Sling .....	68
10634-93	4" x 20" Fixed End Strap w/ 49349-10 Buckle & 43120-20 Wire Hook .....	37	20-EE2-9803X20	3" x 20' Eye/Eye 2 Ply Sling .....	68
10634-93-28	4" x 28' Adjustable End Strap w/ 43120-20 Wire Hook .....	37	20-EE2-9804X6	4" x 6' Eye/Eye 2 Ply Sling .....	68
10751-10	Garment Rope 1/4" x 8'.....	51	20-EE2-9804X8	4" x 8' Eye/Eye 2 Ply Sling .....	68
10765-11	100" Wide x 90.5" Tall Cargo Net.....	59	20-EE2-9804X10	4" x 10' Eye/Eye 2 Ply Sling .....	68
10788-10	Door Pull Strap.....	54	20-EE2-9804X12	4" x 12' Eye/Eye 2 Ply Sling .....	68
10924-10	Trailer Door Limit Strap.....	55	20-EE2-9804X16	4" x 16' Eye/Eye 2 Ply Sling .....	68
10902-11	Driver Assist Strap.....	55	20-EE2-9804X20	4" x 20' Eye/Eye 2 Ply Sling .....	68
20-EE1-9801X3	1" x 3' Eye/Eye 1 Ply Sling .....	67	20-ENR1X3	1" x 3' Purple Endless Round Sling.....	66
20-EE1-9801X4	1" x 4' Eye/Eye 1 Ply Sling .....	67	20-ENR1X4	1" x 4' Purple Endless Round Sling .....	66
20-EE1-9801X6	1" x 6' Eye/Eye 1 Ply Sling .....	67	20-ENR1X6	1" x 6' Purple Endless Round Sling.....	66
20-EE1-9801X10	1" x 10' Eye/Eye 1 Ply Sling .....	67	20-ENR1X8	1" x 8' Purple Endless Round Sling.....	66
20-EE1-9802X3	2" x 3' Eye/Eye 1 Ply Sling .....	67	20-ENR1X12	1" x 12' Purple Endless Round Sling.....	66
20-EE1-9802X4	2" x 4' Eye/Eye 1 Ply Sling .....	67	20-ENR2X3	2" x 3' Green Endless Round Sling.....	66
20-EE1-9802X6	2" x 6' Eye/Eye 1 Ply Sling .....	67	20-ENR2X4	2" x 4' Green Endless Round Sling.....	66
20-EE1-9802X10	2" x 10' Eye/Eye 1 Ply Sling .....	67	20-ENR2X8	2" x 8' Green Endless Round Sling.....	66
20-EE1-9802X12	2" x 12' Eye/Eye 1 Ply Sling .....	67	20-ENR2X12	2" x 12' Green Endless Round Sling.....	66
			20-ENR2X20	2" x 20' Green Endless Round Sling.....	66
			20-ENR3X3	3" x 3' Yellow Endless Round Sling .....	66
			20-ENR3X4	3" x 4' Yellow Endless Round Sling .....	66
			20-ENR3X8	3" x 8' Yellow Endless Round Sling .....	66
			20-ENR3X12	3" x 12' Yellow Endless Round Sling .....	66
			20-ENR3X20	3" x 20' Yellow Endless Round Sling .....	66
			20-ENR4X10	4" x 10' Tan Endless Round Sling.....	66
			20-ENR4X16	4" x 16' Tan Endless Round Sling.....	66
			20-ENR5X4	5" x 5' Red Endless Round Sling .....	66
			20-ENR5X6	5" x 6' Red Endless Round Sling .....	66
			20-ENR5X12	5" x 12' Red Endless Round Sling .....	66
			20-ENR5X20	5" x 20' Red Endless Round Sling .....	66
			20-ENR7X6	7" x 7' Blue Endless Round Sling .....	66
			30AS33-BK	2" x 33" Black Axle Strap w/ Sleeve.....	63
			30ATB	Adjustable Tire Bonnet.....	64
			30RT	Double Adjustable Tire Bonnet.....	64

## INDEX BY PRODUCT NUMBER

40023-12	Wire Hook, Wide - 2" - 833 lb. WLL . . . . .	78	40758-11	Snap Hook, Twisted - 2" - 3,333 lb. WLL . . . . .	80
40024-10	Wire Hook, Narrow - 1" - 1,000 lb. WLL . . . . .	78	40758-13	Snap Hook - 2" - 3,333 lb. WLL . . . . .	80
40024-12	Wire Hook, Narrow - 2" - 833 lb. WLL . . . . .	78	40838-10	Series E Vertical Track (Gray) 10' . . . . .	48
40025-10	D-Ring - 1" - 1,666 lb. WLL . . . . .	80	40838-11	Series E Vertical Track (Galvanized) 10' . . . . .	48
40025-12	D-Ring - 2" - 1,666 lb. WLL . . . . .	80	40849-12	Series F Track (Galvanized) 10', 1" Holes Canada . . . . .	49
40044-10	Flat Hook w/ Keeper - 1" - 1,166 lb. WLL . . . . .	79	40849-14	Series F Track (Galvanized) 10', 1.62" Hole Spacing . . . . .	49
40065-10	Flat Hook - 1" - 333 lb. WLL . . . . .	79	40880-15	Cam Buckle - 2" - 833 lb. WLL Replaces 40880-19 . . . . .	77
40065-12	Flat Hook, Vinyl - 1" - 333 lb. WLL . . . . .	79	40880-22	Cam Buckle - 1" - 600 lb. WLL . . . . .	77
40084-14	Snap Hook - 2" - 2,766 lb. WLL . . . . .	80	40891-18	Flat Hook - 2" - 3,333 lb. WLL . . . . .	79
40316-12	Wire Hook, Narrow - 1" - 166 lb. WLL . . . . .	78	40921-10	Beam Socket . . . . .	51
40340-27	Single Stud Track Fitting - 1,333 lbs. Vertical WLL . . . . .	88	40921-11	Beam Socket Heavy-Duty . . . . .	51
40386-10	Rope Tie Off - Series E (3 piece End Fitting) 1,000 lb. WLL . . . . .	54	40978-11	Delta Ring - 2" - 3,333 lb. WLL . . . . .	80
40386-11	Rope Tie Off - Series E (Spring Actuated Fitting) 1,333 lb. WLL . . . . .	54	40980-11	Track Fitting Series F - 500 lb. WLL . . . . .	82
40386-12	Rope Tie Off - Series F - 500 lb. WLL . . . . .	54	40980-13	Track Fitting Series F - 500 lb. WLL (Canada) . . . . .	82
40386-13	Rope Tie Off - Series F - 500 lb. WLL (Canada) . . . . .	54	40985-05-12	Web Protector - Cordura Sleeve - 12" Long . . . . .	16
40467-33-144	Heavy-Duty Aircraft Track 12' . . . . .	88	40985-05-RL	Web Protector - Cordura Sleeve - 100 Yd. Roll . . . . .	16
40602-10	Series E Strap Assy - 3-pc. End - 12' . . . . .	56	41030-12	Cam Buckle - 1" - 166 lb. WLL Replaces 41030-10 . . . . .	77
40602-11	Series E Strap Assy - 3-pc. End - 16' . . . . .	56	41048-10	Ankra Red Motorcycle Strap - 1" x 5.5' . . . . .	70
40602-12	Series E Strap Assy - 3-pc. End - 20' . . . . .	56	41048-23	Ankra Red Motorcycle Strap - 1" x 13' . . . . .	70
40602-17	Series E Strap Assy - 1-pc. End - 12' . . . . .	56	41313-12	S Hook, Plated - 1" - 400 lb. WLL . . . . .	78
40602-18	Series E Strap Assy - 1-pc. End - 16' . . . . .	56	41313-13	S Hook, Vinyl - 1" - 400 lb. WLL . . . . .	78
40602-19	Series E Strap Assy - 1-pc. End - 20' . . . . .	56	41313-19	S Hook, Vinyl - 1" - 600 lbs. WLL . . . . .	78
40602-20	Series F Strap Assembly - Cam Buckle - 12' . . . . .	56	41325-10	Slat Hook - 1,000 lb. WLL . . . . .	82
40602-21	Series F Strap Assembly - Cam Buckle - 16' . . . . .	56	41409-13	Series E End Fitting (3 Piece) 1,000 lb. WLL . . . . .	82
40602-22	Series F Strap Assembly - Cam Buckle - 20' . . . . .	56	41516-11	Corner Protector - 2" - Aluminum . . . . .	16
40602-97	Plate Trailer Strap Assembly w/ Wire Hooks - Cam Buckle - 12' . . . . .	57	41572-10	Replacement Hooks for Tarp Ties - 100-pc. Bag . . . . .	17
40602-98	Plate Trailer Strap Assembly w/ Wire Hooks - Cam Buckle - 16' . . . . .	57	41631-12	Delta Ring - 4" - 6,666 lb. WLL . . . . .	80
40602-99	Plate Trailer Strap Assembly w/ Wire Hooks - Cam Buckle - 20' . . . . .	57	41632-17-BULK-CUT	3" Yellow Polyester Latex Treated Webbing . . . . .	87
40602-100	LAD II Logistics Strap w/ Single Stud Fitting - Cam Buckle - 12' . . . . .	45	41632-19-BULK-CUT	2" Red Polyester Latex Treated Webbing . . . . .	87
40602-101	LAD II Logistics Strap w/ Single Stud Fitting - Cam Buckle - 16' . . . . .	45	41632-24-BULK-CUT	3" Blue Polyester Latex Treated Webbing . . . . .	87
40602-102	LAD II Logistics Strap w/ Single Stud Fitting - Cam Buckle - 20' . . . . .	45	41632-26-BULK-CUT	2" Blue Polyester Lated Treated Webbing . . . . .	87
40602-103	Series F Strap Assembly - Cam Buckle - 12' - Canada . . . . .	56	41632-31-BULK-CUT	2" Yellow Polyester Latex Treated Webbing . . . . .	87
40602-104	Series F Strap Assembly - Cam Buckle - 16' - Canada . . . . .	56	41645-10	Roller Buckle - 2" - 500 lbs. WLL . . . . .	77
40602-105	Series F Strap Assembly - Cam Buckle - 20' - Canada . . . . .	56	41659-10-27	2" x 27' Winch Strap w/ 40891-18 Flat Hook . . . . .	29
			41659-10-30	2" x 30' Winch Strap w/ 40891-18 Flat Hook . . . . .	29
			41659-11-27	2" x 27' Winch Strap w/ 40978-11 Delta Ring . . . . .	29
			41659-11-30	2" x 30' Winch Strap w/ 40978-11 Delta Ring . . . . .	29
			41659-13-27	2" x 27' Winch Strap w/ 43120-13 Wire Hook . . . . .	29
			41659-13-30	2" x 30' Winch Strap w/ 43120-13 Wire Hook . . . . .	29
			41659-15-27	2" x 27' Winch Strap w/ 43366-21 Chain Anchor . . . . .	29
			41659-15-30	2" x 30' Winch Strap w/ 43366-21 Chain Anchor . . . . .	29

# GENERAL INFORMATION

## INDEX BY PRODUCT NUMBER

41659-16-30	2" x 30' Winch Strap w/o Hardware . . . . .	29	42357-12	Winch Track - 12' Steel. . . . .	10
41659-90-27	2" x 27' ANCRA X-TREME Winch Strap w/ 40891-18 Flat Hook . . . . .	26	42357-21	Winch Track - 6' Aluminum . . . . .	10
41659-90-30	2" x 30' ANCRA X-TREME Winch Strap w/ 40891-18 Flat Hook . . . . .	26	42816-18	Overcenter Buckle - 1" - 600 lb. WLL . . . . .	76
41659-92-30	2" x 30' ANCRA X-TREME Winch Strap w/ 43120-13 Wire Hook . . . . .	26	42948-10	Series A Horizontal Track (Gray) 10' . . . . .	49
41659-93-30	2" x 30' ANCRA X-TREME Winch Strap w/ 43366-21 Chain Anchor . . . . .	26	43044-10	Snap Hook - 1" - 1,666 lb. WLL . . . . .	80
41659-94-30	2" x 30' ANCRA X-TREME Winch Strap w/o Hardware . . . . .	26	43099-10	Flat Hook - 2" - 1,666 lb. WLL . . . . .	79
41660-10-27	3" x 27' Winch Strap w/ 41766-18 Flat Hook . . . . .	30	43120-11	Wire Hook, Narrow - 2" - 1,666 lb. WLL . . . . .	78
41660-10-30	3" x 30' Winch Strap w/ 41766-18 Flat Hook . . . . .	30	43120-13	Wire Hook, Narrow - 2" - 3,333 lb. WLL . . . . .	78
41660-14-27	3" x 27' Winch Strap w/ 43366-14 Chain Anchor . . . . .	30	43120-19	Wire Hook, Narrow - 1.75" - 500 lb. WLL . . . . .	78
41660-14-30	3" x 30' Winch Strap w/ 43366-14 Chain Anchor . . . . .	30	43120-20	Wire Hook, Narrow - 3" - 7,333 lb. WLL . . . . .	78
41660-17-30	3" x 30' Winch Strap w/o Hardware . . . . .	30	43320-32	Ratchet Buckle - 1" - 1,466 lb. WLL . . . . .	74
41660-18-27	3" x 27' Winch Strap w/ 43120-20 Wire Hook . . . . .	30	43365-12	Grab Hook Assembly, Unplated - 5,400 lb. WLL . . . . .	84
41660-18-30	3" x 30' Winch Strap w/ 43120-20 Wire Hook . . . . .	30	43366-14	Chain Anchor w/ Delta Ring - 5,400 lb. WLL . . . . .	83
41660-90-30	3" x 30' ANCRA X-TREME Winch Strap w/ 41766-18 Flat Hook . . . . .	27	43366-21	5/16" Chain Anchor w/ Delta Ring - 3,333 lbs. WLL . . . . .	83
41660-93-30	3" x 30' ANCRA X-TREME Winch Strap w/ 43366-14 Chain Anchors . . . . .	27	43488-20	Combo Winch - Side Mount - Low Profile . . . . .	6
41660-95-30	3" x 30' ANCRA X-TREME Winch Strap w/o Hardware . . . . .	27	43546-10	Gutter Hook - 1" - 250 lb. WLL . . . . .	79
41681-10	Combo Winch - Bottom Mount - Std. . . . .	6	43563-10	Web Winch - Bottom Mount - Std. . . . .	2
41691-10	Web Winch - Frameless . . . . .	3	43563-10-RW	Web Winch - Bottom Mount - Std. Weld-on . . . . .	2
41696-10	Cable Winch - End Mount - RH . . . . .	6	43564-12	Web Winch - Bottom Mount - Std. Storable Portable w/ 2SS. . . . .	2
41696-11	Cable Winch - End Mount - LH . . . . .	6	43564-147	Web Winch - Bottom Mount - Std. Portable w/ 2SS w/ 7mm Frame . . . . .	2
41766-18	Flat Hook - 3" - 5,400 LB. WLL . . . . .	79	43564-147-RW	Web Winch - Bottom Mount - Std. Portable Ratcheting . . . . .	2
41766-19	Flat Hook - 3" - 5,400 lb. WLL w/ Keeper . . . . .	79	43564-16	Web Winch - Side Mount - Low Profile Portable w/ 2SS. . . . .	2
41808-14	Ratchet Buckle - 1 3/4" - 2,000 lb. WLL . . . . .	74	43565-127	Web Winch - Bottom Mount - Storable C Track Slider w/ 7mm Frame . . . . .	3
41820-10-RL	1" Red Nylon Webbing . . . . .	87	43565-127-RW	Web Winch - Bottom Mount - Storable Web C Track Slider . . . . .	3
41820-14-RL	1" Blue Nylon Webbing . . . . .	87	43565-127-XZ	Web Winch - Bottom Mount - Deep Storable C Track Slider - X-Treme Zinc Finish . . . . .	3
41820-15-RL	1" Black Nylon Webbing . . . . .	87	43565-137	Web Winch - Bottom Mount - C Track Slider - Double Cap w/ 7mm Frame . . . . .	3
42012-12 HD	Series F Hook - 800 lb. WLL . . . . .	82	43565-147	Web Winch - Bottom Mount - Storable C Track Slider w/ 7mm Frame . . . . .	3
42098-11	Corner Protector - 3" - Rubber . . . . .	16	43565-157	Web Winch - Bottom Mount - Std. C Track Slider w/ 7mm Frame . . . . .	3
42098-12	Corner Protector - 4" - Rubber . . . . .	16	43565-157-RW	Web Winch - Bottom Mount - Std. C Track Slider Ratcheting . . . . .	3
42195-11	Cam Buckle - 1" - 500 lb. WLL Replaces 42195-10. . . . .	77	43565-157-XZ	Web Winch - Bottom Mount - Std. C Track Slider - X-Treme Zinc Finish . . . . .	3
42313-10	Winch Bar - Std. Painted . . . . .	12	43573-10	Web Winch - Bottom Mount - Std. Storable . . . . .	2
42313-12	Winch Bar - Combination Box End Painted Silver & Yellow . . . . .	12	43573-11	Web Winch - Bottom Mount - Std. Storable 2" Spool . . . . .	2
42313-17	Winch Bar - Std. Chrome . . . . .	12			
42313-19	Winch Bar - Combination Chrome . . . . .	12			
42357-11	Winch Track - 6' Steel. . . . .	10			



## INDEX BY PRODUCT NUMBER

43573-13	Web Winch - Bottom Mount - Std. Storable 4" Spool . . . . .	2	43795-91-30	4" x 30' ANCRA X-TREME Winch Strap w/ 41631-12 Delta Ring . . . . .	28
43579-20	Web Winch - Side Mount - Low Profile . . . . .	3	43795-91-40	4" x 40' ANCRA X-TREME Winch Strap w/ 41631-12 Delta Ring . . . . .	28
43627-13	Replacement Channel Assembly (Al. Beam) . . . . .	51	43795-92-30	4" x 30' ANCRA X-TREME Winch Strap w/o Hardware . . . . .	28
43638-50	Decking/Shoring Beam Series E - 85.7" - 96.6" Long . . . . .	50	43795-93-30	4" x 30' ANCRA X-TREME Winch Strap w/ Half Twist . . . . .	28
43638-51	Decking/Shoring Beam Series E - 91.9" - 102.9" Long . . . . .	50	43795-95-30	4" x 30' ANCRA X-TREME Winch Strap w/ 43366-14 Chain Anchor . . . . .	28
43781-14S	Long Foot Assembly (2 x 4) . . . . .	52	43797-18-BULK-CUT	4" Gray Polyester Latex Treated Webbing . . . . .	87
43781-15S	Short Foot Assembly (2 x 4) . . . . .	52	43797-19-BULK-CUT	4" Blue Polyester Latex Treated Webbing . . . . .	87
43781-16	Long Foot Assembly (4 x 4) . . . . .	52	43797-23-BULK-CUT	4" Red Polyester Latex Treated Webbing . . . . .	87
43781-17	Short Foot Assembly (4 x 4) . . . . .	52	43797-34-BULK-CUT	4" Green Polyester Latex Treated Webbing . . . . .	87
43782-15	Cargo Sta - Standard - 89.75" to 104.5" Long . . . . .	52	43797-36-RL	4" Yellow Polyester Latex Treated Webbing . . . . .	87
43795-10-27	4" x 27' Winch Strap w/ 41766-18 Flat Hook . . . . .	30	43887-10	Mini Ratchet Strap - 1" x 16'- Display Packaged . . . . .	70
43795-10-30	4" x 30' Winch Strap w/ 41766-18 Flat Hook . . . . .	30	43887-11	Mini Ratchet Strap - 1" x 20'- Display Packaged . . . . .	70
43795-10-35	4" x 35' Winch Strap w/ 41766-18 Flat Hook . . . . .	30	43887-15	Mini Ratchet Strap - 1" x 9'- Display Packaged . . . . .	70
43795-10-40	4" x 40' Winch Strap w/ 41766-18 Flat Hook . . . . .	30	43908-10	Combo Winch - Recessed Box . . . . .	6
43795-10-50	4" x 50' Winch Strap w/ 41766-18 Flat Hook . . . . .	30	43986-10	Corner Protector - 4" - Black Plastic . . . . .	16
43795-11-27	4" x 27' Winch Strap w/ 41631-12 Delta Ring . . . . .	30	43991-10	Hoop Set - Cargo Sta . . . . .	52
43795-11-30	4" x 30' Winch Strap w/ 41631-12 Delta Ring . . . . .	30	43997-10	Combo Winch - Leg Mount - Low Profile . . . . .	6
43795-11-35	4" x 35' Winch Strap w/ 41631-12 Delta Ring . . . . .	30	44102-11	H-2 Hook . . . . .	13
43795-11-40	4" x 40' Winch Strap w/ 41631-12 Delta Ring . . . . .	30	44122-10	Corner Iron Hook . . . . .	13
43795-11-50	4" x 50' Winch Strap w/ 41631-12 Delta Ring . . . . .	30	44232-10	Ratchet Buckle - 1" - 400 lb. WLL . . . . .	74
43795-13-30	4" x 30' Winch Strap w/ Half Twisted Loop . . . . .	30	44258-13	Ratchet Buckle - 2" - 1,500 lb. WLL - Low Profile . . . . .	75
43795-13-45	4" x 45' Winch Strap w/ Half Twisted Loop . . . . .	30	44340-11	Strap Assy - 1" - Ratchet Buckle - 10' w/ Wire Hooks . . . . .	70
43795-13-50	4" x 50' Winch Strap w/ Half Twisted Loop . . . . .	30	44557-10	Ancra Lash R/B Strap - 1" x 15'- Bulk - 400 lb. WLL . . . . .	70
43795-13-65	4" x 65' Winch Strap w/ Half Twisted Loop . . . . .	30	44587-10	Ratchet Buckle - 2" - 3,666 lb. WLL - Long Wide Handle . . . . .	75
43795-13-75	4" x 75' Winch Strap w/ Half Twisted Loop . . . . .	30	44627-11	Ratchet Buckle - 2" - 3,333 lb. WLL - Standard Handle . . . . .	75
43795-14-27	4" x 27' Winch Strap w/ 43365-12 Grab Hook . . . . .	30	44639-12	Overcenter Buckle - 1 3/4" - 1,666 lb. WLL . . . . .	76
43795-14-30	4" x 30' Winch Strap w/ 43365-12 Grab Hook . . . . .	30	45143-20	Basket Strap for Tires 7"W x 20"H . . . . .	63
43795-15-27	4" x 27' Winch Strap w/ 43366-14 Chain Anchor . . . . .	31	45143-22	Basket Strap for Tires 8"W x 24"H . . . . .	63
43795-15-30	4" x 30' Winch Strap w/ 43366-14 Chain Anchor . . . . .	31	45228-10	Rave Hook - 1,167 lb. WLL . . . . .	78
43795-19-30	4" x 30' Winch Strap w/o Hardware . . . . .	31	45515-10	Cluster Hook (RTJ) . . . . .	84
43795-40-30	4" x 30' Winch Strap w/ 41766-18 Flat Hook - Blue Webbing . . . . .	31	45545-15	Pan Fitting w/ Black Trim Collar . . . . .	54
43795-60-30	4" x 30' Winch Strap w/ 41766-18 Flat Hook - Red Webbing . . . . .	31	45801-10	Web Winder . . . . .	13
43795-90-27	4" x 27' ANCRA X-TREME Winch Strap w/ 41766-18 Flat Hook . . . . .	28	45849-15	Recessed Pan Fitting 1,666 lb. WLL . . . . .	54
43795-90-30	4" x 30' ANCRA X-TREME Winch Strap w/ 41766-18 Flat Hook . . . . .	28	45867-12	Garment Beam - 96" . . . . .	51
43795-90-40	4" x 40' ANCRA X-TREME Winch Strap w/ 41766-18 Flat Hook . . . . .	28	45867-13	Garment Beam - 102" . . . . .	51
43795-90-40	4" x 40' ANCRA X-TREME Winch Strap w/ 41766-18 Flat Hook . . . . .	28	45880-10	G70 Chain - 5/16" Bulk 4,700 lbs. WLL 400' Barrel . . . . .	19
43795-91-27	4" x 27' ANCRA X-TREME Winch Strap w/ 41631-12 Delta Ring . . . . .	28	45880-11	G70 Chain - 3/8" Bulk 6,600 lbs. WLL 200' Barrel . . . . .	19

# GENERAL INFORMATION

## INDEX BY PRODUCT NUMBER

45880-12	G70 Chain - 1/4" Bulk 3,150 lbs. WLL 400' Barrel . . . . .	19	45943-21	Chain Load Binder - 3/8" Ratchet 9,200 lbs. WLL . . . . .	25
45880-13	G70 Chain - 1/2" Bulk 11,300 lbs. WLL 100' Barrel . . . . .	19	45943-23	Chain Load Binder - 1/2" Ratchet 13,00 lbs. WLL . . . . .	25
45881-10-16	G70 Chain Assy - 5/16" x 16' w/ Clevis Hooks 4,700 lbs. WLL . . . . .	19	45946-10	5/16" Clevis Hook 4,700 lbs. WLL . . . . .	21, 84
45881-10-16-SP	G70 Chain Assy - 5/16" x 16' w/ Clevis Hooks 4,700 lbs. WLL - In Pail . . . . .	20	45946-11	3/8" Clevis Hook 6,600 lbs. WLL . . . . .	21, 84
45881-10-20	G70 Chain Assy - 5/16" x 20' w/ Clevis Hooks 4,700 lbs. WLL . . . . .	19	45946-12	1/4" Clevis Hook 3,150 lbs. WLL . . . . .	21, 84
45881-10-20-SP	G70 Chain Assy - 5/16" x 20' w/ Clevis Hooks 4,700 lbs. WLL - In Pail . . . . .	20	45946-13	1/2 in. Clevis Hook 11,300 lbs. WLL . . . . .	21, 84
45881-10-25	G70 Chain Assy - 5/16" x 25' w/ Clevis Hooks 4,700 lbs. WLL . . . . .	19	45951-12	Flat Latch Repair Kit . . . . .	51
45881-10-25-SP	G70 Chain Assy - 5/16" x 25' w/ Clevis Hooks 4,700 lbs. WLL - In Pail . . . . .	20	45982-10	2" x 27' Ratchet Strap w/ 40891-18 Flat Hooks . . . . .	34
45881-11-16	G70 Chain Assy - 3/8" x 16' w/ Clevis Hooks 6,600 lbs. WLL . . . . .	19	45982-10-27-WK	2" x 27' Ratchet Strap w/ 40891-18 Flat Hooks, w/ Web Keeper Buckle . . . . .	36
45881-11-16-SP	G70 Chain Assy - 3/8" x 16' w/ Clevis Hooks 6,600 lbs. WLL - In Pail . . . . .	20	45982-11	2" x 30' Ratchet Strap w/ 40891-18 Flat Hooks . . . . .	34
45881-11-20	G70 Chain Assy - 3/8" x 20' w/ Clevis Hooks 6,600 lbs. WLL . . . . .	19	45982-11-30-WK	2" x 30' Ratchet Strap w/ 40891-18 Flat Hooks, w/ Web Keeper Buckle . . . . .	36
45881-11-20-SP	G70 Chain Assy - 3/8" x 20' w/ Clevis Hooks 6,600 lbs. WLL - In Pail . . . . .	20	45982-15	2" x 27' Ratchet Strap w/ 43366-21 Chain Anchors . . . . .	34
45881-11-25	G70 Chain Assy - 3/8" x 25' w/ Clevis Hooks 6,600 lbs. WLL . . . . .	19	45982-19	2" x 27' Ratchet Strap w/ 40758-11 Snap Hooks . . . . .	34
45881-11-25-SP	G70 Chain Assy - 3/8" x 25' w/ Clevis Hooks 6,600 lbs. WLL - In Pail . . . . .	20	45982-34	2" x 30' Ratchet Strap w/ 43366-21 Chain Anchors . . . . .	34
45881-13-20	G70 Chain Assy - 1/2" . x 20' w/ Clevis Hooks 11,300 lbs. WLL . . . . .	19	45982-36	2" x 30' Ratchet Strap w/ 40758-11 Snap Hooks . . . . .	34
45881-13-25	G70 Chain Assy - 1/2" . x 25' w/ Clevis Hooks 11,300 lbs. WLL . . . . .	19	45982-42	2" x 27' Ratchet Strap w/ 43120-13 Wire Hooks . . . . .	34
45943-10	Chain Load Binder - 5/16" Lever 5,400 lbs. WLL . . . . .	24	45982-42-27-WK	2" x 27' Ratchet Strap w/ 43120-13 Wire Hooks, w/ Web Keeper Buckle . . . . .	36
45943-10-HD	Chain Load Binder, Heavy-Duty - 5/16" Lever 5,400 lbs. WLL . . . . .	24	45982-43	2" x 30' Ratchet Strap w/ 43120-13 Wire Hooks . . . . .	34
45943-11	Chain Load Binder - 3/8" Lever 9,200 lbs. WLL . . . . .	24	45982-43-30-WK	2" x 30' Ratchet Strap w/ 43120-13 Wire Hooks, w/ Web Keeper Buckle . . . . .	36
45943-12	Chain Load Binder - 1/4" Lever 2,500 lbs. WLL . . . . .	24	45982-90-27	2" x 27' Ratchet Strap w/ 40891-18 Flat Hooks . . . . .	32
45943-13	Chain Load Binder - 1/2" Lever 13,000 lbs. WLL . . . . .	24	45982-90-27-WK	2" x 27' Ratchet Strap w/ 40891-18 Flat Hooks, w/ Web Keeper Buckle . . . . .	36
45943-14	Recoilless Chain Load Binder - 5/16" Lever 5,400 lbs. WLL . . . . .	24	45982-90-30	2" x 30' Ratchet Strap w/ 40891-18 Flat Hooks . . . . .	32
45943-20	Chain Load Binder - 5/16" Ratchet 5,400 lbs. WLL . . . . .	25	45982-90-30-WK	2" x 30' Ratchet Strap w/ 40891-18 Flat Hooks, w/ Web Keeper Buckle . . . . .	36
45943-20-HD	Chain Load Binder, Heavy-Duty - 5/16" Ratchet 5,400 lbs. WLL . . . . .	25	45982-93-30	2" x 30' Ratchet Strap w/ 43366-21 Chain Anchors . . . . .	32
			45982-95-27	2" x 27' Ratchet Strap w/ 43120-13 Wire Hooks . . . . .	32
			45982-95-27-WK	2" x 27' Ratchet Strap w/ 43120-13 Wire Hooks, w/ Web Keeper Buckle . . . . .	36

## INDEX BY PRODUCT NUMBER

45982-95-30	2" x 30' Ratchet Strap w/ 43120-13 Wire Hooks . . . . .	32	48253-17	Plate Trailer Ratchet Strap w/ F Fitting and E Fitting 16' . . . . .	58
45982-95-30-WK	2" x 30' Ratchet Strap w/ 43120-13 Wire Hooks, w/ Web Keeper Buckle . . . . .	36	48253-18	Plate Trailer Ratchet Strap w/ F Fitting and E Fitting 20' . . . . .	58
47105-11	Ratchet Buckle - 2" - 3,666 lb. WLL - Short Wide Handle . . . . .	75	48253-19	Plate Trailer Cam Strap w/ Wire Hook and E Fitting 12' . . . . .	57
47200-60-BULK-CUT	2" Gray Polyester Webbing . . . . .	87	48253-20	Plate Trailer Cam Strap w/ Wire Hook and E Fitting 16' . . . . .	57
47200-61-BULK-CUT	2" Yellow Polyester Webbing . . . . .	87	48253-21	Plate Trailer Cam Strap w/ Wire Hook and E Fitting 20' . . . . .	57
47200-62-BULK-CUT	2" Blue Polyester Webbing . . . . .	87	48253-22	Plate Trailer Cam Strap w/ F Fitting and E Fitting 12' . . . . .	57
47200-64-BULK-CUT	2" Red Polyester Webbing . . . . .	87	48253-23	Plate Trailer Cam Strap w/ F Fitting and E Fitting 16' . . . . .	57
47235-10	Series F Channel - 10' (1" Hole Spacing) . . . . .	49	48253-24	Plate Trailer Cam Strap w/ F Fitting and E Fitting 20' . . . . .	57
47556-11	Double Stud Fitting - 1,666 lbs. WLL . . . . .	88	48407-10	Economy Cargo Sta 87" - 102" - Square Feet . . . . .	52
47608-21	Series E Track Fitting - 1,333 lbs. WLL . . . . .	82	48485-11	Single Replacement Cleat . . . . .	62
47640-31	Lashing Winch - 3,333 lbs. w/ Double Hex Drive . . . . .	7, 64	48487-24	2" x 140" Auto Hauler Winch Strap . . . . .	62
47670-10	Hoop Set - Decking Beam . . . . .	50	48496-11	Lashing Winch - 2,500 lbs. w/ Double Hex Drive . . . . .	7, 64
47772-12	Series E Track Fitting w/ Round Ring - 1,000 lb. WLL . . . . .	54, 83	48672-13	Series E Ratchet Strap - 1-pc. End - 12' . . . . .	58
47800-10	Overcenter Buckle - 1 3/4" - 1,666 lb. WLL . . . . .	76	48672-14	Series E Ratchet Strap - 1-pc. End - 16' . . . . .	58
47934-11	Wheel Dolly Strap 2" x 86" . . . . .	63	48672-15	Series E Ratchet Strap - 1-pc. End - 20' . . . . .	58
47935-11	Wheel Dolly Strap w/ S Hooks . . . . .	63	48672-16	LAD Ratchet Strap w/ Double Stud Fitting 12' . . . . .	45
47935-12	Wheel Dolly Strap w/ Spring E Fittings . . . . .	63	48672-17	LAD Ratchet Strap w/ Double Stud Fitting 16' . . . . .	45
47944-10	Round Ring - 2" - 900 lb. WLL . . . . .	80	48672-18	LAD Ratchet Strap w/ Double Stud Fitting 20' . . . . .	45
47970-10	2" x 27' Ratchet Strap w/ 40891-18 Flat Hooks . . . . .	34	48672-22	Plate Trailer Ratchet Strap Assy w/ Wire Hooks 12' . . . . .	58
47970-11	2" x 30' Ratchet Strap w/ 40891-18 Flat Hooks . . . . .	34	48672-23	Plate Trailer Ratchet Strap Assy w/ Wire Hooks 16' . . . . .	58
47971-10	2" x 27' Ratchet Strap w/ 40891-18 Flat Hooks . . . . .	34	48672-24	Plate Trailer Ratchet Strap Assy w/ Wire Hooks 20' . . . . .	58
47971-11	2" x 30' Ratchet Strap w/ 40891-18 Flat Hooks . . . . .	34	48672-33	Series E TLR Ratchet Strap - 1-pc. End - 12' . . . . .	55
48101-103	Web Winch - 3-Bar - Weld-on . . . . .	5	48672-34	Series E TLR Ratchet Strap - 1-pc. End - 16' . . . . .	55
48101-103-XZ	Web Winch - 3-Bar - Low Profile X-Treme Zinc Finish . . . . .	5	48672-35	Series E TLR Ratchet Strap - 1-pc. End - 20' . . . . .	55
48101-133	Web Winch - 3-Bar - Low Profile Weld-on . . . . .	5	48770-10	Ratchet Buckle - 1" - 500 lb. WLL . . . . .	74
48101-143	Web Winch - 3-Bar - Standard . . . . .	5	48783-10	Web Winch - Bottom Mount - Double Cap . . . . .	2
48101-163-XZ	Web Winch - 3-Bar - Standard X-Treme Zinc Finish . . . . .	5	48904-10	Bolt Plate, 2", 30 degree, Clear Zinc Plated . . . . .	81
48101-173	Web Winch - 3-Bar - Standard C Track Slider . . . . .	5	48922-10	2 x 18" Fixed End Strap w/ 40891-18 Flat Hook & Loop . . . . .	37
48117-21-120.00	Series E Horizontal Track - 10' (Galvanized) . . . . .	48	48922-11	3 x 18" Fixed End Strap w/ 41766-18 Flat Hook & Loop . . . . .	38
48117-21-60.00	Series E Horizontal Track - 5' (Galvanized) . . . . .	48	48922-12	4 x 18" Strap w/ 41766-18 Flat Hook & Loop . . . . .	38
48117-25-120.00	Series E Horizontal Track - 10' (Gray) . . . . .	48	48922-13	2 x 18" Fixed End Strap w/ 43120-13 Wire Hook & Loop . . . . .	37
48117-25-60.00	Series E Horizontal Track - 5' (Gray) . . . . .	48			
48117-32-120.00	Series E Horizontal Track - 10' Black Powdercoat . . . . .	48			
48253-13	Plate Trailer Ratchet Strap w/ Wire Hook and E Fitting 12' . . . . .	58			
48253-14	Plate Trailer Ratchet Strap w/ Wire Hook and E Fitting 16' . . . . .	58			
48253-15	Plate Trailer Ratchet Strap w/ Wire Hook and E Fitting 20' . . . . .	58			
48253-16	Plate Trailer Ratchet Strap w/ F Fitting and E Fitting 12' . . . . .	58			



# GENERAL INFORMATION

## INDEX BY PRODUCT NUMBER

48922-15	4 x 18" Strap w/ 43120-20 Narrow Hook & Loop . . . . .	38	49025-20	Electronic Strap 12'. . . . .	57
48922-16	2" Fixed End Strap w/ 43366-21 Chain Anchor & Loop . . . . .	37	49025-21	Electronic Strap 16'. . . . .	57
48922-17	3 x 33" Strap w/ 43366-12 Chain Anchor & Loop . . . . .	38	49025-22	Electronic Strap 20'. . . . .	57
48922-18	4 x 33" Strap w/ 43366-14 Chain Anchor & Loop . . . . .	38	49039-50	HD Series E Beam Assy - 96" . . . . .	50
48922-20	3 x 18" Strap w/ 43365-12 Grab Hook & Loop . . . . .	38	49039-51	HD Series E Beam Assy - 102" . . . . .	50
48965-10	Ratchet Buckle - 3" - 7,333 lb. WLL . . . . .	76	49039-52	HD Series E Beam Assy - 106" . . . . .	50
48968-11	Roll-Off Container Hook - 5,400 lb. WLL . . . . .	79	49205-25	Heavy-Duty Jack Bar One-Piece - Galvanized - Bolt-on Feet - 85" - 104" . . . . .	53
48987-20	3" x 27' Ratchet Strap w/ 41766-18 Flat Hooks - 5,400 lbs. WLL . . . . .	35	49205-26	Heavy-Duty Jack Bar One-Piece - Galvanized - Bolt-on Feet - 85" - 114" . . . . .	53
48987-21	3" x 30' Ratchet Strap w/ 41766-18 Flat Hooks - 5,400 lbs. WLL . . . . .	35	49205-27	Heavy-Duty Jack Bar One-Piece Galvanized w/ Hoop Bolt-on Feet 85" - 114" . . . . .	53
48987-24	3" x 27' Ratchet Strap w/ 43366-12 Chain Anchors - 5,400 lbs. WLL . . . . .	35	49205-28	Heavy-Duty Jack Bar One-Piece Galvanized w/ Hoop Bolt-on Feet 86" - 104" . . . . .	53
48987-25	3" x 30' Ratchet Strap w/ 43366-12 Chain Anchors - 5,400 lbs. WLL . . . . .	35	49205-31	Universal Jack Bar 51" to 114" . . . . .	53
48987-28	3" x 27' Ratchet Strap w/ 43120-20 Wire Hooks - 5,400 lbs. WLL . . . . .	35	49207-127	Winch Double L Slider Storable - w/ 7mm Frame . . . . .	4
48987-29	3" x 30' Ratchet Strap w/ 43120-20 Wire Hooks - 5,400 lbs. WLL . . . . .	35	49207-127-RW	Winch Double L Slider Storable Web . . . . .	4
48987-90-27	3" x 27' ANCRA X-TREME Ratchet Strap w/ 41766-18 Flat Hooks . . . . .	32	49207-127-XZ	Winch Double L Slider Storable - w/ 7mm Frame X-Treme Zinc Plated . . . . .	4
48987-90-30	3" x 30' ANCRA X-TREME Ratchet Strap w/ 41766-18 Flat Hooks . . . . .	32	49207-137	Winch Double L Slider Standard - w/ 7mm Frame . . . . .	4
48987-92-27	3" x 27' ANCRA X-TREME Ratchet Strap w/ 43366-14 Chain Anchors . . . . .	32	49207-137-RW	Winch Double L Slider Standard . . . . .	4
48987-92-30	3" x 30' ANCRA X-TREME Ratchet Strap w/ 43366-14 Chain Anchors . . . . .	32	49207-137-XZ	Winch Double L Slider Standard - w/ 7mm Frame X-Treme Zinc Plated . . . . .	4
49015-18	18" Door Pull Strap . . . . .	54	49207-187	Winch Double L Slider Low Profile w/ 7mm Frame . . . . .	4
49015-24	24" Door Pull Strap . . . . .	54	49207-187-RW	Winch Double L Slider Low Profile . . . . .	4
49015-36	36" Door Pull Strap . . . . .	54	49207-187-XZ	Winch Double L Slider Low Profile w/ 7mm Frame X-Treme Zinc Plated . . . . .	4
49020-20	6' Auto Tie Down Strap w/ Snap Hooks . . . . .	62	49207-273	3-Bar Standard Double L Slider Winch X-Treme Zinc Finish . . . . .	5
49020-21	8' Auto Tie Down Strap w/ Snap Hooks . . . . .	62	49207-273-XZ	3-Bar Standard Double L Slider Winch X-Treme Zinc Finish . . . . .	5
49020-22	12' Auto Tie Down Strap w/ Snap Hooks . . . . .	62	49207-283-XZ	3-Bar Low Profile Double L Slider Winch X-Treme Zinc Finish . . . . .	5
49021-20	Series E HD Ratchet Buckle Strap - 12' . . . . .	58	49211-10	Rubber Rope Hooks - 100-pc. Bag . . . . .	17
49021-21	Series E HD Ratchet Buckle Strap - 16' . . . . .	58	49242-10-120	Winch Track - 10' Aluminum Double L . . . . .	10
49021-22	Series E HD Ratchet Buckle Strap - 20' . . . . .	58	49246-10-BP	Winch Std Utility Trailer Track Slider w/ Clip . . . . .	4
49021-30	Series E HD TLR Ratchet Buckle Strap - 12' . . . . .	55	49288-10	TrackStar - Accessory Mounting Kit (8" Track & Hardware) . . . . .	71
49021-31	Series E HD TLR Ratchet Buckle Strap - 16' . . . . .	55	49313-13	Series L Track (Galvanized) 10', 1" Notched Holes . . . . .	49
49021-32	Series E HD TLR Ratchet Buckle Strap - 20' . . . . .	55	49344-10	Coil Rack - Light Duty . . . . .	15
49023-20	Auto Tie Down - Series E w/ RTJ Hooks - 6' . . . . .	63	49344-12	Coil Rack - Heavy-Duty . . . . .	15
49023-21	Auto Tie Down - Series E w/ RTJ Hooks - 8' . . . . .	63	49345-10	Floor Chain Tie Down - Welded . . . . .	25
49023-22	Auto Tie Down - Series E w/ RTJ Hooks - 12' . . . . .	63	49346-10	4" x 27' Ratchet Strap w/ 41766-18 Flat Hooks - 5,400 lbs. WLL . . . . .	35

## INDEX BY PRODUCT NUMBER

49346-11	4" x 30' Ratchet Strap w/ 41766-18 Flat Hooks - 5,400 lbs. WLL . . . . .	35	49347-28	2" x 33" Fixed End Strap w/ 43366-21 Chain Anchor & Ratchet. . . . .	37
49346-12	4" x 27' Ratchet Strap w/ Narrow Wire Hooks - 6,600 lbs. WLL . . . . .	35	49347-29	2" x 25' Strap w/ 43366-21 Chain Anchor . . . . .	37
49346-13	4" x 30' Ratchet Strap w/ Narrow Wire Hooks - 6,600 lbs. WLL . . . . .	35	49347-30	2" x 28' Strap w/ 43366-21 Chain Anchor . . . . .	37
49346-14	4" x 27' Ratchet Strap w/ 43366-14 Chain Anchor - 5,400 lbs. WLL . . . . .	35	49347-31	3" x 33" Strap w/ 43366-12 Chain Anchor & Buckle . . . . .	38
49346-15	4" x 30' Ratchet Strap w/ 43366-14 Chain Anchor - 5,400 lbs. WLL . . . . .	35	49347-32	3" x 25' Strap w/ 43366-12 Chain Anchor . . . . .	38
49346-90-27	4" x 27' Ratchet Strap w/ 41766-18 Flat Hooks. . . . .	33	49347-33	3" x 28' Strap w/ 43366-12 Chain Anchor . . . . .	38
49346-90-30	4" x 30' Ratchet Strap w/ 41766-18 Flat Hooks. . . . .	33	49347-34	4" x 33" Strap w/ 43366-14 Chain Anchor & Buckle . . . . .	38
49346-91-27	4" x 27' Ratchet Strap w/ 43366-14 Chain Anchors . . . . .	33	49347-35	4" x 25' Strap w/ 43366-14 Chain Anchor . . . . .	38
49346-91-30	4" x 30' Ratchet Strap w/ 43366-14 Chain Anchors . . . . .	33	49347-36	4" x 28' Strap w/ 43366-14 Chain Anchor . . . . .	38
49346-93-27	4" x 27' Ratchet Strap w/ 43120-13 Wire Hooks. . . . .	33	49347-40	3" x 18" Strap w/ 43365-12 Grab Hook & Buckle . . . . .	38
49346-93-30	4" x 30' Ratchet Strap w/ 43120-13 Wire Hooks. . . . .	33	49347-41	3" x 25' Strap w/ 43365-12 Grab Hook. . . . .	38
49347-10	2" x 18" Fixed End Strap w/ 40891-18 Flat Hook & Ratchet . . . . .	37	49347-42	3" x 28' Strap w/ 43365-12 Grab Hook. . . . .	38
49347-11	2" x 25' Strap w/ 40891-10 Flat Hook. . . . .	37	49348-11	Bar Keep Cargo Bar Holder . . . . .	54
49347-12	2" x 28' Strap w/ 40891-10 Flat Hook. . . . .	37	49349-10	Ratchet Buckle - 4" - 8,000 lb. WLL . . . . .	76
49347-13	3" x 18" Strap w/ 41766-18 Flat Hook & Ratchet . . . . .	38	49359-10	Series A Horizontal Track Aluminum. . . . .	49
49347-14	3" x 25' Strap w/ 41766-18 Flat Hook - 15,000 lb. . . . .	38	49360-13	Decking/Shoring Beam Steel Series E - 92.1" - 102.9" Long . . . . .	50
49347-15	3" x 28' Strap w/ 41766-18 Flat Hook - 15,000 lb. . . . .	38	49368-10	Strap Assy - 1" - Ratchet Buckle - 15' w/ Vinyl S Hooks, 4-pack . . . . .	70
49347-16	4" x 18" Strap w/ 41766-18 Flat Hook & Ratchet . . . . .	38	49368-11	Strap Assy - 1" - Cam Buckle - 6' w/ Vinyl S Hooks, 4-pack . . . . .	70
49347-17	4" x 25' Strap w/ 41766-18 Flat Hook - 15,000 lb. . . . .	38	49368-12	Strap Assy - 2 Cam, 2 Ratchet w/ Vinyl S Hooks, 4-pack . . . . .	70
49347-18	4" x 28' Strap w/ 41766-18 Flat Hook - 15,000 lb. . . . .	38	49371-10	Stake Pocket Anchor . . . . .	54
49347-19	2" x 18" Fixed End Strap w/ 43120-13 Wire Hook & Buckle . . . . .	37	49377-10	Corner Protector - Steel for Chain . . . . .	16
49347-20	2" x 25' Adjustable End w/ 43120-13 Wire Hook . . . . .	37	49377-11	Rubber Coated Steel Corner Protector. . . . .	16
49347-21	2" x 28' Adjustable End w/ 43120-13 Wire Hook . . . . .	37	49382-10	Transmat 30" x 42" Section. . . . .	55
49347-25	4" x 18" Strap w/ 43120-20 Narrow Hook & Buckle . . . . .	38	49384-12	Track Stop. . . . .	42
49347-26	4" x 25' Strap w/ 43120-20 Narrow Hook. . . . .	38	49400-10	Jack Bar Component Kit - Red Handle . . . . .	52
49347-27	4" x 28' Strap w/ 43120-20 Narrow Hook. . . . .	38	49400-11	Jack Bar Component Kit - Black Handle . . . . .	52
			49410-13	Ratchet Buckle - 2" - 3,666 lb. WLL - TLR. . . . .	75
			49414-15	LAD Beam Standard - 95.1" - 105.6" . . . . .	41
			49414-15-RT	Replacement Tube for 49414-15 Standard LAD Beam. . . . .	42
			49414-19	LAD Beam Heavy-Duty - 95.2 - 105.6 . . . . .	41
			49414-19-RT	Replacement Tube for 49414-19 Heavy-Duty LAD Beam. . . . .	41
			49414-21	Aftermarket Beam Standard - 97.3" - 108.8" . . . . .	43
			49414-21-RT	Replacement Tube for 49414-21 . . . . .	43
			49439-10	Shoring Bar, F Series - Round . . . . .	51
			49439-11	Shoring Bar, F Series - Round (1" Hole Track). . . . .	51
			49439-20	Shoring Bar, F Series - Square . . . . .	51
			49439-21	Shoring Bar, F Series - Square (1" Hole Track) . . . . .	51

## INDEX BY PRODUCT NUMBER

49443-10	Housing Assembly (w/ Trigger, Set Screw, Rack & Lever) . . . . .	52	49893-13	18" x 18" PVC Coated Orange Flag & Wooden Dowel . . . . .	14
49445-12	Beam Release Bar . . . . .	42	49893-14	18" x 18" PVC Coated Orange Flag w/ Grommets . . . . .	14
49446-10	Lift-A-Deck Kit with Beam Release Bar . . . . .	42	49894-10	18" x 84" Wide Oversized Load Banner w/ 4 Ropes . . . . .	14
49454-11	Rubber Rope - 3/8" Solid Core - 150' Roll . . . . .	17	49894-11	18" x 84" Wide Oversized Load Banner w/ 2 Ropes . . . . .	14
49454-13	Rubber Rope - 7/16" Solid Core - 150' Roll . . . . .	17	49894-12	14" x 72" Wide Oversized Load Banner w/ 4 Ropes . . . . .	14
49526-10	4" x 5' Strap w/ Hook for Roll-Off Containers . . . . .	31	49894-13	18" x 84" Oversized Load Mesh Banner . . . . .	14
49526-11	4" x 5' Strap w/ Sewn Loop End for Roll-Off Containers . . . . .	31	49894-14	18" x 84" Wide Load Mesh Banner . . . . .	14
49526-90	4" x 5' ANCRA X-TREME Strap w/ Hook for Roll-Off Containers . . . . .	31	49895-10	12" x 96" Canadian D Sign w/ 8 Grommets . . . . .	14
49526-91	4" x 5' ANCRA X-TREME Strap w/ Sewn Loop for Roll-Off Containers . . . . .	31	49895-11	12" x 96" Reflective Canadian D Sign w/ 8 Grommets . . . . .	14
49527-10	GlideLock Slider Bracket - For Double L Track . . . . .	15	49895-12	18" x 96" Reflective Canadian D Sign w/ 8 Grommets . . . . .	14
49542-10	E Fitting w/ D-Ring . . . . .	54, 83	49895-13	18" x 96" Reflective Canadian D Sign w/ 8 Grommets, reverse side: Oversize Load . . . . .	14
49562-17-72.00	LAD Narrow Single Track . . . . .	44	49896-10	1/2" Forged Ring Assy w/ Bolt-on Clip . . . . .	13
49577-10	Chain Corner Protector . . . . .	16	49896-11	1/2" Forged Ring Assy w/ Weld-on Clip . . . . .	13
49583-10	Floor Chain Tie Down - Bolt-on . . . . .	25	49897-10	5/8" Forged Ring Assy w/ Weld-on Clip . . . . .	13
49584-10	Plastic Corner Protector . . . . .	16	49898-10	3/4" Forged Ring Assy w/ Weld-on Clip . . . . .	13
49603-10	TrackStar Wheelchock . . . . .	71	49899-10	1" Forged Ring Assy w/ Weld-on Clip . . . . .	13
49706-10	Winch Standard Wilson Track Slider w/ Clip . . . . .	5	49913-10	Tarp Protector . . . . .	16
49706-11	Winch Low Profile Wilson Track Slider w/ Clip . . . . .	5	49914-10	Swivel J Idler Fitting - 3,333 lb. WLL . . . . .	83
49715-10	Ratchet Buckle - 2" - 1,500 lb. WLL - TLR . . . . .	75	49914-11	Swivel J Idler Fitting Low Profile - 3,333 lb. WLL . . . . .	83
49716-10	Porta Winch . . . . .	8	49917-10	Bolt Plate, 1" 45 degree . . . . .	81
49716-10-RW	Ratcheting Porta Winch . . . . .	8	49917-11	Bolt Plate, 1" Flat . . . . .	81
49716-11	Porta Winch Offset . . . . .	8	49968-10	Bolt Plate, 2" 45 degree . . . . .	81
49717-10	Porta Anchor . . . . .	8	49988-10	Pallet Deck . . . . .	45
49717-11	Porta Anchor Offset . . . . .	8	50013-31	Screw Pin Anchor Shackle - Galvanized, 5/16", 1,500 lbs. WLL . . . . .	22, 85
49723-10	Silvercap Overdrive Ratcheting Cap . . . . .	11	50013-38	Screw Pin Anchor Shackle - Galvanized, 3/8", 2,000 lbs. WLL . . . . .	22, 85
49756-10	Steel Corner Protector . . . . .	16	50013-44	Screw Pin Anchor Shackle - Galvanized, 7/16", 3,000 lbs. WLL . . . . .	22, 85
49768-10	Sliding Double L Hook . . . . .	13	50013-50	Screw Pin Anchor Shackle - Galvanized, 1/2", 4,000 lbs. WLL . . . . .	22, 85
49770-10	Waste Container J Hook - 5,100 lb. WLL . . . . .	79	50013-63	Screw Pin Anchor Shackle - Galvanized, 5/8", 6,500 lbs. WLL . . . . .	22, 85
49789-10-120.00	Winch Track - 10' Aluminum Double L Low Profile . . . . .	10	50013-75	Screw Pin Anchor Shackle - Galvanized, 3/4", 9,500 lbs. WLL . . . . .	22, 85
49811-20L	Low Profile Foot and Channel Assembly . . . . .	42	50014-50	Clevis Pin Anchor Shackle - Galvanized, 1/2", 4,000 lbs. WLL . . . . .	22, 85
49828-10-30	1/4" x 30' Cable Assembly w/ Chain Anchor . . . . .	11	50014-63	Clevis Pin Anchor Shackle - Galvanized, 5/8", 6,500 lbs. WLL . . . . .	22, 85
49828-10-32	1/4" x 32' Cable Assembly w/ Chain Anchor . . . . .	11			
49828-11-30	5/16" x 30' Cable Assembly w/ Chain Anchor . . . . .	11			
49828-11-32	5/16" x 32' Cable Assembly w/ Chain Anchor . . . . .	11			
49828-12-30	7/32" x 30' Cable Assembly w/ Chain Anchor . . . . .	11			
49828-12-32	7/32" x 32' Cable Assembly w/ Chain Anchor . . . . .	11			
49834-10	3 Bar Adjuster - 2" - 1,000 lb. WLL . . . . .	77			
49880-12	12 Ton Bottle Jack w/ 2-Pc. Handle . . . . .	89			
49880-20	20 Ton bottle Jack w/ 2-Pc. Handle . . . . .	89			
49893-10	18" x 18" Safety Flag & Wooden Dowel . . . . .	14			
49893-11	18" x 18" Cotton Flag w/ Steel Rod . . . . .	14			
49893-12	18" x 18" Red Flag w/ Grommets . . . . .	14			



## INDEX BY PRODUCT NUMBER

50015-10	ERGO 360 Winch Bar - Standard . . . . .	12	50090-31	5/16" x 67.5", WLL 4,700 lbs., Towed Machine Load Limit 16,100 lbs. . . . .	20
50015-20	ERGO 360 Winch Bar - Combination . . . . .	12	50090-38	3/8" x 69.0", WLL 6,600 lbs., Towed Machine Load Limit 20,200 lbs. . . . .	20
50015-21	ERGO 360 Winch Bar - Combination Box End . . . . .	12	50091-31	5/16" - G70 Clevis Hook w/ Keeper - WLL 4,700 lbs. . . . .	21, 84
50016-25	Quick Links - Zinc Plated, 1/4", 880 lbs. WLL . . . . .	22, 85	50091-38	3/8" - G70 Clevis Hook w/ Keeper - WLL 6,600 lbs. . . . .	21, 84
50016-31	Quick Links - Zinc Plated, 5/16", 1,760 lbs. WLL . . . . .	22, 85	50091-50	1/2" - G70 Clevis Hook w/ Keeper - WLL 11,300 lbs. . . . .	21, 84
50016-38	Quick Links - Zinc Plated, 3/8", 2,200 lbs. WLL . . . . .	22, 85	50092-10	EZ Winder Web Winder . . . . .	13
50017-10	Twin Clevis G70 - Zinc Plated, 5/16", 4,700 lbs. WLL . . . . .	23, 86	500-C8-RD	2" x 8' Red Ratchet Strap w/ Twisted Snap Hook . . . . .	63
50017-11	Twin Clevis G70 - Zinc Plated, 3/8", 6,600 lbs. WLL . . . . .	23, 86	50105-10	Poly Deck Board for LAD System for 16" Beam Center. . . . .	46
50017-12	Twin Clevis G70 - Zinc Plated, 7/16", 11,300 lbs. WLL . . . . .	23, 86	50105-11	Poly Deck Board for LAD System for 24" Beam Center. . . . .	46
50019-10	Slip Hooks G70 - Zinc Plated - No Latch, 1/4", 3,150 lbs. WLL . . . . .	23, 86	50115-10	Series E Track Fitting - Heavy-Duty w/ Round Ring 2,000 lb. WLL . . . . .	54, 82
50019-11	Slip Hooks G70 - Zinc Plated - No Latch, 5/16", 4,700 lbs. WLL . . . . .	23, 86	50115-11	Series E Track Fitting - Heavy-Duty w/ D-Ring 2,000 lb. WLL . . . . .	54, 82
50019-12	Slip Hooks G70 - Zinc Plated - No Latch, 3/8", 6,600 lbs. WLL . . . . .	23, 86	50117-10	Lever Binder Locking Clip . . . . .	25
50019-13	Slip Hooks G70 - Zinc Plated - No Latch, 1/2", 11,300 lbs. WLL . . . . .	23, 86	50140-10	EZ Binder Lever Load Binder . . . . .	24
50019-20	Slip Hooks G70 - Zinc Plated - w/ Safety Latch, 1/4", 3,150 lbs. WLL . . . . .	23, 86	50158-10	Series E Wide Top Decking Beam - 92.9" - 103.8" . . . . .	50
50019-21	Slip Hooks G70 - Zinc Plated - w/ Safety Latch, 5/16", 4,700 lbs. WLL . . . . .	23, 86	50179-10	2" x 102" Auto Hauler Ratchet Strap w/ Wire Hooks . . . . .	62
50019-22	Slip Hooks G70 - Zinc Plated - w/ Safety Latch, 3/8", 6,600 lbs. WLL . . . . .	23, 86	50179-11	2" x 102" Auto Hauler Ratchet Strap w/ Low Profile Swivel J Hooks. . . . .	62
50019-23	Slip Hooks G70 - Zinc Plated - w/ Safety Latch, 1/2", 11,300 lbs. WLL . . . . .	23, 86	50186-10	Wide Top Aftermarket Beam - 97.2" - 108.8" . . . . .	43
50024-10	Tarp Hook . . . . .	13	50186-10-RT	Replacement Tube for 50186-10 . . . . .	43
50037-10	Ratchet Buckle - 2" - 3,666 lb. WLL - Web Keeper LWH. . . . .	75	50187-31	Lift-A-Deck II Foot Assembly . . . . .	42
50055-10	Beam Release Bar Holder . . . . .	42	50188-10	Foot and Channel Assy for Aftermarket Beams . . . . .	43
50058-18-72.00	LAD Flanged Single Track . . . . .	44	50191-10	Heavy-Duty Aftermarket Beam - 97.3" - 108.8" . . . . .	43
50072-14-72.00	LAD Flanged Double Track . . . . .	45	50191-10-RT	Replacement Tube for 50191-10 . . . . .	43
50080-11	Wide Top LAD Beam Assembly - 95.1" - 105.6" . . . . .	41	50192-14-72.00	LAD Standard Single Track . . . . .	44
50080-11-RT	Replacement Tube for 50080-11 . . . . .	42	50193-30-72.00	Heavy-Duty Beveled Aircraft Style Track 72" . . . . .	88
50089-12	X-TREME Corner Guards - 12" x 8" x 8" - Made In The USA . . . . .	17	50194-100	Low Profile Allen Sleeve Nut and Bolt Kit for Beams . . . . .	42, 43, 51
50089-24	X-TREME Corner Guards - 24" x 8" x 8" - Made In The USA . . . . .	17	50199-10	Cargo Net for Short Bed Pickups . . . . .	72
50089-36	X-TREME Corner Guards - 36" x 8" x 8" - Made In The USA . . . . .	17	50199-11	Cargo Net for Long Bed Pickups . . . . .	72
50089-48	X-TREME Corner Guards - 48" x 8" x 8" - Made In The USA . . . . .	17	50312-10	Wide Top LAD Beam w/ Reinforced 1-in. Sides . . . . .	41
			50354-10	5th Wheel Release Hook . . . . .	55
			50391-10	Premium Cargo Strap Winder . . . . .	13
			50364-38-10	G70 - XHD™ 3/8" Chain Assembly, 10-ft . . . . .	20

## INDEX BY PRODUCT NUMBER

50364-38-20	G70 - XHD™ 3/8" Chain Assembly, 20-ft . . . . .	20
50398-10	Cargo Control Display - Wall Mounted . . . . .	89
50398-20	Cargo Control Display - Freestanding . . . . .	89
52210GL	Goldline EPDM Tarp Ties, 10"- 50 per Box . . . . .	18
52210SE	Silverline Elite EPDM Tarp Ties, 10"- 50 per Box . . . . .	18
52210C	Natural Rubber Tarp Ties, 10"- 50 per Box . . . . .	18
52215GL	Goldline EPDM Tarp Ties, 15"- 50 per Box . . . . .	18
52215SE	Silverline Elite EPDM Tarp Ties, 15"- 50 per Box . . . . .	18
52215C	Natural Rubber Tarp Ties, 15"- 50 per Box . . . . .	18
52221GL	Goldline EPDM Tarp Ties, 21"- 50 per Box . . . . .	18
52221SE	Silverline Elite EPDM Tarp Ties, 21"- 50 per Box . . . . .	18
52221C	Natural Rubber Tarp Ties, 21"- 50 per Box . . . . .	18
52231GL	Goldline EPDM Tarp Ties, 31"- 50 per Box . . . . .	18
52231SE	Silverline Elite EPDM Tarp Ties, 31"- 50 per Box . . . . .	18
52231C	Natural Rubber Tarp Ties, 31"- 50 per Box . . . . .	18
52241GL	Goldline EPDM Tarp Ties, 41"- 50 per Box . . . . .	18
52241SE	Silverline Elite G4EPDM Tarp Ties, 41"- 50 per Box . . . . .	18
52241C	Natural Rubber Tarp Ties, 41"- 50 per Box . . . . .	18
95001	1" x 8' Cam Straps w/ Vinyl-Coated S Hooks, 2-pack . . . . .	70
95002	1" x 10' Ratchet Straps Vinyl-Coated S Hooks, 2-pack . . . . .	71
95003	1" x 6' Retractable Ratchet Straps w/ Vinyl Coated S Hooks, 2-pack . . . . .	71
95004	1" x 8' Cam Straps w/ Vinyl-Coated S Hooks, 4-pack . . . . .	71
95005	1" x 10' Ratchet Straps w/ Vinyl-Coated S Hooks, 4-pack . . . . .	71
95006	Two 1" Cam Straps & Two 1" Ratchet Straps w/ Vinyl-Coated S Hooks, 4-pack . . . . .	71
95007	1" x 12' Endless Ratchet Straps, 2-pack . . . . .	71
LR0401-01	Fork Lift Stand . . . . .	89

## INDEX BY PRODUCT NAME

Adjuster, 3-Bar Slide . . . . .	77	Cleat, Single . . . . .	62	Hooks, Waste . . . . .	79
Allen Sleeve Nut & Bolt Kit, Low Profile . . . . .	42	Clevis Hooks . . . . .	21, 84	Hooks, Wire . . . . .	78
Anchor, Chain . . . . .	83	Clevis, Twin . . . . .	23, 86	Hoop Set, Cargo Sta . . . . .	52
Auto Tie Downs . . . . .	62, 63, 64	Coil Racks . . . . .	15	Hoops, Decking Beam . . . . .	50
Banners, Safety . . . . .	14	Corner Protectors . . . . .	16, 17	Jack Bar Component Kits . . . . .	52
Bar, Beam Release . . . . .	42	Deck Board, Security Divider . . . . .	46	Jack Bars . . . . .	53
Bars, Cargo Sta . . . . .	52	Deck Board, Security Divider Kit . . . . .	46	Jacks, Bottle . . . . .	89
Bars, Jack . . . . .	53	Decking Beam Hoops . . . . .	50	Load Binder . . . . .	24, 25
Bars, Shoring . . . . .	51	Decking/Shoring Beams . . . . .	41, 43, 50	Lift-A-Deck III . . . . .	40, 41–45
Bars, Winch . . . . .	12	Display, Cargo Control . . . . .	89	Lift-A-Deck III Straps . . . . .	45
Beam, Foot & Channel Assembly . . . . .	41, 42, 51	Dolly Straps . . . . .	63	Lift-A-DeckFoot Assembly . . . . .	42
Beam Release Bar . . . . .	42	Door Pull Straps . . . . .	54	Lift-A-Deck Poly Deck Board . . . . .	46
Beam Release Bar Holder . . . . .	42	D-Rings, Forged . . . . .	13	Lifting Slings . . . . .	66, 67, 68
Beam Replacement Tube . . . . .	42	Electronic Restraint Straps . . . . .	57	Links, Quick . . . . .	22, 85
Beam Sockets . . . . .	51	ERGO 360 Winch Bars . . . . .	12	Locking Clip, Lever Binder . . . . .	25
Beam, Garment . . . . .	51	EZ Binder . . . . .	24	Merchandising Aids . . . . .	90
Beams, Decking/Shoring . . . . .	41, 43, 50, 51	EZ Winder . . . . .	13	Mini Ratchet Strap . . . . .	70
Binders, Chain Load . . . . .	24, 25	F Series - Shoring Bar . . . . .	51	Nets, Cargo . . . . .	72
Binder, Ratchet . . . . .	25	Fittings, Pan . . . . .	54	Nets, Custom . . . . .	59
Binder, Recoilless . . . . .	24	Fittings, Track . . . . .	82, 83, 88,	Overcenter Buckles . . . . .	76
Bolt Plates . . . . .	81	Flag, Safety . . . . .	14	Pallet Deck . . . . .	45
Bottle Jacks . . . . .	89	Flat Hooks . . . . .	79	Pan Fittings . . . . .	54
Buckle, Roller . . . . .	77	Floor Chain Tie Down . . . . .	25	Poly Deck Board, LAD . . . . .	46
Buckles, Cam . . . . .	77	Foot & Channel Assembly, Low Profile . . . . .	42	Plate Trailer Straps . . . . .	57, 58
Buckles, Overcenter . . . . .	76	Fork Lift Stand . . . . .	89	Plates, Bolt . . . . .	81
Buckles, Ratchet . . . . .	74, 75, 76	Friction Mat . . . . .	54	PortaAnchor . . . . .	8
Cable Assemblies . . . . .	11	Garment Beam . . . . .	51	PortaWinch . . . . .	8
Cam Buckle Strap		Garment Rope . . . . .	51	Protectors, Corner . . . . .	16, 17
Assemblies . . . . .	45, 56, 57, 70, 71	GlideLock . . . . .	15	Protector, Tarp . . . . .	16
Cam Buckles . . . . .	77	Goldline EPDM Tarp Ties . . . . .	18	Protectors, Web . . . . .	16
Cargo Bar Holder . . . . .	54	Grab Hook Assembly . . . . .	84	Ratchet Buckle Strap	
Cargo Nets . . . . .	59, 72	Holder, Cargo Bar . . . . .	54	Replacements . . . . .	37, 38
Cargo Sta . . . . .	52	Hook, Clevis . . . . .	21, 84	Ratchet Buckle Strap, Series E . . . . .	55, 58
Cargo Sta Replacements . . . . .	52	Hook, Container . . . . .	79	Ratchet Strap	
Cargo Sta, Hoop Set . . . . .	52	Hook, Corner Iron . . . . .	13	Assemblies . . . . .	32–38, 55, 58, 62, 63, 70
Chain . . . . .	19, 20	Hook, Double L Track Slider . . . . .	13	Ratchet Strap Assy, Web Keeper . . . . .	36
Chain Anchor . . . . .	83	Hook, Grab . . . . .	84	Ratchet Strap, Mini . . . . .	70
Chain Assemblies . . . . .	19, 20	Hook, H-2 . . . . .	13	Ratchet Buckles . . . . .	74, 75, 76
Chain Attachments . . . . .	21, 22, 23, 83, 84, 85, 86	Hook, H-2 . . . . .	13	Ratcheting Cap, OverDrive . . . . .	11
Chain Binder, Lever . . . . .	24	Hook, Rave . . . . .	78	Release Hook, 5th Wheel . . . . .	55
Chain Binder, Ratchet . . . . .	25	Hook, RTJ Cluster . . . . .	84	Retract-A-Roll III . . . . .	47
Chain Binder, Recoilless . . . . .	24	Hook, Rubber Rope . . . . .	17	Rings . . . . .	80
Chain Binder, Safety Clip . . . . .	25	Hook, S . . . . .	78	Rings, Delta . . . . .	80
Chain Binder, XHD . . . . .	25	Hook, Swivel J . . . . .	83	Roll-On/Roll-Off Container Straps . . . . .	31
Chain Hardware . . . . .	21, 22, 23, 83, 84, 85, 86	Hook, Tarp . . . . .	13	Roller Buckle . . . . .	77
Channel Assembly,		Hooks, Flat . . . . .	79	Rope Tie Offs . . . . .	54
Replacement . . . . .	42, 43, 51	Hooks, Slip . . . . .	23, 84, 86	Rope, Rubber . . . . .	17
		Hooks, Snap . . . . .	80		



## INDEX BY PRODUCT NAME

RTJ Cluster Hook . . . . .	84	Tarp Protector . . . . .	16
Rubber Rope . . . . .	17	Tarp Ties . . . . .	18
Rubber Rope Hook . . . . .	17	Tension Limiting Ratchet Assemblies . . . . .	55
Series A Track . . . . .	49	Tie Downs, Auto . . . . .	62, 63
Series E Heavy-Duty Strap . . . . .	56	Tie Downs, Cam Buckle Packaged . . . . .	70, 71
Series E Ratchet Buckle Strap . . . . .	55, 58	Tie Downs, Combo Packs . . . . .	70, 71
Series E Track . . . . .	48	Tie Downs, Floor Chain . . . . .	25
Series E Transit Strap . . . . .	63	Tie Downs, Ratcheting Packaged . . . . .	70, 71
Series F Channel Track . . . . .	49	Tie Offs . . . . .	54
Series F Track . . . . .	49	Ties, Tarp . . . . .	18
Shackles . . . . .	22, 85	Tire Bonnets . . . . .	64
Shoring Bar - F Series . . . . .	51	Track, Lift-A-Deck II . . . . .	44, 45
Signs, Safety . . . . .	14	Track, Aircraft . . . . .	88
Silverline Elite EPDM Tarp Ties . . . . .	18	Track Fittings . . . . .	54, 82, 83, 88
Silverline Tarp Ties . . . . .	18	Track, Heavy-Duty . . . . .	88
Slings, Eye to Eye Web . . . . .	67, 68	Track, Series A . . . . .	49
Slings, Round . . . . .	66	Track, Series E . . . . .	48
Slip Hooks . . . . .	21, 84, 86	Track, Series F . . . . .	49
SilverCap OverDrive Ratcheting Cap . . . . .	11	Track, Series F Channel . . . . .	49
Snap Hooks . . . . .	80	Track Stop . . . . .	42
Socket, Beam . . . . .	51	Trackstar Accessory Mounting Kit . . . . .	71
Stake Pocket Anchor . . . . .	54	Trackstar WheelChock . . . . .	71
Strap, Ancra Lash . . . . .	70	Transmat . . . . .	55
Strap, Ratchet Assembly . . . . .	32- 38, 58, 62, 63, 70	Truck & Trailer Fittings (pan, anchor) . . . . .	54
Strap, Cam Buckle Assembly . . . . .	45, 55, 56, 57, 70, 71	Utility Strap . . . . .	70
Strap, Driver Assist. . . . .	55	Web Protectors . . . . .	16
Strap, Lift-A-Deck II Assemblies . . . . .	45	Web Winder . . . . .	13
Strap, Mini Ratchet . . . . .	70	Webbing . . . . .	87
Strap, Motorcycle . . . . .	70	WheelChock . . . . .	71
Strap, Series E . . . . .	56	Winch Bars . . . . .	12
Strap, Series E Transit. . . . .	63	Winch Straps . . . . .	26, 27, 28, 29, 30, 31, 62
Strap, Trailer Door Limit. . . . .	55	Winch Track . . . . .	10
Straps, Cam Buckle . . . . .	45, 56, 57, 70, 71	Winches Web . . . . .	2, 3, 4, 55
Straps, Container. . . . .	31	Winch, Cable. . . . .	6
Straps, Dolly . . . . .	63	Winches, Combination . . . . .	6
Straps, Door Pull . . . . .	54	Winches, Lashing . . . . .	7, 64
Straps, Electronic . . . . .	57	Winches, PortaWinch, PortaAnchor. . . . .	8
Straps, Plate Trailer . . . . .	57, 58	Winches, Sliders . . . . .	3, 4, 5
Straps, Ratchet Buckle . . . . .	32-38, 55, 58, 62, 63, 70	Winder, Web . . . . .	13
Straps, Series F . . . . .	56	Wire Hooks . . . . .	78
Straps, Tension Limiting Ratchet . . . . .	55	Winches, 3-Bar . . . . .	5
Straps, Transit w/ RTJ Hooks . . . . .	63	X-TREME Guard Corner Protector . . . . .	17
Straps, Utility. . . . .	70, 71	X-TREME Winch Strap, Assemblies . . . . .	26, 27, 28, 31, 32, 33, 36
Straps, Winch . . . . .	26, 27, 28, 29, 30, 31, 62		